

DS281 NEUTRON ACER TENDL-2019 LIBRARY; T=293.16K
Principal cross sections

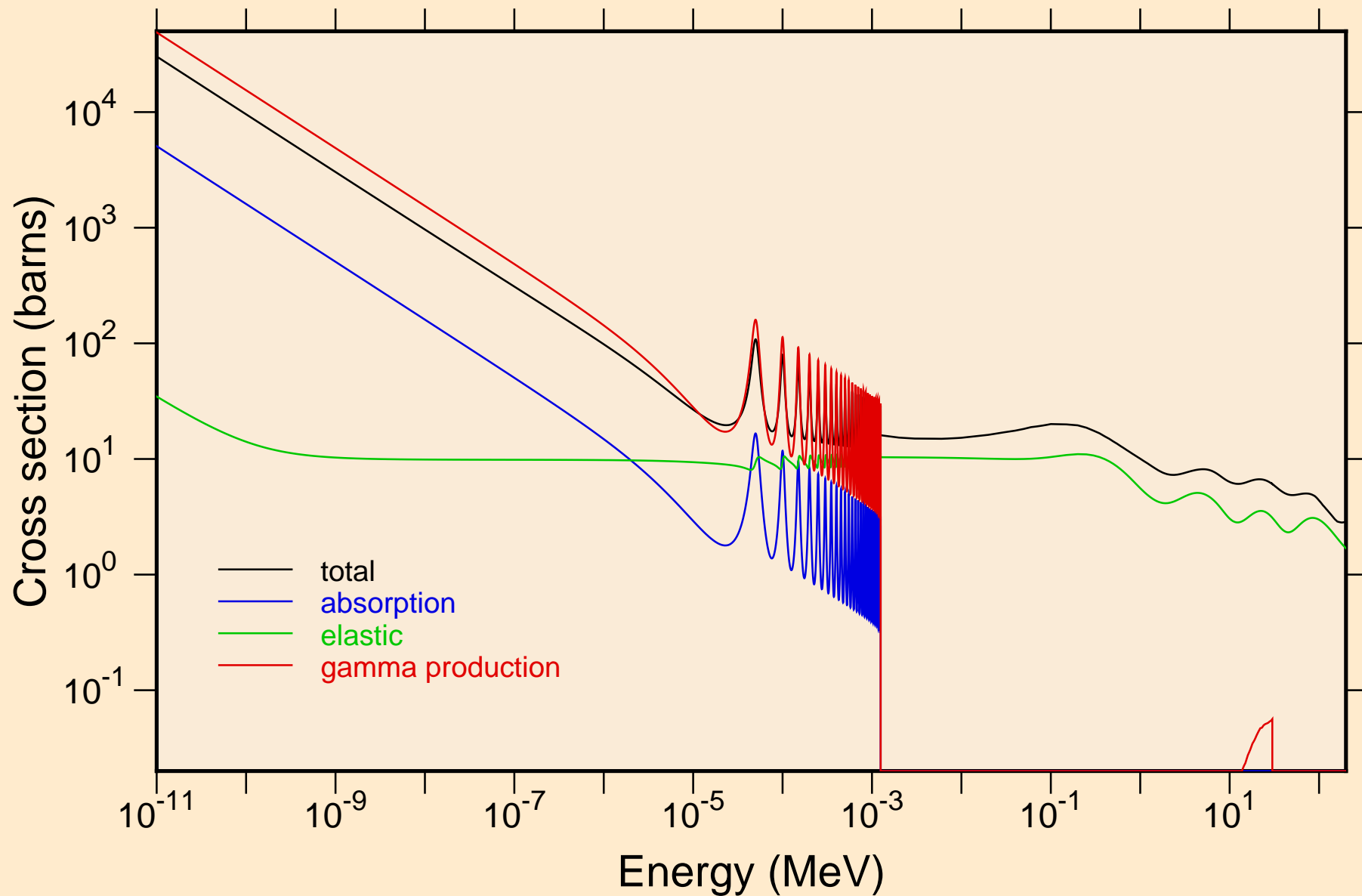

DS281 NEUTRON ACER TENDL-2019 LIBRARY; T=293.16K
resonance total cross section

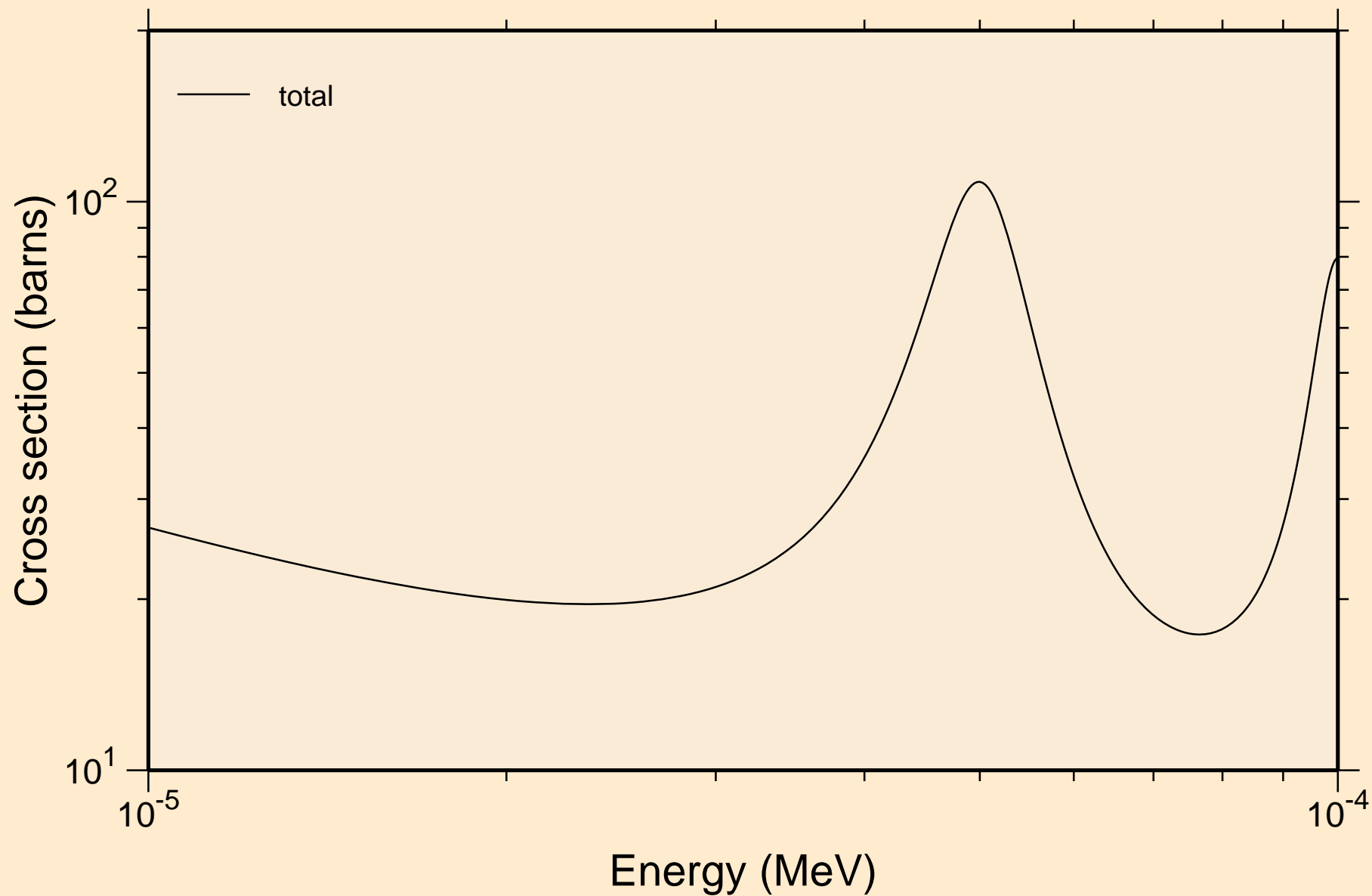

DS281 NEUTRON ACER TENDL-2019 LIBRARY; T=293.16K
resonance total cross section

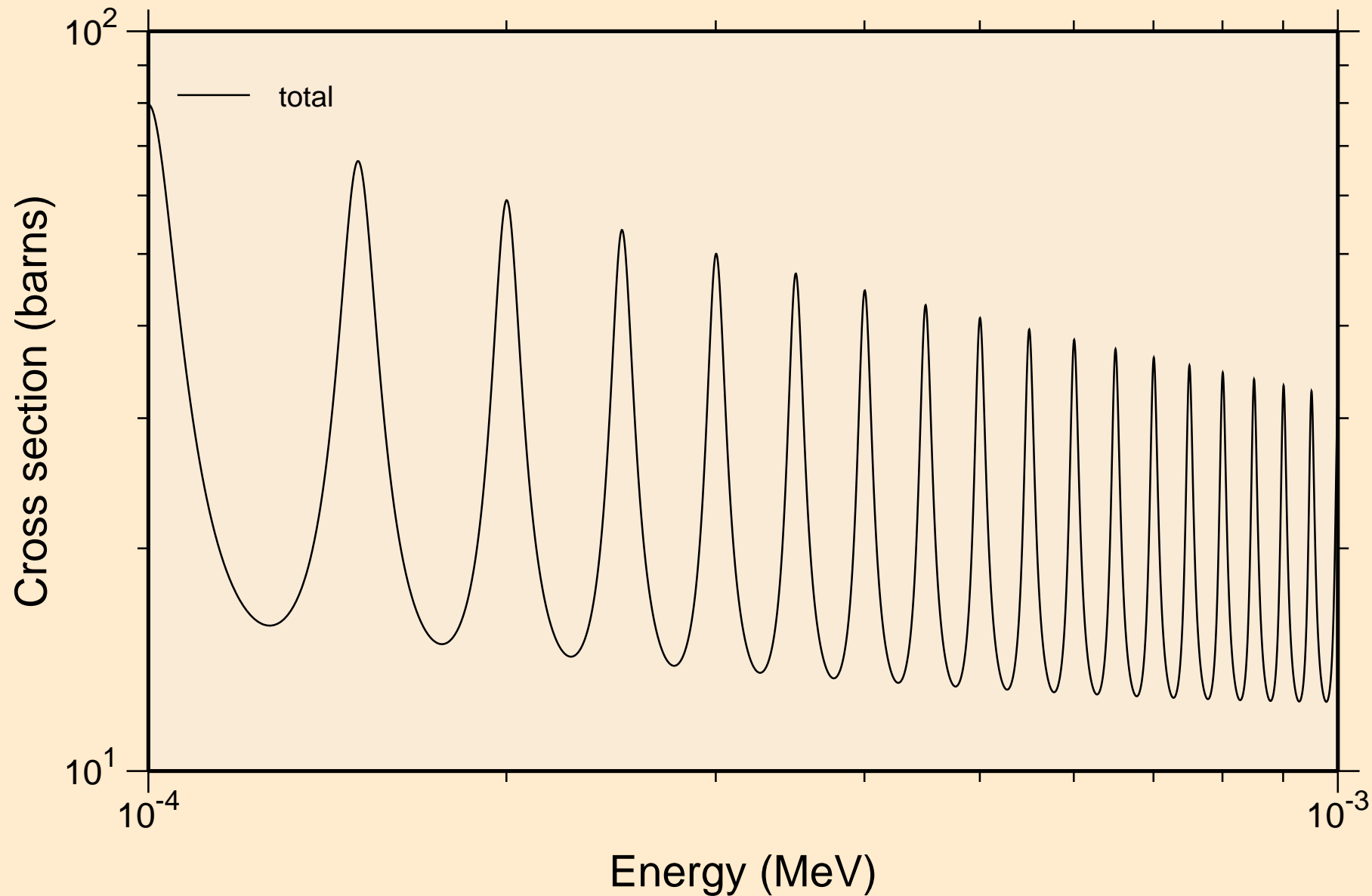

DS281 NEUTRON ACER TENDL-2019 LIBRARY; T=293.16K
resonance total cross section

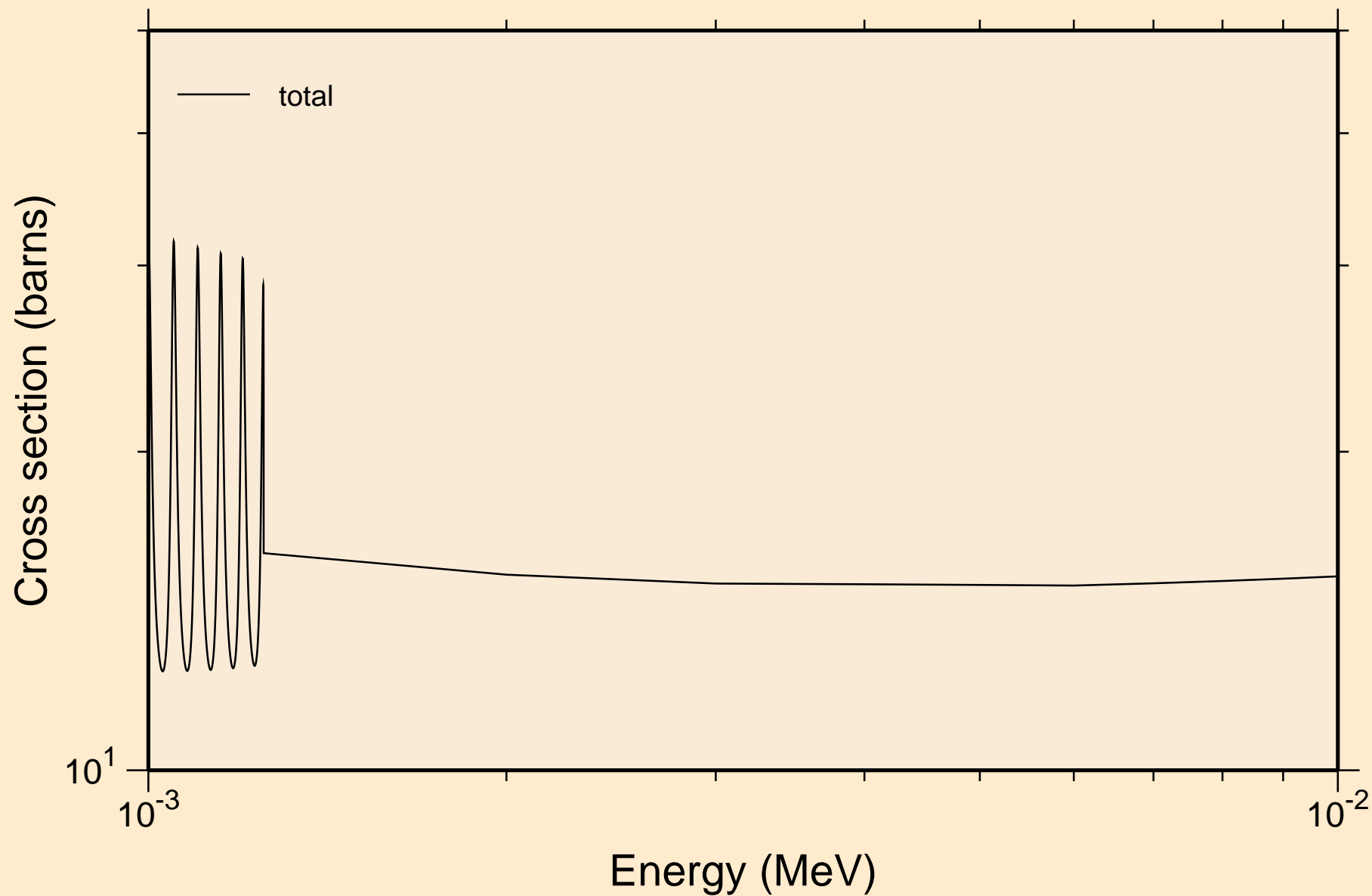

DS281 NEUTRON ACER TENDL-2019 LIBRARY; T=293.16K
resonance total cross section

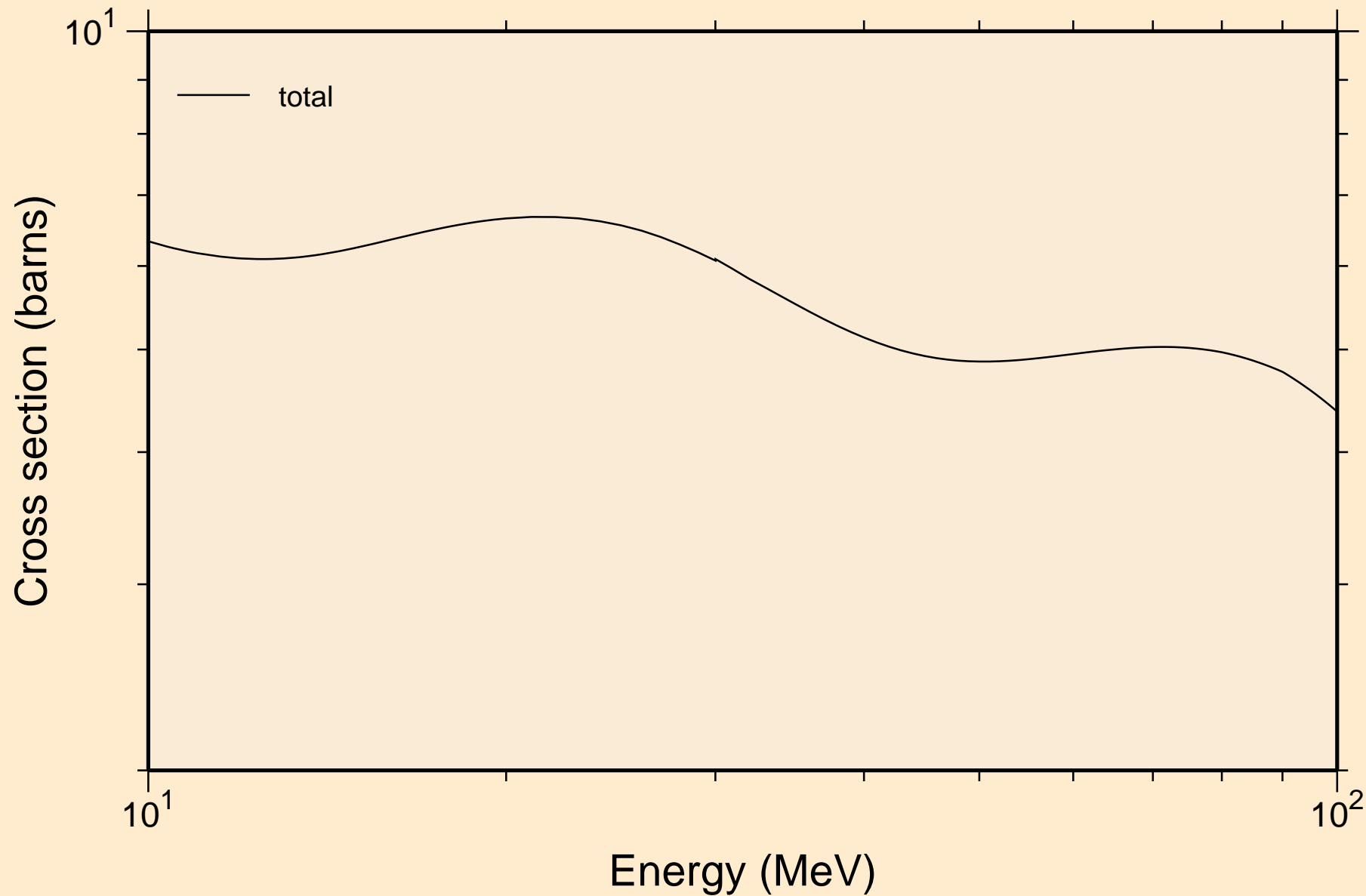

DS281 NEUTRON ACER TENDL-2019 LIBRARY; T=293.16K
resonance absorption cross sections

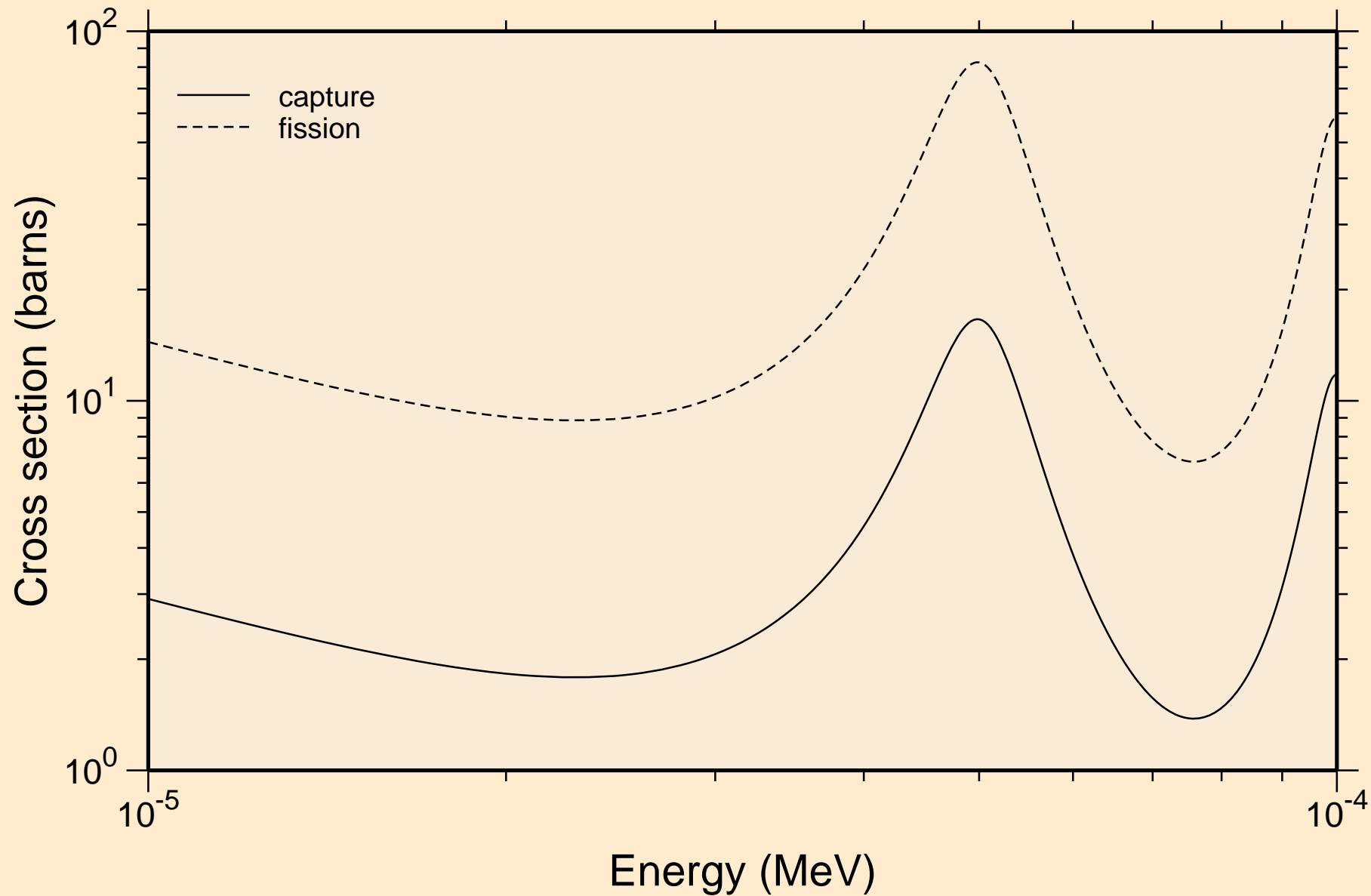

DS281 NEUTRON ACER TENDL-2019 LIBRARY; T=293.16K
resonance absorption cross sections

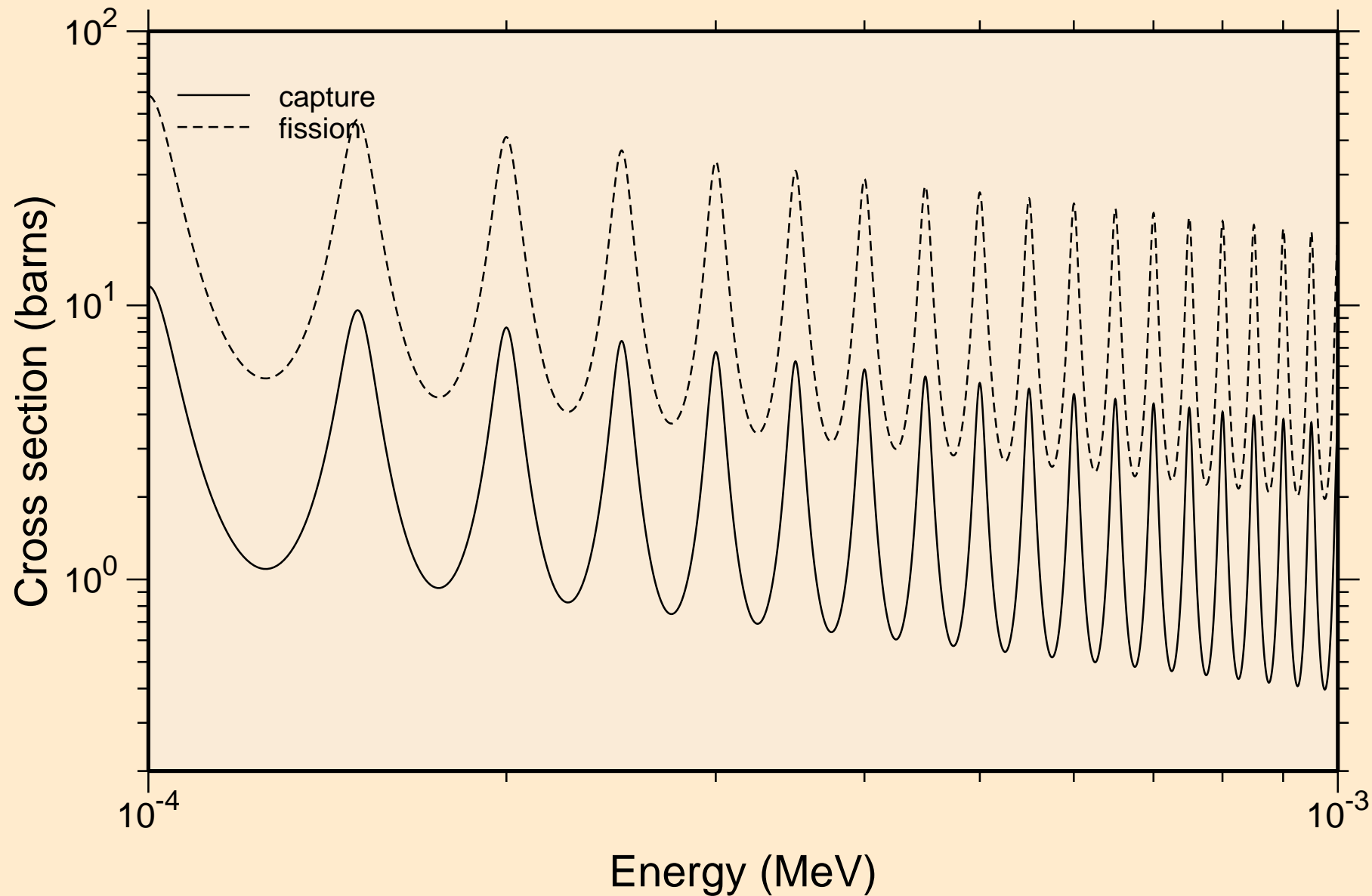

DS281 NEUTRON ACER TENDL-2019 LIBRARY; T=293.16K
resonance absorption cross sections

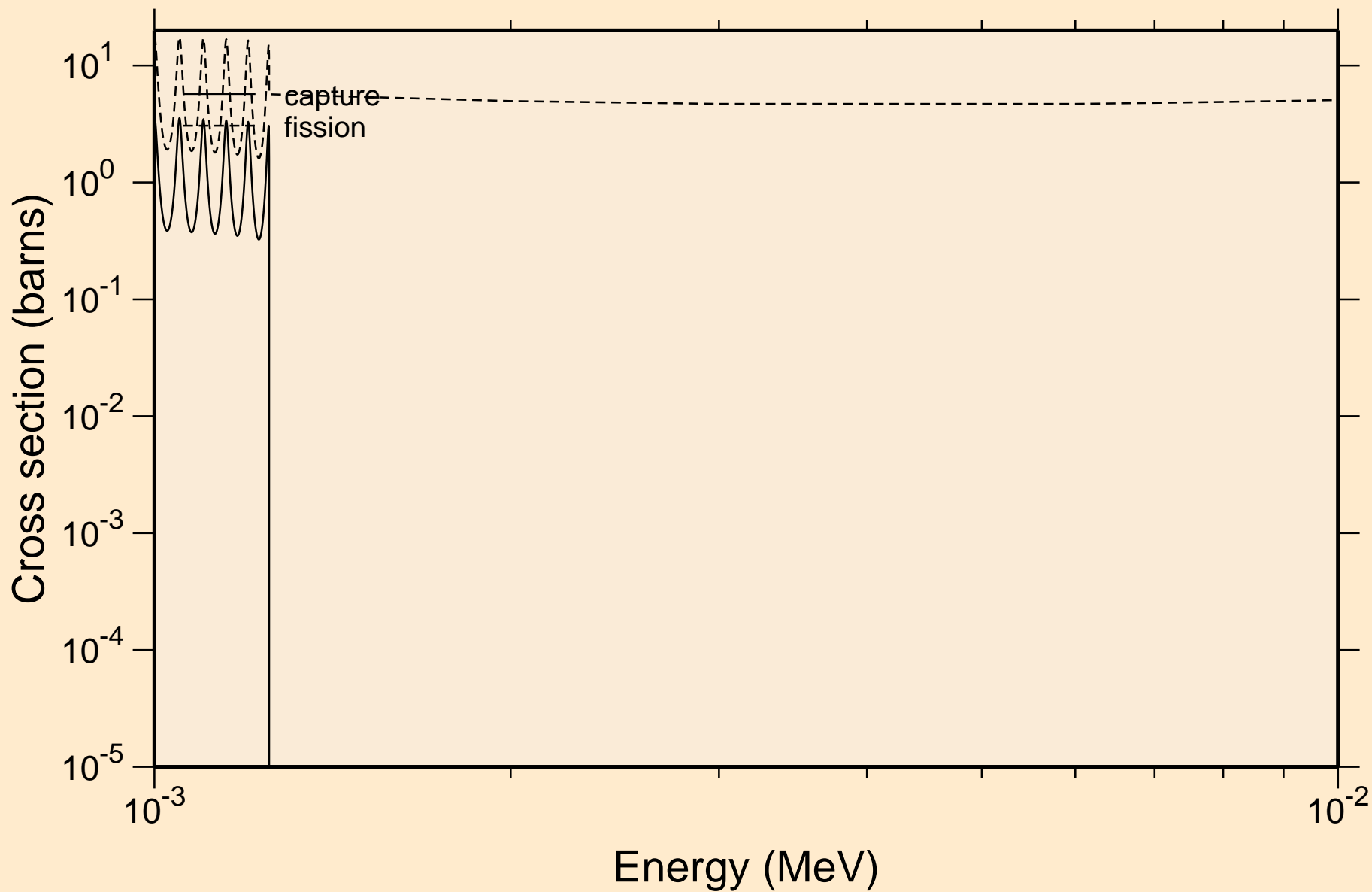

DS281 NEUTRON ACER TENDL-2019 LIBRARY; T=293.16K
resonance absorption cross sections

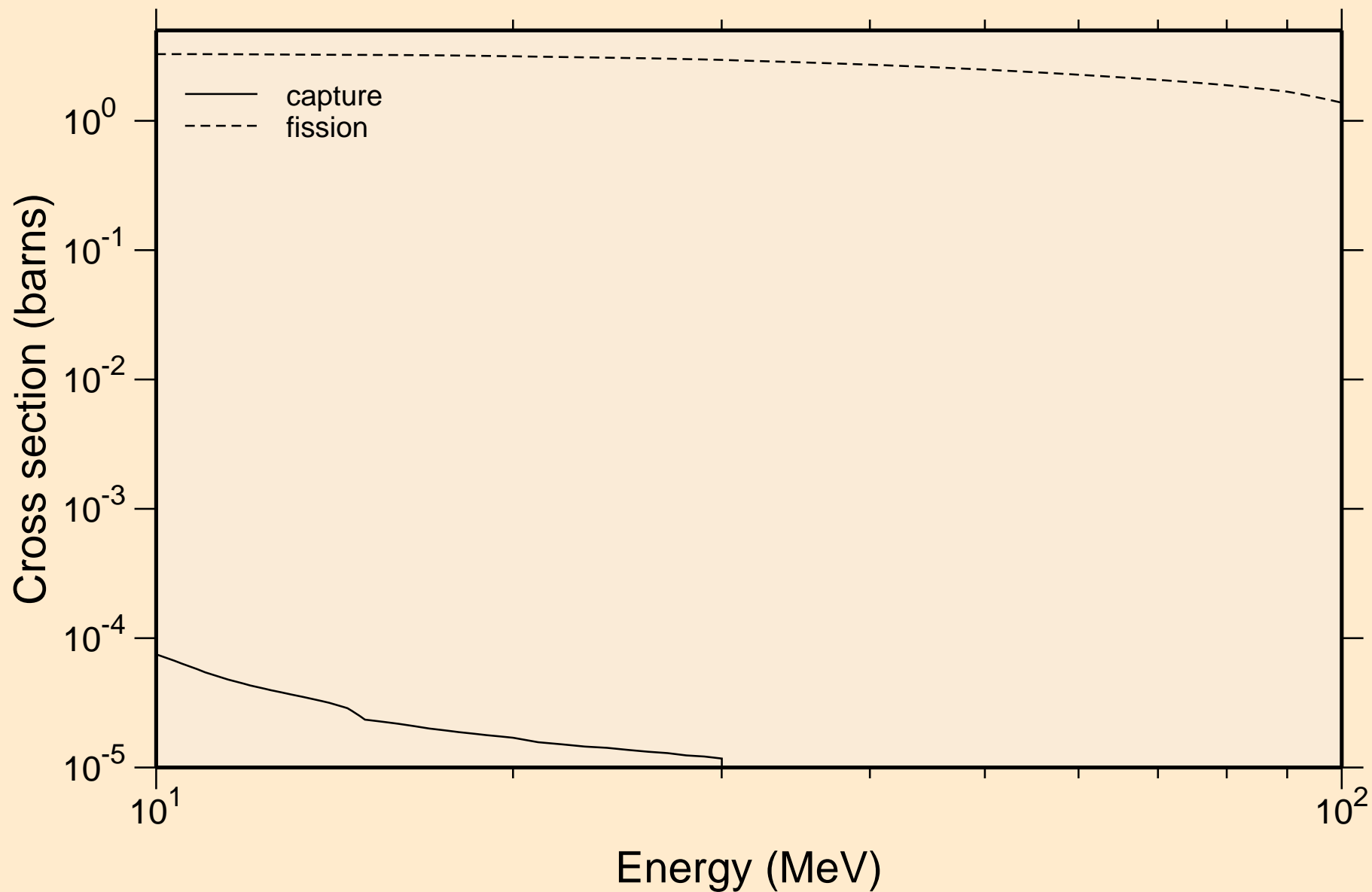

DS281 NEUTRON ACER TENDL-2019 LIBRARY; T=293.16K
Heating

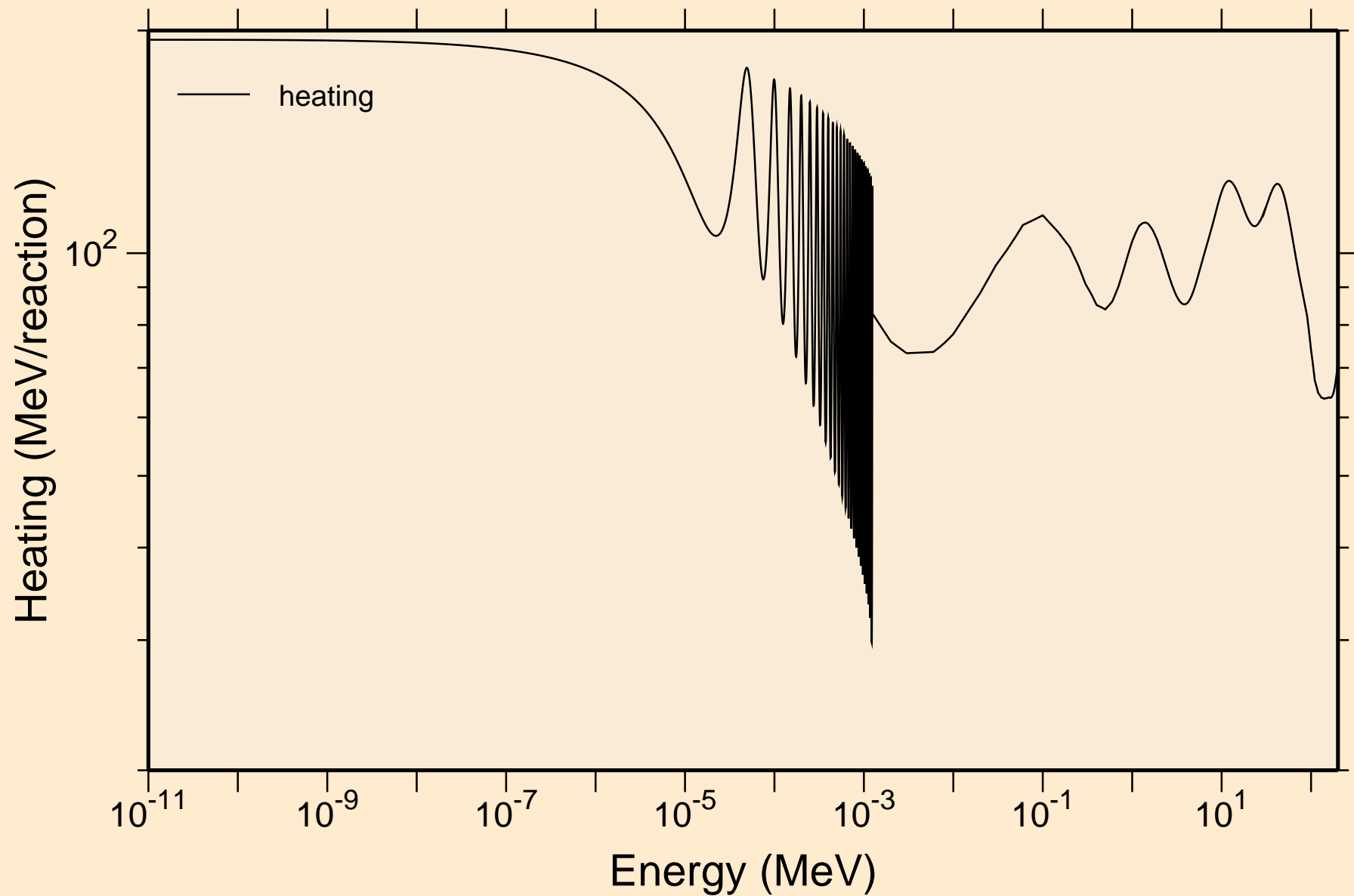

DS281 NEUTRON ACER TENDL-2019 LIBRARY; T=293.16K
Damage

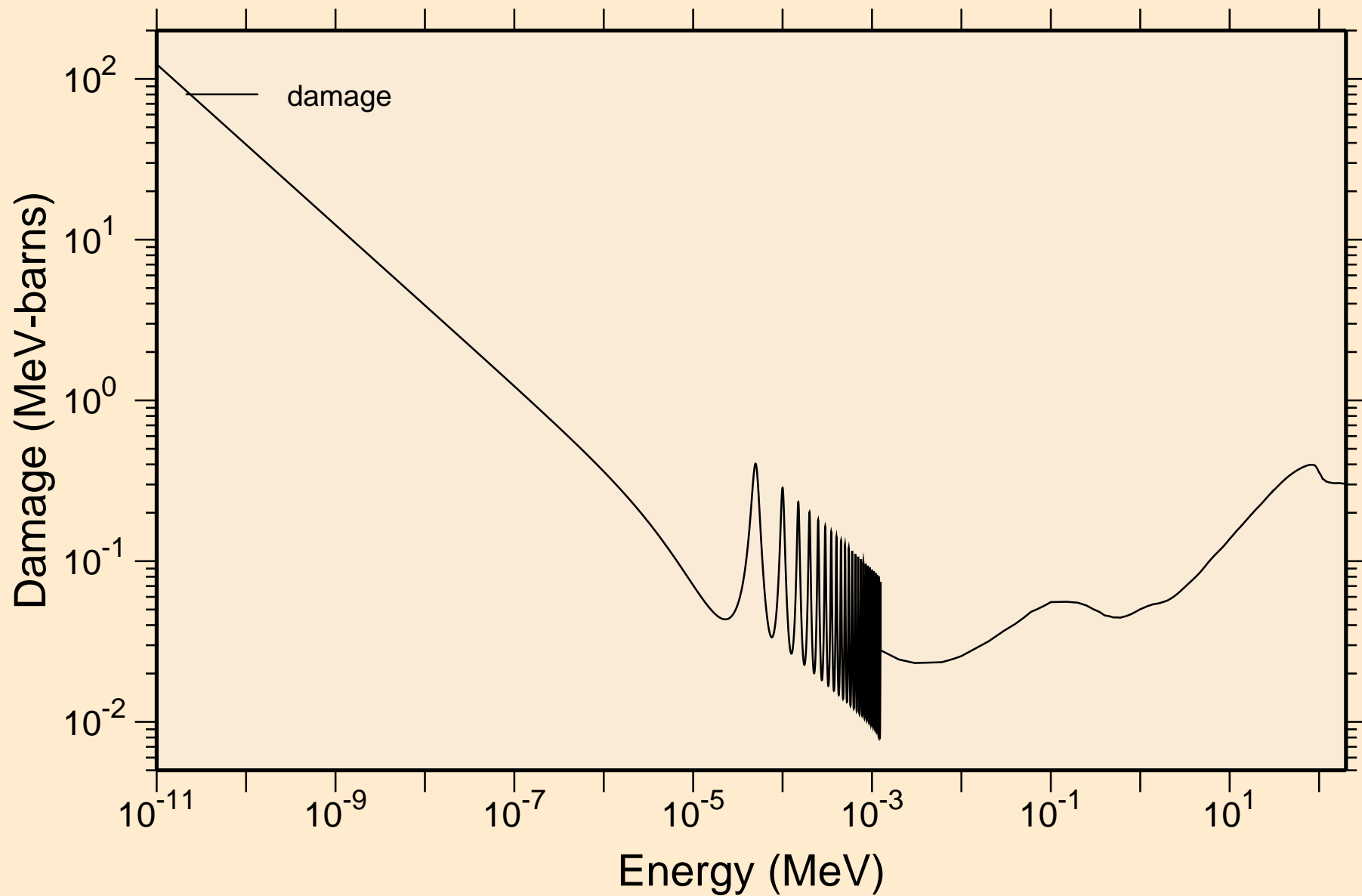

DS281 NEUTRON ACER TENDL-2019 LIBRARY; T=293.16K
Non-threshold reactions

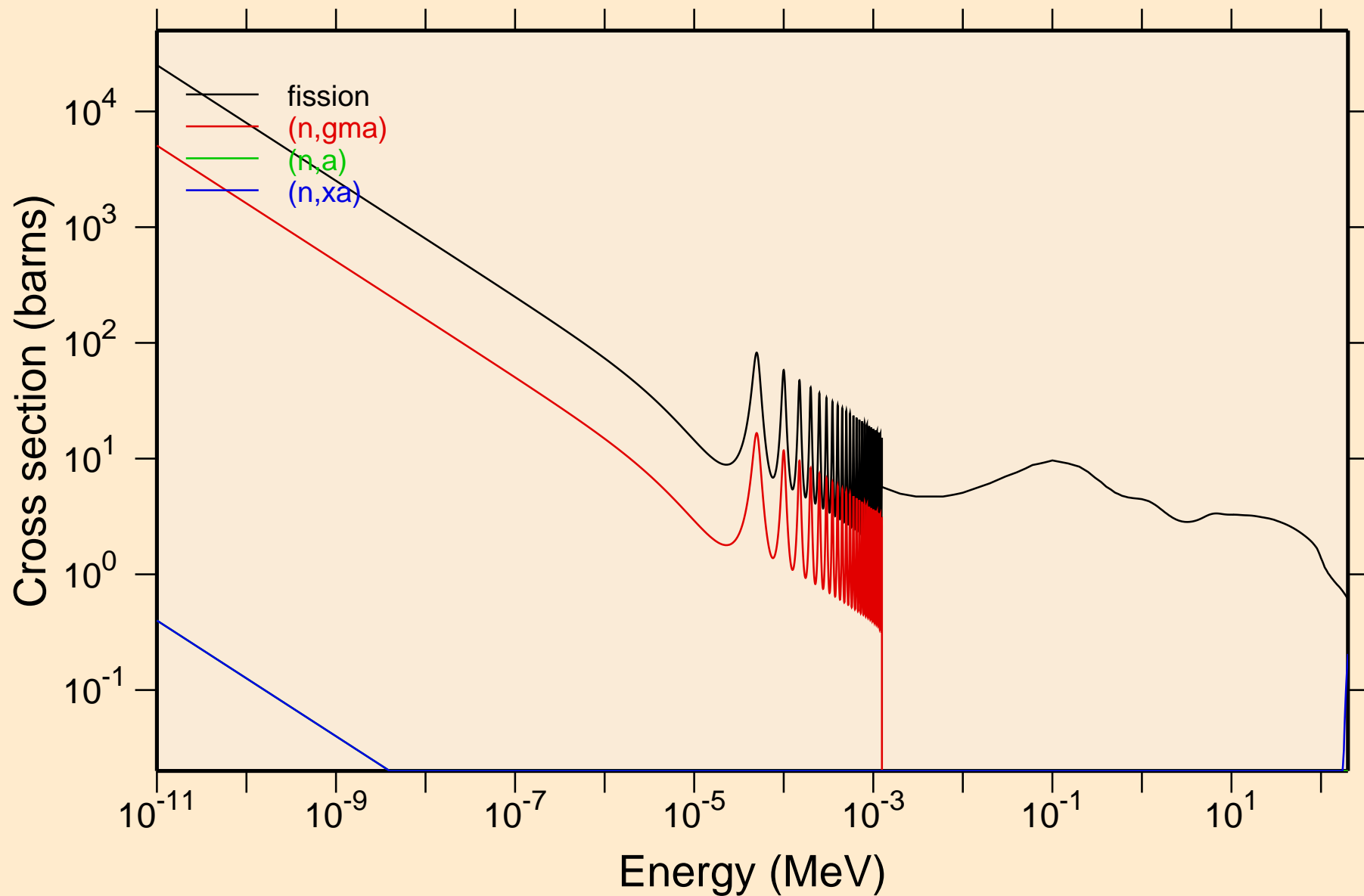

DS281 NEUTRON ACER TENDL-2019 LIBRARY; T=293.16K
Principal cross sections

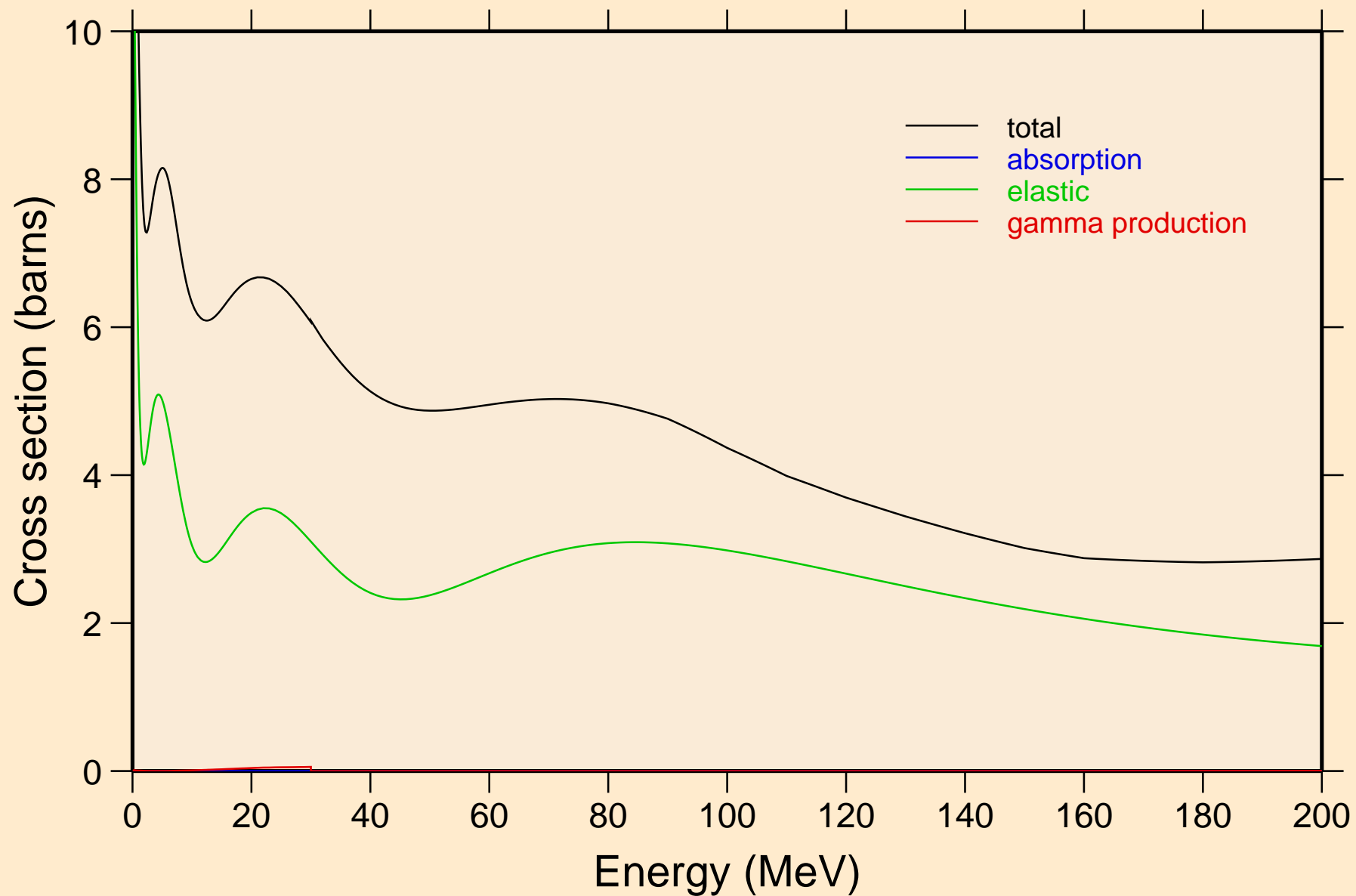

DS281 NEUTRON ACER TENDL-2019 LIBRARY; T=293.16K
Heating

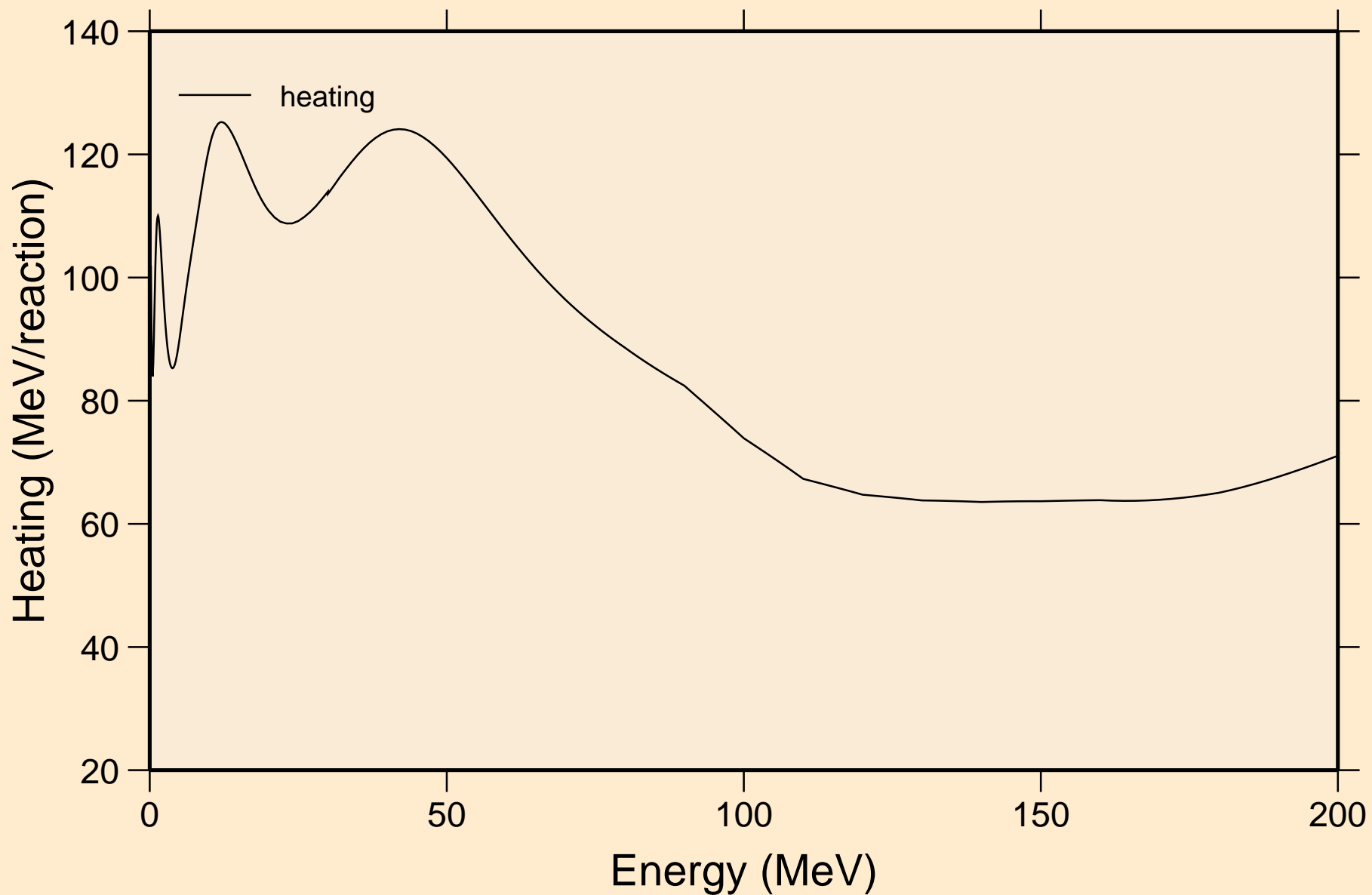

DS281 NEUTRON ACER TENDL-2019 LIBRARY; T=293.16K
Damage

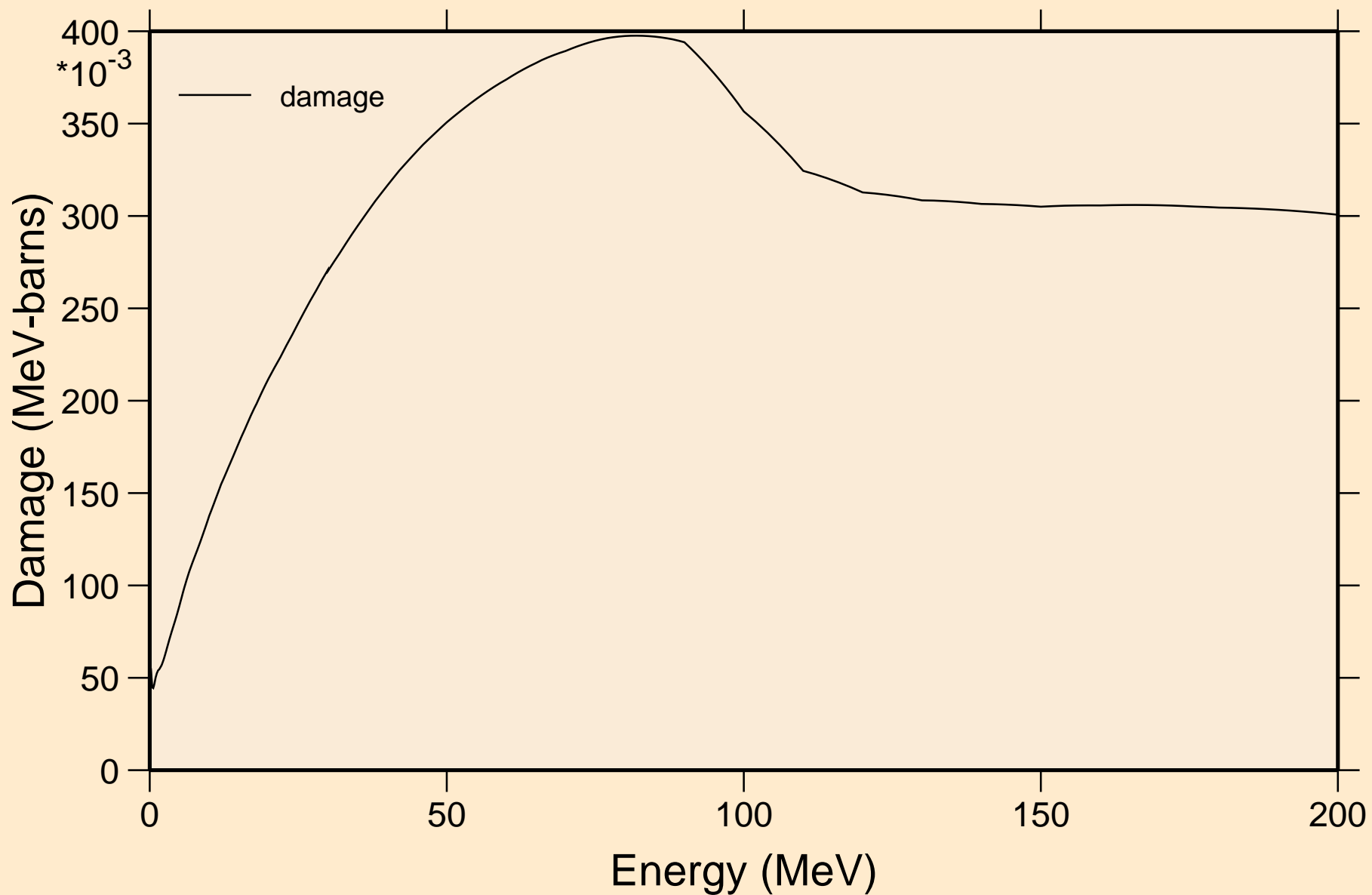

DS281 NEUTRON ACER TENDL-2019 LIBRARY; T=293.16K
Non-threshold reactions

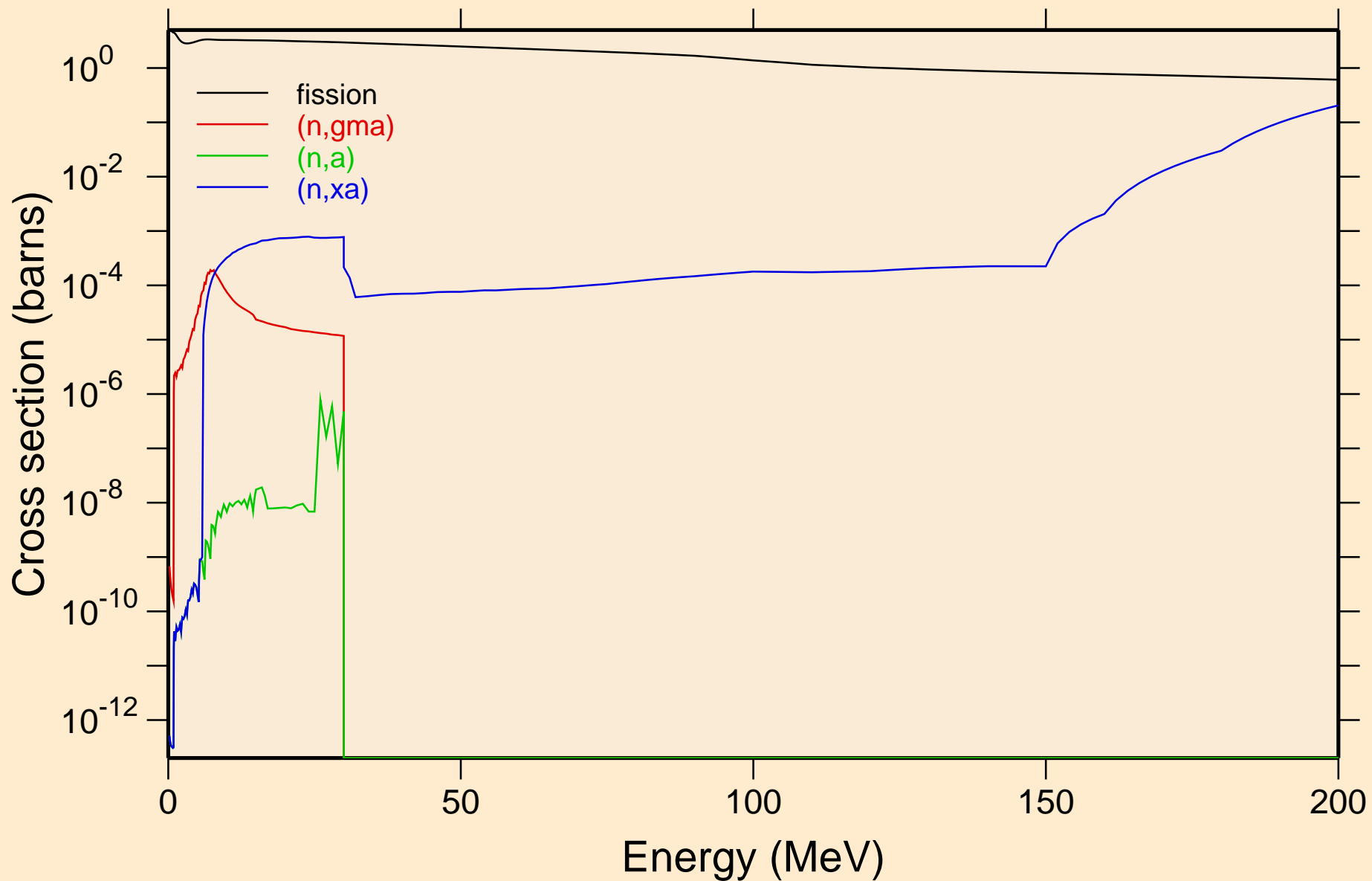

DS281 NEUTRON ACER TENDL-2019 LIBRARY; T=293.16K
Inelastic levels

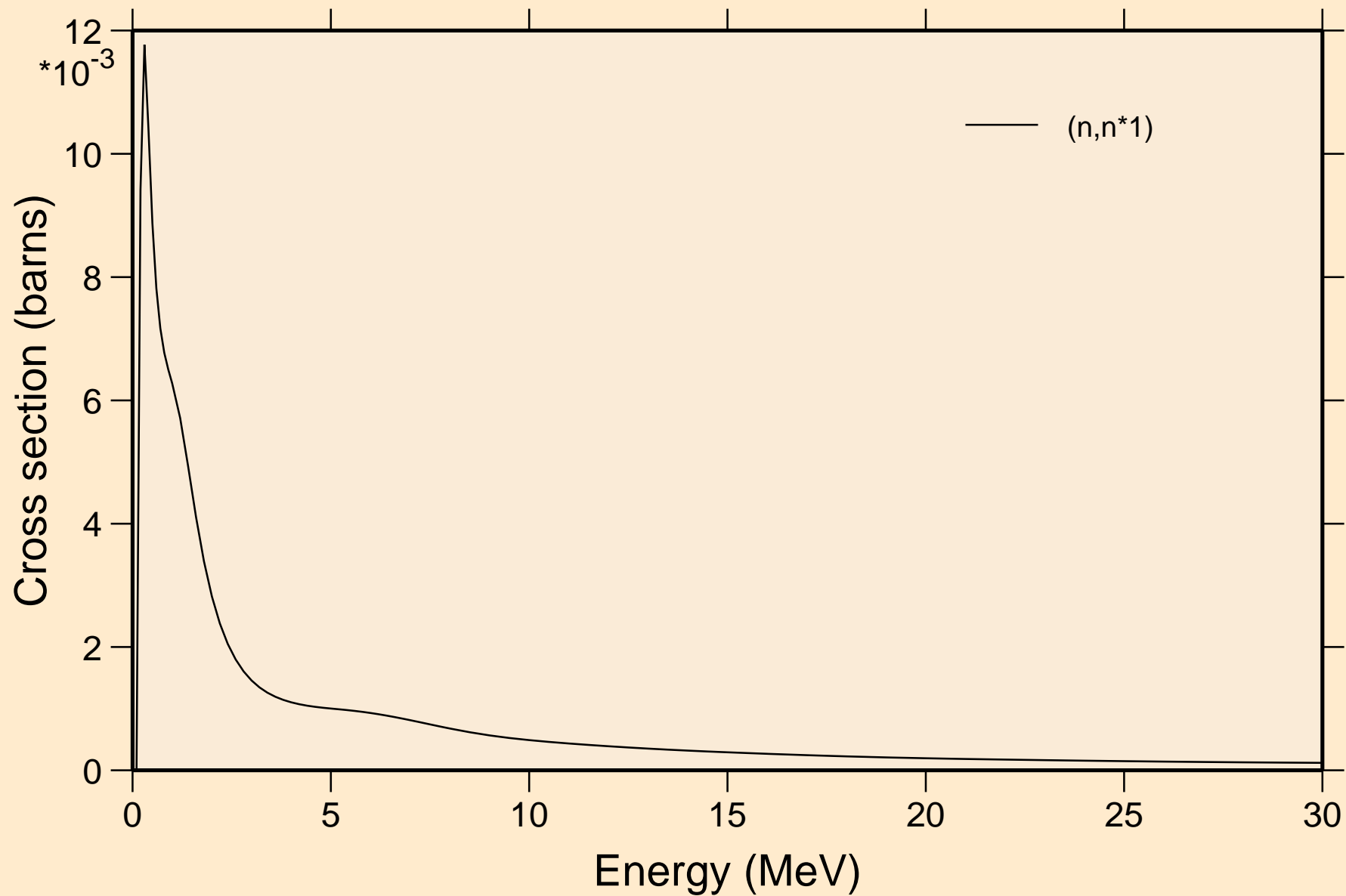

DS281 NEUTRON ACER TENDL-2019 LIBRARY; T=293.16K
Threshold reactions

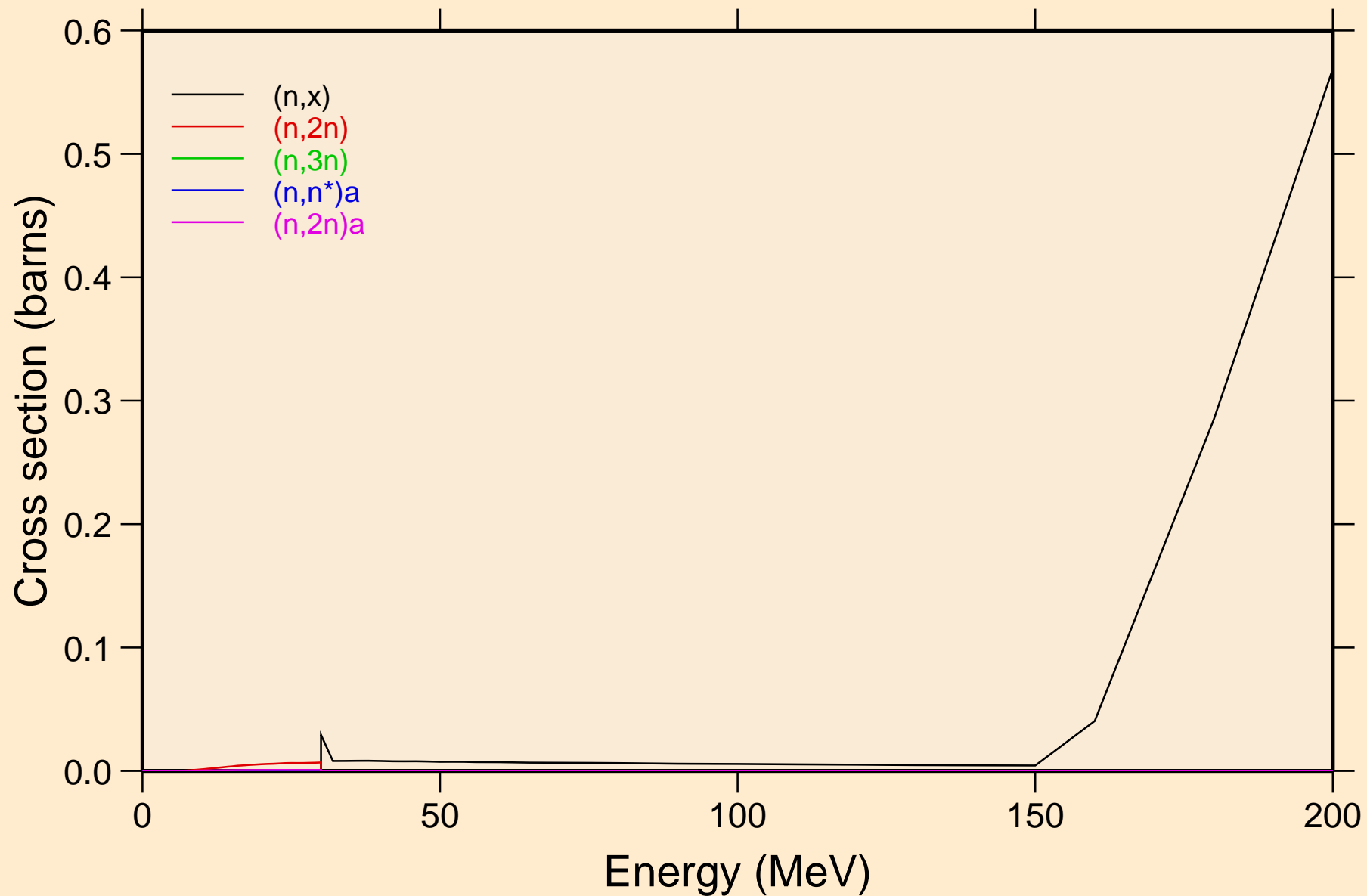

DS281 NEUTRON ACER TENDL-2019 LIBRARY; T=293.16K
Threshold reactions

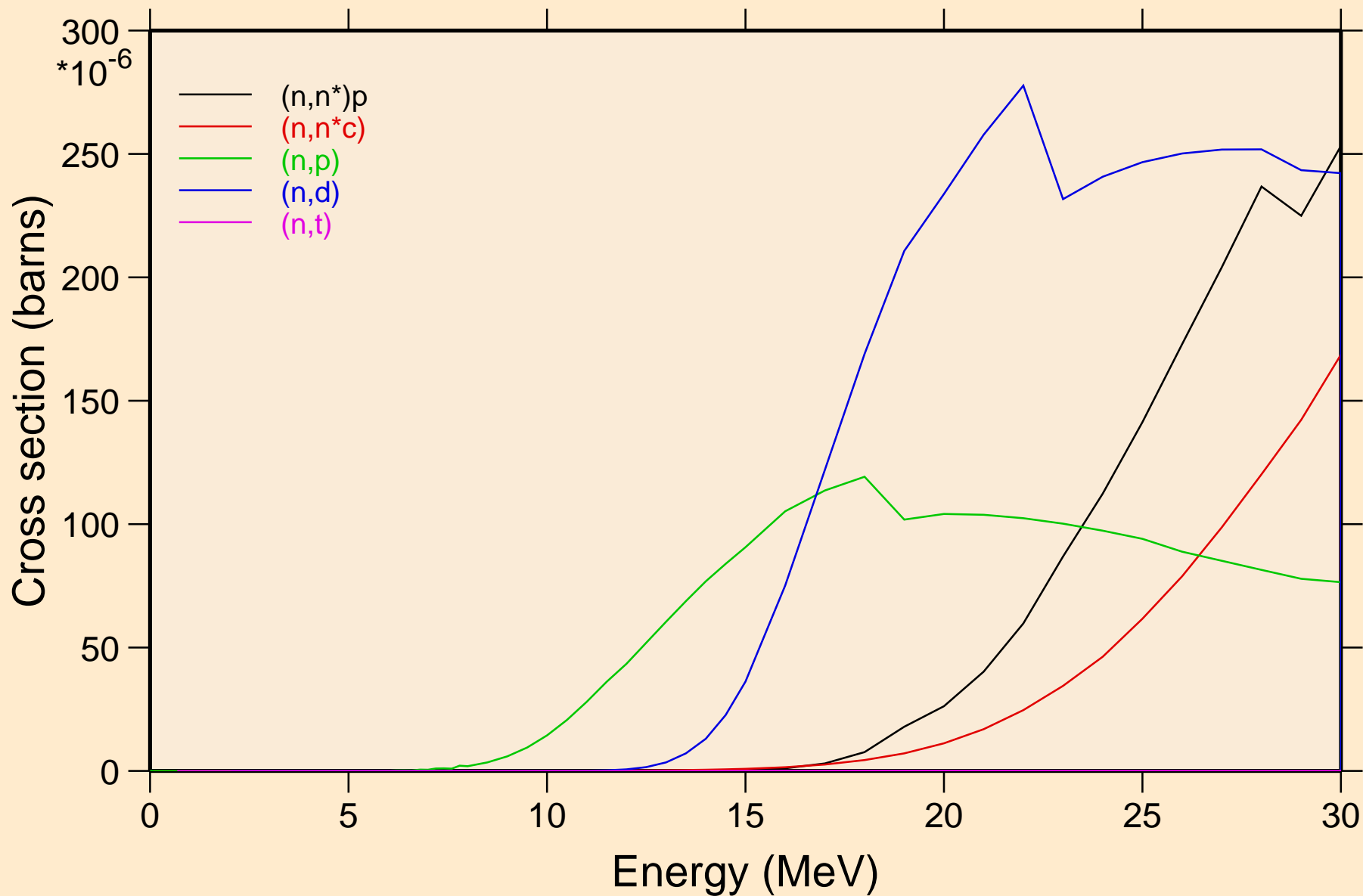

DS281 NEUTRON ACER TENDL-2019 LIBRARY; T=293.16K
Threshold reactions

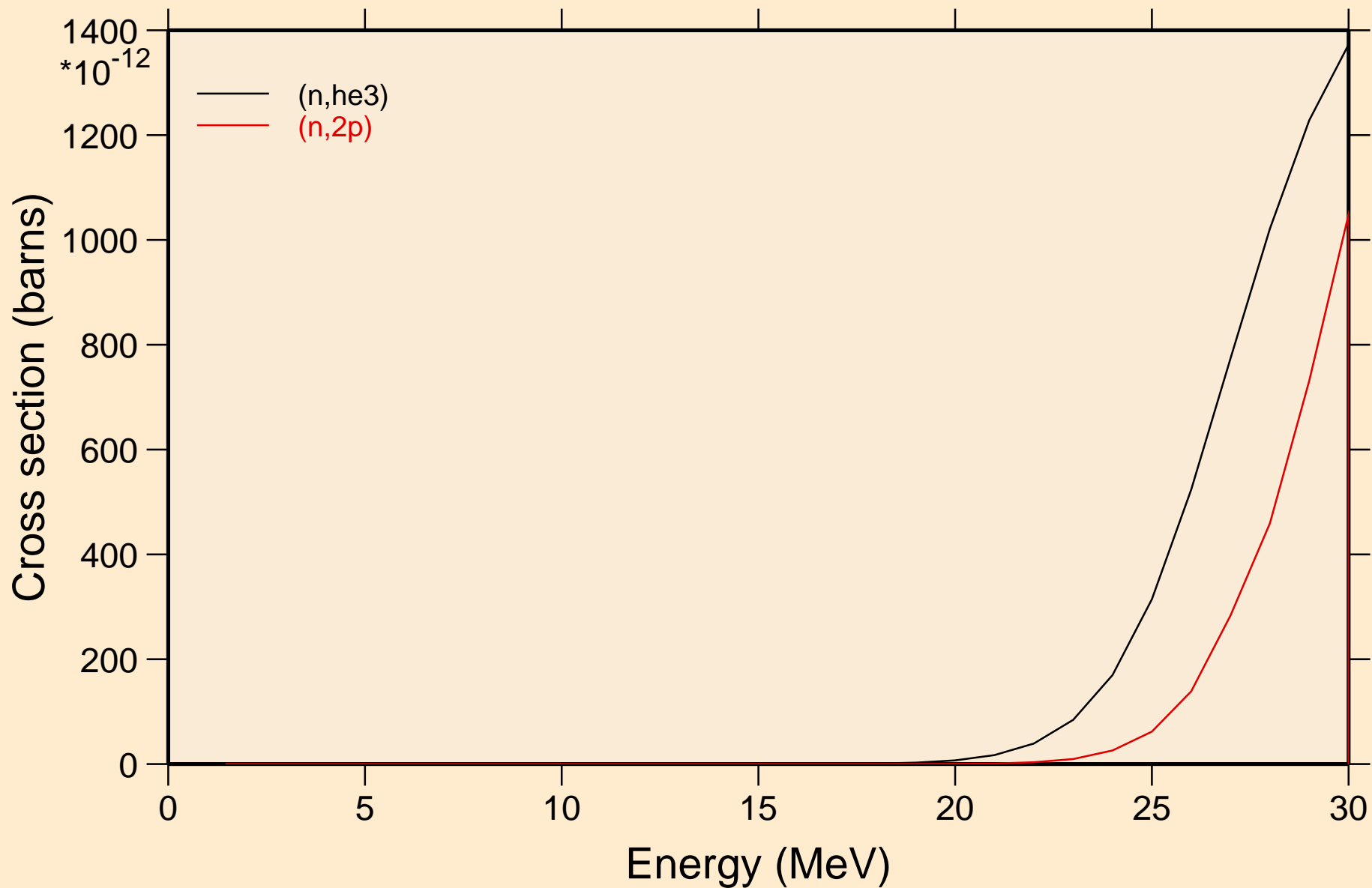

DS281 NEUTRON ACER TENDL-2019 LIBRARY; T=293.16K
Threshold reactions

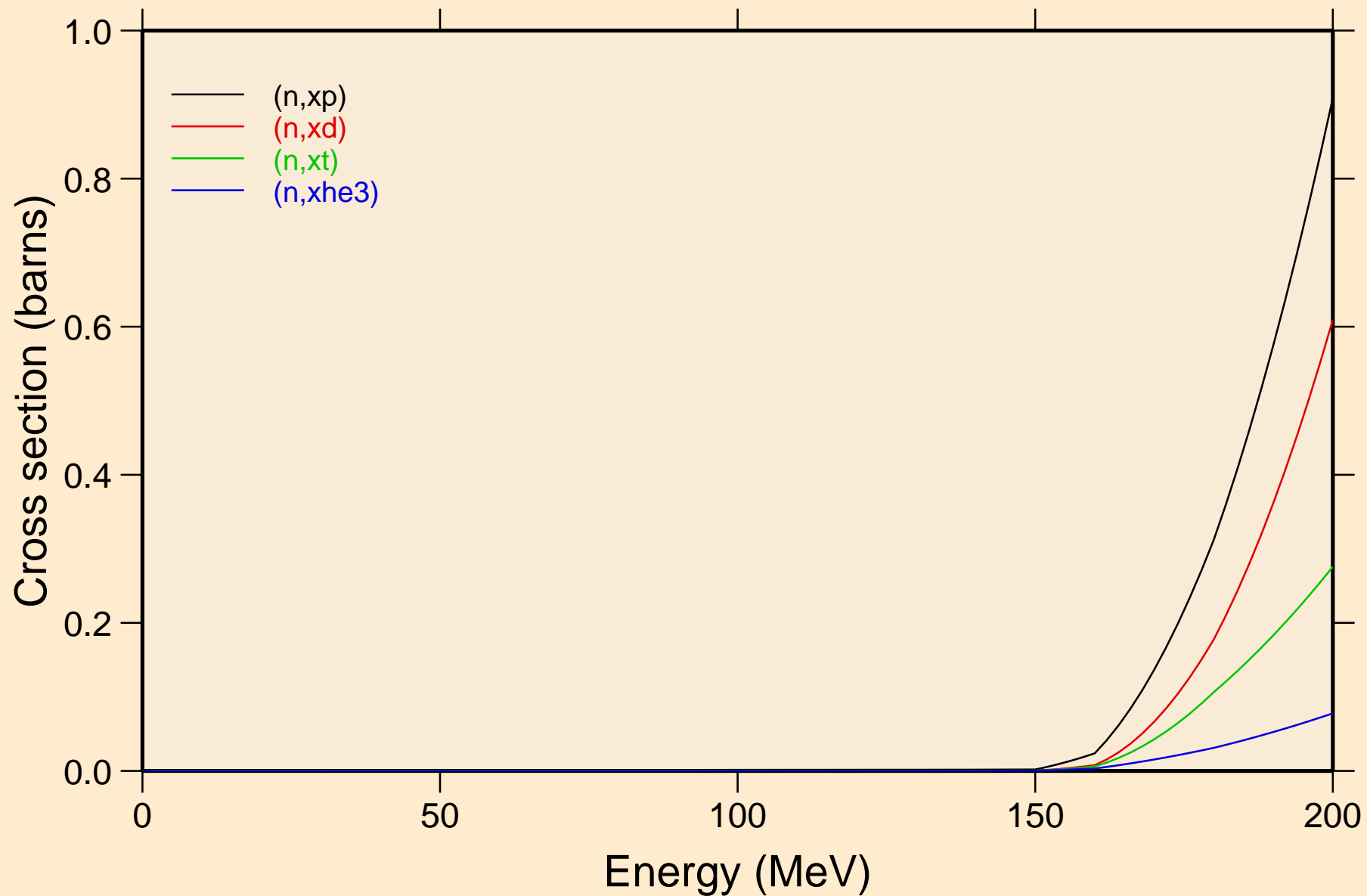

DS281 NEUTRON ACER TENDL-2019 LIBRARY; T=293.16K
angular distribution for elastic

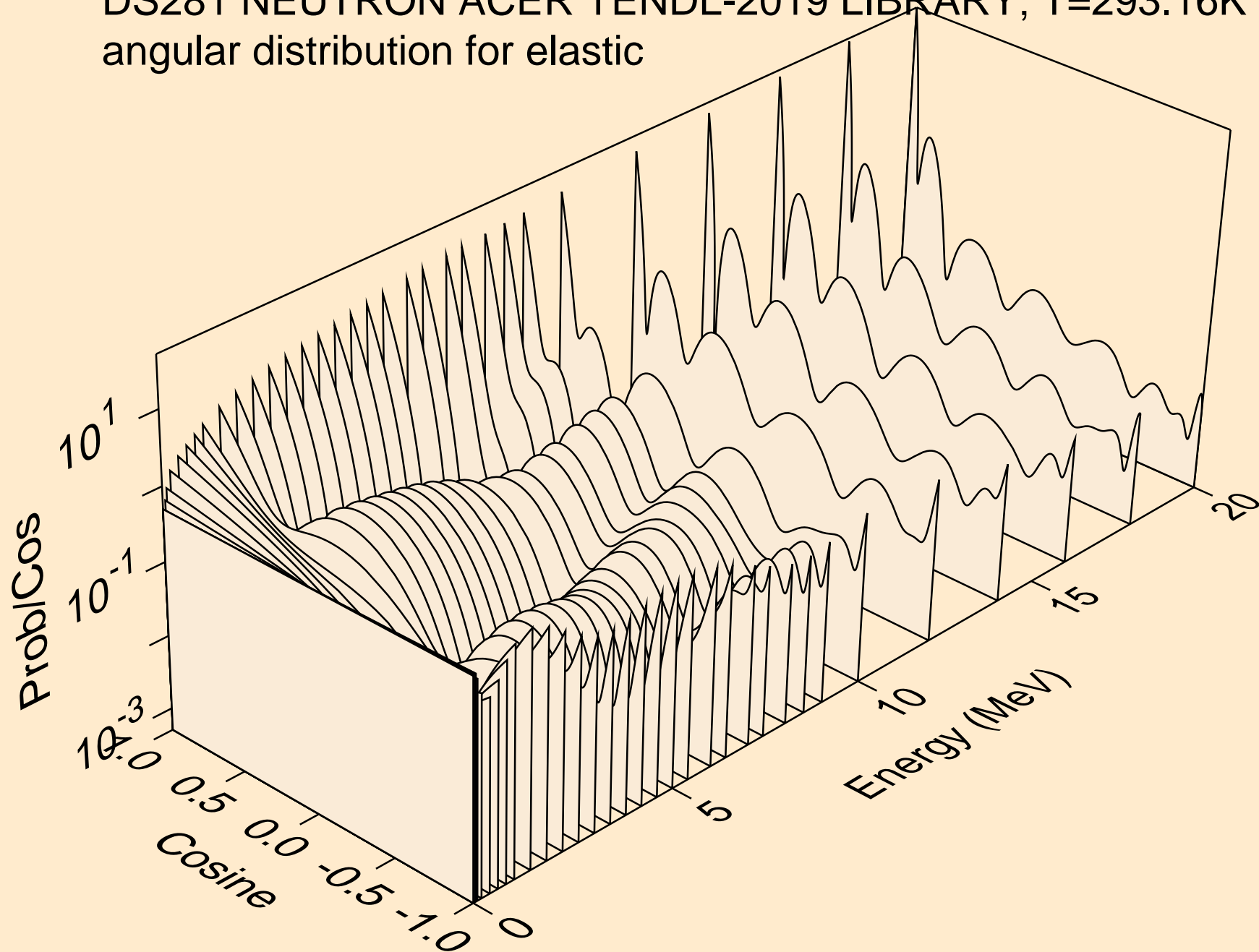

DS281 NEUTRON ACER TENDL-2019 LIBRARY; T=293.16K
angular distribution for elastic

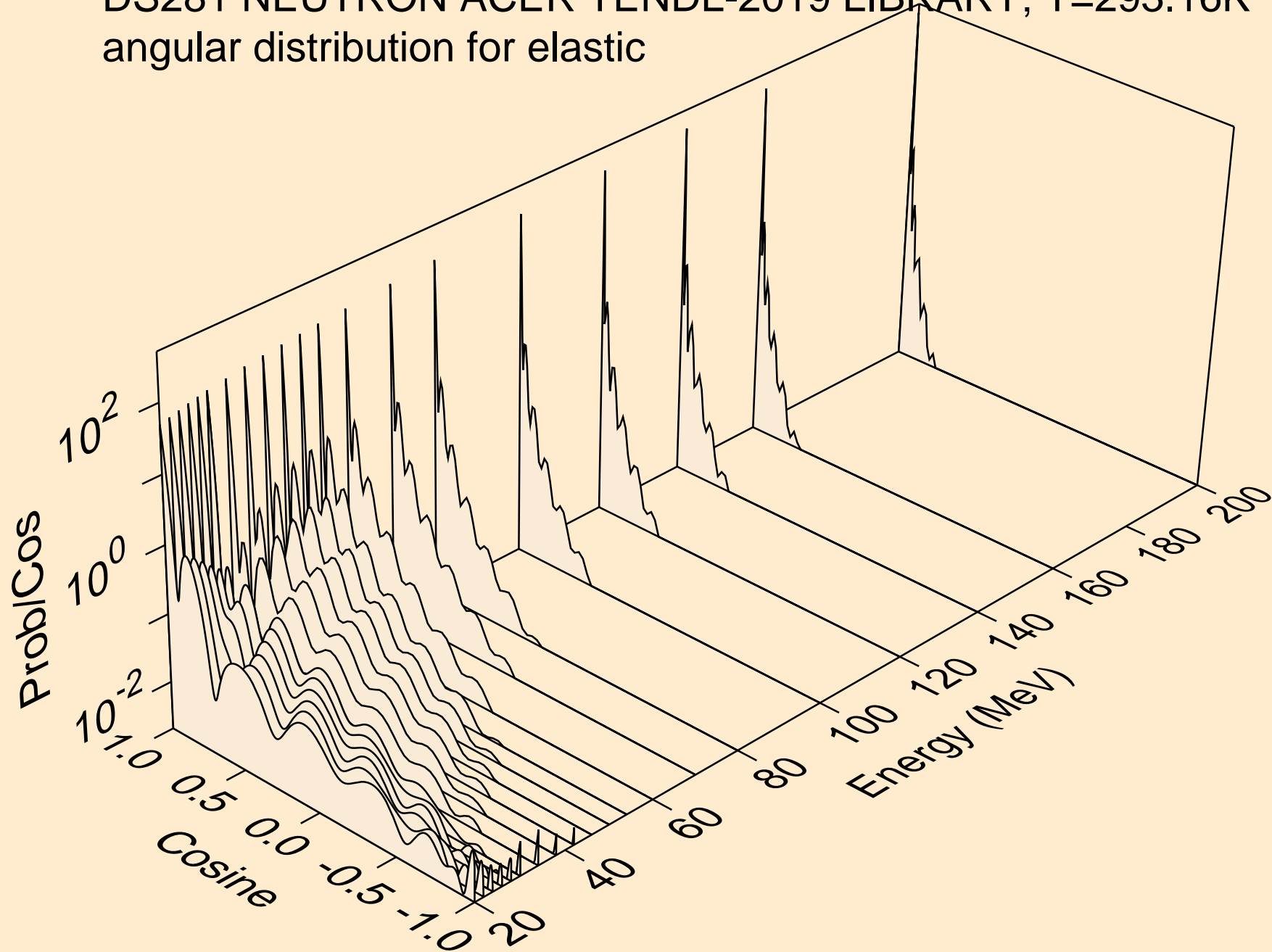

DS281 NEUTRON ACER TENDL-2019 LIBRARY; T=293.16K
angular distribution for (n,n*1)

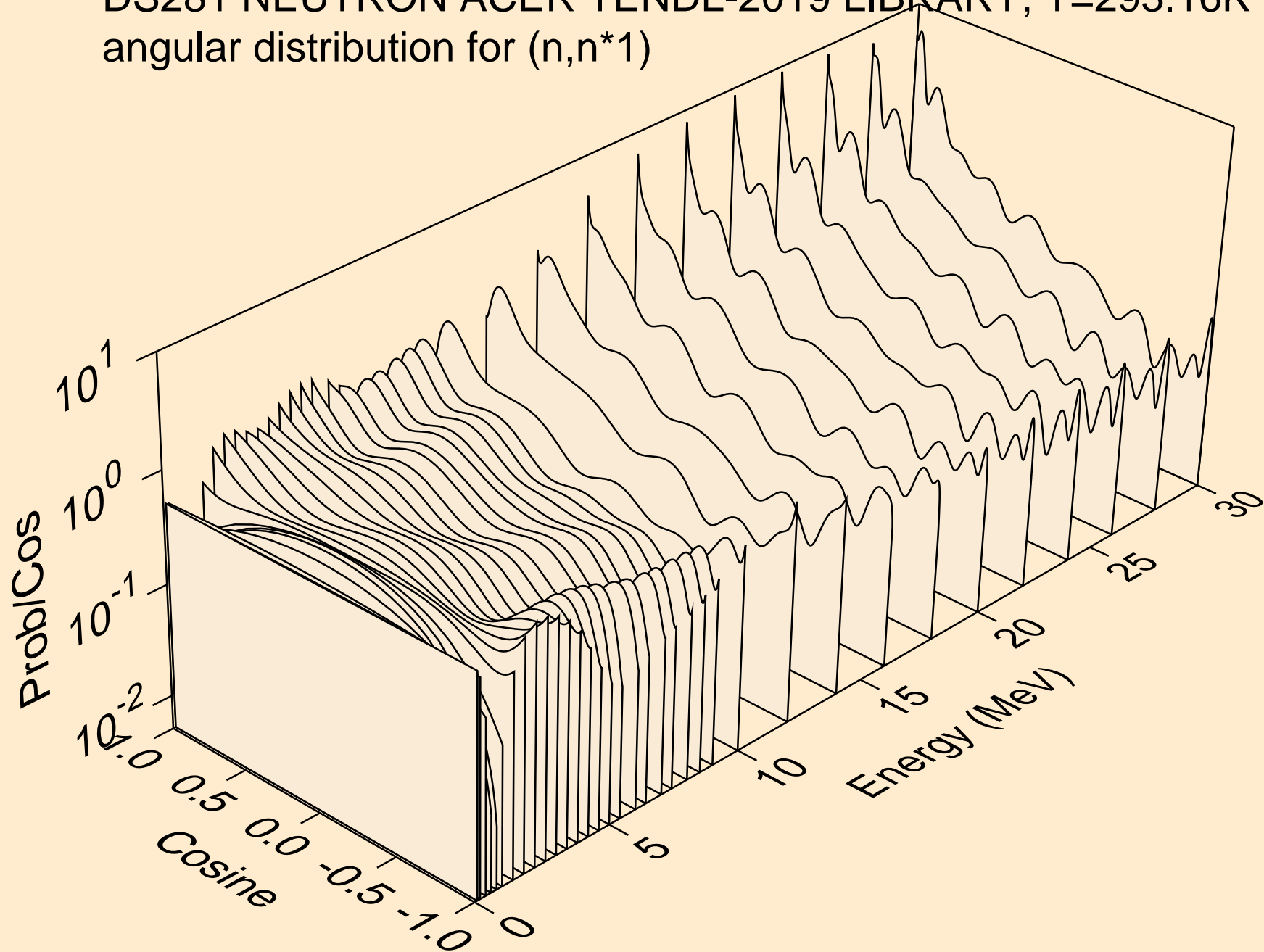

DS281 NEUTRON ACER TENDL-2019 LIBRARY; T=293.16K
Total fission nubar

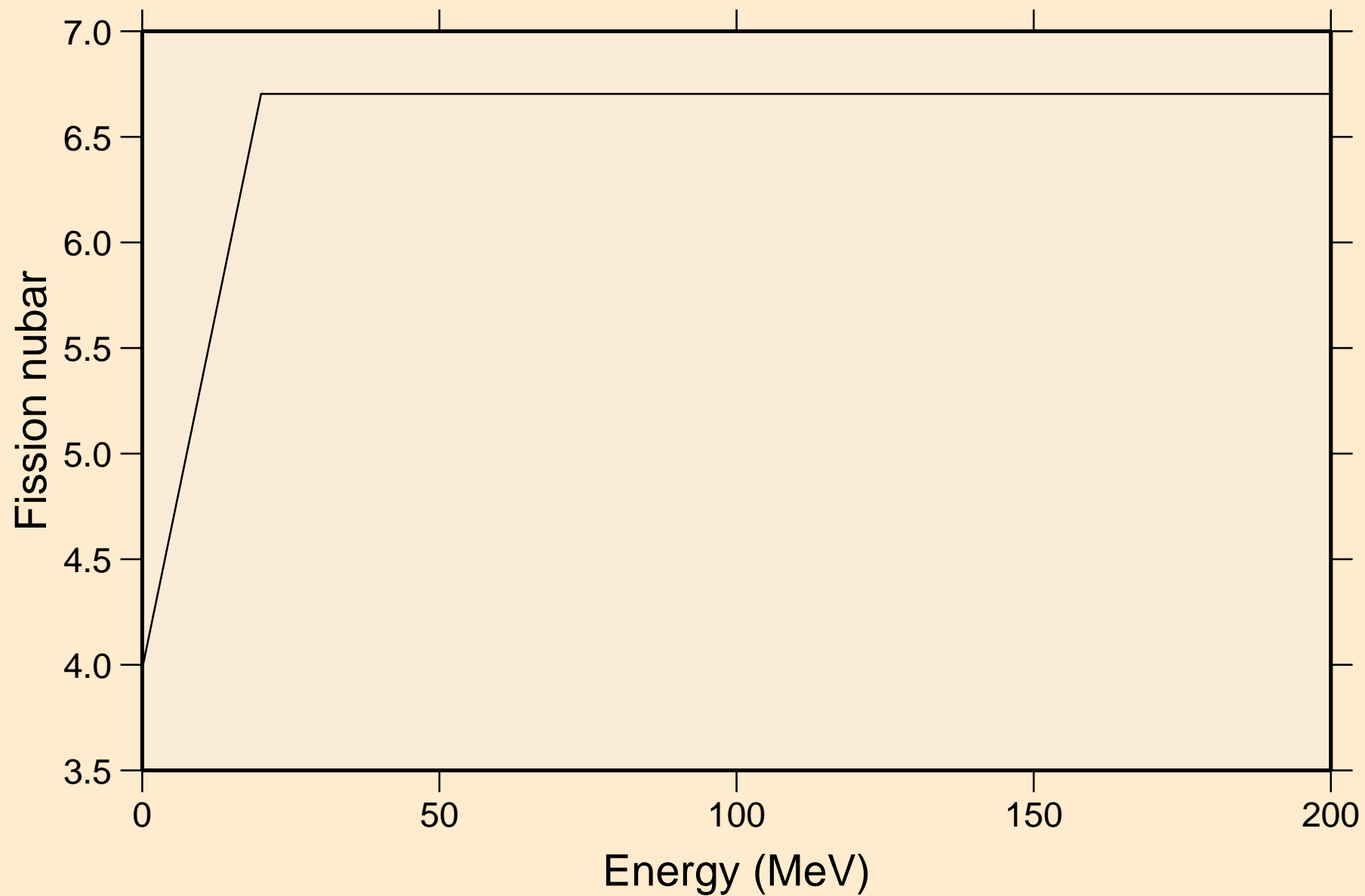

DS281 NEUTRON ACER TENDL-2019 LIBRARY; T=293.16K
Neutron emission for (n,x)

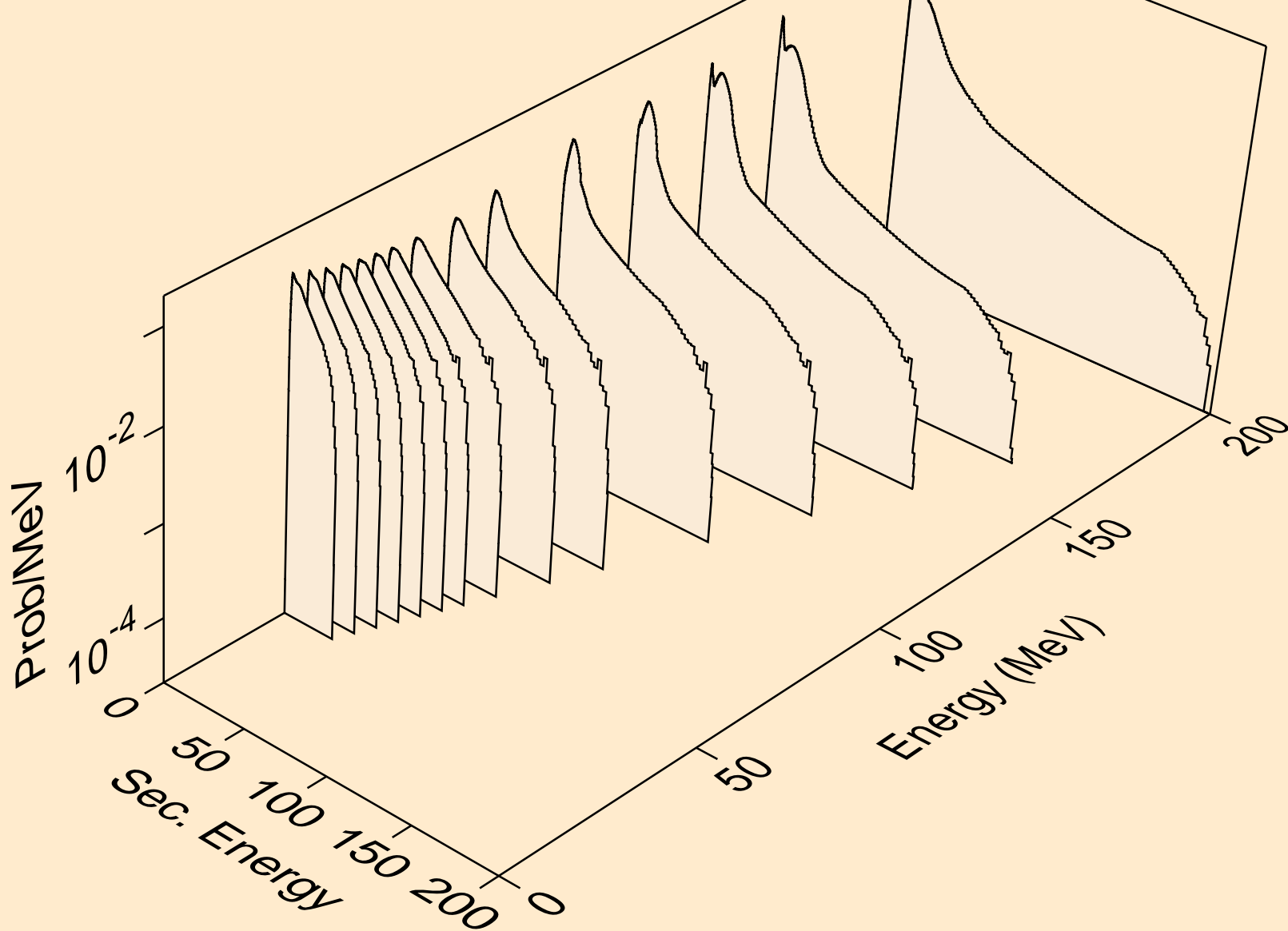

DS281 NEUTRON ACER TENDL-2019 LIBRARY; T=293.16K
Neutron emission for (n,2n)

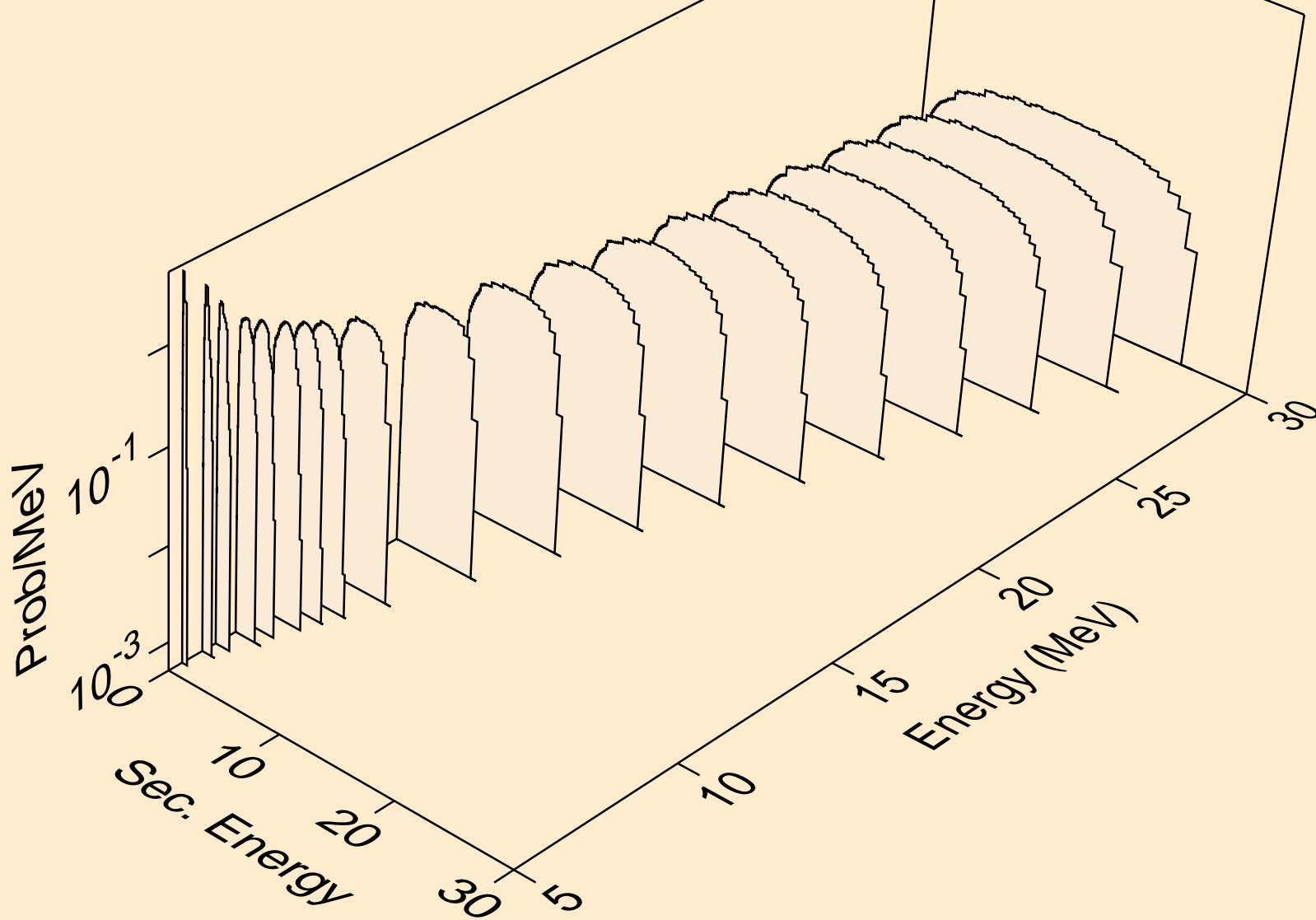

DS281 NEUTRON ACER TENDL-2019 LIBRARY; T=293.16K
Neutron emission for (n,3n)

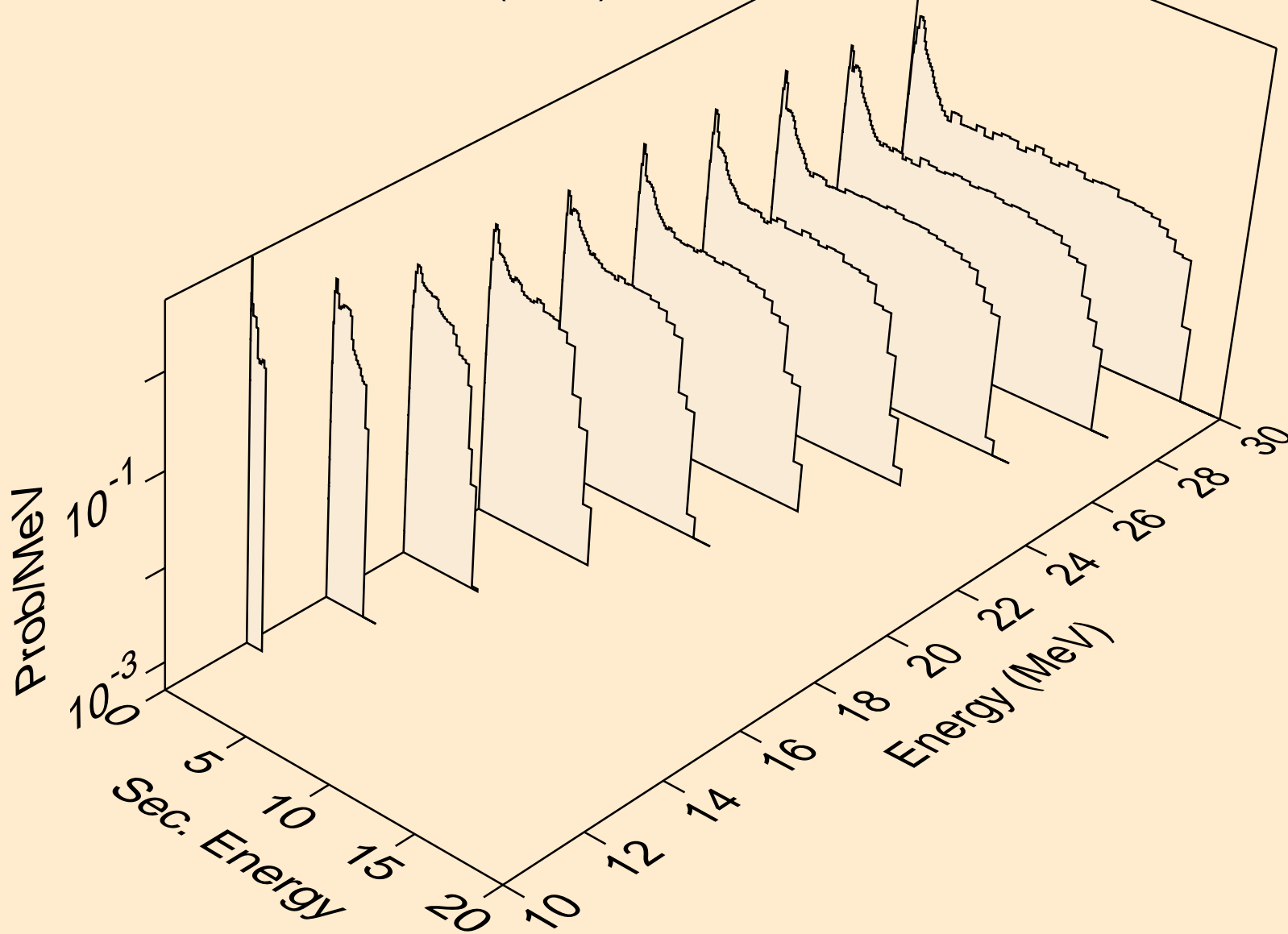

DS281 NEUTRON ACER TENDL-2019 LIBRARY; T=293.16K
Neutron emission for fission

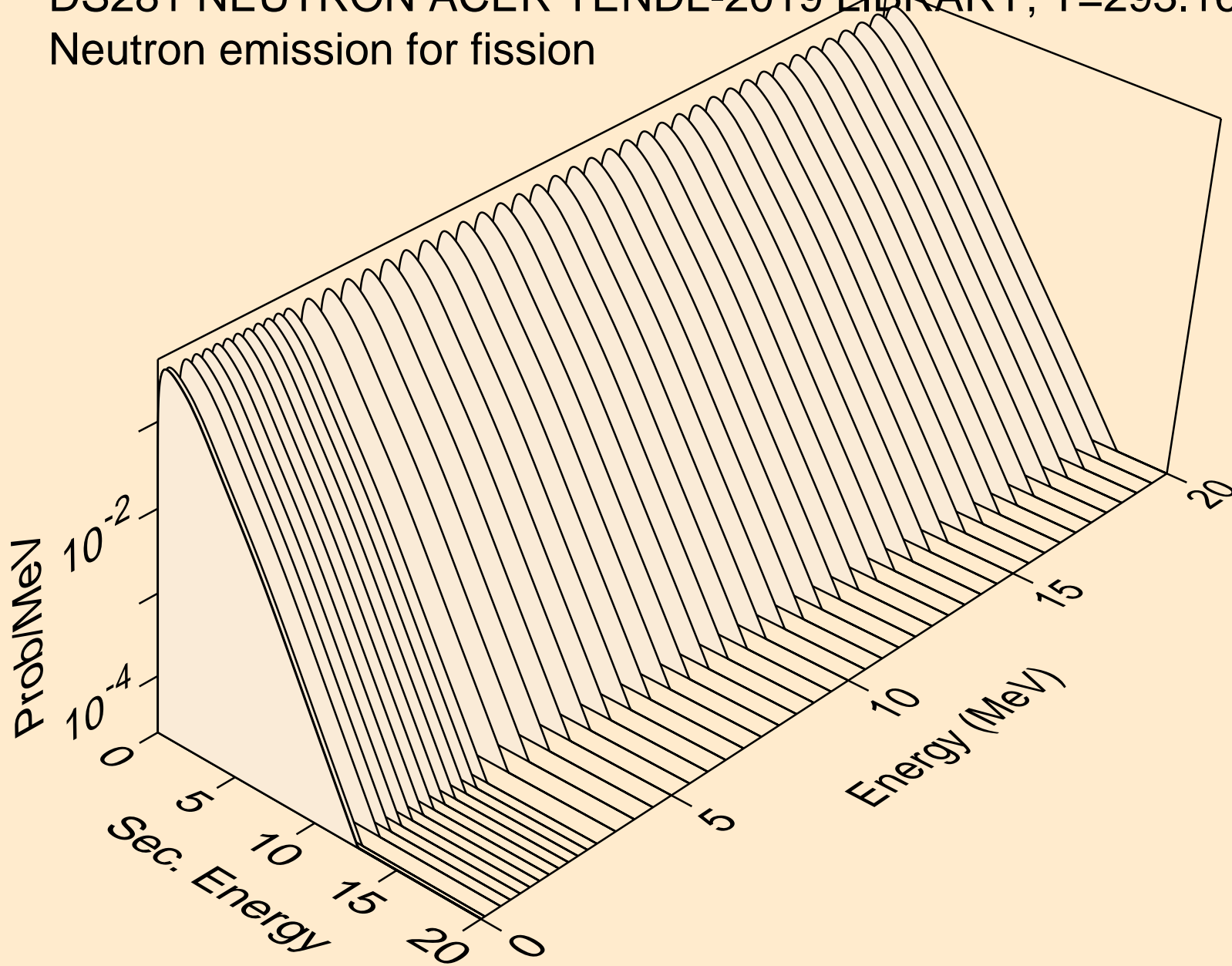

DS281 NEUTRON ACER TENDL-2019 LIBRARY; T=293.16K
Neutron emission for (n,n*)a

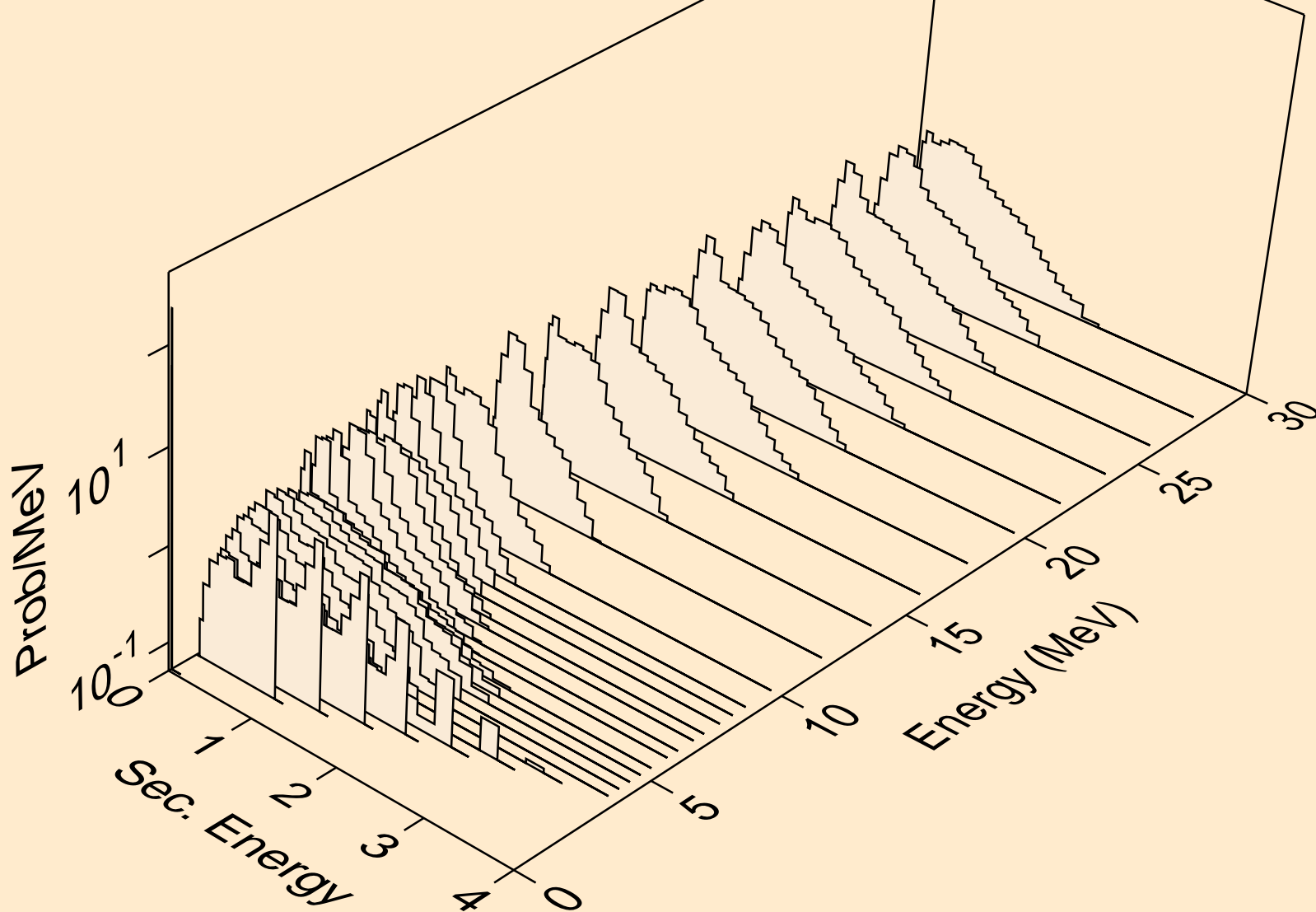

DS281 NEUTRON ACER TENDL-2019 LIBRARY; T=293.16K
Neutron emission for (n,2n)a

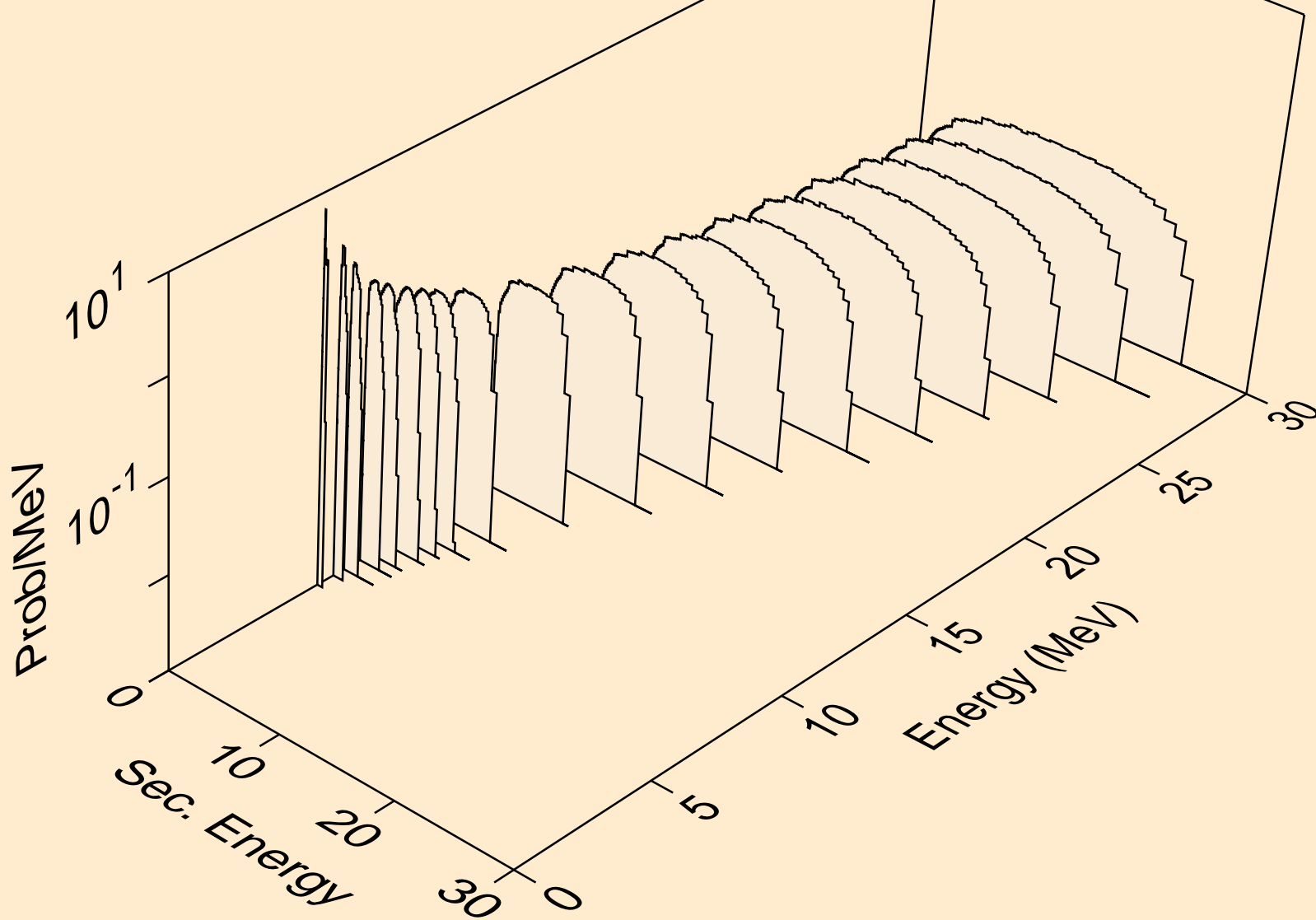

DS281 NEUTRON ACER TENDL-2019 LIBRARY; T=293.16K
Neutron emission for (n,n*)p

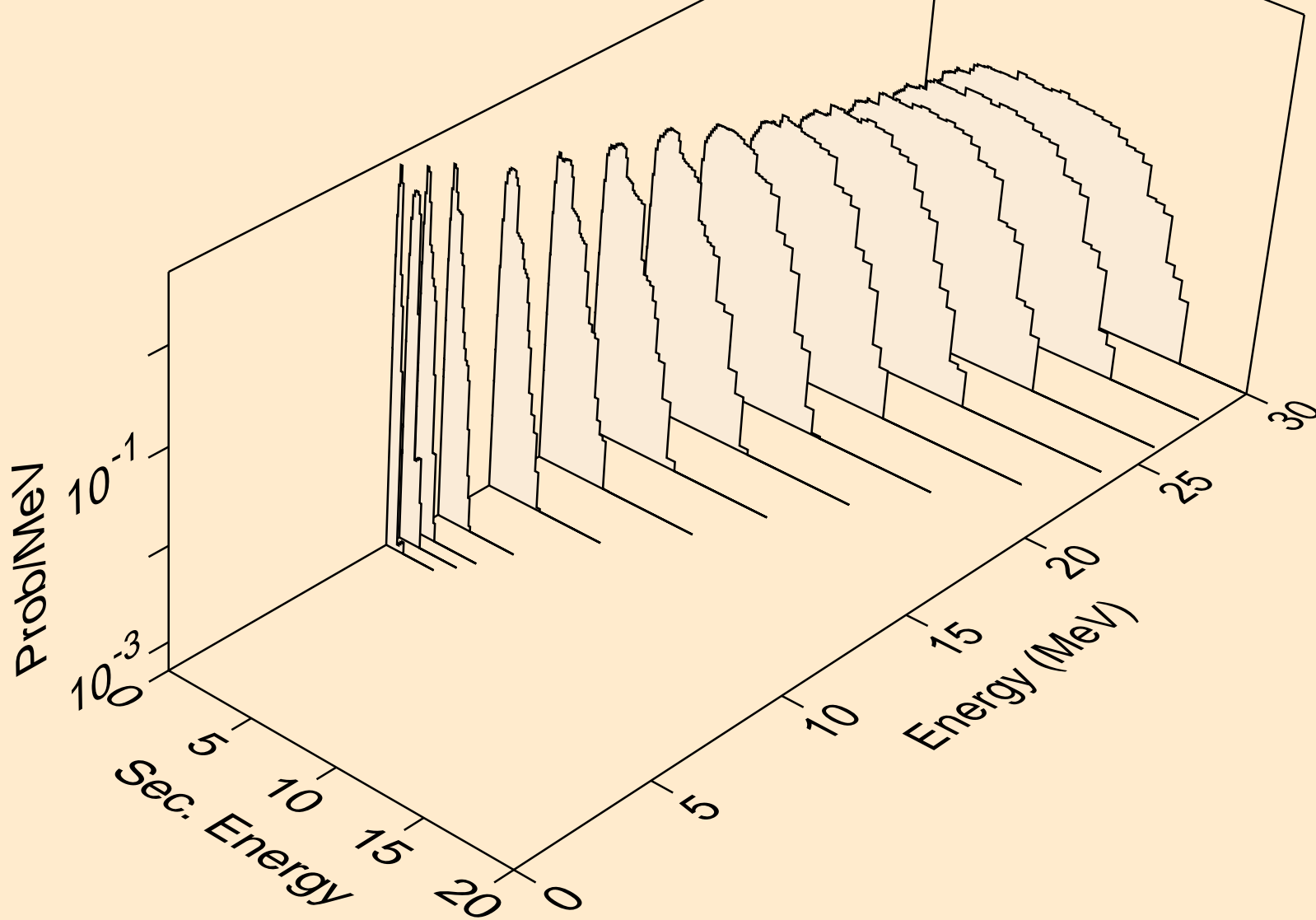

DS281 NEUTRON ACER TENDL-2019 LIBRARY; T=293.16K
Neutron emission for (n,n*c)

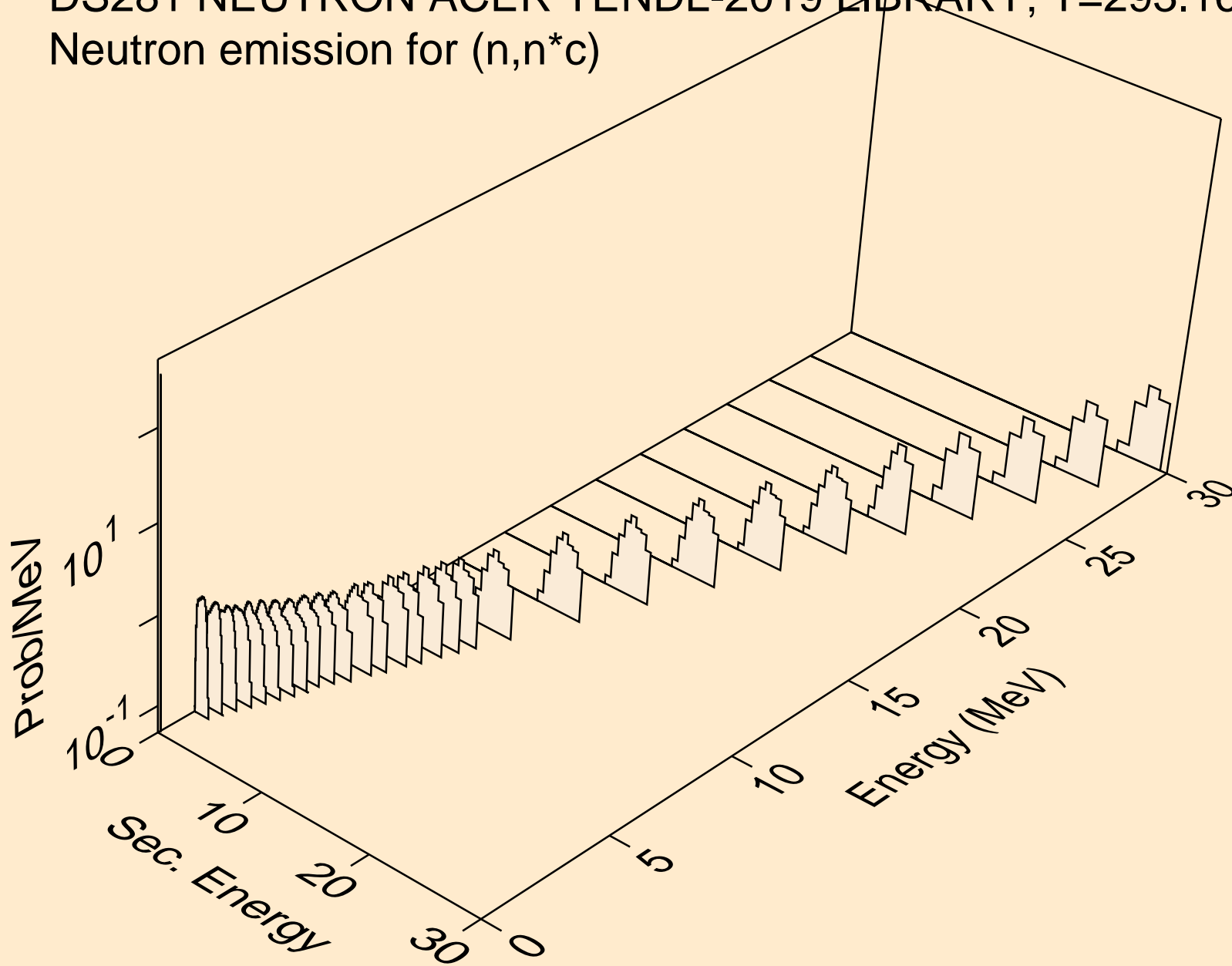

DS281 NEUTRON ACER TENDL-2019 LIBRARY; T=293.16K

Delayed nubar

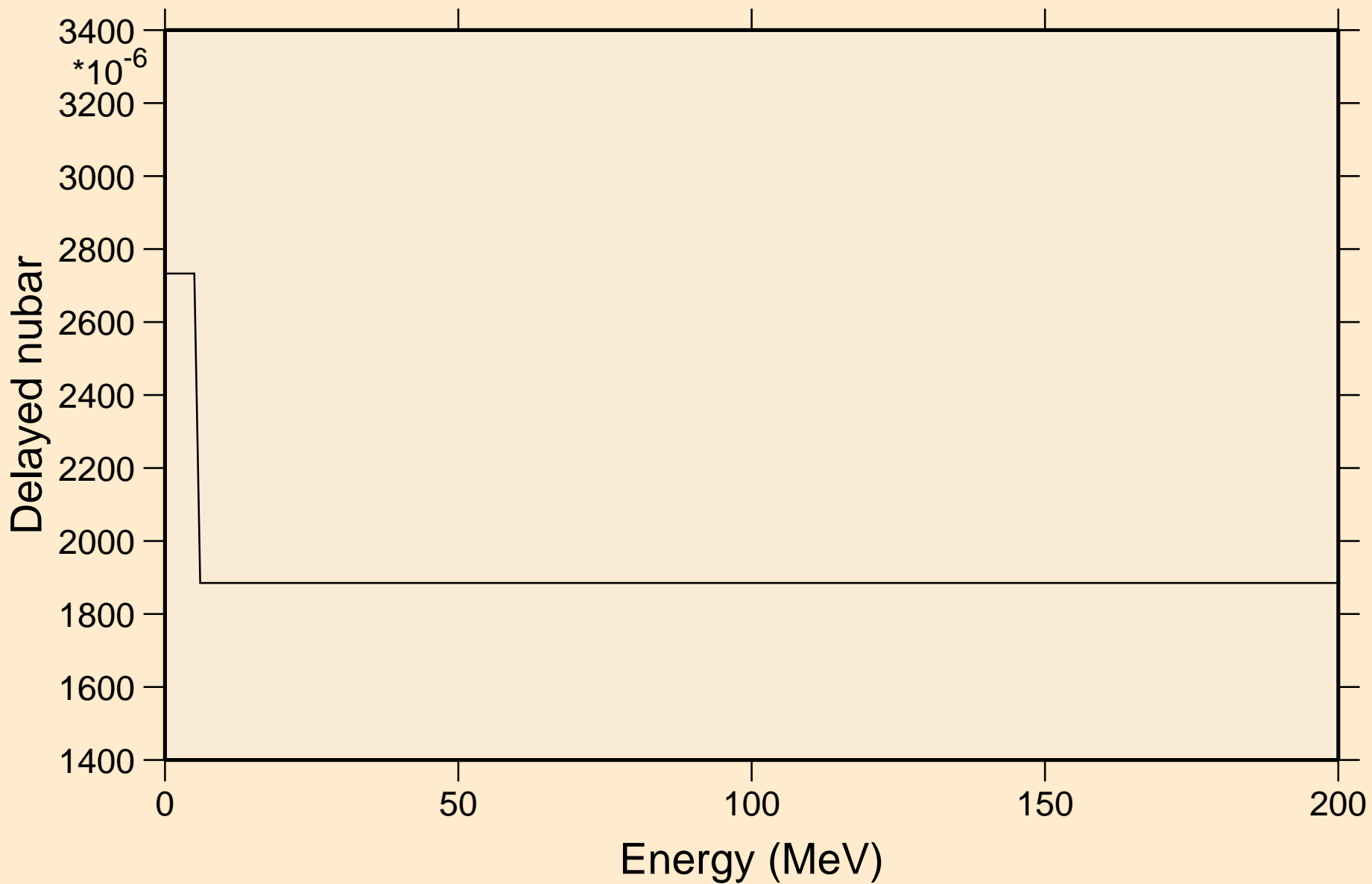

DS281 NEUTRON ACER TENDL-2019 LIBRARY; T=293.16K
Delayed neutron spectra

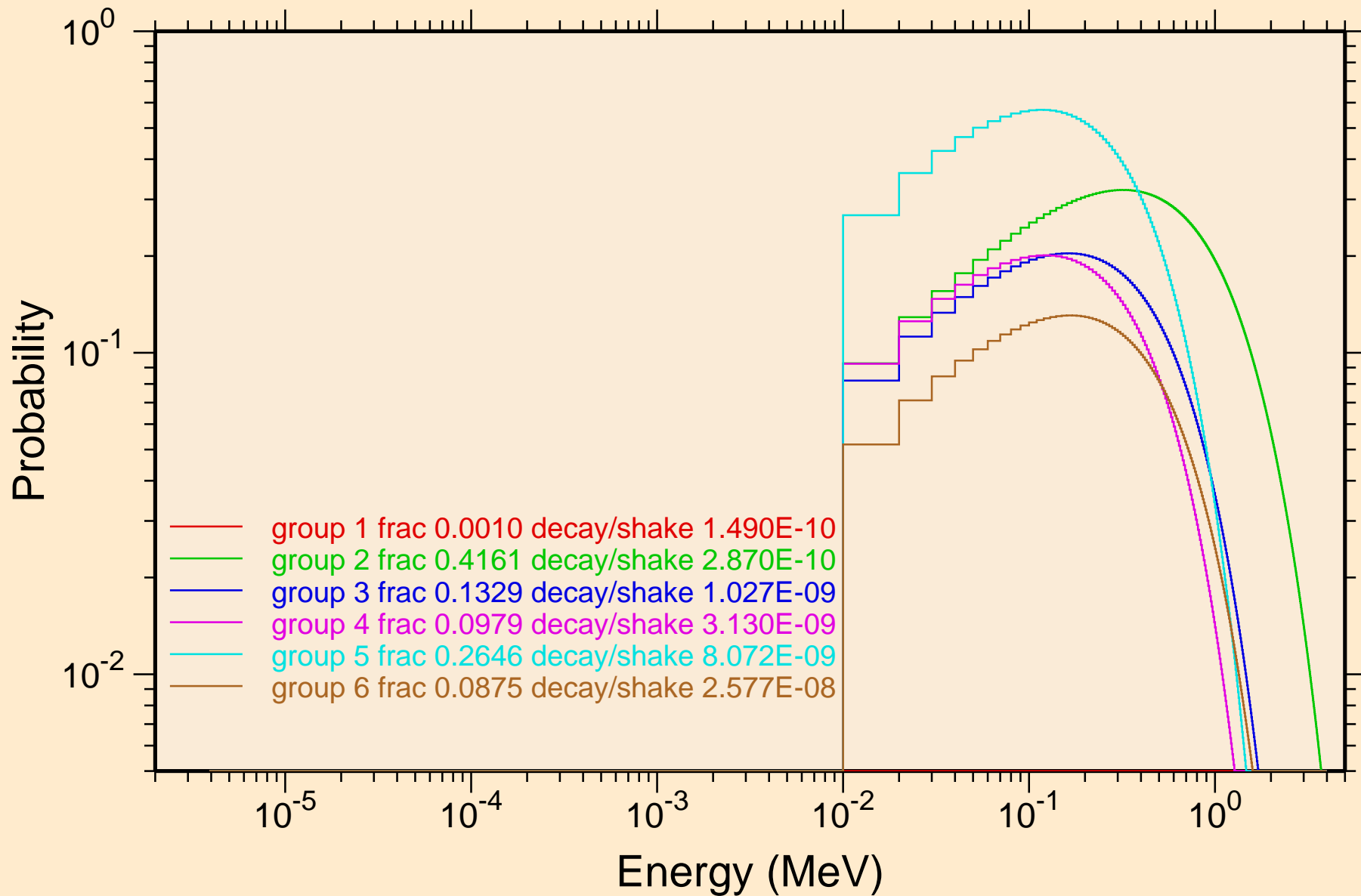

DS281 NEUTRON ACER TENDL-2019 LIBRARY; T=293.16K
Photon emission for (n,x)

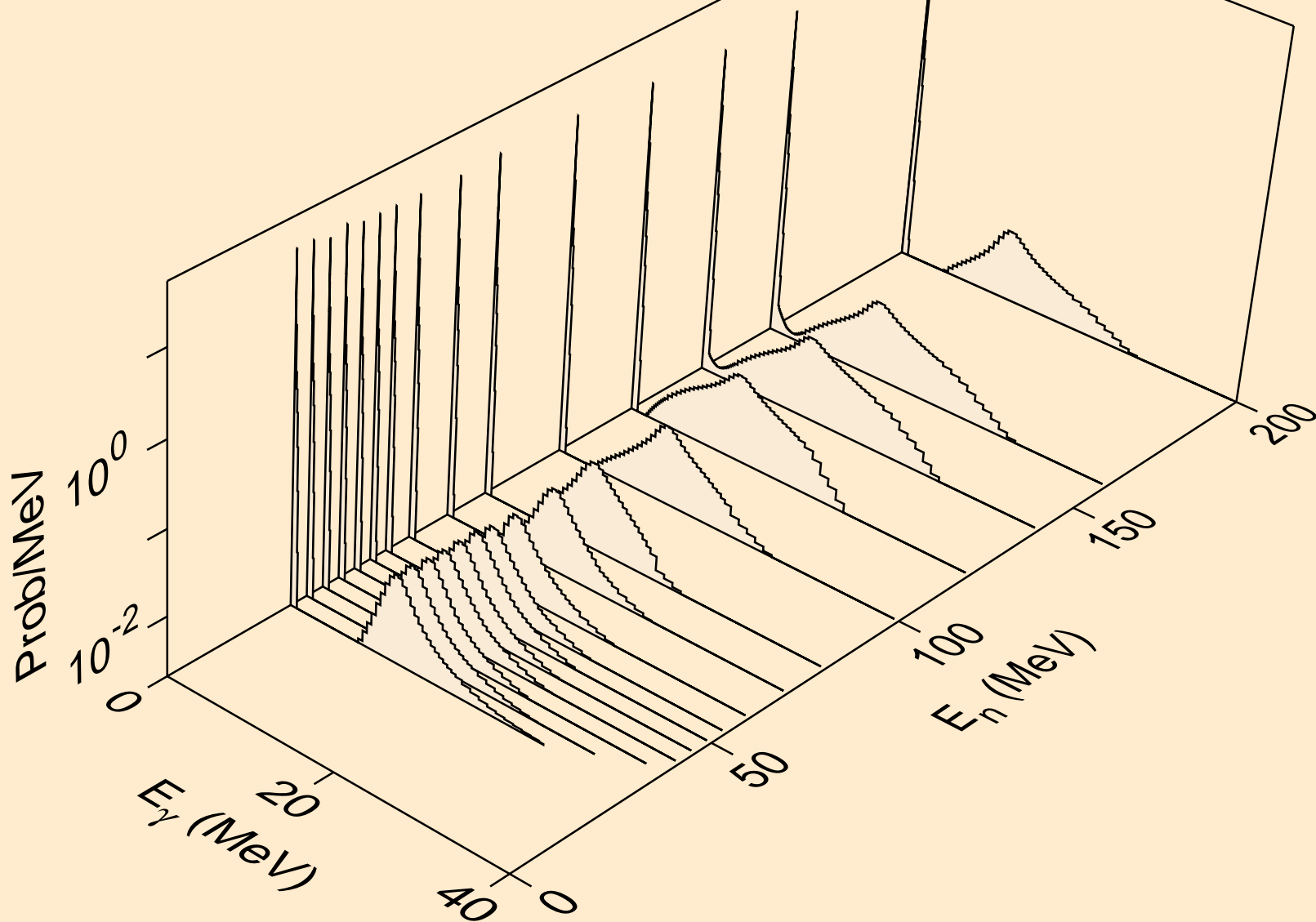

DS281 NEUTRON ACER TENDL-2019 LIBRARY; T=293.16K
Photon emission for (n,2n)

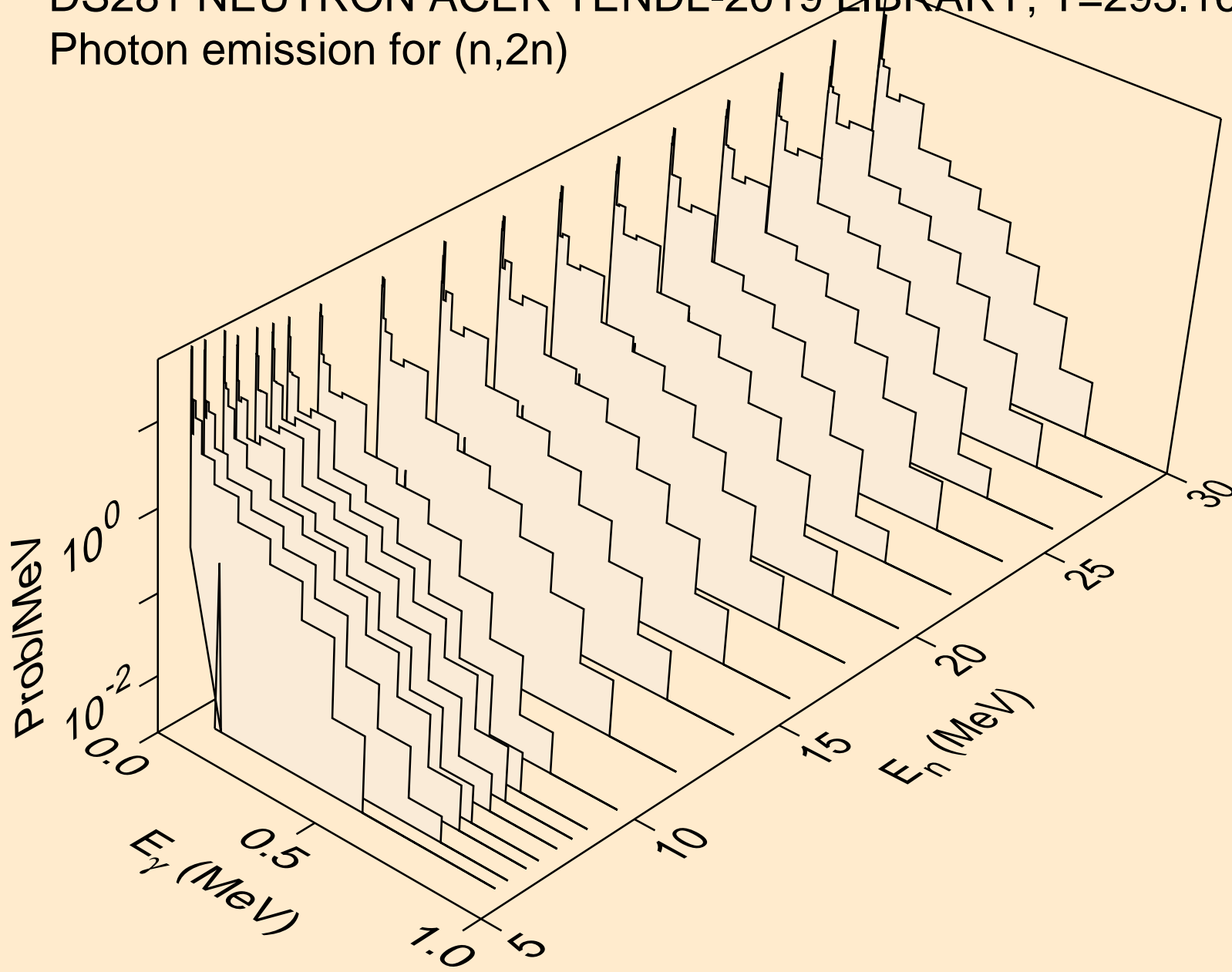

DS281 NEUTRON ACER TENDL-2019 LIBRARY; T=293.16K
Photon emission for (n,3n)

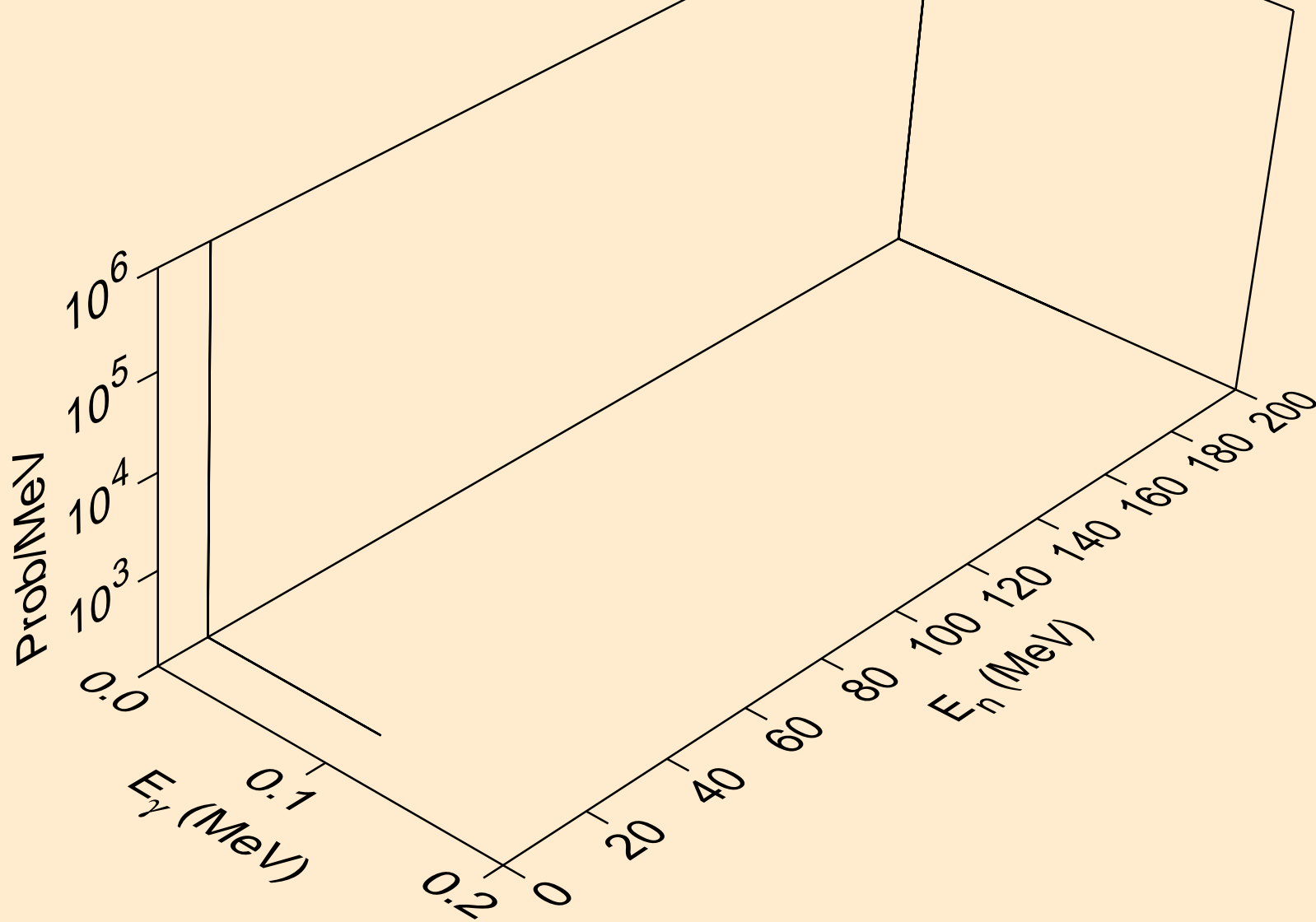

DS281 NEUTRON ACER TENDL-2019 LIBRARY; T=293.16K
Photon emission for (n,n*)a

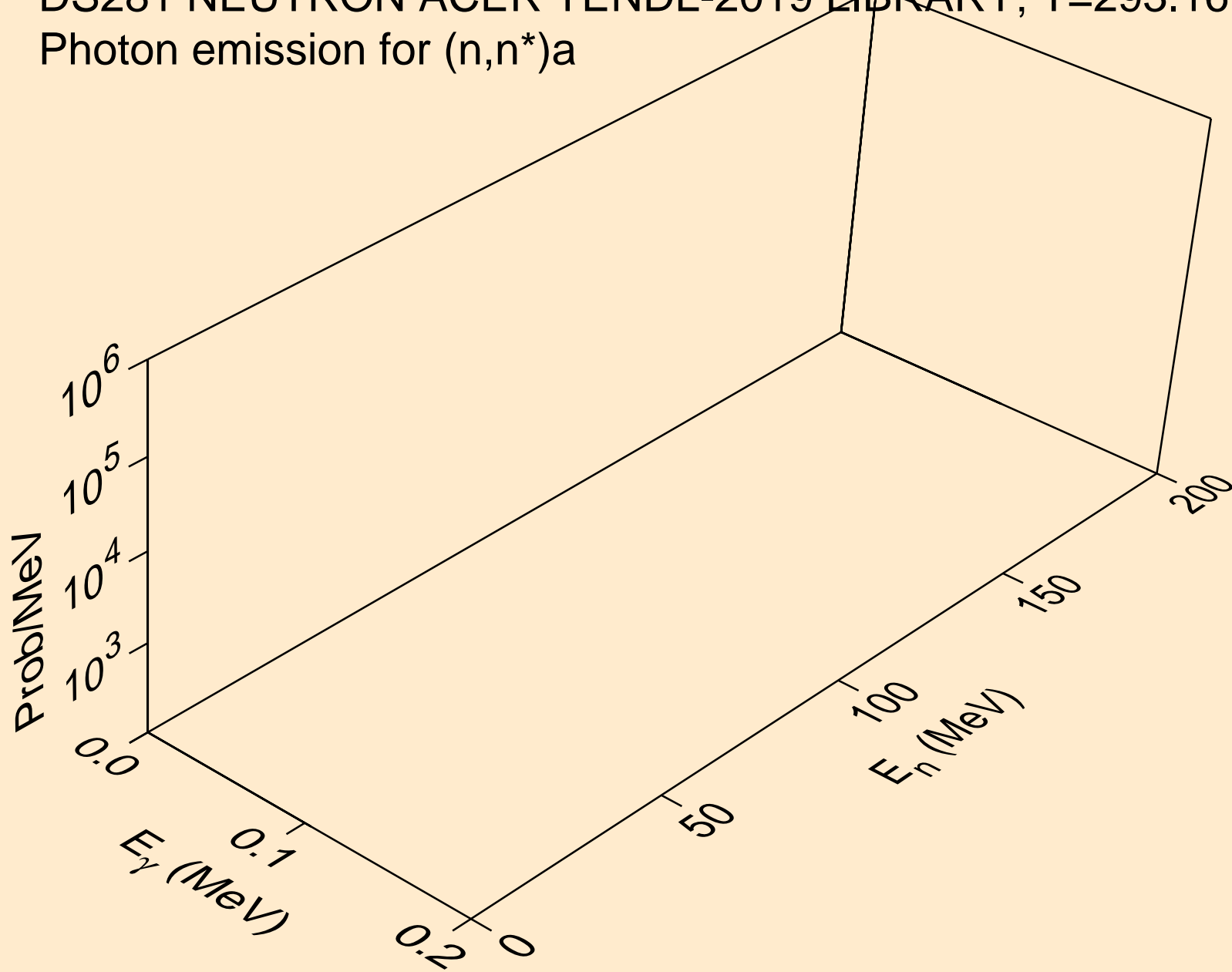

DS281 NEUTRON ACER TENDL-2019 LIBRARY; T=293.16K
Photon emission for (n,2n)a

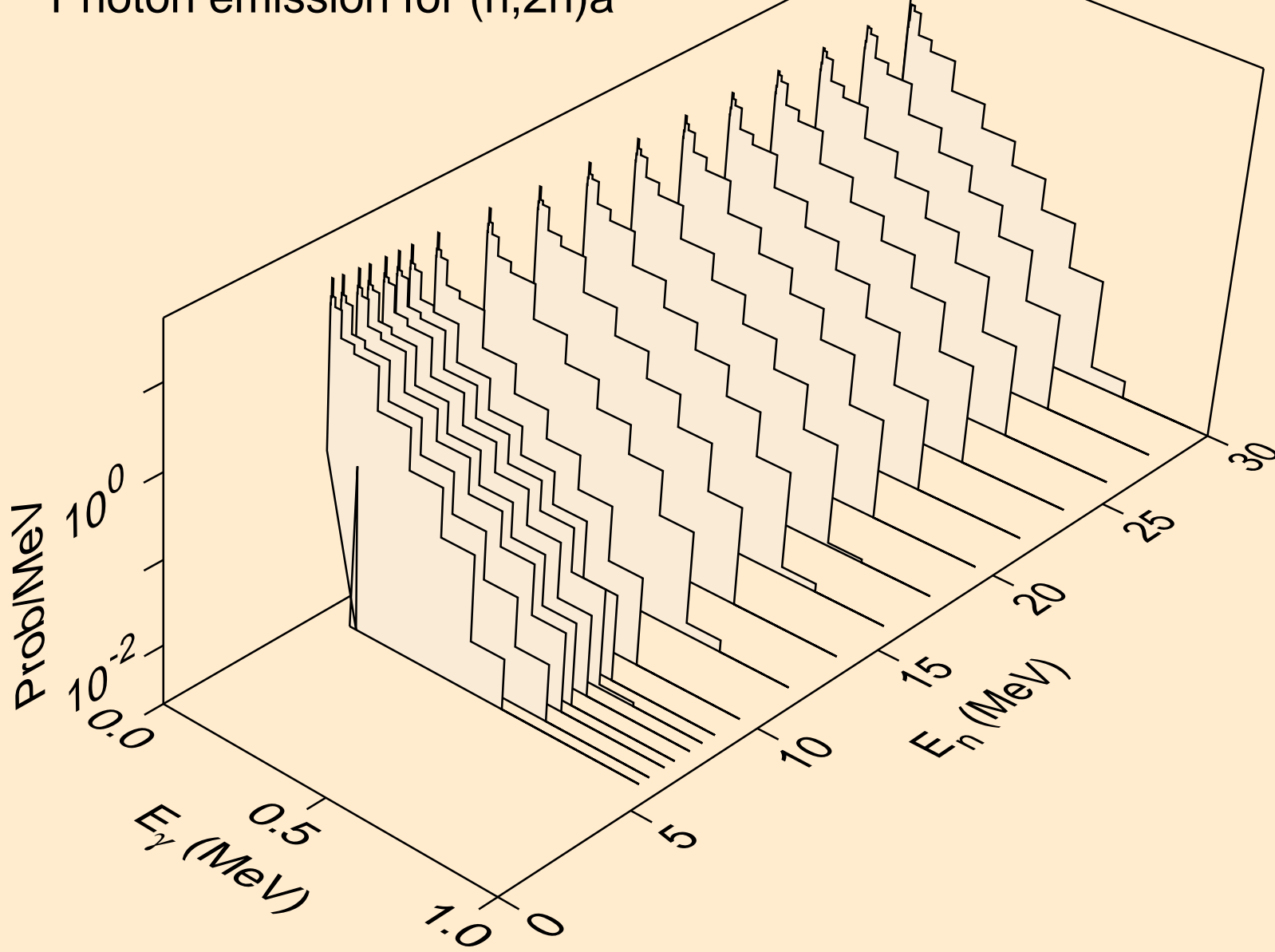

DS281 NEUTRON ACER TENDL-2019 LIBRARY; T=293.16K
Photon emission for (n,n*)p

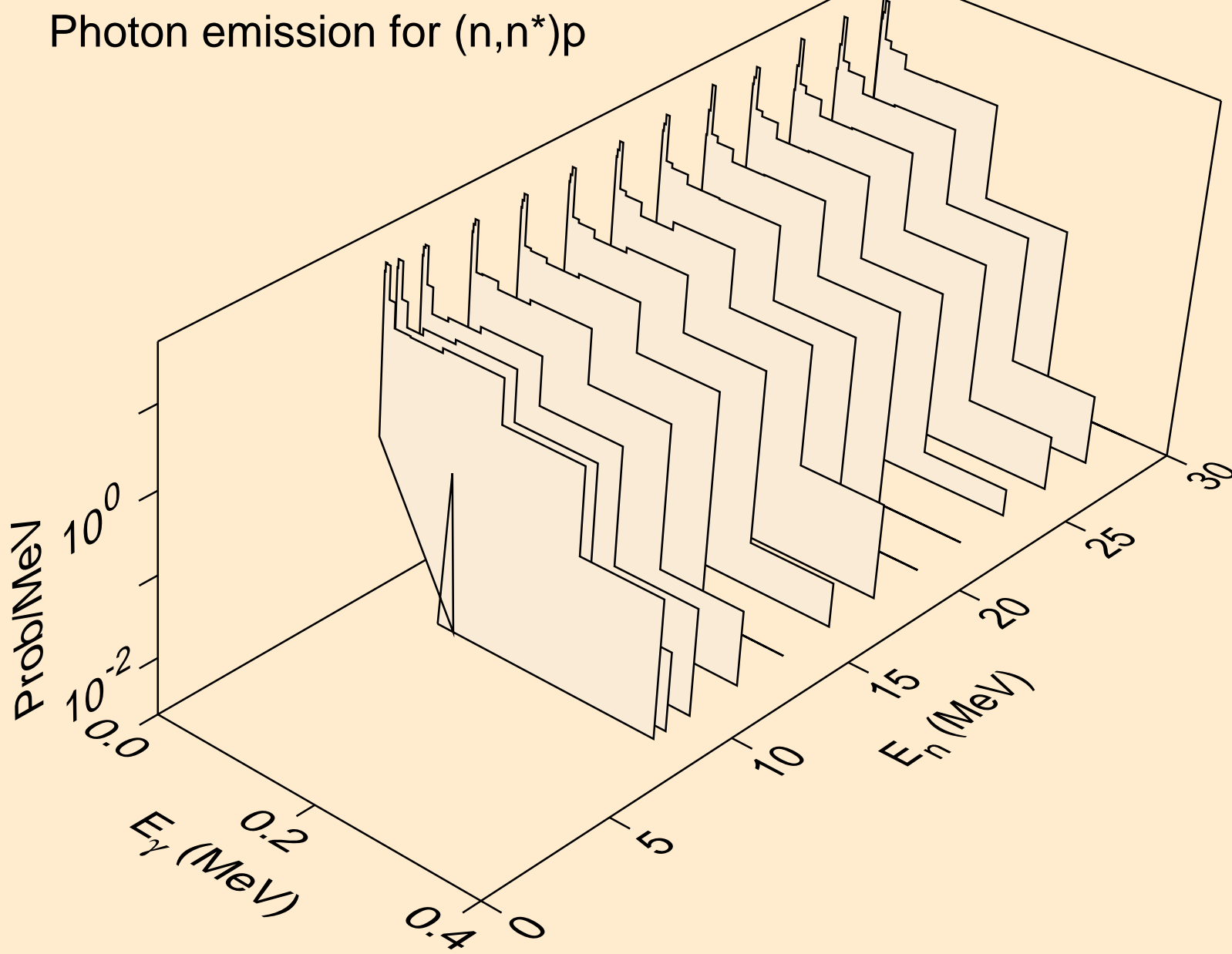

DS281 NEUTRON ACER TENDL-2019 LIBRARY; T=293.16K
Photon emission for (n,n*c)

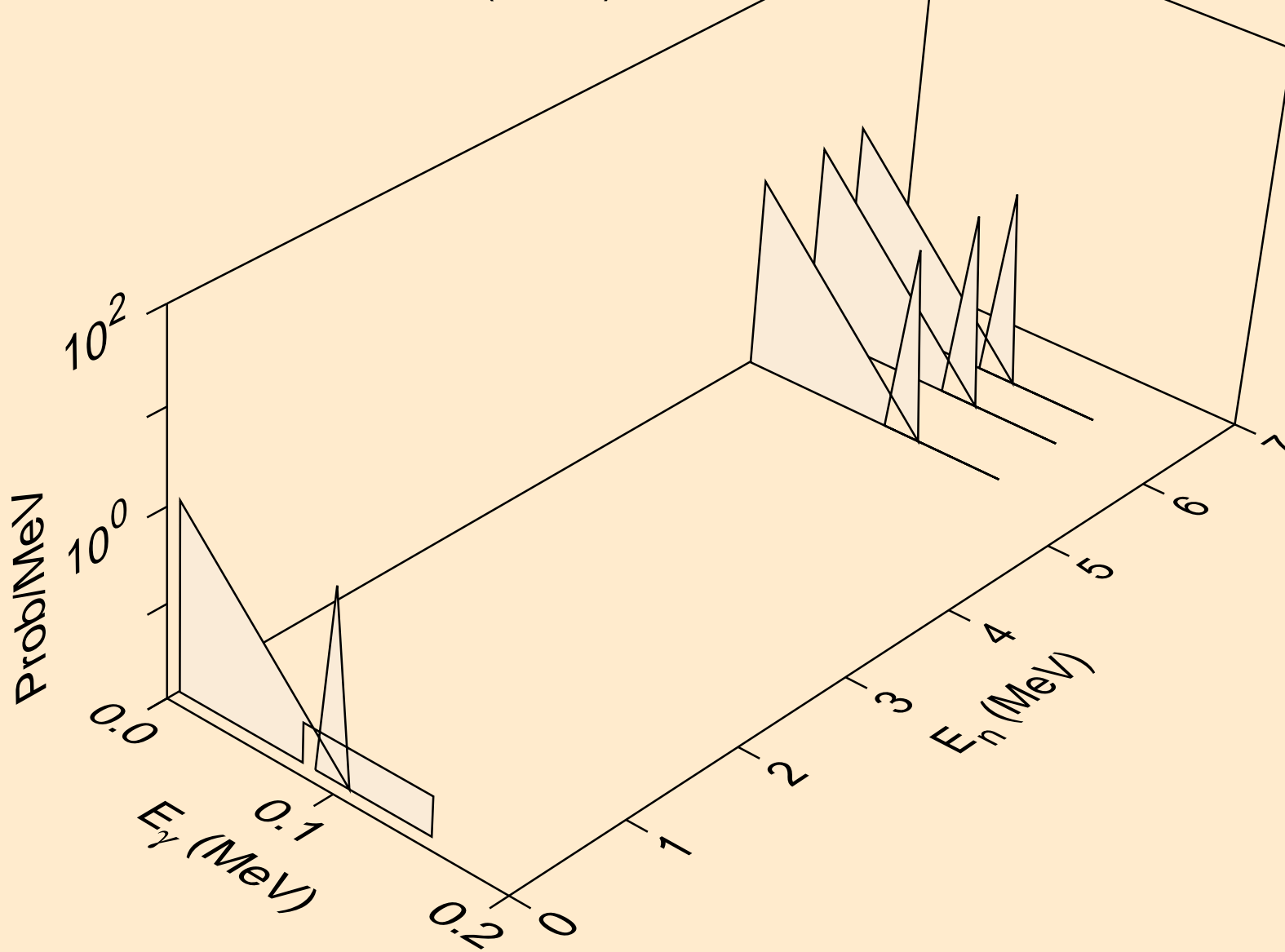

DS281 NEUTRON ACER TENDL-2019 LIBRARY; T=293.16K
Photon emission for (n,gma)

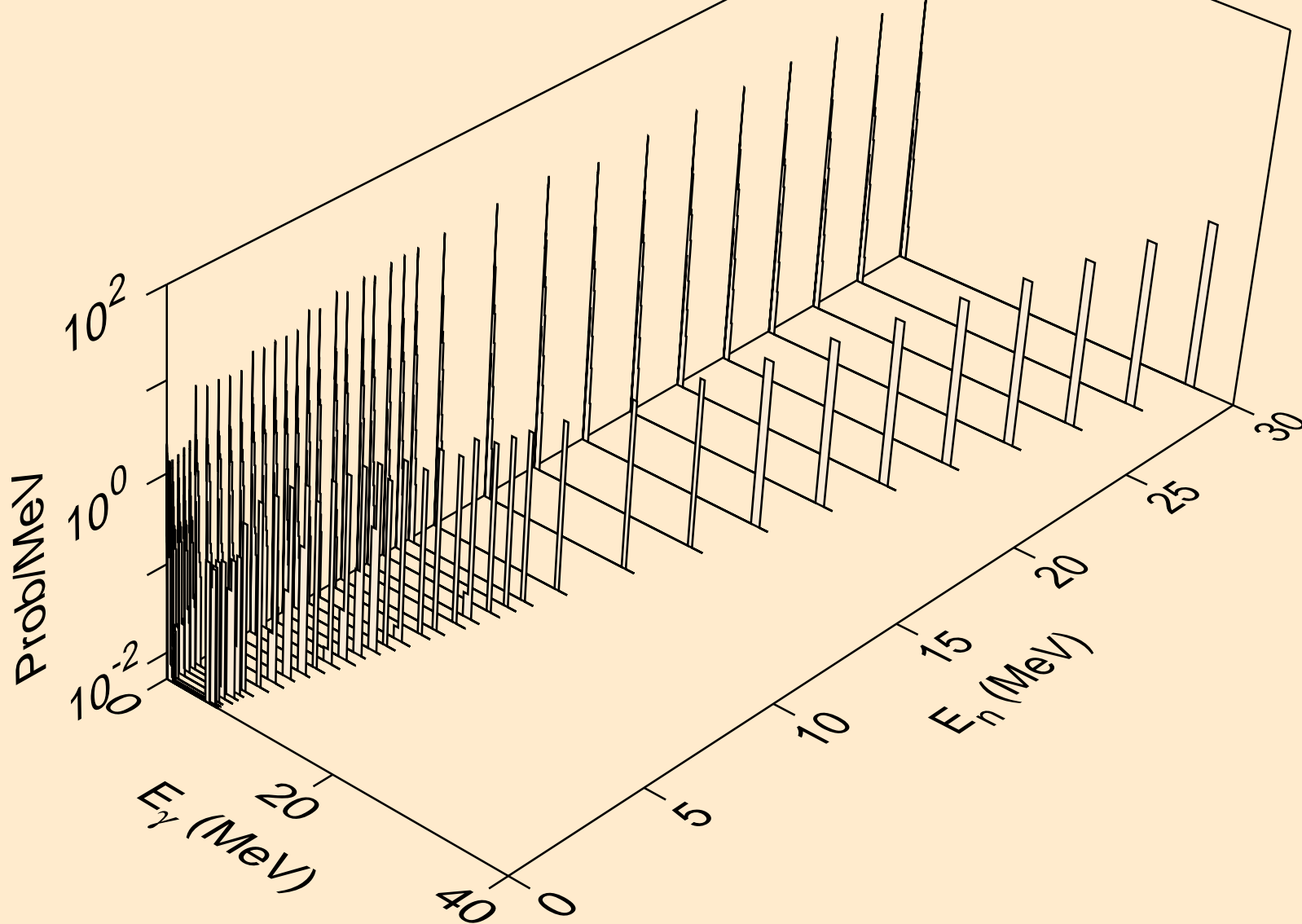

DS281 NEUTRON ACER TENDL-2019 LIBRARY; T=293.16K
Photon emission for (n,p)

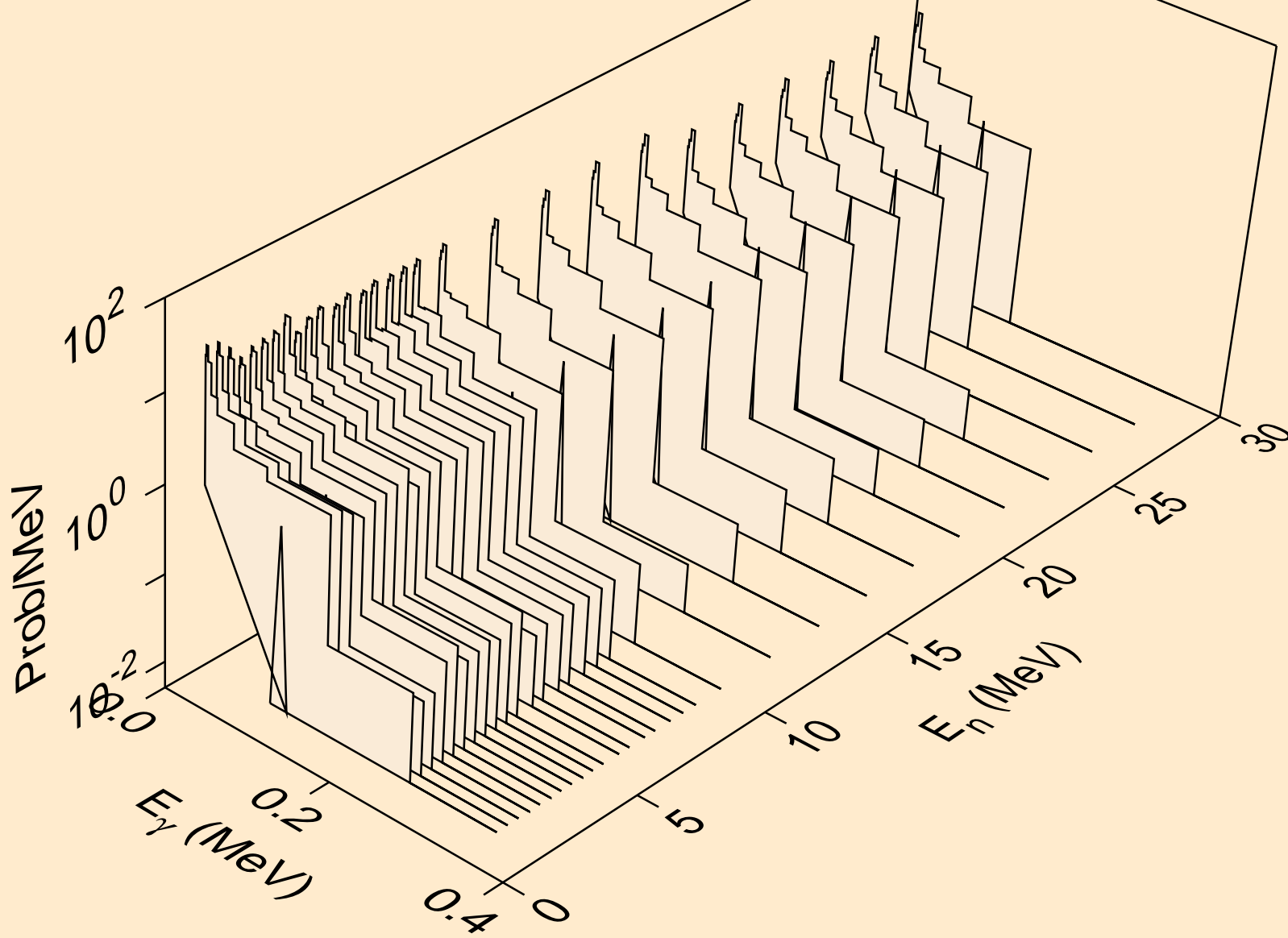

DS281 NEUTRON ACER TENDL-2019 LIBRARY; T=293.16K
Photon emission for (n,d)

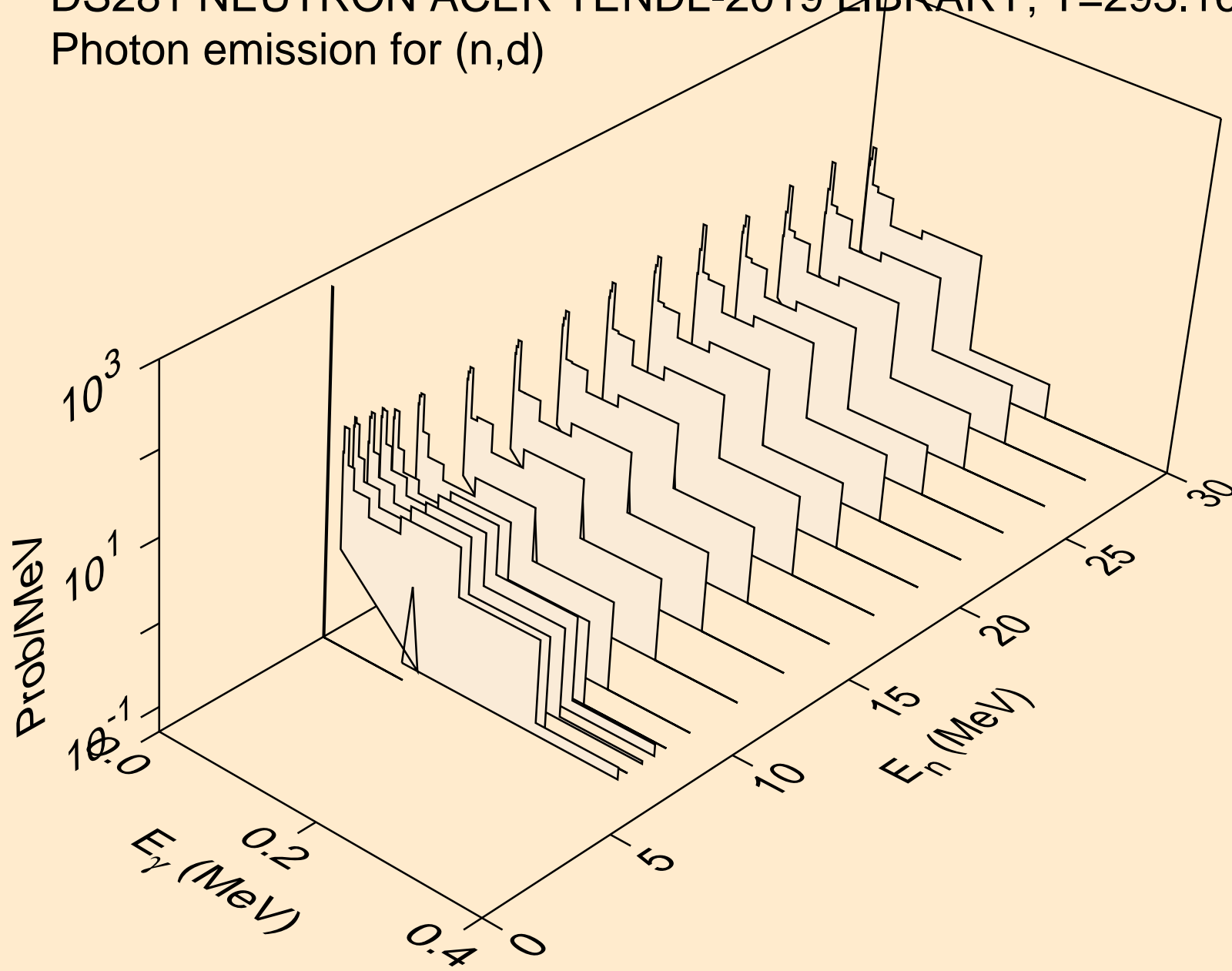

DS281 NEUTRON ACER TENDL-2019 LIBRARY; T=293.16K
Photon emission for (n,t)

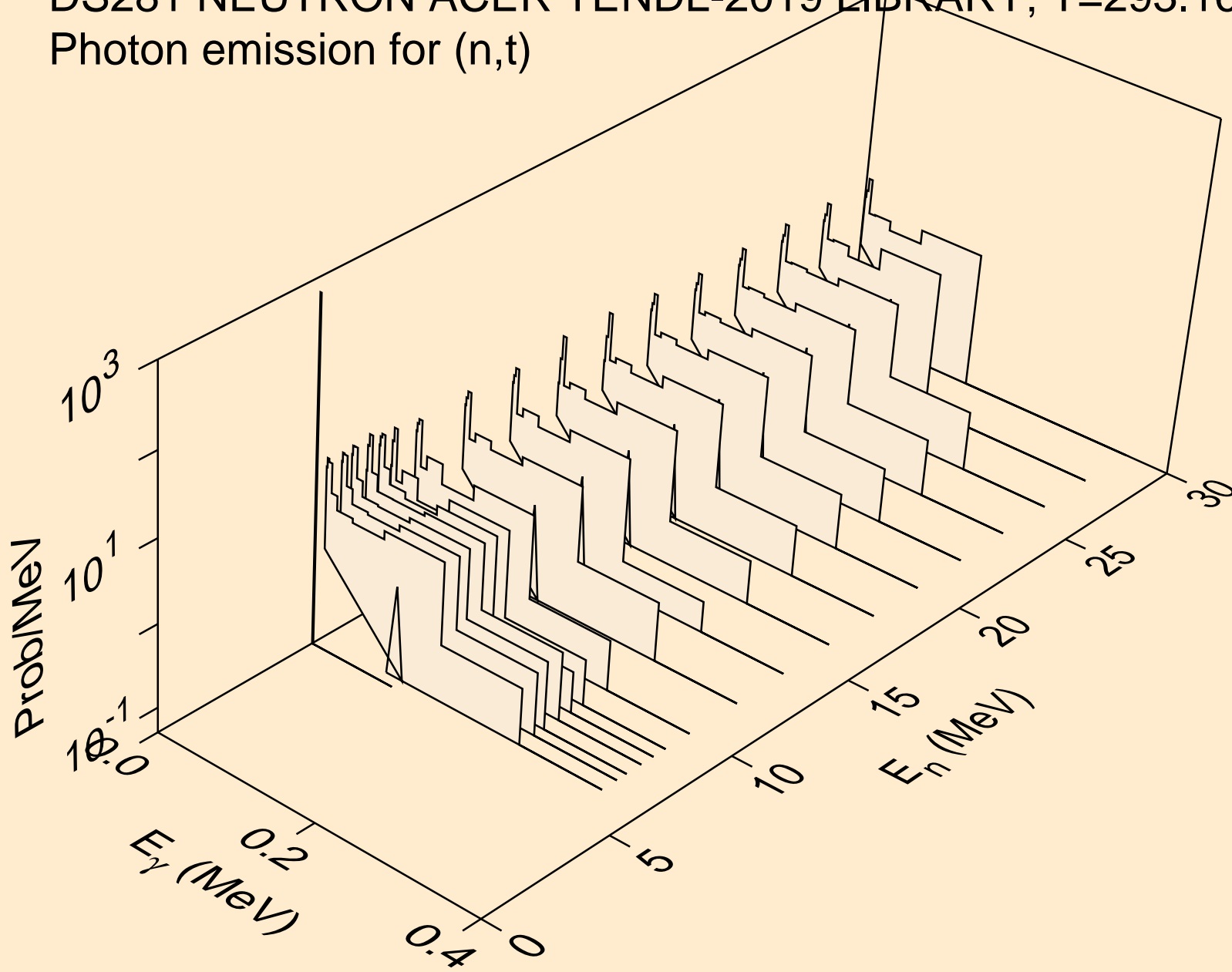

DS281 NEUTRON ACER TENDL-2019 LIBRARY; T=293.16K
Photon emission for (n,he3)

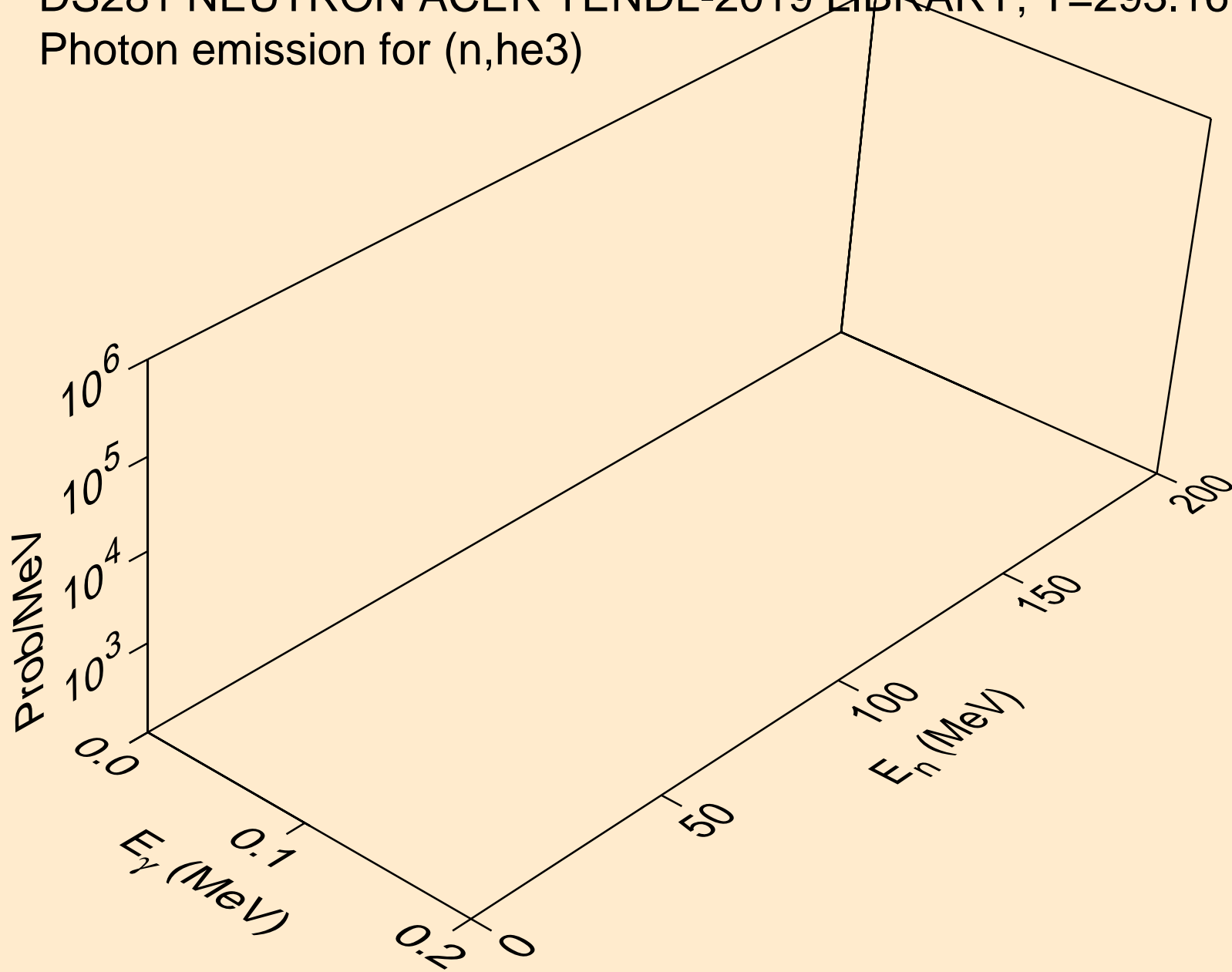

DS281 NEUTRON ACER TENDL-2019 LIBRARY; T=293.16K
Photon emission for (n,a)

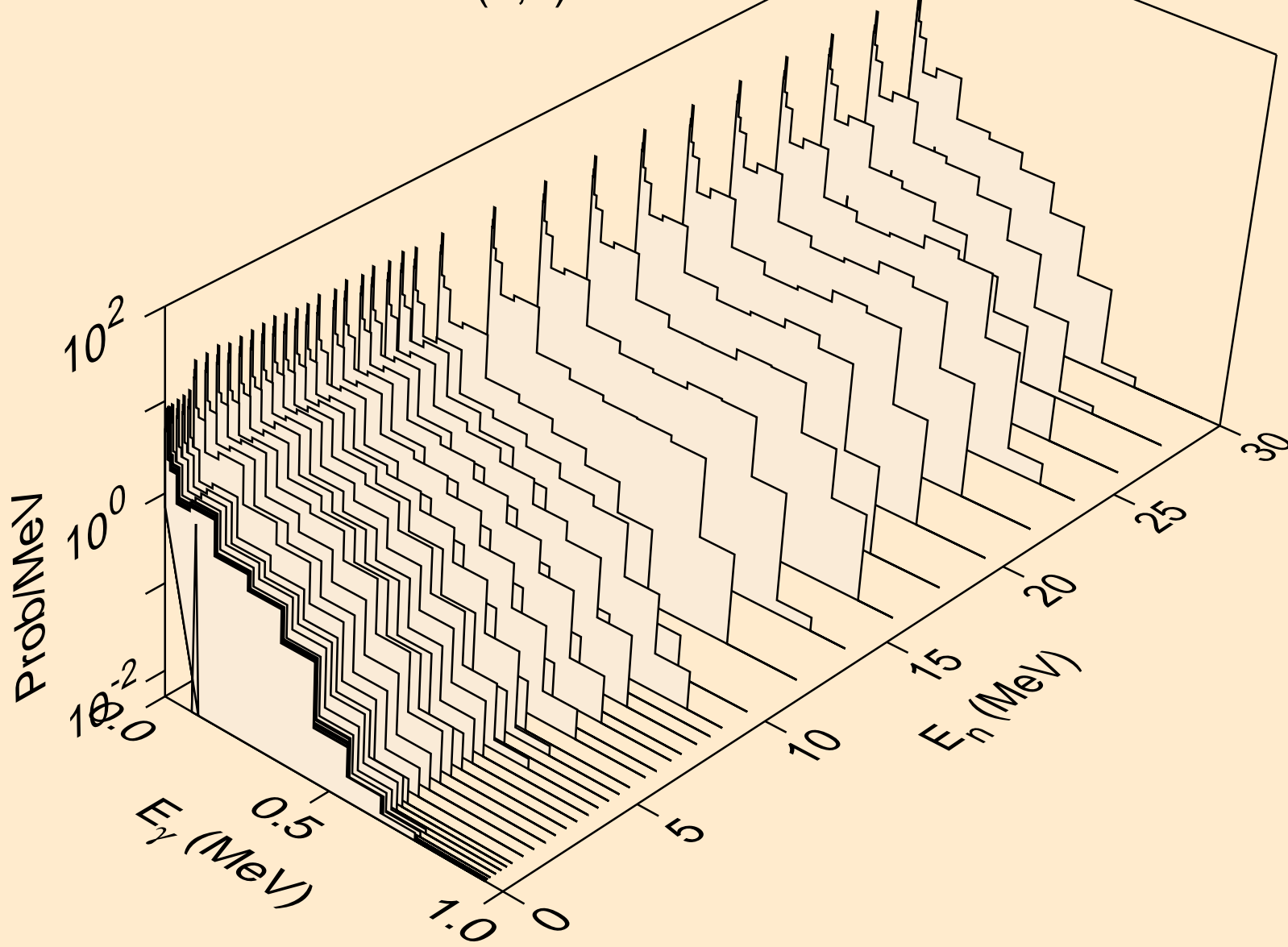

DS281 NEUTRON ACER TENDL-2019 LIBRARY; T=293.16K
Photon emission for (n,2p)

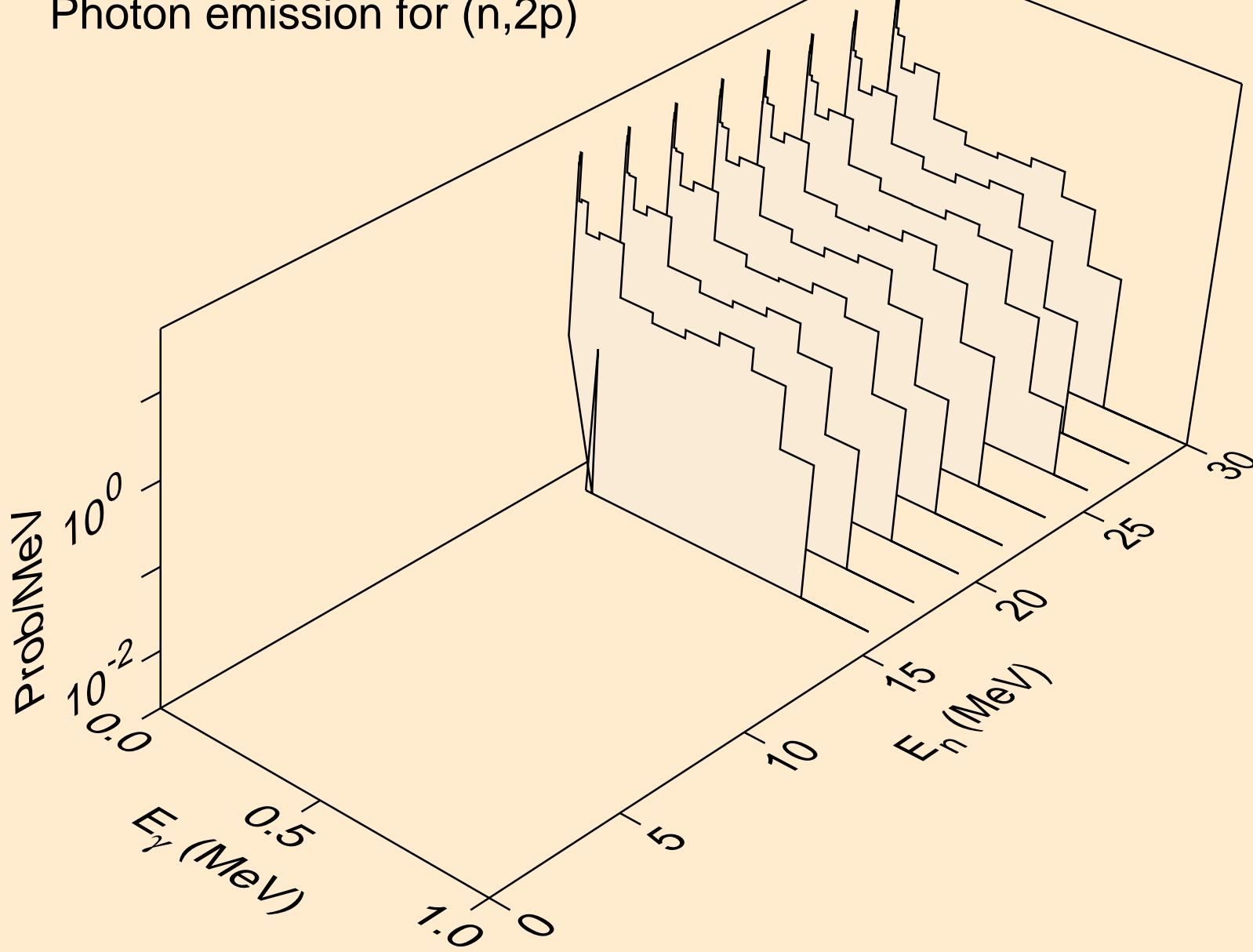

DS281 NEUTRON ACER TENDL-2019 LIBRARY; T=293.16K
thermal capture photon spectrum

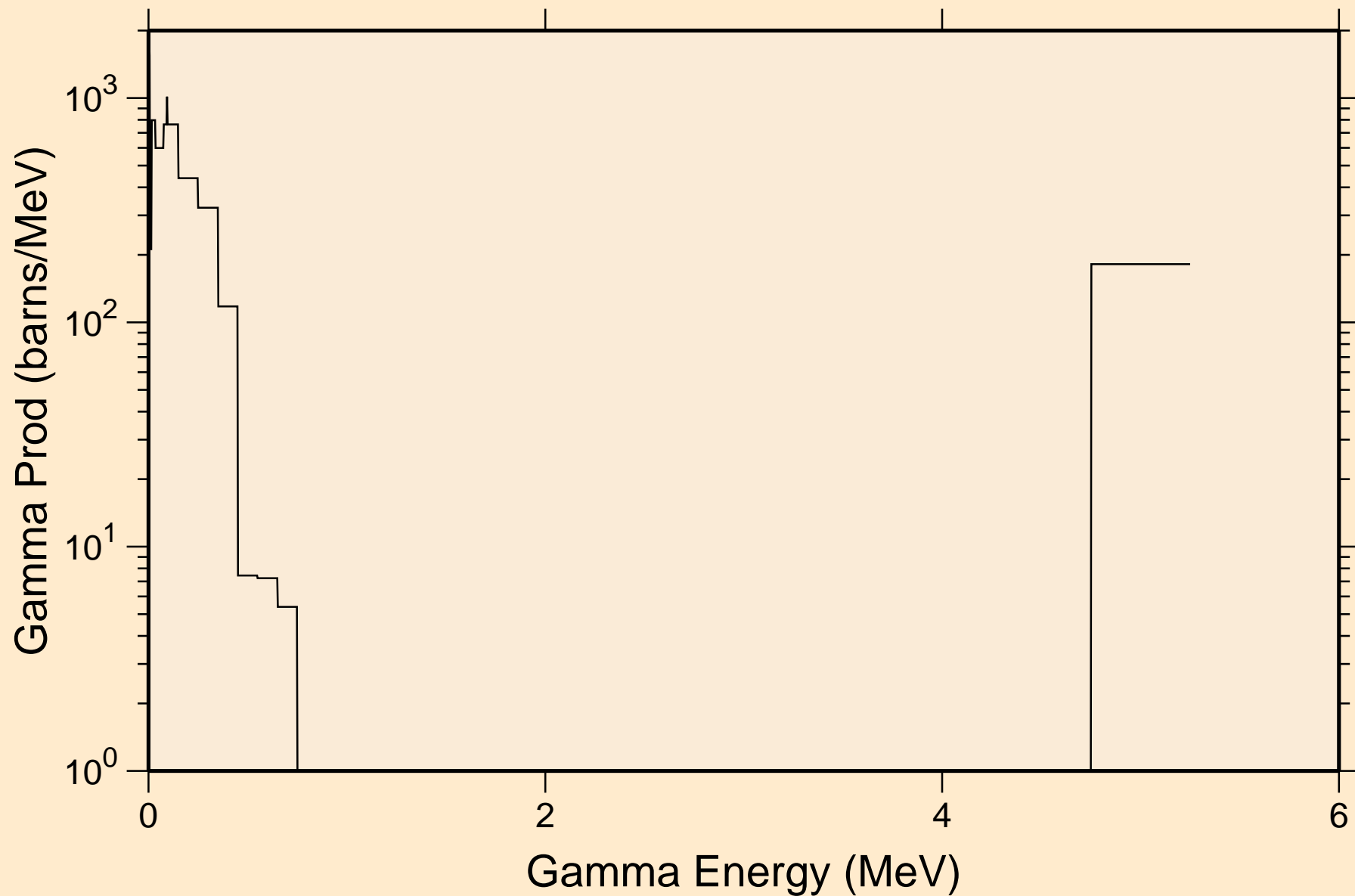

DS281 NEUTRON ACER TENDL-2019 LIBRARY; T=293.16K
14 MeV photon spectrum

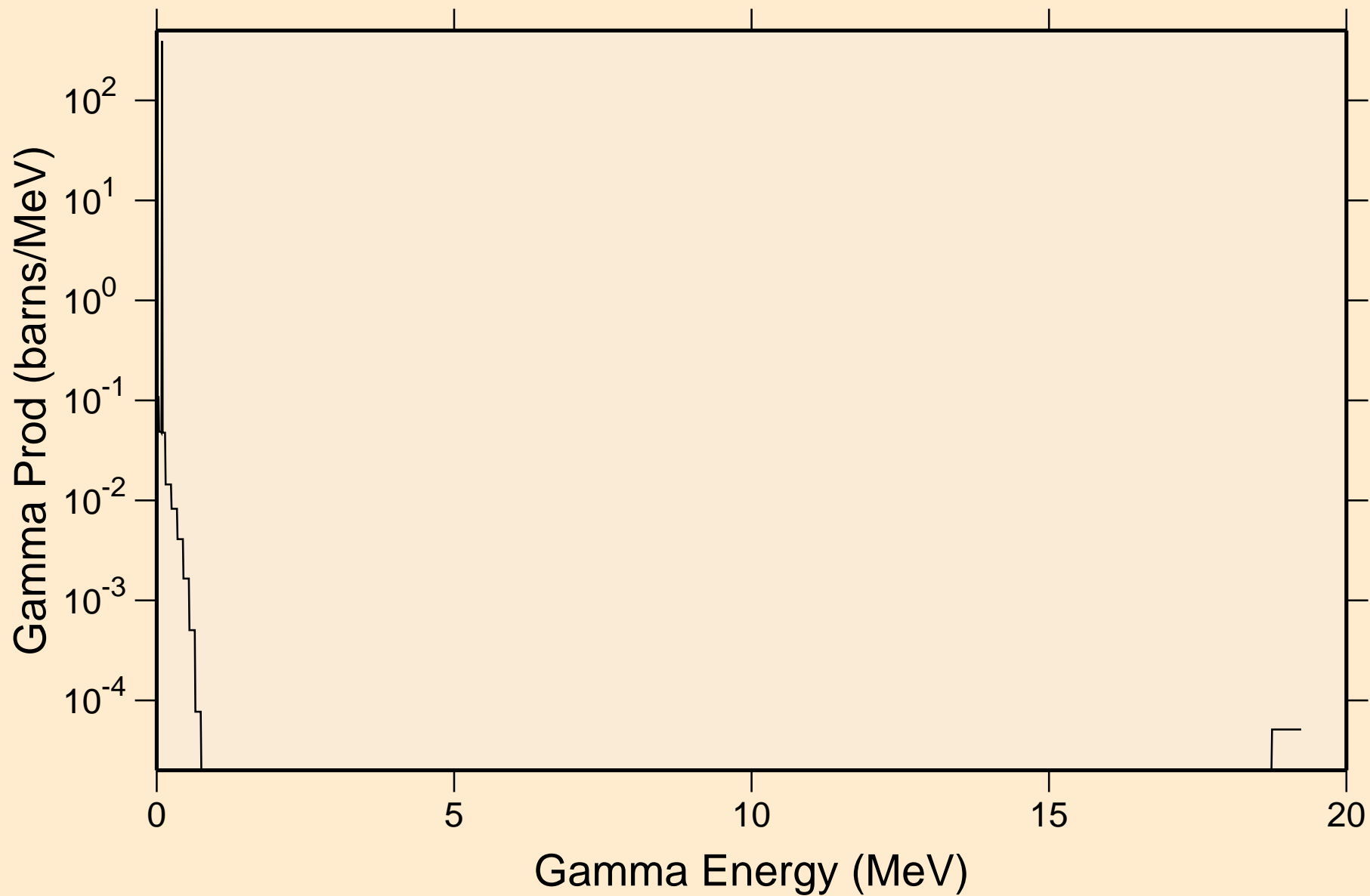

DS281 NEUTRON ACER TENDL-2019 LIBRARY; T=293.16K
Particle heating contributions

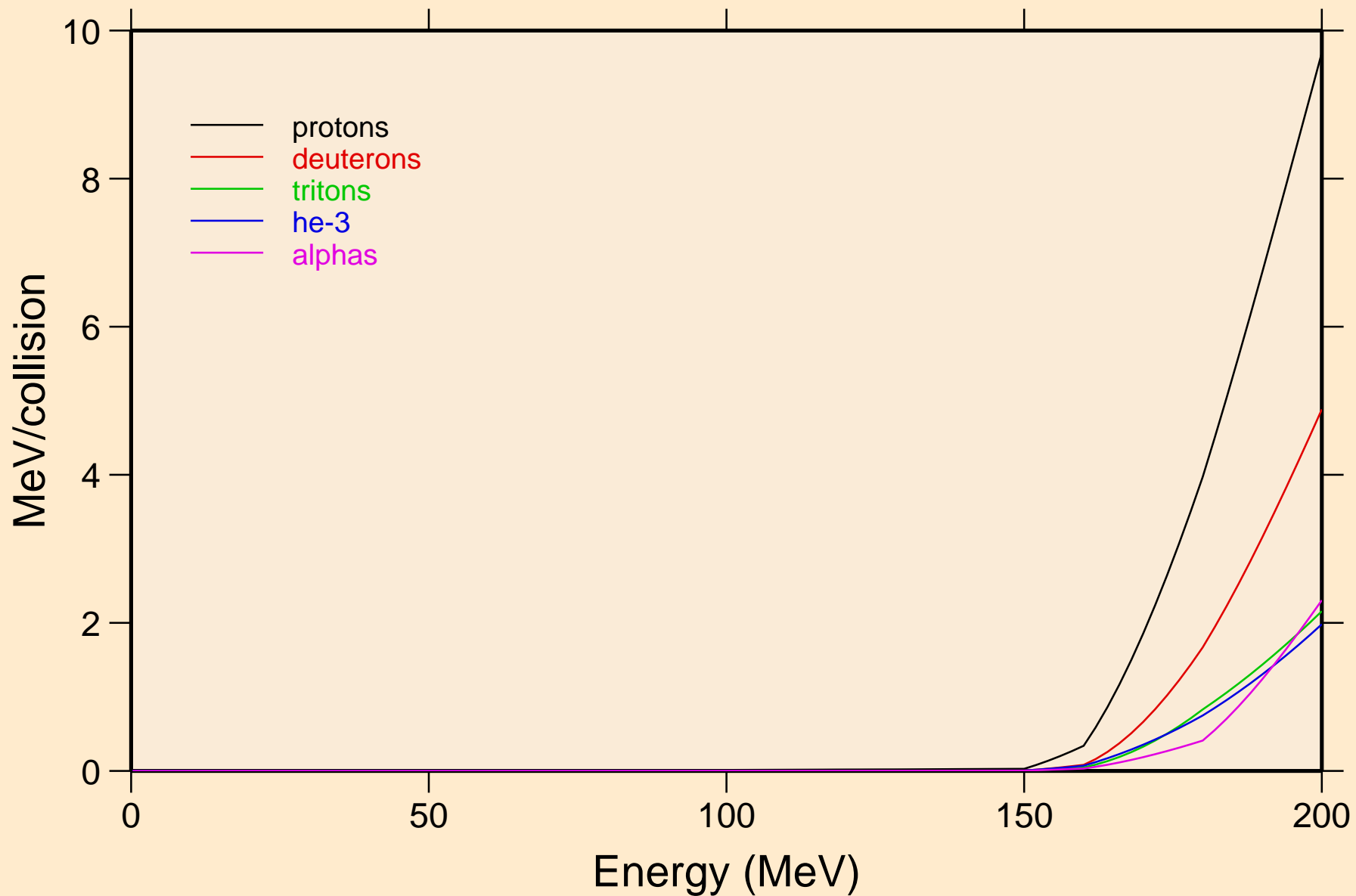

DS281 NEUTRON ACER TENDL-2019 LIBRARY; T=293.16K
Recoil Heating

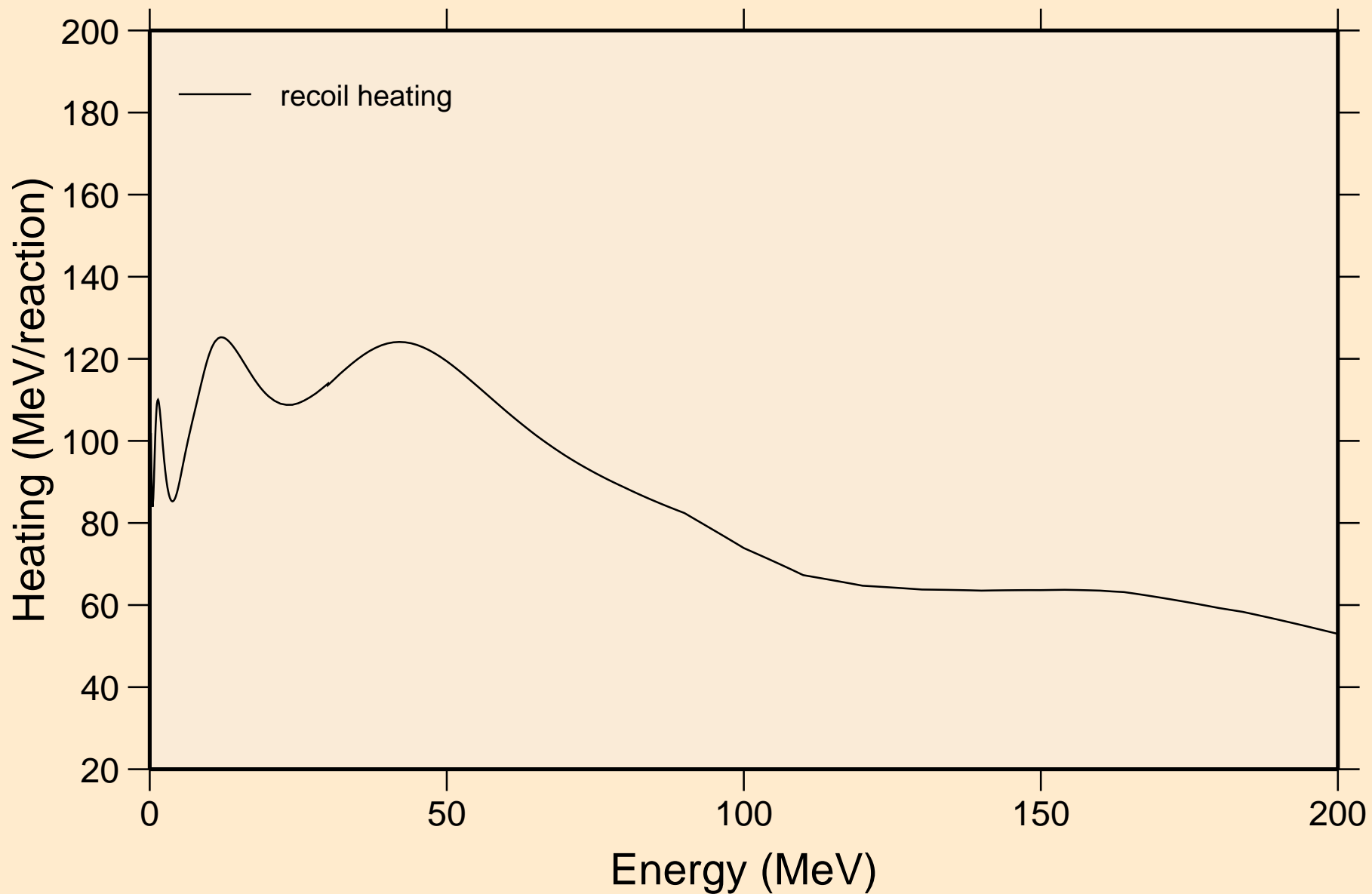

DS281 NEUTRON ACER TENDL-2019 LIBRARY; T=293.16K
Particle production cross sections

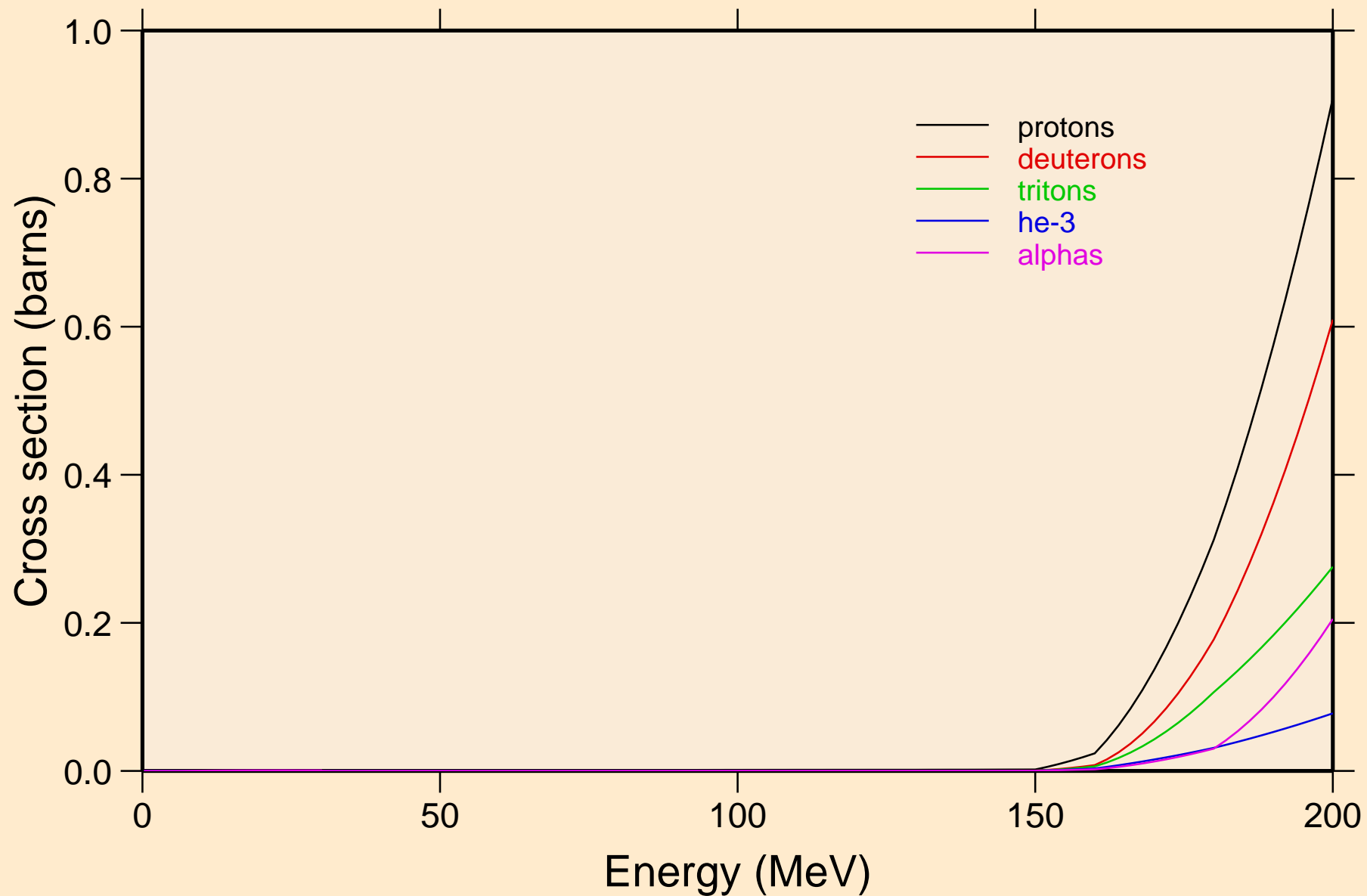

DS281 NEUTRON ACER TENDL-2019 LIBRARY; T=293.16K
protons from (n,x)

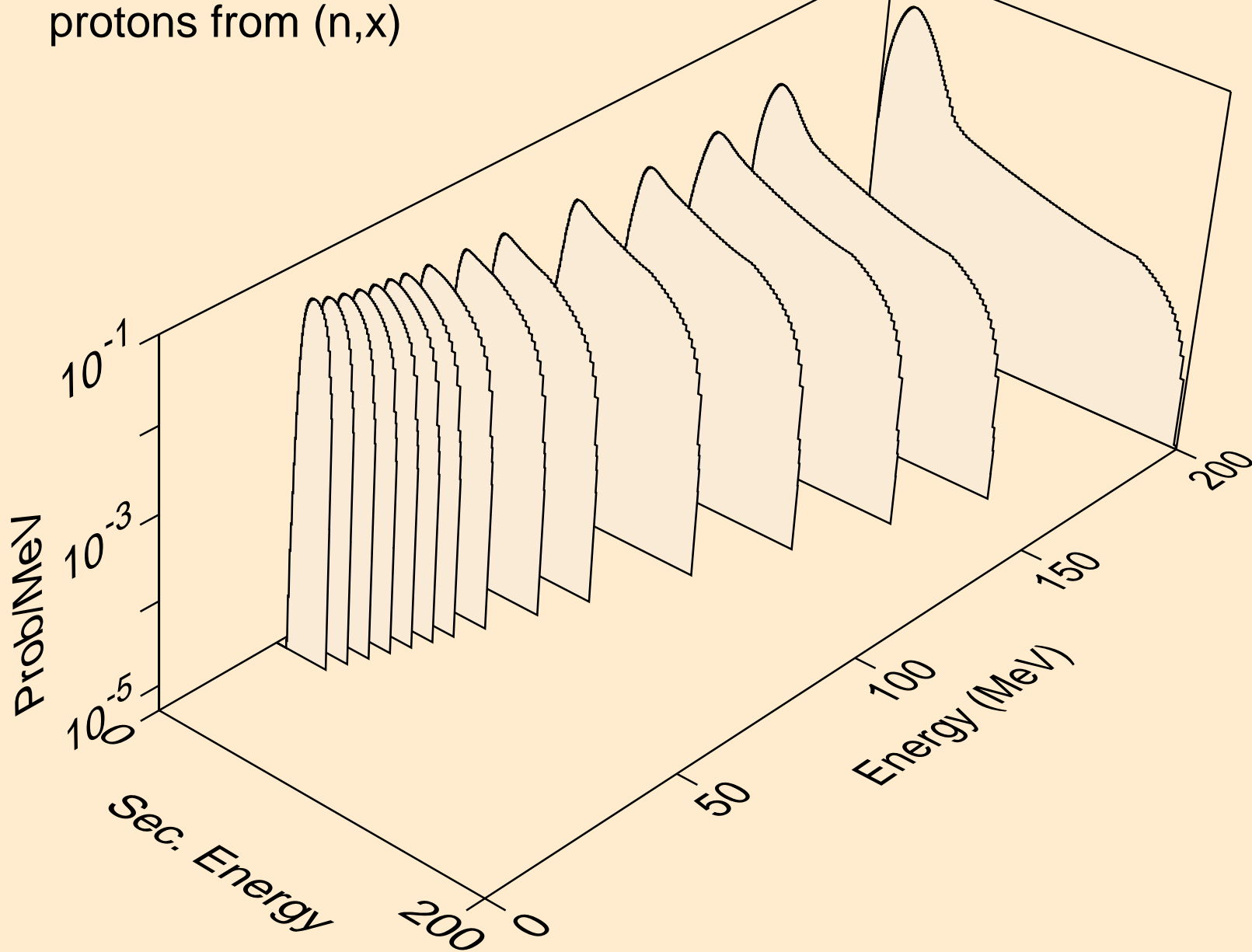

DS281 NEUTRON ACER TENDL-2019 LIBRARY; T=293.16K
protons from (n,n*)p

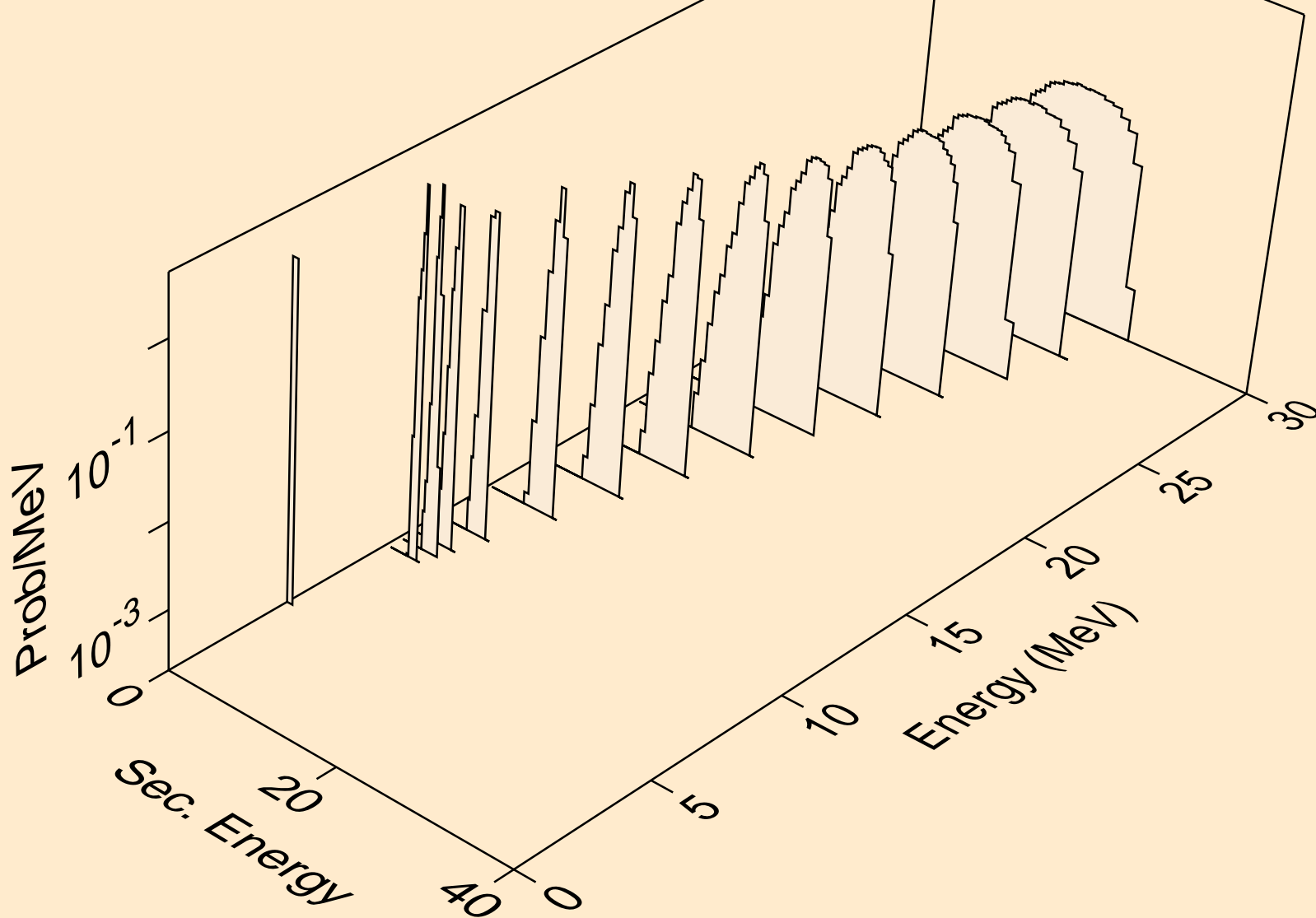

DS281 NEUTRON ACER TENDL-2019 LIBRARY; T=293.16K
protons from (n,p)

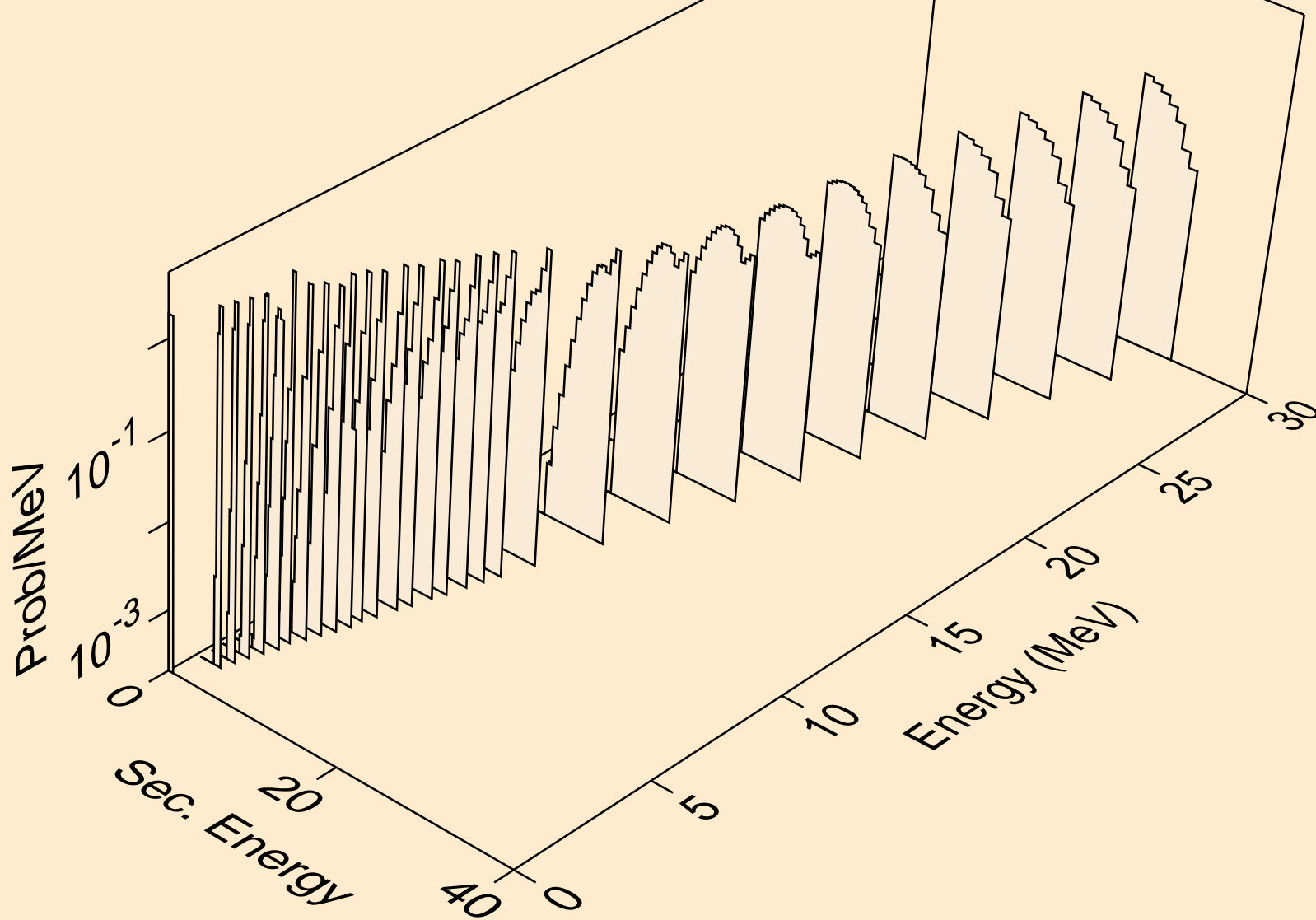

DS281 NEUTRON ACER TENDL-2019 LIBRARY; T=293.16K
protons from (n,2p)

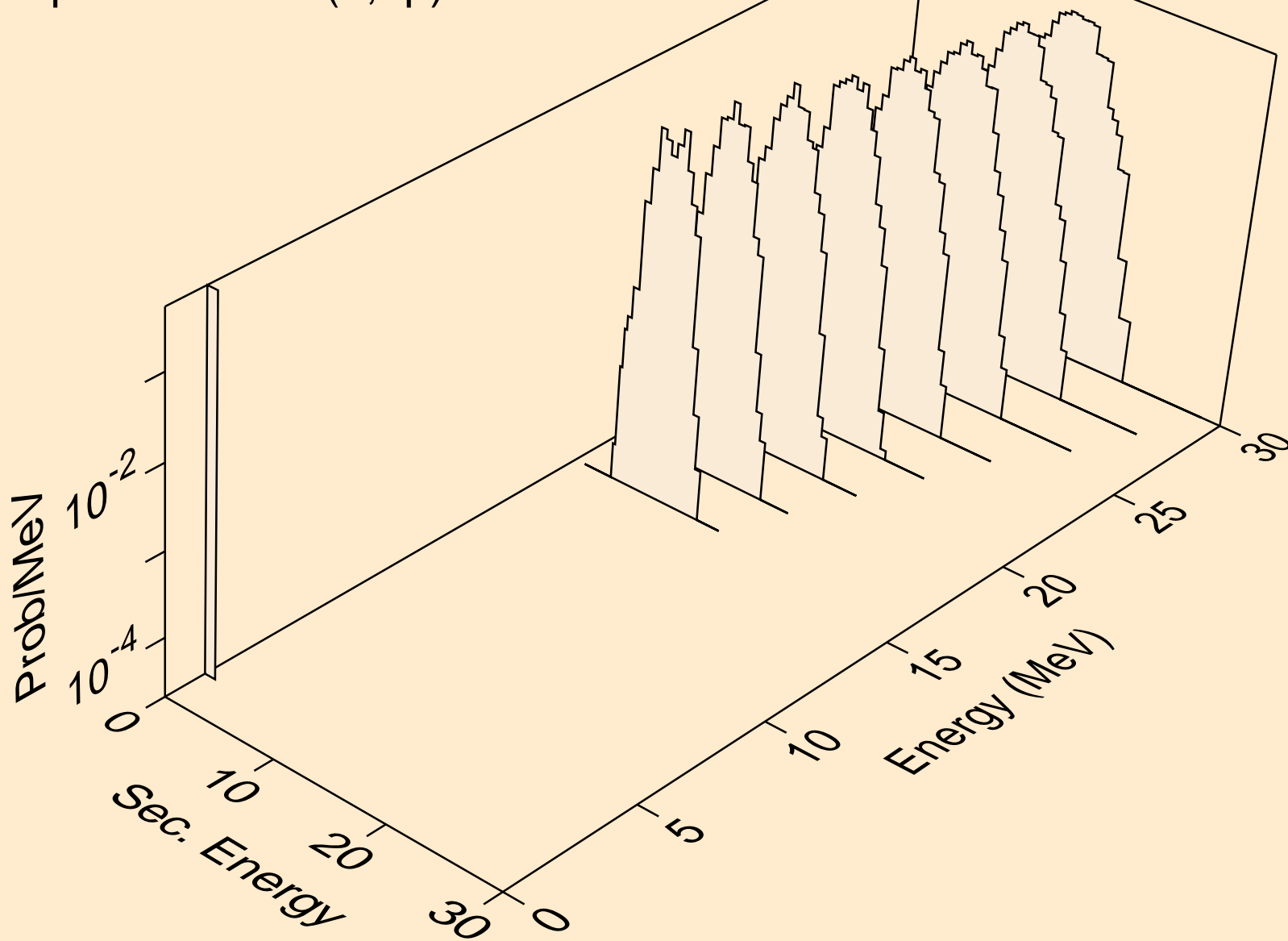

DS281 NEUTRON ACER TENDL-2019 LIBRARY; T=293.16K
deuterons from (n,x)

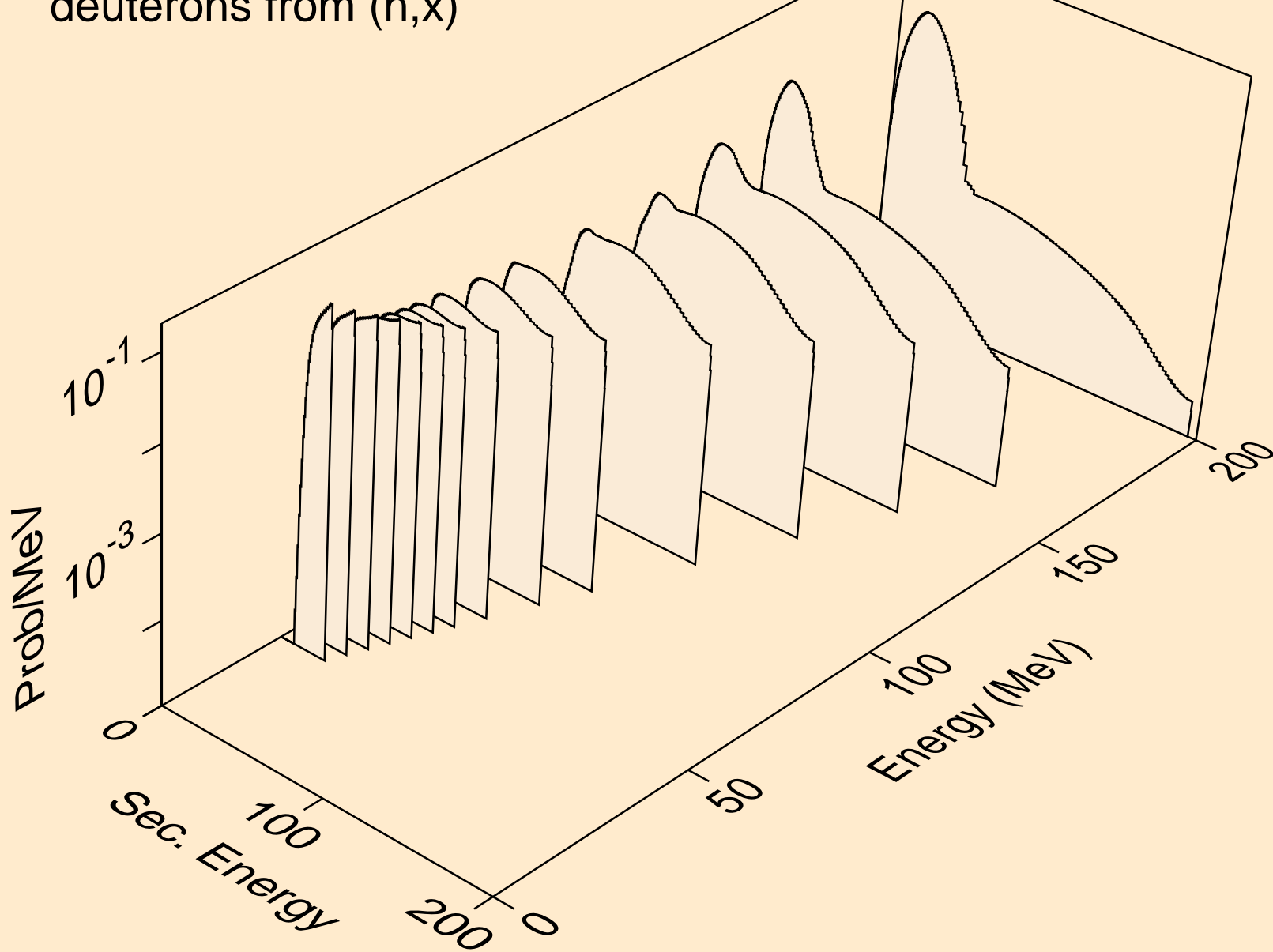

DS281 NEUTRON ACER TENDL-2019 LIBRARY; T=293.16K
deuterons from (n,d)

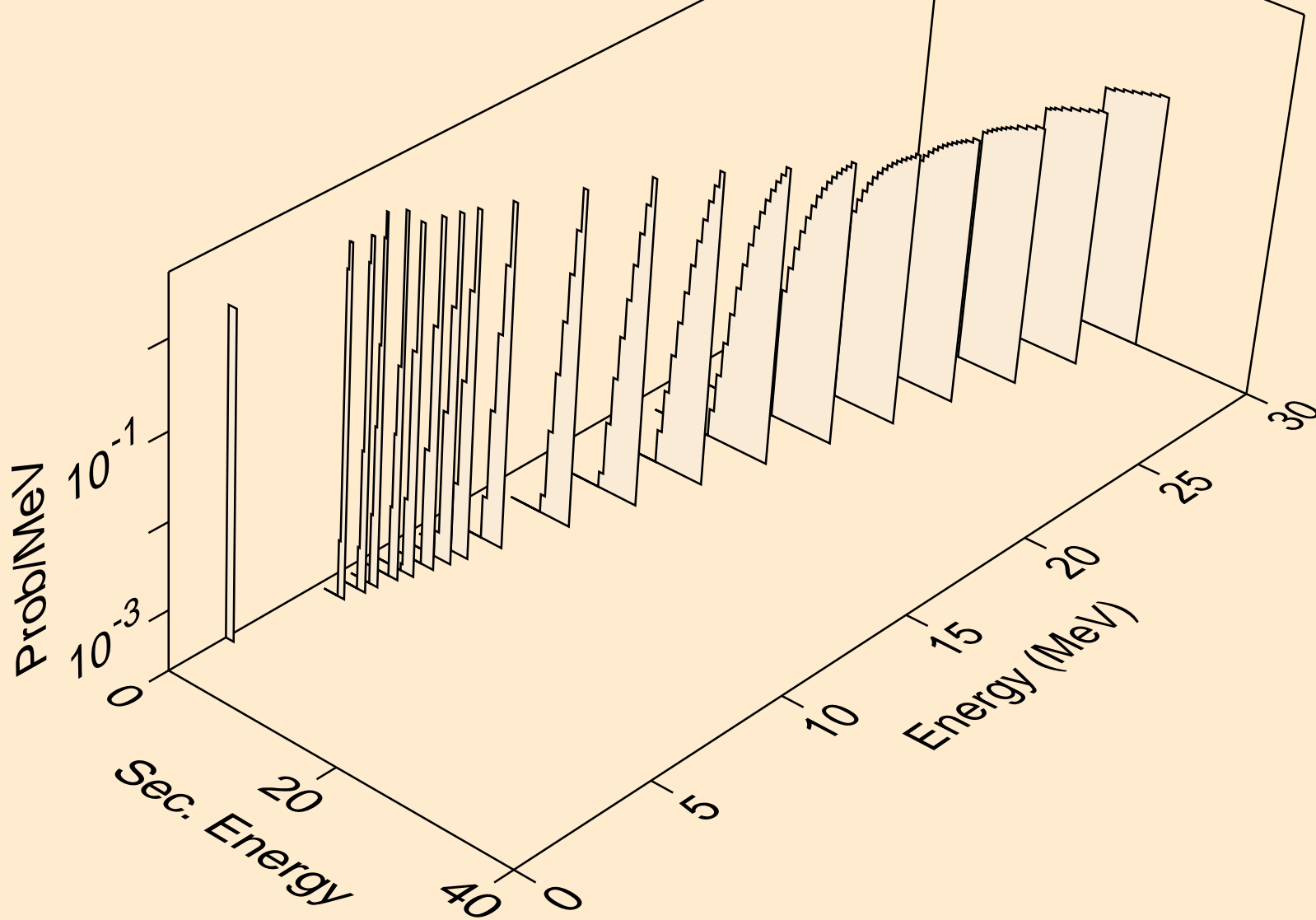

DS281 NEUTRON ACER TENDL-2019 LIBRARY; T=293.16K
tritons from (n,x)

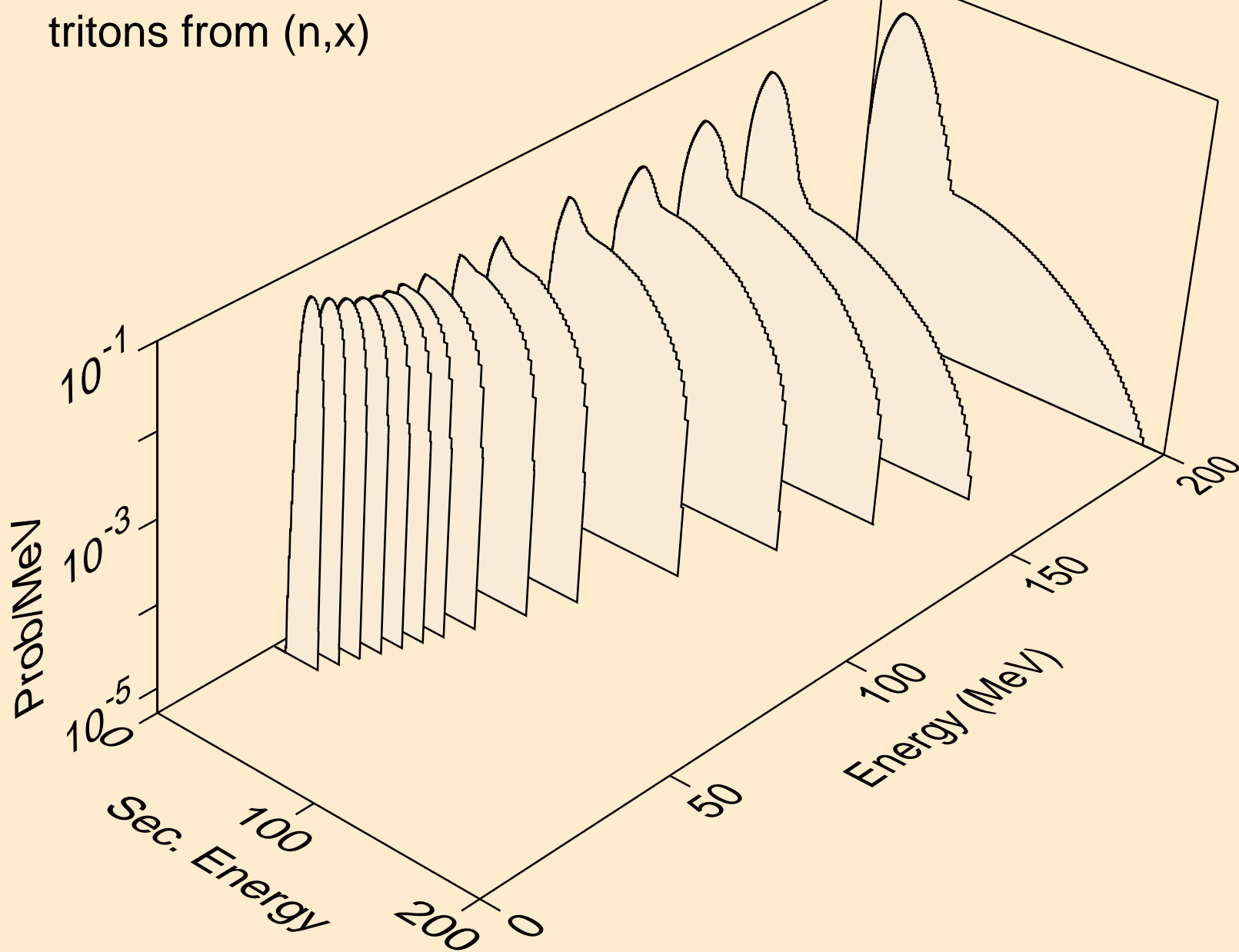

DS281 NEUTRON ACER TENDL-2019 LIBRARY; T=293.16K
tritons from (n,t)

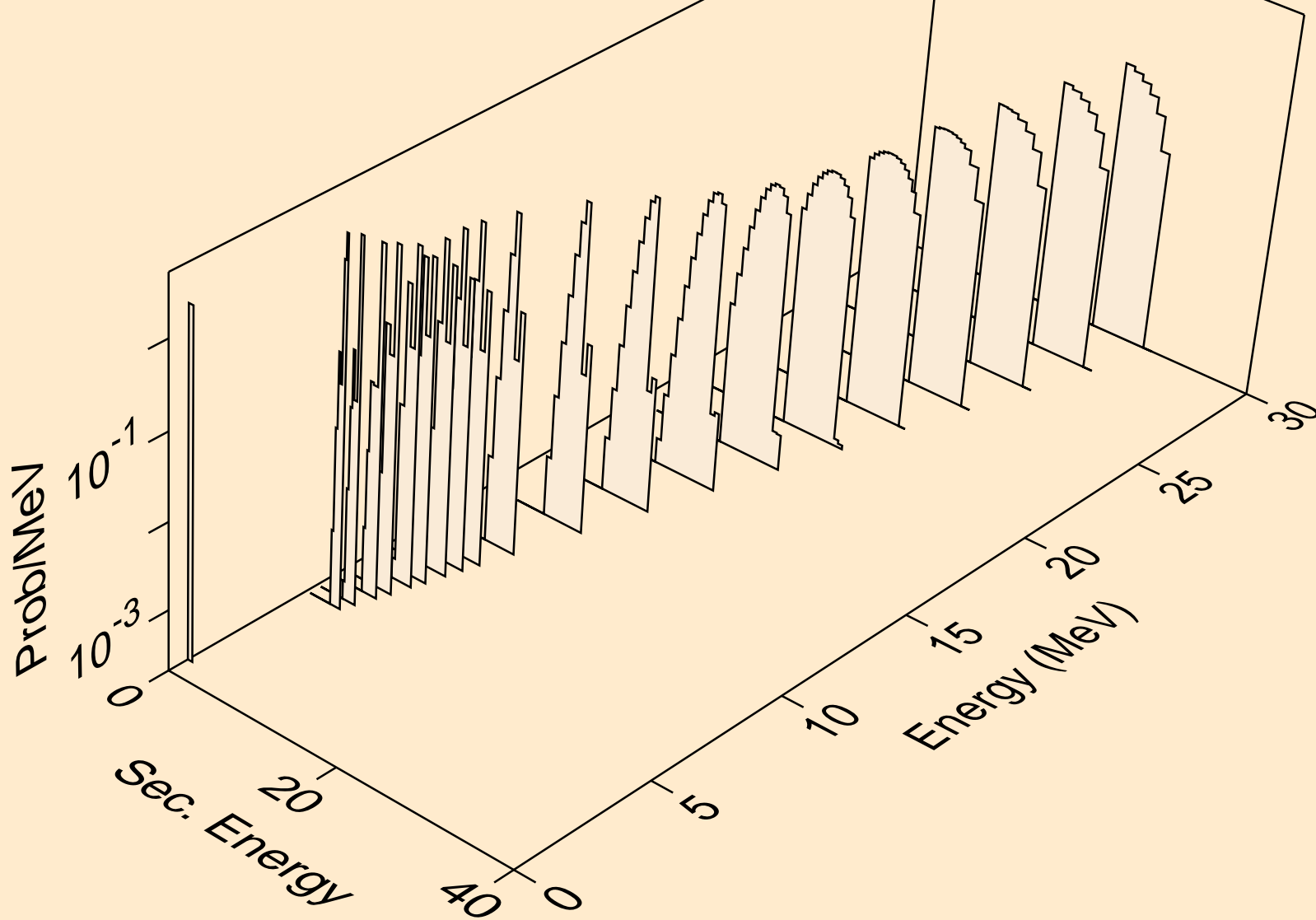

DS281 NEUTRON ACER TENDL-2019 LIBRARY; T=293.16K
he3s from (n,x)

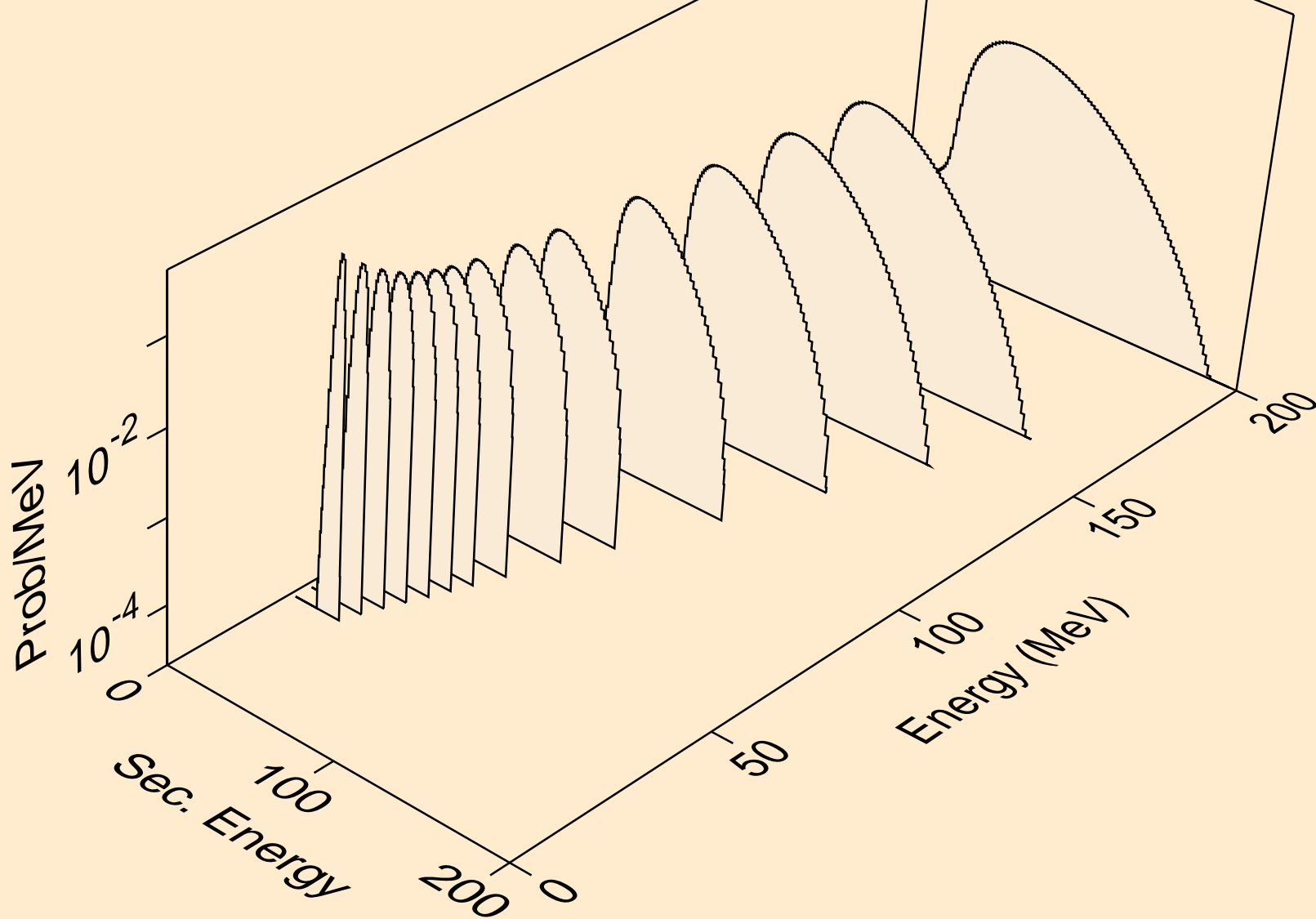

DS281 NEUTRON ACER TENDL-2019 LIBRARY; T=293.16K
he3s from (n,he3)

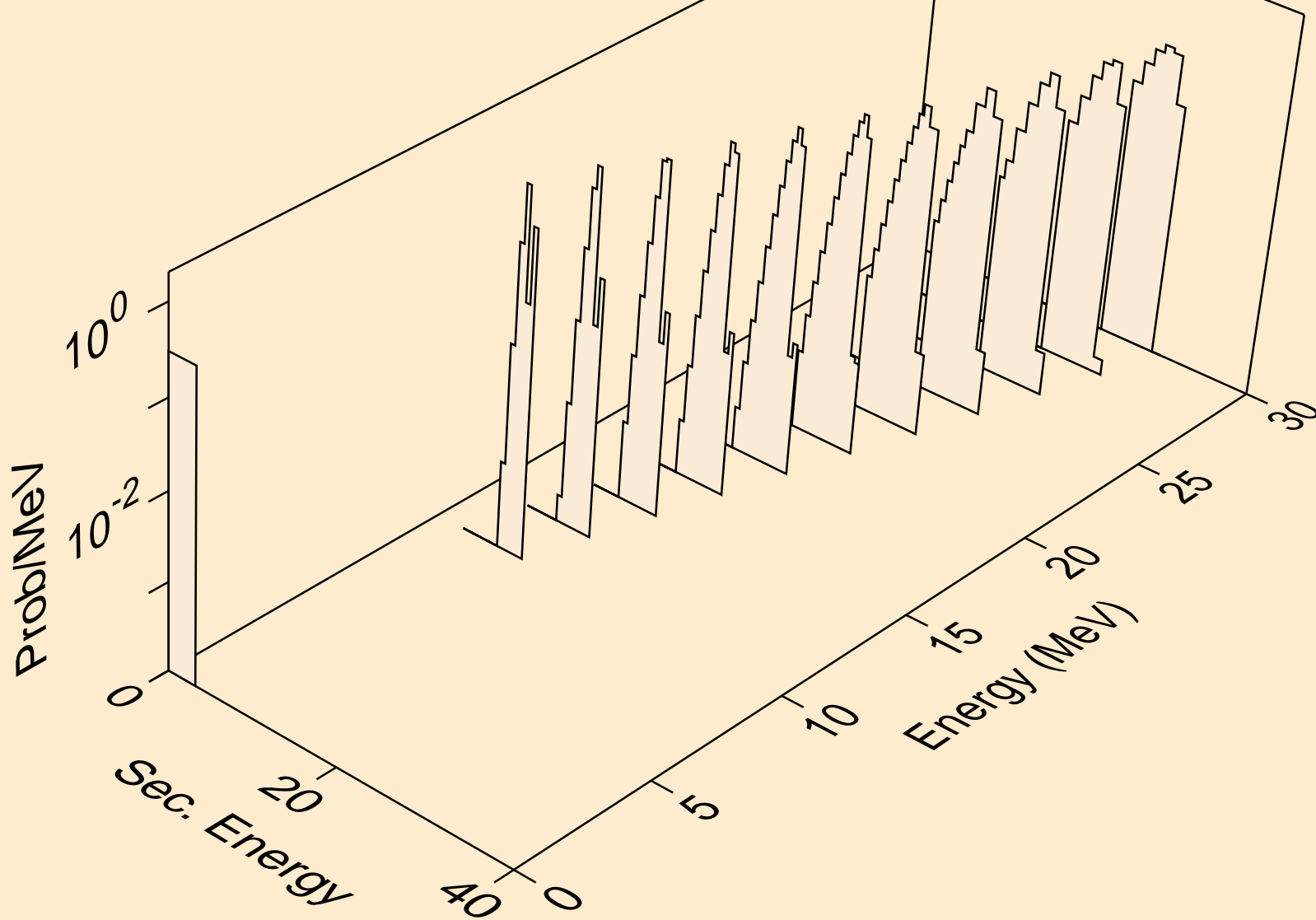

DS281 NEUTRON ACER TENDL-2019 LIBRARY; T=293.16K
alphas from (n,x)

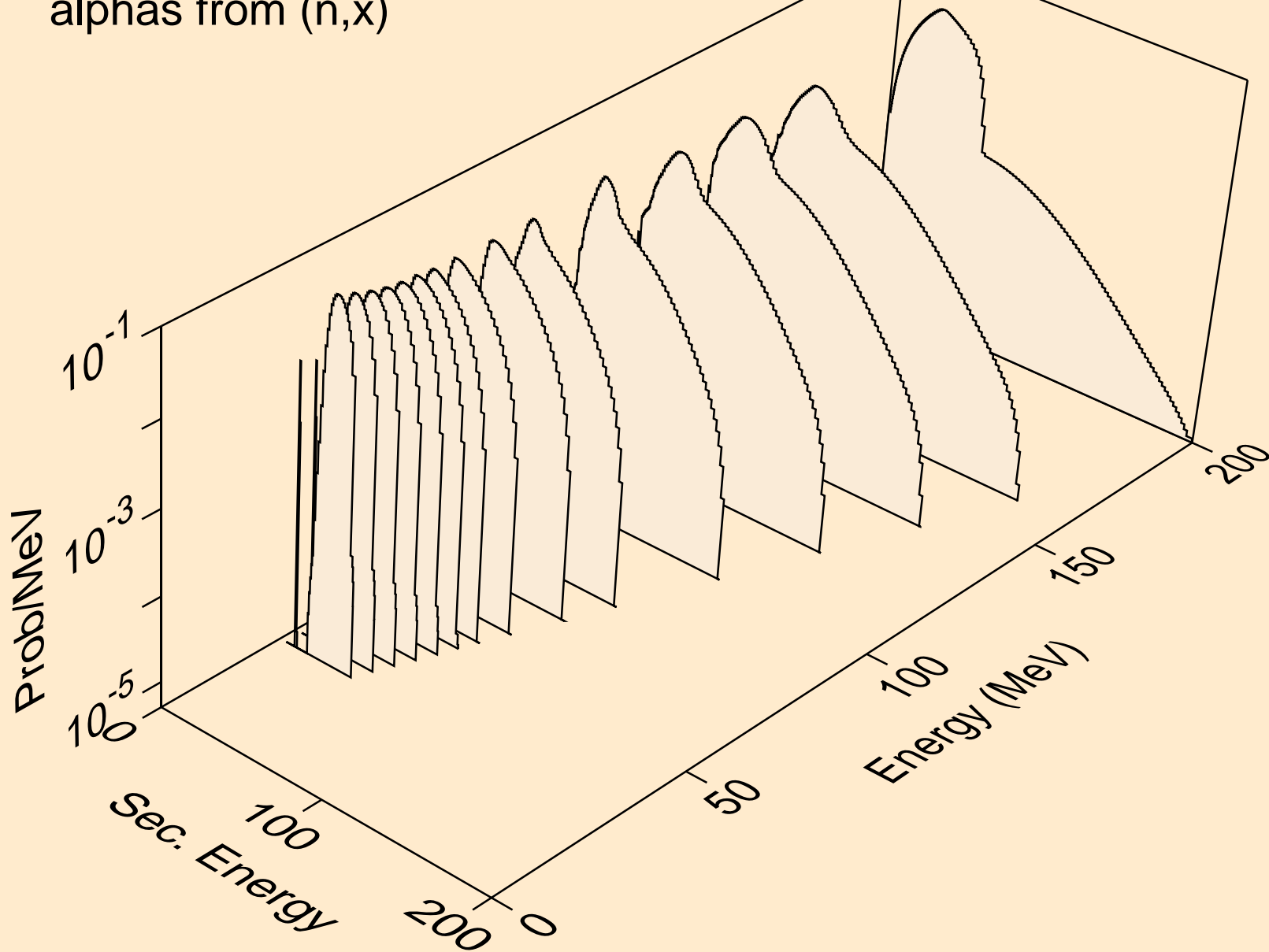

DS281 NEUTRON ACER TENDL-2019 LIBRARY; T=293.16K
alphas from (n,n*)a

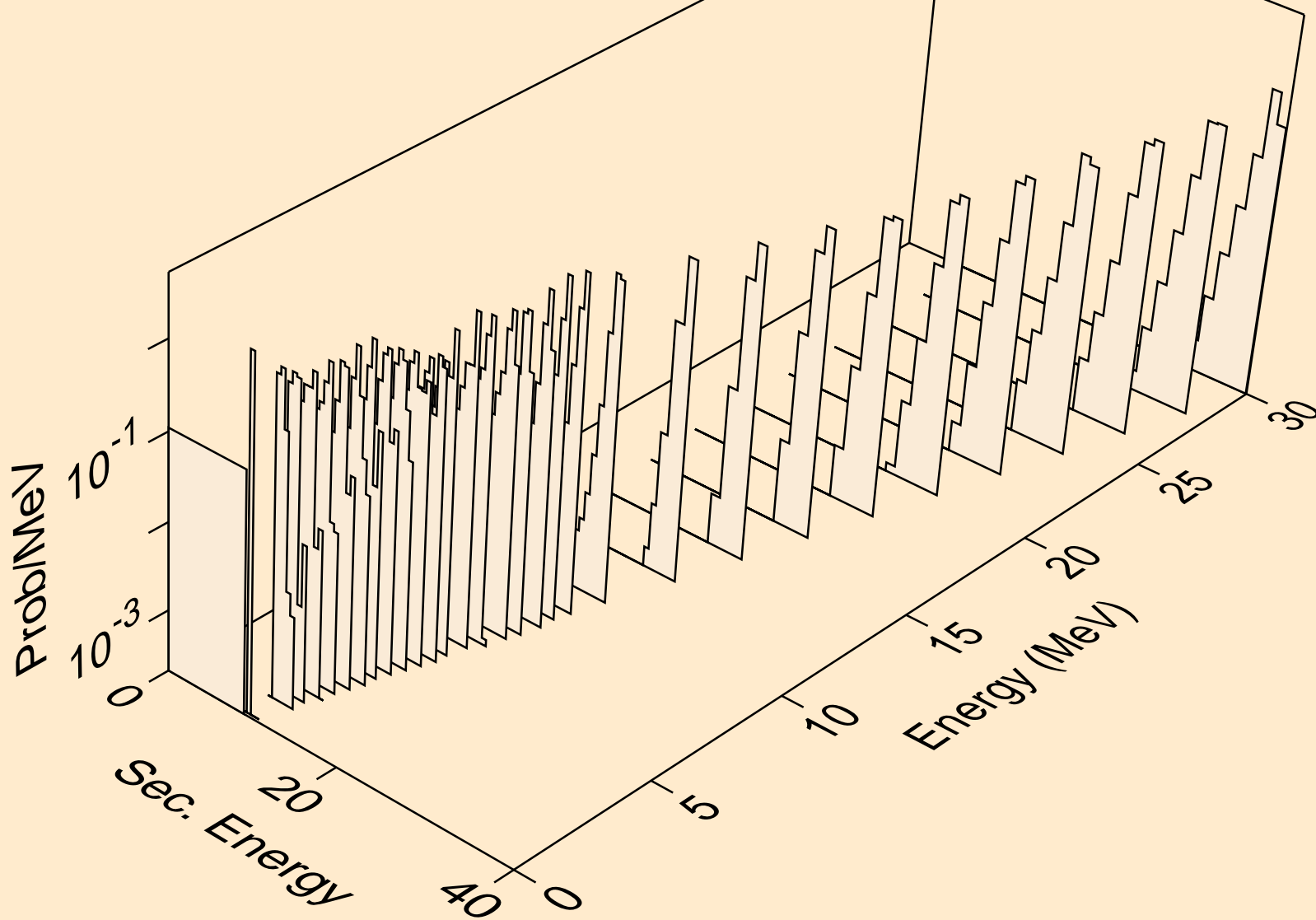

DS281 NEUTRON ACER TENDL-2019 LIBRARY; T=293.16K
alphas from (n,2n)a

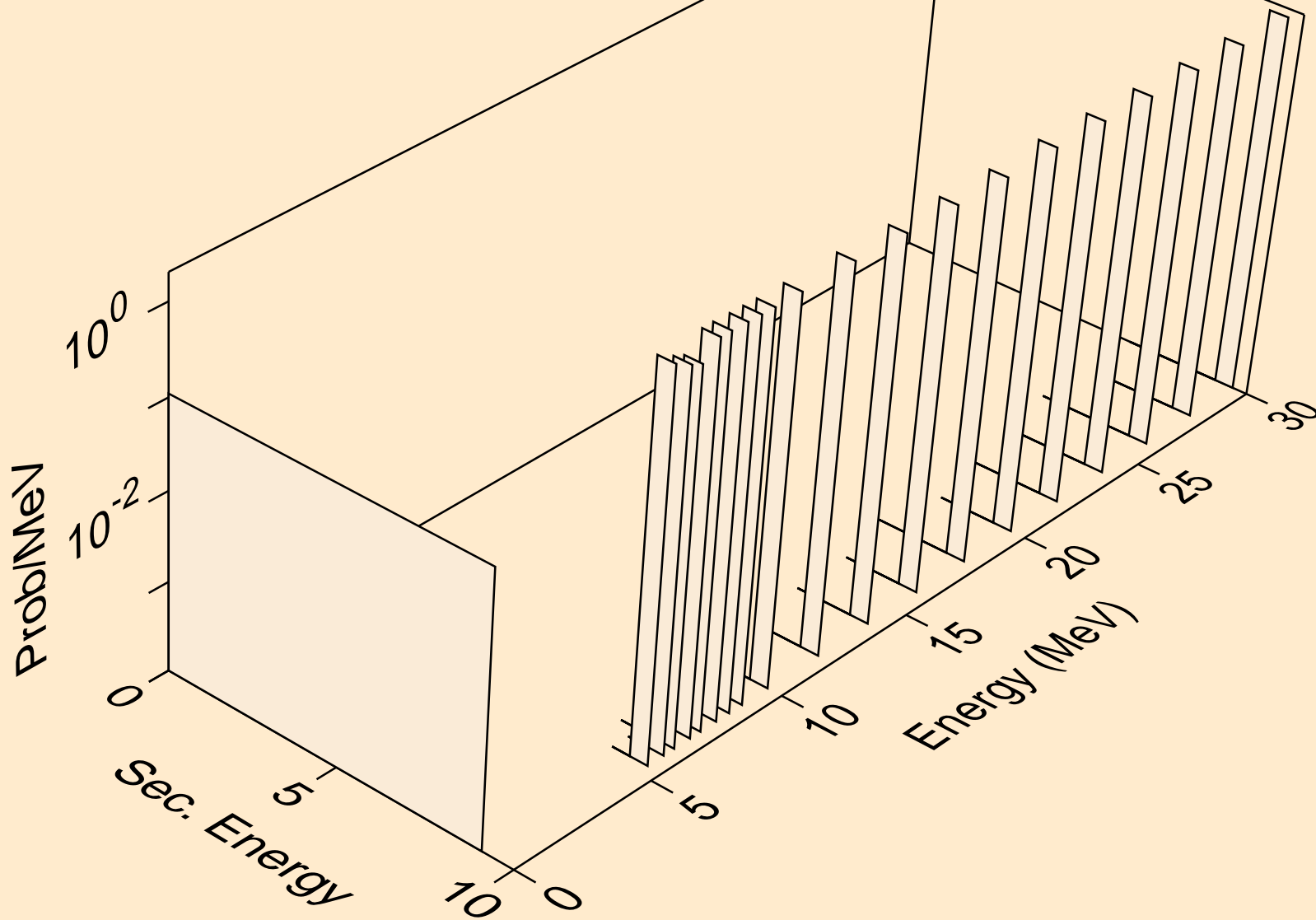

DS281 NEUTRON ACER TENDL-2019 LIBRARY; T=293.16K
alphas from (n,a)

