

F017 NEUTRON ACER TENDL-2019 LIBRARY; T=293.16K
Principal cross sections

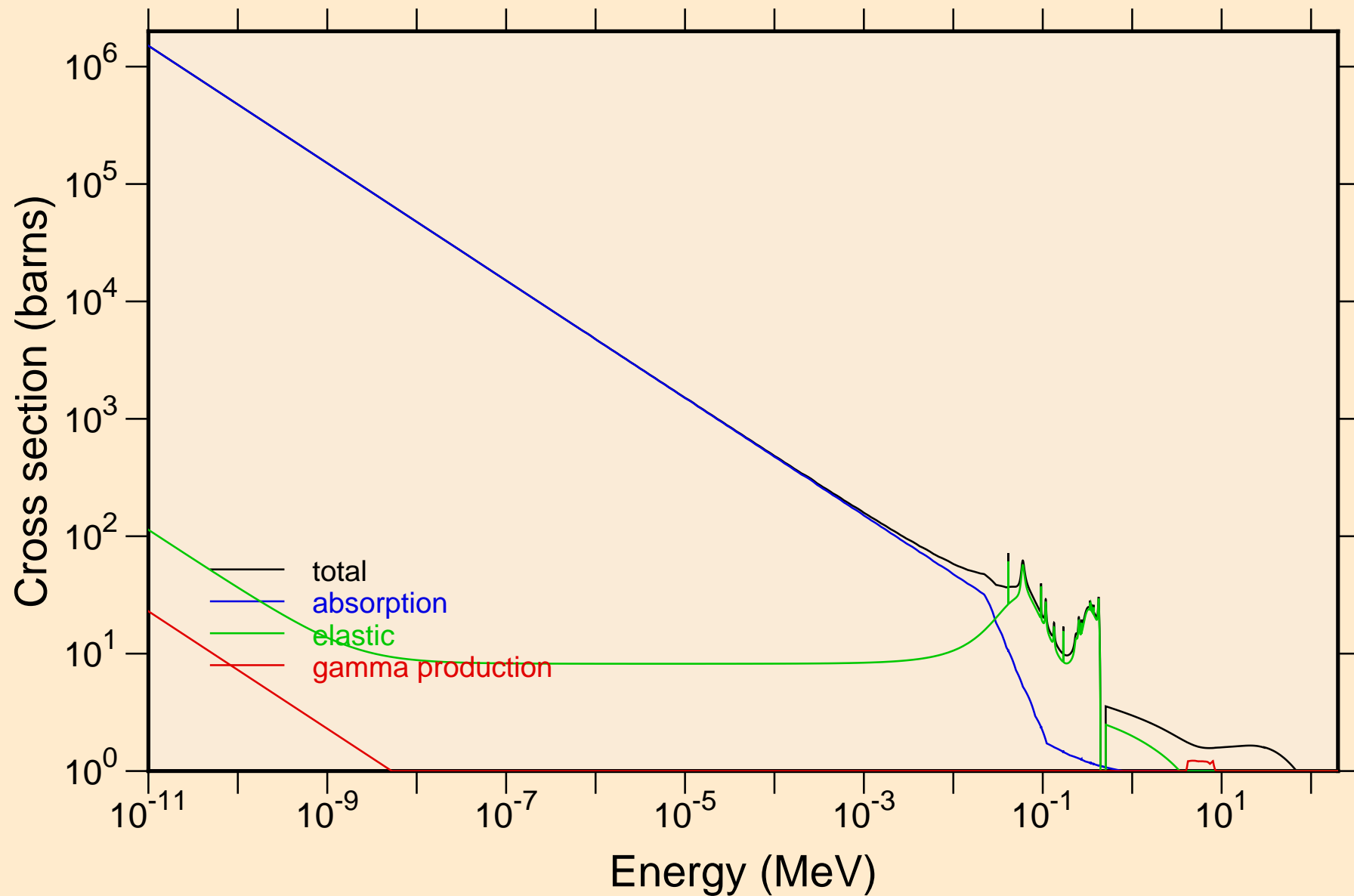

F017 NEUTRON ACER TENDL-2019 LIBRARY; T=293.16K
resonance total cross section

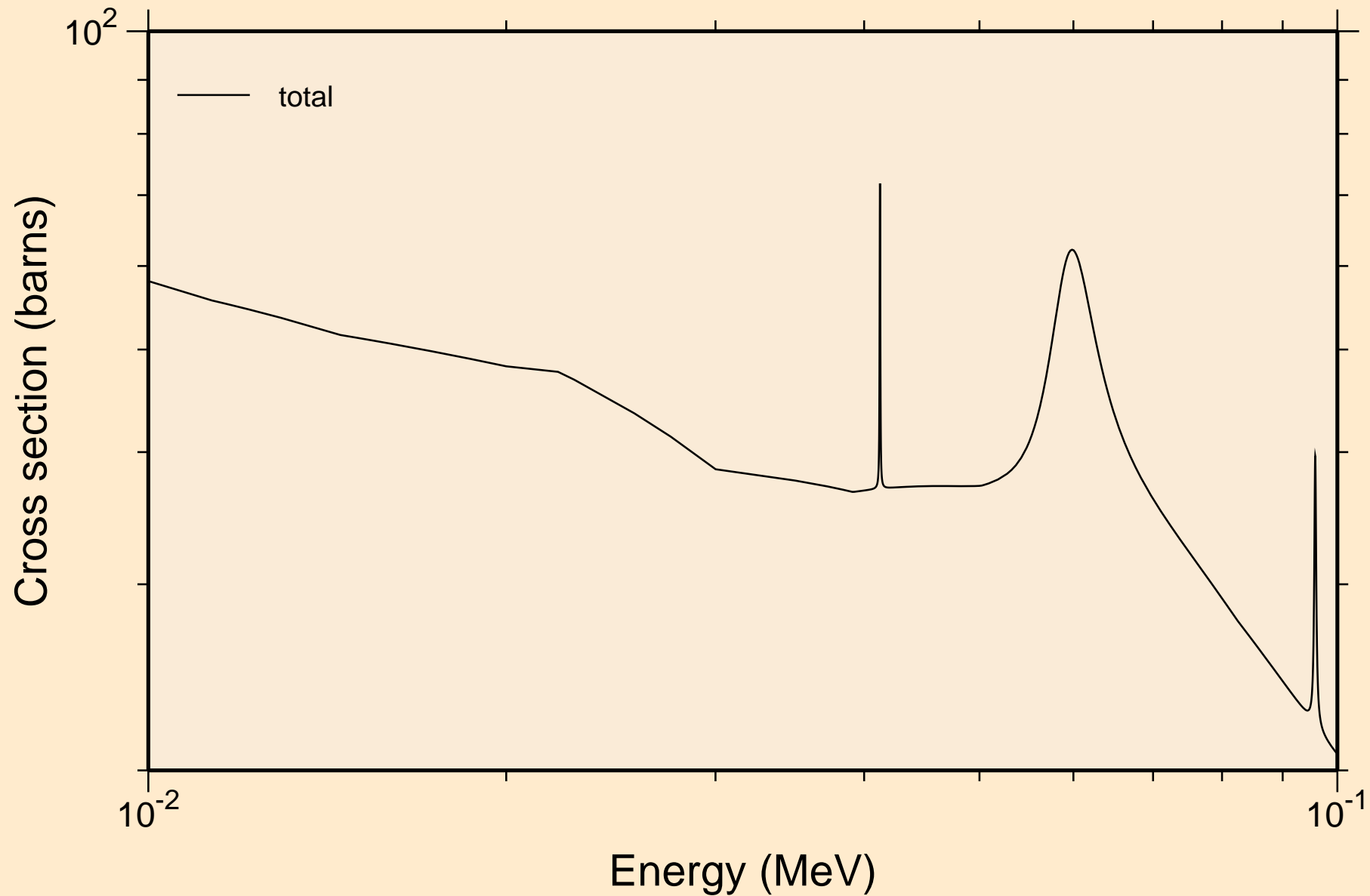

F017 NEUTRON ACER TENDL-2019 LIBRARY; T=293.16K
resonance total cross section

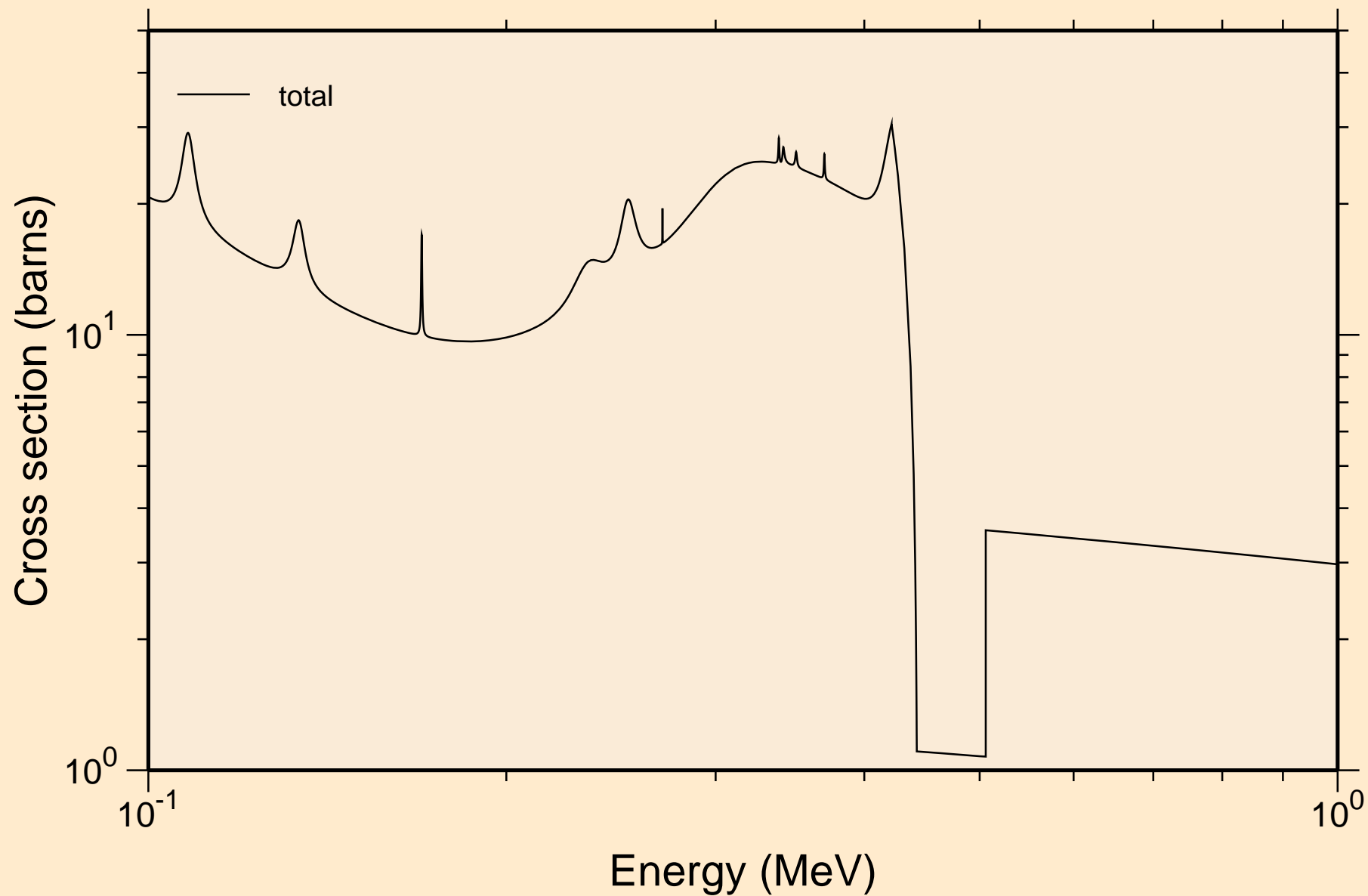

F017 NEUTRON ACER TENDL-2019 LIBRARY; T=293.16K
resonance total cross section

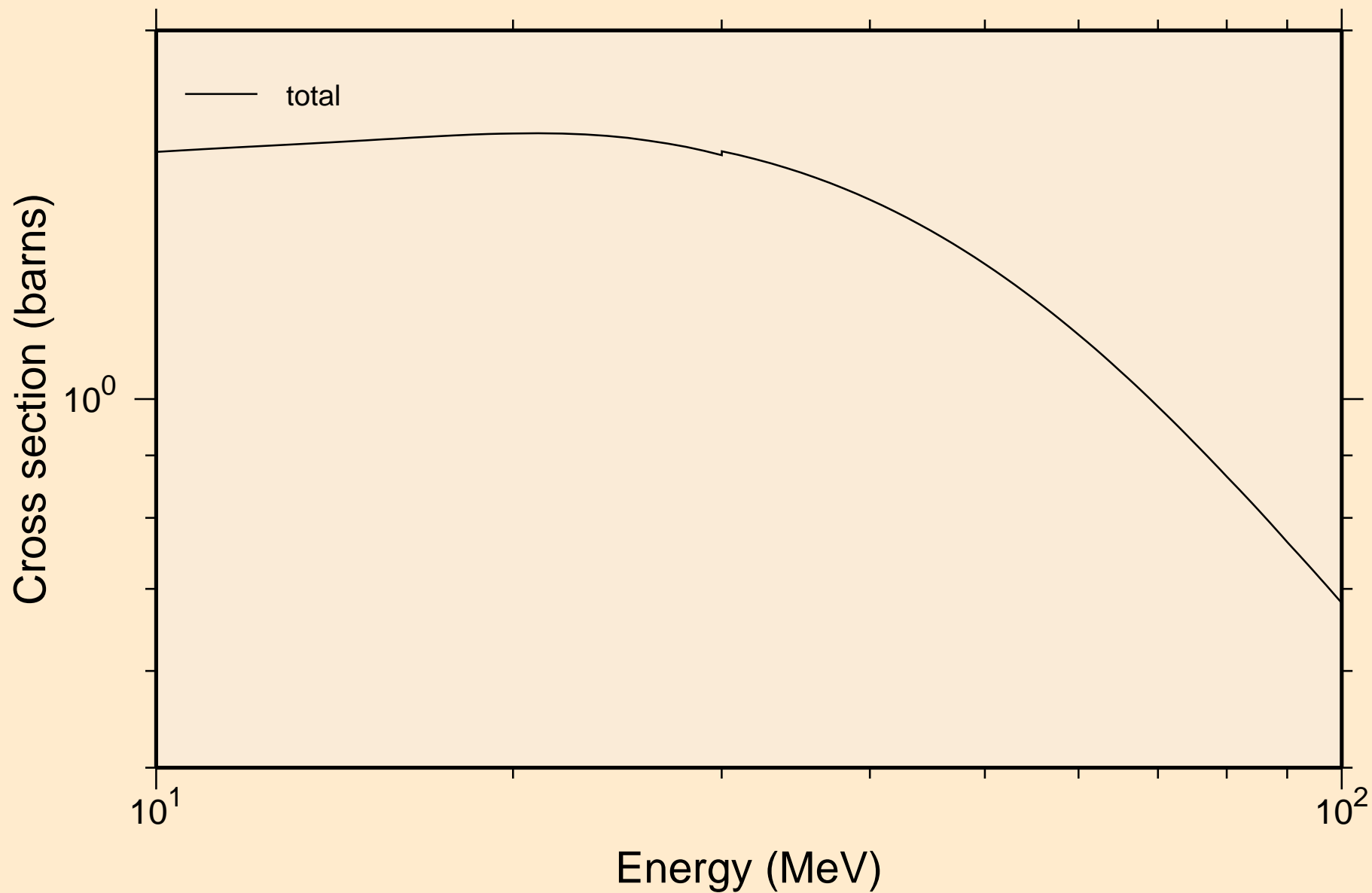

F017 NEUTRON ACER TENDL-2019 LIBRARY; T=293.16K
resonance absorption cross sections

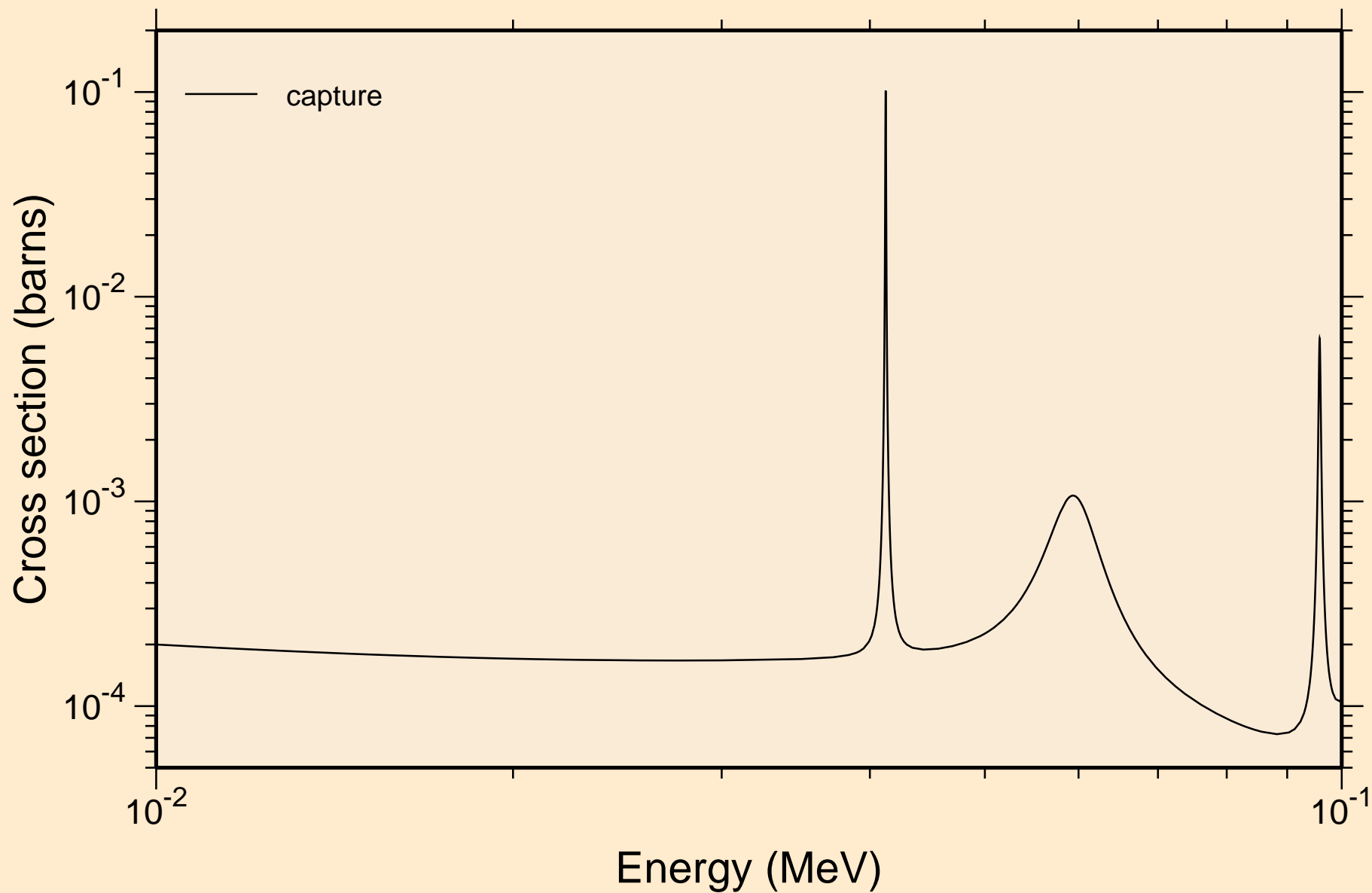

F017 NEUTRON ACER TENDL-2019 LIBRARY; T=293.16K
resonance absorption cross sections

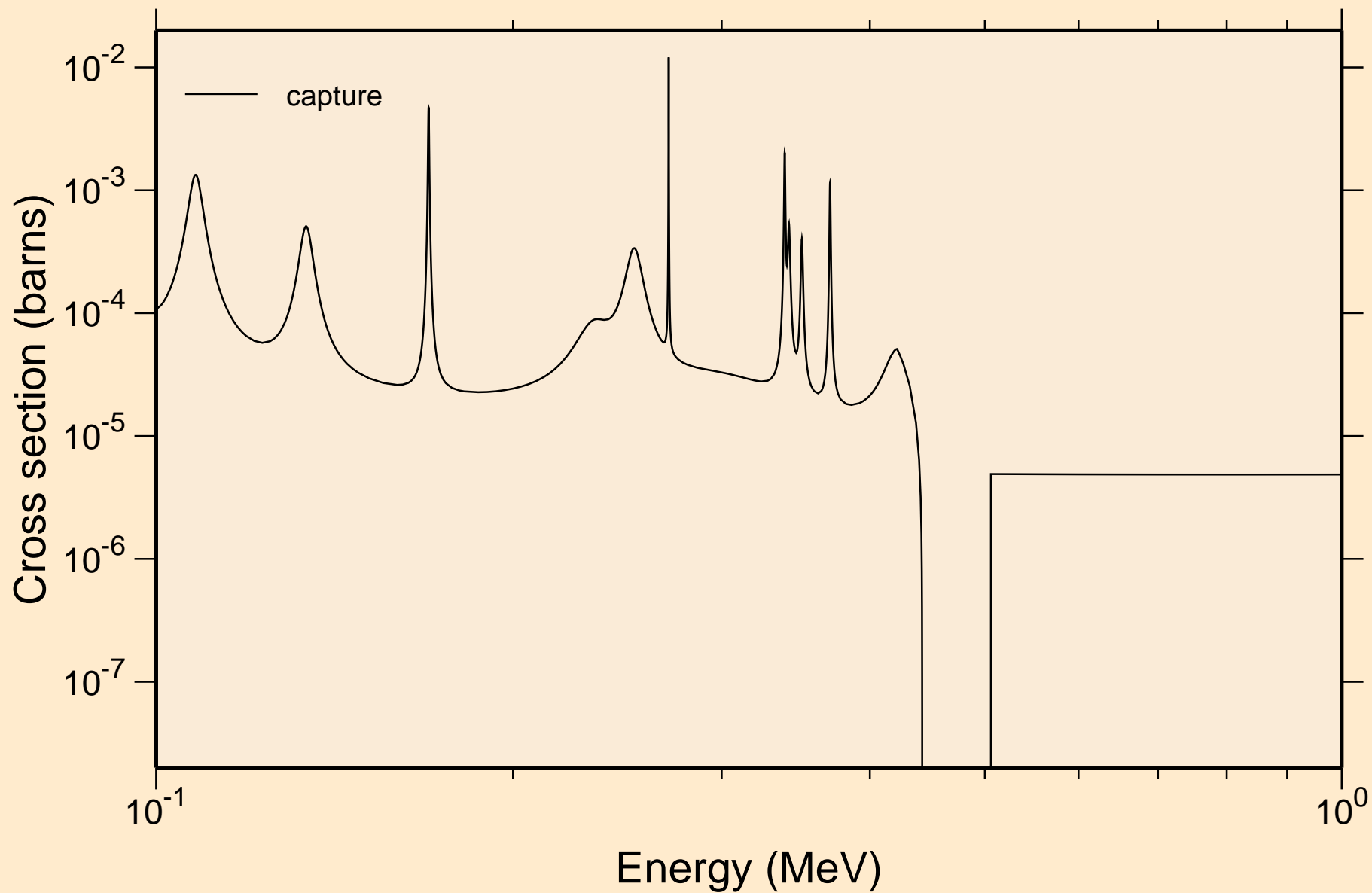

F017 NEUTRON ACER TENDL-2019 LIBRARY; T=293.16K
resonance absorption cross sections

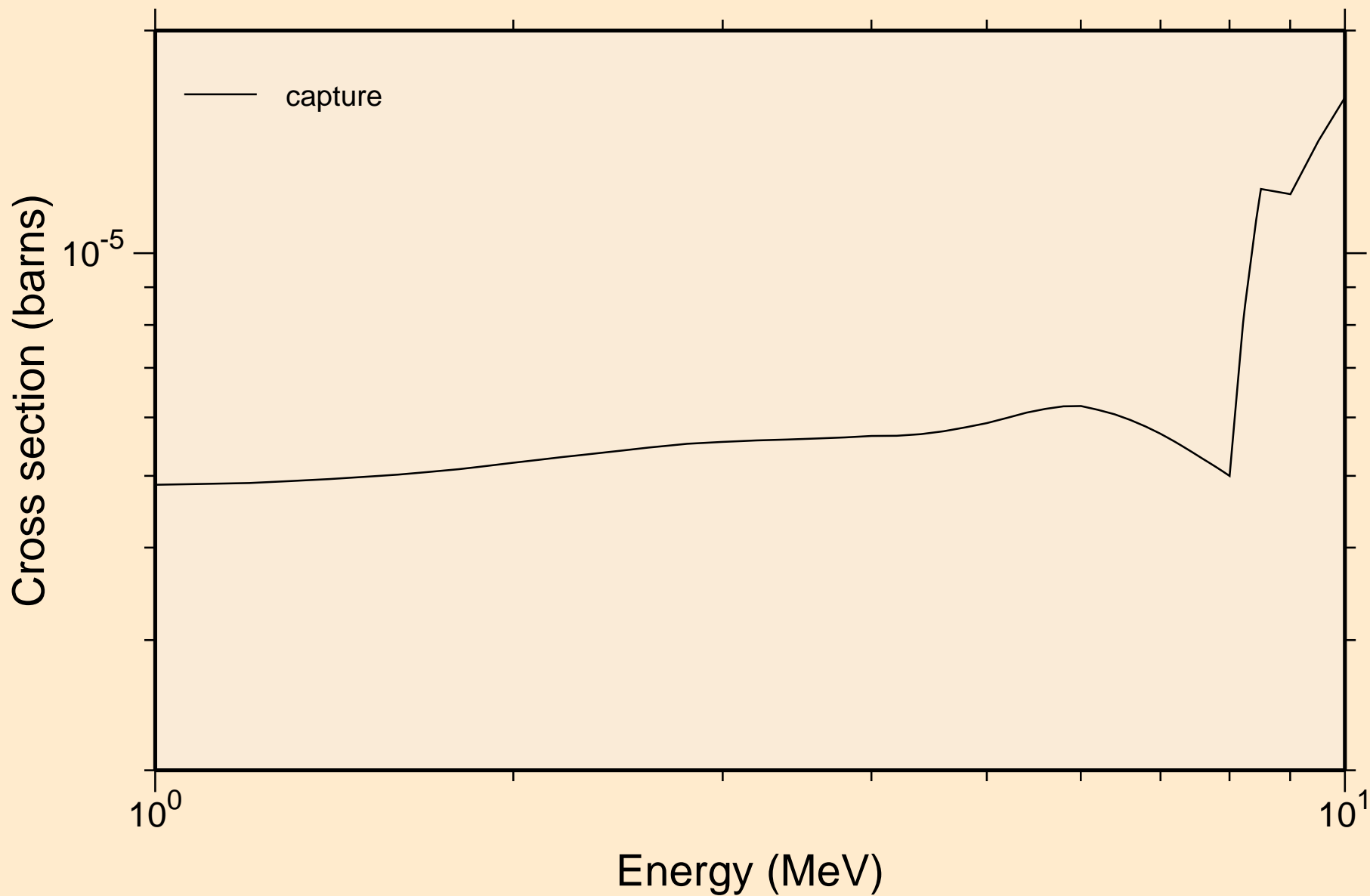

F017 NEUTRON ACER TENDL-2019 LIBRARY; T=293.16K
Heating

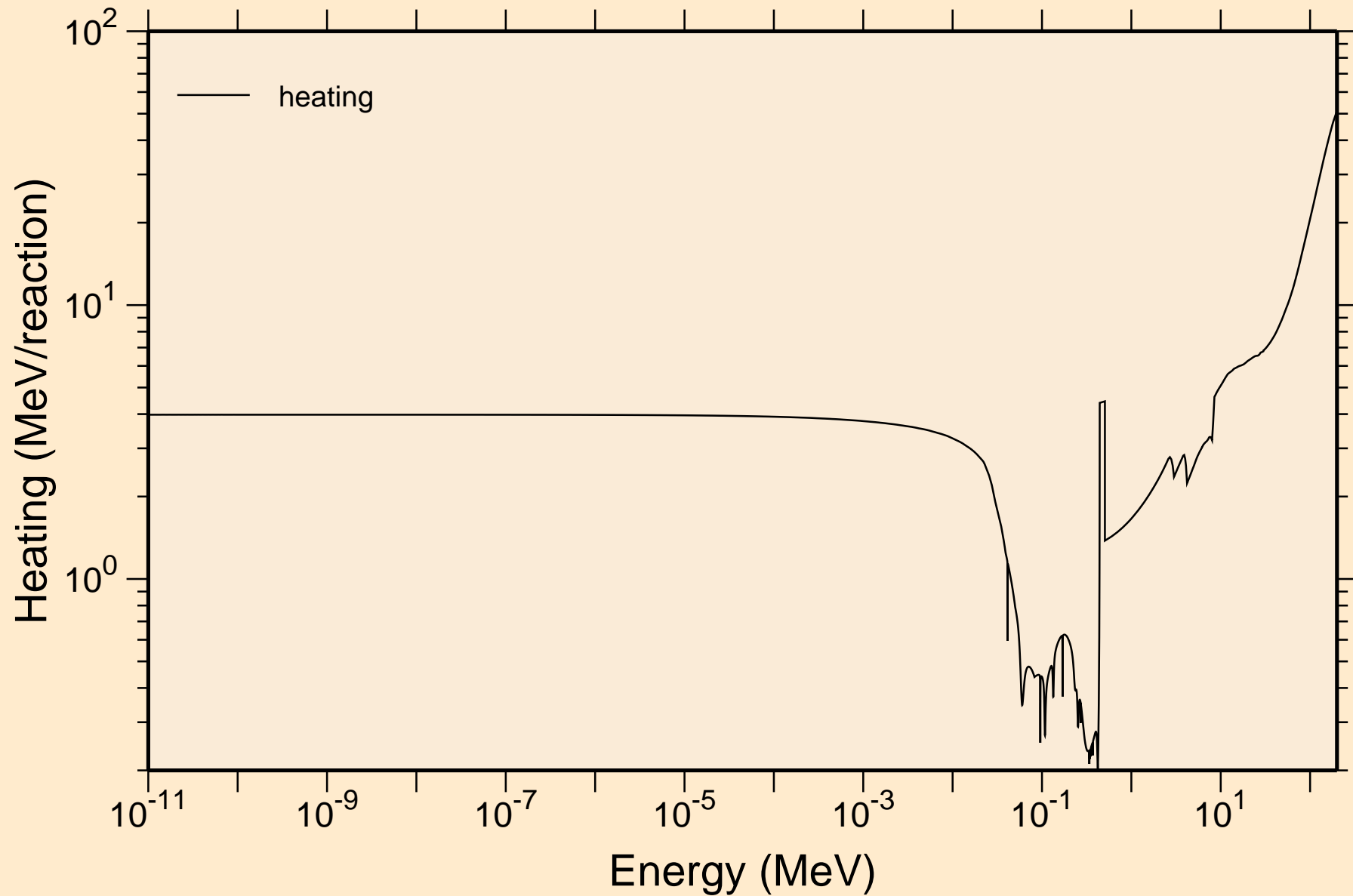

F017 NEUTRON ACER TENDL-2019 LIBRARY; T=293.16K
Damage

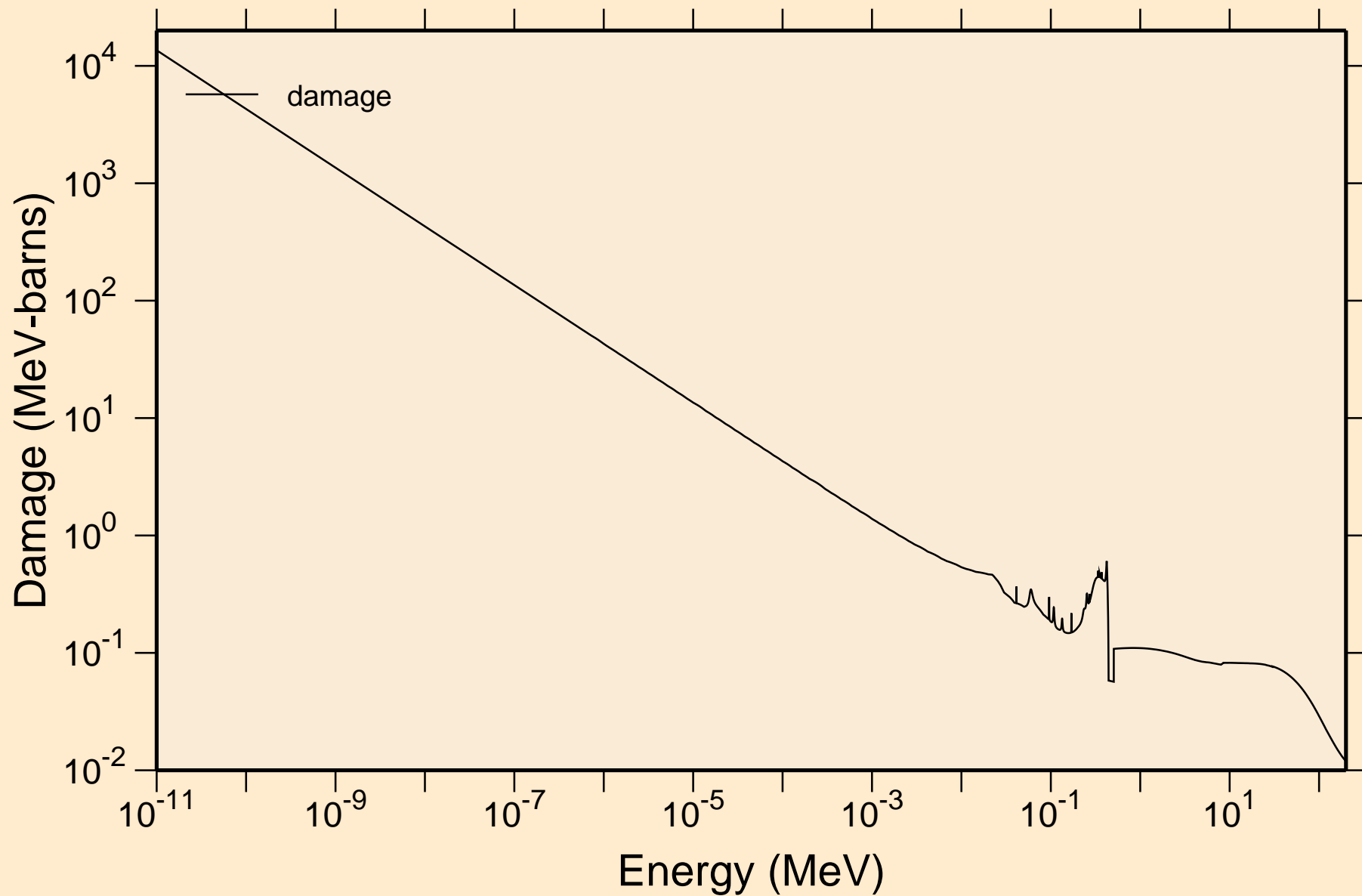

F017 NEUTRON ACER TENDL-2019 LIBRARY; T=293.16K
Non-threshold reactions

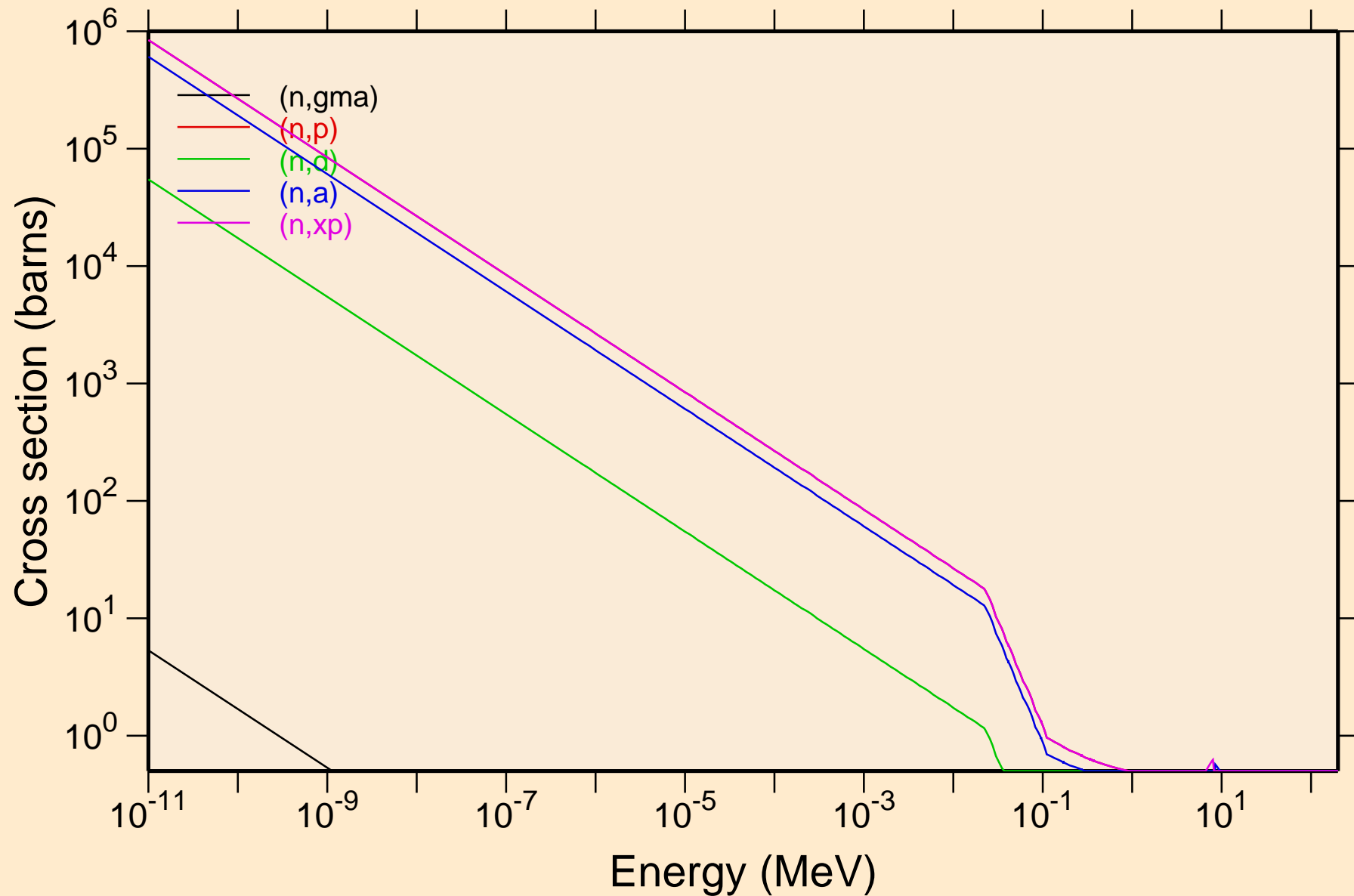

F017 NEUTRON ACER TENDL-2019 LIBRARY; T=293.16K
Non-threshold reactions

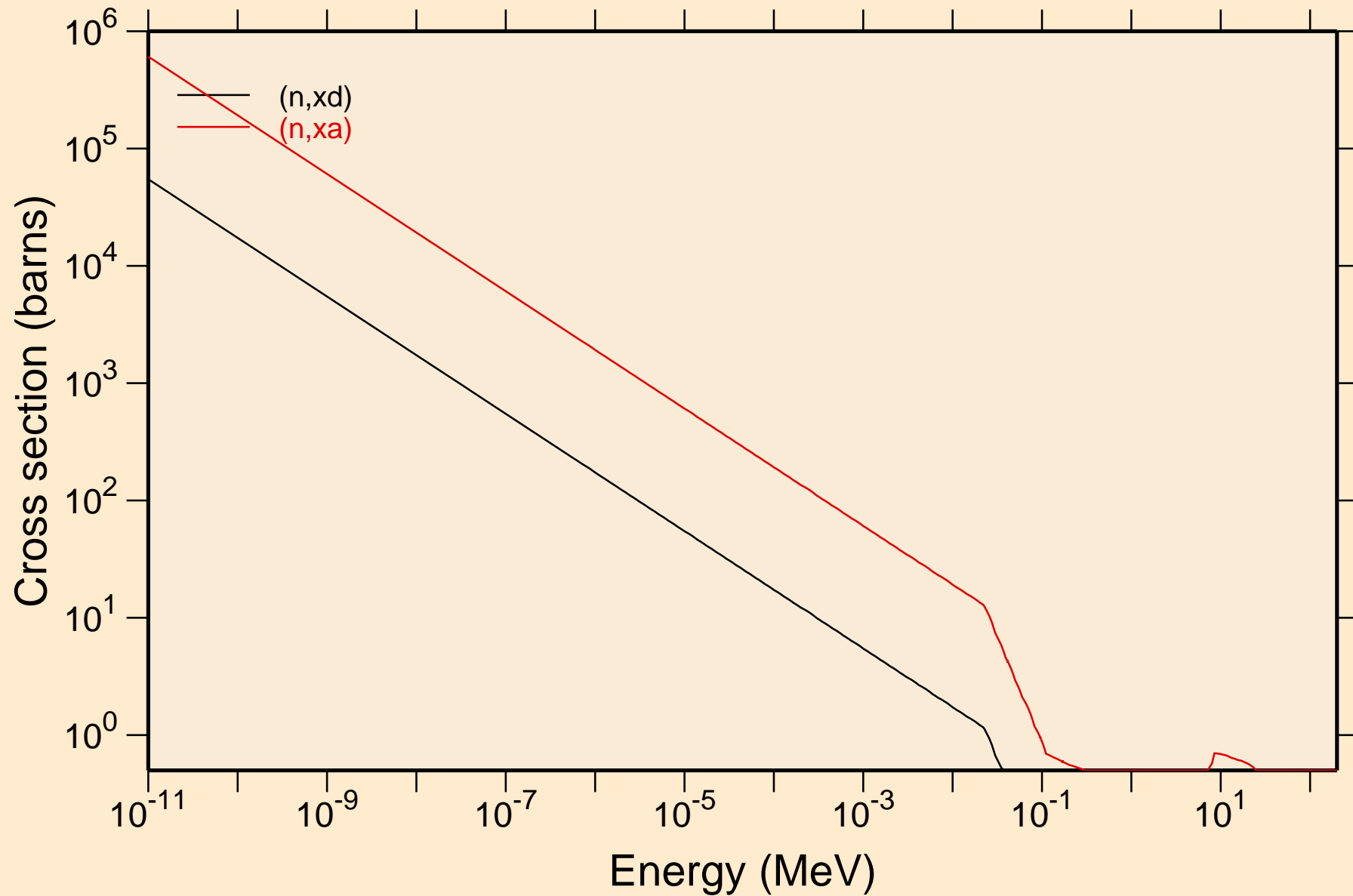

F017 NEUTRON ACER TENDL-2019 LIBRARY; T=293.16K

Principal cross sections

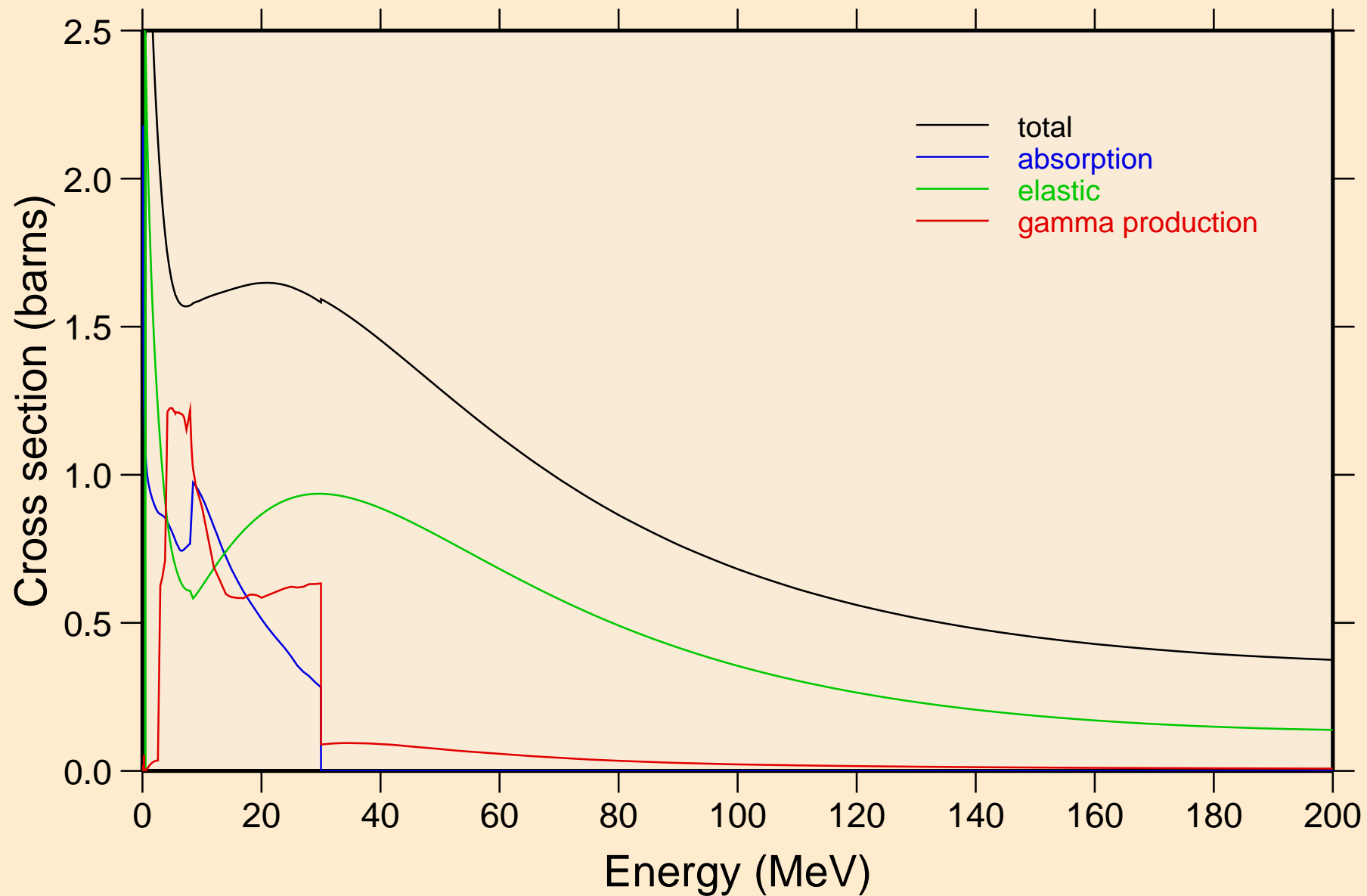

F017 NEUTRON ACER TENDL-2019 LIBRARY; T=293.16K
Heating

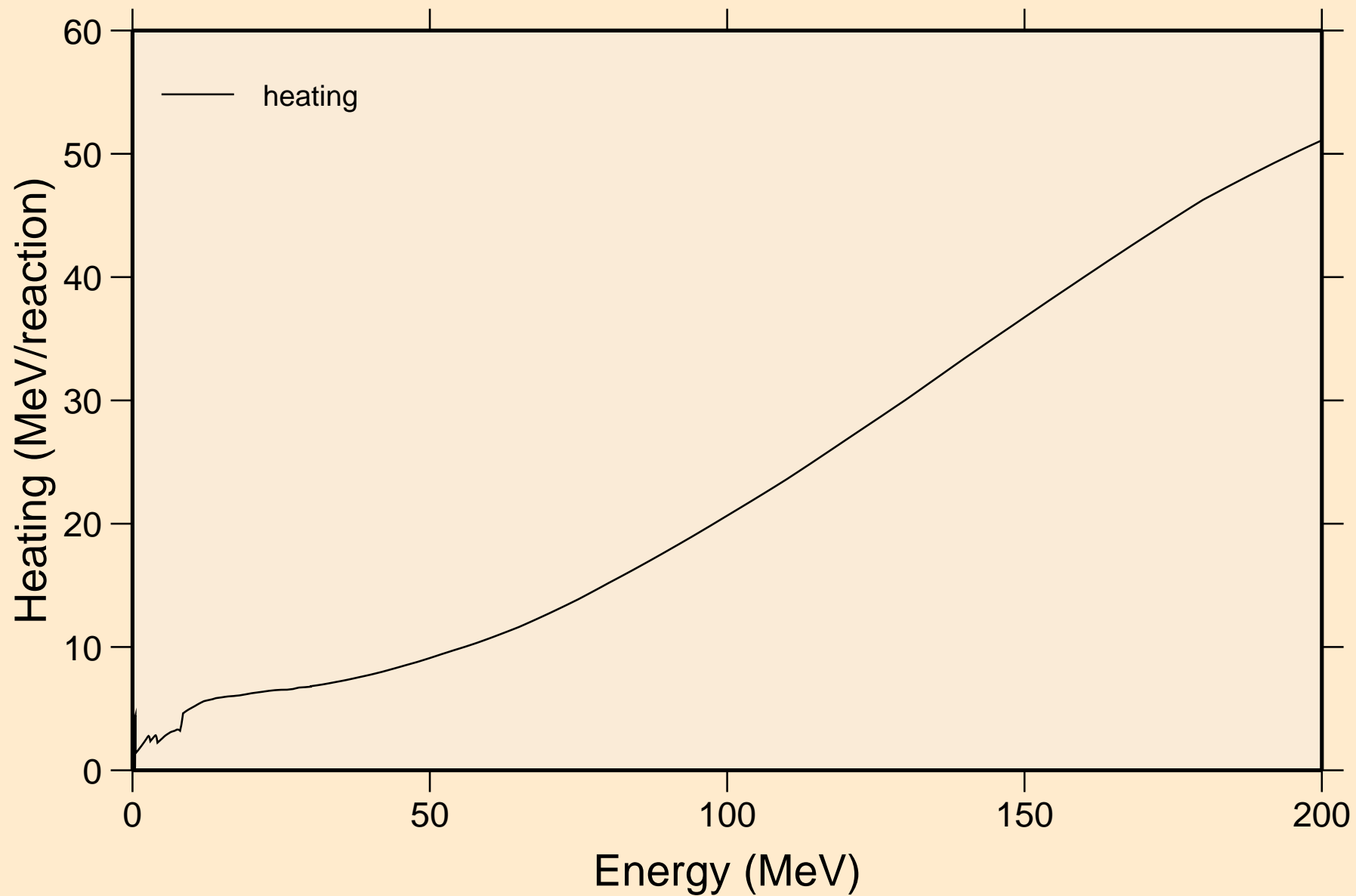

F017 NEUTRON ACER TENDL-2019 LIBRARY; T=293.16K
Damage

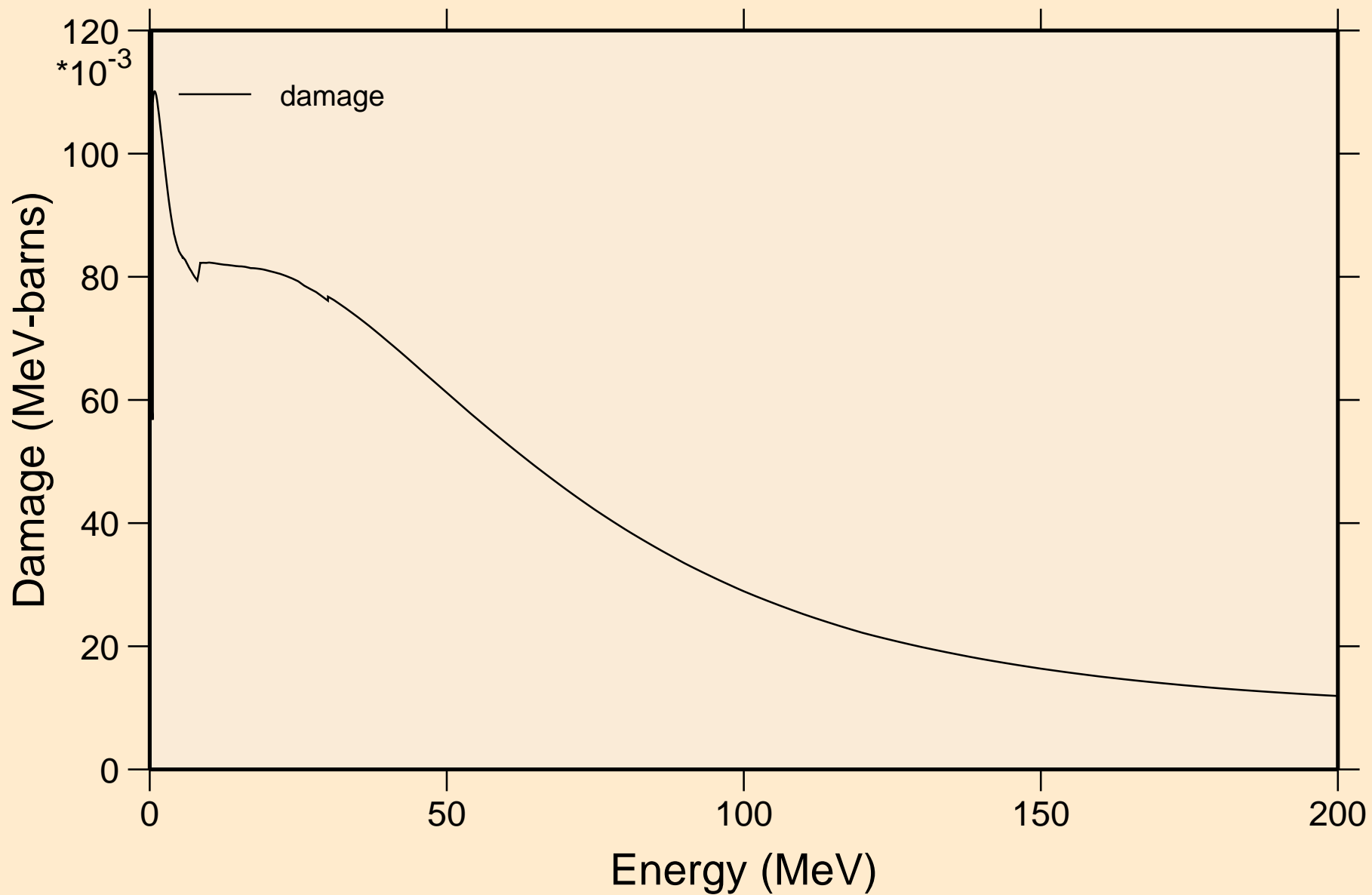

F017 NEUTRON ACER TENDL-2019 LIBRARY; T=293.16K
Non-threshold reactions

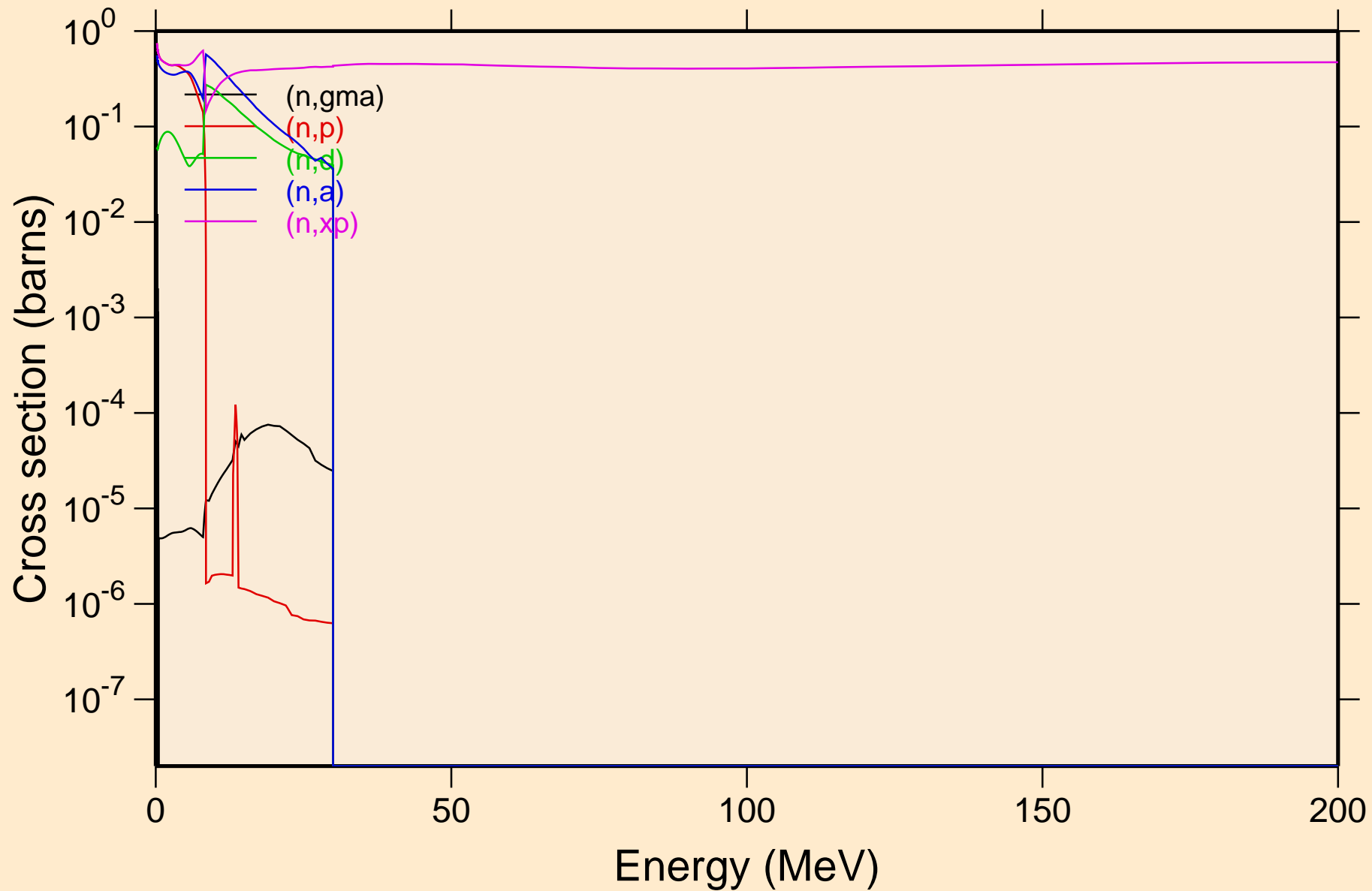

F017 NEUTRON ACER TENDL-2019 LIBRARY; T=293.16K
Non-threshold reactions

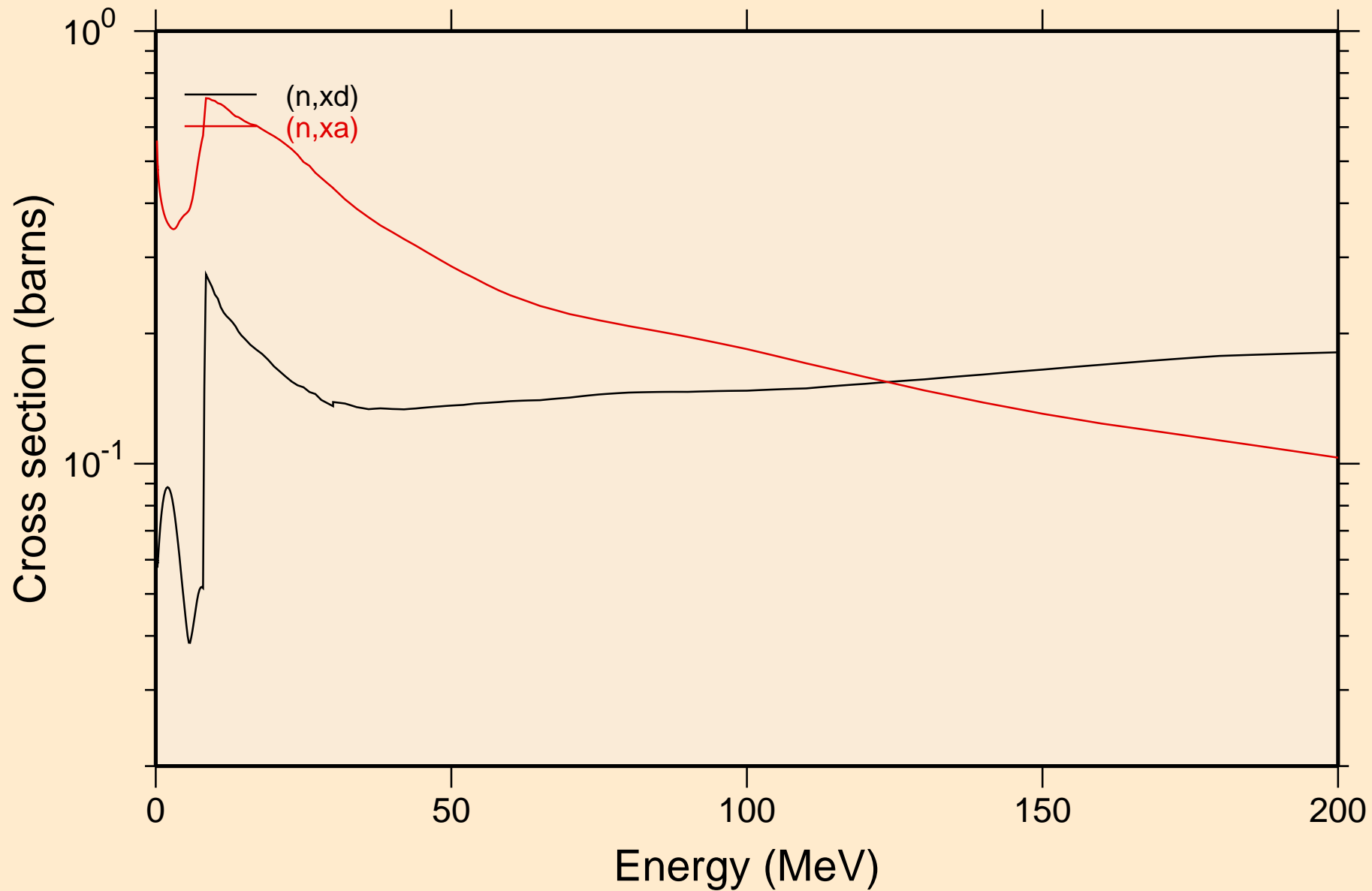

F017 NEUTRON ACER TENDL-2019 LIBRARY; T=293.16K
Inelastic levels

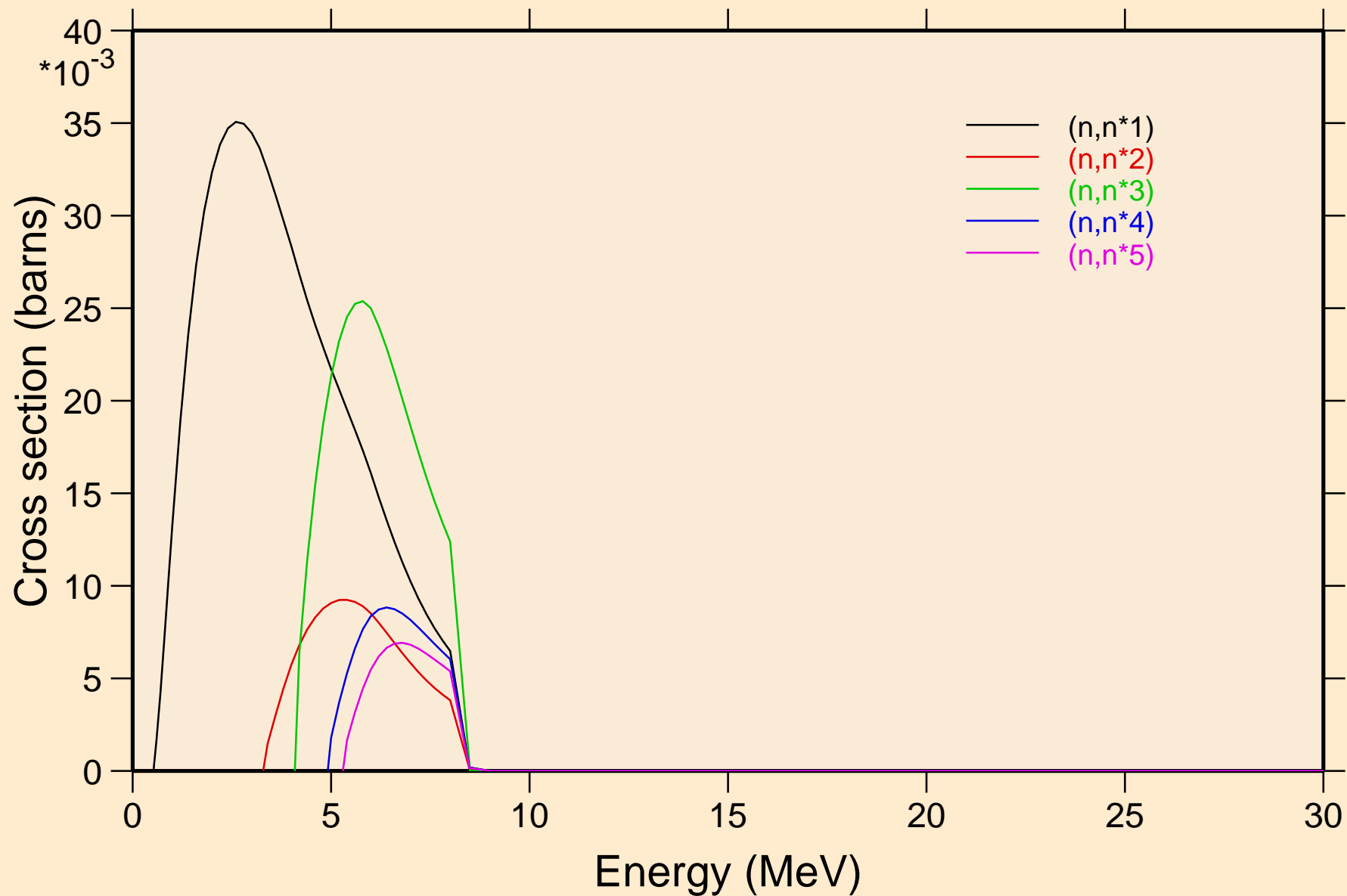

F017 NEUTRON ACER TENDL-2019 LIBRARY; T=293.16K
Inelastic levels

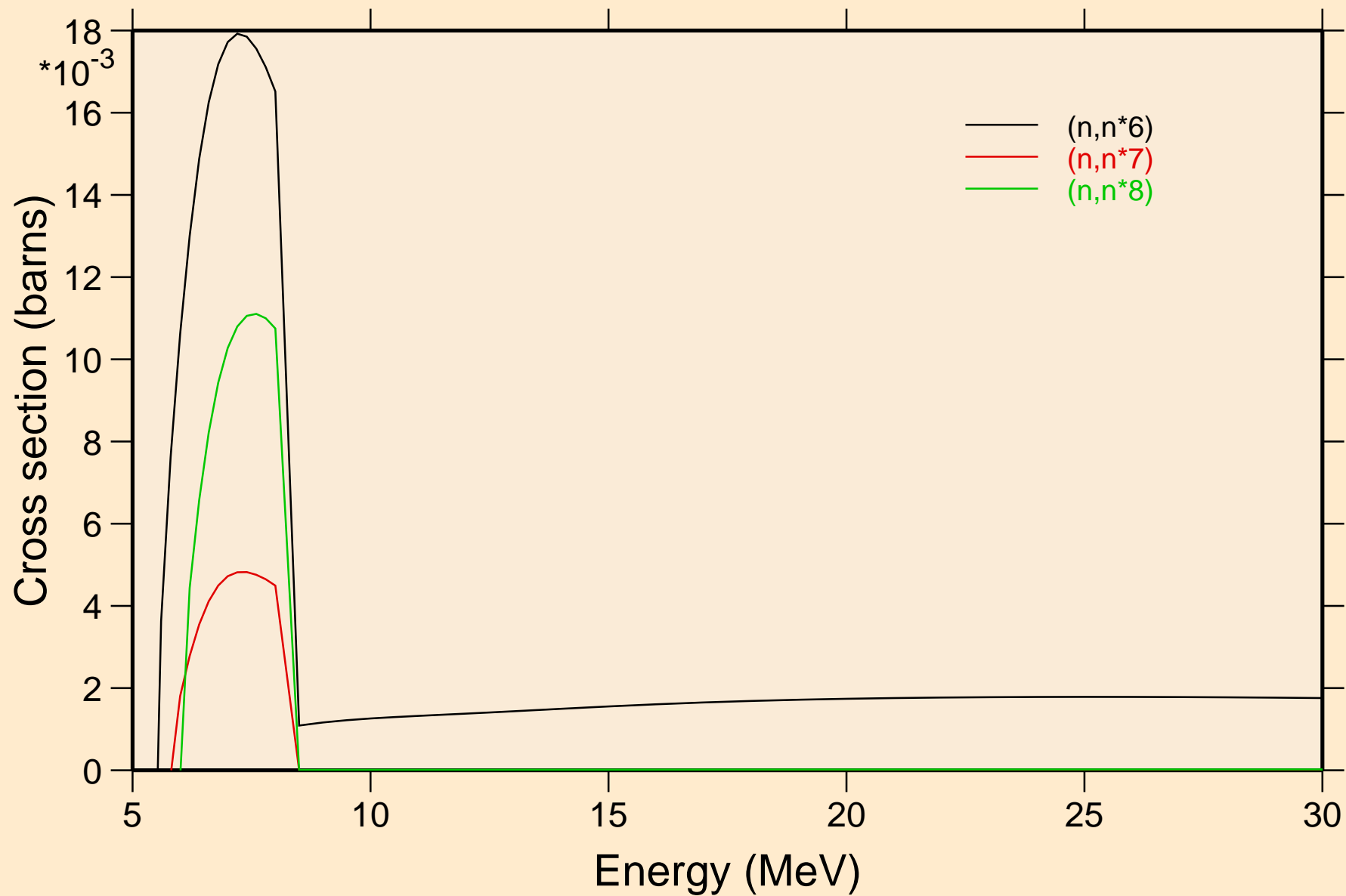

F017 NEUTRON ACER TENDL-2019 LIBRARY; T=293.16K
Threshold reactions

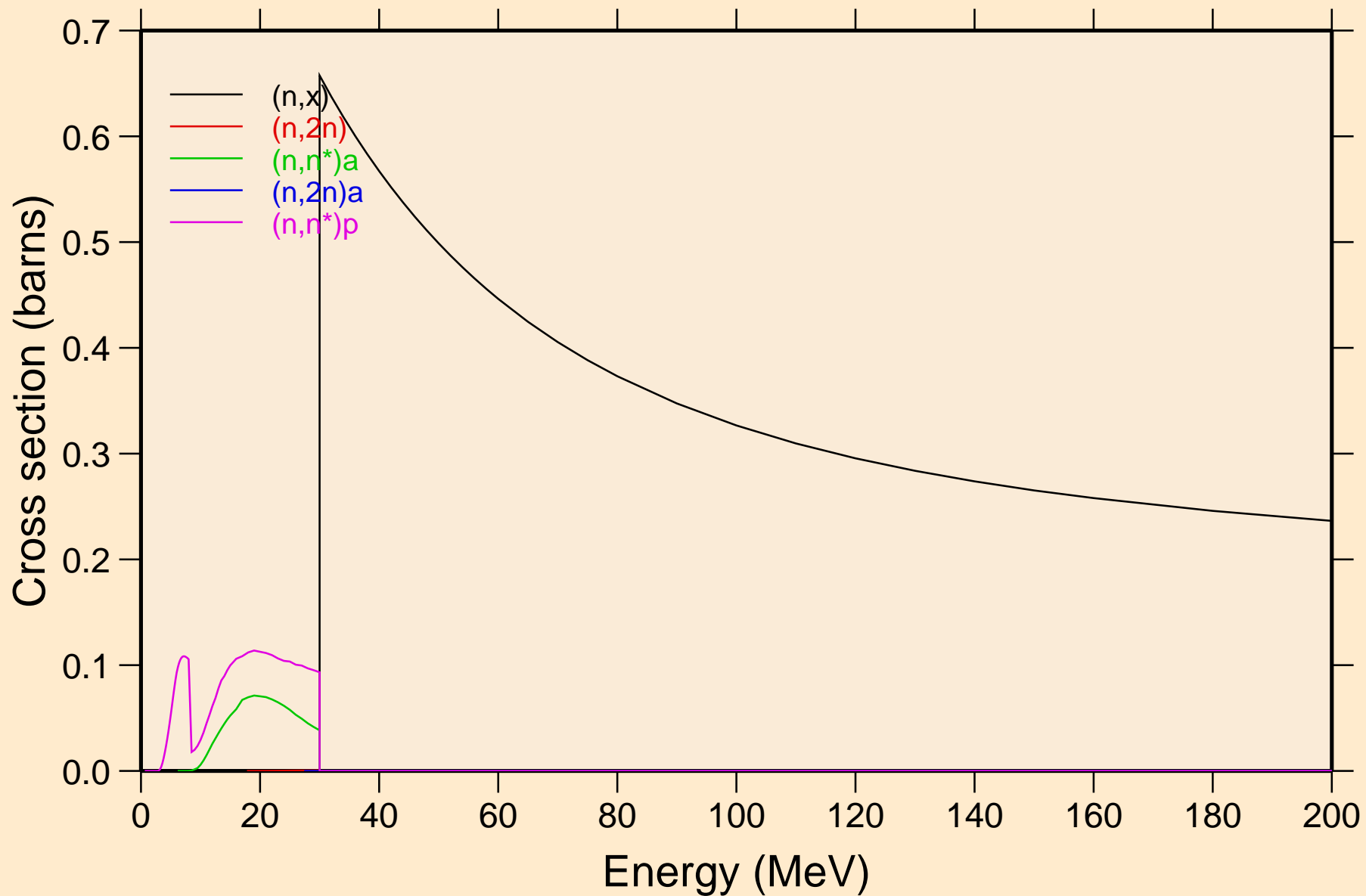

F017 NEUTRON ACER TENDL-2019 LIBRARY; T=293.16K
Threshold reactions

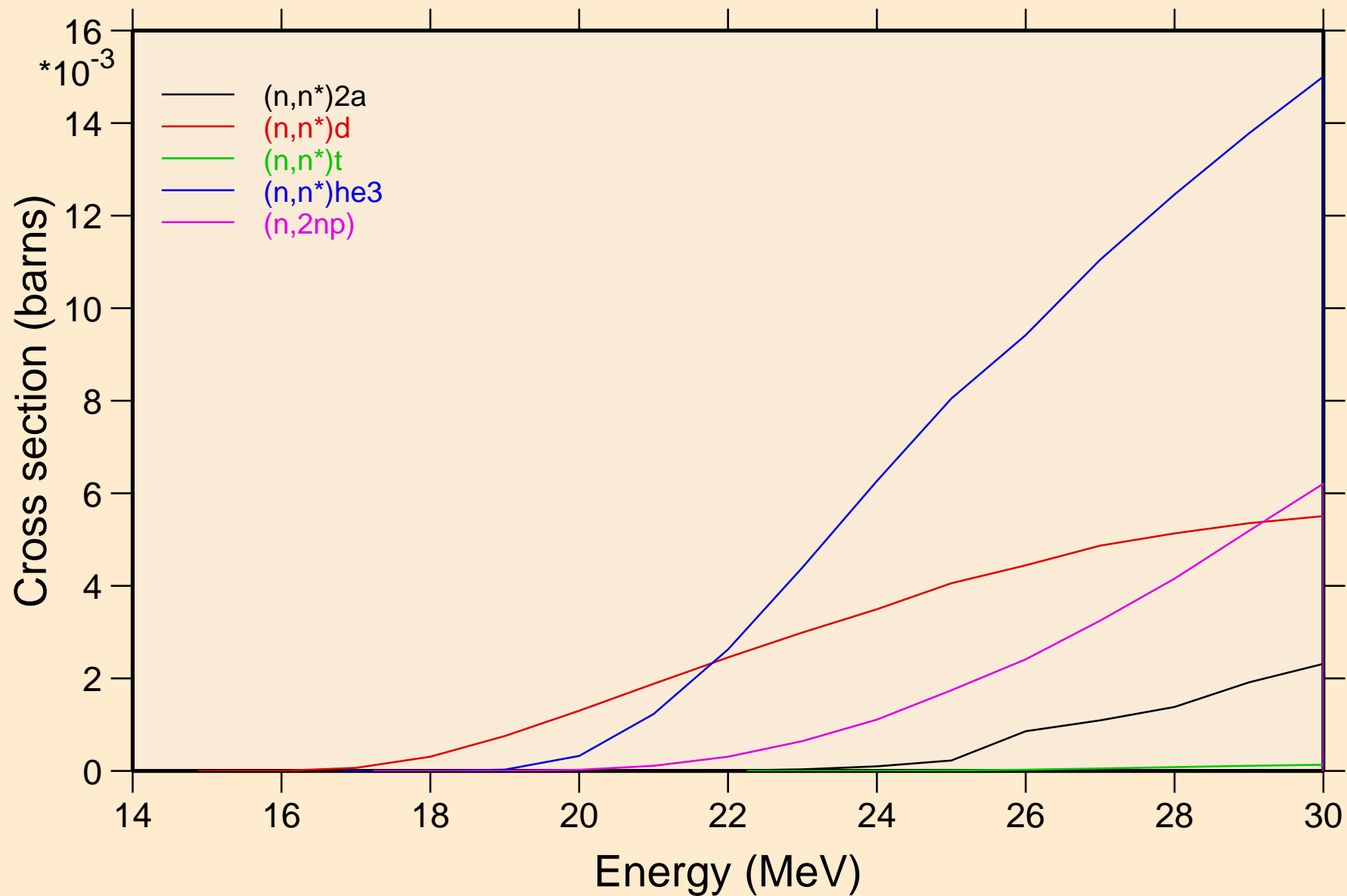

F017 NEUTRON ACER TENDL-2019 LIBRARY; T=293.16K
Threshold reactions

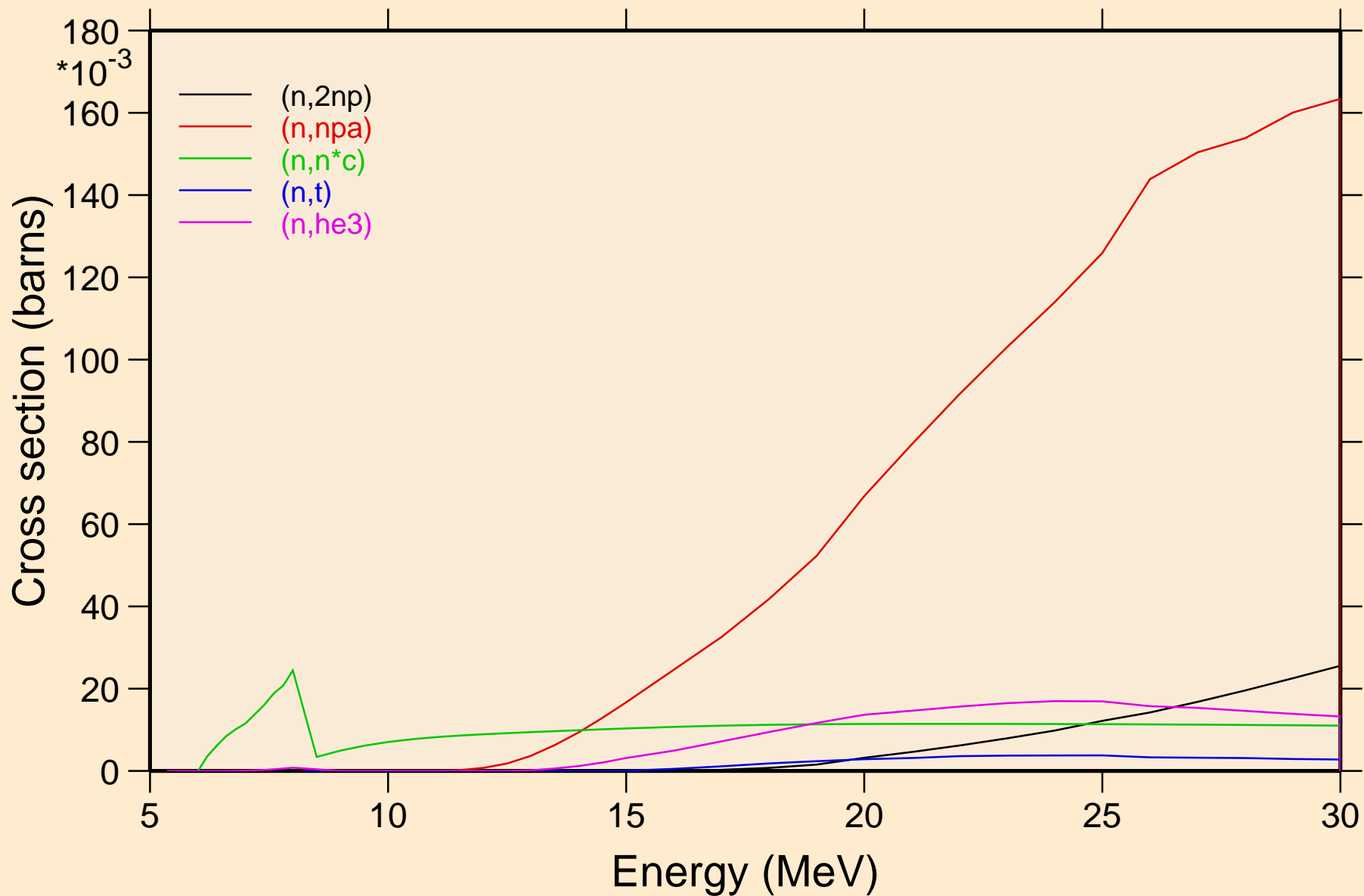

F017 NEUTRON ACER TENDL-2019 LIBRARY; T=293.16K
Threshold reactions

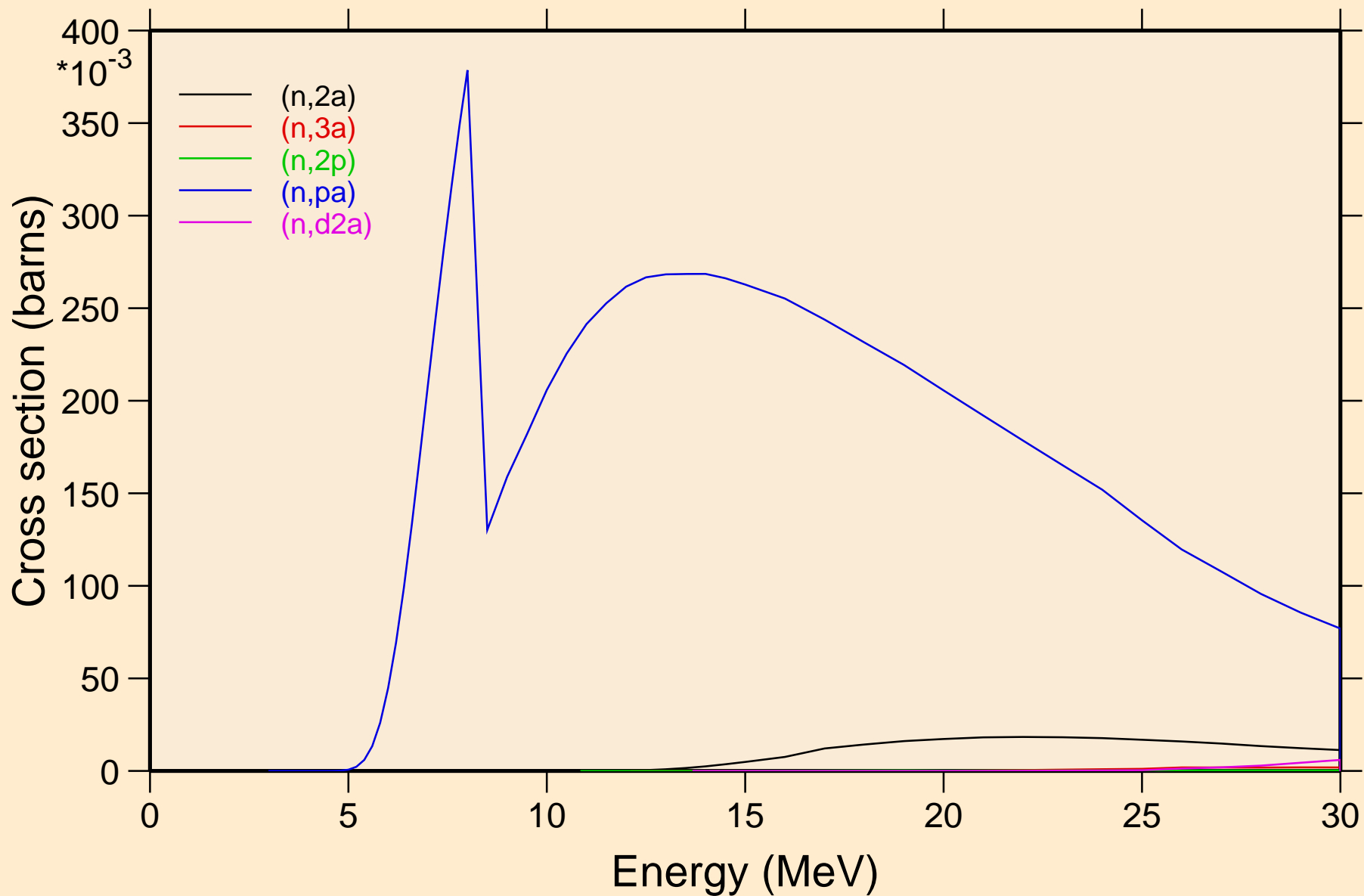

F017 NEUTRON ACER TENDL-2019 LIBRARY; T=293.16K
Threshold reactions

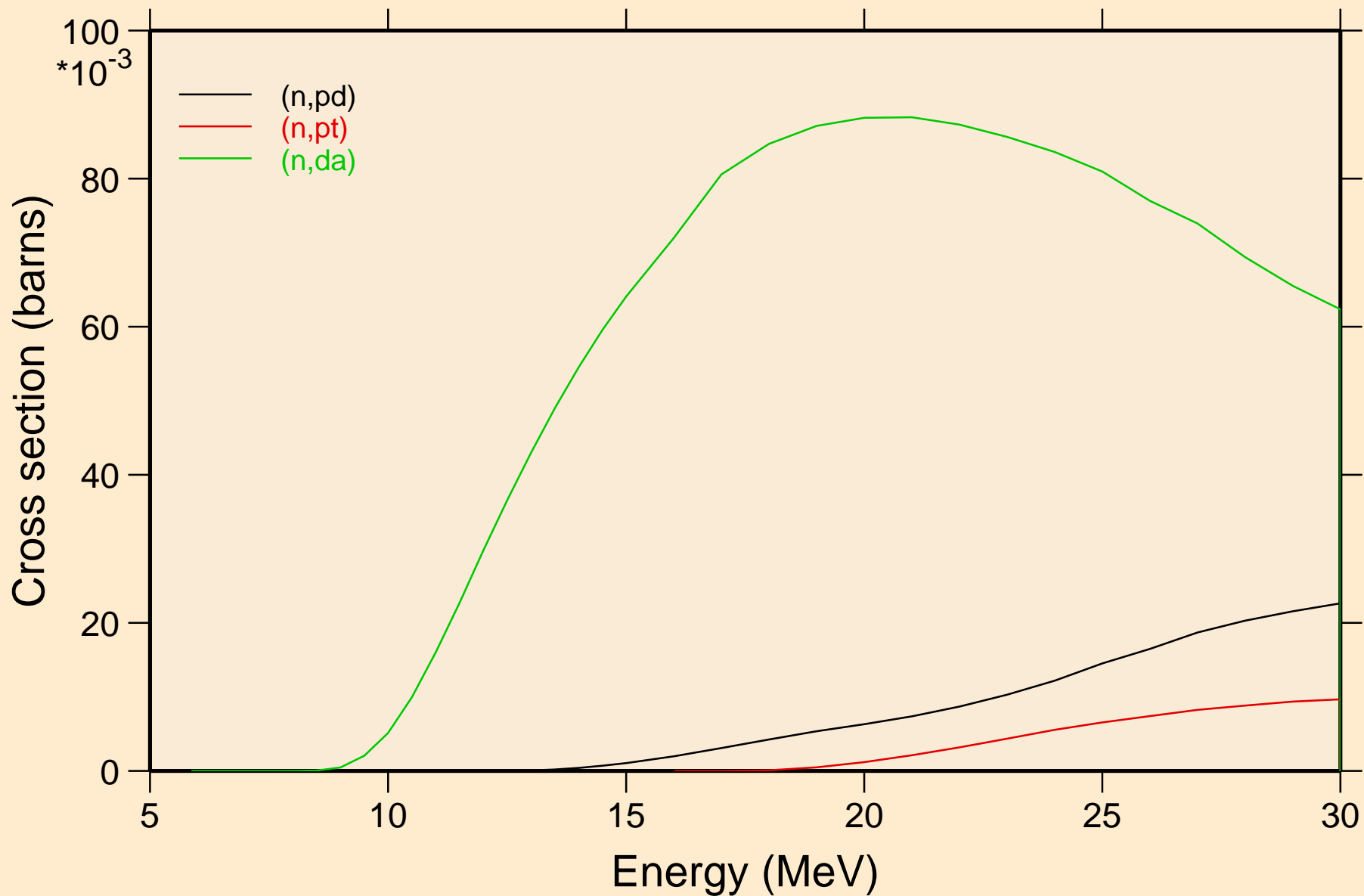

F017 NEUTRON ACER TENDL-2019 LIBRARY; T=293.16K
Threshold reactions

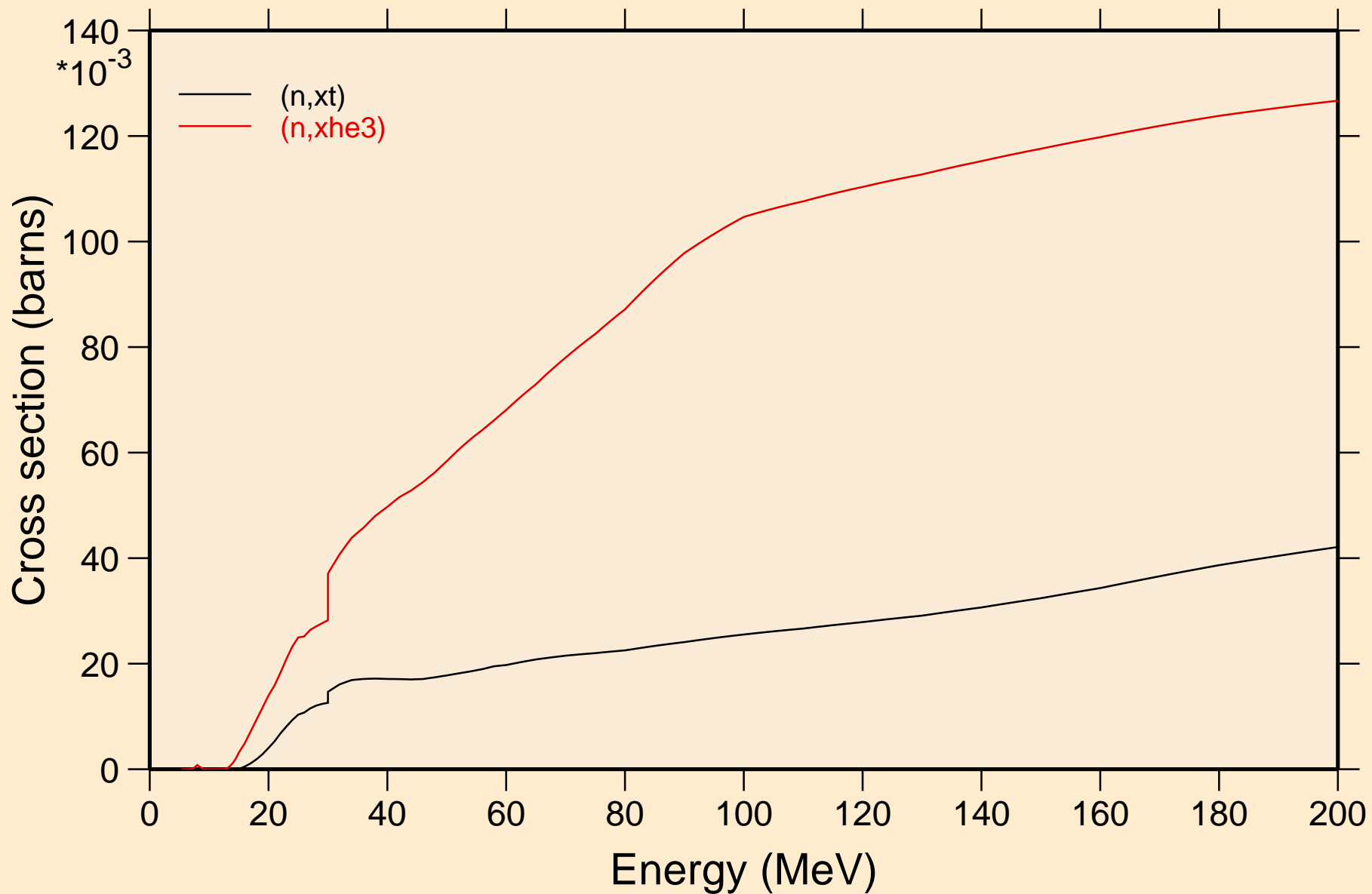

F017 NEUTRON ACER TENDL-2019 LIBRARY; T=293.16K
angular distribution for elastic

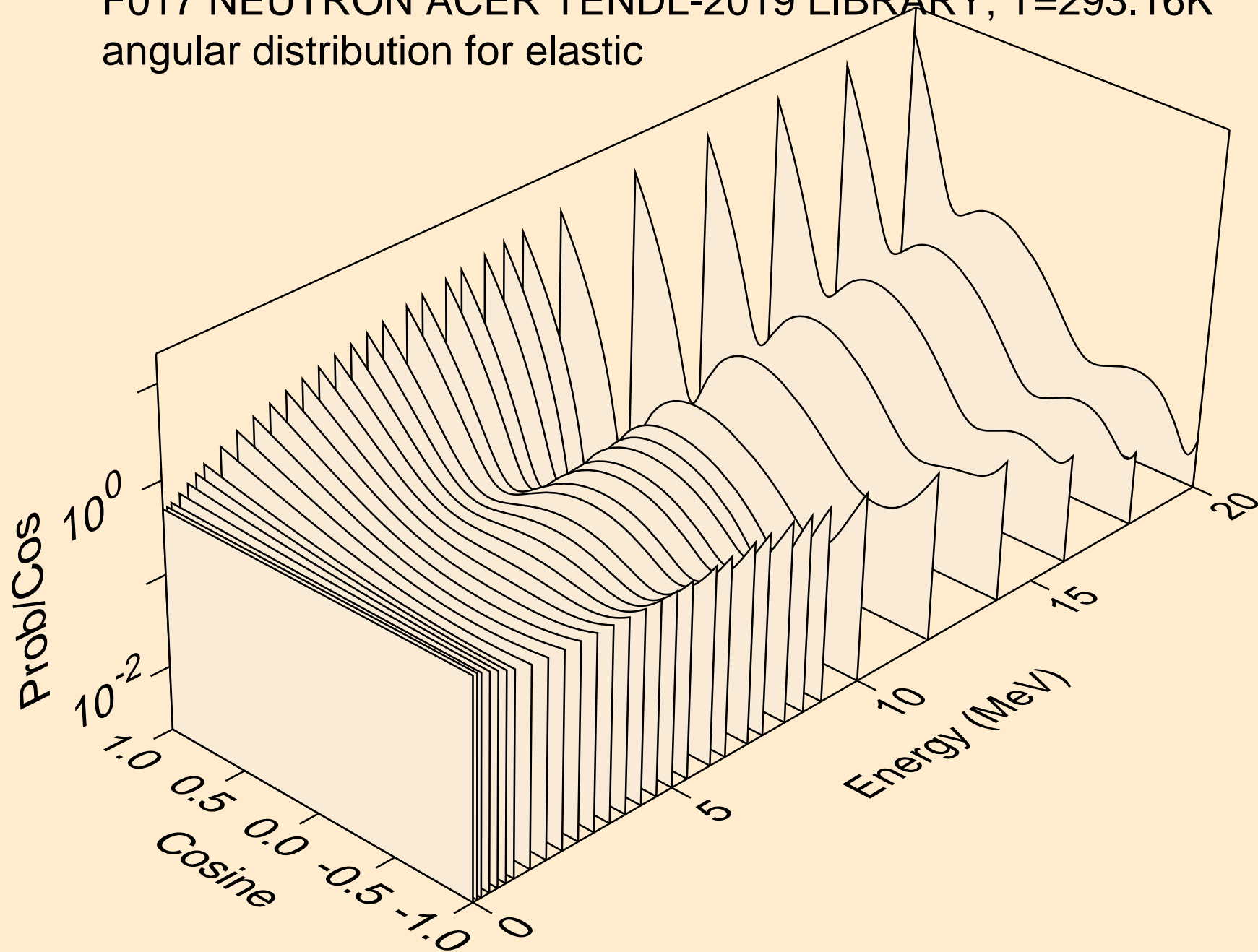

F017 NEUTRON ACER TENDL-2019 LIBRARY; T=293.16K
angular distribution for elastic

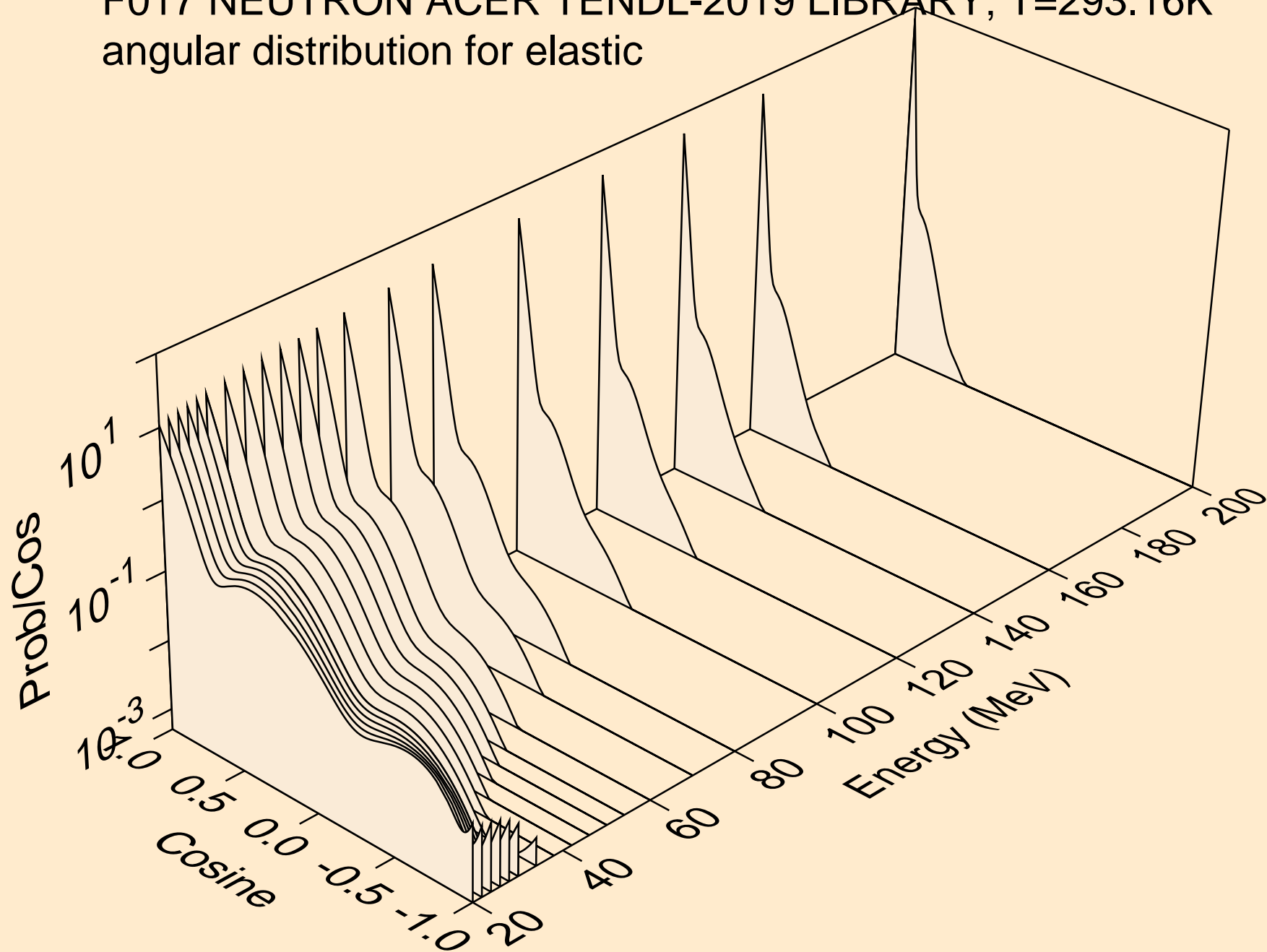

F017 NEUTRON ACER TENDL-2019 LIBRARY; T=293.16K
angular distribution for (n,n*1)

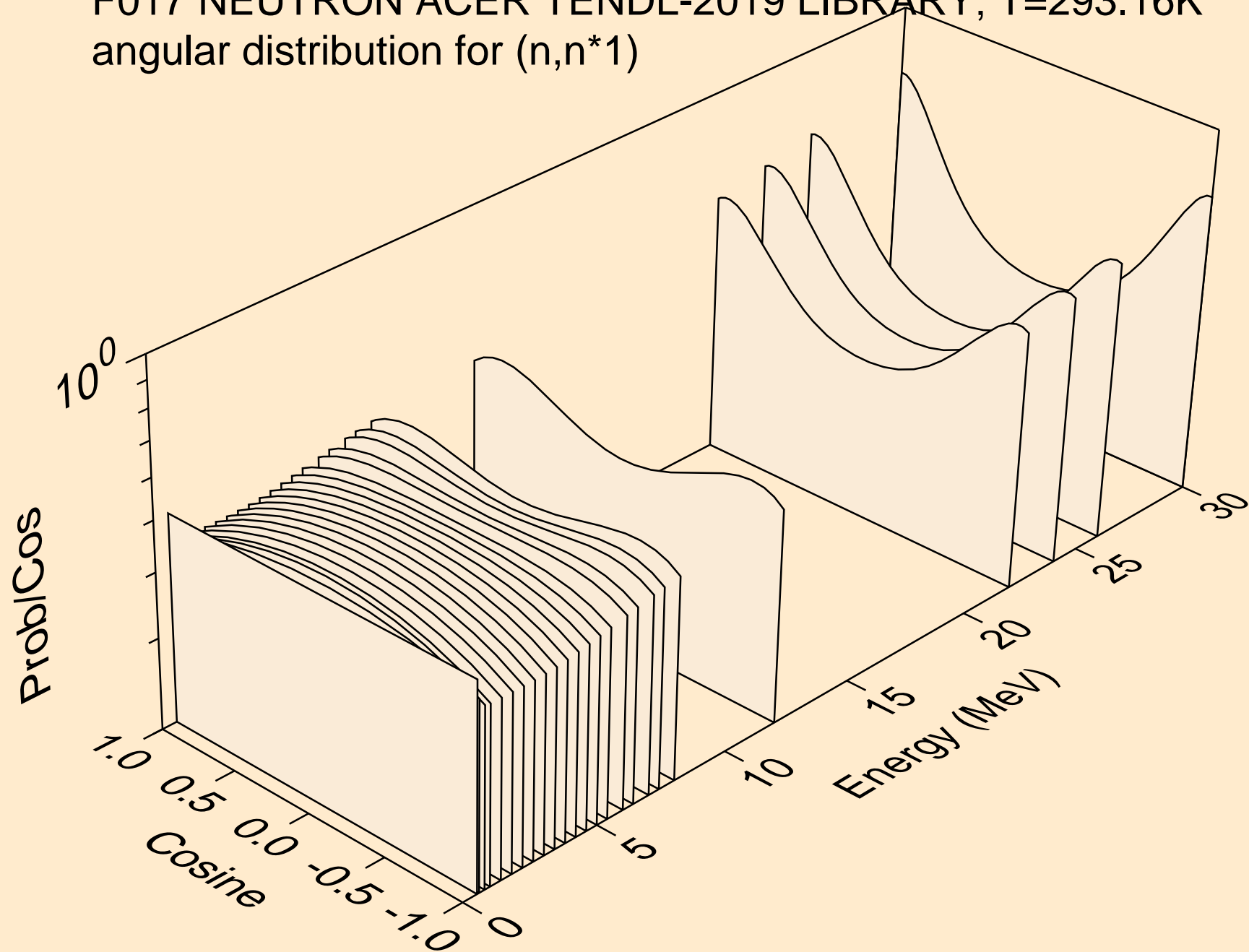

F017 NEUTRON ACER TENDL-2019 LIBRARY; T=293.16K
angular distribution for (n,n*2)

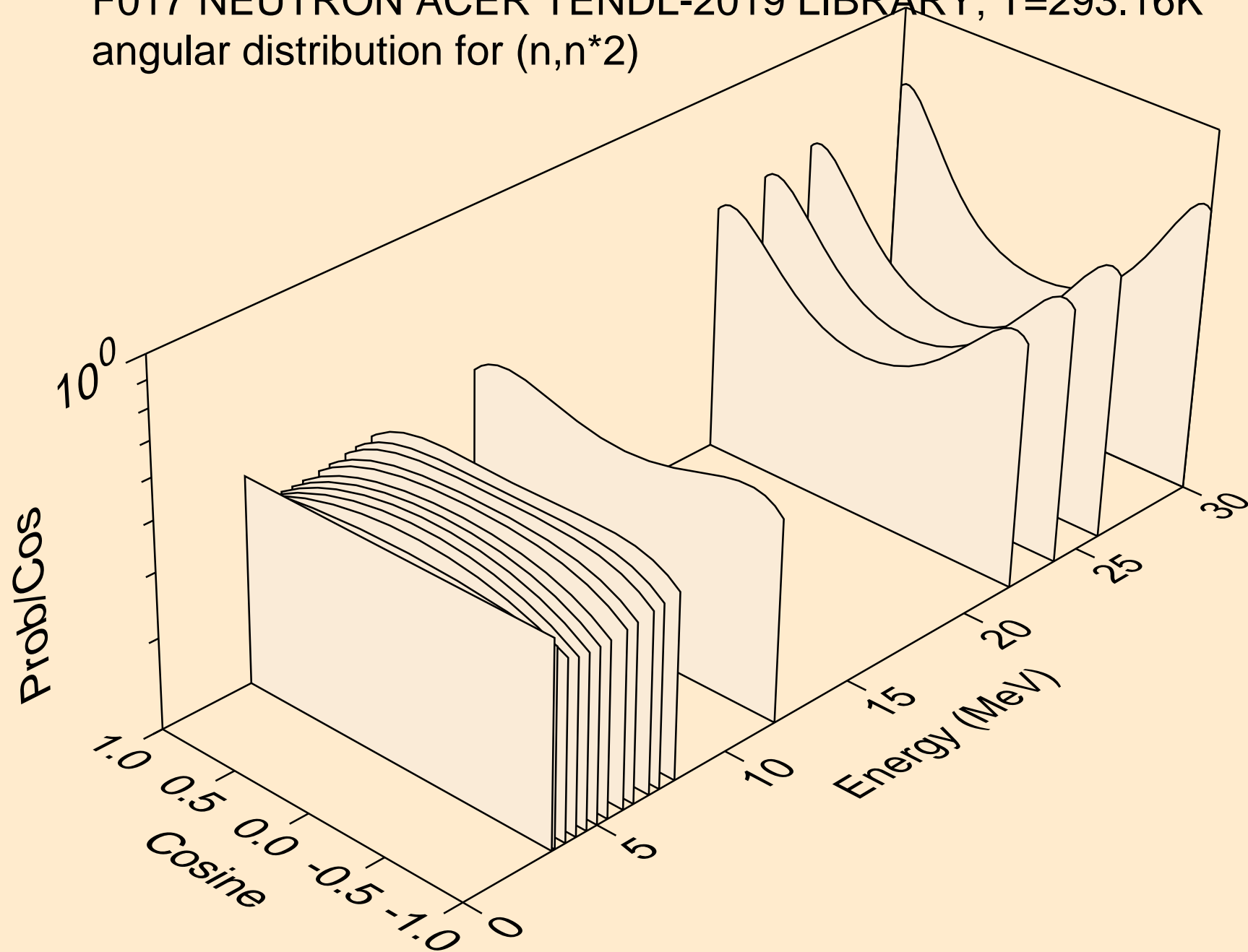

F017 NEUTRON ACER TENDL-2019 LIBRARY; T=293.16K
angular distribution for (n,n*3)

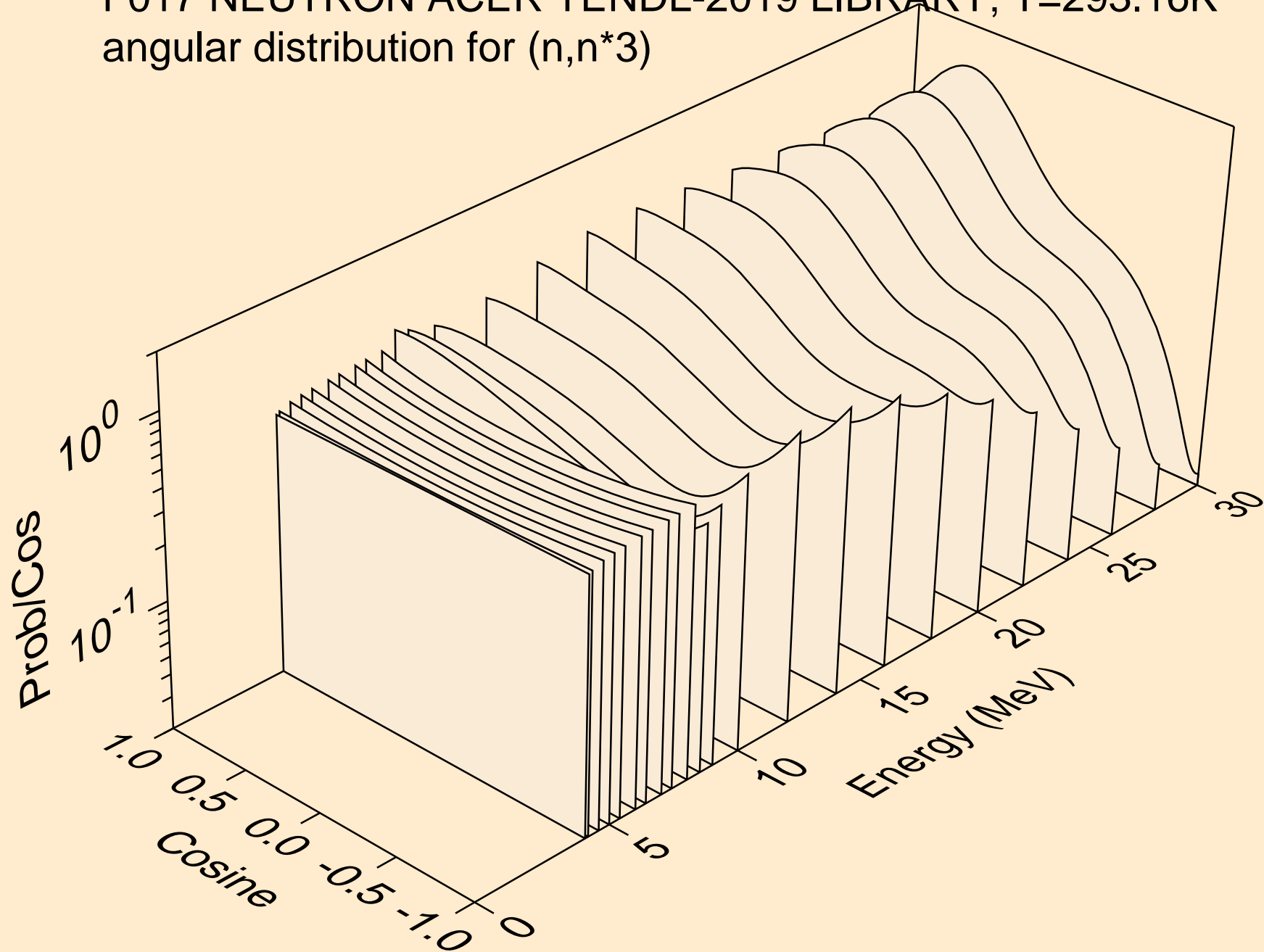

F017 NEUTRON ACER TENDL-2019 LIBRARY; T=293.16K
angular distribution for (n,n*4)

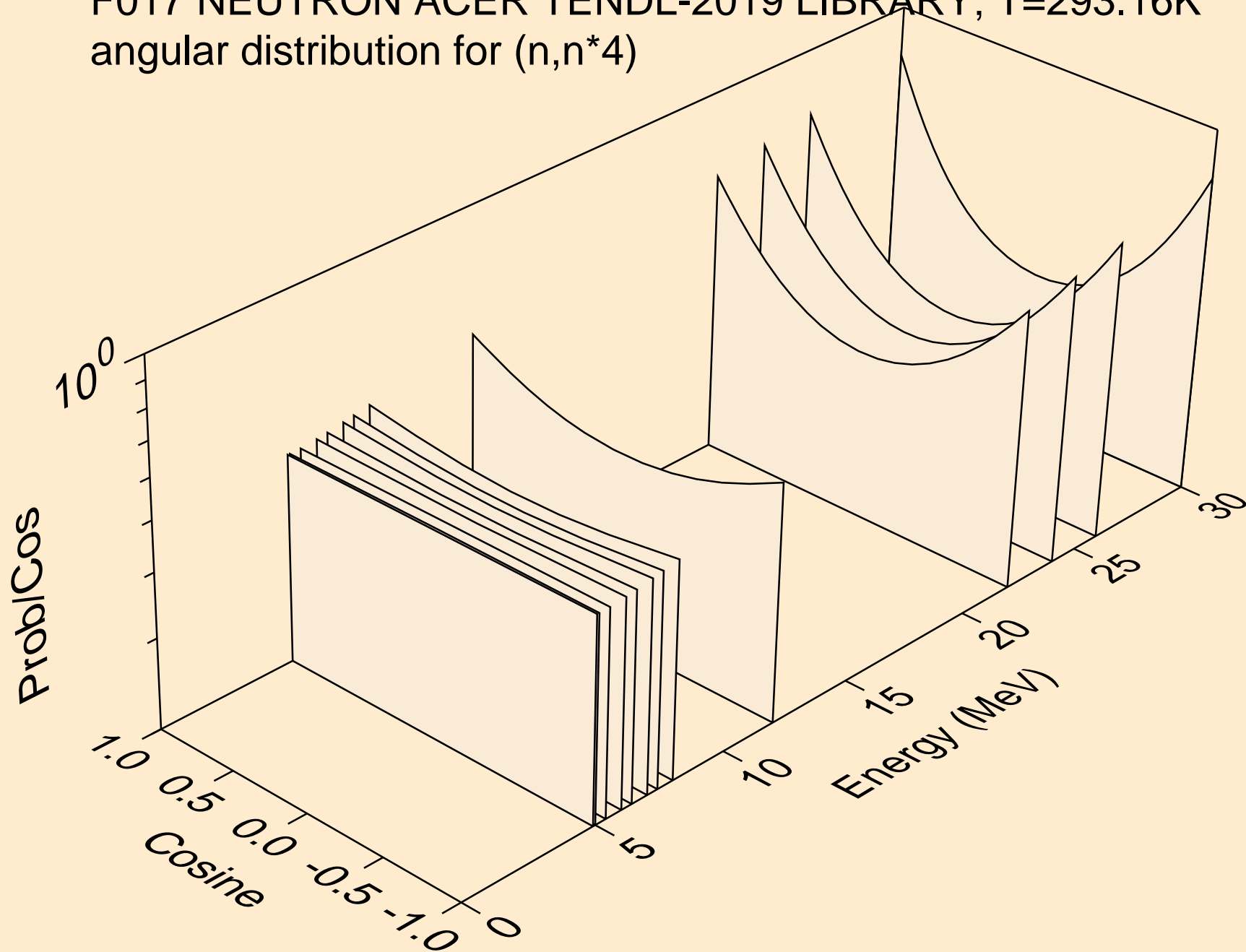

F017 NEUTRON ACER TENDL-2019 LIBRARY; T=293.16K
angular distribution for (n,n*5)

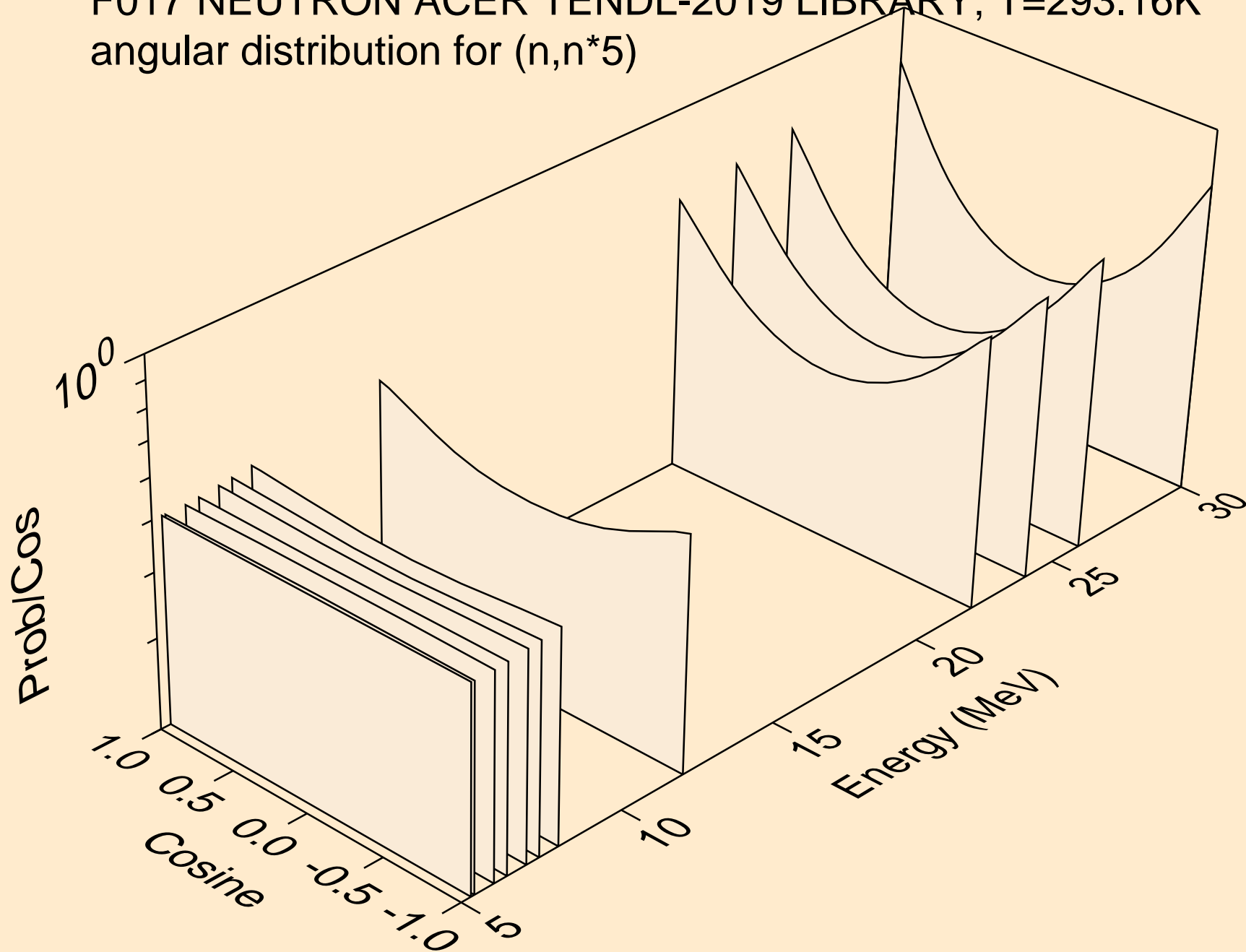

F017 NEUTRON ACER TENDL-2019 LIBRARY; T=293.16K
angular distribution for (n,n*6)

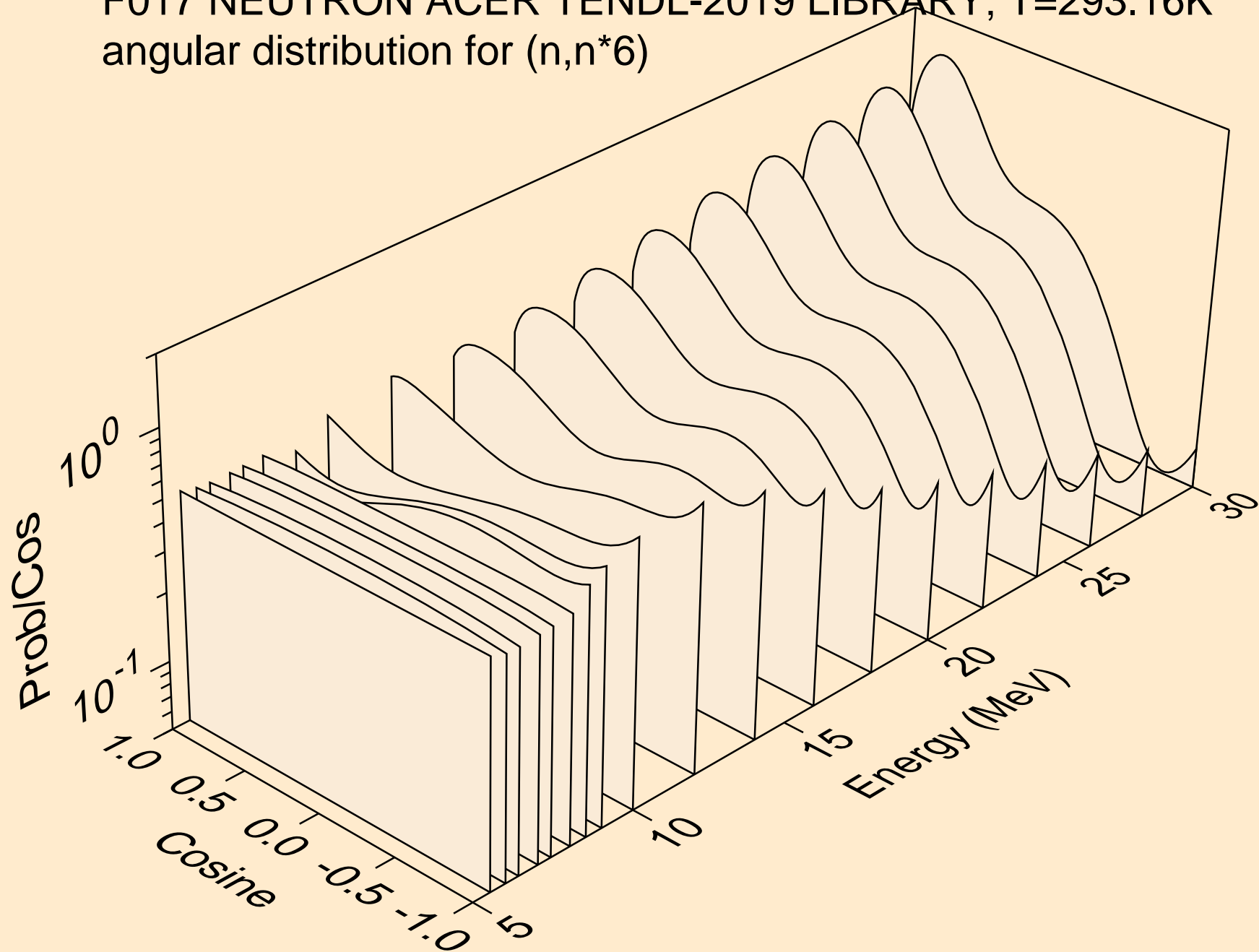

F017 NEUTRON ACER TENDL-2019 LIBRARY; T=293.16K
angular distribution for (n,n*7)

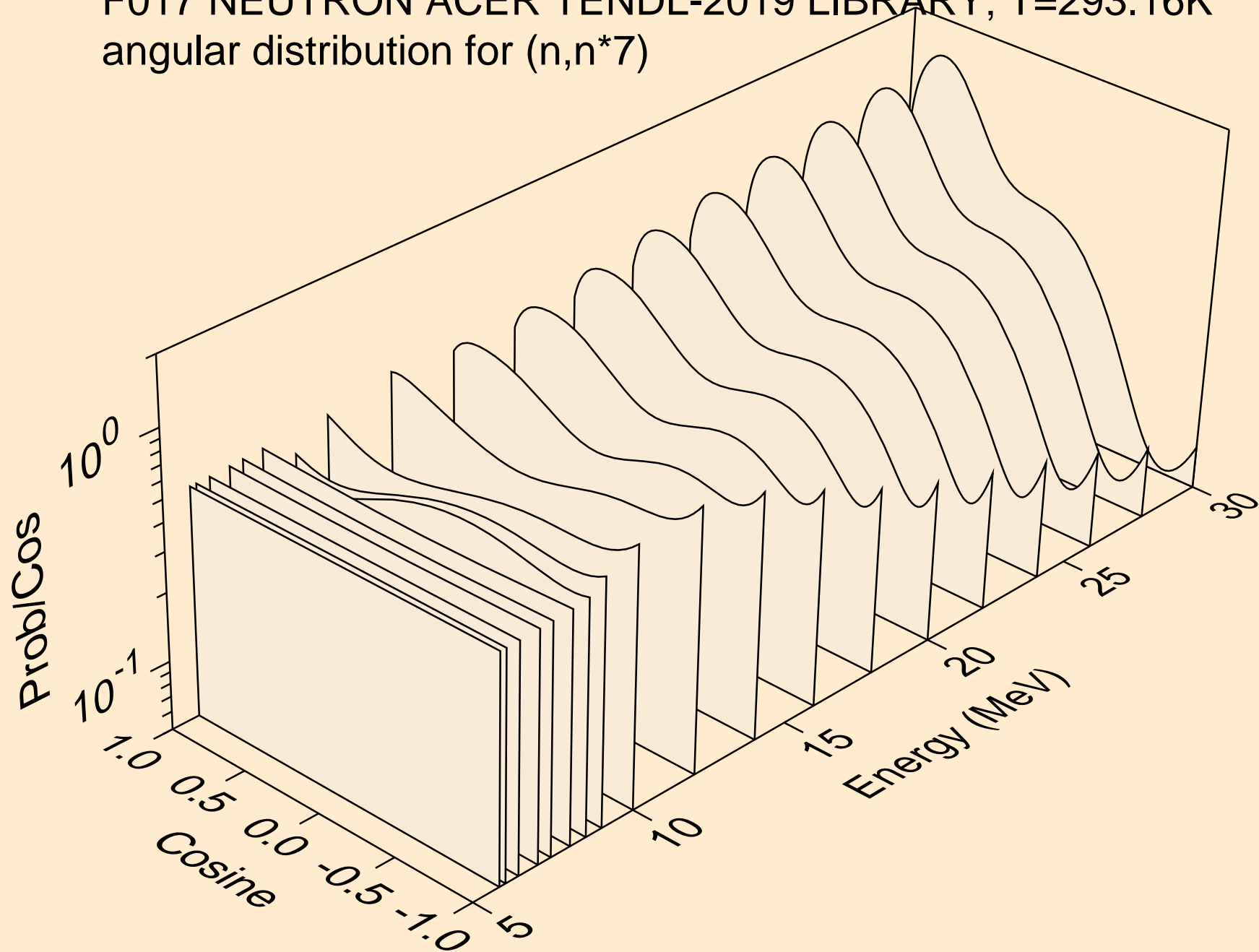

F017 NEUTRON ACER TENDL-2019 LIBRARY; T=293.16K
angular distribution for (n,n*8)

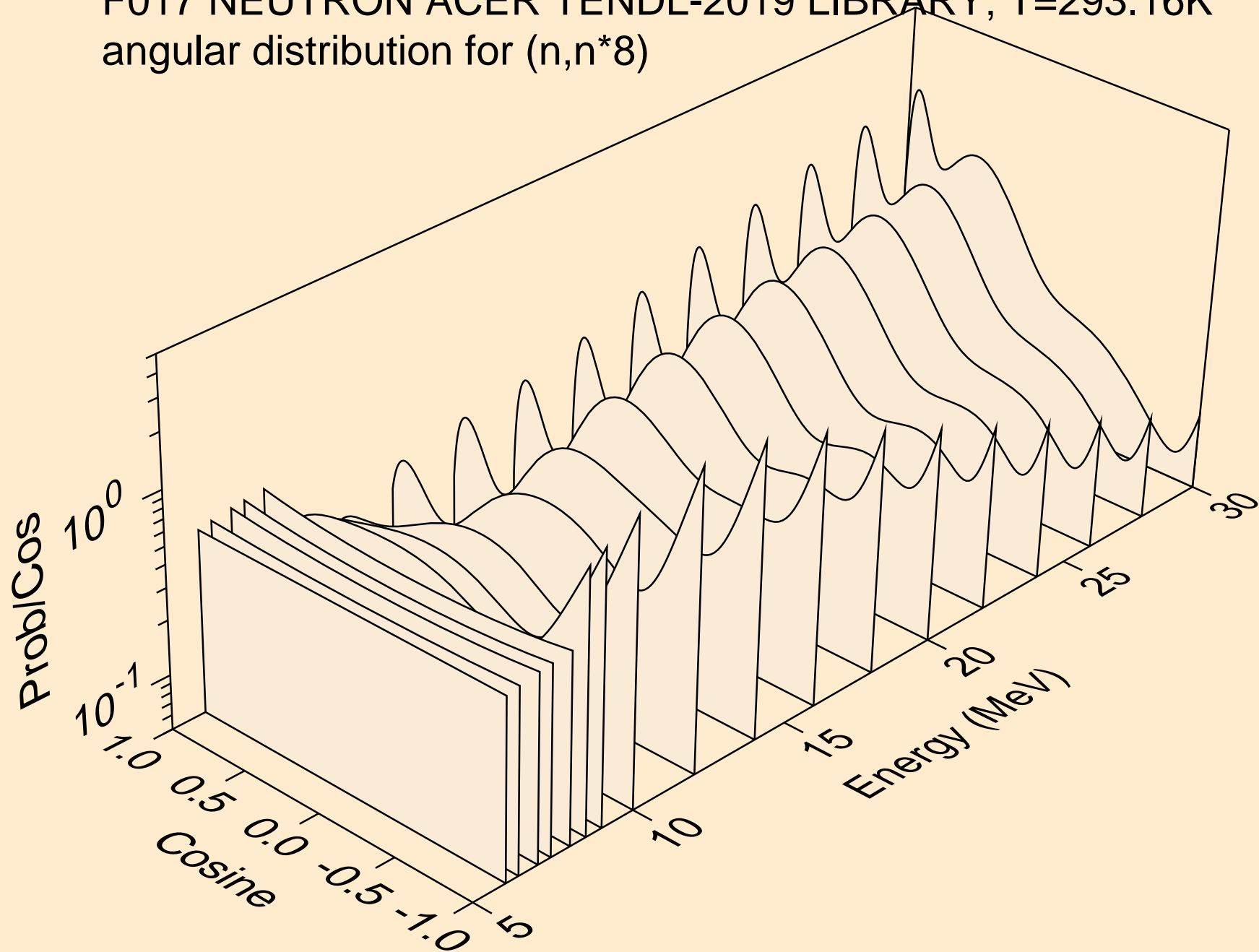

F017 NEUTRON ACER TENDL-2019 LIBRARY; T=293.16K
Neutron emission for (n,x)

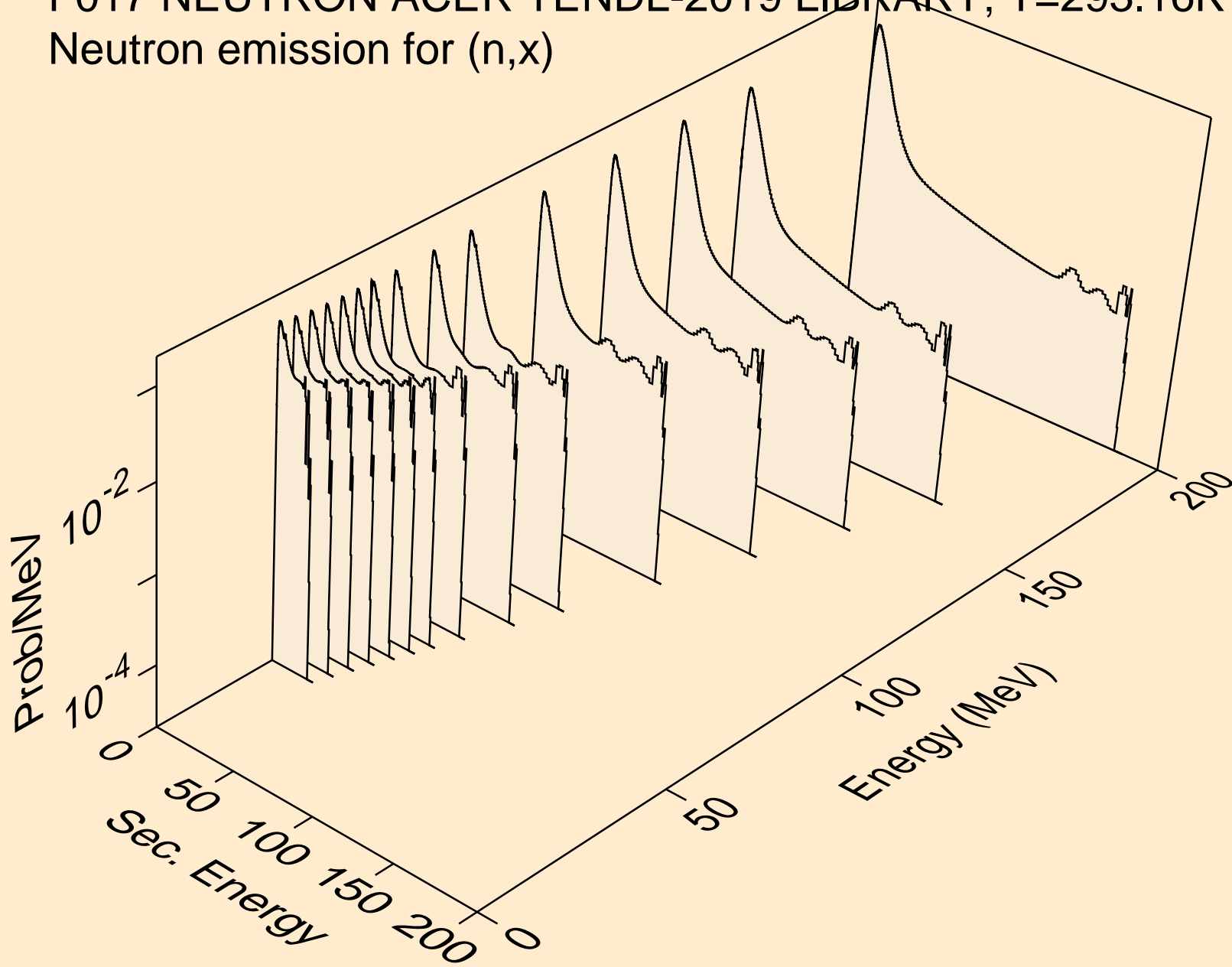

F017 NEUTRON ACER TENDL-2019 LIBRARY; T=293.16K
Neutron emission for (n,2n)

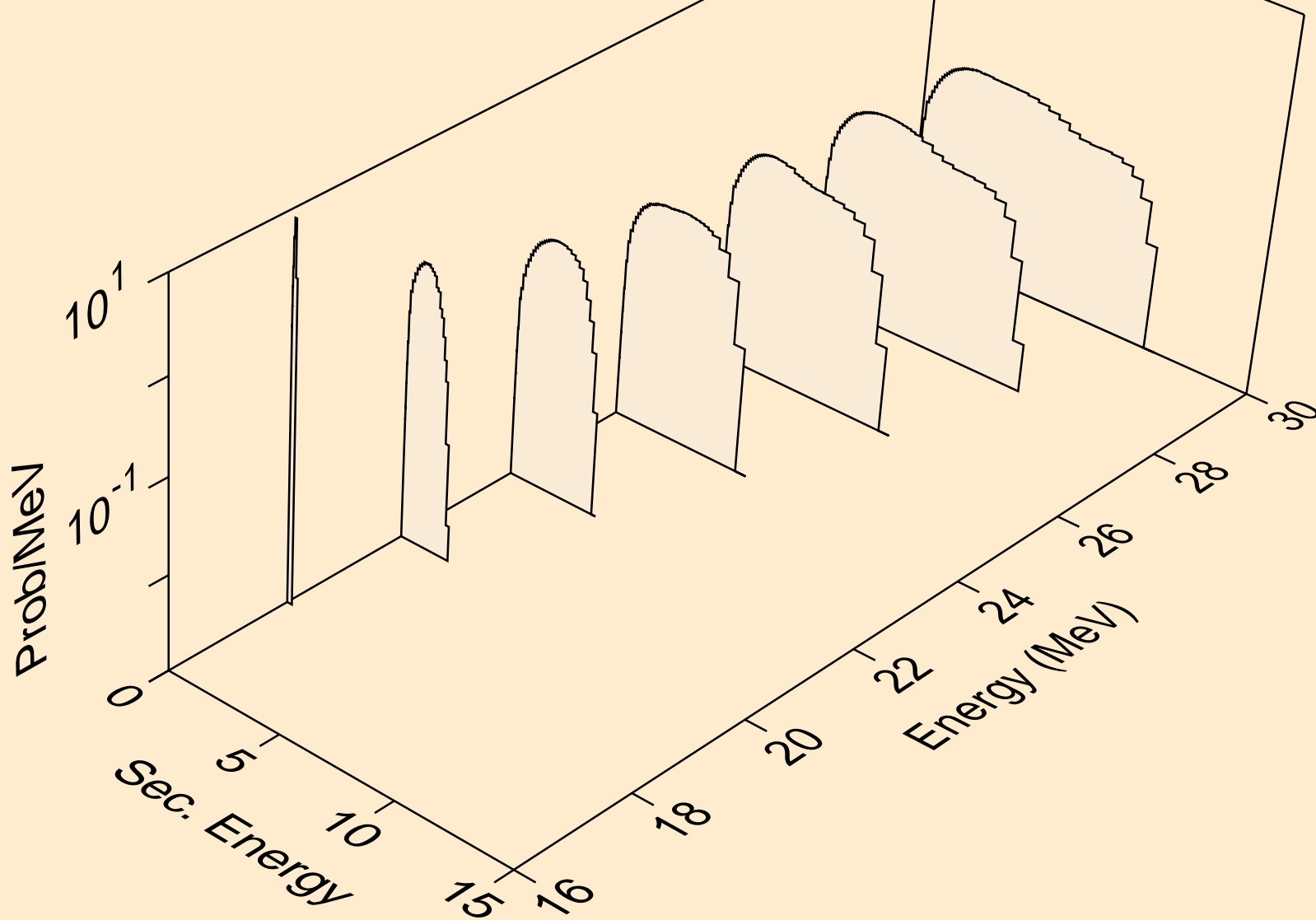

F017 NEUTRON ACER TENDL-2019 LIBRARY; T=293.16K
Neutron emission for (n,n*)a

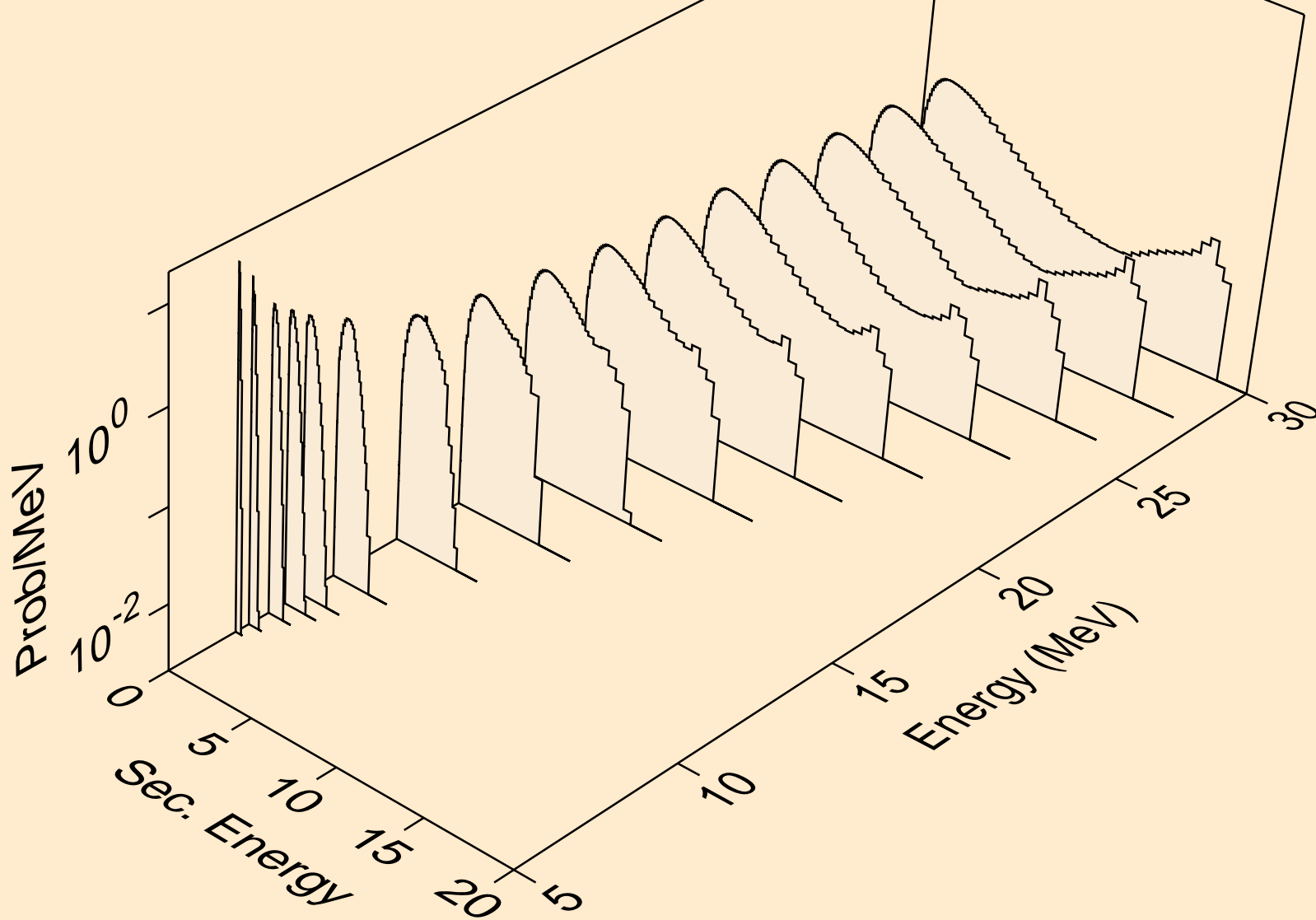

F017 NEUTRON ACER TENDL-2019 LIBRARY; T=293.16K
Neutron emission for (n,2n)a

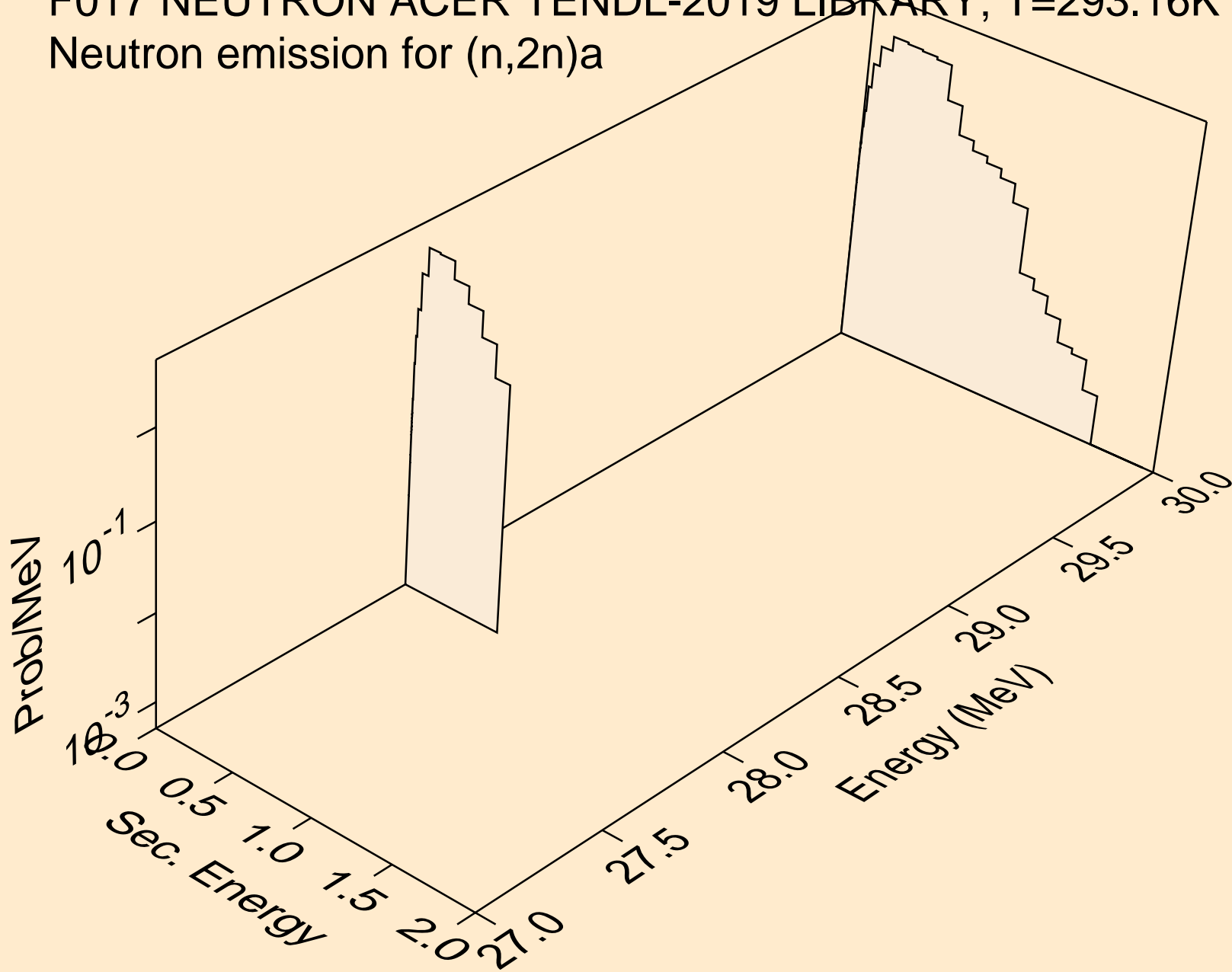

F017 NEUTRON ACER TENDL-2019 LIBRARY; T=293.16K
Neutron emission for (n,n*)p

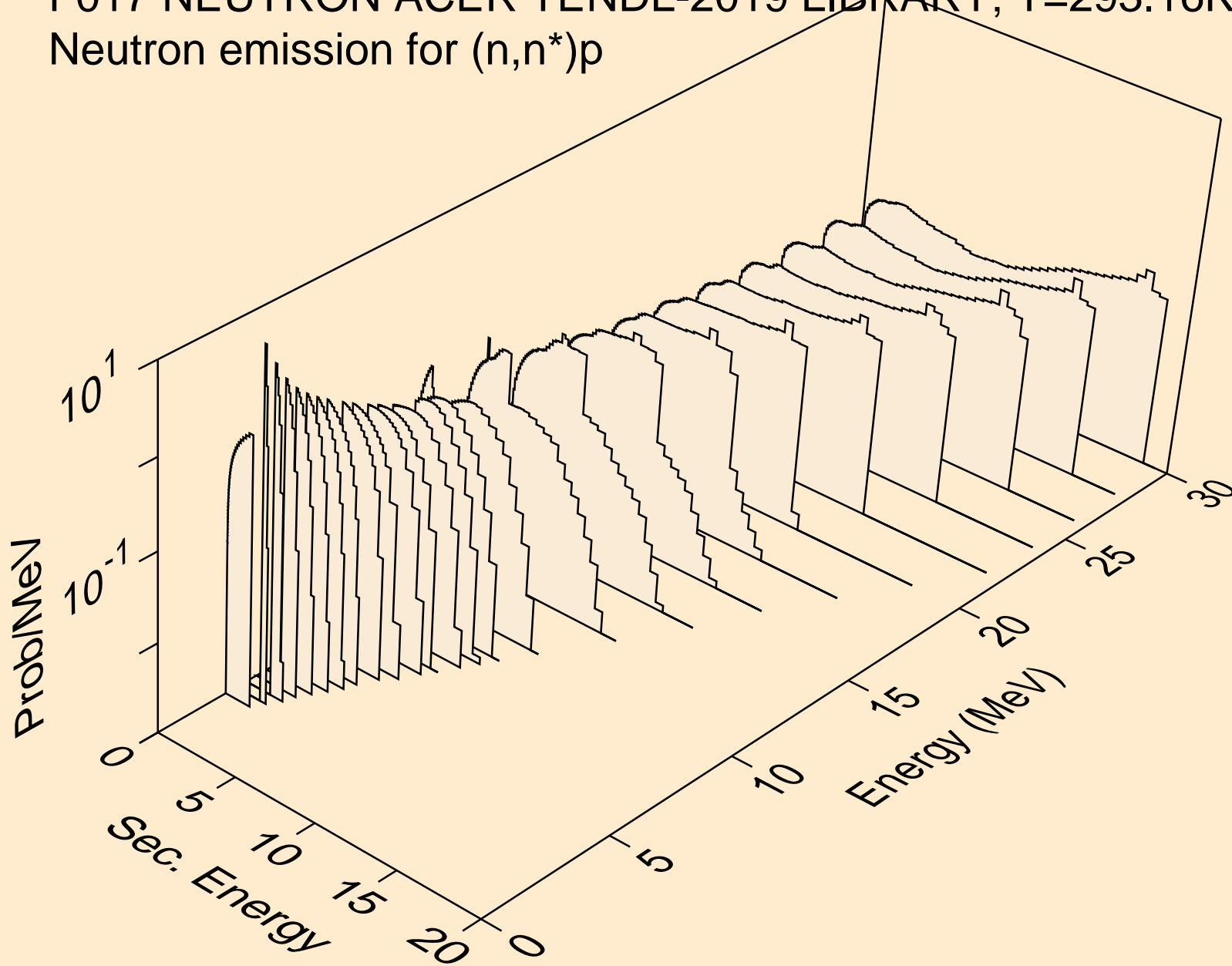

F017 NEUTRON ACER TENDL-2019 LIBRARY; T=293.16K
Neutron emission for (n,n*)2a

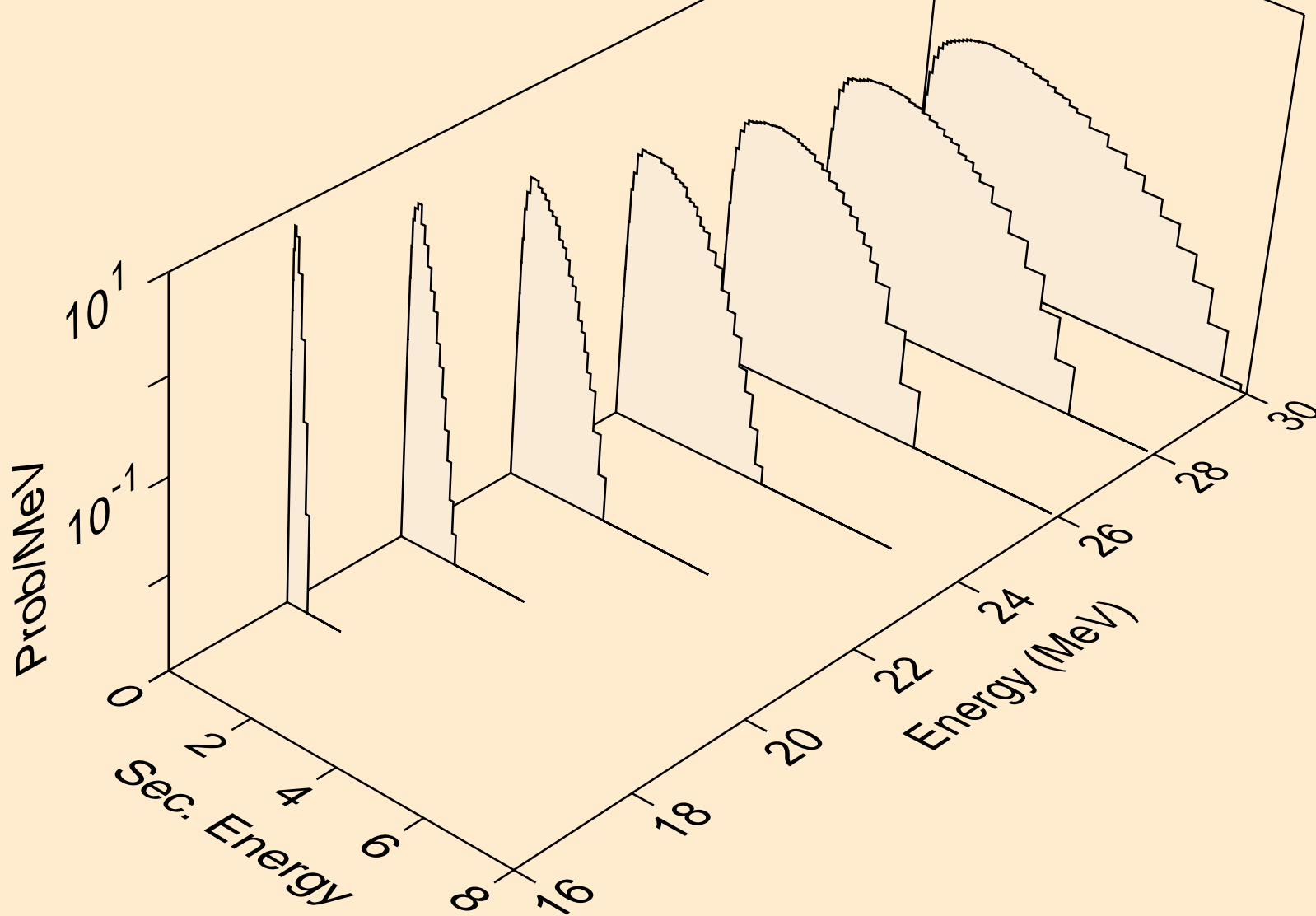

F017 NEUTRON ACER TENDL-2019 LIBRARY; T=293.16K
Neutron emission for (n,n*)d

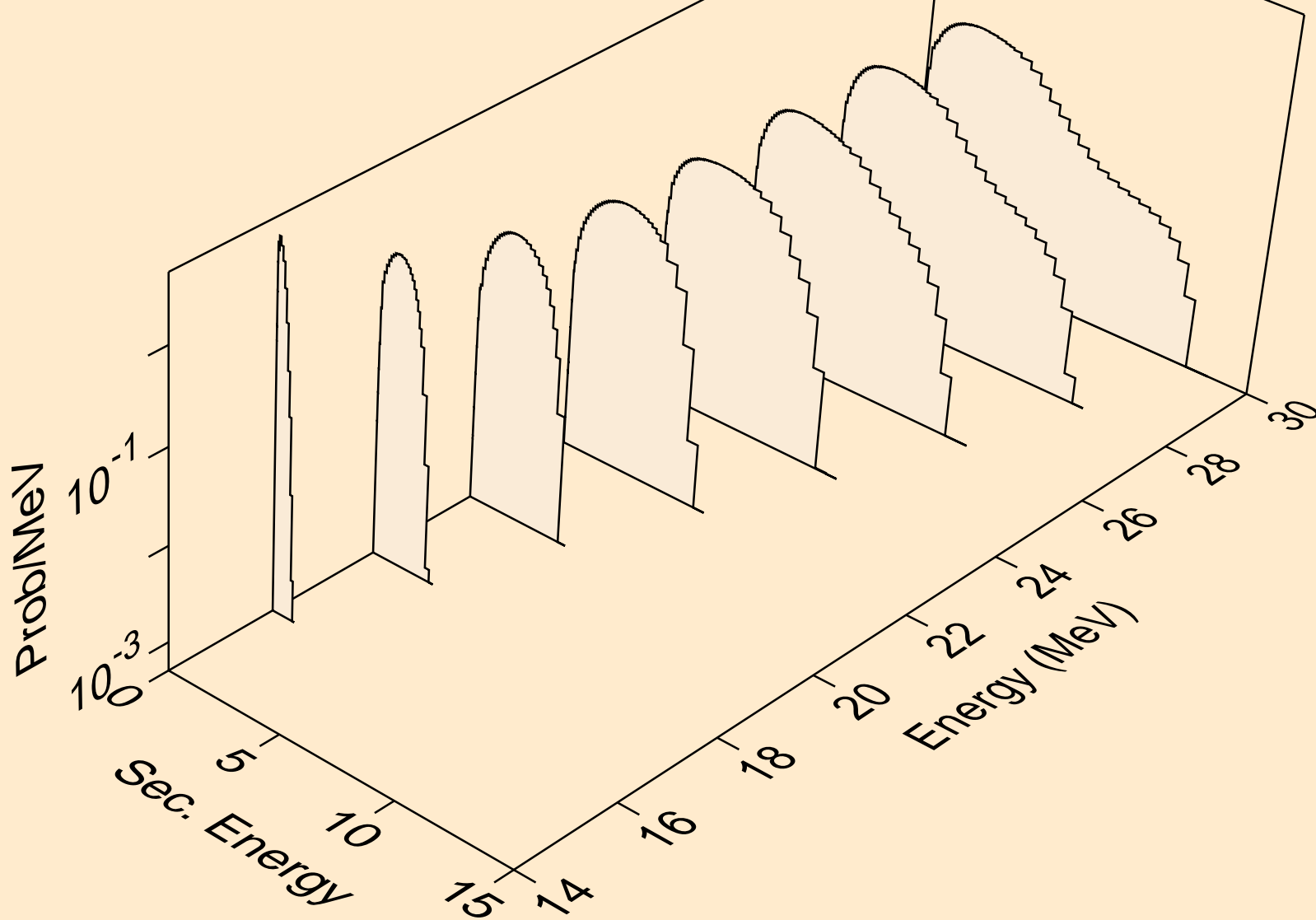

F017 NEUTRON ACER TENDL-2019 LIBRARY; T=293.16K
Neutron emission for (n,n*)t

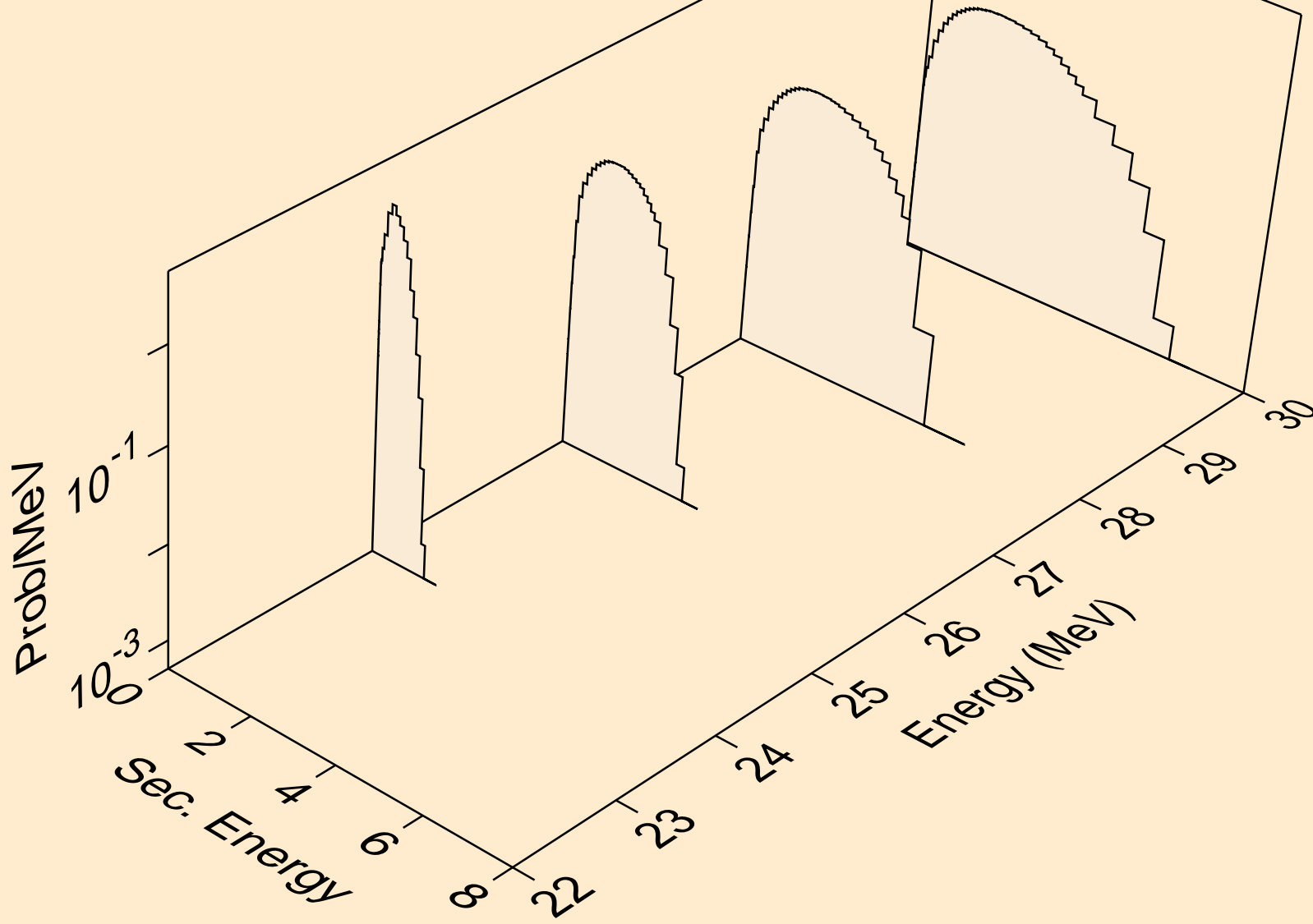

F017 NEUTRON ACER TENDL-2019 LIBRARY; T=293.16K
Neutron emission for (n,n*)he3

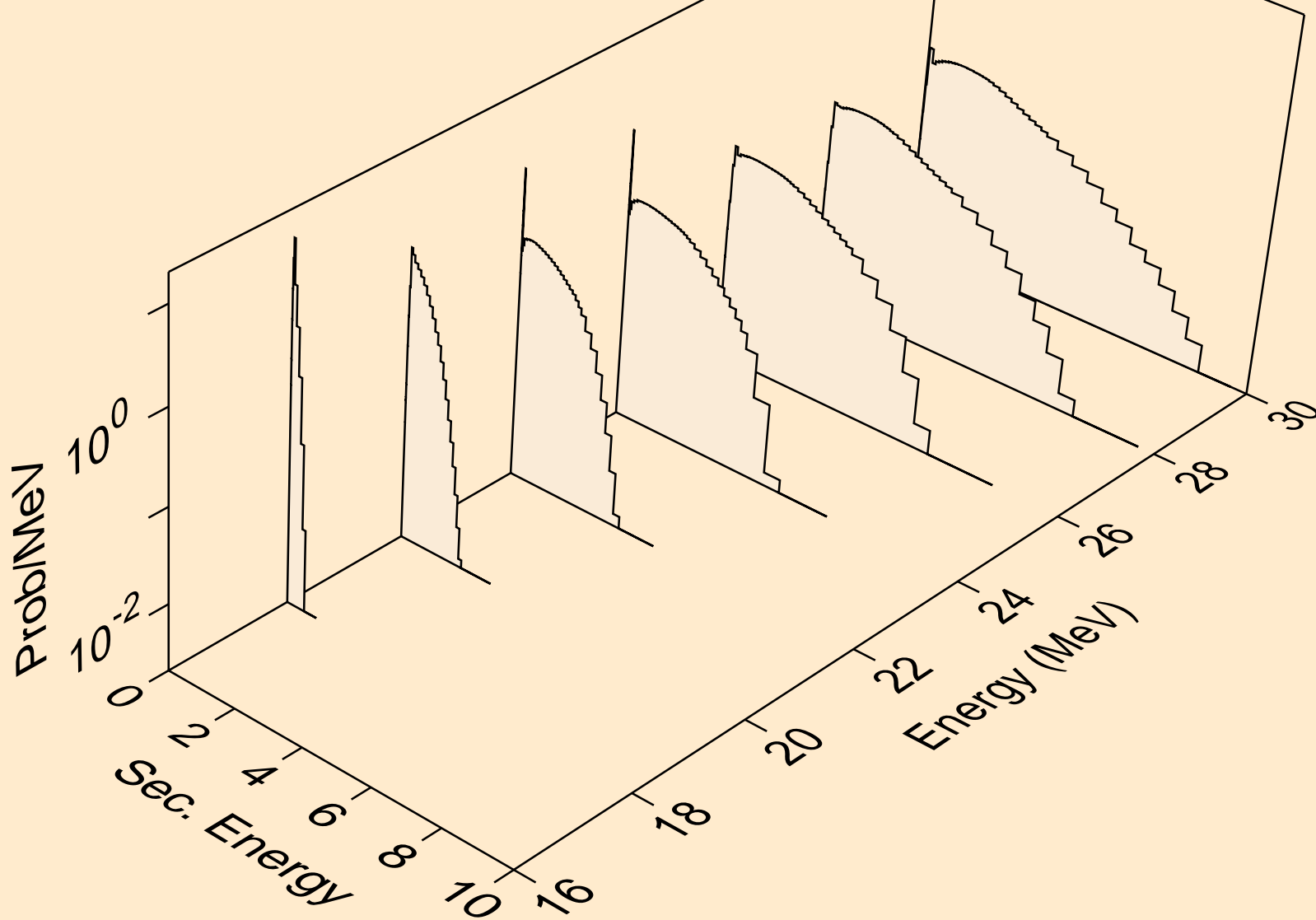

F017 NEUTRON ACER TENDL-2019 LIBRARY; T=293.16K
Neutron emission for (n,2np)

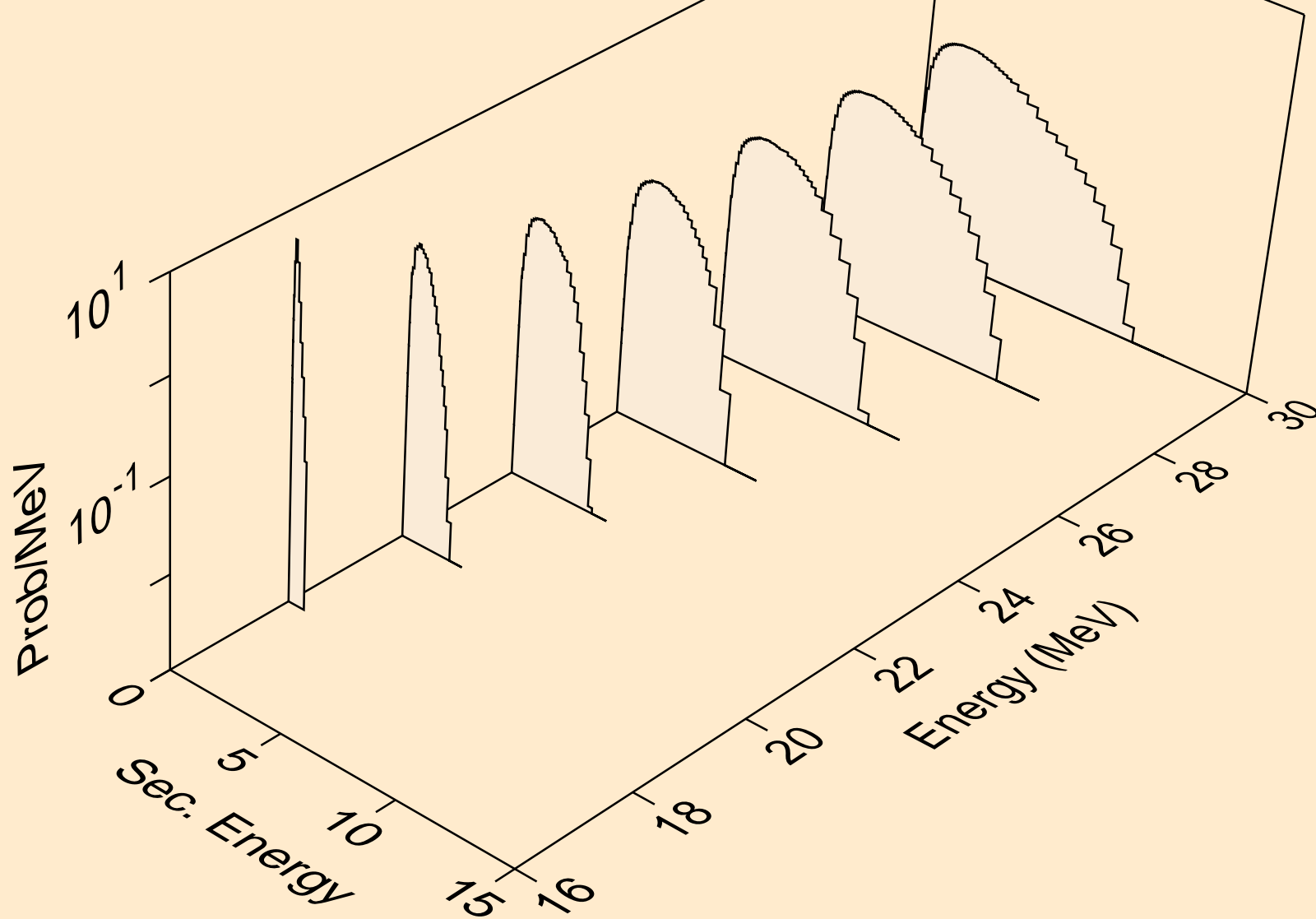

F017 NEUTRON ACER TENDL-2019 LIBRARY; T=293.16K
Neutron emission for (n,2np)

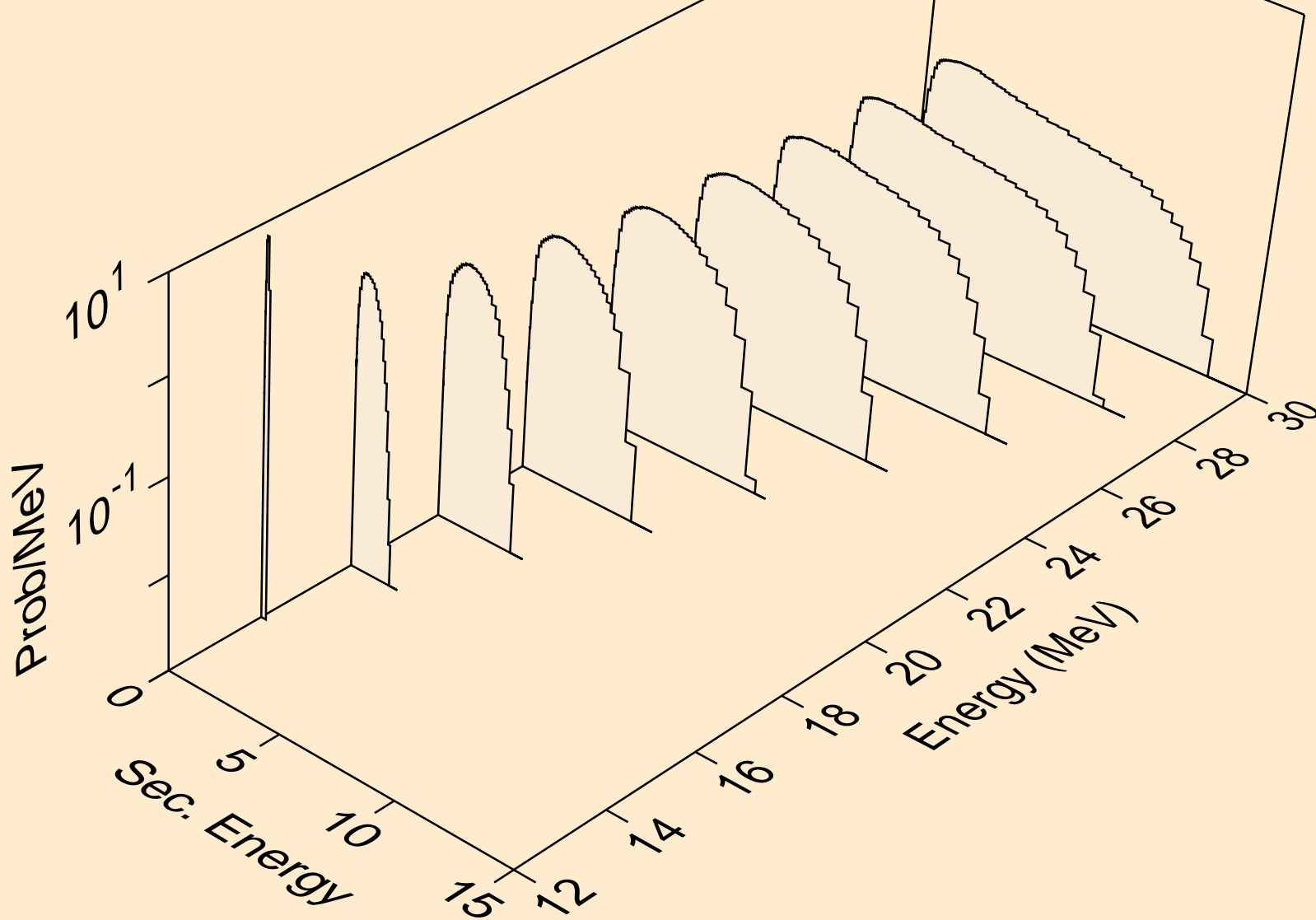

F017 NEUTRON ACER TENDL-2019 LIBRARY; T=293.16K
Neutron emission for (n,npa)

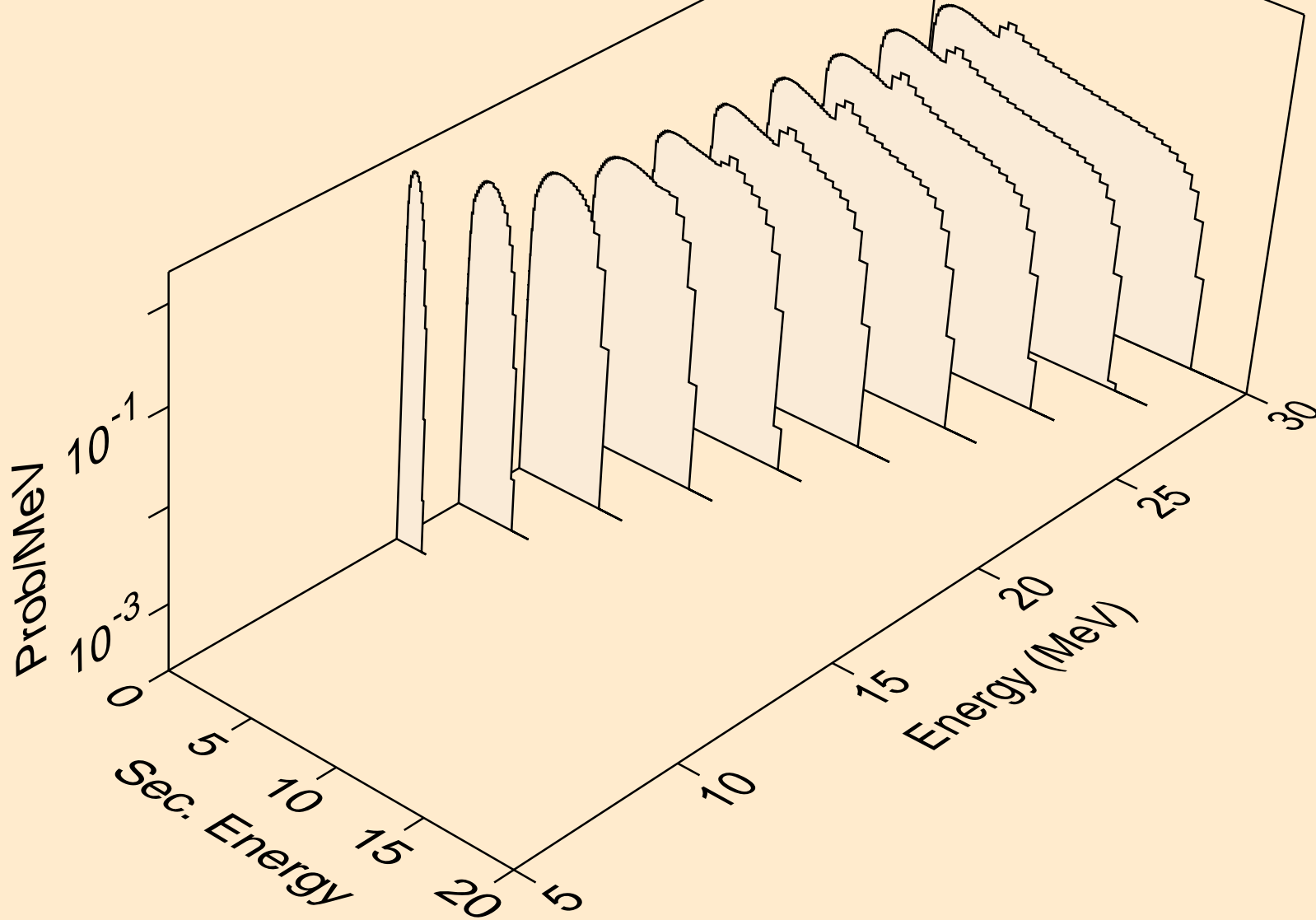

F017 NEUTRON ACER TENDL-2019 LIBRARY; T=293.16K
Neutron emission for (n,n*c)

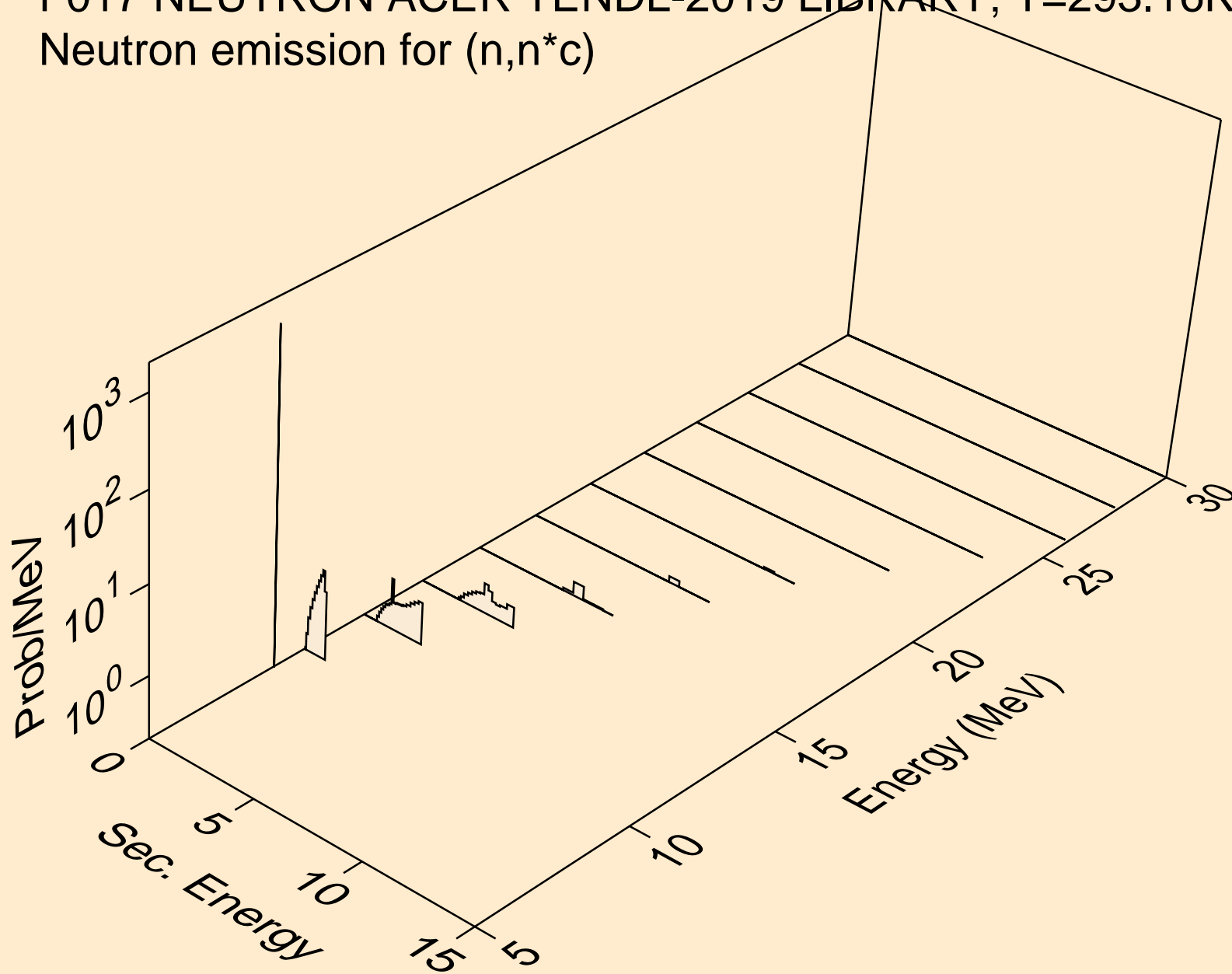

F017 NEUTRON ACER TENDL-2019 LIBRARY; T=293.16K
Photon emission for (n,x)

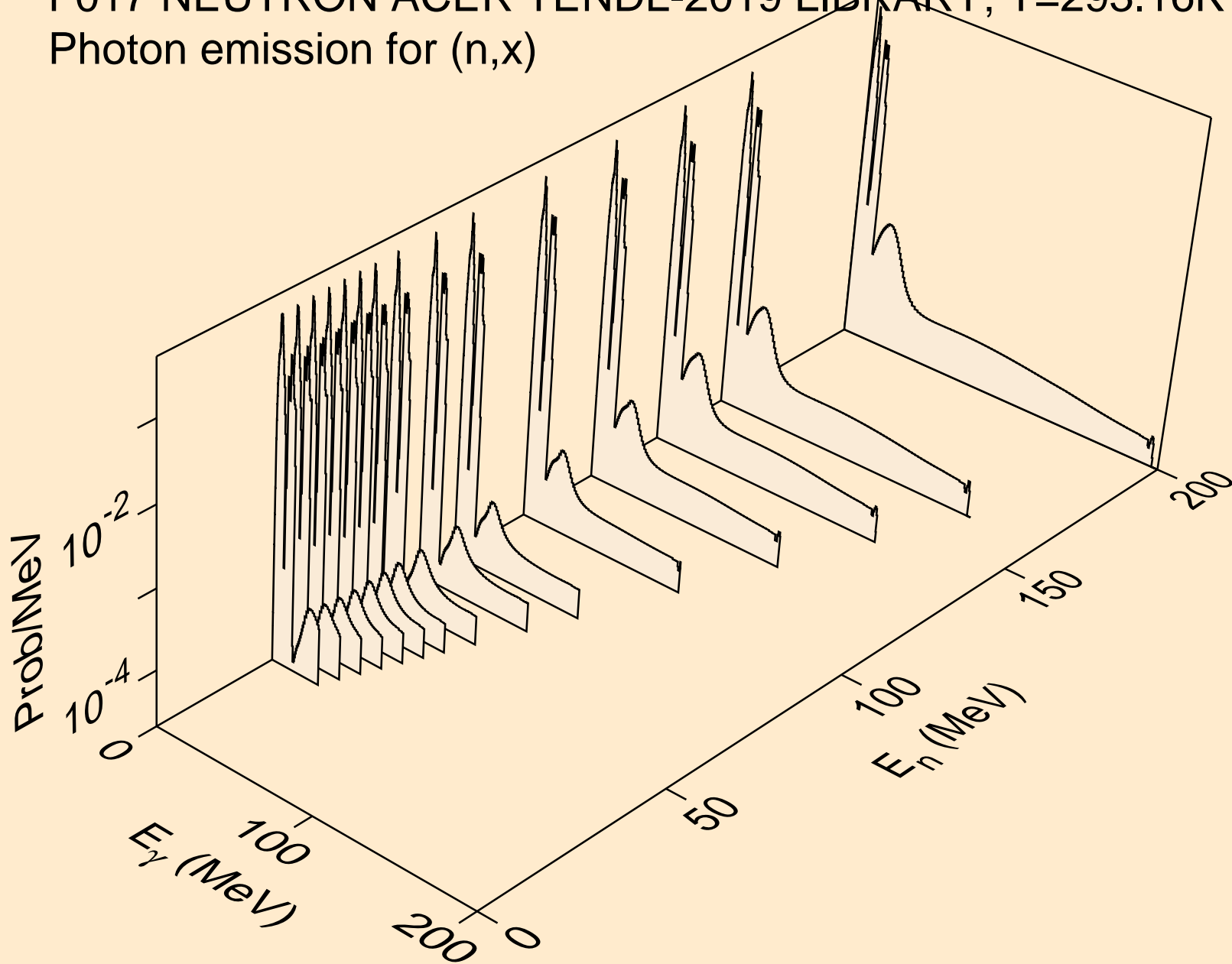

F017 NEUTRON ACER TENDL-2019 LIBRARY; T=293.16K
Photon emission for (n,2n)

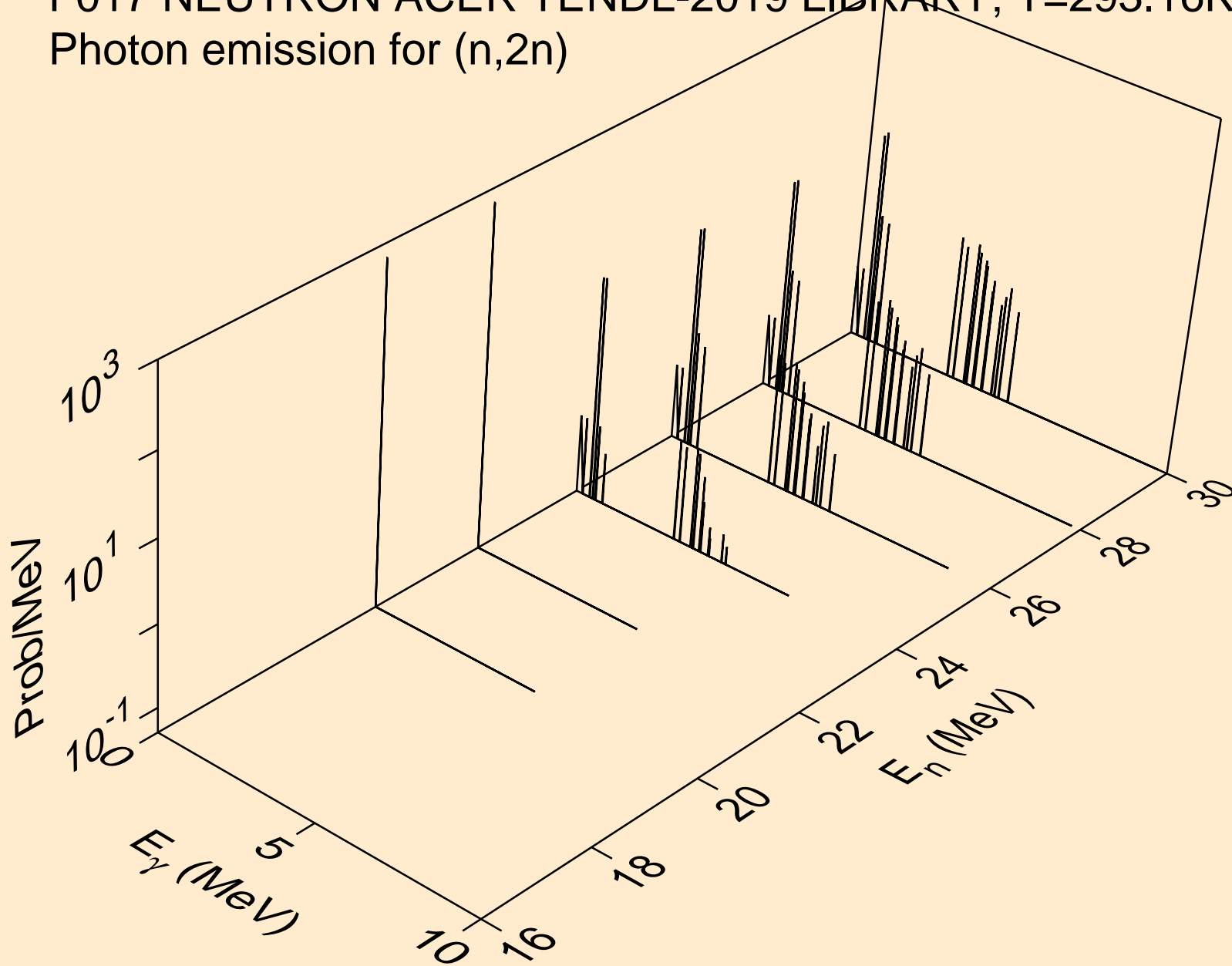

F017 NEUTRON ACER TENDL-2019 LIBRARY; T=293.16K
Photon emission for (n,n*)a

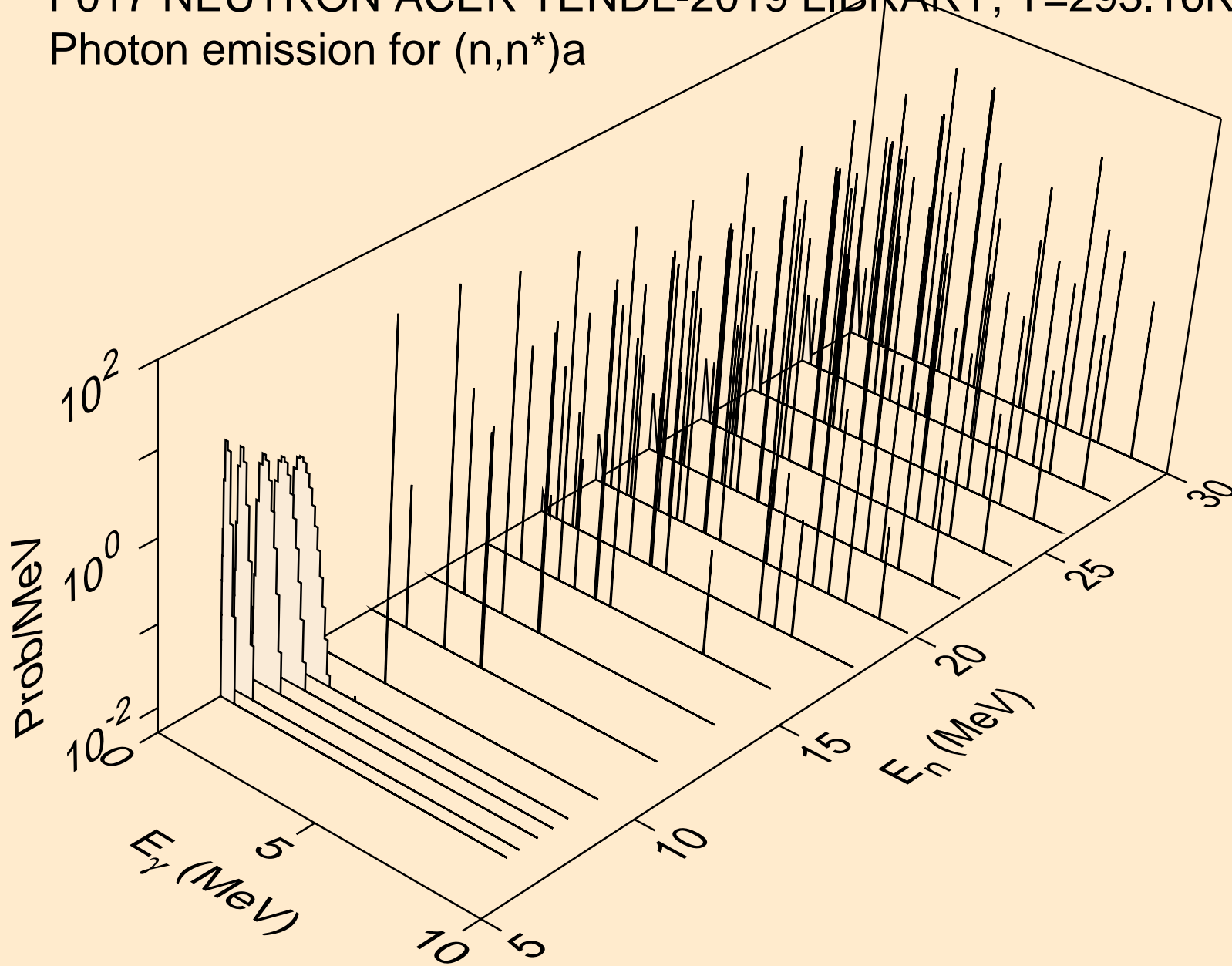

F017 NEUTRON ACER TENDL-2019 LIBRARY; T=293.16K
Photon emission for (n,2n)a

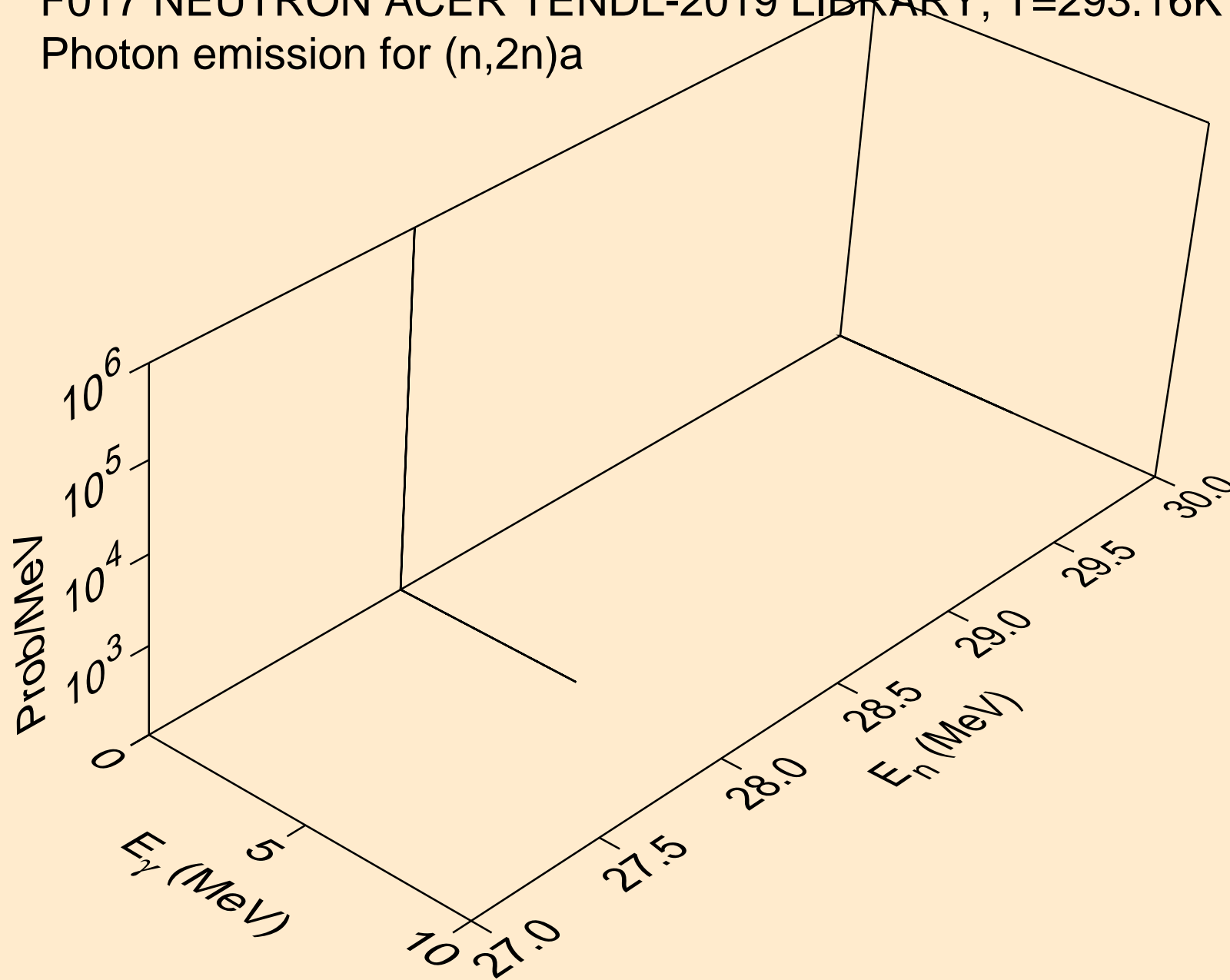

F017 NEUTRON ACER TENDL-2019 LIBRARY; T=293.16K
Photon emission for (n,n*)p

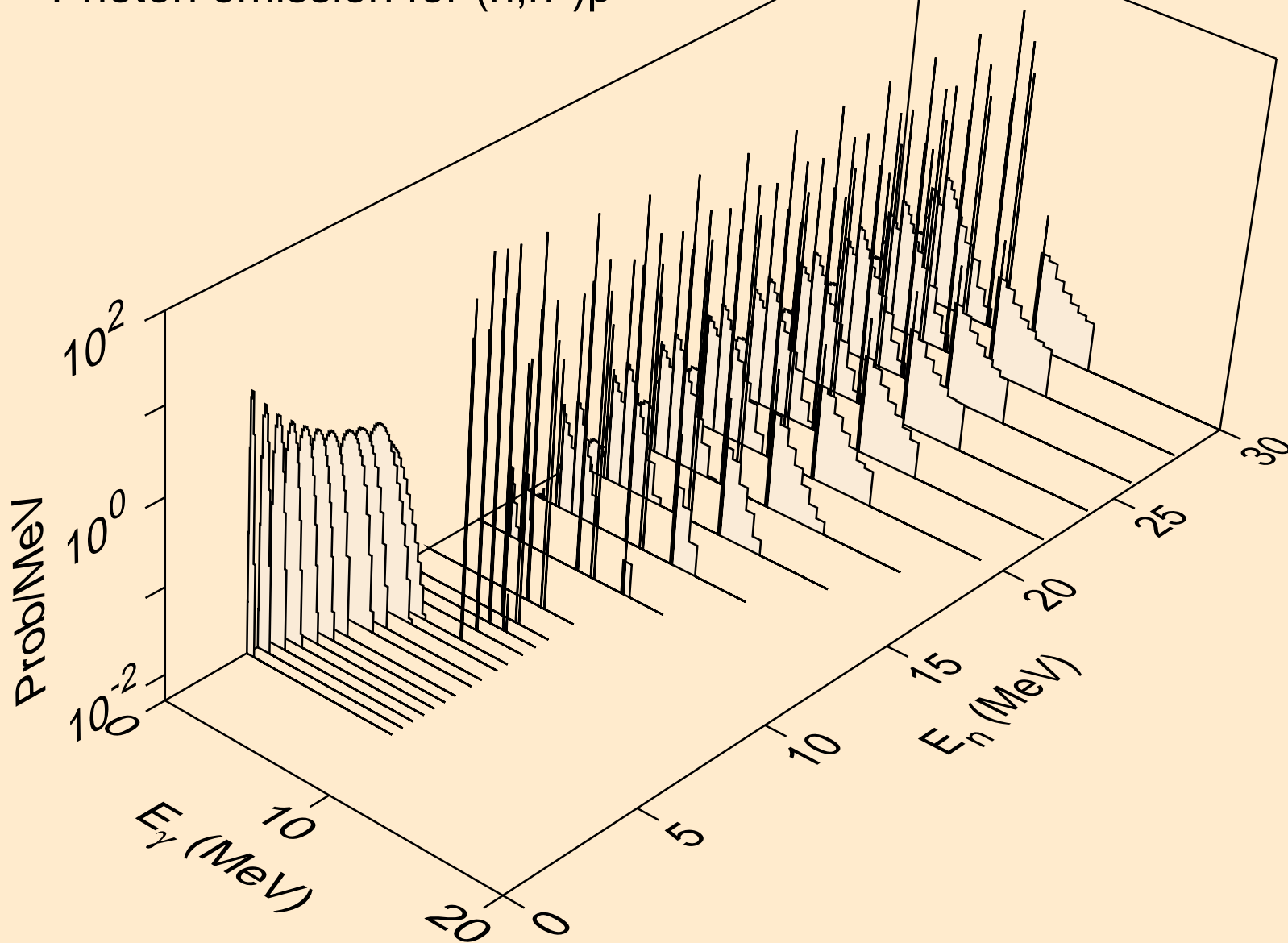

F017 NEUTRON ACER TENDL-2019 LIBRARY; T=293.16K
Photon emission for (n,n*)2a

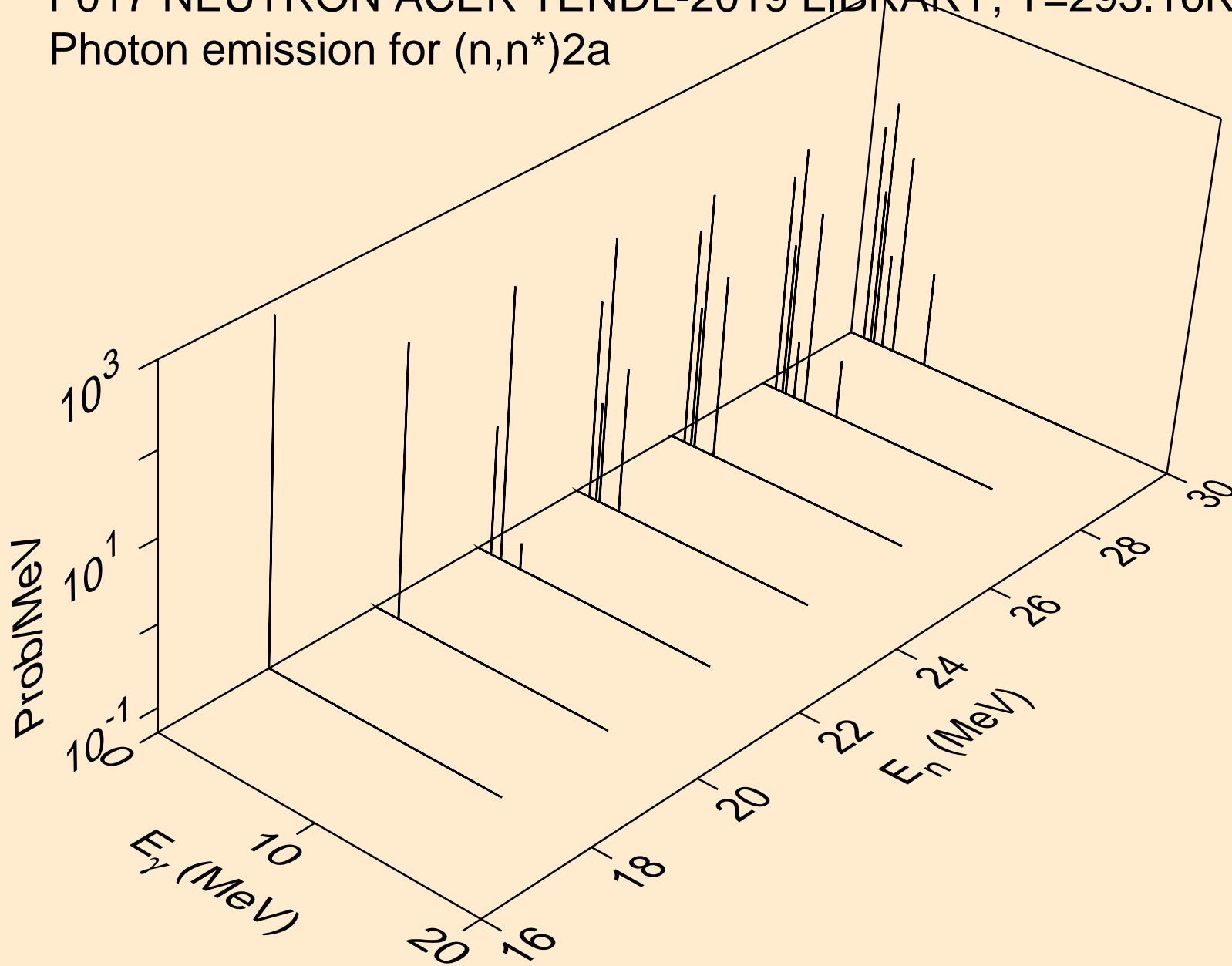

F017 NEUTRON ACER TENDL-2019 LIBRARY; T=293.16K
Photon emission for (n,n*)d

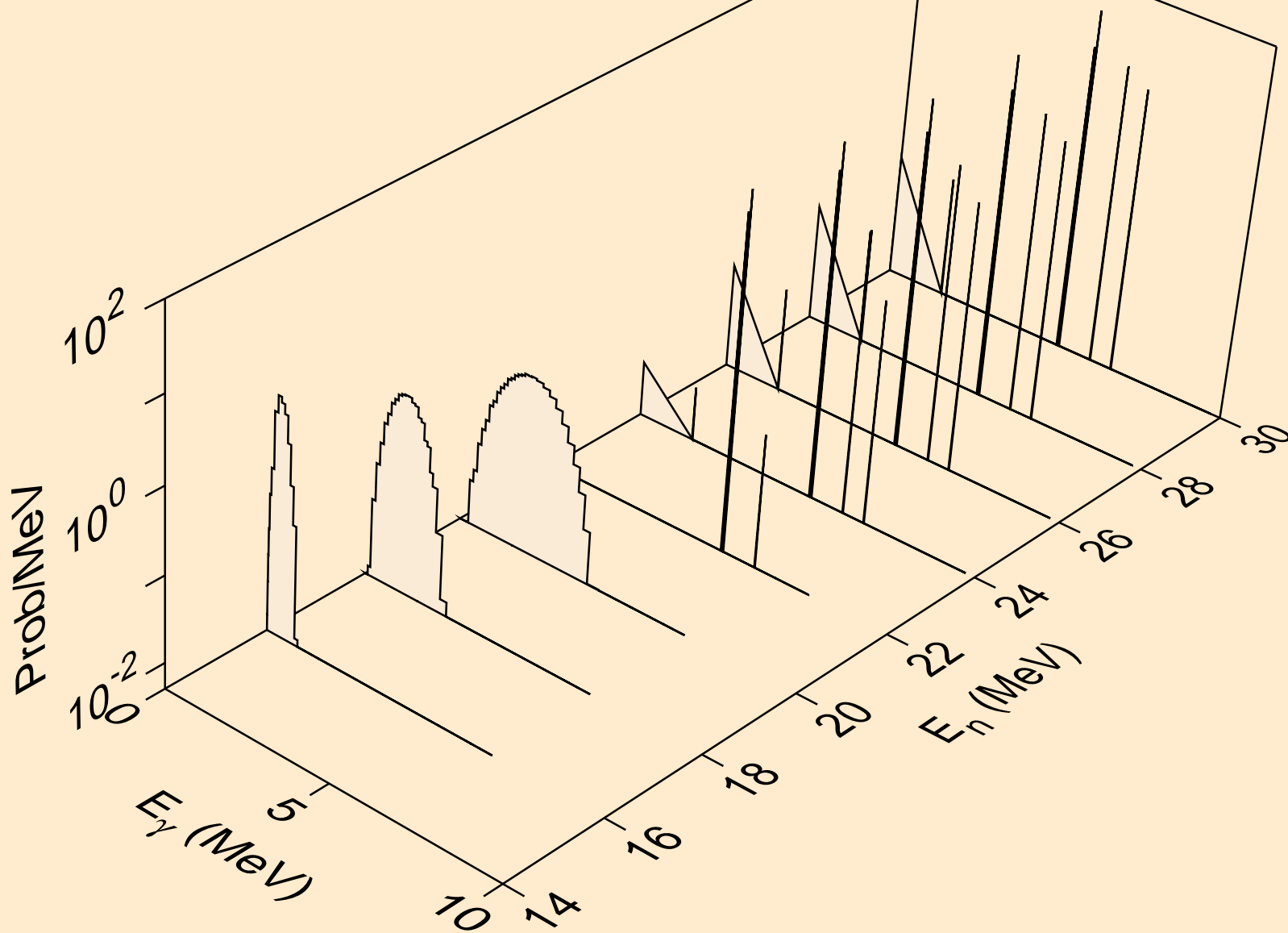

F017 NEUTRON ACER TENDL-2019 LIBRARY; T=293.16K
Photon emission for (n,n*)t

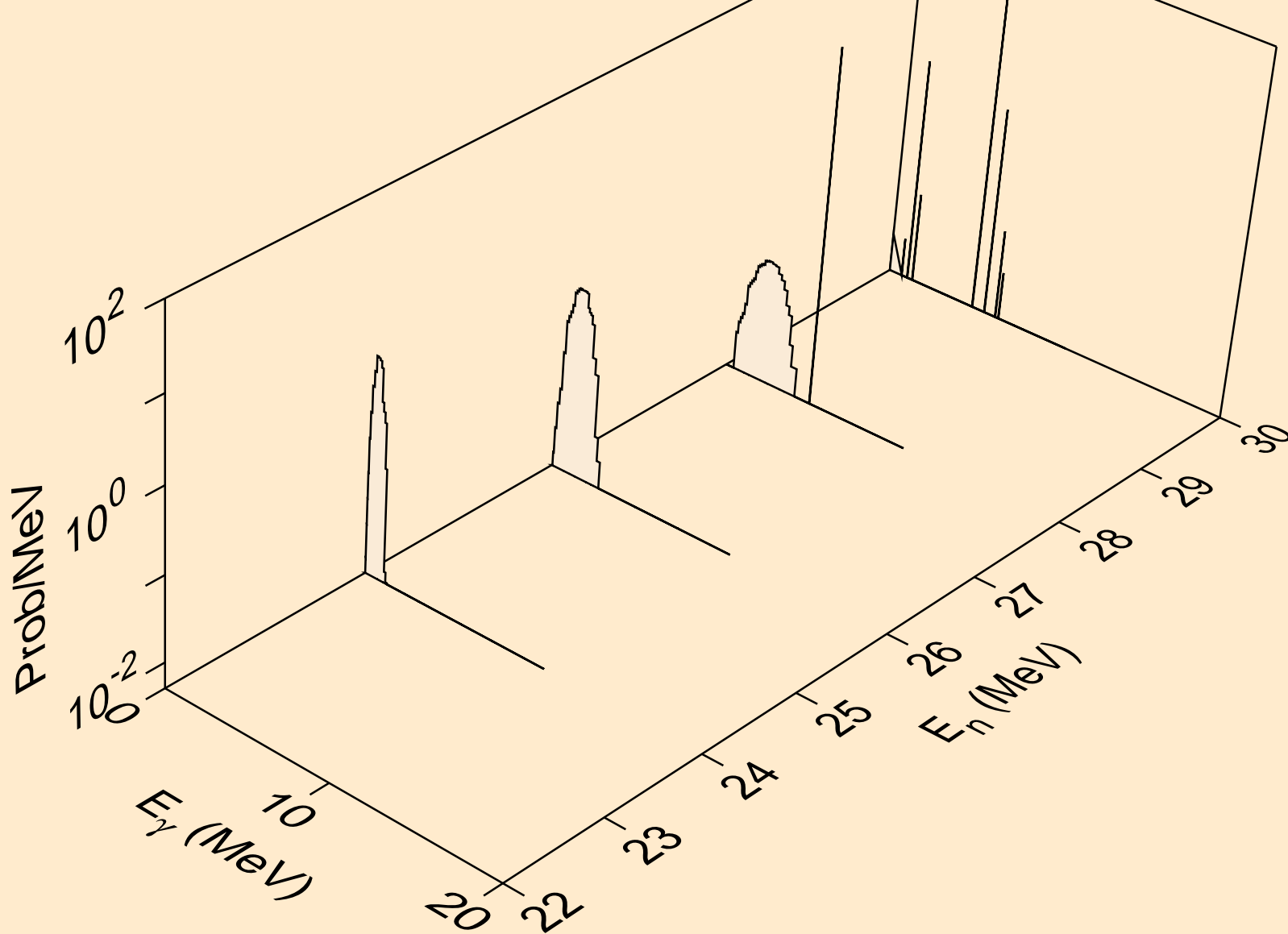

F017 NEUTRON ACER TENDL-2019 LIBRARY; T=293.16K
Photon emission for (n,n*)he3

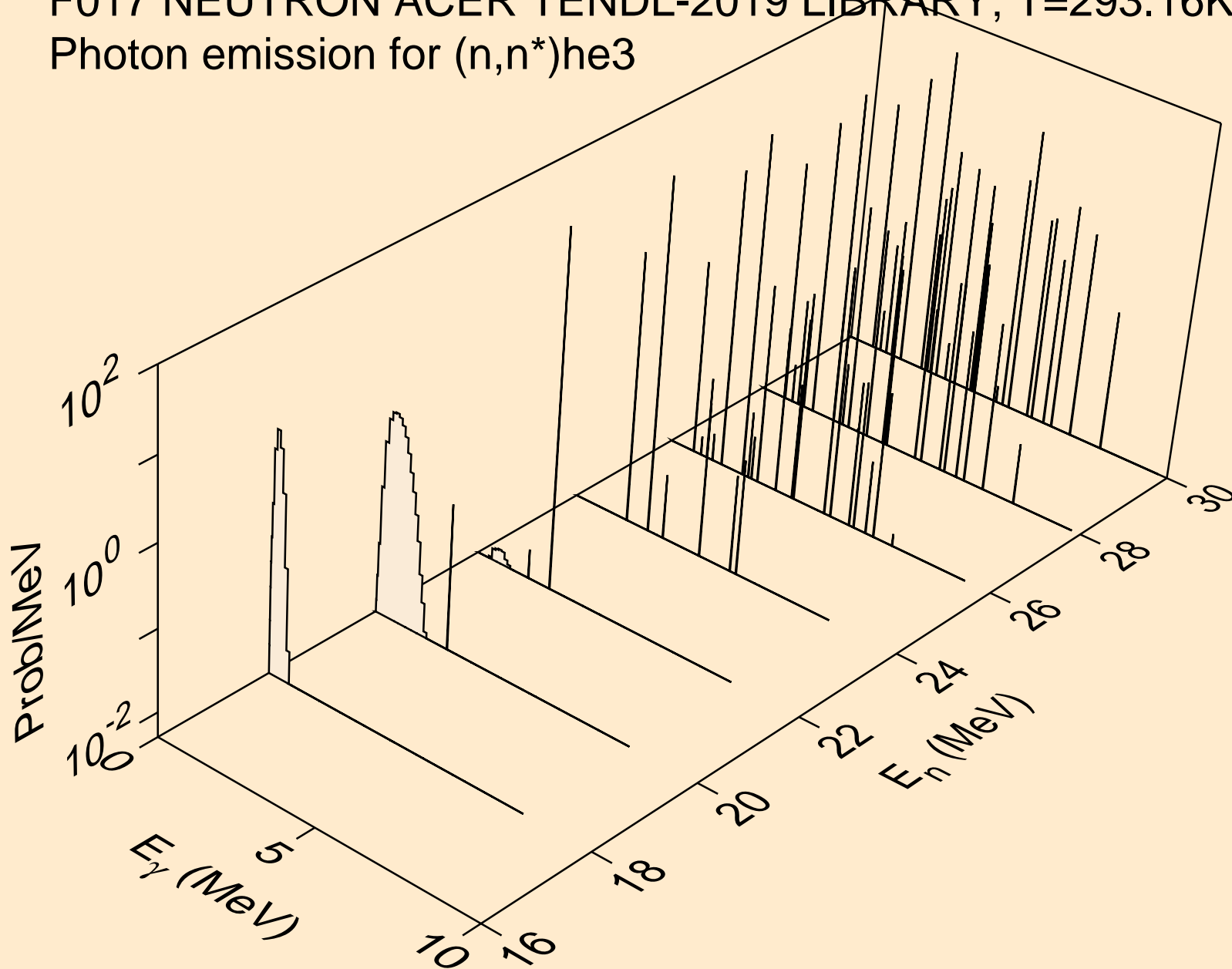

F017 NEUTRON ACER TENDL-2019 LIBRARY; T=293.16K
Photon emission for (n,2np)

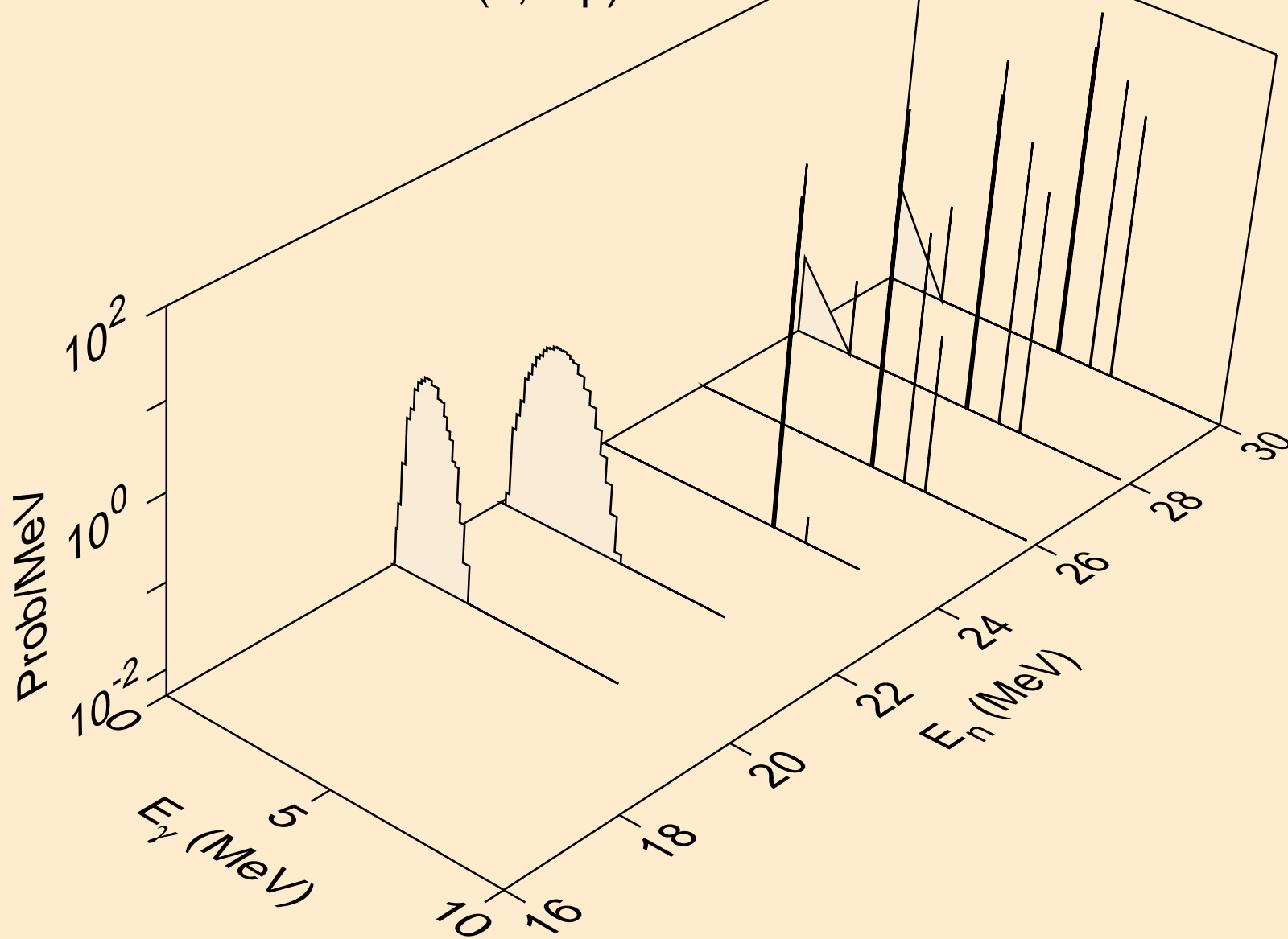

F017 NEUTRON ACER TENDL-2019 LIBRARY; T=293.16K
Photon emission for (n,2np)

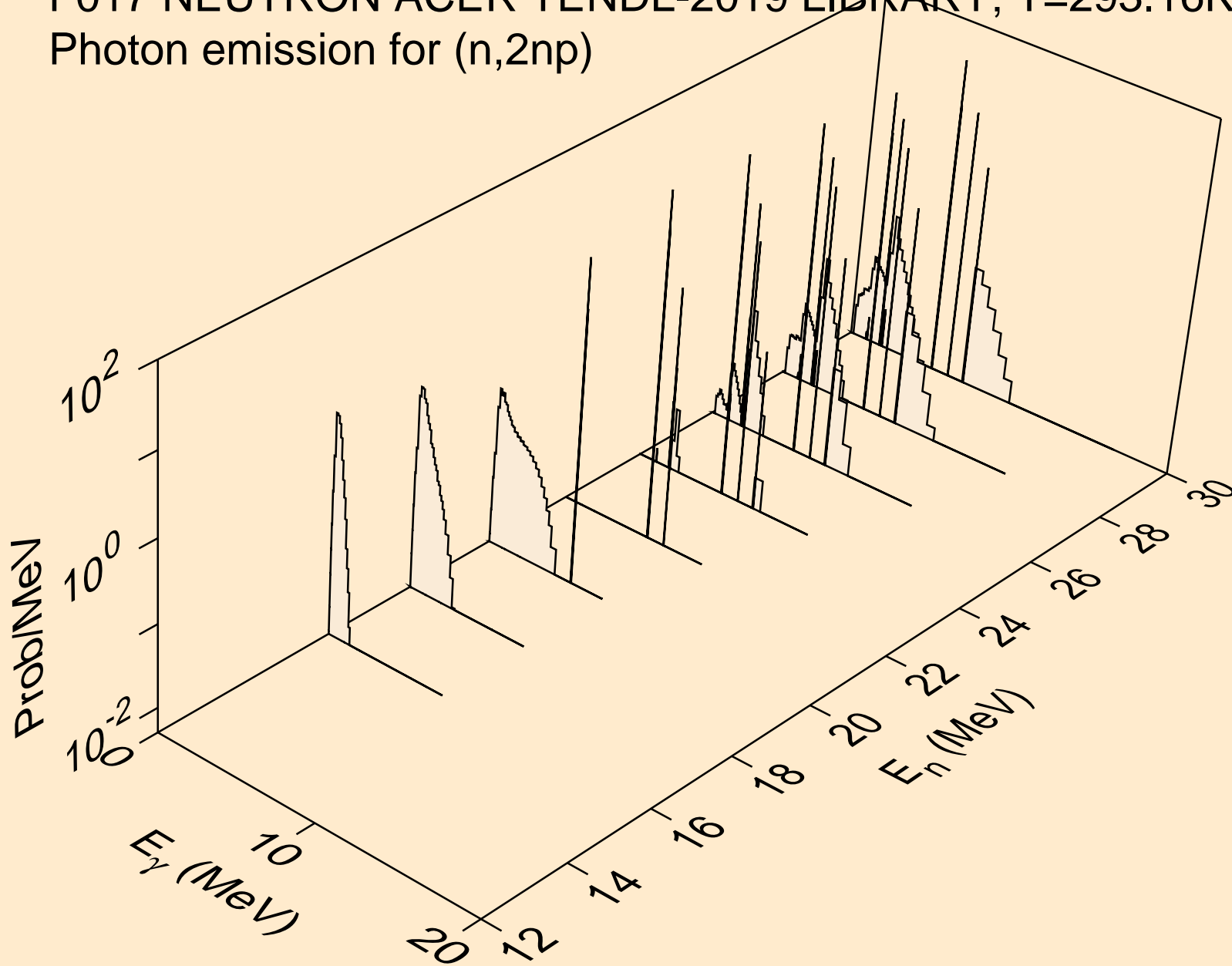

F017 NEUTRON ACER TENDL-2019 LIBRARY; T=293.16K
Photon emission for (n,npa)

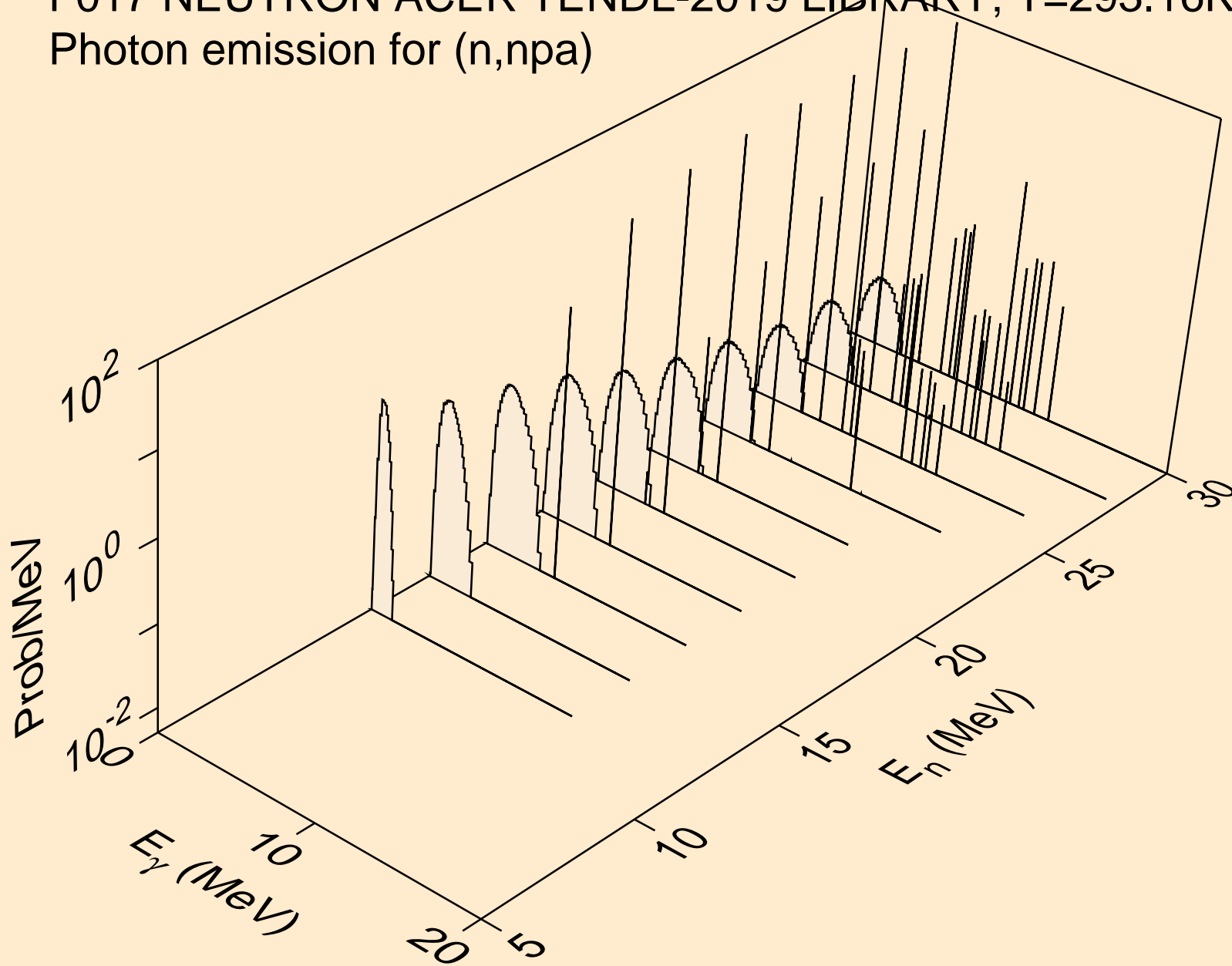

F017 NEUTRON ACER TENDL-2019 LIBRARY; T=293.16K
Photon emission for (n,n*c)

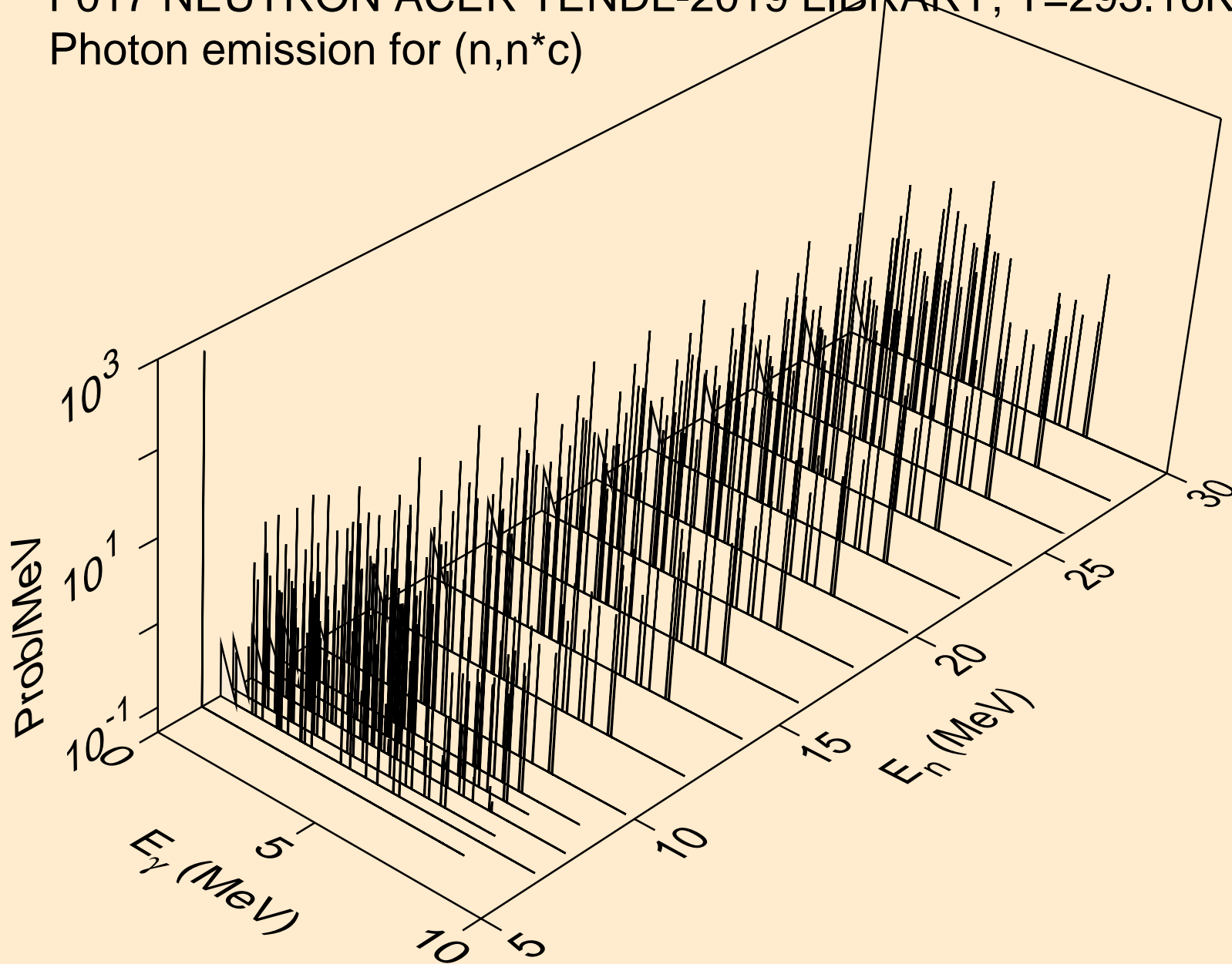

F017 NEUTRON ACER TENDL-2019 LIBRARY; T=293.16K
Photon emission for (n,gma)

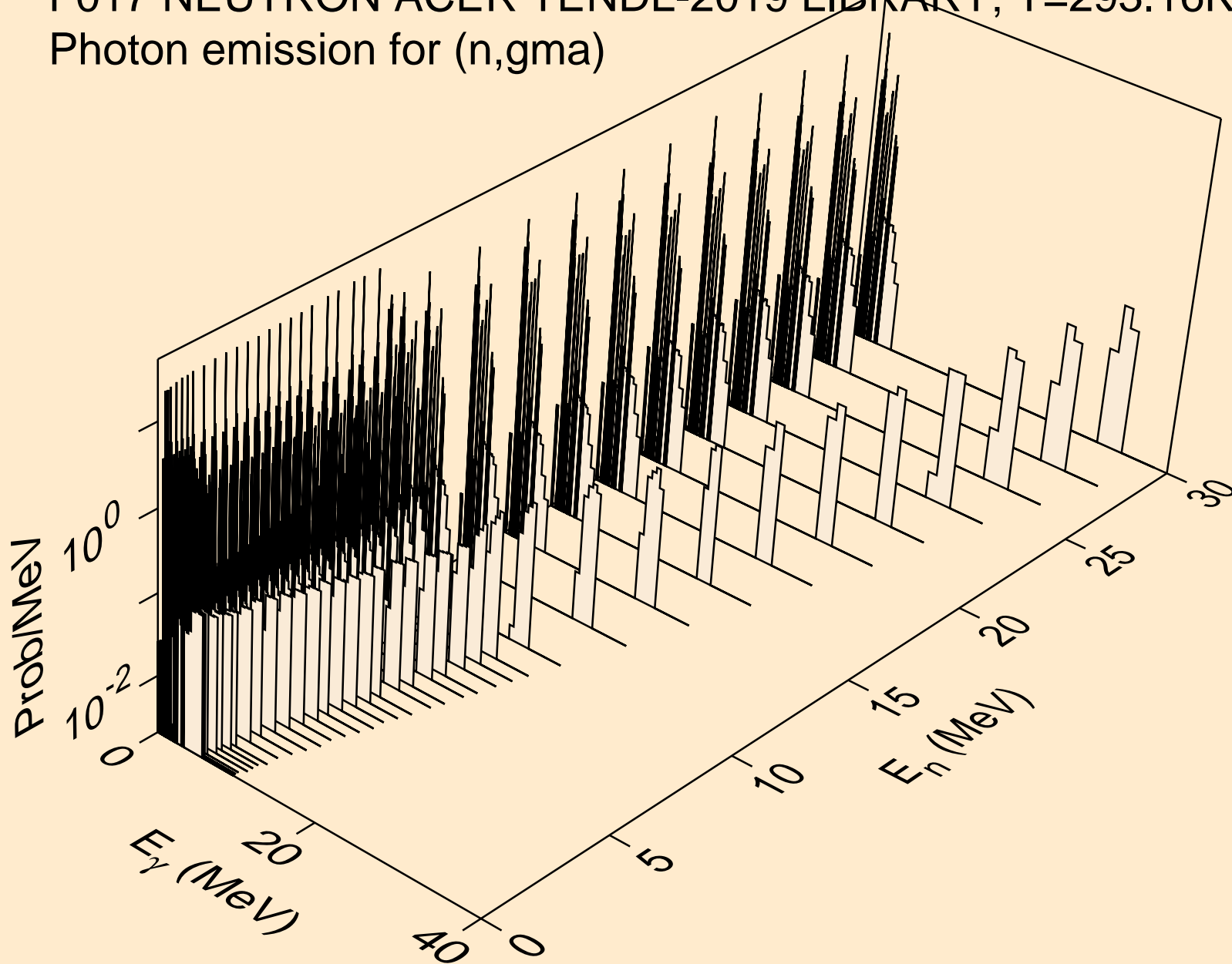

F017 NEUTRON ACER TENDL-2019 LIBRARY; T=293.16K
Photon emission for (n,p)

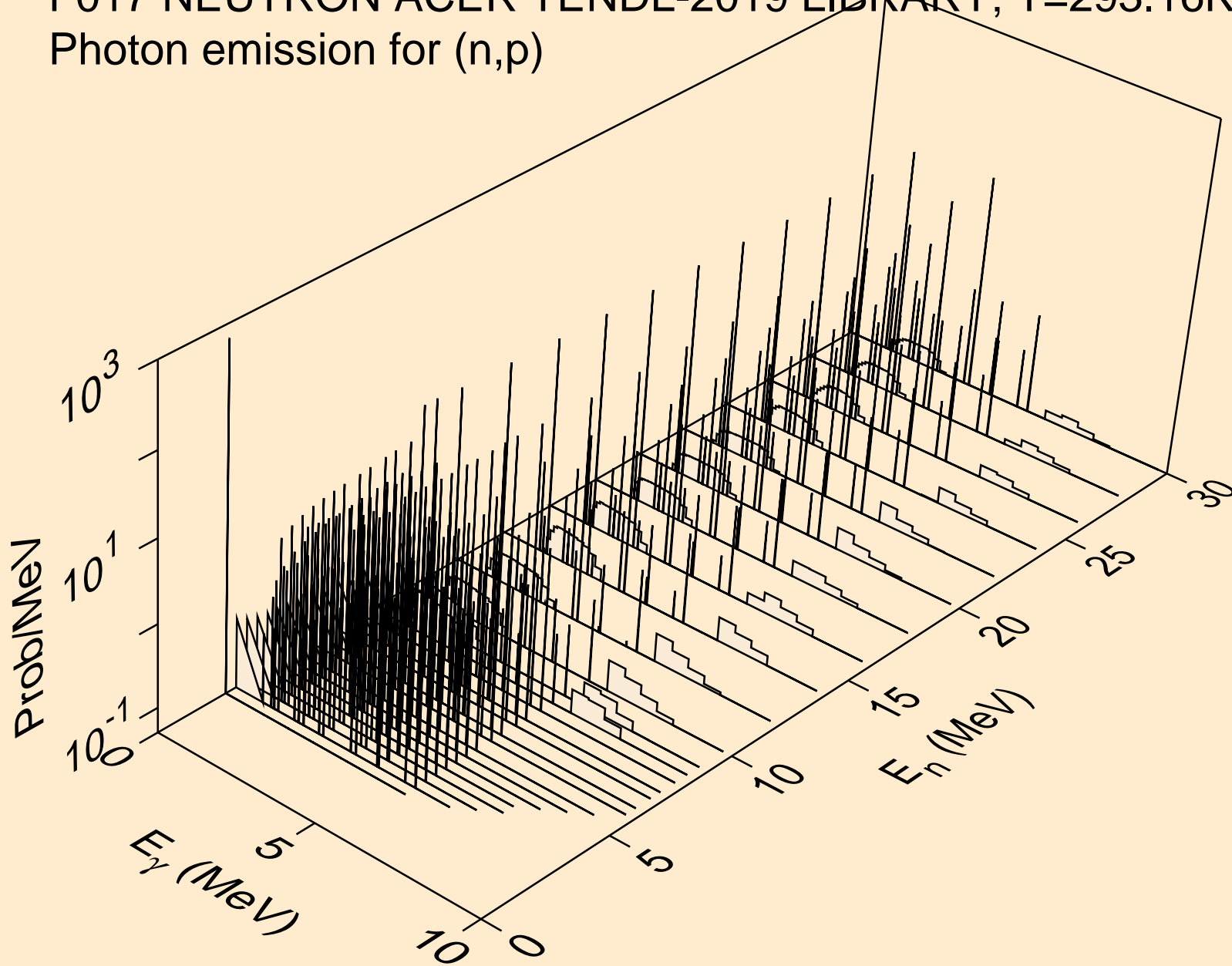

F017 NEUTRON ACER TENDL-2019 LIBRARY; T=293.16K
Photon emission for (n,d)

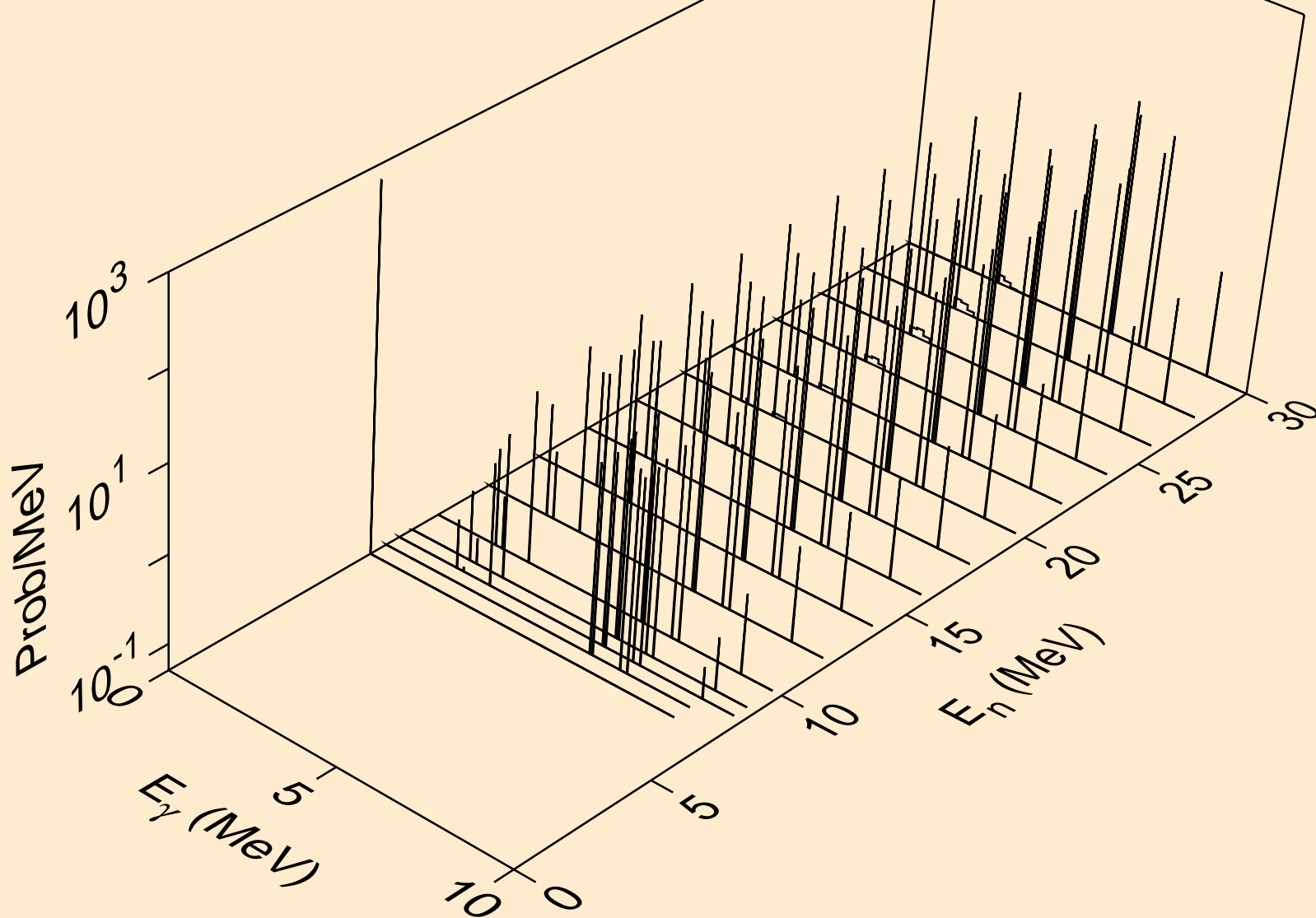

F017 NEUTRON ACER TENDL-2019 LIBRARY; T=293.16K
Photon emission for (n,t)

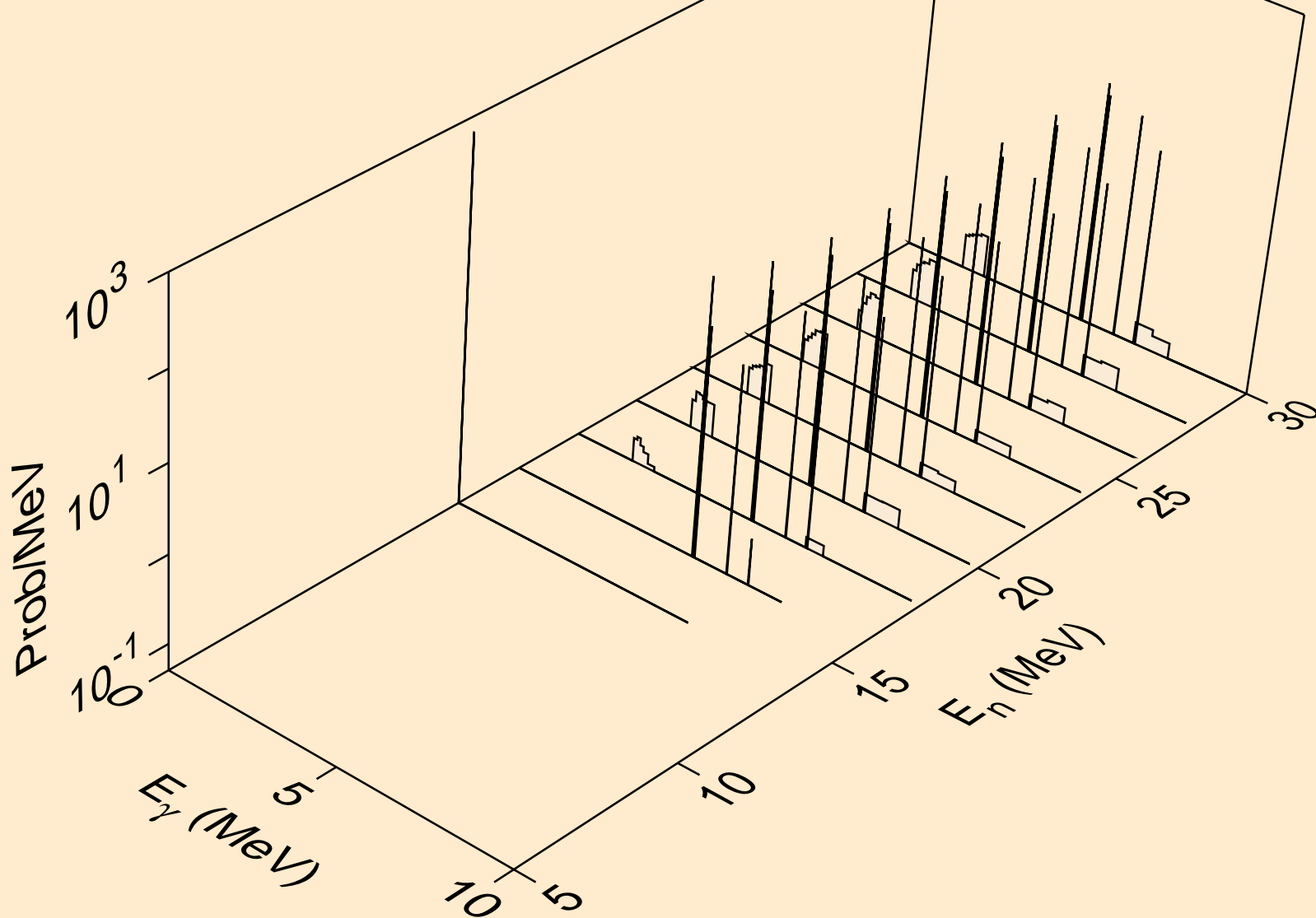

F017 NEUTRON ACER TENDL-2019 LIBRARY; T=293.16K
Photon emission for (n,he3)

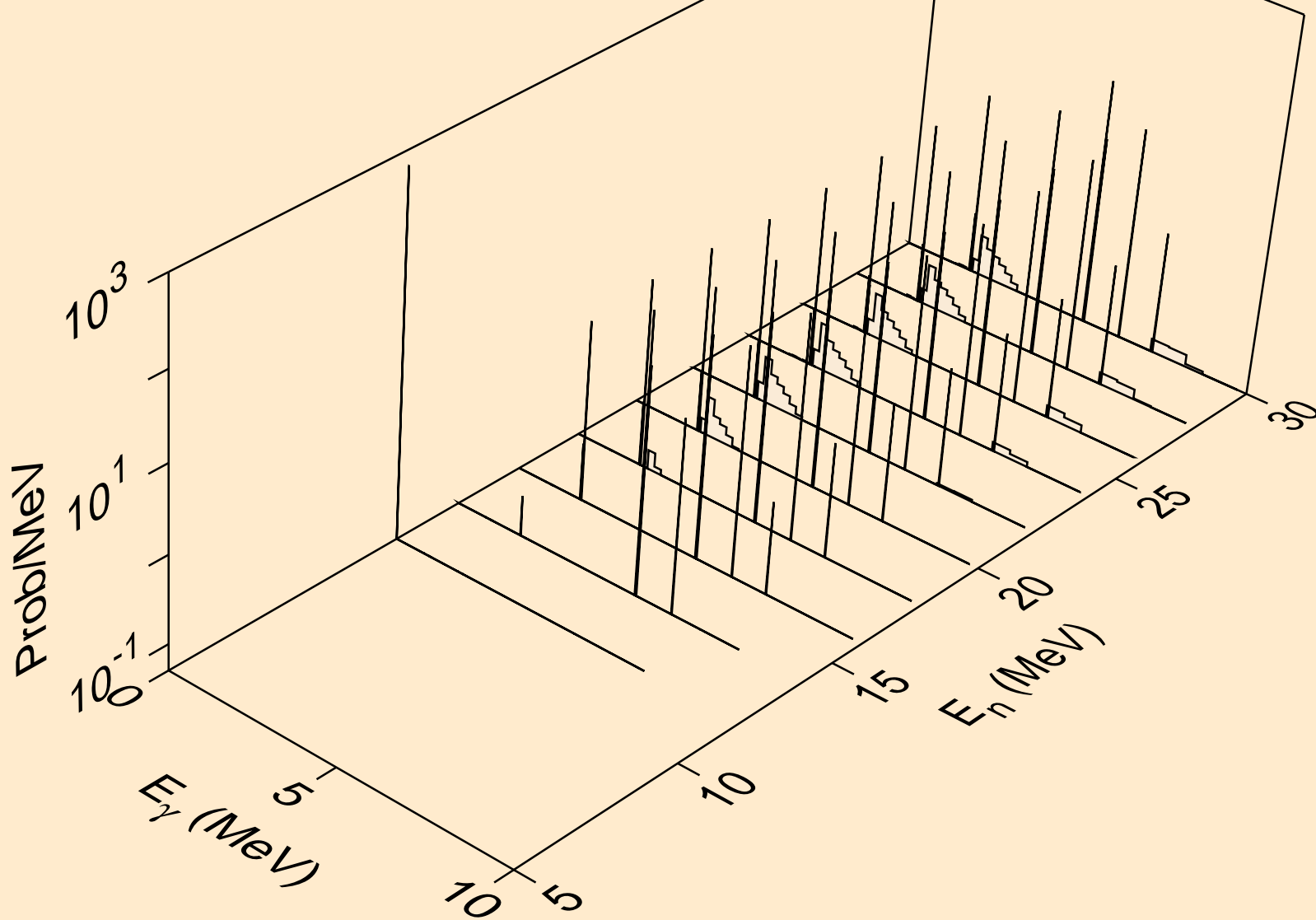

F017 NEUTRON ACER TENDL-2019 LIBRARY; T=293.16K
Photon emission for (n,a)

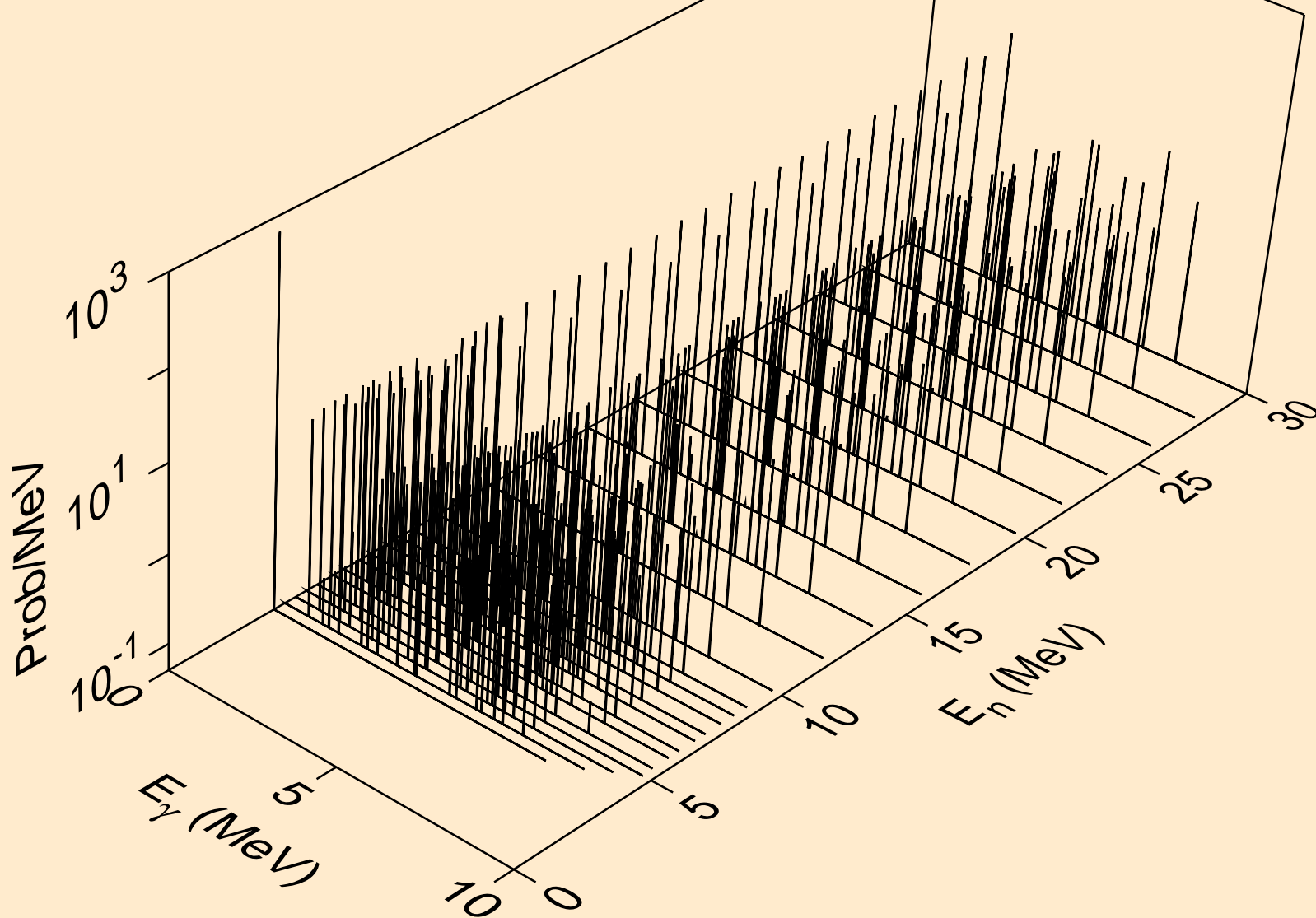

F017 NEUTRON ACER TENDL-2019 LIBRARY; T=293.16K
Photon emission for (n,2a)

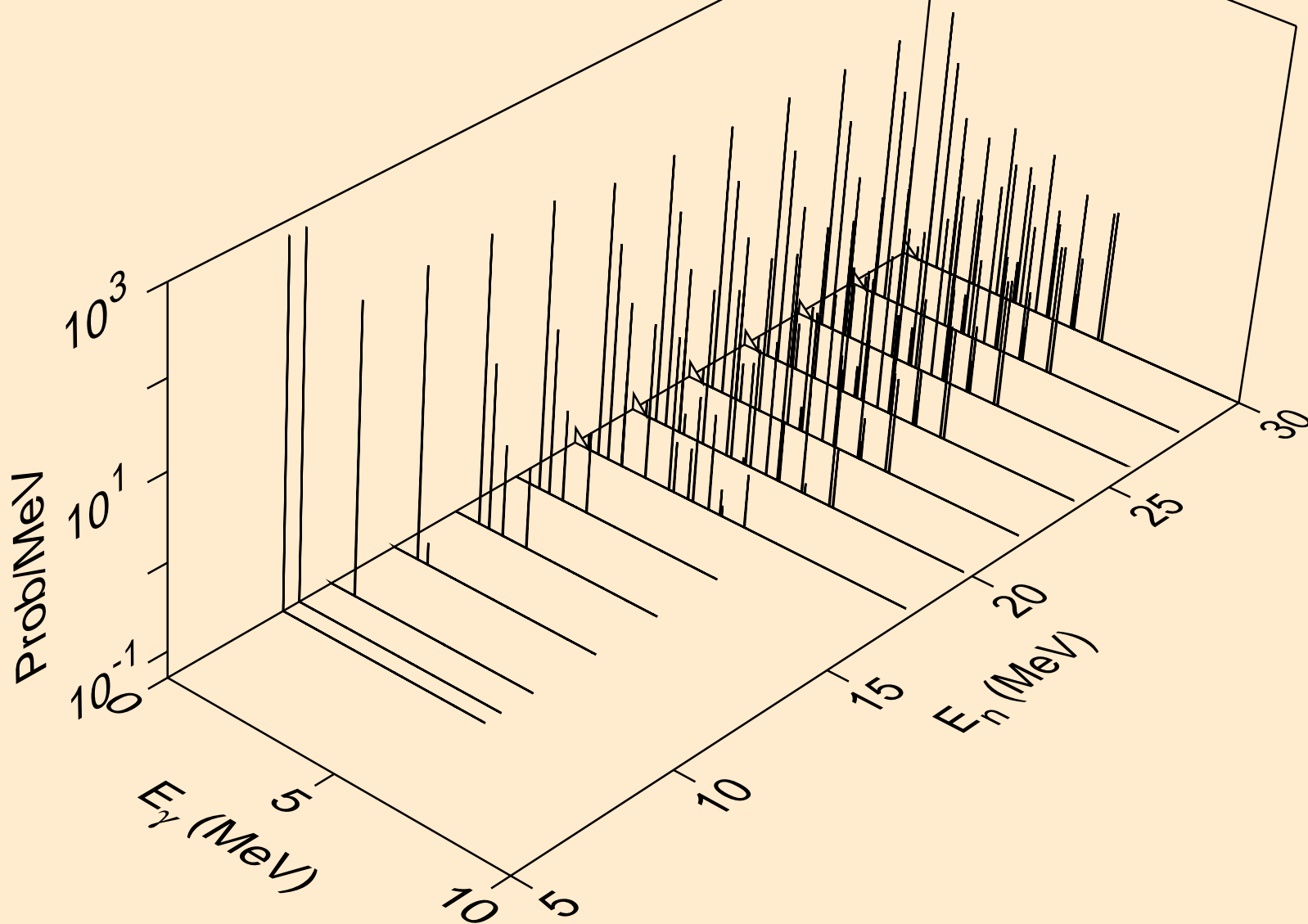

F017 NEUTRON ACER TENDL-2019 LIBRARY; T=293.16K
Photon emission for (n,3a)

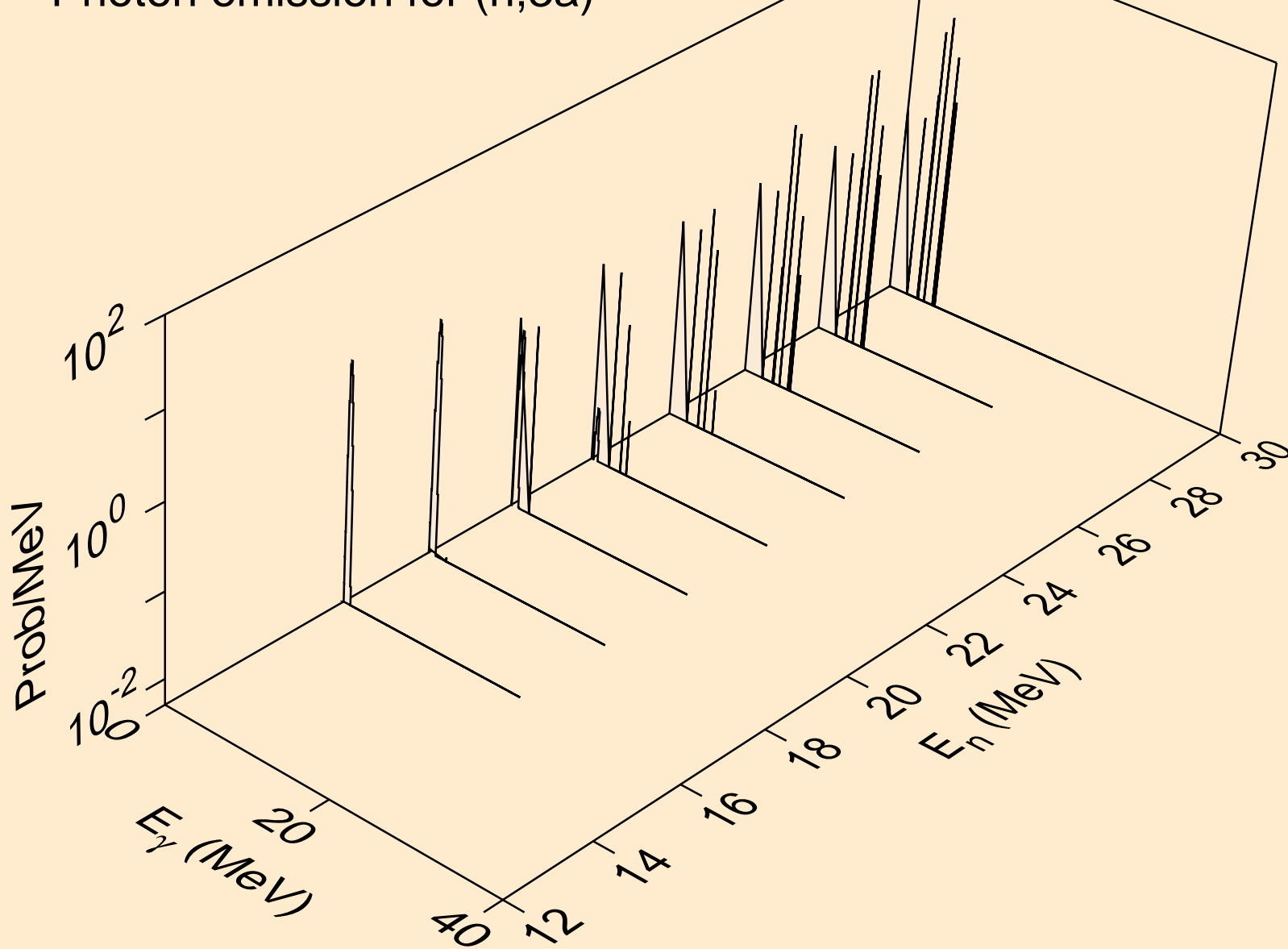

F017 NEUTRON ACER TENDL-2019 LIBRARY; T=293.16K
Photon emission for (n,2p)

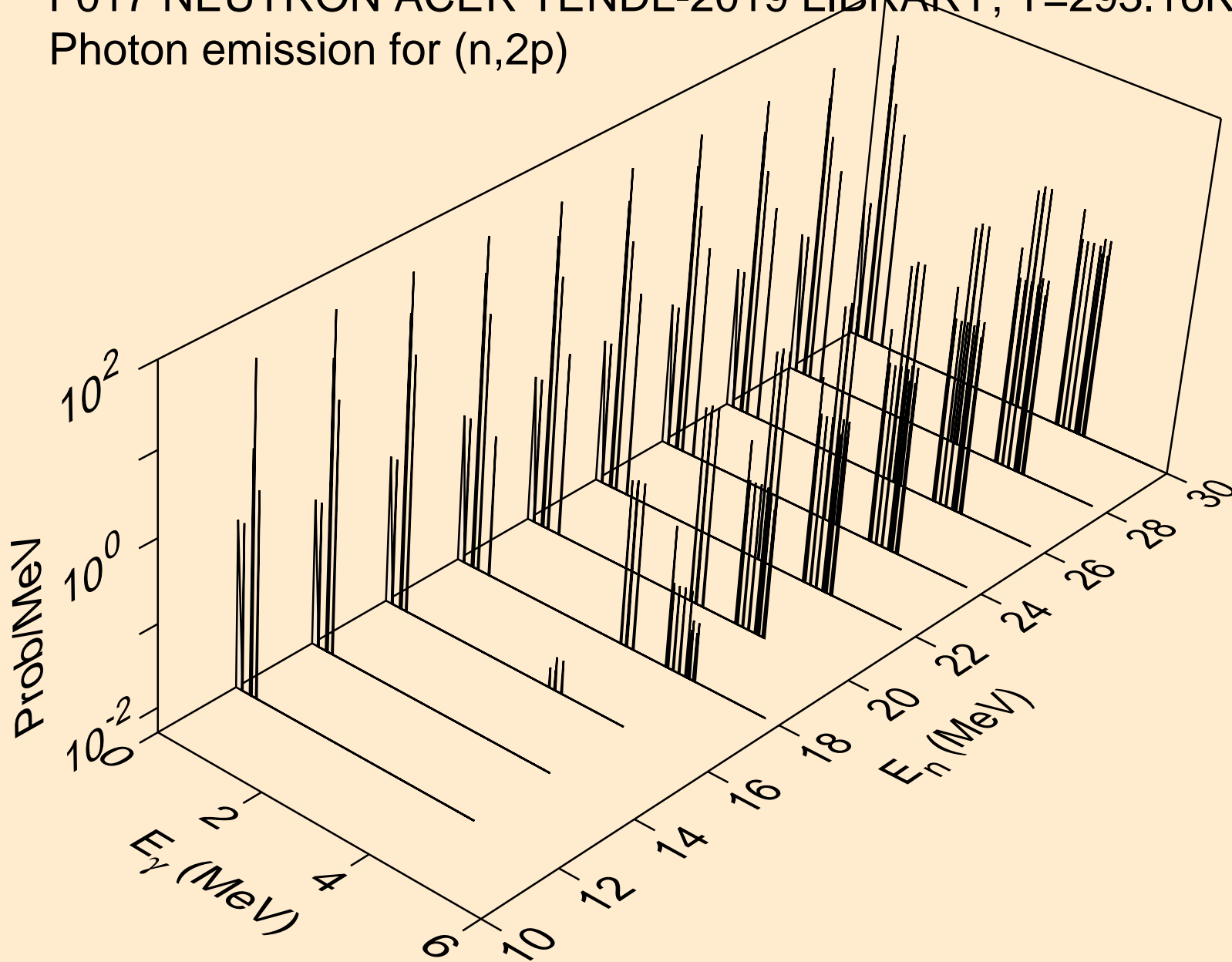

F017 NEUTRON ACER TENDL-2019 LIBRARY; T=293.16K
Photon emission for (n,p α)

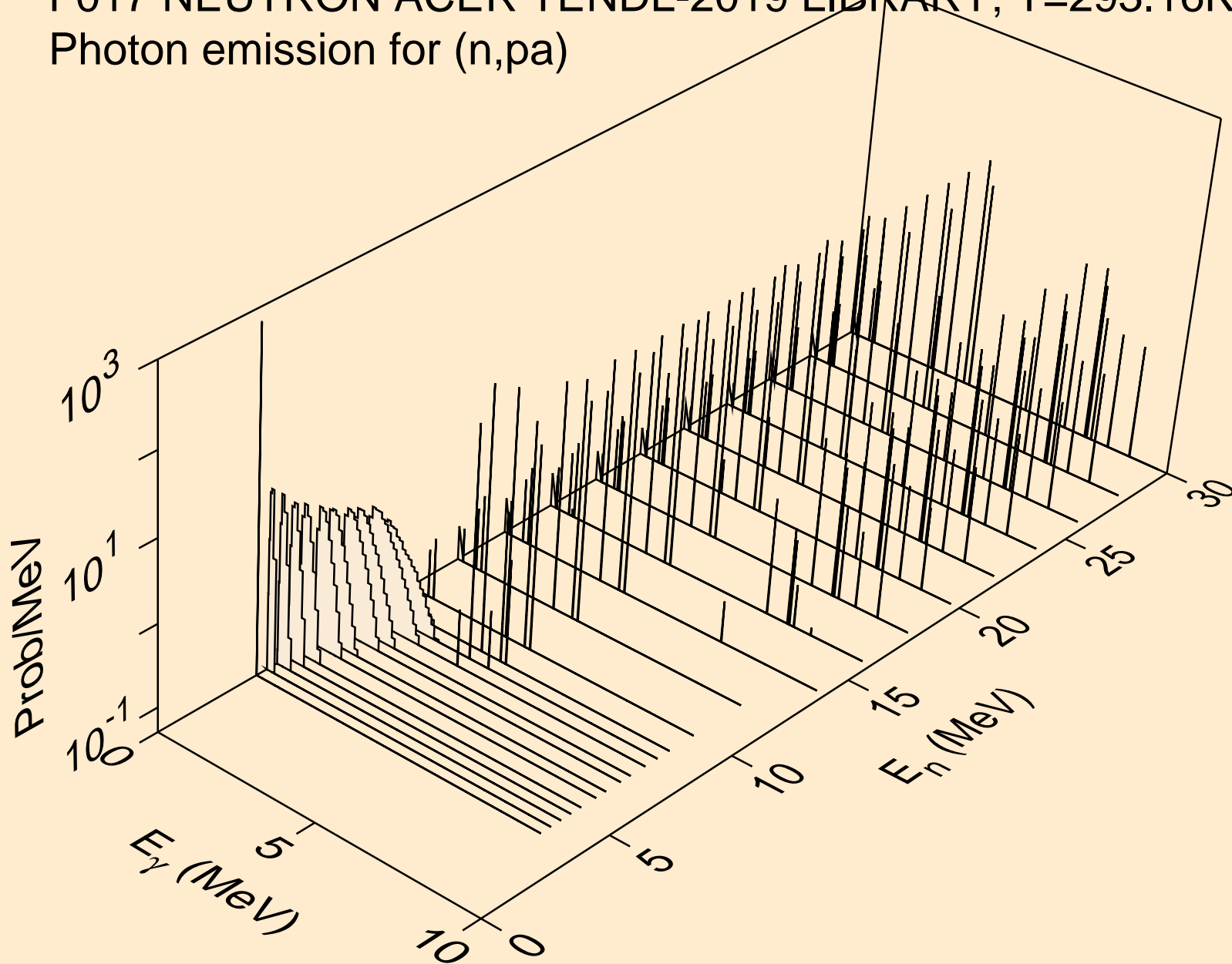

F017 NEUTRON ACER TENDL-2019 LIBRARY; T=293.16K
Photon emission for (n,d2a)

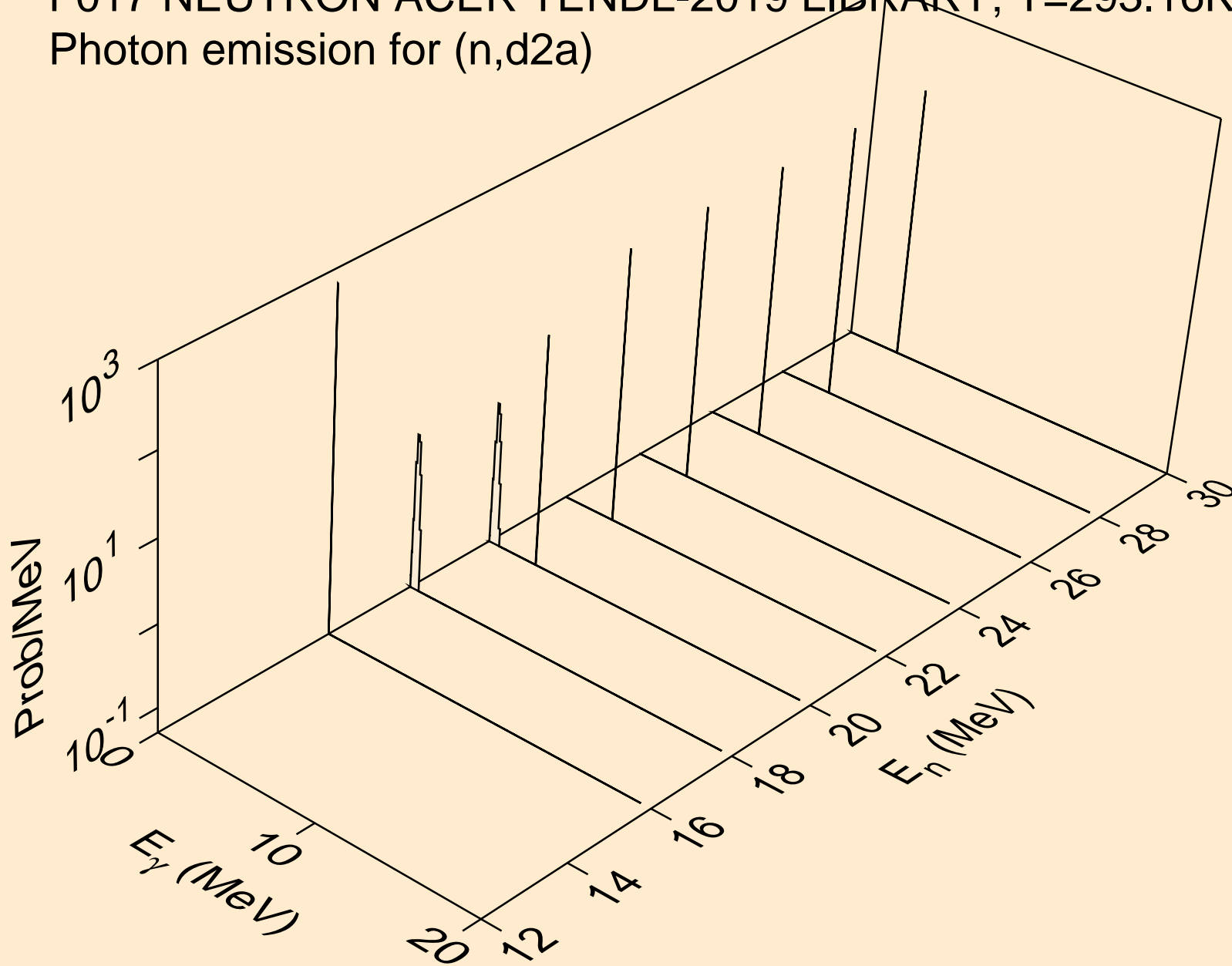

F017 NEUTRON ACER TENDL-2019 LIBRARY; T=293.16K
Photon emission for (n,pd)

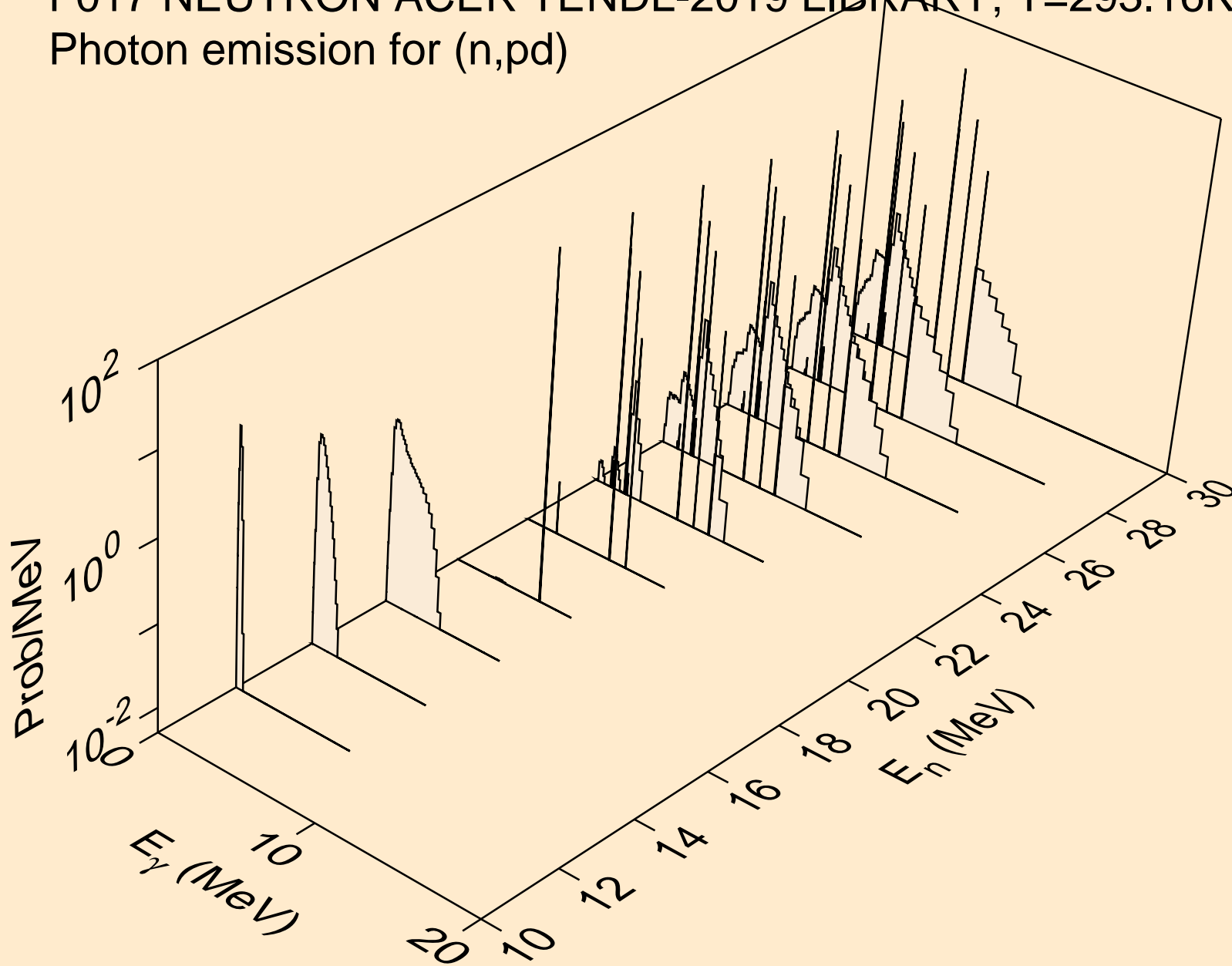

F017 NEUTRON ACER TENDL-2019 LIBRARY; T=293.16K
Photon emission for (n,pt)

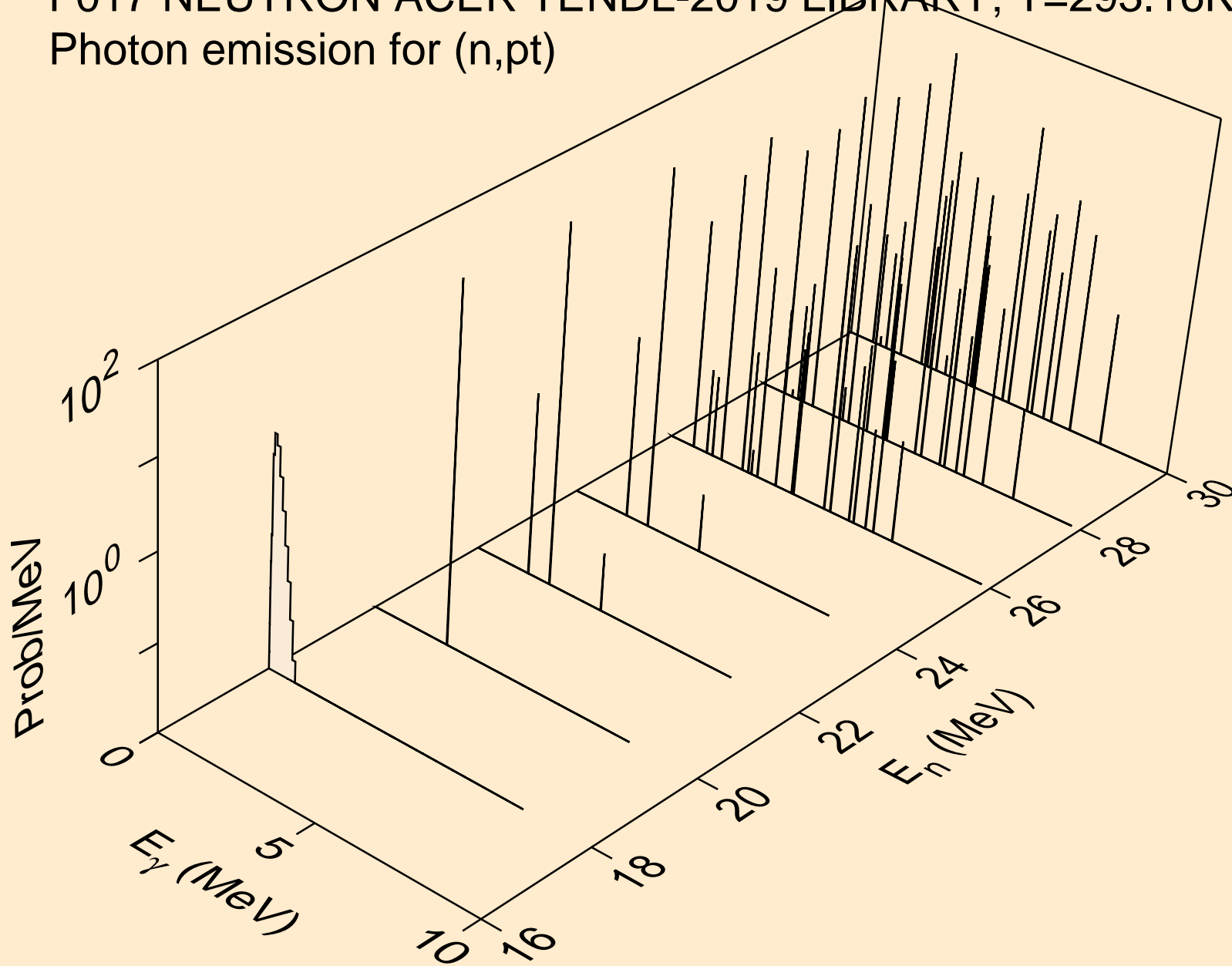

F017 NEUTRON ACER TENDL-2019 LIBRARY; T=293.16K
Photon emission for (n,da)

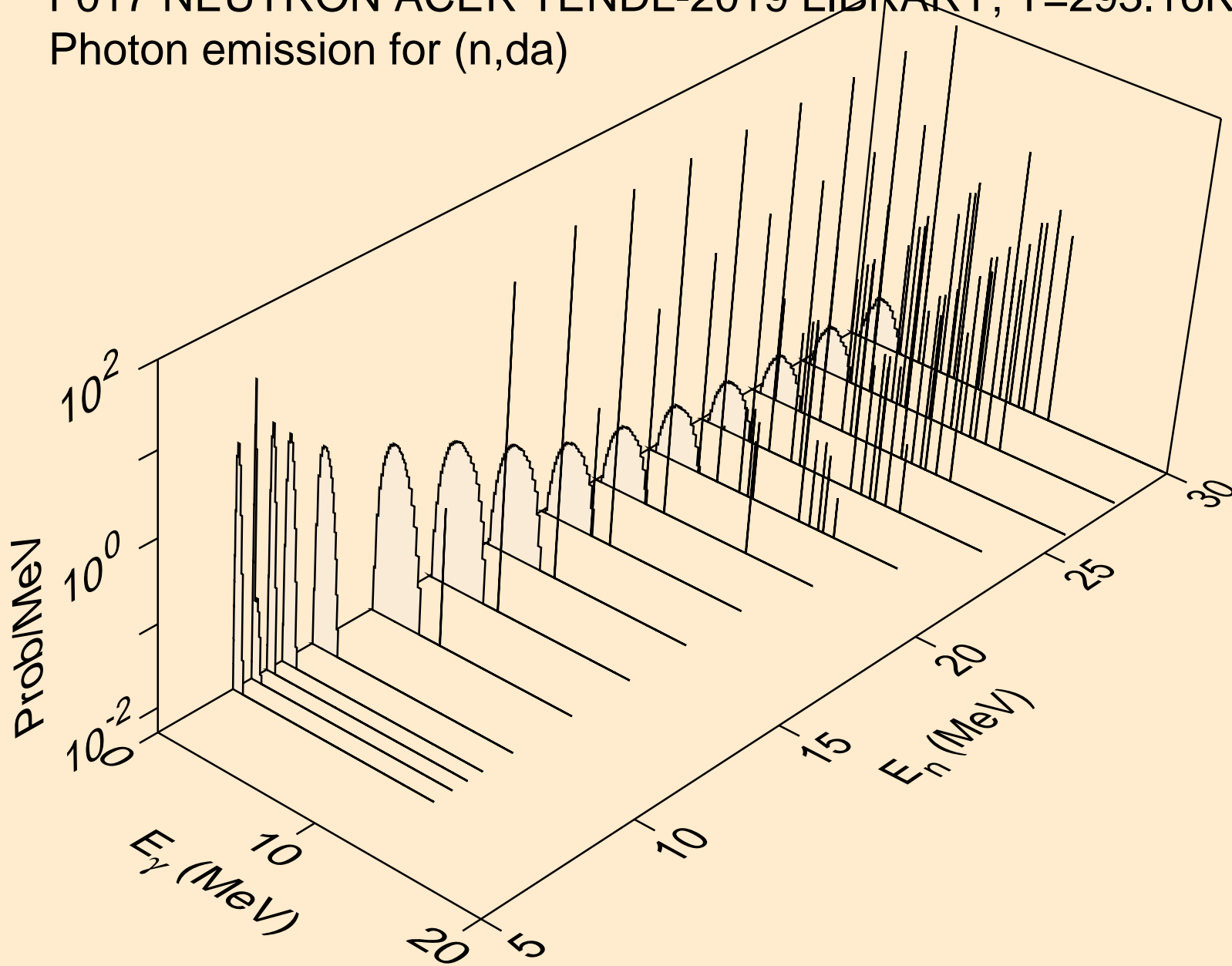

F017 NEUTRON ACER TENDL-2019 LIBRARY; T=293.16K
thermal capture photon spectrum

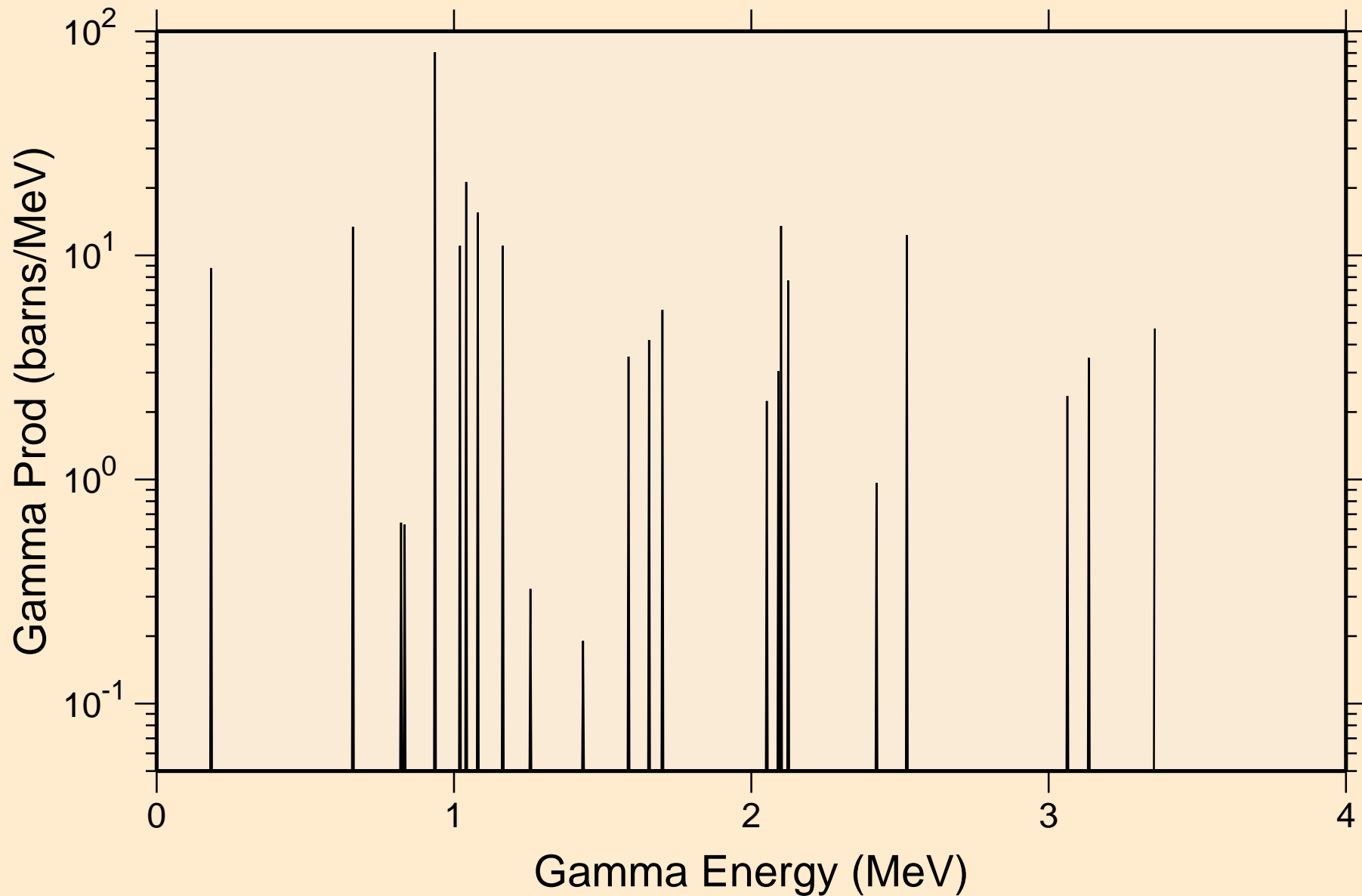

F017 NEUTRON ACER TENDL-2019 LIBRARY; T=293.16K
14 MeV photon spectrum

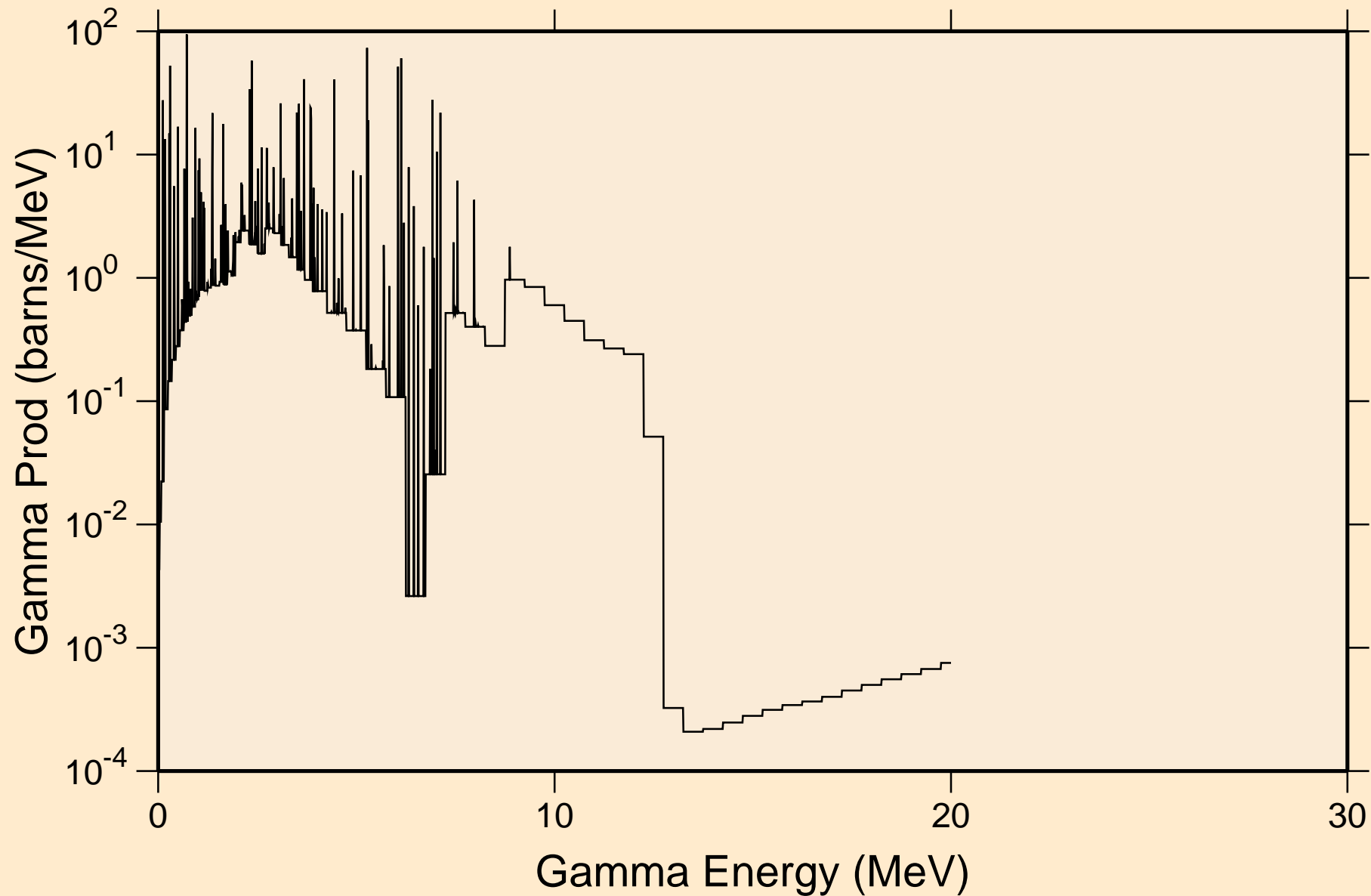

F017 NEUTRON ACER TENDL-2019 LIBRARY; T=293.16K

Particle heating contributions

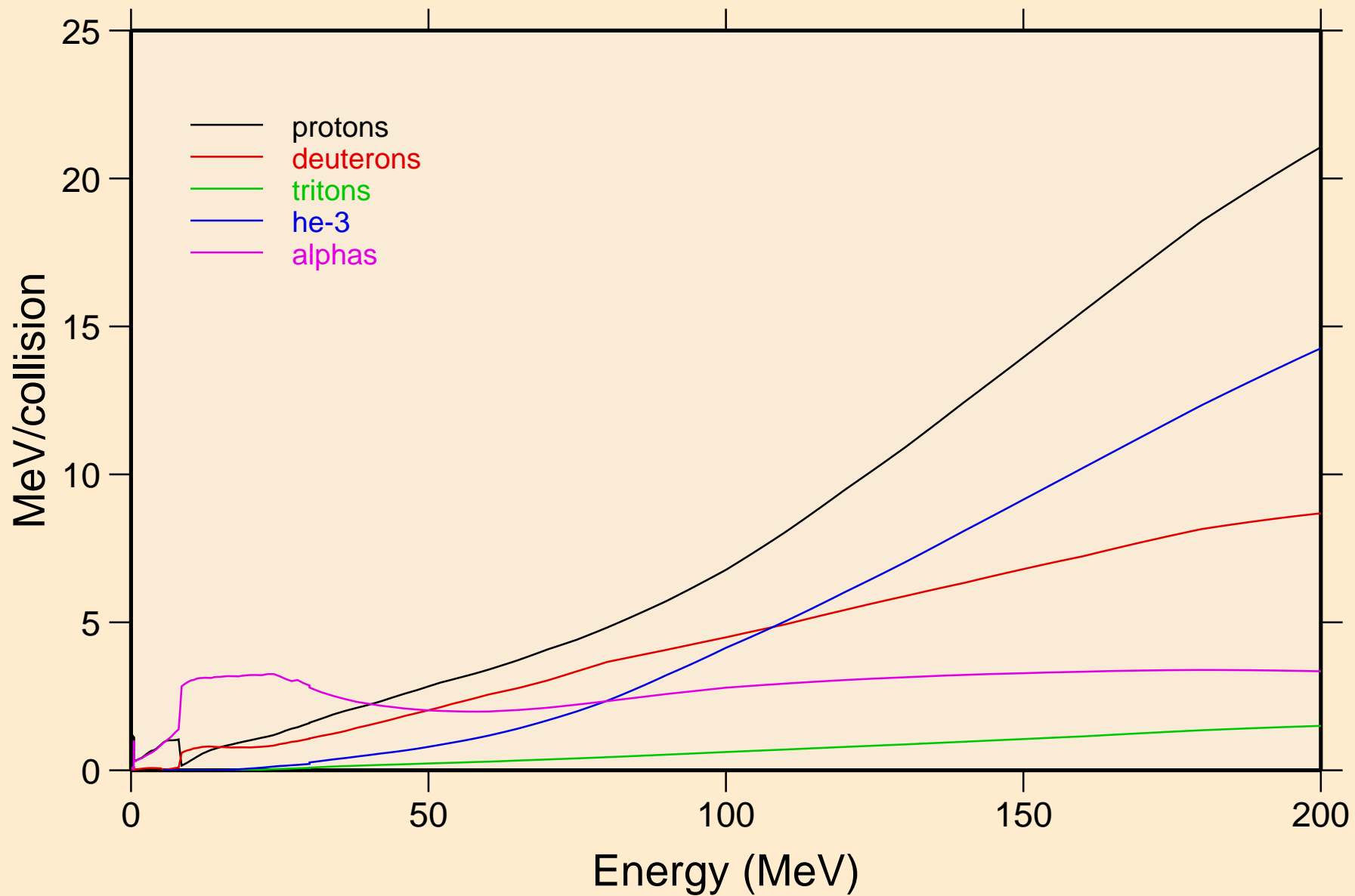

F017 NEUTRON ACER TENDL-2019 LIBRARY; T=293.16K
Recoil Heating

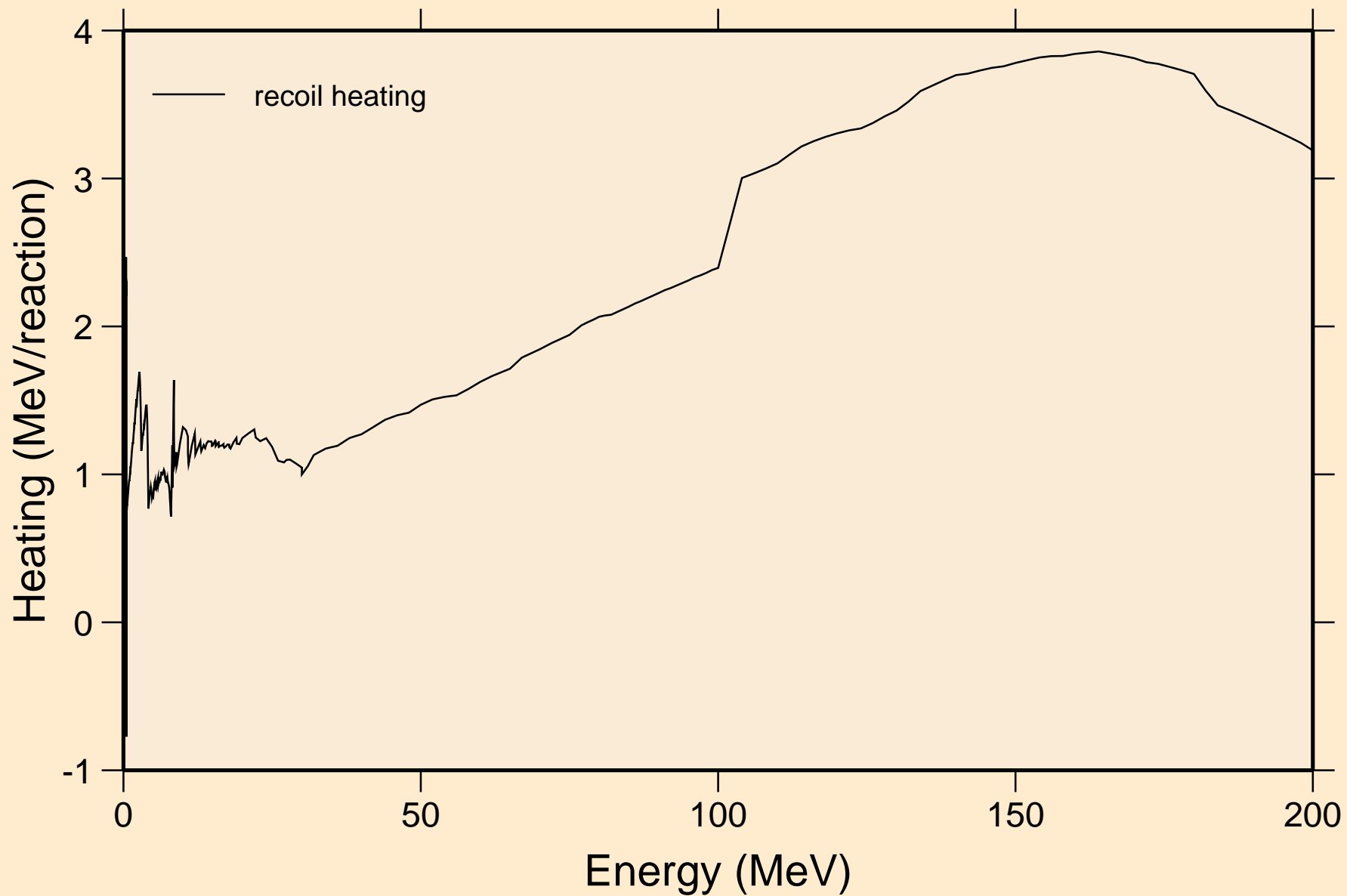

F017 NEUTRON ACER TENDL-2019 LIBRARY; T=293.16K
Particle production cross sections

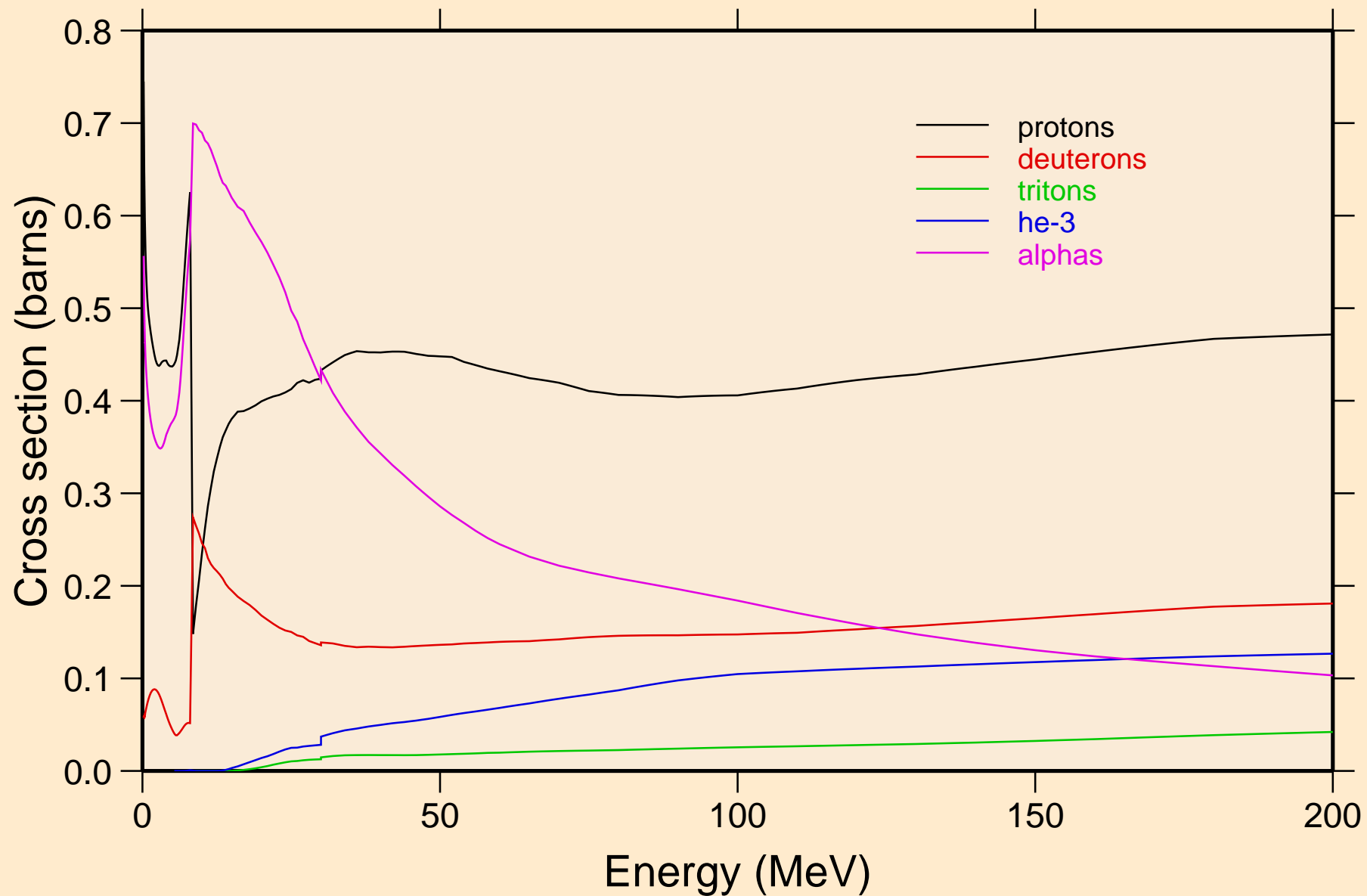

F017 NEUTRON ACER TENDL-2019 LIBRARY; T=293.16K
protons from (n,x)

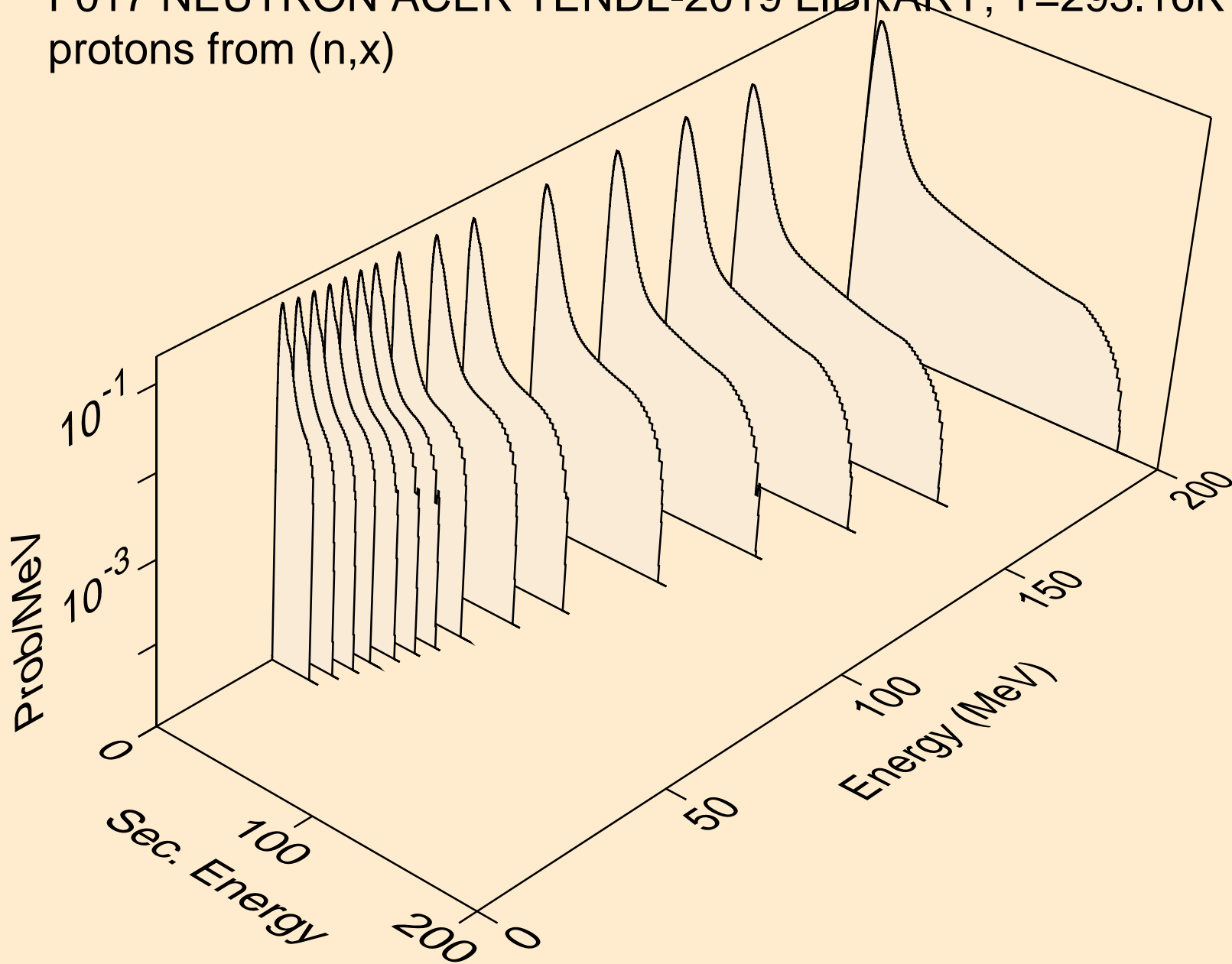

F017 NEUTRON ACER TENDL-2019 LIBRARY; T=293.16K
protons from (n,n*)p

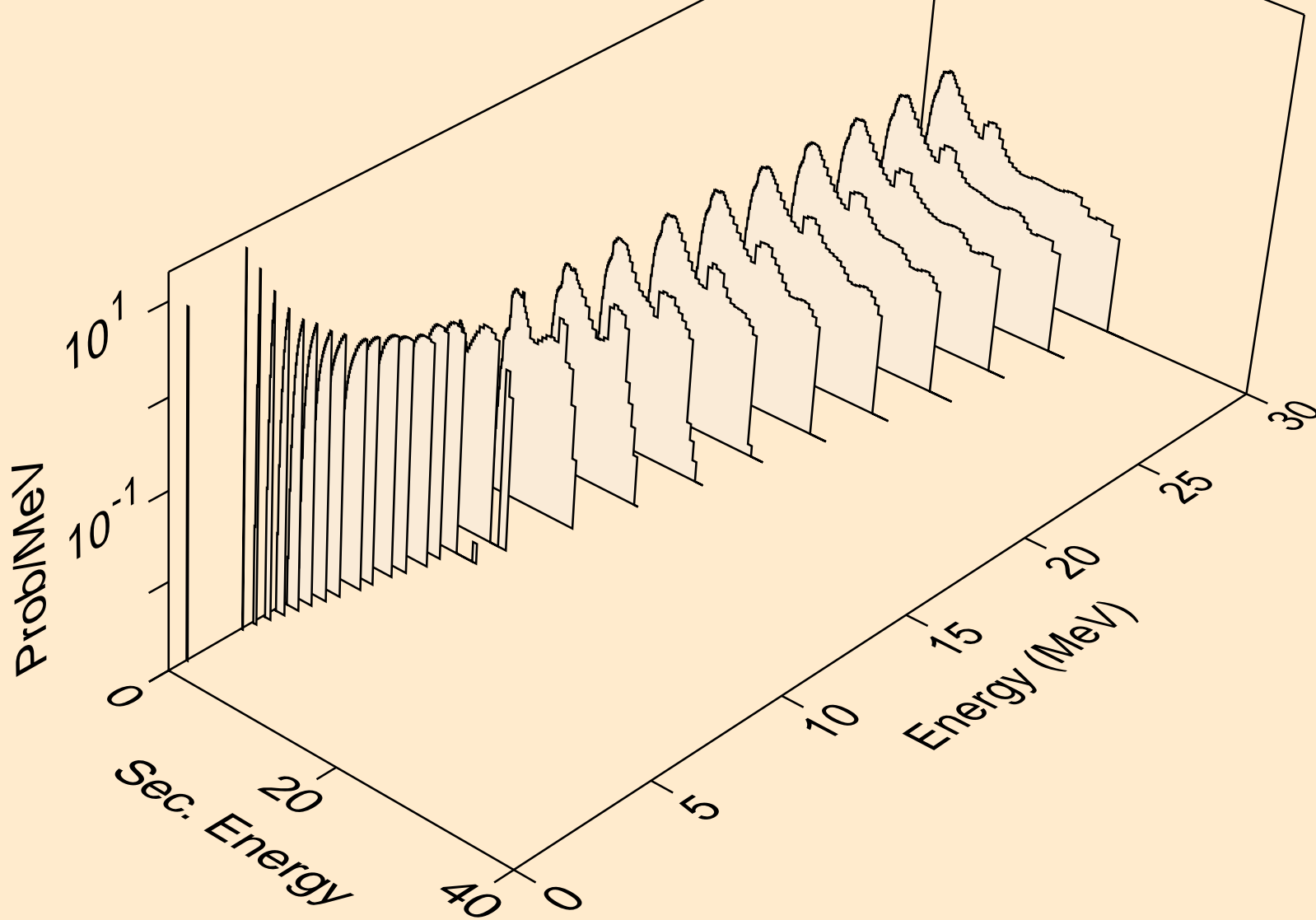

F017 NEUTRON ACER TENDL-2019 LIBRARY; T=293.16K
protons from (n,2np)

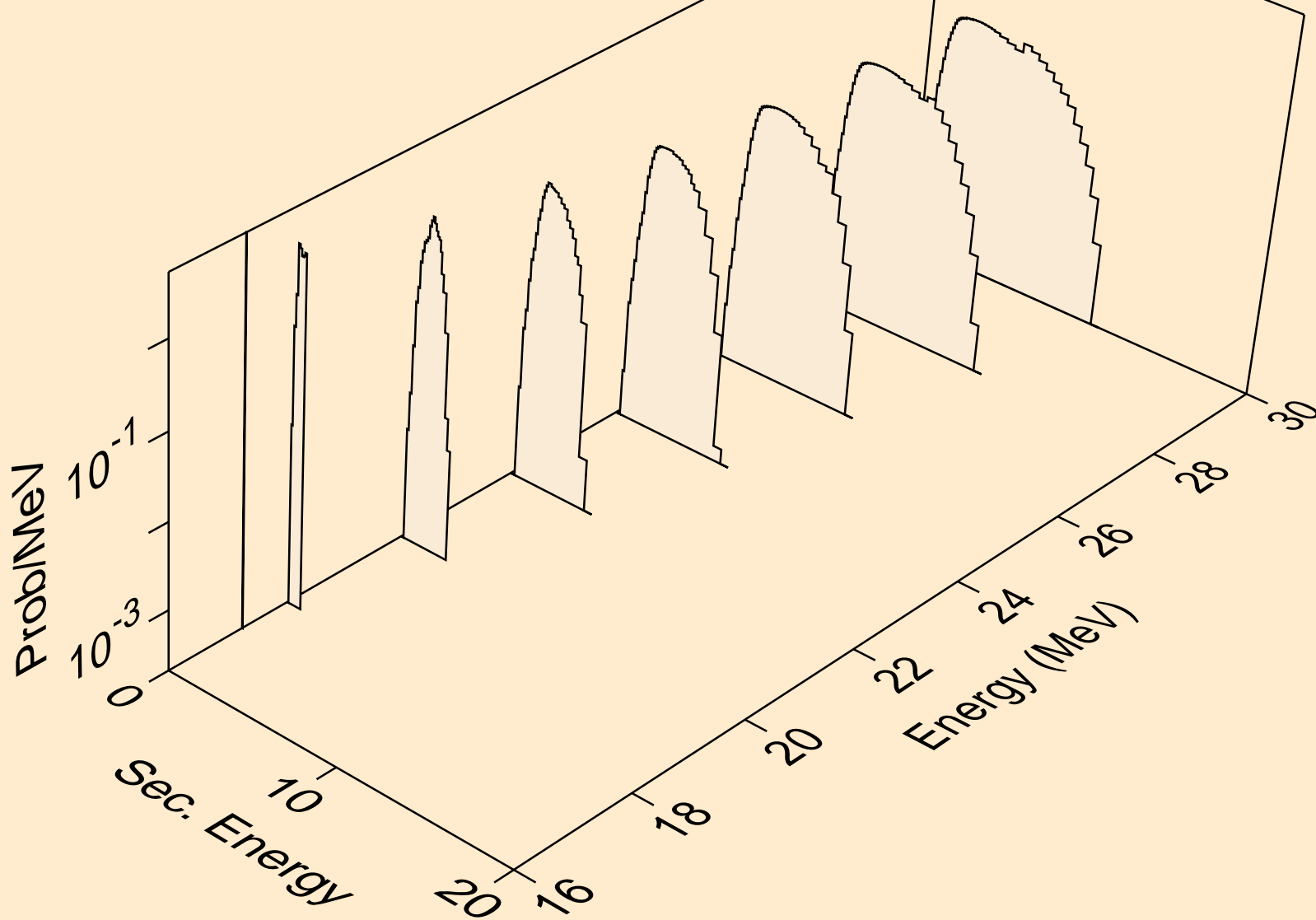

F017 NEUTRON ACER TENDL-2019 LIBRARY; T=293.16K
protons from (n,2np)

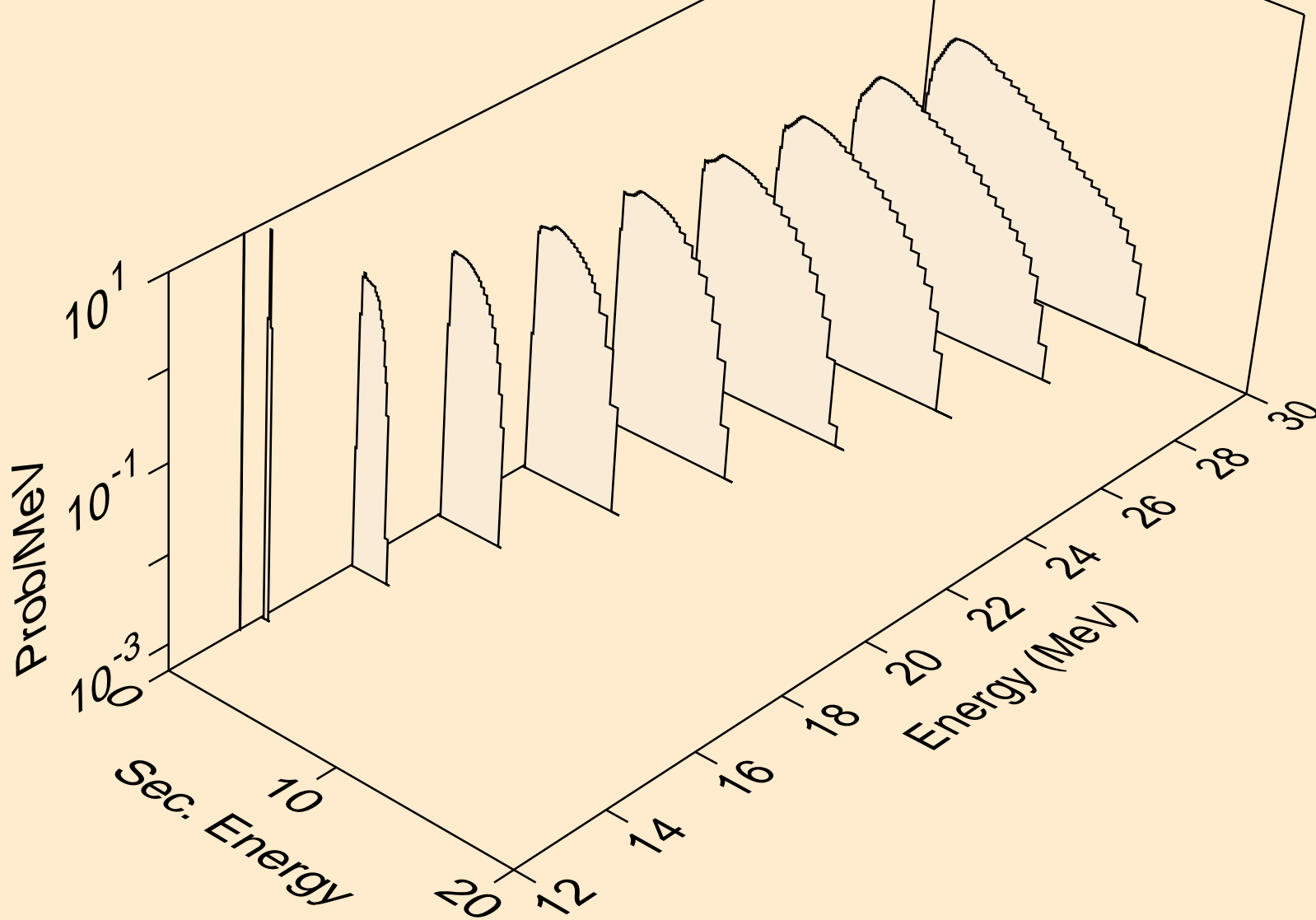

F017 NEUTRON ACER TENDL-2019 LIBRARY; T=293.16K
protons from (n,npa)

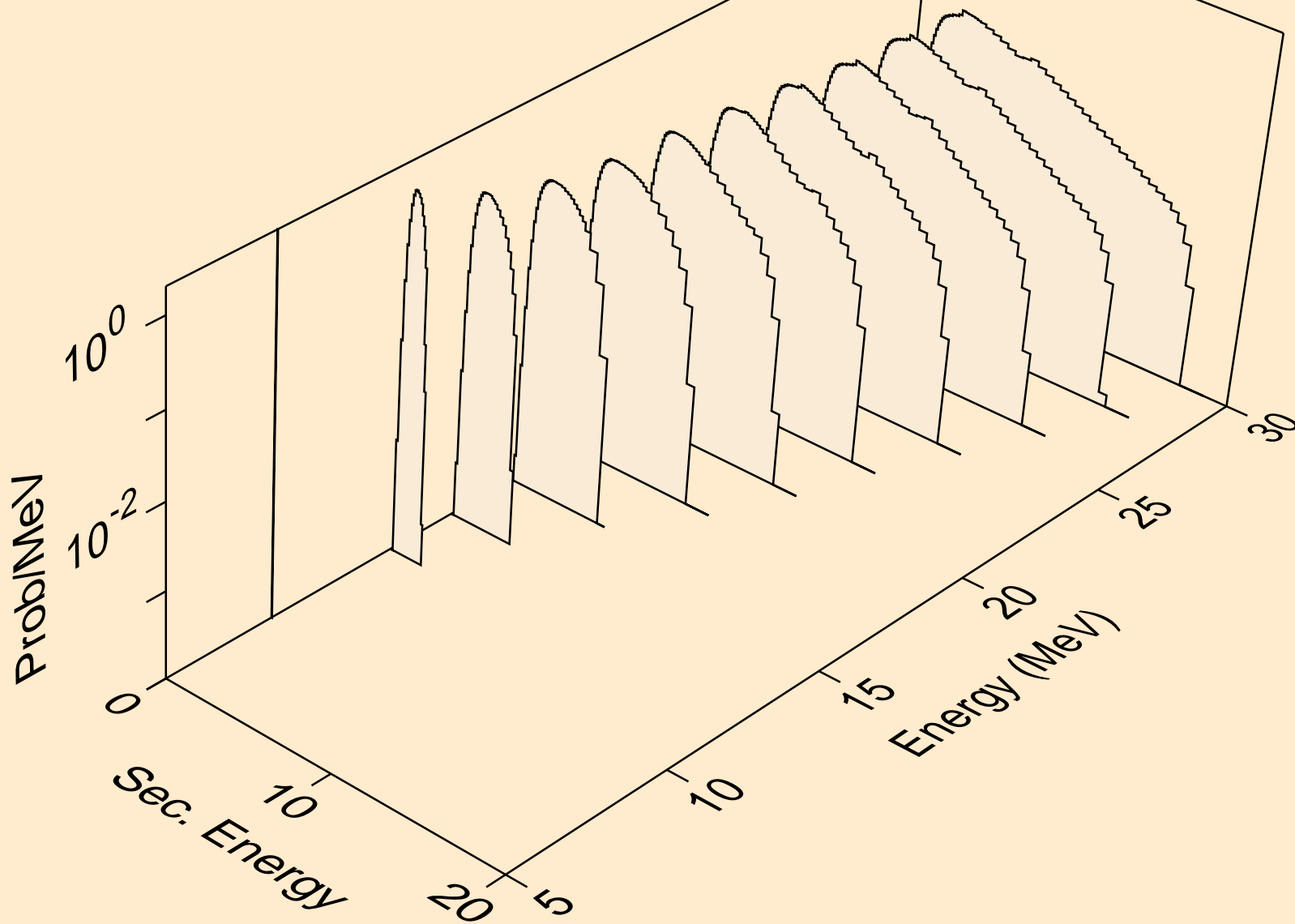

F017 NEUTRON ACER TENDL-2019 LIBRARY; T=293.16K
protons from (n,p)

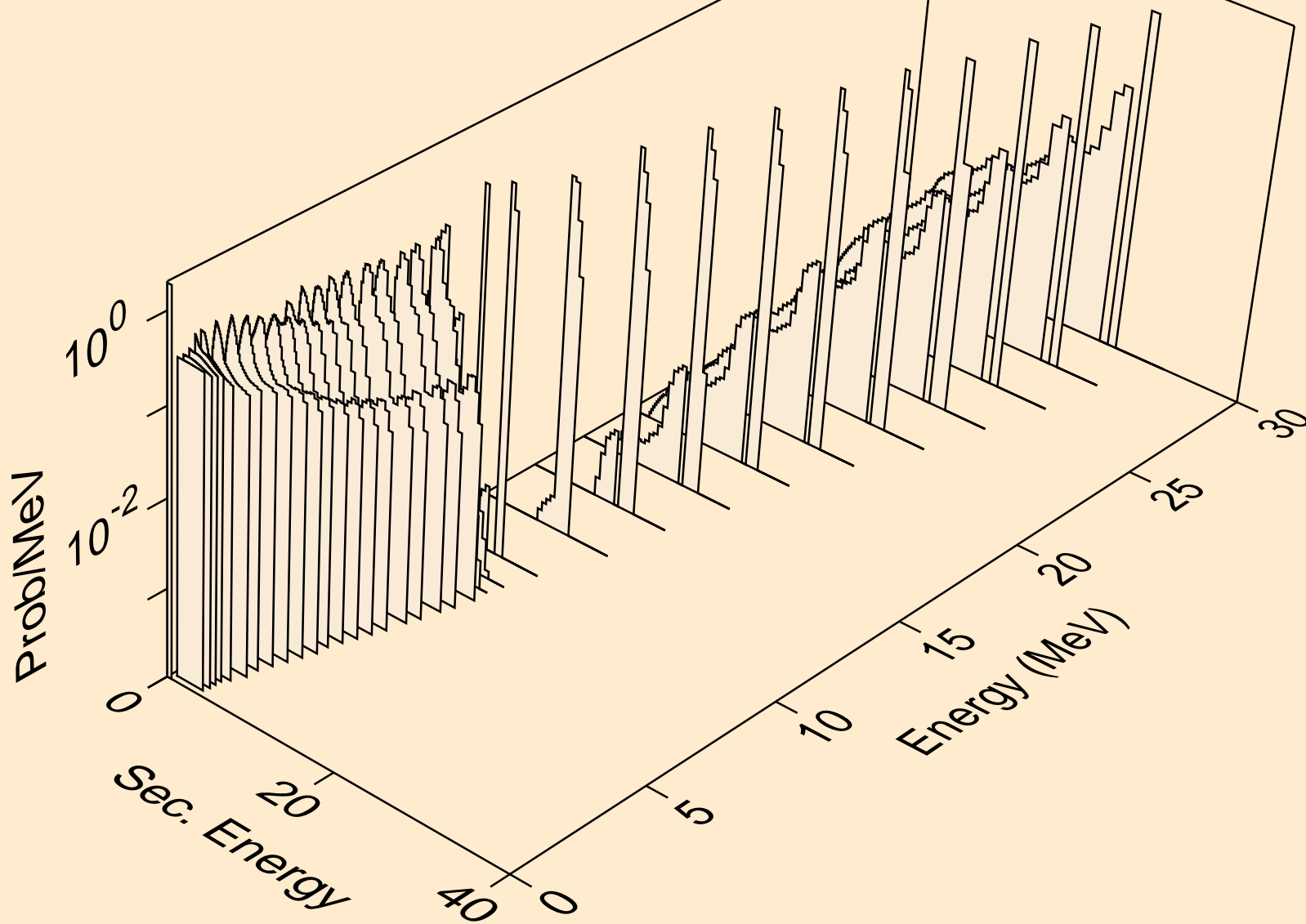

F017 NEUTRON ACER TENDL-2019 LIBRARY; T=293.16K
protons from (n,2p)

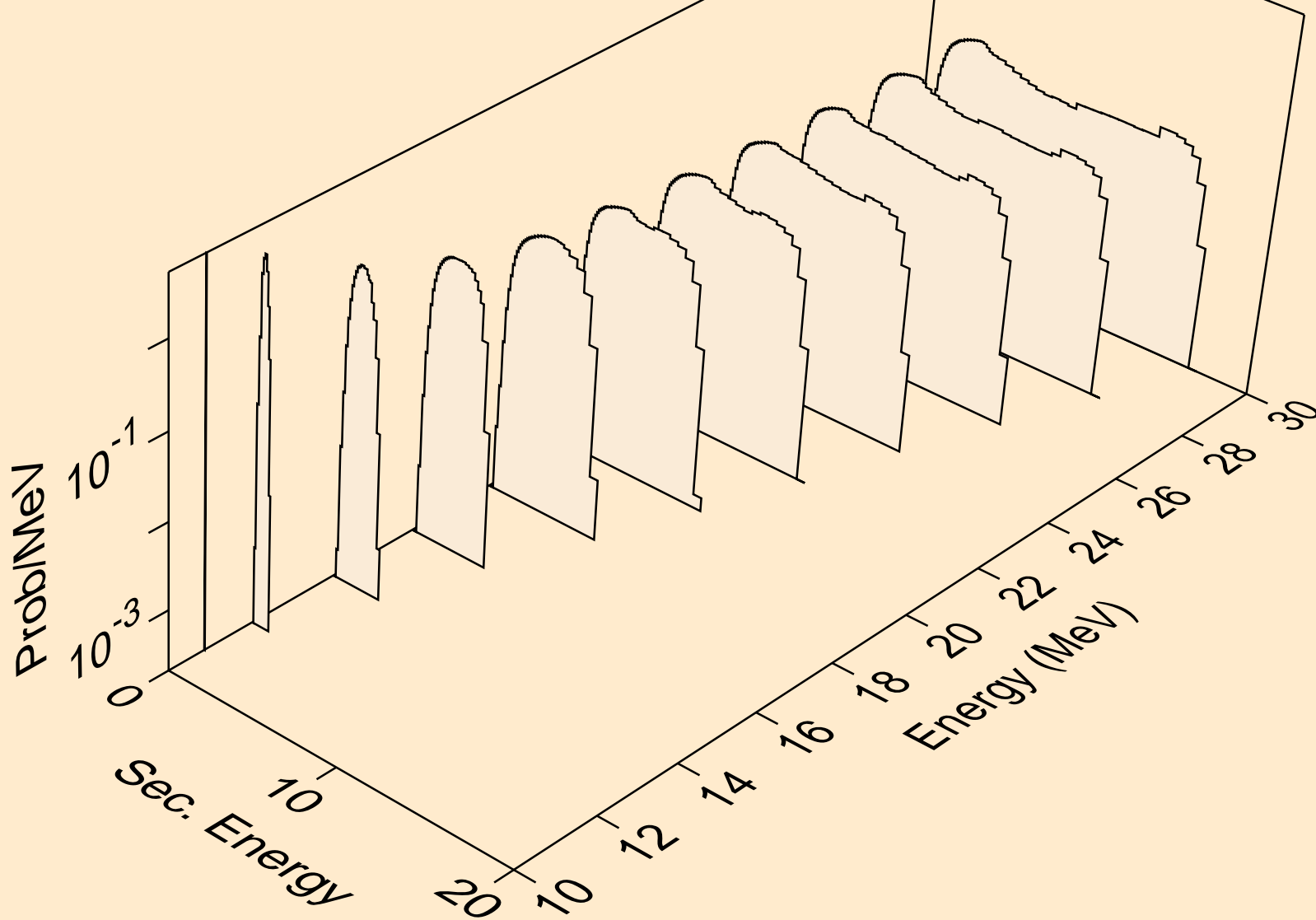

F017 NEUTRON ACER TENDL-2019 LIBRARY; T=293.16K
protons from (n,p)

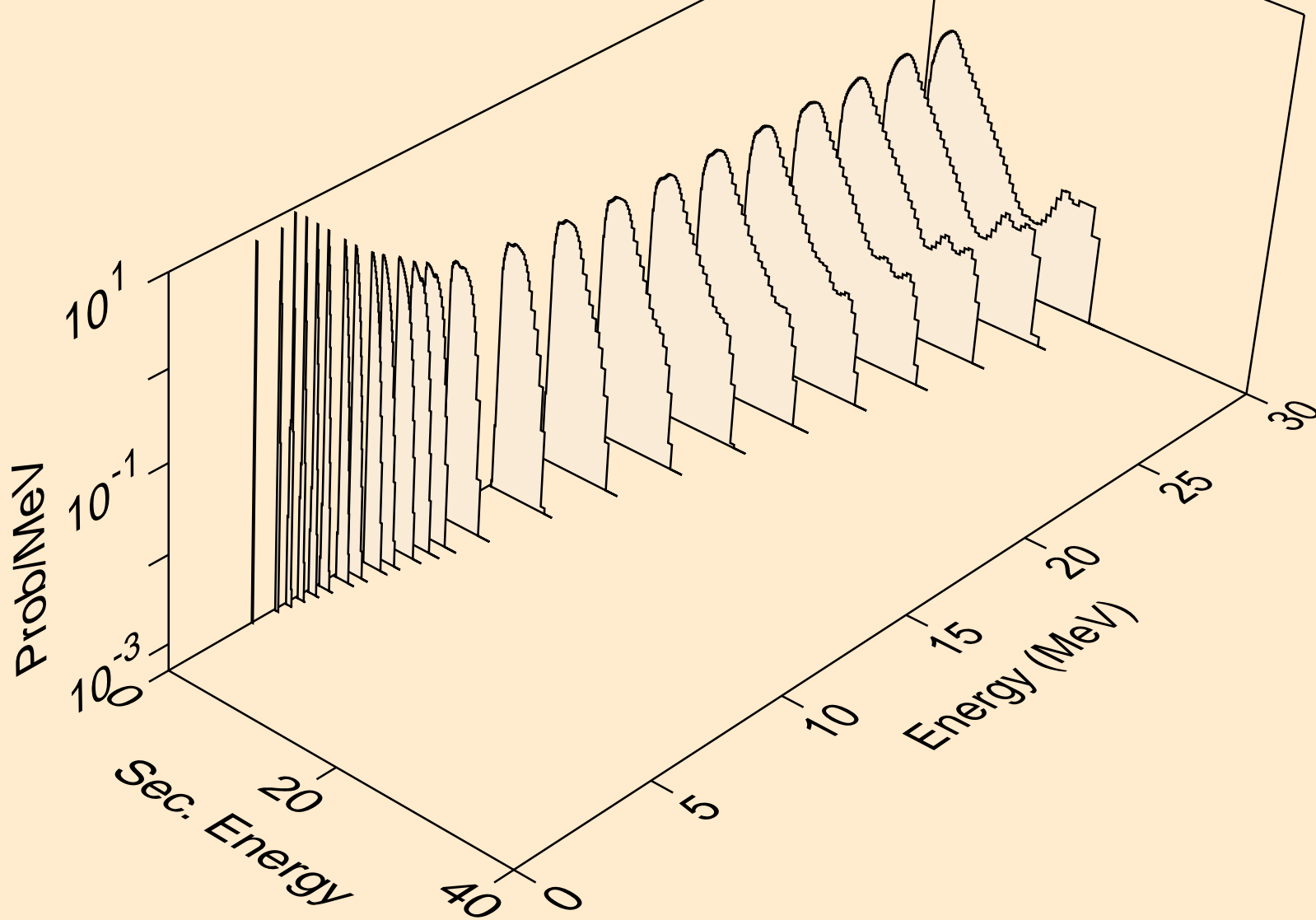

F017 NEUTRON ACER TENDL-2019 LIBRARY; T=293.16K
protons from (n,pd)

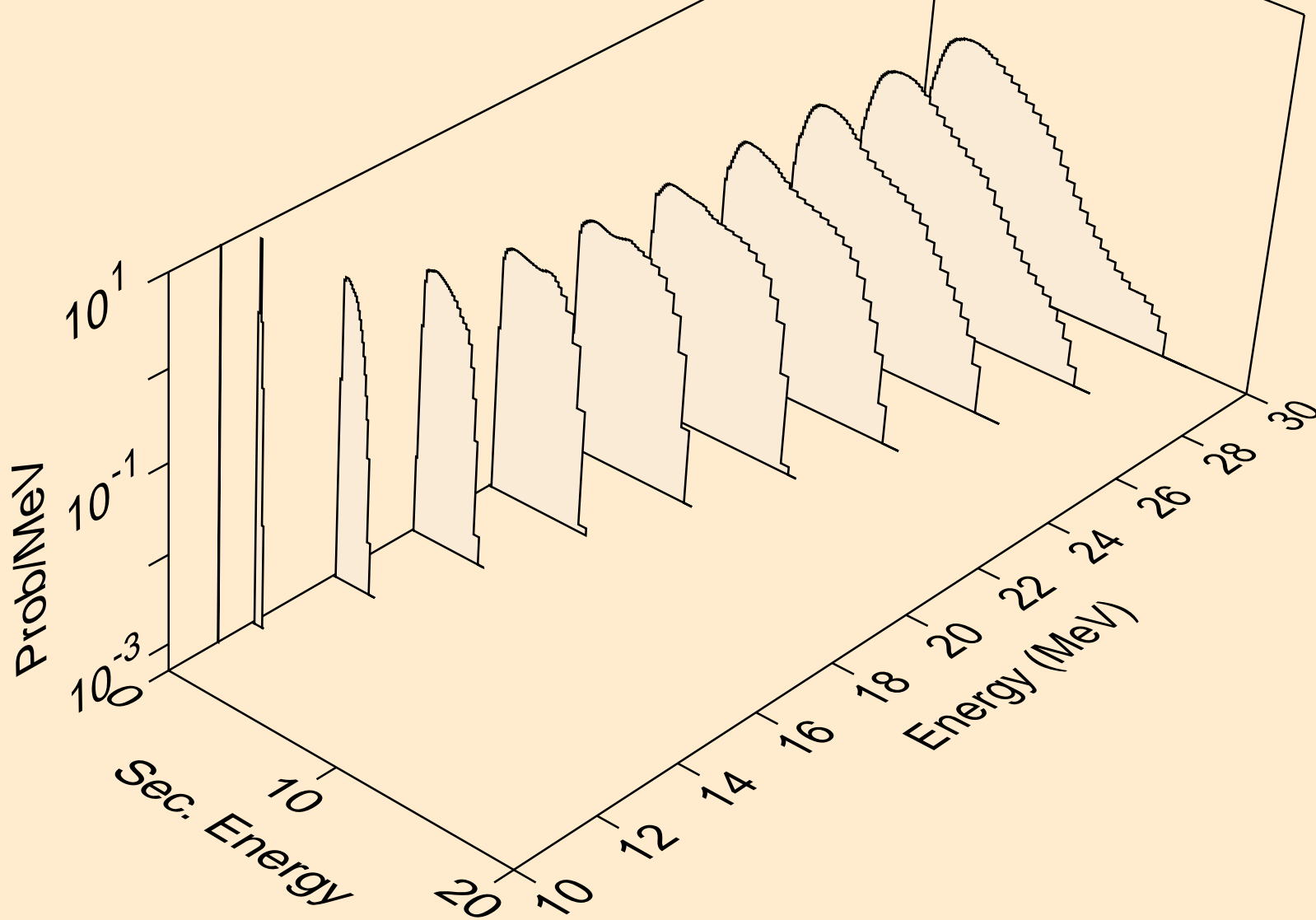

F017 NEUTRON ACER TENDL-2019 LIBRARY; T=293.16K
protons from (n,pt)

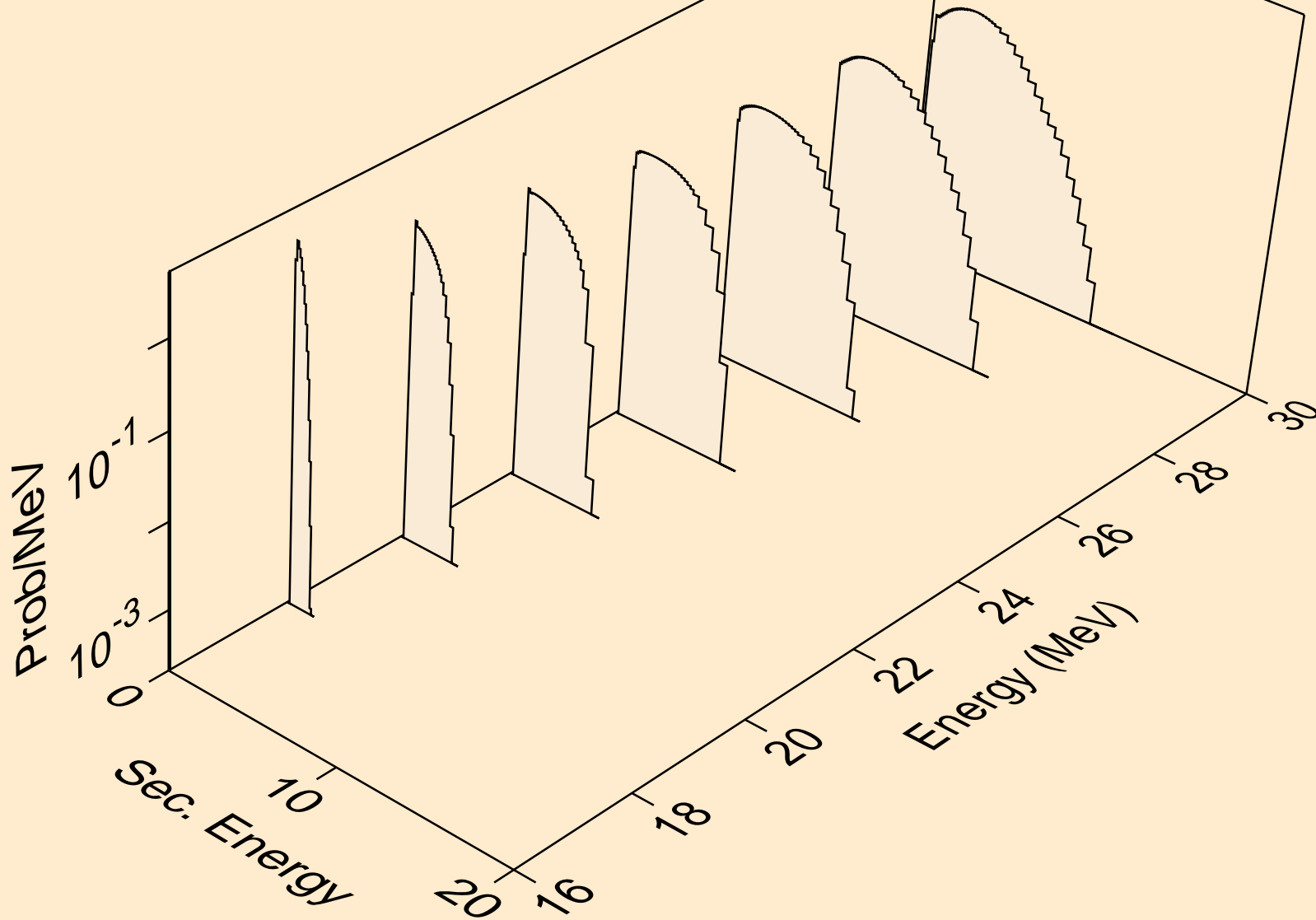

F017 NEUTRON ACER TENDL-2019 LIBRARY; T=293.16K
deuterons from (n,x)

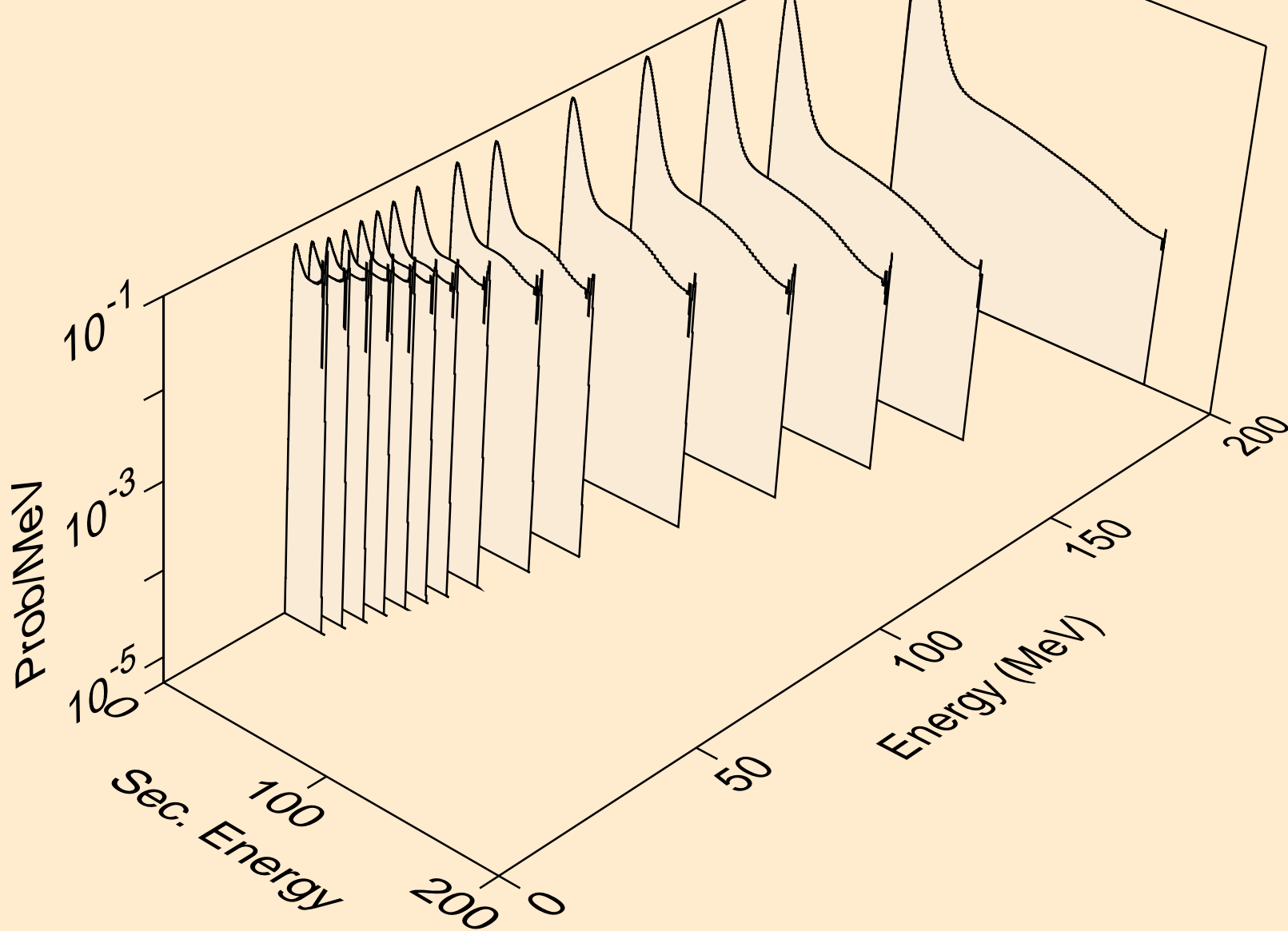

F017 NEUTRON ACER TENDL-2019 LIBRARY; T=293.16K
deuterons from (n,n*)d

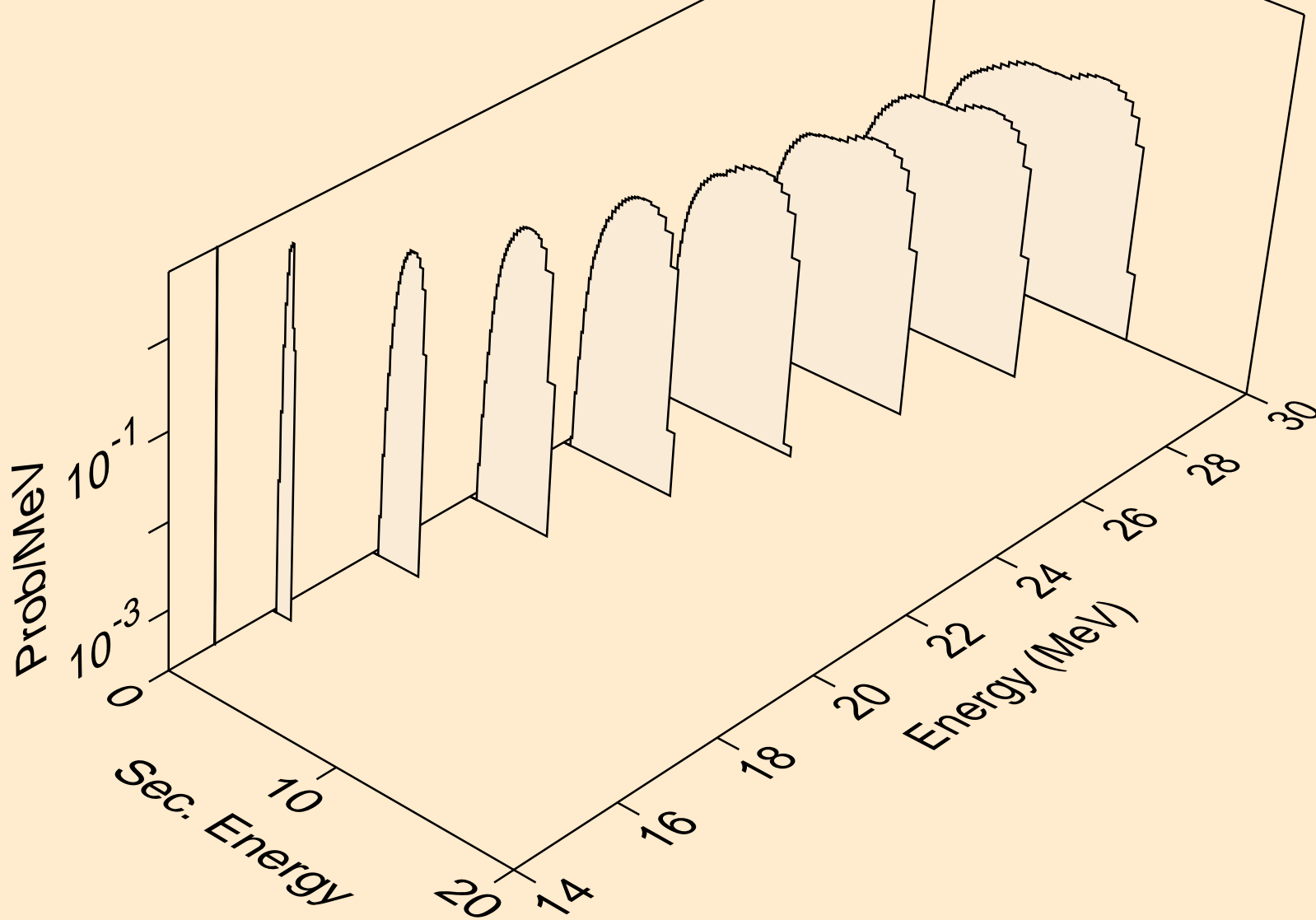

F017 NEUTRON ACER TENDL-2019 LIBRARY; T=293.16K
deuterons from (n,d)

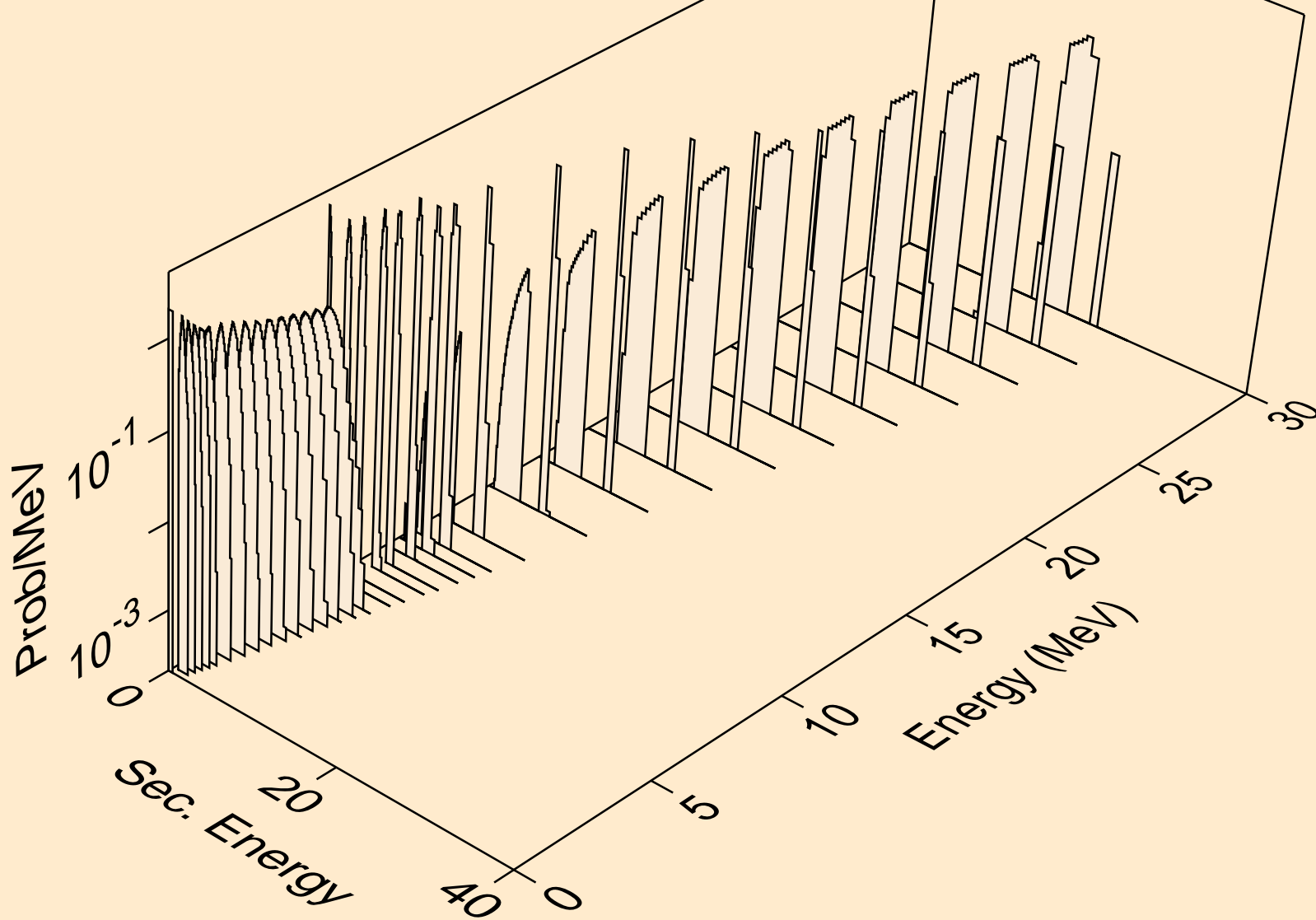

F017 NEUTRON ACER TENDL-2019 LIBRARY; T=293.16K
deuterons from (n,d2a)

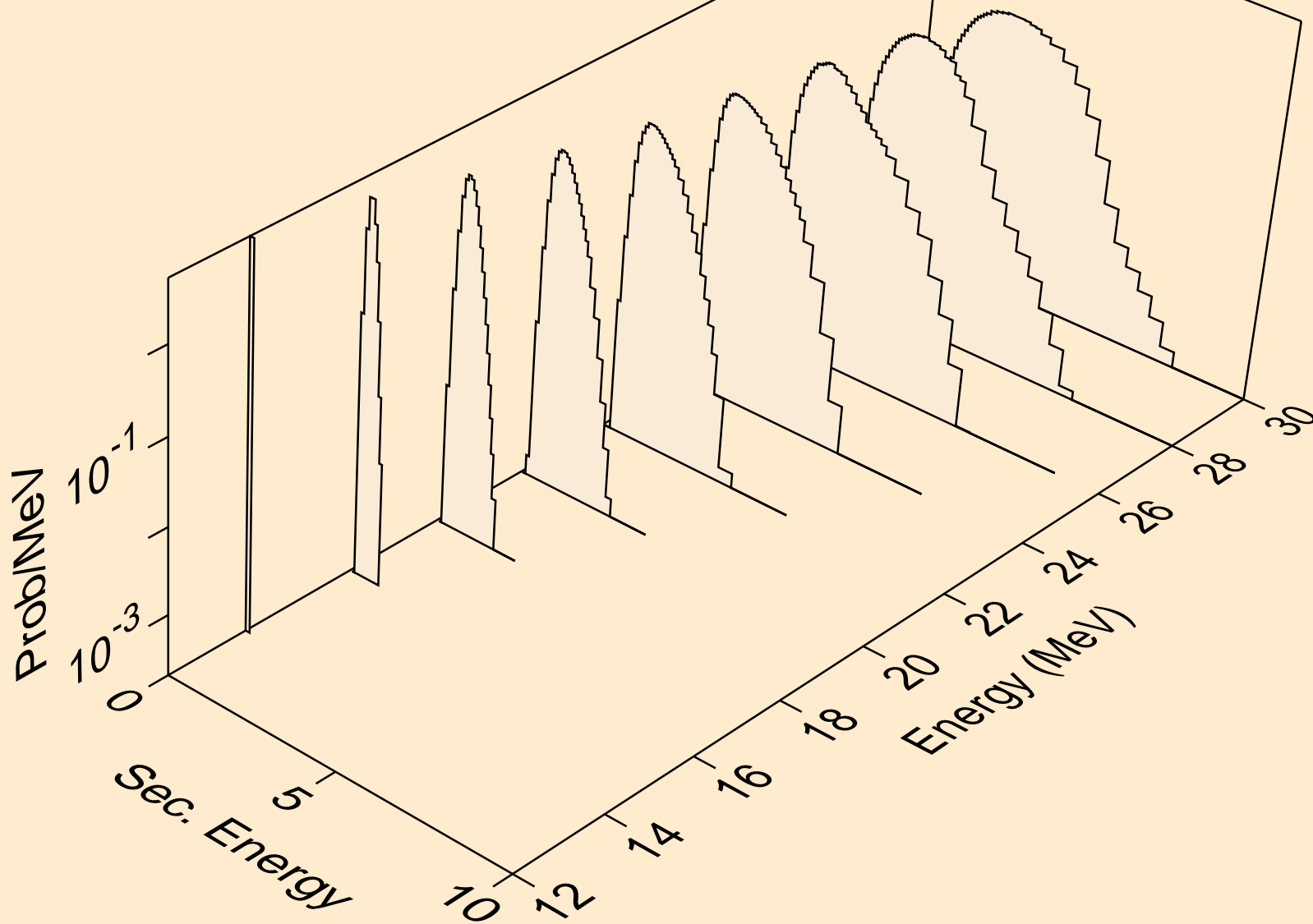

F017 NEUTRON ACER TENDL-2019 LIBRARY; T=293.16K
deuterons from (n,pd)

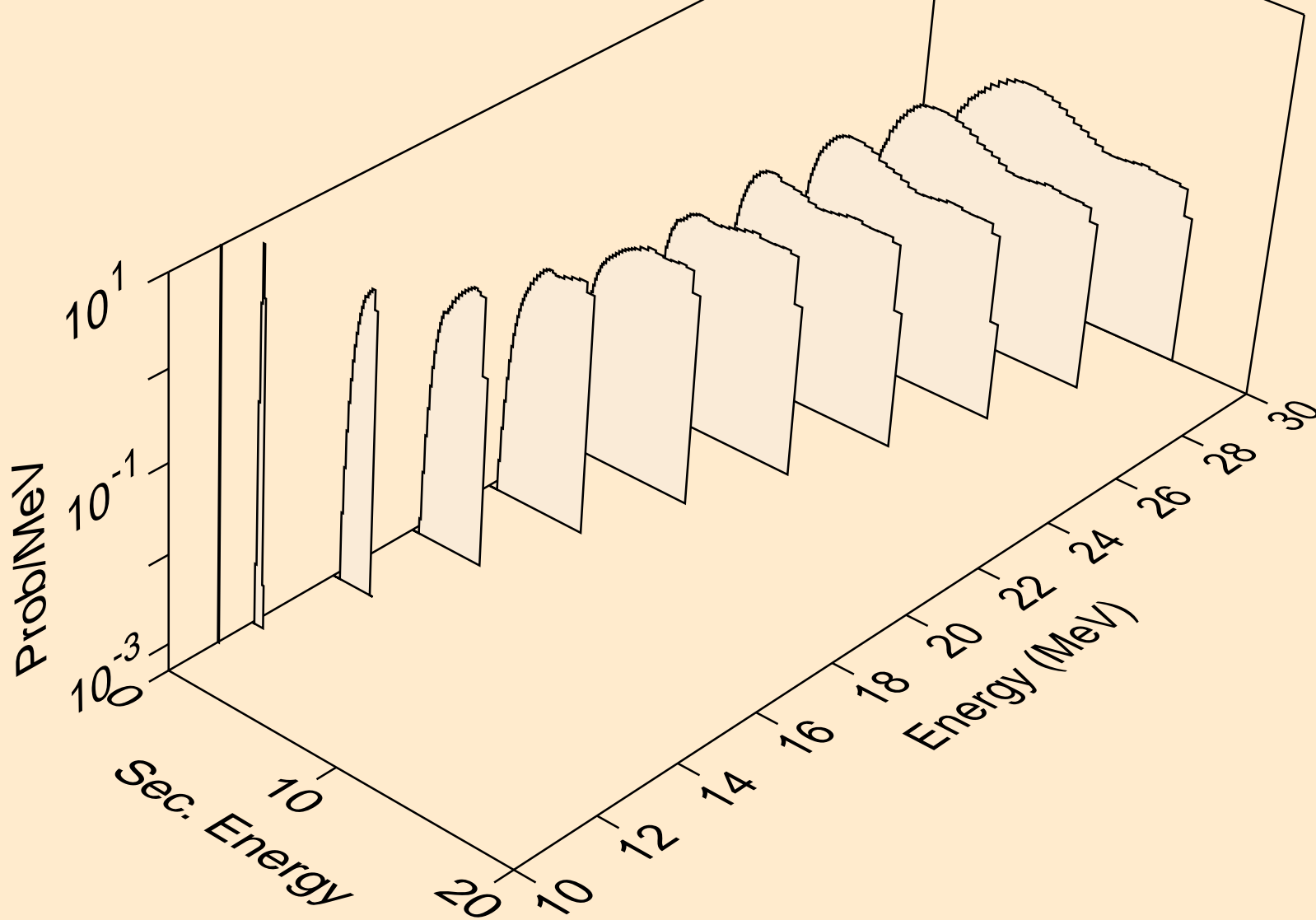

F017 NEUTRON ACER TENDL-2019 LIBRARY; T=293.16K
deuterons from (n,da)

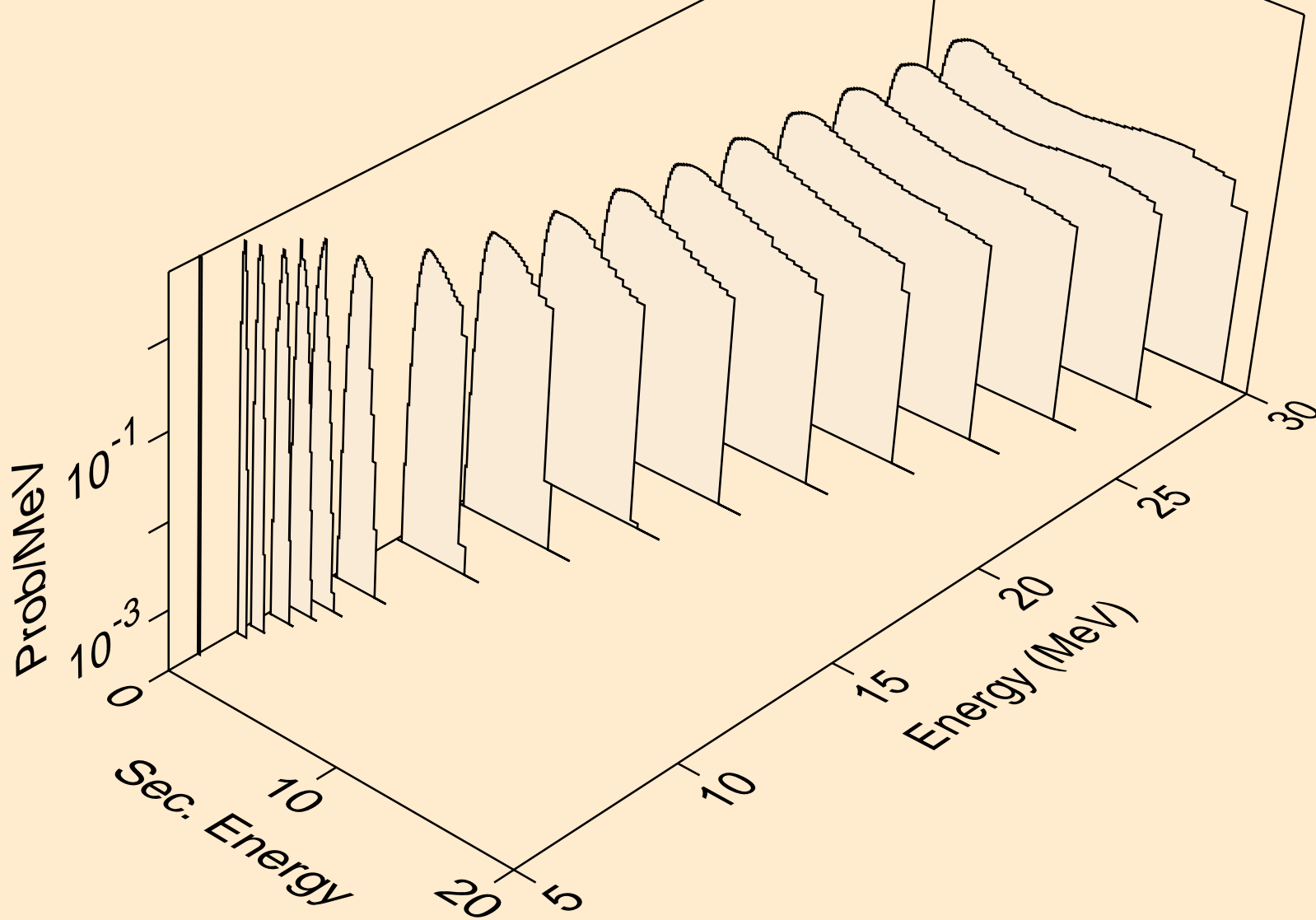

F017 NEUTRON ACER TENDL-2019 LIBRARY; T=293.16K
tritons from (n,x)

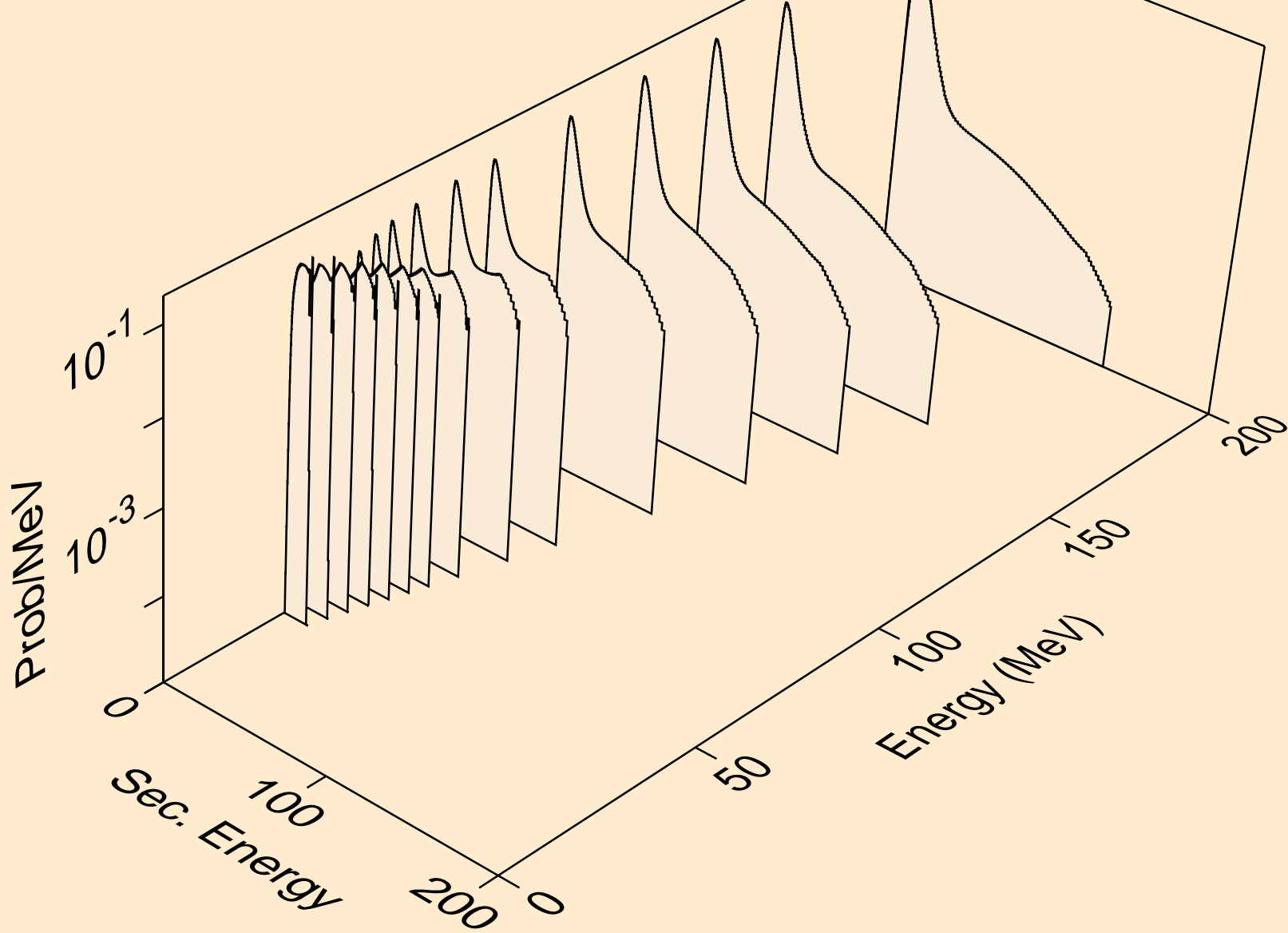

F017 NEUTRON ACER TENDL-2019 LIBRARY; T=293.16K
tritons from (n,n*)t

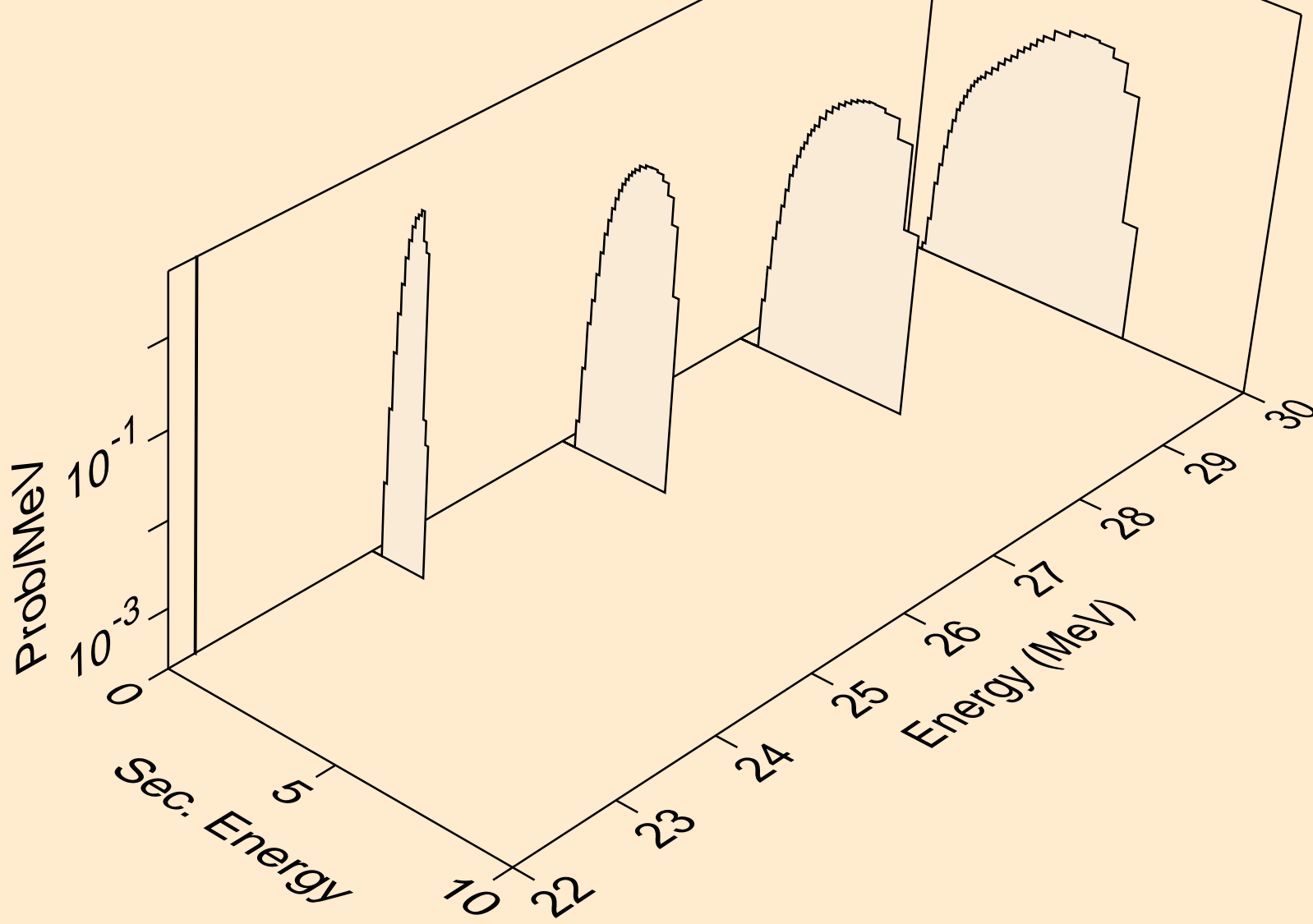

F017 NEUTRON ACER TENDL-2019 LIBRARY; T=293.16K
tritons from (n,t)

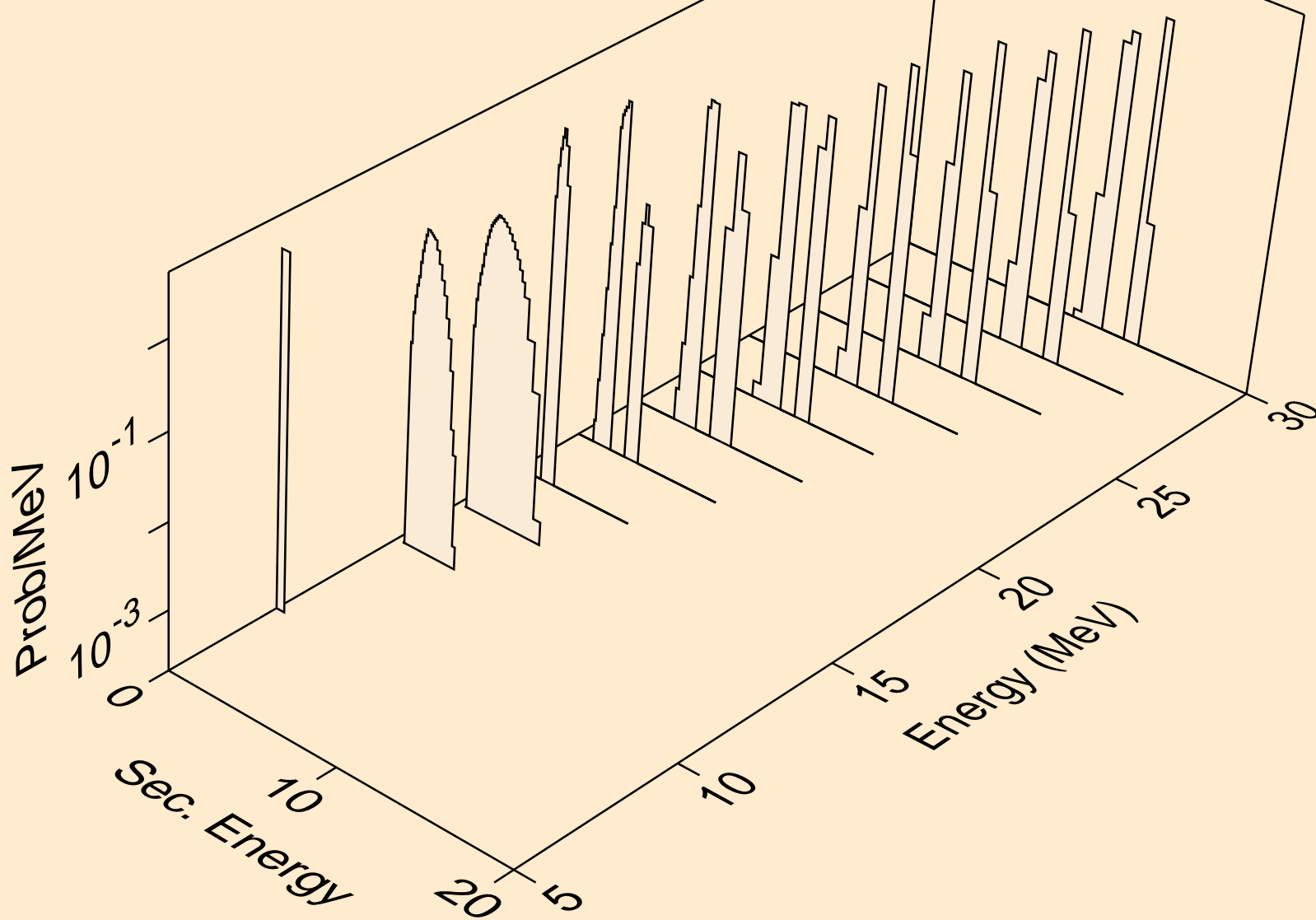

F017 NEUTRON ACER TENDL-2019 LIBRARY; T=293.16K
tritons from (n,pt)

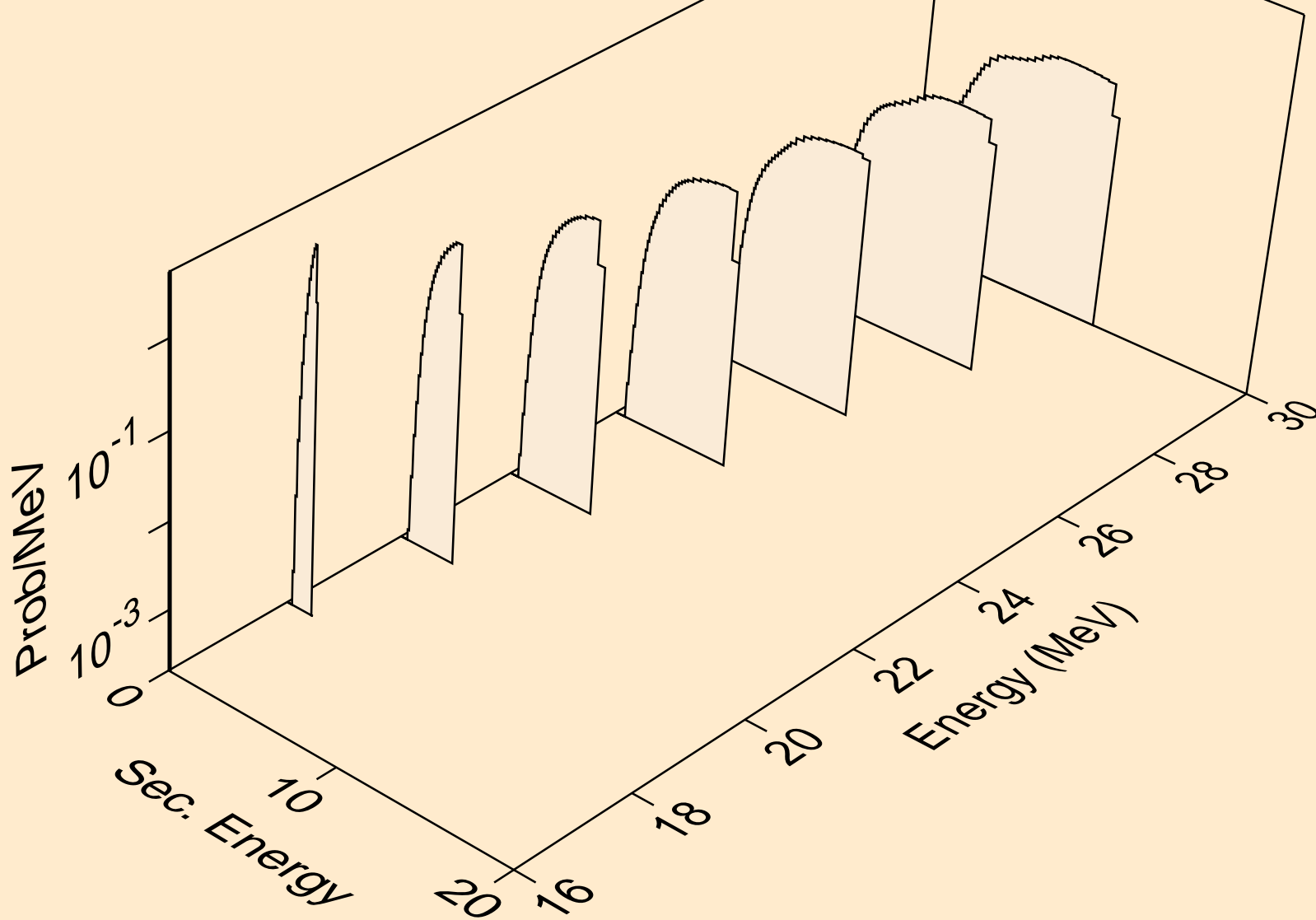

F017 NEUTRON ACER TENDL-2019 LIBRARY; T=293.16K
he3s from (n,x)

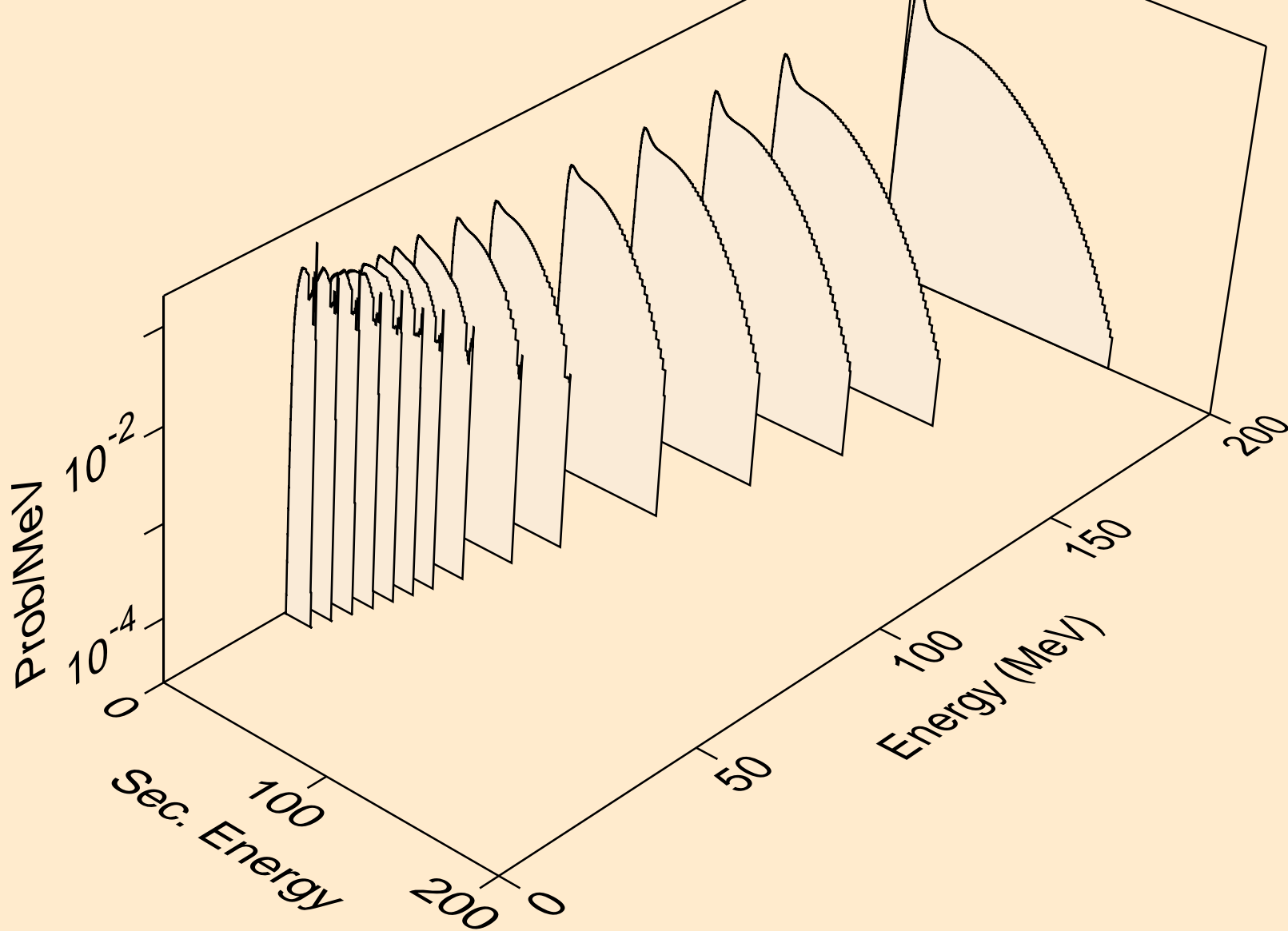

F017 NEUTRON ACER TENDL-2019 LIBRARY; T=293.16K
he3s from (n,n*)he3

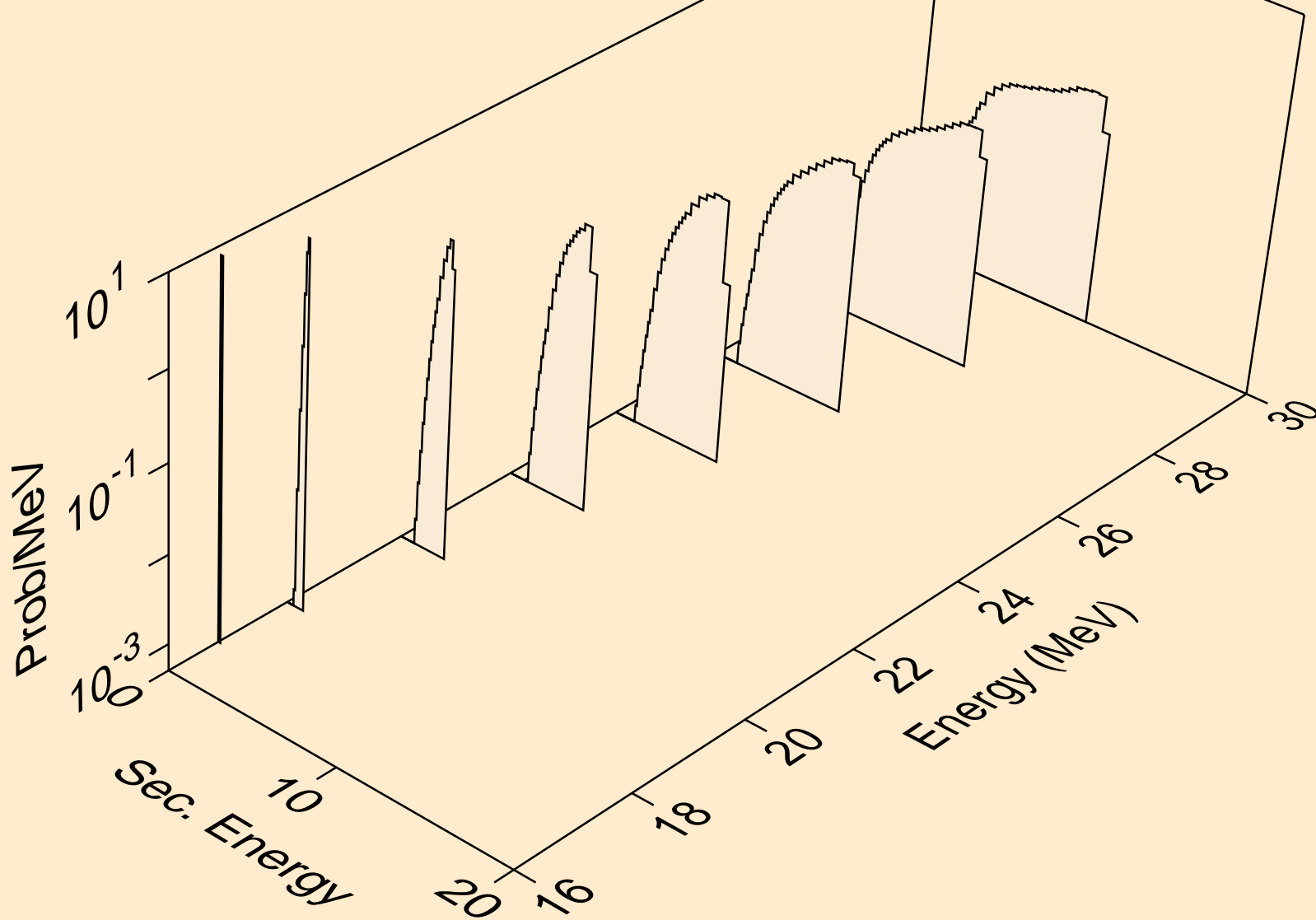

F017 NEUTRON ACER TENDL-2019 LIBRARY; T=293.16K
he3s from (n,he3)

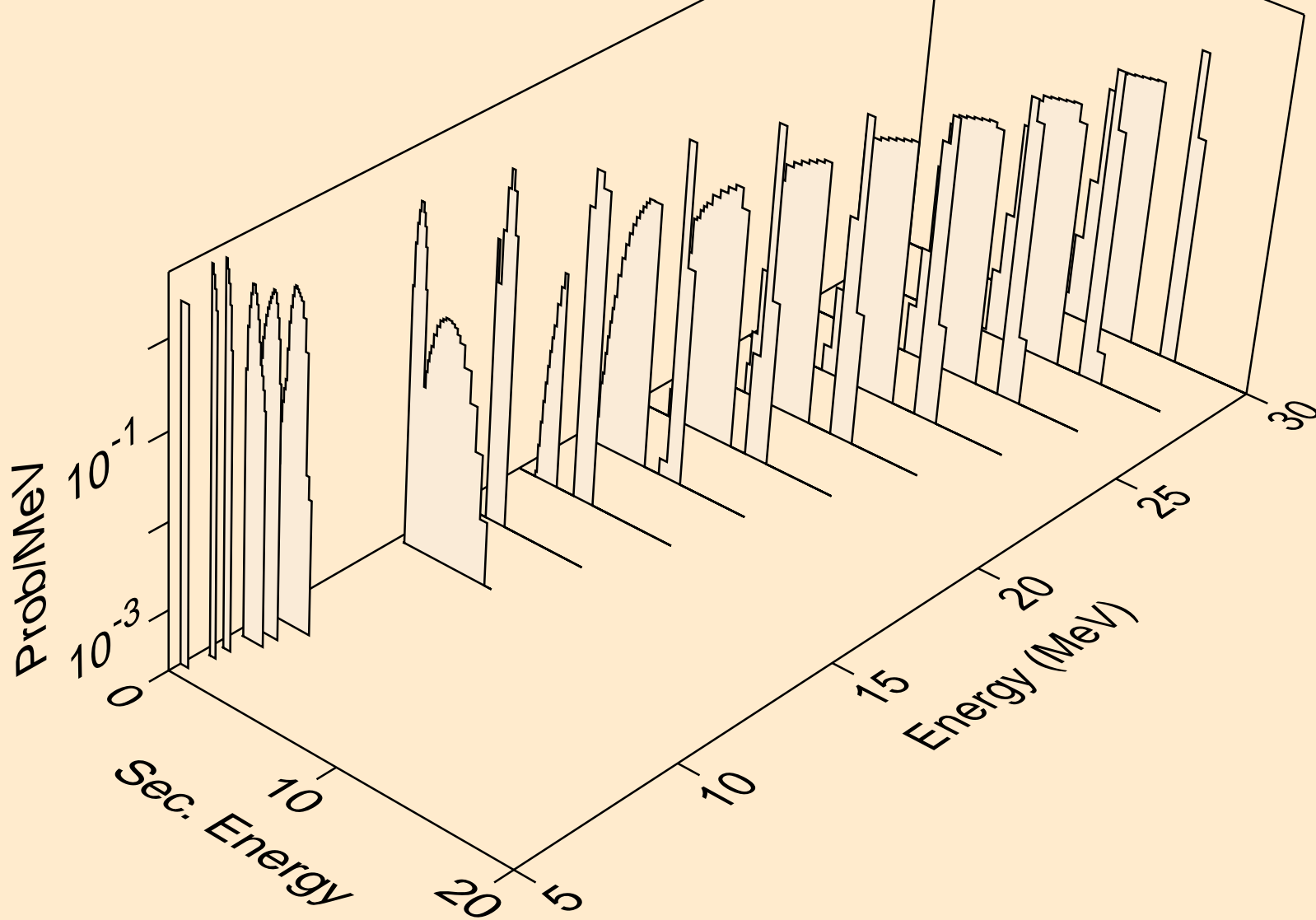

F017 NEUTRON ACER TENDL-2019 LIBRARY; T=293.16K
alphas from (n,x)

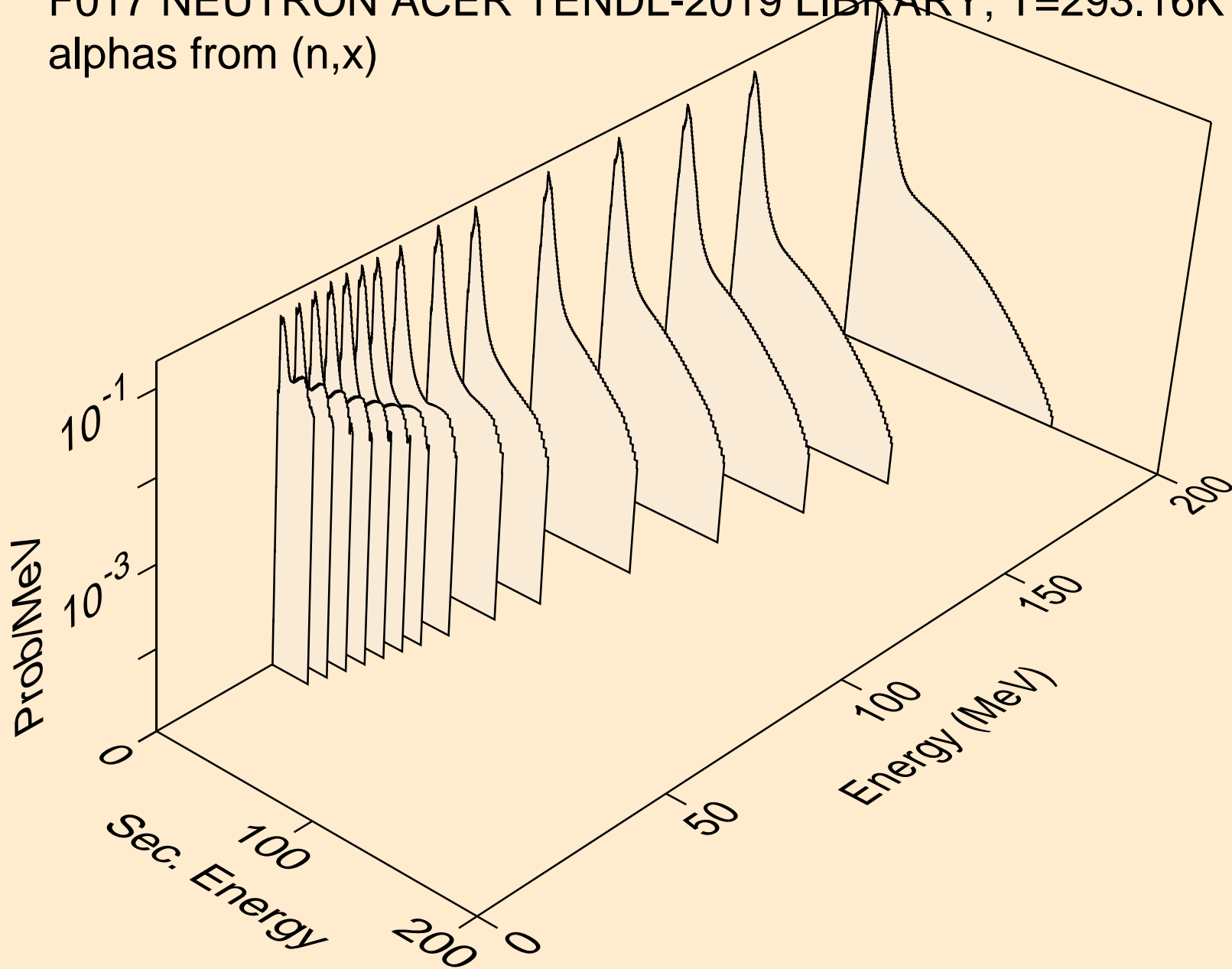

F017 NEUTRON ACER TENDL-2019 LIBRARY; T=293.16K
alphas from (n,n*)a

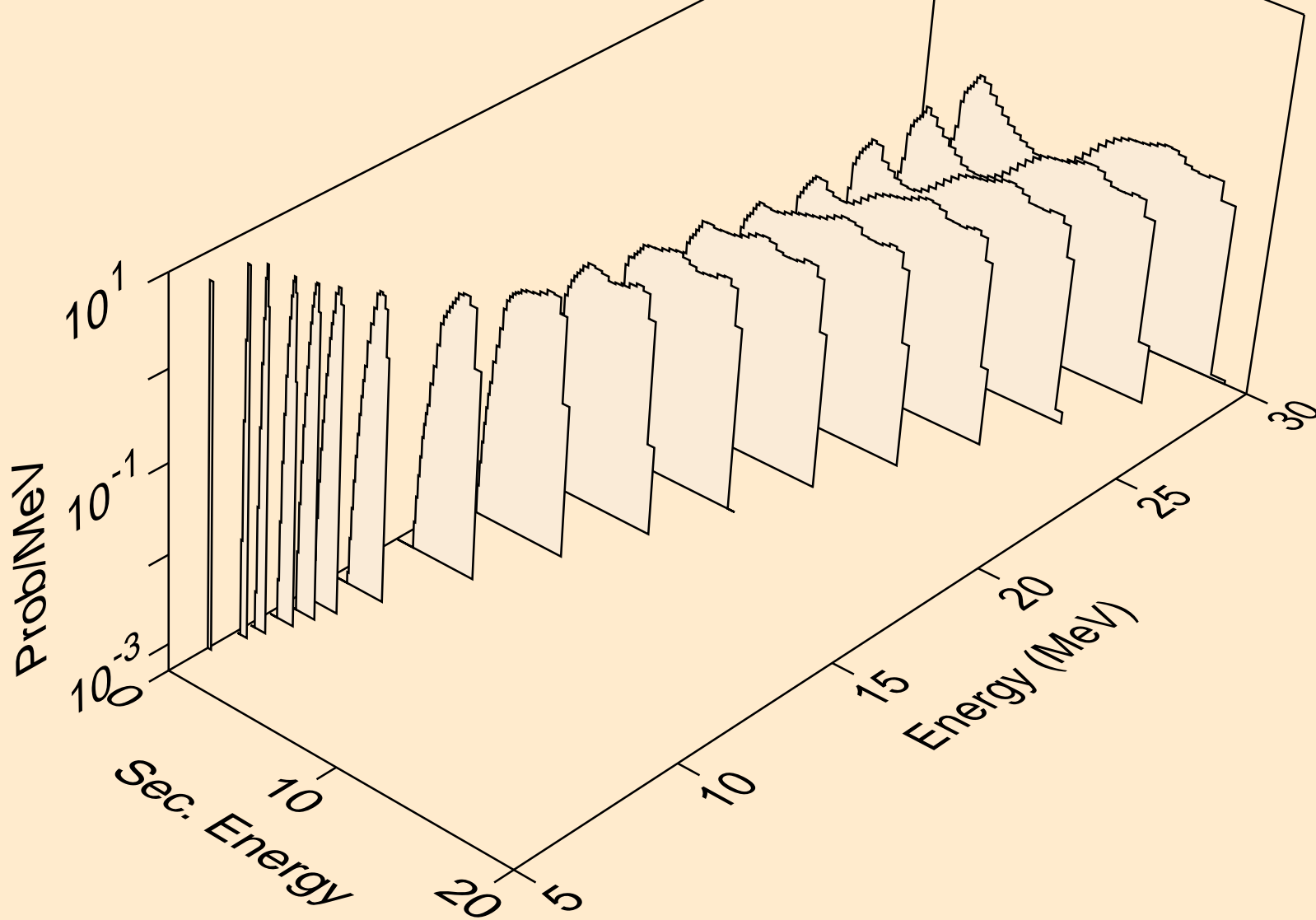

F017 NEUTRON ACER TENDL-2019 LIBRARY; T=293.16K
alphas from (n,2n)a

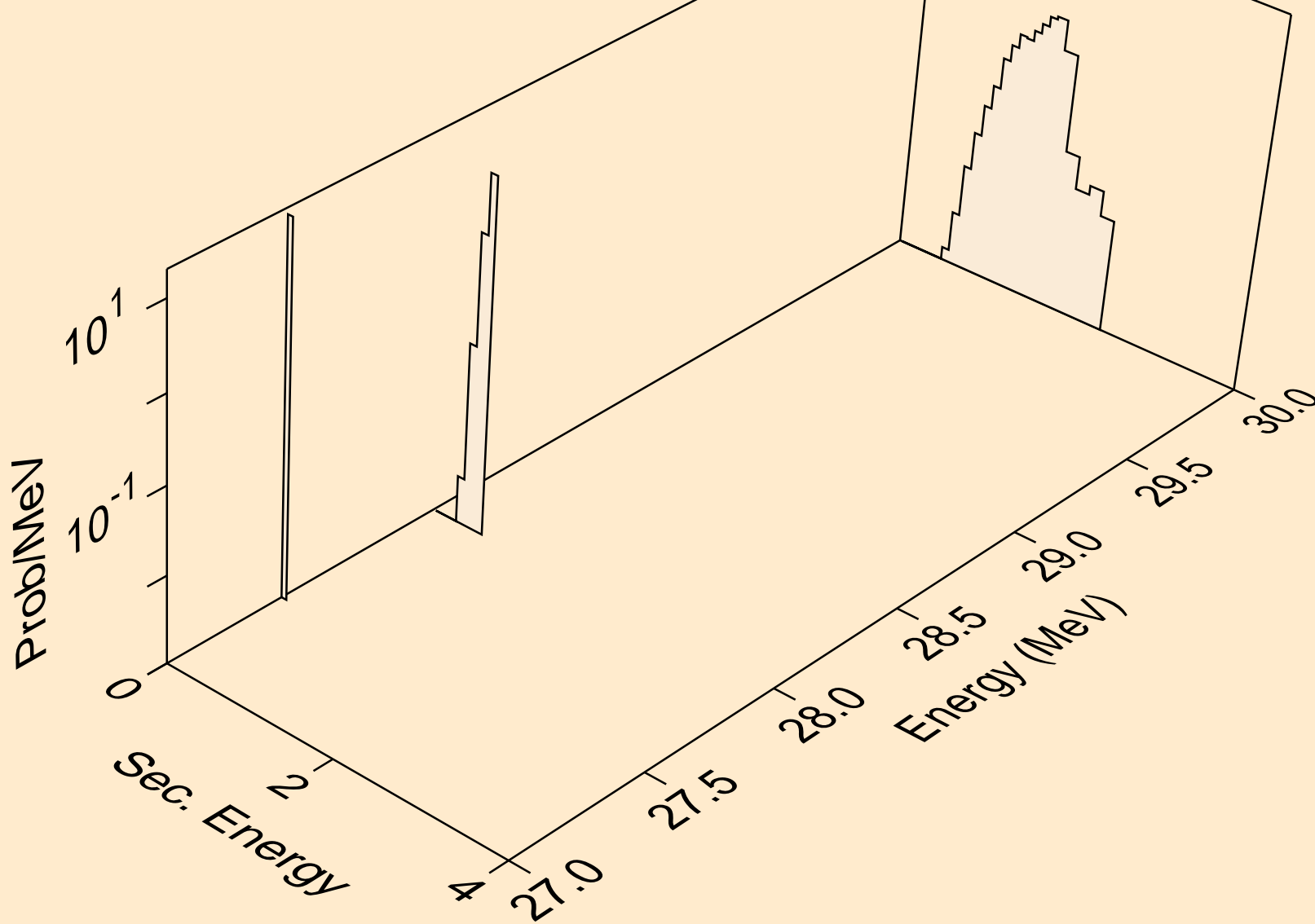

F017 NEUTRON ACER TENDL-2019 LIBRARY; T=293.16K
alphas from (n,n*)2a

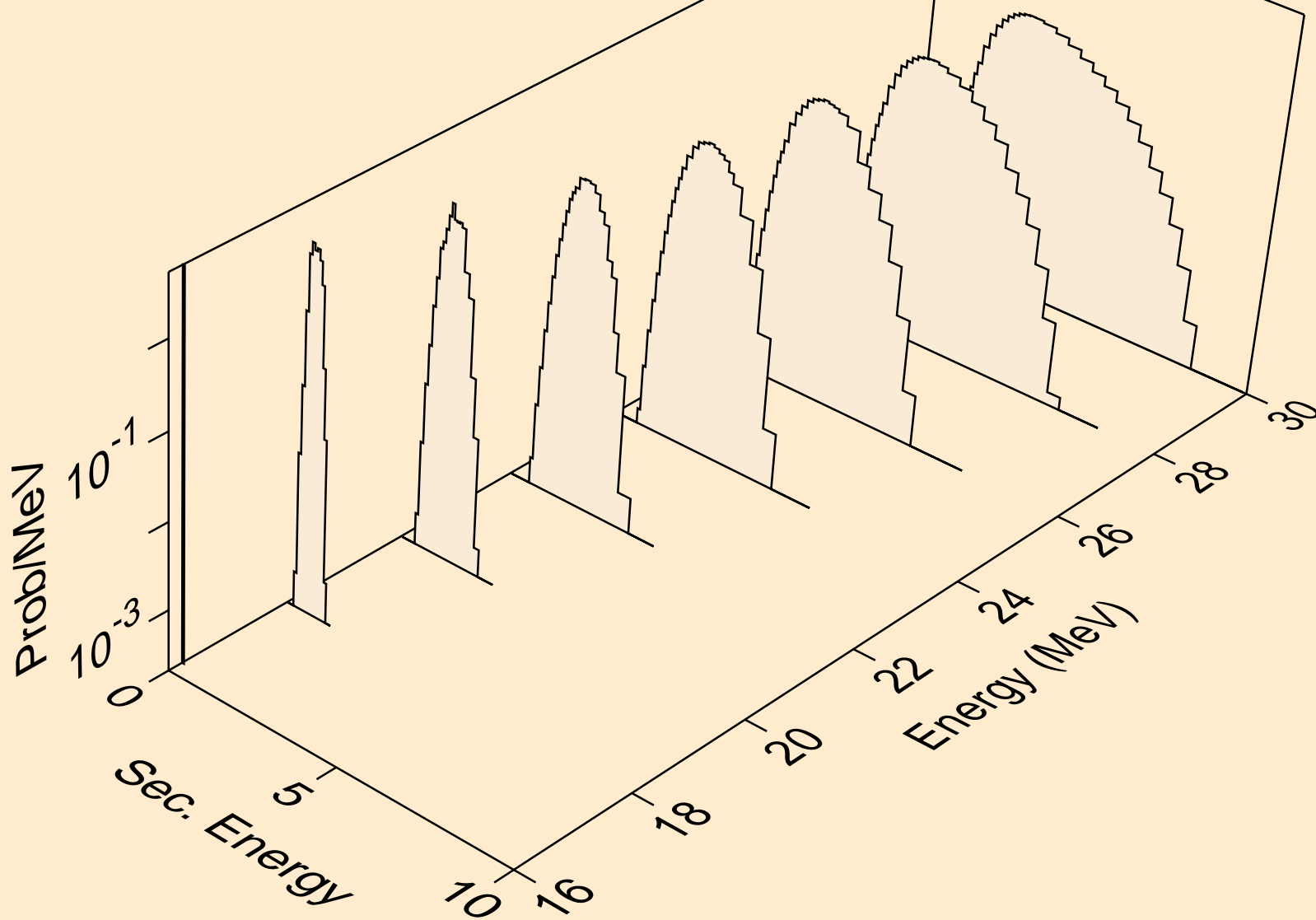

F017 NEUTRON ACER TENDL-2019 LIBRARY; T=293.16K
alphas from (n,npa)

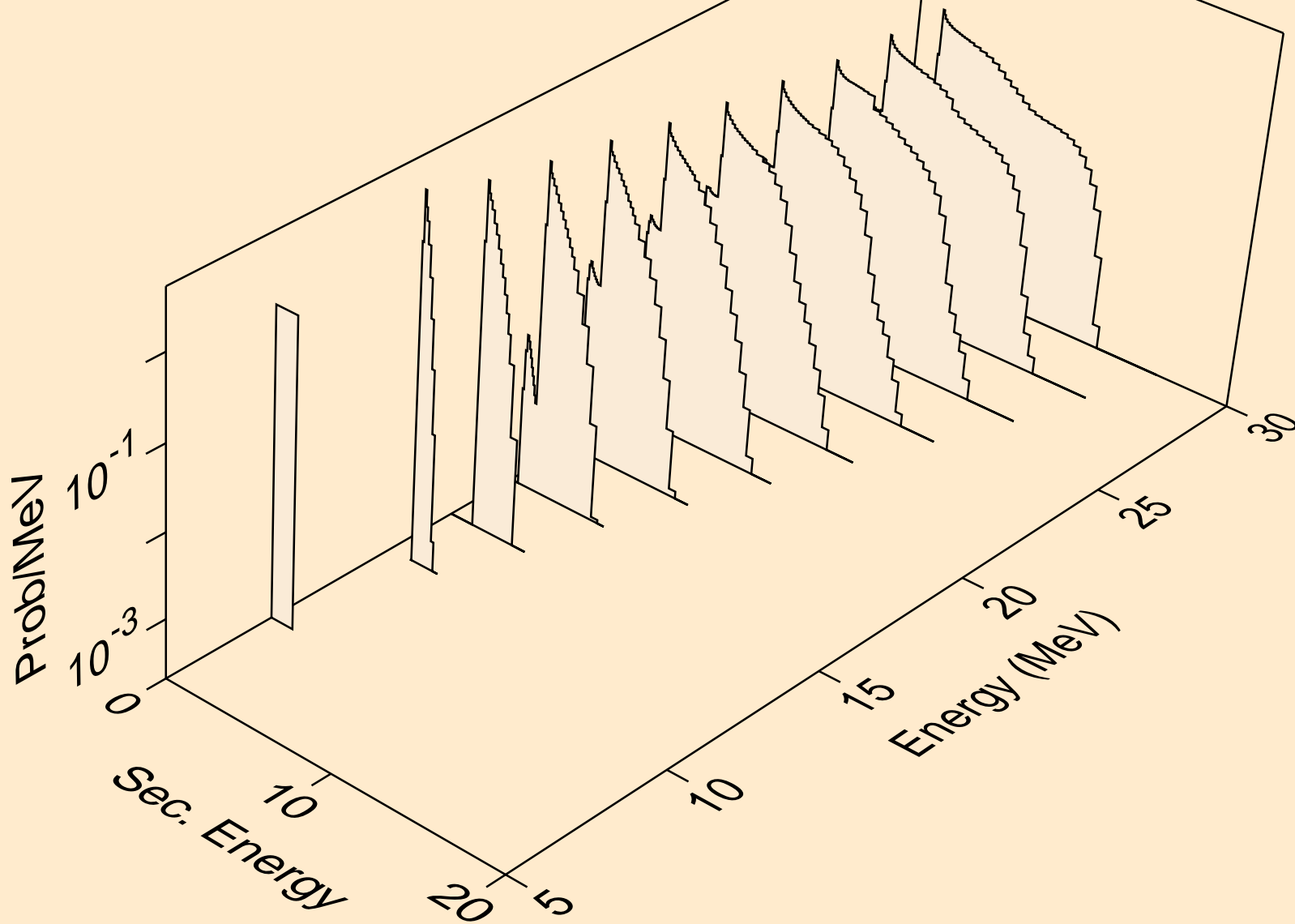

F017 NEUTRON ACER TENDL-2019 LIBRARY; T=293.16K
alphas from (n,a)

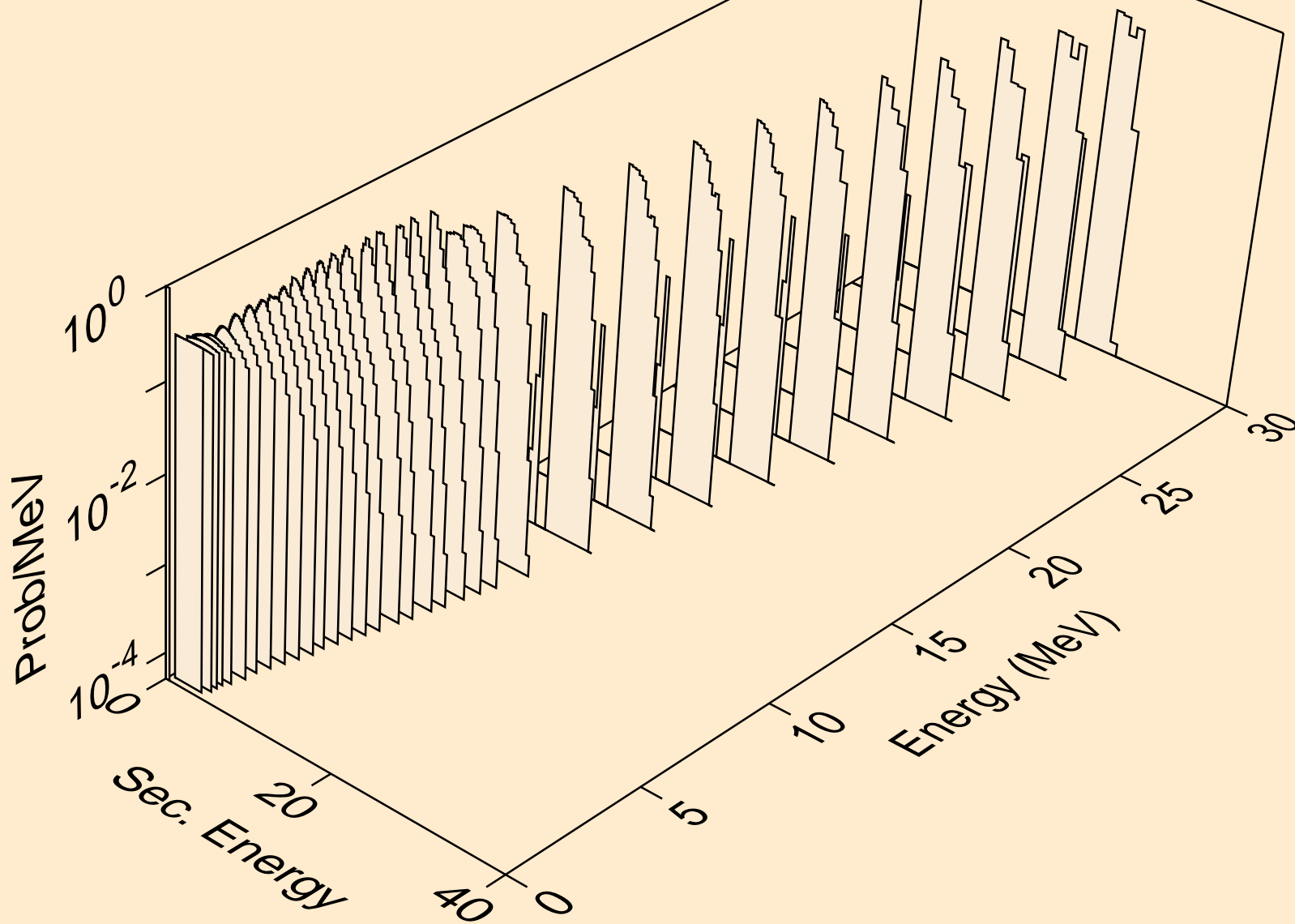

F017 NEUTRON ACER TENDL-2019 LIBRARY; T=293.16K
alphas from (n,2a)

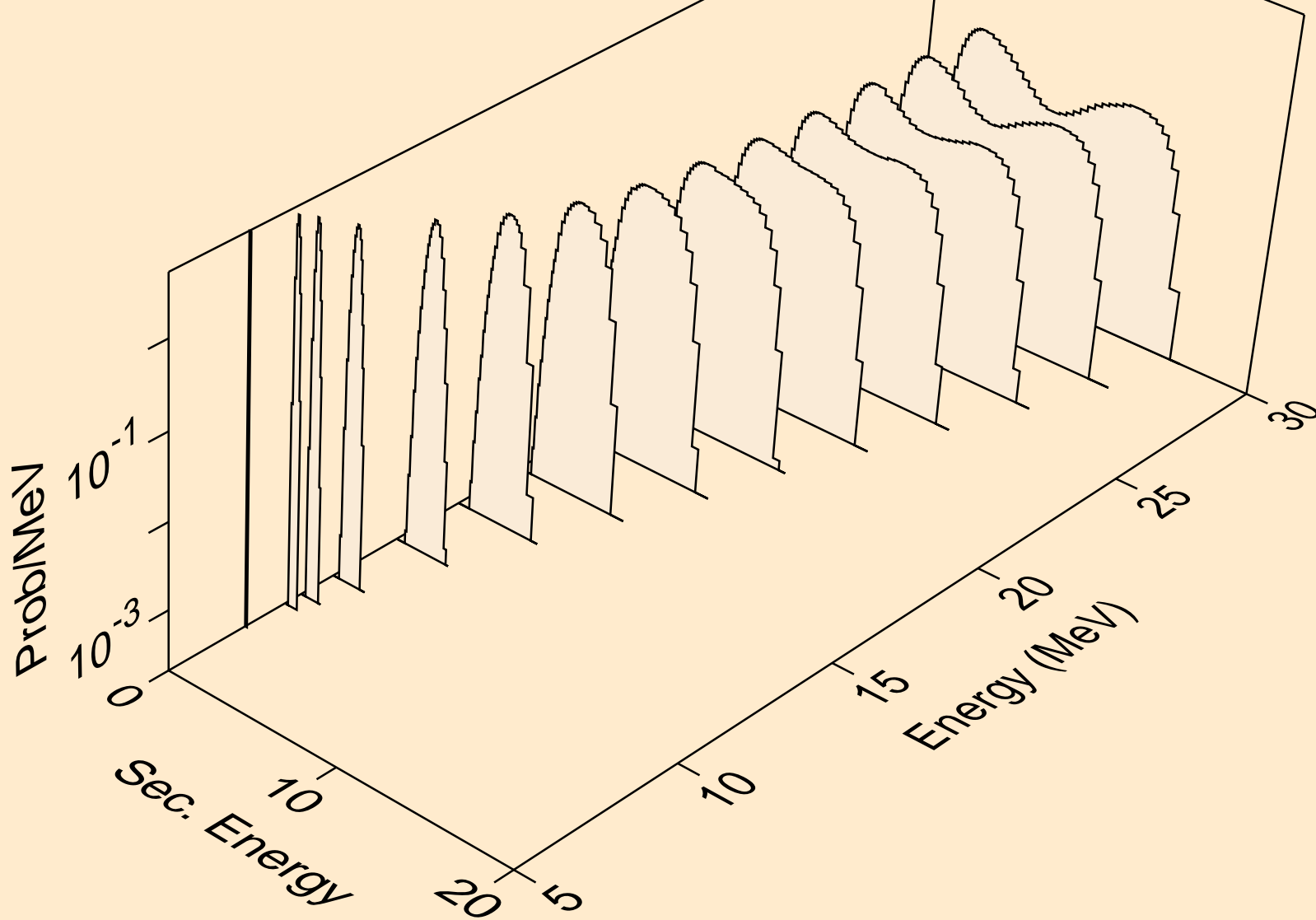

F017 NEUTRON ACER TENDL-2019 LIBRARY; T=293.16K
alphas from (n,3a)

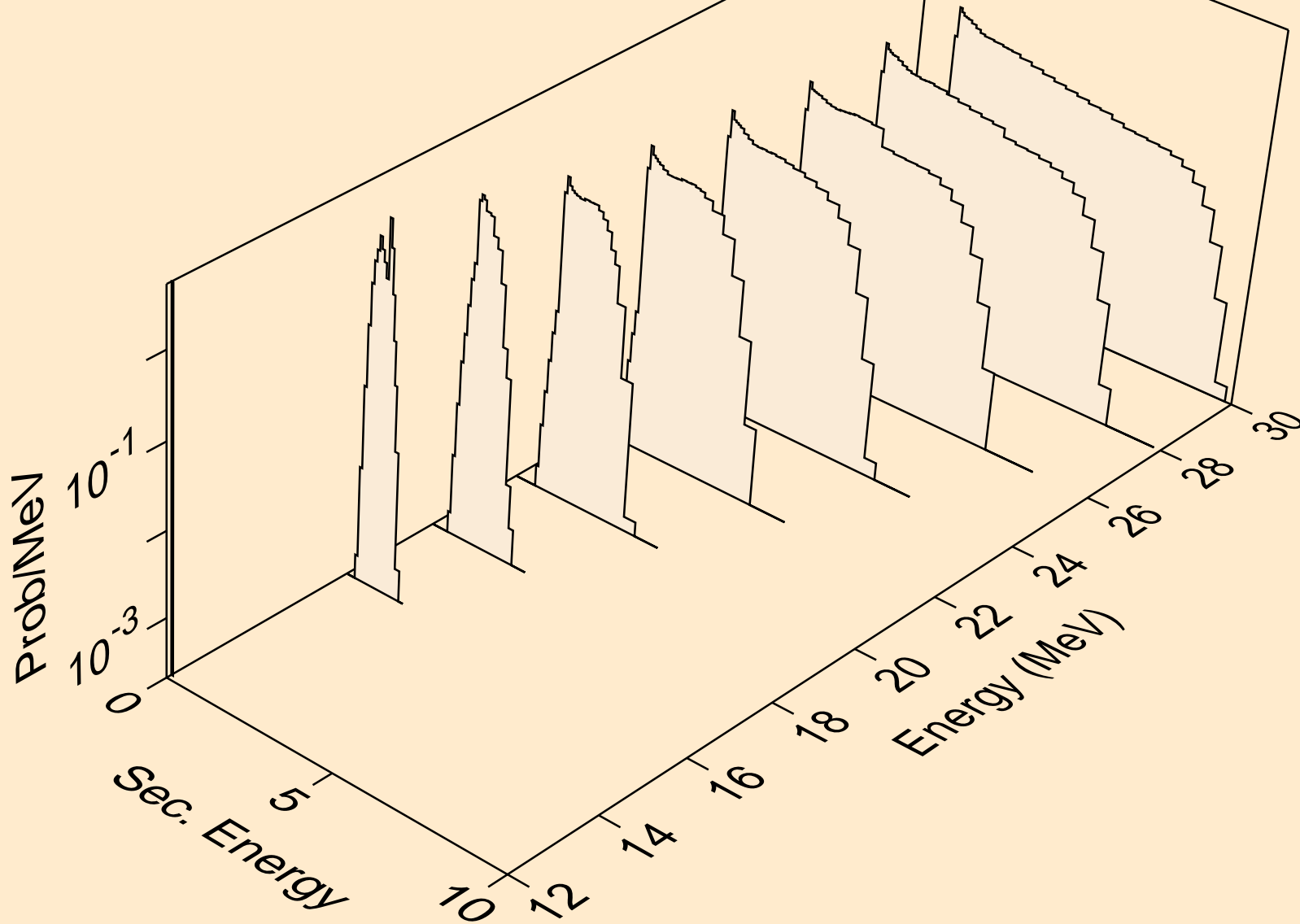

F017 NEUTRON ACER TENDL-2019 LIBRARY; T=293.16K
alphas from (n,pa)

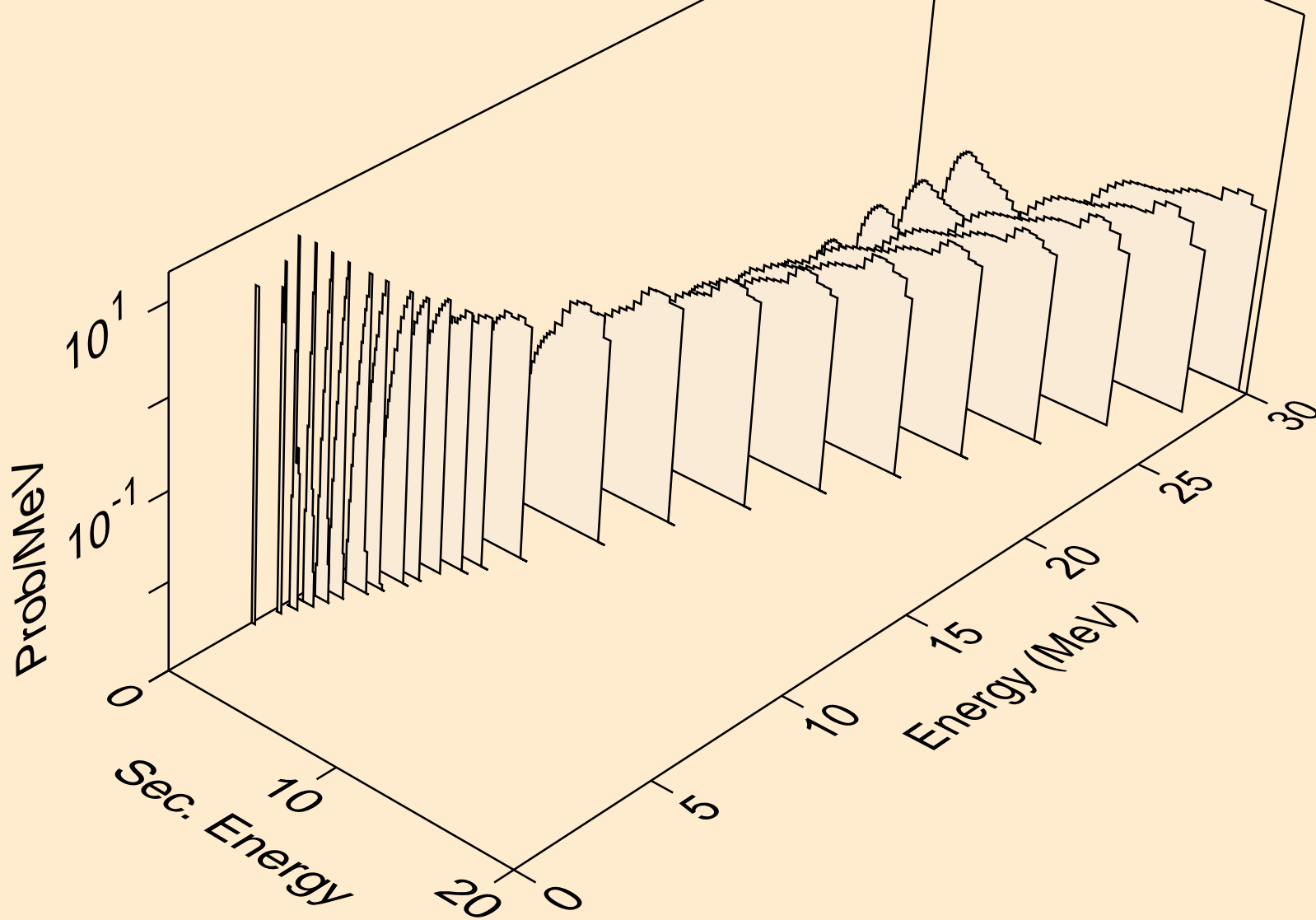

F017 NEUTRON ACER TENDL-2019 LIBRARY; T=293.16K
alphas from (n,d2a)

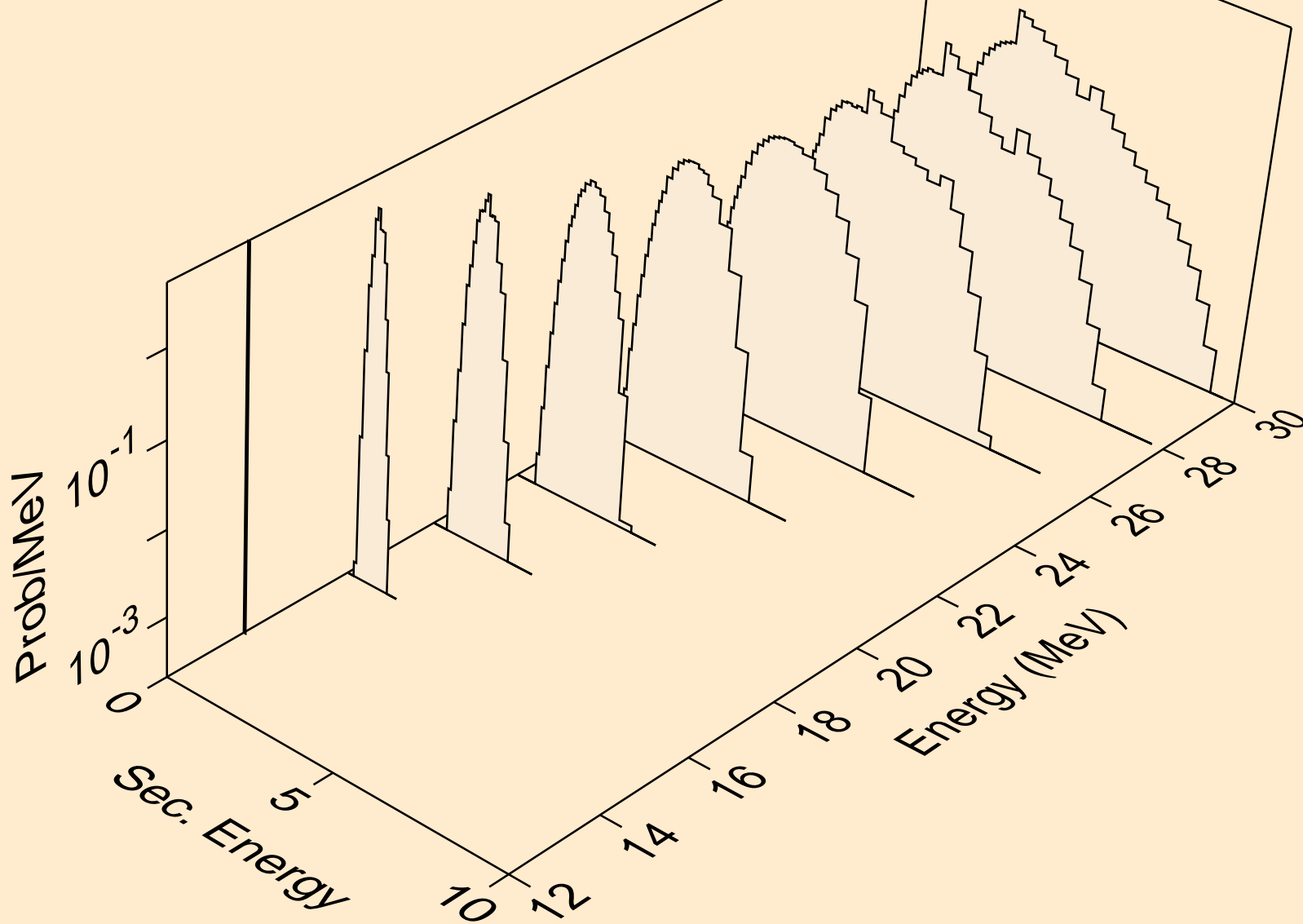

F017 NEUTRON ACER TENDL-2019 LIBRARY; T=293.16K
alphas from (n,da)

