

F022 NEUTRON ACER TENDL-2019 LIBRARY; T=293.16K  
Principal cross sections

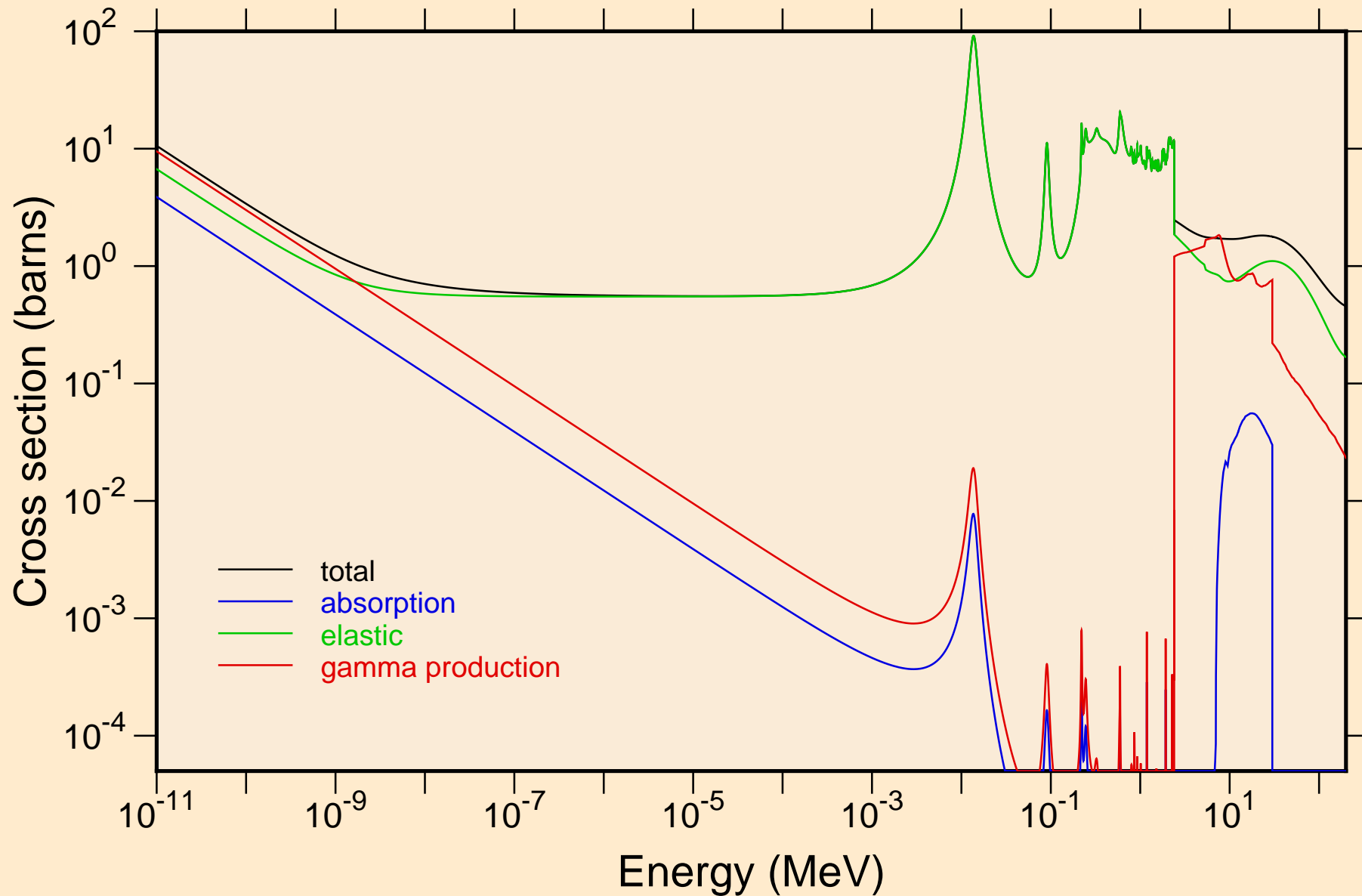

F022 NEUTRON ACER TENDL-2019 LIBRARY; T=293.16K  
resonance total cross section

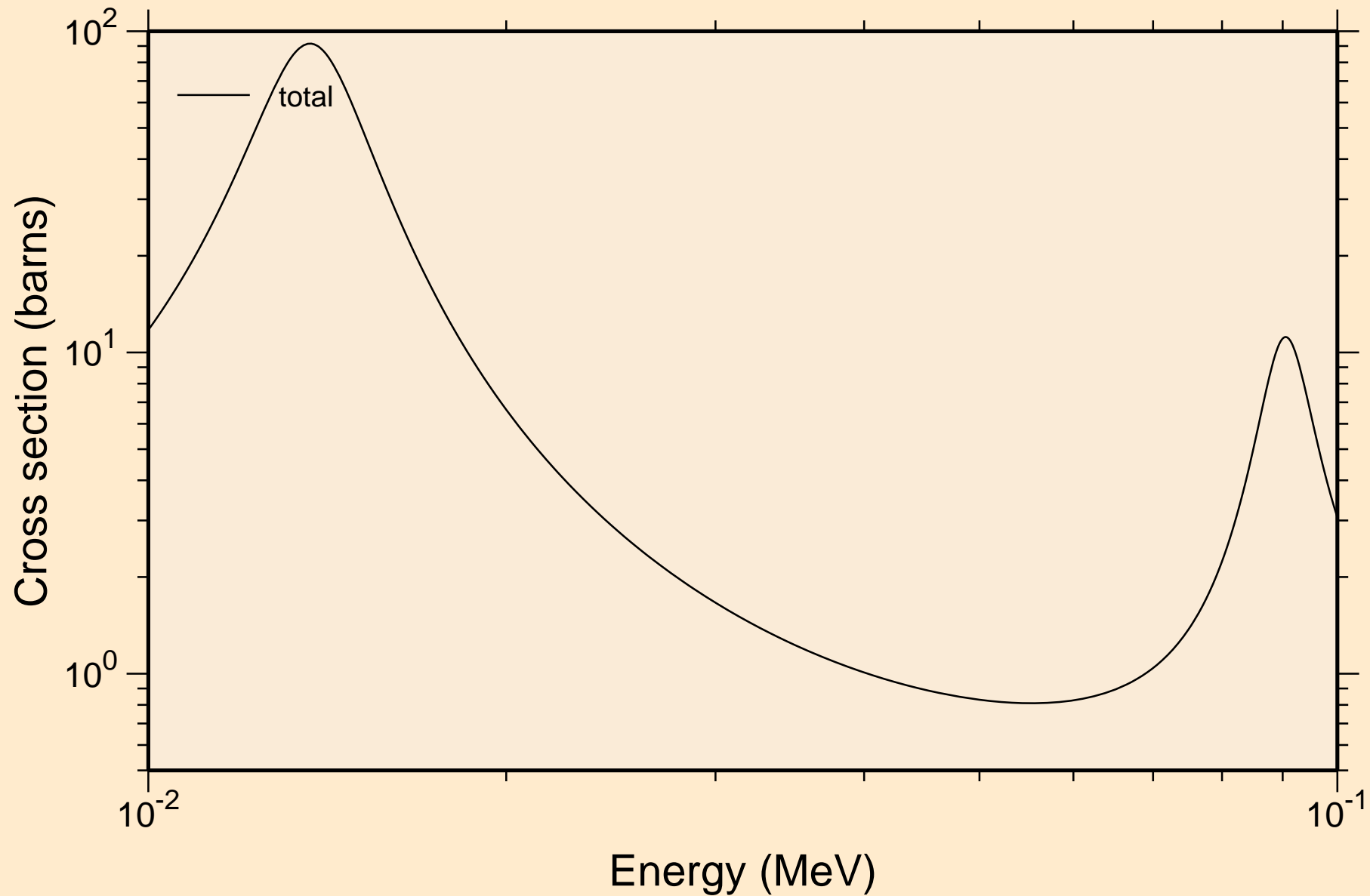

F022 NEUTRON ACER TENDL-2019 LIBRARY; T=293.16K  
resonance total cross section

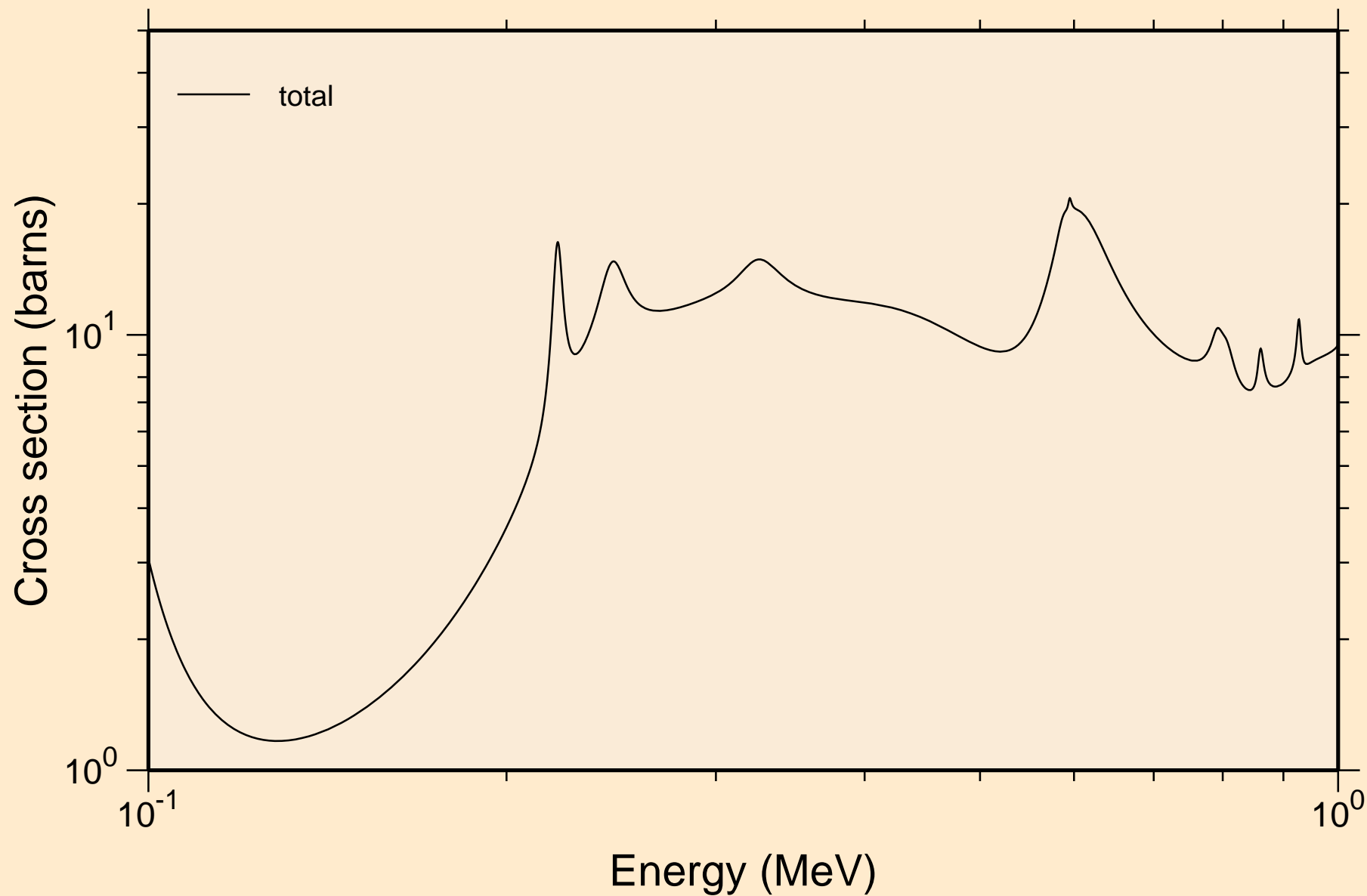

F022 NEUTRON ACER TENDL-2019 LIBRARY; T=293.16K  
resonance total cross section

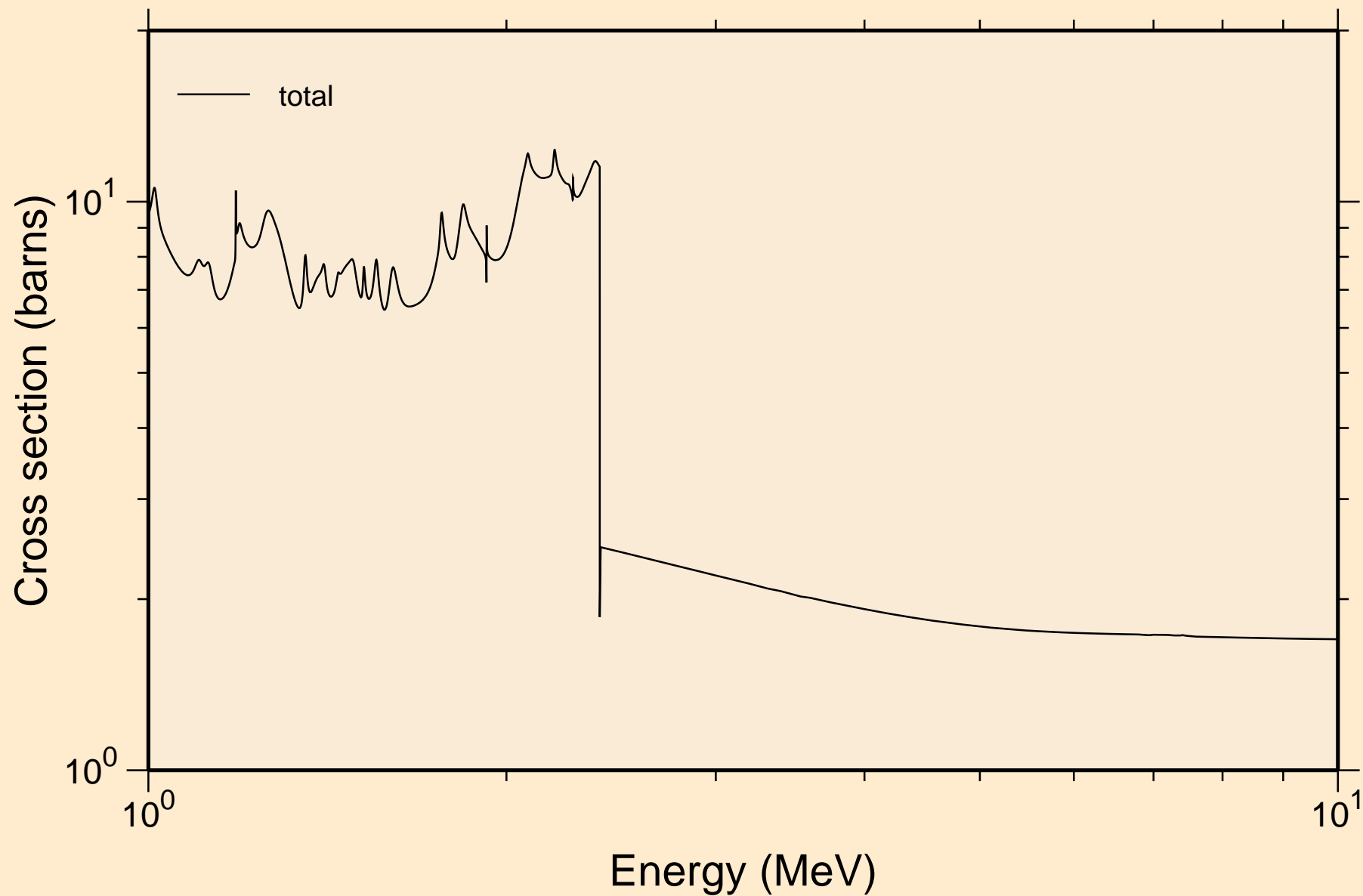

F022 NEUTRON ACER TENDL-2019 LIBRARY; T=293.16K  
resonance absorption cross sections

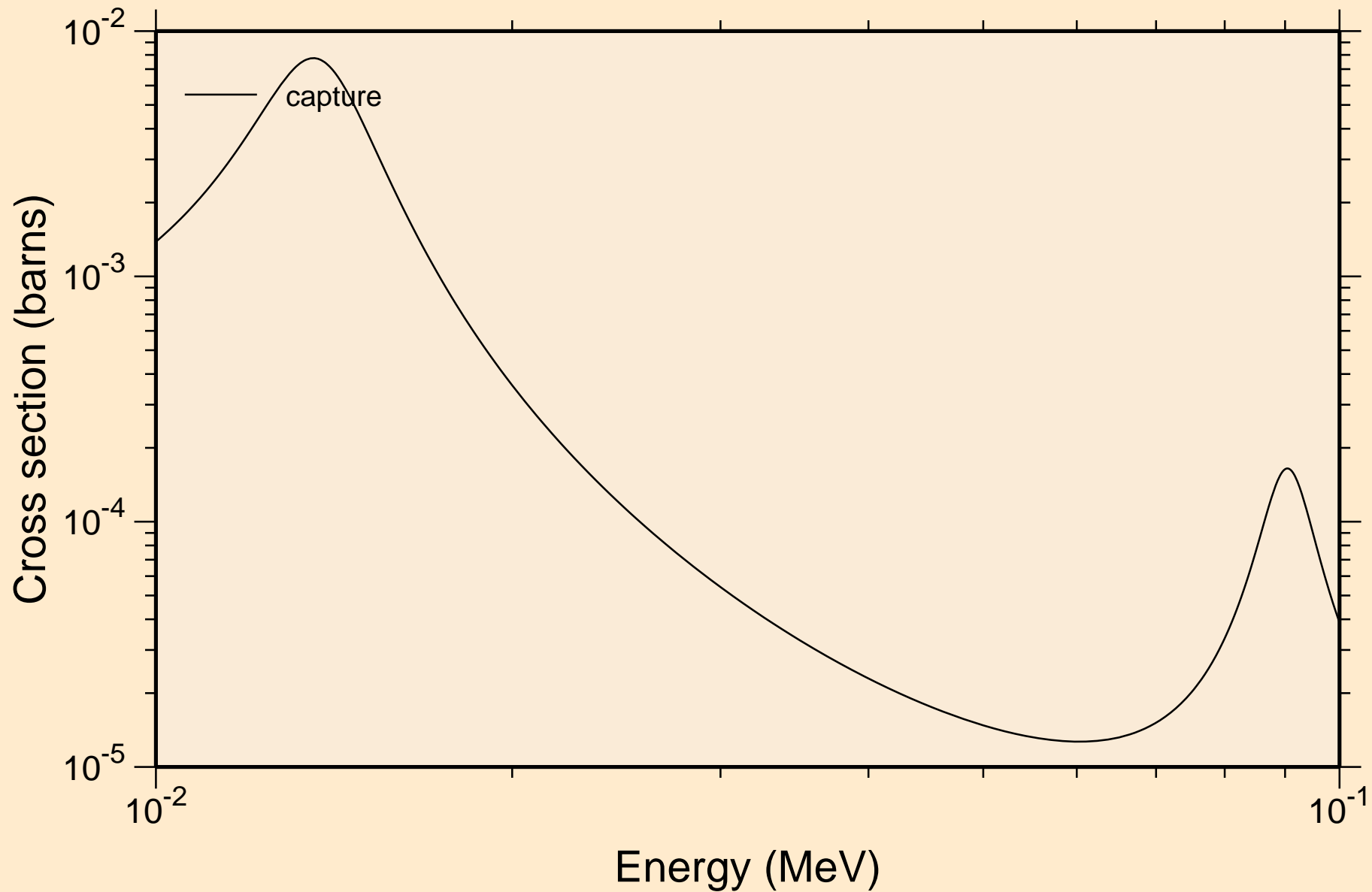

F022 NEUTRON ACER TENDL-2019 LIBRARY; T=293.16K  
resonance absorption cross sections

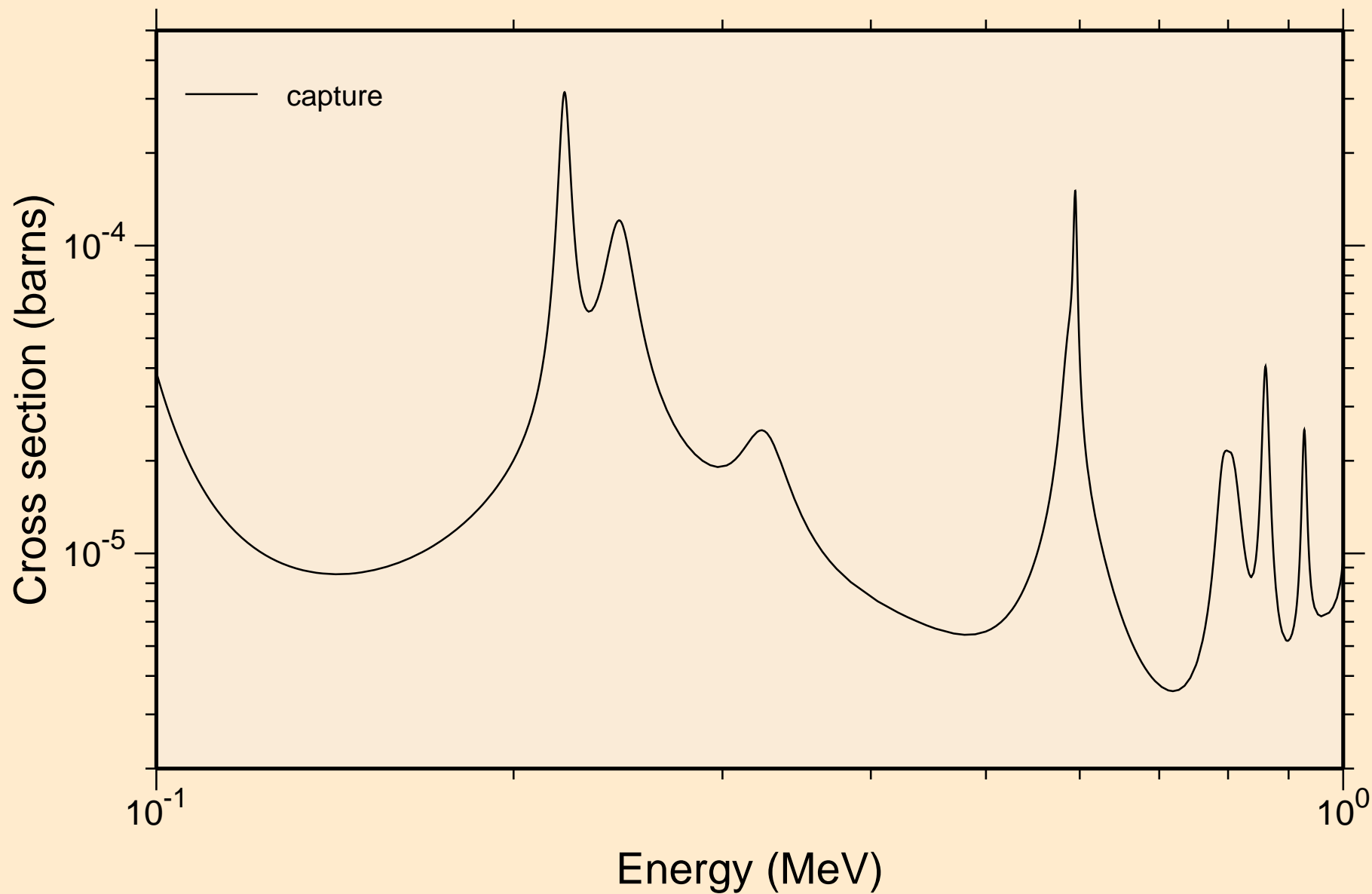

F022 NEUTRON ACER TENDL-2019 LIBRARY; T=293.16K  
resonance absorption cross sections

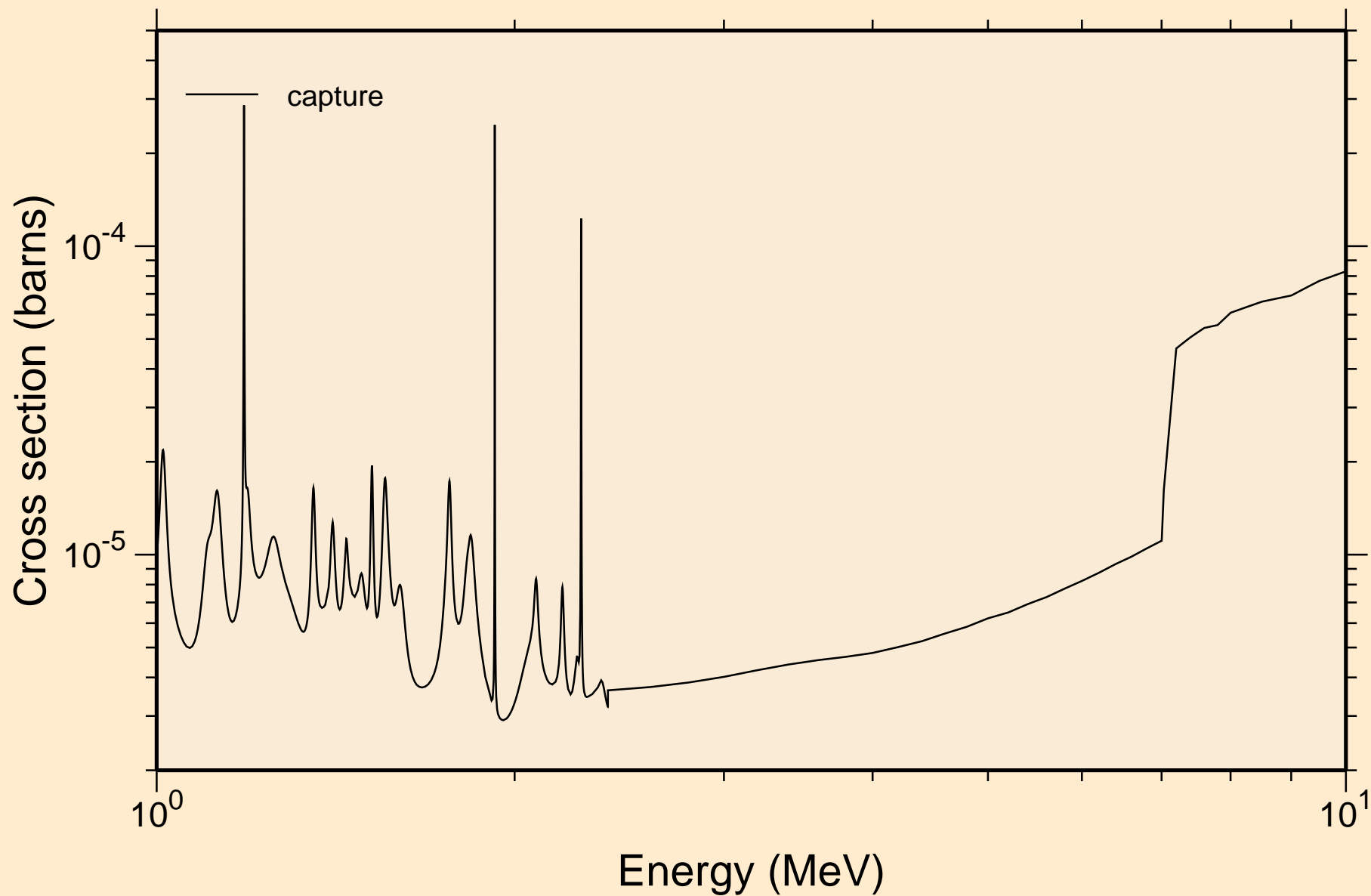

F022 NEUTRON ACER TENDL-2019 LIBRARY; T=293.16K  
Heating

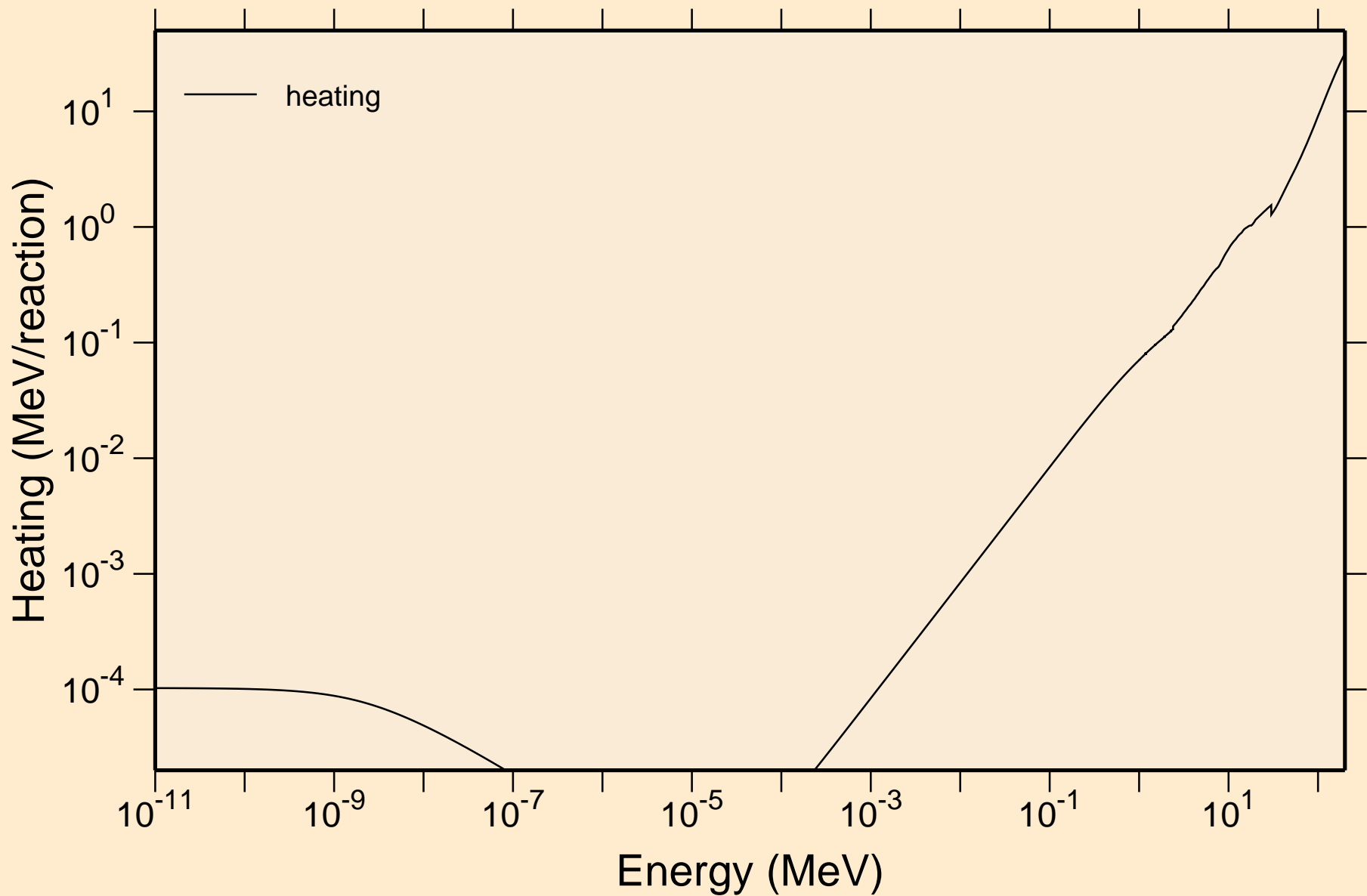



F022 NEUTRON ACER TENDL-2019 LIBRARY; T=293.16K  
Damage

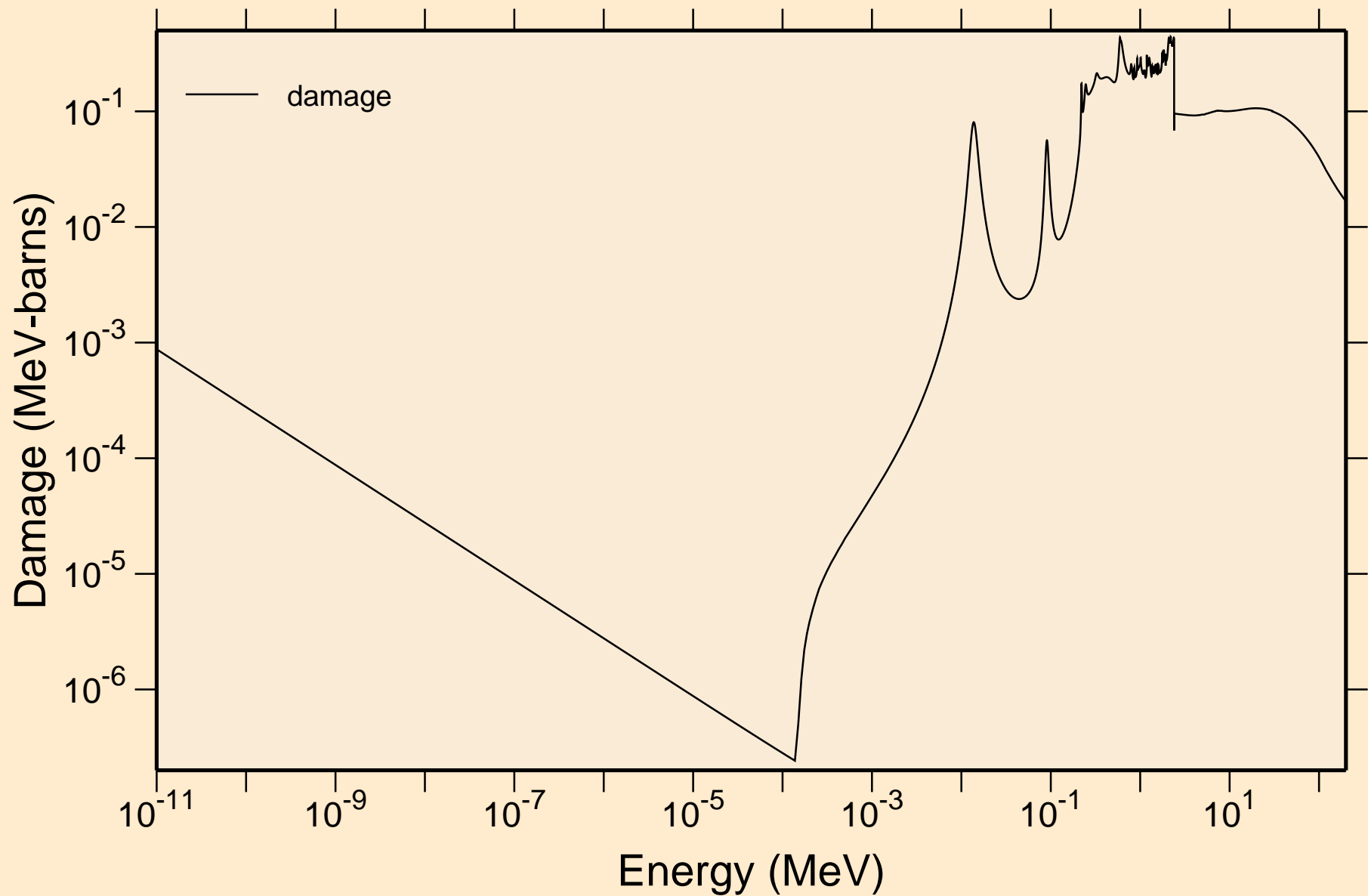

F022 NEUTRON ACER TENDL-2019 LIBRARY; T=293.16K  
Non-threshold reactions

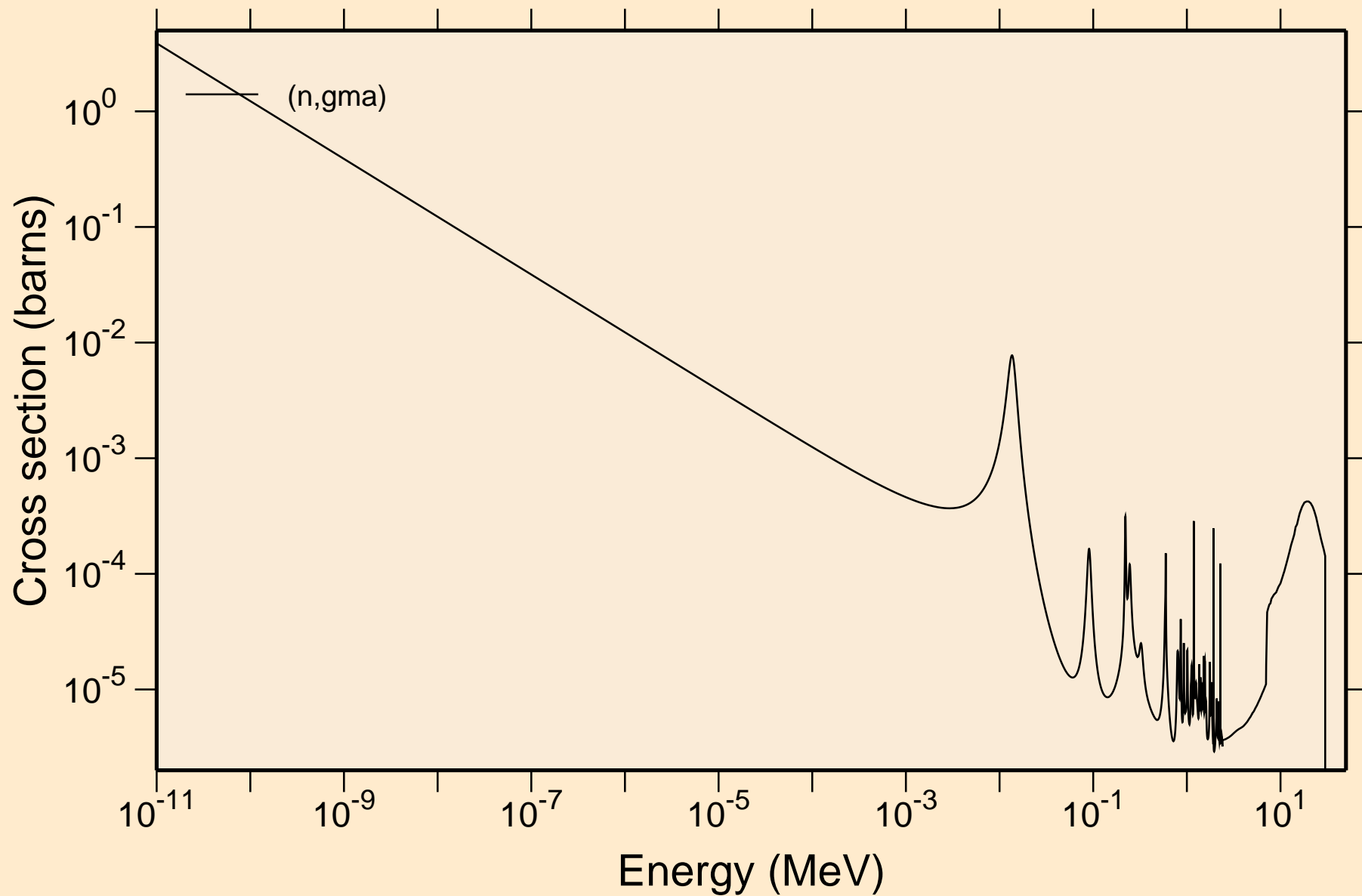

F022 NEUTRON ACER TENDL-2019 LIBRARY; T=293.16K  
Principal cross sections

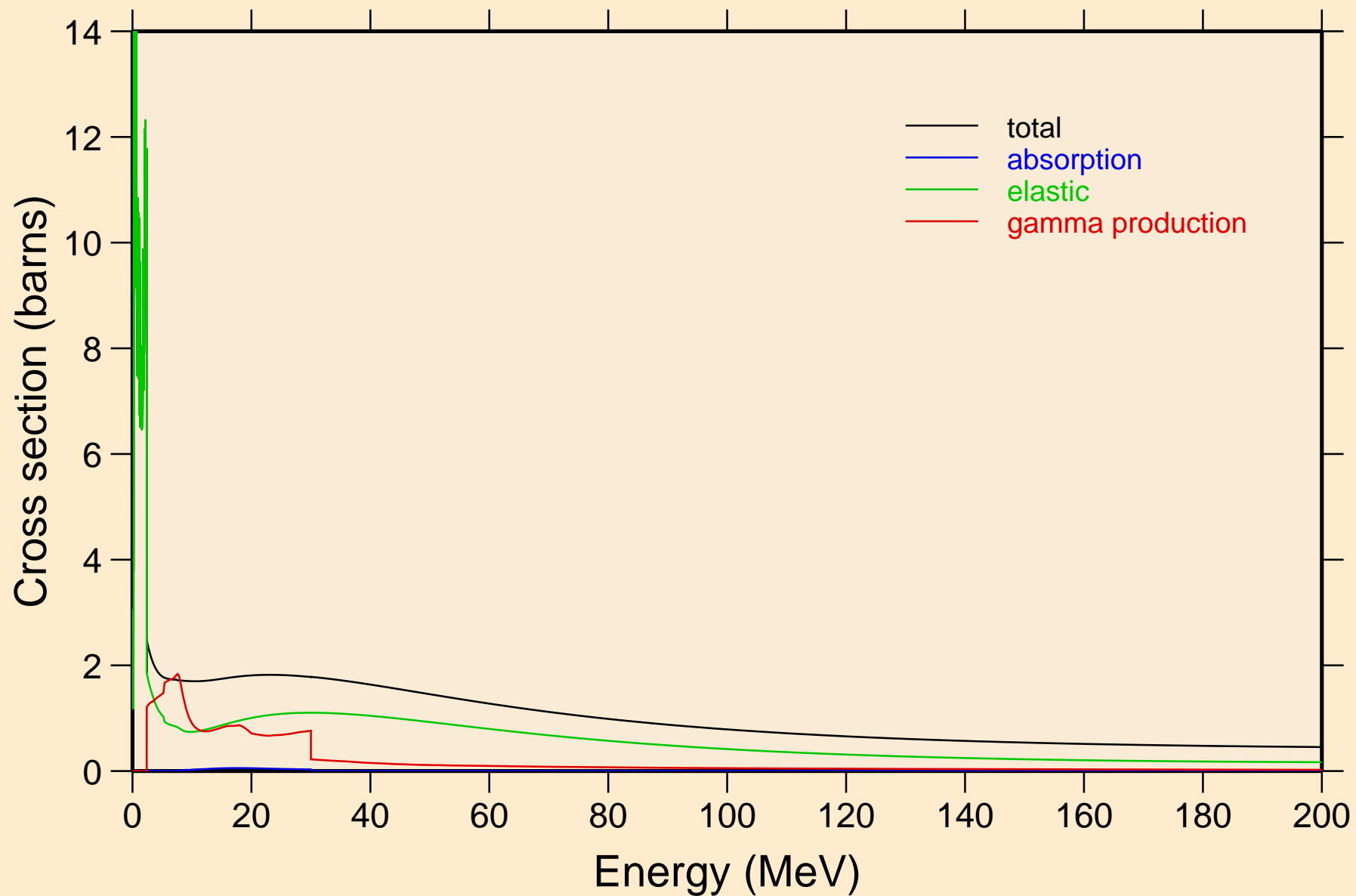

F022 NEUTRON ACER TENDL-2019 LIBRARY; T=293.16K  
Heating

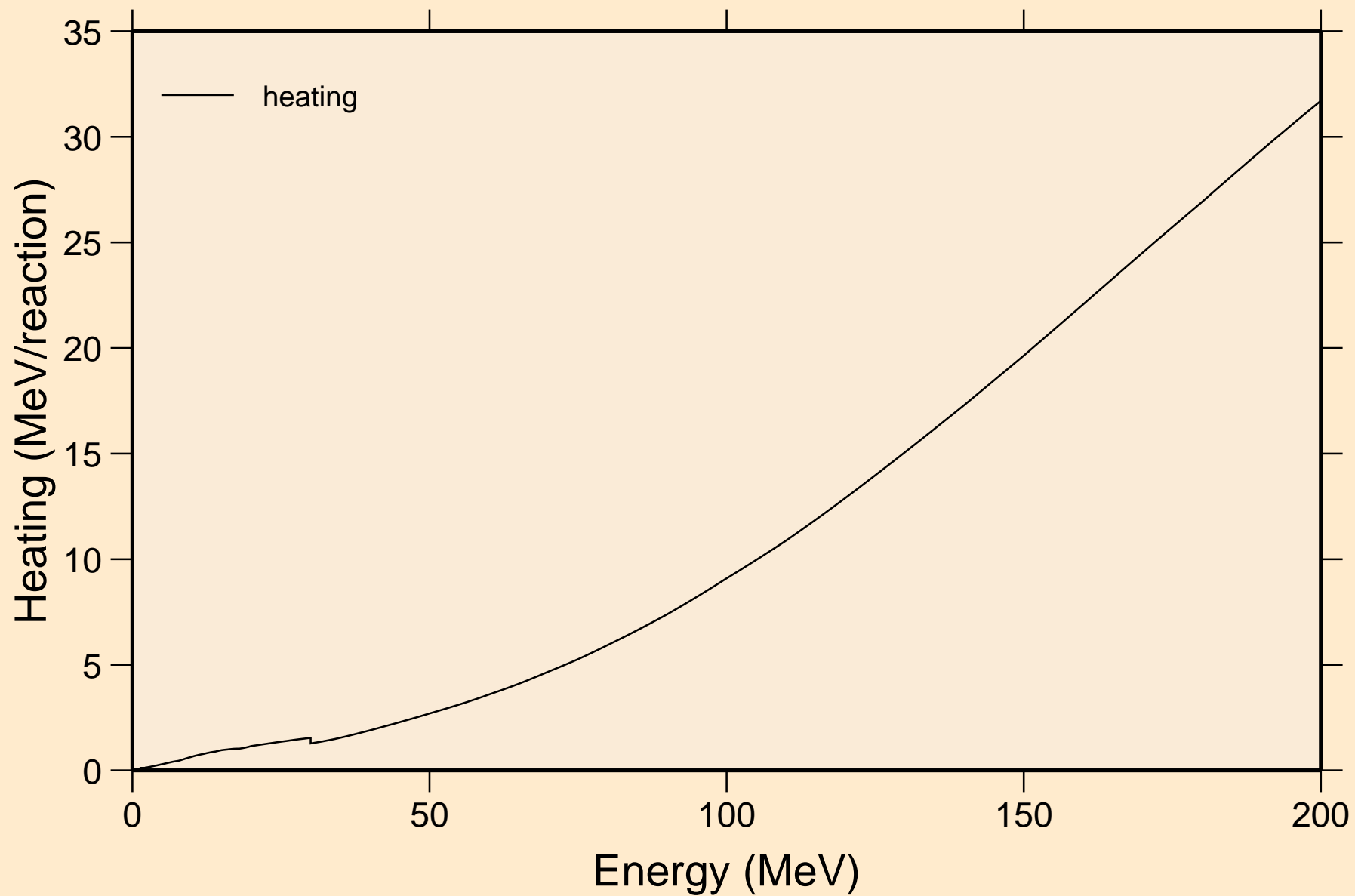

F022 NEUTRON ACER TENDL-2019 LIBRARY; T=293.16K  
Damage

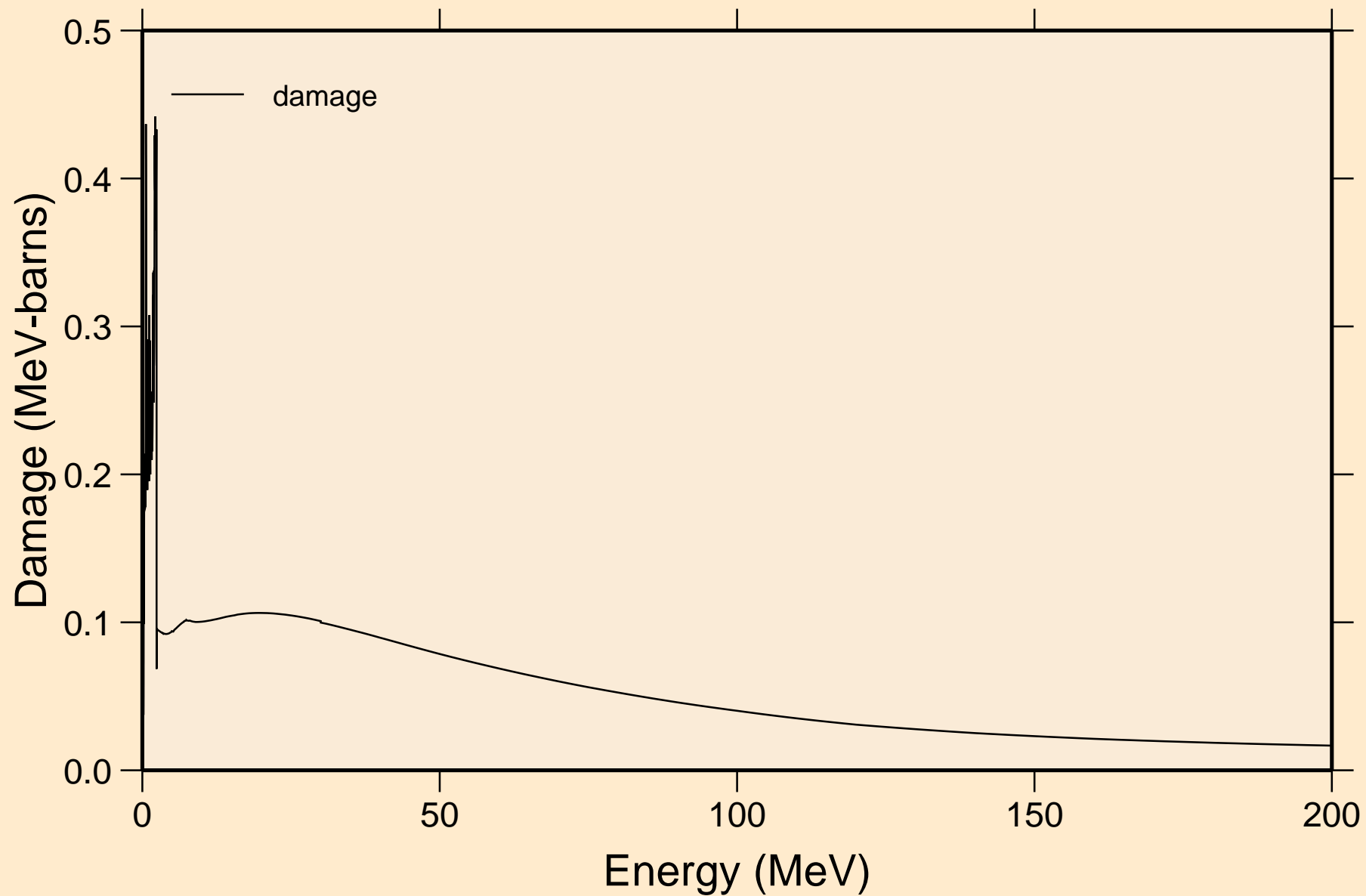

F022 NEUTRON ACER TENDL-2019 LIBRARY; T=293.16K  
Non-threshold reactions

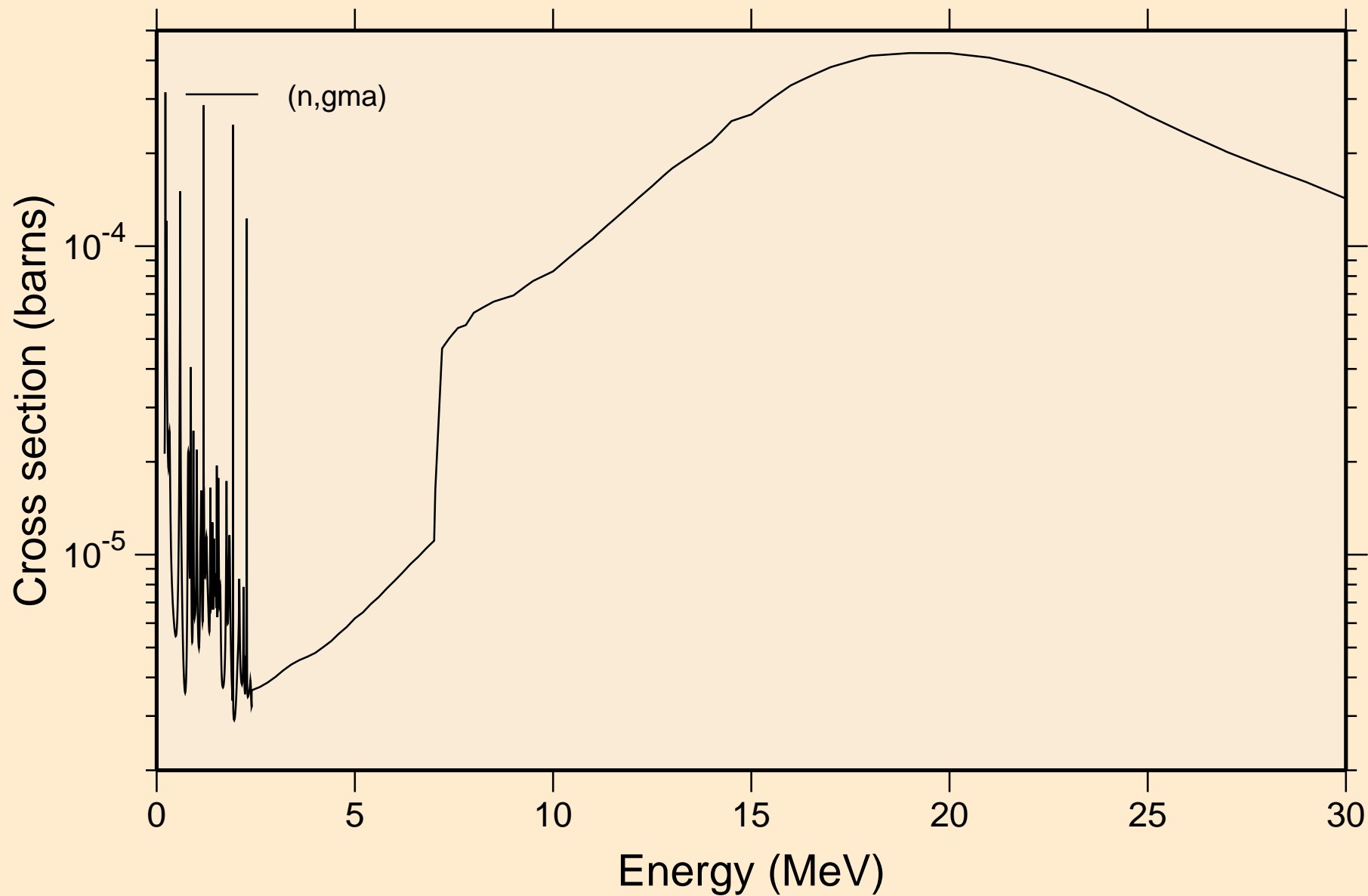

F022 NEUTRON ACER TENDL-2019 LIBRARY; T=293.16K  
Inelastic levels

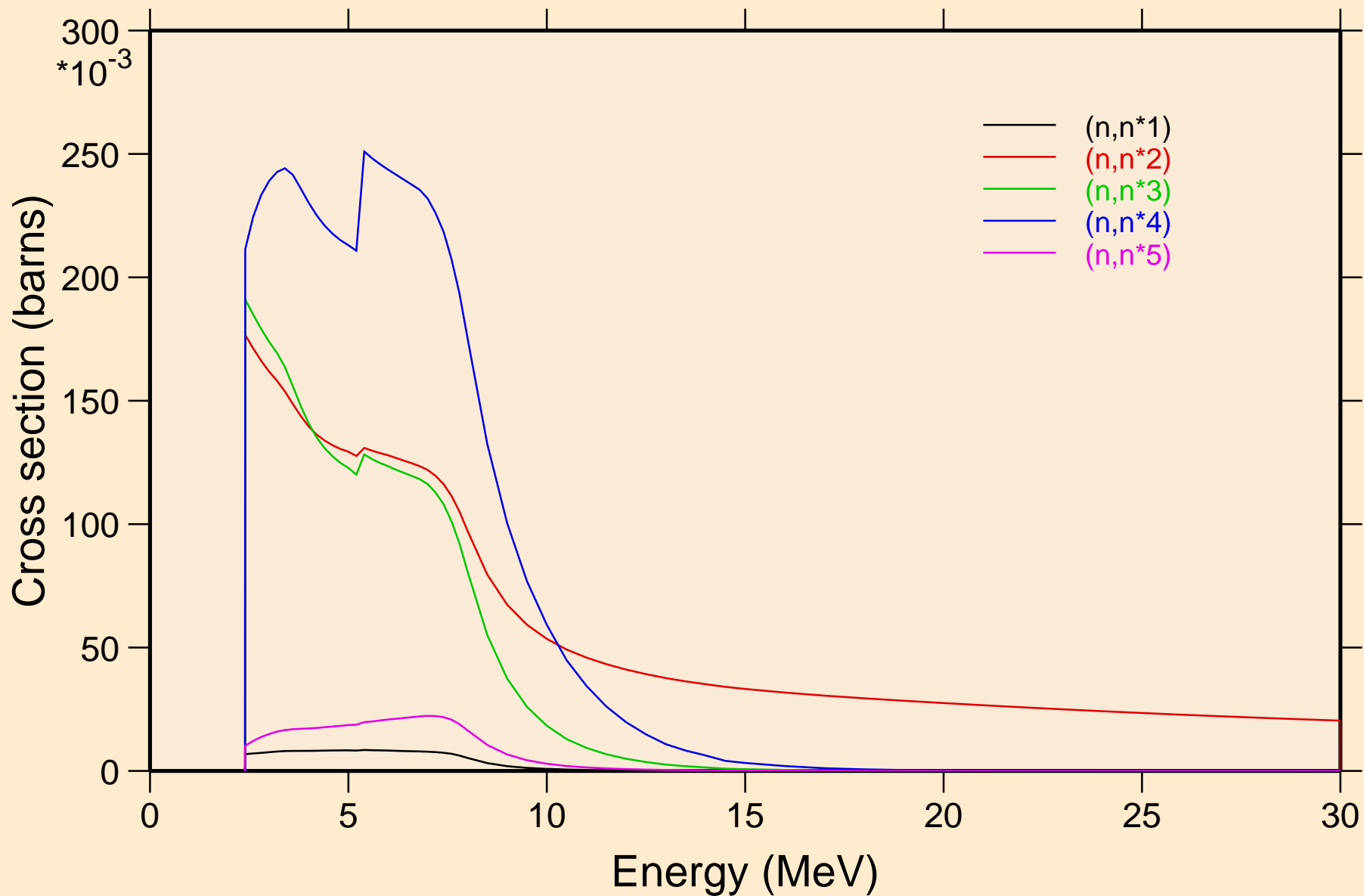

F022 NEUTRON ACER TENDL-2019 LIBRARY; T=293.16K  
Inelastic levels

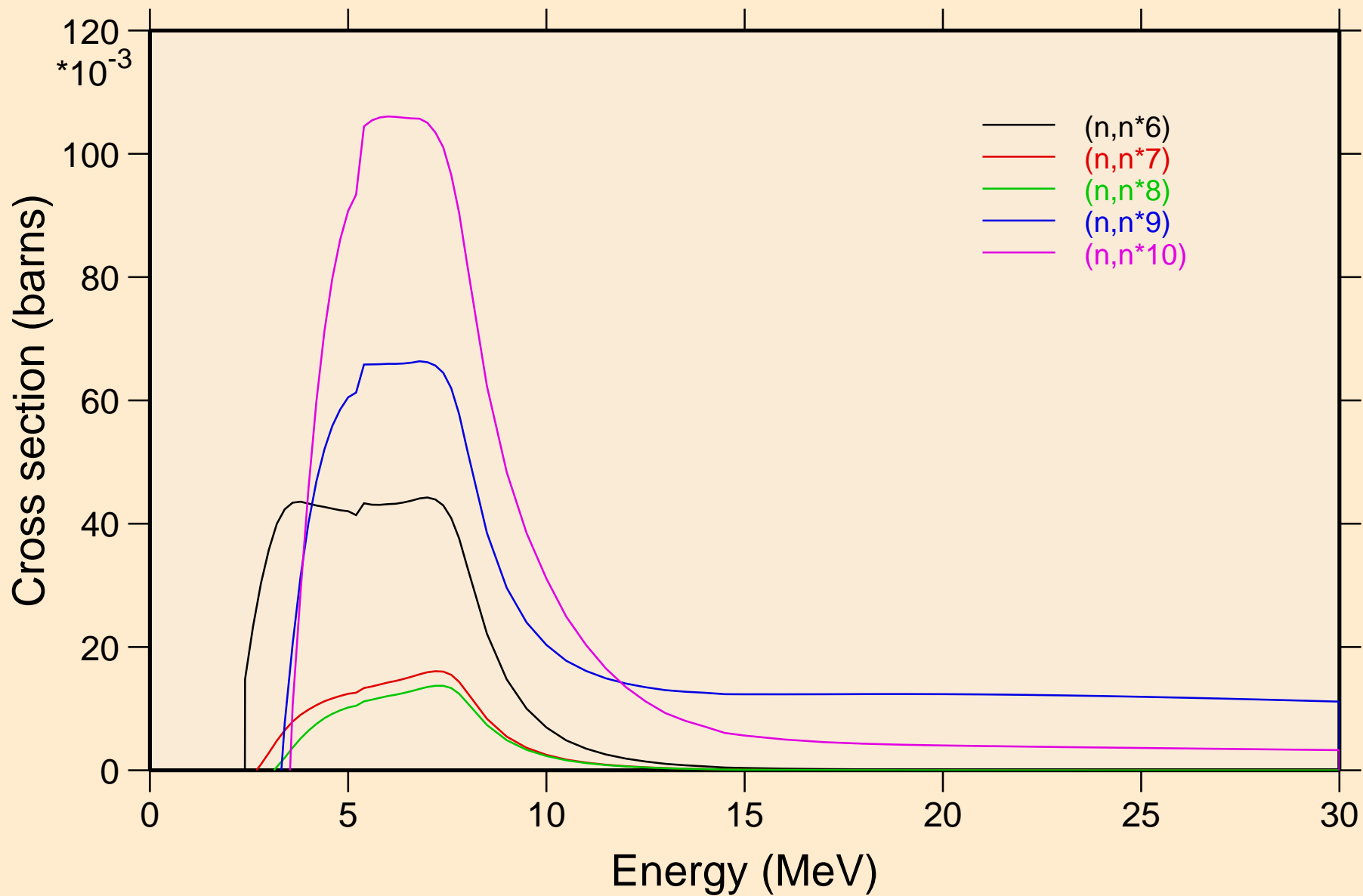



F022 NEUTRON ACER TENDL-2019 LIBRARY; T=293.16K  
Inelastic levels

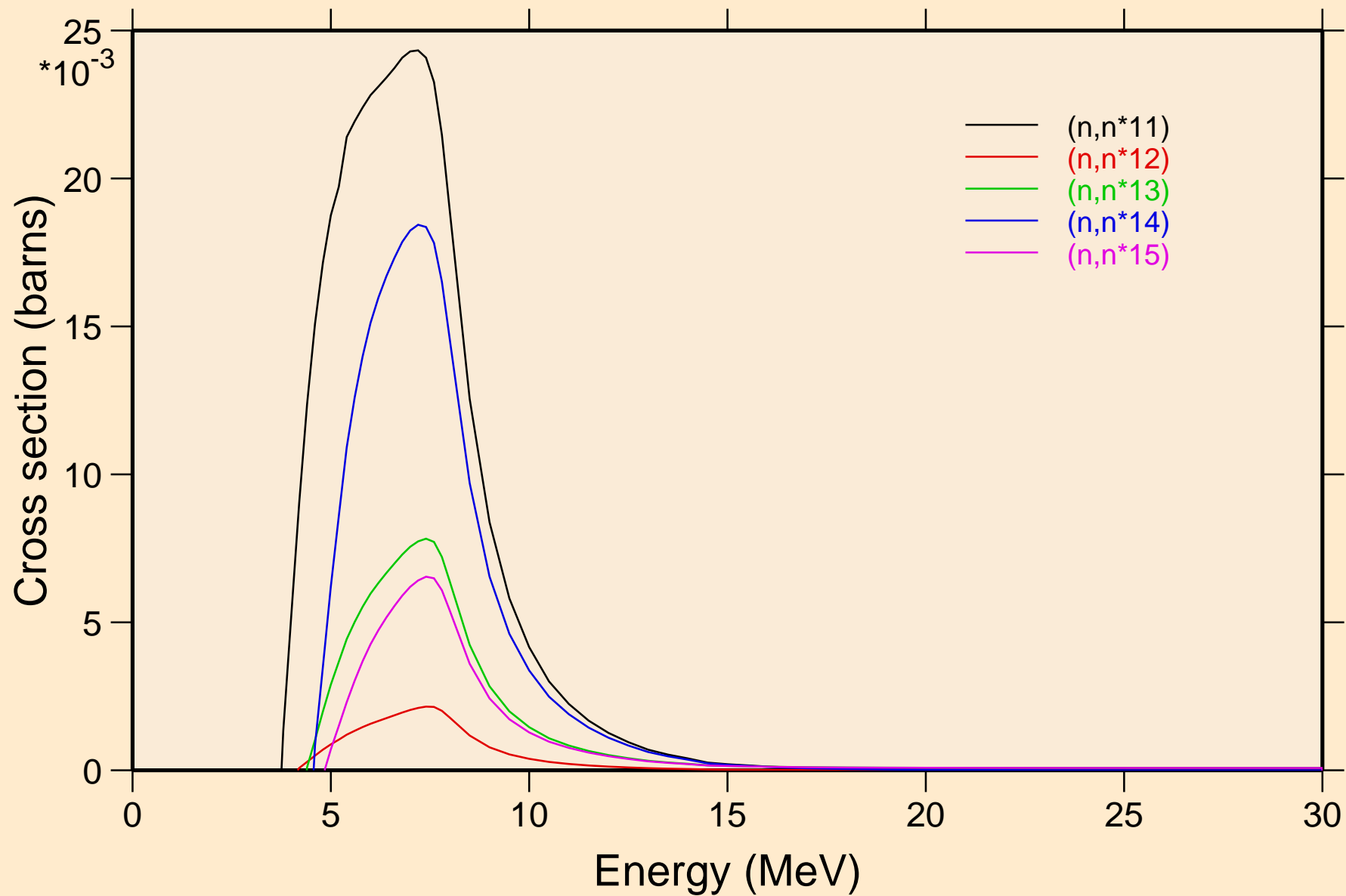

F022 NEUTRON ACER TENDL-2019 LIBRARY; T=293.16K  
Inelastic levels

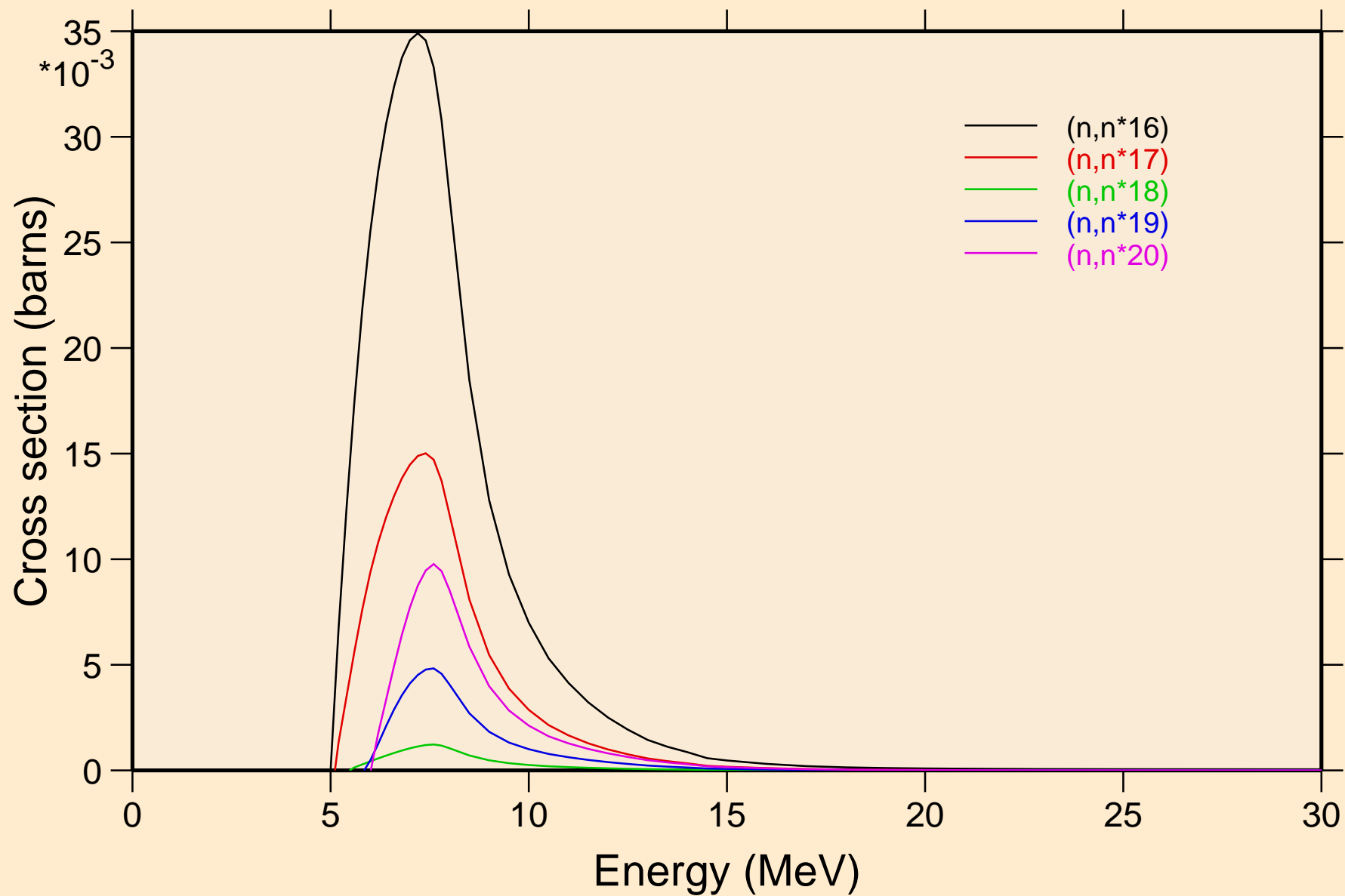

F022 NEUTRON ACER TENDL-2019 LIBRARY; T=293.16K  
Inelastic levels

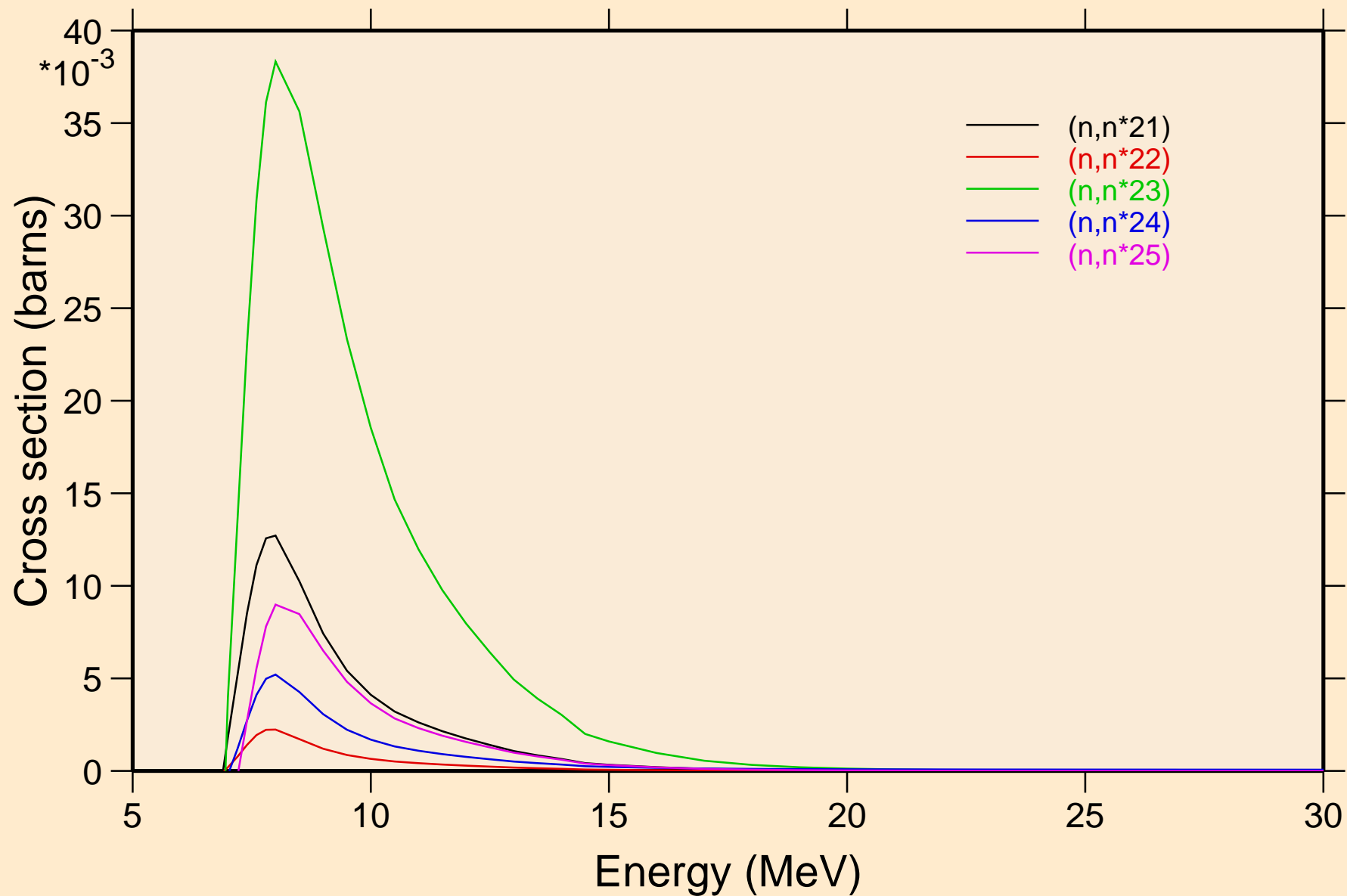

F022 NEUTRON ACER TENDL-2019 LIBRARY; T=293.16K  
Inelastic levels

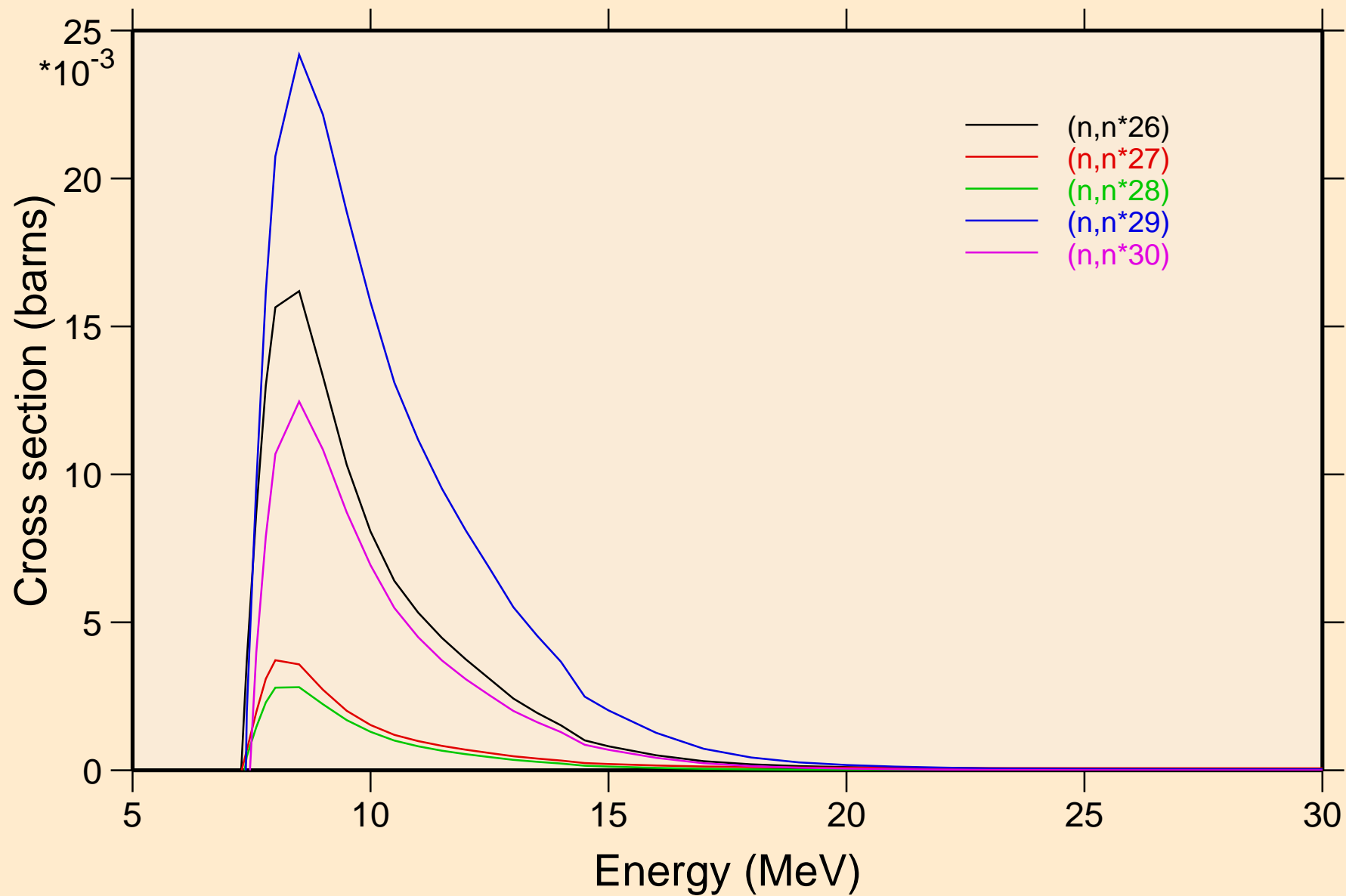

F022 NEUTRON ACER TENDL-2019 LIBRARY; T=293.16K  
Threshold reactions

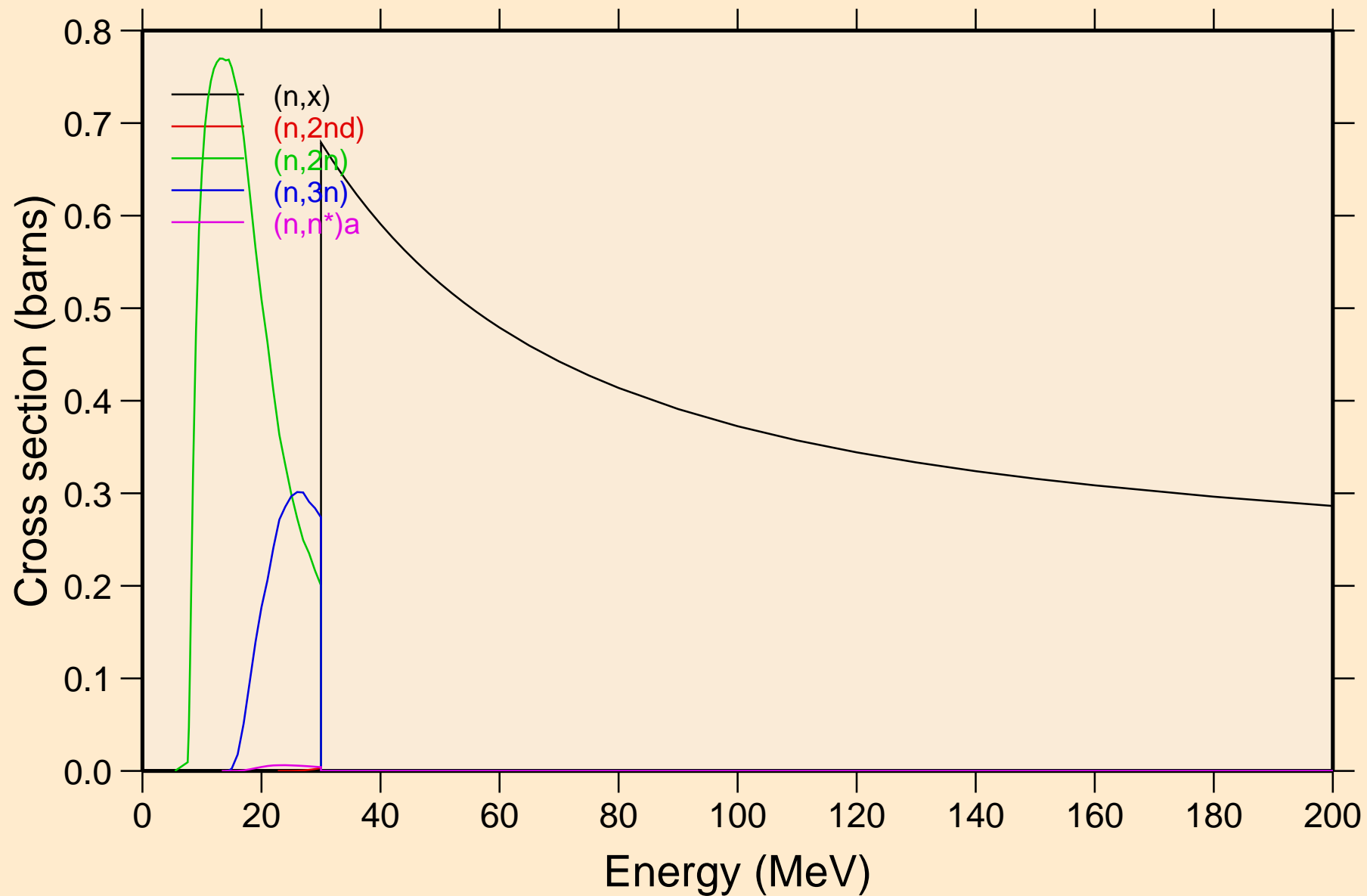

F022 NEUTRON ACER TENDL-2019 LIBRARY; T=293.16K  
Threshold reactions

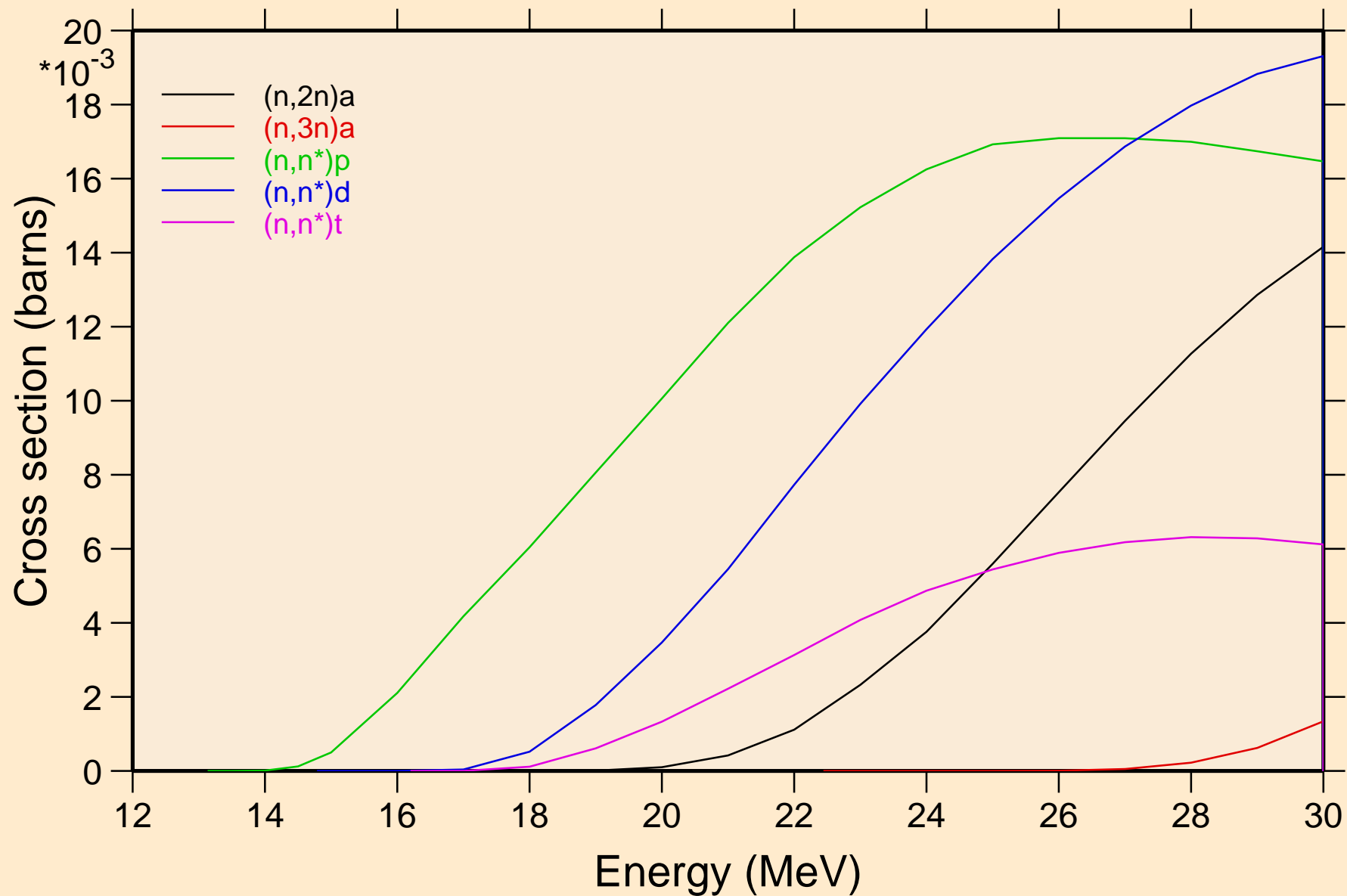

F022 NEUTRON ACER TENDL-2019 LIBRARY; T=293.16K  
Threshold reactions

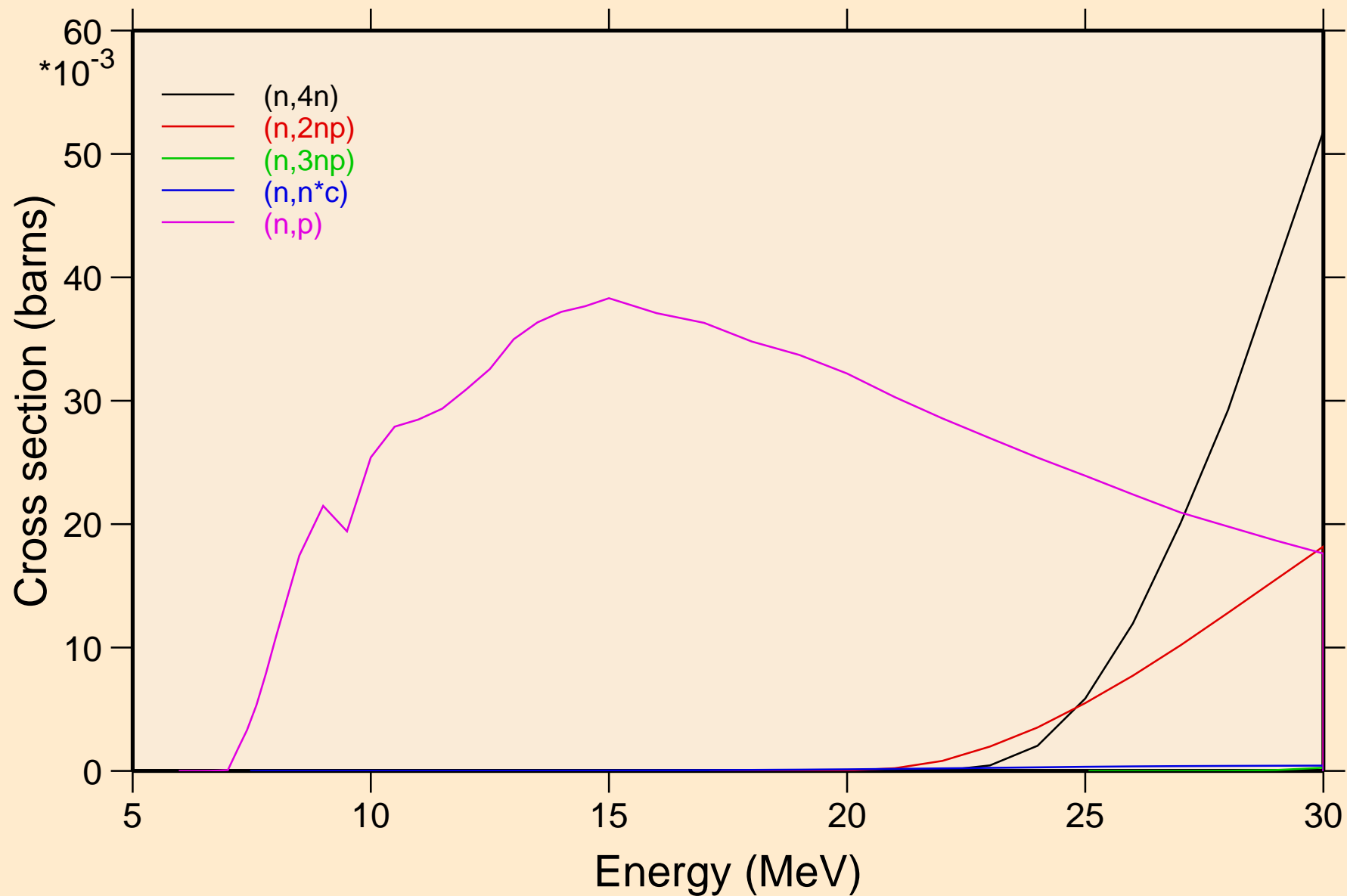

F022 NEUTRON ACER TENDL-2019 LIBRARY; T=293.16K  
Threshold reactions

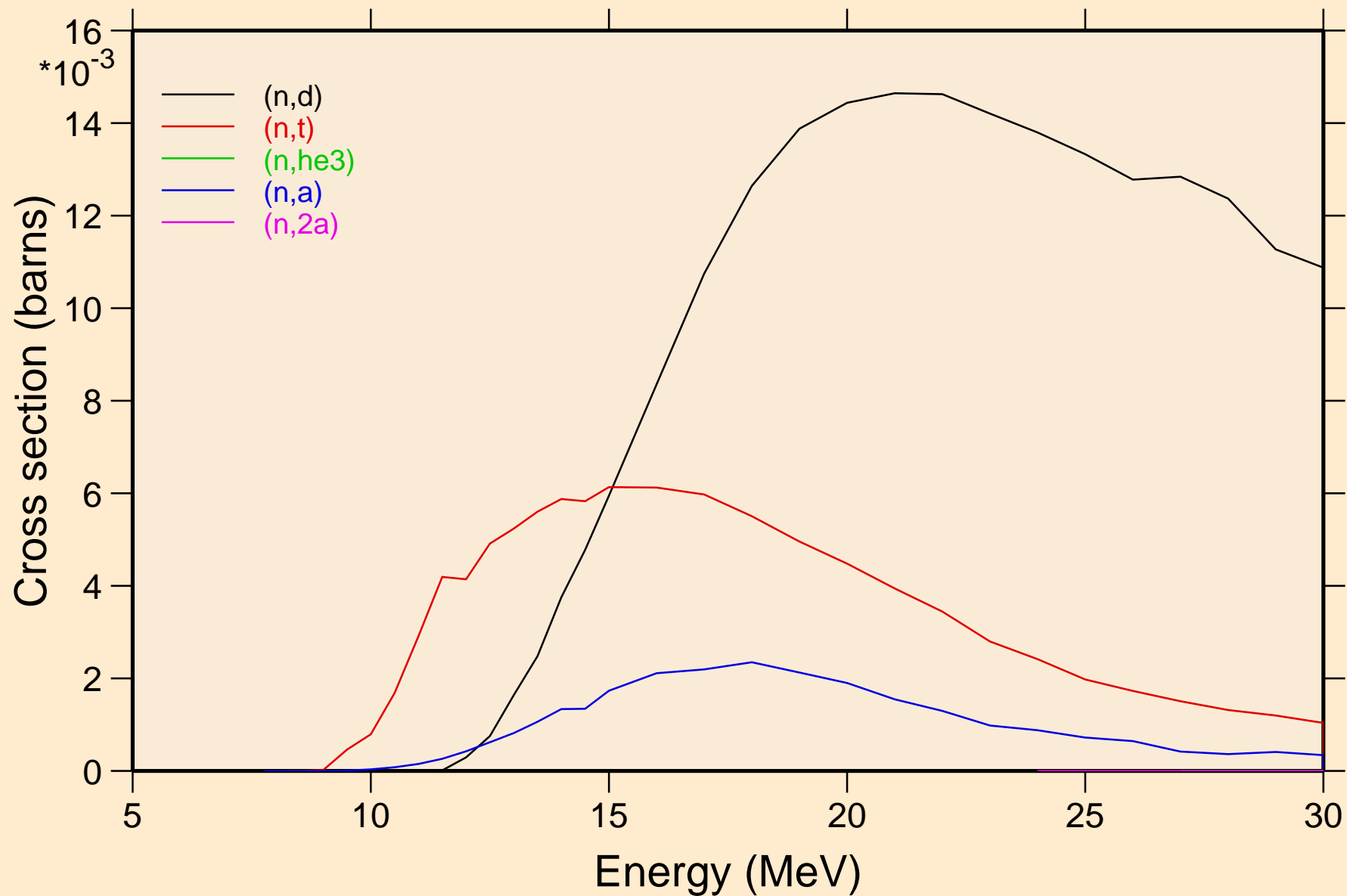



F022 NEUTRON ACER TENDL-2019 LIBRARY; T=293.16K  
Threshold reactions

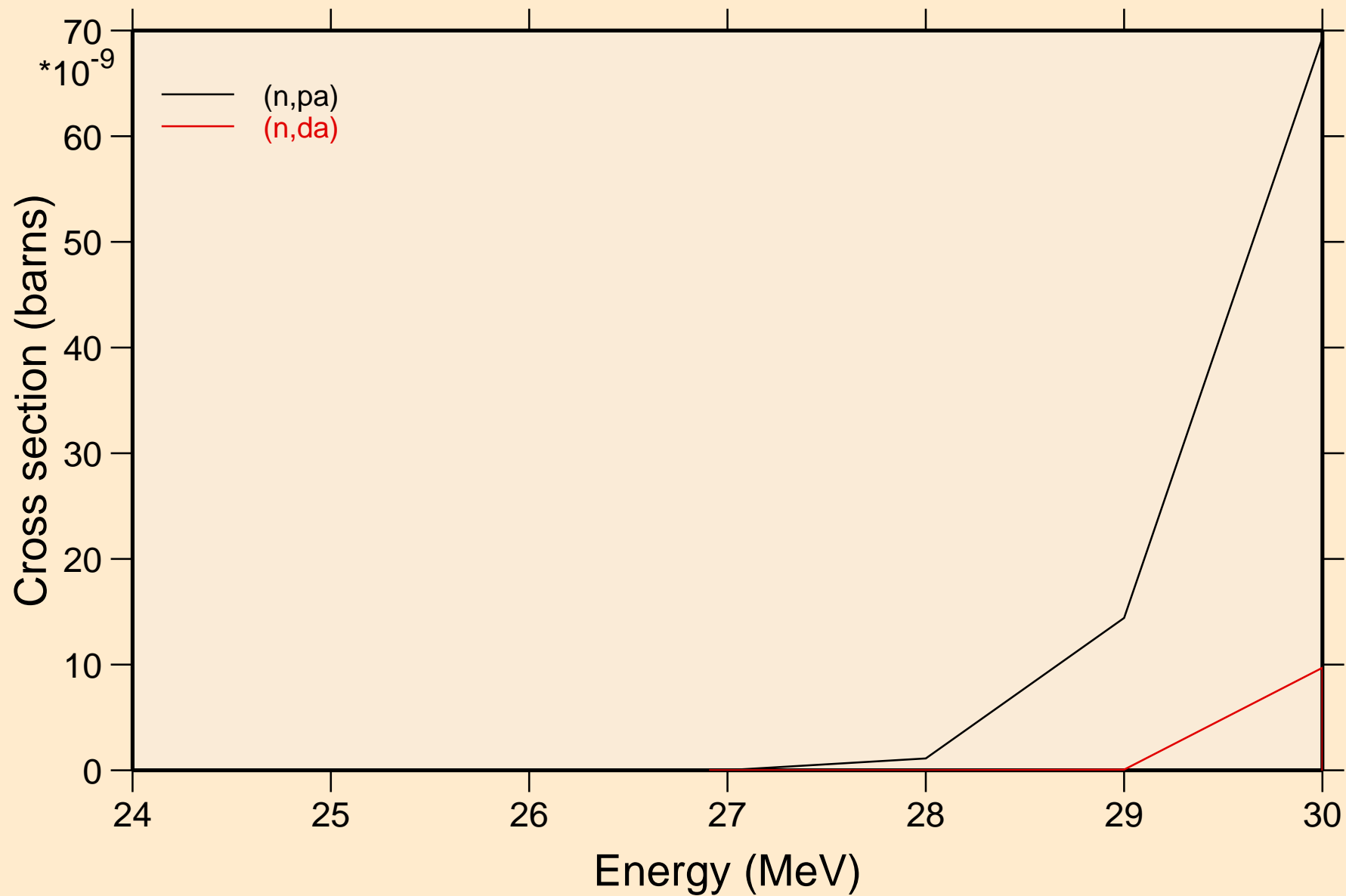

F022 NEUTRON ACER TENDL-2019 LIBRARY; T=293.16K  
Threshold reactions

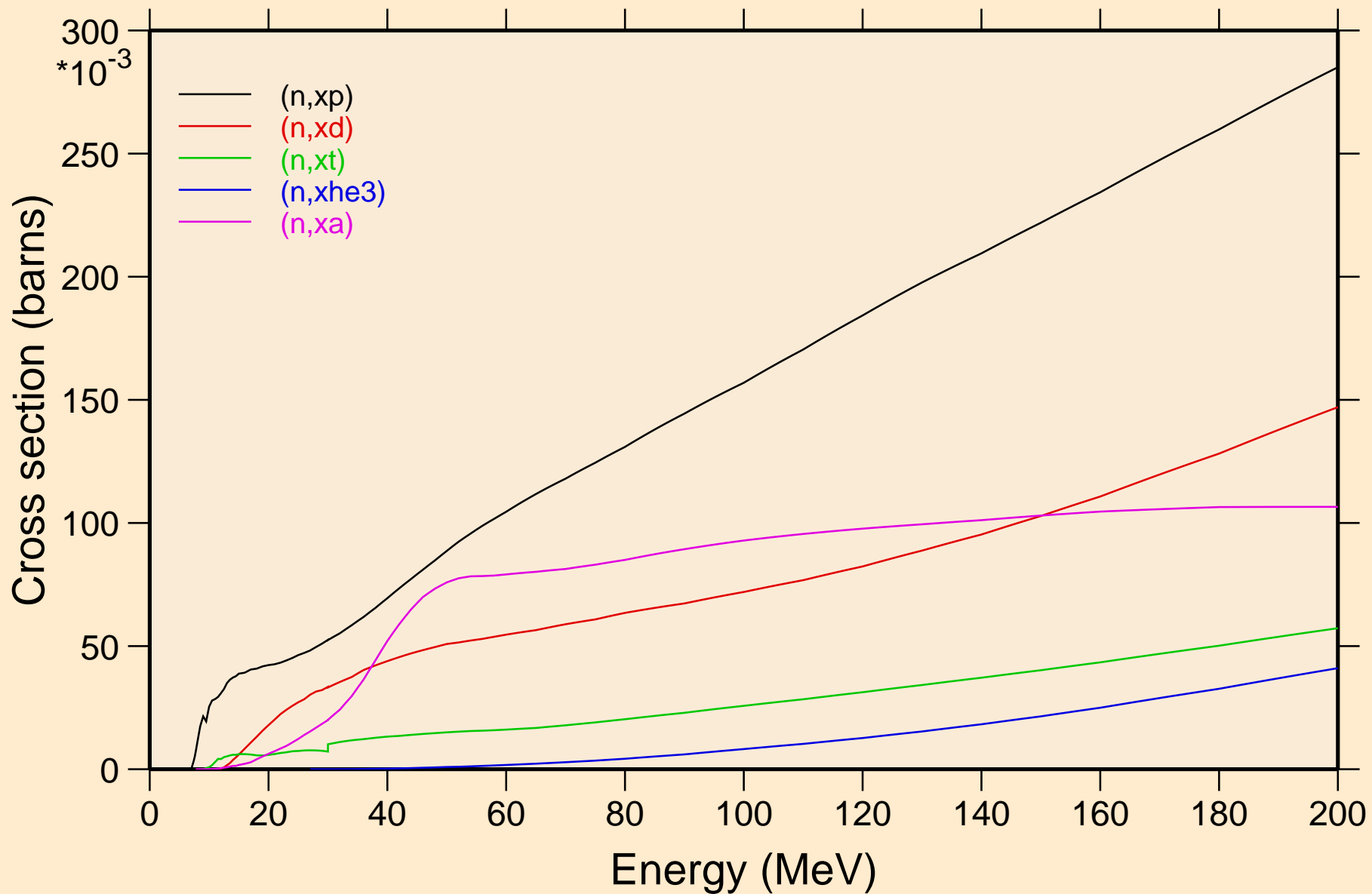

F022 NEUTRON ACER TENDL-2019 LIBRARY; T=293.16K  
angular distribution for elastic

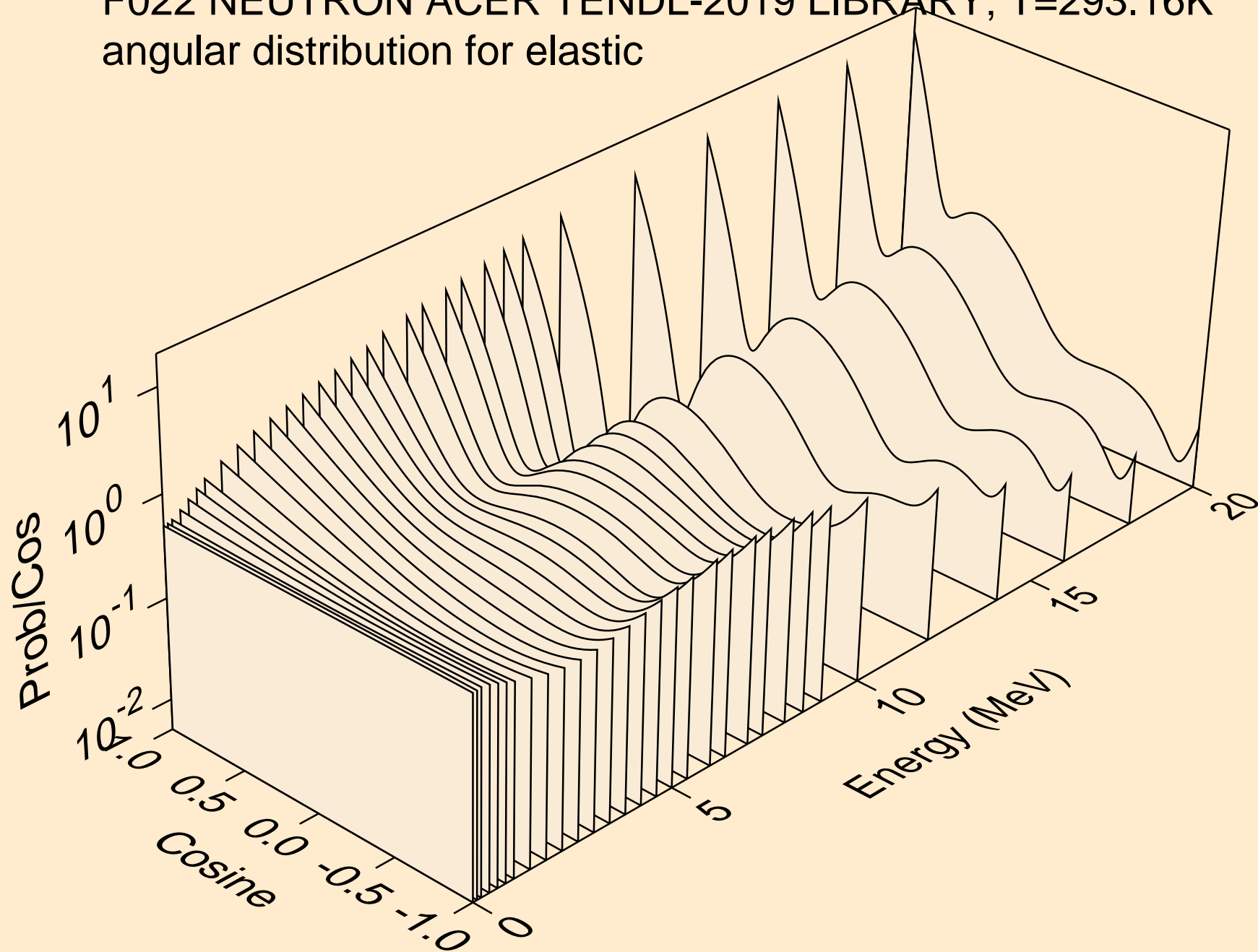

F022 NEUTRON ACER TENDL-2019 LIBRARY; T=293.16K  
angular distribution for elastic

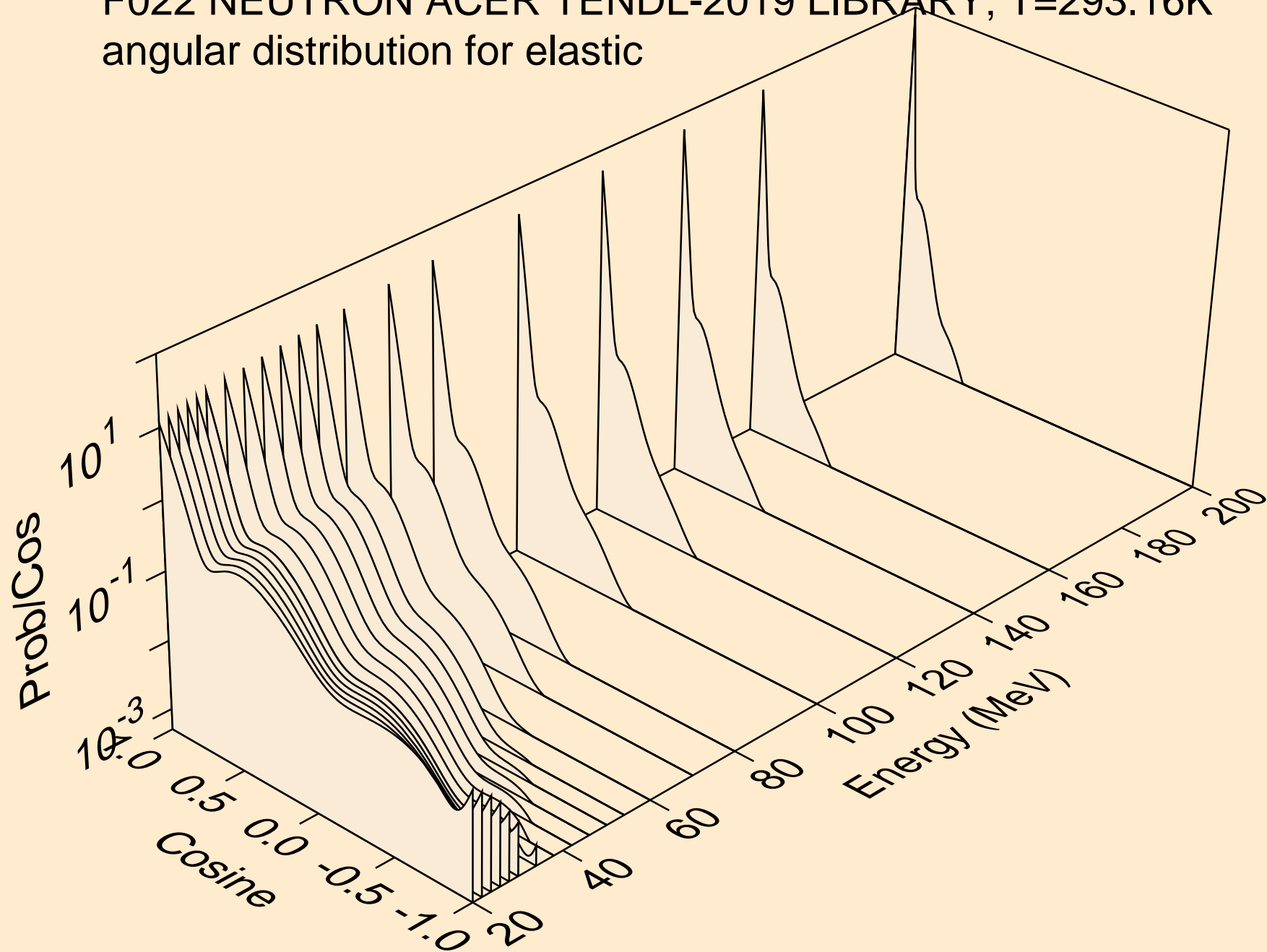

F022 NEUTRON ACER TENDL-2019 LIBRARY; T=293.16K  
angular distribution for (n,n\*1)

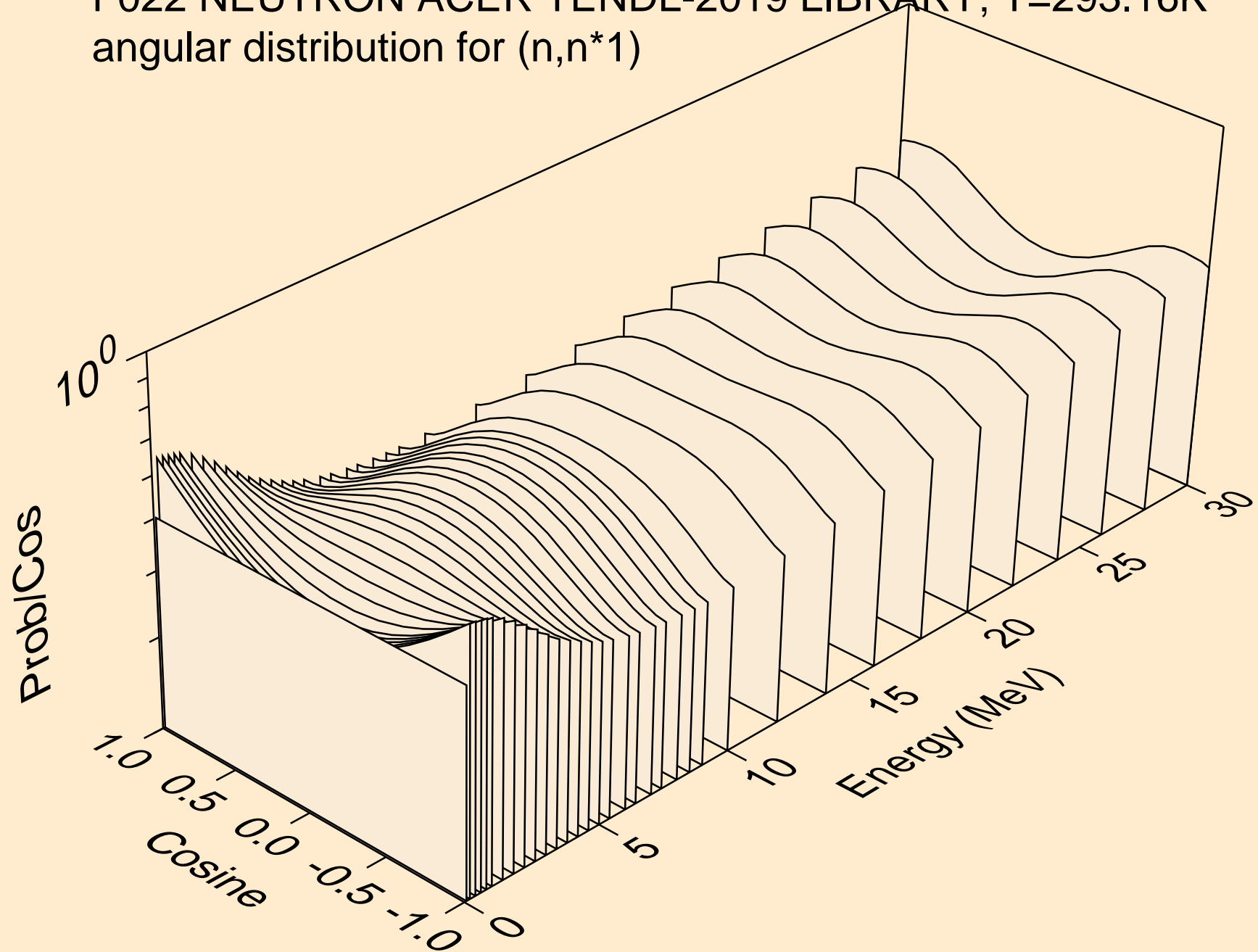

F022 NEUTRON ACER TENDL-2019 LIBRARY; T=293.16K  
angular distribution for (n,n\*2)

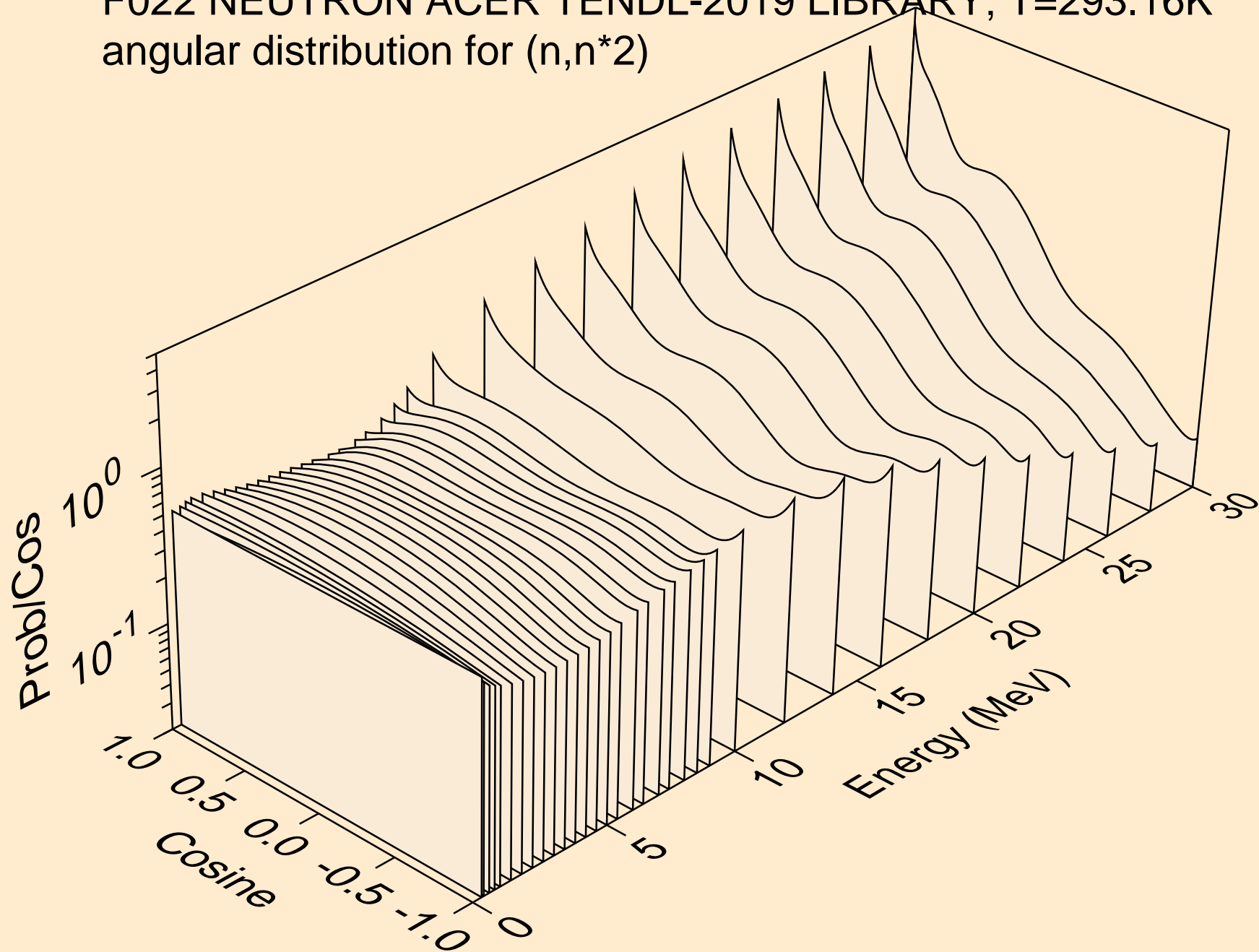

F022 NEUTRON ACER TENDL-2019 LIBRARY; T=293.16K  
angular distribution for (n,n\*3)

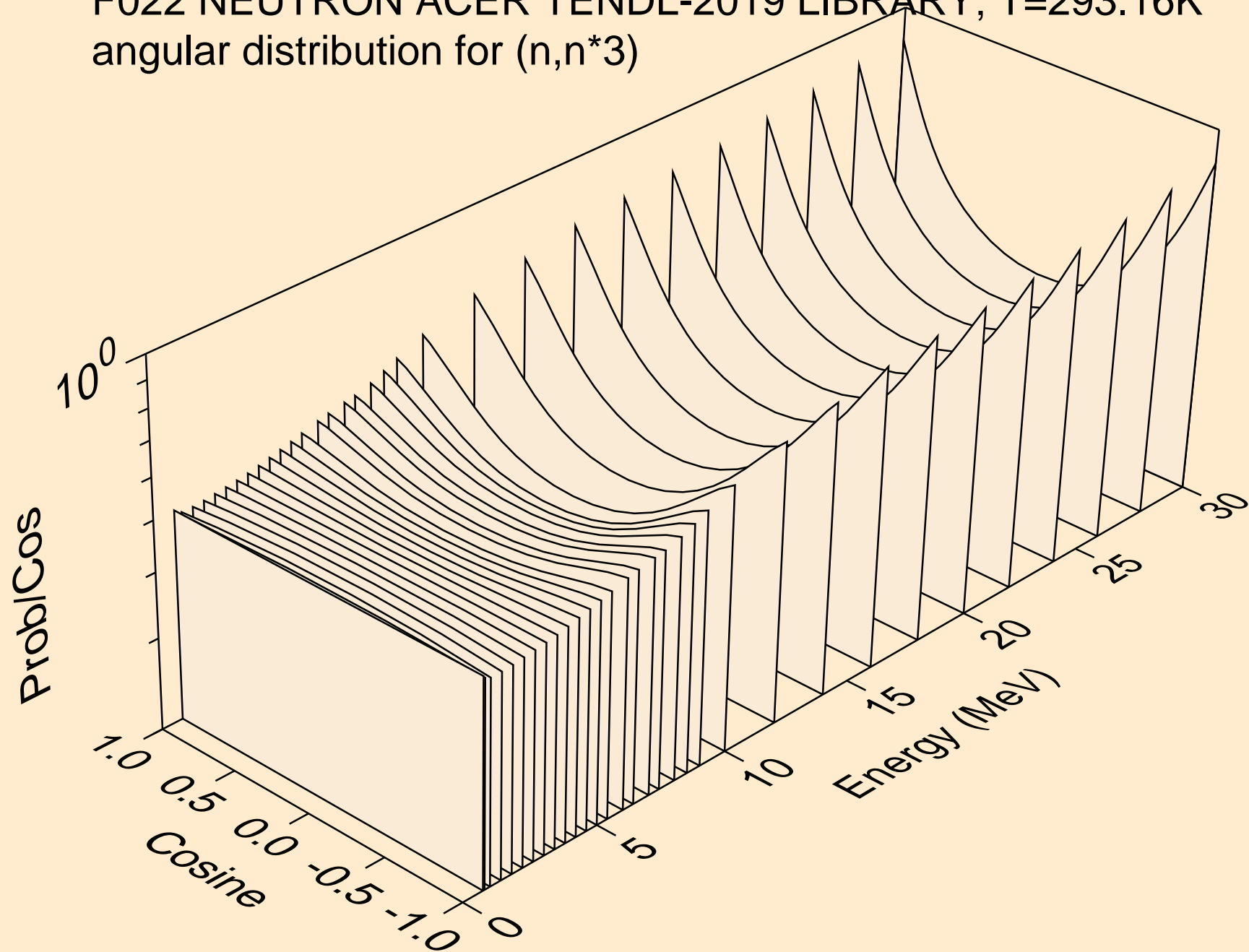

F022 NEUTRON ACER TENDL-2019 LIBRARY; T=293.16K  
angular distribution for (n,n\*4)

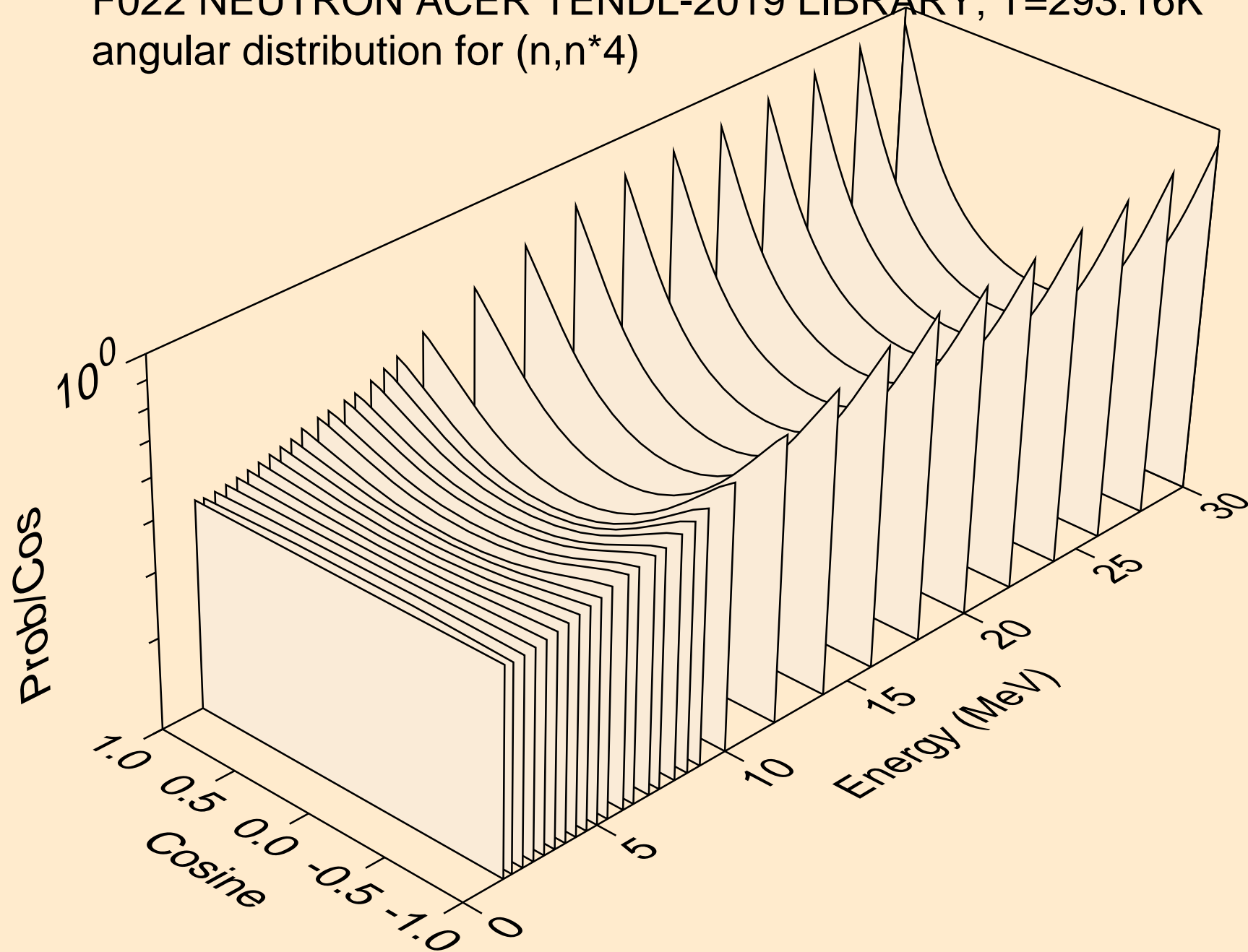



F022 NEUTRON ACER TENDL-2019 LIBRARY; T=293.16K  
angular distribution for (n,n\*5)

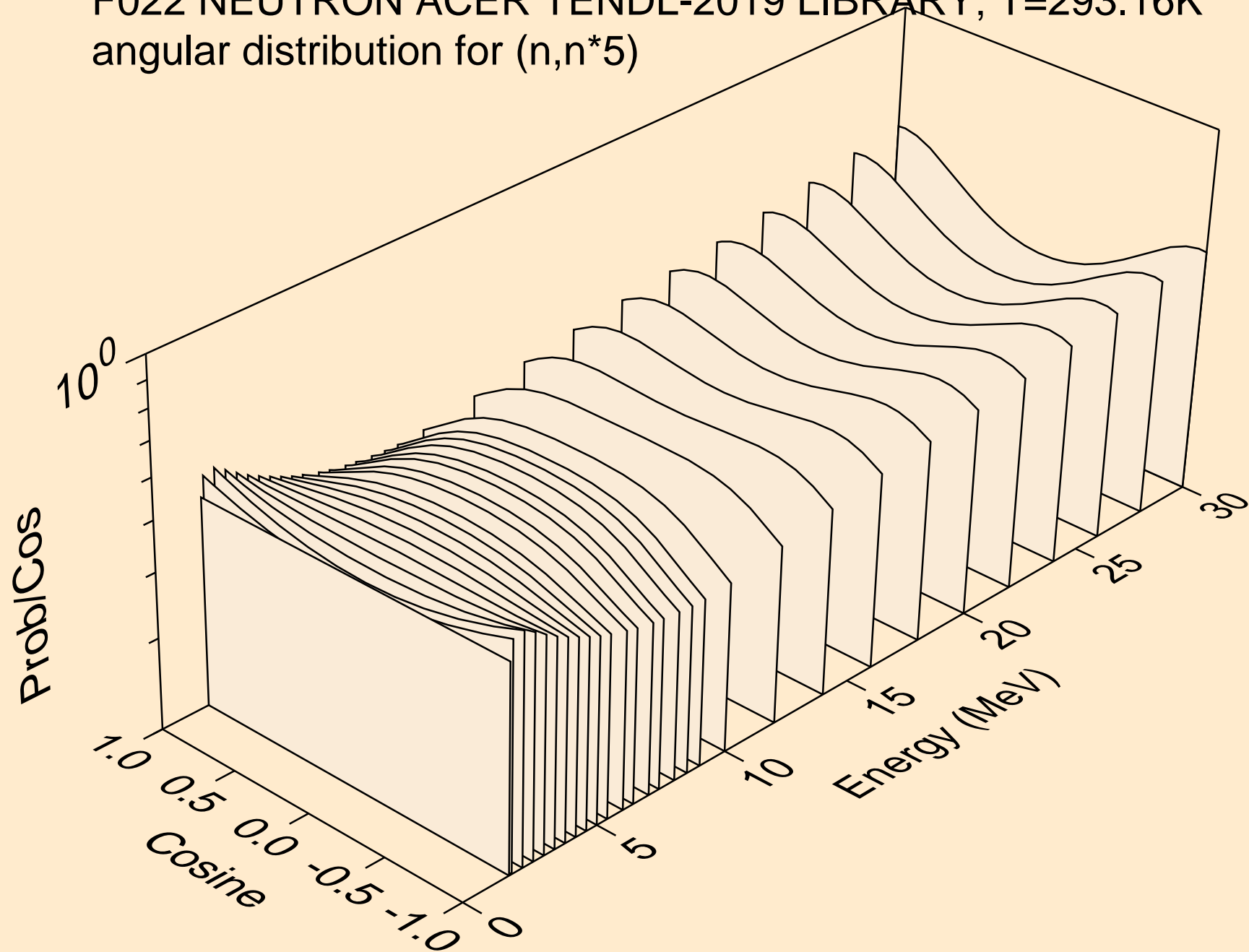

F022 NEUTRON ACER TENDL-2019 LIBRARY; T=293.16K  
angular distribution for (n,n\*6)

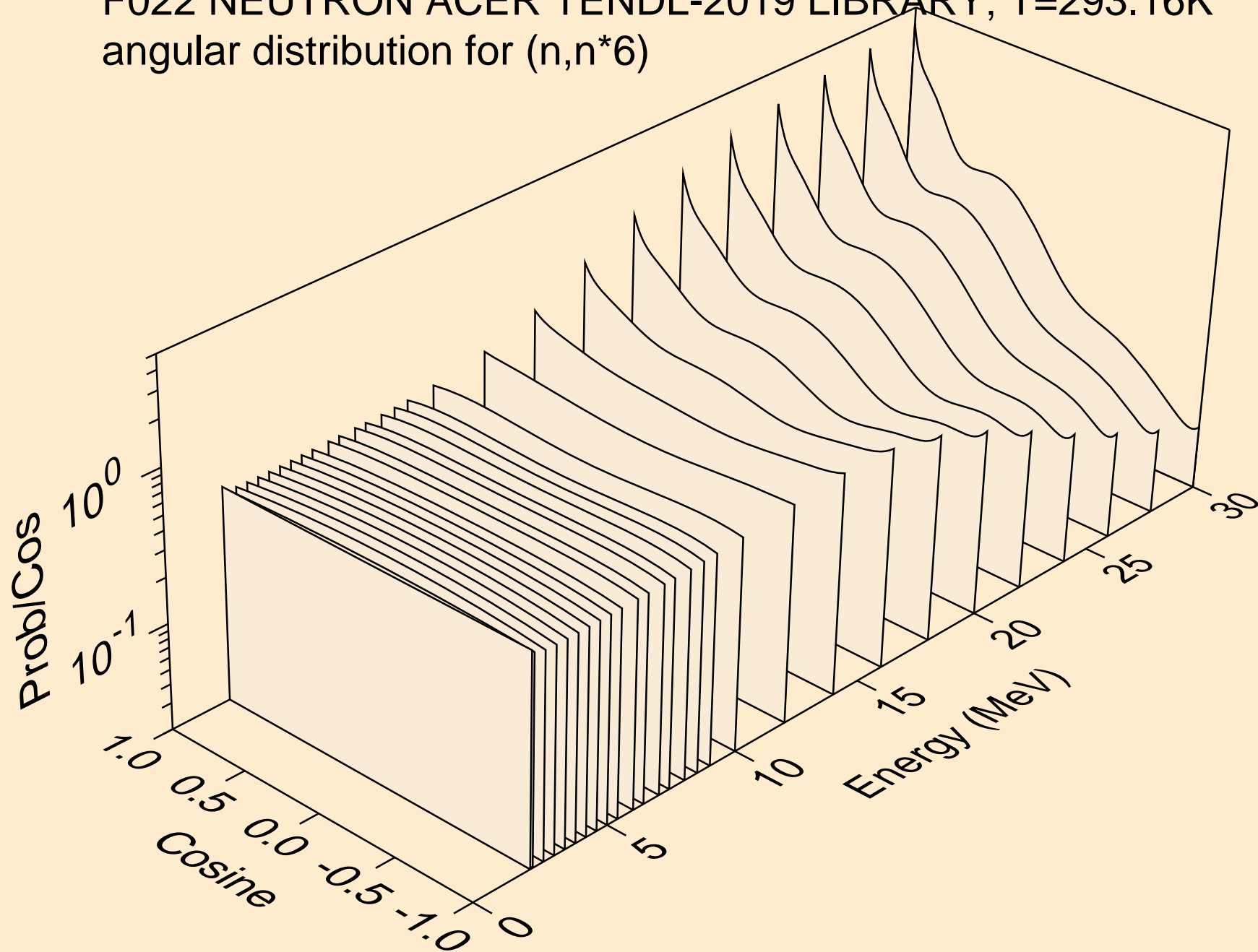

F022 NEUTRON ACER TENDL-2019 LIBRARY; T=293.16K  
angular distribution for (n,n\*7)

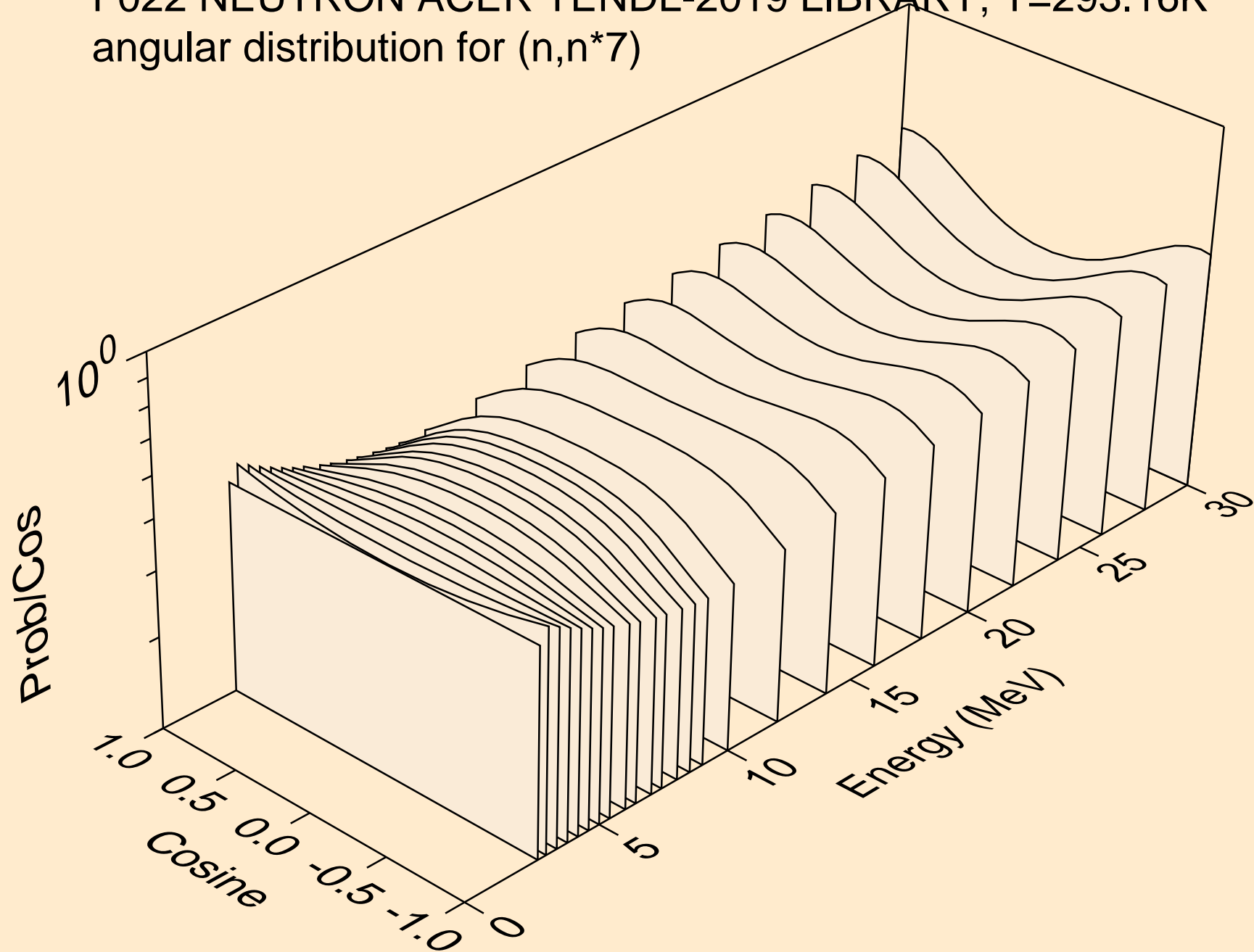

F022 NEUTRON ACER TENDL-2019 LIBRARY; T=293.16K  
angular distribution for (n,n\*8)

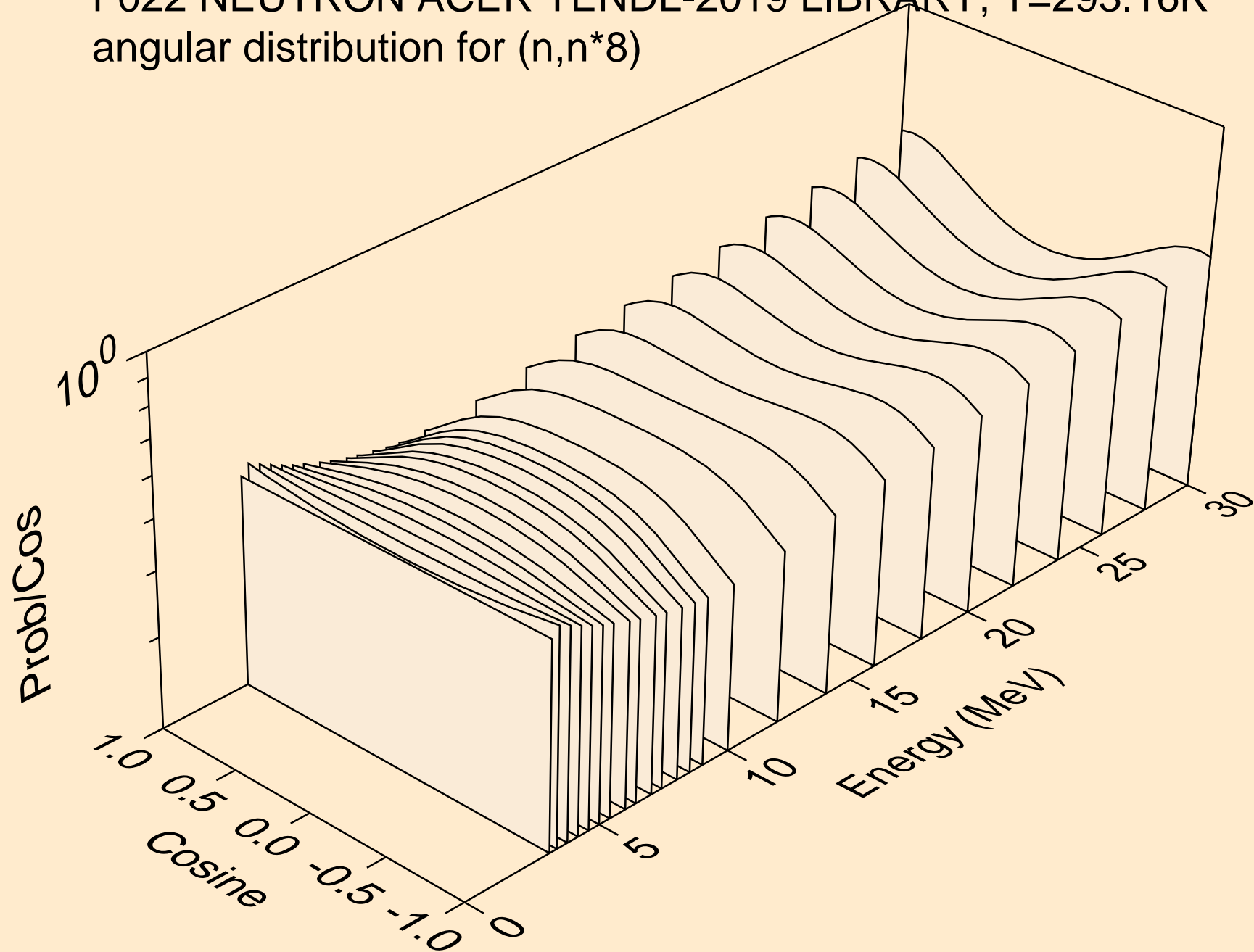

F022 NEUTRON ACER TENDL-2019 LIBRARY; T=293.16K  
angular distribution for (n,n\*9)

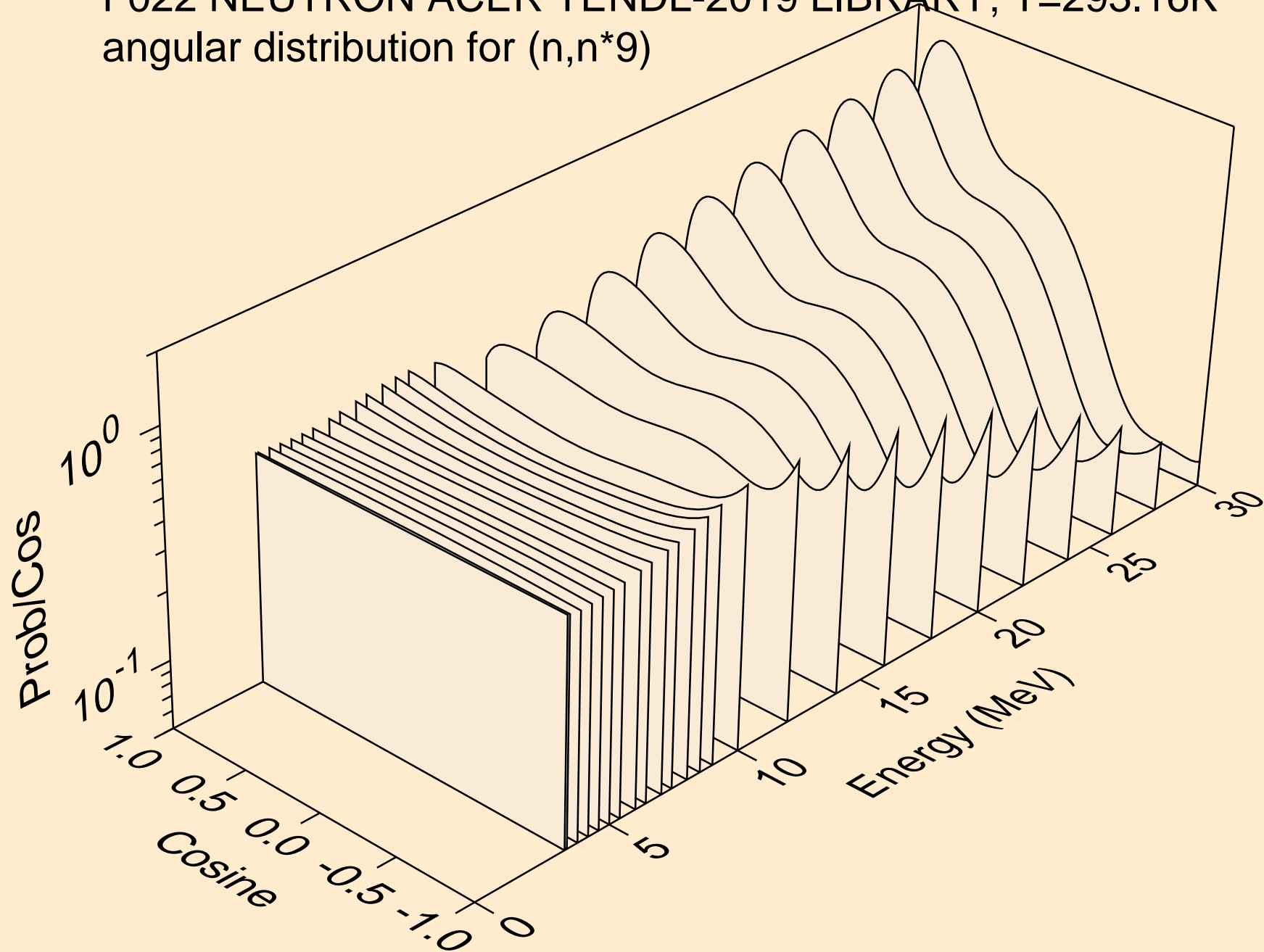

F022 NEUTRON ACER TENDL-2019 LIBRARY; T=293.16K  
angular distribution for (n,n\*10)

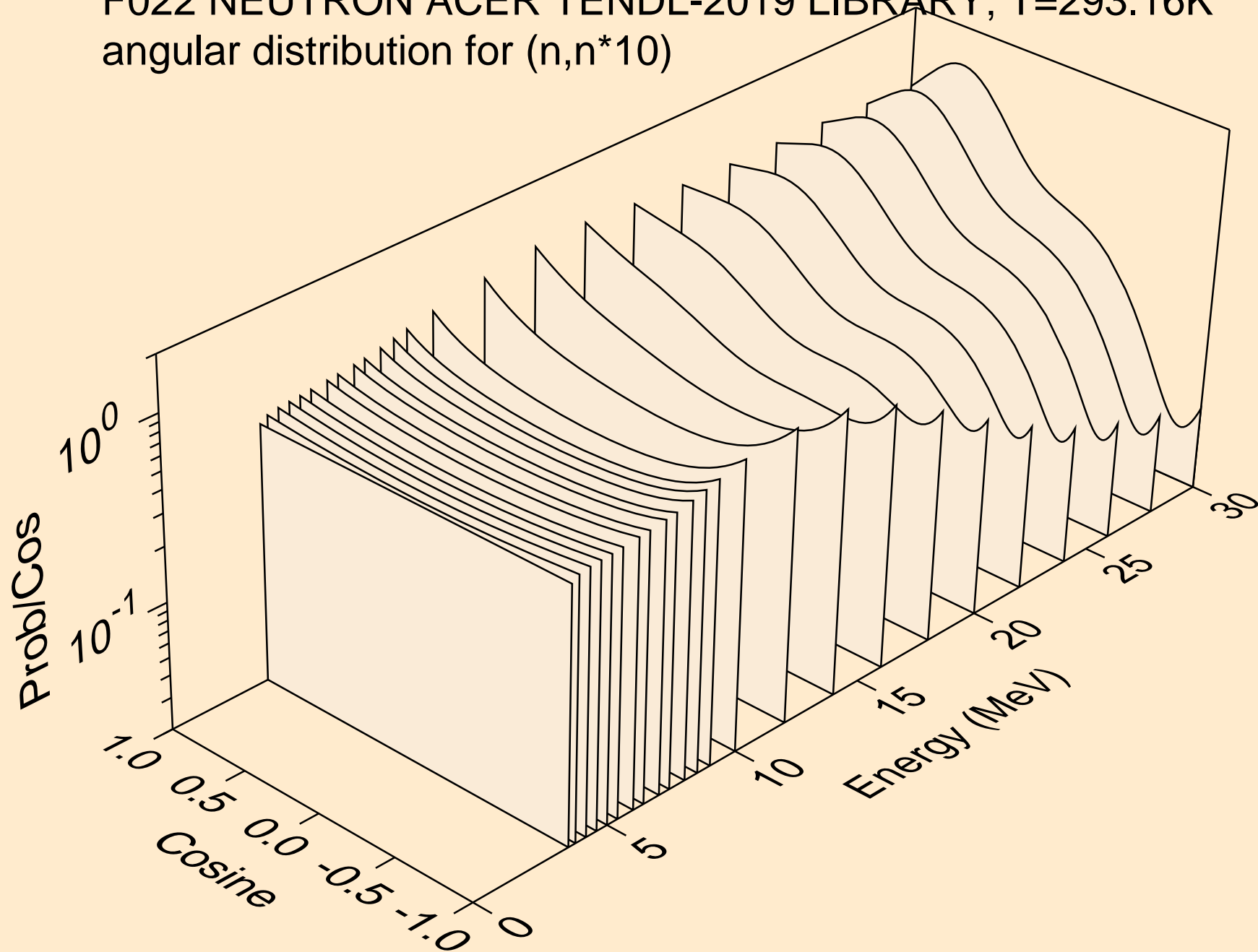

F022 NEUTRON ACER TENDL-2019 LIBRARY; T=293.16K  
angular distribution for (n,n\*11)

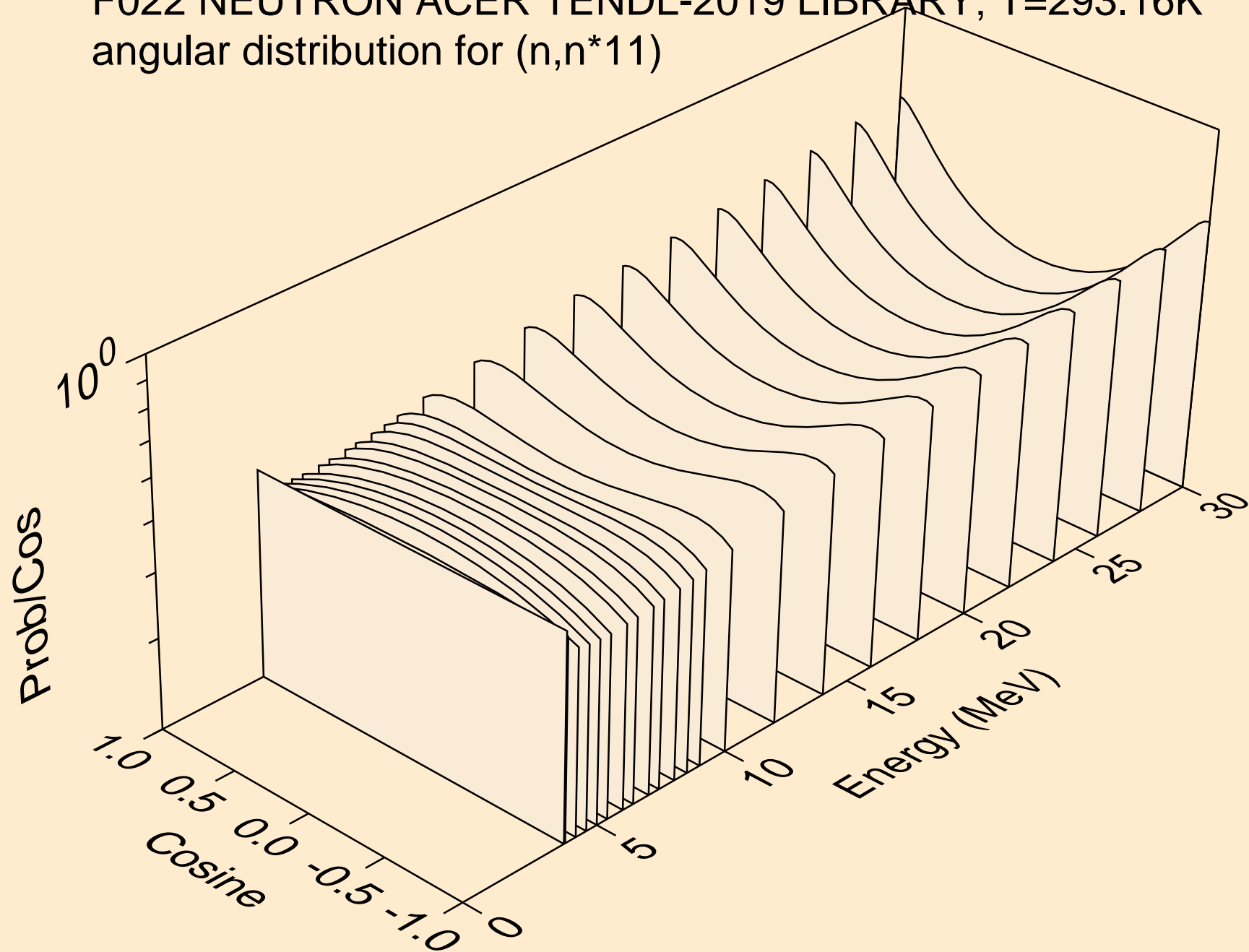

F022 NEUTRON ACER TENDL-2019 LIBRARY; T=293.16K  
angular distribution for (n,n\*12)

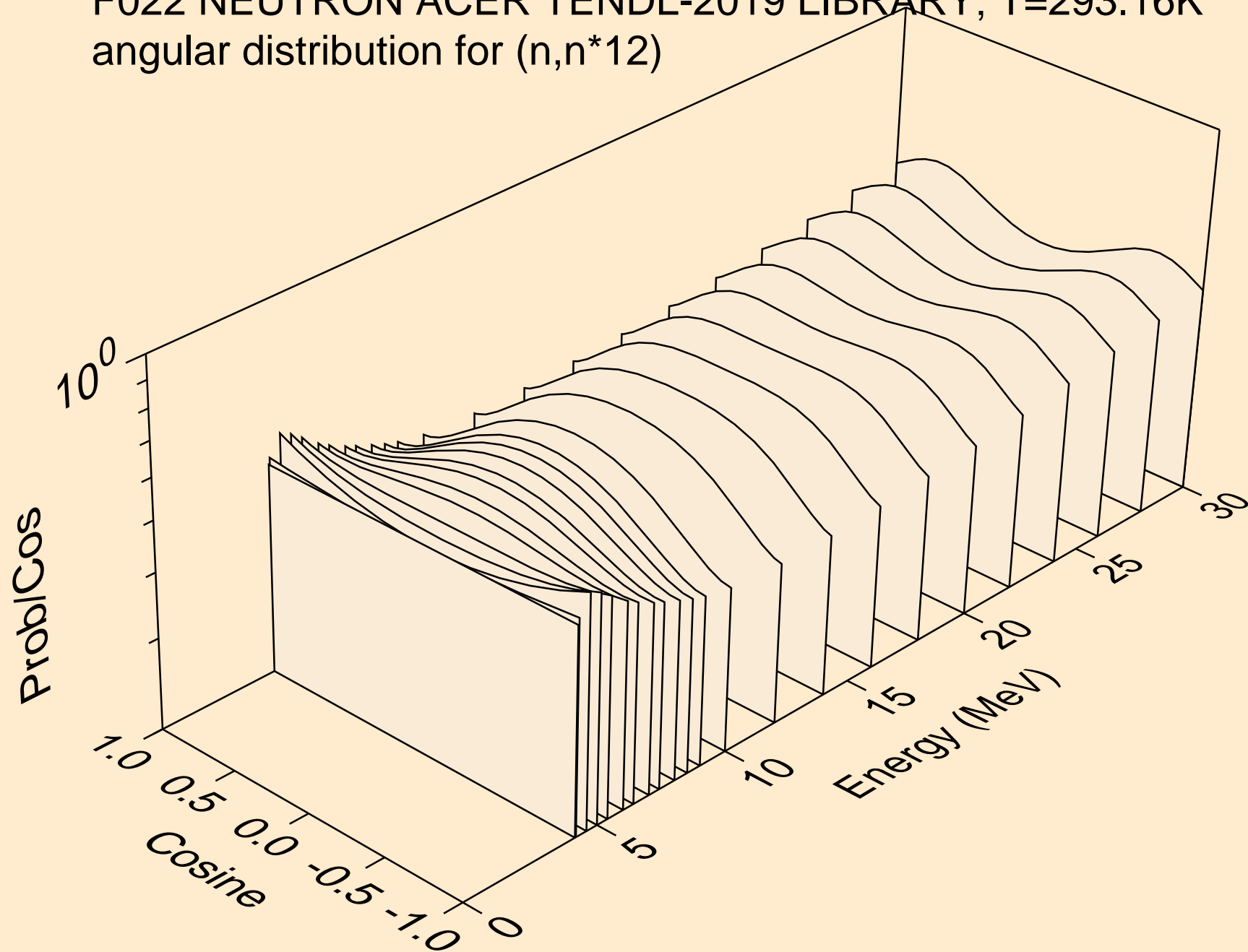



F022 NEUTRON ACER TENDL-2019 LIBRARY; T=293.16K  
angular distribution for (n,n\*13)

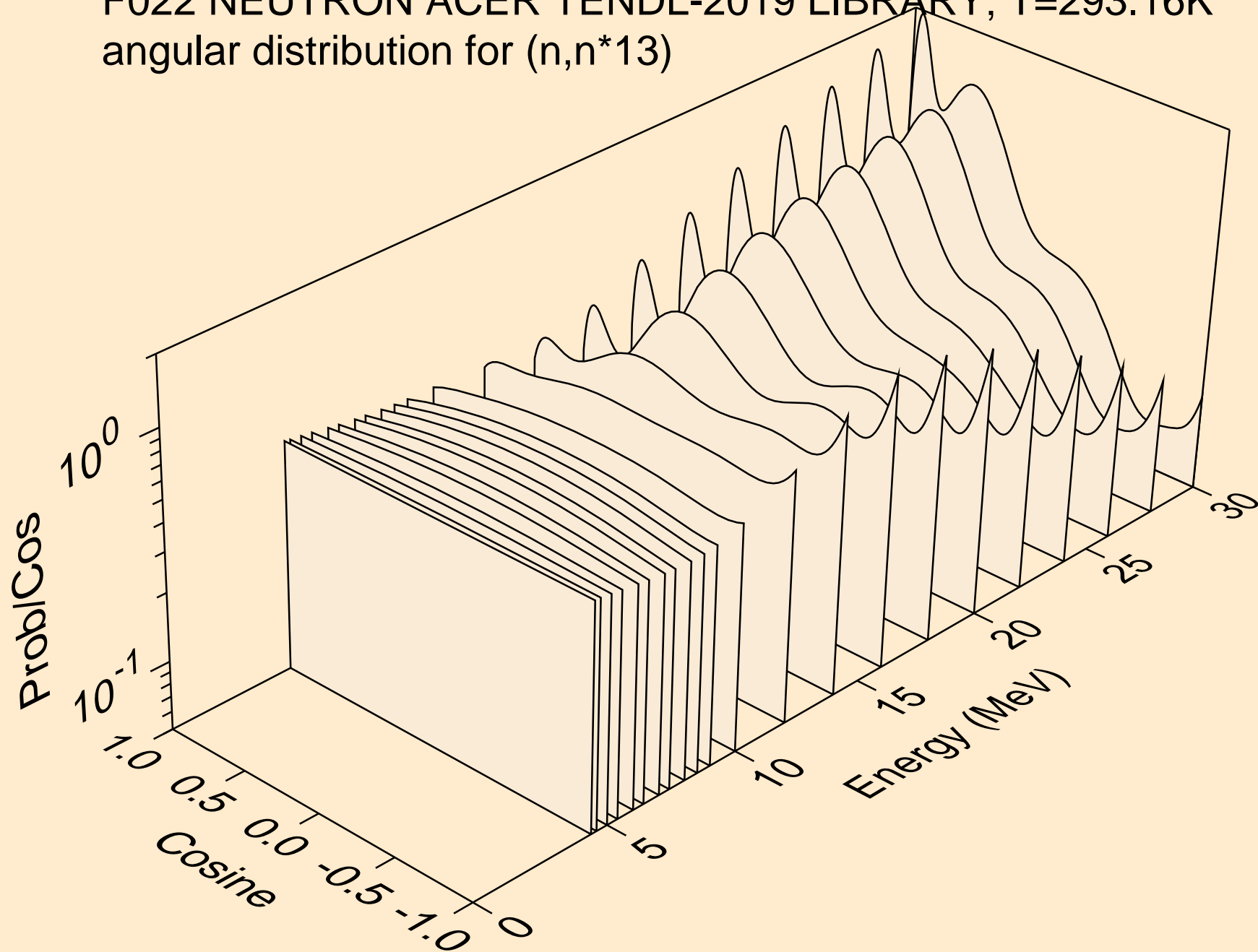

F022 NEUTRON ACER TENDL-2019 LIBRARY; T=293.16K  
angular distribution for (n,n\*14)

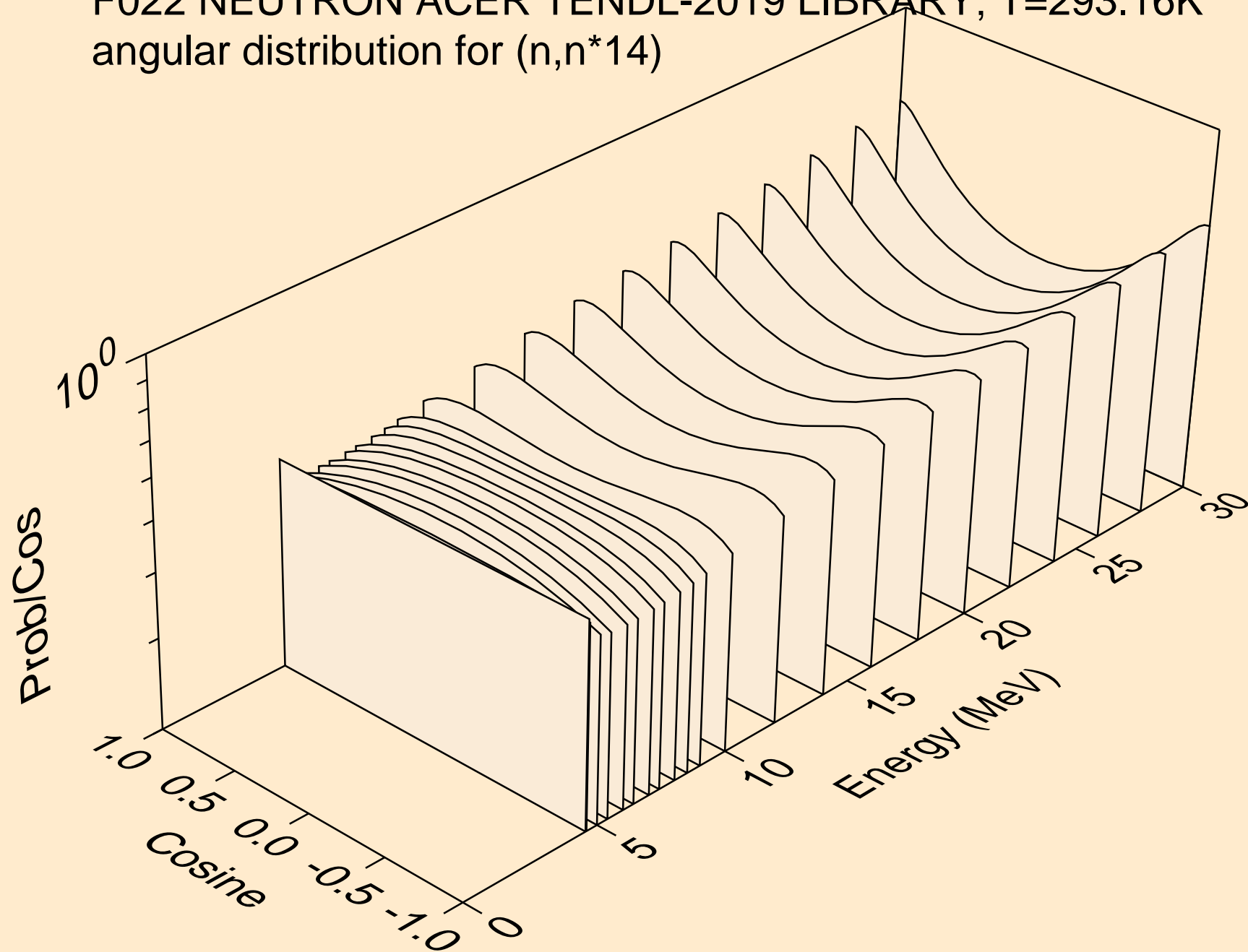

F022 NEUTRON ACER TENDL-2019 LIBRARY; T=293.16K  
angular distribution for (n,n\*15)

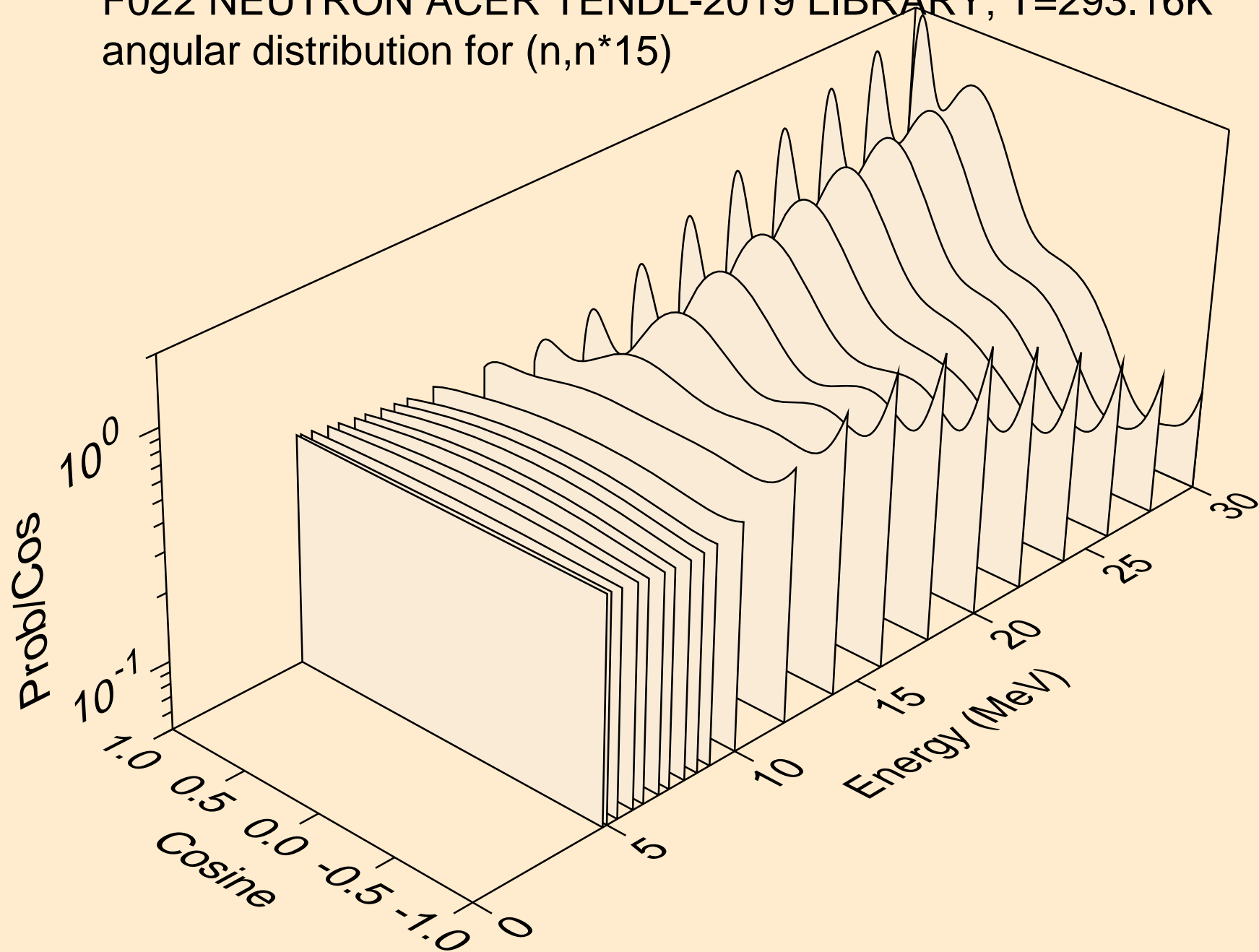

F022 NEUTRON ACER TENDL-2019 LIBRARY; T=293.16K  
angular distribution for (n,n\*16)

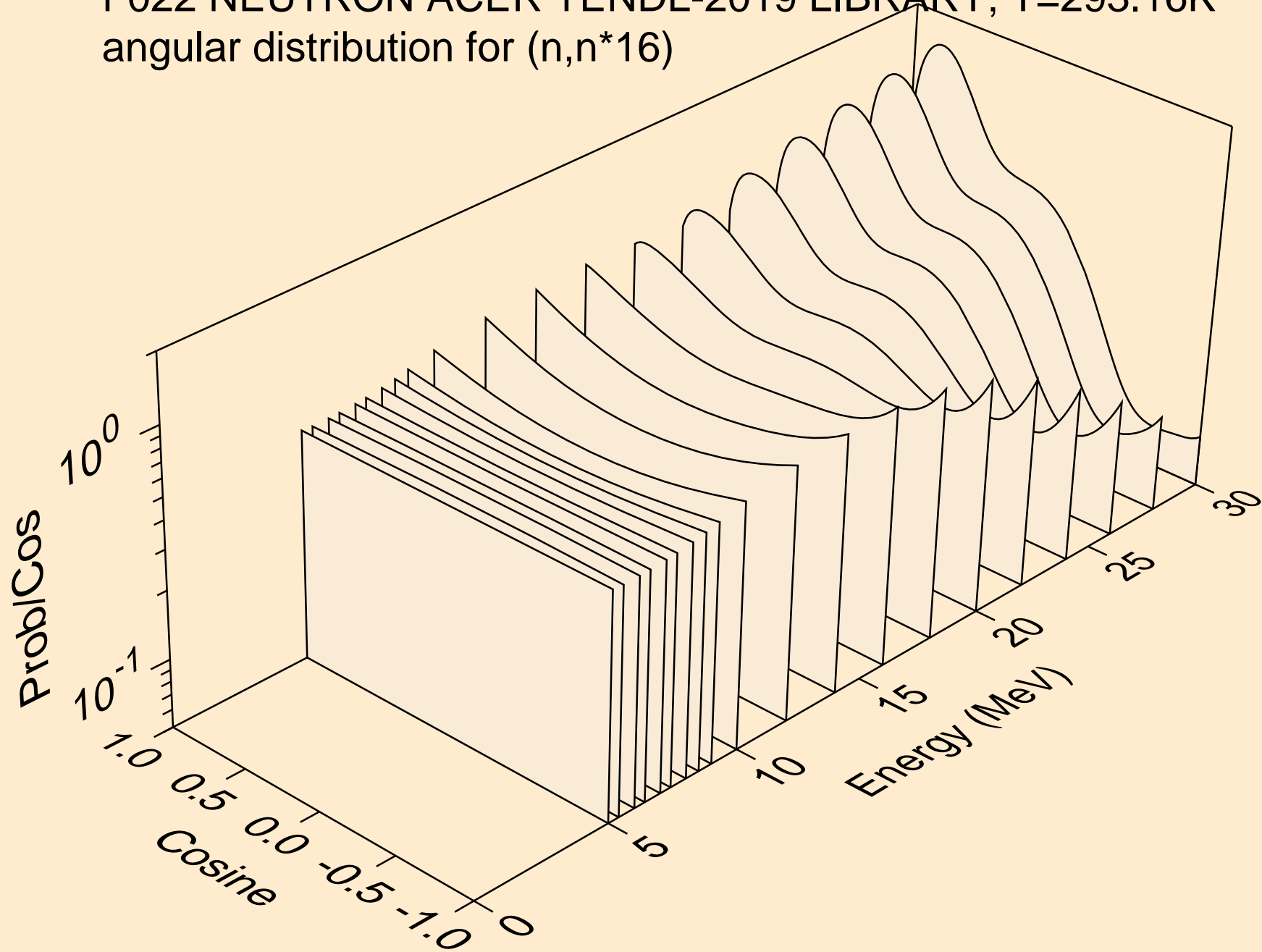

F022 NEUTRON ACER TENDL-2019 LIBRARY; T=293.16K  
angular distribution for (n,n\*17)

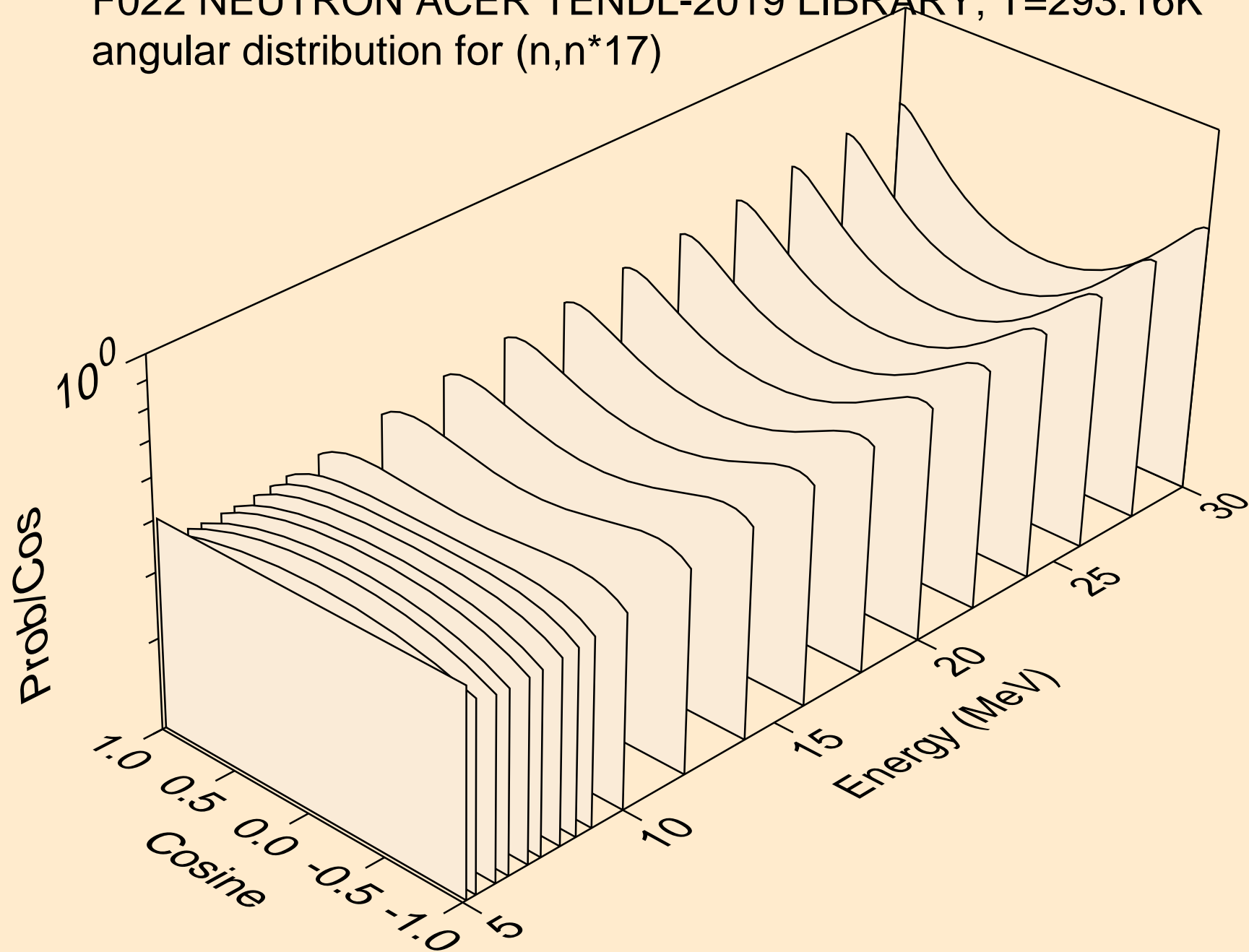

F022 NEUTRON ACER TENDL-2019 LIBRARY; T=293.16K  
angular distribution for (n,n\*18)

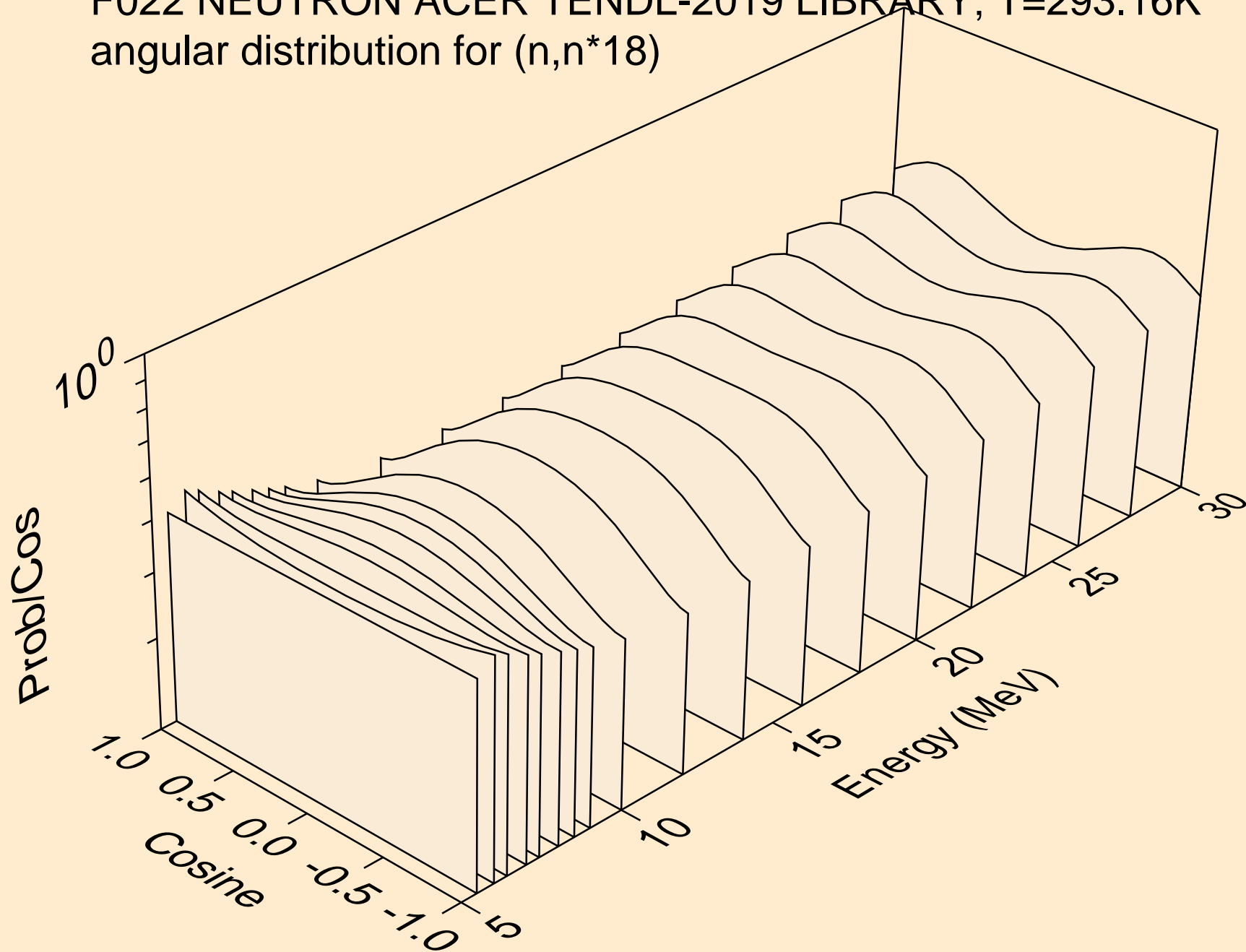

F022 NEUTRON ACER TENDL-2019 LIBRARY; T=293.16K  
angular distribution for (n,n\*19)

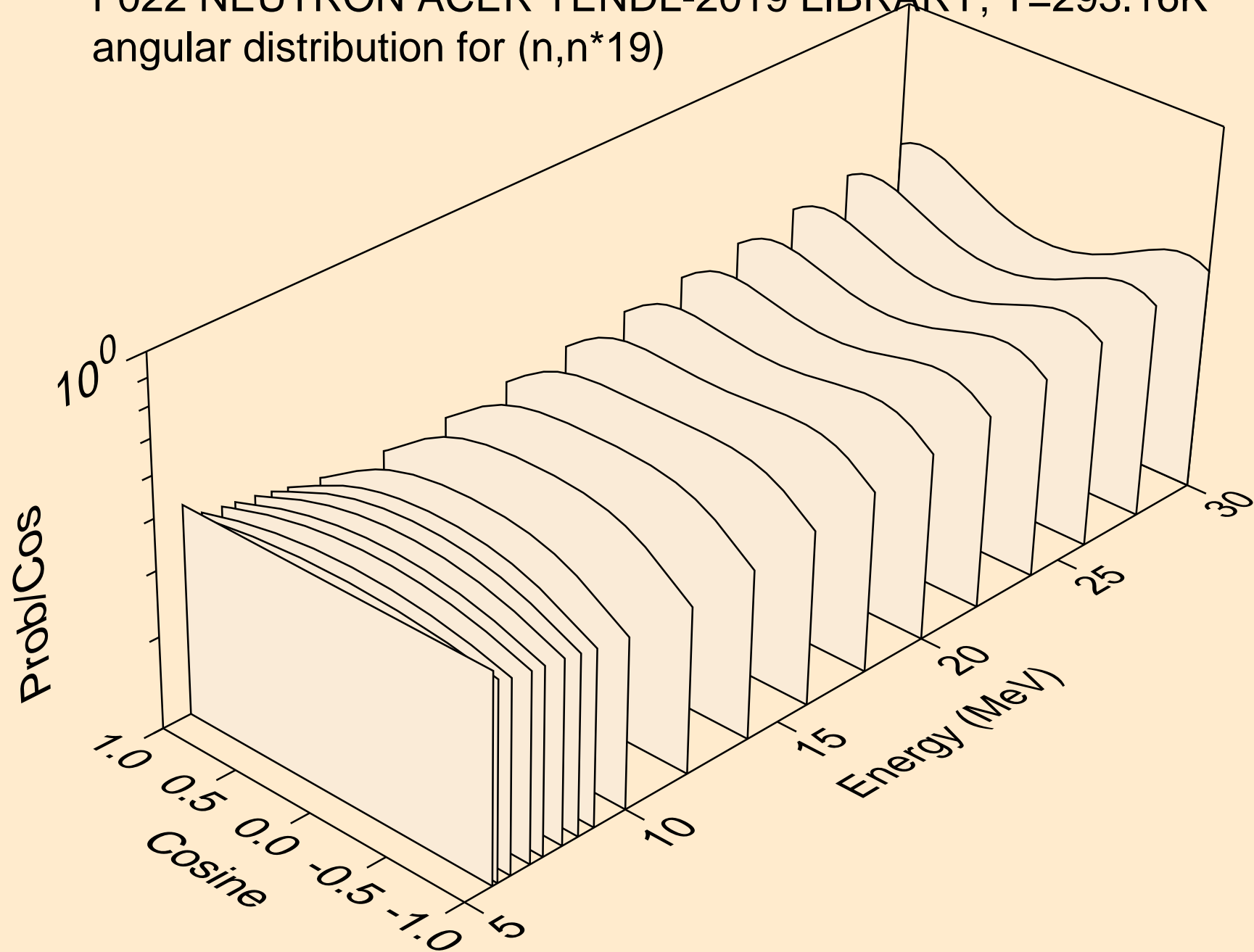

F022 NEUTRON ACER TENDL-2019 LIBRARY; T=293.16K  
angular distribution for (n,n\*20)

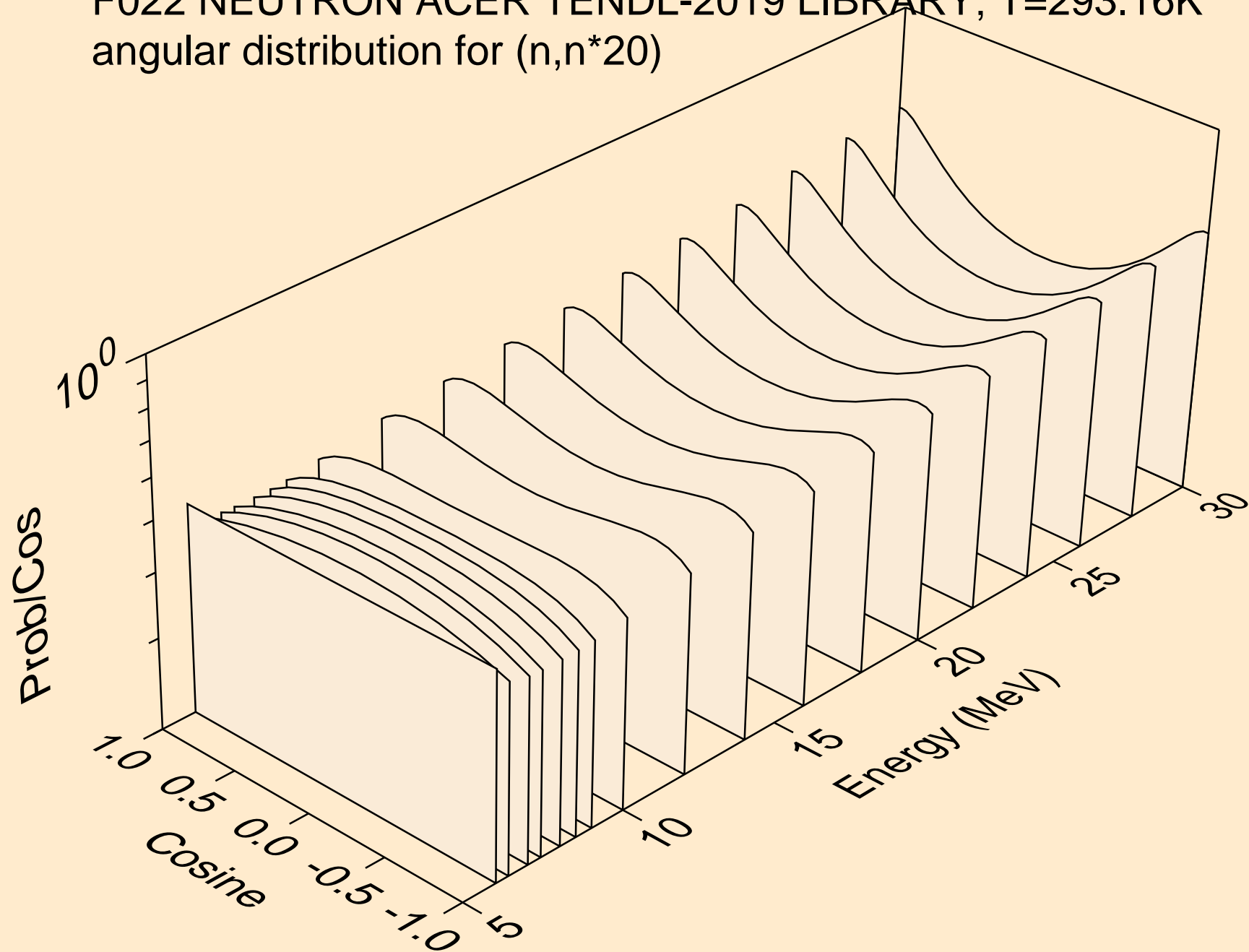



F022 NEUTRON ACER TENDL-2019 LIBRARY; T=293.16K  
angular distribution for (n,n\*21)

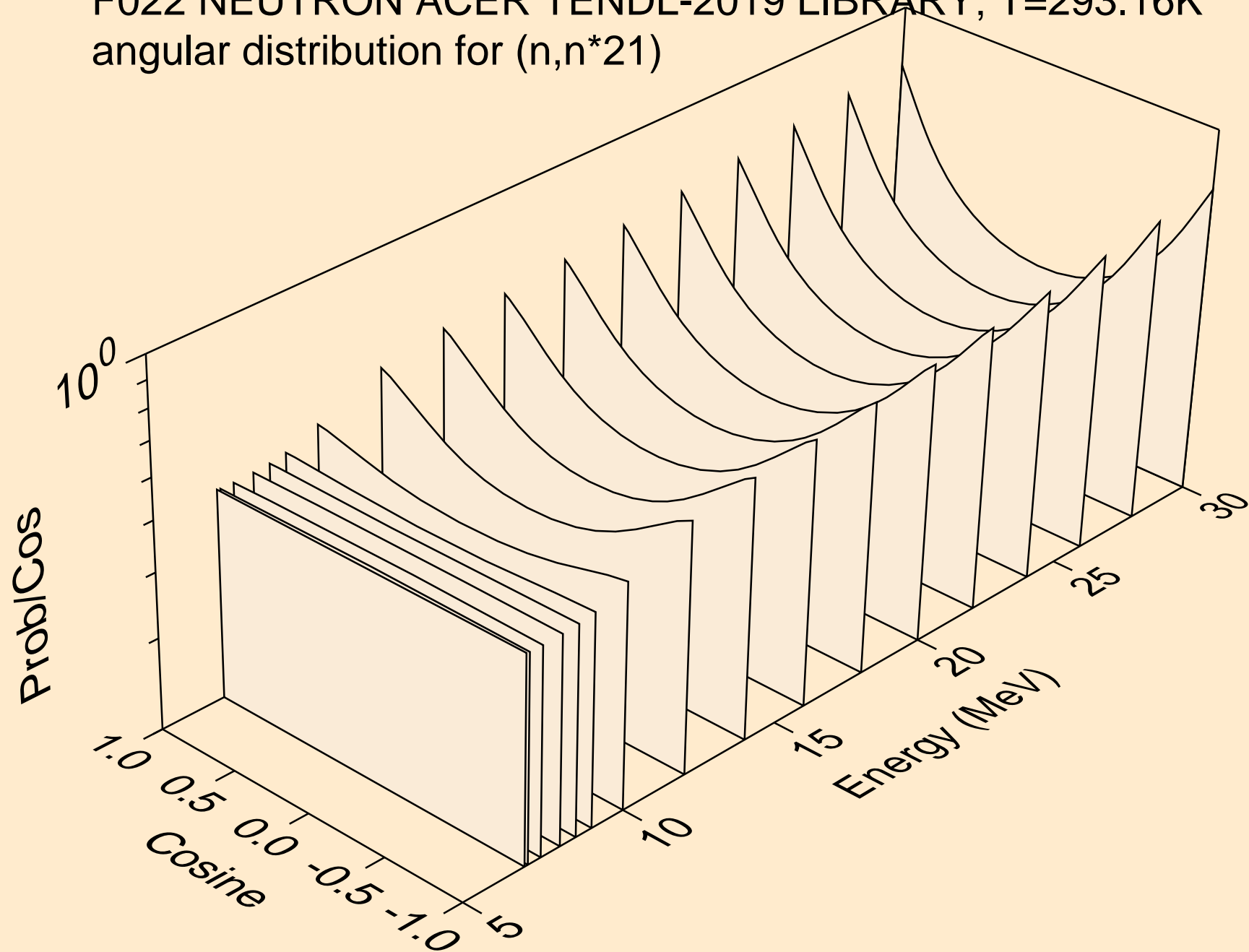

F022 NEUTRON ACER TENDL-2019 LIBRARY; T=293.16K  
angular distribution for (n,n\*22)

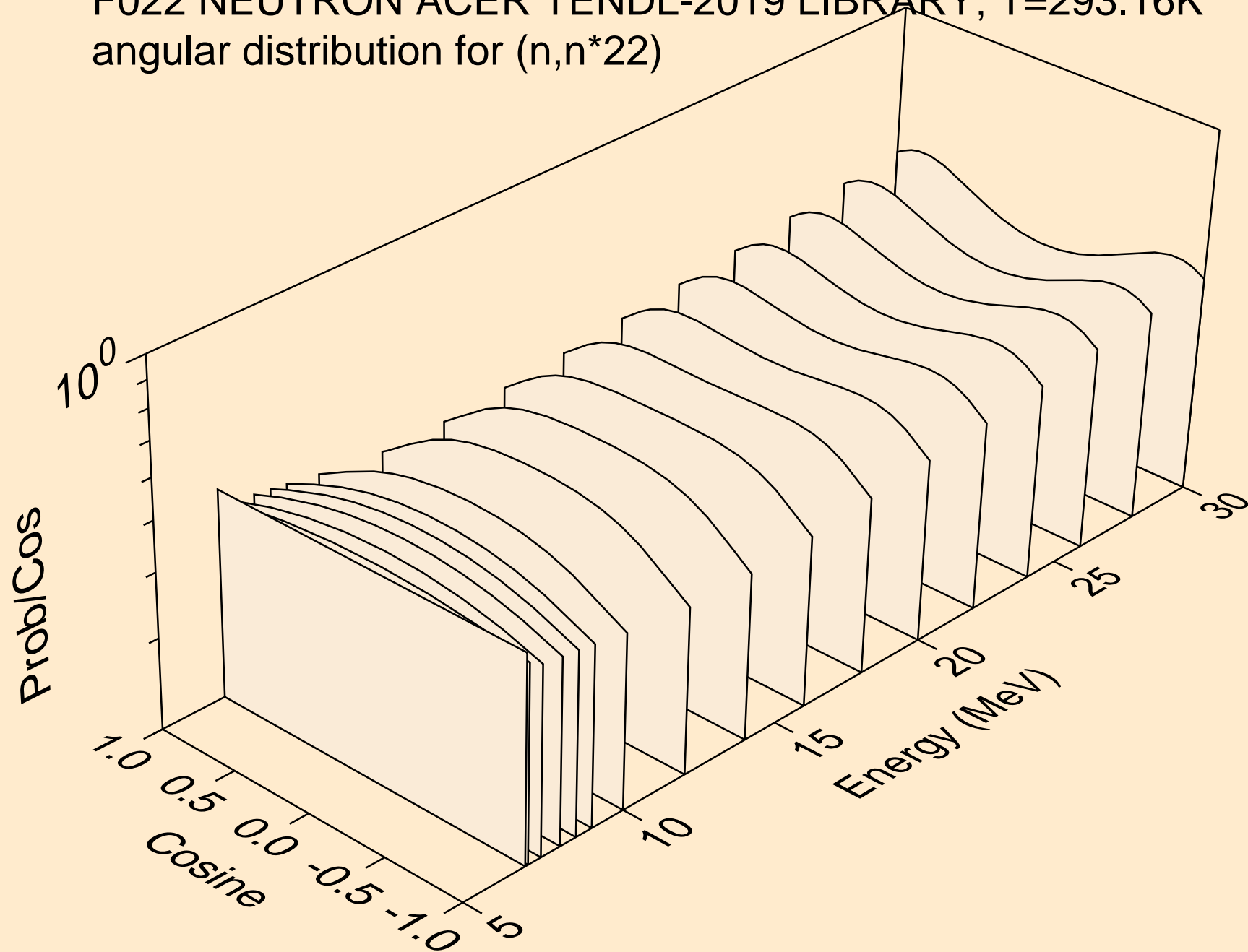

F022 NEUTRON ACER TENDL-2019 LIBRARY; T=293.16K  
angular distribution for (n,n\*23)

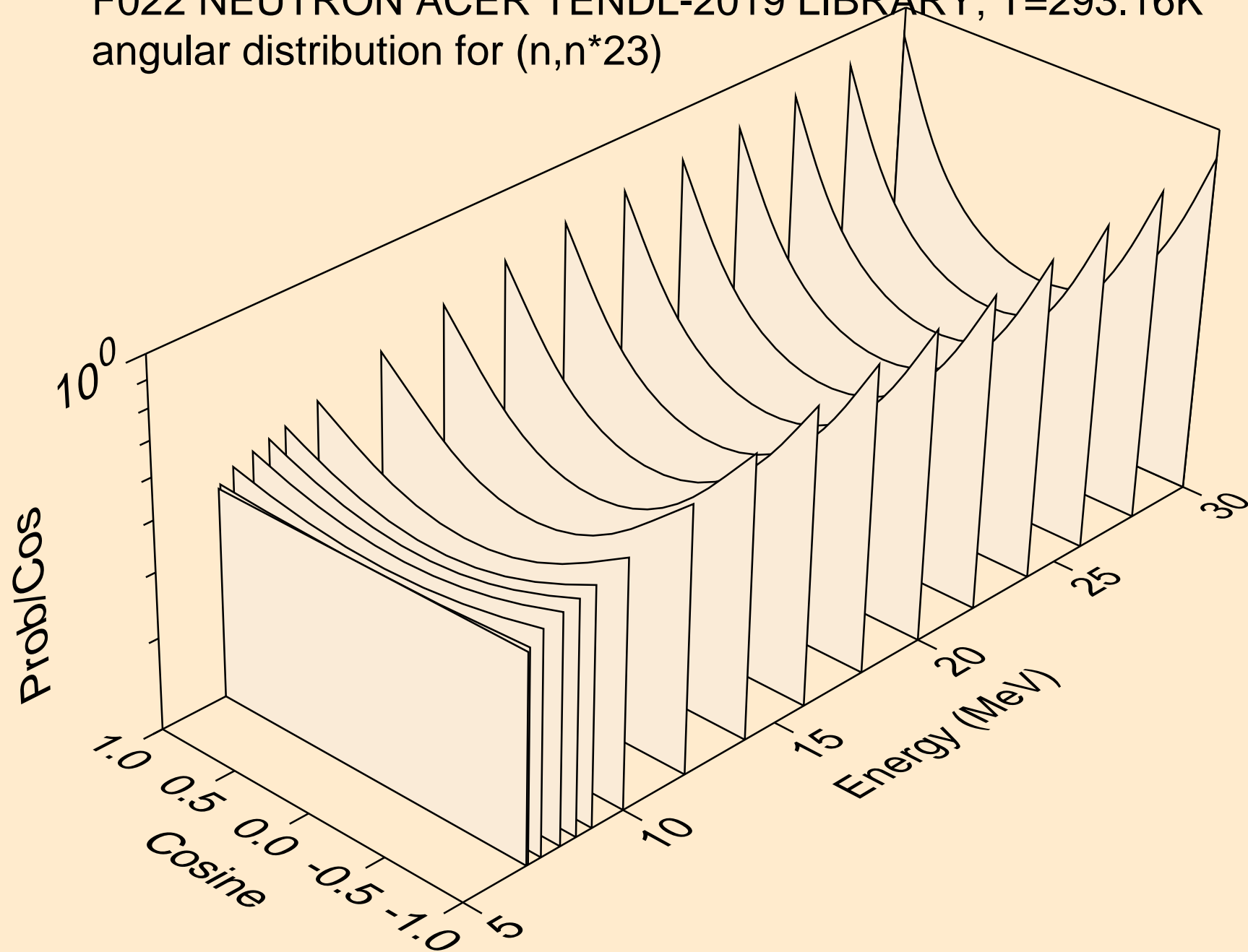

F022 NEUTRON ACER TENDL-2019 LIBRARY; T=293.16K  
angular distribution for (n,n\*24)

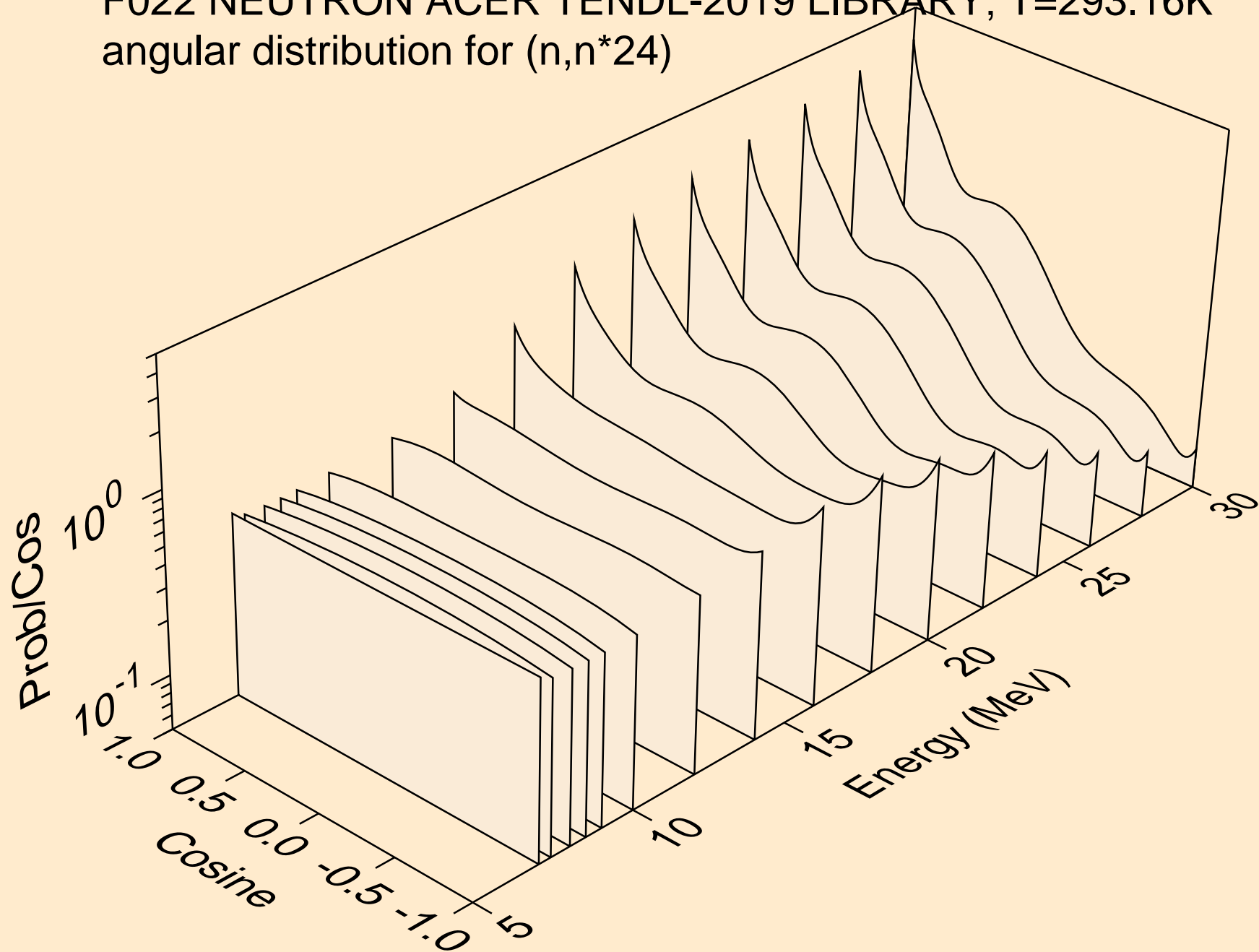

F022 NEUTRON ACER TENDL-2019 LIBRARY; T=293.16K  
angular distribution for (n,n\*25)

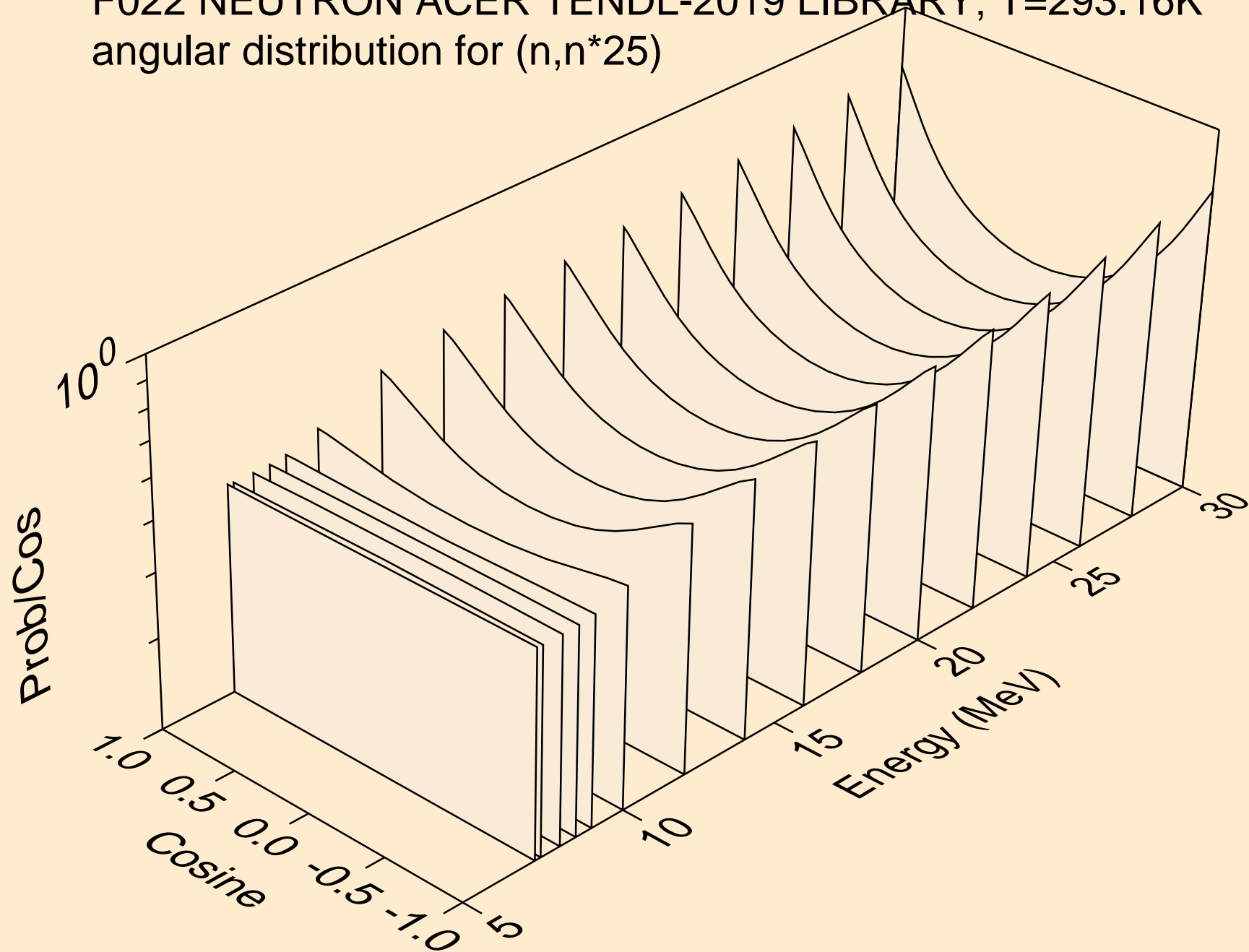

F022 NEUTRON ACER TENDL-2019 LIBRARY; T=293.16K  
angular distribution for (n,n\*26)

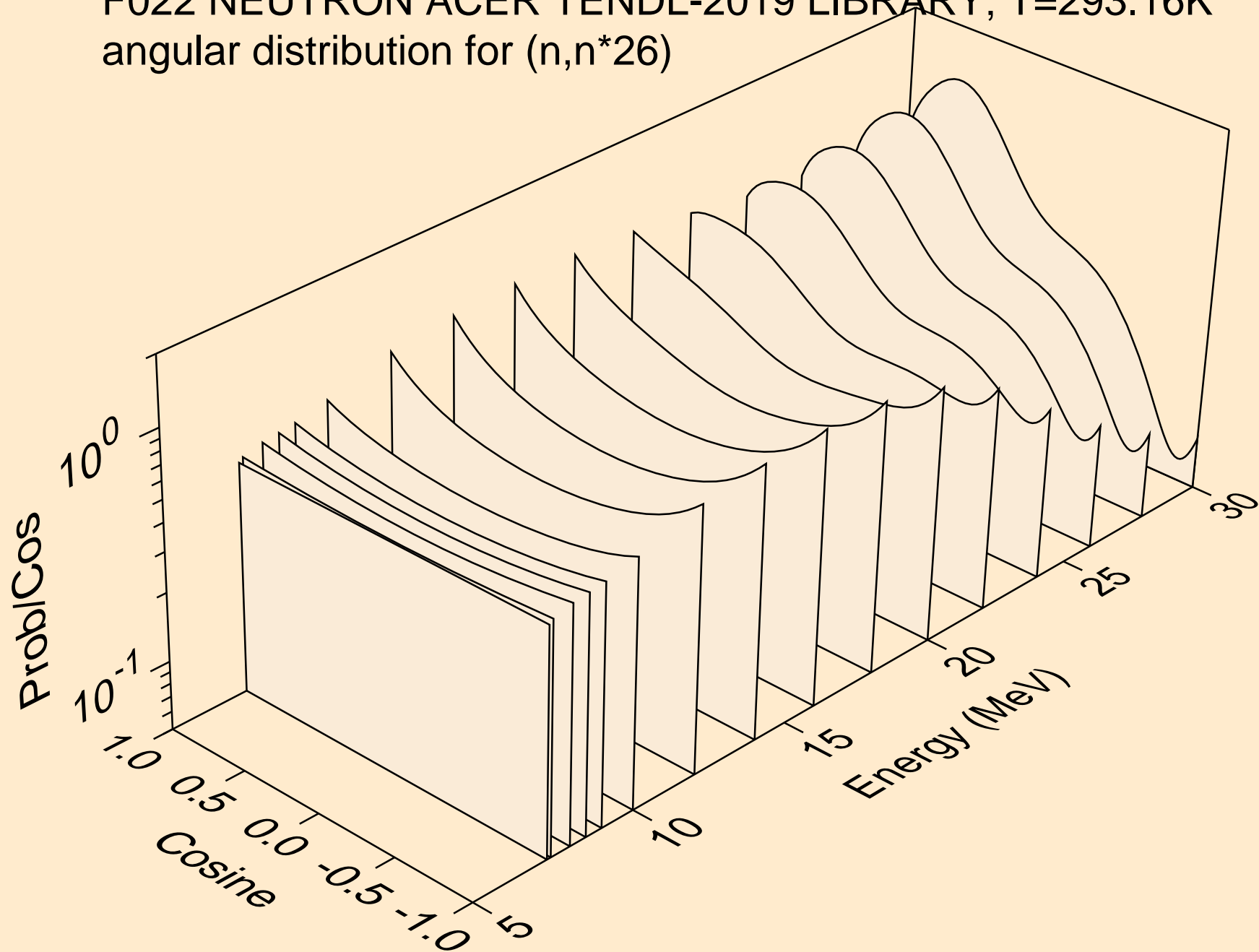

F022 NEUTRON ACER TENDL-2019 LIBRARY; T=293.16K  
angular distribution for (n,n\*27)

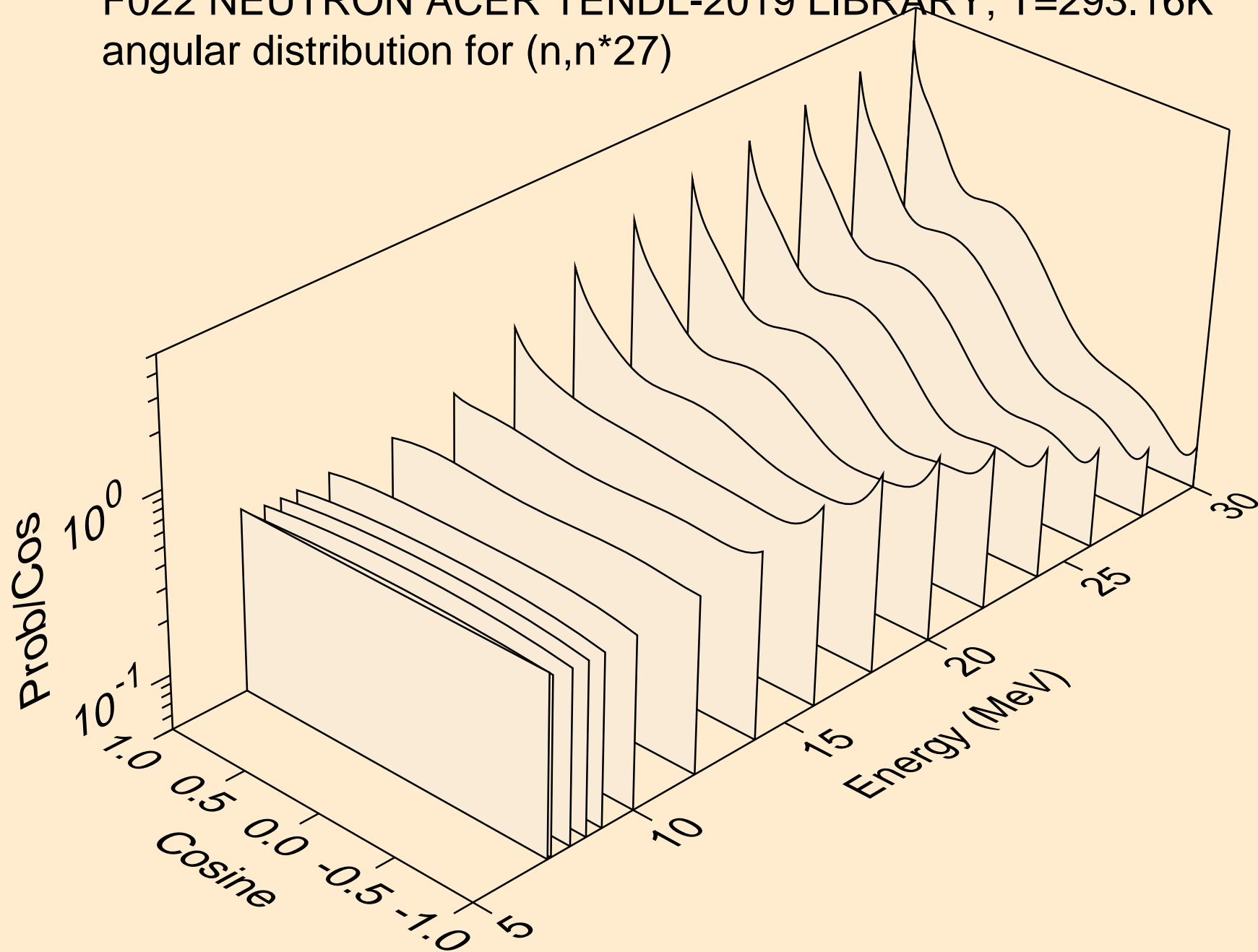

F022 NEUTRON ACER TENDL-2019 LIBRARY; T=293.16K  
angular distribution for (n,n\*28)

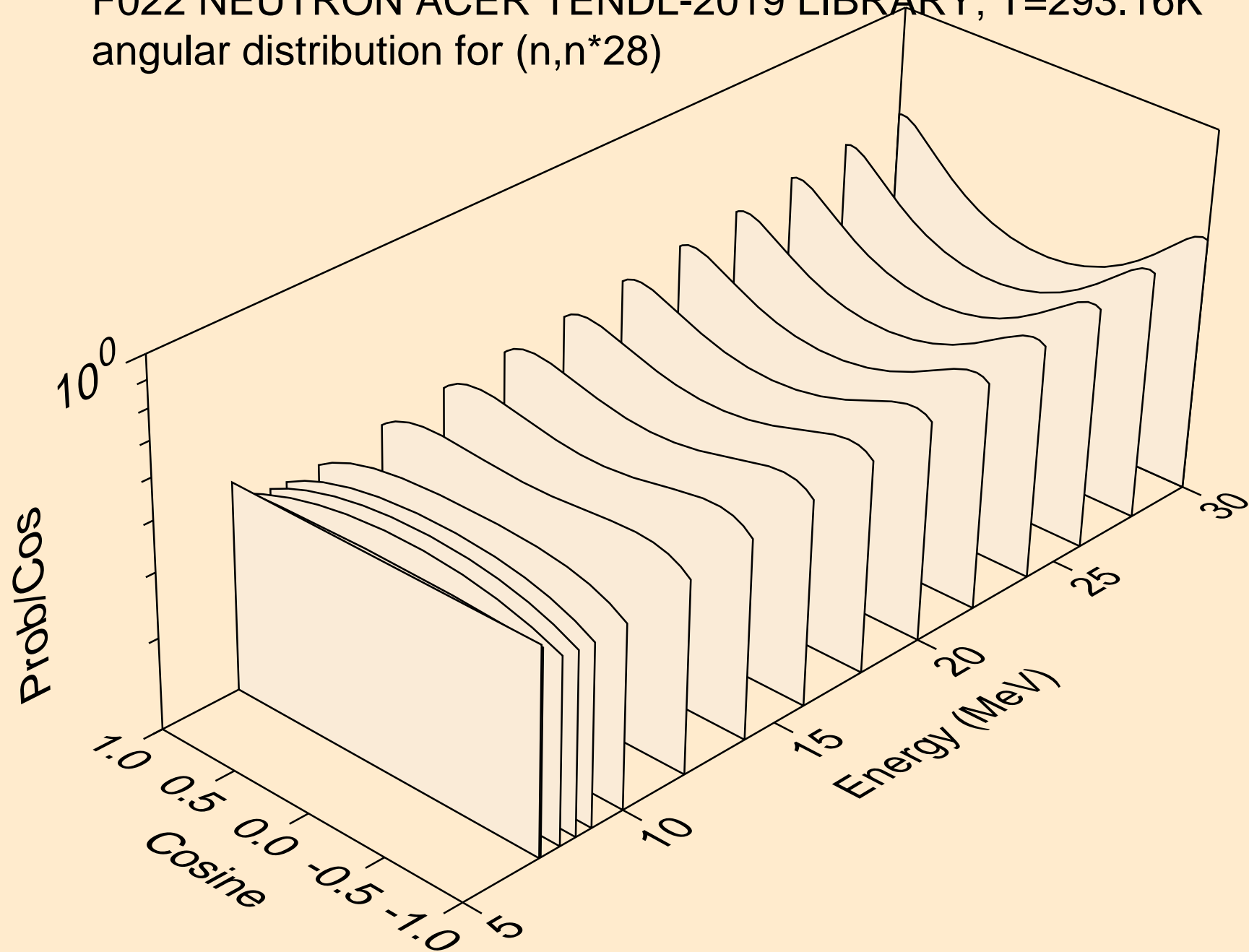



F022 NEUTRON ACER TENDL-2019 LIBRARY; T=293.16K  
angular distribution for (n,n\*29)

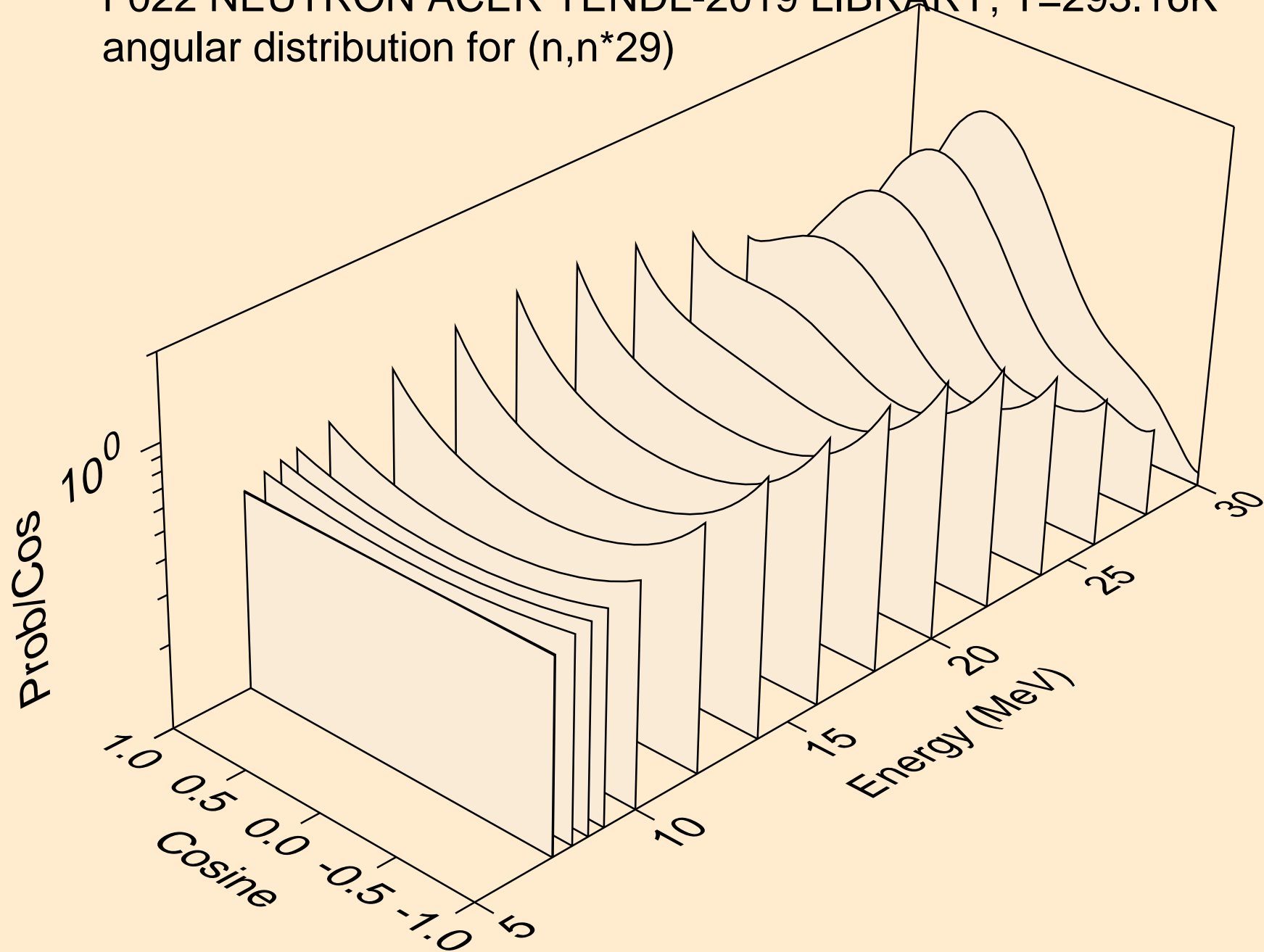

F022 NEUTRON ACER TENDL-2019 LIBRARY; T=293.16K  
angular distribution for (n,n\*30)

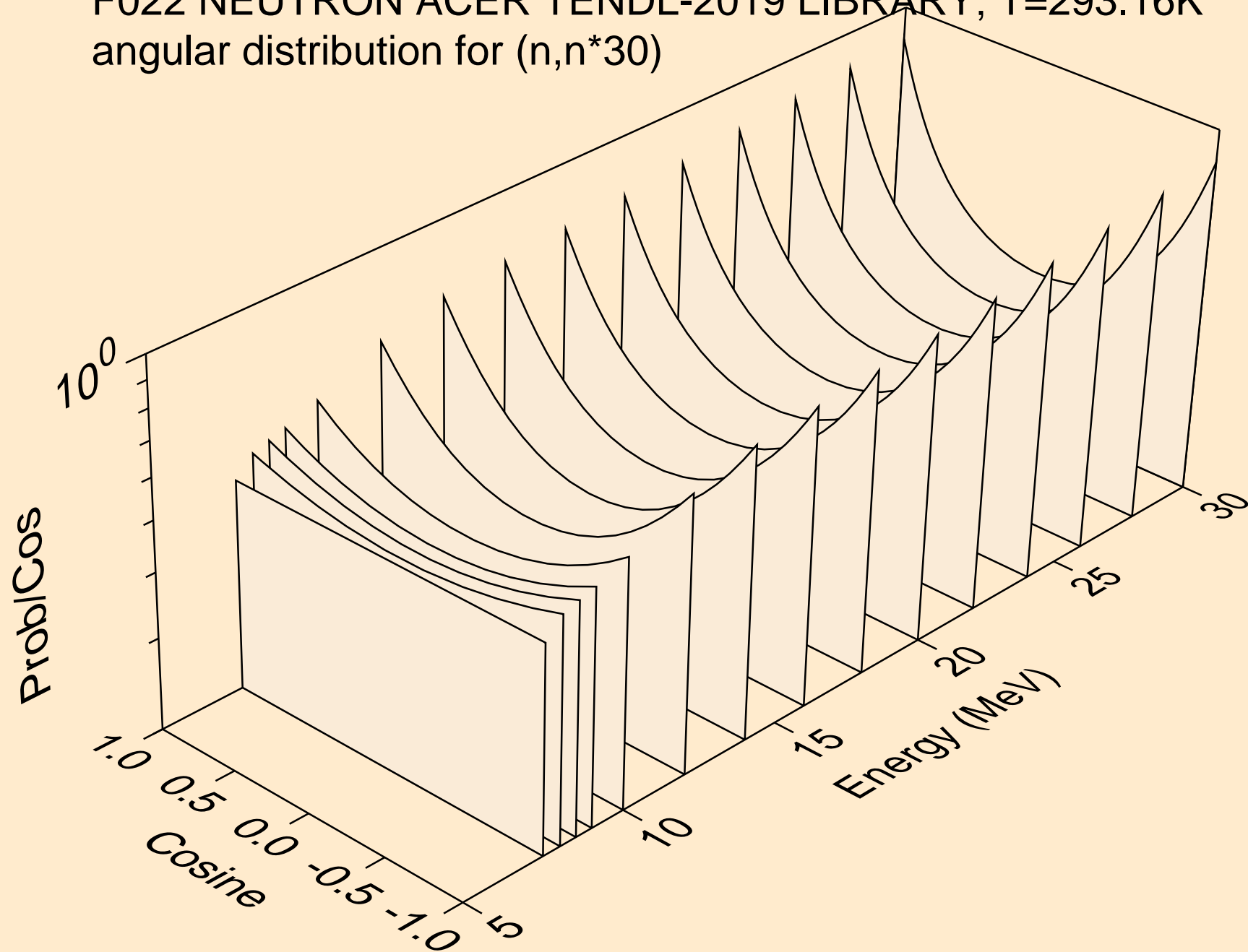

F022 NEUTRON ACER TENDL-2019 LIBRARY; T=293.16K  
Neutron emission for (n,x)

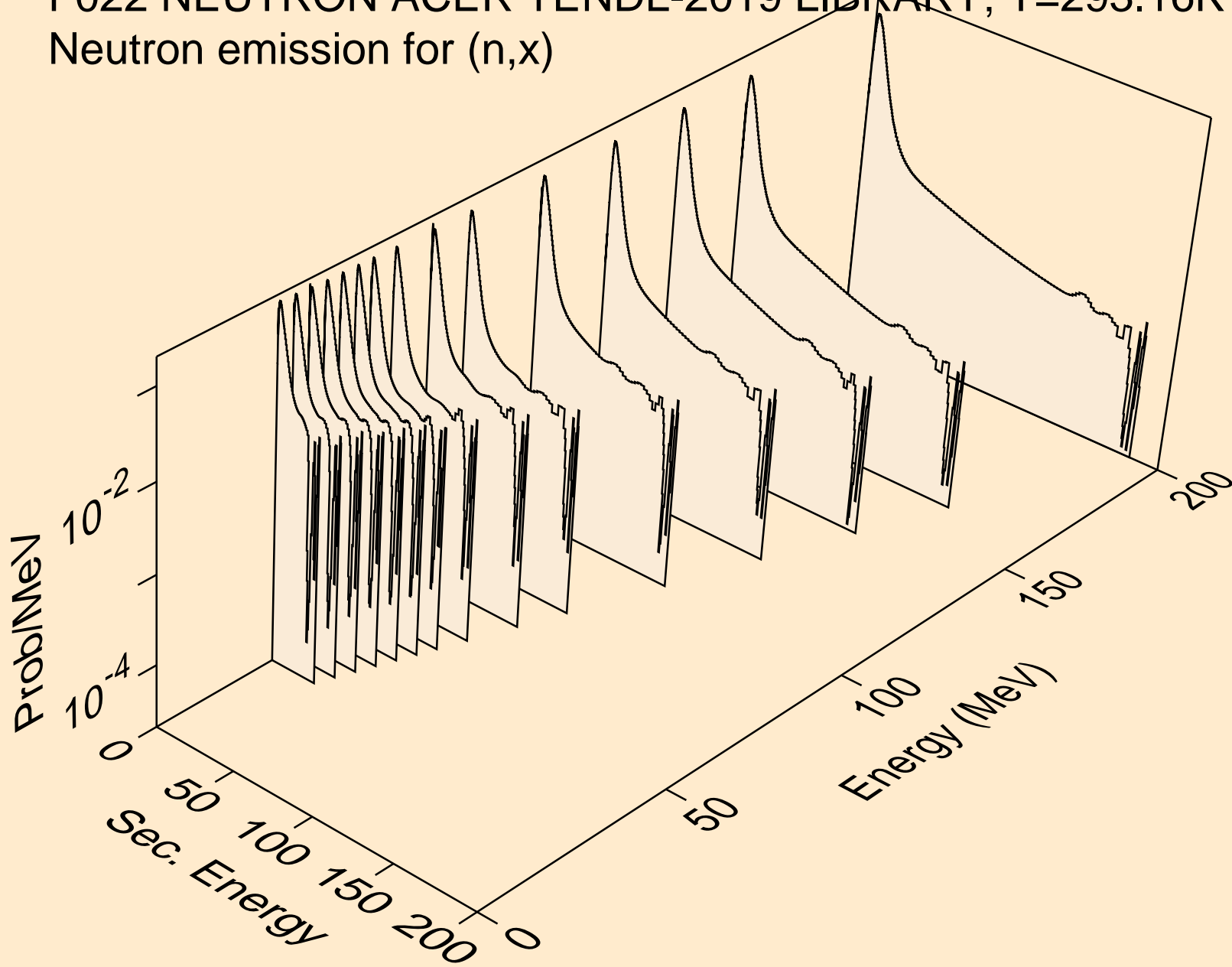

F022 NEUTRON ACER TENDL-2019 LIBRARY; T=293.16K  
Neutron emission for (n,2nd)

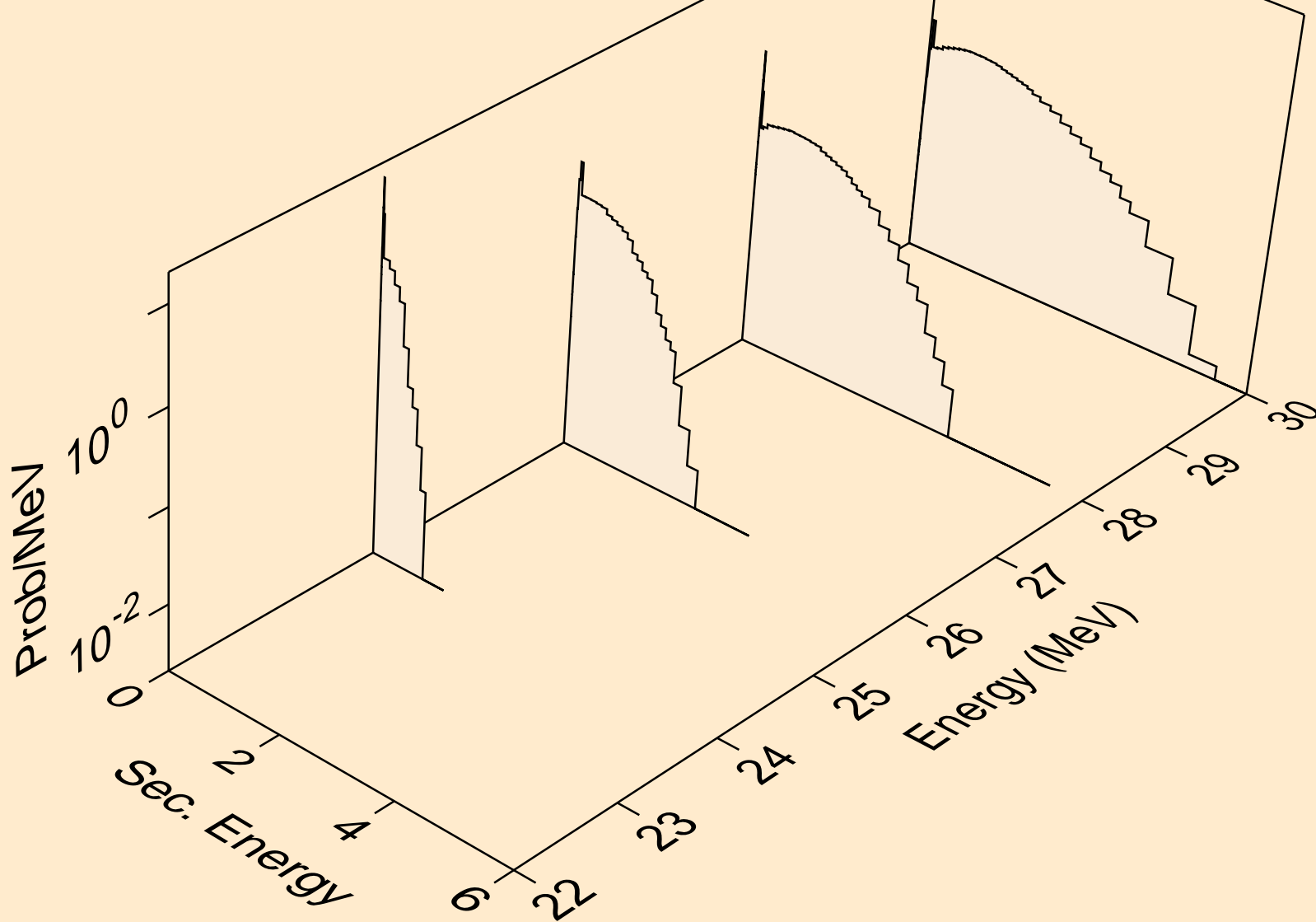

F022 NEUTRON ACER TENDL-2019 LIBRARY; T=293.16K  
Neutron emission for (n,2n)

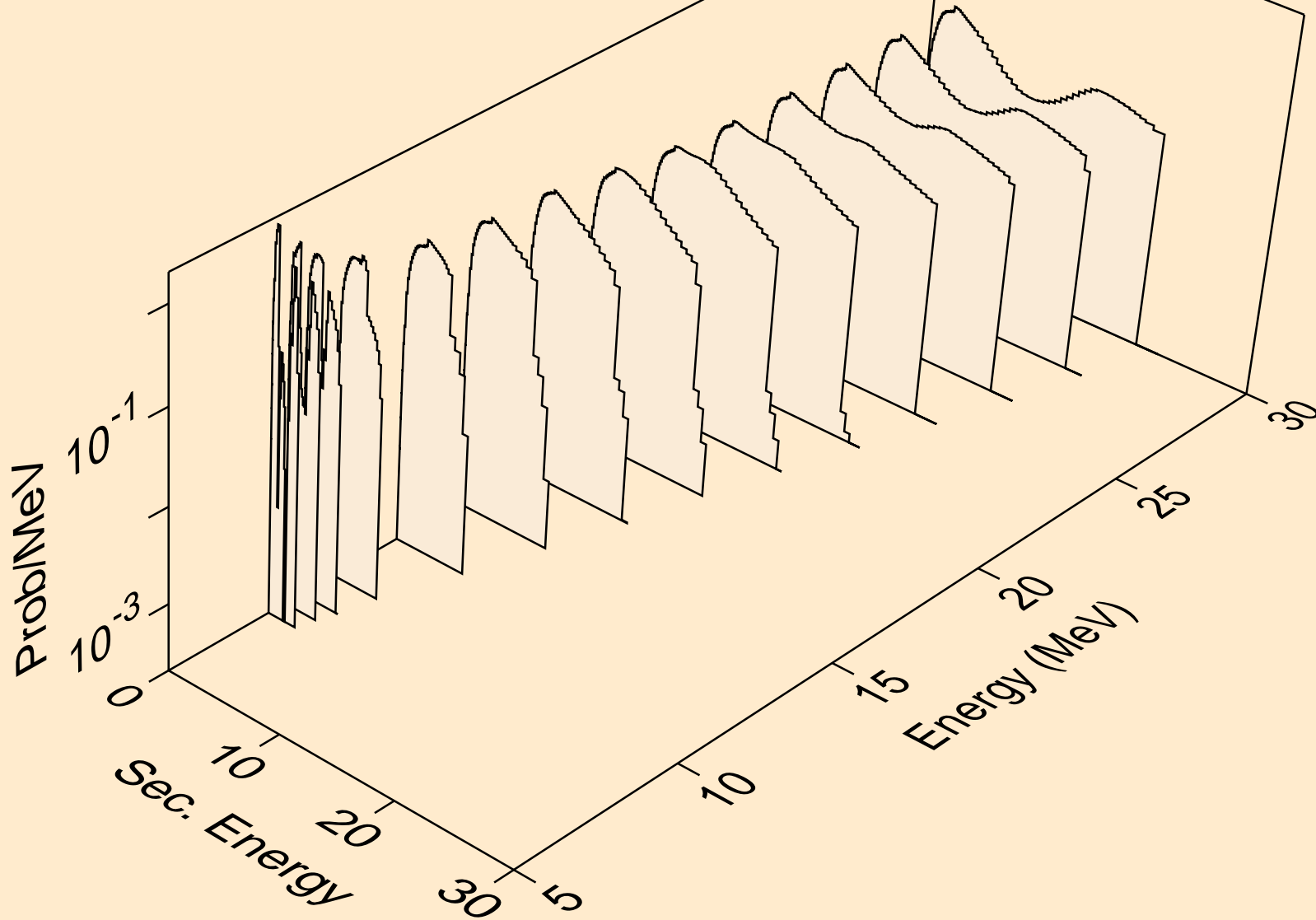

F022 NEUTRON ACER TENDL-2019 LIBRARY; T=293.16K  
Neutron emission for (n,3n)

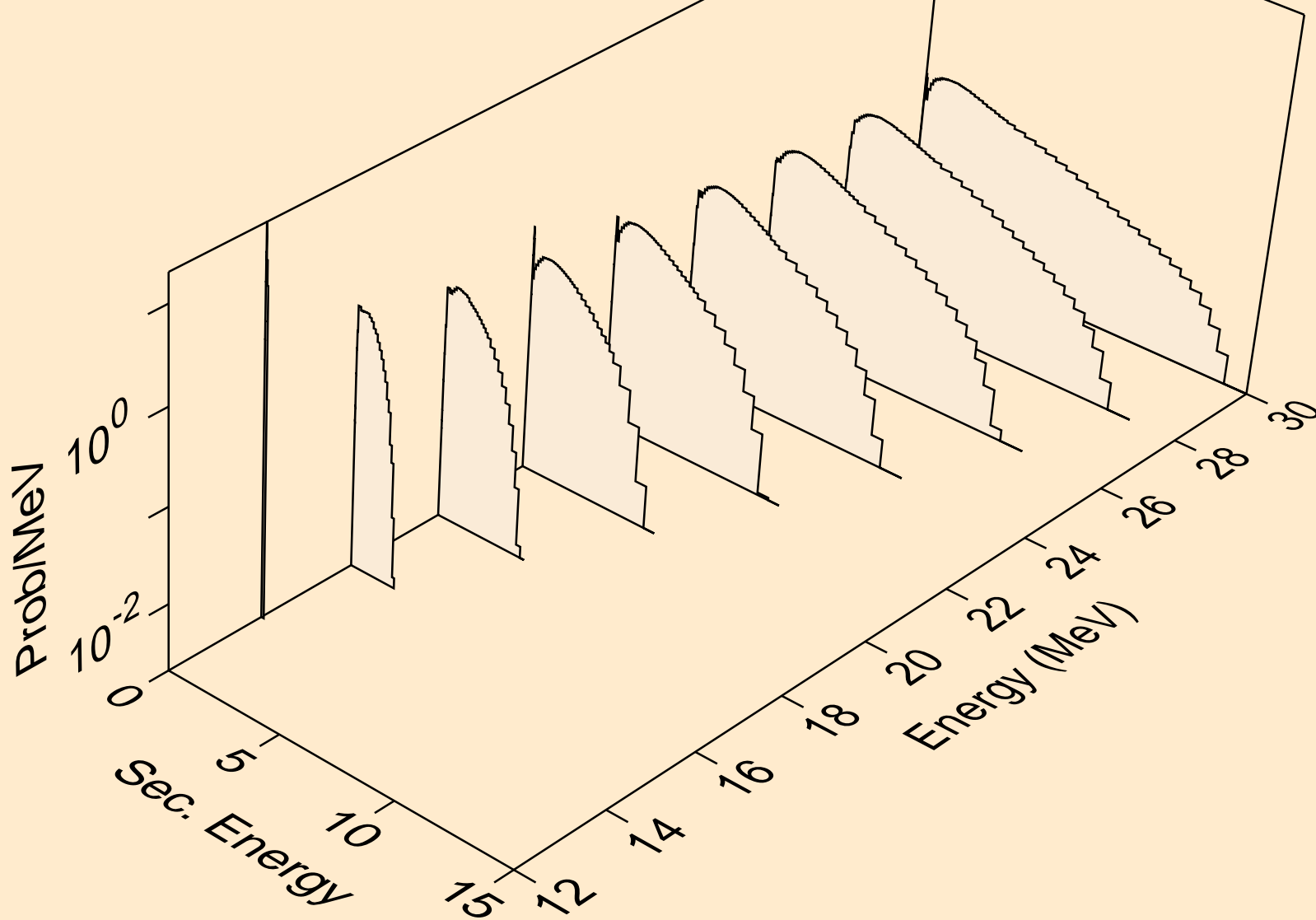

F022 NEUTRON ACER TENDL-2019 LIBRARY; T=293.16K  
Neutron emission for (n,n\*)a

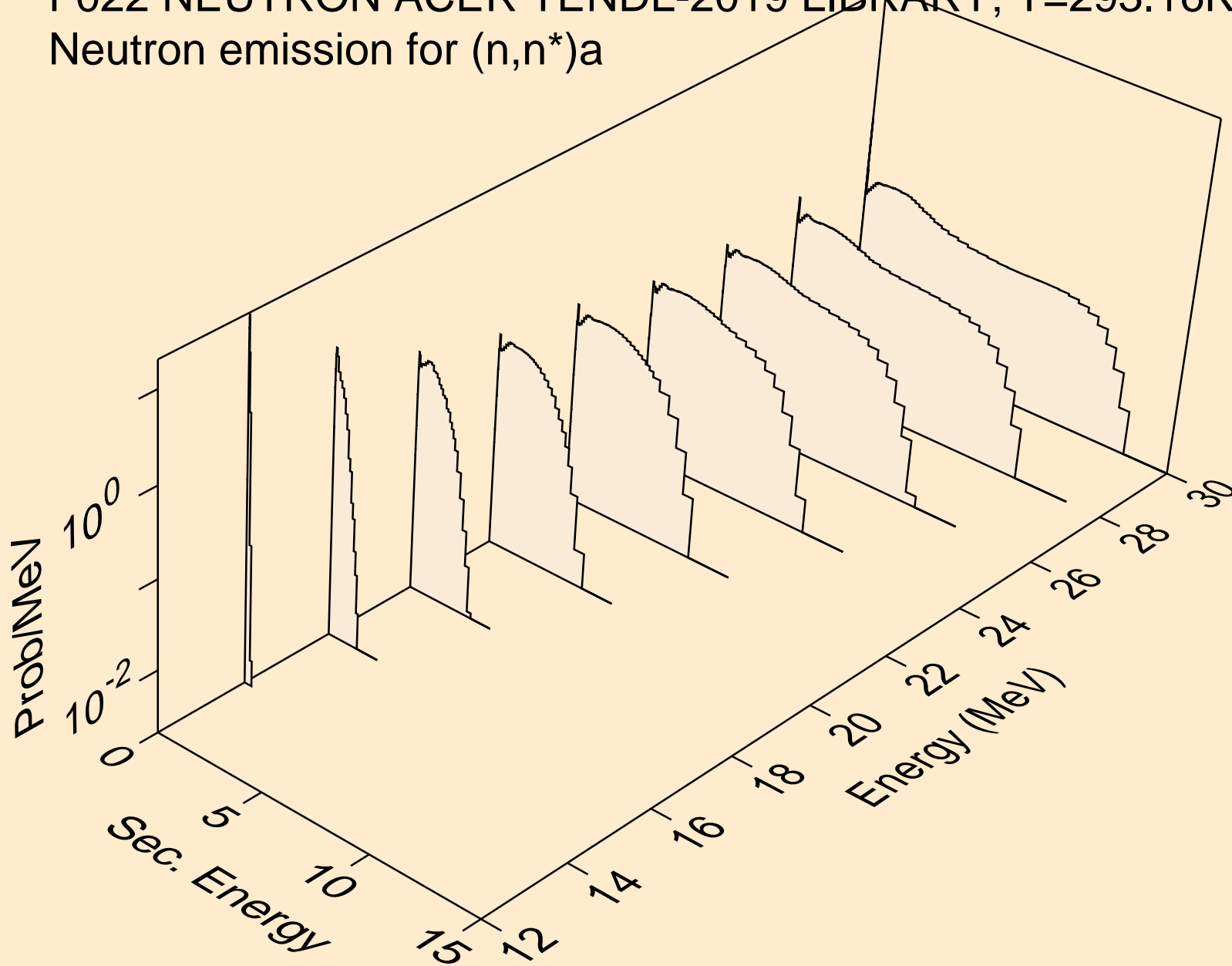

F022 NEUTRON ACER TENDL-2019 LIBRARY; T=293.16K  
Neutron emission for (n,2n)a

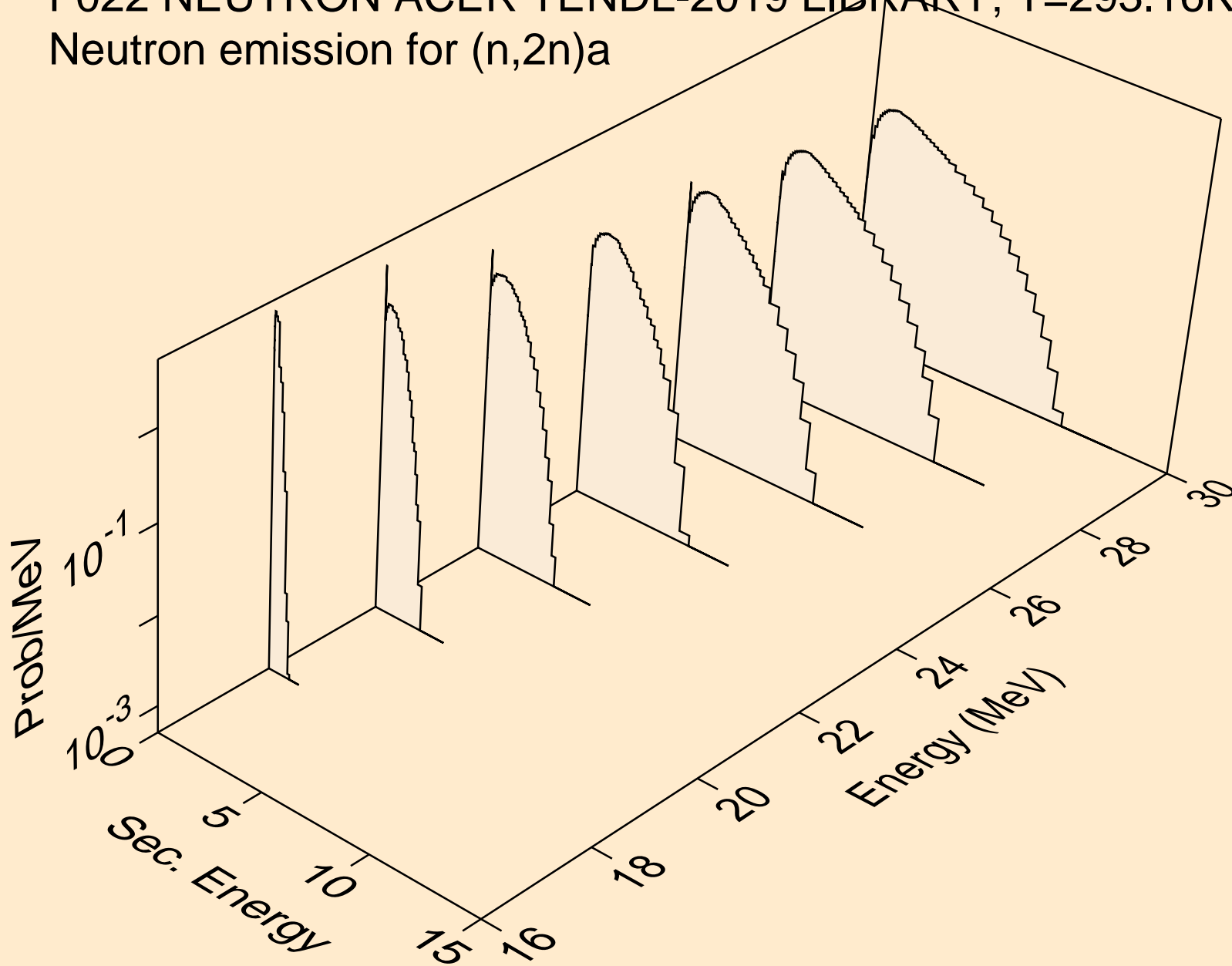



F022 NEUTRON ACER TENDL-2019 LIBRARY; T=293.16K  
Neutron emission for (n,3n)a

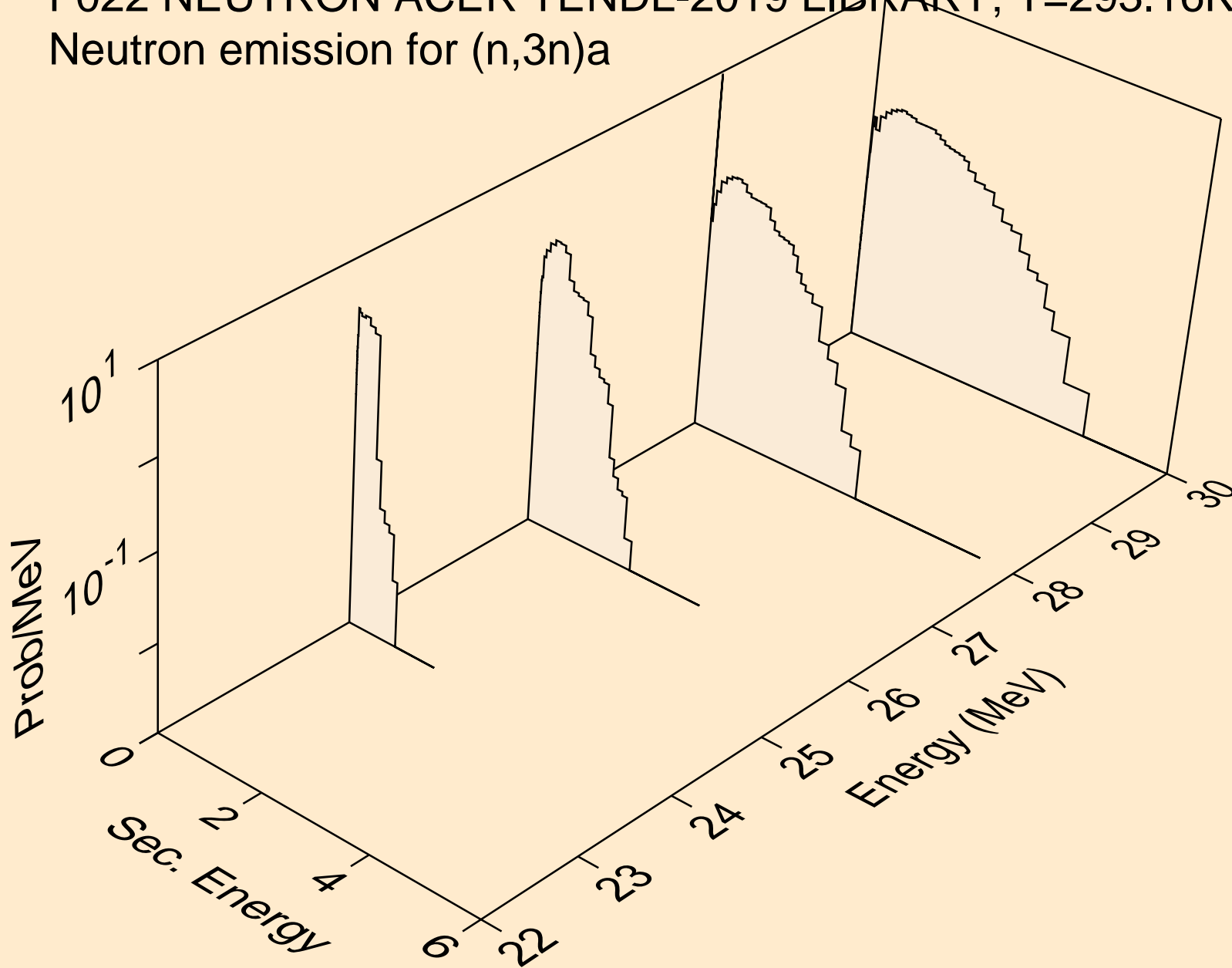

F022 NEUTRON ACER TENDL-2019 LIBRARY; T=293.16K  
Neutron emission for (n,n\*)p

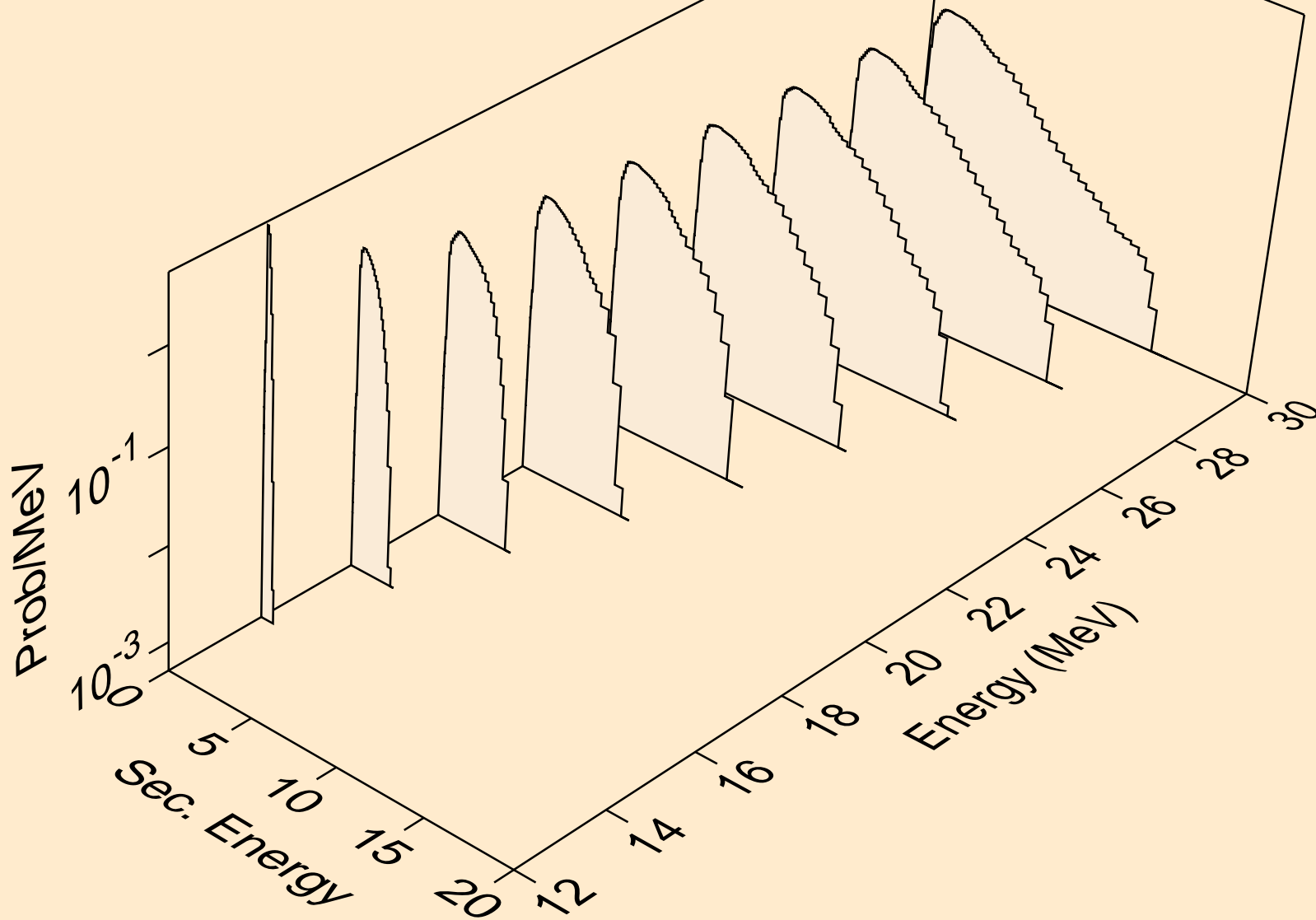

F022 NEUTRON ACER TENDL-2019 LIBRARY; T=293.16K  
Neutron emission for (n,n\*)d

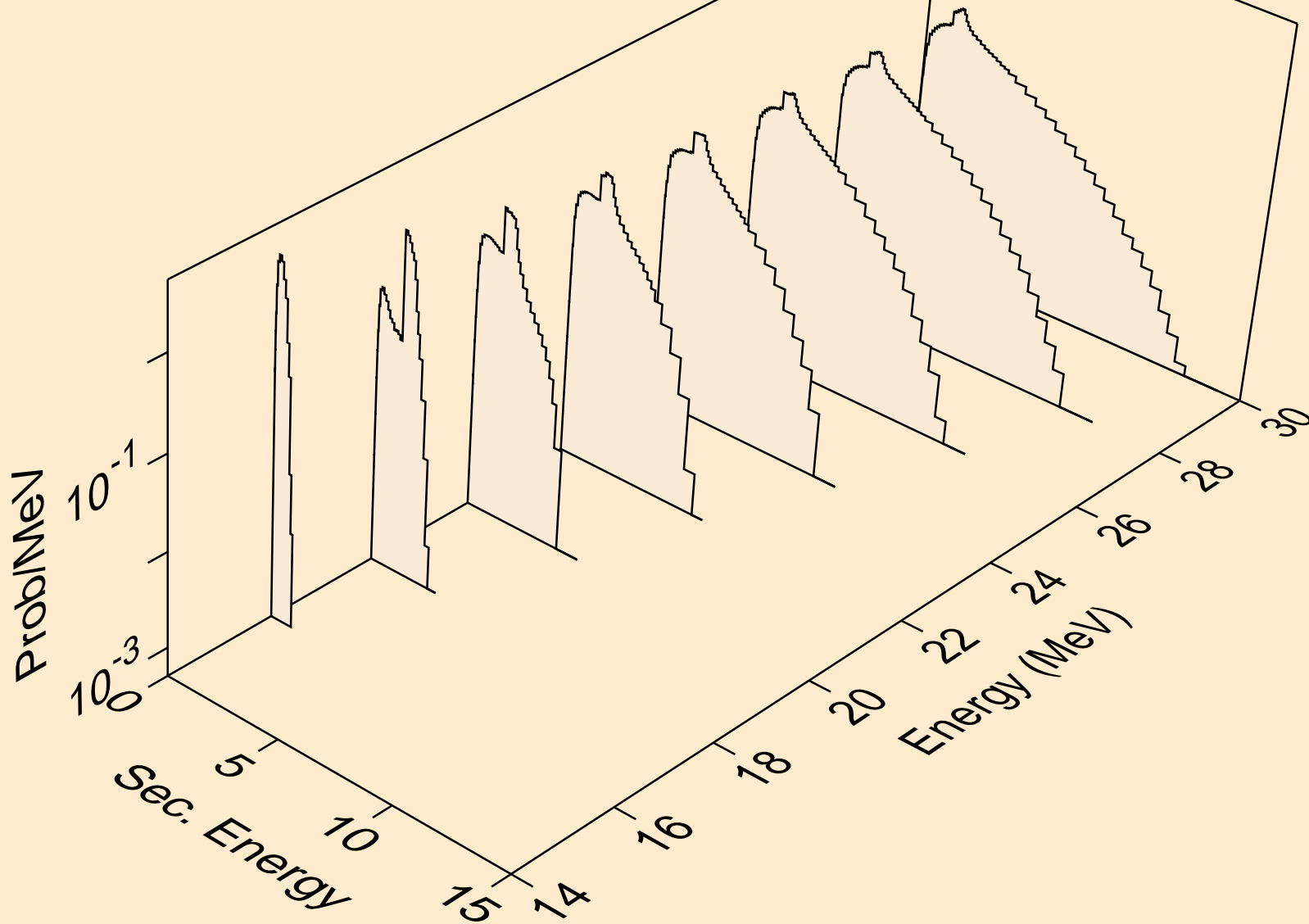

F022 NEUTRON ACER TENDL-2019 LIBRARY; T=293.16K  
Neutron emission for (n,n\*)t

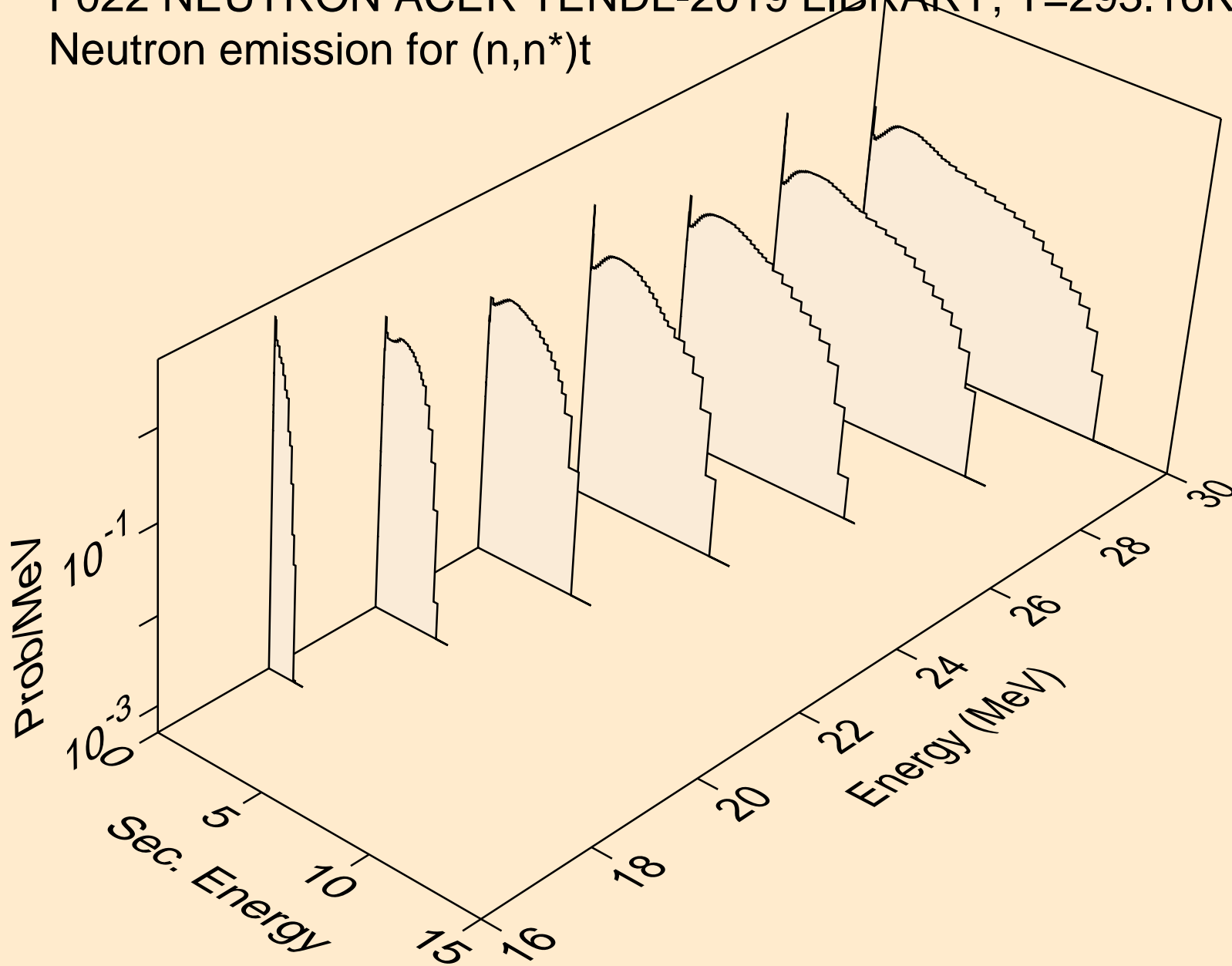

F022 NEUTRON ACER TENDL-2019 LIBRARY; T=293.16K  
Neutron emission for (n,4n)

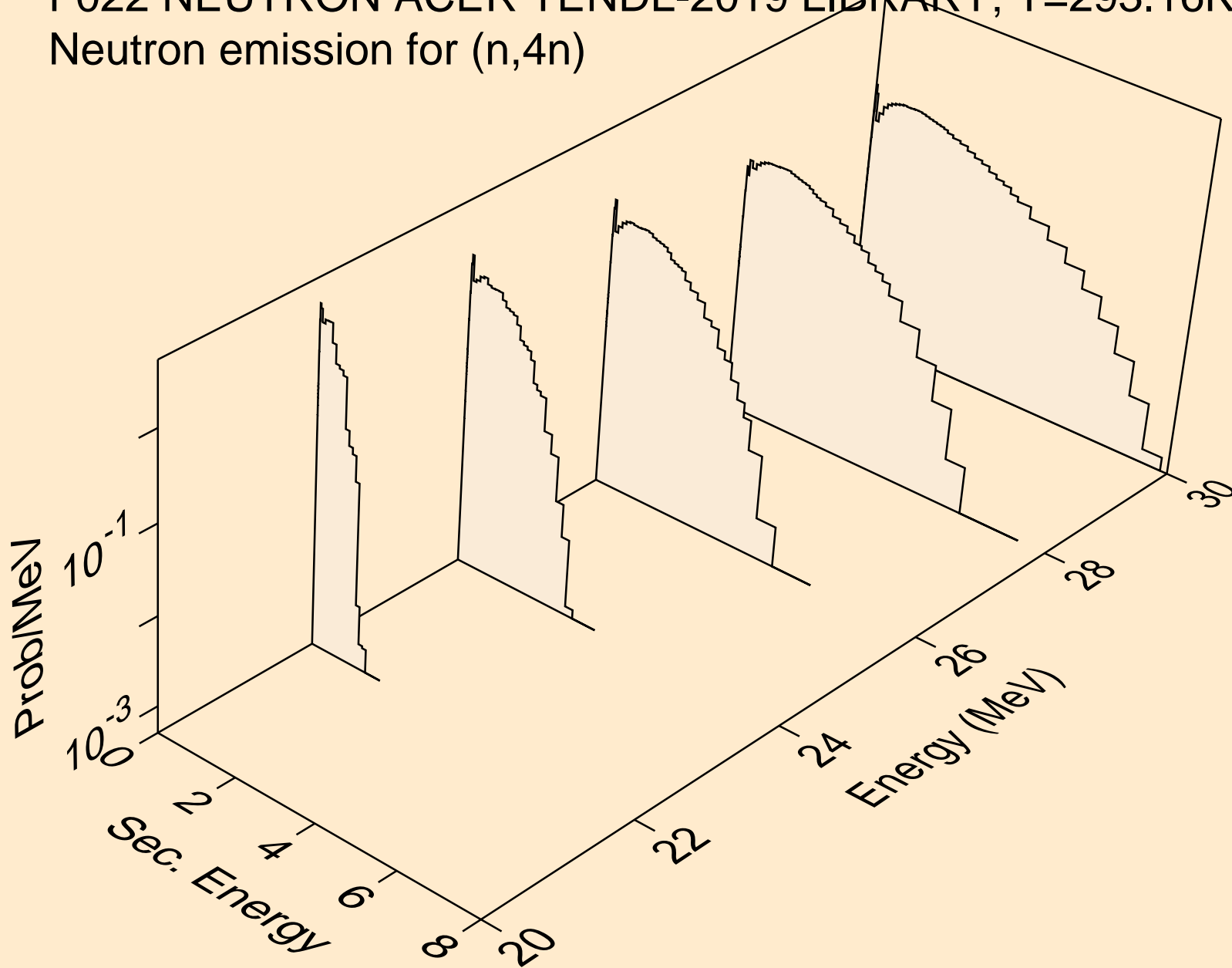

F022 NEUTRON ACER TENDL-2019 LIBRARY; T=293.16K  
Neutron emission for (n,2np)

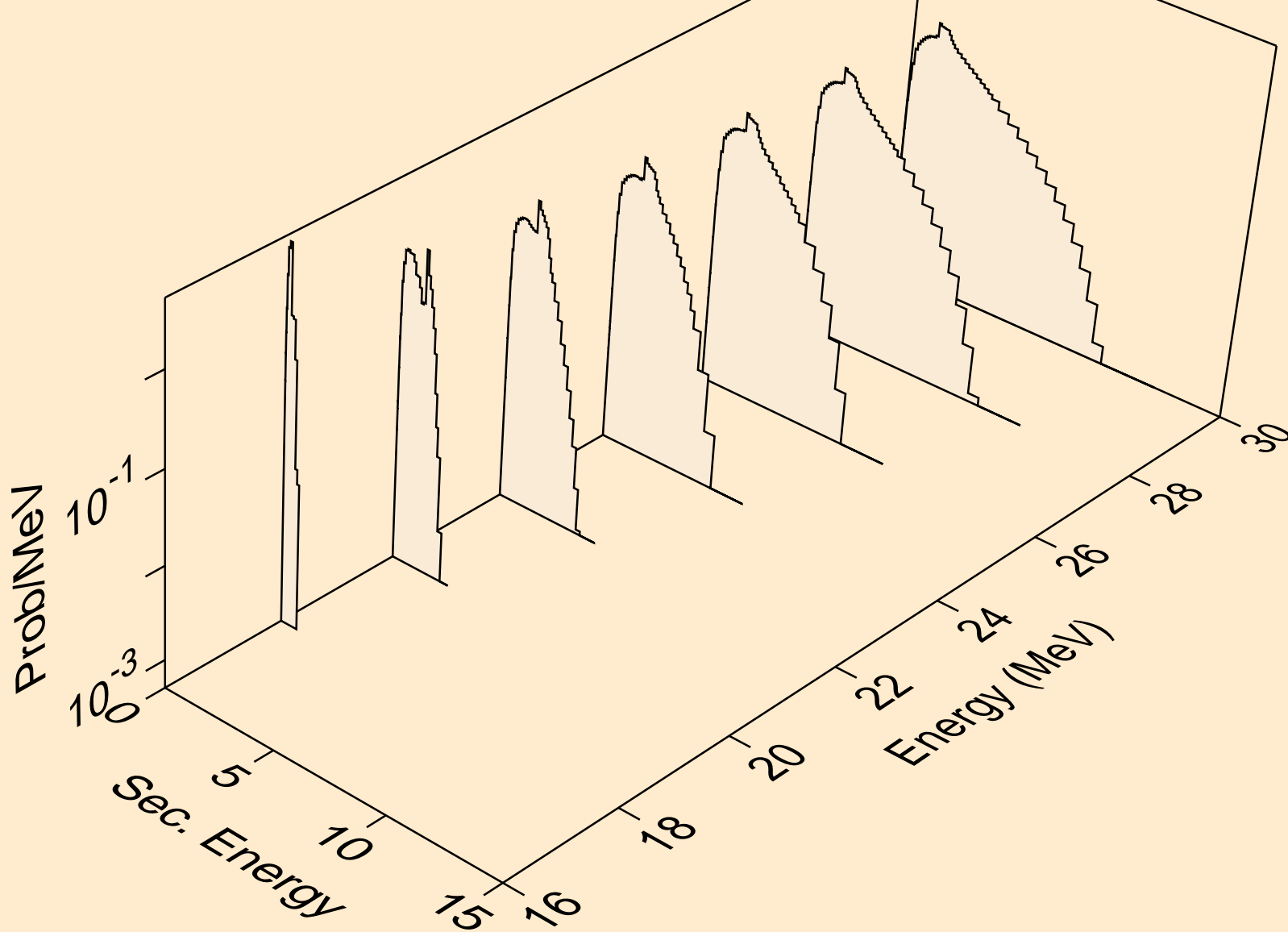

F022 NEUTRON ACER TENDL-2019 LIBRARY; T=293.16K  
Neutron emission for (n,3np)

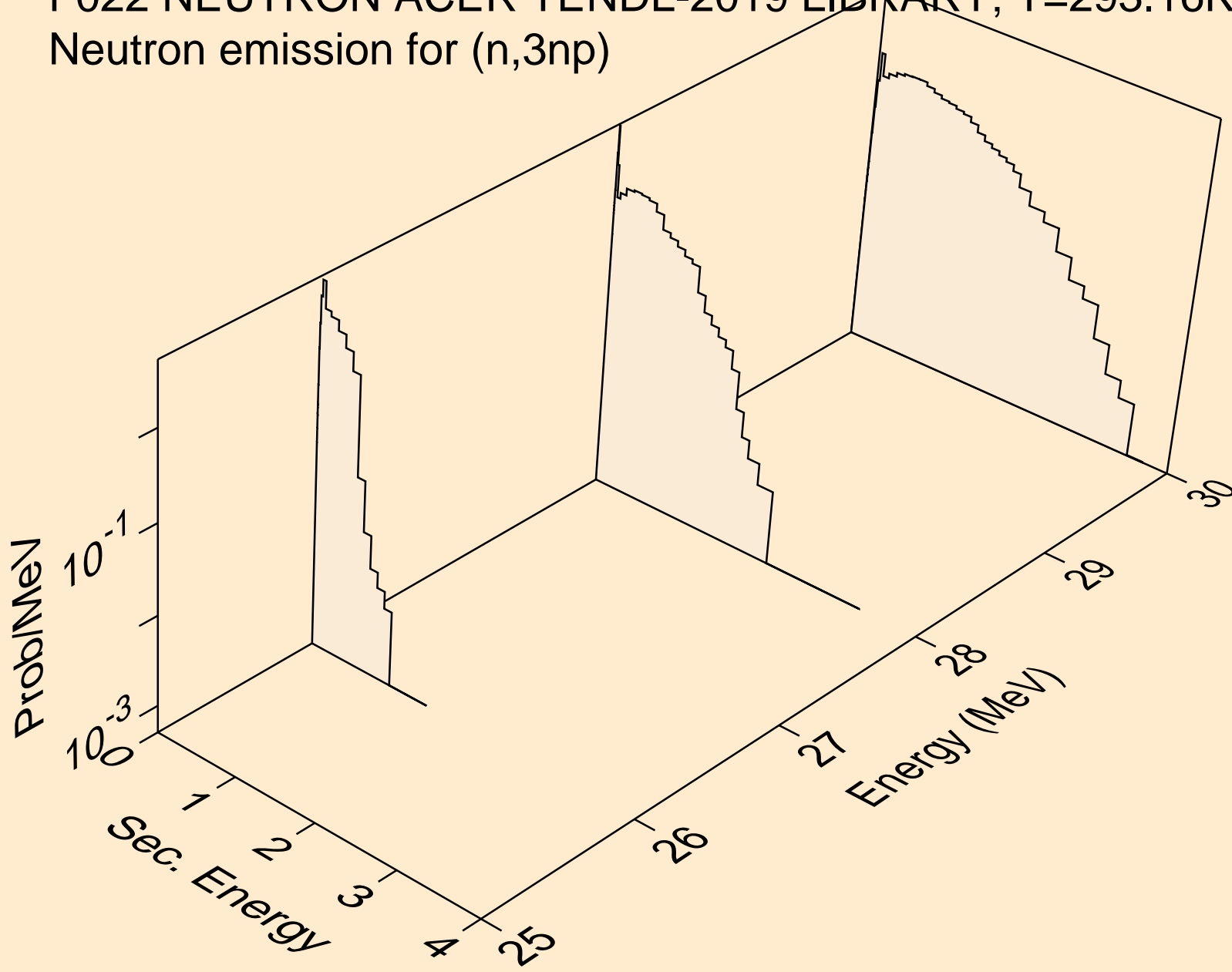

F022 NEUTRON ACER TENDL-2019 LIBRARY; T=293.16K  
Neutron emission for (n,n\*c)

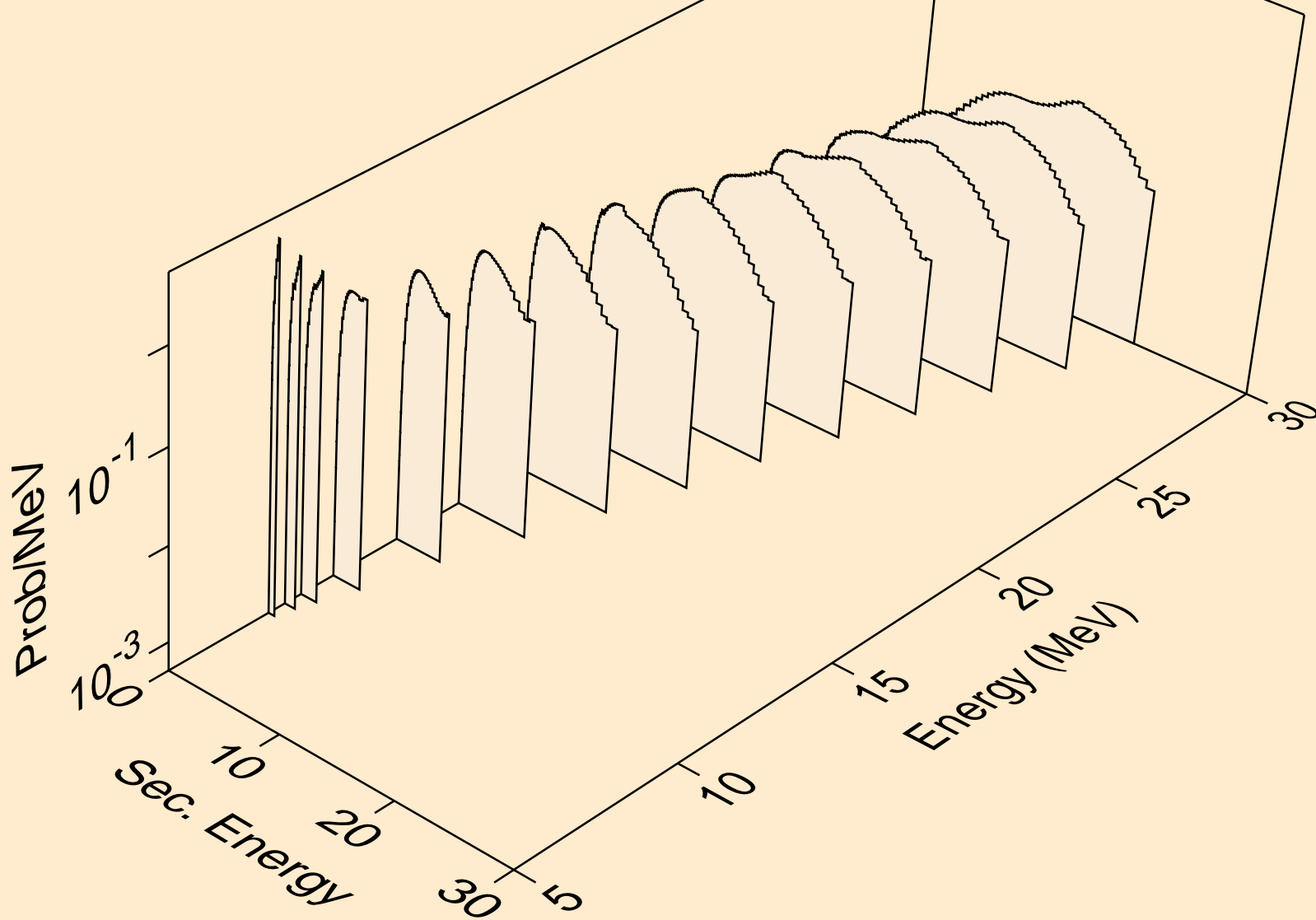



F022 NEUTRON ACER TENDL-2019 LIBRARY; T=293.16K  
Photon emission for (n,x)

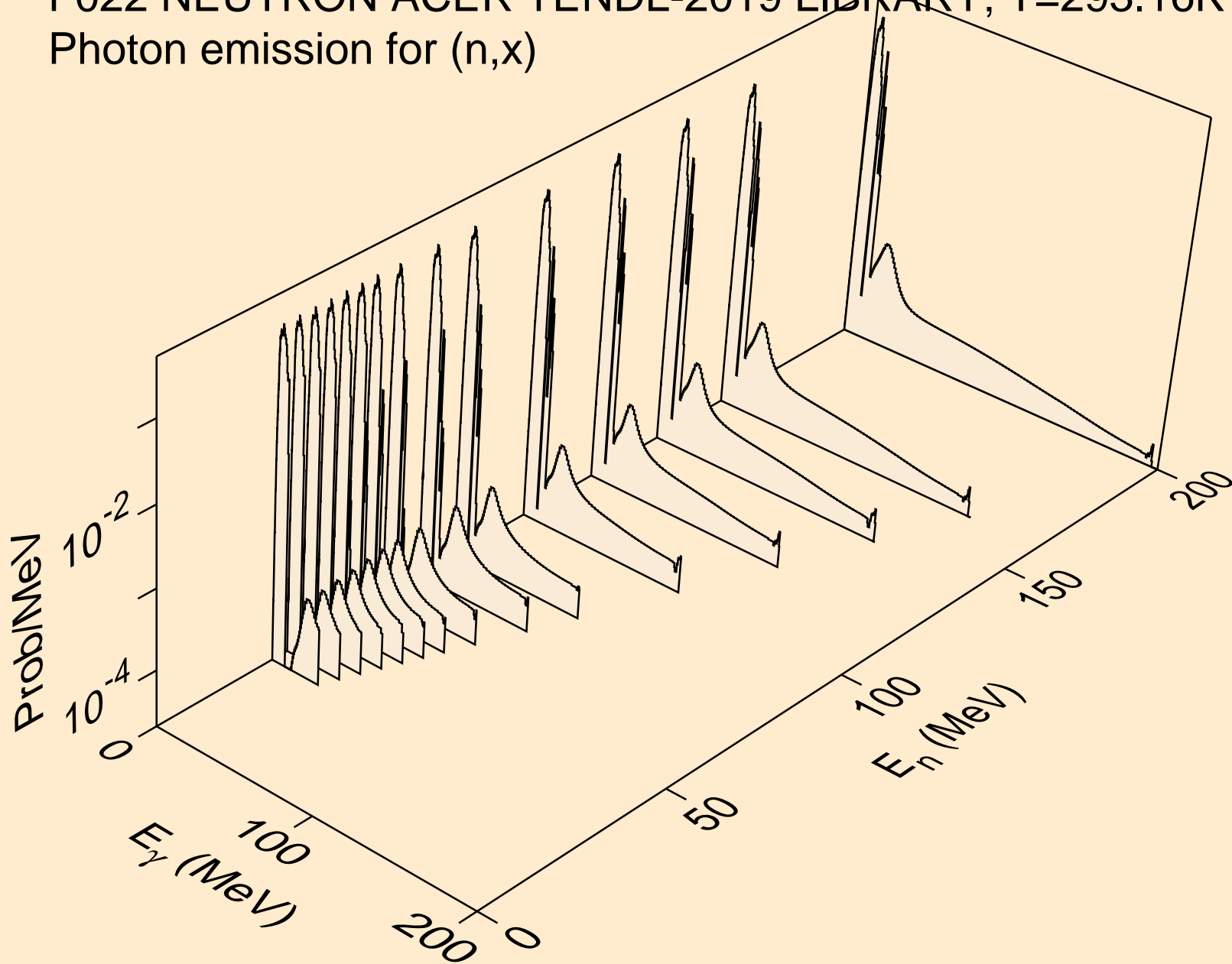

F022 NEUTRON ACER TENDL-2019 LIBRARY; T=293.16K  
Photon emission for (n,2nd)

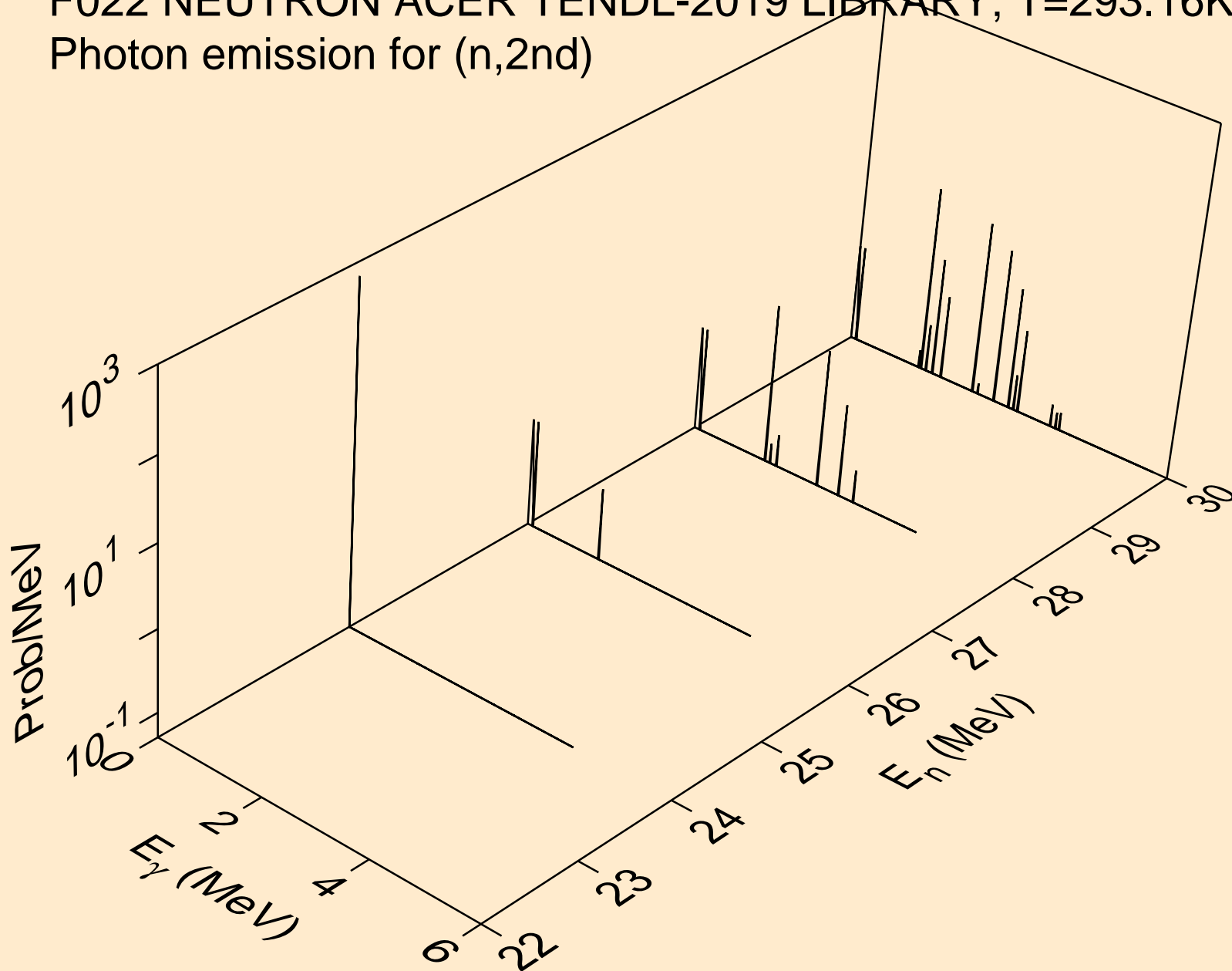

F022 NEUTRON ACER TENDL-2019 LIBRARY; T=293.16K  
Photon emission for (n,2n)

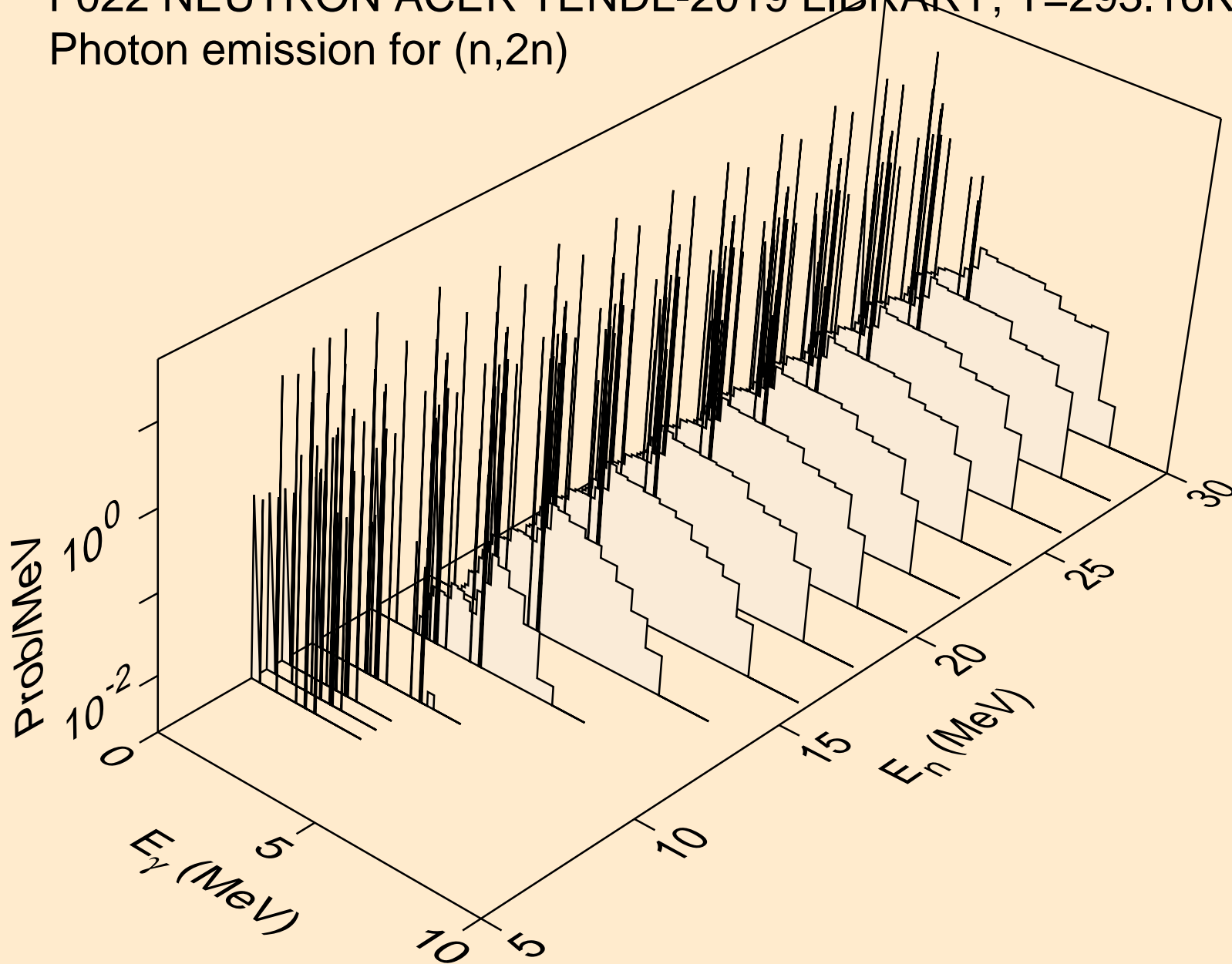

F022 NEUTRON ACER TENDL-2019 LIBRARY; T=293.16K  
Photon emission for (n,3n)

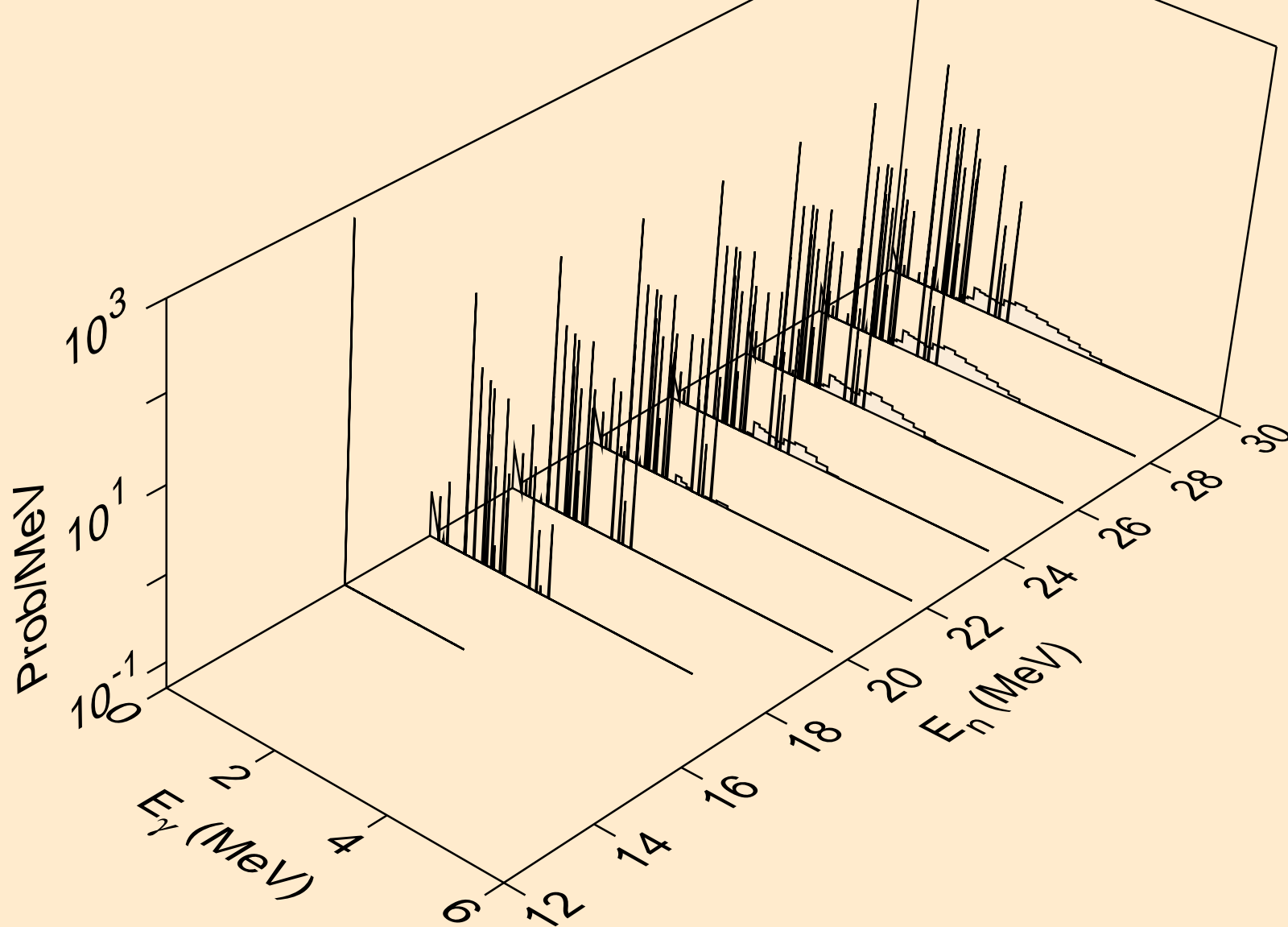

F022 NEUTRON ACER TENDL-2019 LIBRARY; T=293.16K  
Photon emission for (n,n\*)a

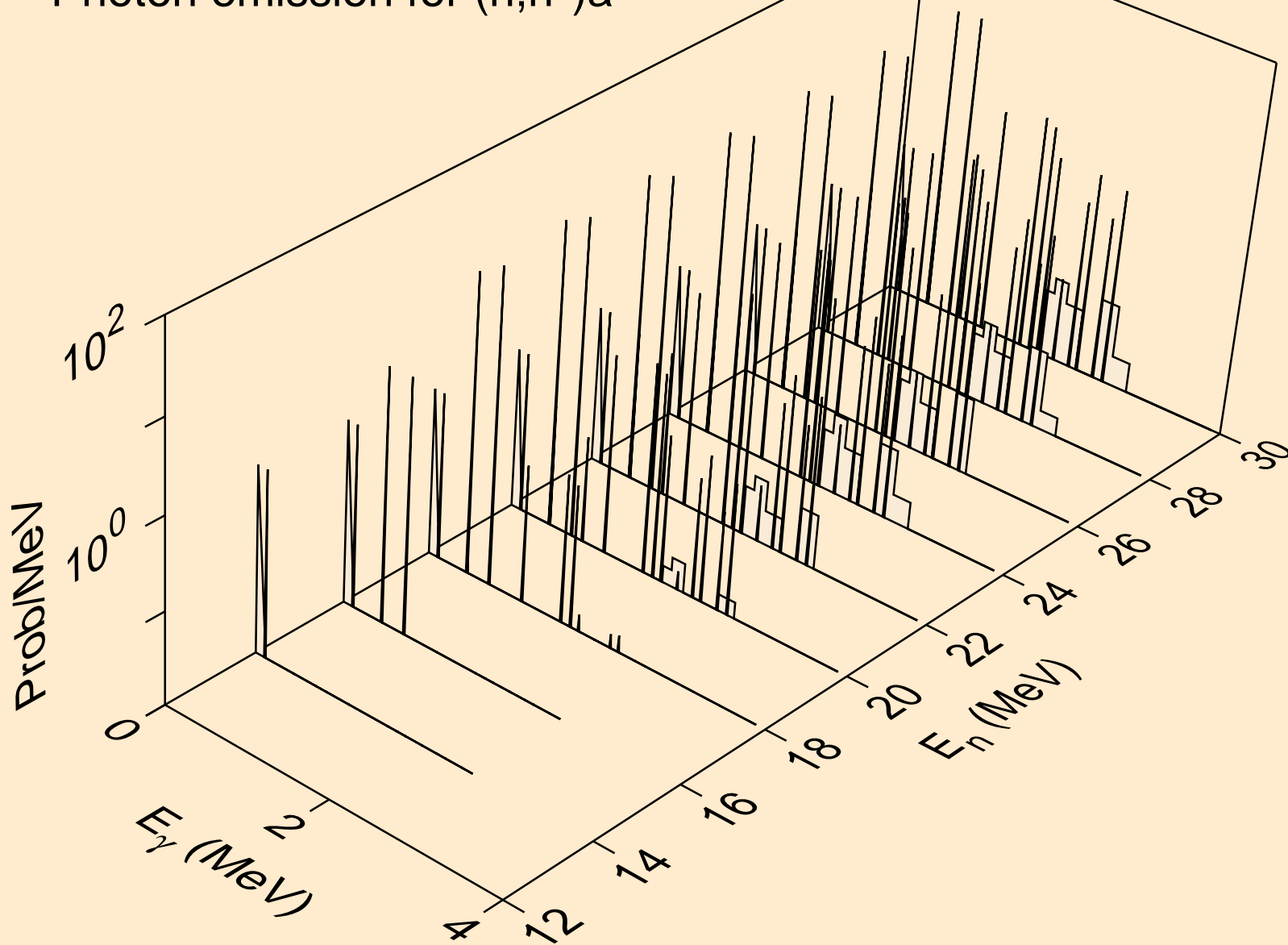

F022 NEUTRON ACER TENDL-2019 LIBRARY; T=293.16K  
Photon emission for (n,2n)a

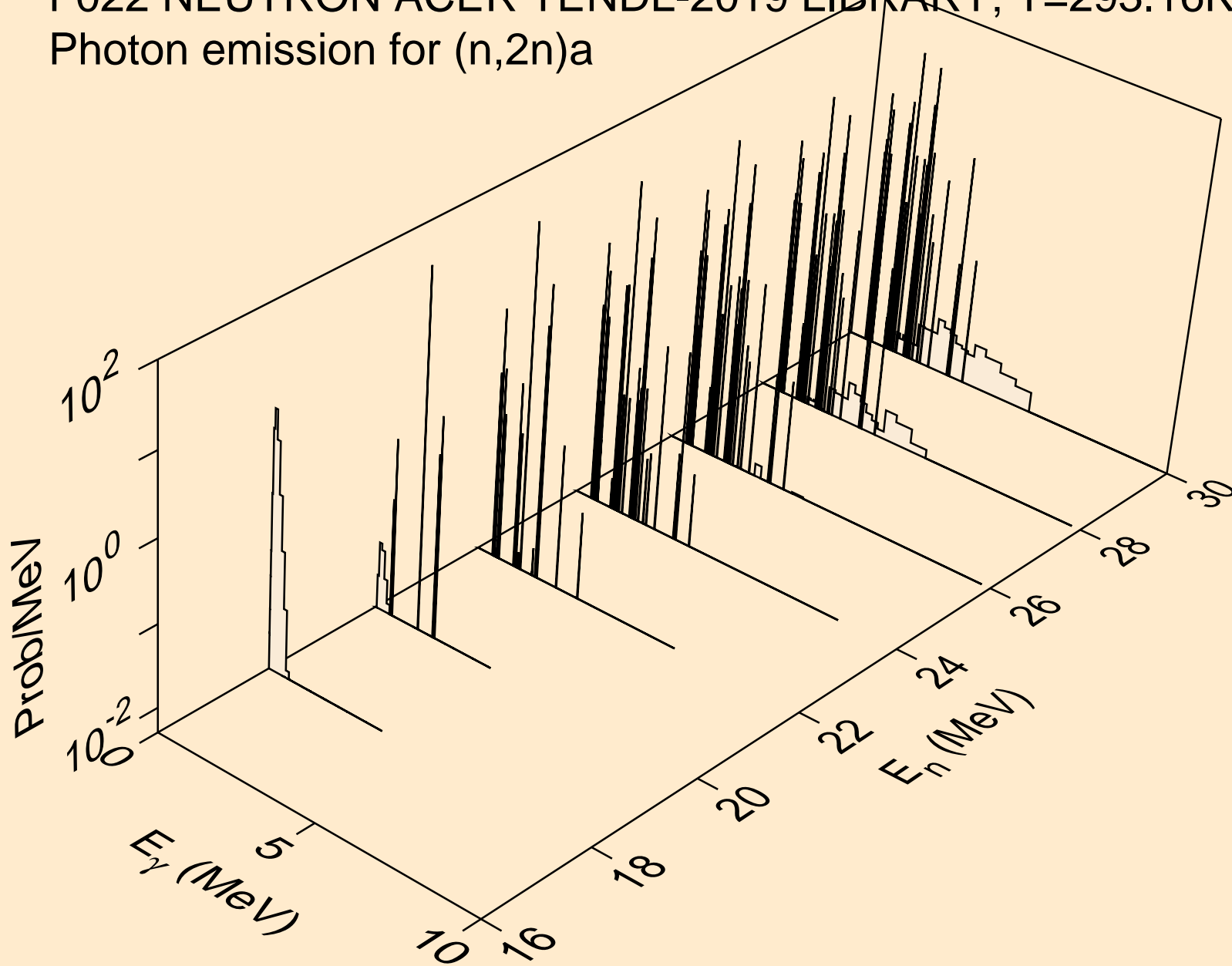

F022 NEUTRON ACER TENDL-2019 LIBRARY; T=293.16K  
Photon emission for (n,3n)a

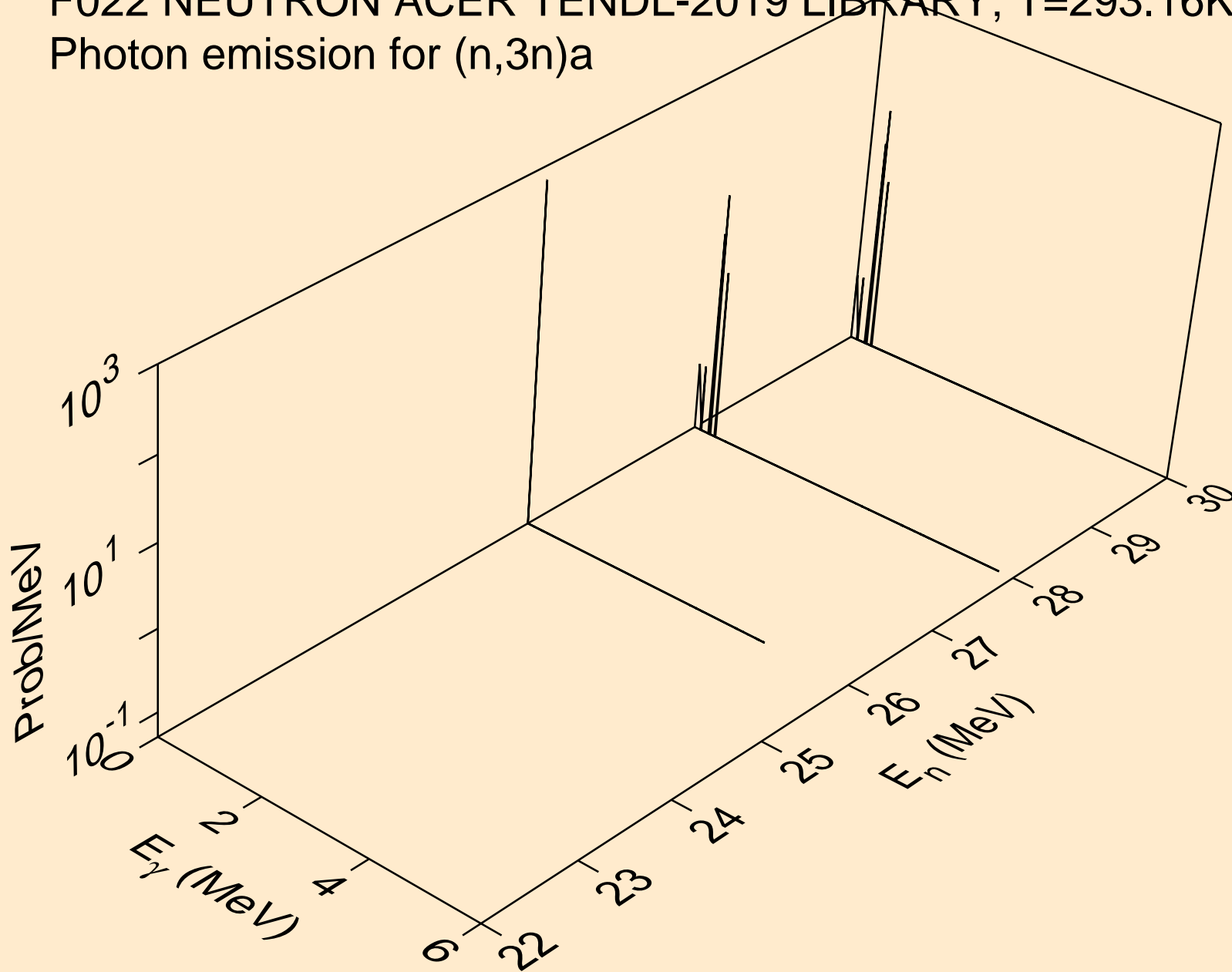

F022 NEUTRON ACER TENDL-2019 LIBRARY; T=293.16K  
Photon emission for (n,n\*)p

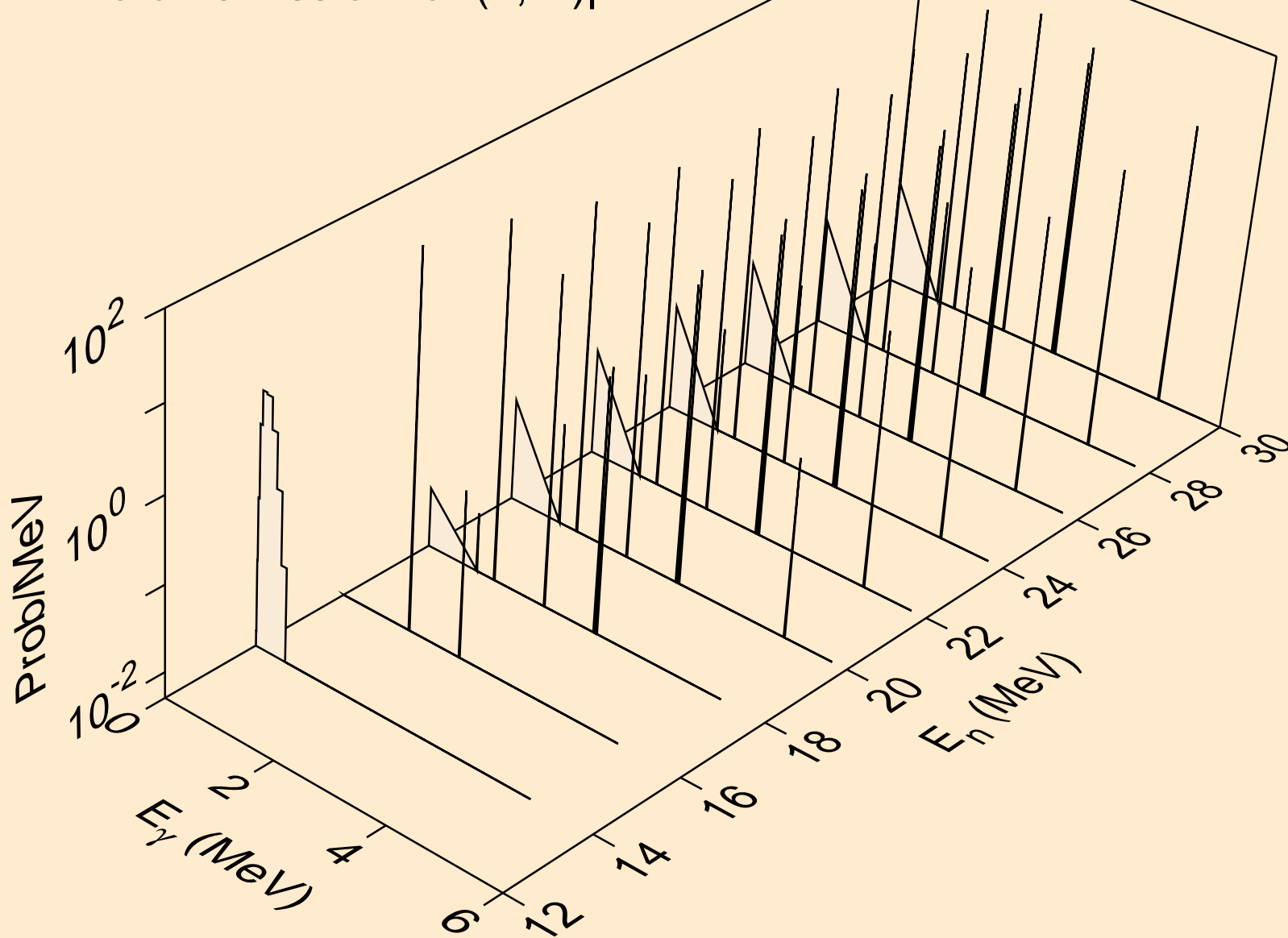



F022 NEUTRON ACER TENDL-2019 LIBRARY; T=293.16K  
Photon emission for (n,n\*)d

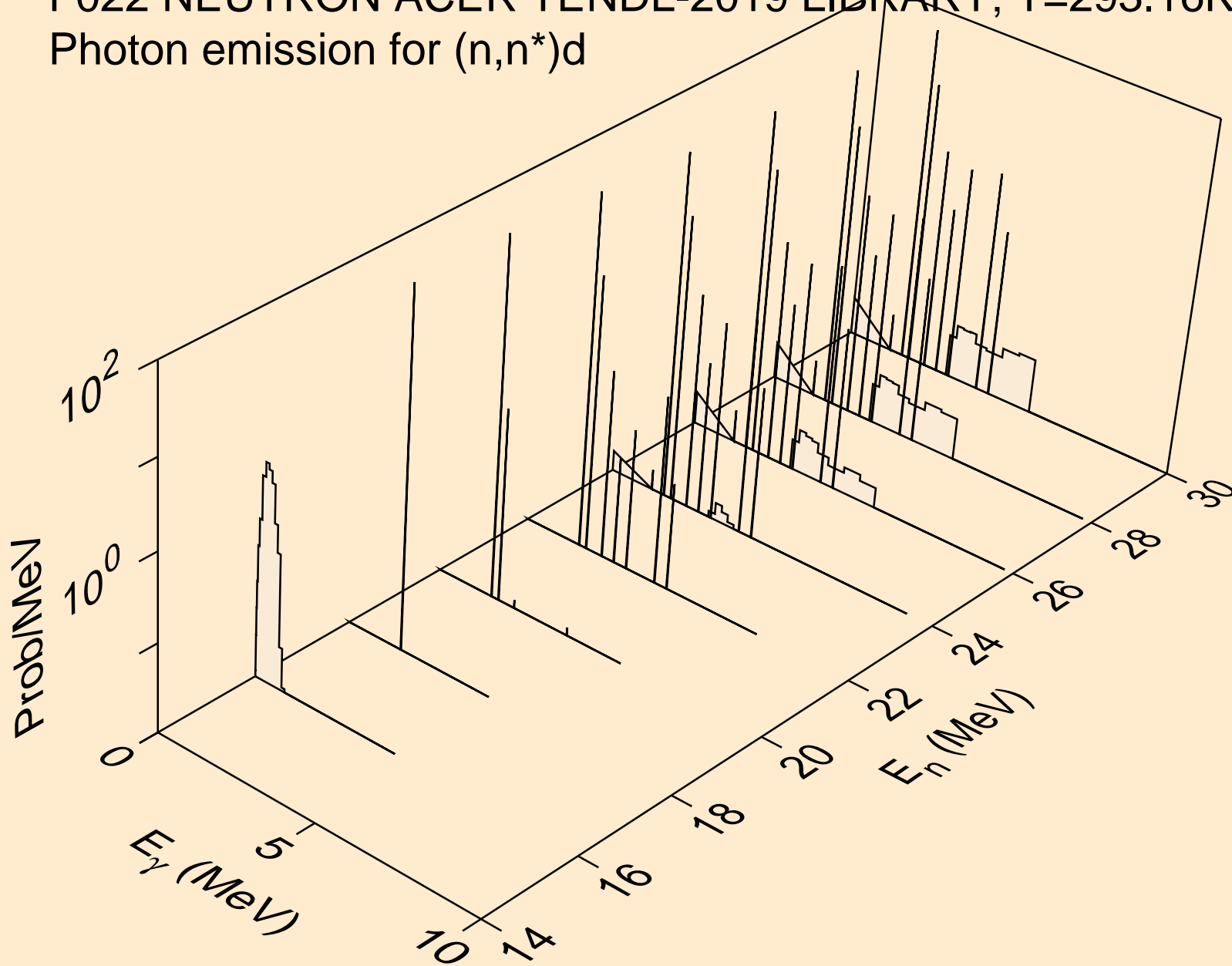

F022 NEUTRON ACER TENDL-2019 LIBRARY; T=293.16K  
Photon emission for (n,n\*)t

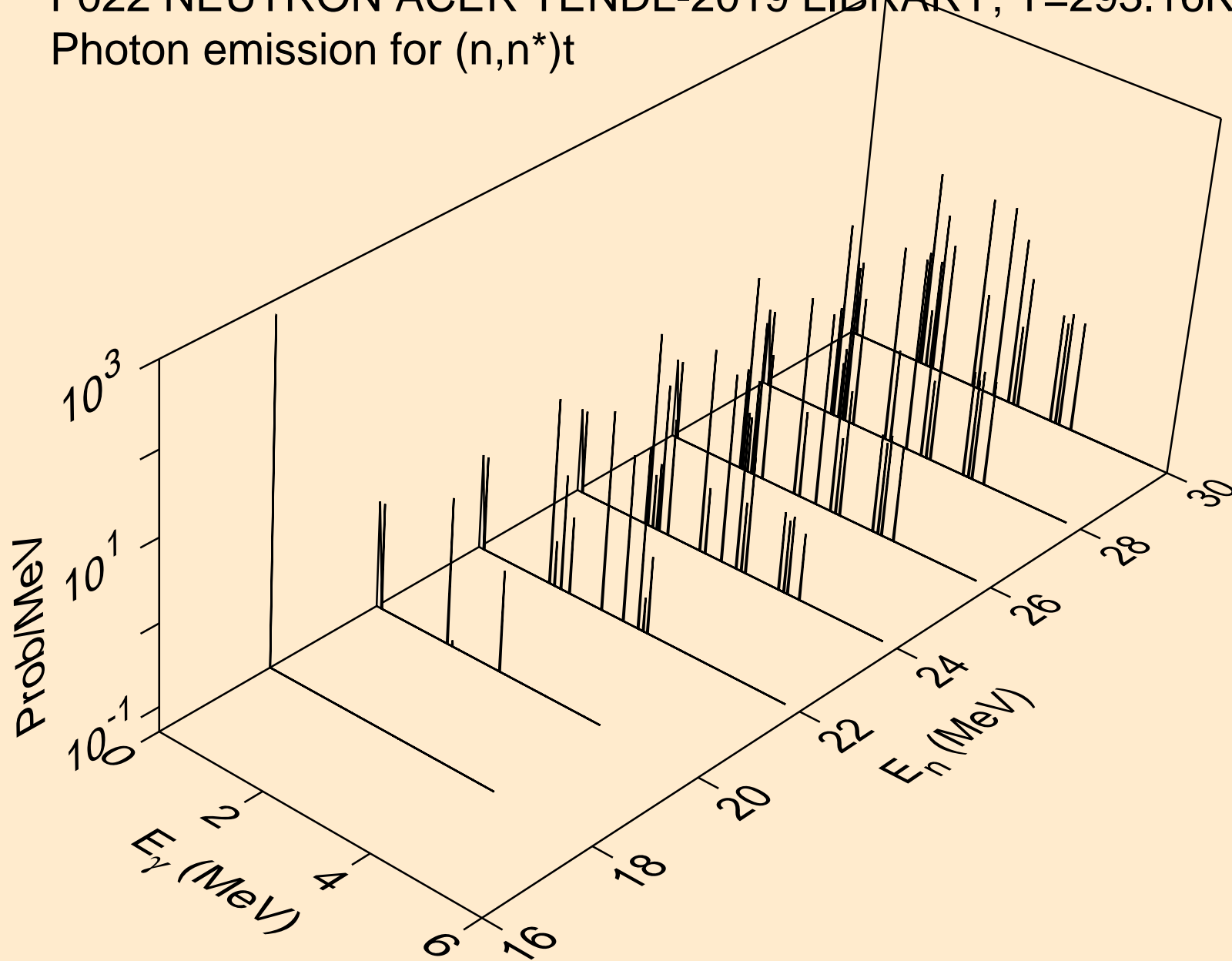

F022 NEUTRON ACER TENDL-2019 LIBRARY; T=293.16K  
Photon emission for (n,4n)

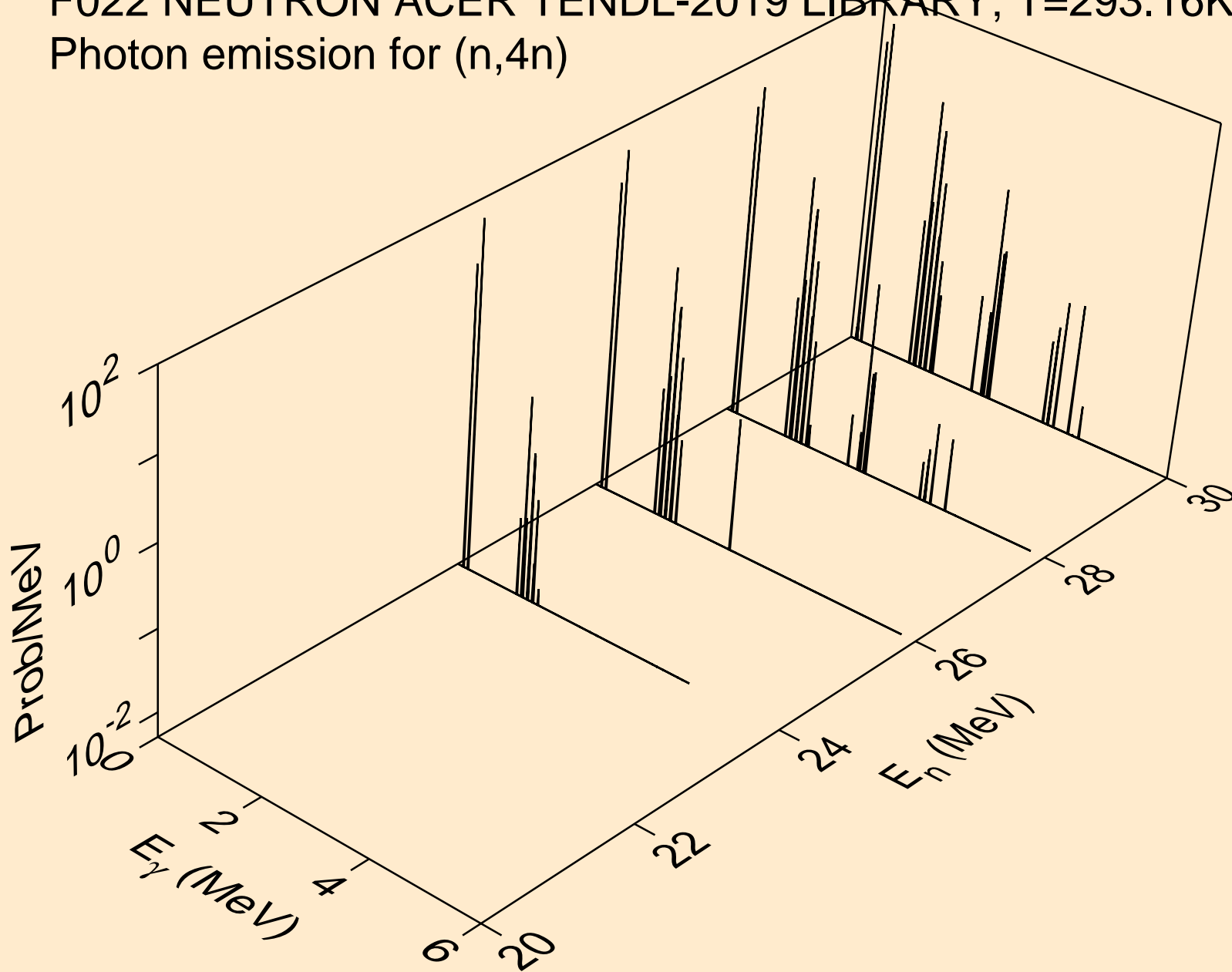

F022 NEUTRON ACER TENDL-2019 LIBRARY; T=293.16K  
Photon emission for (n,2np)

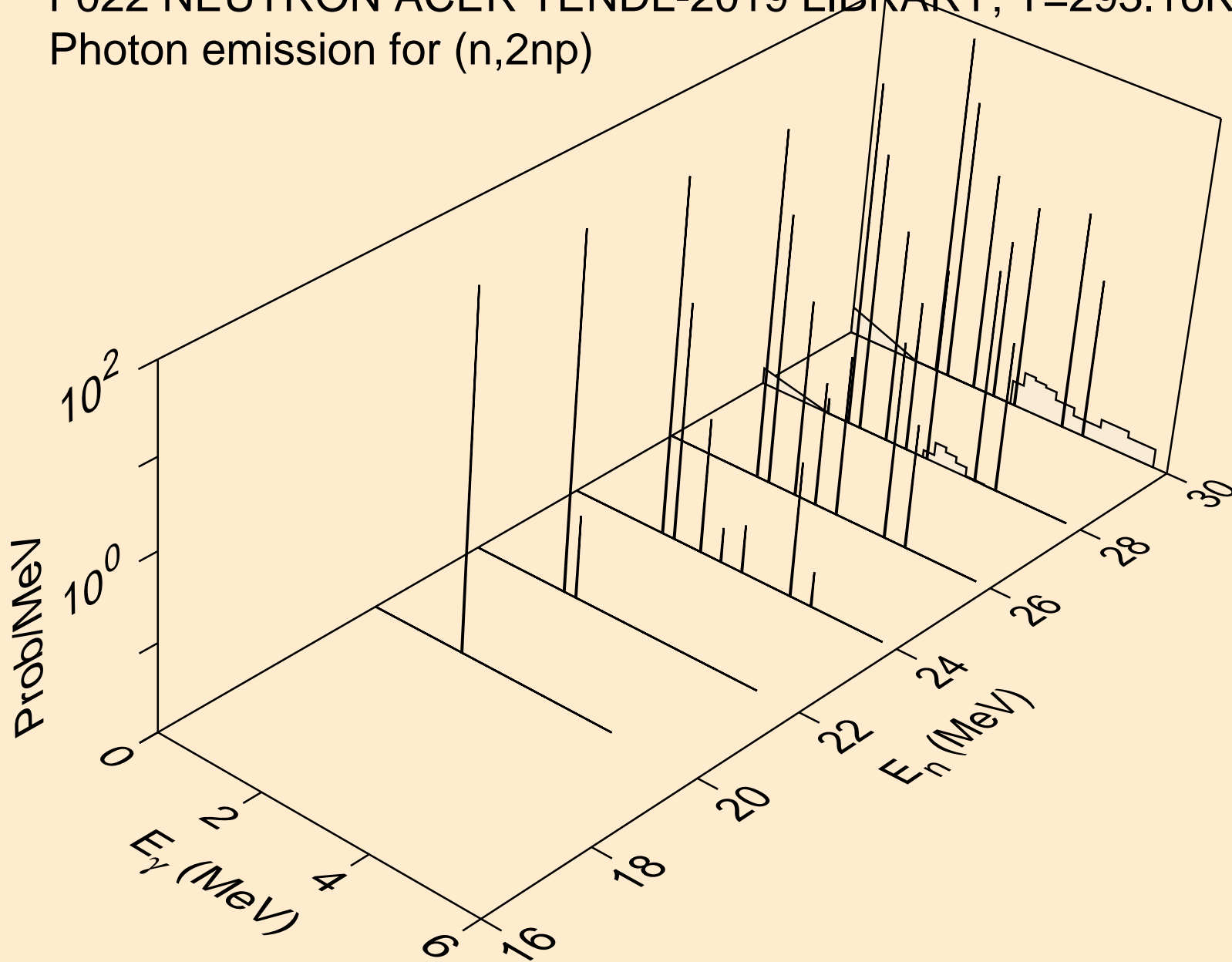

F022 NEUTRON ACER TENDL-2019 LIBRARY; T=293.16K  
Photon emission for (n,3np)

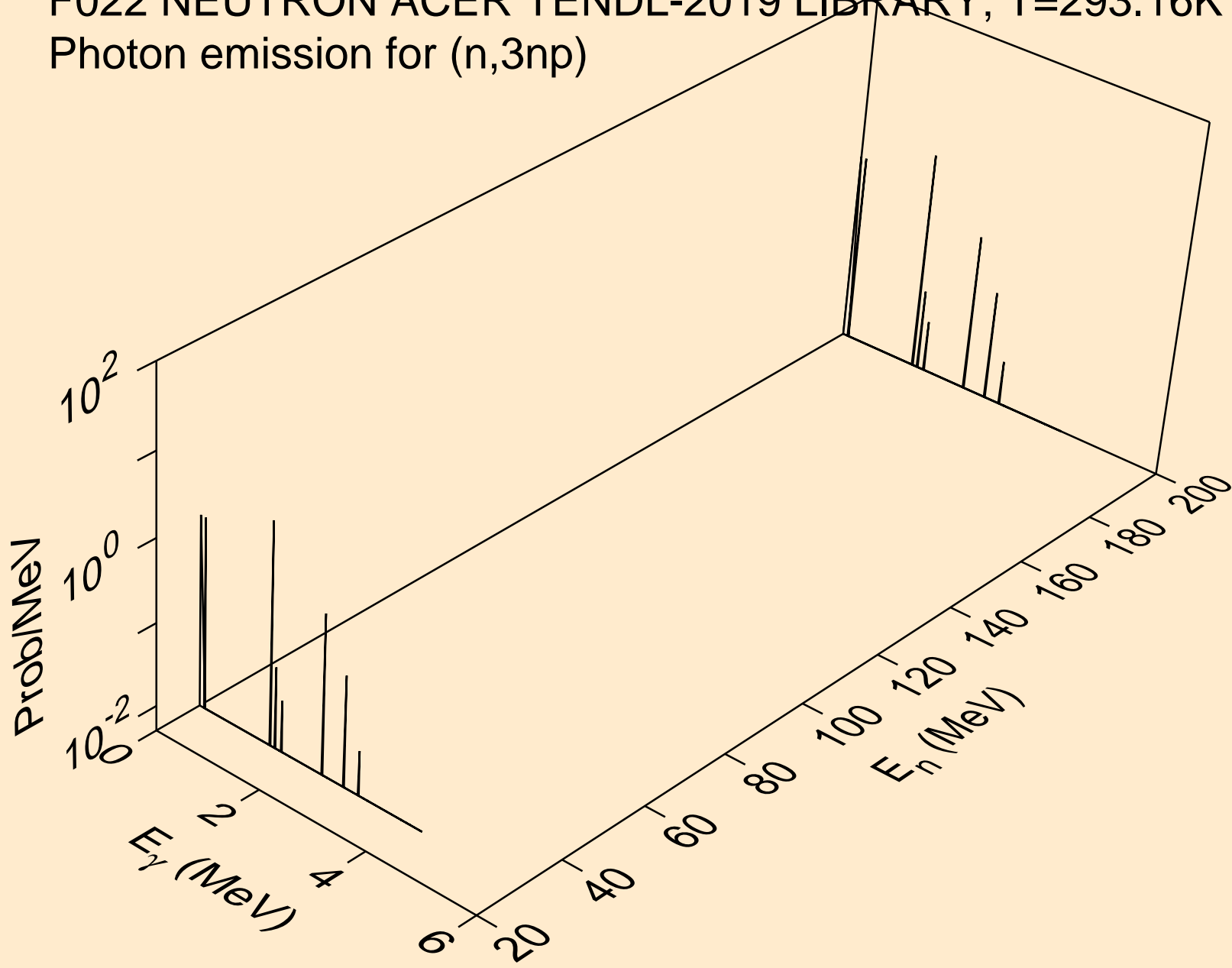

F022 NEUTRON ACER TENDL-2019 LIBRARY; T=293.16K  
Photon emission for (n,n\*c)

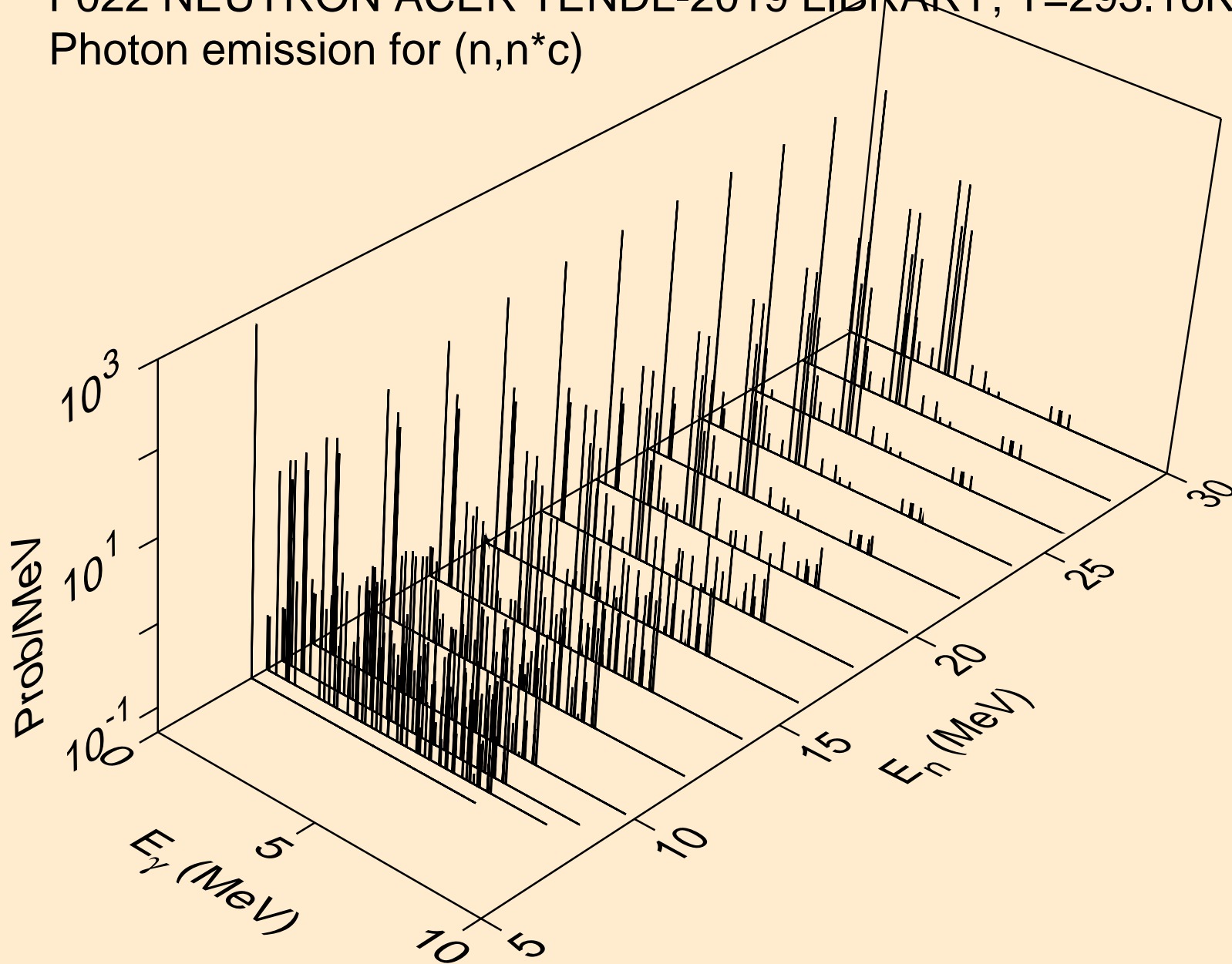

F022 NEUTRON ACER TENDL-2019 LIBRARY; T=293.16K  
Photon emission for (n,gma)

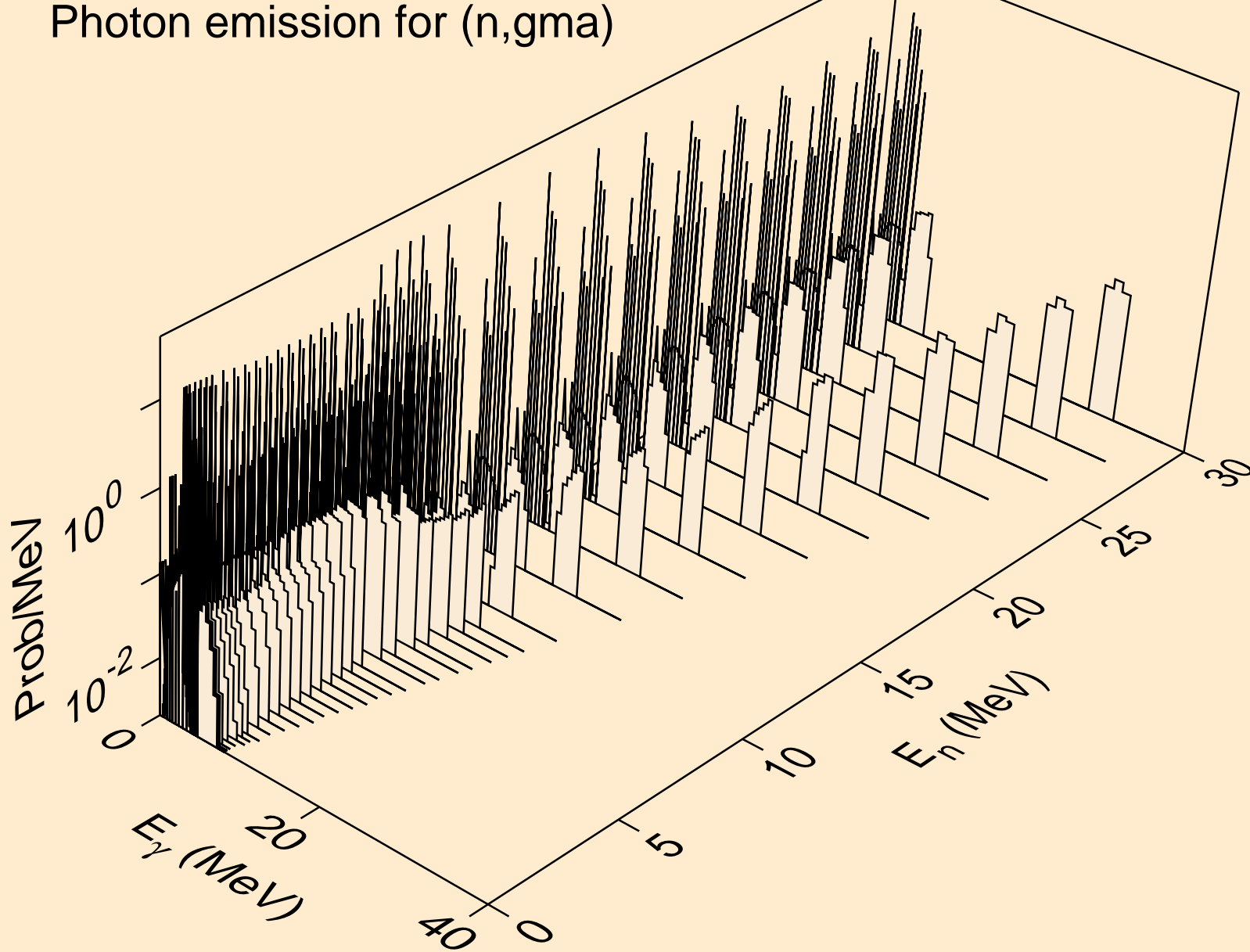

F022 NEUTRON ACER TENDL-2019 LIBRARY; T=293.16K  
Photon emission for (n,p)

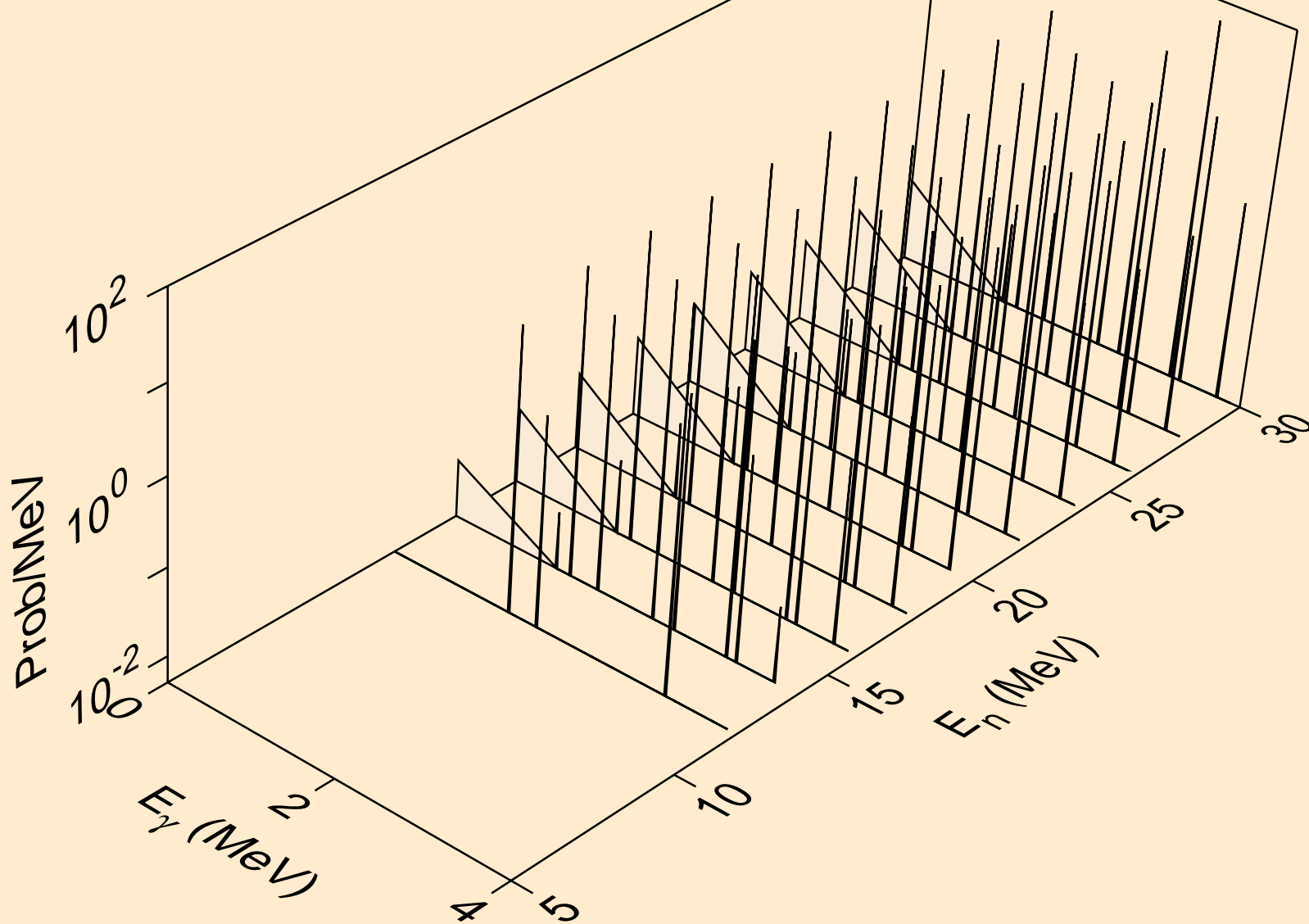



F022 NEUTRON ACER TENDL-2019 LIBRARY; T=293.16K  
Photon emission for (n,d)

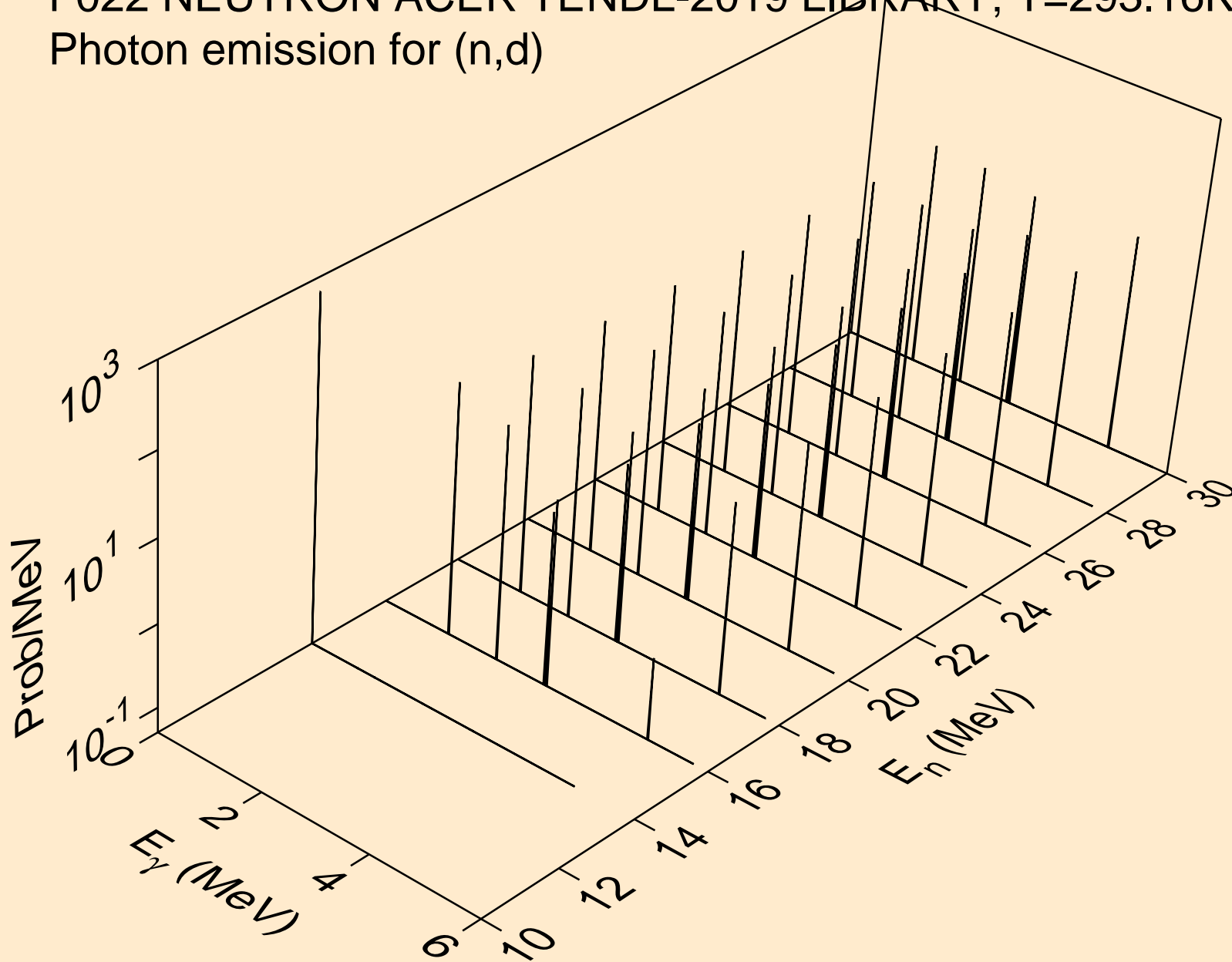

F022 NEUTRON ACER TENDL-2019 LIBRARY; T=293.16K  
Photon emission for (n,t)

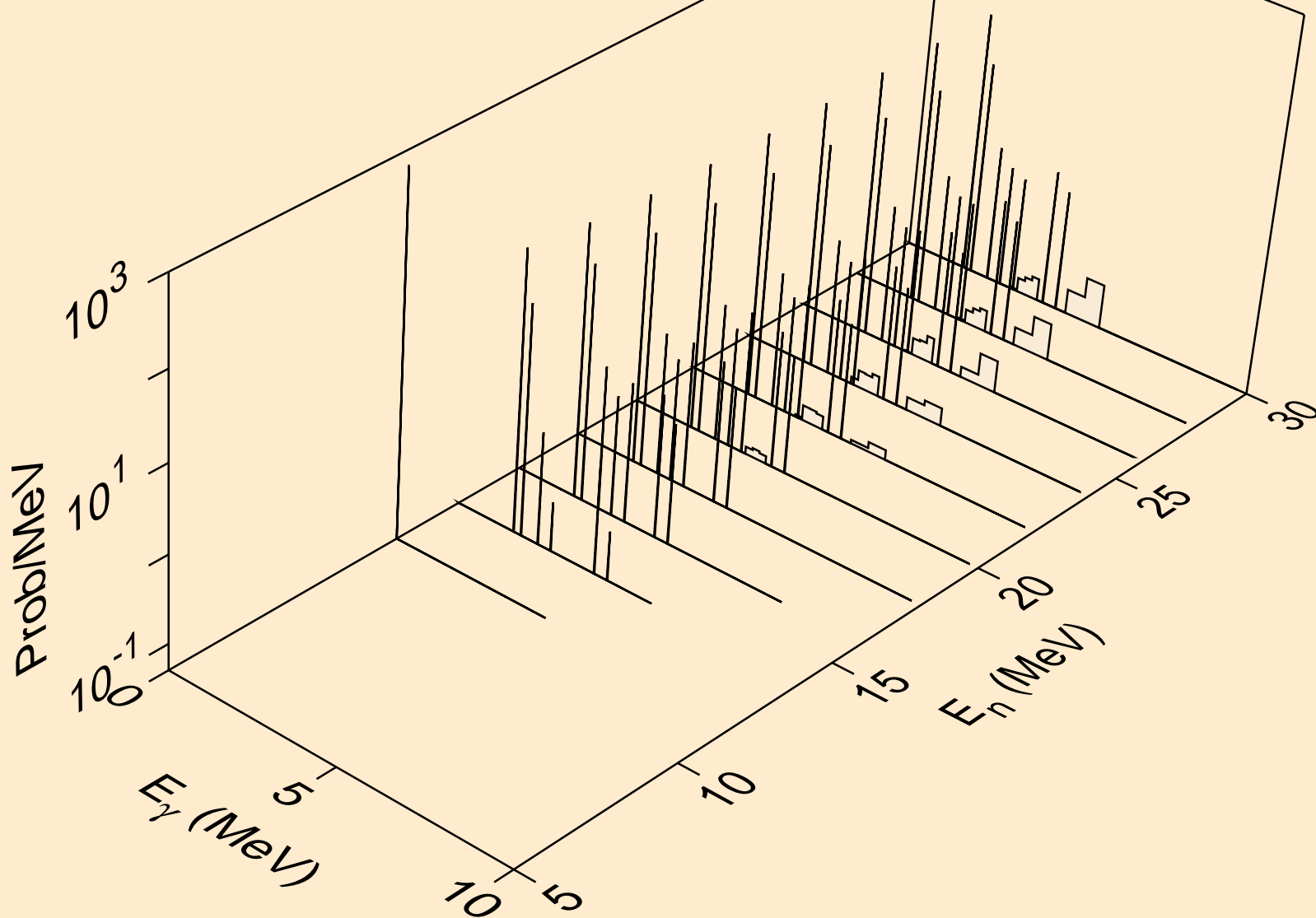

F022 NEUTRON ACER TENDL-2019 LIBRARY; T=293.16K  
Photon emission for (n,he3)

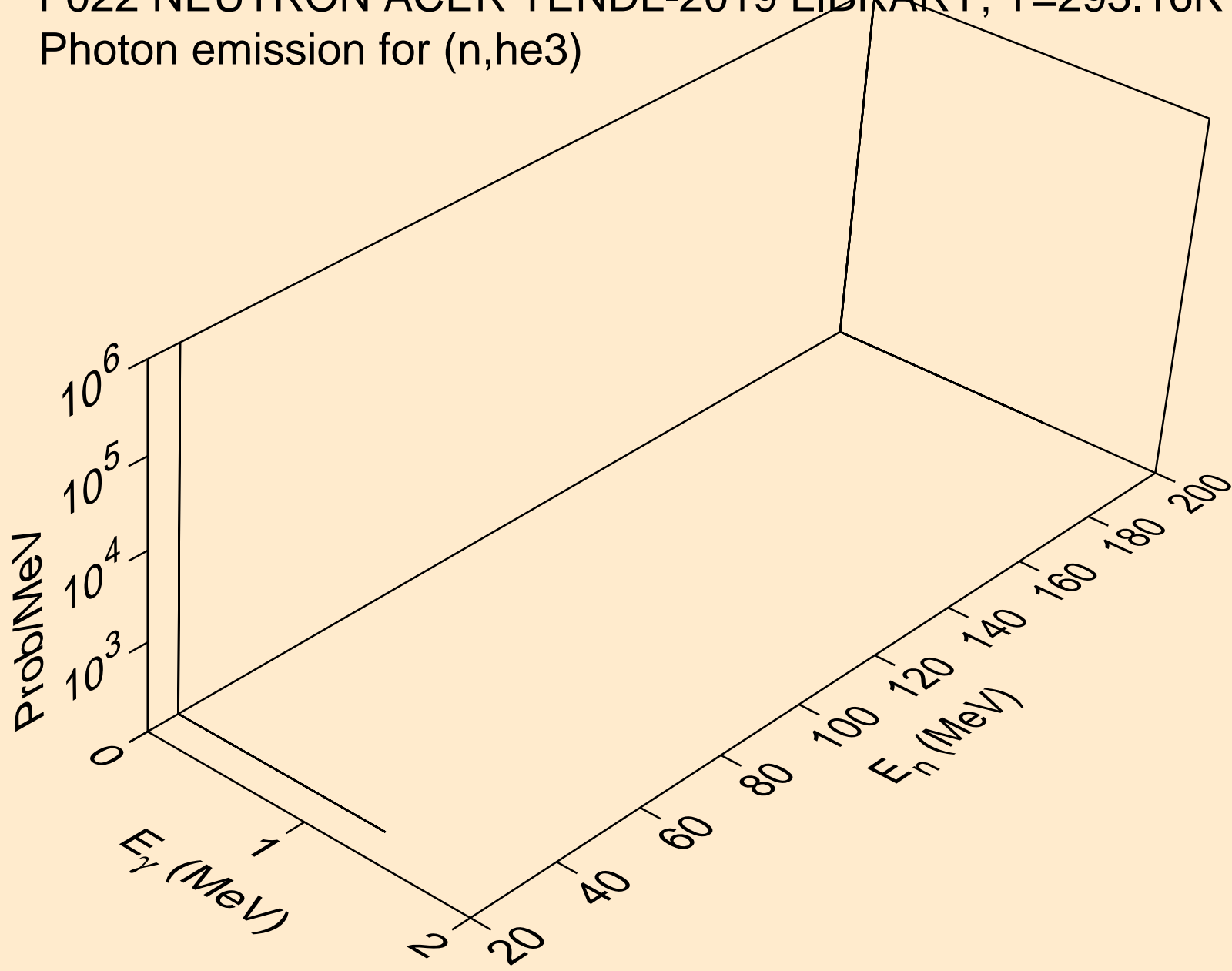

F022 NEUTRON ACER TENDL-2019 LIBRARY; T=293.16K  
Photon emission for (n,a)

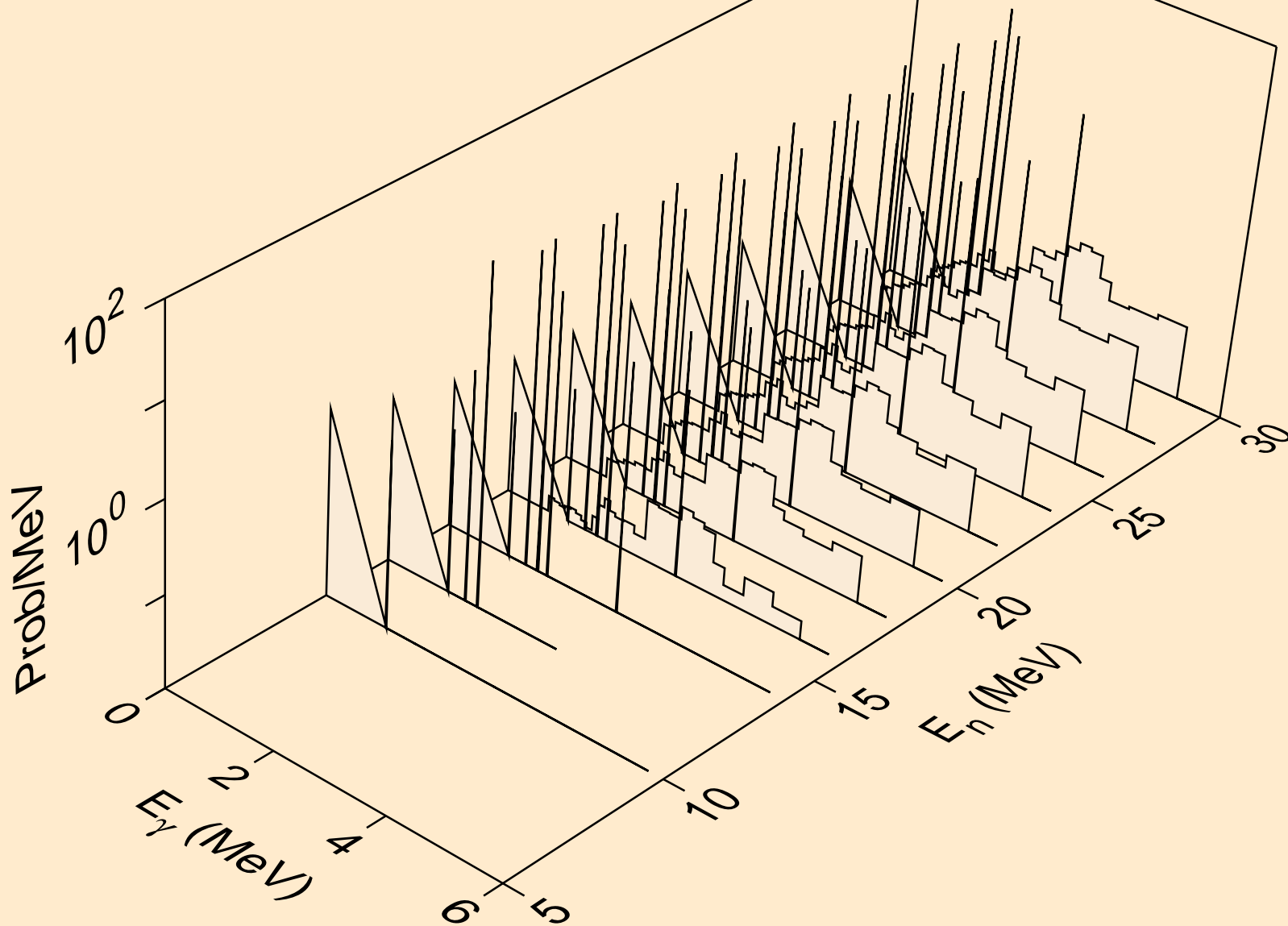

F022 NEUTRON ACER TENDL-2019 LIBRARY; T=293.16K  
Photon emission for (n,2a)

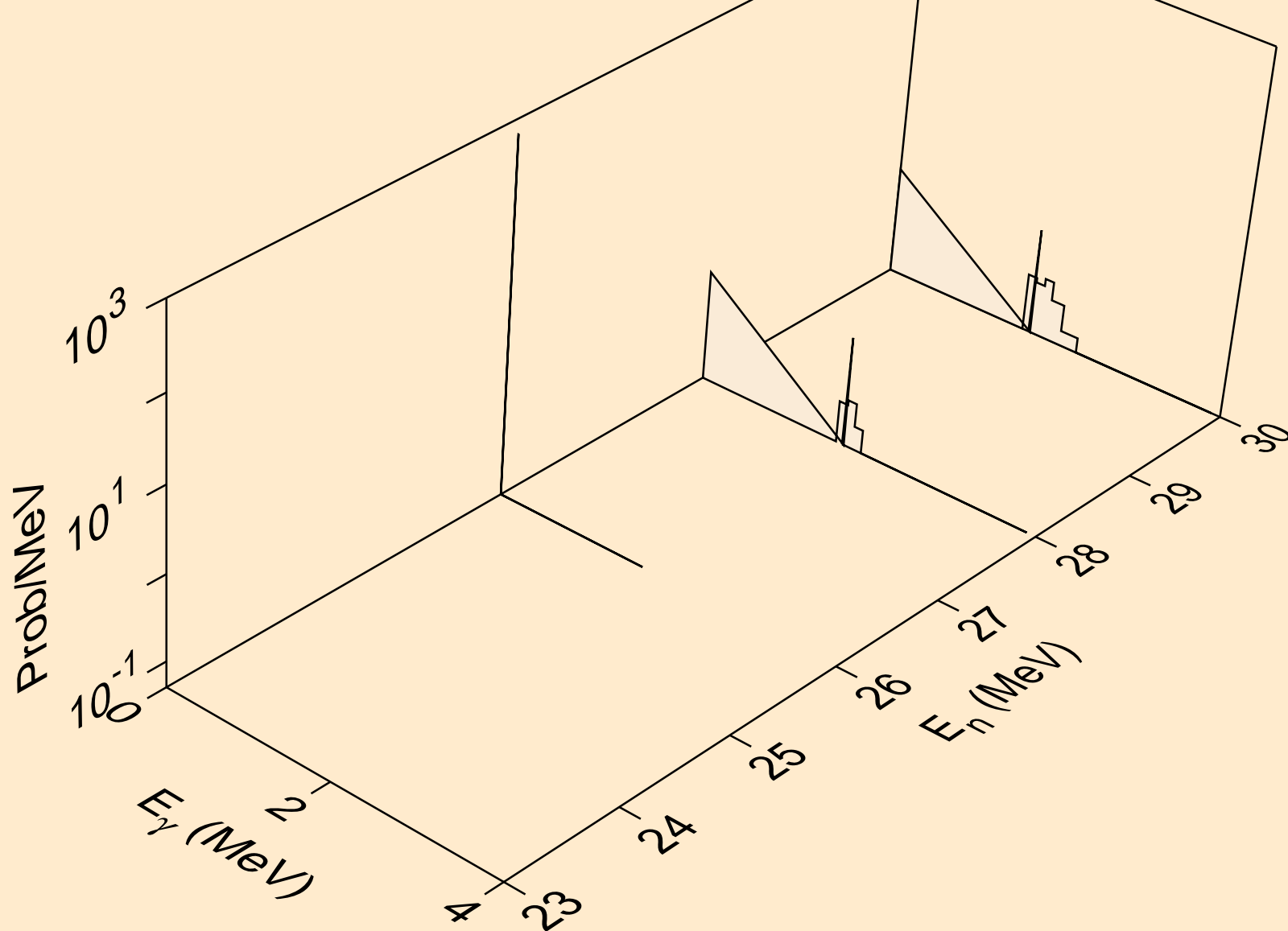

F022 NEUTRON ACER TENDL-2019 LIBRARY; T=293.16K  
Photon emission for (n,p)

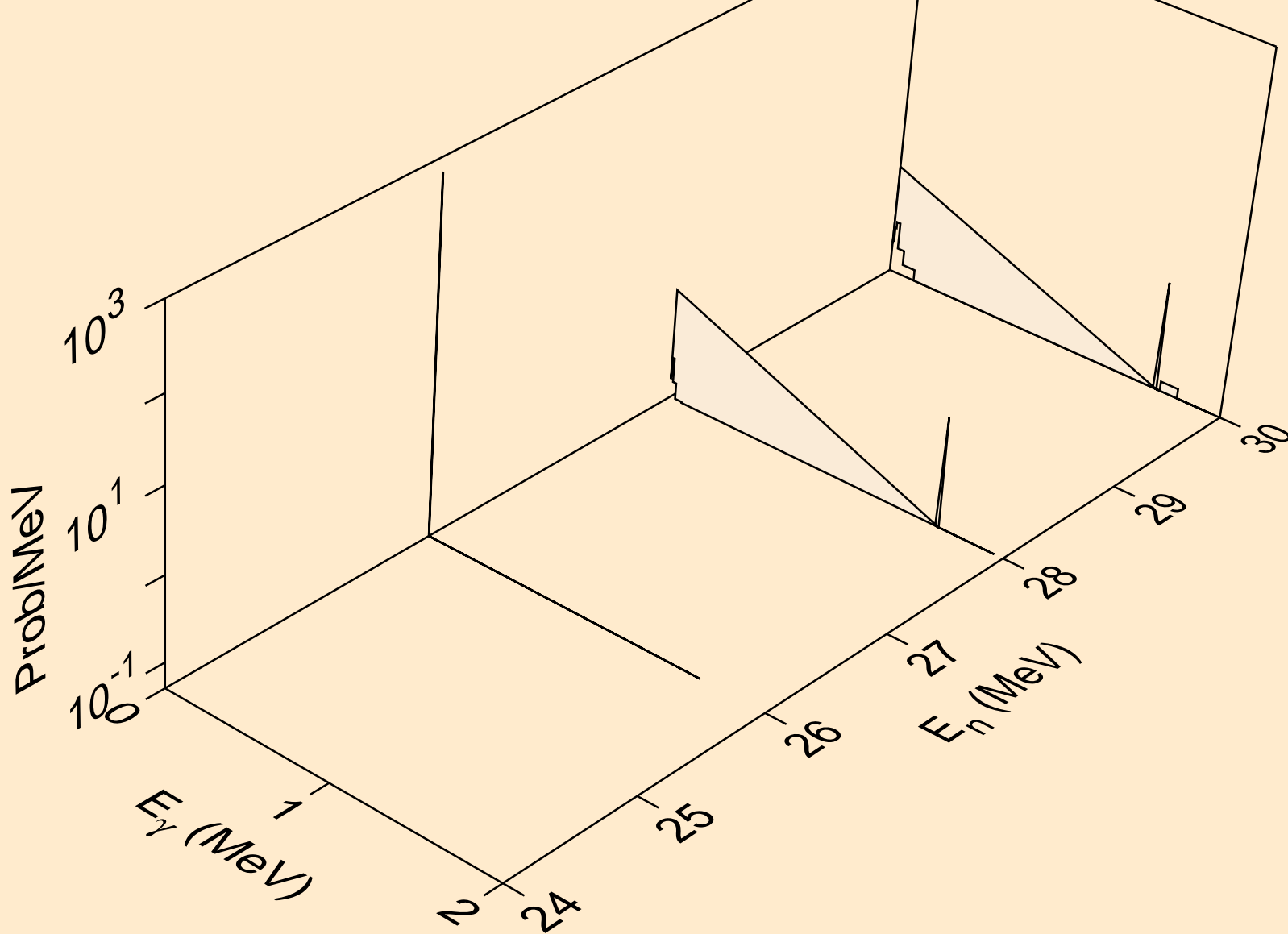

F022 NEUTRON ACER TENDL-2019 LIBRARY; T=293.16K  
Photon emission for (n,da)

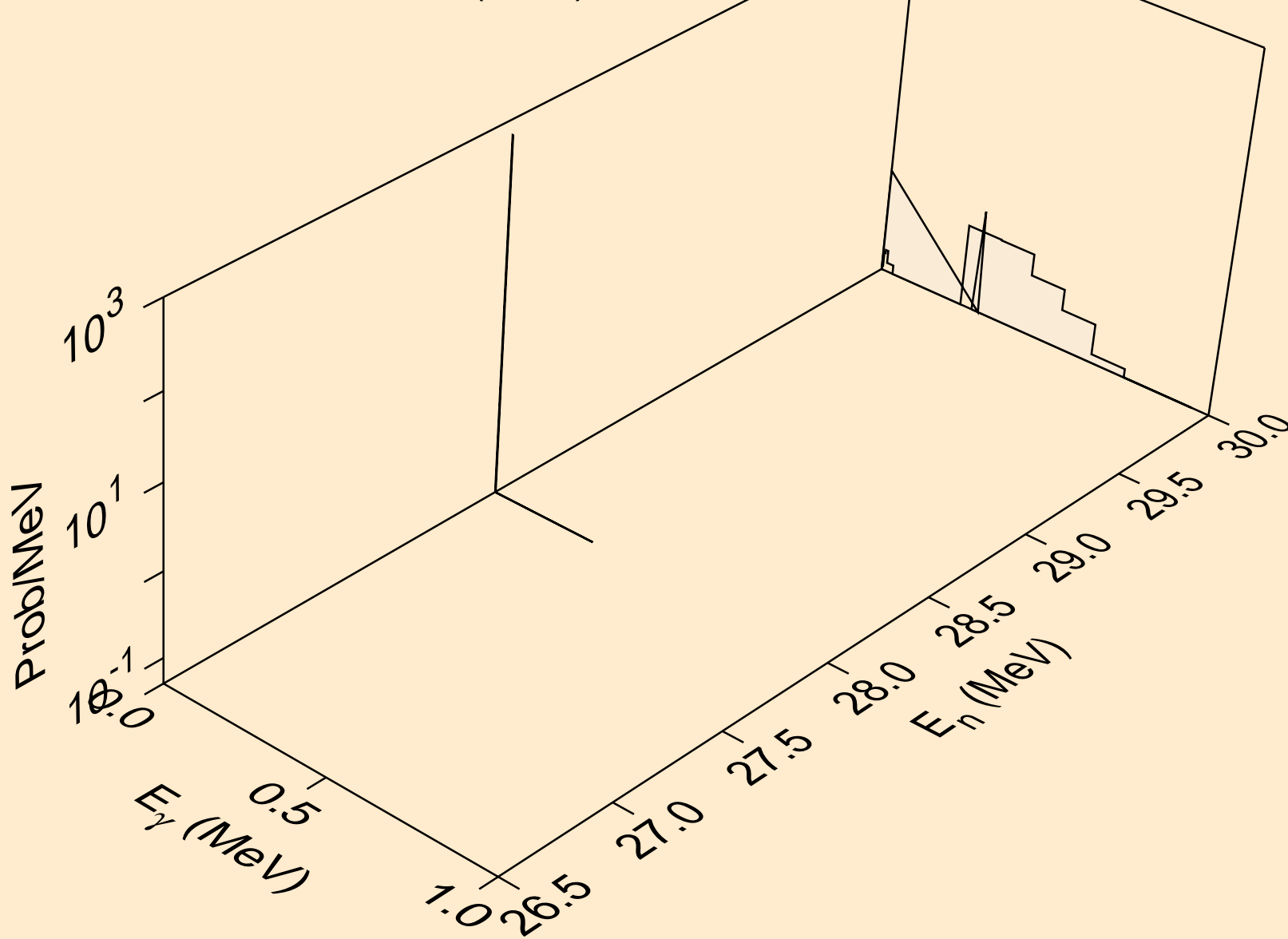

F022 NEUTRON ACER TENDL-2019 LIBRARY; T=293.16K  
thermal capture photon spectrum

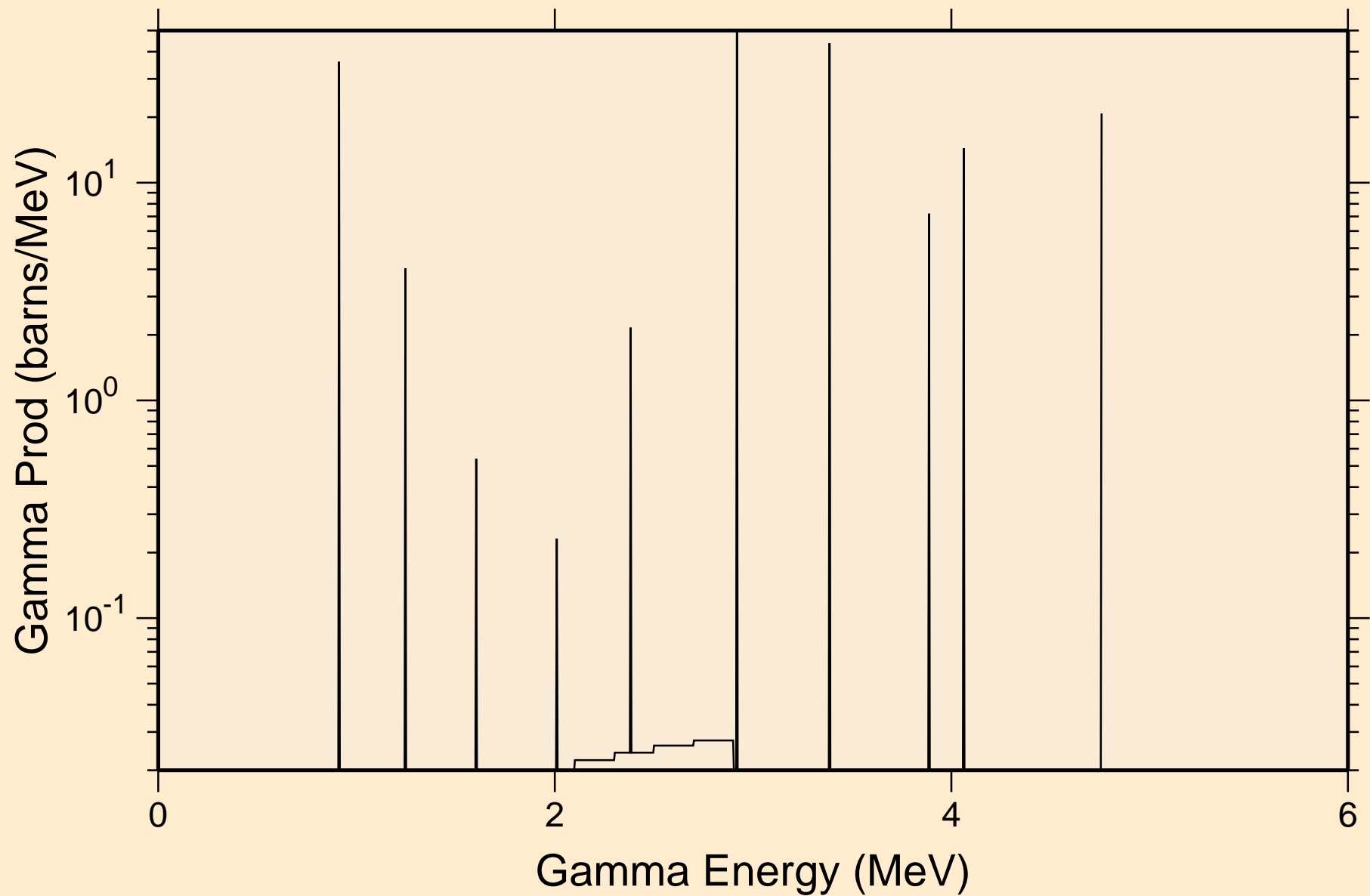



F022 NEUTRON ACER TENDL-2019 LIBRARY; T=293.16K  
14 MeV photon spectrum

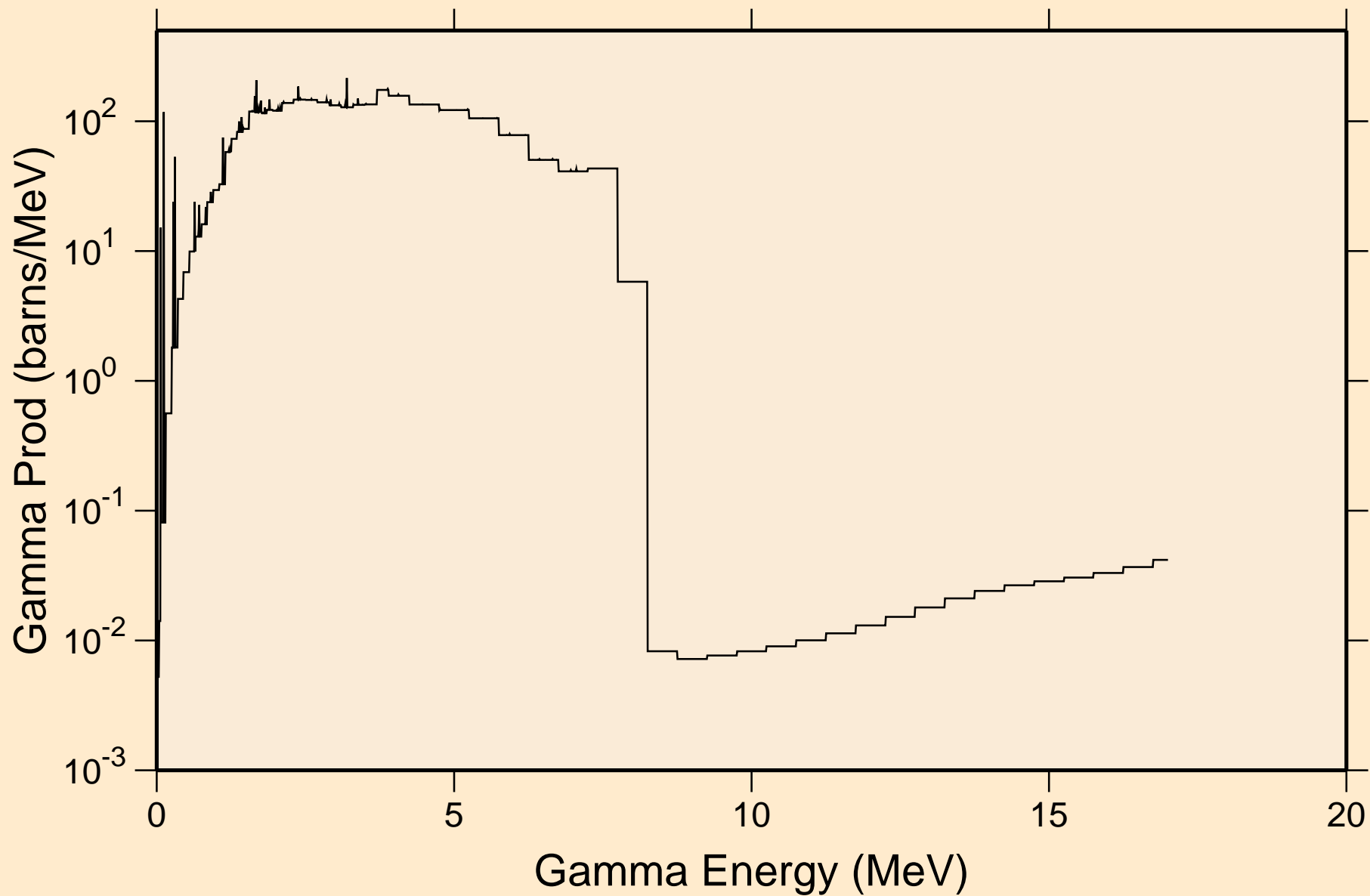

F022 NEUTRON ACER TENDL-2019 LIBRARY; T=293.16K  
Particle heating contributions

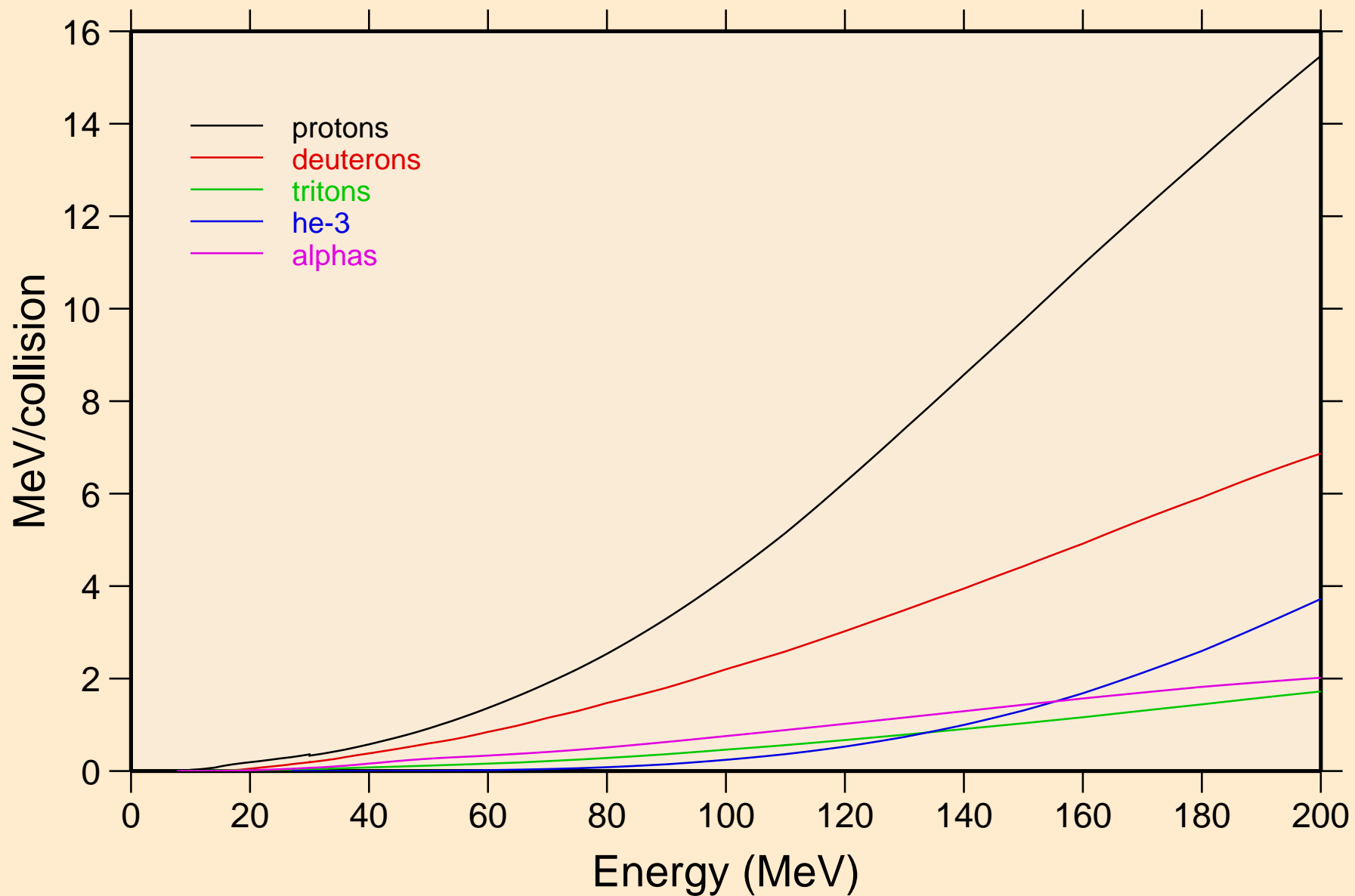

F022 NEUTRON ACER TENDL-2019 LIBRARY; T=293.16K  
Recoil Heating

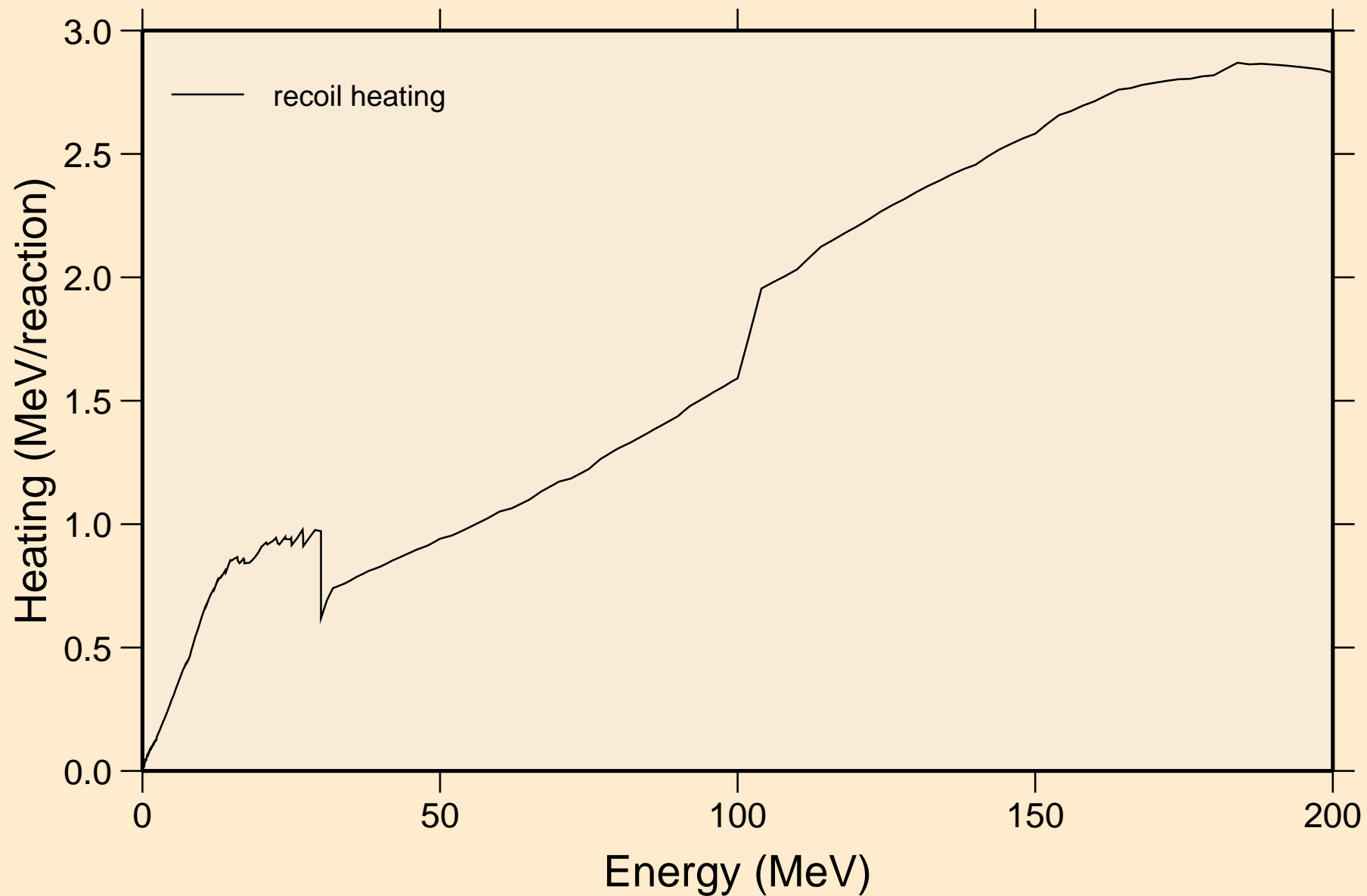

# F022 NEUTRON ACER TENDL-2019 LIBRARY; T=293.16K

## Particle production cross sections

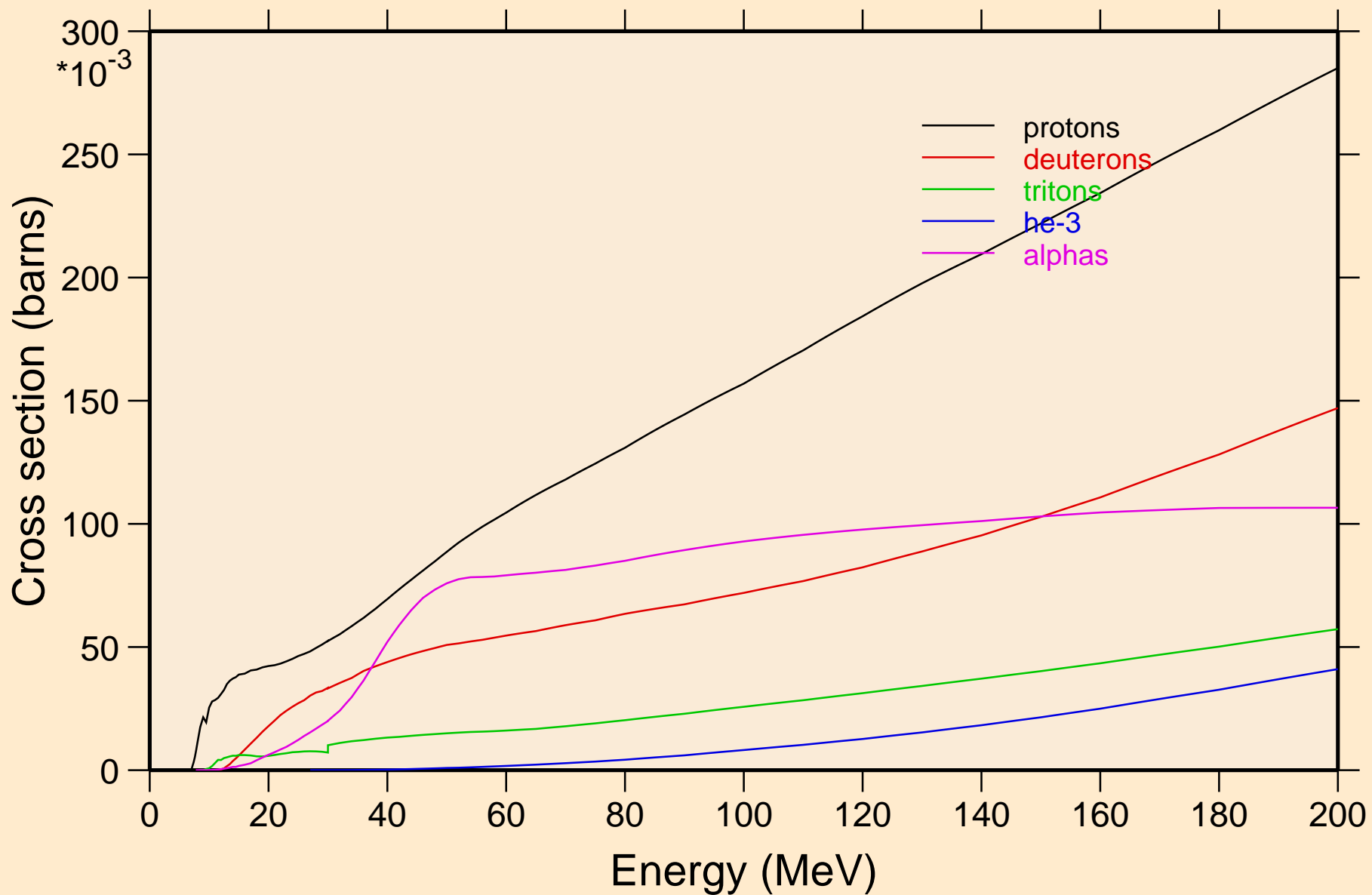

F022 NEUTRON ACER TENDL-2019 LIBRARY; T=293.16K  
protons from (n,x)

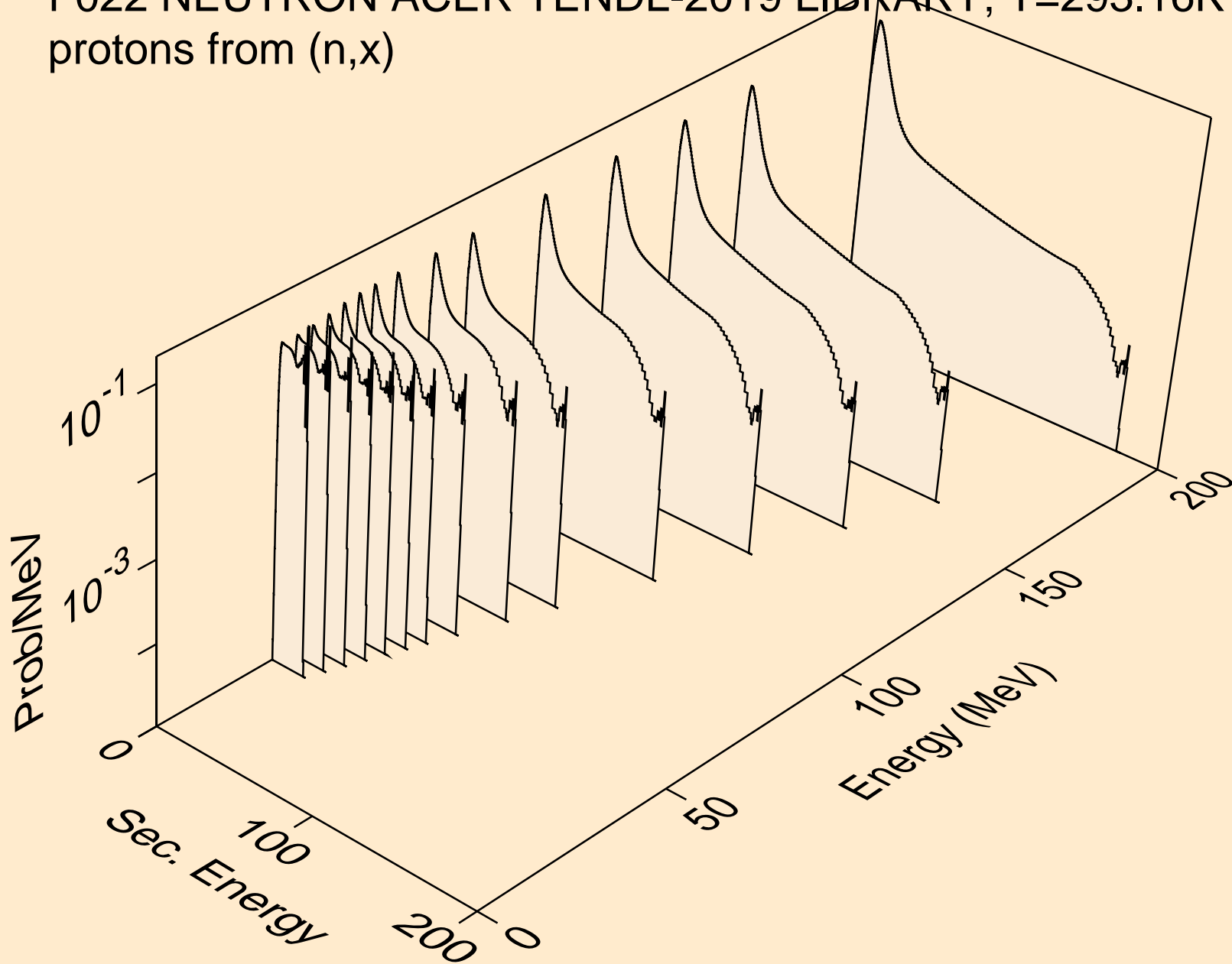

F022 NEUTRON ACER TENDL-2019 LIBRARY; T=293.16K  
protons from (n,n\*)p

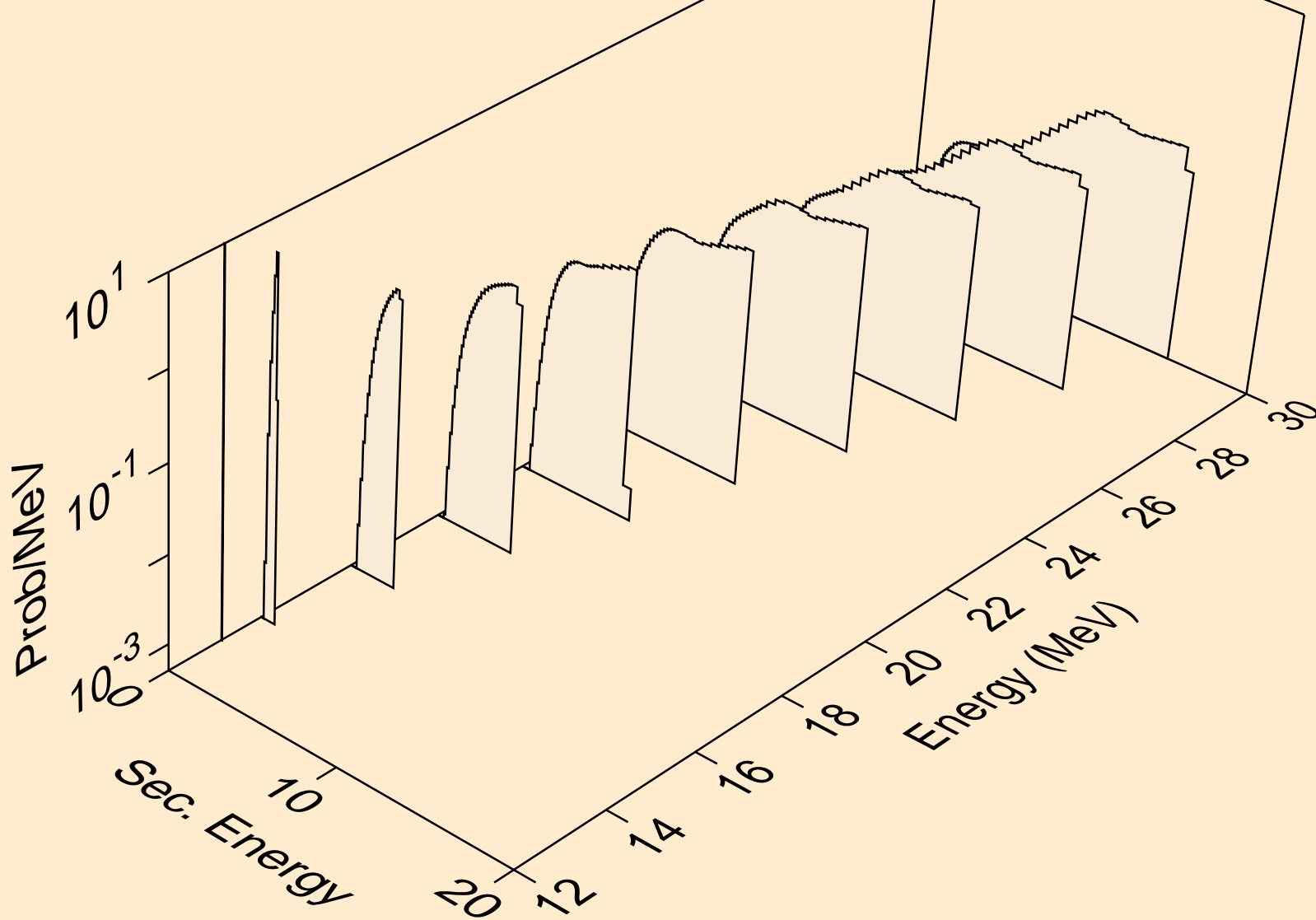

F022 NEUTRON ACER TENDL-2019 LIBRARY; T=293.16K  
protons from (n,2np)

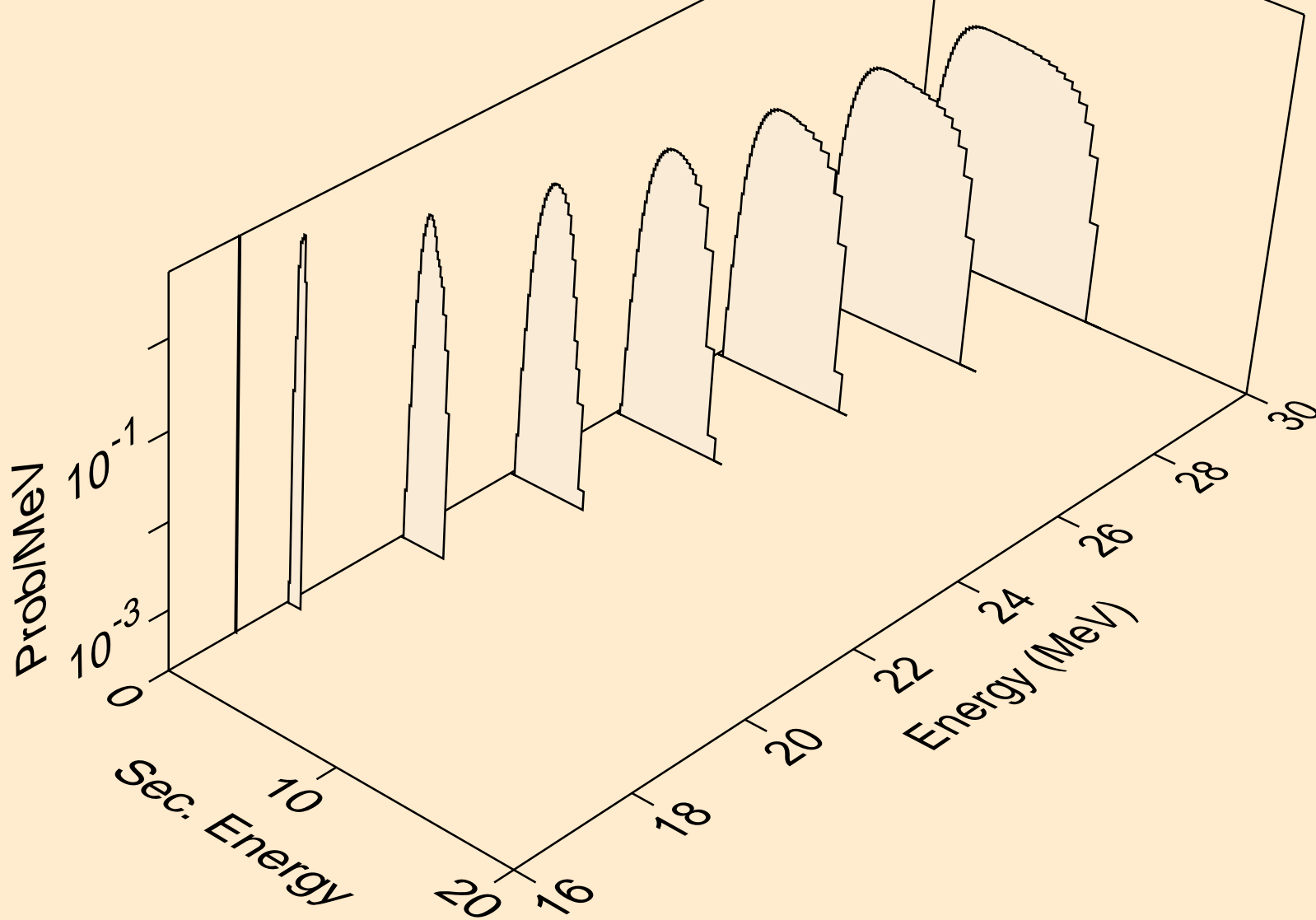

F022 NEUTRON ACER TENDL-2019 LIBRARY; T=293.16K  
protons from (n,3np)

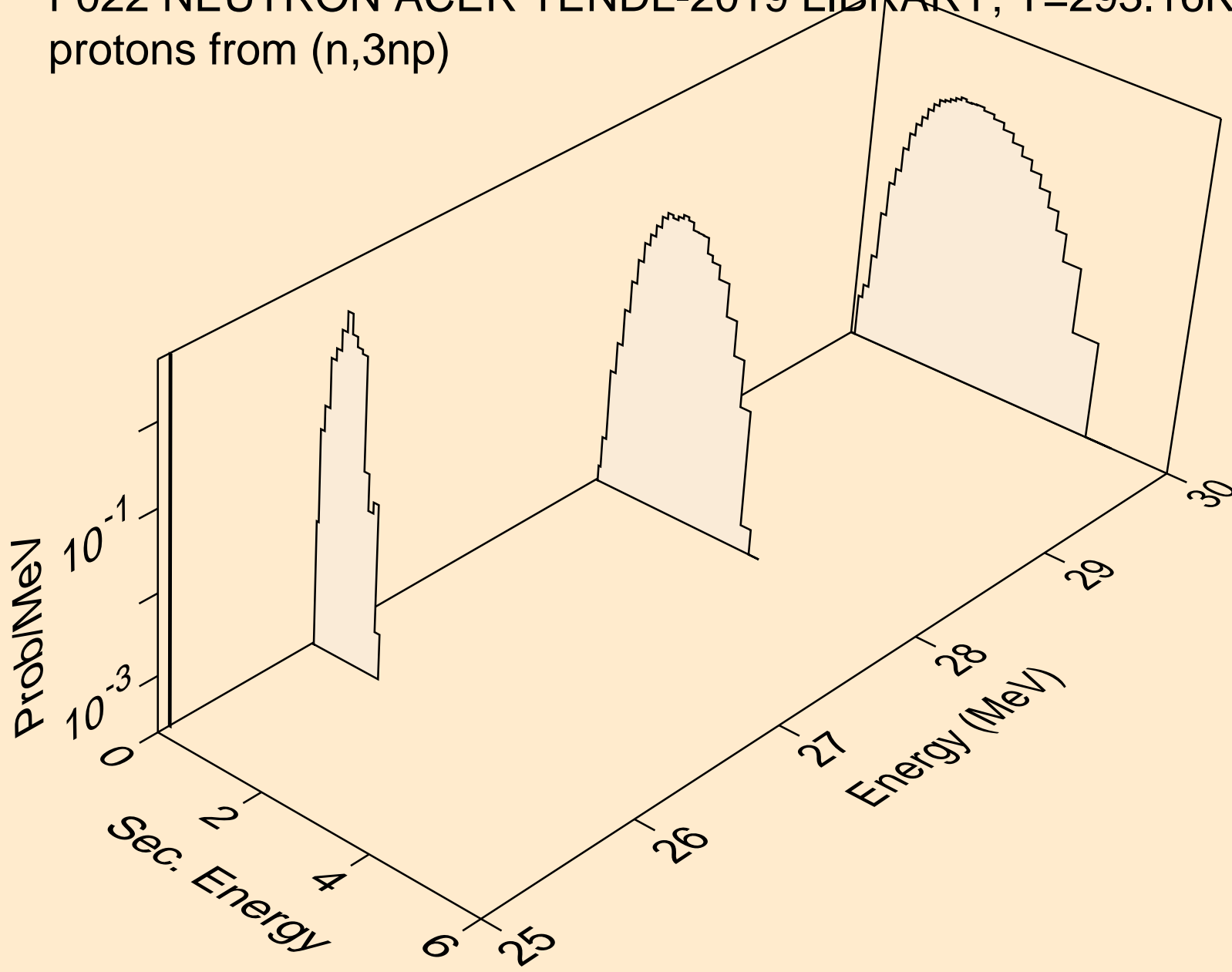



F022 NEUTRON ACER TENDL-2019 LIBRARY; T=293.16K  
protons from (n,p)

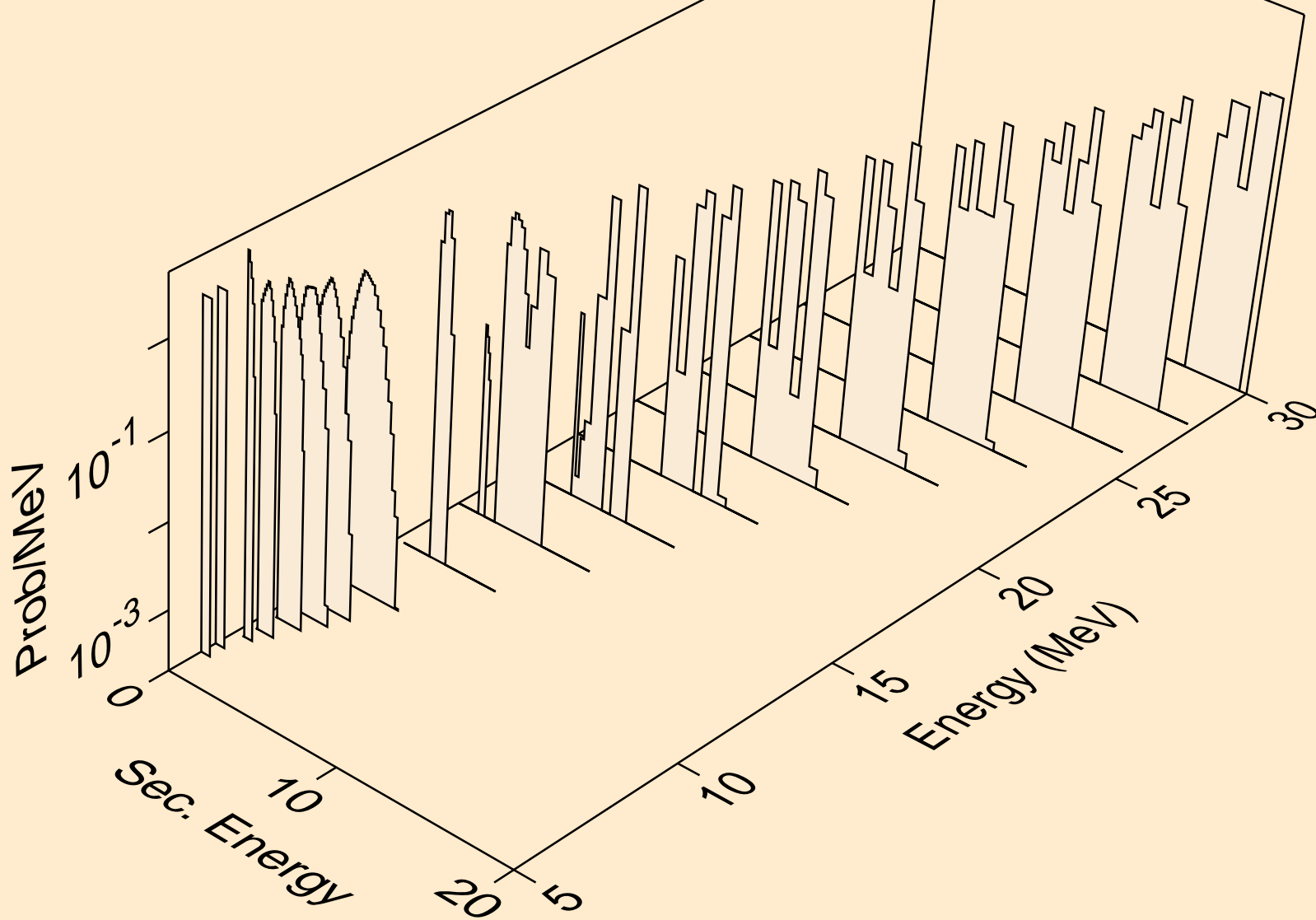

F022 NEUTRON ACER TENDL-2019 LIBRARY; T=293.16K  
protons from (n,p)

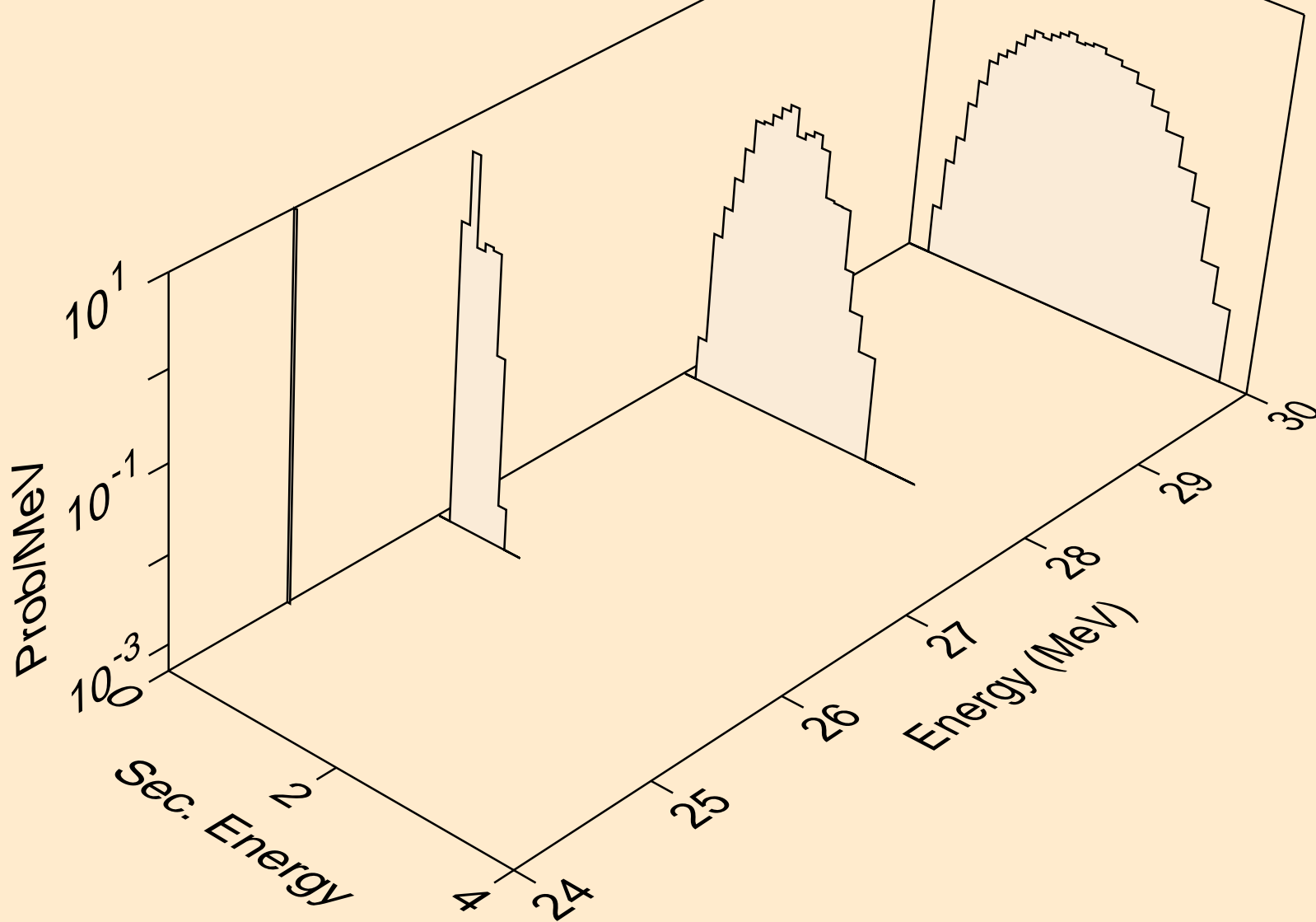

F022 NEUTRON ACER TENDL-2019 LIBRARY; T=293.16K  
deuterons from (n,x)

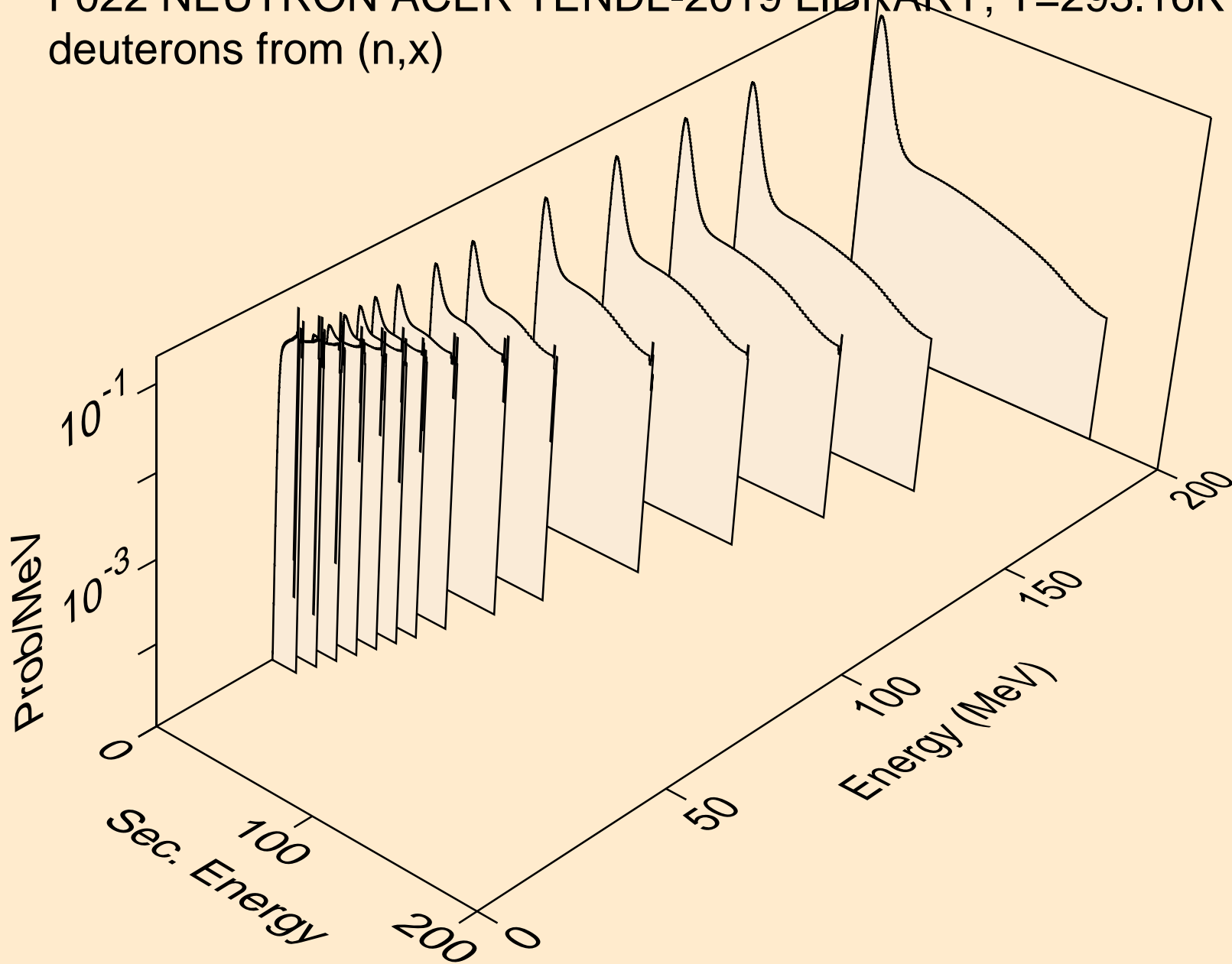

F022 NEUTRON ACER TENDL-2019 LIBRARY; T=293.16K  
deuterons from (n,2nd)

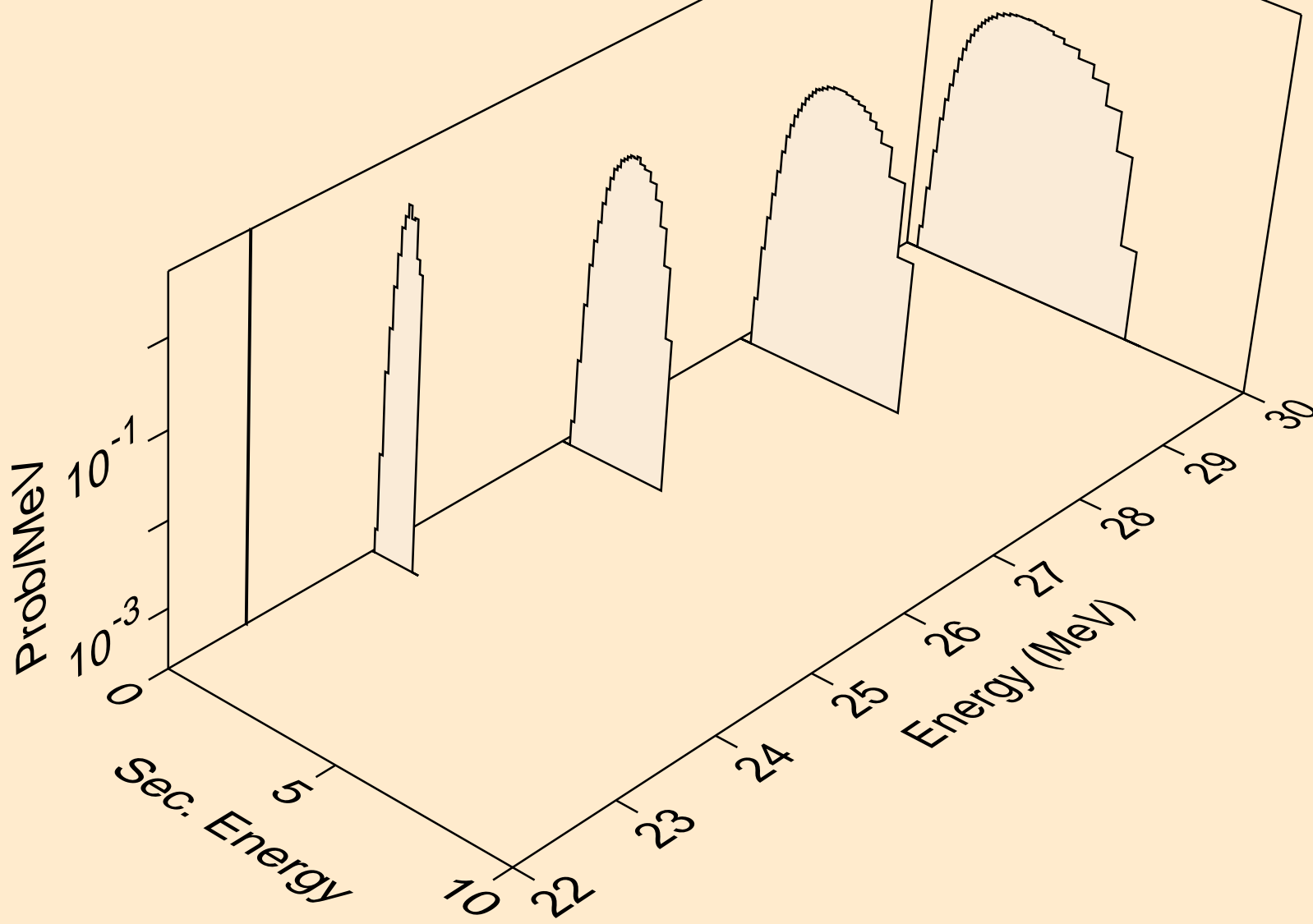

F022 NEUTRON ACER TENDL-2019 LIBRARY; T=293.16K  
deuterons from (n,n\*)d

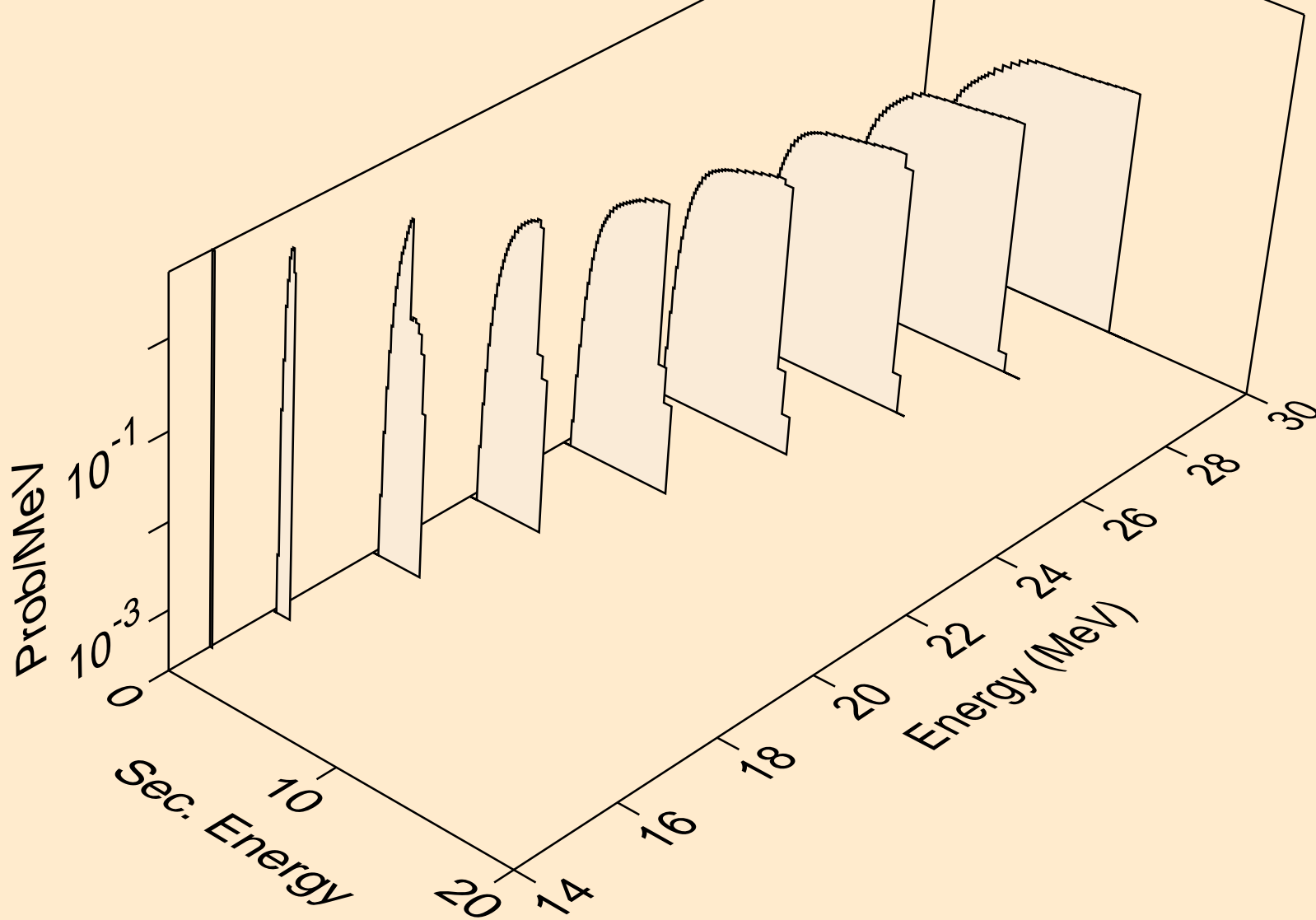

F022 NEUTRON ACER TENDL-2019 LIBRARY; T=293.16K  
deuterons from (n,d)

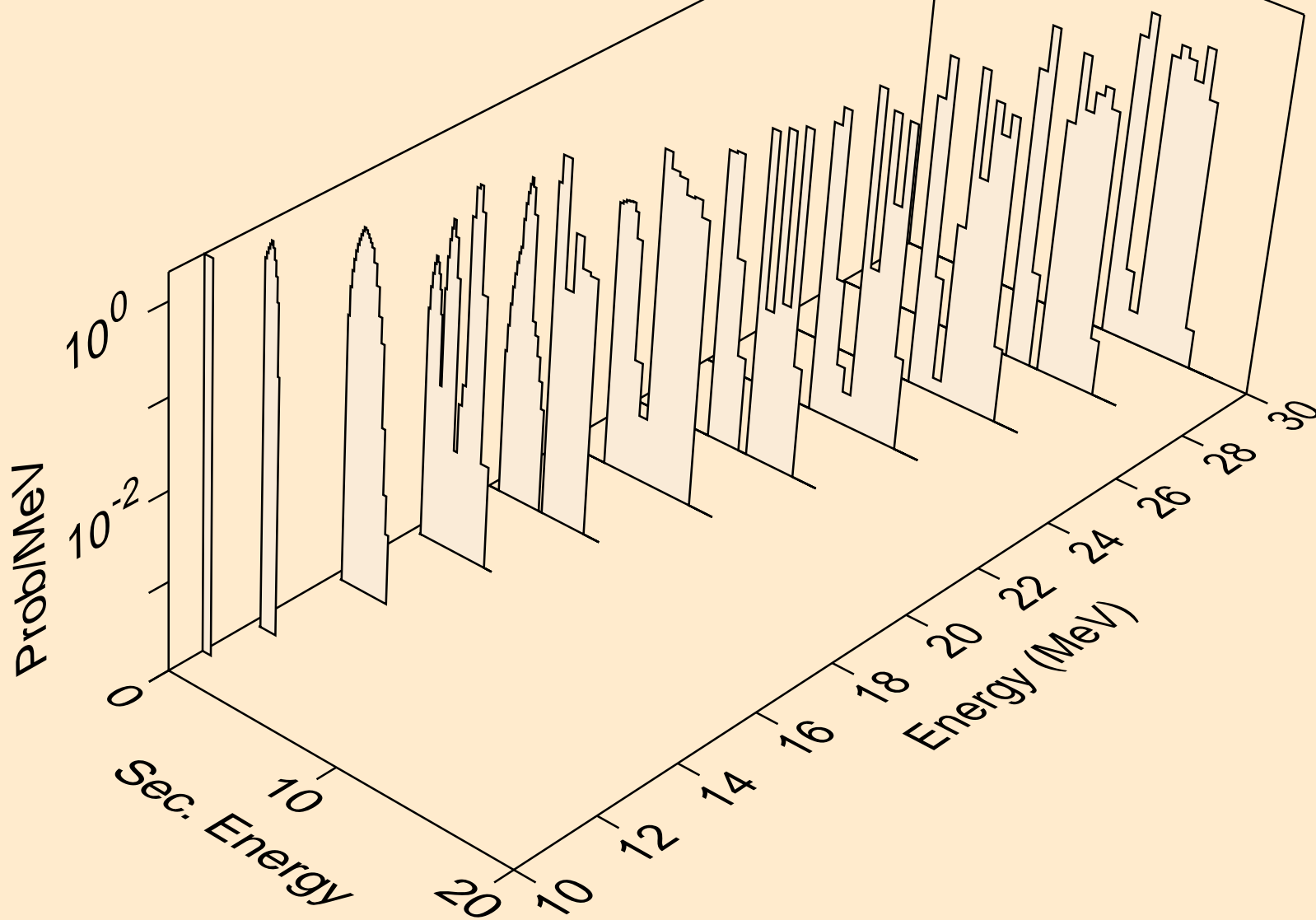

F022 NEUTRON ACER TENDL-2019 LIBRARY; T=293.16K  
deuterons from (n,da)

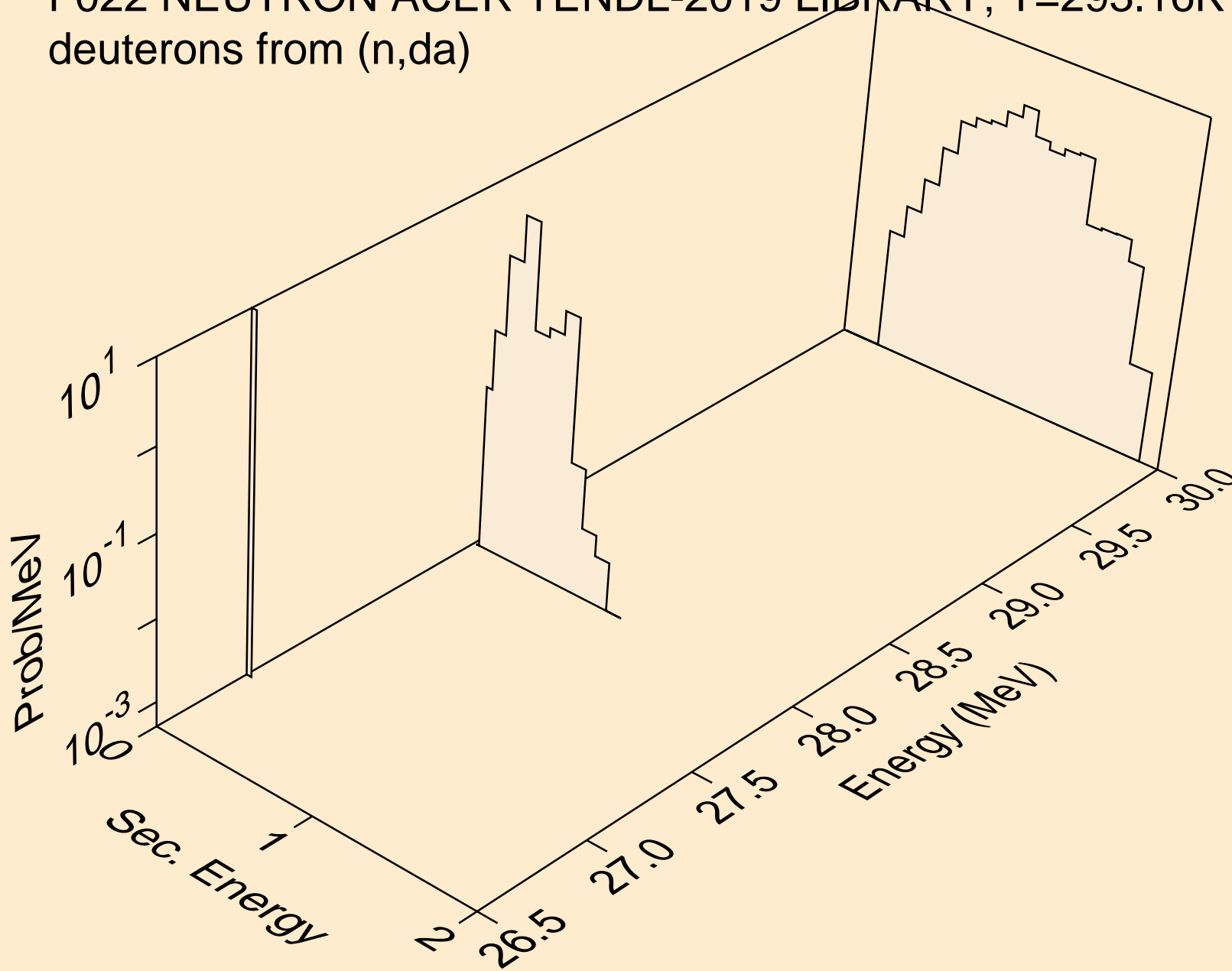

F022 NEUTRON ACER TENDL-2019 LIBRARY; T=293.16K  
tritons from (n,x)

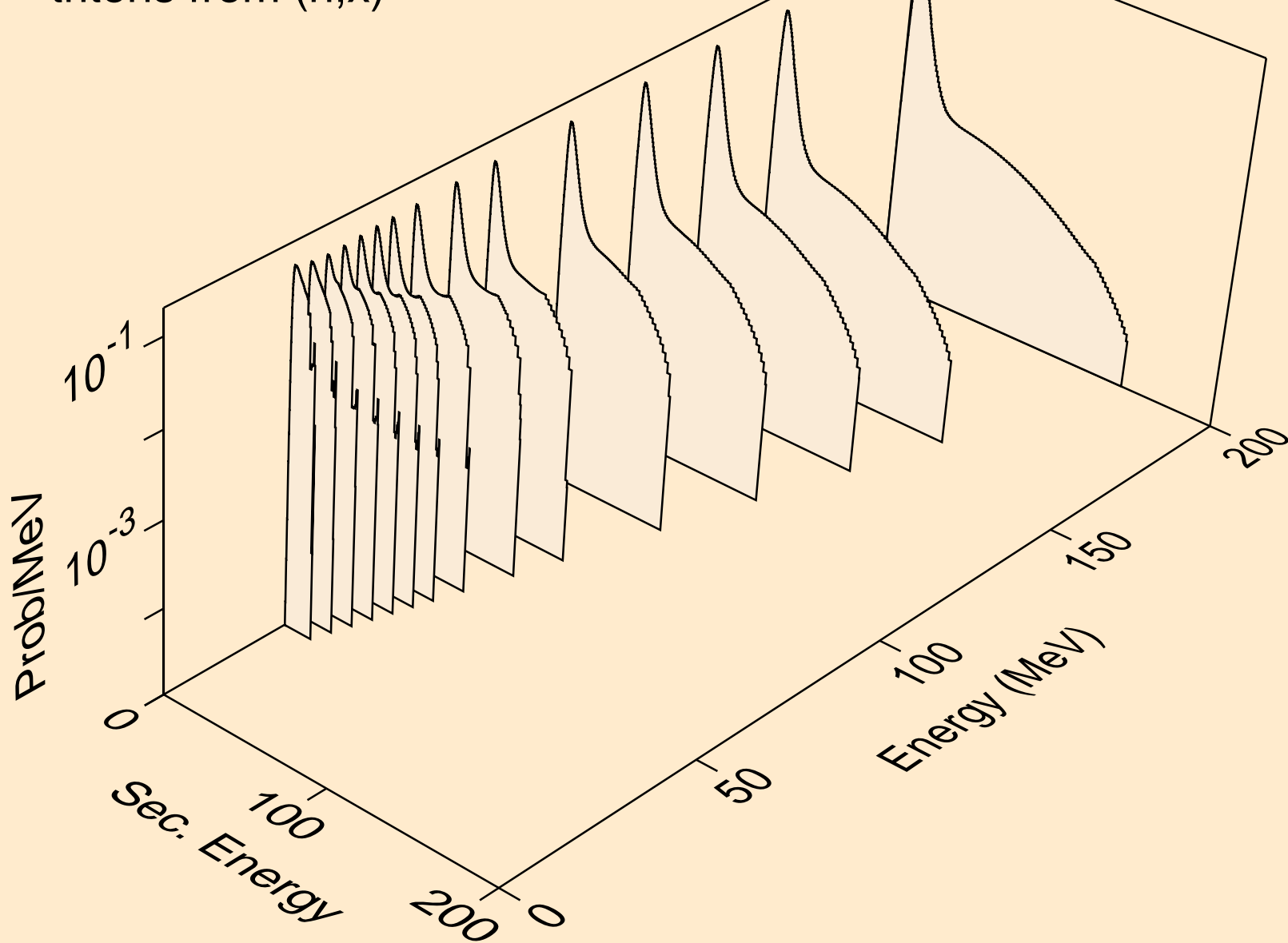



F022 NEUTRON ACER TENDL-2019 LIBRARY; T=293.16K  
tritons from (n,n\*)t

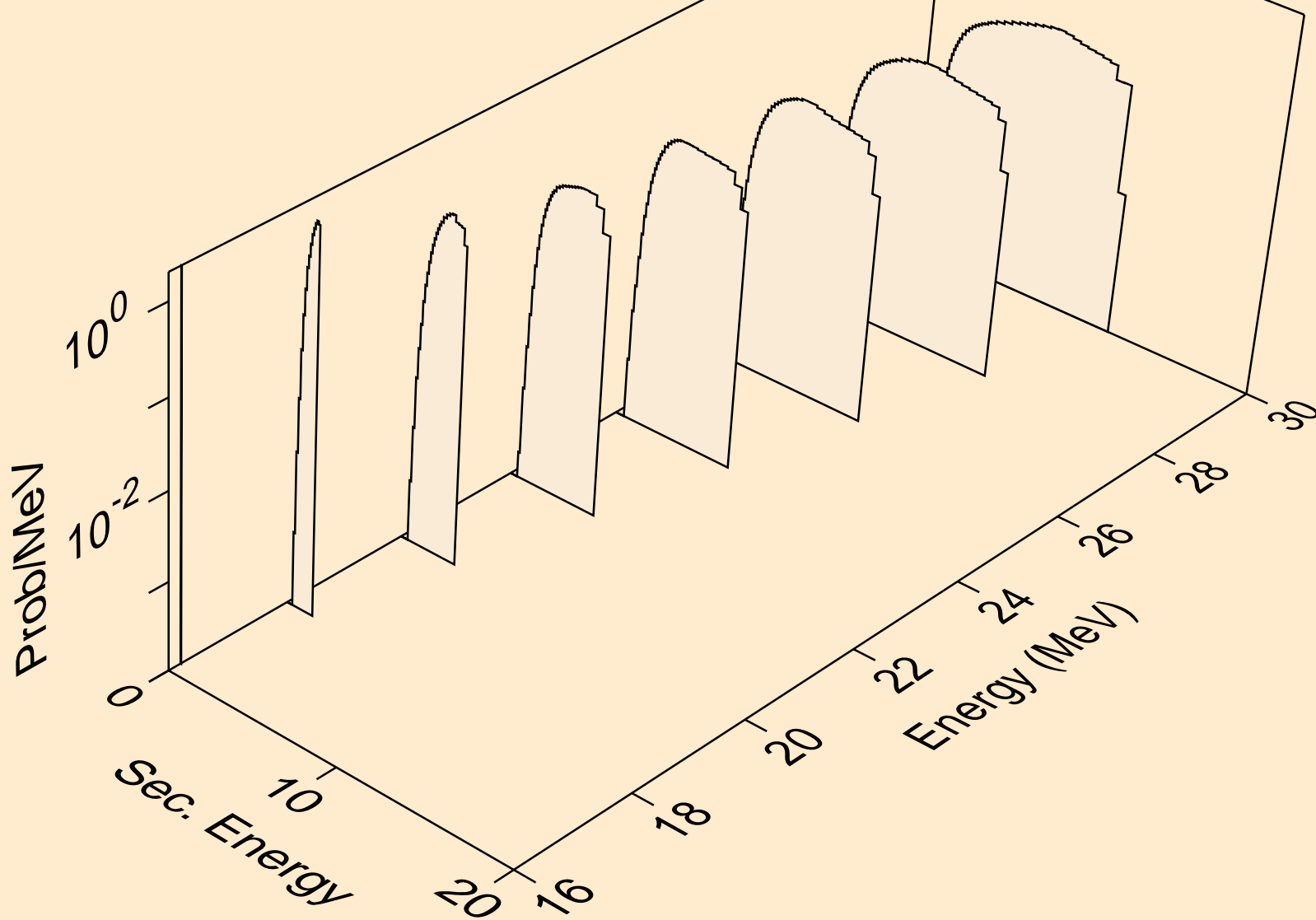

F022 NEUTRON ACER TENDL-2019 LIBRARY; T=293.16K  
tritons from (n,t)

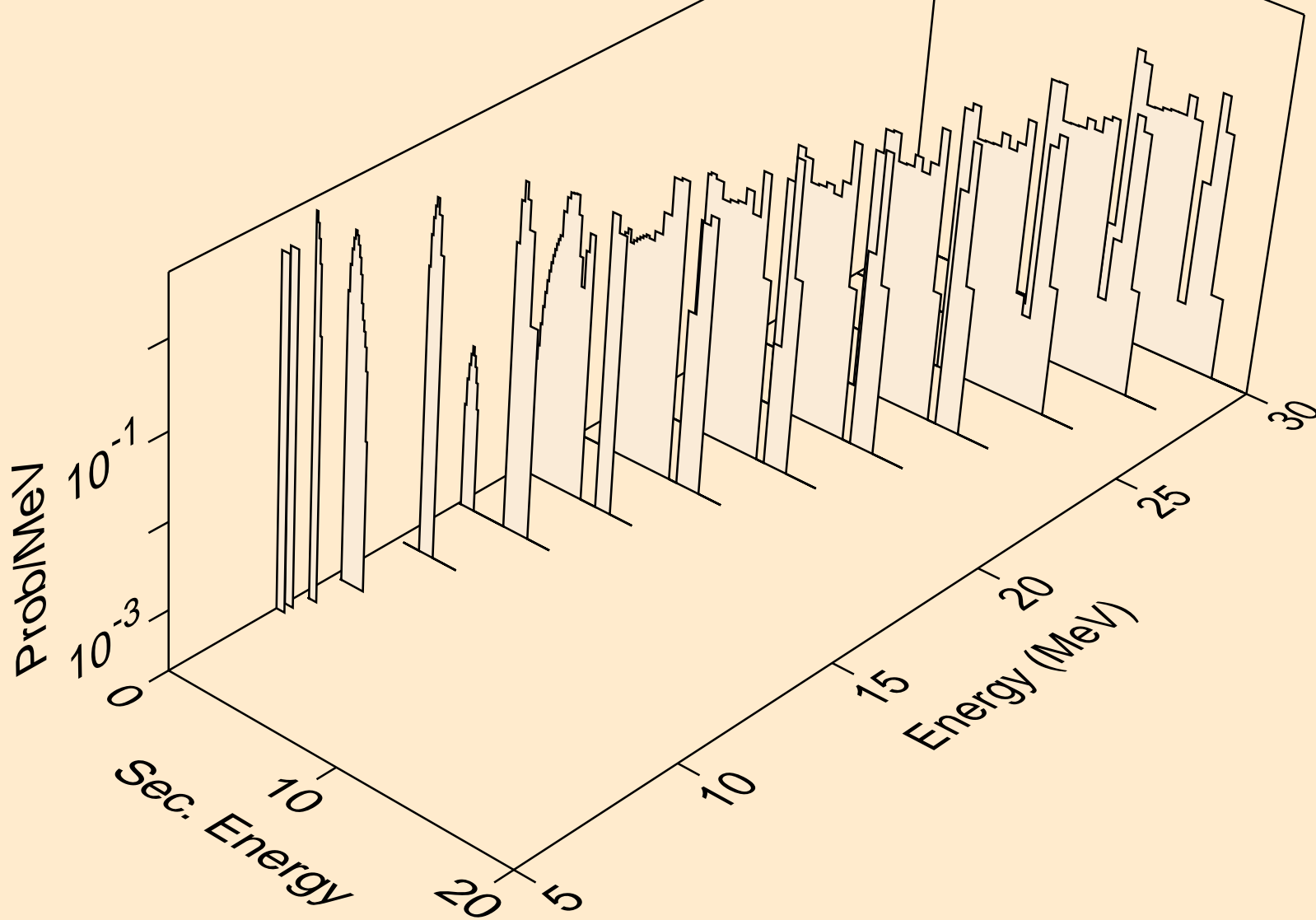

F022 NEUTRON ACER TENDL-2019 LIBRARY; T=293.16K  
he3s from (n,x)

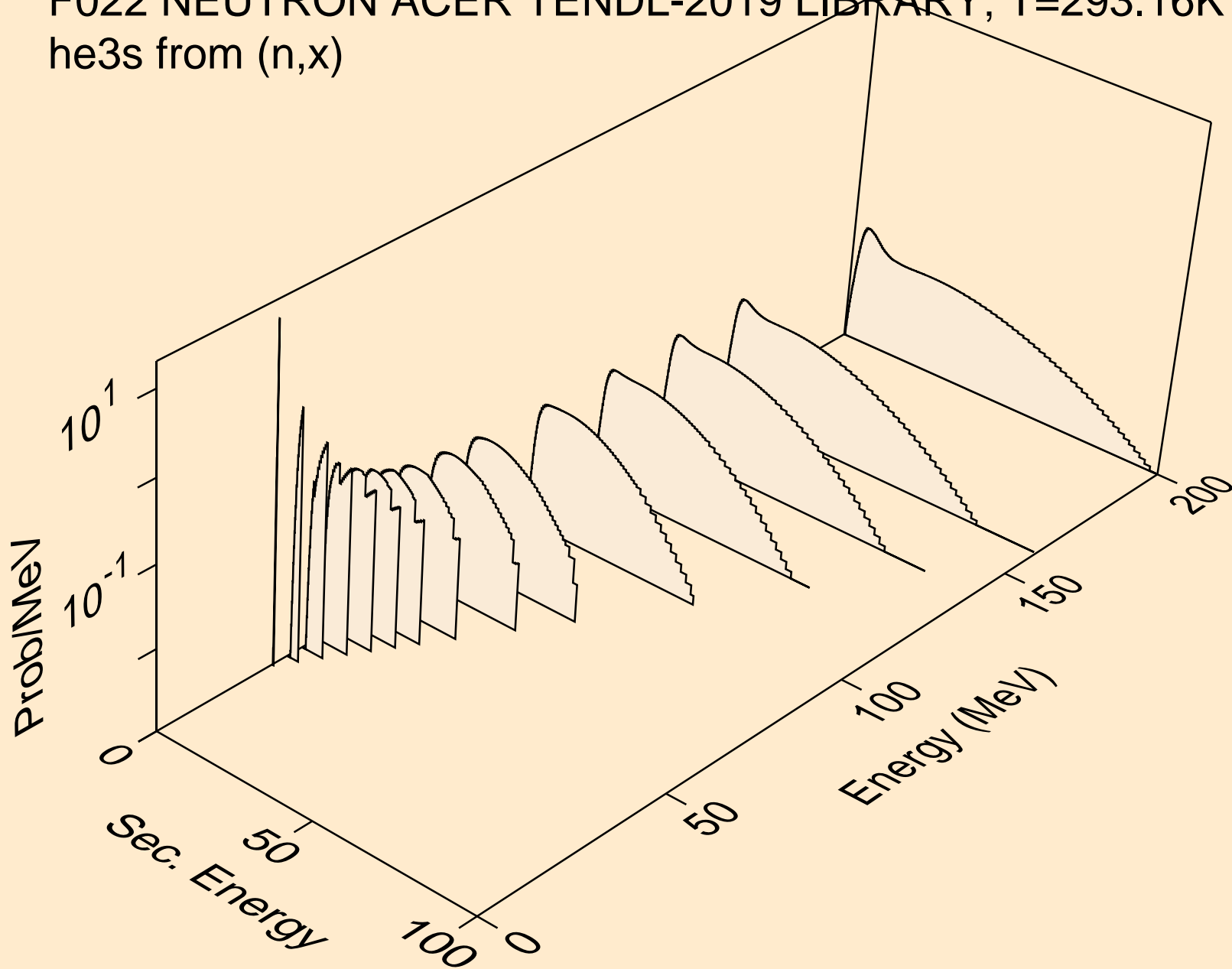

F022 NEUTRON ACER TENDL-2019 LIBRARY; T=293.16K  
he3s from (n,he3)

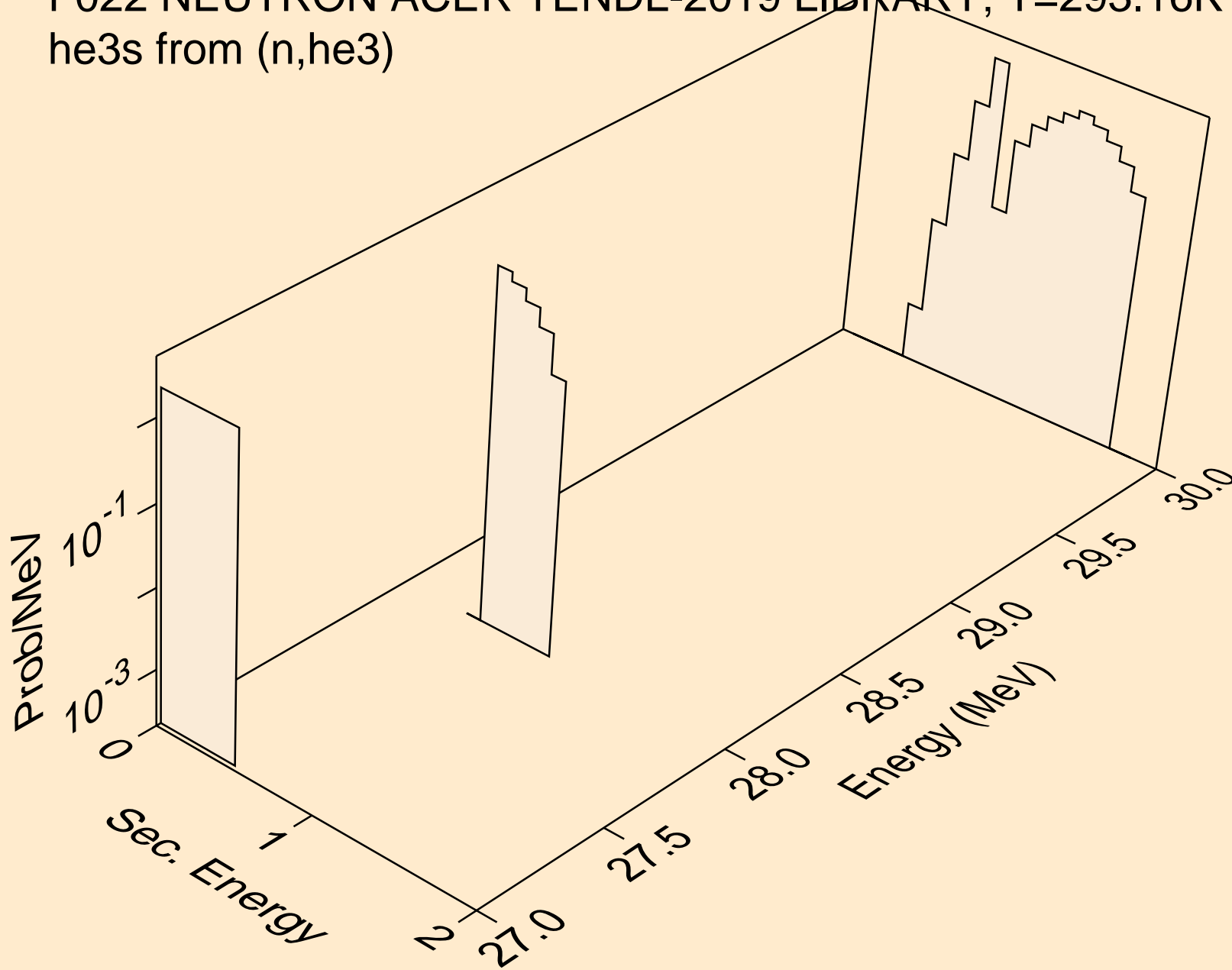

F022 NEUTRON ACER TENDL-2019 LIBRARY; T=293.16K  
alphas from (n,x)

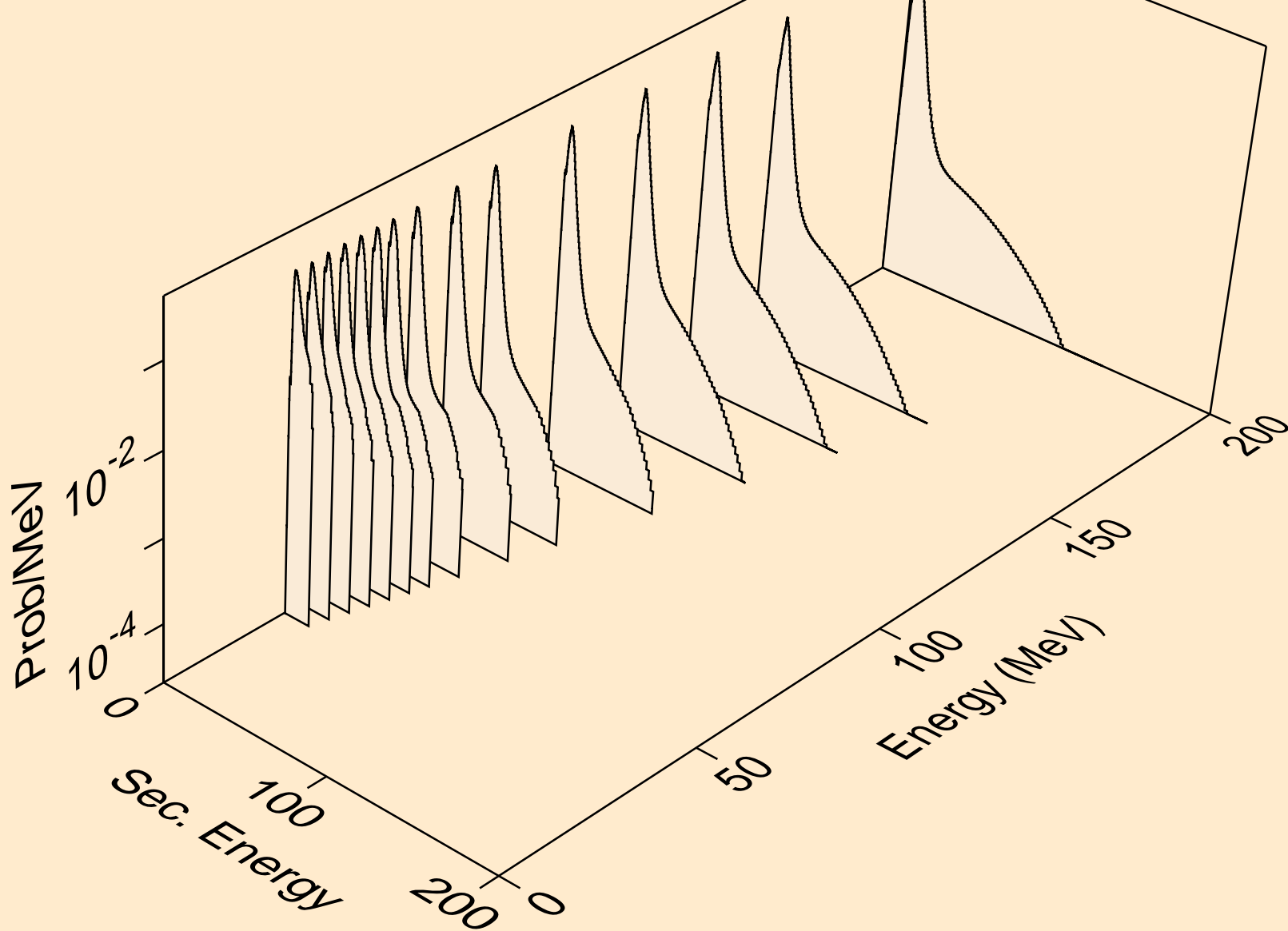

F022 NEUTRON ACER TENDL-2019 LIBRARY; T=293.16K  
alphas from (n,n\*)a

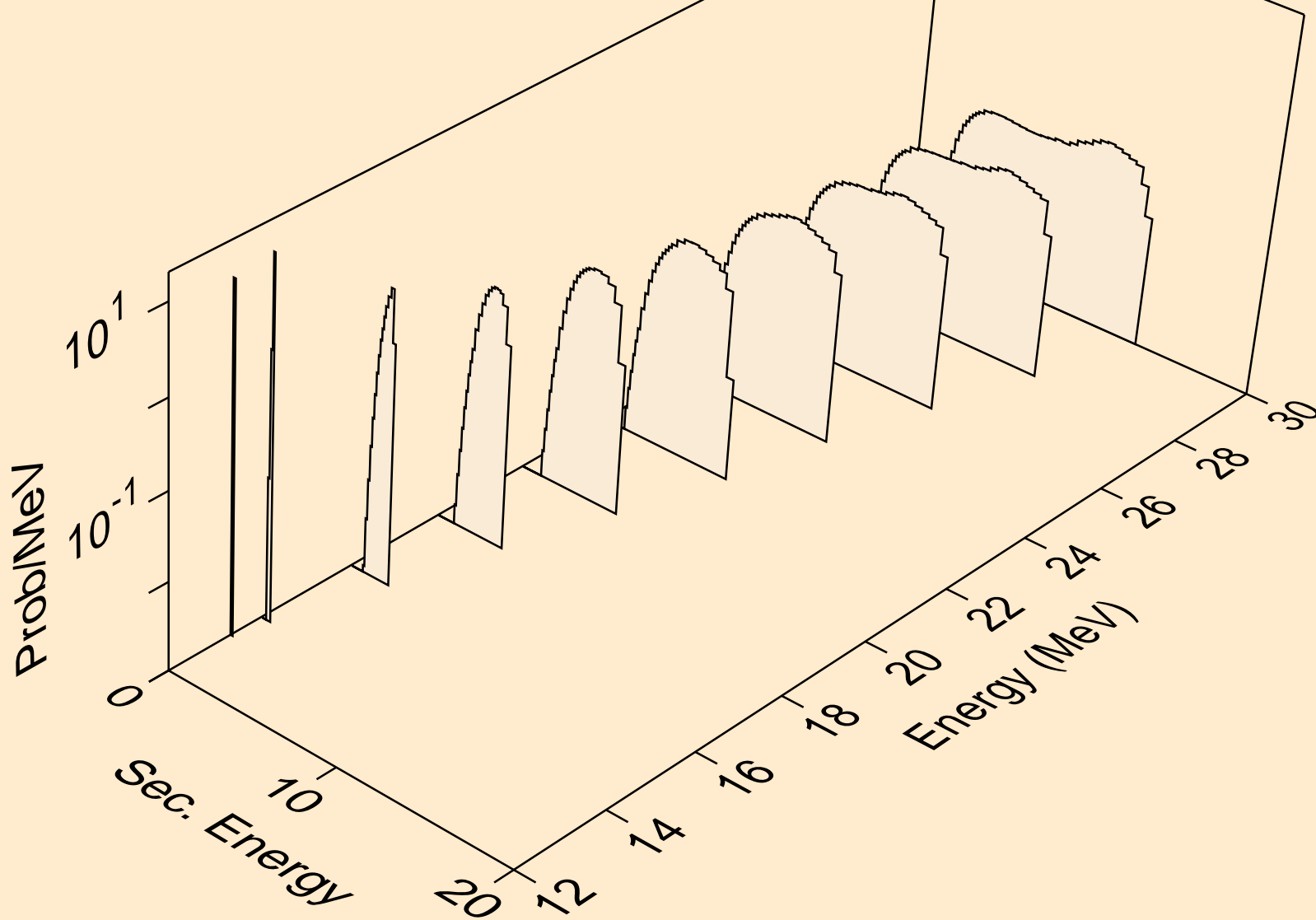

F022 NEUTRON ACER TENDL-2019 LIBRARY; T=293.16K  
alphas from (n,2n)a

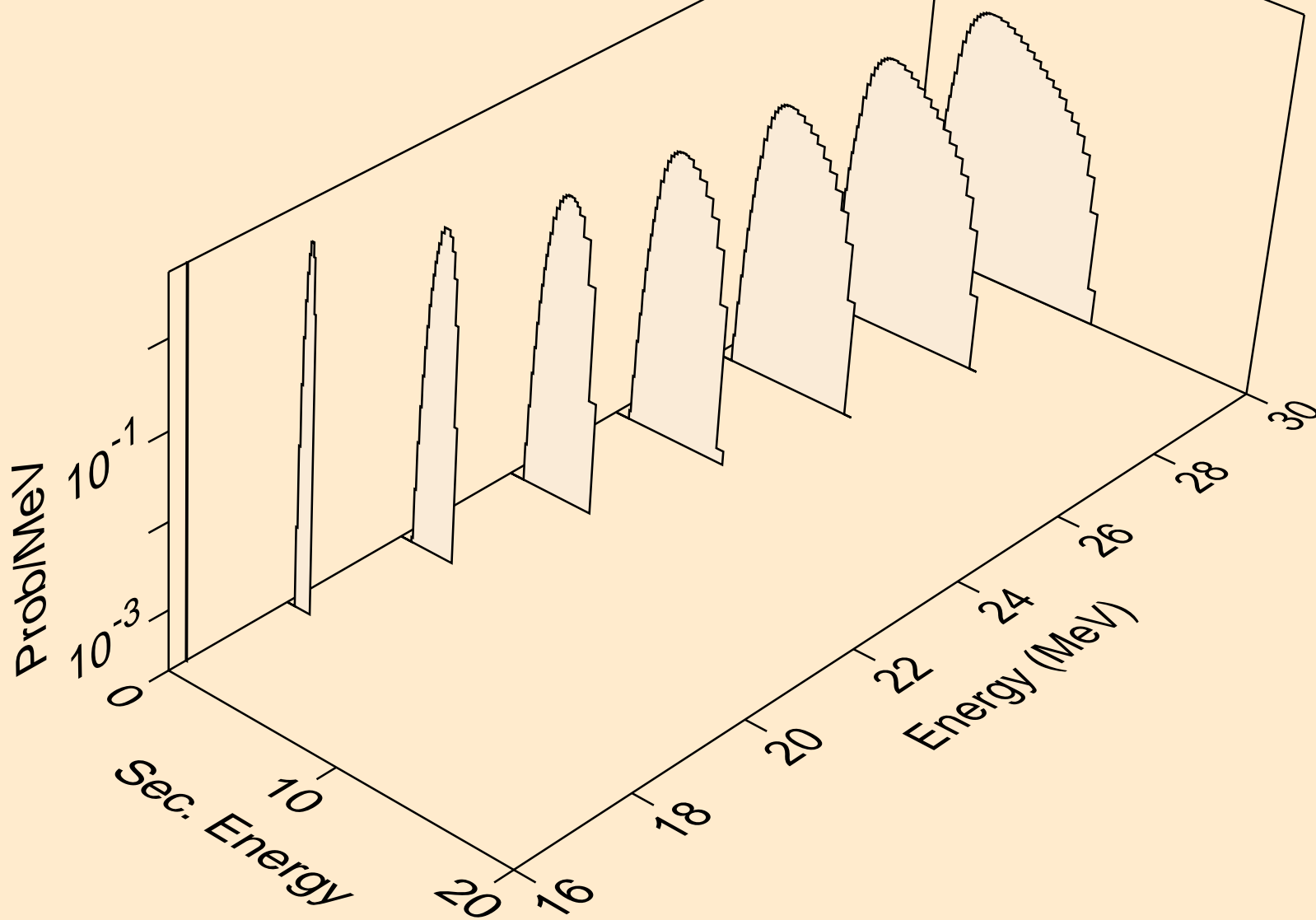

F022 NEUTRON ACER TENDL-2019 LIBRARY; T=293.16K  
alphas from (n,3n)a

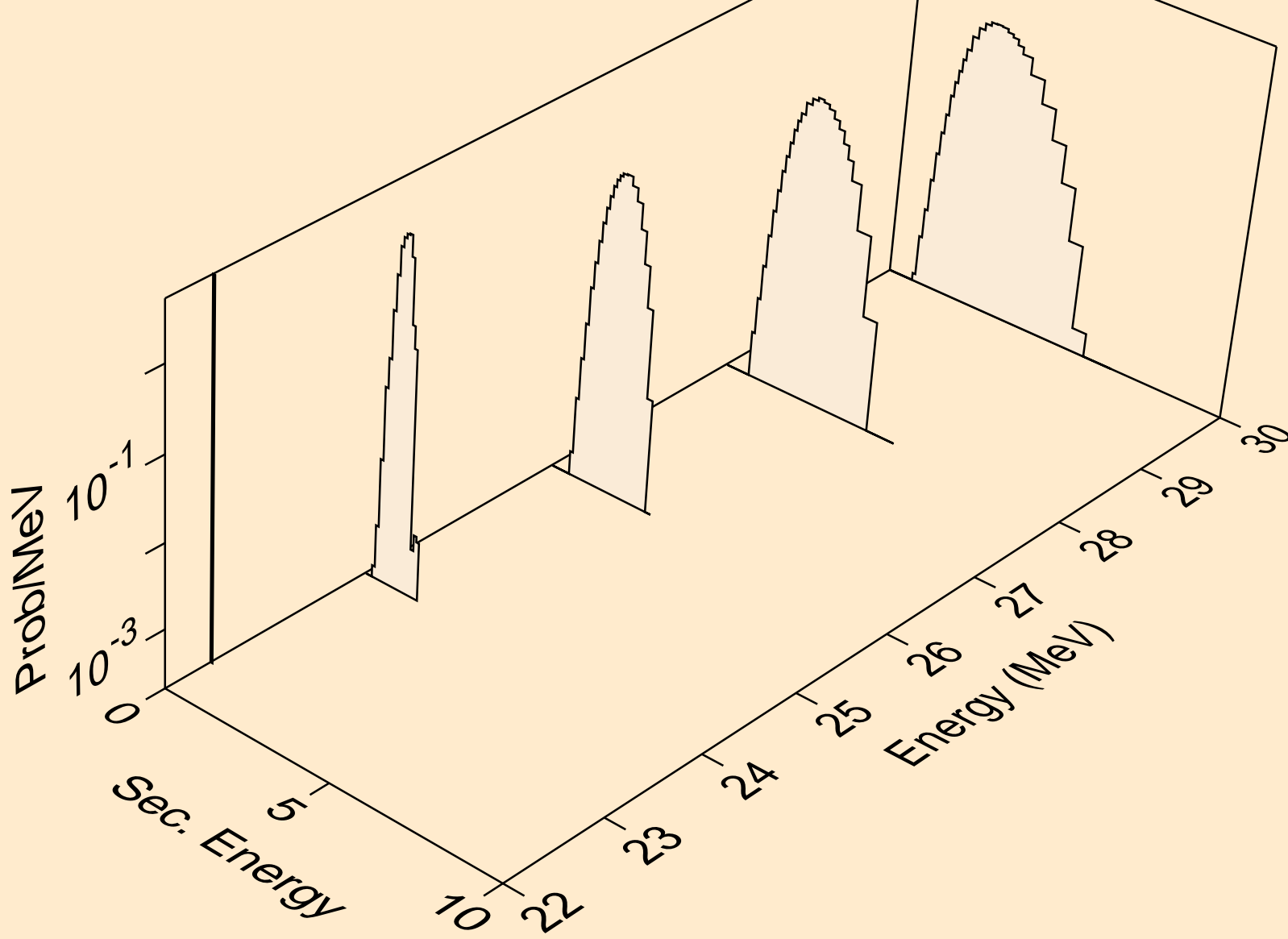



F022 NEUTRON ACER TENDL-2019 LIBRARY; T=293.16K  
alphas from (n,a)

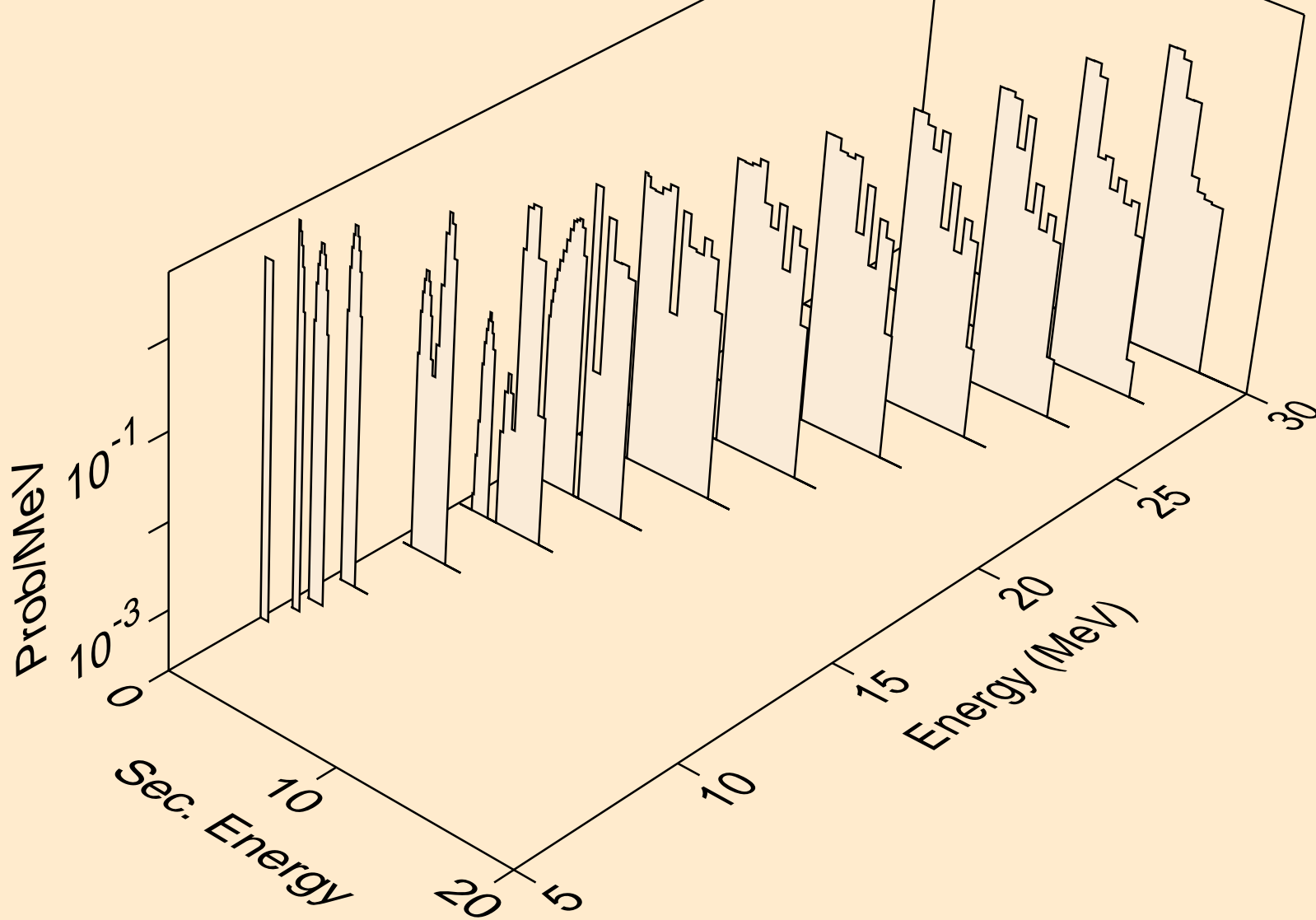

F022 NEUTRON ACER TENDL-2019 LIBRARY; T=293.16K  
alphas from (n,2a)

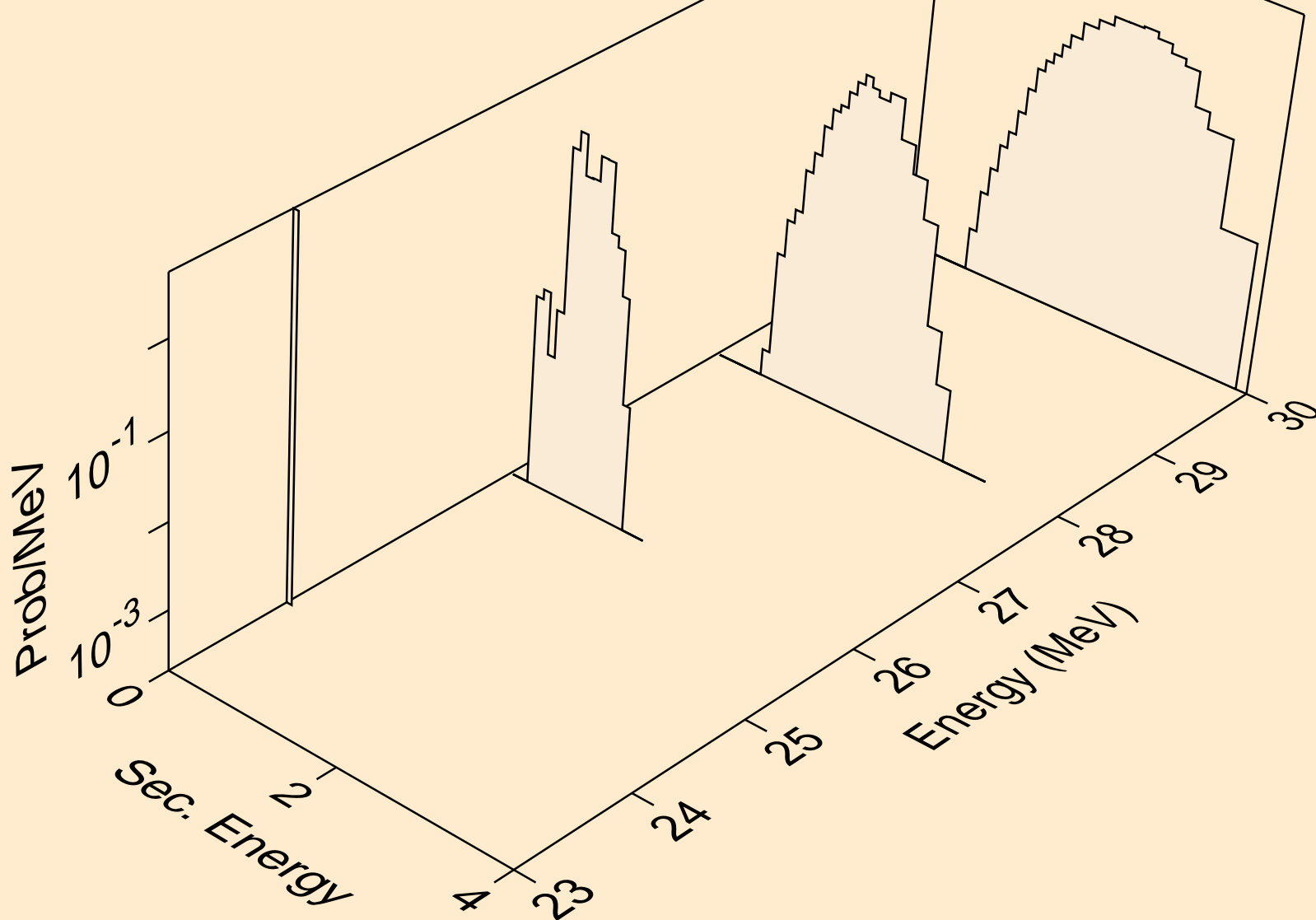

F022 NEUTRON ACER TENDL-2019 LIBRARY; T=293.16K  
alphas from (n,pa)

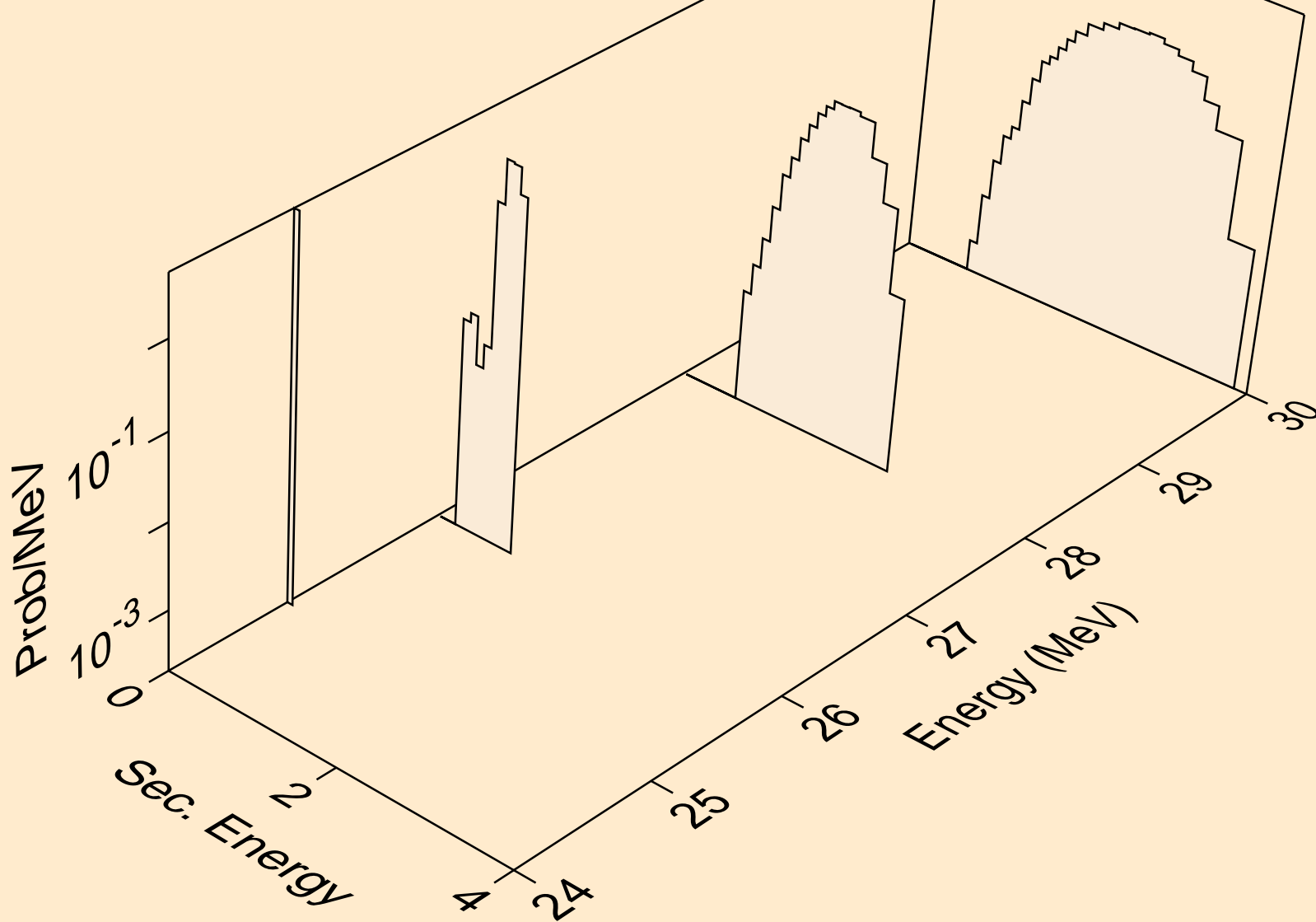

F022 NEUTRON ACER TENDL-2019 LIBRARY; T=293.16K  
alphas from (n,da)

