

F023 NEUTRON ACER TENDL-2019 LIBRARY; T=293.16K
Principal cross sections

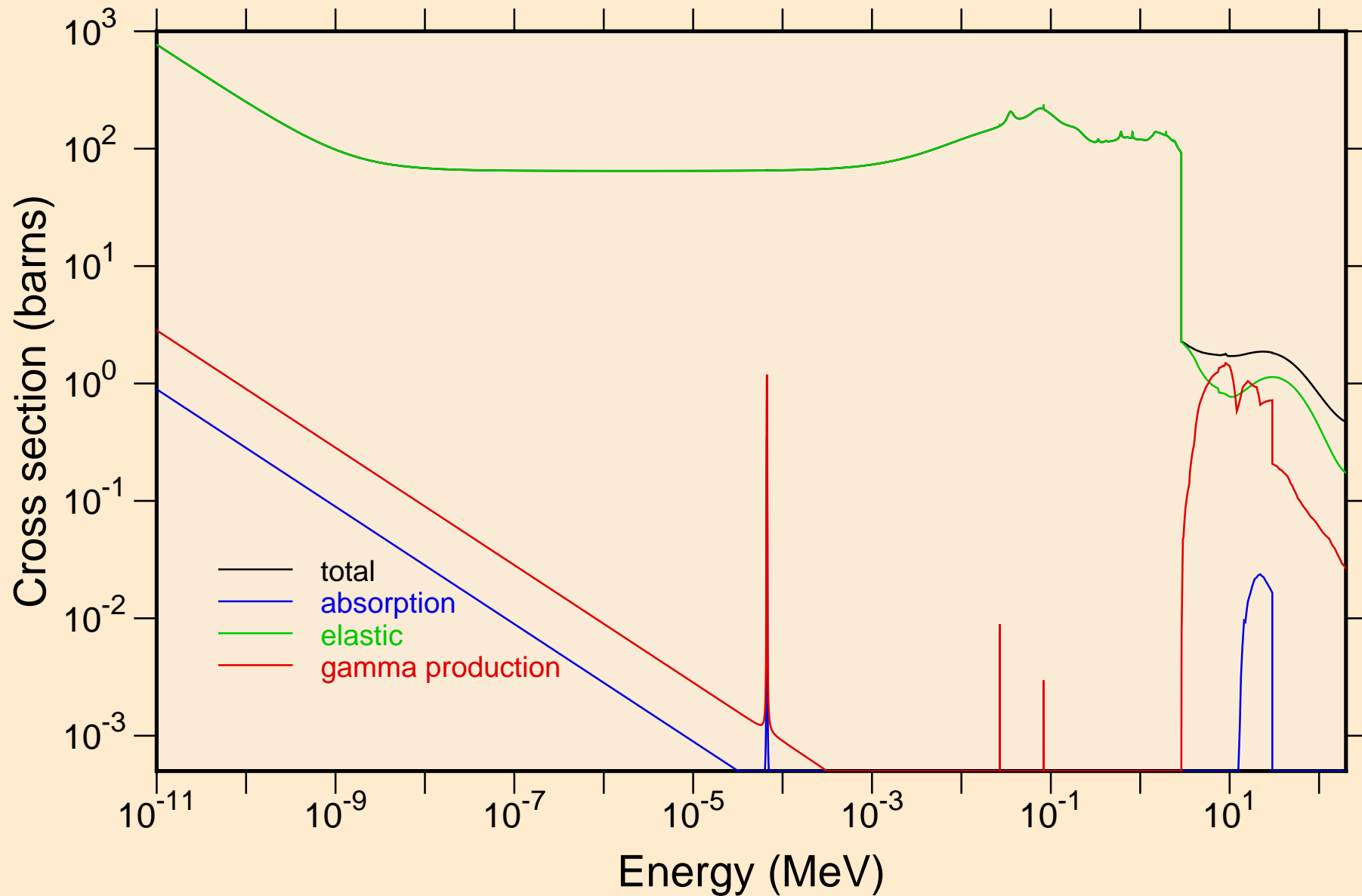

F023 NEUTRON ACER TENDL-2019 LIBRARY; T=293.16K
Heating

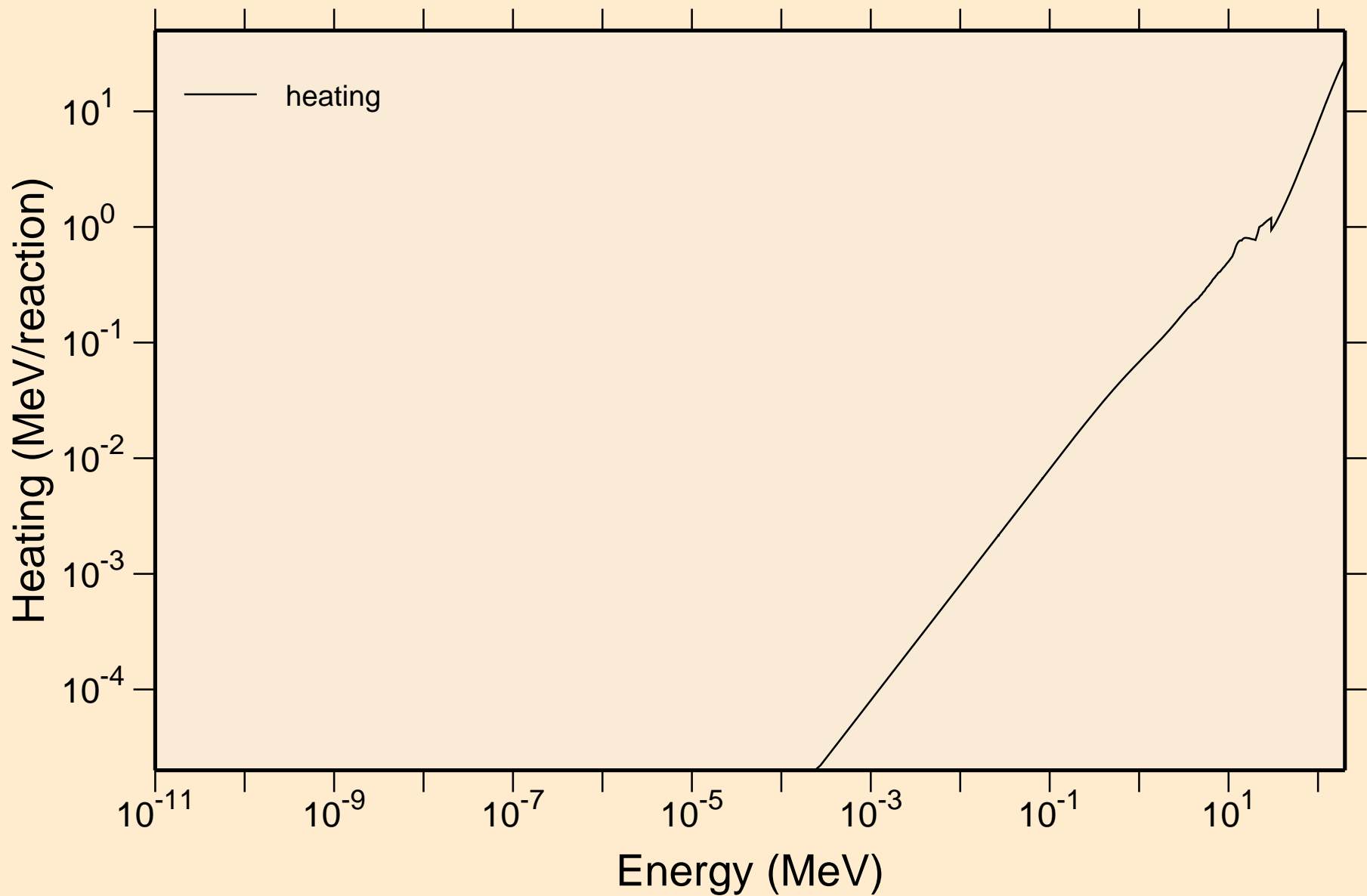

F023 NEUTRON ACER TENDL-2019 LIBRARY; T=293.16K
Damage

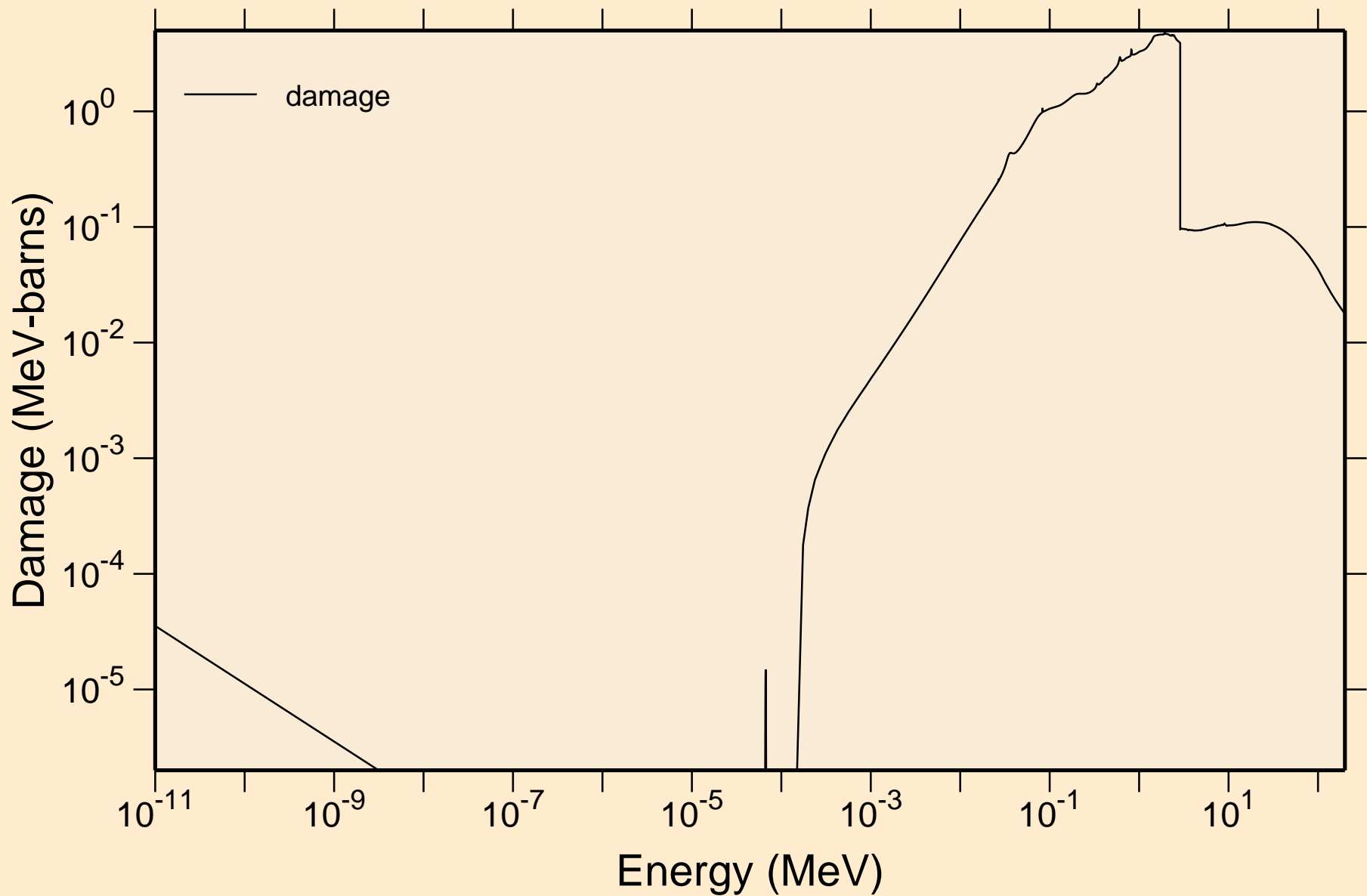

F023 NEUTRON ACER TENDL-2019 LIBRARY; T=293.16K
Non-threshold reactions

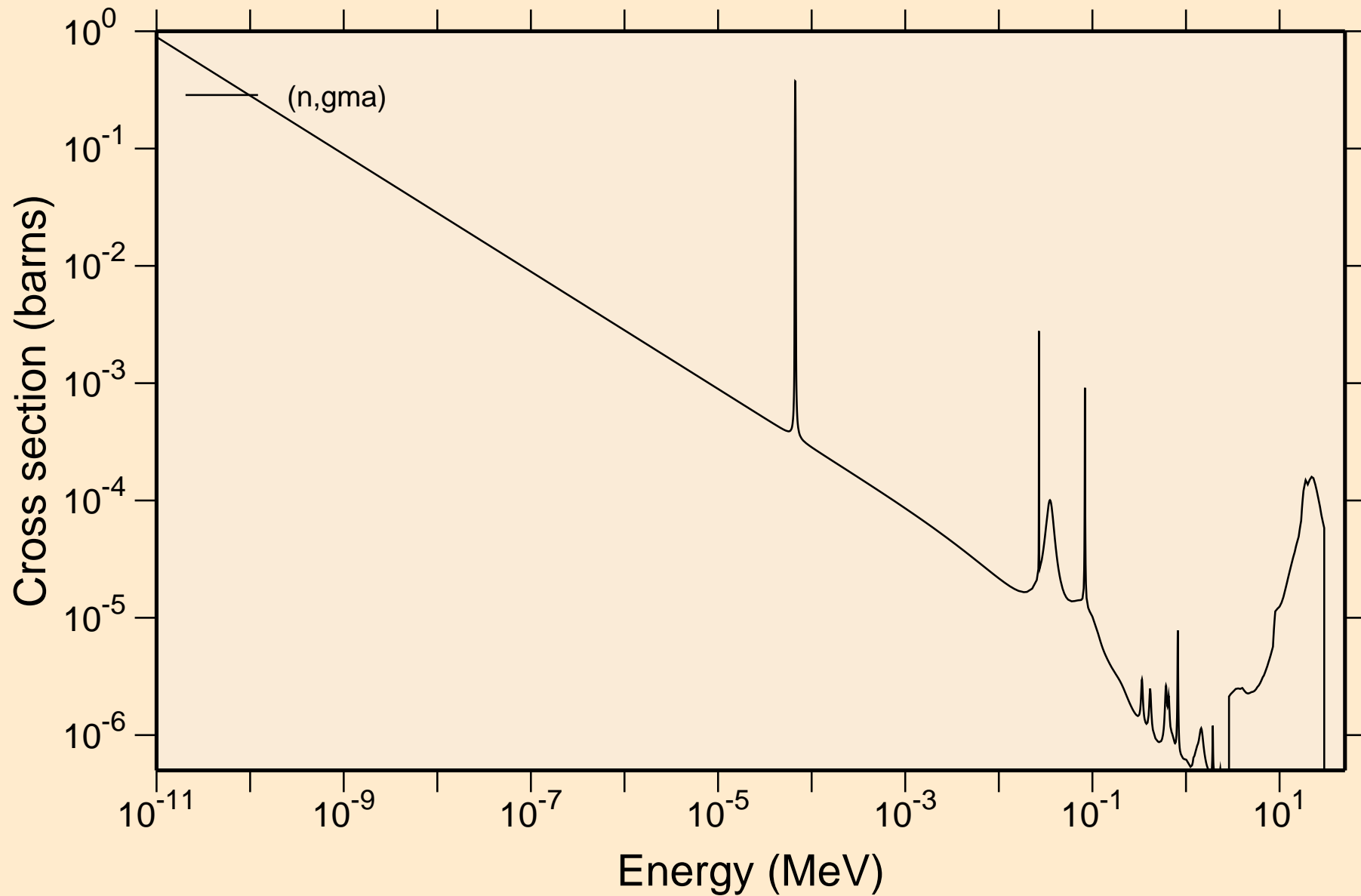

F023 NEUTRON ACER TENDL-2019 LIBRARY; T=293.16K
Principal cross sections

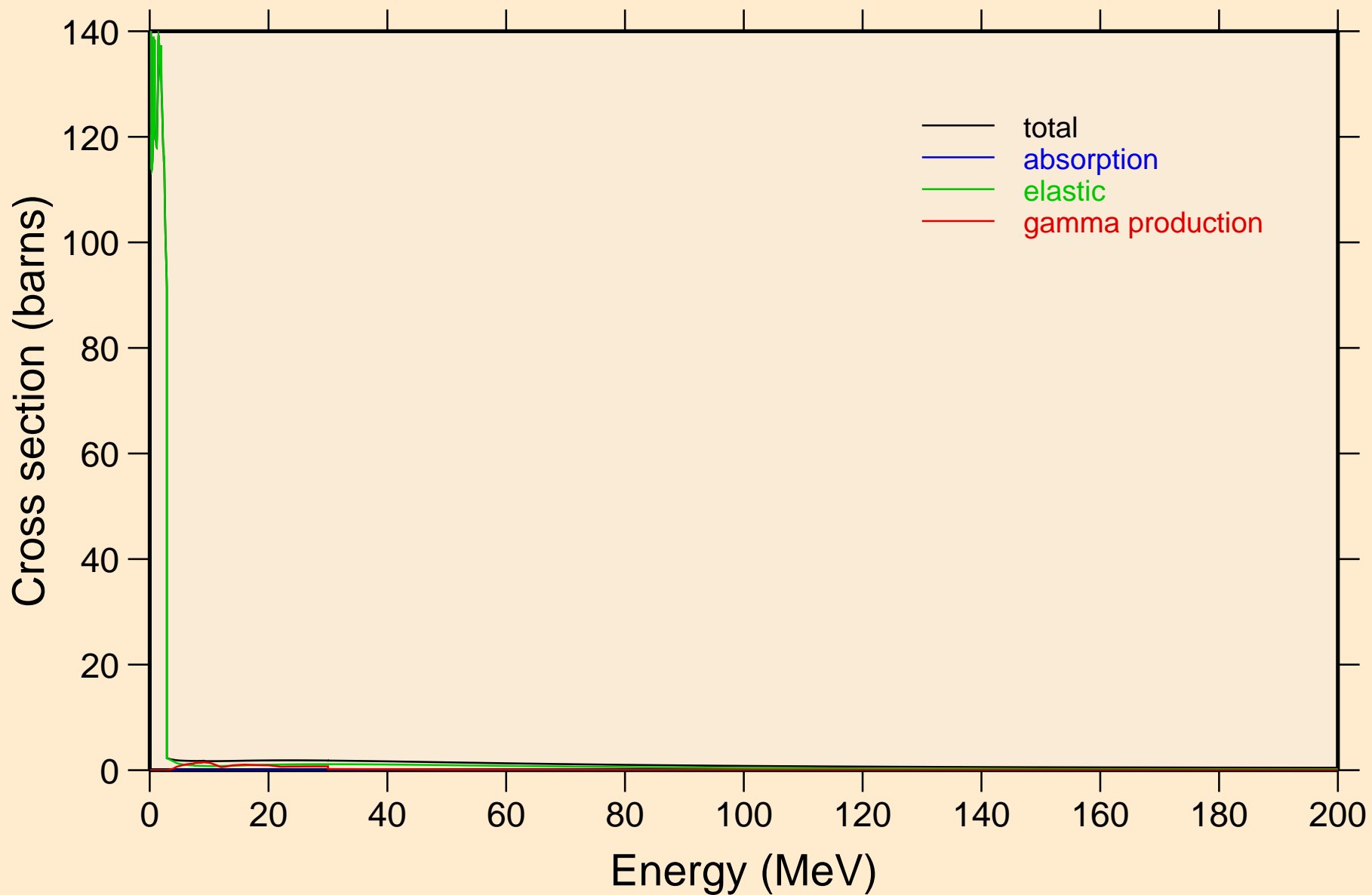

F023 NEUTRON ACER TENDL-2019 LIBRARY; T=293.16K
Heating

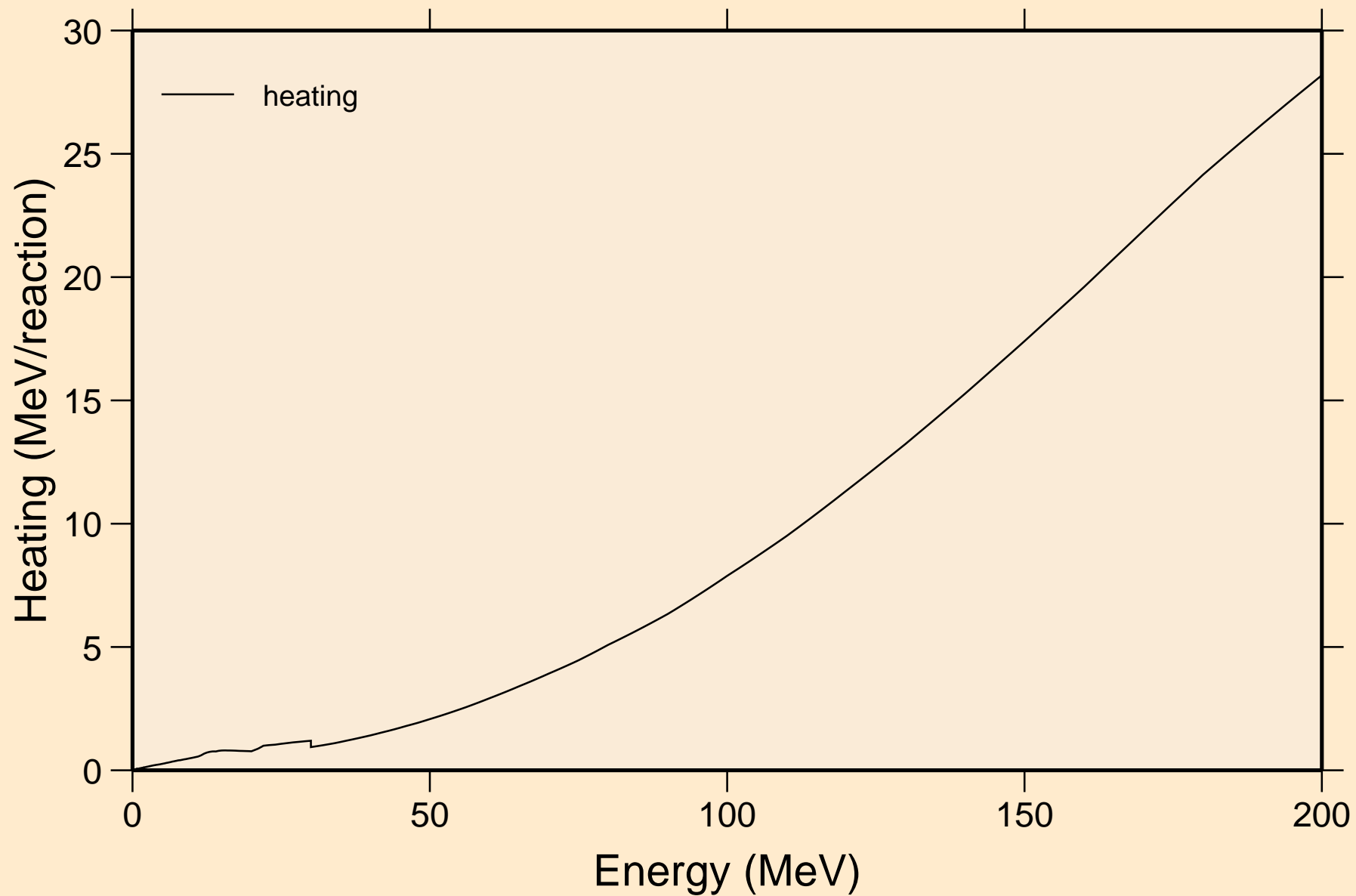

F023 NEUTRON ACER TENDL-2019 LIBRARY; T=293.16K
Damage

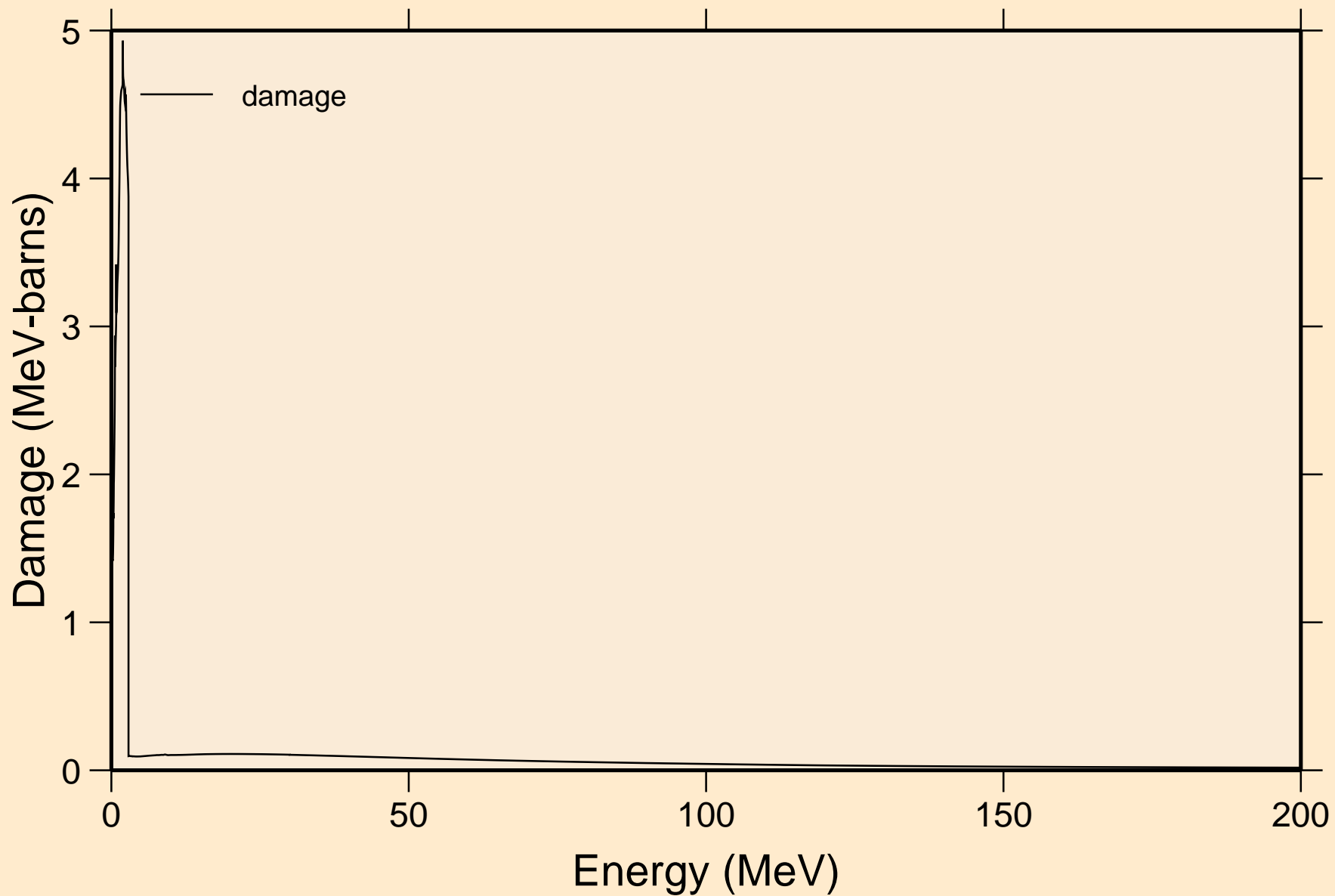

F023 NEUTRON ACER TENDL-2019 LIBRARY; T=293.16K
Non-threshold reactions

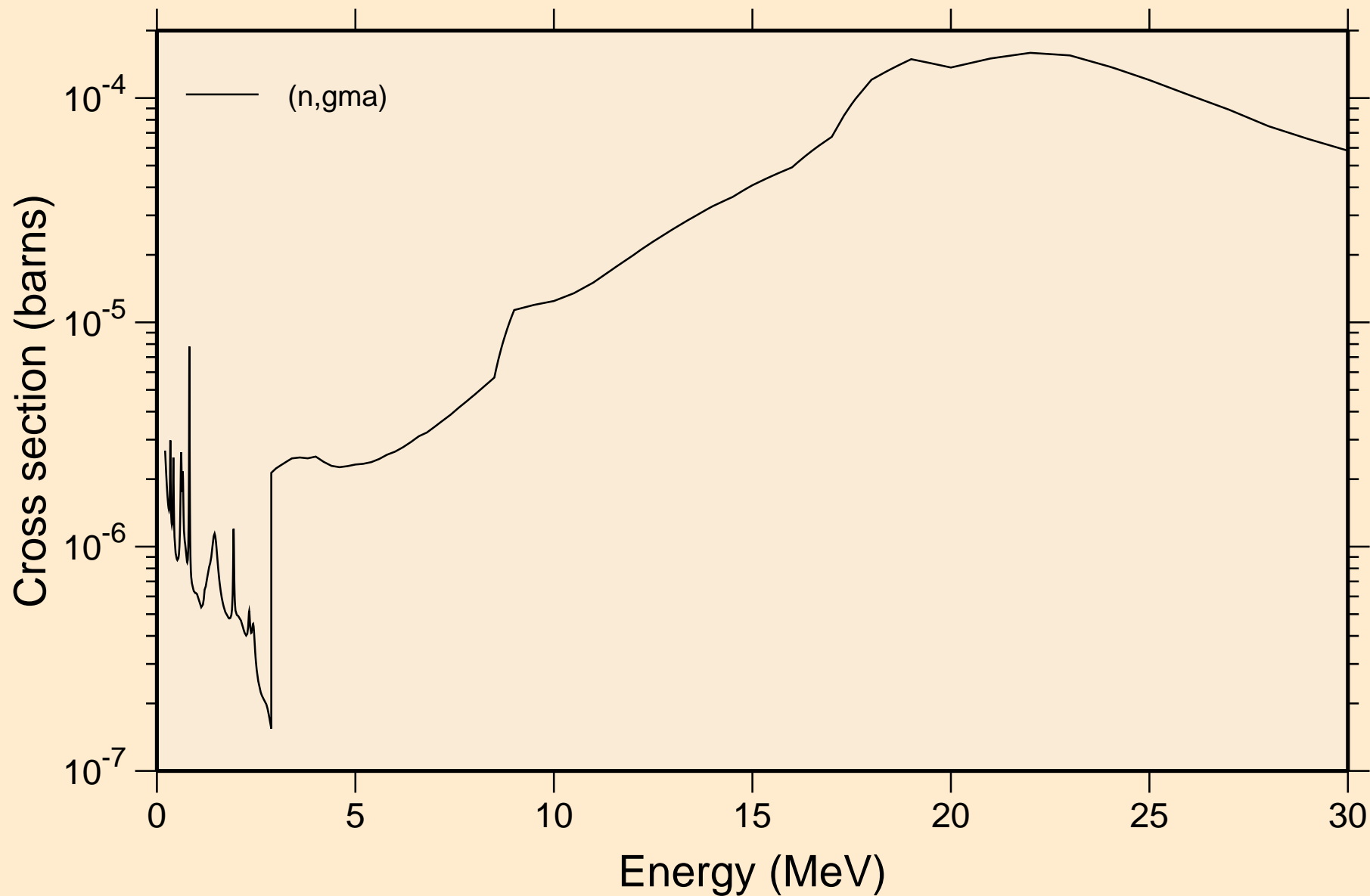

F023 NEUTRON ACER TENDL-2019 LIBRARY; T=293.16K
Inelastic levels

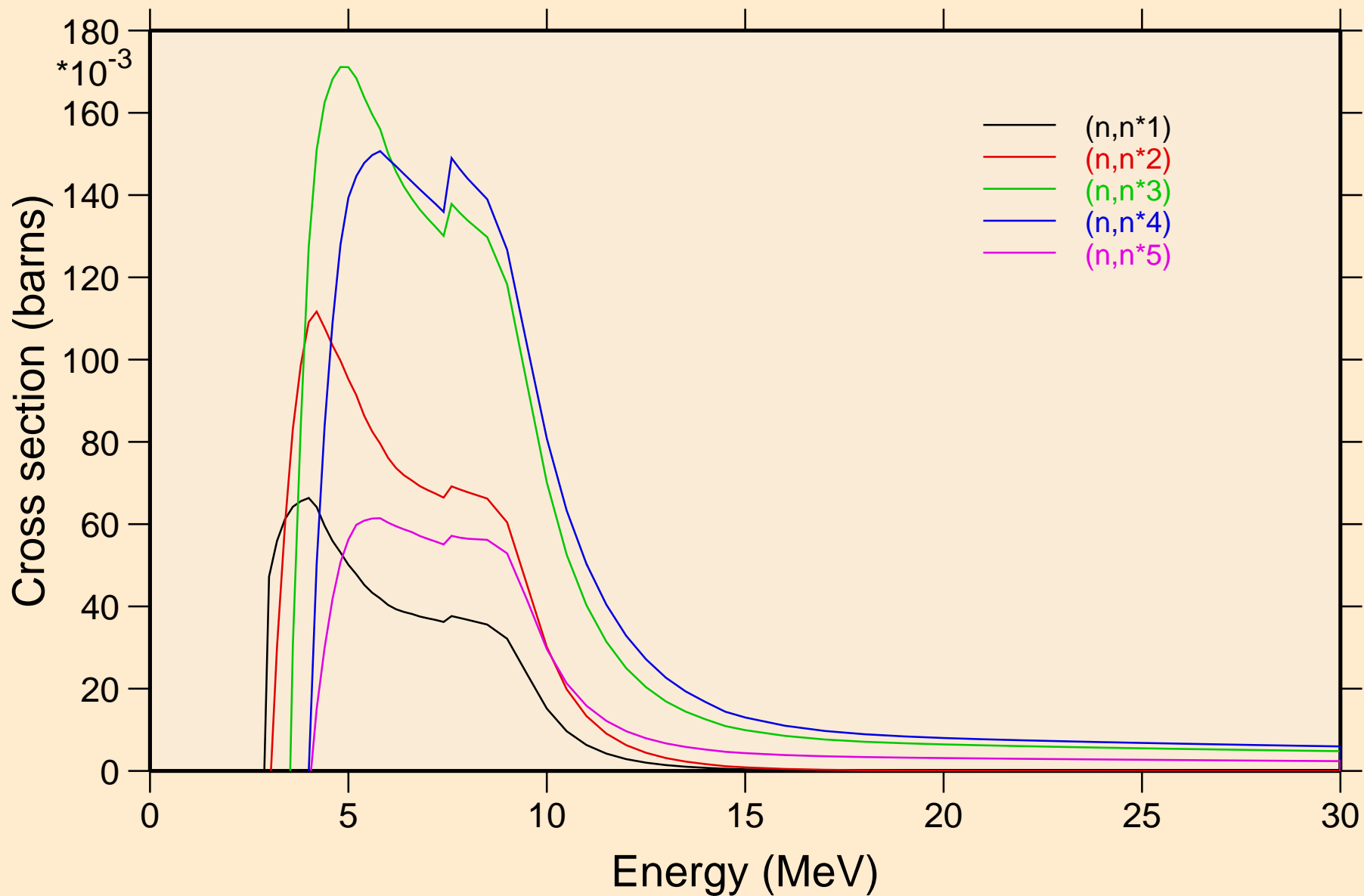

F023 NEUTRON ACER TENDL-2019 LIBRARY; T=293.16K
Inelastic levels

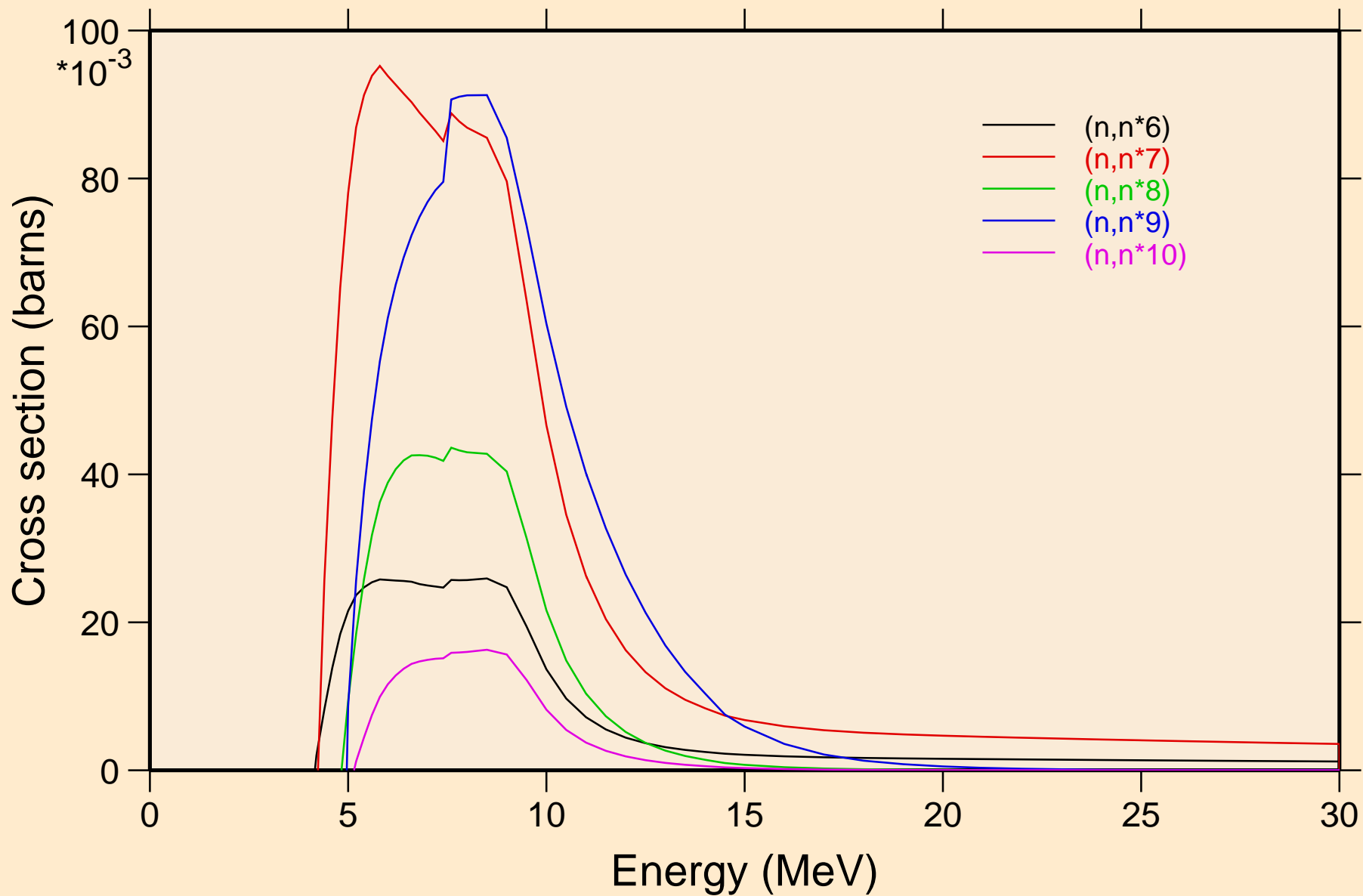

F023 NEUTRON ACER TENDL-2019 LIBRARY; T=293.16K
Inelastic levels

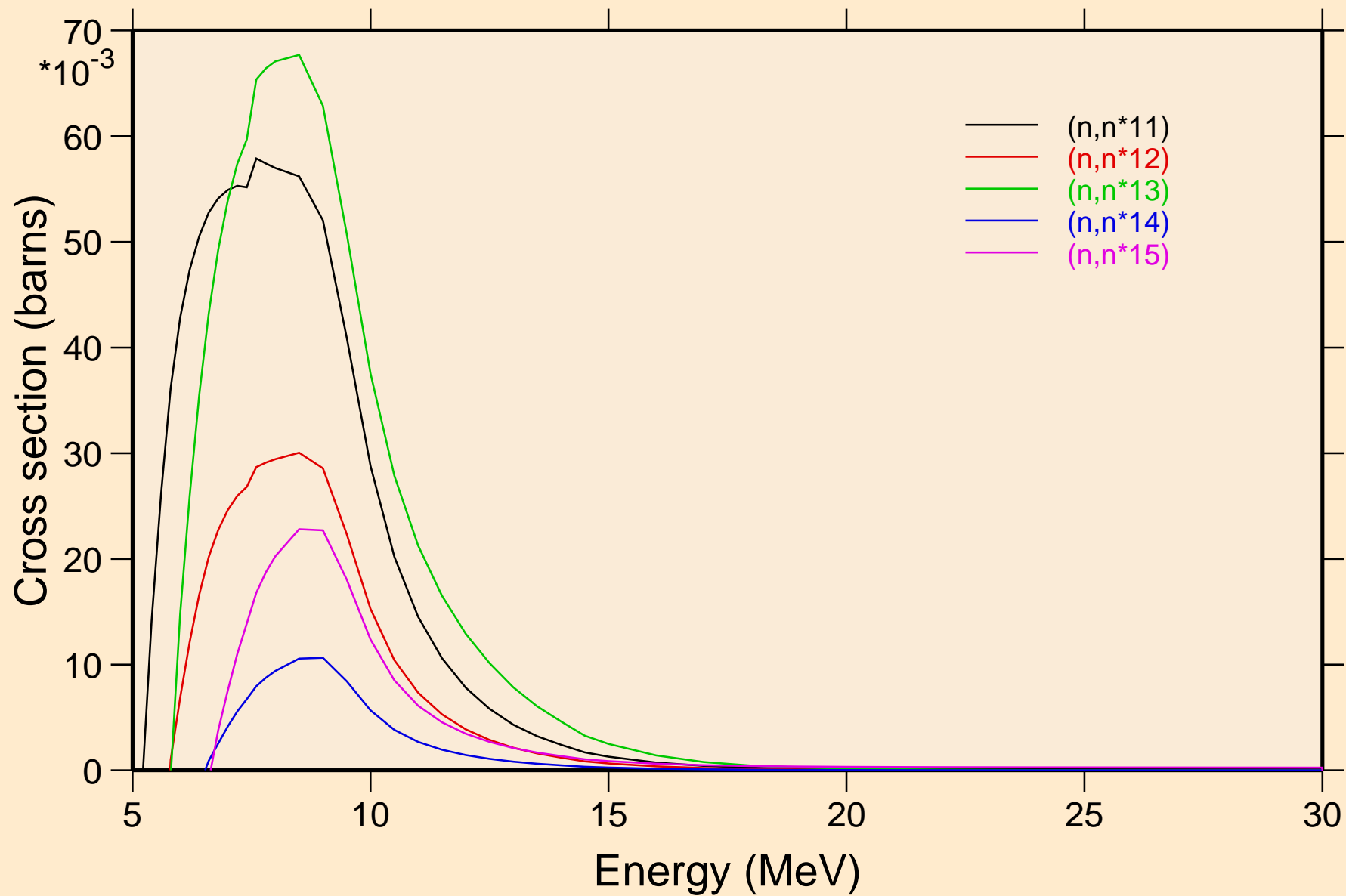

F023 NEUTRON ACER TENDL-2019 LIBRARY; T=293.16K
Inelastic levels

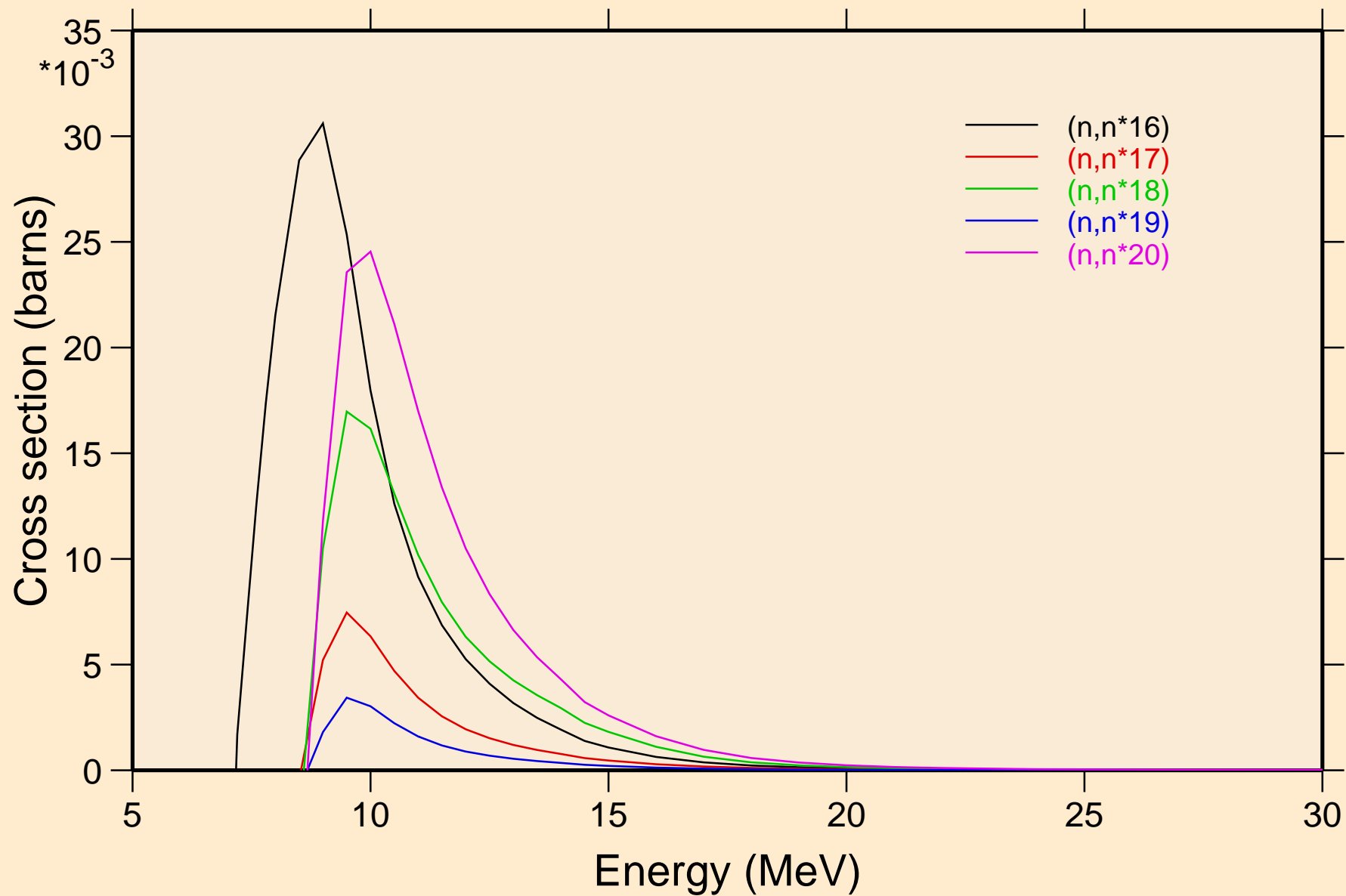

F023 NEUTRON ACER TENDL-2019 LIBRARY; T=293.16K
Inelastic levels

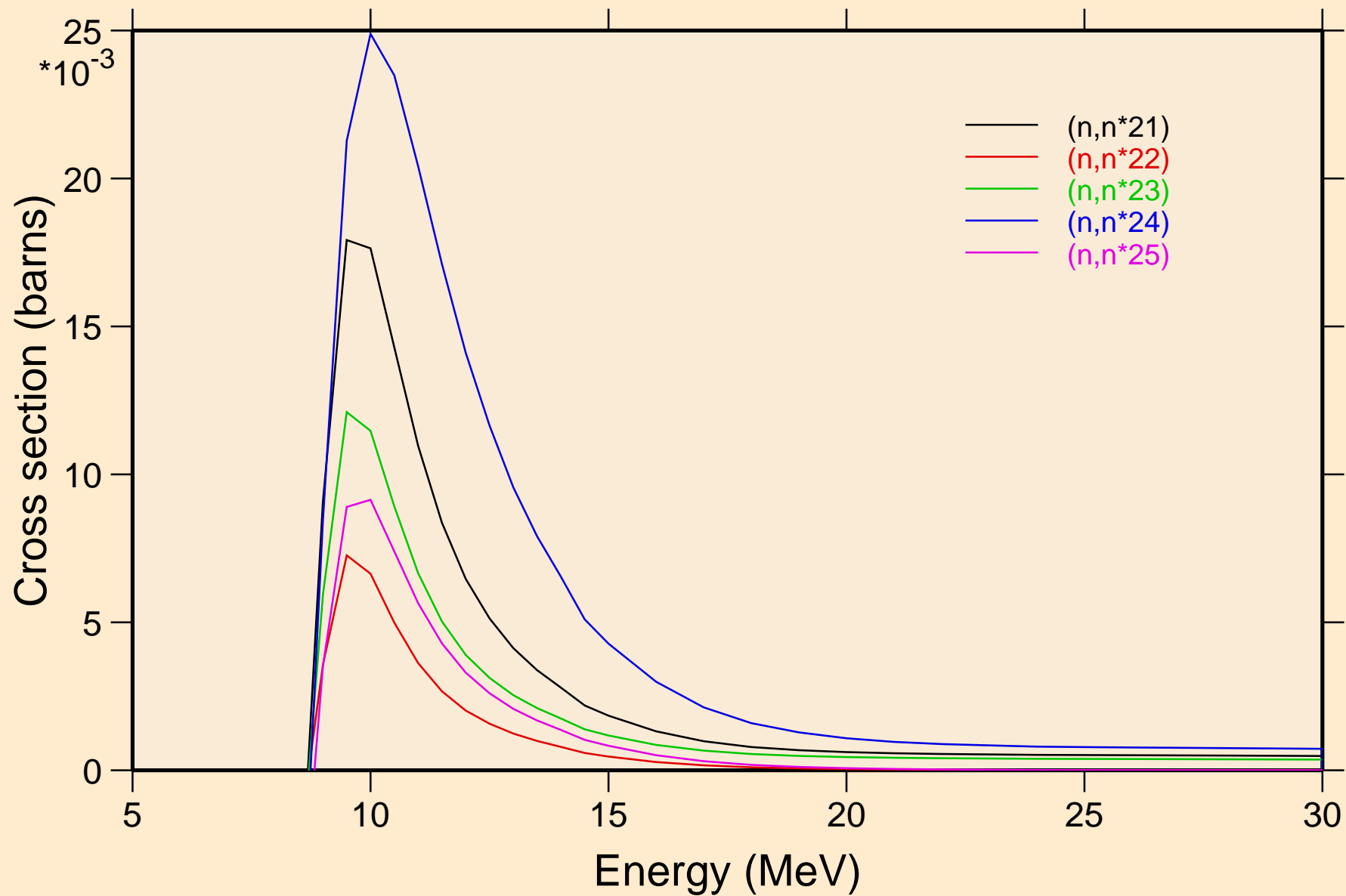

F023 NEUTRON ACER TENDL-2019 LIBRARY; T=293.16K
Inelastic levels

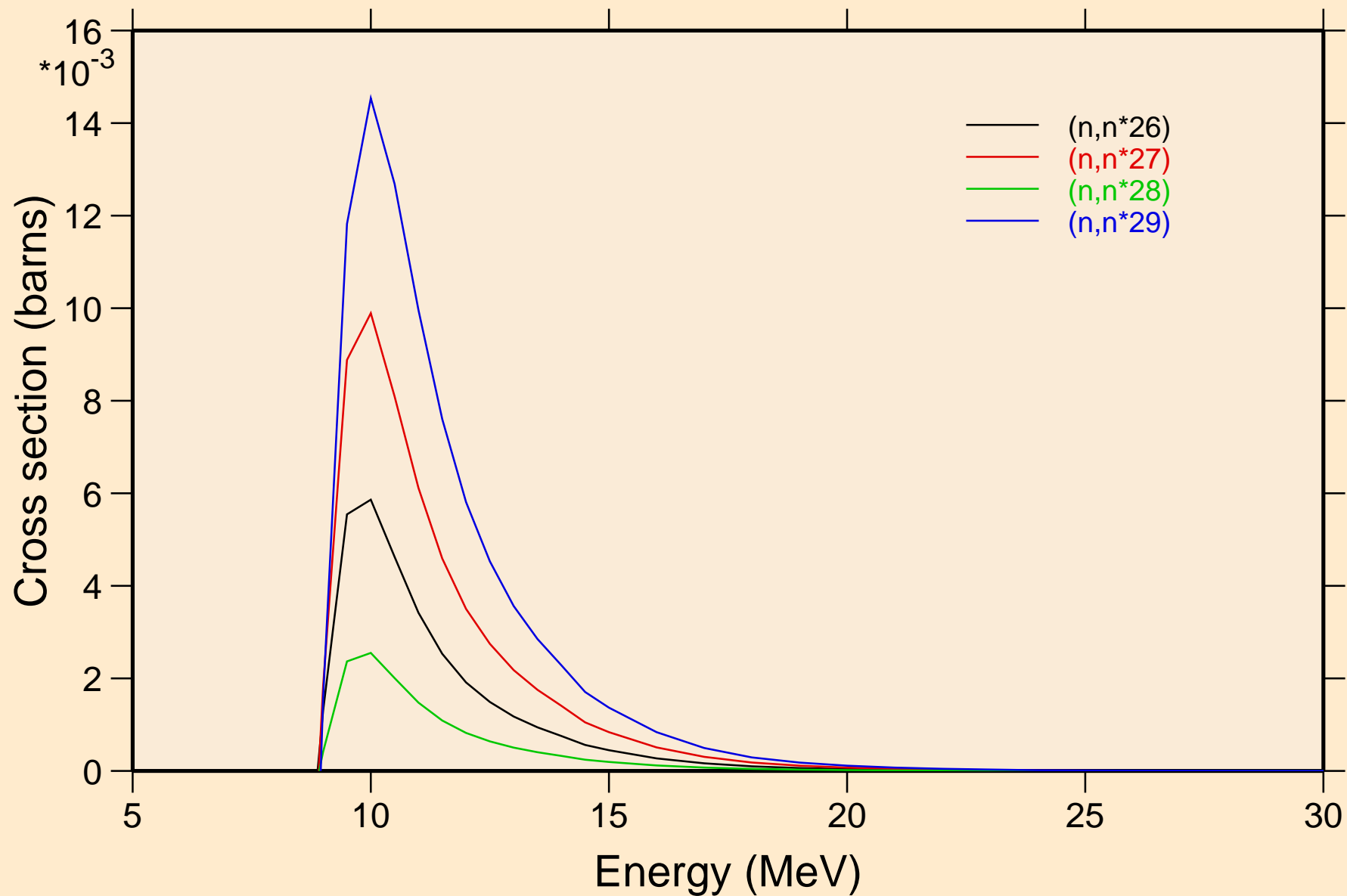

F023 NEUTRON ACER TENDL-2019 LIBRARY; T=293.16K
Threshold reactions

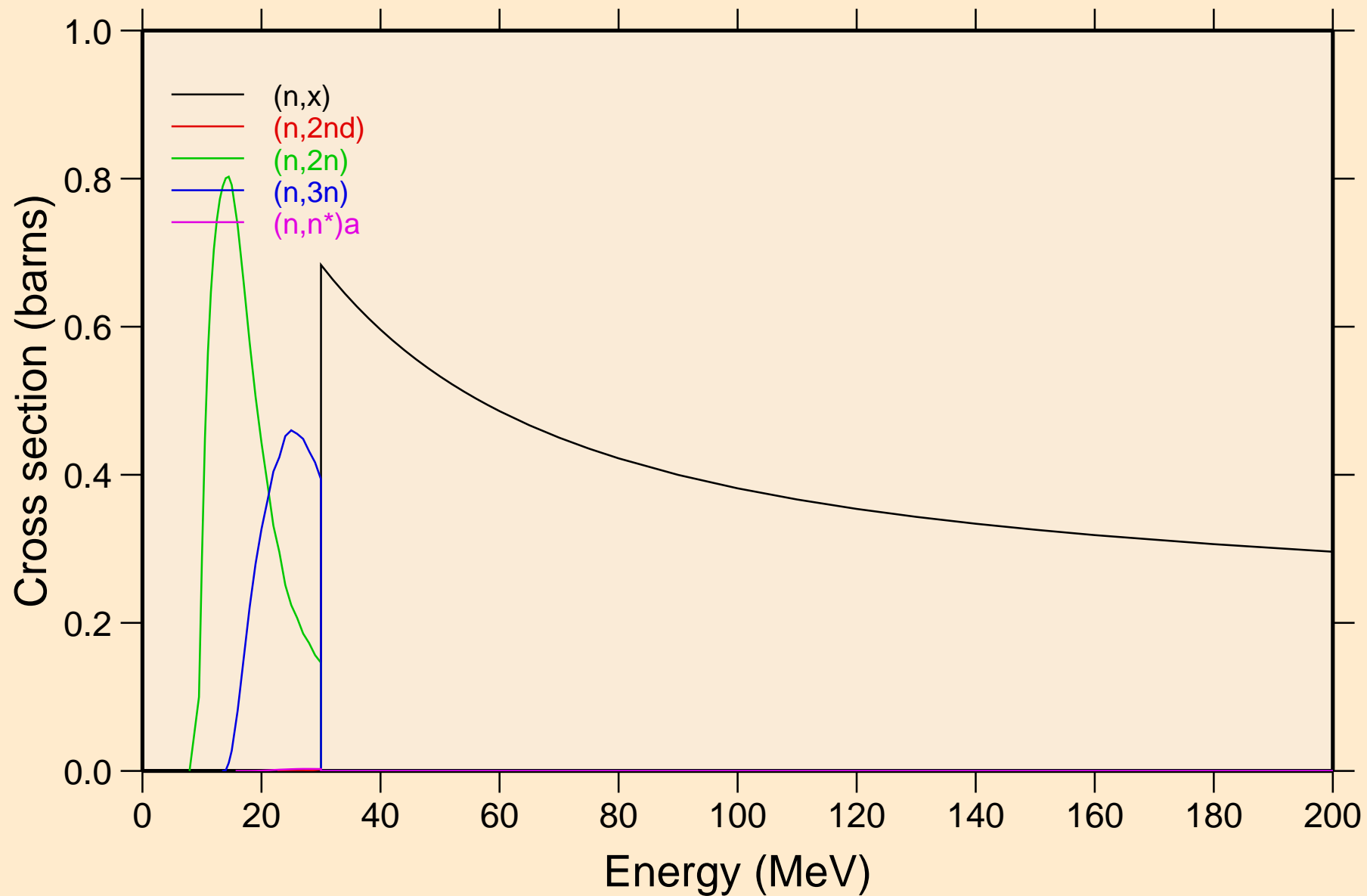

F023 NEUTRON ACER TENDL-2019 LIBRARY; T=293.16K
Threshold reactions

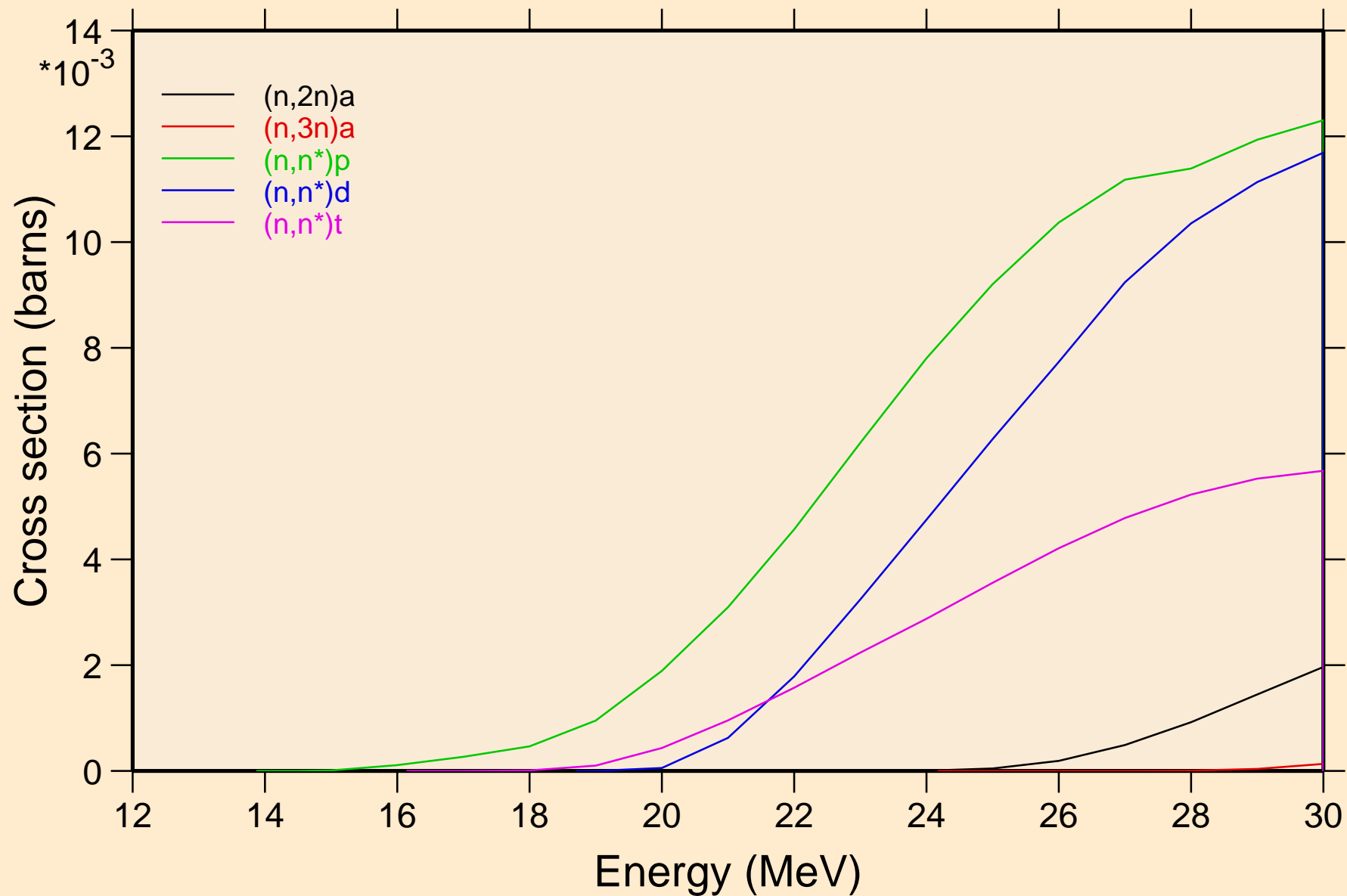

F023 NEUTRON ACER TENDL-2019 LIBRARY; T=293.16K
Threshold reactions

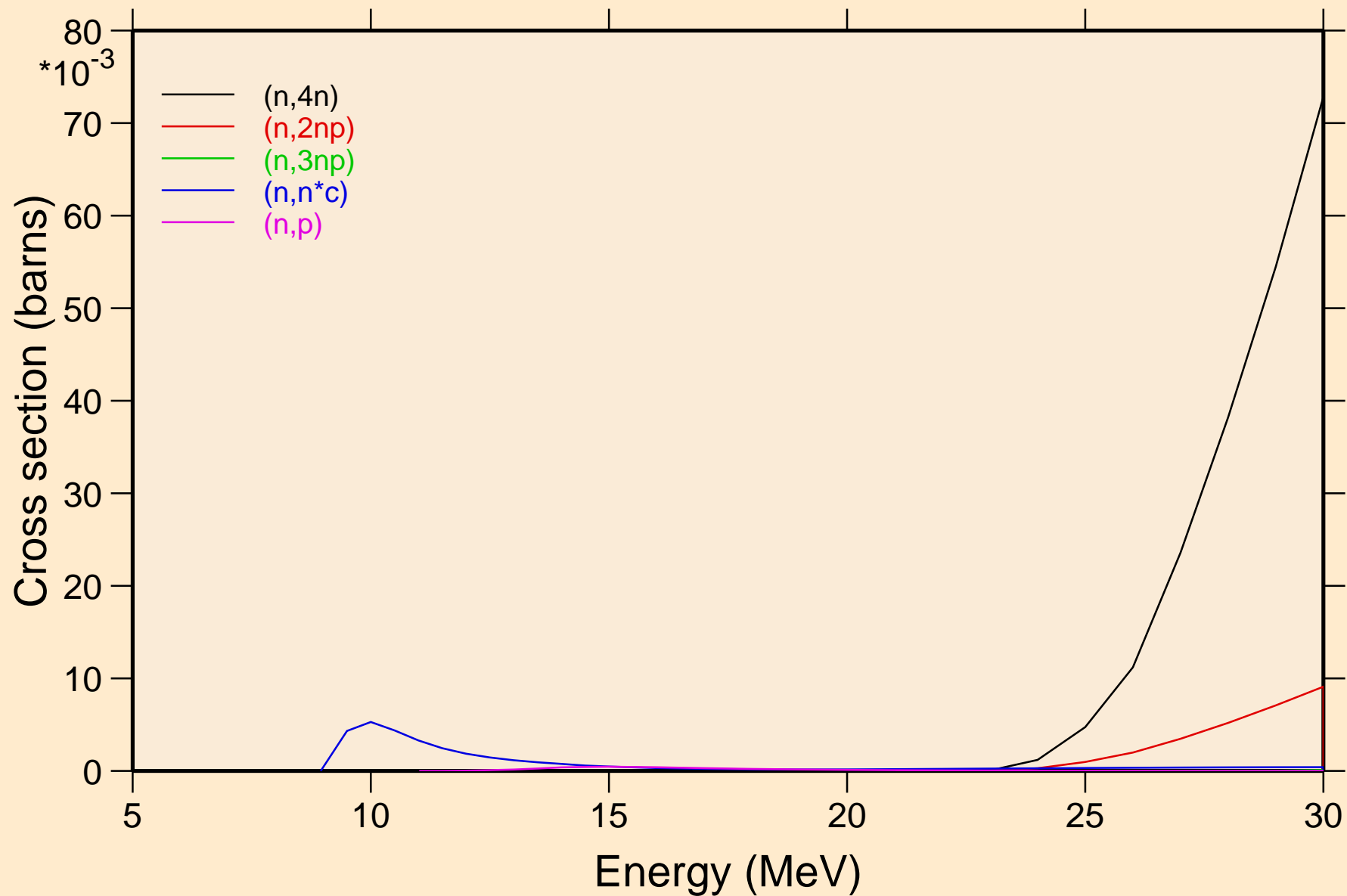

F023 NEUTRON ACER TENDL-2019 LIBRARY; T=293.16K
Threshold reactions

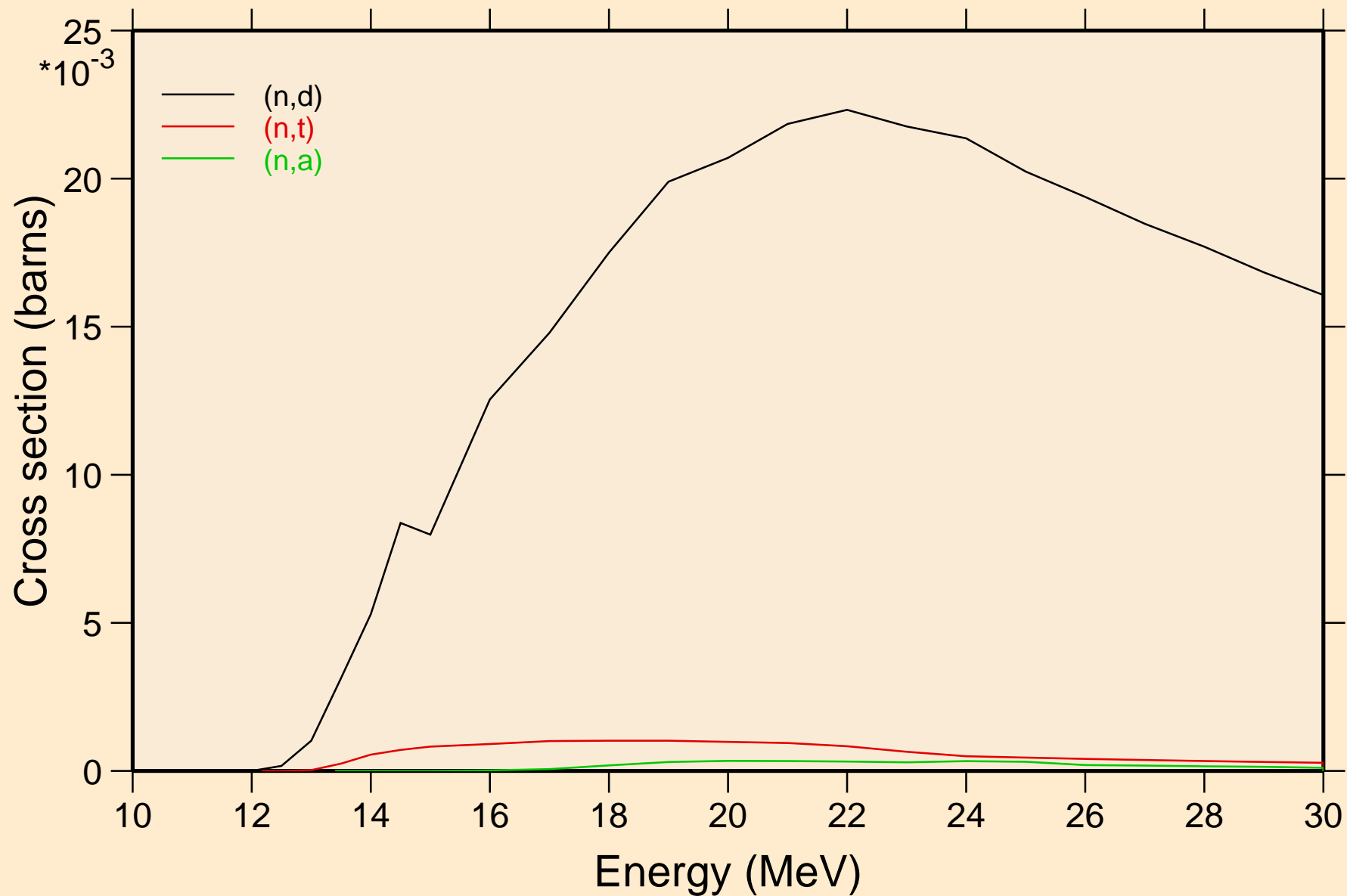

F023 NEUTRON ACER TENDL-2019 LIBRARY; T=293.16K
Threshold reactions

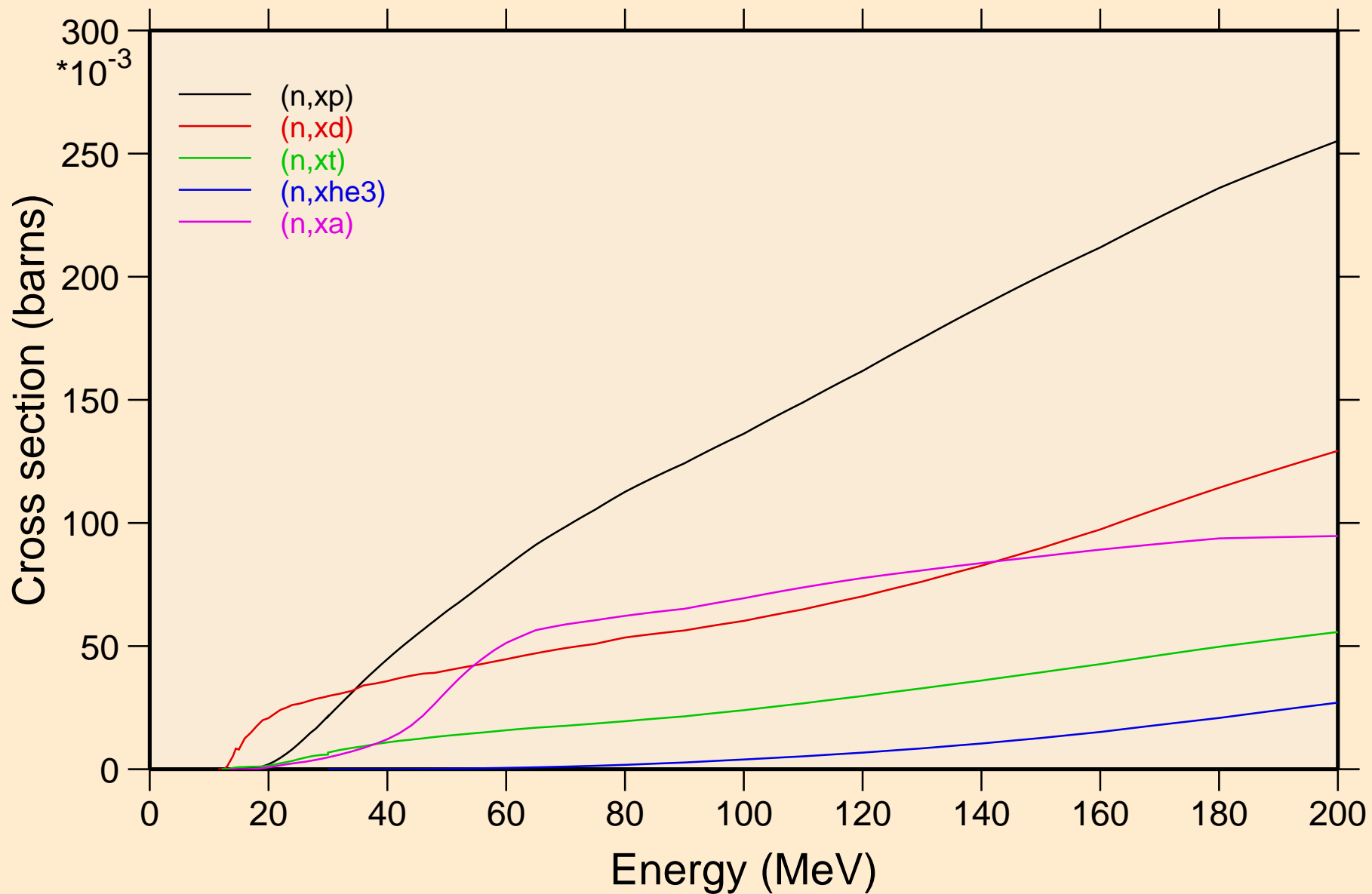

F023 NEUTRON ACER TENDL-2019 LIBRARY; T=293.16K
angular distribution for elastic

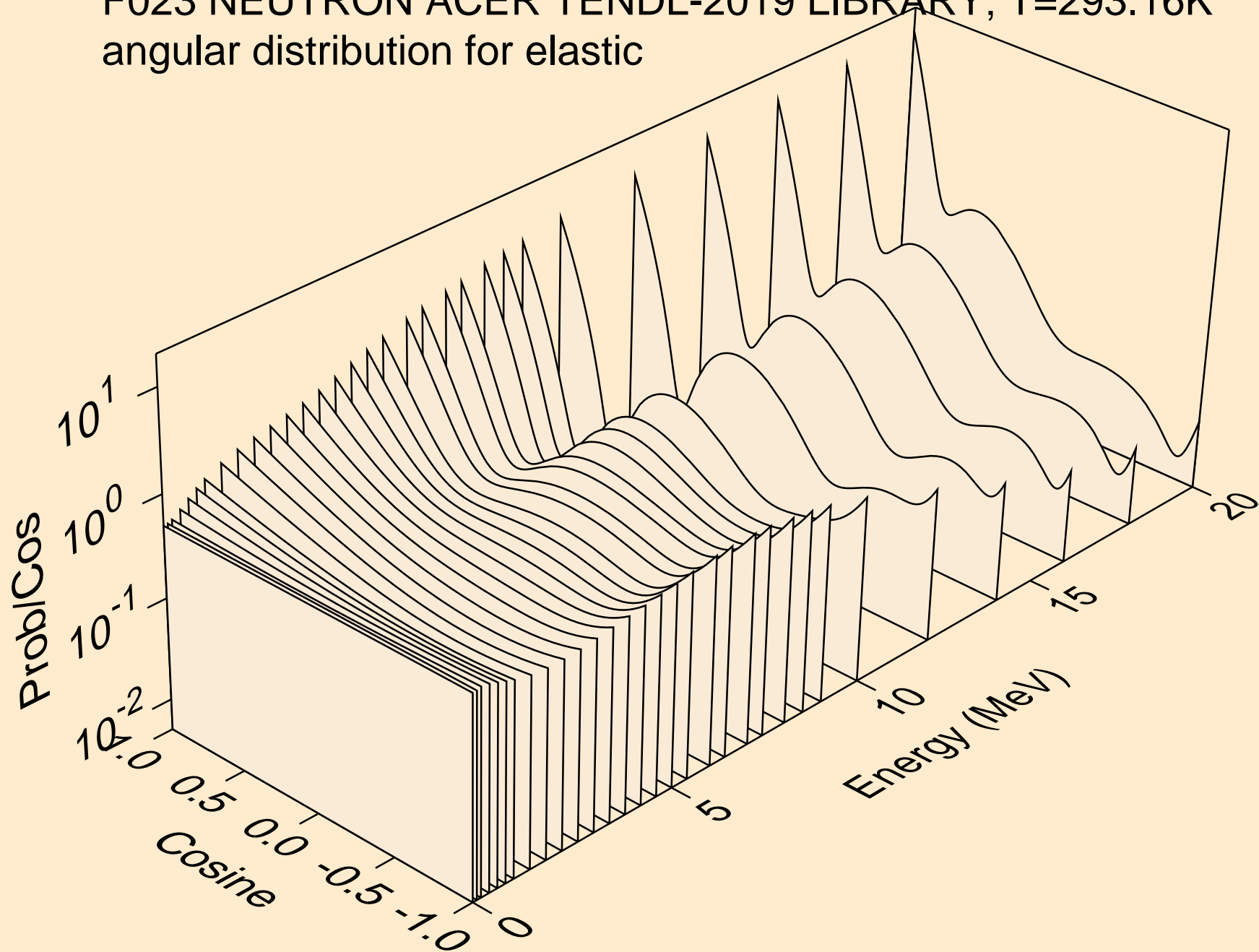

F023 NEUTRON ACER TENDL-2019 LIBRARY; T=293.16K
angular distribution for elastic

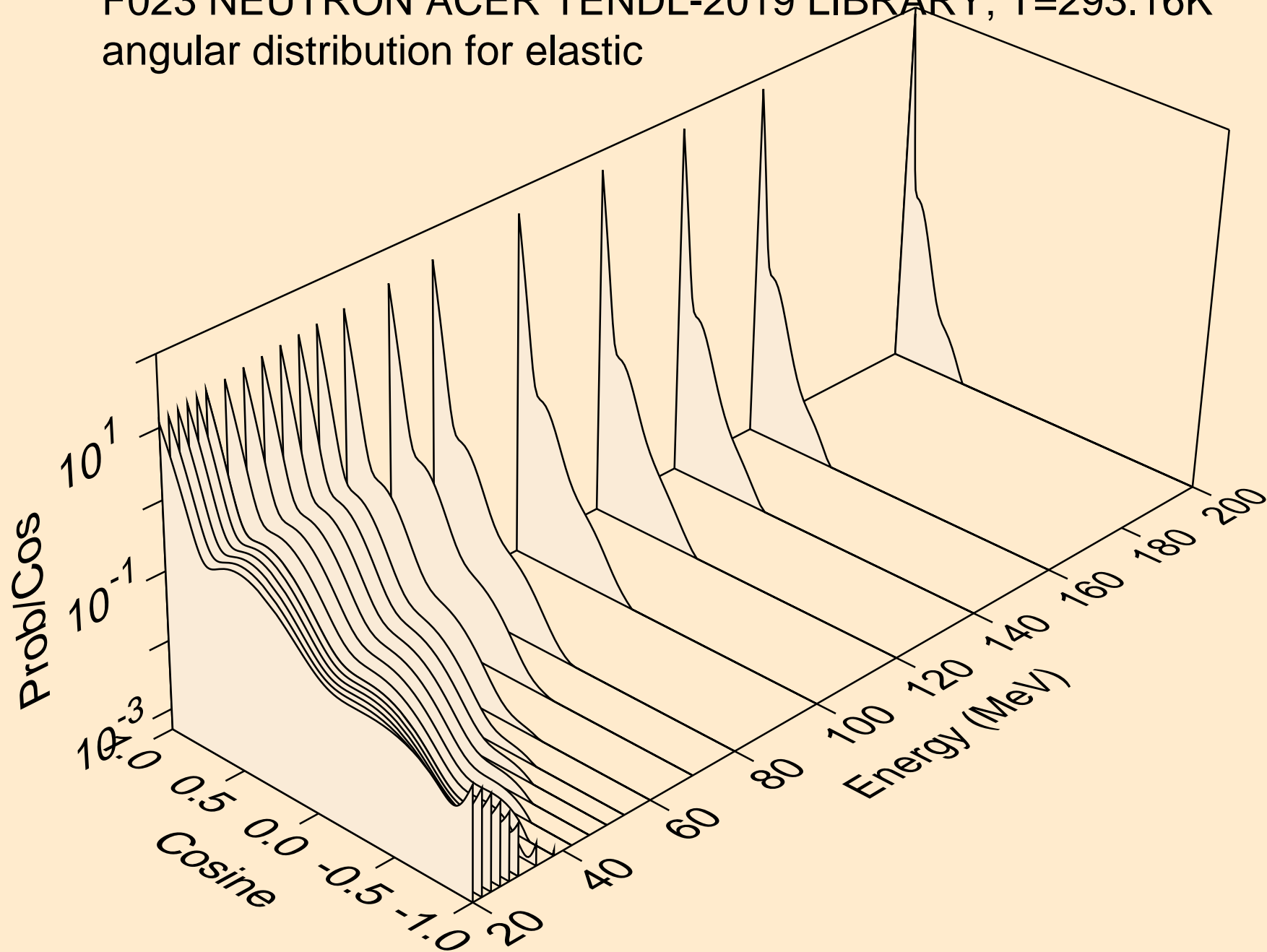

F023 NEUTRON ACER TENDL-2019 LIBRARY; T=293.16K
angular distribution for (n,n*1)

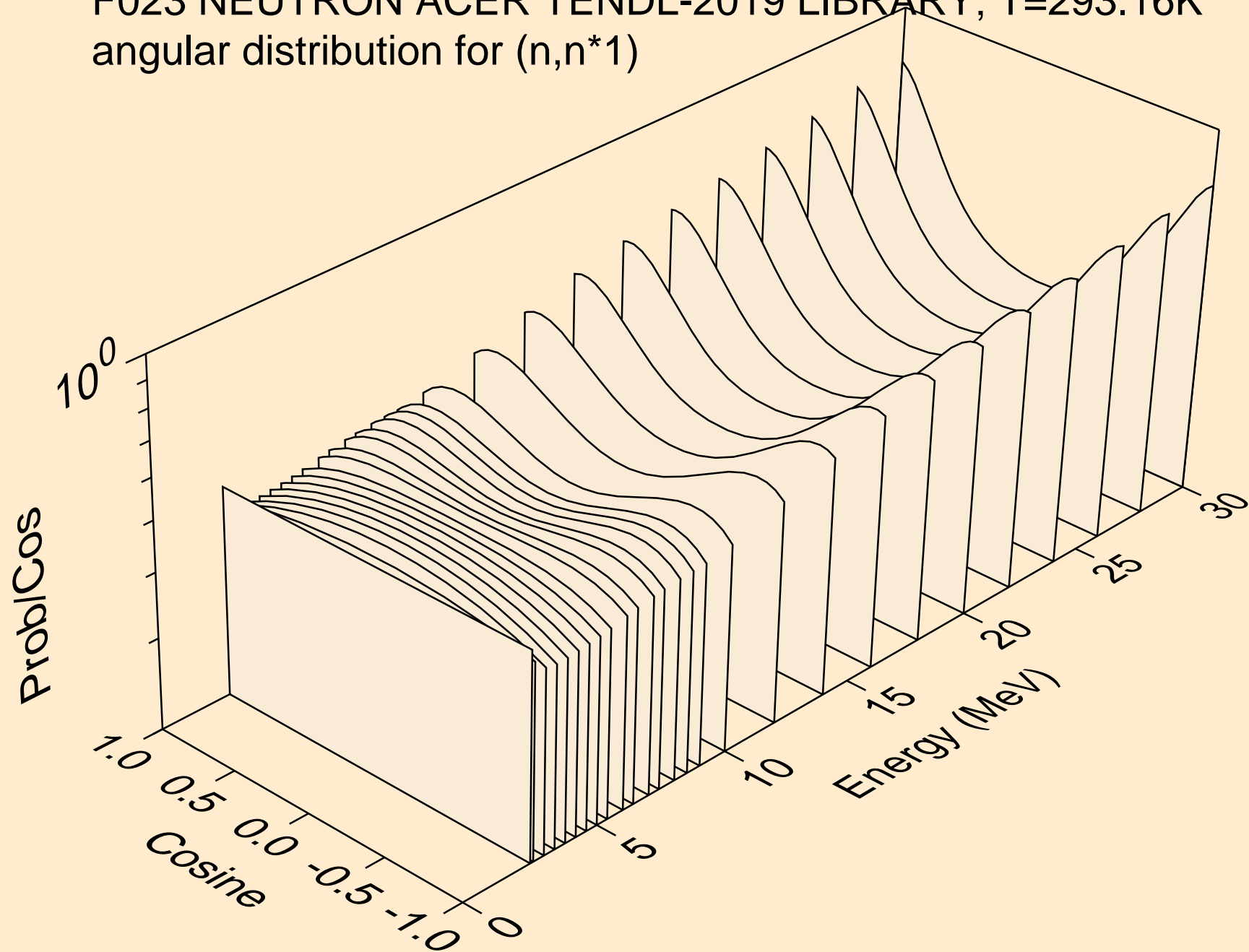

F023 NEUTRON ACER TENDL-2019 LIBRARY; T=293.16K
angular distribution for (n,n*2)

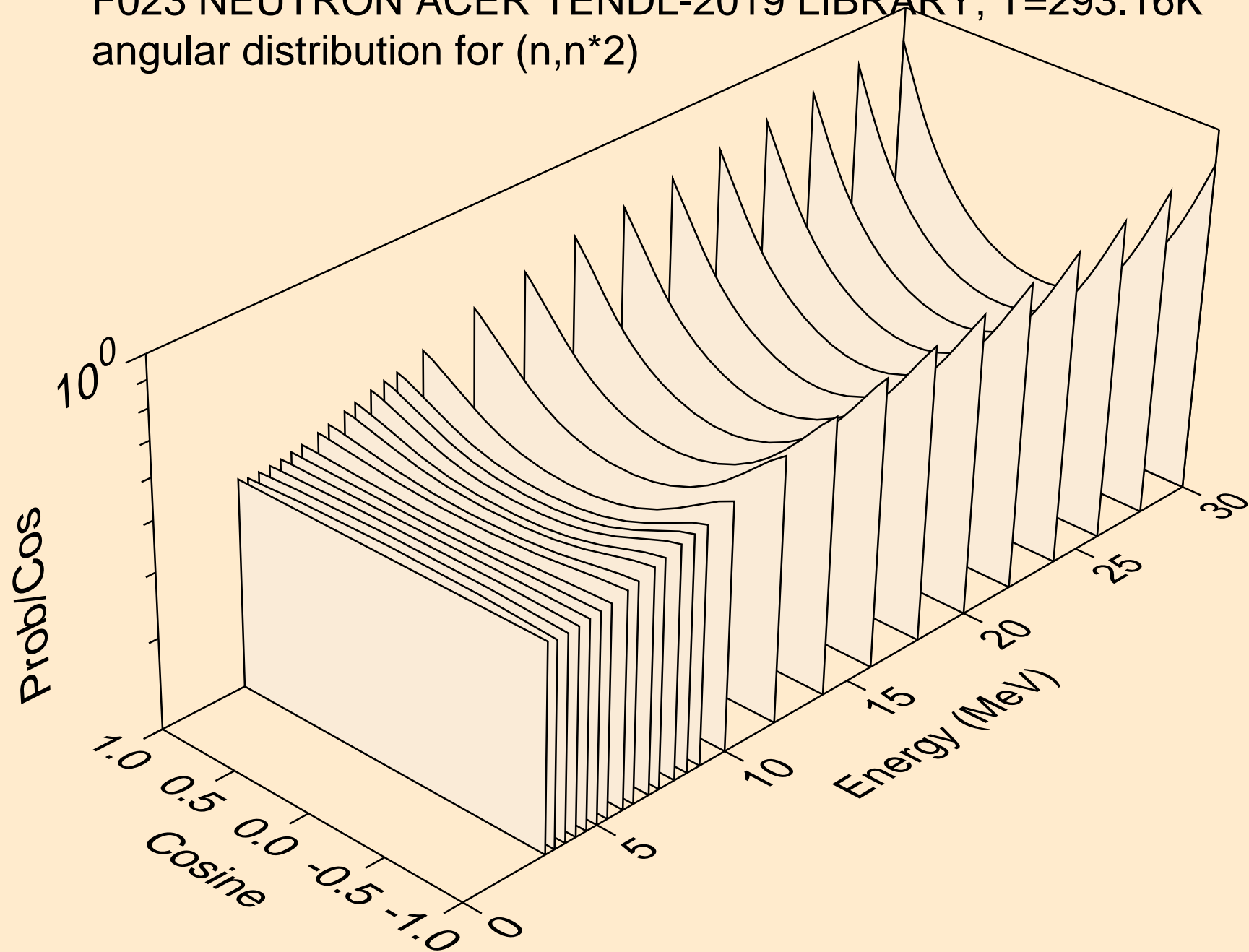

F023 NEUTRON ACER TENDL-2019 LIBRARY; T=293.16K
angular distribution for (n,n*3)

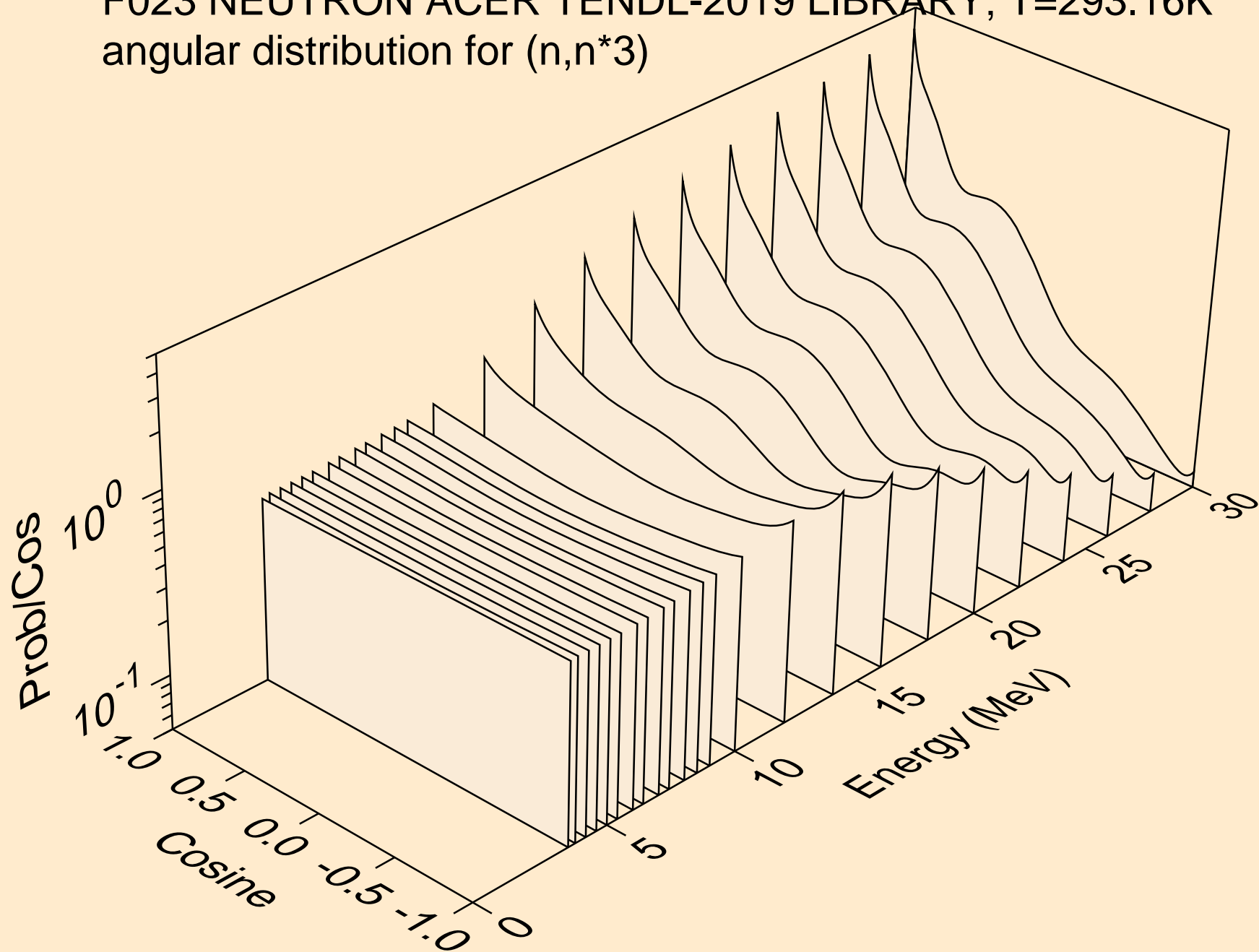

F023 NEUTRON ACER TENDL-2019 LIBRARY; T=293.16K
angular distribution for (n,n*4)

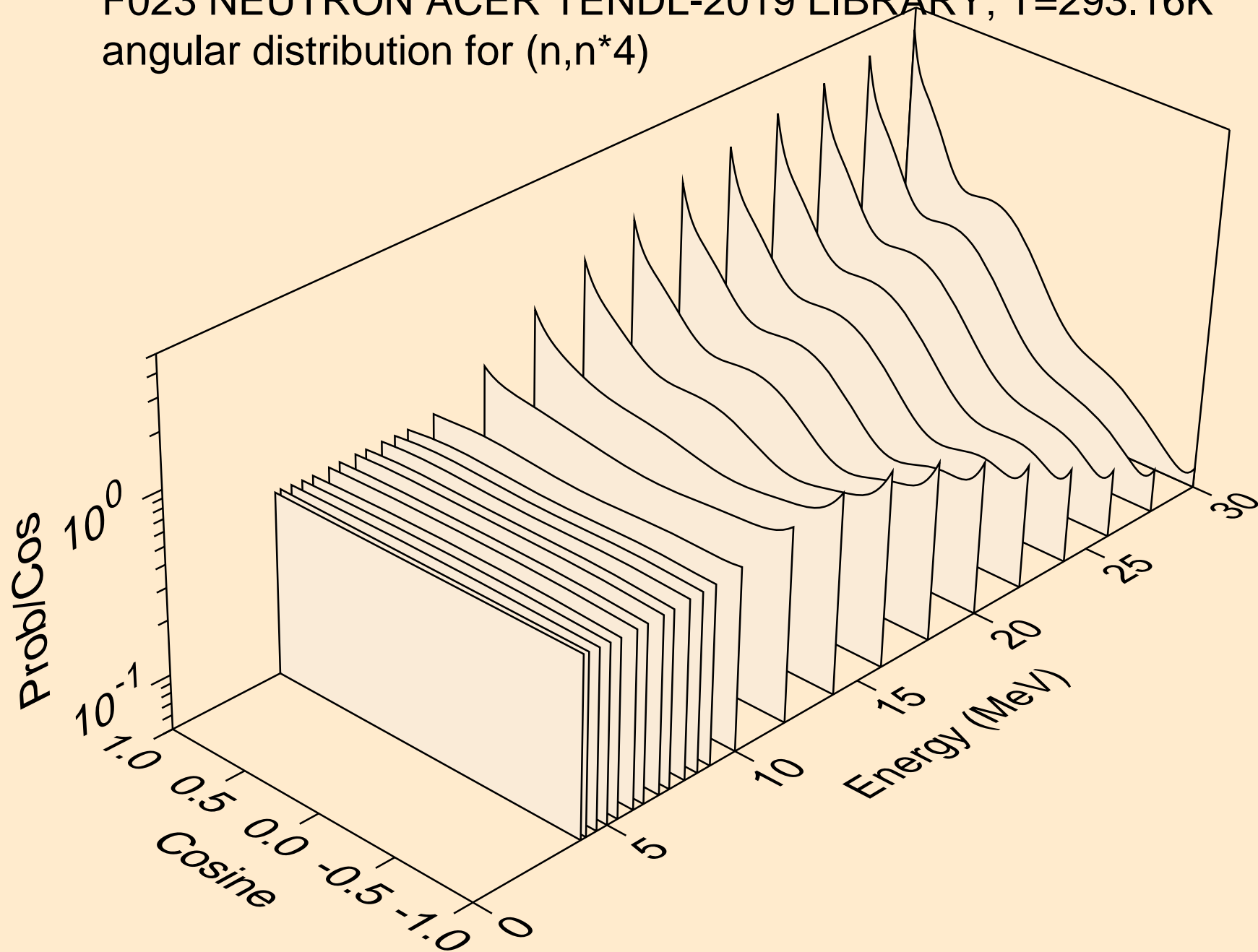

F023 NEUTRON ACER TENDL-2019 LIBRARY; T=293.16K
angular distribution for (n,n*5)

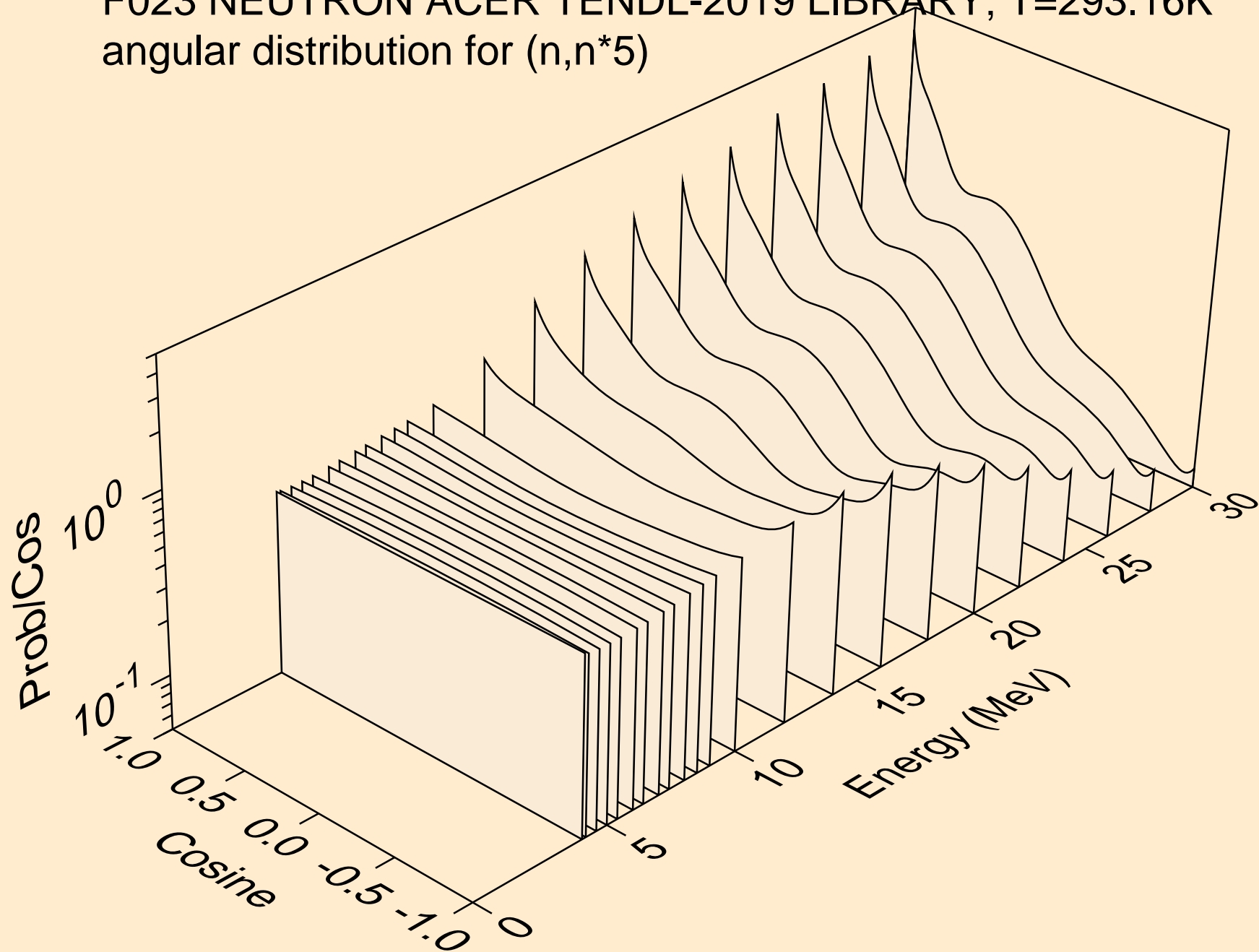

F023 NEUTRON ACER TENDL-2019 LIBRARY; T=293.16K
angular distribution for (n,n*6)

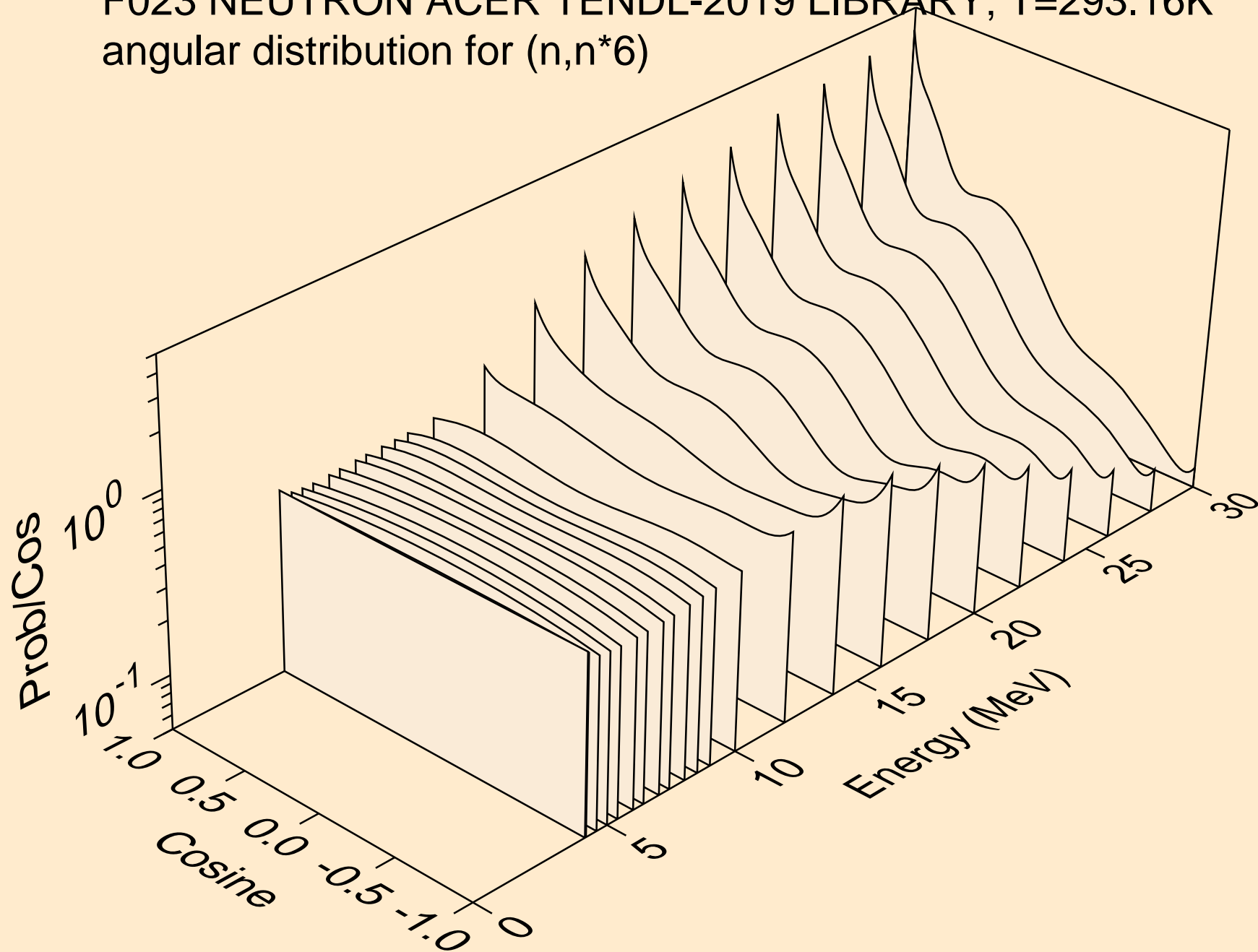

F023 NEUTRON ACER TENDL-2019 LIBRARY; T=293.16K
angular distribution for (n,n*7)

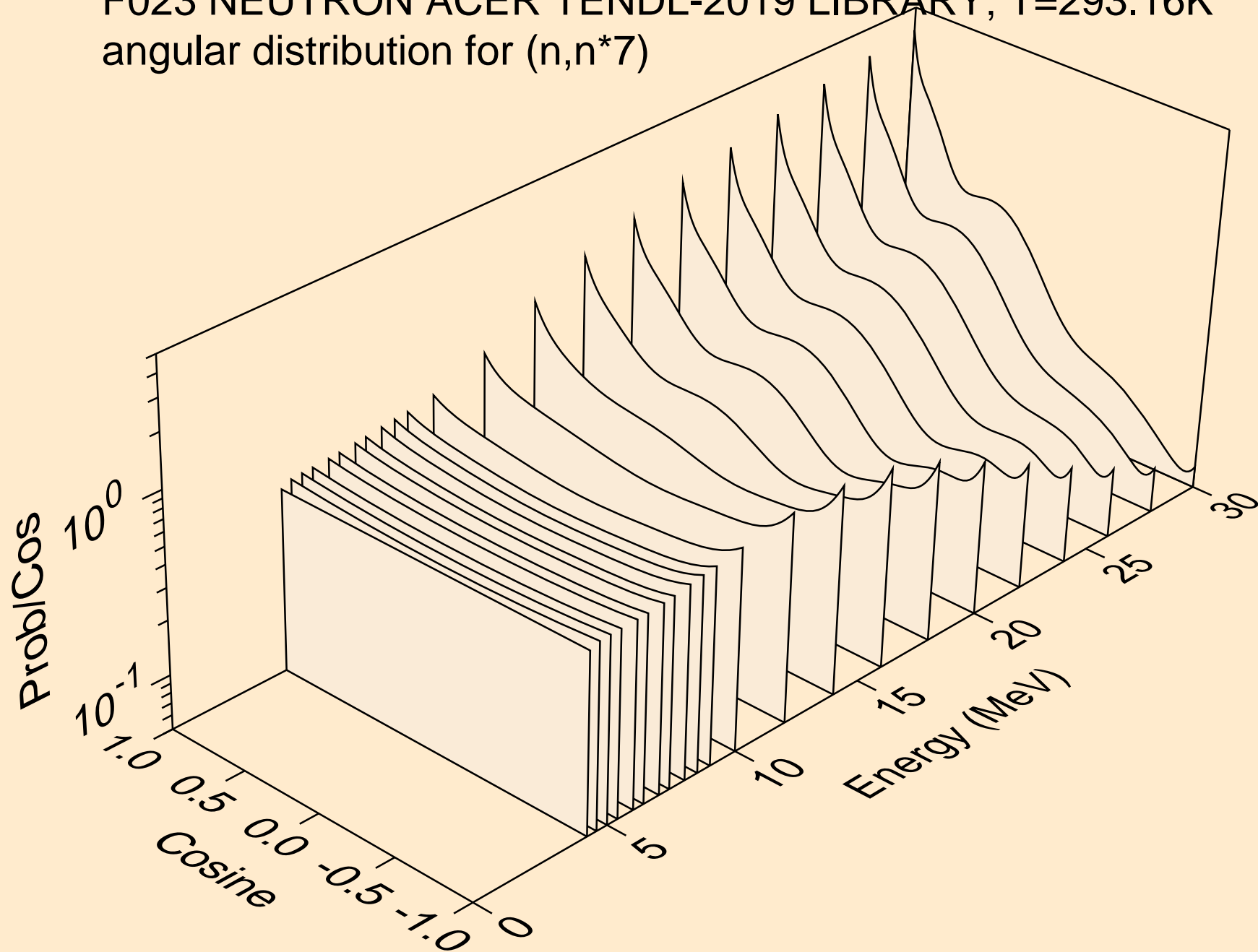

F023 NEUTRON ACER TENDL-2019 LIBRARY; T=293.16K
angular distribution for (n,n*8)

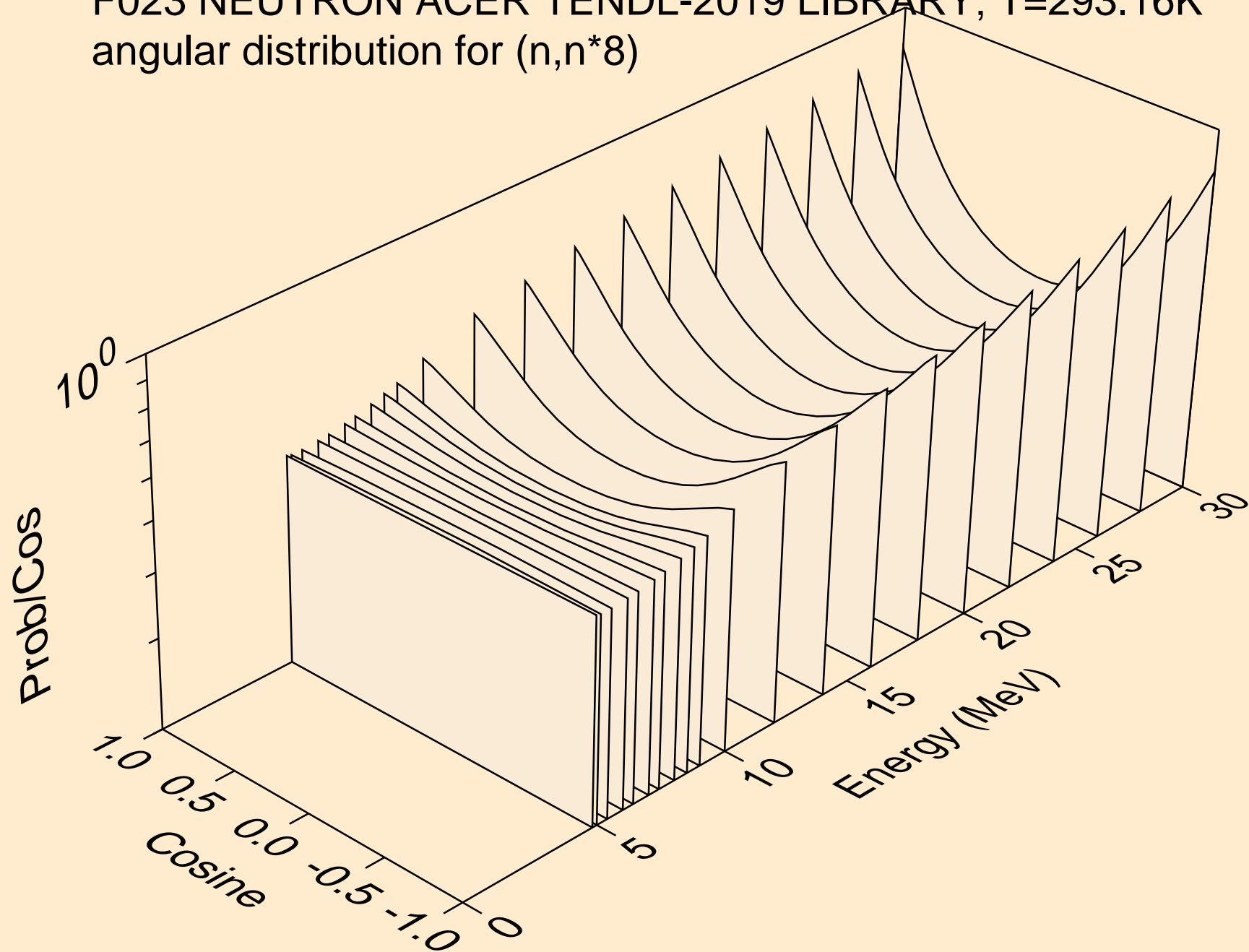

F023 NEUTRON ACER TENDL-2019 LIBRARY; T=293.16K
angular distribution for (n,n*9)

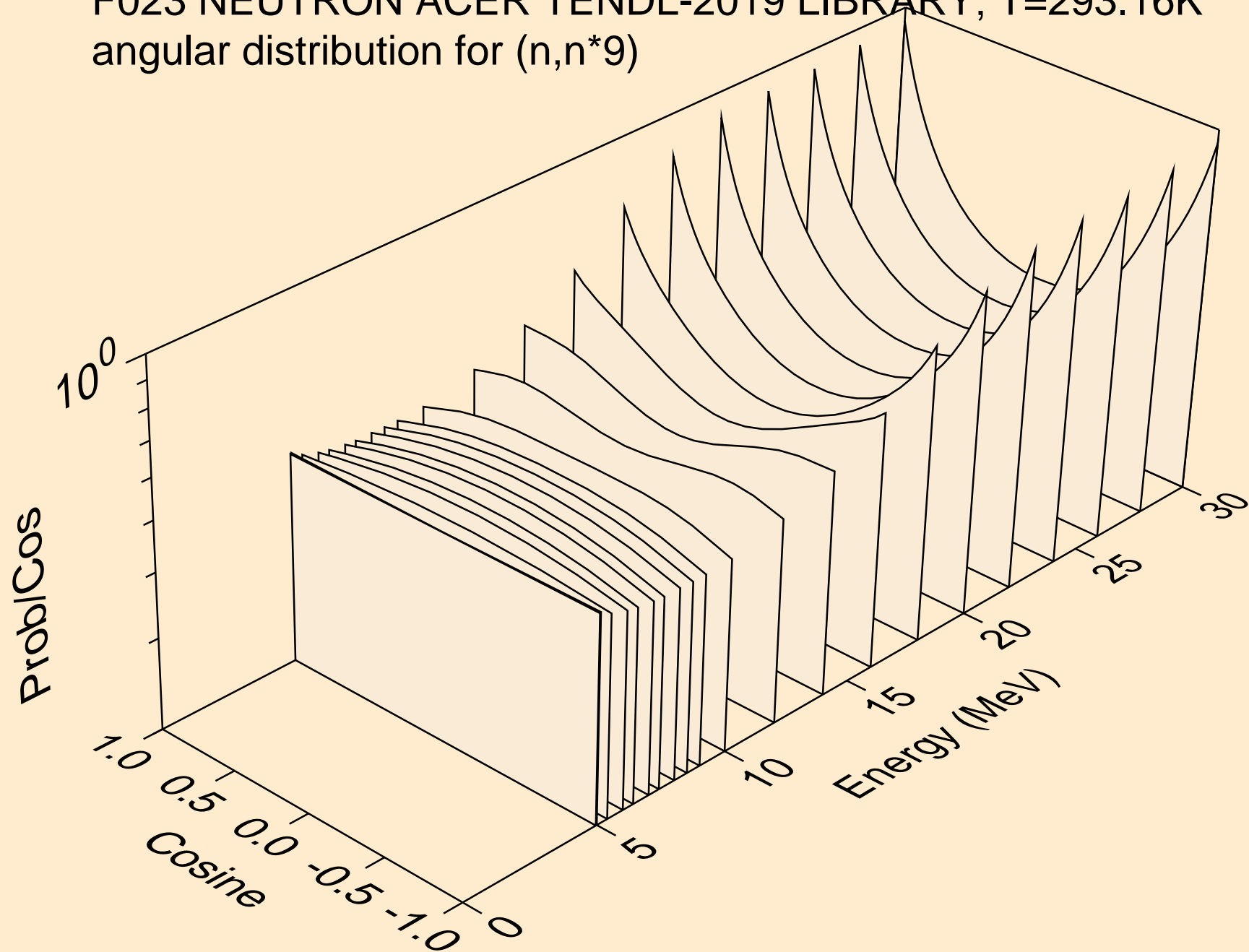

F023 NEUTRON ACER TENDL-2019 LIBRARY; T=293.16K
angular distribution for (n,n*10)

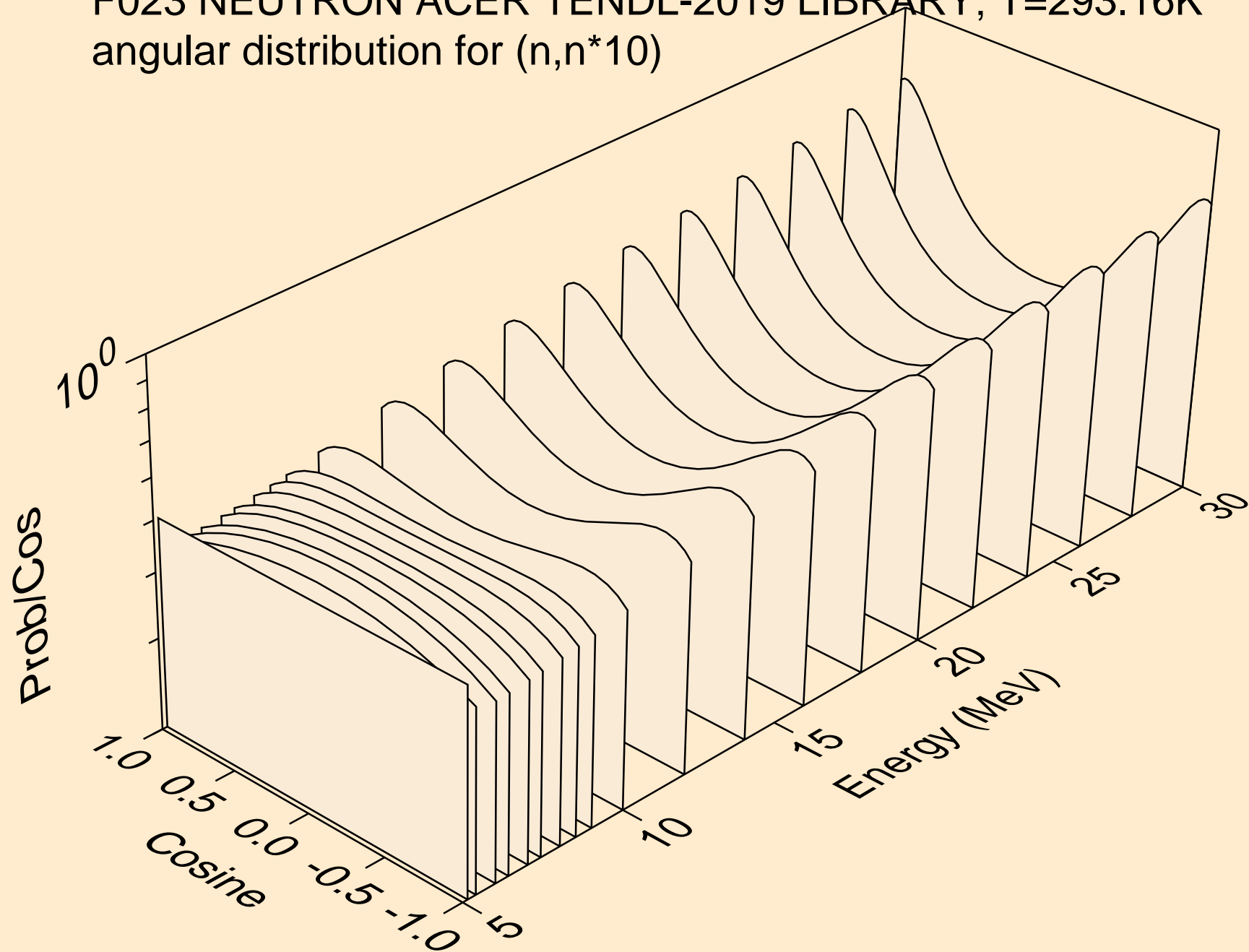

F023 NEUTRON ACER TENDL-2019 LIBRARY; T=293.16K
angular distribution for (n,n*11)

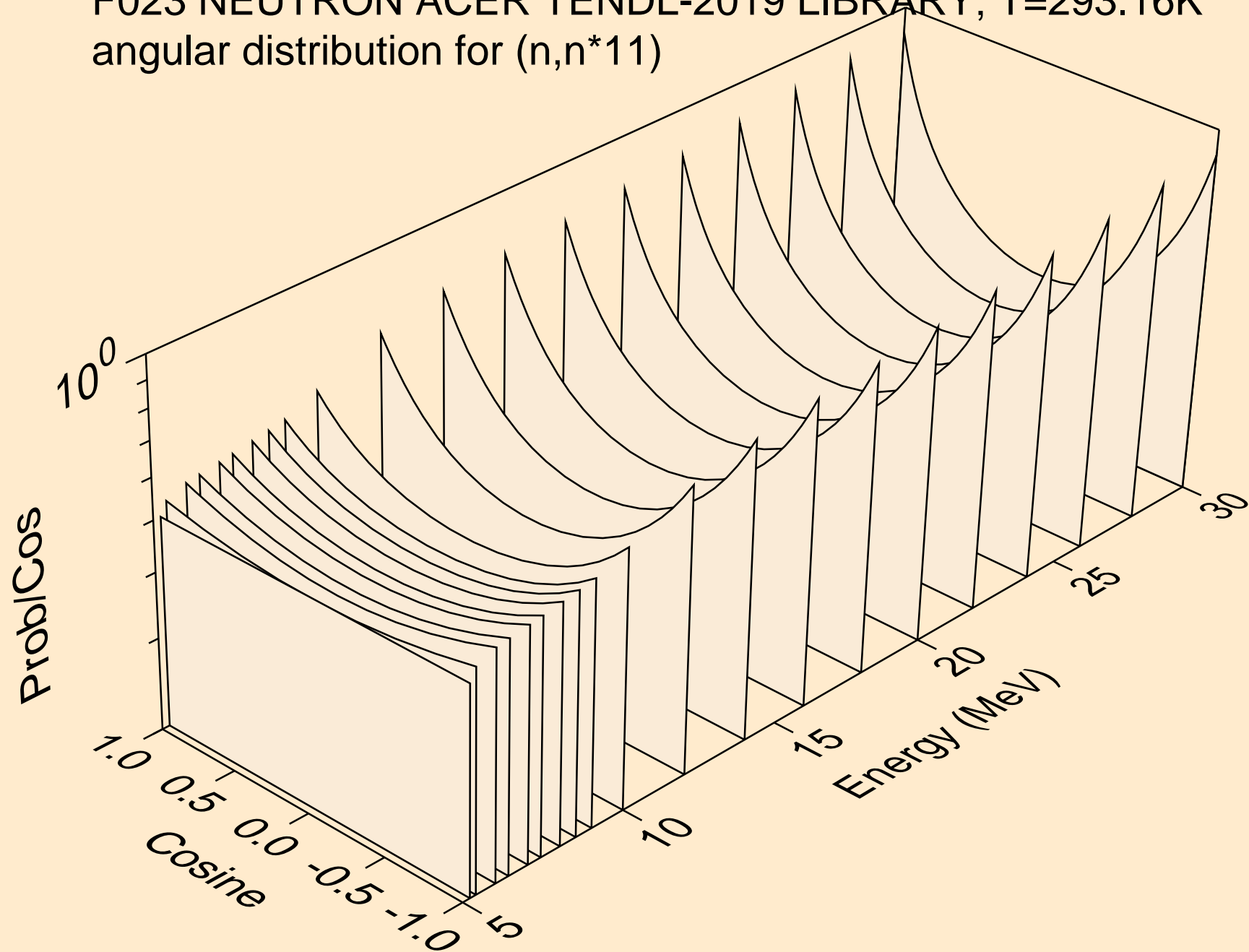

F023 NEUTRON ACER TENDL-2019 LIBRARY; T=293.16K
angular distribution for (n,n*12)

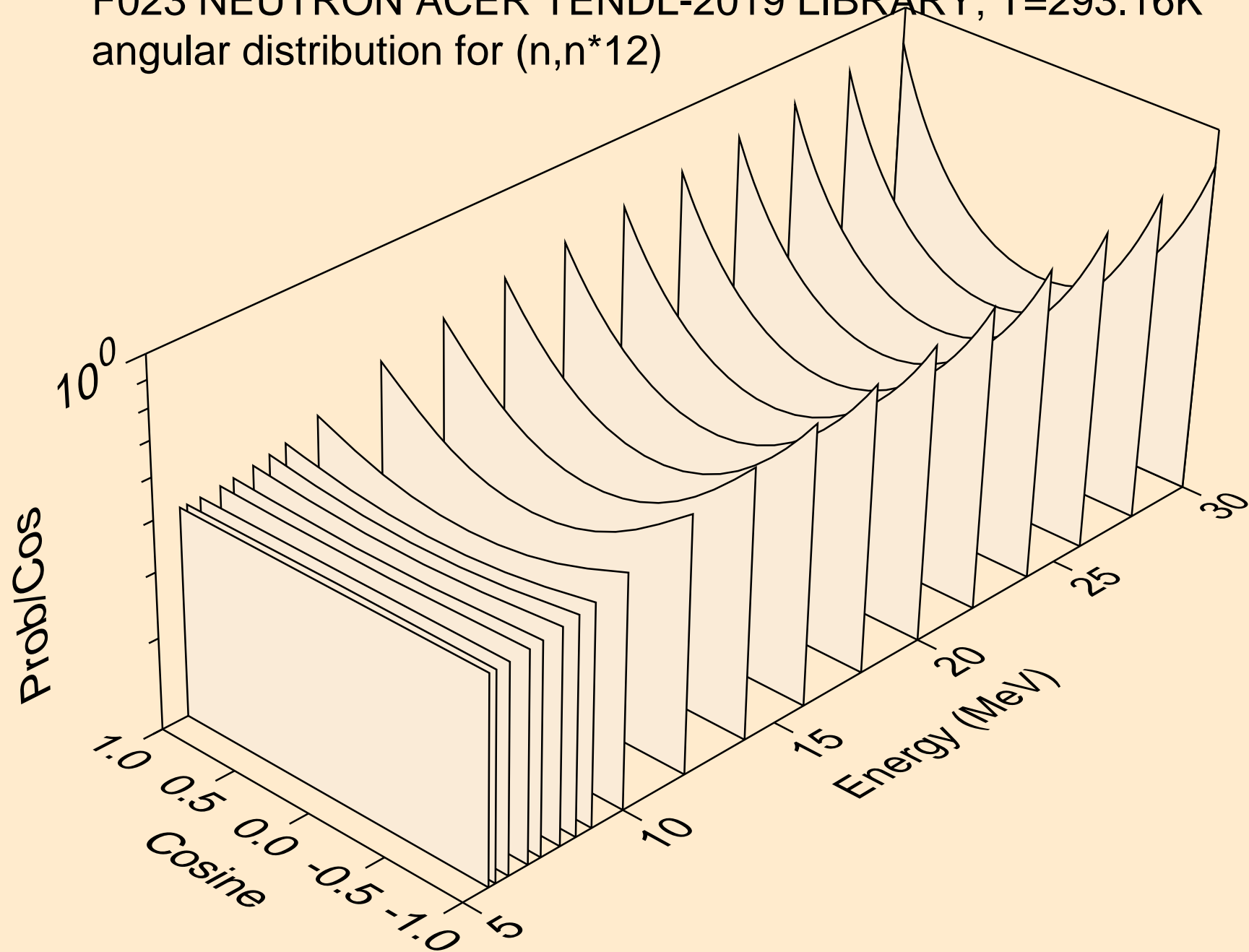

F023 NEUTRON ACER TENDL-2019 LIBRARY; T=293.16K
angular distribution for (n,n*13)

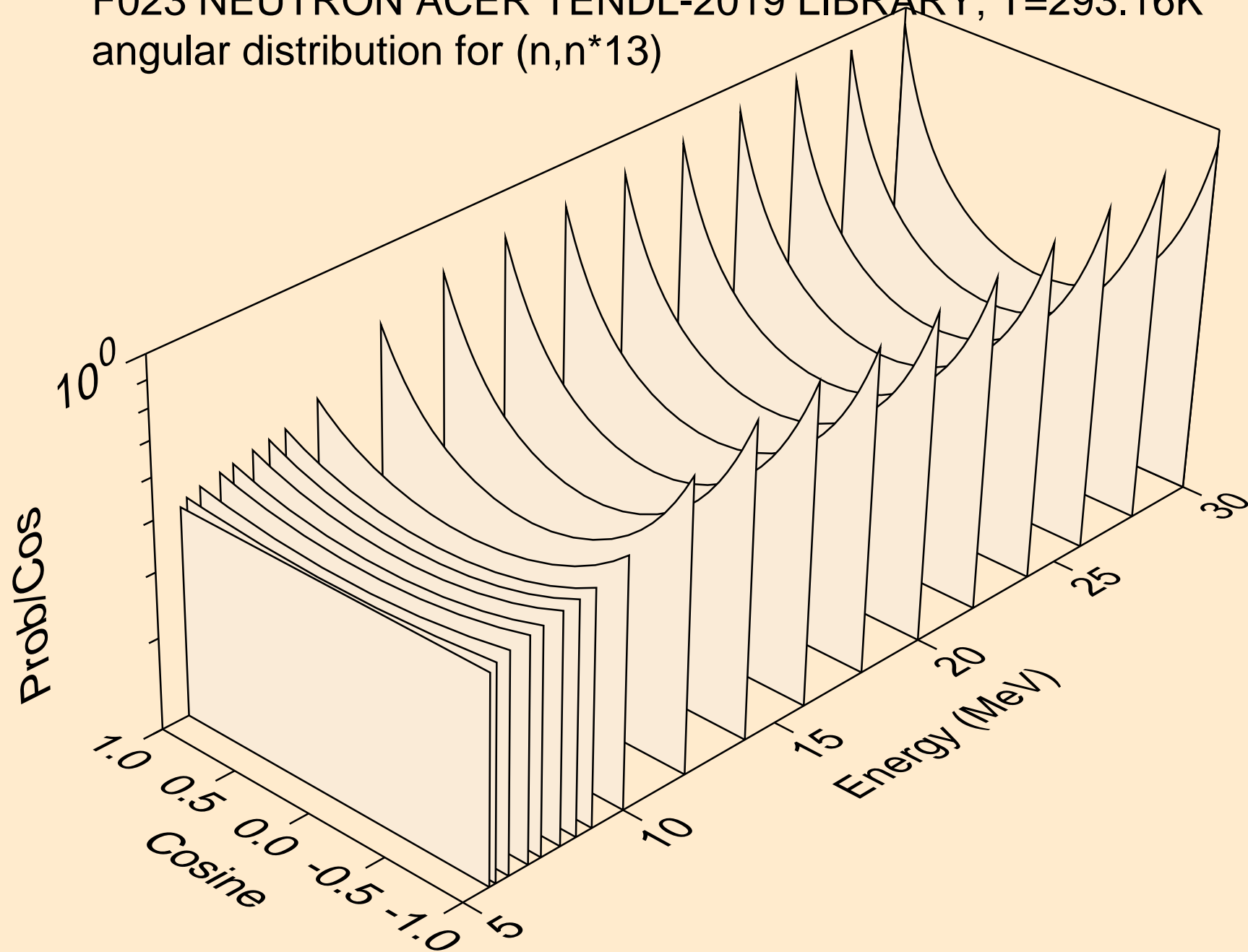

F023 NEUTRON ACER TENDL-2019 LIBRARY; T=293.16K
angular distribution for (n,n*14)

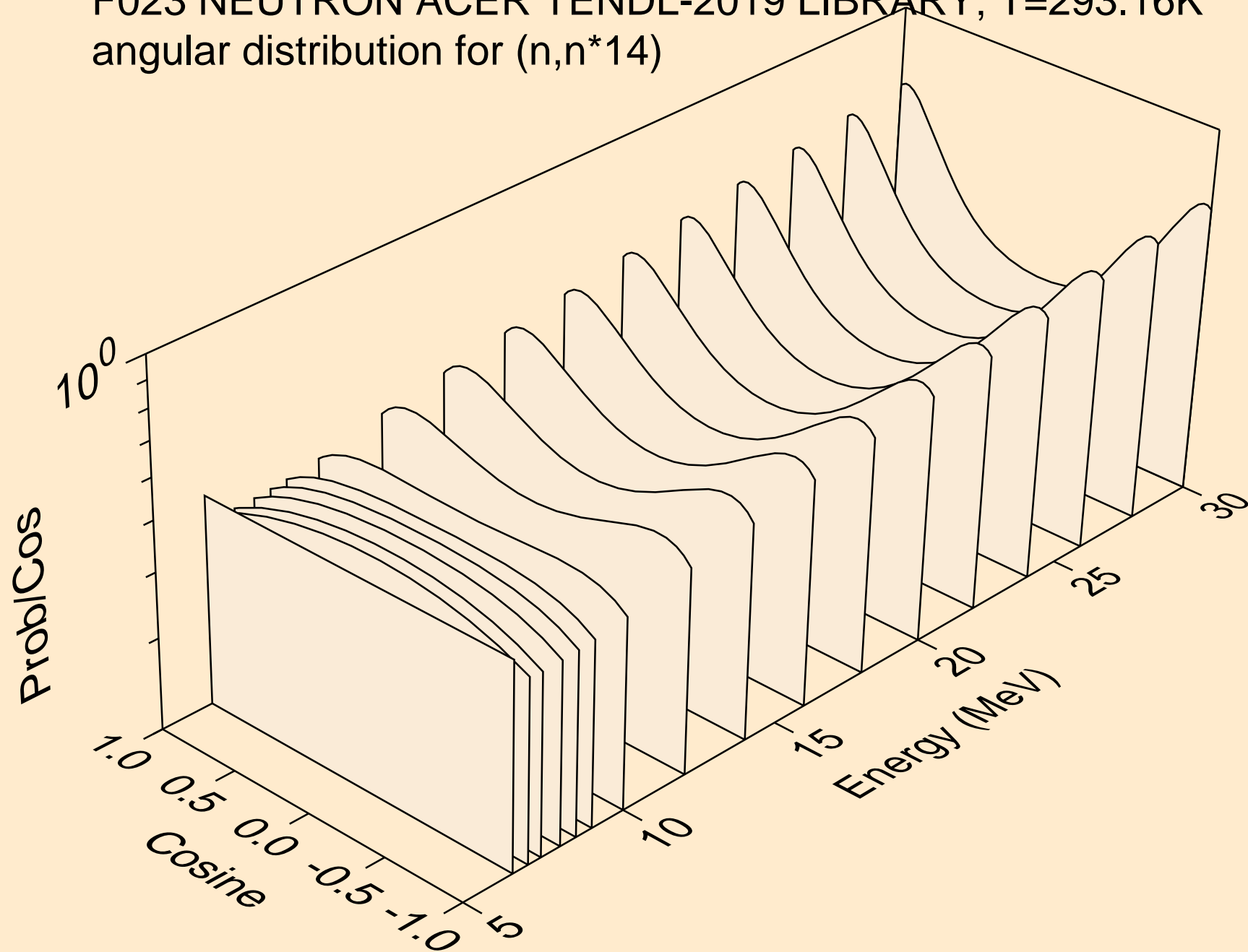

F023 NEUTRON ACER TENDL-2019 LIBRARY; T=293.16K
angular distribution for (n,n*15)

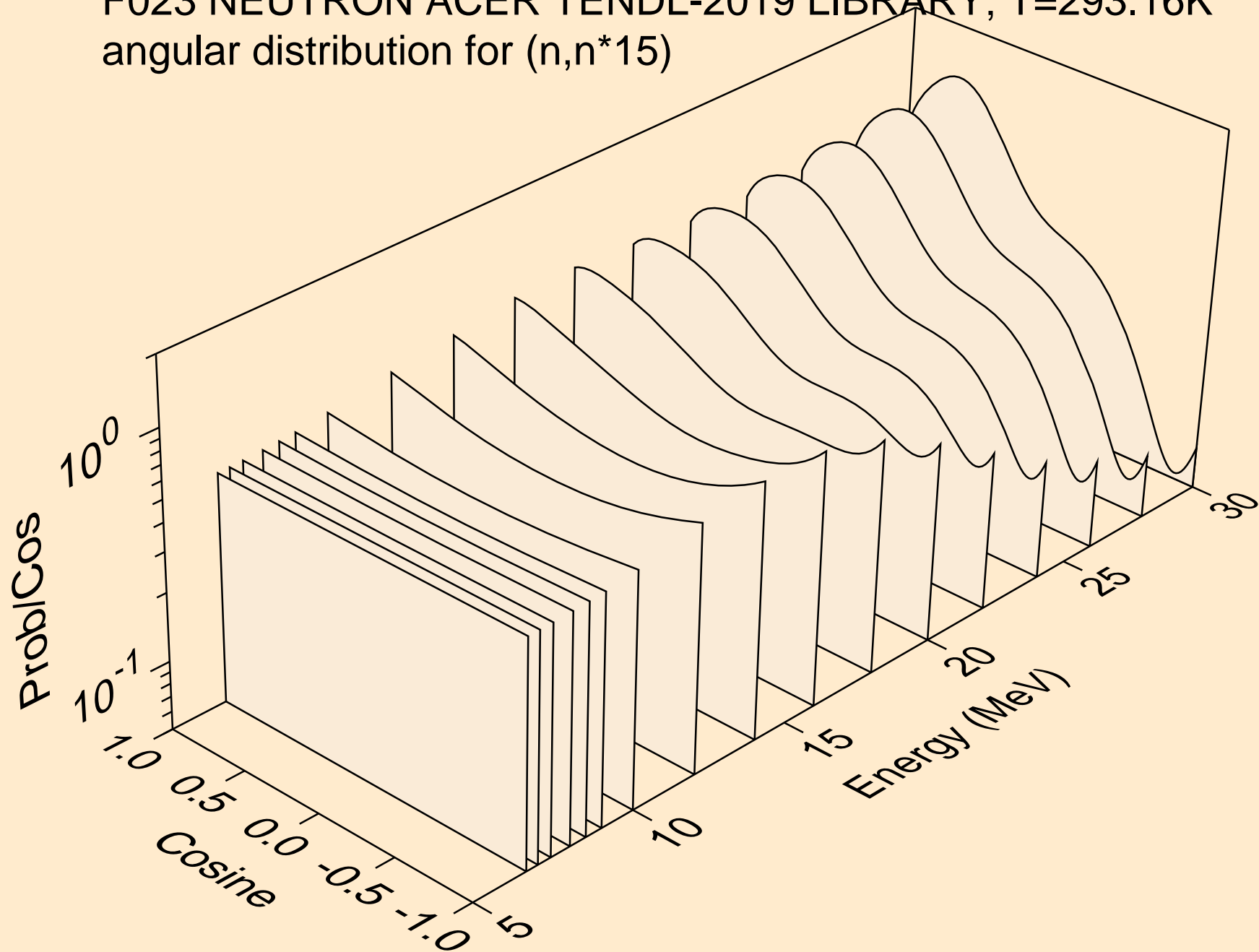

F023 NEUTRON ACER TENDL-2019 LIBRARY; T=293.16K
angular distribution for (n,n*16)

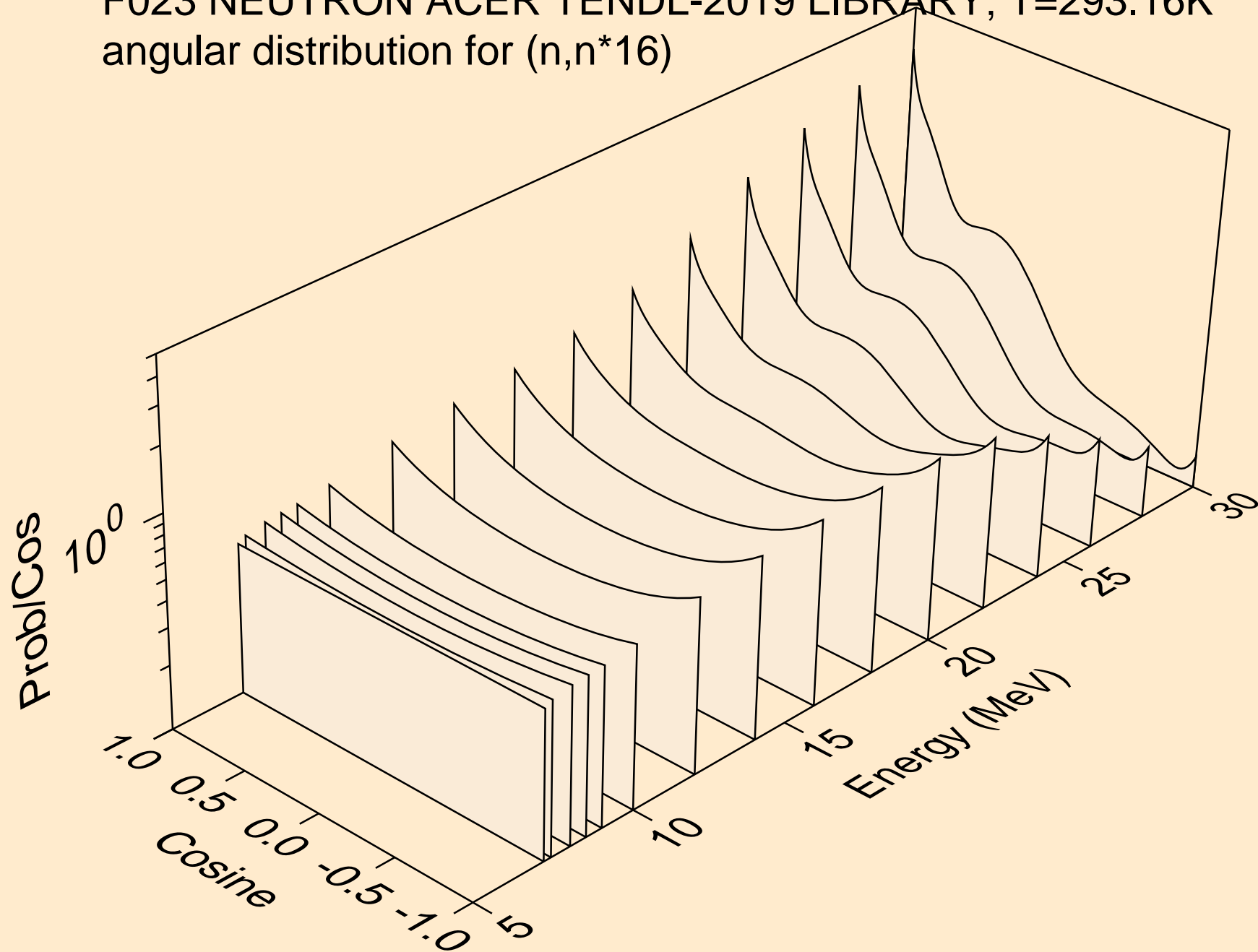

F023 NEUTRON ACER TENDL-2019 LIBRARY; T=293.16K
angular distribution for (n,n*17)

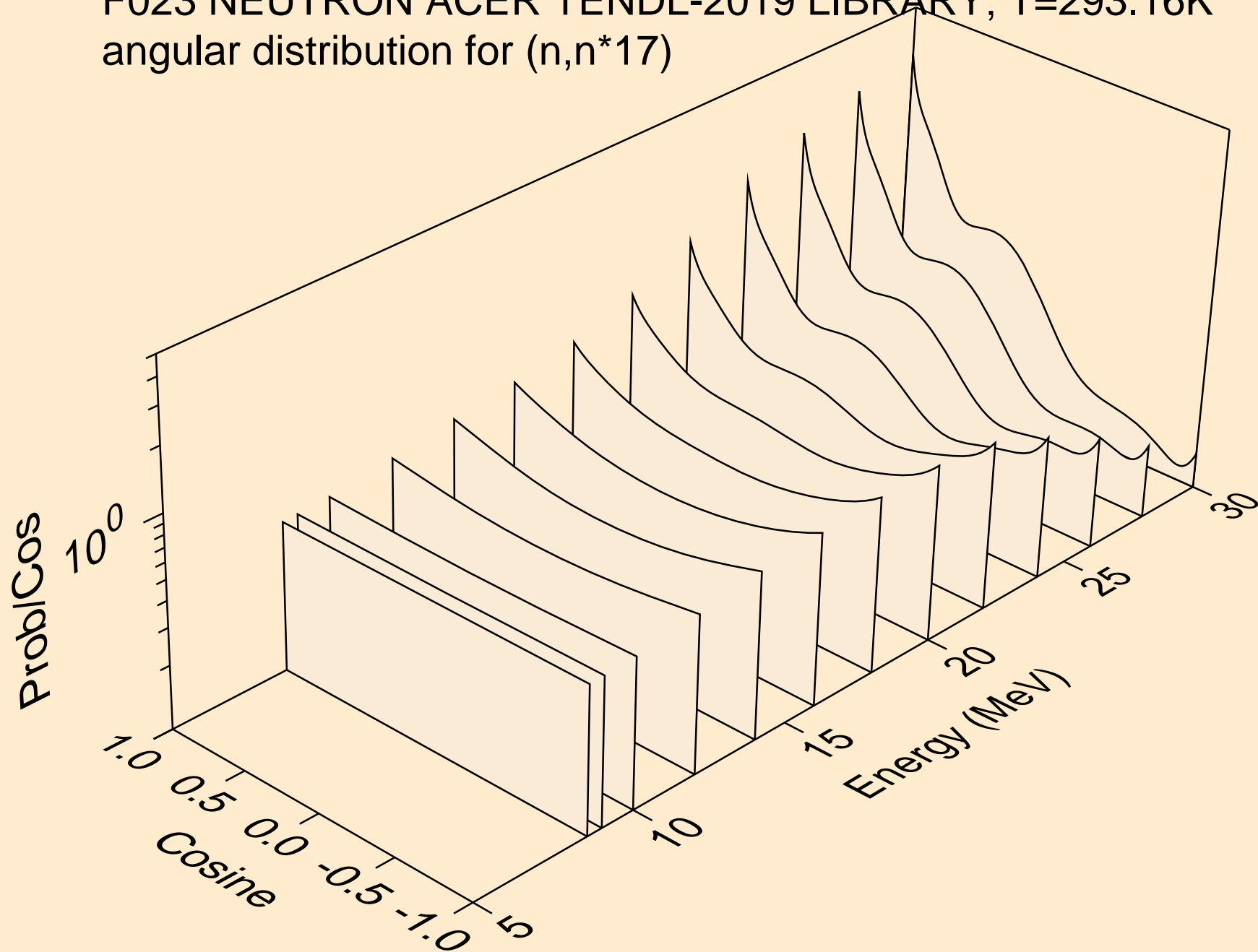

F023 NEUTRON ACER TENDL-2019 LIBRARY; T=293.16K
angular distribution for (n,n*18)

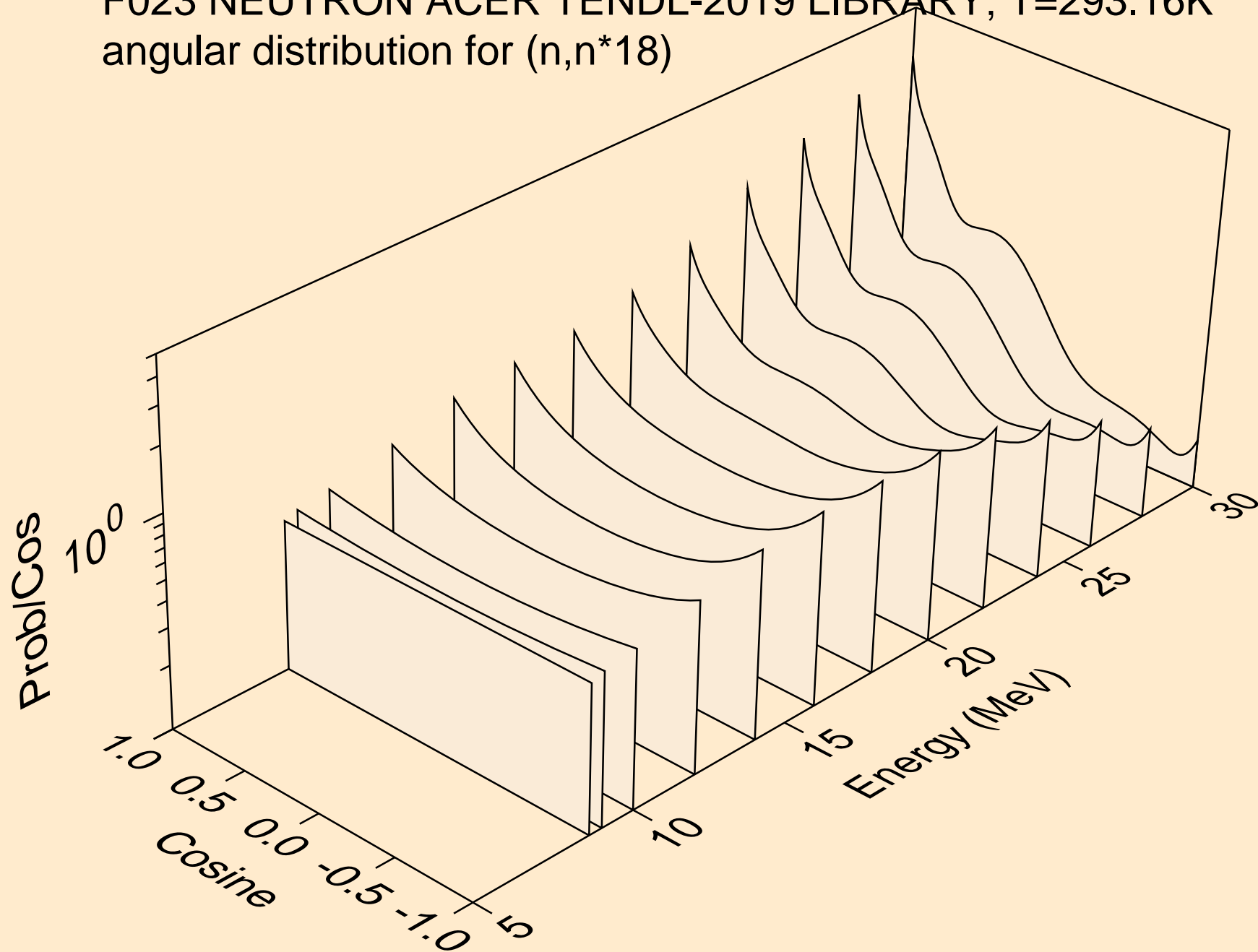

F023 NEUTRON ACER TENDL-2019 LIBRARY; T=293.16K
angular distribution for (n,n*19)

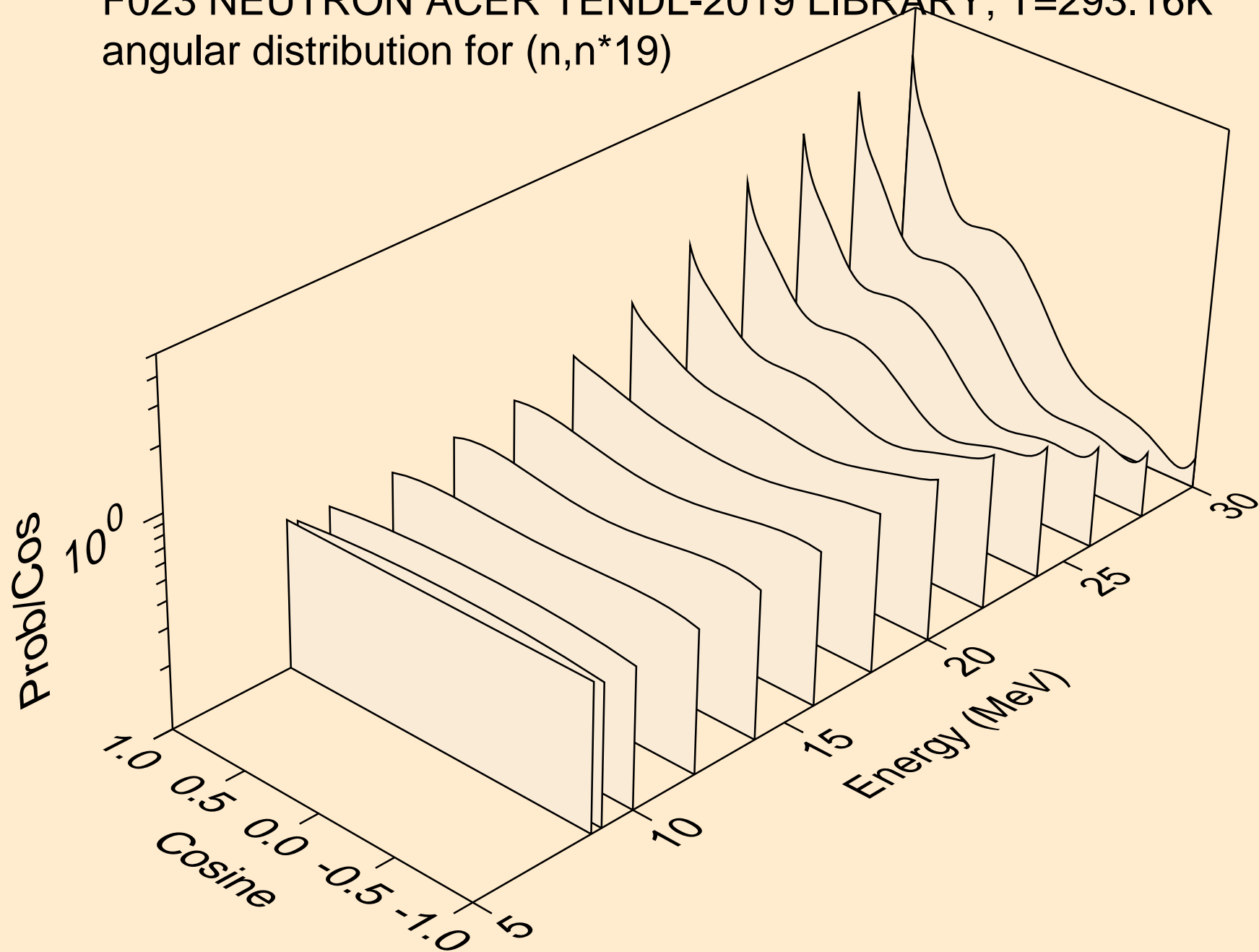

F023 NEUTRON ACER TENDL-2019 LIBRARY; T=293.16K
angular distribution for (n,n*20)

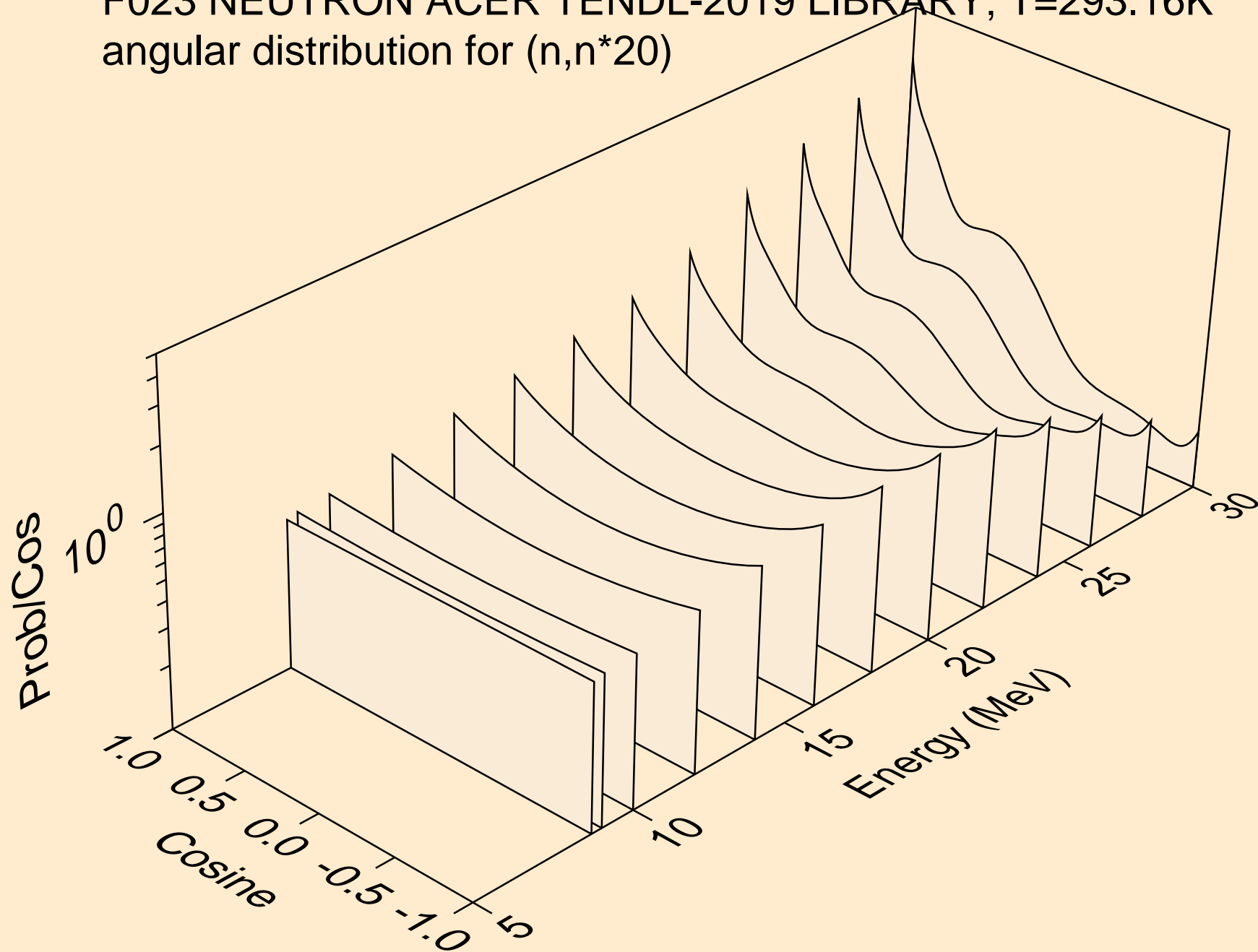

F023 NEUTRON ACER TENDL-2019 LIBRARY; T=293.16K
angular distribution for (n,n*21)

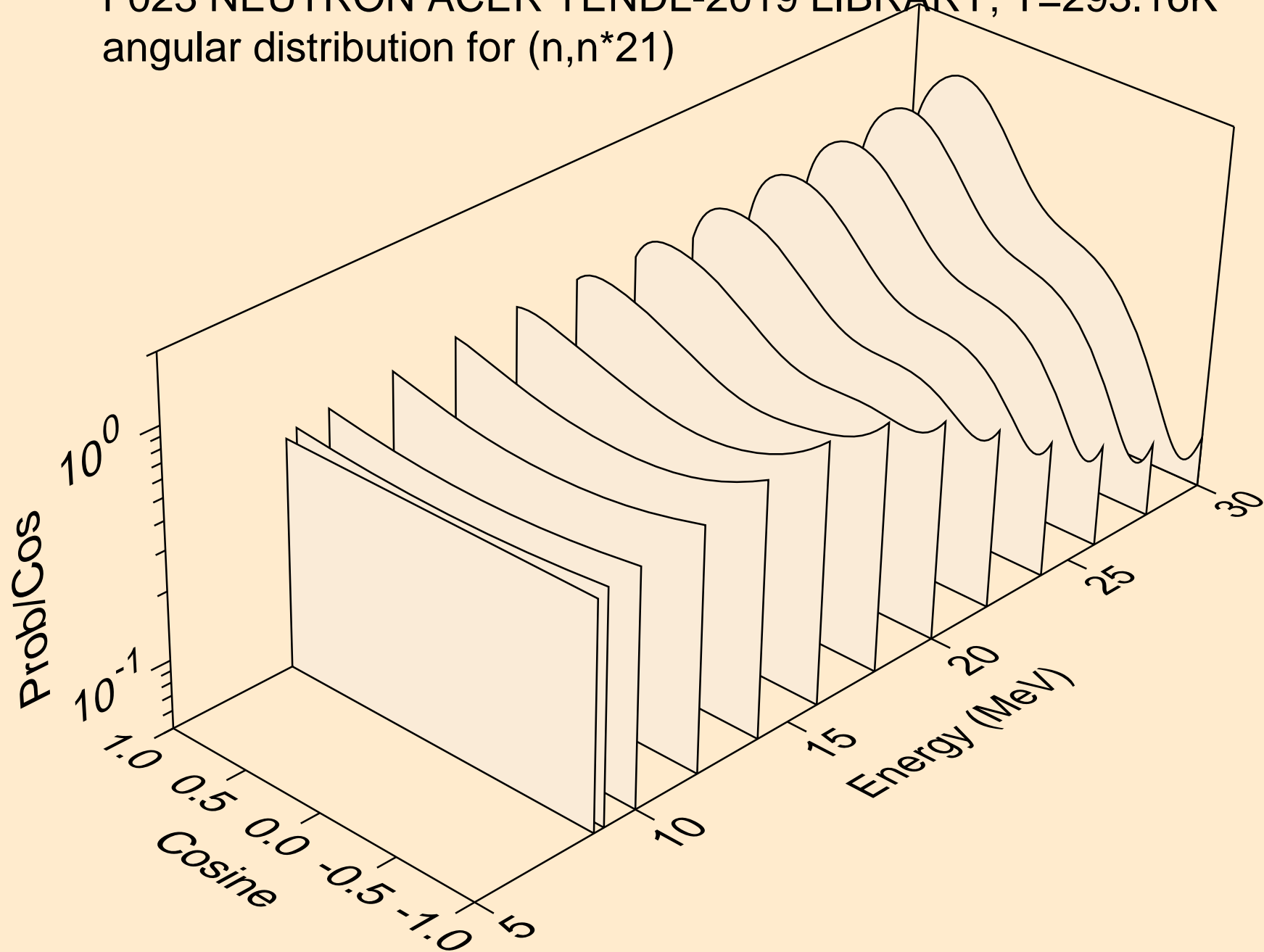

F023 NEUTRON ACER TENDL-2019 LIBRARY; T=293.16K
angular distribution for (n,n*22)

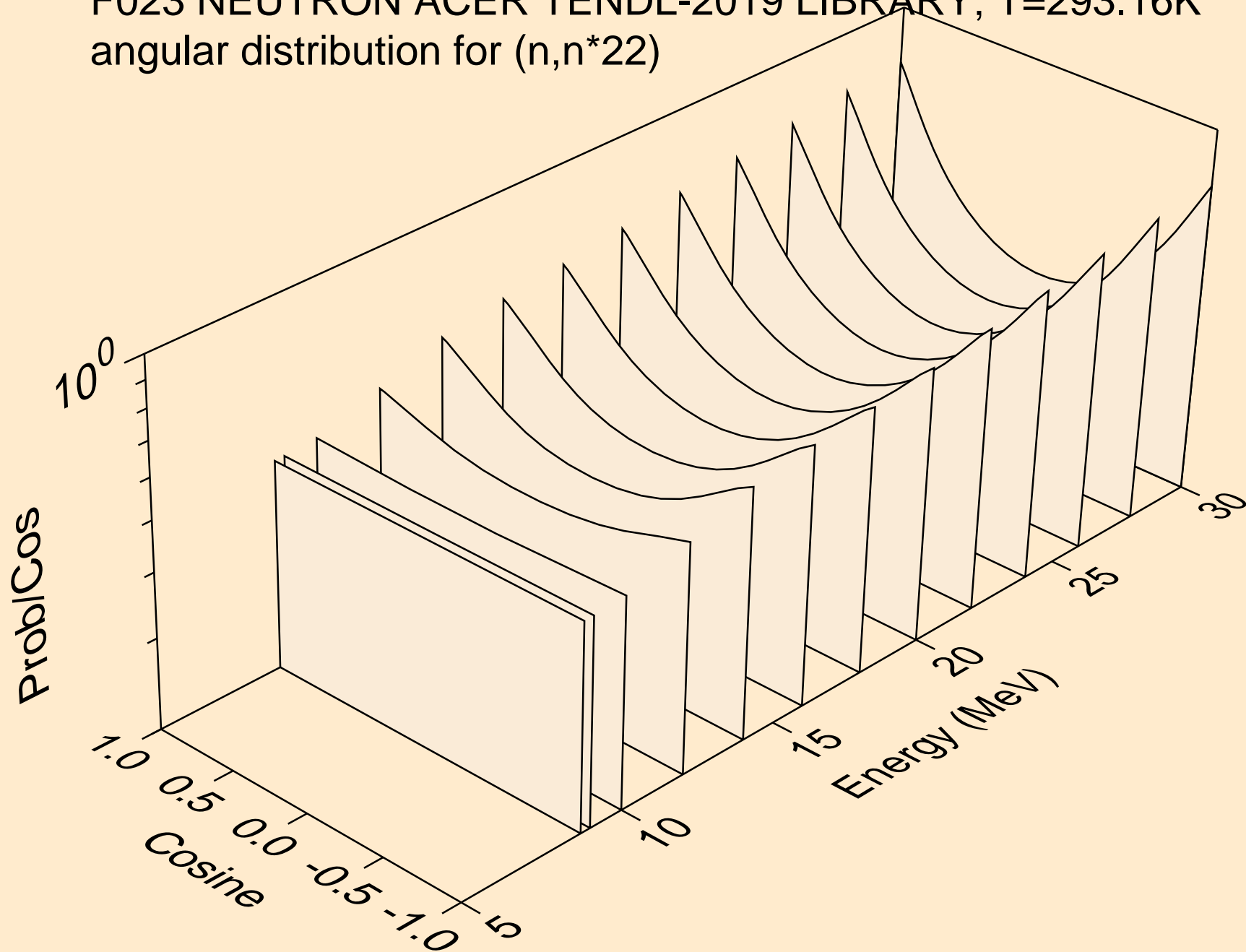

F023 NEUTRON ACER TENDL-2019 LIBRARY; T=293.16K
angular distribution for (n,n*23)

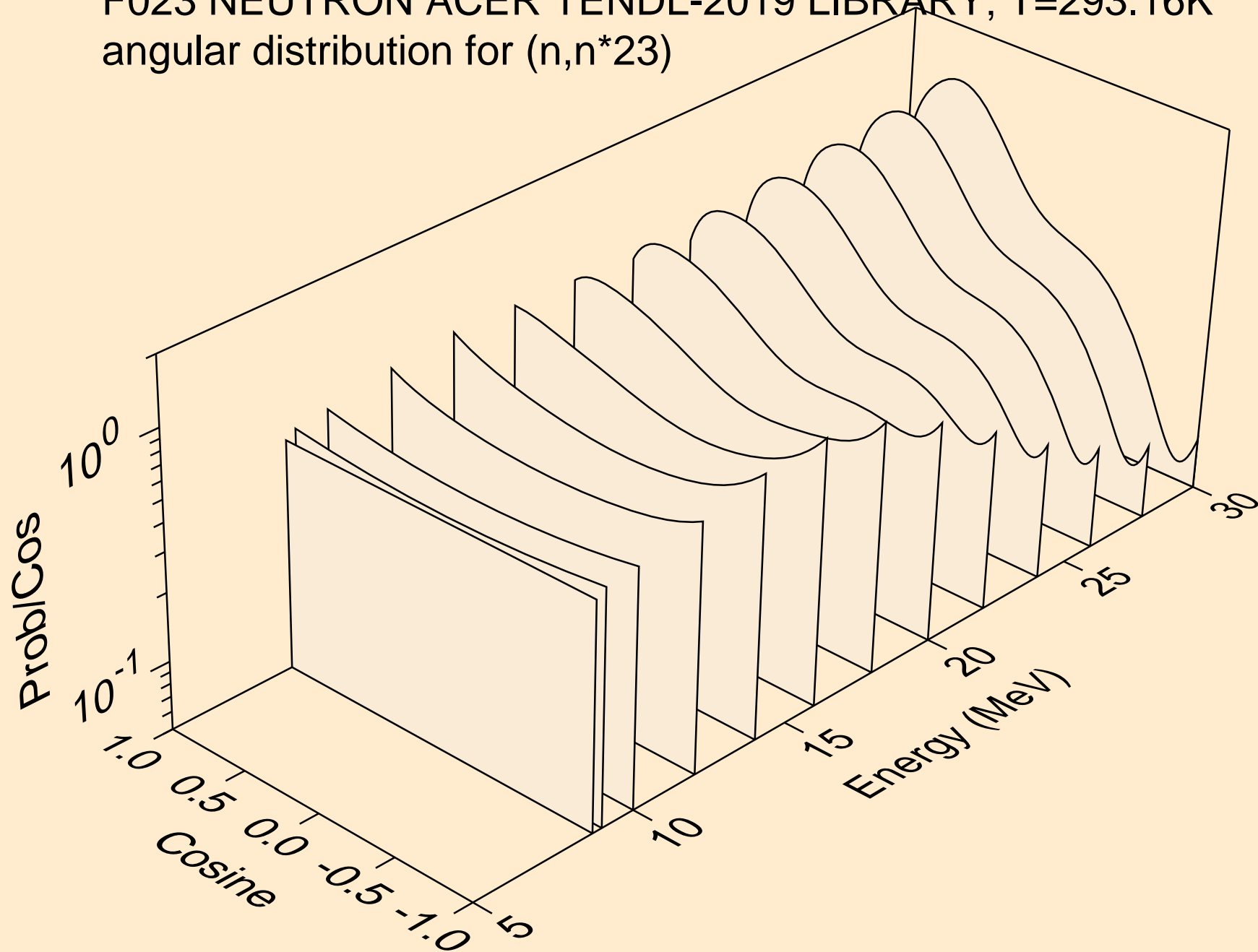

F023 NEUTRON ACER TENDL-2019 LIBRARY; T=293.16K
angular distribution for (n,n*24)

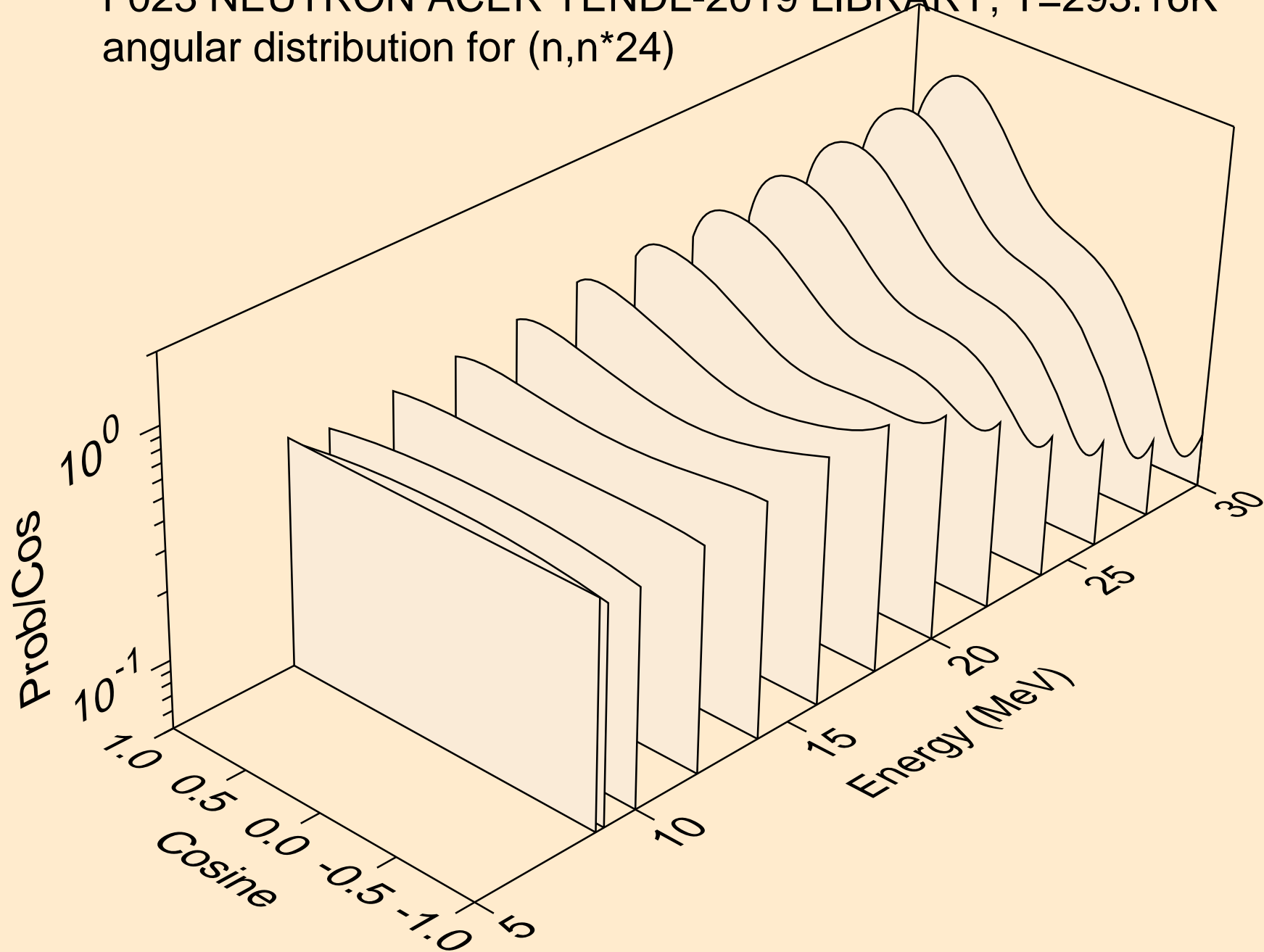

F023 NEUTRON ACER TENDL-2019 LIBRARY; T=293.16K
angular distribution for (n,n*25)

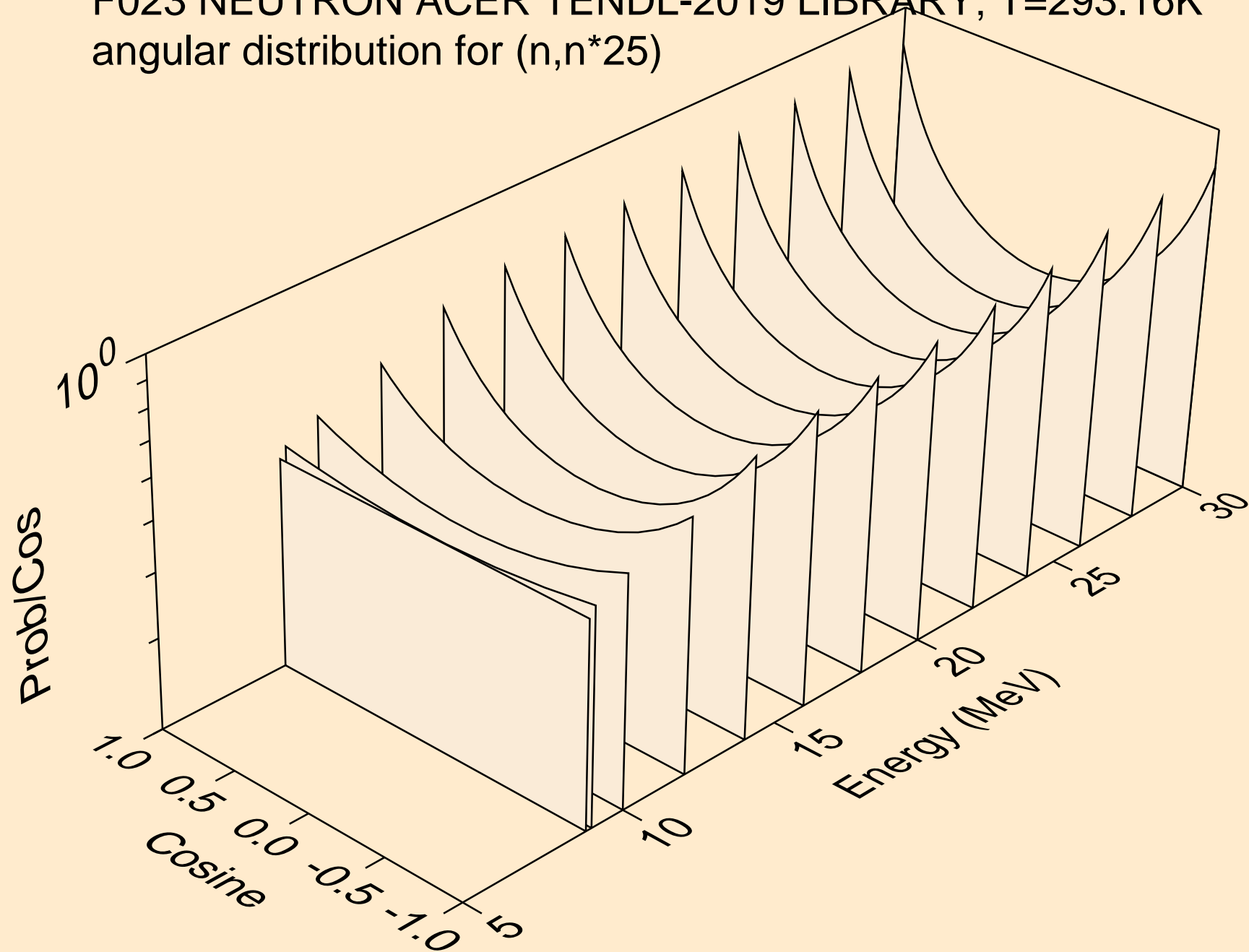

F023 NEUTRON ACER TENDL-2019 LIBRARY; T=293.16K
angular distribution for (n,n*26)

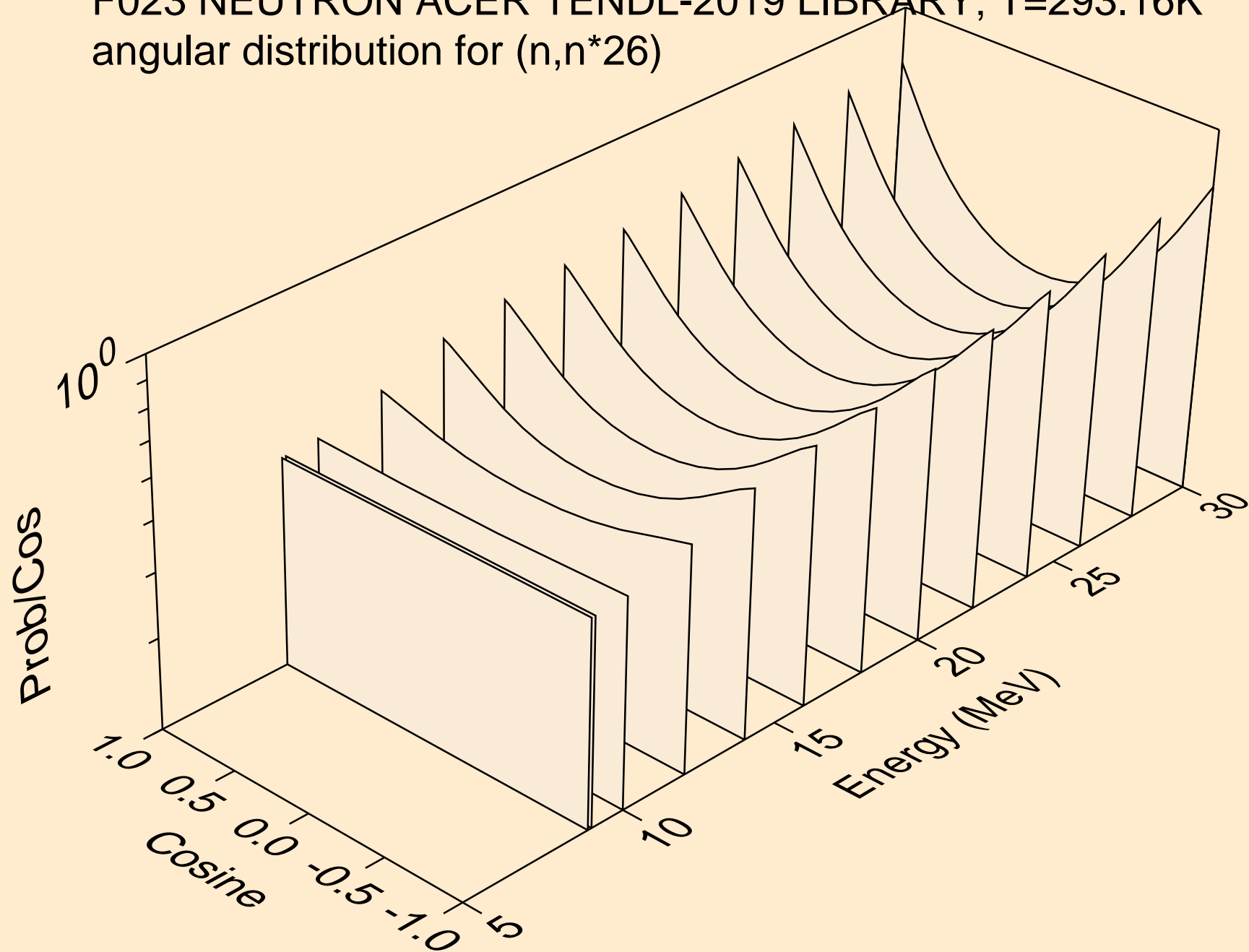

F023 NEUTRON ACER TENDL-2019 LIBRARY; T=293.16K
angular distribution for (n,n*27)

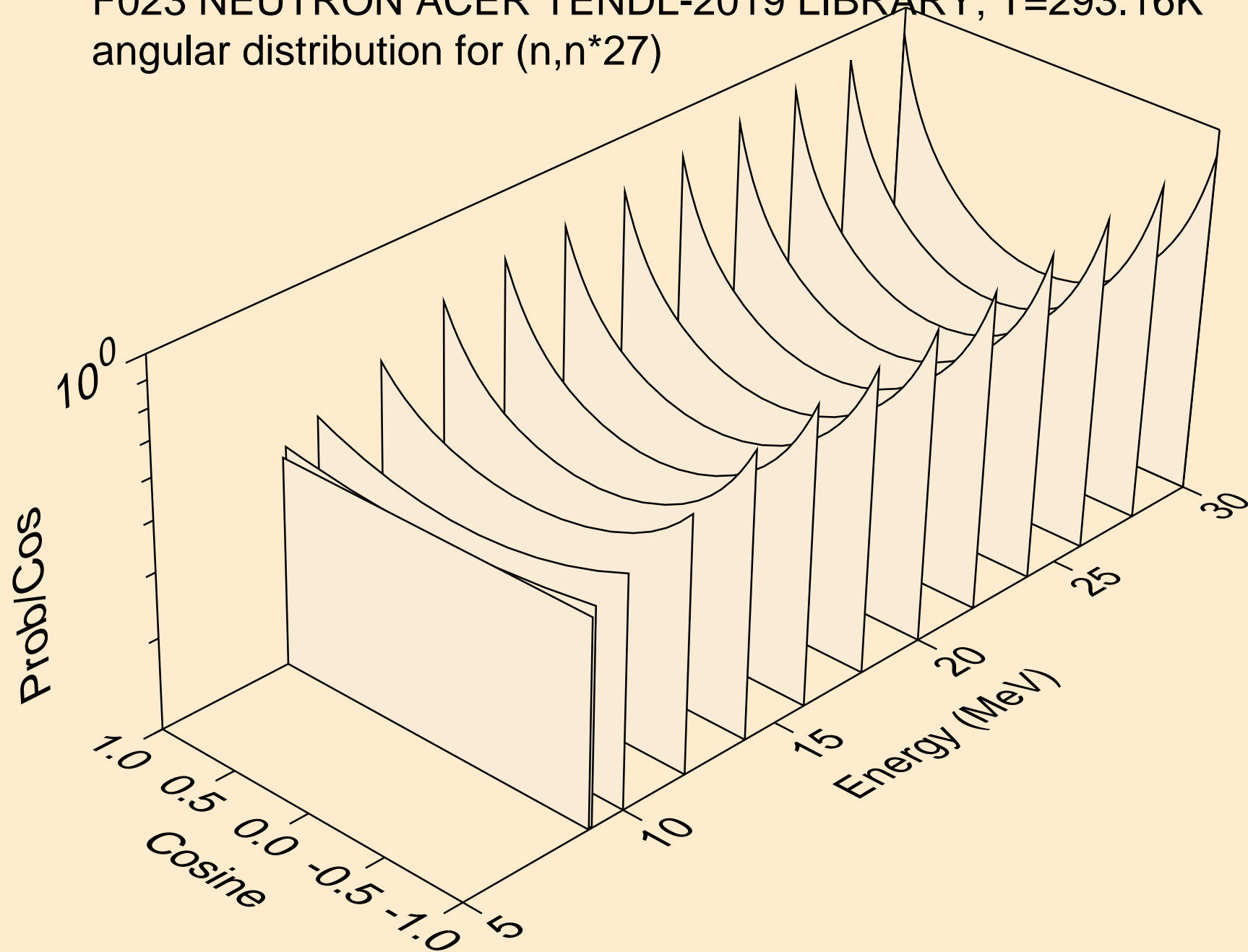

F023 NEUTRON ACER TENDL-2019 LIBRARY; T=293.16K
angular distribution for (n,n*28)

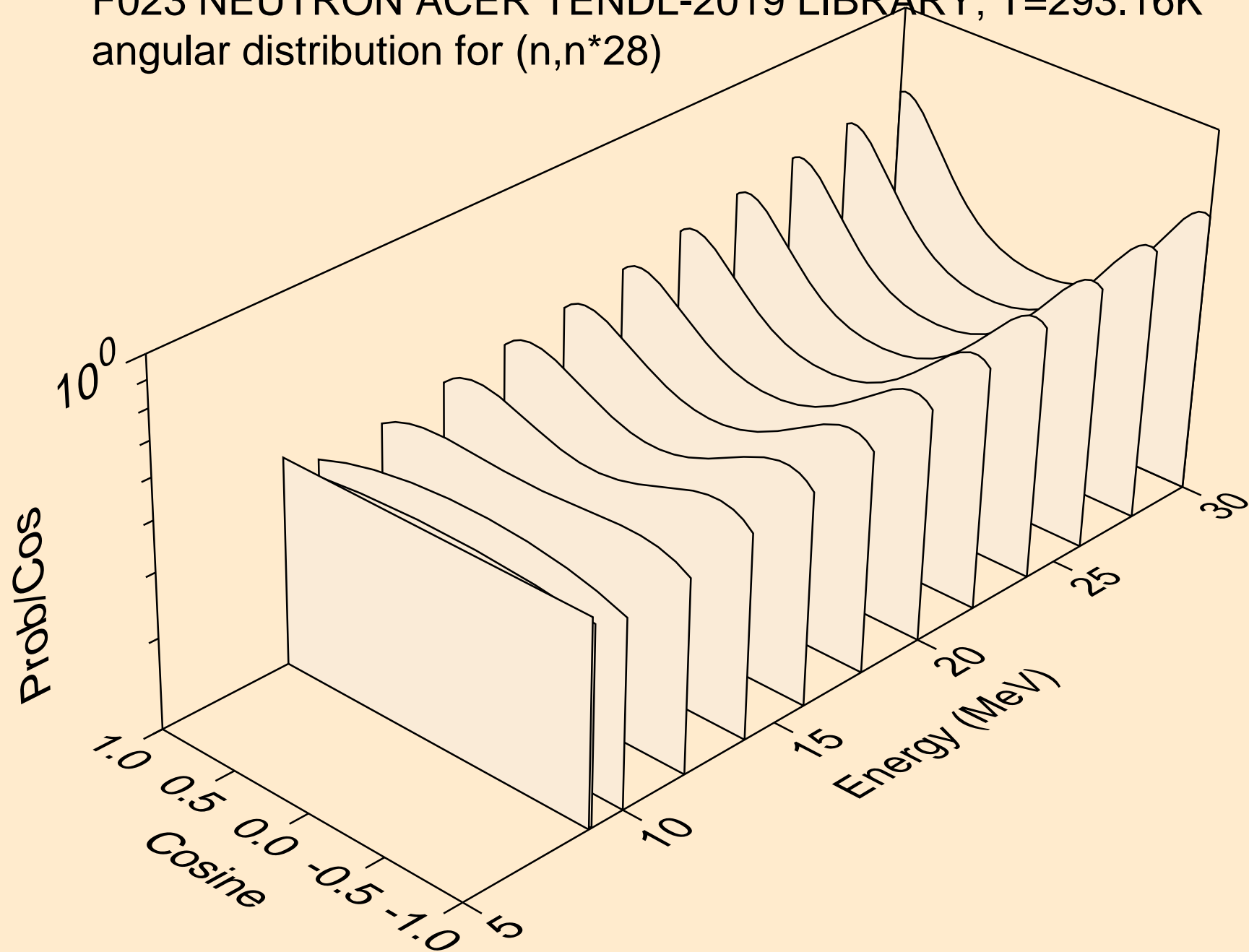

F023 NEUTRON ACER TENDL-2019 LIBRARY; T=293.16K
angular distribution for (n,n*29)

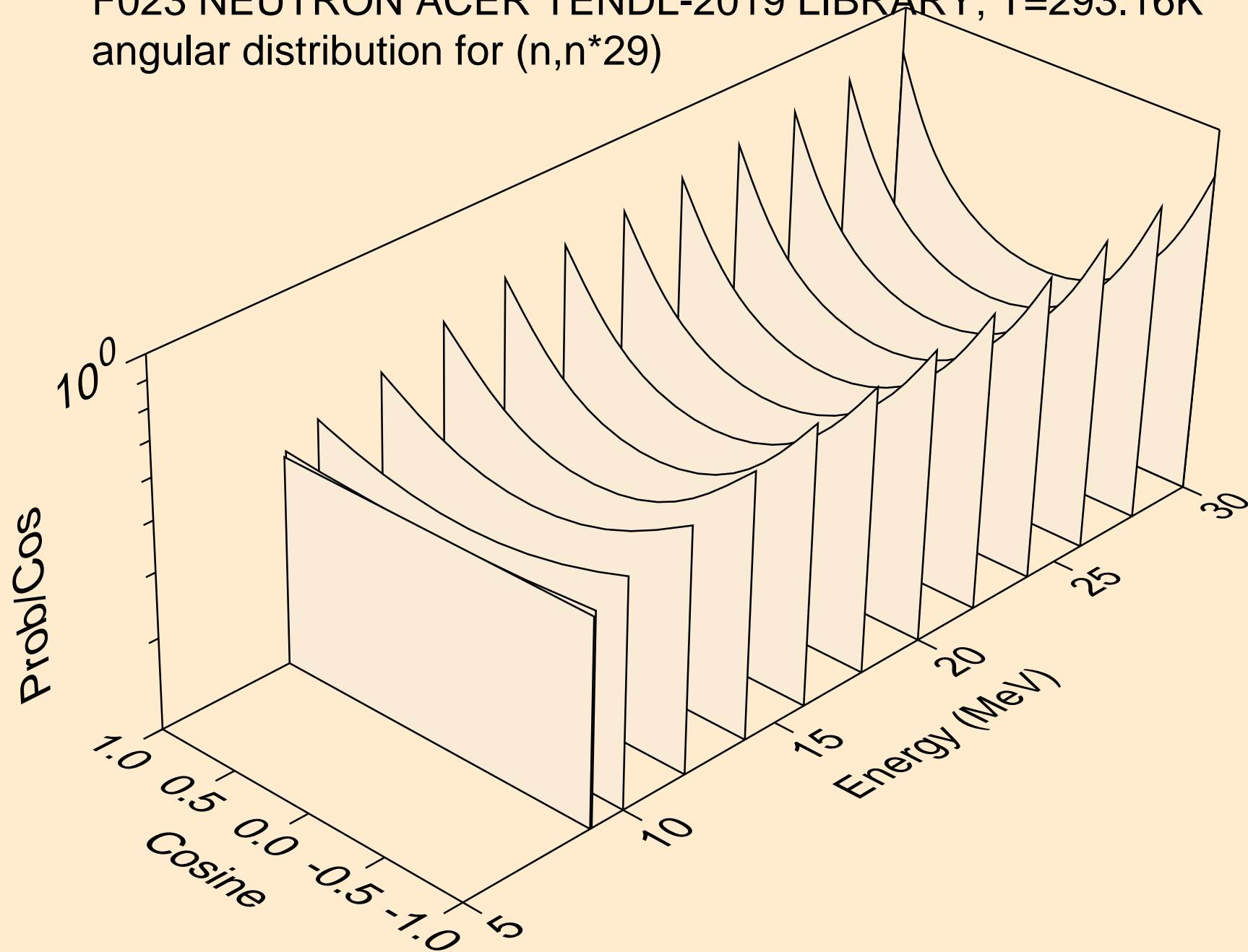

F023 NEUTRON ACER TENDL-2019 LIBRARY; T=293.16K
Neutron emission for (n,x)

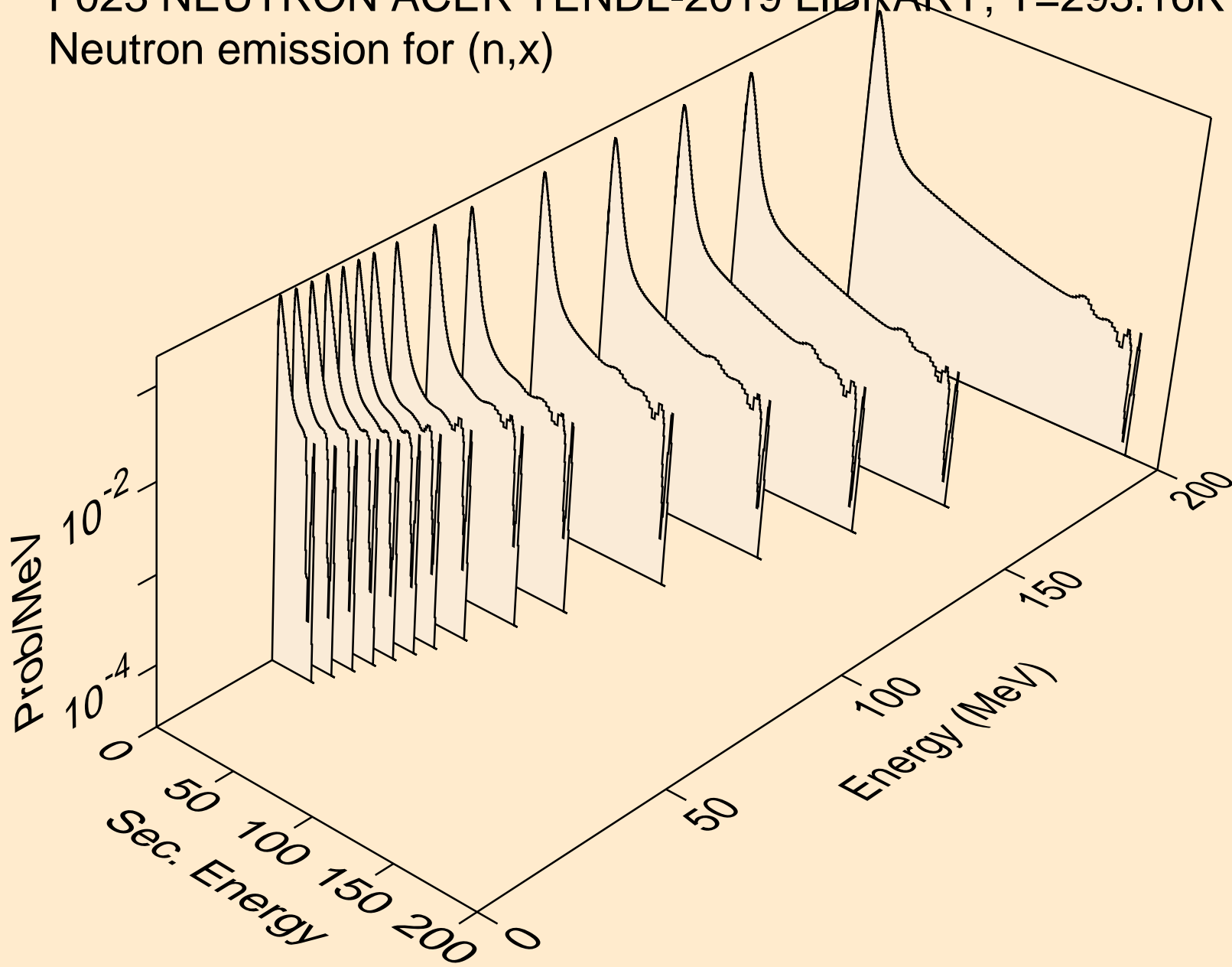

F023 NEUTRON ACER TENDL-2019 LIBRARY; T=293.16K
Neutron emission for (n,2nd)

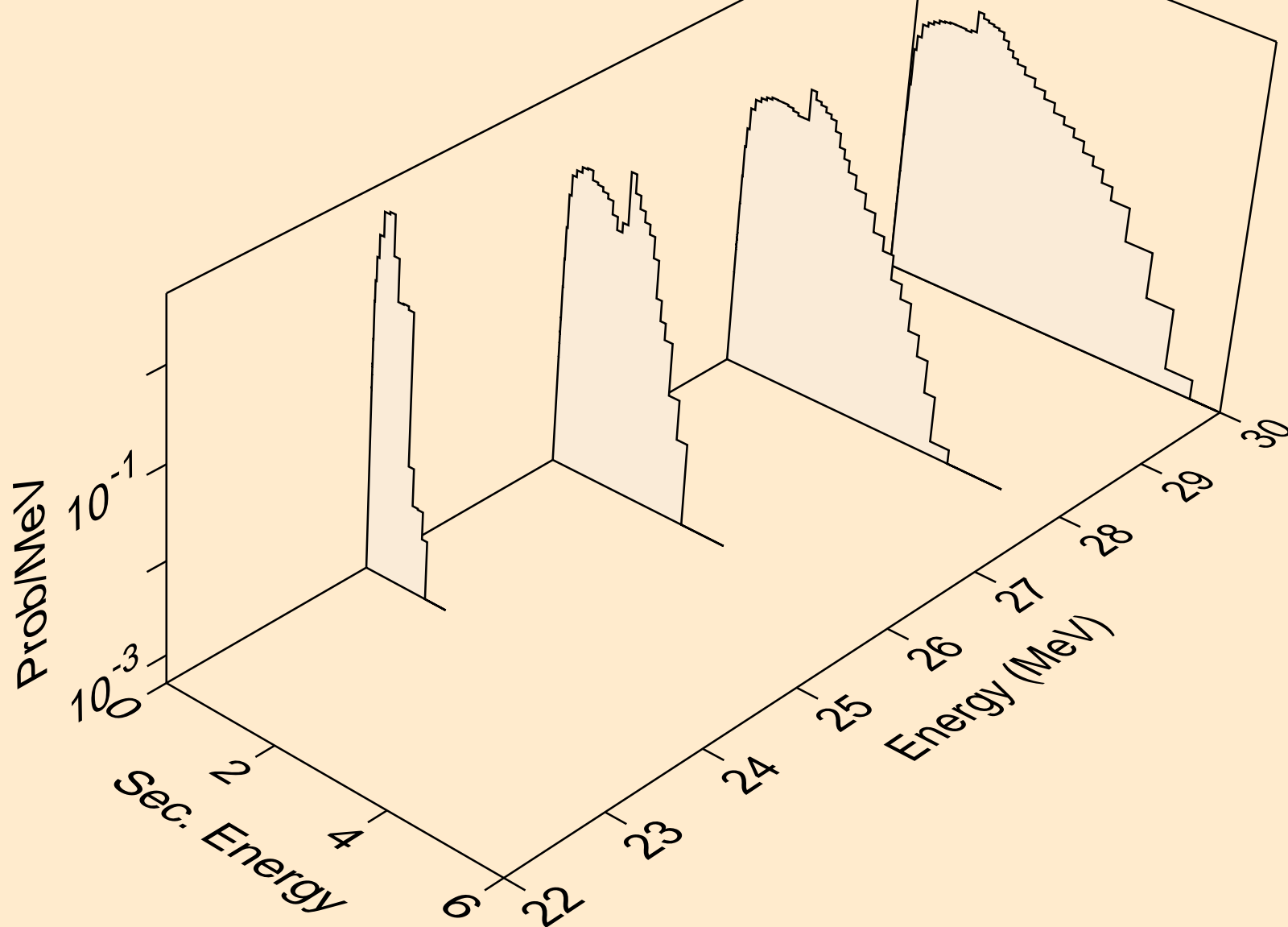

F023 NEUTRON ACER TENDL-2019 LIBRARY; T=293.16K
Neutron emission for (n,2n)

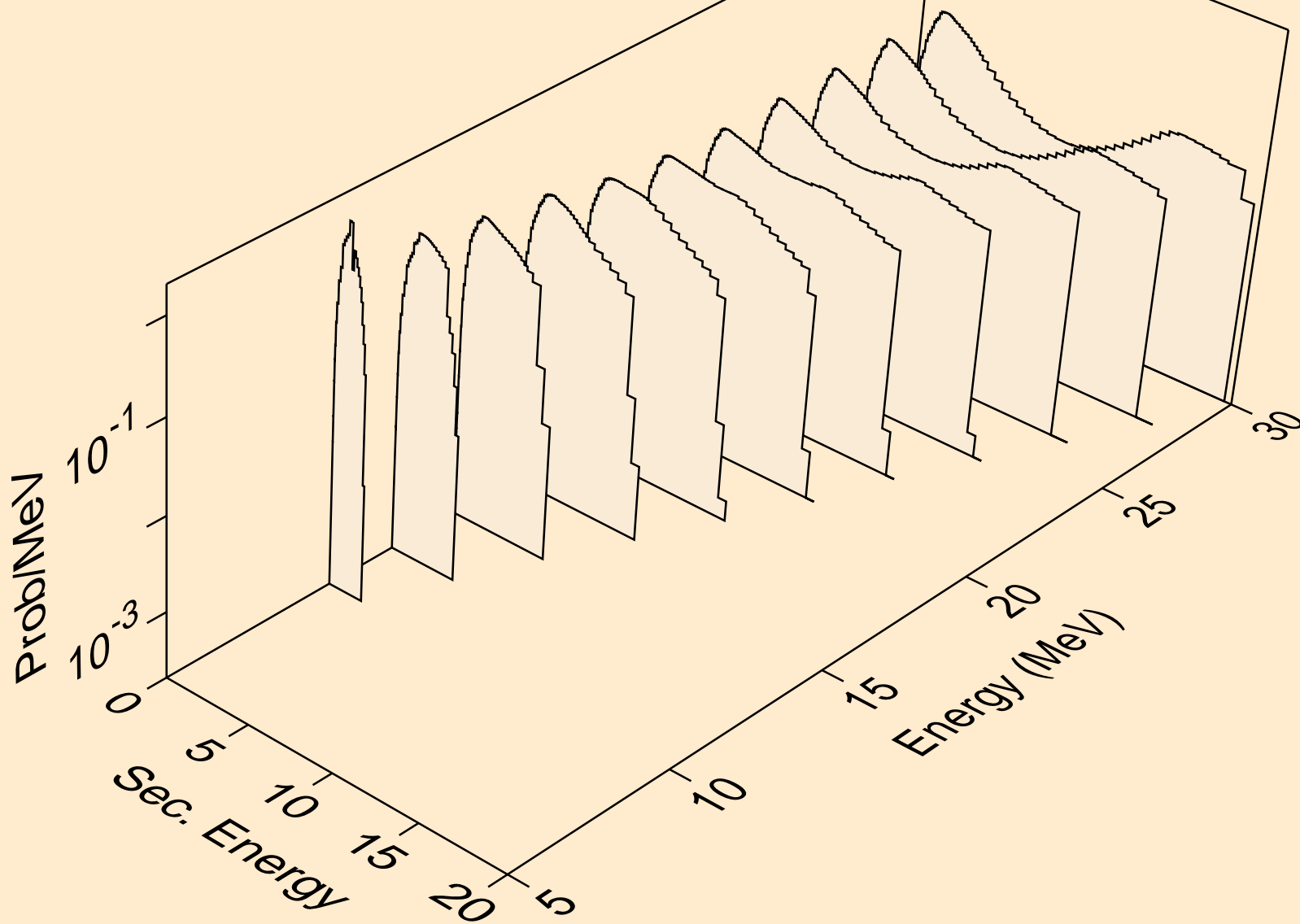

F023 NEUTRON ACER TENDL-2019 LIBRARY; T=293.16K
Neutron emission for (n,3n)

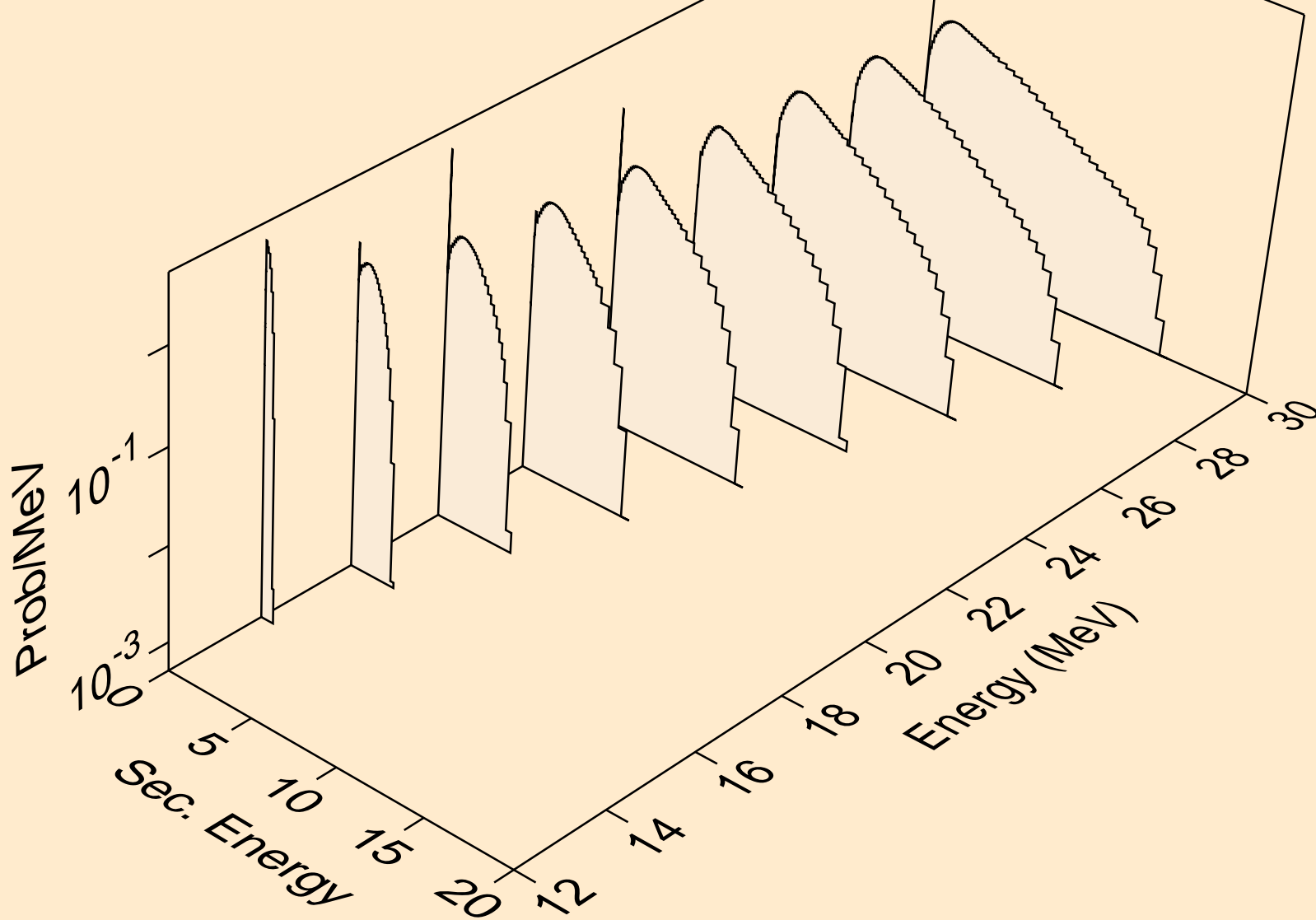

F023 NEUTRON ACER TENDL-2019 LIBRARY; T=293.16K
Neutron emission for (n,n*)a

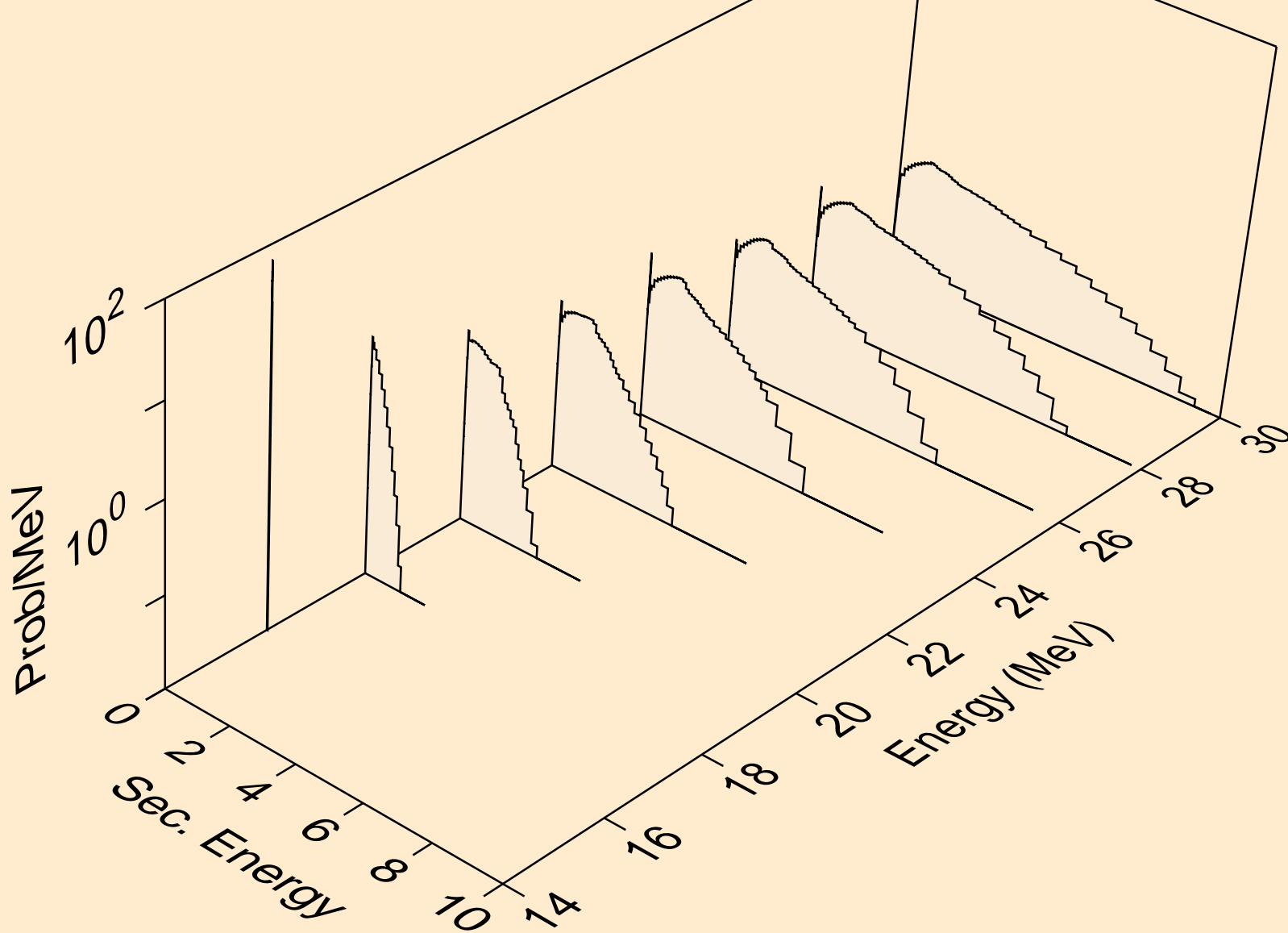

F023 NEUTRON ACER TENDL-2019 LIBRARY; T=293.16K
Neutron emission for (n,2n)a

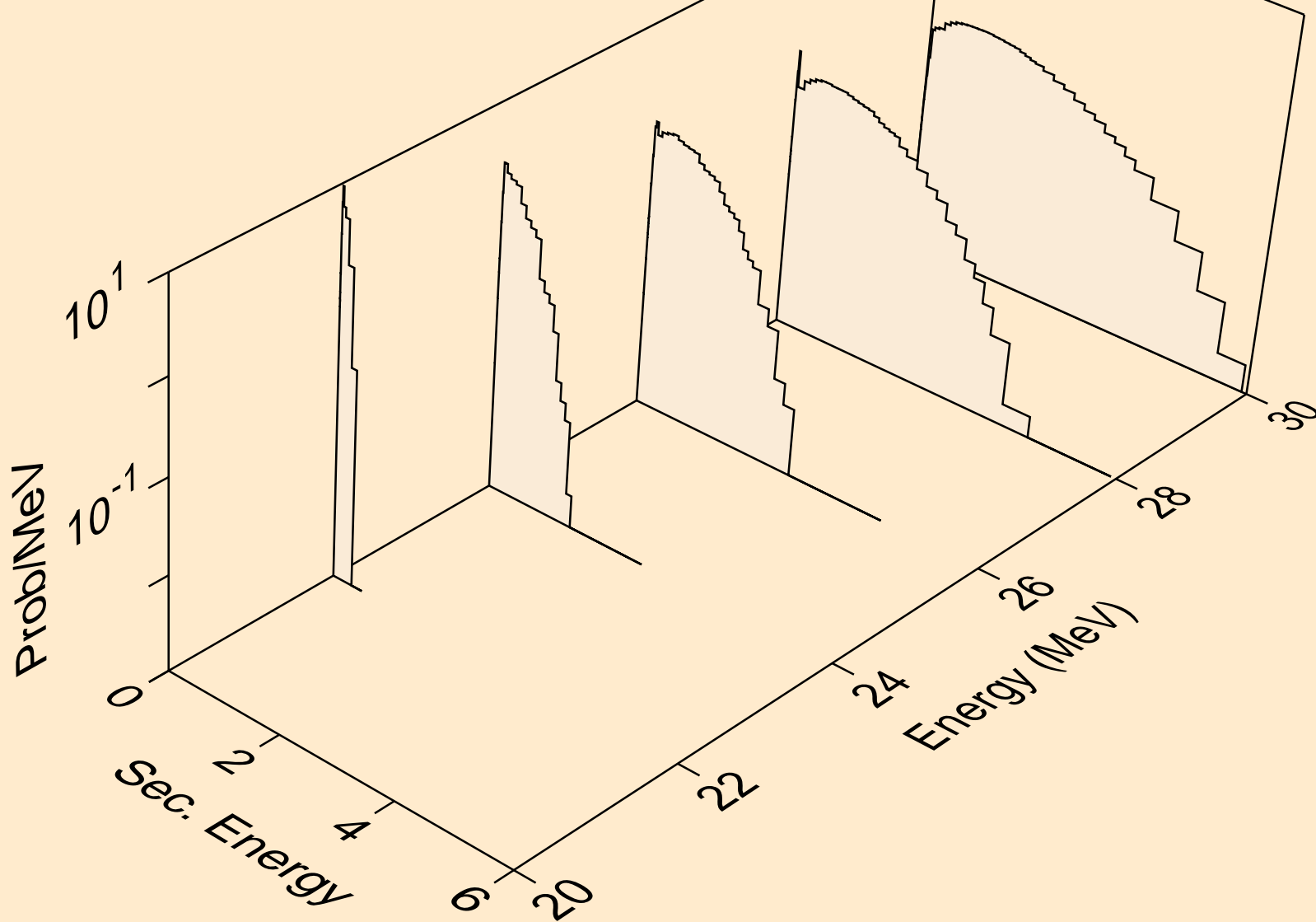

F023 NEUTRON ACER TENDL-2019 LIBRARY; T=293.16K
Neutron emission for (n,3n)a

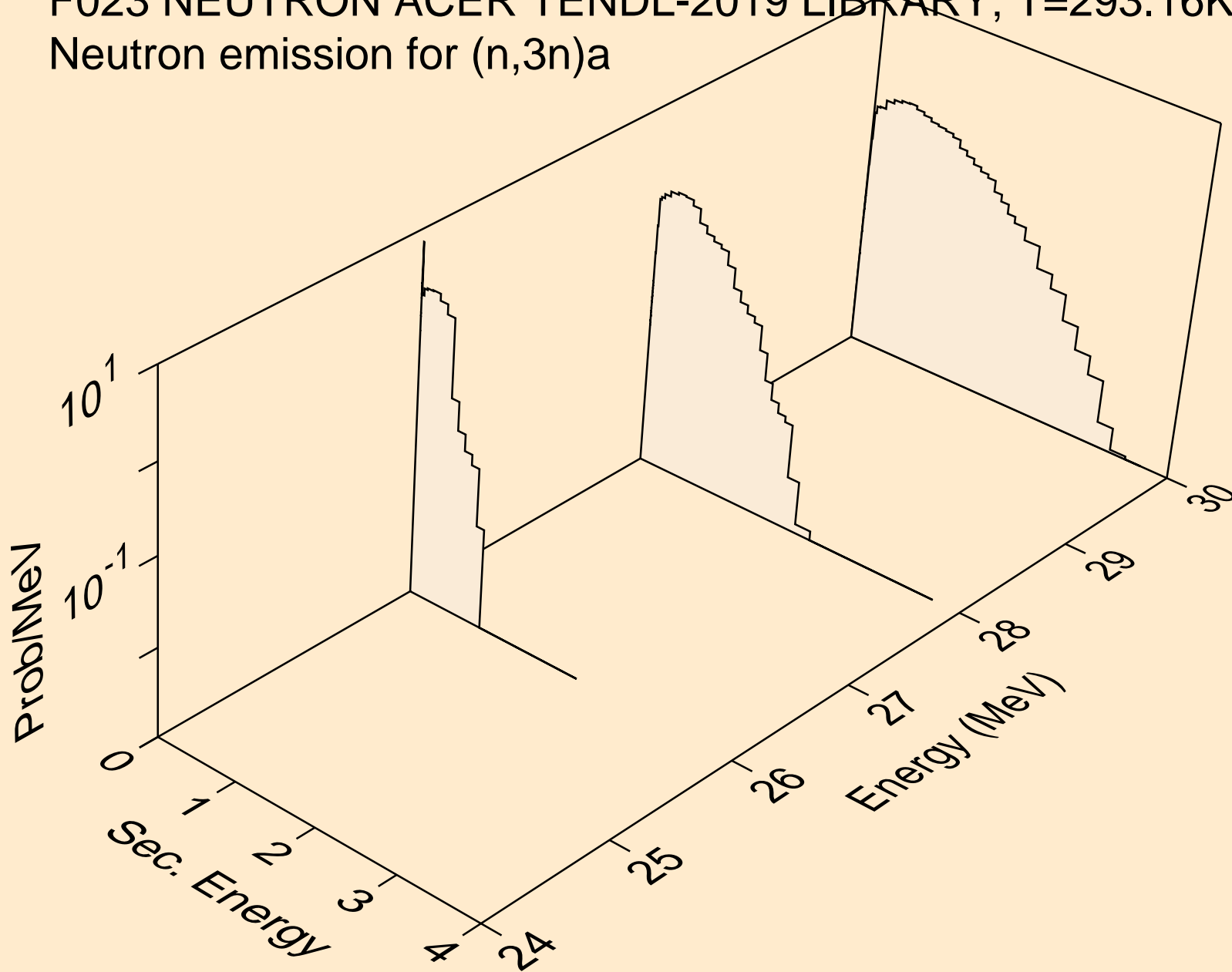

F023 NEUTRON ACER TENDL-2019 LIBRARY; T=293.16K
Neutron emission for (n,n*)p

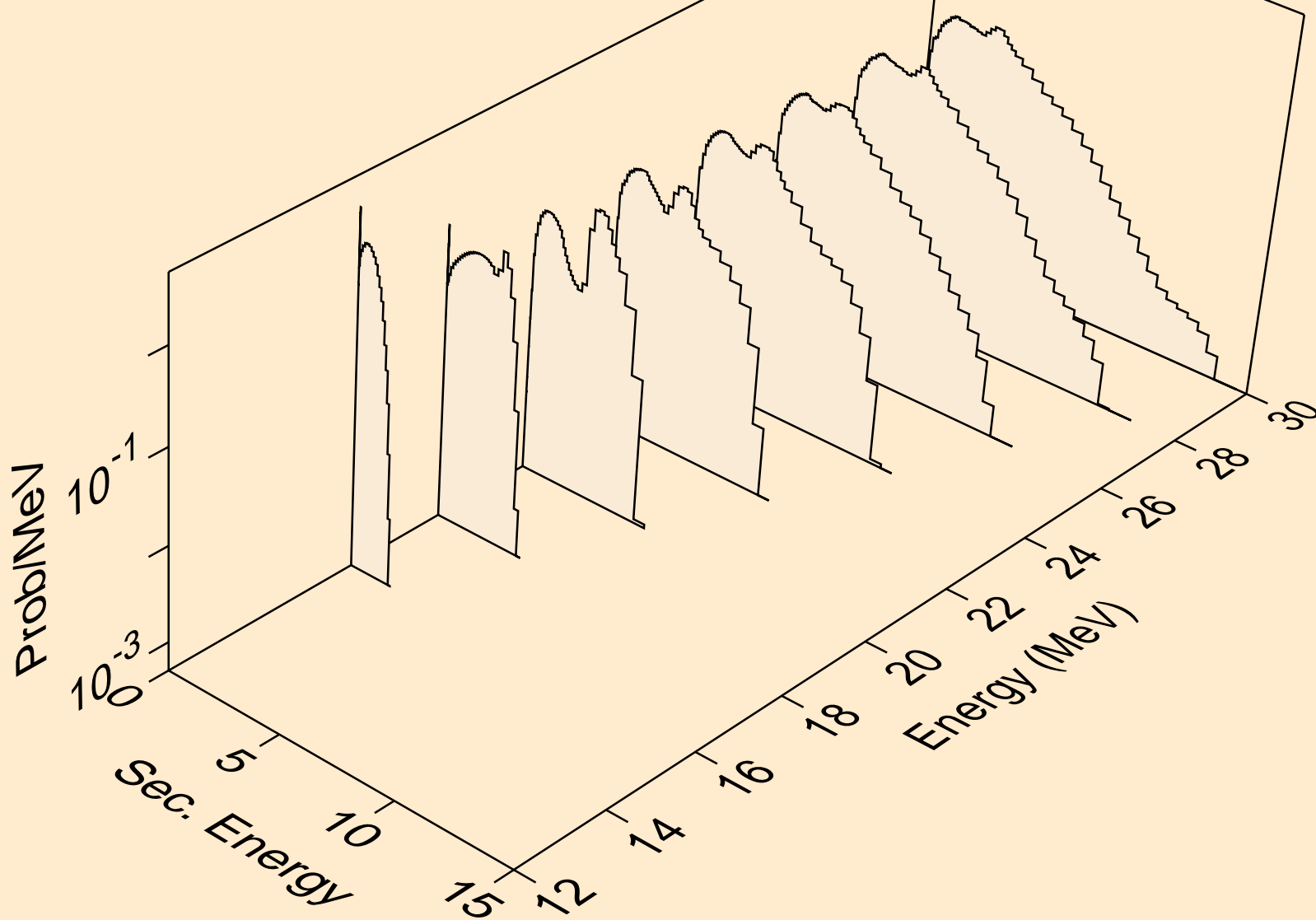

F023 NEUTRON ACER TENDL-2019 LIBRARY; T=293.16K
Neutron emission for (n,n*)d

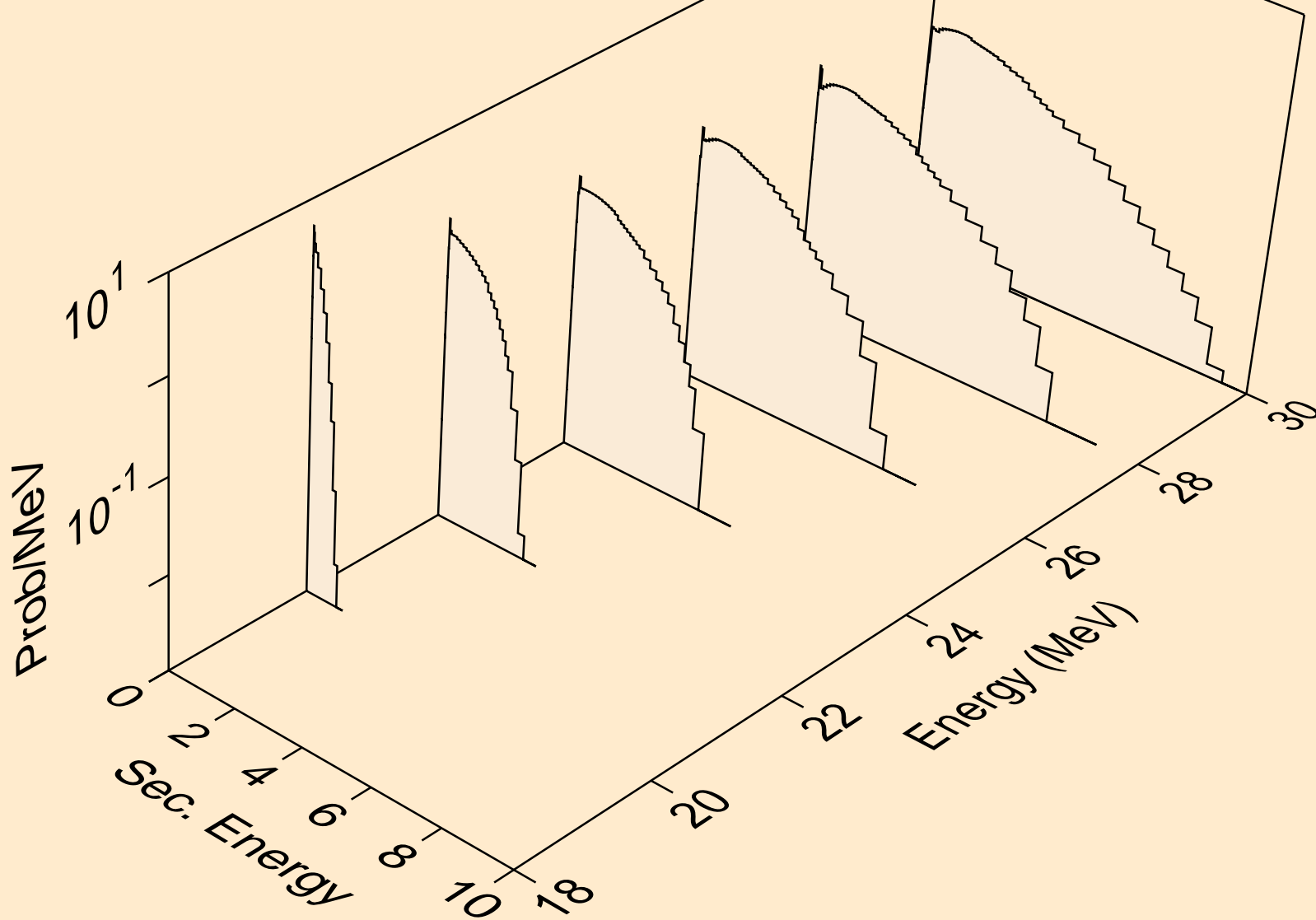

F023 NEUTRON ACER TENDL-2019 LIBRARY; T=293.16K
Neutron emission for (n,n*)t

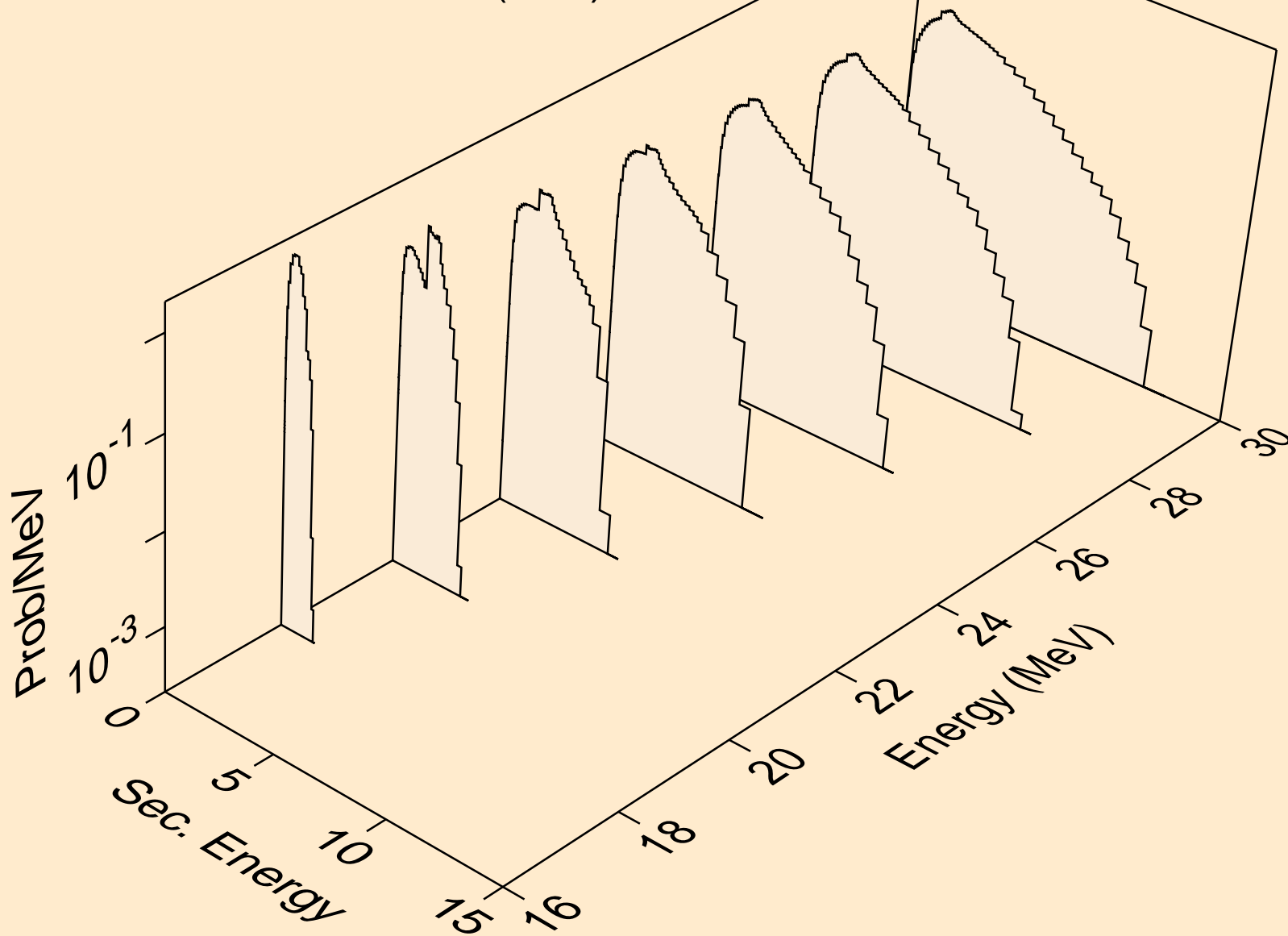

F023 NEUTRON ACER TENDL-2019 LIBRARY; T=293.16K
Neutron emission for (n,4n)

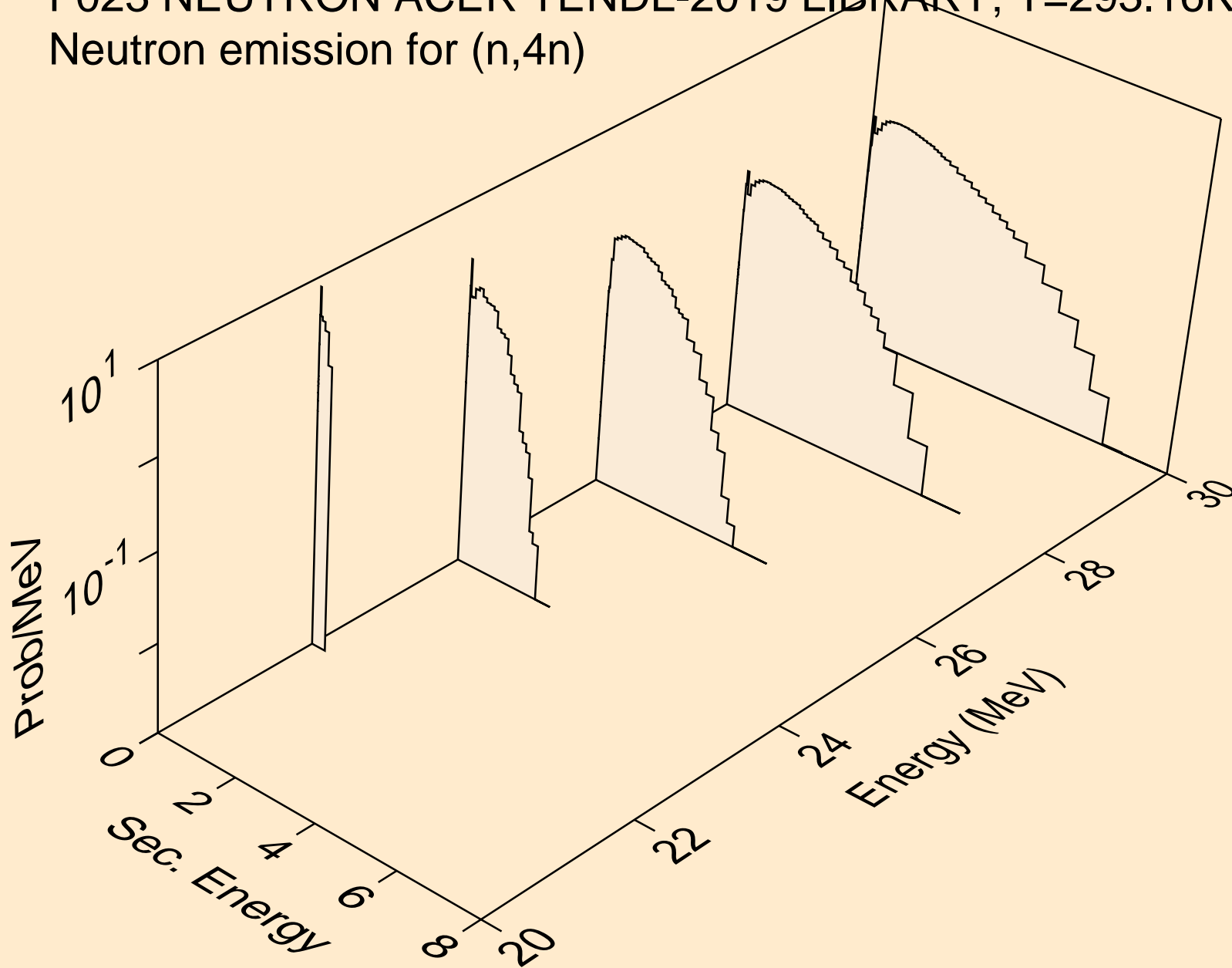

F023 NEUTRON ACER TENDL-2019 LIBRARY; T=293.16K
Neutron emission for (n,2np)

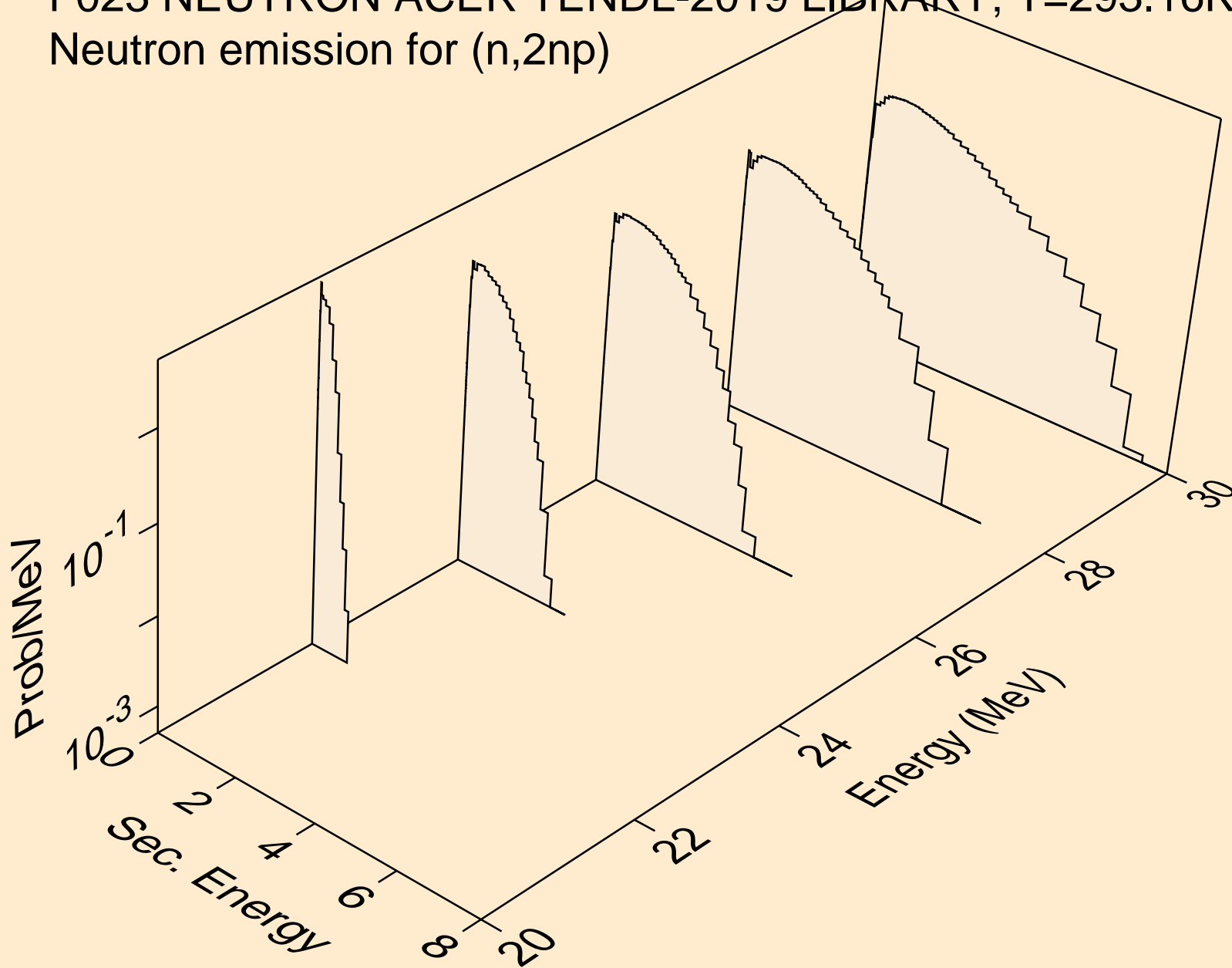

F023 NEUTRON ACER TENDL-2019 LIBRARY; T=293.16K
Neutron emission for (n,3np)

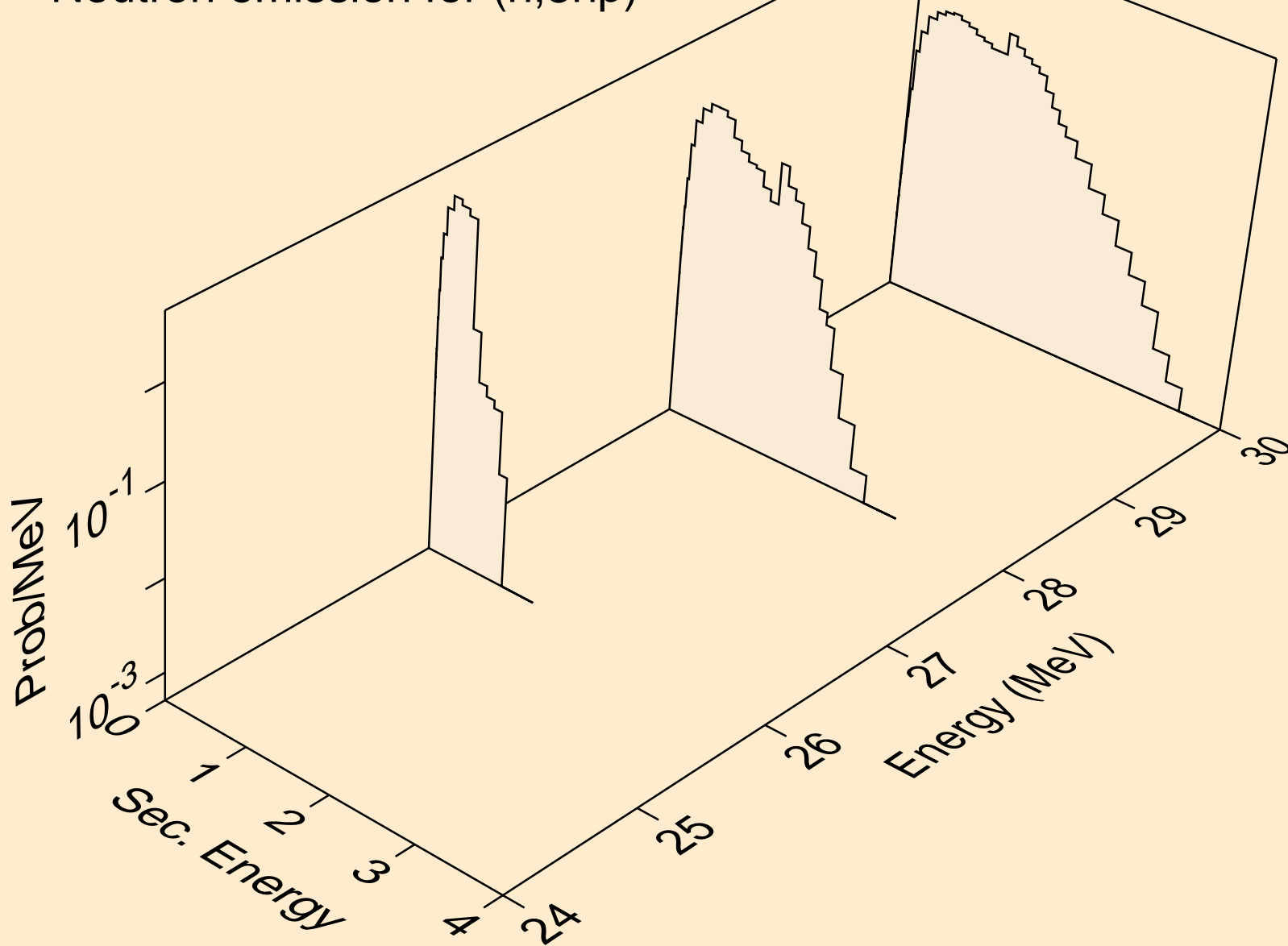

F023 NEUTRON ACER TENDL-2019 LIBRARY; T=293.16K
Neutron emission for (n,n*c)

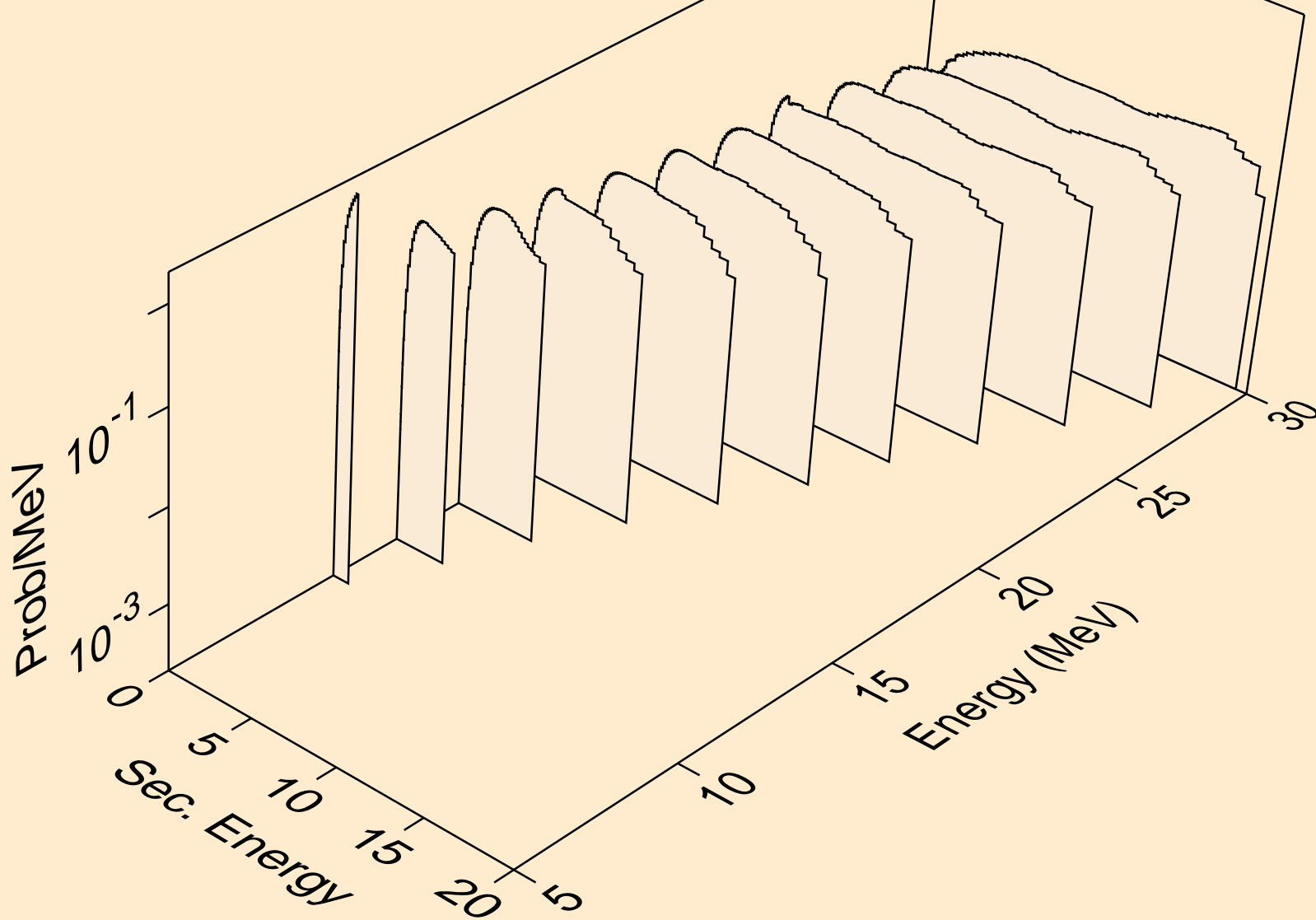

F023 NEUTRON ACER TENDL-2019 LIBRARY; T=293.16K
Photon emission for (n,x)

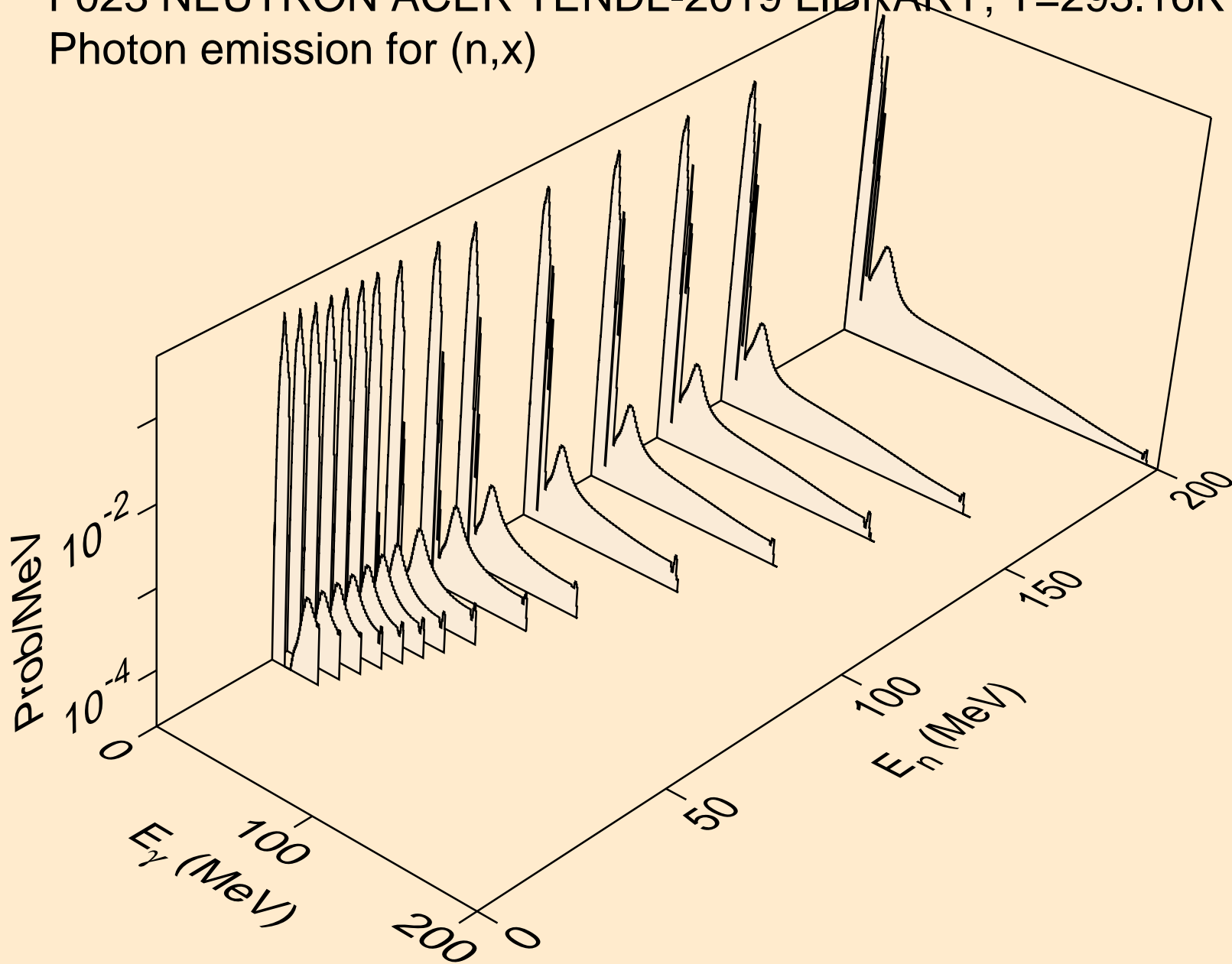

F023 NEUTRON ACER TENDL-2019 LIBRARY; T=293.16K
Photon emission for (n,2nd)

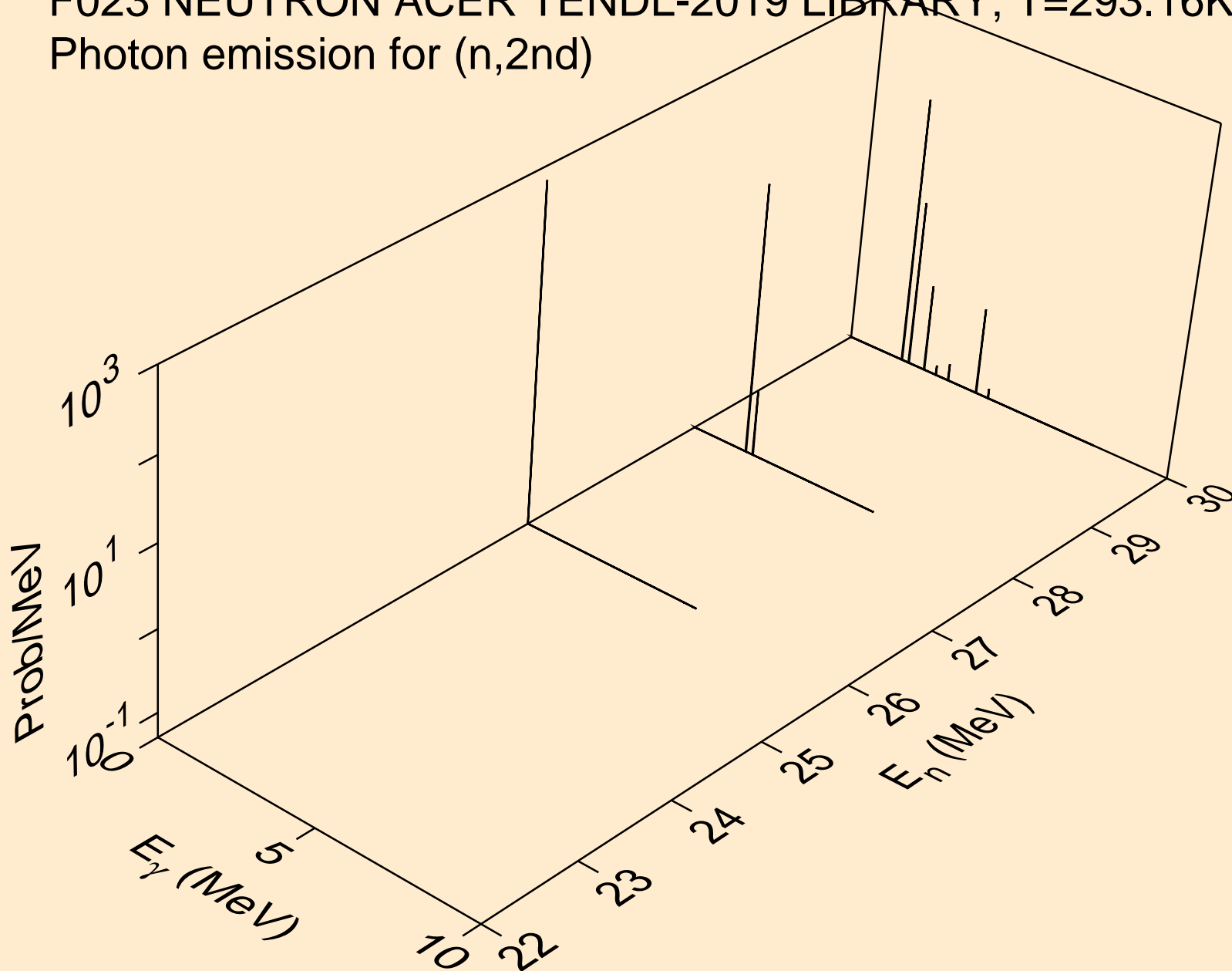

F023 NEUTRON ACER TENDL-2019 LIBRARY; T=293.16K
Photon emission for (n,2n)

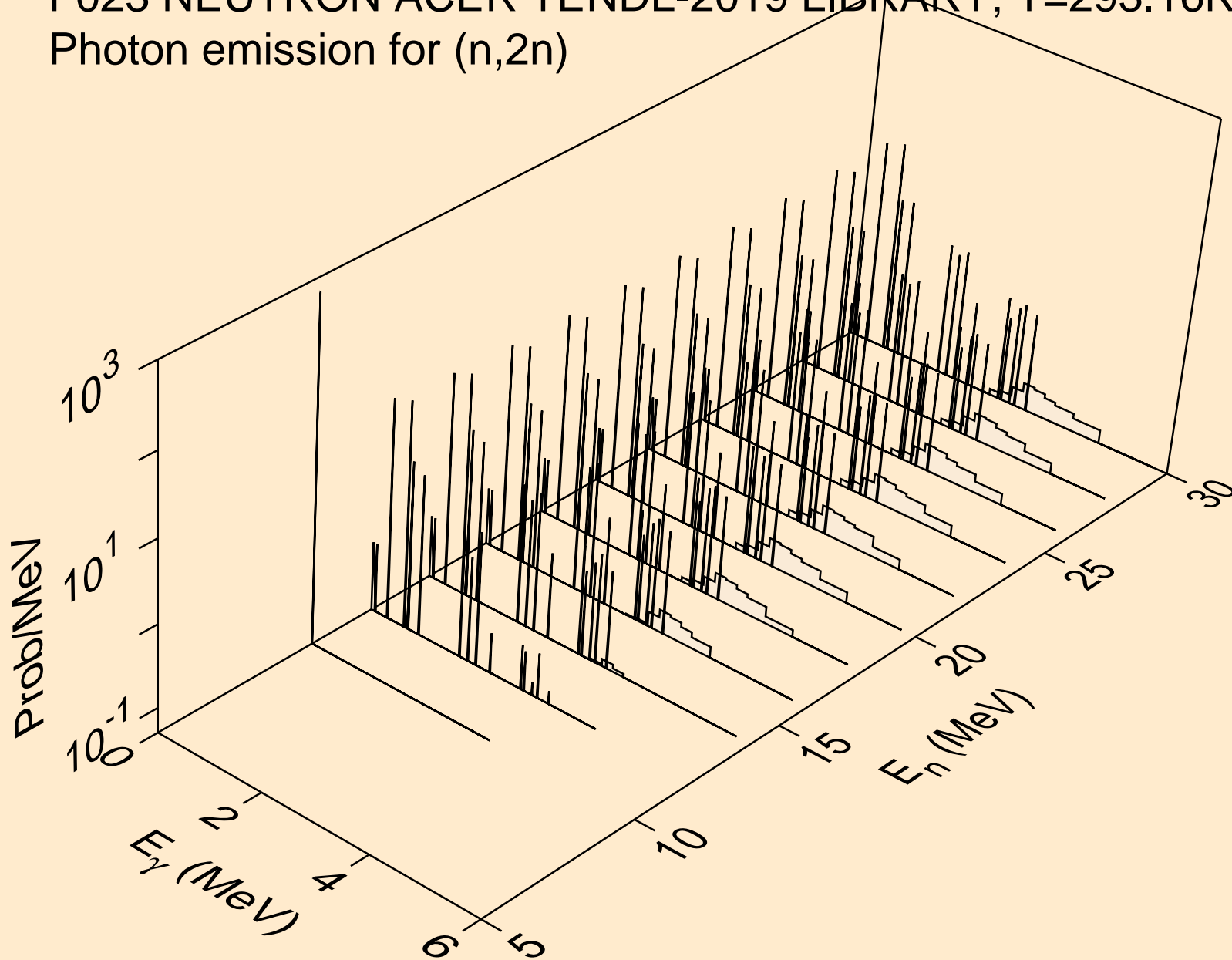

F023 NEUTRON ACER TENDL-2019 LIBRARY; T=293.16K
Photon emission for (n,3n)

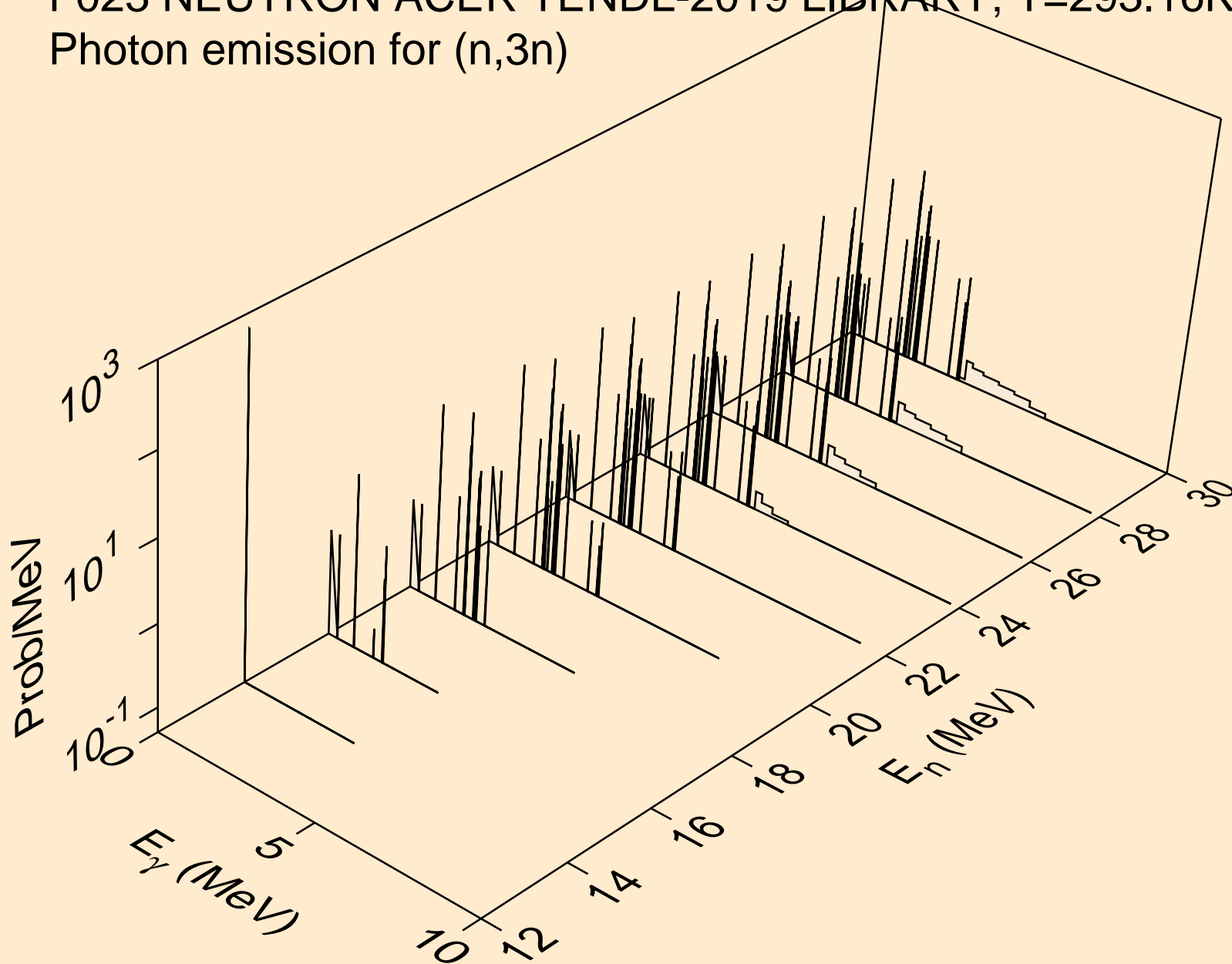

F023 NEUTRON ACER TENDL-2019 LIBRARY; T=293.16K
Photon emission for (n,n*)a

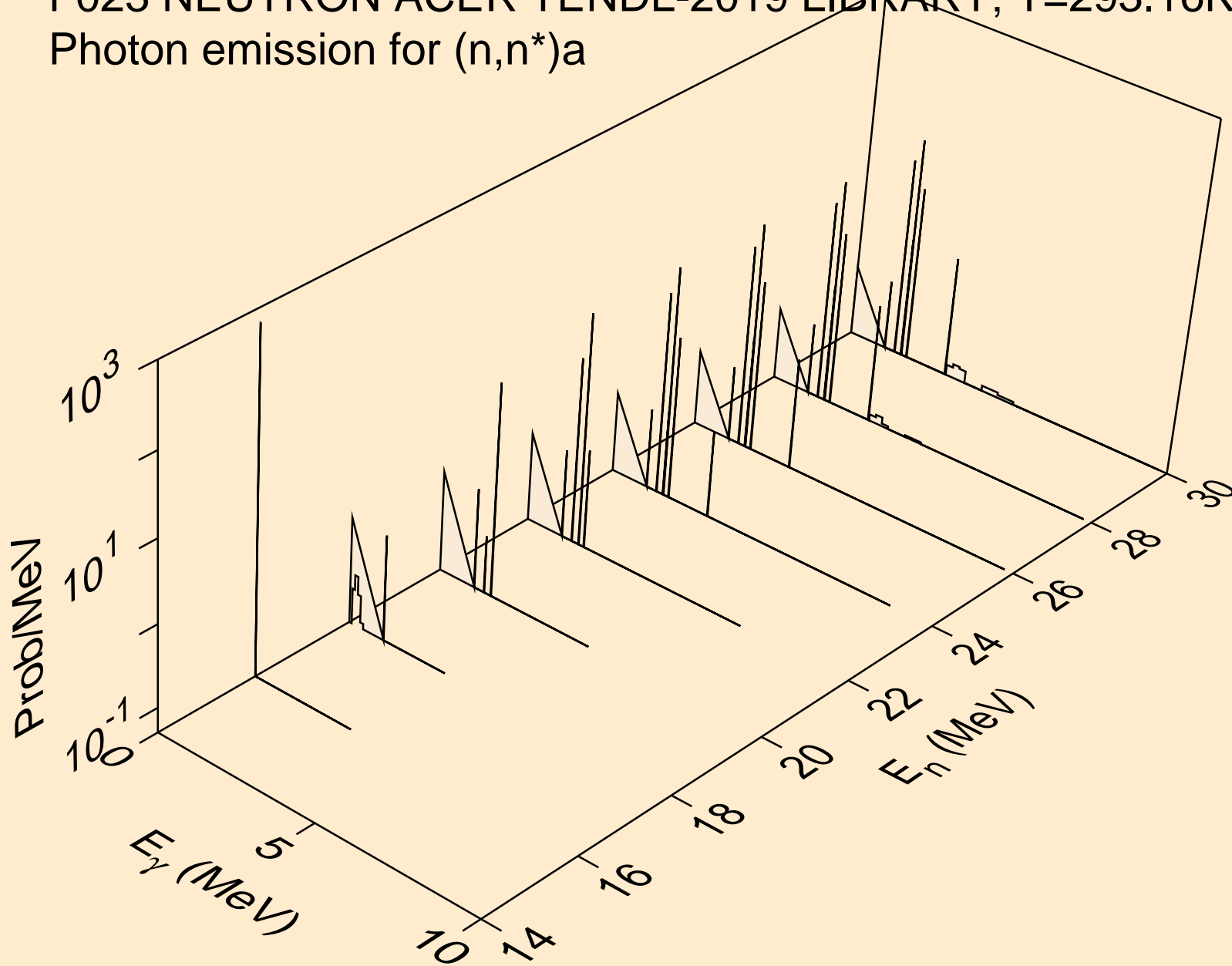

F023 NEUTRON ACER TENDL-2019 LIBRARY; T=293.16K
Photon emission for (n,2n)a

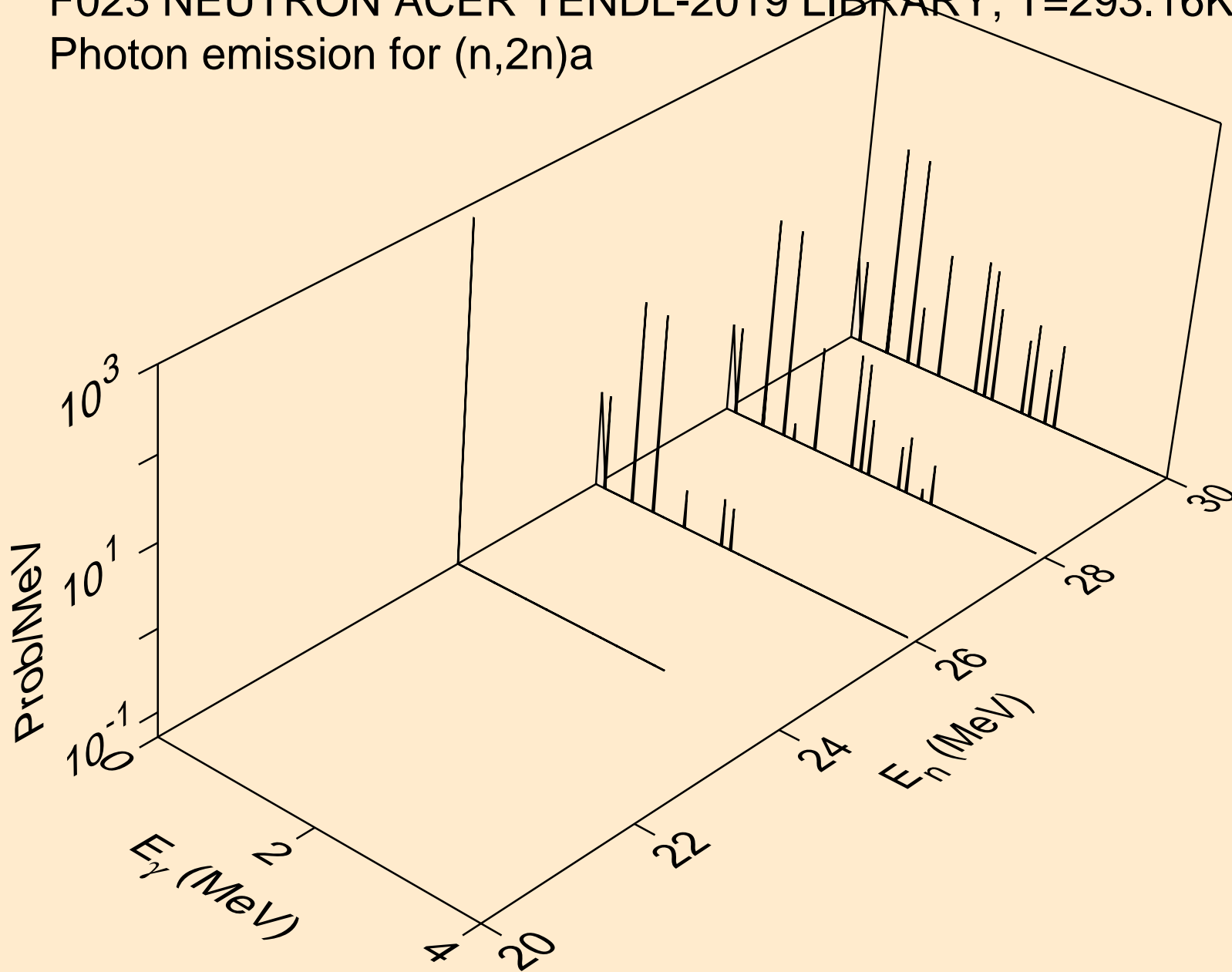

F023 NEUTRON ACER TENDL-2019 LIBRARY; T=293.16K
Photon emission for (n,3n)a

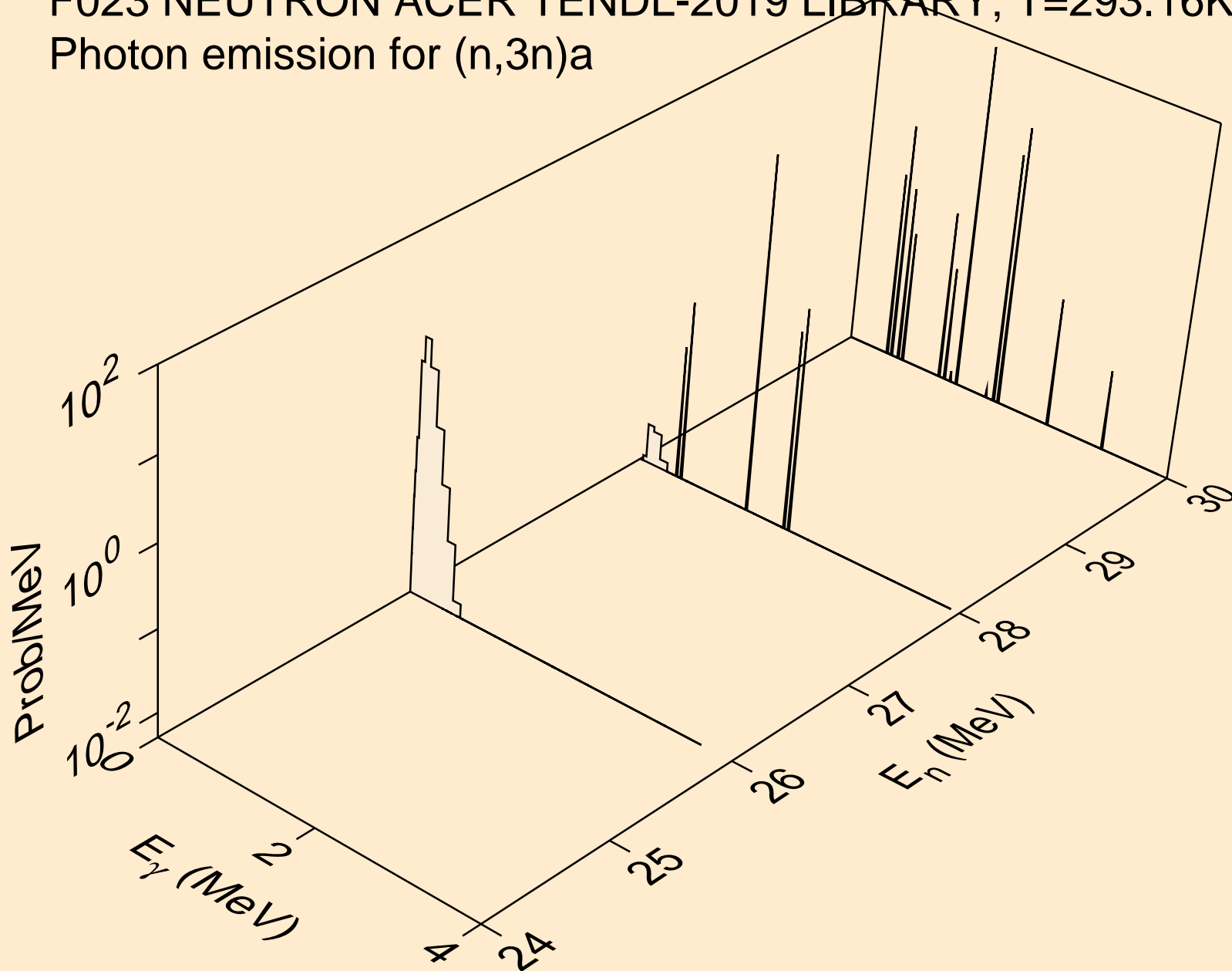

F023 NEUTRON ACER TENDL-2019 LIBRARY; T=293.16K
Photon emission for (n,n*)p

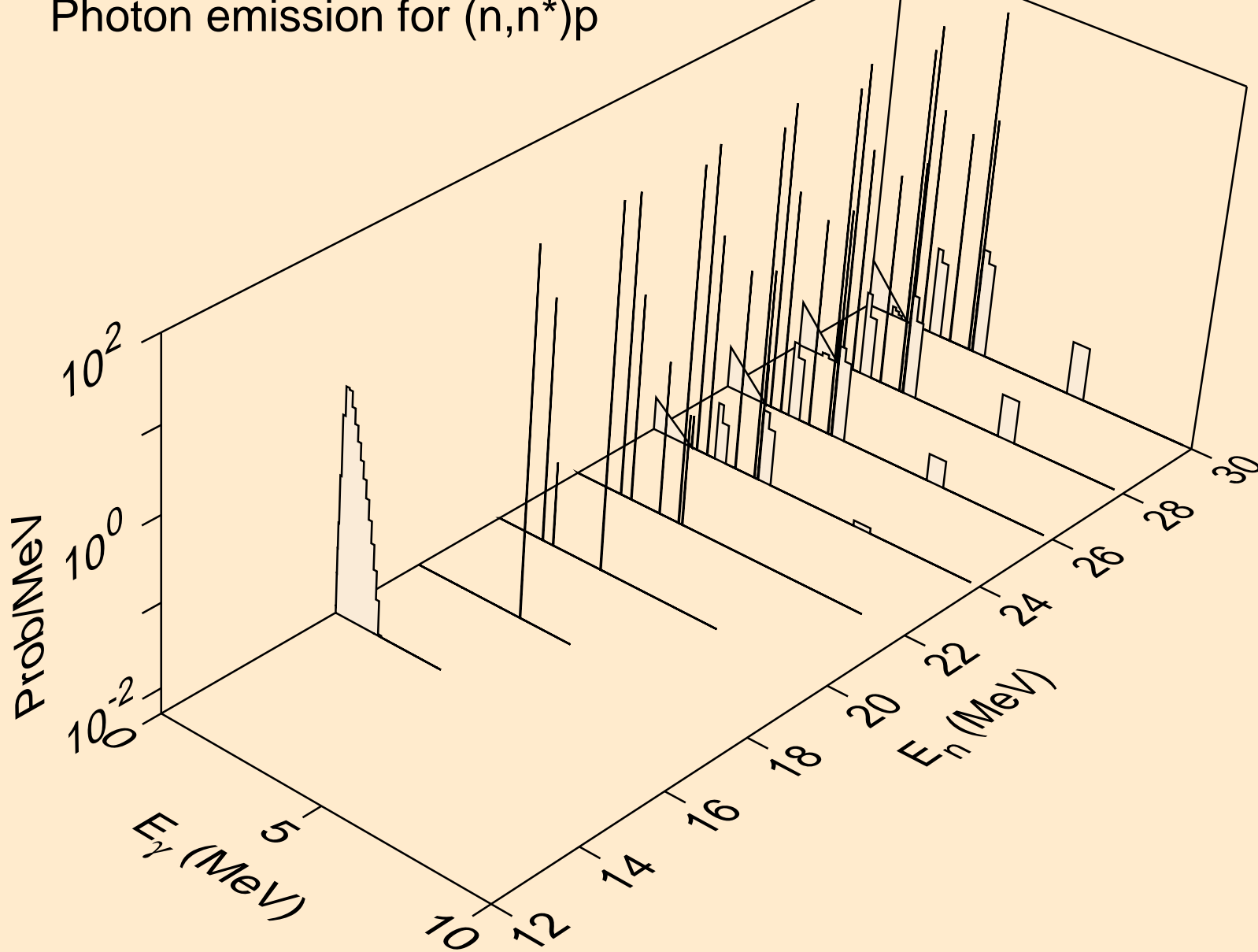

F023 NEUTRON ACER TENDL-2019 LIBRARY; T=293.16K
Photon emission for (n,n*)d

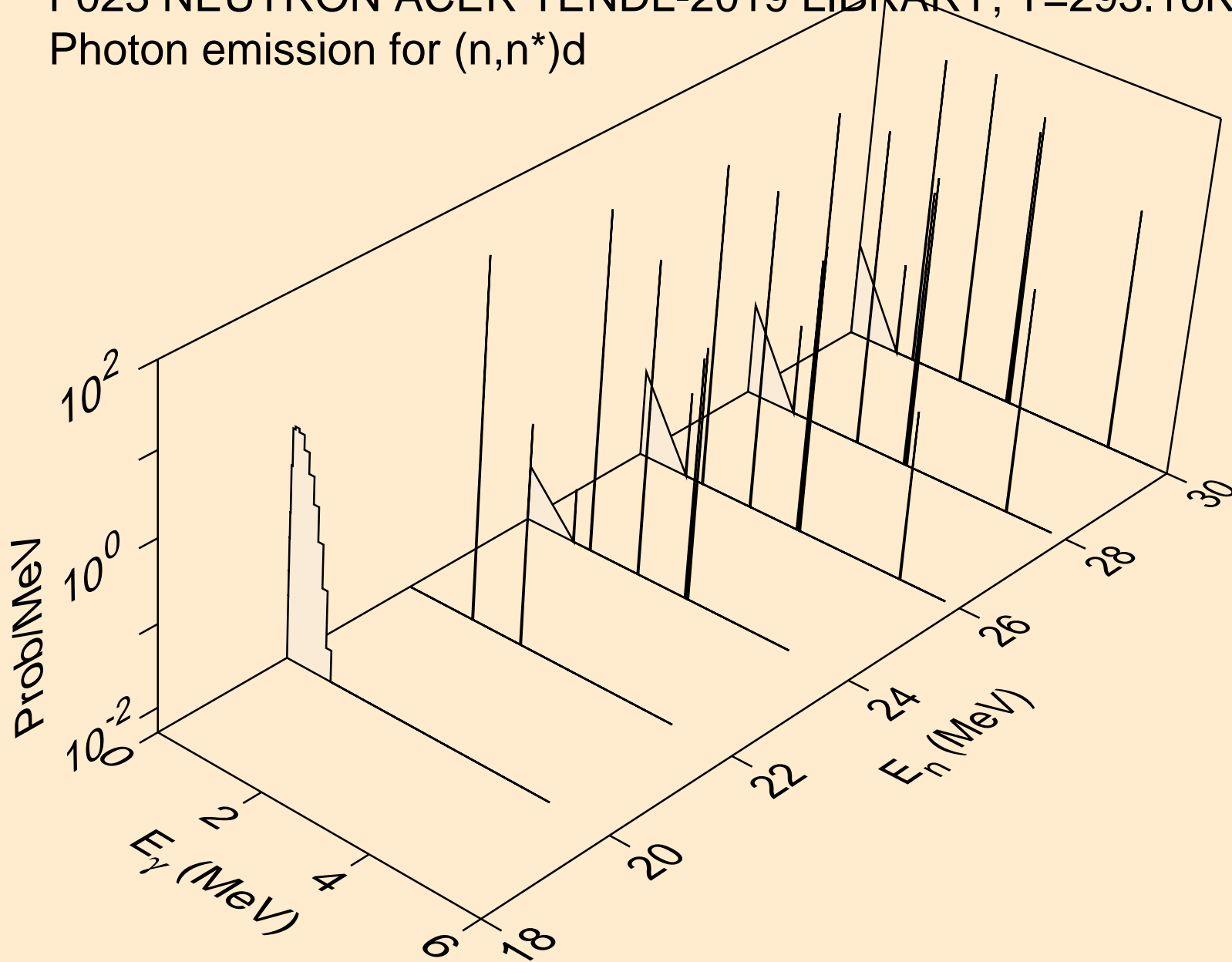

F023 NEUTRON ACER TENDL-2019 LIBRARY; T=293.16K
Photon emission for (n,n*)t

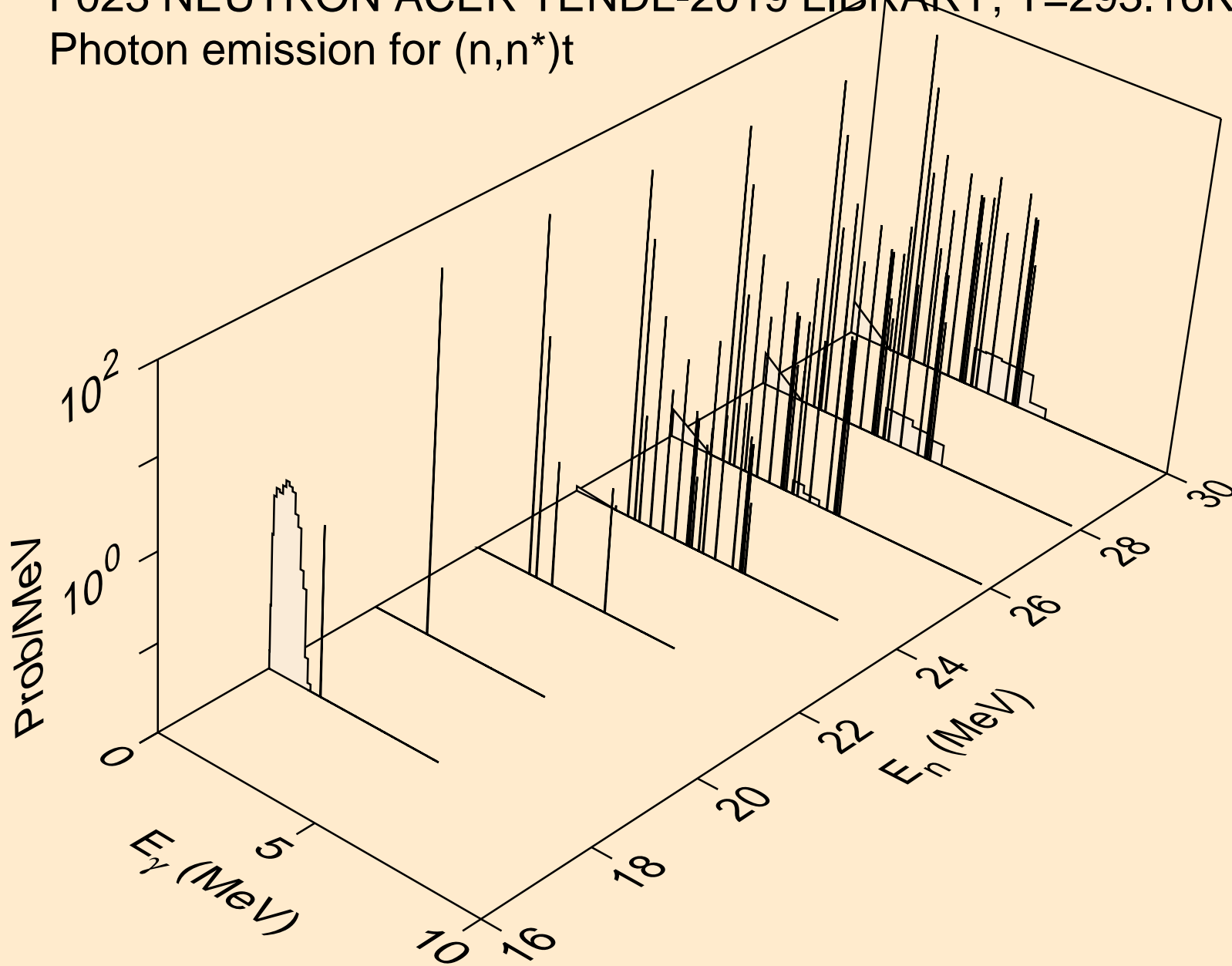

F023 NEUTRON ACER TENDL-2019 LIBRARY; T=293.16K
Photon emission for (n,4n)

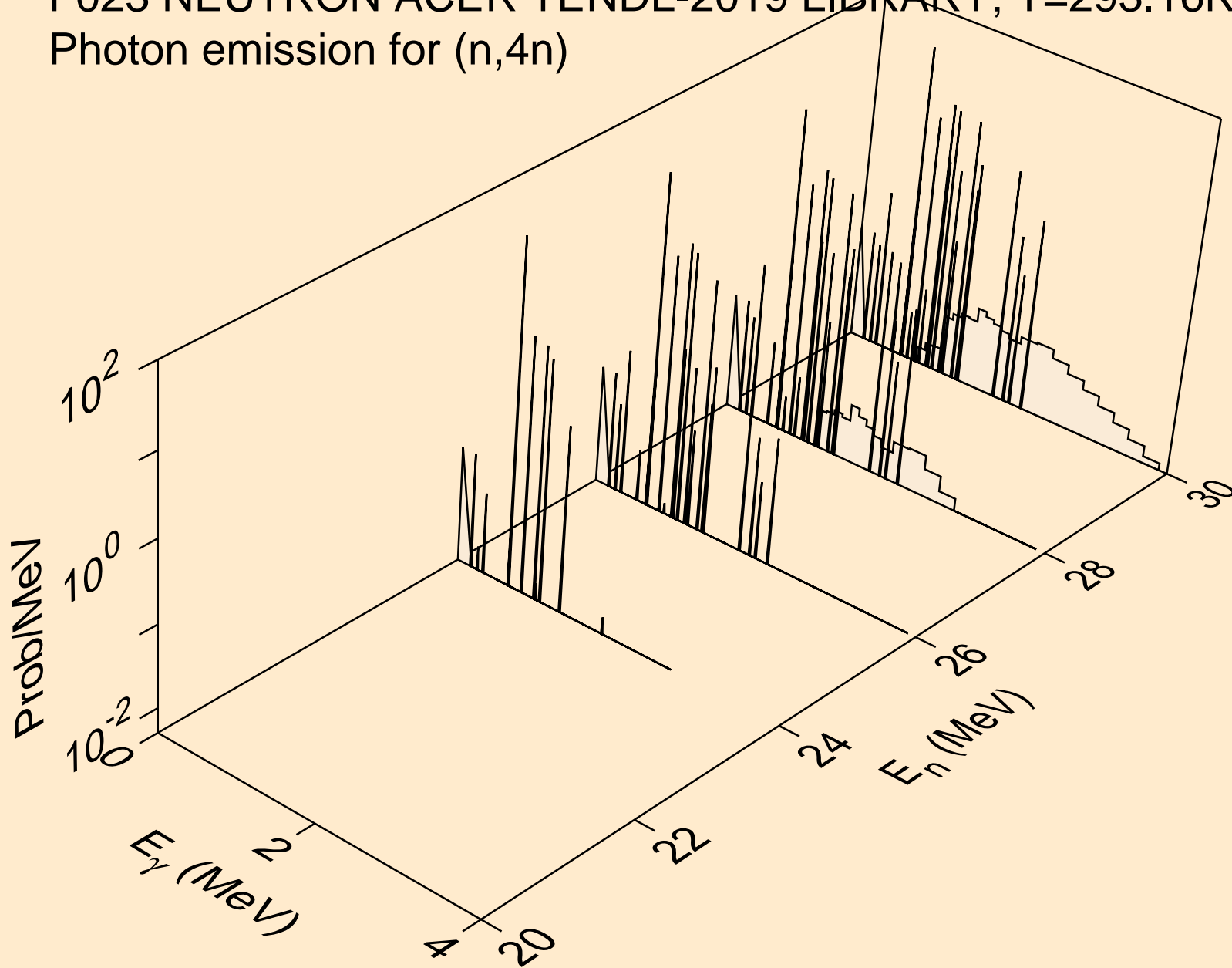

F023 NEUTRON ACER TENDL-2019 LIBRARY; T=293.16K
Photon emission for (n,2np)

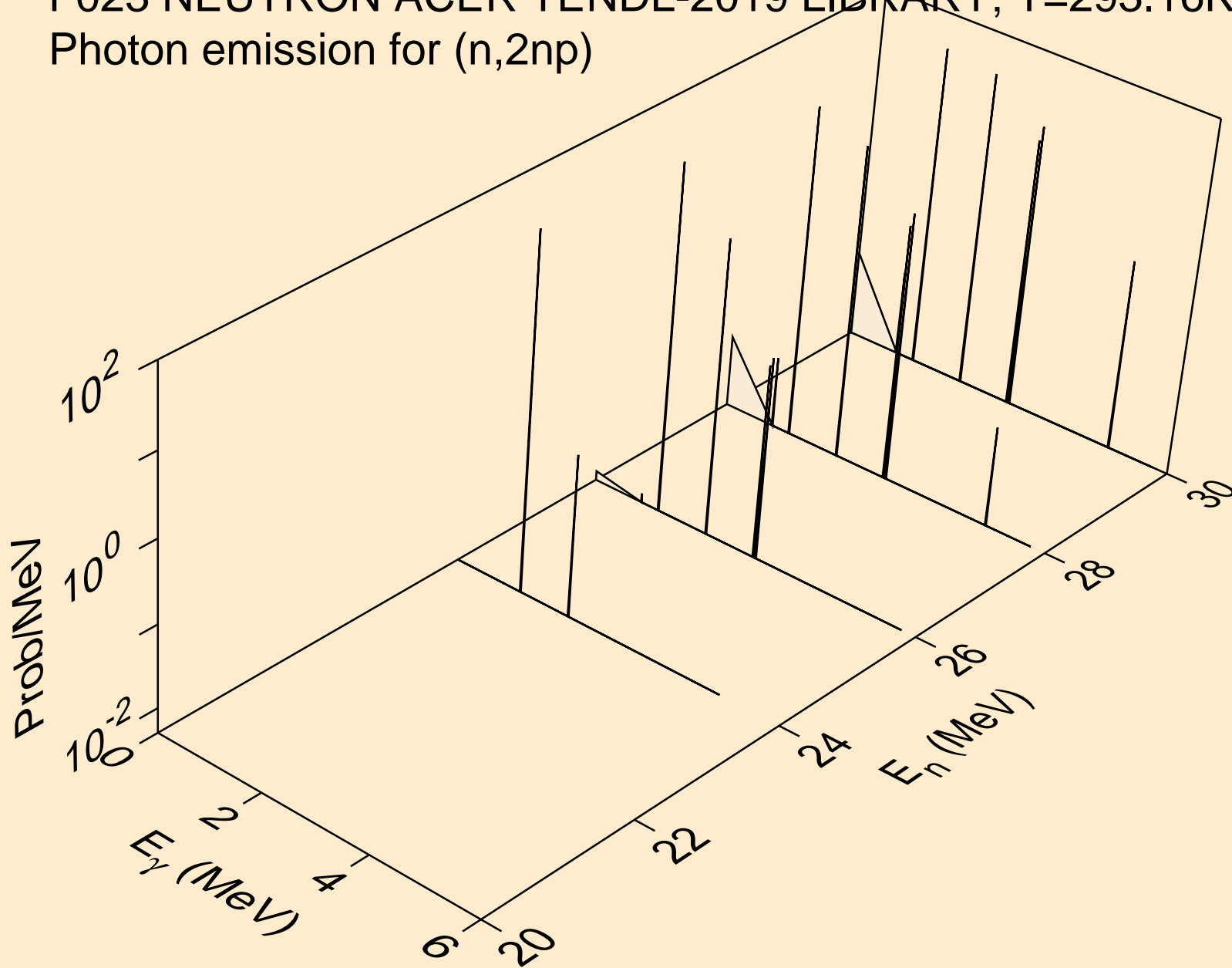

F023 NEUTRON ACER TENDL-2019 LIBRARY; T=293.16K
Photon emission for (n,3np)

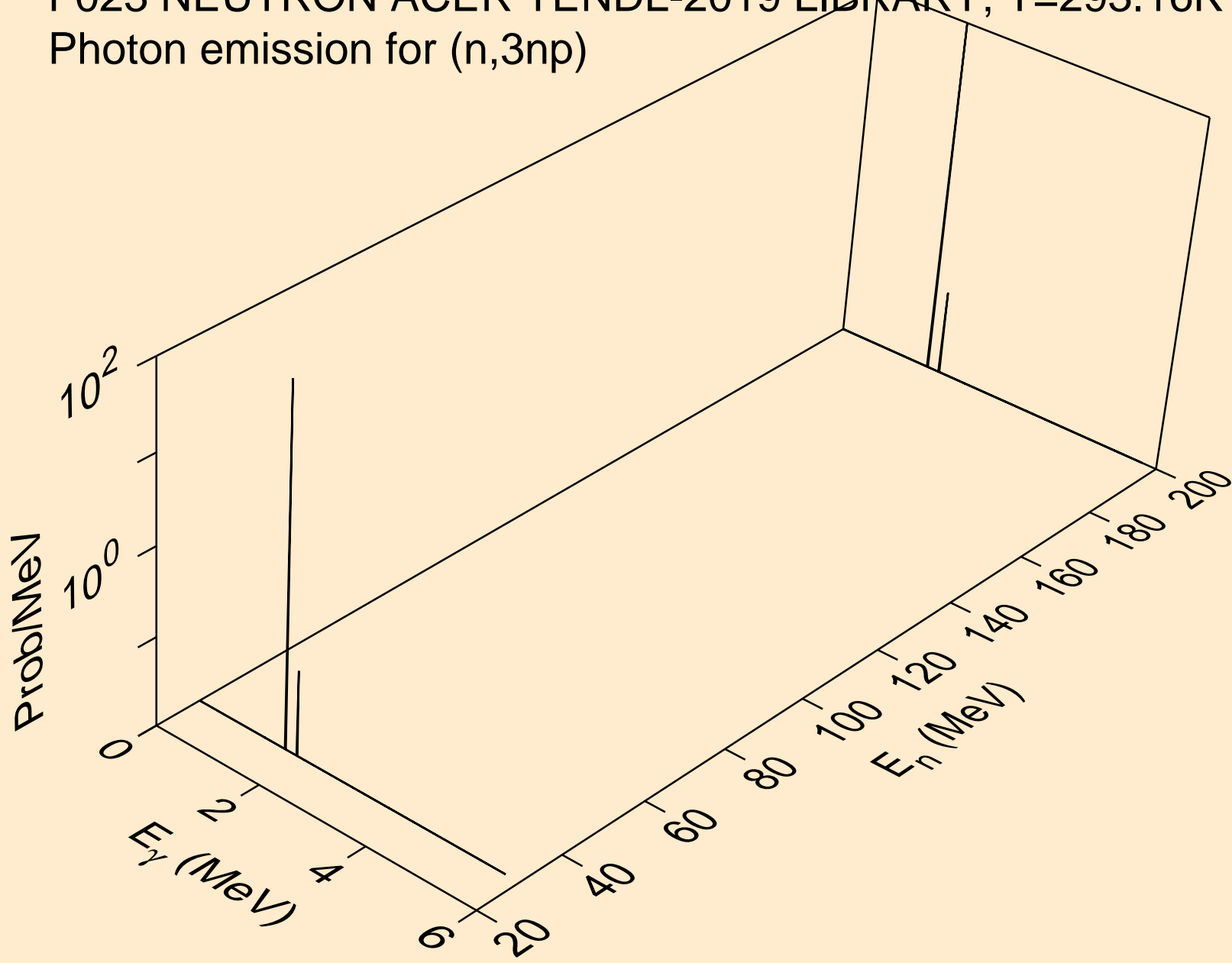

F023 NEUTRON ACER TENDL-2019 LIBRARY; T=293.16K
Photon emission for (n,n*c)

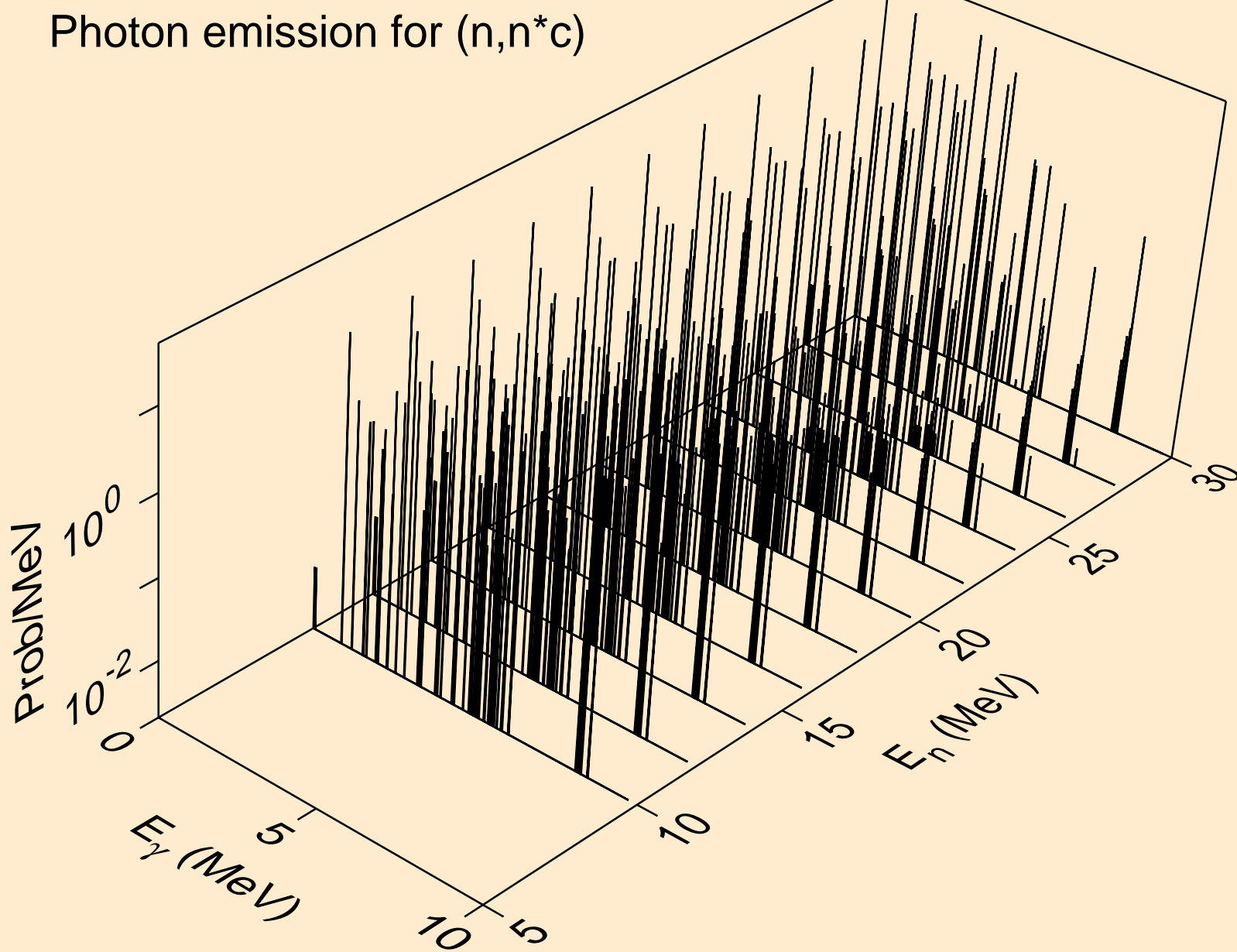

F023 NEUTRON ACER TENDL-2019 LIBRARY; T=293.16K
Photon emission for (n,gma)

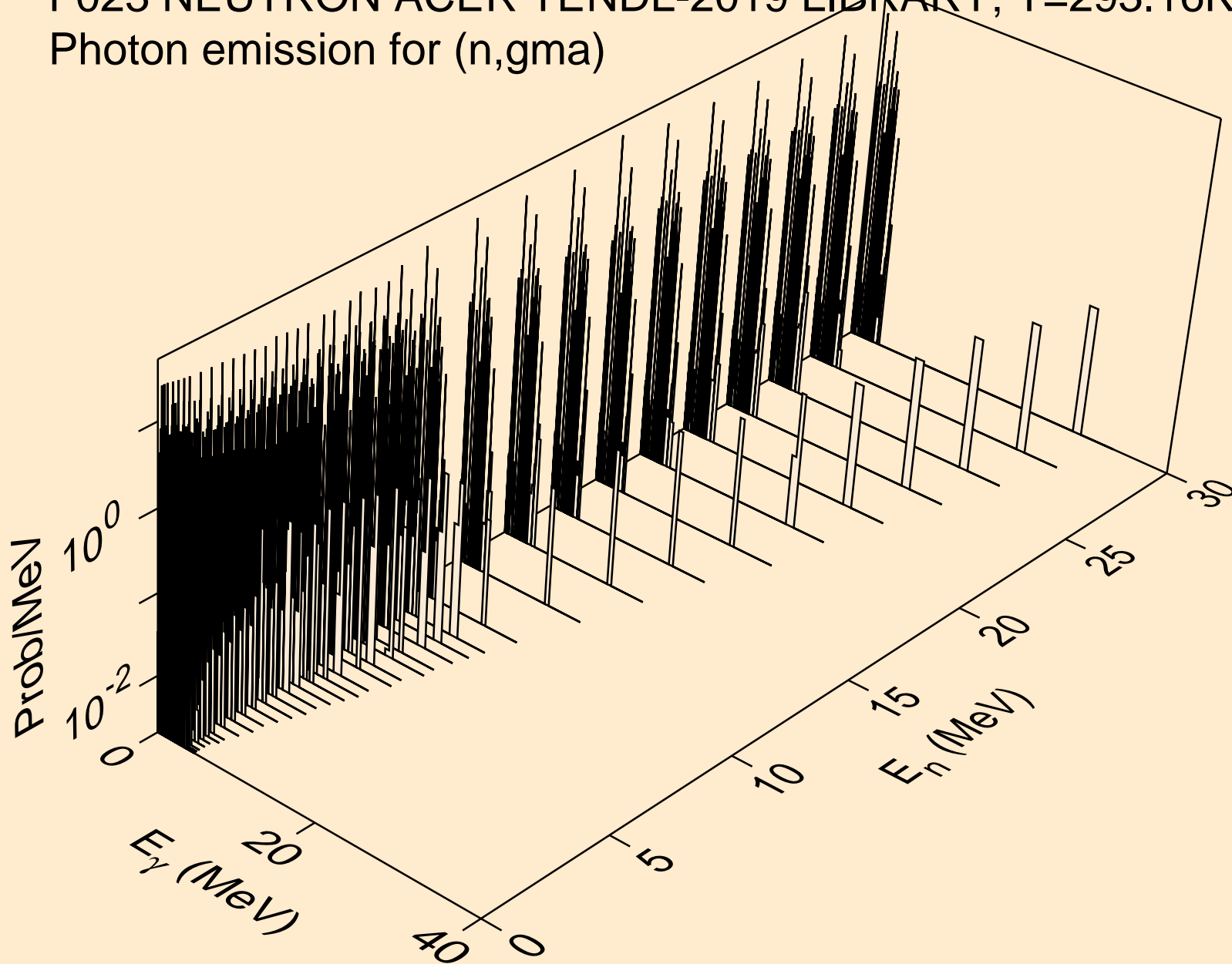

F023 NEUTRON ACER TENDL-2019 LIBRARY; T=293.16K
Photon emission for (n,p)

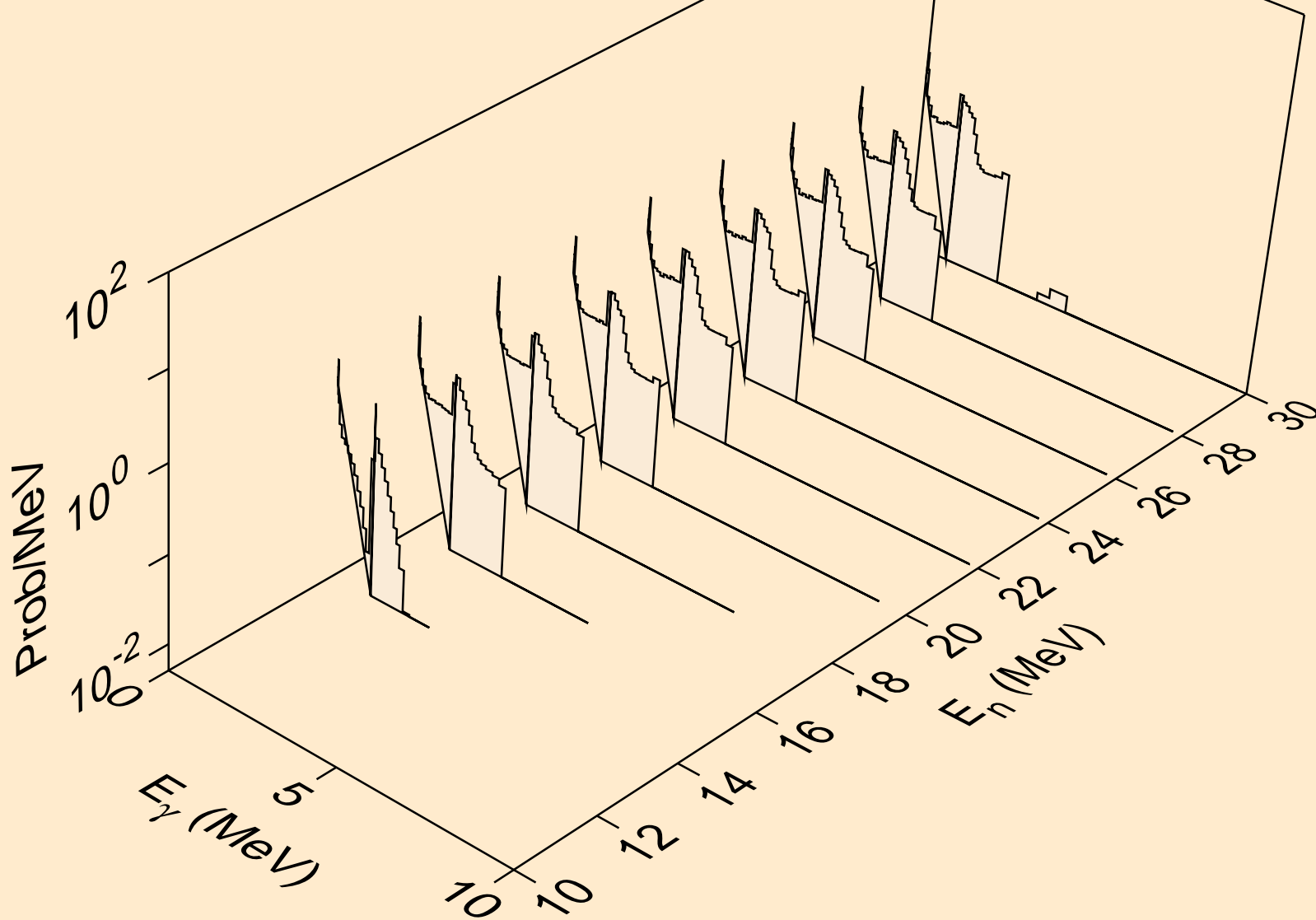

F023 NEUTRON ACER TENDL-2019 LIBRARY; T=293.16K
Photon emission for (n,d)

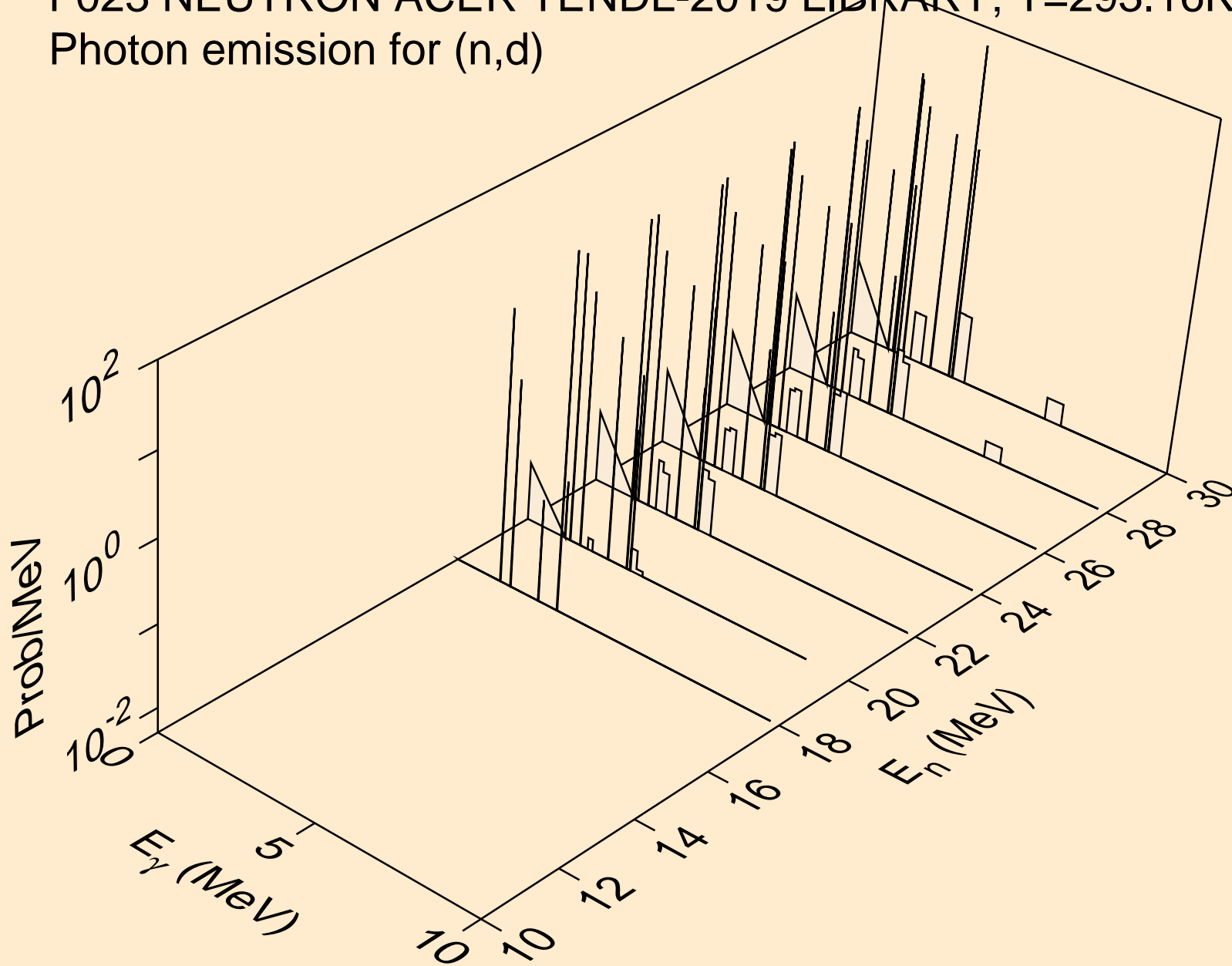

F023 NEUTRON ACER TENDL-2019 LIBRARY; T=293.16K
Photon emission for (n,t)

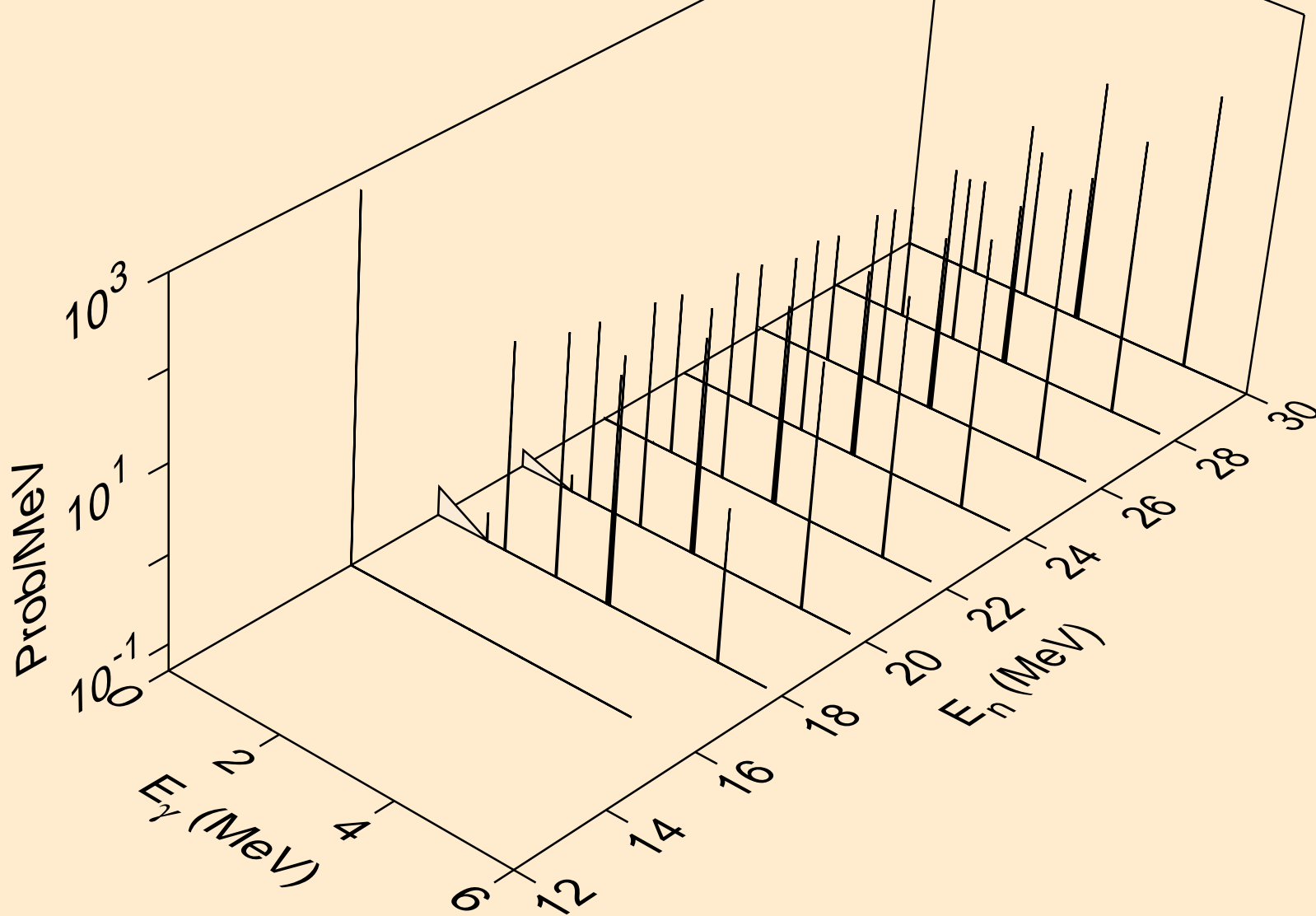

F023 NEUTRON ACER TENDL-2019 LIBRARY; T=293.16K
Photon emission for (n,a)

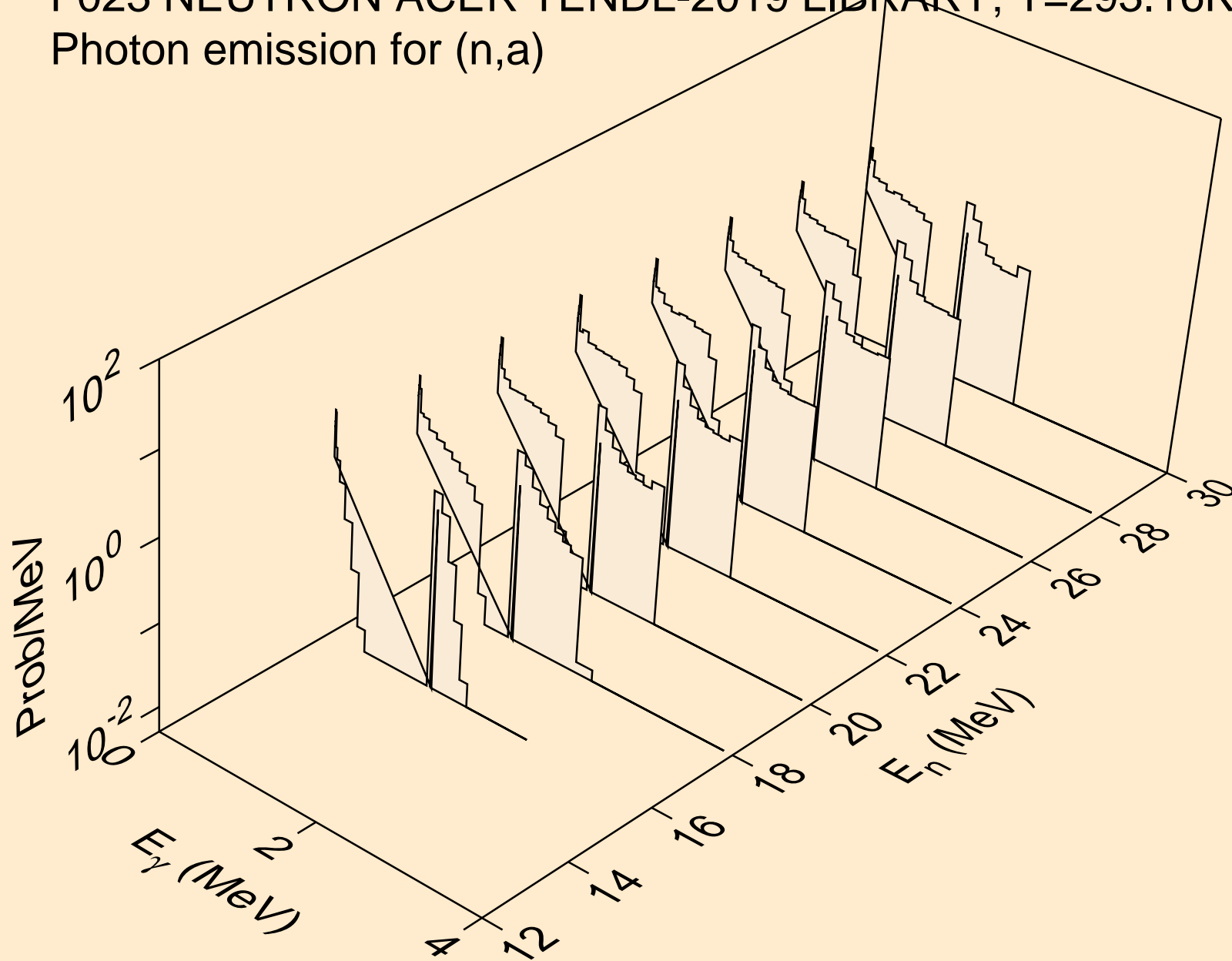

F023 NEUTRON ACER TENDL-2019 LIBRARY; T=293.16K
thermal capture photon spectrum

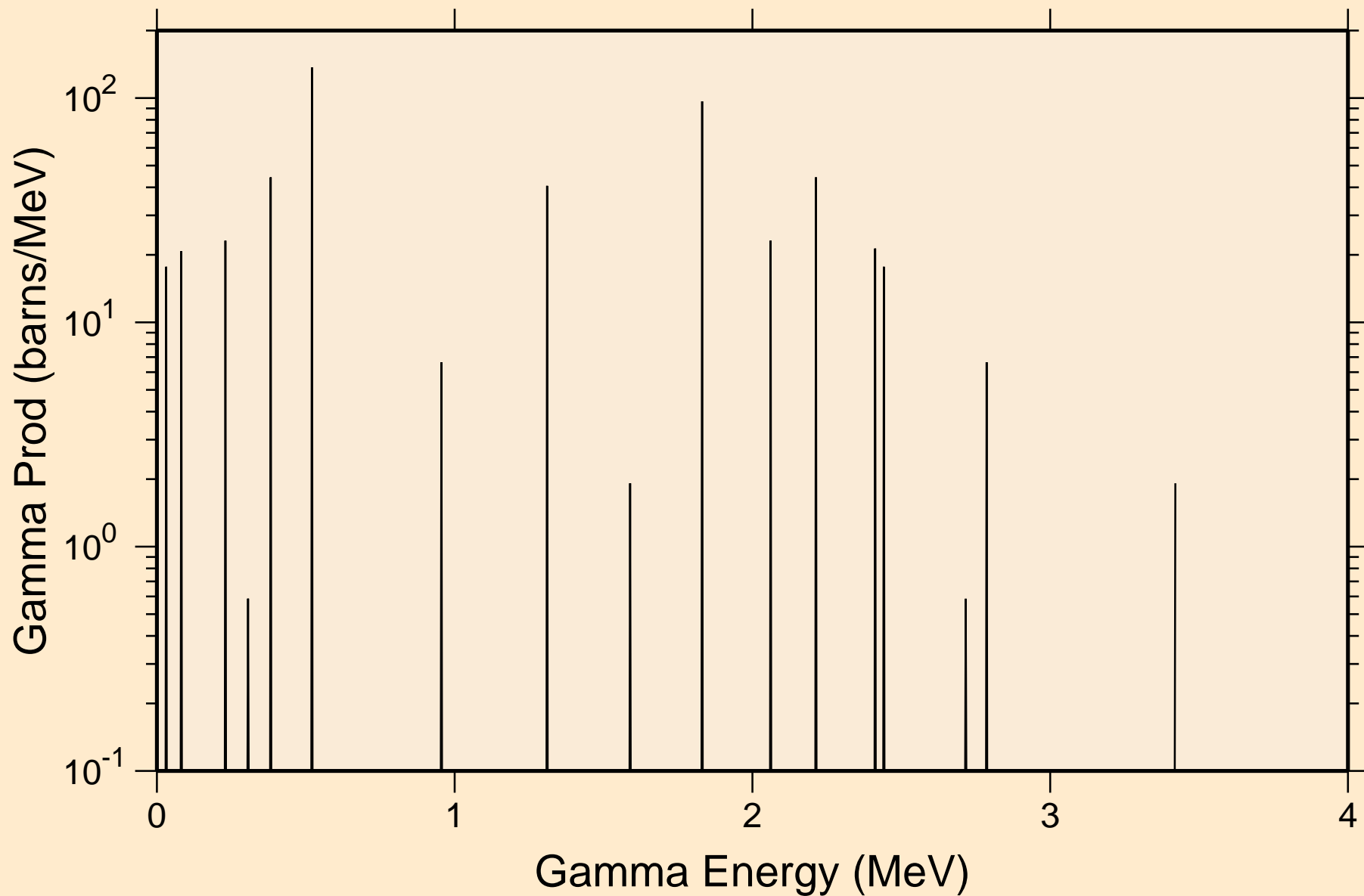

F023 NEUTRON ACER TENDL-2019 LIBRARY; T=293.16K
14 MeV photon spectrum

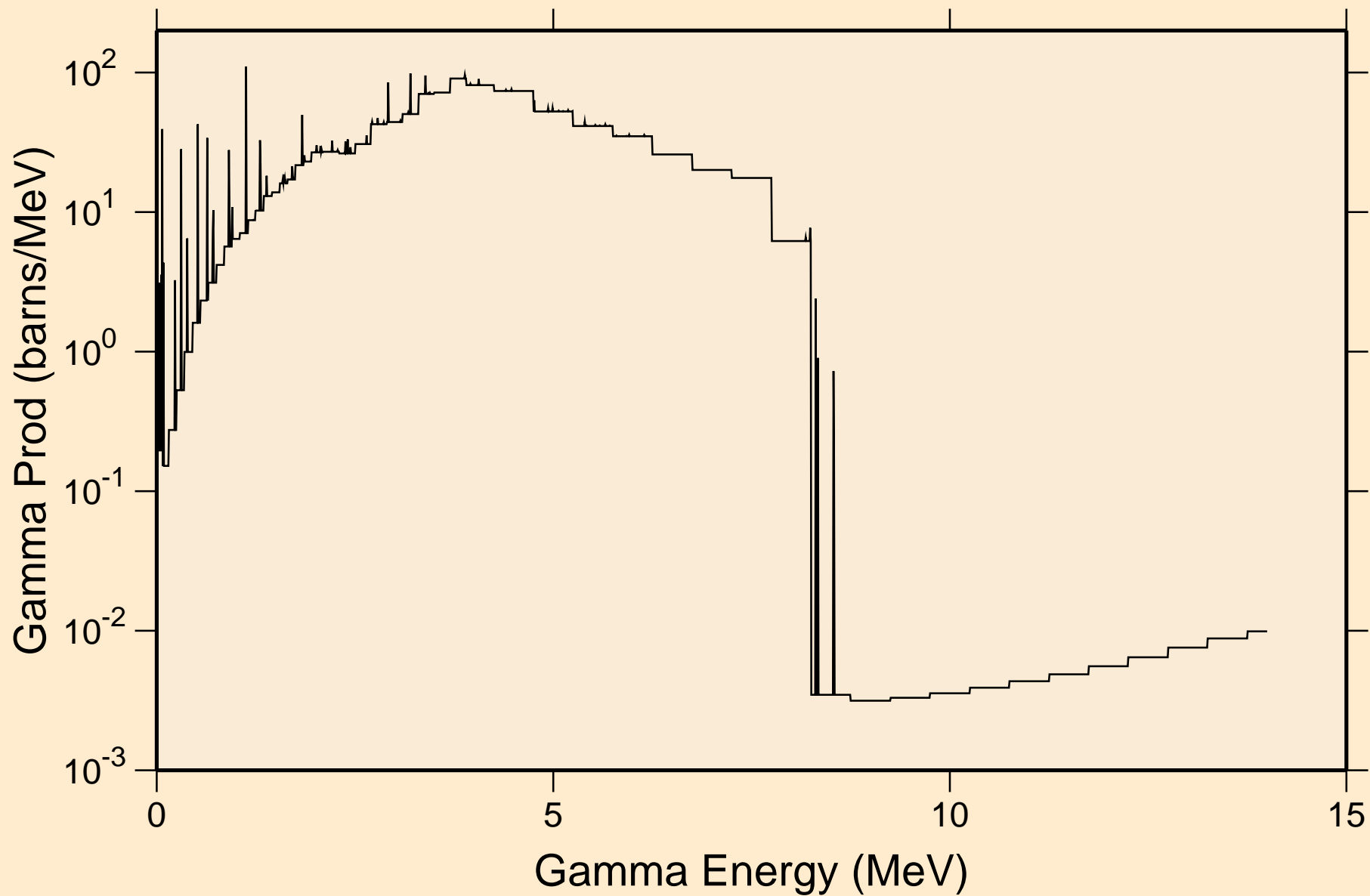

F023 NEUTRON ACER TENDL-2019 LIBRARY; T=293.16K
Particle heating contributions

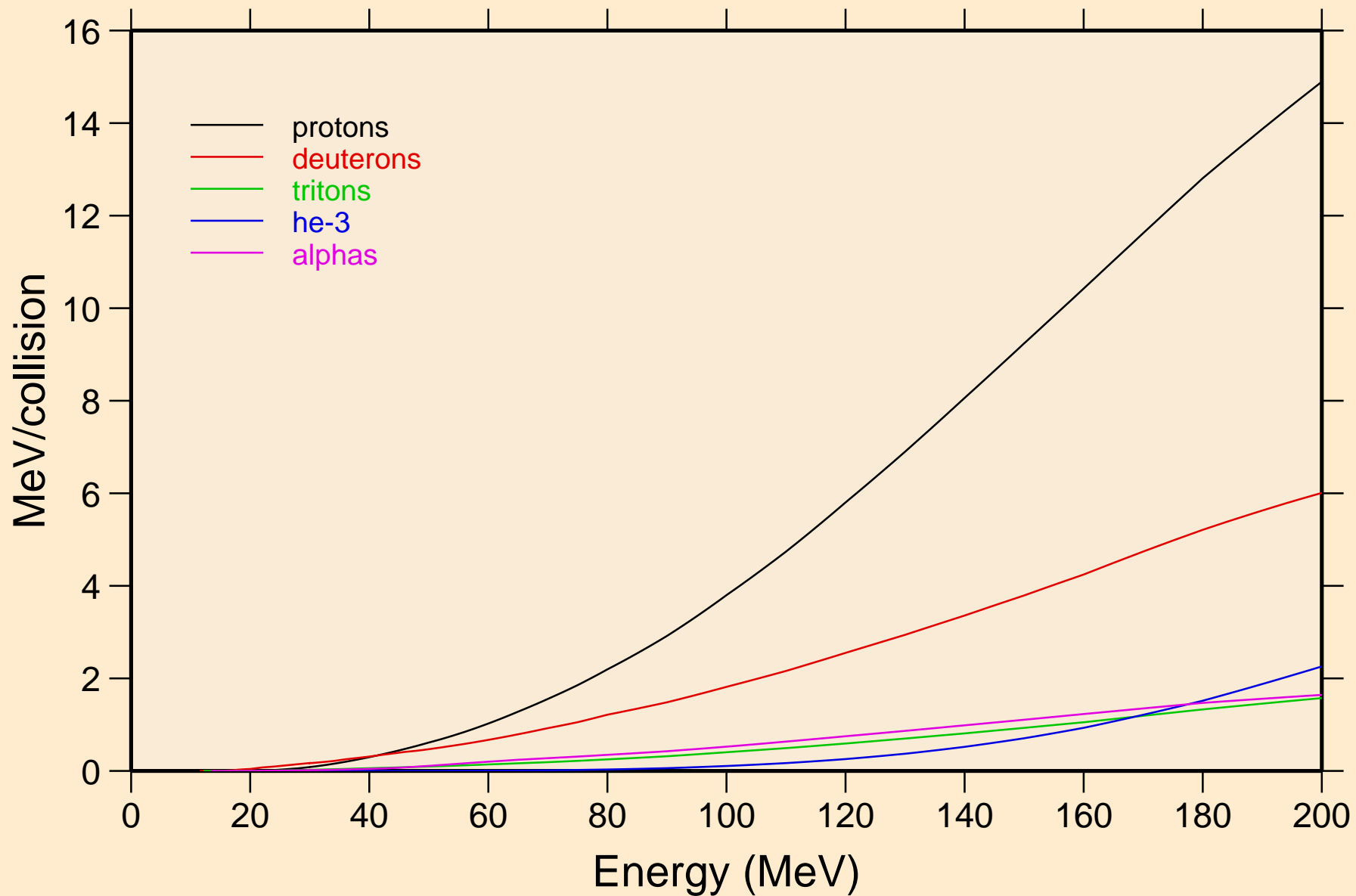

F023 NEUTRON ACER TENDL-2019 LIBRARY; T=293.16K
Recoil Heating

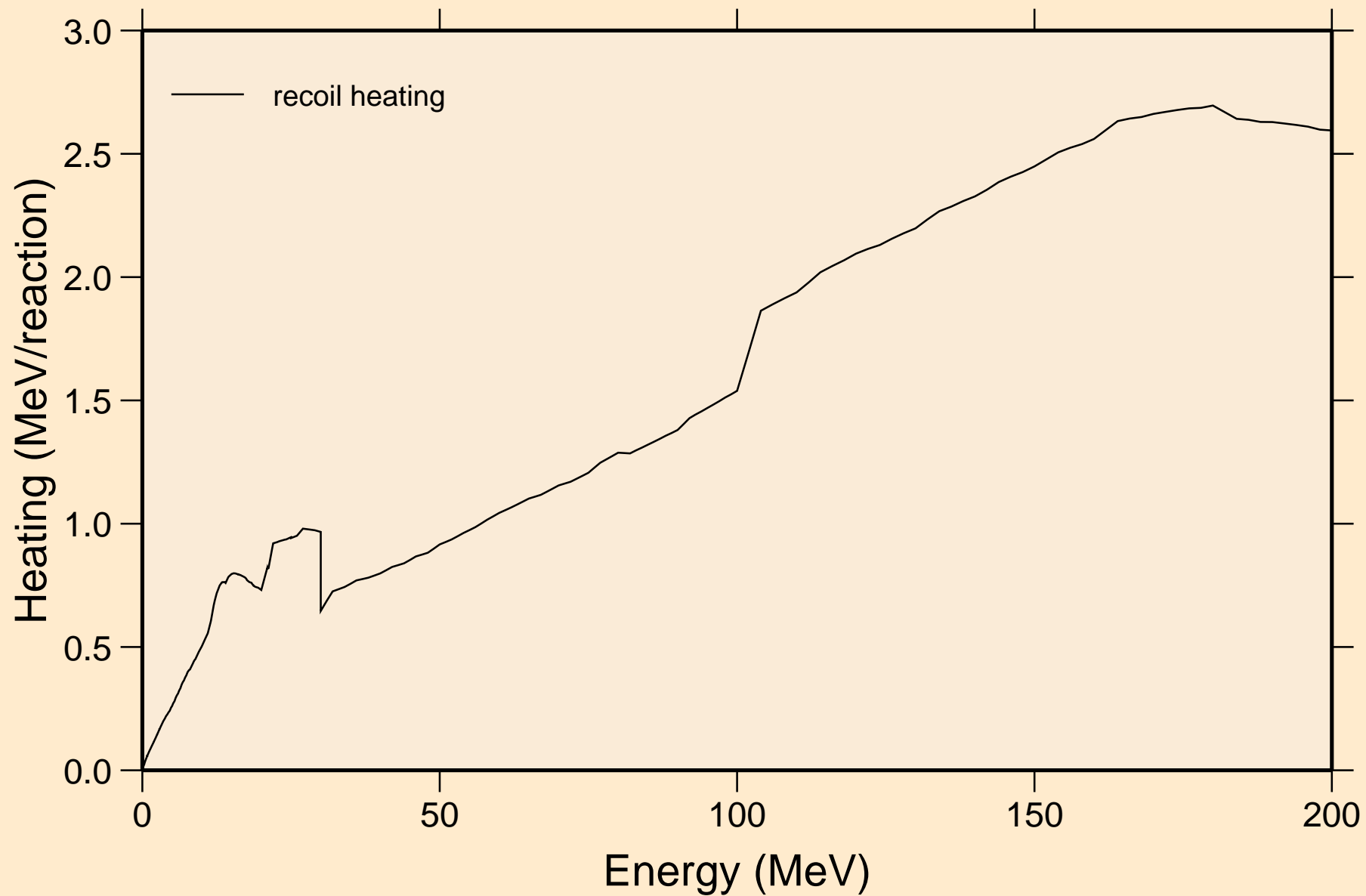

F023 NEUTRON ACER TENDL-2019 LIBRARY; T=293.16K

Particle production cross sections

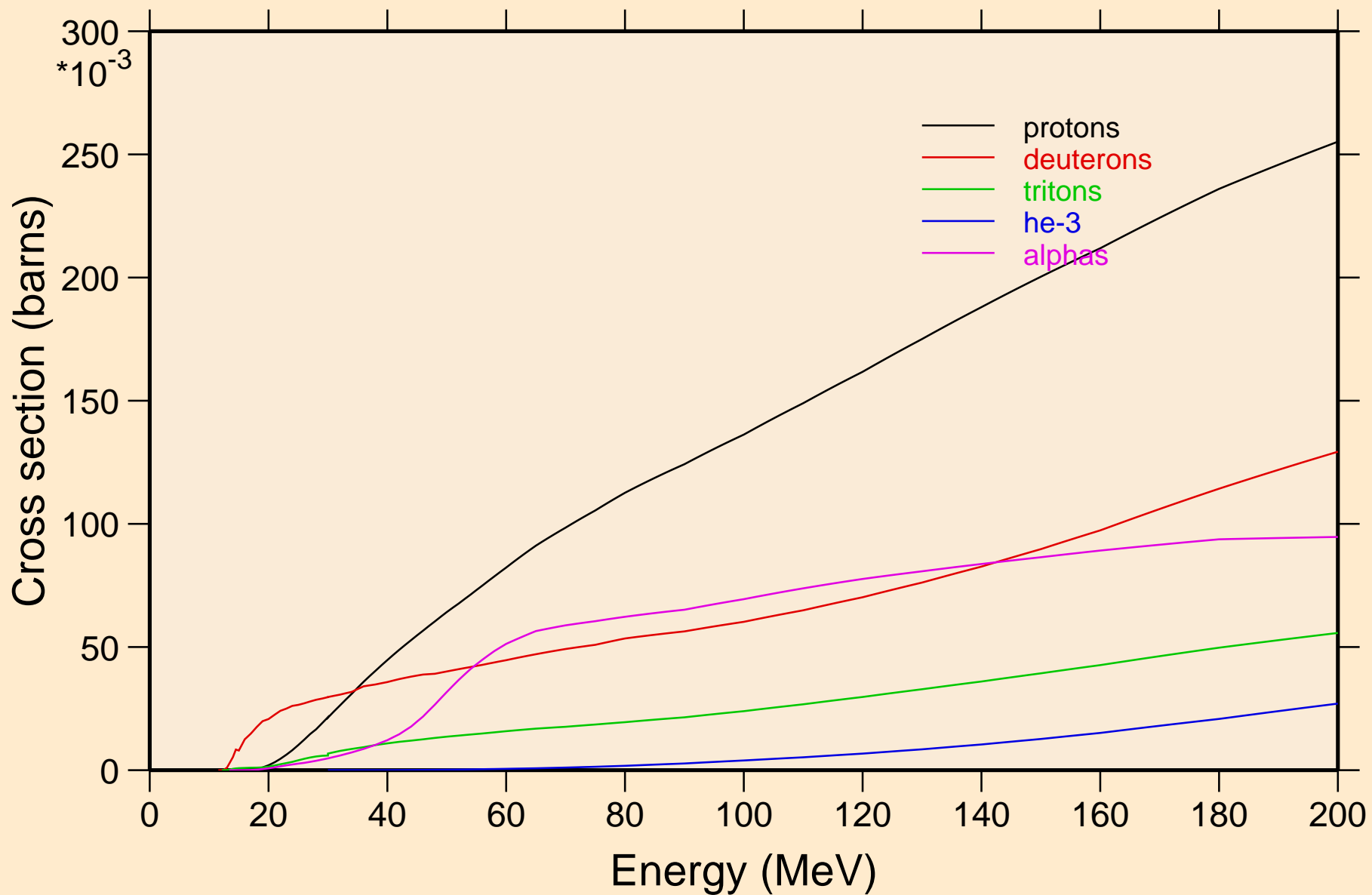

F023 NEUTRON ACER TENDL-2019 LIBRARY; T=293.16K
protons from (n,x)

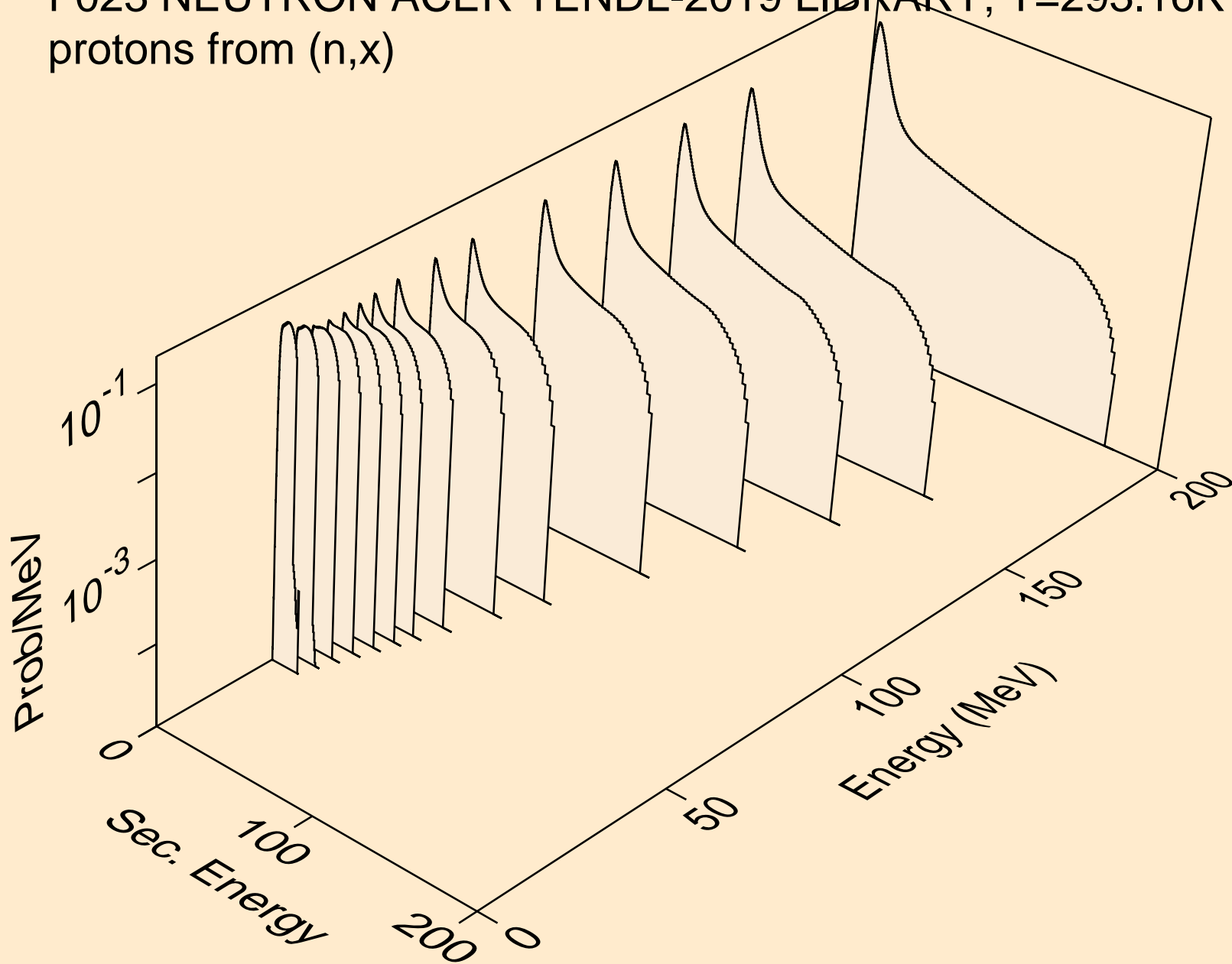

F023 NEUTRON ACER TENDL-2019 LIBRARY; T=293.16K
protons from (n,n*)p

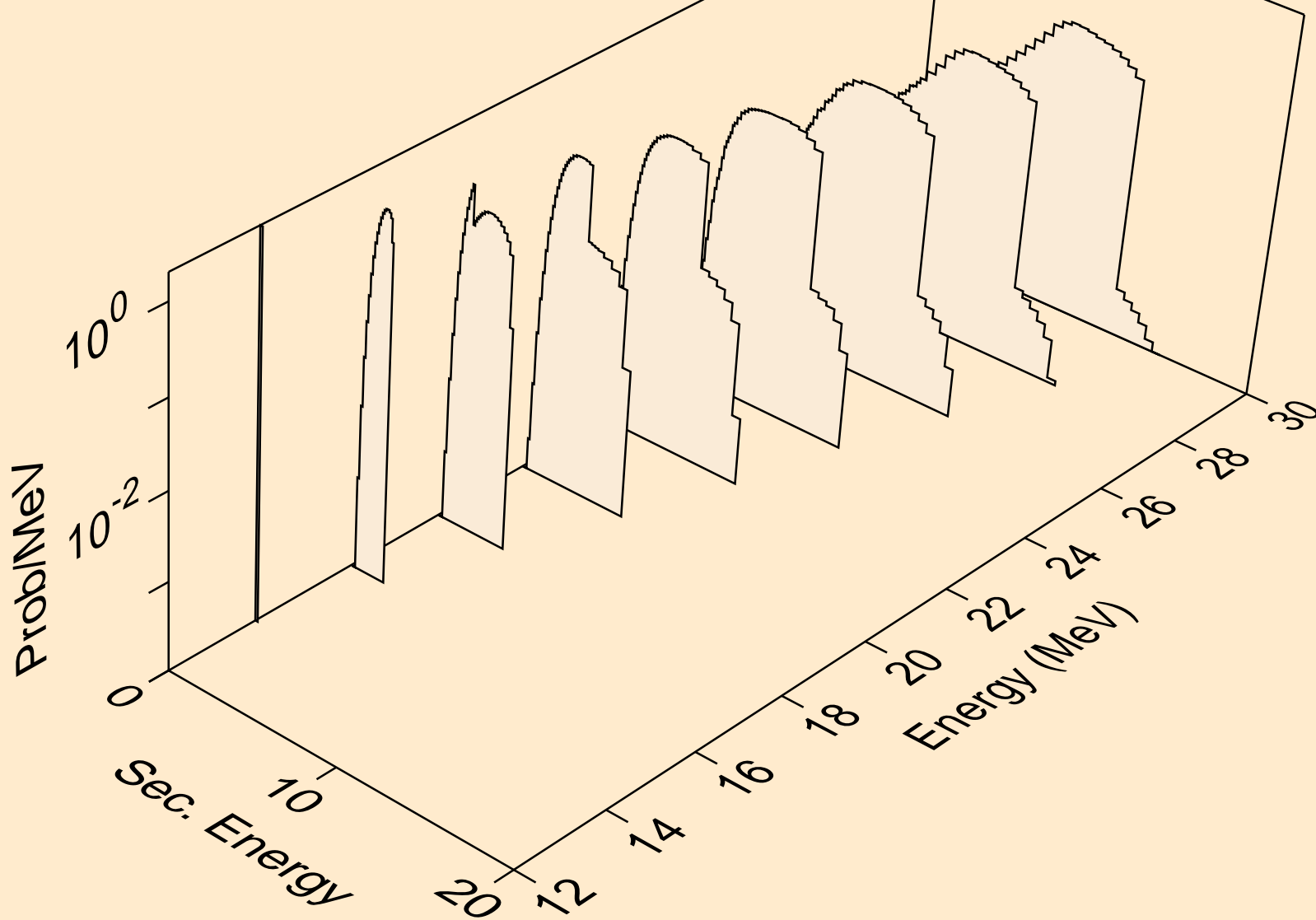

F023 NEUTRON ACER TENDL-2019 LIBRARY; T=293.16K
protons from (n,2np)

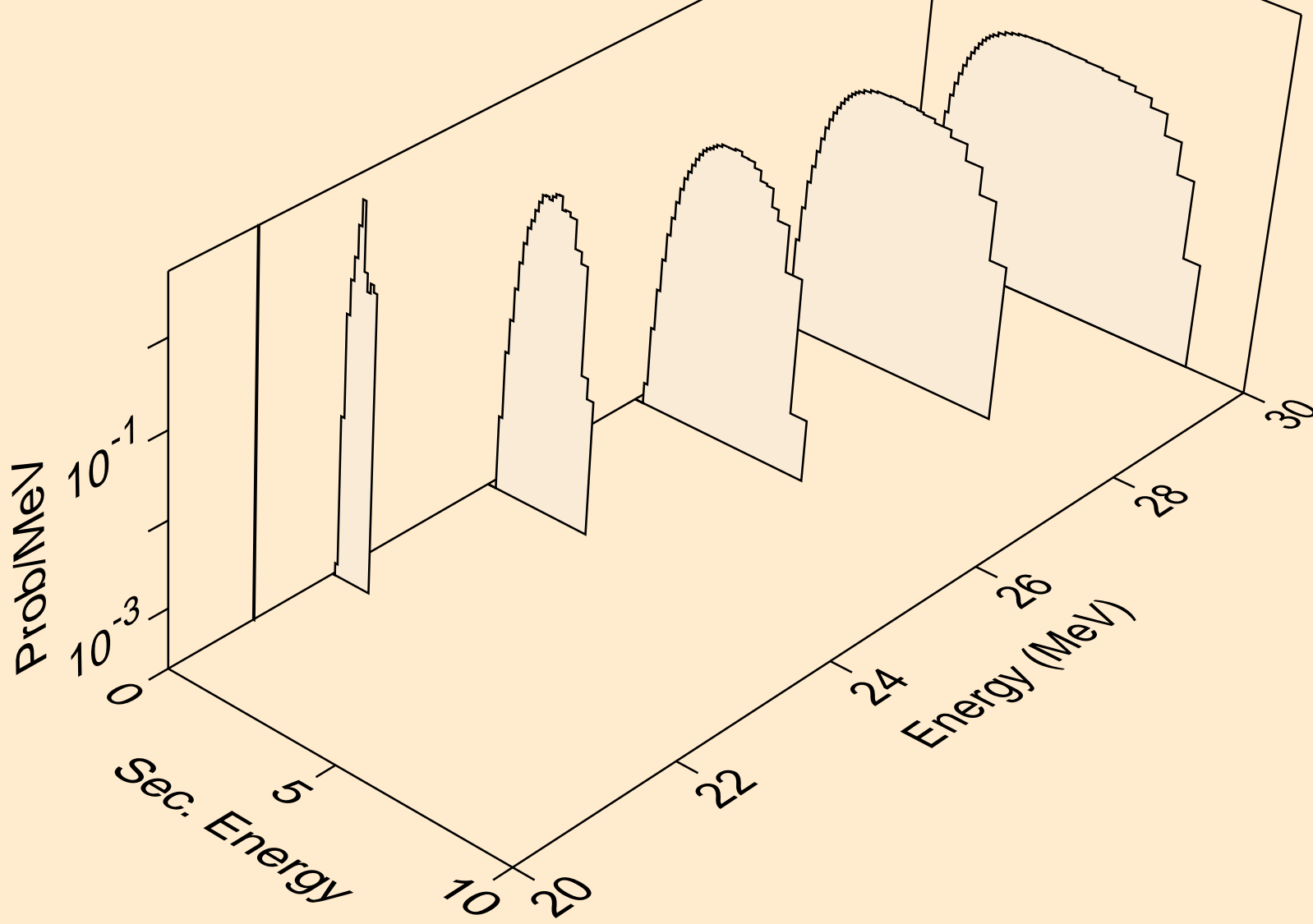

F023 NEUTRON ACER TENDL-2019 LIBRARY; T=293.16K
protons from (n,3np)

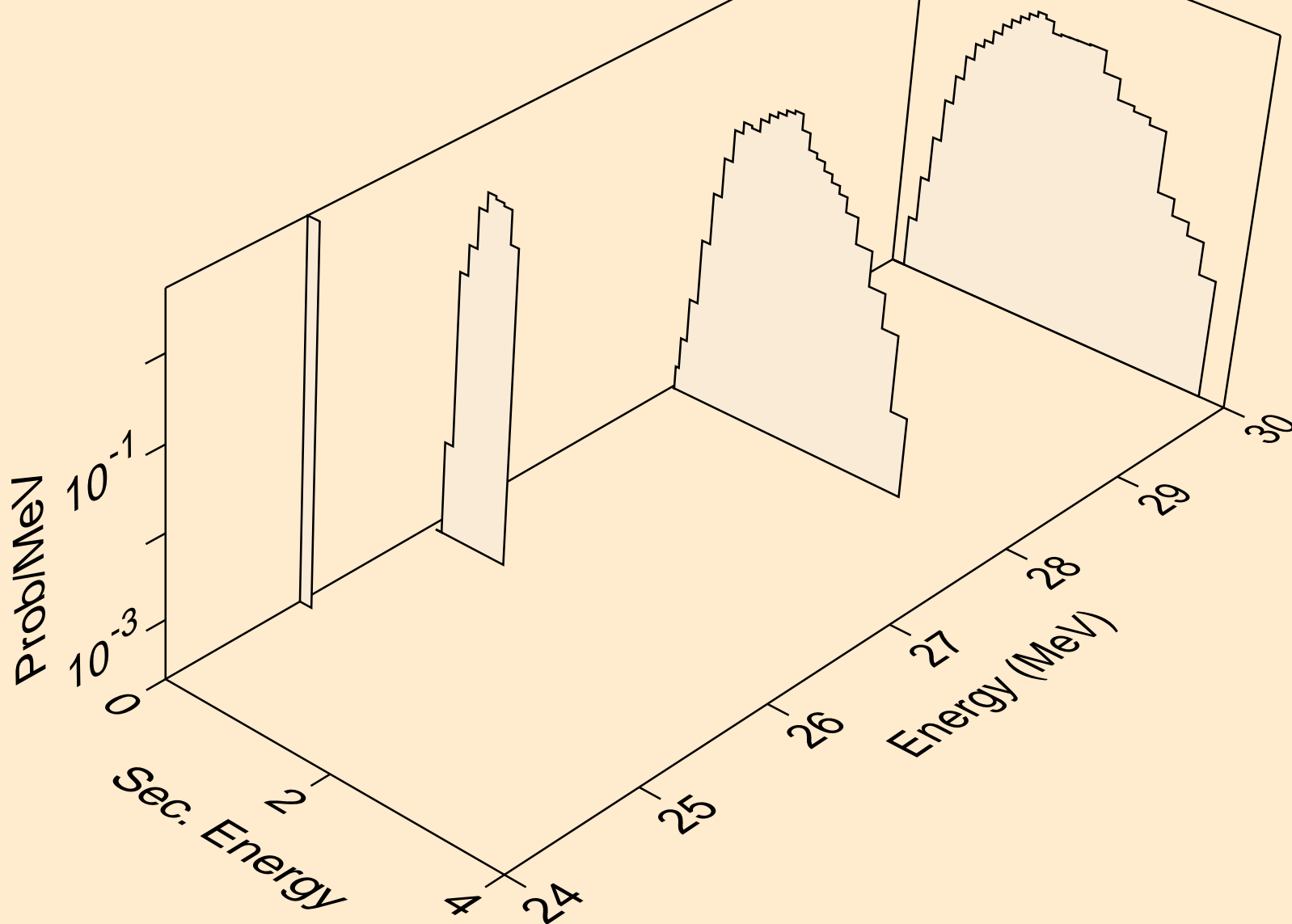

F023 NEUTRON ACER TENDL-2019 LIBRARY; T=293.16K
protons from (n,p)

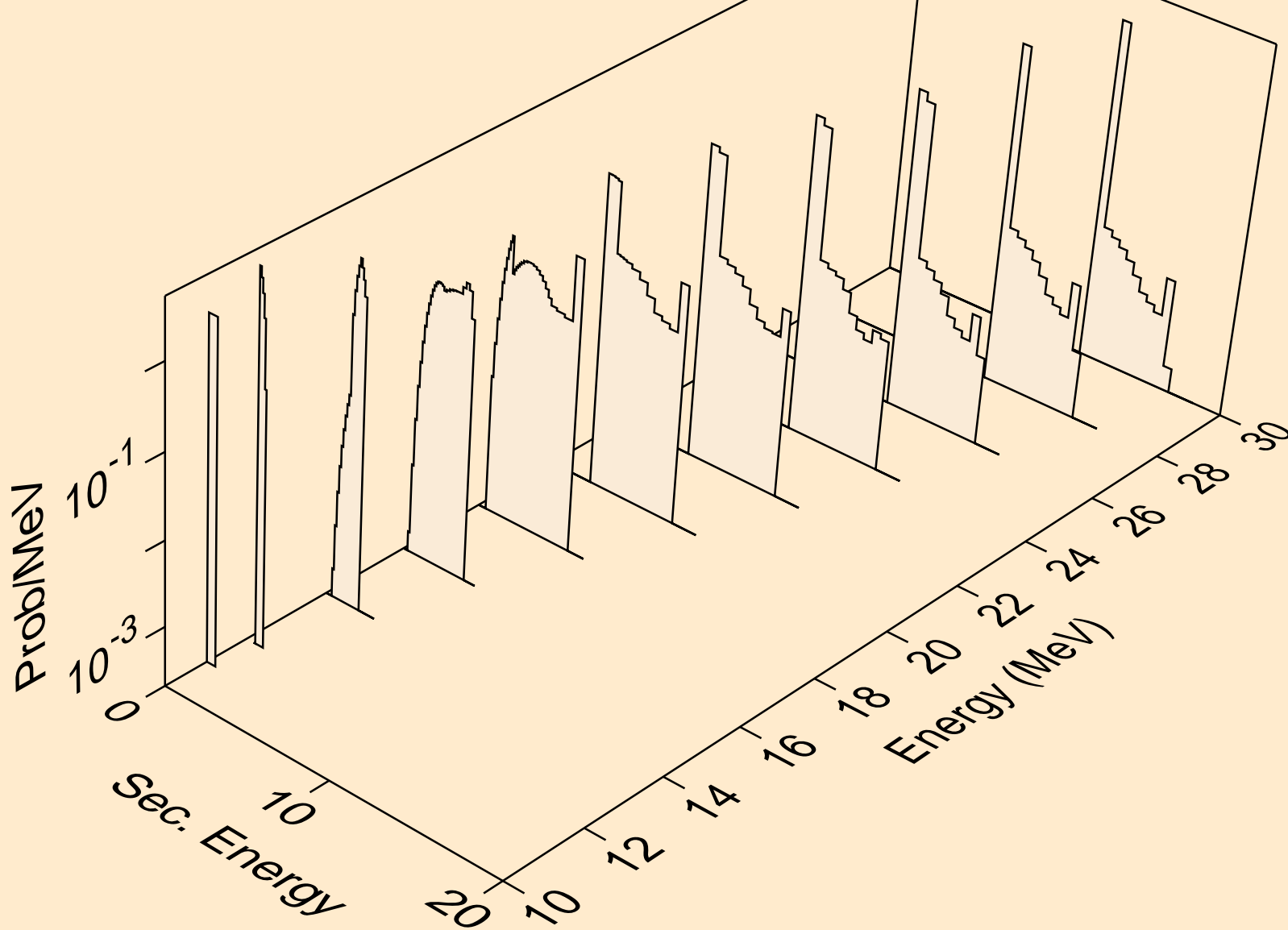

F023 NEUTRON ACER TENDL-2019 LIBRARY; T=293.16K
deuterons from (n,x)

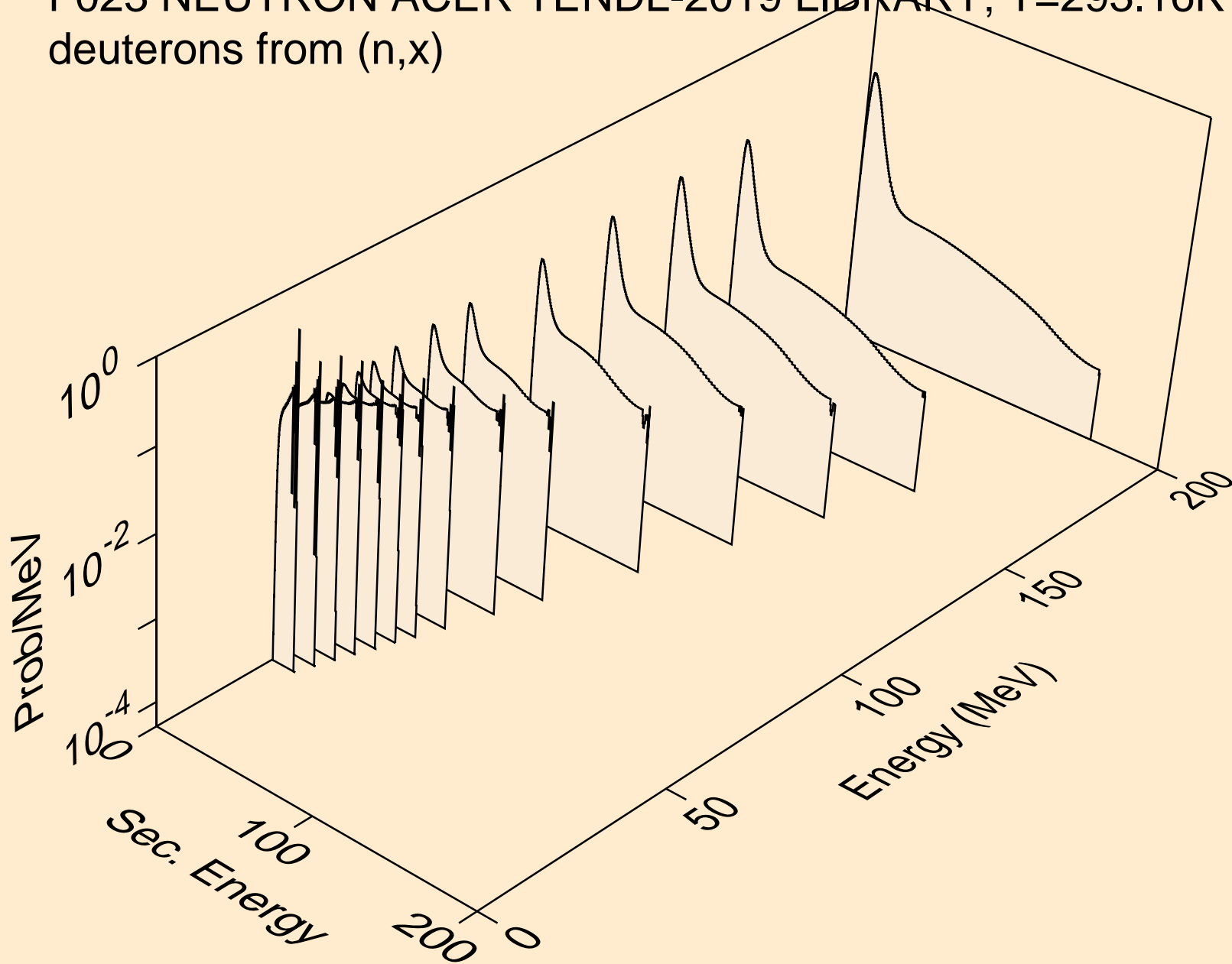

F023 NEUTRON ACER TENDL-2019 LIBRARY; T=293.16K
deuterons from (n,2nd)

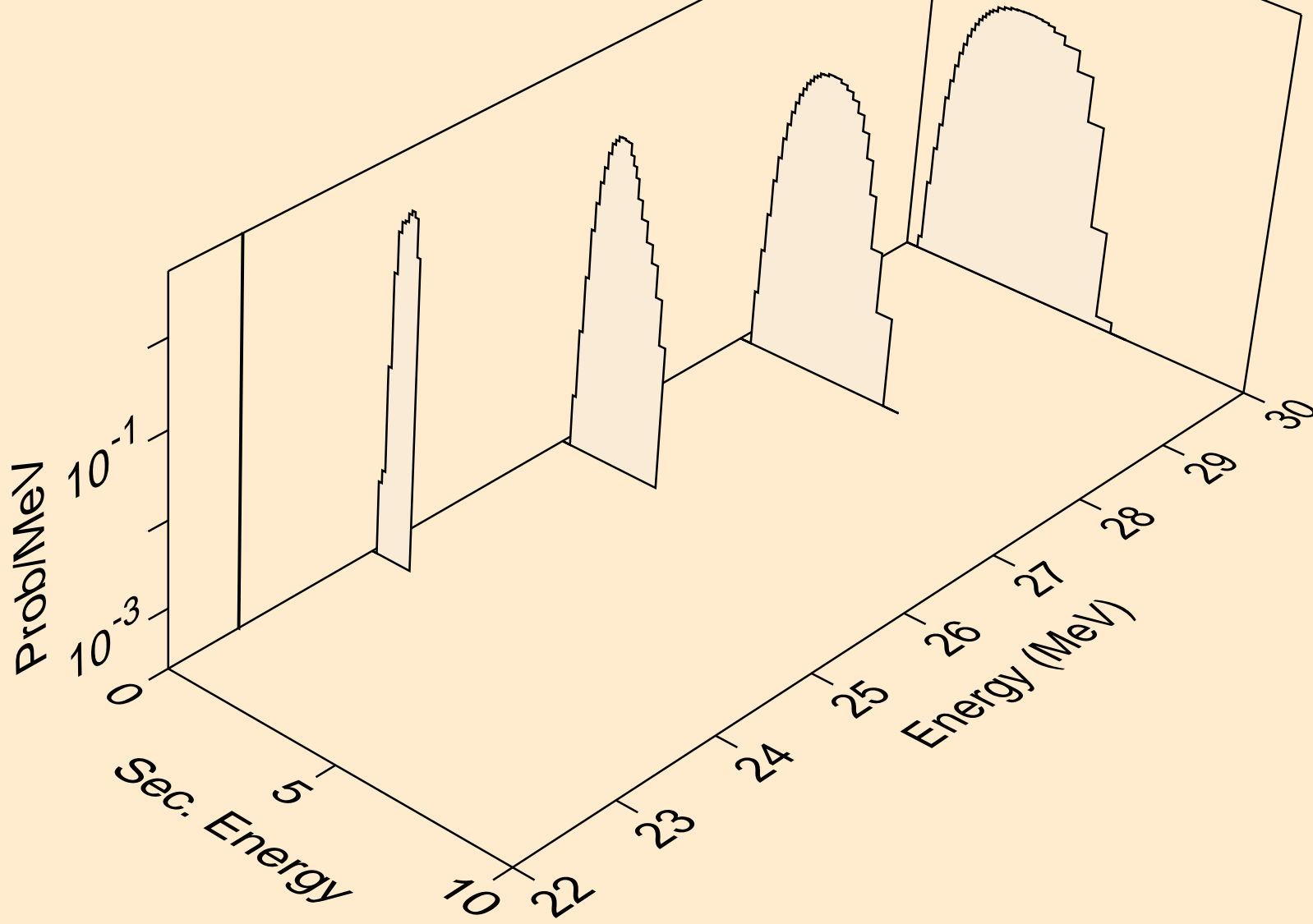

F023 NEUTRON ACER TENDL-2019 LIBRARY; T=293.16K
deuterons from (n,n*)d

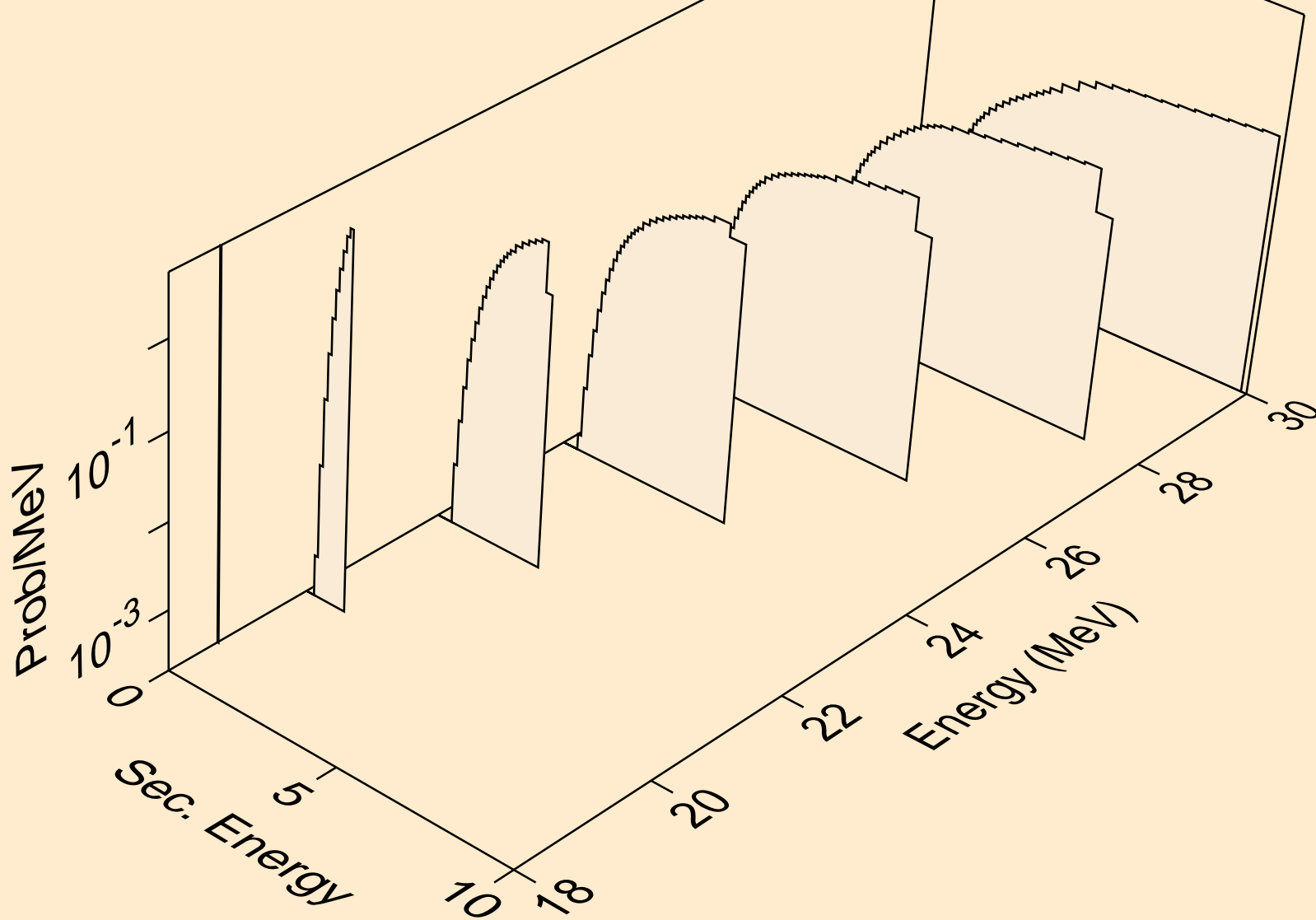

F023 NEUTRON ACER TENDL-2019 LIBRARY; T=293.16K
deuterons from (n,d)

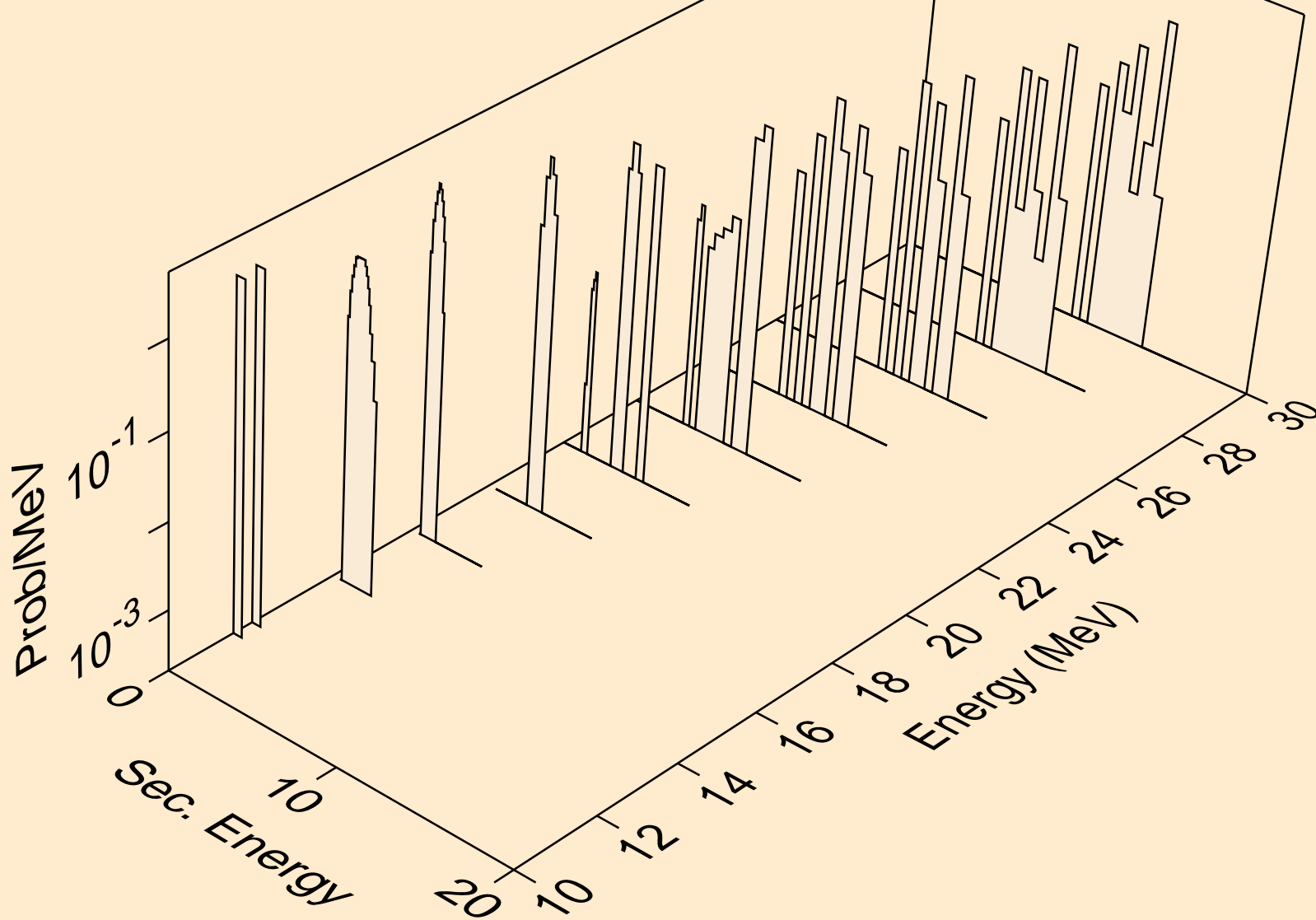

F023 NEUTRON ACER TENDL-2019 LIBRARY; T=293.16K
tritons from (n,x)

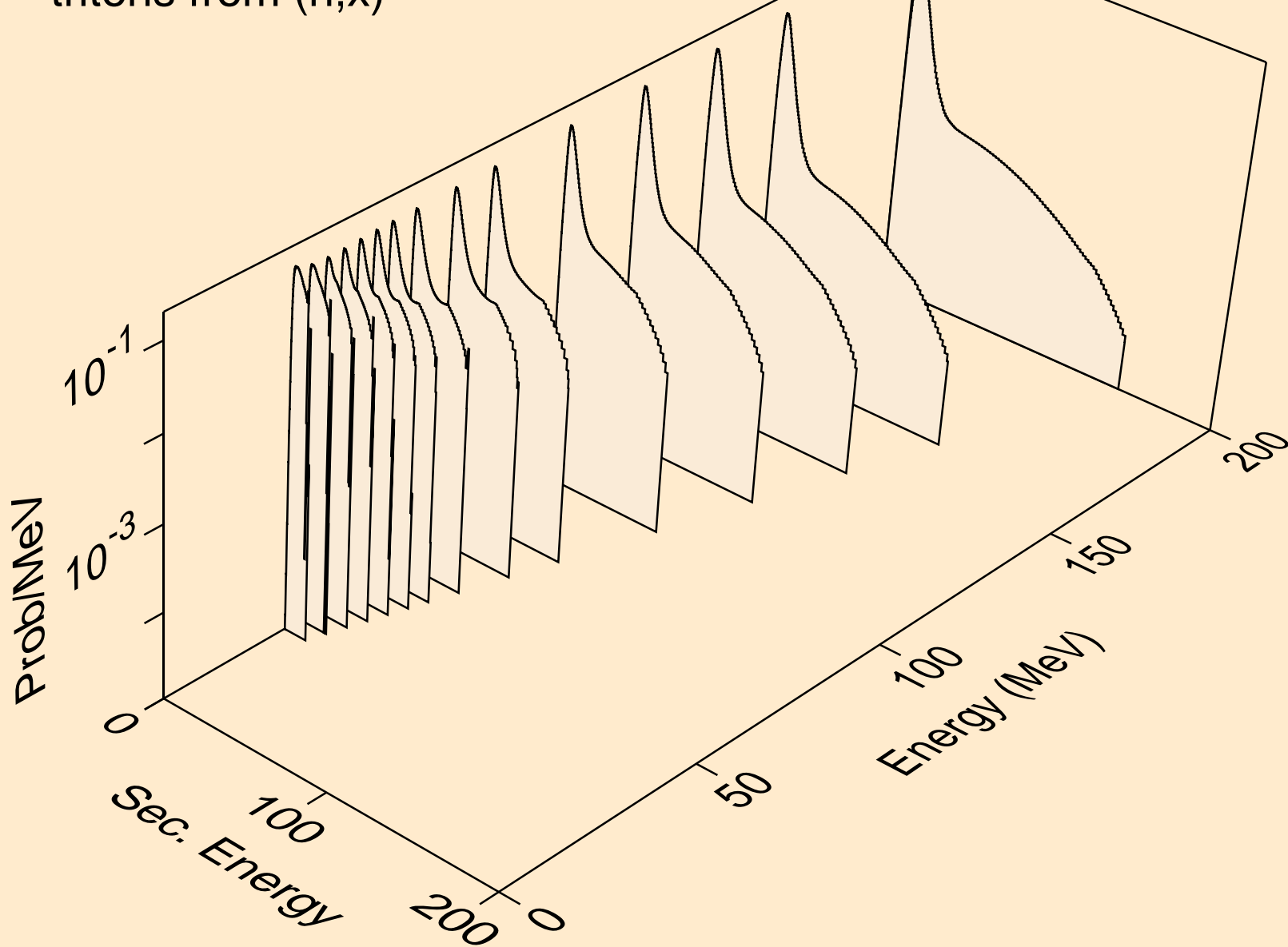

F023 NEUTRON ACER TENDL-2019 LIBRARY; T=293.16K
tritons from (n,n*)t

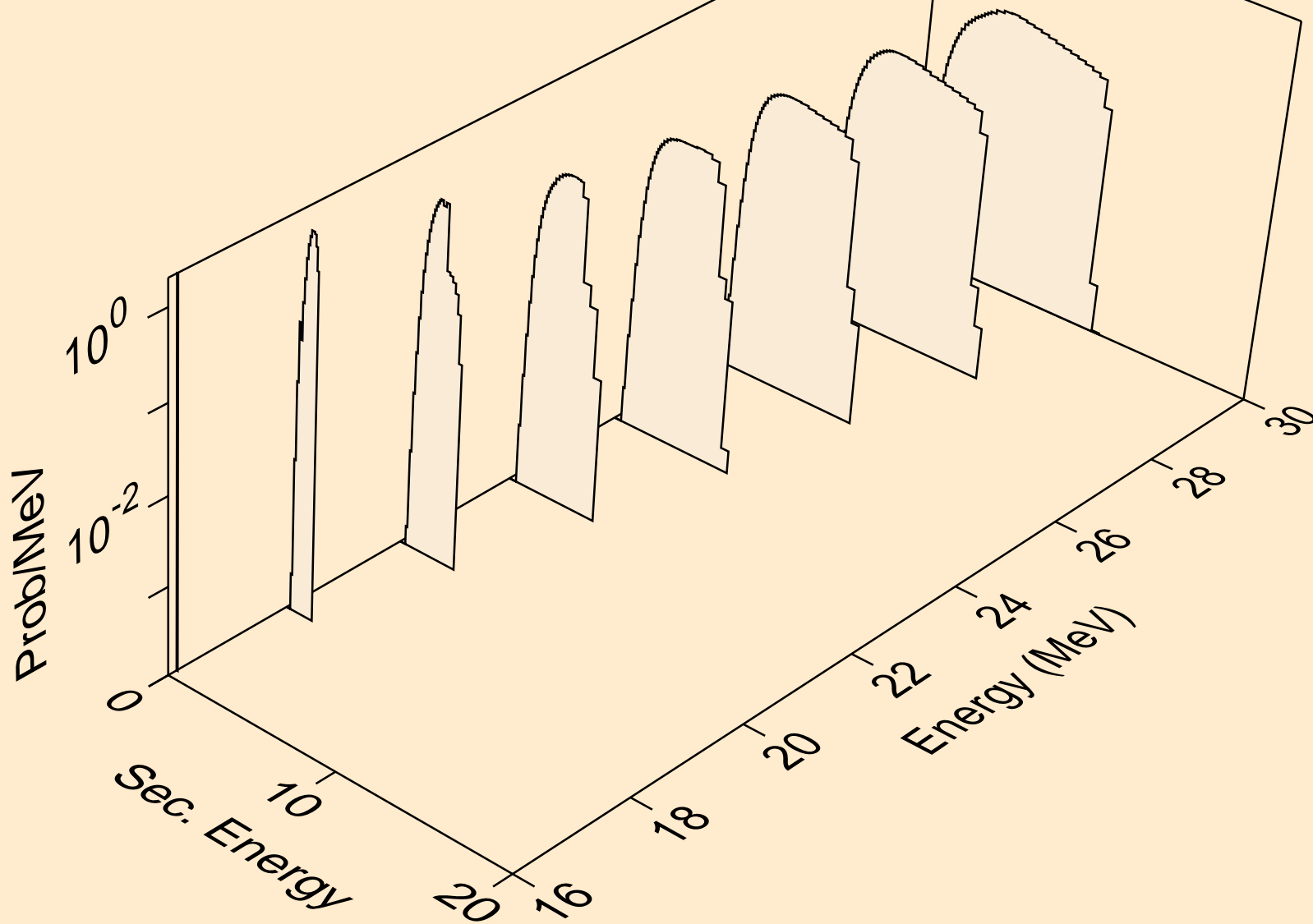

F023 NEUTRON ACER TENDL-2019 LIBRARY; T=293.16K
tritons from (n,t)

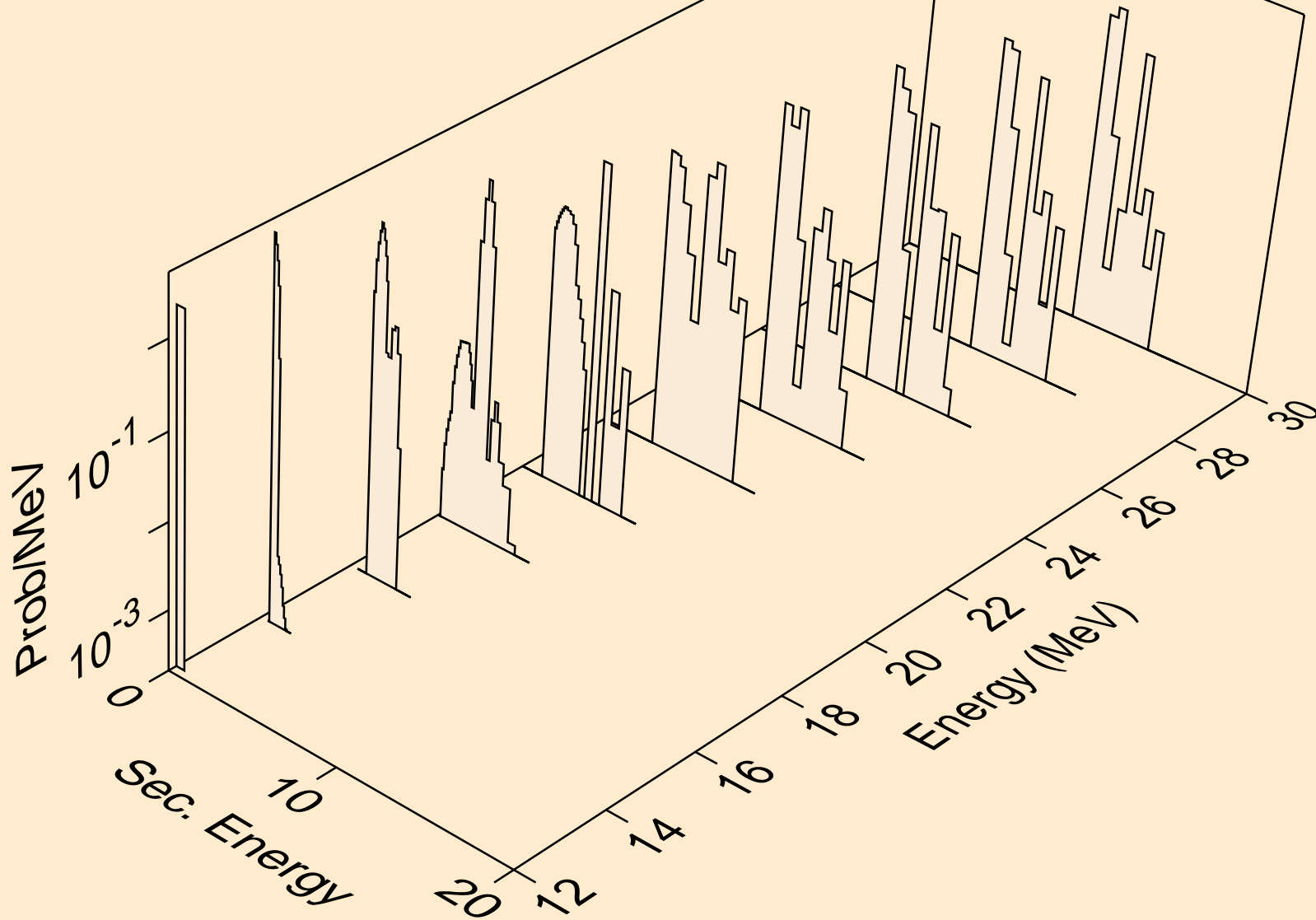

F023 NEUTRON ACER TENDL-2019 LIBRARY; T=293.16K
he3s from (n,x)

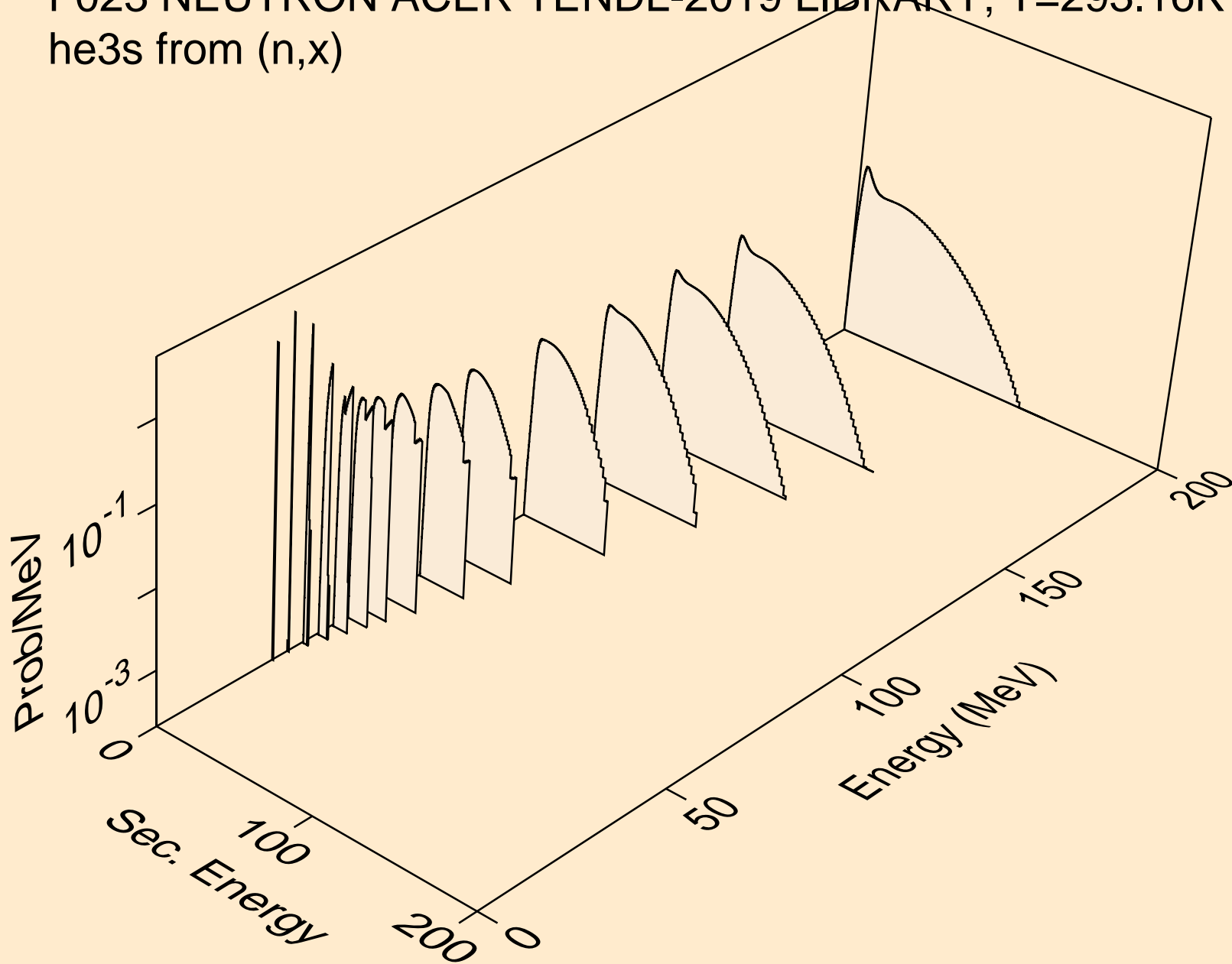

F023 NEUTRON ACER TENDL-2019 LIBRARY; T=293.16K
alphas from (n,x)

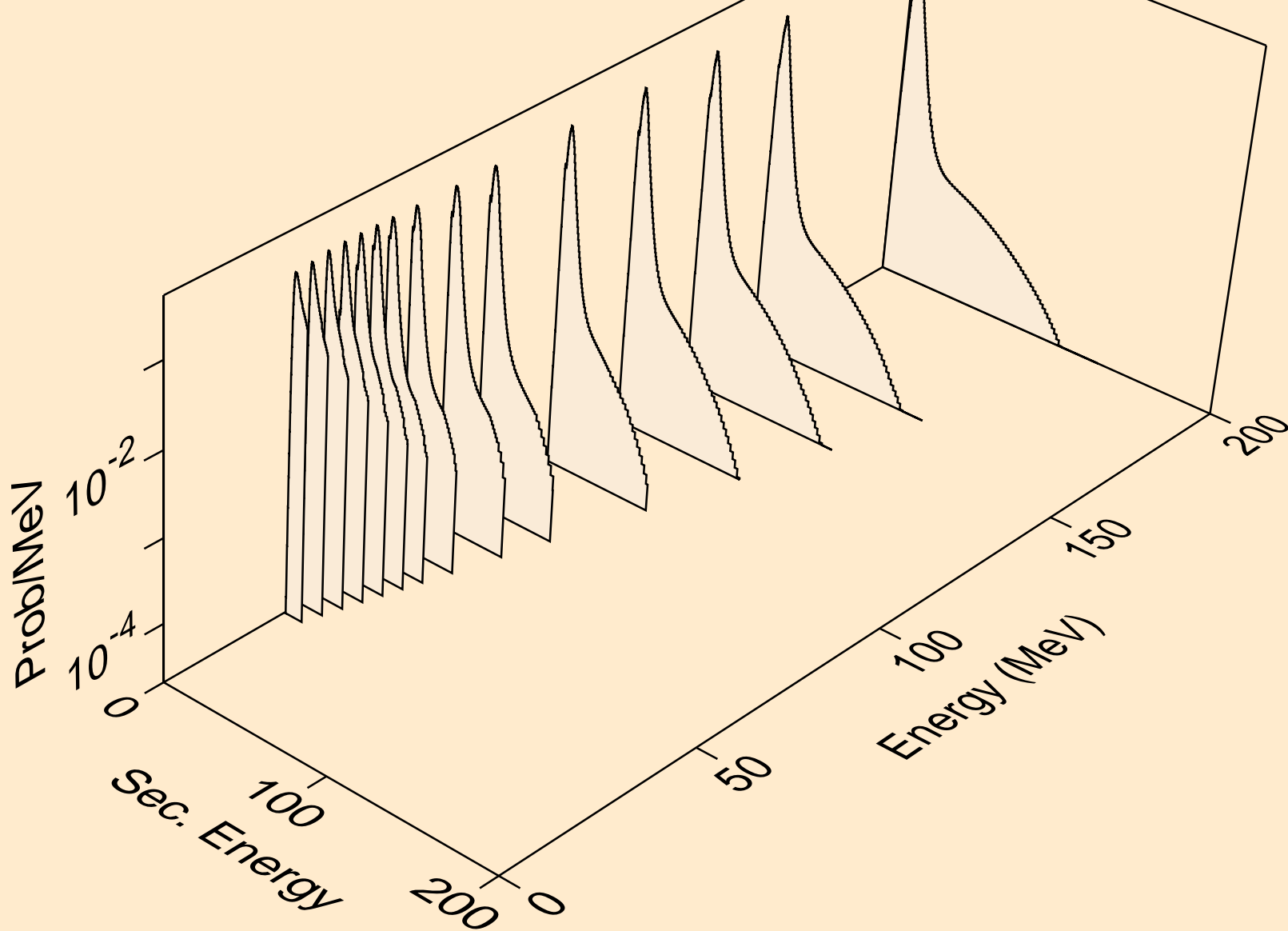

F023 NEUTRON ACER TENDL-2019 LIBRARY; T=293.16K
alphas from (n,n*)a

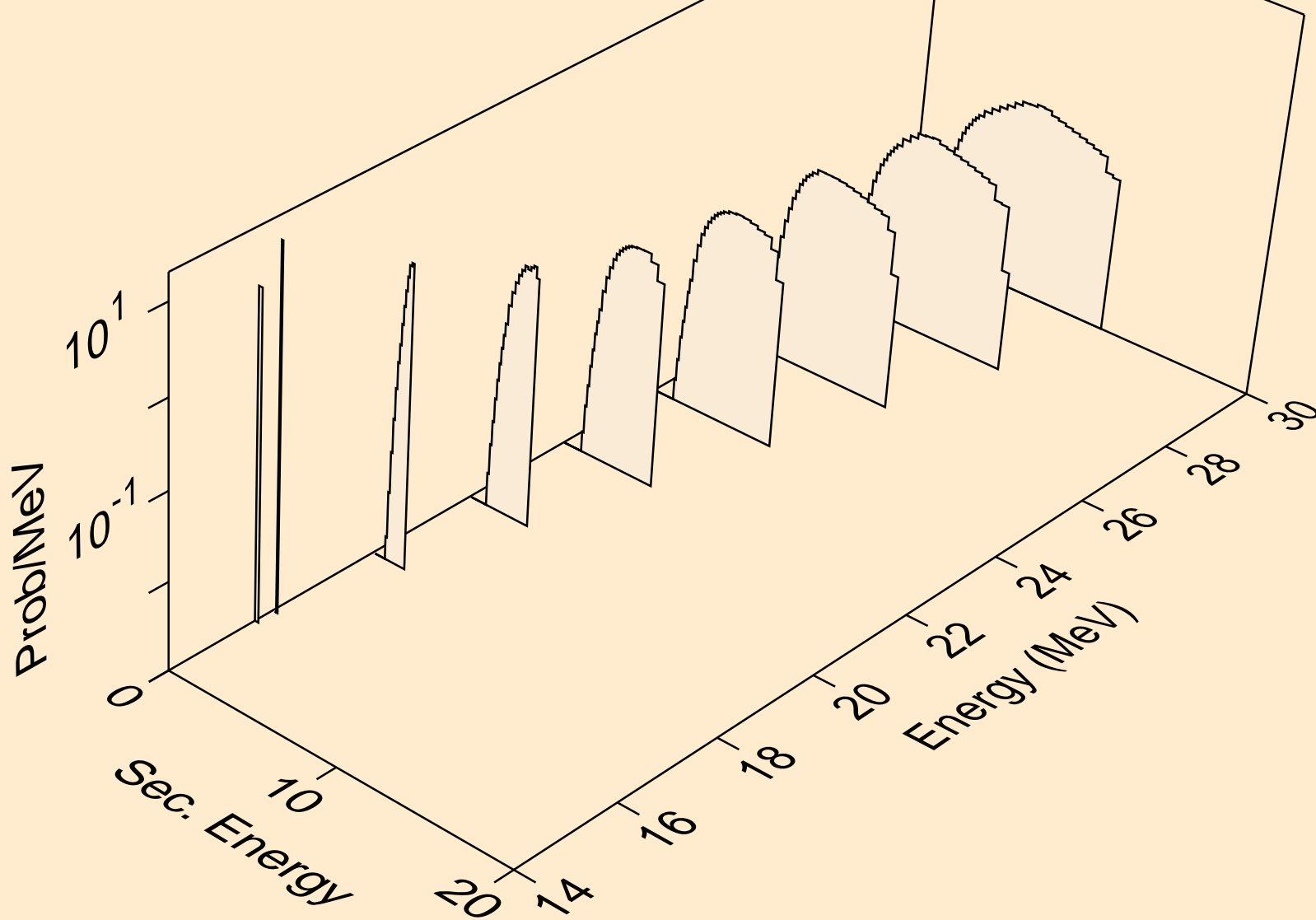

F023 NEUTRON ACER TENDL-2019 LIBRARY; T=293.16K
alphas from (n,2n)a

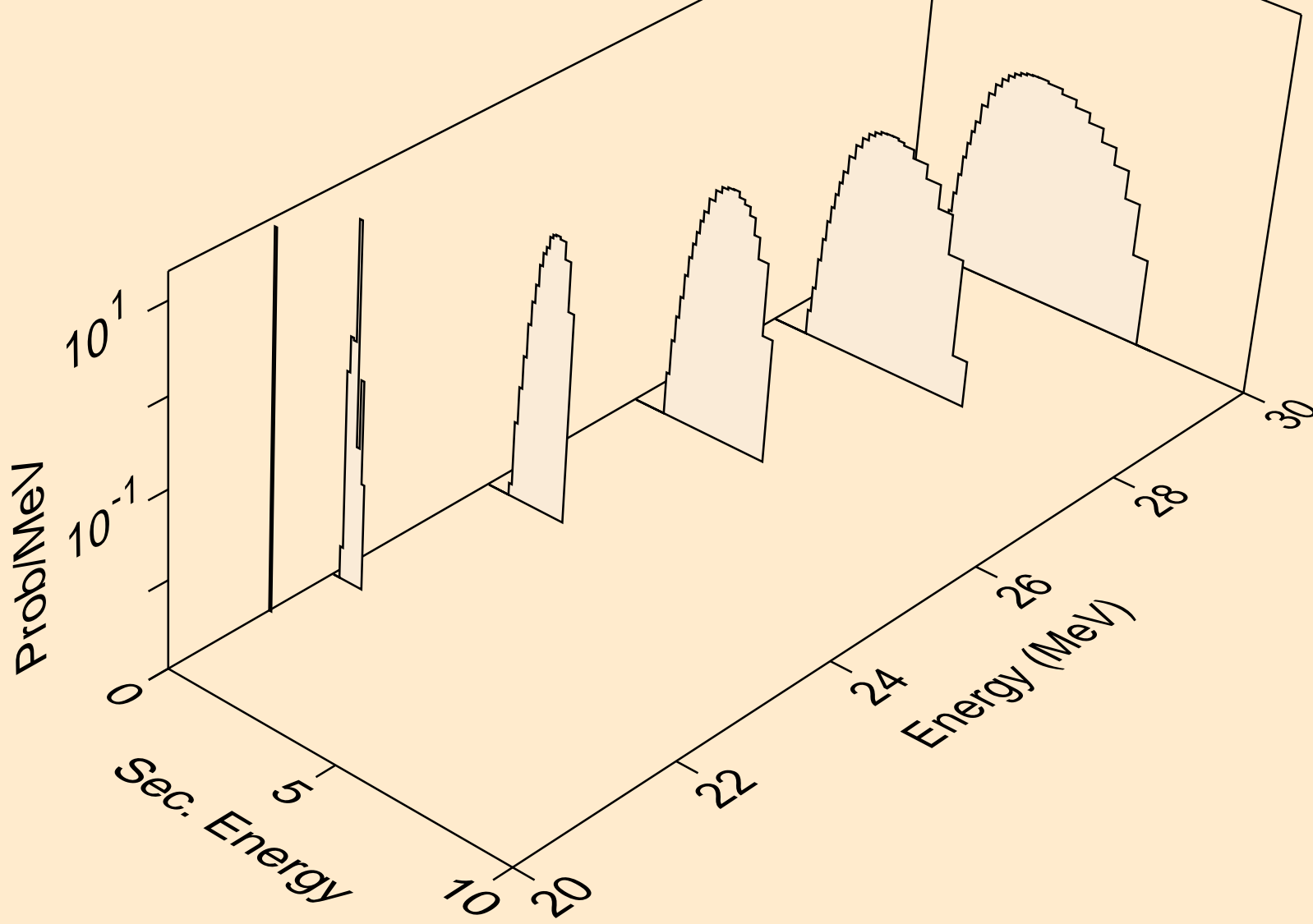

F023 NEUTRON ACER TENDL-2019 LIBRARY; T=293.16K
alphas from (n,3n)a

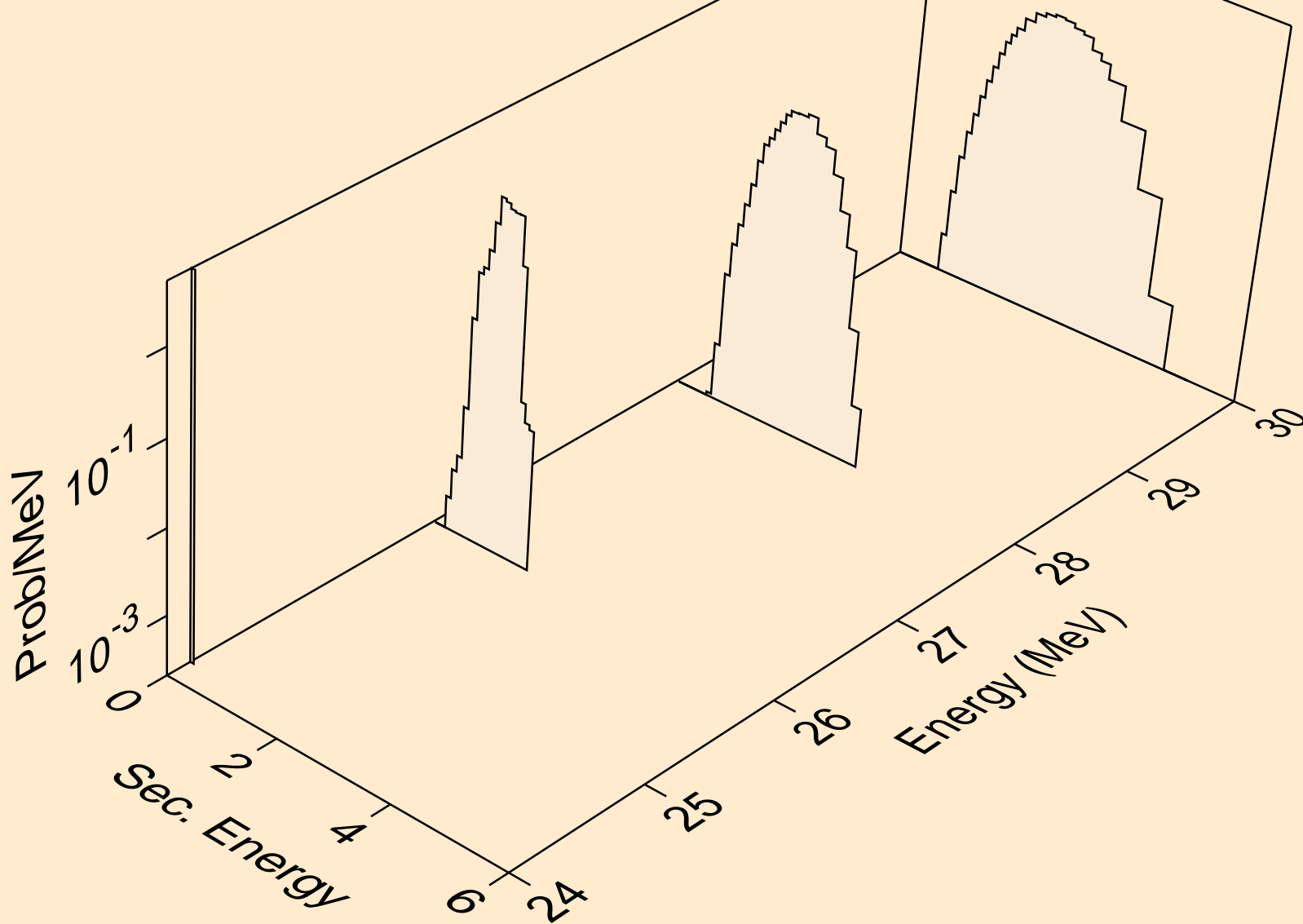

F023 NEUTRON ACER TENDL-2019 LIBRARY; T=293.16K
alphas from (n,a)

