

FE052M NEUTRON ACER TENDL-2019 LIBRARY; T=293.16K

Principal cross sections

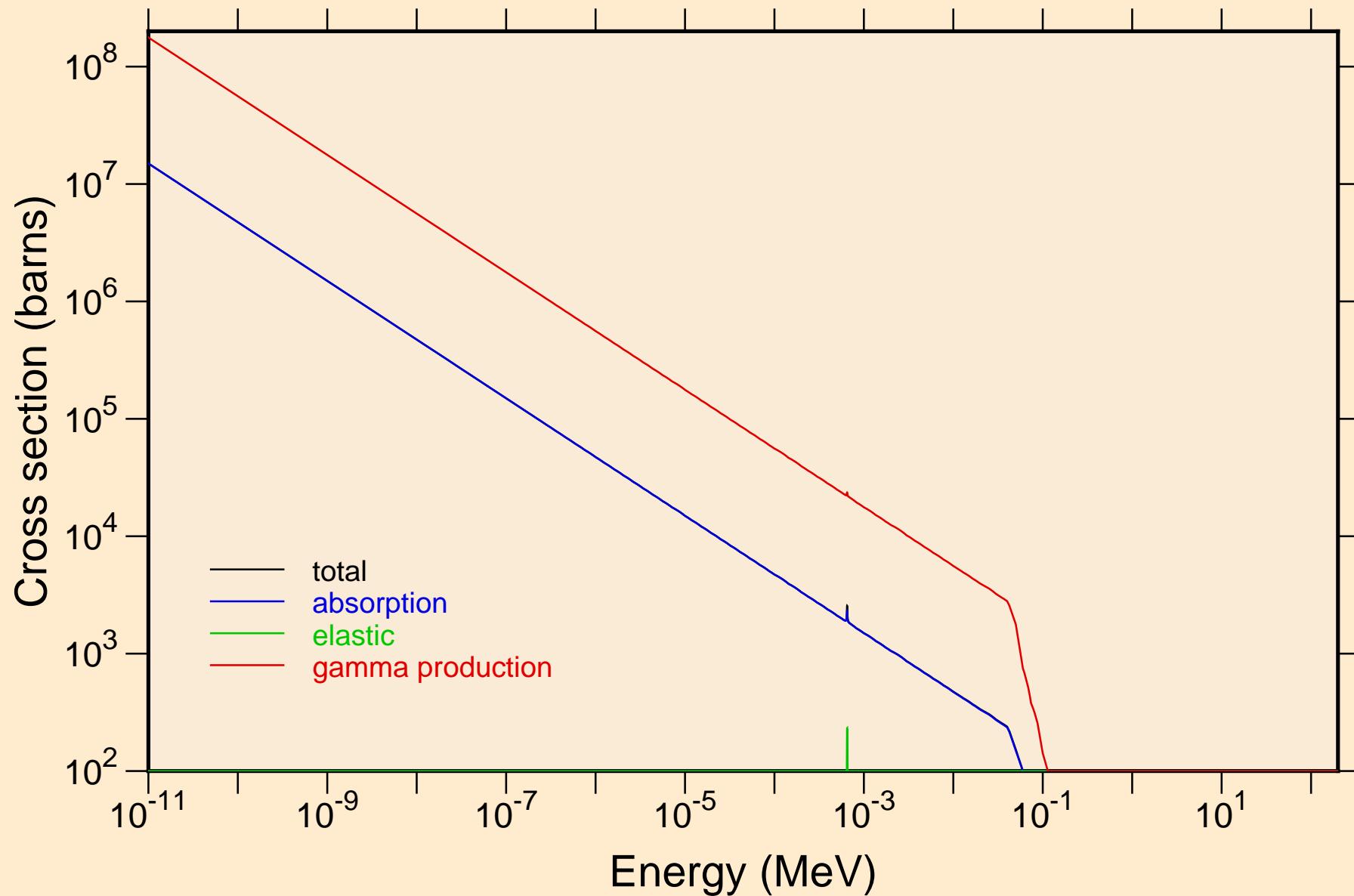

FE052M NEUTRON ACER TENDL-2019 LIBRARY; T=293.16K
resonance total cross section

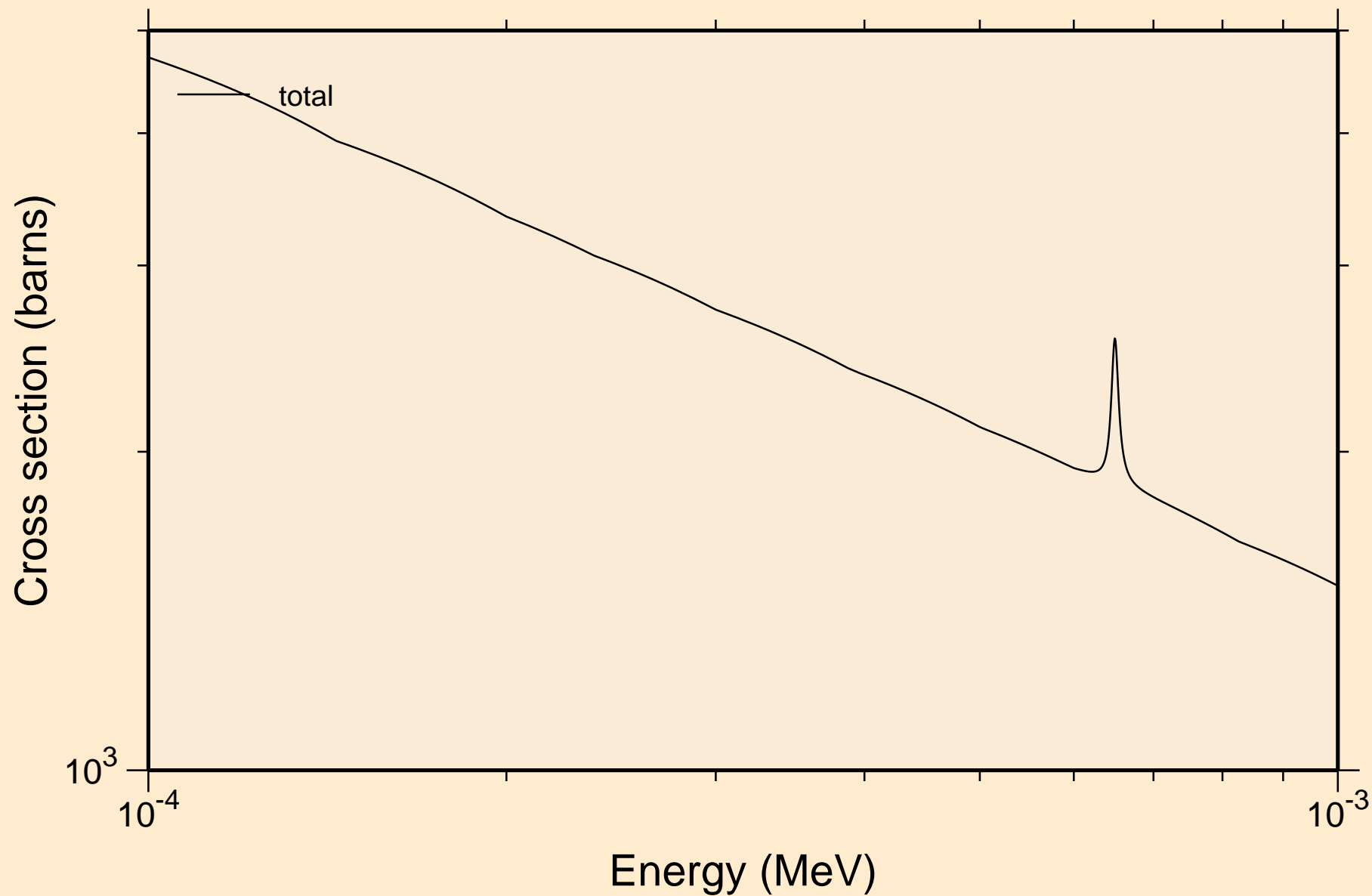

FE052M NEUTRON ACER TENDL-2019 LIBRARY; T=293.16K
resonance total cross section

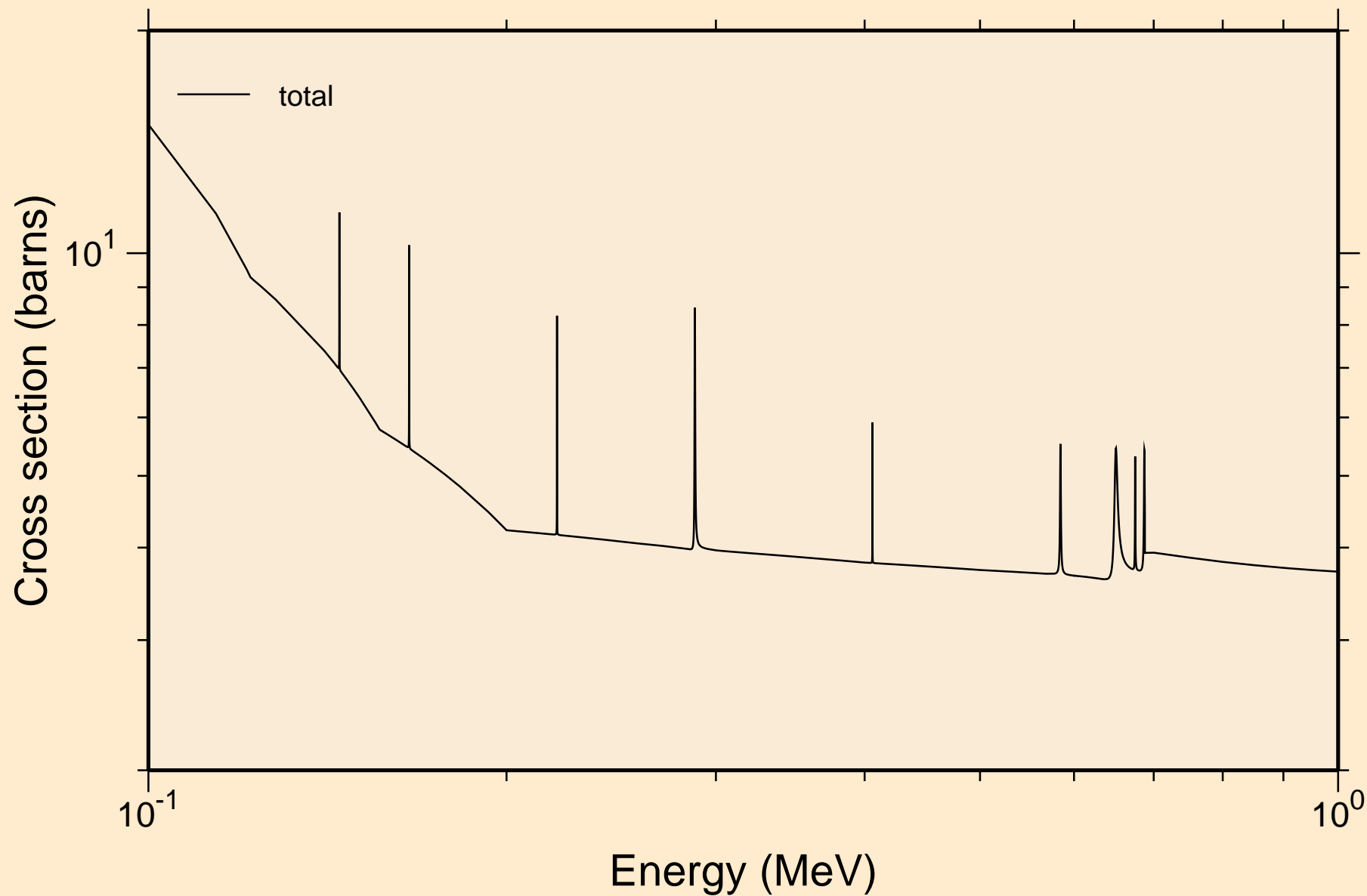

FE052M NEUTRON ACER TENDL-2019 LIBRARY; T=293.16K
resonance total cross section

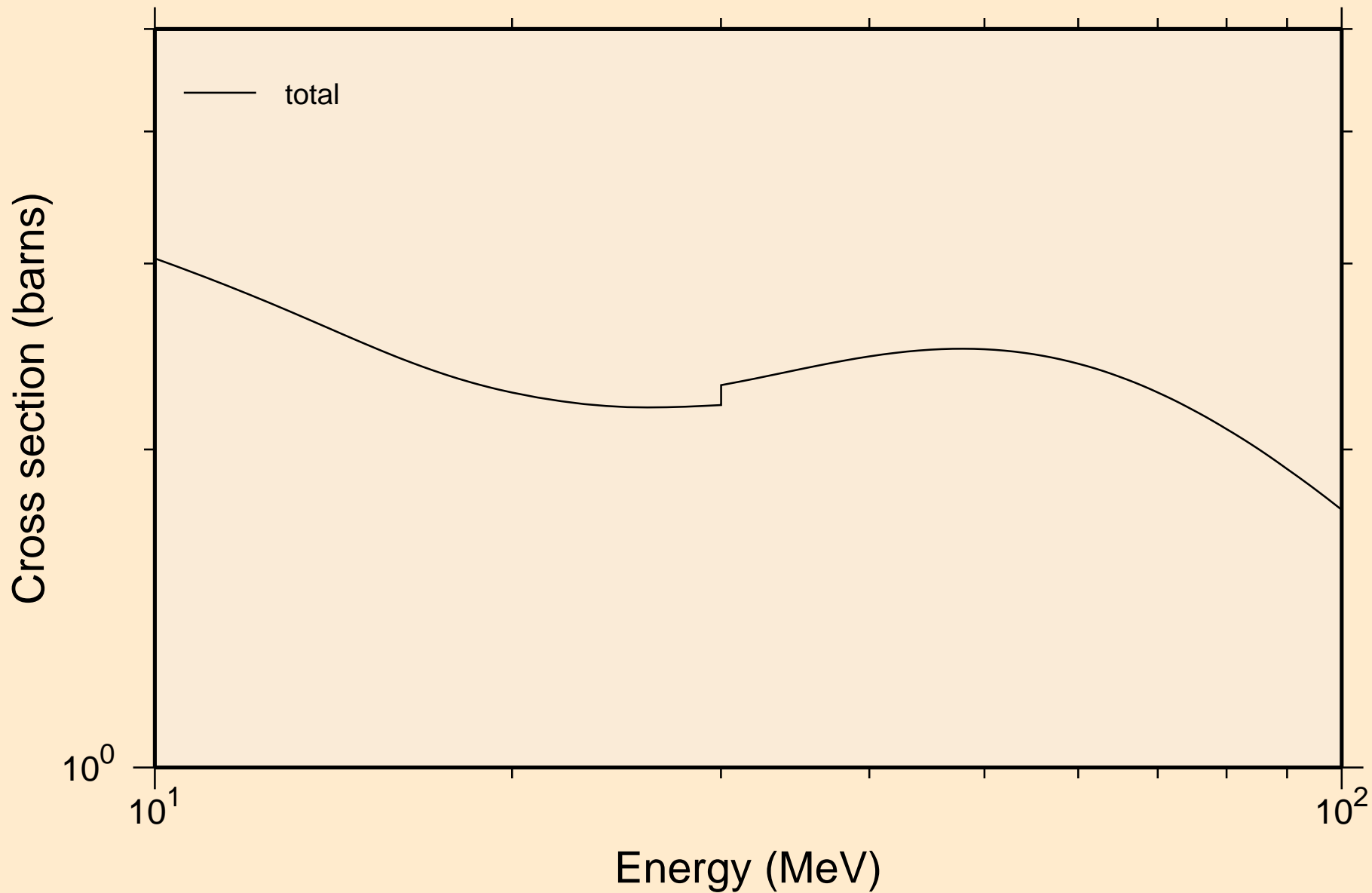

FE052M NEUTRON ACER TENDL-2019 LIBRARY; T=293.16K
resonance absorption cross sections

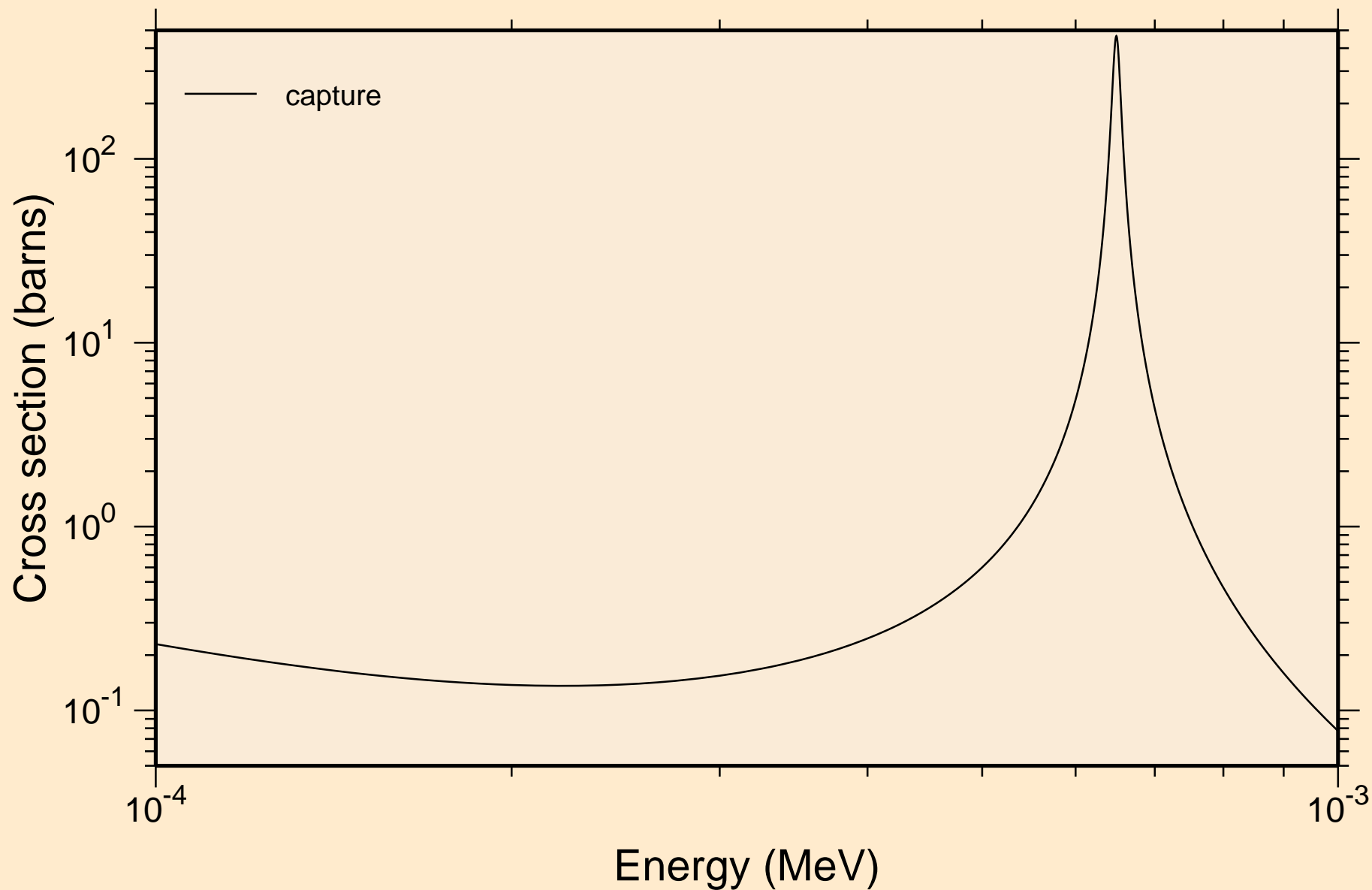

FE052M NEUTRON ACER TENDL-2019 LIBRARY; T=293.16K
resonance absorption cross sections

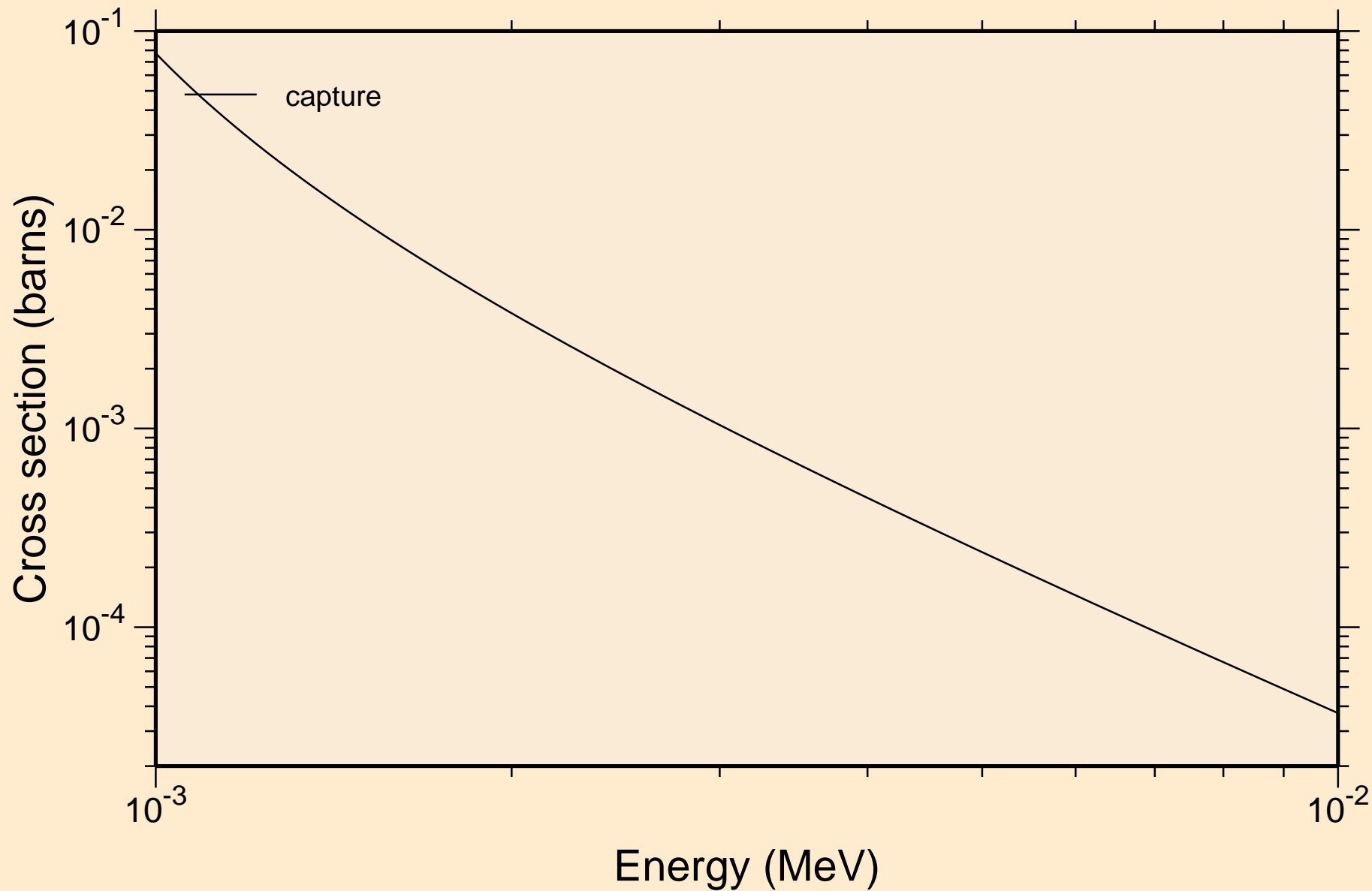

FE052M NEUTRON ACER TENDL-2019 LIBRARY; T=293.16K
resonance absorption cross sections

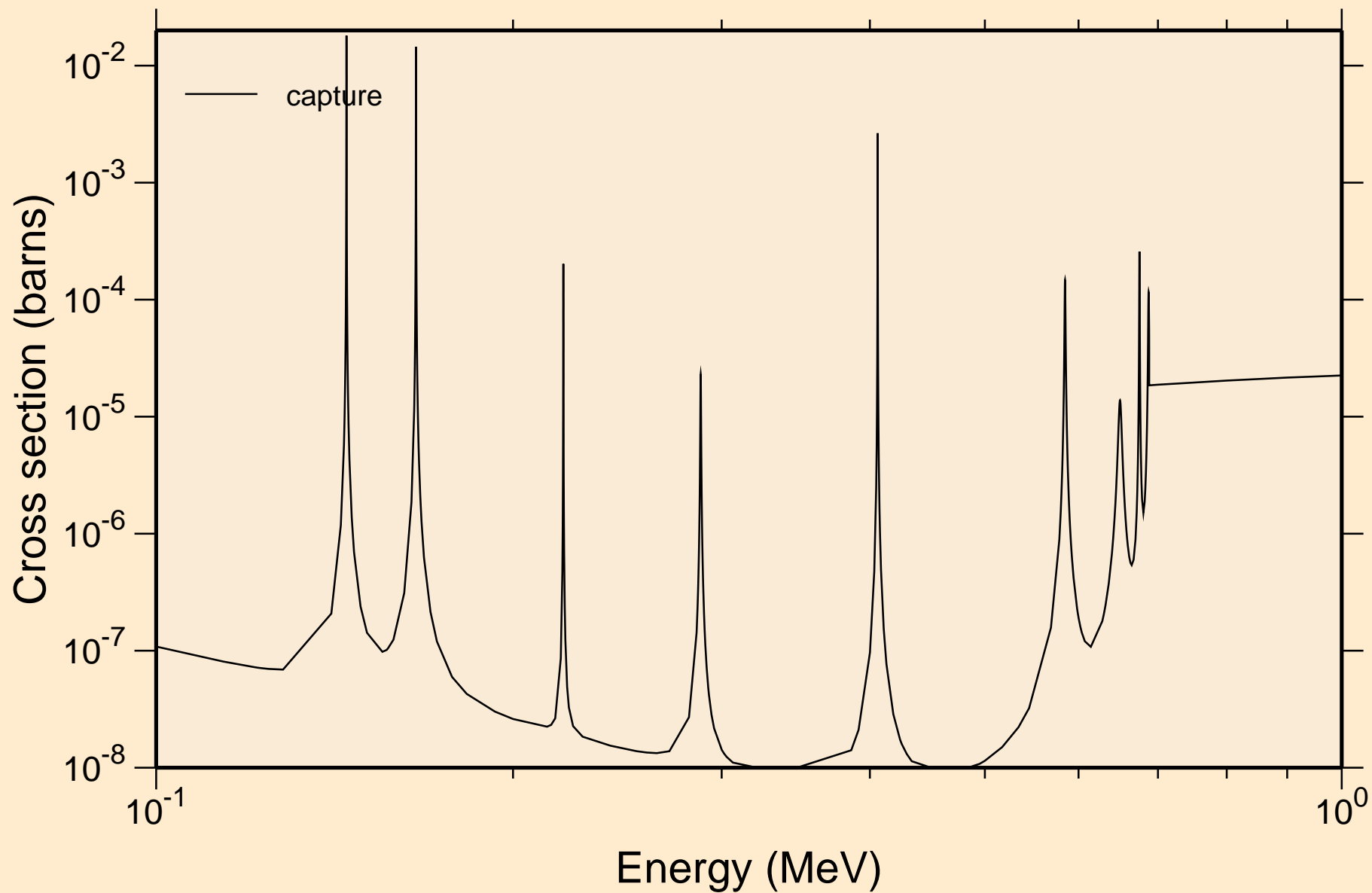

FE052M NEUTRON ACER TENDL-2019 LIBRARY; T=293.16K
resonance absorption cross sections

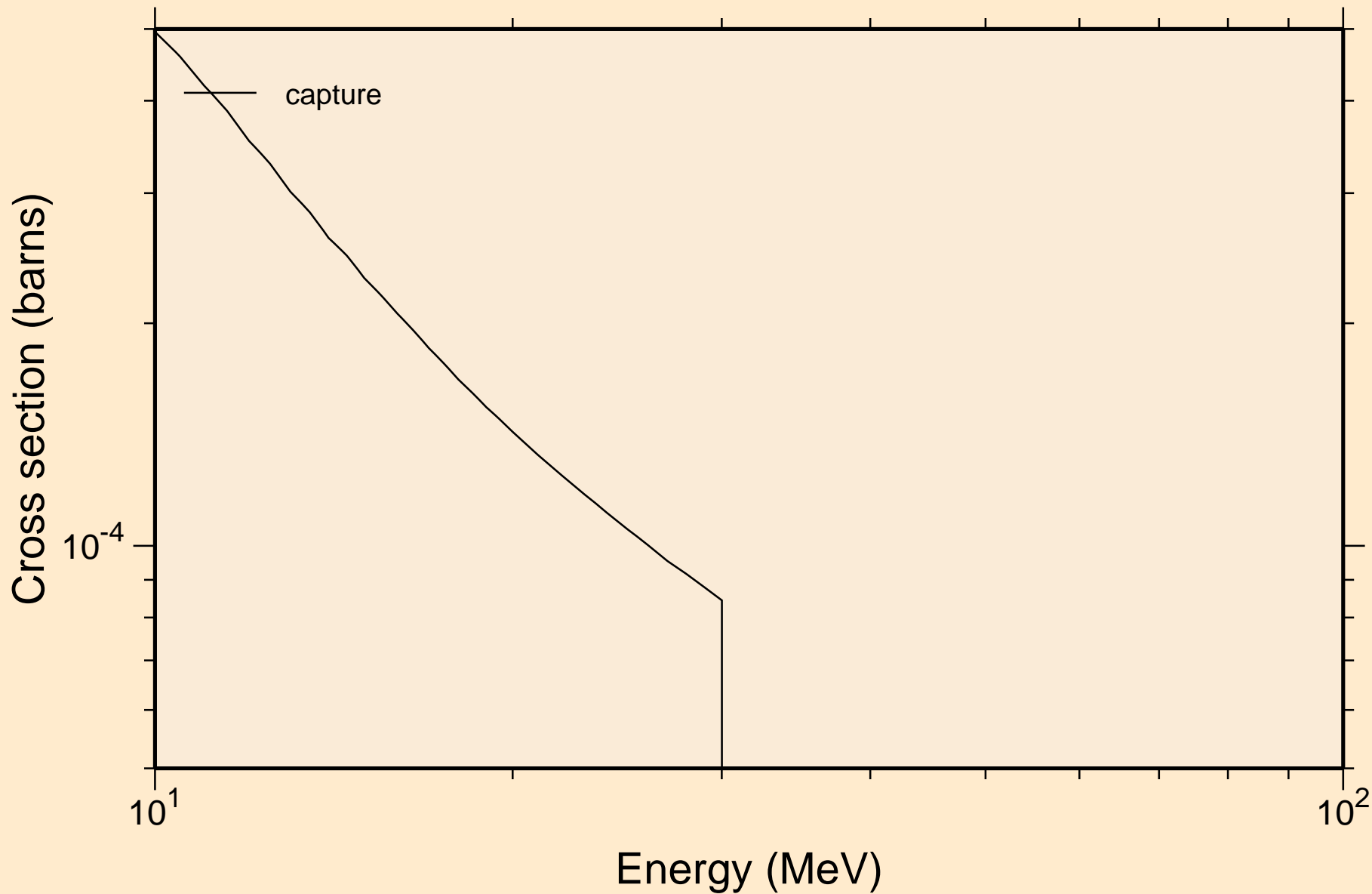

FE052M NEUTRON ACER TENDL-2019 LIBRARY; T=293.16K
Heating

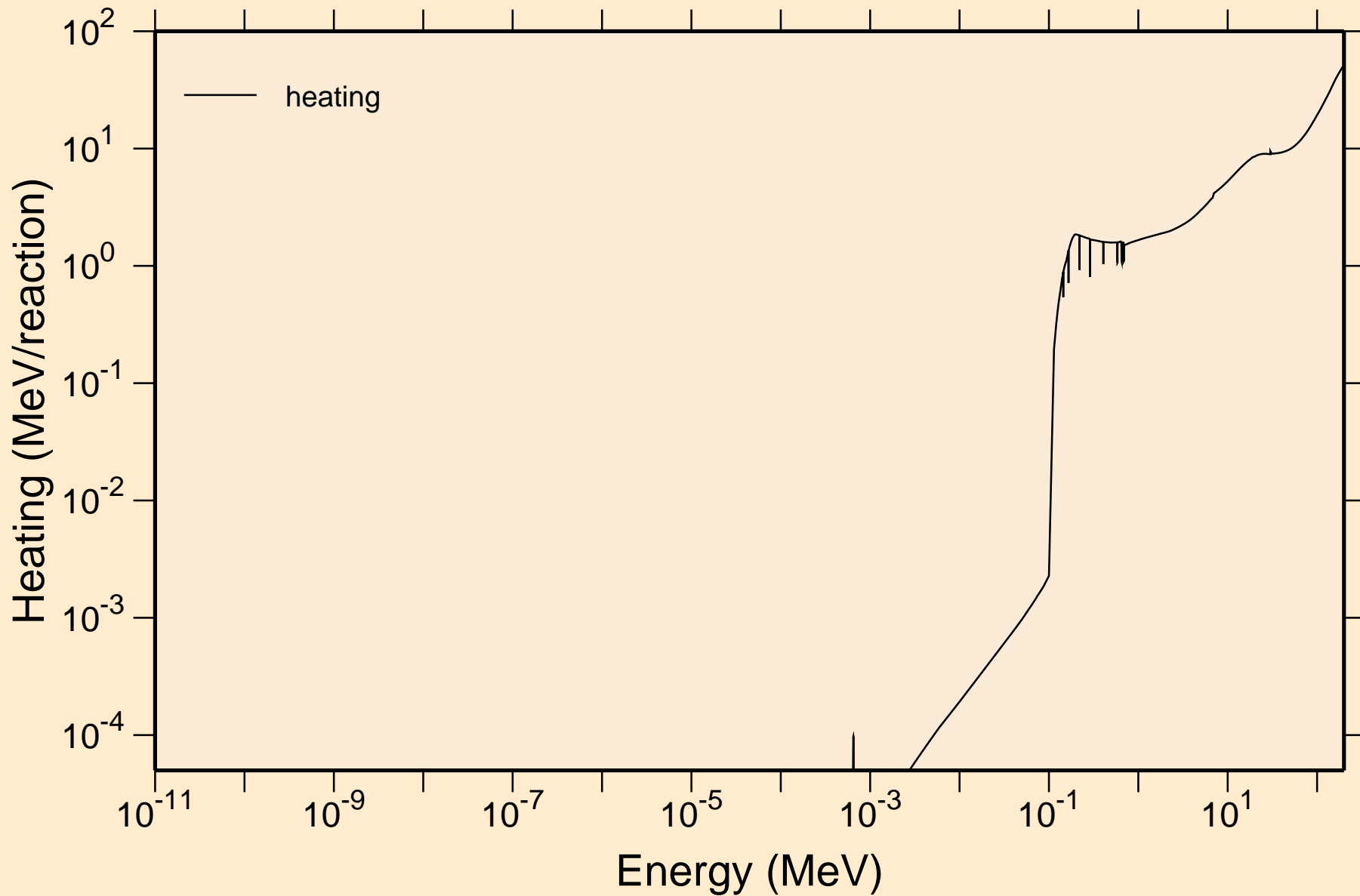

FE052M NEUTRON ACER TENDL-2019 LIBRARY; T=293.16K
Damage

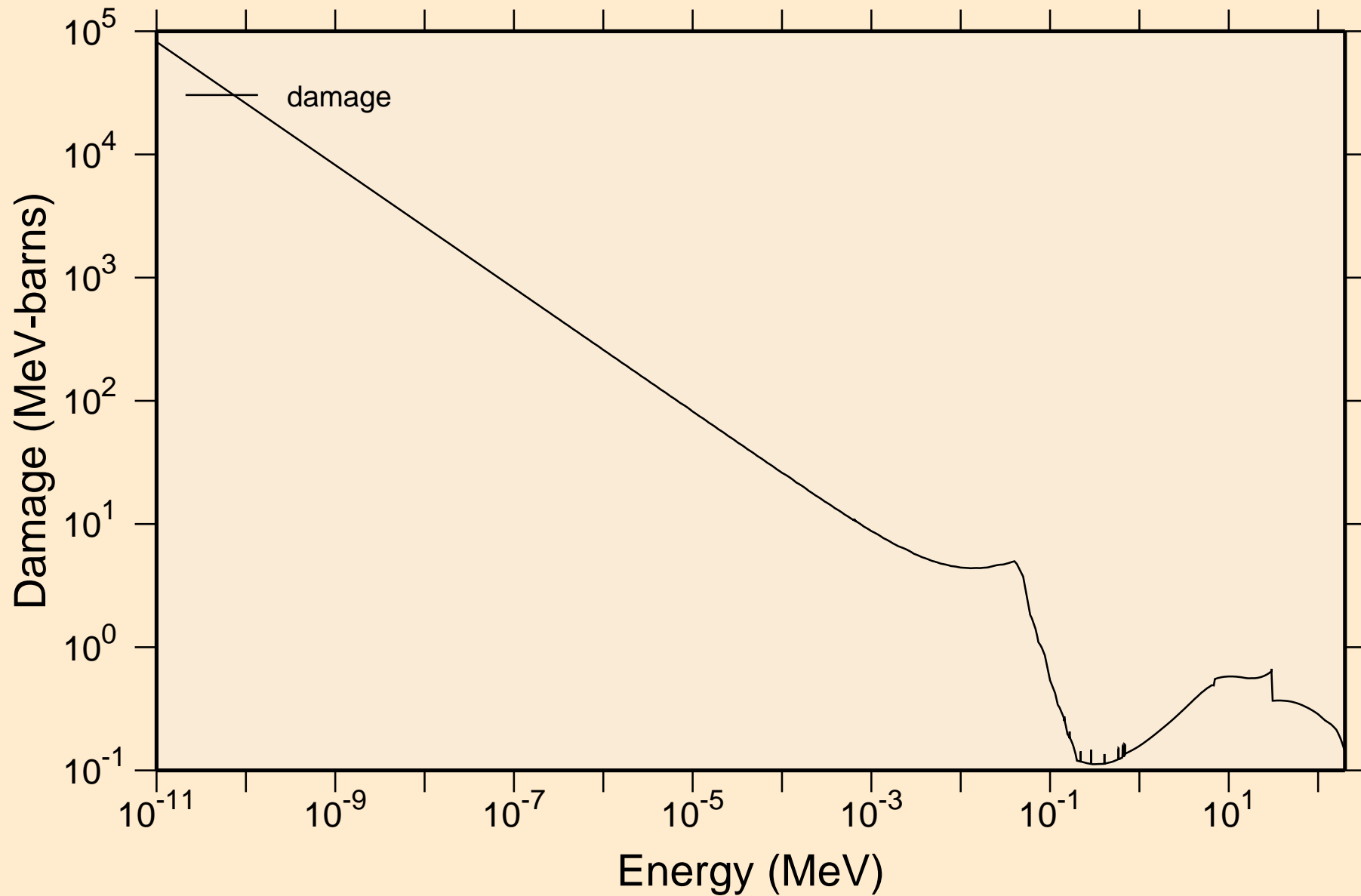

FE052M NEUTRON ACER TENDL-2019 LIBRARY; T=293.16K
Non-threshold reactions

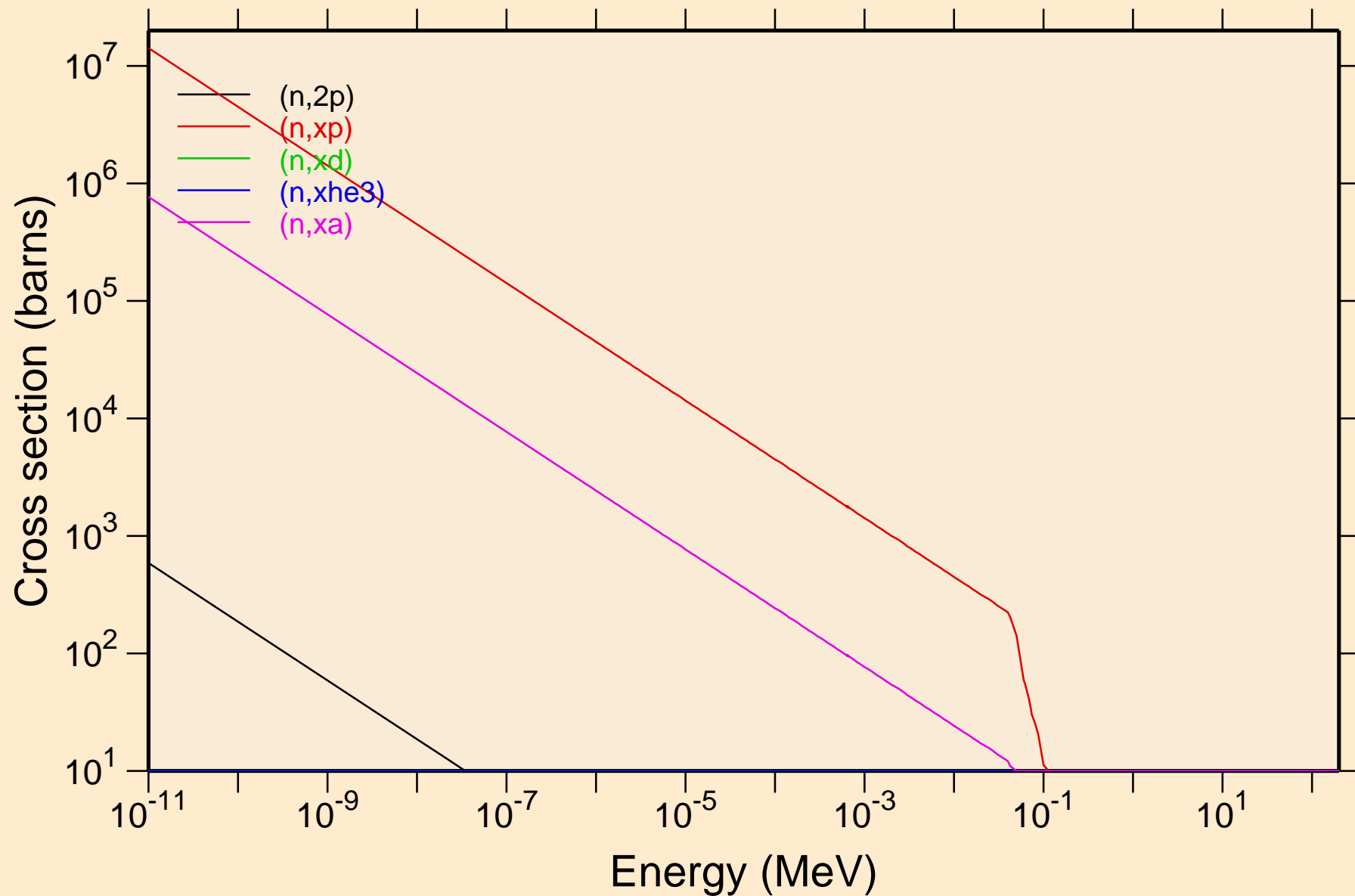

FE052M NEUTRON ACER TENDL-2019 LIBRARY; T=293.16K
Principal cross sections

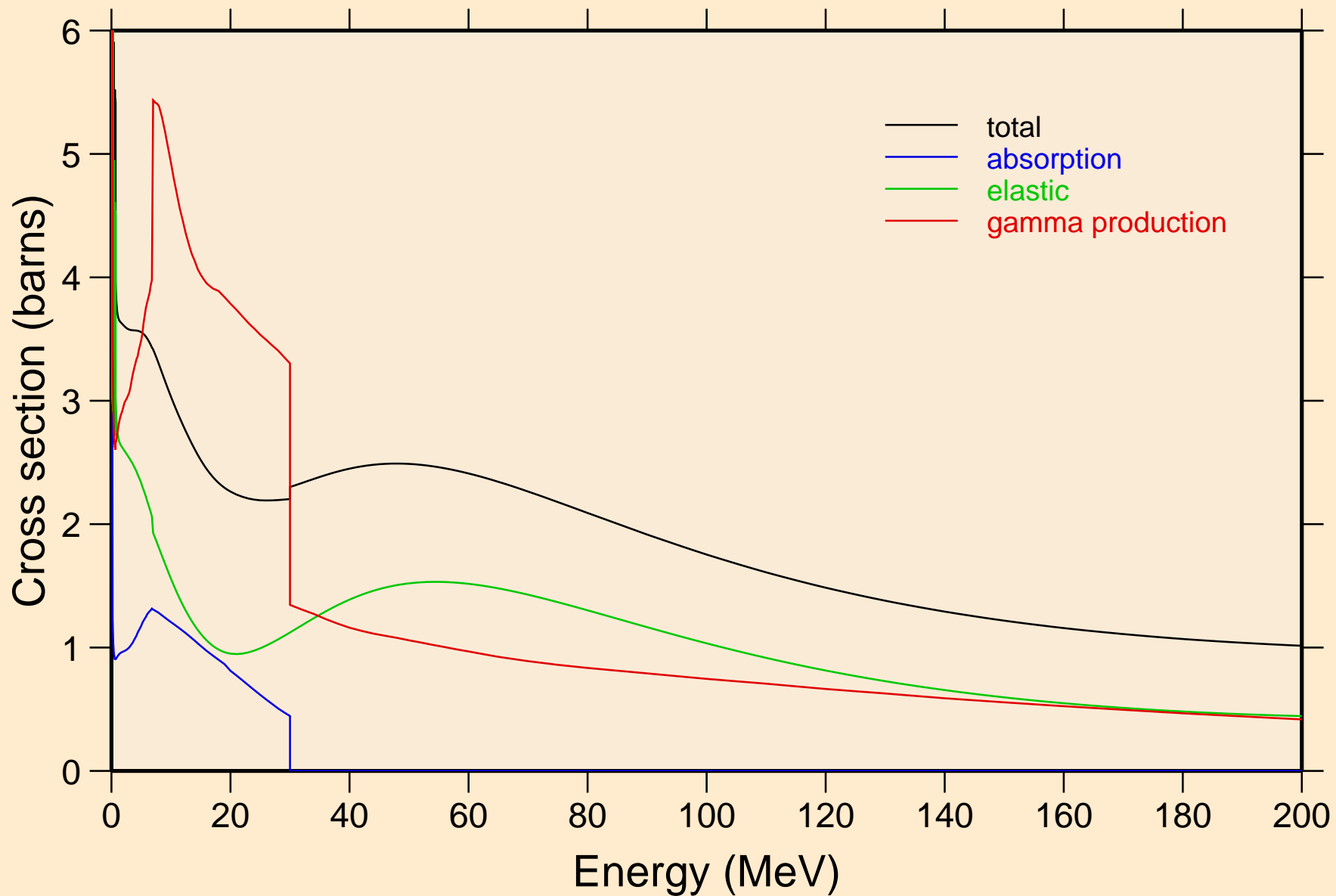

FE052M NEUTRON ACER TENDL-2019 LIBRARY; T=293.16K
Heating

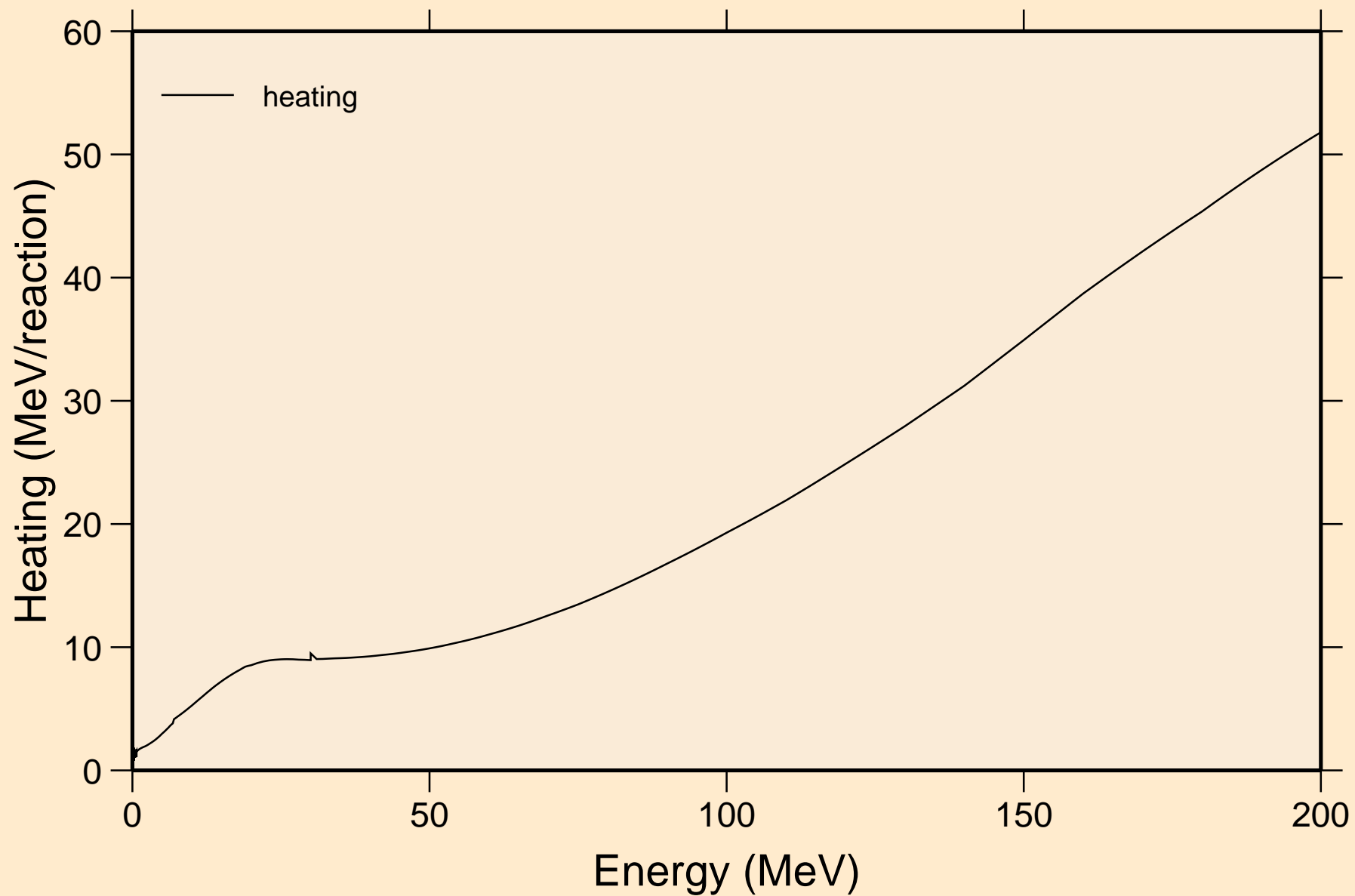

FE052M NEUTRON ACER TENDL-2019 LIBRARY; T=293.16K
Damage

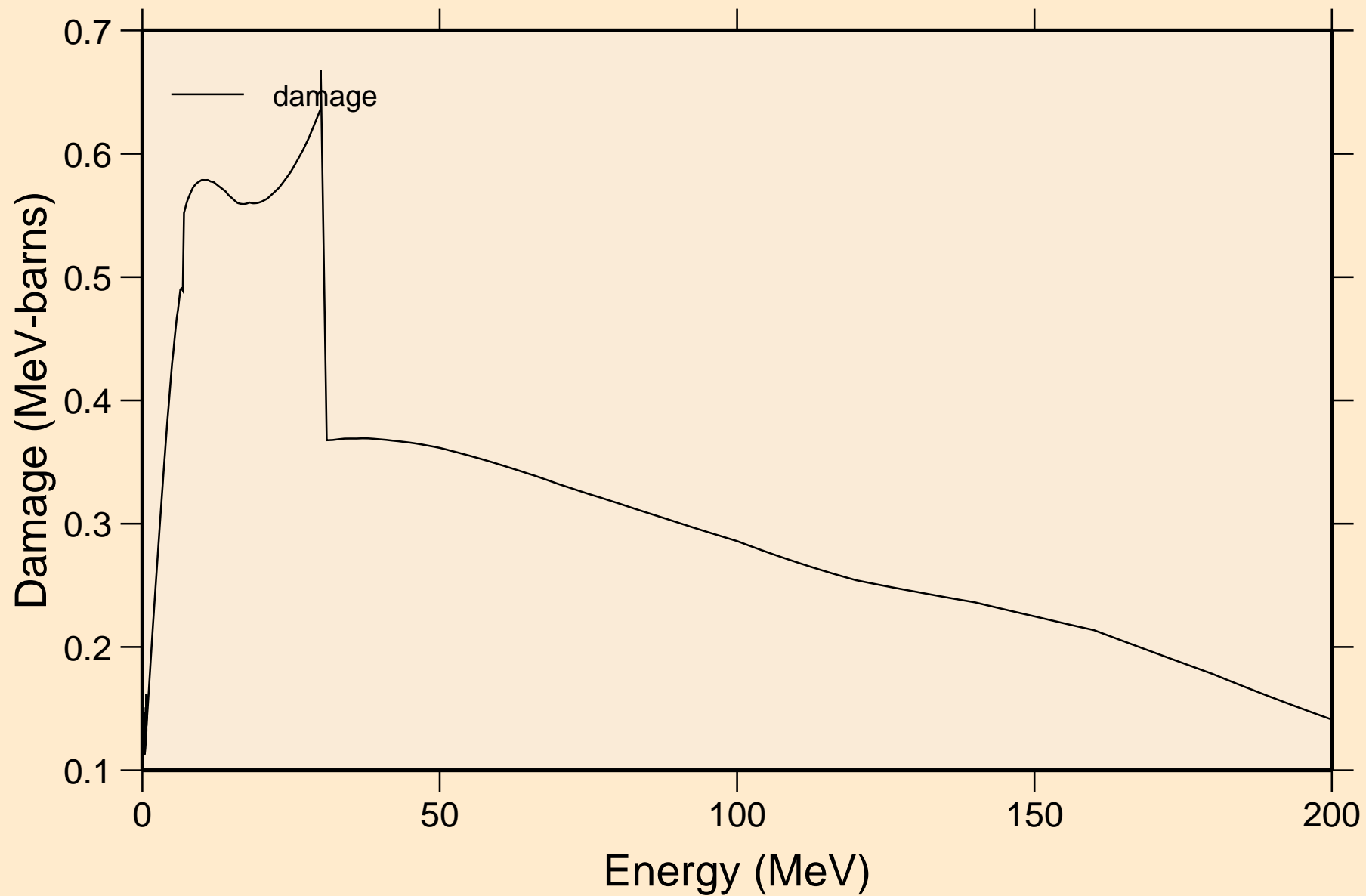

FE052M NEUTRON ACER TENDL-2019 LIBRARY; T=293.16K
Non-threshold reactions

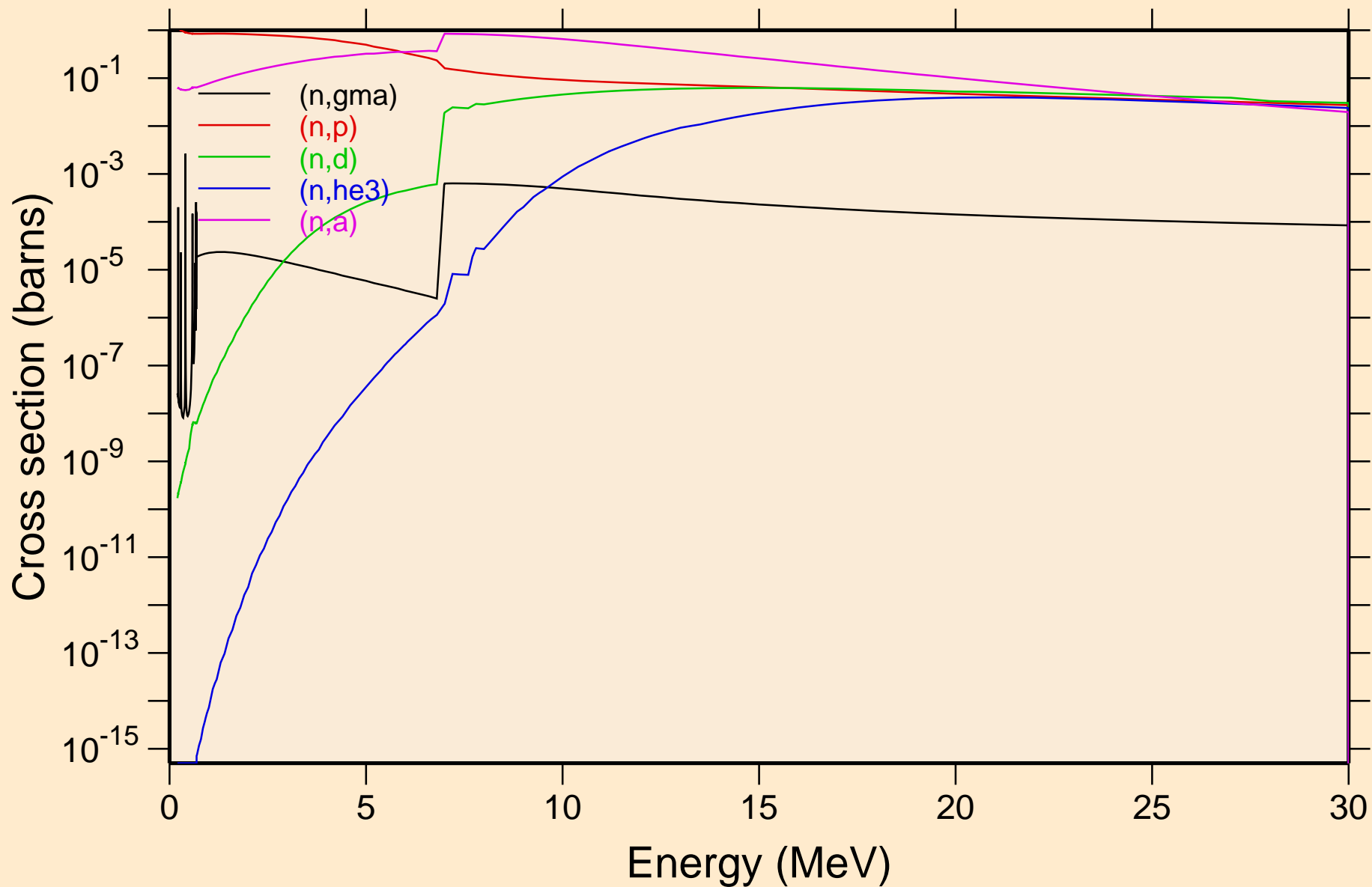

FE052M NEUTRON ACER TENDL-2019 LIBRARY; T=293.16K
Non-threshold reactions

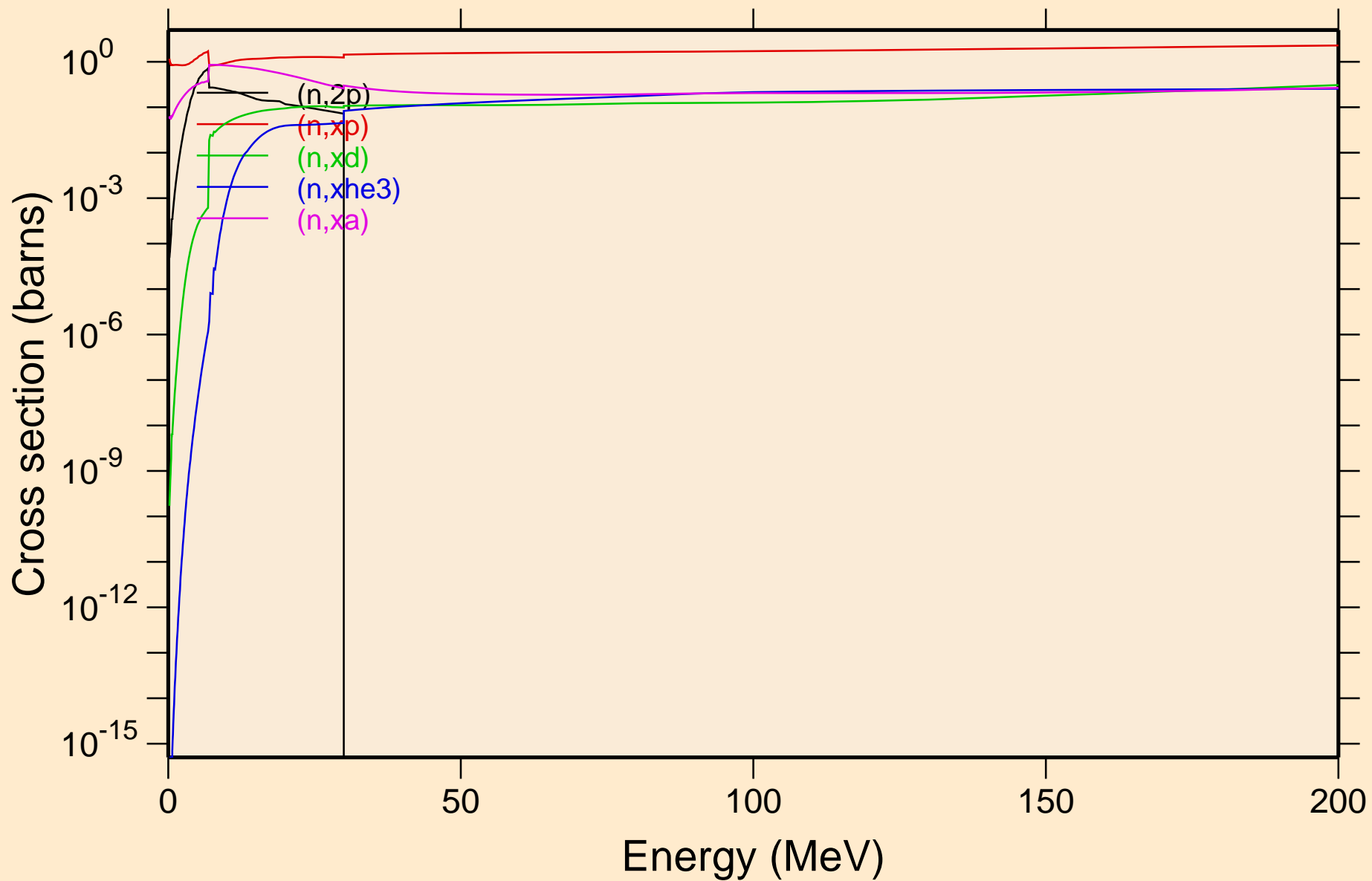

FE052M NEUTRON ACER TENDL-2019 LIBRARY; T=293.16K
Inelastic levels

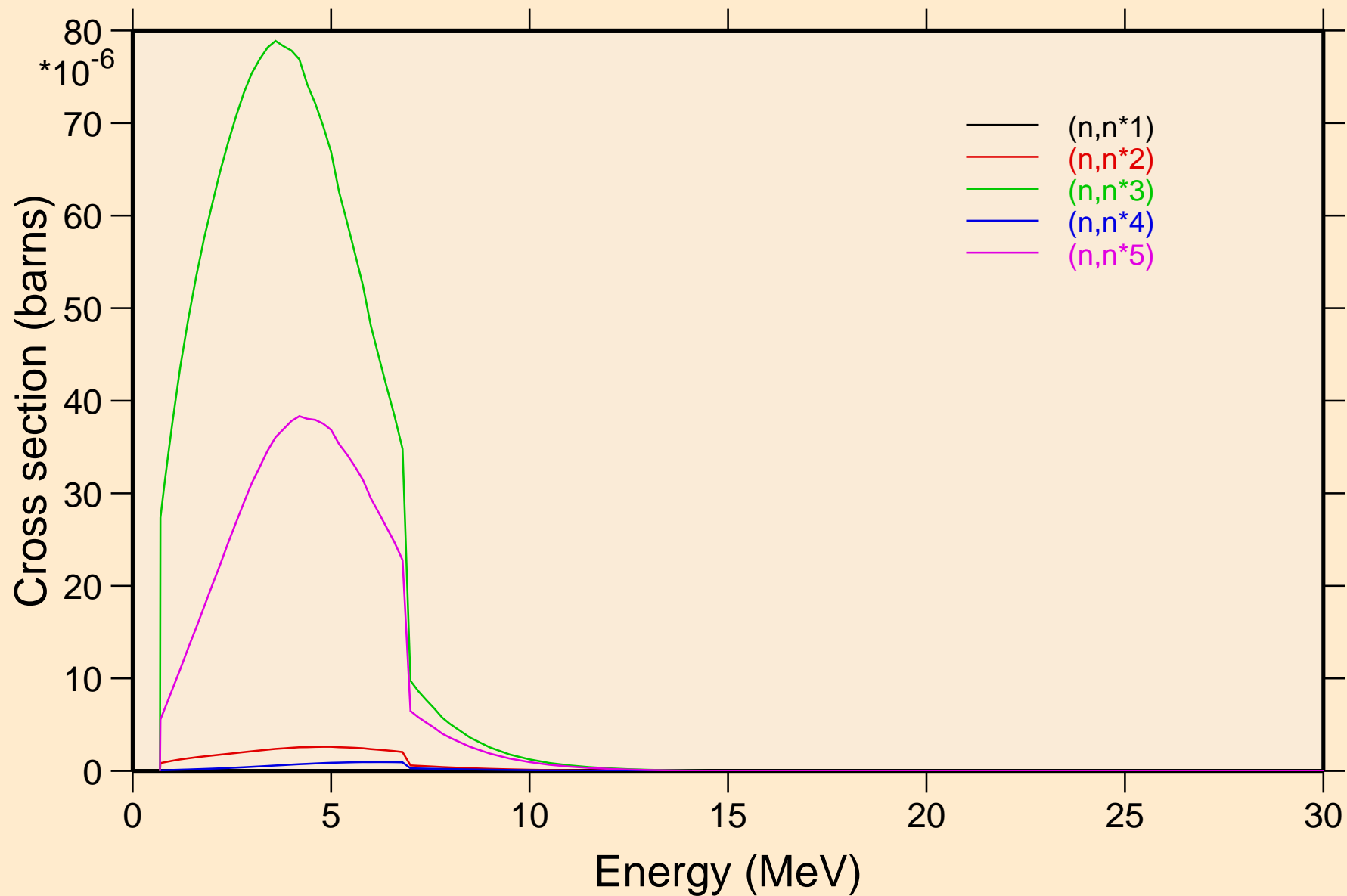

FE052M NEUTRON ACER TENDL-2019 LIBRARY; T=293.16K
Inelastic levels

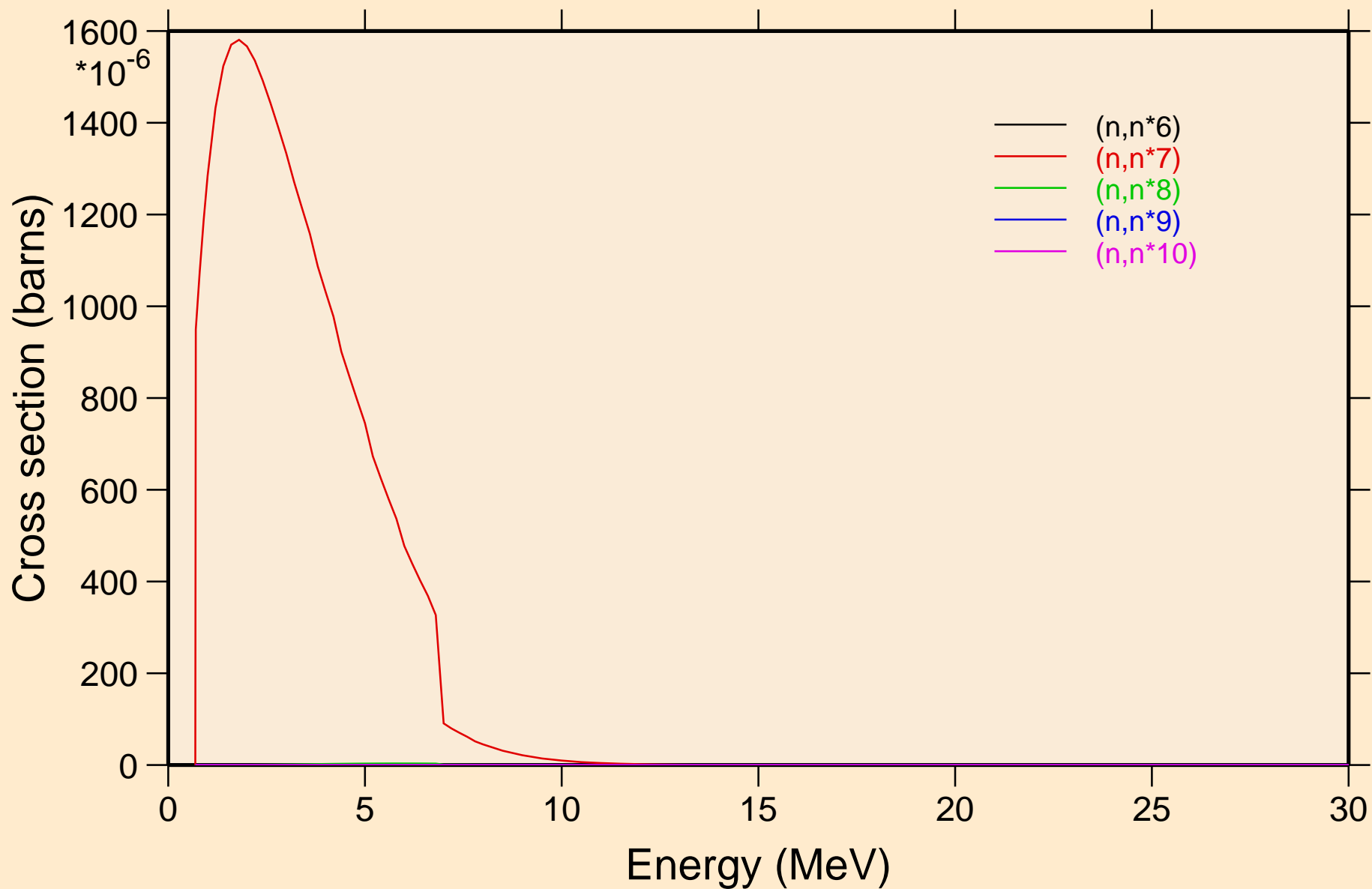

FE052M NEUTRON ACER TENDL-2019 LIBRARY; T=293.16K
Inelastic levels

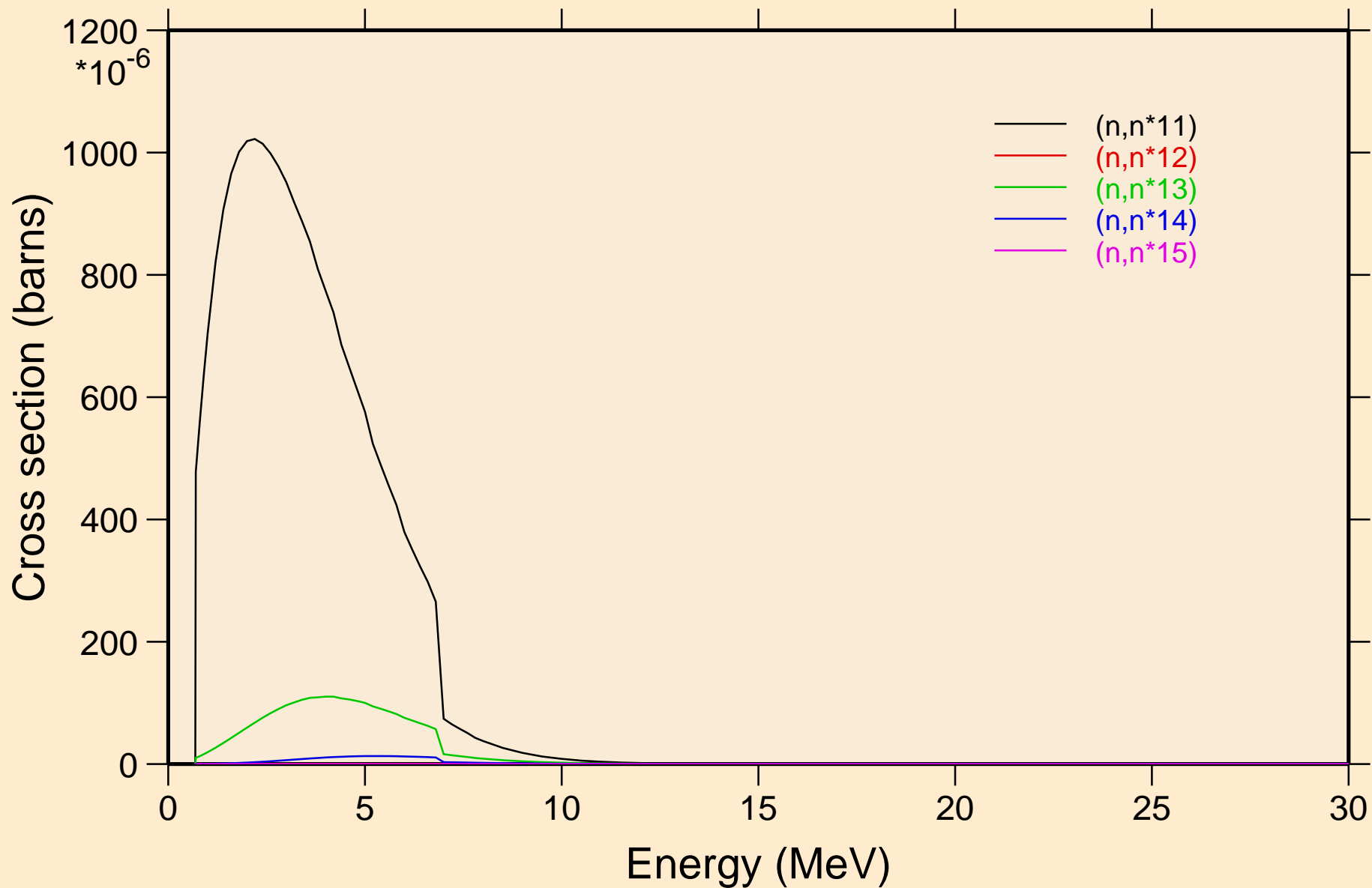

FE052M NEUTRON ACER TENDL-2019 LIBRARY; T=293.16K
Inelastic levels

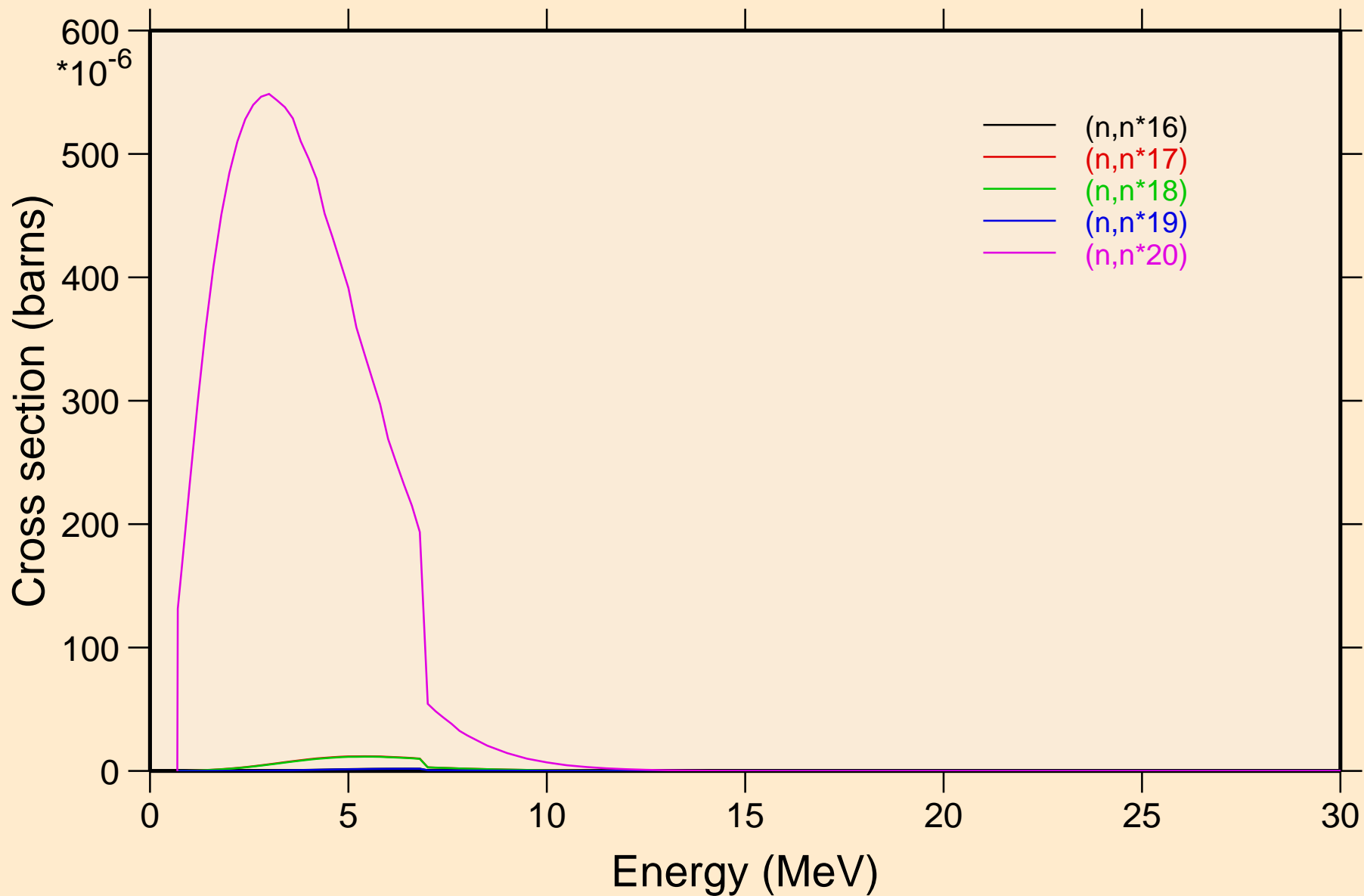

FE052M NEUTRON ACER TENDL-2019 LIBRARY; T=293.16K
Inelastic levels

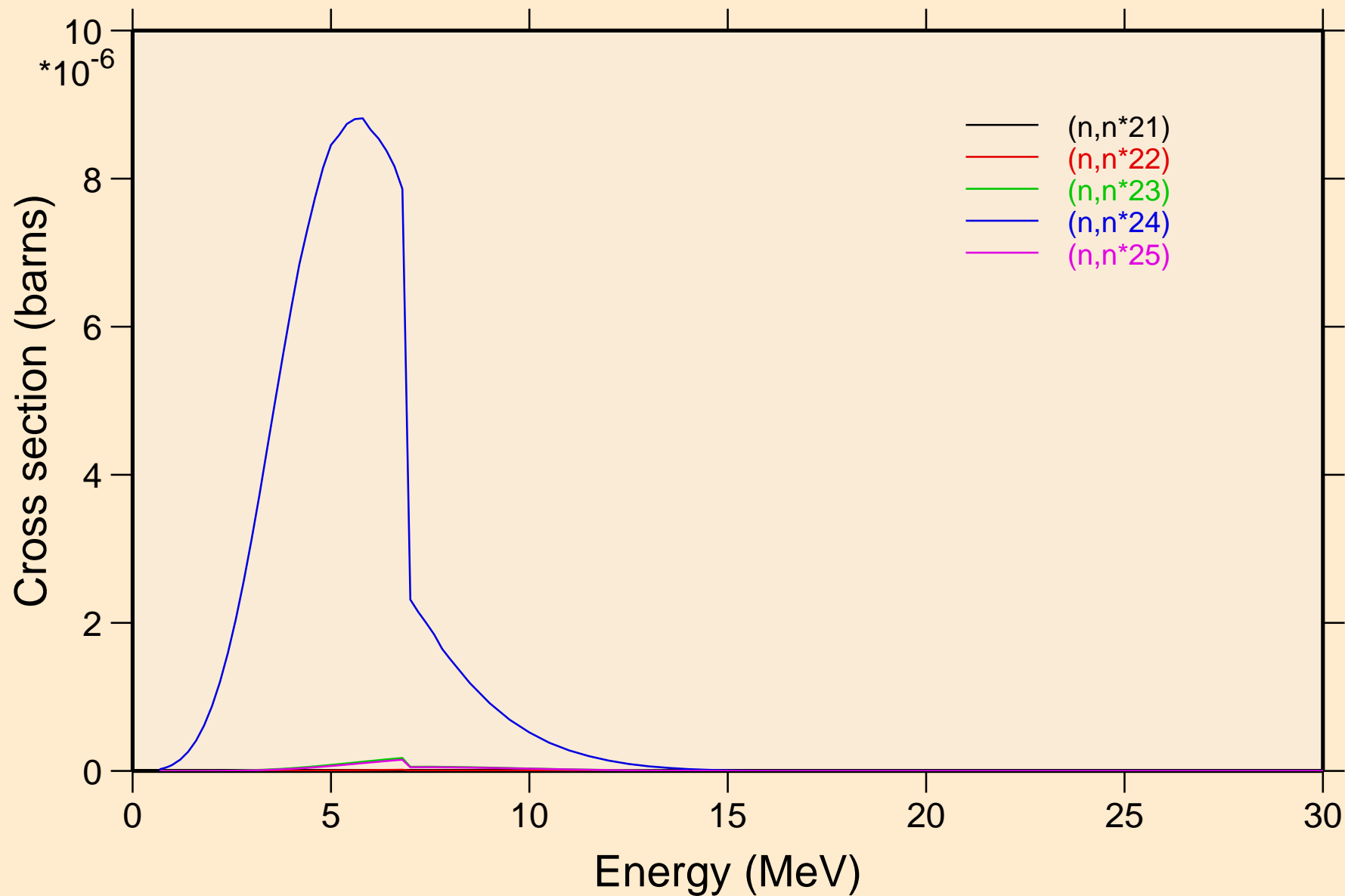

FE052M NEUTRON ACER TENDL-2019 LIBRARY; T=293.16K
Inelastic levels

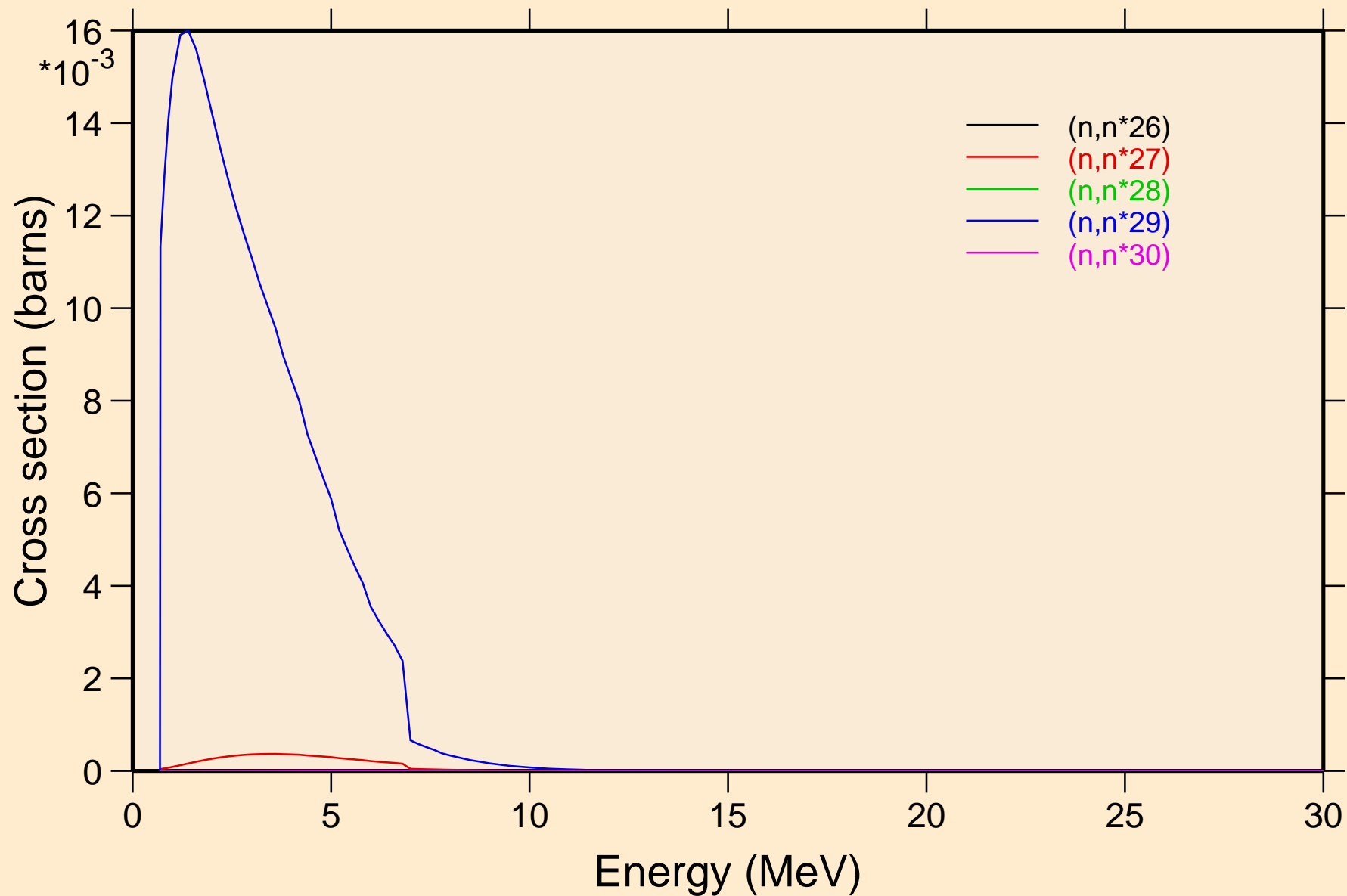

FE052M NEUTRON ACER TENDL-2019 LIBRARY; T=293.16K
Inelastic levels

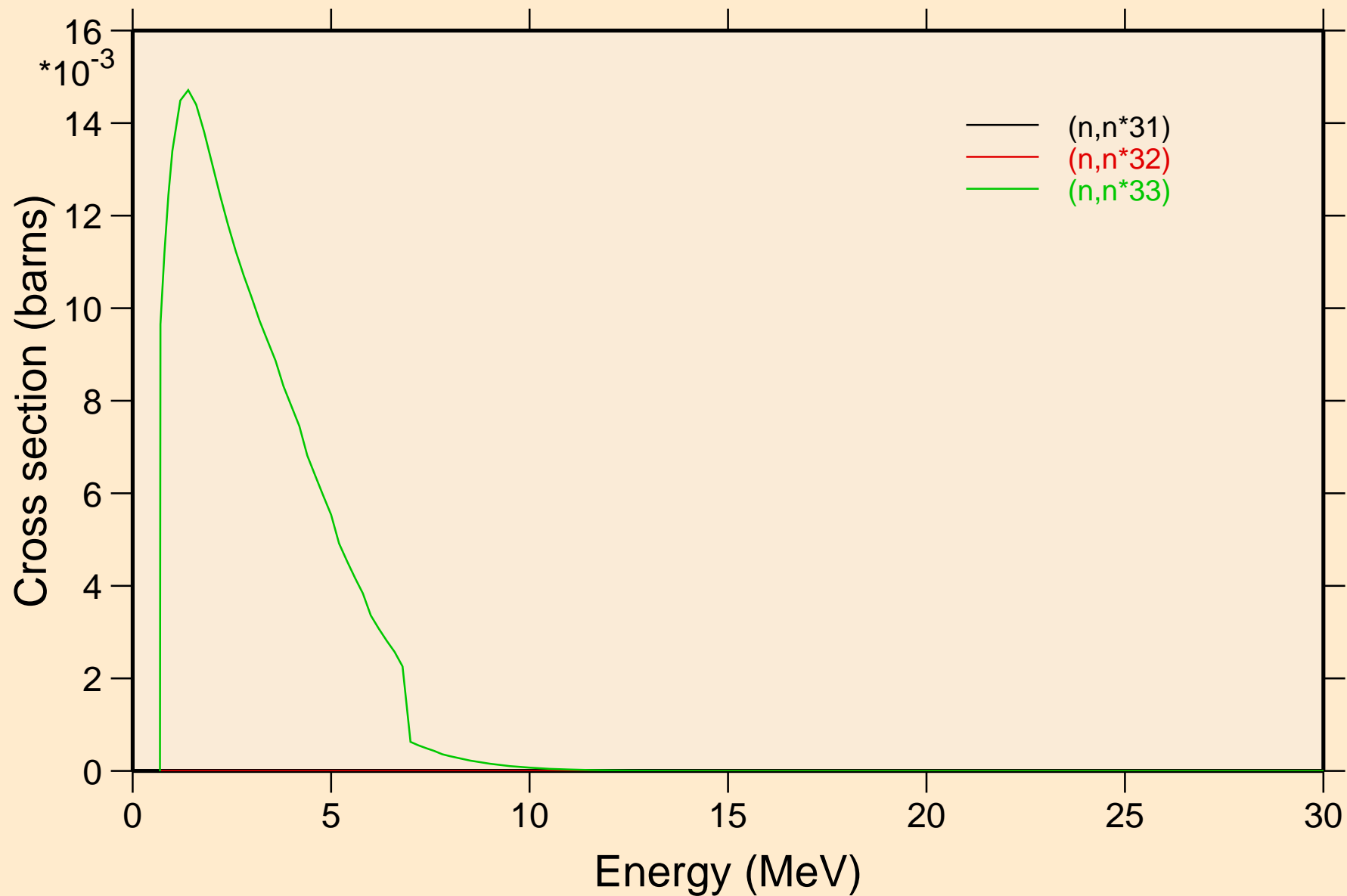

FE052M NEUTRON ACER TENDL-2019 LIBRARY; T=293.16K
Threshold reactions

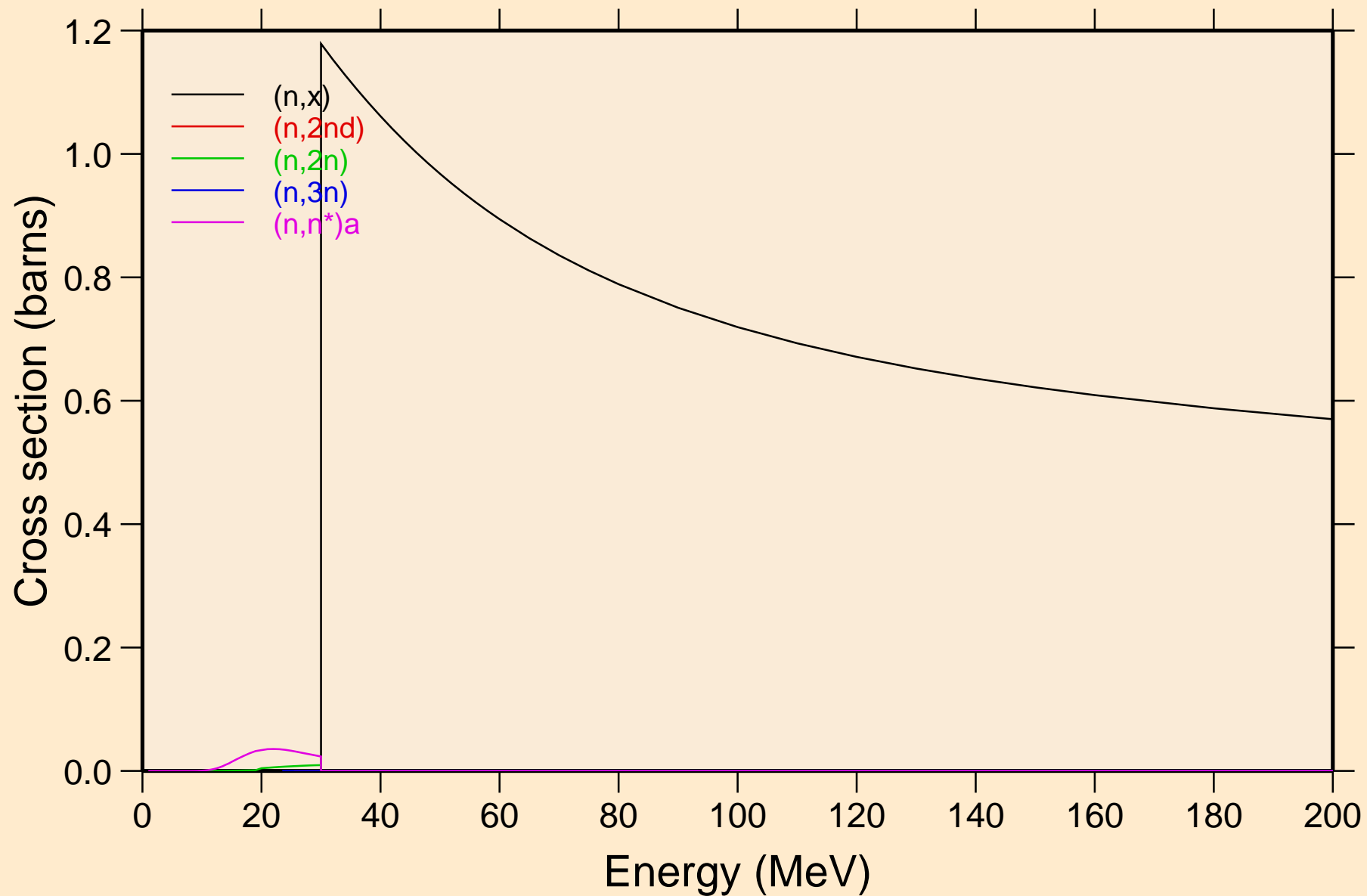

FE052M NEUTRON ACER TENDL-2019 LIBRARY; T=293.16K
Threshold reactions

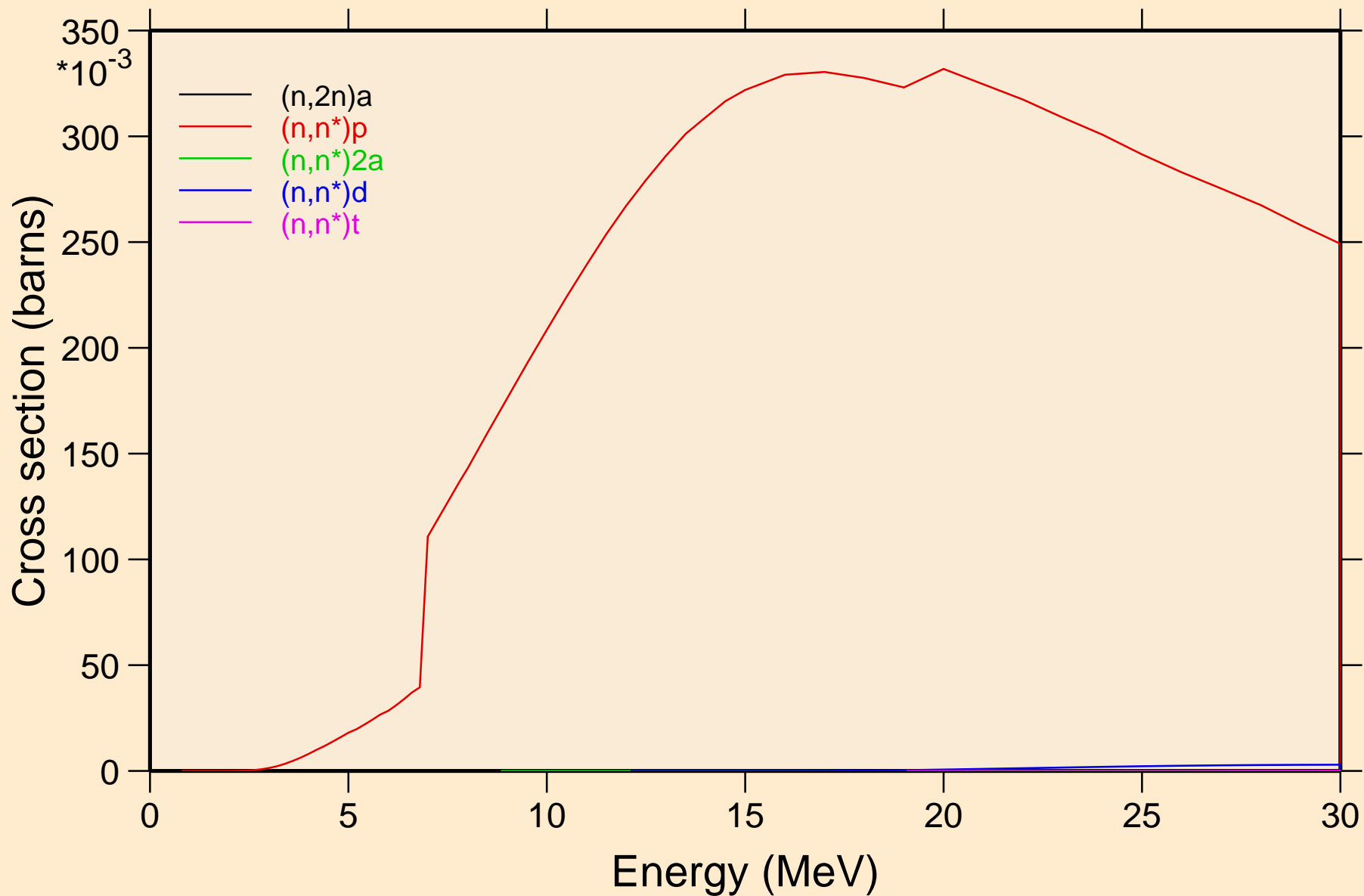

FE052M NEUTRON ACER TENDL-2019 LIBRARY; T=293.16K
Threshold reactions

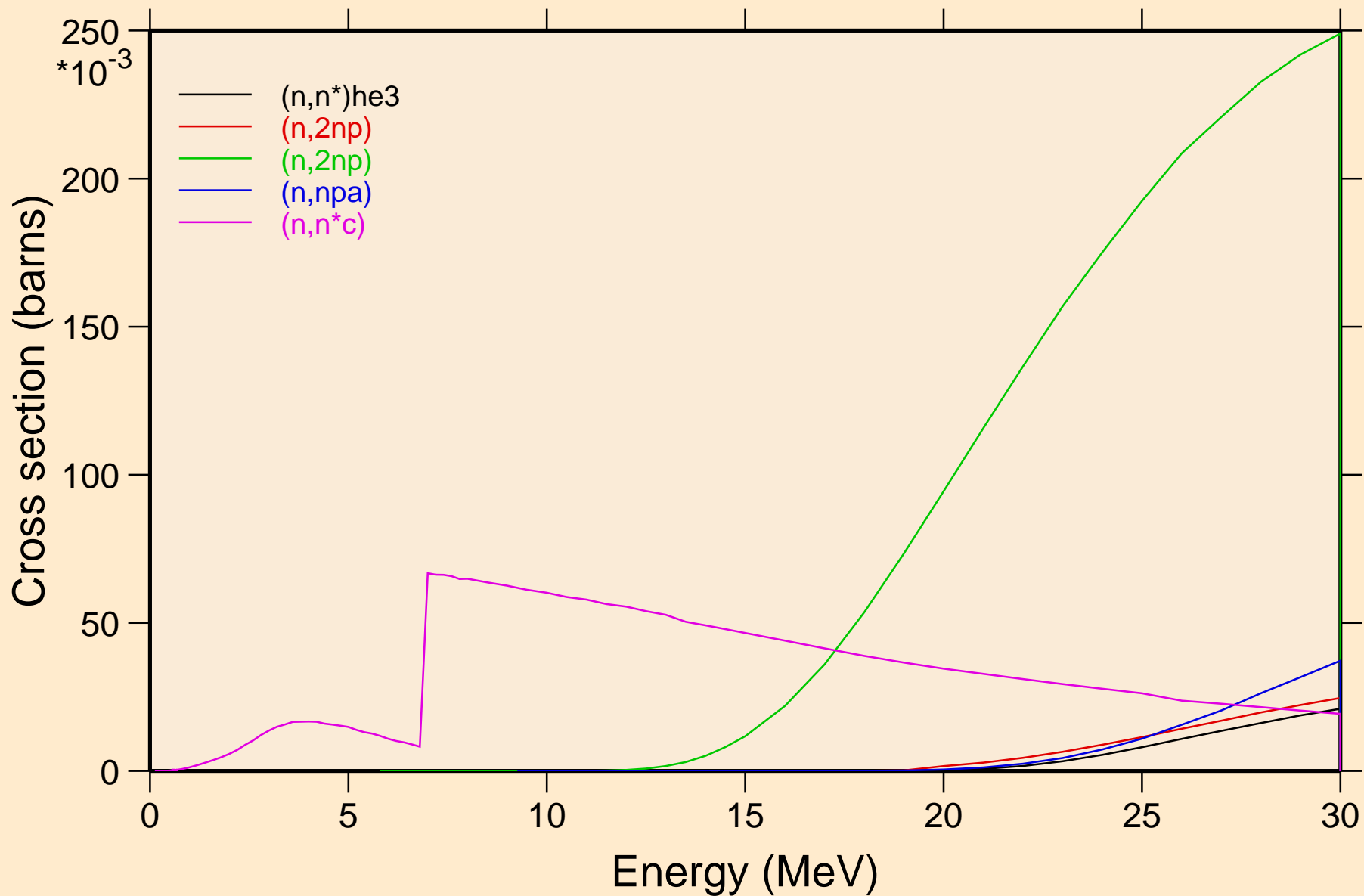

FE052M NEUTRON ACER TENDL-2019 LIBRARY; T=293.16K
Threshold reactions

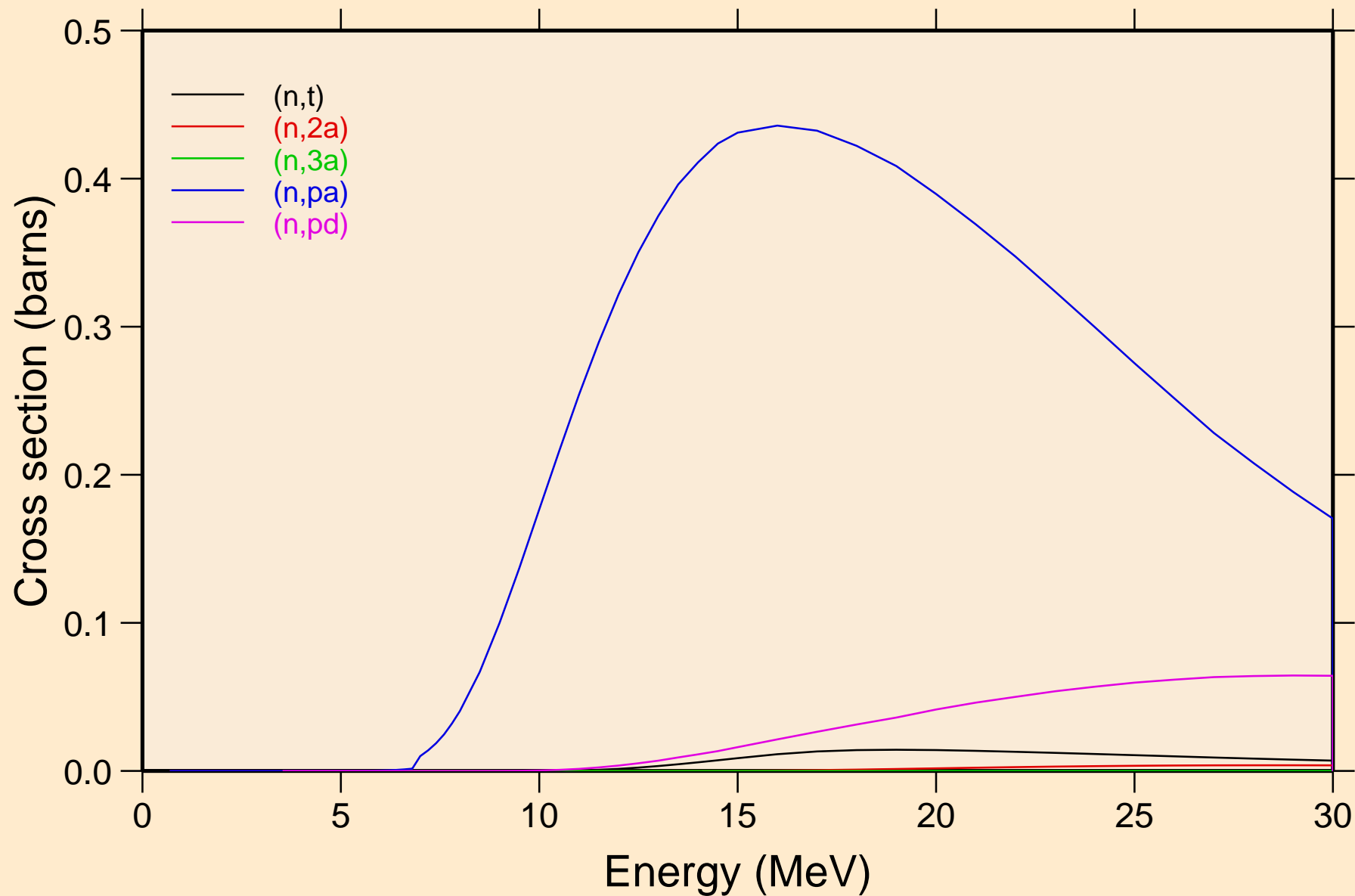

FE052M NEUTRON ACER TENDL-2019 LIBRARY; T=293.16K
Threshold reactions

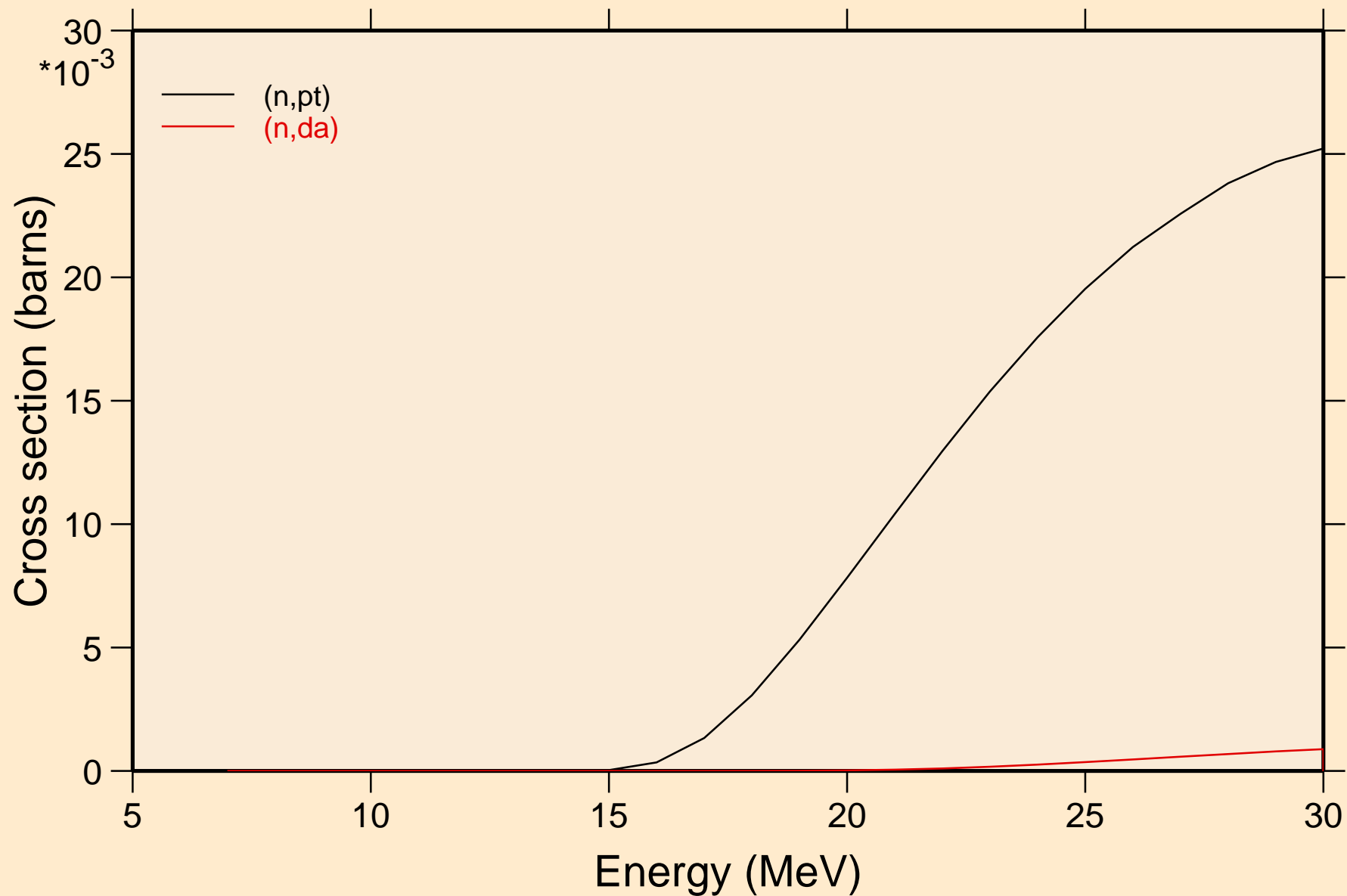

FE052M NEUTRON ACER TENDL-2019 LIBRARY; T=293.16K
Threshold reactions

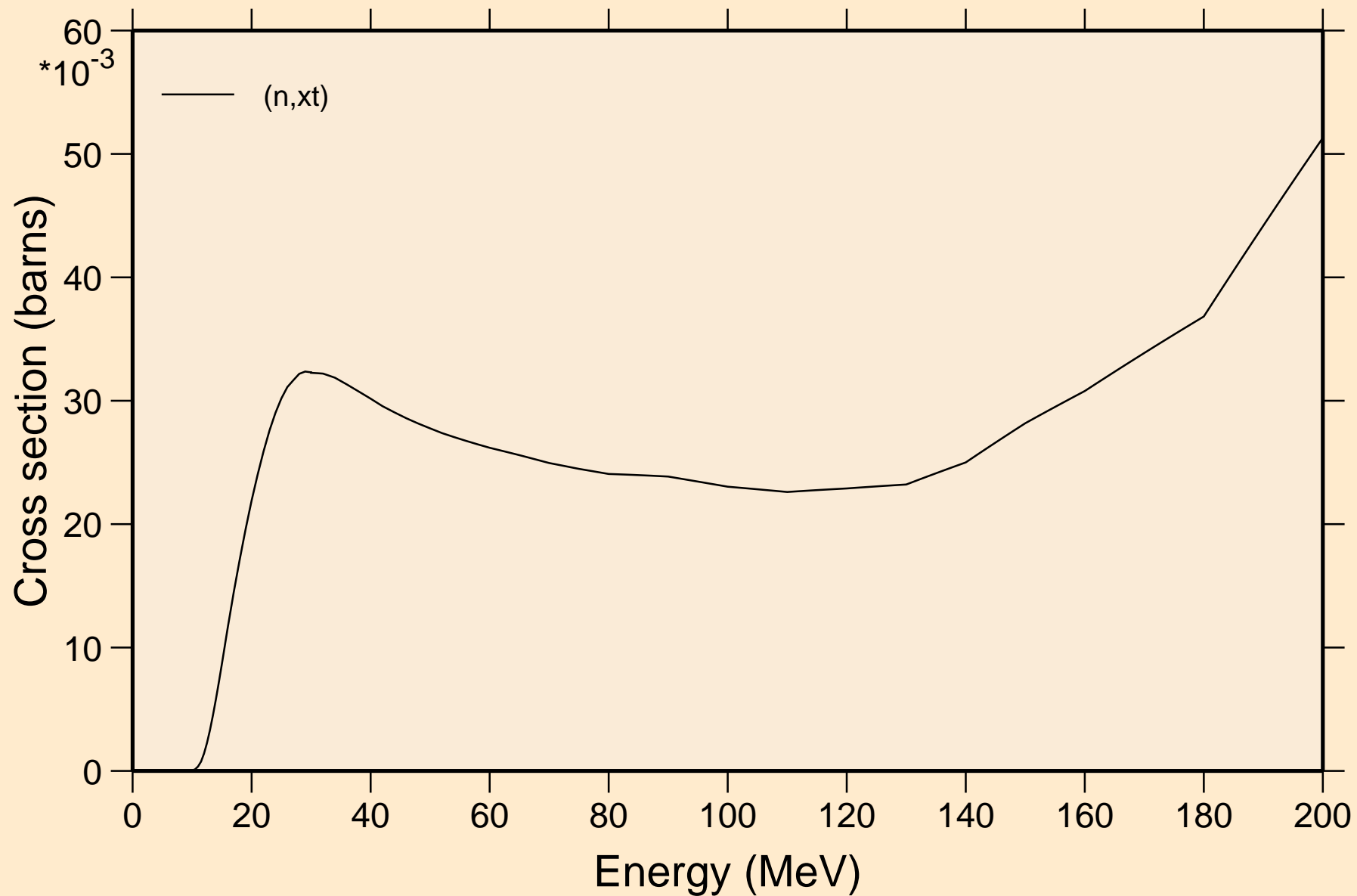

FE052M NEUTRON ACER TENDL-2019 LIBRARY; T=293.16K
angular distribution for elastic

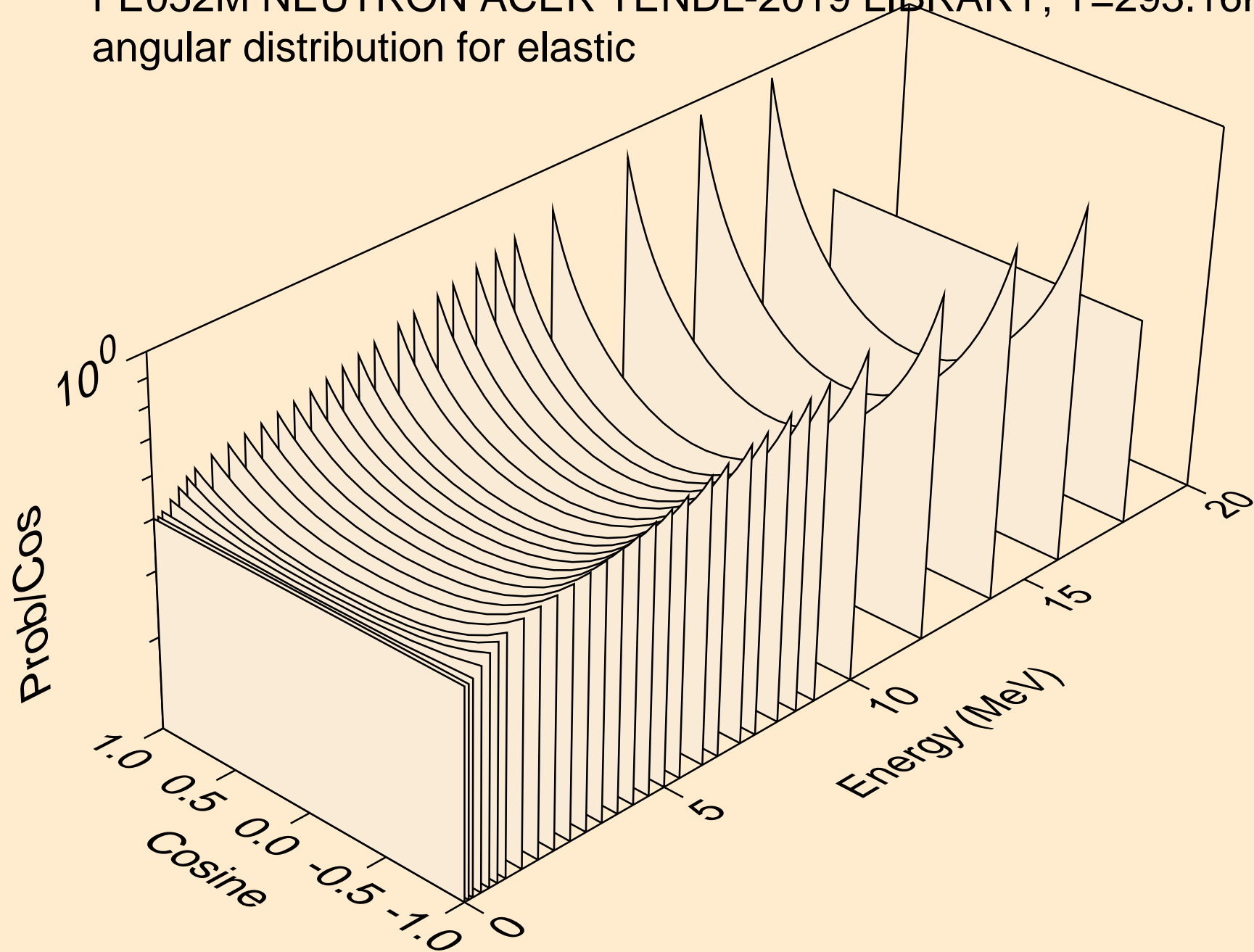

FE052M NEUTRON ACER TENDL-2019 LIBRARY; T=293.16K
angular distribution for elastic

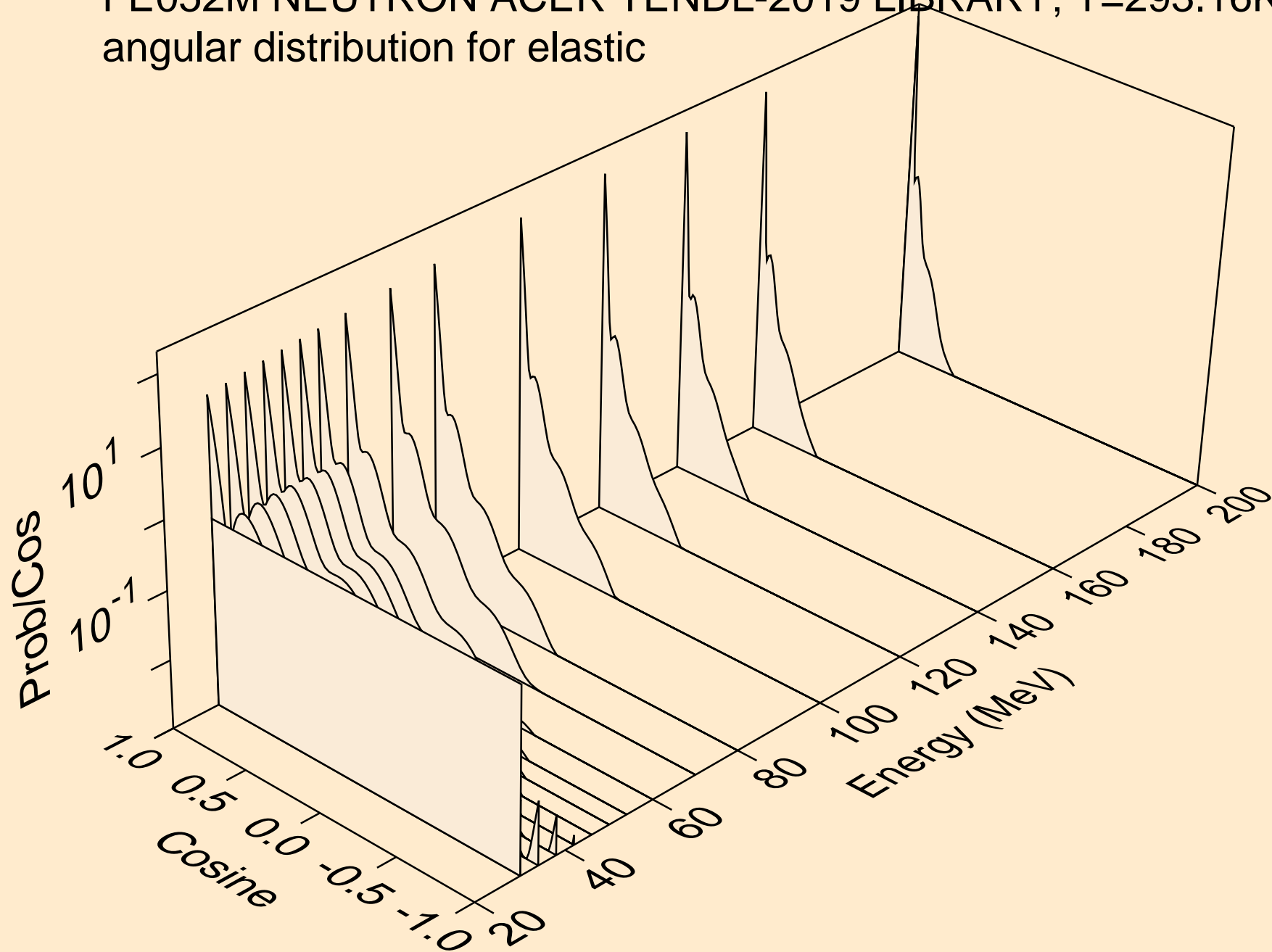

FE052M NEUTRON ACER TENDL-2019 LIBRARY; T=293.16K
angular distribution for (n,n*1)

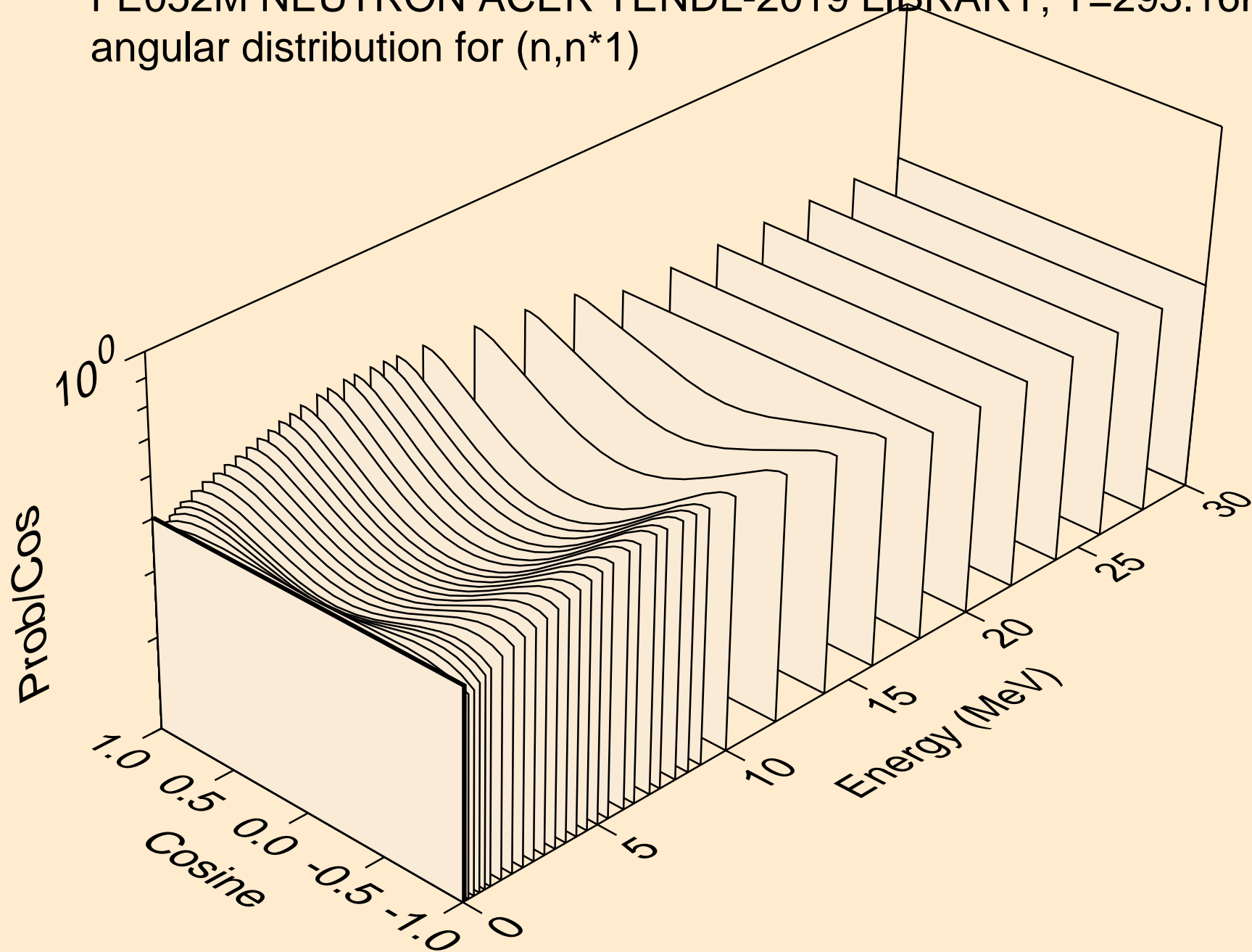

FE052M NEUTRON ACER TENDL-2019 LIBRARY; T=293.16K
angular distribution for (n,n*2)

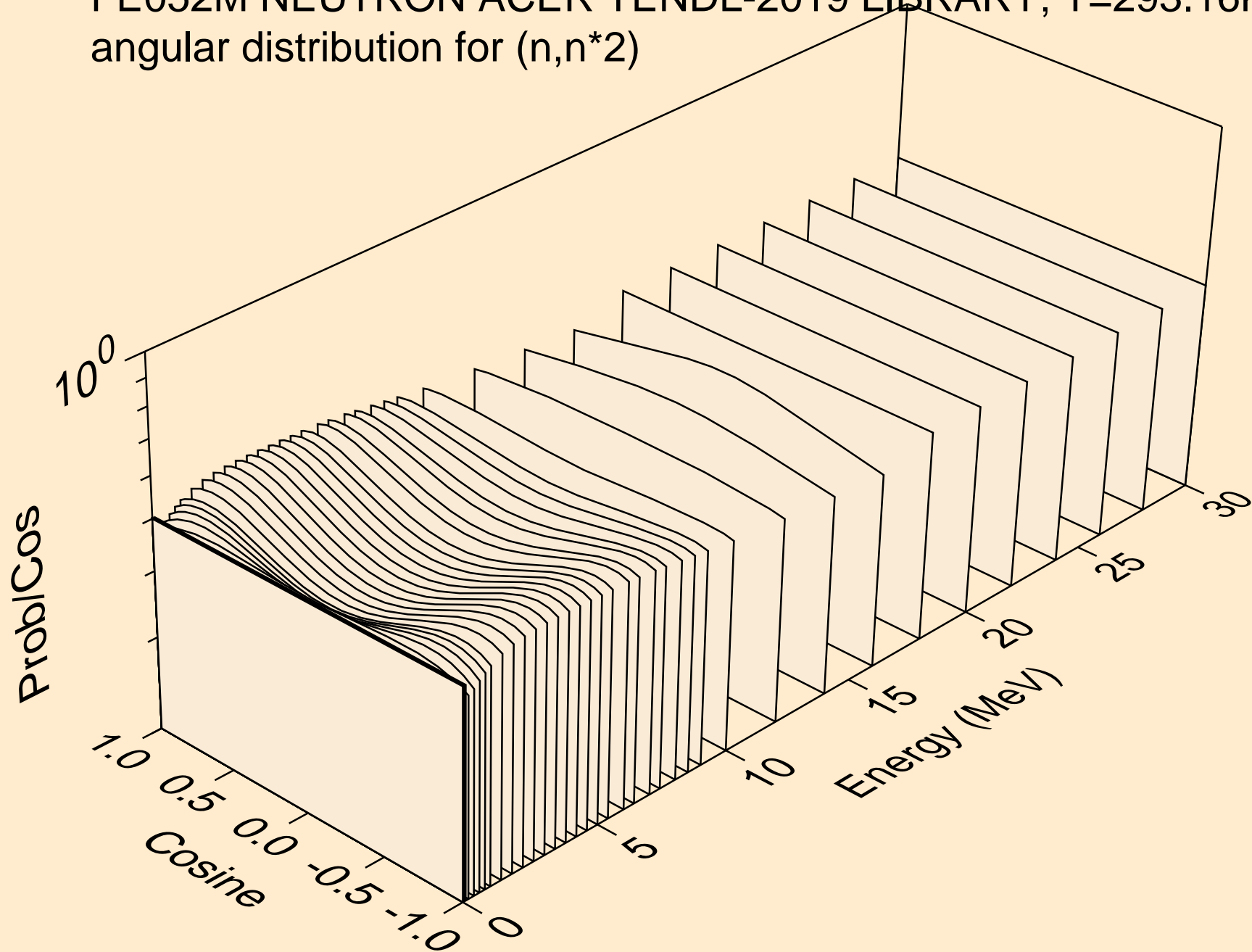

FE052M NEUTRON ACER TENDL-2019 LIBRARY; T=293.16K
angular distribution for (n,n*3)

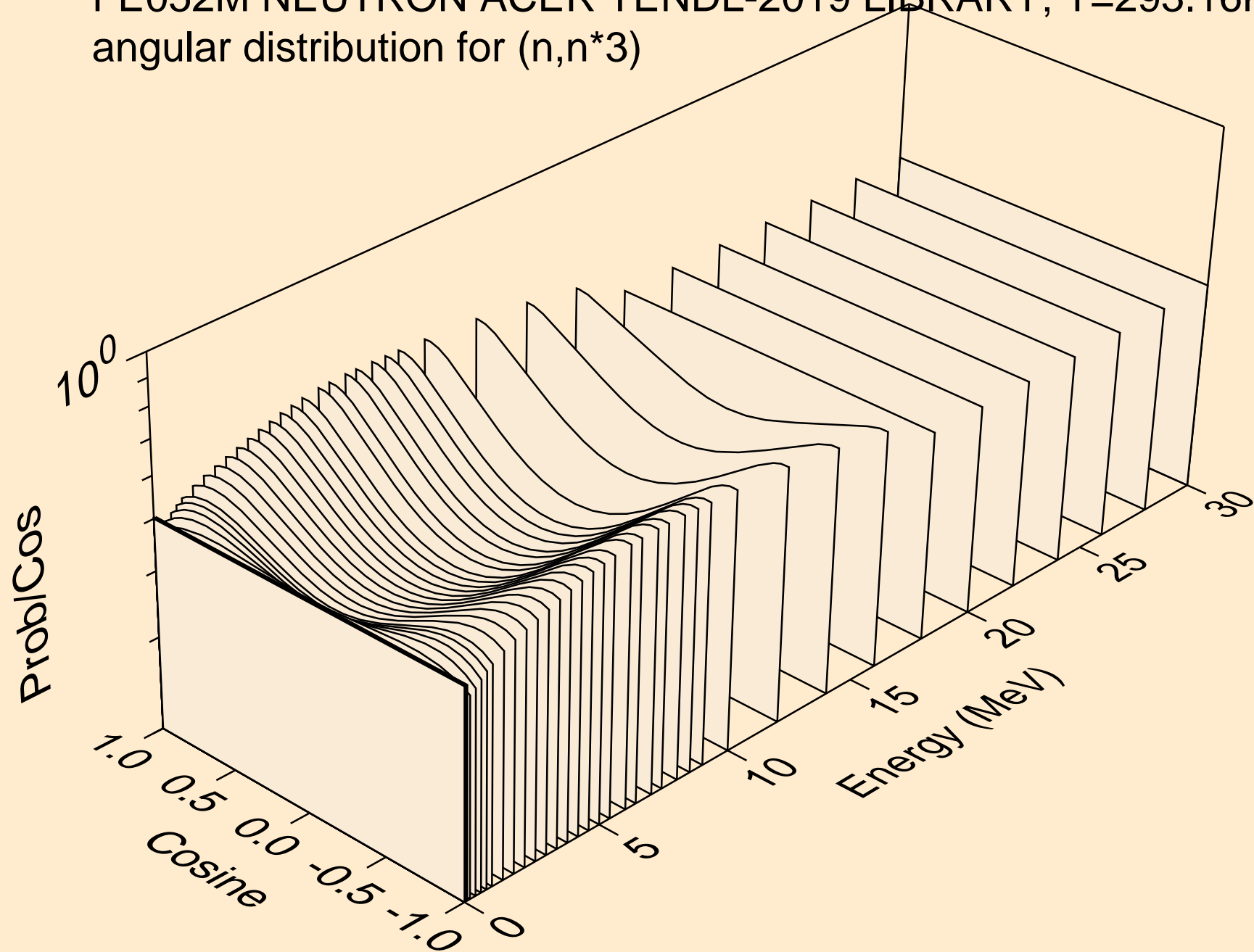

FE052M NEUTRON ACER TENDL-2019 LIBRARY; T=293.16K
angular distribution for (n,n*4)

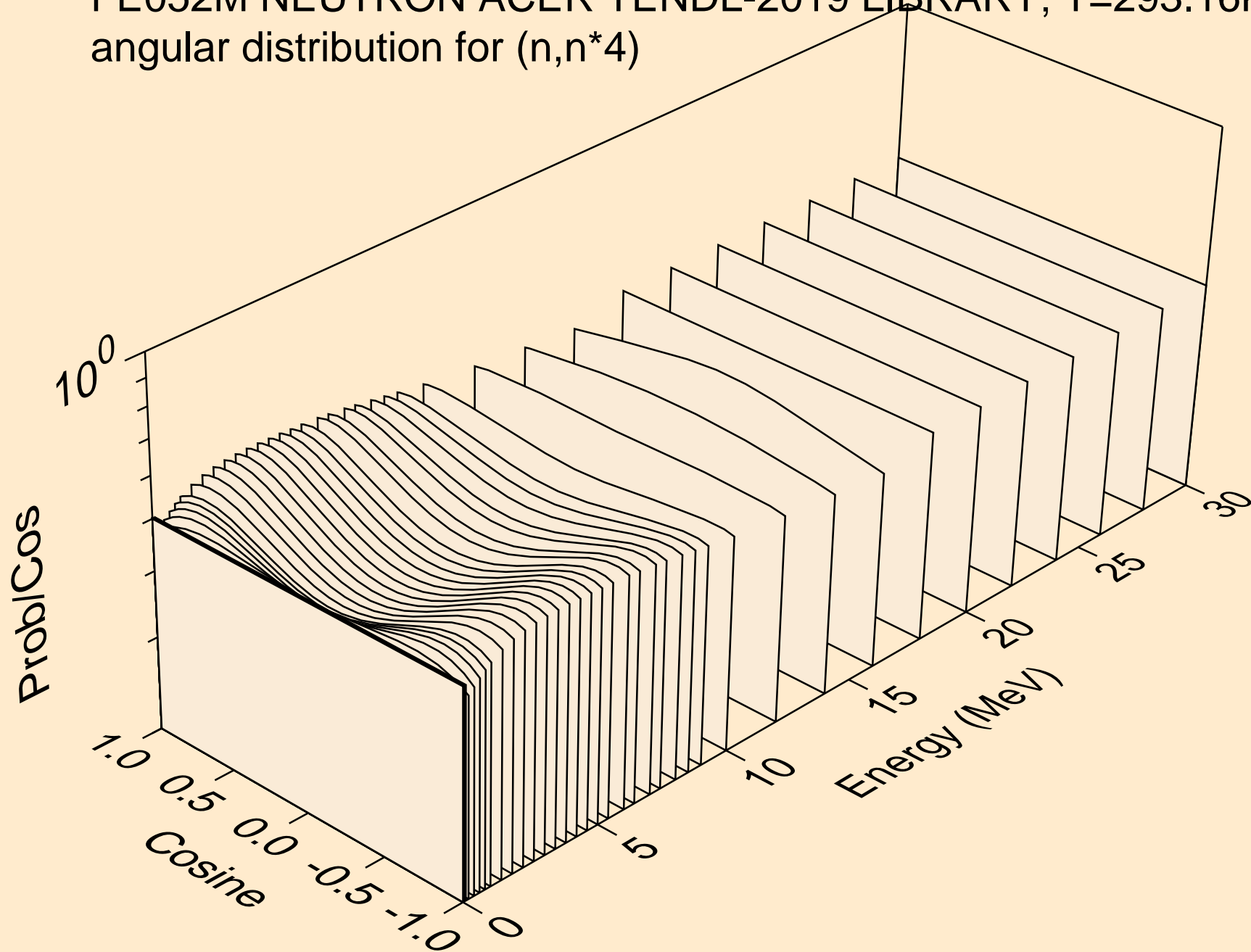

FE052M NEUTRON ACER TENDL-2019 LIBRARY; T=293.16K
angular distribution for (n,n*5)

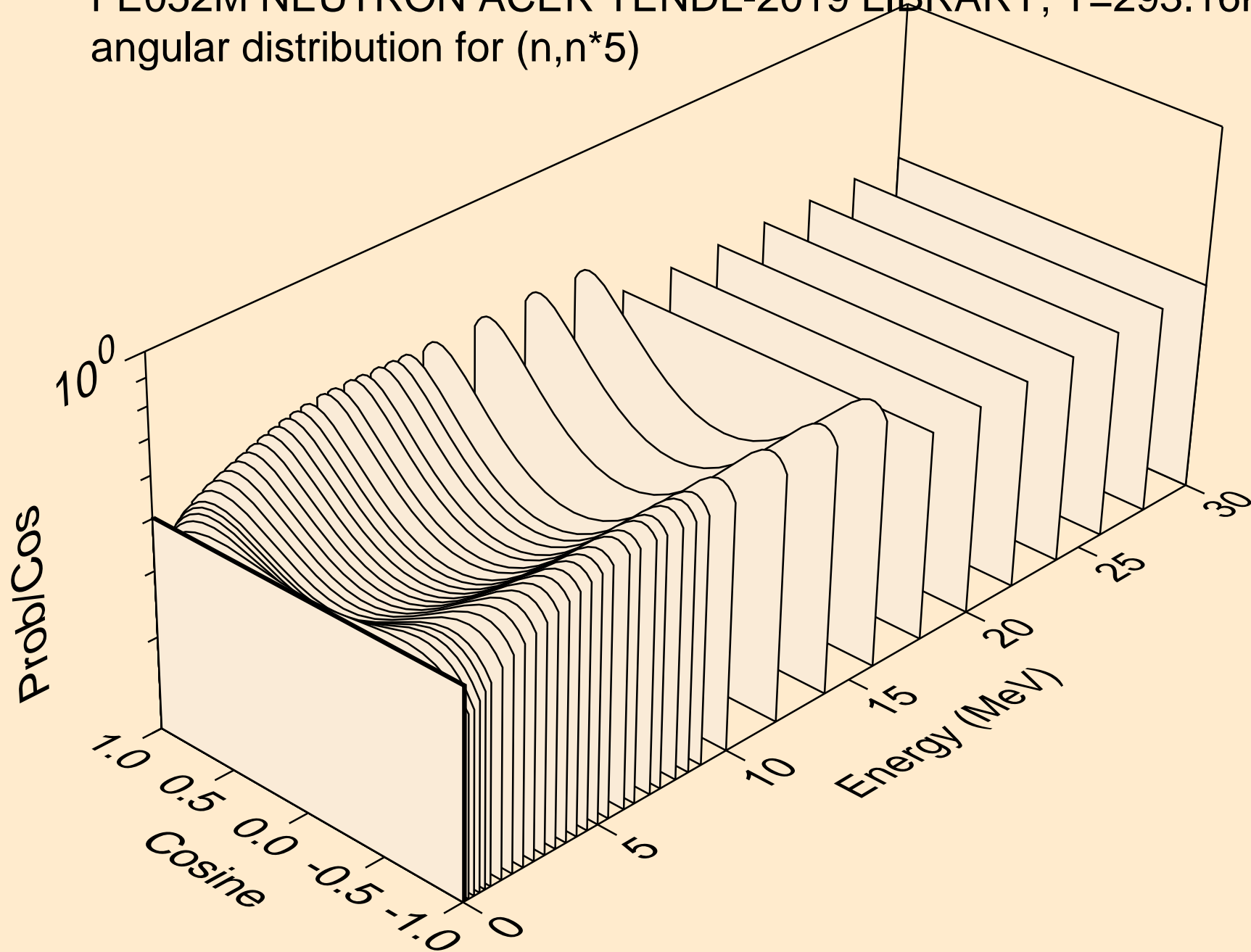

FE052M NEUTRON ACER TENDL-2019 LIBRARY; T=293.16K
angular distribution for (n,n*6)

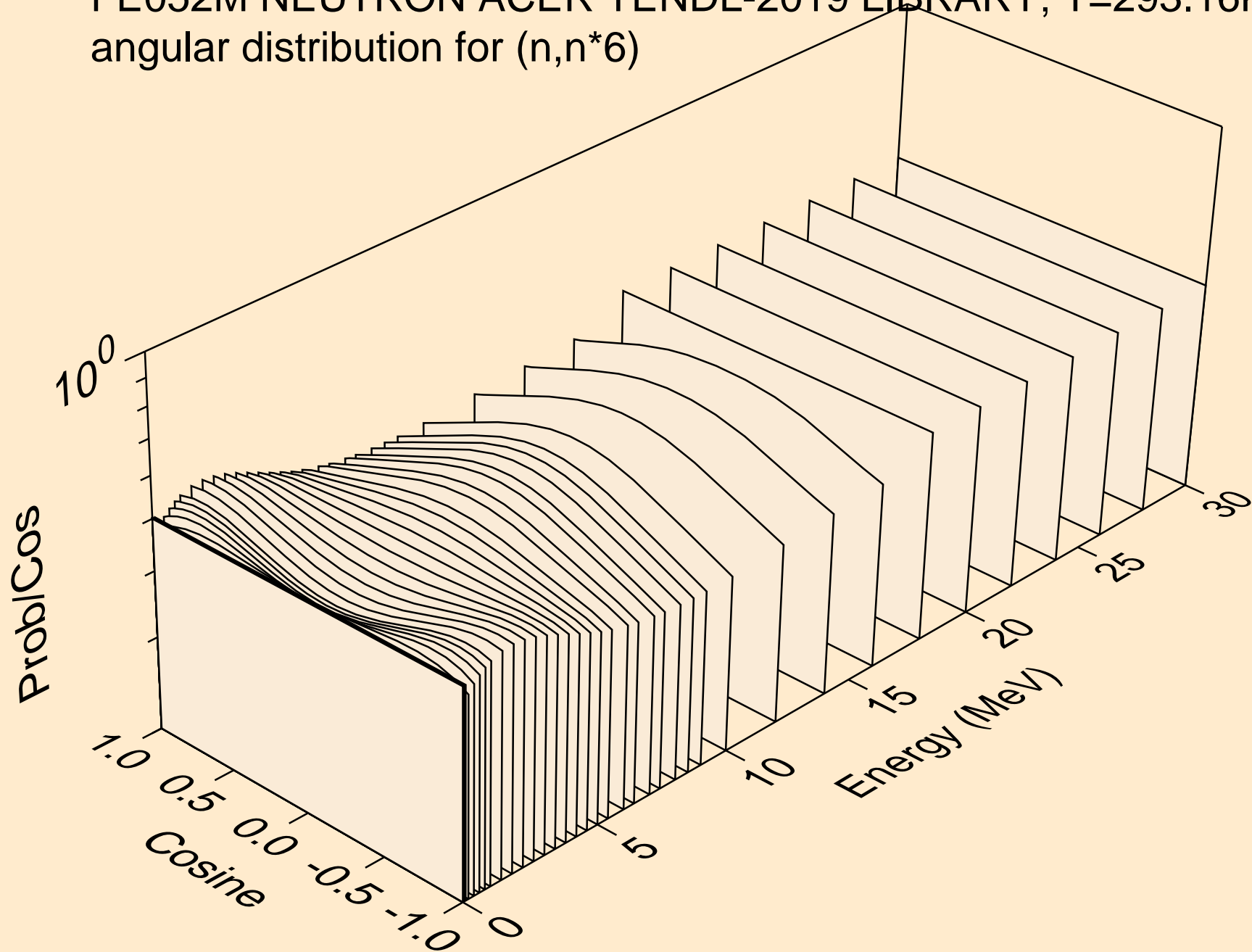

FE052M NEUTRON ACER TENDL-2019 LIBRARY; T=293.16K
angular distribution for (n,n*7)

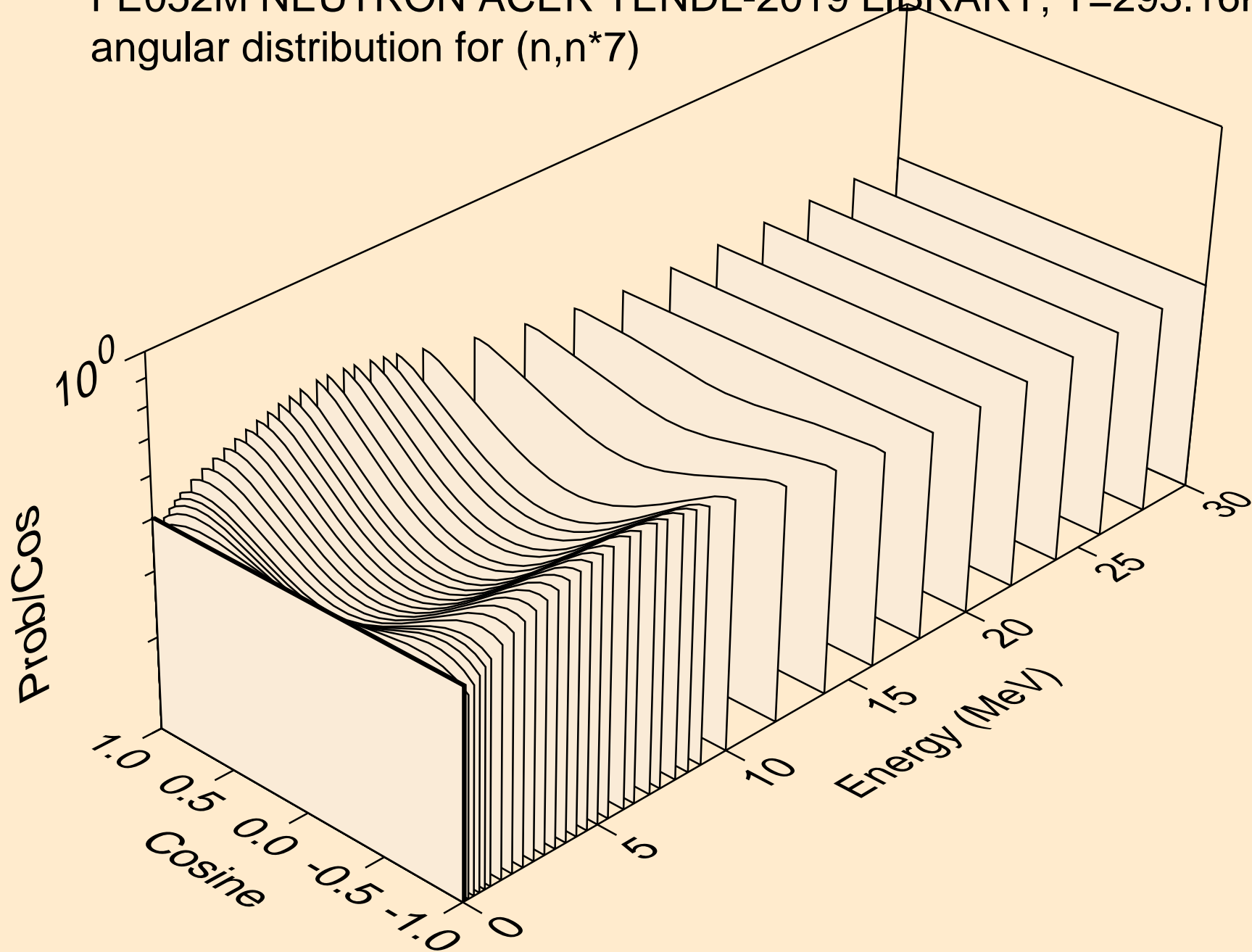

FE052M NEUTRON ACER TENDL-2019 LIBRARY; T=293.16K
angular distribution for (n,n*8)

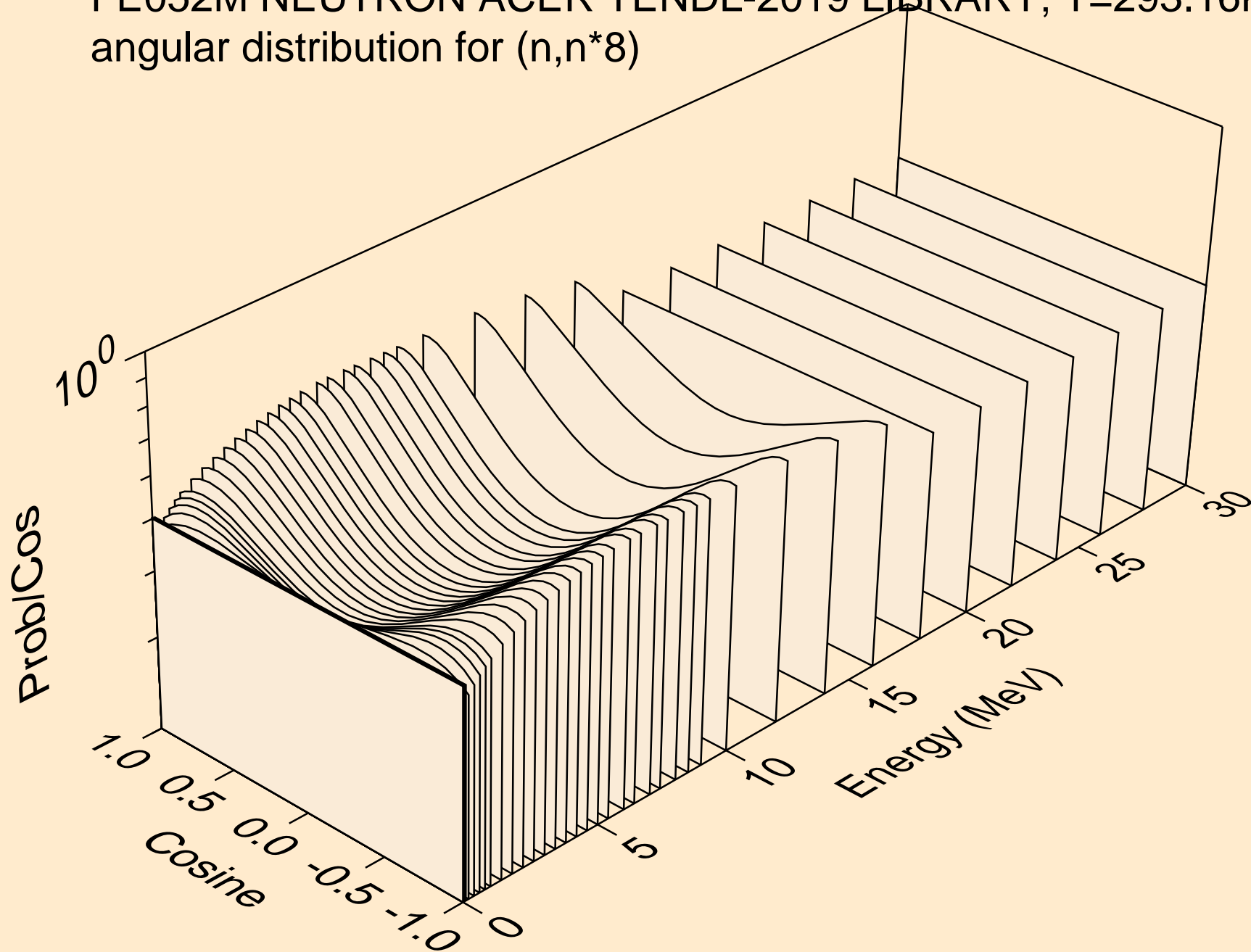

FE052M NEUTRON ACER TENDL-2019 LIBRARY; T=293.16K
angular distribution for (n,n*9)

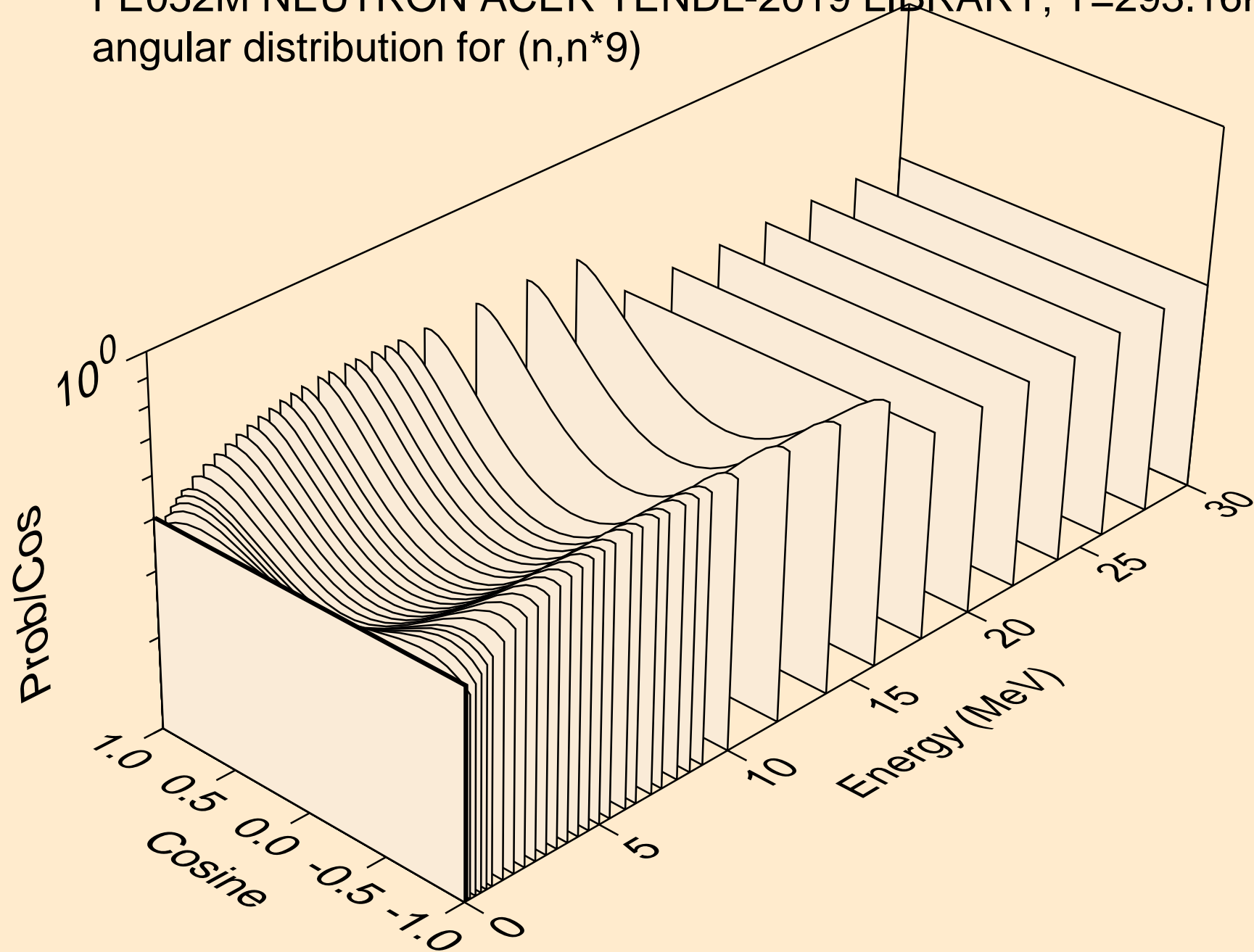

FE052M NEUTRON ACER TENDL-2019 LIBRARY; T=293.16K
angular distribution for (n,n*10)

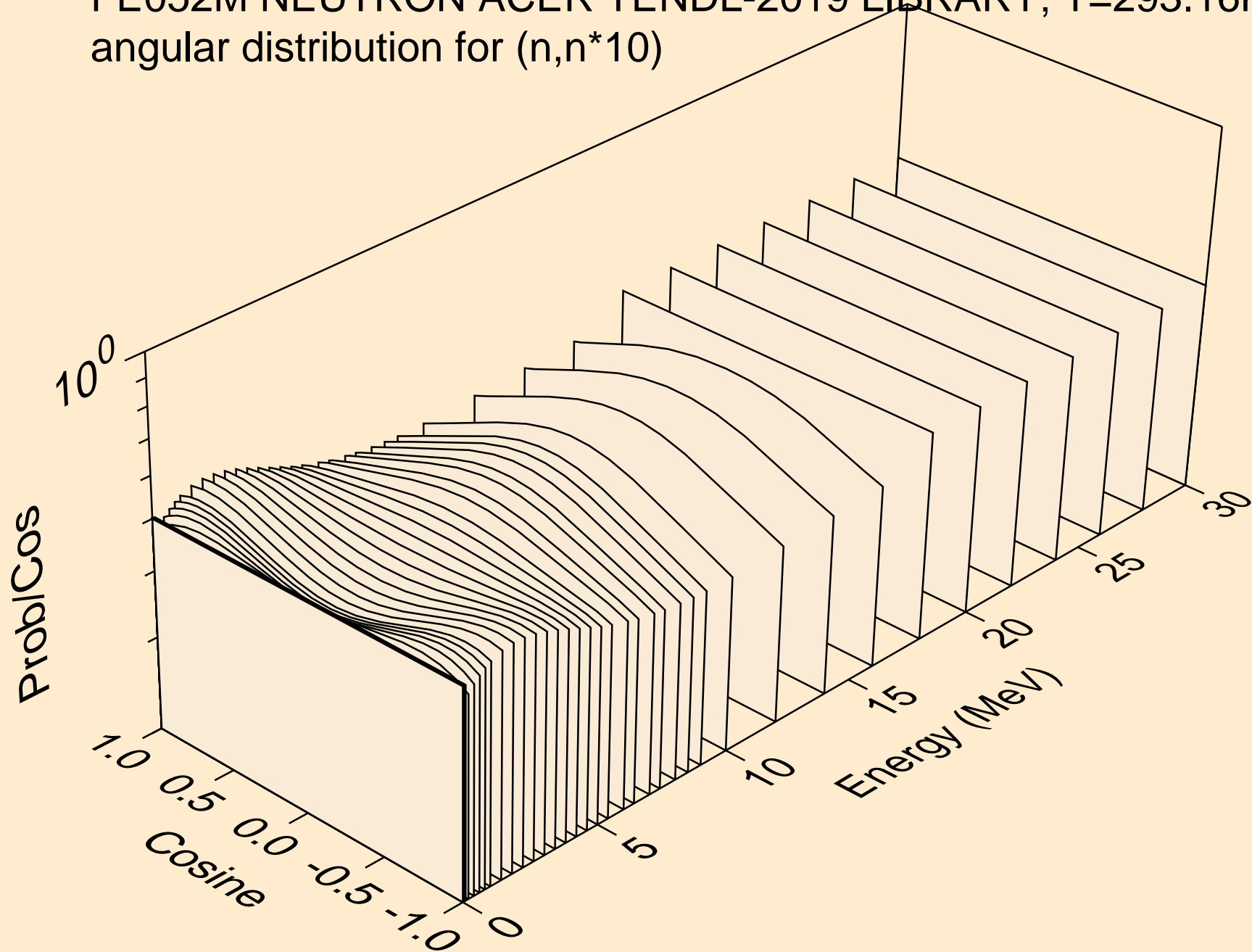

FE052M NEUTRON ACER TENDL-2019 LIBRARY; T=293.16K
angular distribution for (n,n*11)

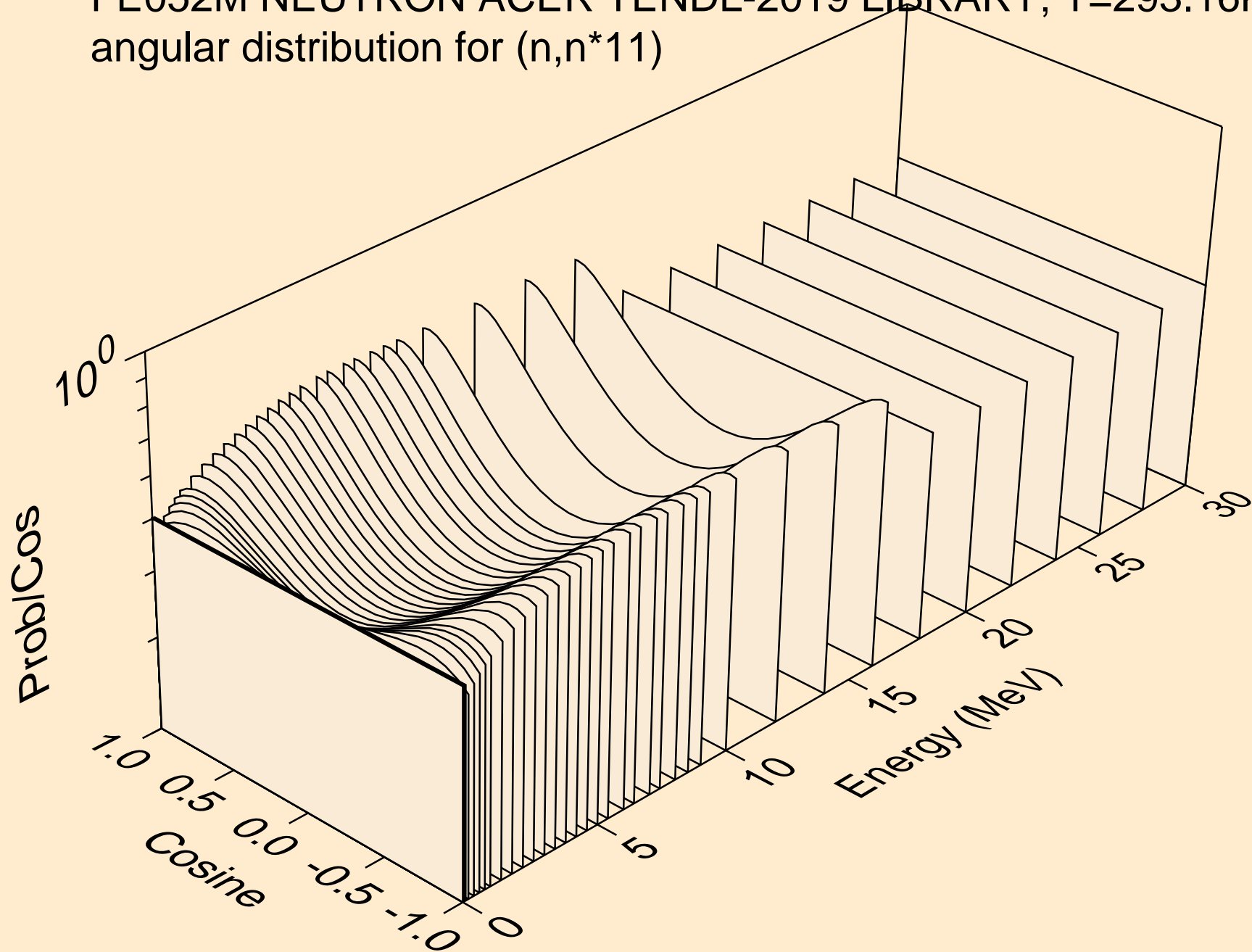

FE052M NEUTRON ACER TENDL-2019 LIBRARY; T=293.16K
angular distribution for (n,n*12)

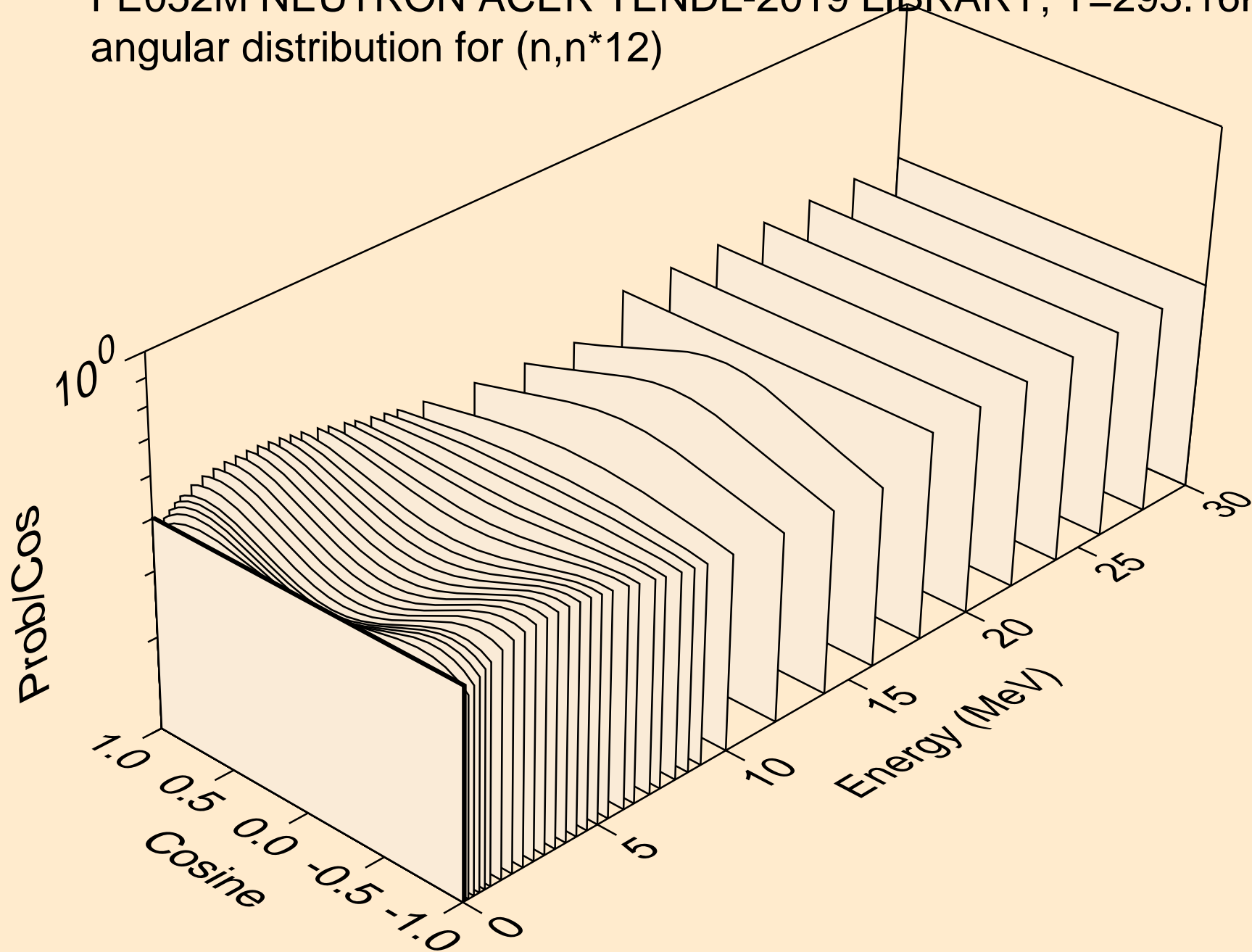

FE052M NEUTRON ACER TENDL-2019 LIBRARY; T=293.16K
angular distribution for (n,n*13)

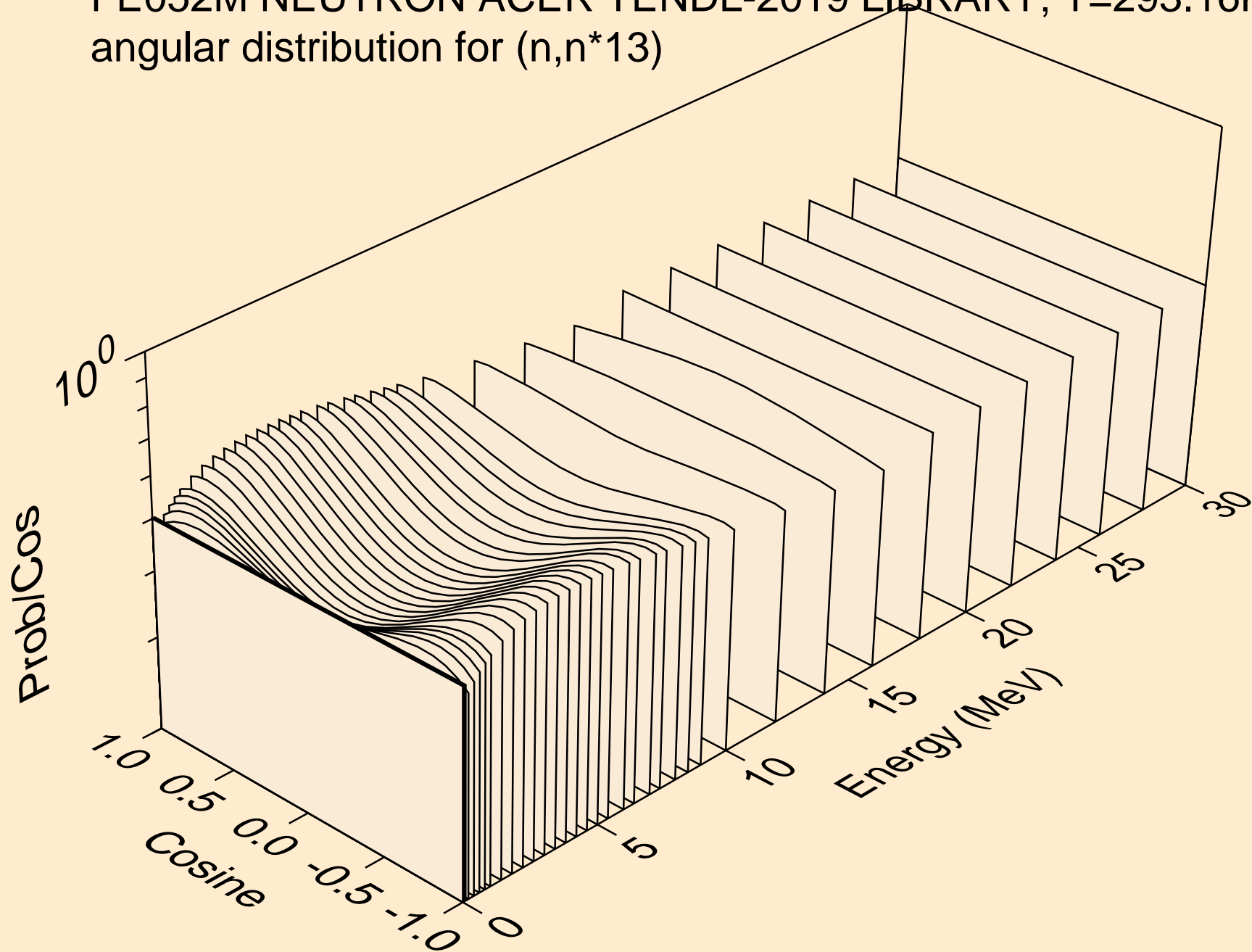

FE052M NEUTRON ACER TENDL-2019 LIBRARY; T=293.16K
angular distribution for (n,n*14)

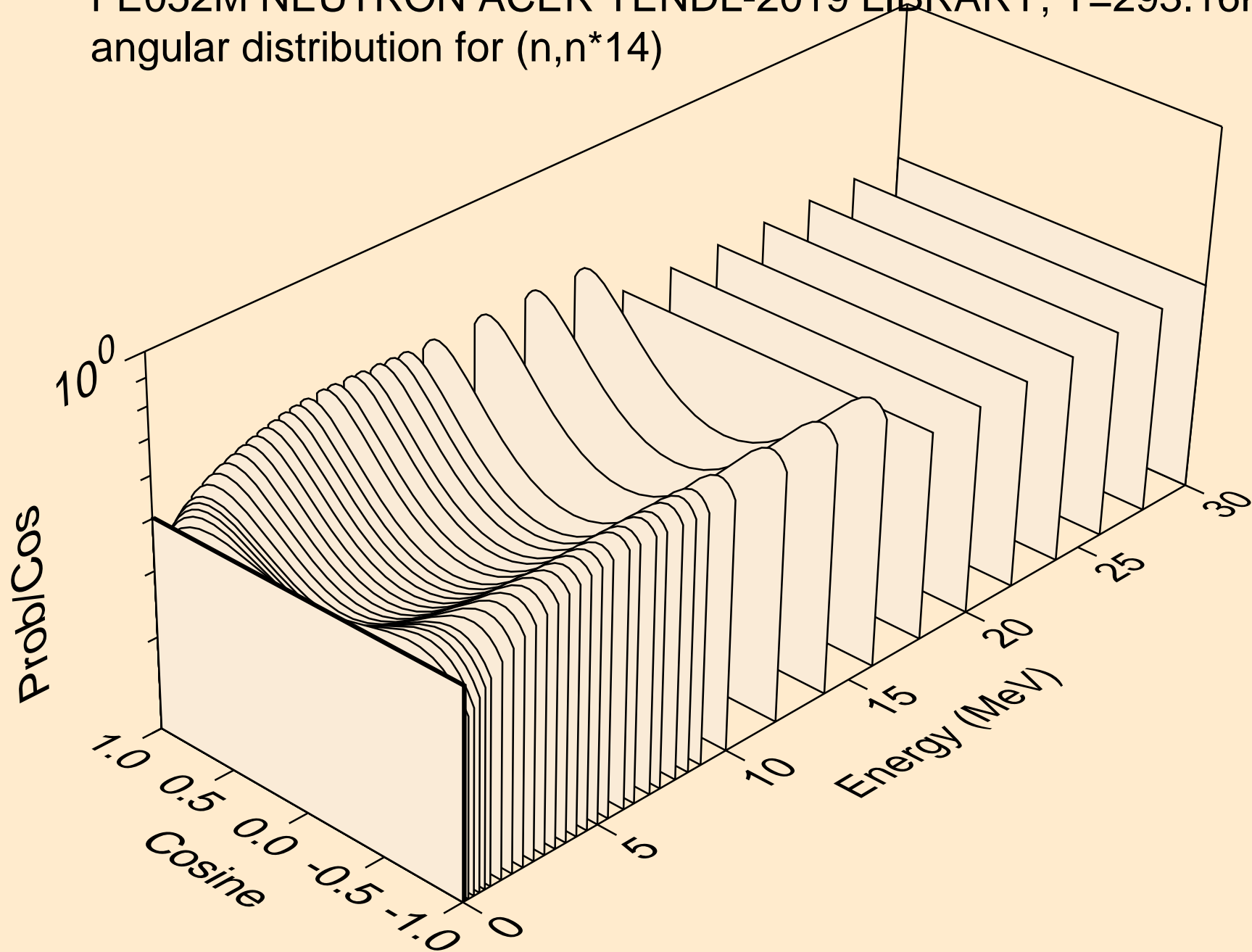

FE052M NEUTRON ACER TENDL-2019 LIBRARY; T=293.16K
angular distribution for (n,n*15)

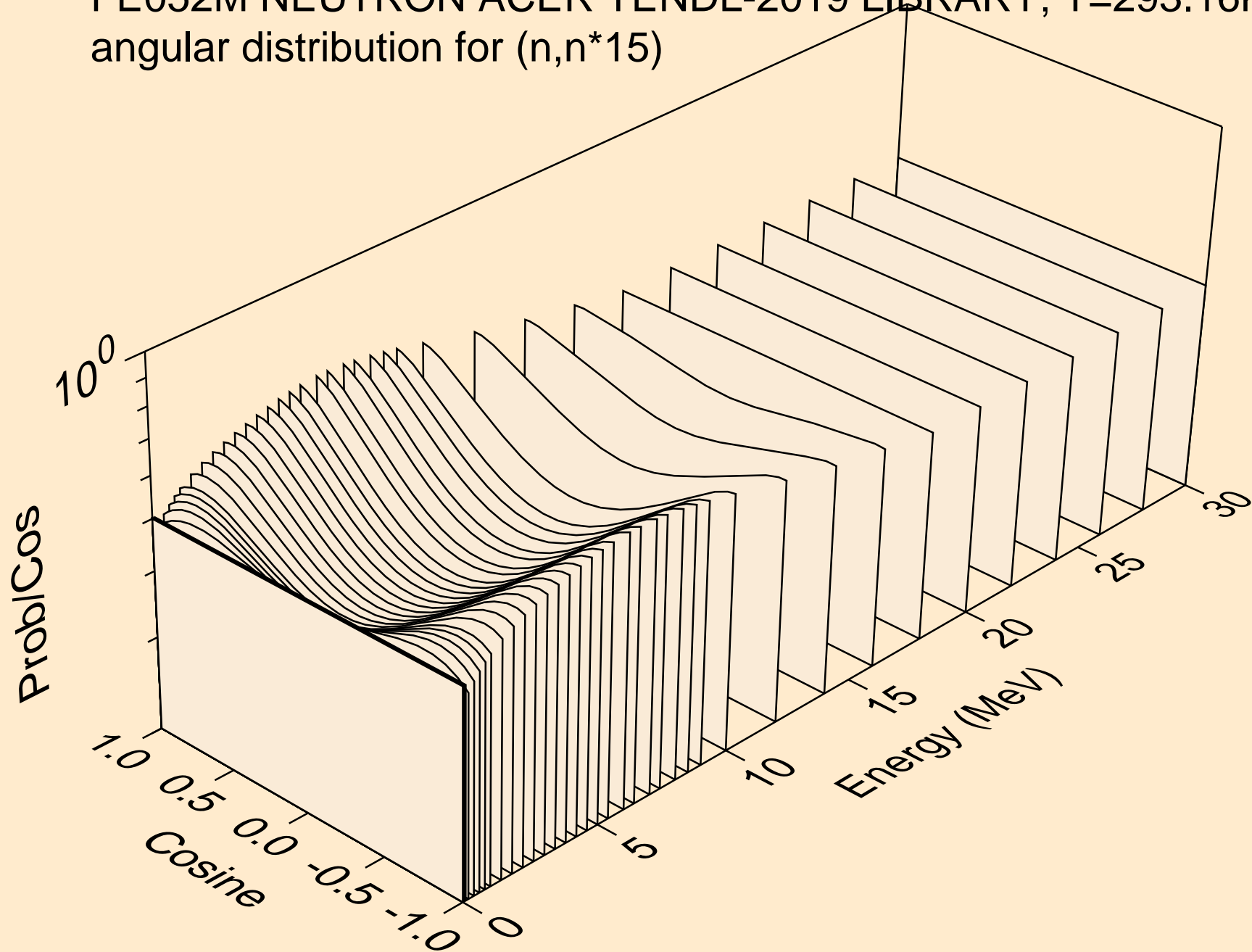

FE052M NEUTRON ACER TENDL-2019 LIBRARY; T=293.16K
angular distribution for (n,n*16)

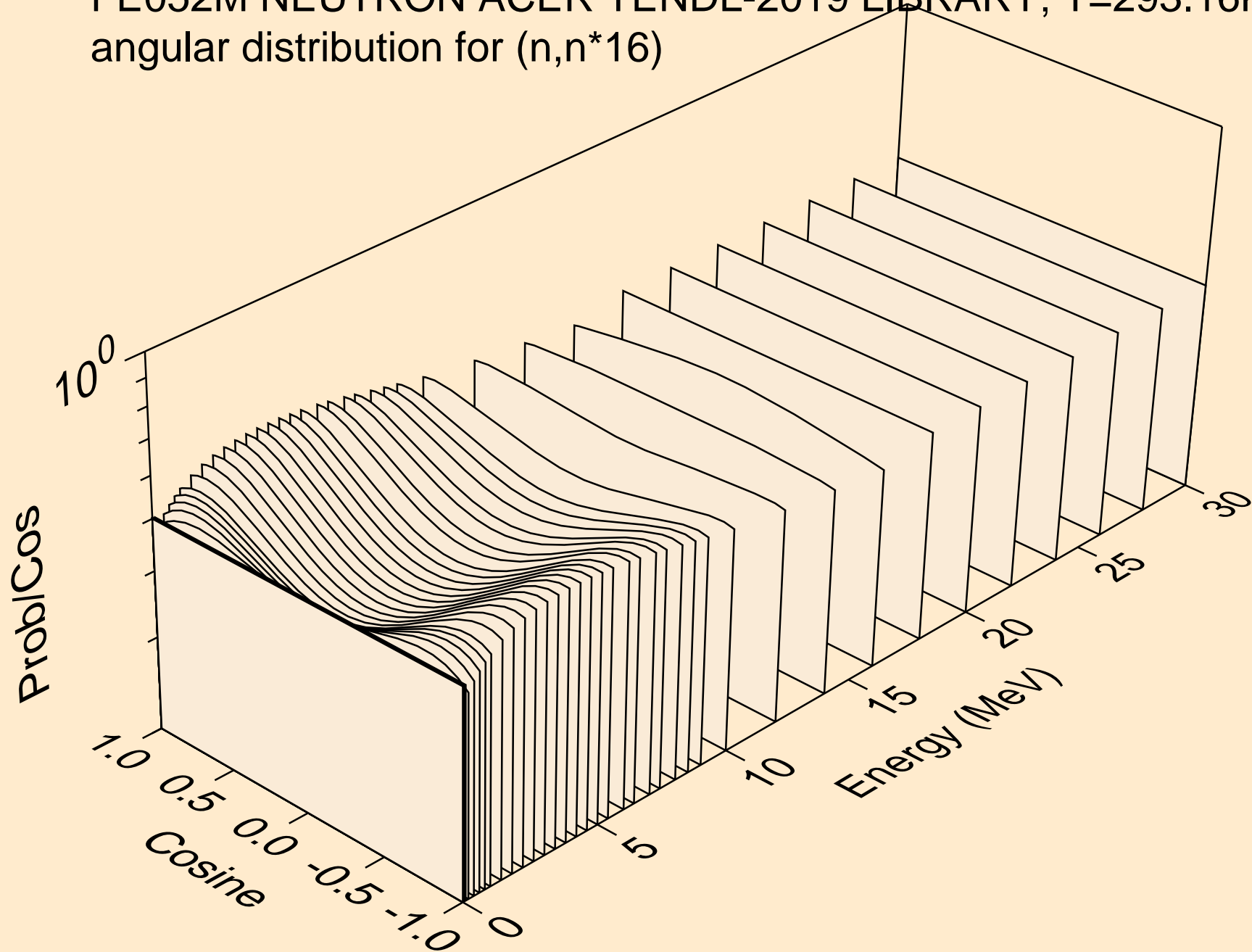

FE052M NEUTRON ACER TENDL-2019 LIBRARY; T=293.16K
angular distribution for (n,n*17)

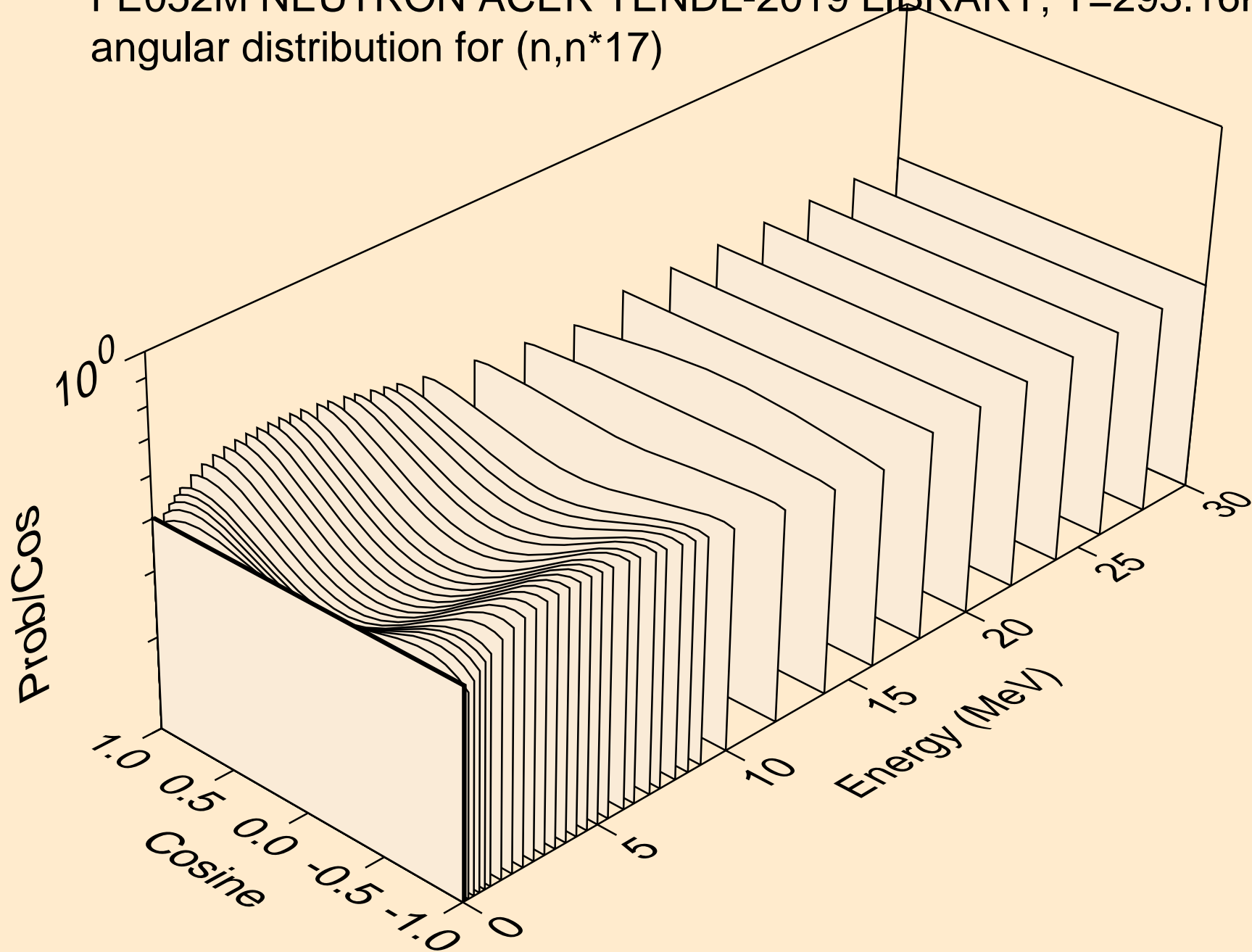

FE052M NEUTRON ACER TENDL-2019 LIBRARY; T=293.16K
angular distribution for (n,n*18)

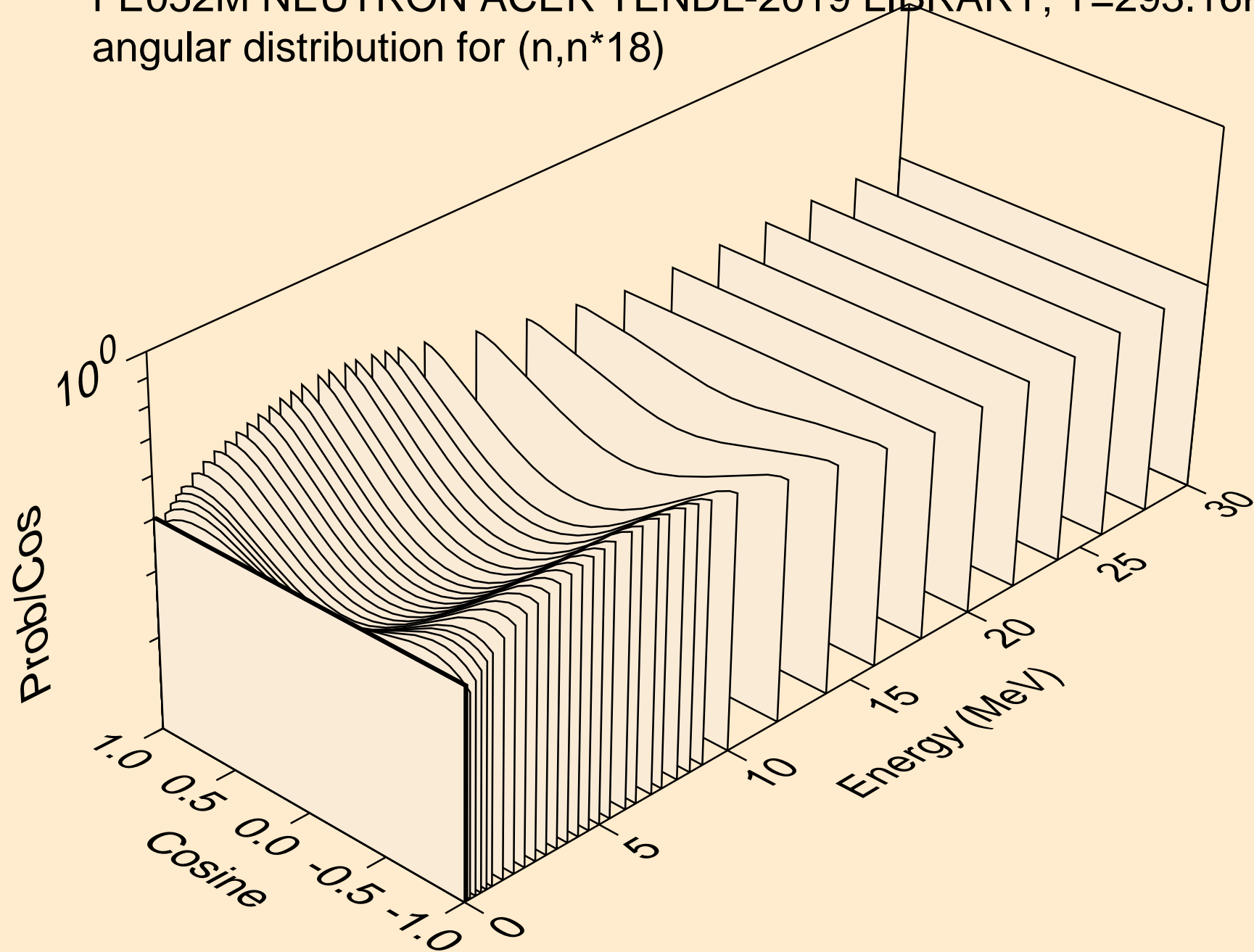

FE052M NEUTRON ACER TENDL-2019 LIBRARY; T=293.16K
angular distribution for (n,n*19)

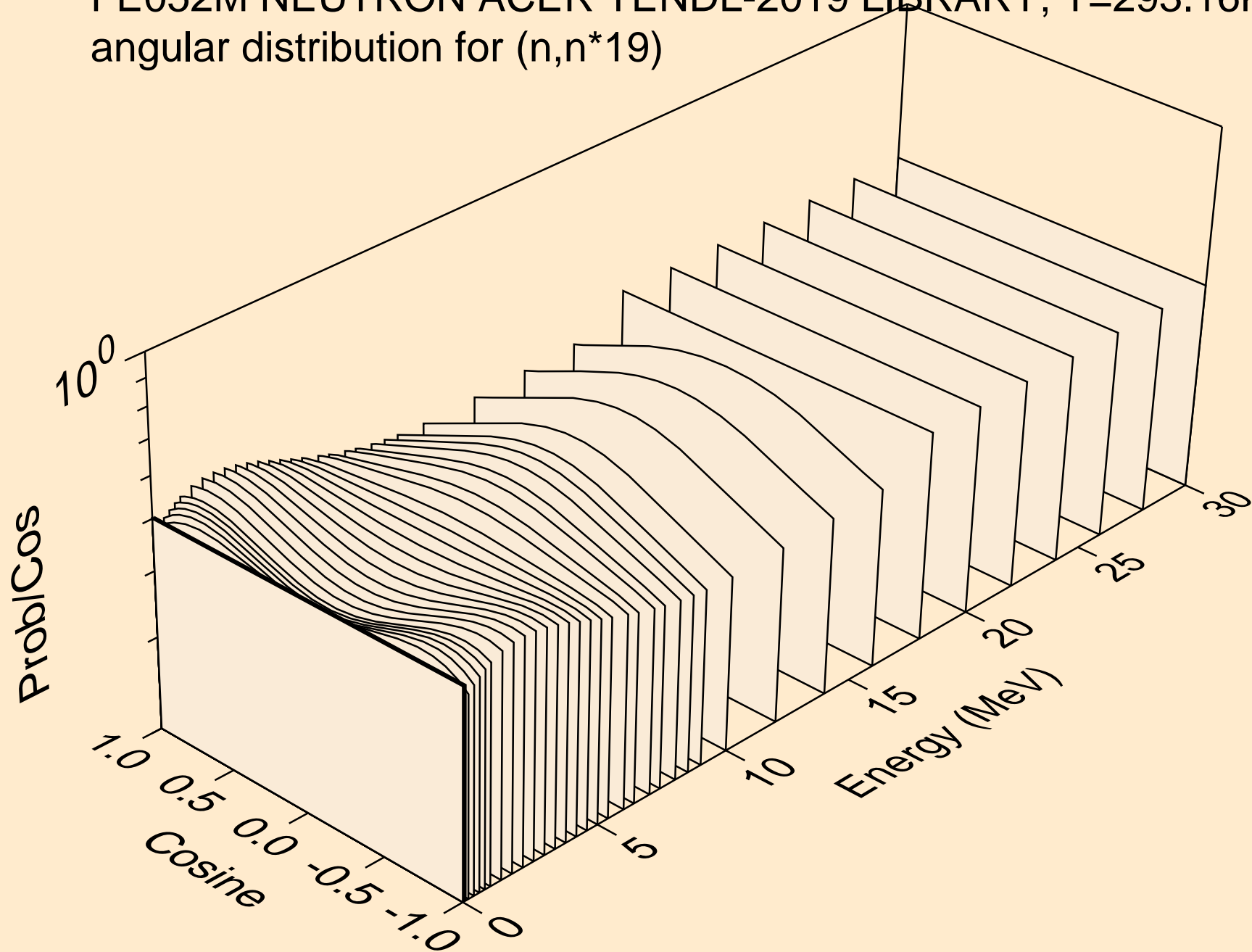

FE052M NEUTRON ACER TENDL-2019 LIBRARY; T=293.16K
angular distribution for (n,n*20)

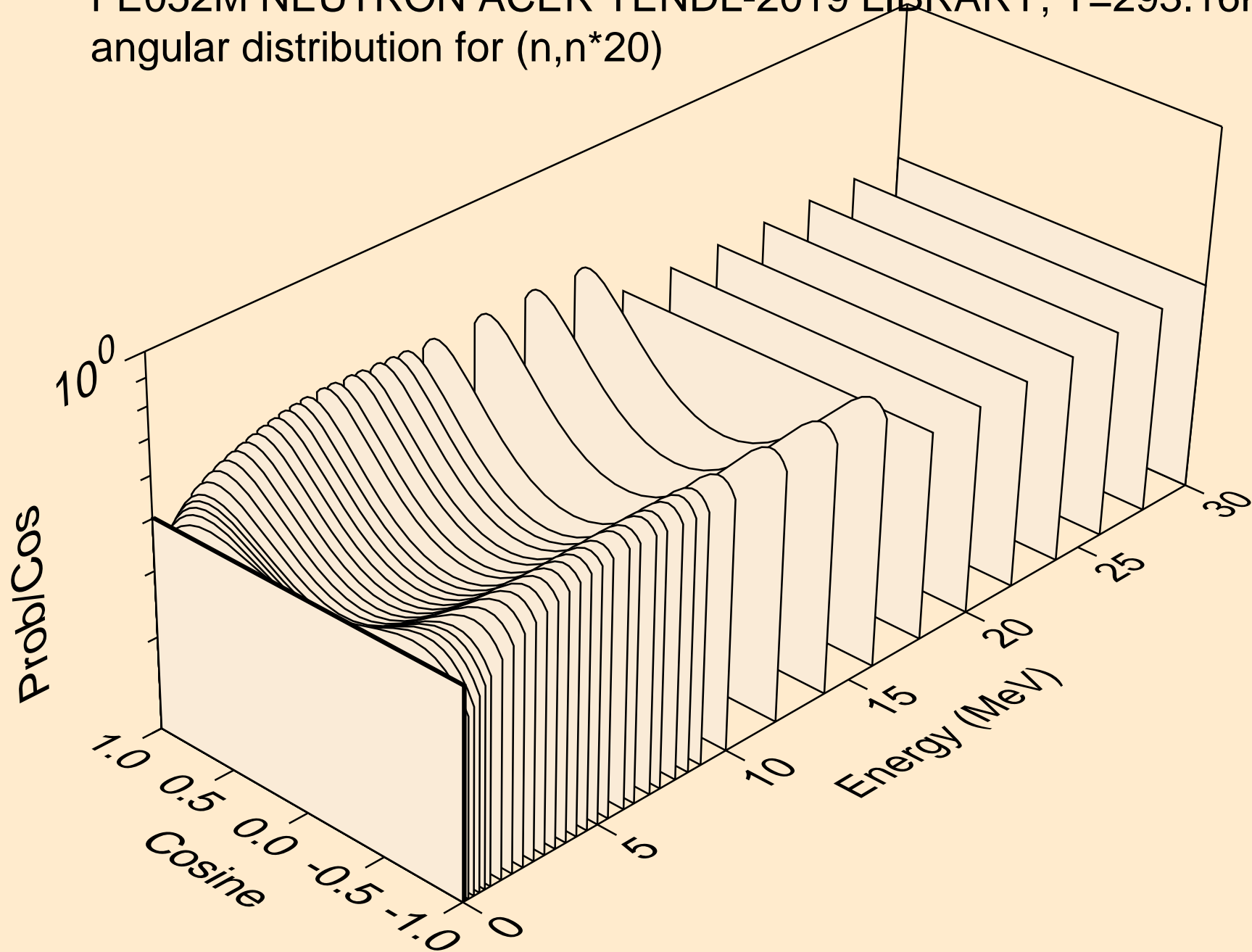

FE052M NEUTRON ACER TENDL-2019 LIBRARY; T=293.16K
angular distribution for (n,n*21)

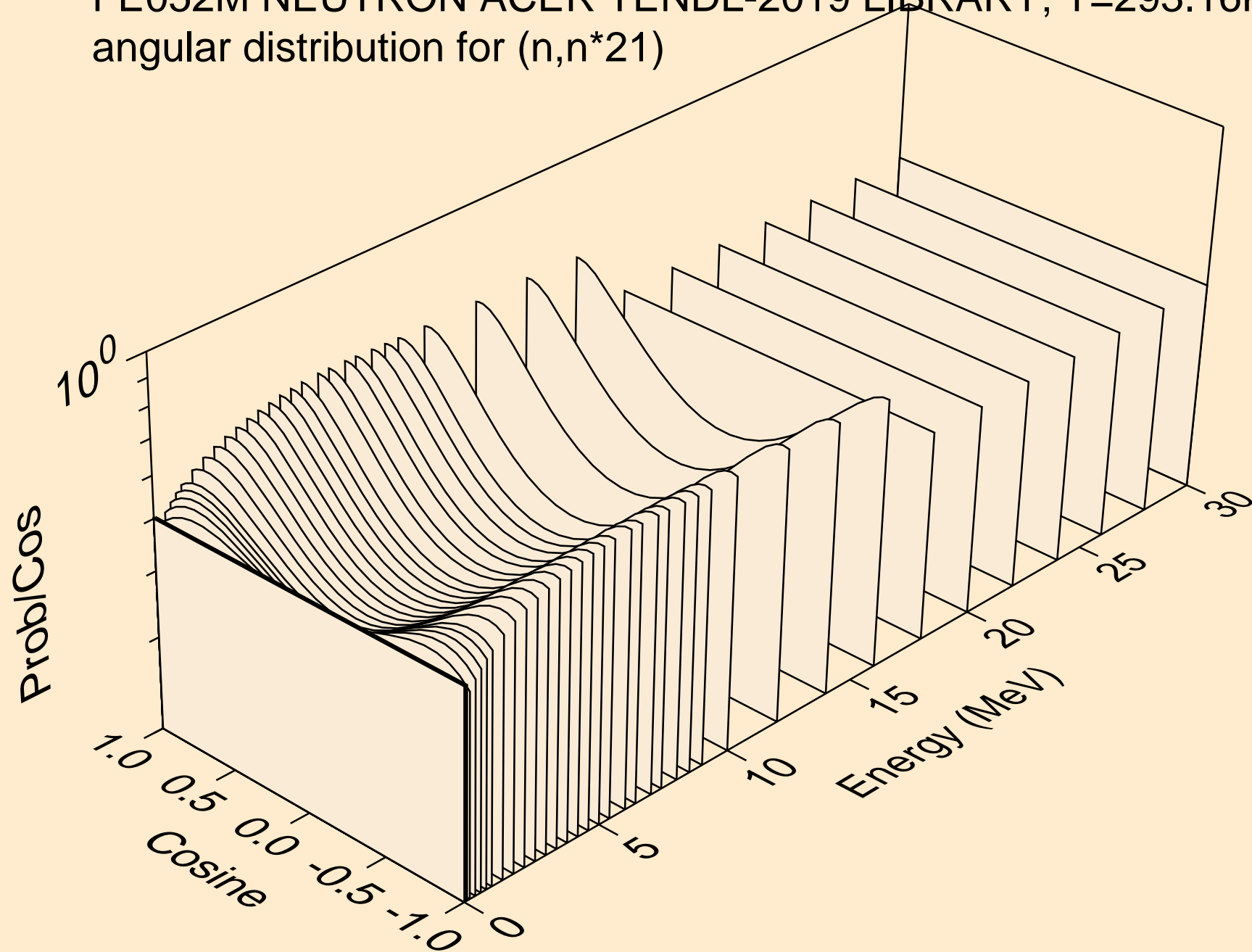

FE052M NEUTRON ACER TENDL-2019 LIBRARY; T=293.16K
angular distribution for (n,n*22)

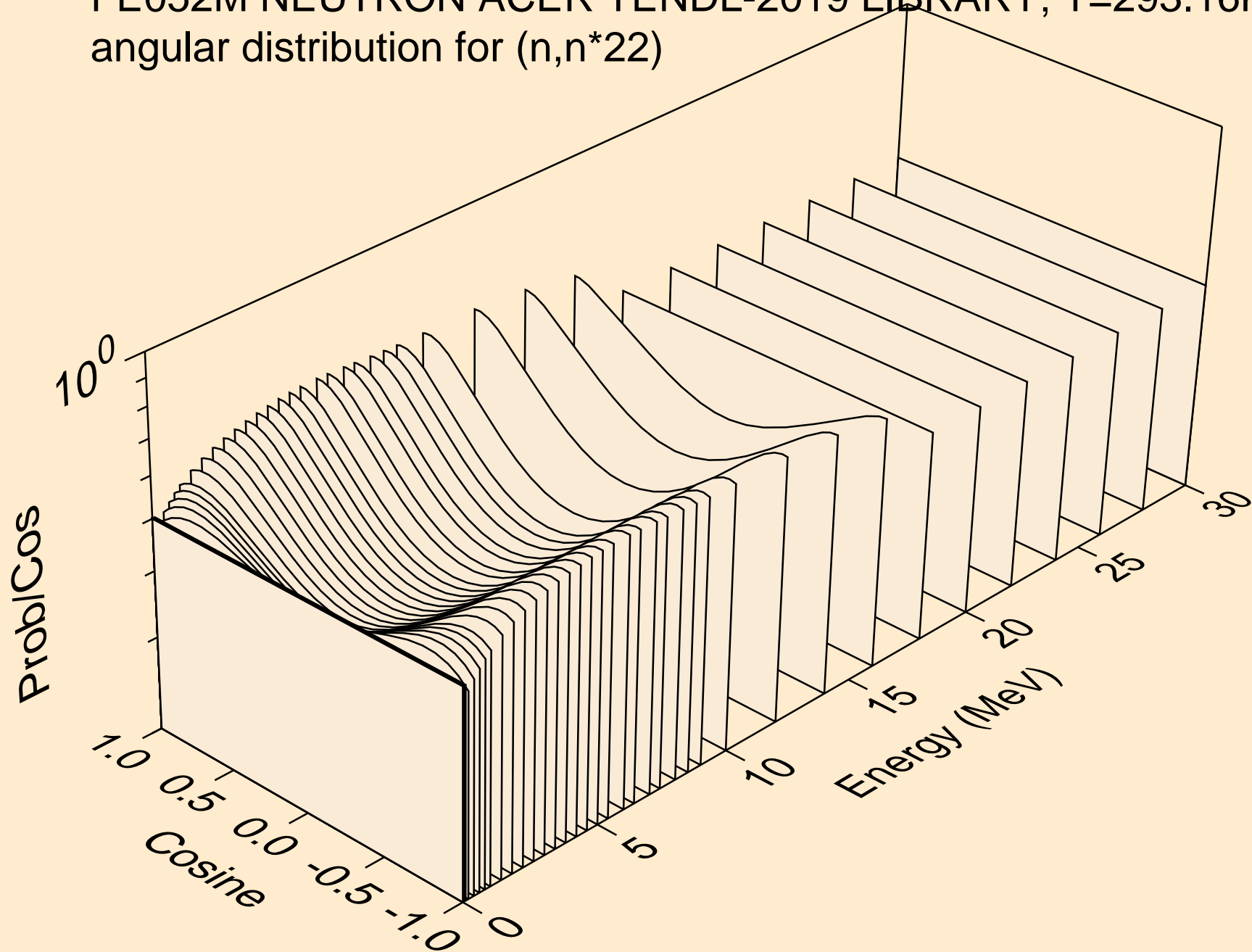

FE052M NEUTRON ACER TENDL-2019 LIBRARY; T=293.16K
angular distribution for (n,n*23)

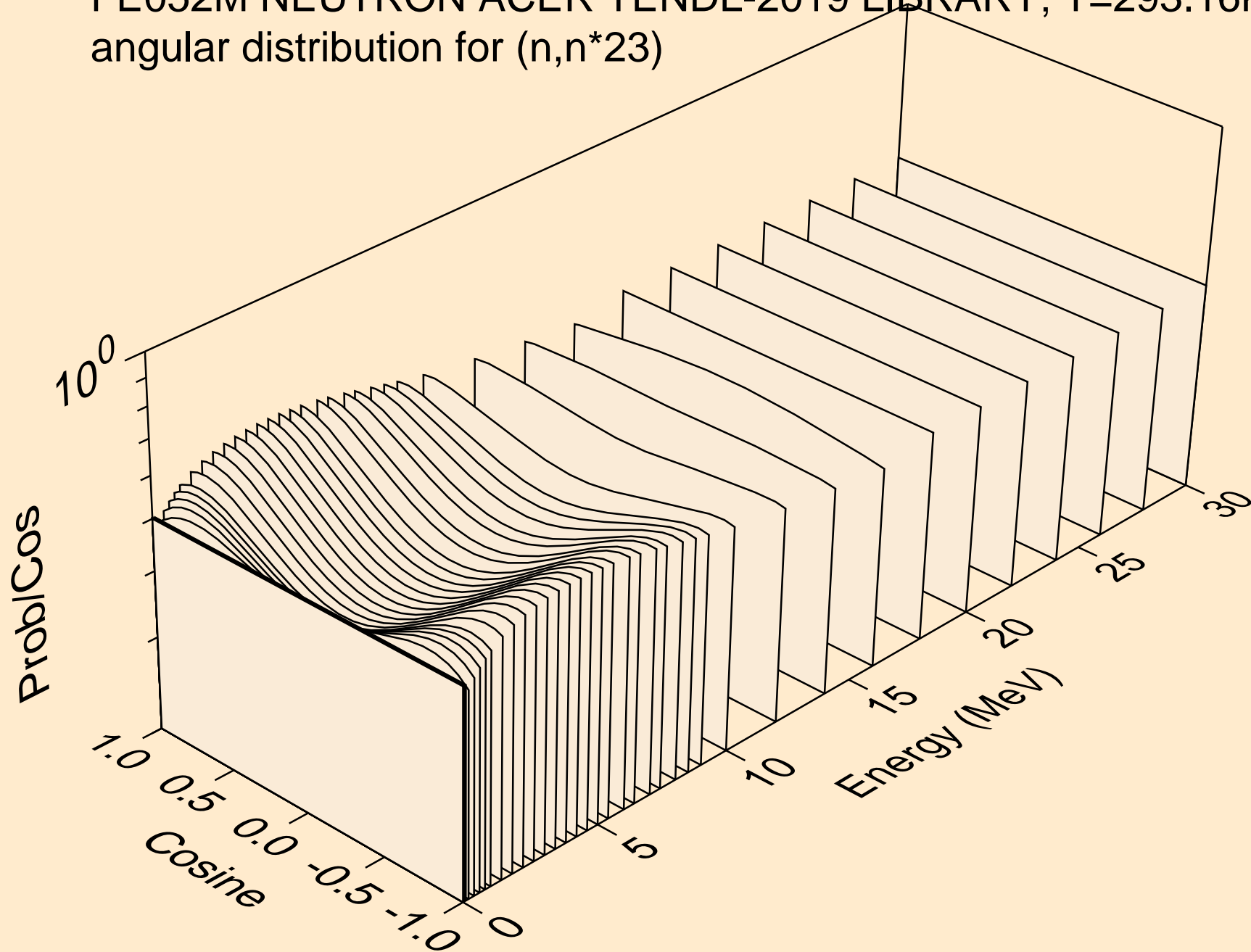

FE052M NEUTRON ACER TENDL-2019 LIBRARY; T=293.16K
angular distribution for (n,n*24)

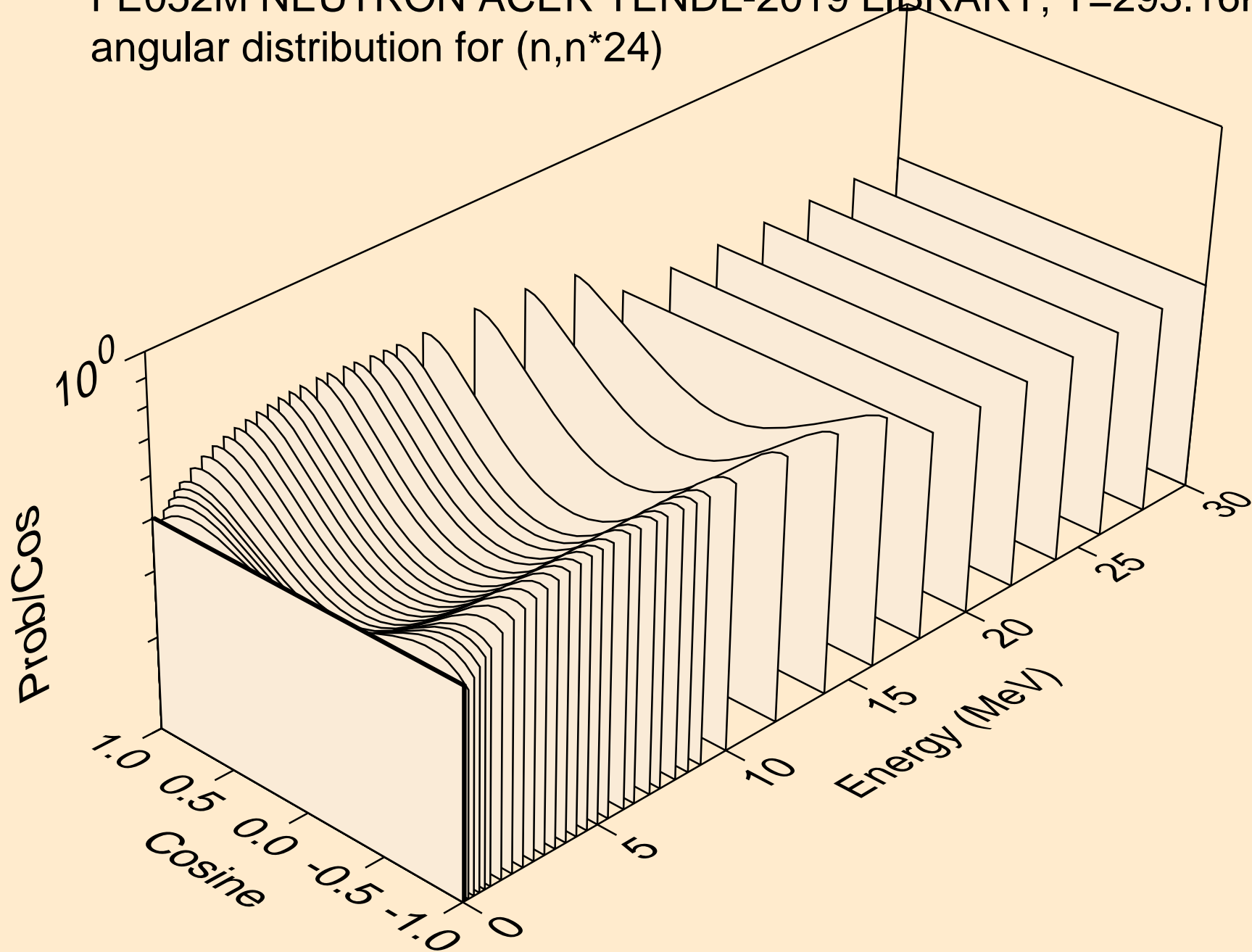

FE052M NEUTRON ACER TENDL-2019 LIBRARY; T=293.16K
angular distribution for (n,n*25)

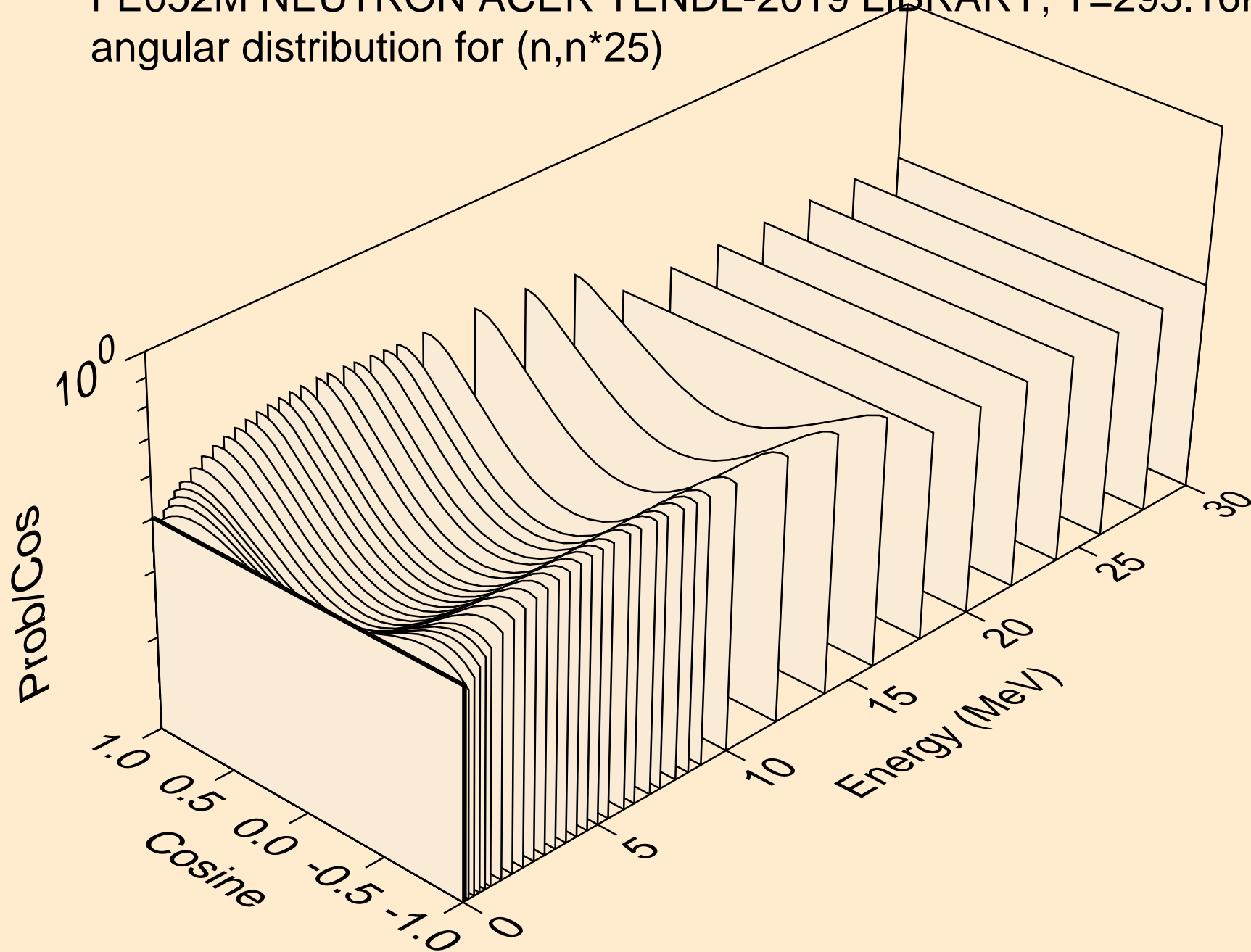

FE052M NEUTRON ACER TENDL-2019 LIBRARY; T=293.16K
angular distribution for (n,n*26)

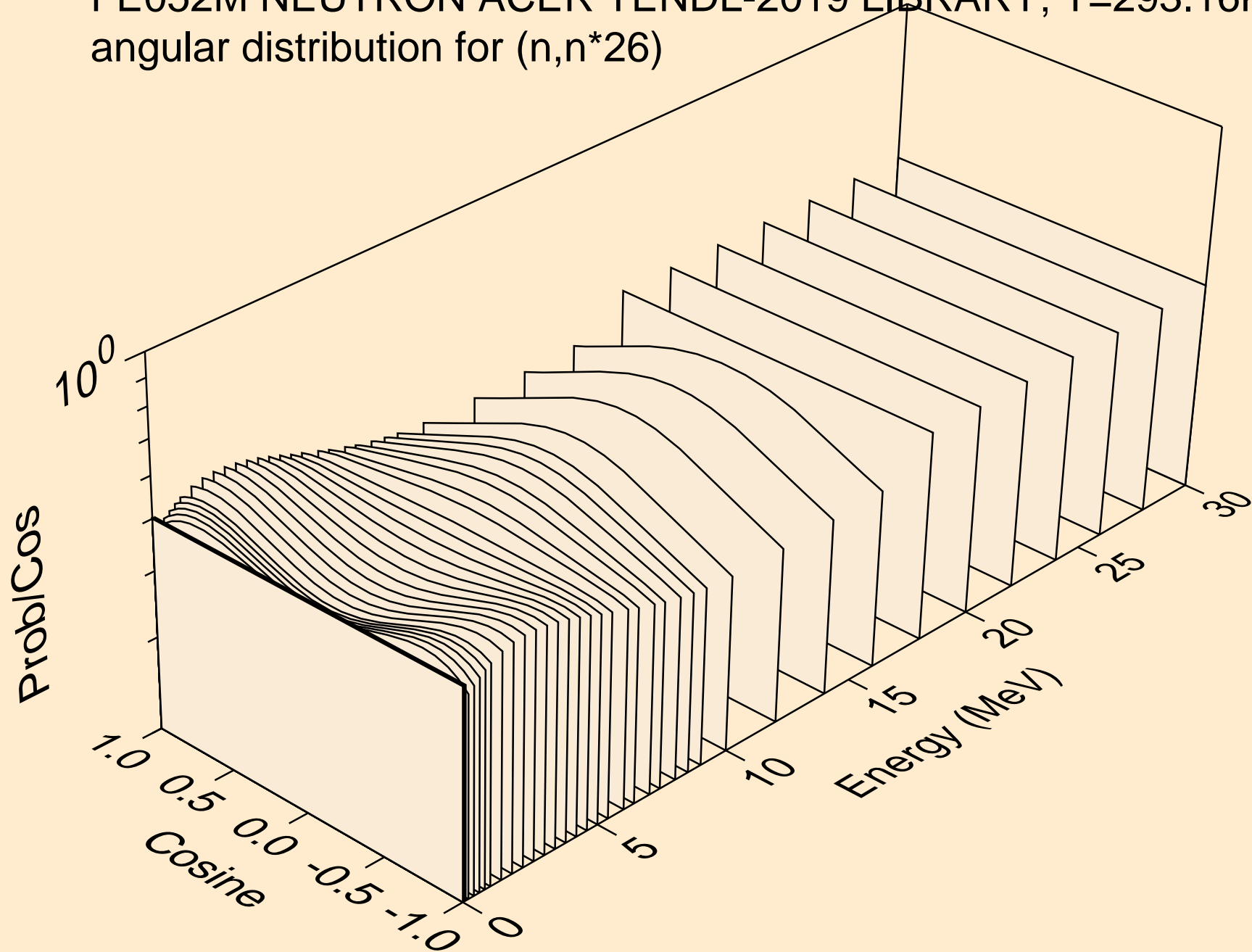

FE052M NEUTRON ACER TENDL-2019 LIBRARY; T=293.16K
angular distribution for (n,n*27)

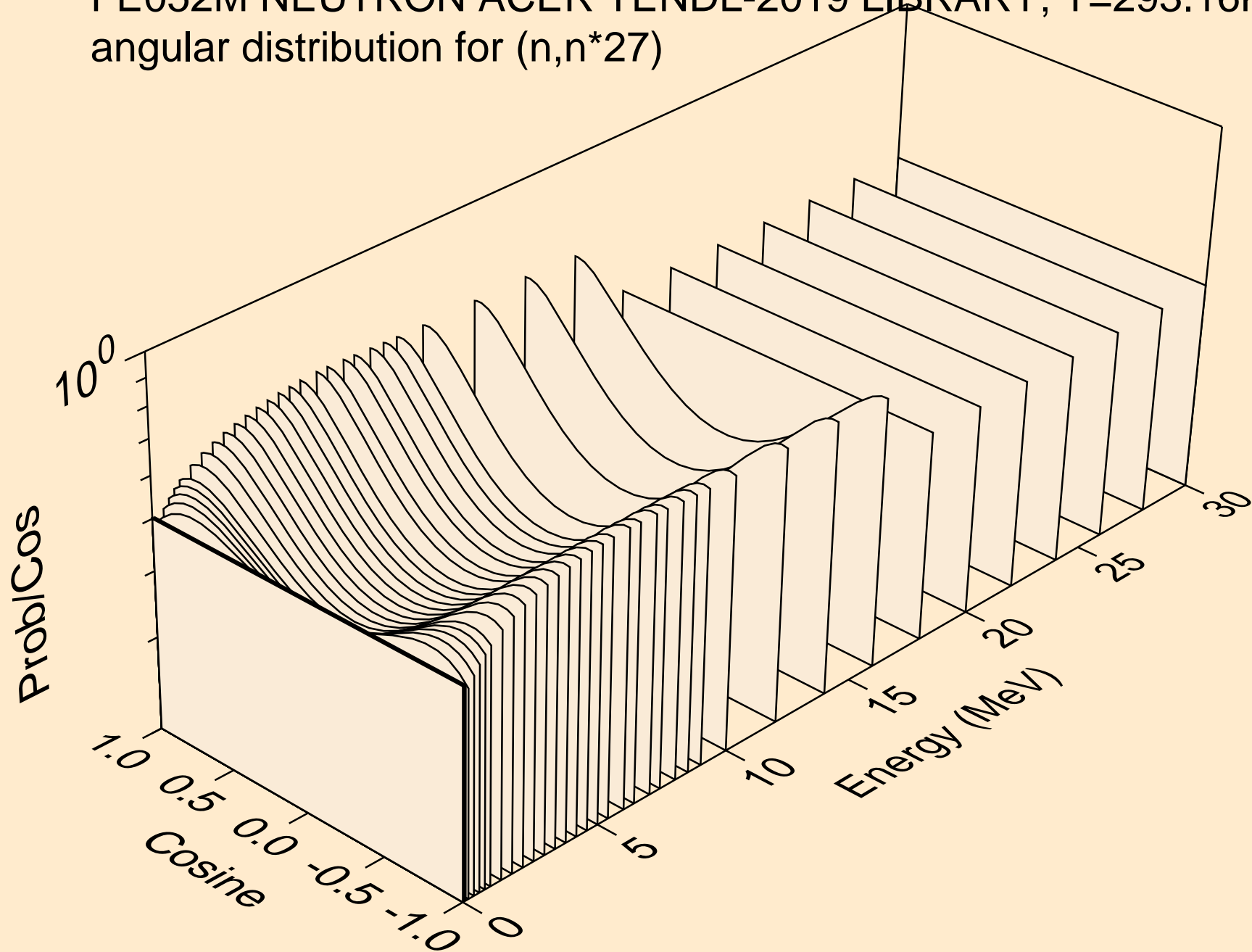

FE052M NEUTRON ACER TENDL-2019 LIBRARY; T=293.16K
angular distribution for (n,n*28)

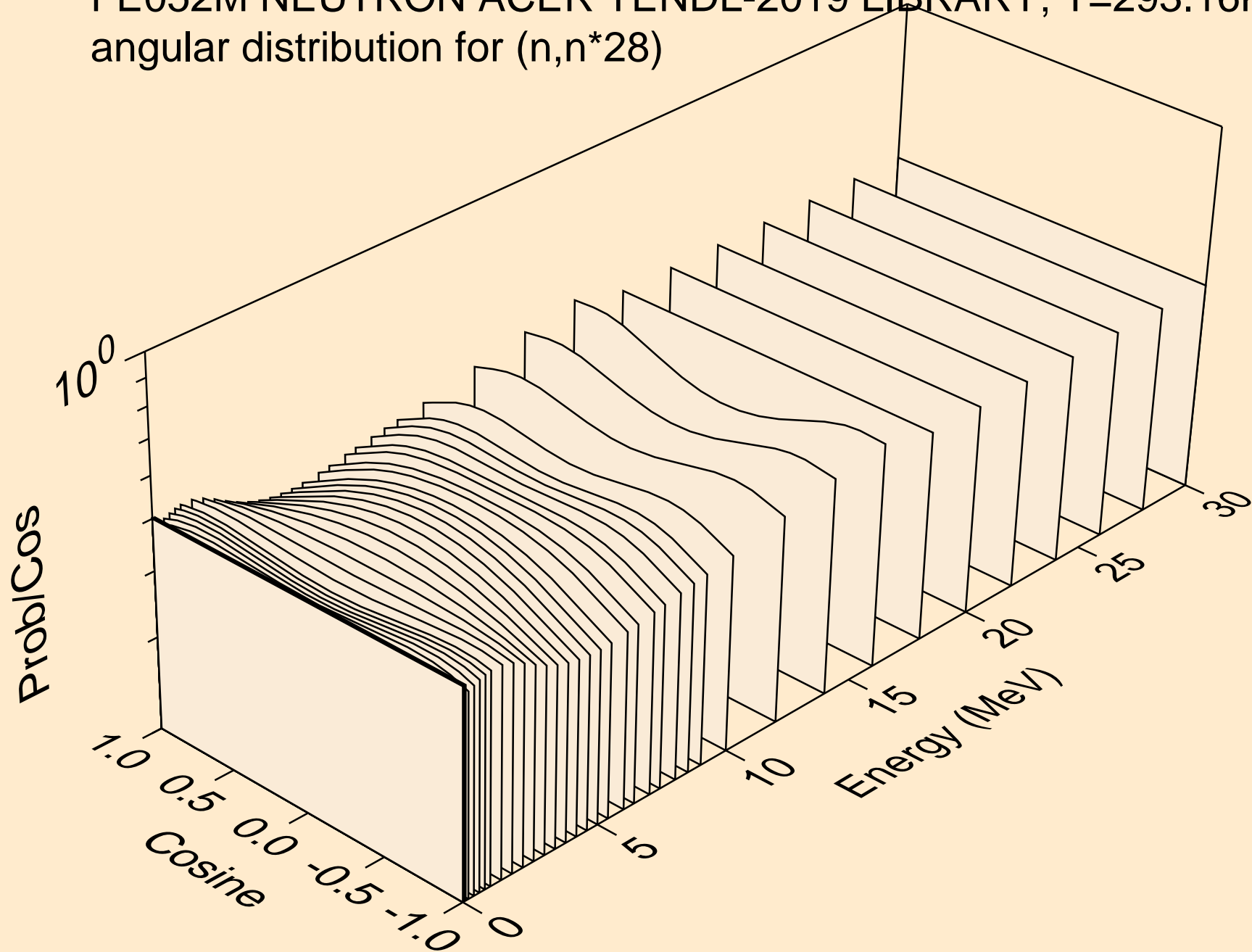

FE052M NEUTRON ACER TENDL-2019 LIBRARY; T=293.16K
angular distribution for (n,n*29)

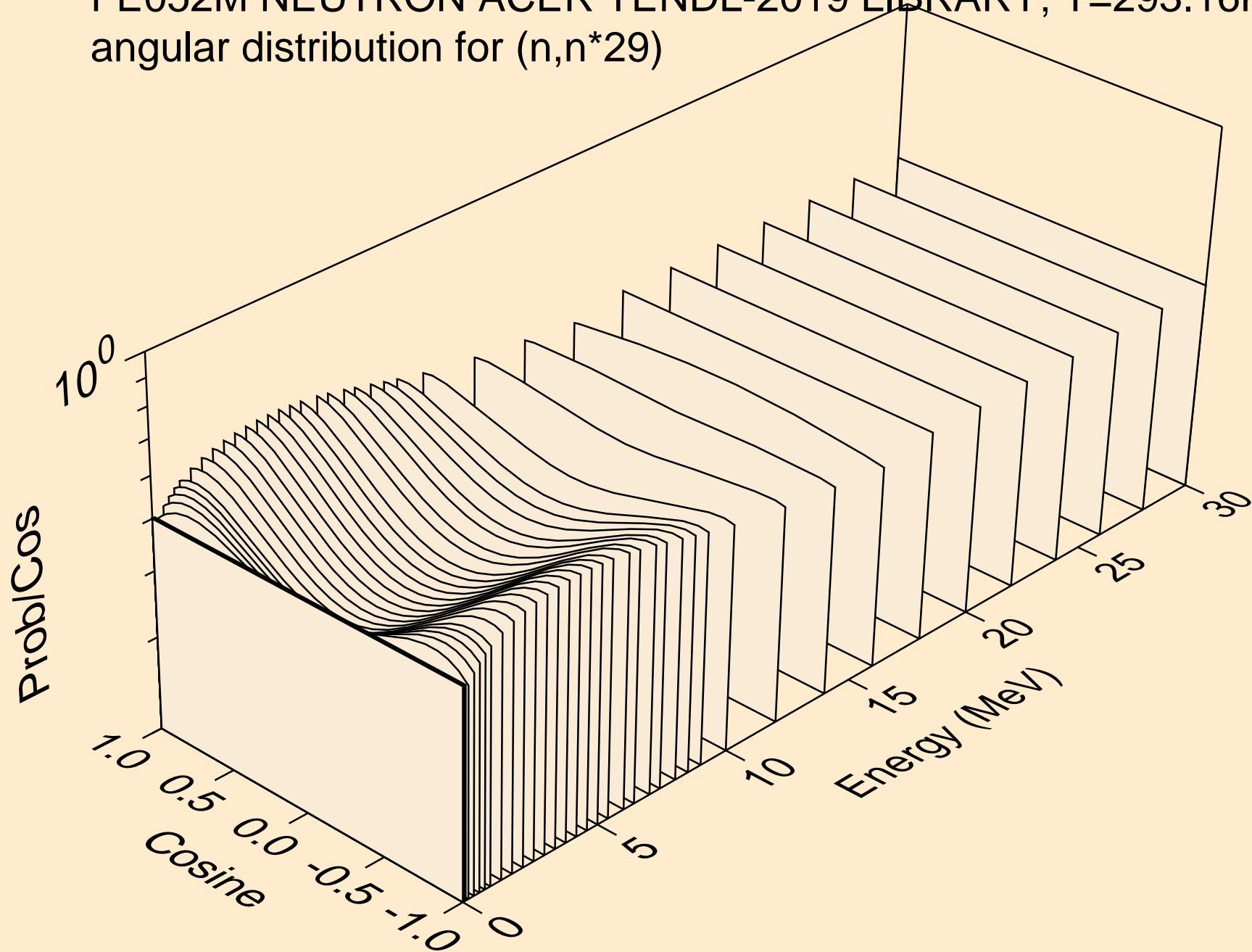

FE052M NEUTRON ACER TENDL-2019 LIBRARY; T=293.16K
angular distribution for (n,n*30)

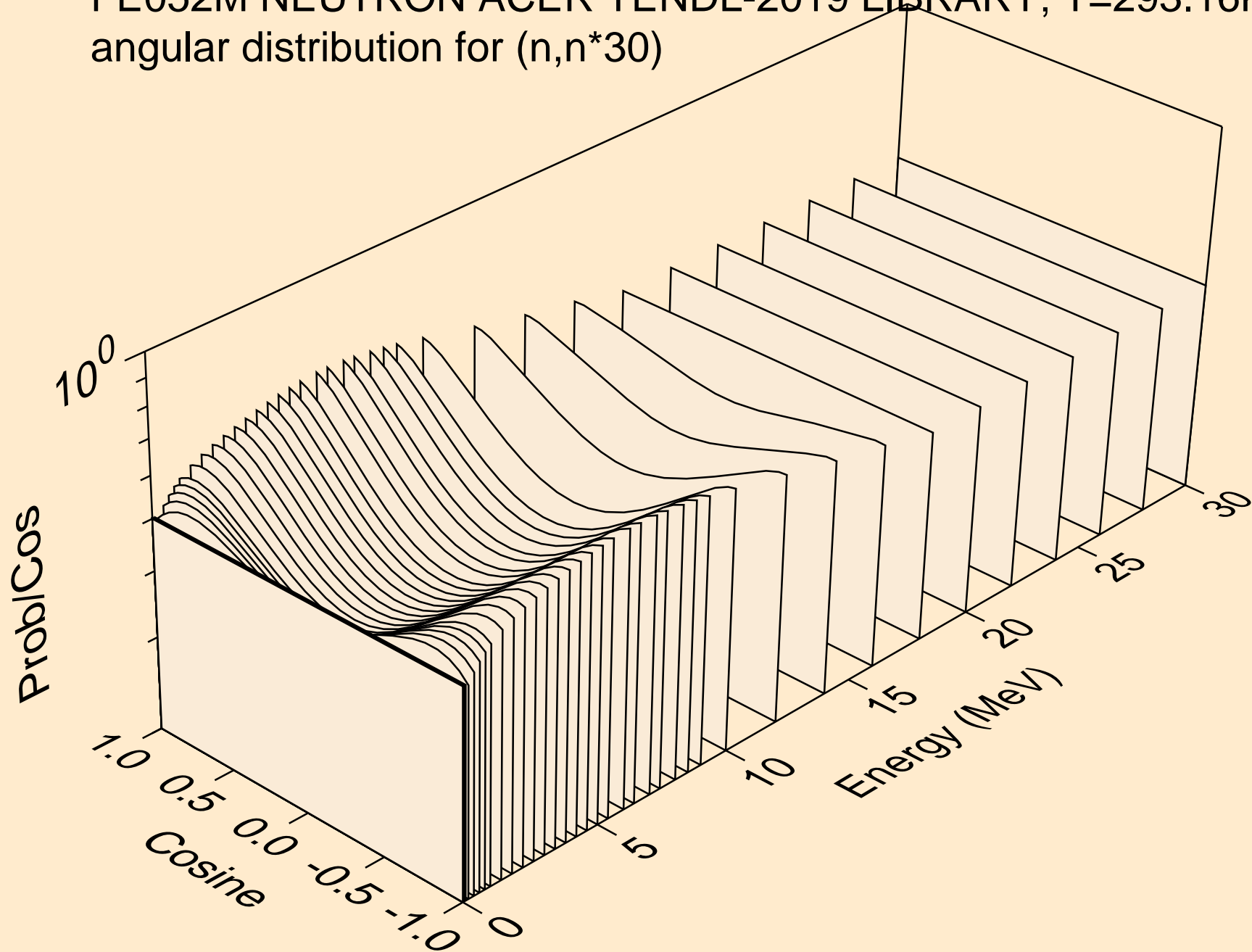

FE052M NEUTRON ACER TENDL-2019 LIBRARY; T=293.16K
angular distribution for (n,n*31)

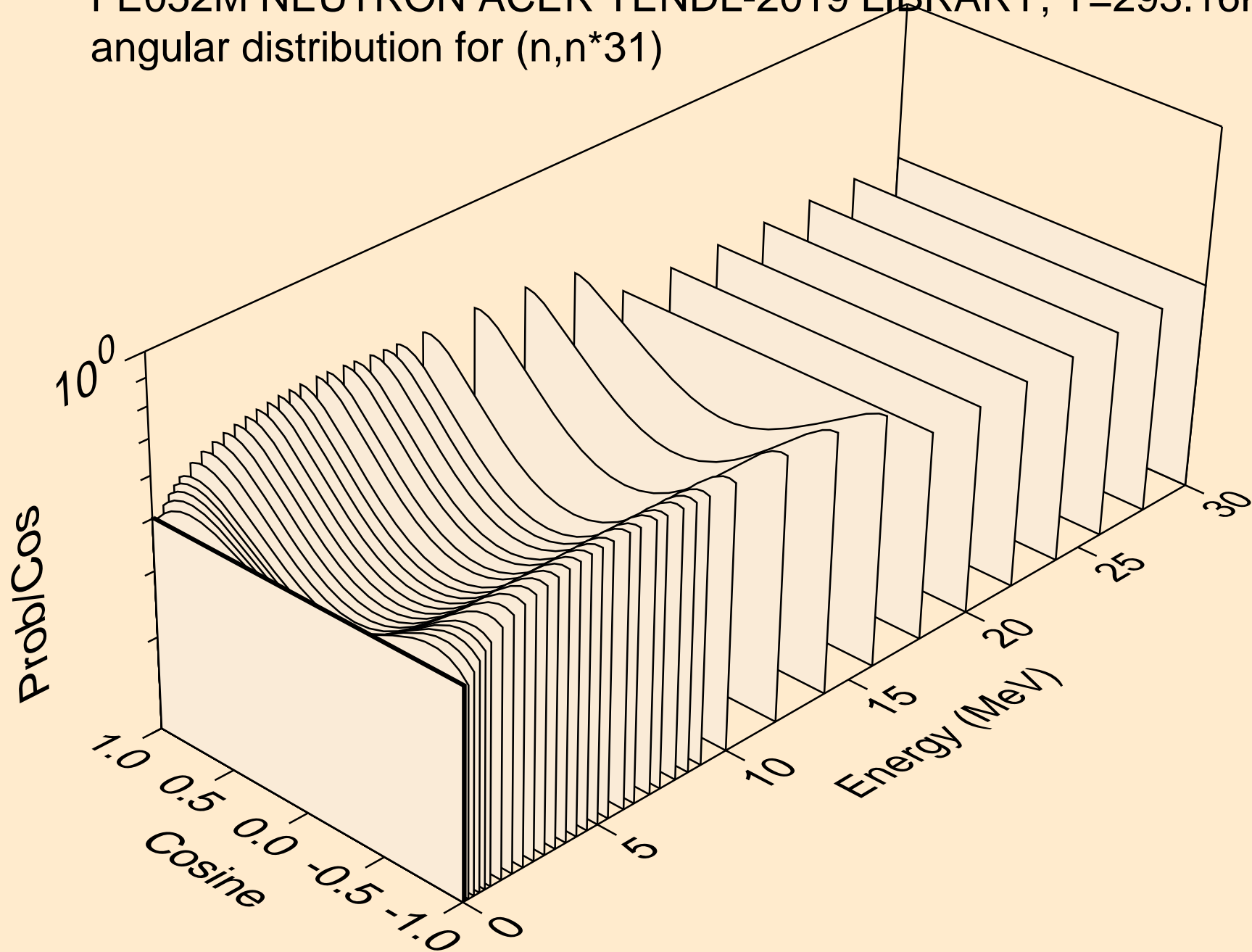

FE052M NEUTRON ACER TENDL-2019 LIBRARY; T=293.16K
angular distribution for (n,n*32)

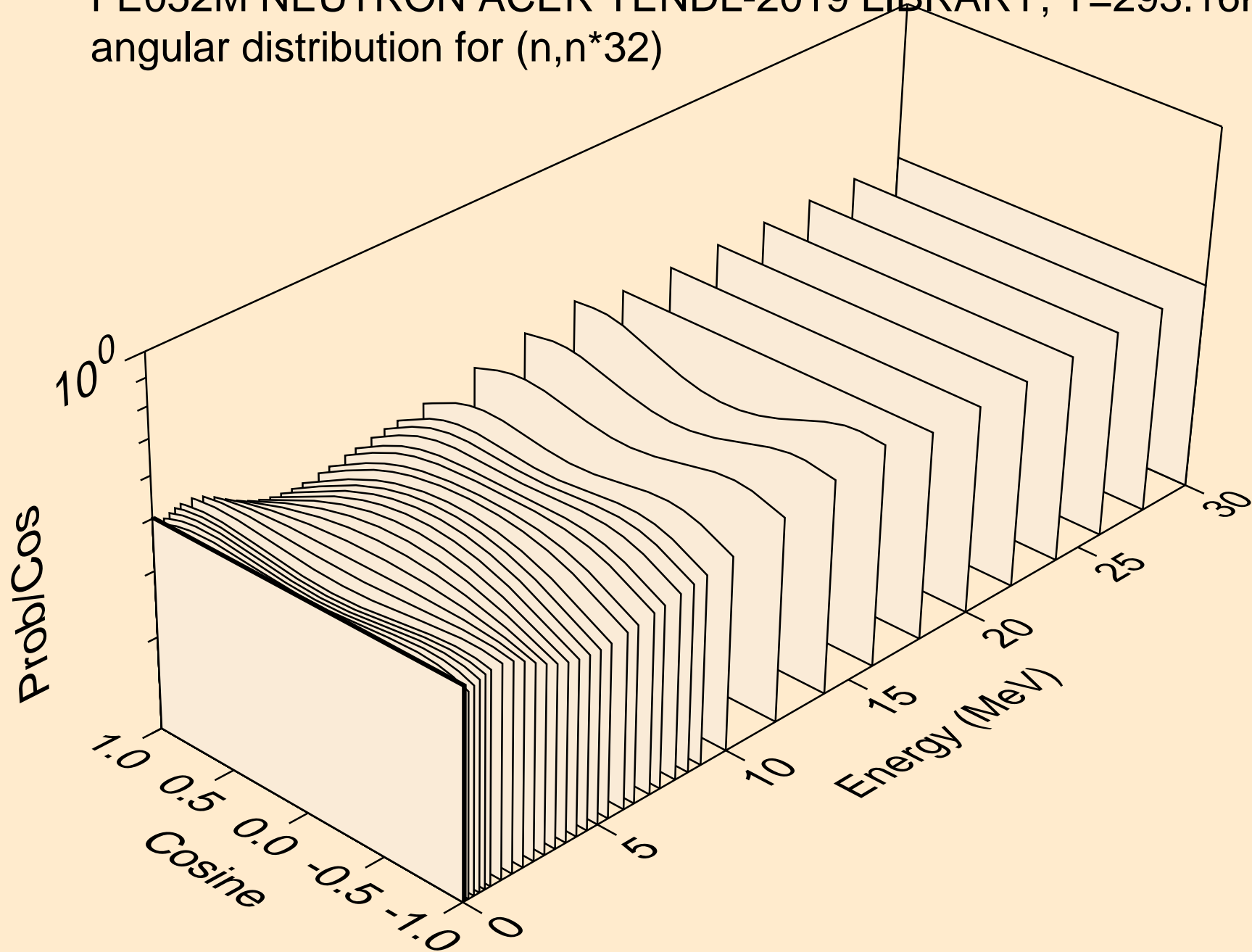

FE052M NEUTRON ACER TENDL-2019 LIBRARY; T=293.16K
angular distribution for (n,n*33)

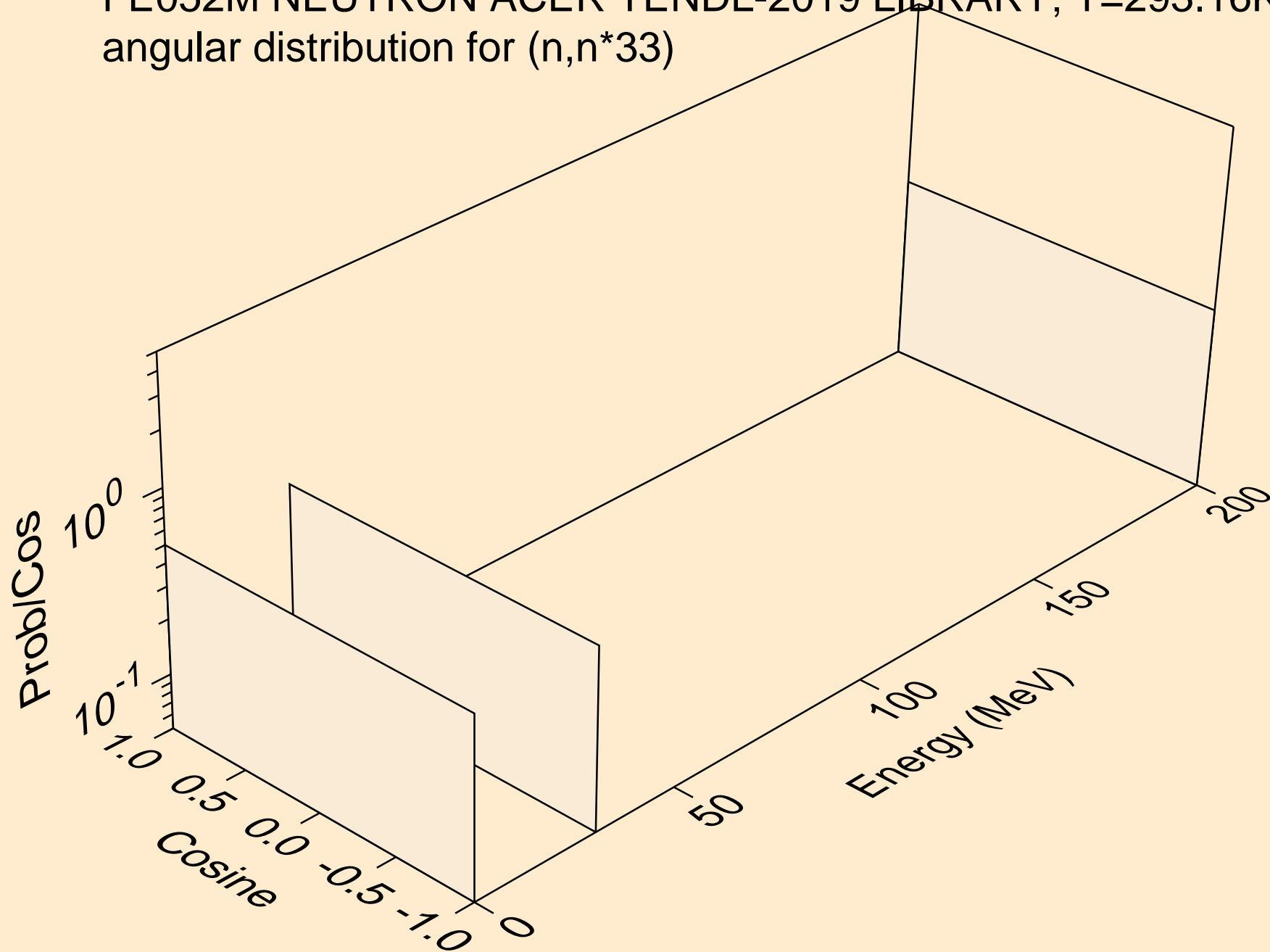

FE052M NEUTRON ACER TENDL-2019 LIBRARY; T=293.16K
Neutron emission for (n,x)

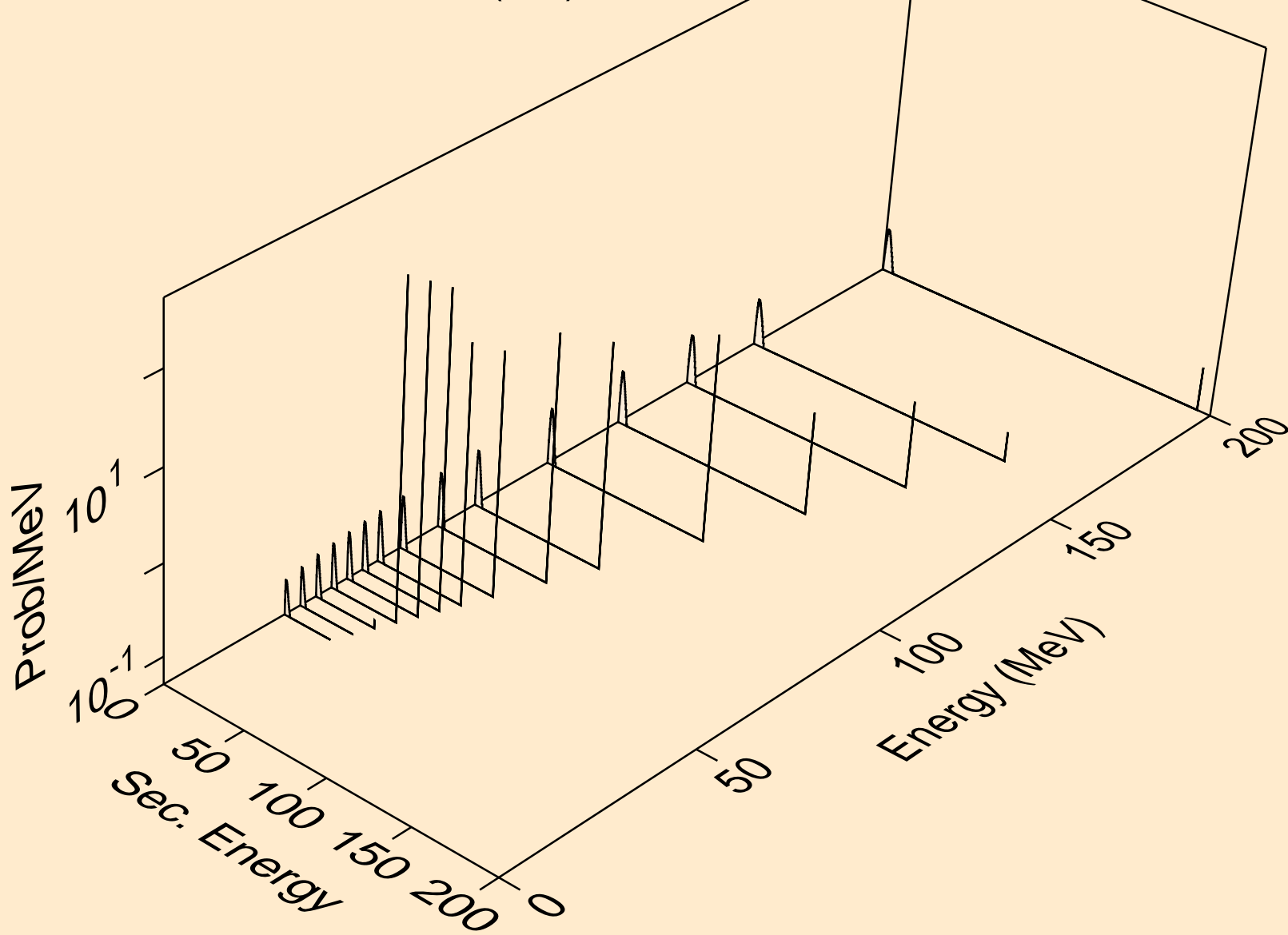

FE052M NEUTRON ACER TENDL-2019 LIBRARY; T=293.16K
Neutron emission for (n,2nd)

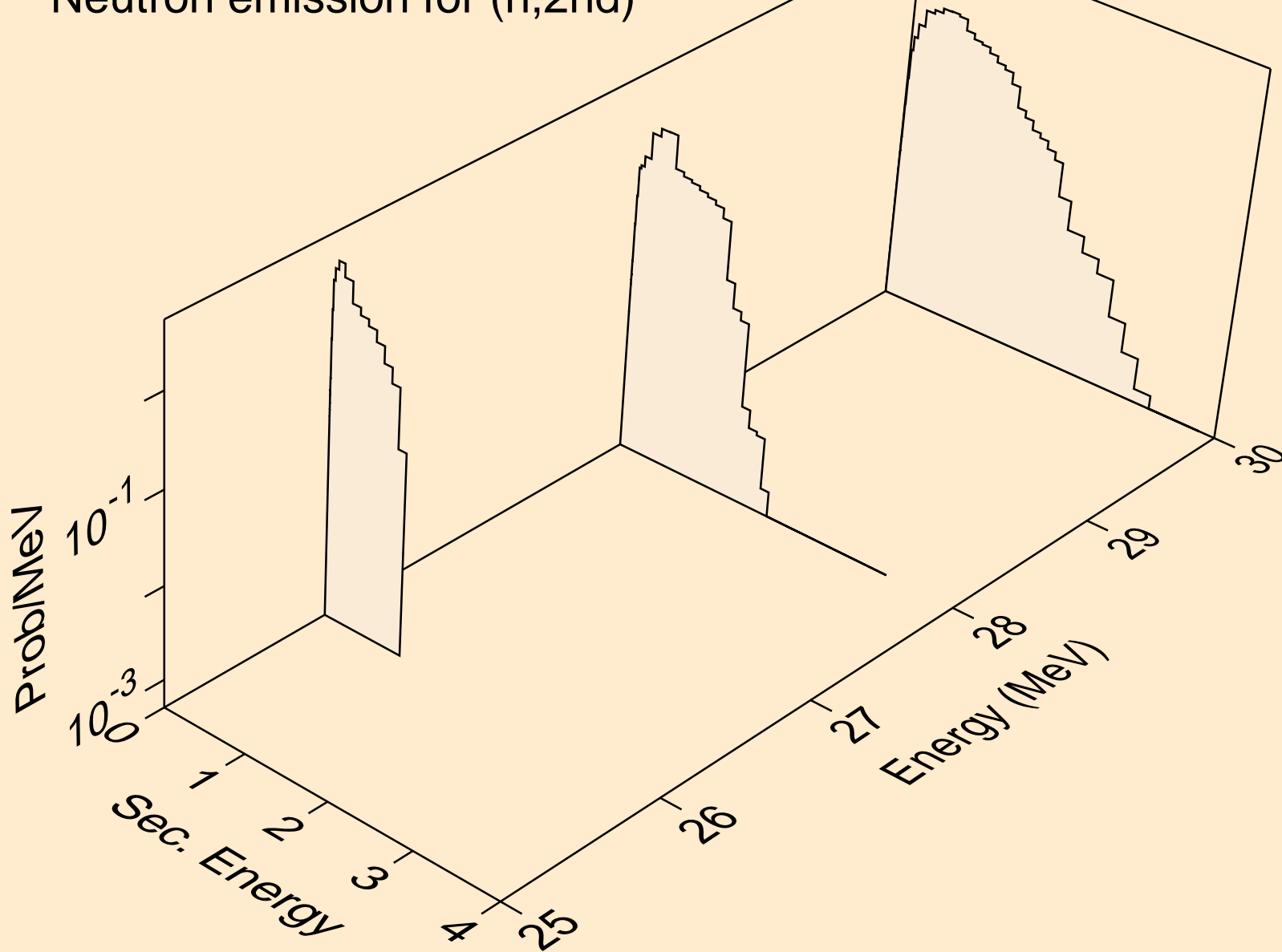

FE052M NEUTRON ACER TENDL-2019 LIBRARY; T=293.16K
Neutron emission for (n,2n)

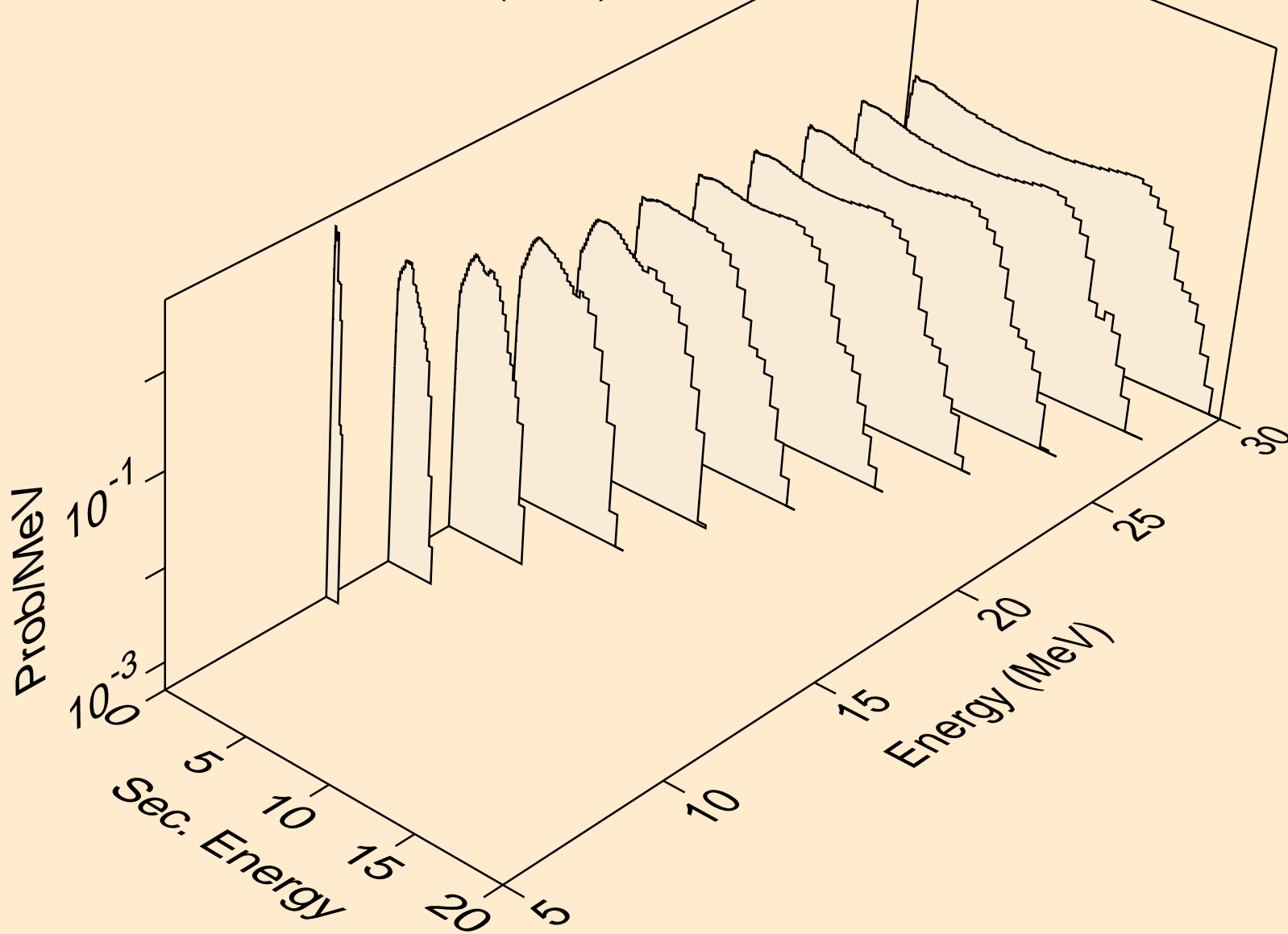

FE052M NEUTRON ACER TENDL-2019 LIBRARY; T=293.16K
Neutron emission for (n,3n)

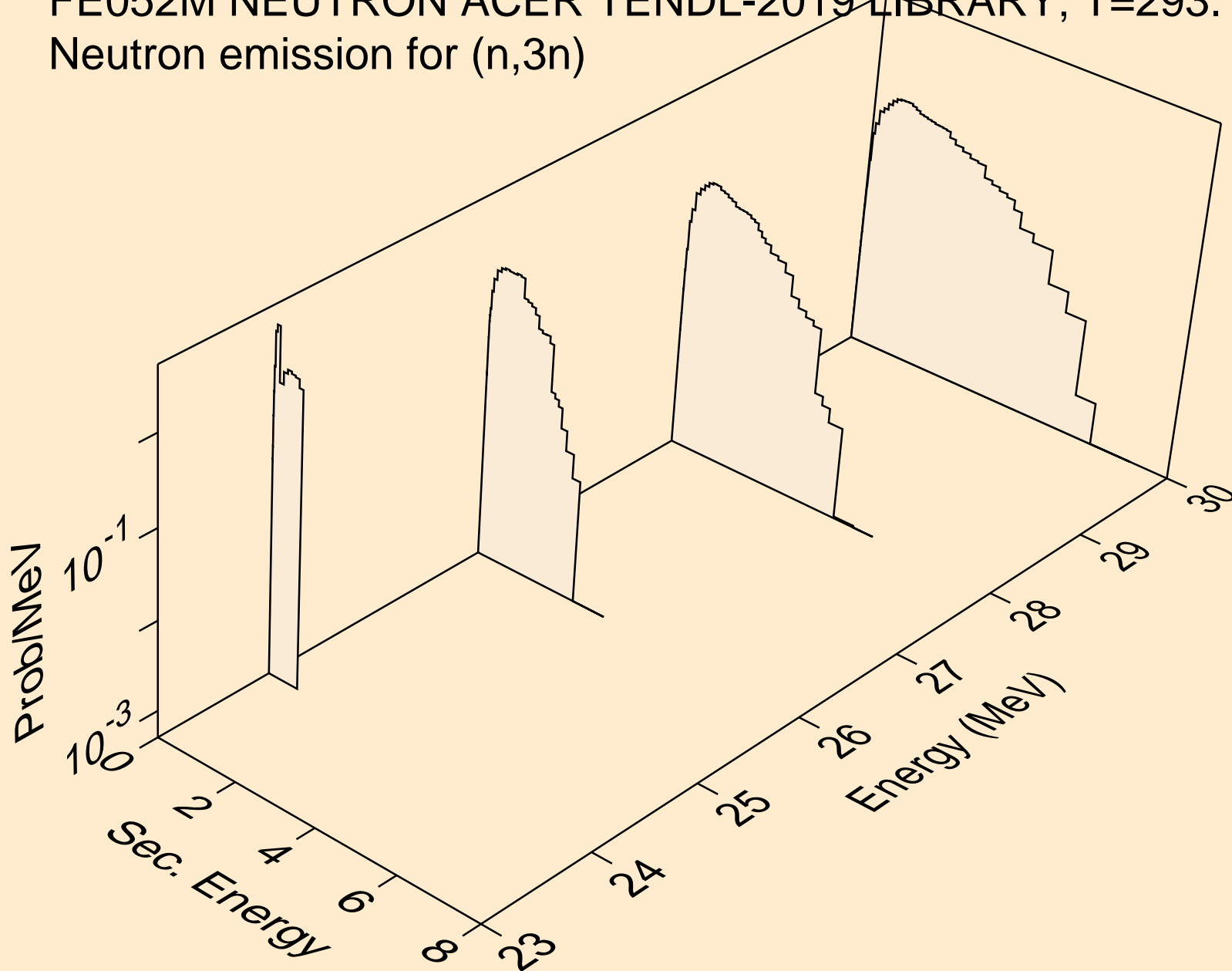

FE052M NEUTRON ACER TENDL-2019 LIBRARY; T=293.16K
Neutron emission for (n,n*)a

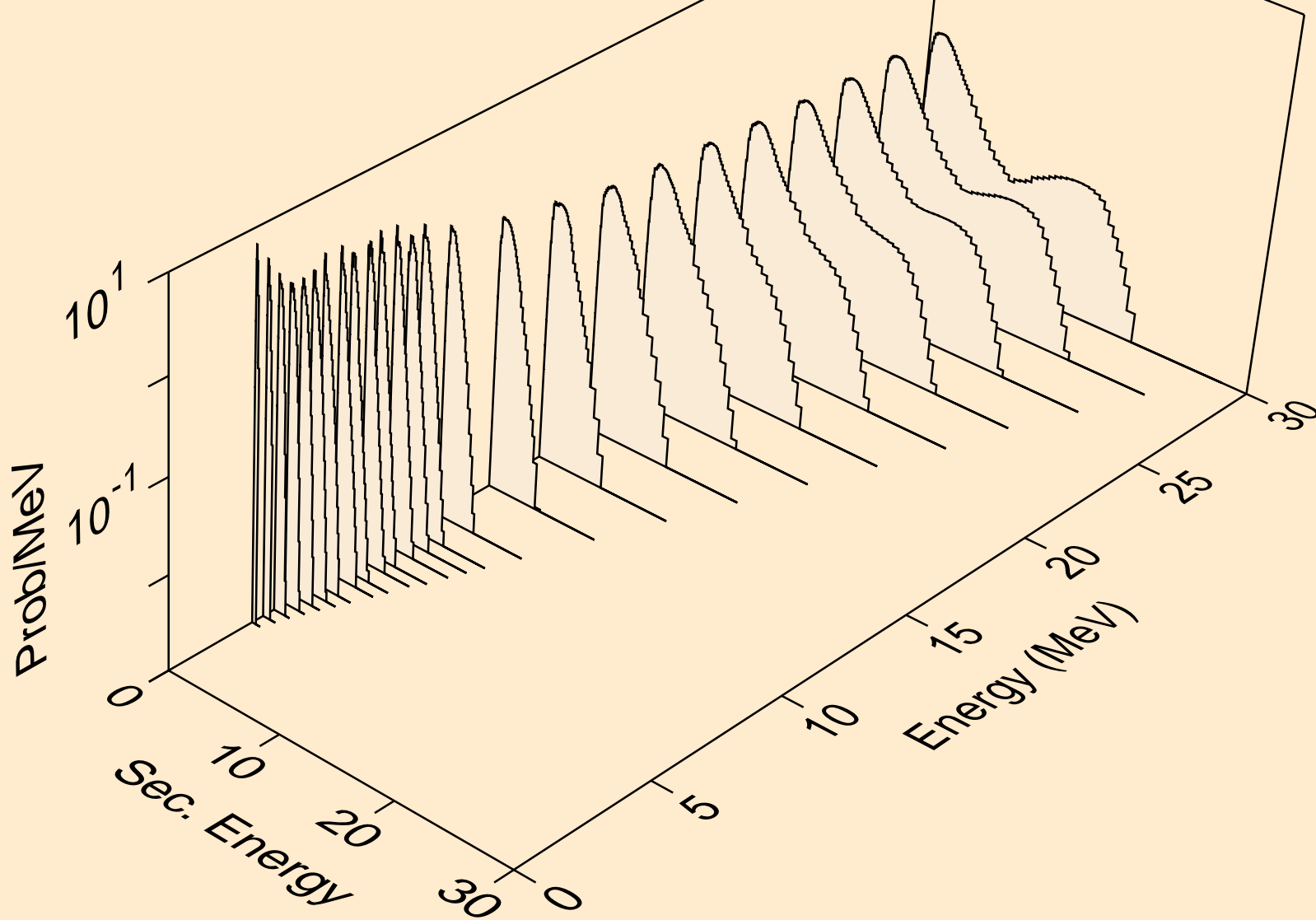

FE052M NEUTRON ACER TENDL-2019 LIBRARY; T=293.16K
Neutron emission for (n,2n)a

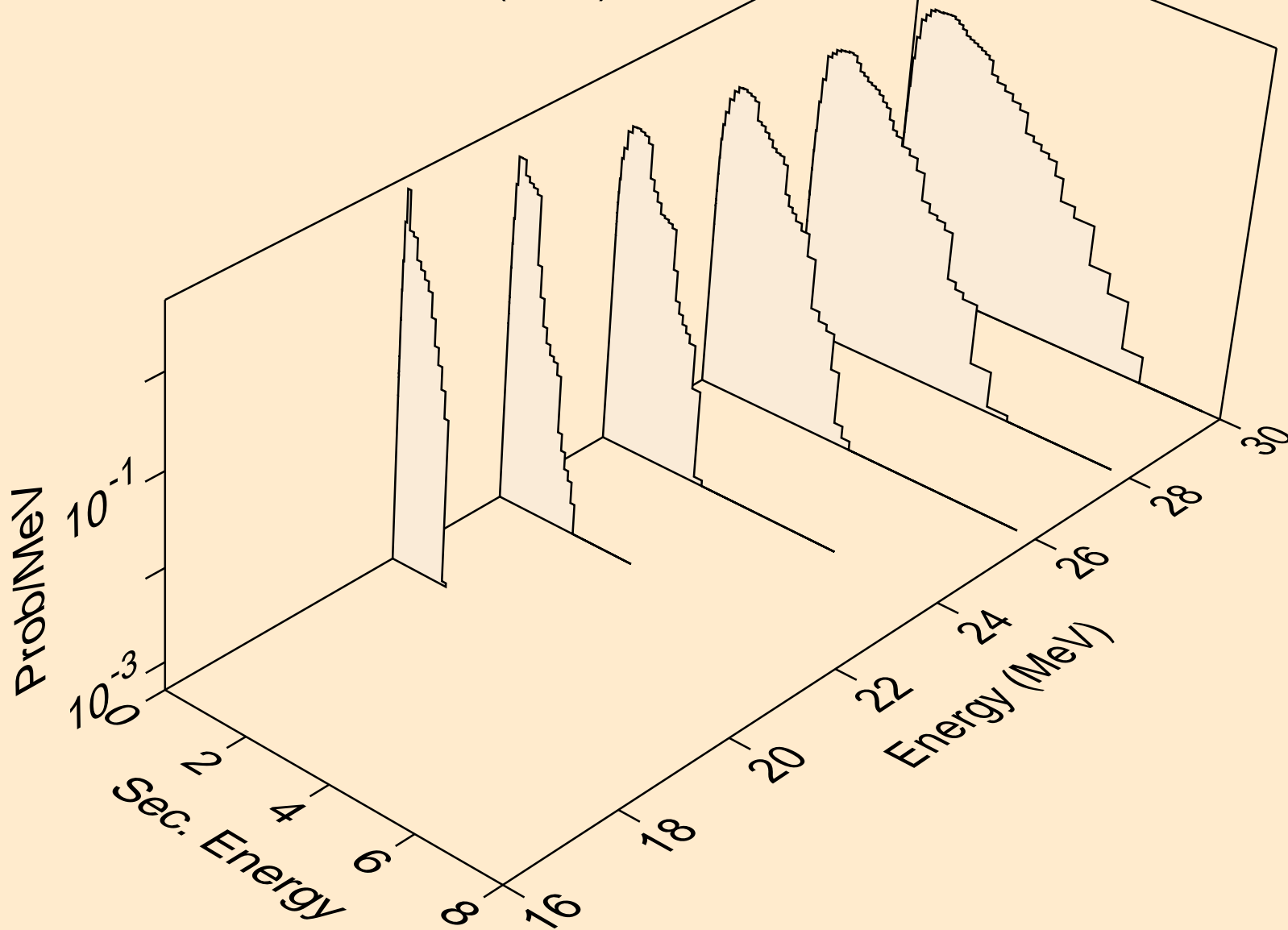

FE052M NEUTRON ACER TENDL-2019 LIBRARY; T=293.16K
Neutron emission for (n,n*)p

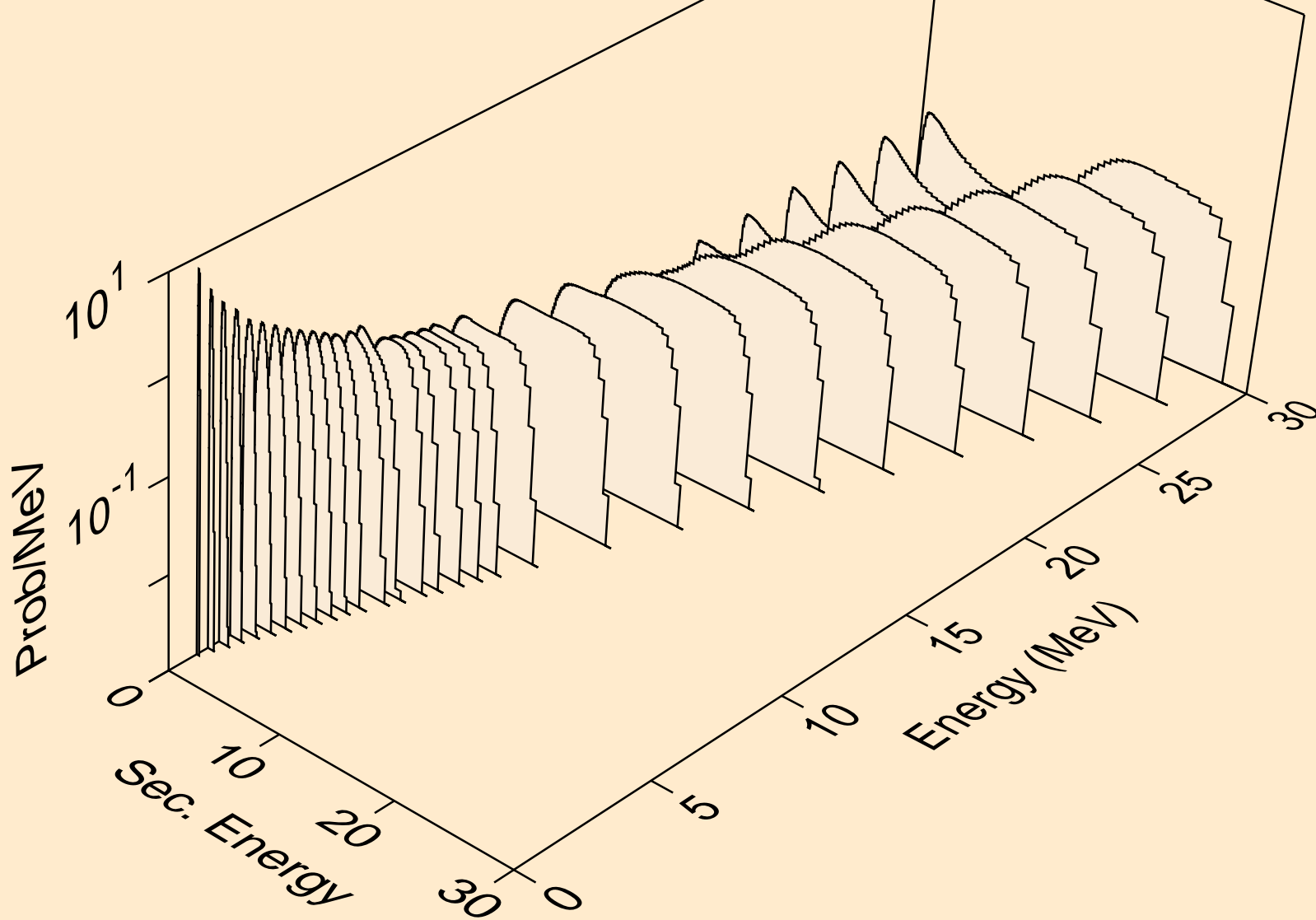

FE052M NEUTRON ACER TENDL-2019 LIBRARY; T=293.16K
Neutron emission for (n,n*)2a

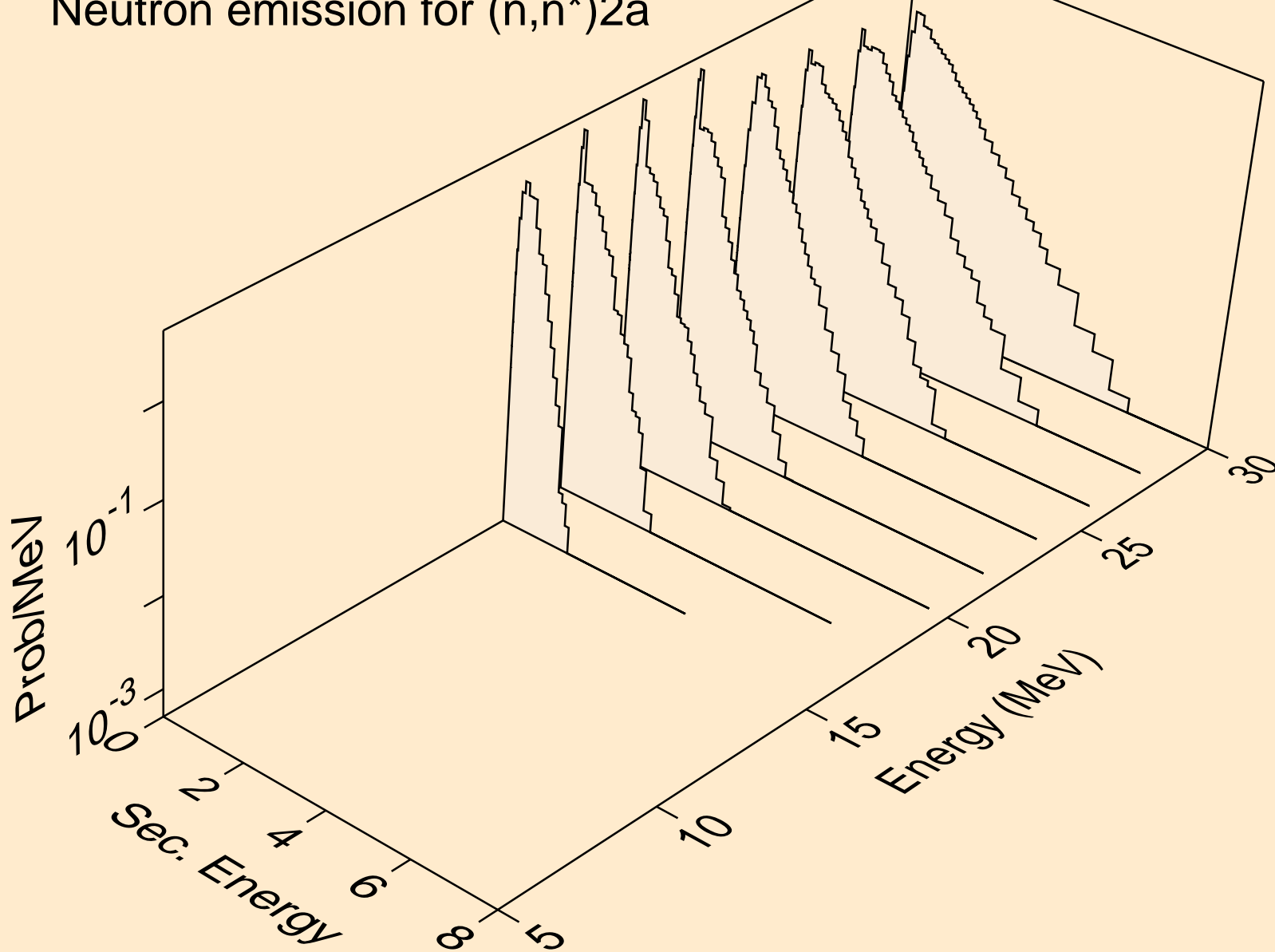

FE052M NEUTRON ACER TENDL-2019 LIBRARY; T=293.16K
Neutron emission for (n,n*)d

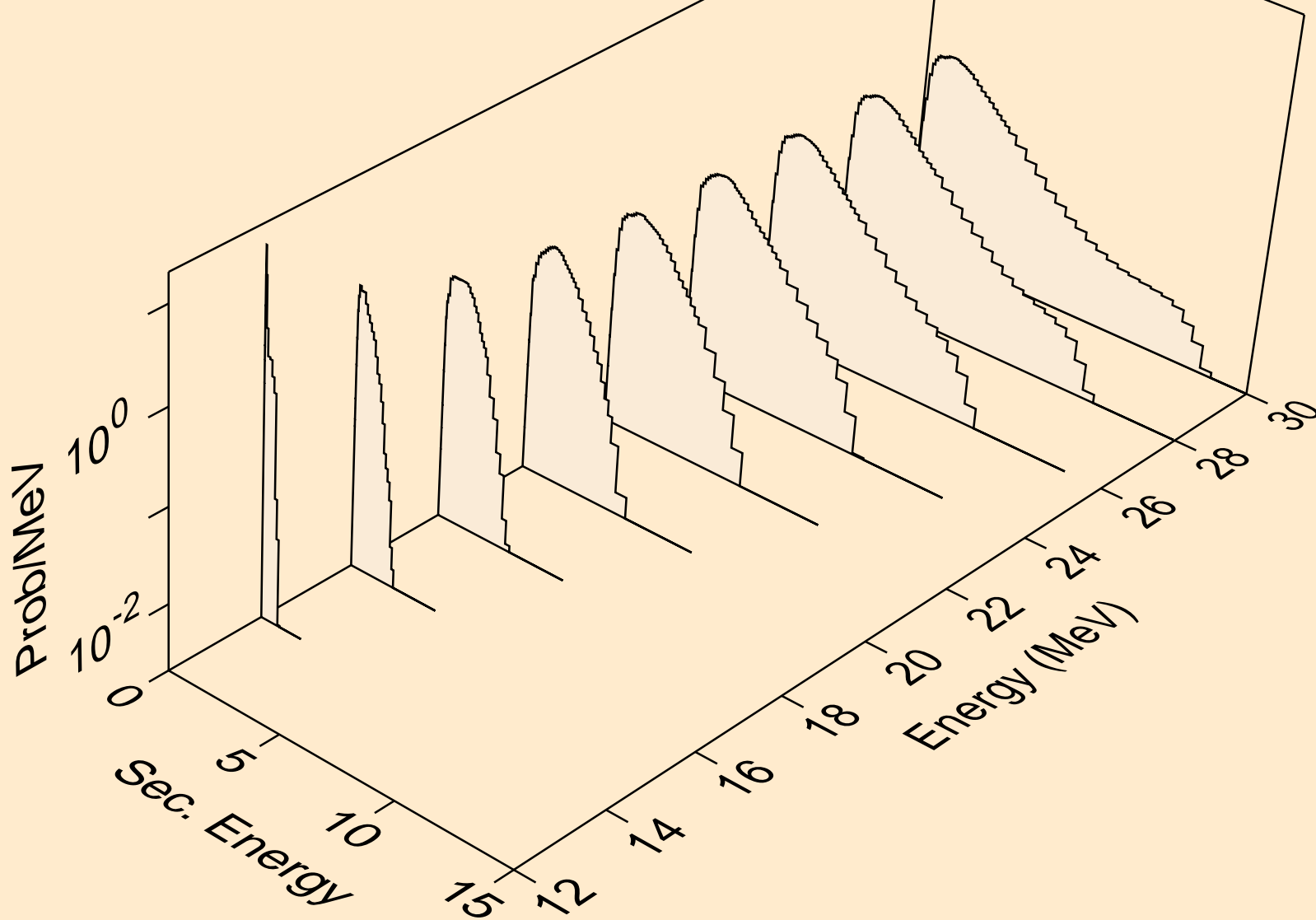

FE052M NEUTRON ACER TENDL-2019 LIBRARY; T=293.16K
Neutron emission for (n,n*)t

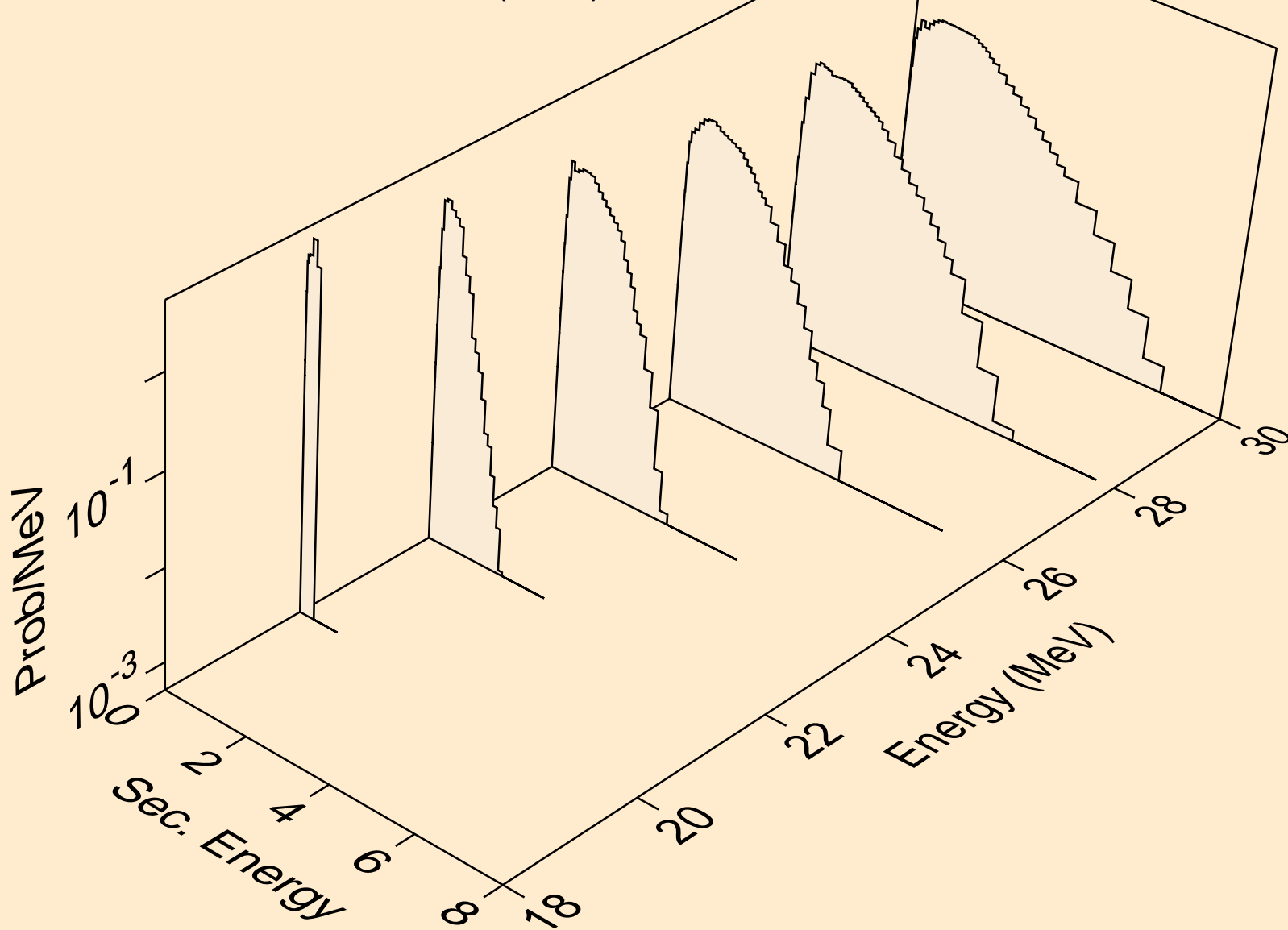

FE052M NEUTRON ACER TENDL-2019 LIBRARY; T=293.16K
Neutron emission for (n,n*)he3

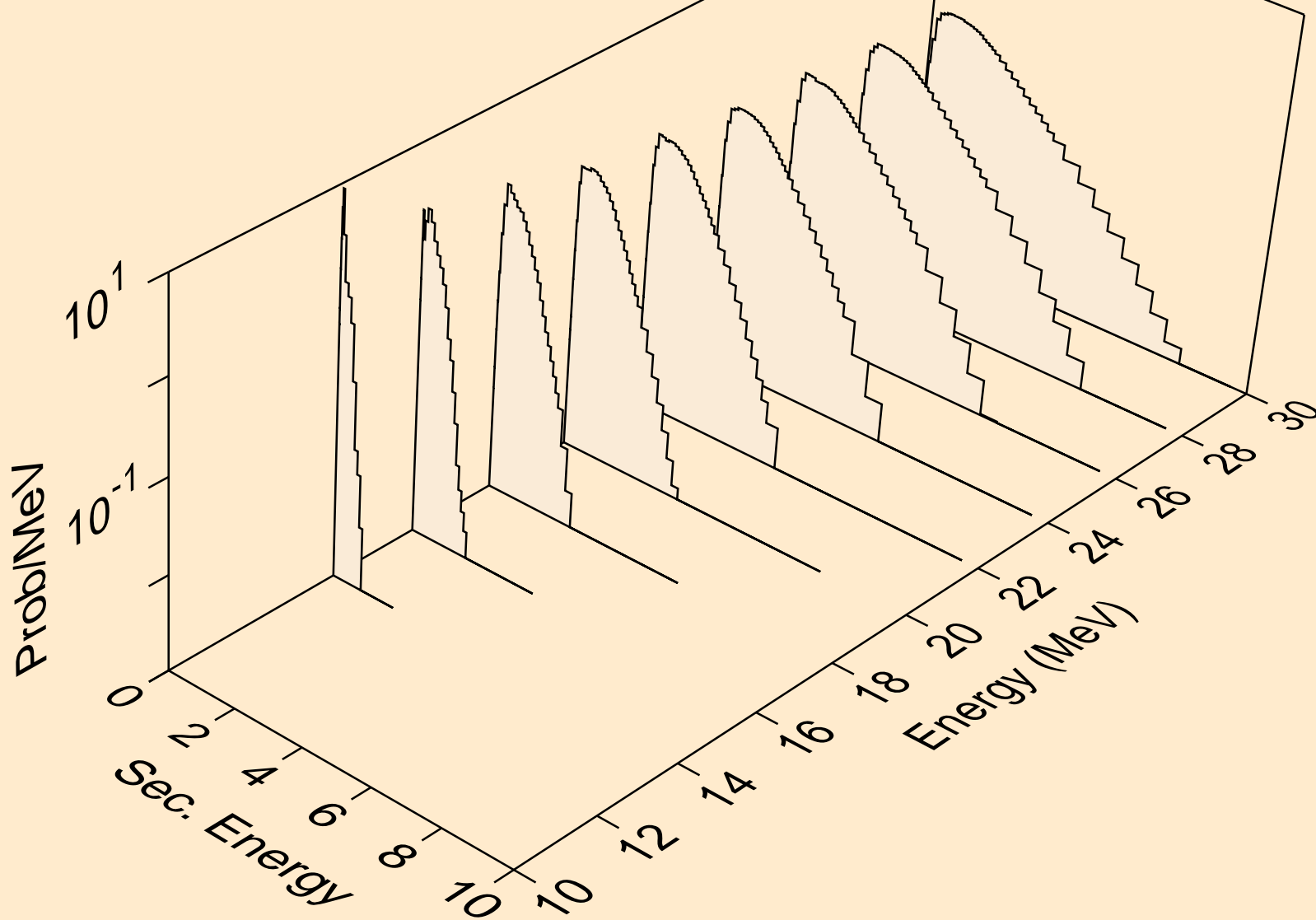

FE052M NEUTRON ACER TENDL-2019 LIBRARY; T=293.16K
Neutron emission for (n,2np)

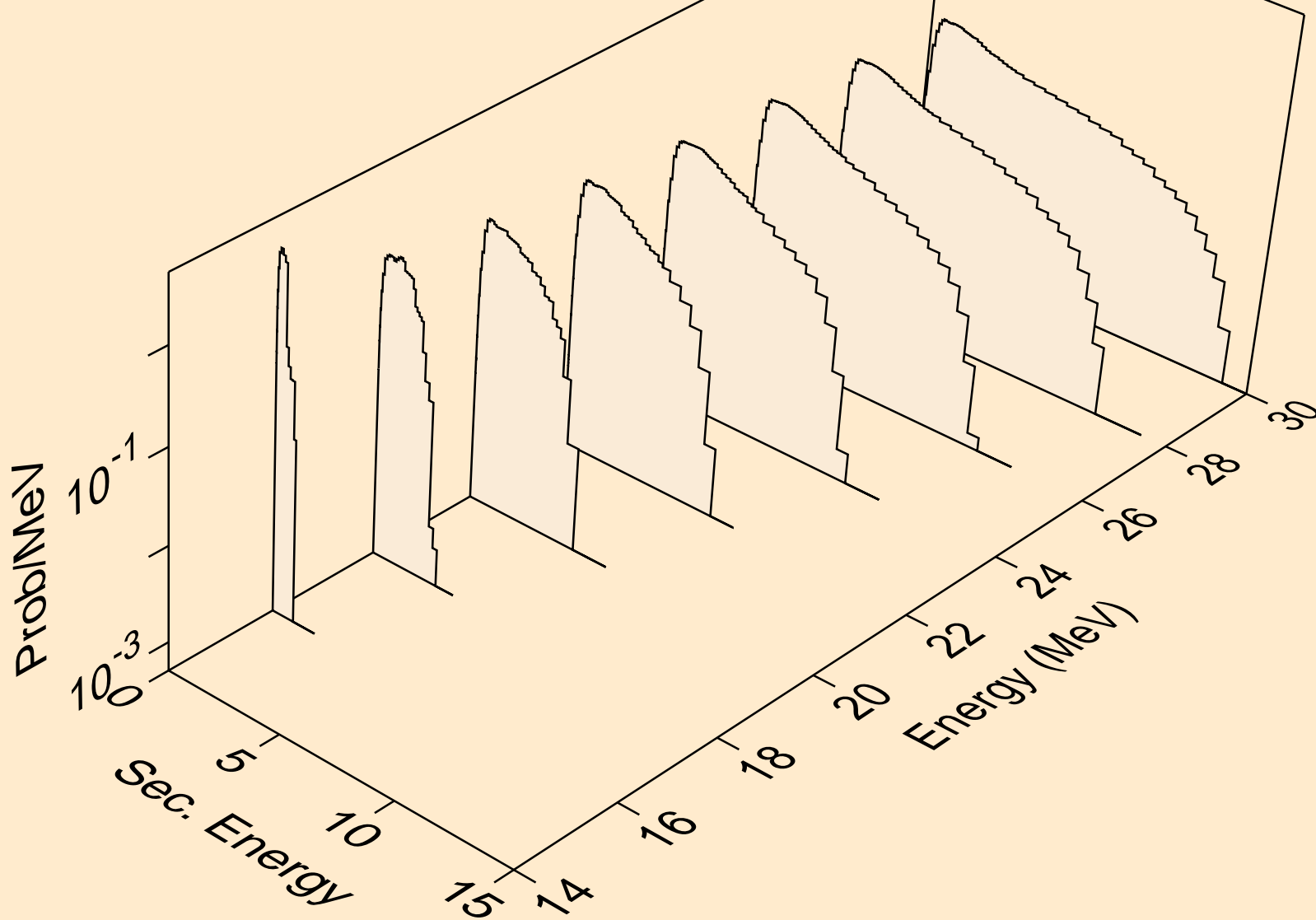

FE052M NEUTRON ACER TENDL-2019 LIBRARY; T=293.16K
Neutron emission for (n,2np)

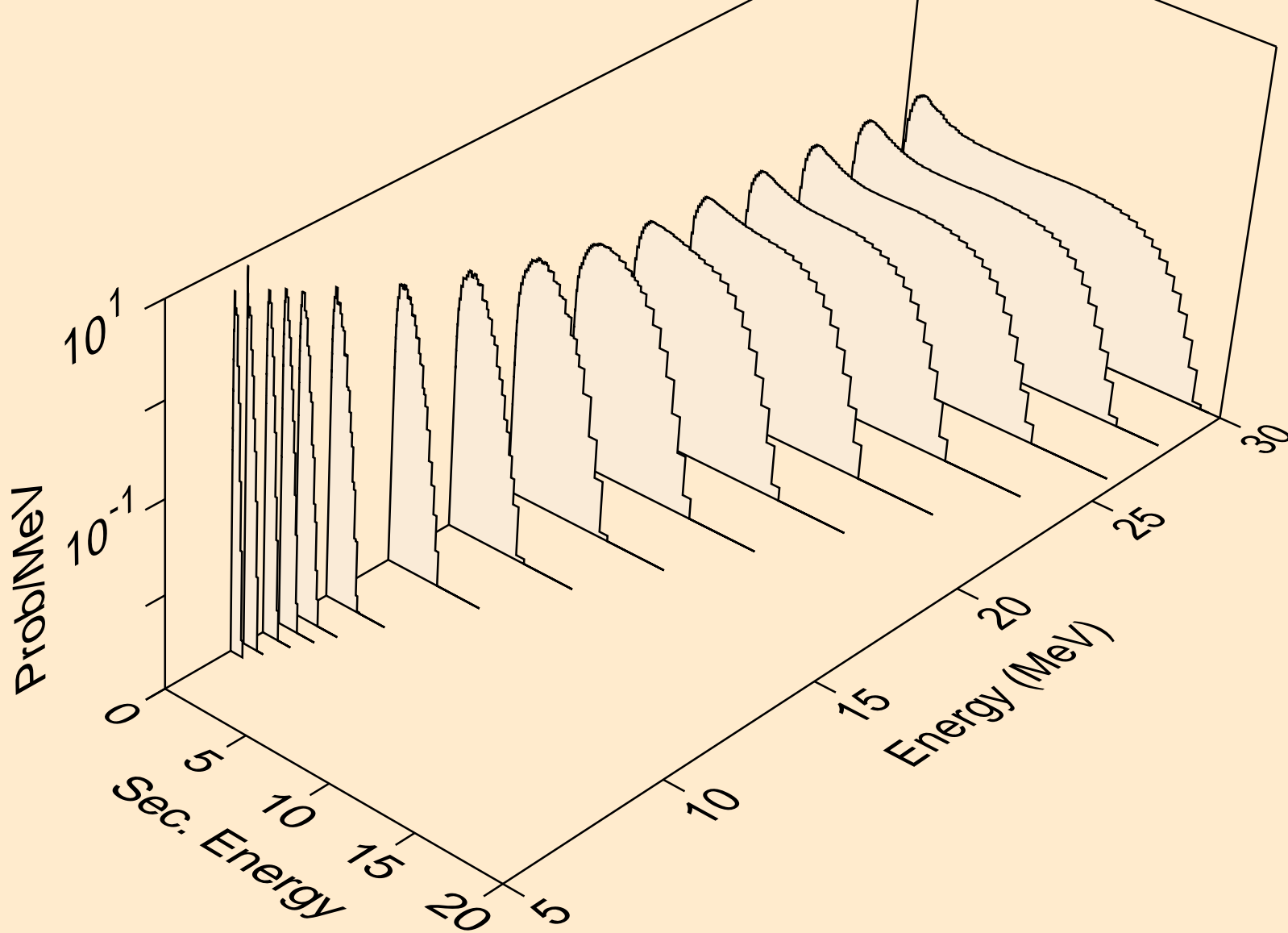

FE052M NEUTRON ACER TENDL-2019 LIBRARY; T=293.16K
Neutron emission for (n,npa)

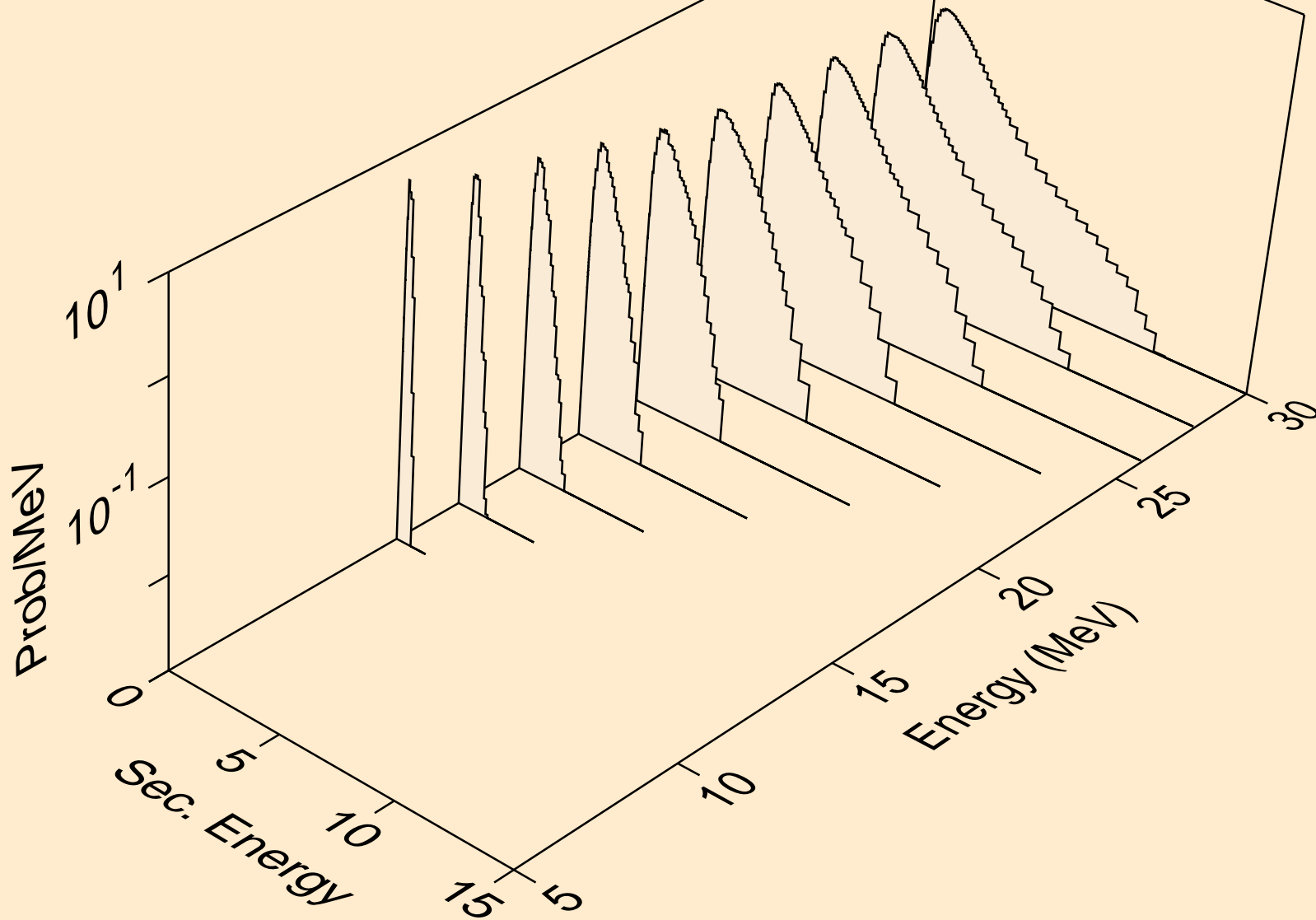

FE052M NEUTRON ACER TENDL-2019 LIBRARY; T=293.16K
Neutron emission for (n,n*c)

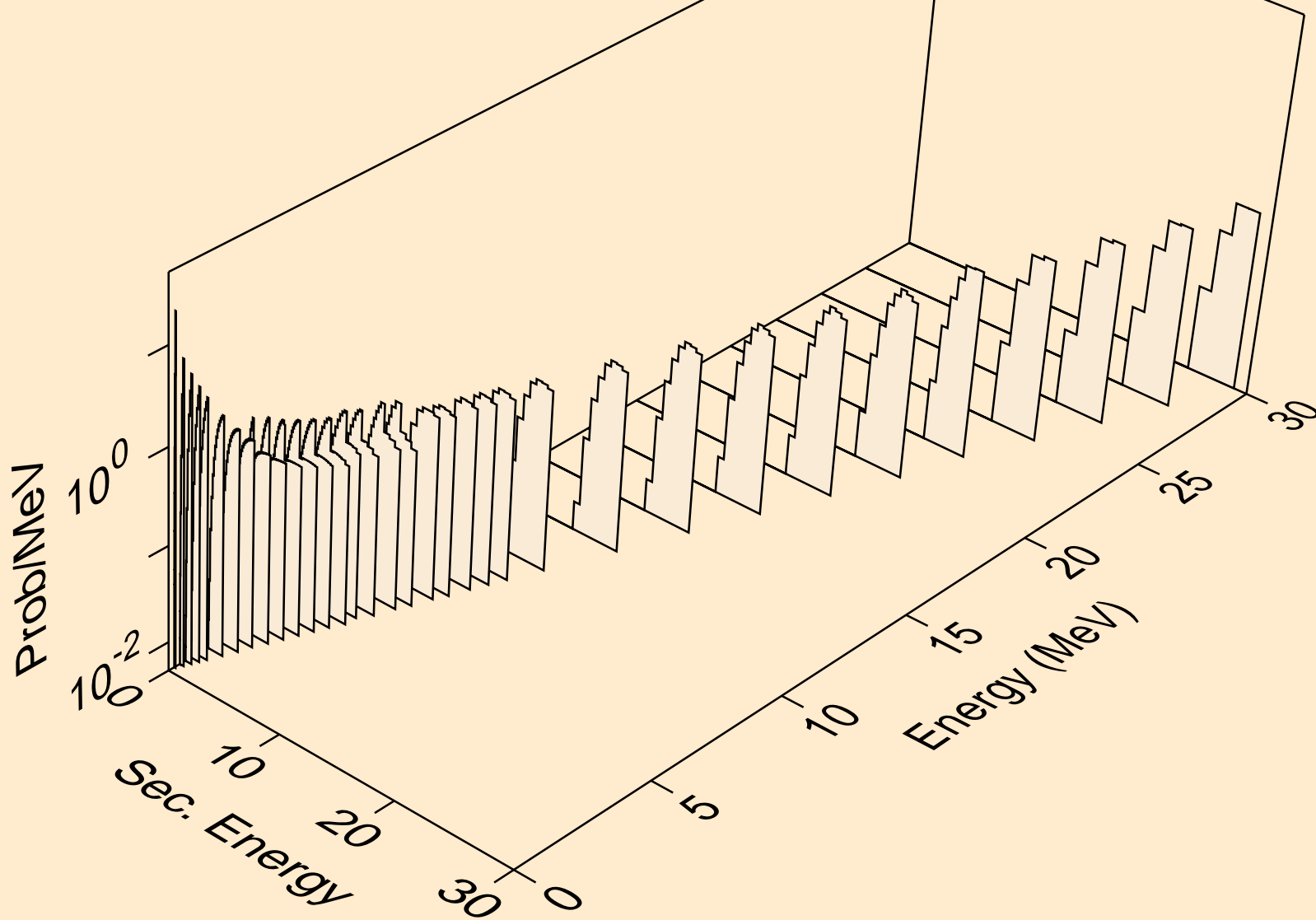

FE052M NEUTRON ACER TENDL-2019 LIBRARY; T=293.16K
Photon emission for (n,x)

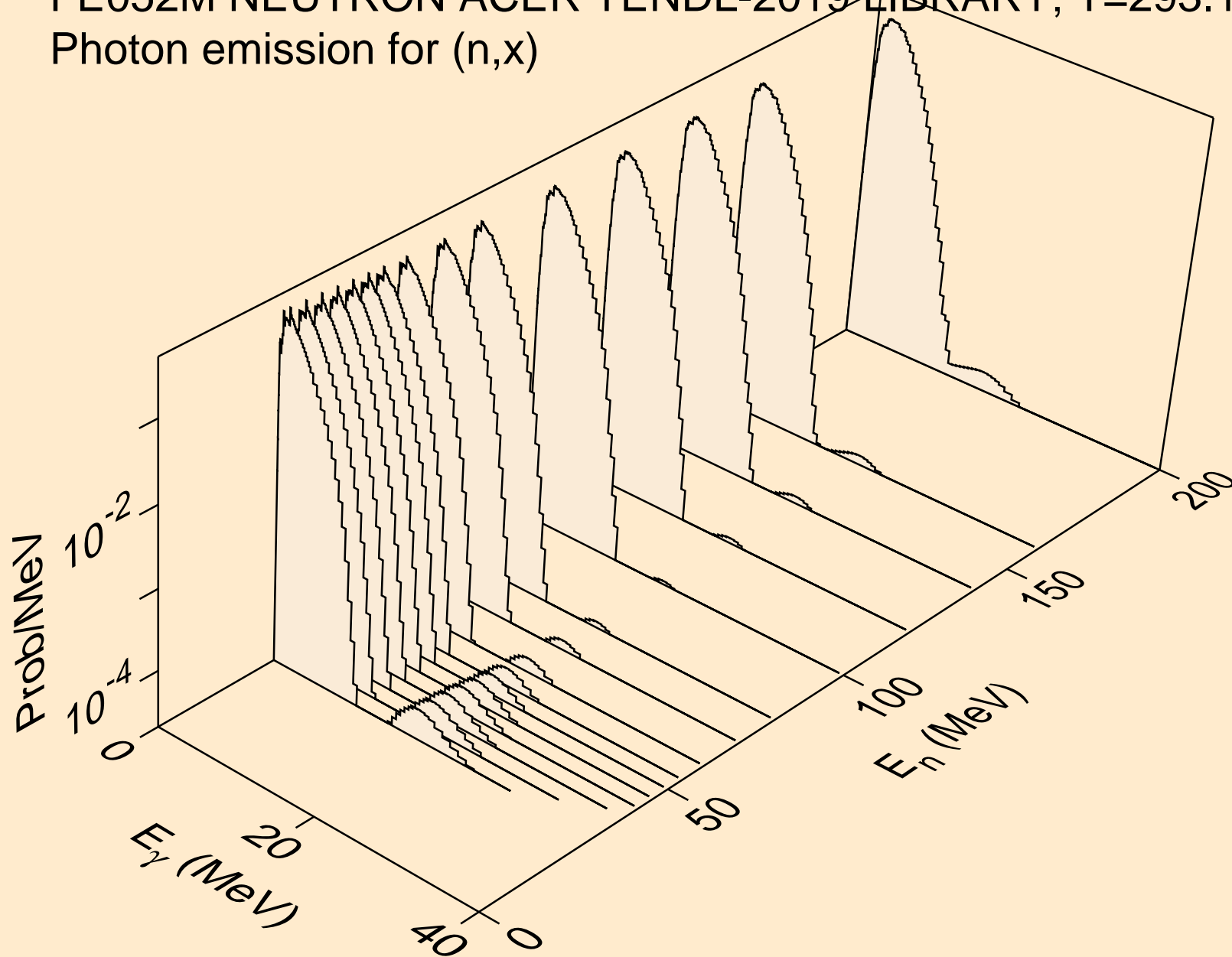

FE052M NEUTRON ACER TENDL-2019 LIBRARY; T=293.16K
Photon emission for (n,2nd)

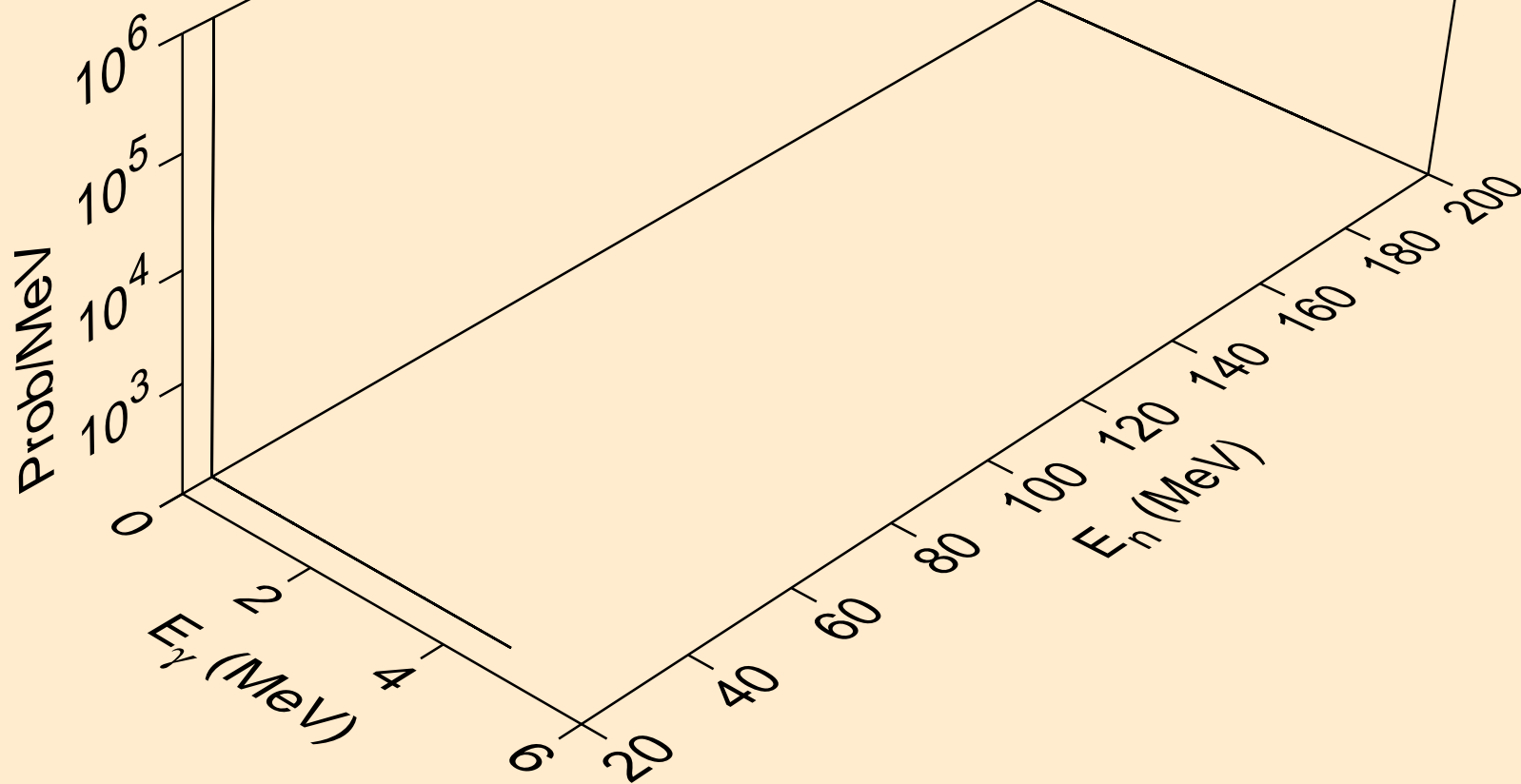

FE052M NEUTRON ACER TENDL-2019 LIBRARY; T=293.16K
Photon emission for (n,2n)

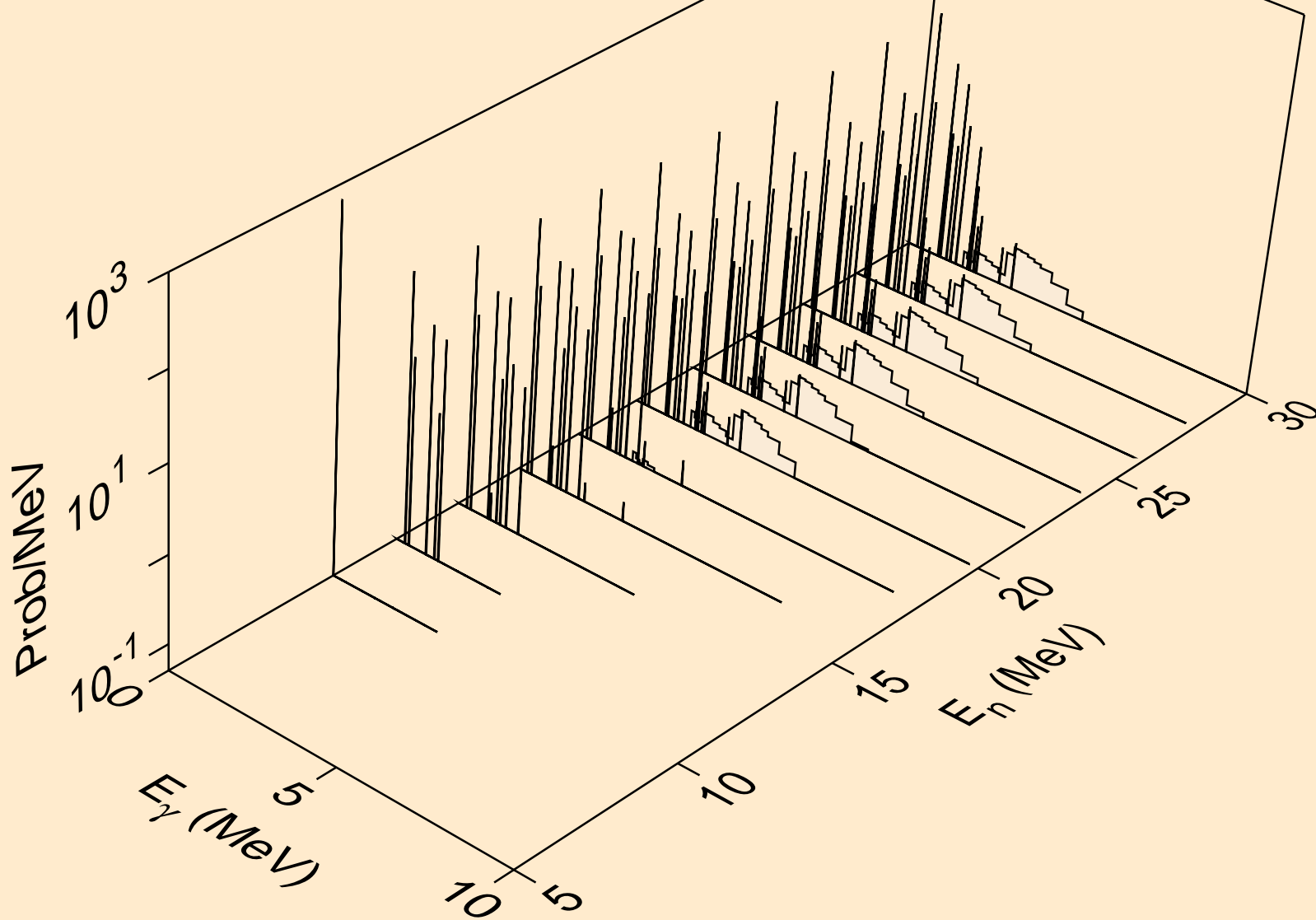

FE052M NEUTRON ACER TENDL-2019 LIBRARY; T=293.16K
Photon emission for (n,3n)

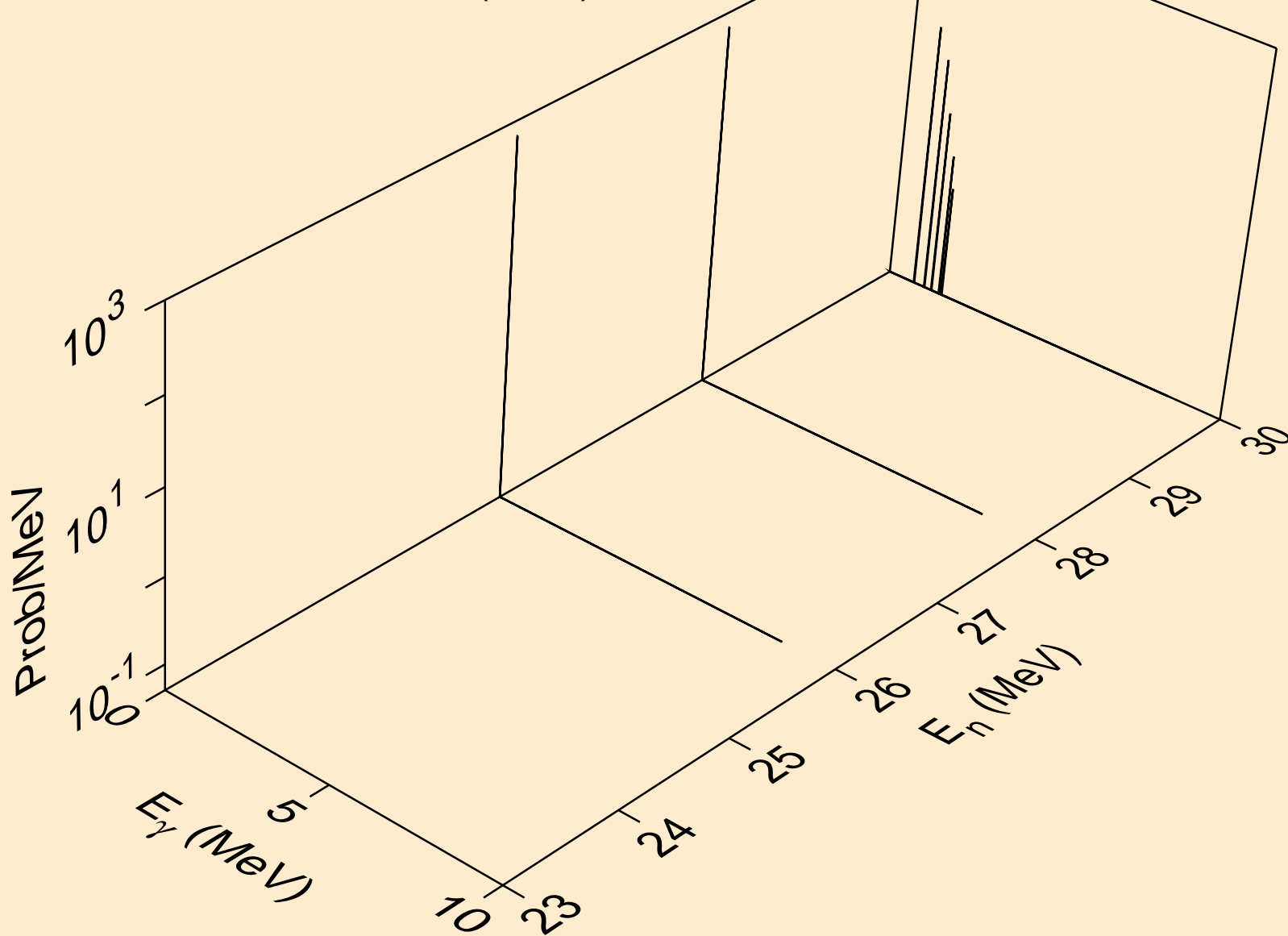

FE052M NEUTRON ACER TENDL-2019 LIBRARY; T=293.16K
Photon emission for (n,n*)a

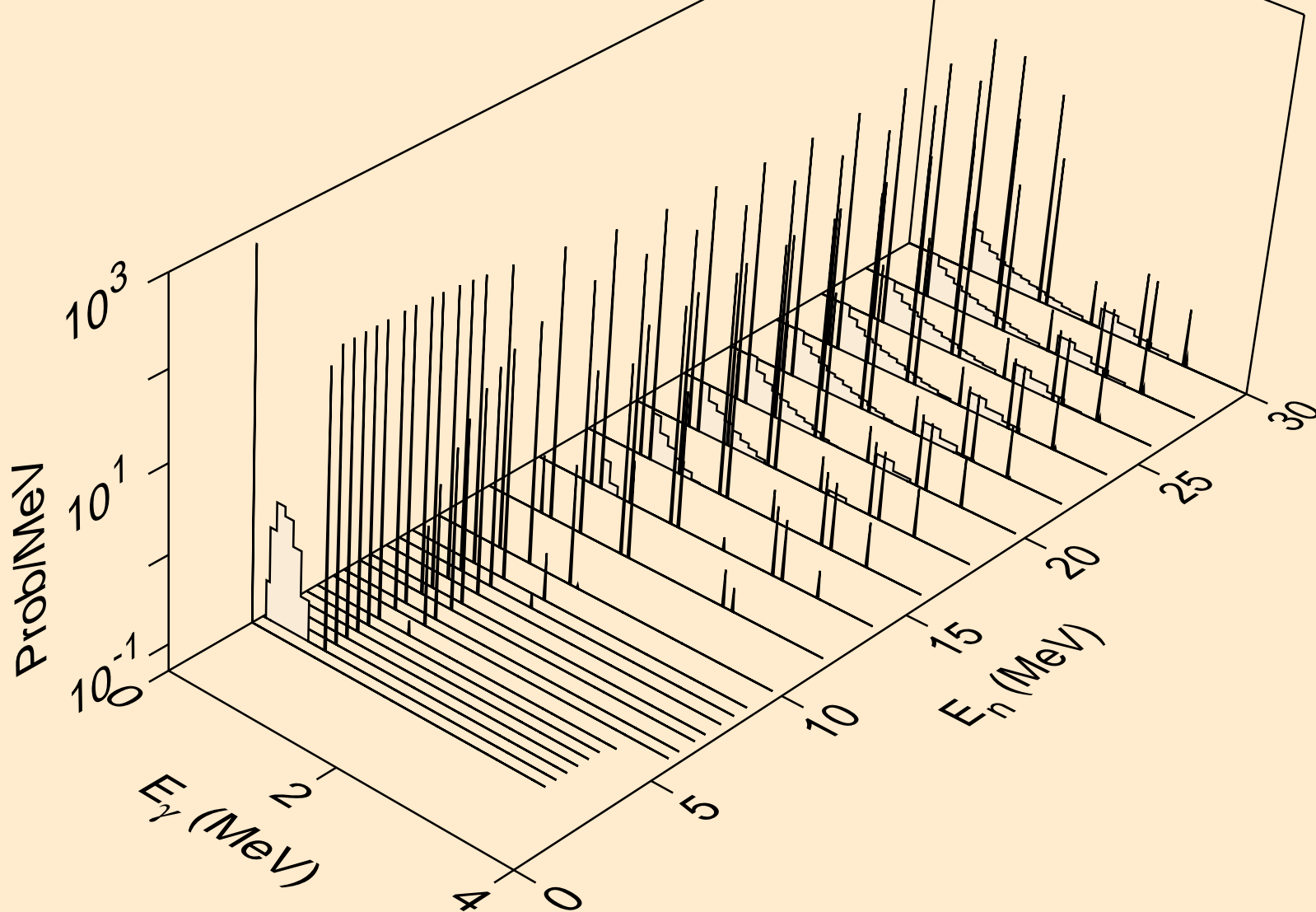

FE052M NEUTRON ACER TENDL-2019 LIBRARY; T=293.16K
Photon emission for (n,2n)a

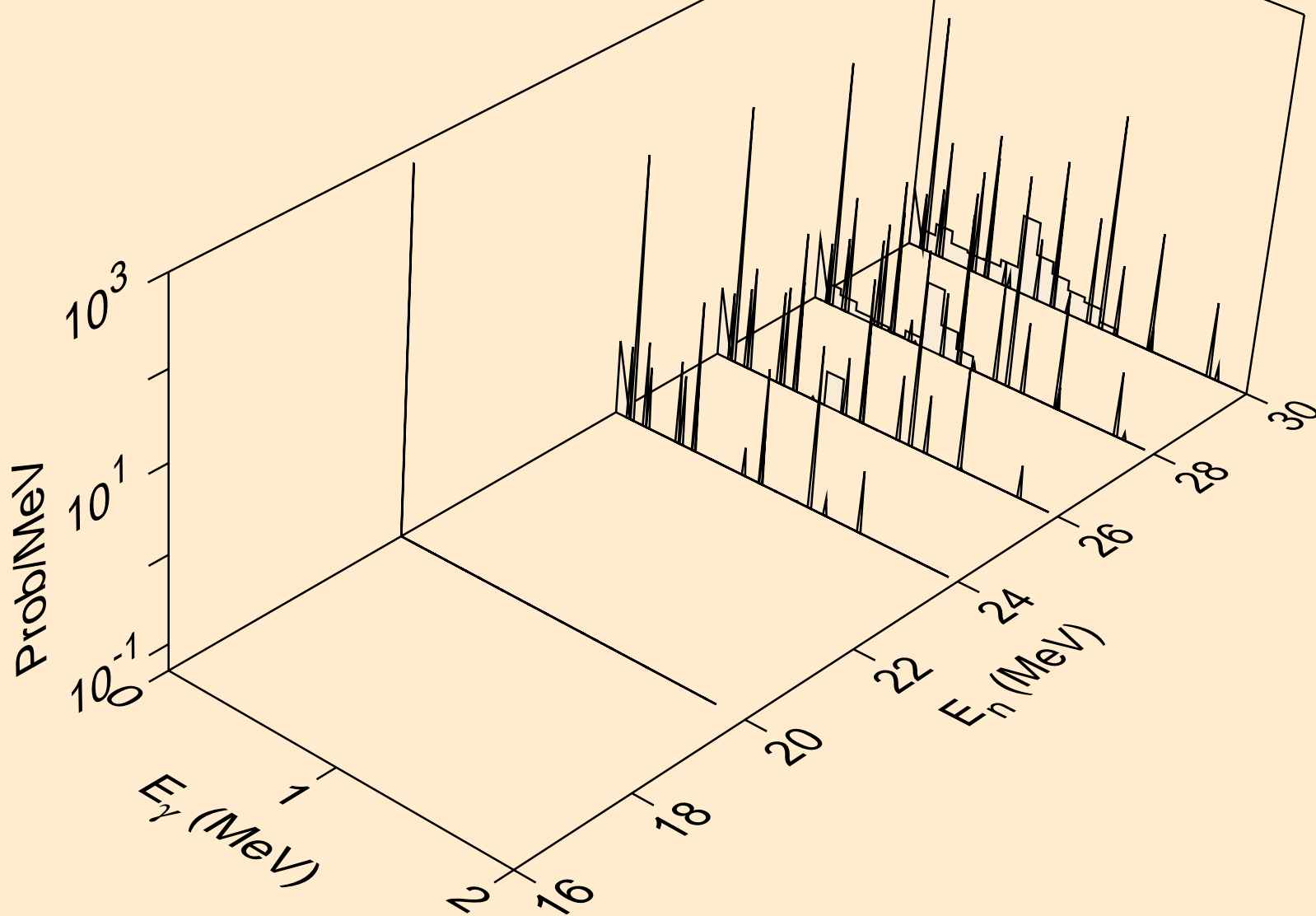

FE052M NEUTRON ACER TENDL-2019 LIBRARY; T=293.16K
Photon emission for (n,n*)p

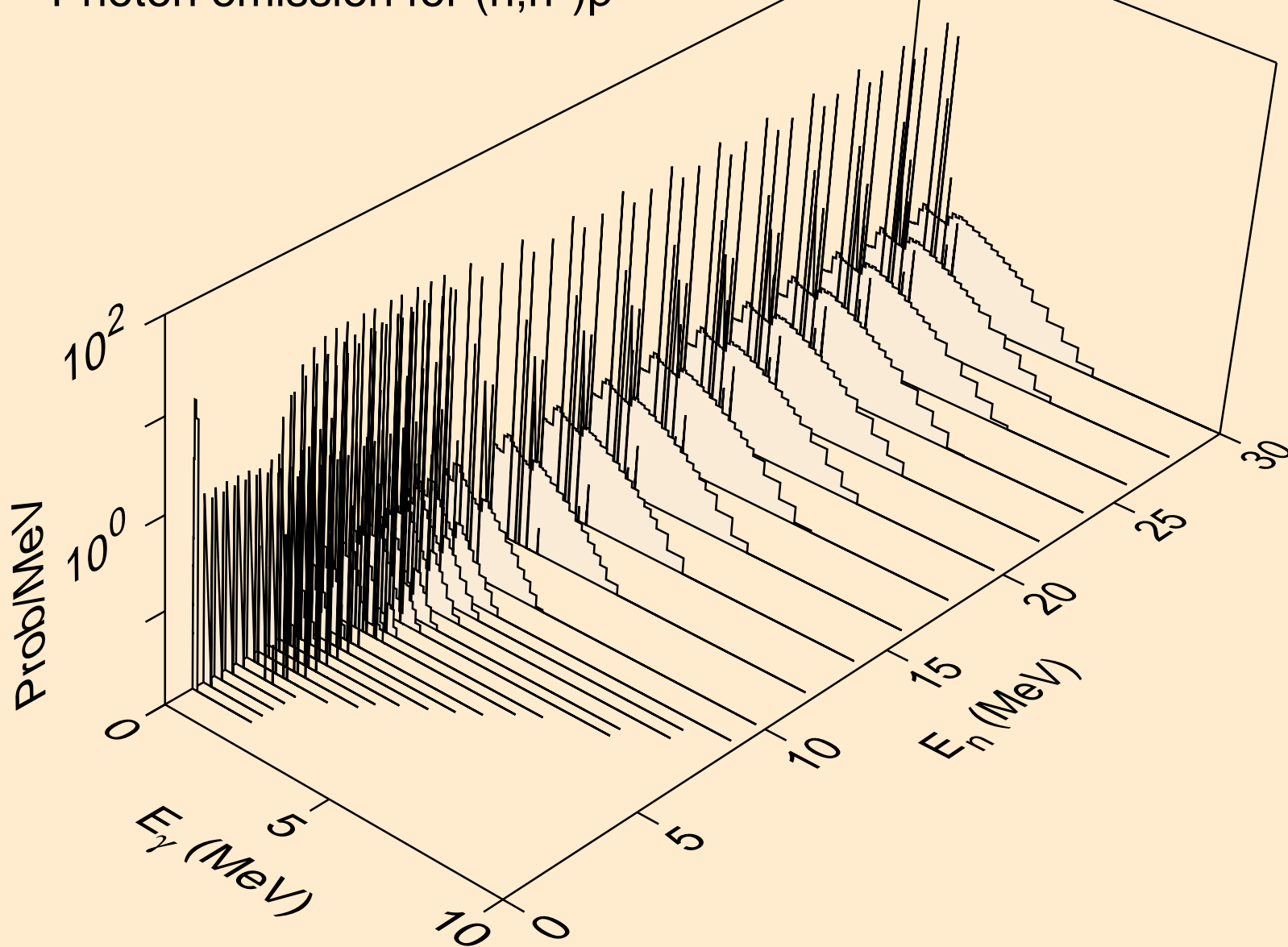

FE052M NEUTRON ACER TENDL-2019 LIBRARY; T=293.16K
Photon emission for (n,n*)2a

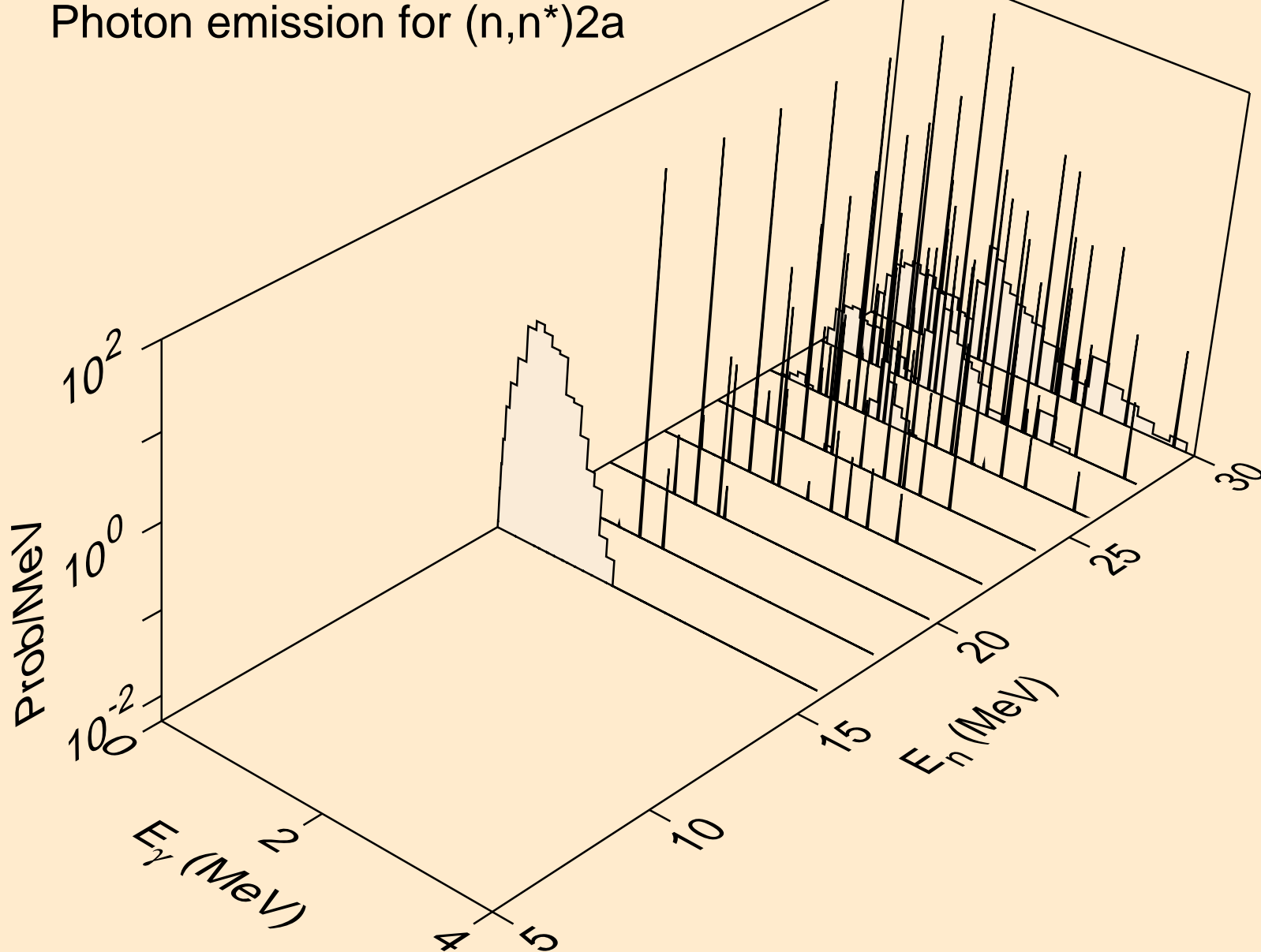

FE052M NEUTRON ACER TENDL-2019 LIBRARY; T=293.16K
Photon emission for (n,n*)d

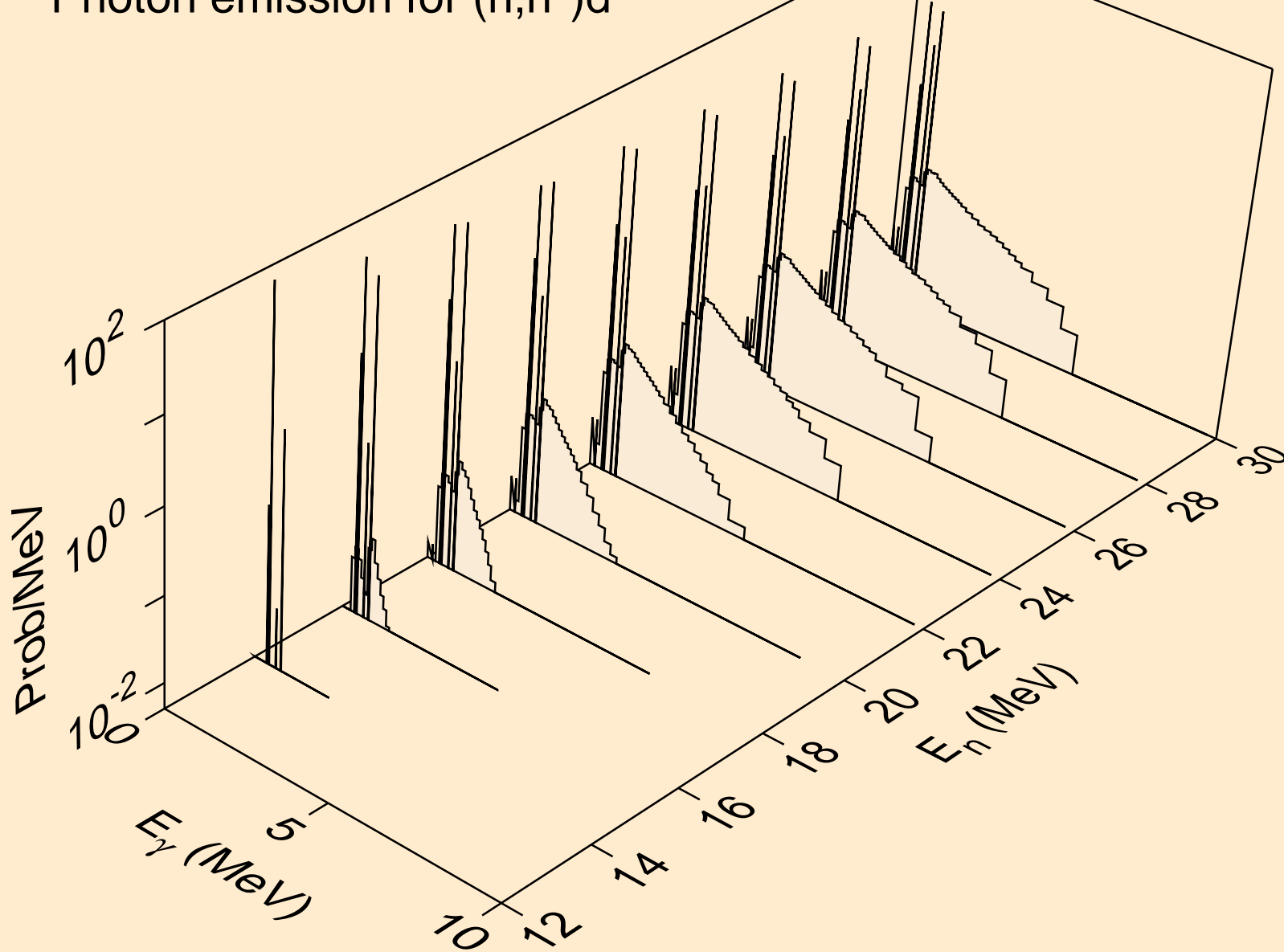

FE052M NEUTRON ACER TENDL-2019 LIBRARY; T=293.16K
Photon emission for (n,n*)t

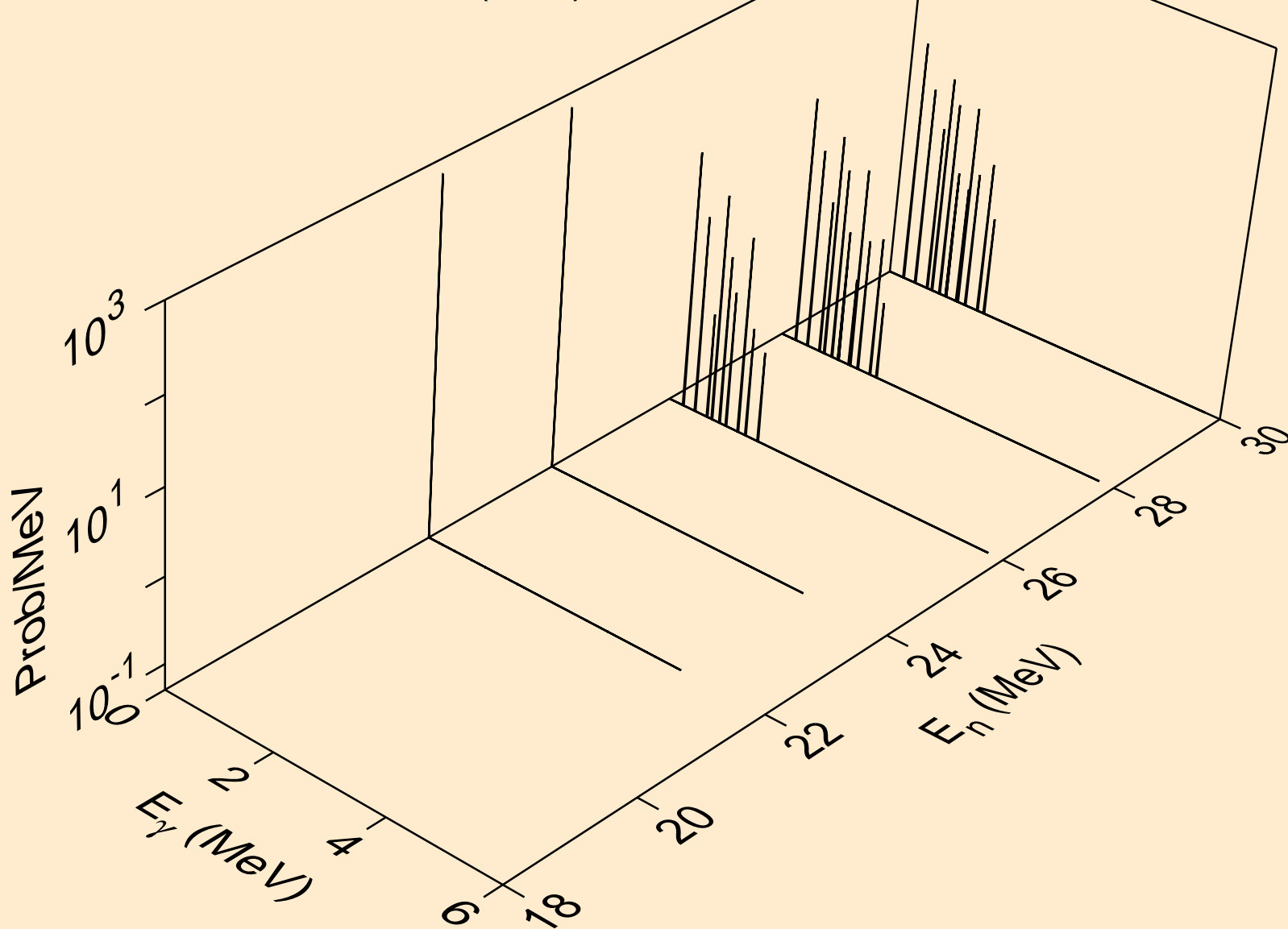

FE052M NEUTRON ACER TENDL-2019 LIBRARY; T=293.16K
Photon emission for (n,n*)he3

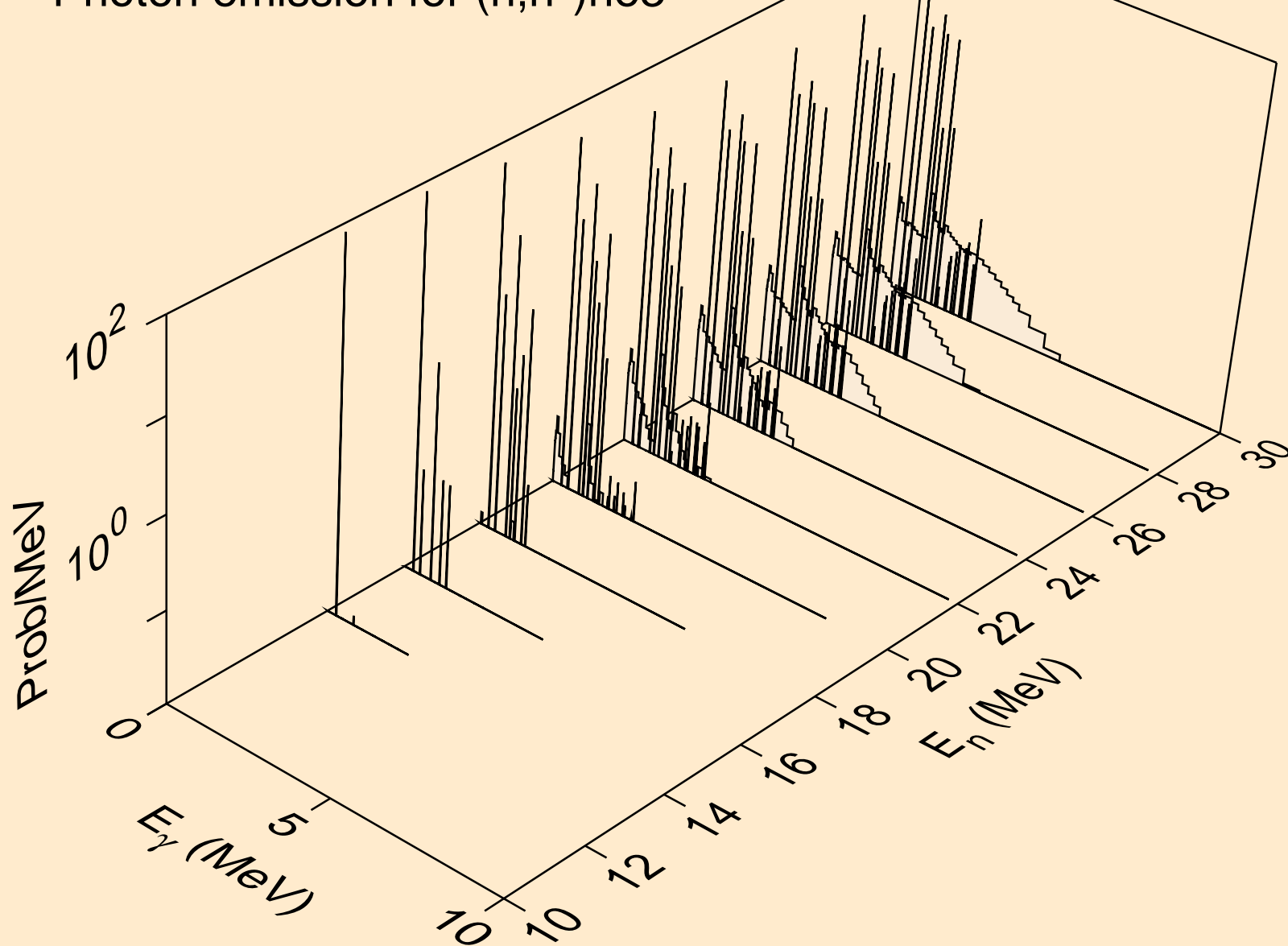

FE052M NEUTRON ACER TENDL-2019 LIBRARY; T=293.16K
Photon emission for (n,2np)

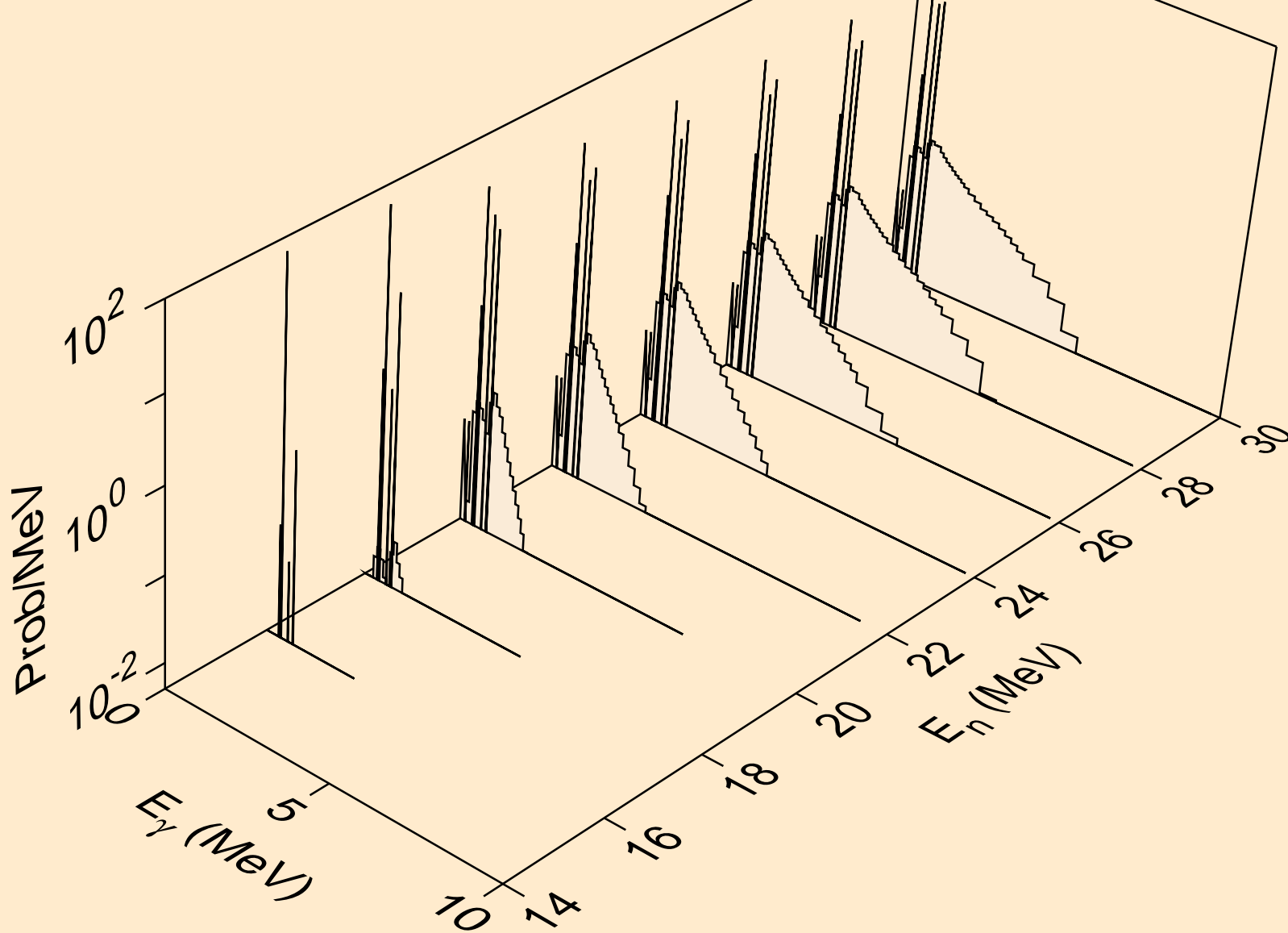

FE052M NEUTRON ACER TENDL-2019 LIBRARY; T=293.16K
Photon emission for (n,2np)

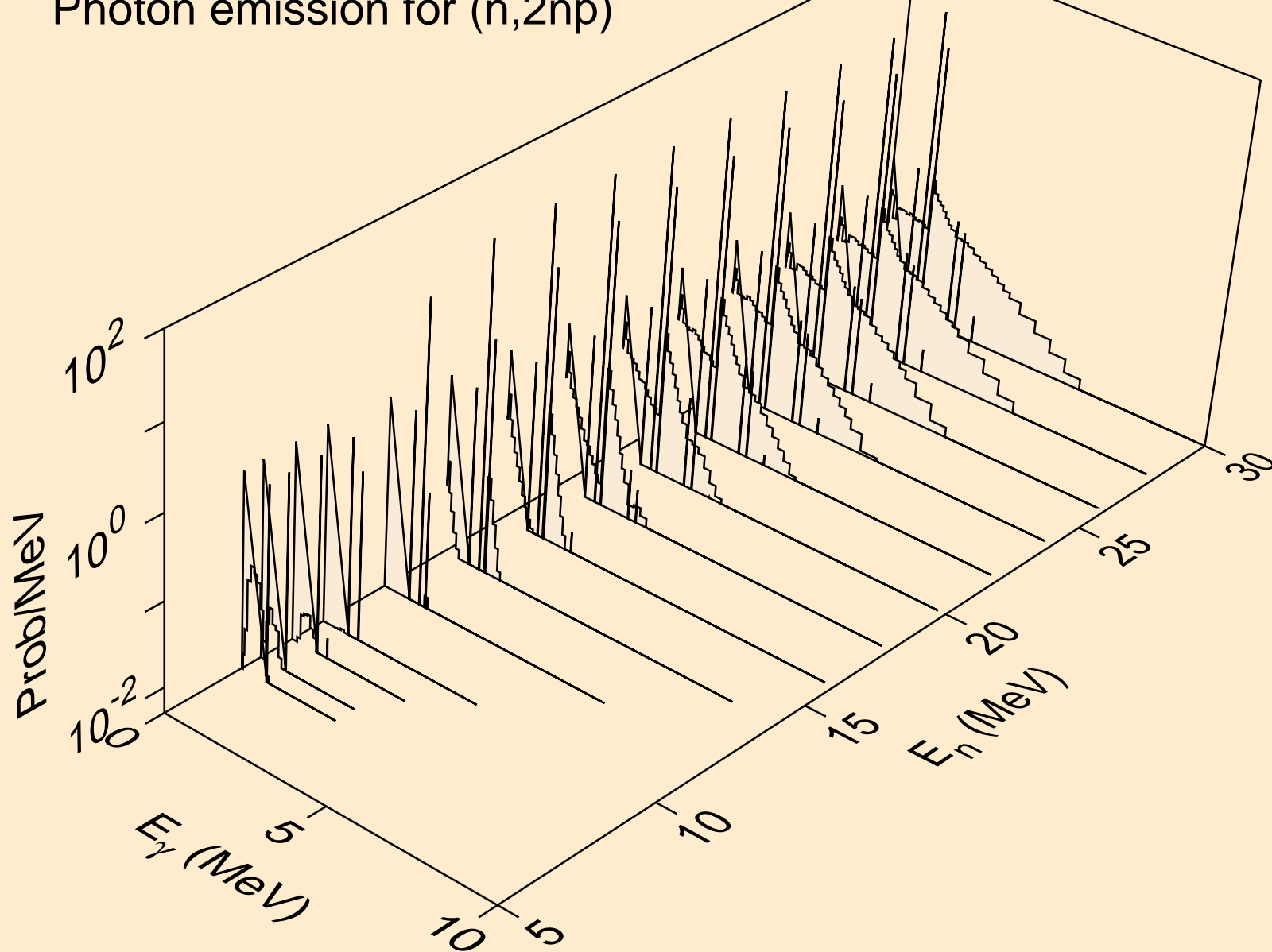

FE052M NEUTRON ACER TENDL-2019 LIBRARY; T=293.16K
Photon emission for (n,npa)

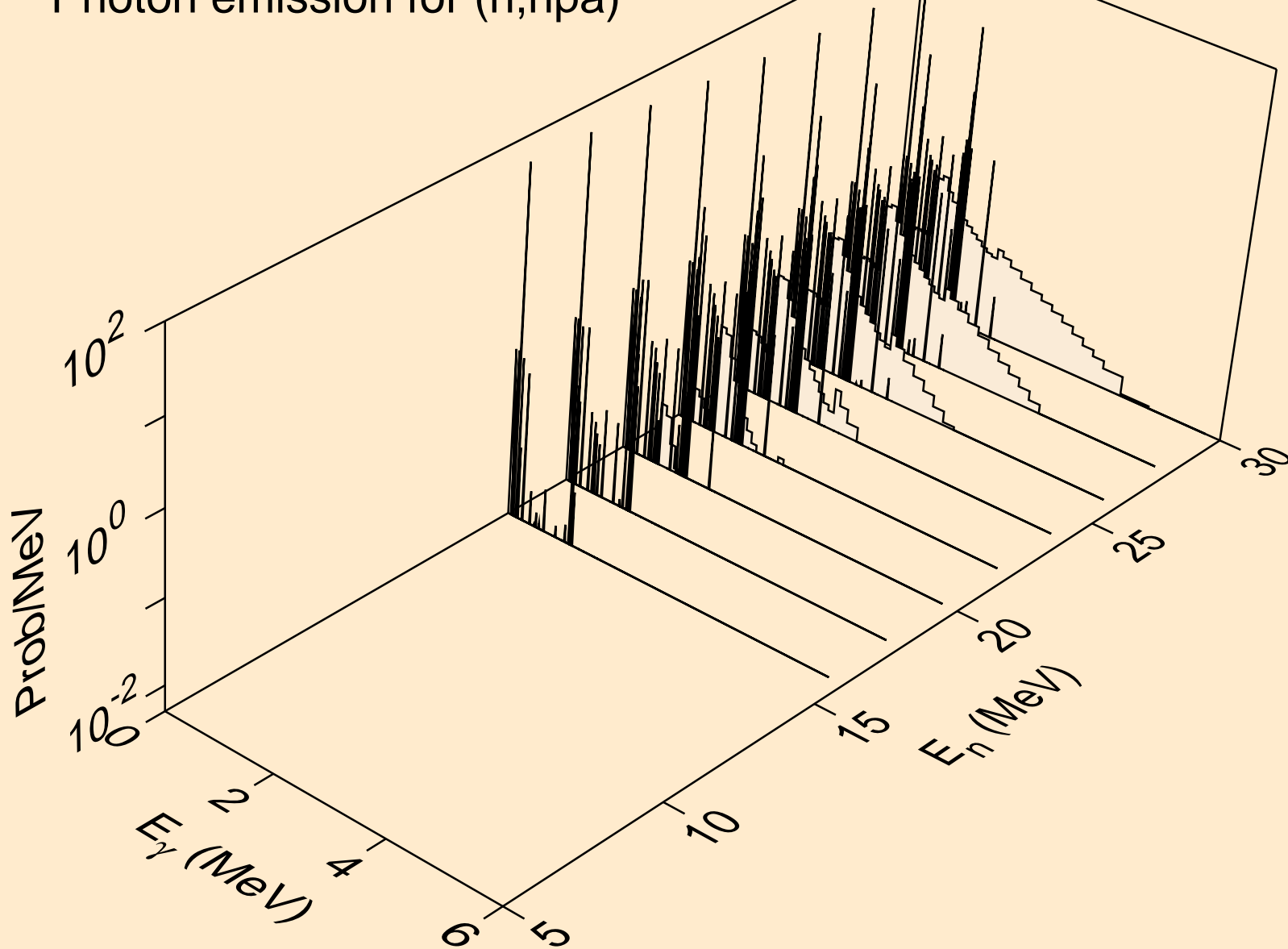

FE052M NEUTRON ACER TENDL-2019 LIBRARY; T=293.16K
Photon emission for (n,n*1)

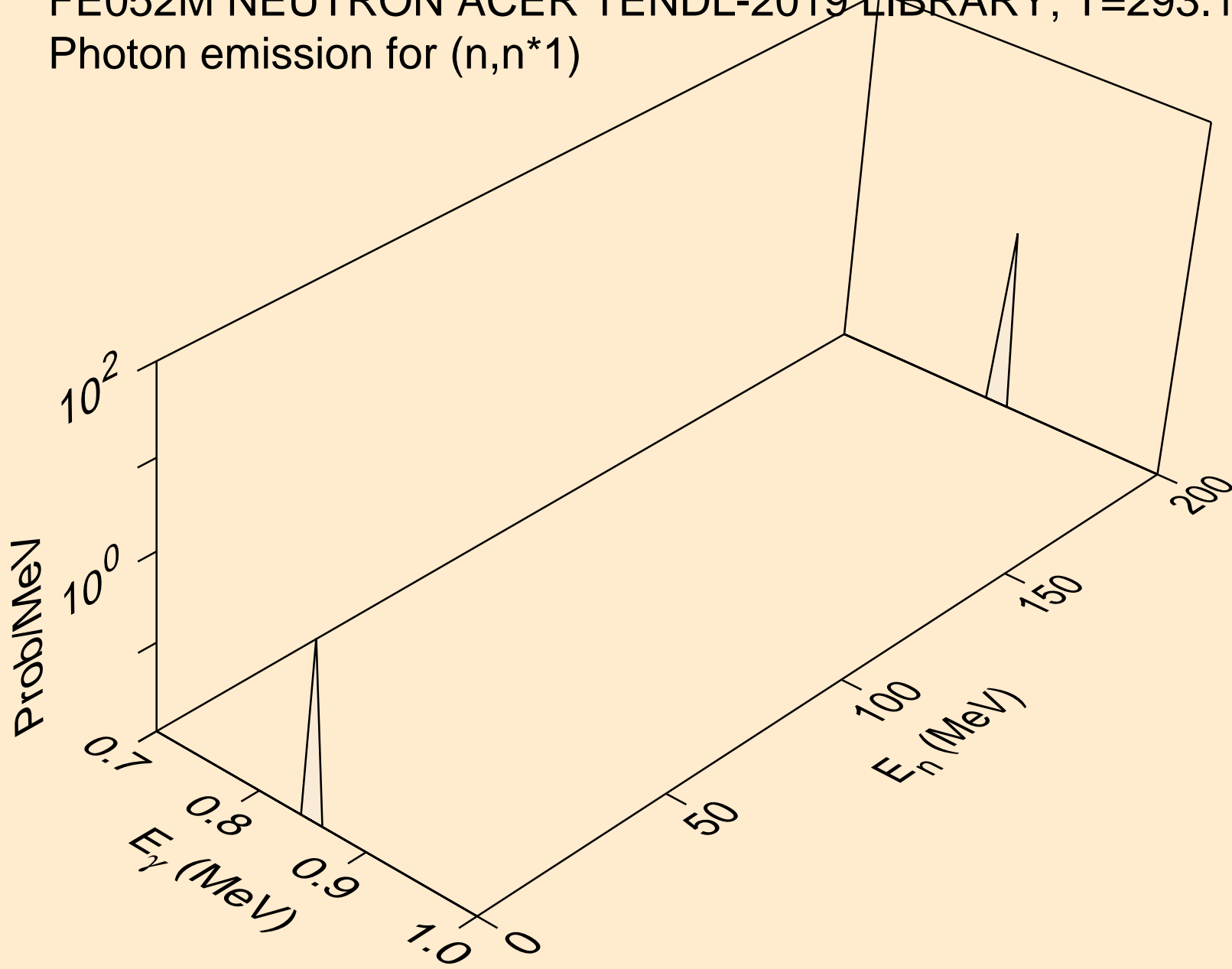

FE052M NEUTRON ACER TENDL-2019 LIBRARY; T=293.16K
Photon emission for (n,n*2)

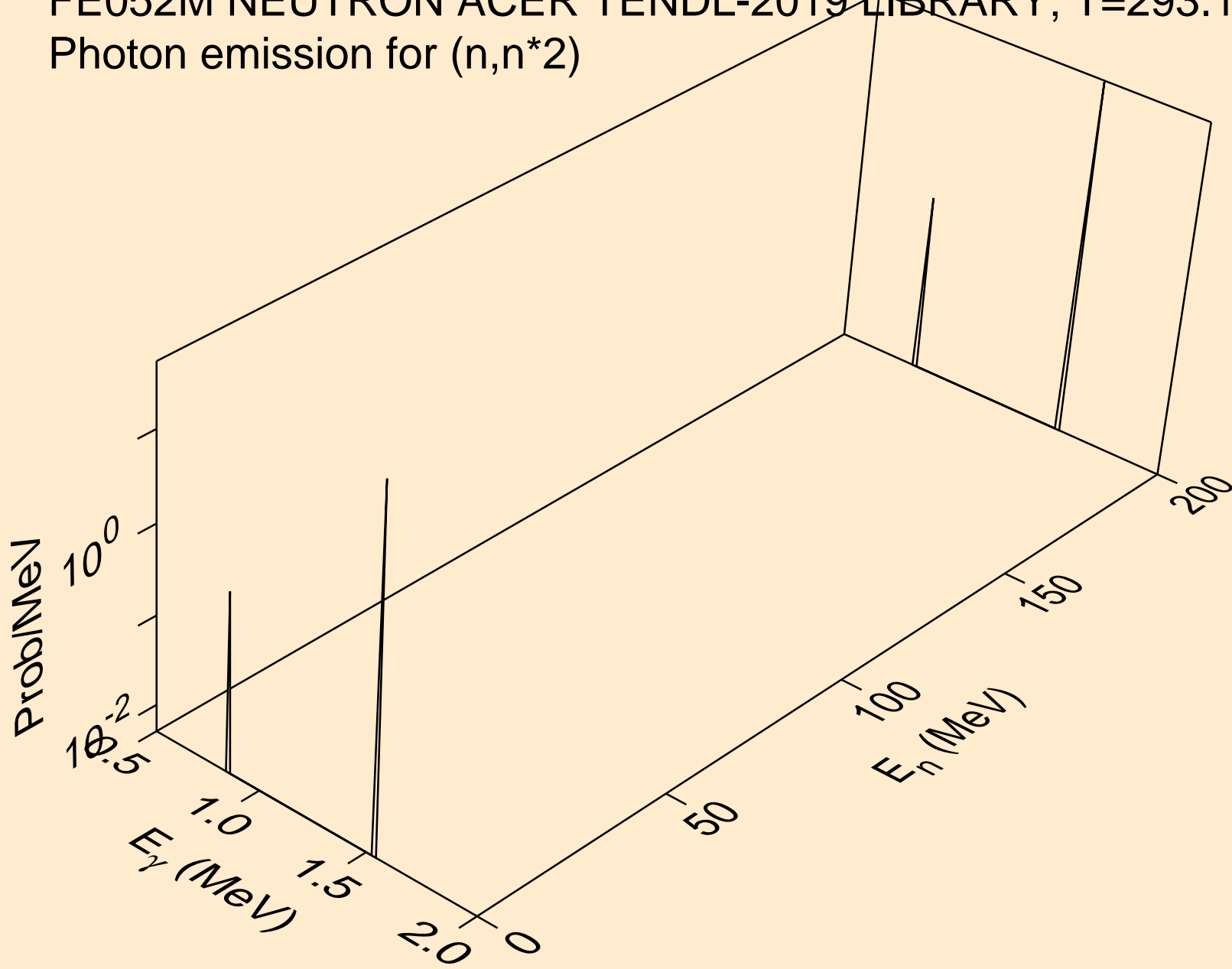

FE052M NEUTRON ACER TENDL-2019 LIBRARY; T=293.16K
Photon emission for (n,n*3)

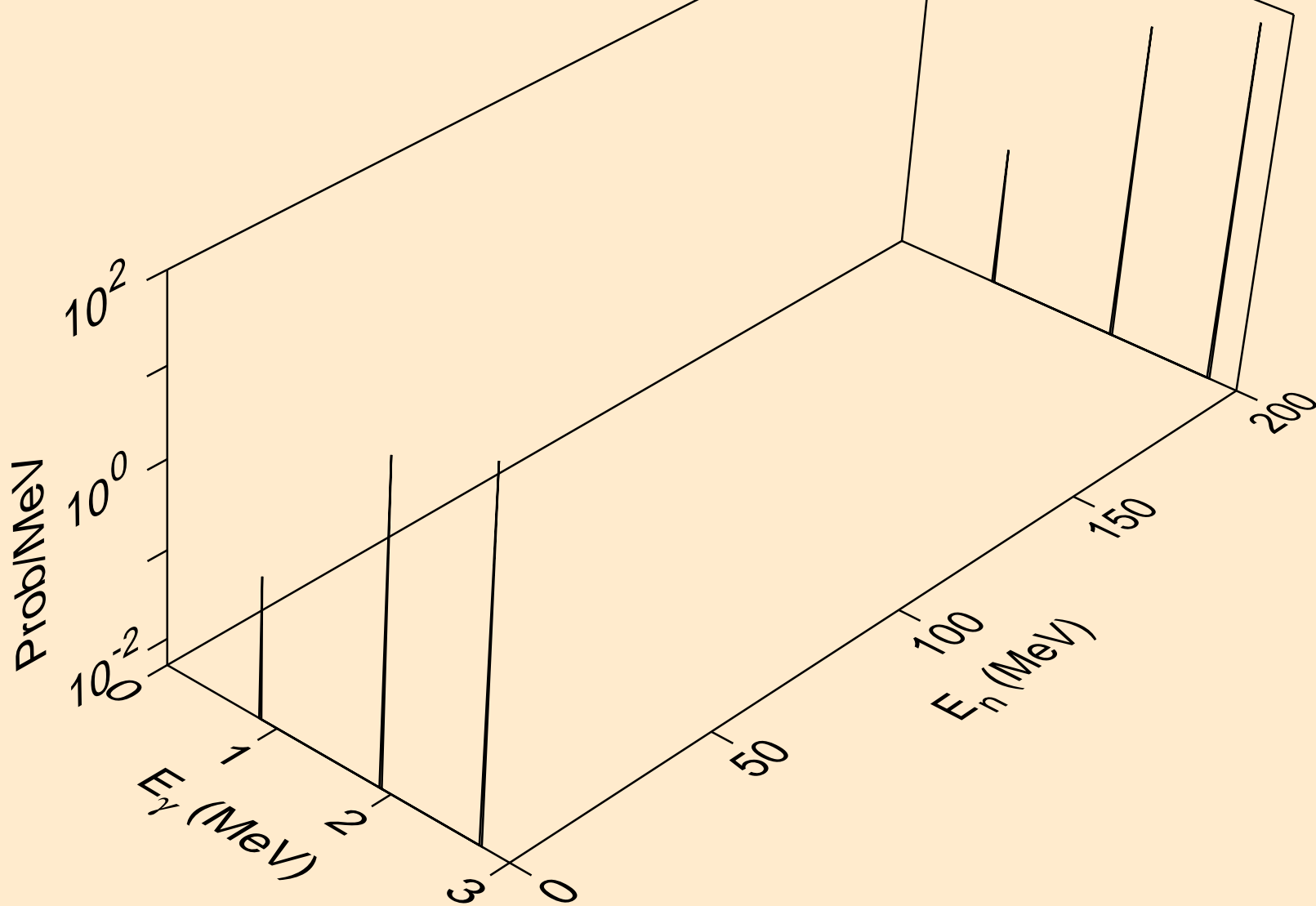

FE052M NEUTRON ACER TENDL-2019 LIBRARY; T=293.16K
Photon emission for (n,n*4)

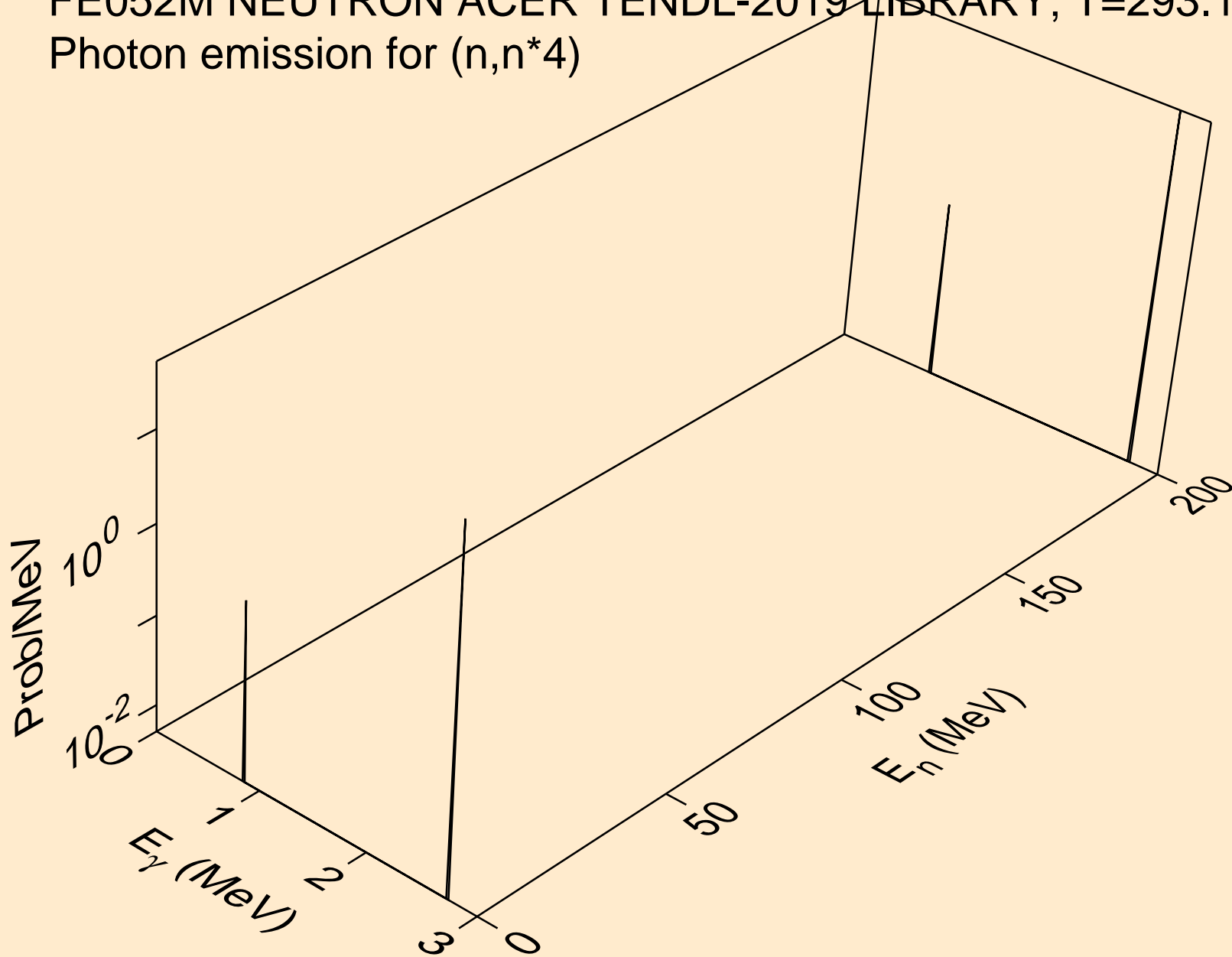

FE052M NEUTRON ACER TENDL-2019 LIBRARY; T=293.16K
Photon emission for (n,n*5)

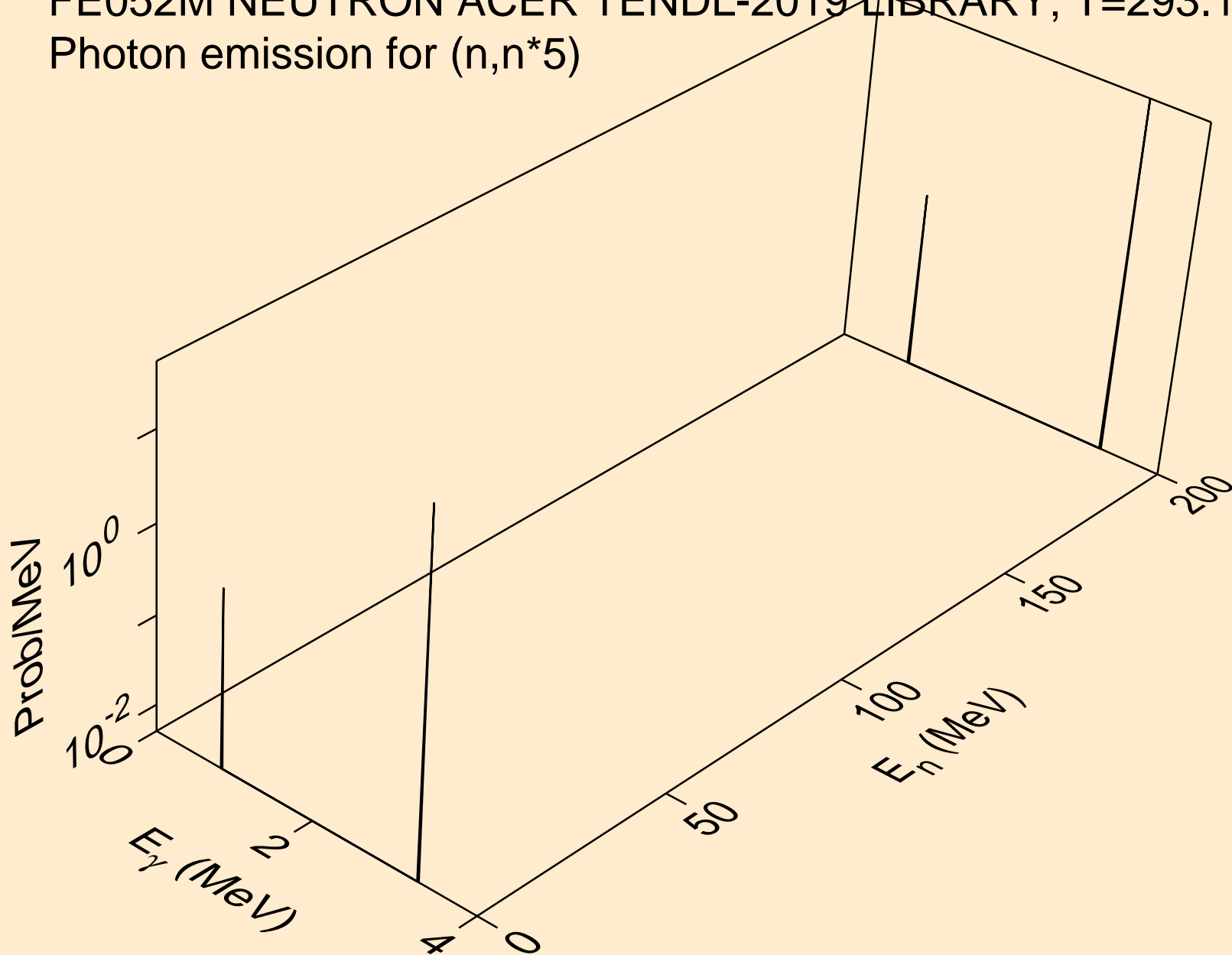

FE052M NEUTRON ACER TENDL-2019 LIBRARY; T=293.16K
Photon emission for (n,n*6)

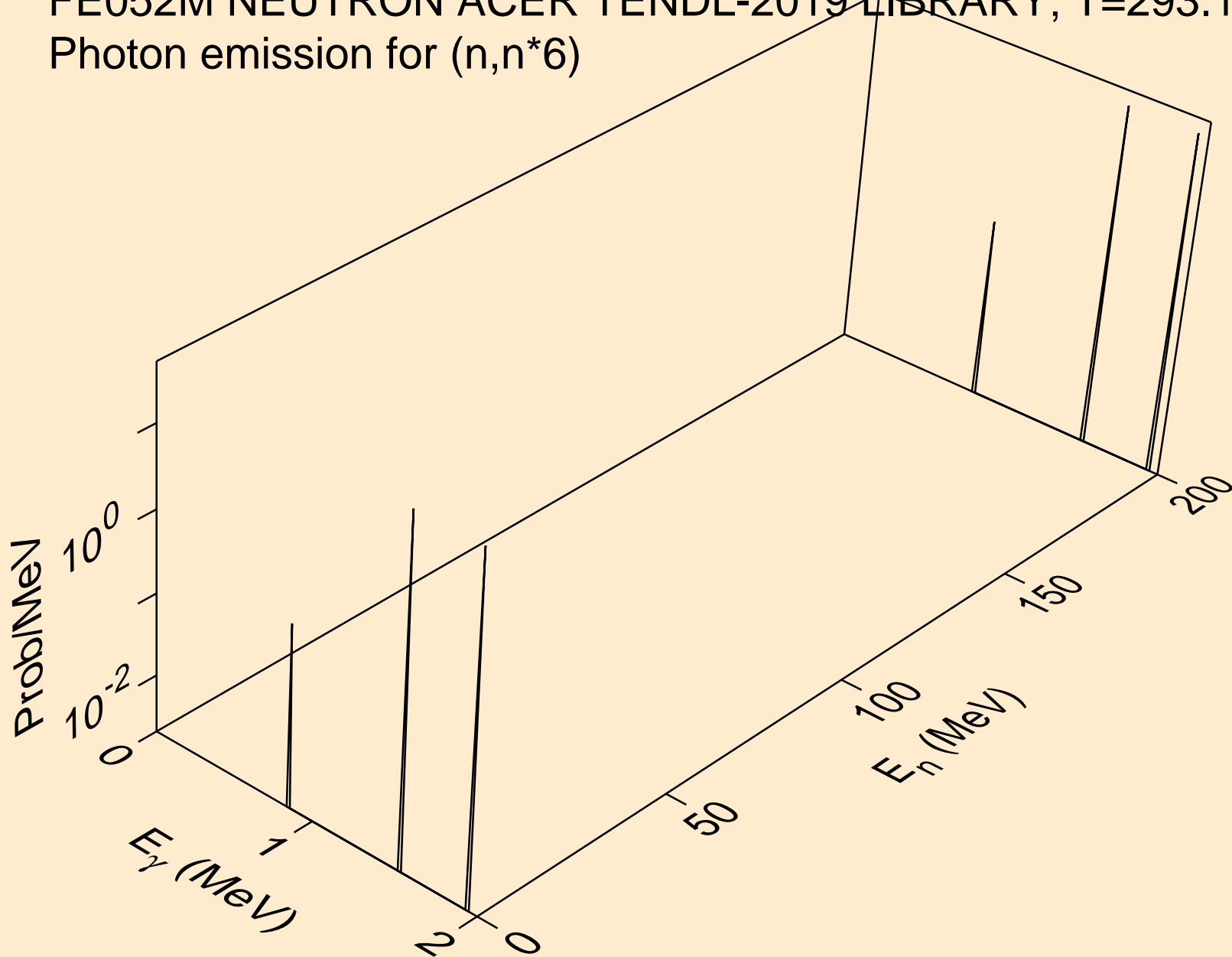

FE052M NEUTRON ACER TENDL-2019 LIBRARY; T=293.16K
Photon emission for (n,n*7)

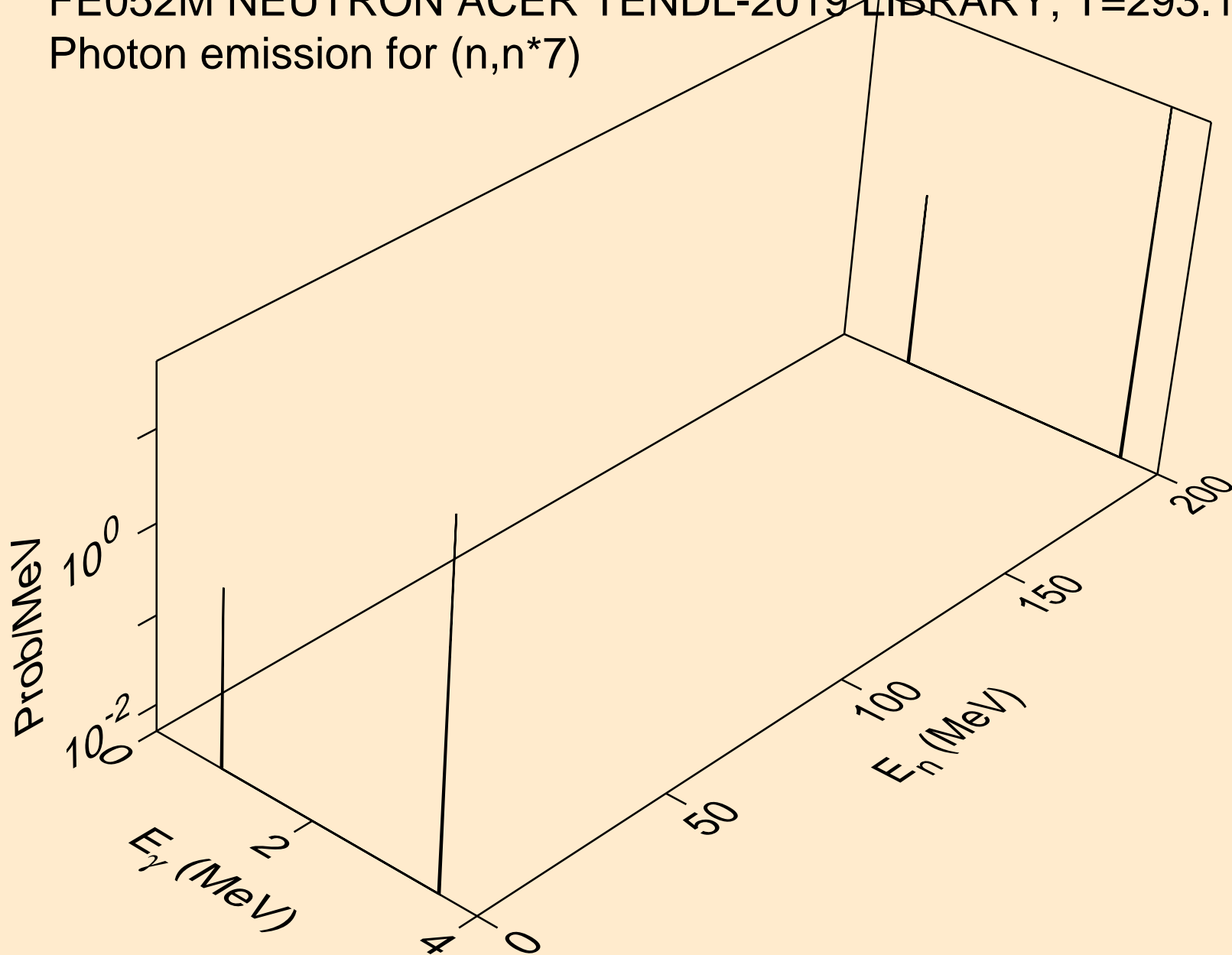

FE052M NEUTRON ACER TENDL-2019 LIBRARY; T=293.16K
Photon emission for (n,n*8)

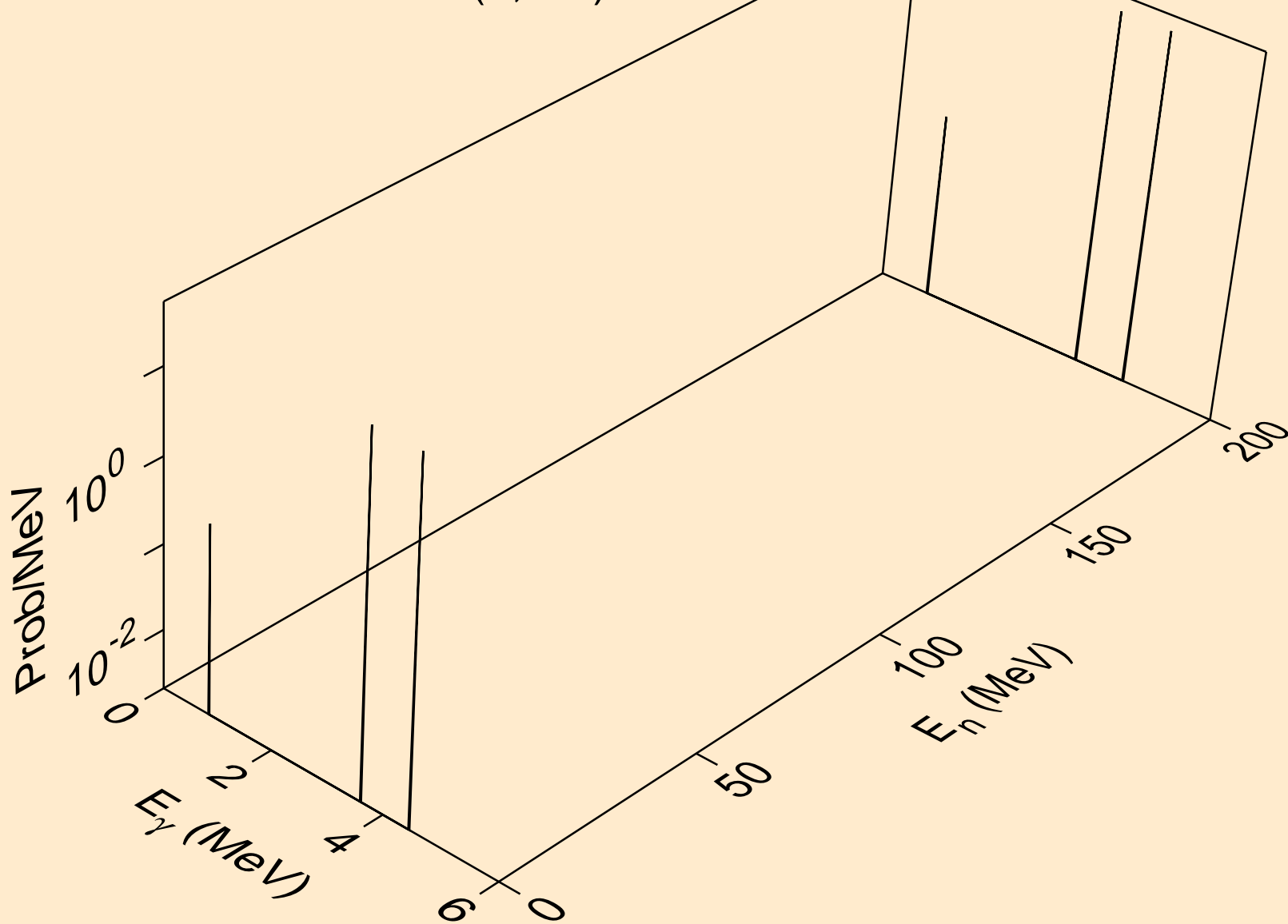

FE052M NEUTRON ACER TENDL-2019 LIBRARY; T=293.16K
Photon emission for (n,n*9)

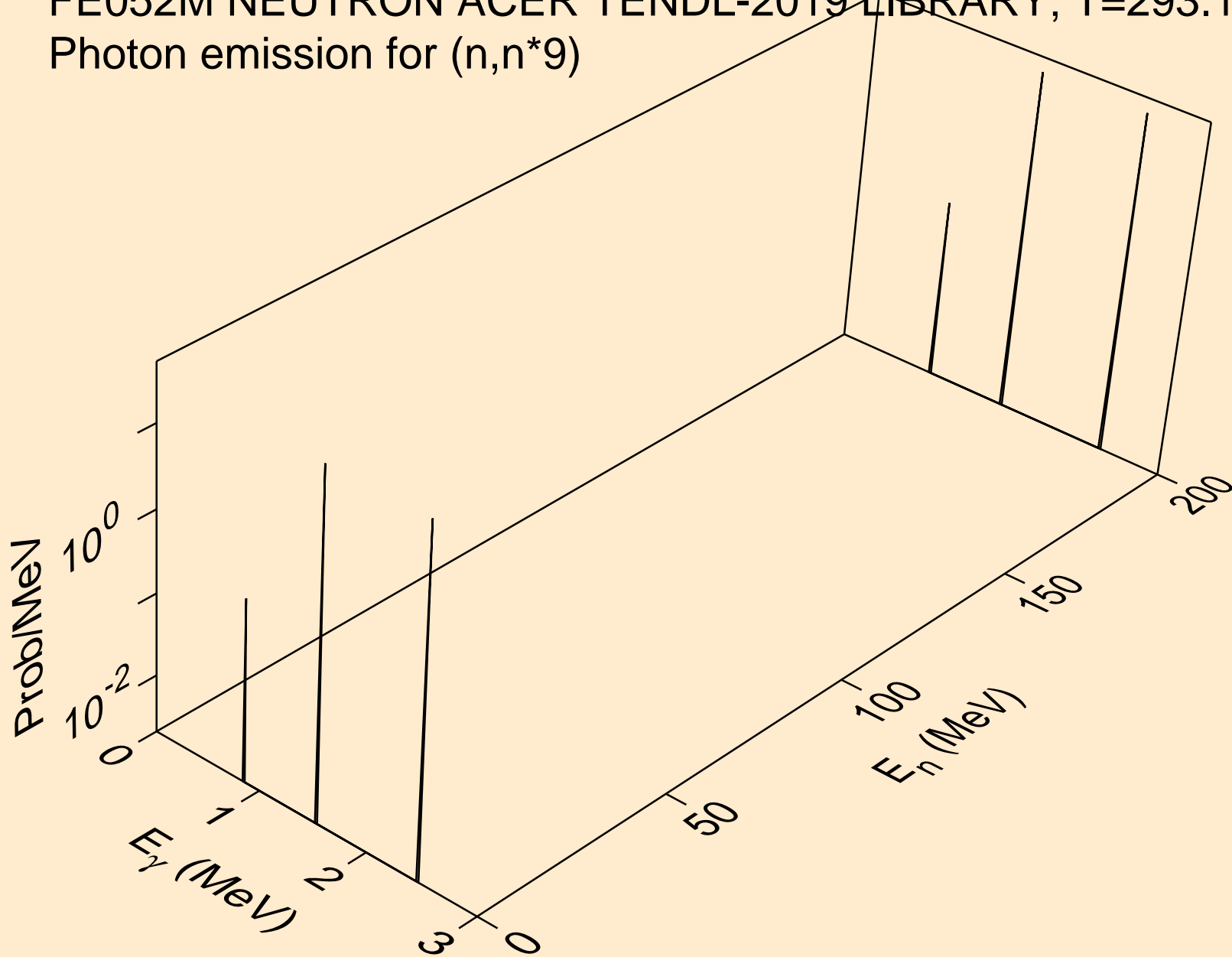

FE052M NEUTRON ACER TENDL-2019 LIBRARY; T=293.16K
Photon emission for (n,n*10)

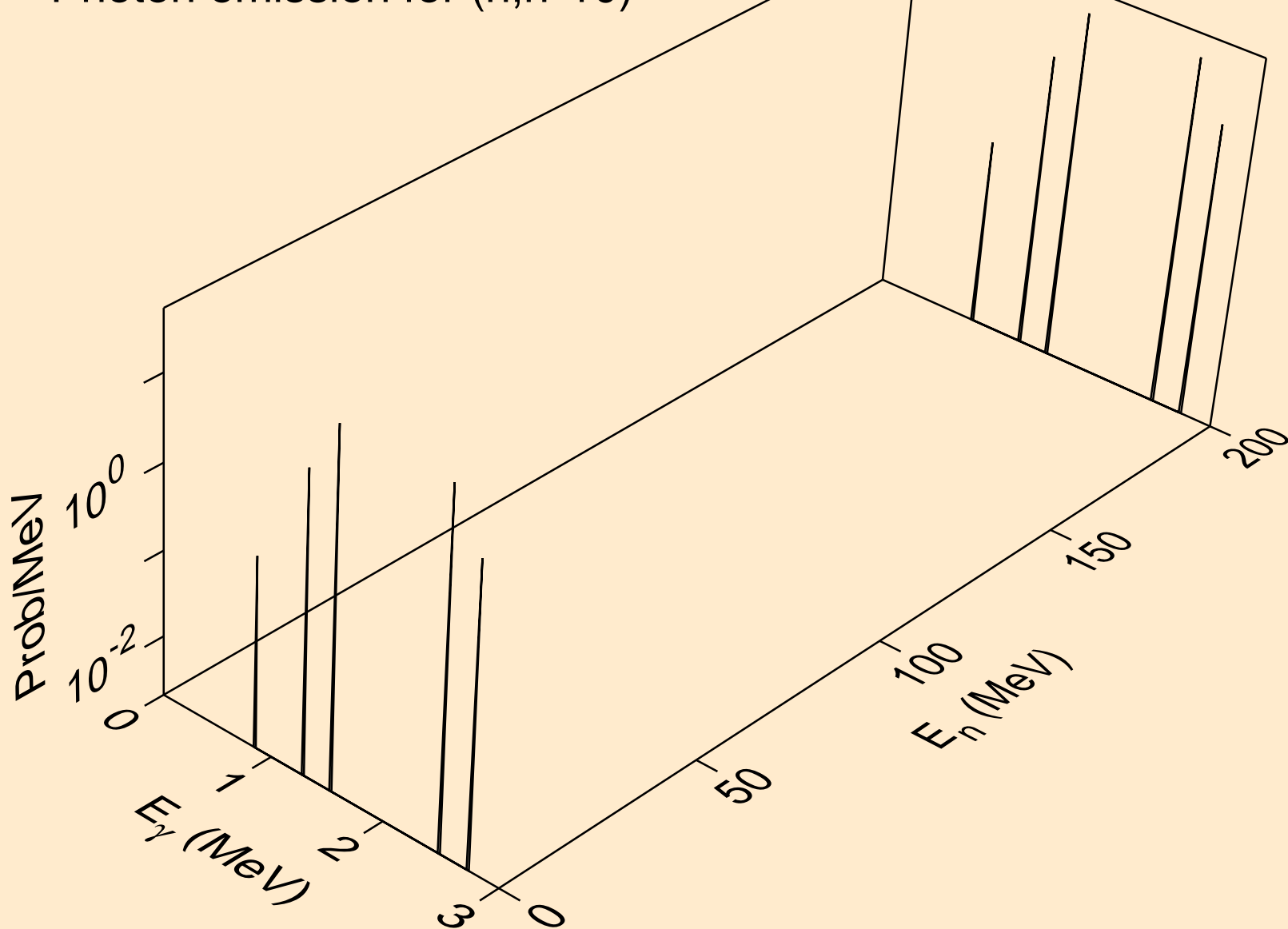

FE052M NEUTRON ACER TENDL-2019 LIBRARY; T=293.16K
Photon emission for (n,n*11)

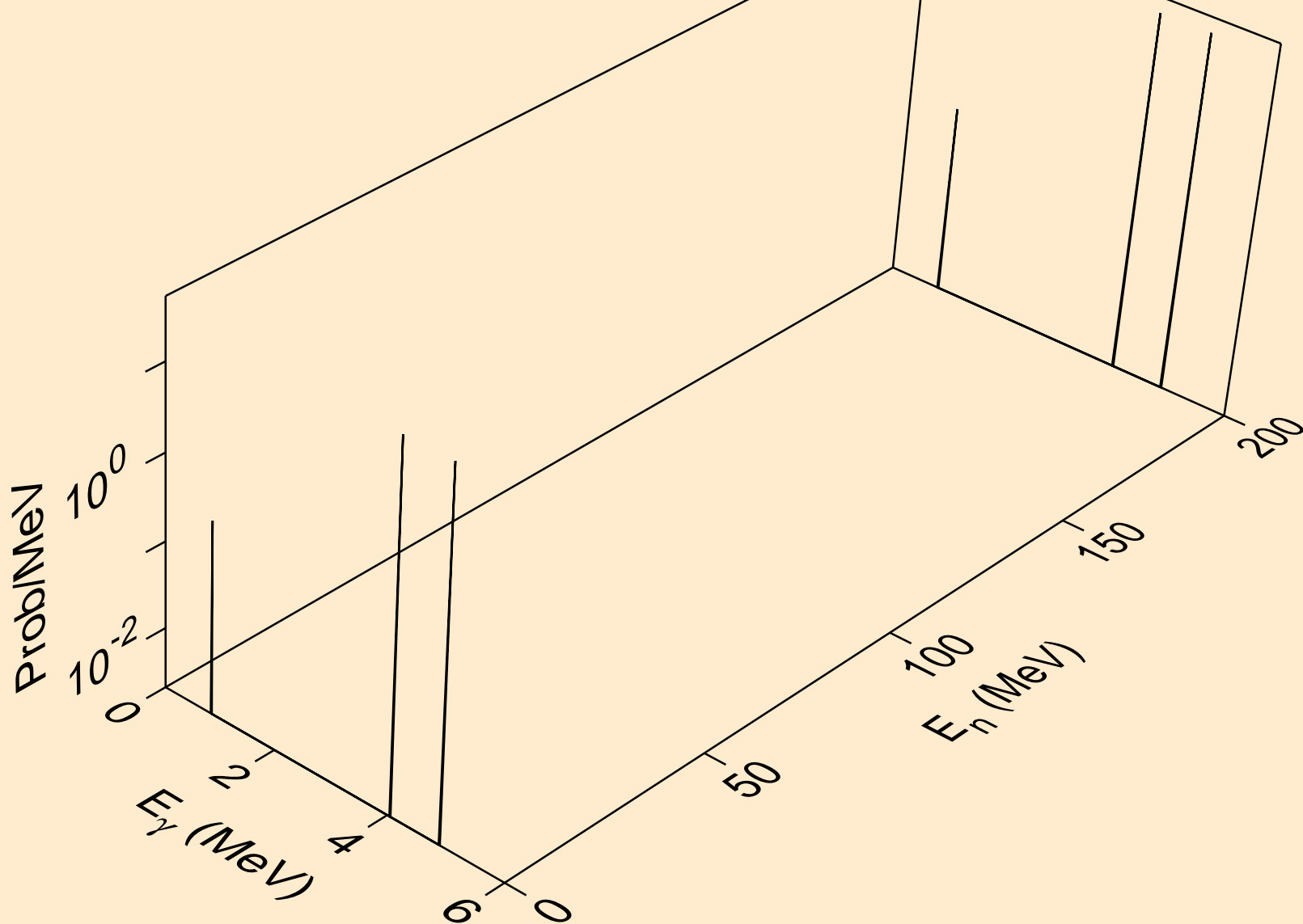

FE052M NEUTRON ACER TENDL-2019 LIBRARY; T=293.16K
Photon emission for (n,n*12)

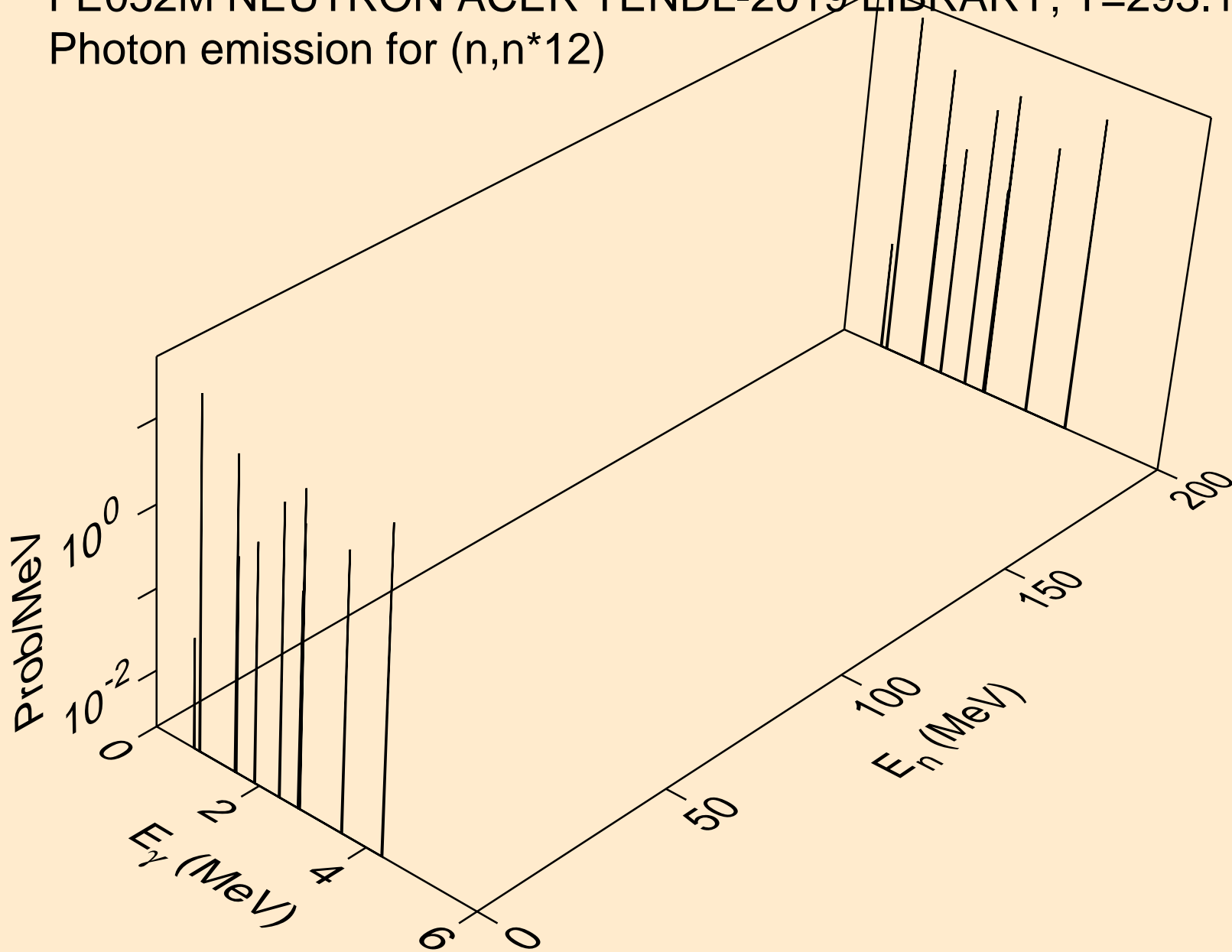

FE052M NEUTRON ACER TENDL-2019 LIBRARY; T=293.16K
Photon emission for (n,n*13)

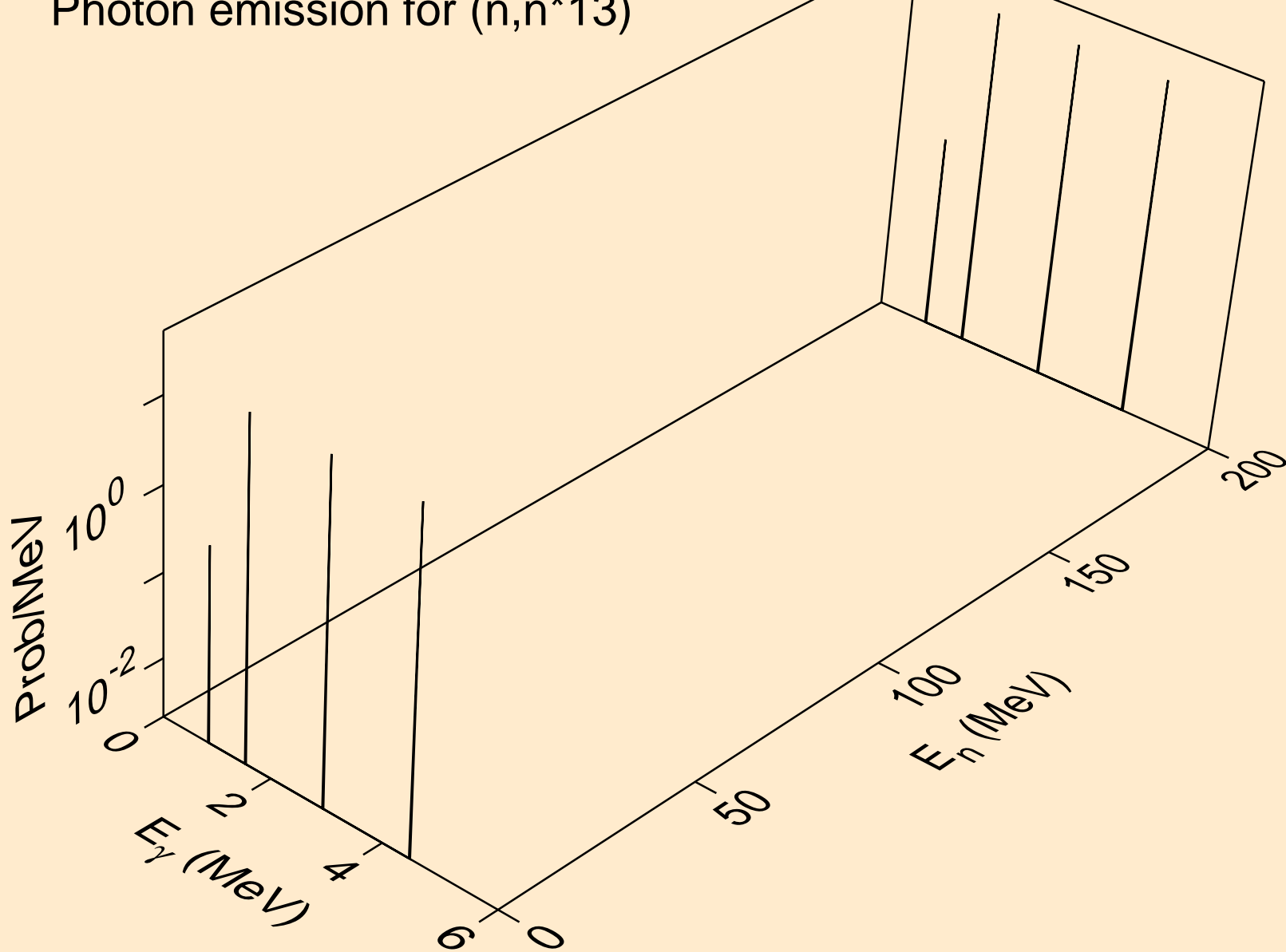

FE052M NEUTRON ACER TENDL-2019 LIBRARY; T=293.16K
Photon emission for (n,n*14)

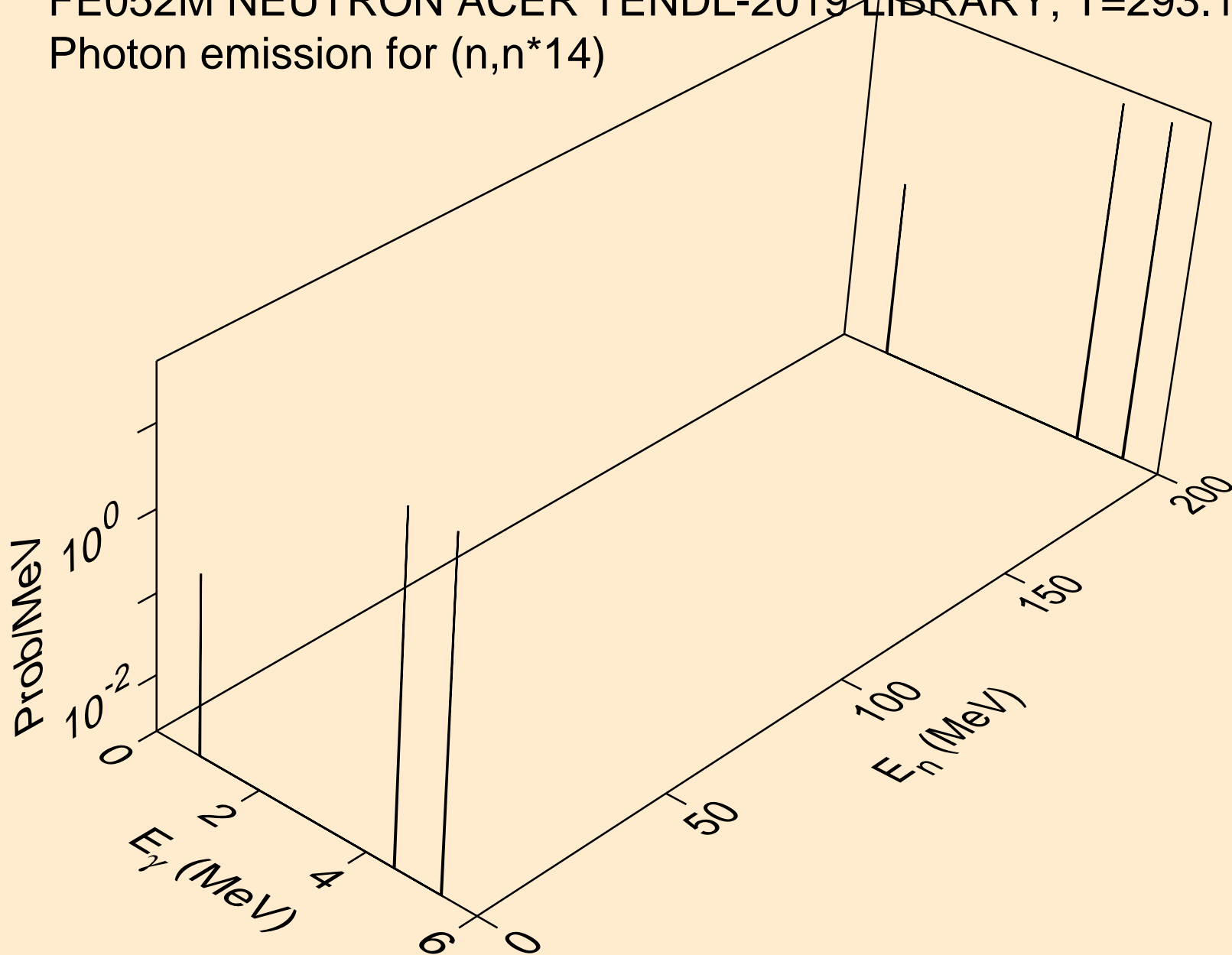

FE052M NEUTRON ACER TENDL-2019 LIBRARY; T=293.16K
Photon emission for (n,n*15)

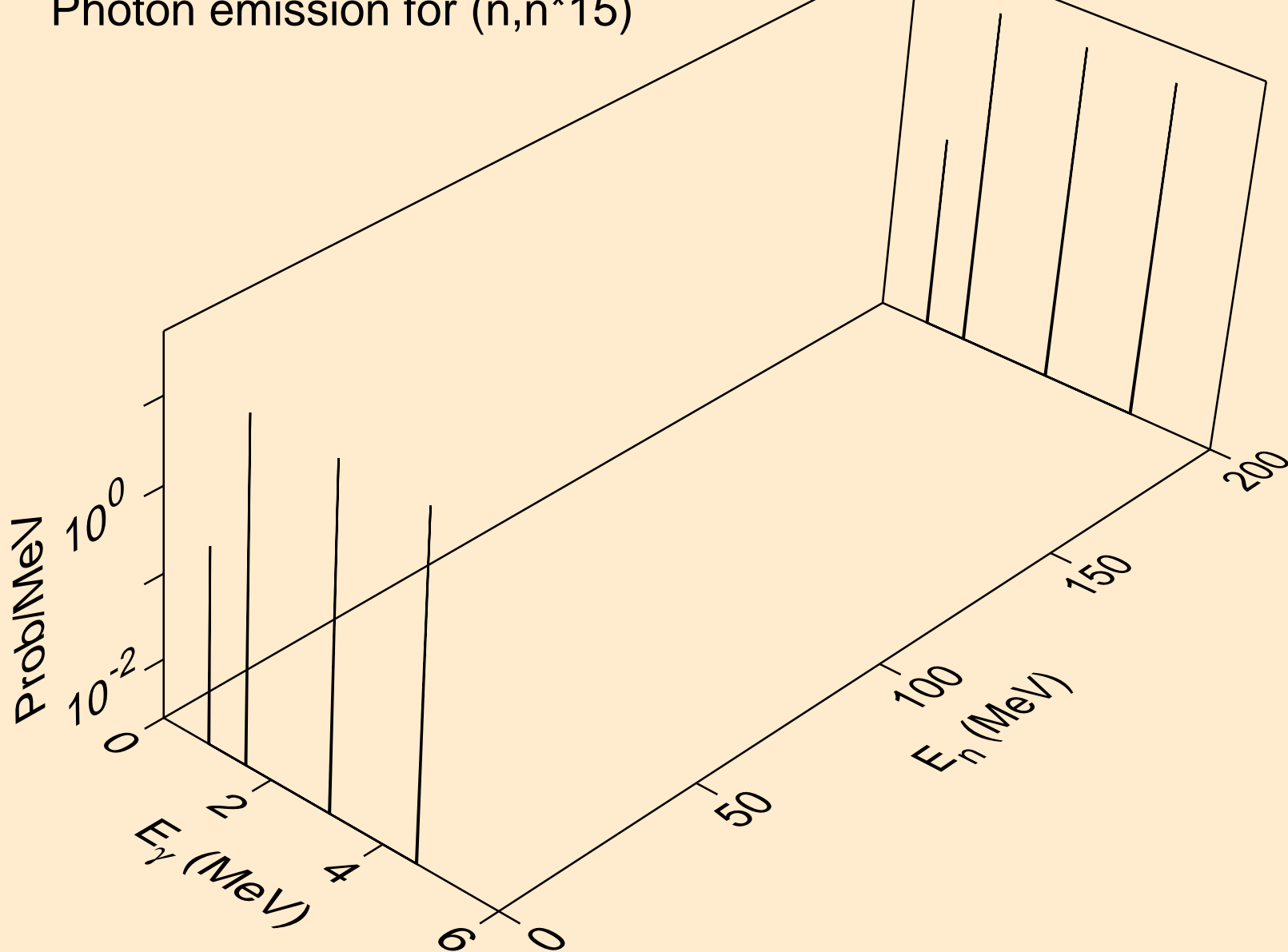

FE052M NEUTRON ACER TENDL-2019 LIBRARY; T=293.16K
Photon emission for (n,n*16)

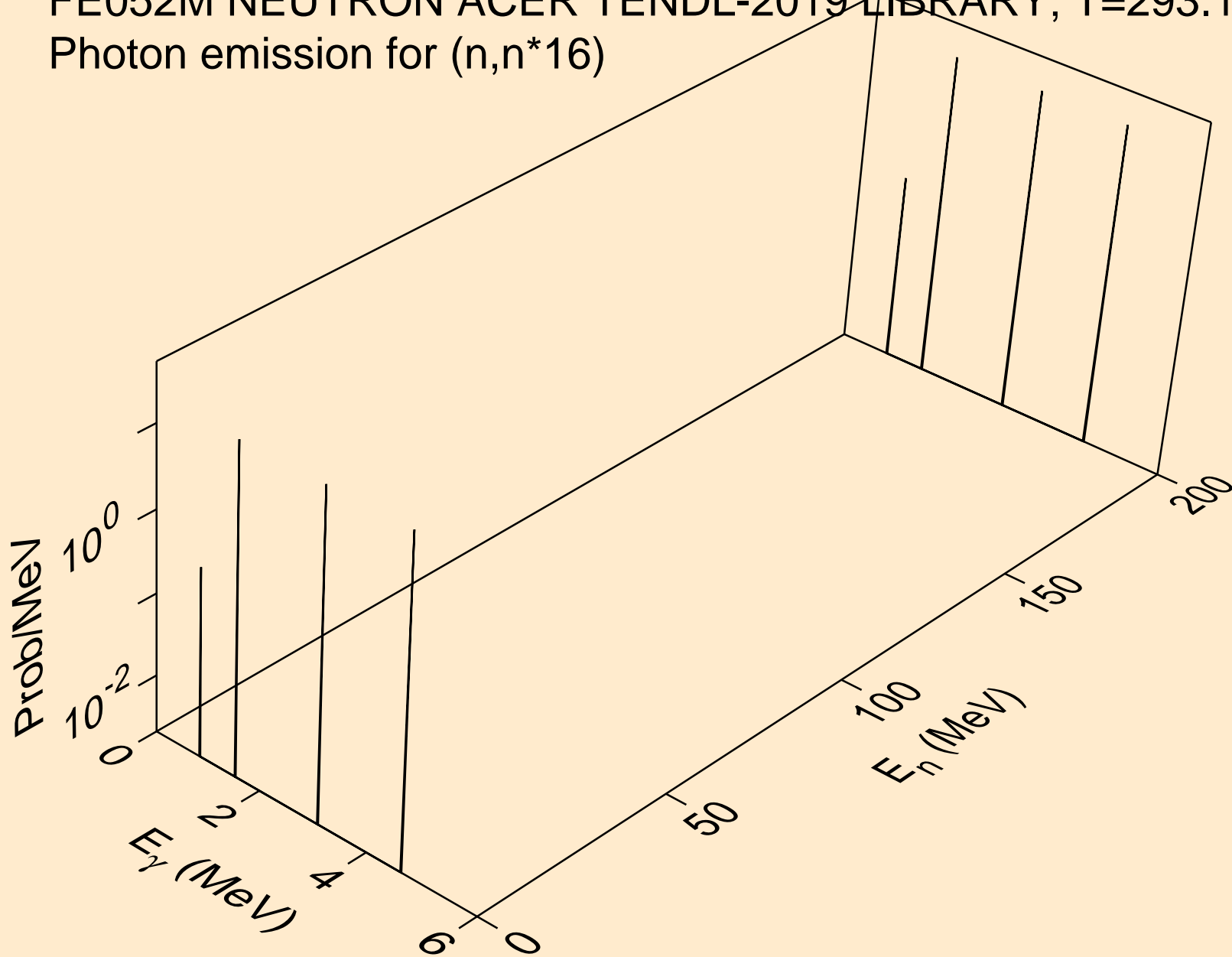

FE052M NEUTRON ACER TENDL-2019 LIBRARY; T=293.16K
Photon emission for (n,n*17)

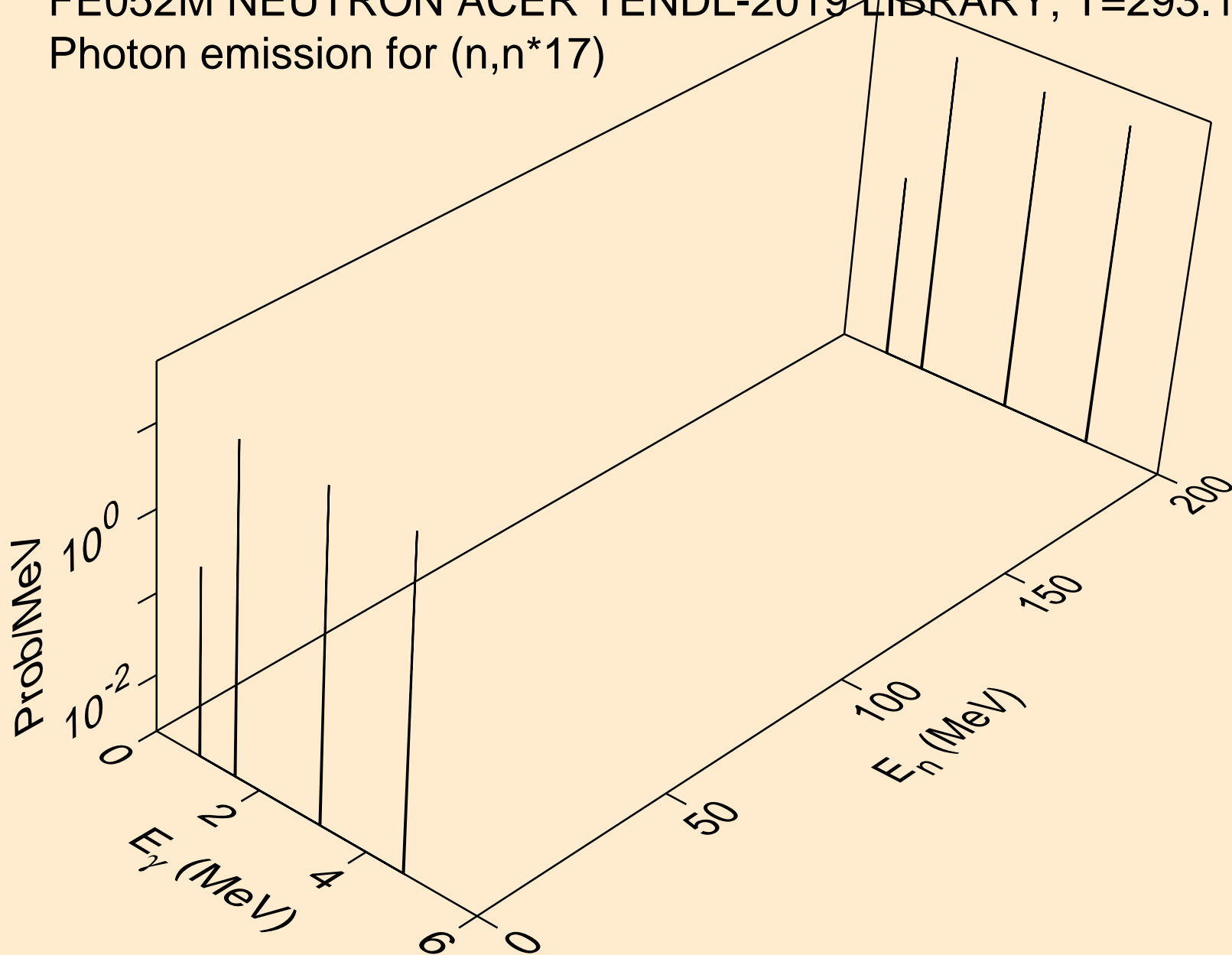

FE052M NEUTRON ACER TENDL-2019 LIBRARY; T=293.16K
Photon emission for (n,n*18)

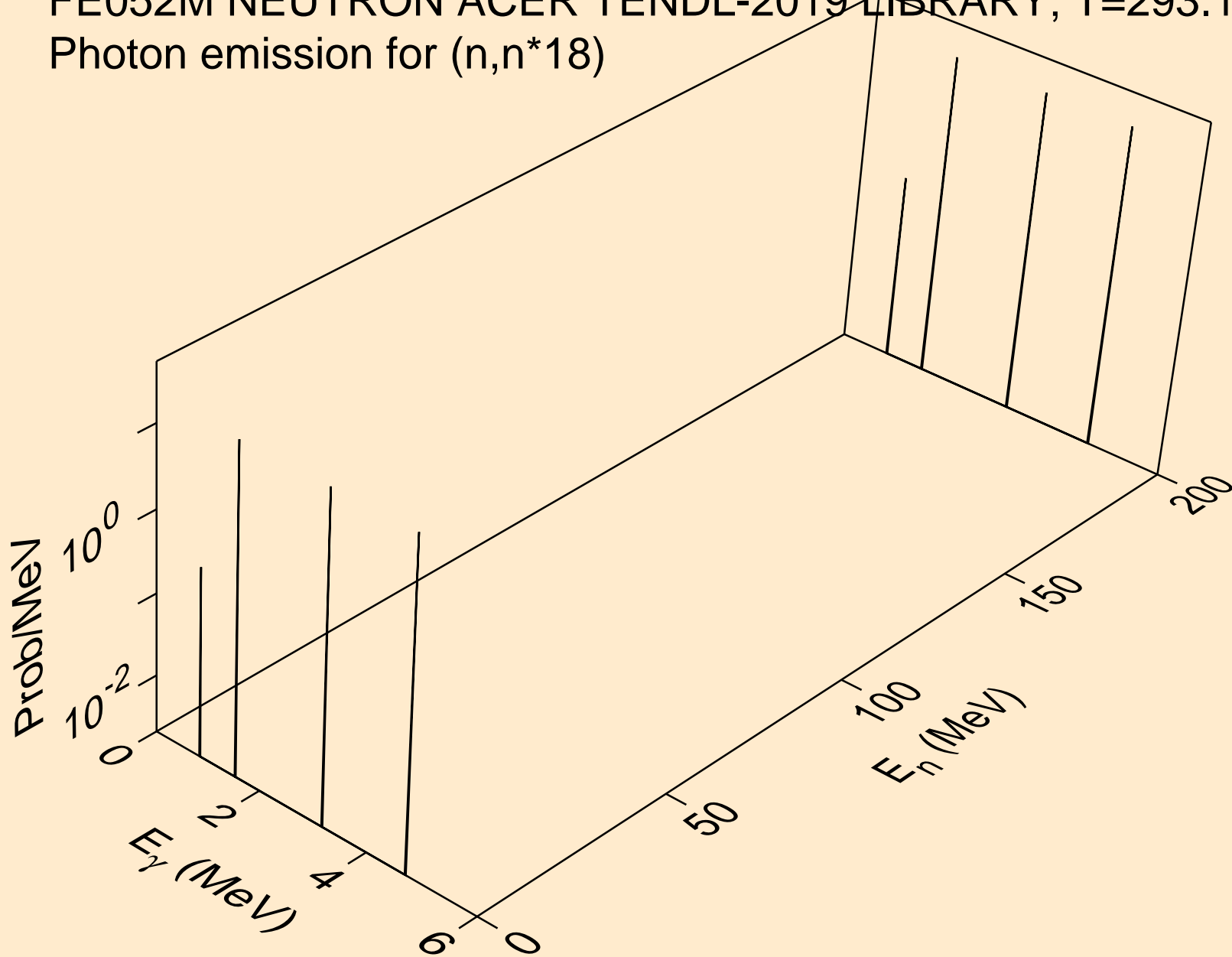

FE052M NEUTRON ACER TENDL-2019 LIBRARY; T=293.16K
Photon emission for (n,n*19)

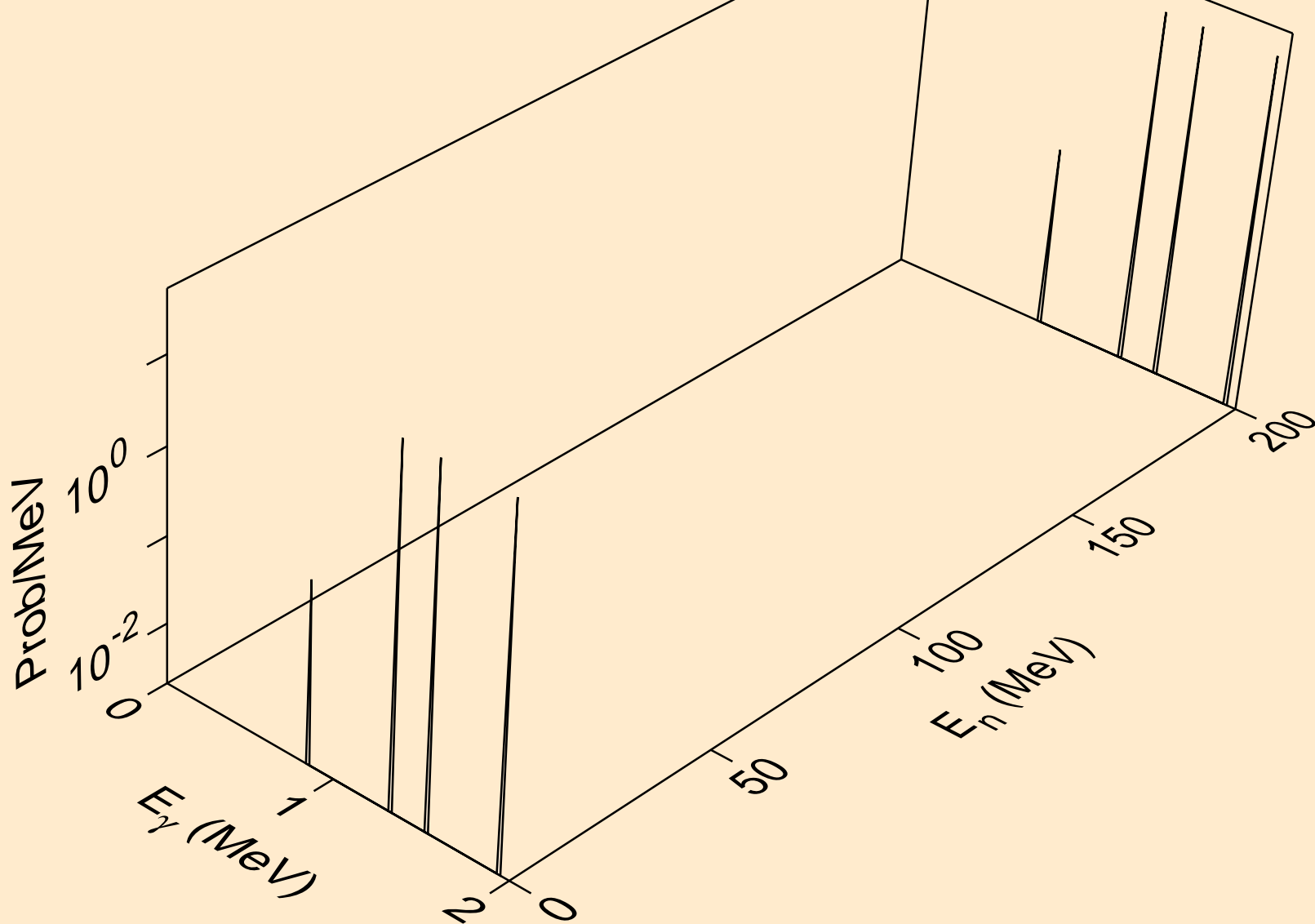

FE052M NEUTRON ACER TENDL-2019 LIBRARY; T=293.16K
Photon emission for (n,n*20)

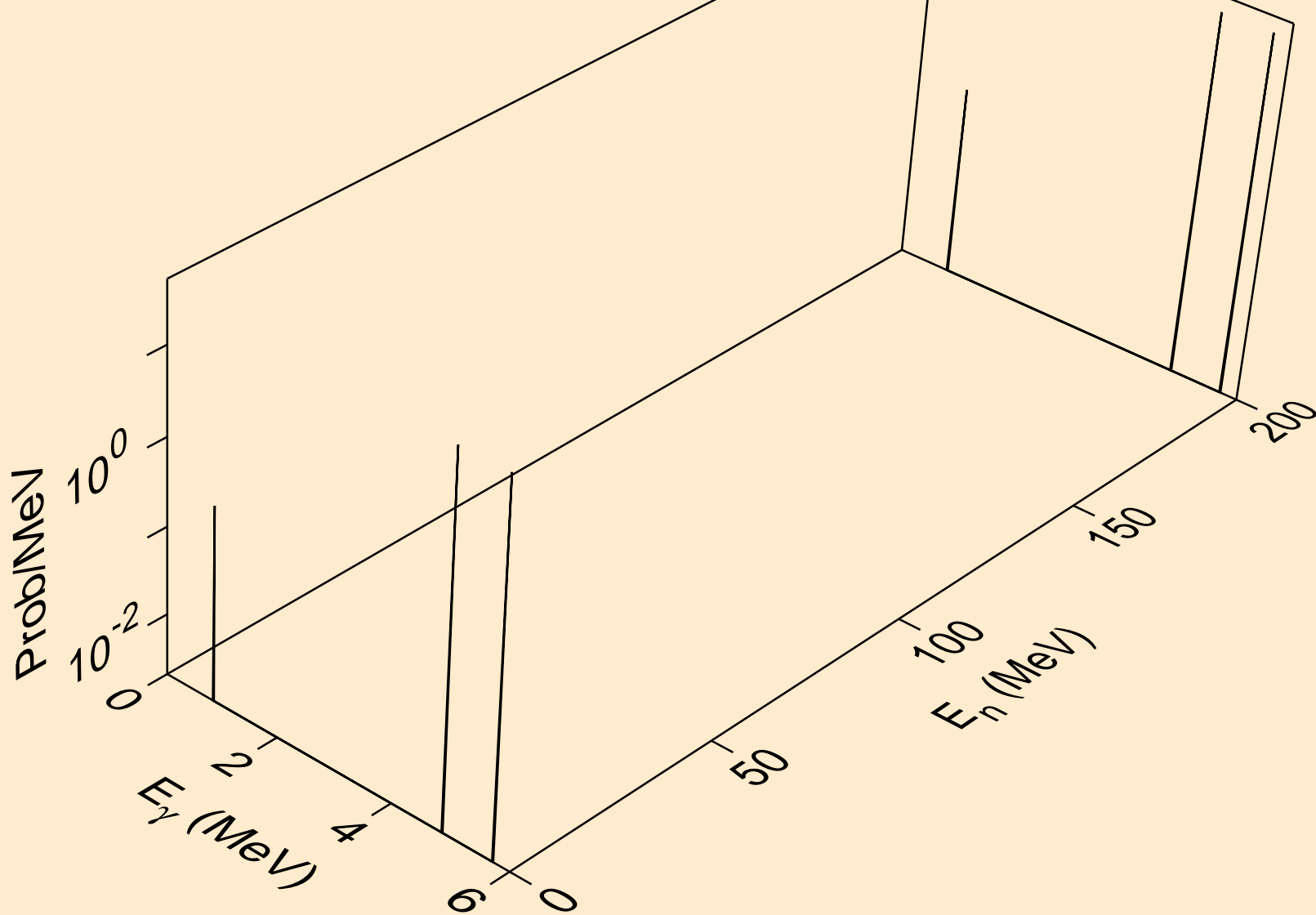

FE052M NEUTRON ACER TENDL-2019 LIBRARY; T=293.16K
Photon emission for (n,n*21)

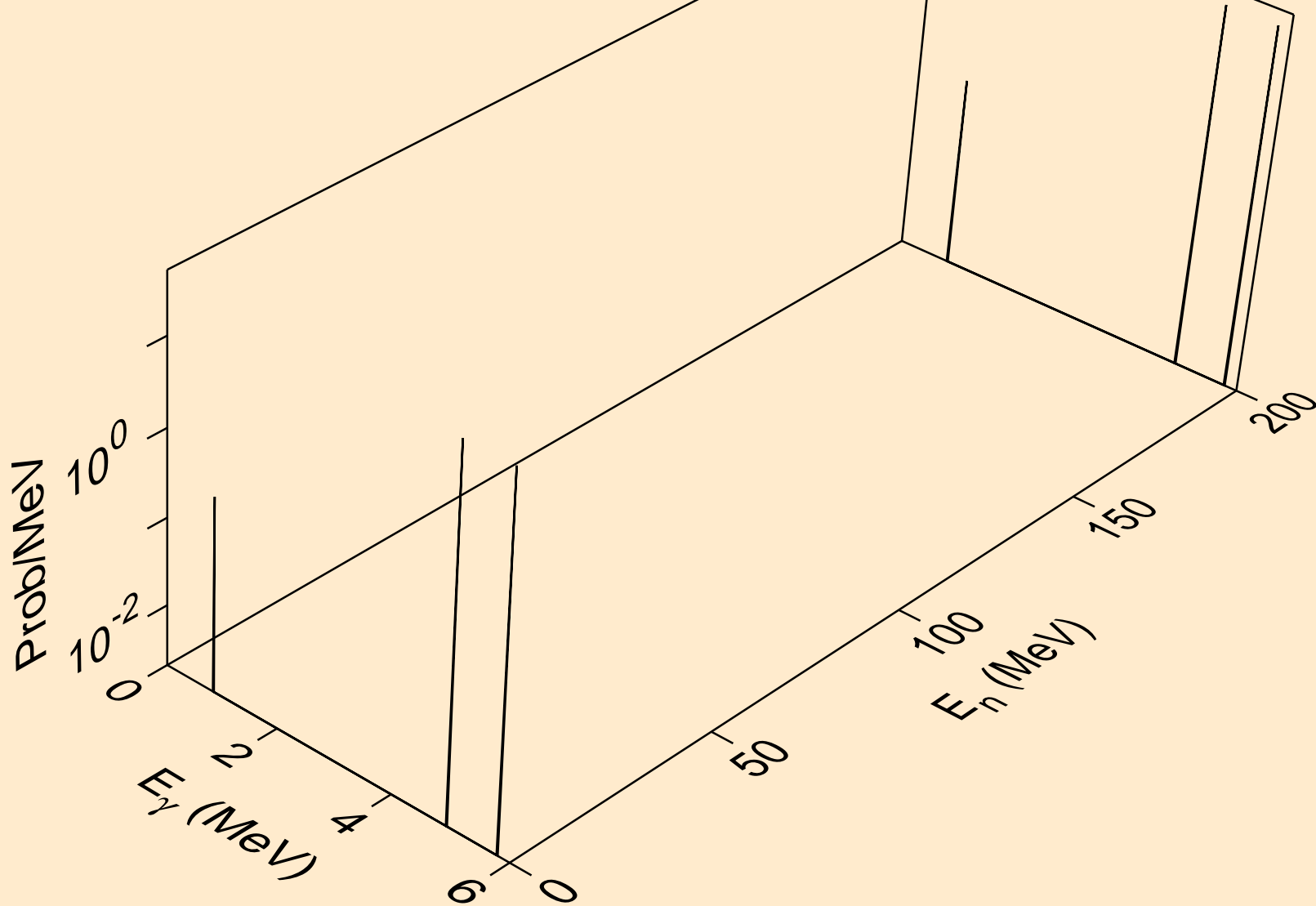

FE052M NEUTRON ACER TENDL-2019 LIBRARY; T=293.16K
Photon emission for (n,n*22)

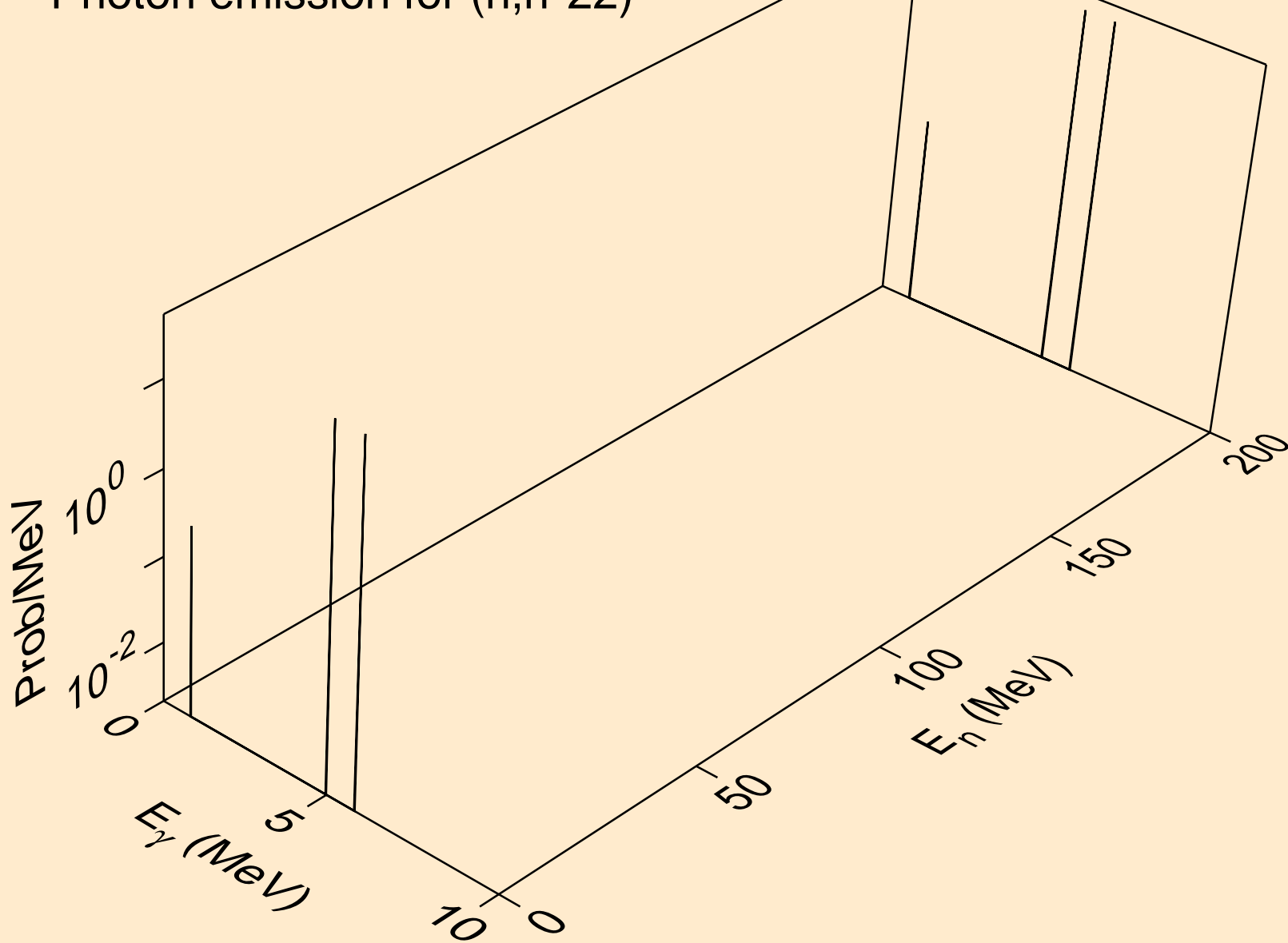

FE052M NEUTRON ACER TENDL-2019 LIBRARY; T=293.16K
Photon emission for (n,n*23)

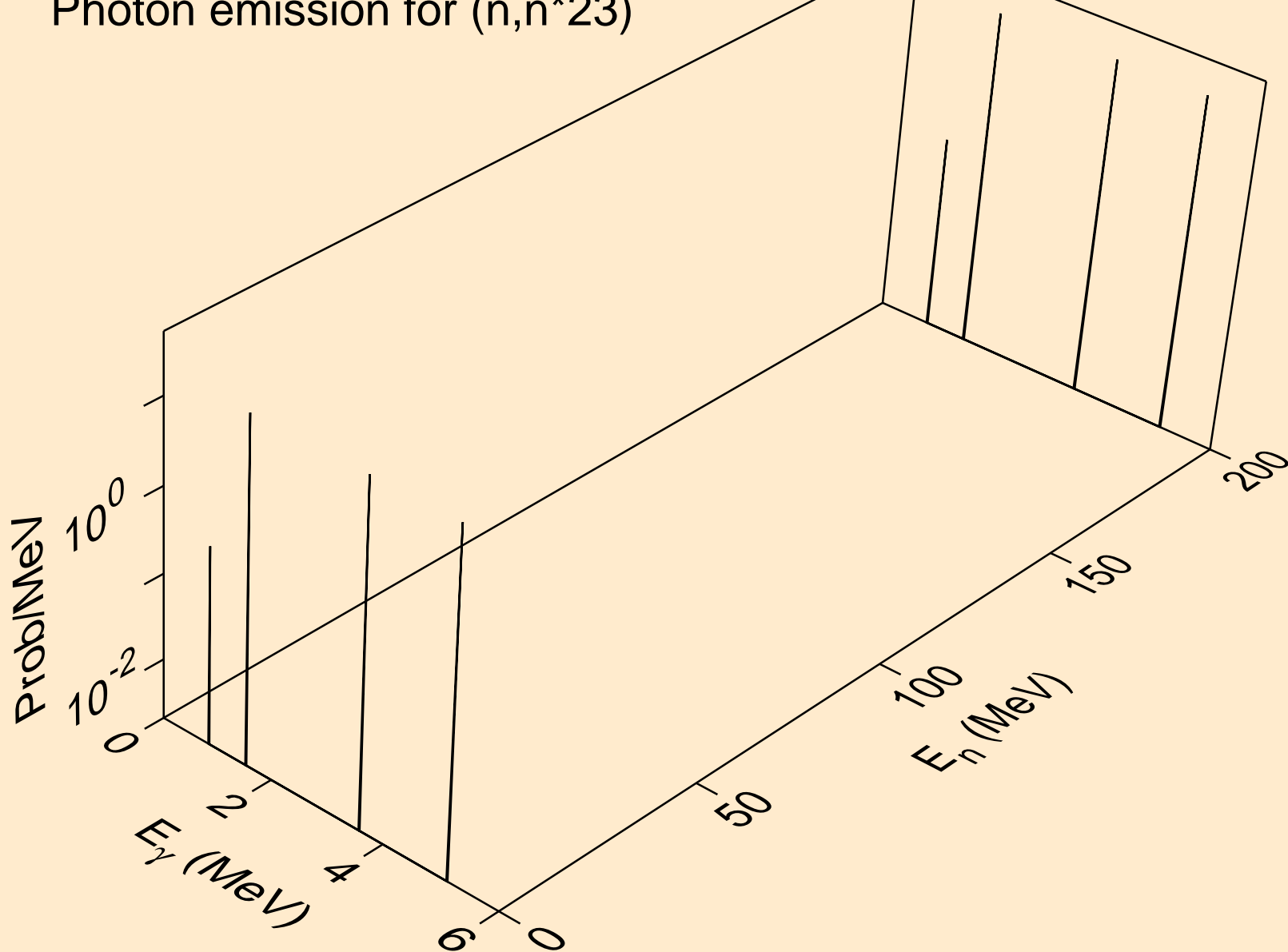

FE052M NEUTRON ACER TENDL-2019 LIBRARY; T=293.16K
Photon emission for (n,n*24)

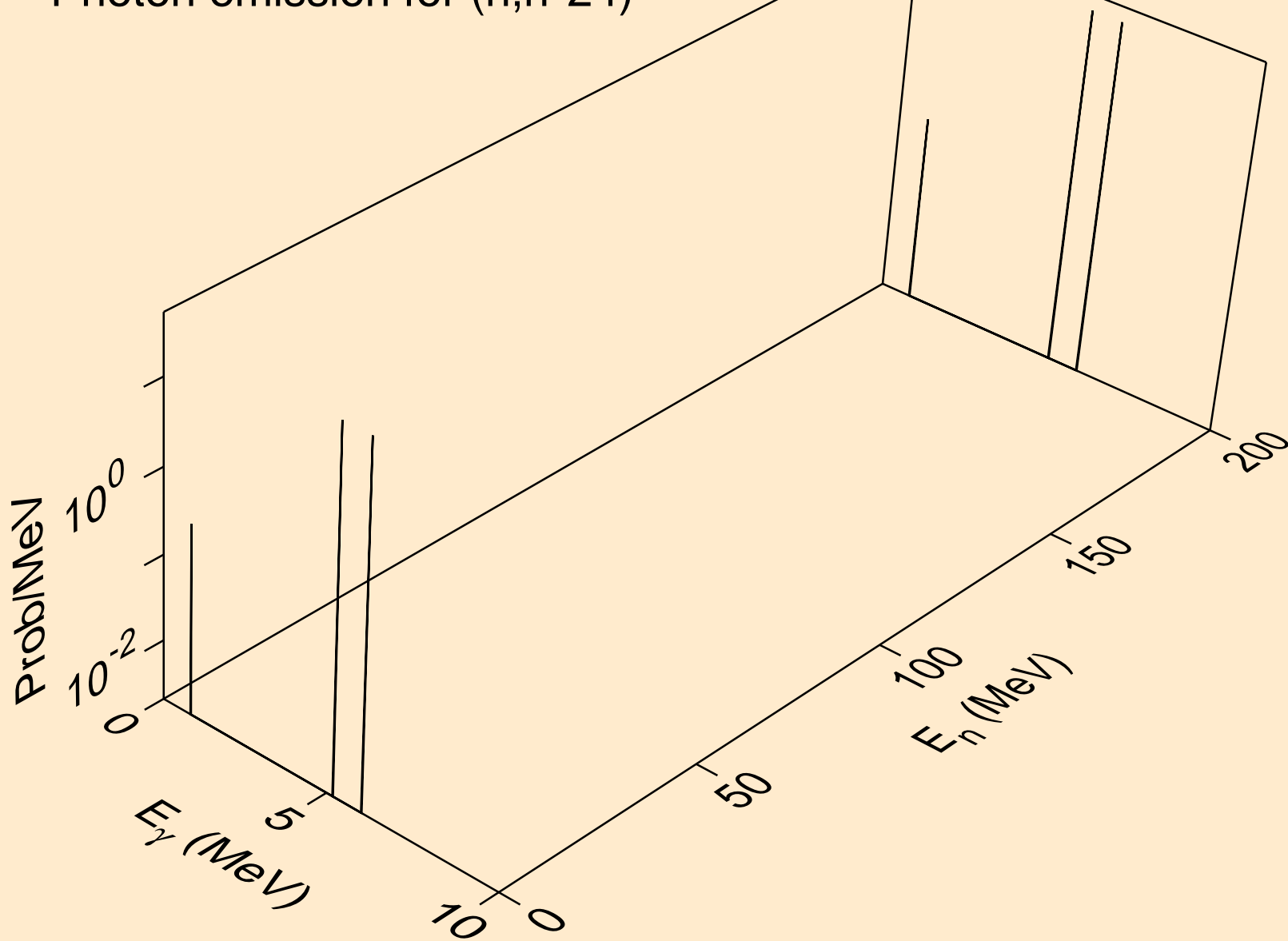

FE052M NEUTRON ACER TENDL-2019 LIBRARY; T=293.16K
Photon emission for (n,n*25)

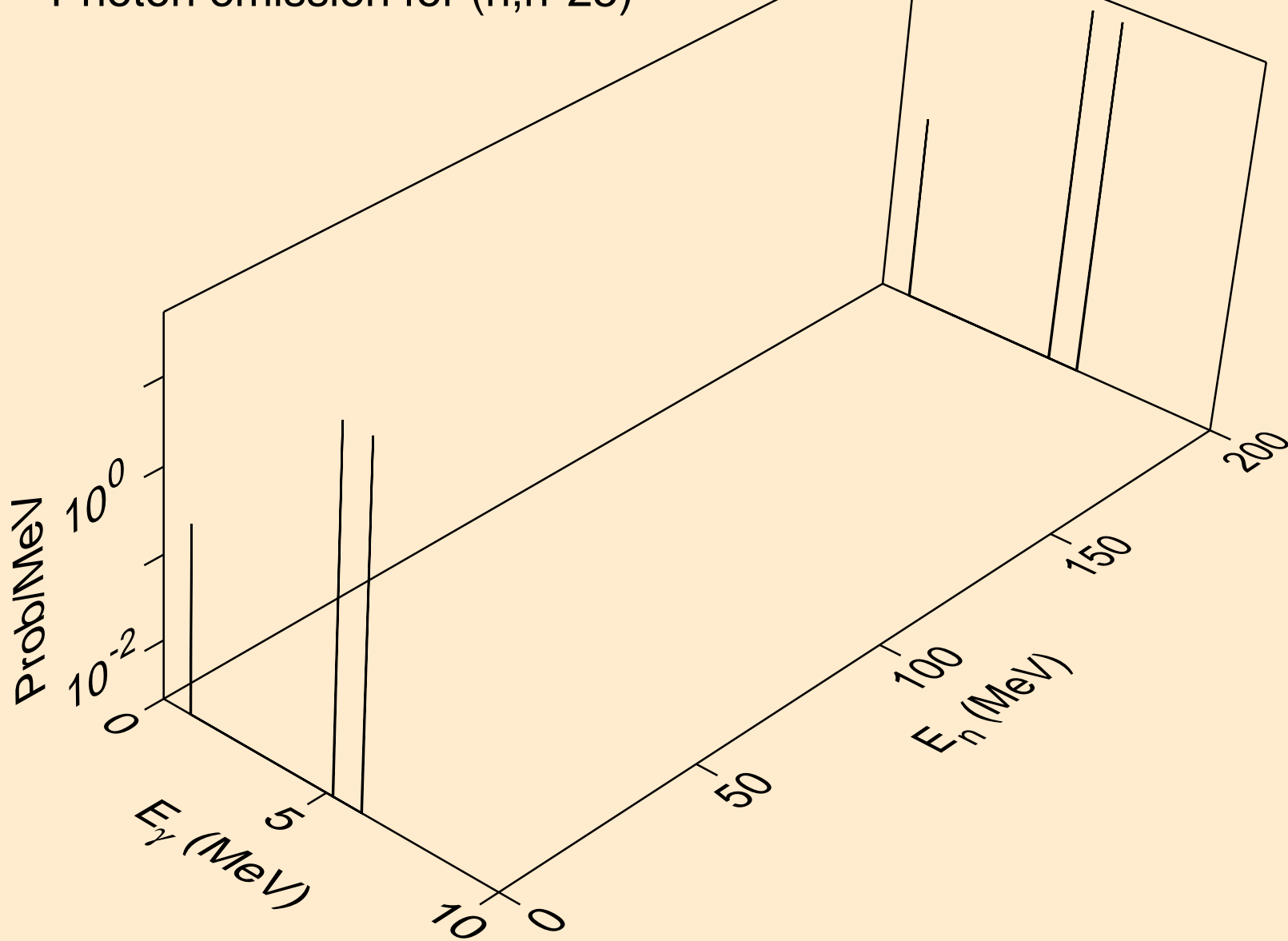

FE052M NEUTRON ACER TENDL-2019 LIBRARY; T=293.16K
Photon emission for (n,n*26)

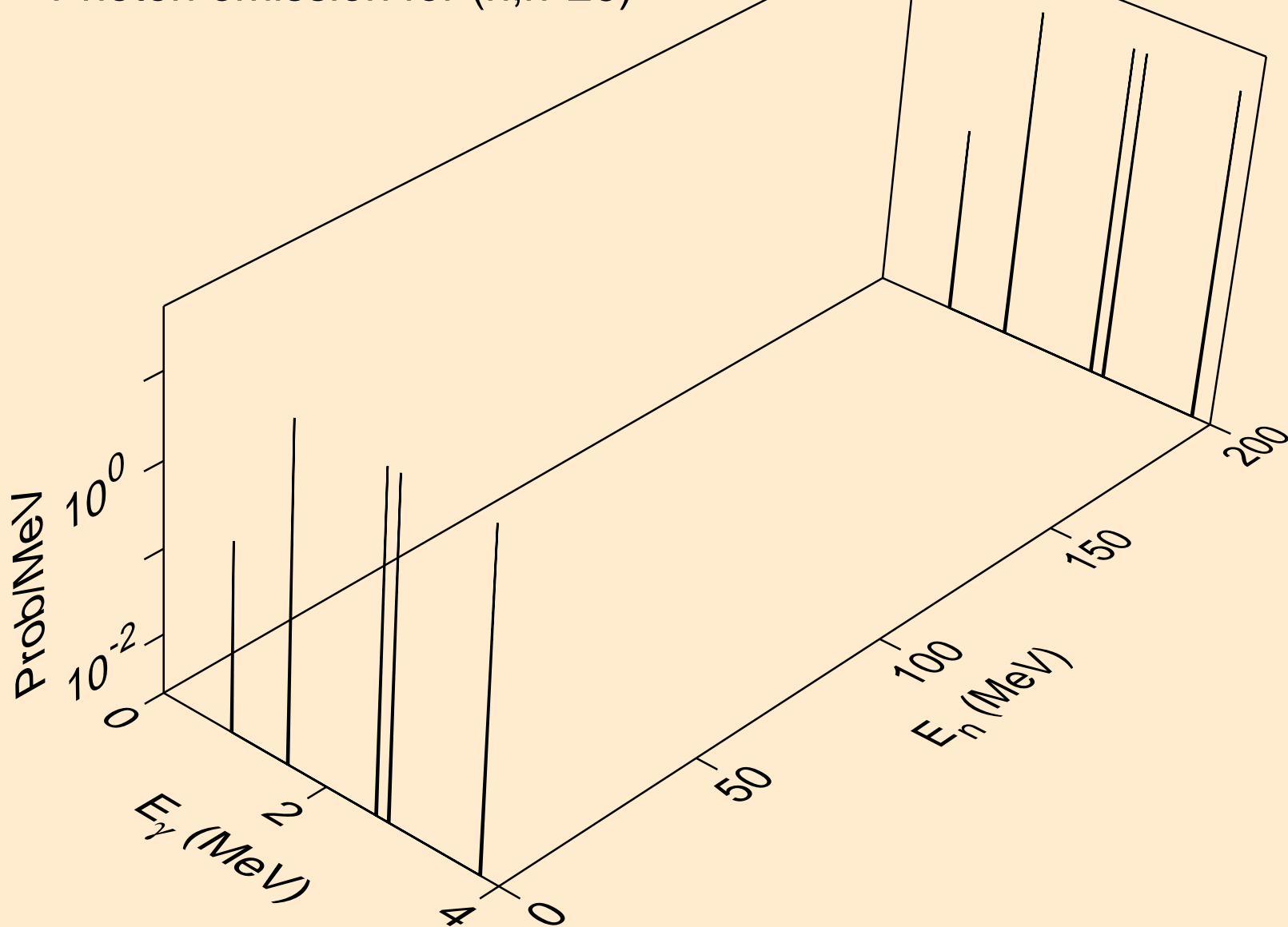

FE052M NEUTRON ACER TENDL-2019 LIBRARY; T=293.16K
Photon emission for (n,n*27)

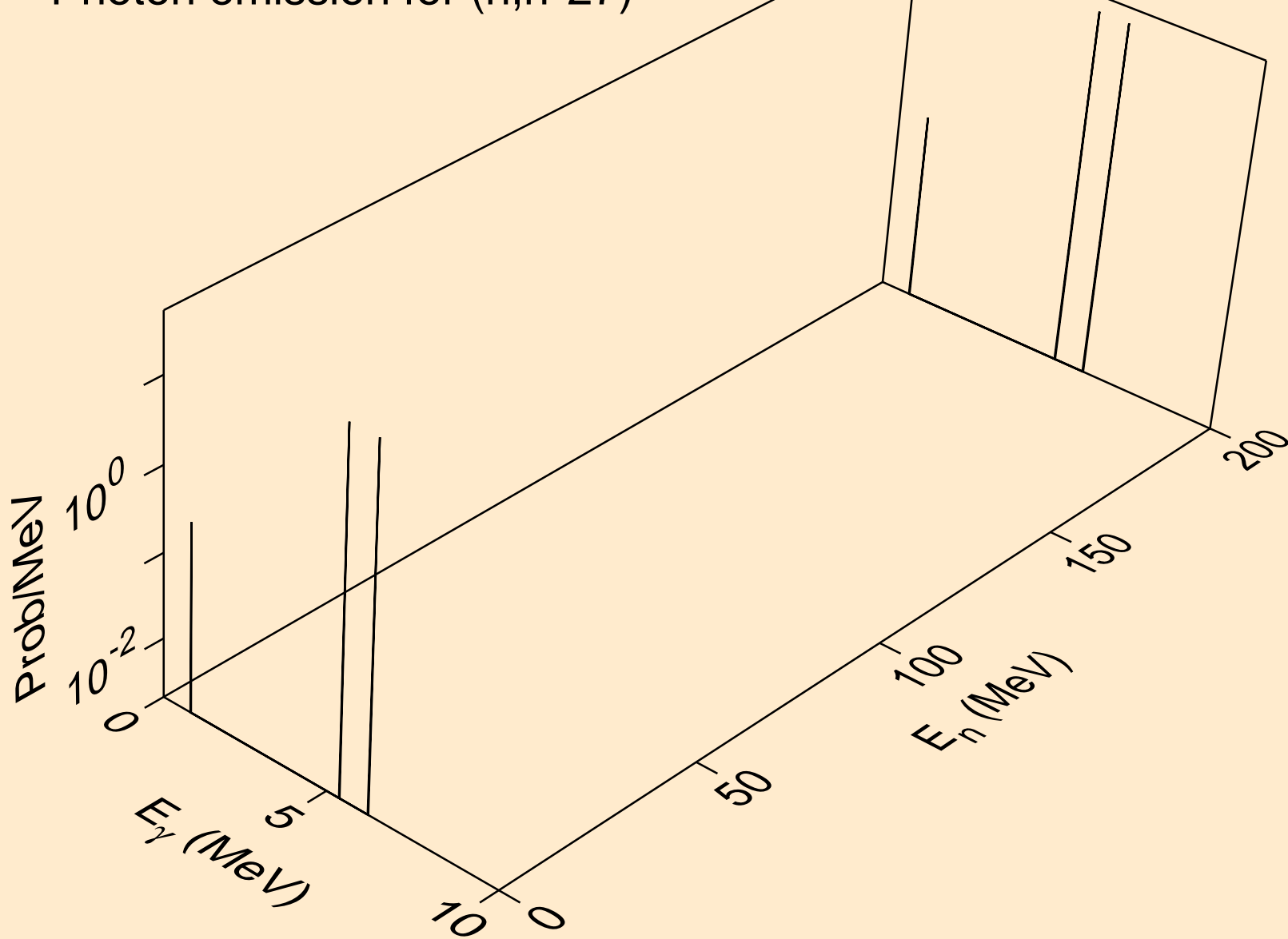

FE052M NEUTRON ACER TENDL-2019 LIBRARY; T=293.16K
Photon emission for (n,n*28)

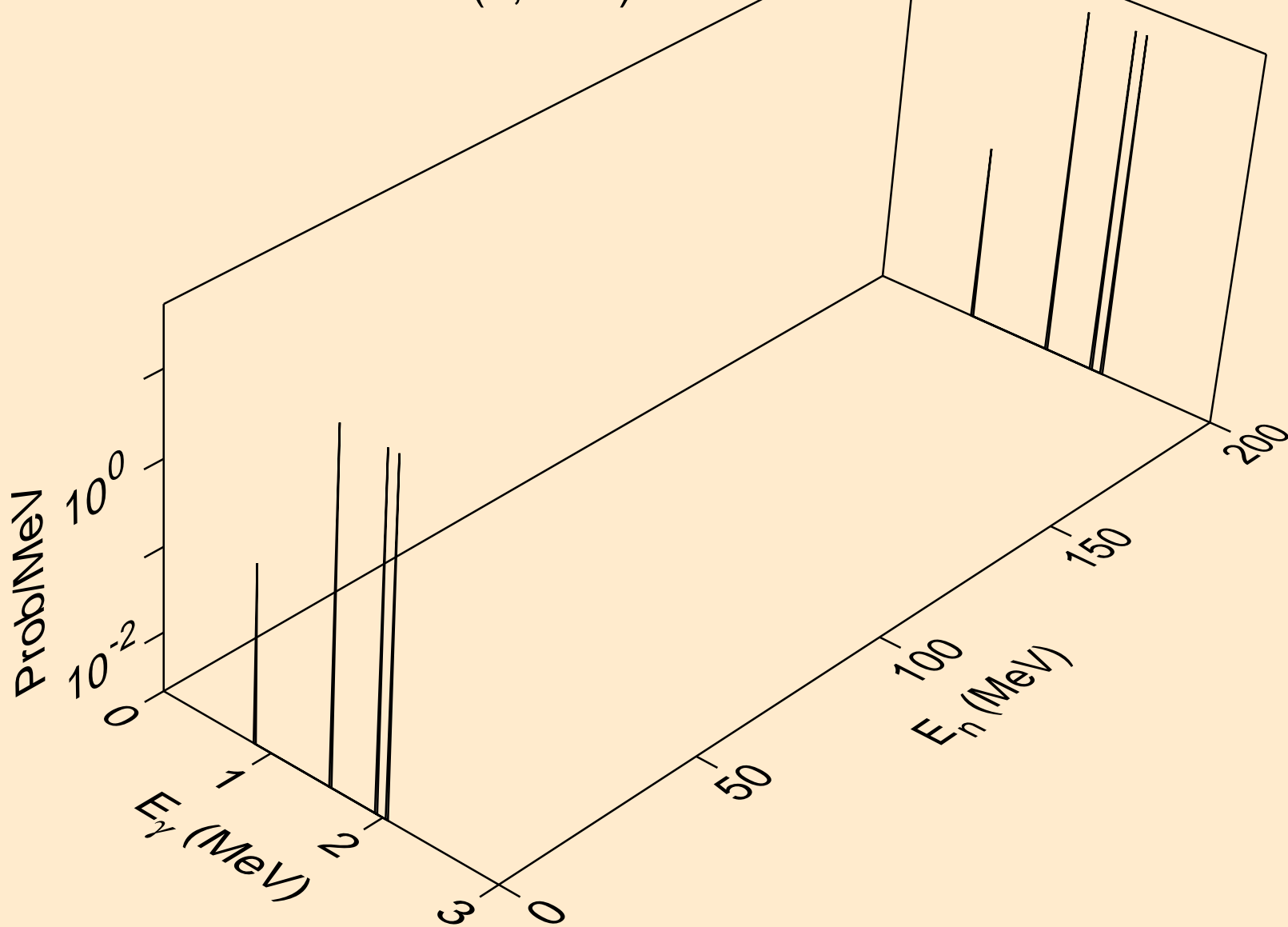

FE052M NEUTRON ACER TENDL-2019 LIBRARY; T=293.16K
Photon emission for (n,n*29)

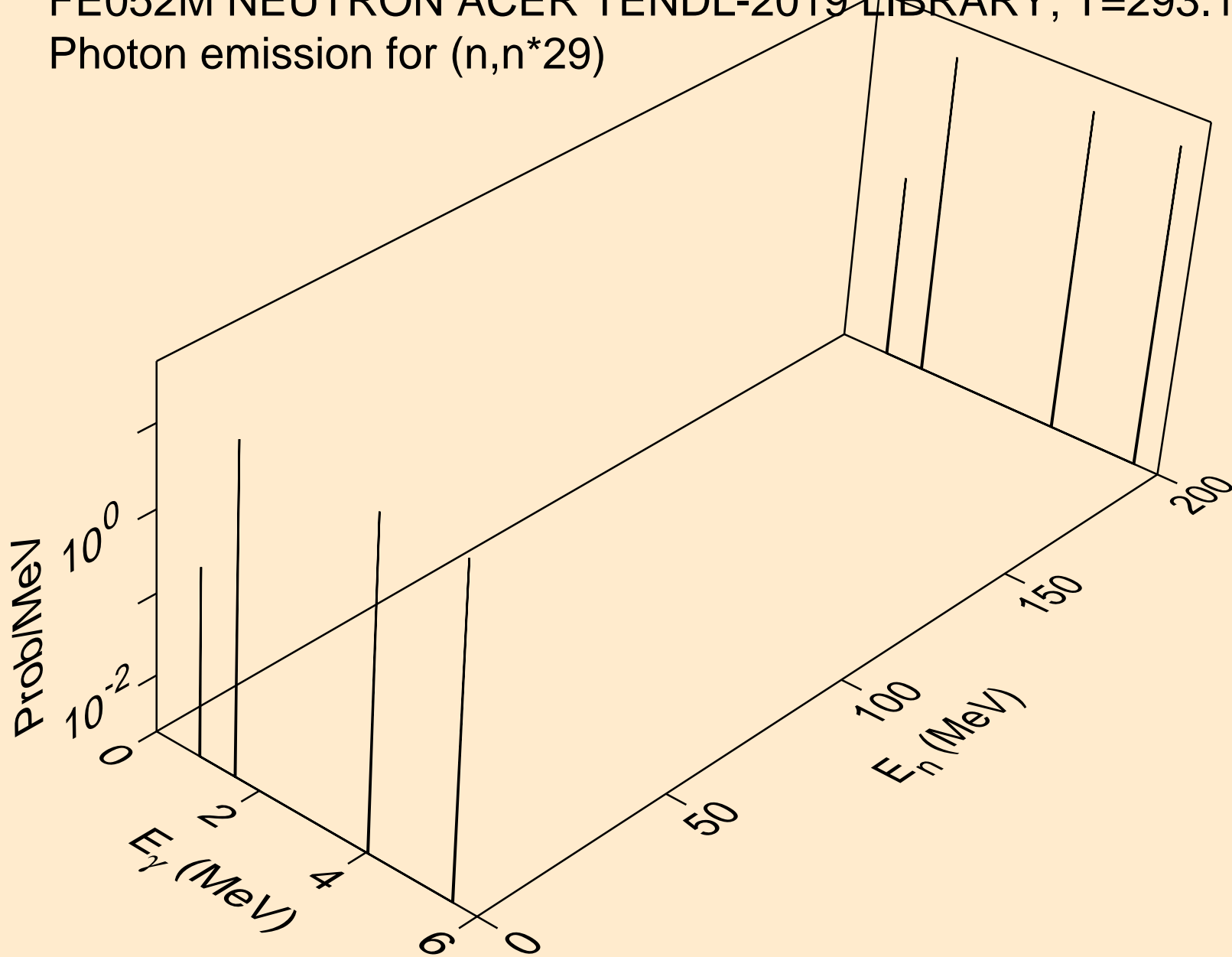

FE052M NEUTRON ACER TENDL-2019 LIBRARY; T=293.16K
Photon emission for (n,n*30)

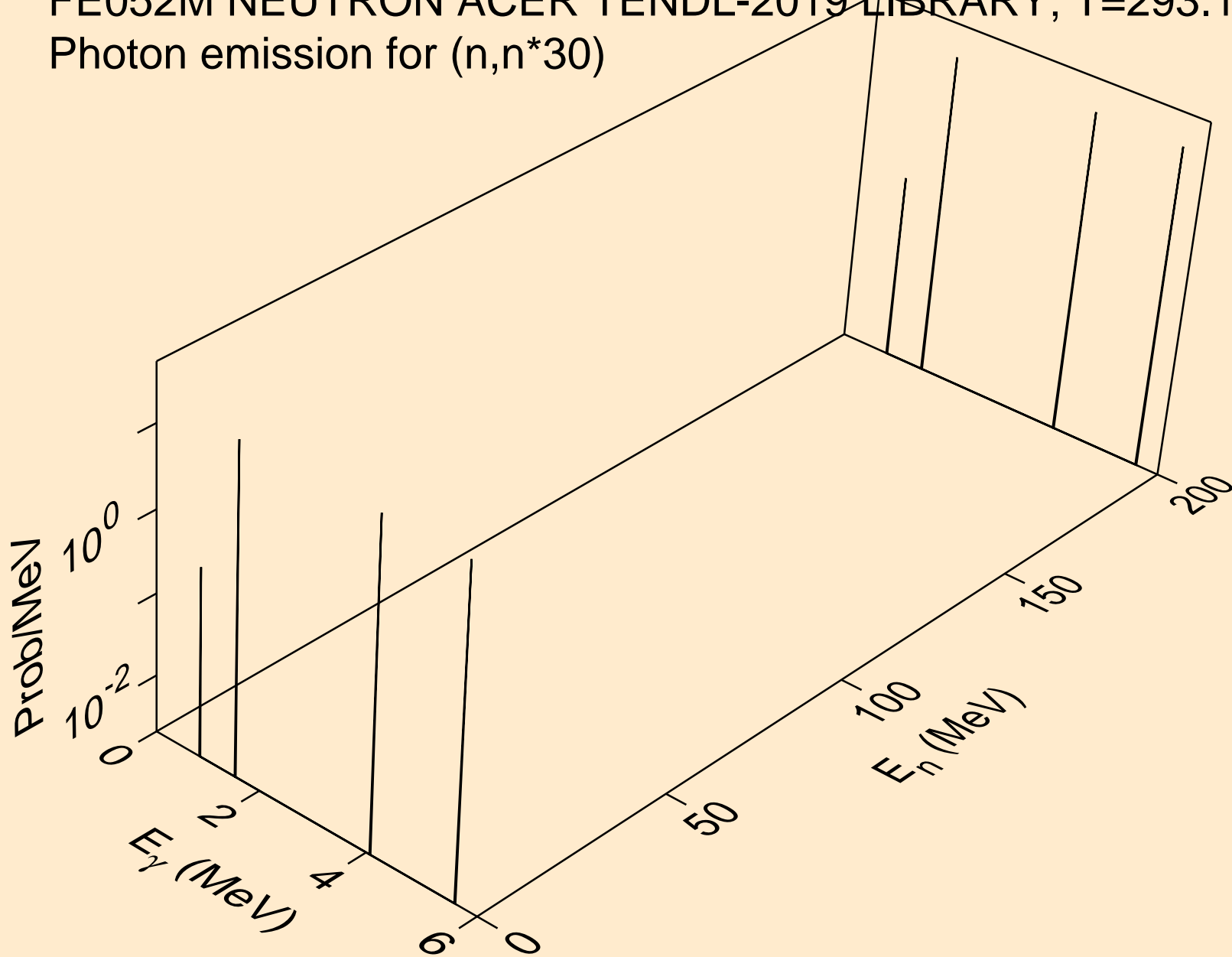

FE052M NEUTRON ACER TENDL-2019 LIBRARY; T=293.16K
Photon emission for (n,n*31)

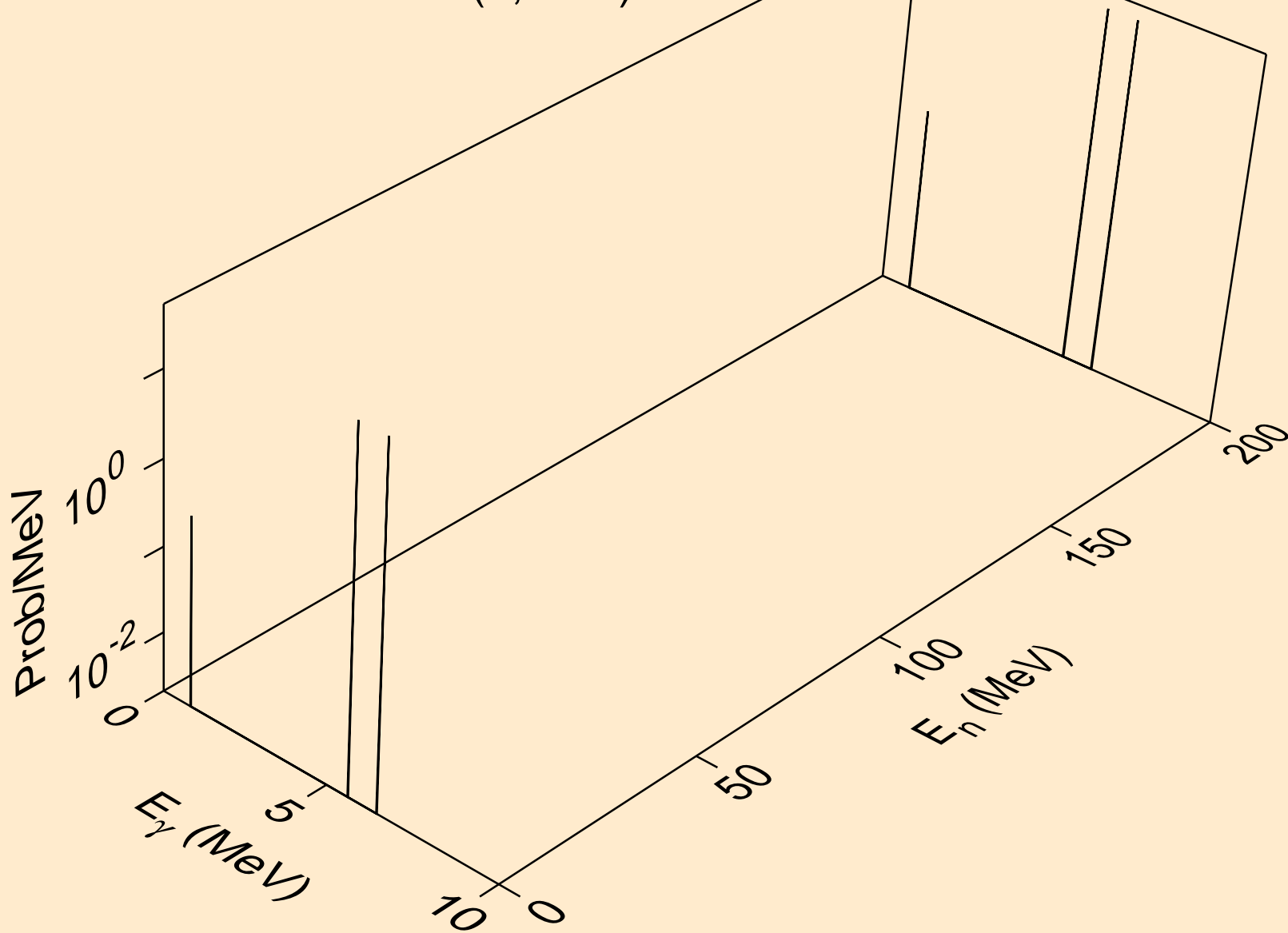

FE052M NEUTRON ACER TENDL-2019 LIBRARY; T=293.16K
Photon emission for (n,n*32)

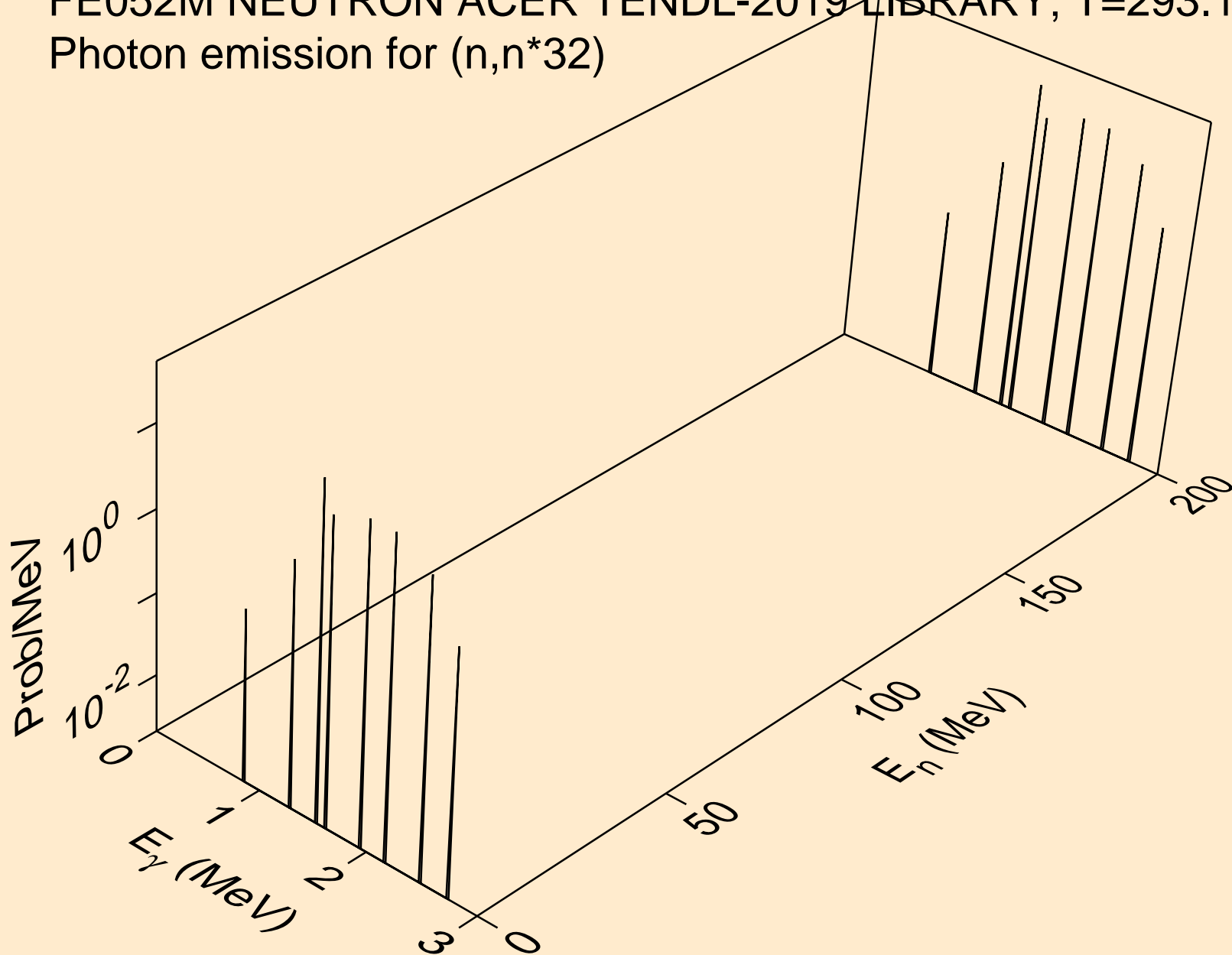

FE052M NEUTRON ACER TENDL-2019 LIBRARY; T=293.16K
Photon emission for (n,n*33)

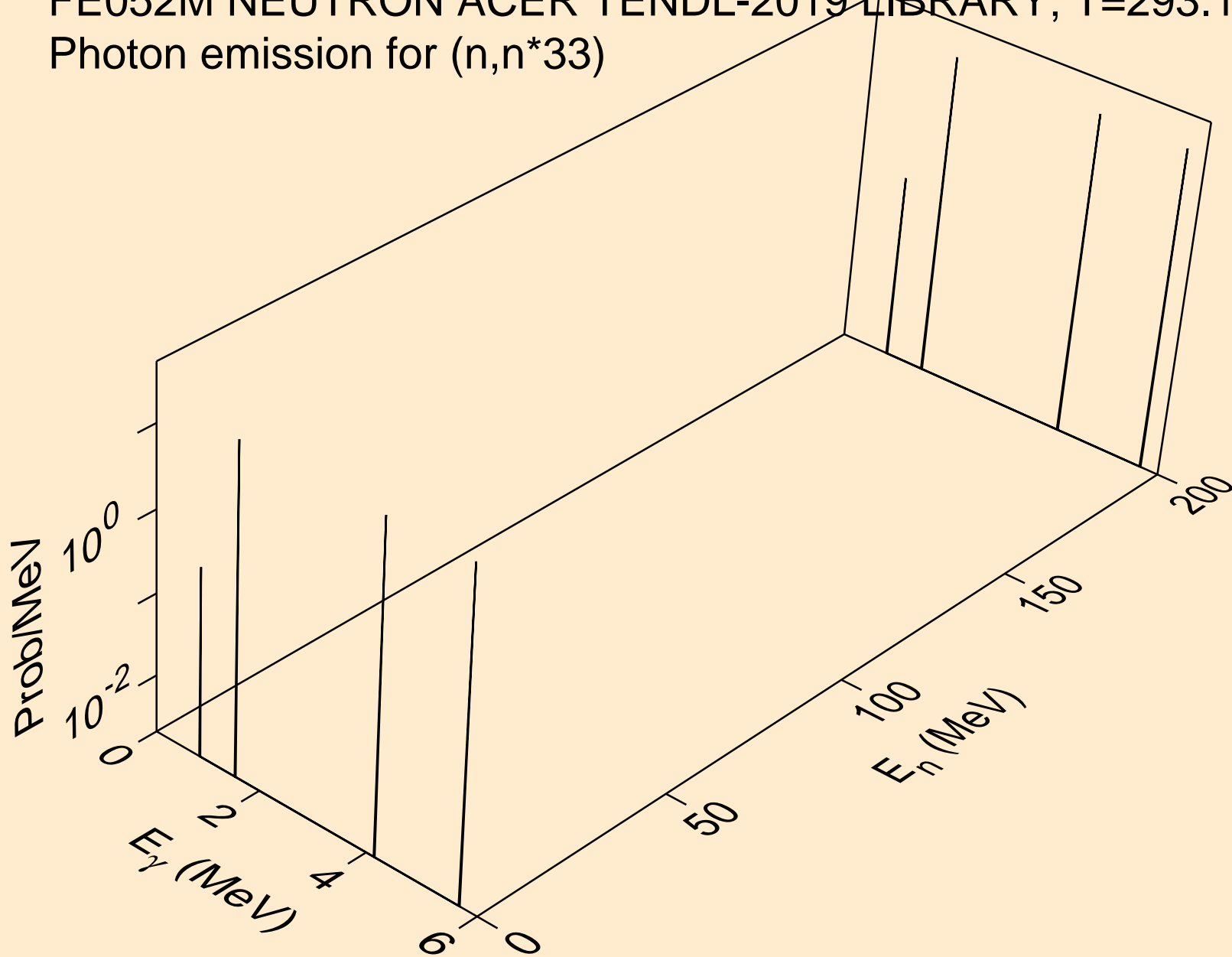

FE052M NEUTRON ACER TENDL-2019 LIBRARY; T=293.16K
Photon emission for (n,n*c)

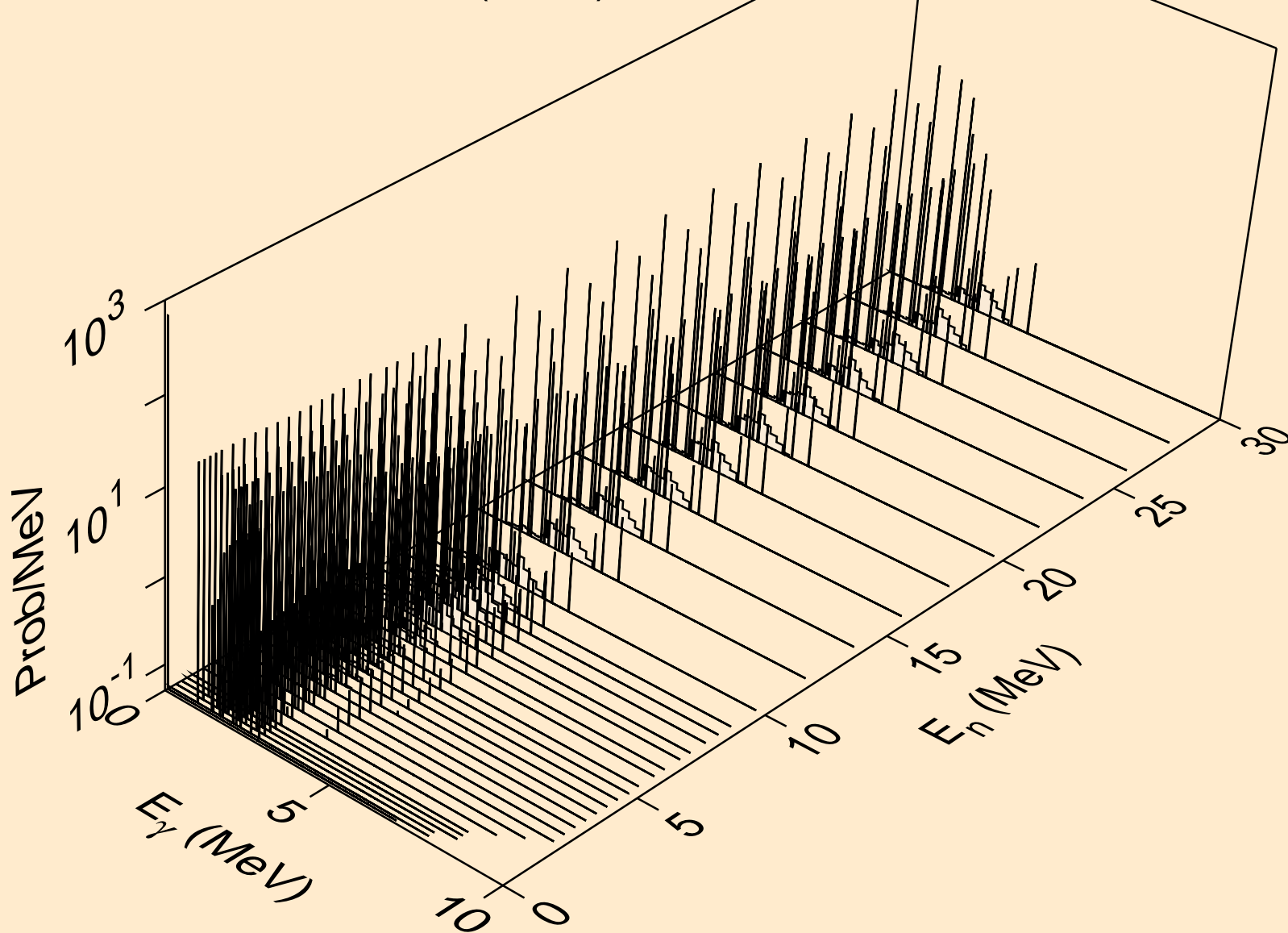

FE052M NEUTRON ACER TENDL-2019 LIBRARY; T=293.16K
Photon emission for (n,gma)

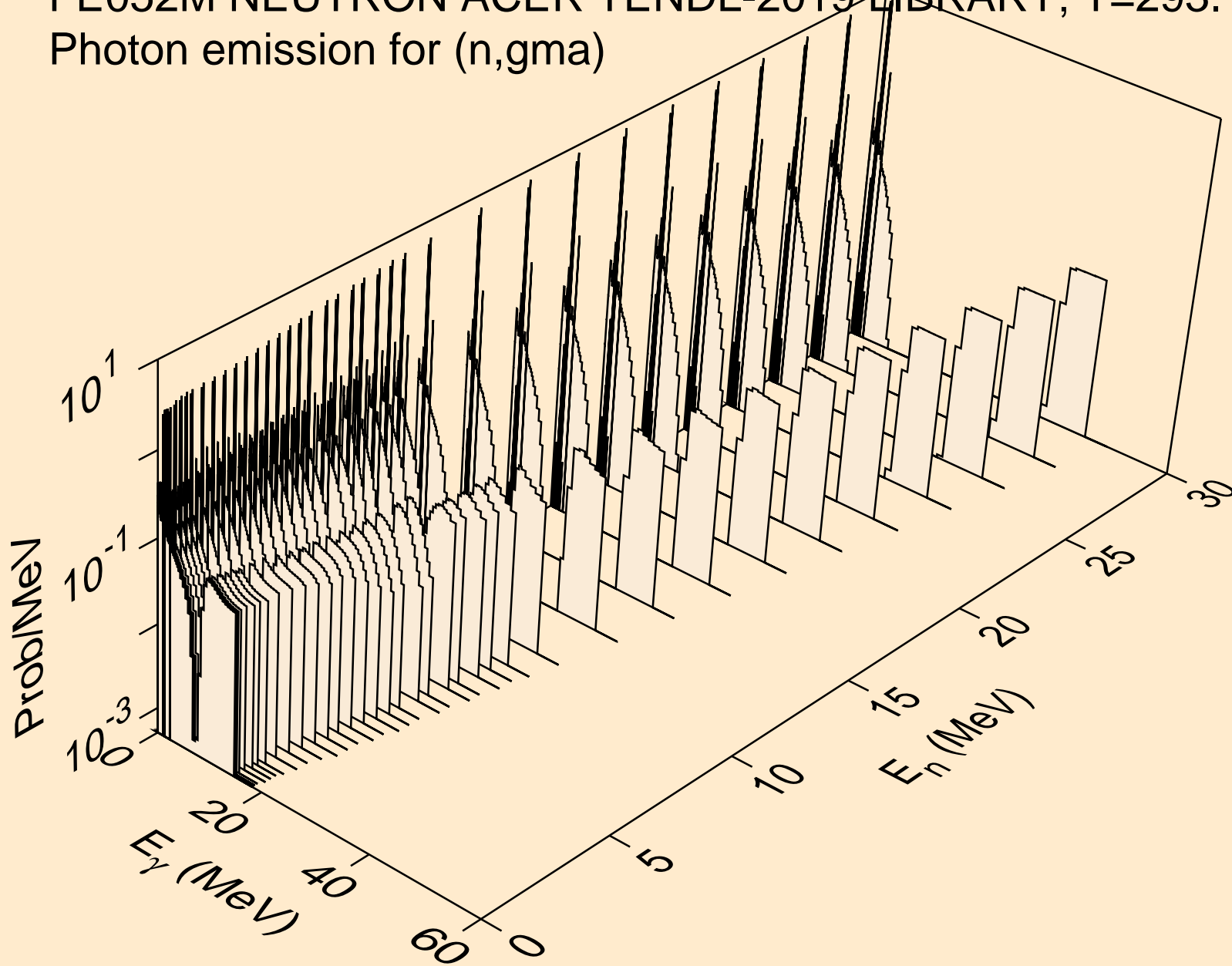

FE052M NEUTRON ACER TENDL-2019 LIBRARY; T=293.16K
Photon emission for (n,p)

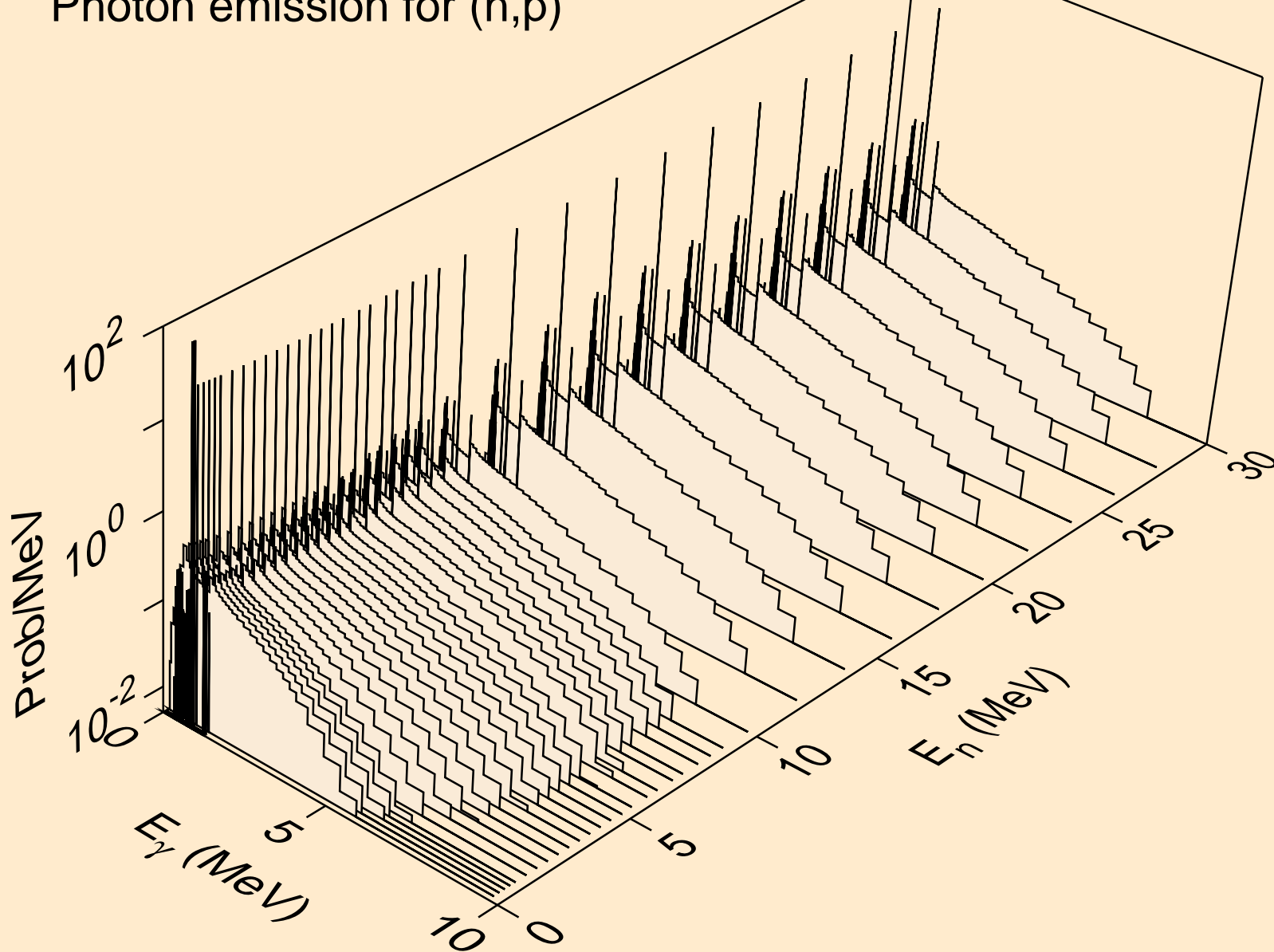

FE052M NEUTRON ACER TENDL-2019 LIBRARY; T=293.16K
Photon emission for (n,d)

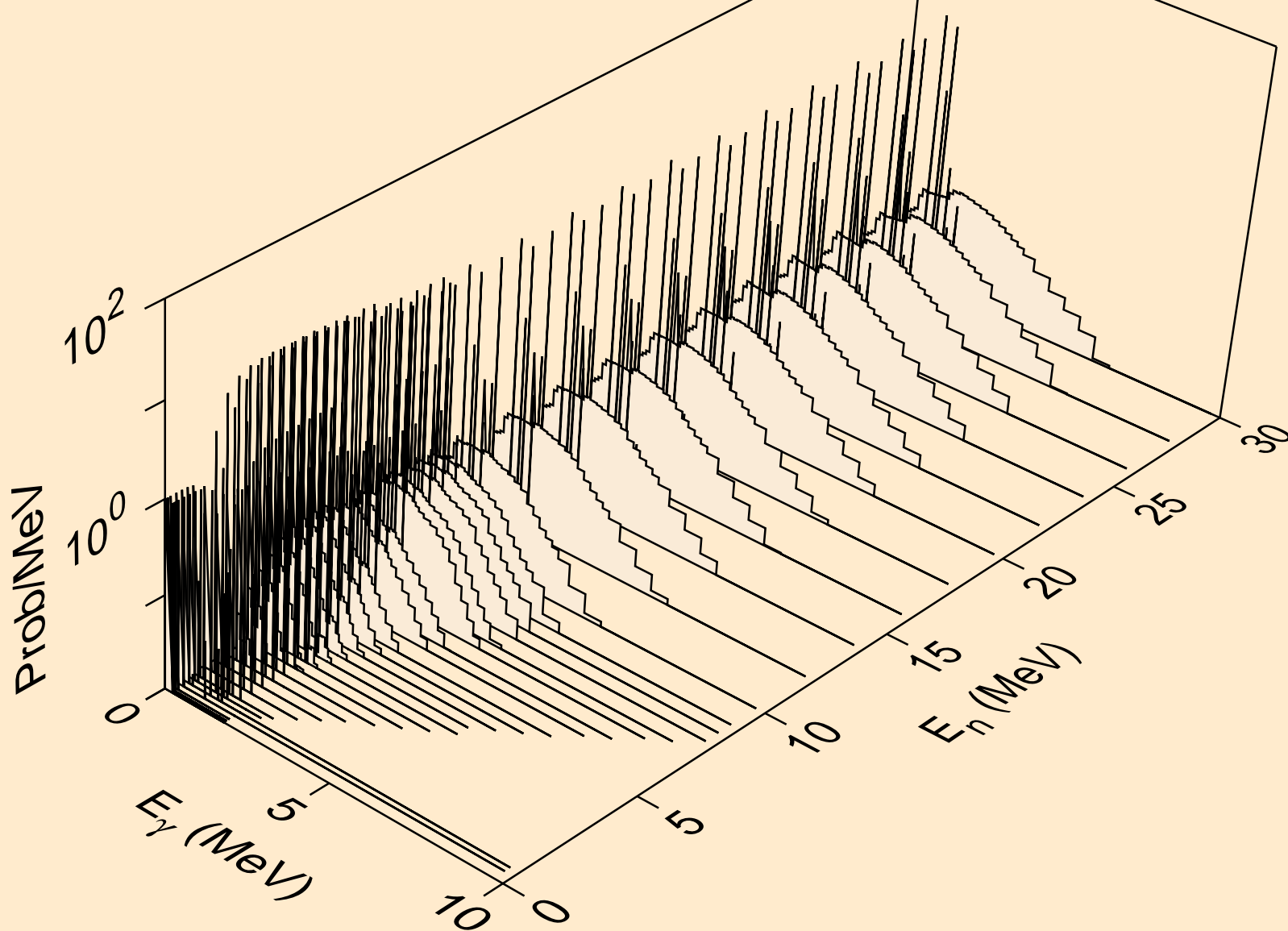

FE052M NEUTRON ACER TENDL-2019 LIBRARY; T=293.16K
Photon emission for (n,t)

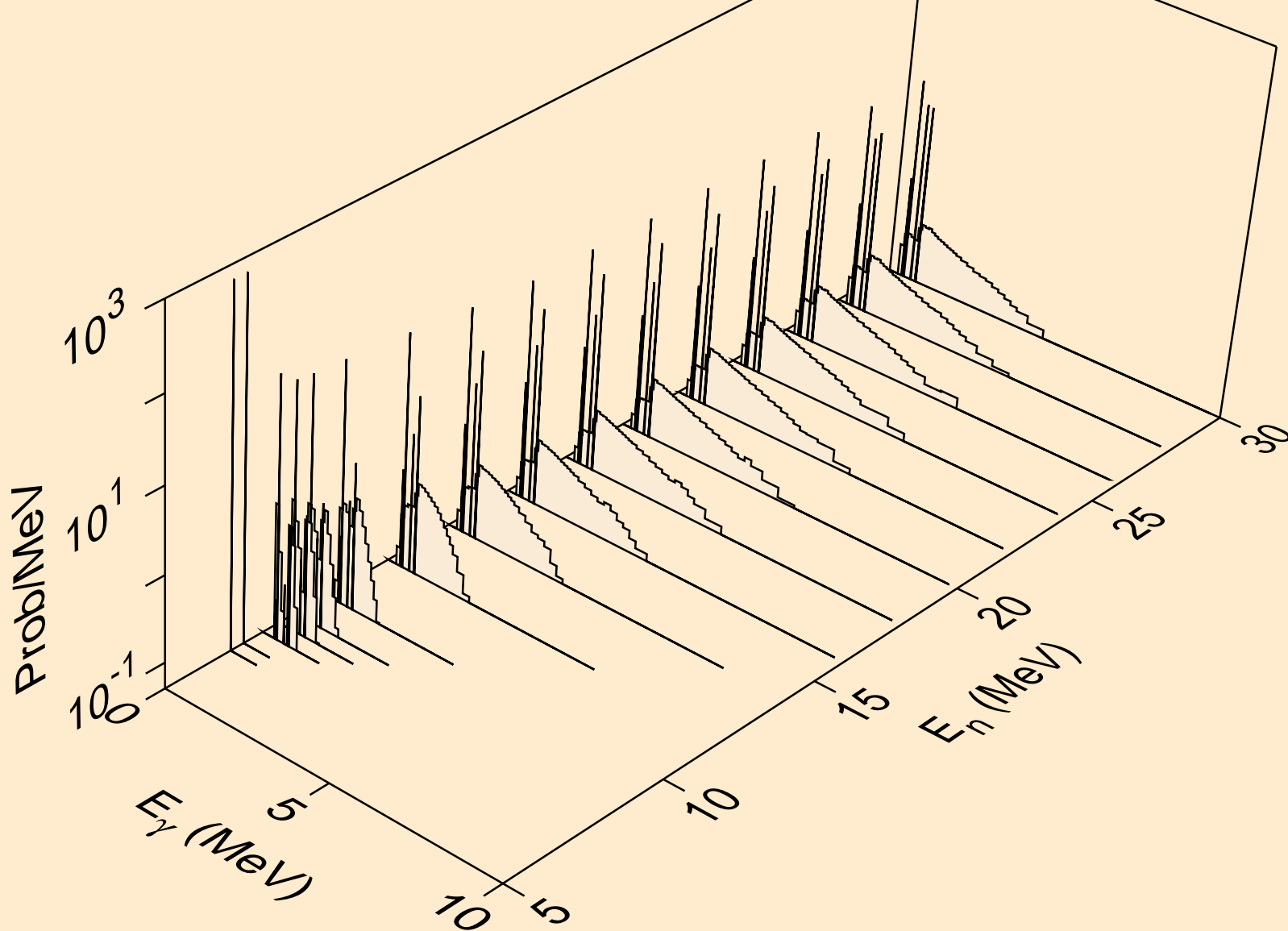

FE052M NEUTRON ACER TENDL-2019 LIBRARY; T=293.16K
Photon emission for (n,he3)

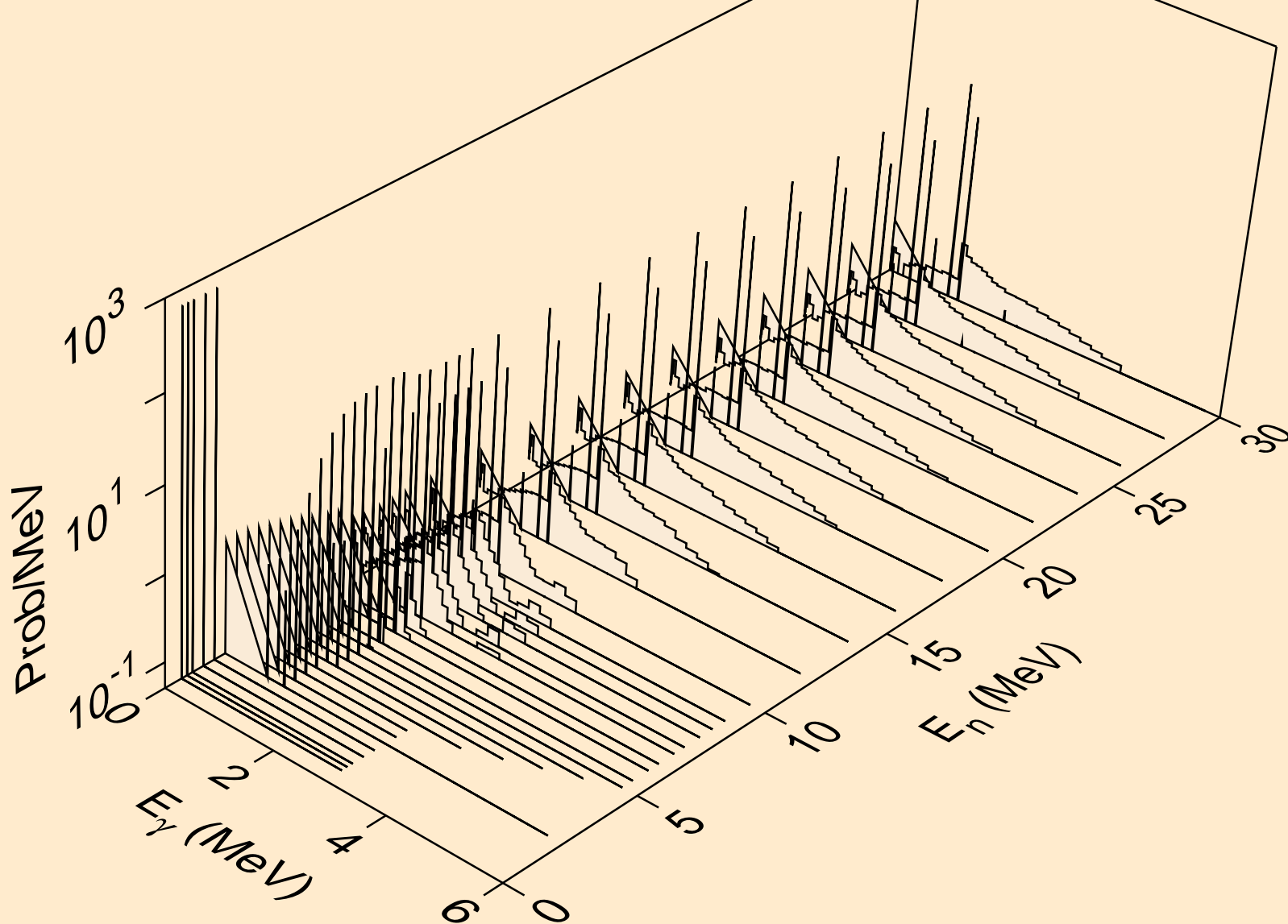

FE052M NEUTRON ACER TENDL-2019 LIBRARY; T=293.16K
Photon emission for (n,a)

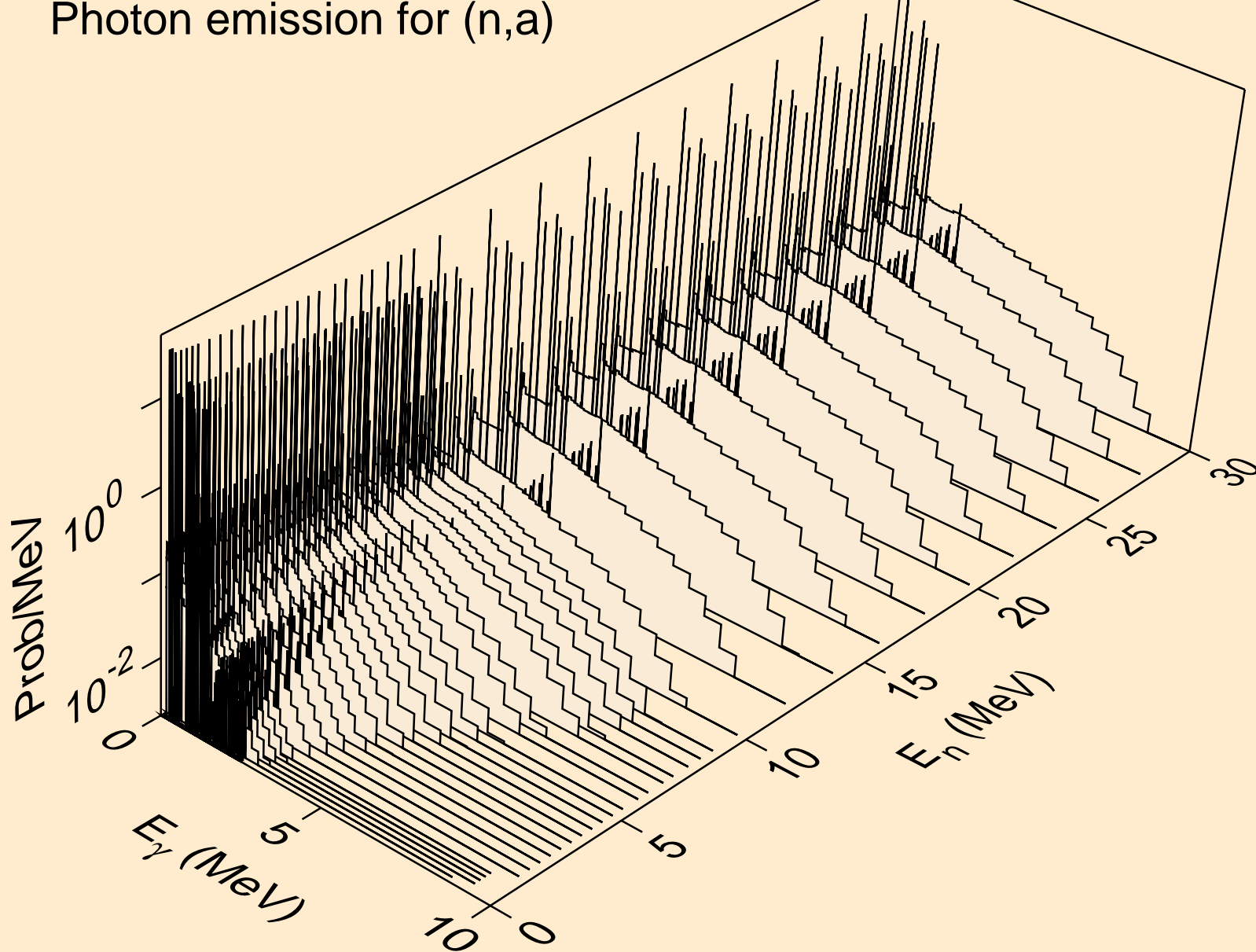

FE052M NEUTRON ACER TENDL-2019 LIBRARY; T=293.16K
Photon emission for (n,2a)

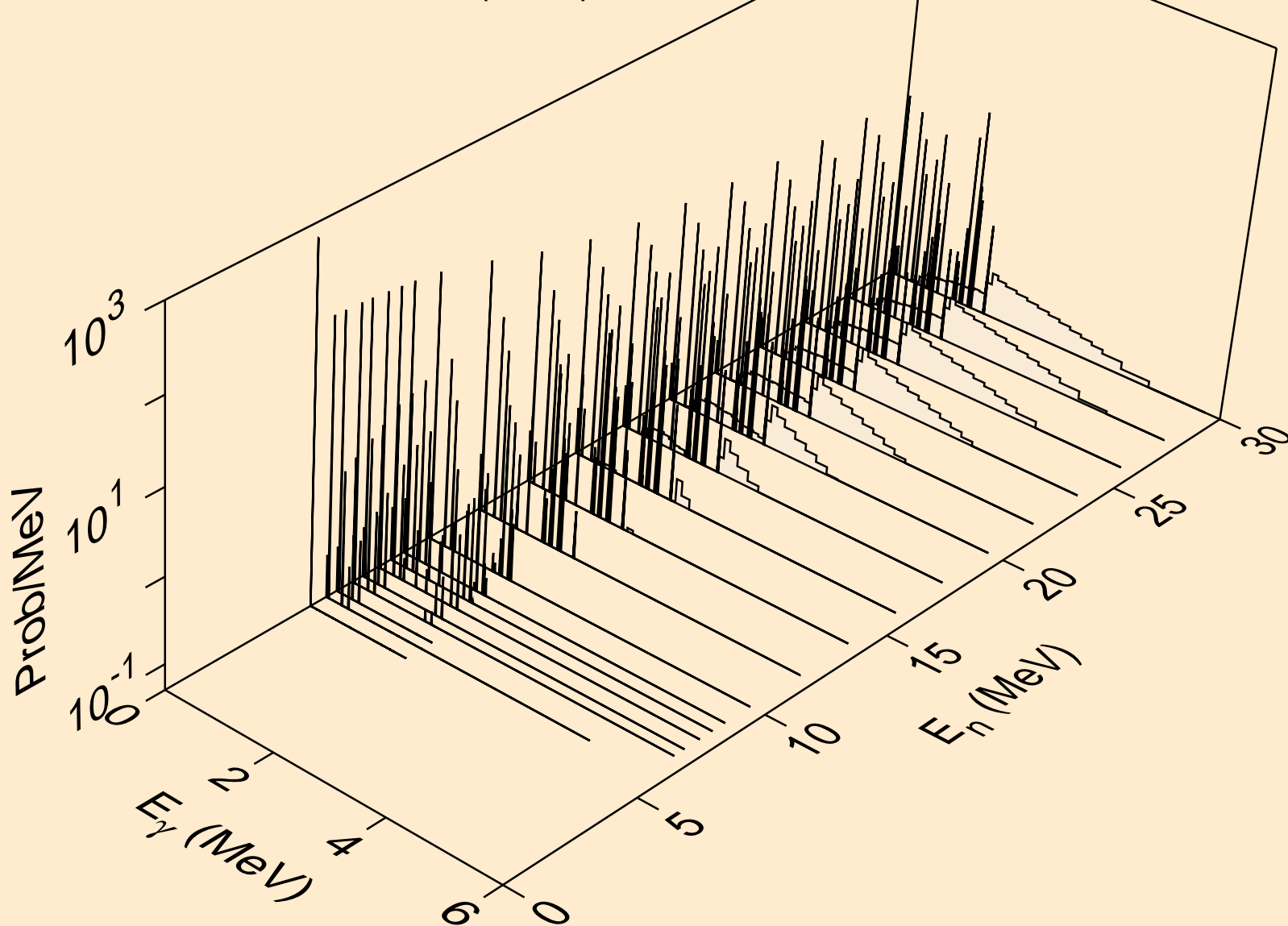

FE052M NEUTRON ACER TENDL-2019 LIBRARY; T=293.16K
Photon emission for (n,3a)

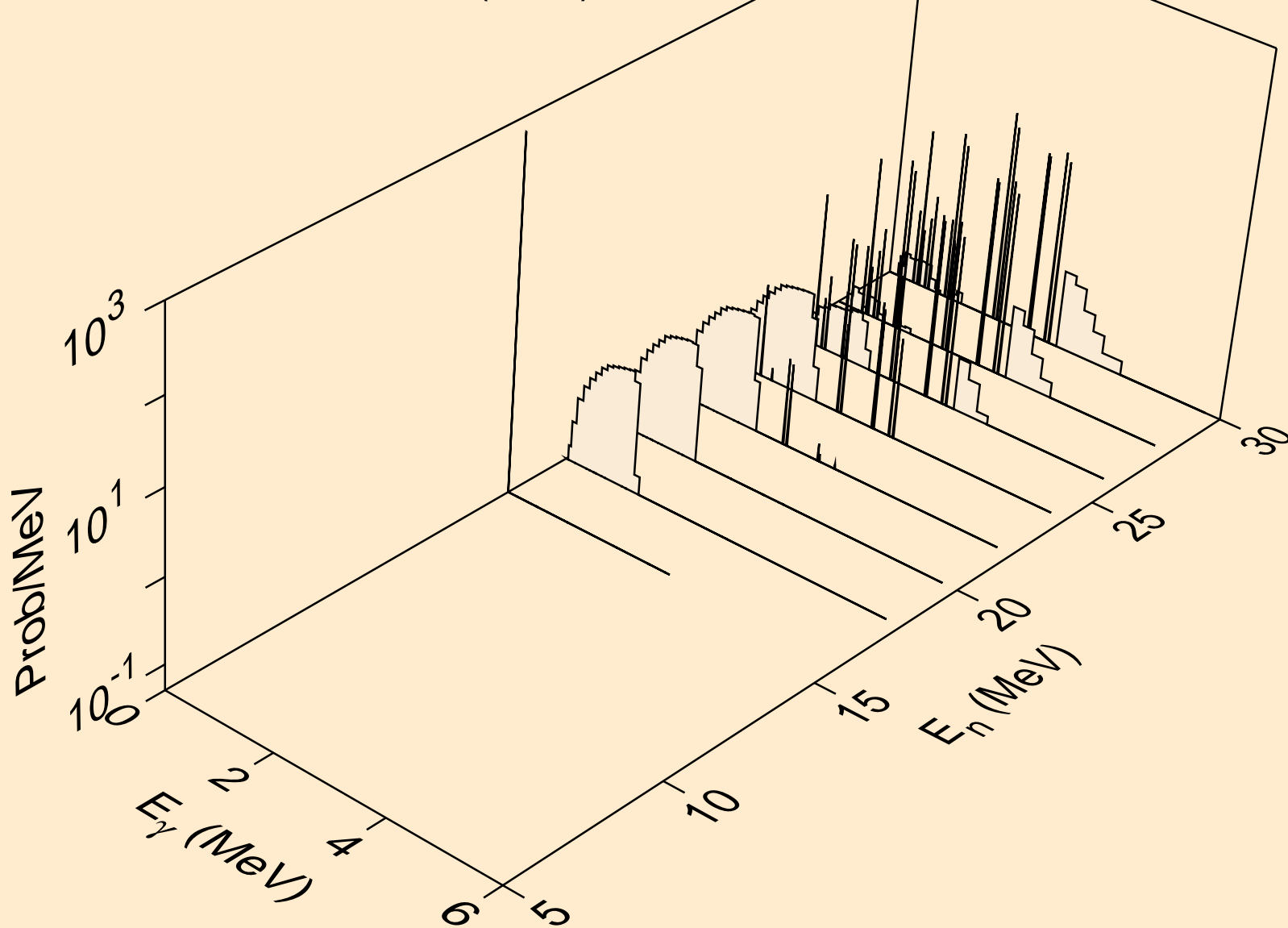

FE052M NEUTRON ACER TENDL-2019 LIBRARY; T=293.16K
Photon emission for (n,2p)

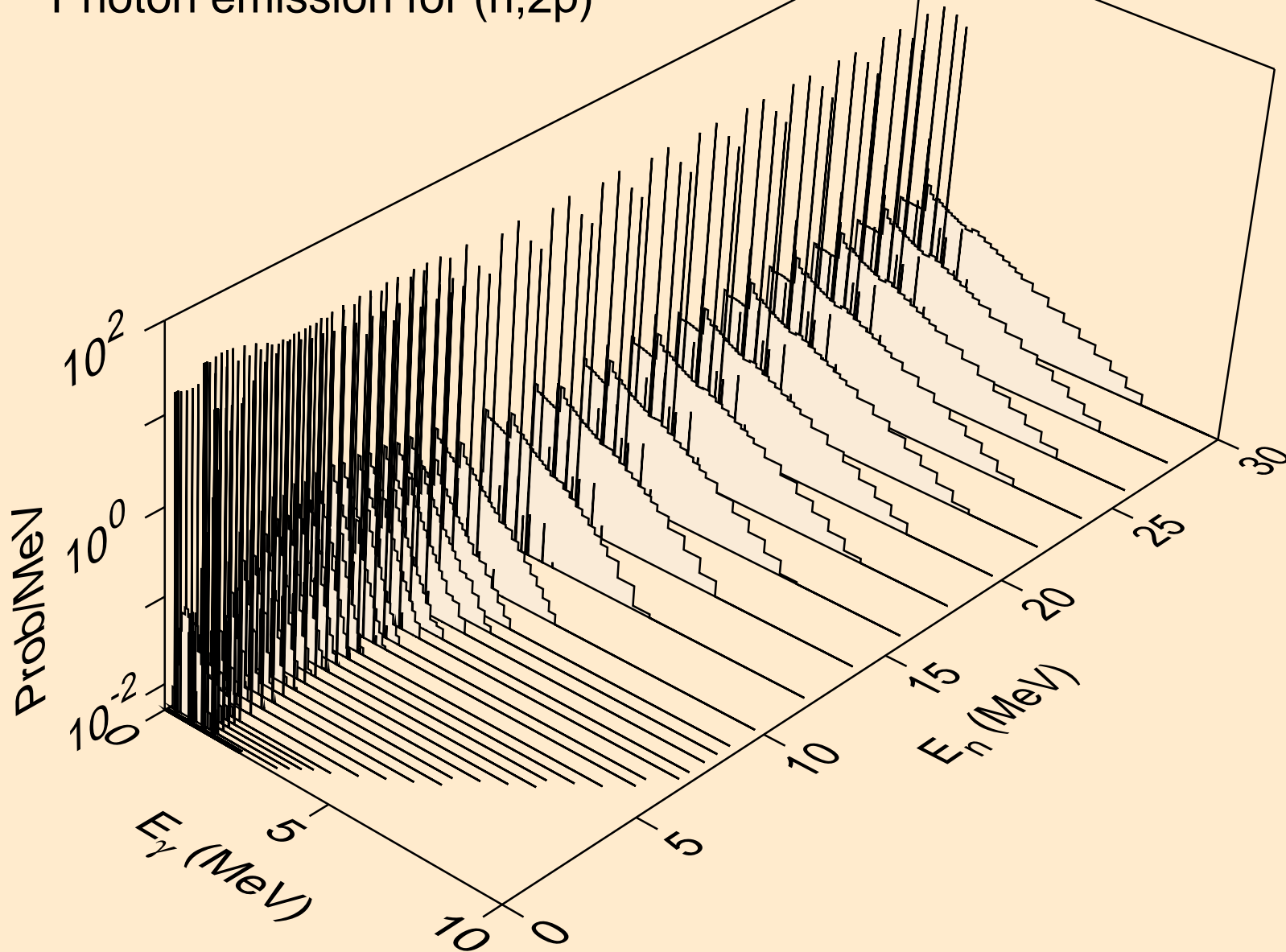

FE052M NEUTRON ACER TENDL-2019 LIBRARY; T=293.16K
Photon emission for (n,p α)

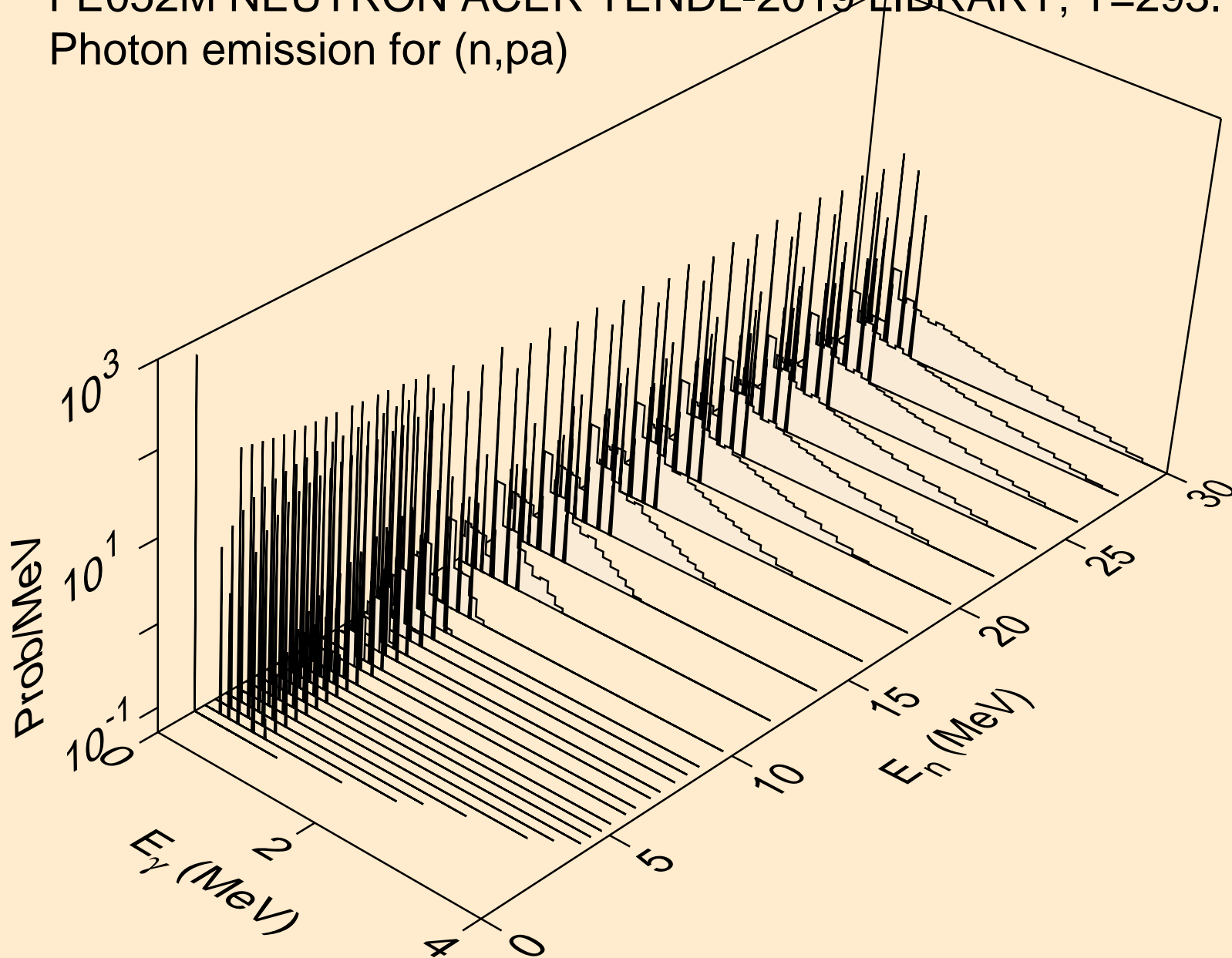

FE052M NEUTRON ACER TENDL-2019 LIBRARY; T=293.16K
Photon emission for (n,pd)

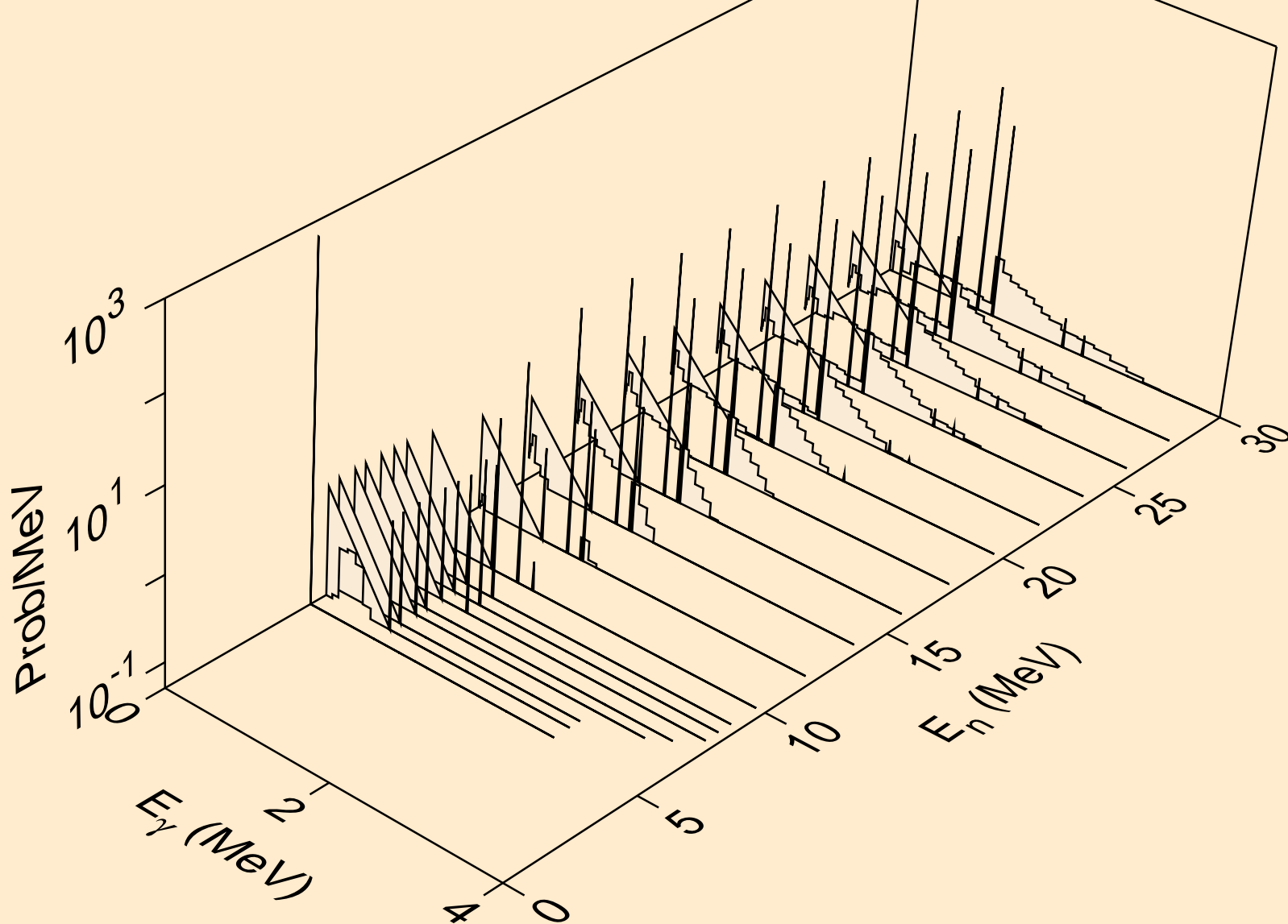

FE052M NEUTRON ACER TENDL-2019 LIBRARY; T=293.16K
Photon emission for (n,pt)

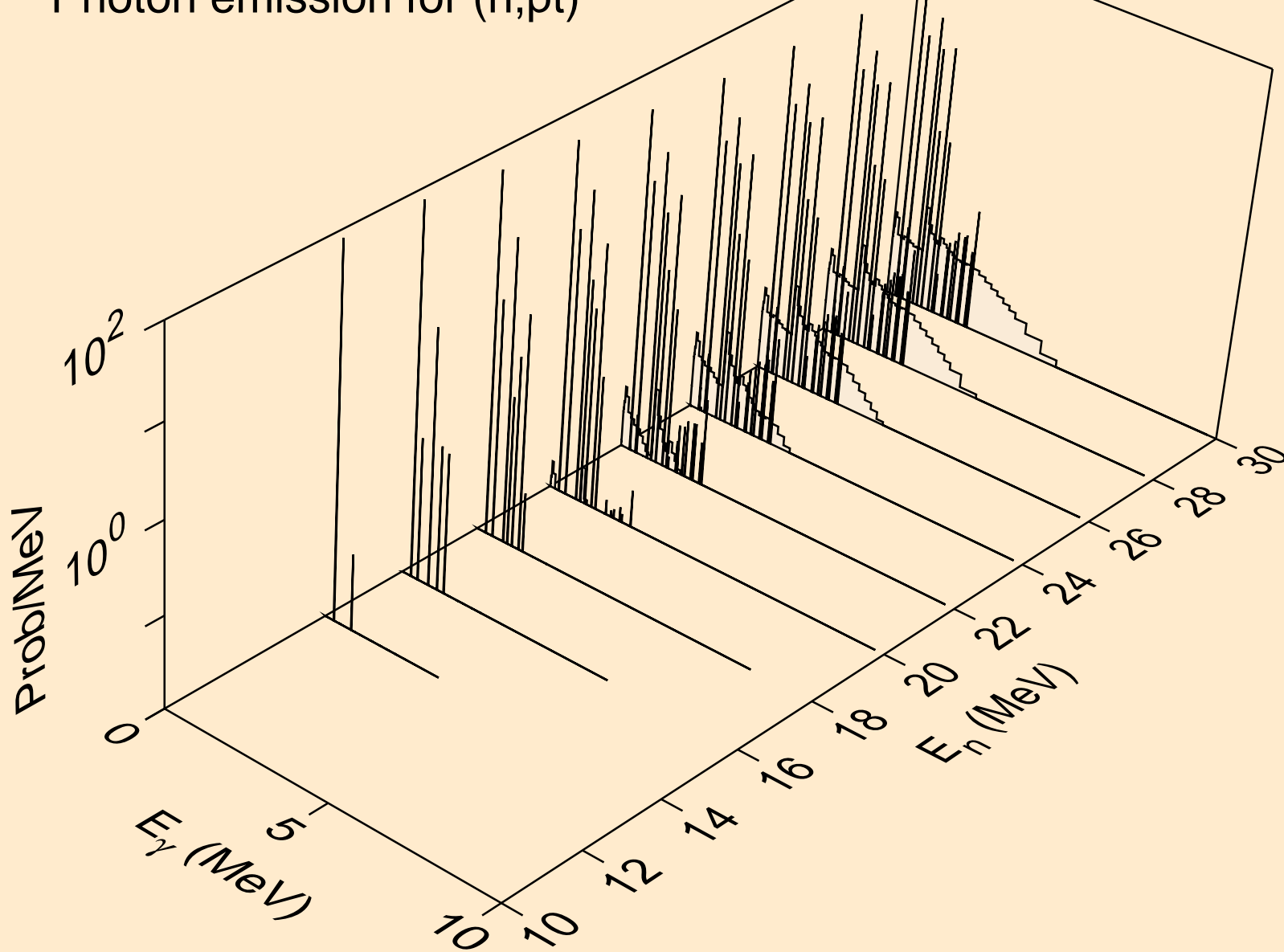

FE052M NEUTRON ACER TENDL-2019 LIBRARY; T=293.16K
Photon emission for (n,da)

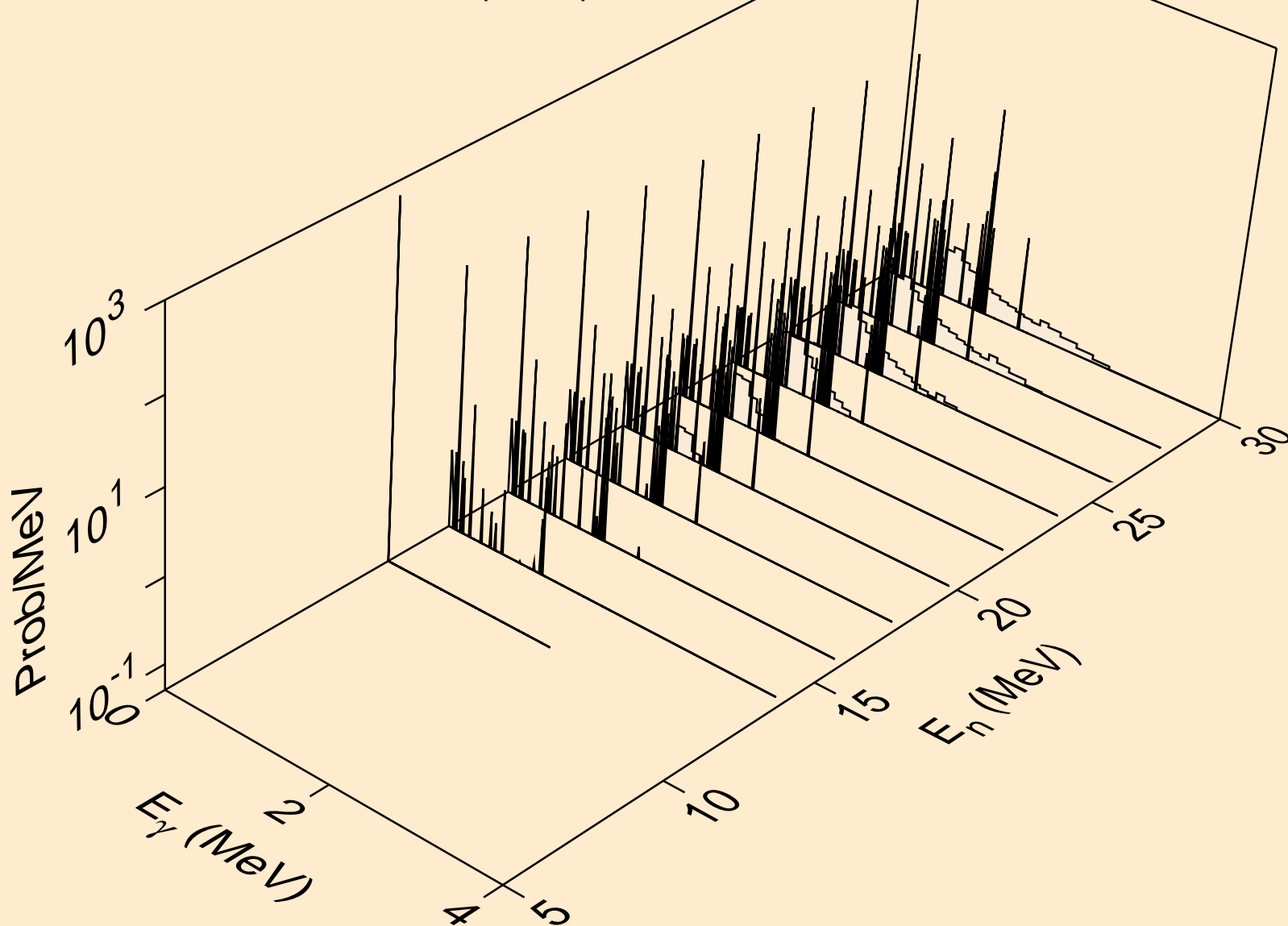

FE052M NEUTRON ACER TENDL-2019 LIBRARY; T=293.16K
thermal capture photon spectrum

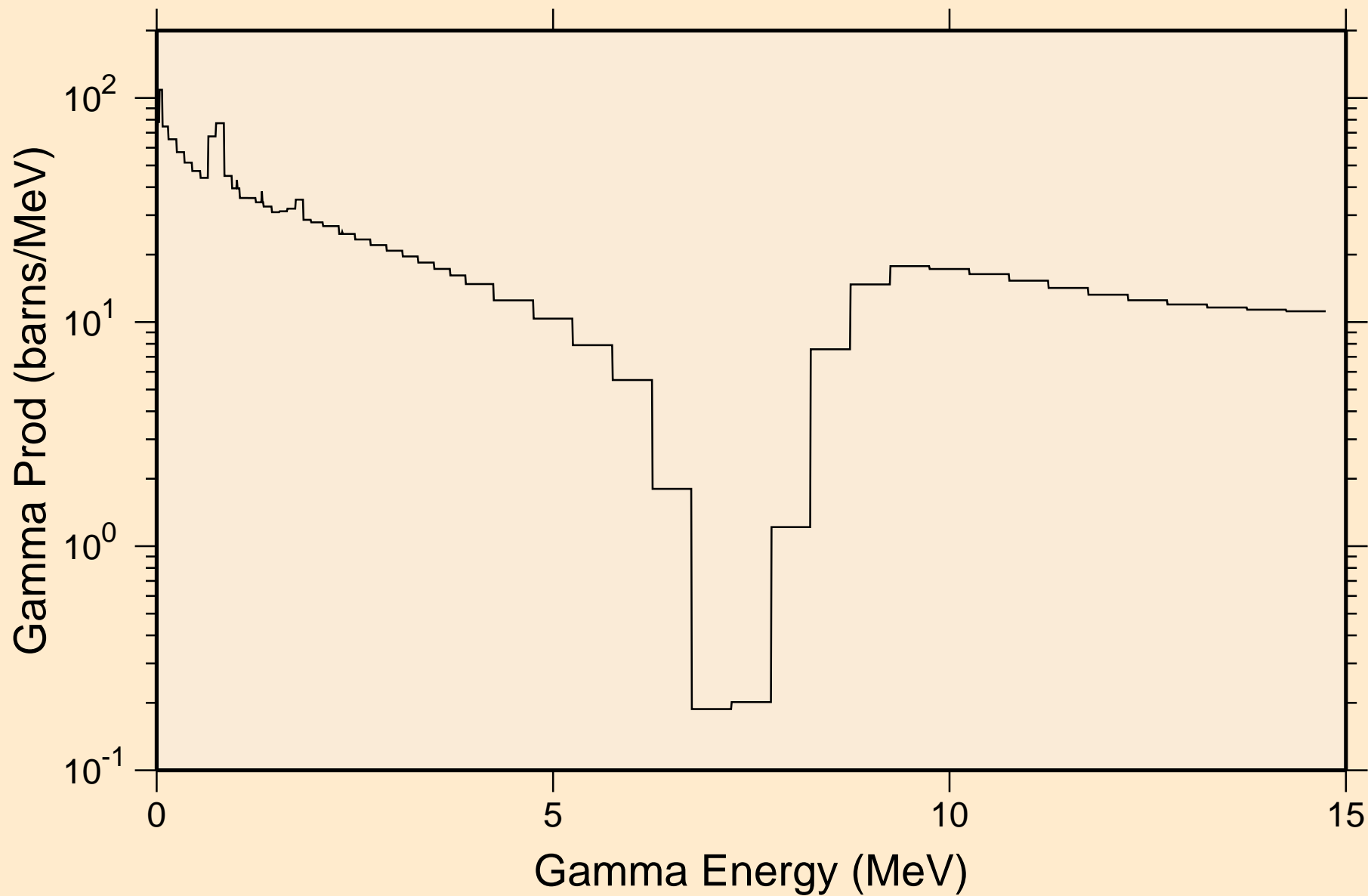

FE052M NEUTRON ACER TENDL-2019 LIBRARY; T=293.16K
14 MeV photon spectrum

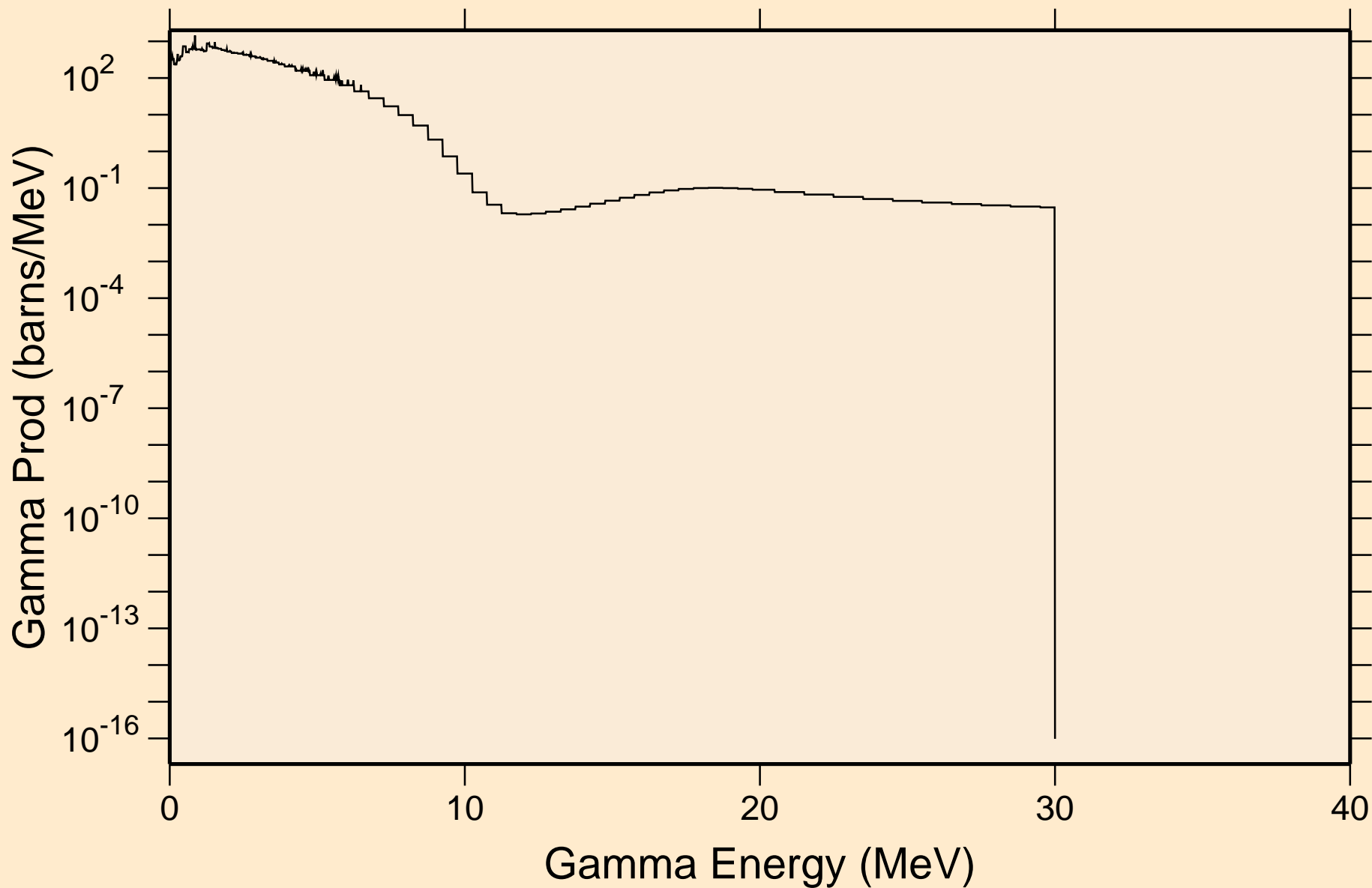

FE052M NEUTRON ACER TENDL-2019 LIBRARY; T=293.16K
Particle heating contributions

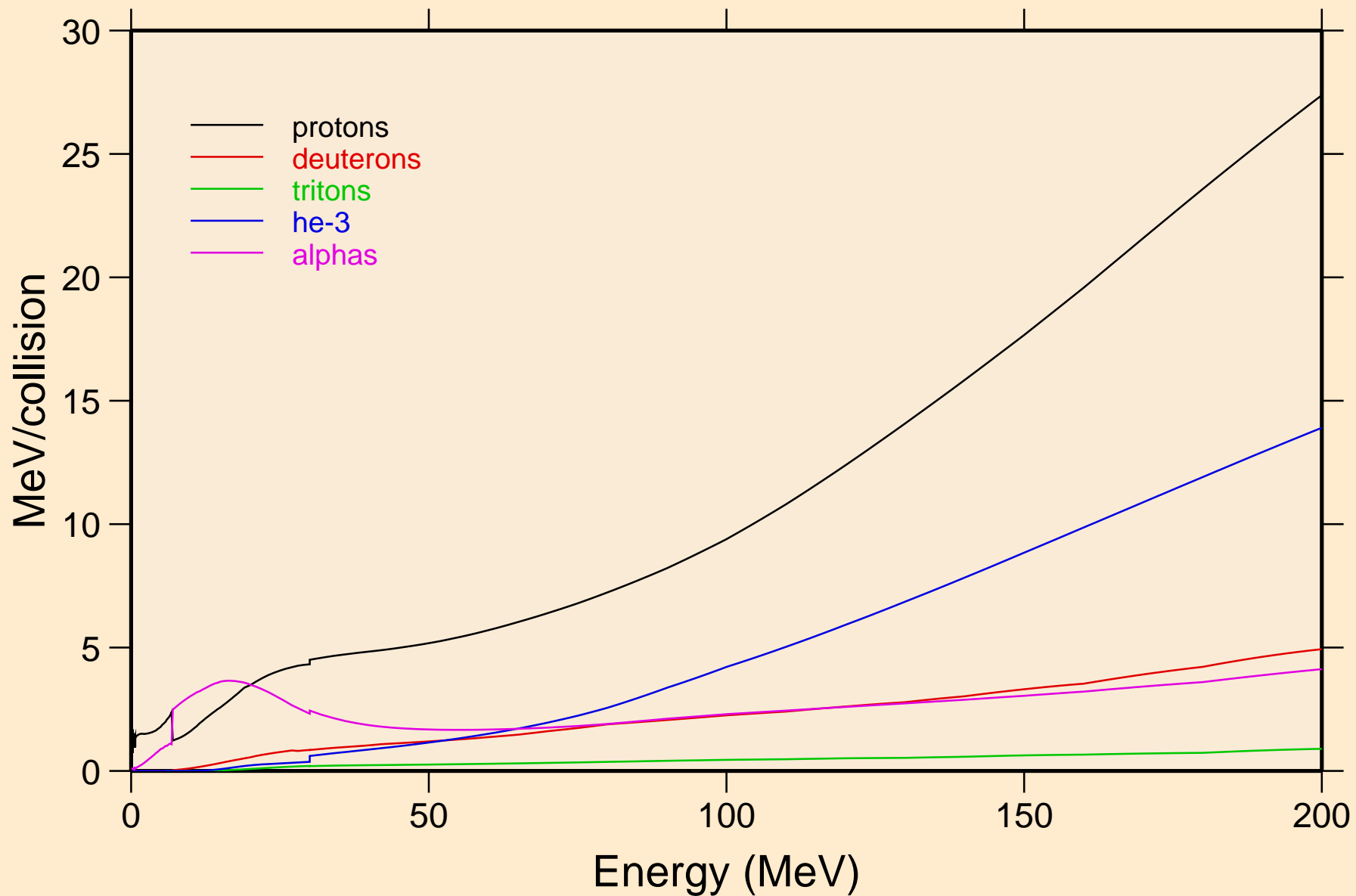

FE052M NEUTRON ACER TENDL-2019 LIBRARY; T=293.16K
Recoil Heating

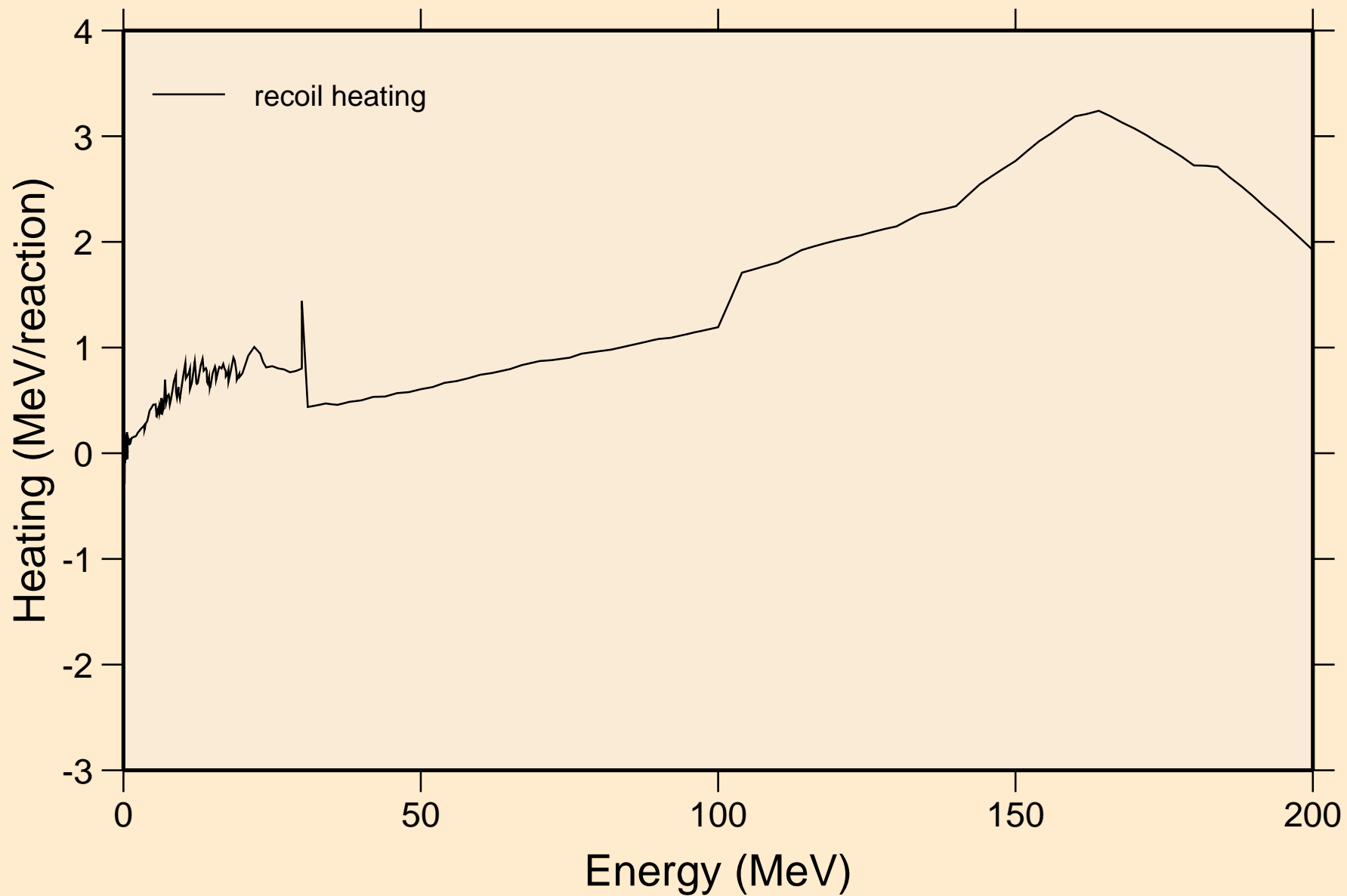

FE052M NEUTRON ACER TENDL-2019 LIBRARY; T=293.16K
Particle production cross sections

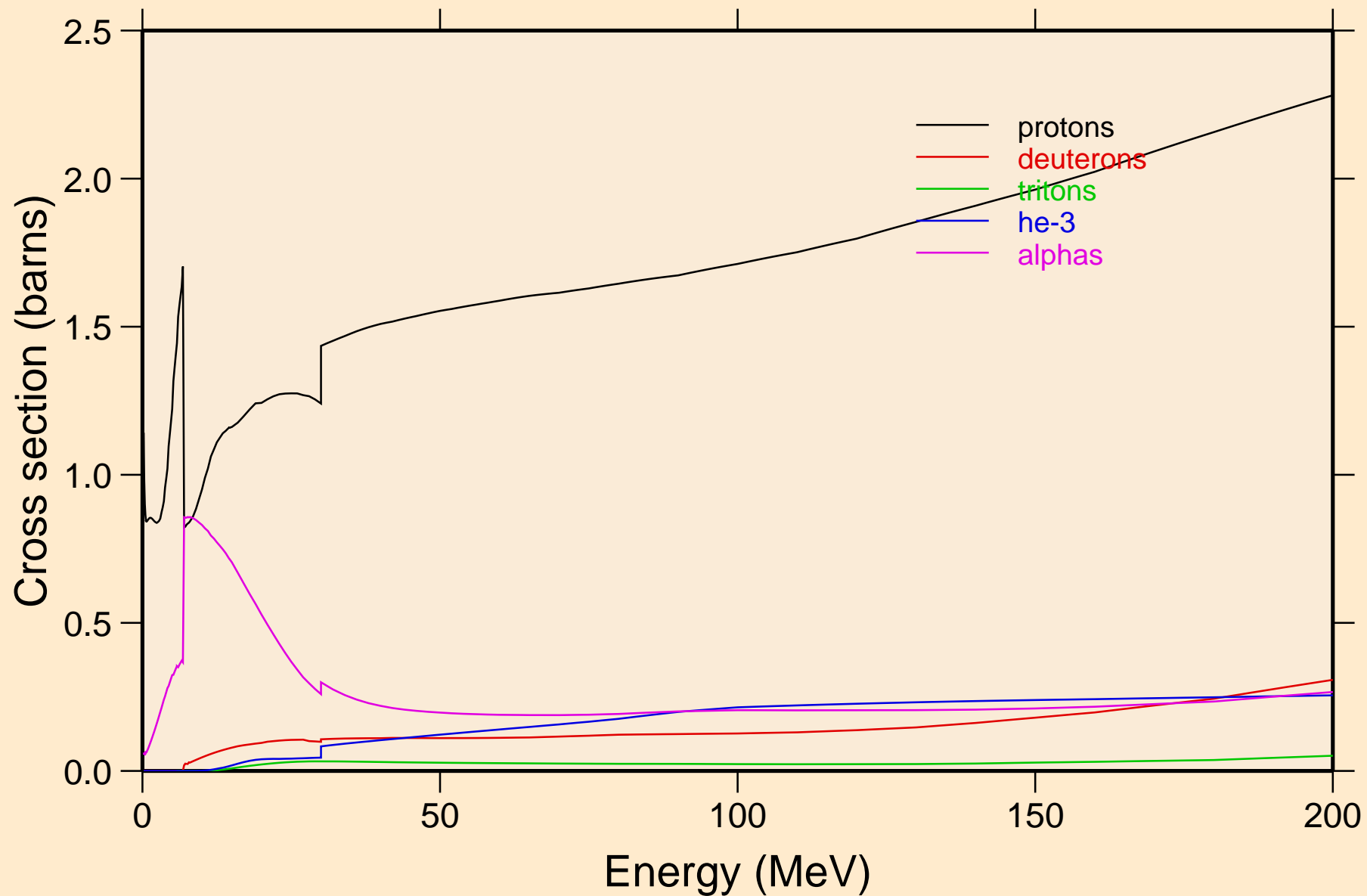

FE052M NEUTRON ACER TENDL-2019 LIBRARY; T=293.16K
protons from (n,x)

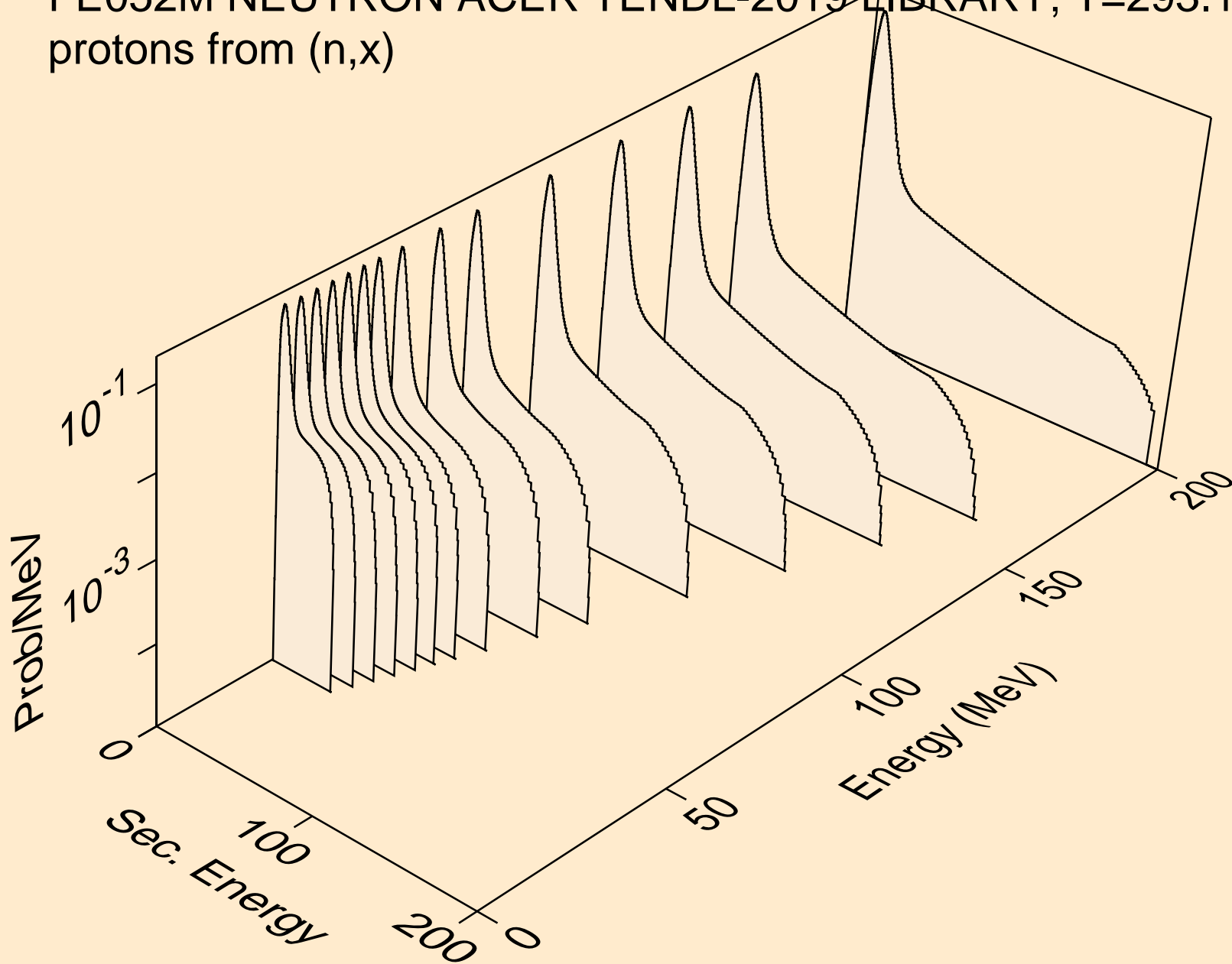

FE052M NEUTRON ACER TENDL-2019 LIBRARY; T=293.16K
protons from (n,n*)p

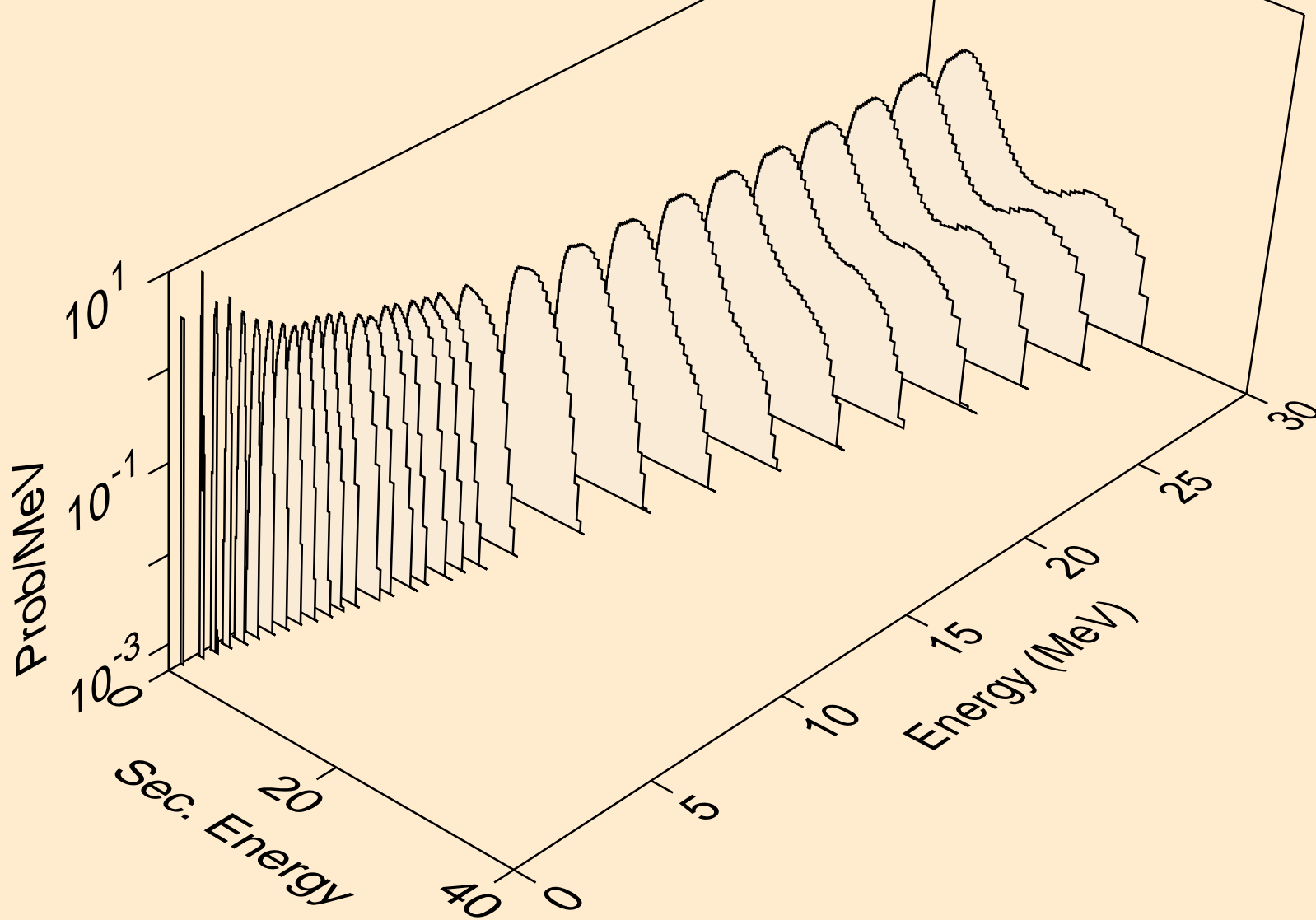

FE052M NEUTRON ACER TENDL-2019 LIBRARY; T=293.16K
protons from (n,2np)

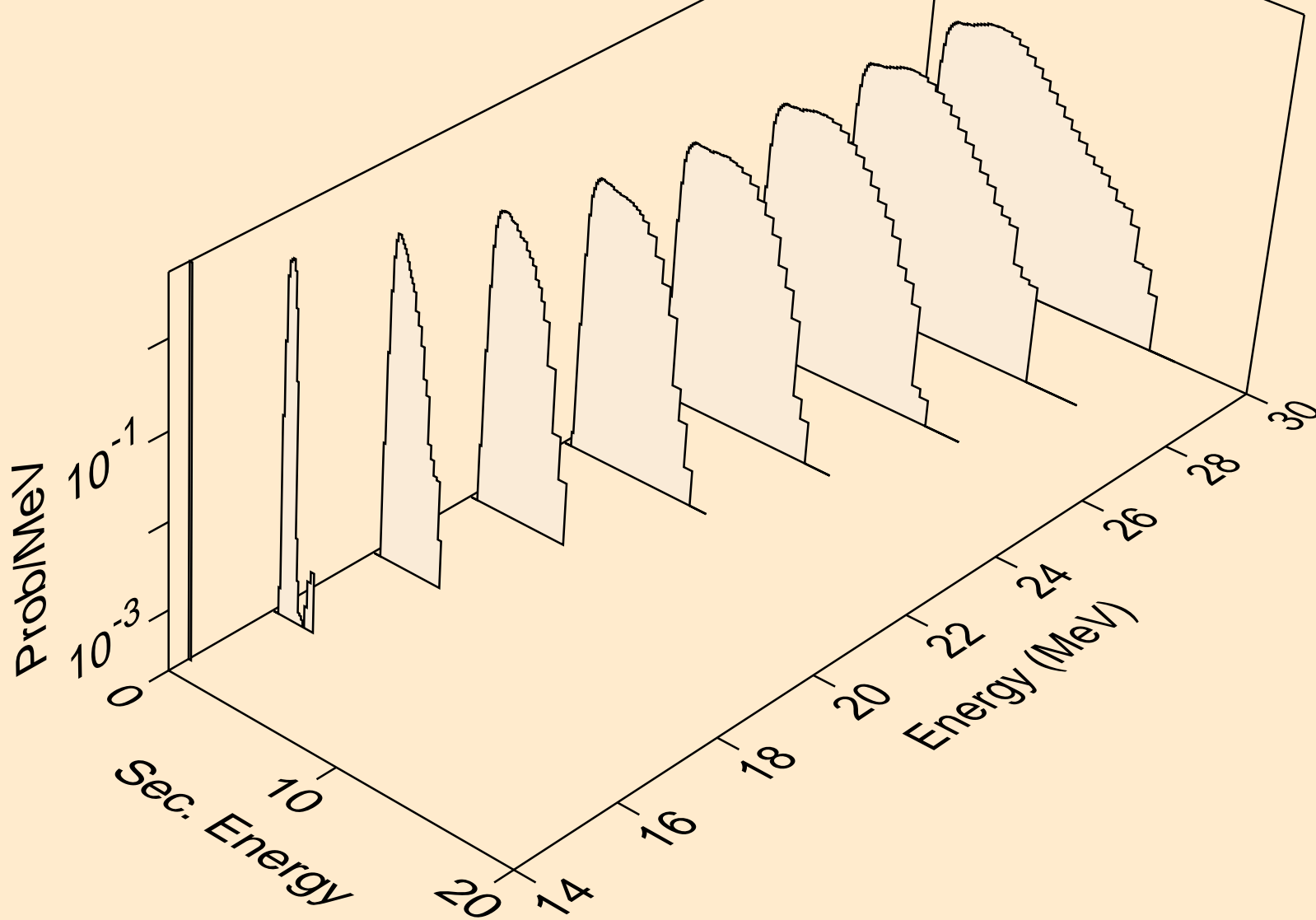

FE052M NEUTRON ACER TENDL-2019 LIBRARY; T=293.16K
protons from (n,2np)

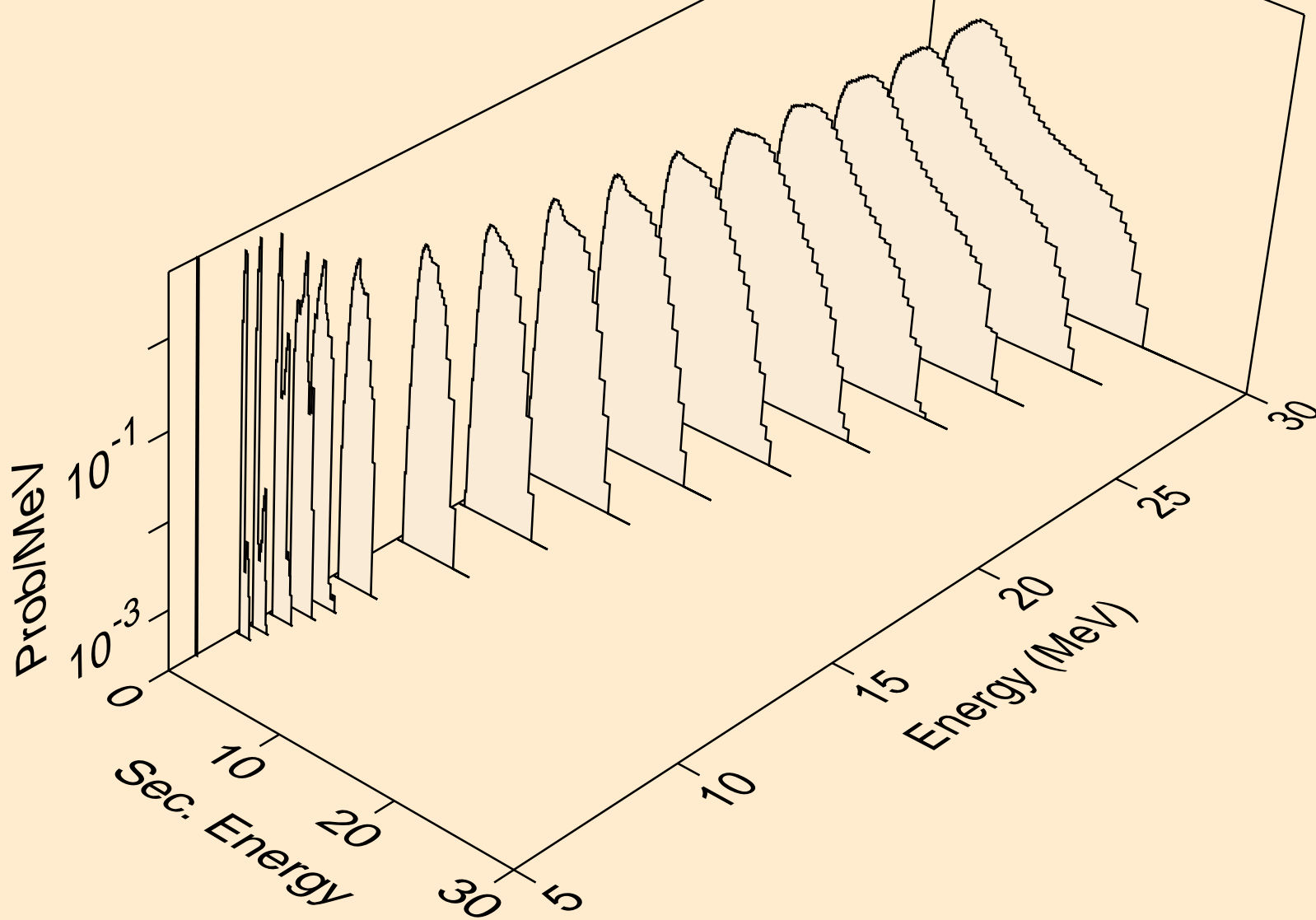

FE052M NEUTRON ACER TENDL-2019 LIBRARY; T=293.16K
protons from (n,npa)

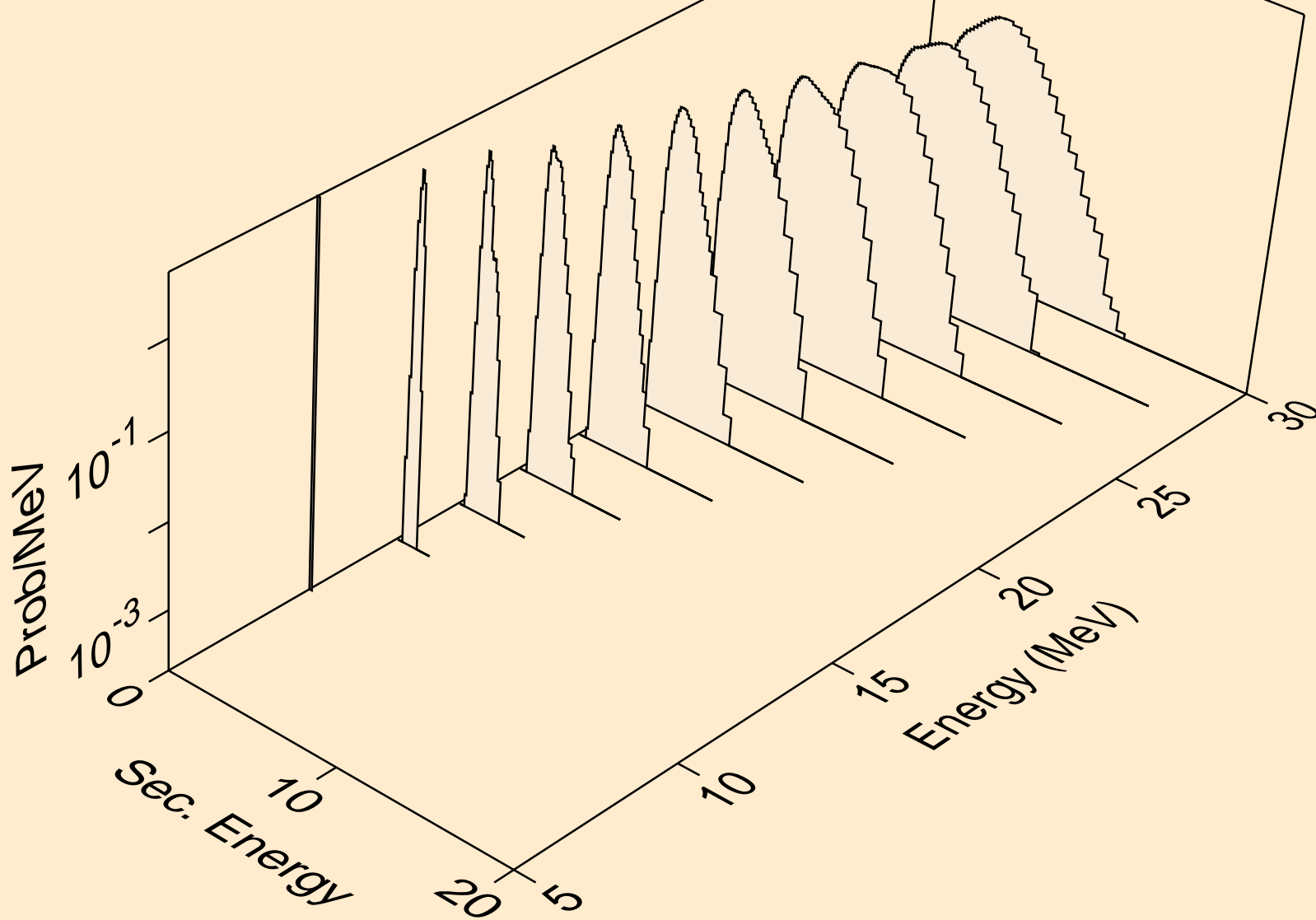

FE052M NEUTRON ACER TENDL-2019 LIBRARY; T=293.16K
protons from (n,p)

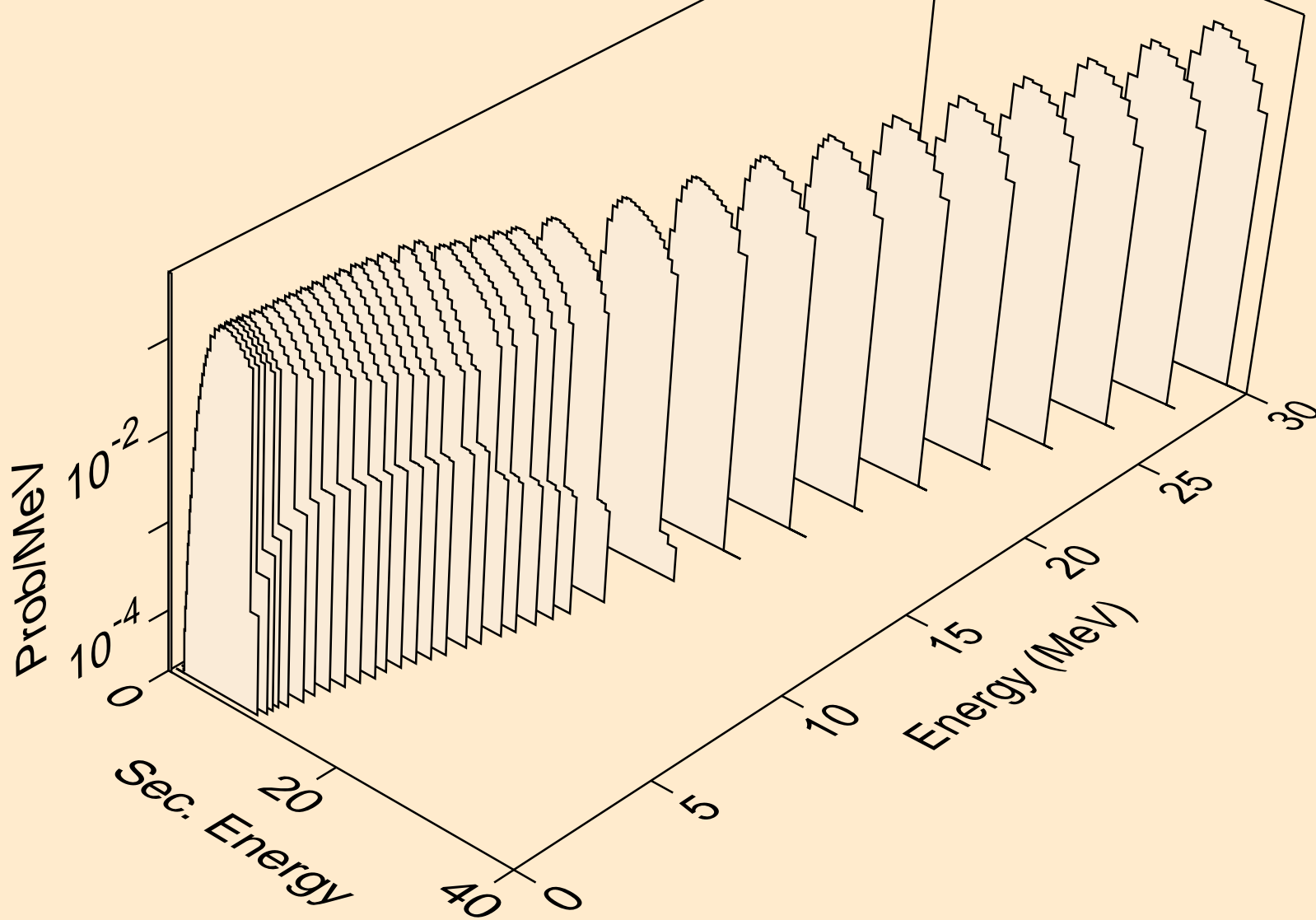

FE052M NEUTRON ACER TENDL-2019 LIBRARY; T=293.16K
protons from (n,2p)

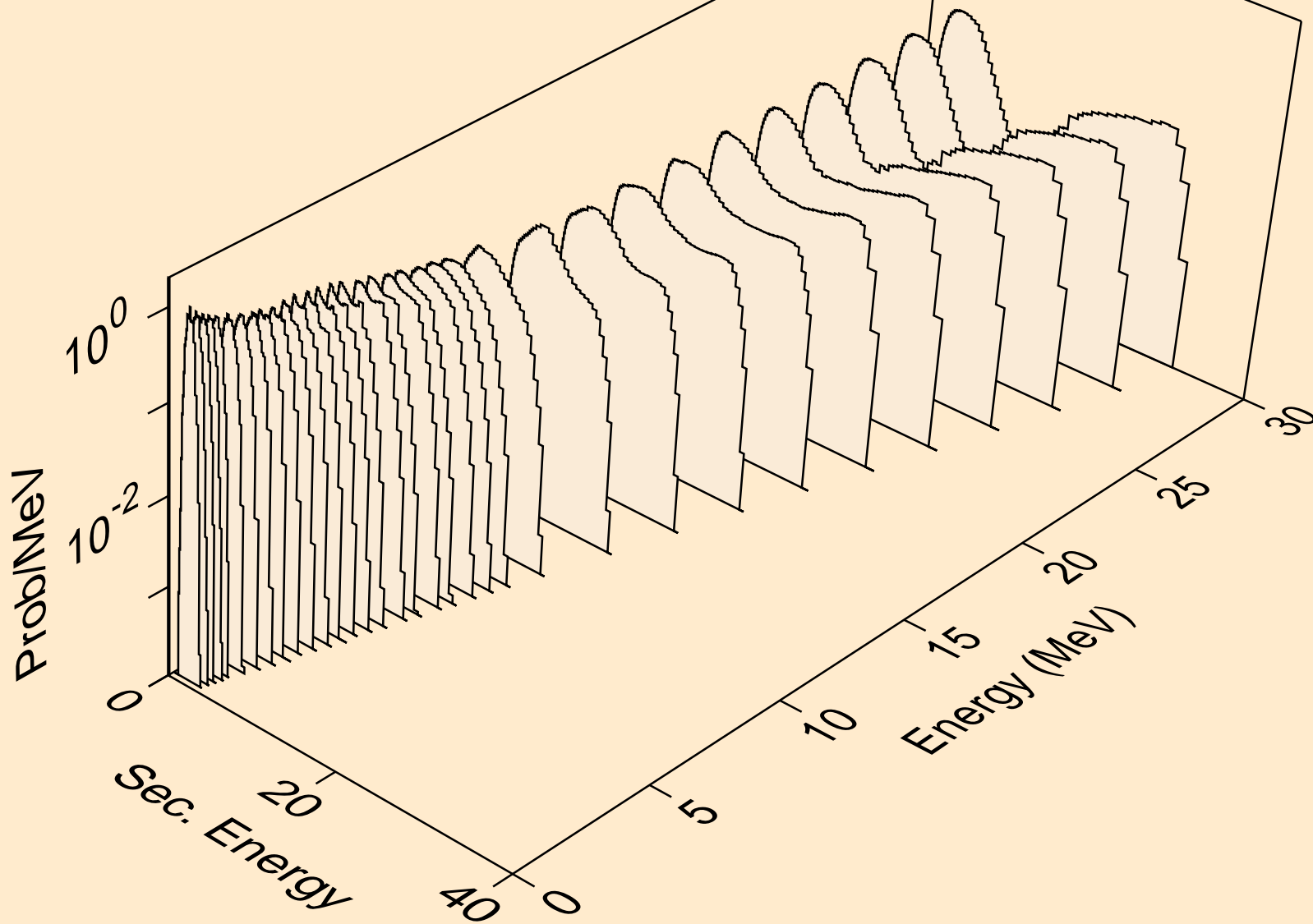

FE052M NEUTRON ACER TENDL-2019 LIBRARY; T=293.16K
protons from (n,p)

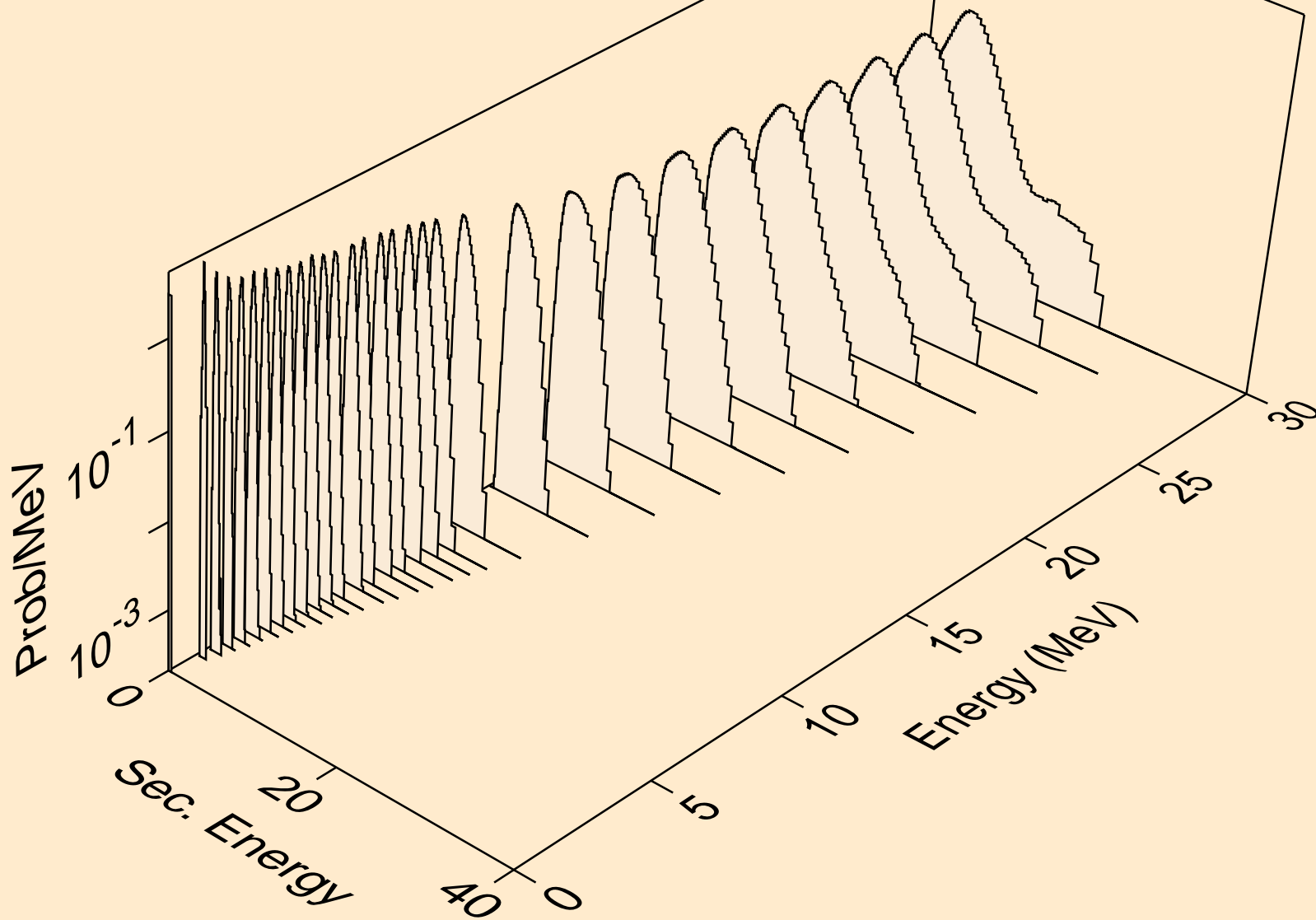

FE052M NEUTRON ACER TENDL-2019 LIBRARY; T=293.16K
protons from (n,pd)

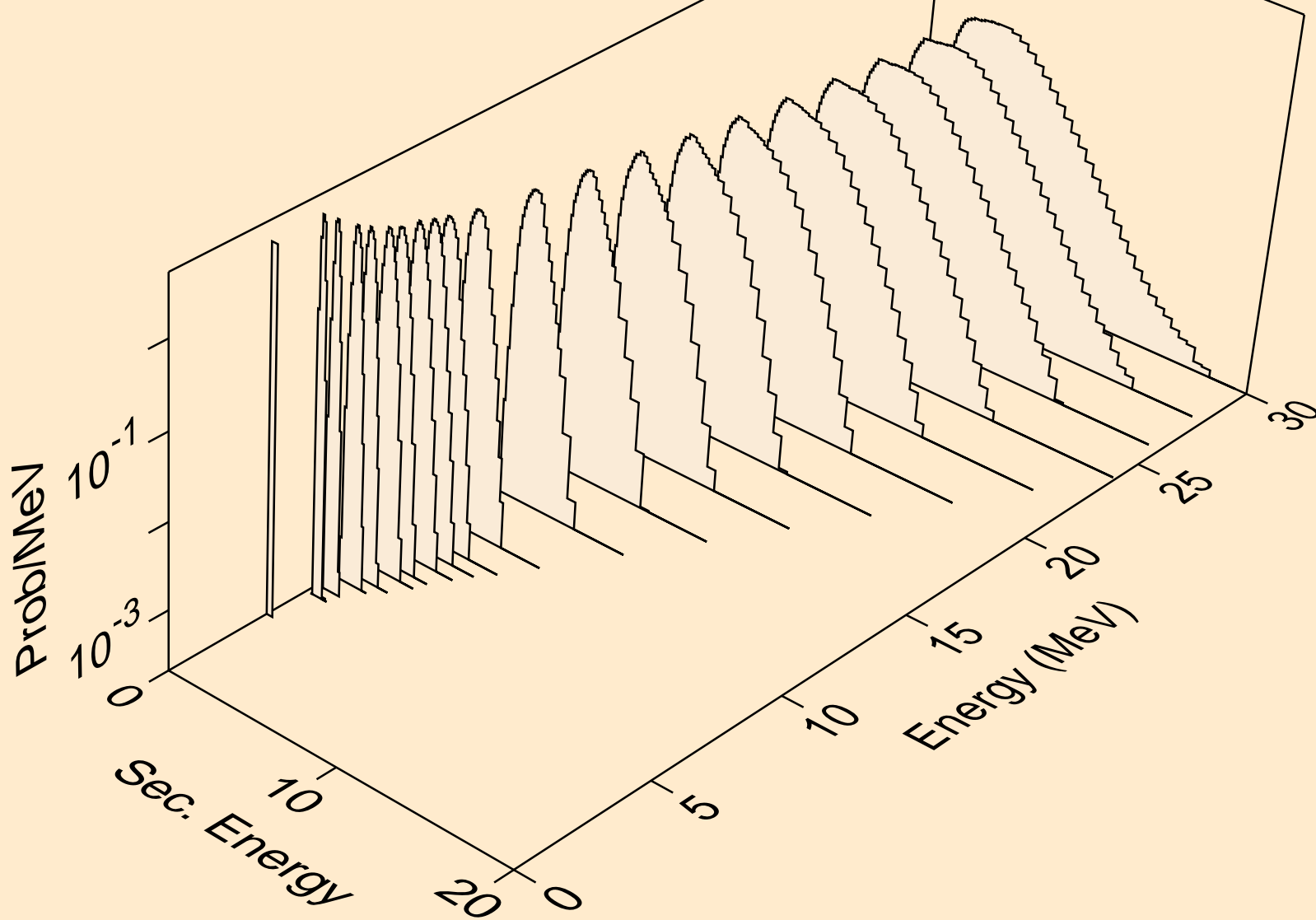

FE052M NEUTRON ACER TENDL-2019 LIBRARY; T=293.16K
protons from (n,pt)

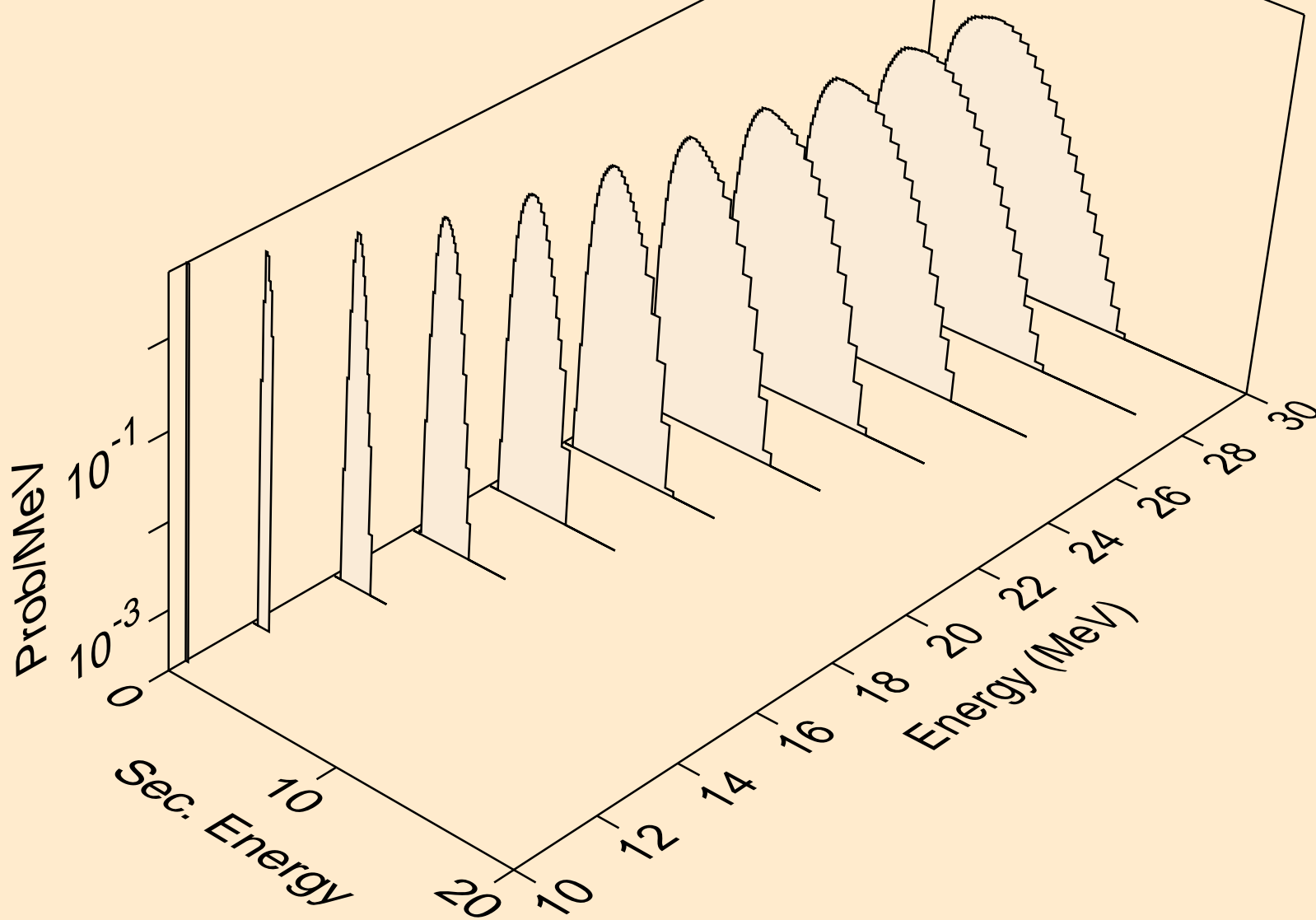

FE052M NEUTRON ACER TENDL-2019 LIBRARY; T=293.16K
deuterons from (n,x)

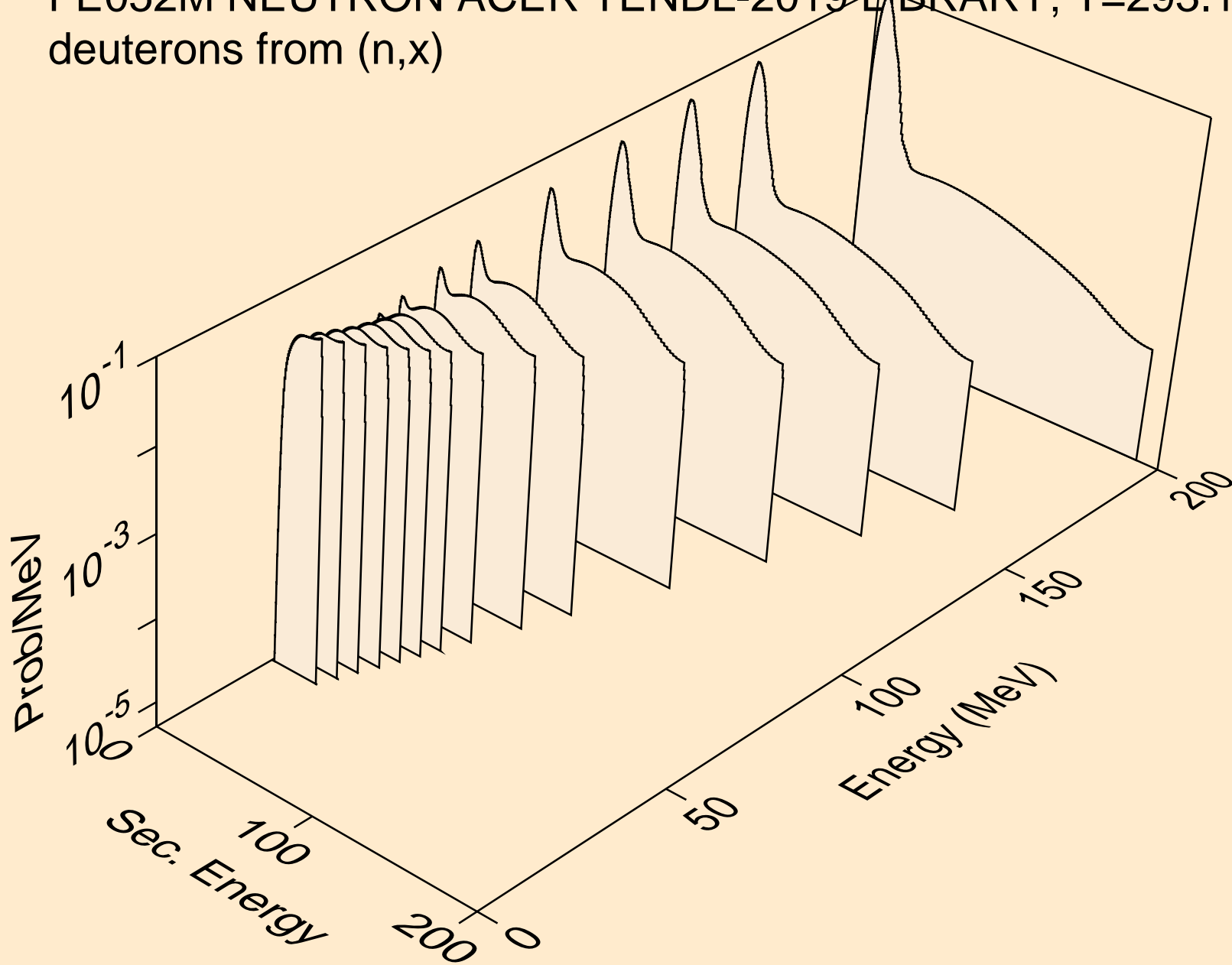

FE052M NEUTRON ACER TENDL-2019 LIBRARY; T=293.16K
deuterons from (n,2nd)

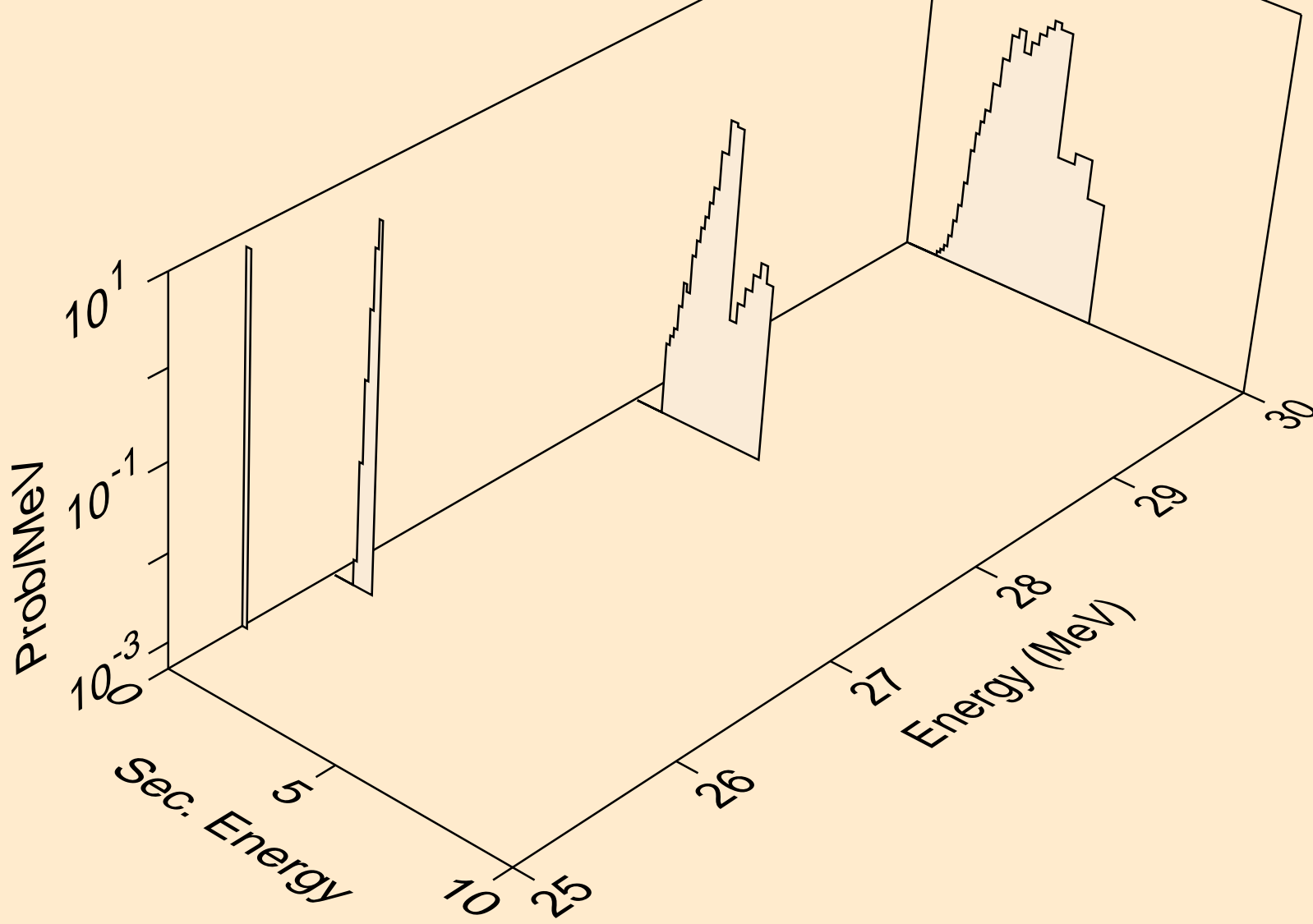

FE052M NEUTRON ACER TENDL-2019 LIBRARY; T=293.16K
deuterons from (n,n*)d

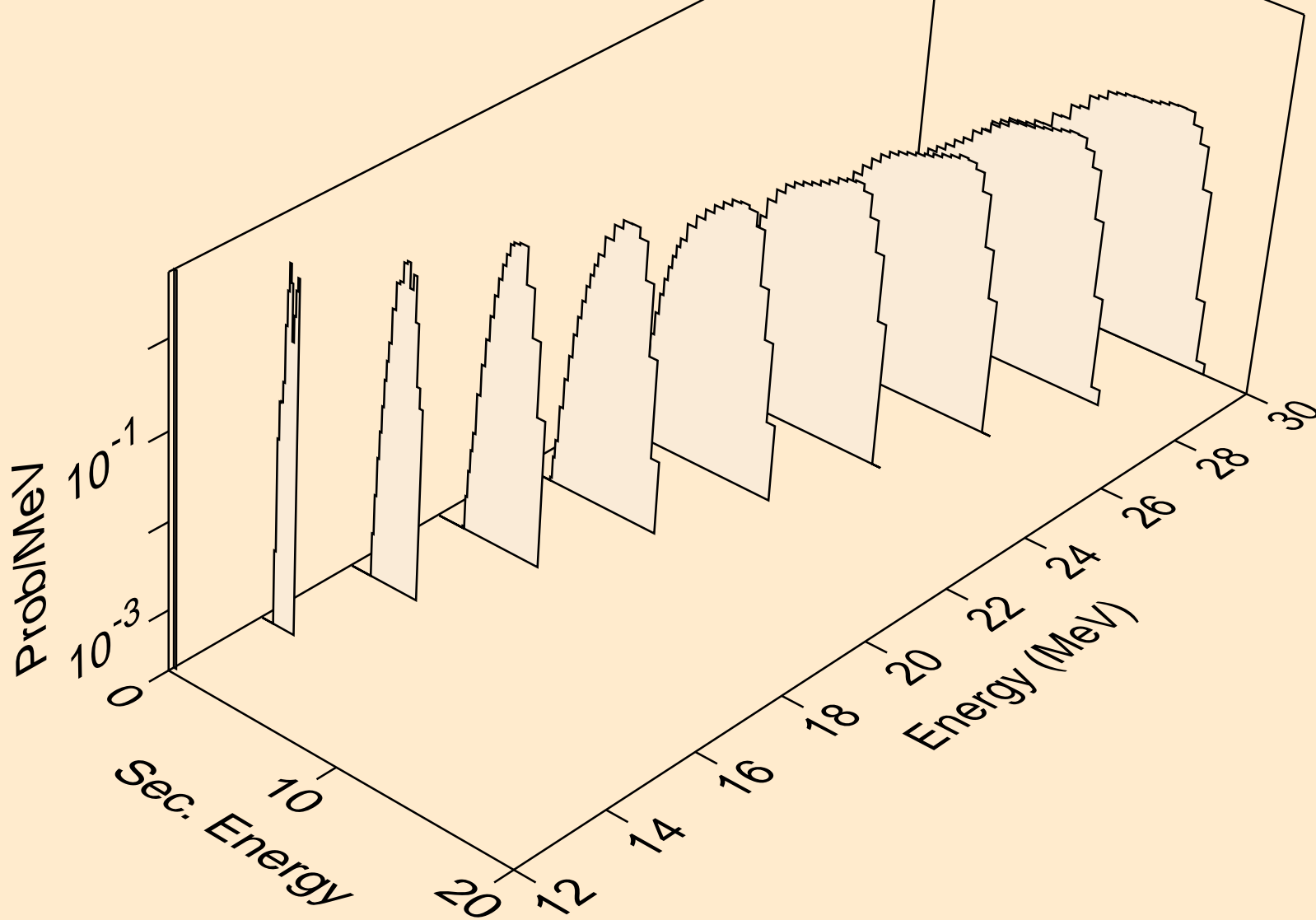

FE052M NEUTRON ACER TENDL-2019 LIBRARY; T=293.16K
deuterons from (n,d)

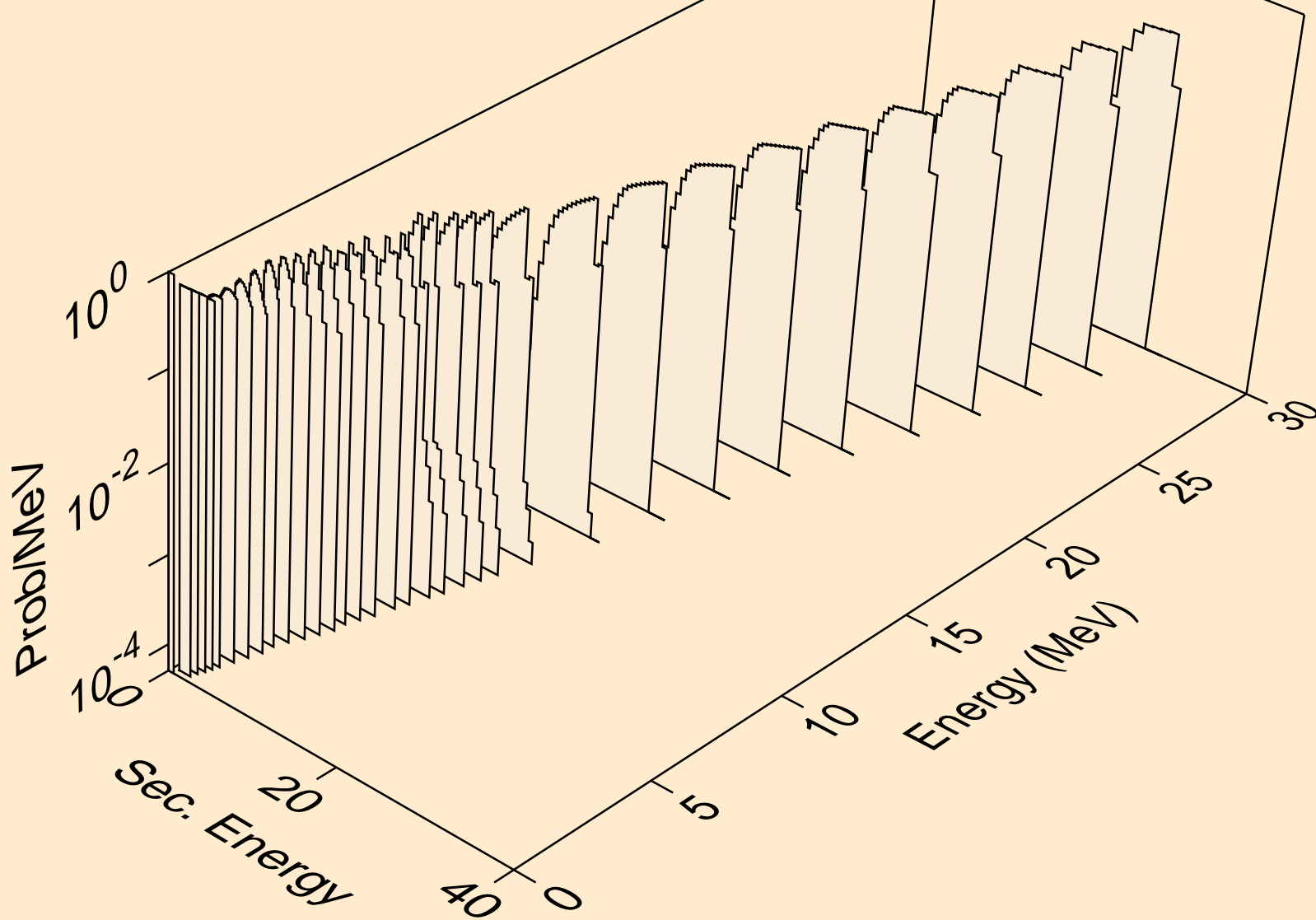

FE052M NEUTRON ACER TENDL-2019 LIBRARY; T=293.16K
deuterons from (n,pd)

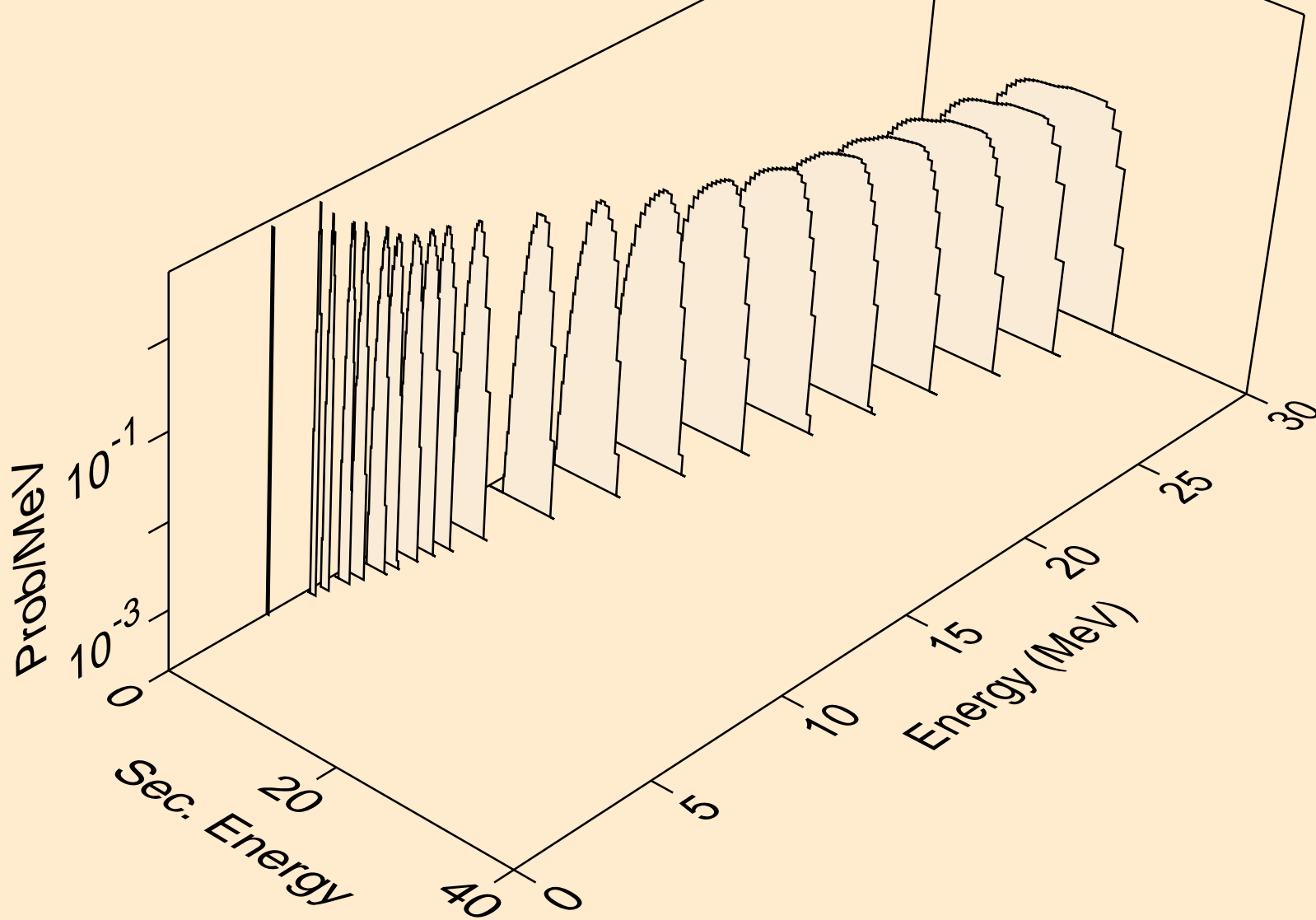

FE052M NEUTRON ACER TENDL-2019 LIBRARY; T=293.16K
deuterons from (n,da)

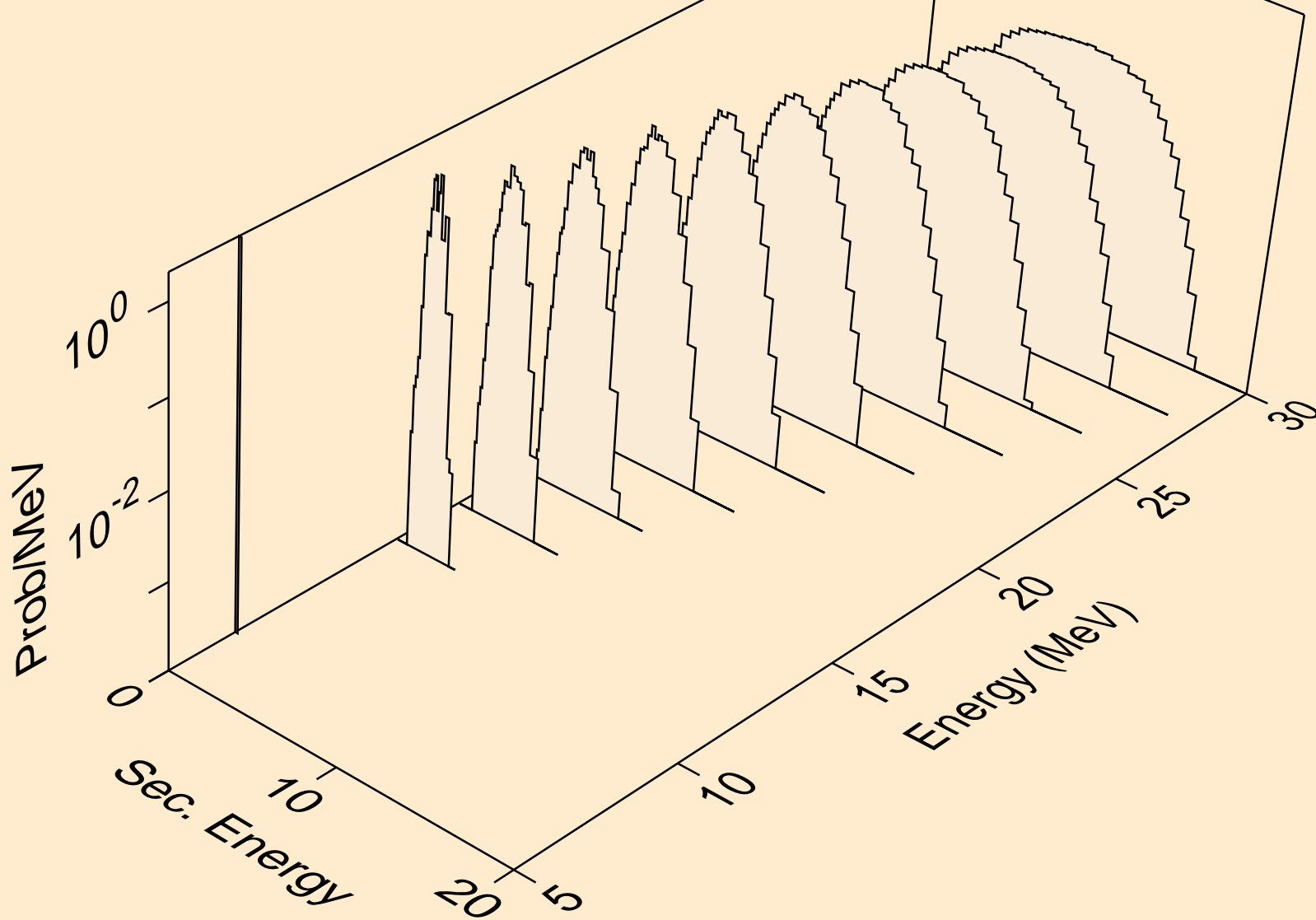

FE052M NEUTRON ACER TENDL-2019 LIBRARY; T=293.16K
tritons from (n,x)

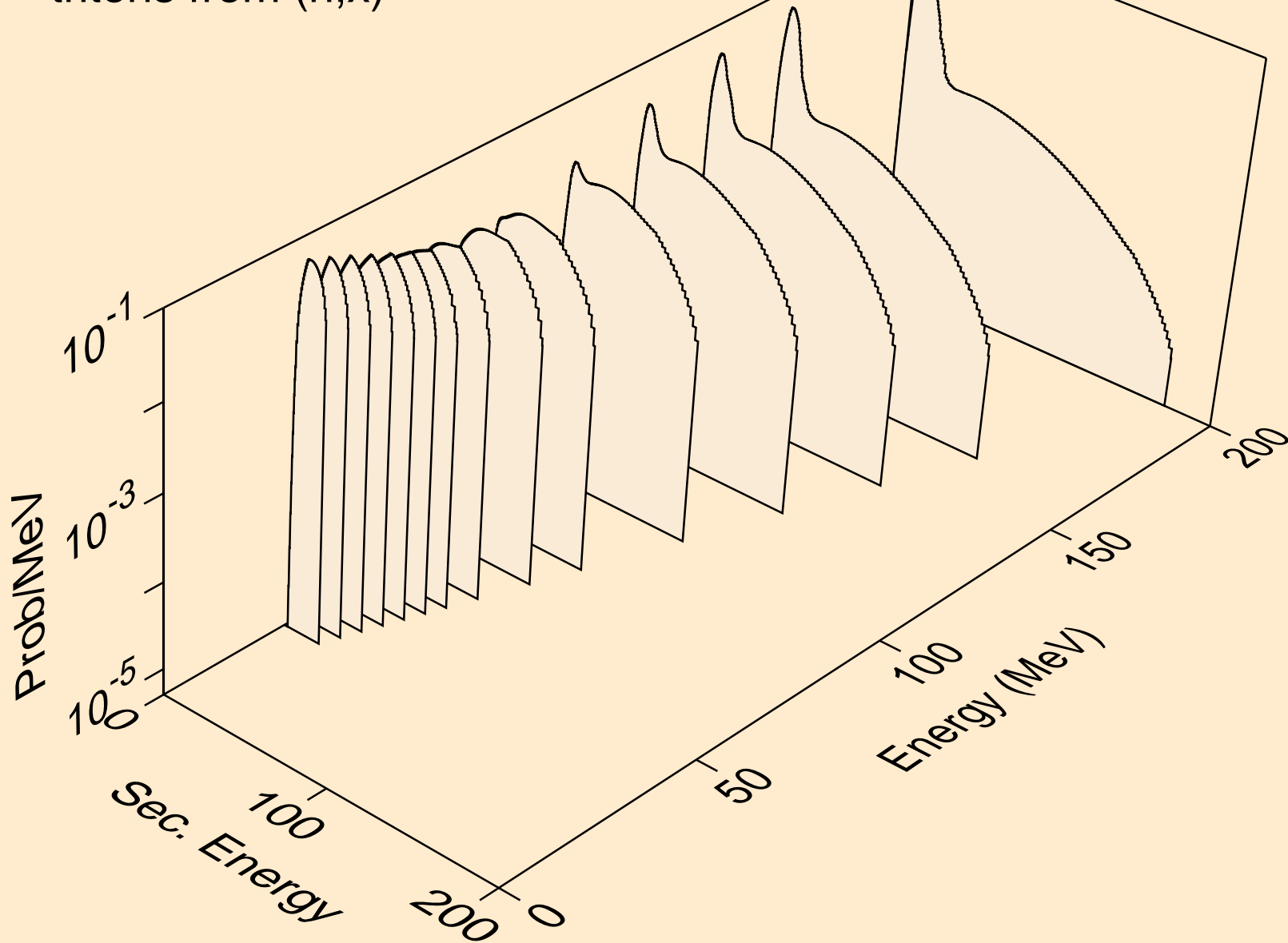

FE052M NEUTRON ACER TENDL-2019 LIBRARY; T=293.16K
tritons from (n,n*)t

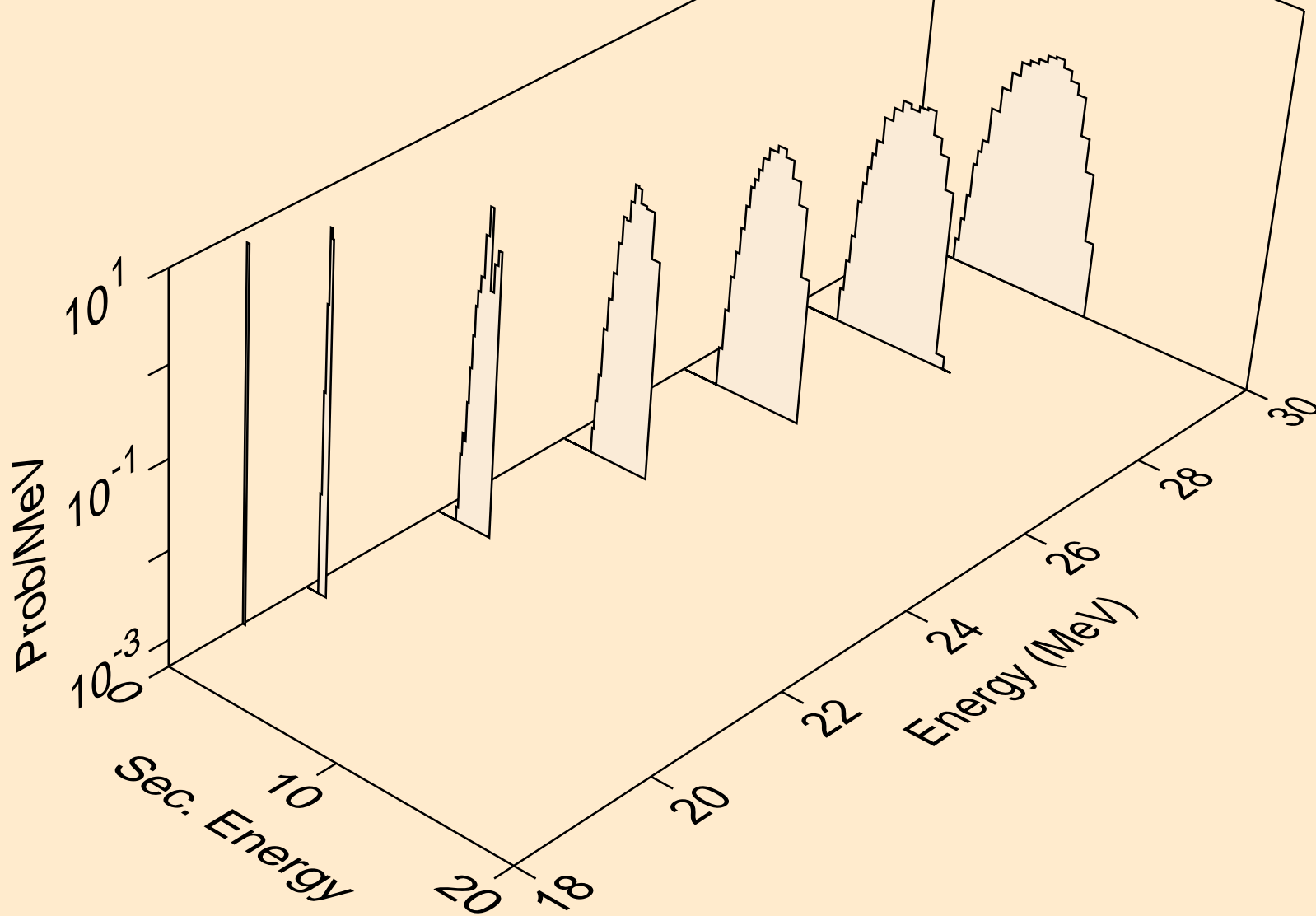

FE052M NEUTRON ACER TENDL-2019 LIBRARY; T=293.16K
tritons from (n,t)

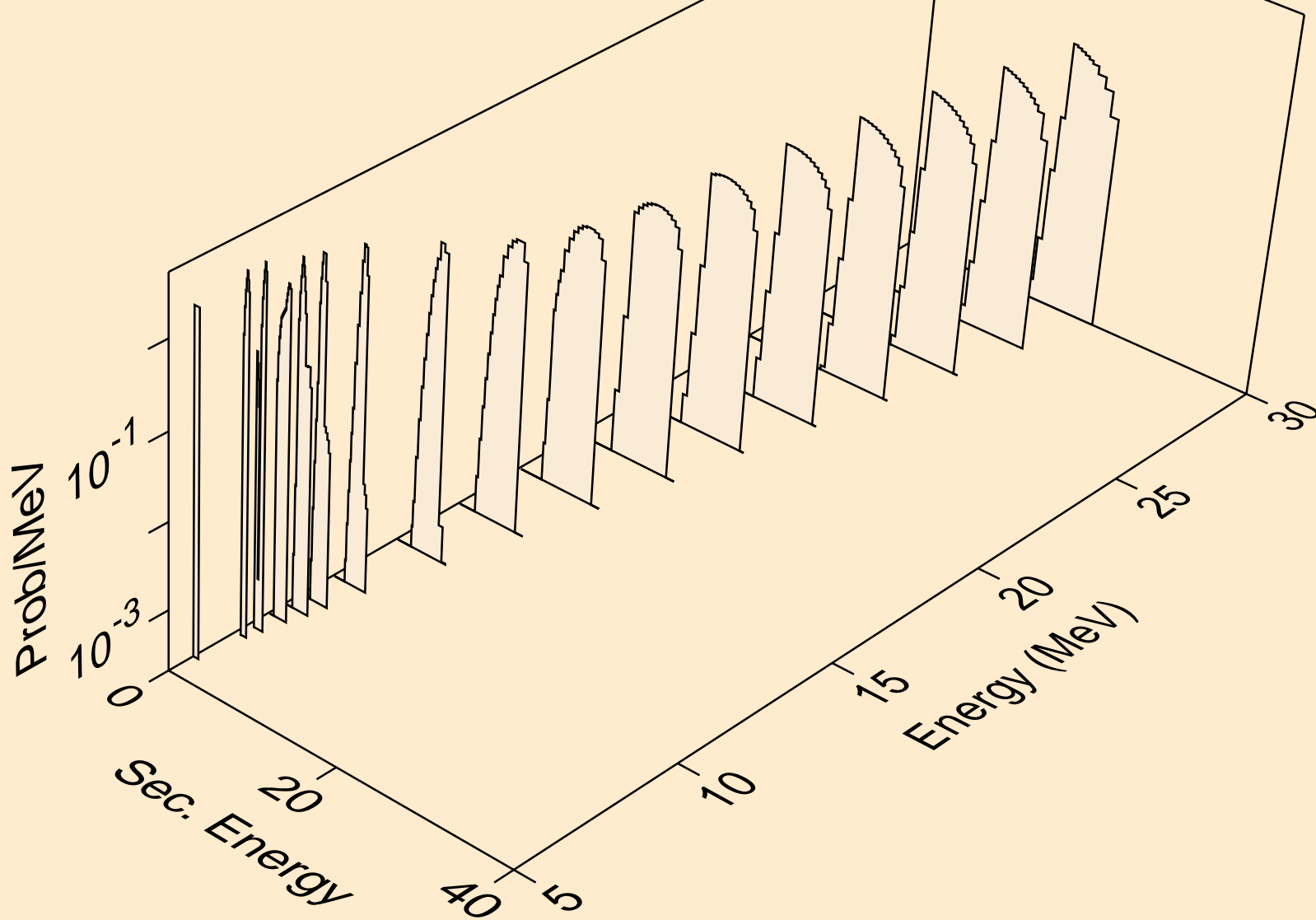

FE052M NEUTRON ACER TENDL-2019 LIBRARY; T=293.16K
tritons from (n,pt)

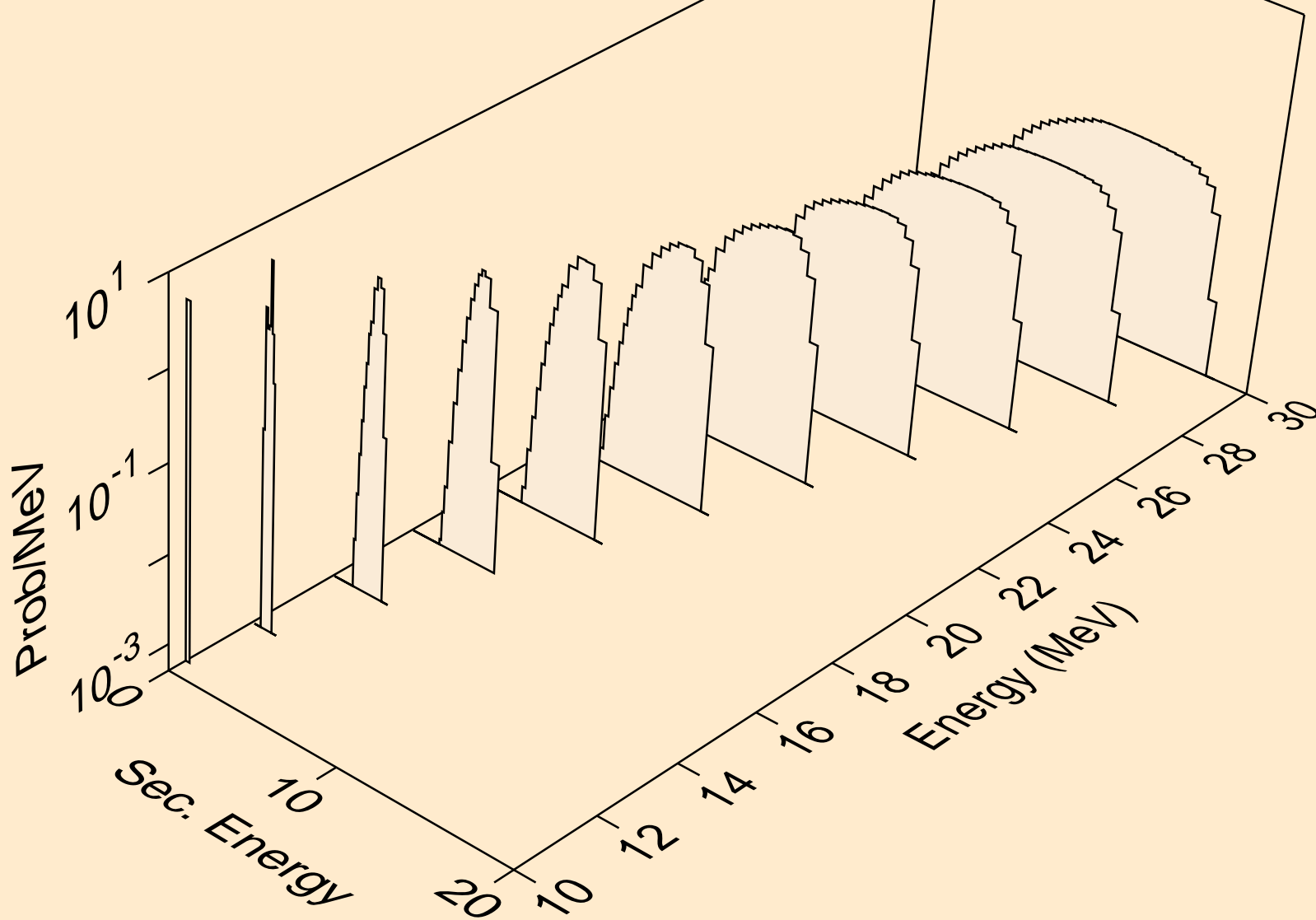

FE052M NEUTRON ACER TENDL-2019 LIBRARY; T=293.16K
he3s from (n,x)

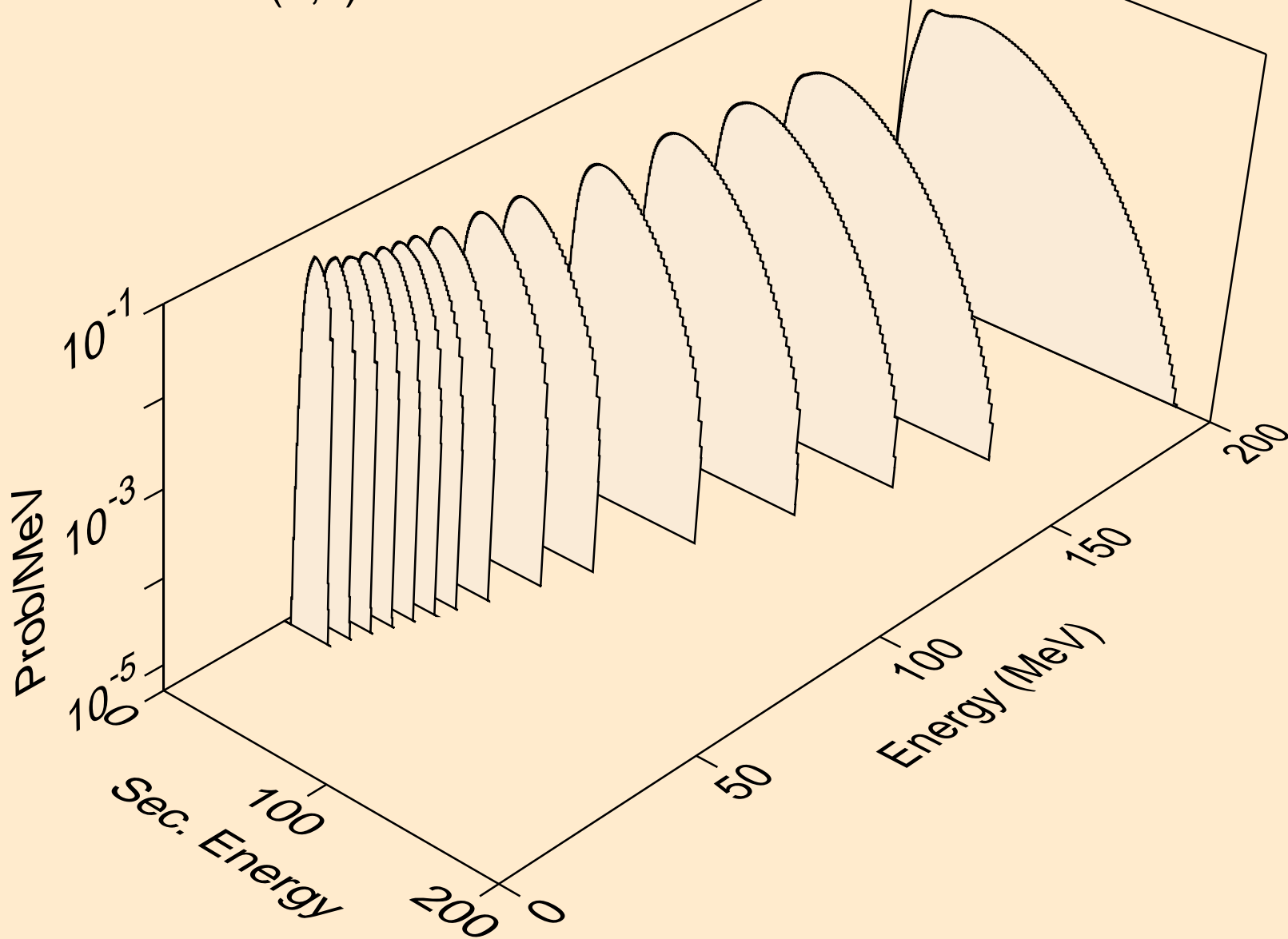

FE052M NEUTRON ACER TENDL-2019 LIBRARY; T=293.16K
he3s from (n,n*)he3

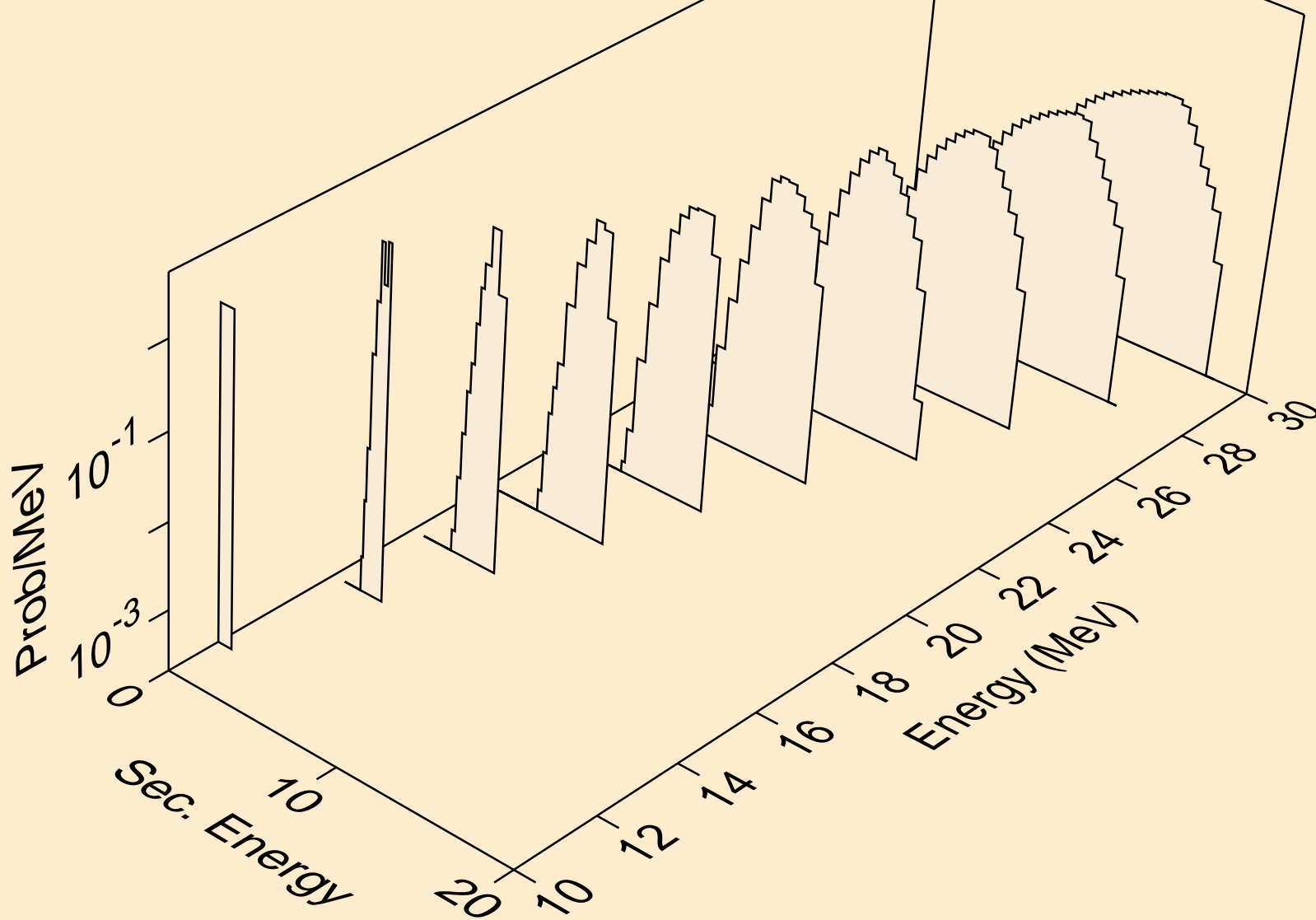

FE052M NEUTRON ACER TENDL-2019 LIBRARY; T=293.16K
he3s from (n,he3)

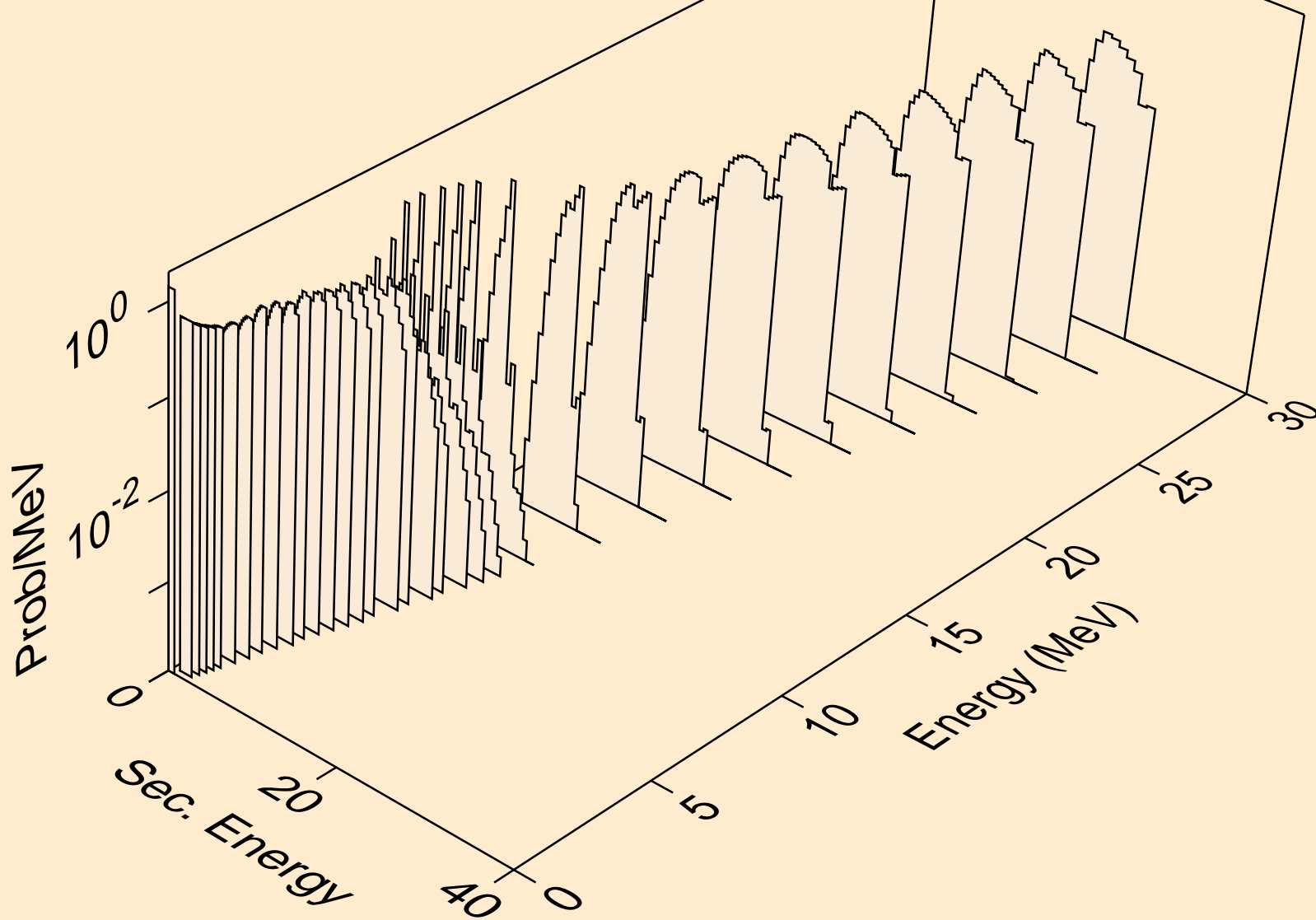

FE052M NEUTRON ACER TENDL-2019 LIBRARY; T=293.16K
alphas from (n,x)

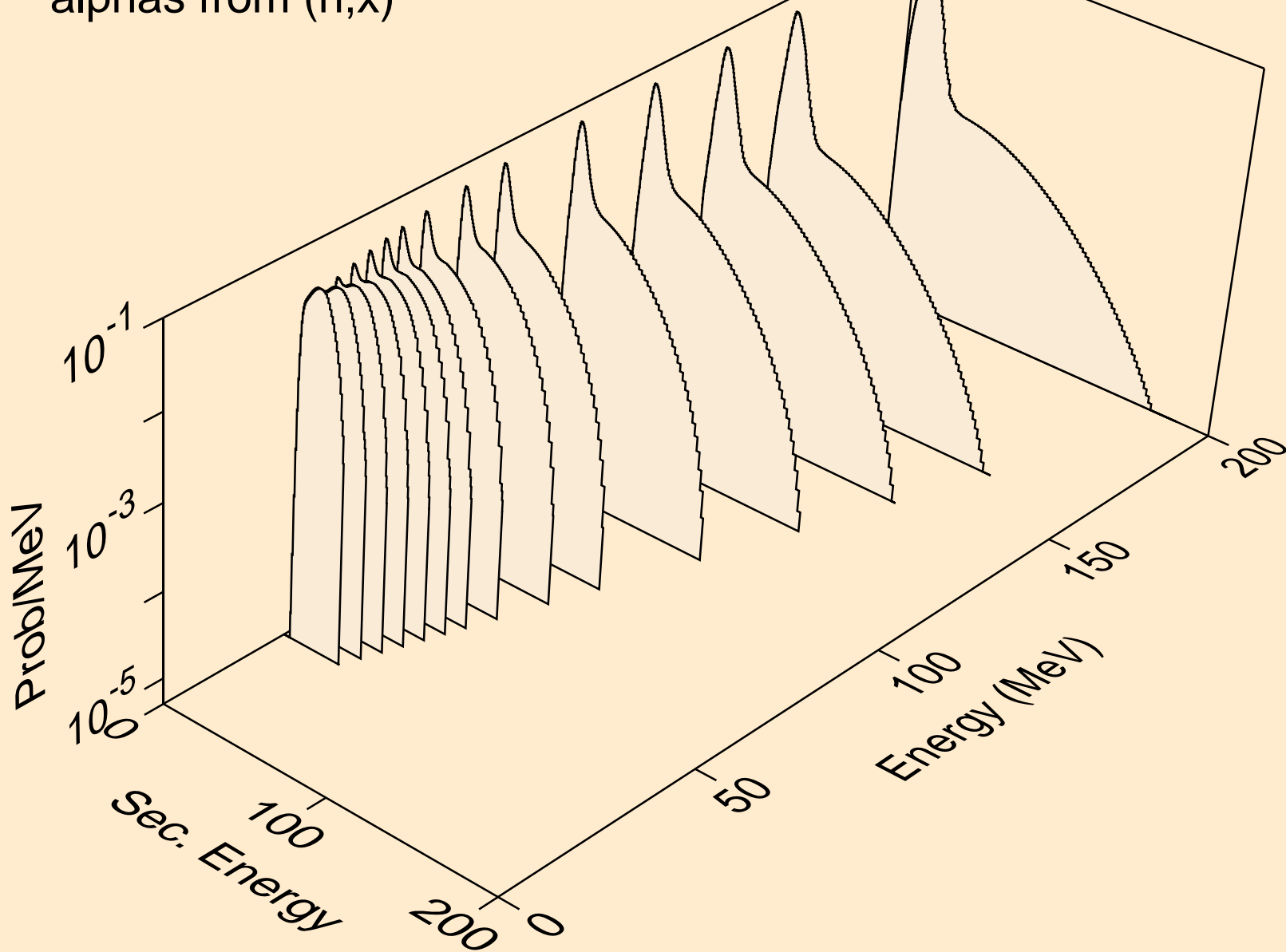

FE052M NEUTRON ACER TENDL-2019 LIBRARY; T=293.16K
alphas from (n,n*)a

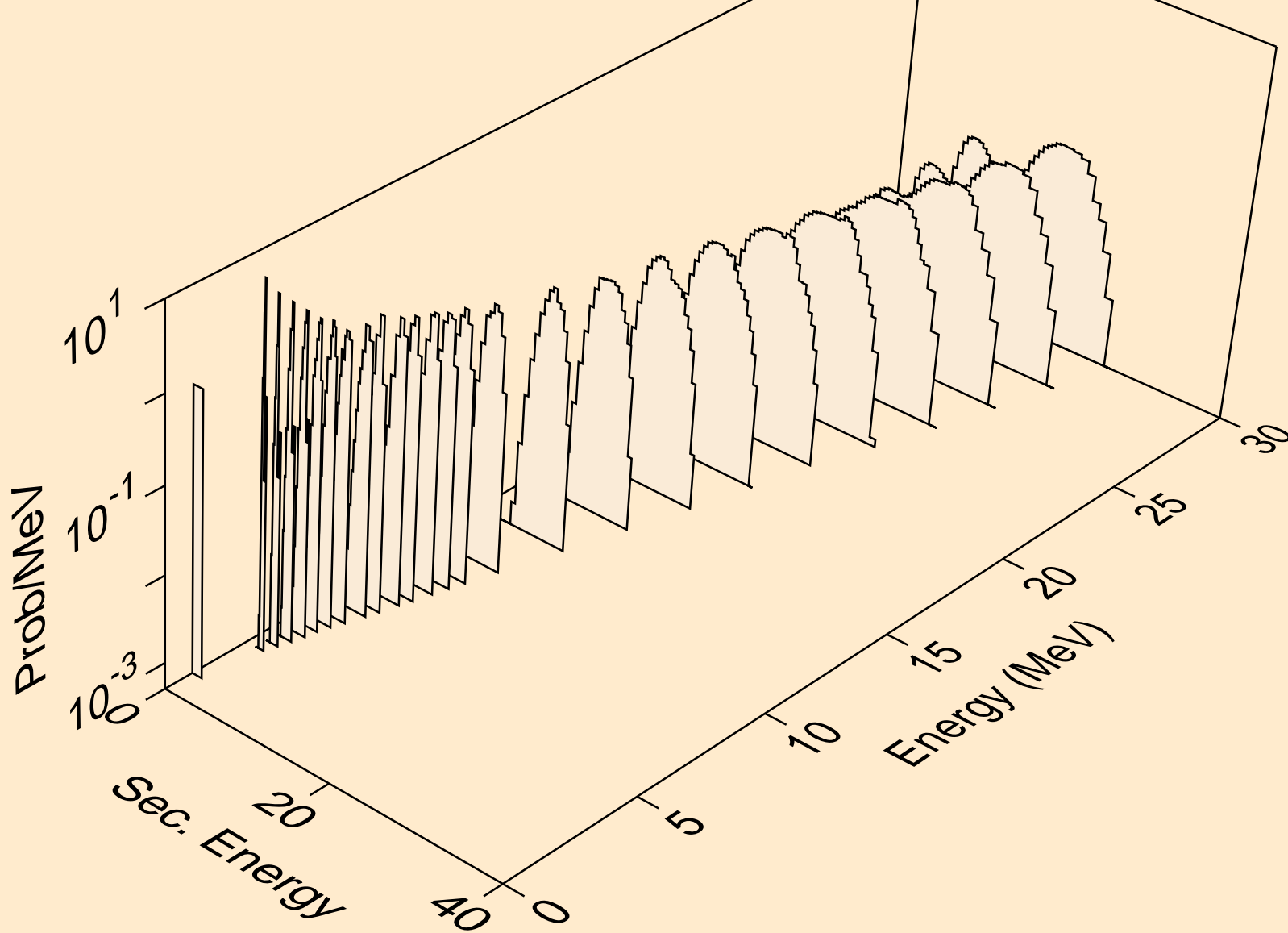

FE052M NEUTRON ACER TENDL-2019 LIBRARY; T=293.16K
alphas from (n,2n)a

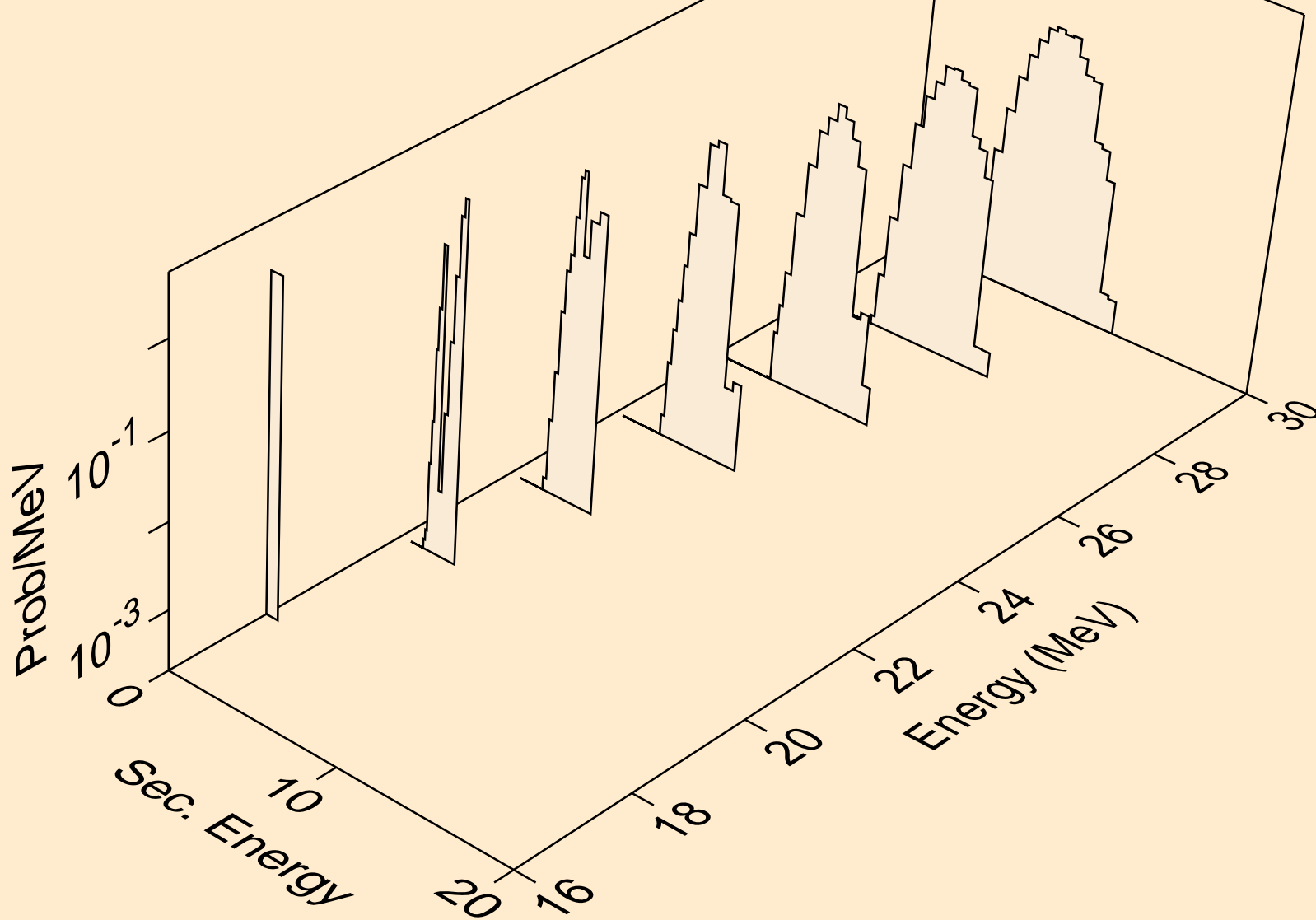

FE052M NEUTRON ACER TENDL-2019 LIBRARY; T=293.16K
alphas from (n,n*)2a

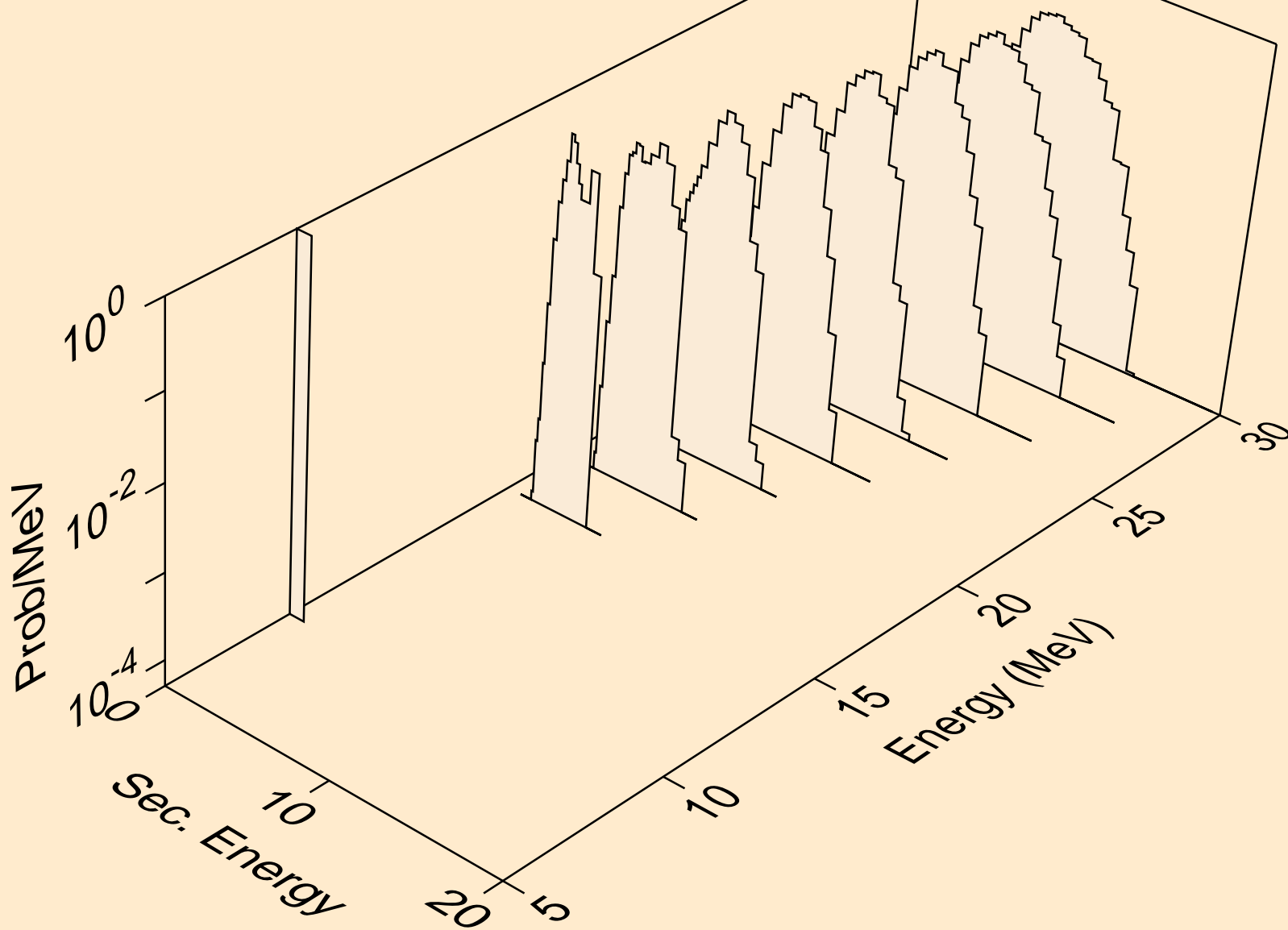

FE052M NEUTRON ACER TENDL-2019 LIBRARY; T=293.16K
alphas from (n,npa)

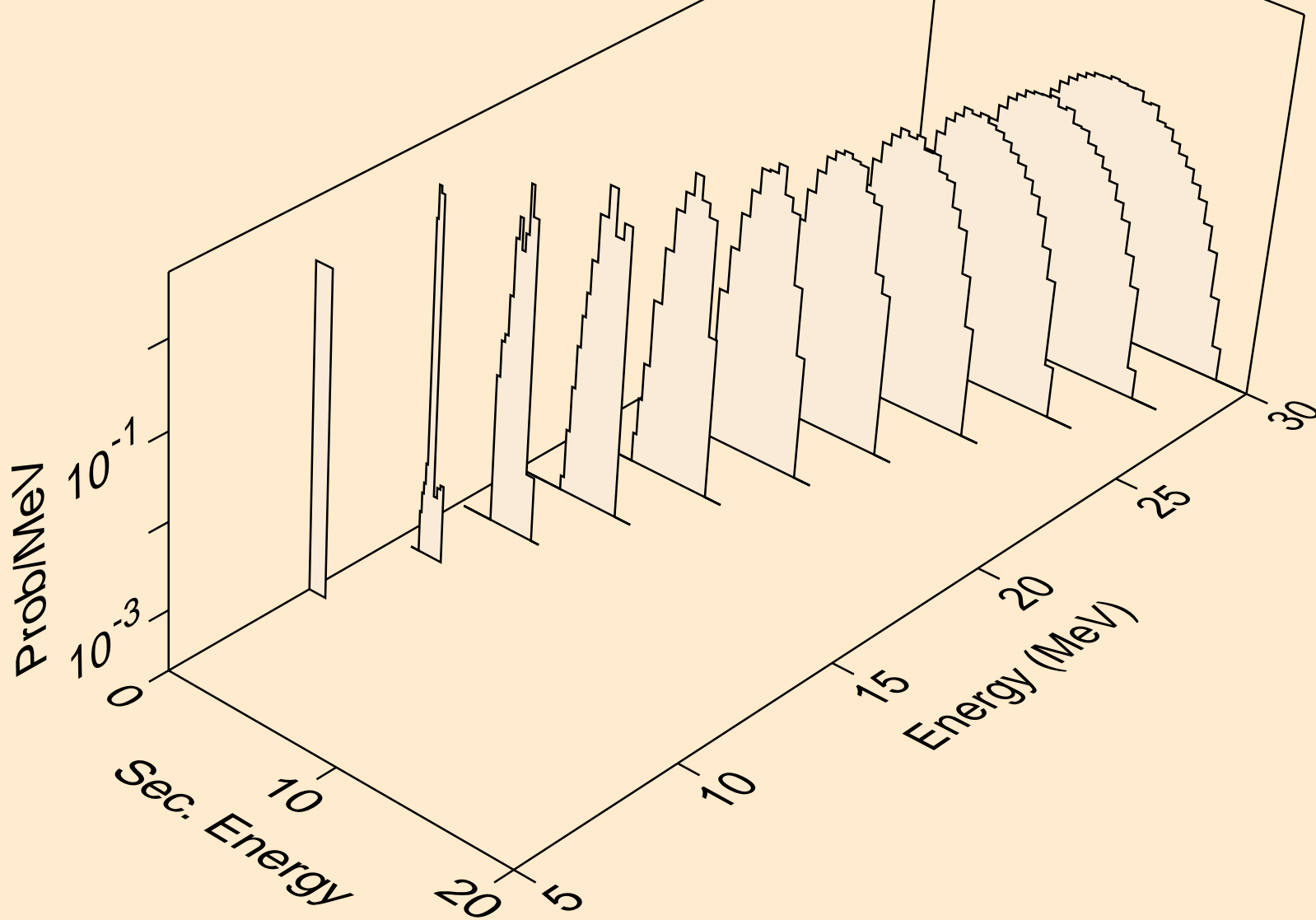

FE052M NEUTRON ACER TENDL-2019 LIBRARY; T=293.16K
alphas from (n,a)

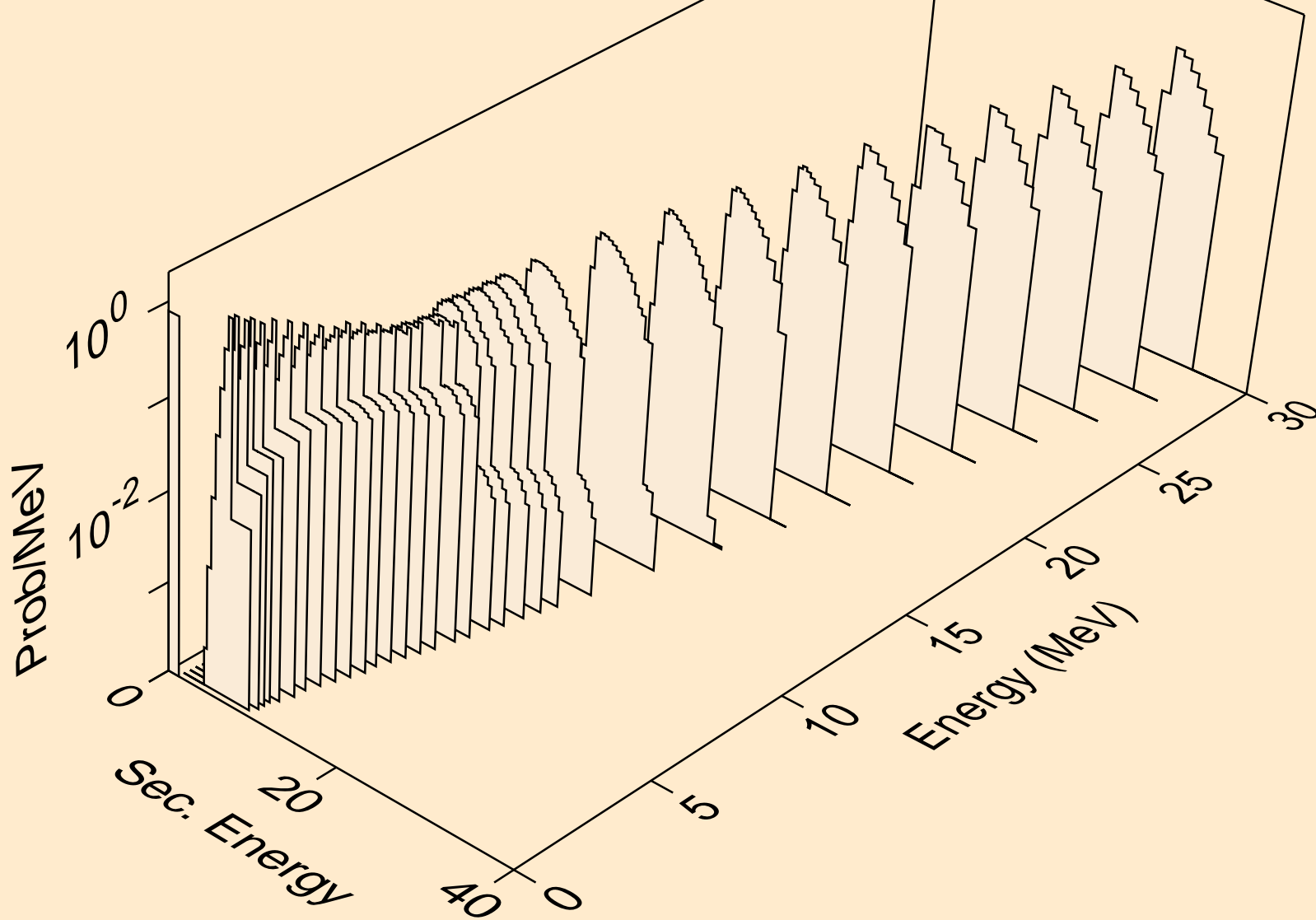

FE052M NEUTRON ACER TENDL-2019 LIBRARY; T=293.16K
alphas from (n,2a)

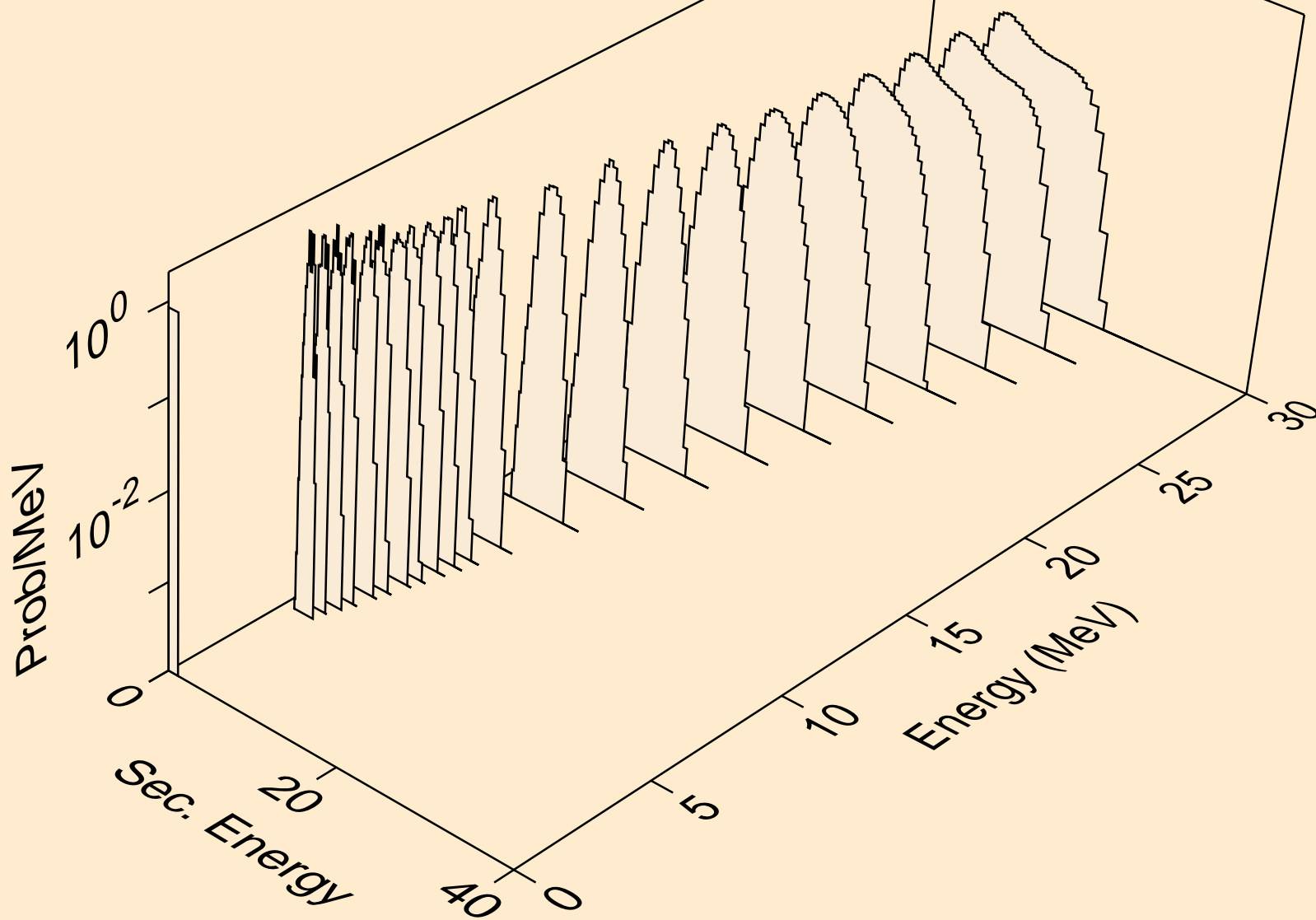

FE052M NEUTRON ACER TENDL-2019 LIBRARY; T=293.16K
alphas from (n,3a)

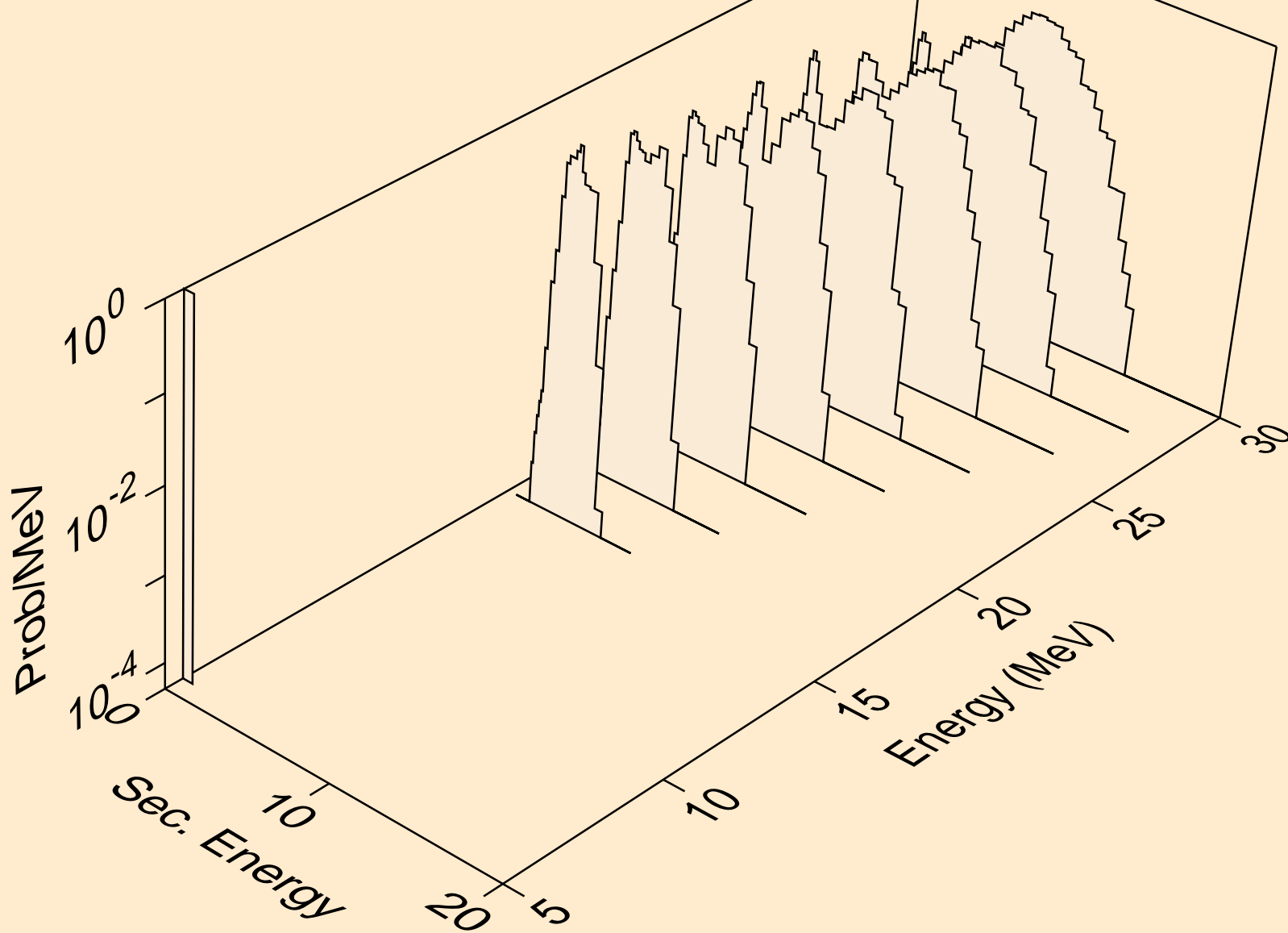

FE052M NEUTRON ACER TENDL-2019 LIBRARY; T=293.16K
alphas from (n,pa)

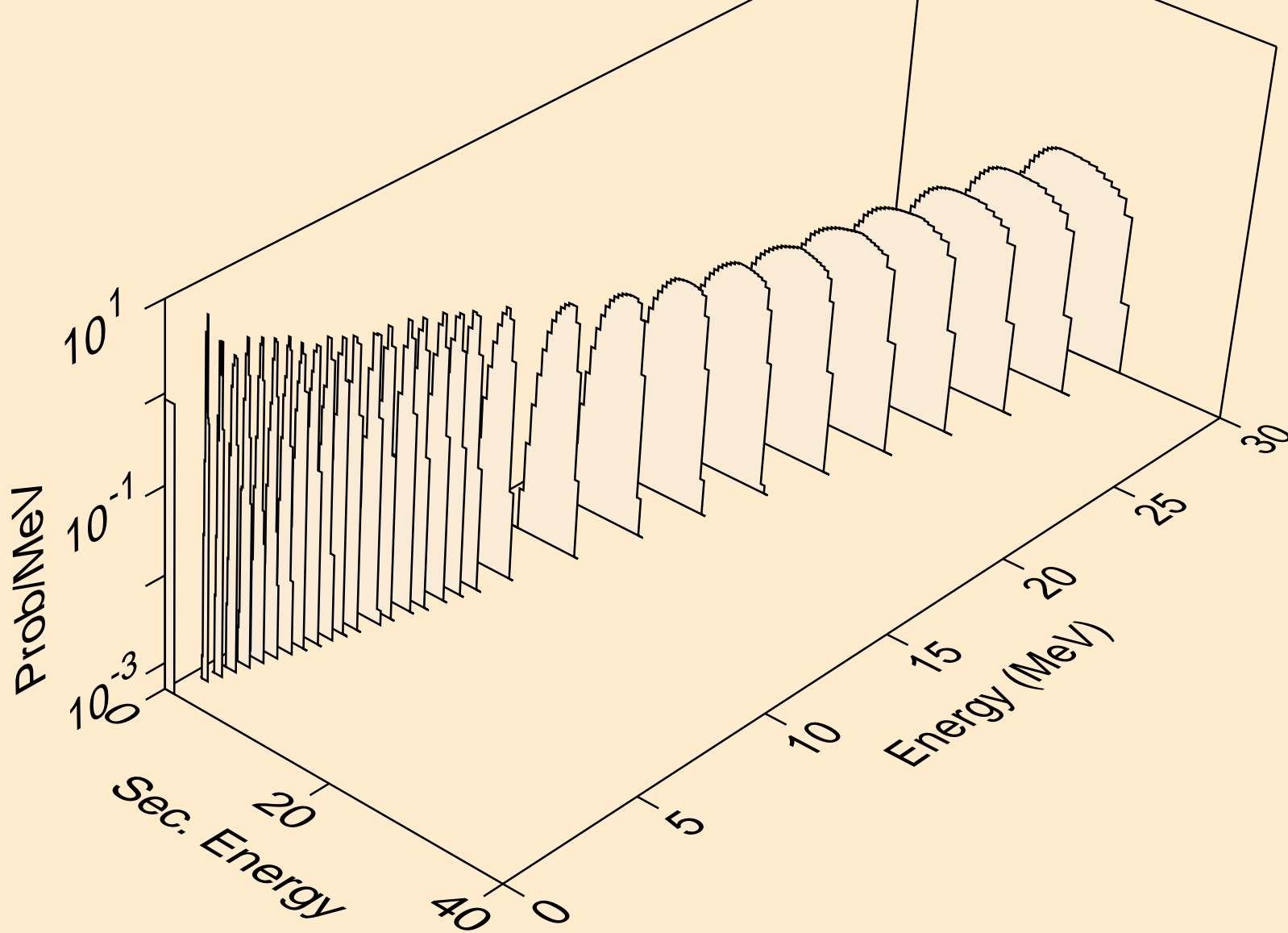

FE052M NEUTRON ACER TENDL-2019 LIBRARY; T=293.16K
alphas from (n,da)

