

FE053 NEUTRON ACER TENDL-2019 LIBRARY; T=293.16K  
Principal cross sections

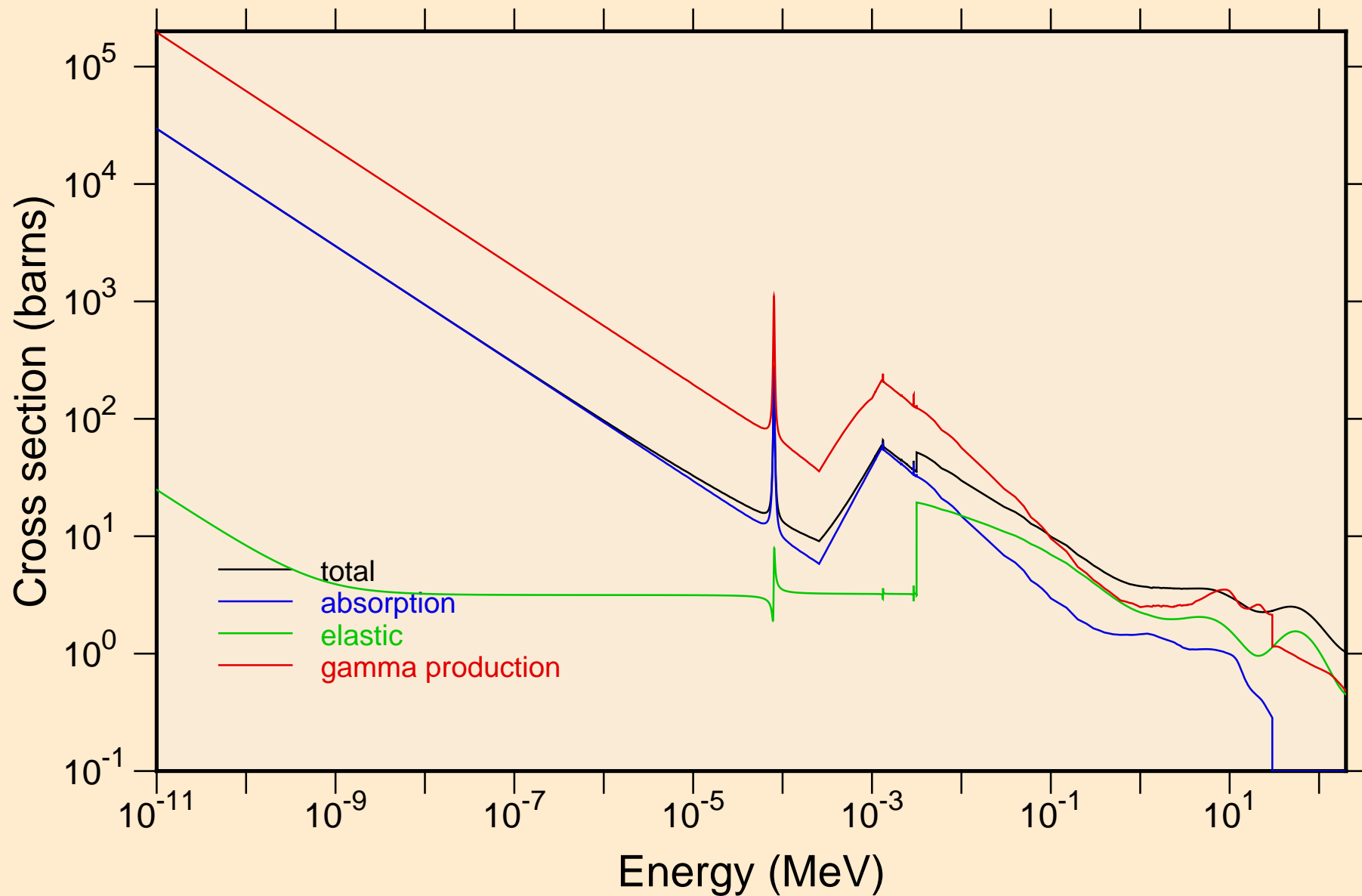

FE053 NEUTRON ACER TENDL-2019 LIBRARY; T=293.16K  
resonance total cross section

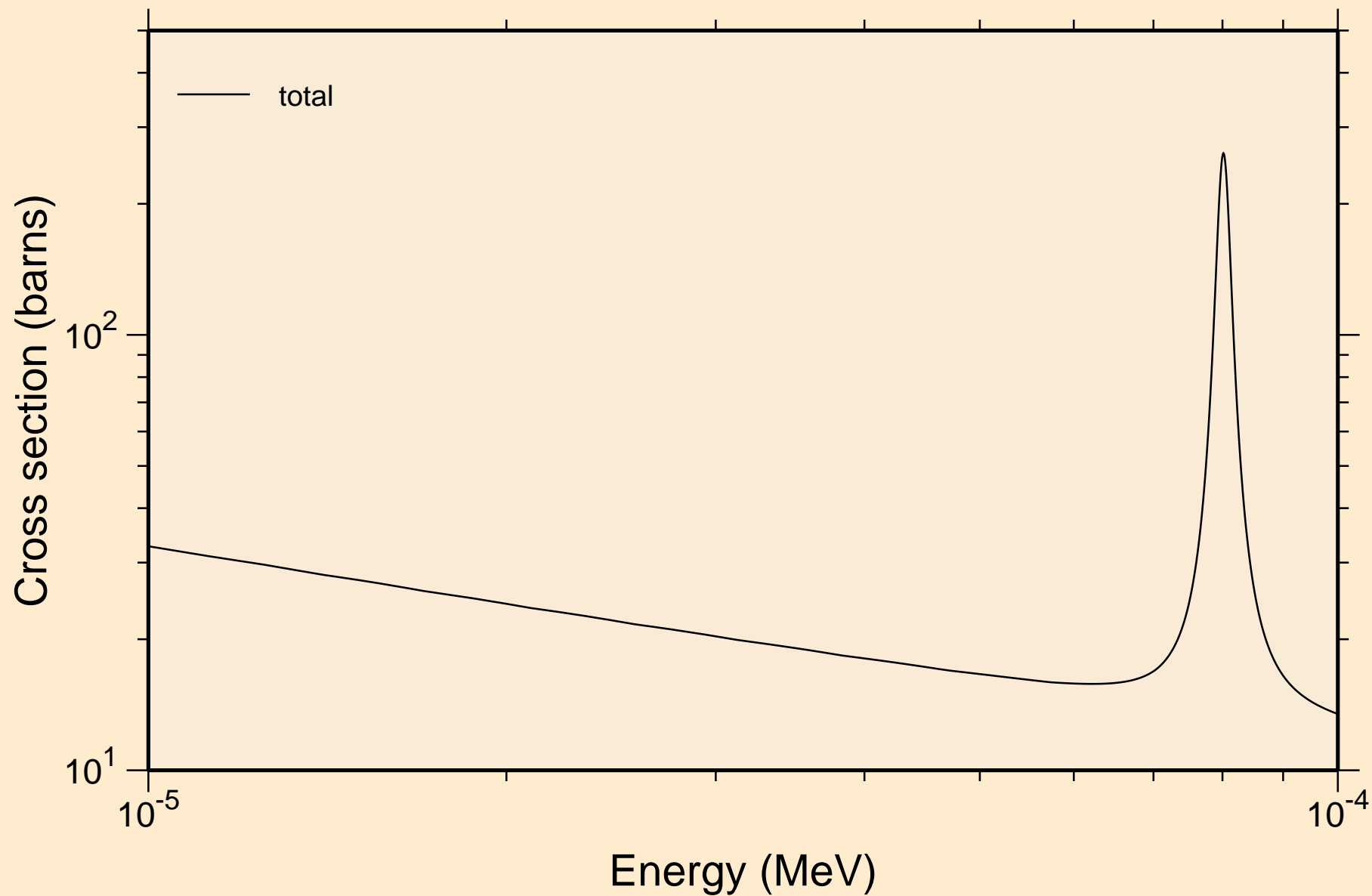

FE053 NEUTRON ACER TENDL-2019 LIBRARY; T=293.16K  
resonance total cross section

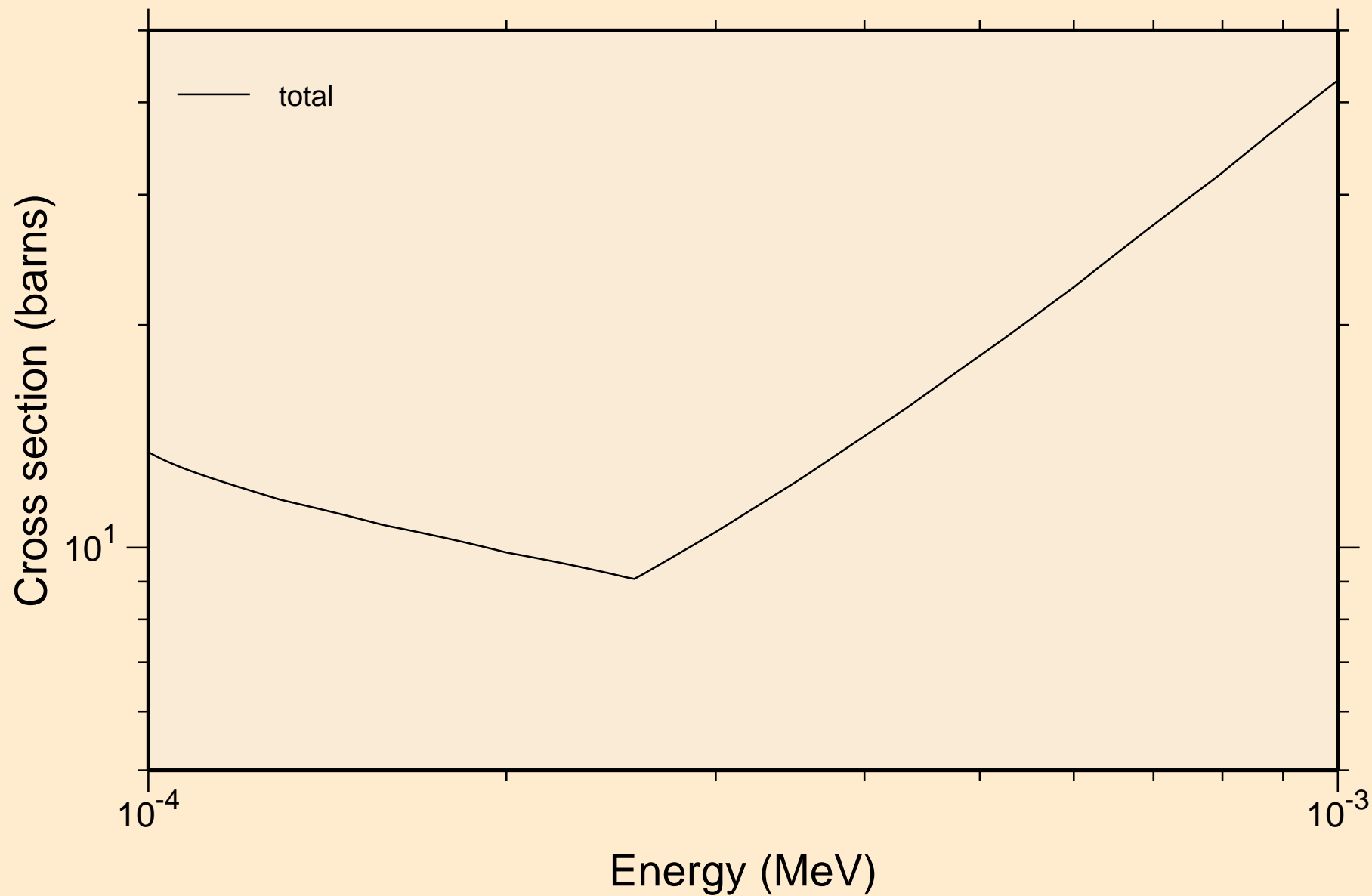

FE053 NEUTRON ACER TENDL-2019 LIBRARY; T=293.16K  
resonance total cross section

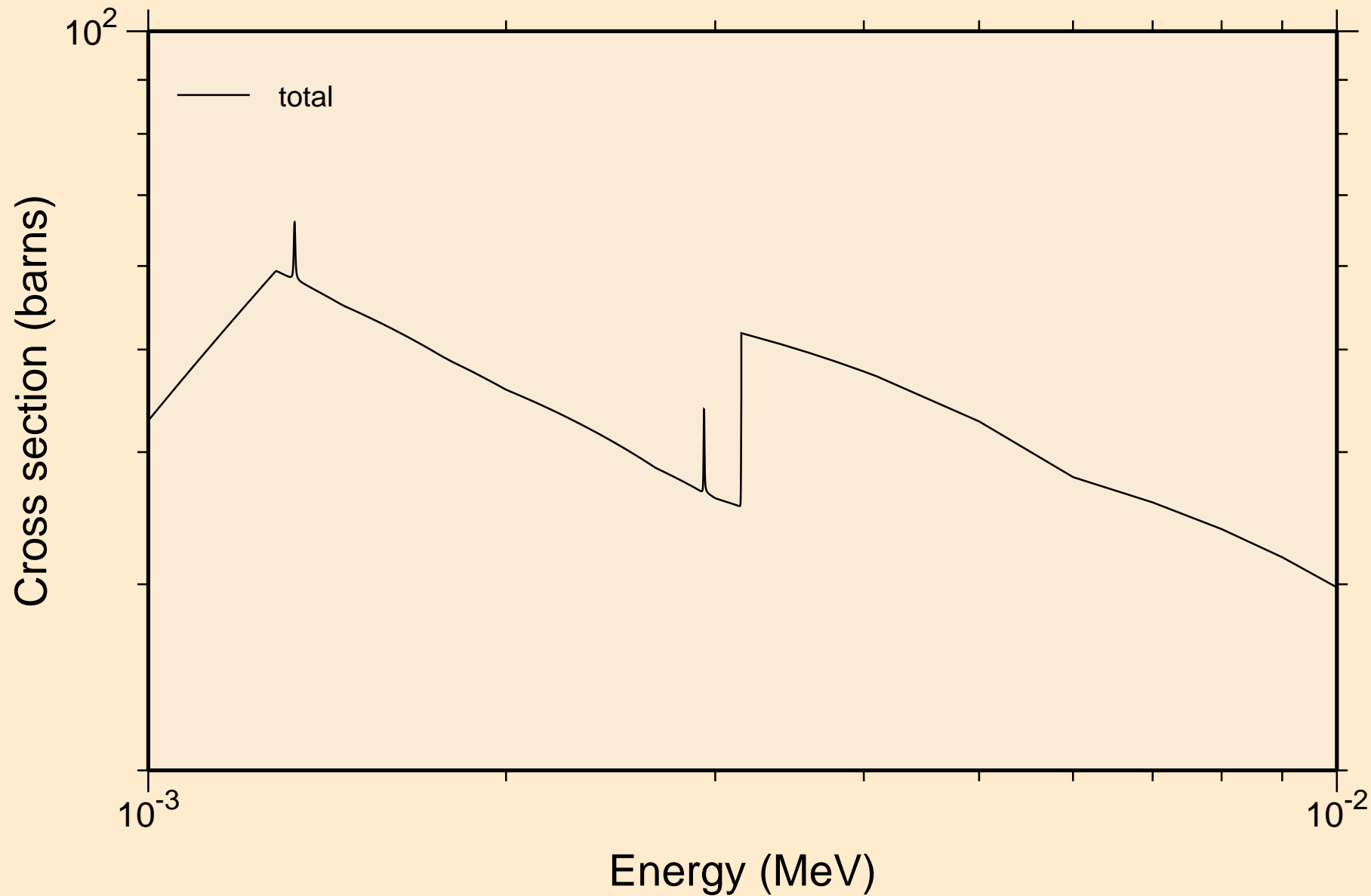

FE053 NEUTRON ACER TENDL-2019 LIBRARY; T=293.16K  
resonance total cross section

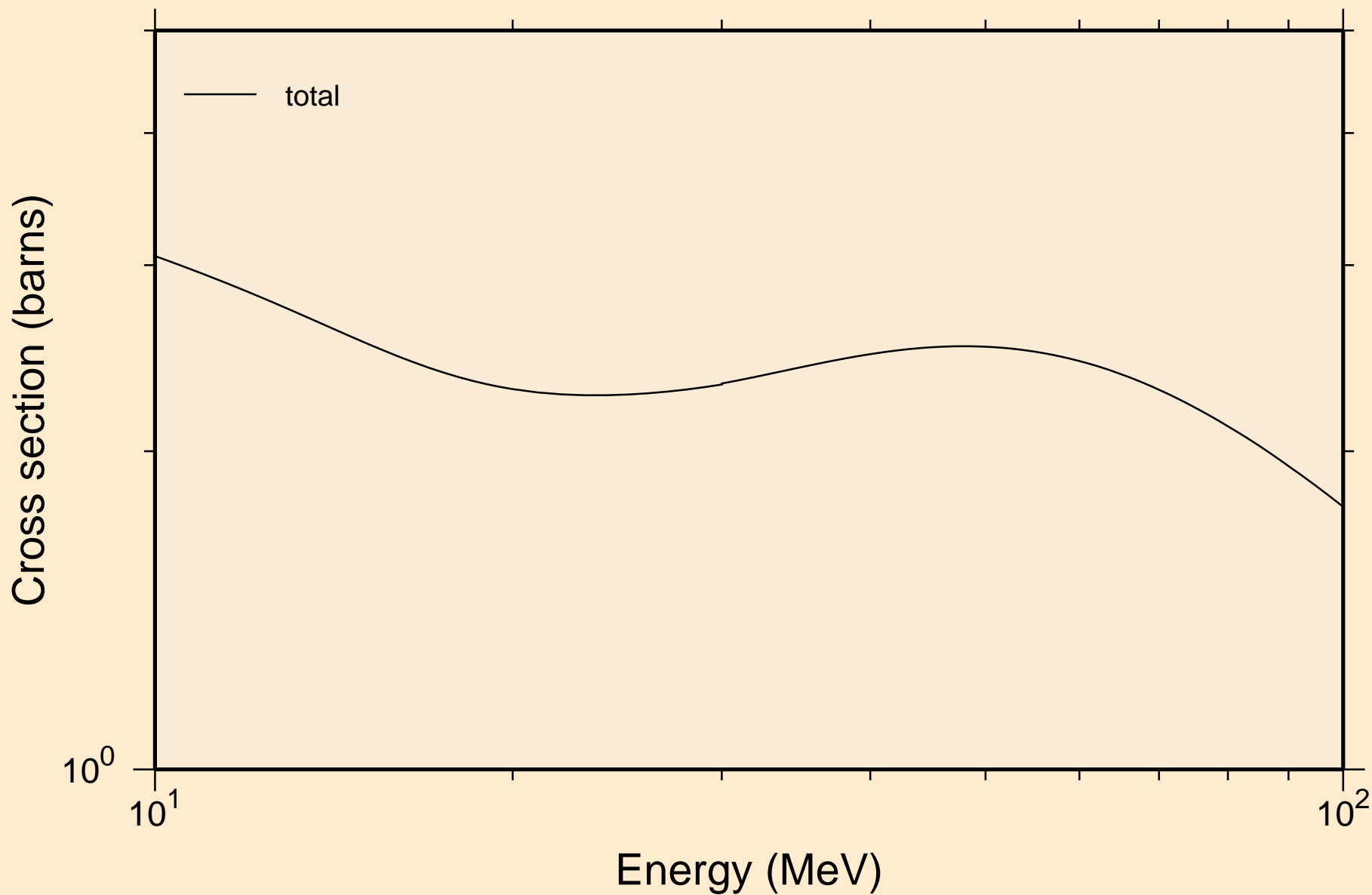

FE053 NEUTRON ACER TENDL-2019 LIBRARY; T=293.16K  
resonance absorption cross sections

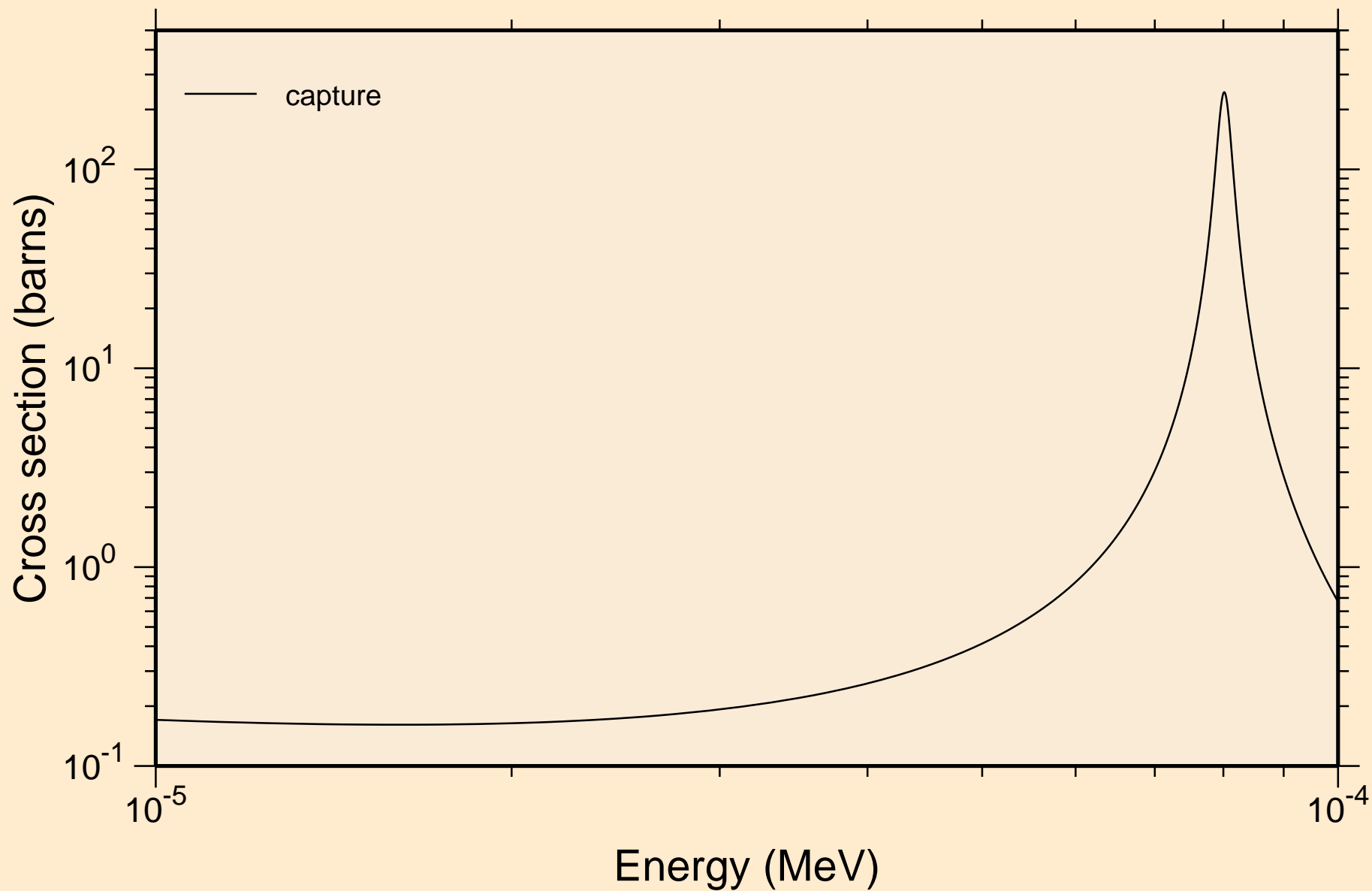

FE053 NEUTRON ACER TENDL-2019 LIBRARY; T=293.16K  
resonance absorption cross sections

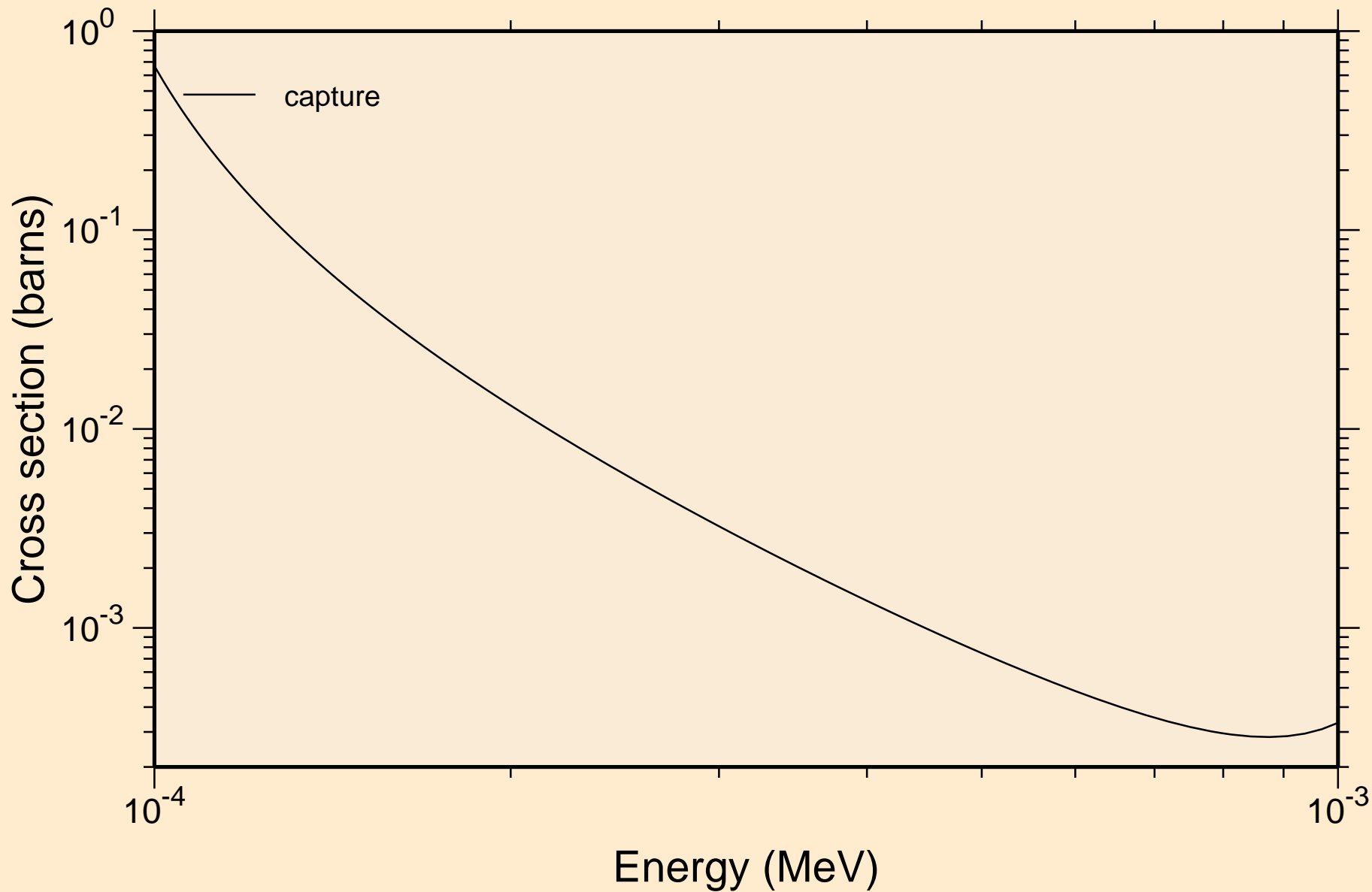

FE053 NEUTRON ACER TENDL-2019 LIBRARY; T=293.16K  
resonance absorption cross sections

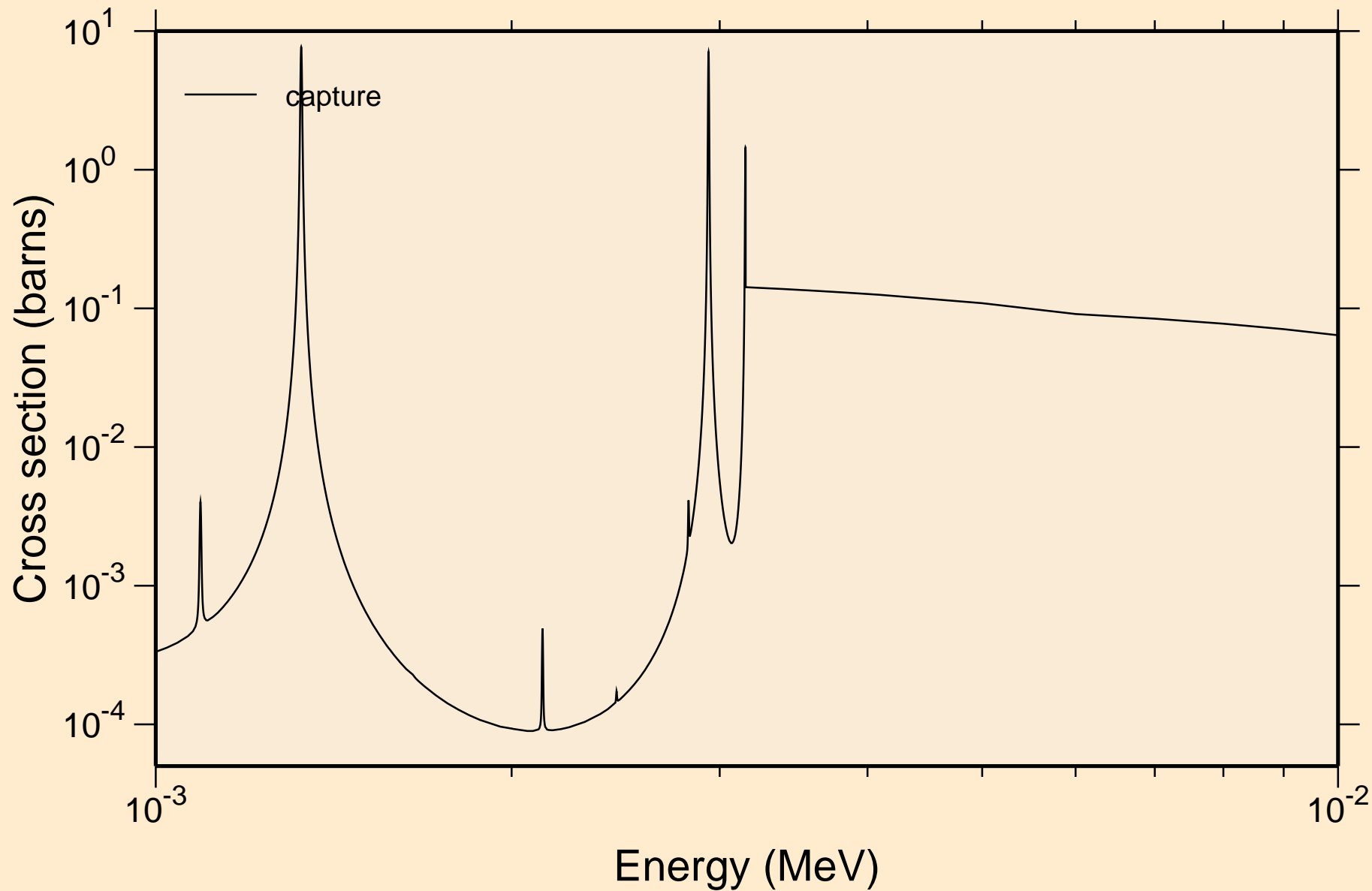



FE053 NEUTRON ACER TENDL-2019 LIBRARY; T=293.16K  
resonance absorption cross sections

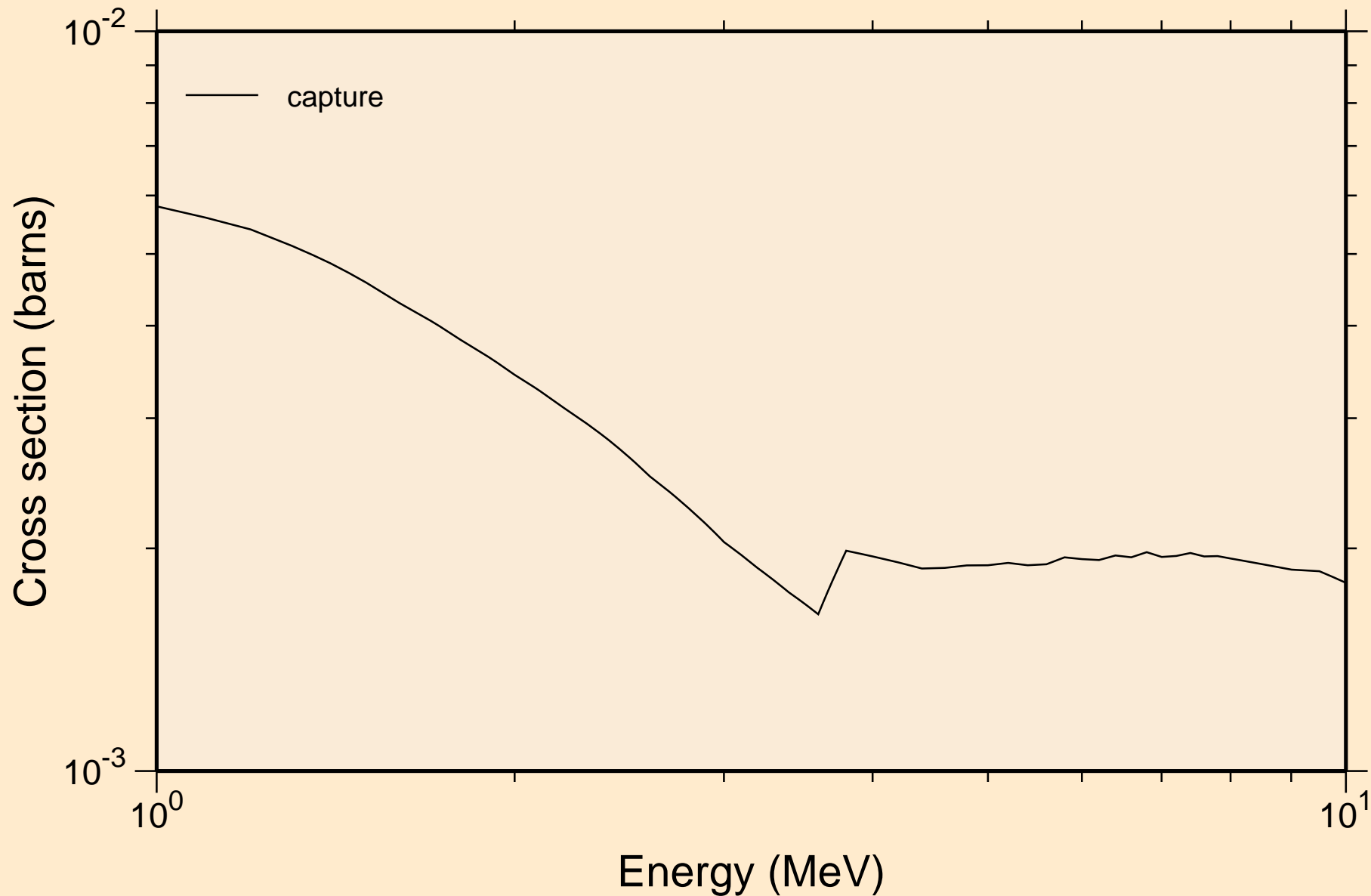

FE053 NEUTRON ACER TENDL-2019 LIBRARY; T=293.16K  
Heating

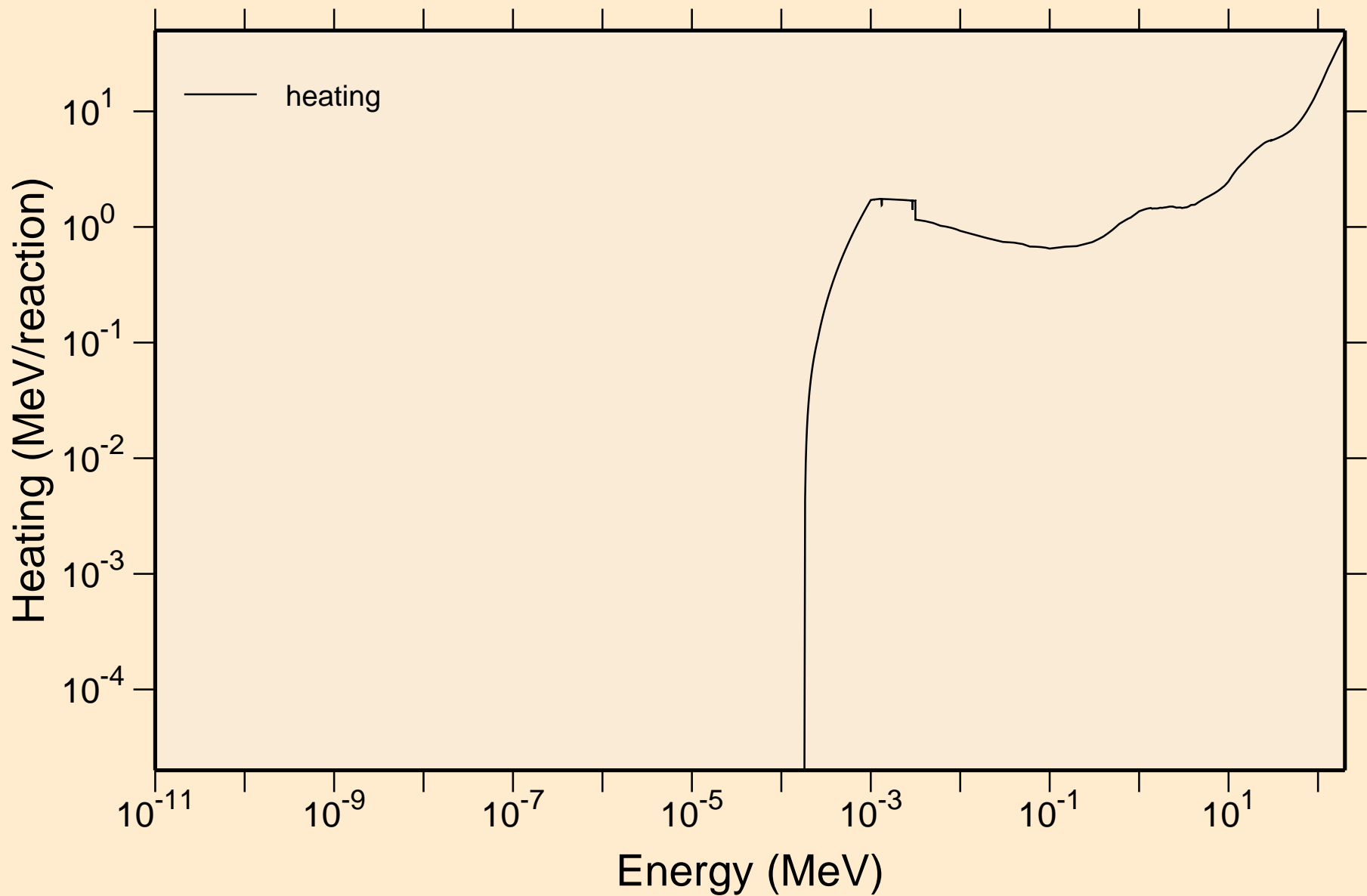

FE053 NEUTRON ACER TENDL-2019 LIBRARY; T=293.16K  
Damage

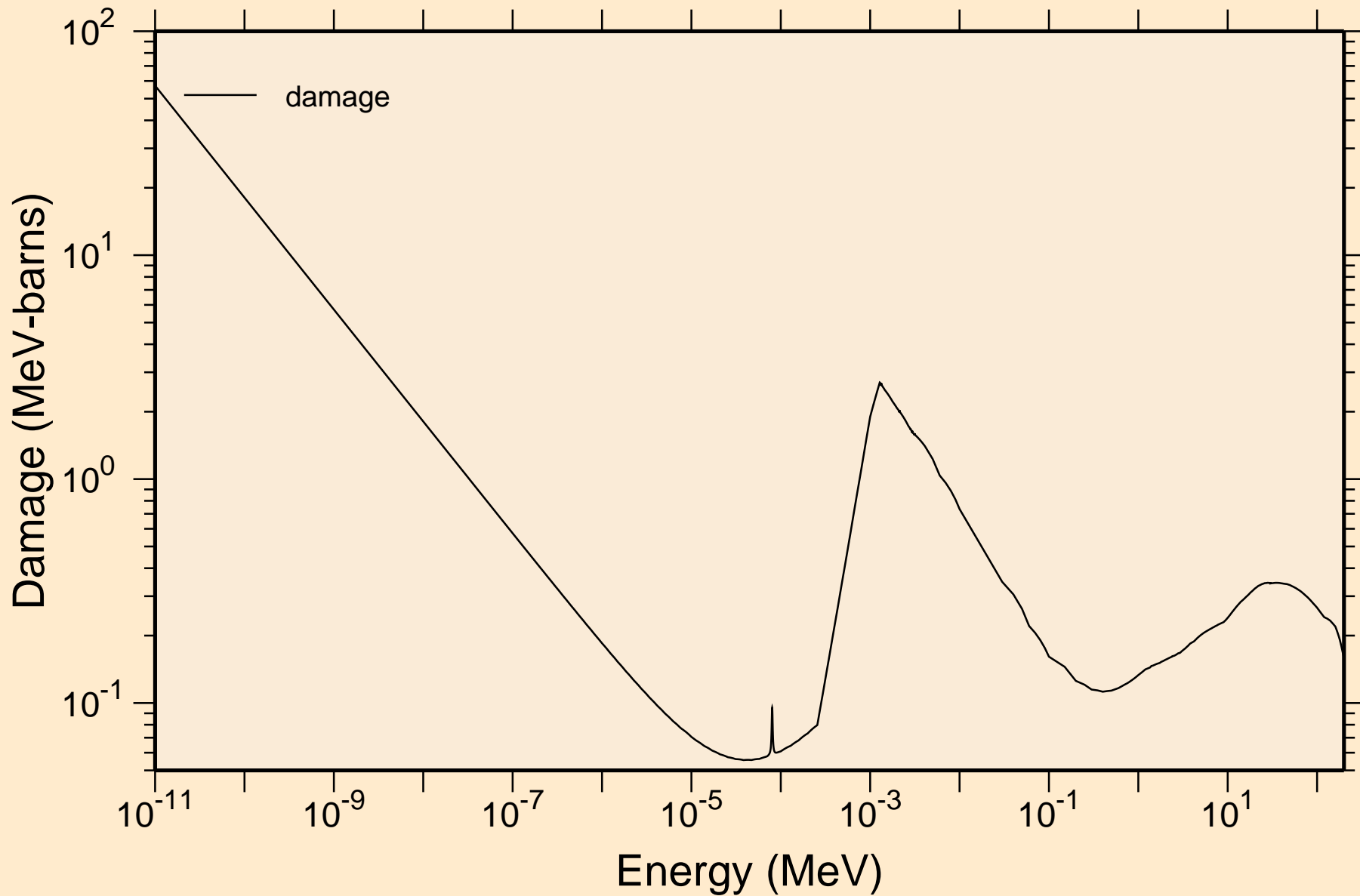

# FE053 NEUTRON ACER TENDL-2019 LIBRARY; T=293.16K

## Non-threshold reactions

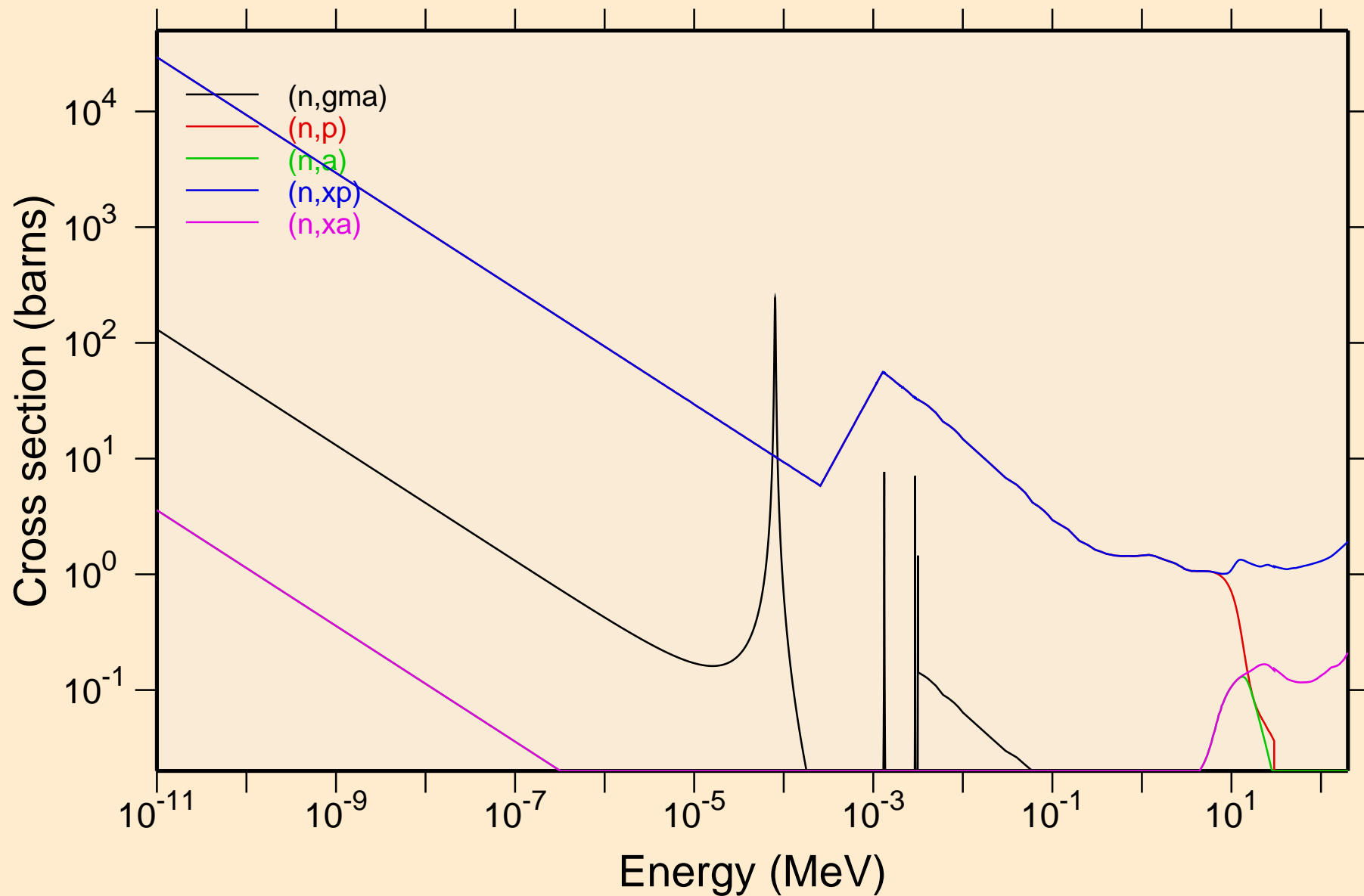

# FE053 NEUTRON ACER TENDL-2019 LIBRARY; T=293.16K

## Principal cross sections

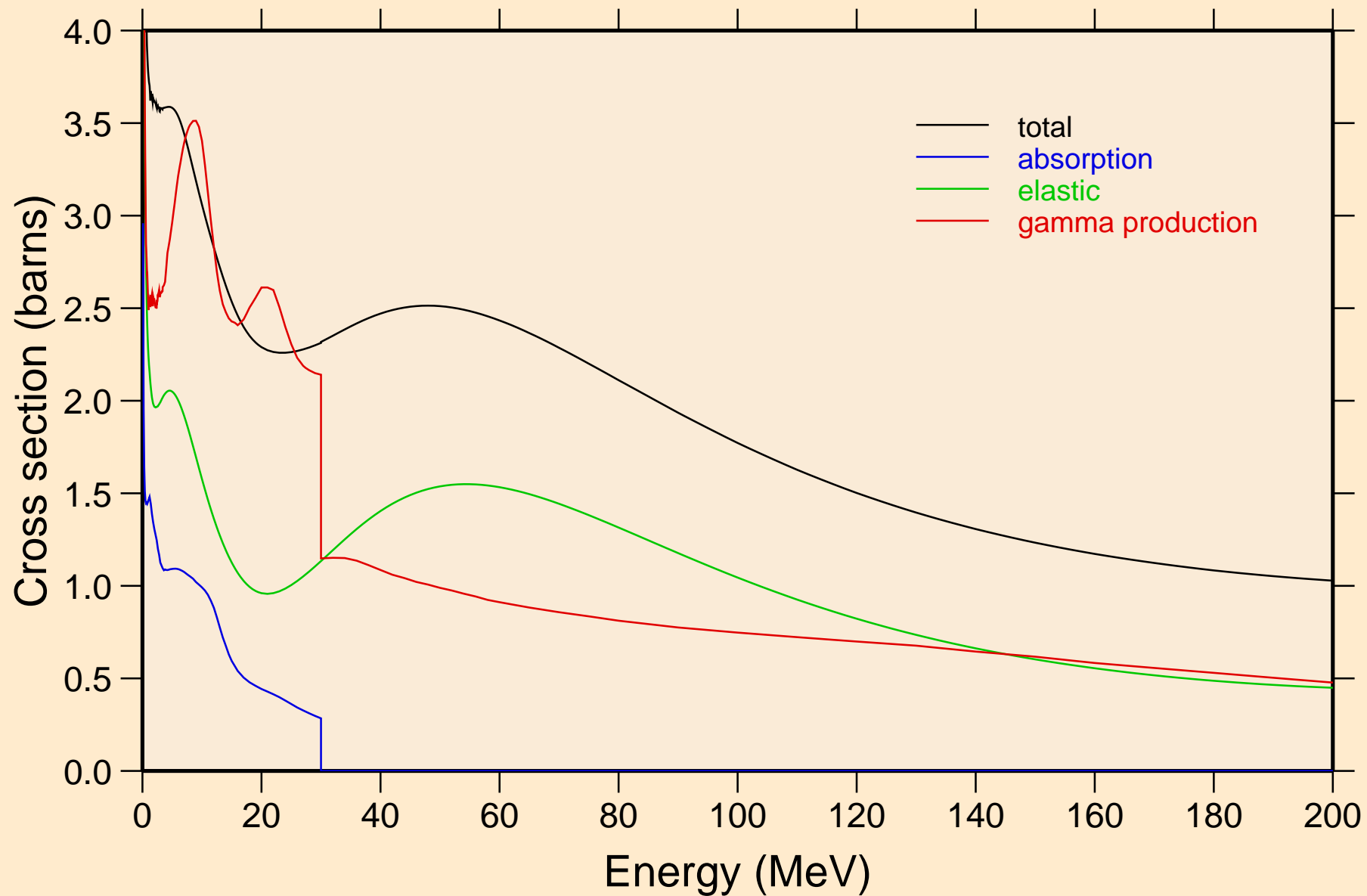

FE053 NEUTRON ACER TENDL-2019 LIBRARY; T=293.16K  
Heating

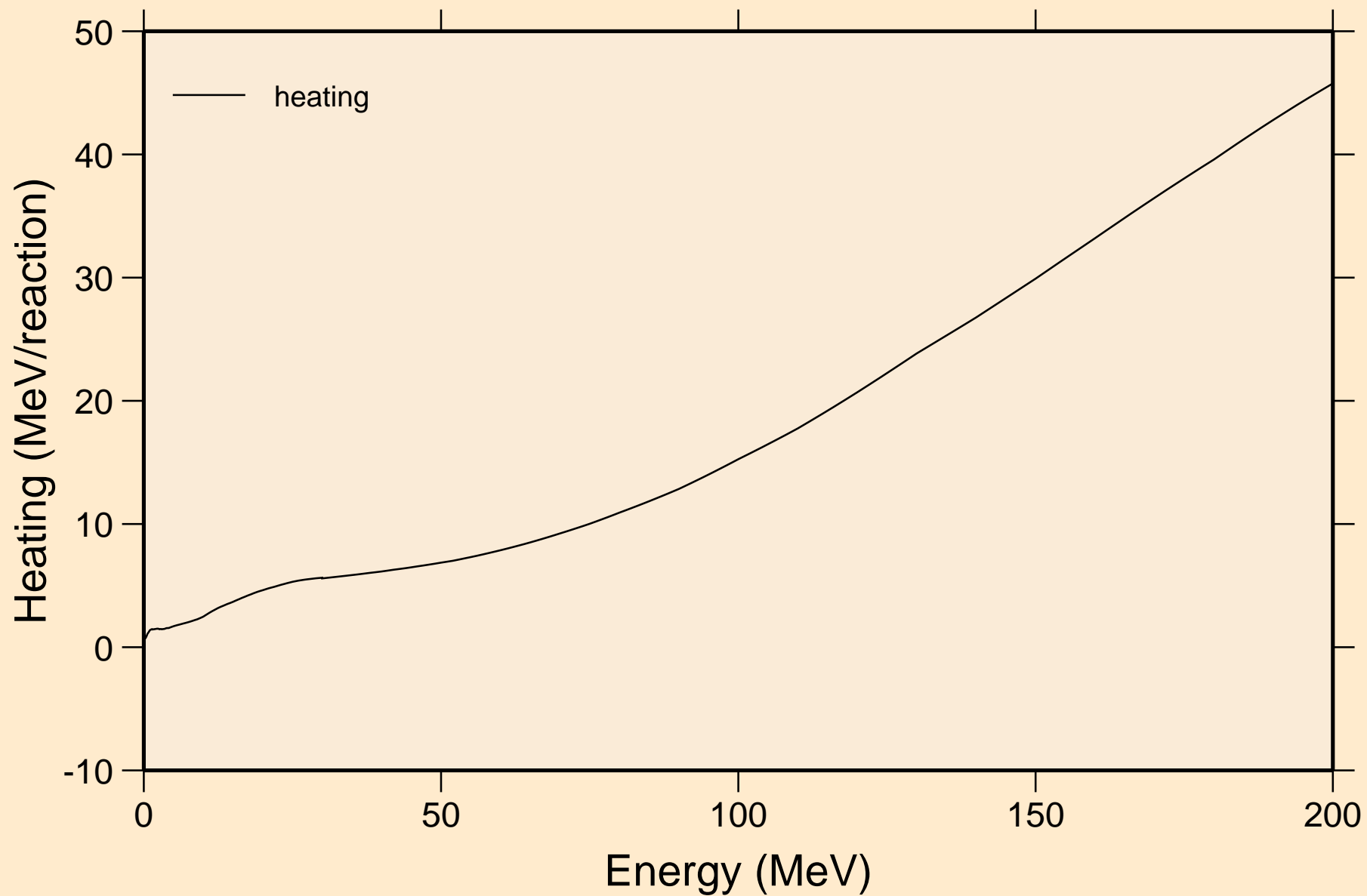

FE053 NEUTRON ACER TENDL-2019 LIBRARY; T=293.16K  
Damage

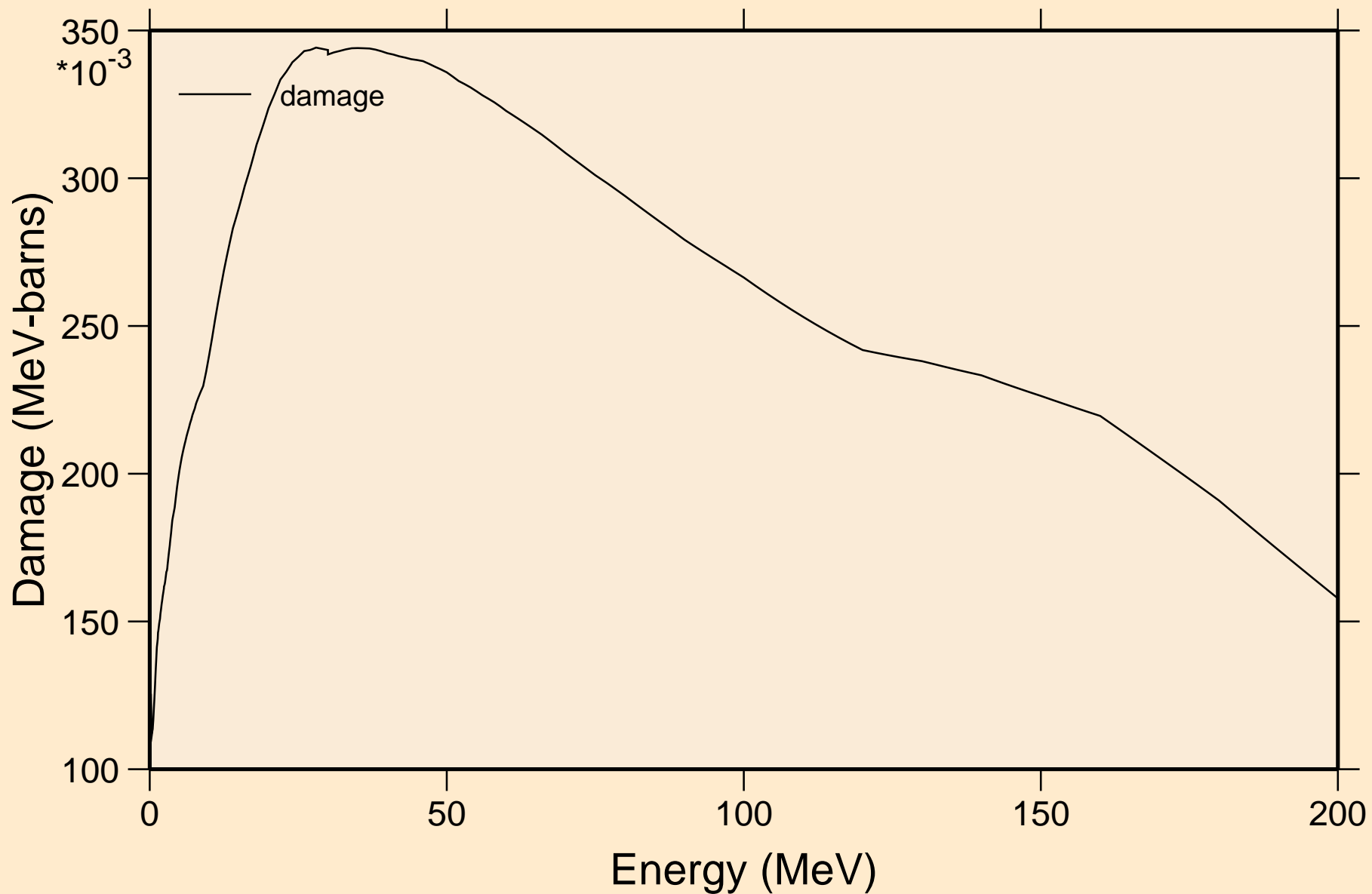

FE053 NEUTRON ACER TENDL-2019 LIBRARY; T=293.16K  
Non-threshold reactions

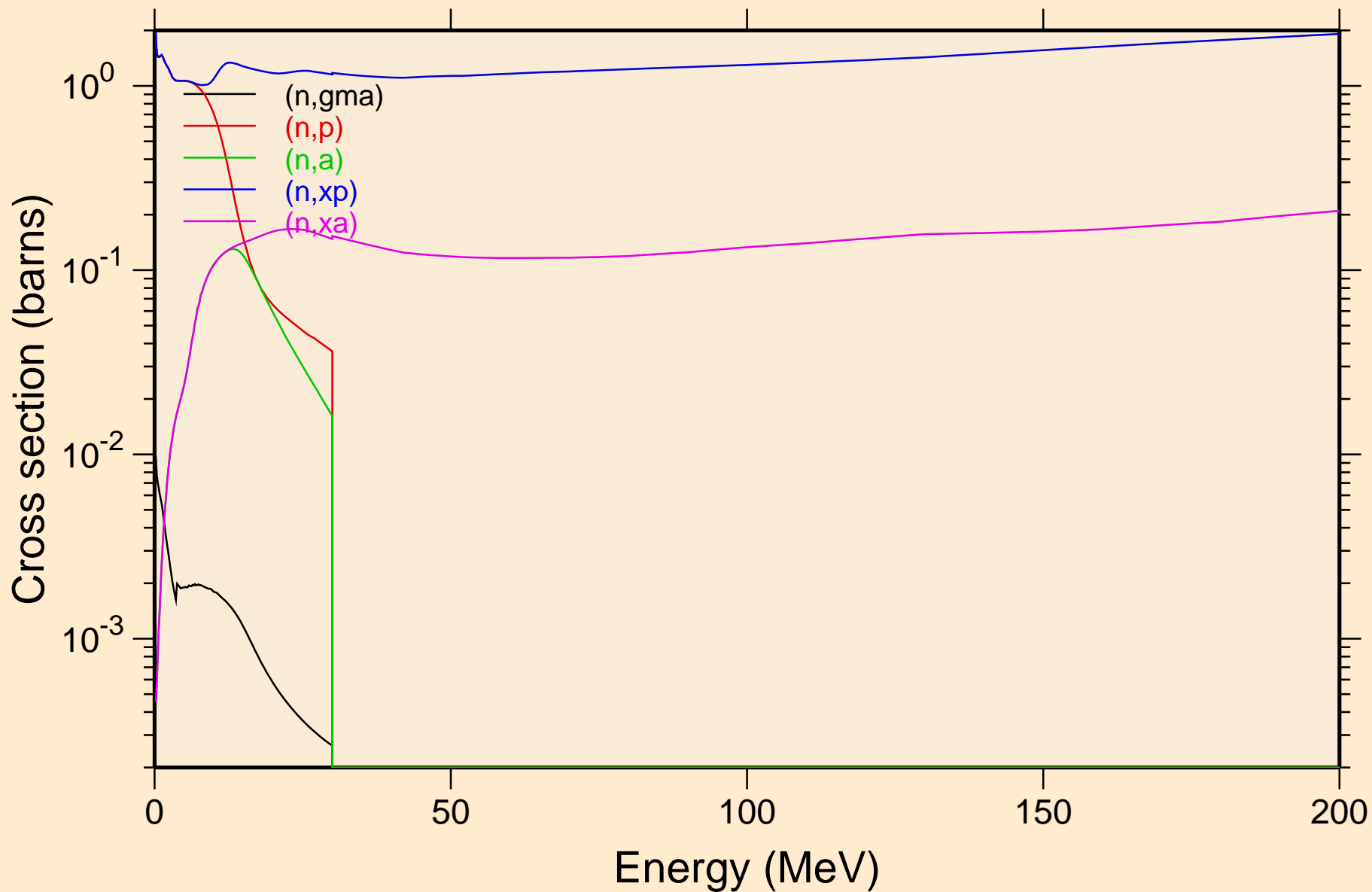



FE053 NEUTRON ACER TENDL-2019 LIBRARY; T=293.16K  
Inelastic levels

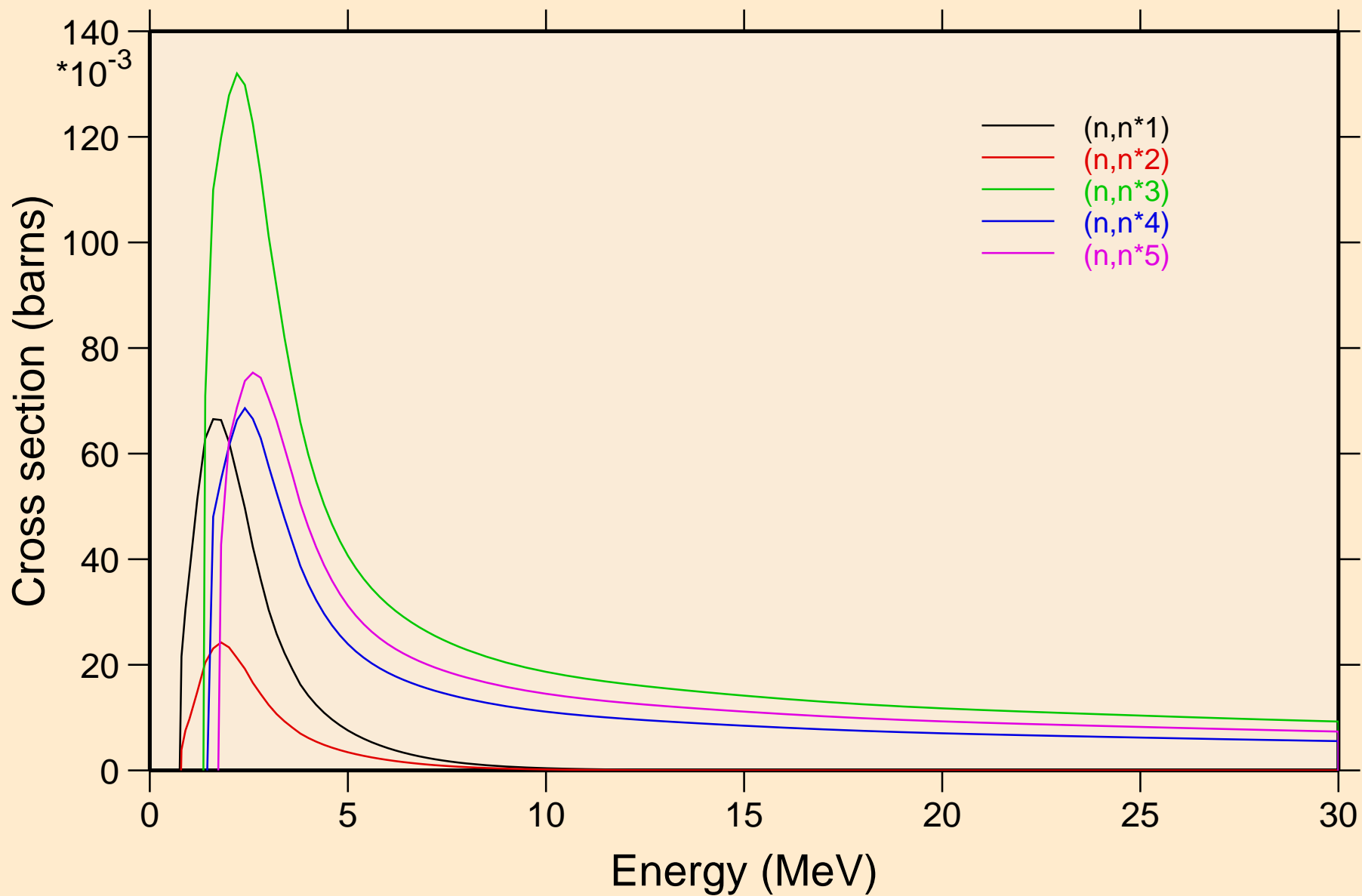

FE053 NEUTRON ACER TENDL-2019 LIBRARY; T=293.16K  
Inelastic levels

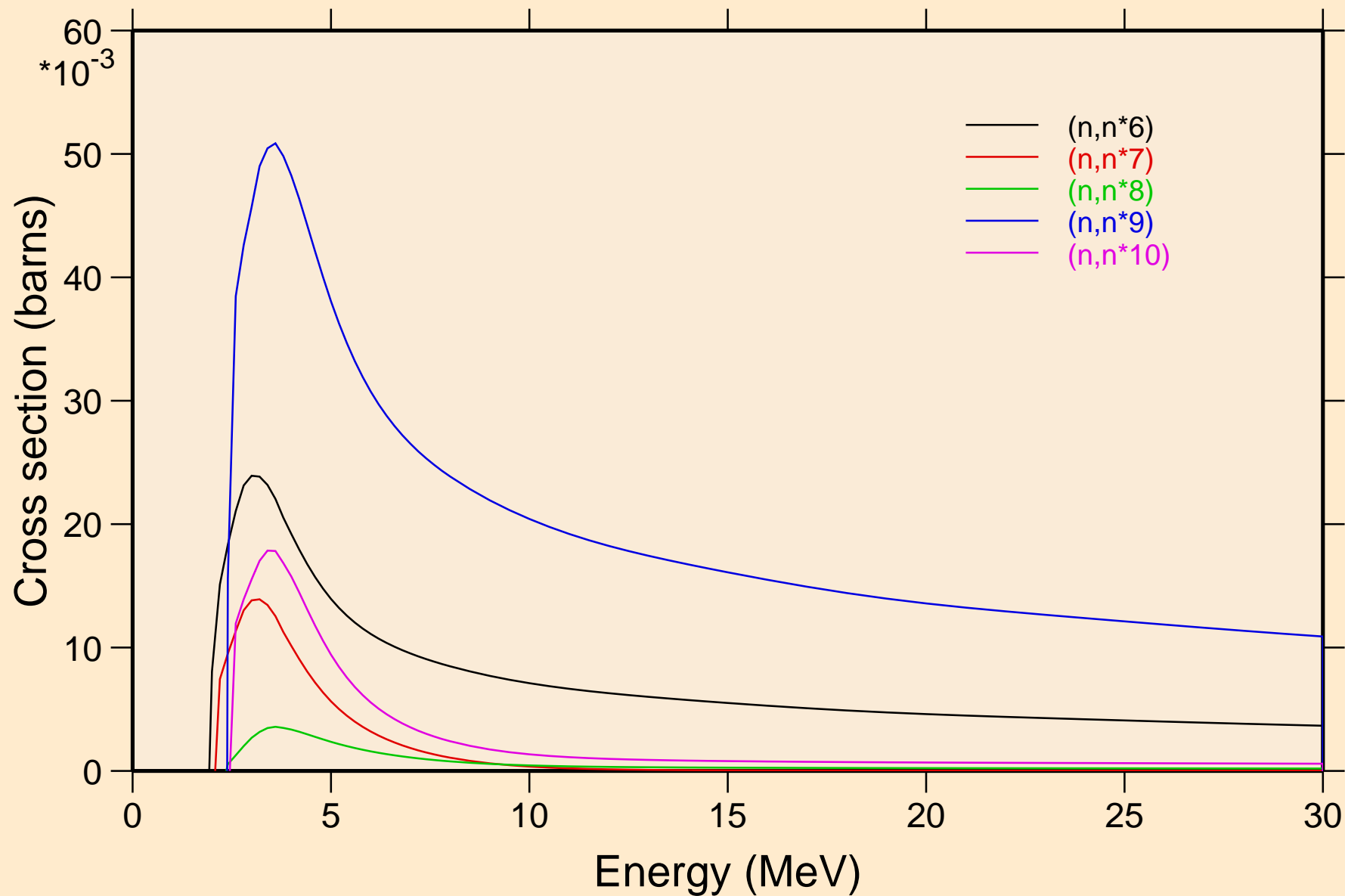

FE053 NEUTRON ACER TENDL-2019 LIBRARY; T=293.16K  
Inelastic levels

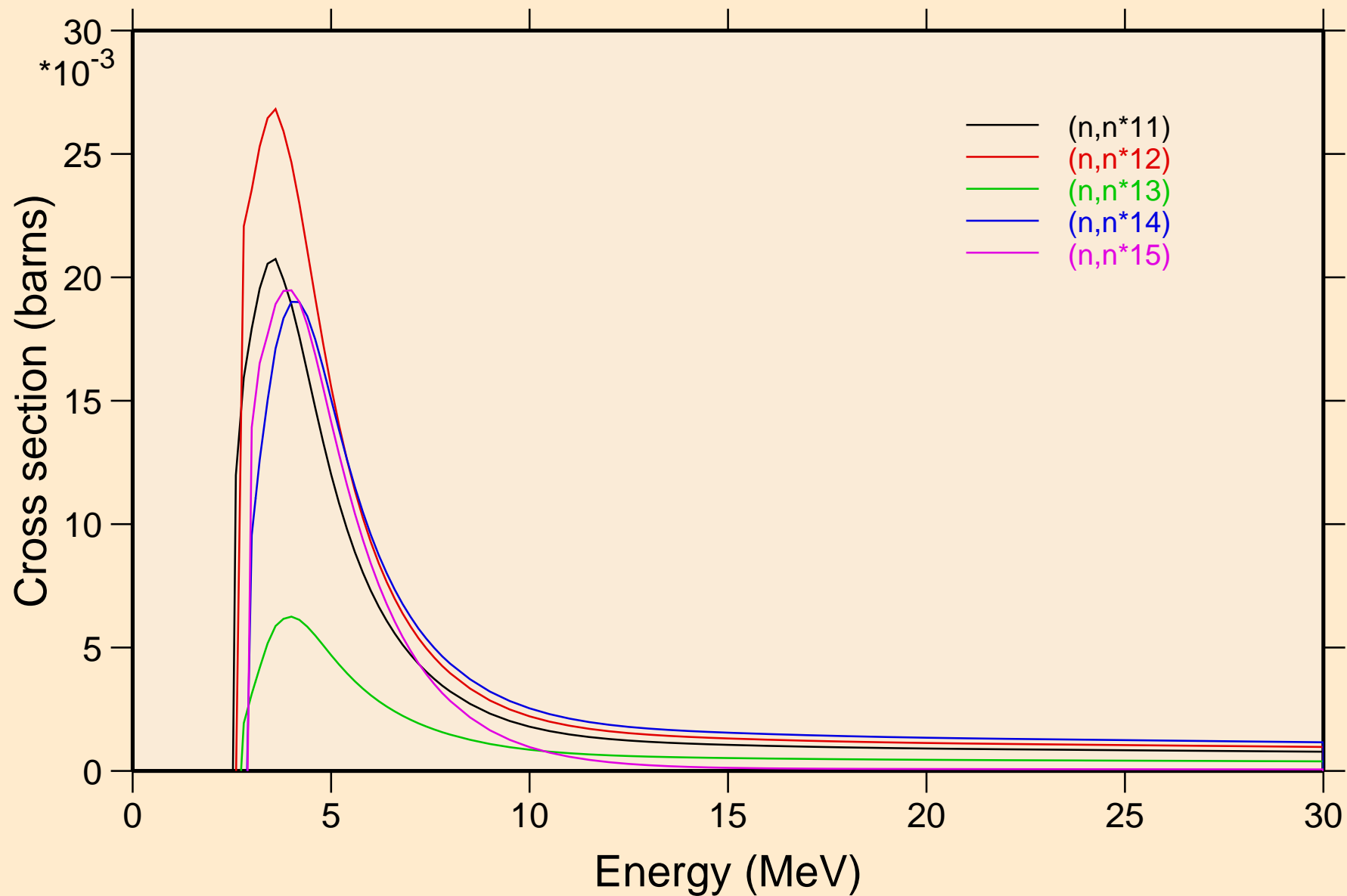

FE053 NEUTRON ACER TENDL-2019 LIBRARY; T=293.16K  
Inelastic levels

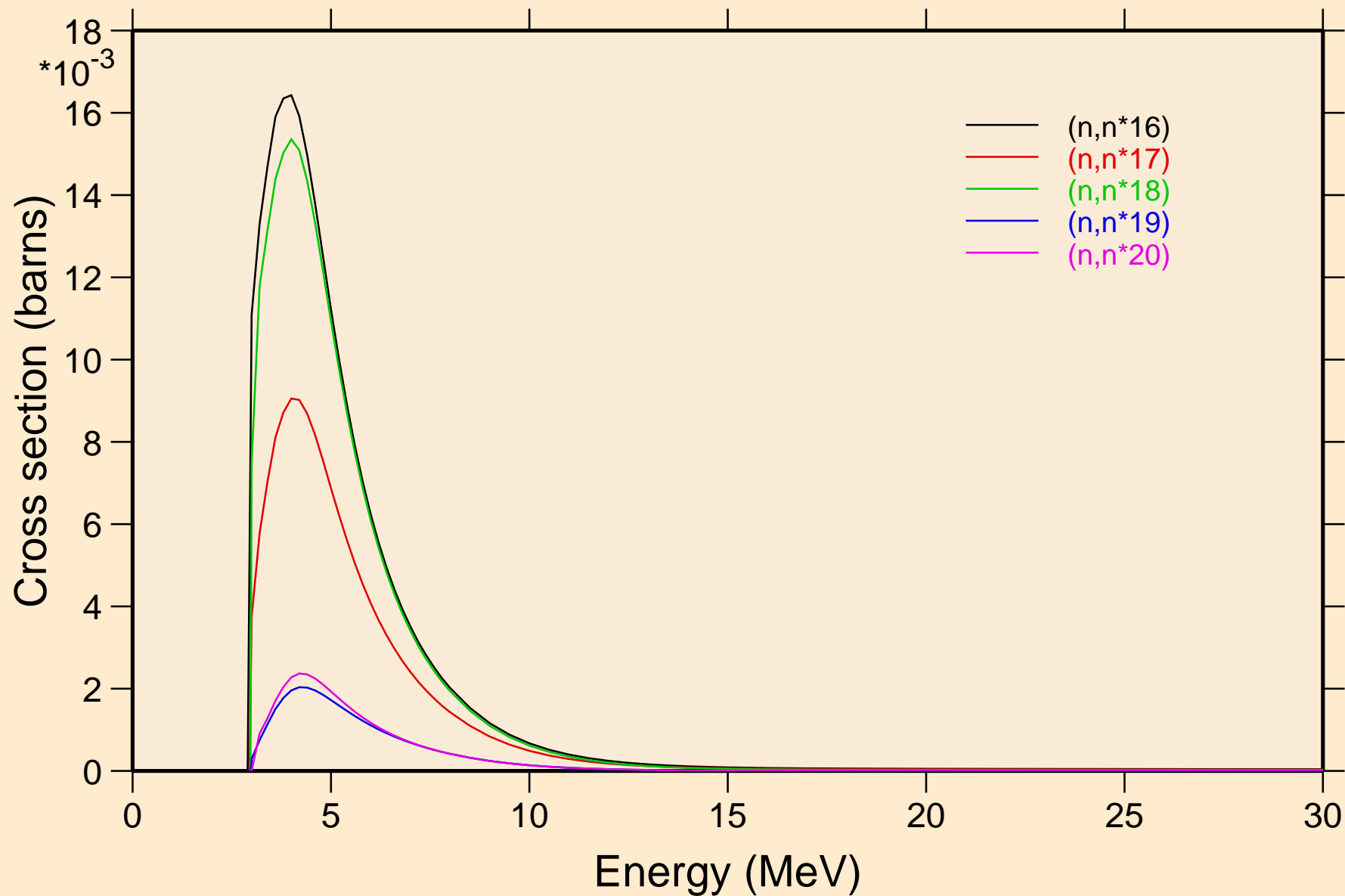

FE053 NEUTRON ACER TENDL-2019 LIBRARY; T=293.16K  
Inelastic levels

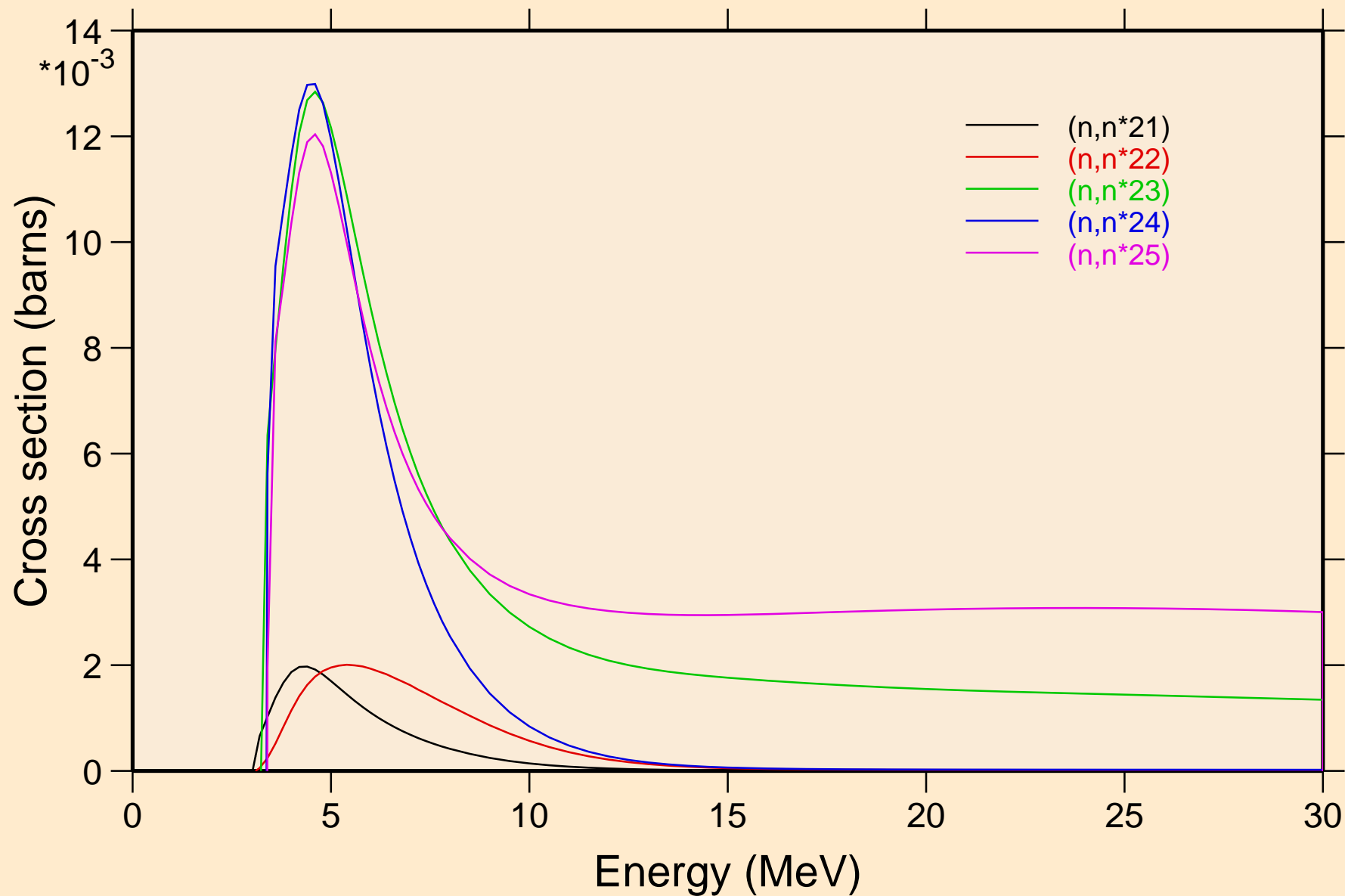

FE053 NEUTRON ACER TENDL-2019 LIBRARY; T=293.16K  
Threshold reactions

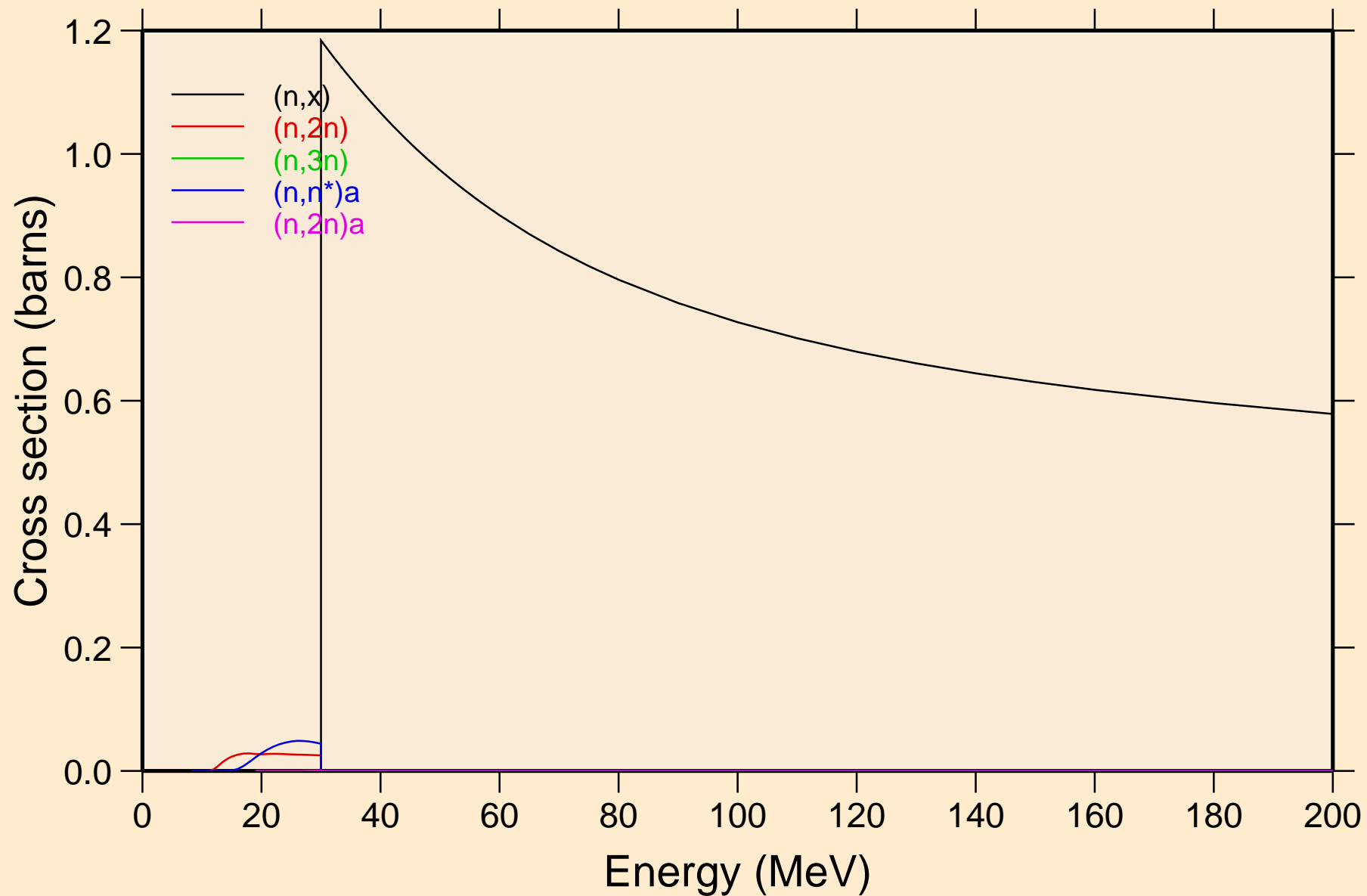

FE053 NEUTRON ACER TENDL-2019 LIBRARY; T=293.16K  
Threshold reactions

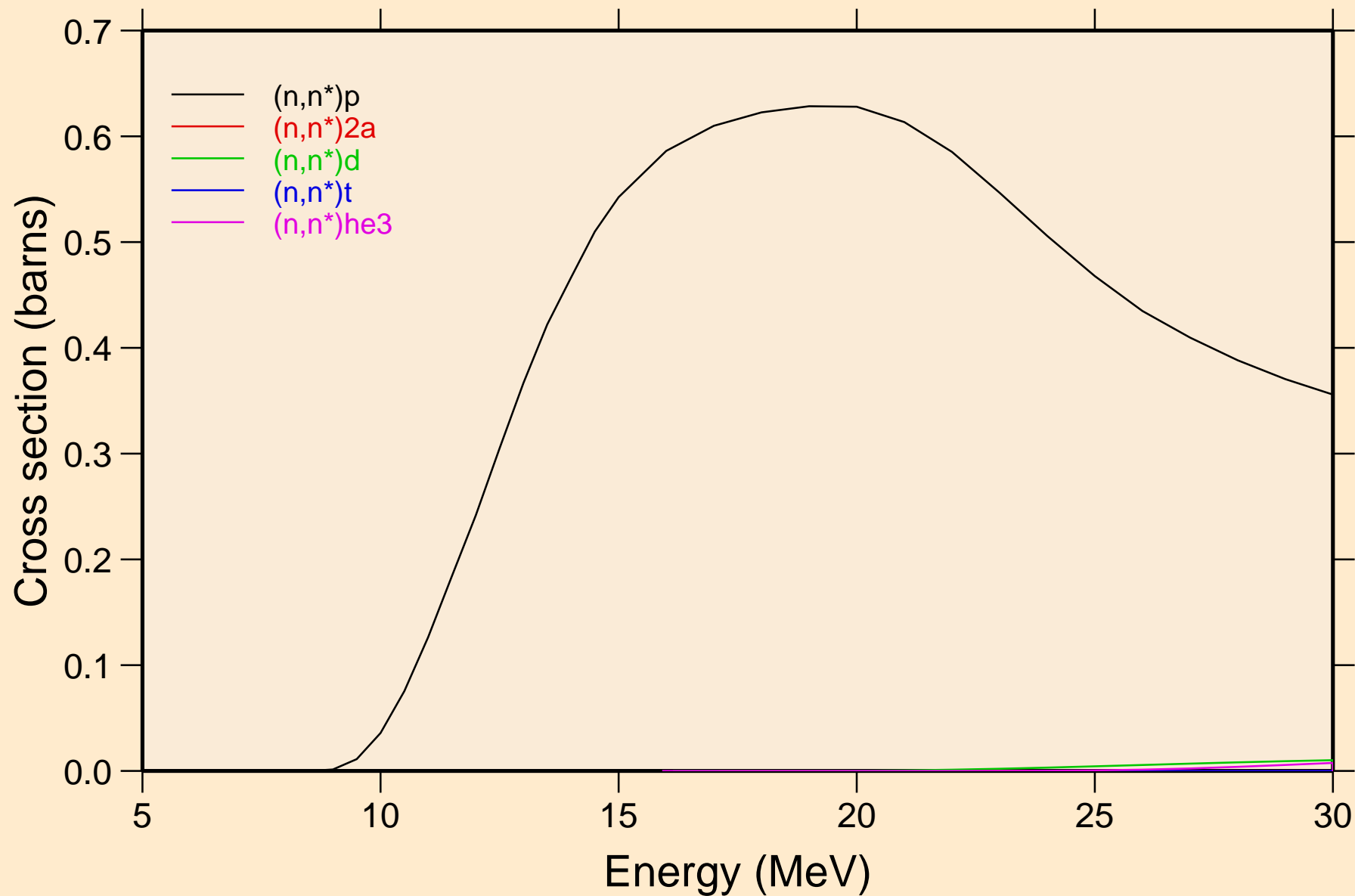

# FE053 NEUTRON ACER TENDL-2019 LIBRARY; T=293.16K

## Threshold reactions

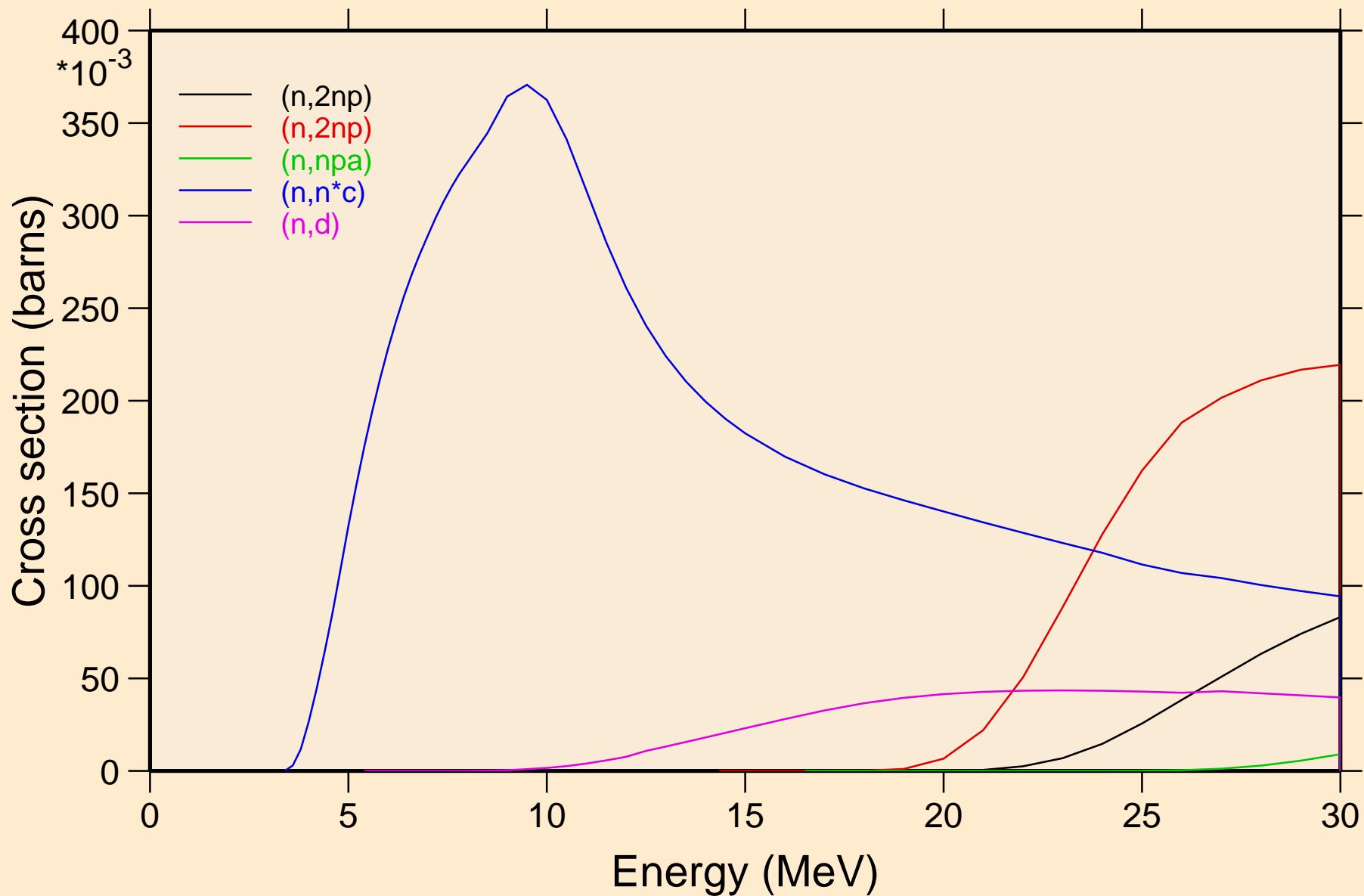



FE053 NEUTRON ACER TENDL-2019 LIBRARY; T=293.16K  
Threshold reactions

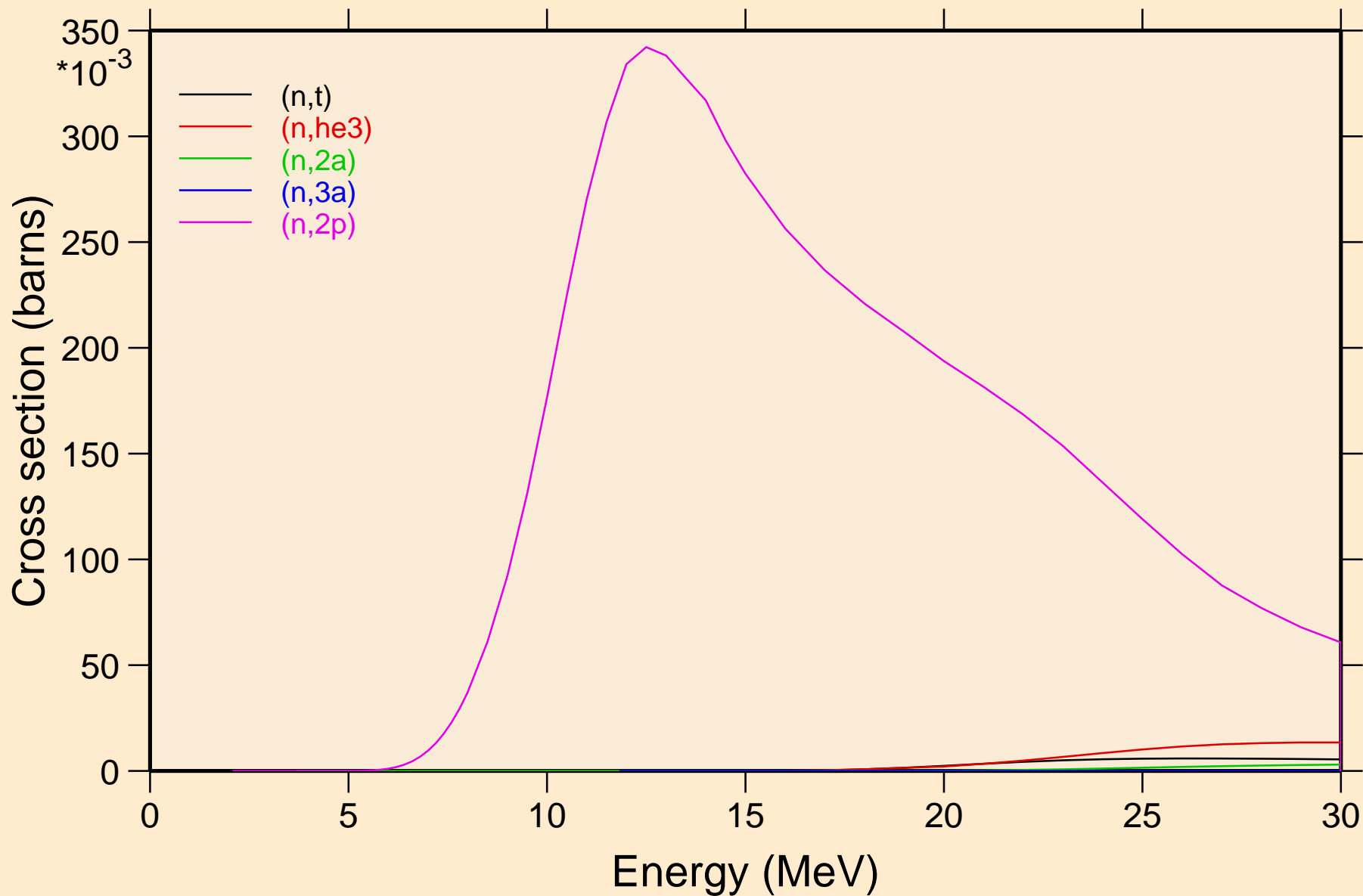

FE053 NEUTRON ACER TENDL-2019 LIBRARY; T=293.16K  
Threshold reactions

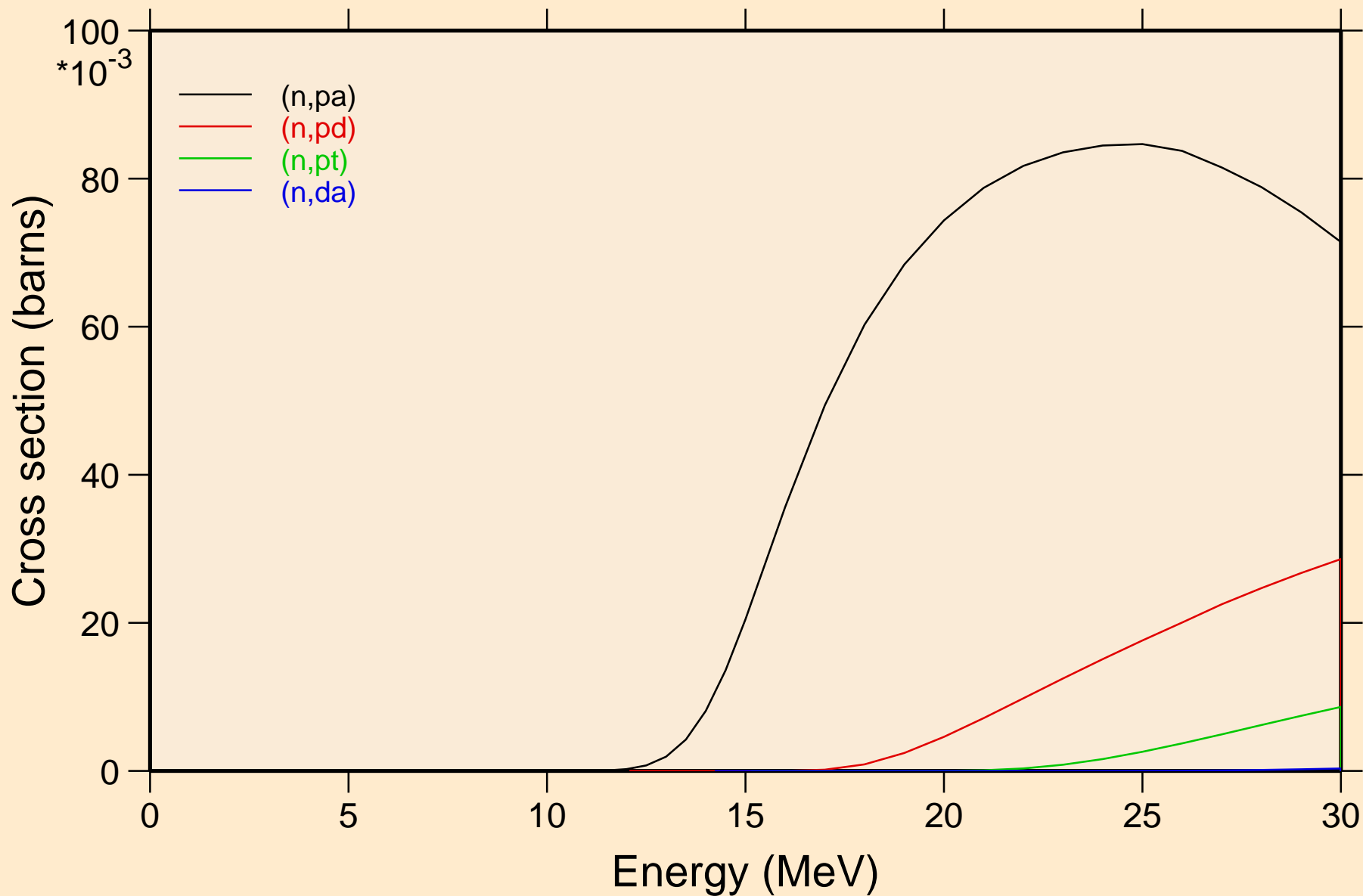

FE053 NEUTRON ACER TENDL-2019 LIBRARY; T=293.16K  
Threshold reactions

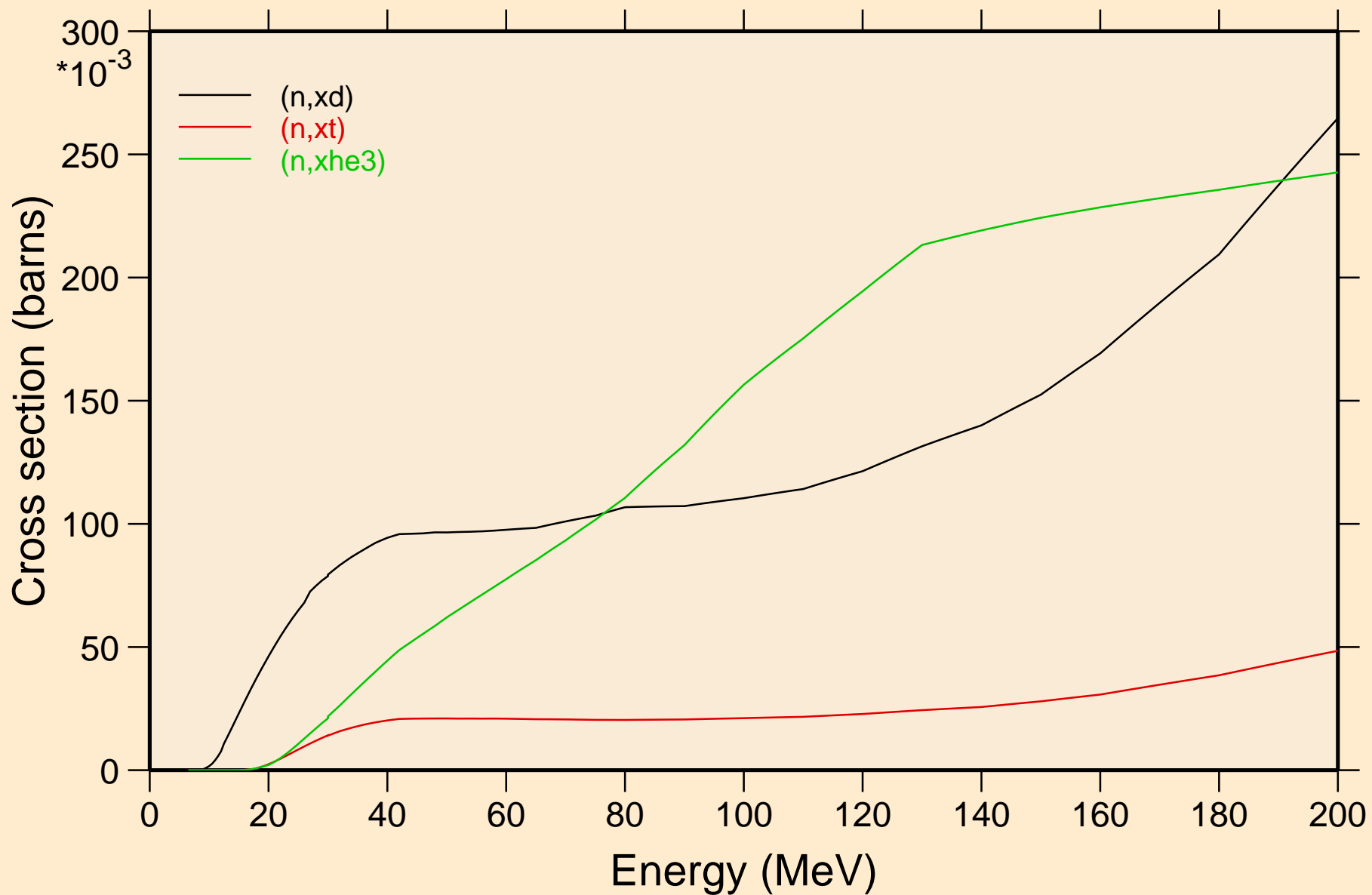

FE053 NEUTRON ACER TENDL-2019 LIBRARY; T=293.16K  
angular distribution for elastic

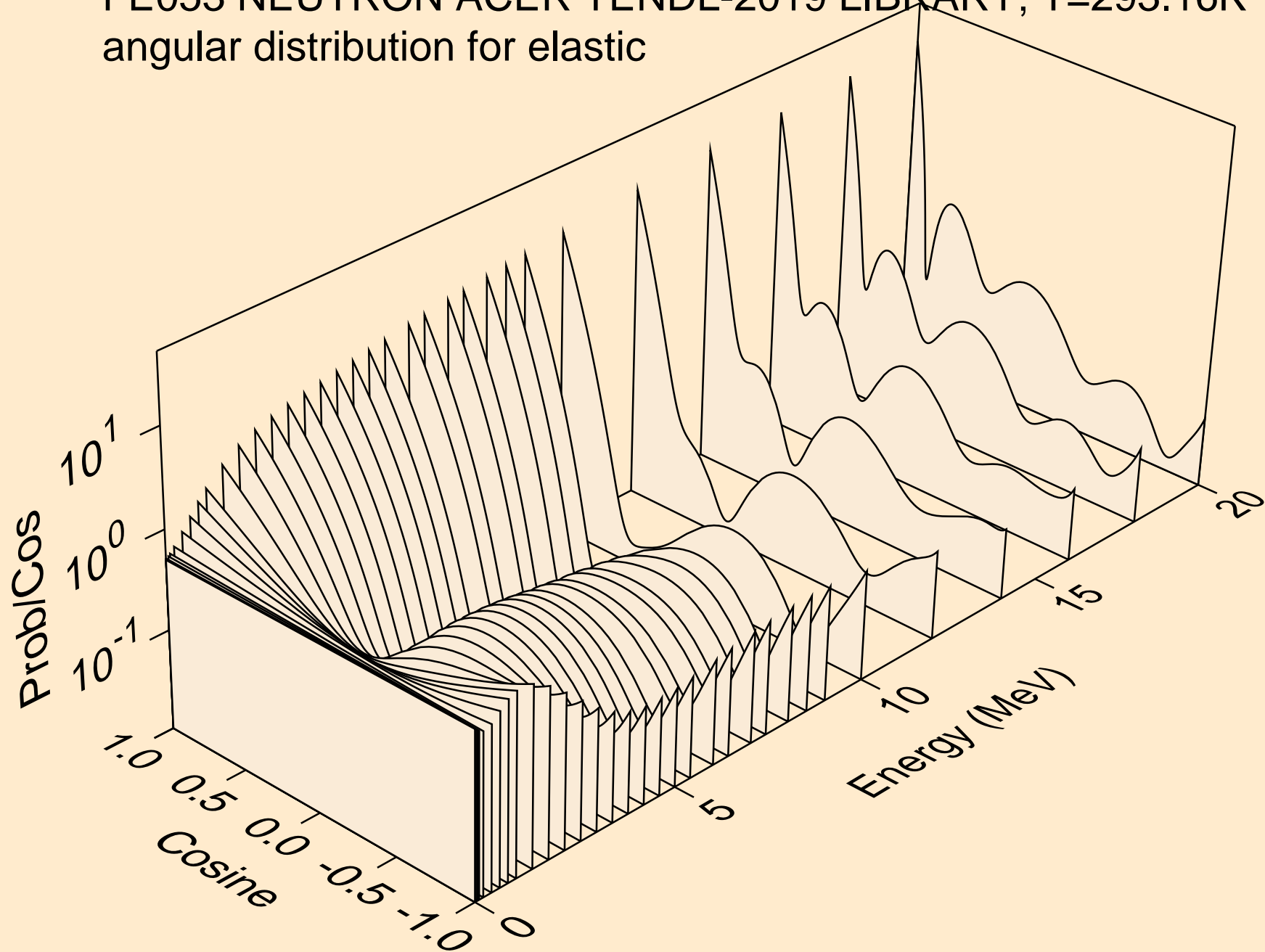

FE053 NEUTRON ACER TENDL-2019 LIBRARY; T=293.16K  
angular distribution for elastic

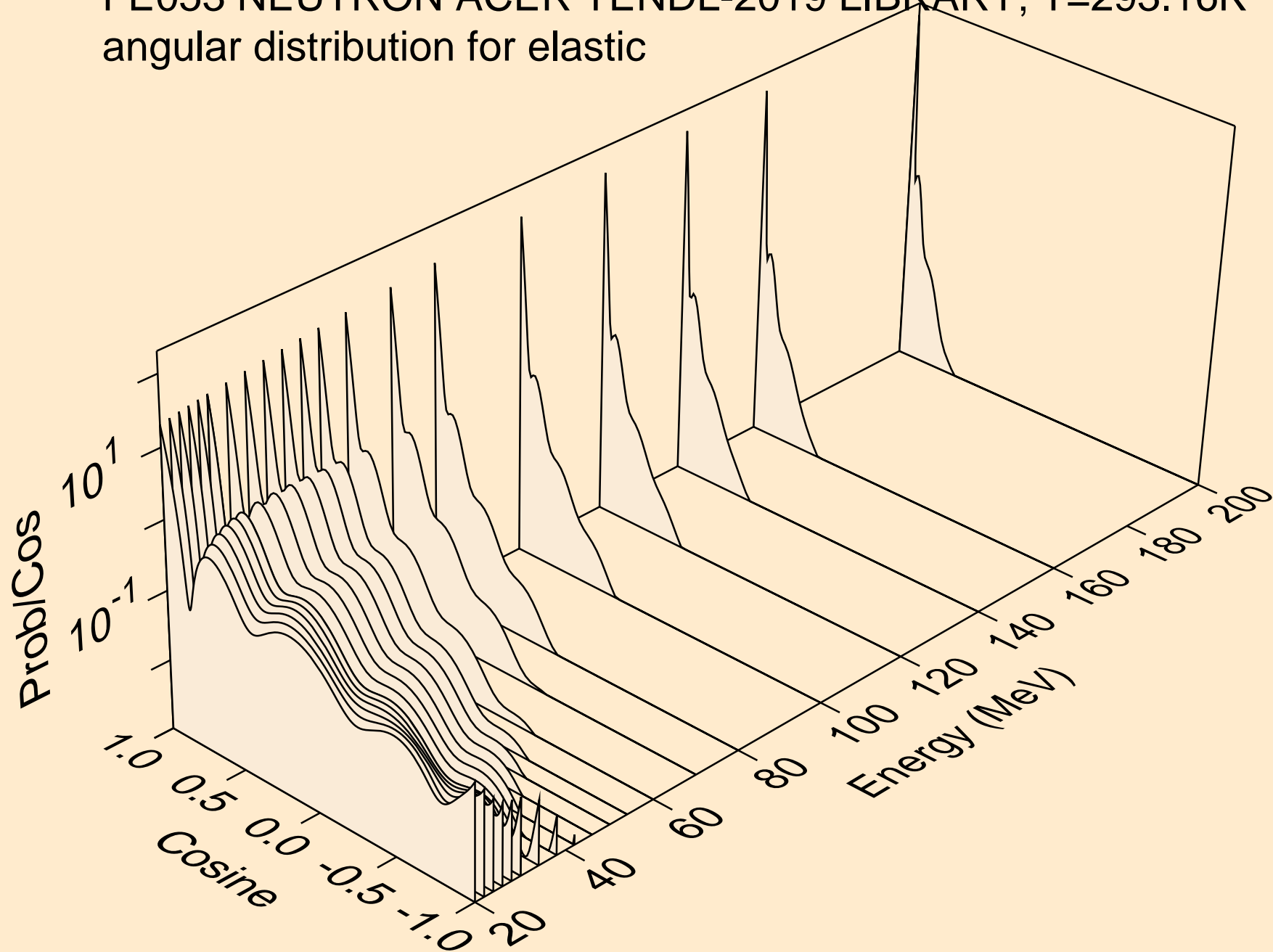

FE053 NEUTRON ACER TENDL-2019 LIBRARY; T=293.16K  
angular distribution for (n,n\*1)

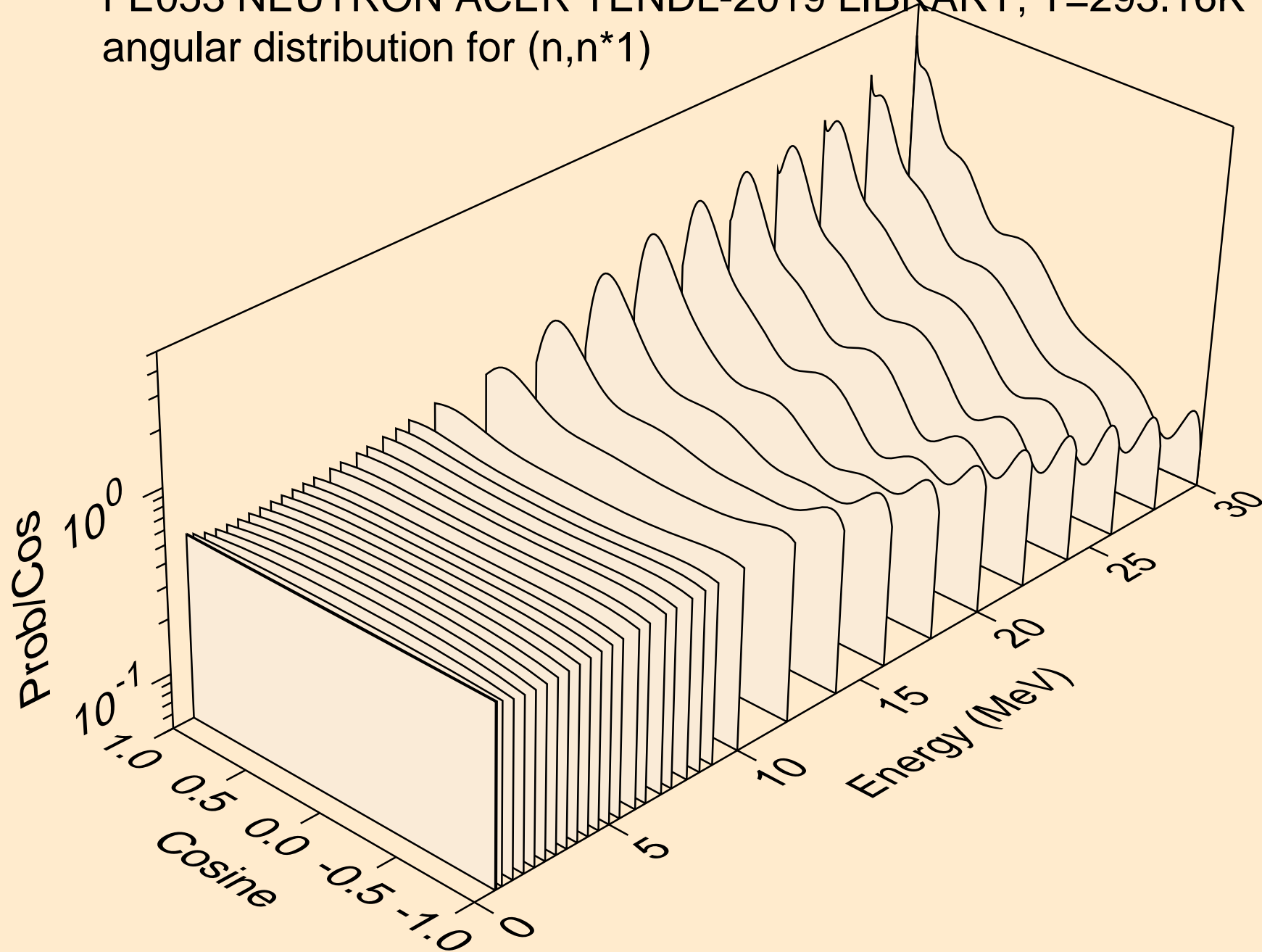

FE053 NEUTRON ACER TENDL-2019 LIBRARY; T=293.16K  
angular distribution for (n,n\*2)

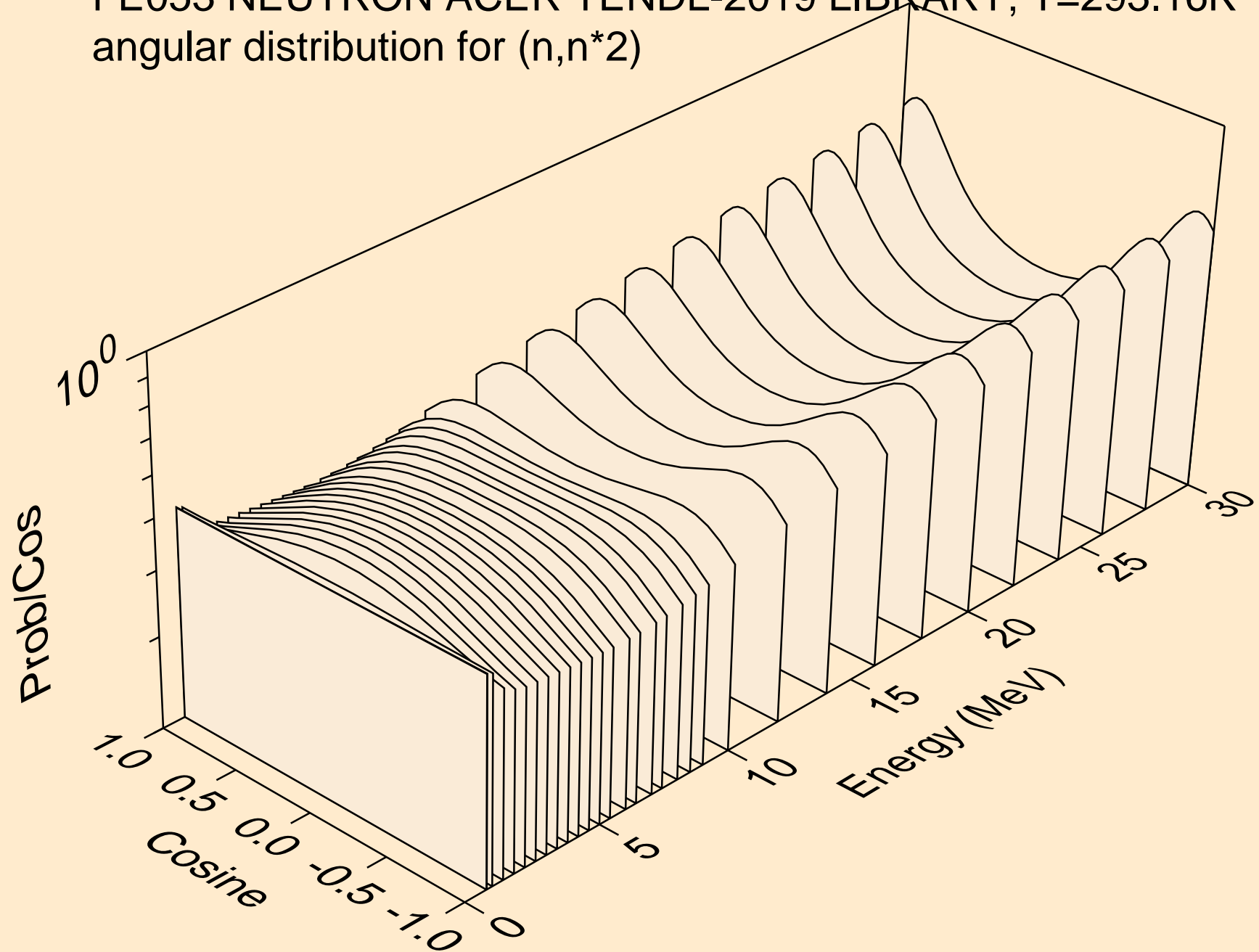

FE053 NEUTRON ACER TENDL-2019 LIBRARY; T=293.16K  
angular distribution for (n,n\*3)

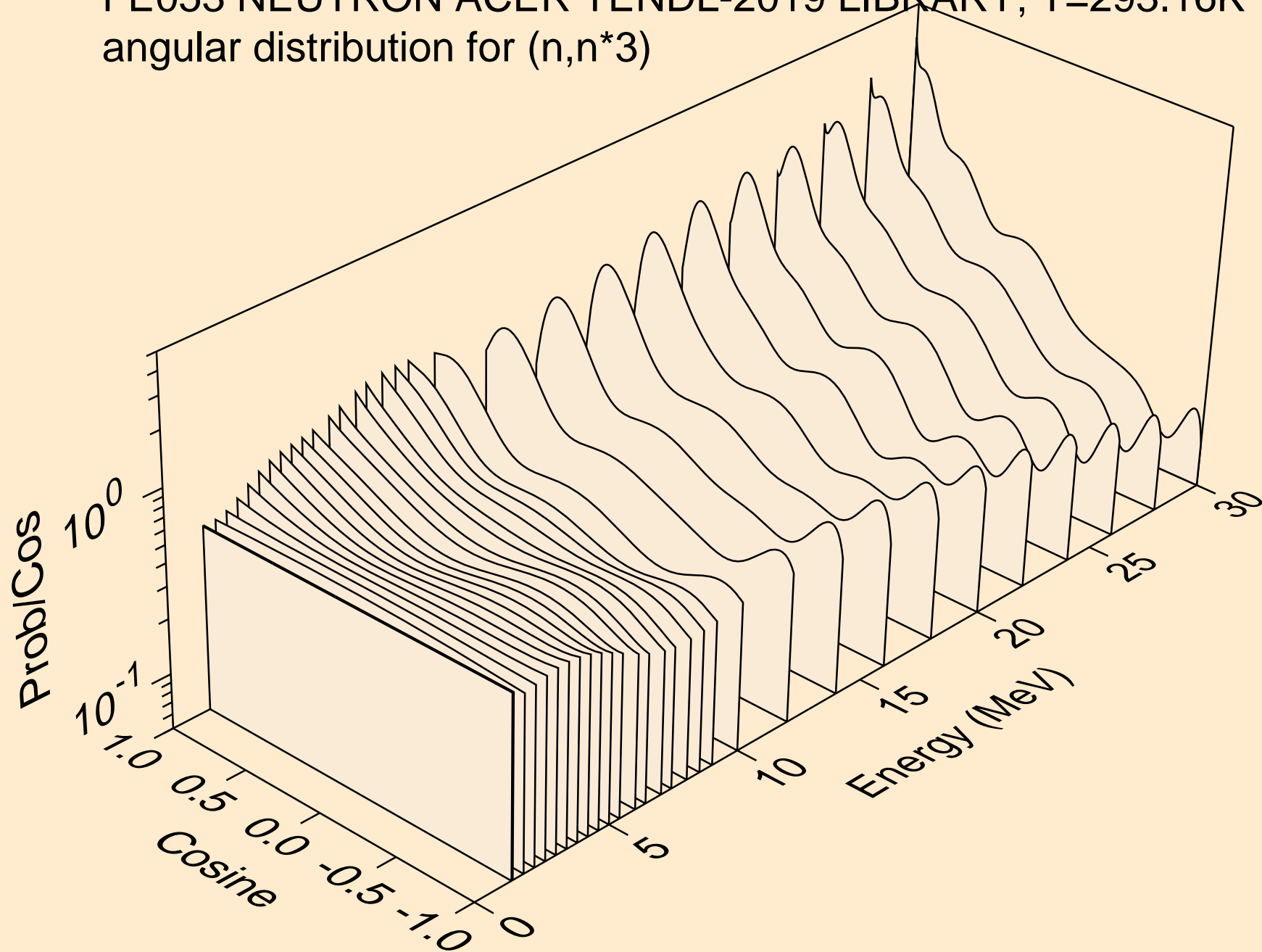



FE053 NEUTRON ACER TENDL-2019 LIBRARY; T=293.16K  
angular distribution for (n,n\*4)

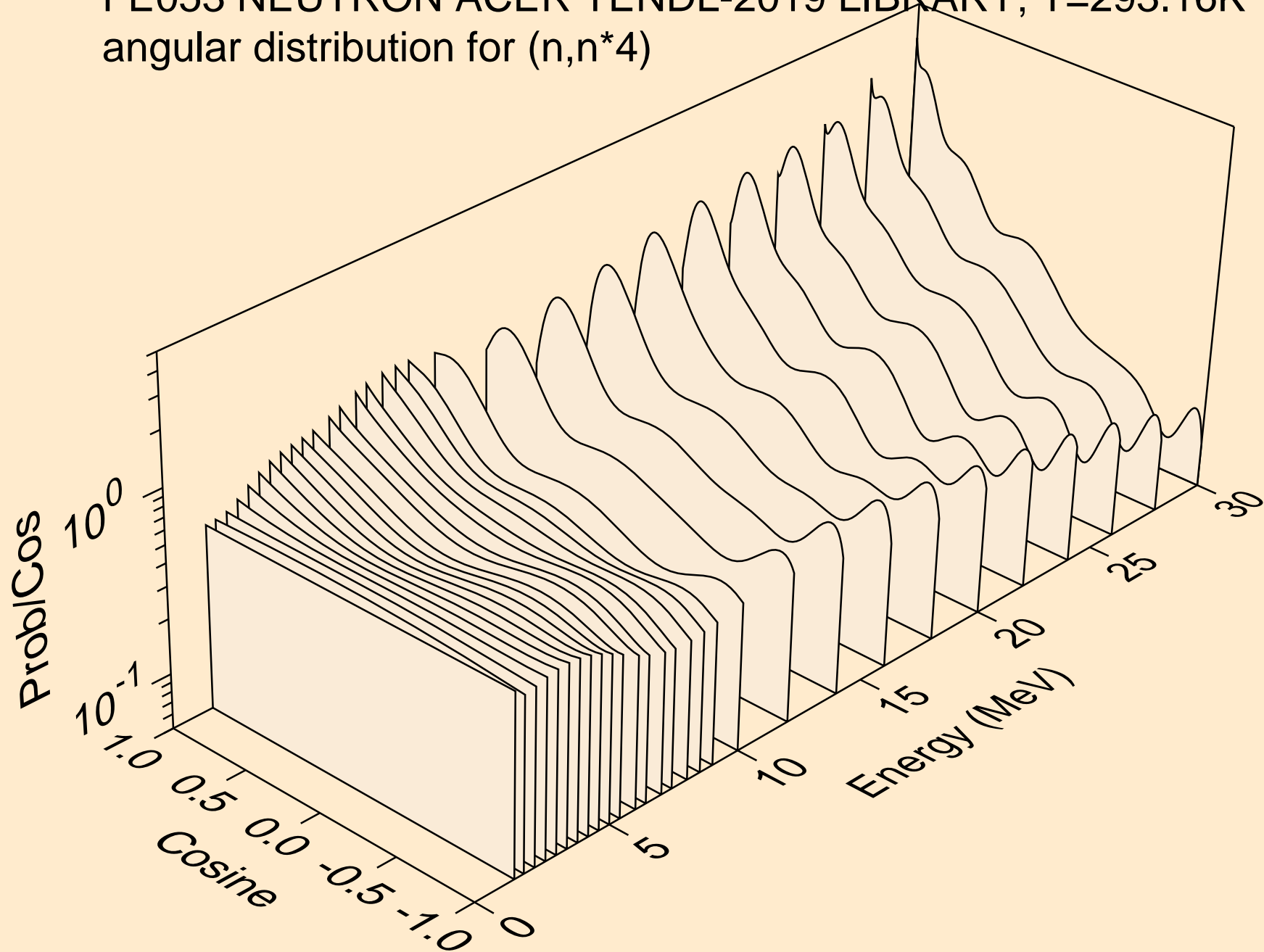

FE053 NEUTRON ACER TENDL-2019 LIBRARY; T=293.16K  
angular distribution for (n,n\*5)

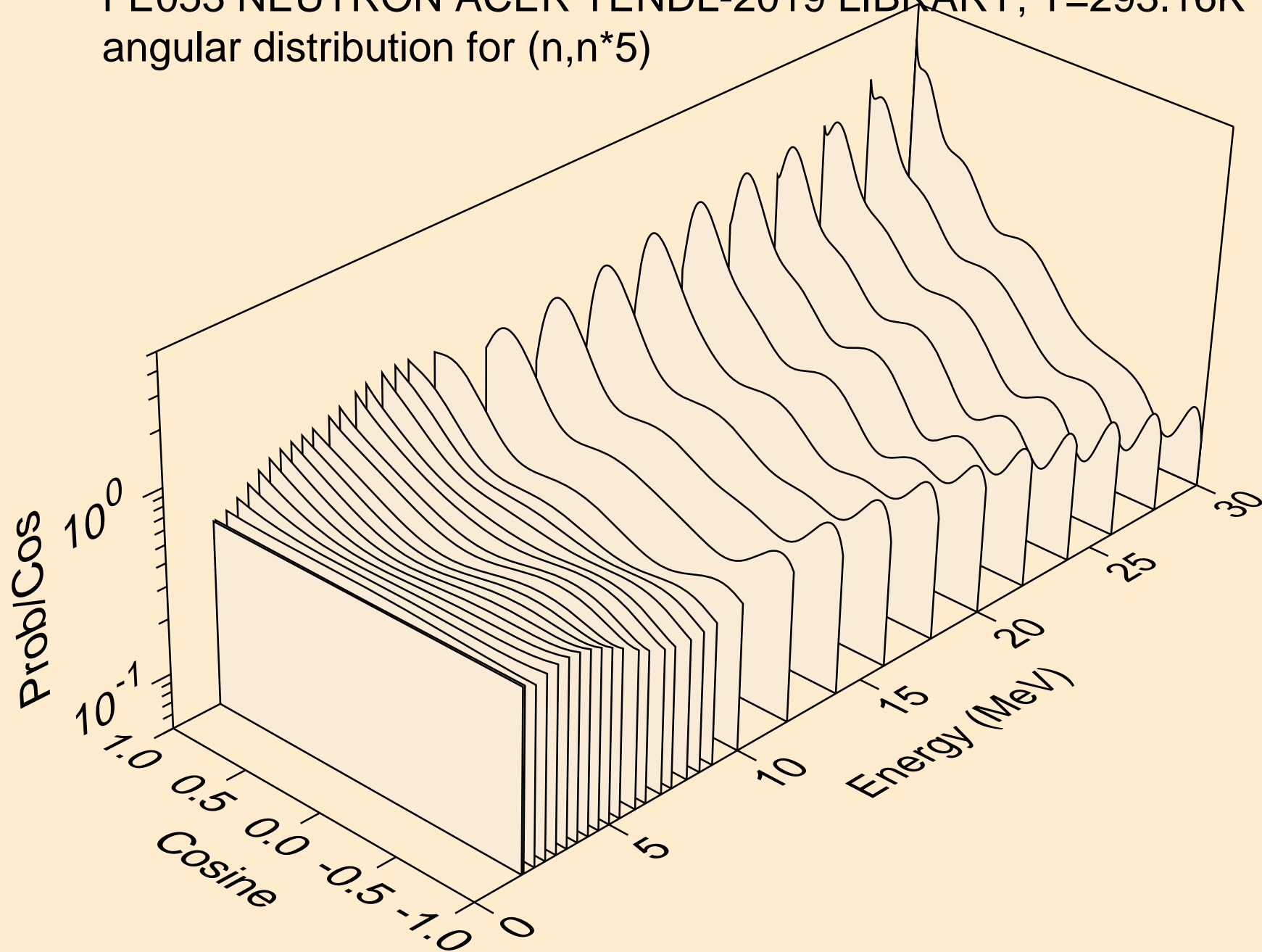

FE053 NEUTRON ACER TENDL-2019 LIBRARY; T=293.16K  
angular distribution for (n,n\*6)

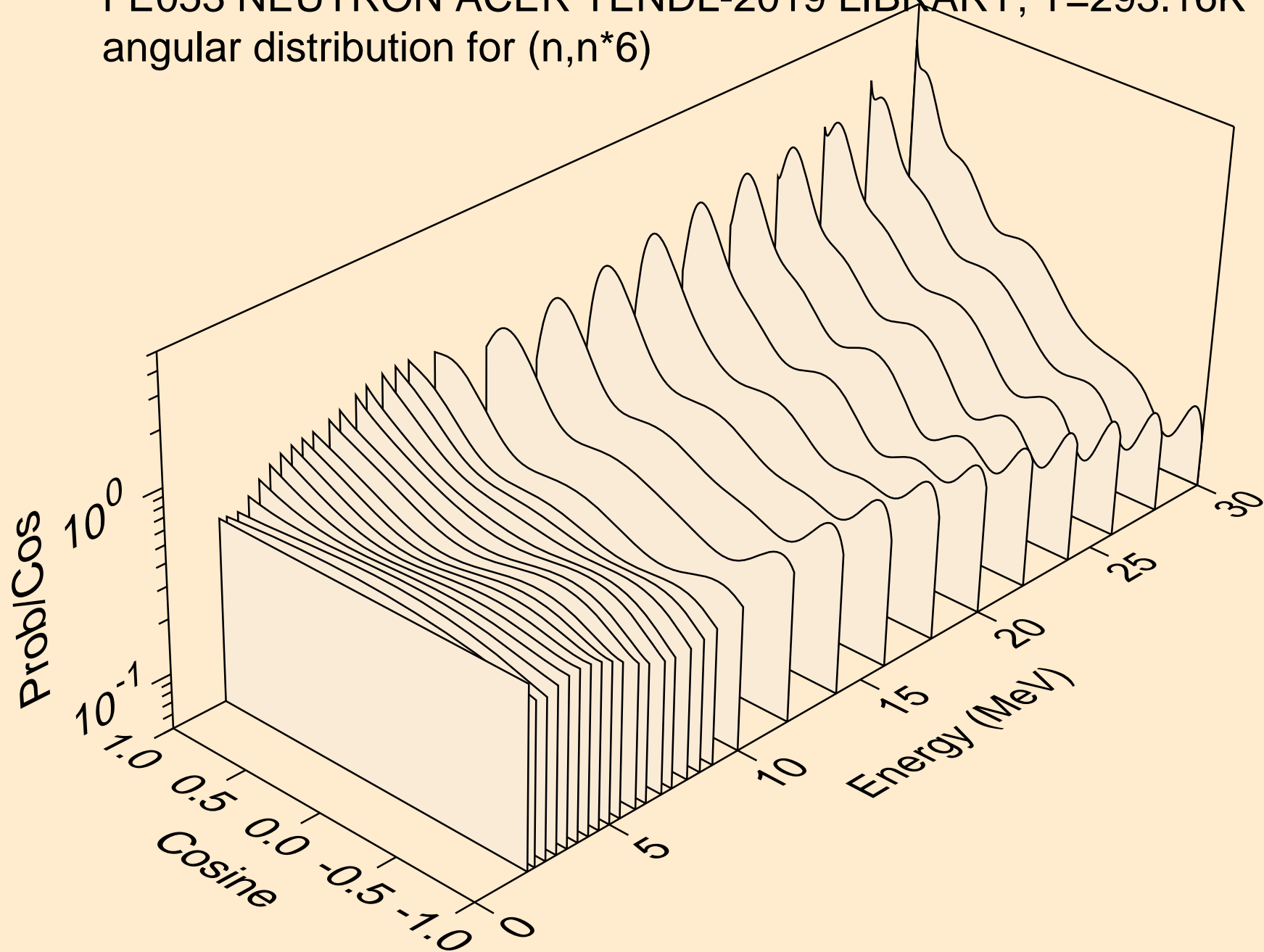

FE053 NEUTRON ACER TENDL-2019 LIBRARY; T=293.16K  
angular distribution for (n,n\*7)

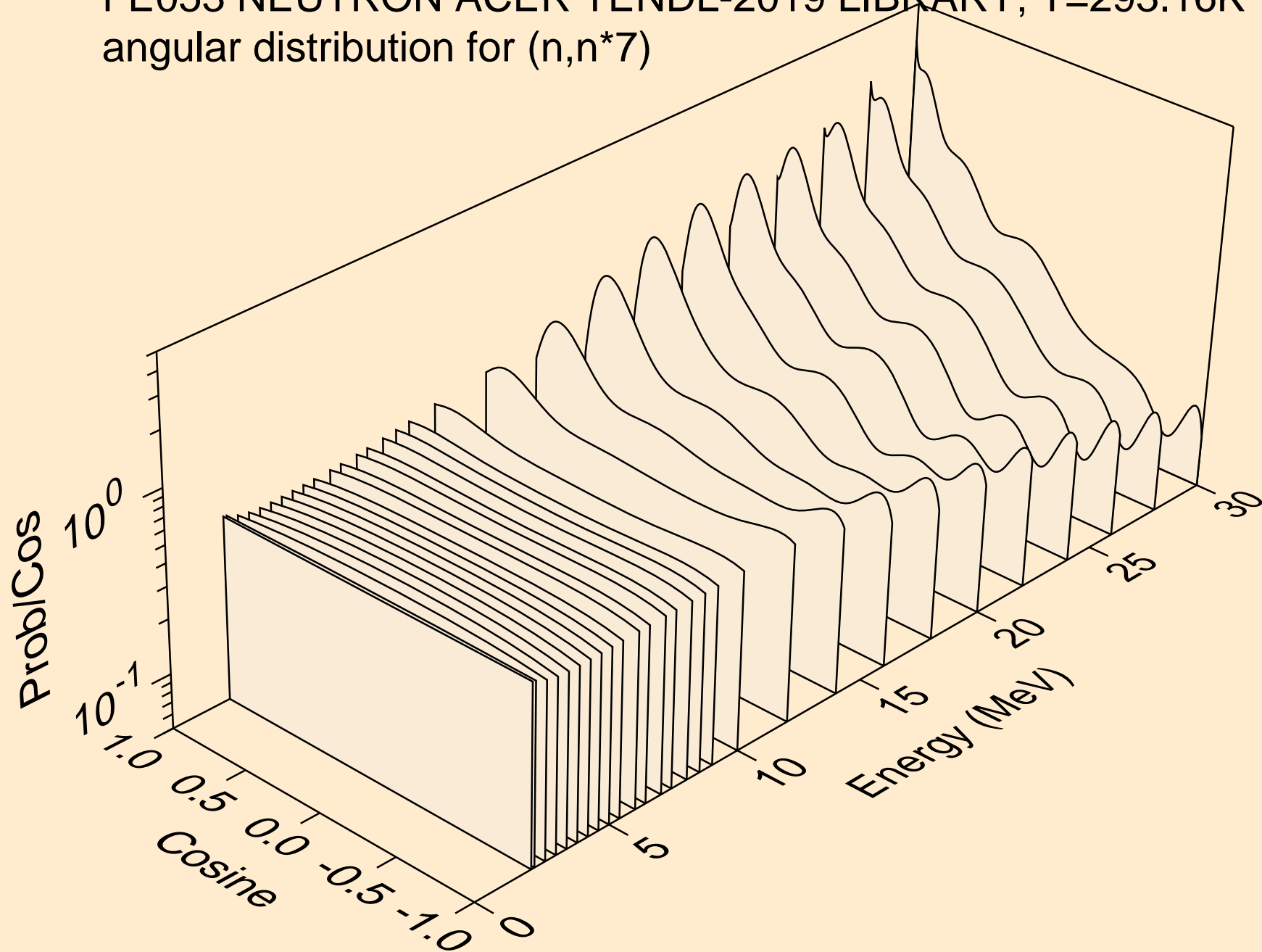

FE053 NEUTRON ACER TENDL-2019 LIBRARY; T=293.16K  
angular distribution for (n,n\*8)

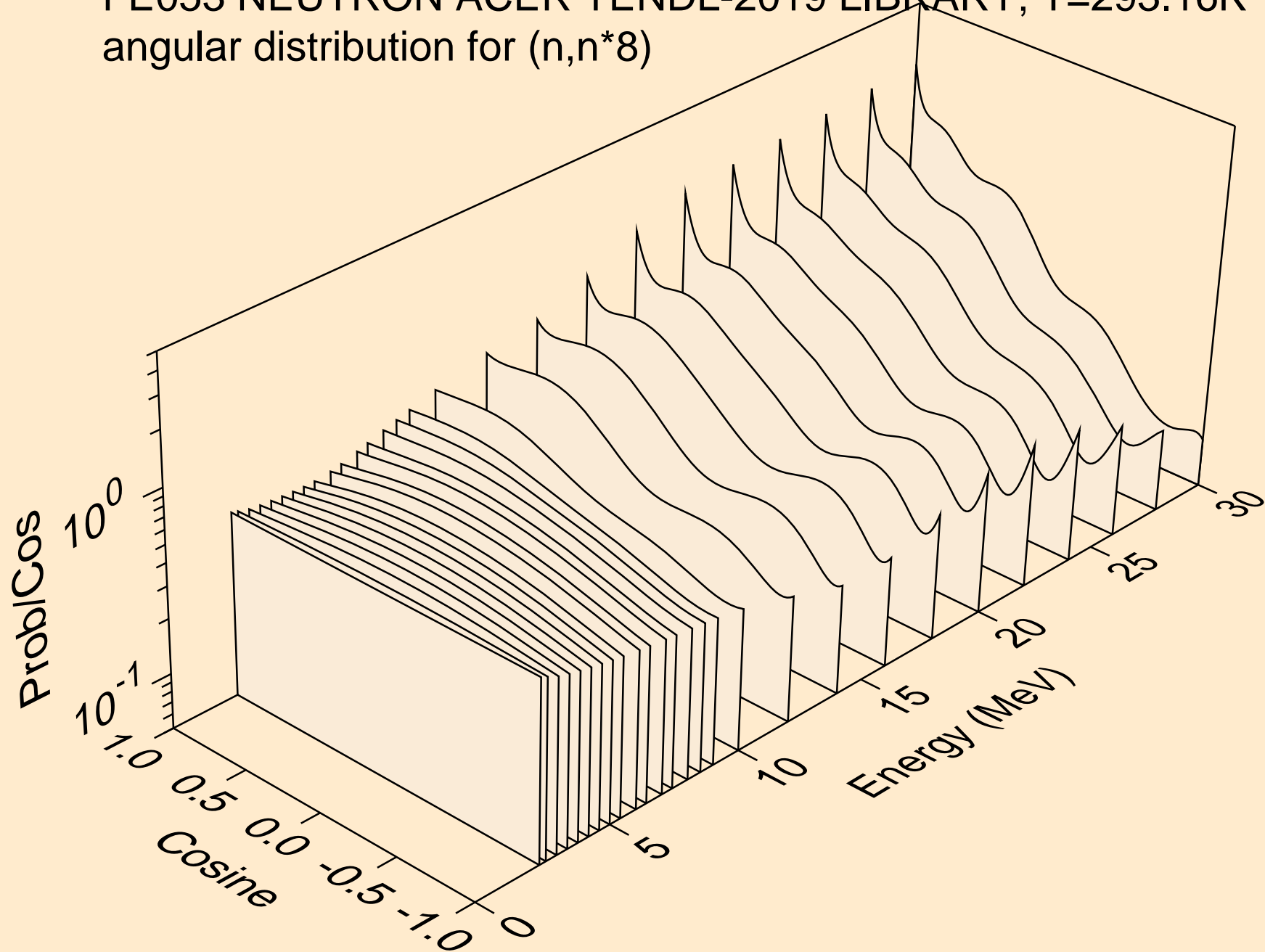

FE053 NEUTRON ACER TENDL-2019 LIBRARY; T=293.16K  
angular distribution for (n,n\*9)

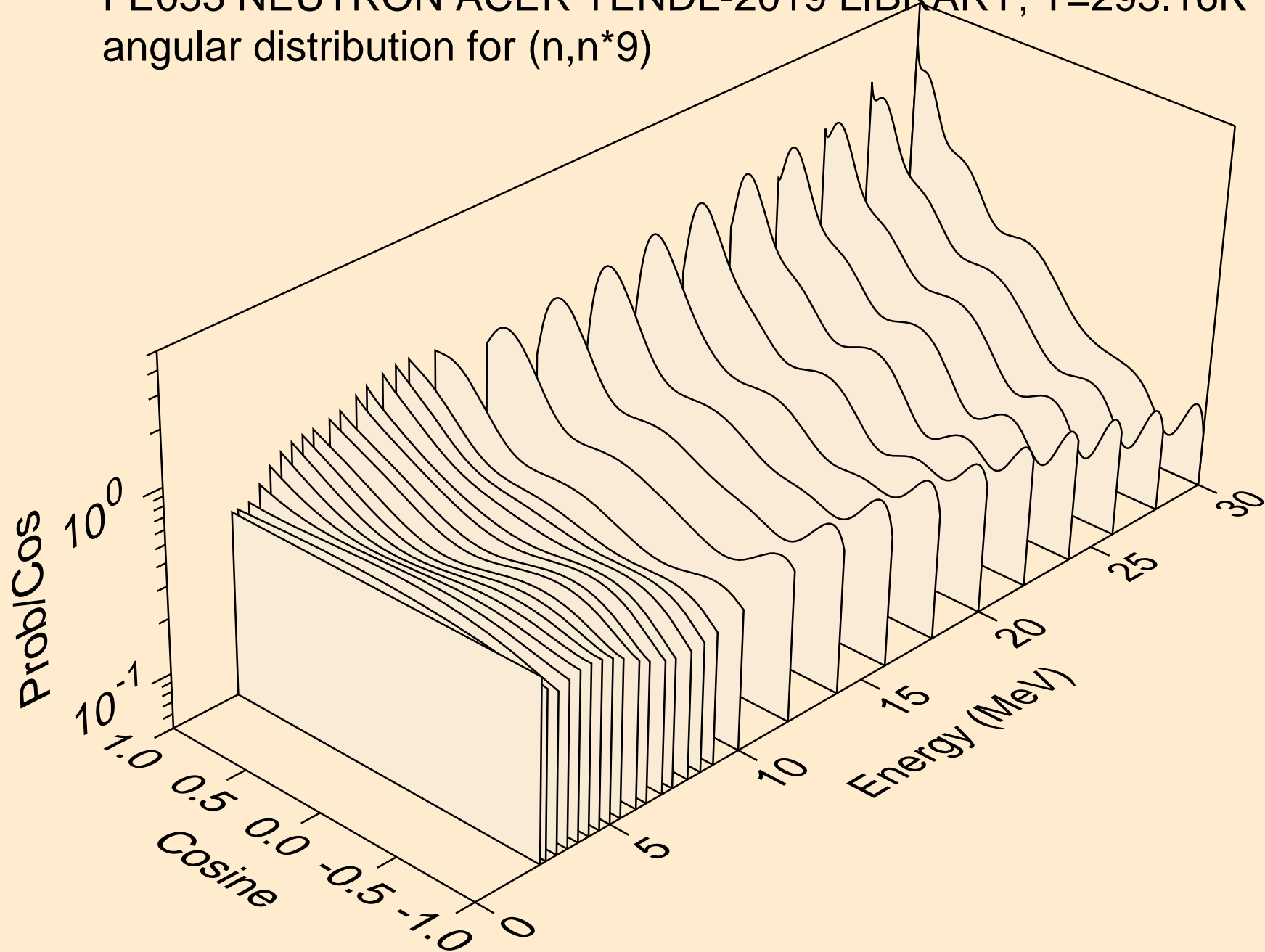

FE053 NEUTRON ACER TENDL-2019 LIBRARY; T=293.16K  
angular distribution for (n,n\*10)

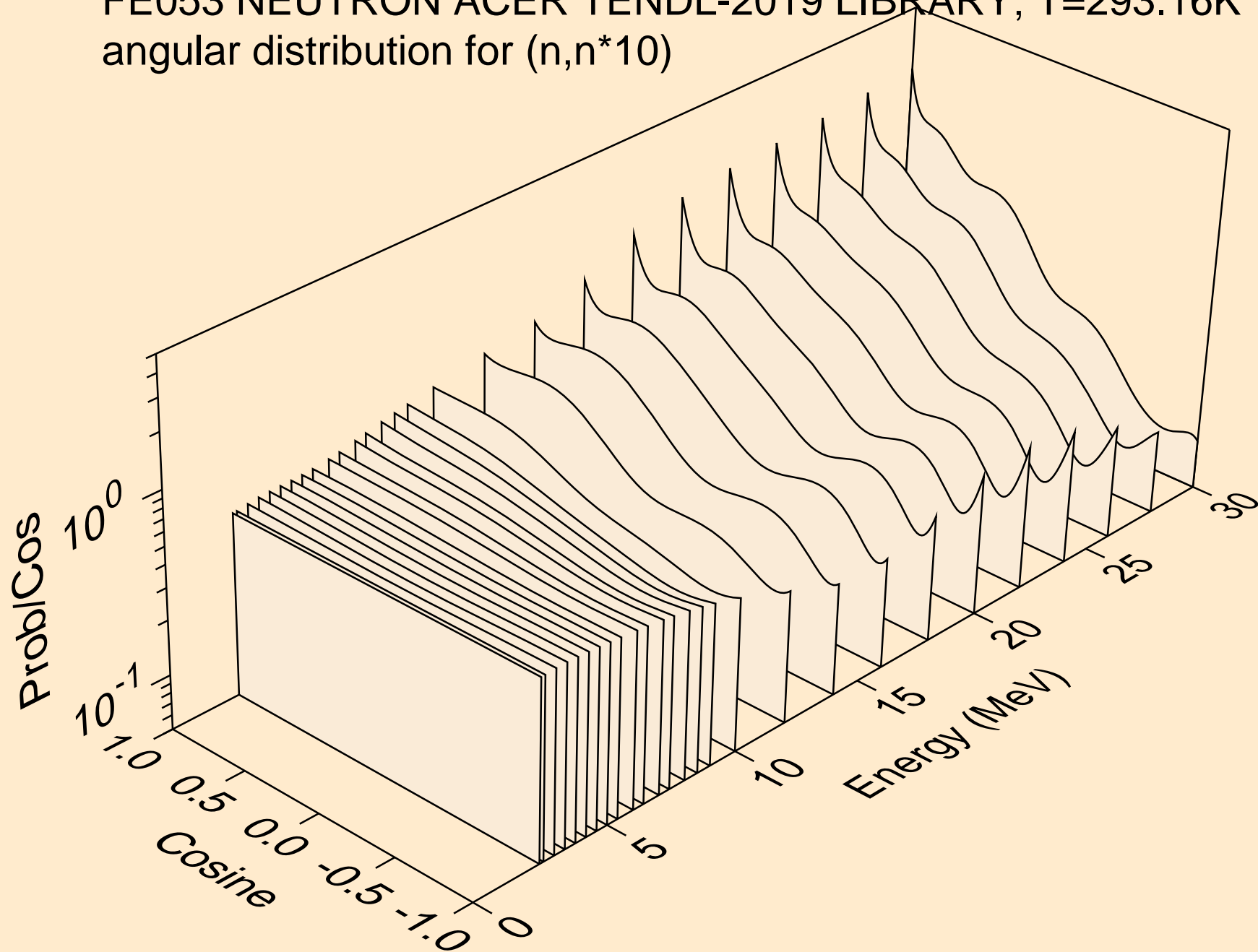

FE053 NEUTRON ACER TENDL-2019 LIBRARY; T=293.16K  
angular distribution for (n,n\*11)

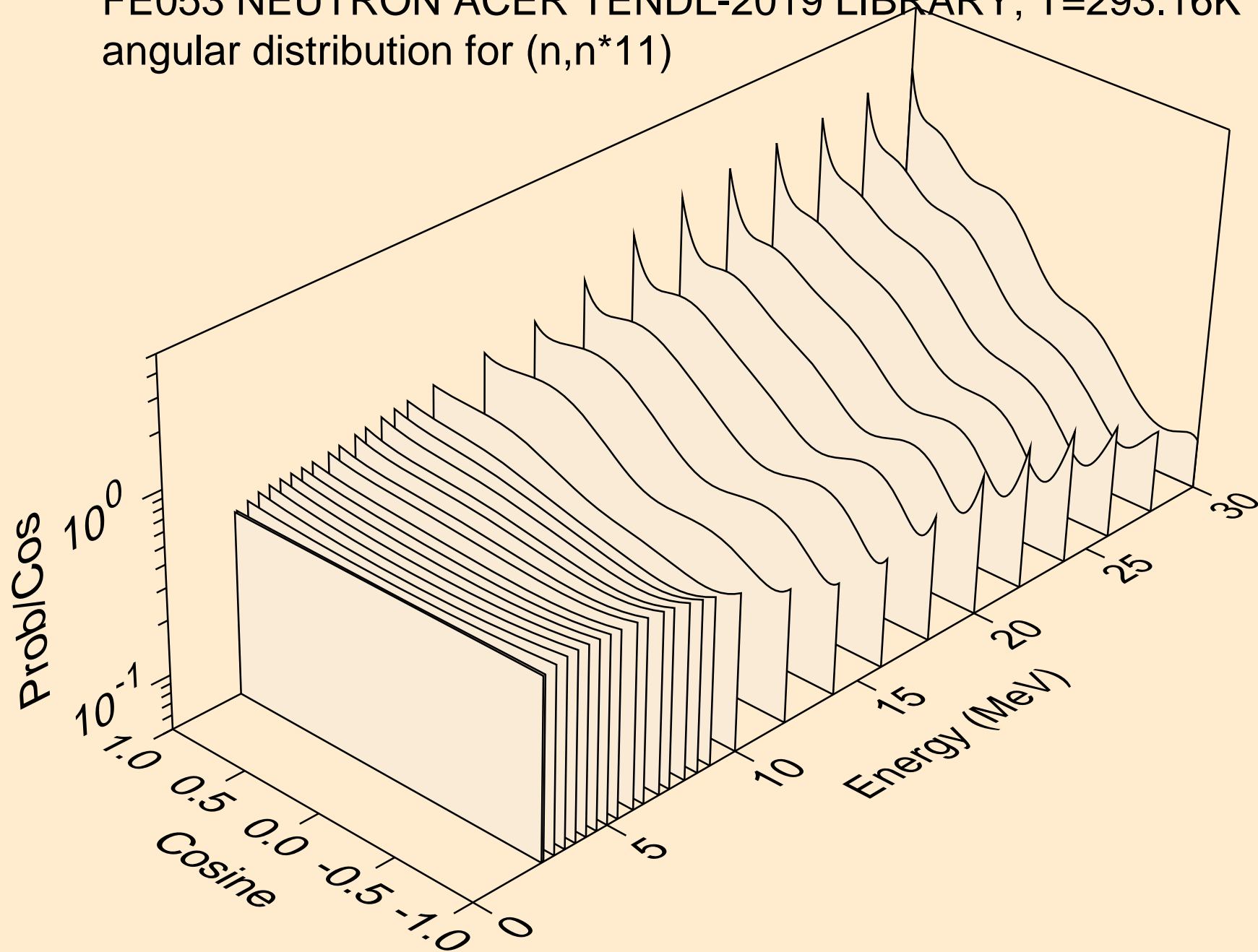



FE053 NEUTRON ACER TENDL-2019 LIBRARY; T=293.16K  
angular distribution for (n,n\*12)

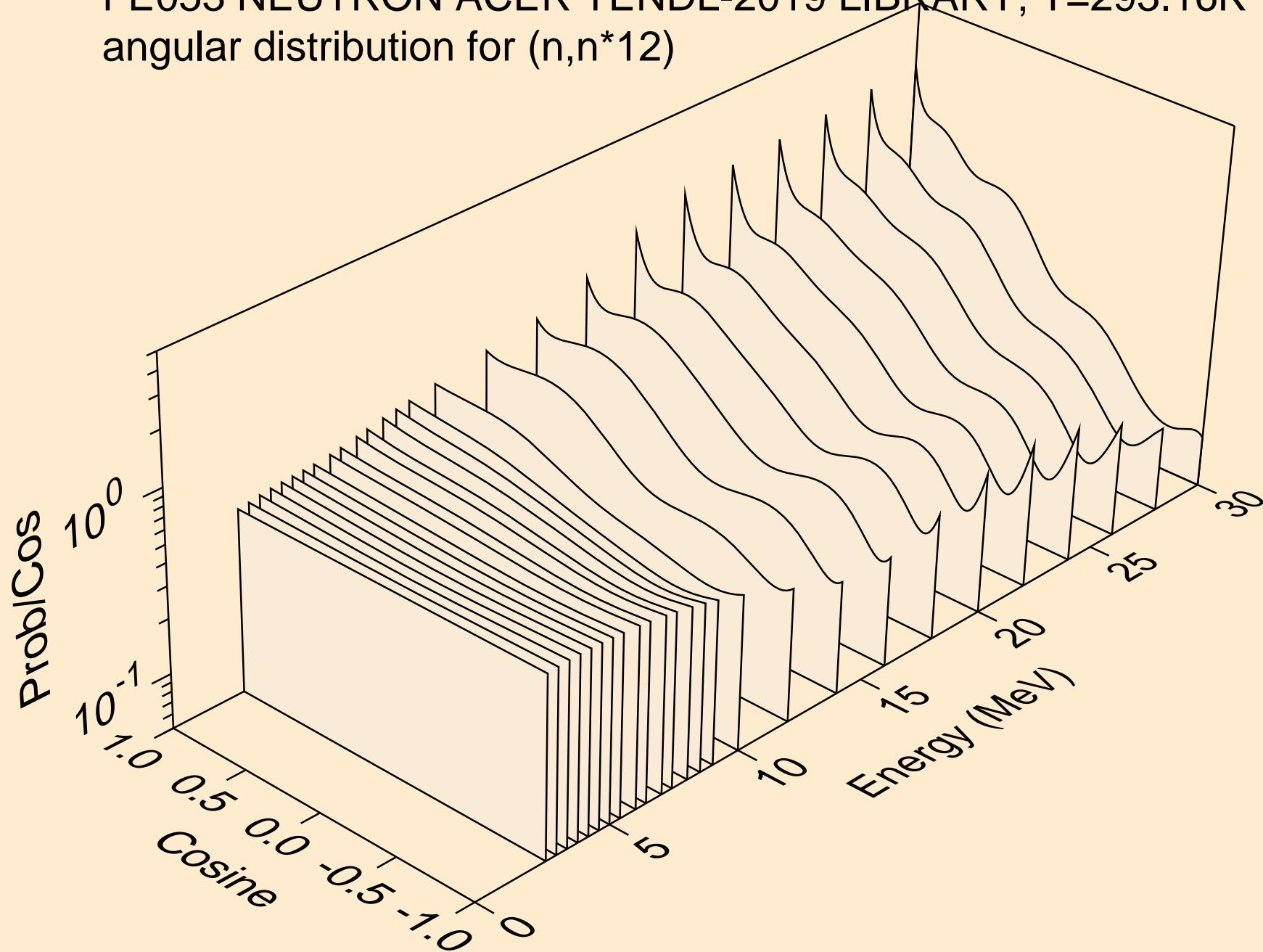

FE053 NEUTRON ACER TENDL-2019 LIBRARY; T=293.16K  
angular distribution for (n,n\*13)

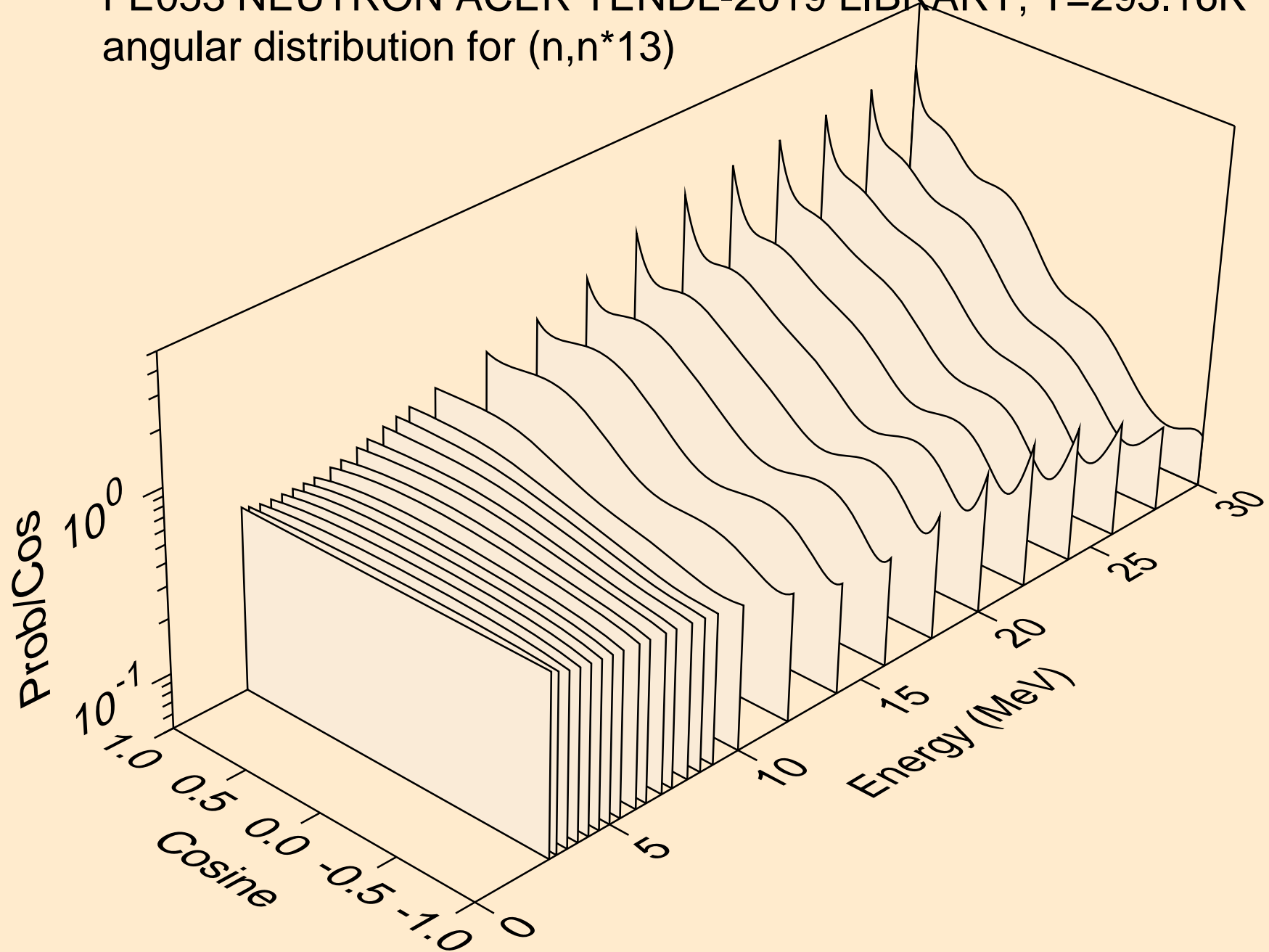

FE053 NEUTRON ACER TENDL-2019 LIBRARY; T=293.16K  
angular distribution for (n,n\*14)

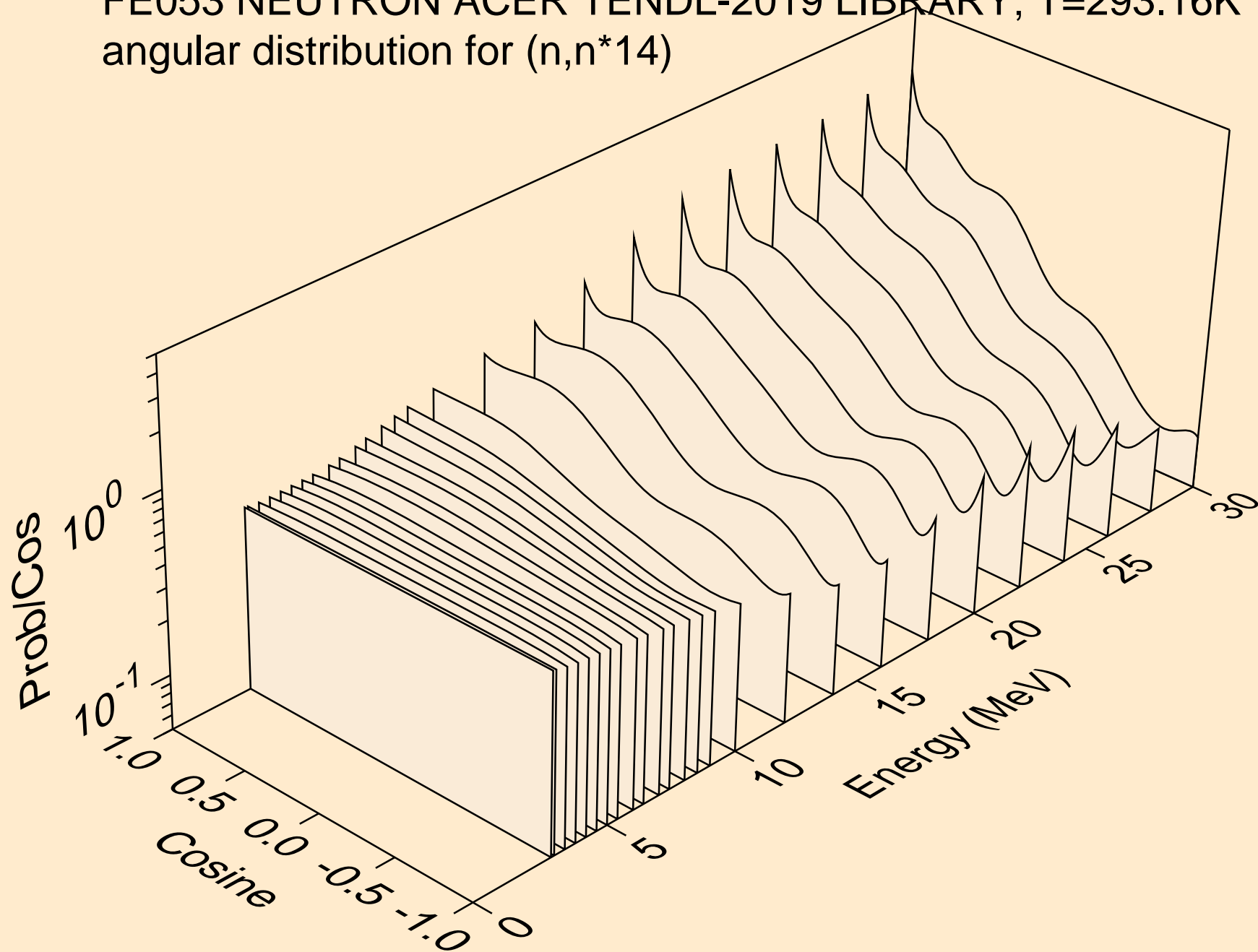

FE053 NEUTRON ACER TENDL-2019 LIBRARY; T=293.16K  
angular distribution for (n,n\*15)

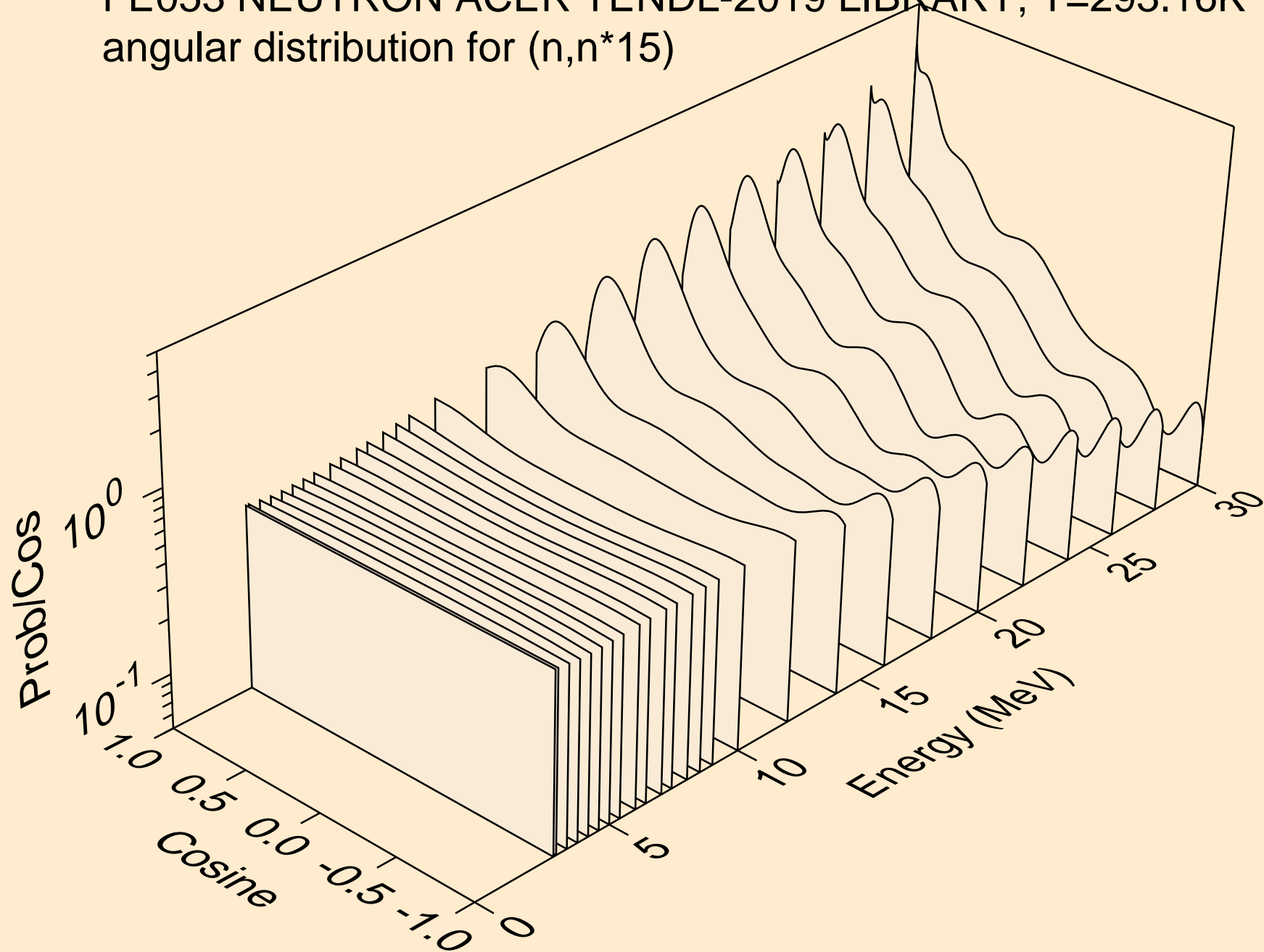

FE053 NEUTRON ACER TENDL-2019 LIBRARY; T=293.16K  
angular distribution for (n,n\*16)

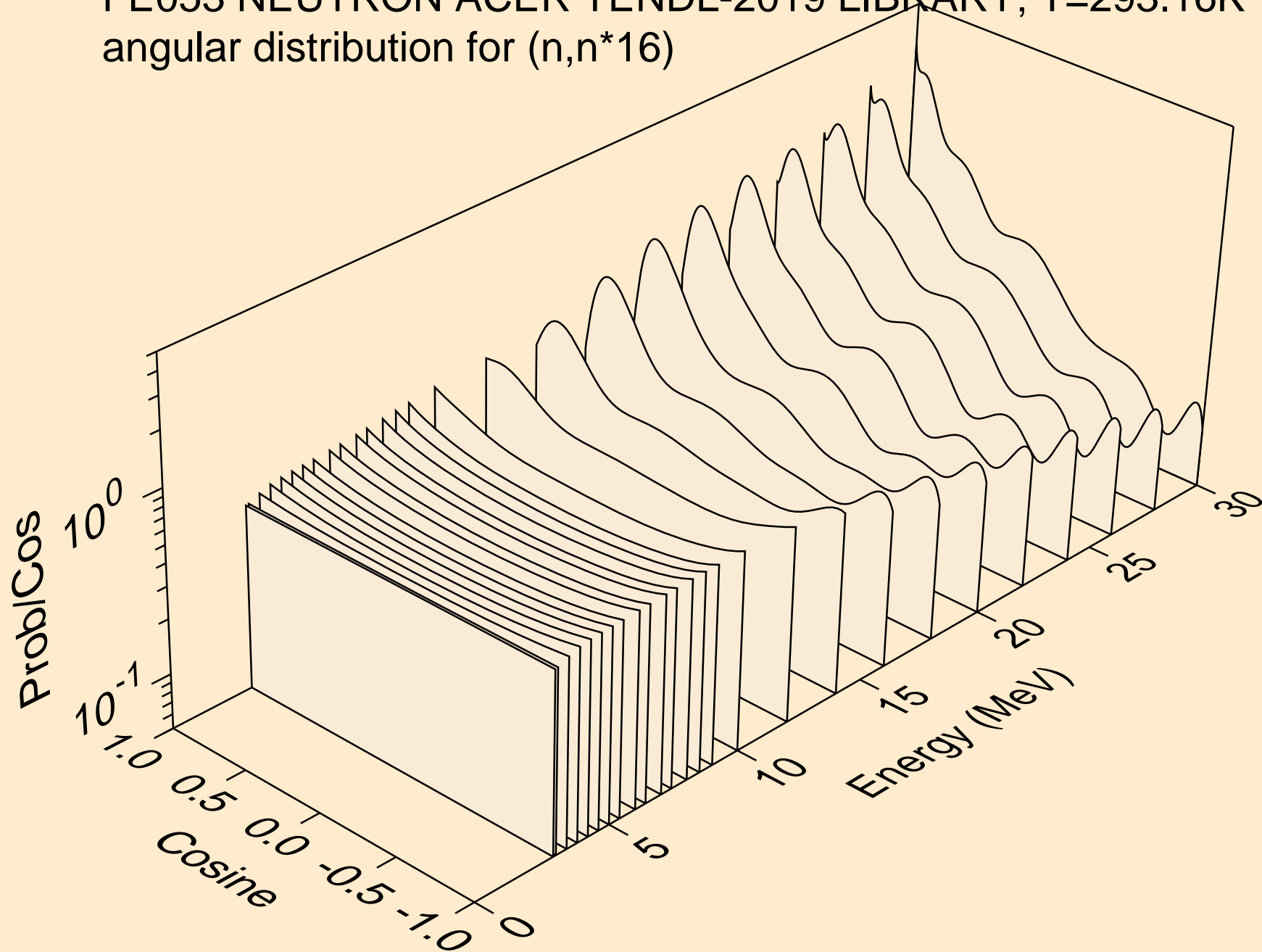

FE053 NEUTRON ACER TENDL-2019 LIBRARY; T=293.16K  
angular distribution for (n,n\*17)

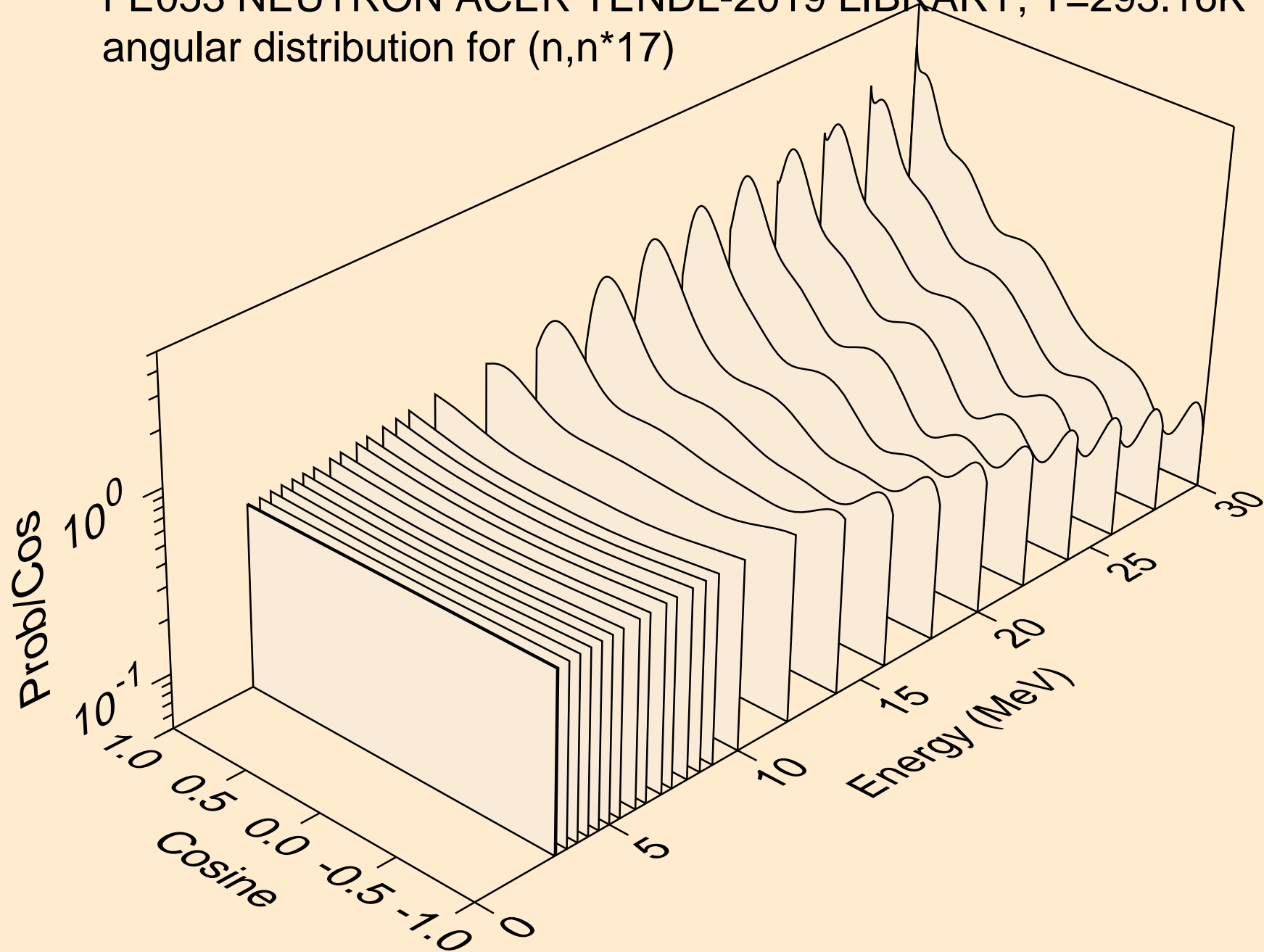

FE053 NEUTRON ACER TENDL-2019 LIBRARY; T=293.16K  
angular distribution for (n,n\*18)

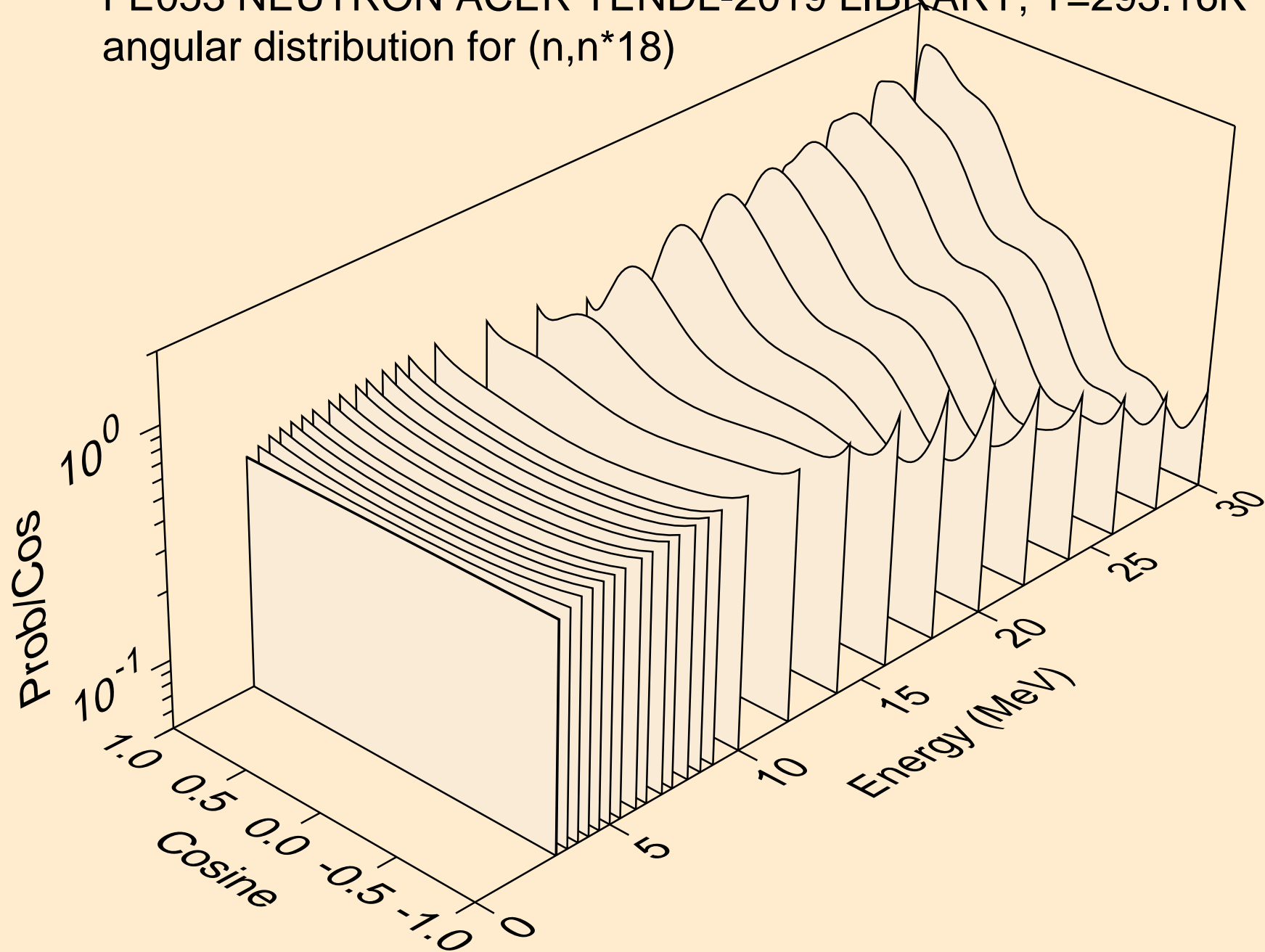

FE053 NEUTRON ACER TENDL-2019 LIBRARY; T=293.16K  
angular distribution for (n,n\*19)

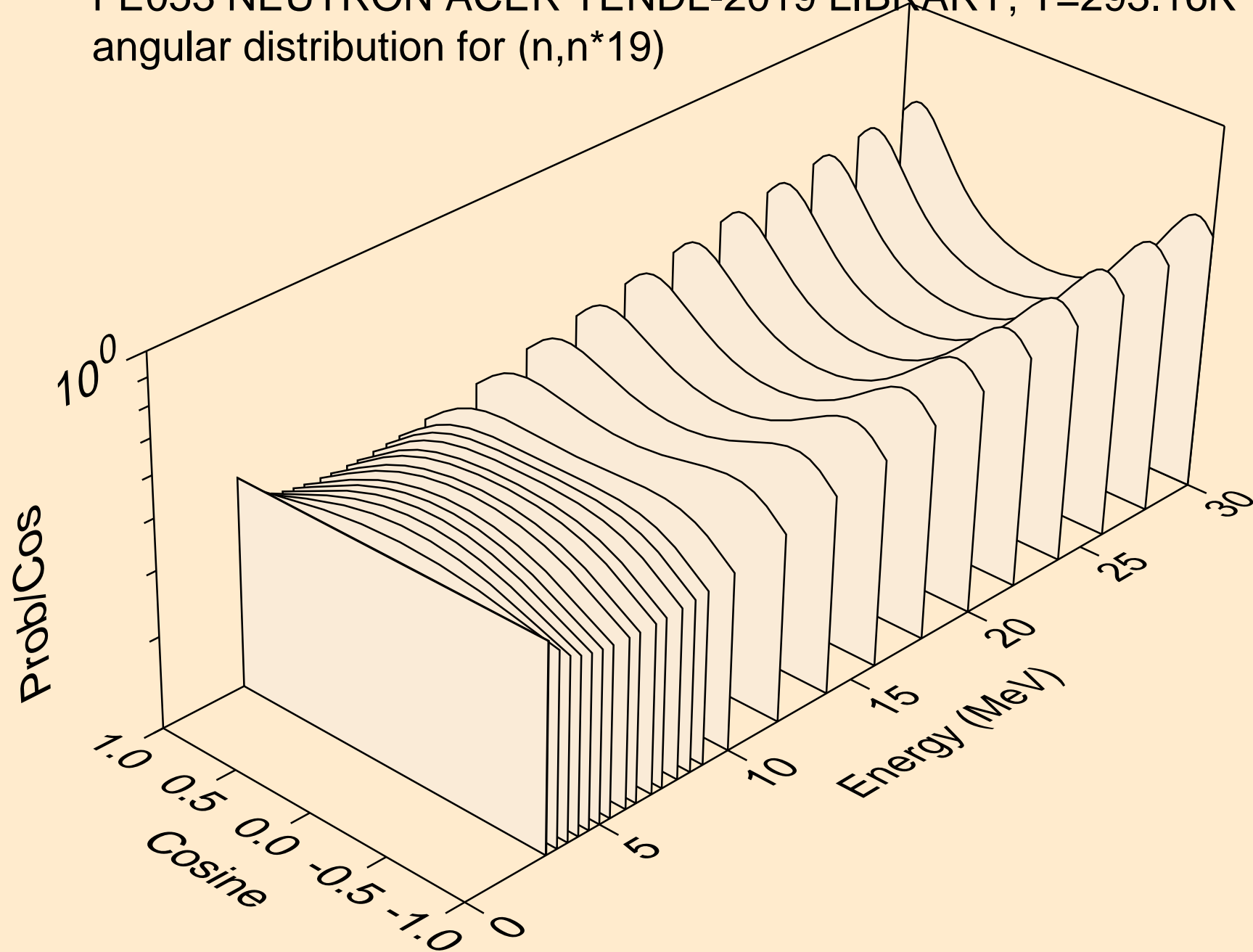



FE053 NEUTRON ACER TENDL-2019 LIBRARY; T=293.16K  
angular distribution for (n,n\*20)

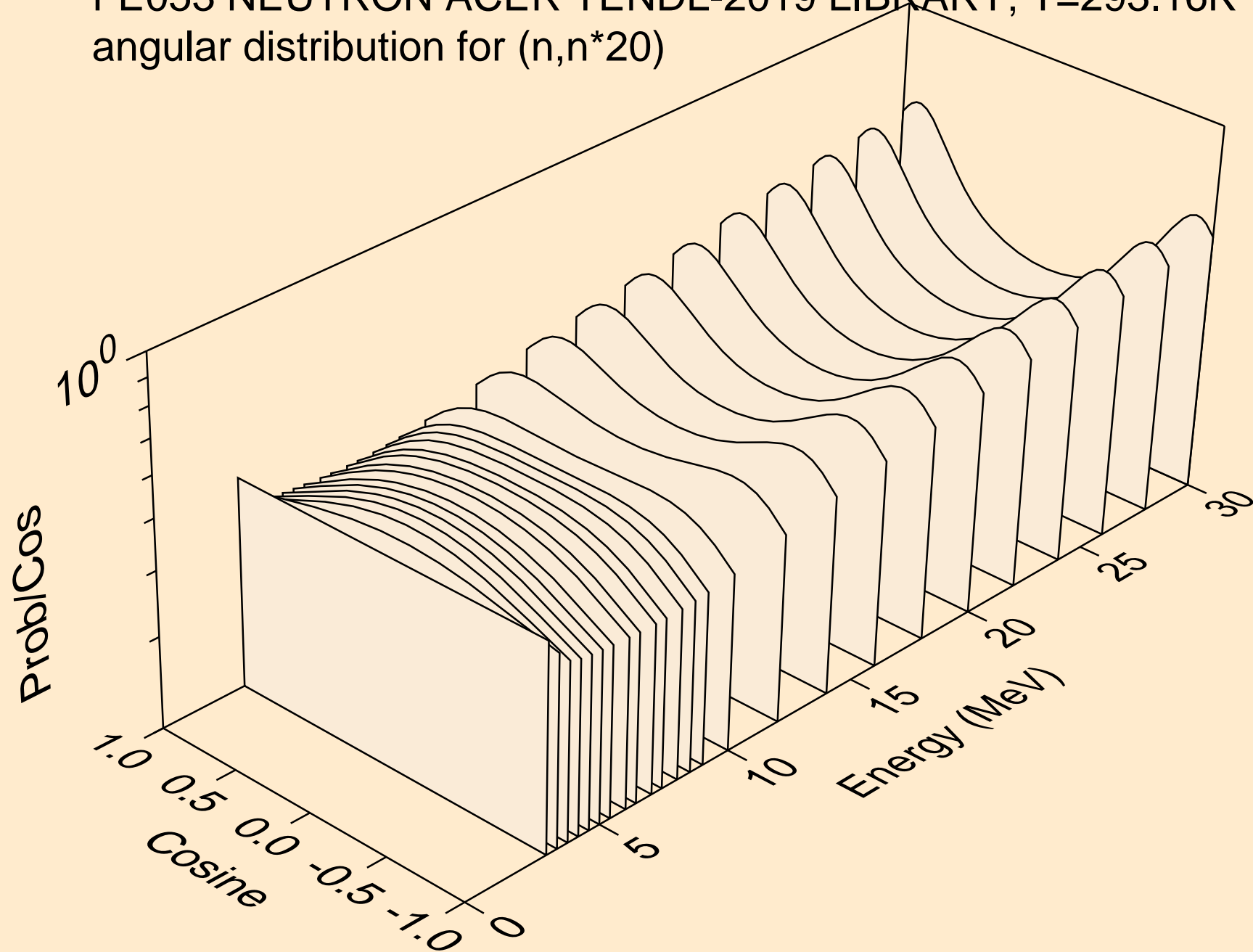

FE053 NEUTRON ACER TENDL-2019 LIBRARY; T=293.16K  
angular distribution for (n,n\*21)

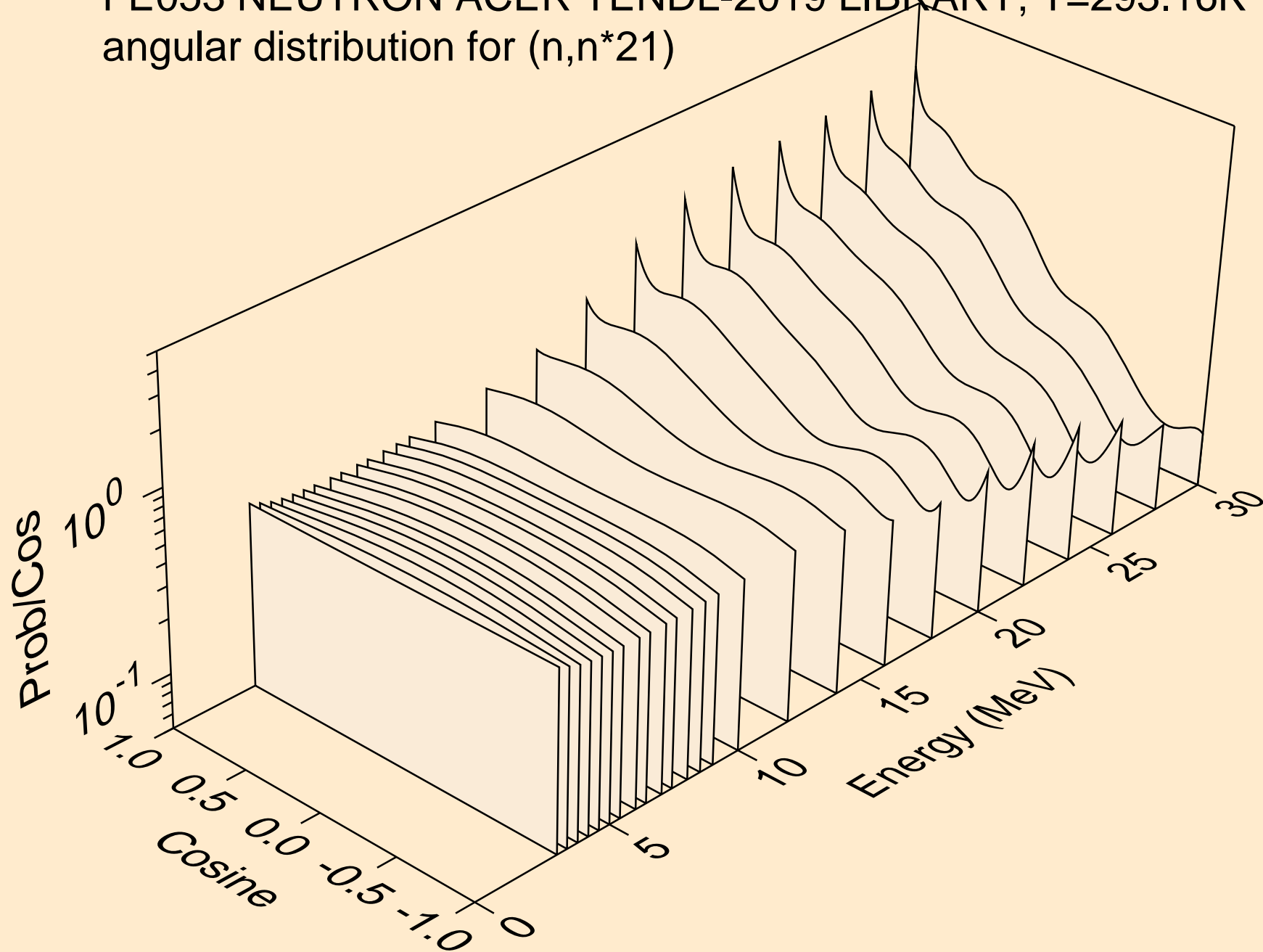

FE053 NEUTRON ACER TENDL-2019 LIBRARY; T=293.16K  
angular distribution for (n,n\*22)

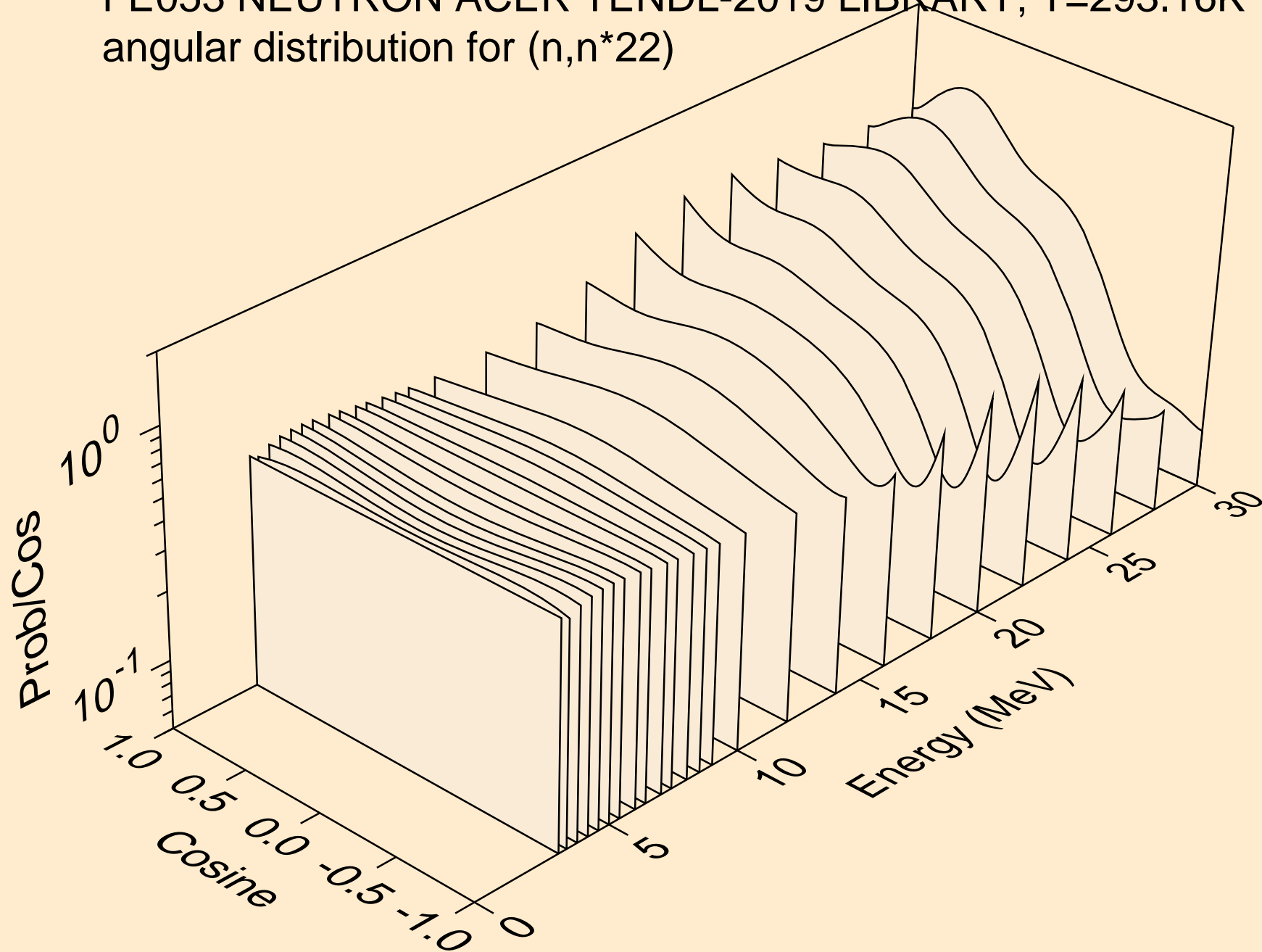

FE053 NEUTRON ACER TENDL-2019 LIBRARY; T=293.16K  
angular distribution for (n,n\*23)

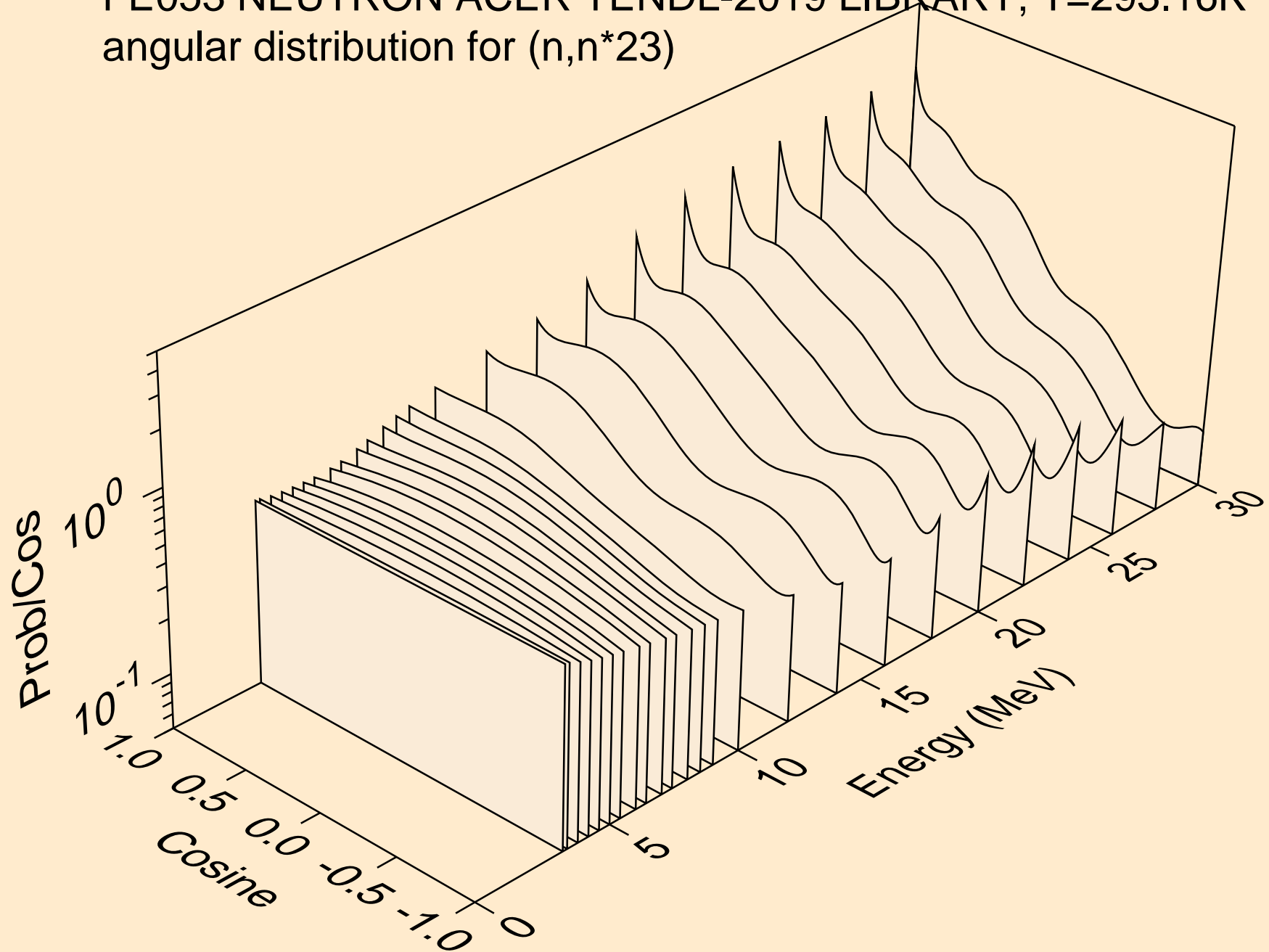

FE053 NEUTRON ACER TENDL-2019 LIBRARY; T=293.16K  
angular distribution for (n,n\*24)

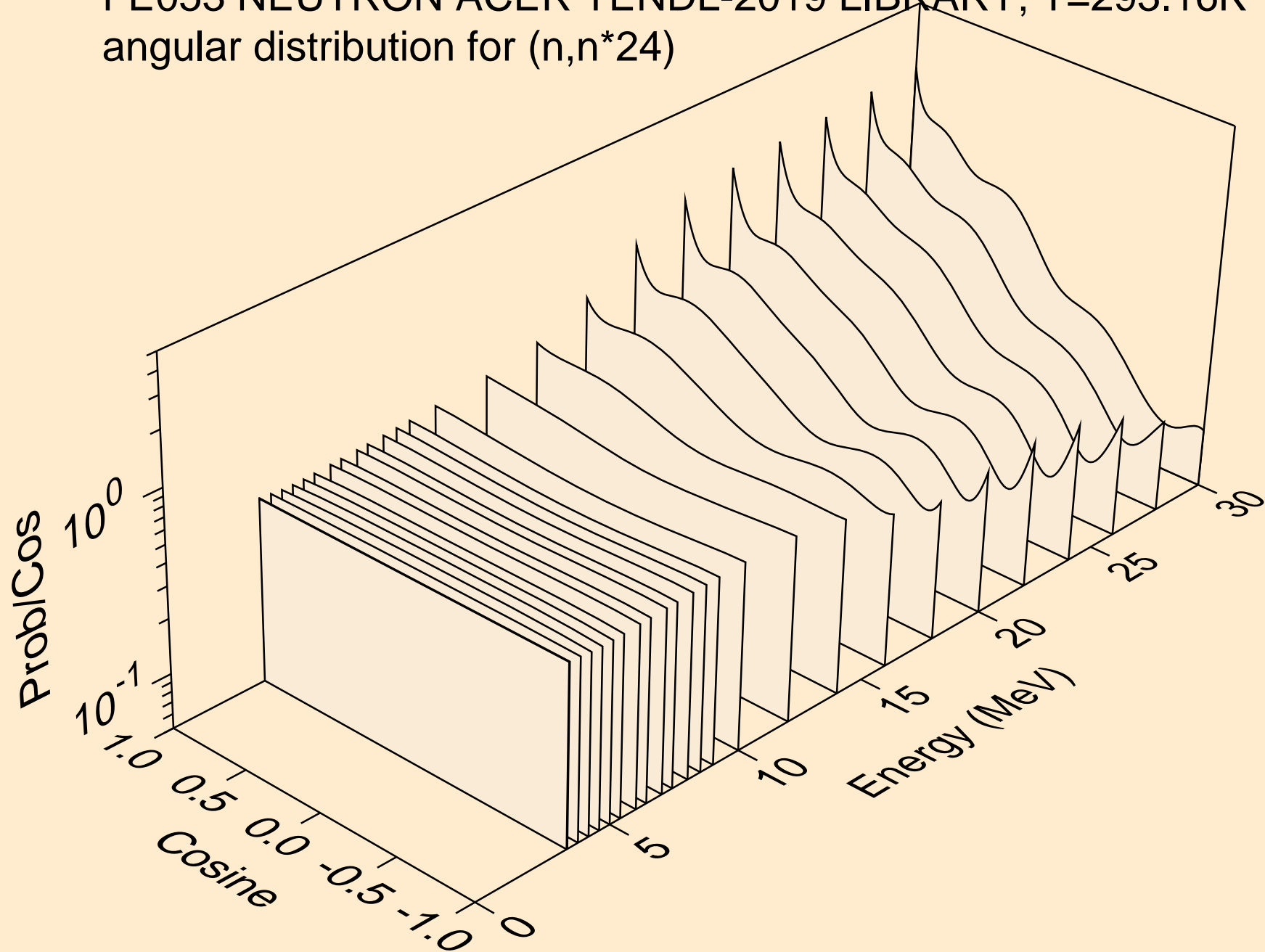

FE053 NEUTRON ACER TENDL-2019 LIBRARY; T=293.16K  
angular distribution for (n,n\*25)

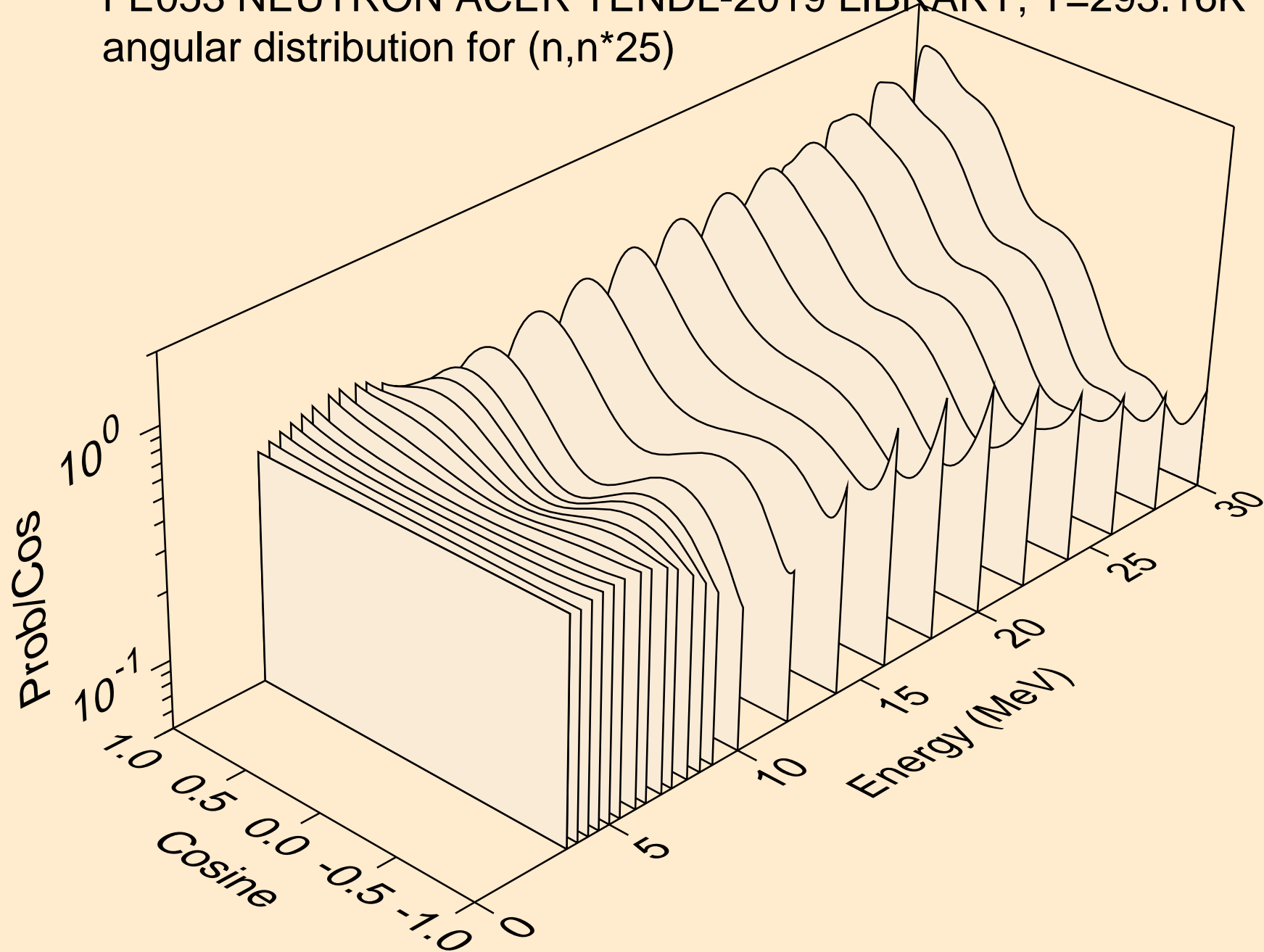

FE053 NEUTRON ACER TENDL-2019 LIBRARY; T=293.16K  
Neutron emission for (n,x)

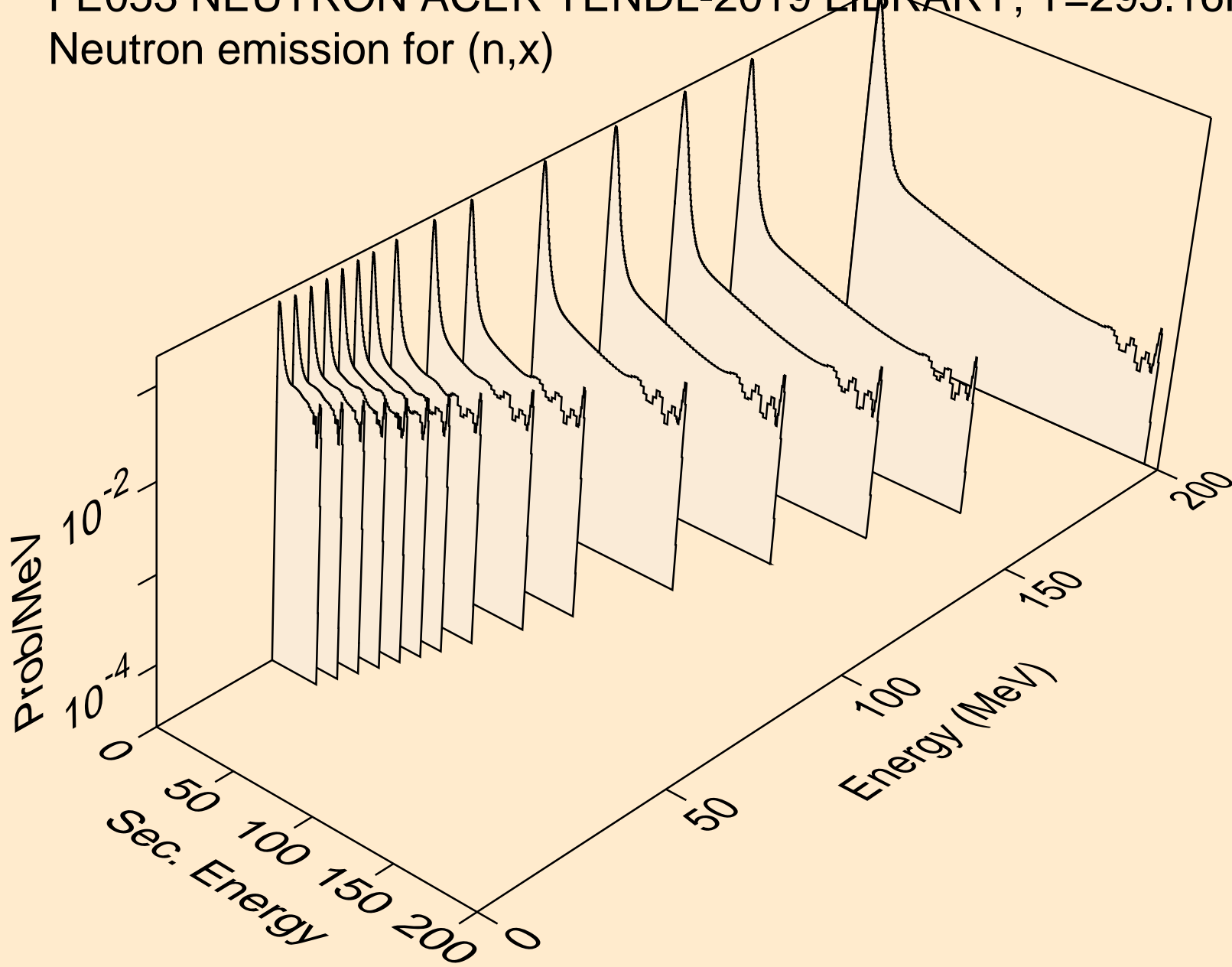

FE053 NEUTRON ACER TENDL-2019 LIBRARY; T=293.16K  
Neutron emission for (n,2n)

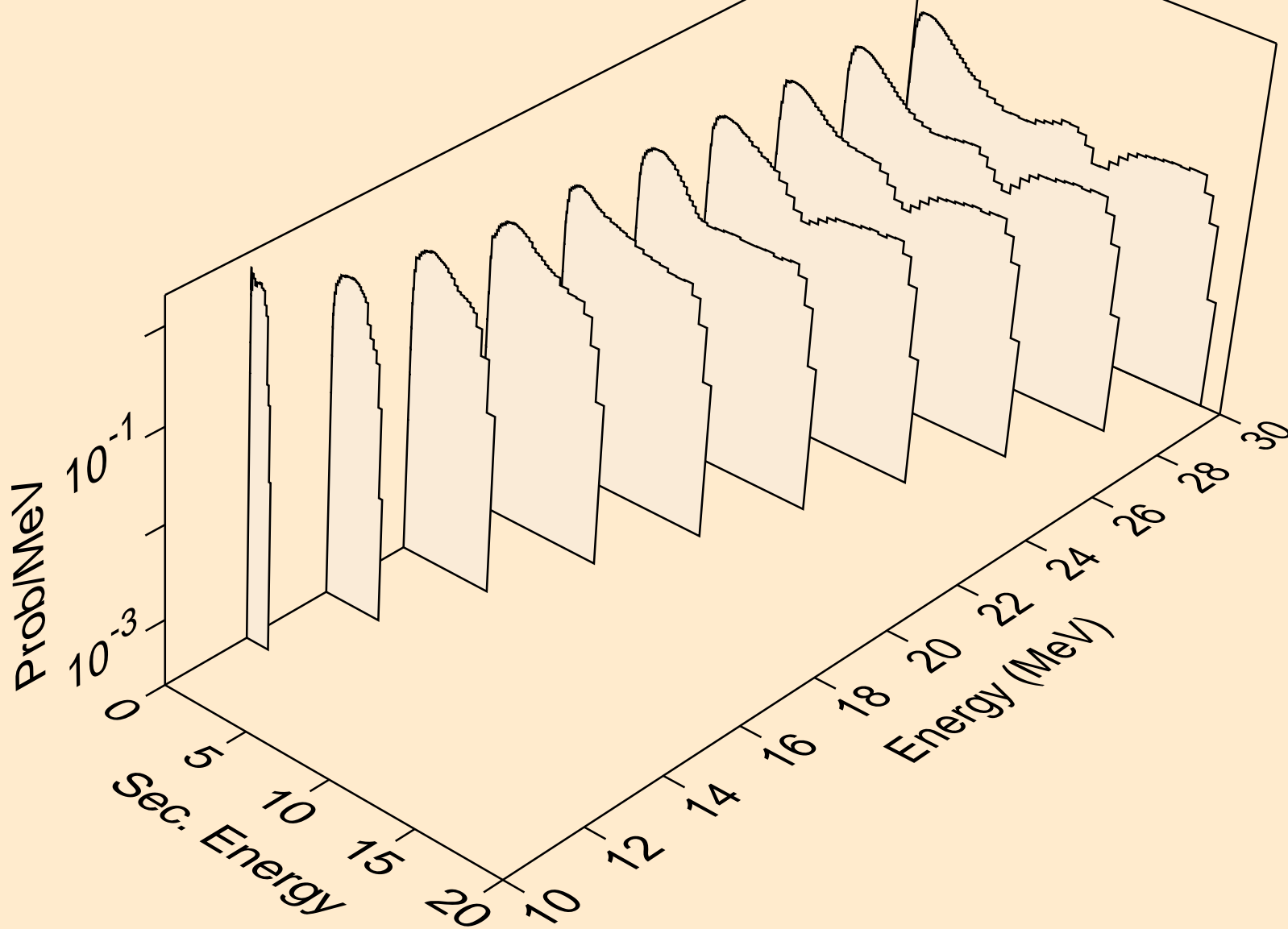



FE053 NEUTRON ACER TENDL-2019 LIBRARY; T=293.16K  
Neutron emission for (n,3n)

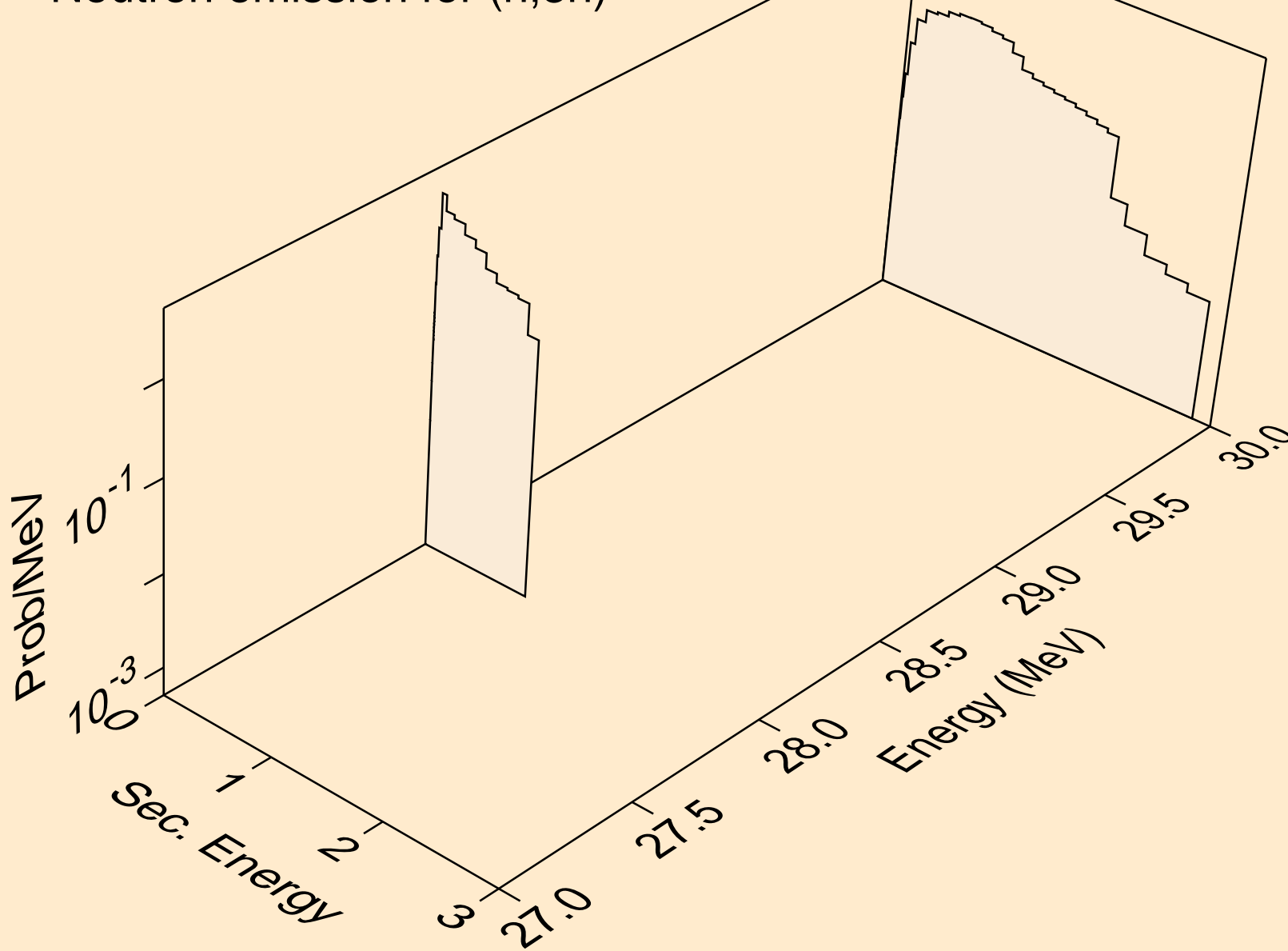

FE053 NEUTRON ACER TENDL-2019 LIBRARY; T=293.16K  
Neutron emission for (n,n\*)a

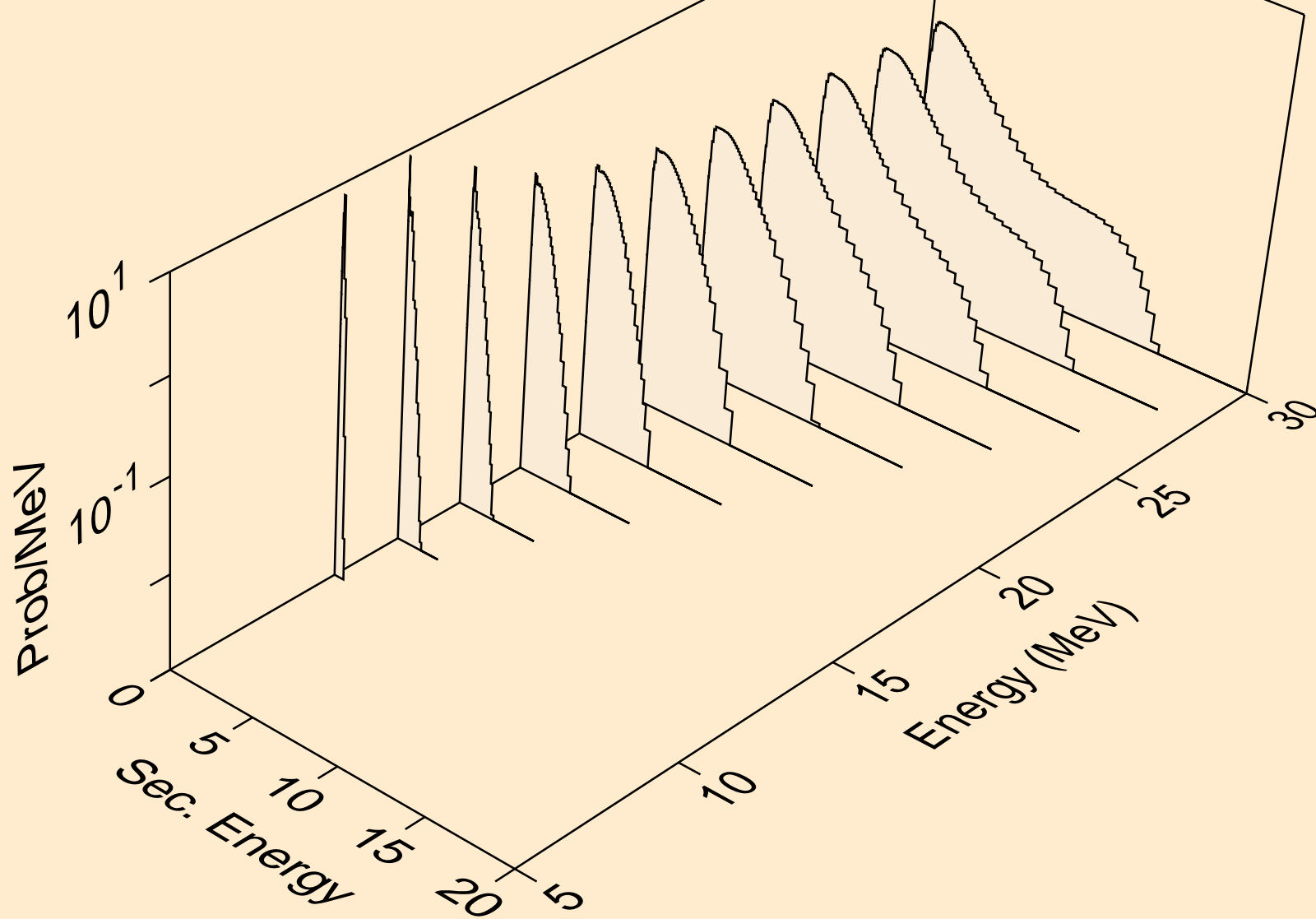

FE053 NEUTRON ACER TENDL-2019 LIBRARY; T=293.16K  
Neutron emission for (n,2n)a

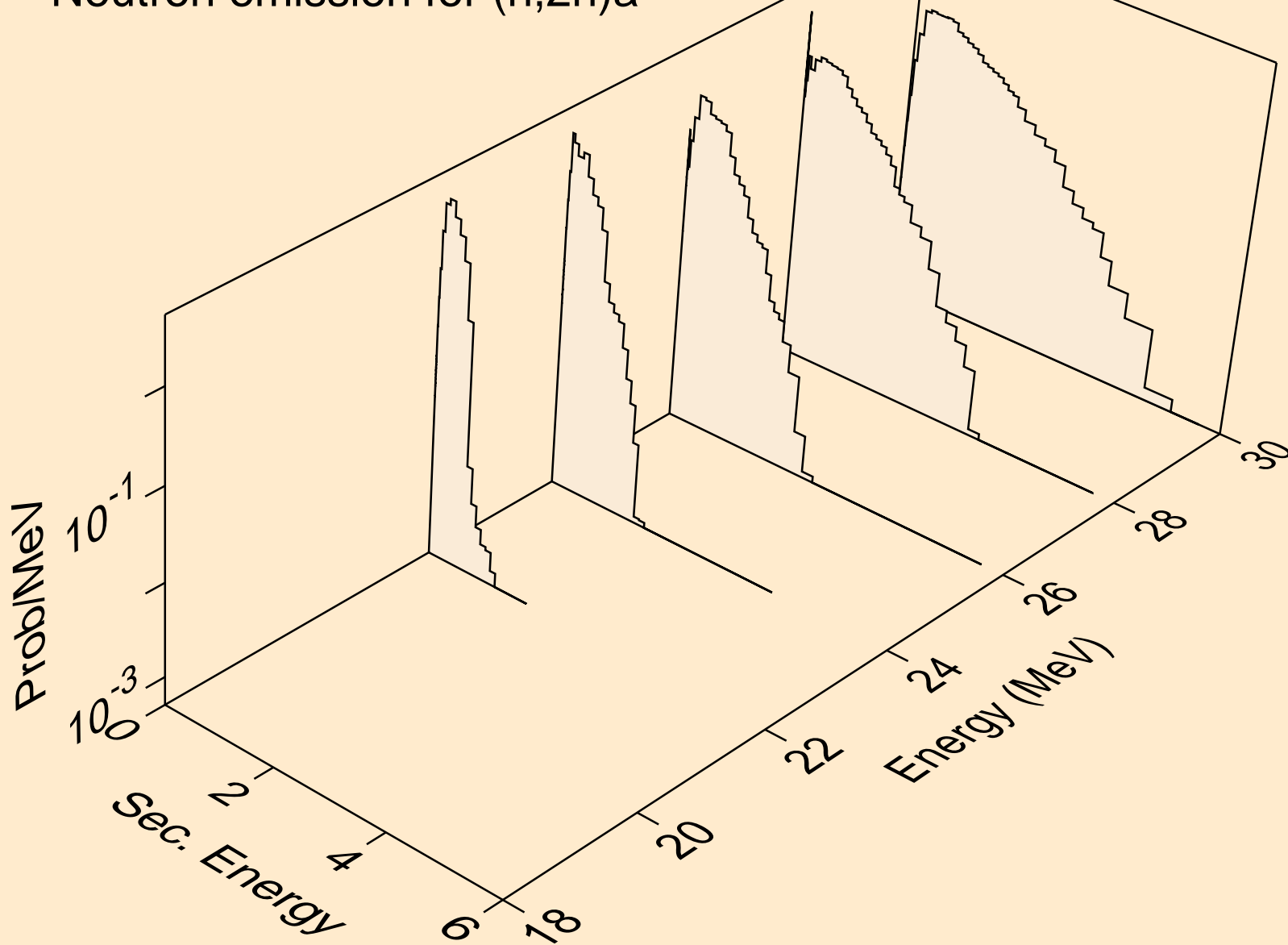

FE053 NEUTRON ACER TENDL-2019 LIBRARY; T=293.16K  
Neutron emission for (n,n\*)p

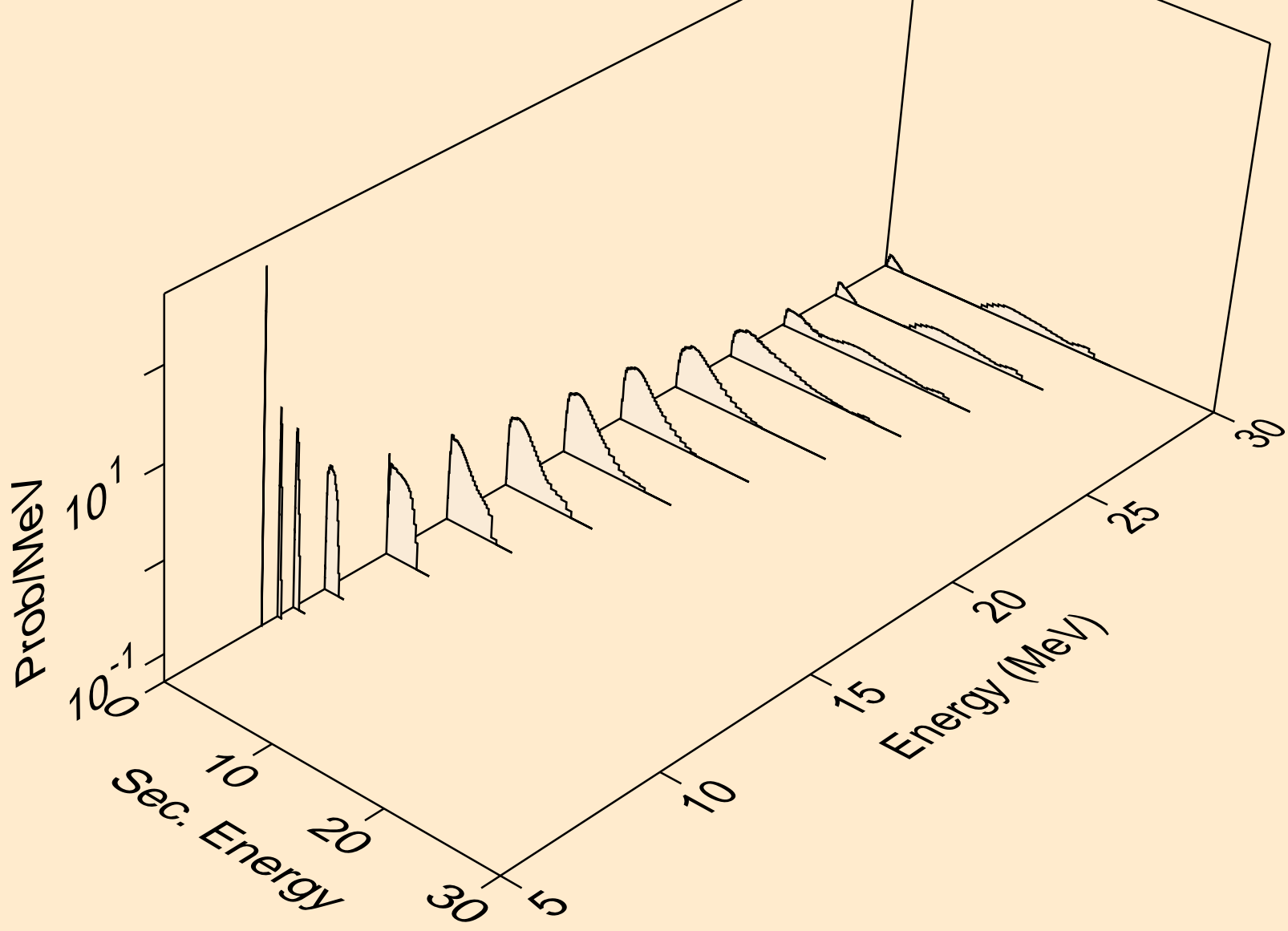

FE053 NEUTRON ACER TENDL-2019 LIBRARY; T=293.16K  
Neutron emission for (n,n\*)2a

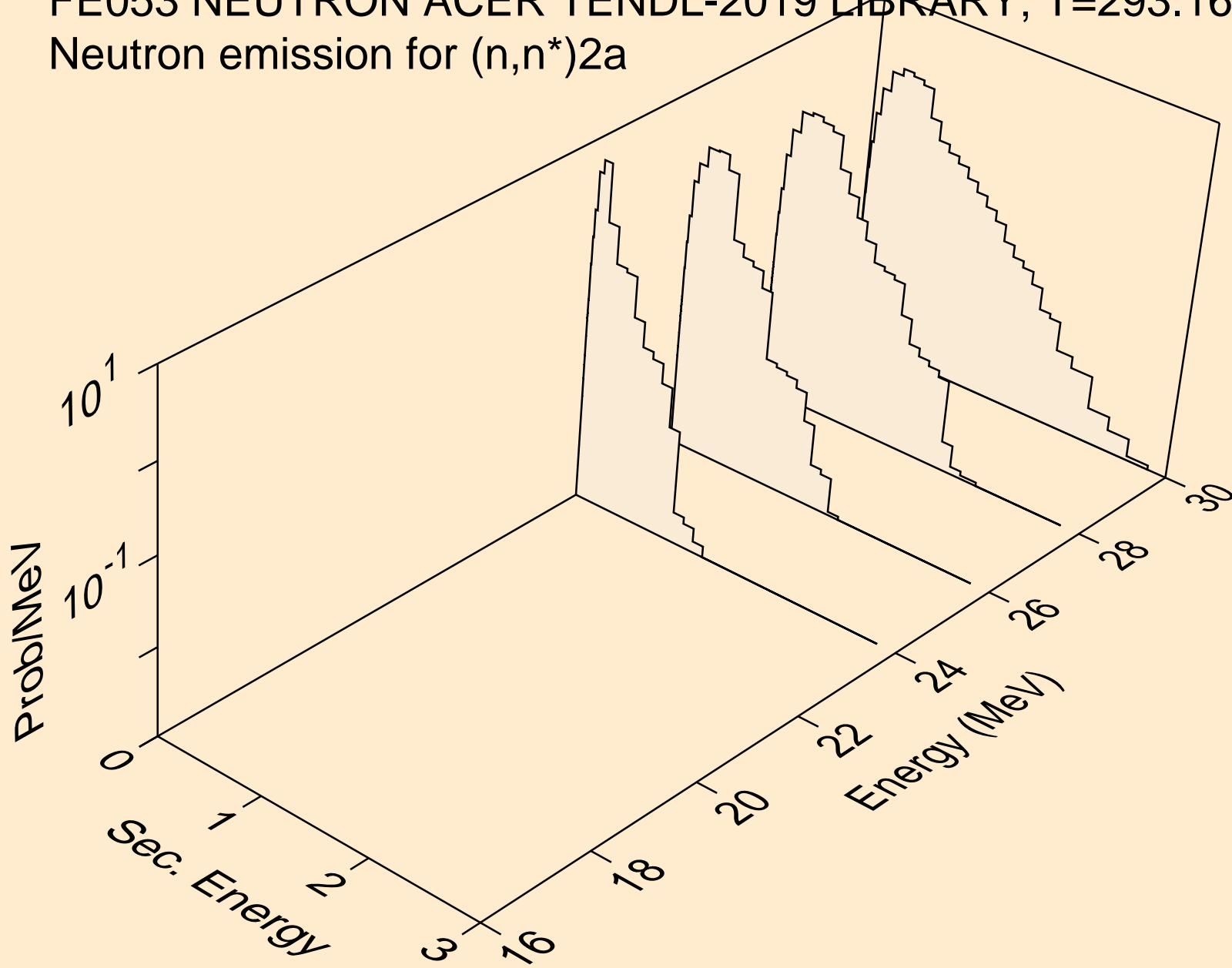

FE053 NEUTRON ACER TENDL-2019 LIBRARY; T=293.16K  
Neutron emission for (n,n\*)d

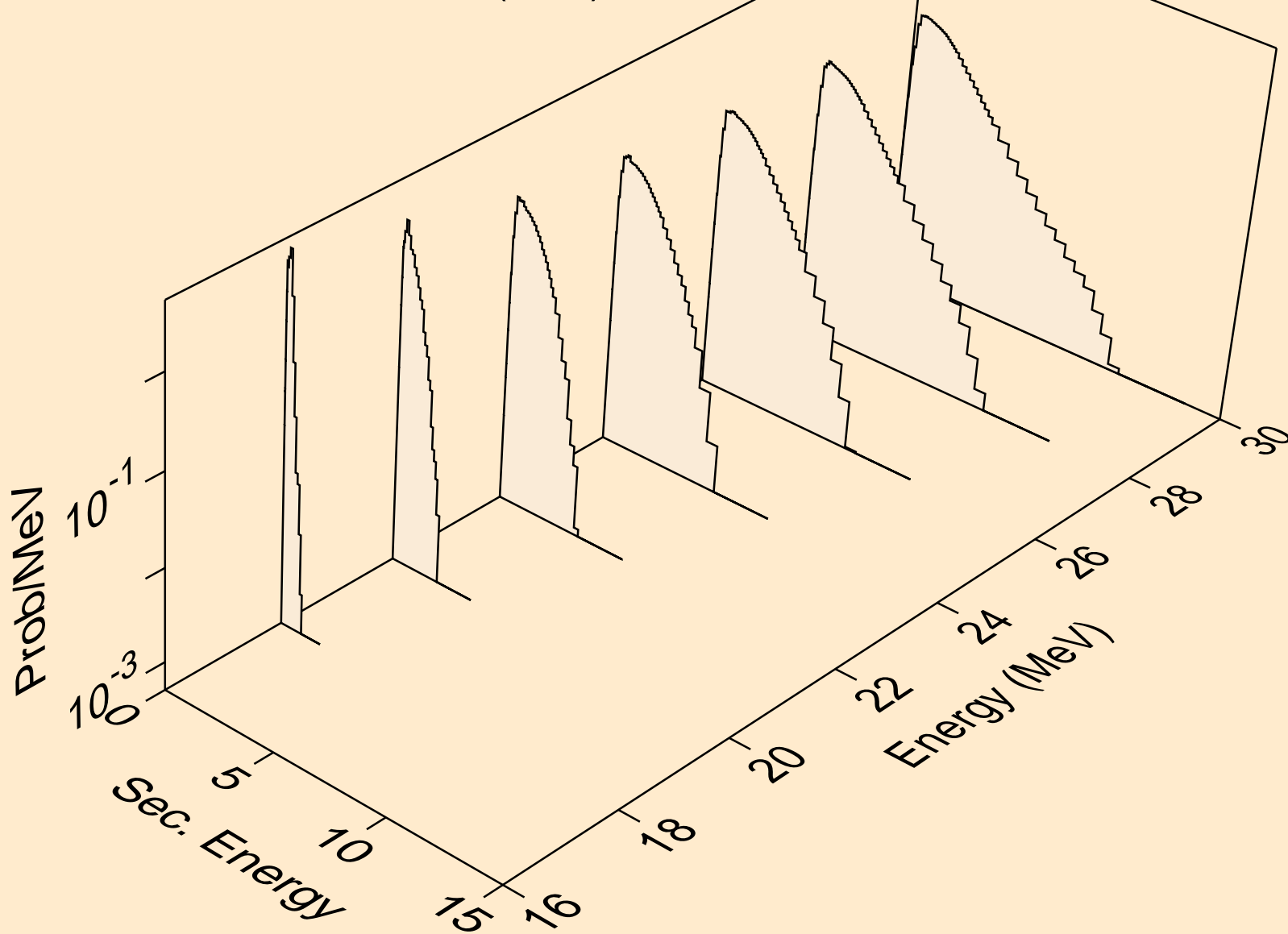

FE053 NEUTRON ACER TENDL-2019 LIBRARY; T=293.16K  
Neutron emission for (n,n\*)t

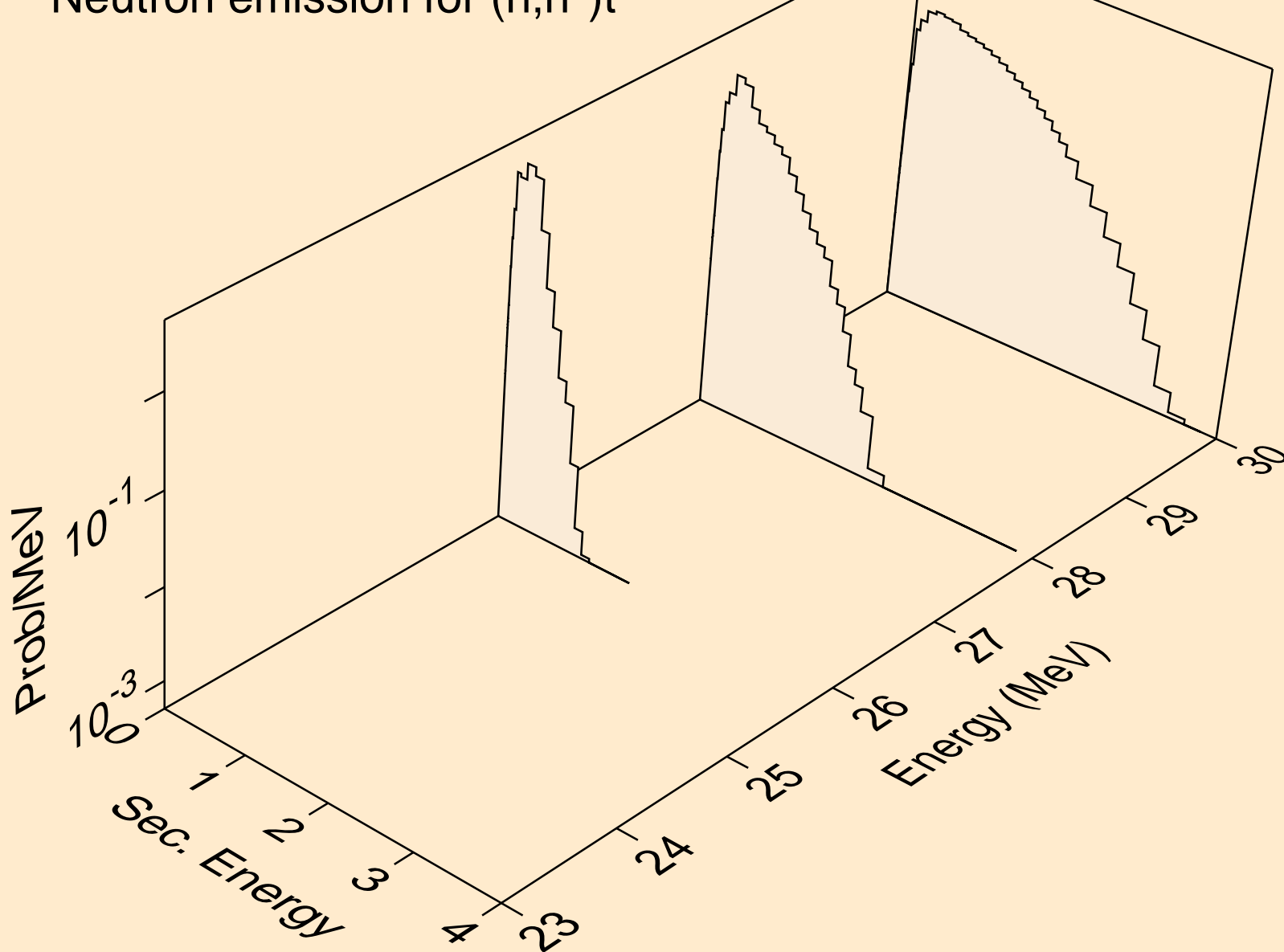

FE053 NEUTRON ACER TENDL-2019 LIBRARY; T=293.16K  
Neutron emission for (n,n\*)he3

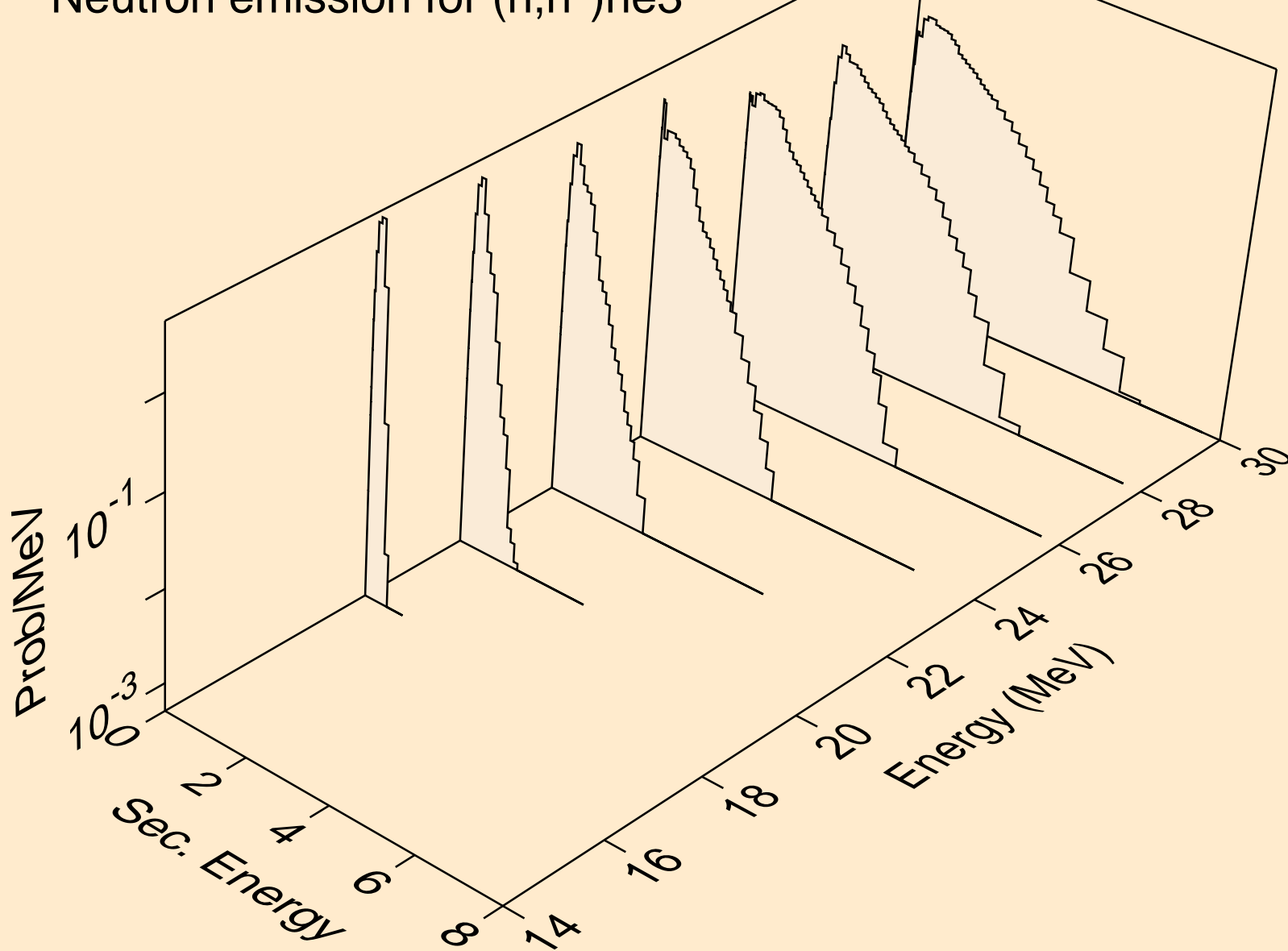



FE053 NEUTRON ACER TENDL-2019 LIBRARY; T=293.16K  
Neutron emission for (n,2np)

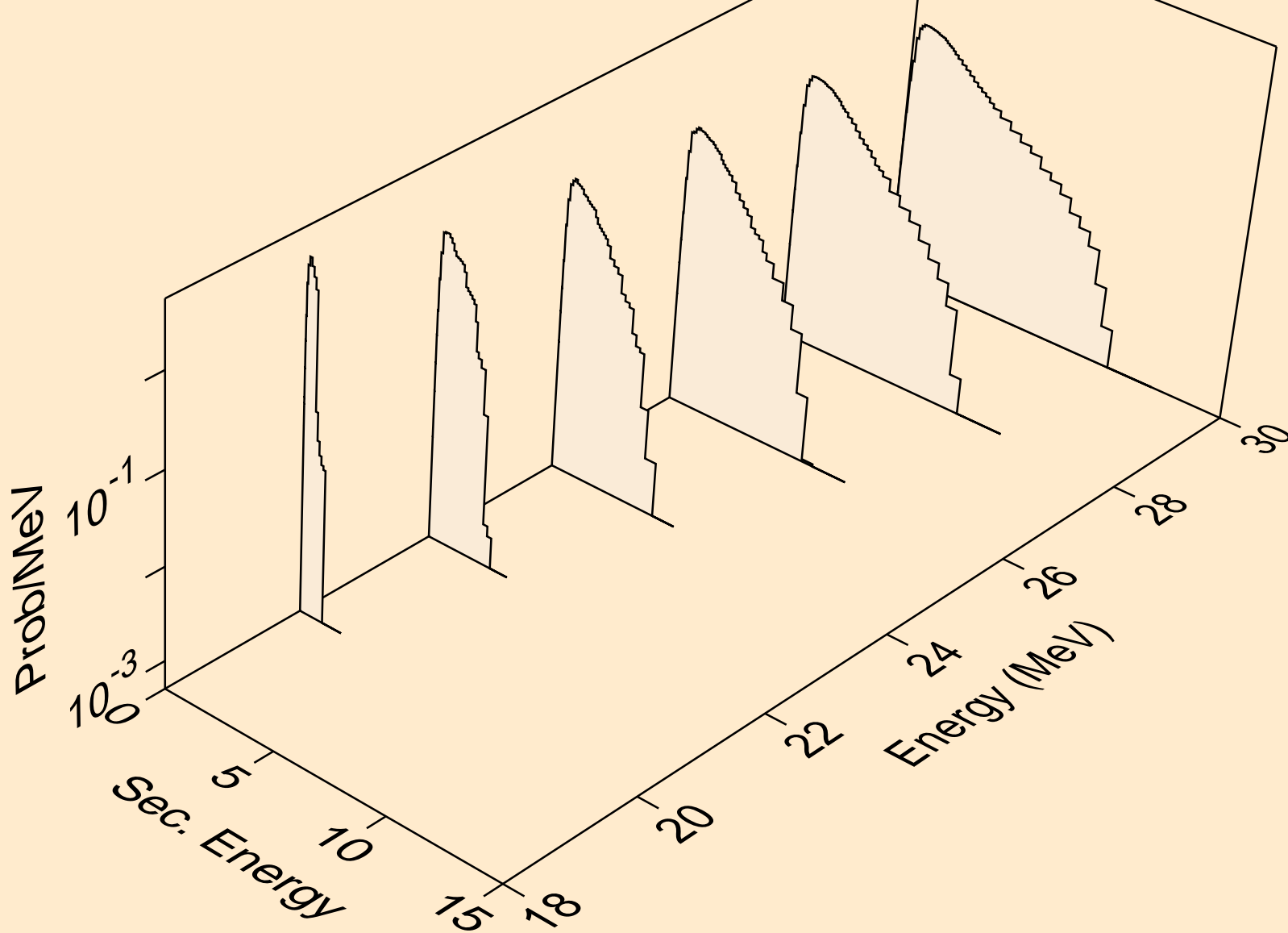

FE053 NEUTRON ACER TENDL-2019 LIBRARY; T=293.16K  
Neutron emission for (n,2np)

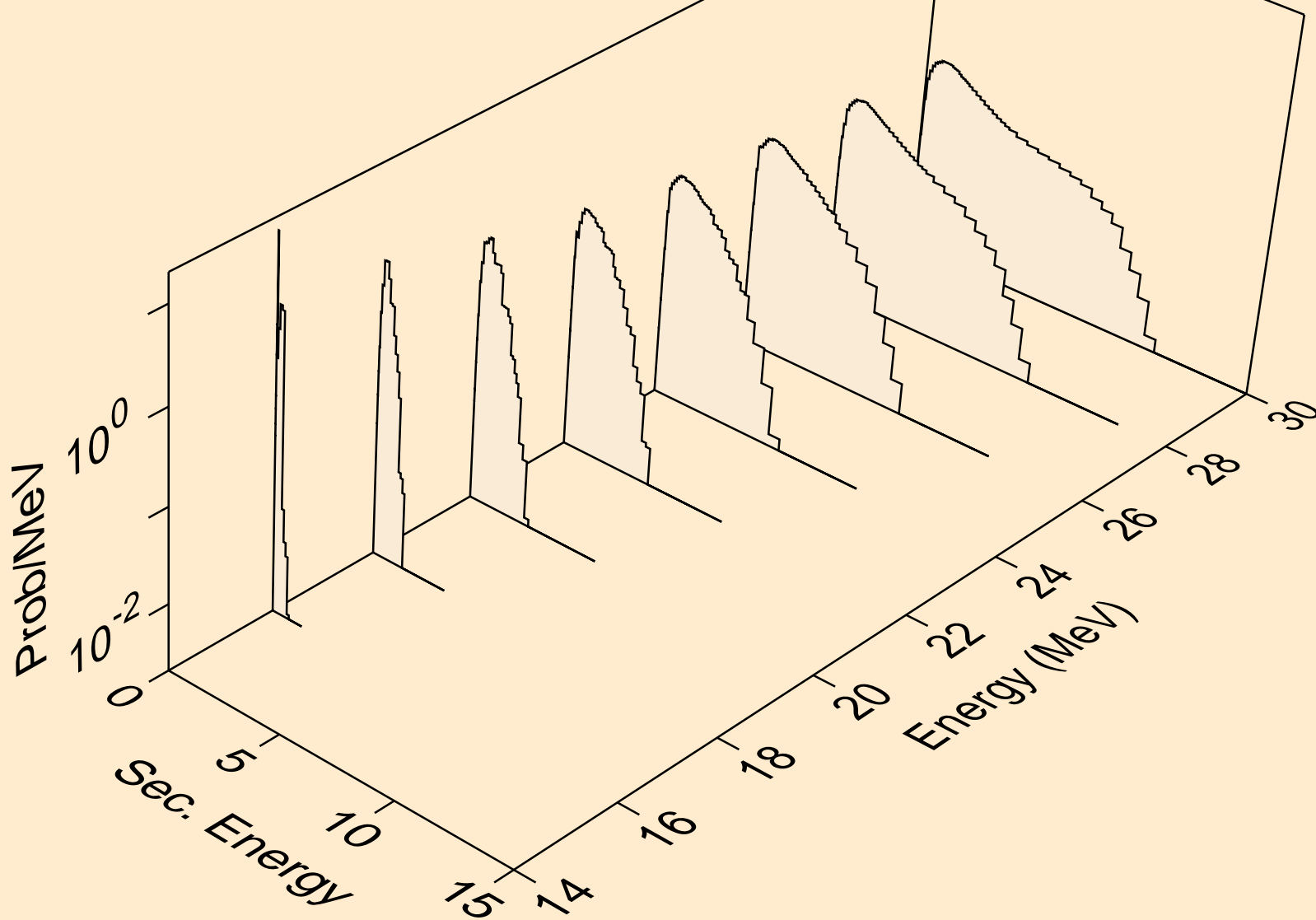

FE053 NEUTRON ACER TENDL-2019 LIBRARY; T=293.16K  
Neutron emission for (n,npa)

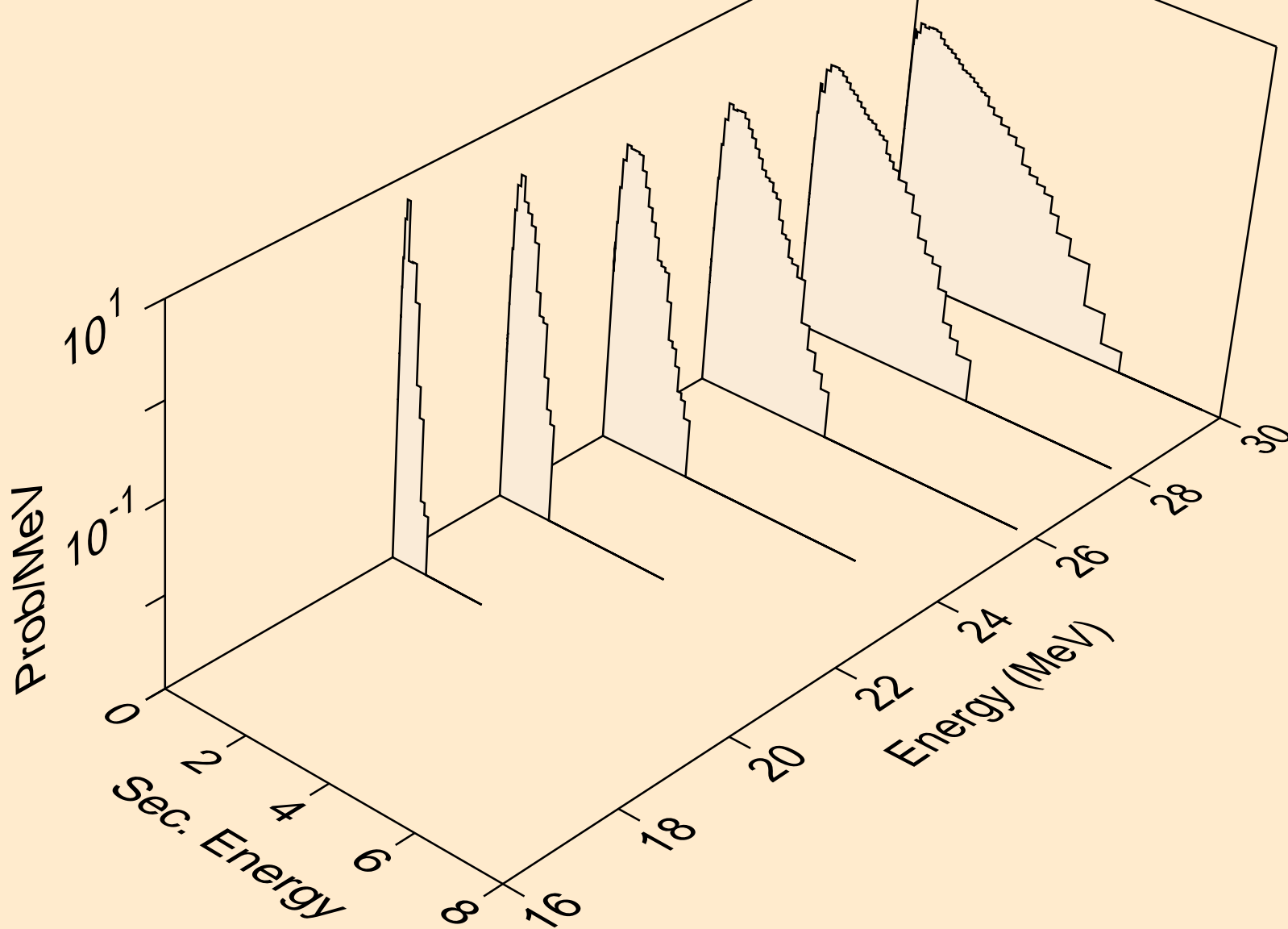

FE053 NEUTRON ACER TENDL-2019 LIBRARY; T=293.16K  
Neutron emission for (n,n\*c)

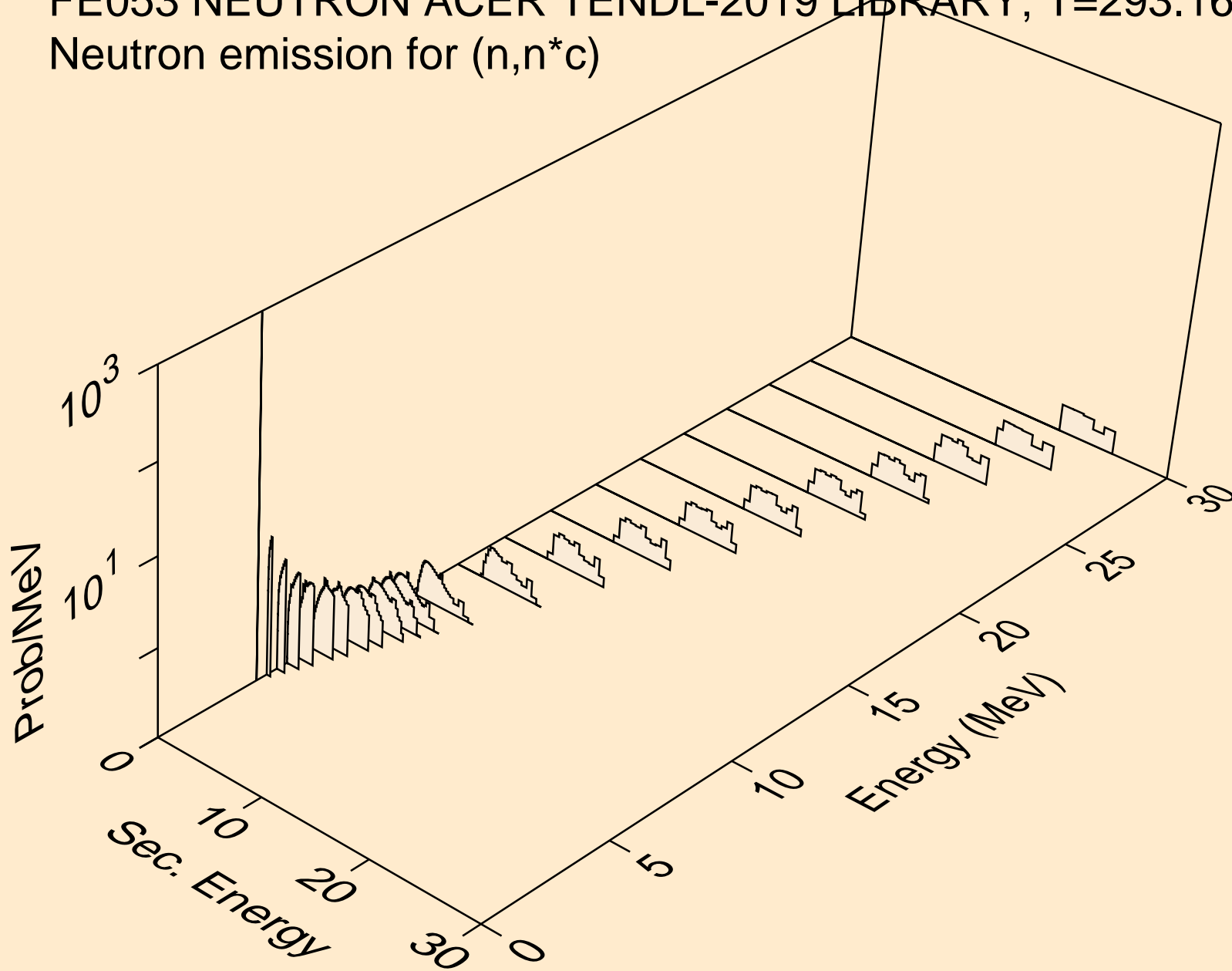

FE053 NEUTRON ACER TENDL-2019 LIBRARY; T=293.16K  
Photon emission for (n,x)

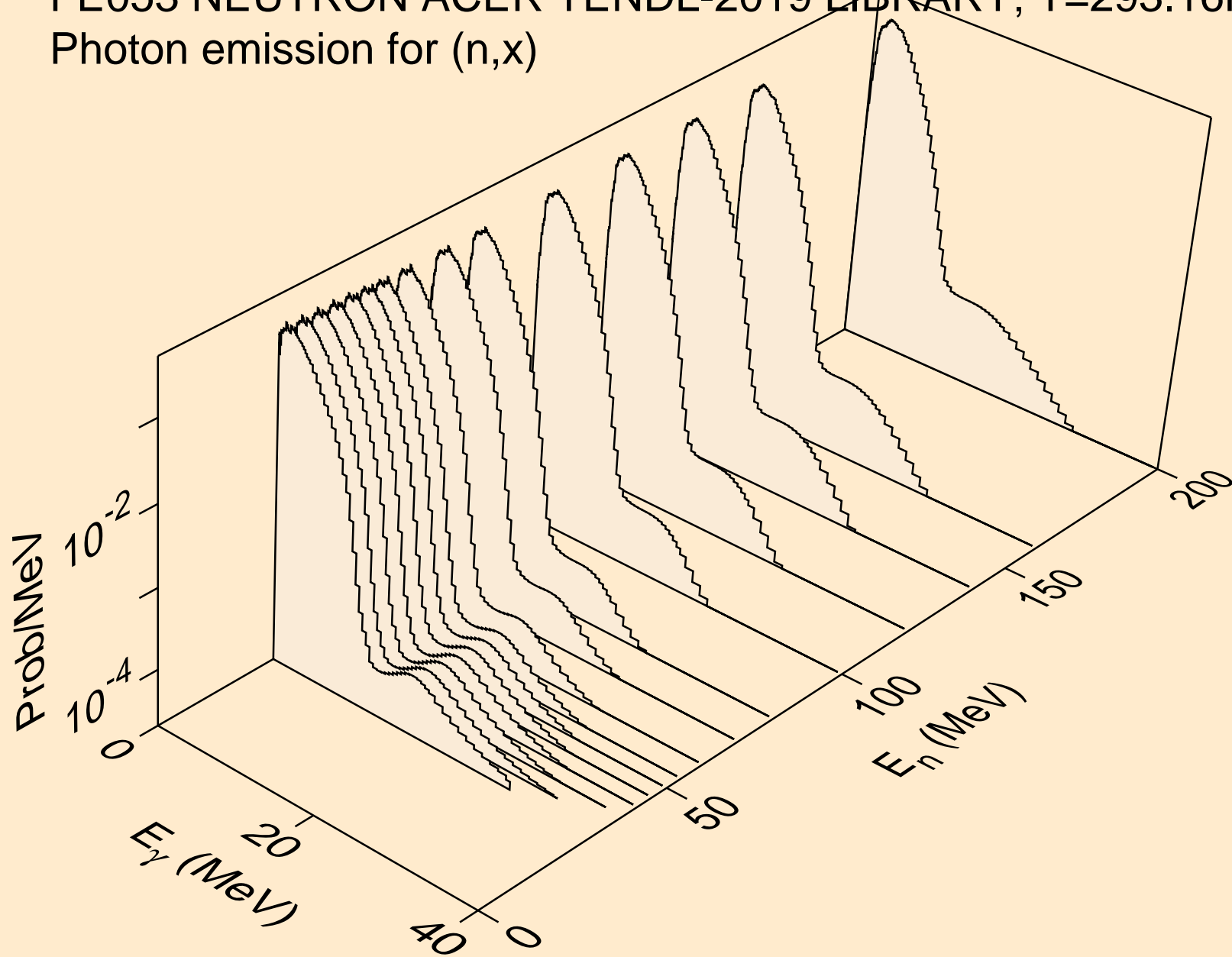

FE053 NEUTRON ACER TENDL-2019 LIBRARY; T=293.16K  
Photon emission for (n,2n)

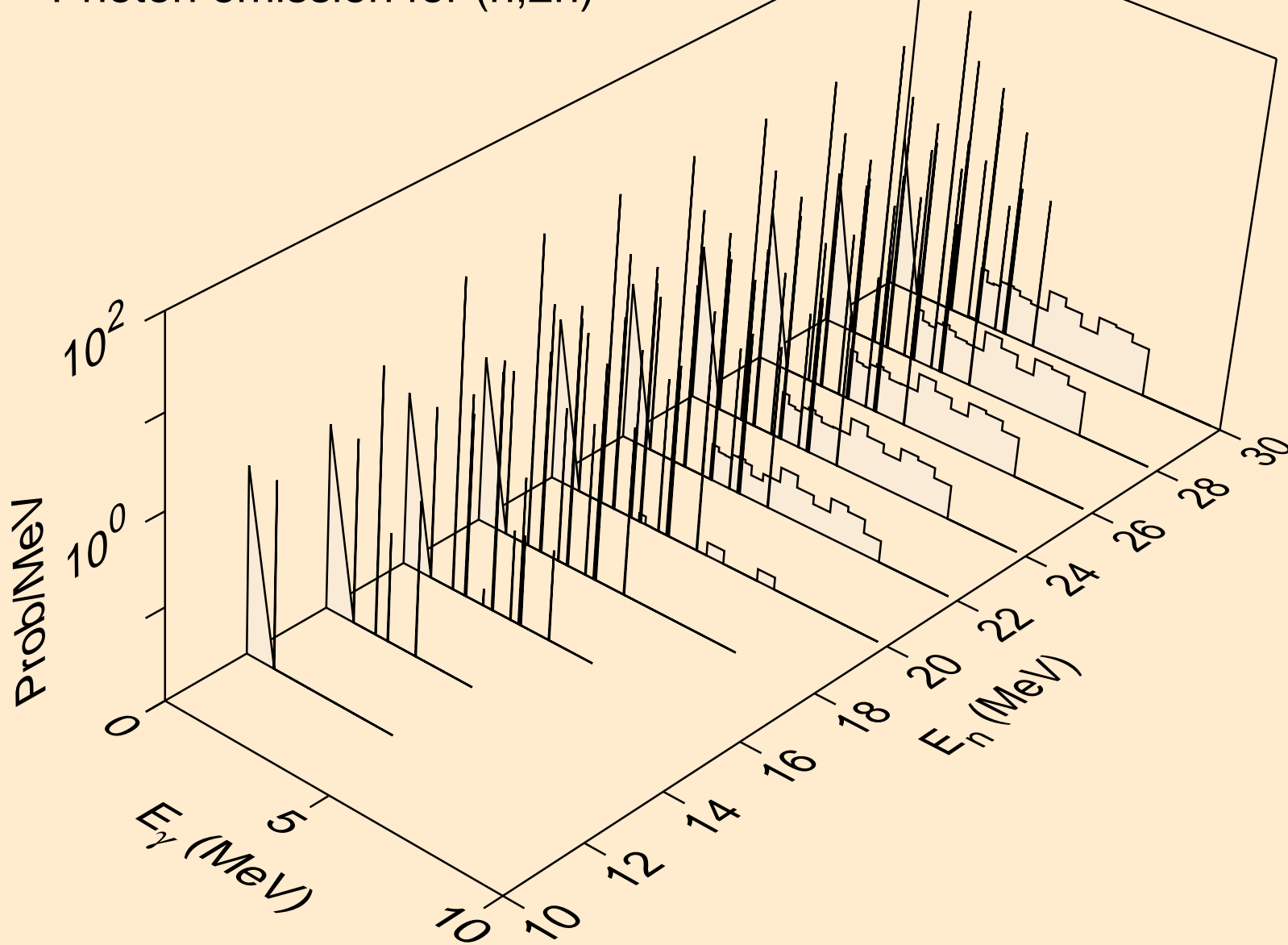

FE053 NEUTRON ACER TENDL-2019 LIBRARY; T=293.16K  
Photon emission for (n,3n)

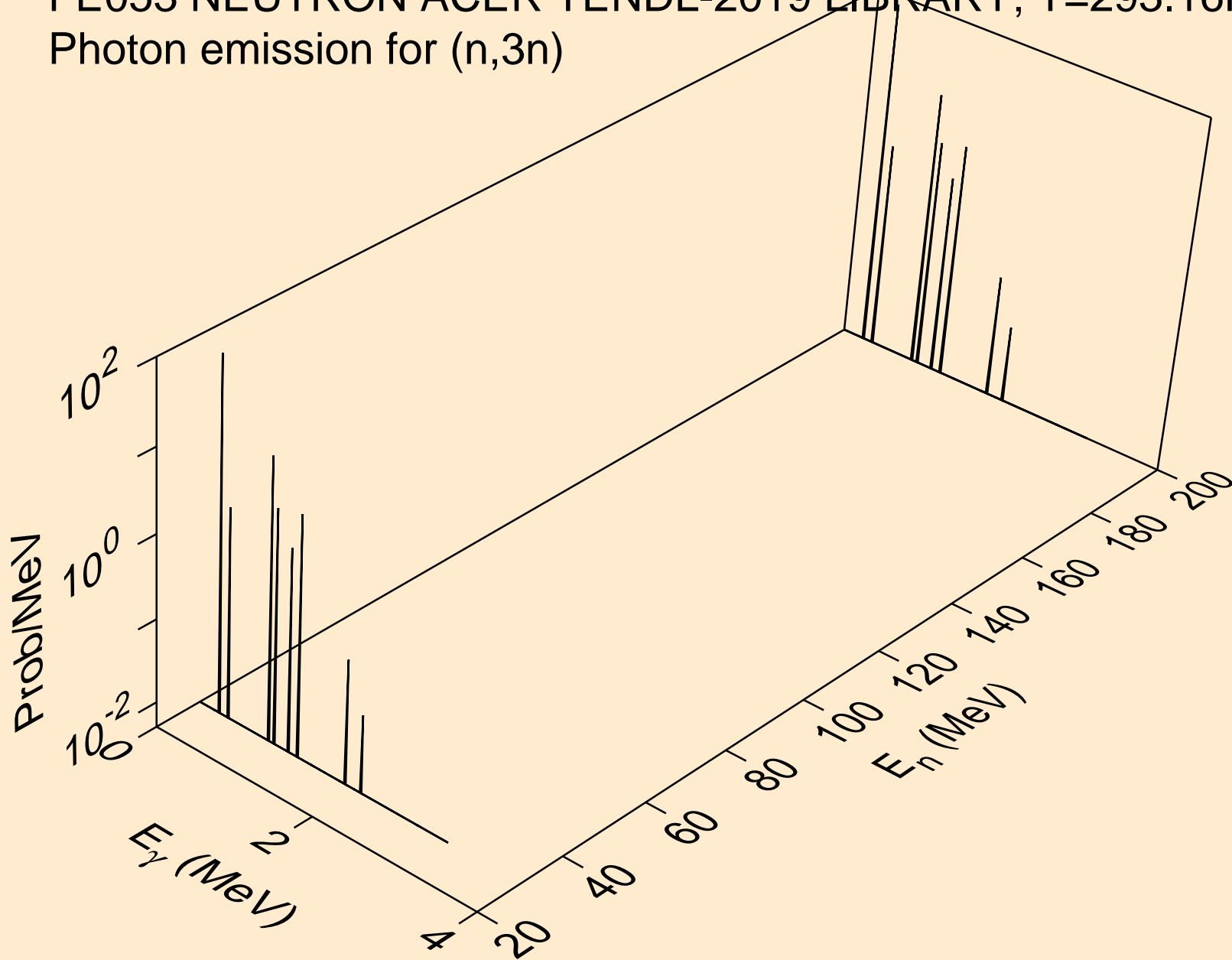

FE053 NEUTRON ACER TENDL-2019 LIBRARY; T=293.16K  
Photon emission for (n,n\*)a

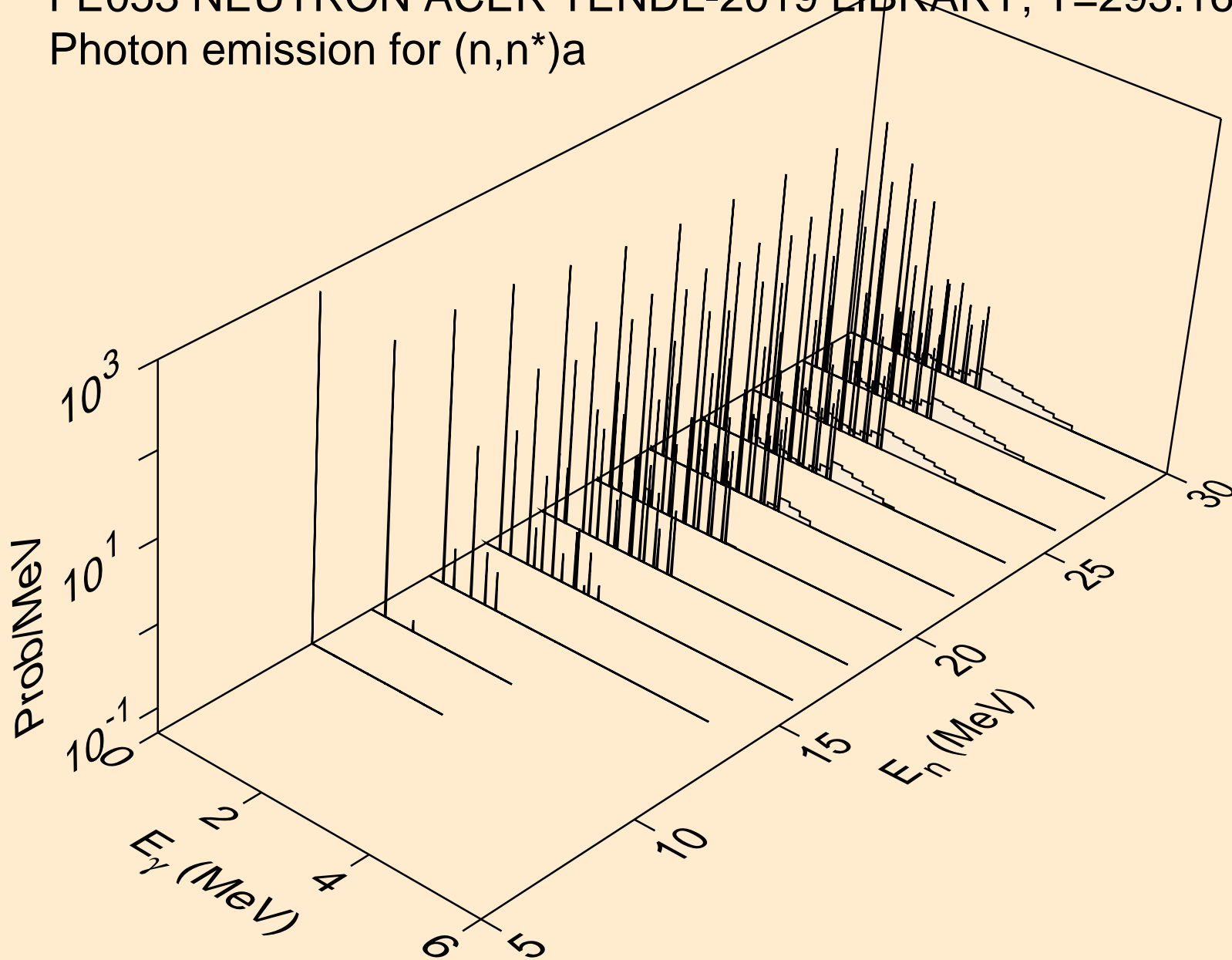



FE053 NEUTRON ACER TENDL-2019 LIBRARY; T=293.16K  
Photon emission for (n,2n)a

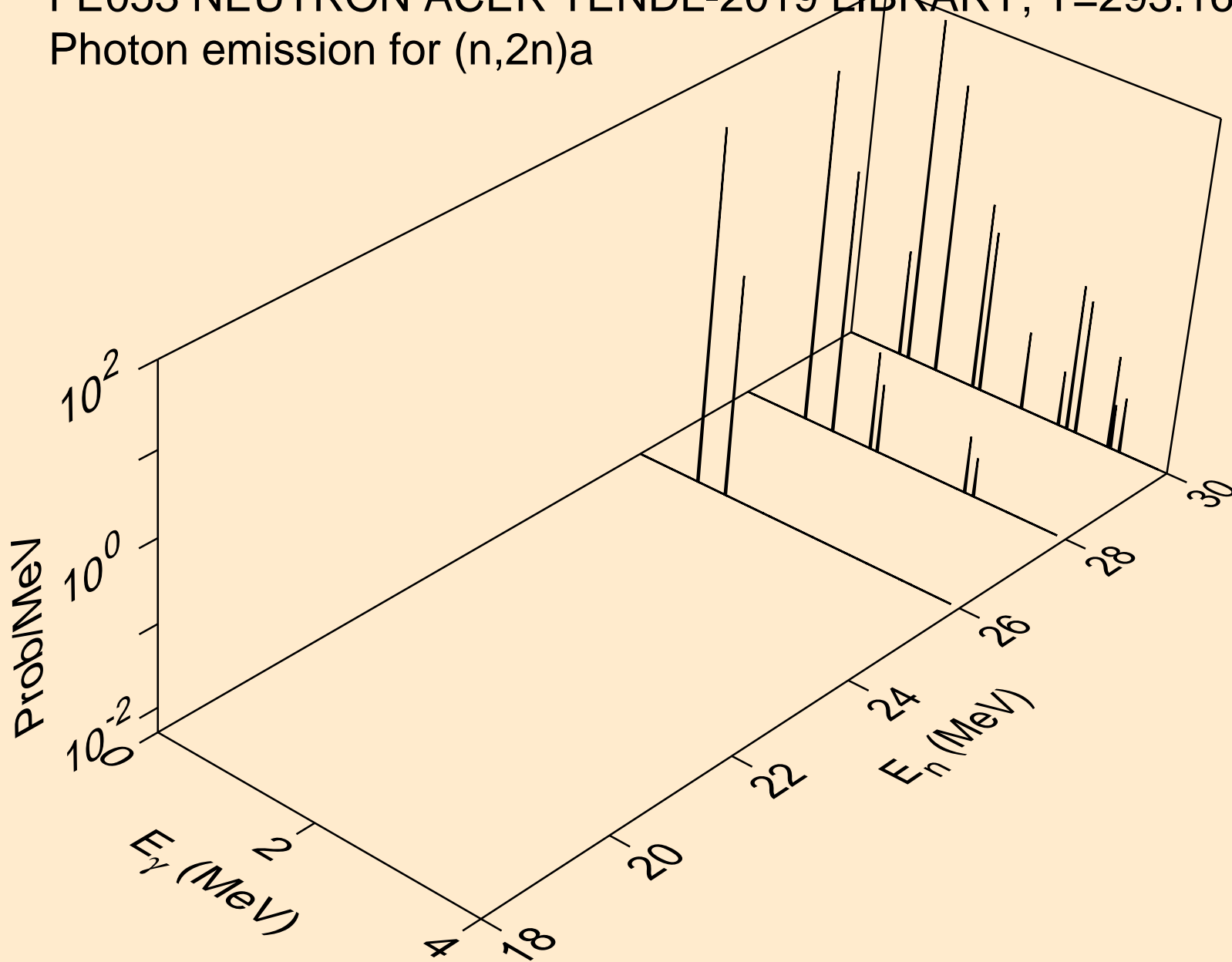

FE053 NEUTRON ACER TENDL-2019 LIBRARY; T=293.16K  
Photon emission for (n,n\*)p

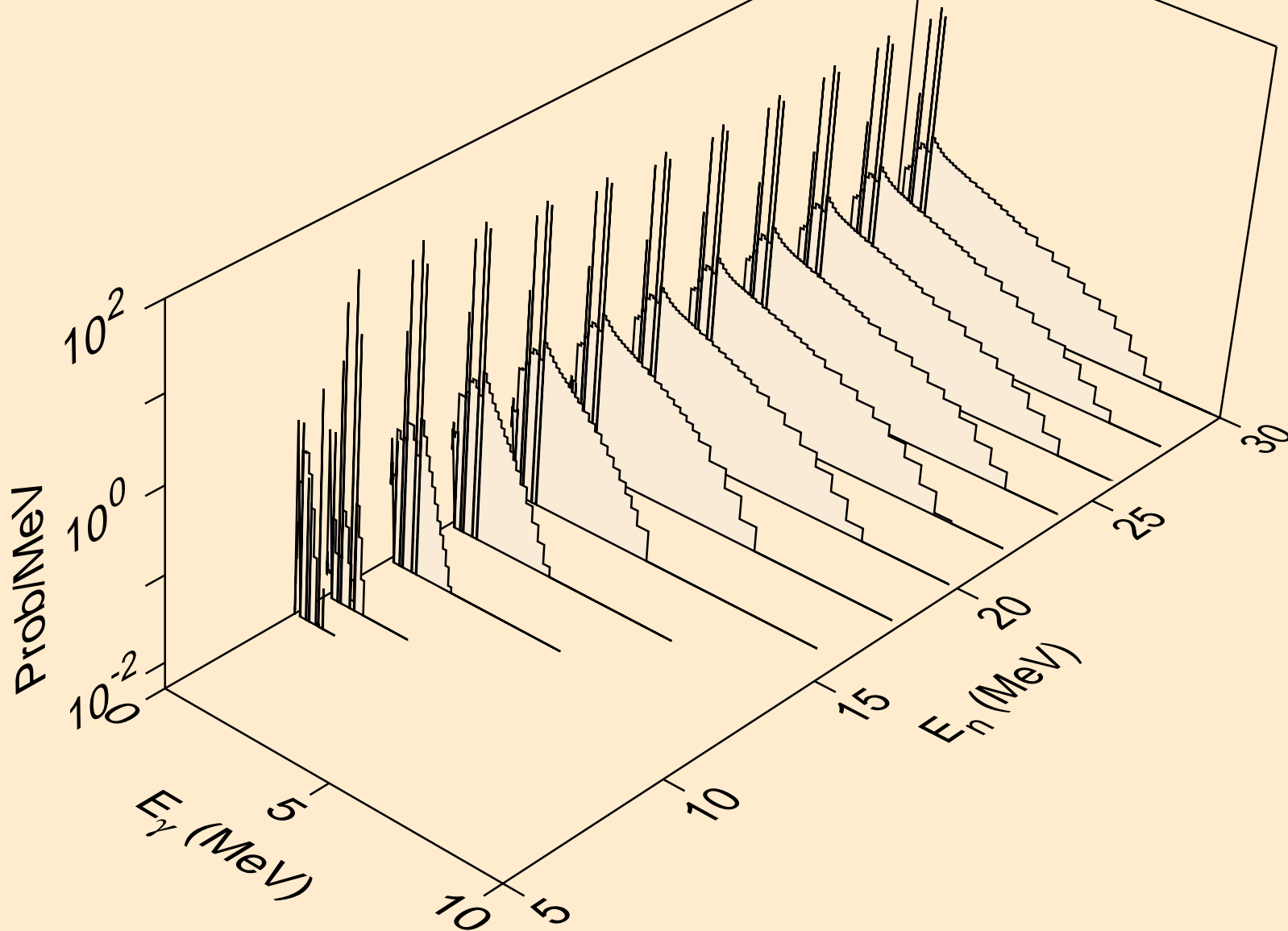

FE053 NEUTRON ACER TENDL-2019 LIBRARY; T=293.16K  
Photon emission for (n,n\*)2a

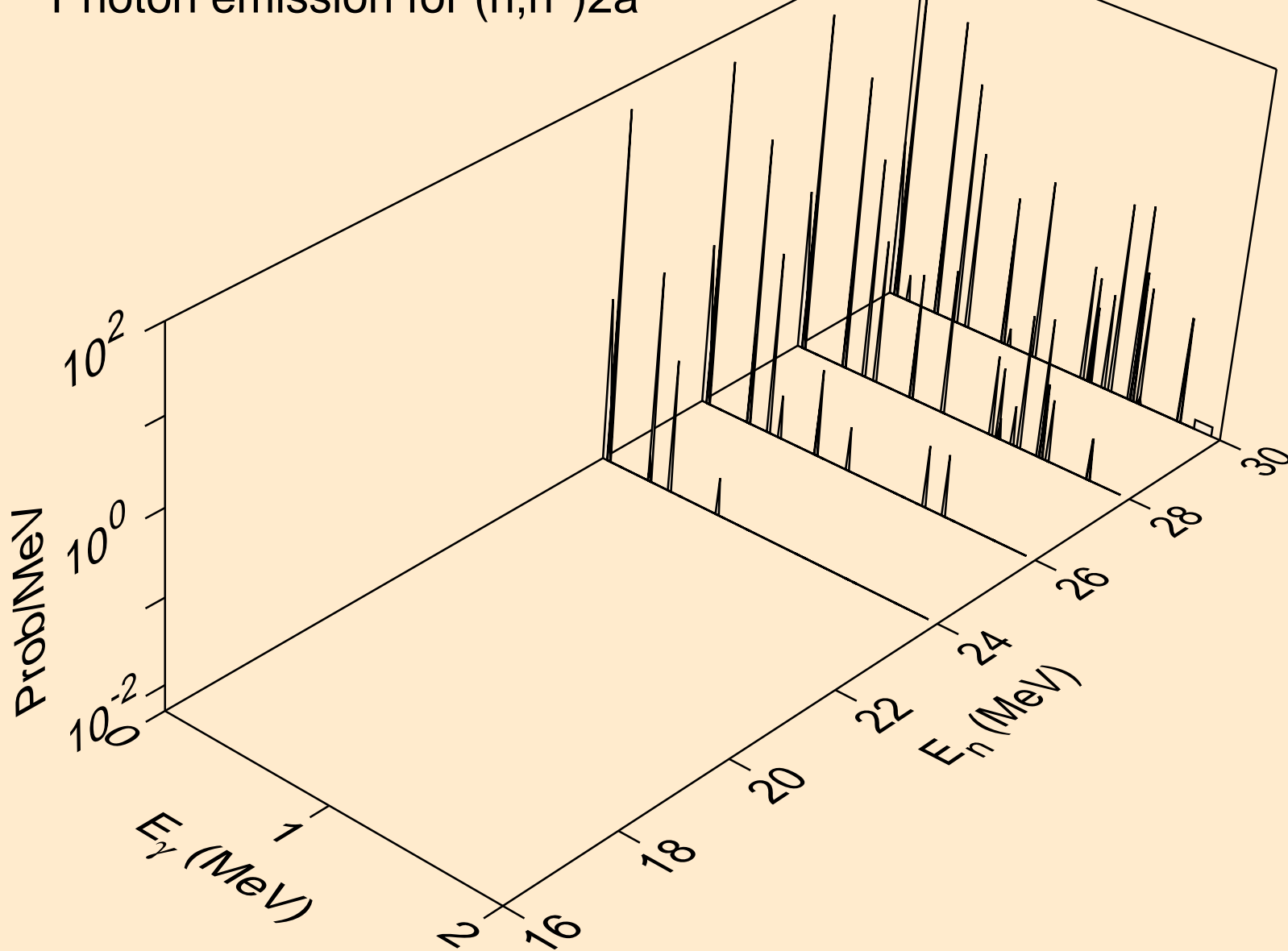

FE053 NEUTRON ACER TENDL-2019 LIBRARY; T=293.16K  
Photon emission for (n,n\*)d

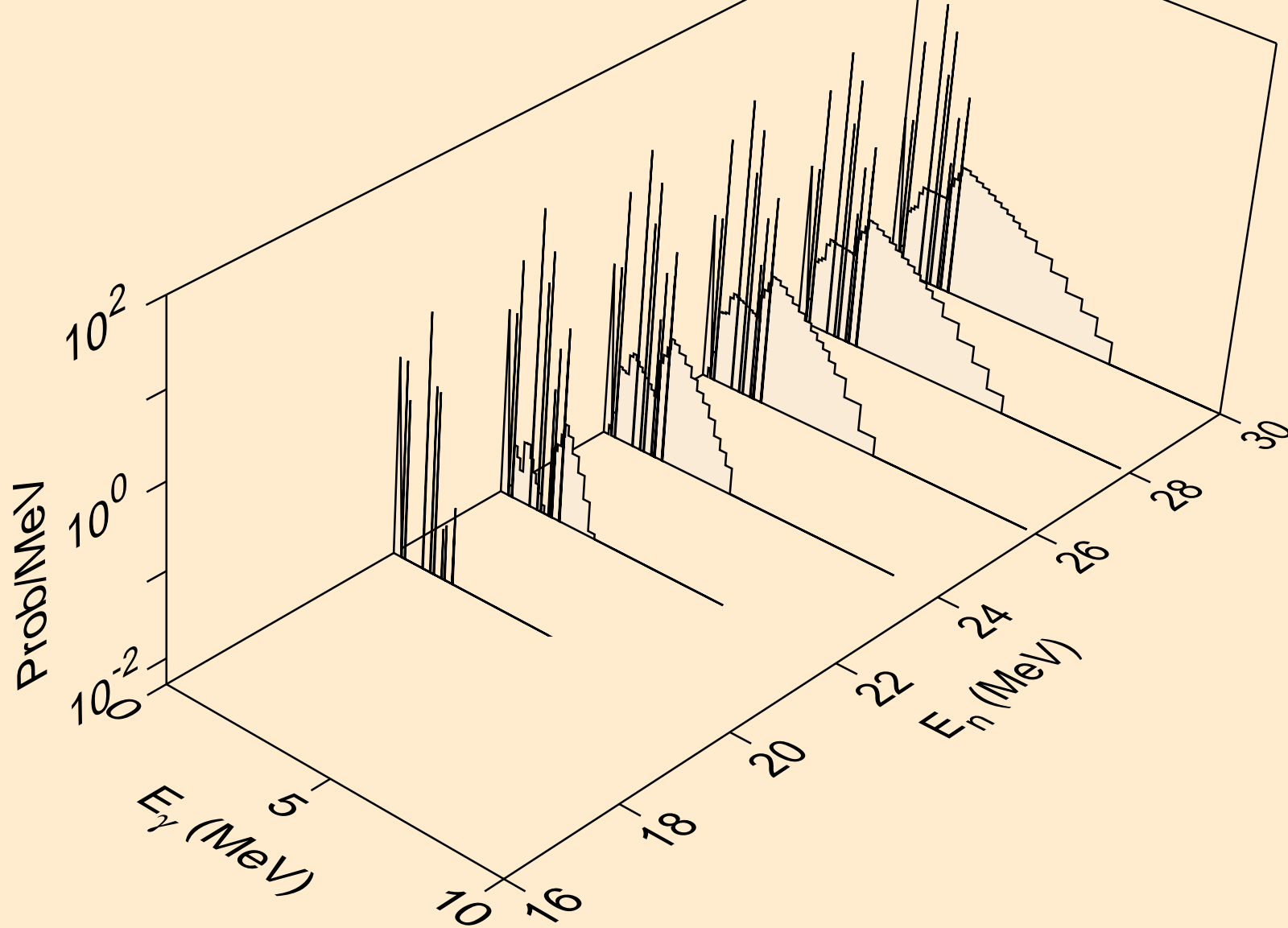

FE053 NEUTRON ACER TENDL-2019 LIBRARY; T=293.16K  
Photon emission for (n,n\*)t

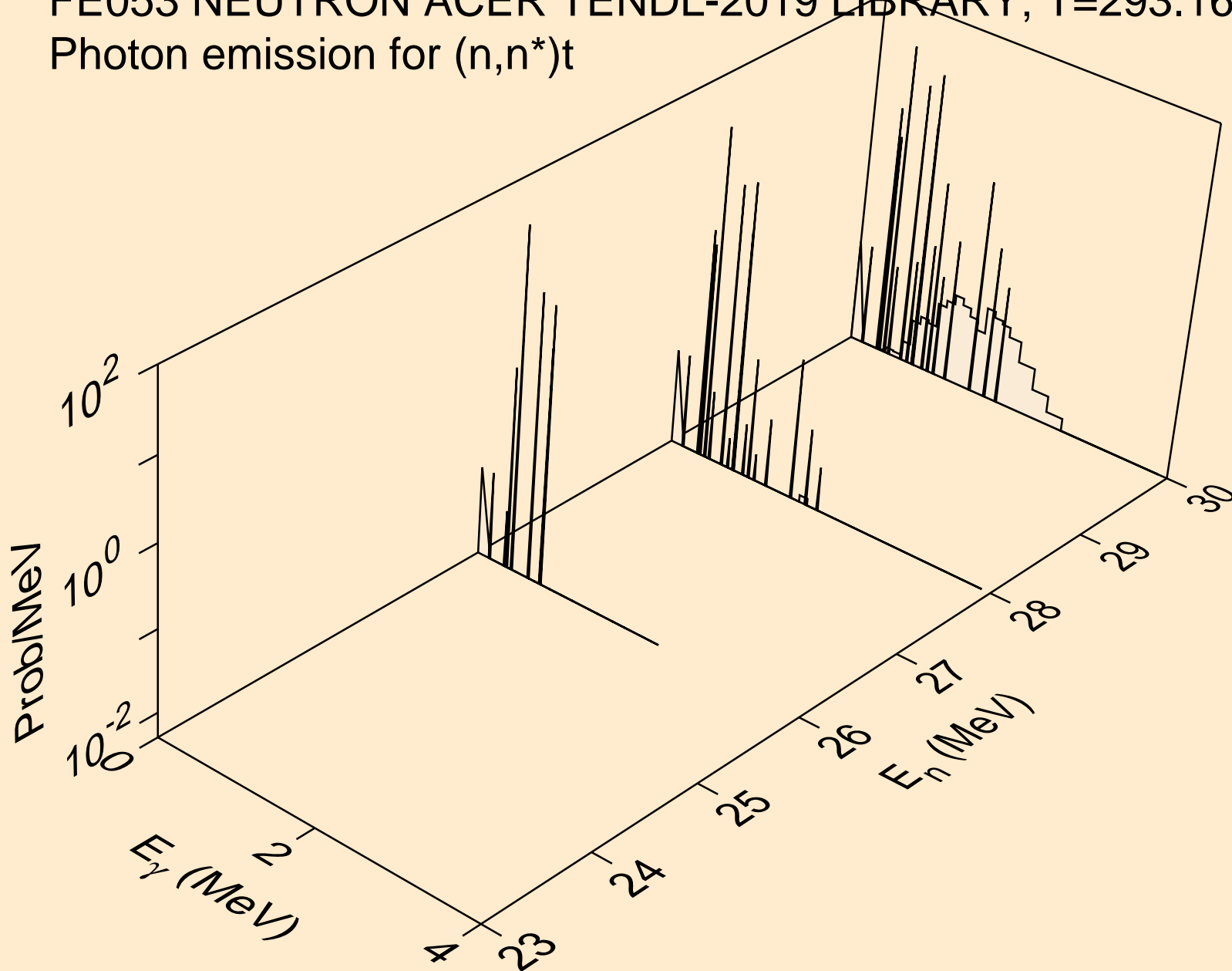

FE053 NEUTRON ACER TENDL-2019 LIBRARY; T=293.16K  
Photon emission for (n,n\*)he3

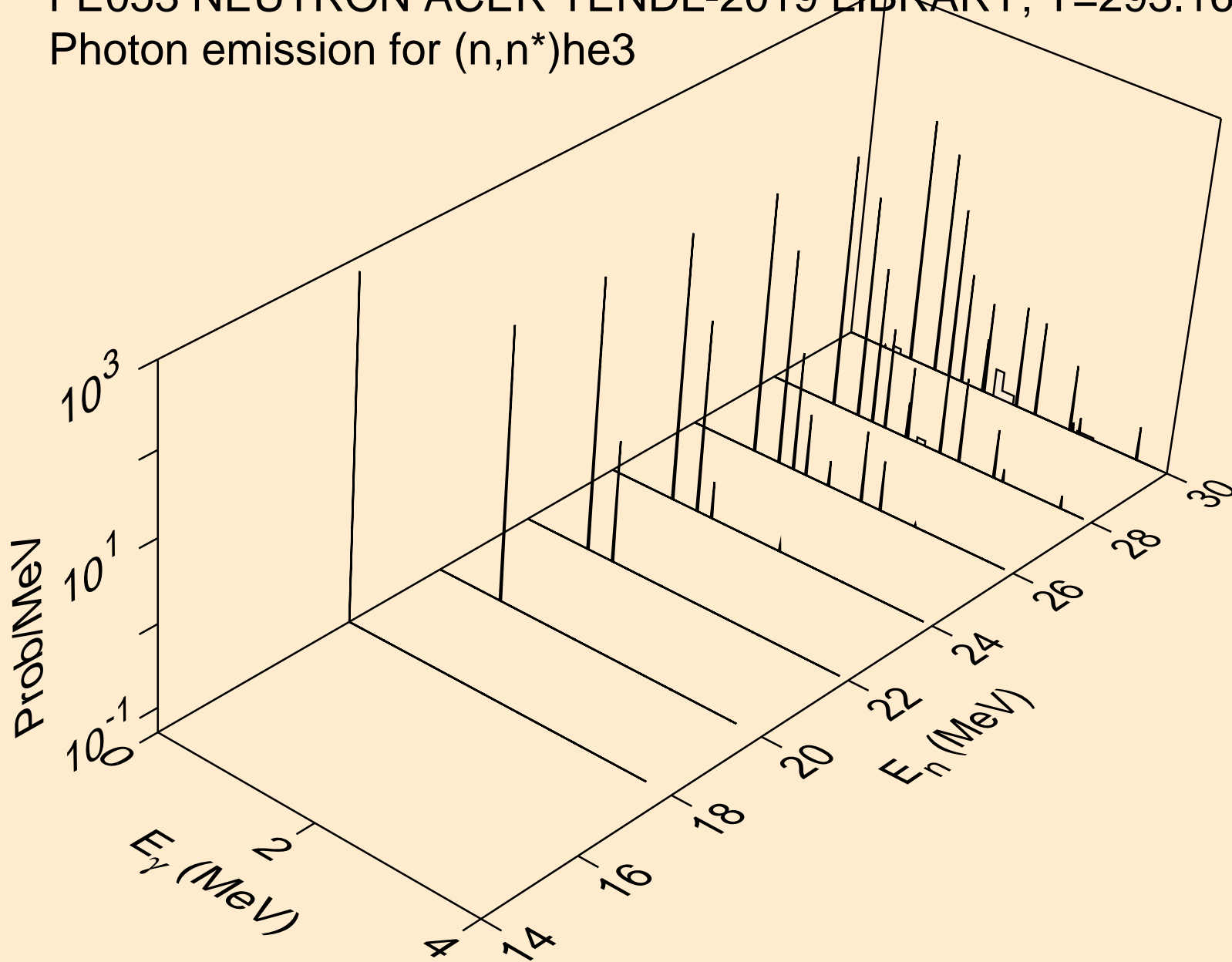

FE053 NEUTRON ACER TENDL-2019 LIBRARY; T=293.16K  
Photon emission for (n,2np)

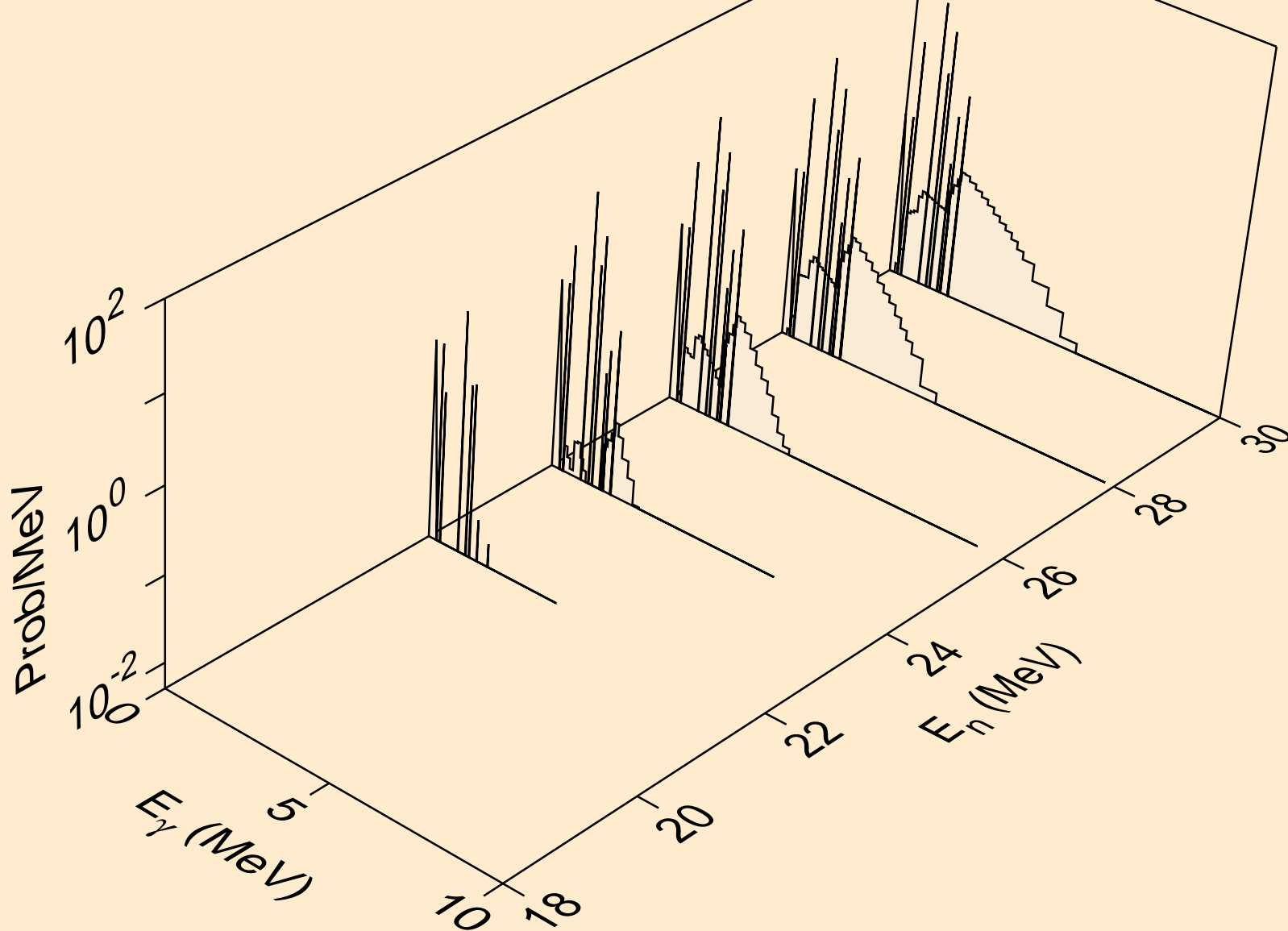

FE053 NEUTRON ACER TENDL-2019 LIBRARY; T=293.16K  
Photon emission for (n,2np)

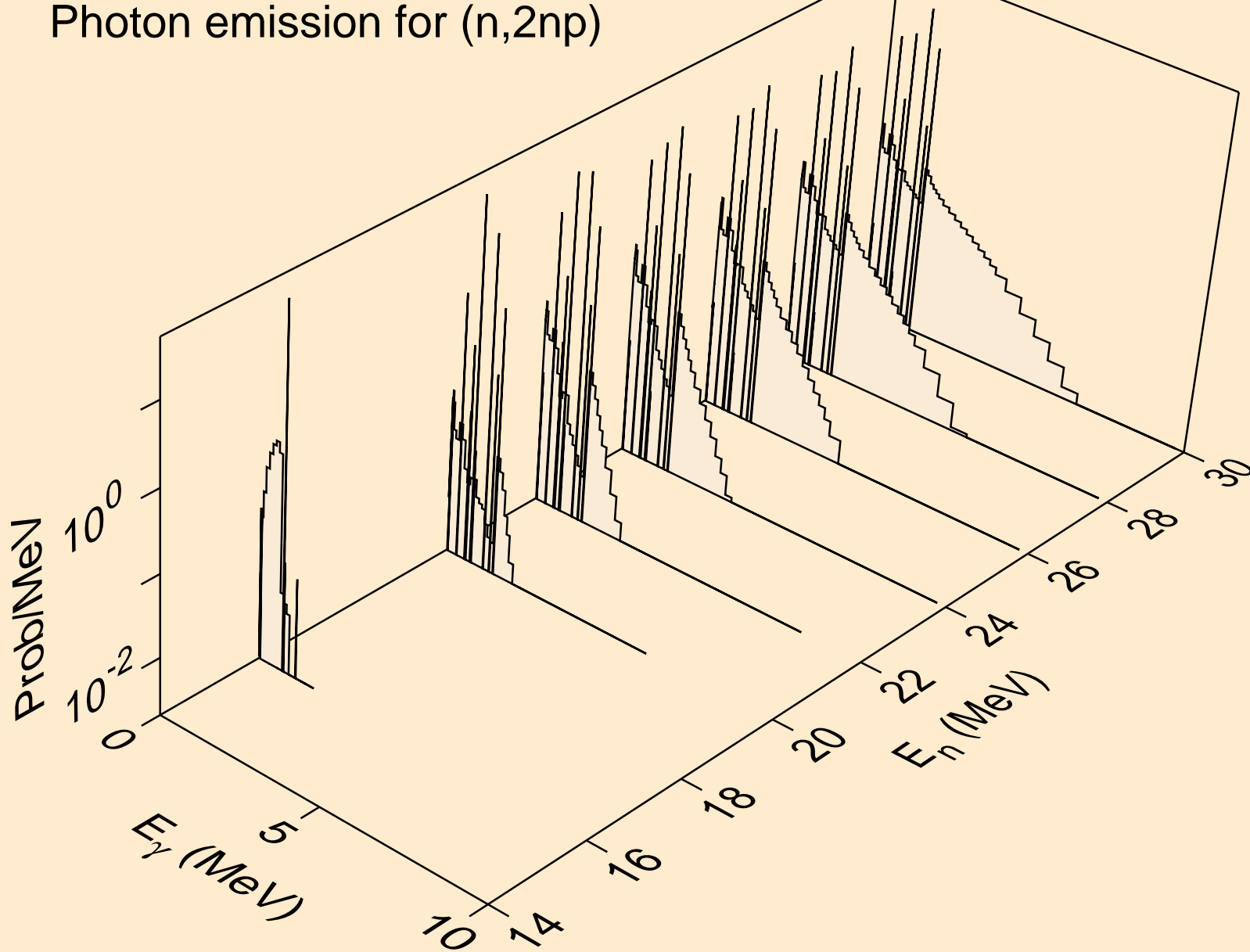



FE053 NEUTRON ACER TENDL-2019 LIBRARY; T=293.16K  
Photon emission for (n,npa)

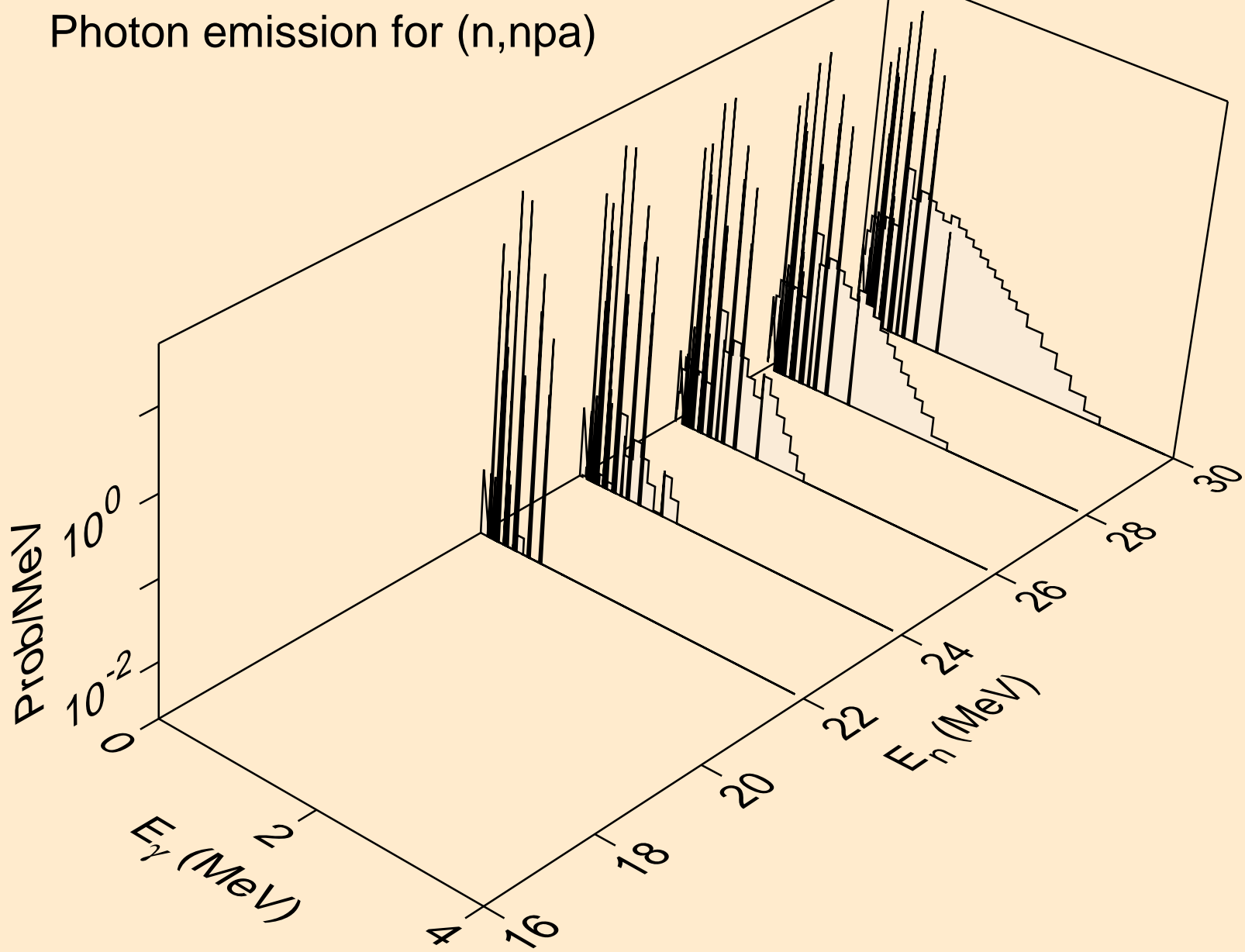

FE053 NEUTRON ACER TENDL-2019 LIBRARY; T=293.16K  
Photon emission for (n,n\*c)

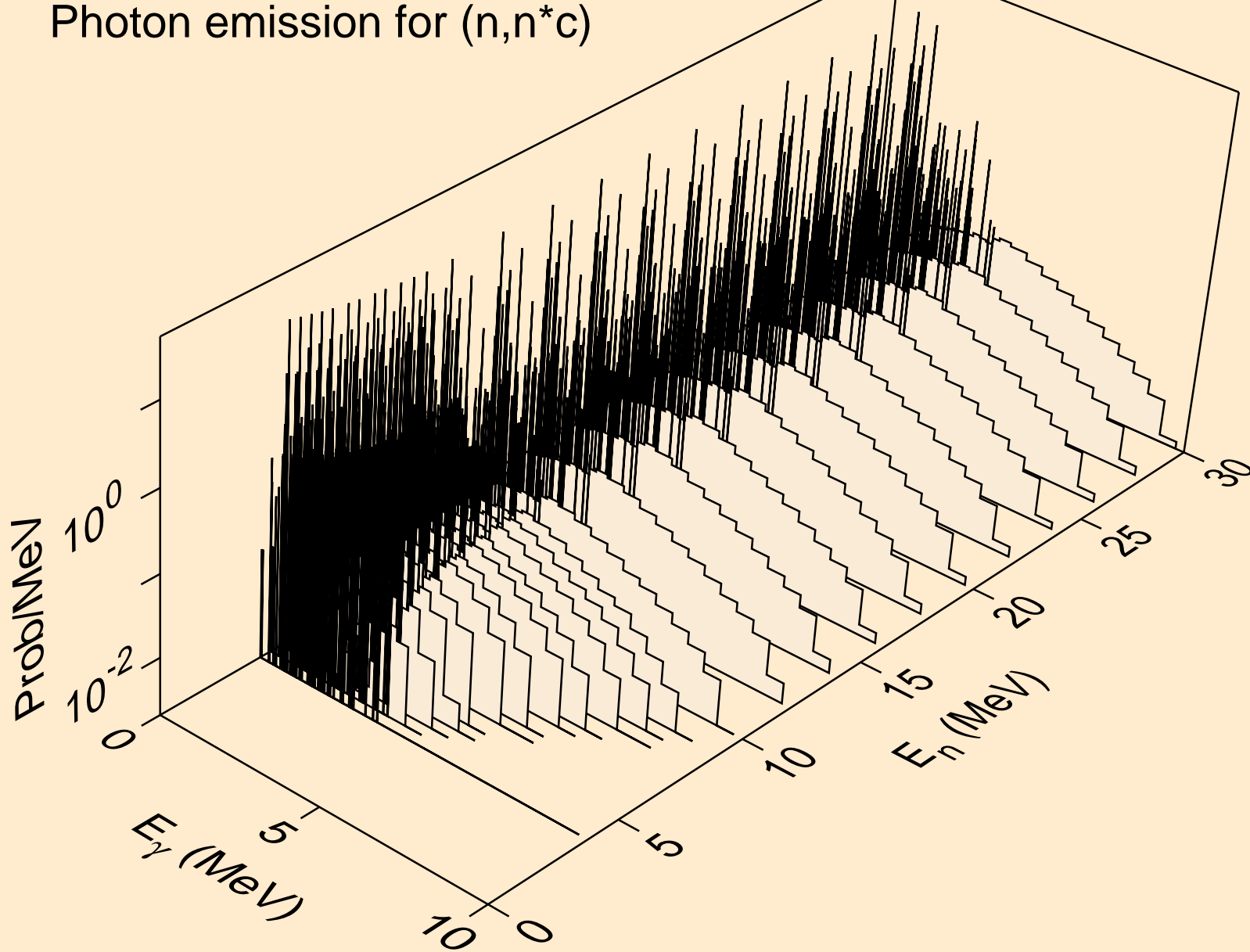

FE053 NEUTRON ACER TENDL-2019 LIBRARY; T=293.16K  
Photon emission for (n,gma)

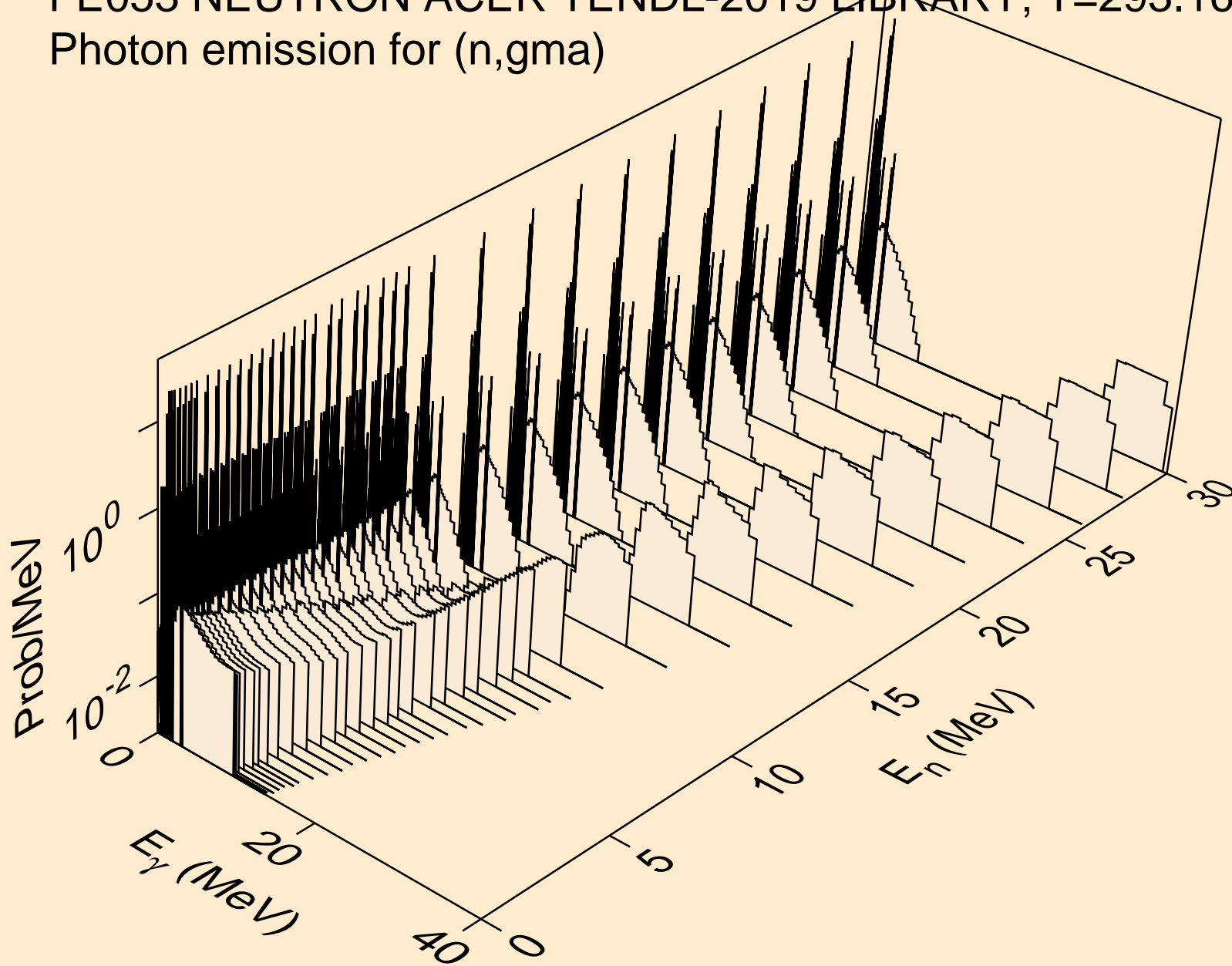

FE053 NEUTRON ACER TENDL-2019 LIBRARY; T=293.16K  
Photon emission for (n,p)

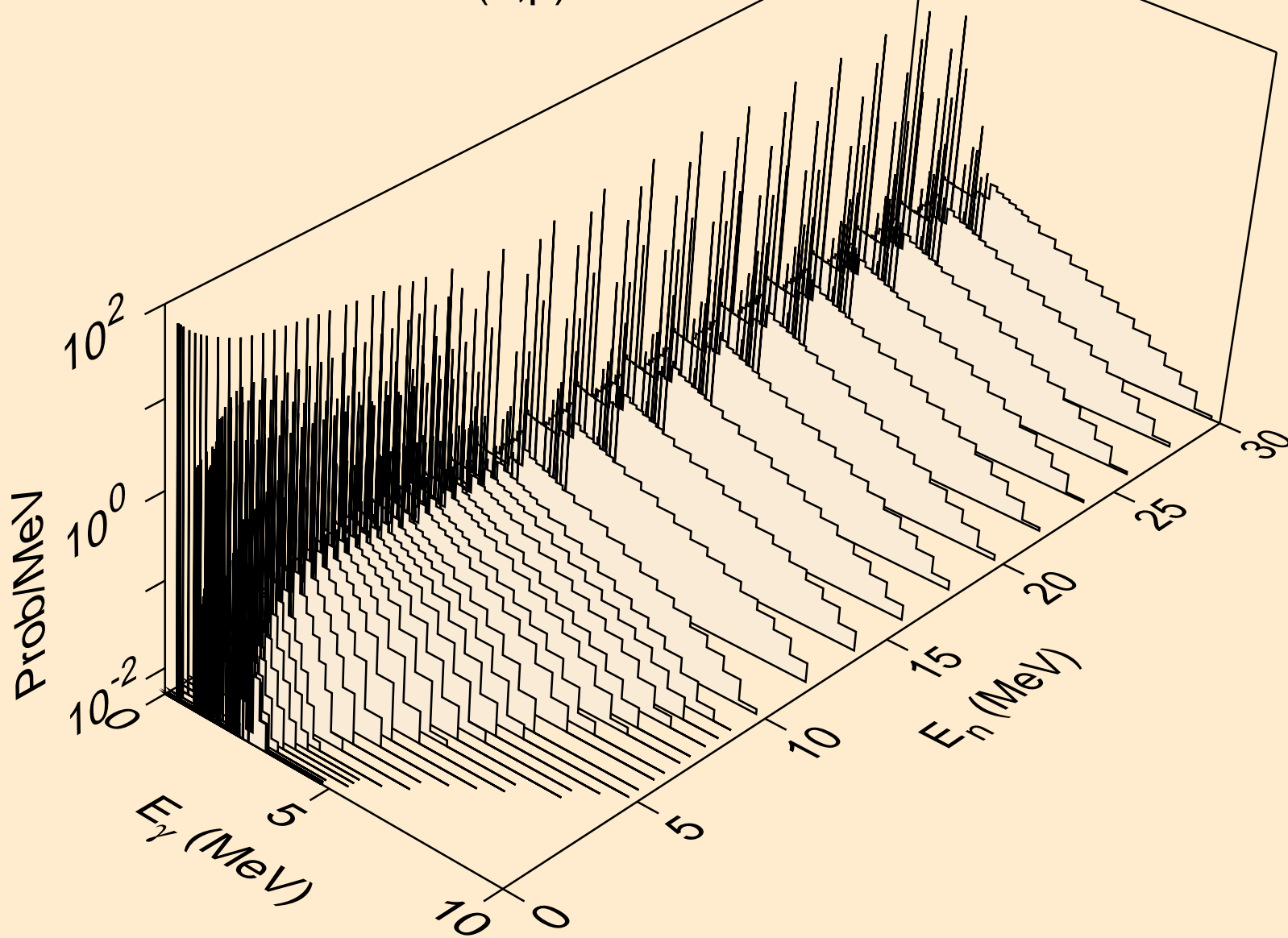

FE053 NEUTRON ACER TENDL-2019 LIBRARY; T=293.16K  
Photon emission for (n,d)

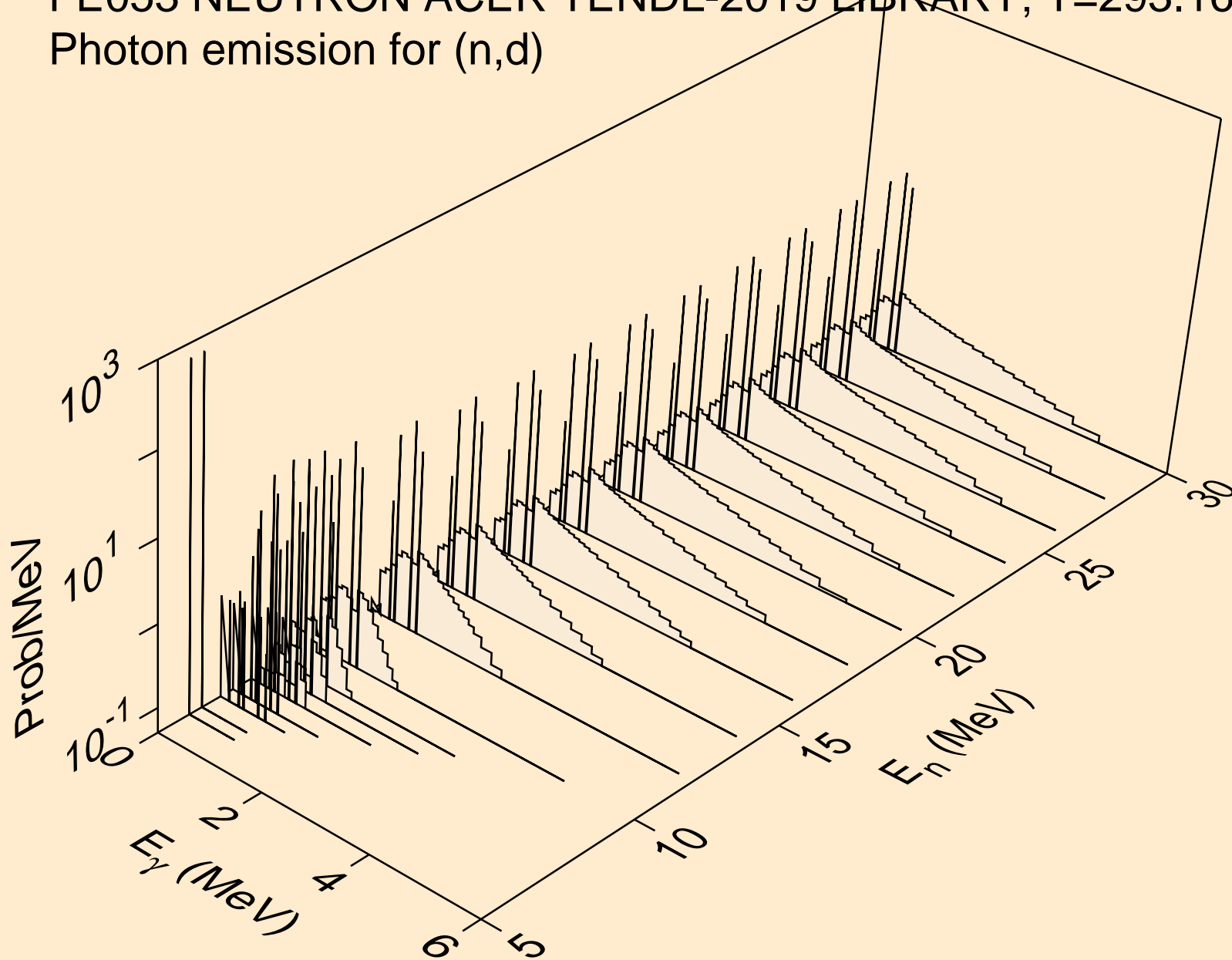

FE053 NEUTRON ACER TENDL-2019 LIBRARY; T=293.16K  
Photon emission for (n,t)

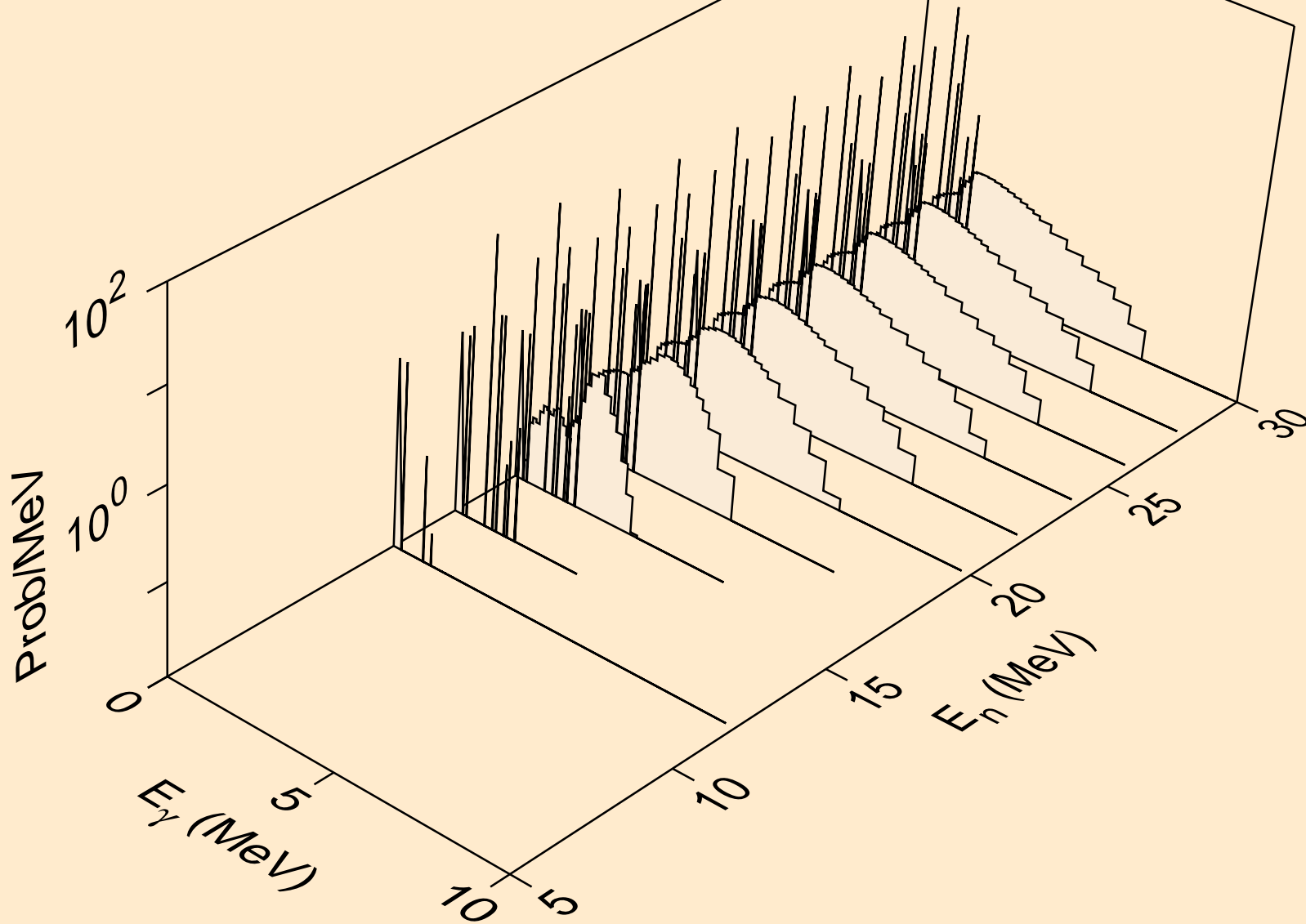

FE053 NEUTRON ACER TENDL-2019 LIBRARY; T=293.16K  
Photon emission for (n,he3)

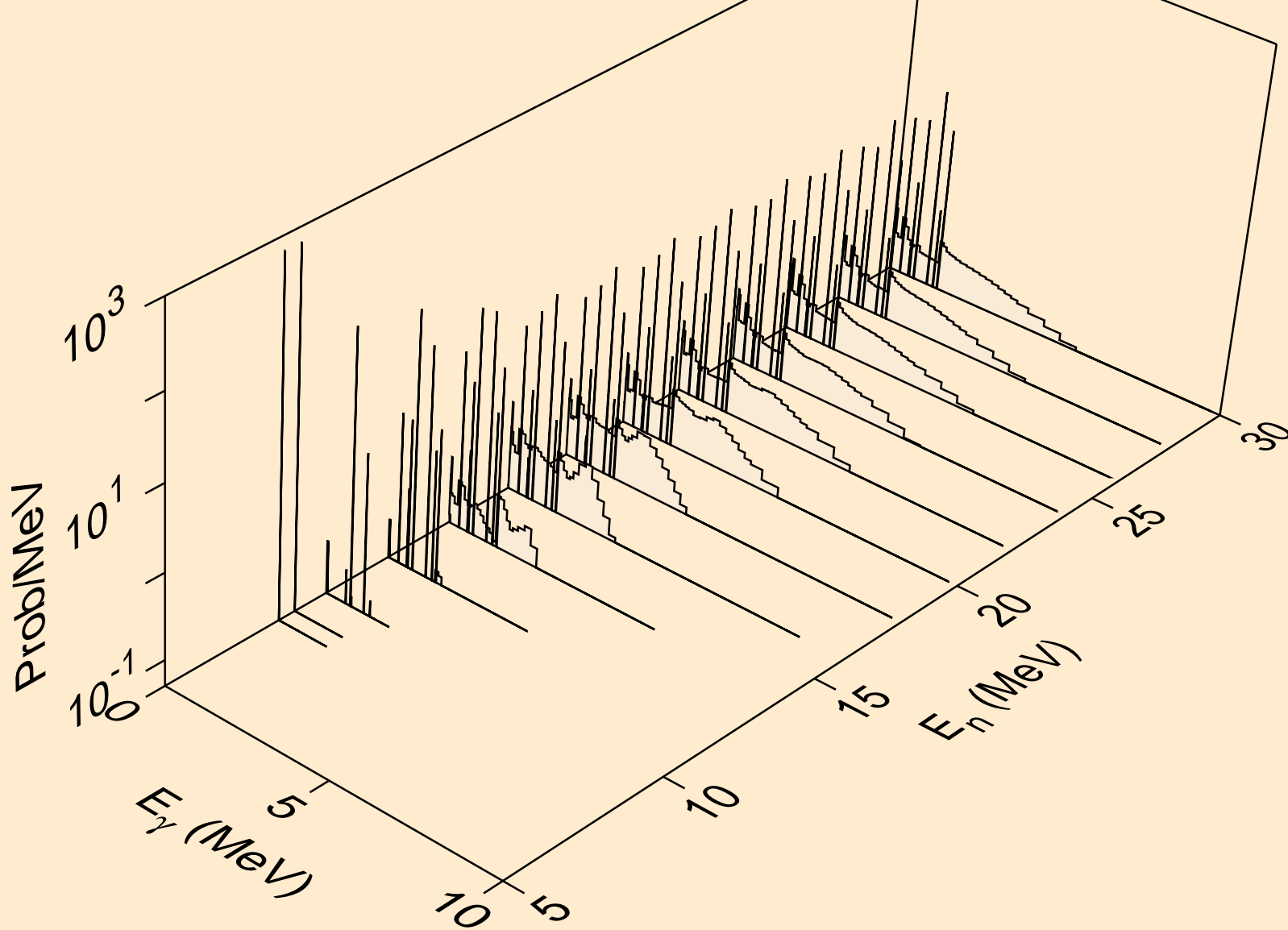

FE053 NEUTRON ACER TENDL-2019 LIBRARY; T=293.16K  
Photon emission for (n,a)

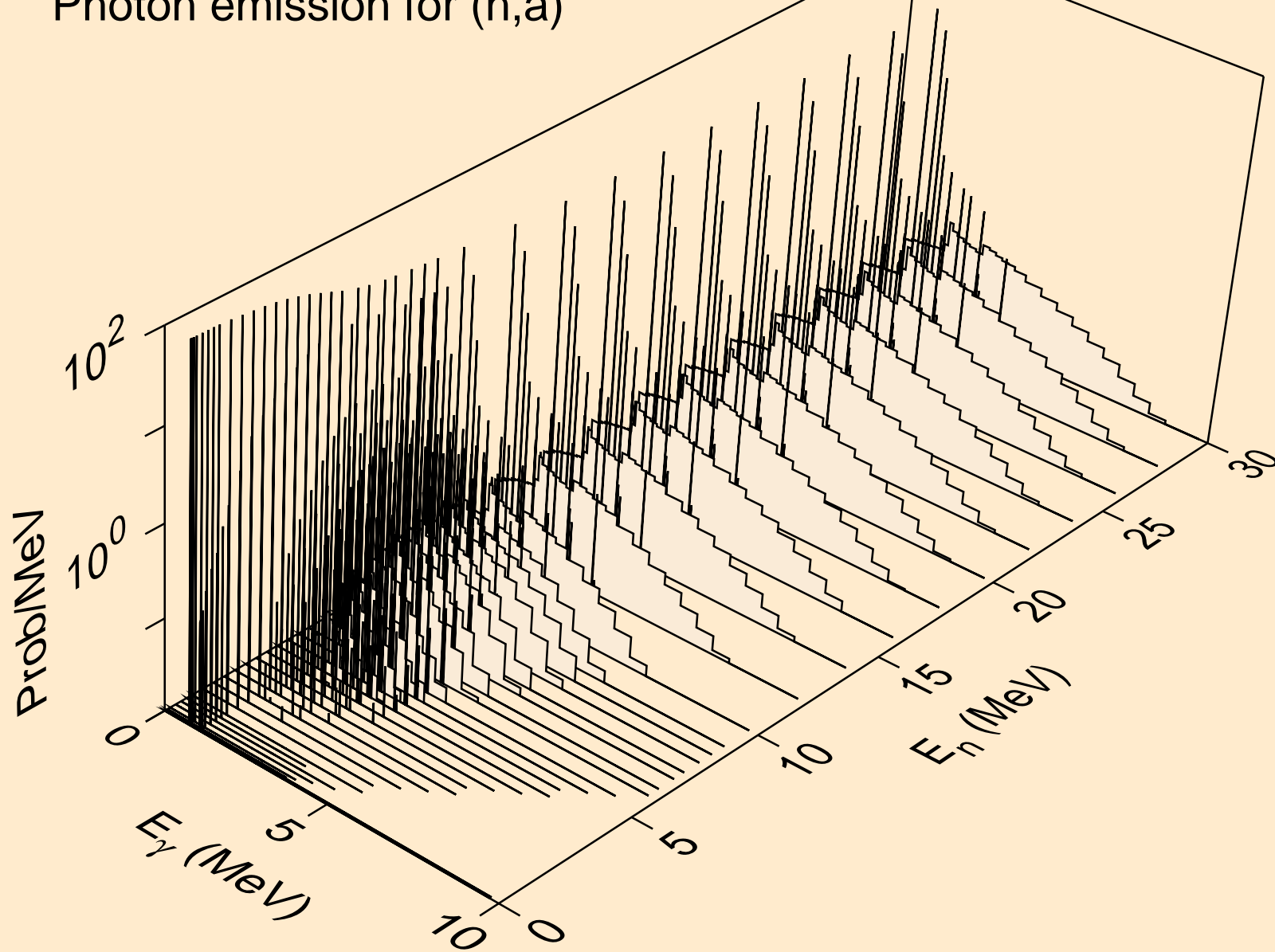



FE053 NEUTRON ACER TENDL-2019 LIBRARY; T=293.16K  
Photon emission for (n,2a)

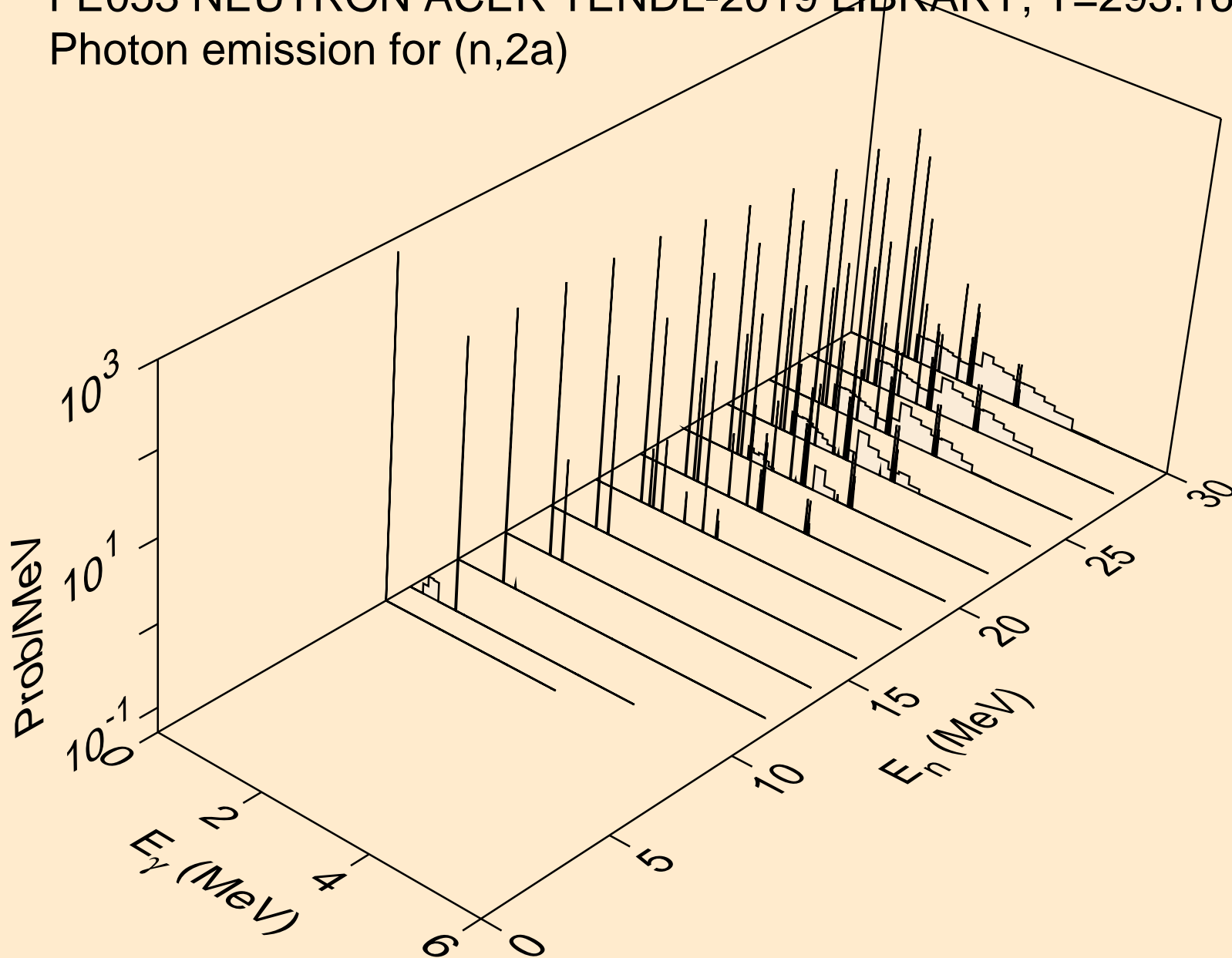

FE053 NEUTRON ACER TENDL-2019 LIBRARY; T=293.16K  
Photon emission for (n,3a)

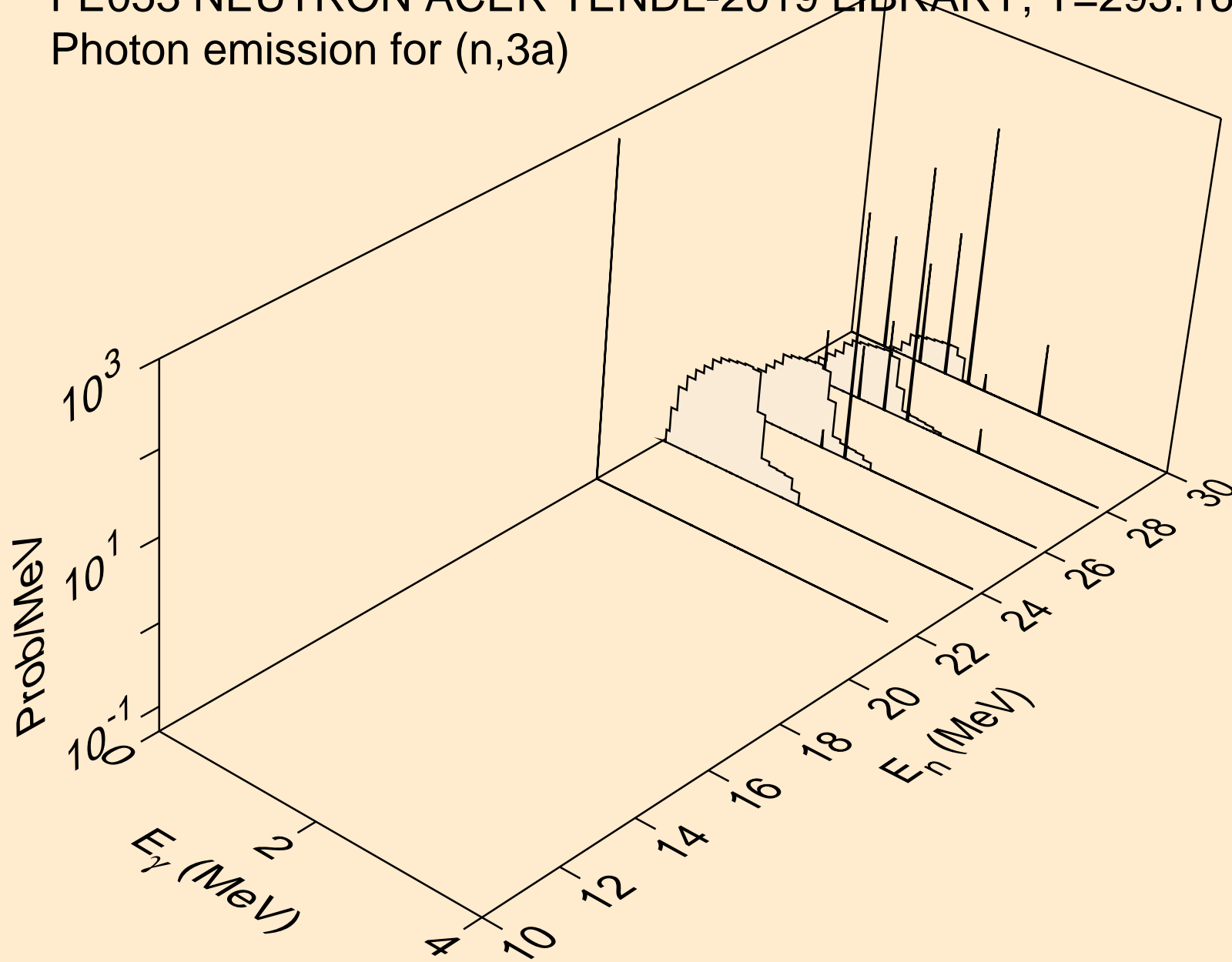

FE053 NEUTRON ACER TENDL-2019 LIBRARY; T=293.16K  
Photon emission for (n,2p)

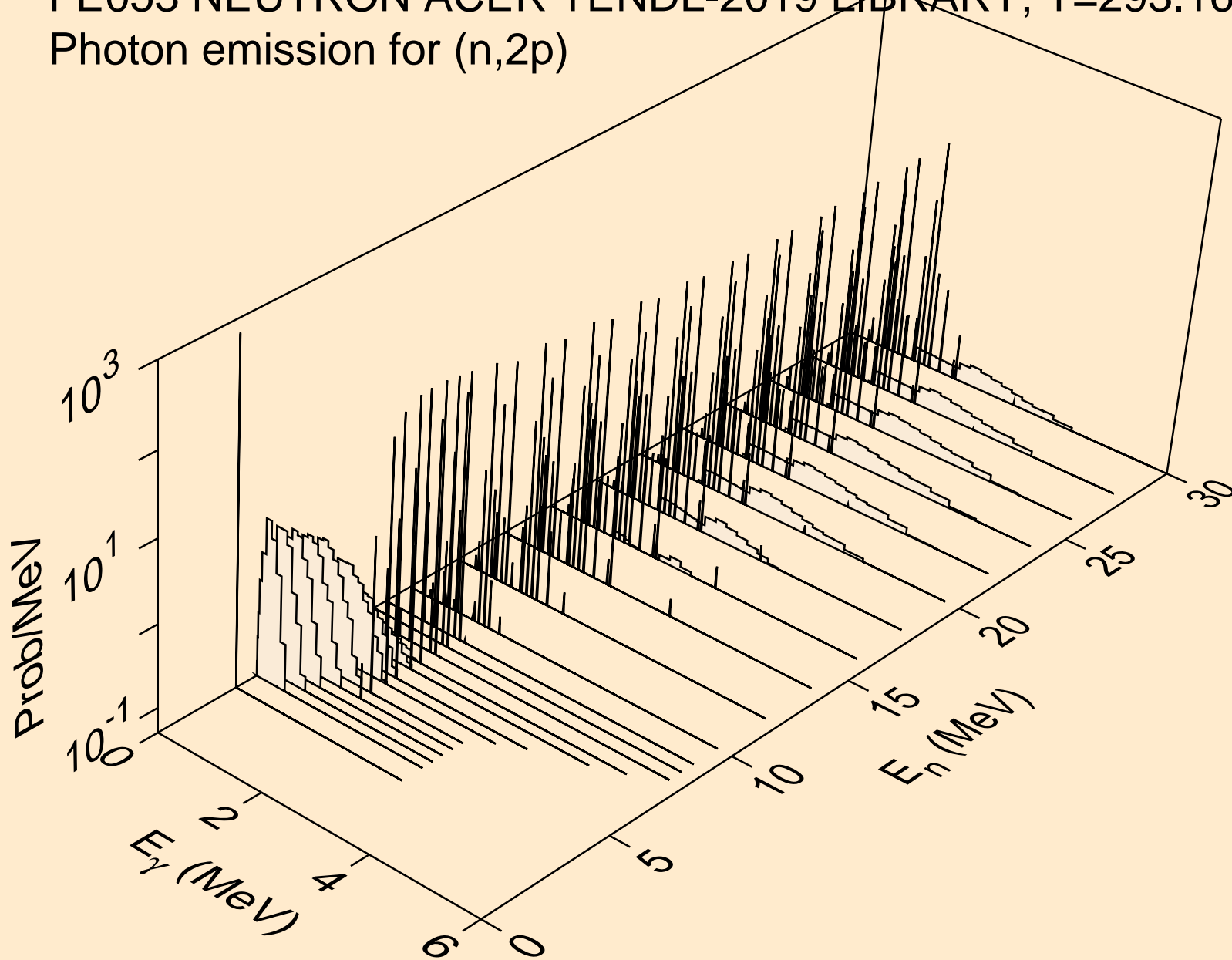

FE053 NEUTRON ACER TENDL-2019 LIBRARY; T=293.16K  
Photon emission for (n,p $\alpha$ )

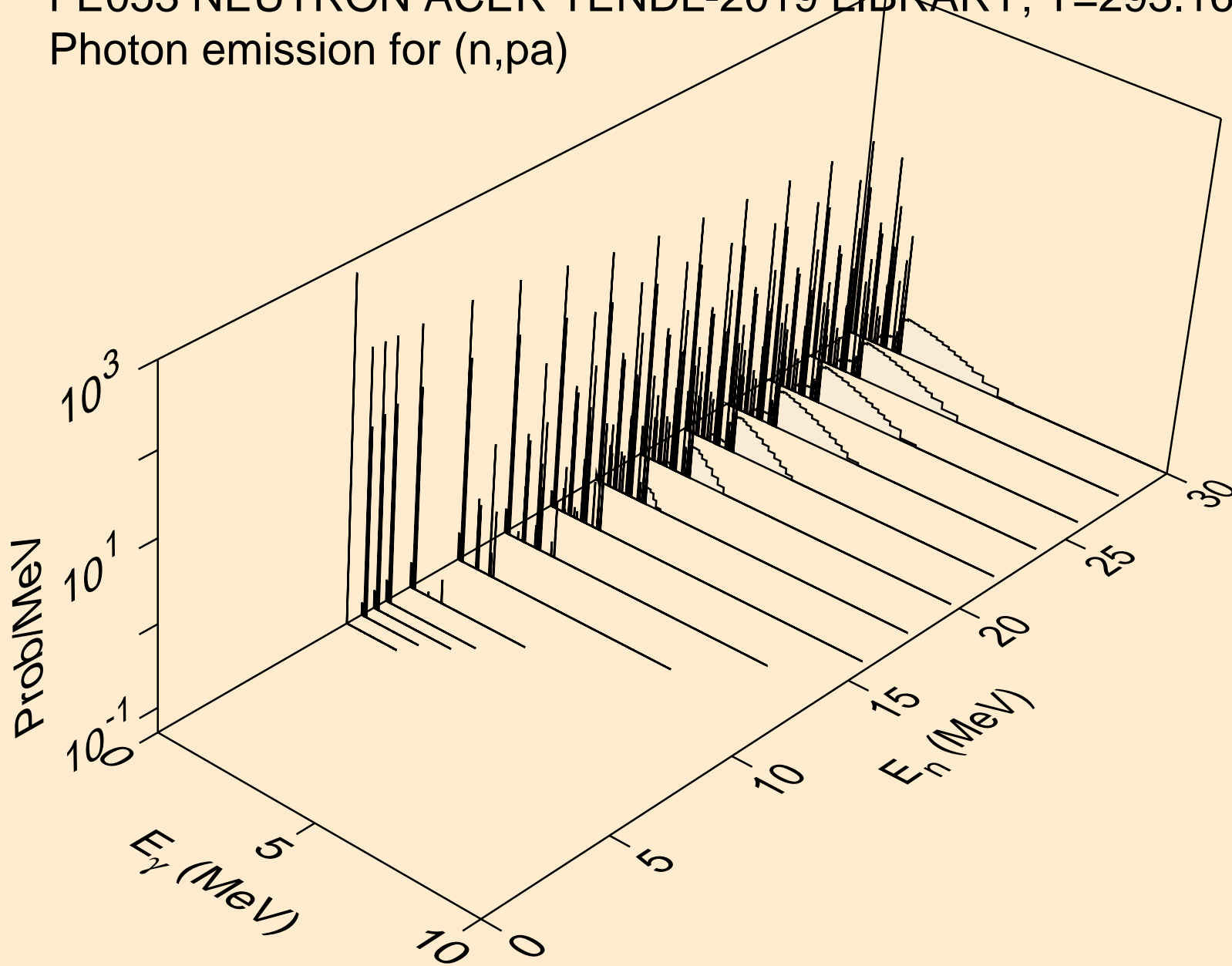

FE053 NEUTRON ACER TENDL-2019 LIBRARY; T=293.16K  
Photon emission for (n,pd)

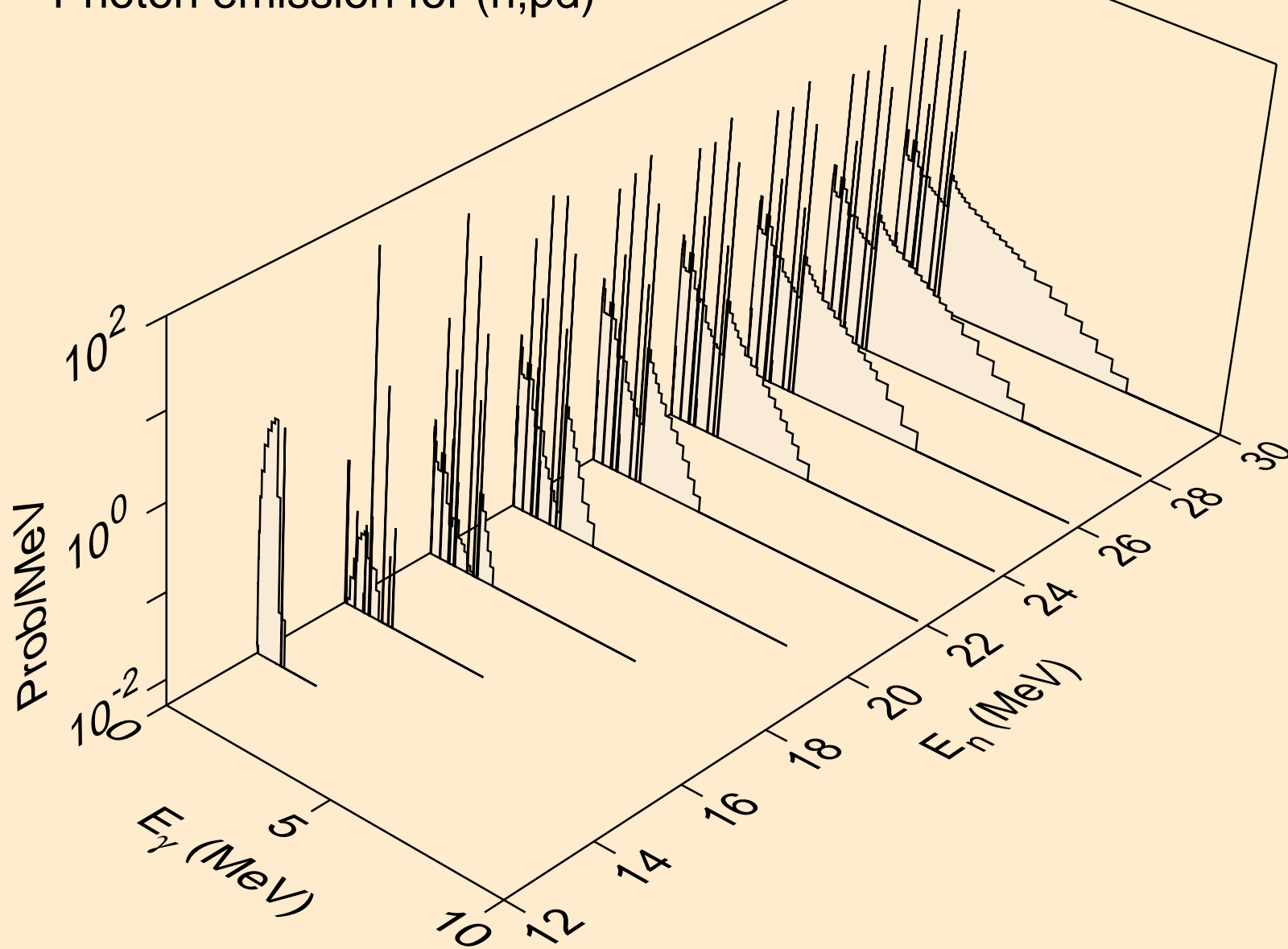

FE053 NEUTRON ACER TENDL-2019 LIBRARY; T=293.16K  
Photon emission for (n,pt)

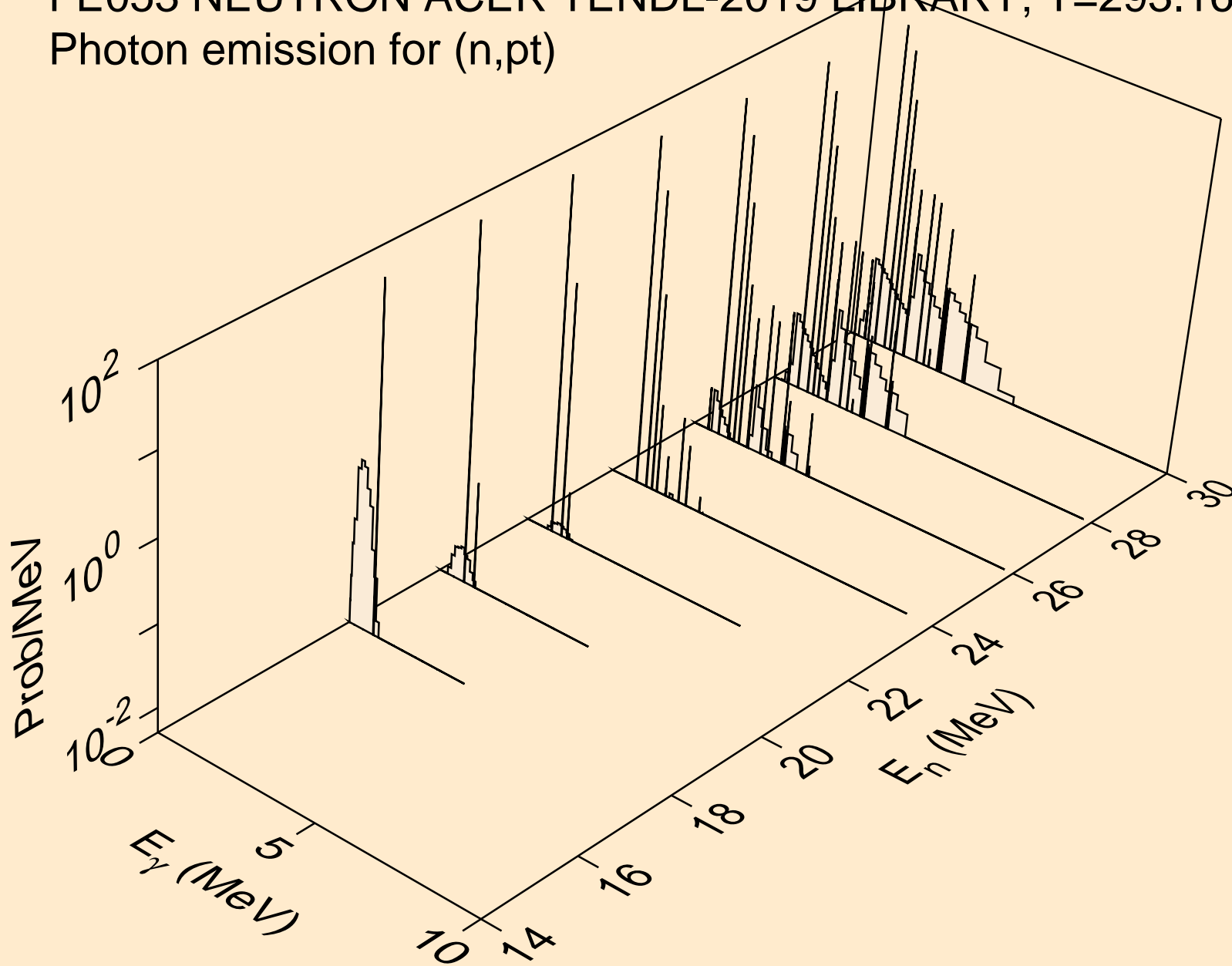

FE053 NEUTRON ACER TENDL-2019 LIBRARY; T=293.16K  
Photon emission for (n,da)

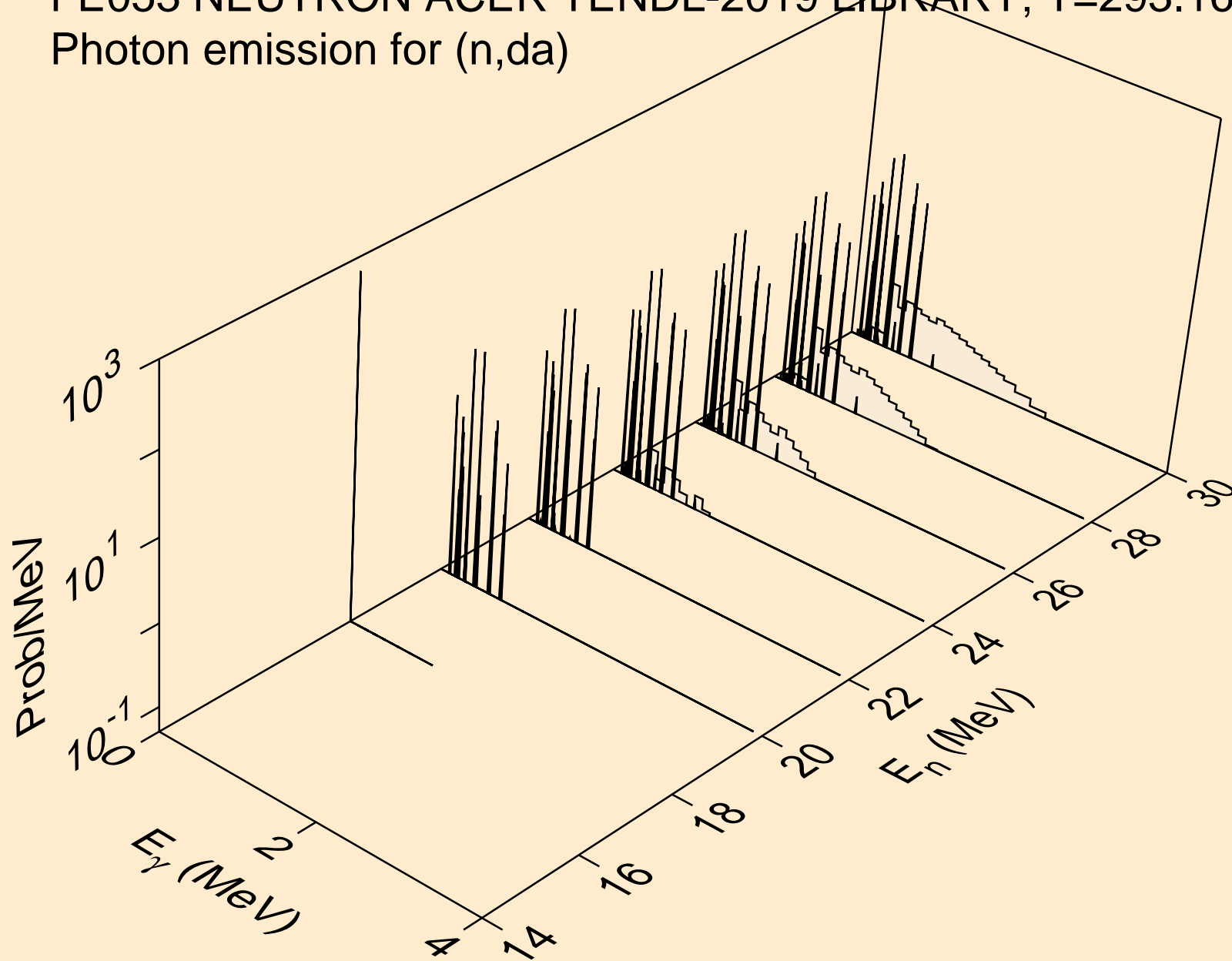

FE053 NEUTRON ACER TENDL-2019 LIBRARY; T=293.16K  
thermal capture photon spectrum

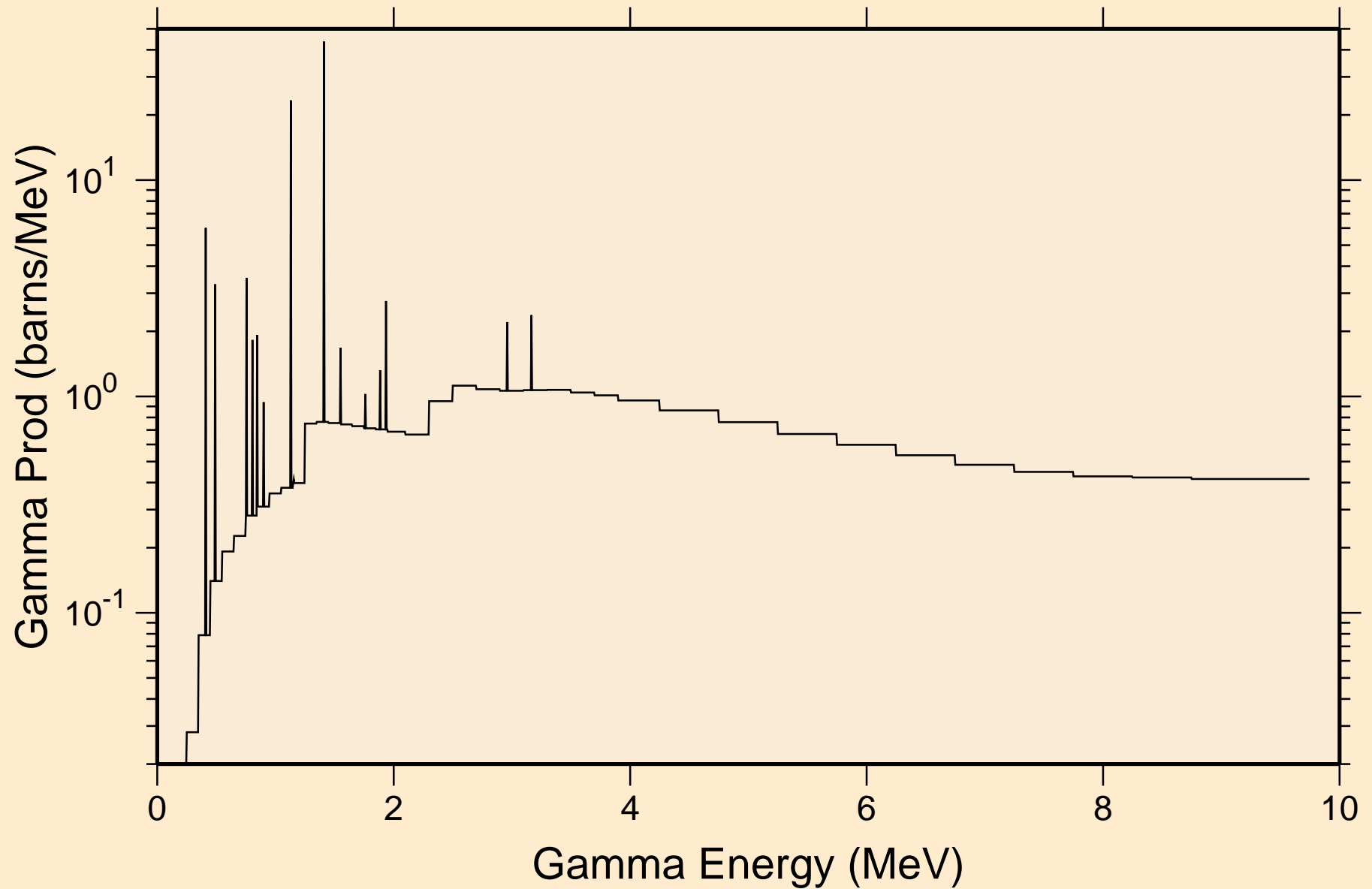



FE053 NEUTRON ACER TENDL-2019 LIBRARY; T=293.16K  
14 MeV photon spectrum

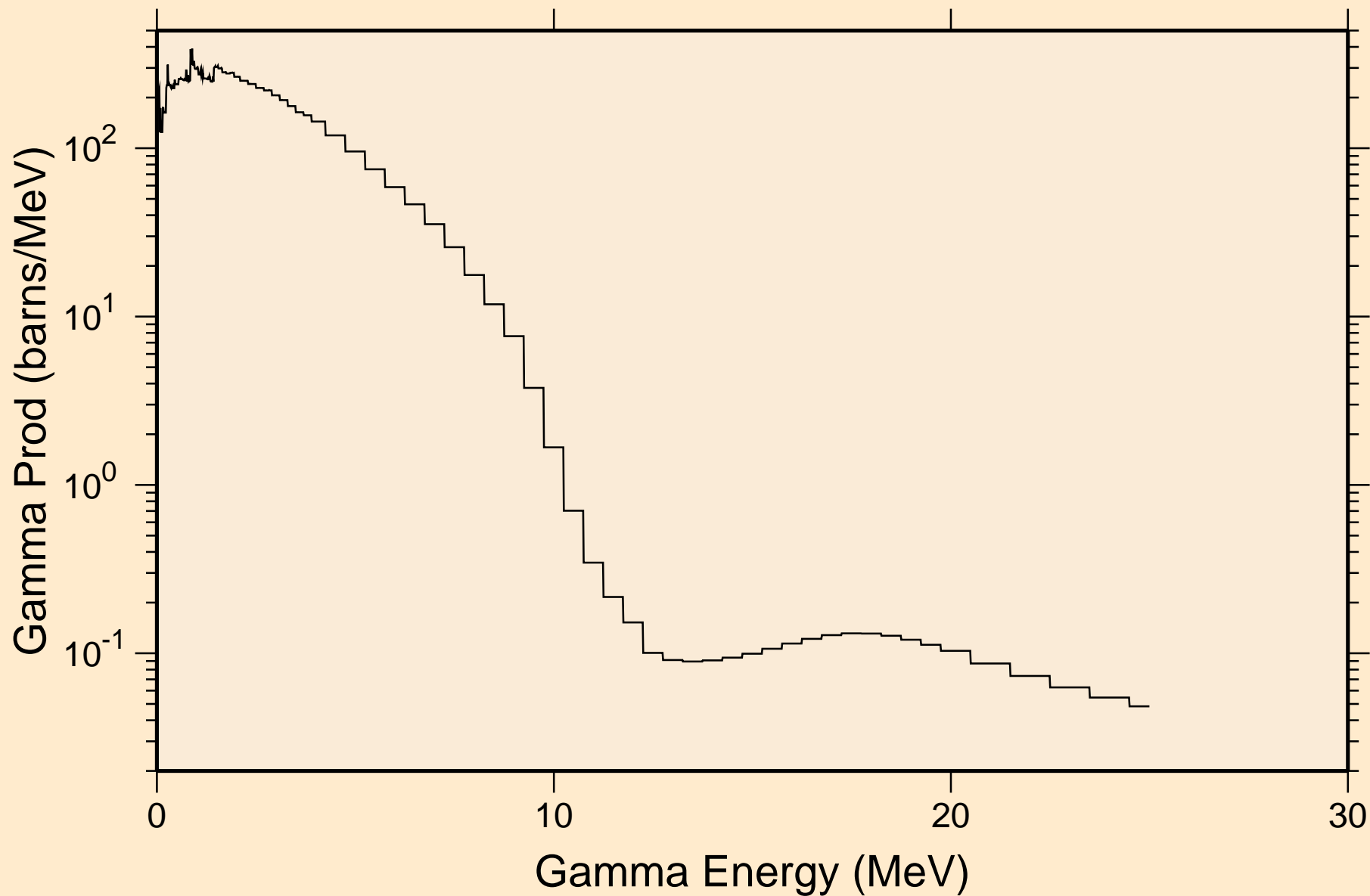

# FE053 NEUTRON ACER TENDL-2019 LIBRARY; T=293.16K

## Particle heating contributions

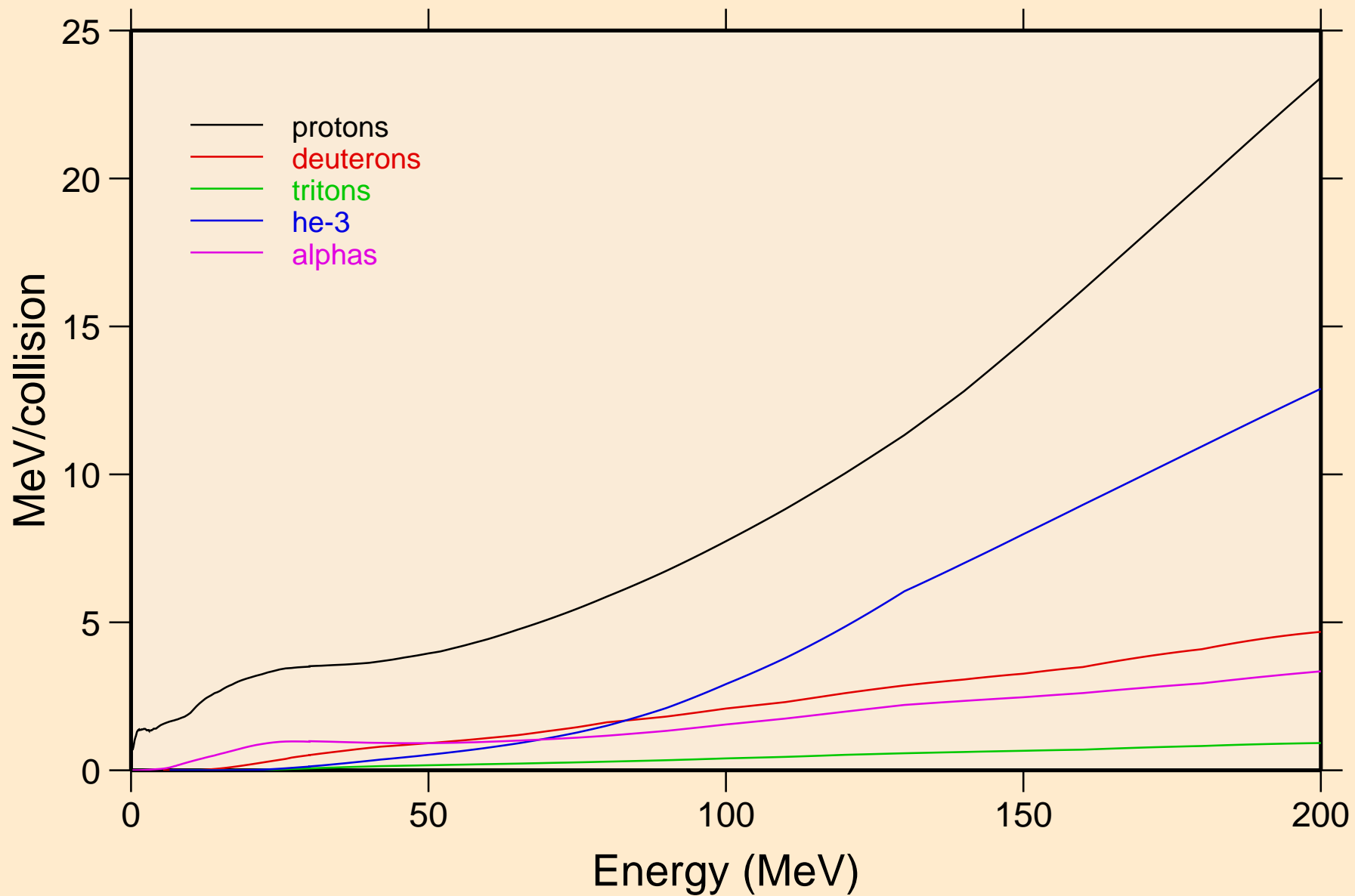

FE053 NEUTRON ACER TENDL-2019 LIBRARY; T=293.16K  
Recoil Heating

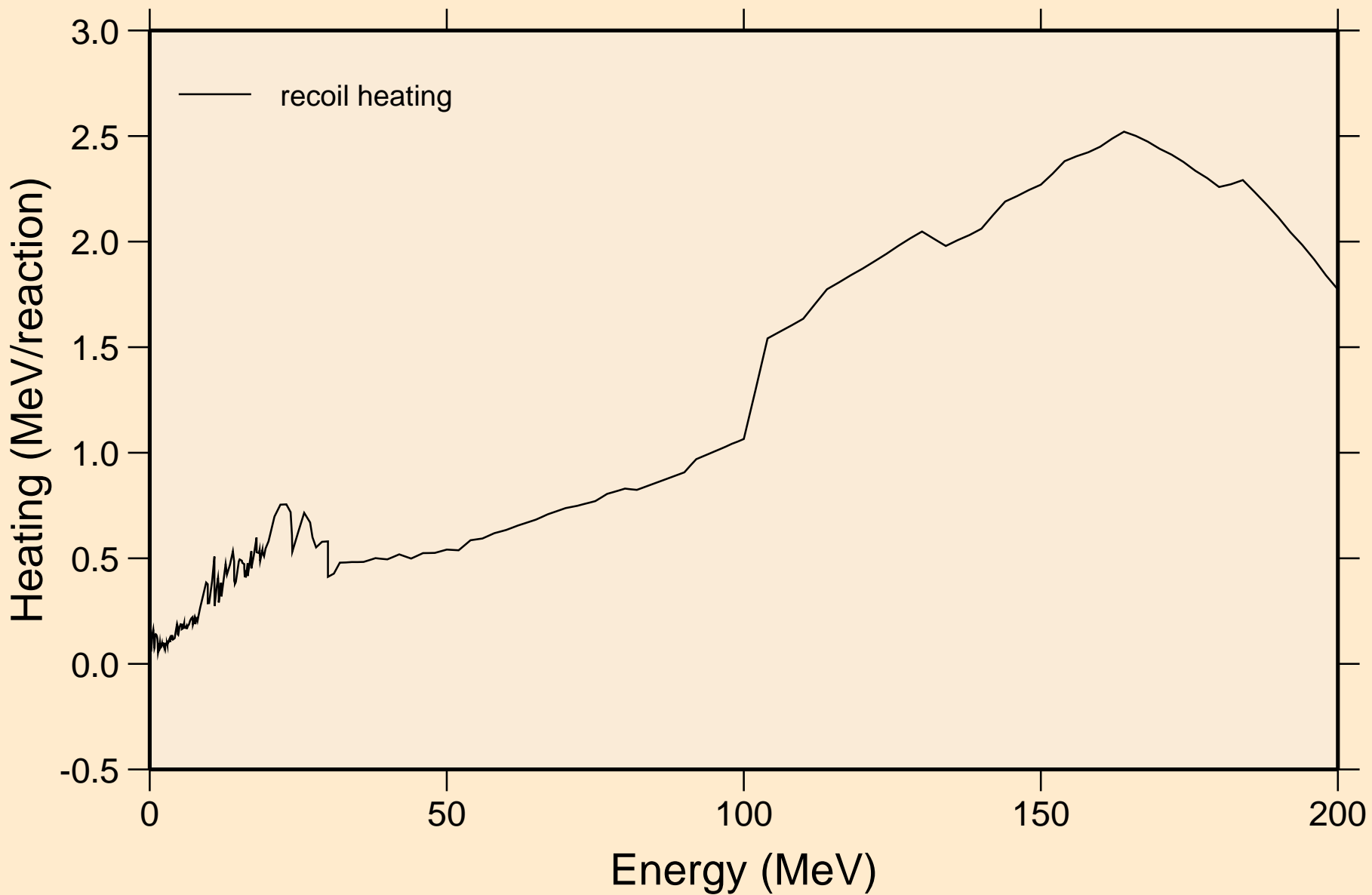

# FE053 NEUTRON ACER TENDL-2019 LIBRARY; T=293.16K

## Particle production cross sections

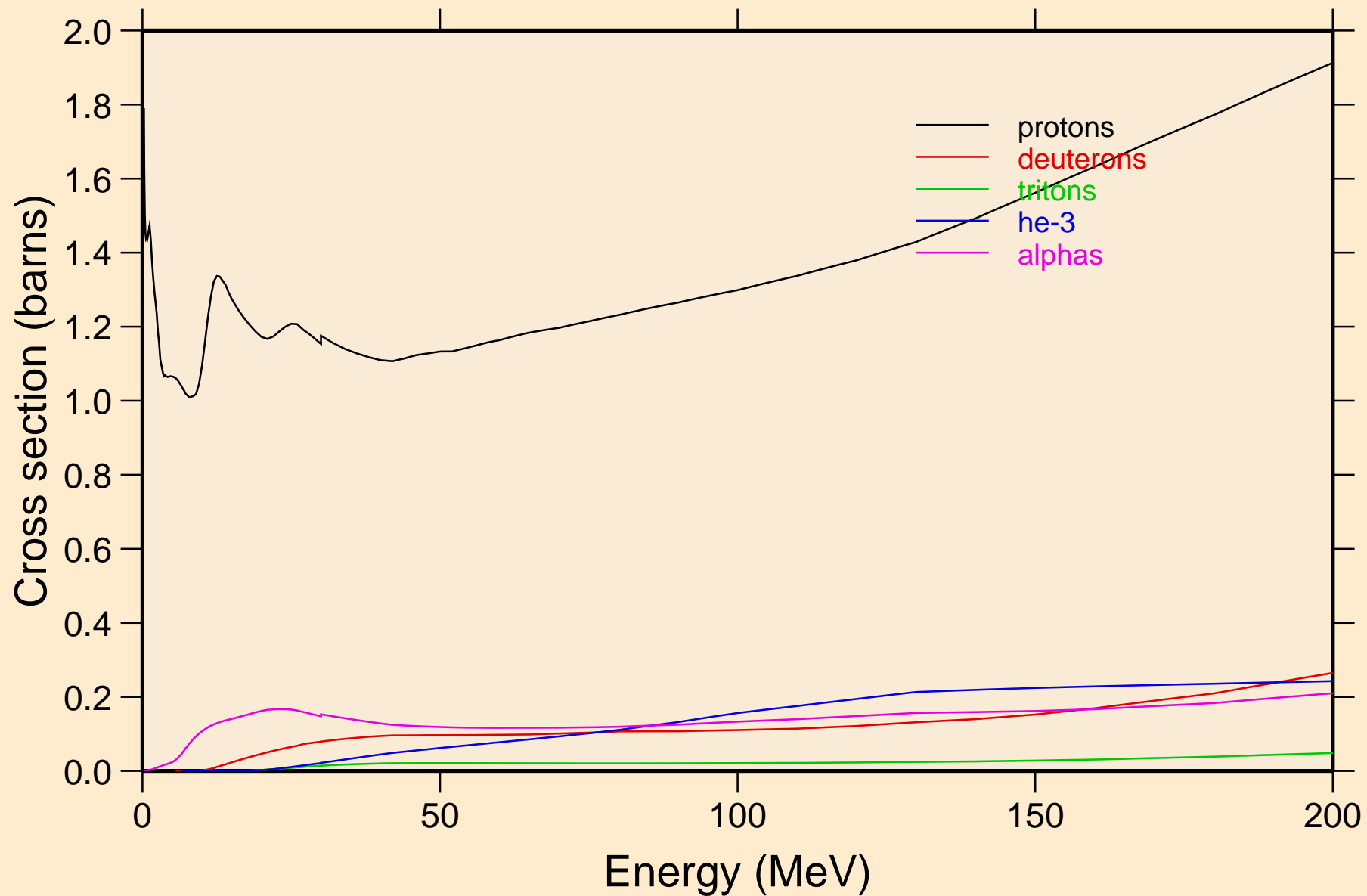

FE053 NEUTRON ACER TENDL-2019 LIBRARY; T=293.16K  
protons from (n,x)

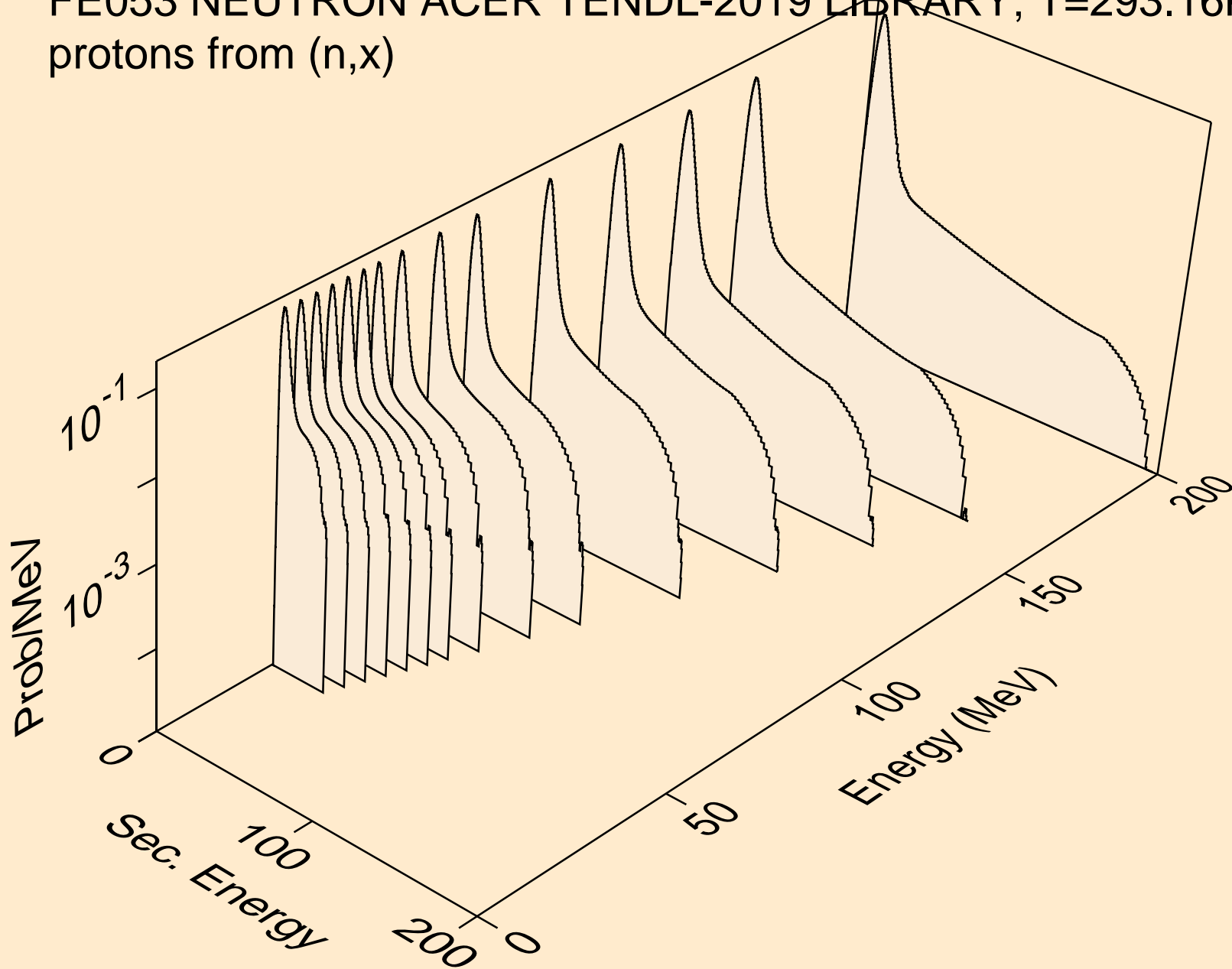

FE053 NEUTRON ACER TENDL-2019 LIBRARY; T=293.16K  
protons from (n,n\*)p

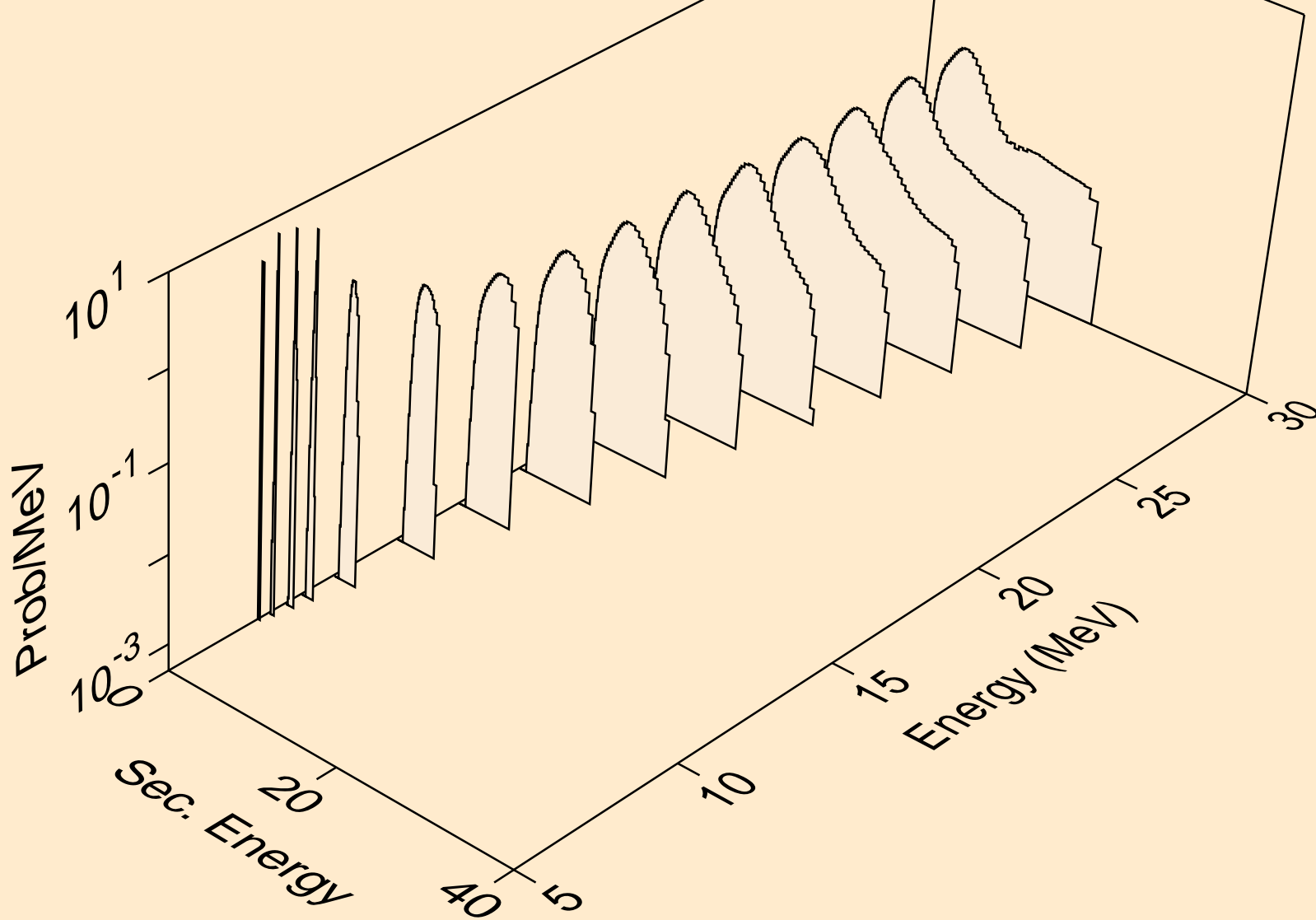

FE053 NEUTRON ACER TENDL-2019 LIBRARY; T=293.16K  
protons from (n,2np)

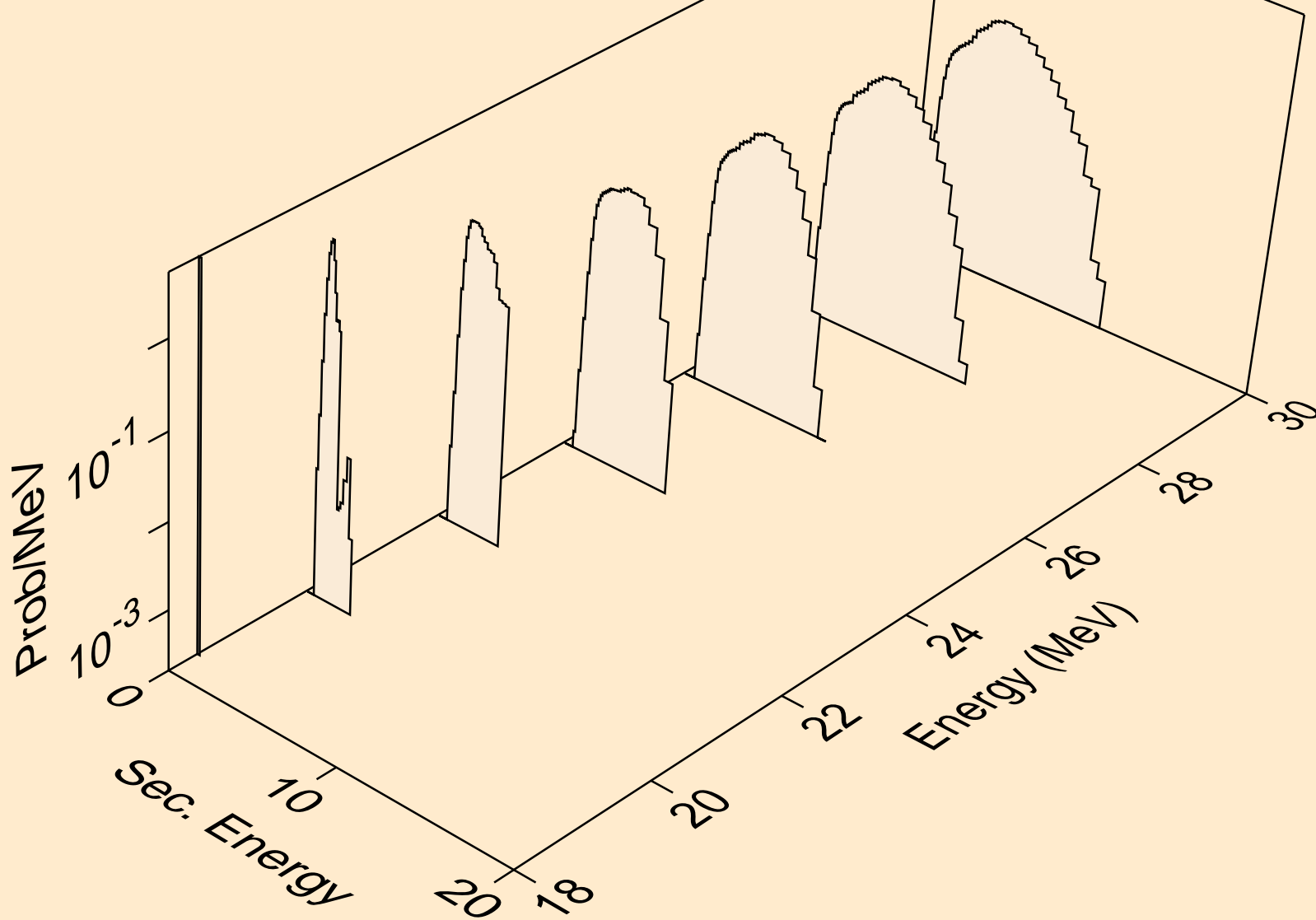

FE053 NEUTRON ACER TENDL-2019 LIBRARY; T=293.16K  
protons from (n,2np)

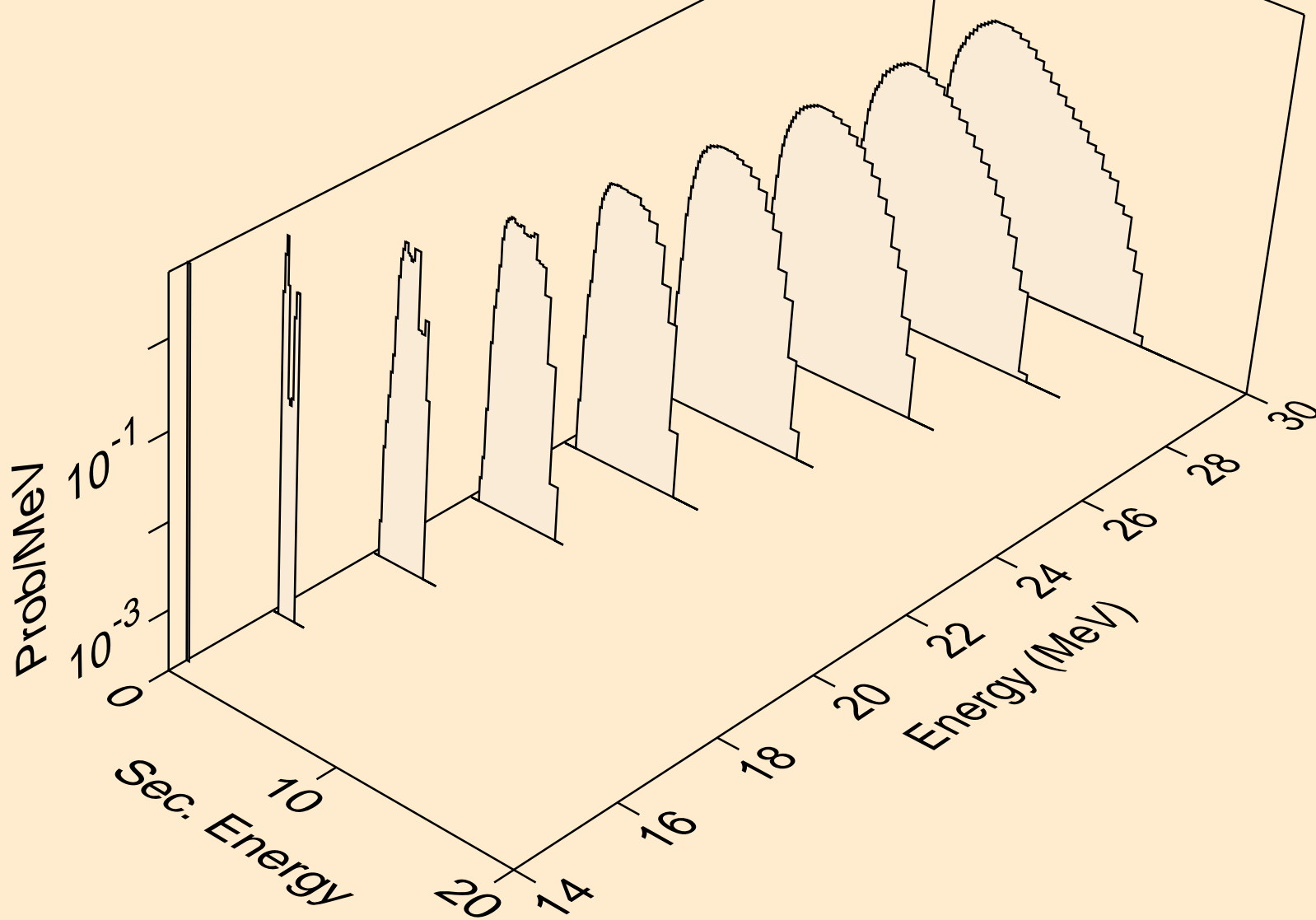



FE053 NEUTRON ACER TENDL-2019 LIBRARY; T=293.16K  
protons from (n,npa)

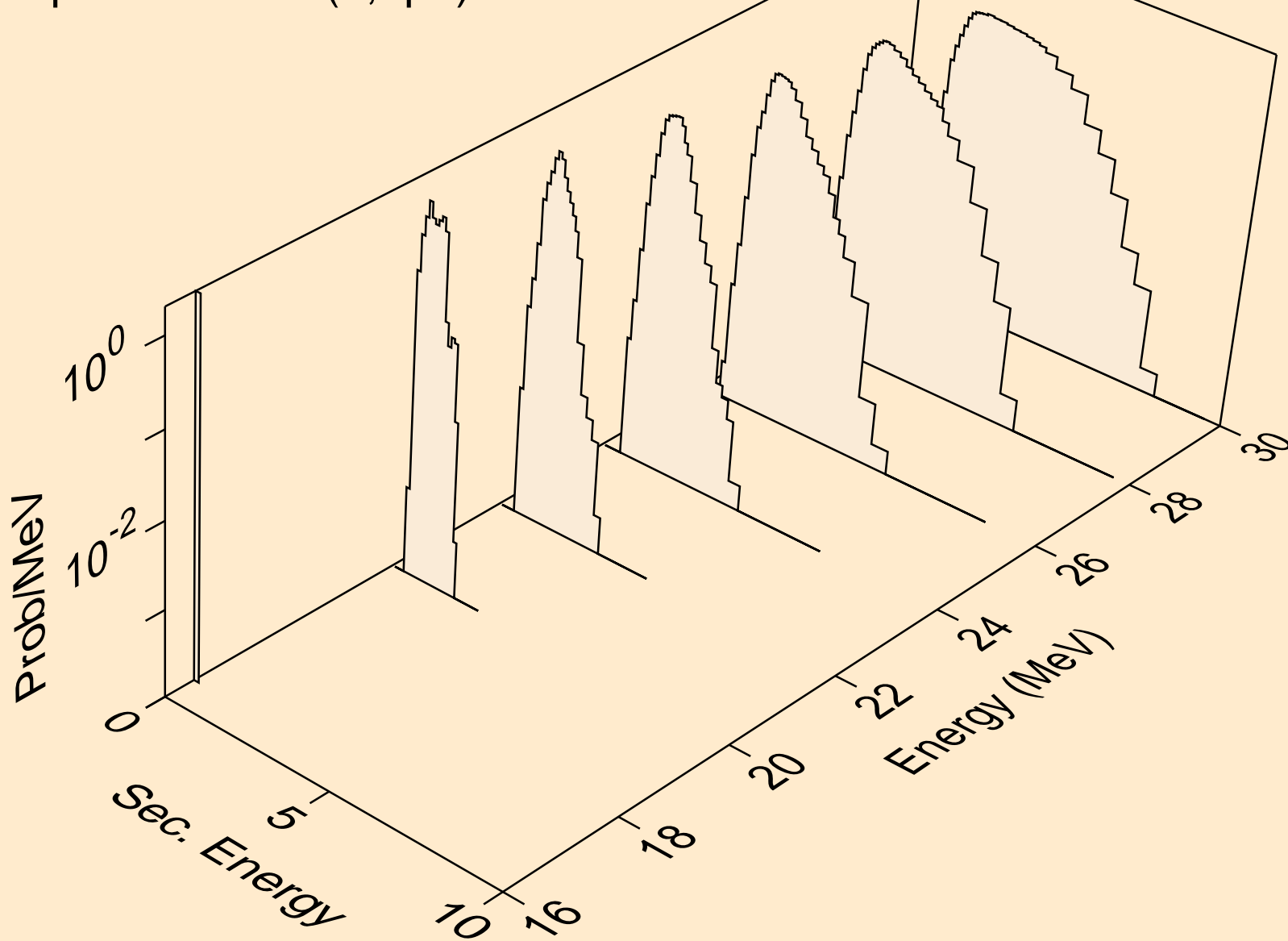

FE053 NEUTRON ACER TENDL-2019 LIBRARY; T=293.16K  
protons from (n,p)

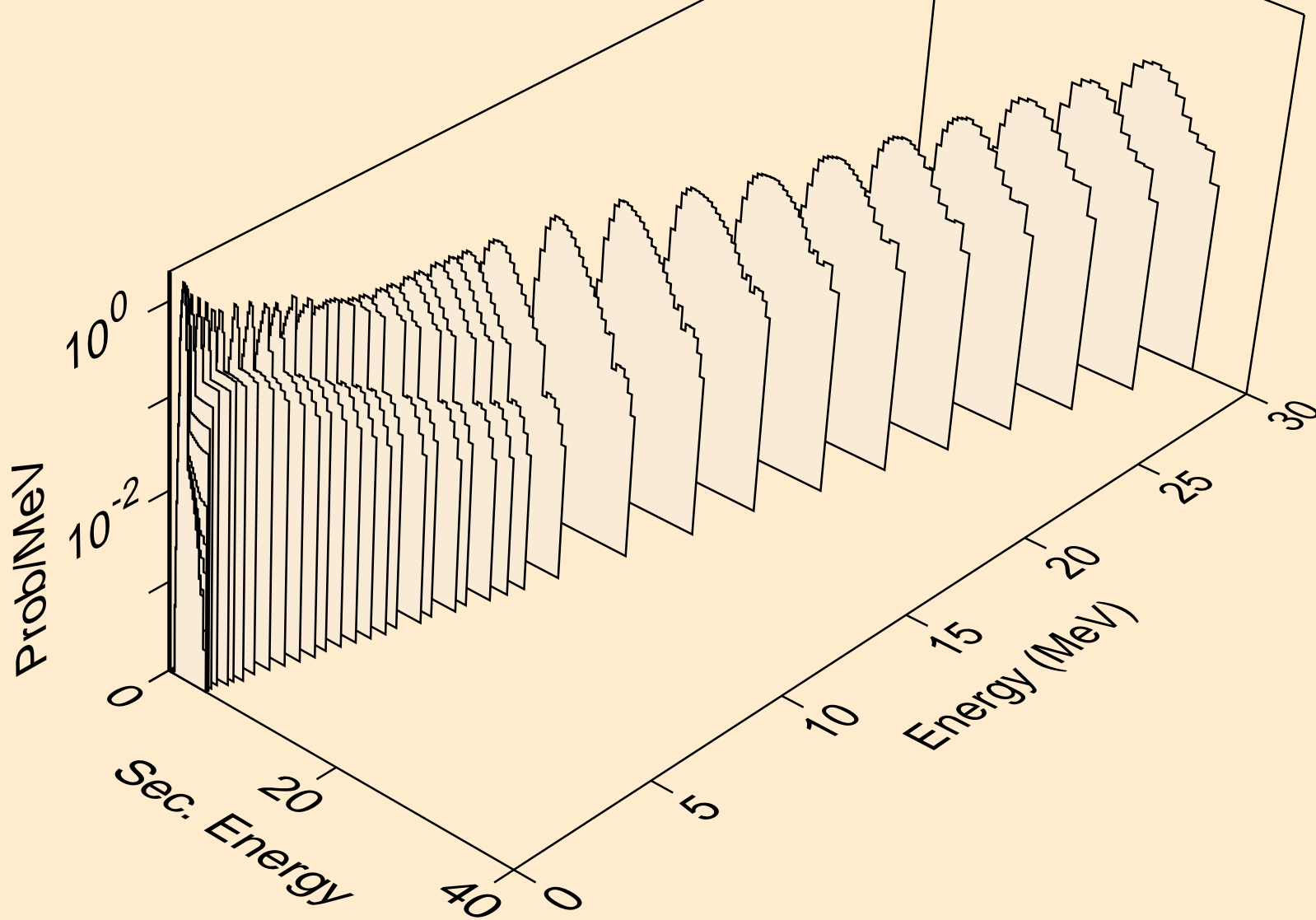

FE053 NEUTRON ACER TENDL-2019 LIBRARY; T=293.16K  
protons from (n,2p)

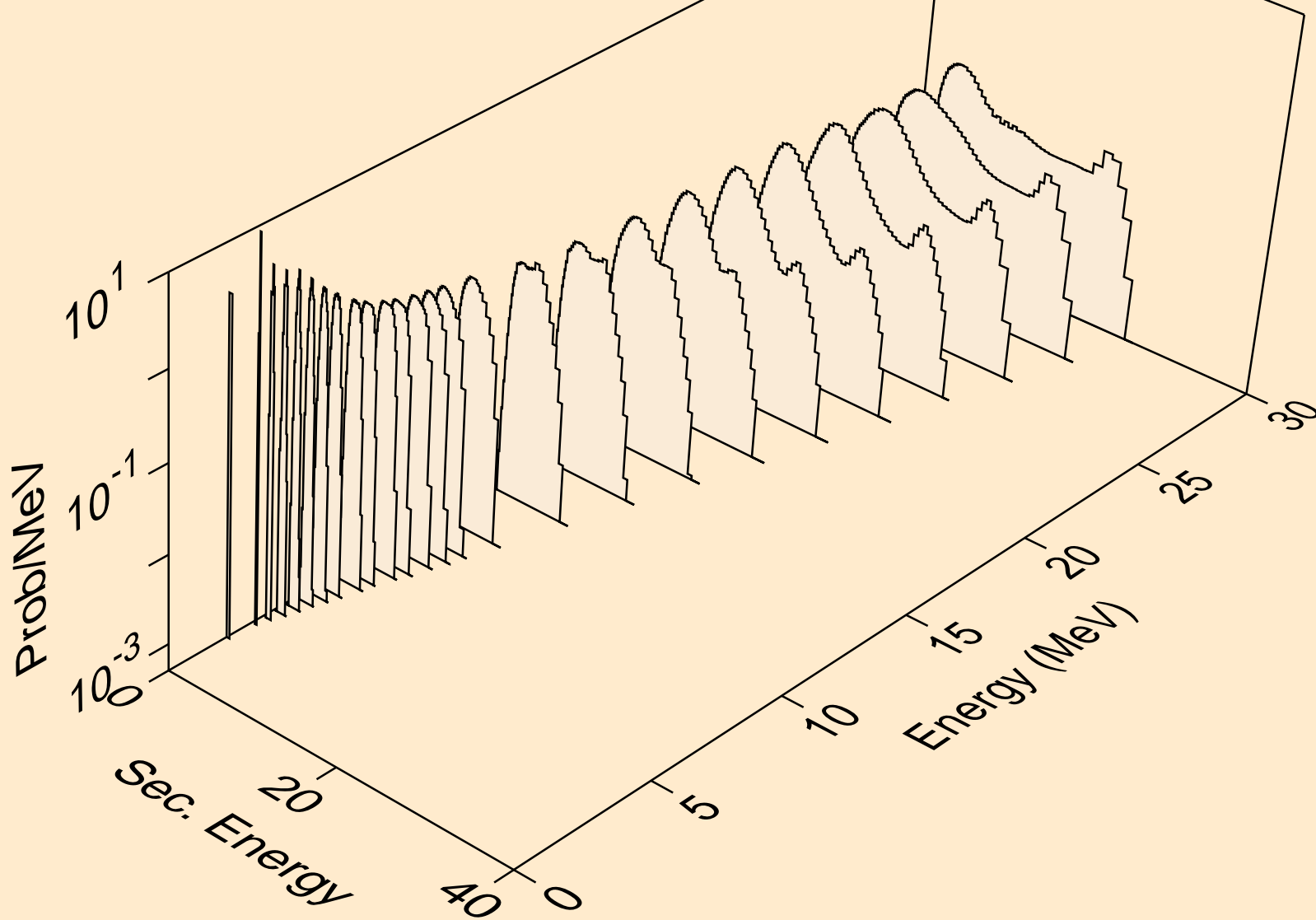

FE053 NEUTRON ACER TENDL-2019 LIBRARY; T=293.16K  
protons from (n,p)

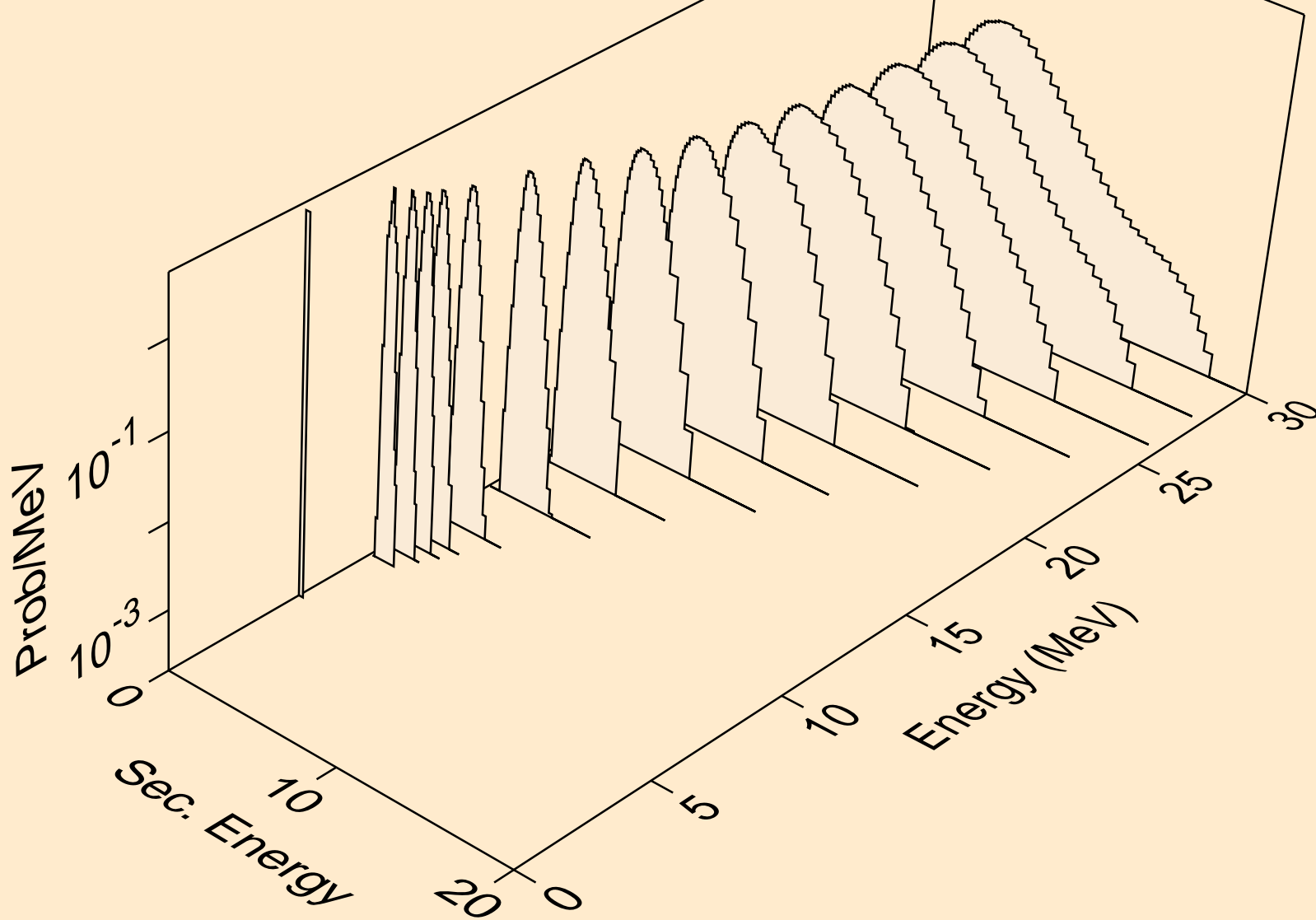

FE053 NEUTRON ACER TENDL-2019 LIBRARY; T=293.16K  
protons from (n,pd)

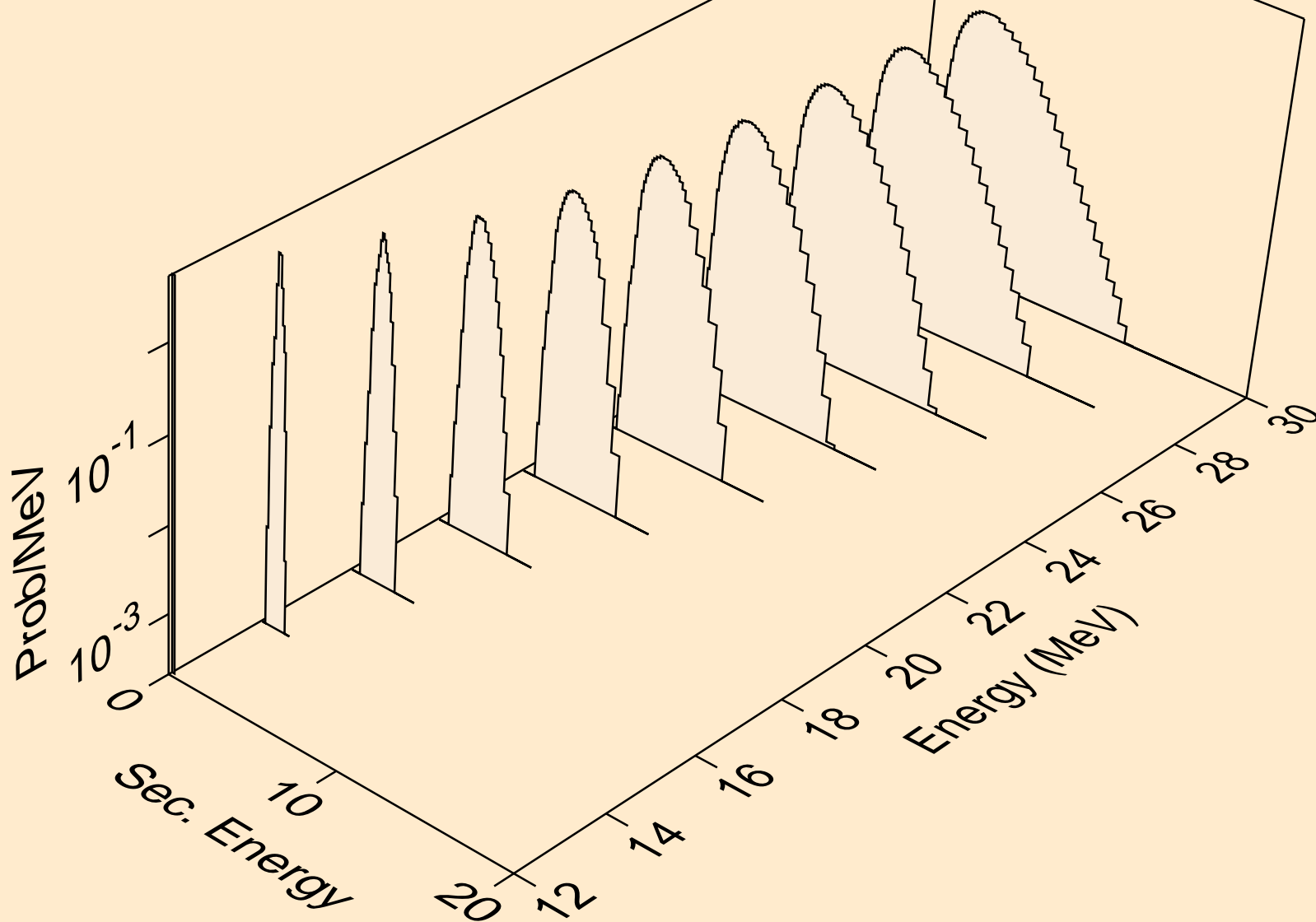

FE053 NEUTRON ACER TENDL-2019 LIBRARY; T=293.16K  
protons from (n,pt)

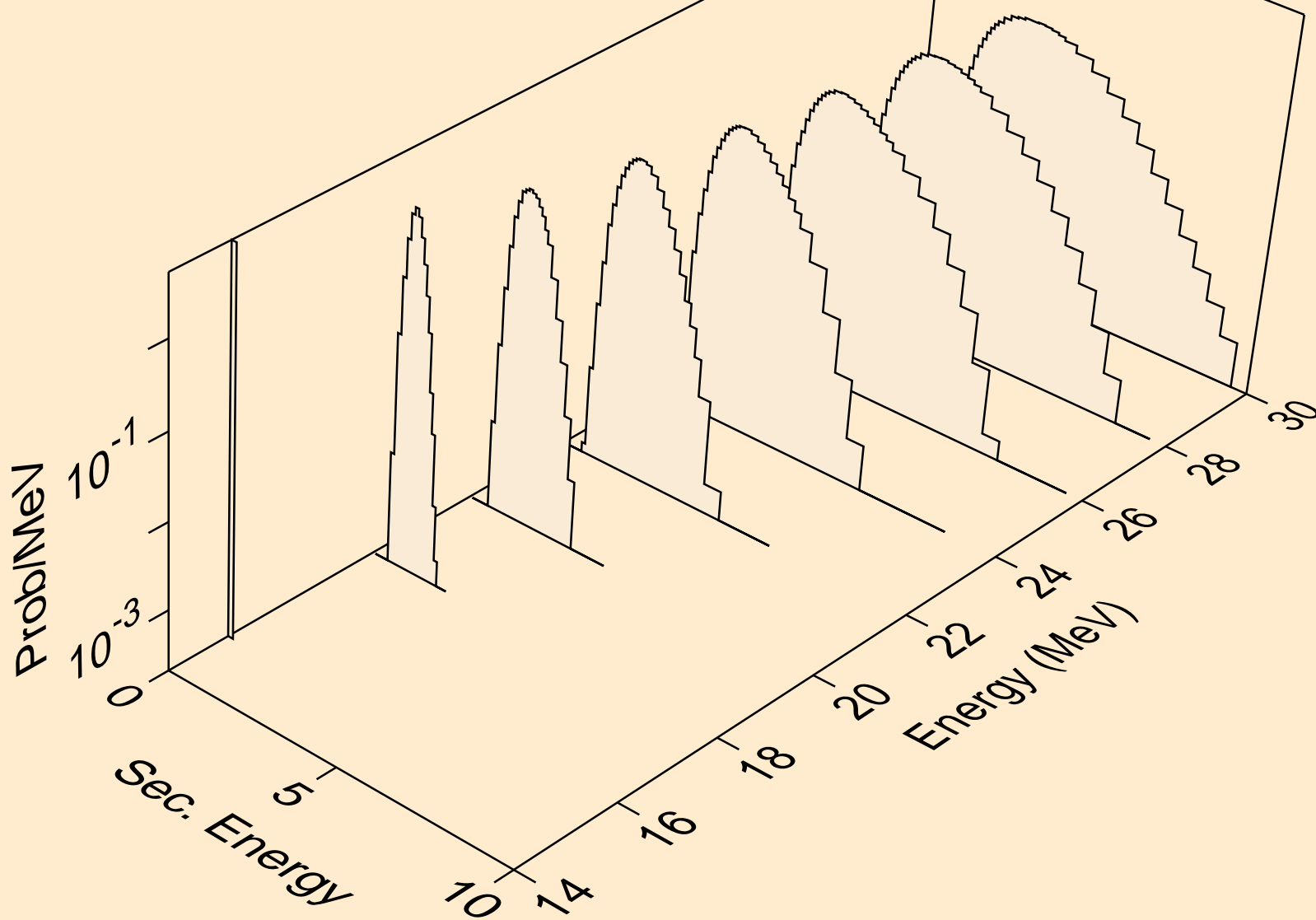

FE053 NEUTRON ACER TENDL-2019 LIBRARY; T=293.16K  
deuterons from (n,x)

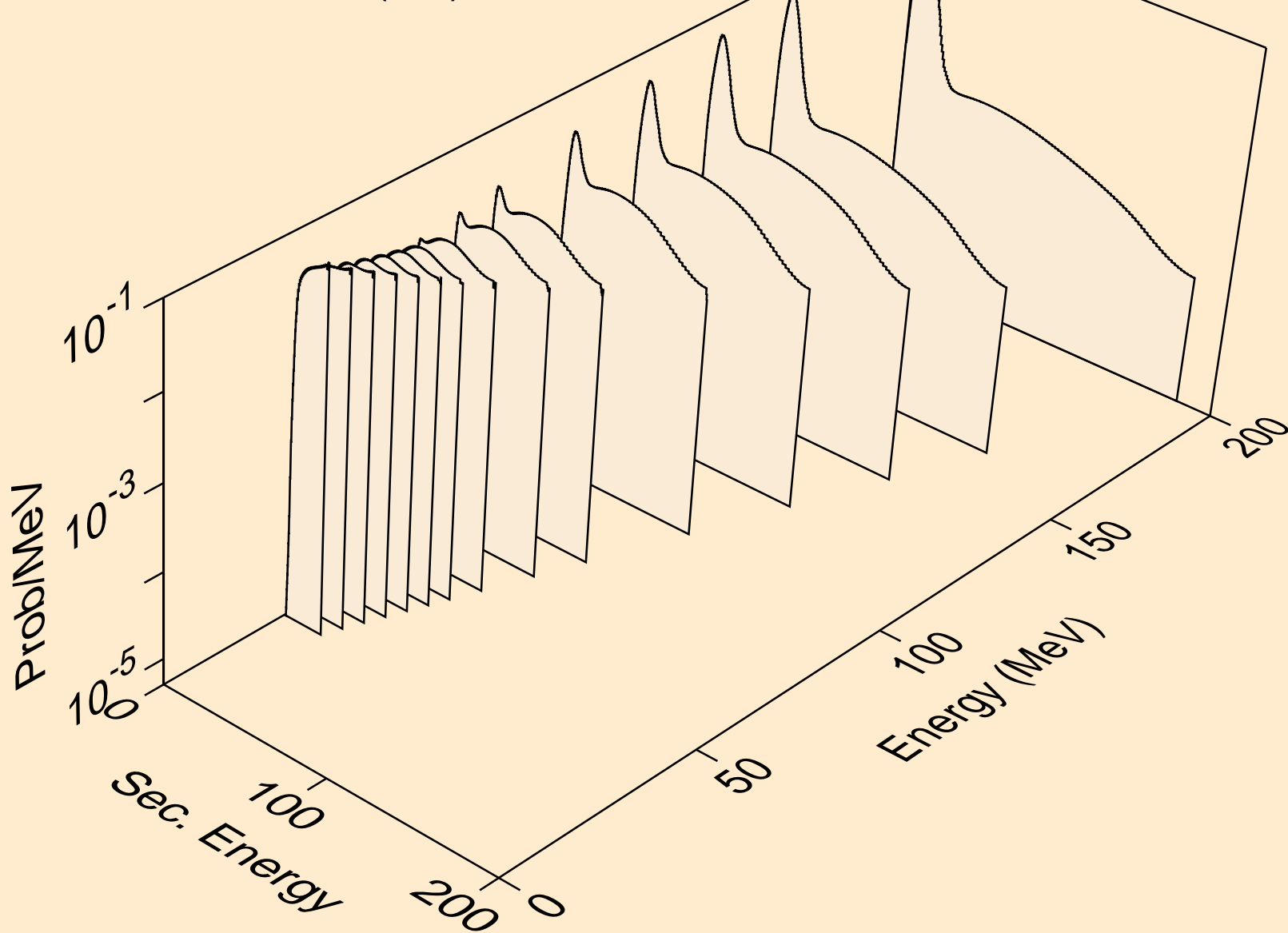

FE053 NEUTRON ACER TENDL-2019 LIBRARY; T=293.16K  
deuterons from (n,n\*)d

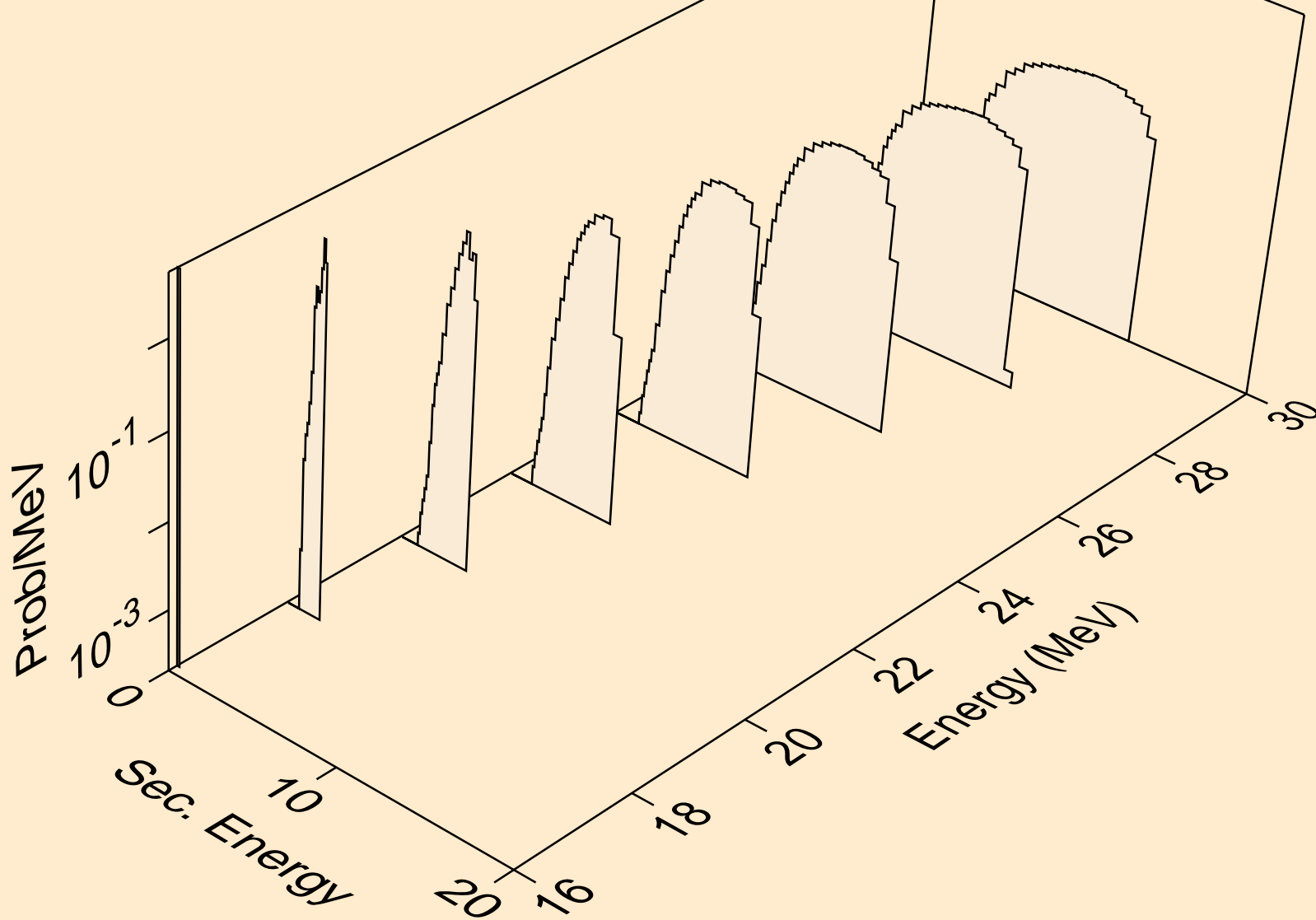



FE053 NEUTRON ACER TENDL-2019 LIBRARY; T=293.16K  
deuterons from (n,d)

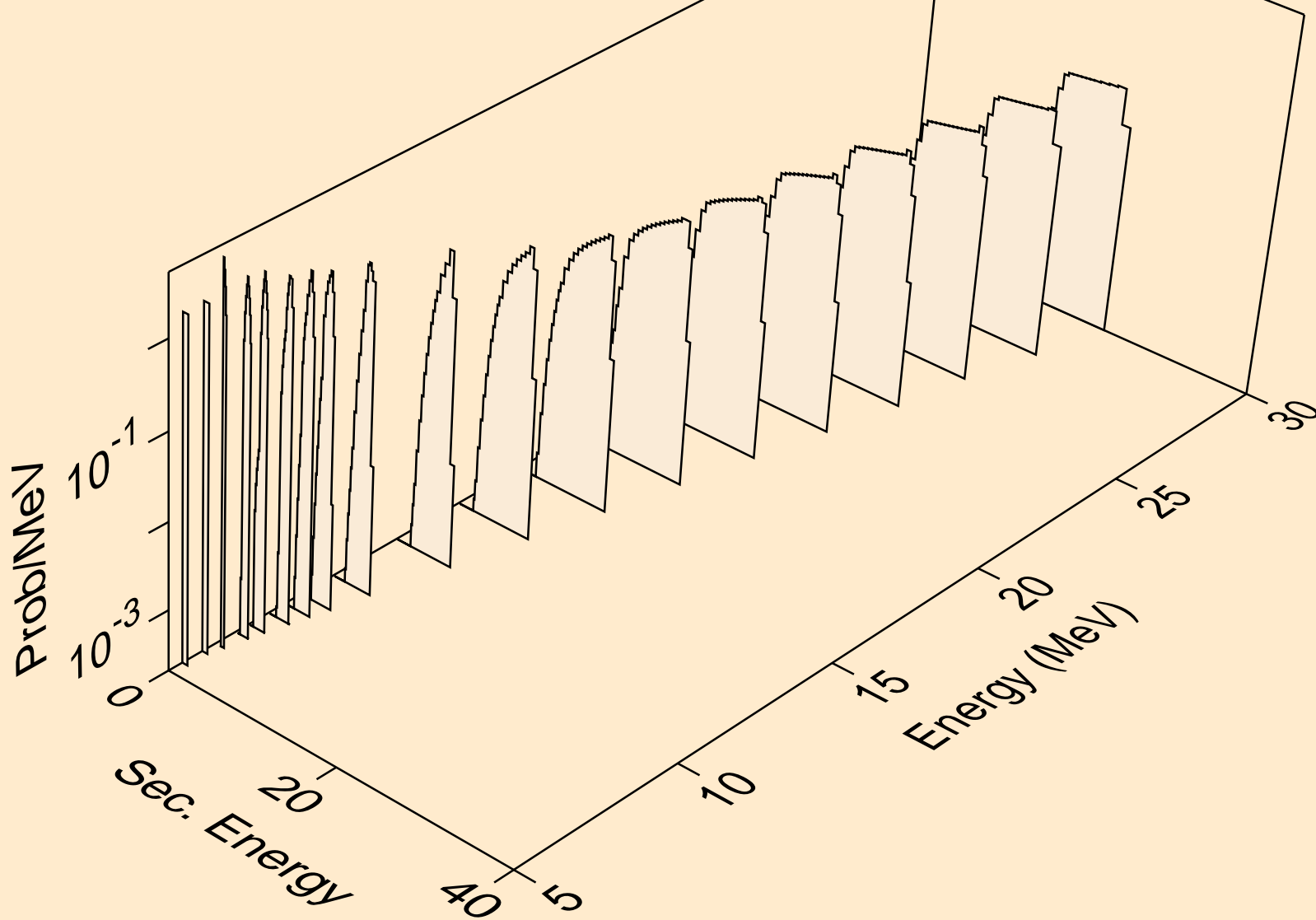

FE053 NEUTRON ACER TENDL-2019 LIBRARY; T=293.16K  
deuterons from (n,pd)

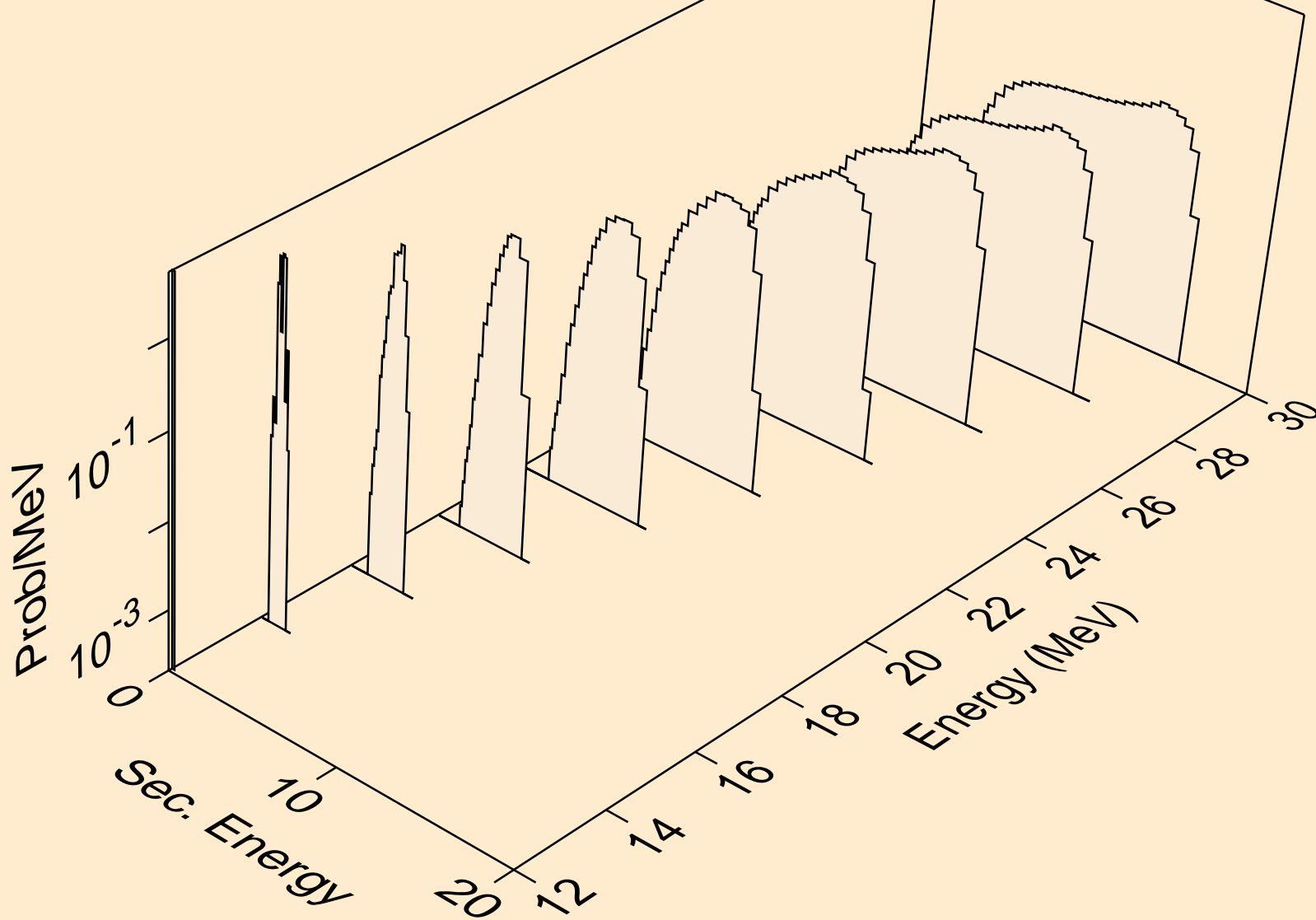

FE053 NEUTRON ACER TENDL-2019 LIBRARY; T=293.16K  
deuterons from (n,da)

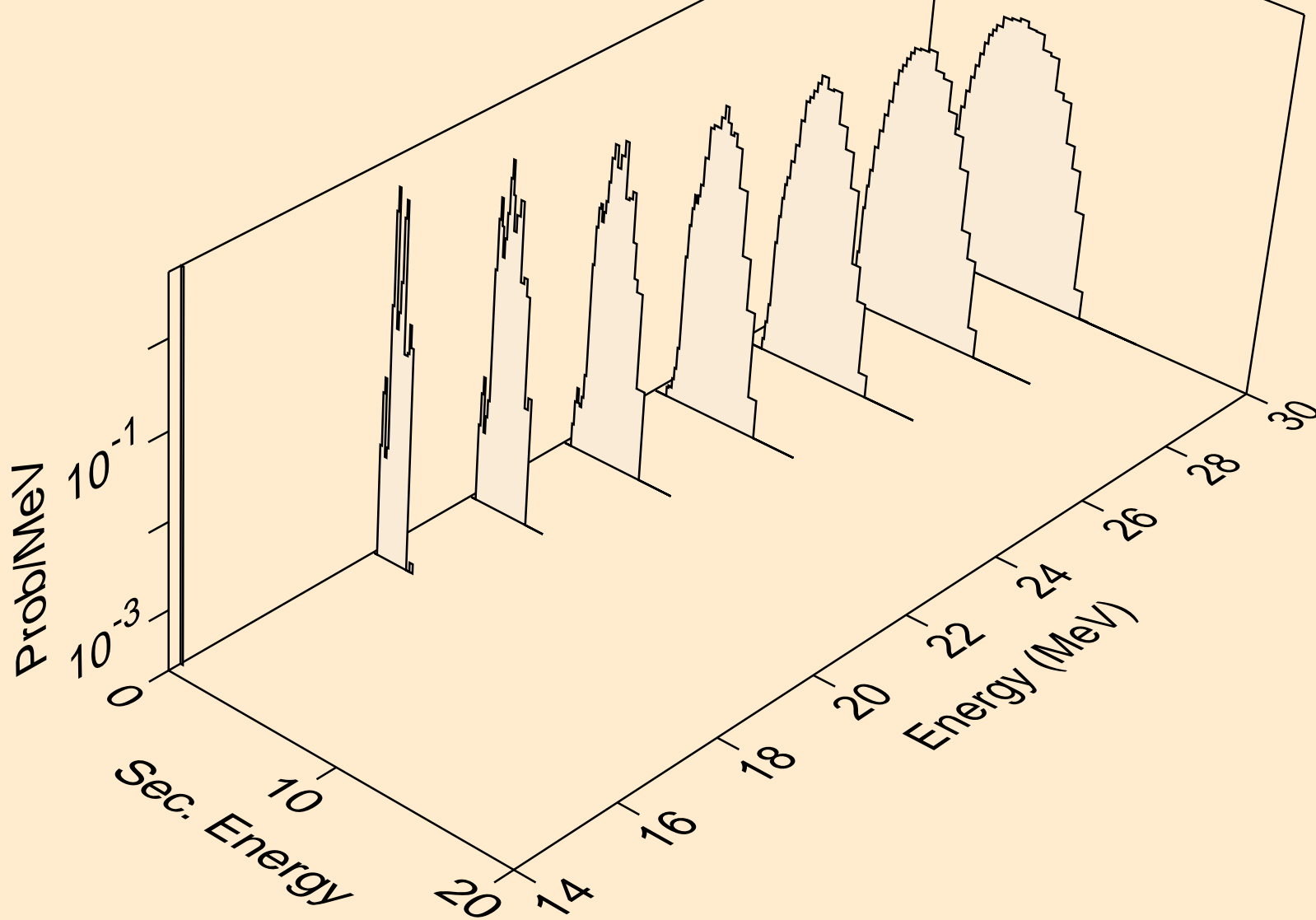

FE053 NEUTRON ACER TENDL-2019 LIBRARY; T=293.16K  
tritons from (n,x)

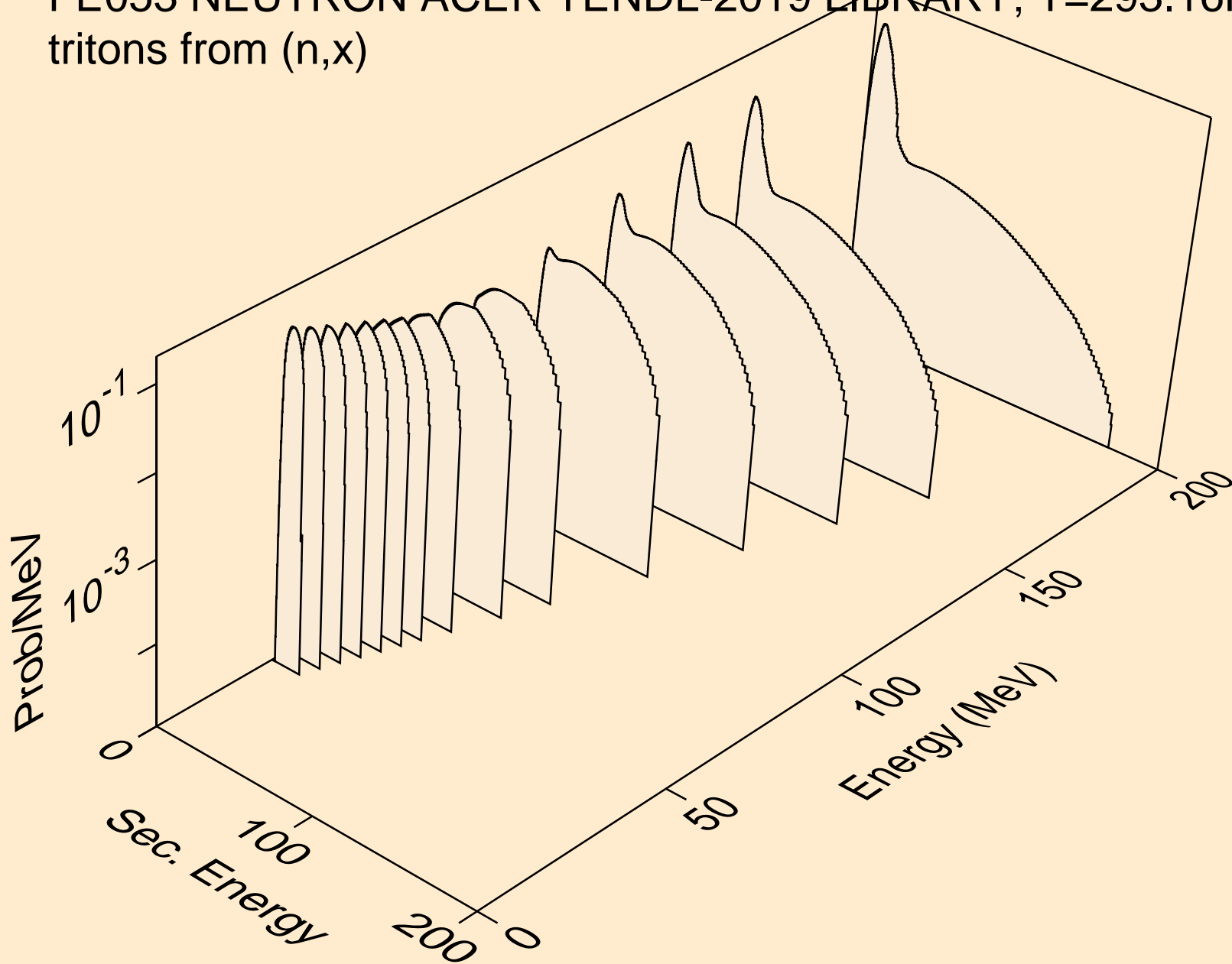

FE053 NEUTRON ACER TENDL-2019 LIBRARY; T=293.16K  
tritons from (n,n\*)t

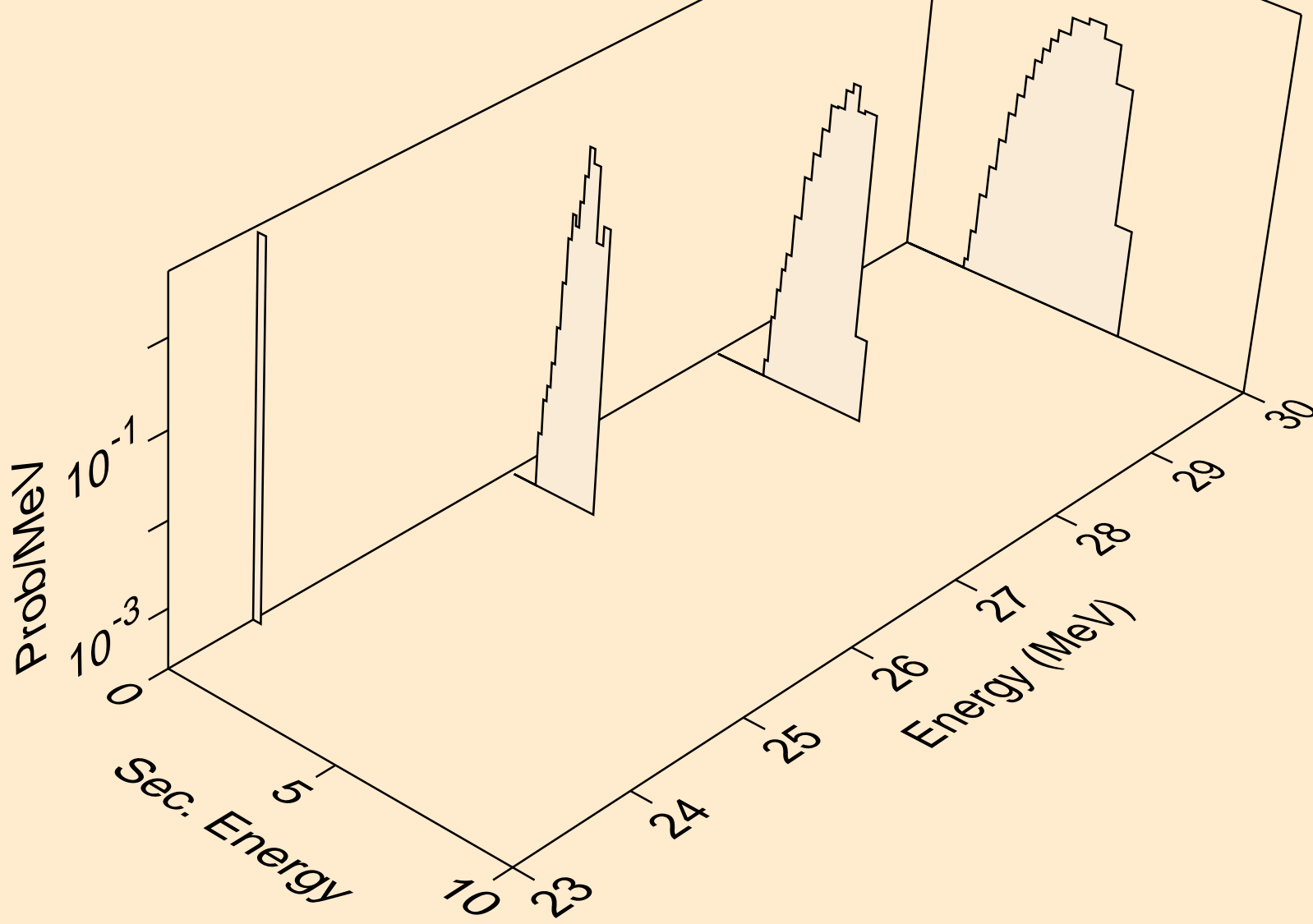

FE053 NEUTRON ACER TENDL-2019 LIBRARY; T=293.16K  
tritons from (n,t)

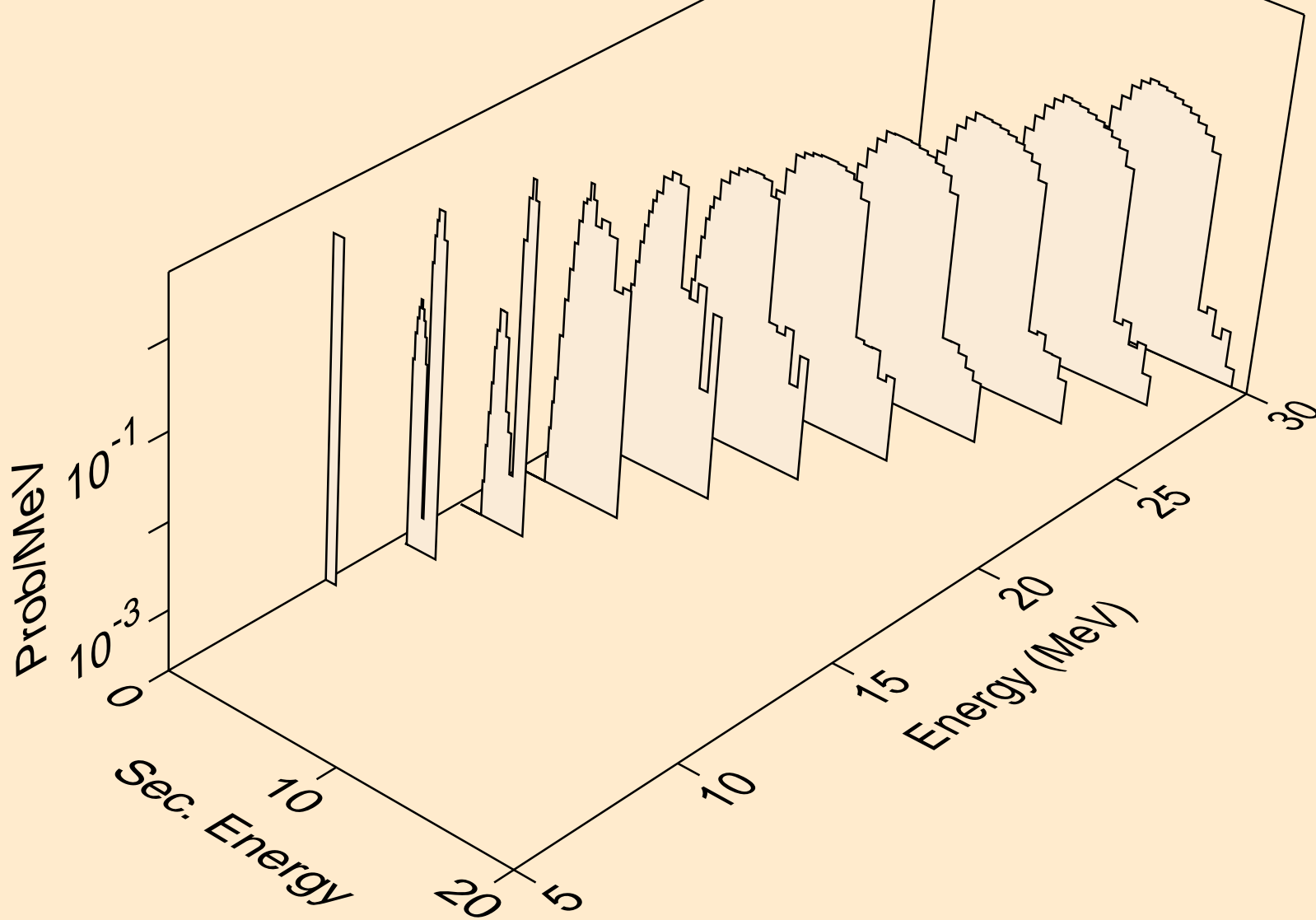

FE053 NEUTRON ACER TENDL-2019 LIBRARY; T=293.16K  
tritons from (n,pt)

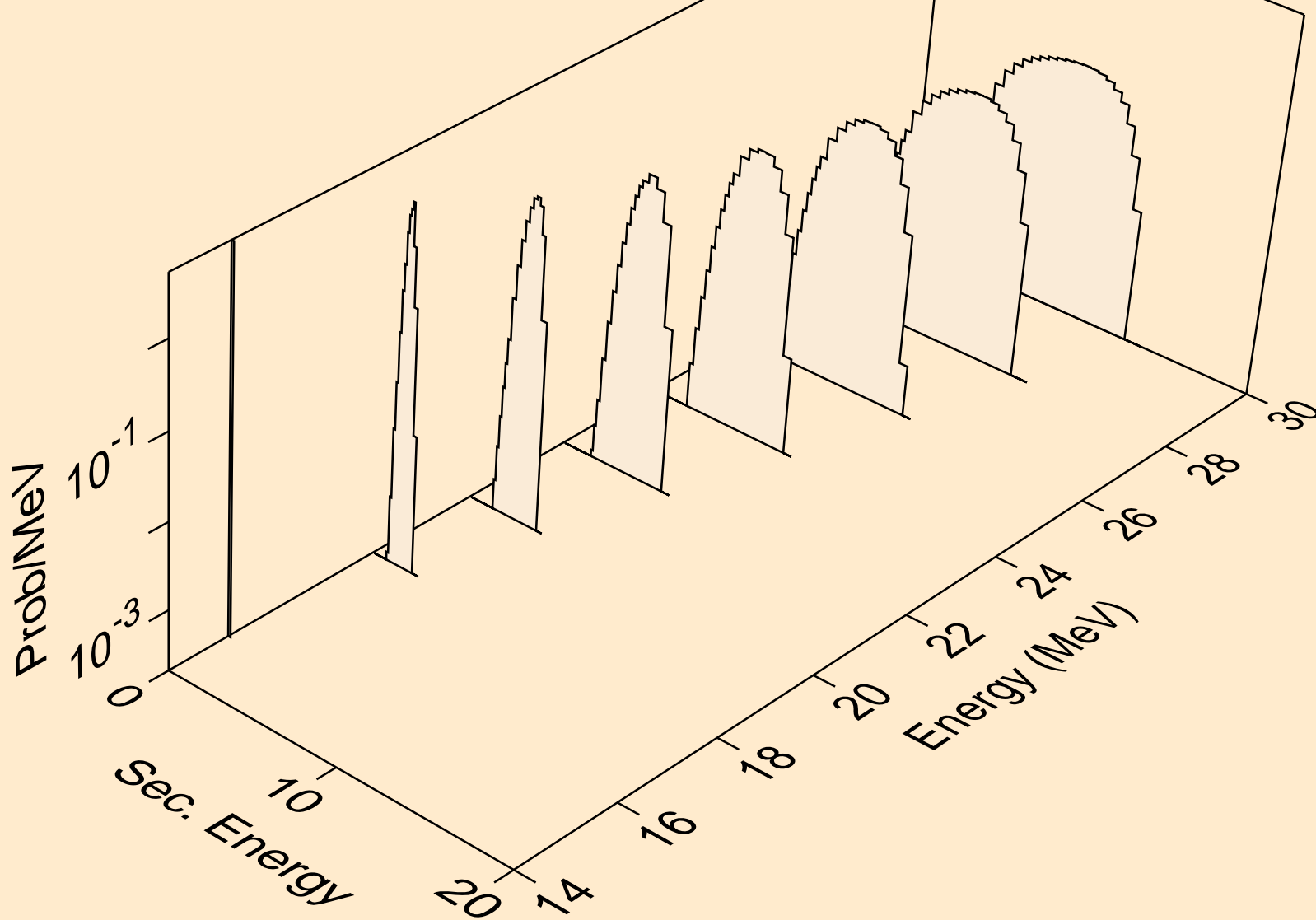

FE053 NEUTRON ACER TENDL-2019 LIBRARY; T=293.16K  
he3s from (n,x)

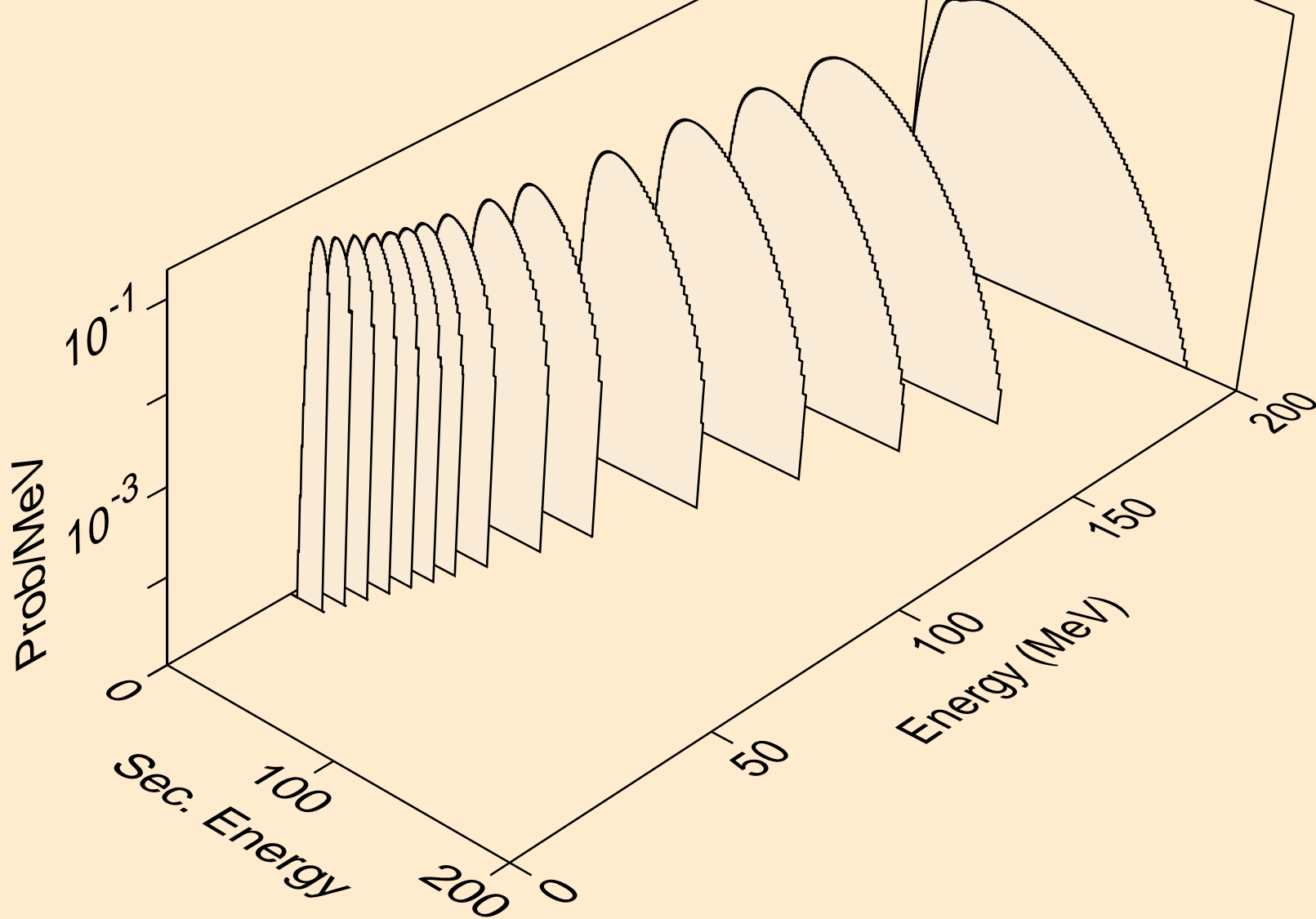



FE053 NEUTRON ACER TENDL-2019 LIBRARY; T=293.16K  
he3s from (n,n\*)he3

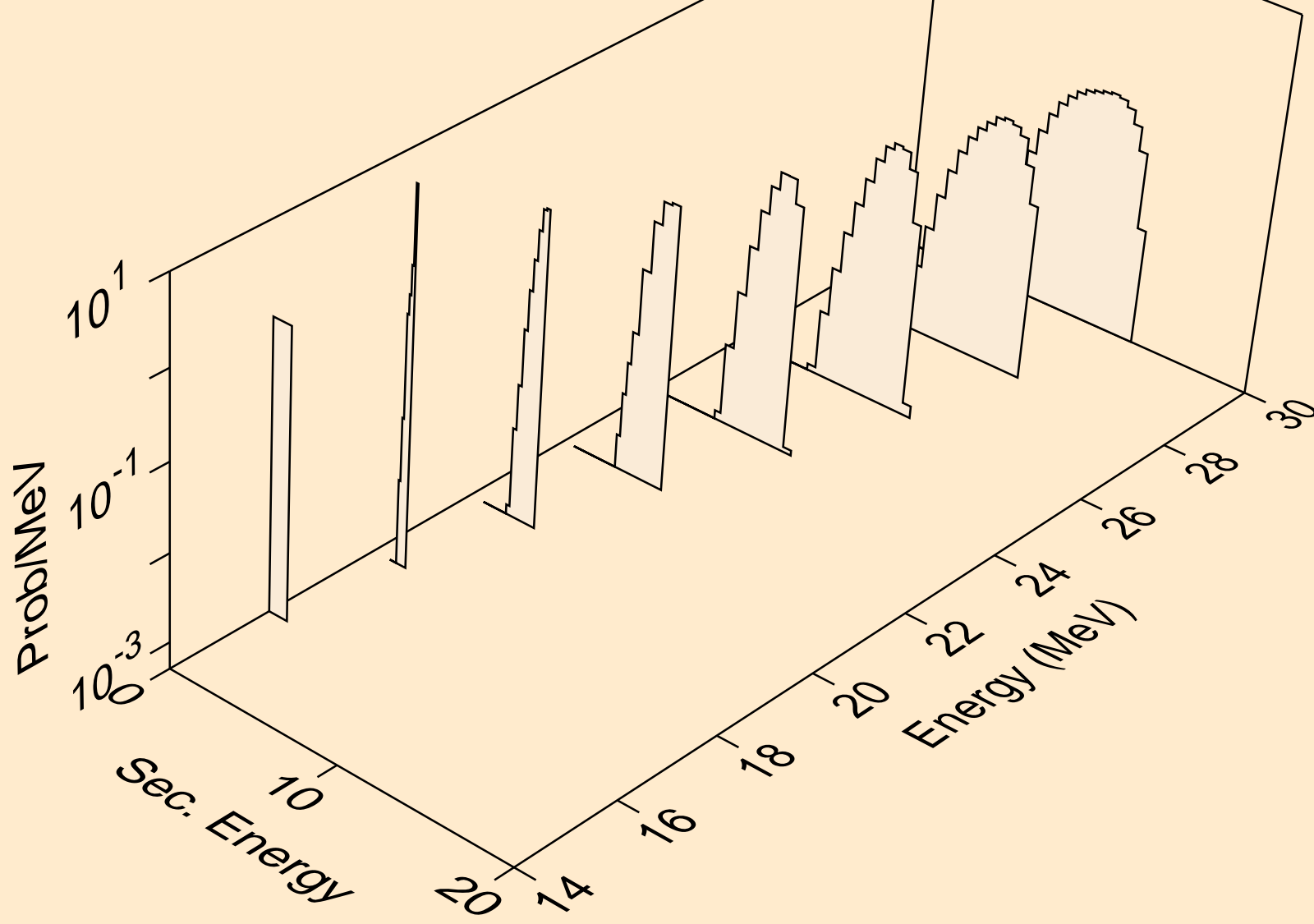

FE053 NEUTRON ACER TENDL-2019 LIBRARY; T=293.16K  
he3s from (n,he3)

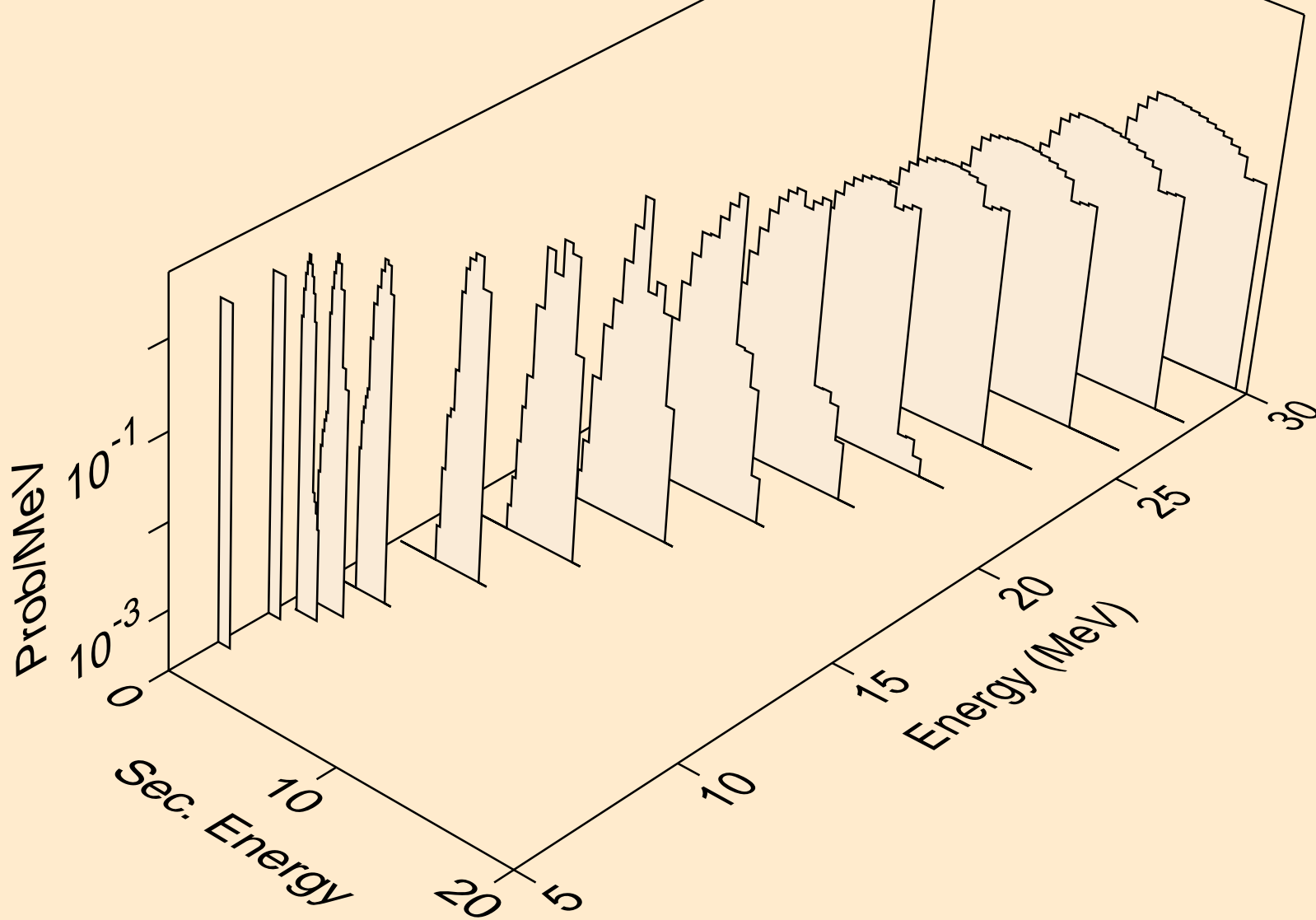

FE053 NEUTRON ACER TENDL-2019 LIBRARY; T=293.16K  
alphas from (n,x)

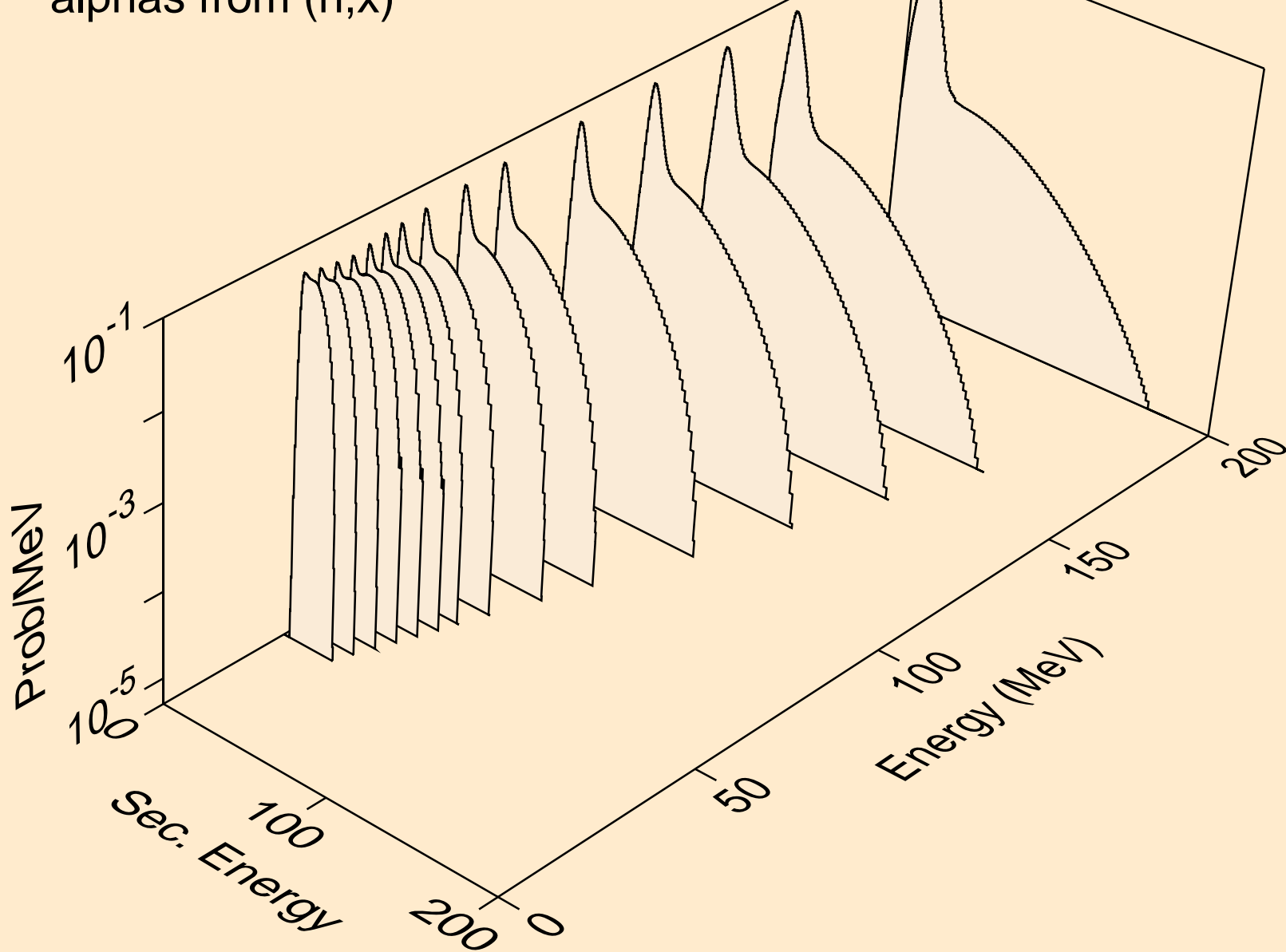

FE053 NEUTRON ACER TENDL-2019 LIBRARY; T=293.16K  
alphas from (n,n\*)a

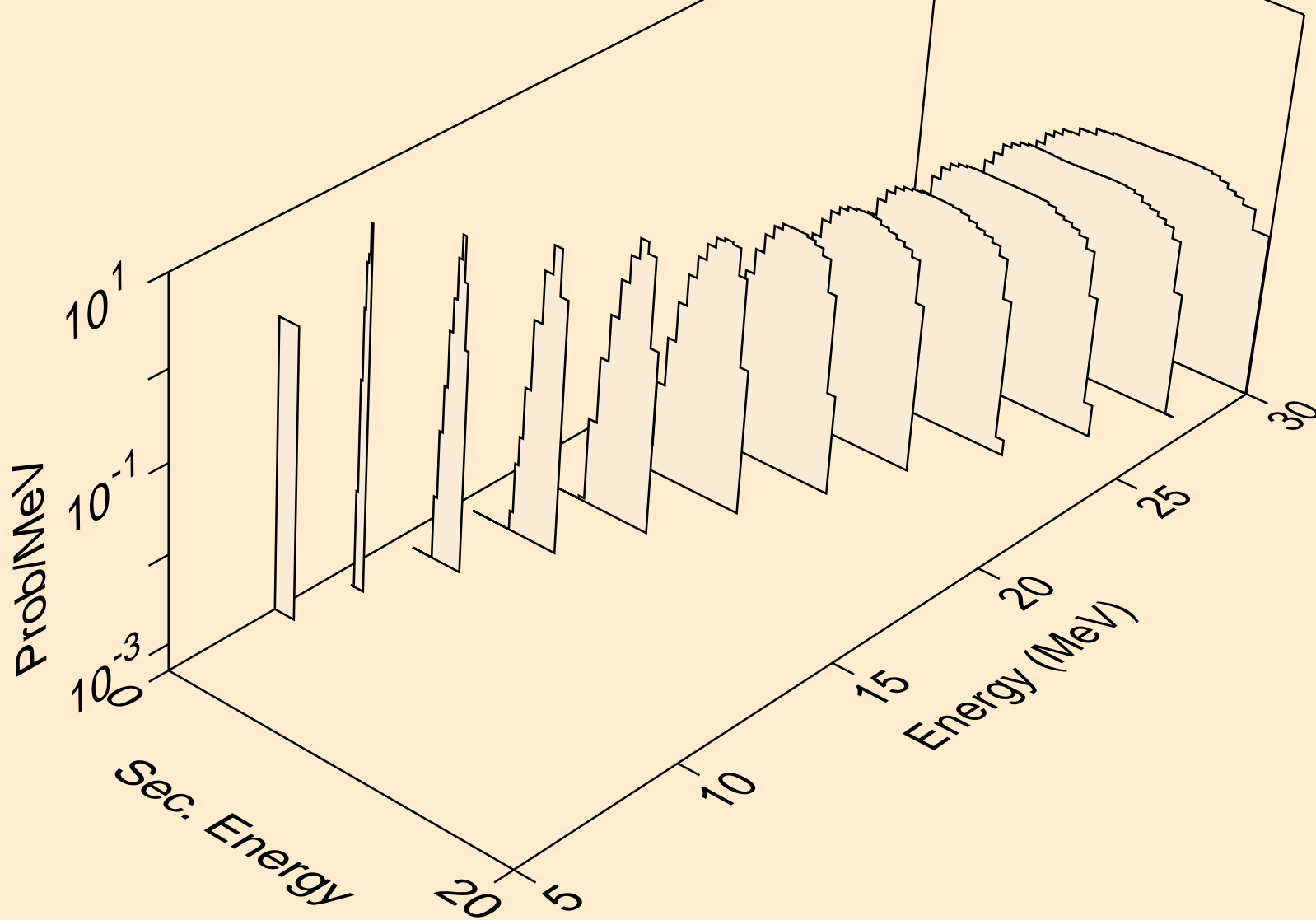

FE053 NEUTRON ACER TENDL-2019 LIBRARY; T=293.16K  
alphas from (n,2n)a

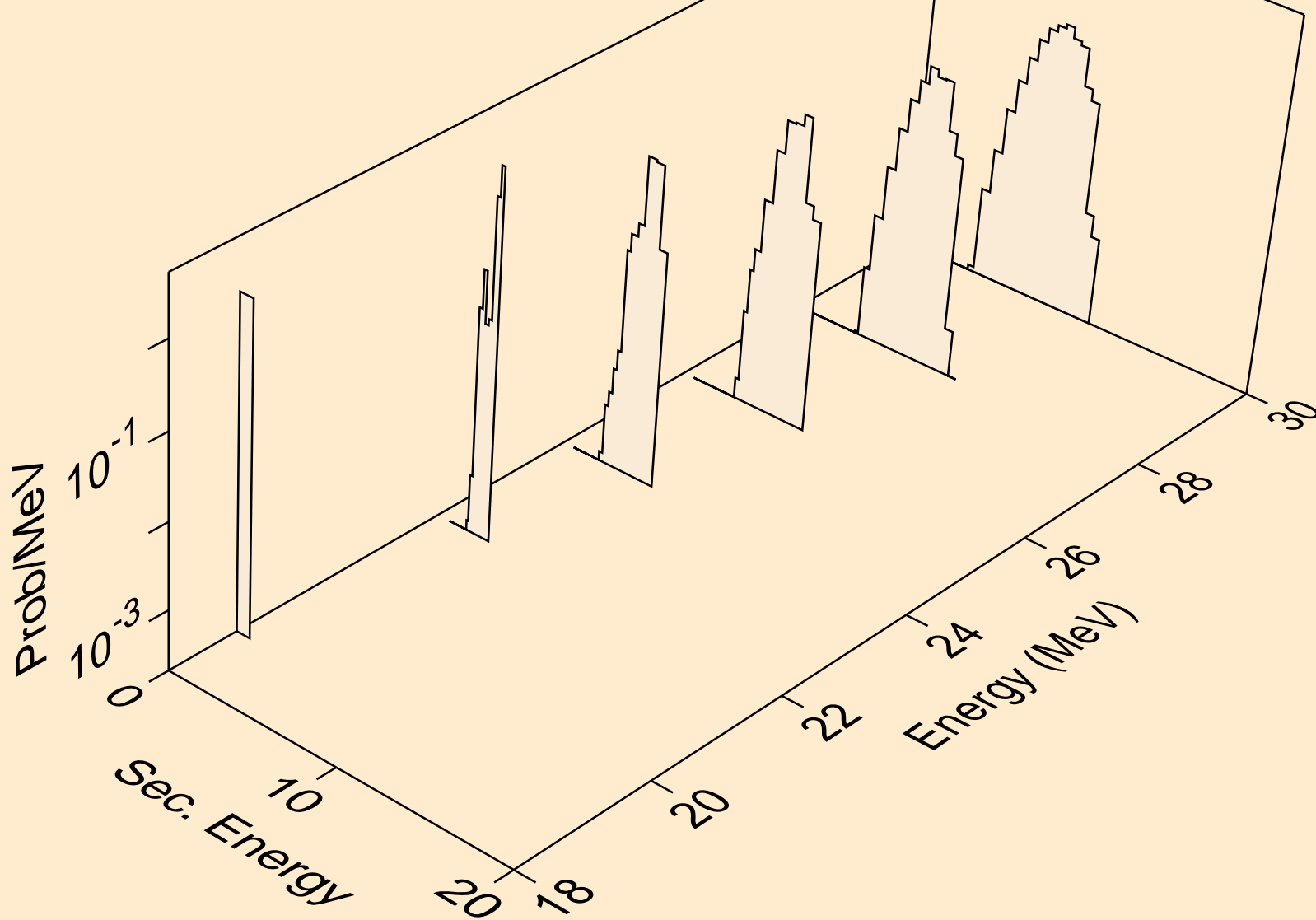

FE053 NEUTRON ACER TENDL-2019 LIBRARY; T=293.16K  
alphas from (n,n\*)2a

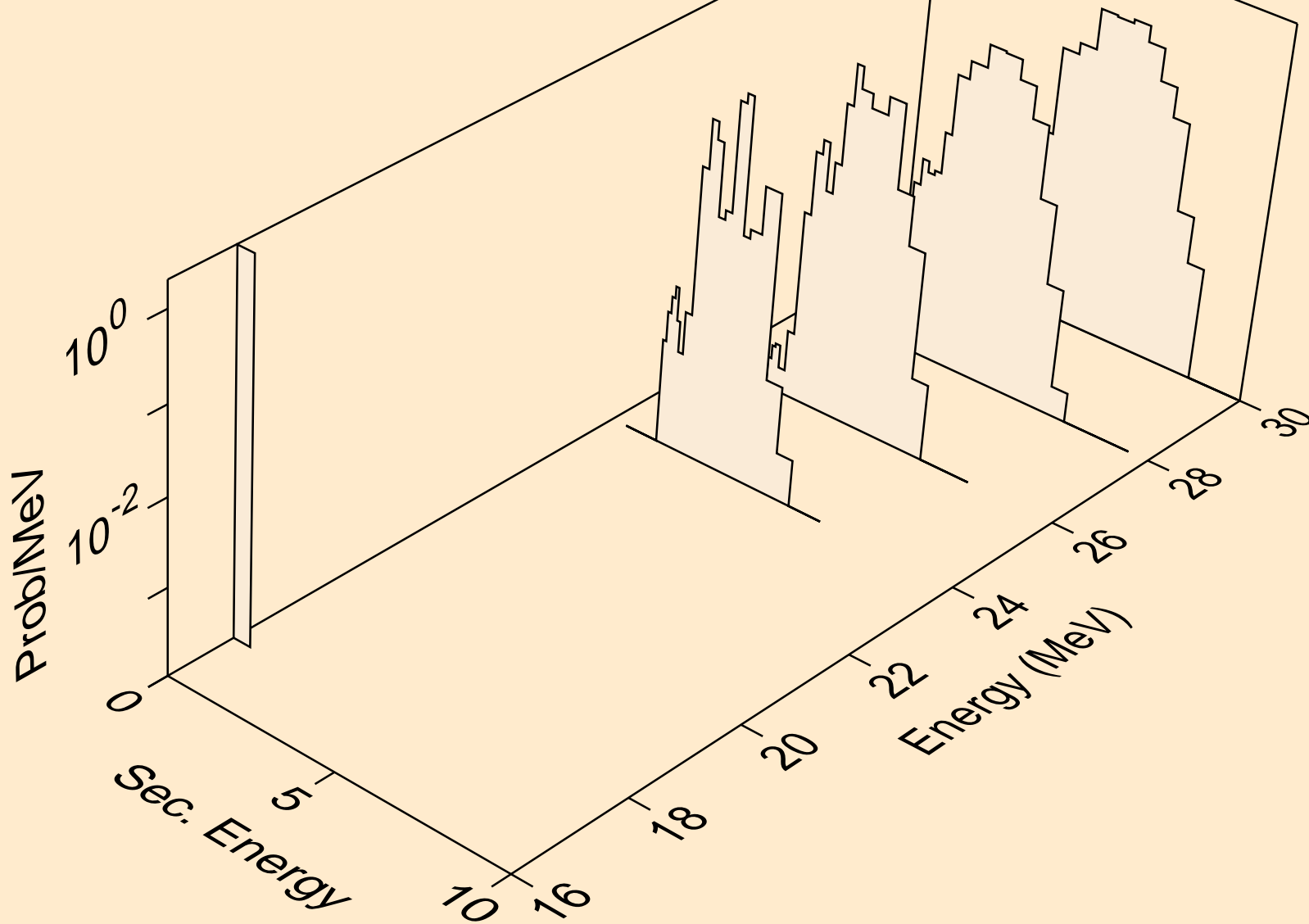

FE053 NEUTRON ACER TENDL-2019 LIBRARY; T=293.16K  
alphas from (n,npa)

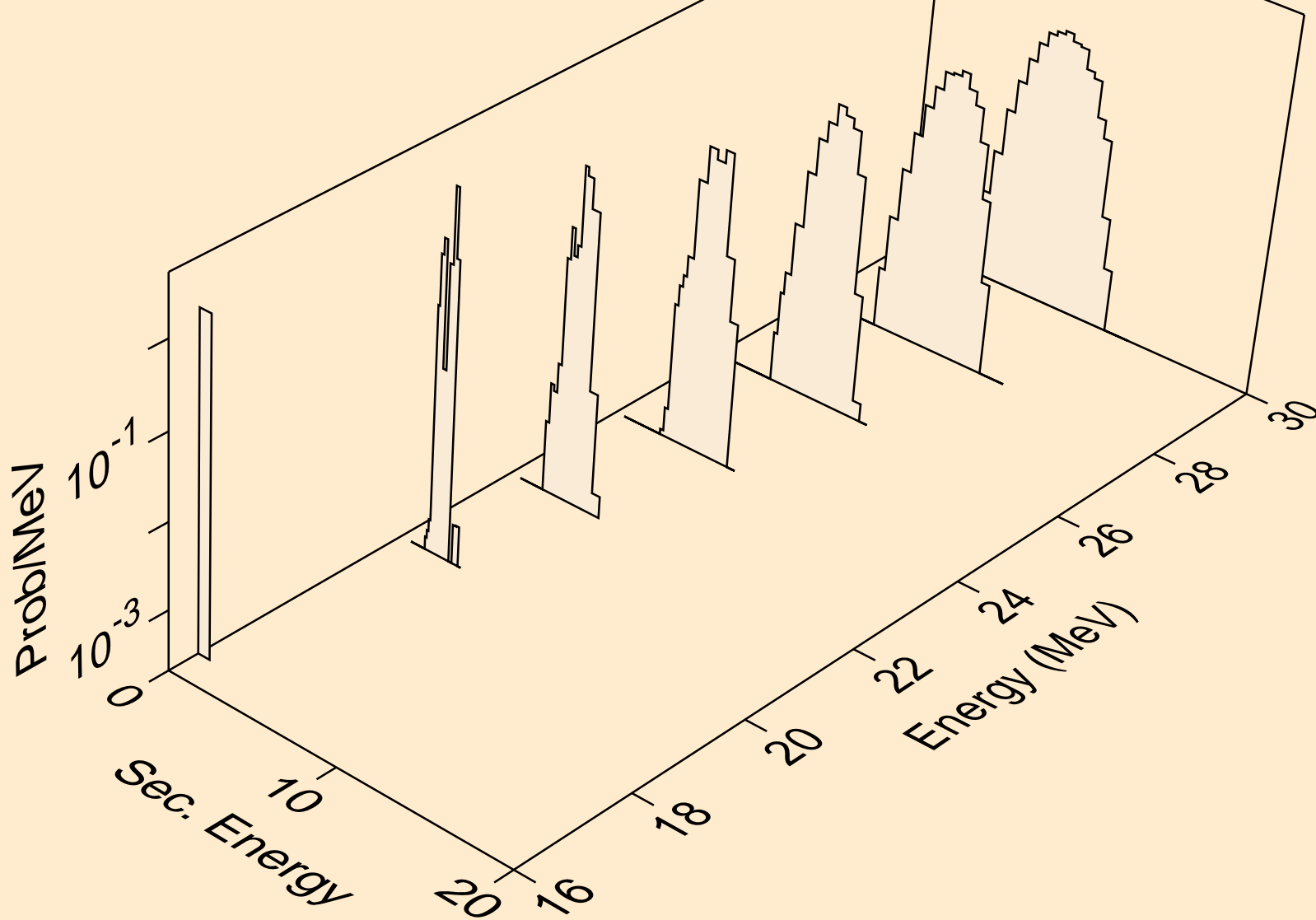

FE053 NEUTRON ACER TENDL-2019 LIBRARY; T=293.16K  
alphas from (n,a)

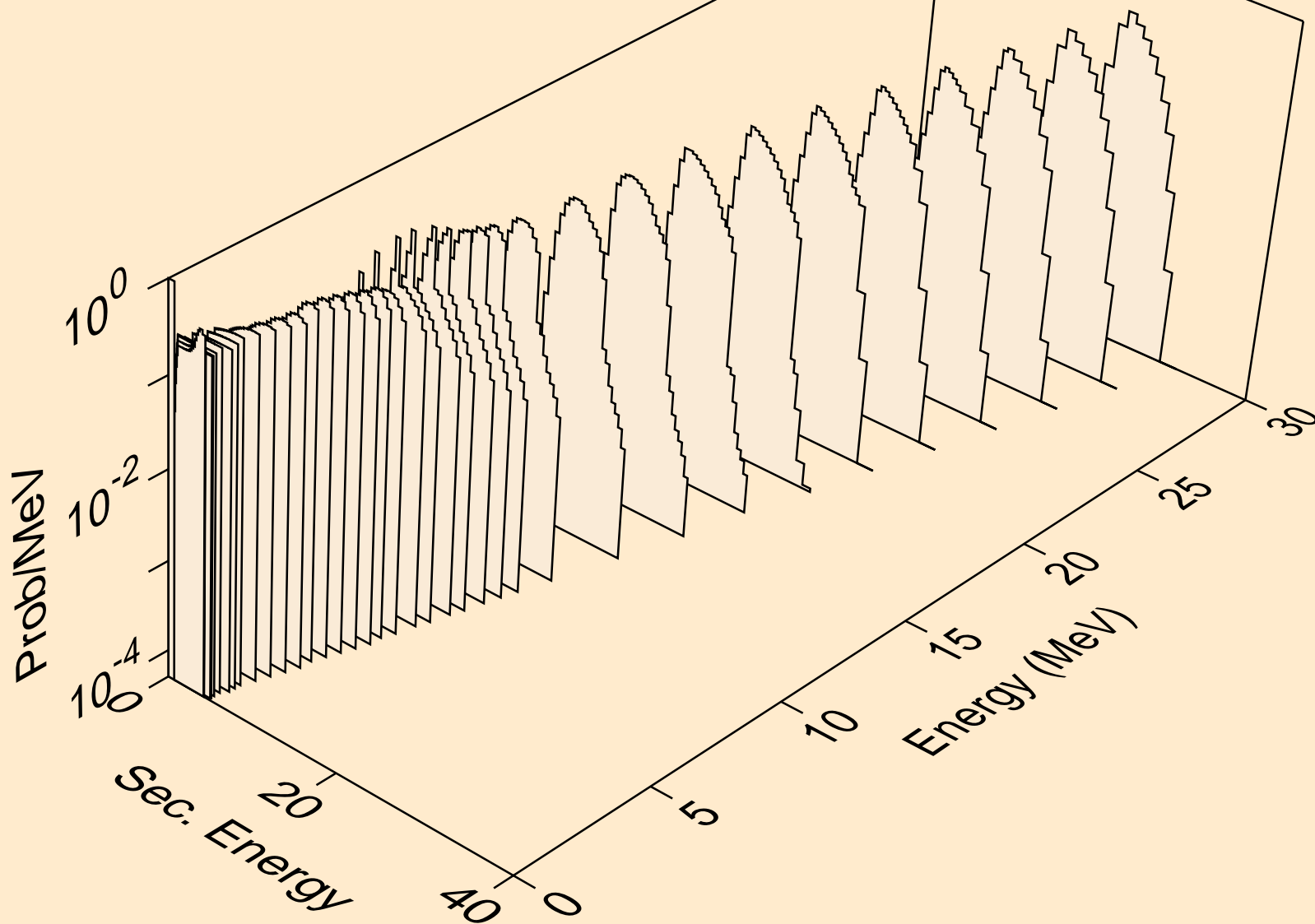



FE053 NEUTRON ACER TENDL-2019 LIBRARY; T=293.16K  
alphas from (n,2a)

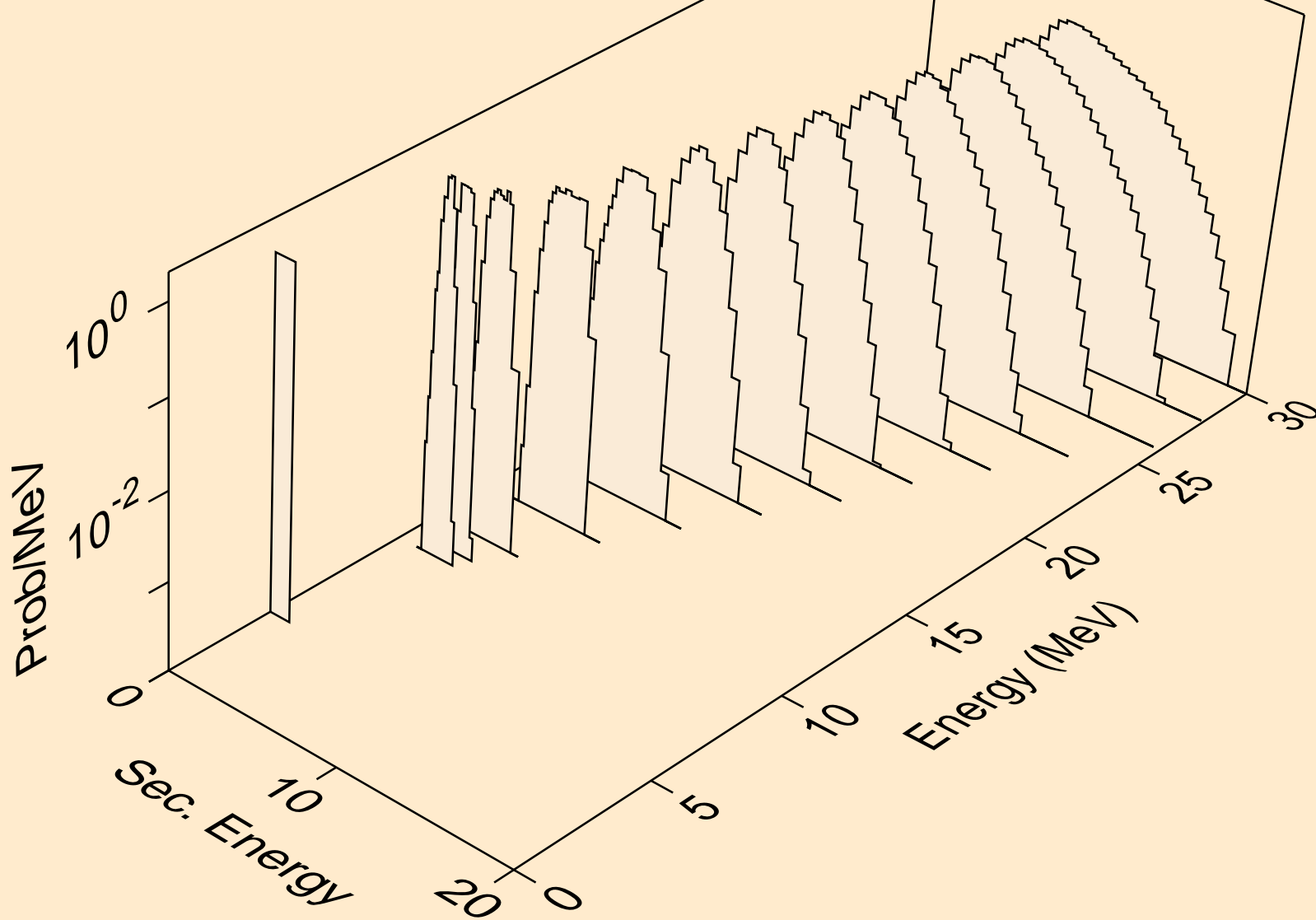

FE053 NEUTRON ACER TENDL-2019 LIBRARY; T=293.16K  
alphas from (n,3a)

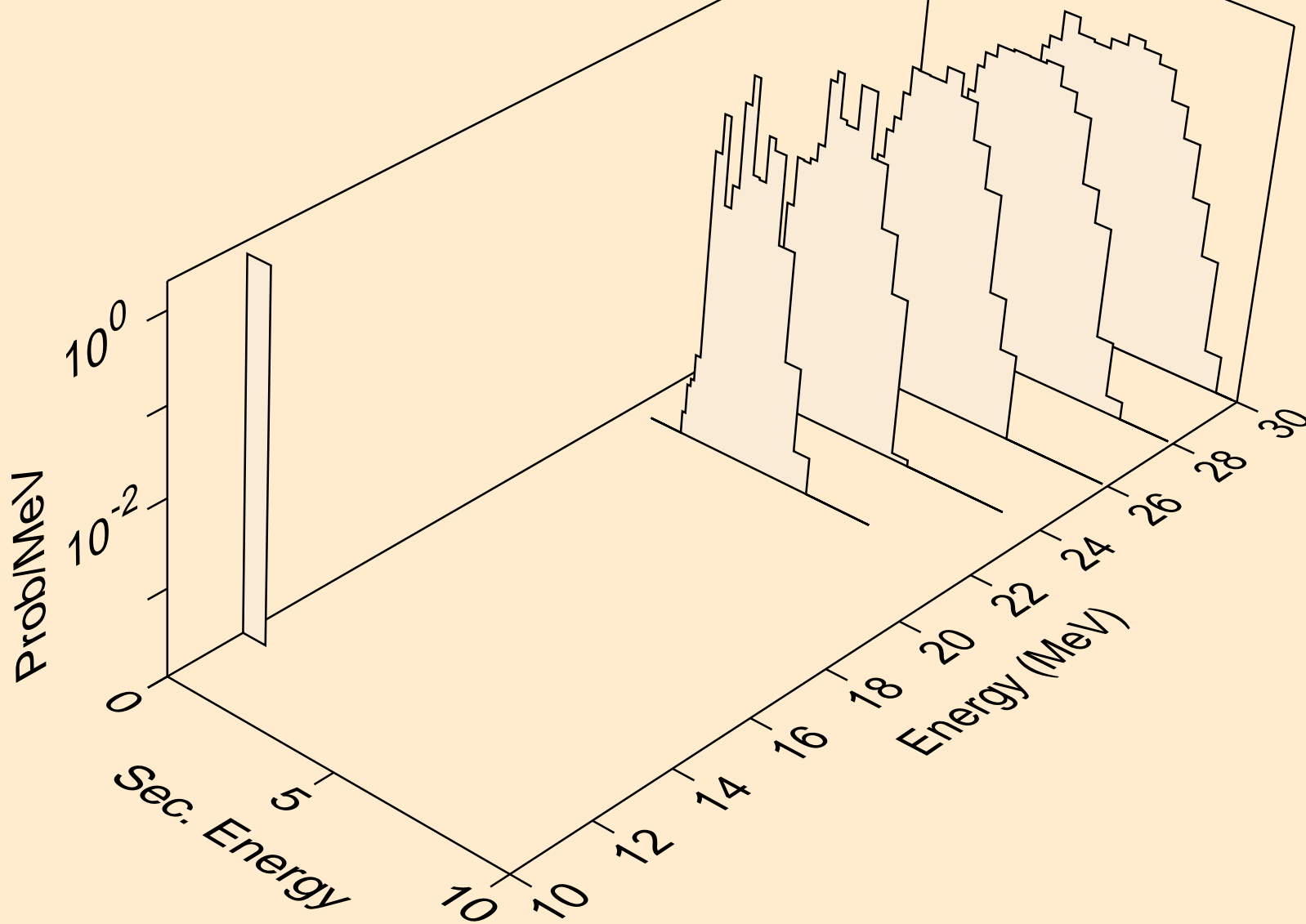

FE053 NEUTRON ACER TENDL-2019 LIBRARY; T=293.16K  
alphas from (n,pa)

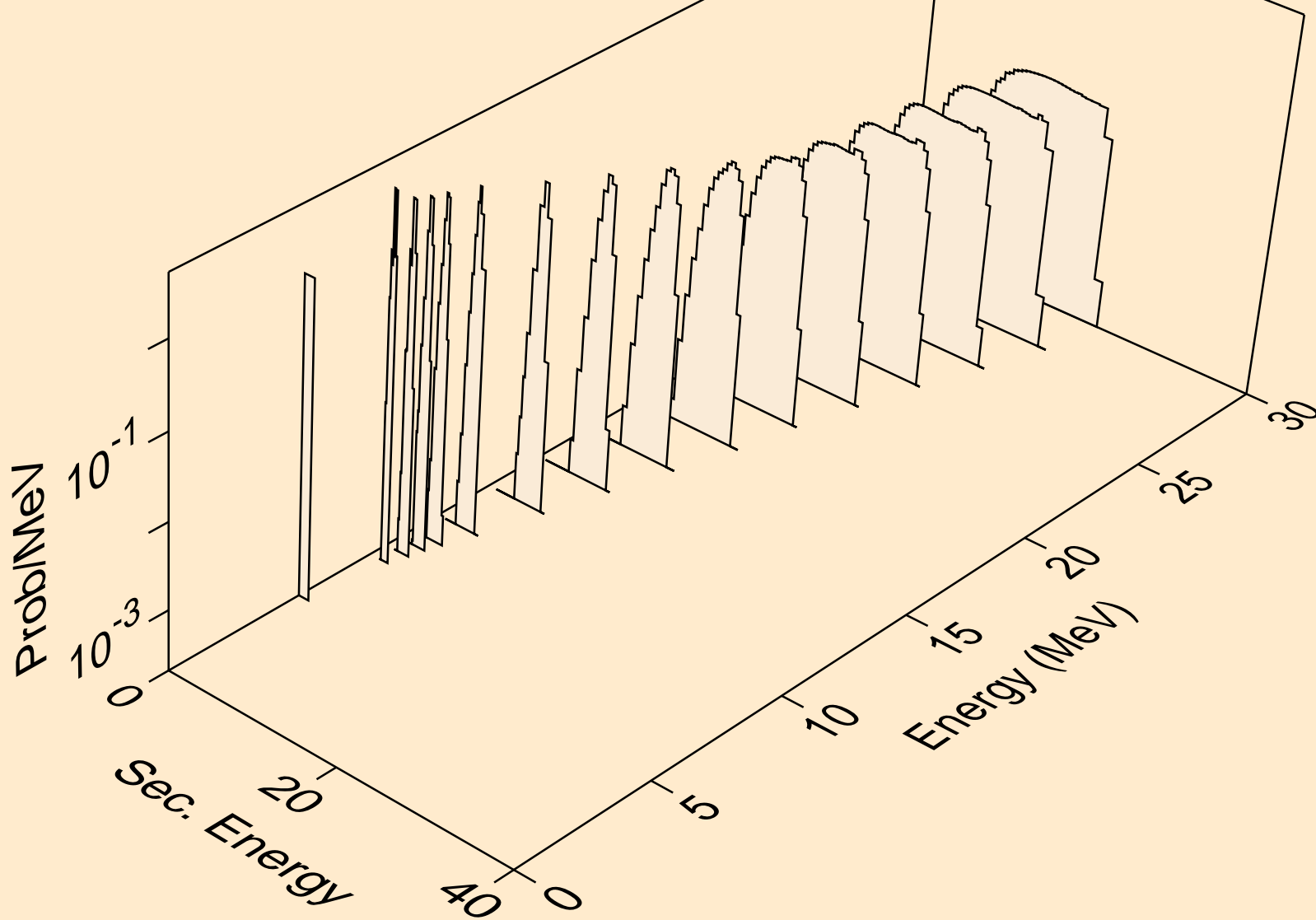

FE053 NEUTRON ACER TENDL-2019 LIBRARY; T=293.16K  
alphas from (n,da)

