

FE060 NEUTRON ACER TENDL-2019 LIBRARY; T=293.16K
Principal cross sections

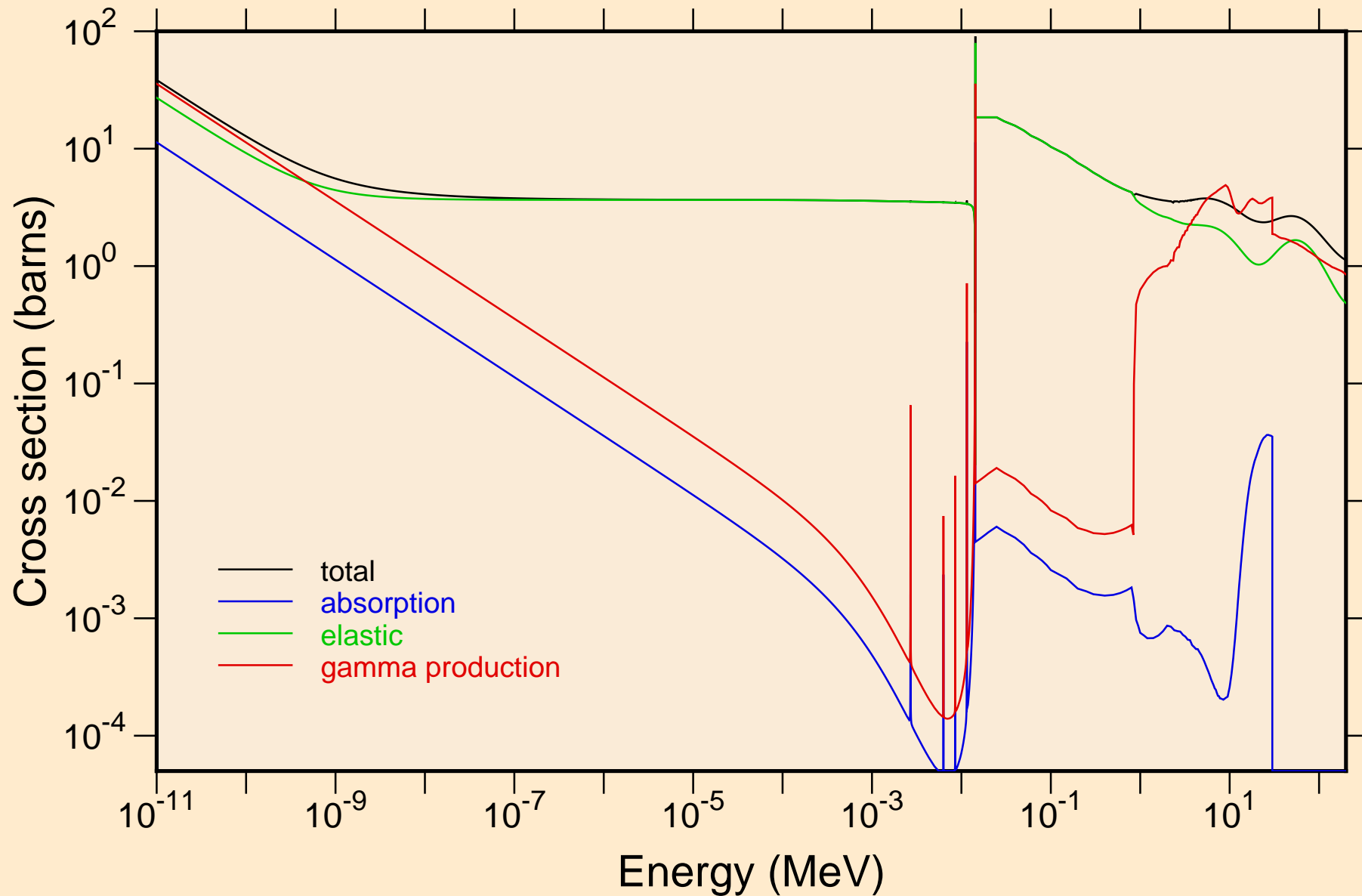

FE060 NEUTRON ACER TENDL-2019 LIBRARY; T=293.16K
Heating

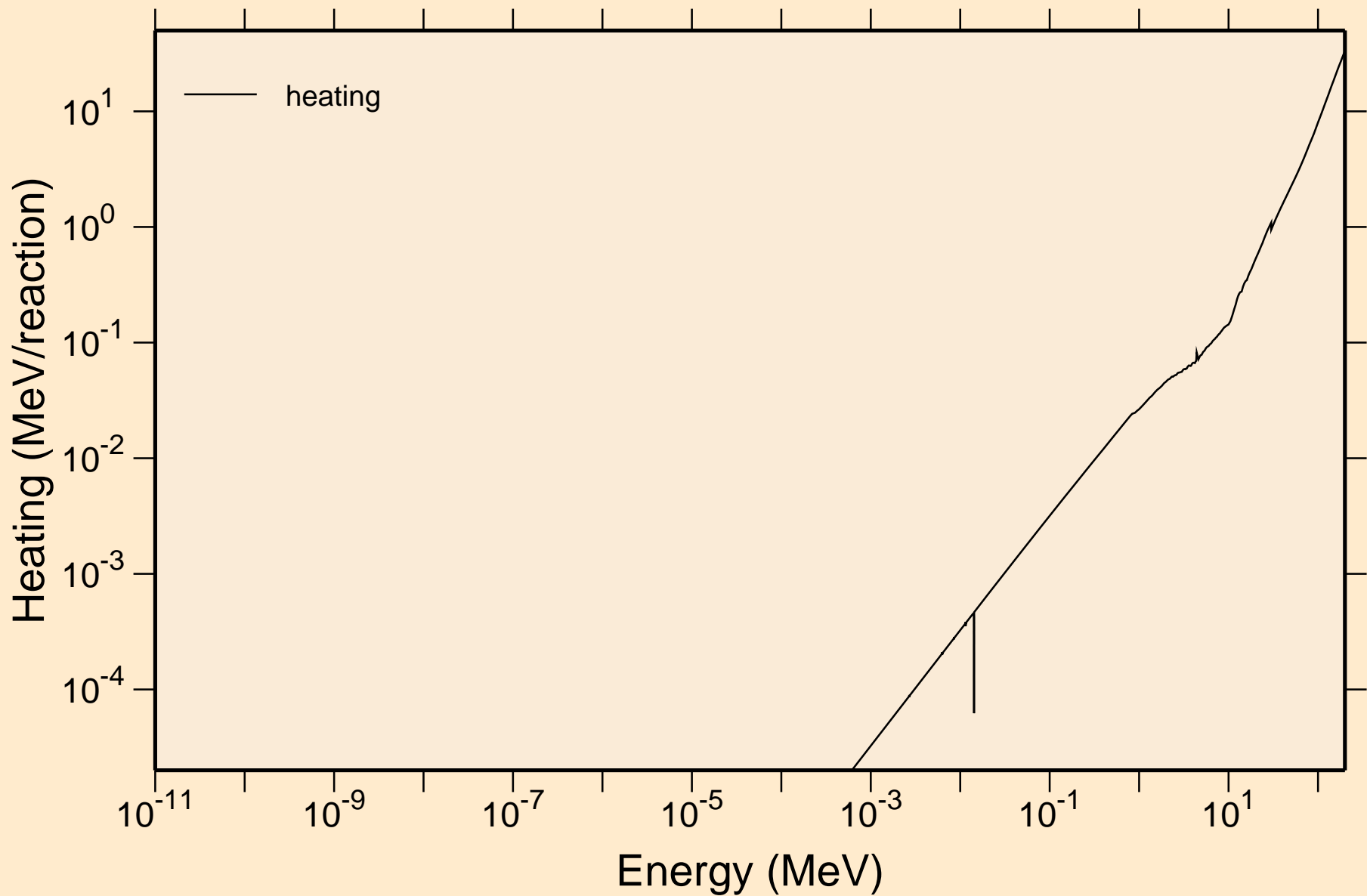

FE060 NEUTRON ACER TENDL-2019 LIBRARY; T=293.16K
Damage

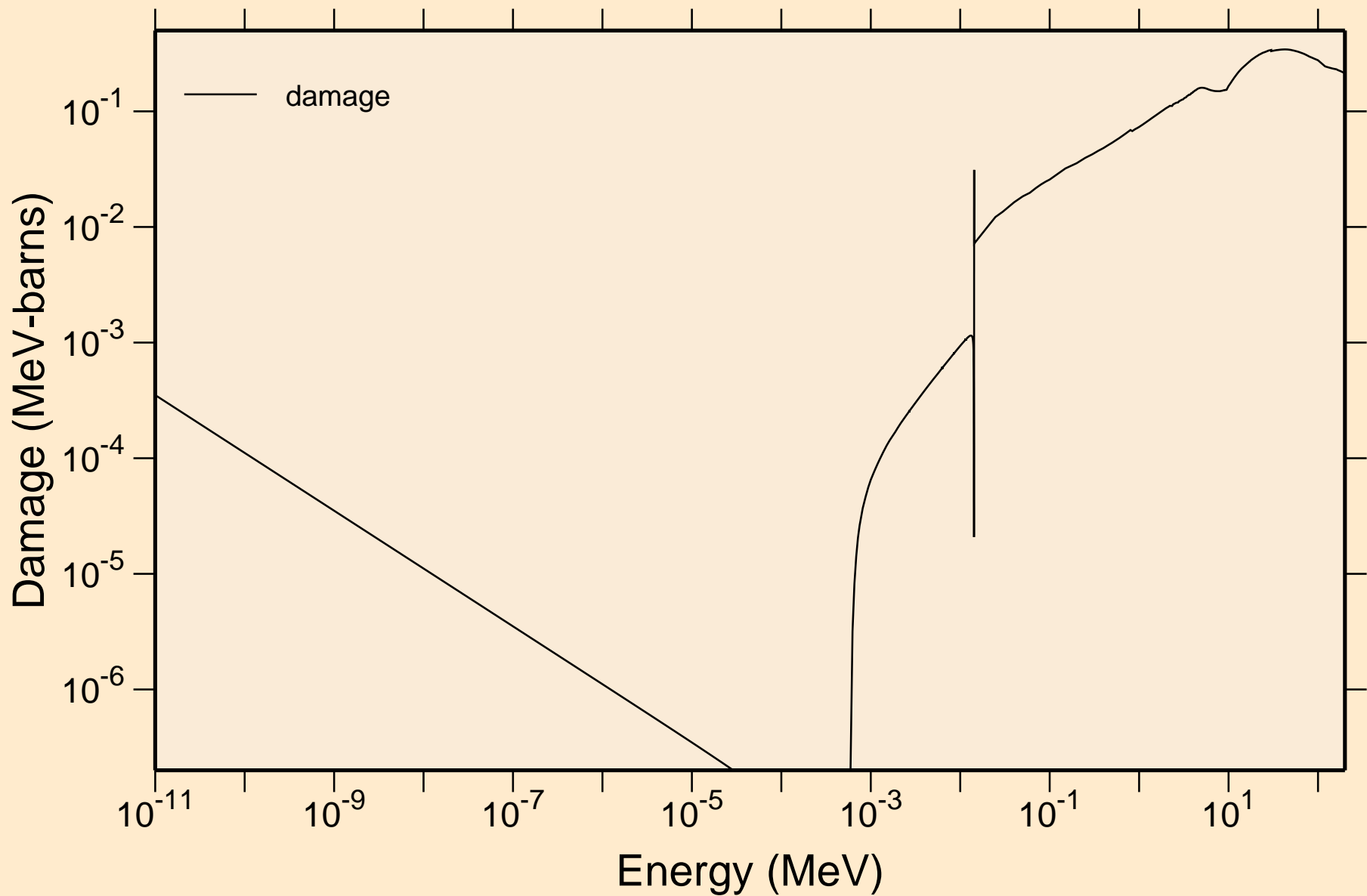

FE060 NEUTRON ACER TENDL-2019 LIBRARY; T=293.16K
Non-threshold reactions

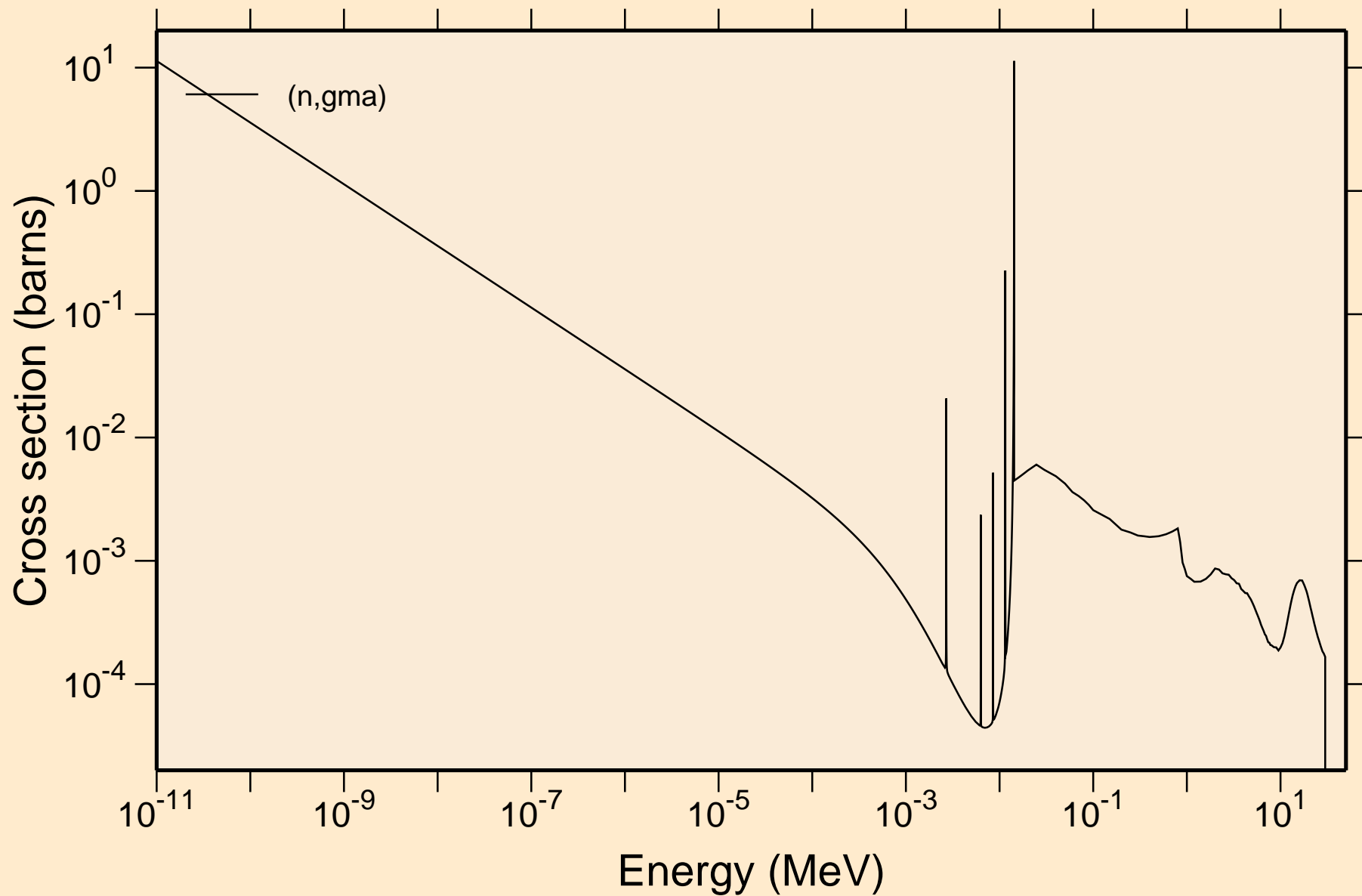

FE060 NEUTRON ACER TENDL-2019 LIBRARY; T=293.16K
Principal cross sections

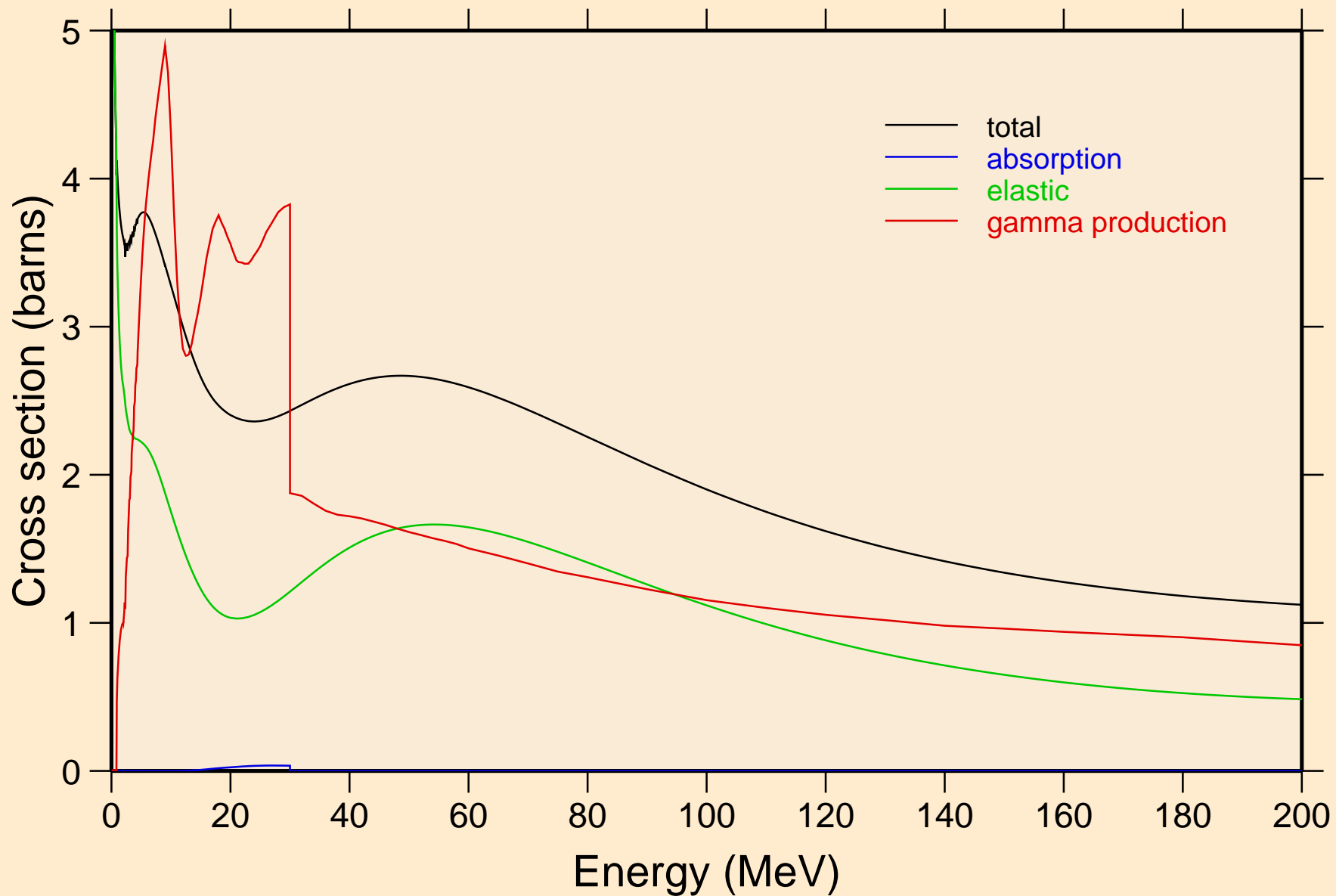

FE060 NEUTRON ACER TENDL-2019 LIBRARY; T=293.16K
Heating

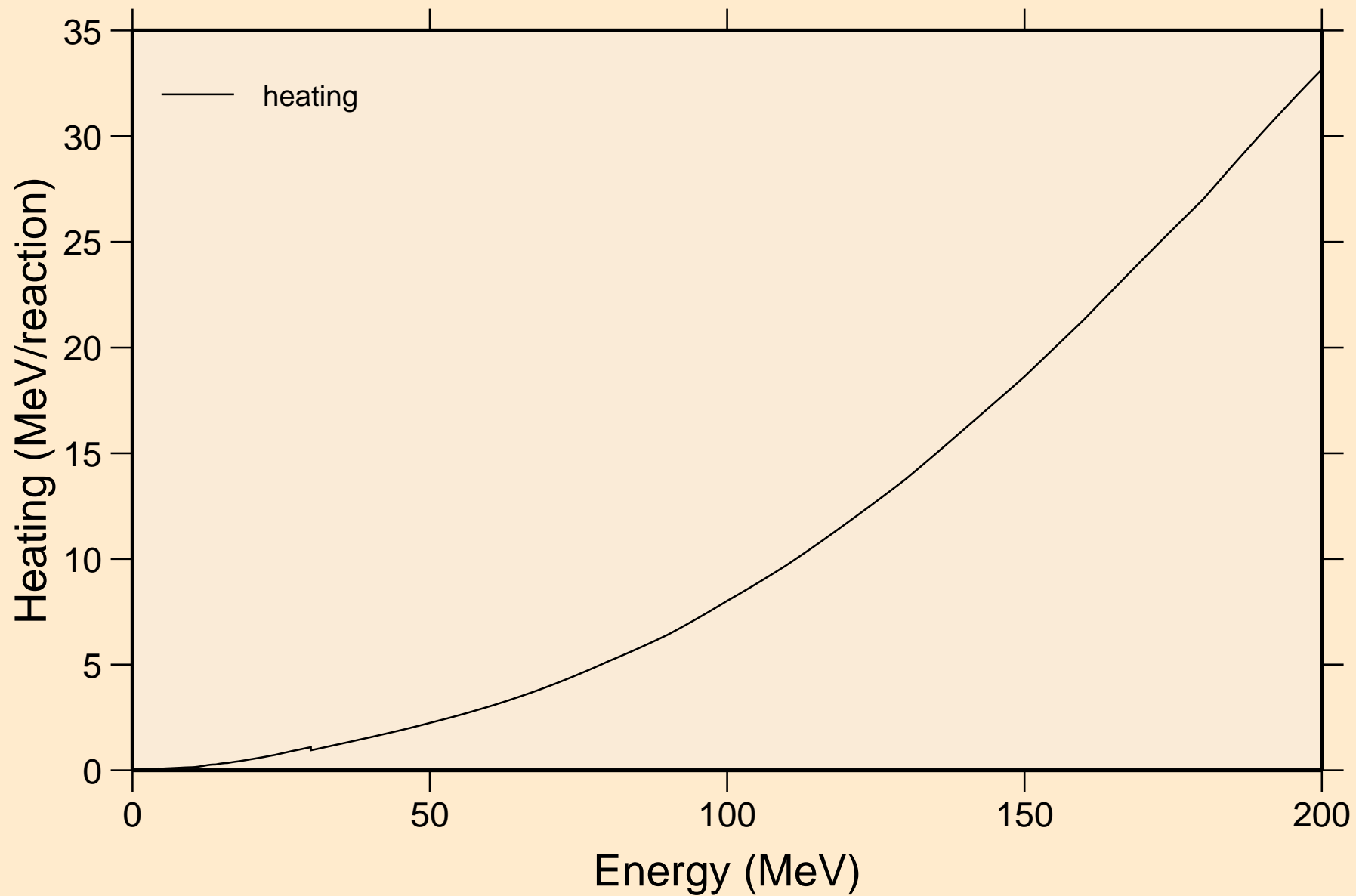

FE060 NEUTRON ACER TENDL-2019 LIBRARY; T=293.16K
Damage

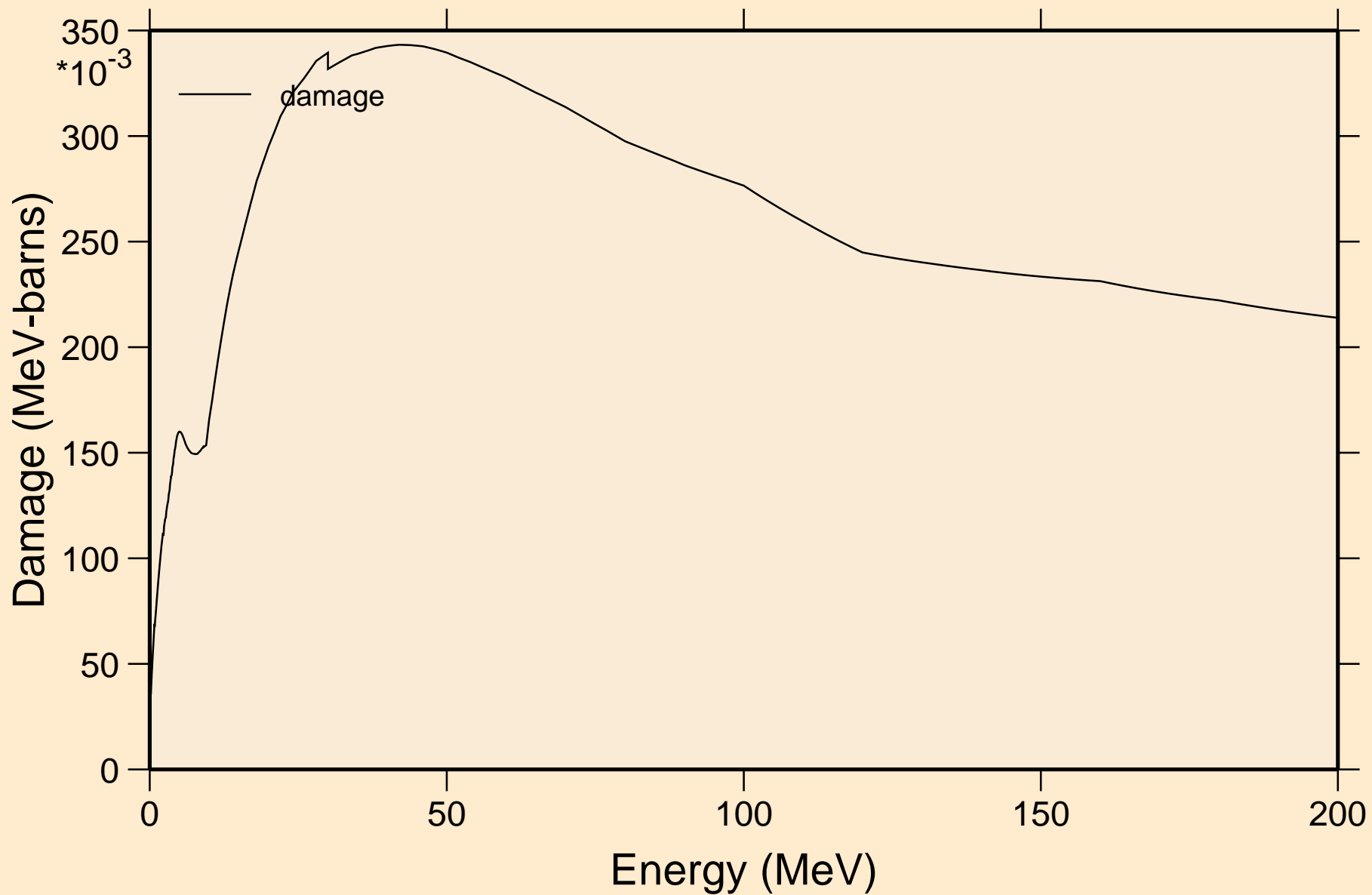

FE060 NEUTRON ACER TENDL-2019 LIBRARY; T=293.16K
Non-threshold reactions

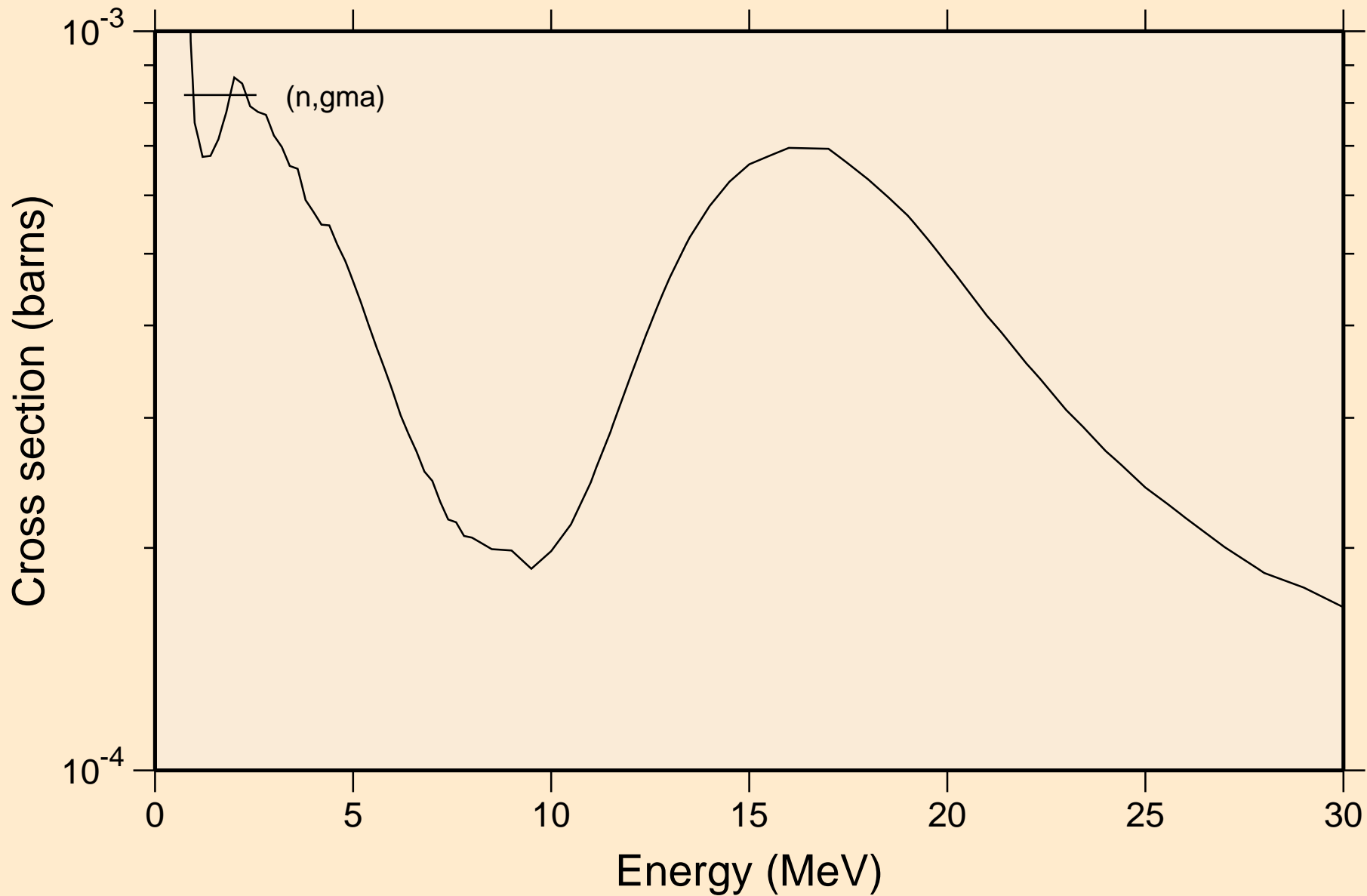

FE060 NEUTRON ACER TENDL-2019 LIBRARY; T=293.16K
Inelastic levels

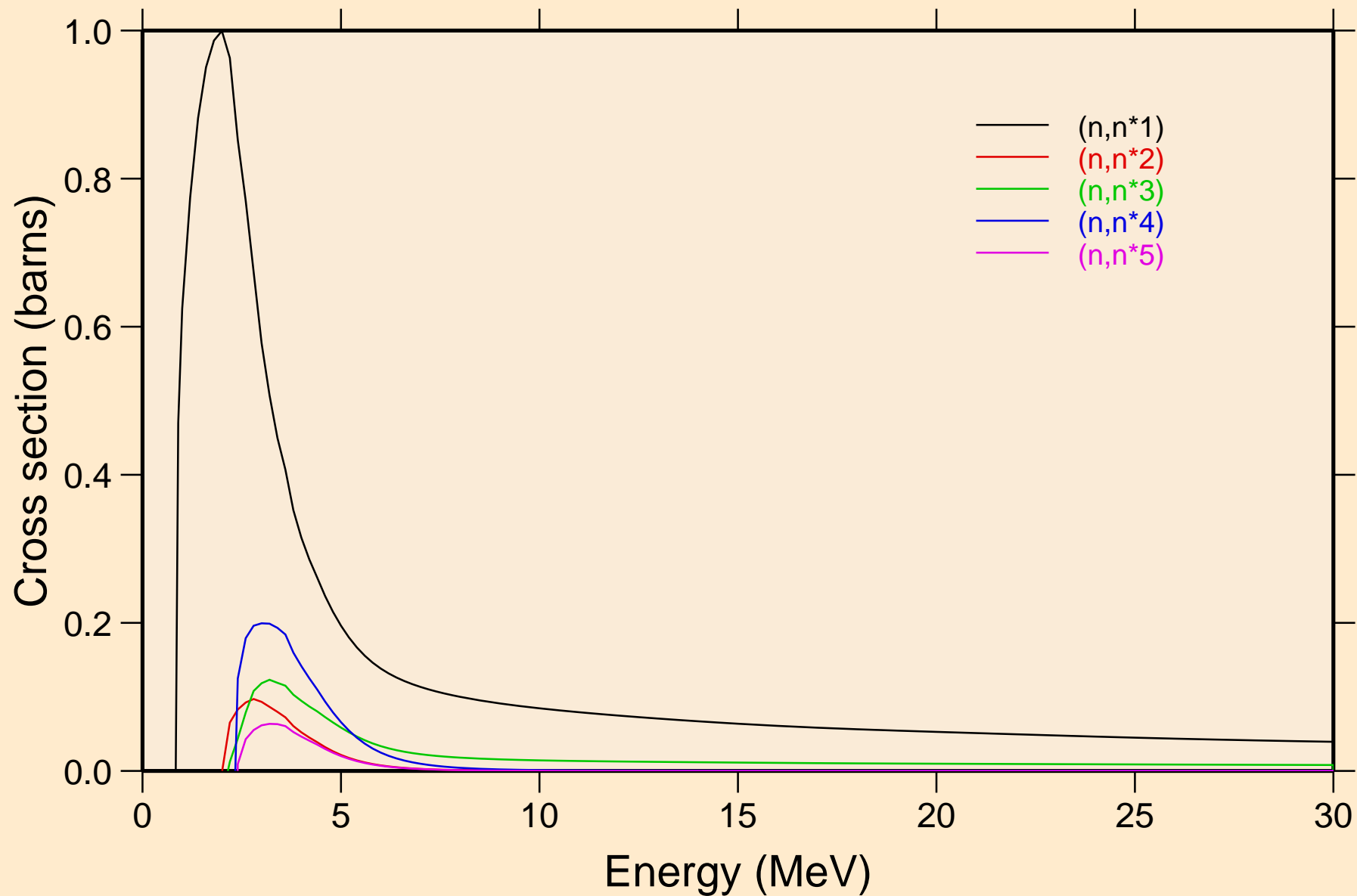

FE060 NEUTRON ACER TENDL-2019 LIBRARY; T=293.16K
Inelastic levels

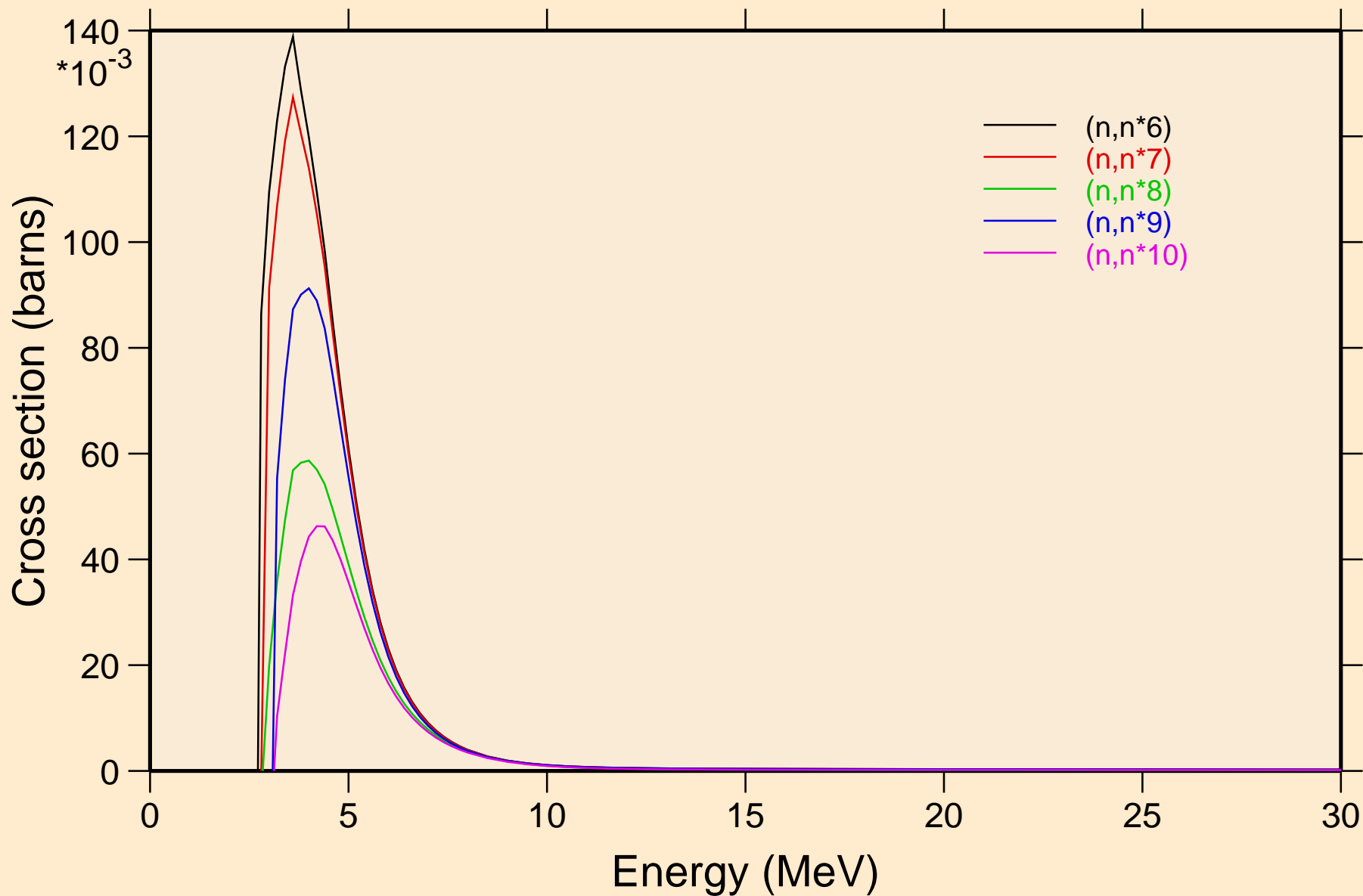

FE060 NEUTRON ACER TENDL-2019 LIBRARY; T=293.16K
Inelastic levels

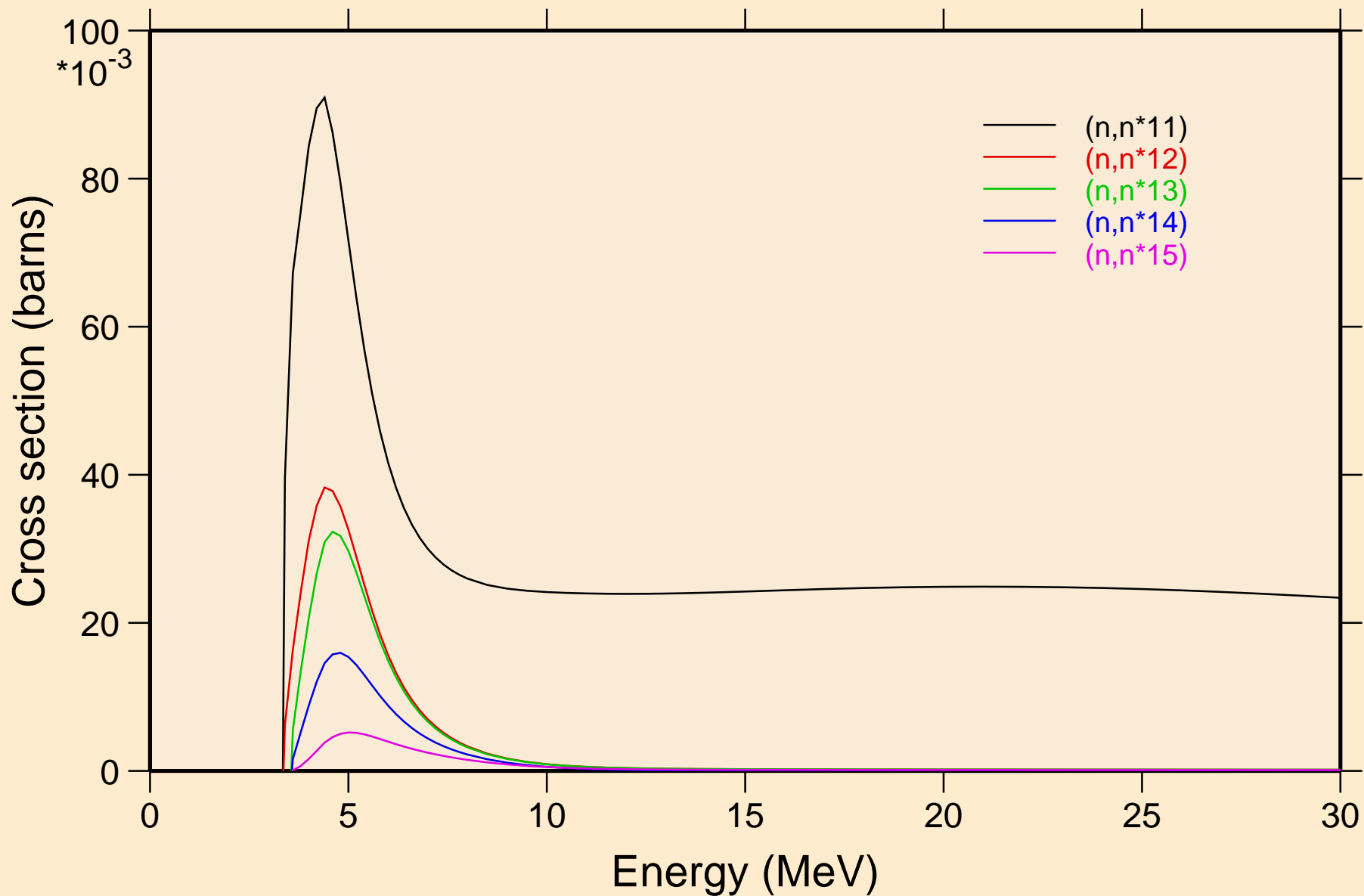

FE060 NEUTRON ACER TENDL-2019 LIBRARY; T=293.16K
Inelastic levels

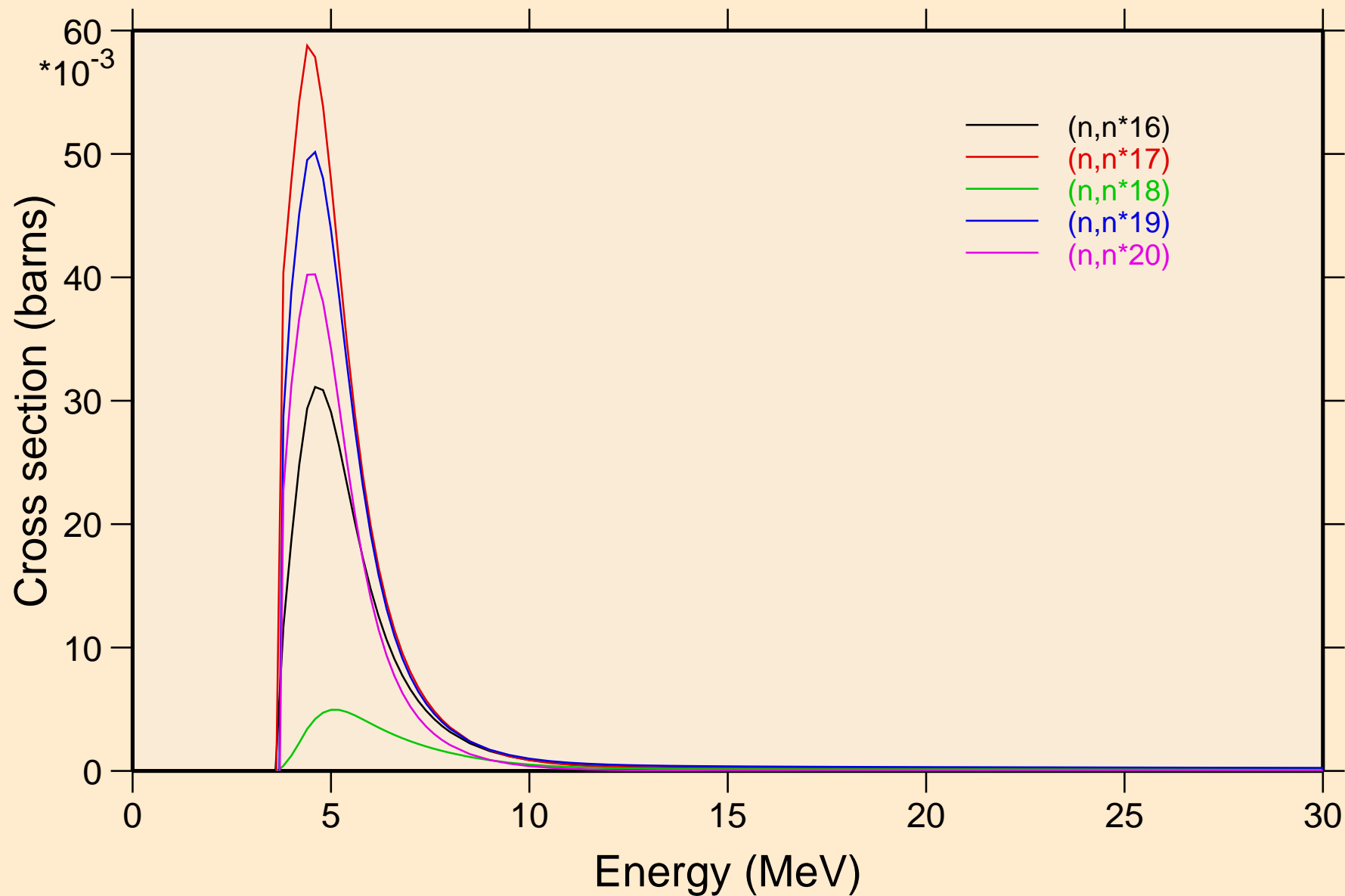

FE060 NEUTRON ACER TENDL-2019 LIBRARY; T=293.16K
Inelastic levels

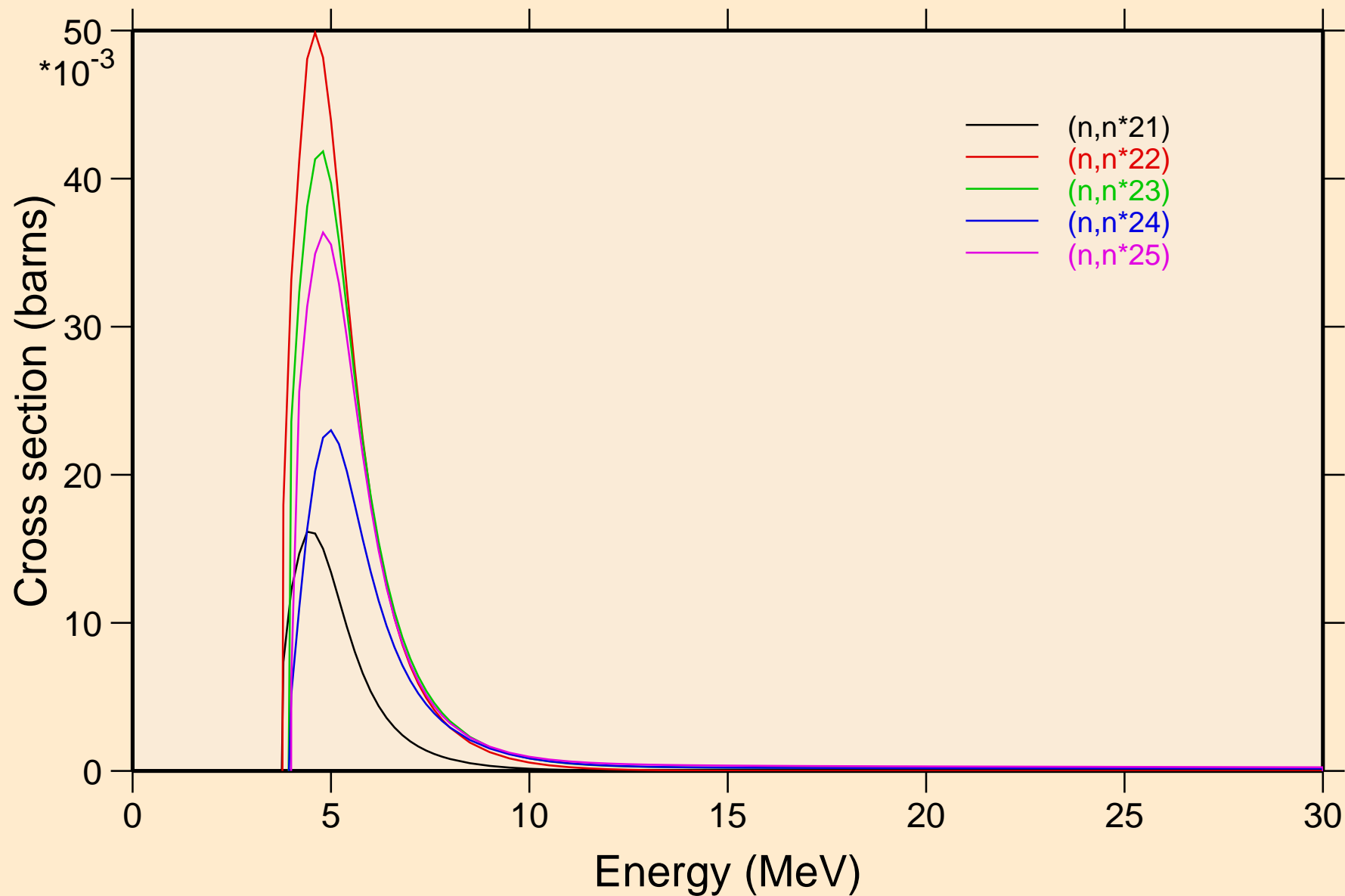

FE060 NEUTRON ACER TENDL-2019 LIBRARY; T=293.16K
Inelastic levels

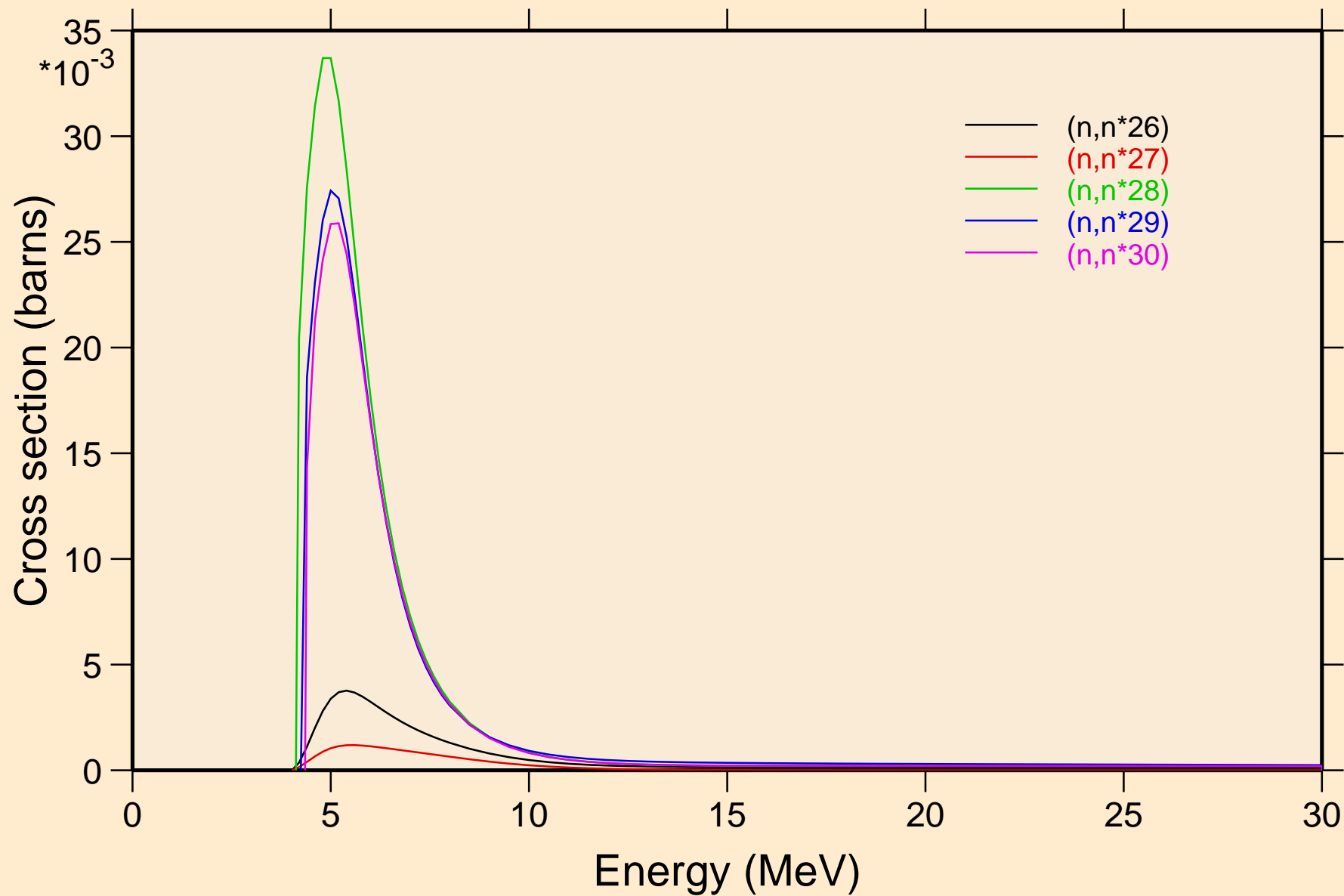

FE060 NEUTRON ACER TENDL-2019 LIBRARY; T=293.16K
Threshold reactions

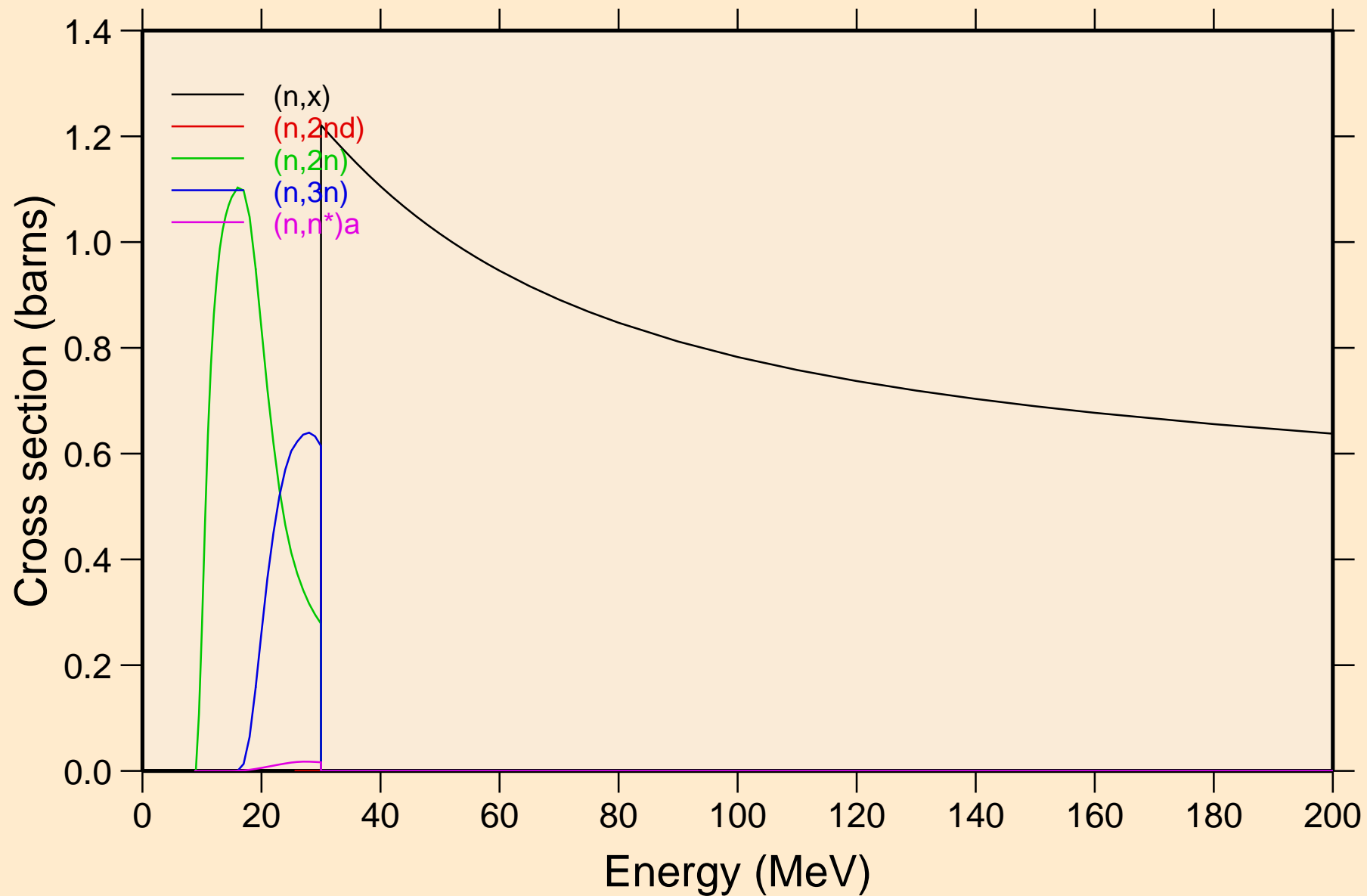

FE060 NEUTRON ACER TENDL-2019 LIBRARY; T=293.16K
Threshold reactions

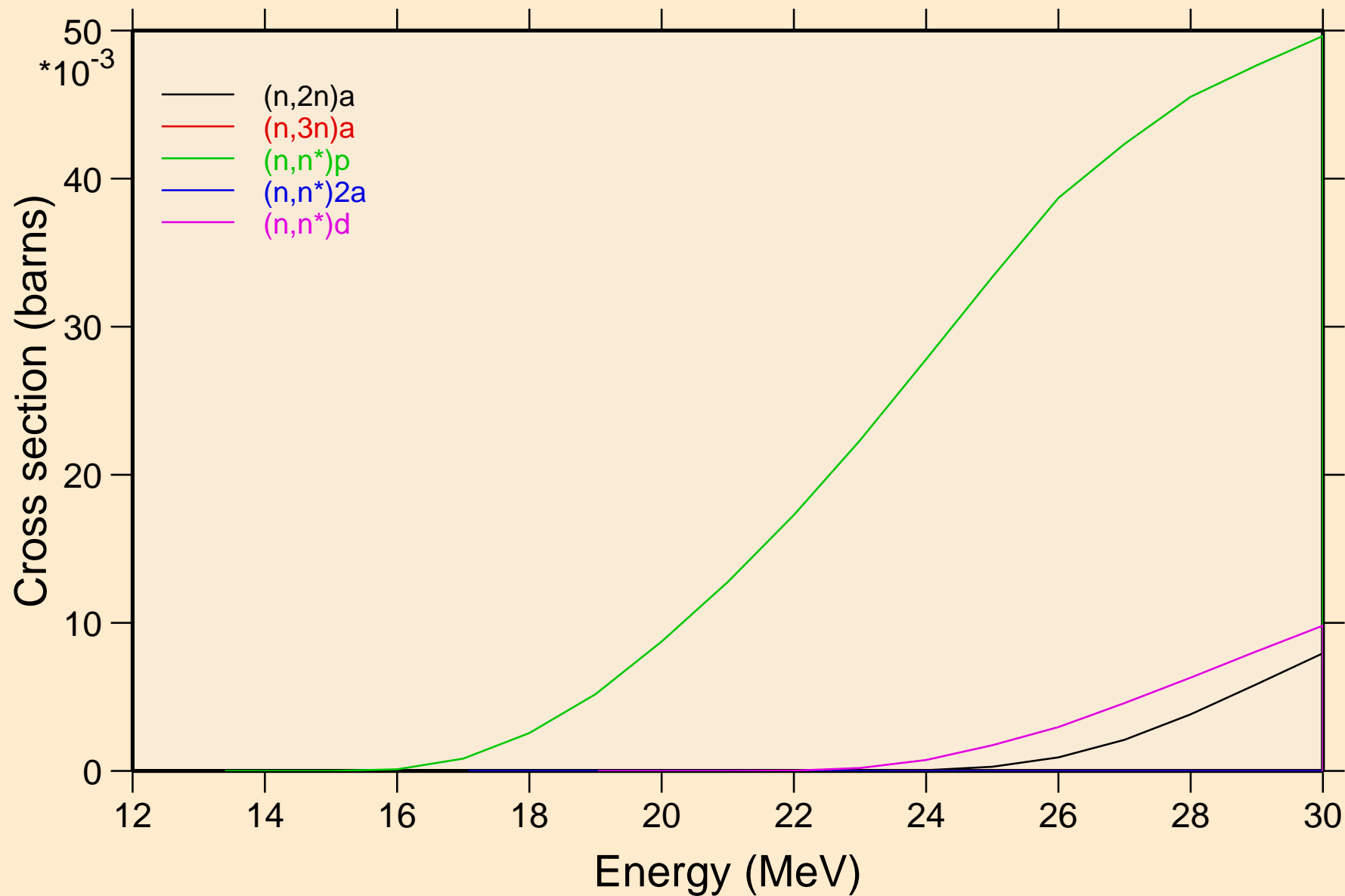

FE060 NEUTRON ACER TENDL-2019 LIBRARY; T=293.16K
Threshold reactions

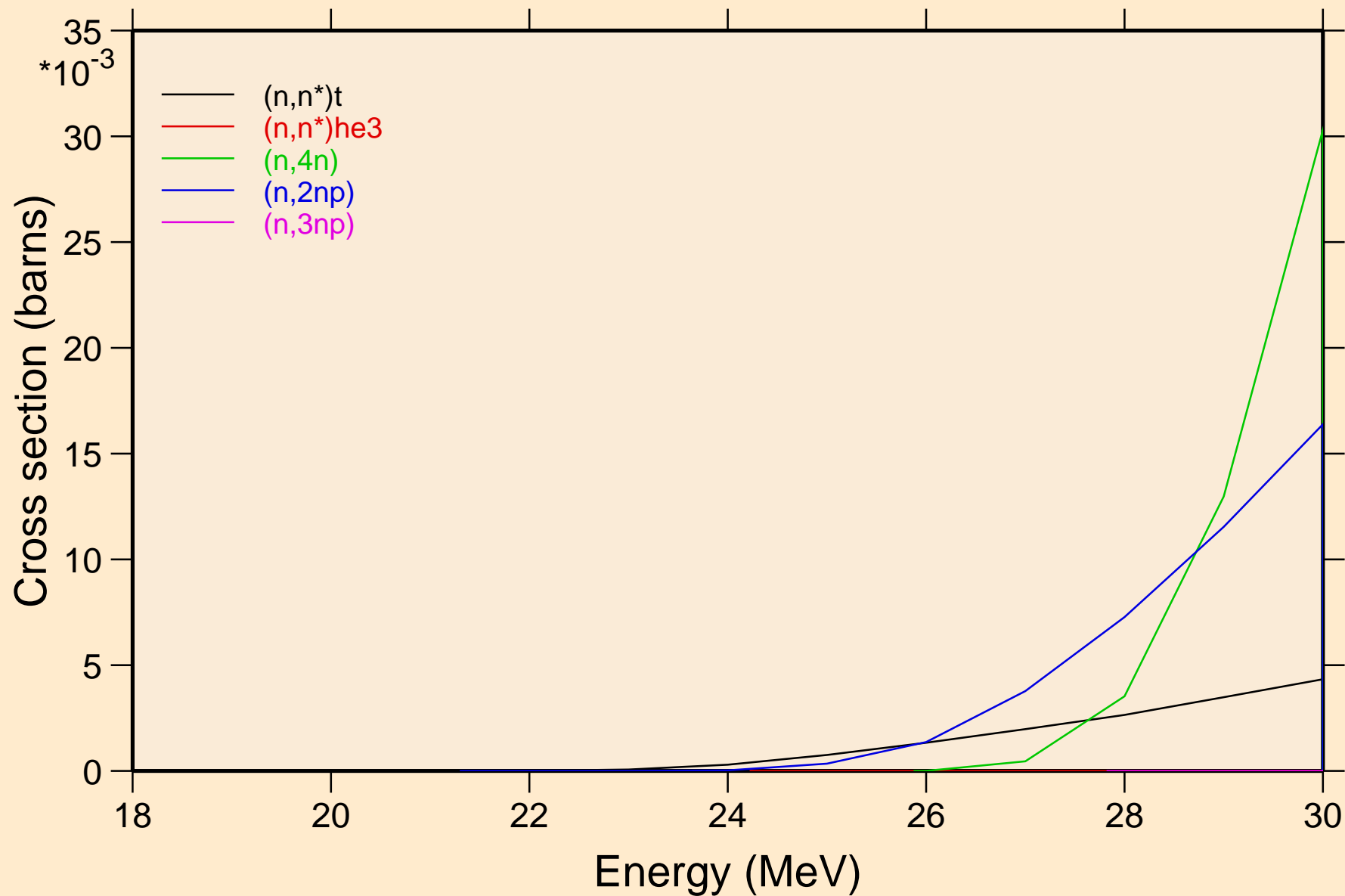

FE060 NEUTRON ACER TENDL-2019 LIBRARY; T=293.16K
Threshold reactions

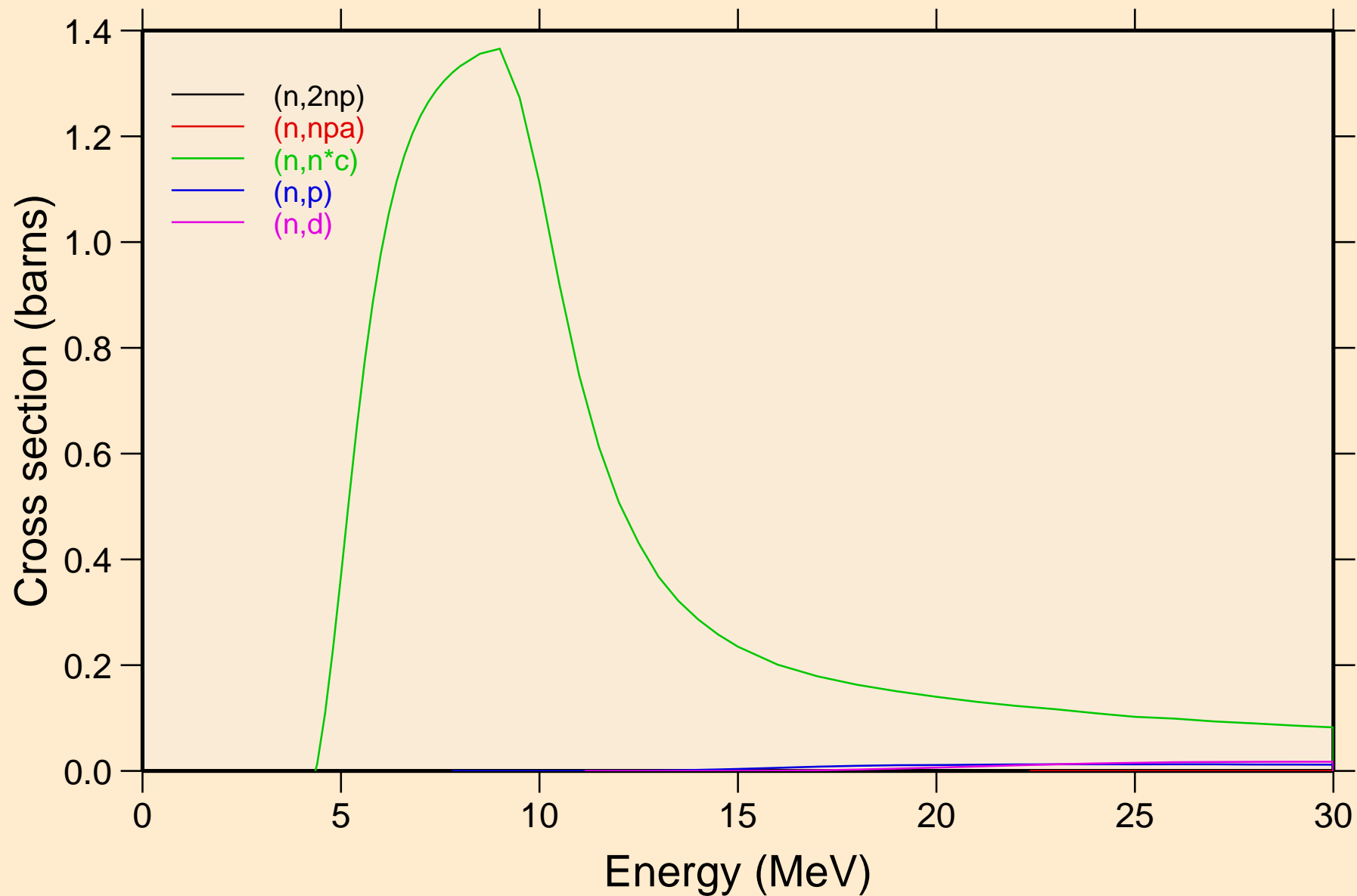

FE060 NEUTRON ACER TENDL-2019 LIBRARY; T=293.16K
Threshold reactions

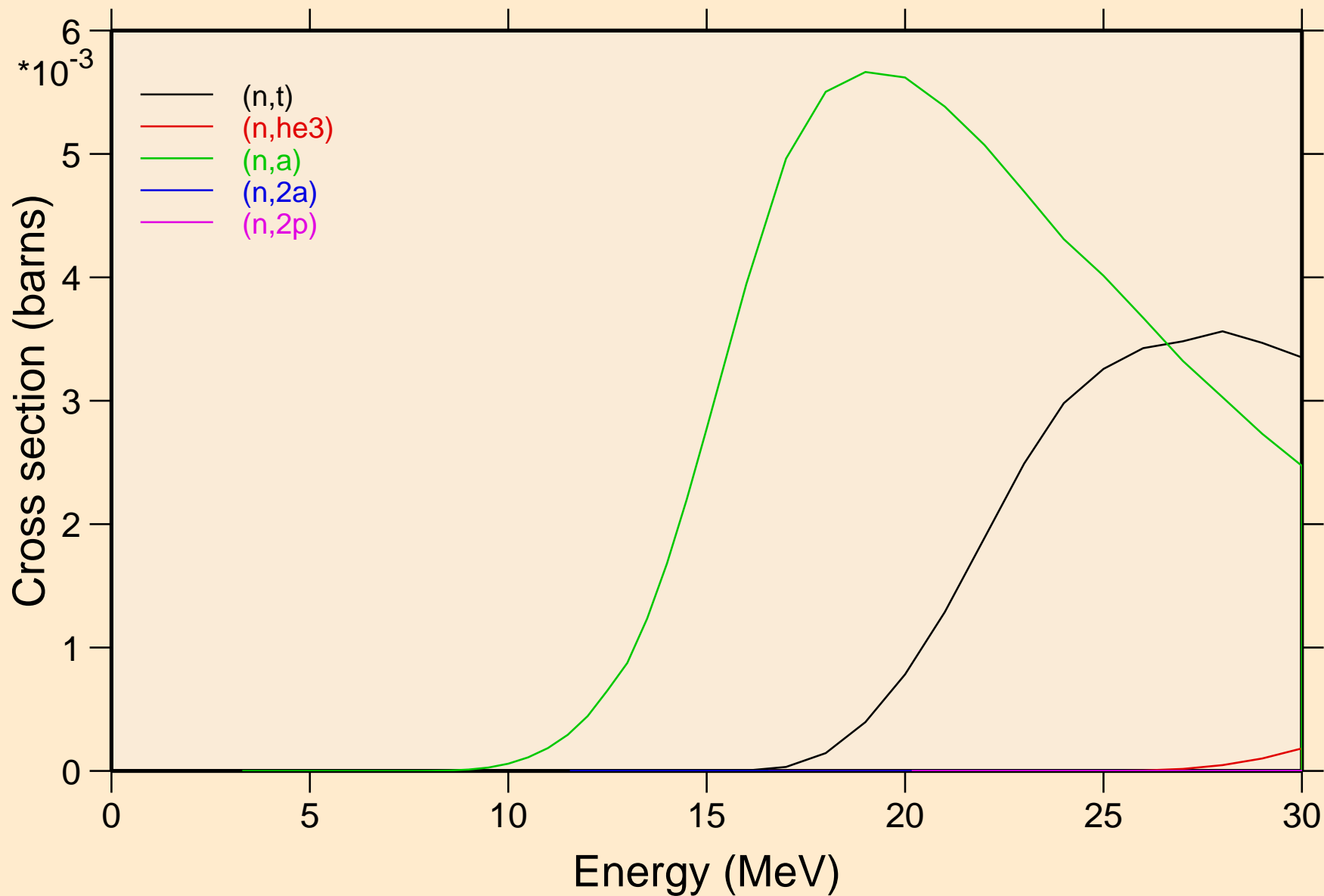

FE060 NEUTRON ACER TENDL-2019 LIBRARY; T=293.16K
Threshold reactions

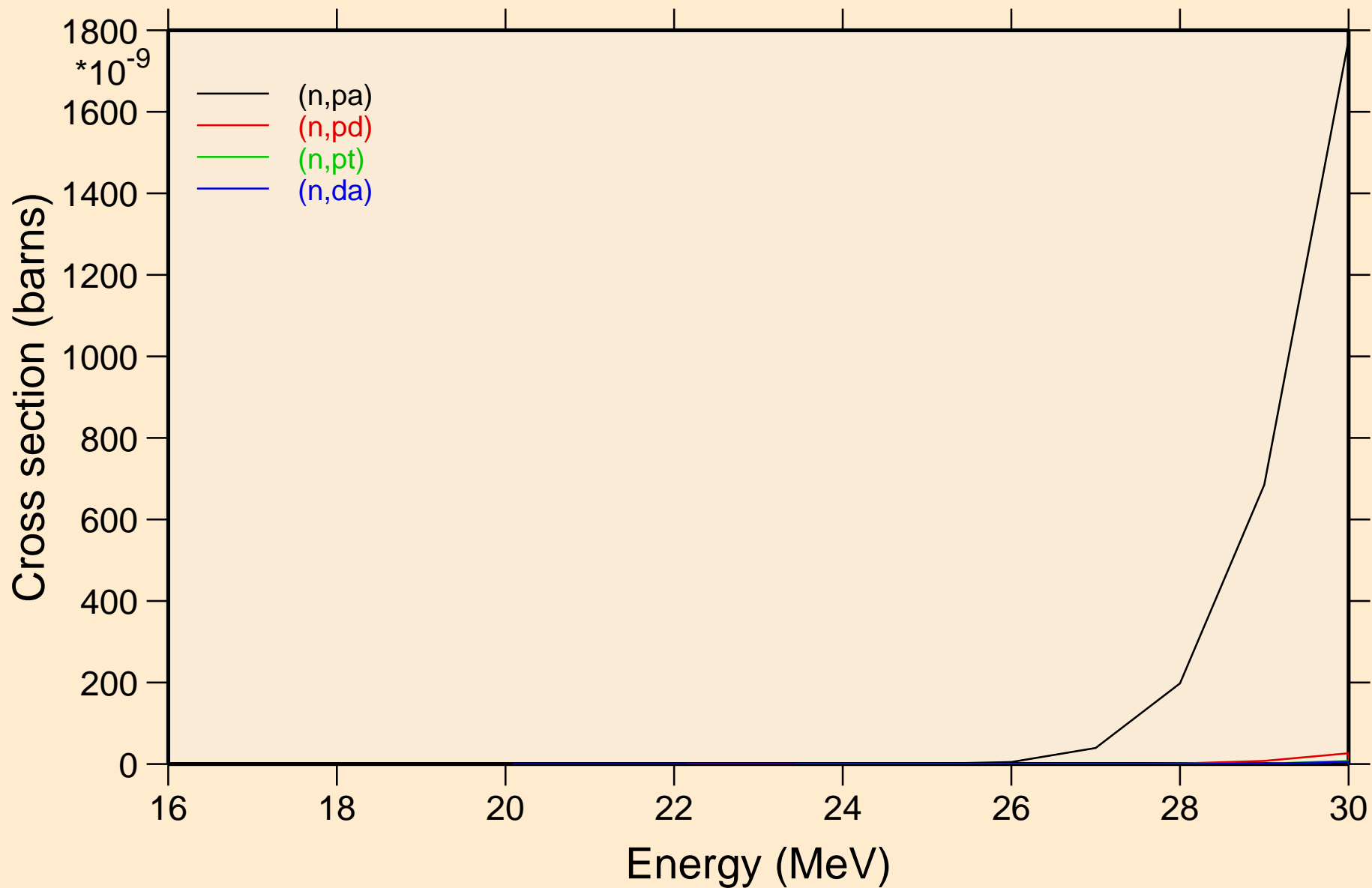

FE060 NEUTRON ACER TENDL-2019 LIBRARY; T=293.16K
Threshold reactions

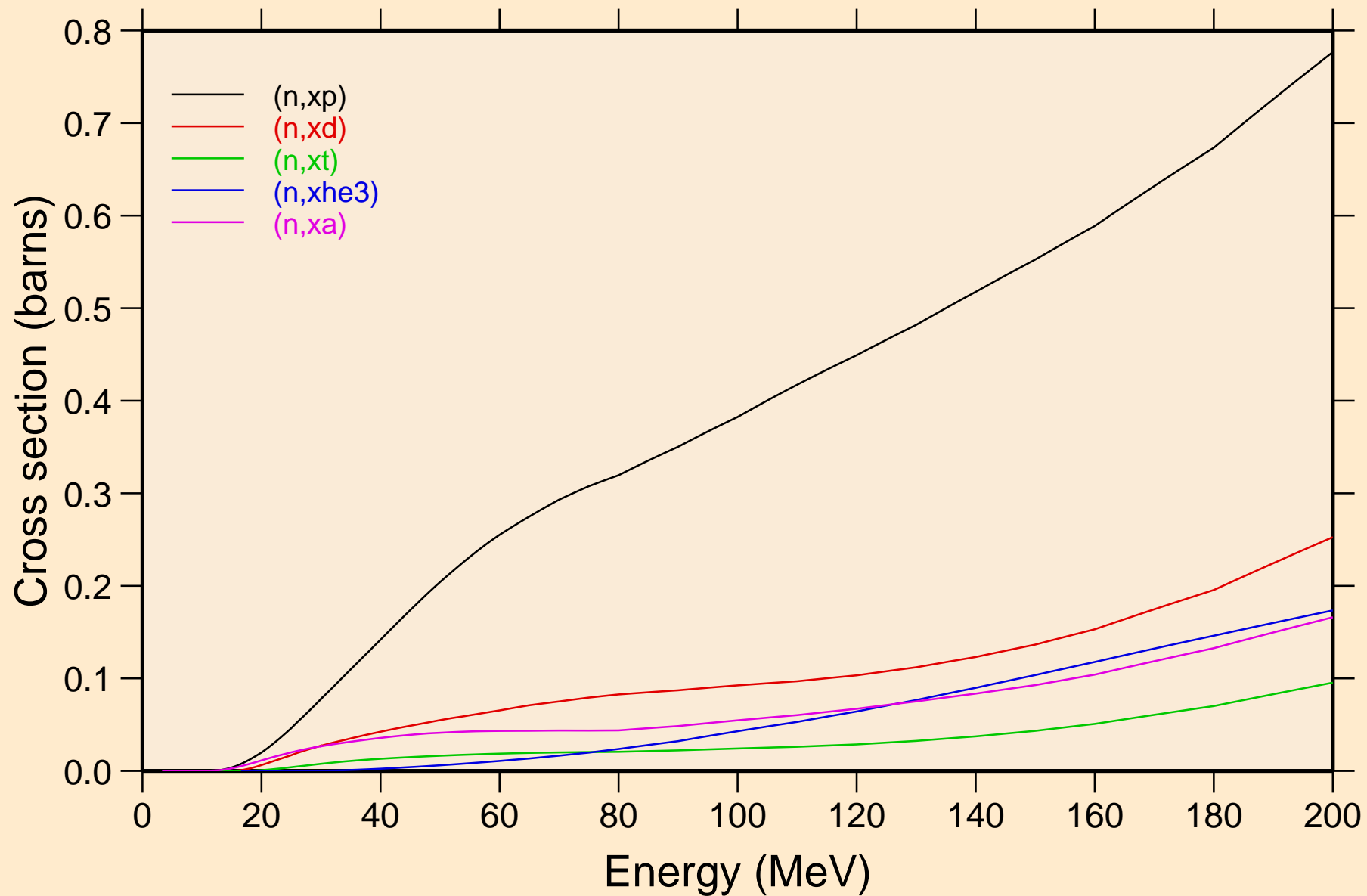

FE060 NEUTRON ACER TENDL-2019 LIBRARY; T=293.16K
angular distribution for elastic

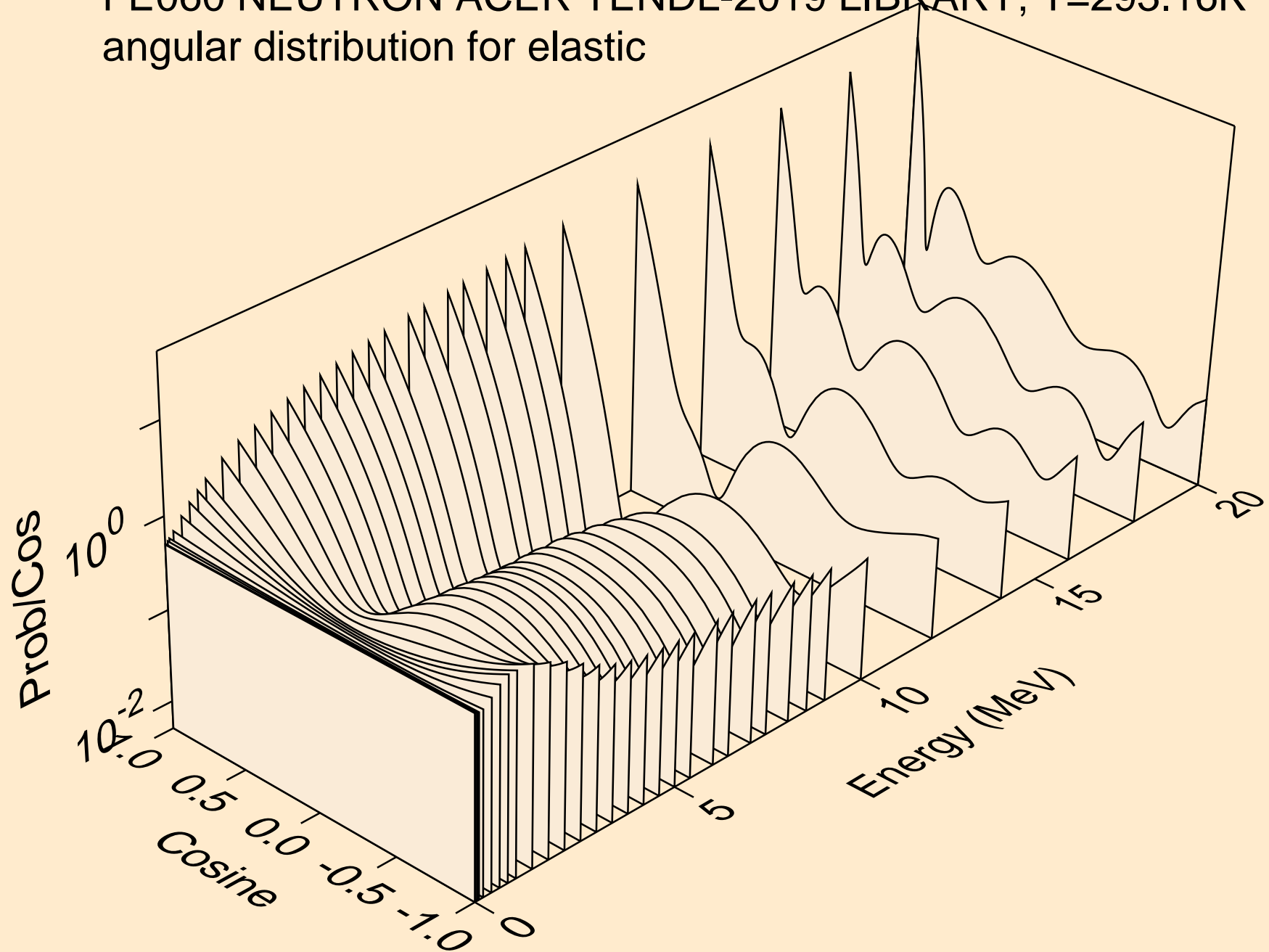

FE060 NEUTRON ACER TENDL-2019 LIBRARY; T=293.16K
angular distribution for elastic

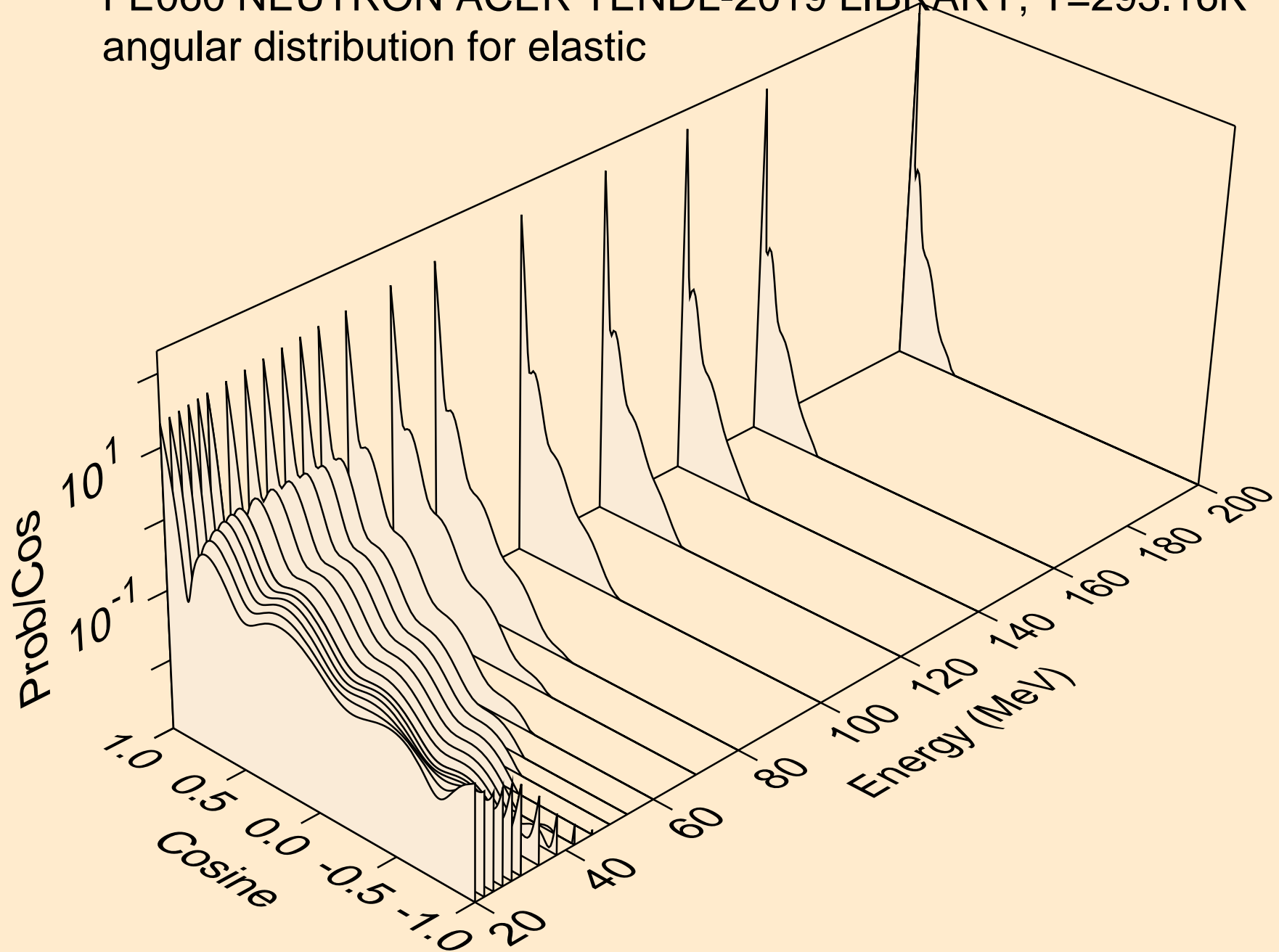

FE060 NEUTRON ACER TENDL-2019 LIBRARY; T=293.16K
angular distribution for (n,n*1)

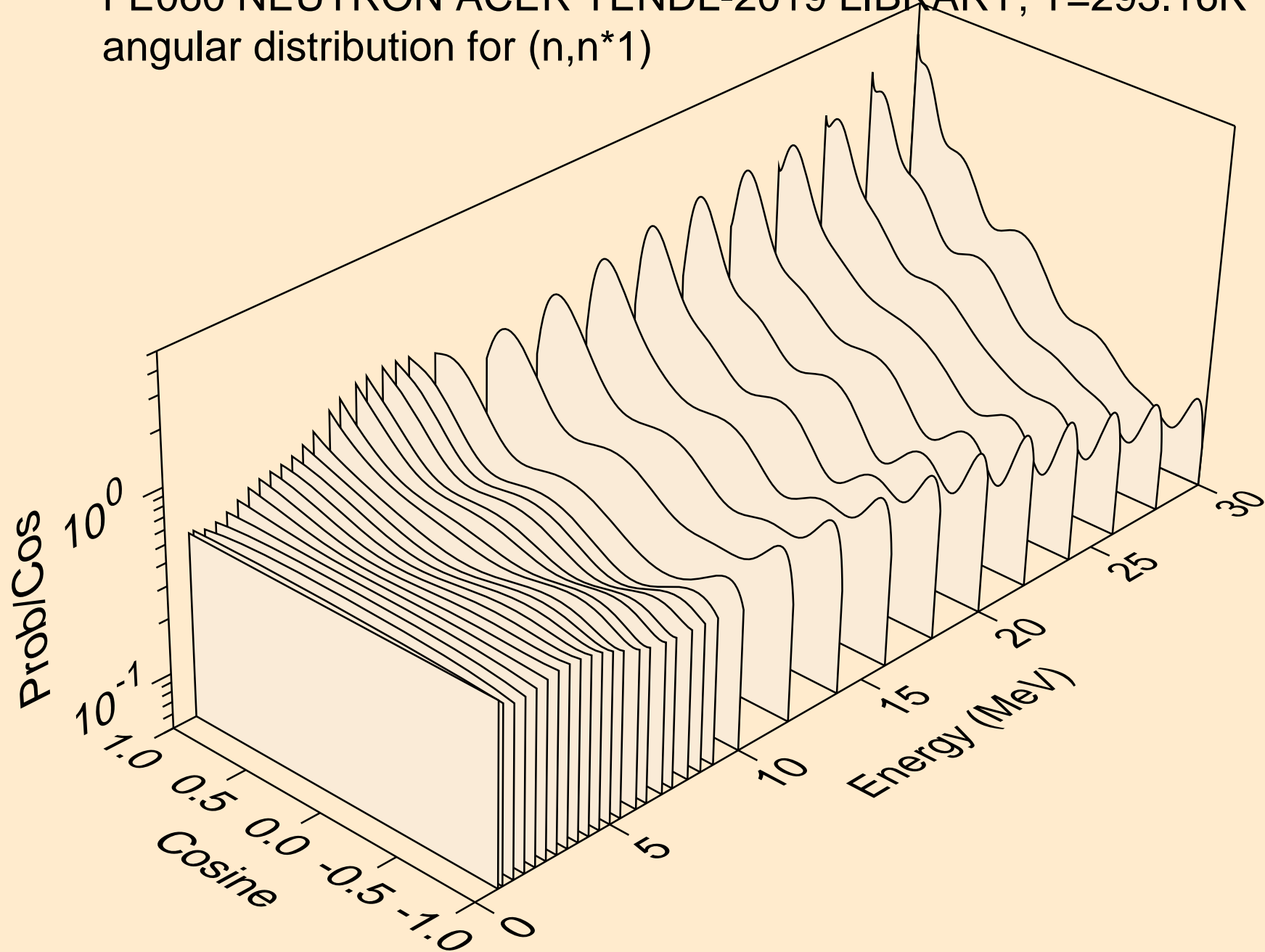

FE060 NEUTRON ACER TENDL-2019 LIBRARY; T=293.16K
angular distribution for (n,n*2)

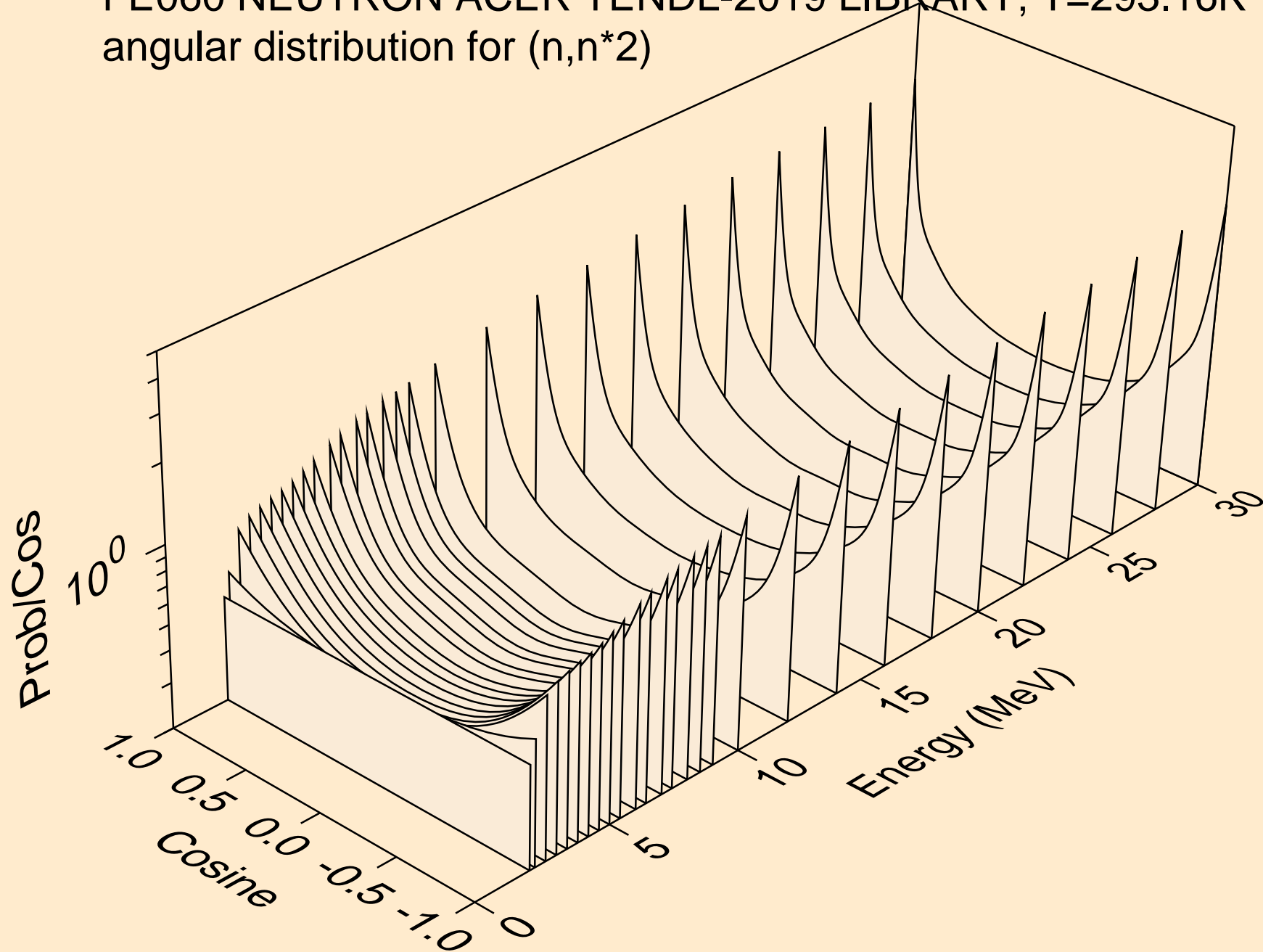

FE060 NEUTRON ACER TENDL-2019 LIBRARY; T=293.16K
angular distribution for (n,n*3)

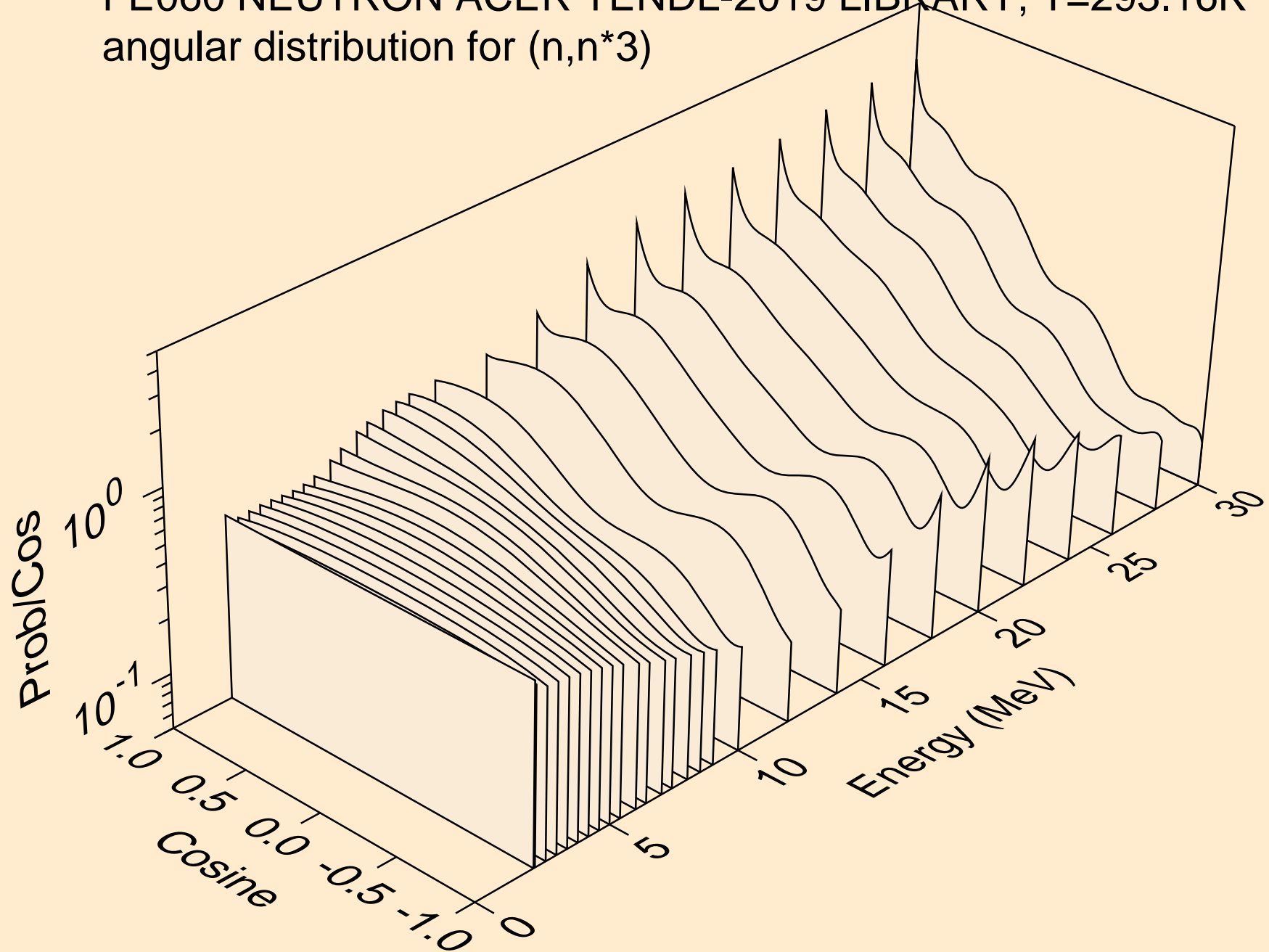

FE060 NEUTRON ACER TENDL-2019 LIBRARY; T=293.16K
angular distribution for (n,n*4)

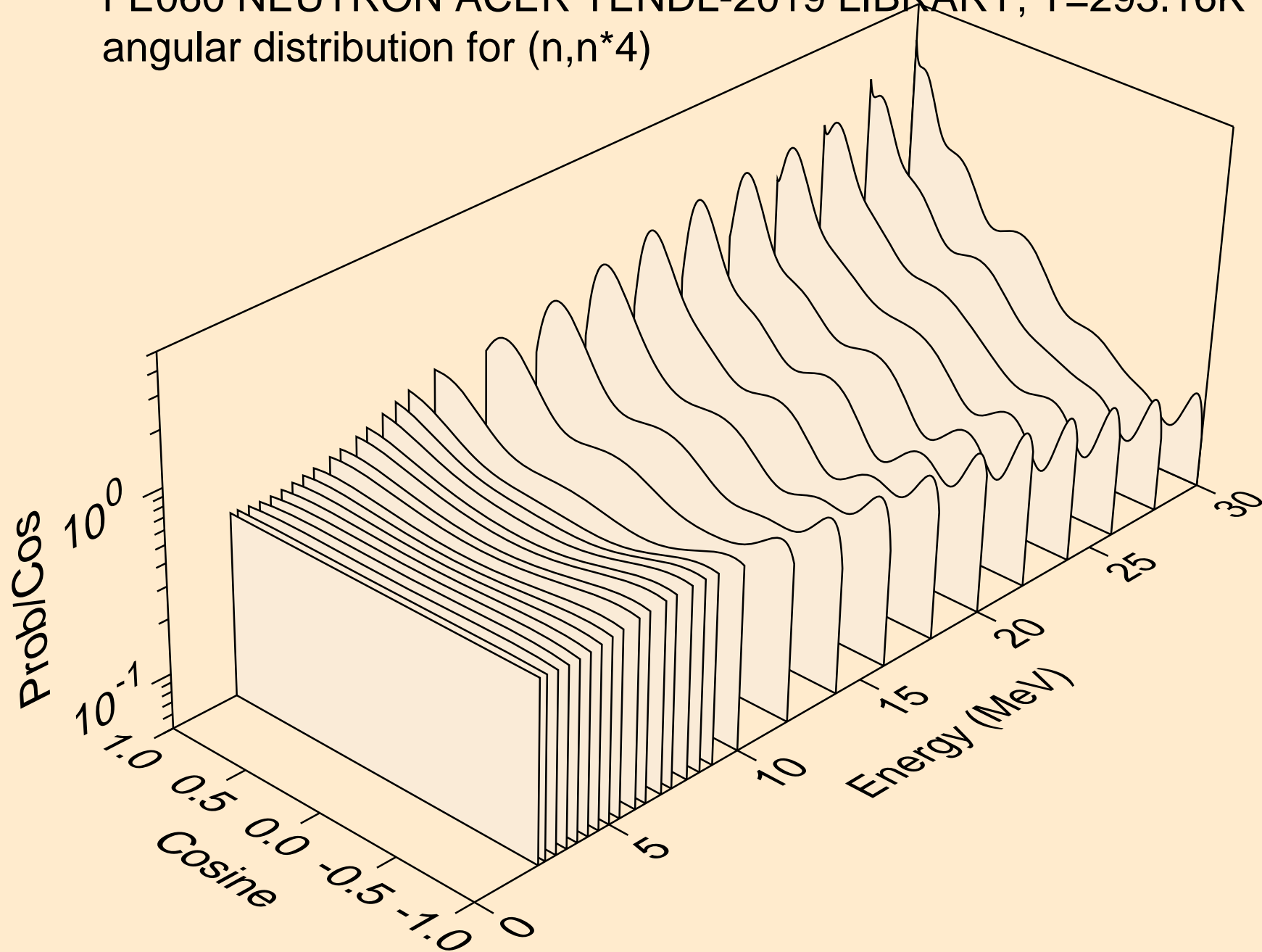

FE060 NEUTRON ACER TENDL-2019 LIBRARY; T=293.16K
angular distribution for (n,n*5)

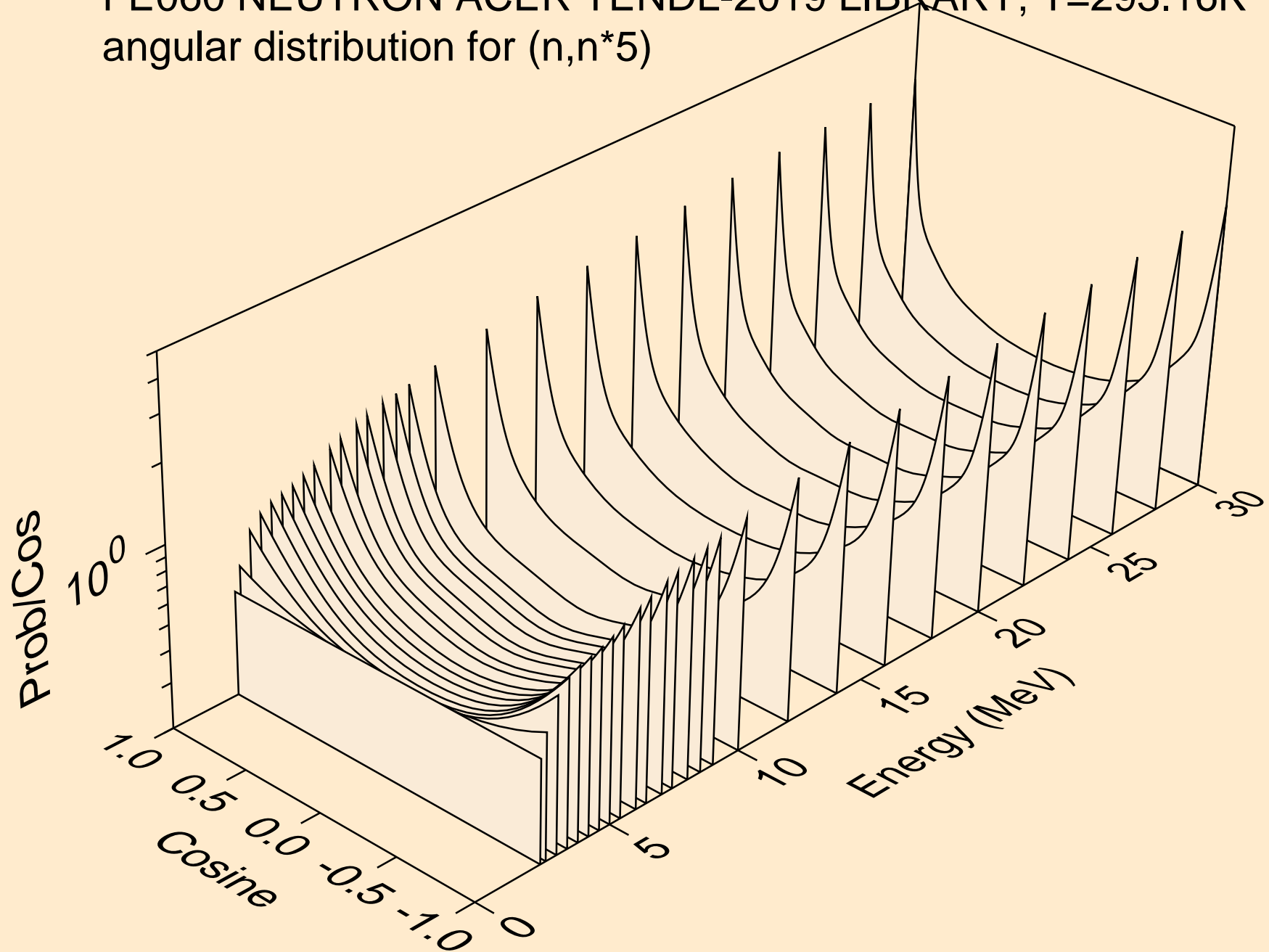

FE060 NEUTRON ACER TENDL-2019 LIBRARY; T=293.16K
angular distribution for (n,n*6)

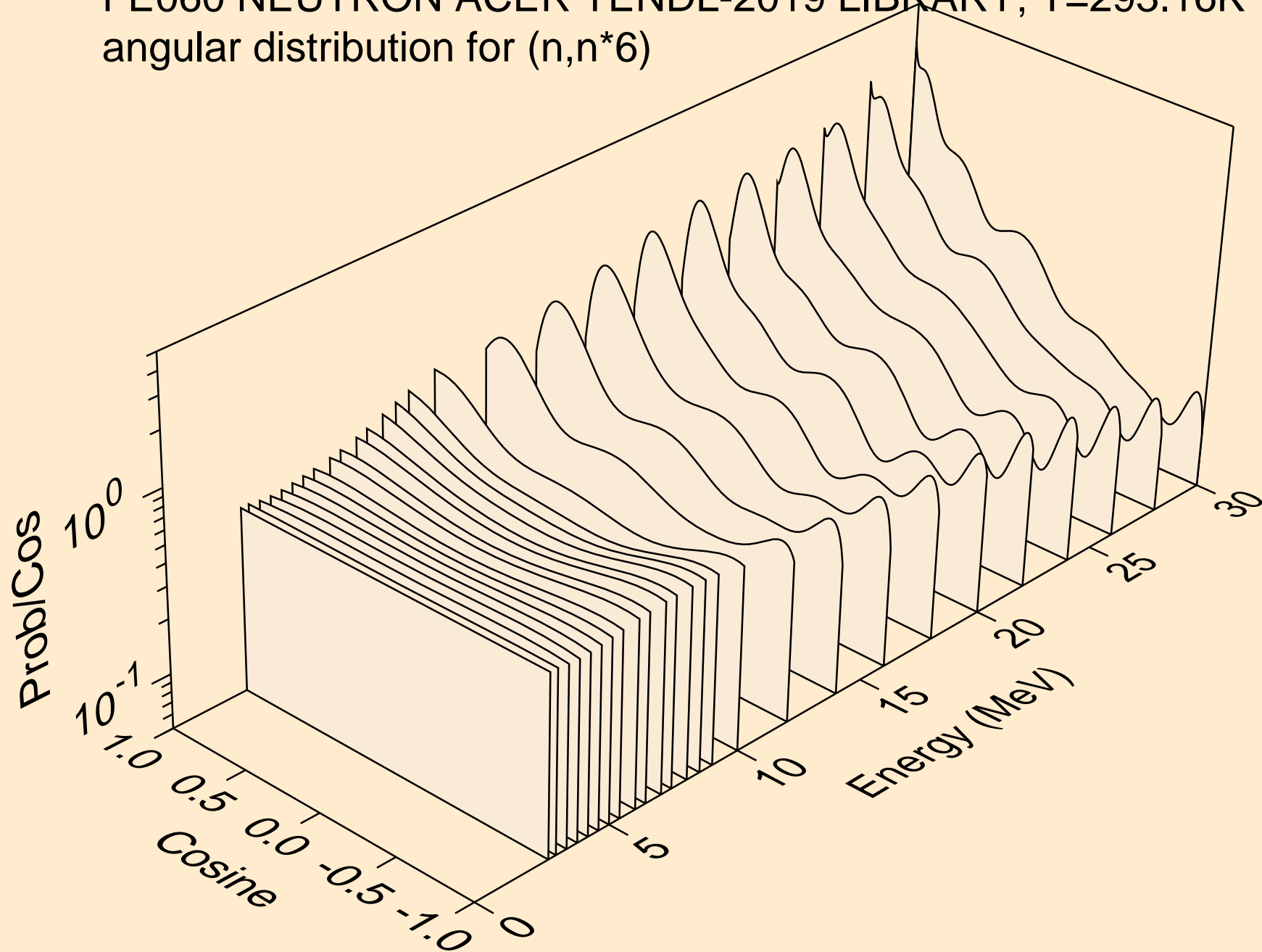

FE060 NEUTRON ACER TENDL-2019 LIBRARY; T=293.16K
angular distribution for (n,n*7)

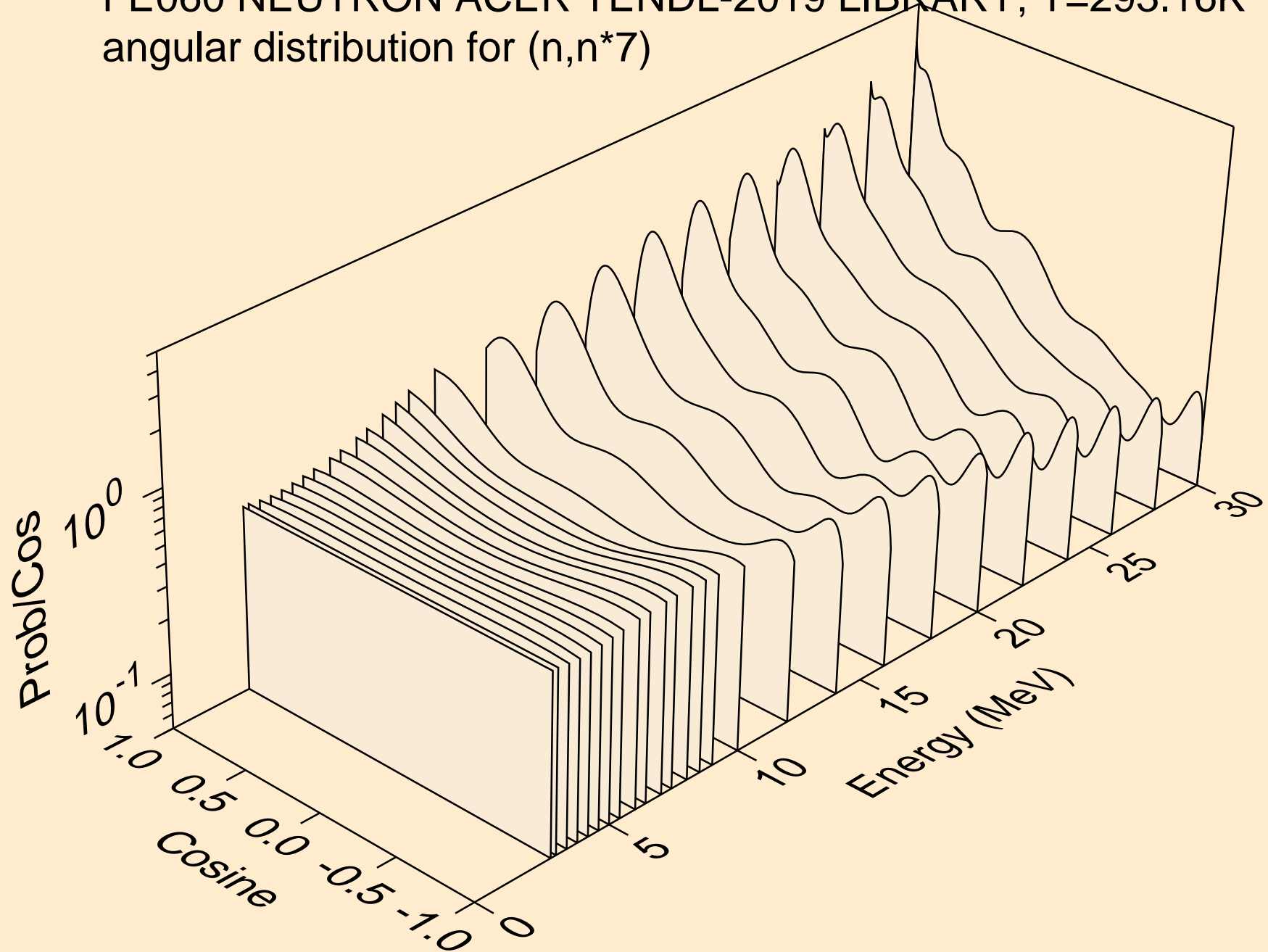

FE060 NEUTRON ACER TENDL-2019 LIBRARY; T=293.16K
angular distribution for (n,n*8)

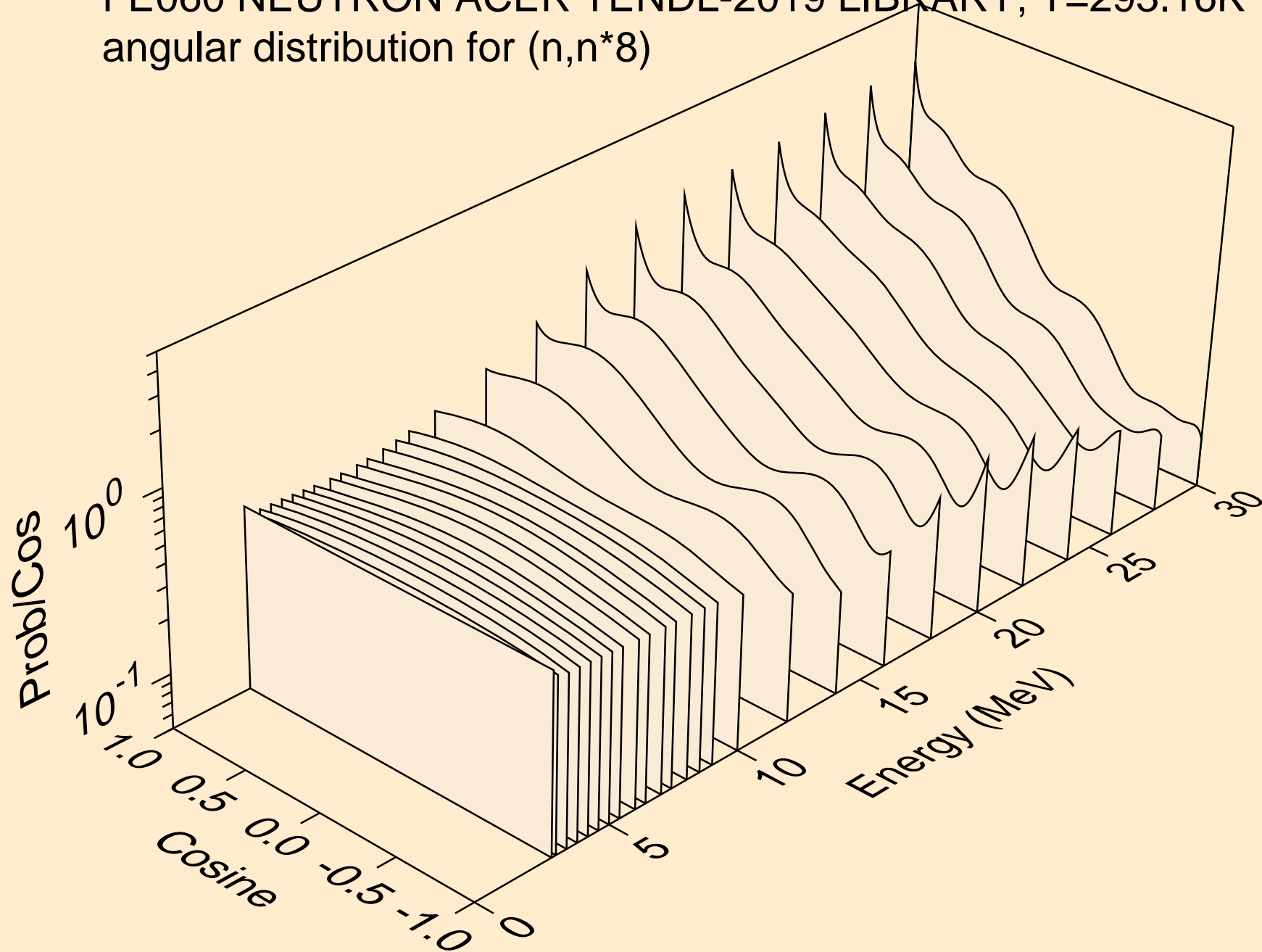

FE060 NEUTRON ACER TENDL-2019 LIBRARY; T=293.16K
angular distribution for (n,n*9)

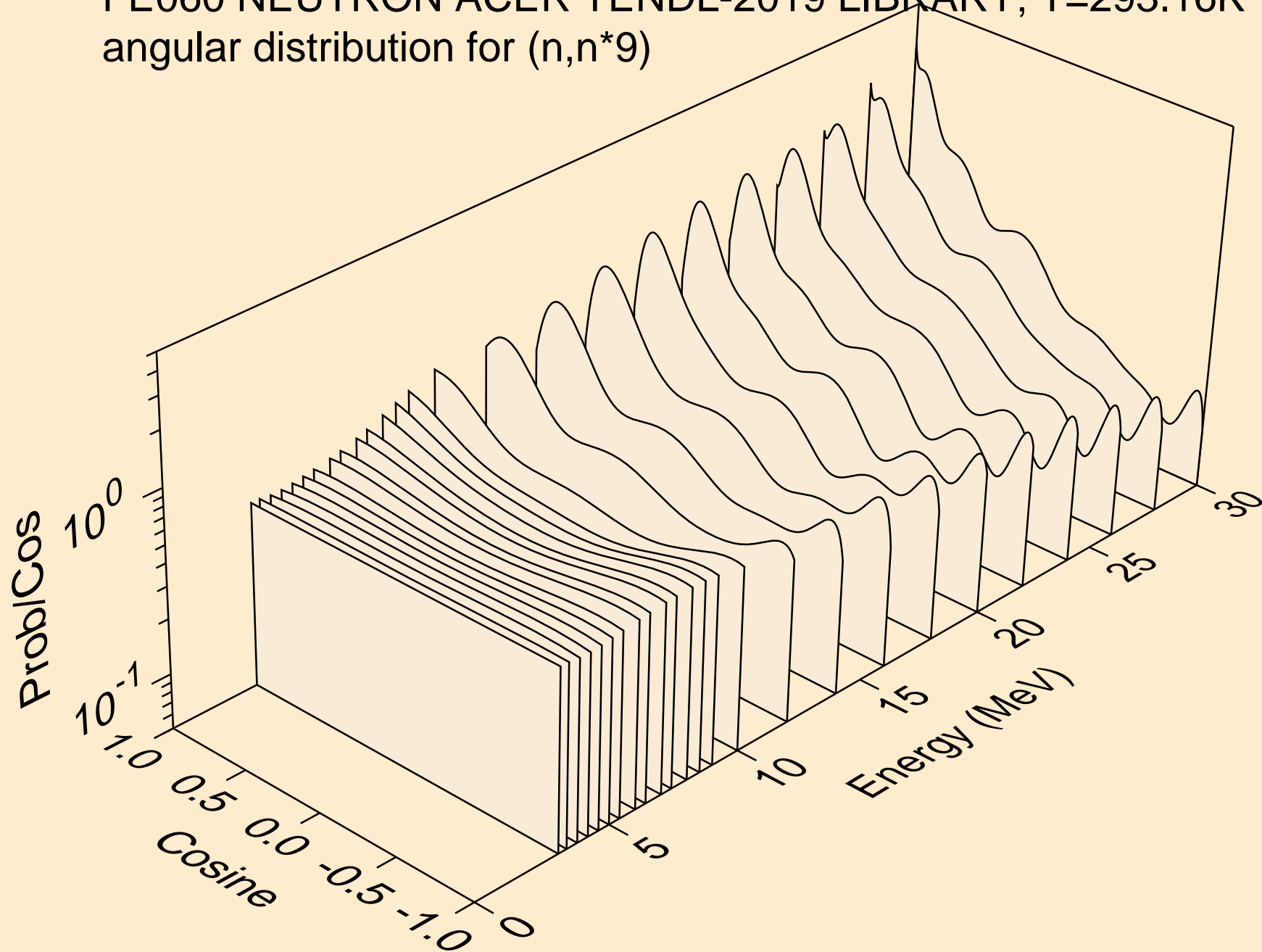

FE060 NEUTRON ACER TENDL-2019 LIBRARY; T=293.16K
angular distribution for (n,n*10)

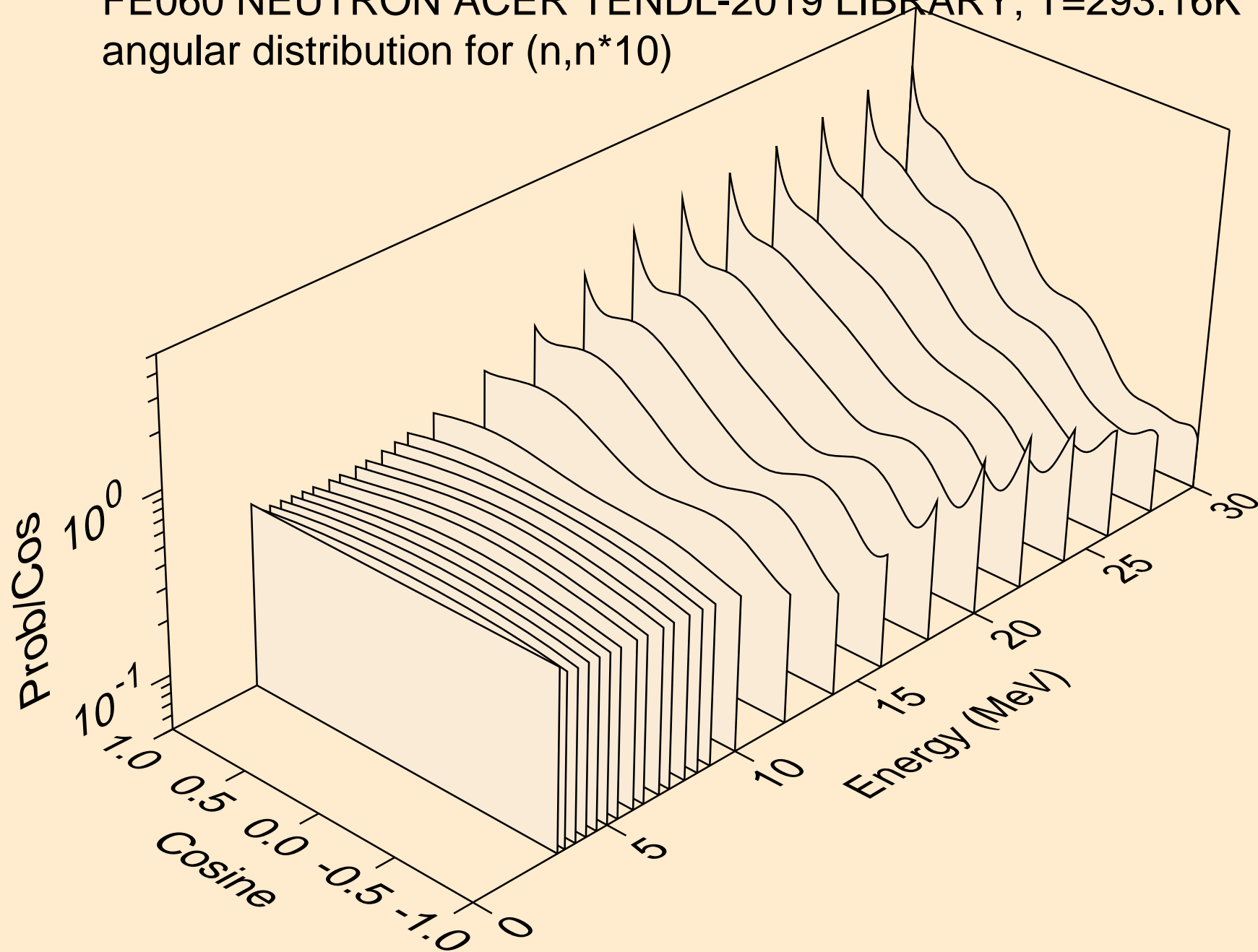

FE060 NEUTRON ACER TENDL-2019 LIBRARY; T=293.16K
angular distribution for (n,n*11)

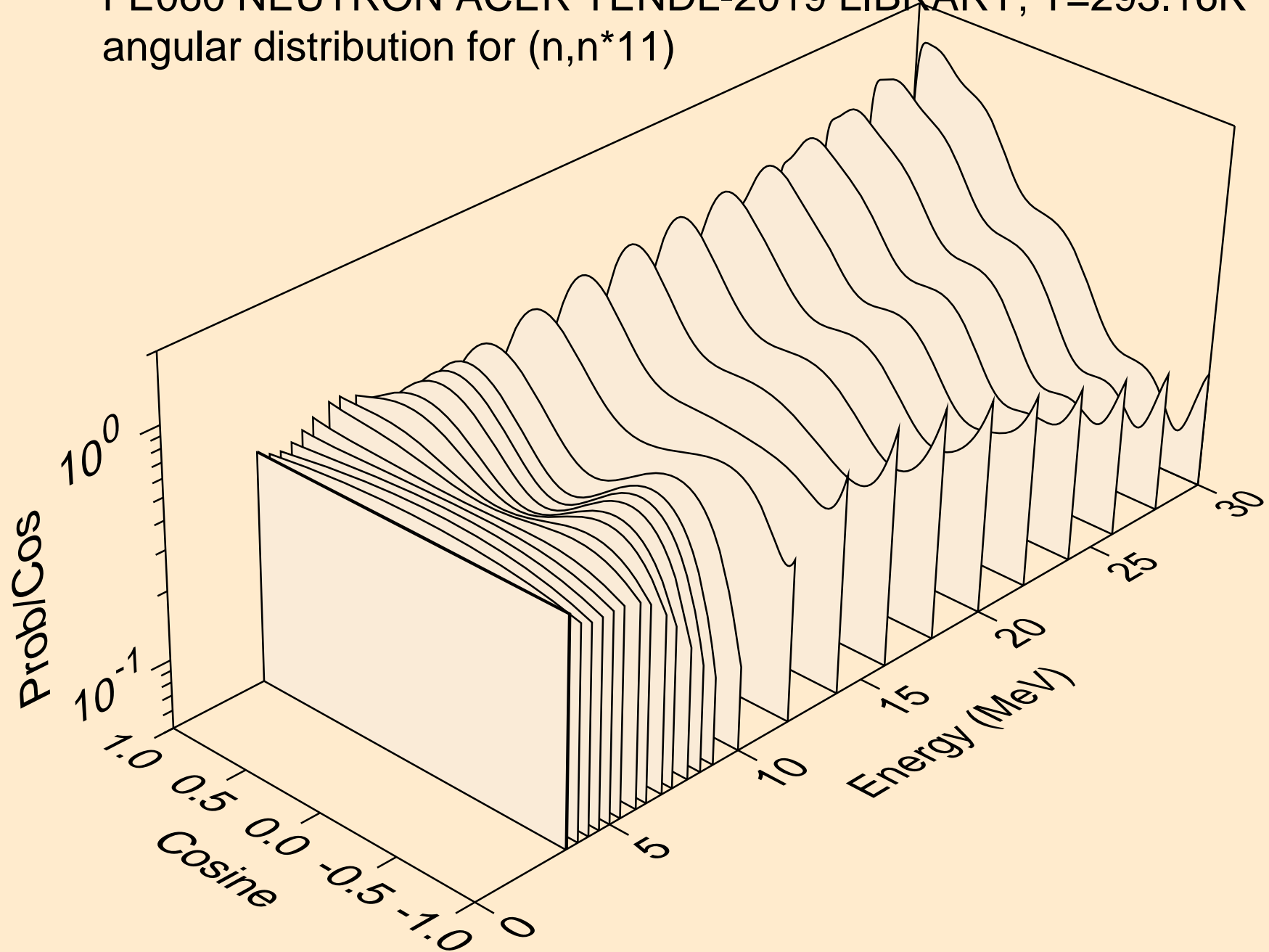

FE060 NEUTRON ACER TENDL-2019 LIBRARY; T=293.16K
angular distribution for (n,n*12)

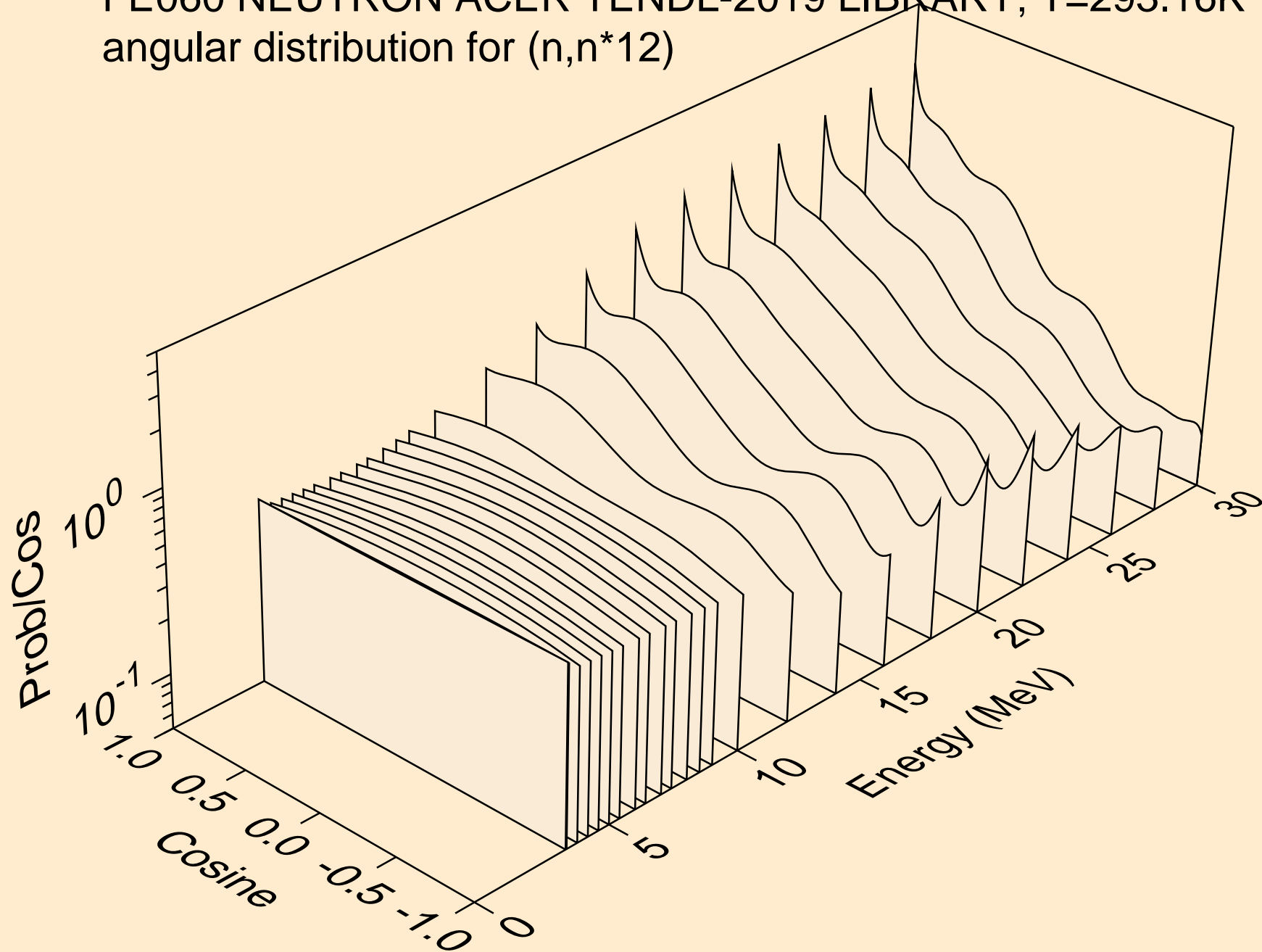

FE060 NEUTRON ACER TENDL-2019 LIBRARY; T=293.16K
angular distribution for (n,n*13)

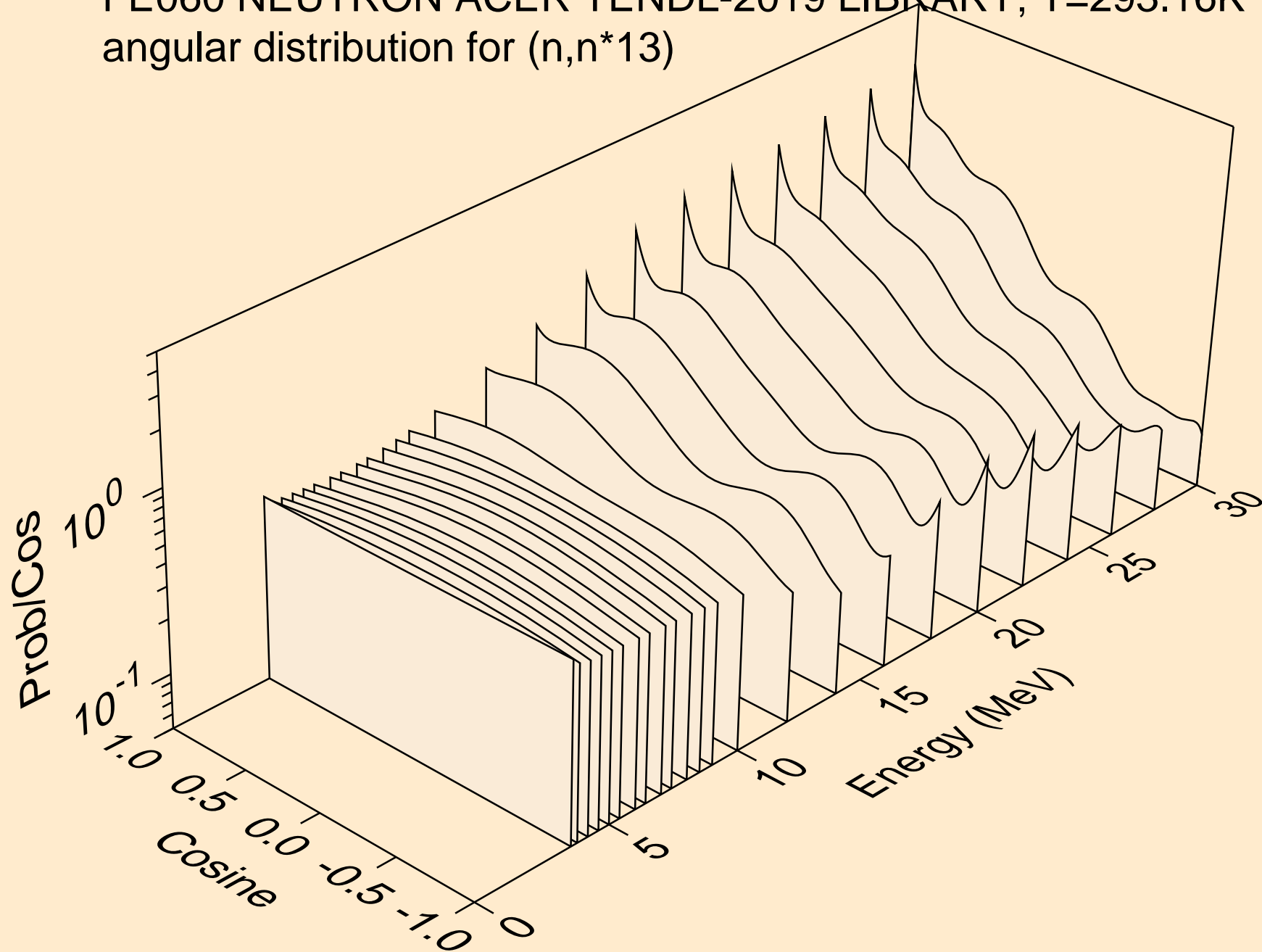

FE060 NEUTRON ACER TENDL-2019 LIBRARY; T=293.16K
angular distribution for (n,n*14)

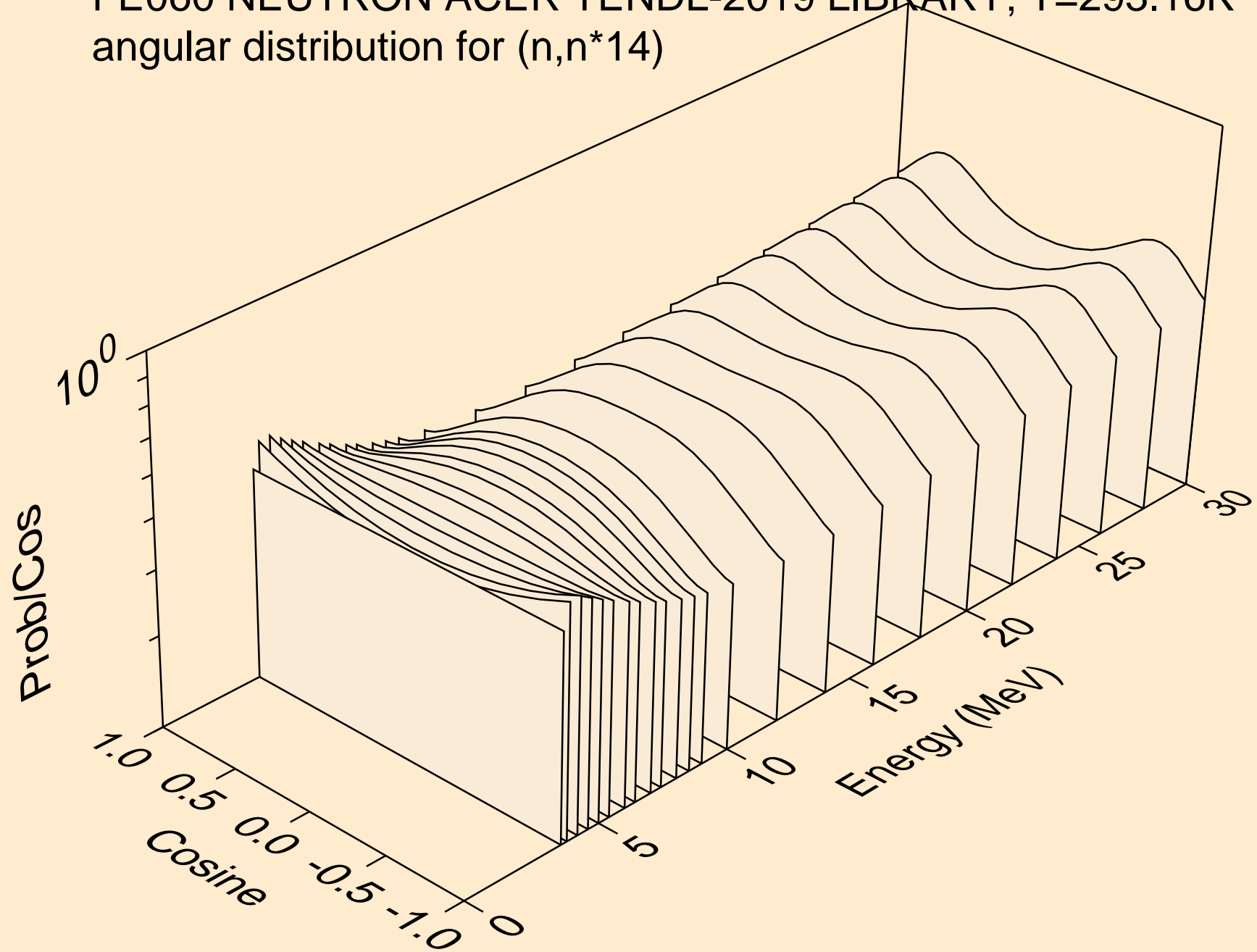

FE060 NEUTRON ACER TENDL-2019 LIBRARY; T=293.16K
angular distribution for (n,n*15)

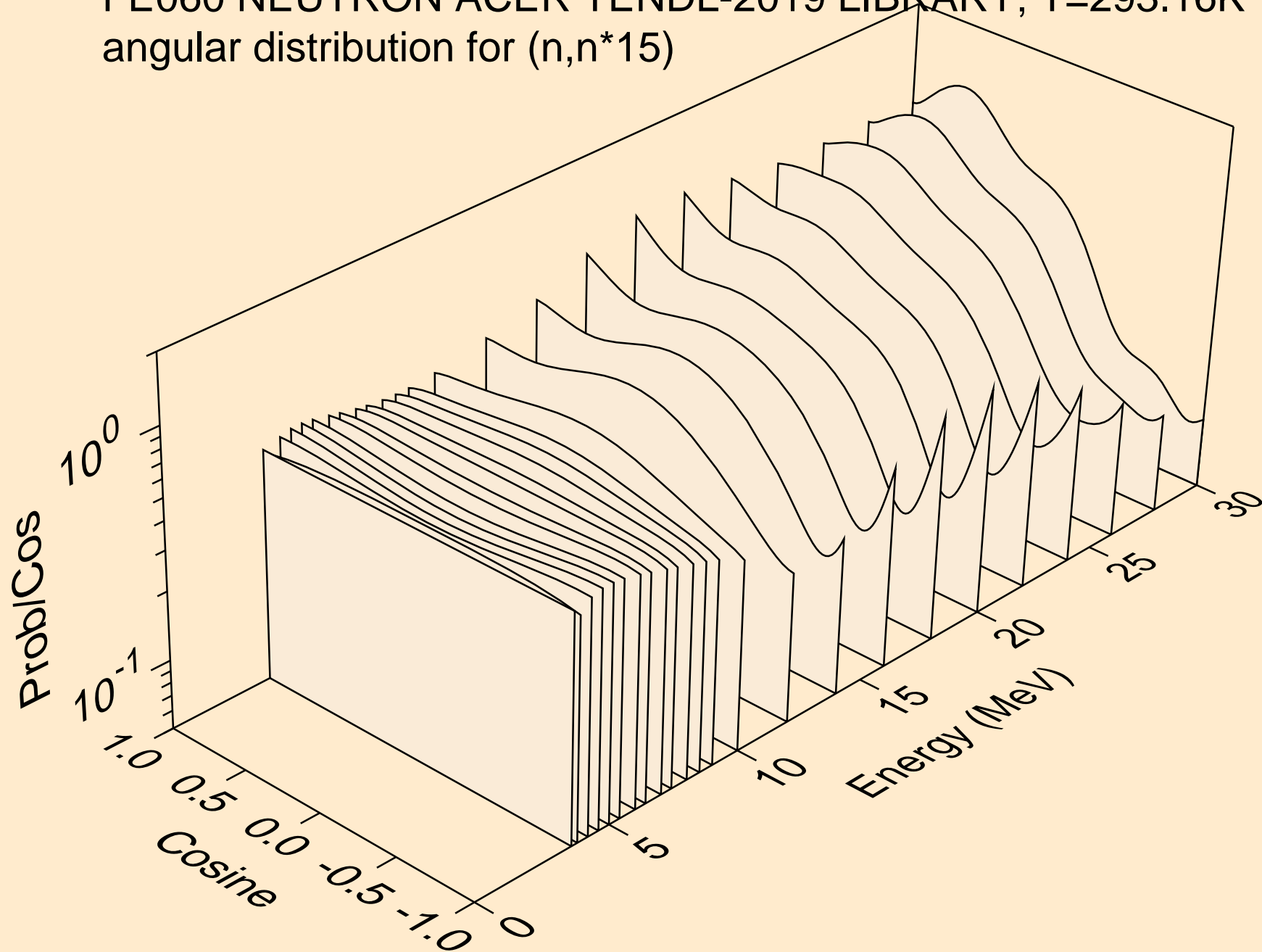

FE060 NEUTRON ACER TENDL-2019 LIBRARY; T=293.16K
angular distribution for (n,n*16)

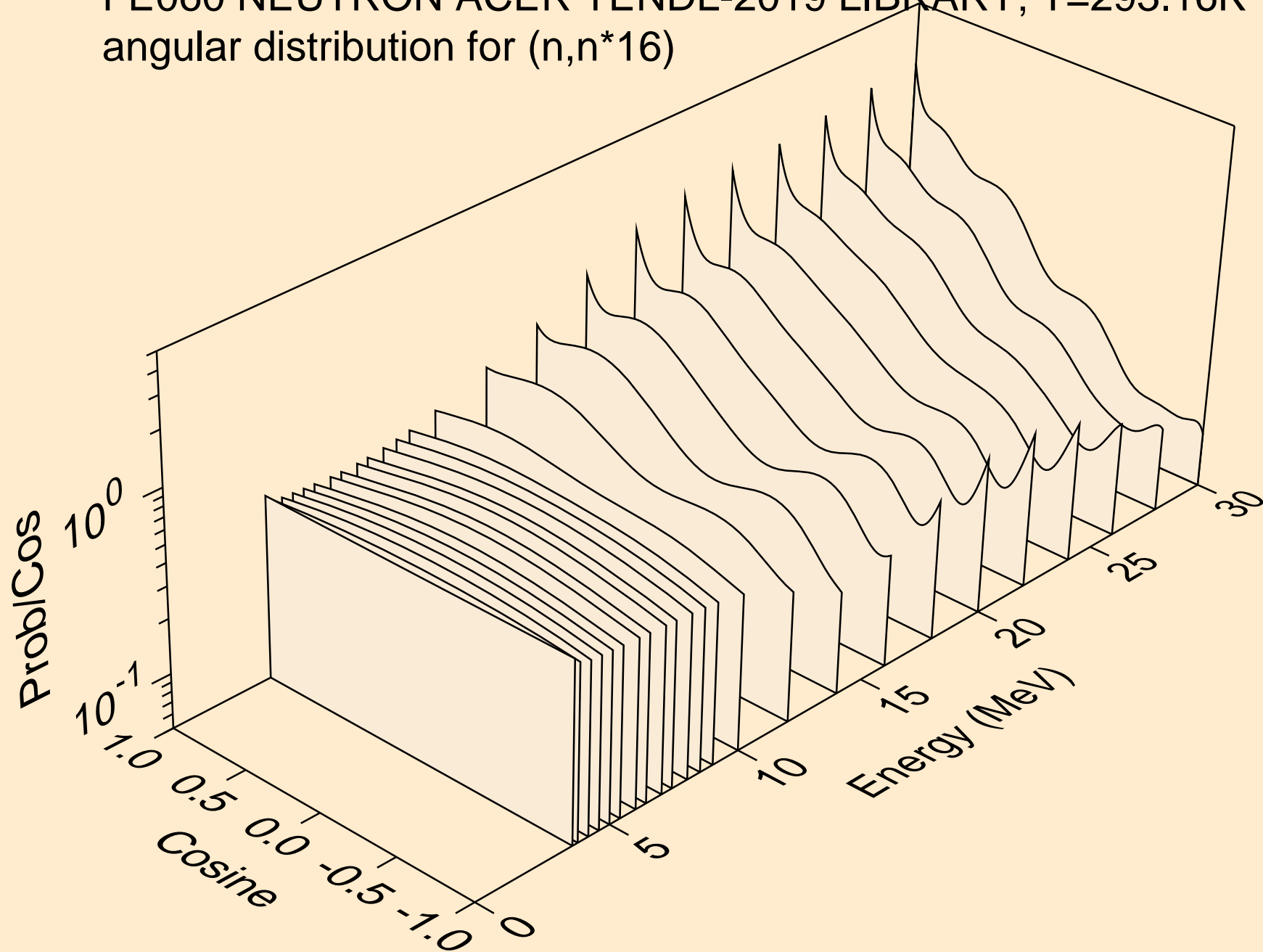

FE060 NEUTRON ACER TENDL-2019 LIBRARY; T=293.16K
angular distribution for (n,n*17)

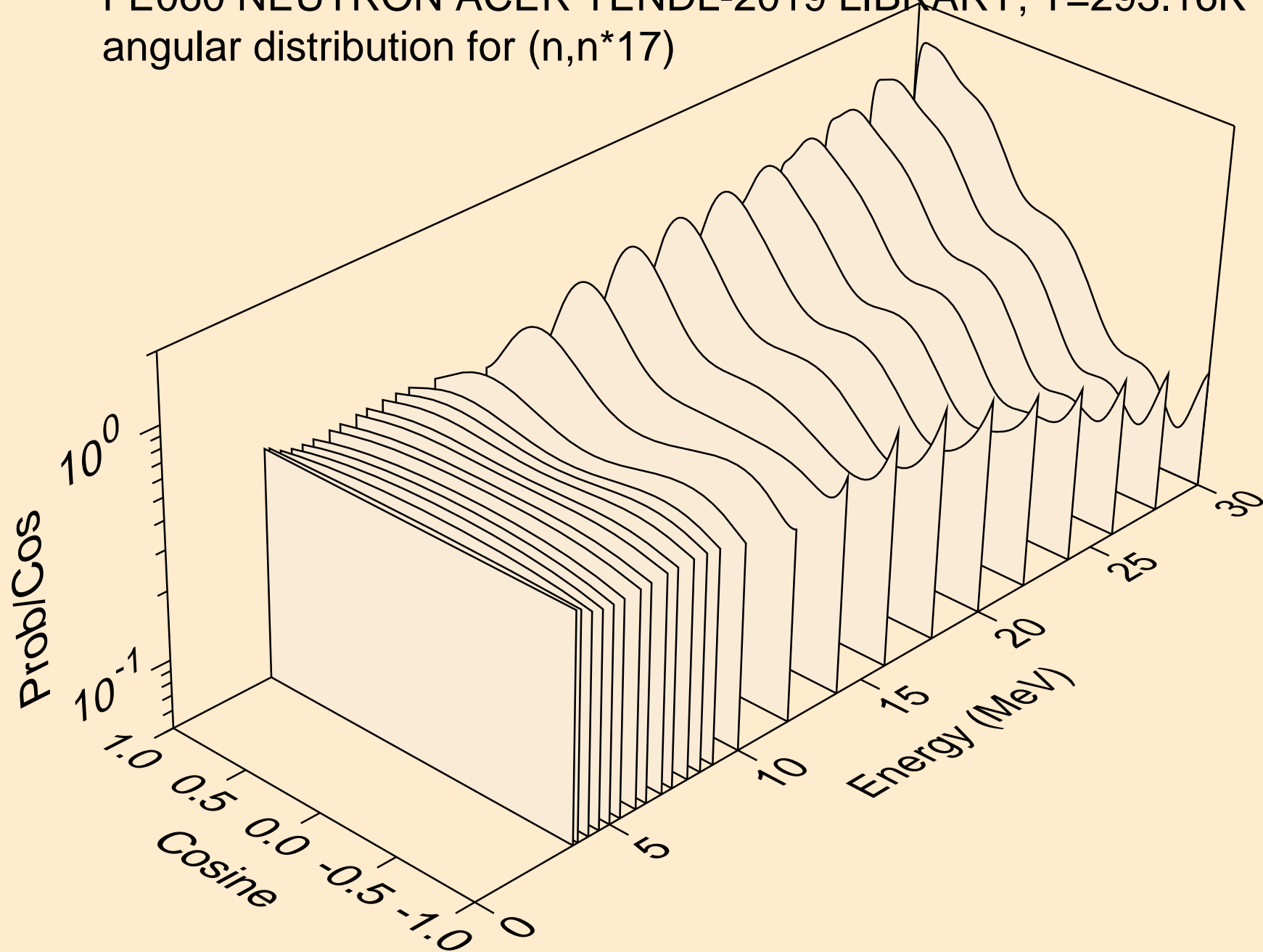

FE060 NEUTRON ACER TENDL-2019 LIBRARY; T=293.16K
angular distribution for (n,n*18)

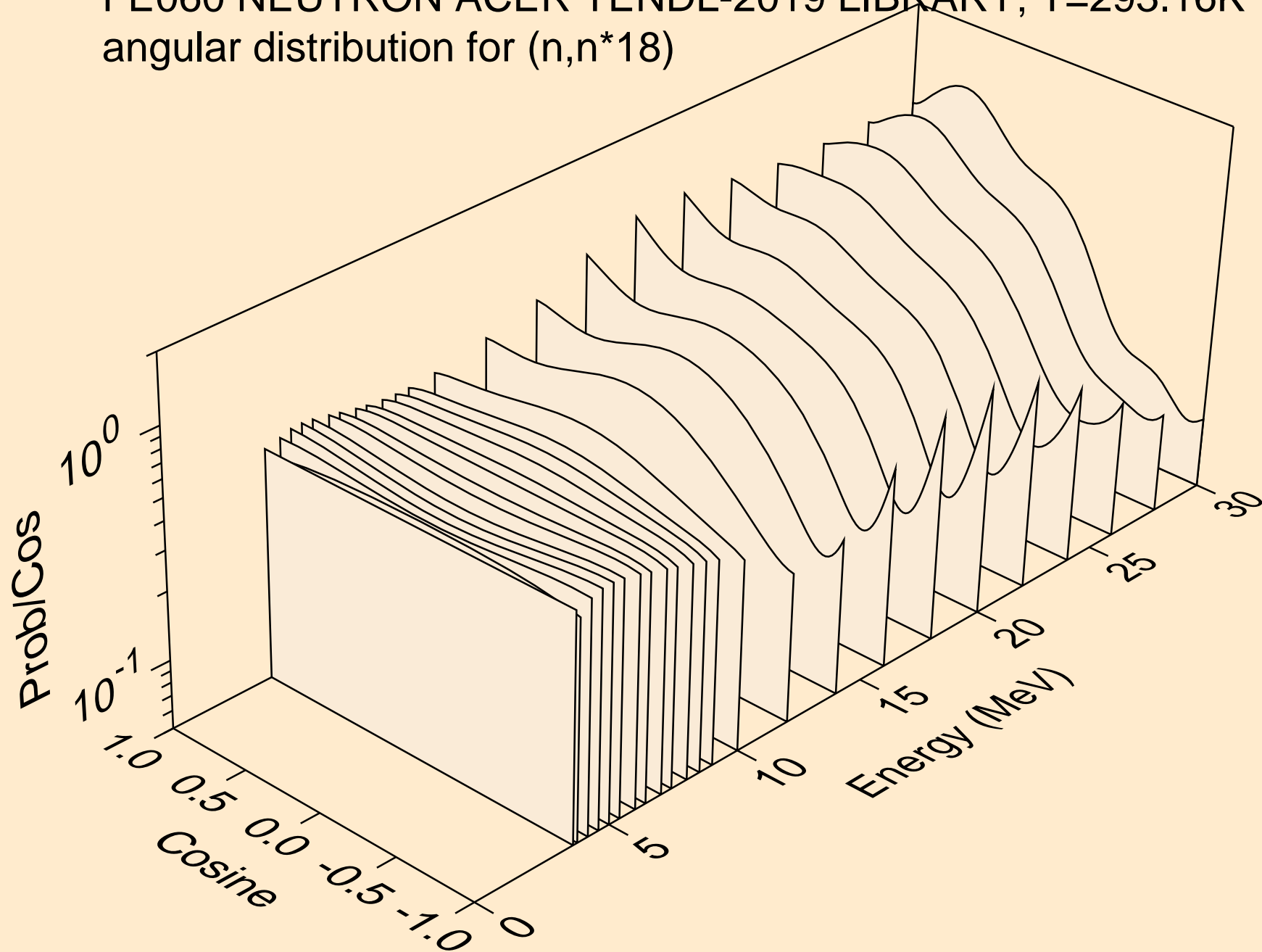

FE060 NEUTRON ACER TENDL-2019 LIBRARY; T=293.16K
angular distribution for (n,n*19)

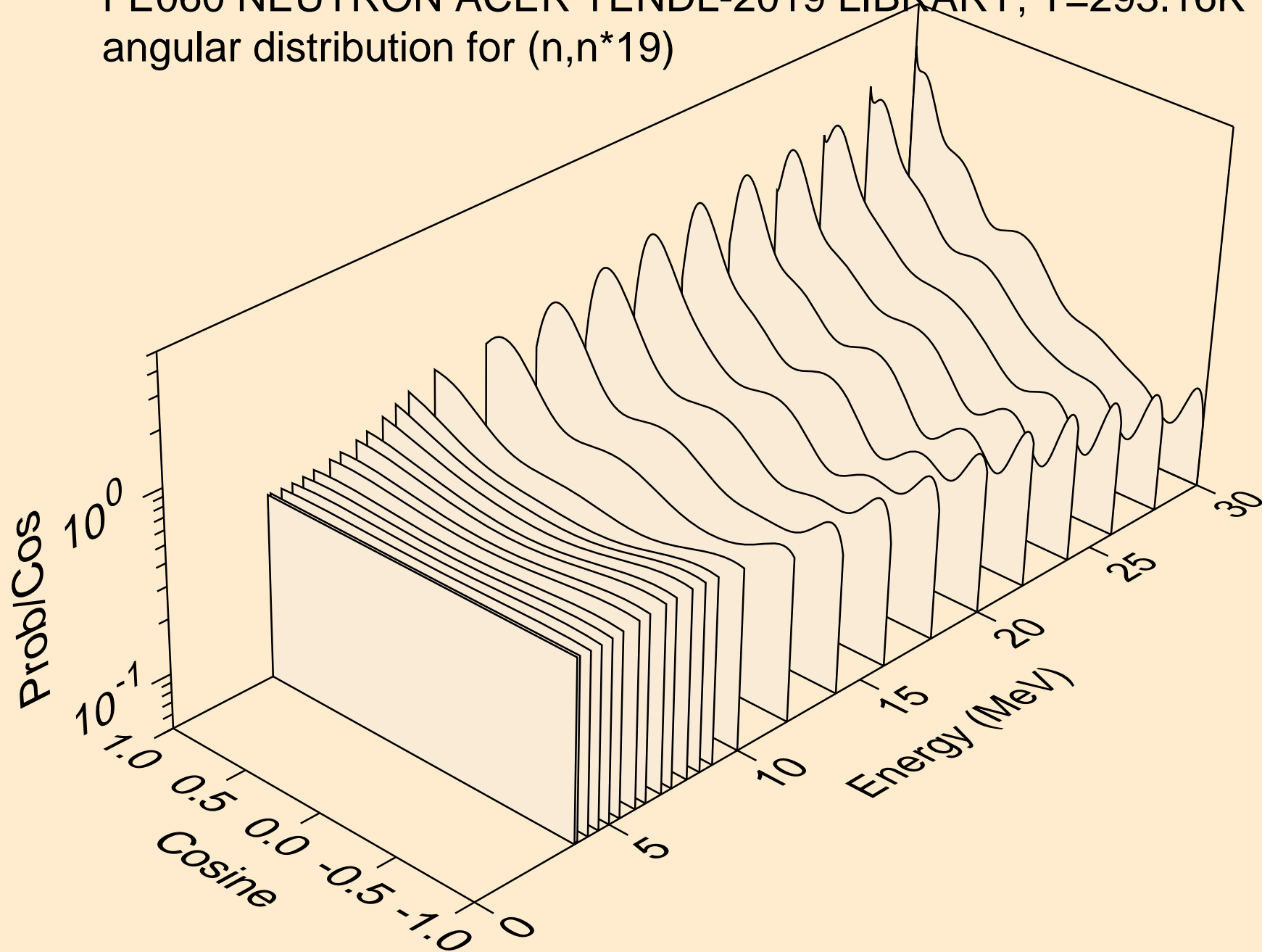

FE060 NEUTRON ACER TENDL-2019 LIBRARY; T=293.16K
angular distribution for (n,n*20)

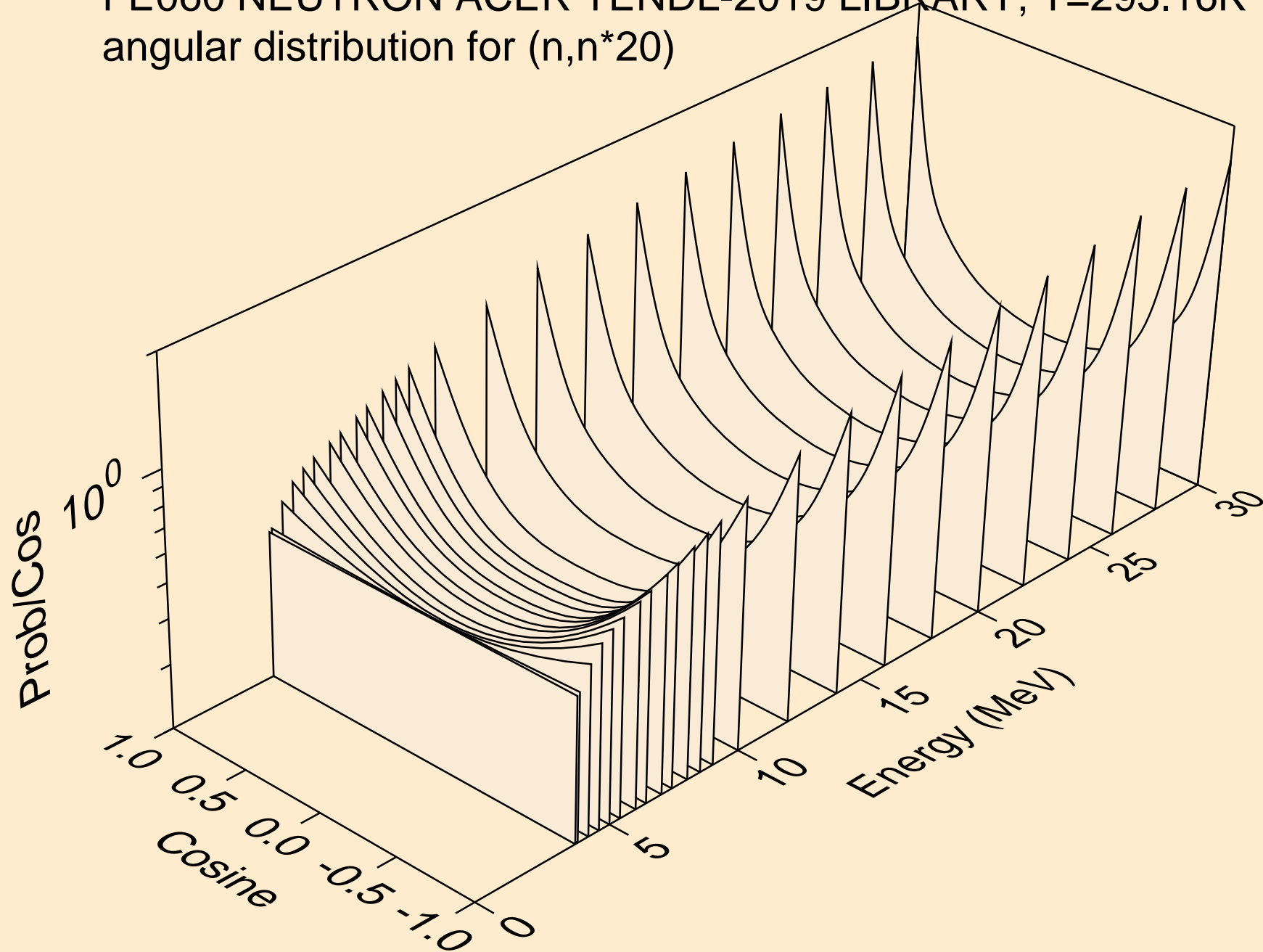

FE060 NEUTRON ACER TENDL-2019 LIBRARY; T=293.16K
angular distribution for (n,n*21)

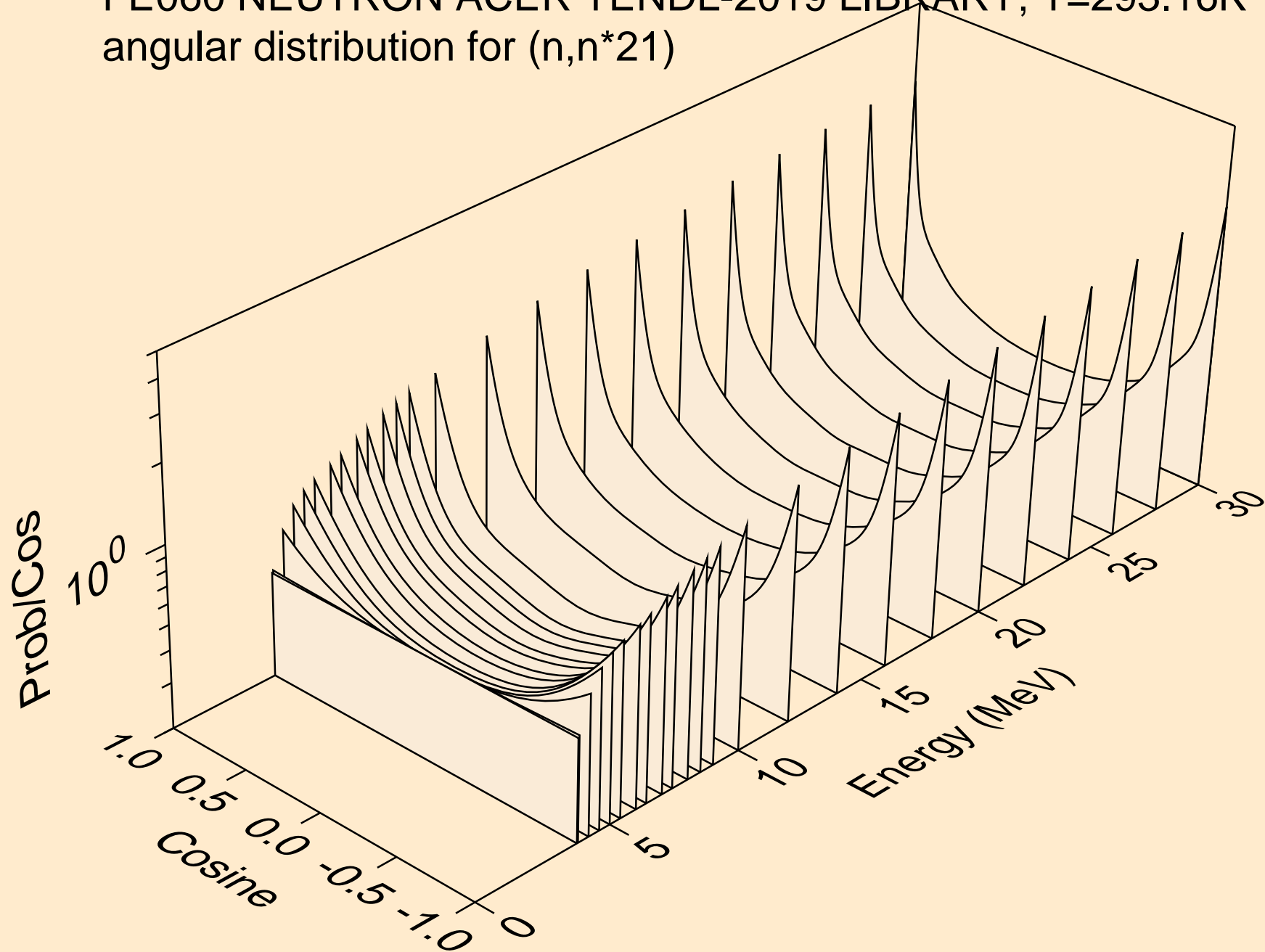

FE060 NEUTRON ACER TENDL-2019 LIBRARY; T=293.16K
angular distribution for (n,n*22)

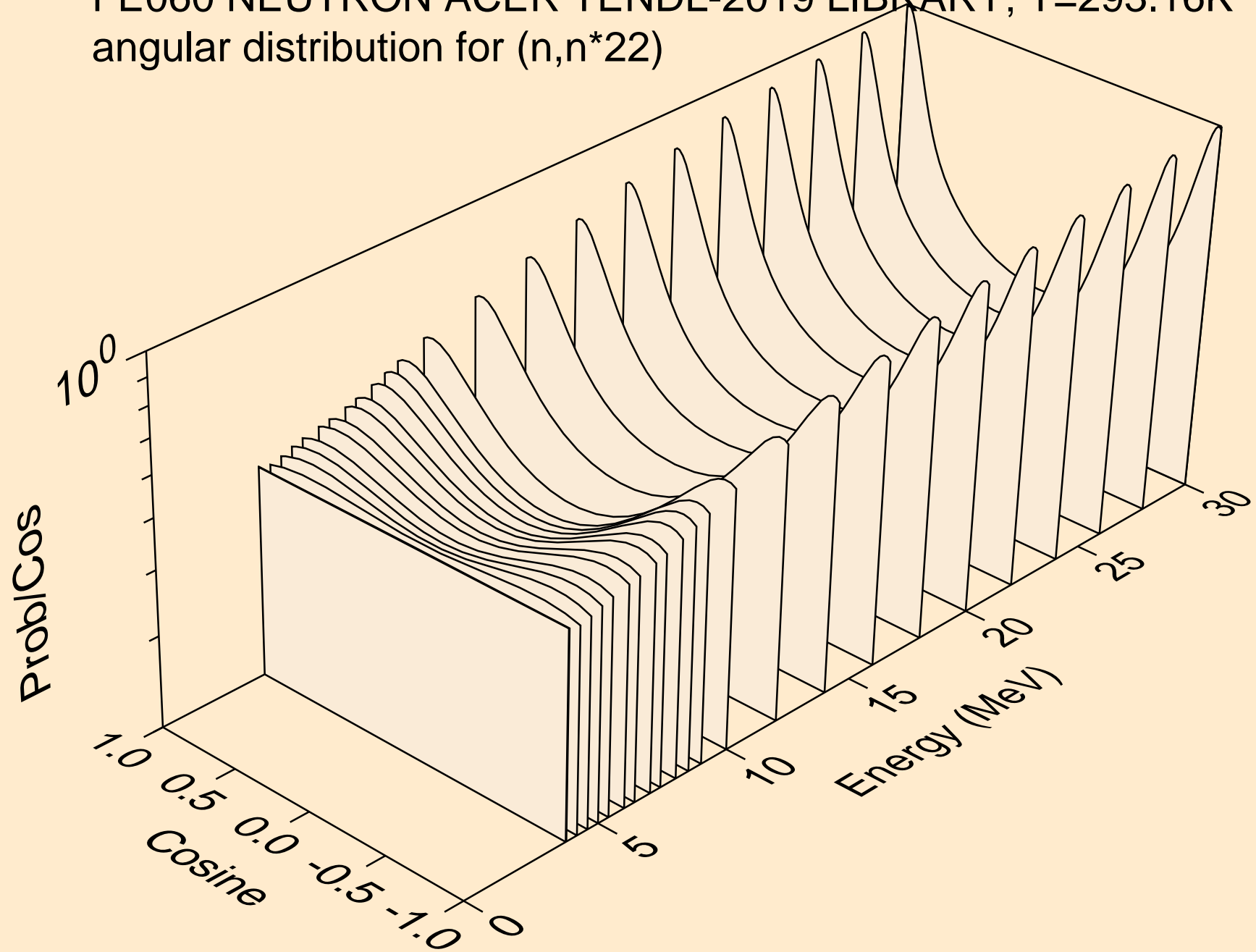

FE060 NEUTRON ACER TENDL-2019 LIBRARY; T=293.16K
angular distribution for (n,n*23)

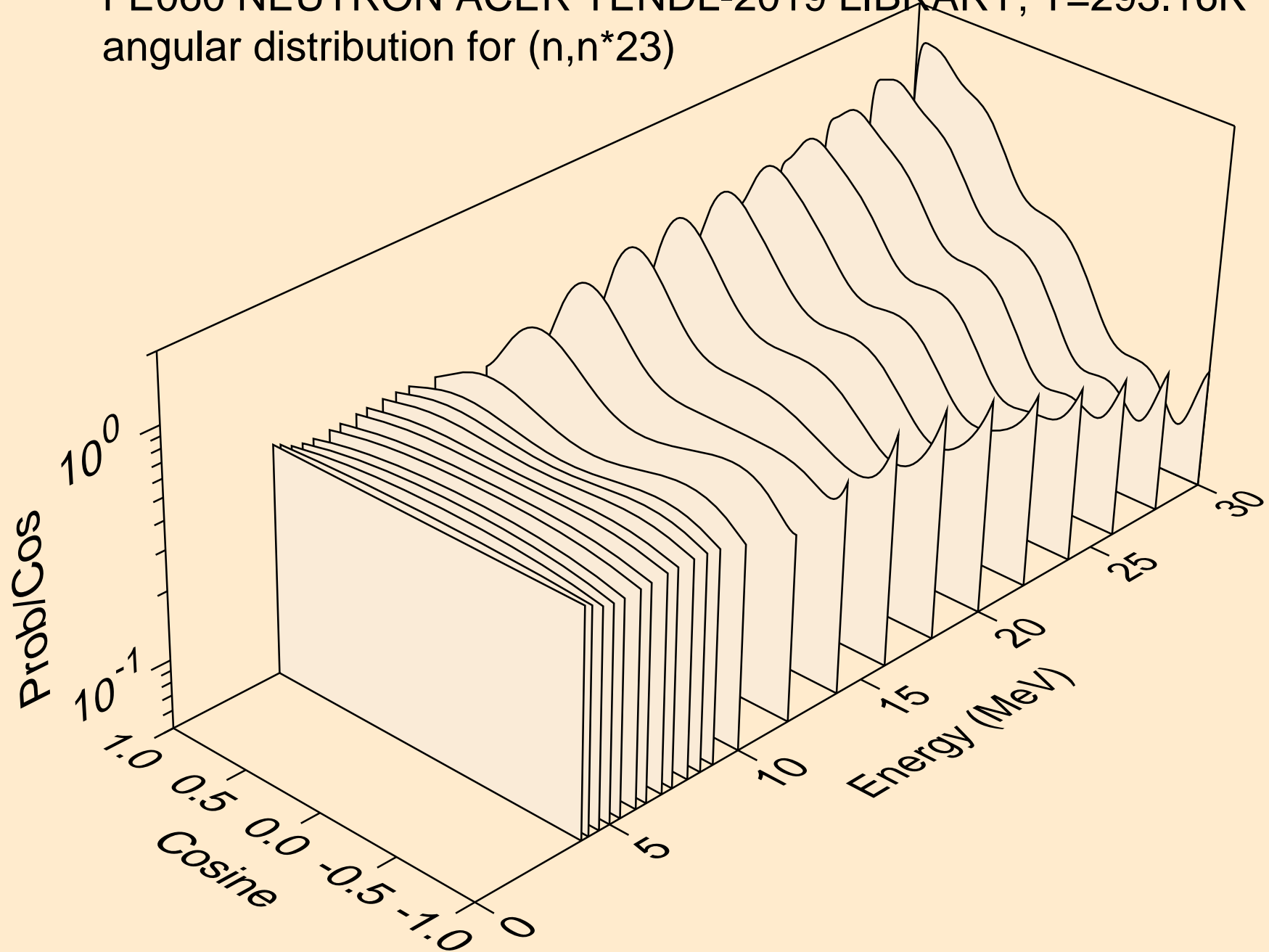

FE060 NEUTRON ACER TENDL-2019 LIBRARY; T=293.16K
angular distribution for (n,n*24)

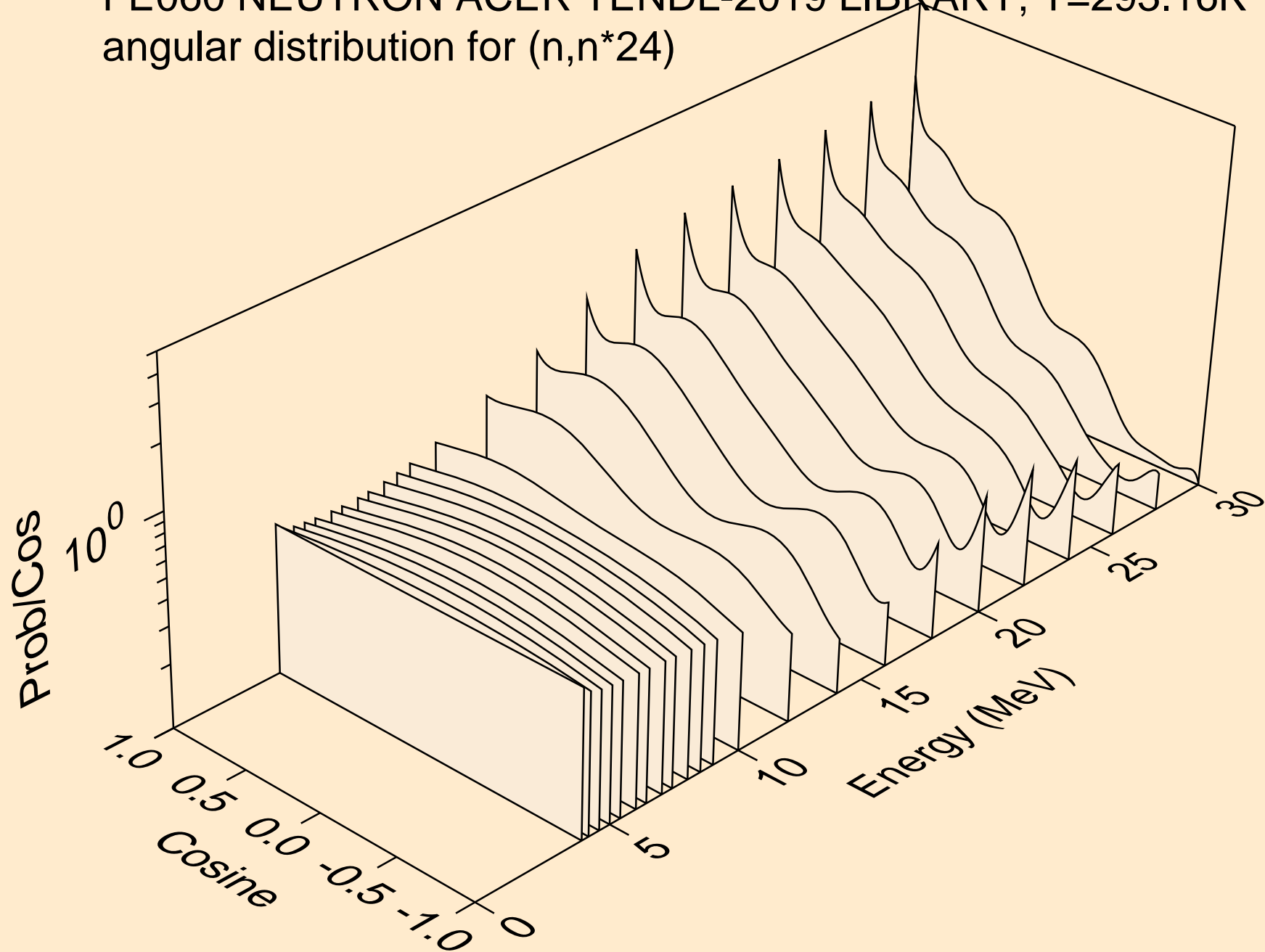

FE060 NEUTRON ACER TENDL-2019 LIBRARY; T=293.16K
angular distribution for (n,n*25)

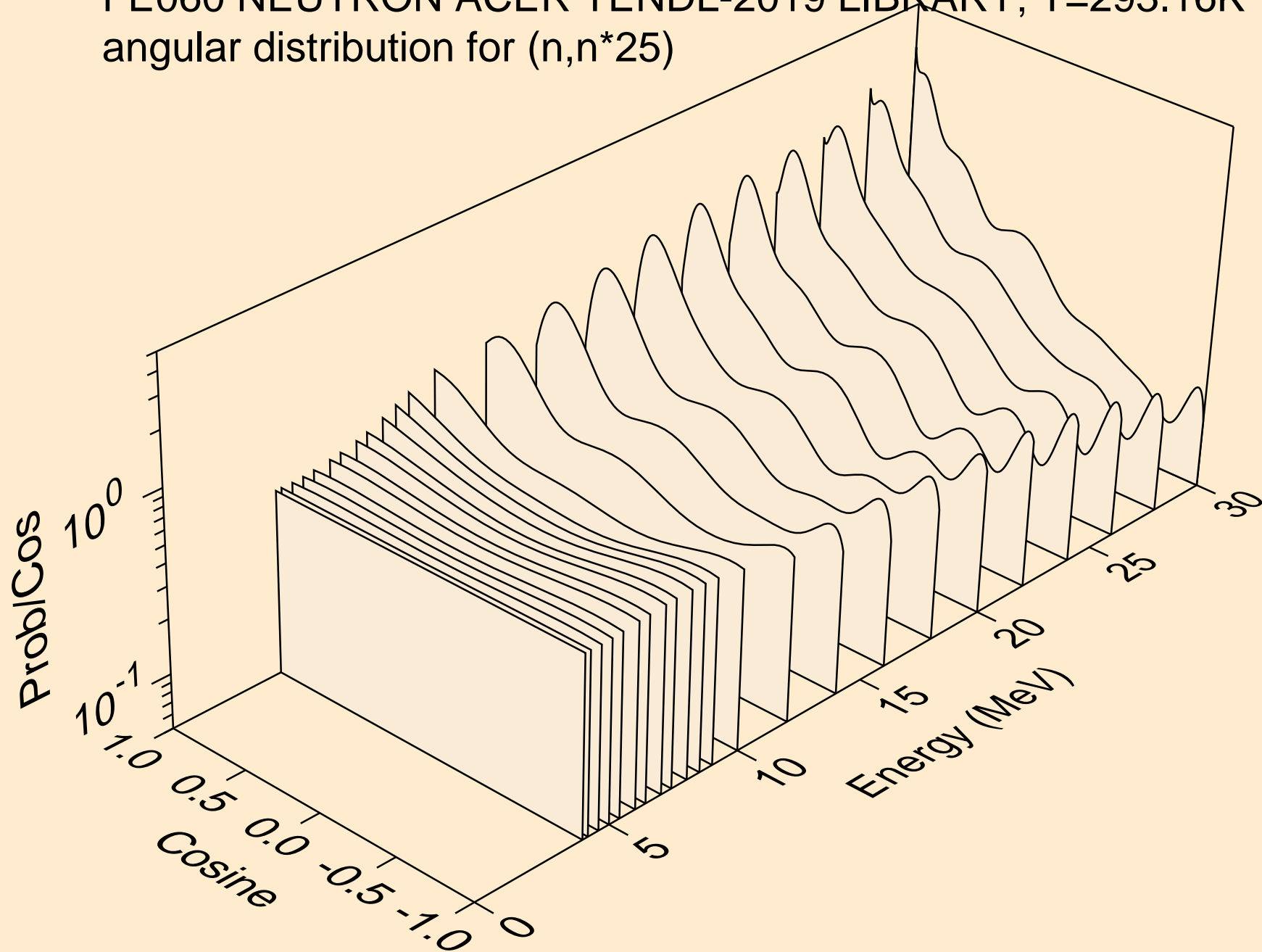

FE060 NEUTRON ACER TENDL-2019 LIBRARY; T=293.16K
angular distribution for (n,n*26)

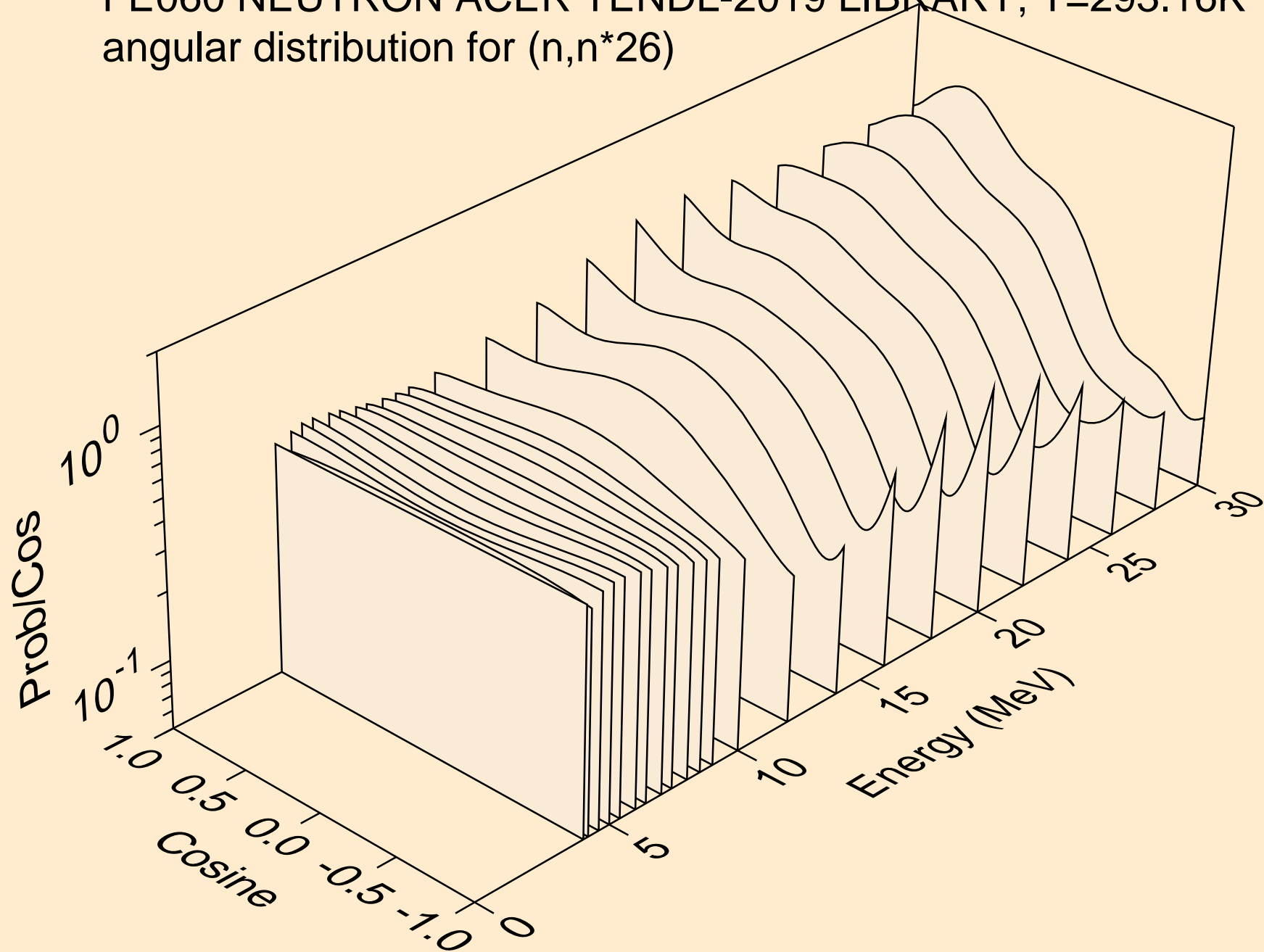

FE060 NEUTRON ACER TENDL-2019 LIBRARY; T=293.16K
angular distribution for (n,n*27)

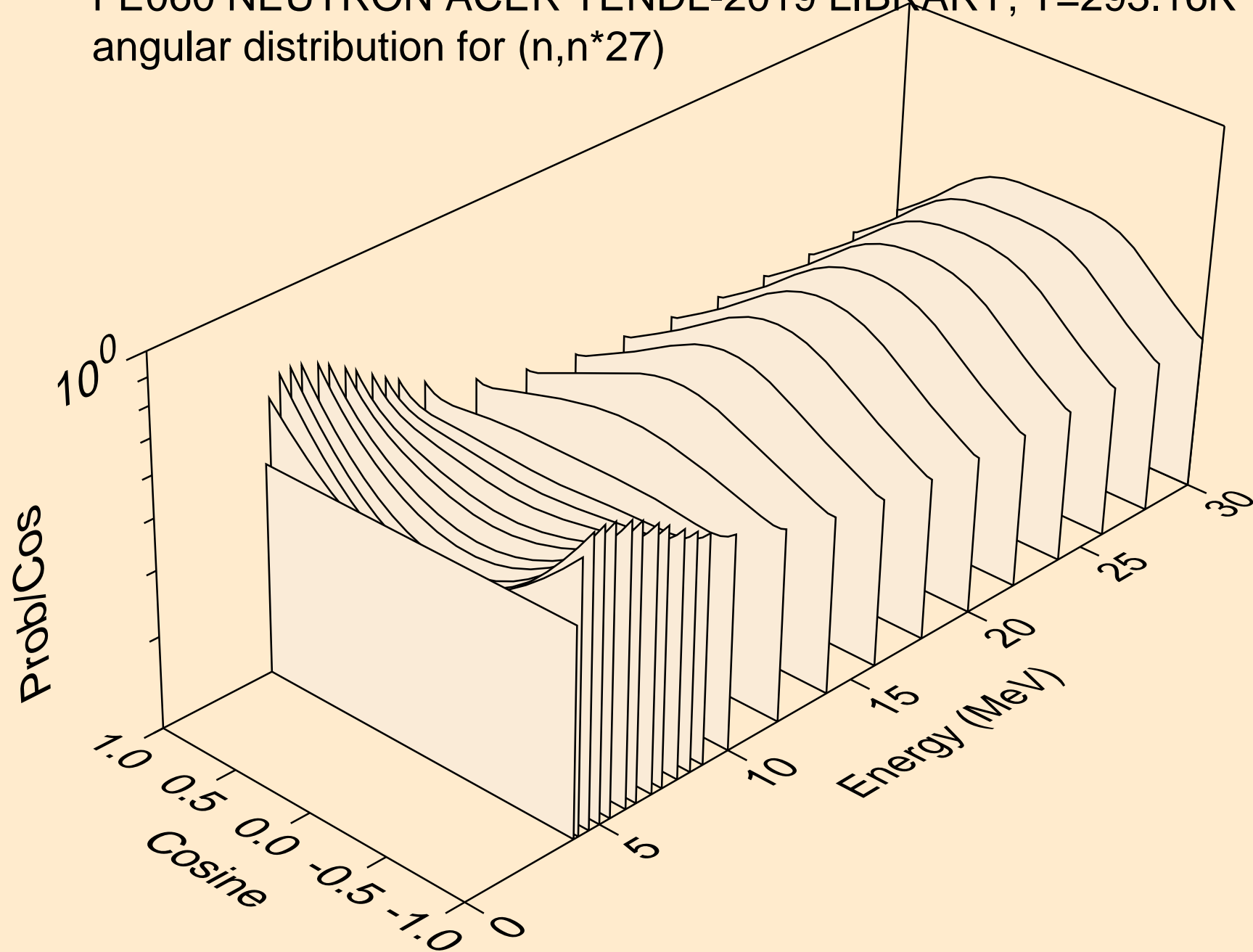

FE060 NEUTRON ACER TENDL-2019 LIBRARY; T=293.16K
angular distribution for (n,n*28)

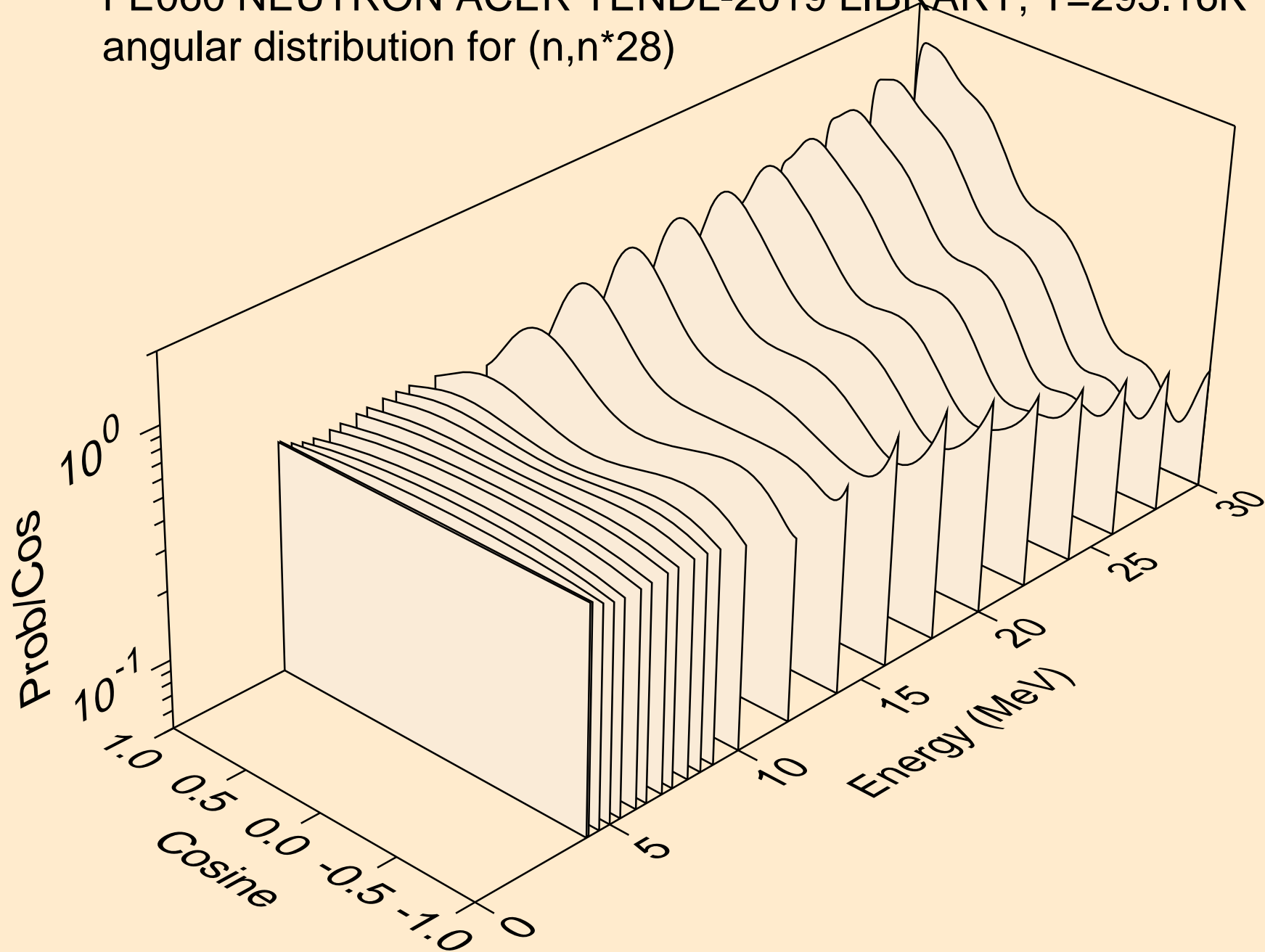

FE060 NEUTRON ACER TENDL-2019 LIBRARY; T=293.16K
angular distribution for (n,n*29)

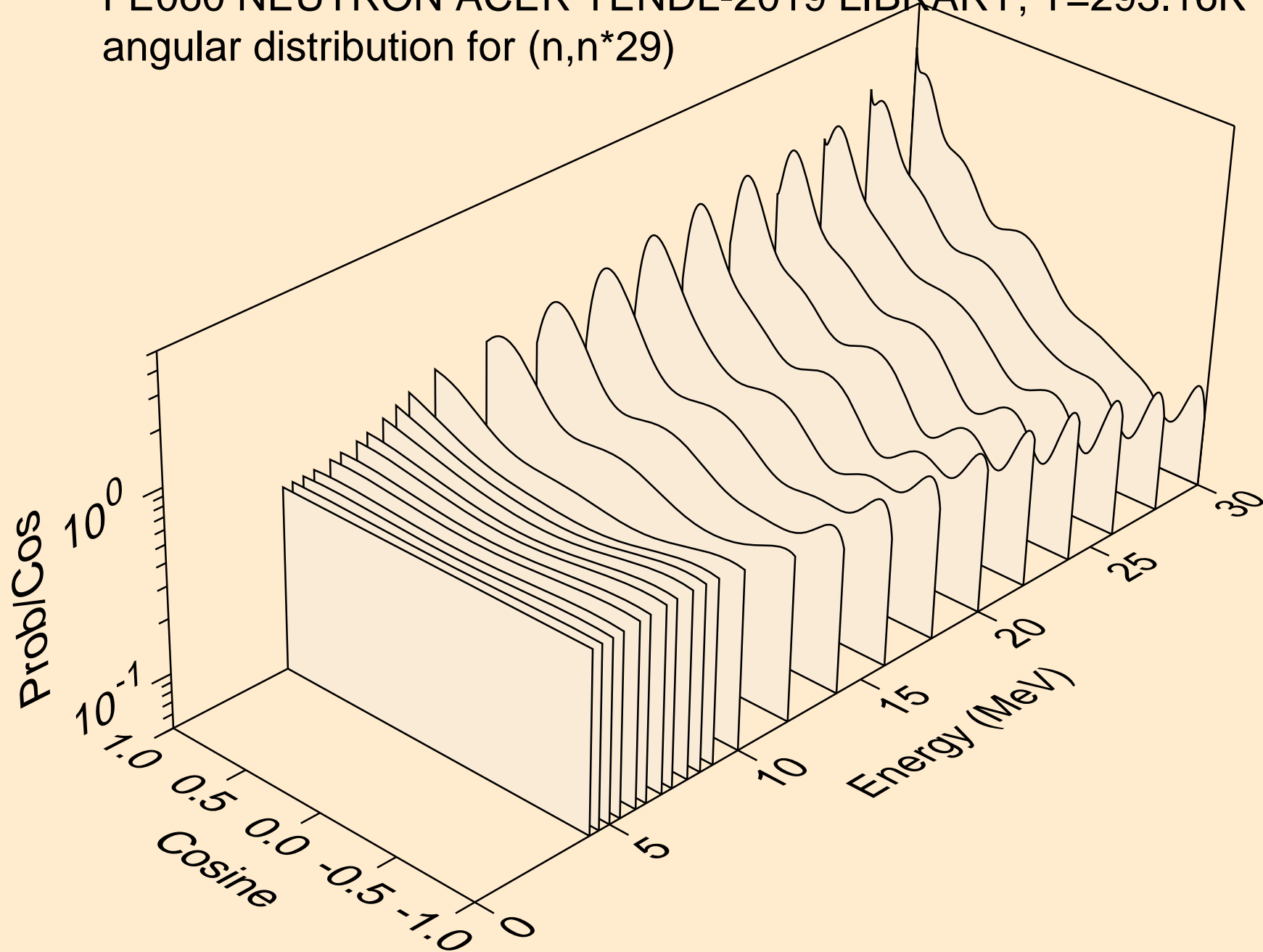

FE060 NEUTRON ACER TENDL-2019 LIBRARY; T=293.16K
angular distribution for (n,n*30)

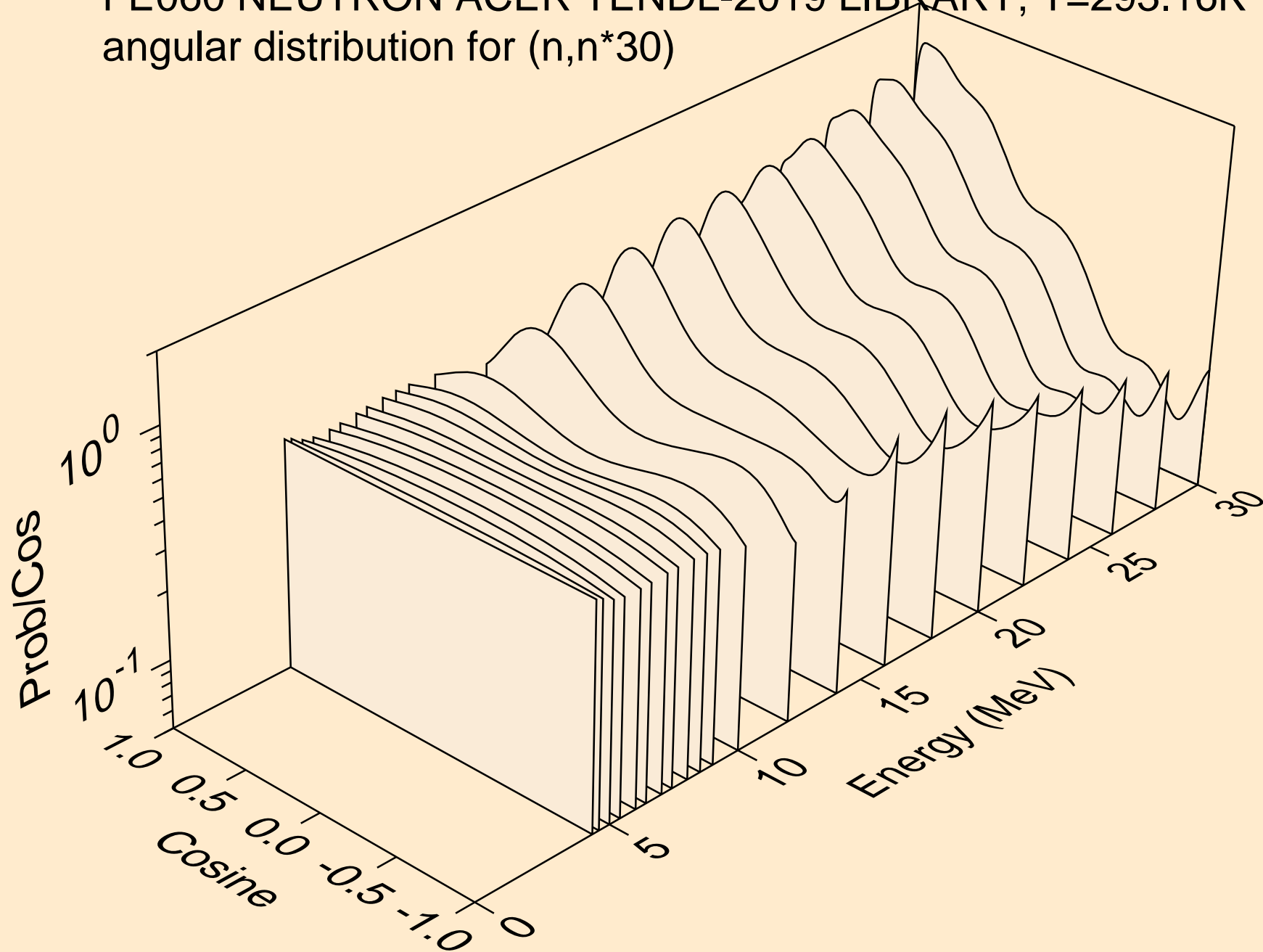

FE060 NEUTRON ACER TENDL-2019 LIBRARY; T=293.16K
Neutron emission for (n,x)

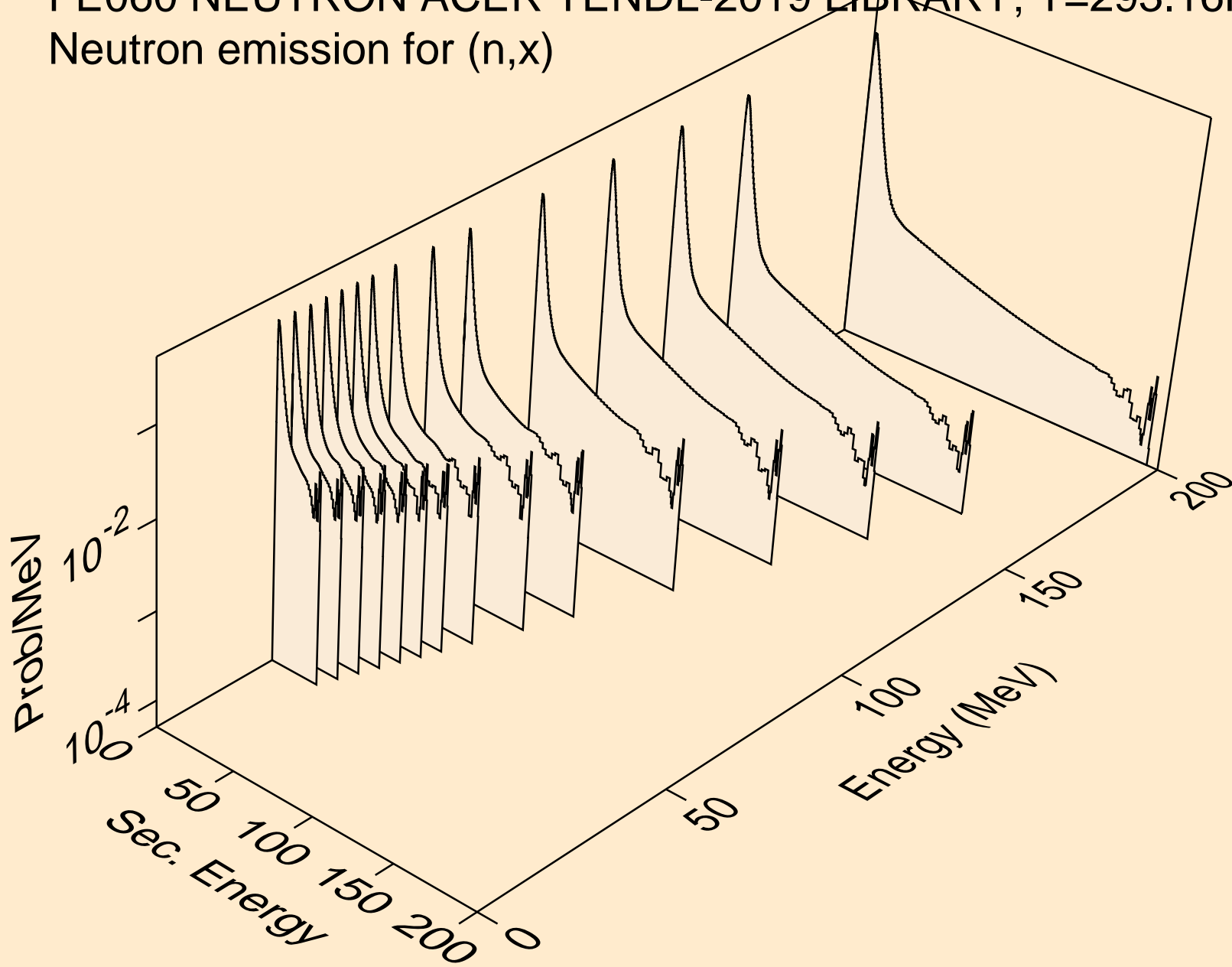

FE060 NEUTRON ACER TENDL-2019 LIBRARY; T=293.16K
Neutron emission for (n,2nd)

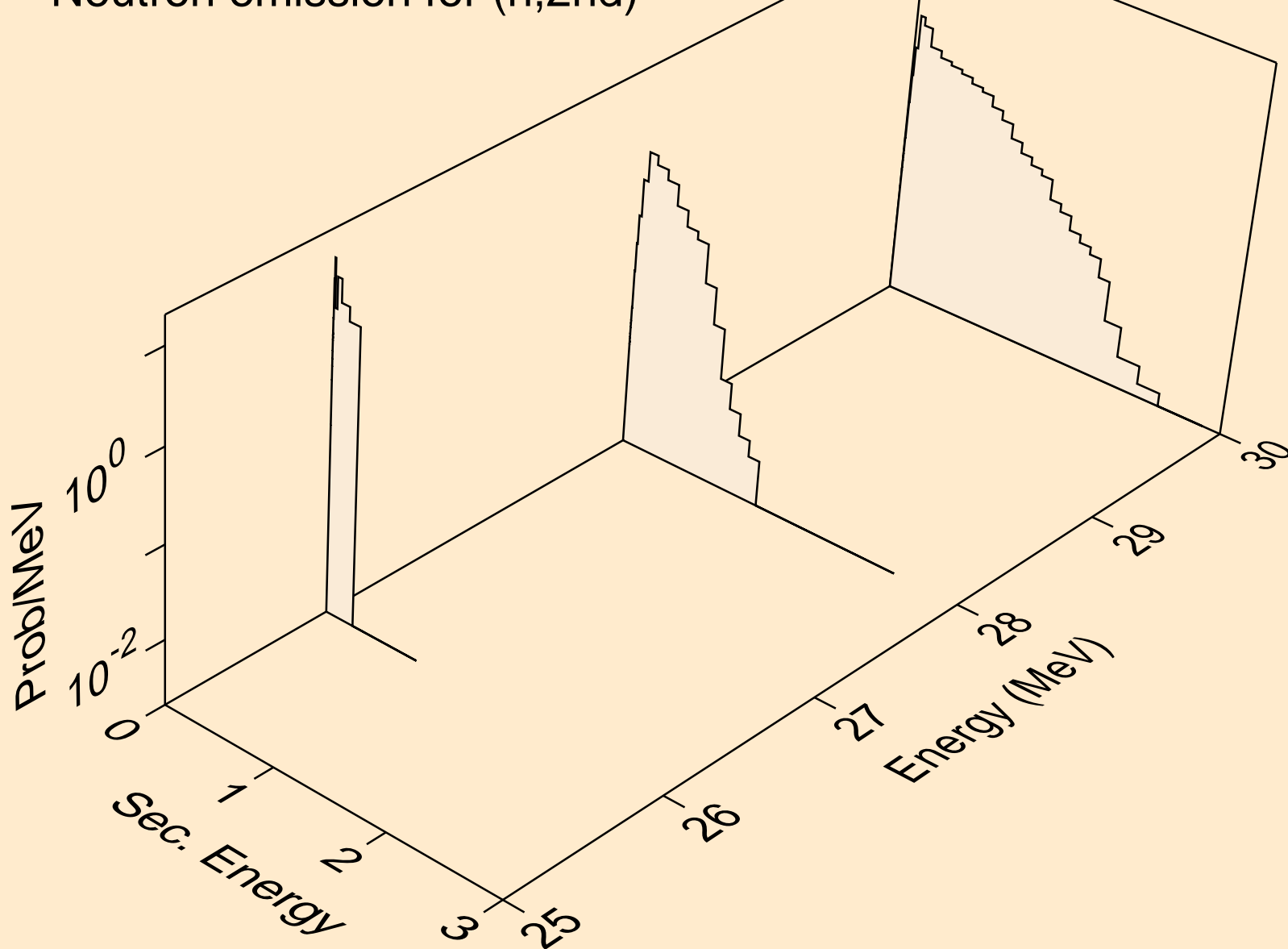

FE060 NEUTRON ACER TENDL-2019 LIBRARY; T=293.16K
Neutron emission for (n,2n)

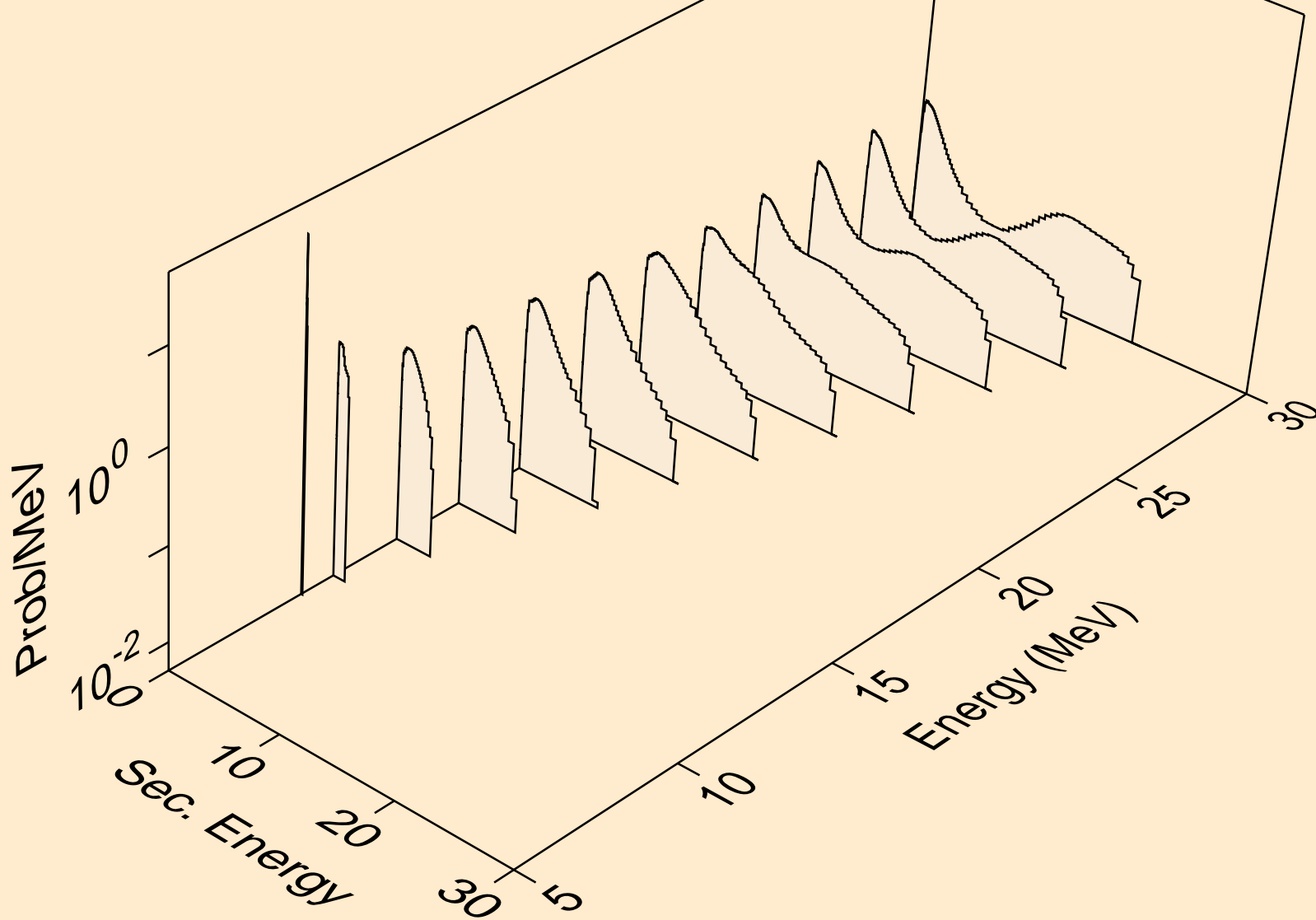

FE060 NEUTRON ACER TENDL-2019 LIBRARY; T=293.16K
Neutron emission for (n,3n)

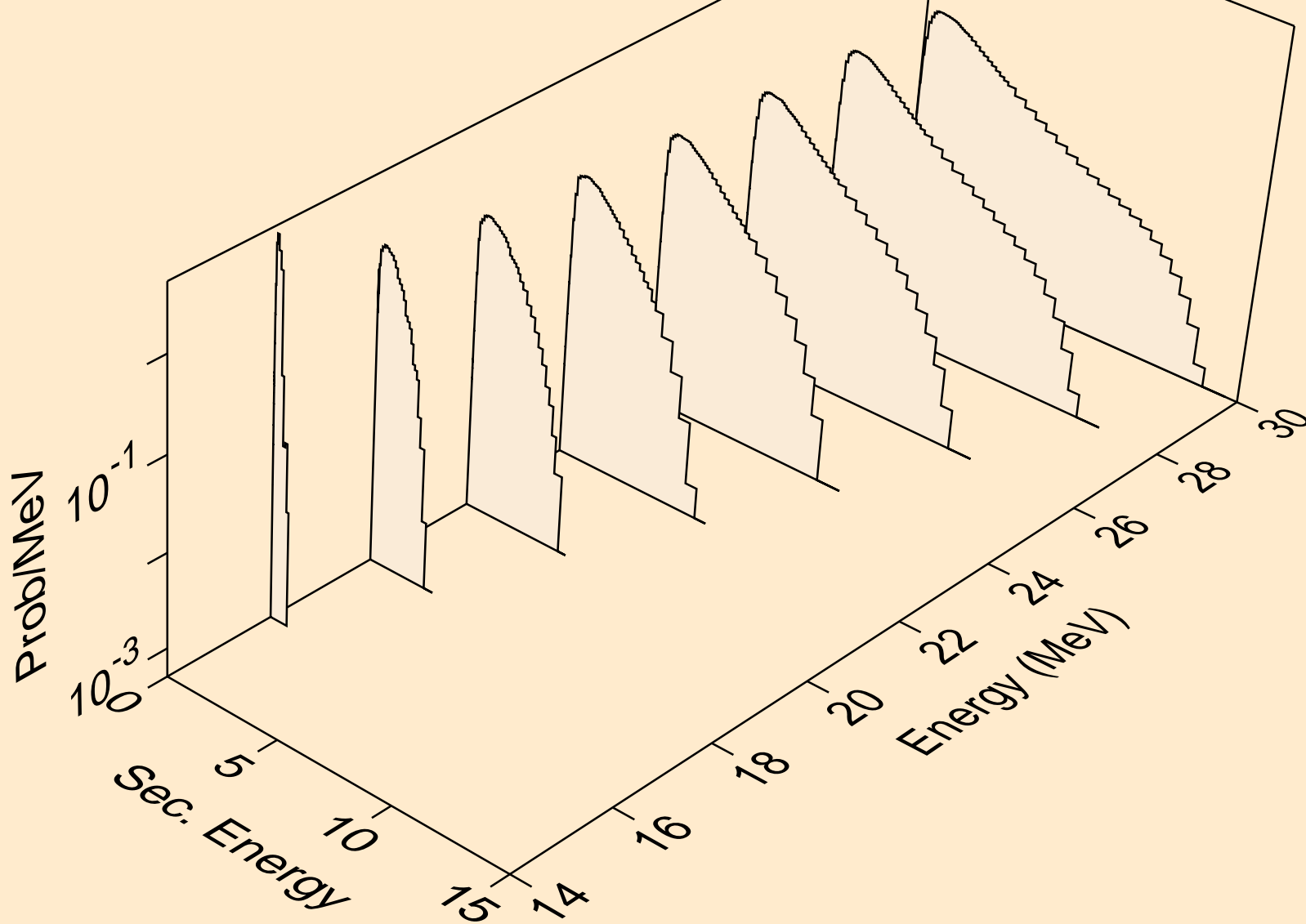

FE060 NEUTRON ACER TENDL-2019 LIBRARY; T=293.16K
Neutron emission for (n,n*)a

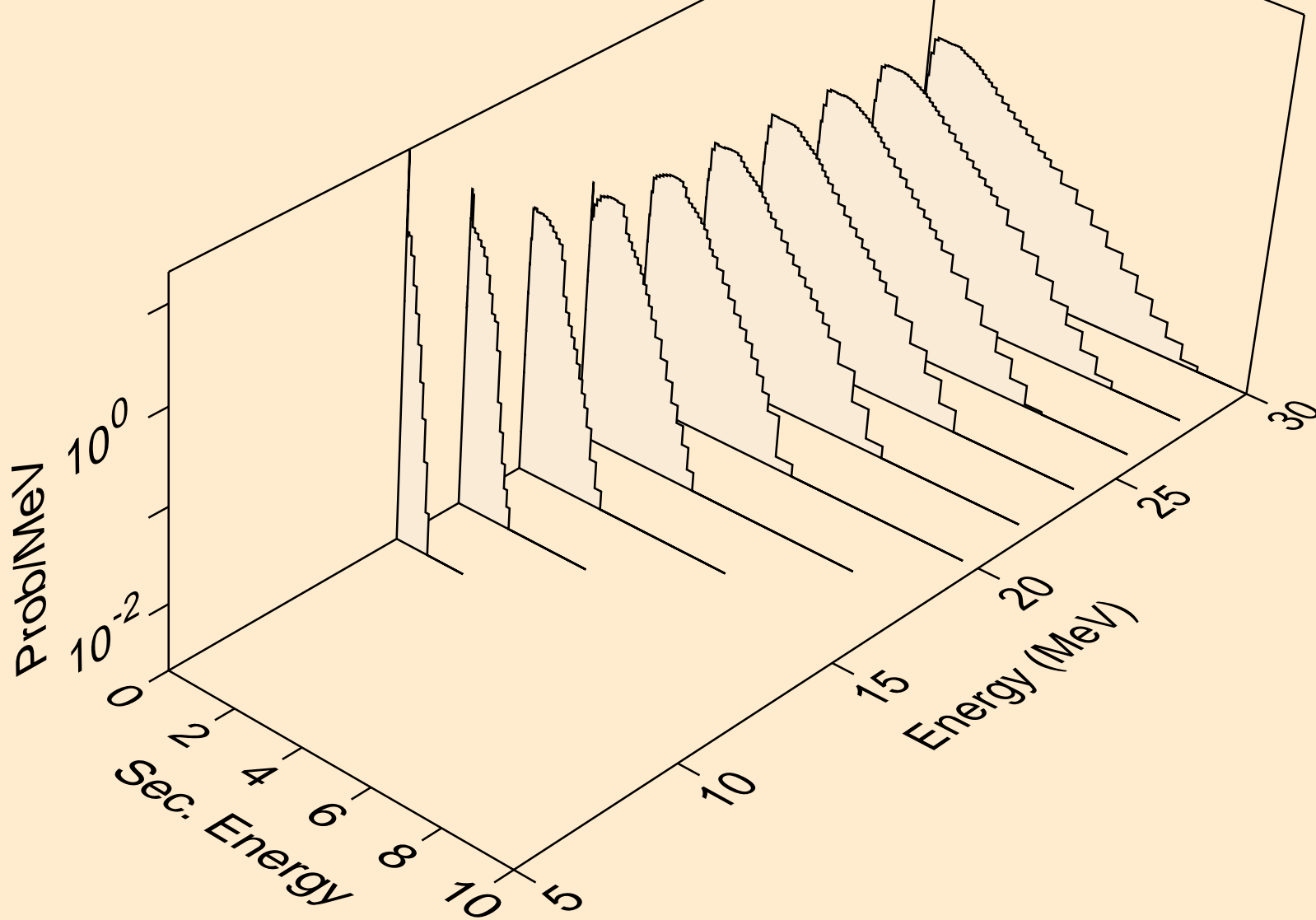

FE060 NEUTRON ACER TENDL-2019 LIBRARY; T=293.16K
Neutron emission for (n,2n)a

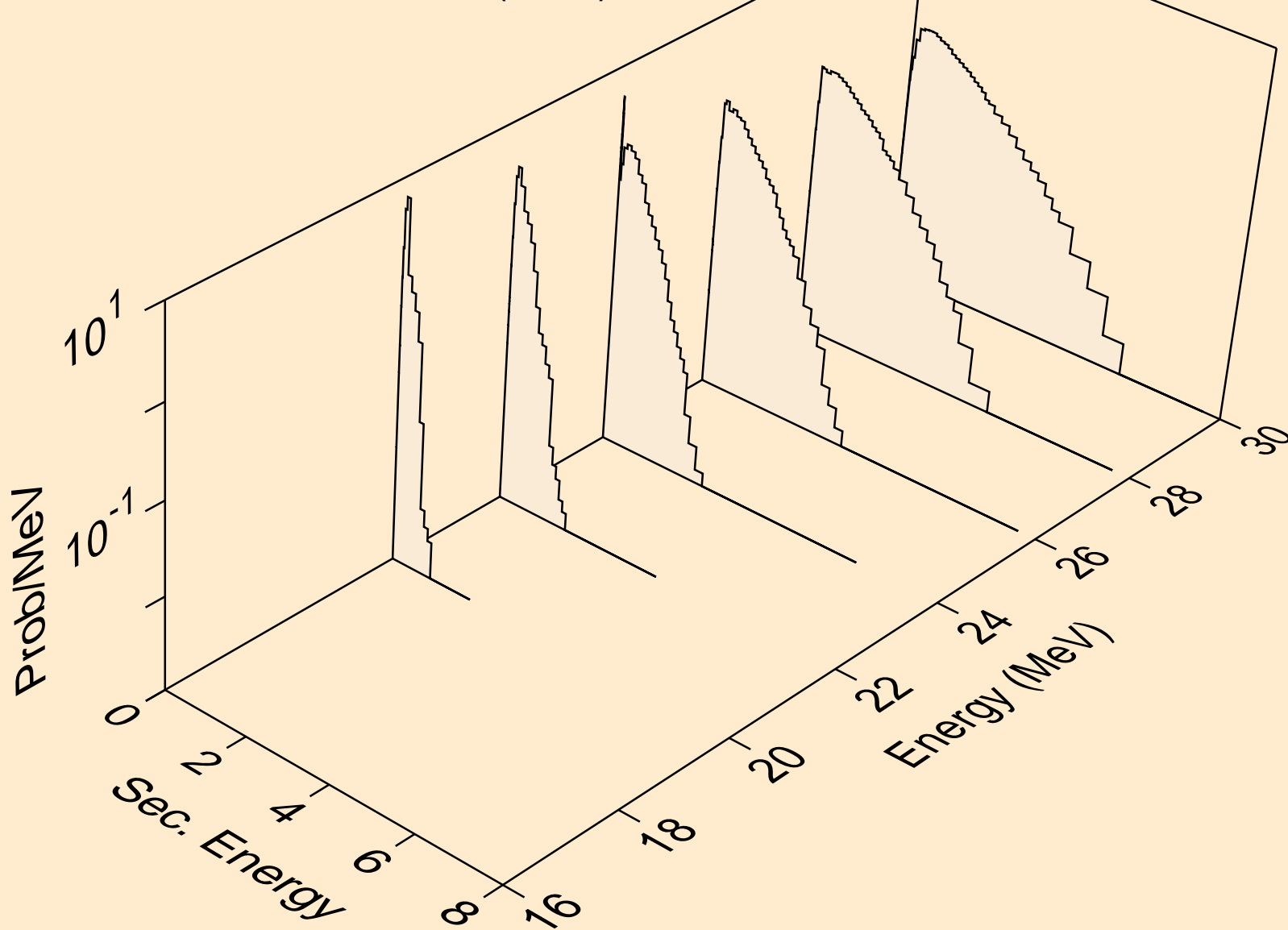

FE060 NEUTRON ACER TENDL-2019 LIBRARY; T=293.16K
Neutron emission for (n,3n)a

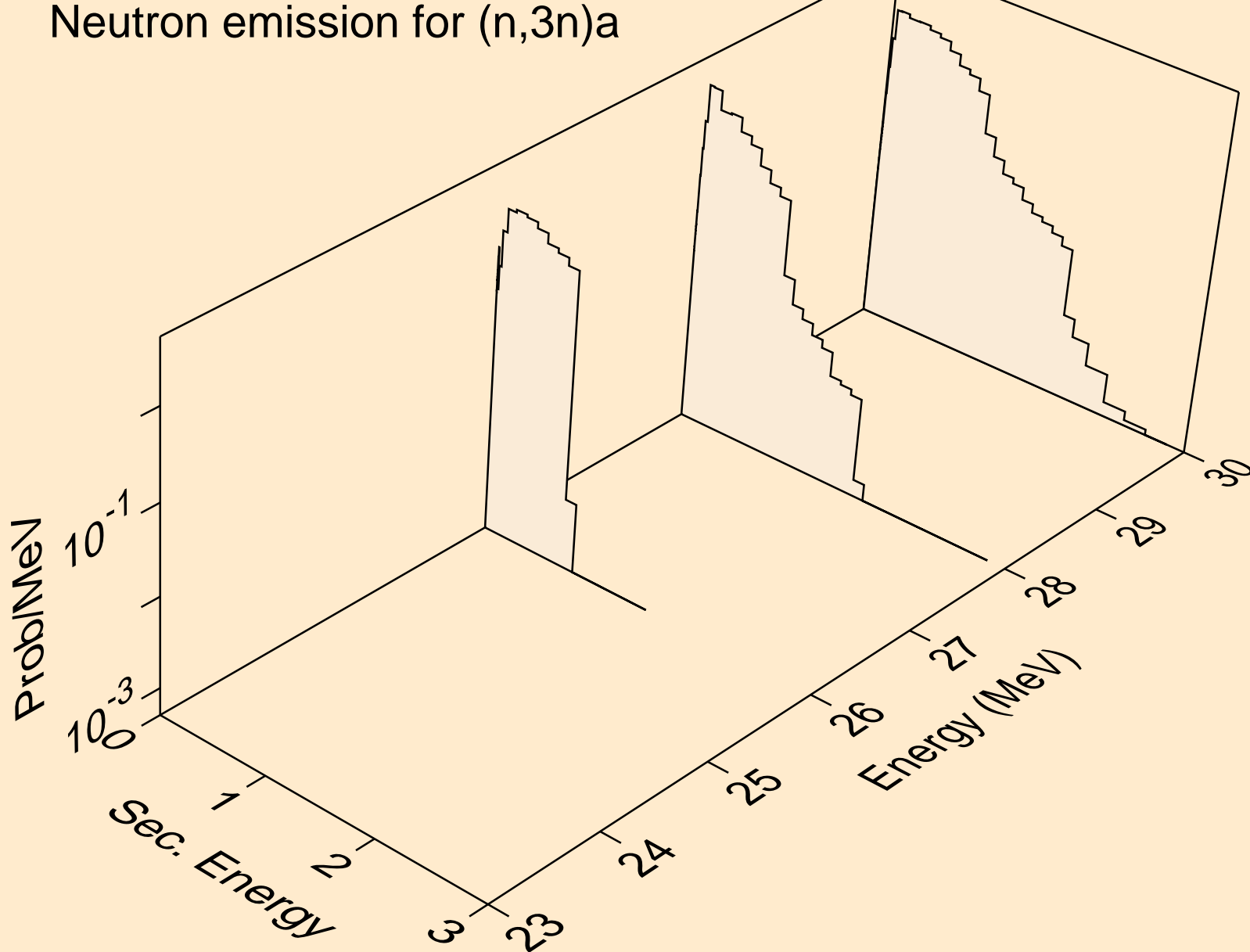

FE060 NEUTRON ACER TENDL-2019 LIBRARY; T=293.16K
Neutron emission for (n,n*)p

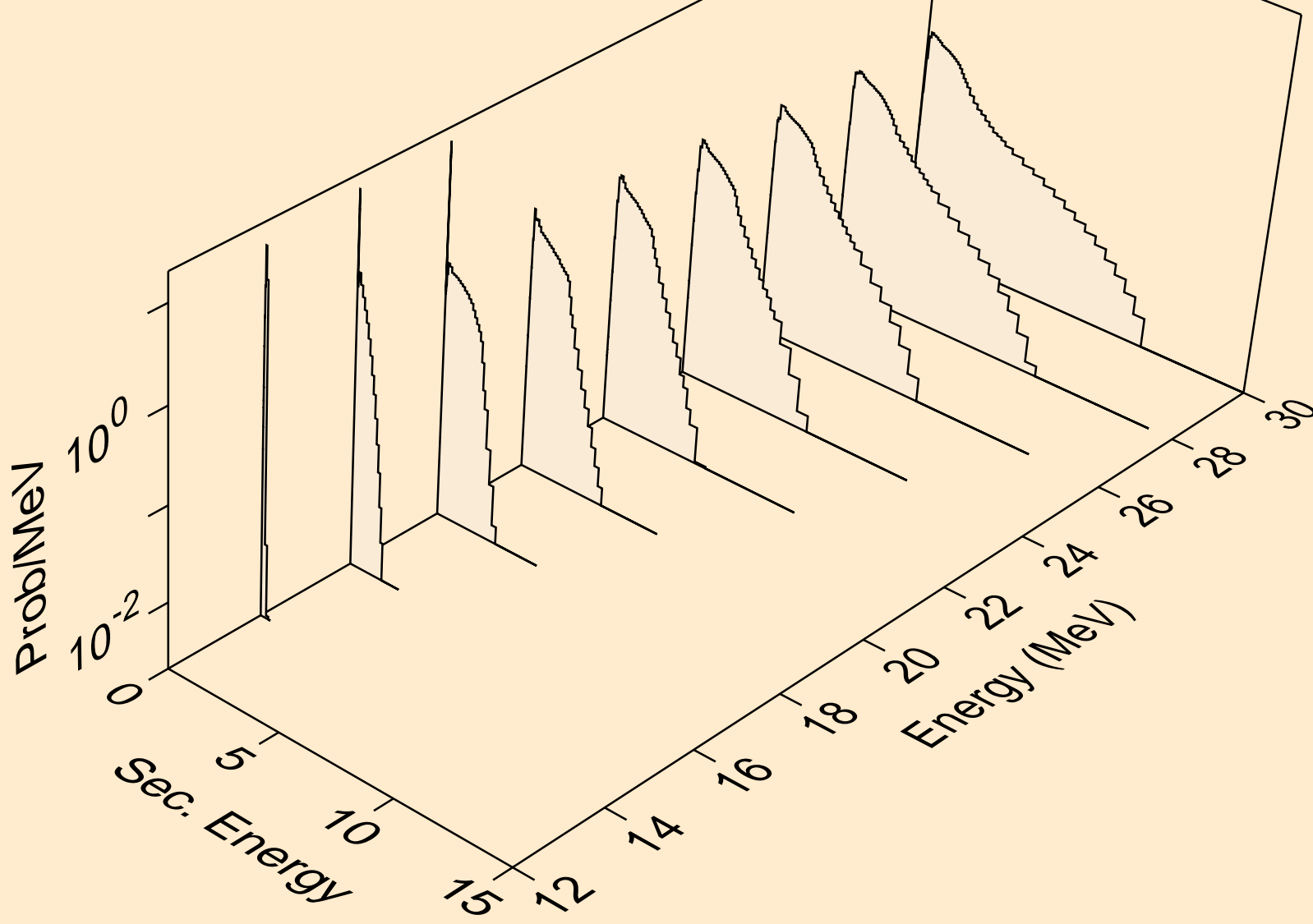

FE060 NEUTRON ACER TENDL-2019 LIBRARY; T=293.16K
Neutron emission for (n,n*)2a

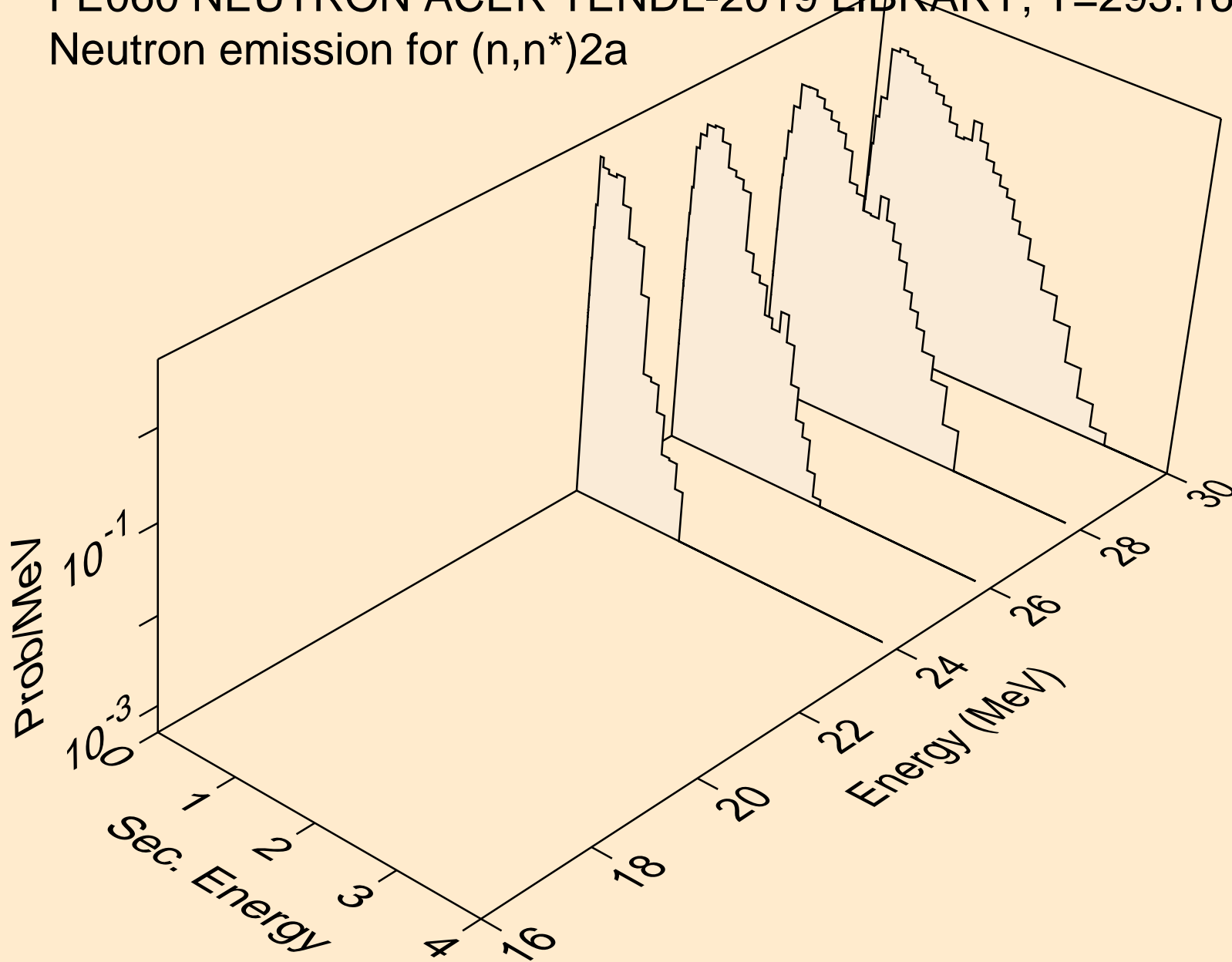

FE060 NEUTRON ACER TENDL-2019 LIBRARY; T=293.16K
Neutron emission for (n,n*)d

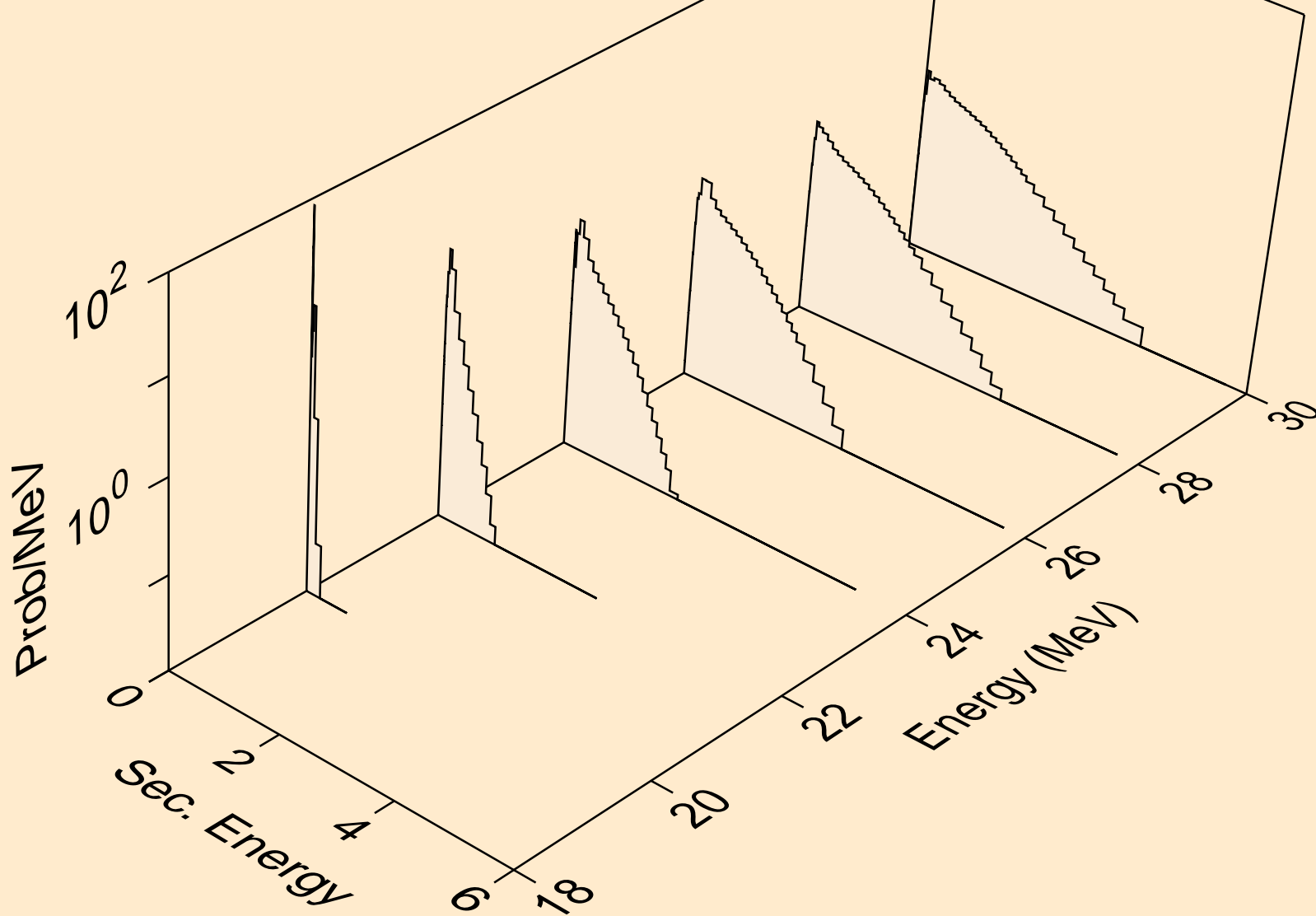

FE060 NEUTRON ACER TENDL-2019 LIBRARY; T=293.16K
Neutron emission for (n,n*)t

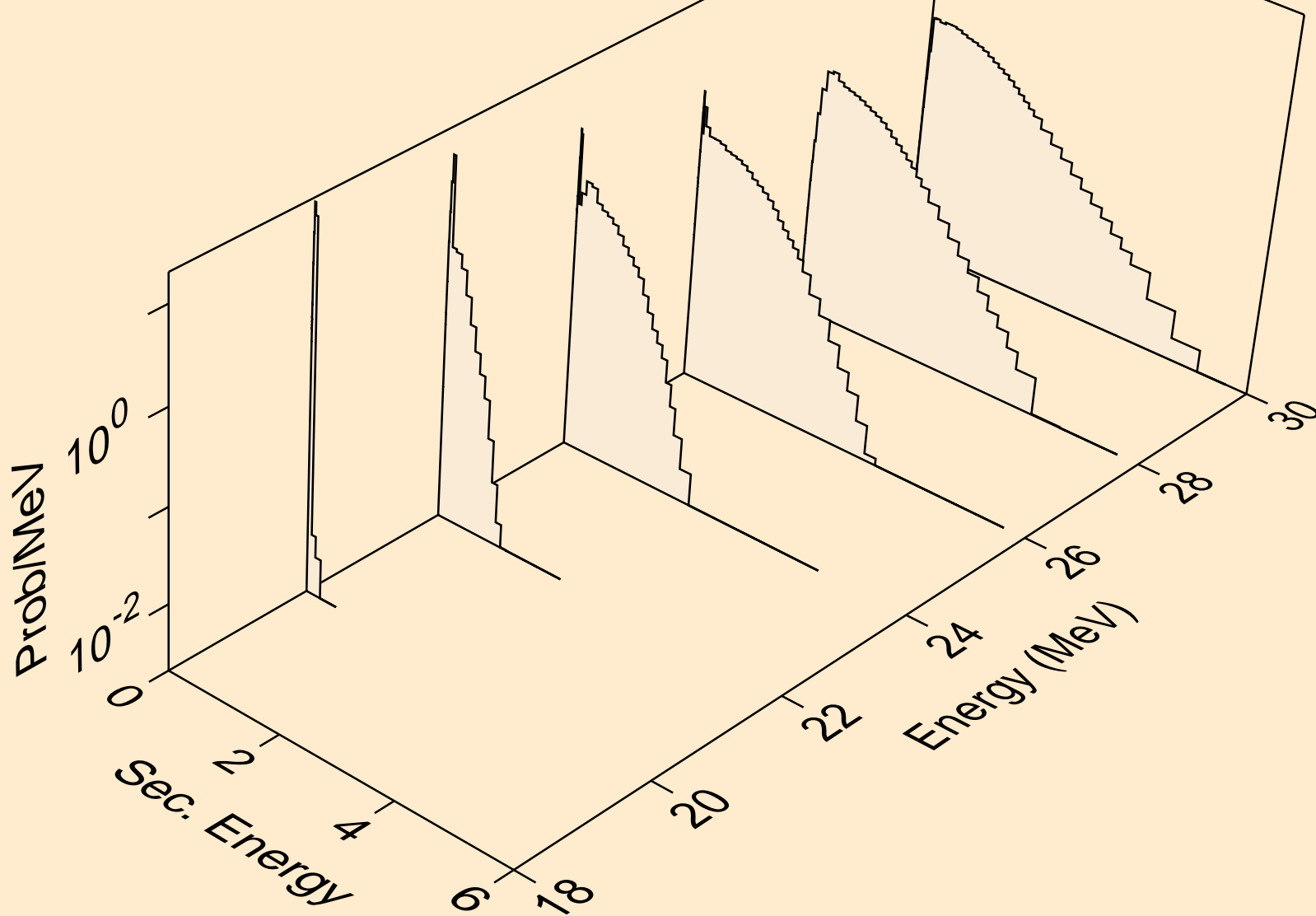

FE060 NEUTRON ACER TENDL-2019 LIBRARY; T=293.16K
Neutron emission for (n,n*)he3

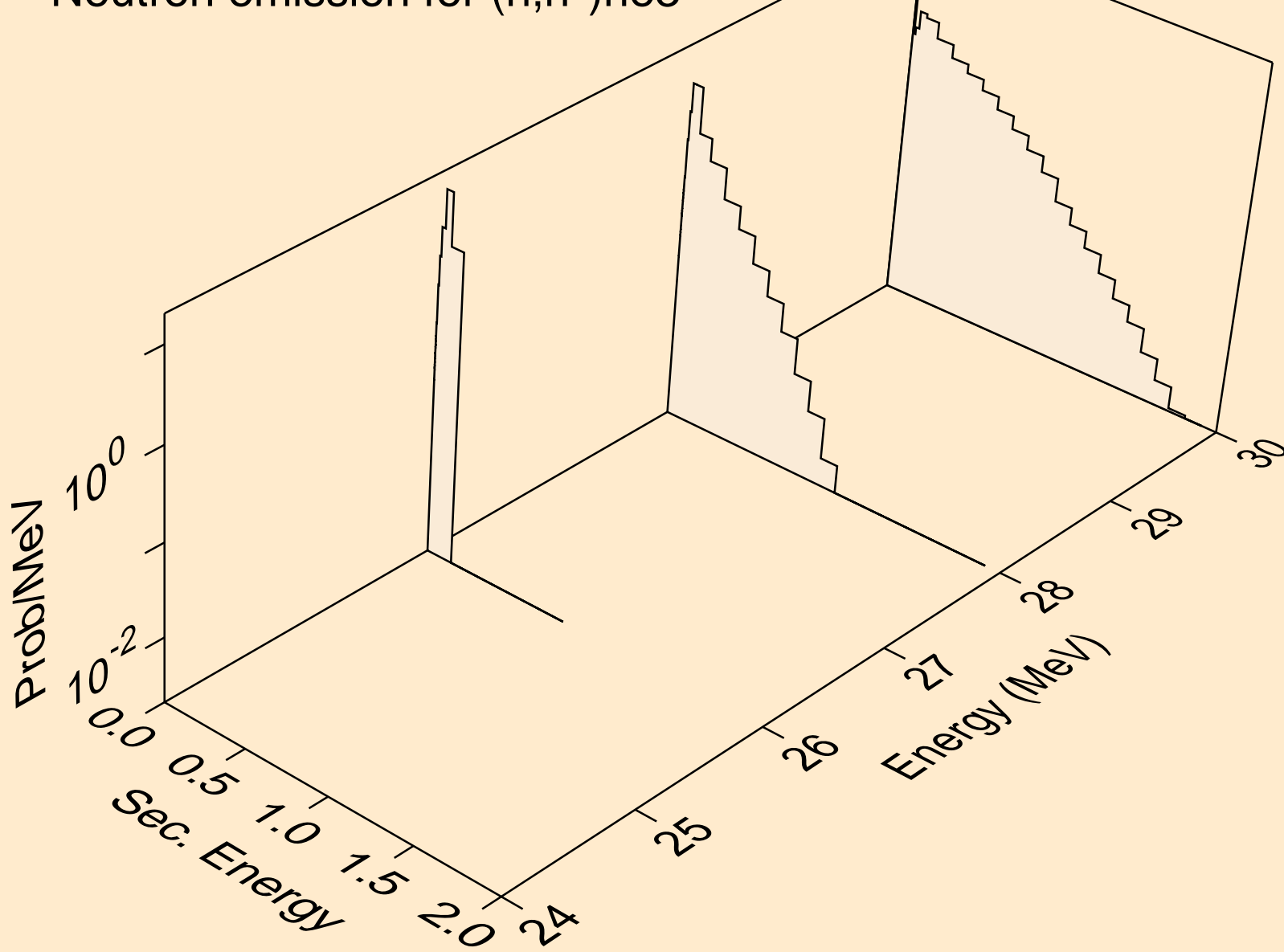

FE060 NEUTRON ACER TENDL-2019 LIBRARY; T=293.16K
Neutron emission for (n,4n)

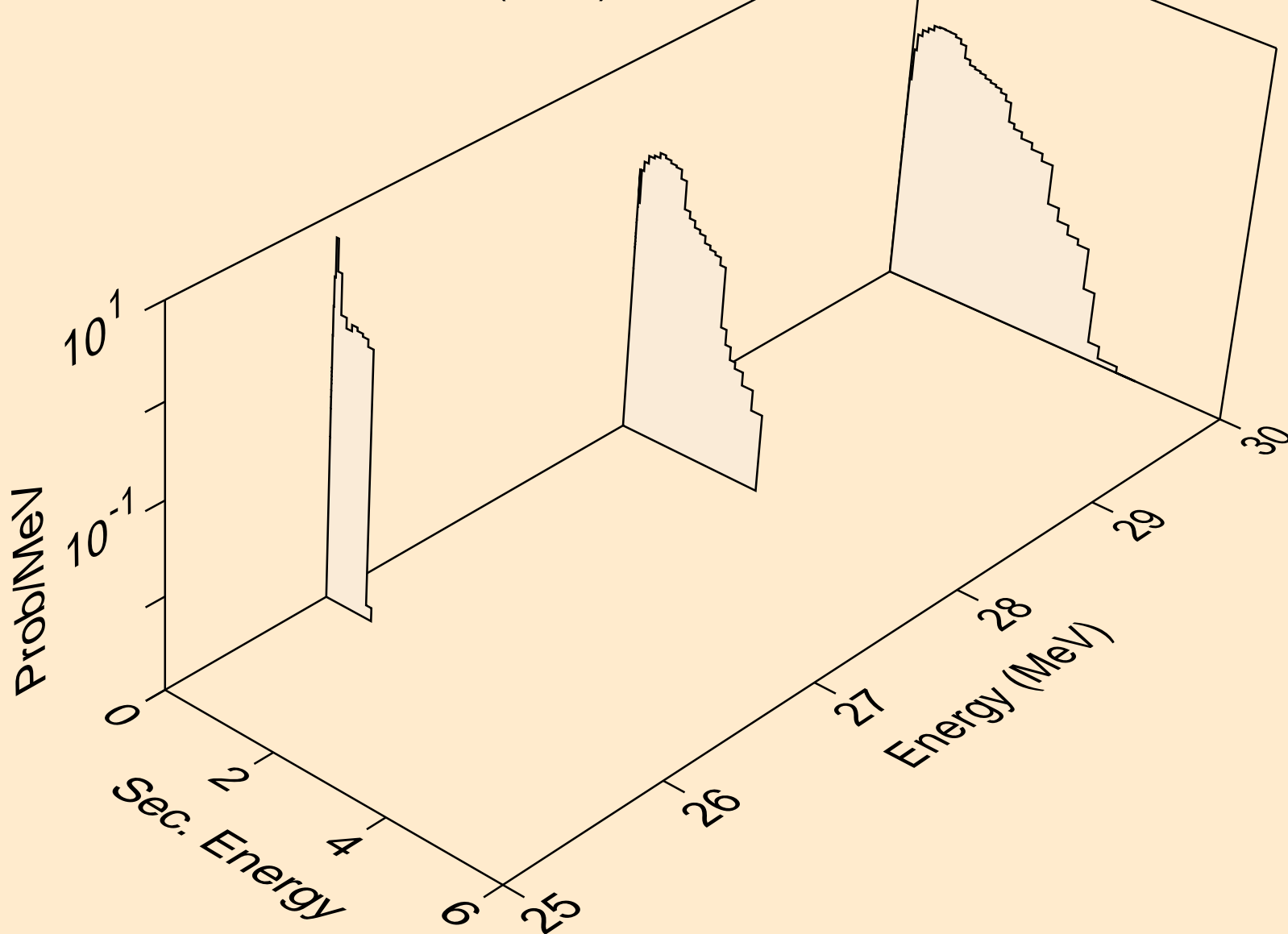

FE060 NEUTRON ACER TENDL-2019 LIBRARY; T=293.16K
Neutron emission for (n,2np)

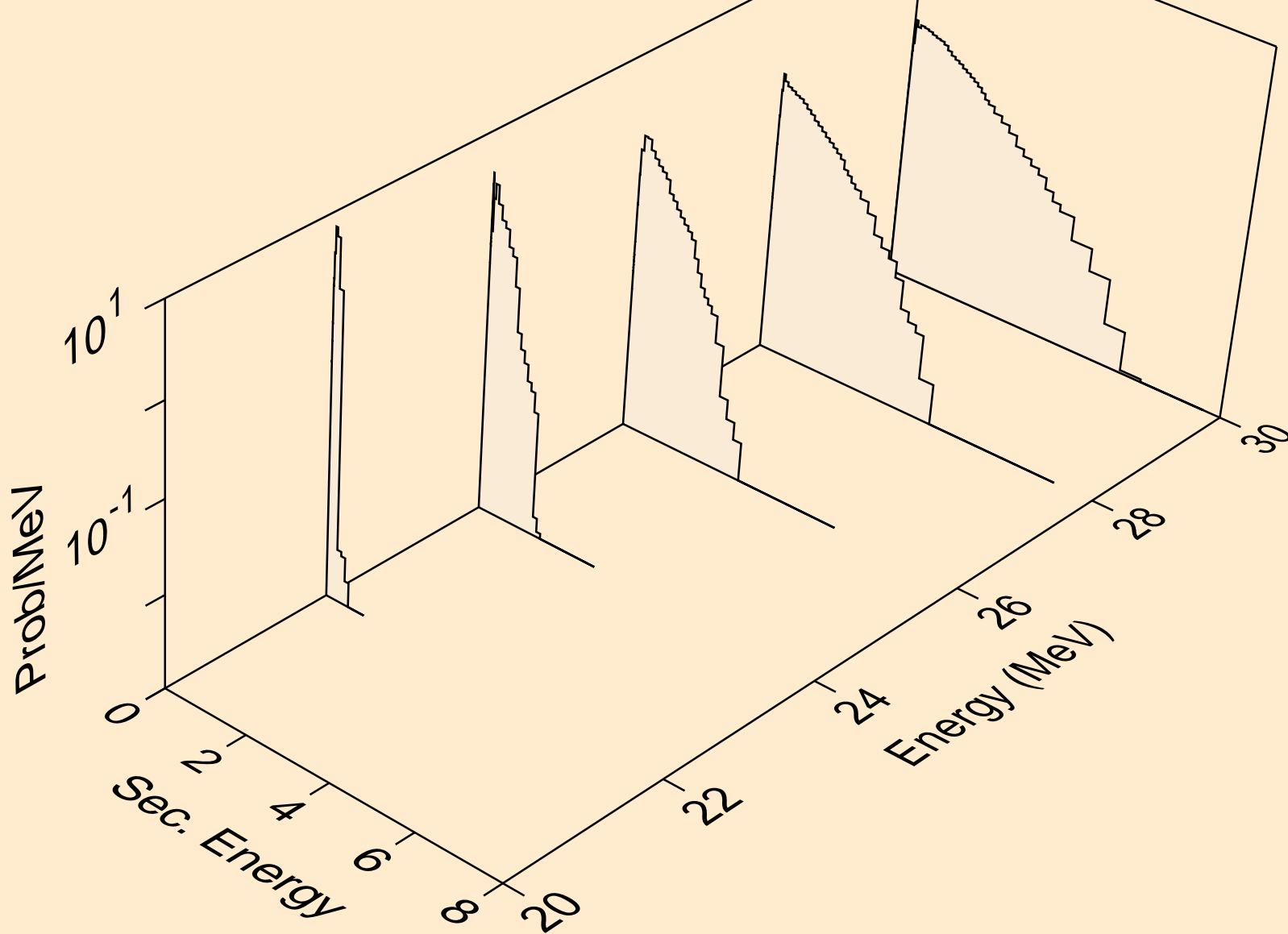

FE060 NEUTRON ACER TENDL-2019 LIBRARY; T=293.16K
Neutron emission for (n,3np)

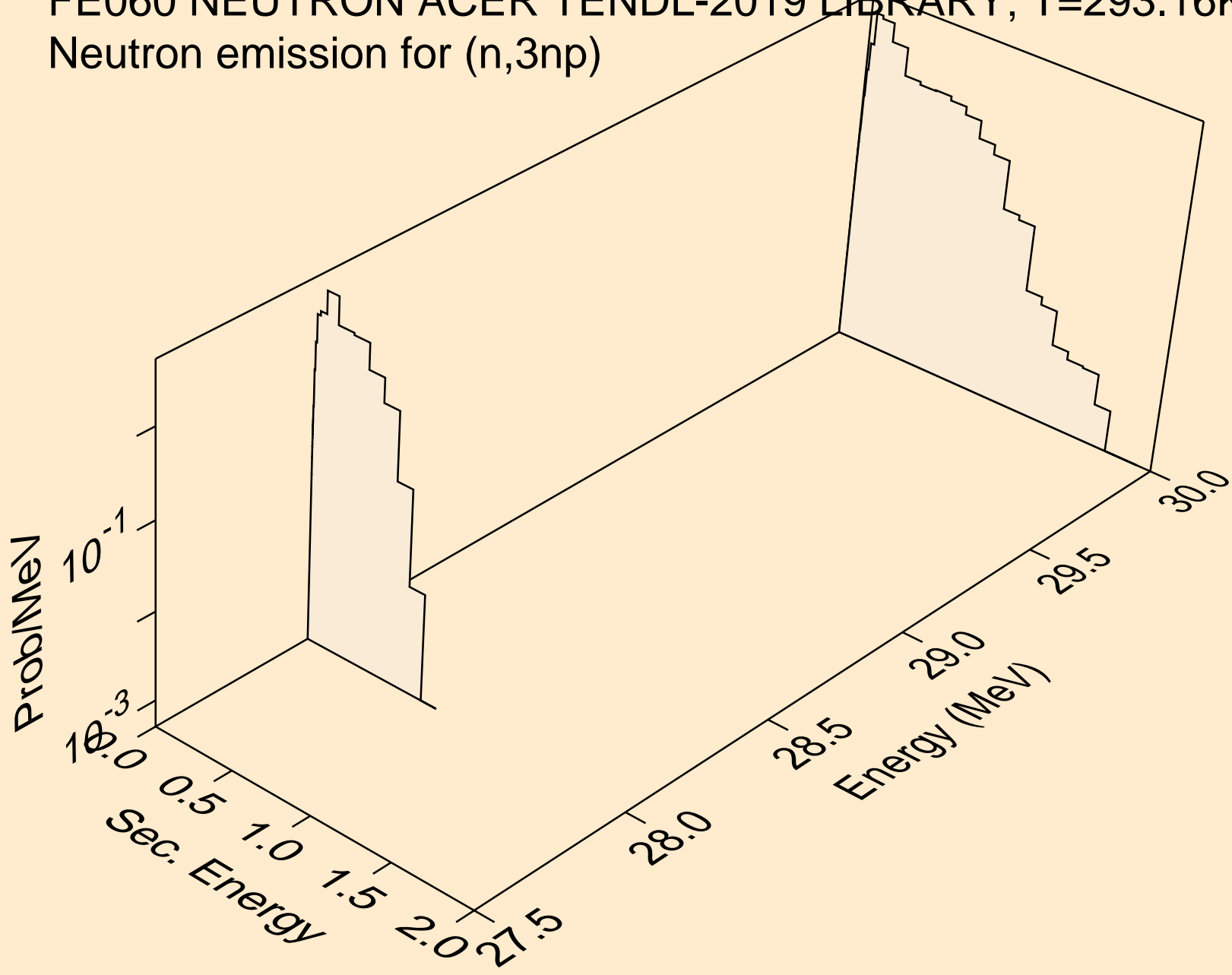

FE060 NEUTRON ACER TENDL-2019 LIBRARY; T=293.16K
Neutron emission for (n,2np)

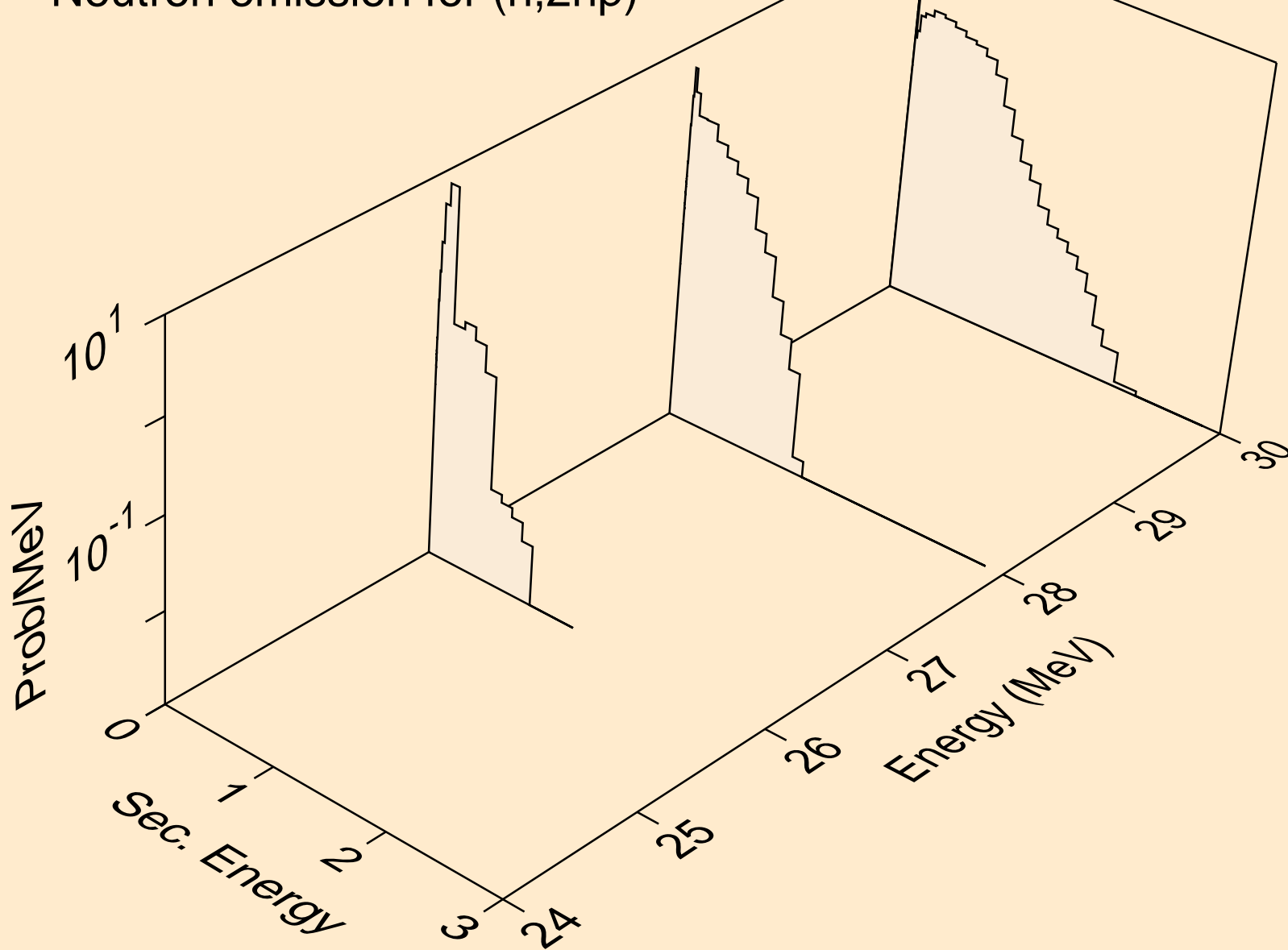

FE060 NEUTRON ACER TENDL-2019 LIBRARY; T=293.16K
Neutron emission for (n,npa)

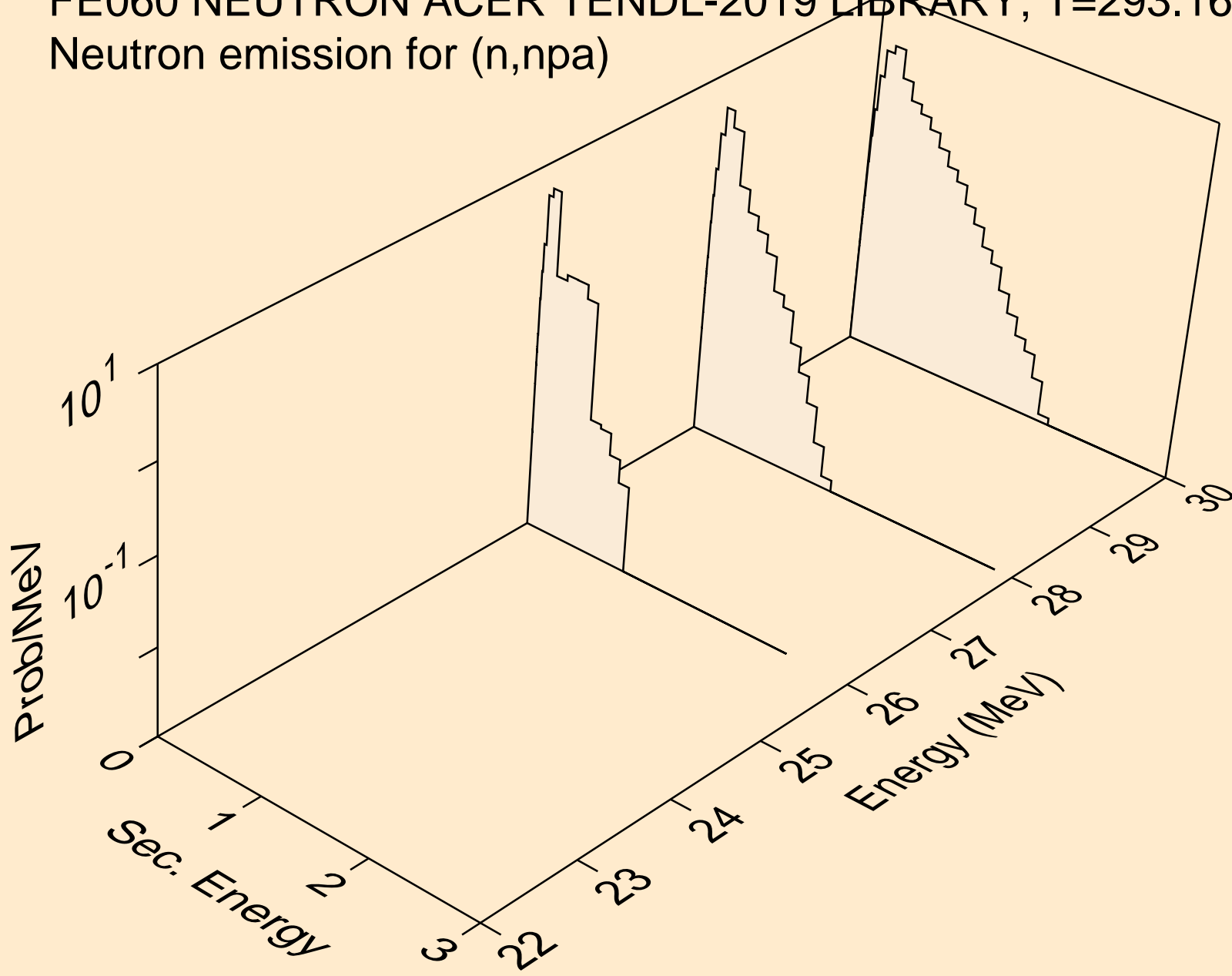

FE060 NEUTRON ACER TENDL-2019 LIBRARY; T=293.16K
Neutron emission for (n,n*c)

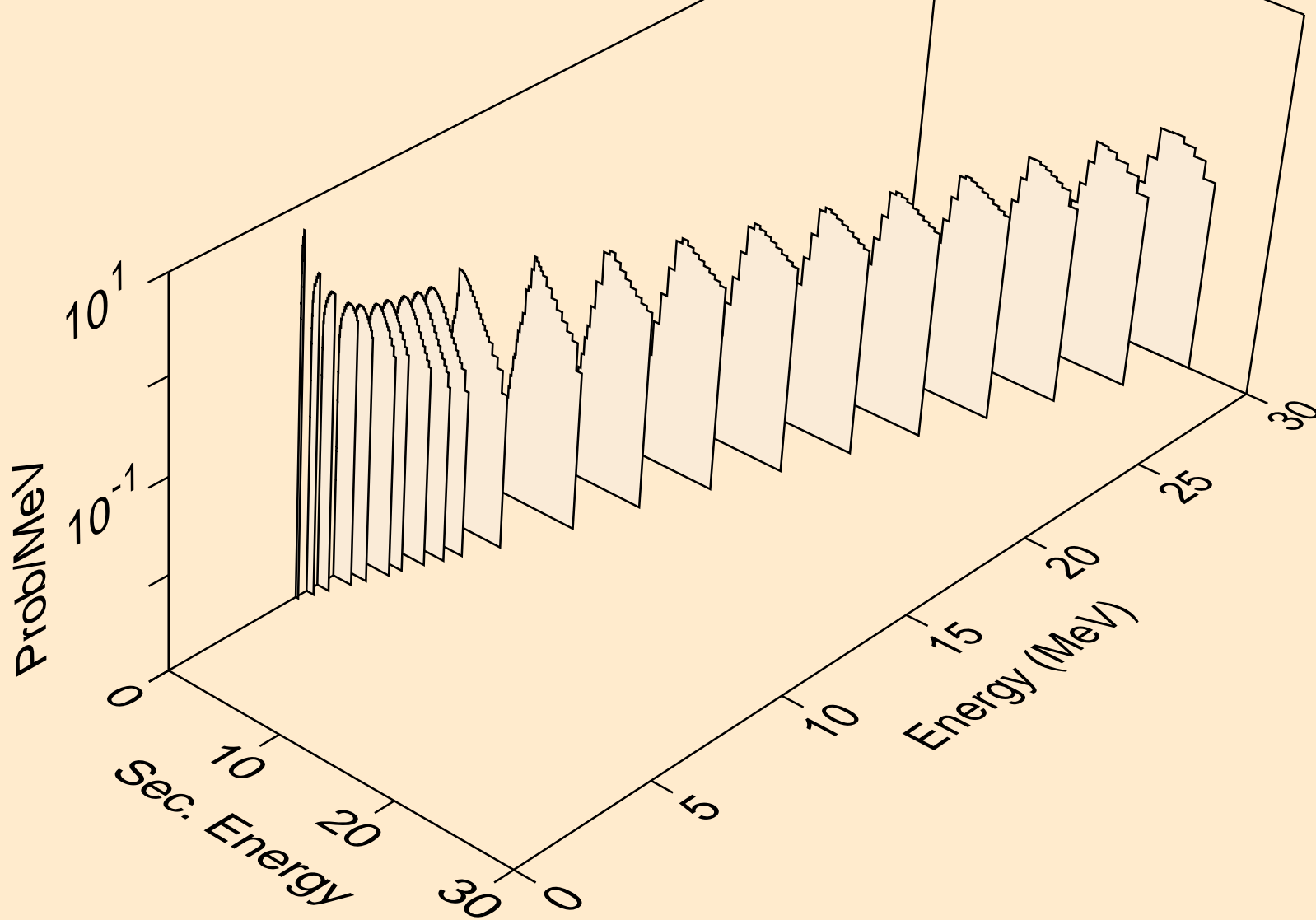

FE060 NEUTRON ACER TENDL-2019 LIBRARY; T=293.16K
Photon emission for (n,x)

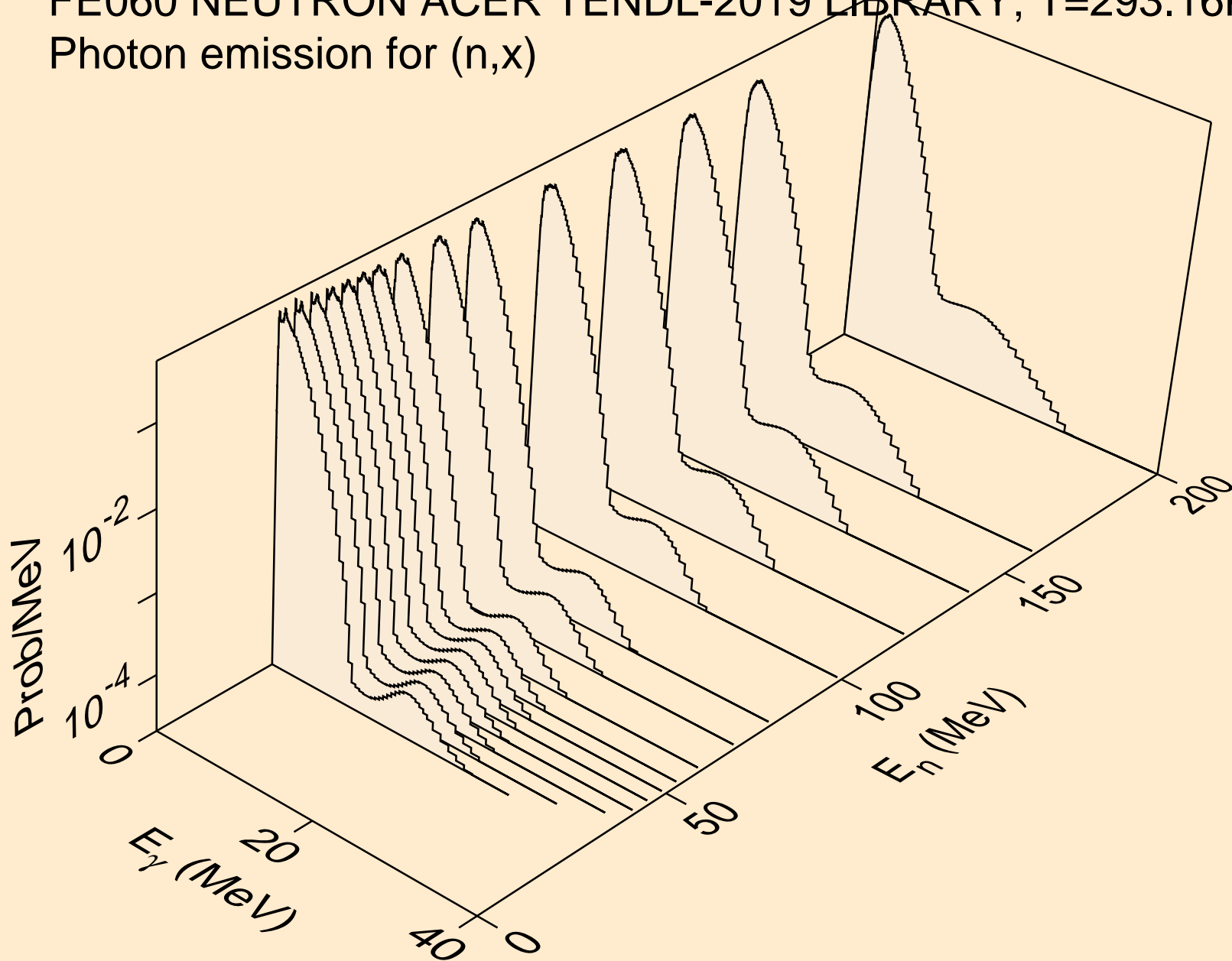

FE060 NEUTRON ACER TENDL-2019 LIBRARY; T=293.16K
Photon emission for (n,2nd)

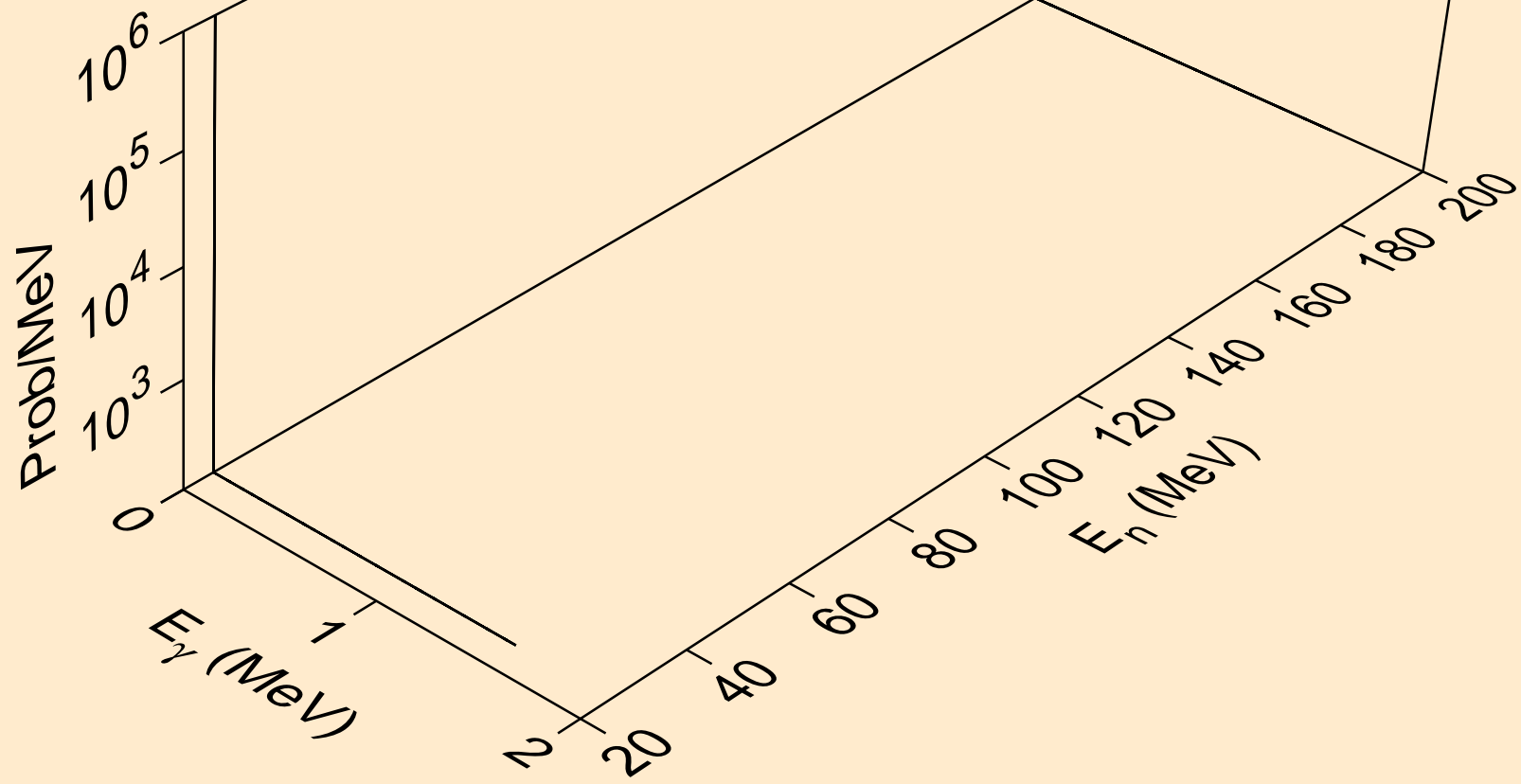

FE060 NEUTRON ACER TENDL-2019 LIBRARY; T=293.16K
Photon emission for (n,2n)

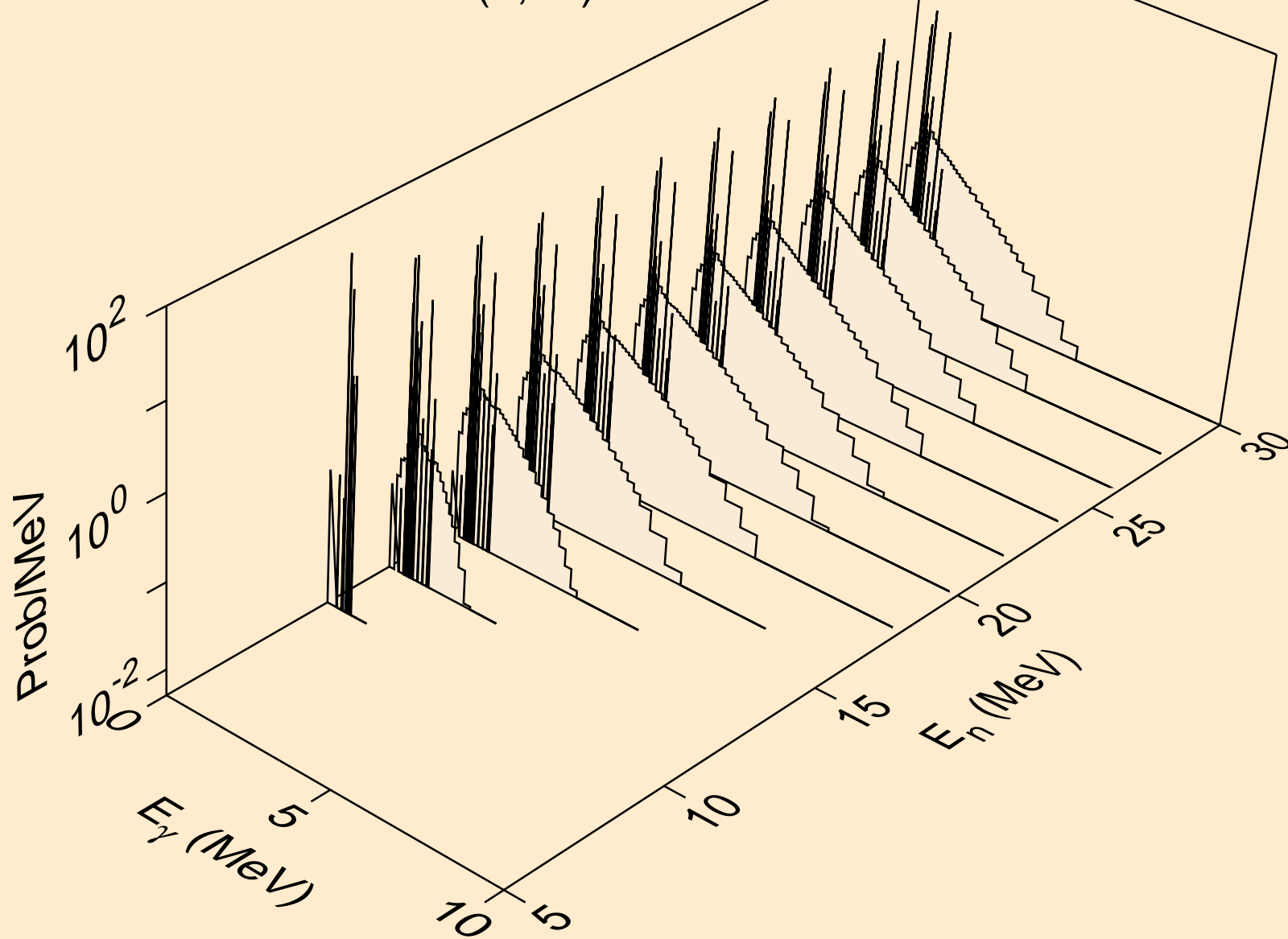

FE060 NEUTRON ACER TENDL-2019 LIBRARY; T=293.16K
Photon emission for (n,3n)

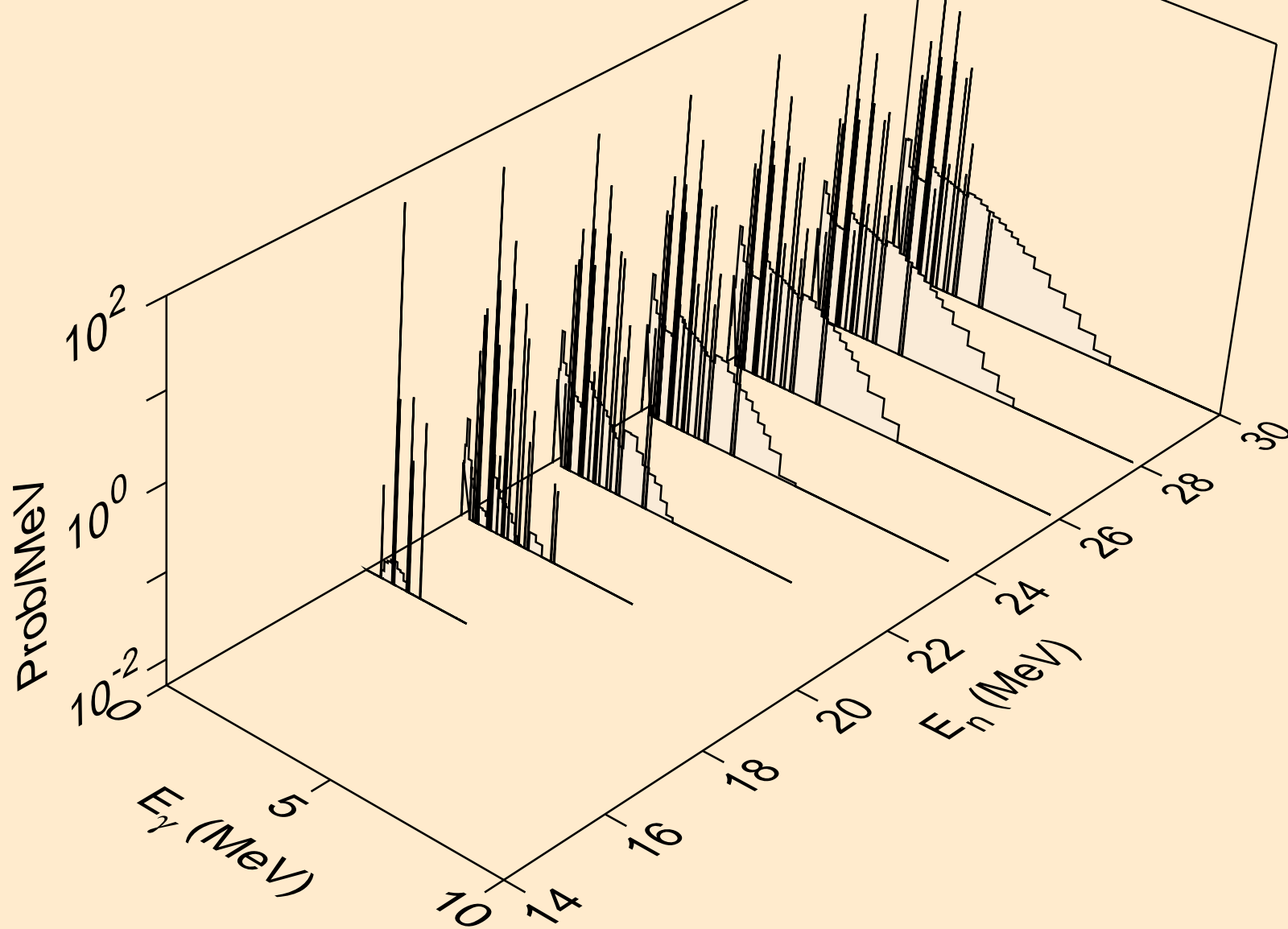

FE060 NEUTRON ACER TENDL-2019 LIBRARY; T=293.16K
Photon emission for (n,n*)a

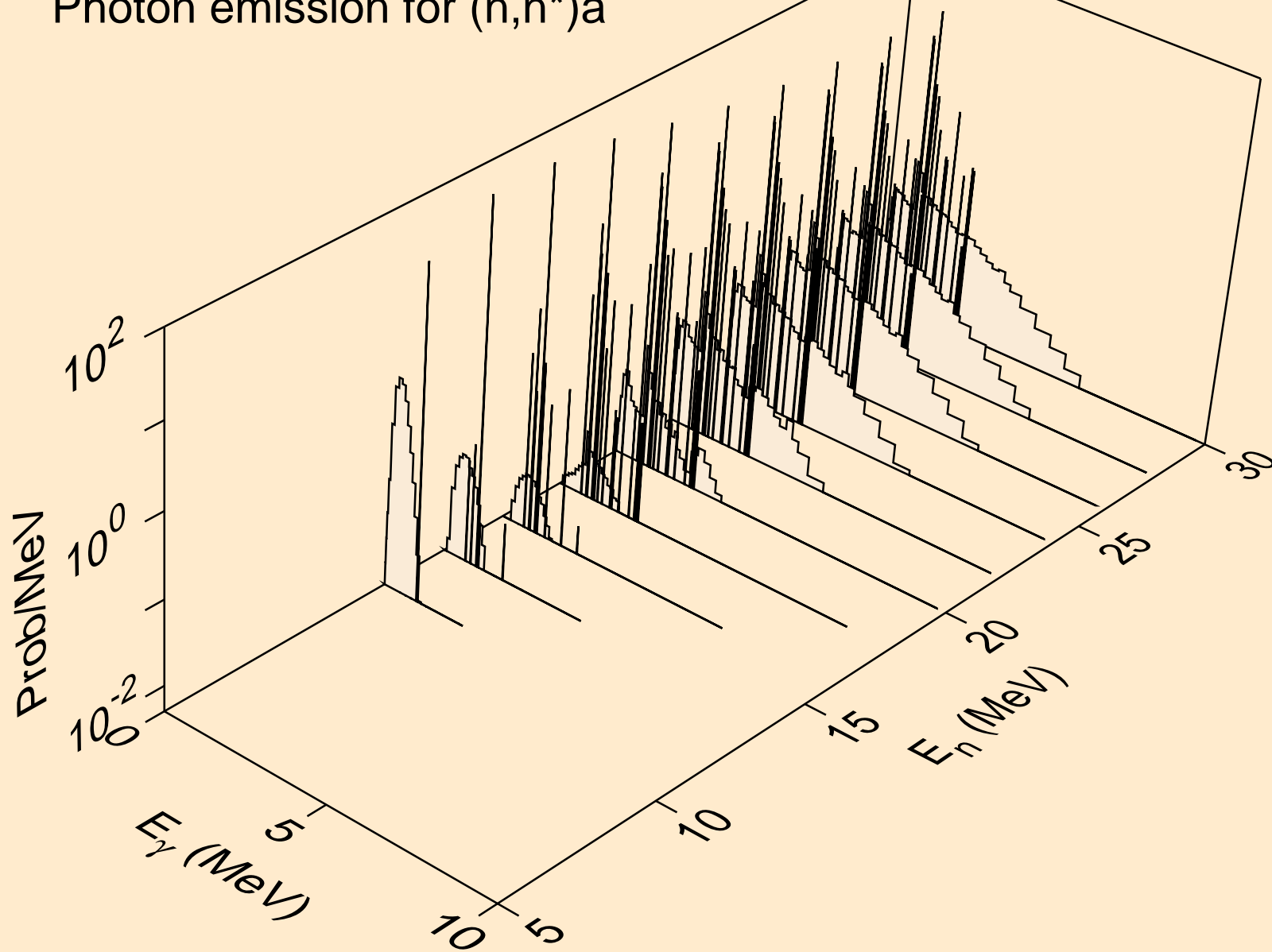

FE060 NEUTRON ACER TENDL-2019 LIBRARY; T=293.16K
Photon emission for (n,2n)a

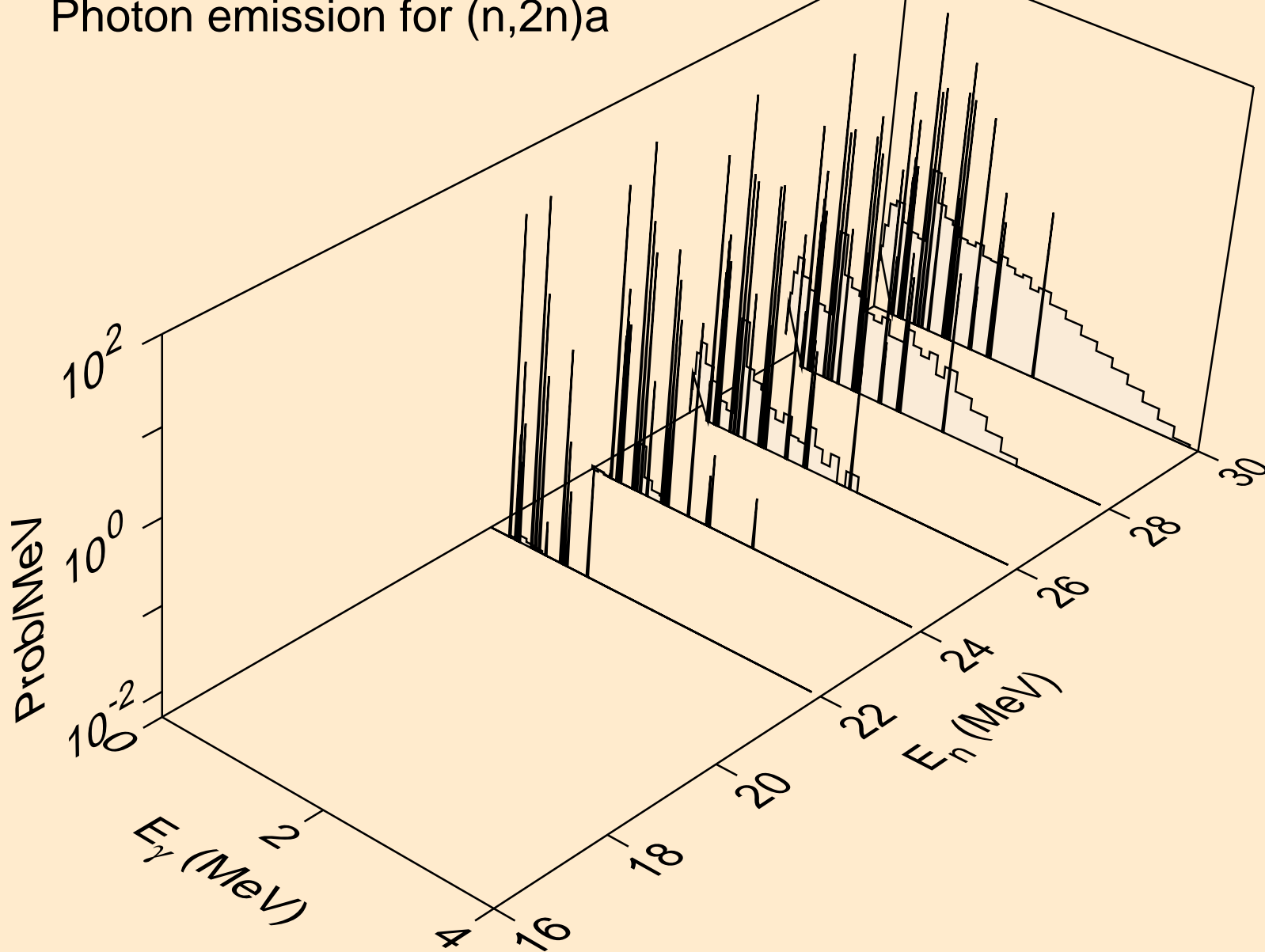

FE060 NEUTRON ACER TENDL-2019 LIBRARY; T=293.16K
Photon emission for (n,3n)a

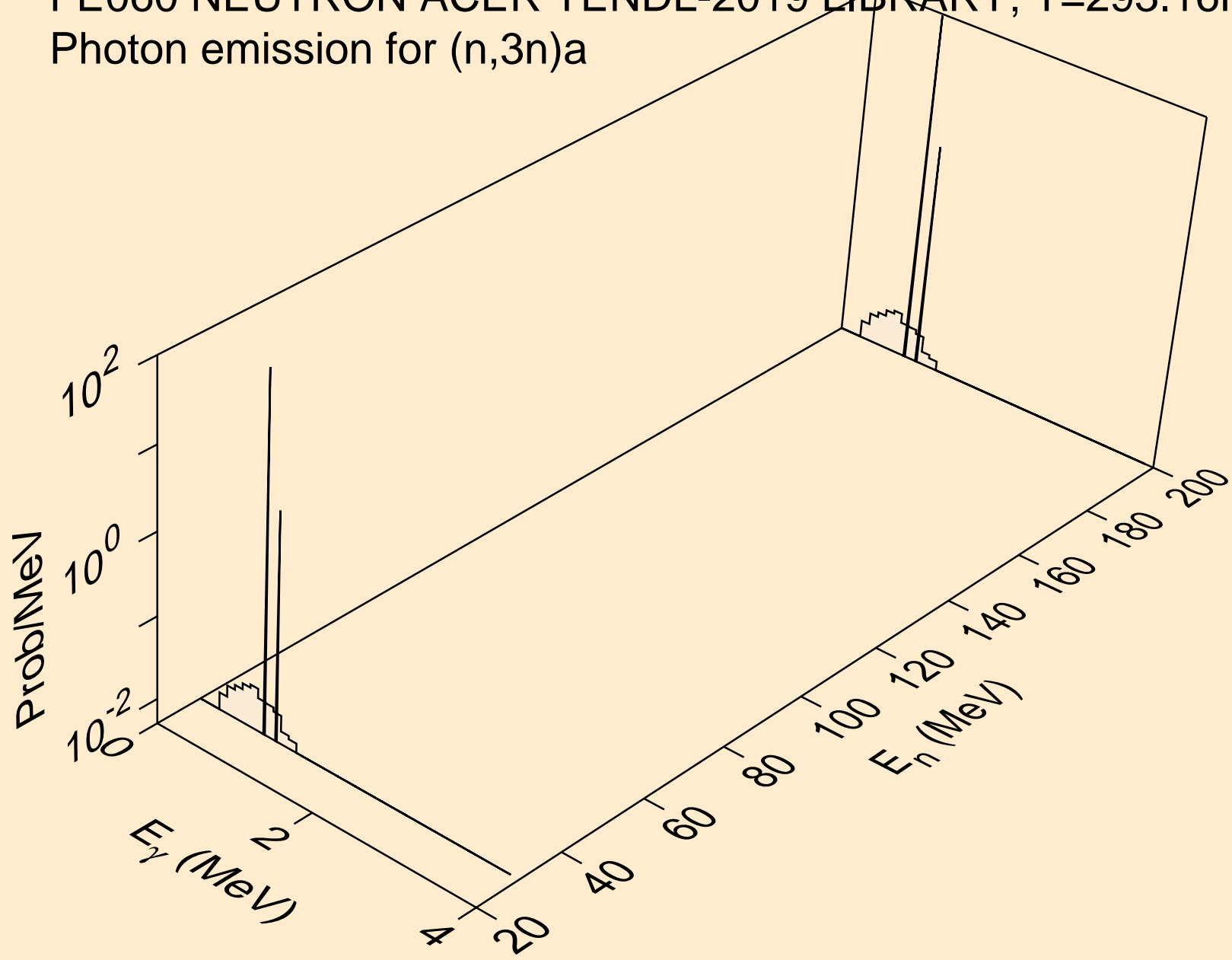

FE060 NEUTRON ACER TENDL-2019 LIBRARY; T=293.16K
Photon emission for (n,n*)p

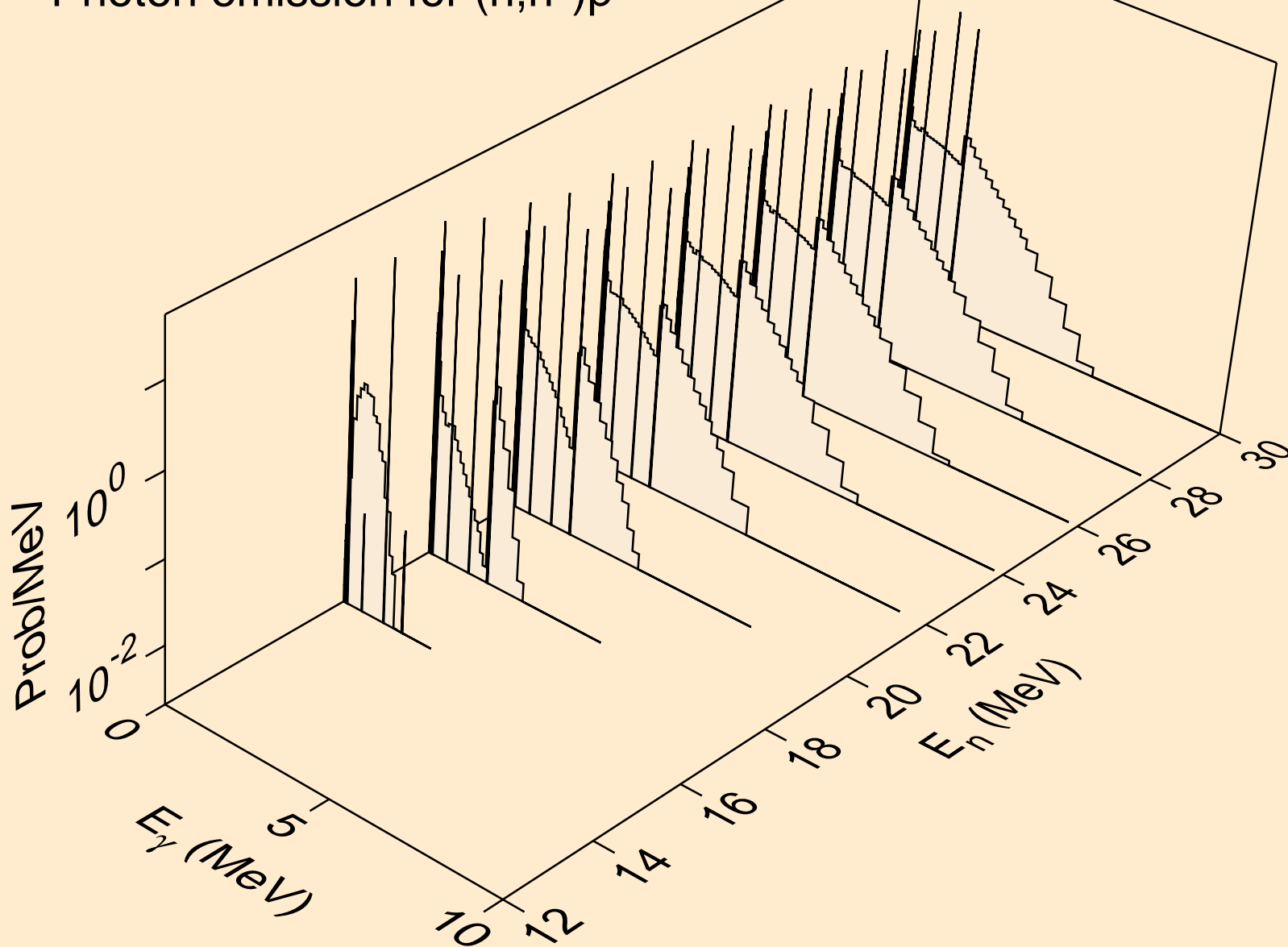

FE060 NEUTRON ACER TENDL-2019 LIBRARY; T=293.16K
Photon emission for (n,n*)2a

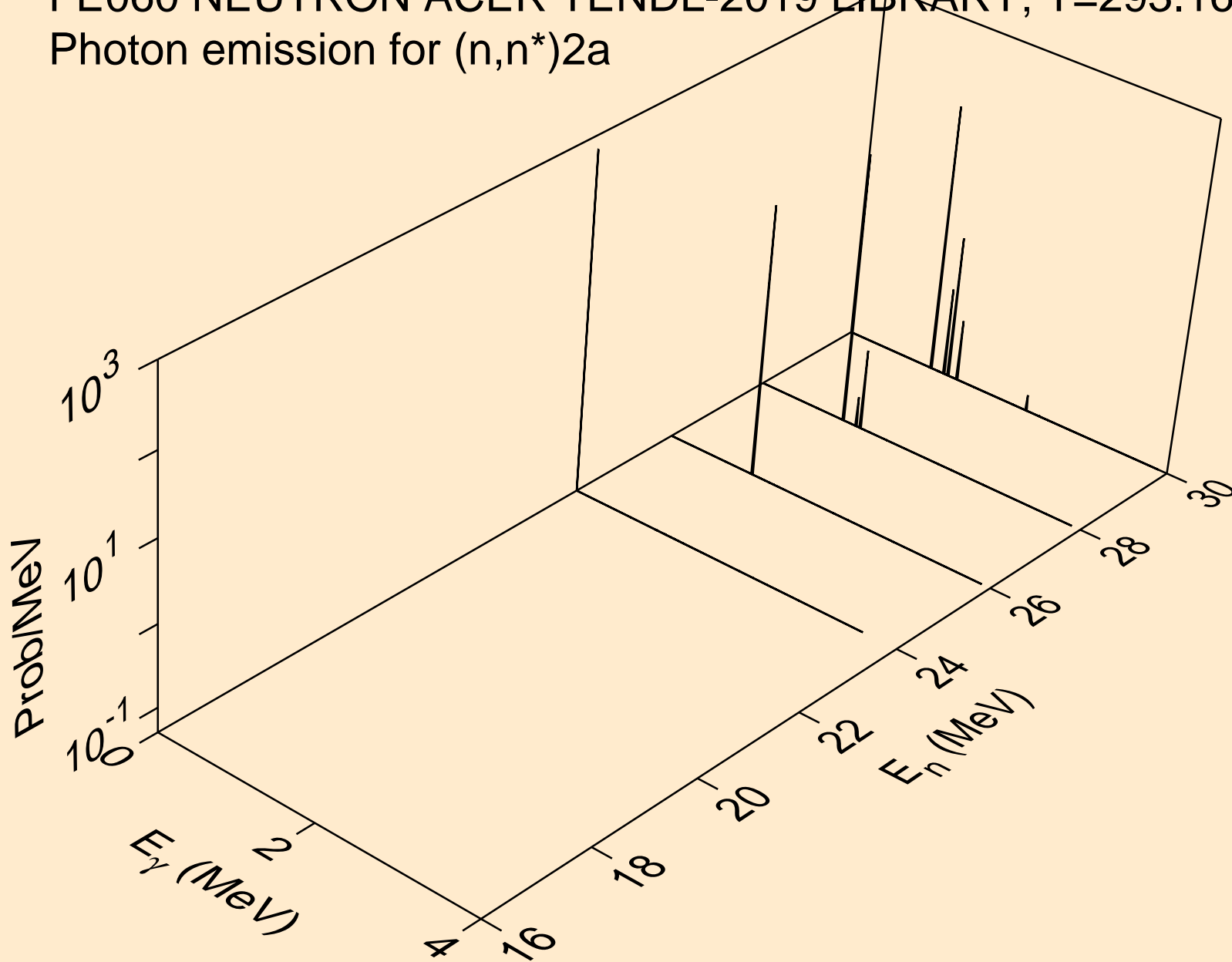

FE060 NEUTRON ACER TENDL-2019 LIBRARY; T=293.16K
Photon emission for (n,n*)d

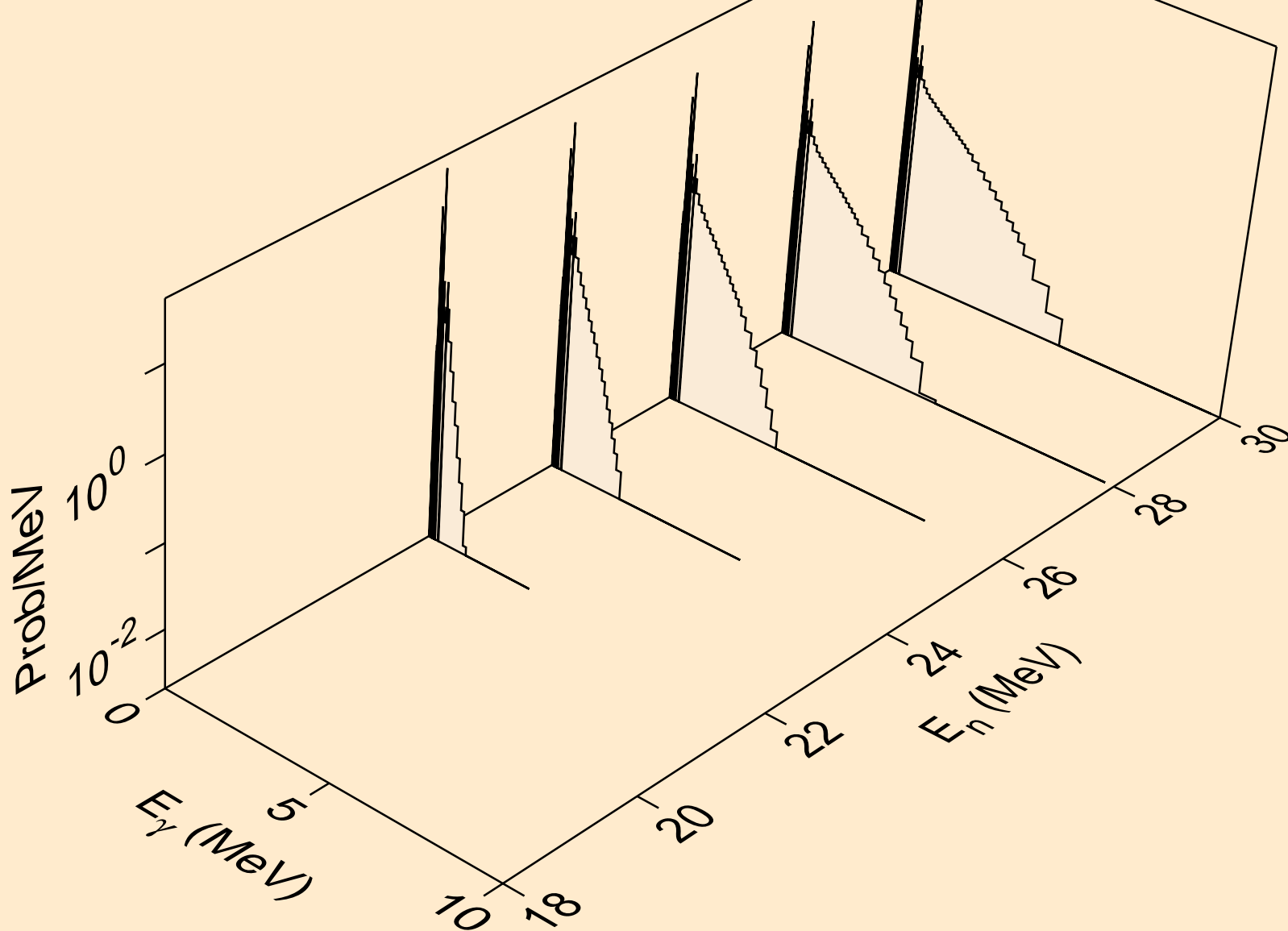

FE060 NEUTRON ACER TENDL-2019 LIBRARY; T=293.16K
Photon emission for (n,n*)t

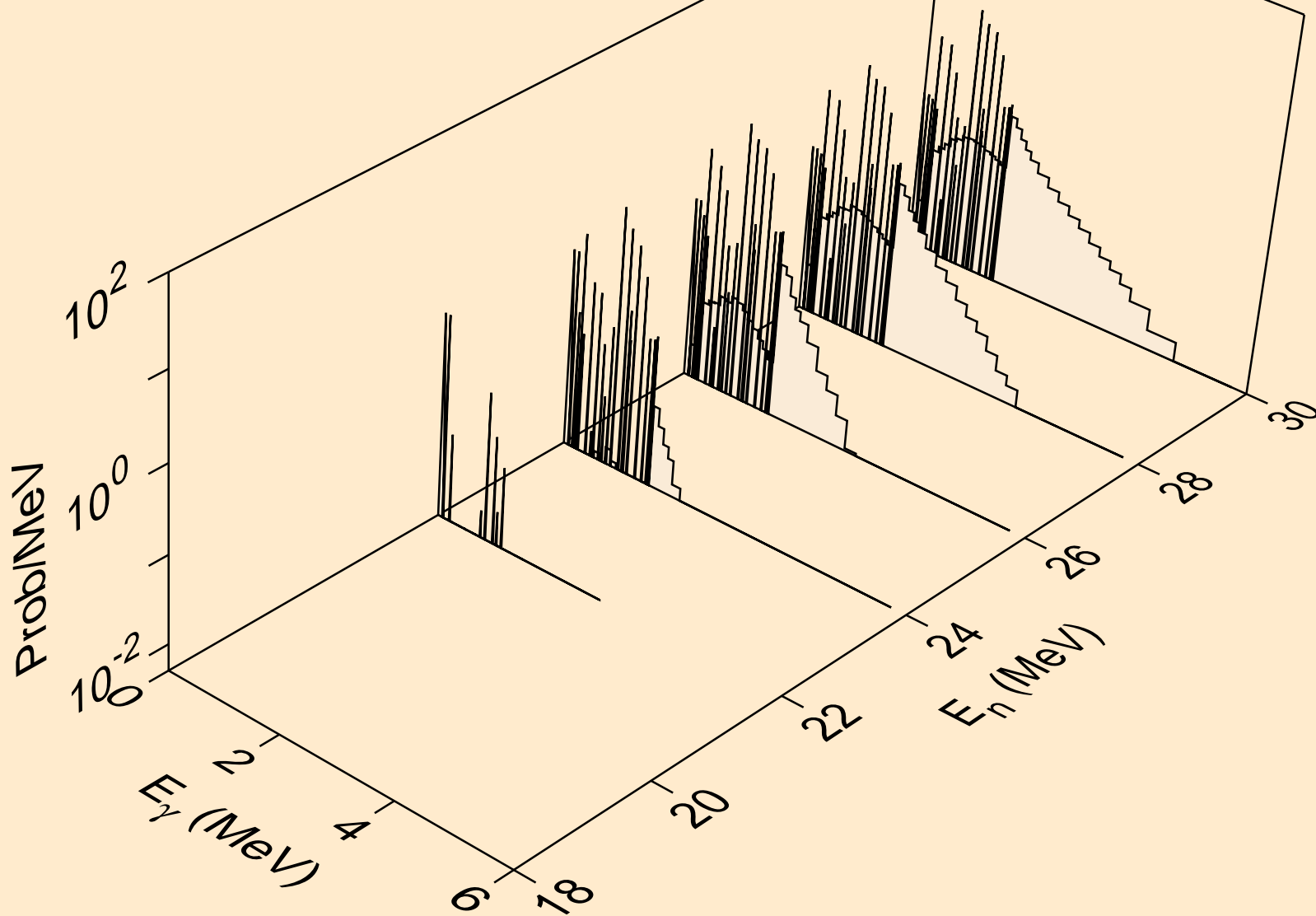

FE060 NEUTRON ACER TENDL-2019 LIBRARY; T=293.16K
Photon emission for (n,n*)he3

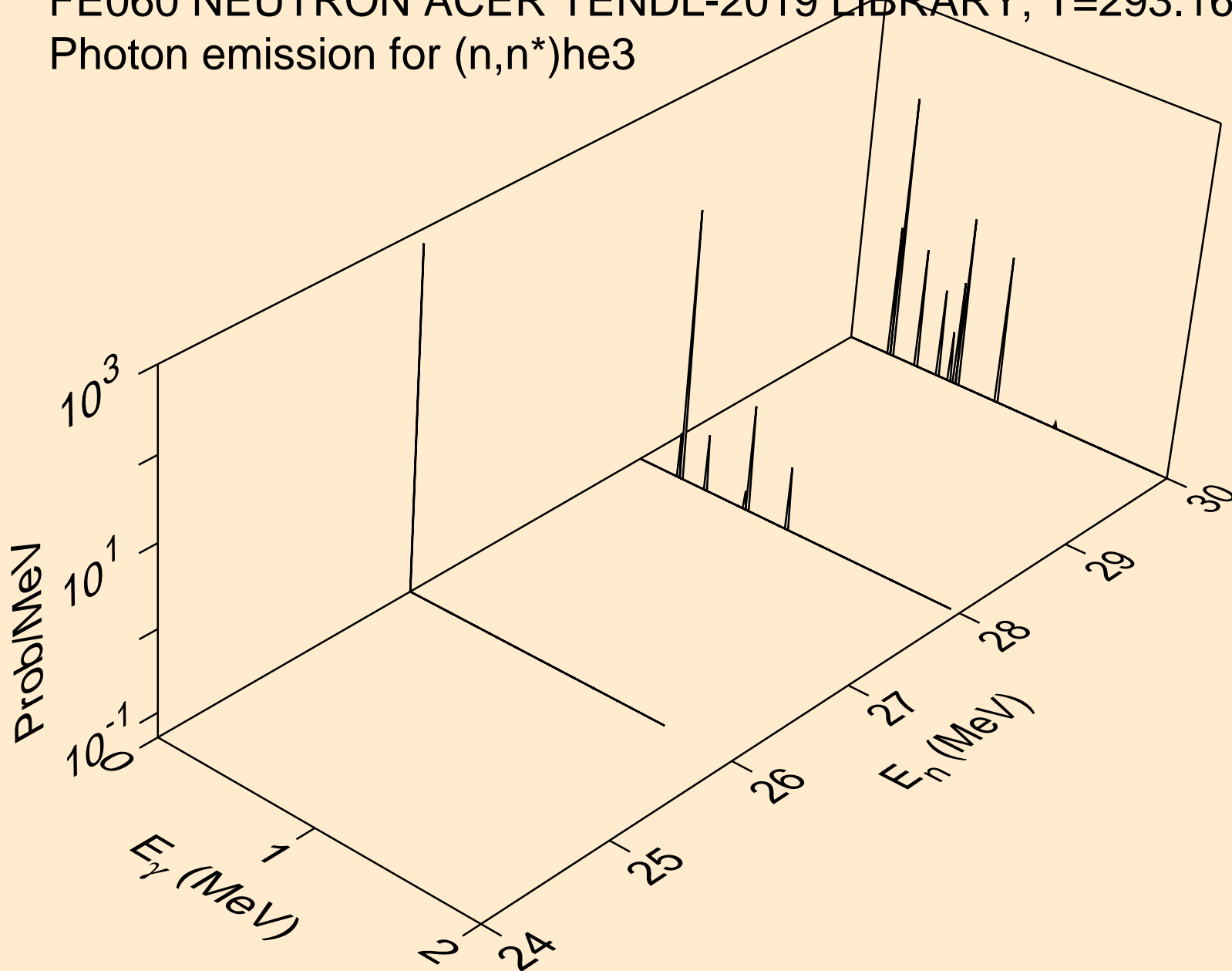

FE060 NEUTRON ACER TENDL-2019 LIBRARY; T=293.16K
Photon emission for (n,4n)

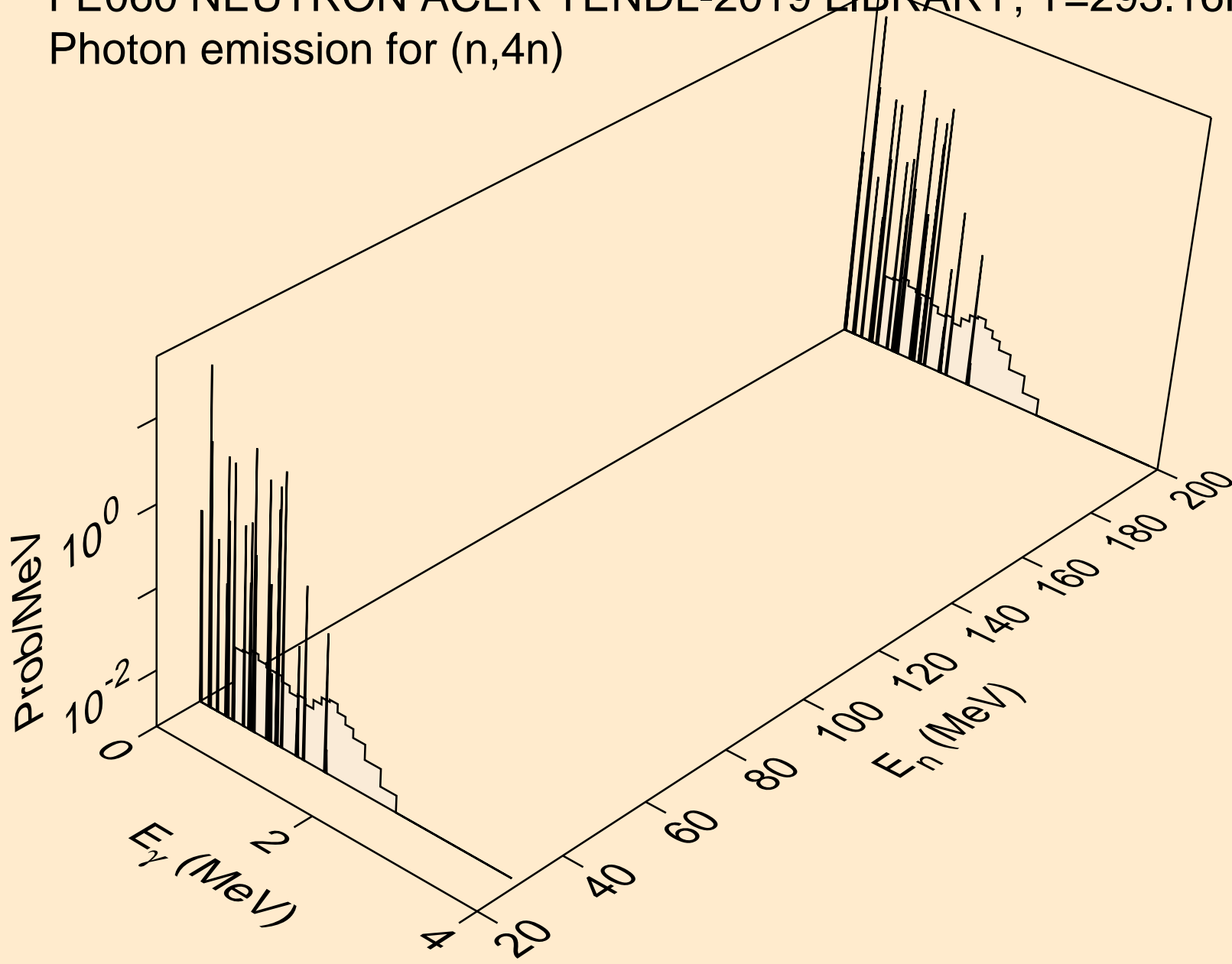

FE060 NEUTRON ACER TENDL-2019 LIBRARY; T=293.16K
Photon emission for (n,2np)

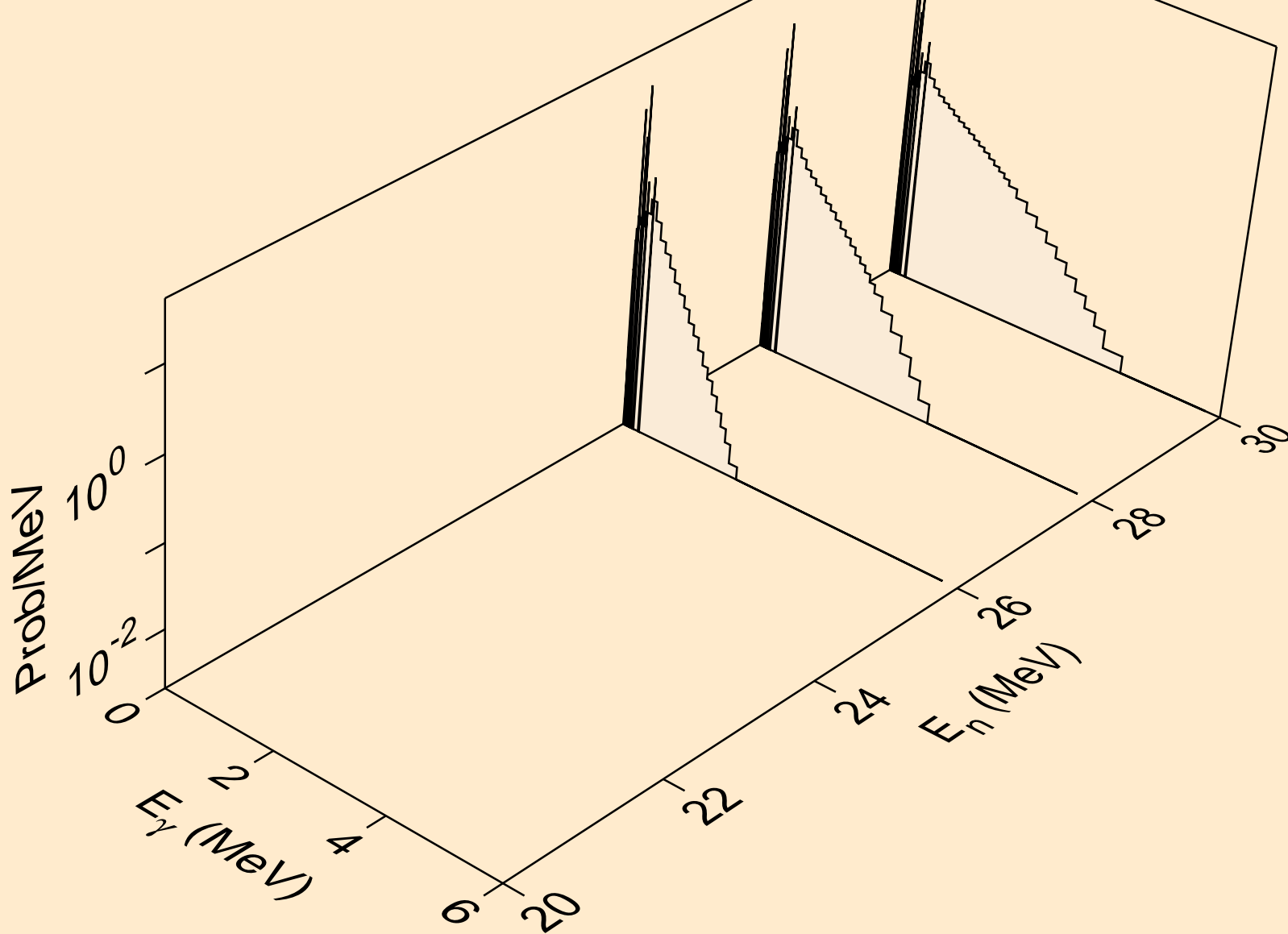

FE060 NEUTRON ACER TENDL-2019 LIBRARY; T=293.16K
Photon emission for (n,3np)

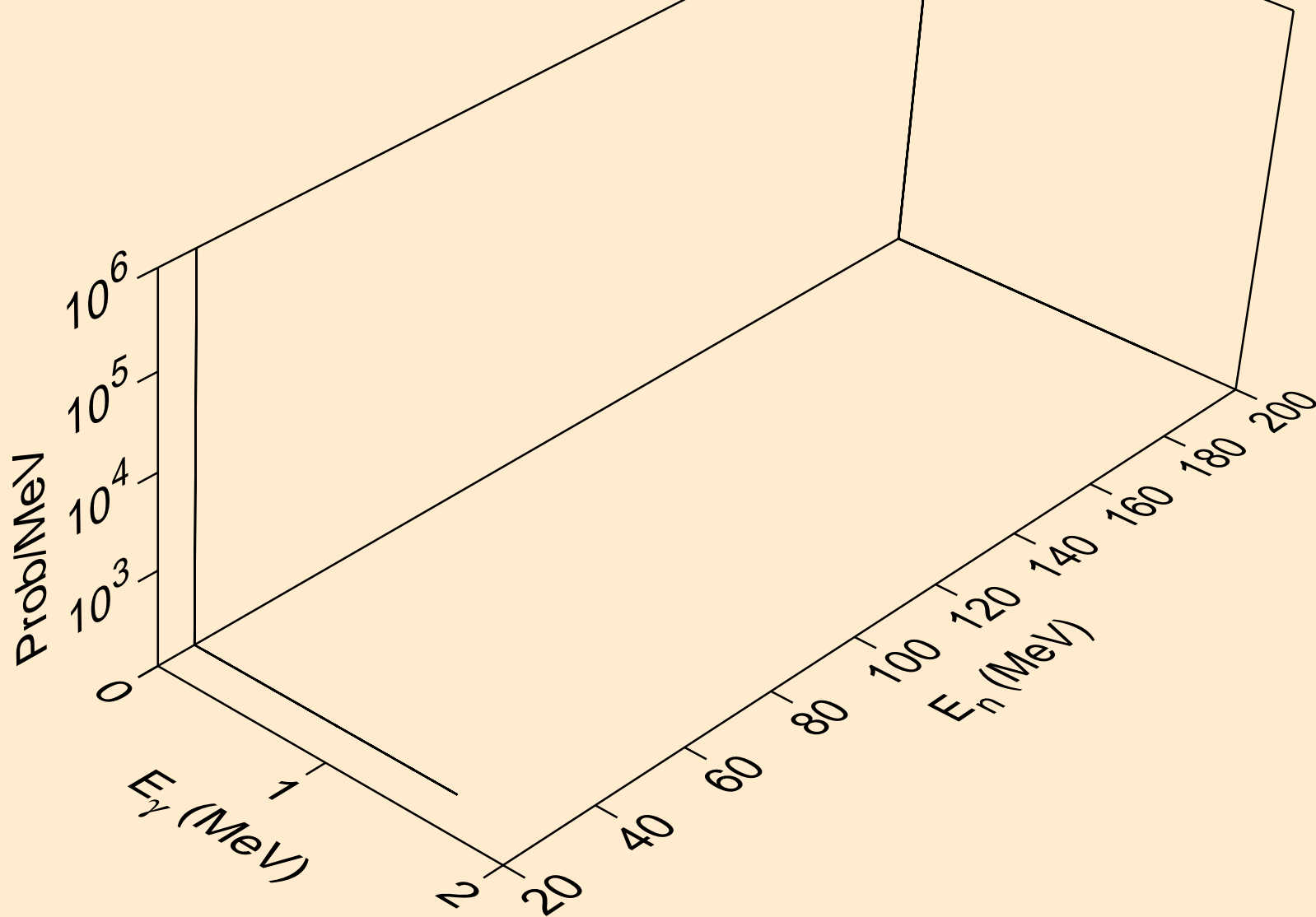

FE060 NEUTRON ACER TENDL-2019 LIBRARY; T=293.16K
Photon emission for (n,2np)

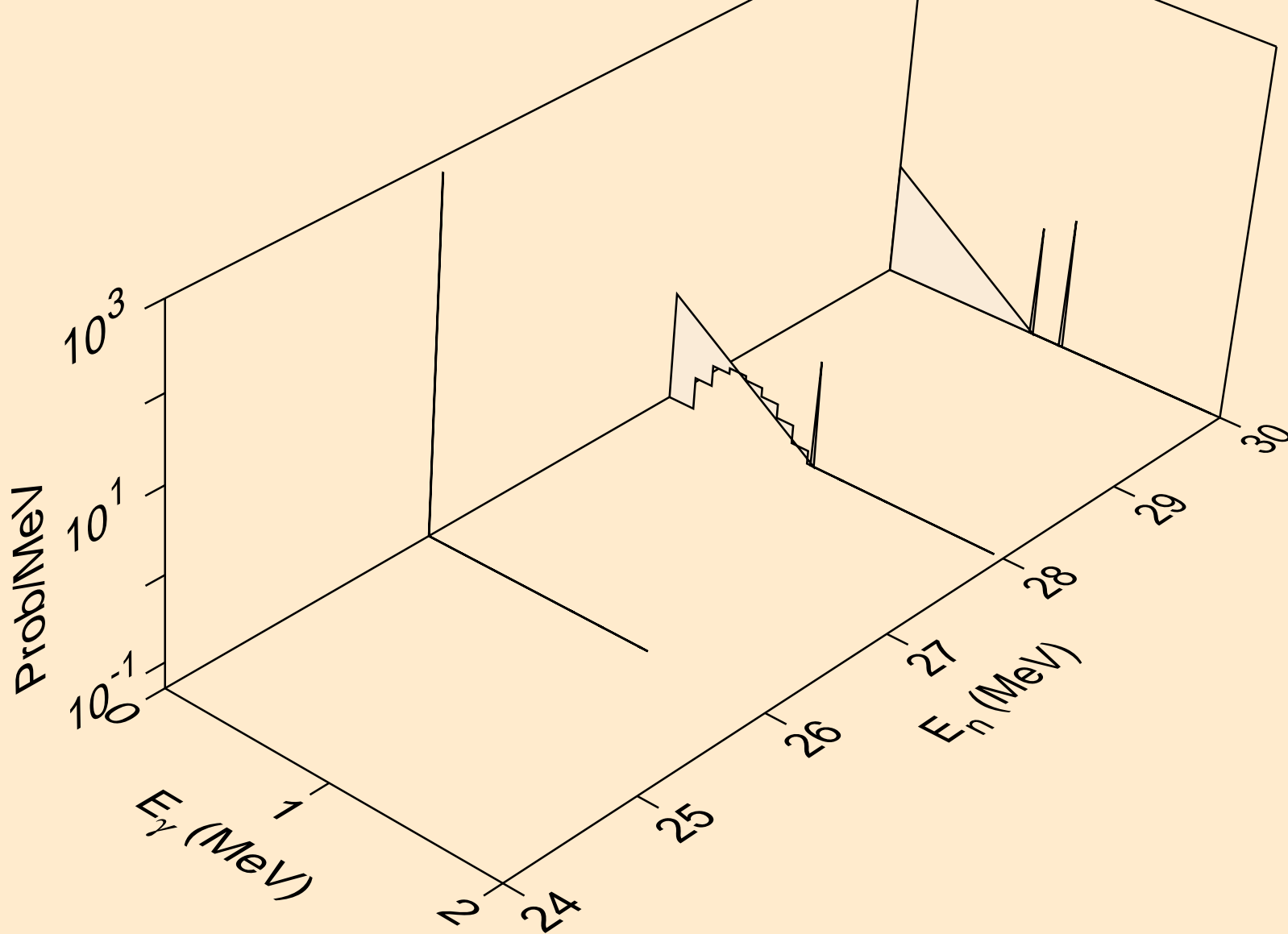

FE060 NEUTRON ACER TENDL-2019 LIBRARY; T=293.16K
Photon emission for (n,npa)

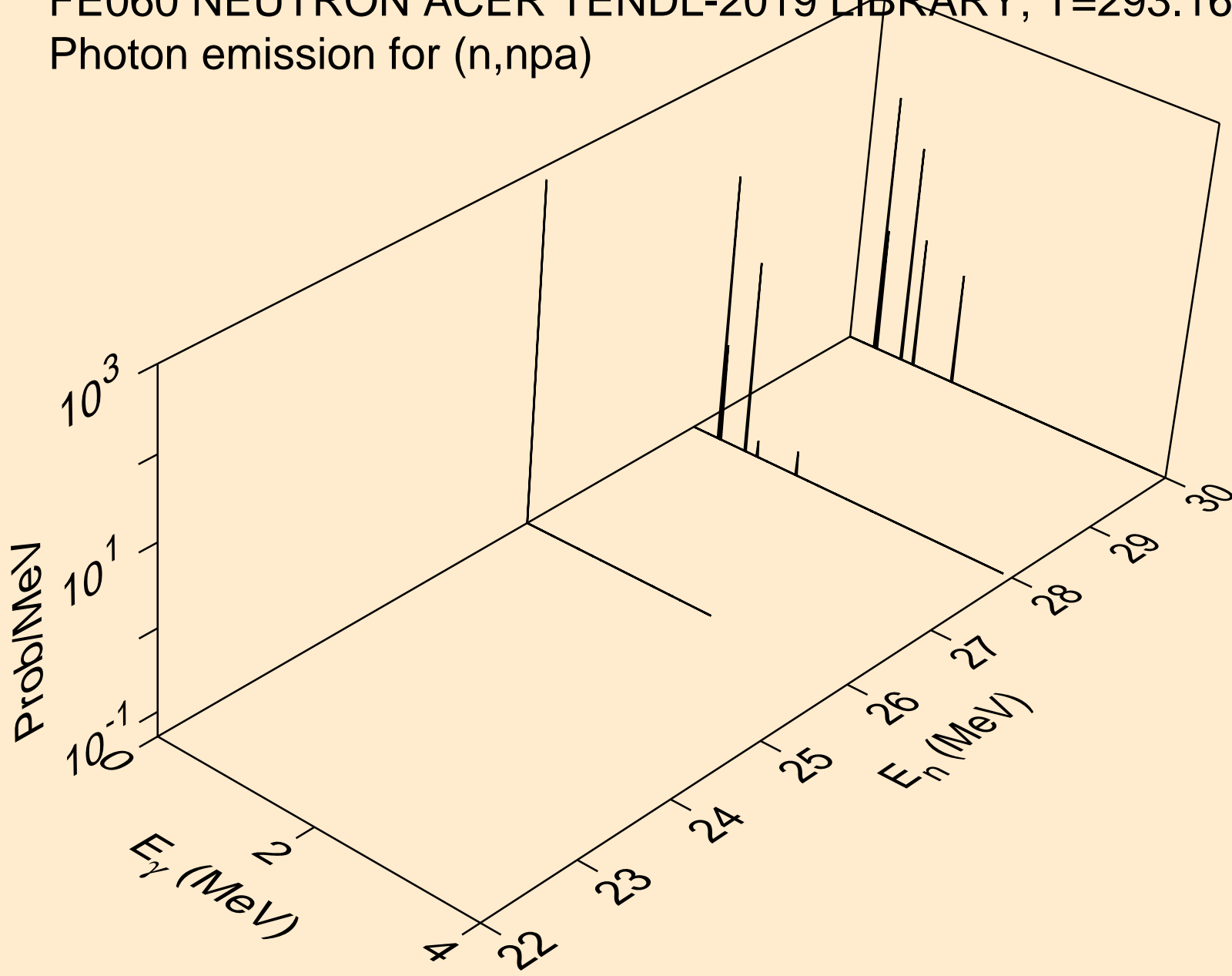

FE060 NEUTRON ACER TENDL-2019 LIBRARY; T=293.16K
Photon emission for (n,n*c)

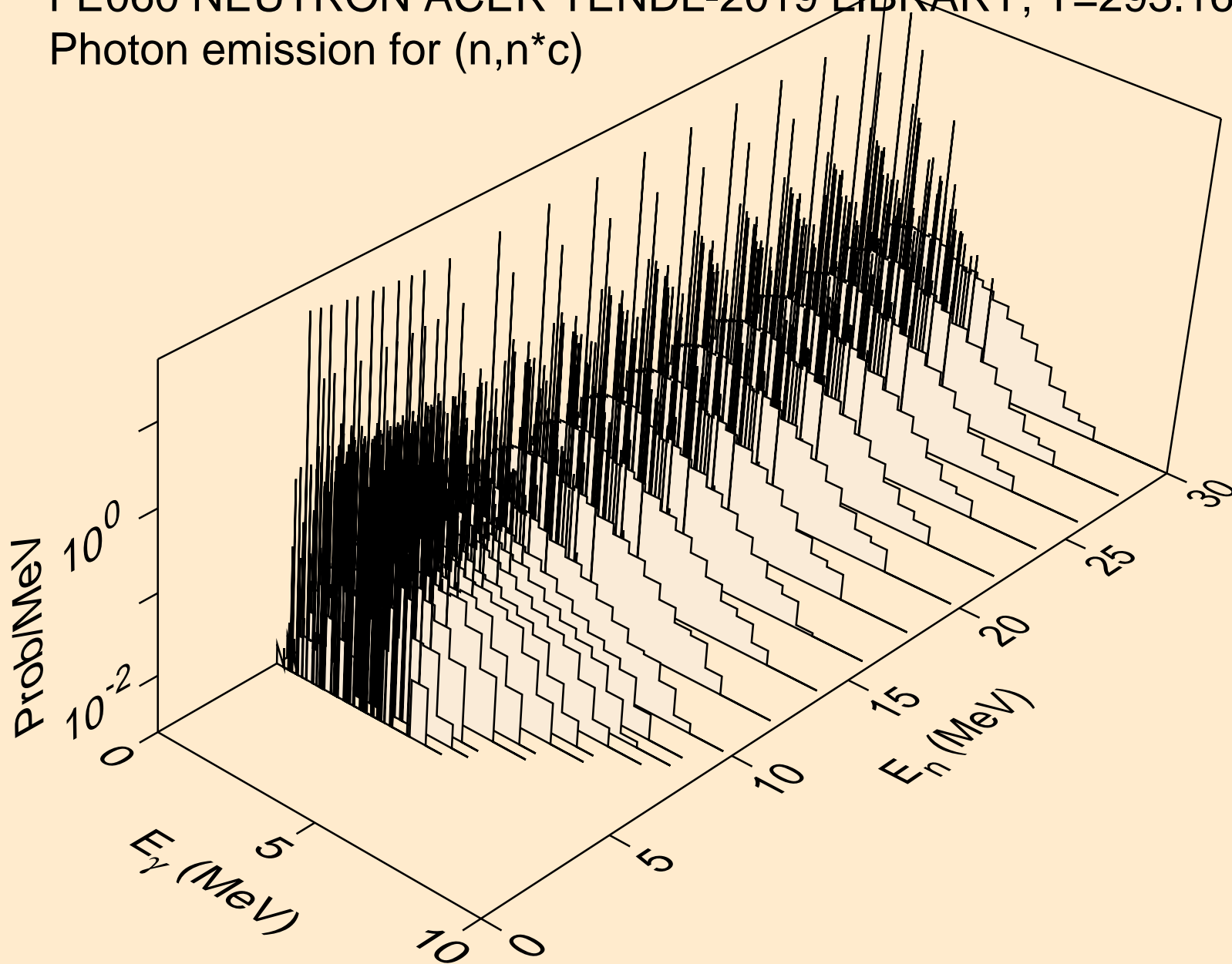

FE060 NEUTRON ACER TENDL-2019 LIBRARY; T=293.16K
Photon emission for (n,gma)

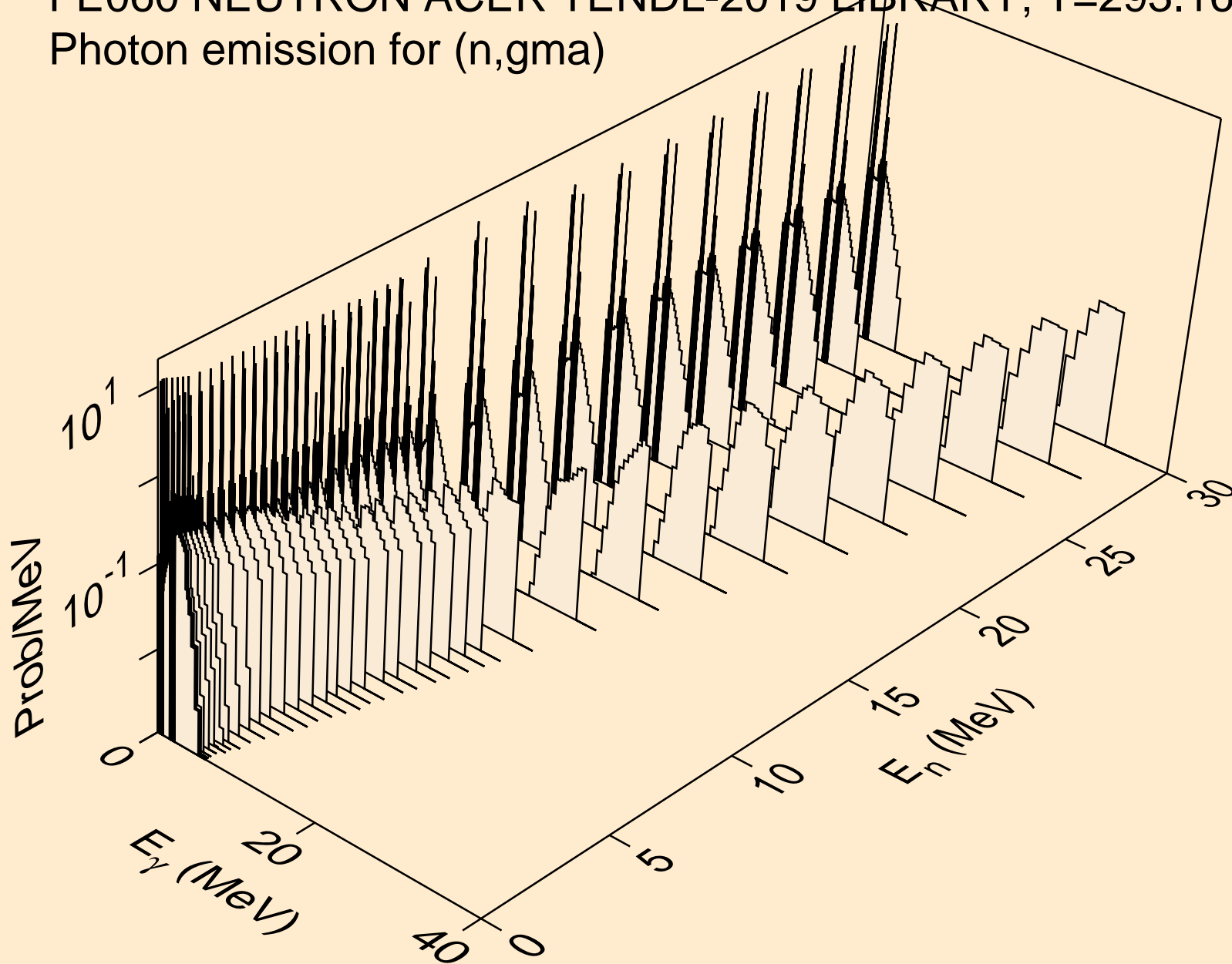

FE060 NEUTRON ACER TENDL-2019 LIBRARY; T=293.16K
Photon emission for (n,p)

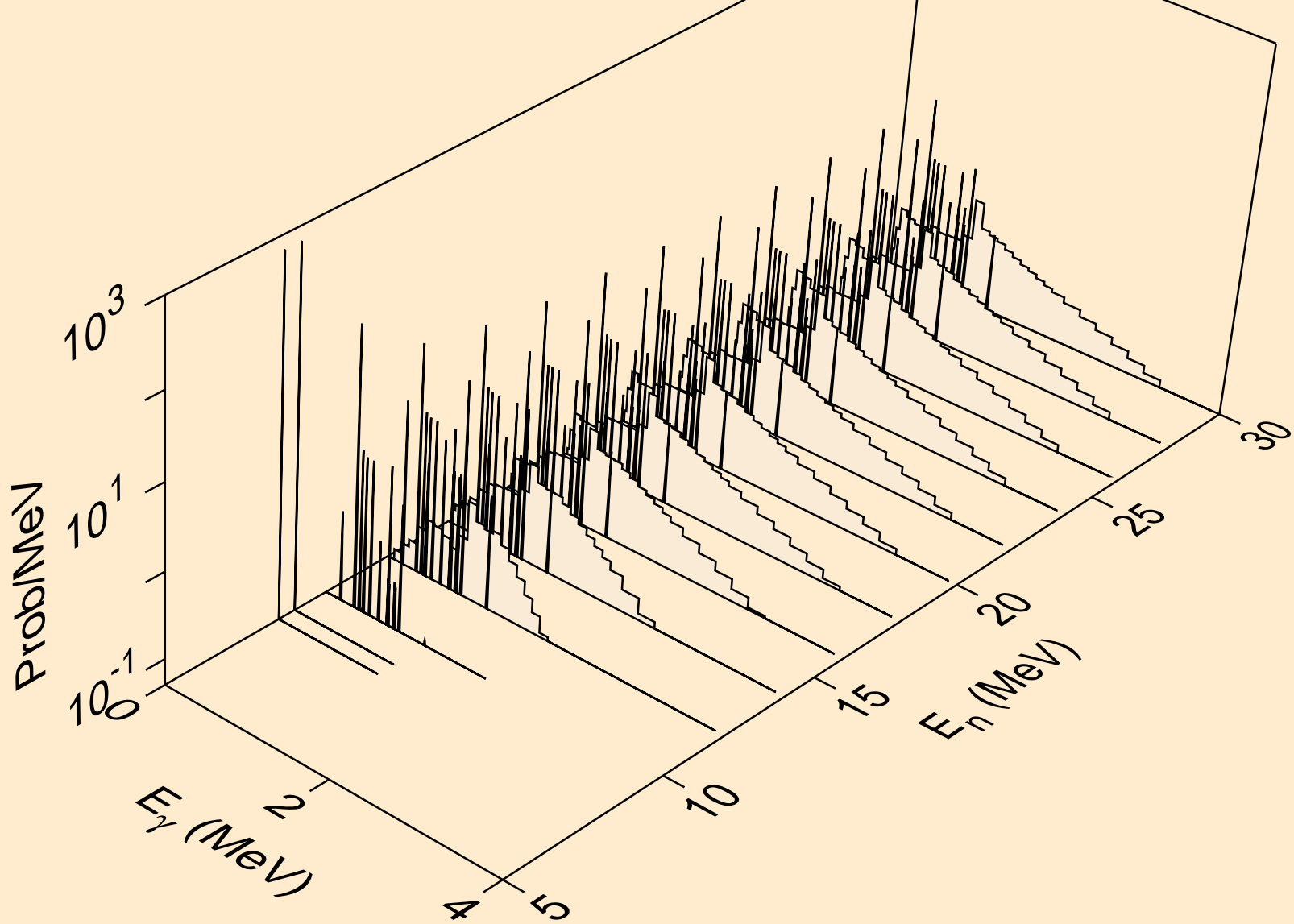

FE060 NEUTRON ACER TENDL-2019 LIBRARY; T=293.16K
Photon emission for (n,d)

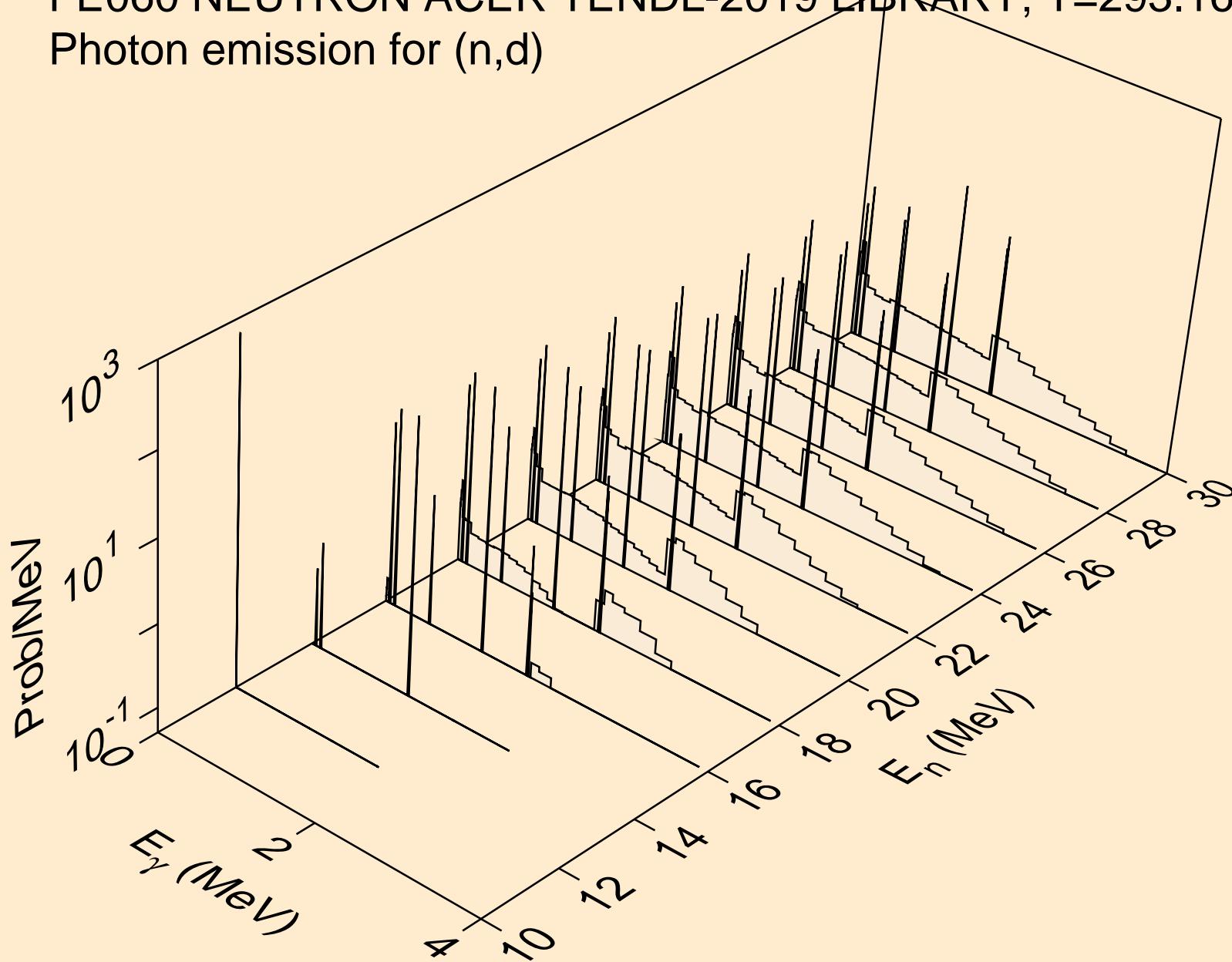

FE060 NEUTRON ACER TENDL-2019 LIBRARY; T=293.16K
Photon emission for (n,t)

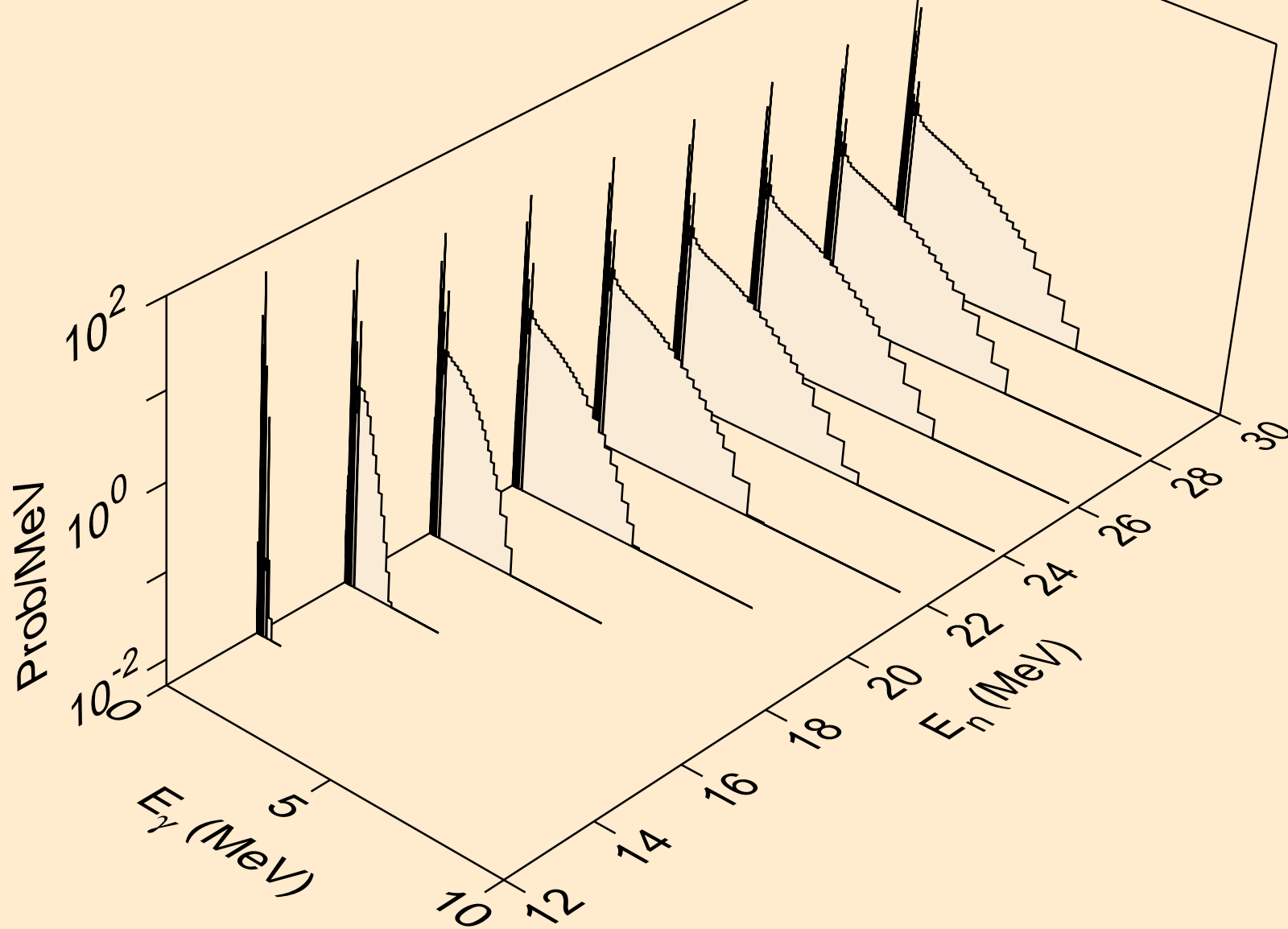

FE060 NEUTRON ACER TENDL-2019 LIBRARY; T=293.16K
Photon emission for (n,he3)

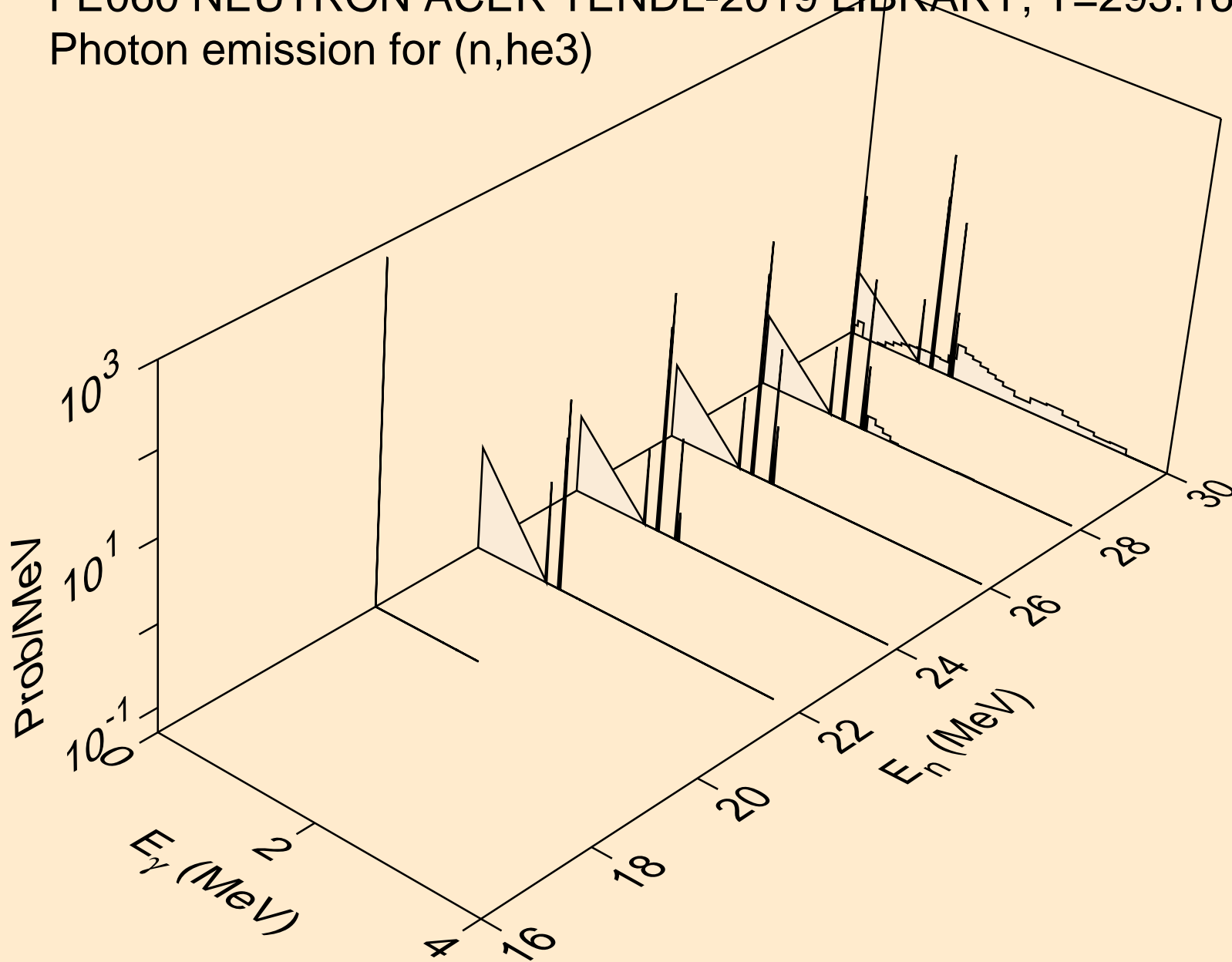

FE060 NEUTRON ACER TENDL-2019 LIBRARY; T=293.16K
Photon emission for (n,a)

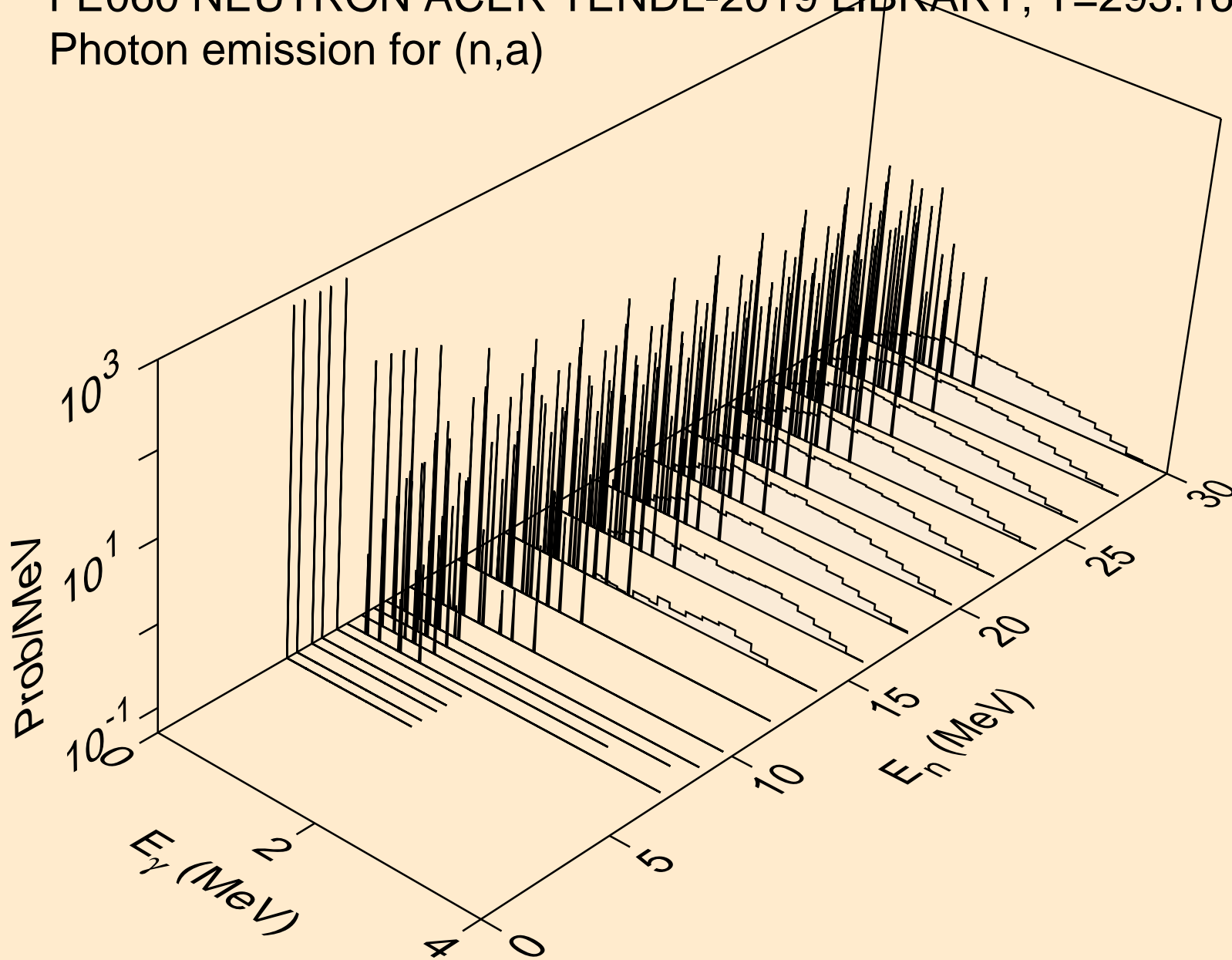

FE060 NEUTRON ACER TENDL-2019 LIBRARY; T=293.16K
Photon emission for (n,2a)

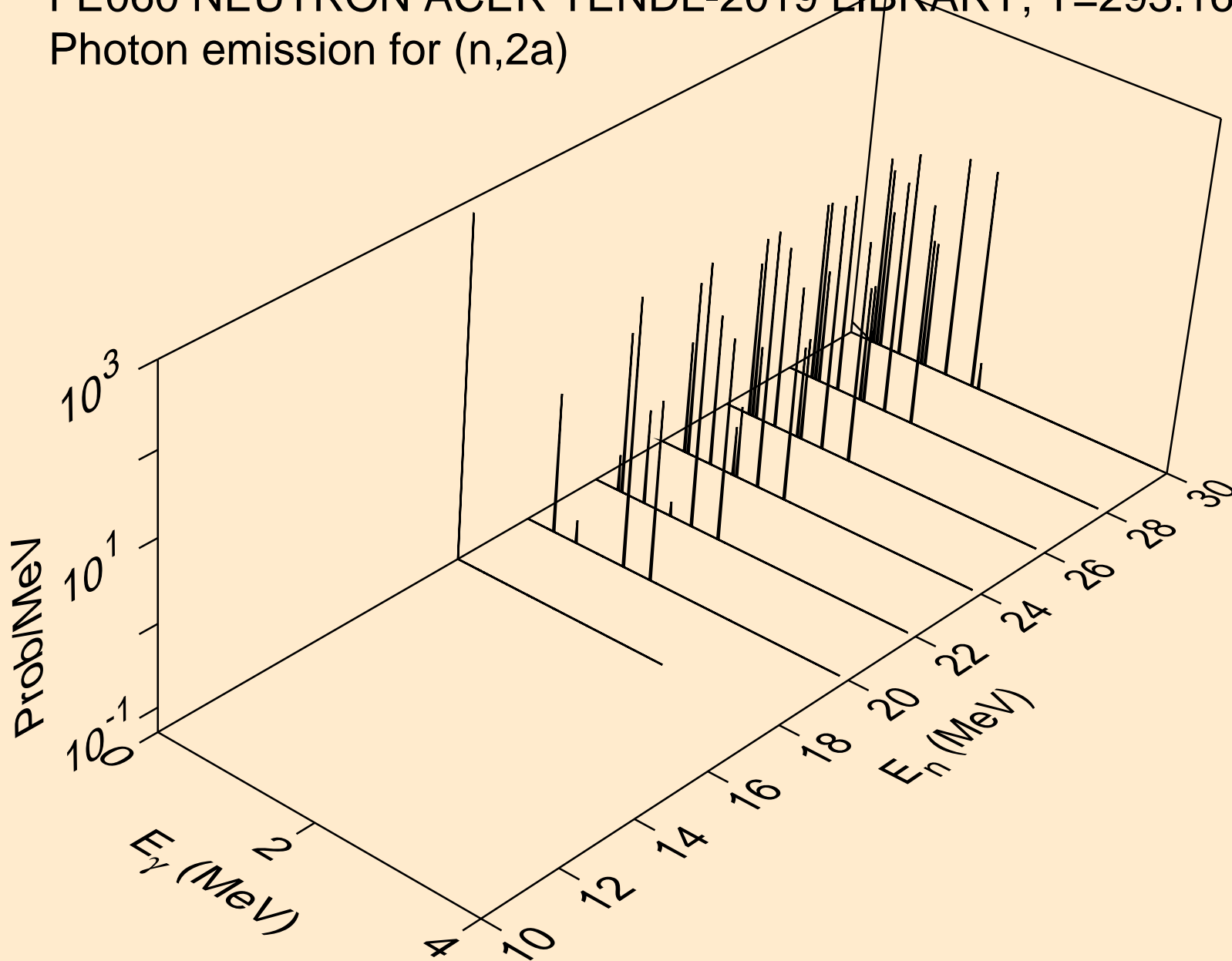

FE060 NEUTRON ACER TENDL-2019 LIBRARY; T=293.16K
Photon emission for (n,2p)

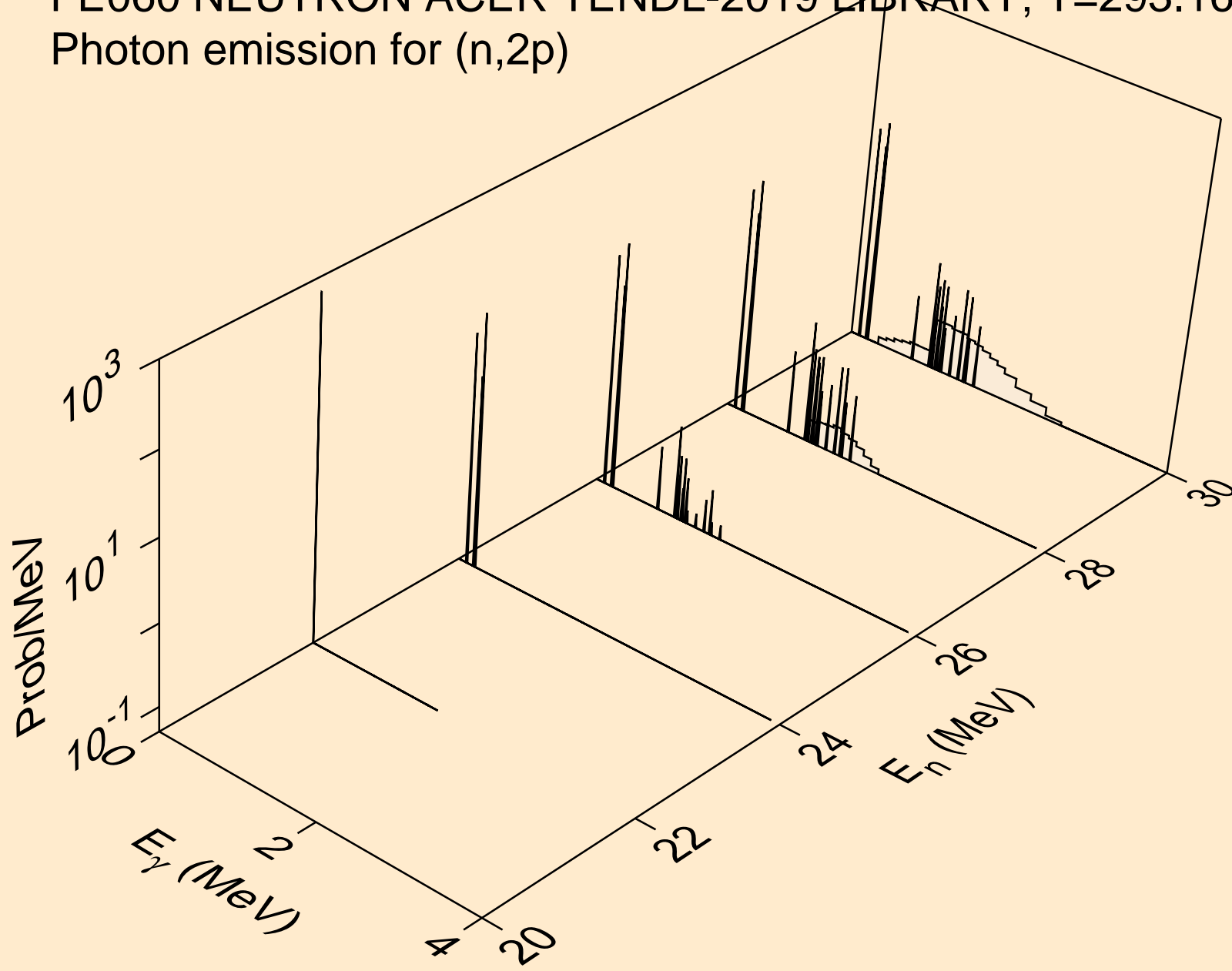

FE060 NEUTRON ACER TENDL-2019 LIBRARY; T=293.16K
Photon emission for (n,p α)

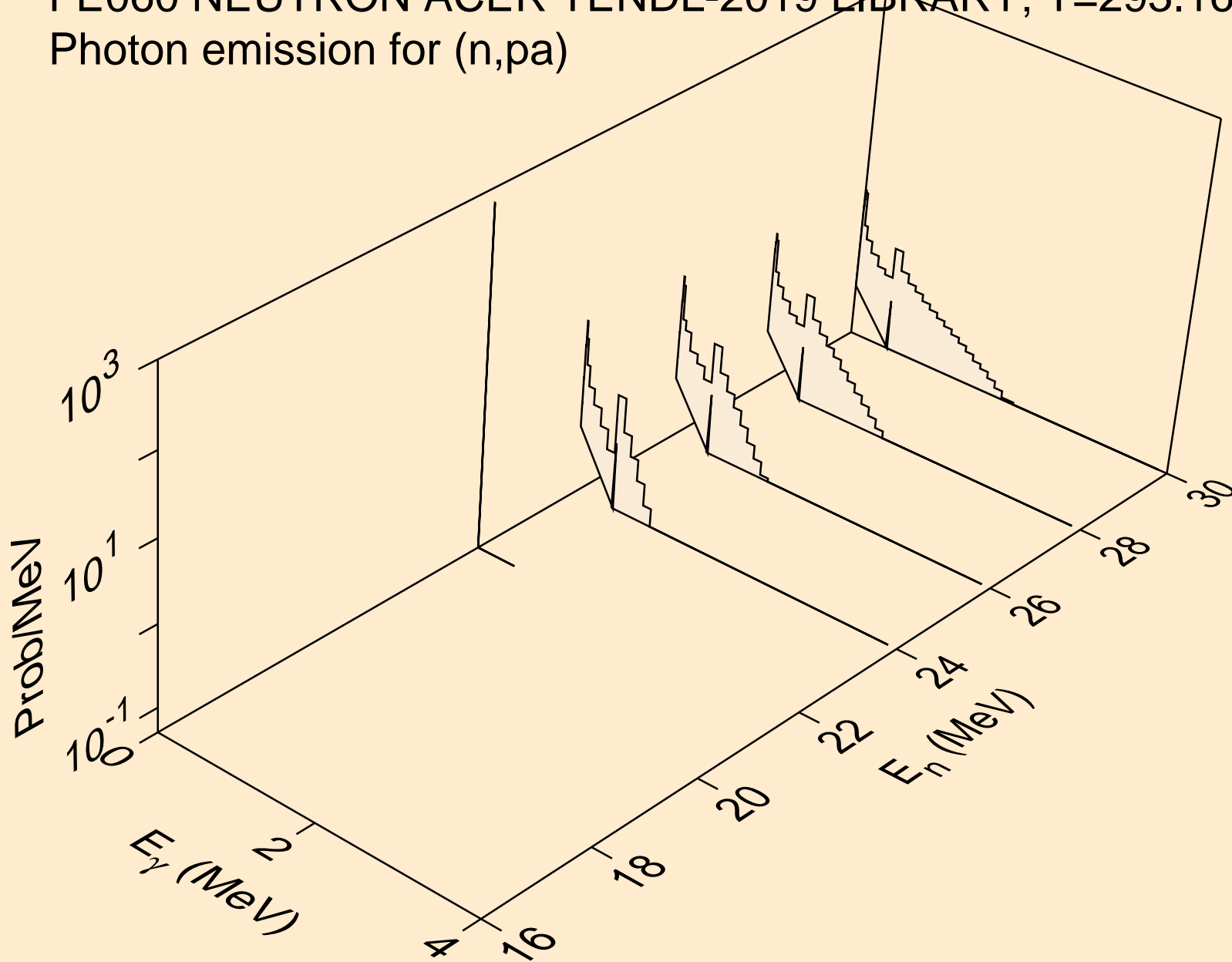

FE060 NEUTRON ACER TENDL-2019 LIBRARY; T=293.16K
Photon emission for (n,pd)

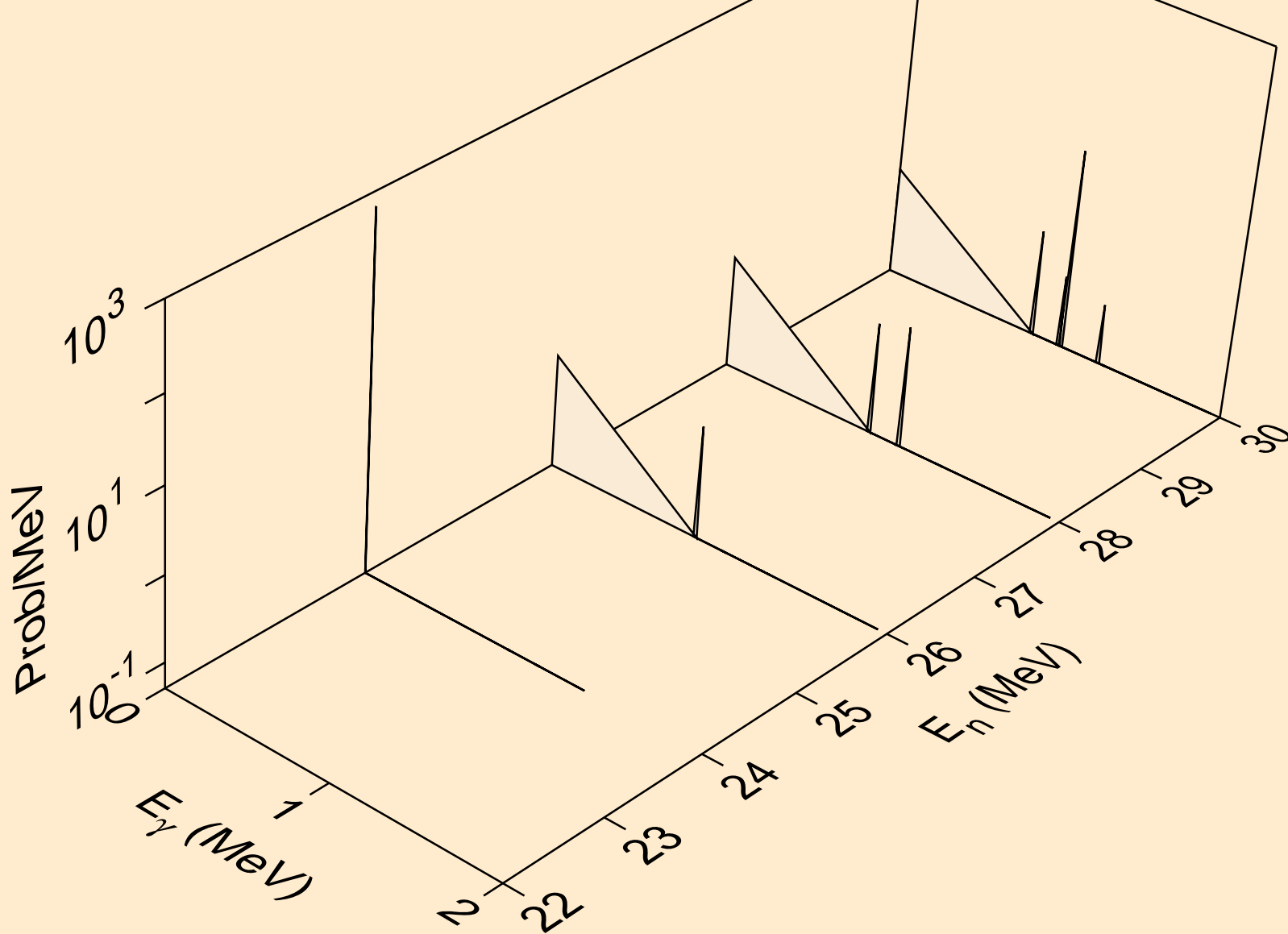

FE060 NEUTRON ACER TENDL-2019 LIBRARY; T=293.16K
Photon emission for (n,pt)

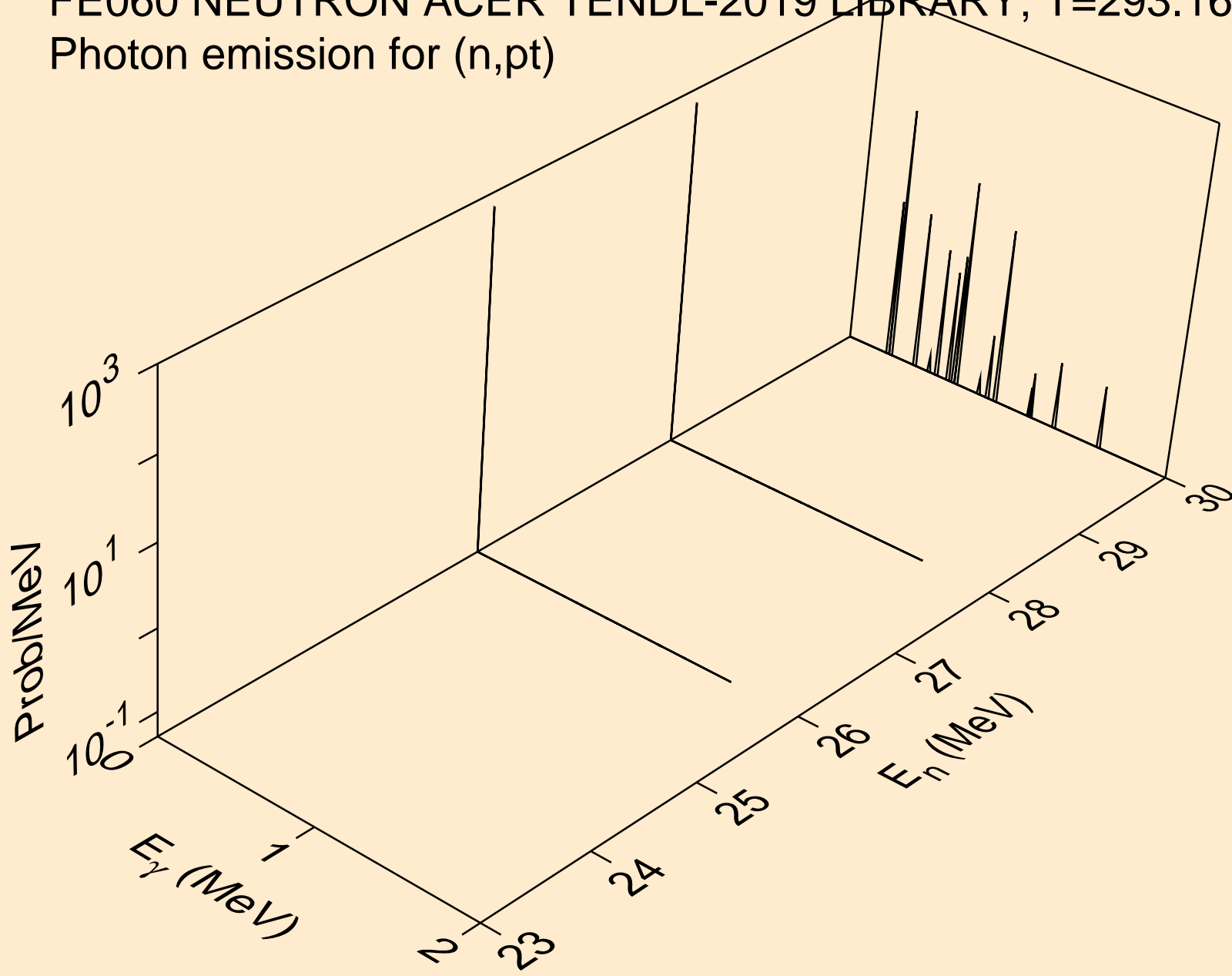

FE060 NEUTRON ACER TENDL-2019 LIBRARY; T=293.16K
Photon emission for (n,da)

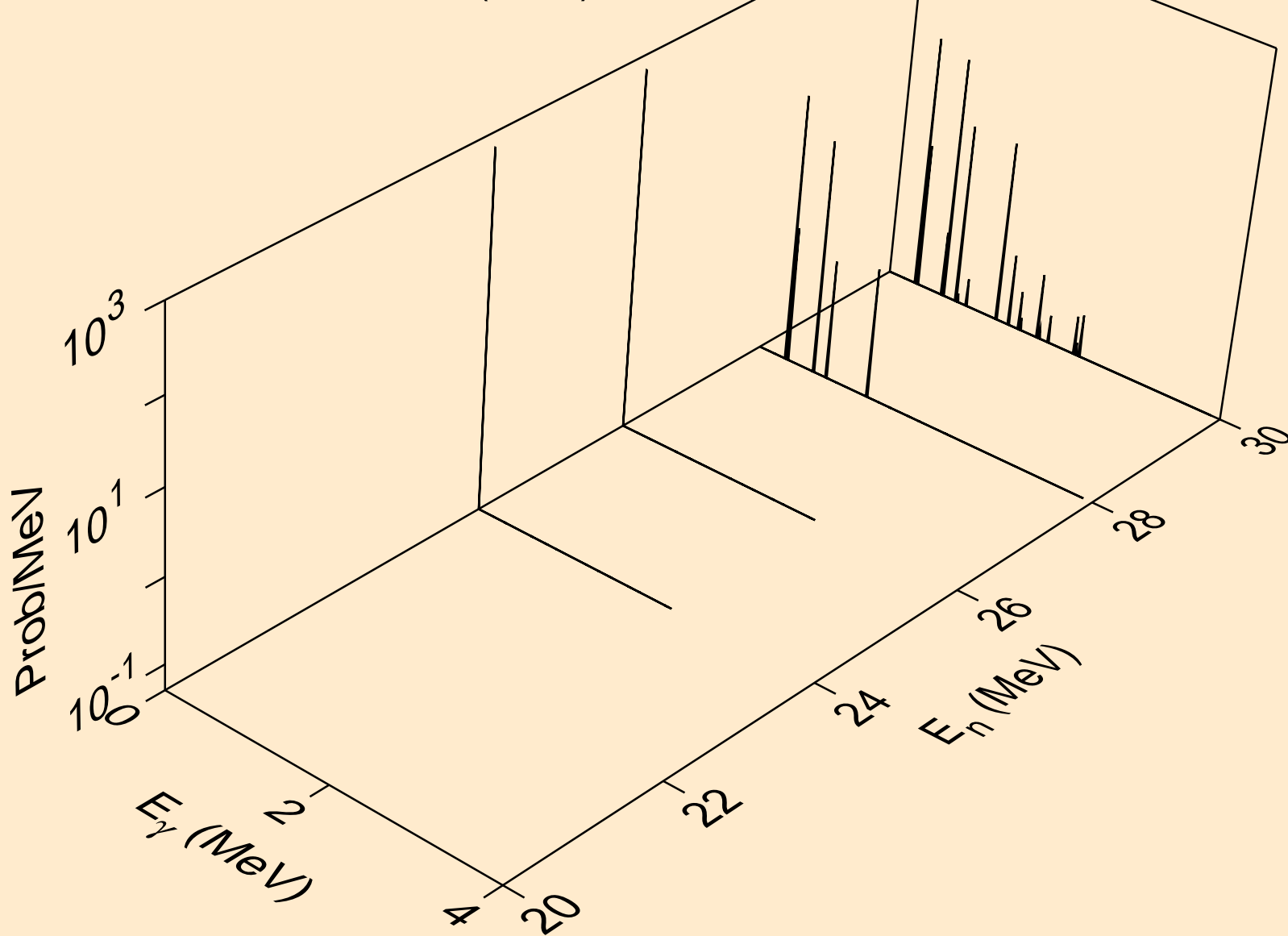

FE060 NEUTRON ACER TENDL-2019 LIBRARY; T=293.16K
thermal capture photon spectrum

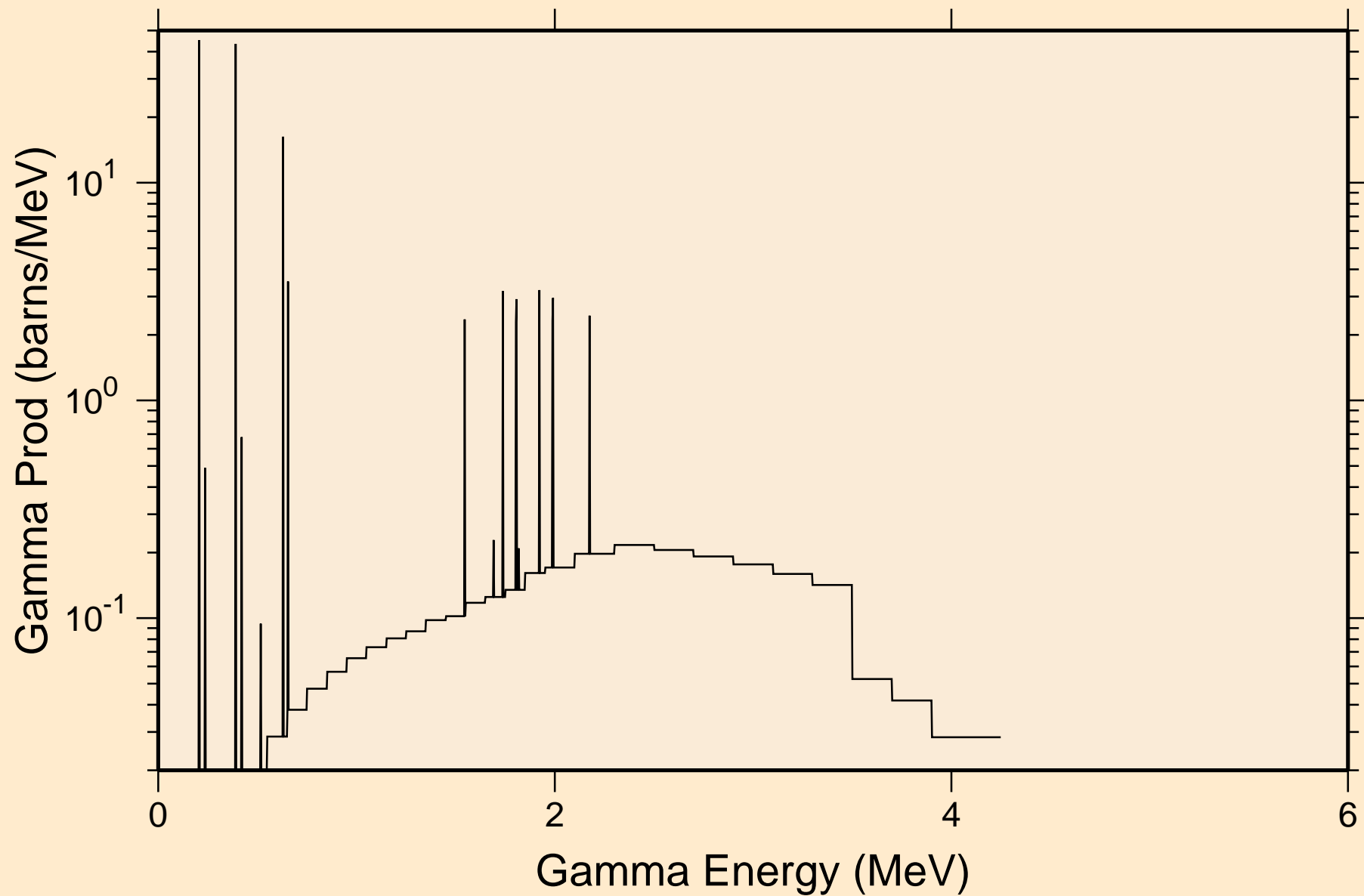

FE060 NEUTRON ACER TENDL-2019 LIBRARY; T=293.16K
14 MeV photon spectrum

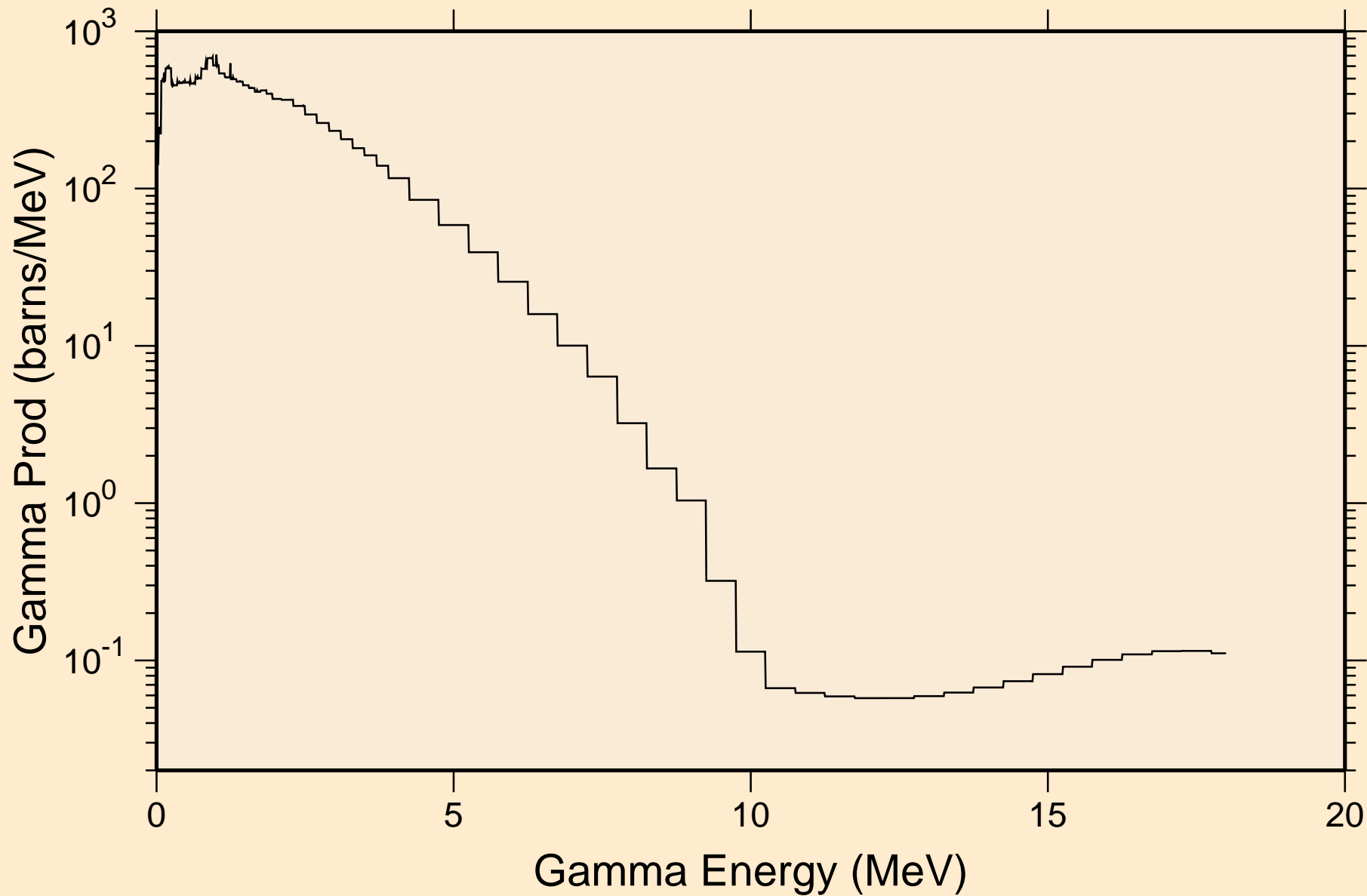

FE060 NEUTRON ACER TENDL-2019 LIBRARY; T=293.16K
Particle heating contributions

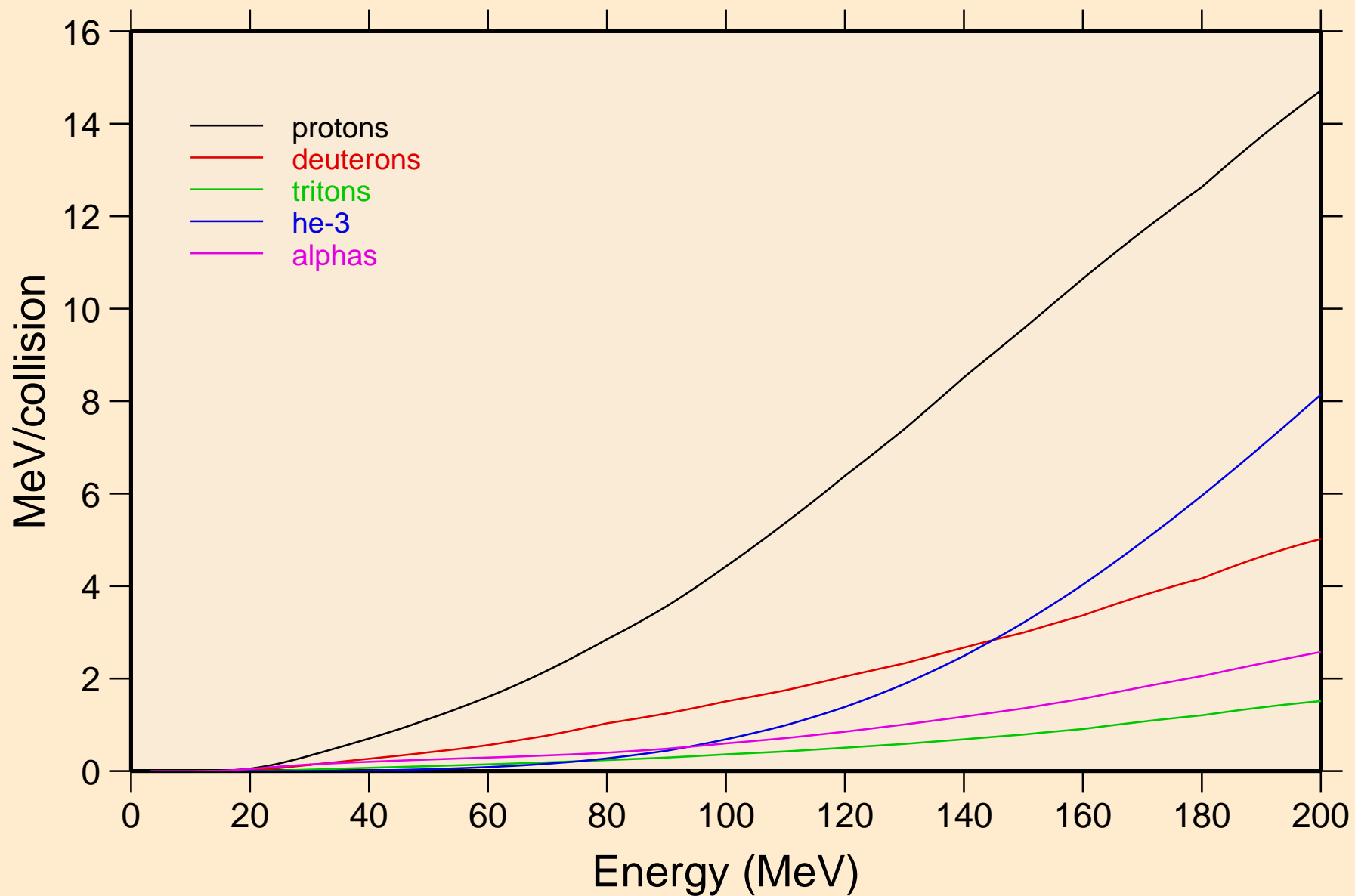

FE060 NEUTRON ACER TENDL-2019 LIBRARY; T=293.16K
Recoil Heating

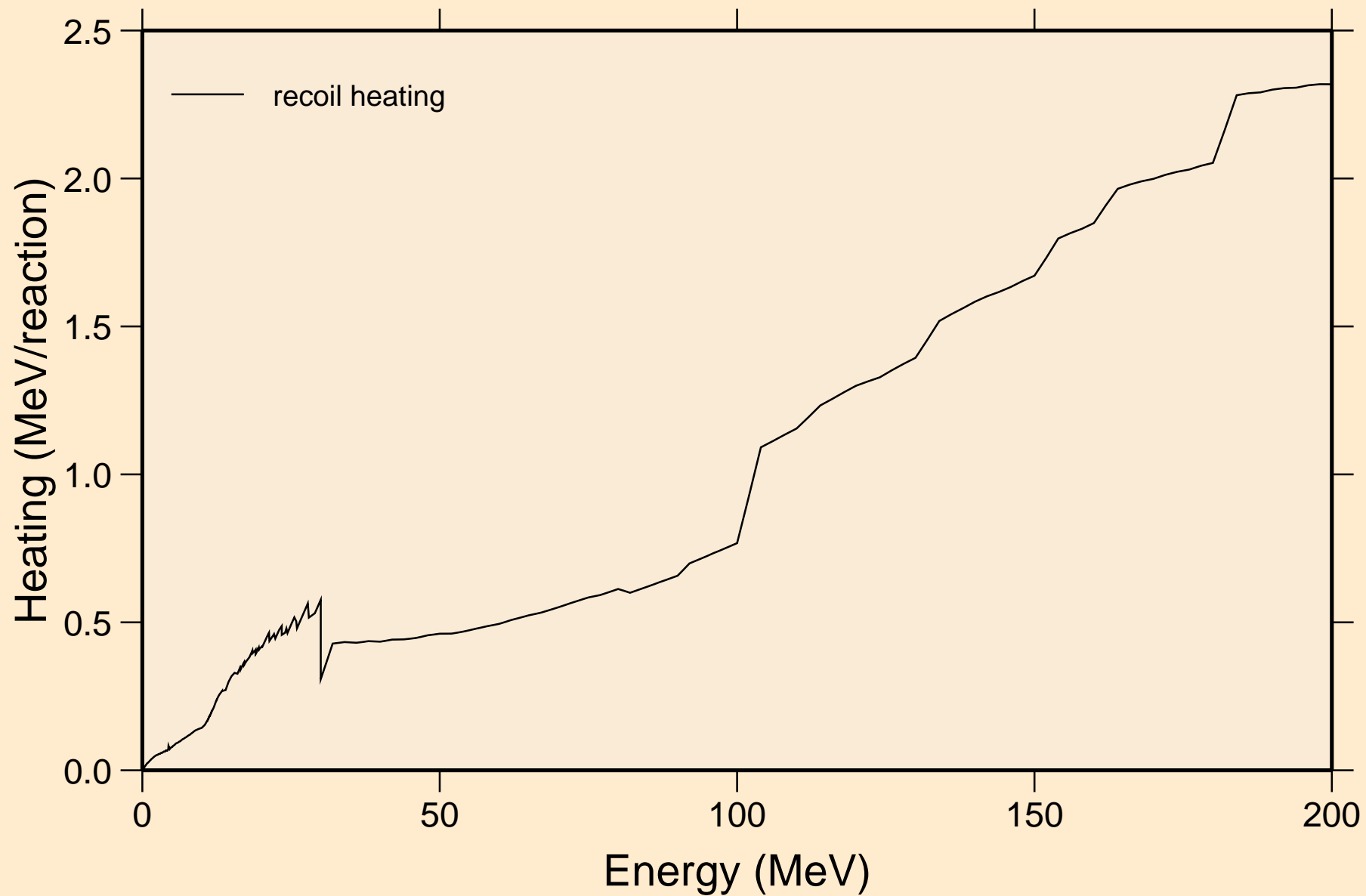

FE060 NEUTRON ACER TENDL-2019 LIBRARY; T=293.16K
Particle production cross sections

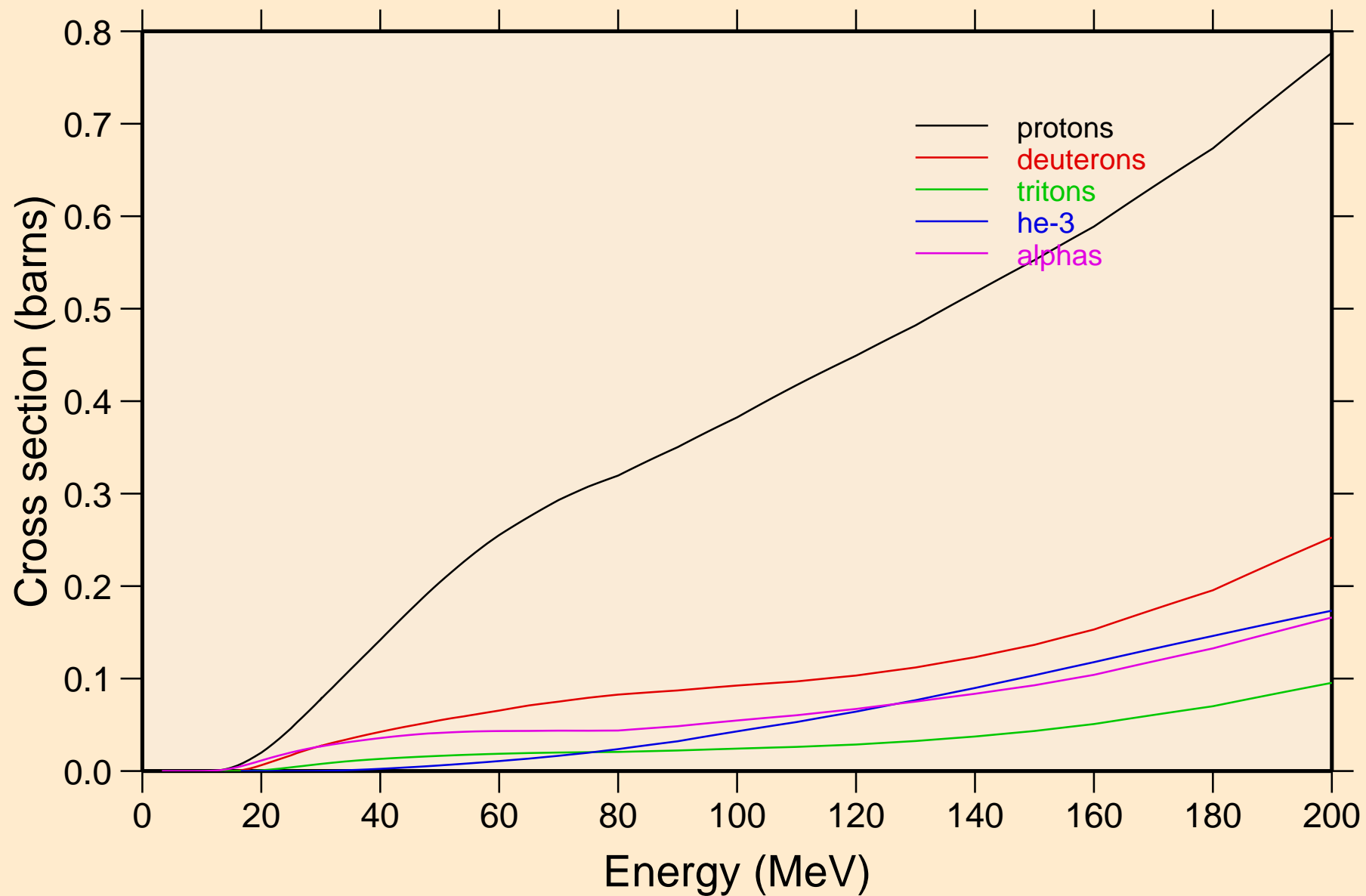

FE060 NEUTRON ACER TENDL-2019 LIBRARY; T=293.16K
protons from (n,x)

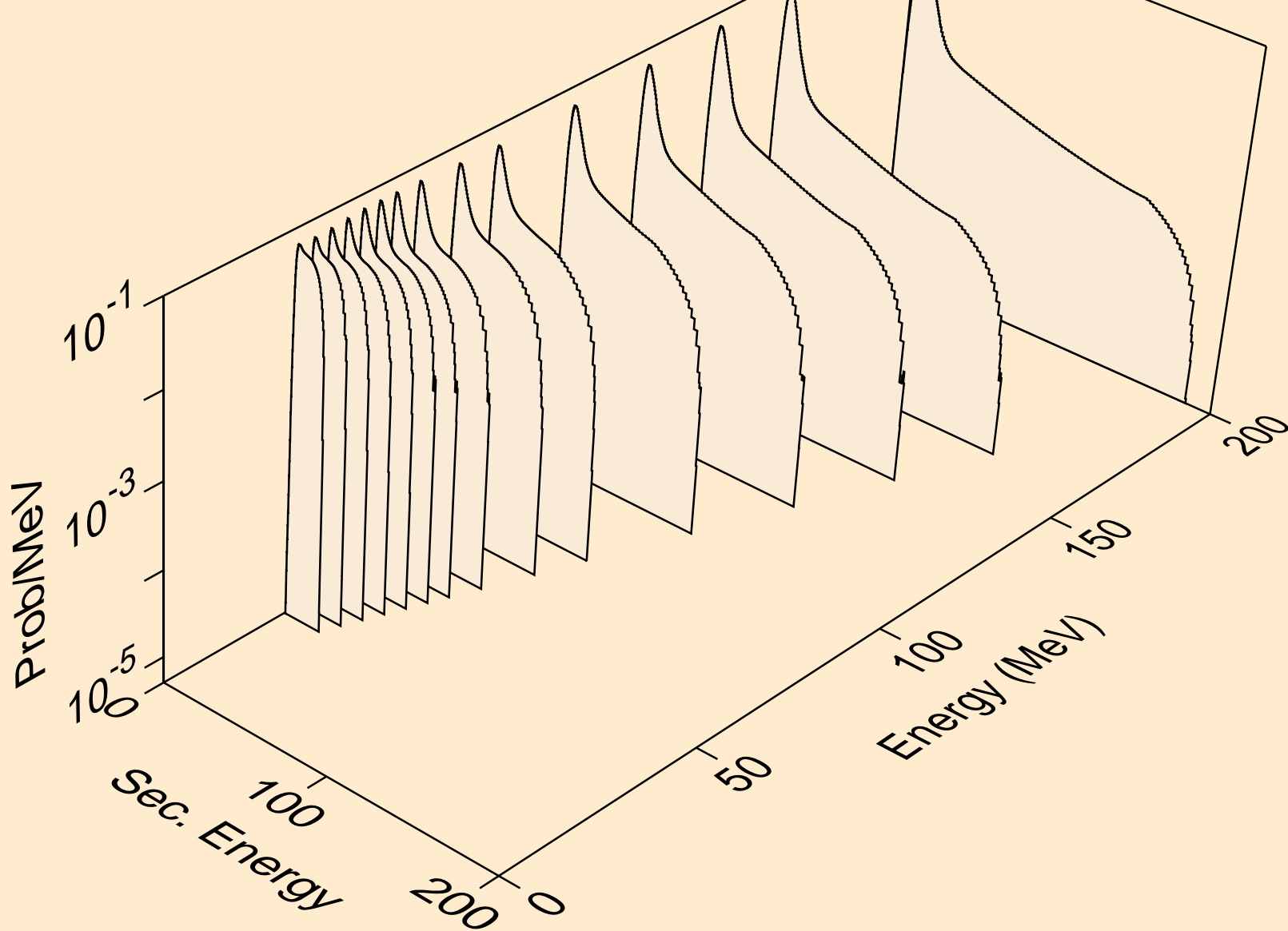

FE060 NEUTRON ACER TENDL-2019 LIBRARY; T=293.16K
protons from (n,n*)p

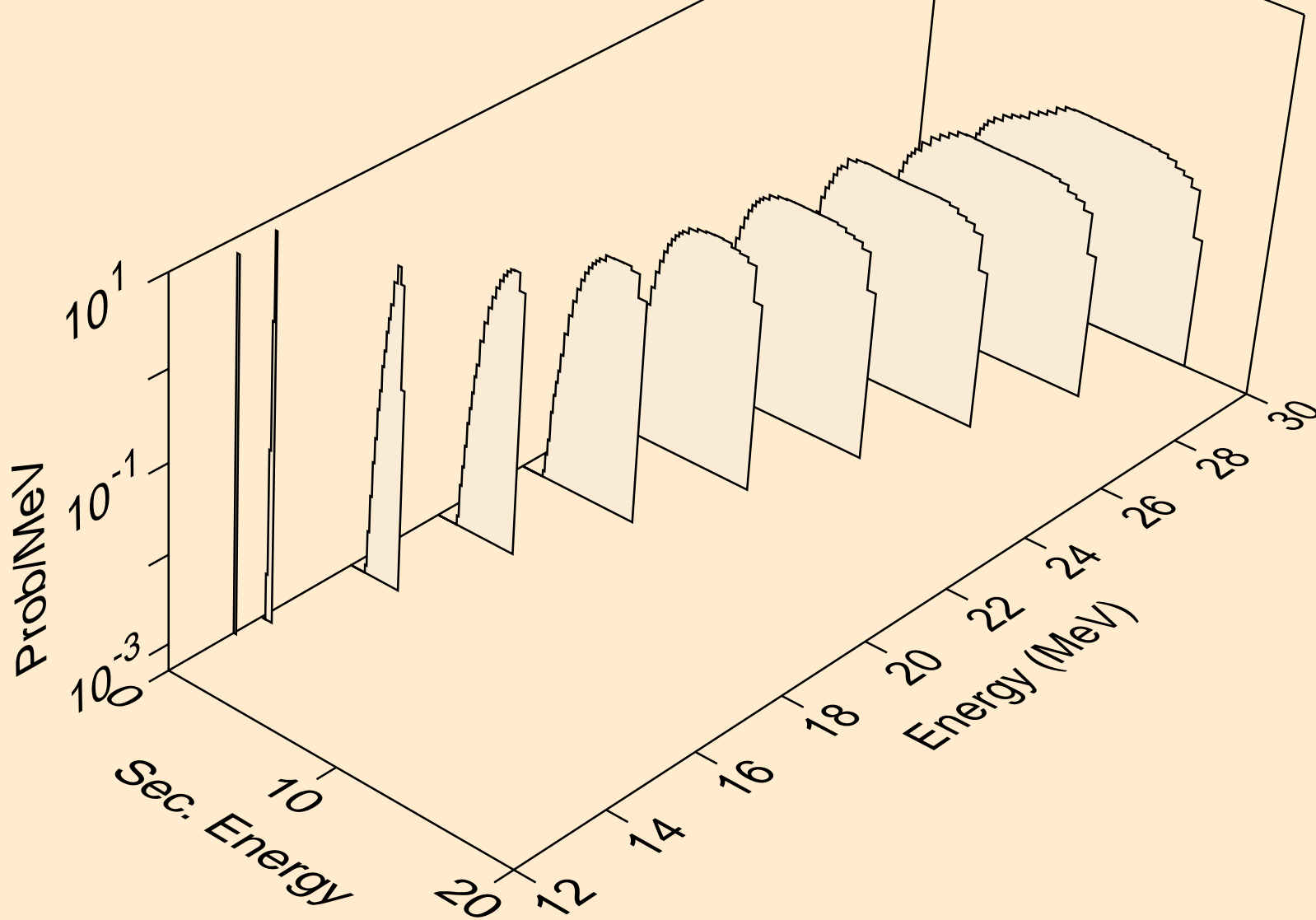

FE060 NEUTRON ACER TENDL-2019 LIBRARY; T=293.16K
protons from (n,2np)

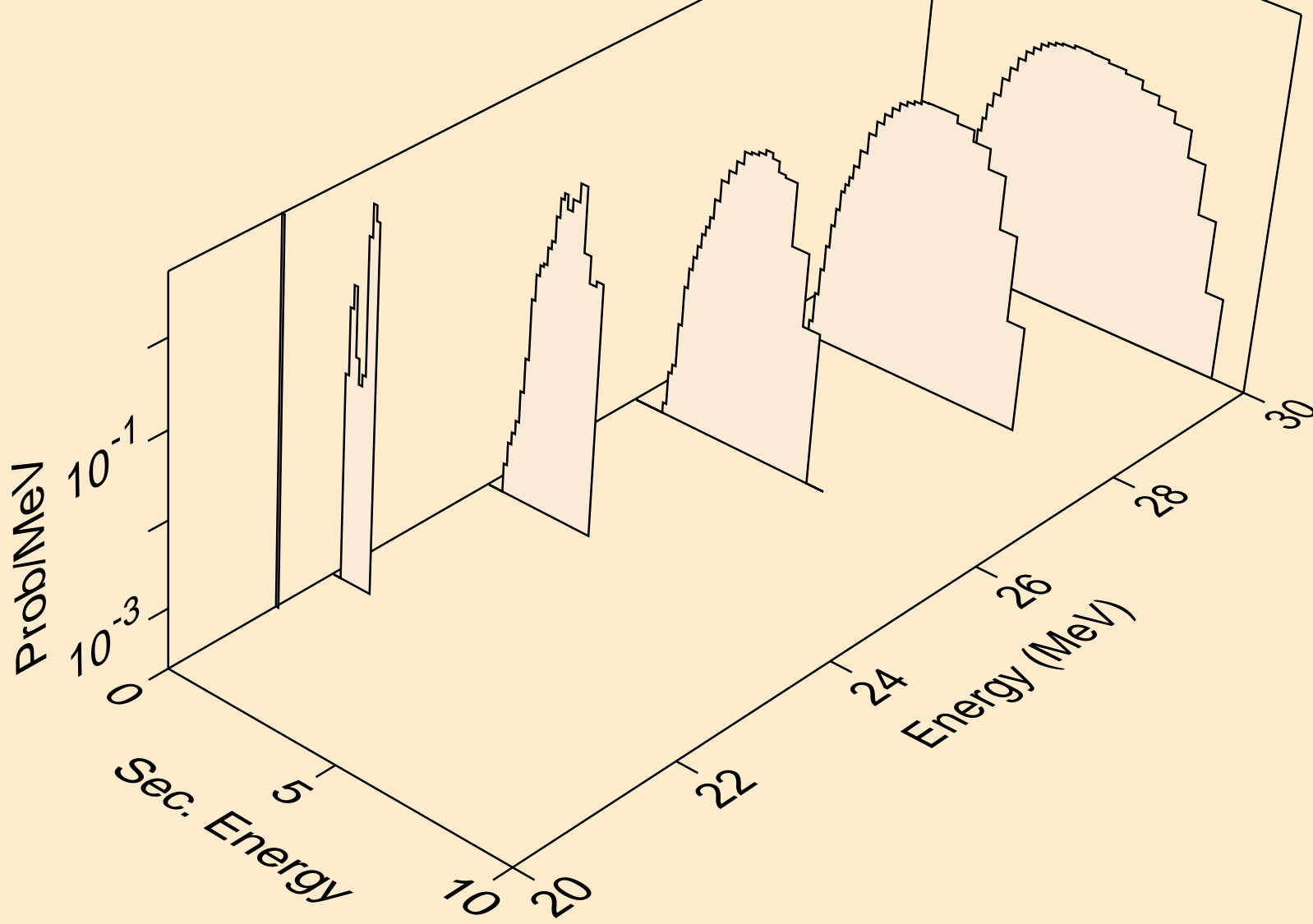

FE060 NEUTRON ACER TENDL-2019 LIBRARY; T=293.16K
protons from (n,3np)

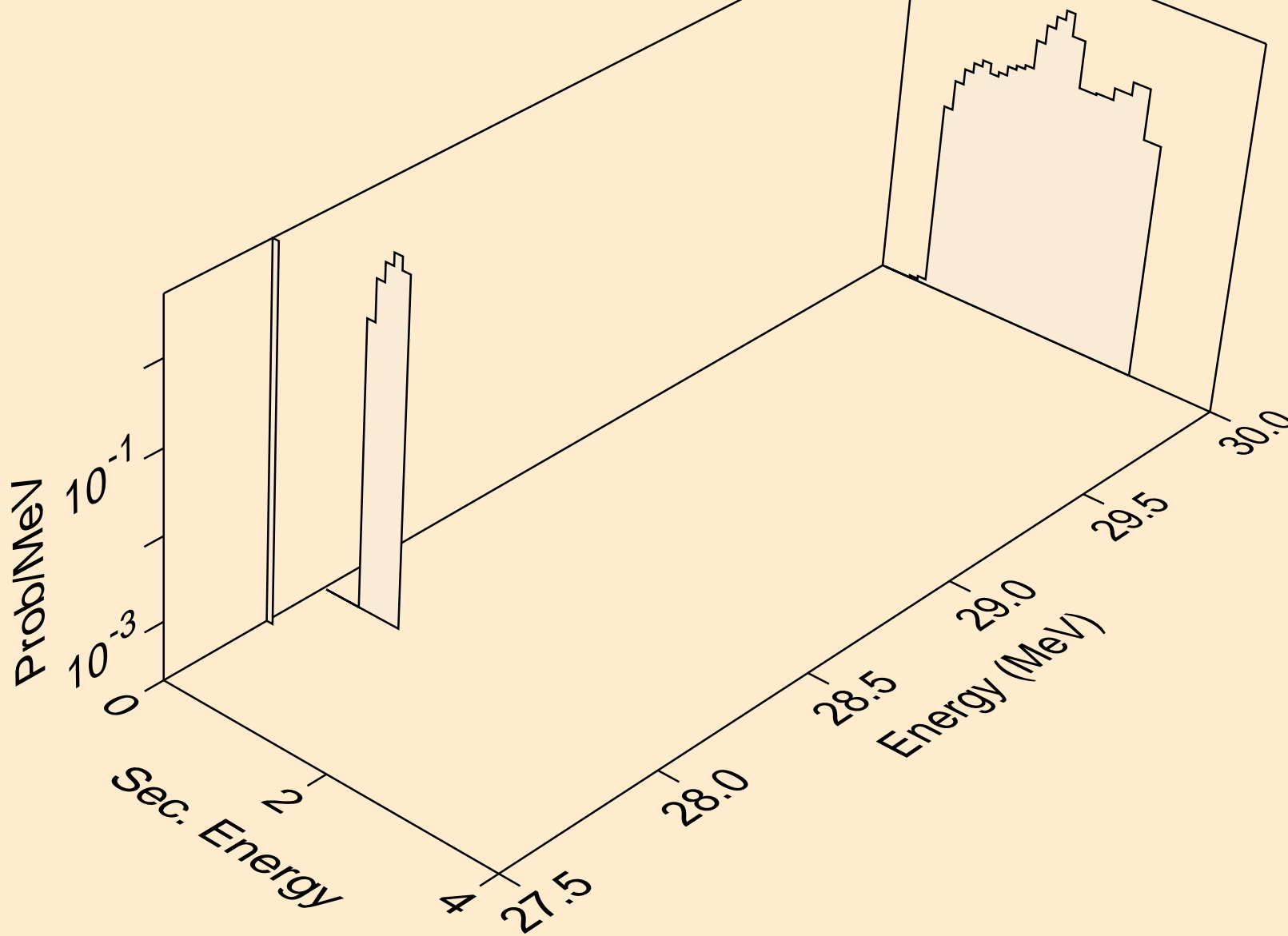

FE060 NEUTRON ACER TENDL-2019 LIBRARY; T=293.16K
protons from (n,2np)

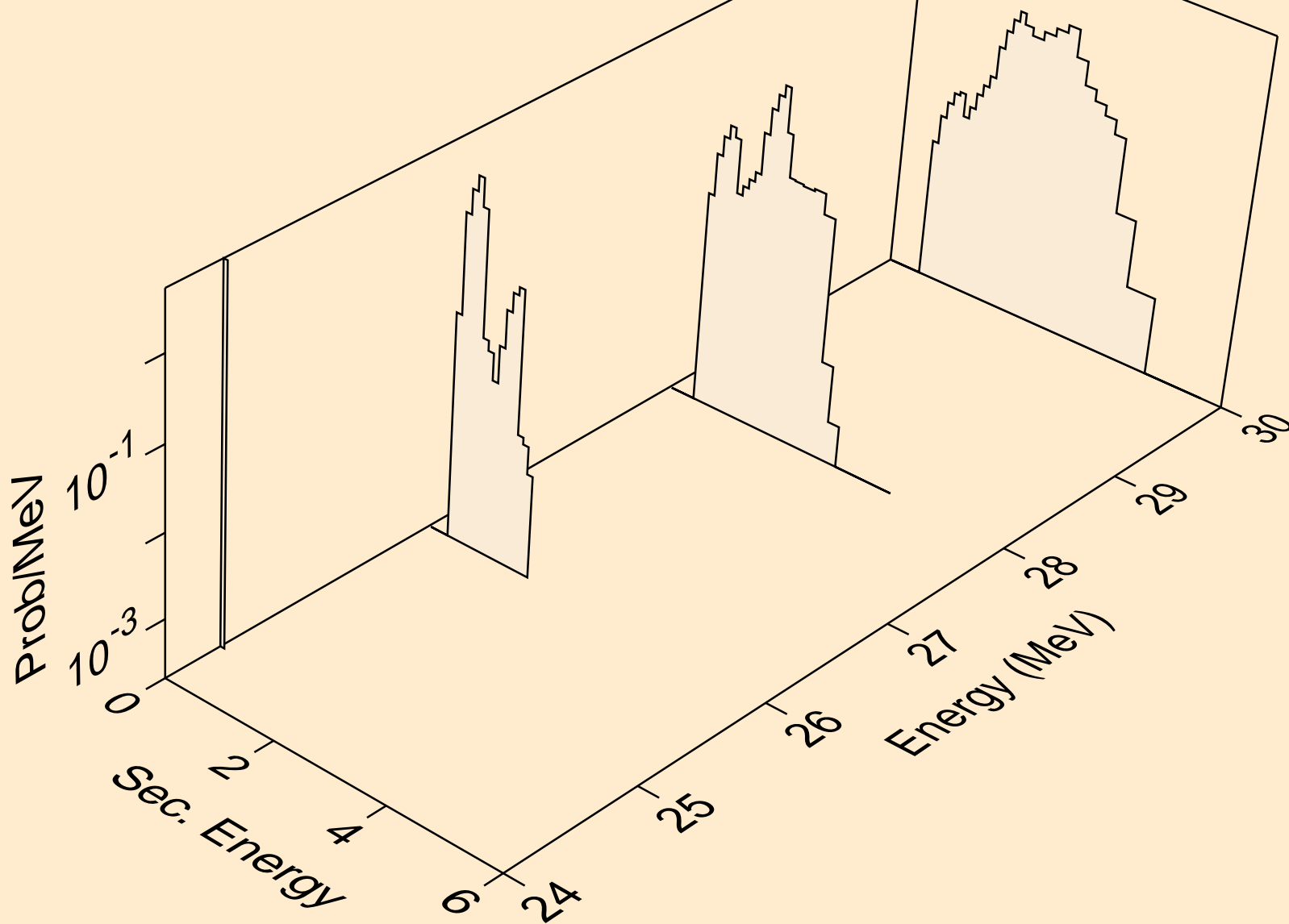

FE060 NEUTRON ACER TENDL-2019 LIBRARY; T=293.16K
protons from (n,npa)

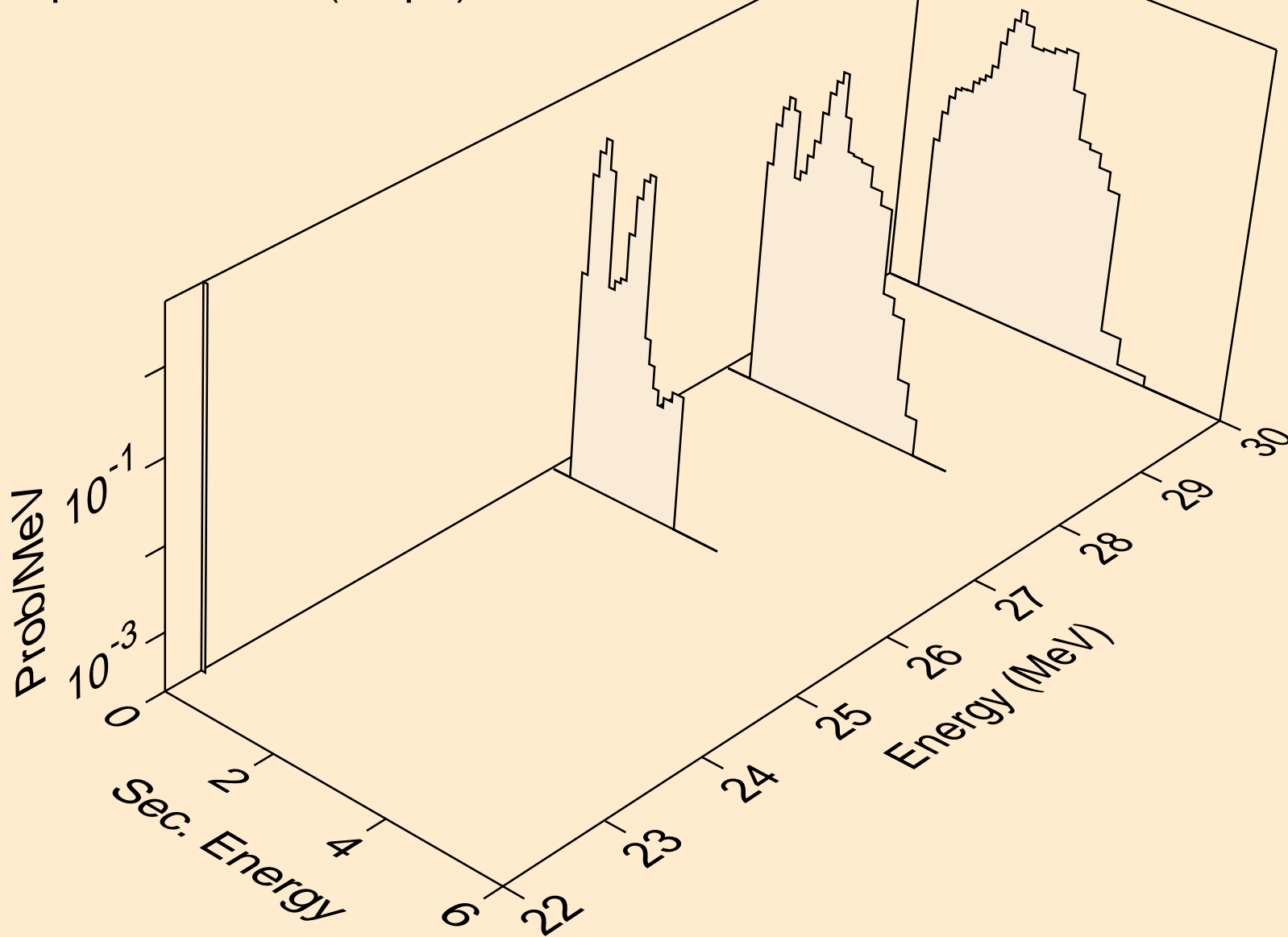

FE060 NEUTRON ACER TENDL-2019 LIBRARY; T=293.16K
protons from (n,p)

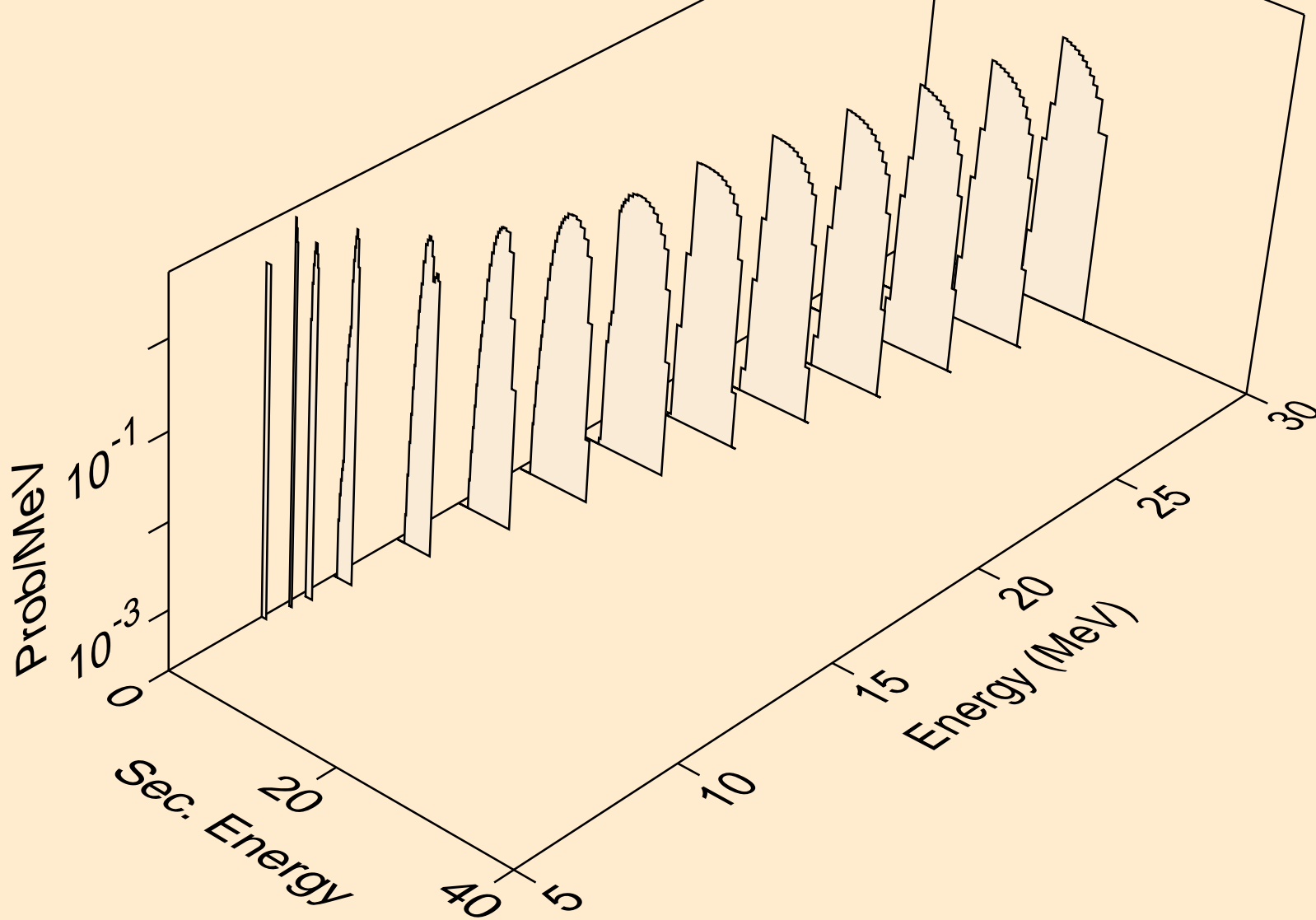

FE060 NEUTRON ACER TENDL-2019 LIBRARY; T=293.16K
protons from (n,2p)

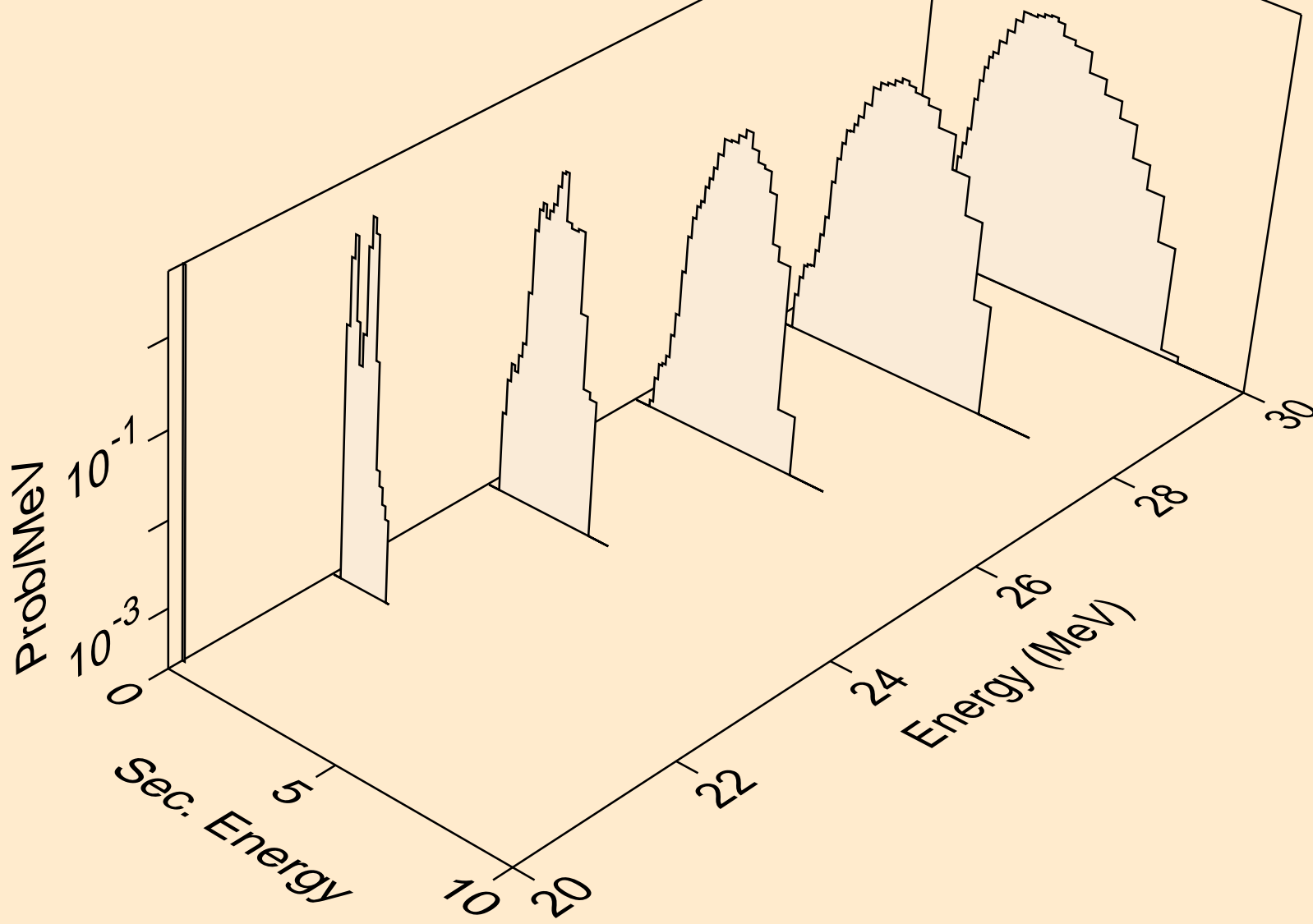

FE060 NEUTRON ACER TENDL-2019 LIBRARY; T=293.16K
protons from (n,p)

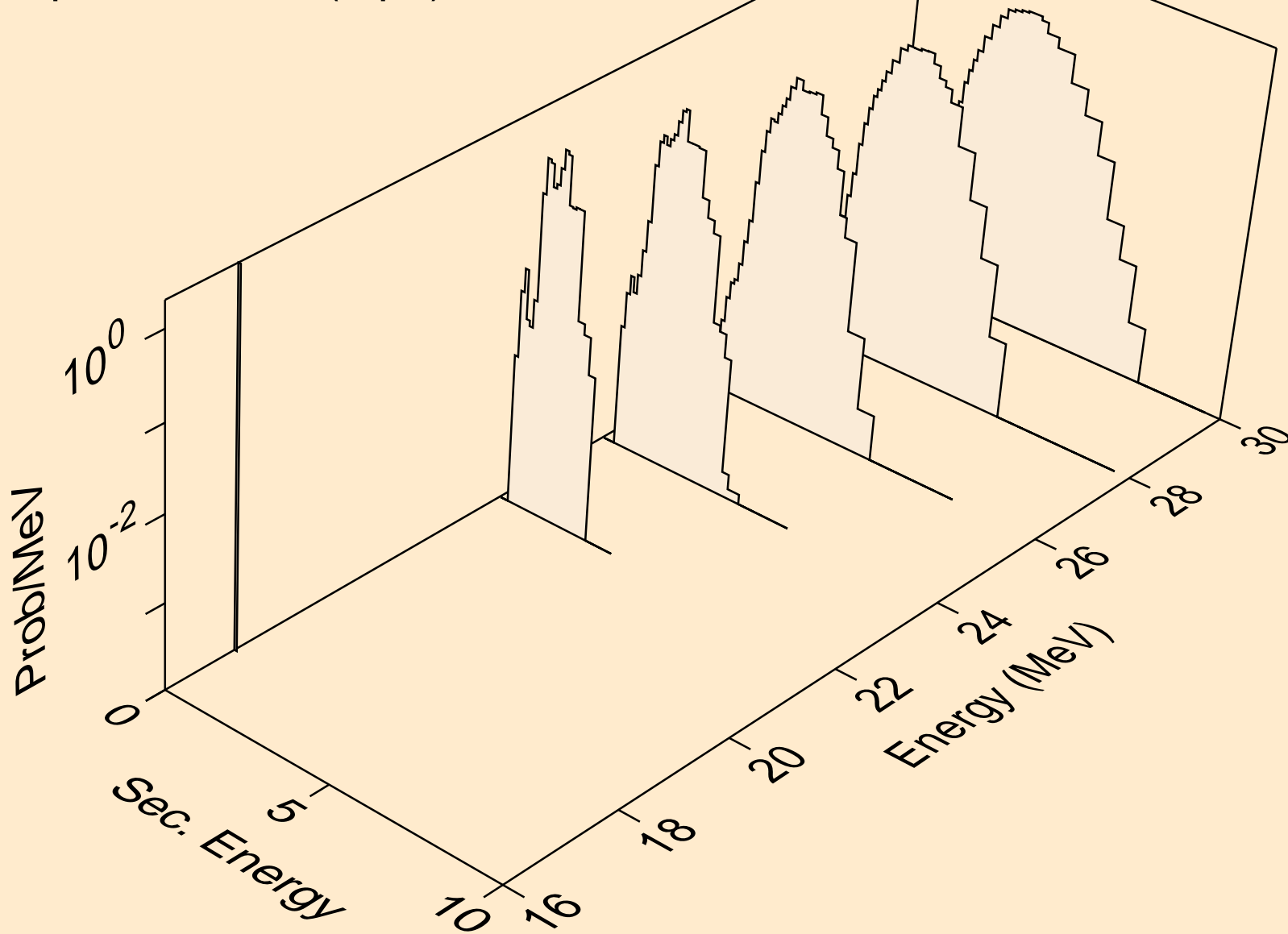

FE060 NEUTRON ACER TENDL-2019 LIBRARY; T=293.16K
protons from (n,pd)

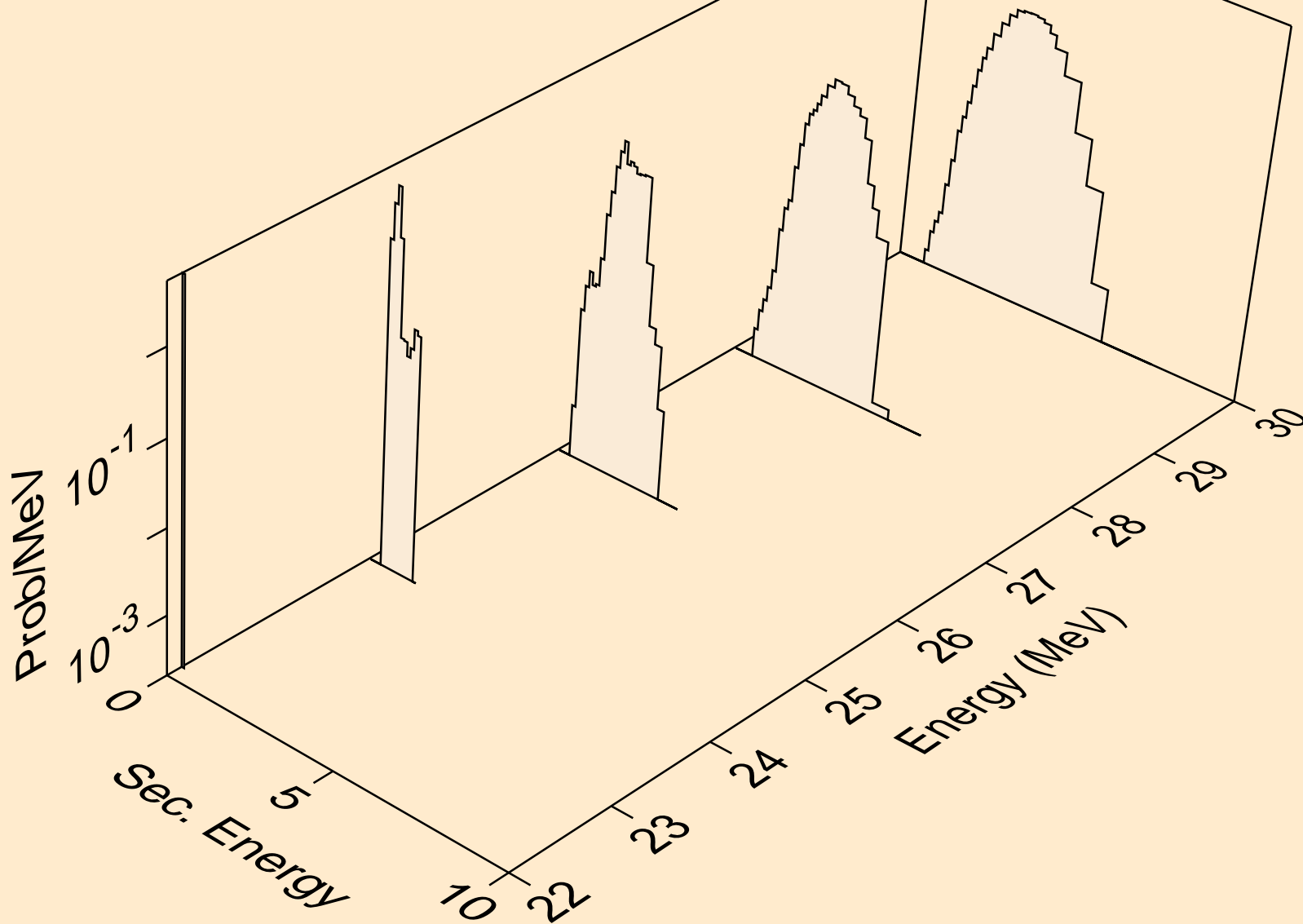

FE060 NEUTRON ACER TENDL-2019 LIBRARY; T=293.16K
protons from (n,pt)

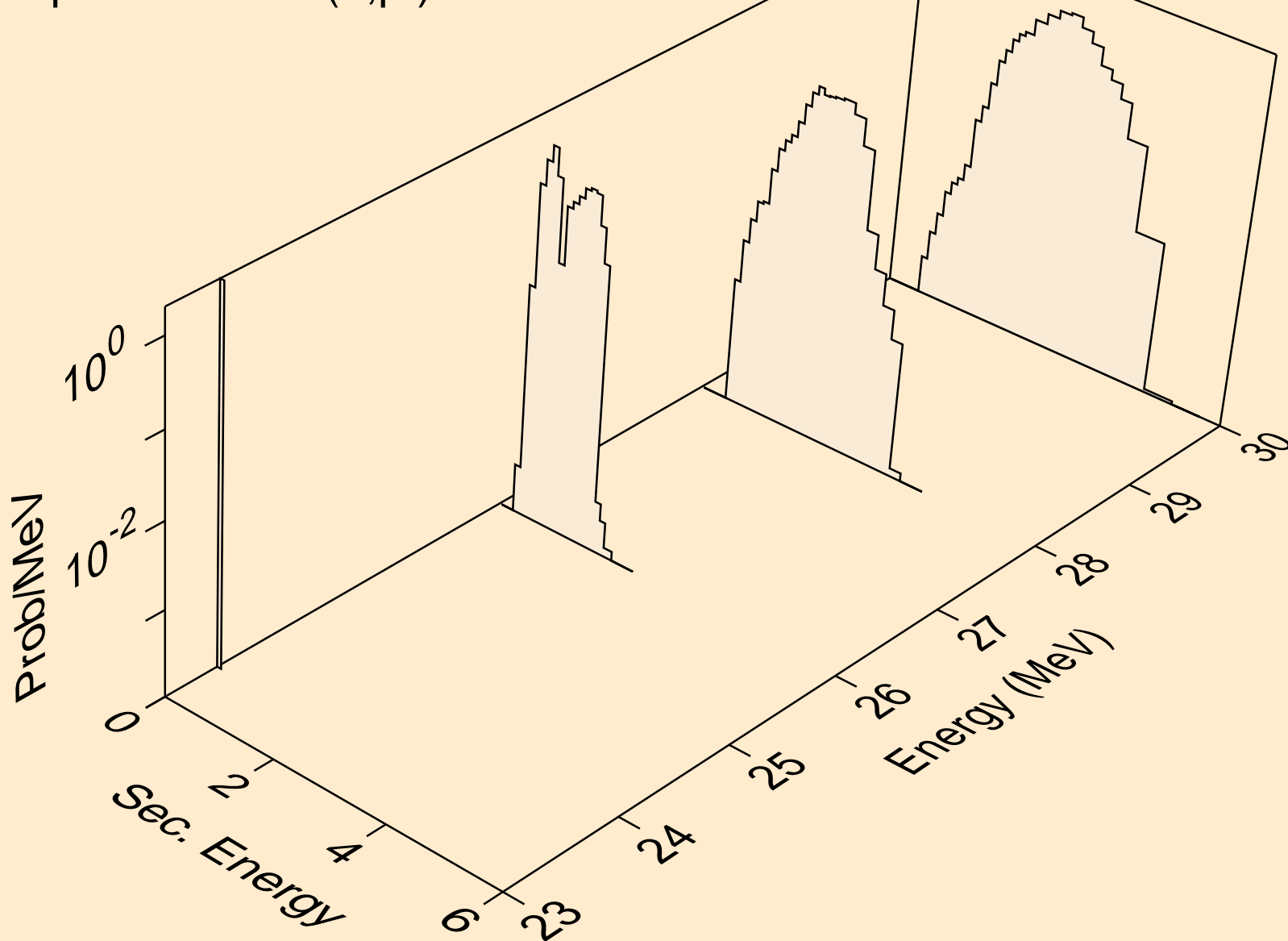

FE060 NEUTRON ACER TENDL-2019 LIBRARY; T=293.16K
deuterons from (n,x)

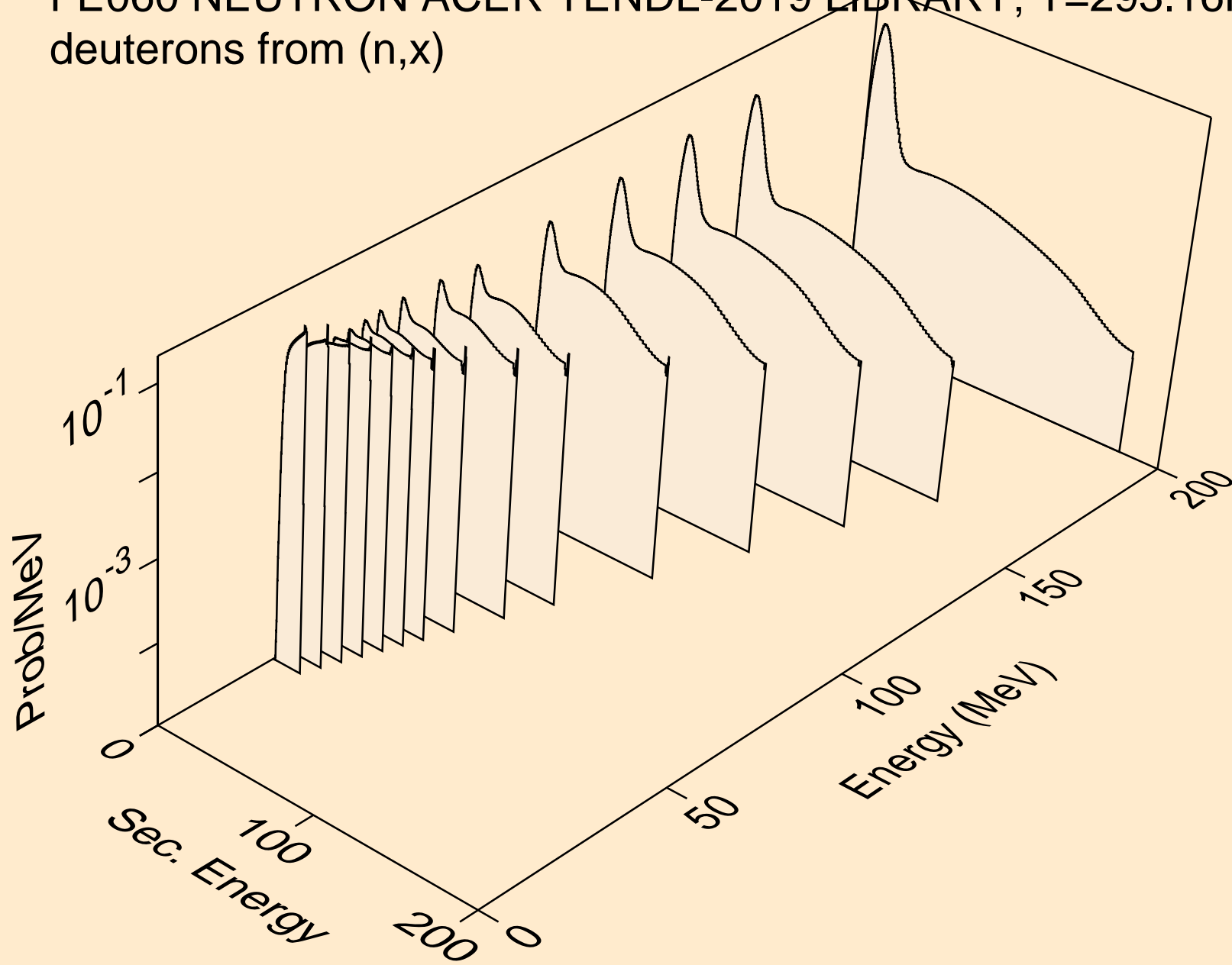

FE060 NEUTRON ACER TENDL-2019 LIBRARY; T=293.16K
deuterons from (n,2nd)

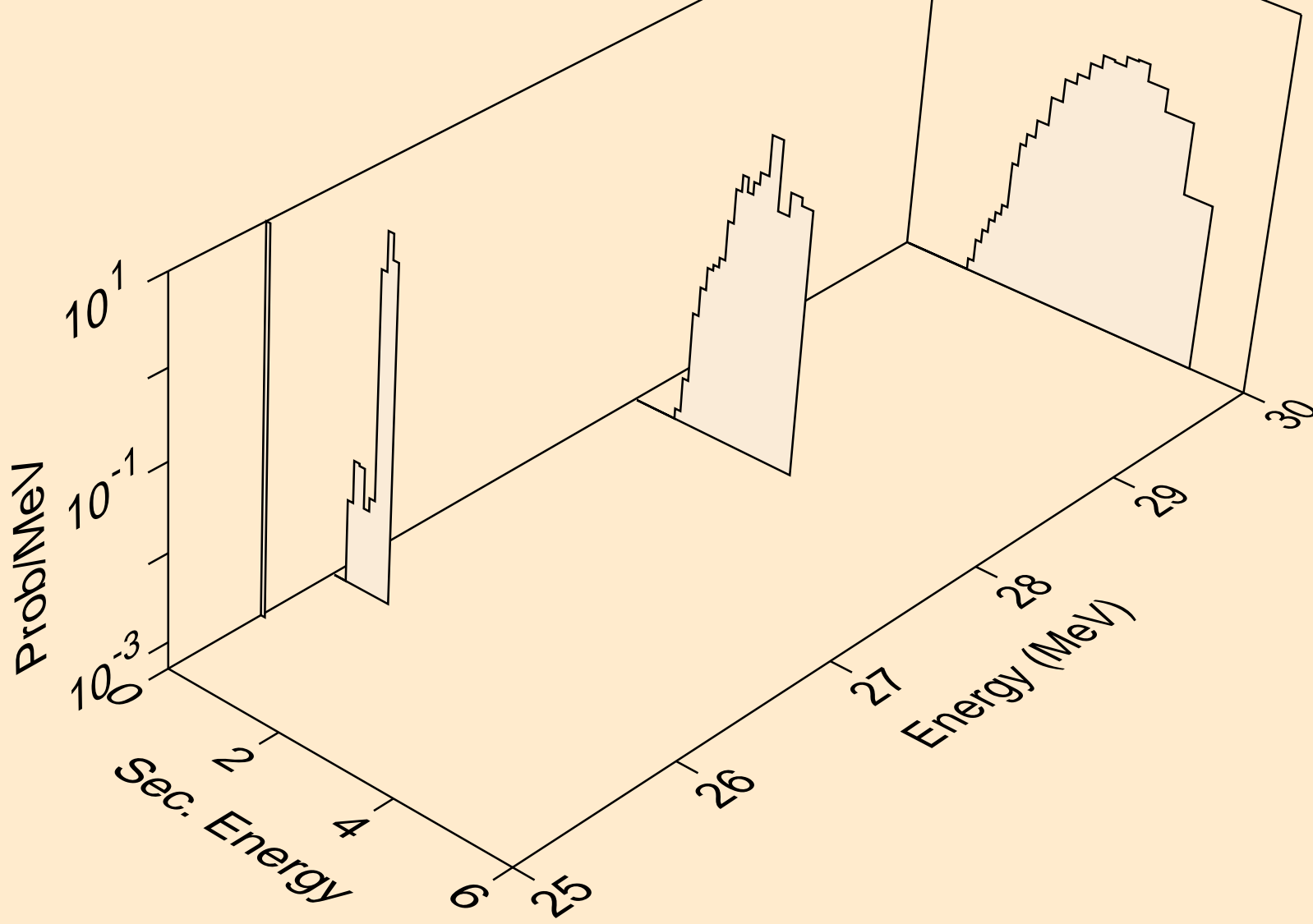

FE060 NEUTRON ACER TENDL-2019 LIBRARY; T=293.16K
deuterons from (n,n*)d

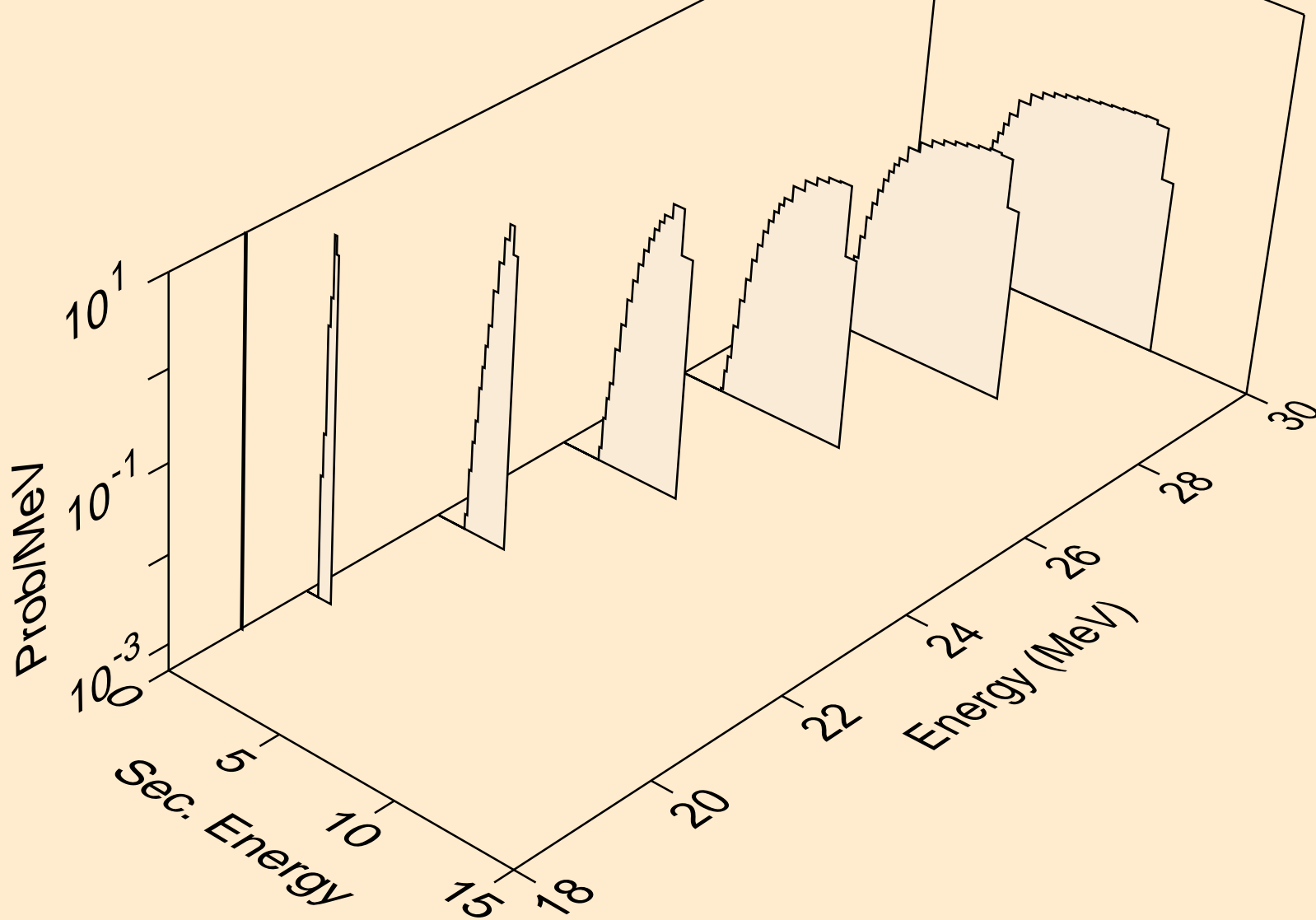

FE060 NEUTRON ACER TENDL-2019 LIBRARY; T=293.16K
deuterons from (n,d)

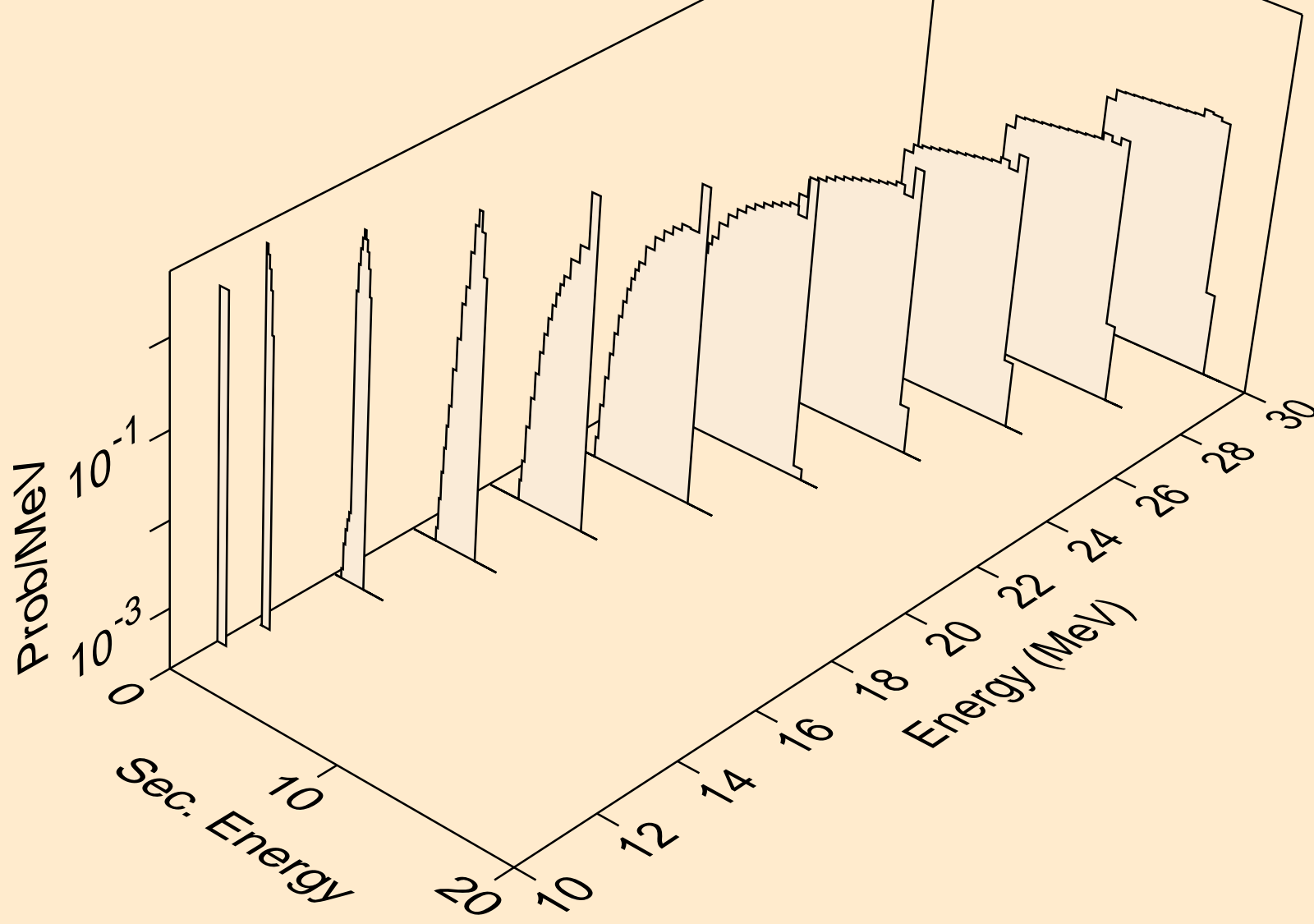

FE060 NEUTRON ACER TENDL-2019 LIBRARY; T=293.16K
deuterons from (n,pd)

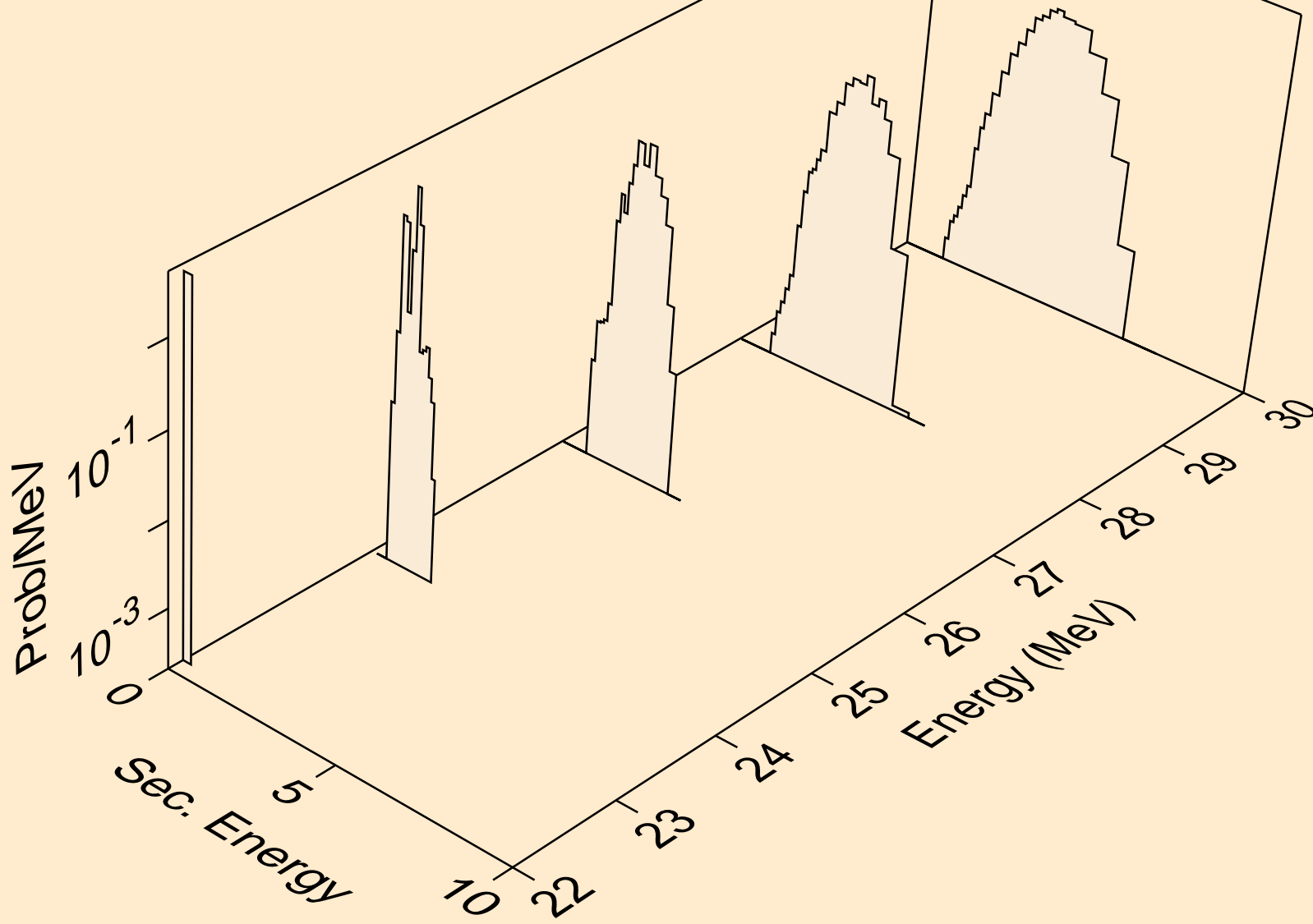

FE060 NEUTRON ACER TENDL-2019 LIBRARY; T=293.16K
deuterons from (n,da)

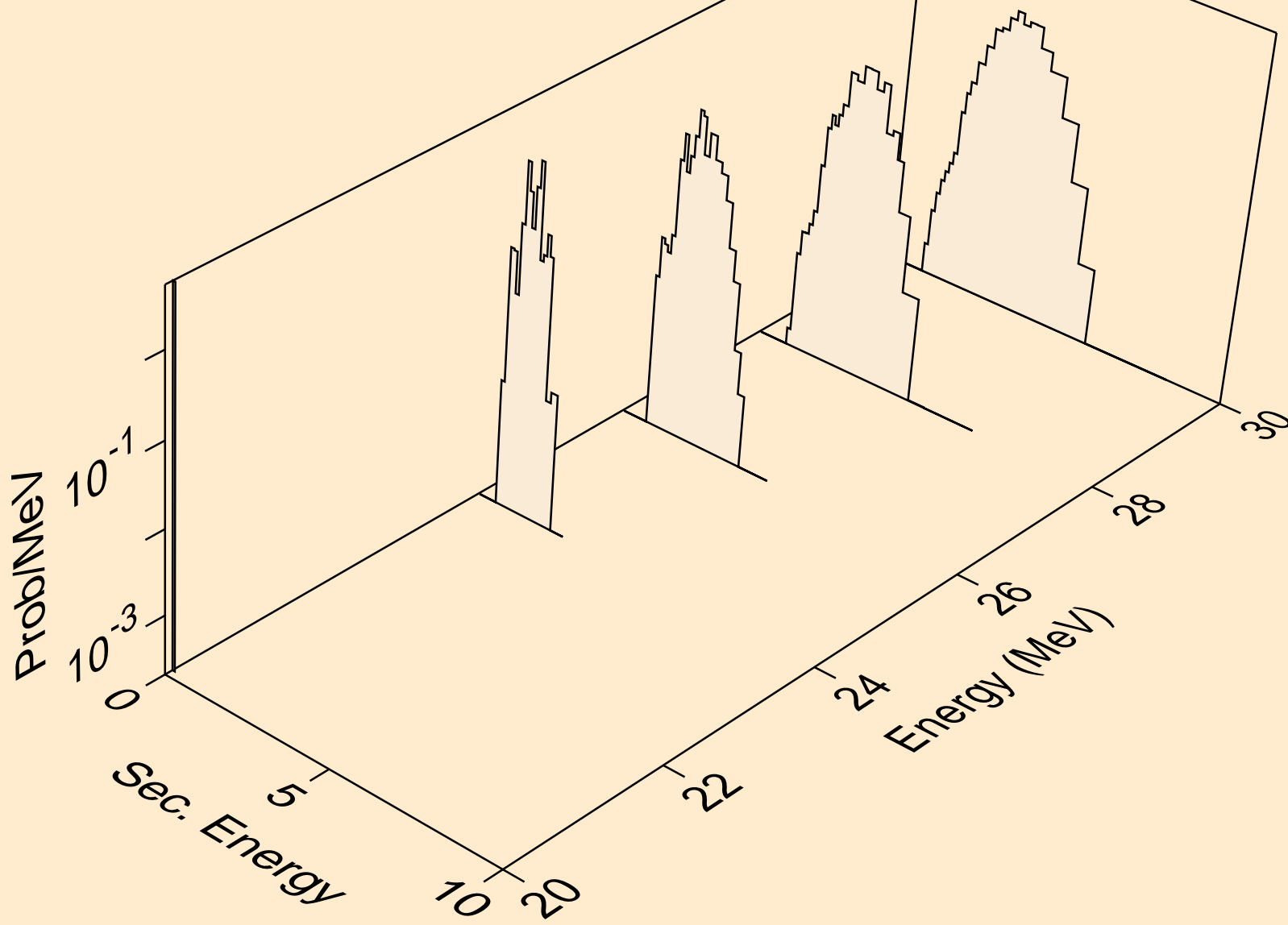

FE060 NEUTRON ACER TENDL-2019 LIBRARY; T=293.16K
tritons from (n,x)

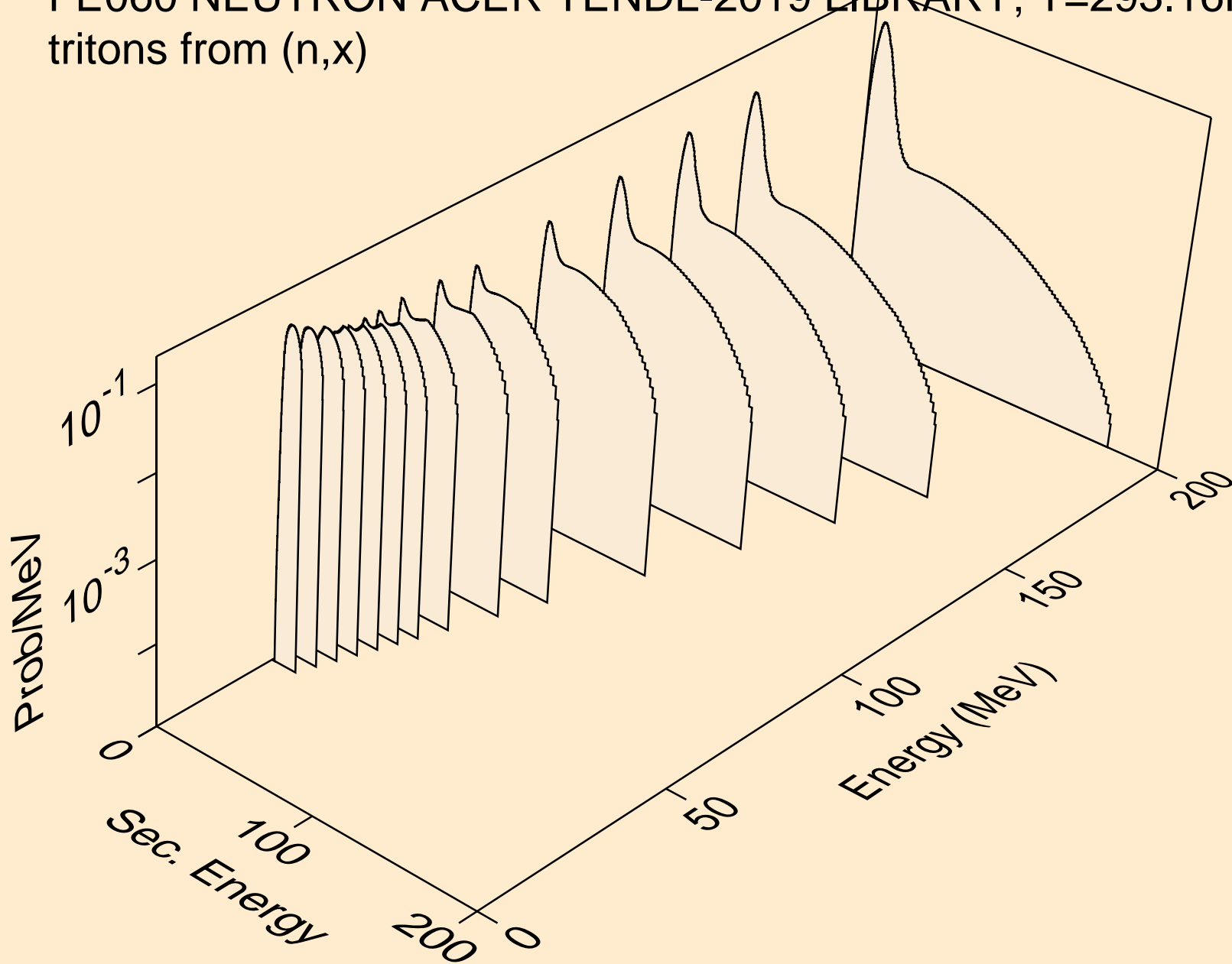

FE060 NEUTRON ACER TENDL-2019 LIBRARY; T=293.16K
tritons from (n,n*)t

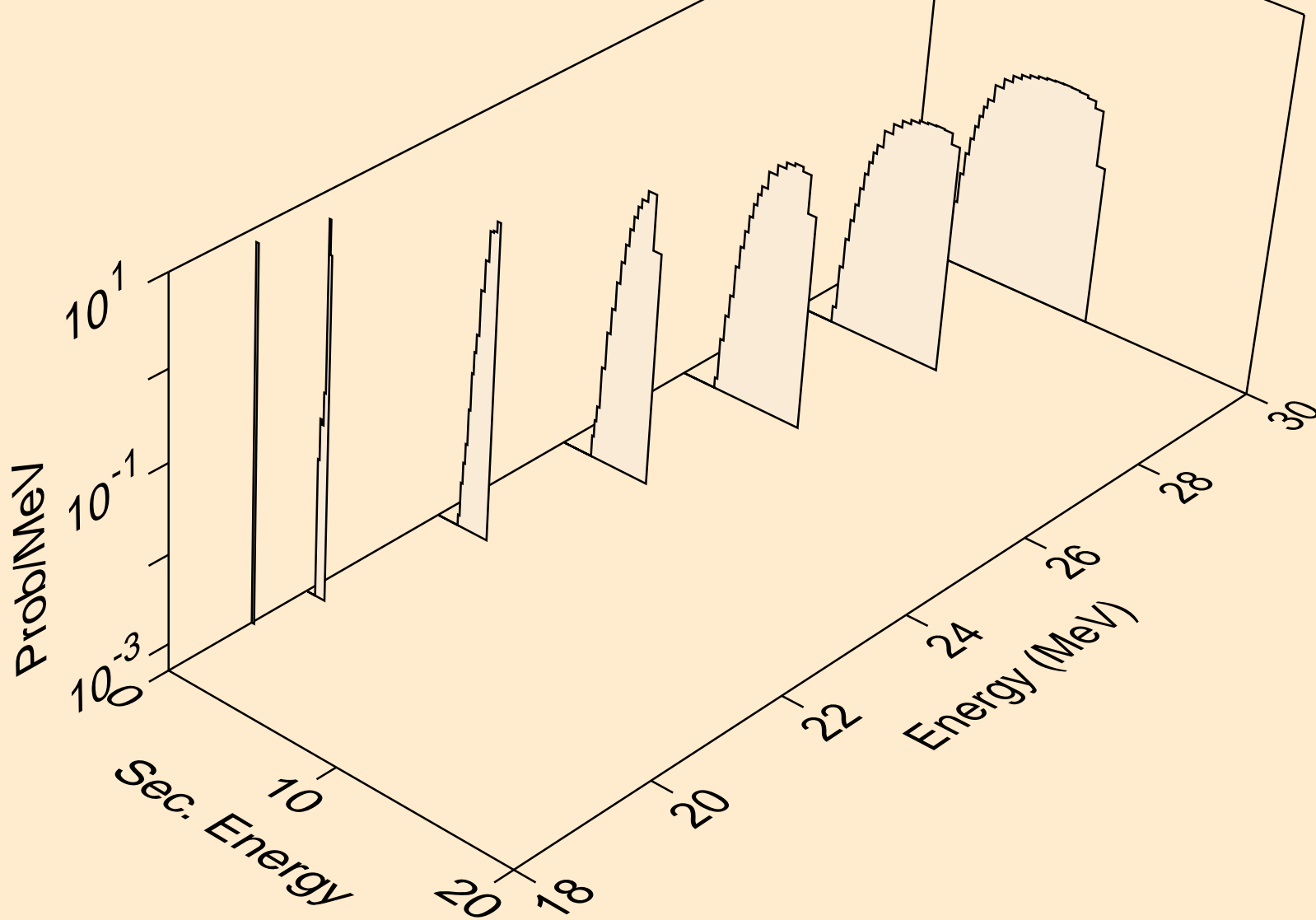

FE060 NEUTRON ACER TENDL-2019 LIBRARY; T=293.16K
tritons from (n,t)

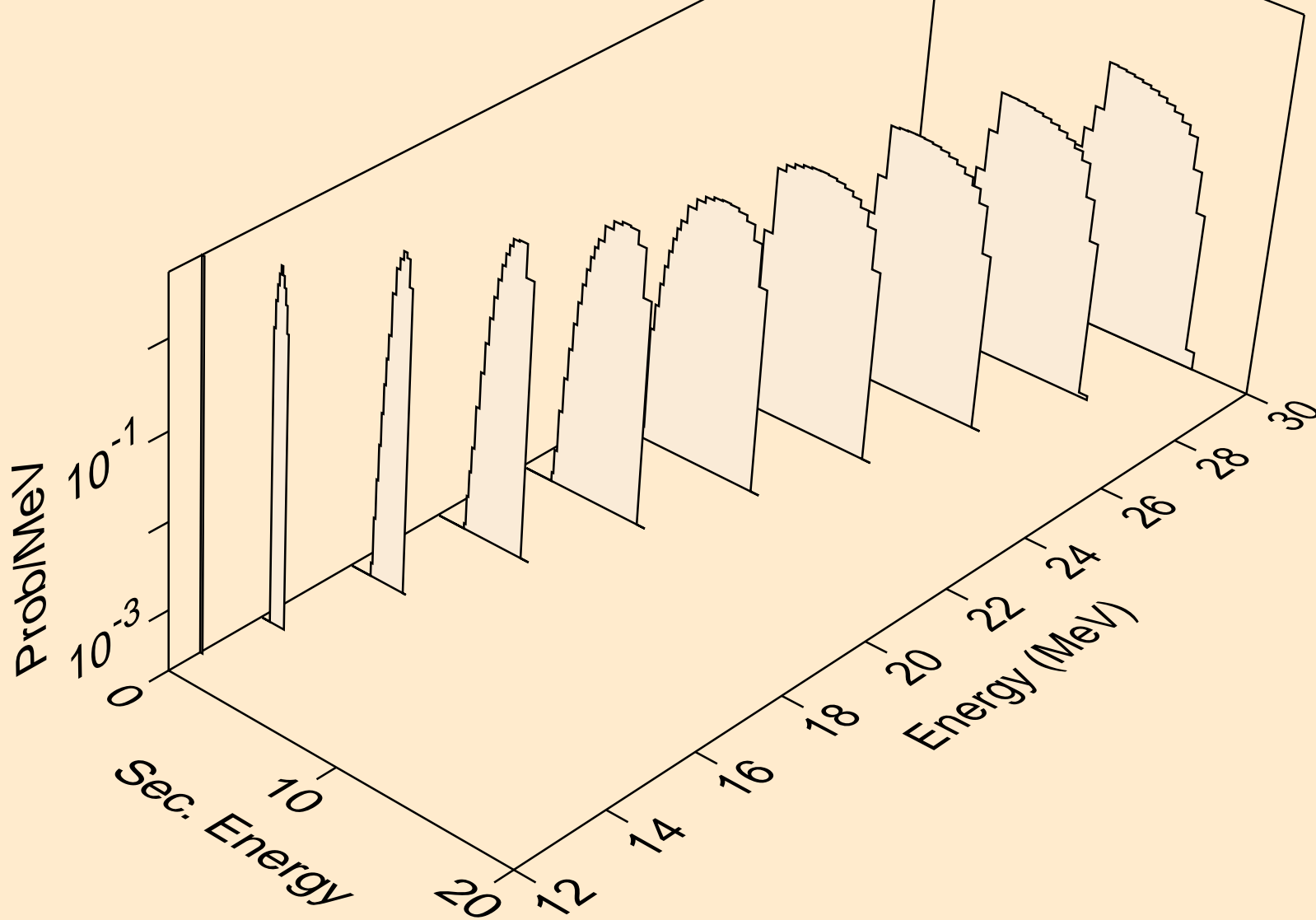

FE060 NEUTRON ACER TENDL-2019 LIBRARY; T=293.16K
tritons from (n,pt)

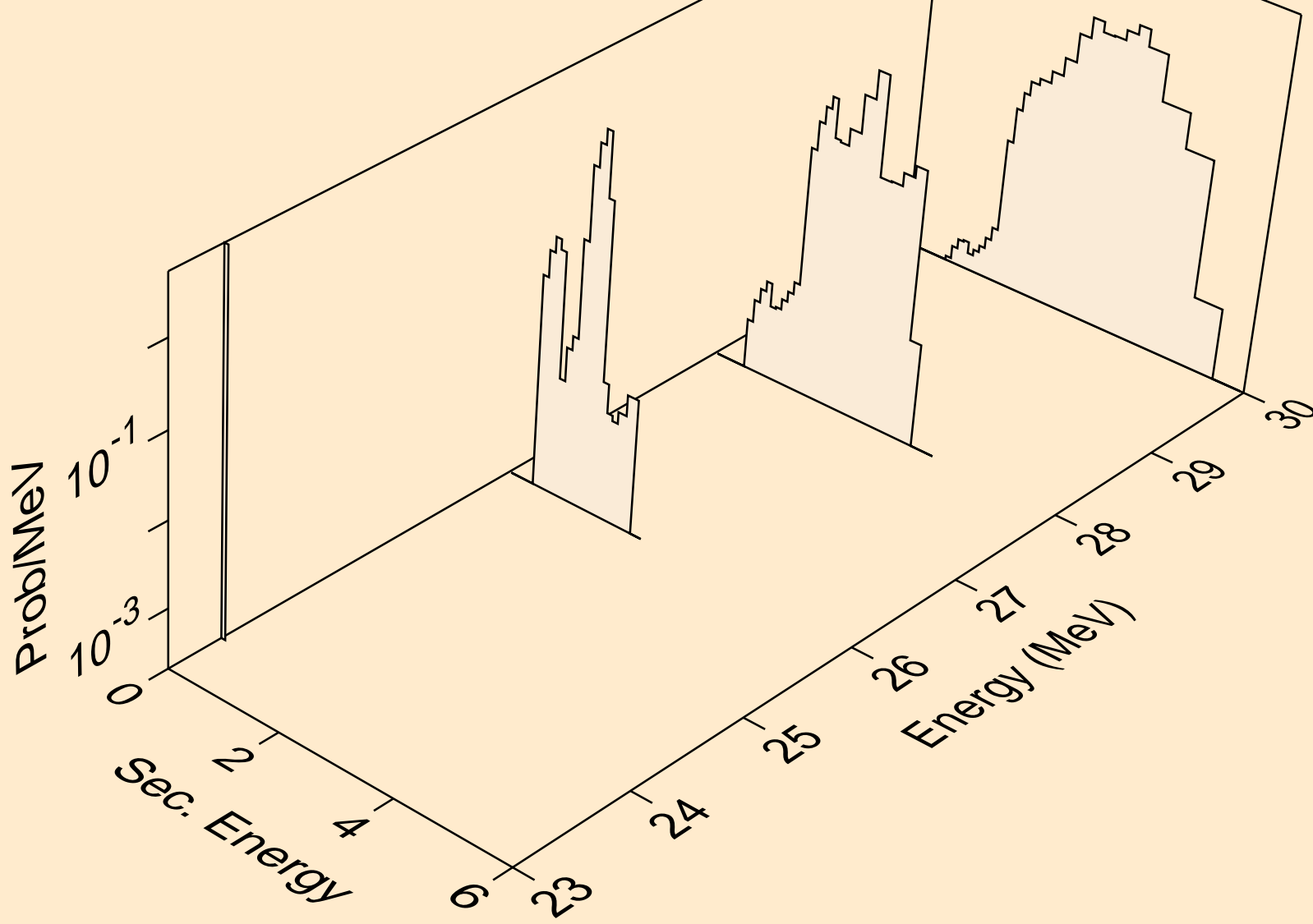

FE060 NEUTRON ACER TENDL-2019 LIBRARY; T=293.16K
he3s from (n,x)

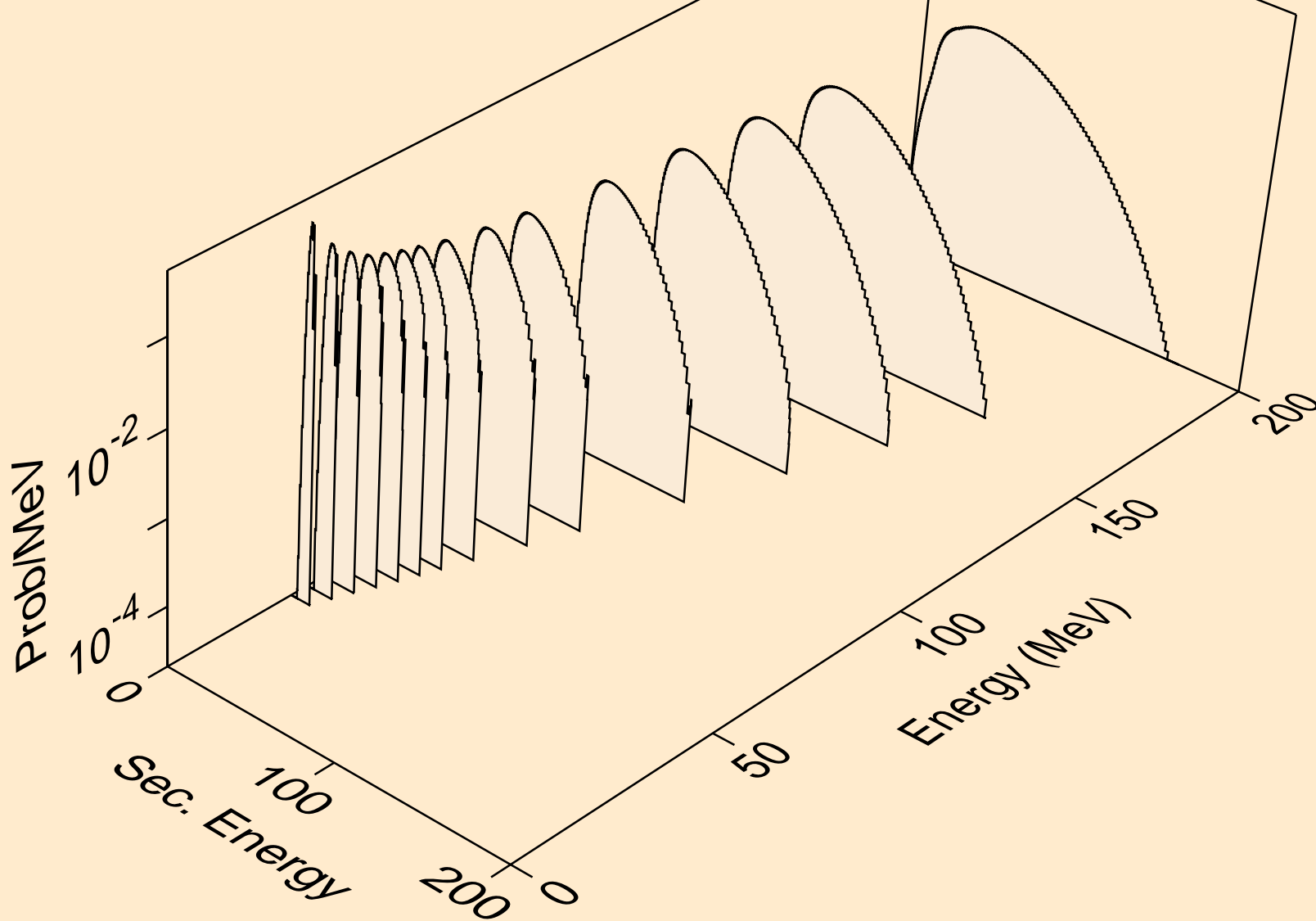

FE060 NEUTRON ACER TENDL-2019 LIBRARY; T=293.16K
he3s from (n,n*)he3

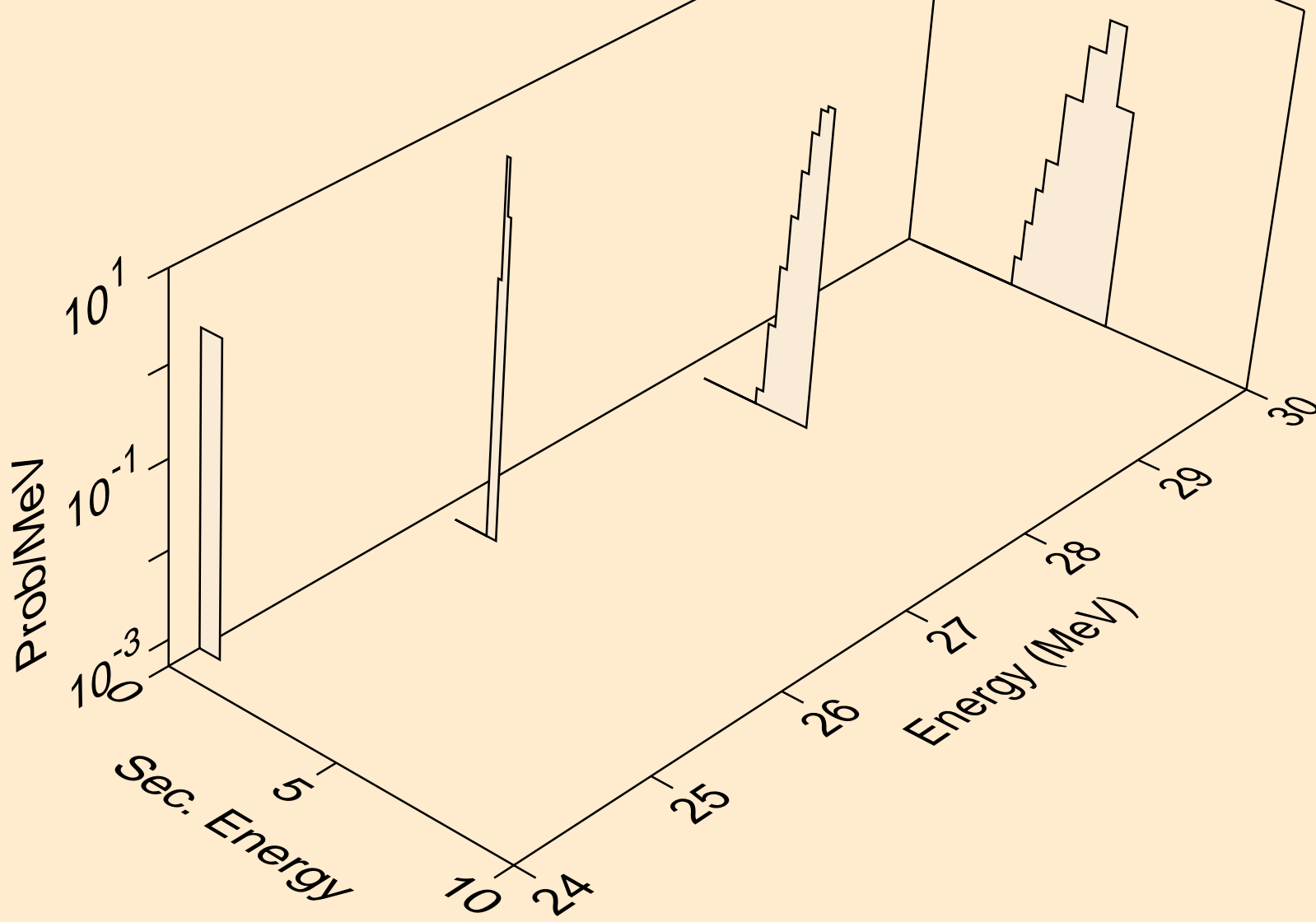

FE060 NEUTRON ACER TENDL-2019 LIBRARY; T=293.16K
he3s from (n,he3)

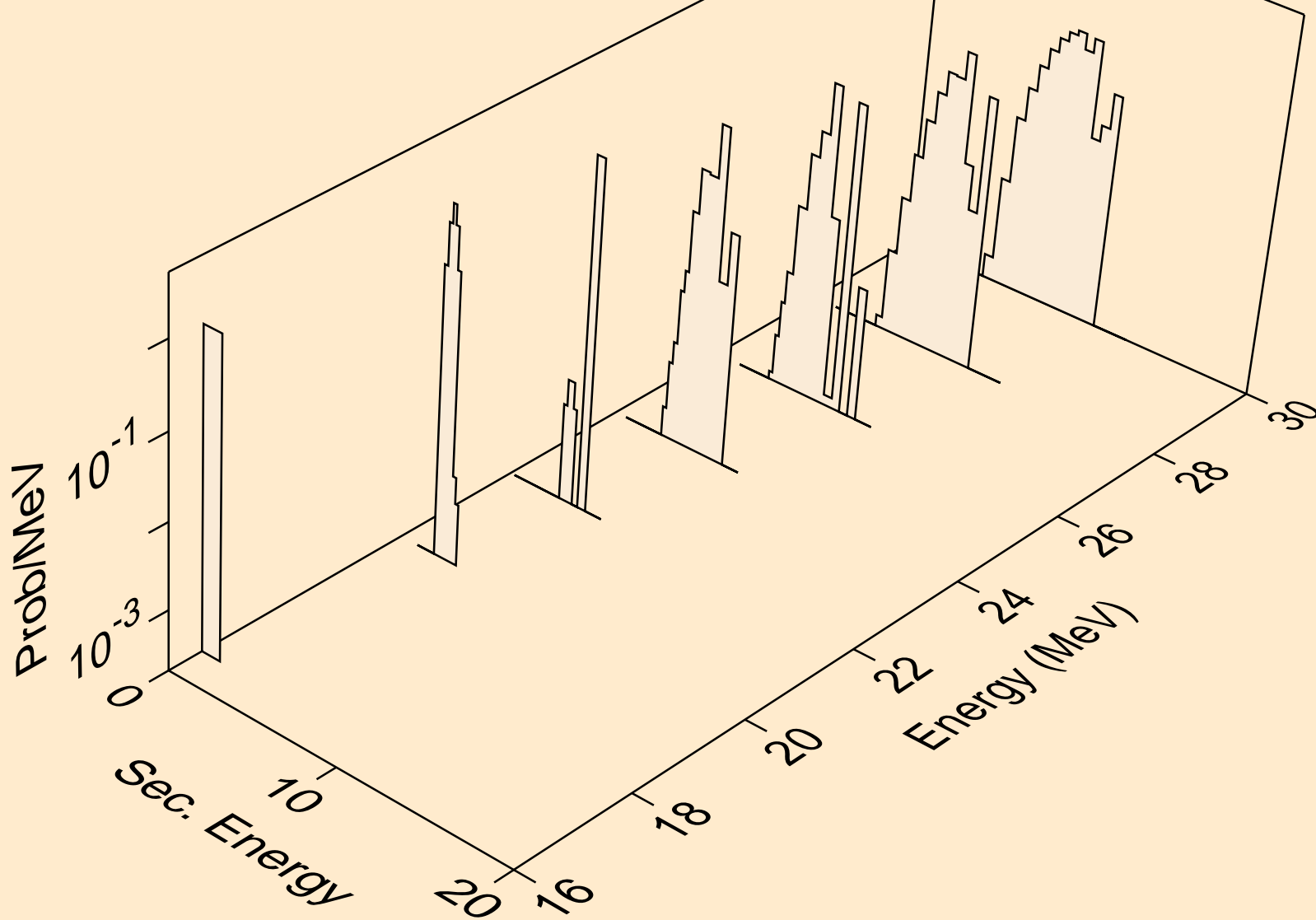

FE060 NEUTRON ACER TENDL-2019 LIBRARY; T=293.16K
alphas from (n,x)

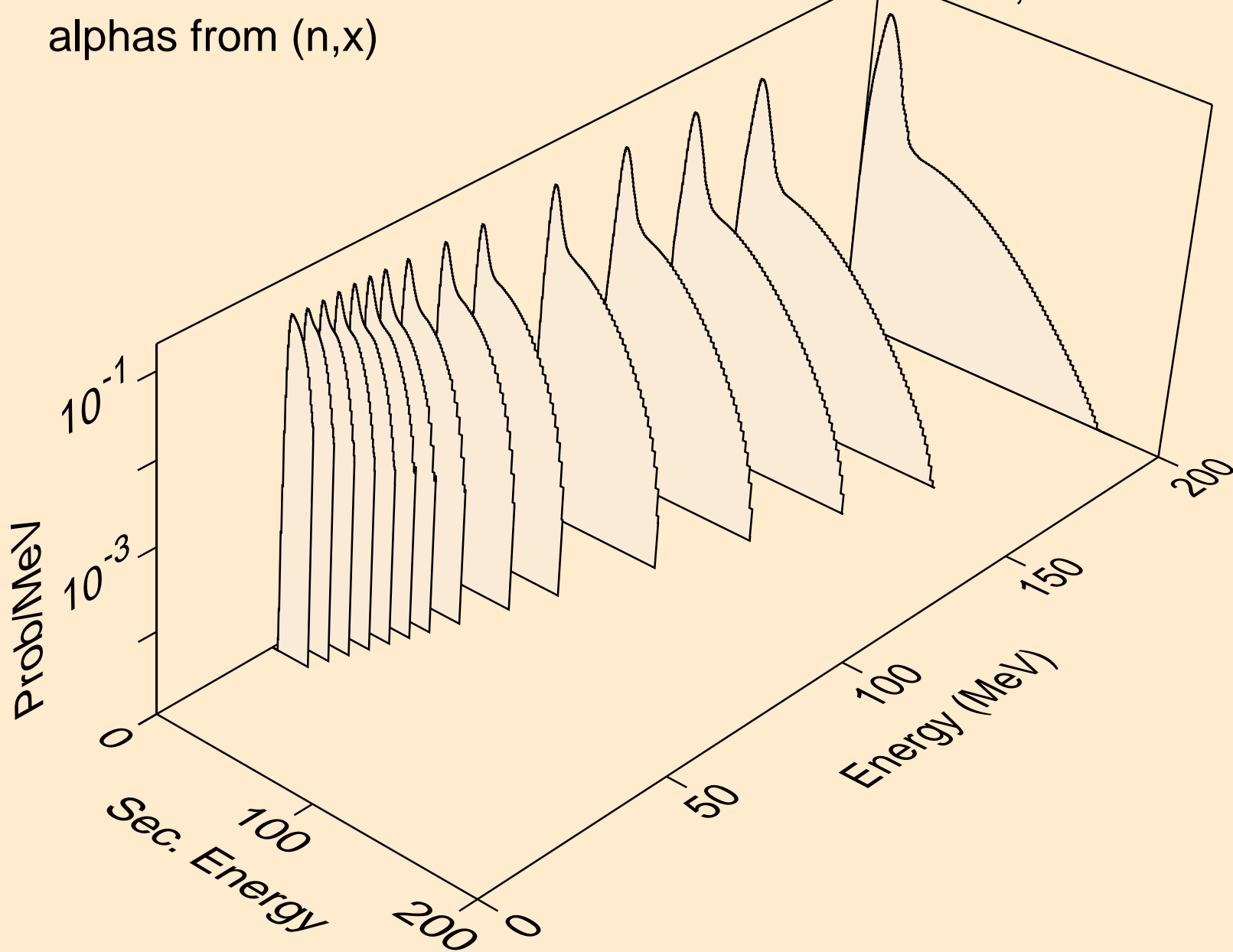

FE060 NEUTRON ACER TENDL-2019 LIBRARY; T=293.16K
alphas from (n,n*)a

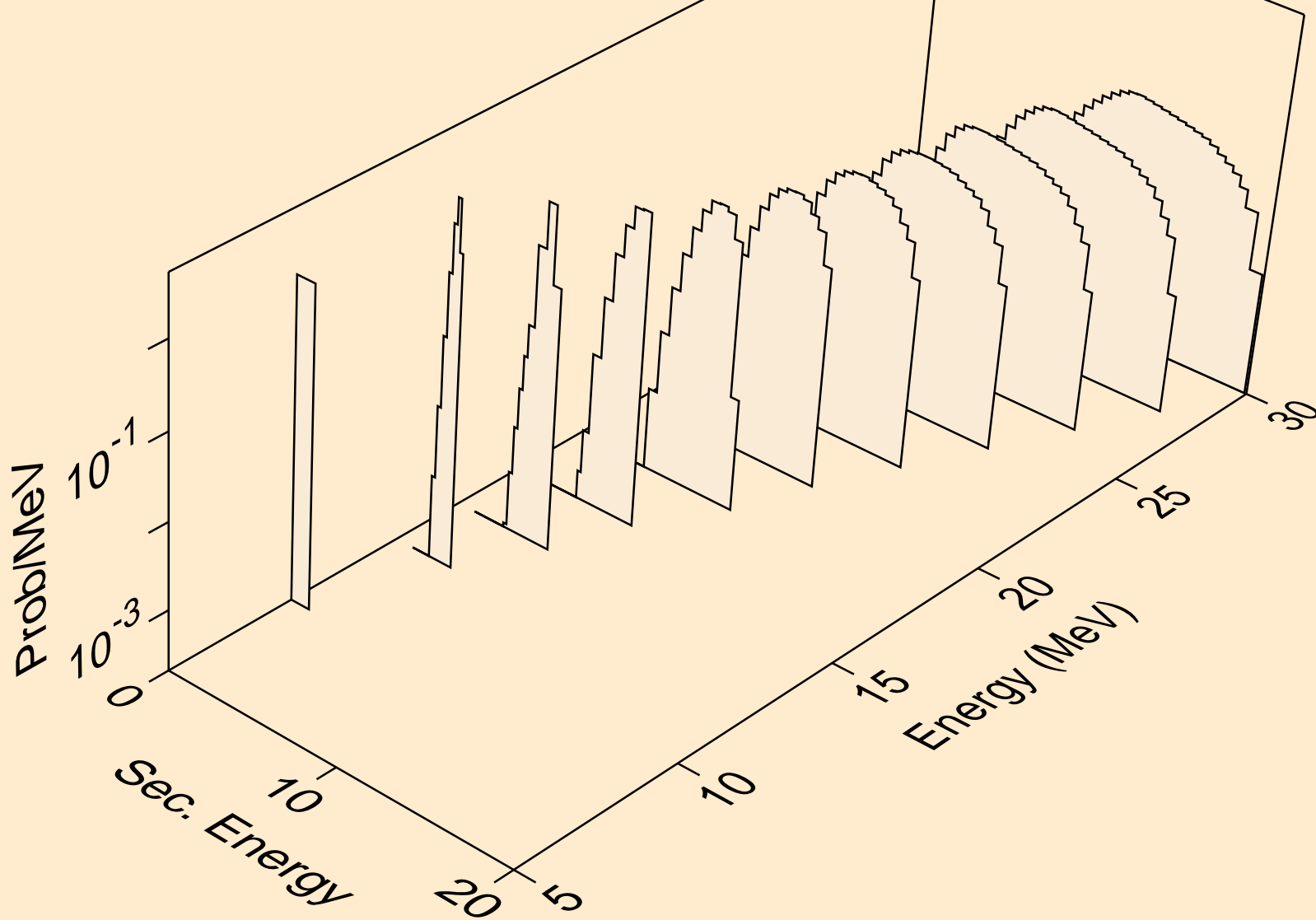

FE060 NEUTRON ACER TENDL-2019 LIBRARY; T=293.16K
alphas from (n,2n)a

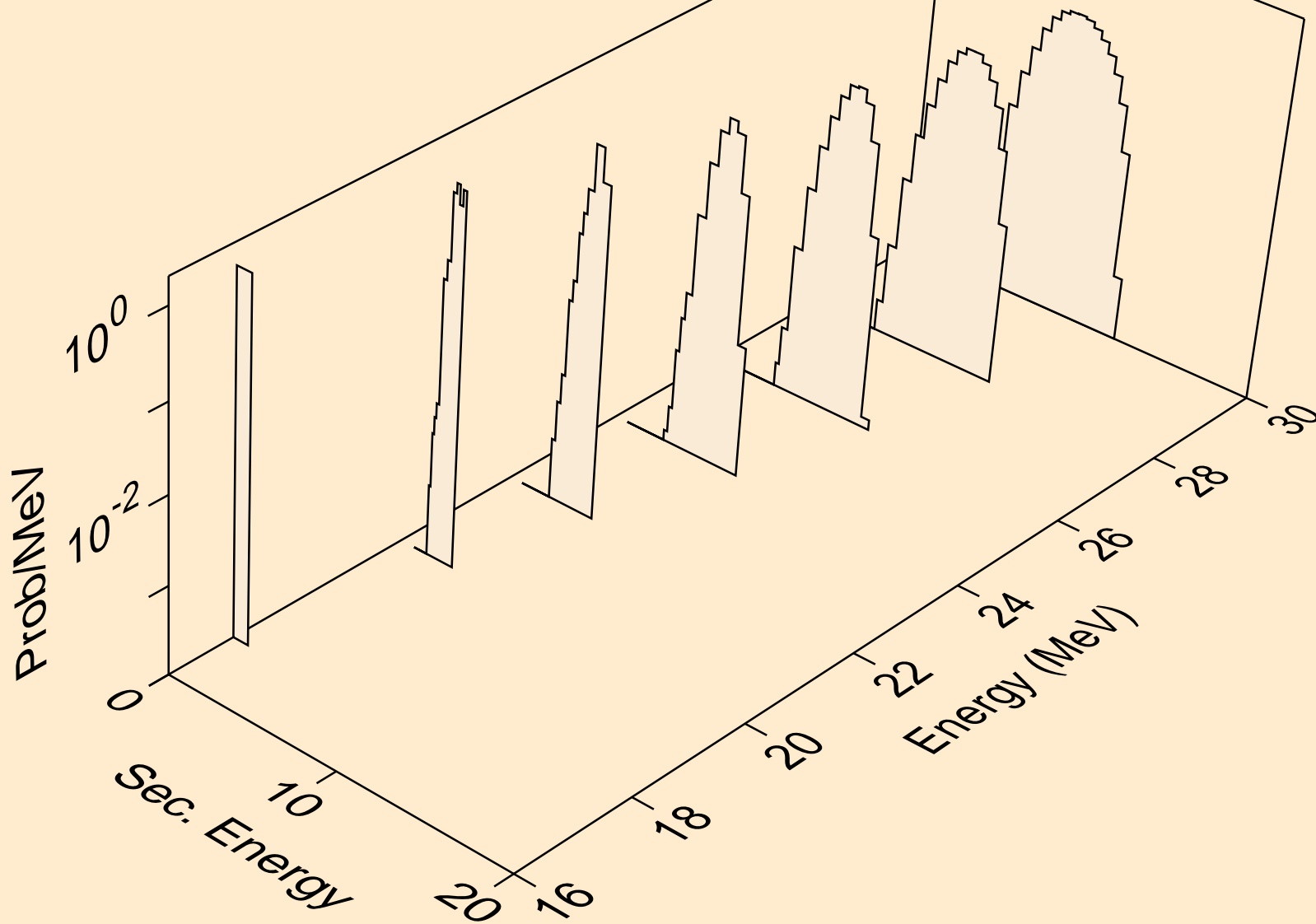

FE060 NEUTRON ACER TENDL-2019 LIBRARY; T=293.16K
alphas from (n,3n)a

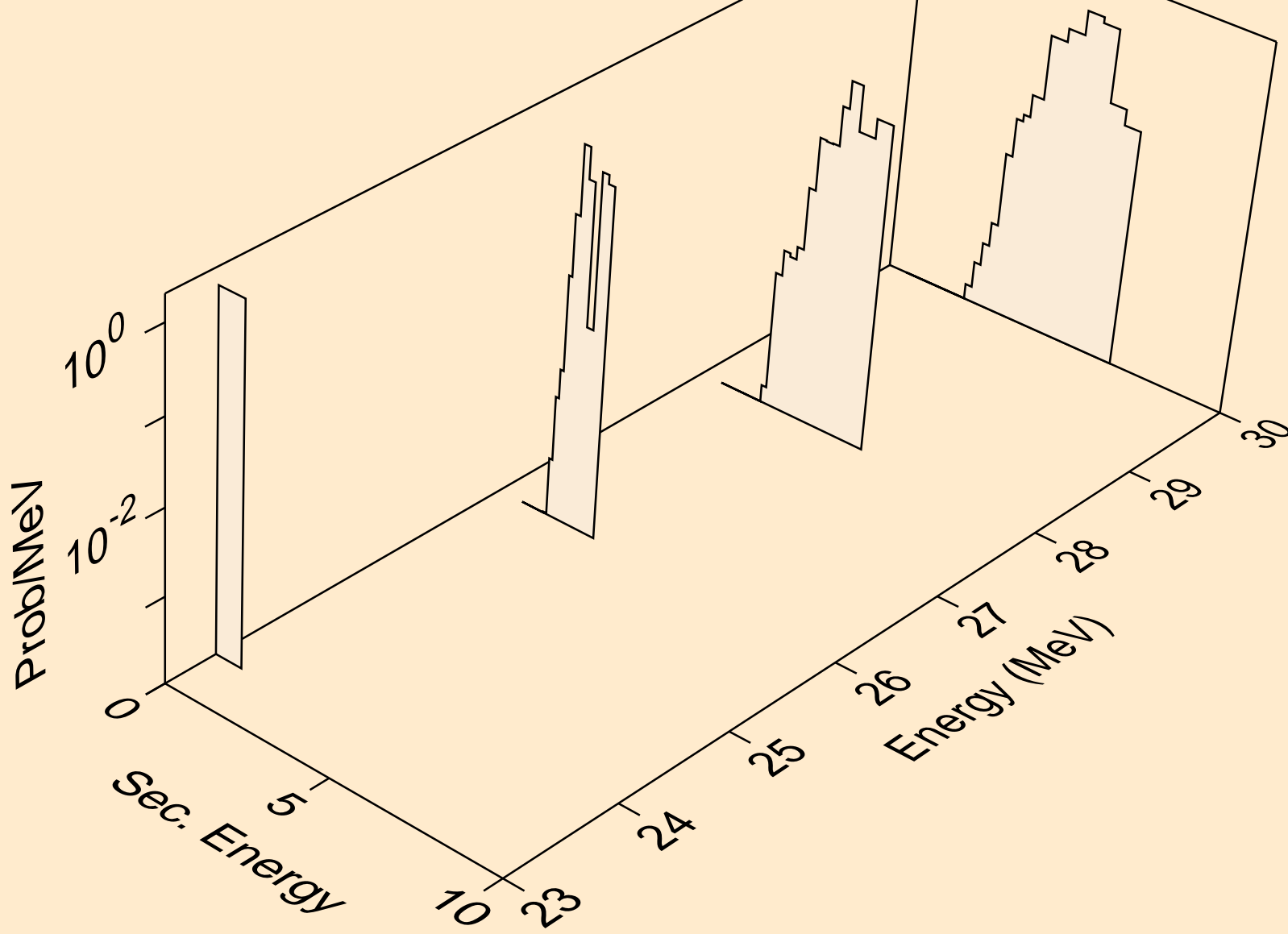

FE060 NEUTRON ACER TENDL-2019 LIBRARY; T=293.16K
alphas from (n,n*)2a

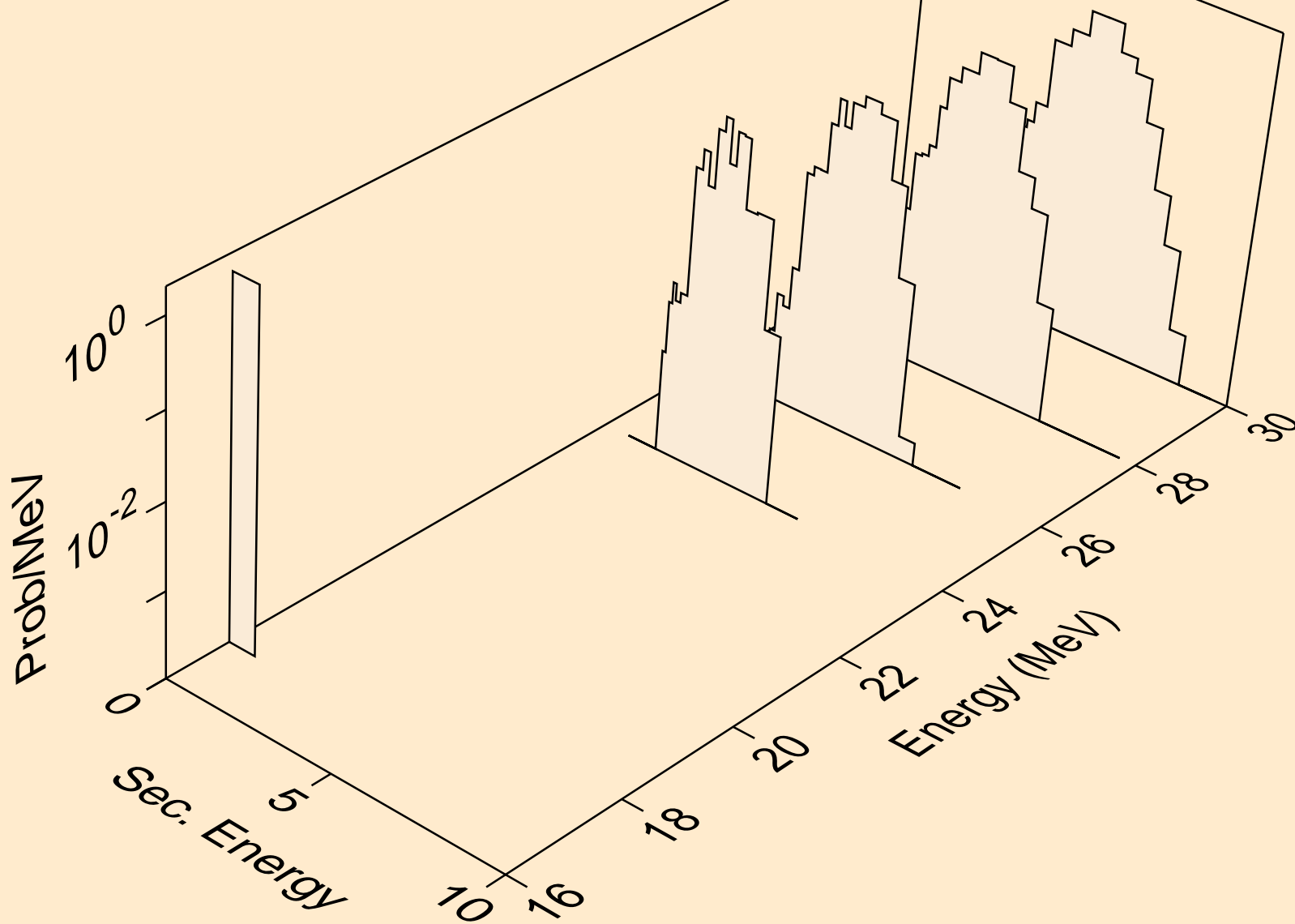

FE060 NEUTRON ACER TENDL-2019 LIBRARY; T=293.16K
alphas from (n,npa)

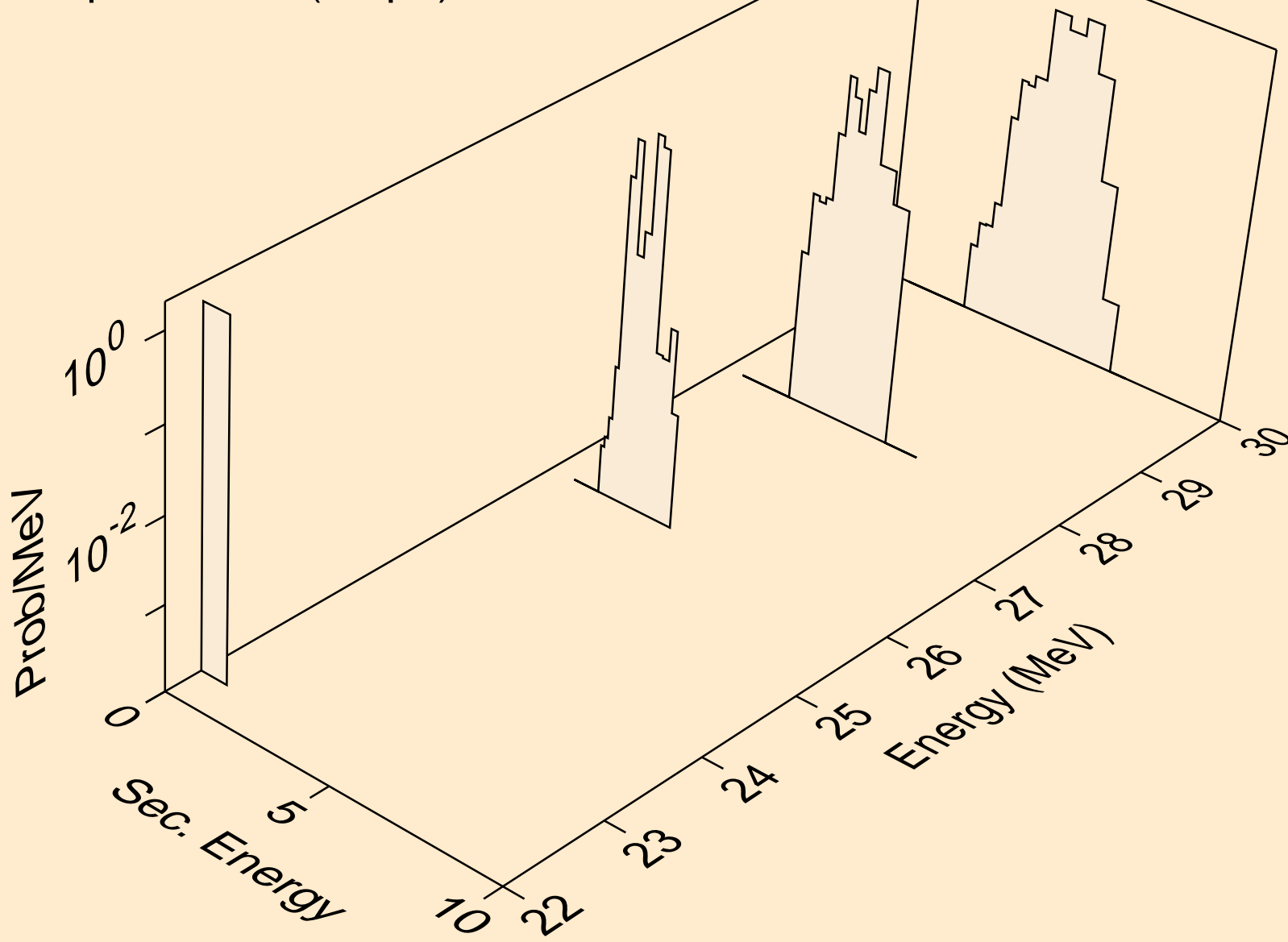

FE060 NEUTRON ACER TENDL-2019 LIBRARY; T=293.16K
alphas from (n,a)

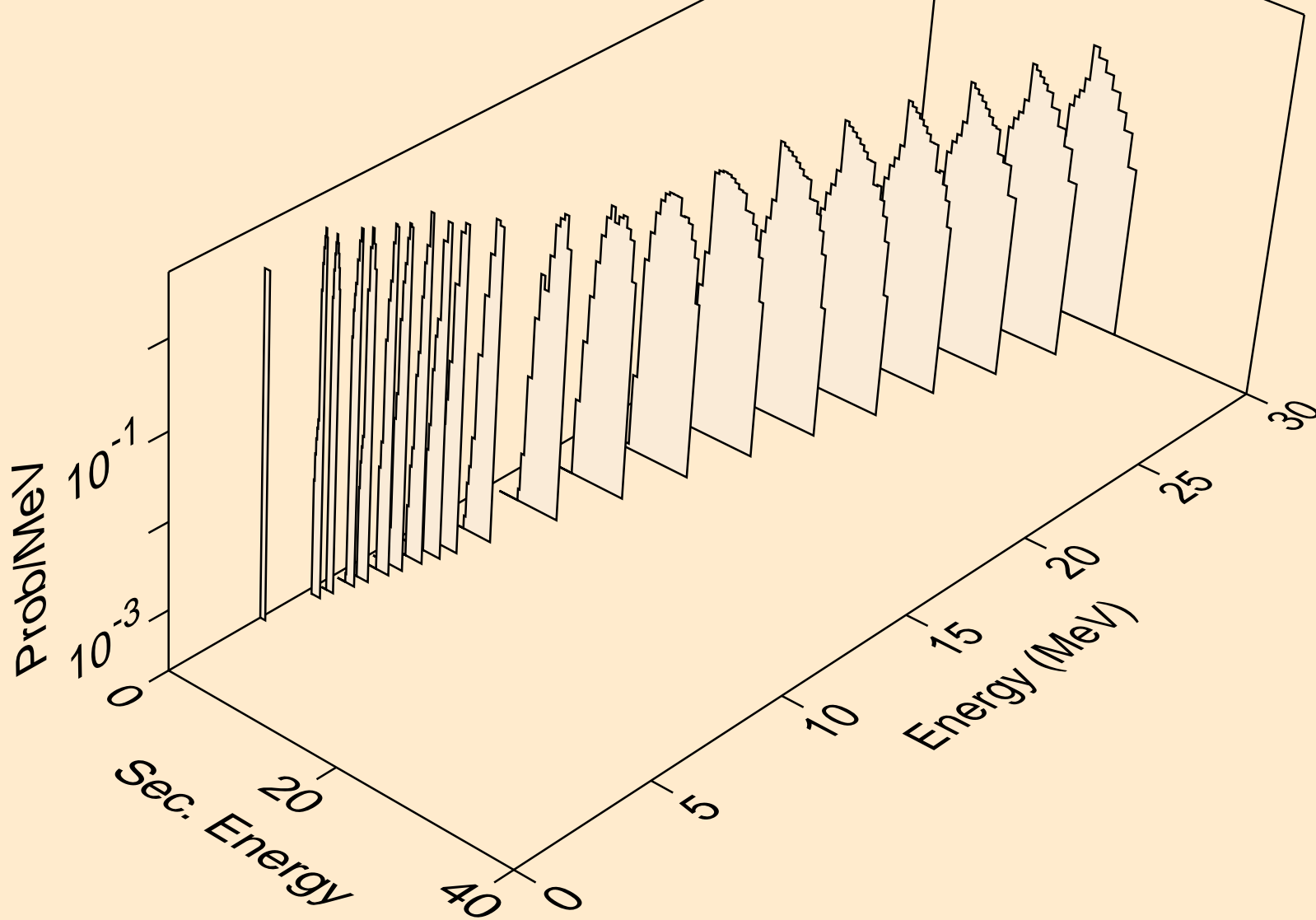

FE060 NEUTRON ACER TENDL-2019 LIBRARY; T=293.16K
alphas from (n,2a)

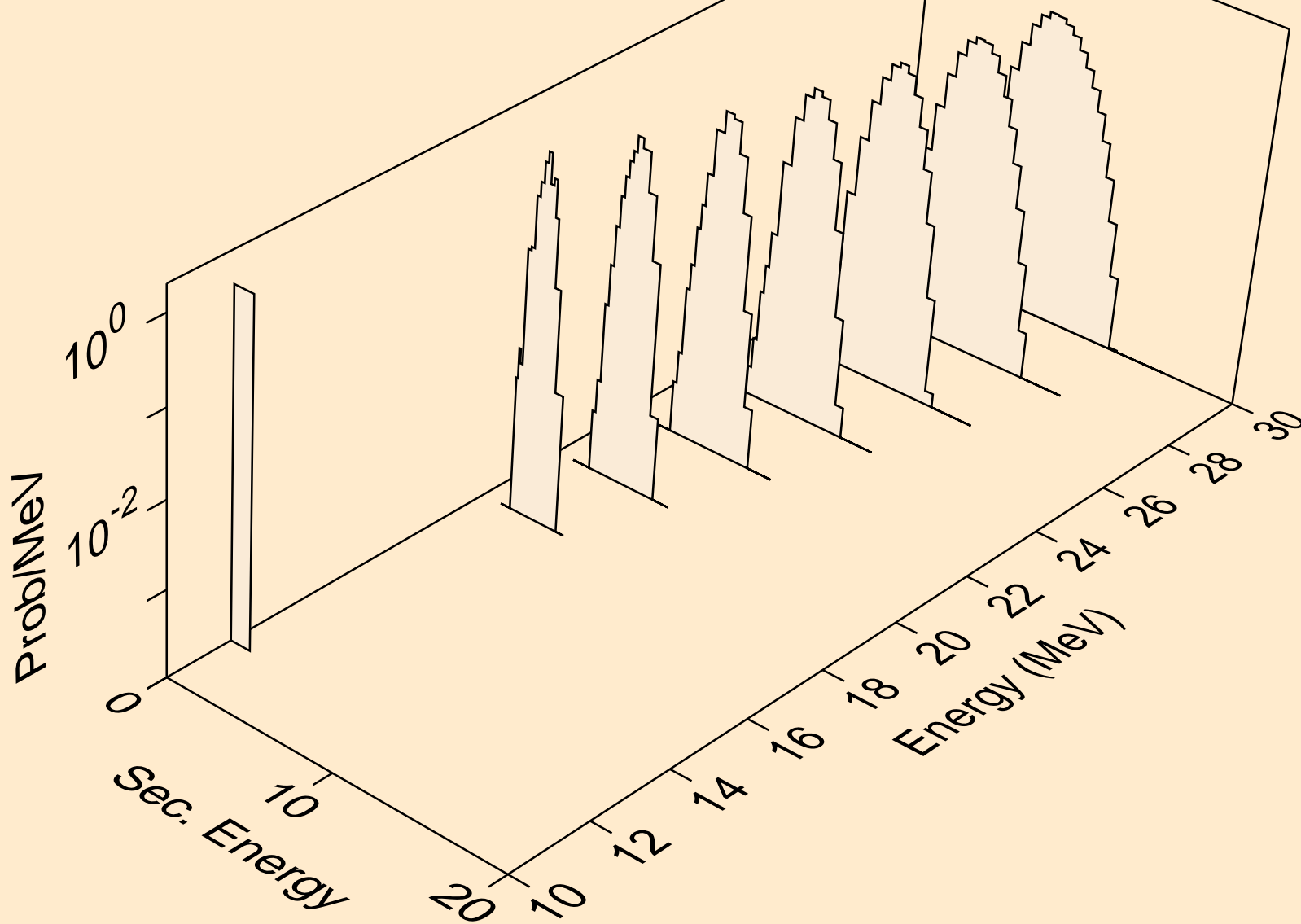

FE060 NEUTRON ACER TENDL-2019 LIBRARY; T=293.16K
alphas from (n,pa)

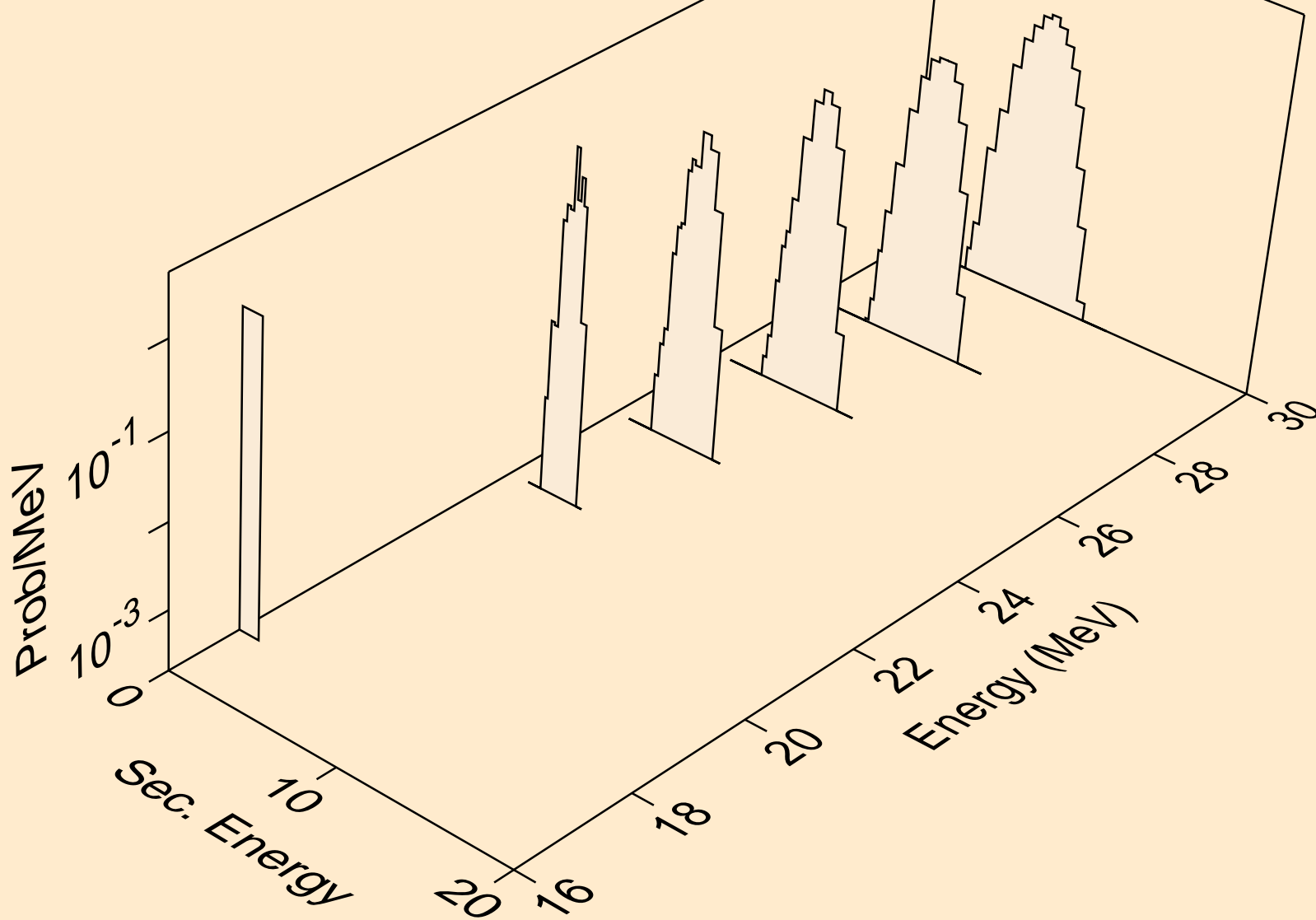

FE060 NEUTRON ACER TENDL-2019 LIBRARY; T=293.16K
alphas from (n,da)

