

FR204 NEUTRON ACER TENDL-2019 LIBRARY; T=293.16K
Principal cross sections

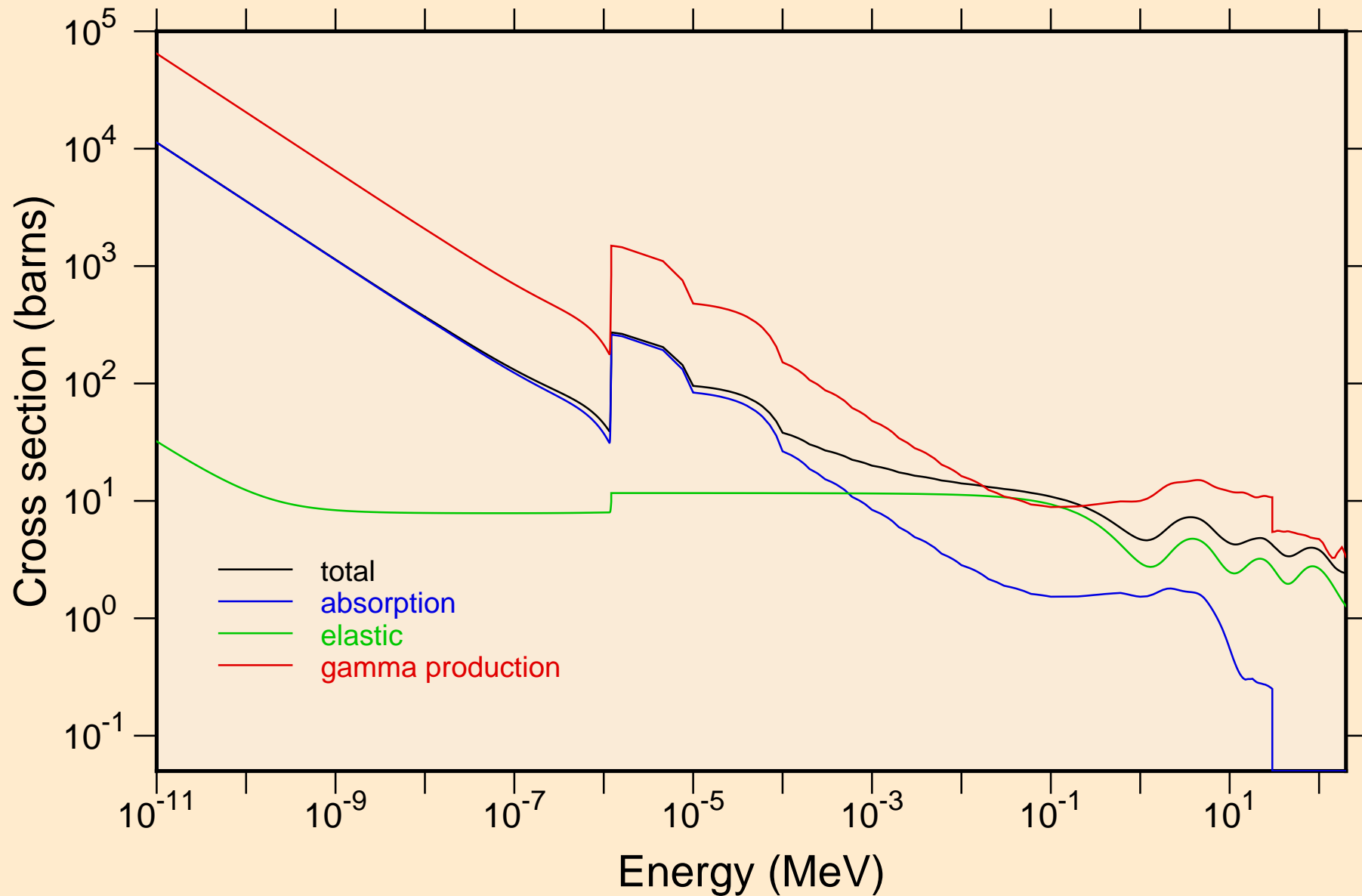

FR204 NEUTRON ACER TENDL-2019 LIBRARY; T=293.16K
Heating

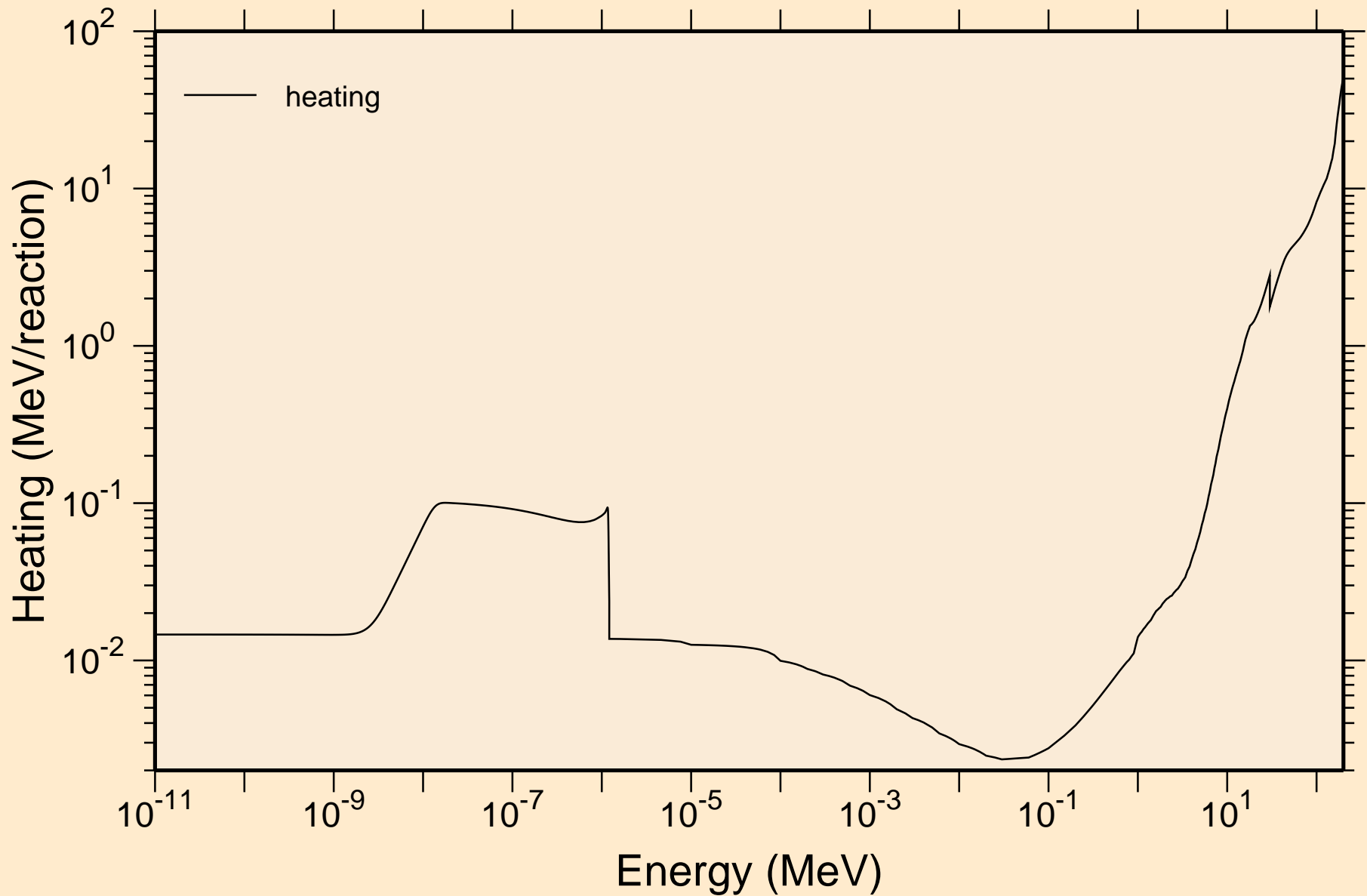

FR204 NEUTRON ACER TENDL-2019 LIBRARY; T=293.16K
Damage

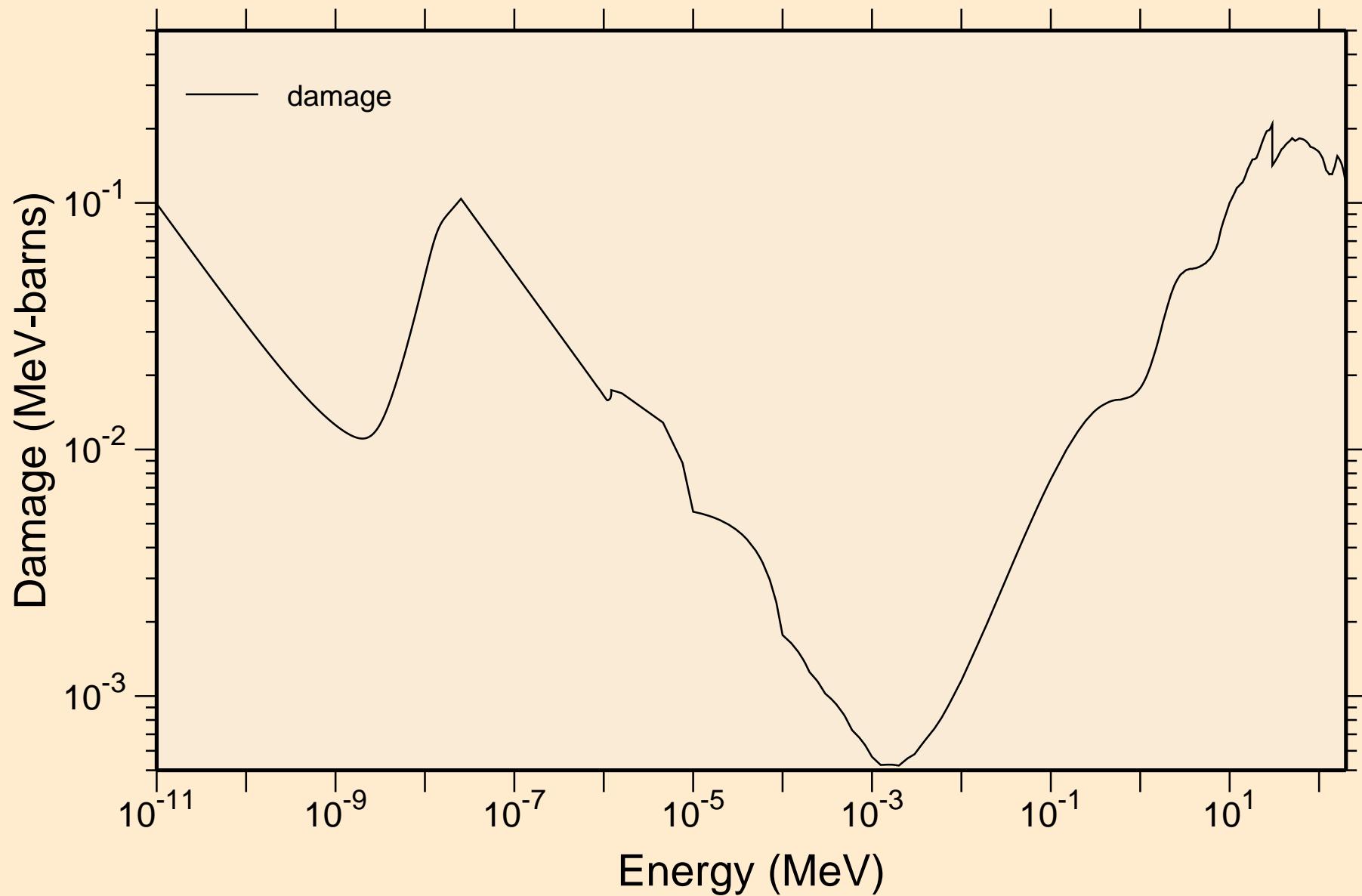

FR204 NEUTRON ACER TENDL-2019 LIBRARY; T=293.16K
Non-threshold reactions

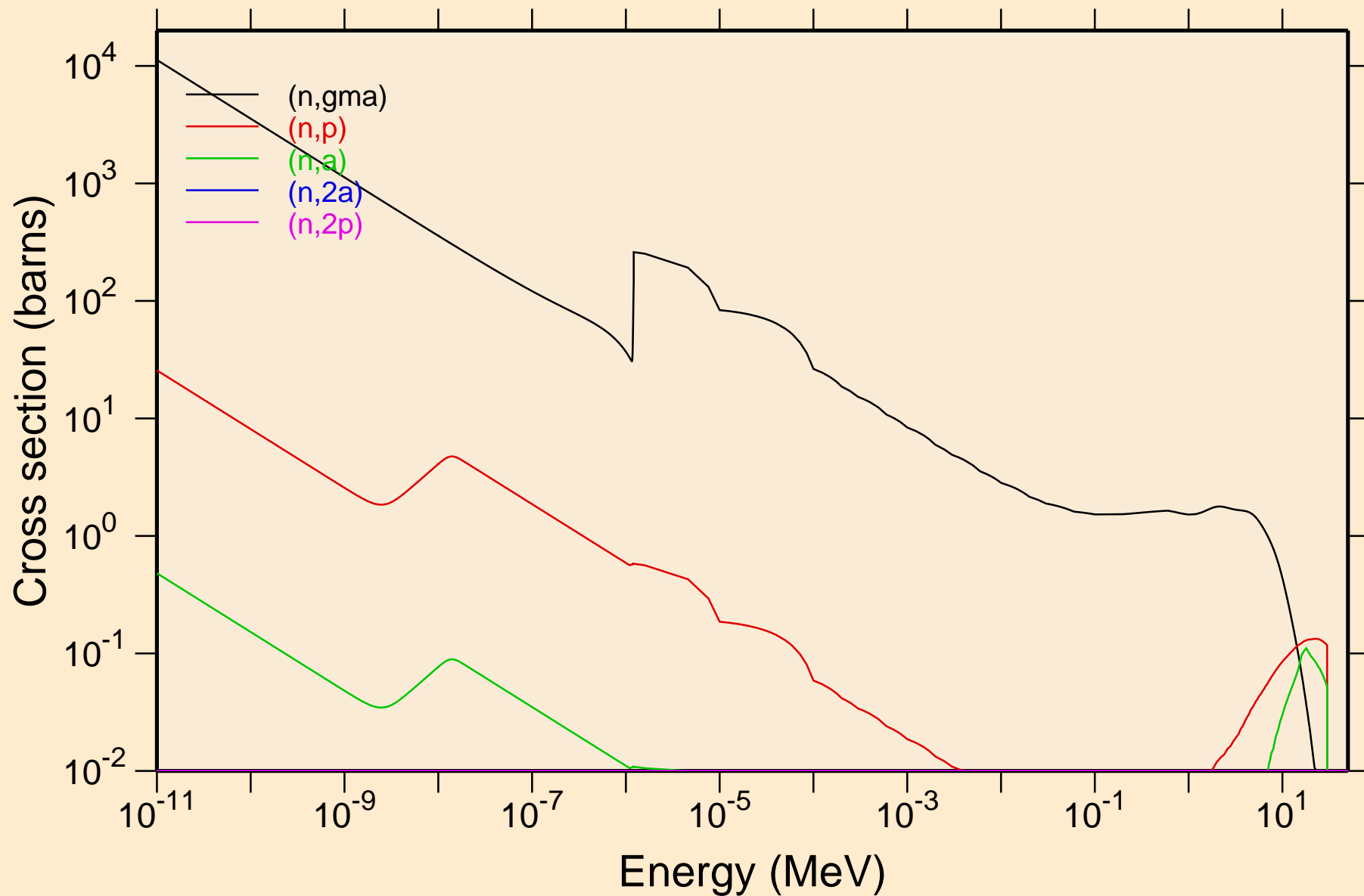

FR204 NEUTRON ACER TENDL-2019 LIBRARY; T=293.16K
Non-threshold reactions

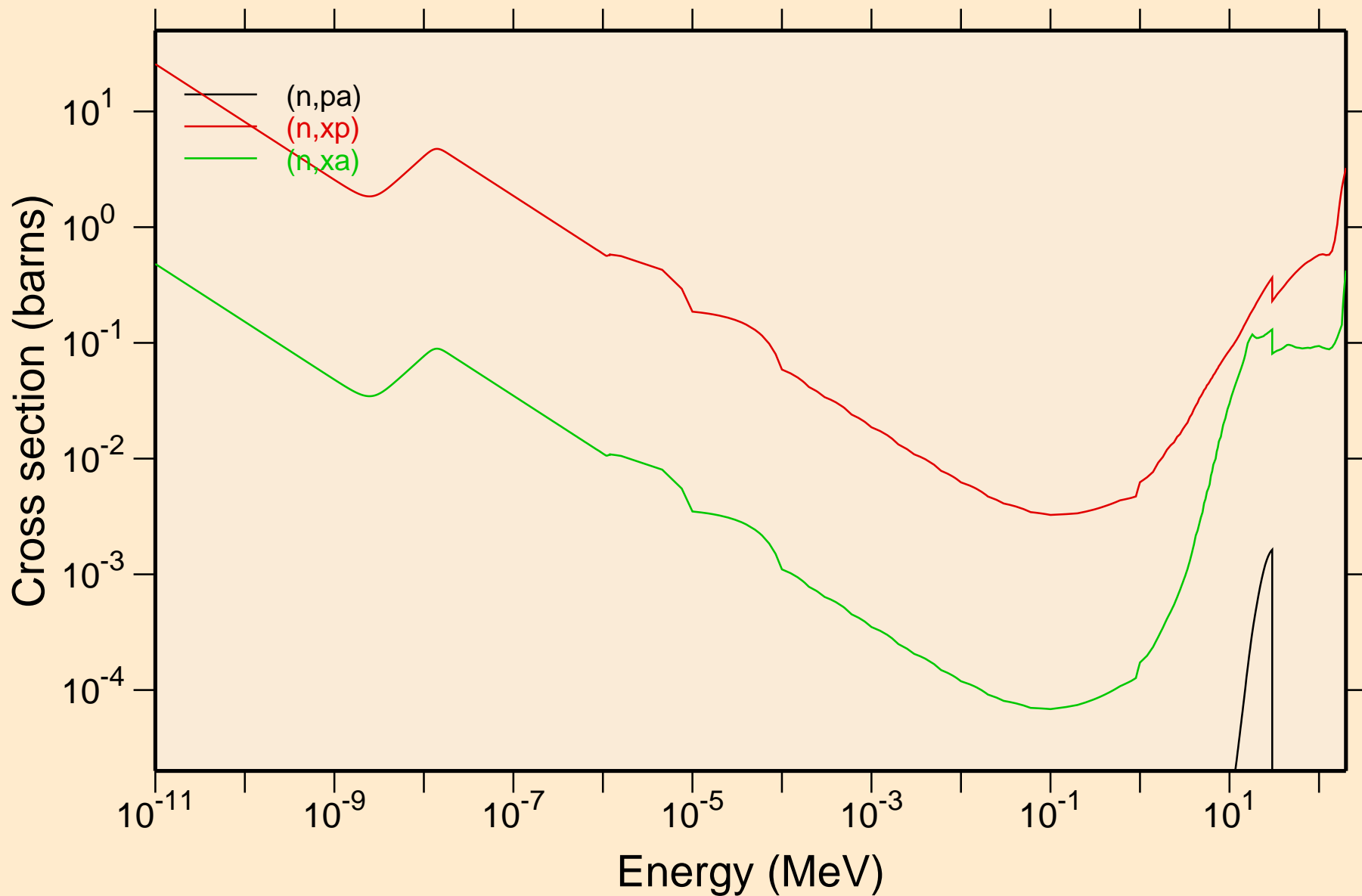

FR204 NEUTRON ACER TENDL-2019 LIBRARY; T=293.16K
Principal cross sections

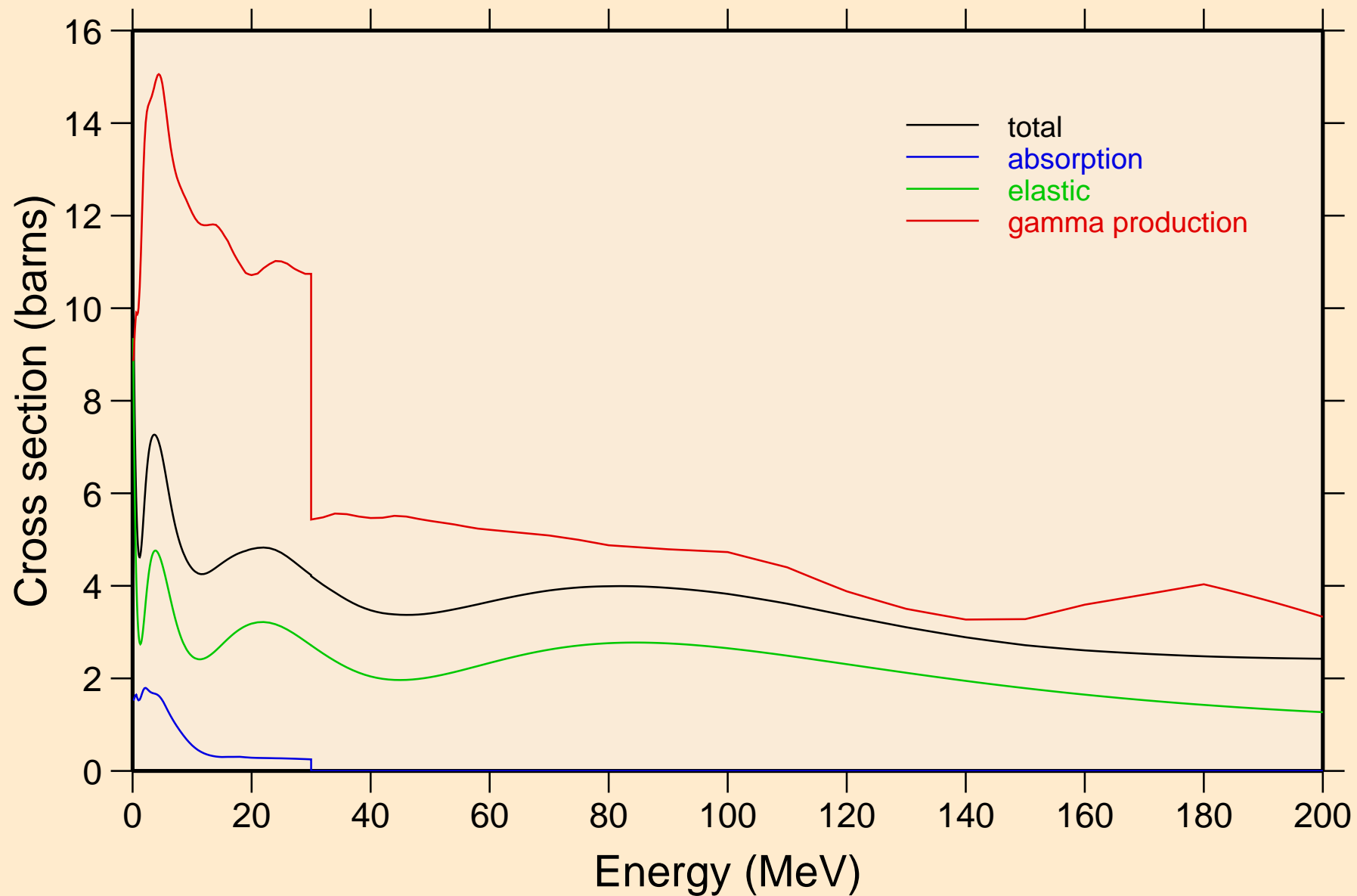

FR204 NEUTRON ACER TENDL-2019 LIBRARY; T=293.16K
Heating

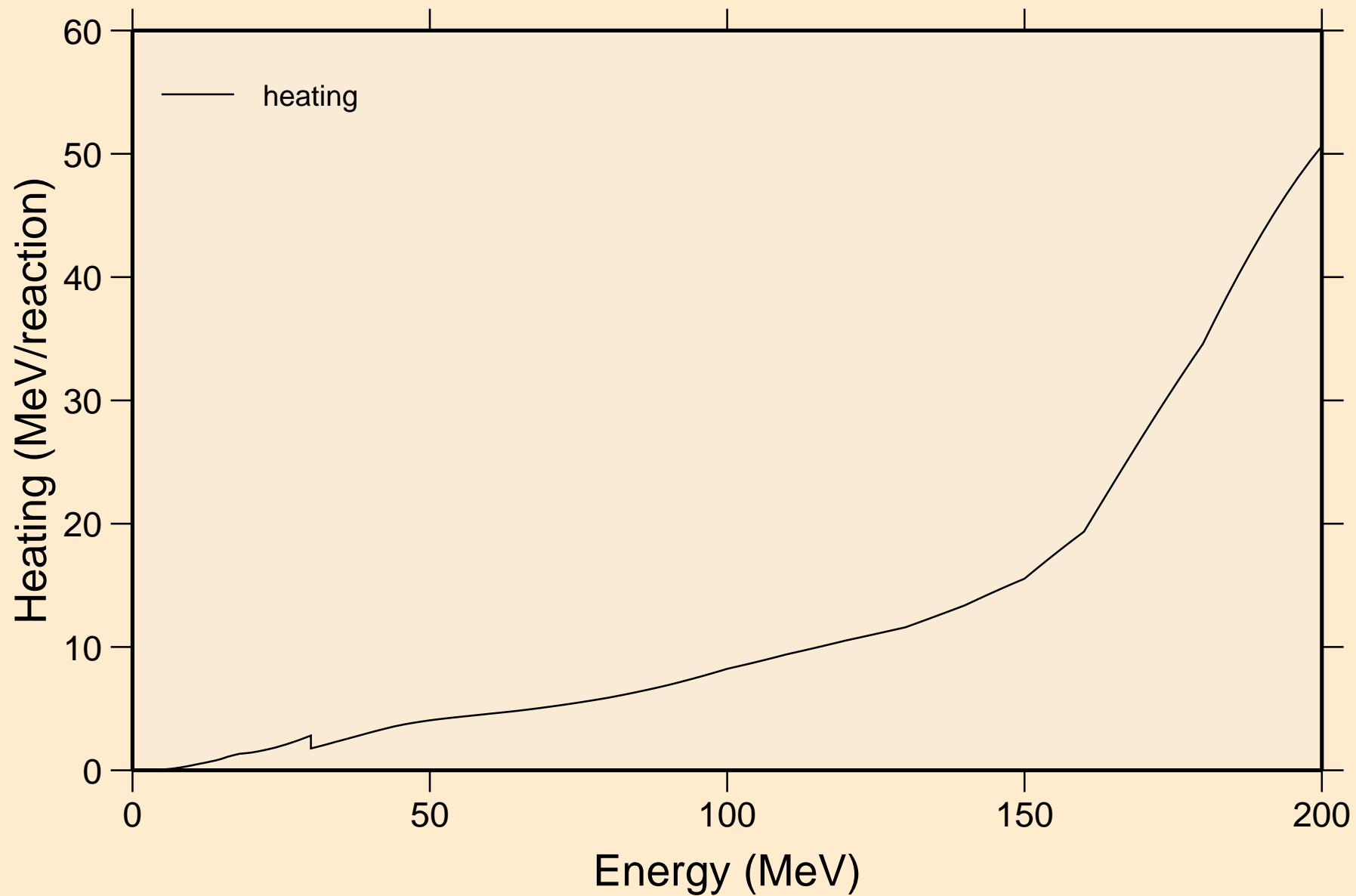

FR204 NEUTRON ACER TENDL-2019 LIBRARY; T=293.16K
Damage

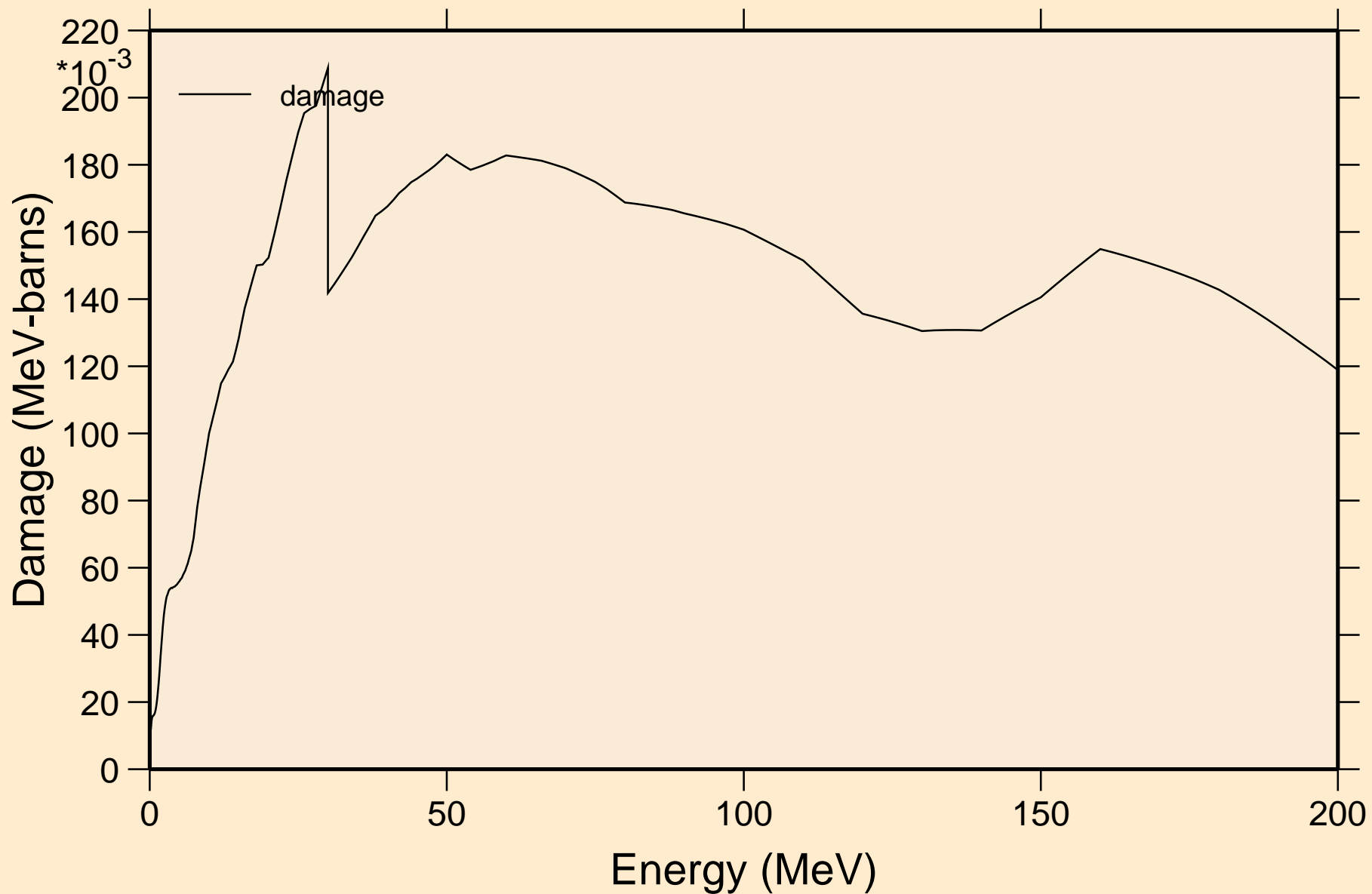

FR204 NEUTRON ACER TENDL-2019 LIBRARY; T=293.16K
Non-threshold reactions

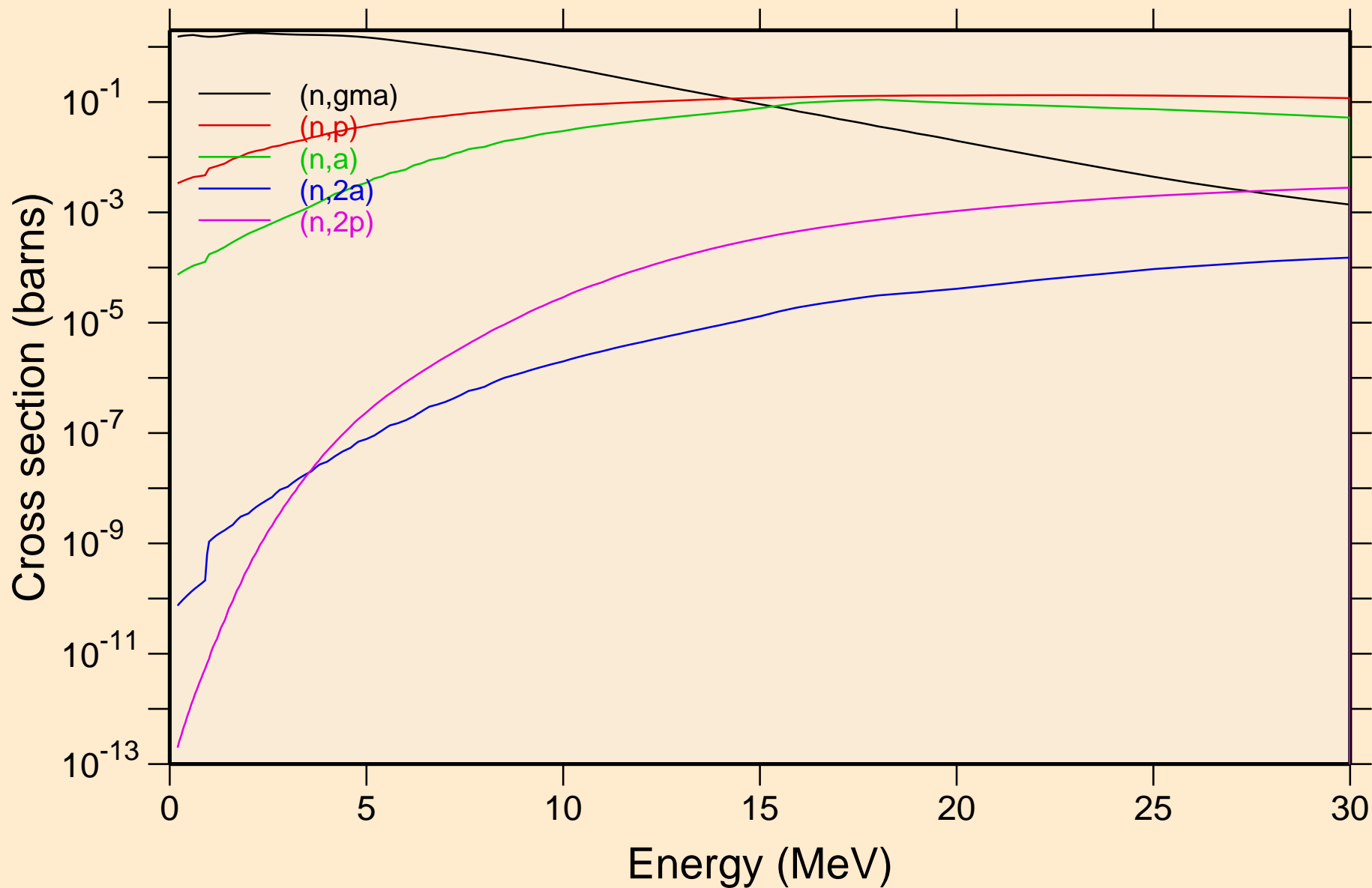

FR204 NEUTRON ACER TENDL-2019 LIBRARY; T=293.16K
Non-threshold reactions

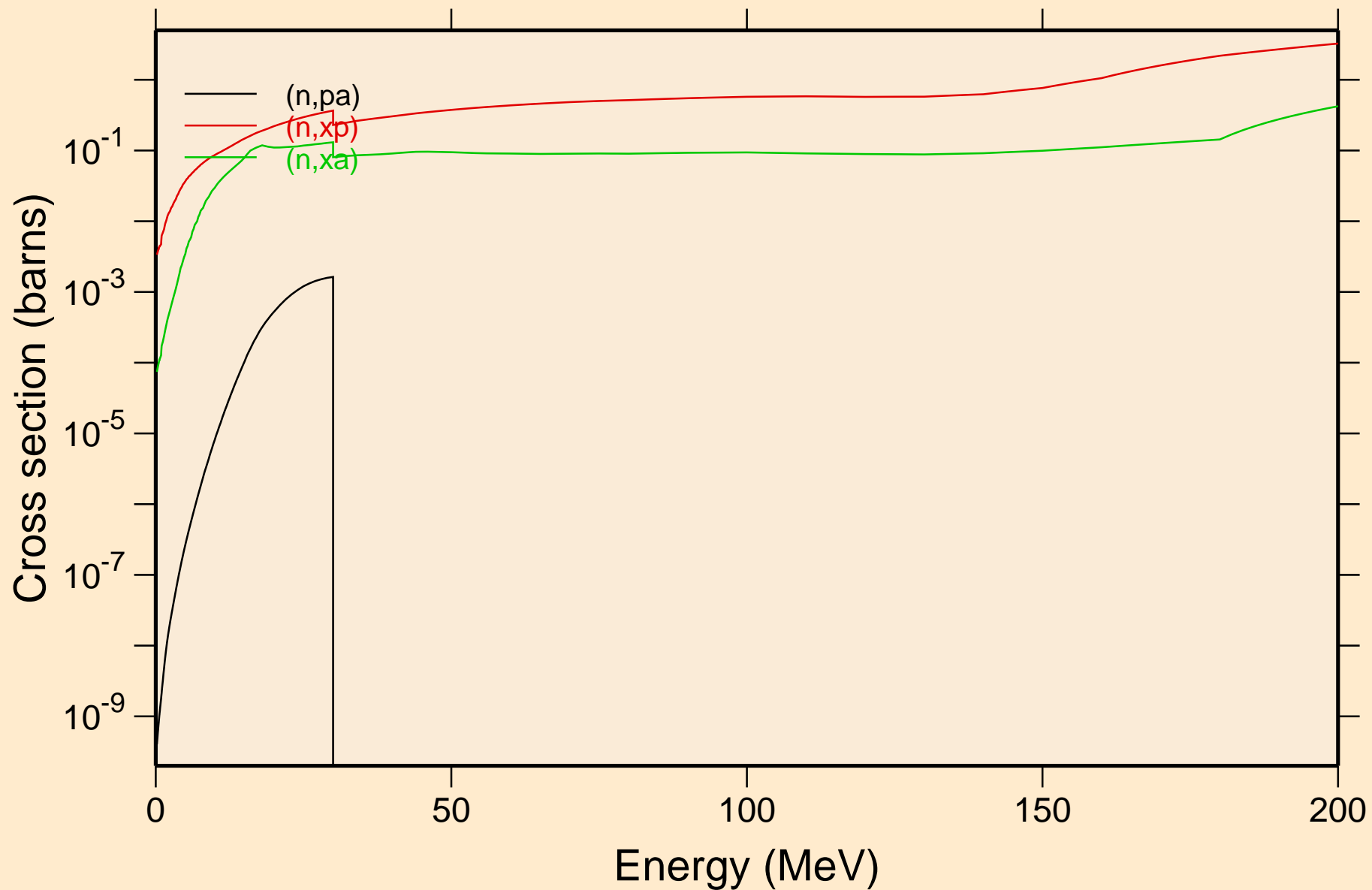

FR204 NEUTRON ACER TENDL-2019 LIBRARY; T=293.16K
Inelastic levels

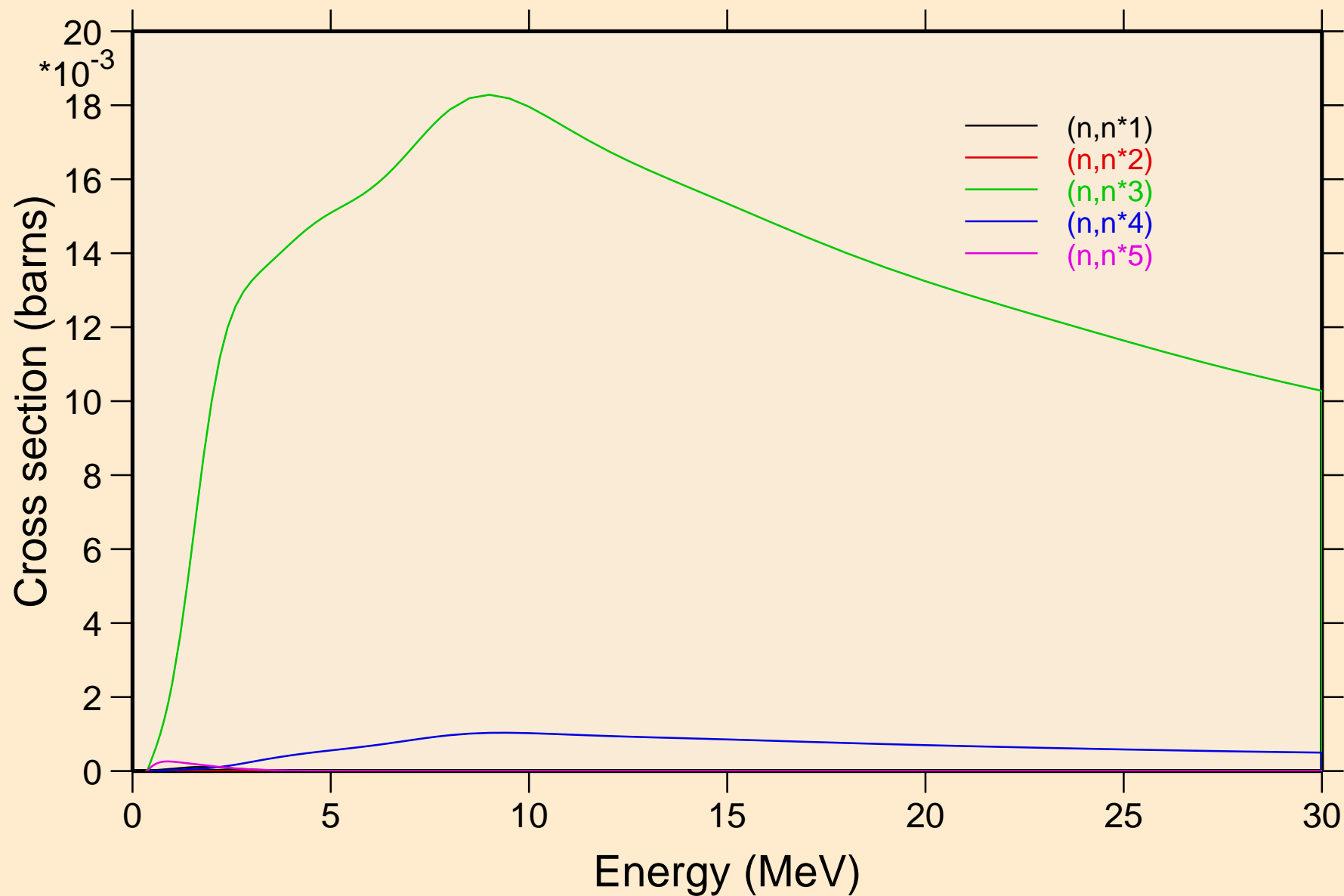

FR204 NEUTRON ACER TENDL-2019 LIBRARY; T=293.16K
Inelastic levels

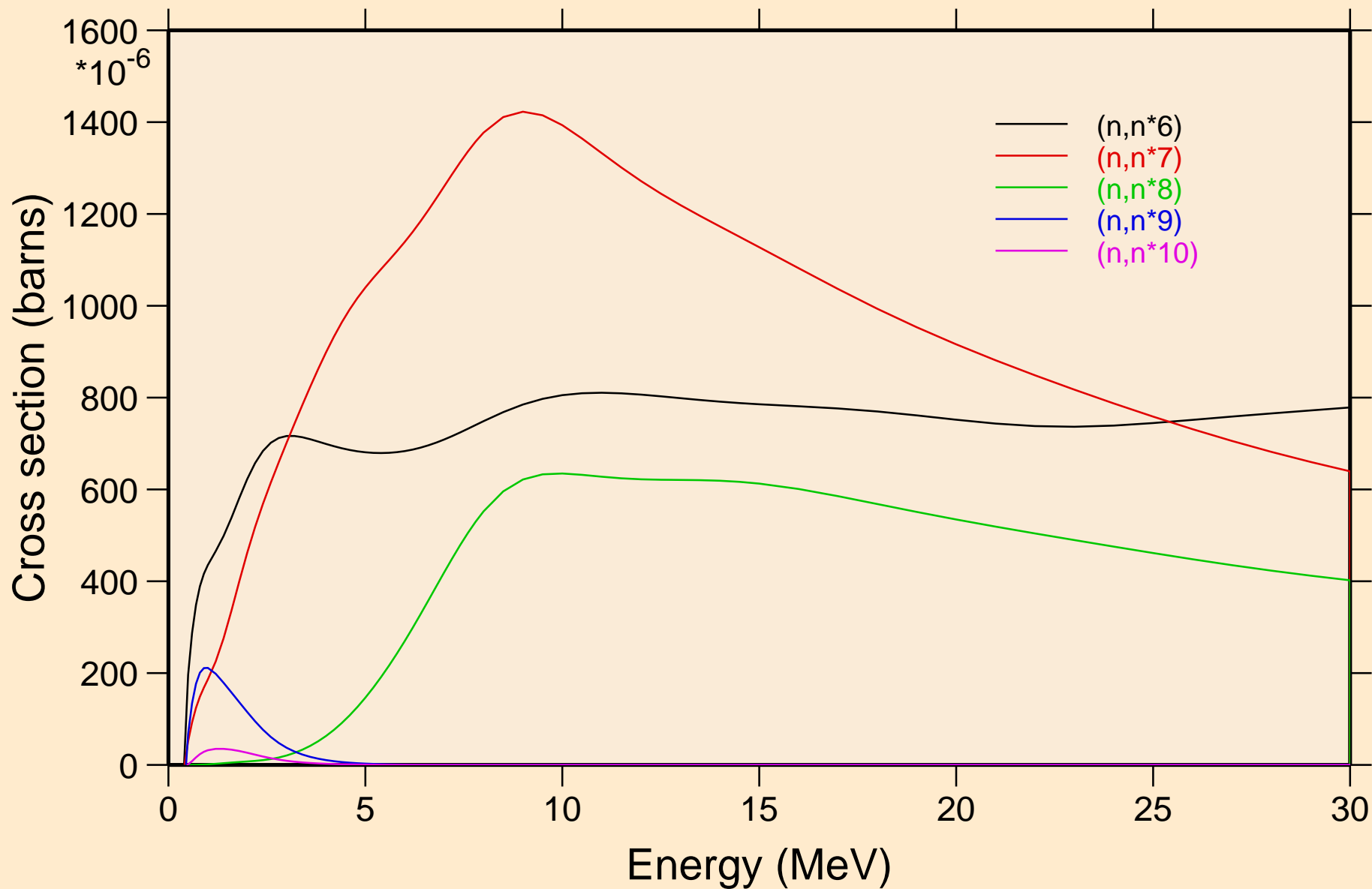

FR204 NEUTRON ACER TENDL-2019 LIBRARY; T=293.16K
Inelastic levels

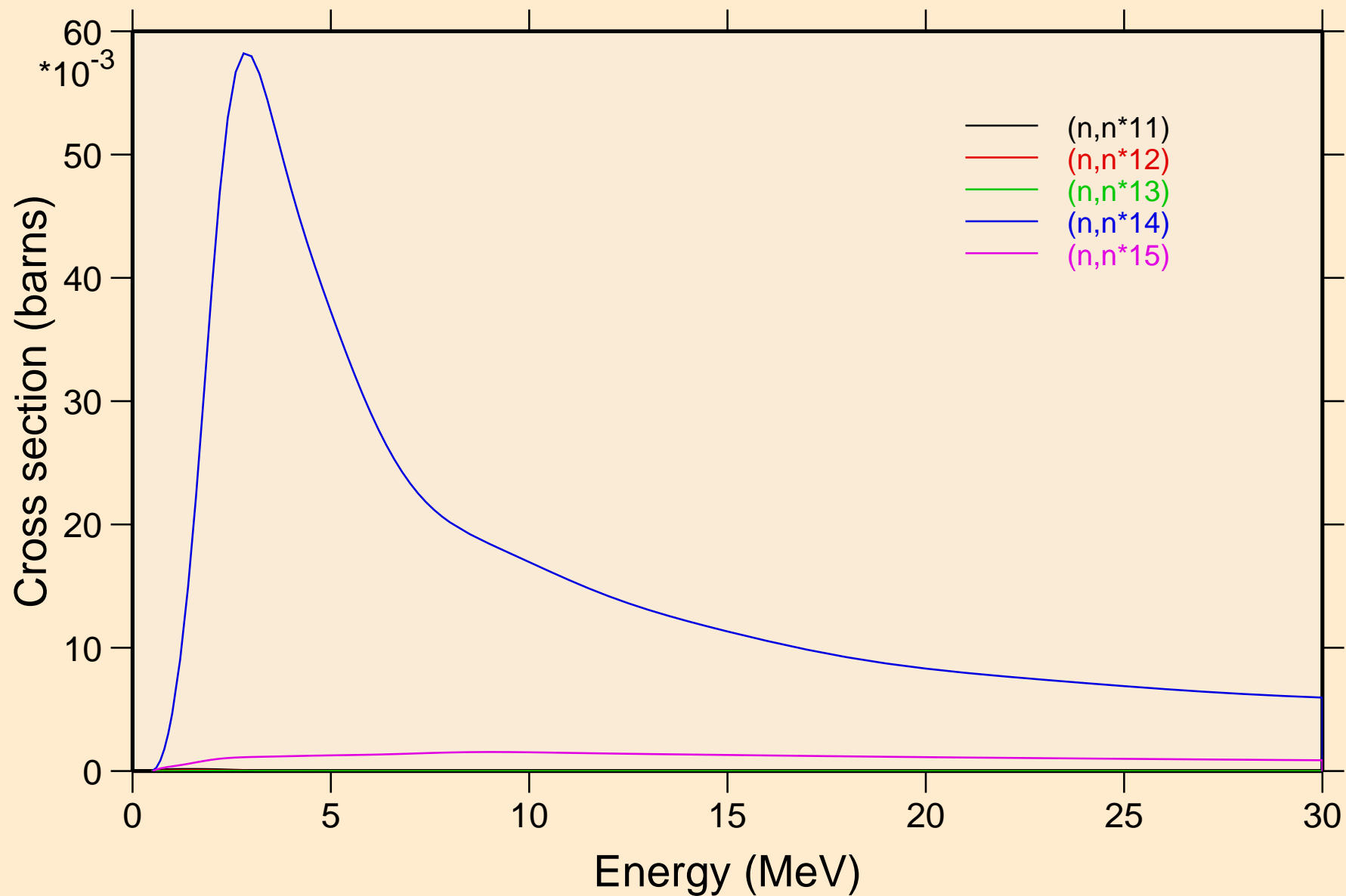

FR204 NEUTRON ACER TENDL-2019 LIBRARY; T=293.16K
Inelastic levels

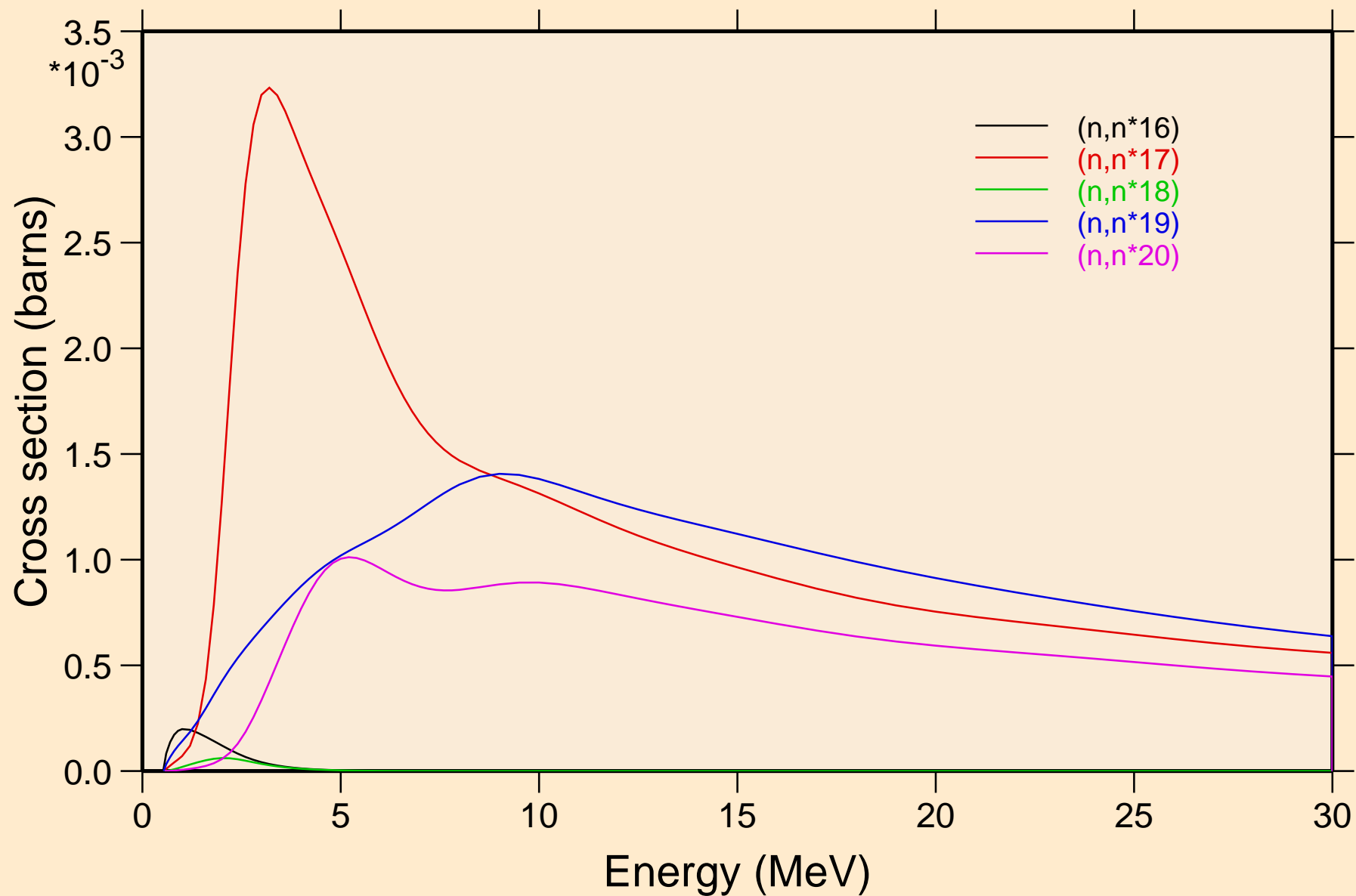

FR204 NEUTRON ACER TENDL-2019 LIBRARY; T=293.16K
Inelastic levels

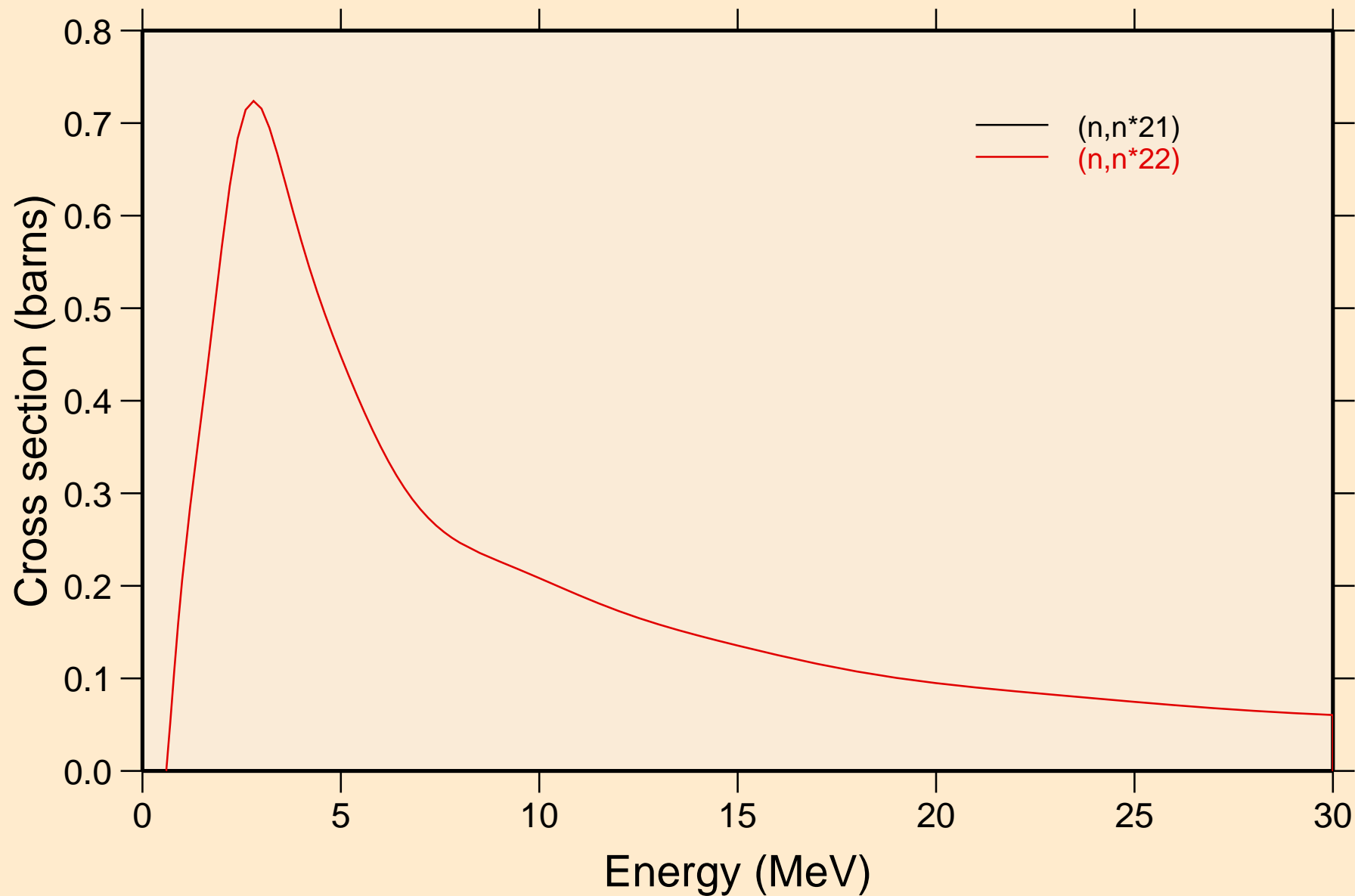

FR204 NEUTRON ACER TENDL-2019 LIBRARY; T=293.16K
Threshold reactions

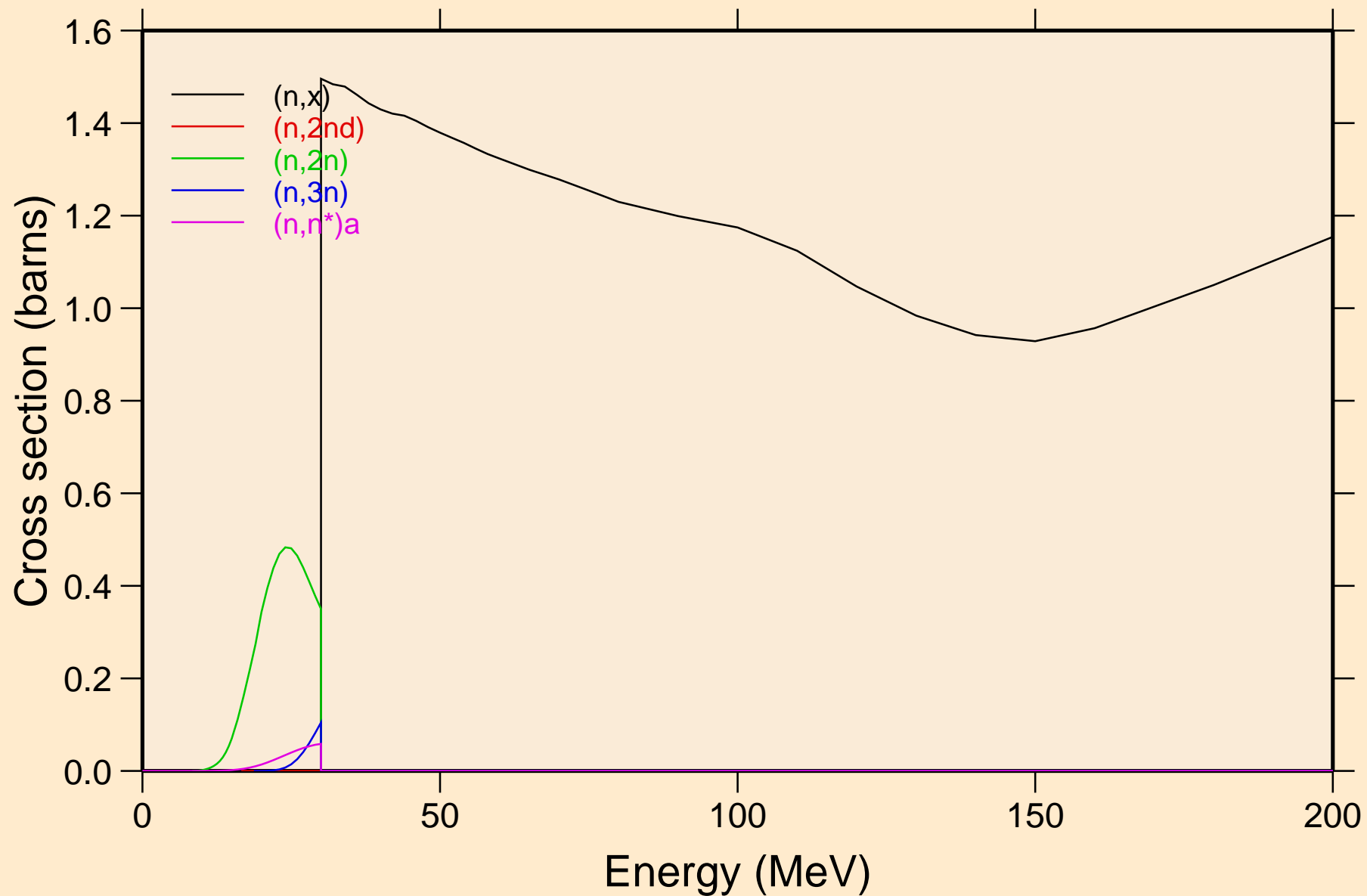

FR204 NEUTRON ACER TENDL-2019 LIBRARY; T=293.16K
Threshold reactions

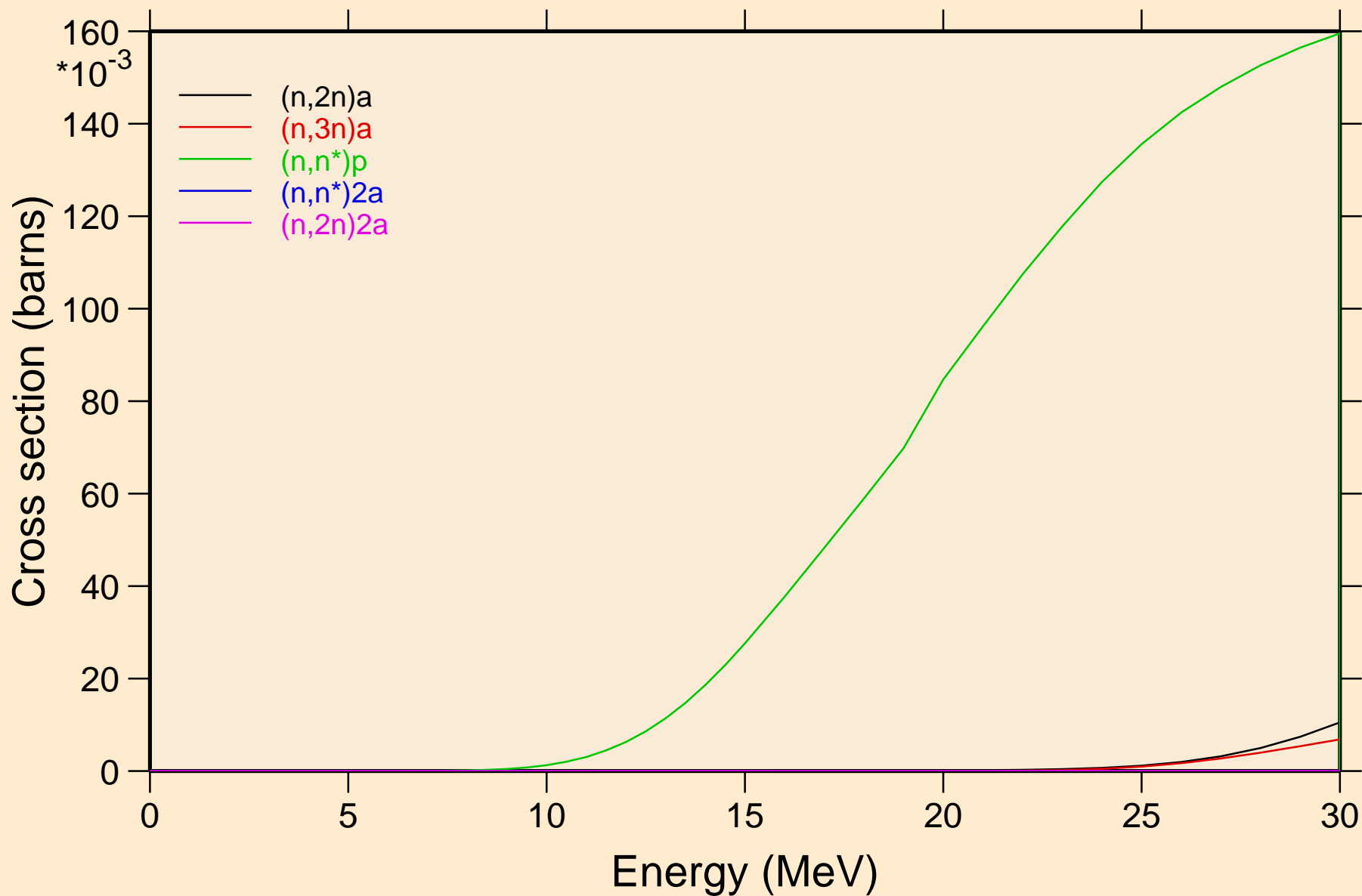

FR204 NEUTRON ACER TENDL-2019 LIBRARY; T=293.16K
Threshold reactions

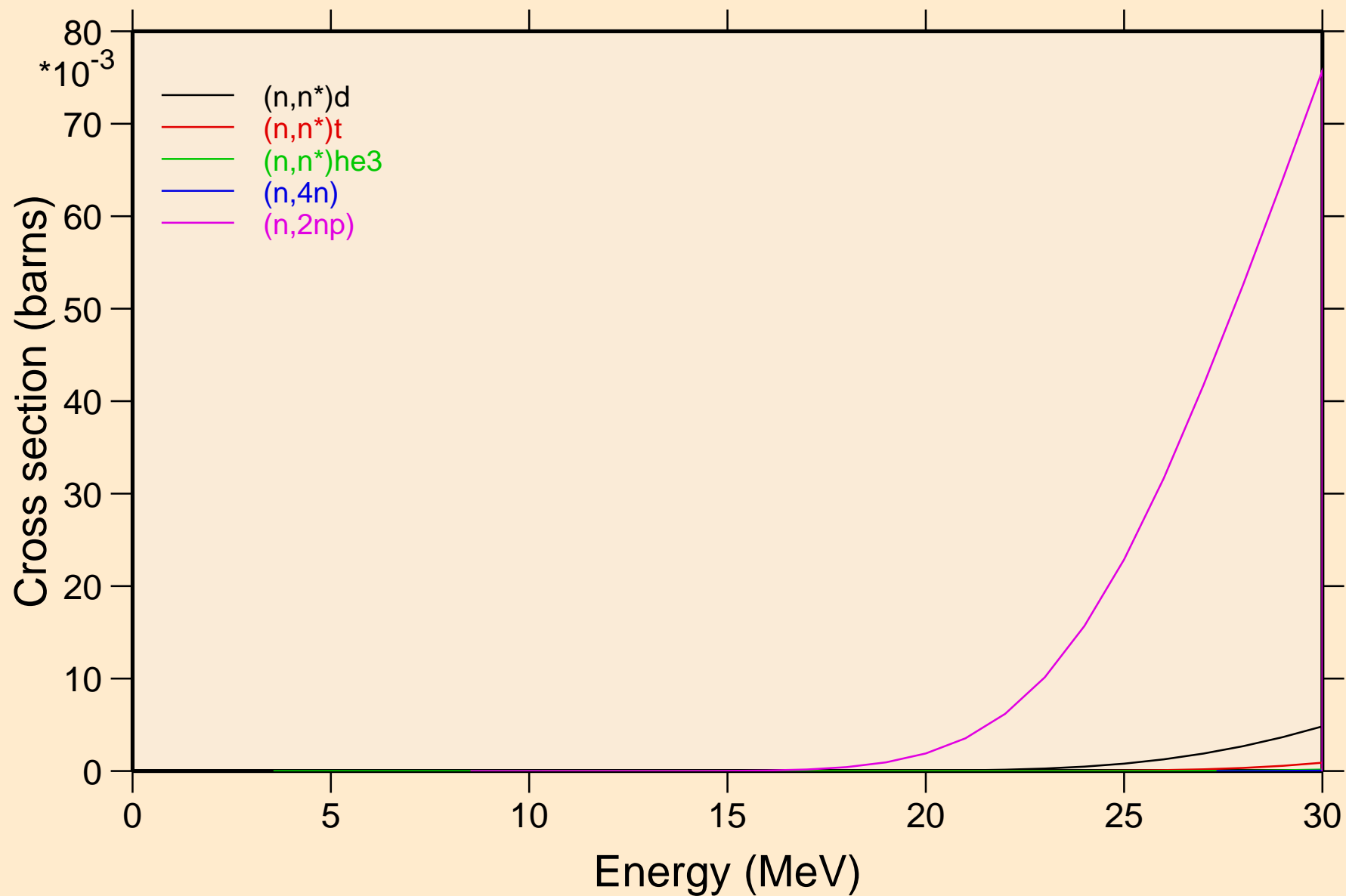

FR204 NEUTRON ACER TENDL-2019 LIBRARY; T=293.16K
Threshold reactions

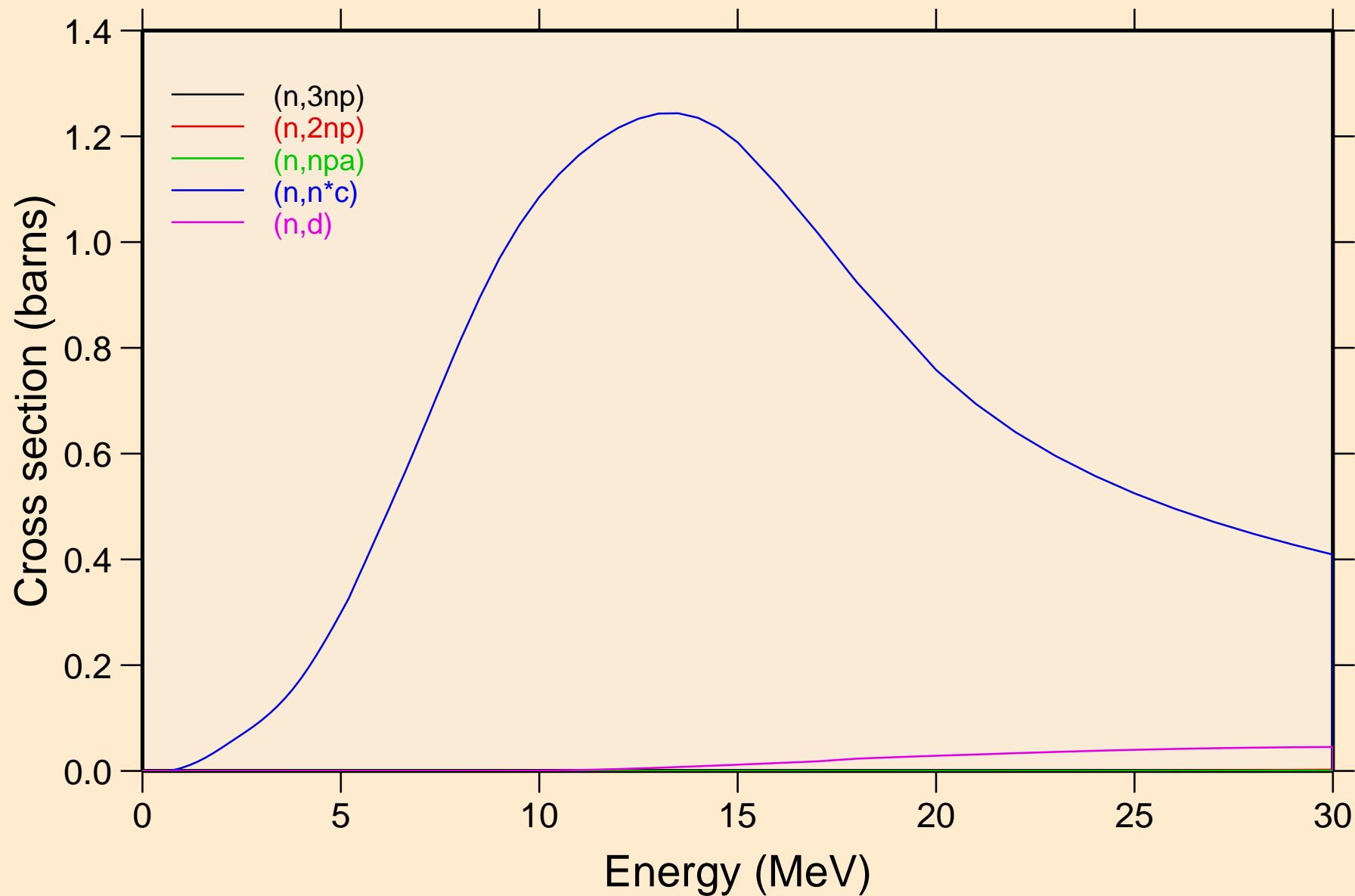

FR204 NEUTRON ACER TENDL-2019 LIBRARY; T=293.16K
Threshold reactions

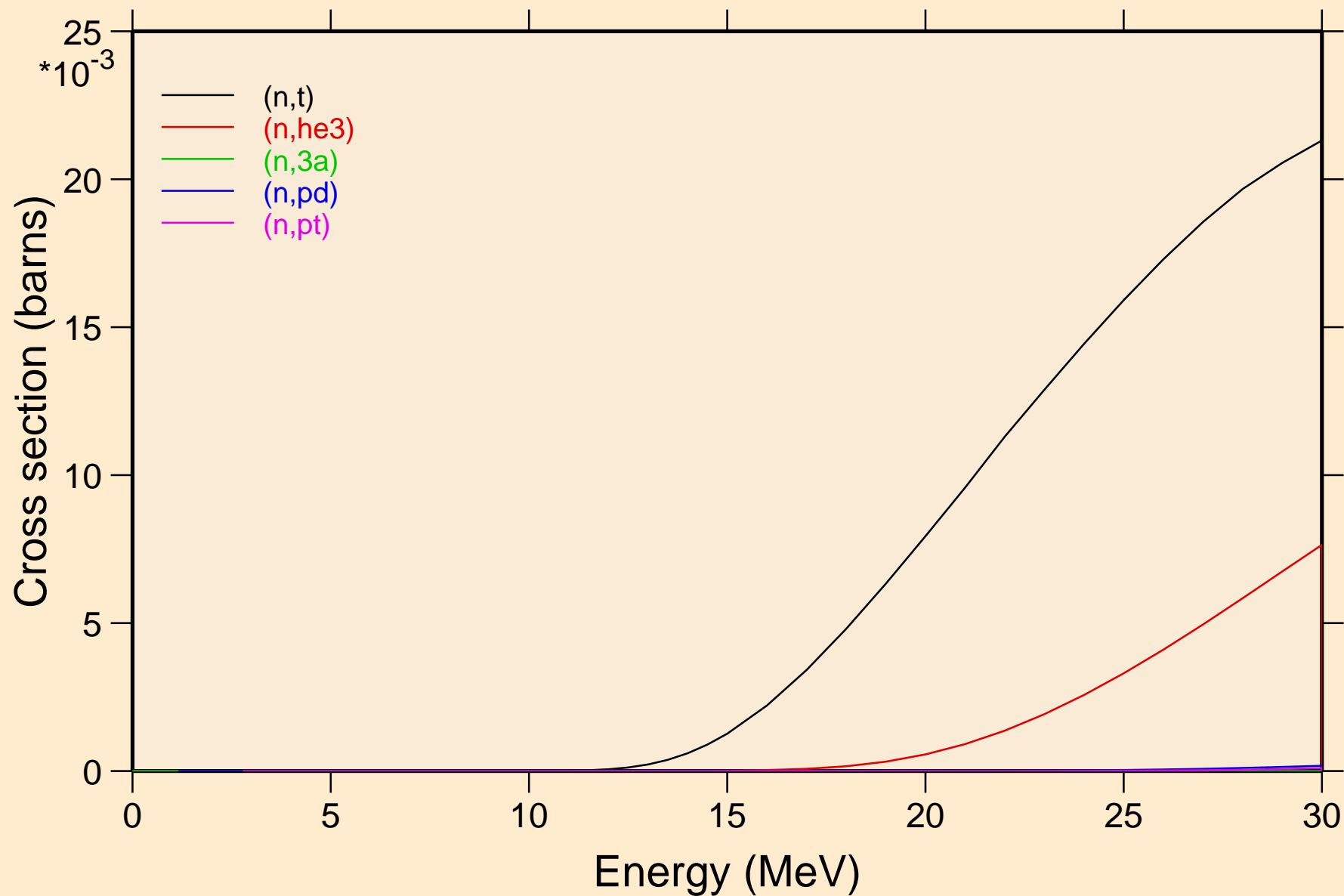

FR204 NEUTRON ACER TENDL-2019 LIBRARY; T=293.16K
Threshold reactions

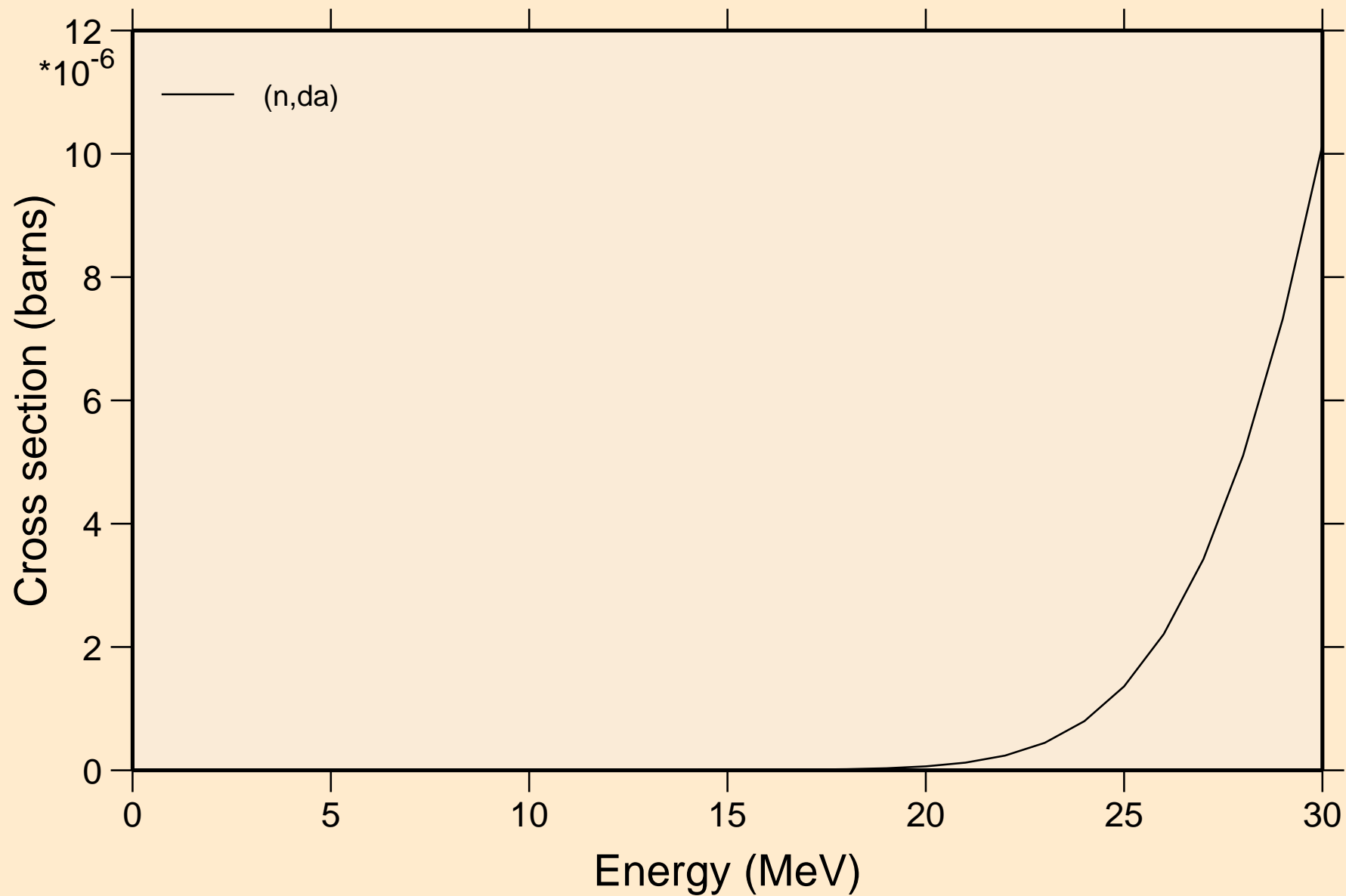

FR204 NEUTRON ACER TENDL-2019 LIBRARY; T=293.16K
Threshold reactions

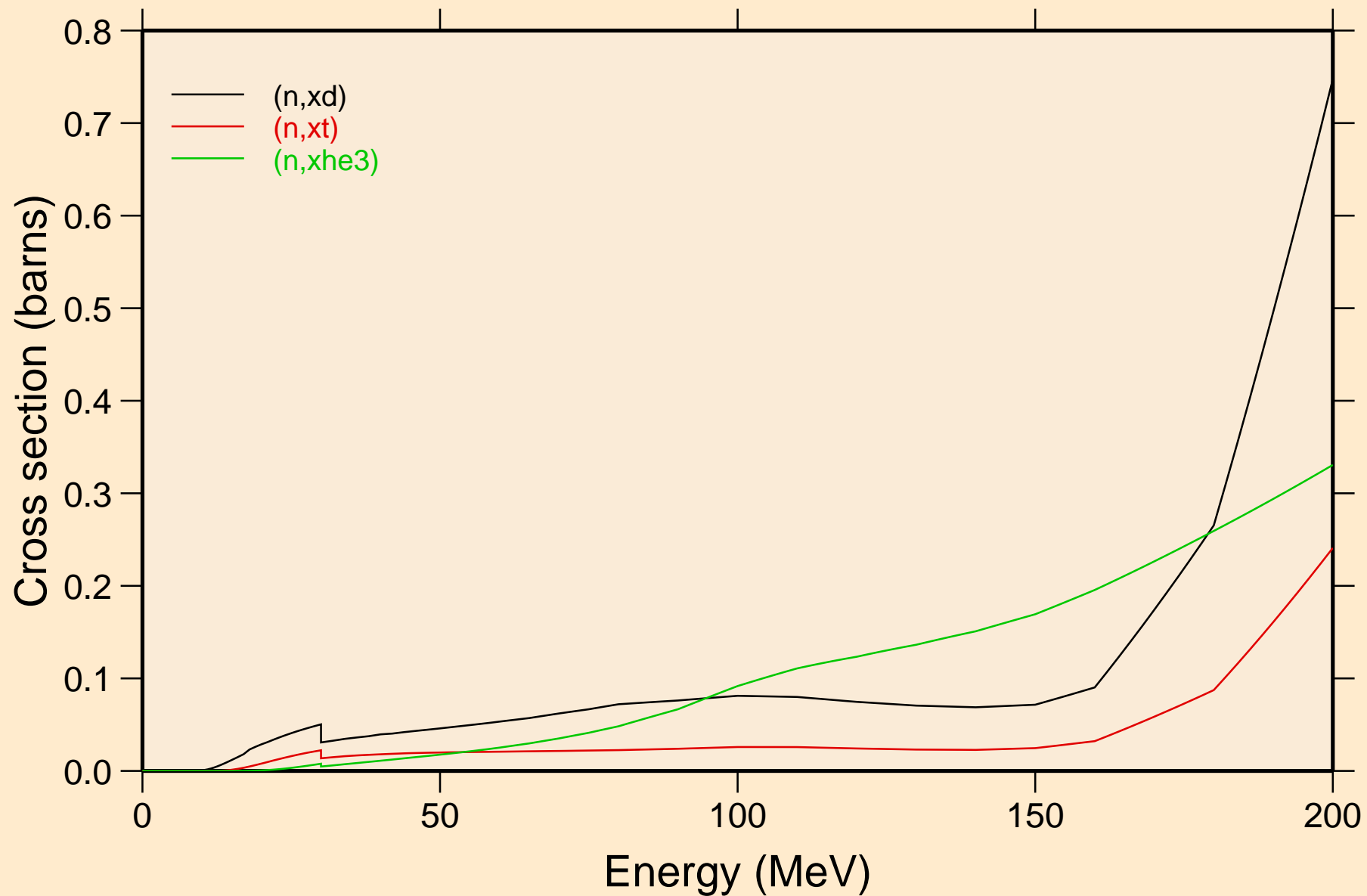

FR204 NEUTRON ACER TENDL-2019 LIBRARY; T=293.16K
angular distribution for elastic

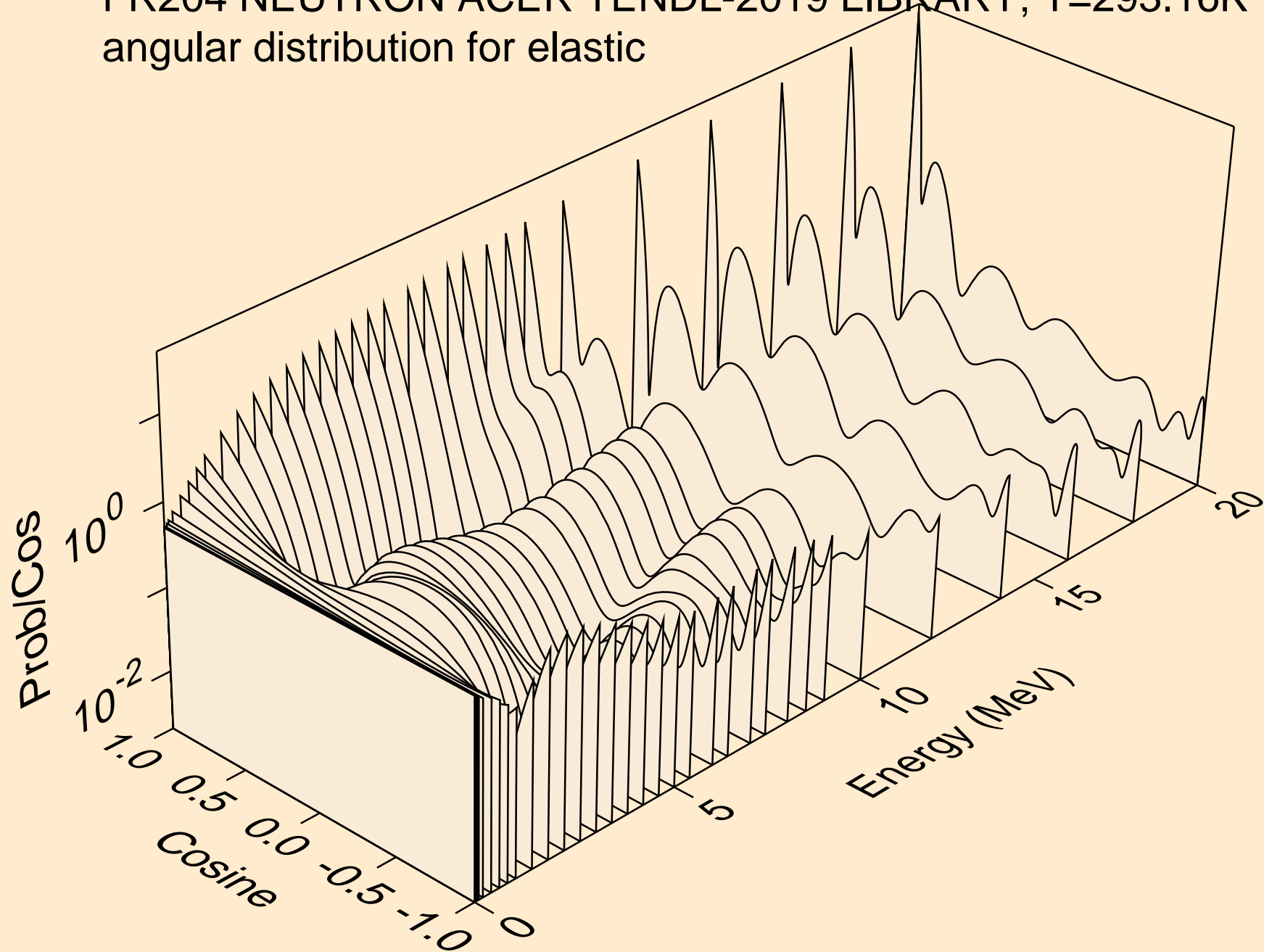

FR204 NEUTRON ACER TENDL-2019 LIBRARY; T=293.16K
angular distribution for elastic

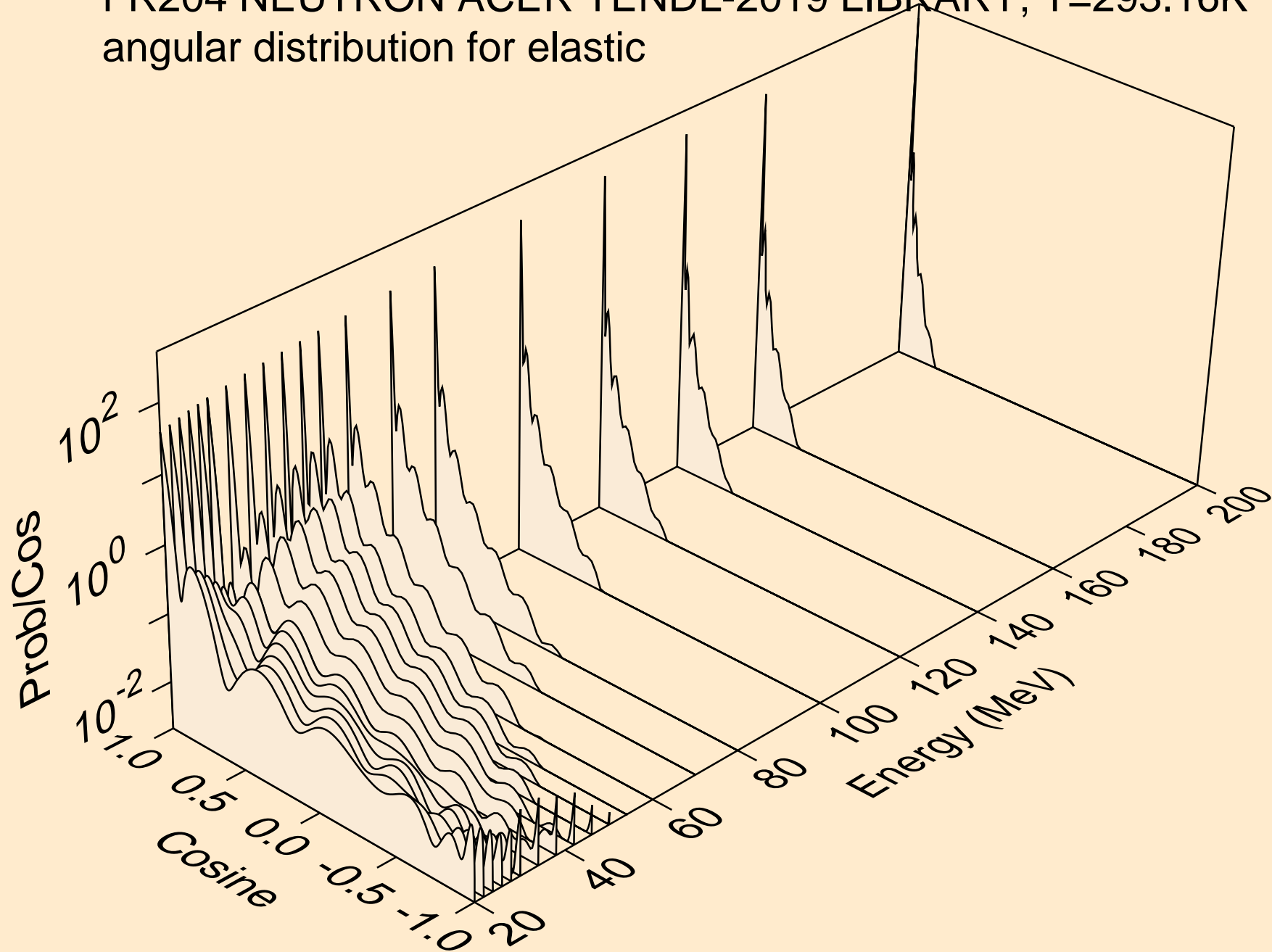

FR204 NEUTRON ACER TENDL-2019 LIBRARY; T=293.16K
angular distribution for (n,n*1)

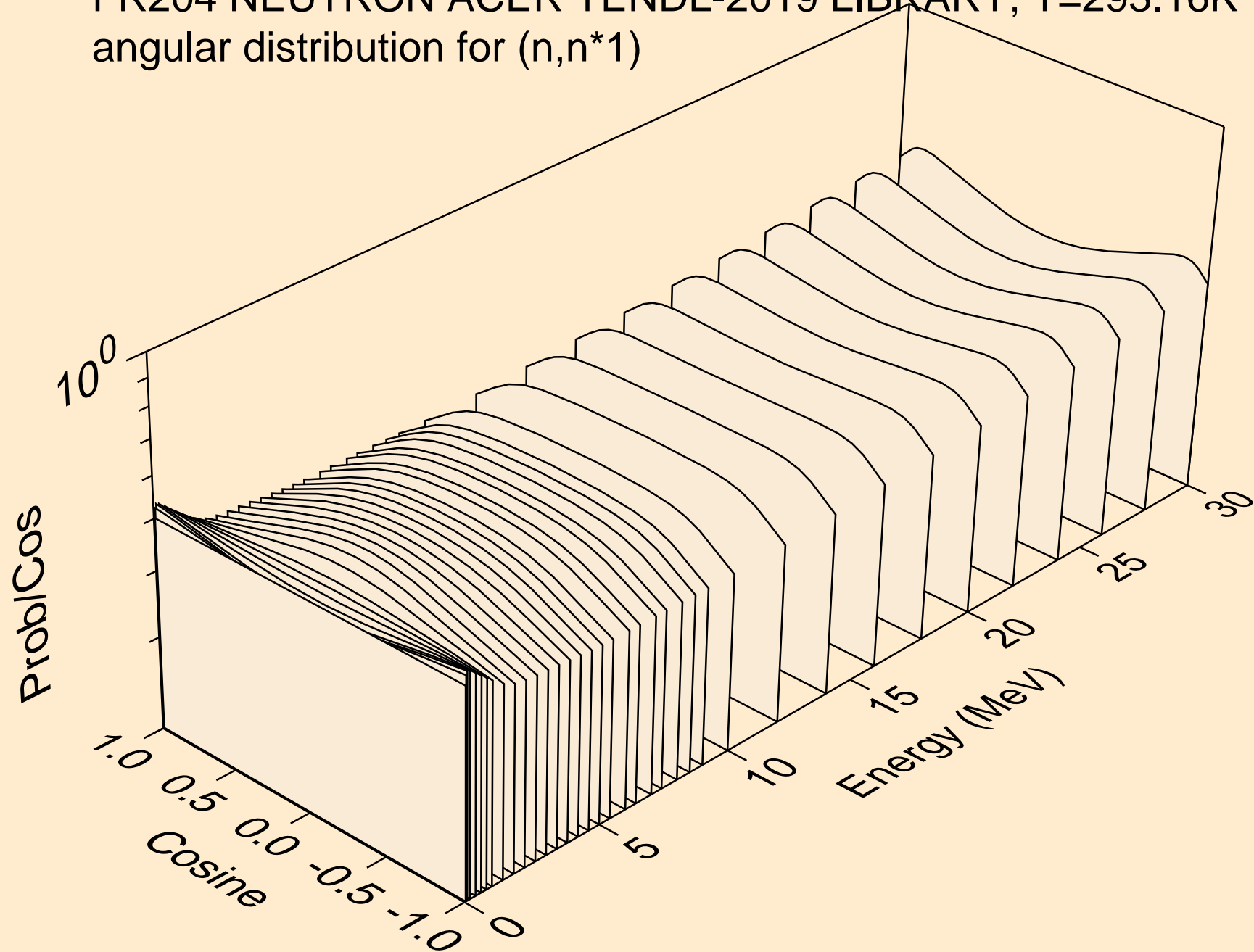

FR204 NEUTRON ACER TENDL-2019 LIBRARY; T=293.16K
angular distribution for (n,n*2)

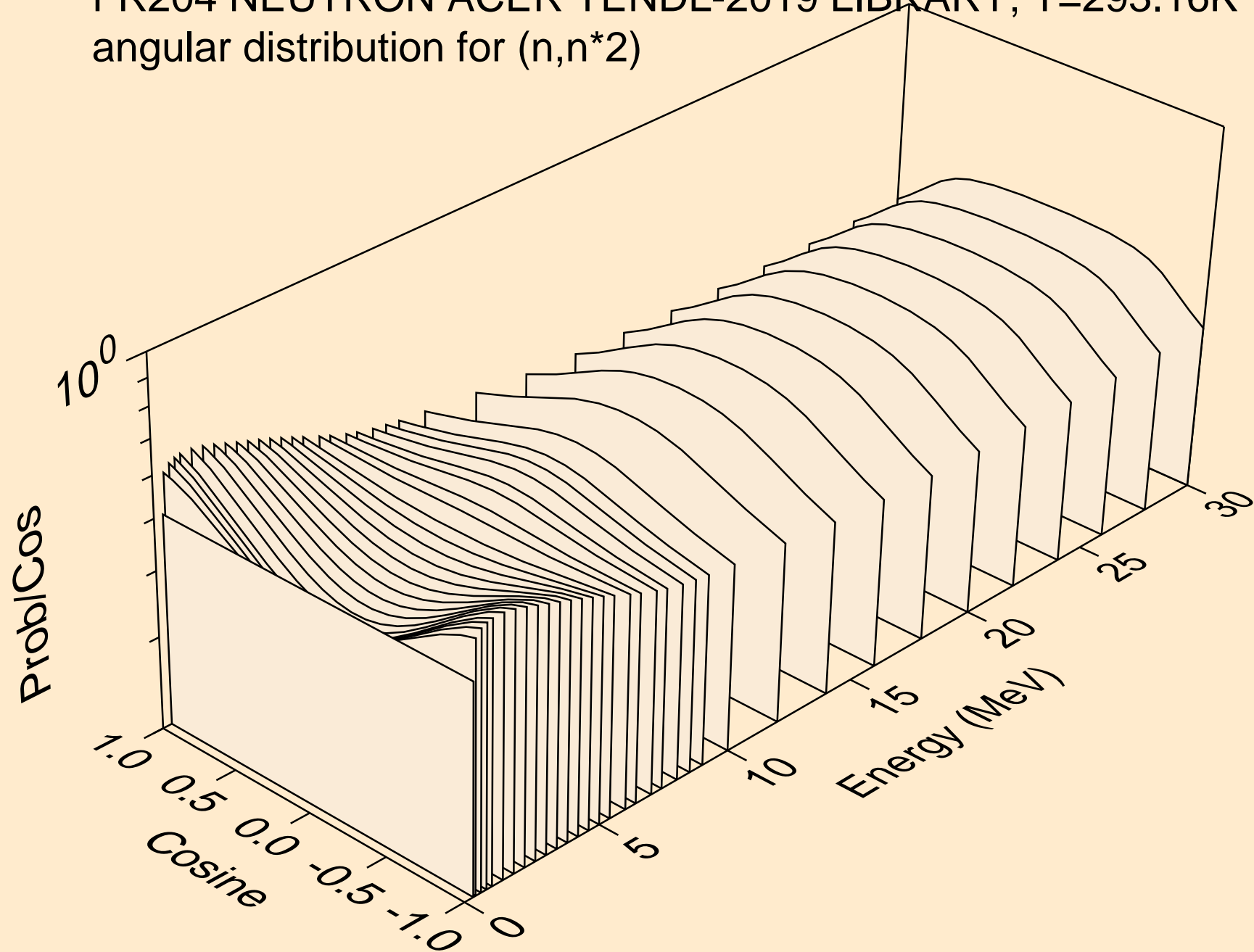

FR204 NEUTRON ACER TENDL-2019 LIBRARY; T=293.16K
angular distribution for (n,n*3)

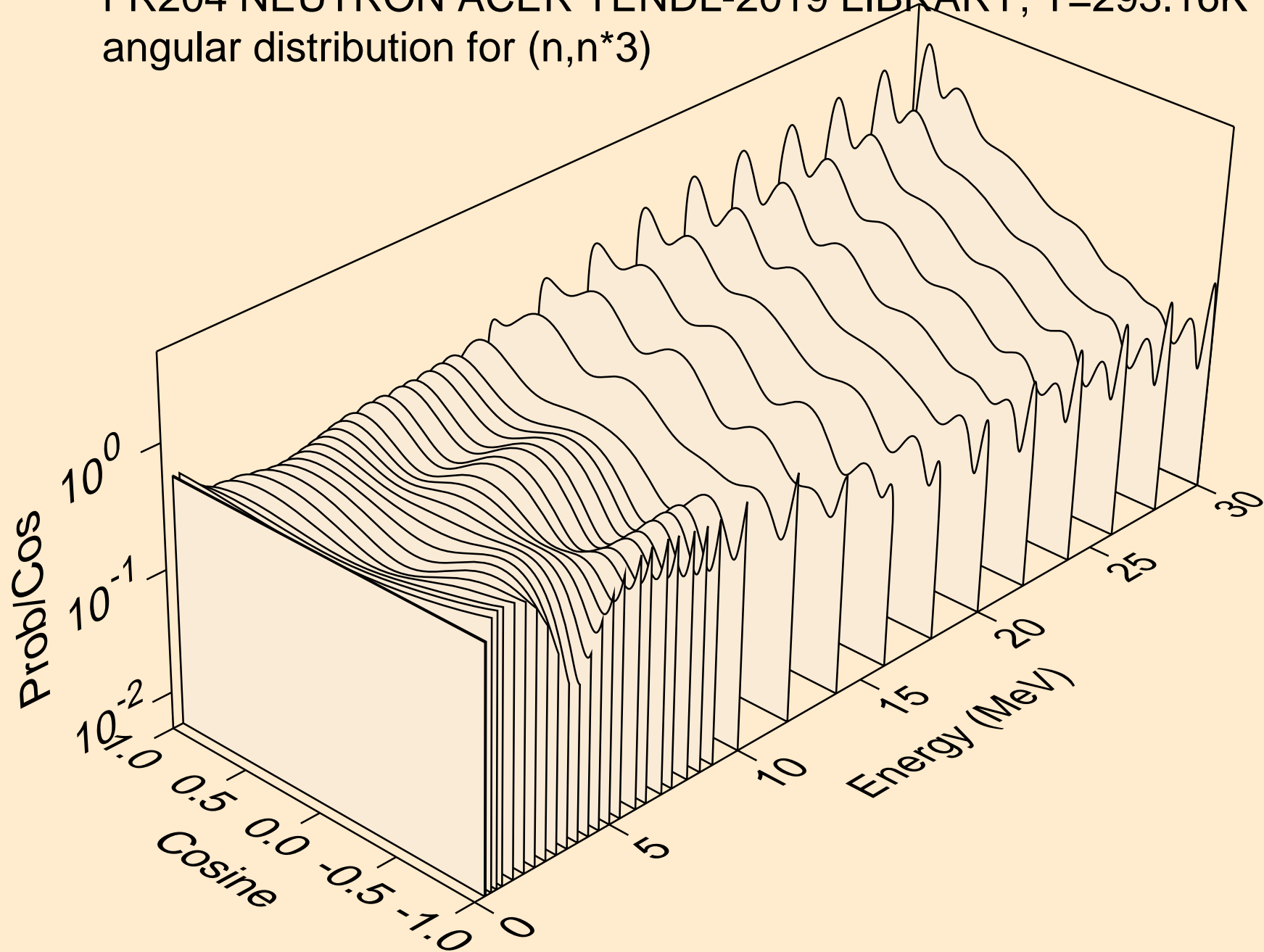

FR204 NEUTRON ACER TENDL-2019 LIBRARY; T=293.16K
angular distribution for (n,n*4)

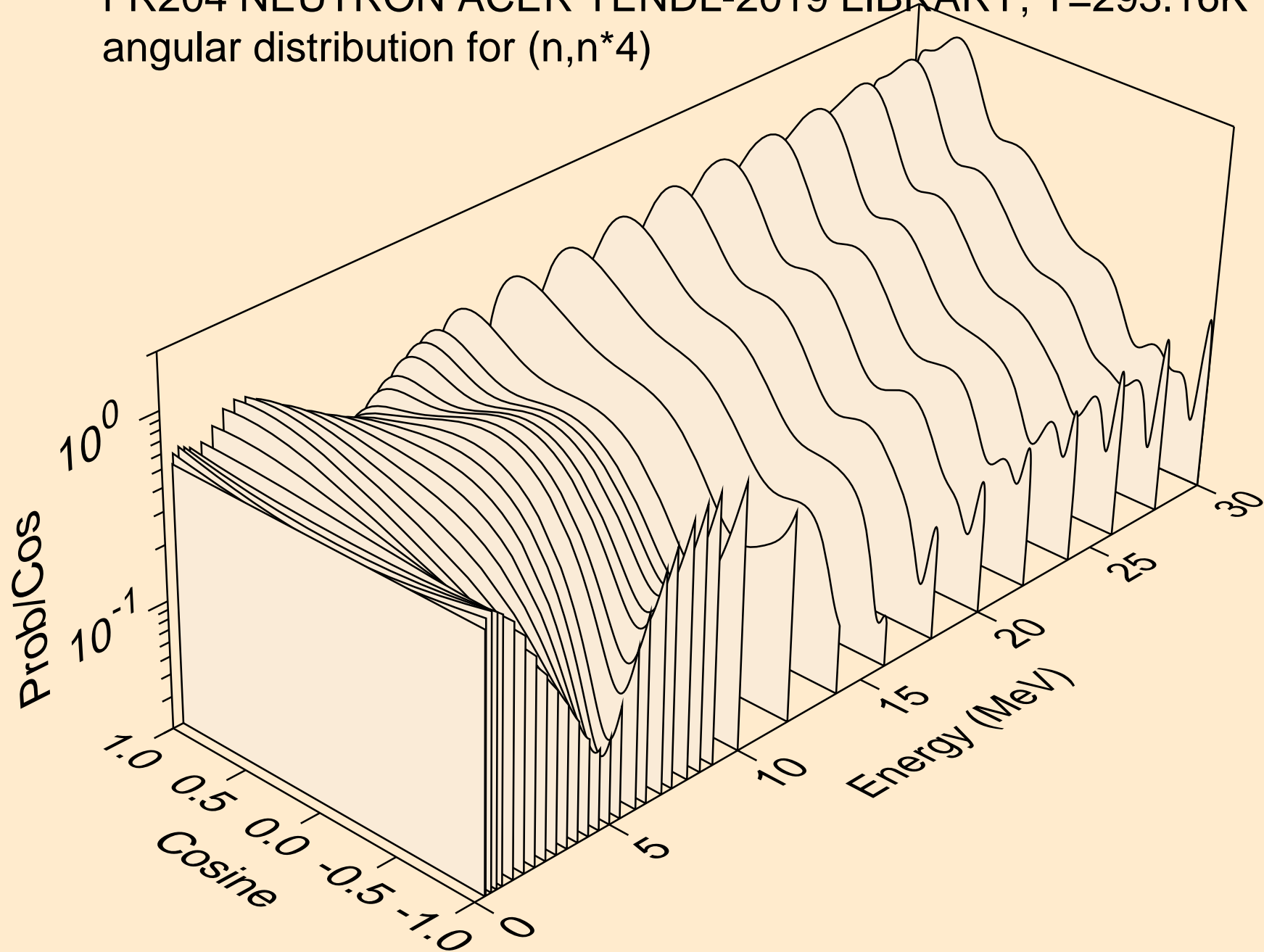

FR204 NEUTRON ACER TENDL-2019 LIBRARY; T=293.16K
angular distribution for (n,n*5)

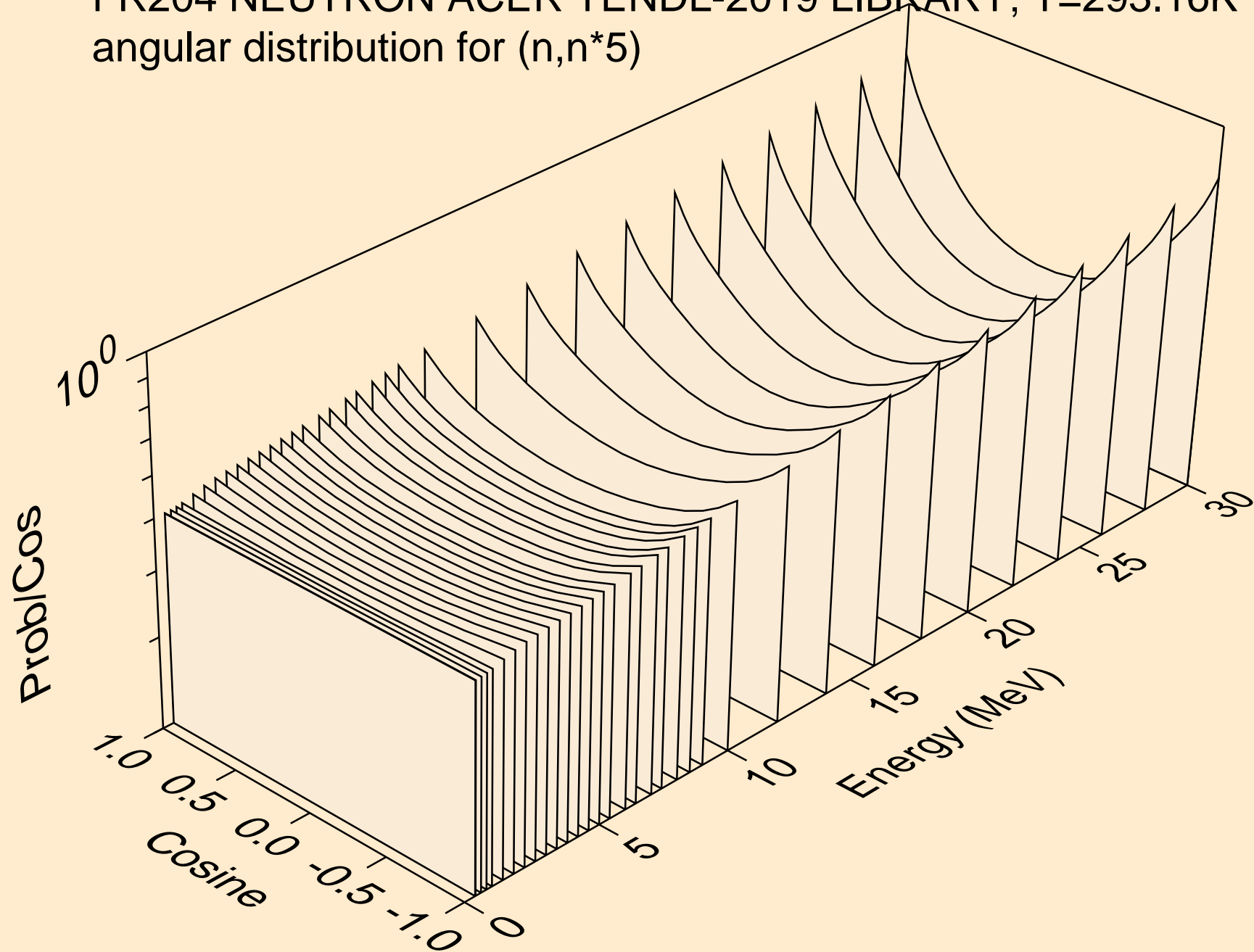

FR204 NEUTRON ACER TENDL-2019 LIBRARY; T=293.16K
angular distribution for (n,n*6)

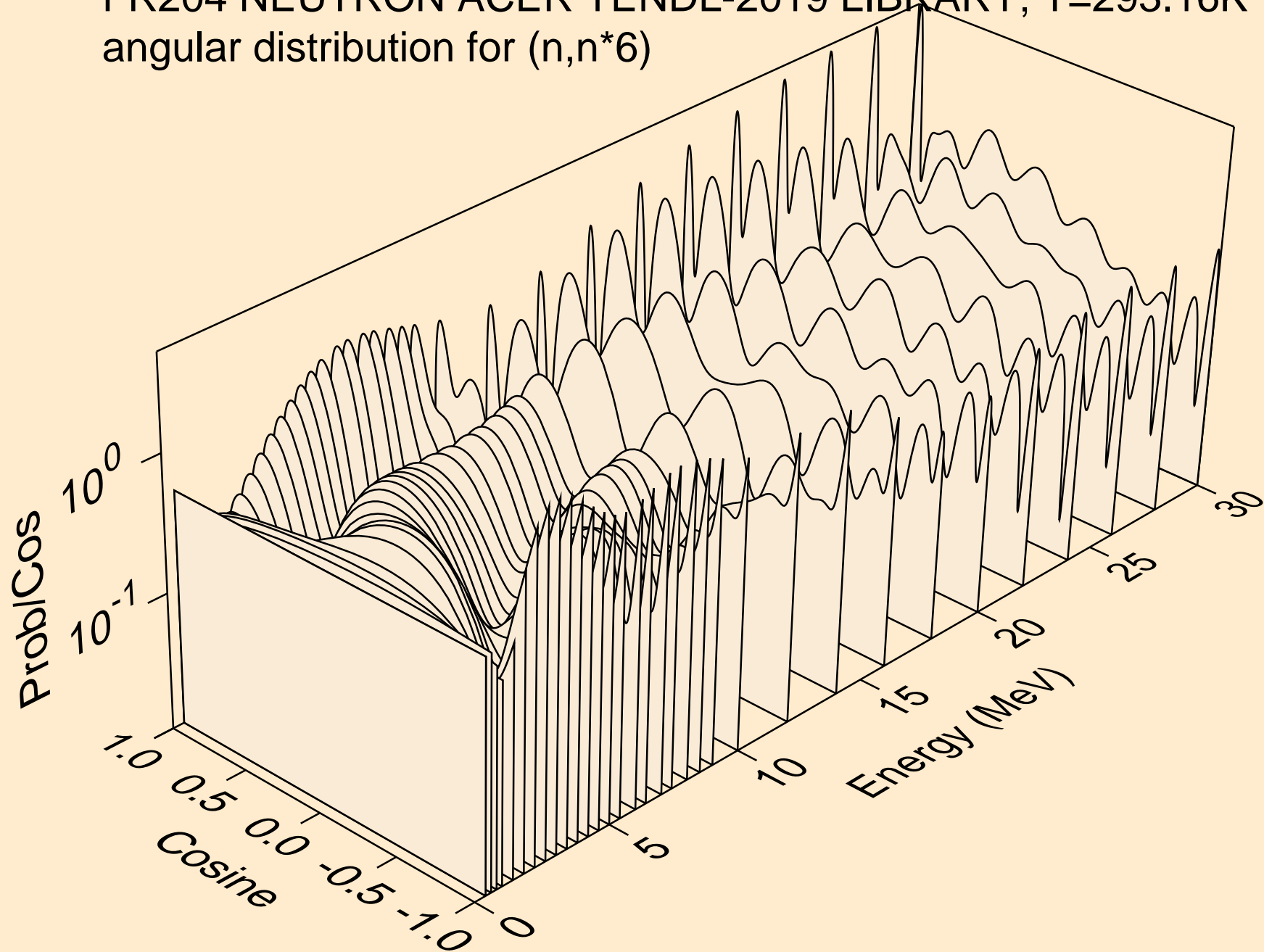

FR204 NEUTRON ACER TENDL-2019 LIBRARY; T=293.16K
angular distribution for (n,n*7)

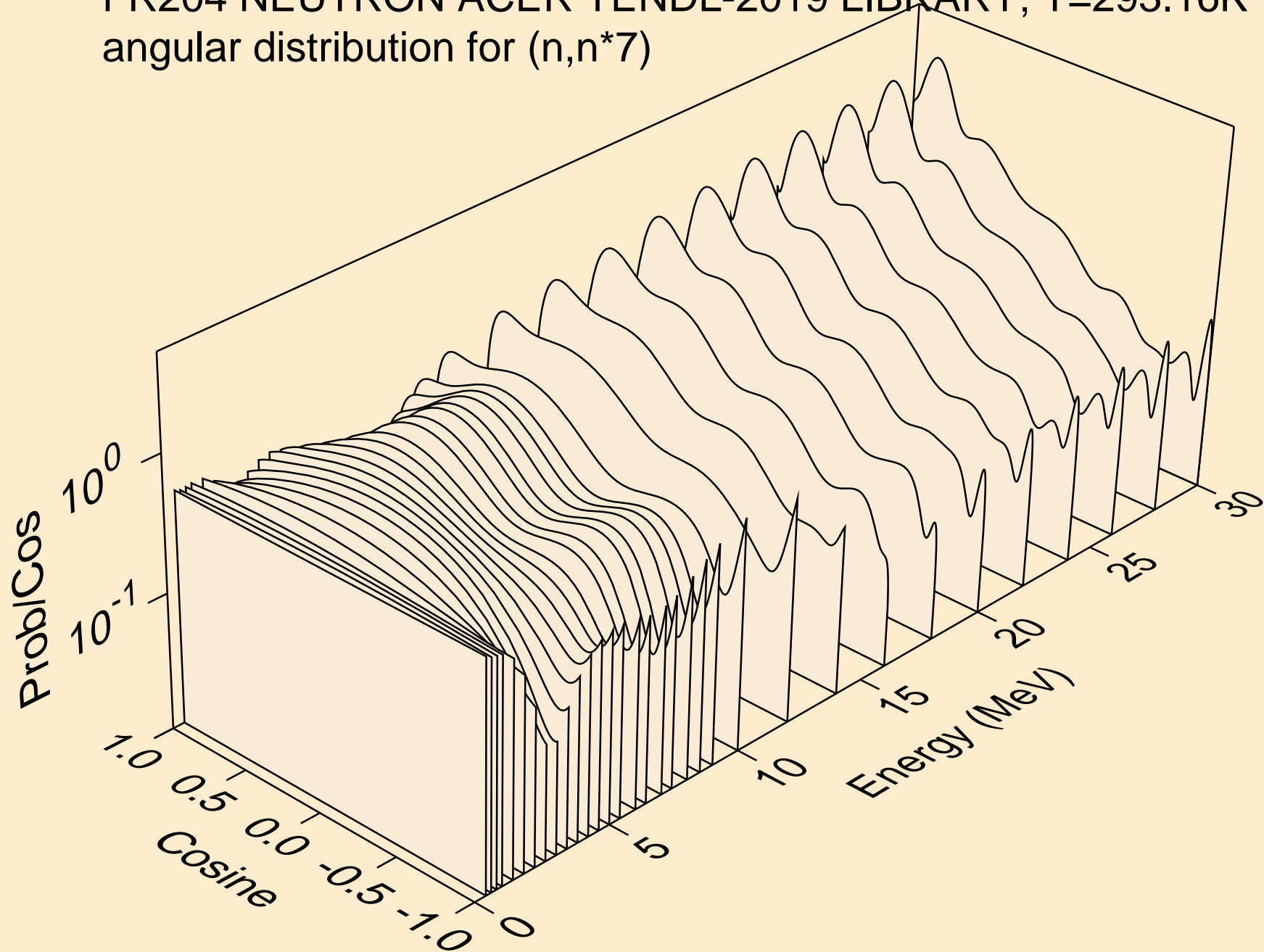

FR204 NEUTRON ACER TENDL-2019 LIBRARY; T=293.16K
angular distribution for (n,n*8)

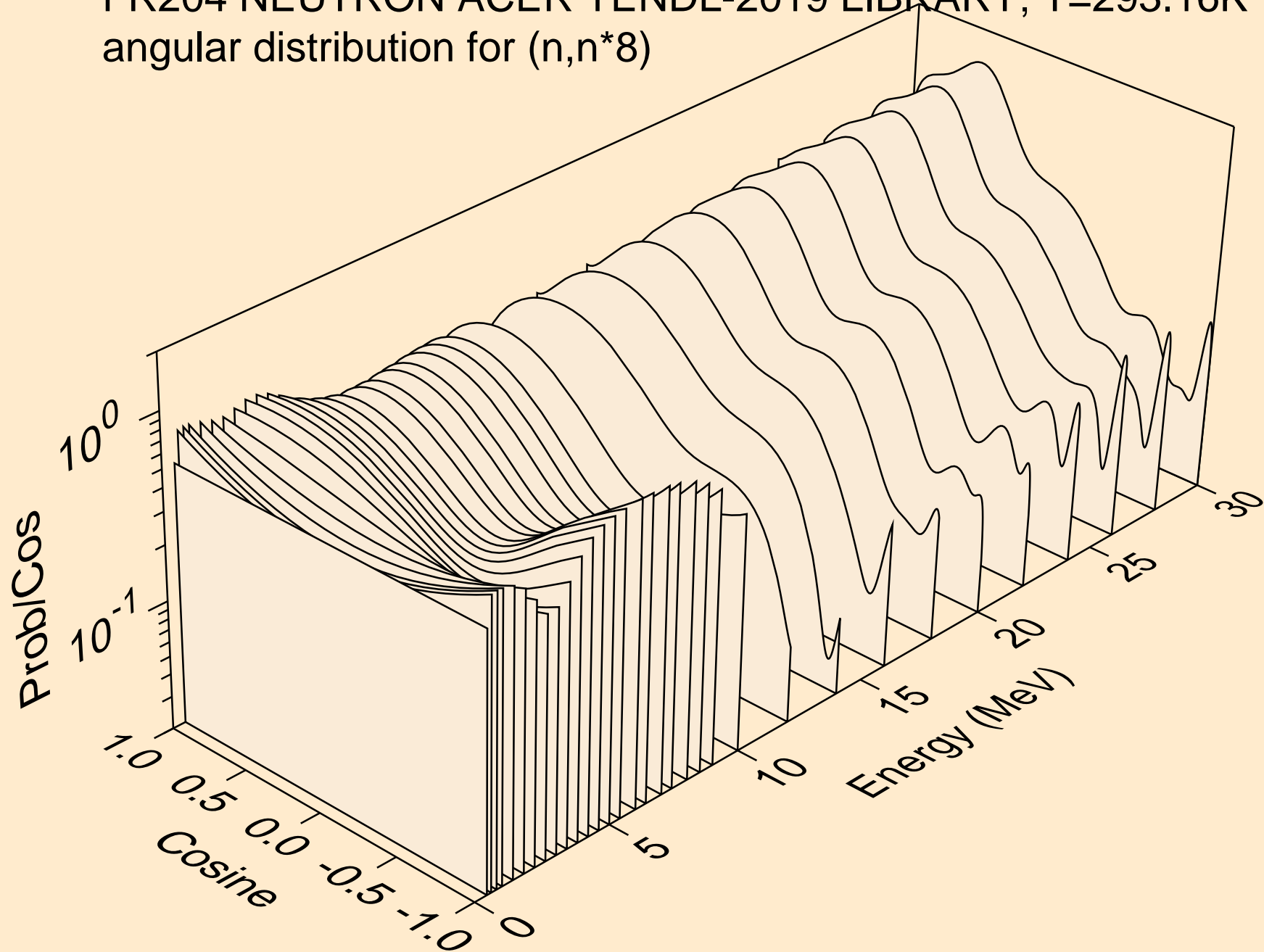

FR204 NEUTRON ACER TENDL-2019 LIBRARY; T=293.16K
angular distribution for (n,n*9)

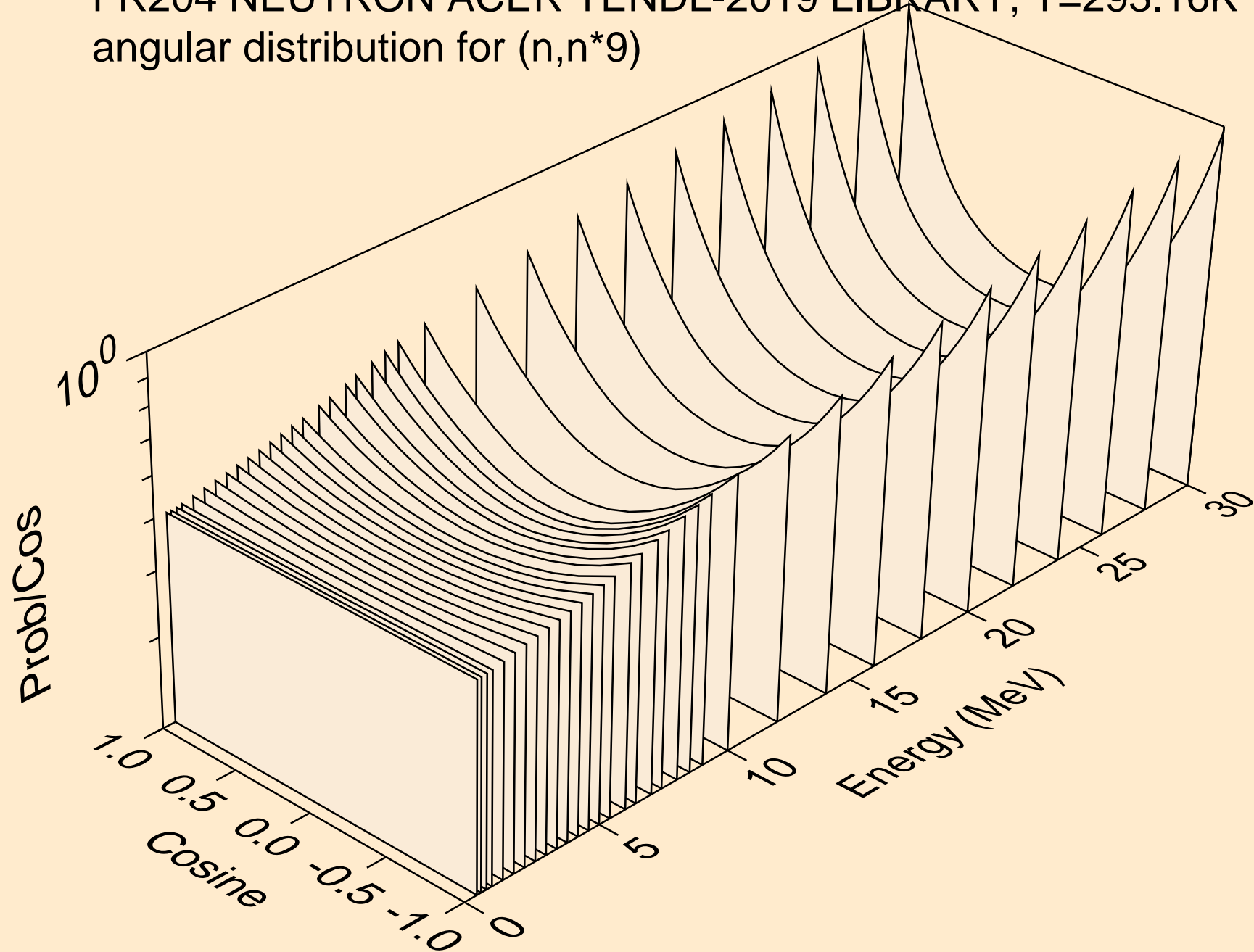

FR204 NEUTRON ACER TENDL-2019 LIBRARY; T=293.16K
angular distribution for (n,n*10)

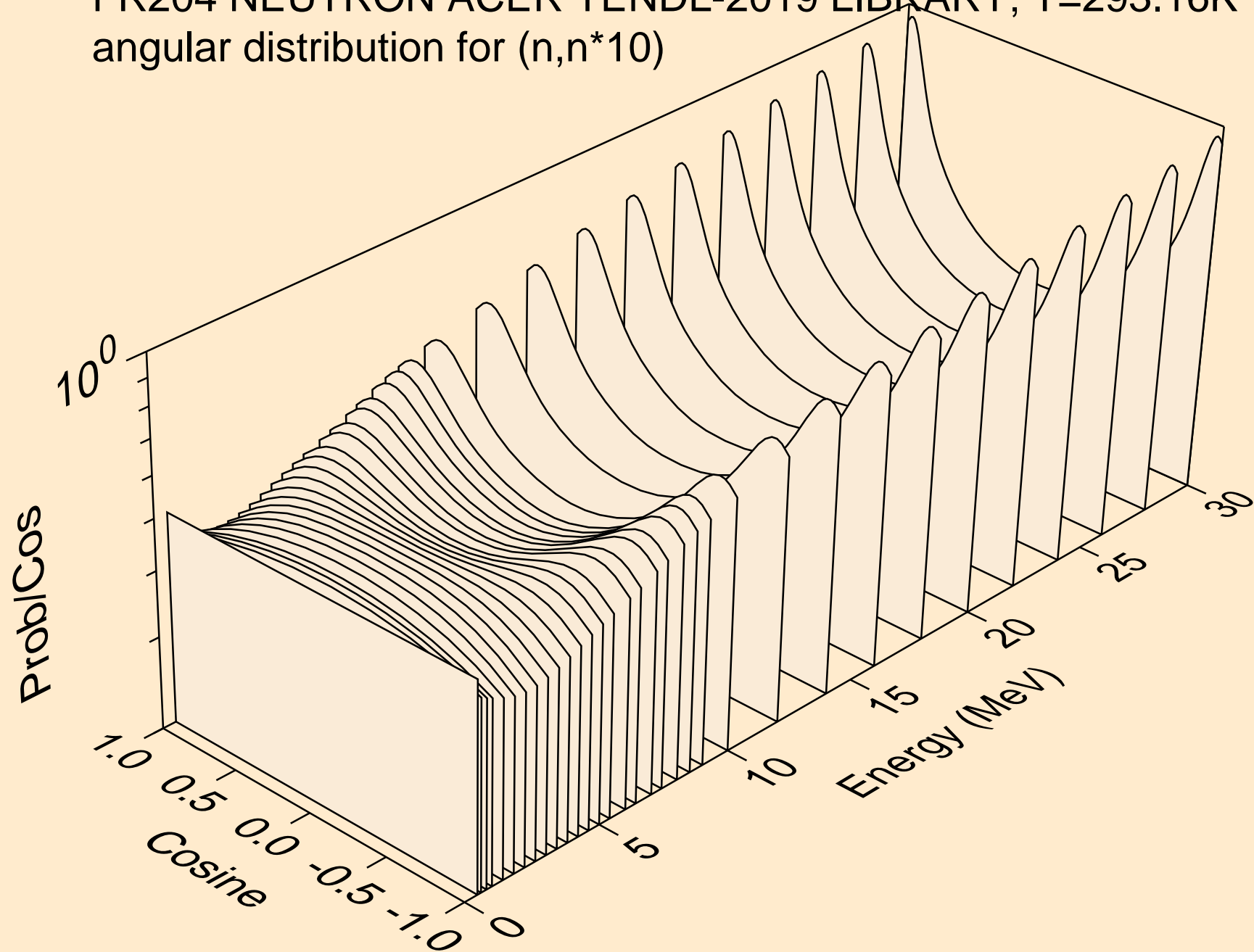

FR204 NEUTRON ACER TENDL-2019 LIBRARY; T=293.16K
angular distribution for (n,n*11)

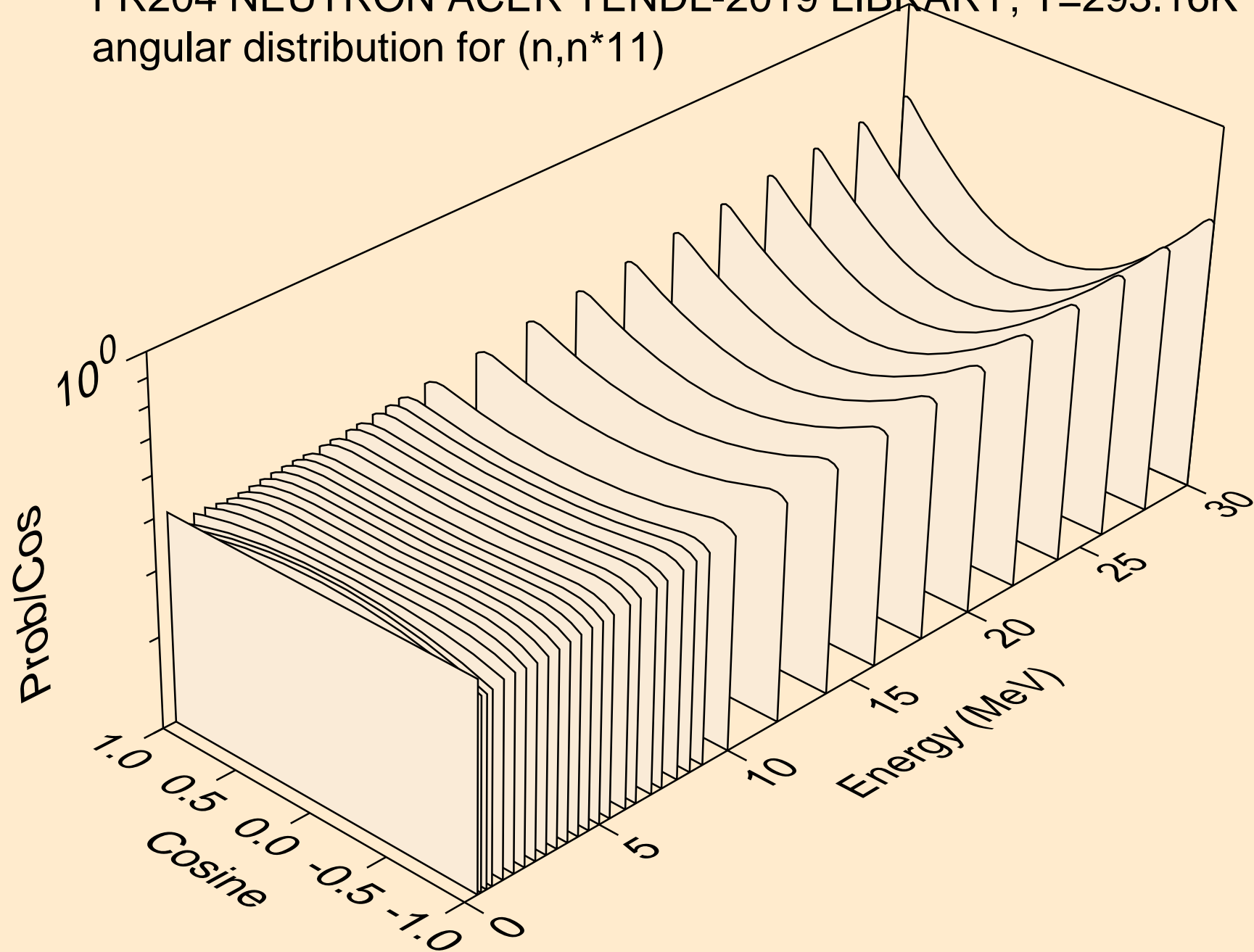

FR204 NEUTRON ACER TENDL-2019 LIBRARY; T=293.16K
angular distribution for (n,n*12)

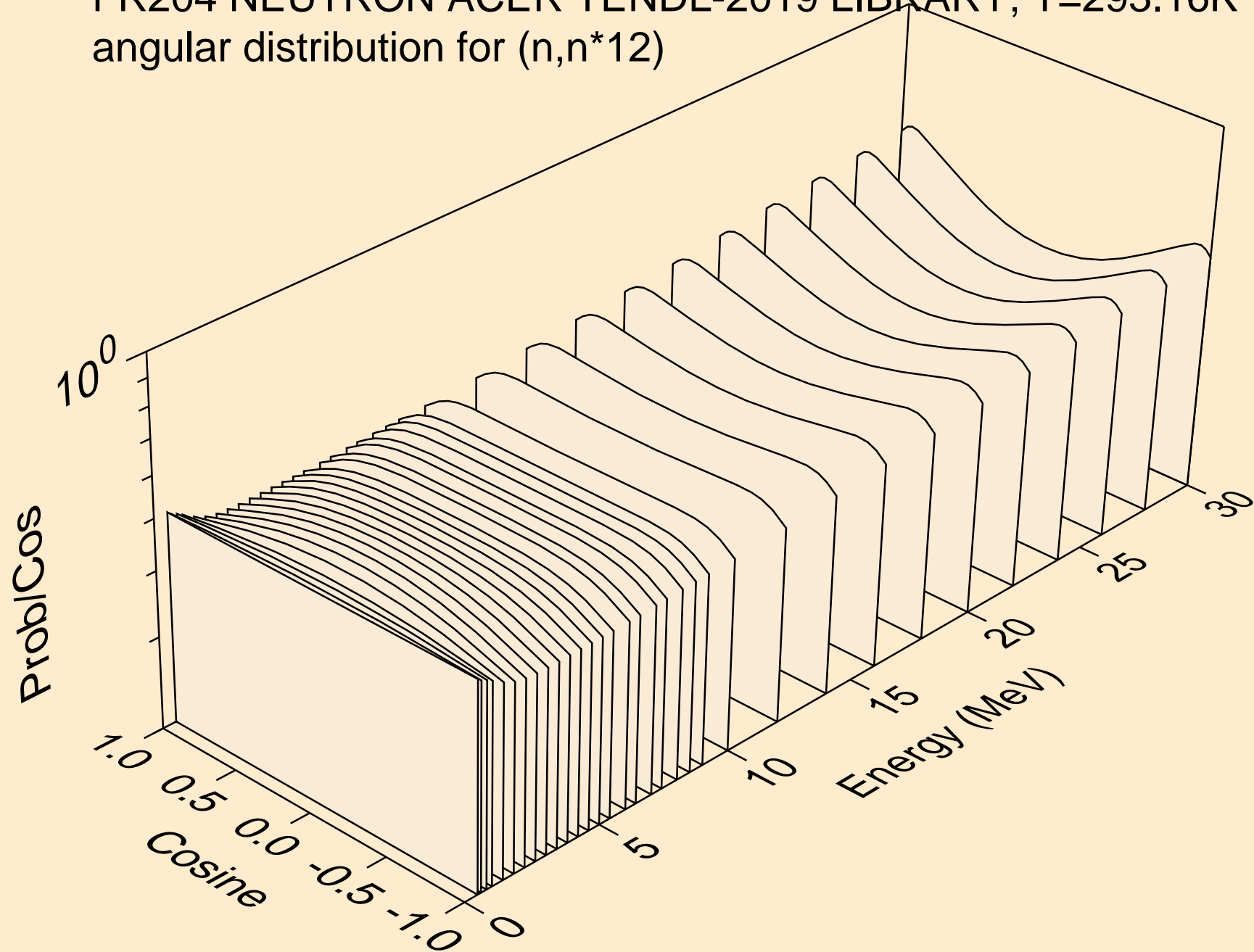

FR204 NEUTRON ACER TENDL-2019 LIBRARY; T=293.16K
angular distribution for (n,n*13)

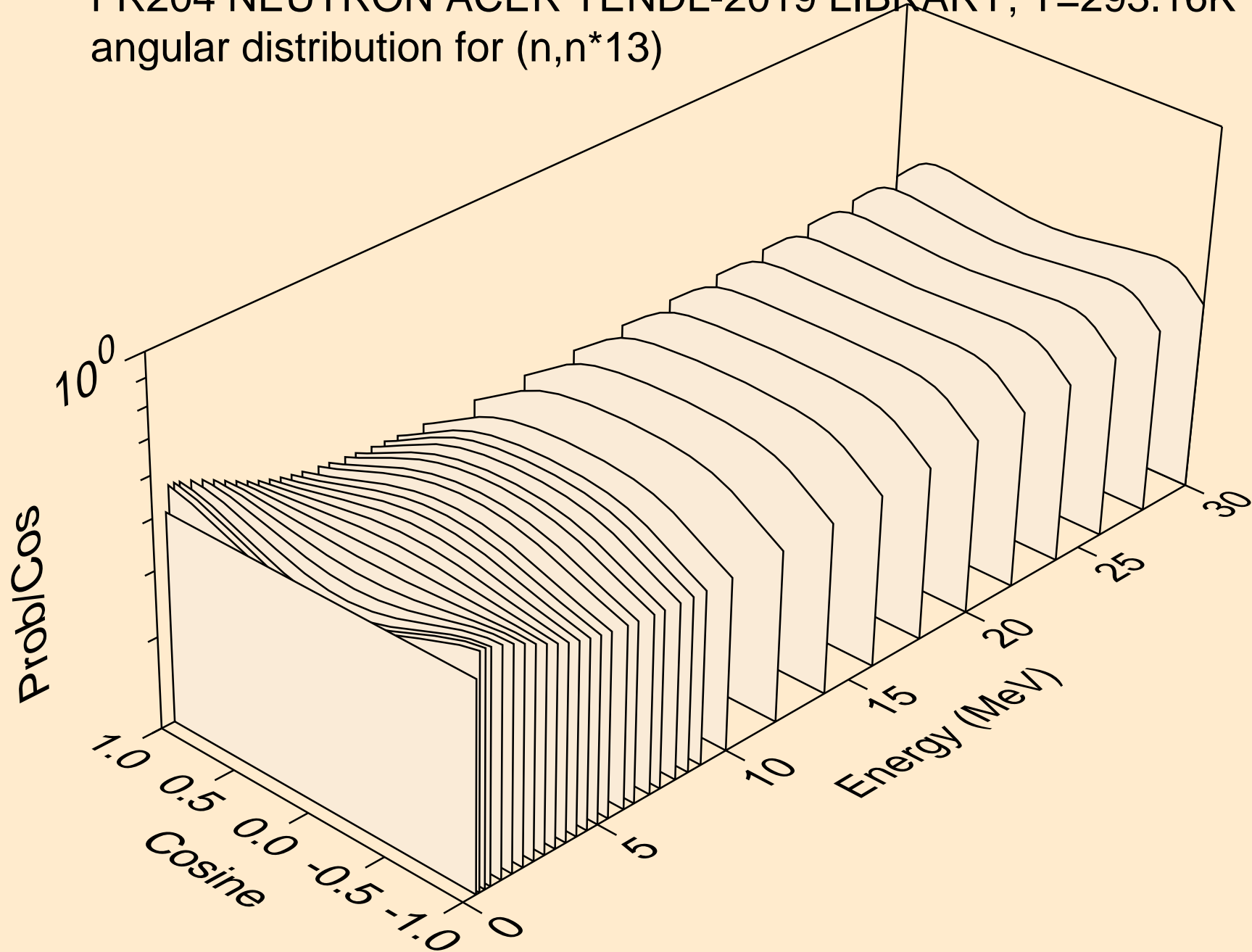

FR204 NEUTRON ACER TENDL-2019 LIBRARY; T=293.16K
angular distribution for (n,n*14)

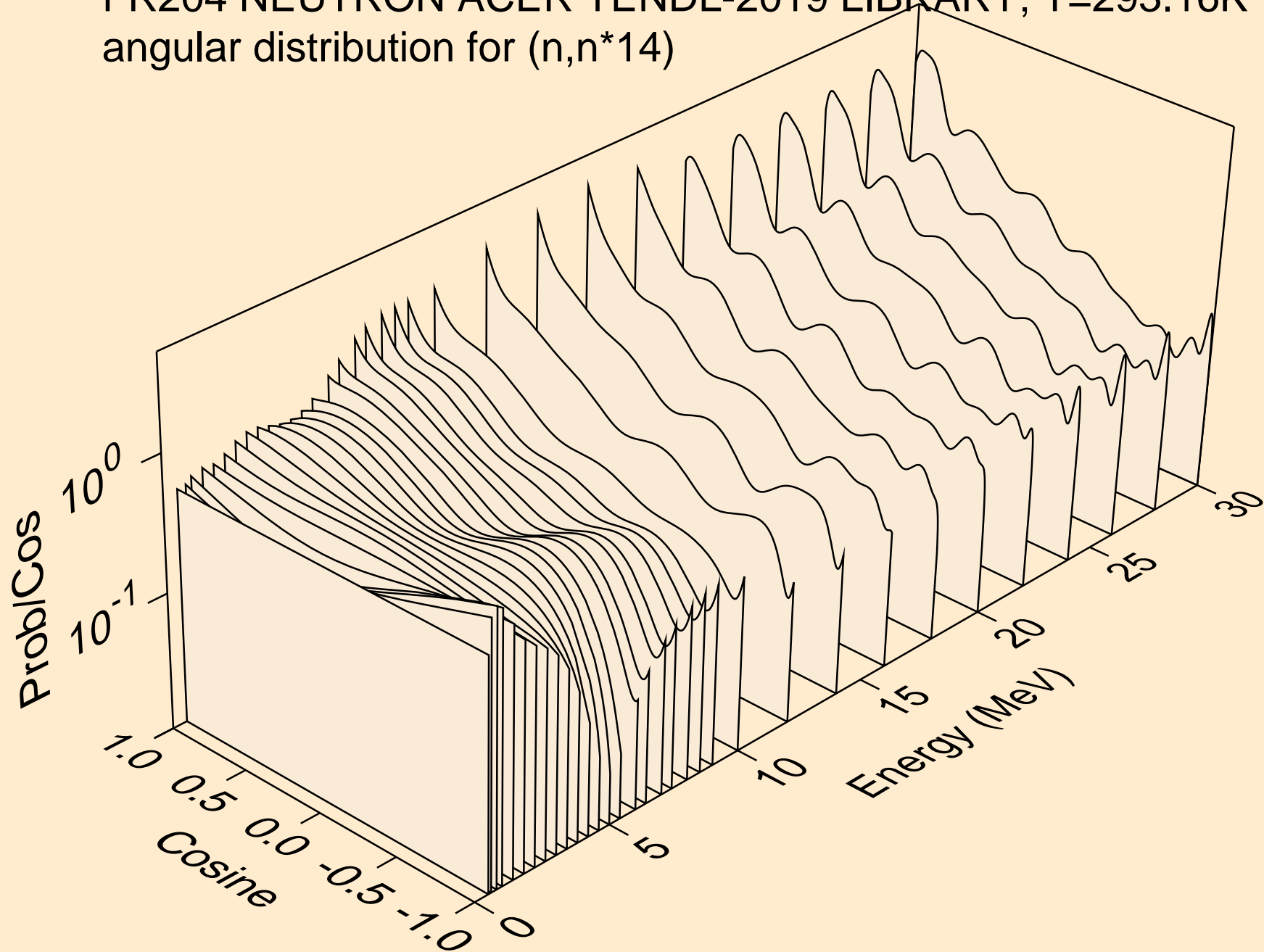

FR204 NEUTRON ACER TENDL-2019 LIBRARY; T=293.16K
angular distribution for (n,n*15)

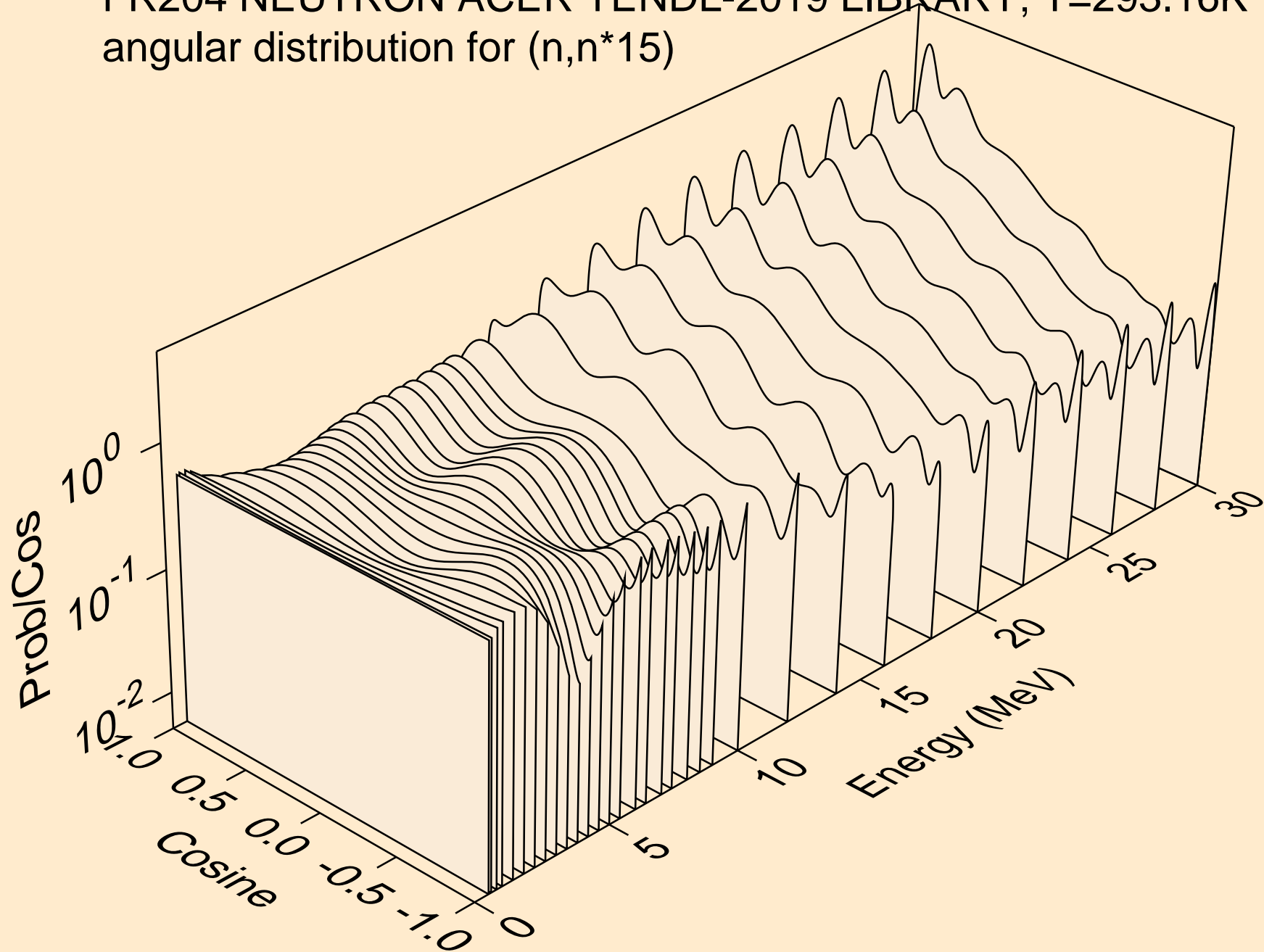

FR204 NEUTRON ACER TENDL-2019 LIBRARY; T=293.16K
angular distribution for (n,n*16)

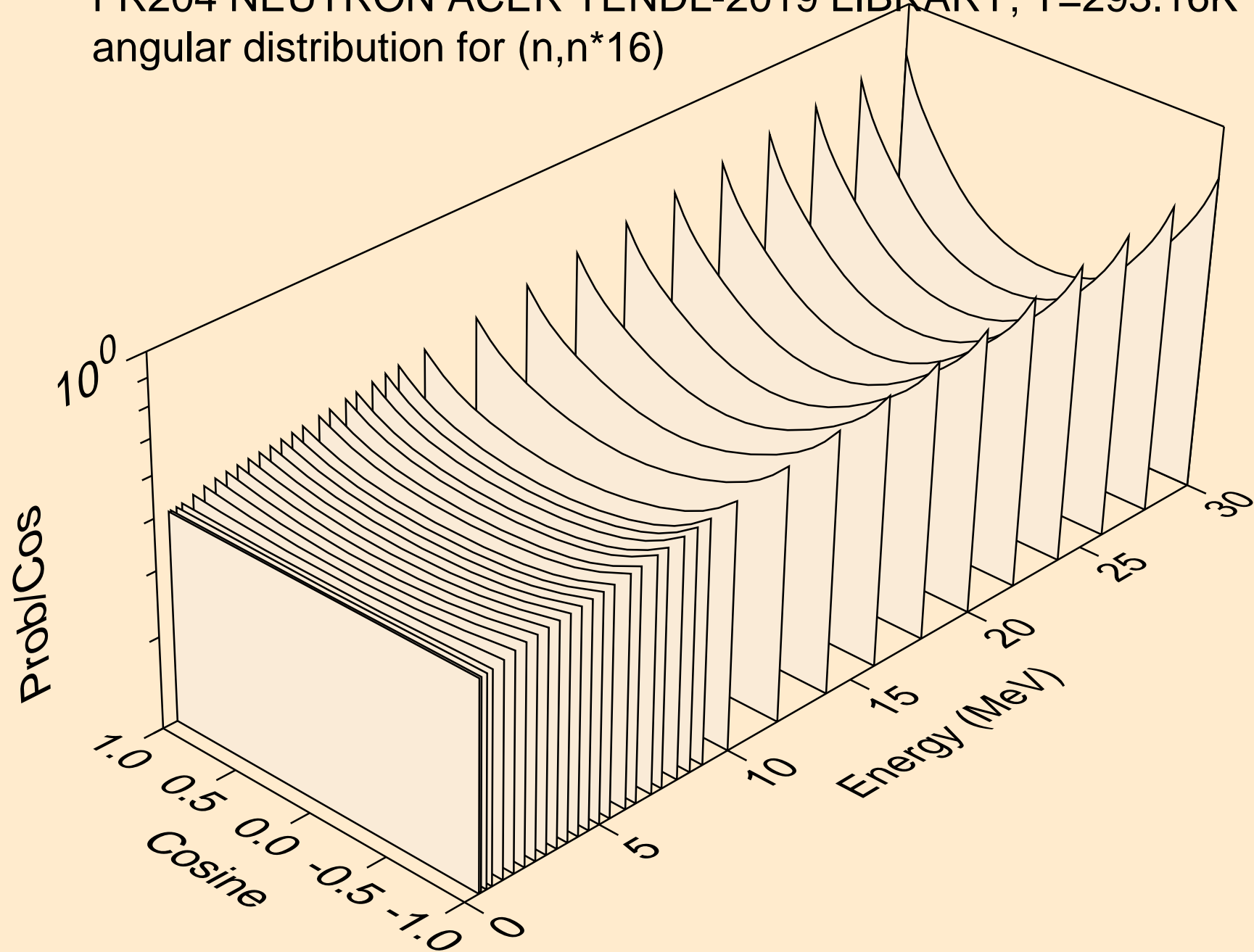

FR204 NEUTRON ACER TENDL-2019 LIBRARY; T=293.16K
angular distribution for (n,n*17)

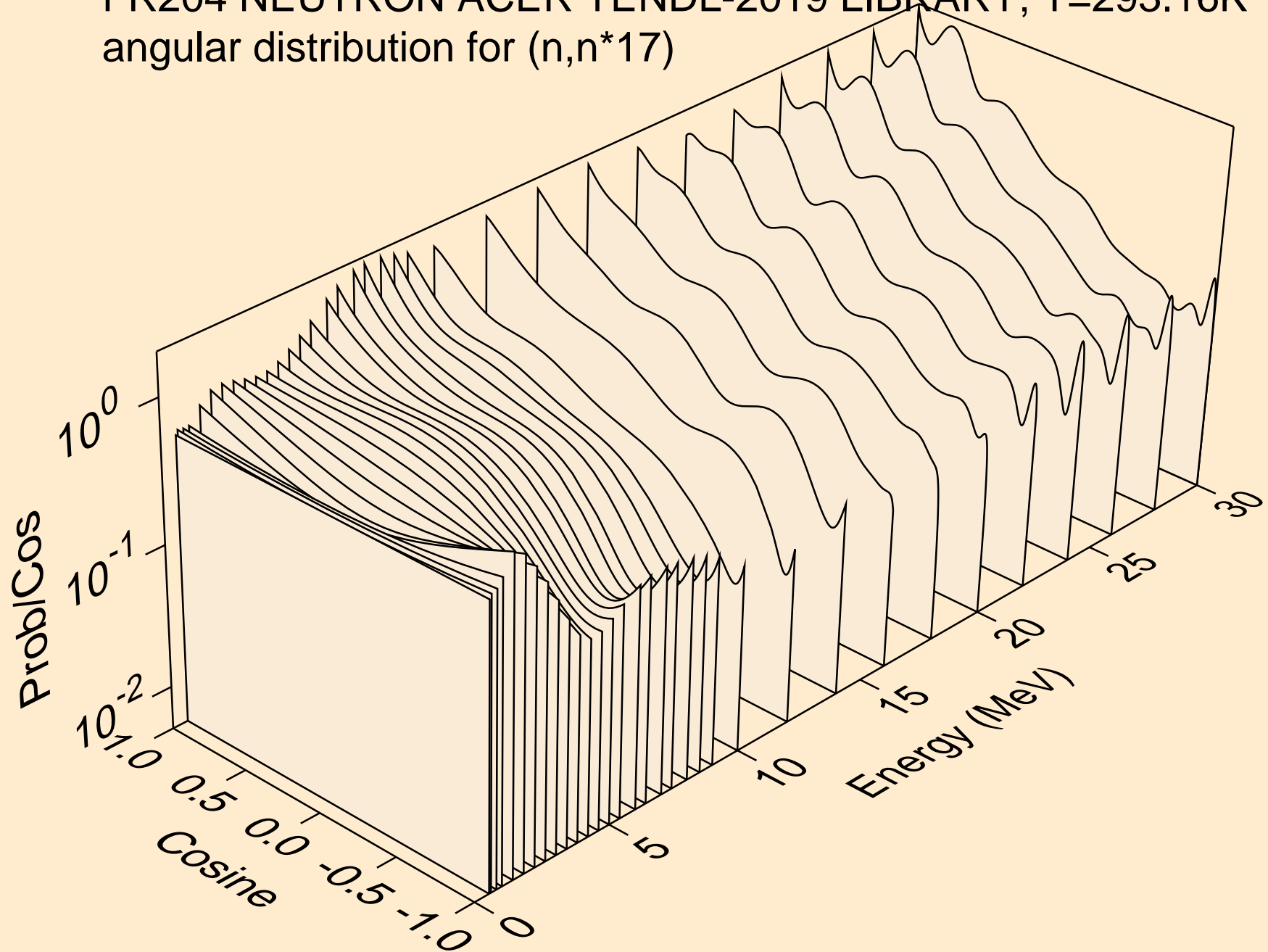

FR204 NEUTRON ACER TENDL-2019 LIBRARY; T=293.16K
angular distribution for (n,n*18)

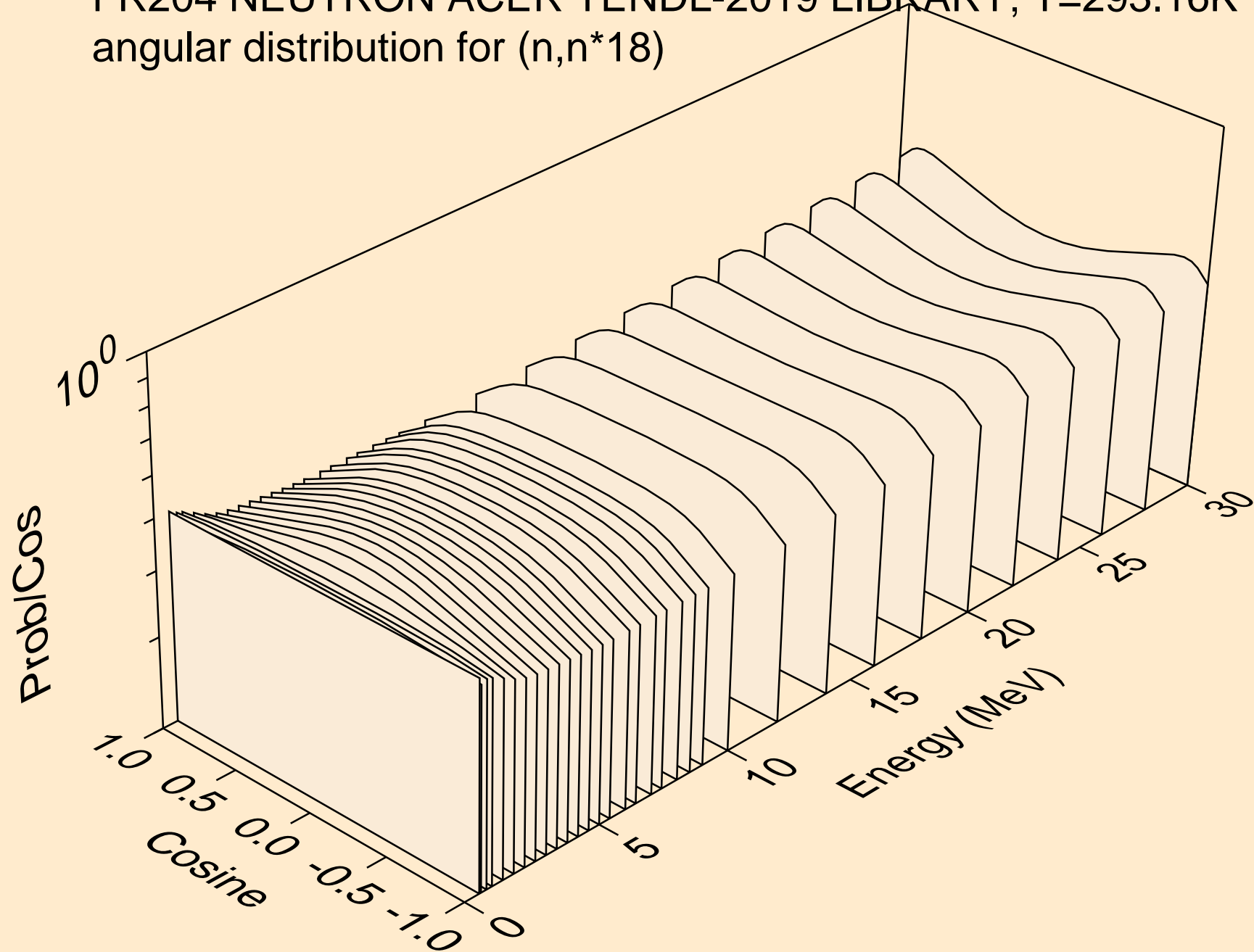

FR204 NEUTRON ACER TENDL-2019 LIBRARY; T=293.16K
angular distribution for (n,n*19)

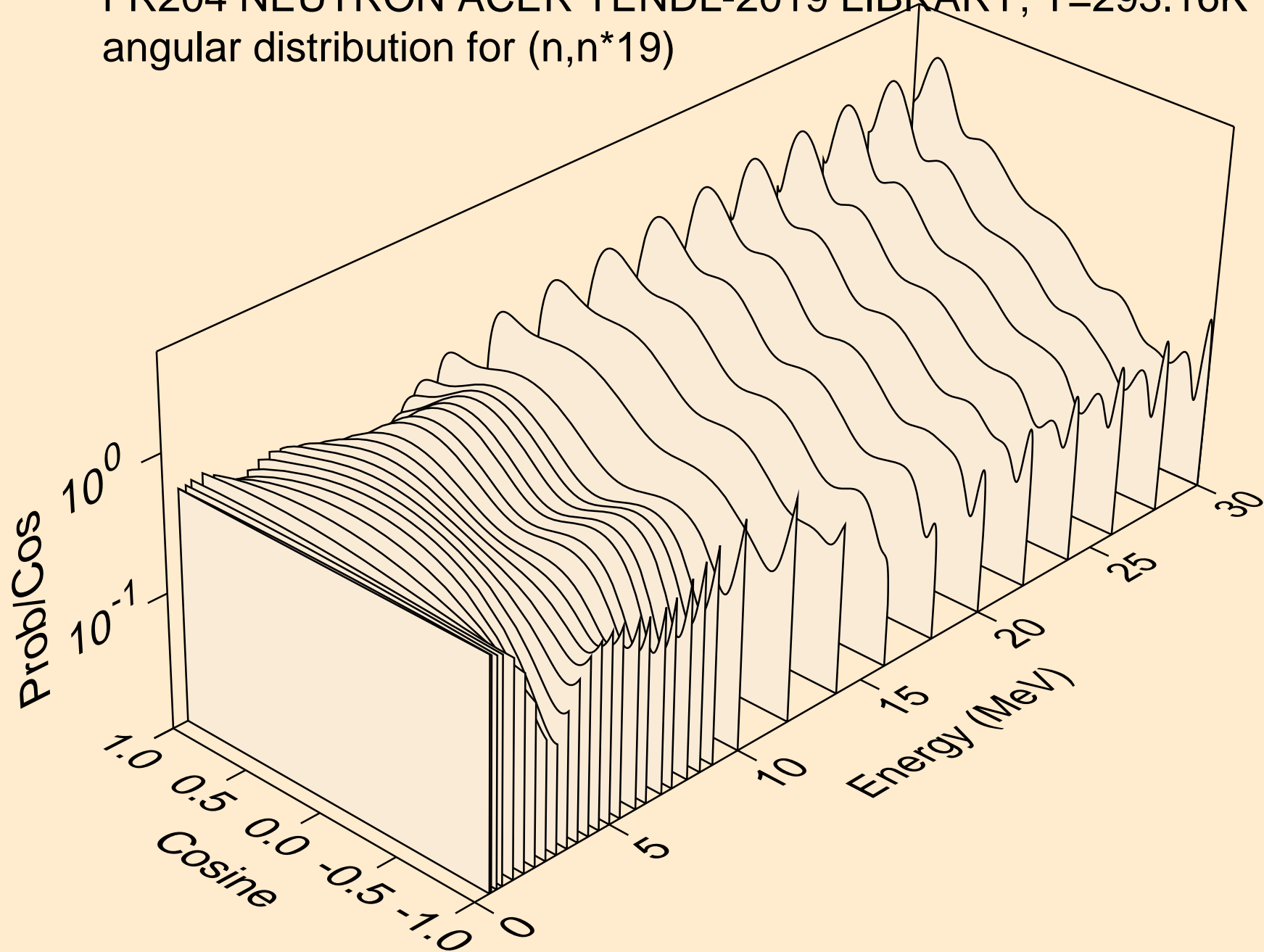

FR204 NEUTRON ACER TENDL-2019 LIBRARY; T=293.16K
angular distribution for (n,n*20)

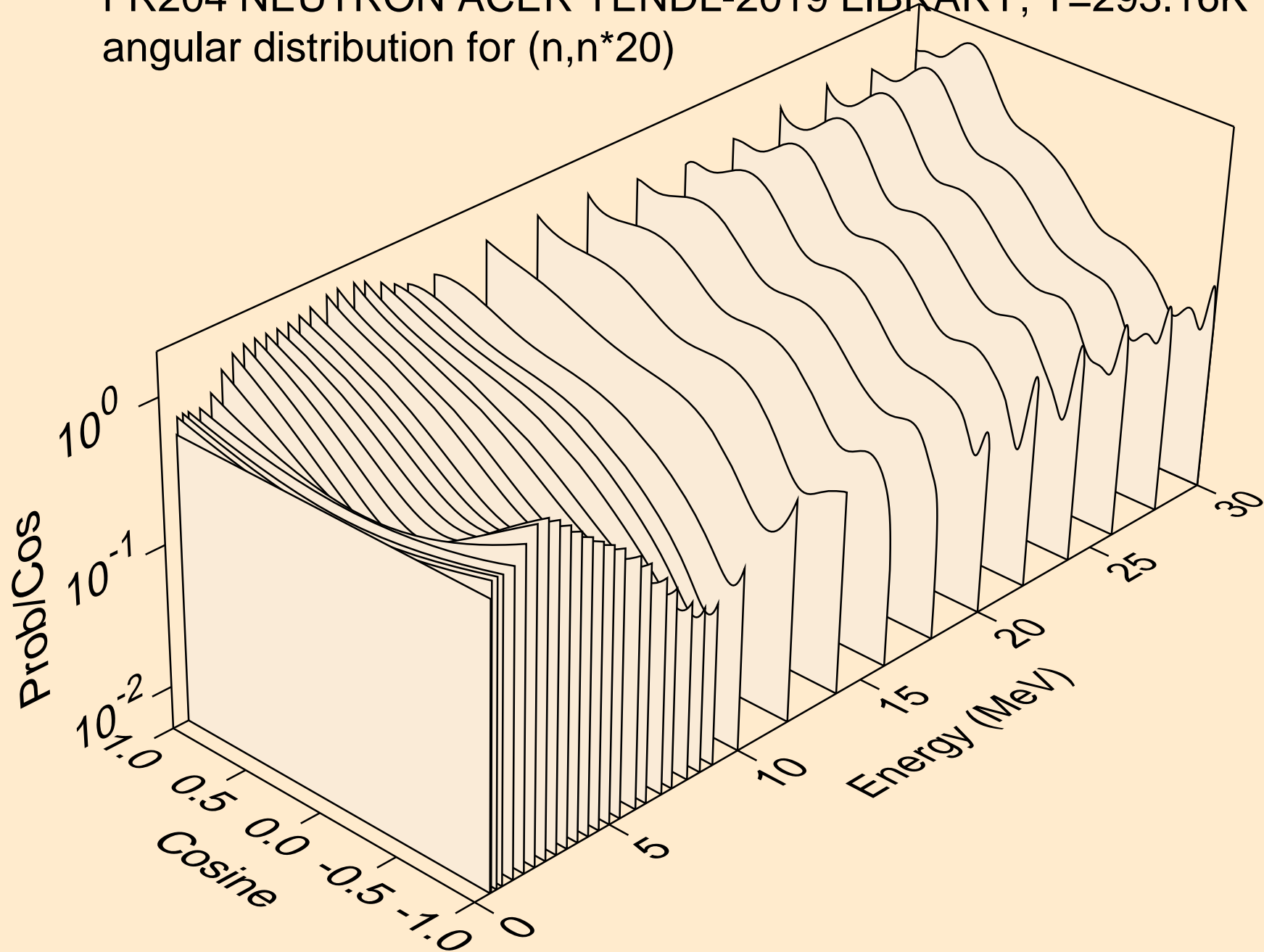

FR204 NEUTRON ACER TENDL-2019 LIBRARY; T=293.16K
angular distribution for (n,n*21)

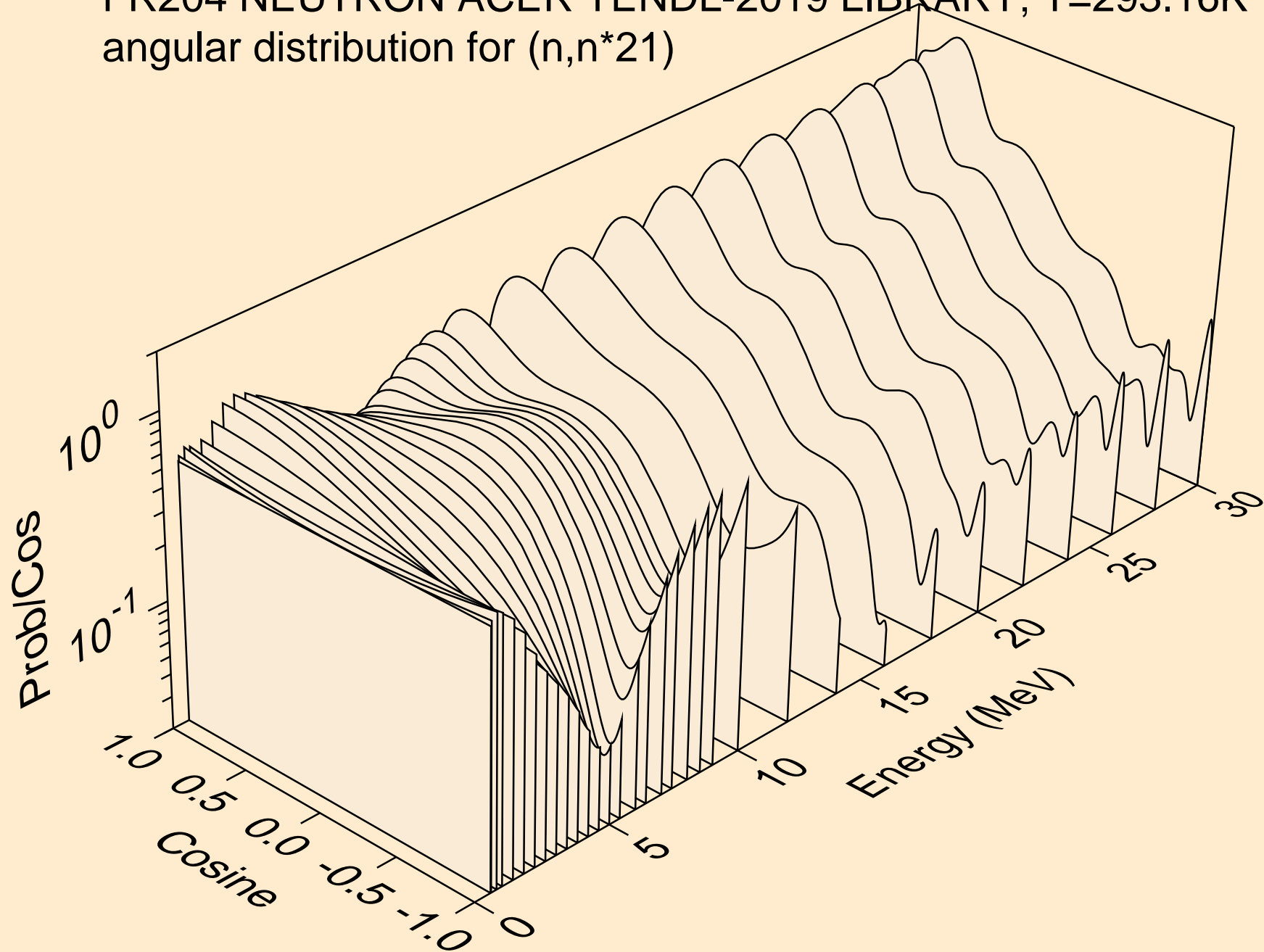

FR204 NEUTRON ACER TENDL-2019 LIBRARY; T=293.16K
angular distribution for (n,n*22)

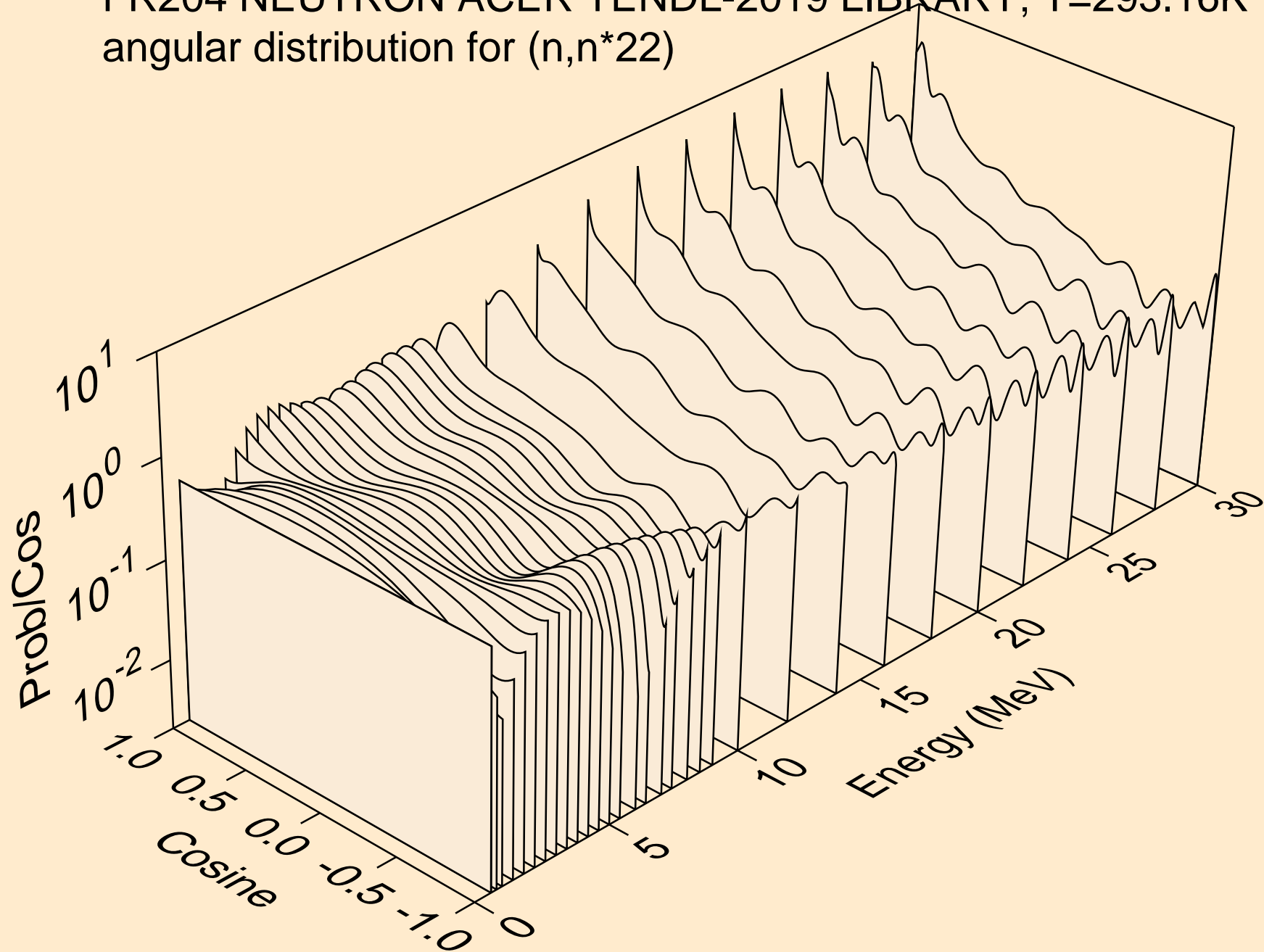

FR204 NEUTRON ACER TENDL-2019 LIBRARY; T=293.16K
Neutron emission for (n,x)

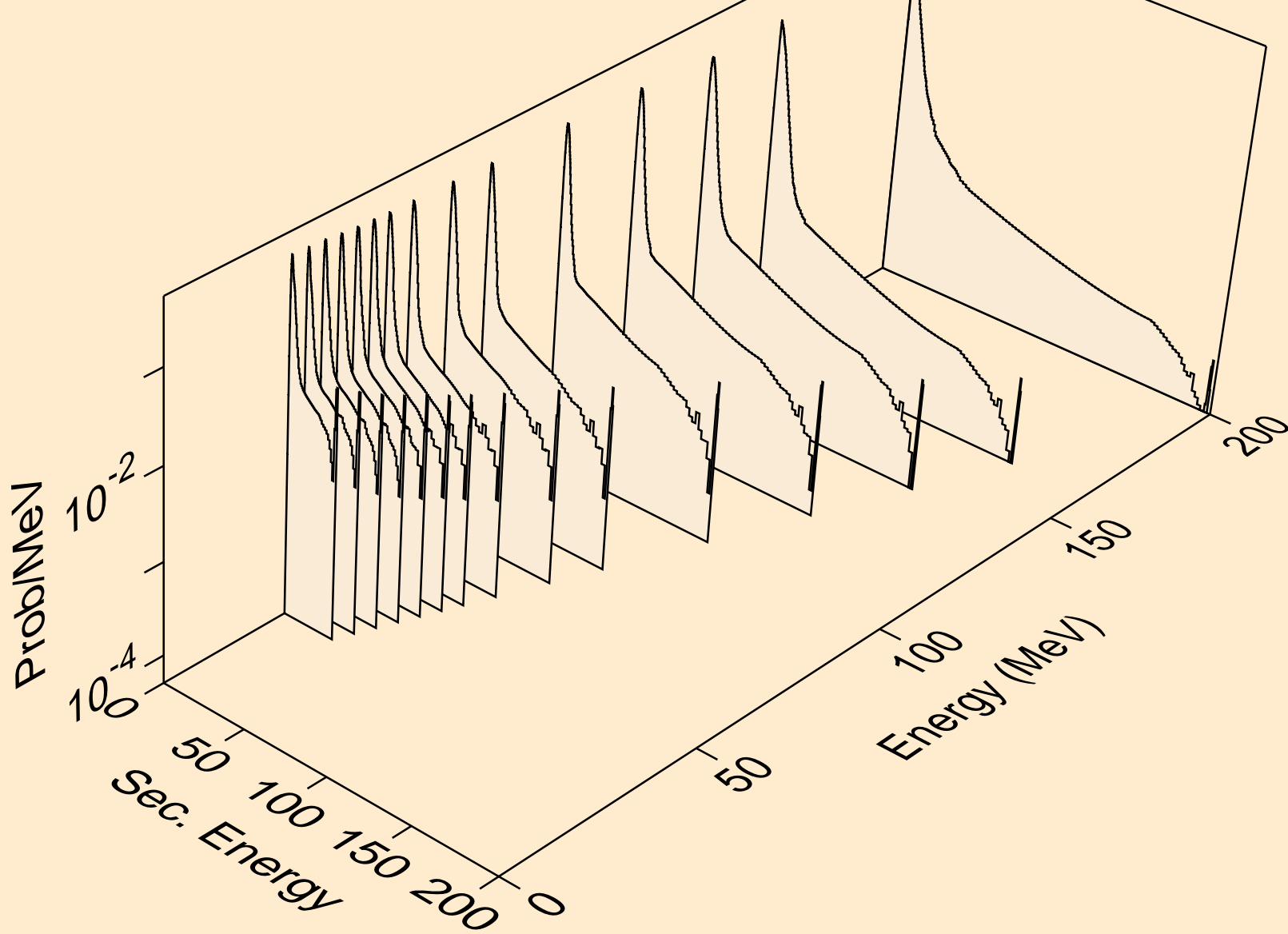

FR204 NEUTRON ACER TENDL-2019 LIBRARY; T=293.16K
Neutron emission for (n,2nd)

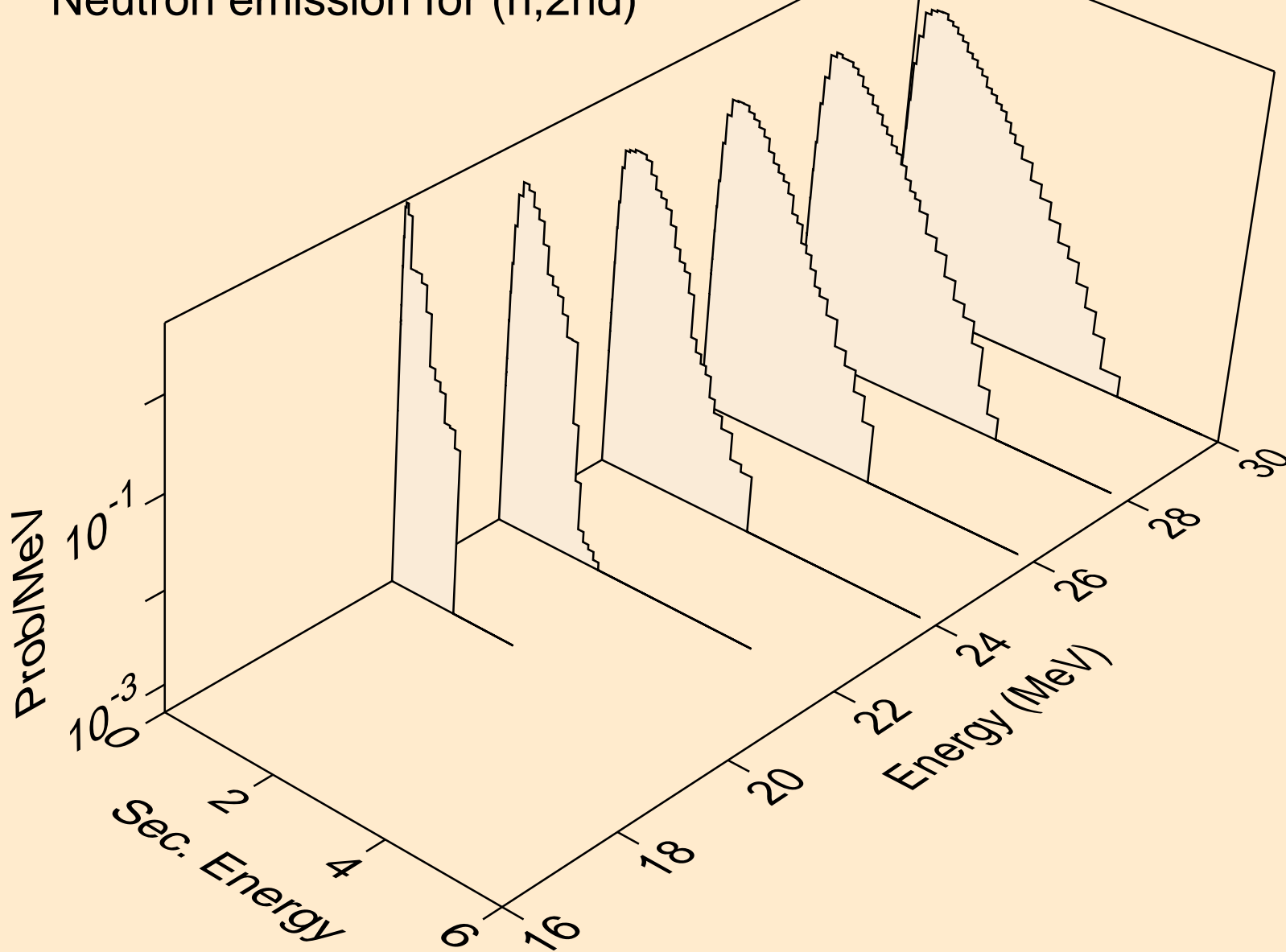

FR204 NEUTRON ACER TENDL-2019 LIBRARY; T=293.16K
Neutron emission for (n,2n)

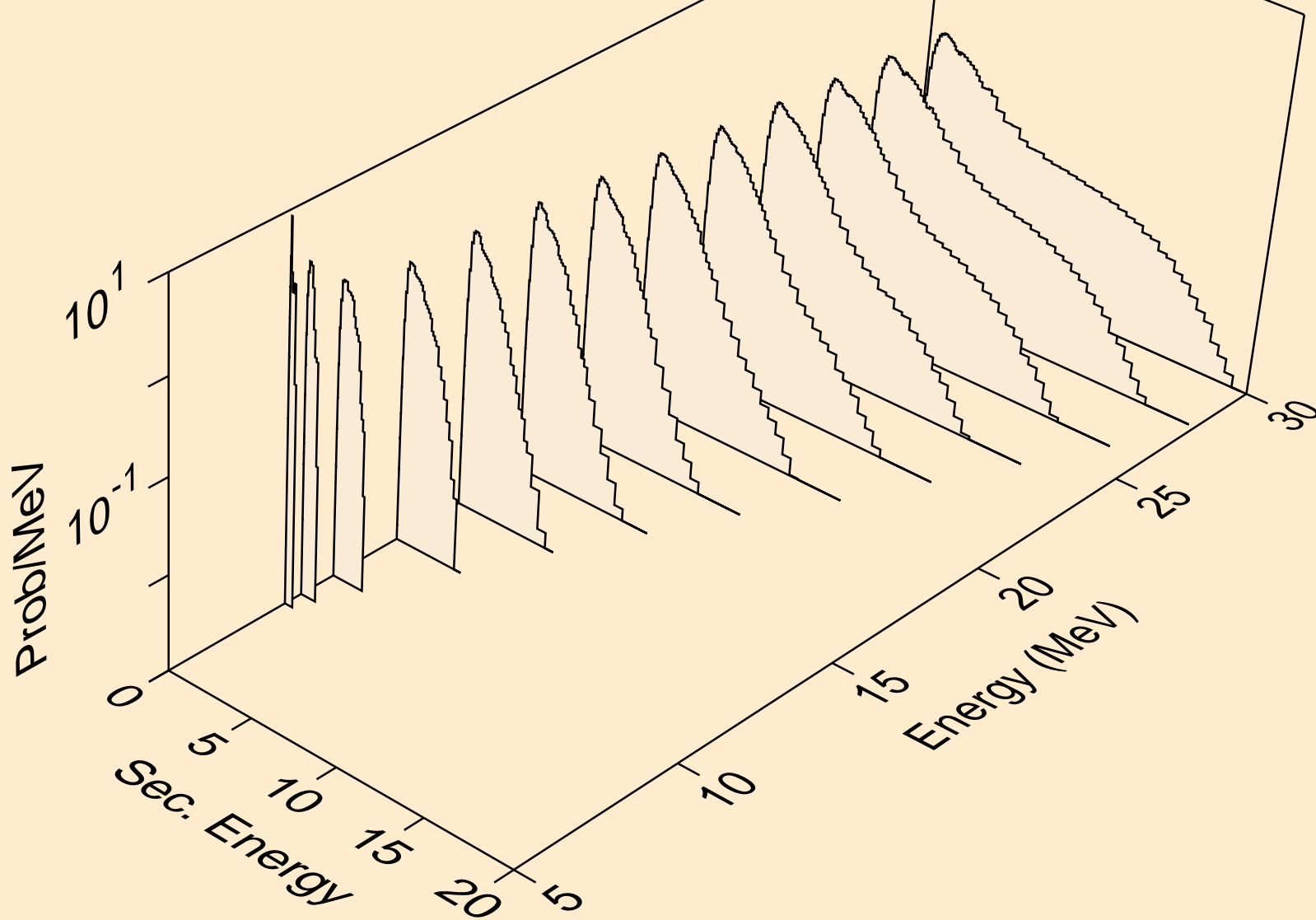

FR204 NEUTRON ACER TENDL-2019 LIBRARY; T=293.16K
Neutron emission for (n,3n)

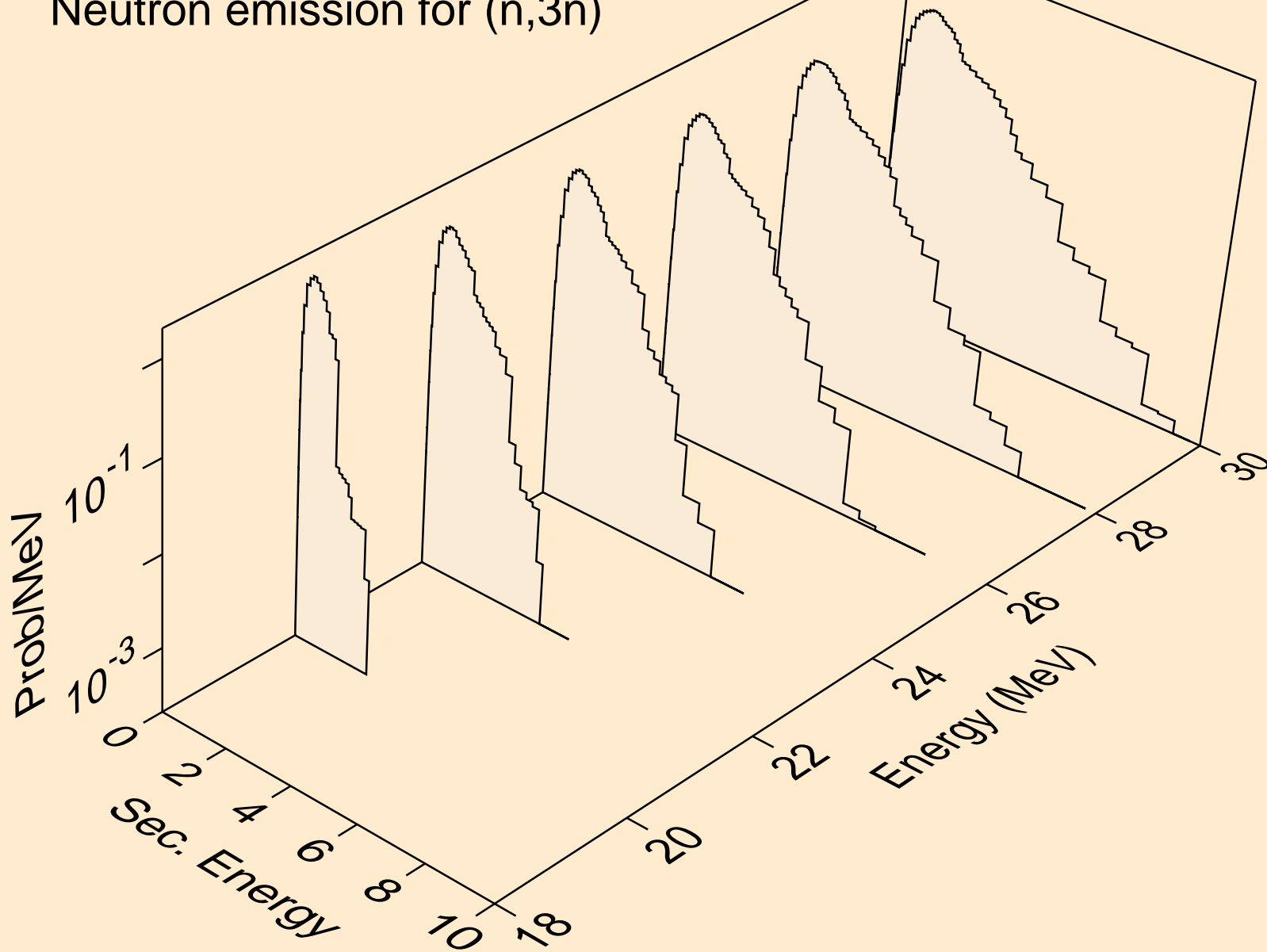

FR204 NEUTRON ACER TENDL-2019 LIBRARY; T=293.16K
Neutron emission for (n,n*)a

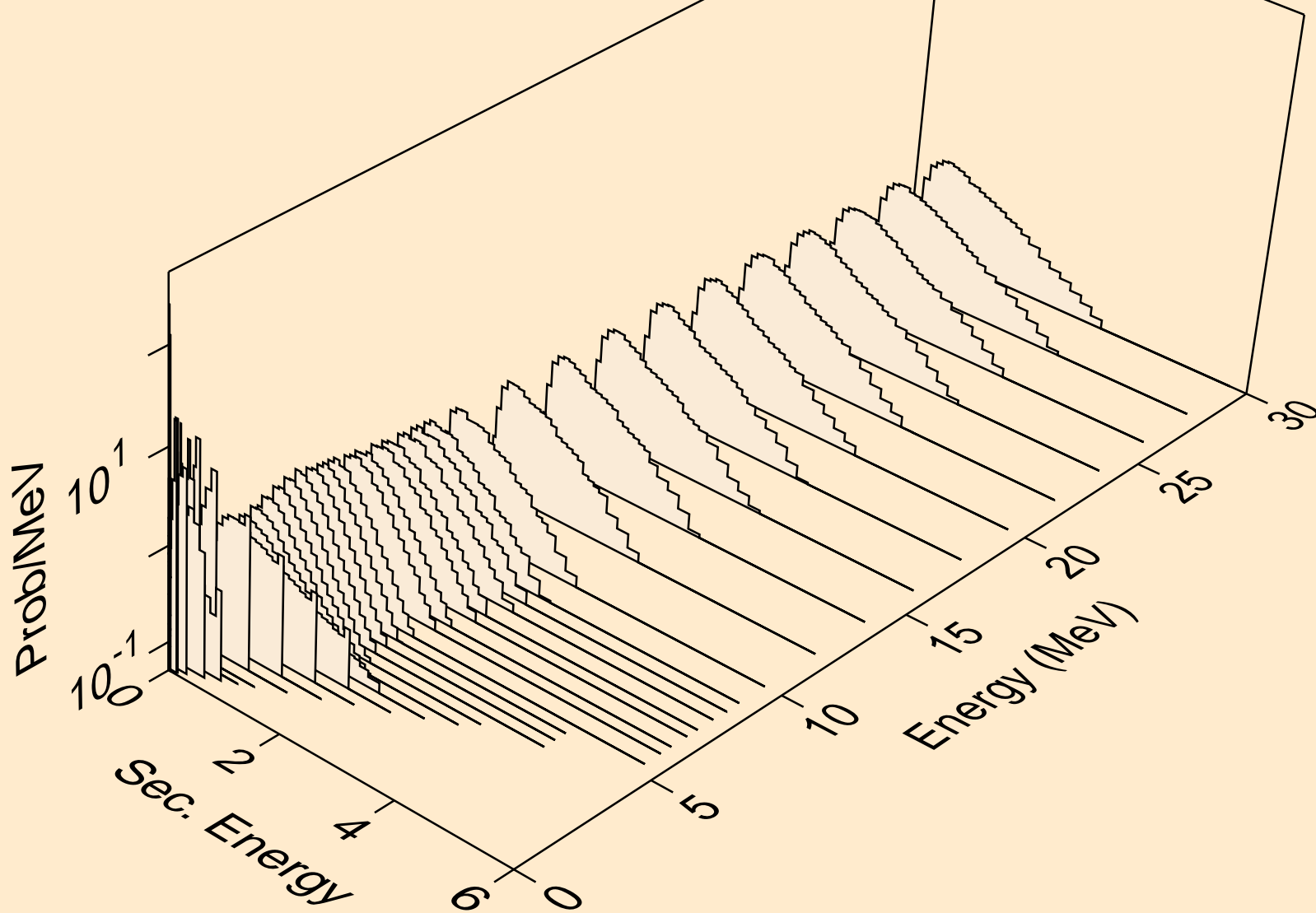

FR204 NEUTRON ACER TENDL-2019 LIBRARY; T=293.16K
Neutron emission for (n,2n)a

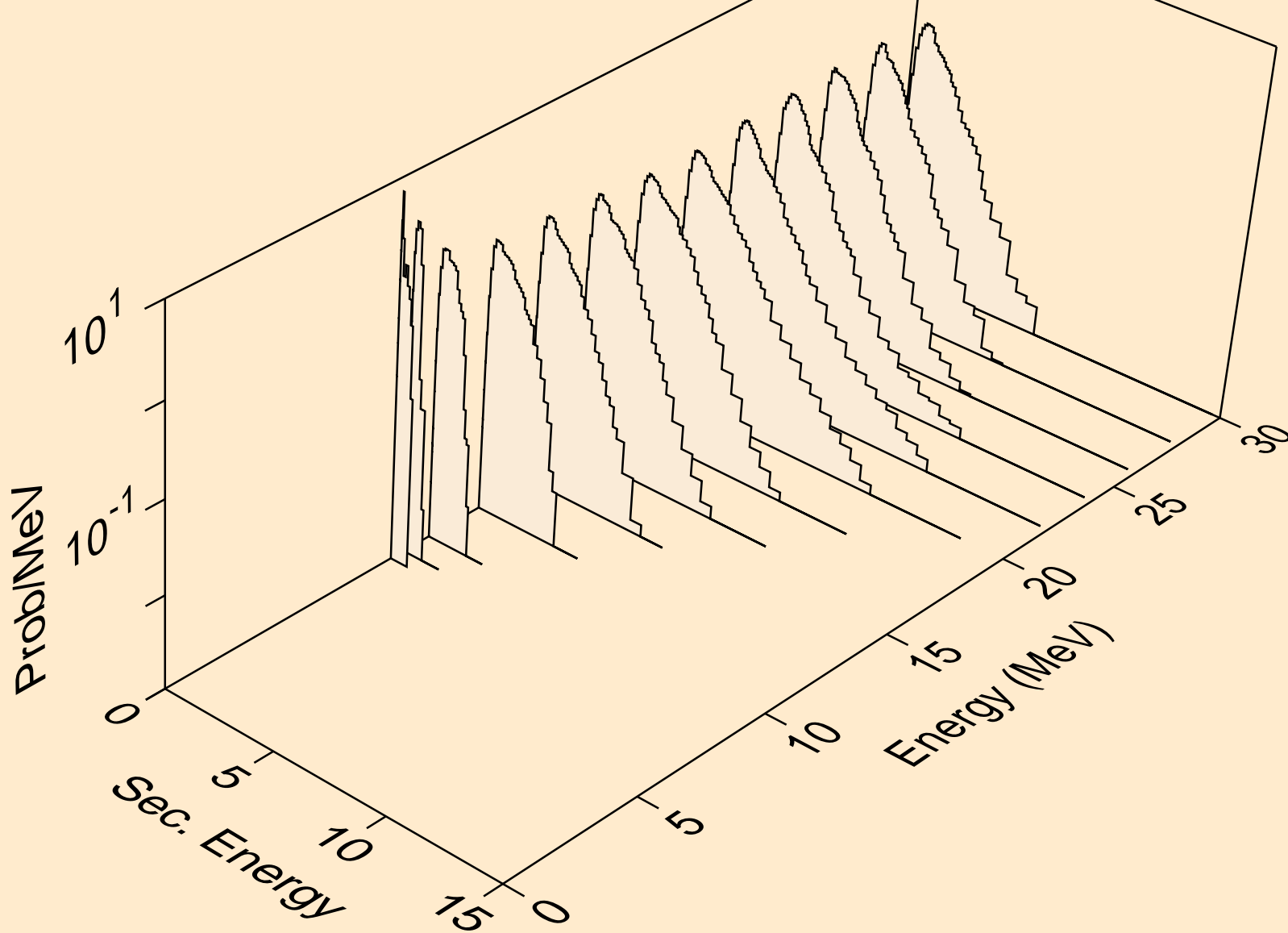

FR204 NEUTRON ACER TENDL-2019 LIBRARY; T=293.16K
Neutron emission for (n,3n)a

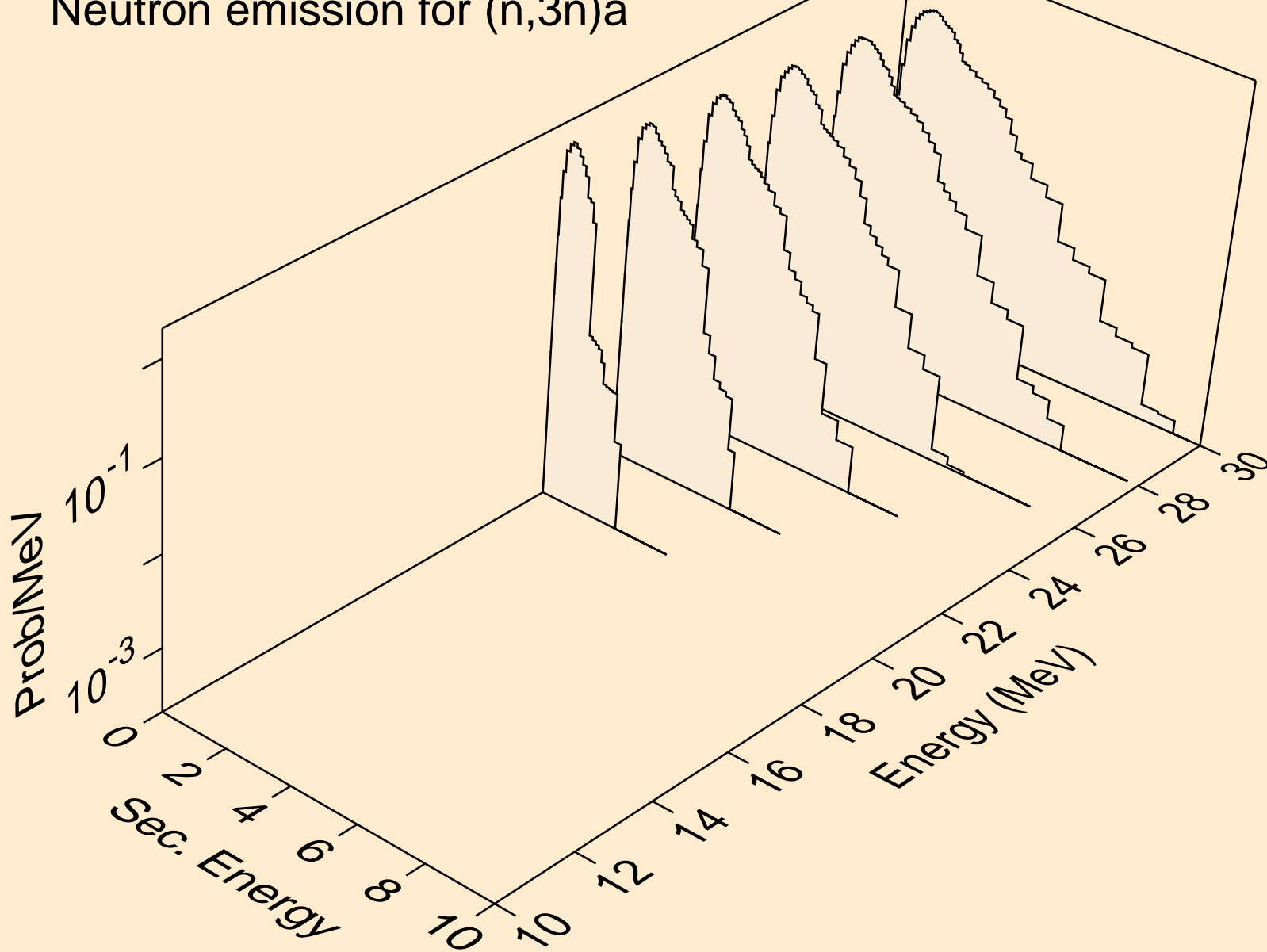

FR204 NEUTRON ACER TENDL-2019 LIBRARY; T=293.16K
Neutron emission for (n,n*)p

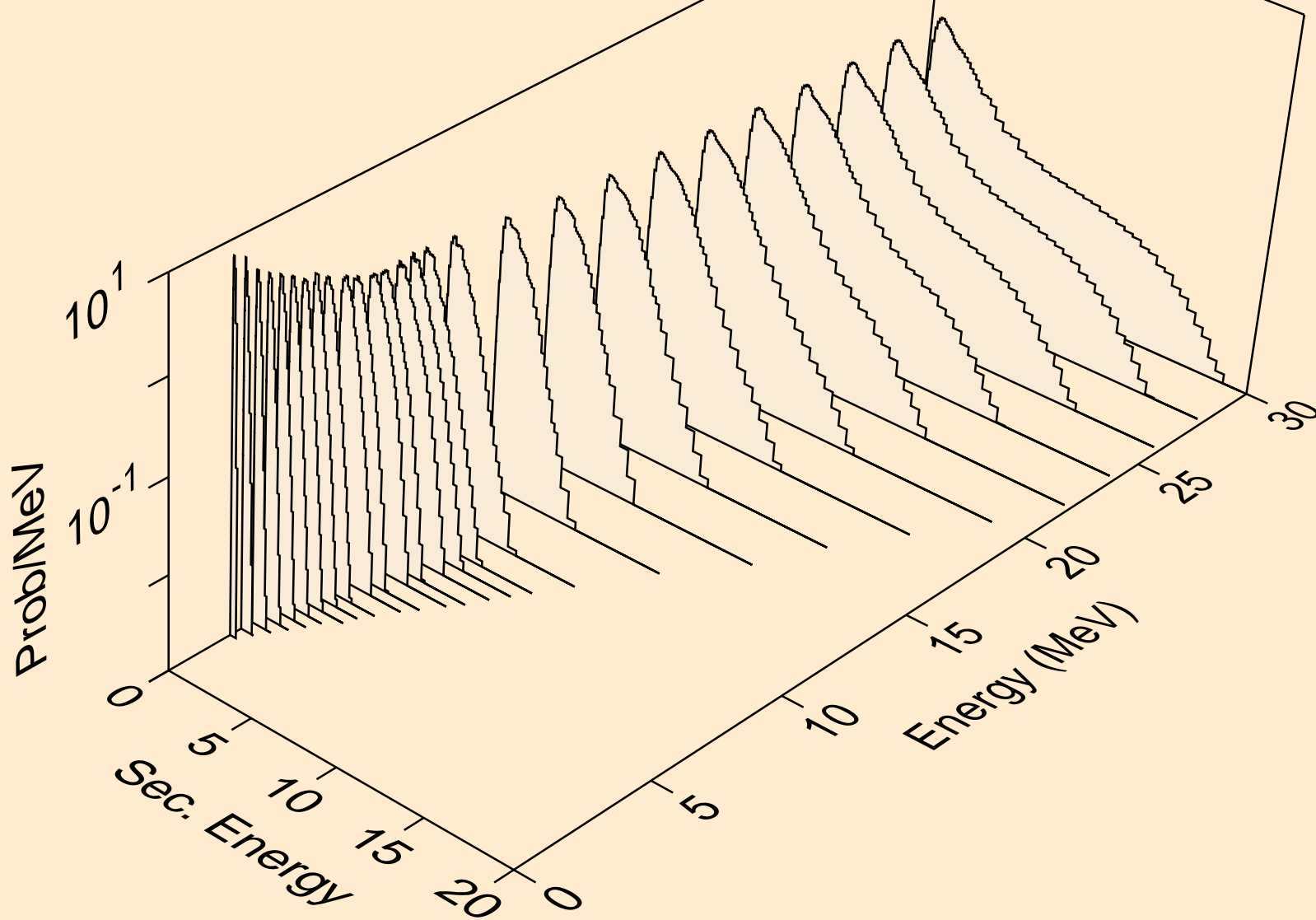

FR204 NEUTRON ACER TENDL-2019 LIBRARY; T=293.16K
Neutron emission for (n,n*)2a

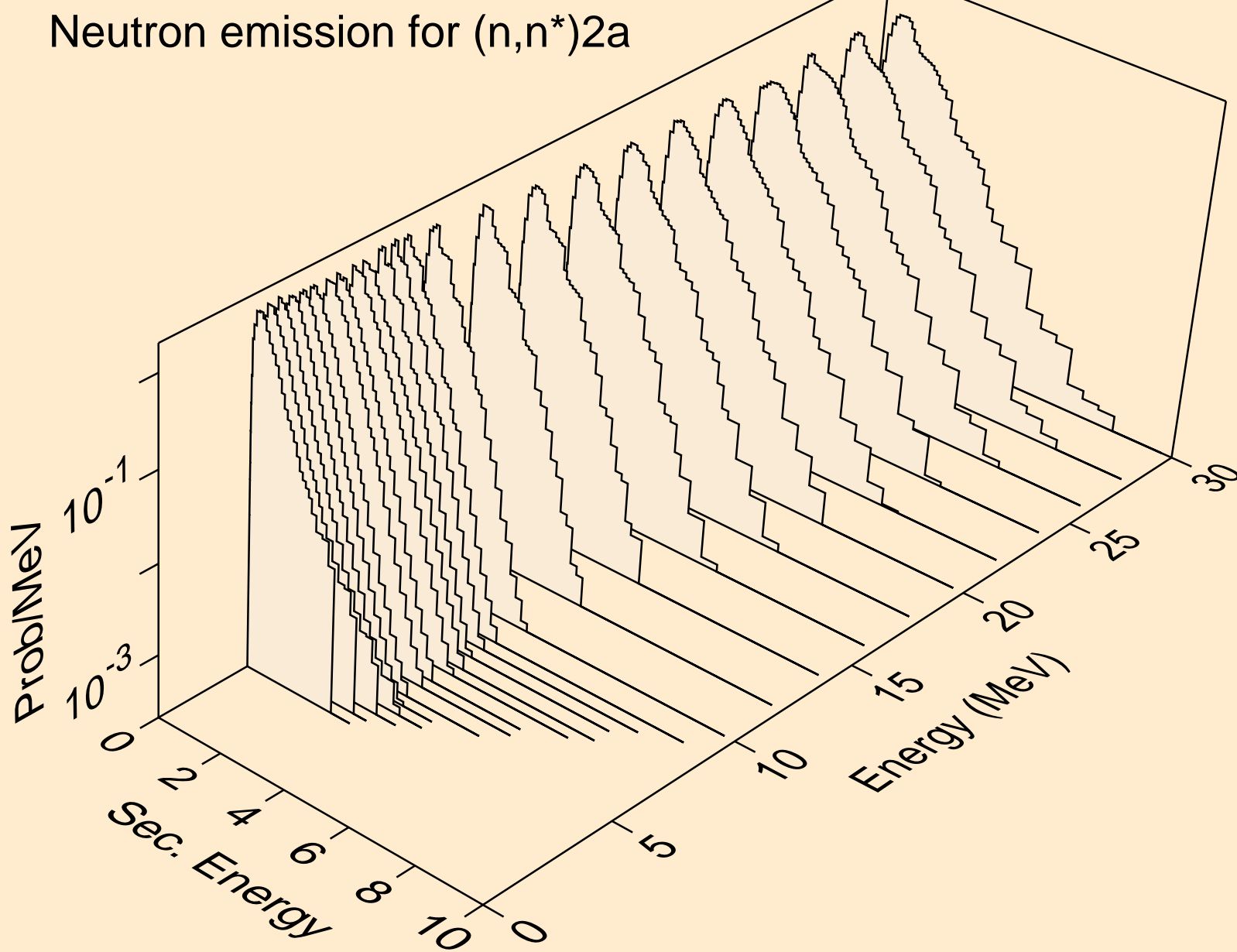

FR204 NEUTRON ACER TENDL-2019 LIBRARY; T=293.16K
Neutron emission for (n,2n)2a

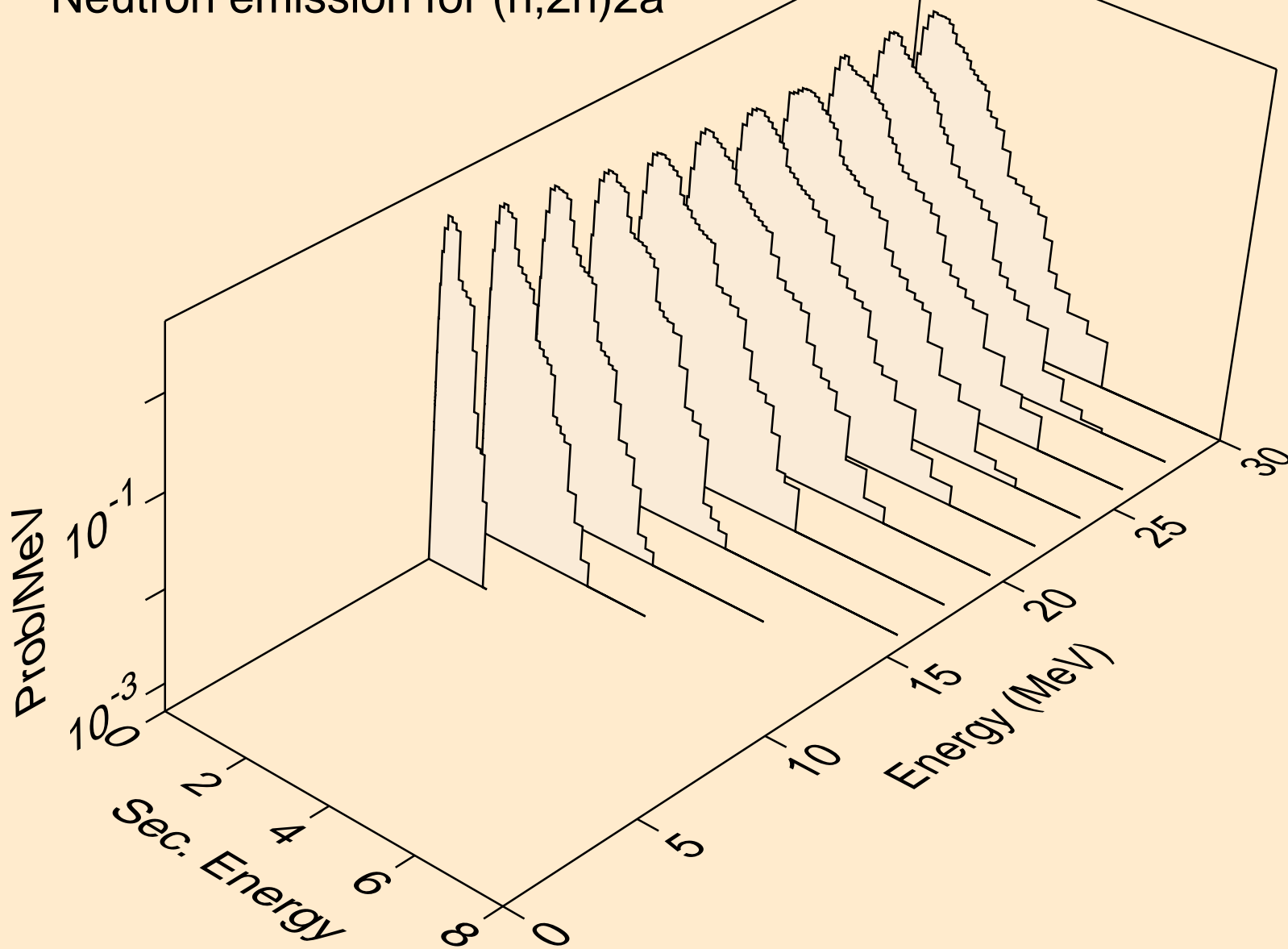

FR204 NEUTRON ACER TENDL-2019 LIBRARY; T=293.16K
Neutron emission for (n,n*)d

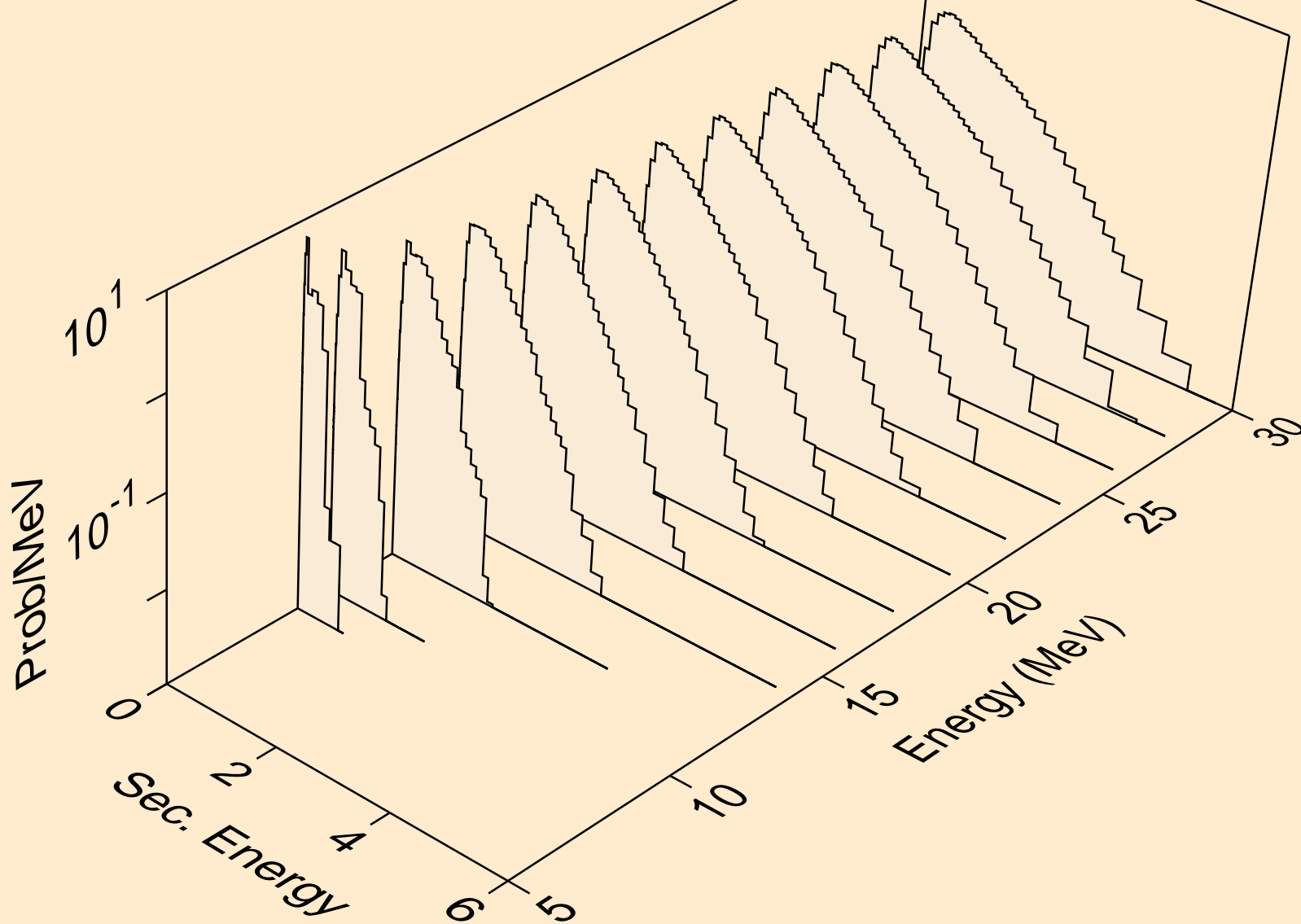

FR204 NEUTRON ACER TENDL-2019 LIBRARY; T=293.16K
Neutron emission for (n,n*)t

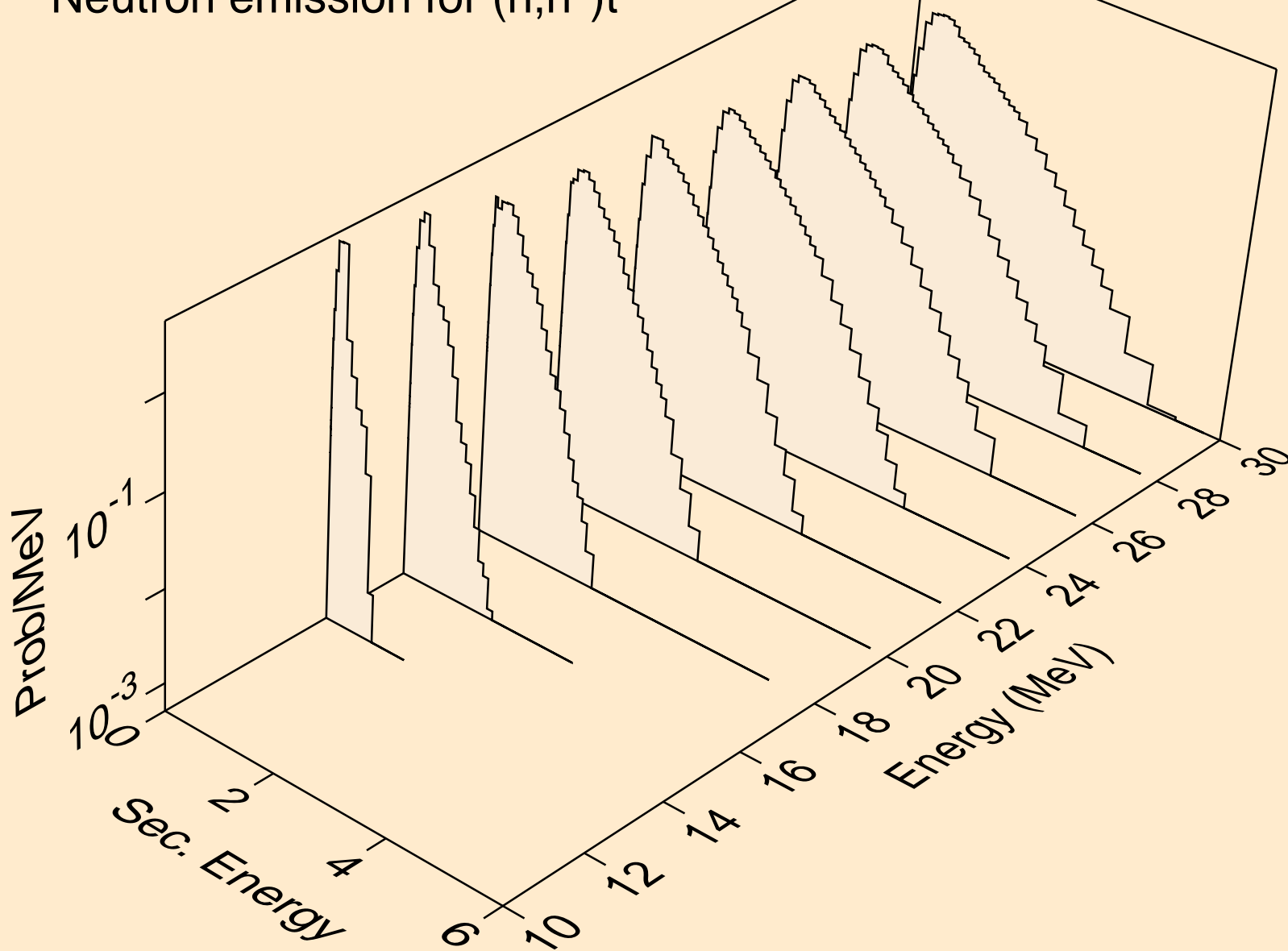

FR204 NEUTRON ACER TENDL-2019 LIBRARY; T=293.16K
Neutron emission for (n,n*)he3

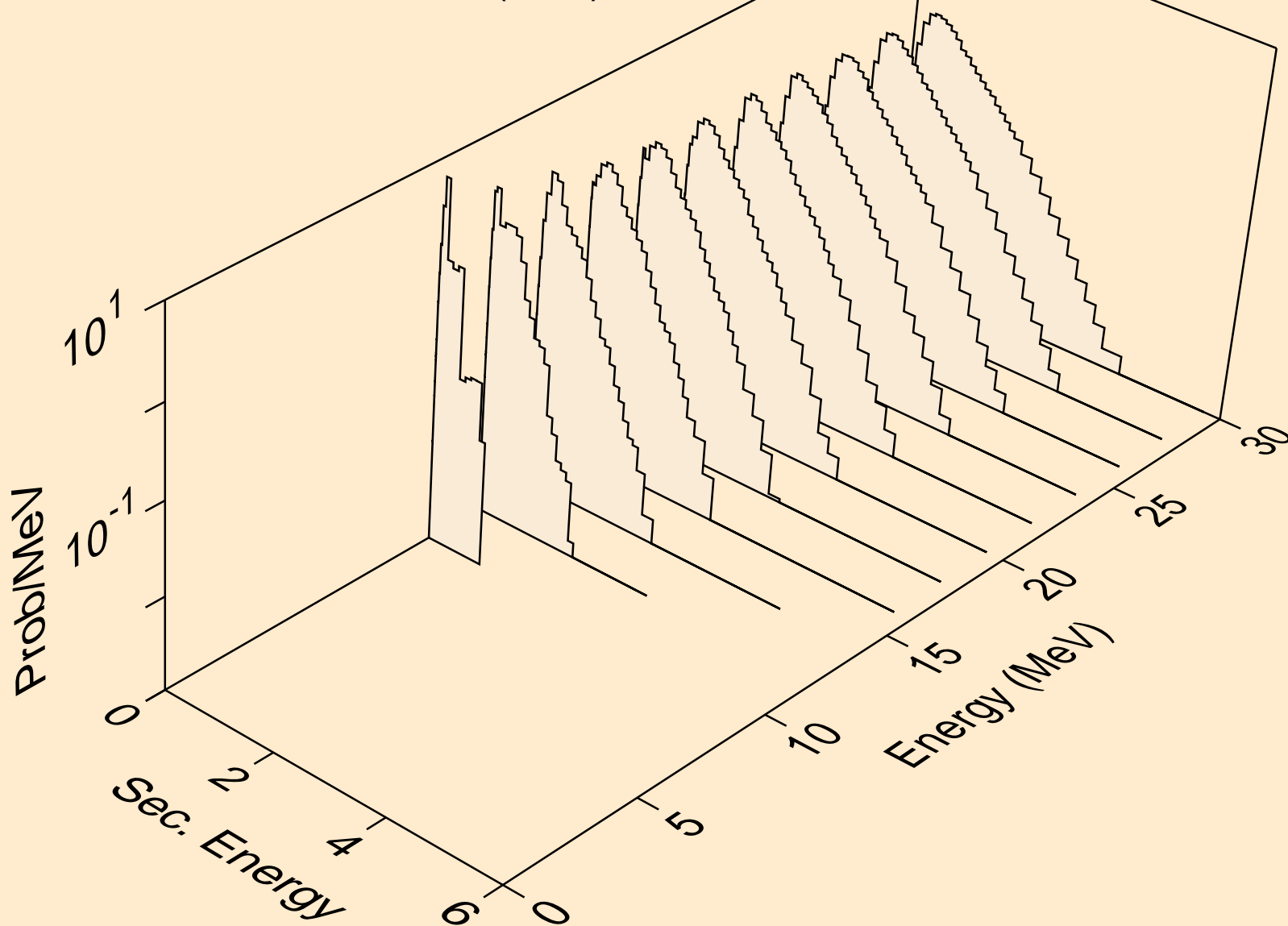

FR204 NEUTRON ACER TENDL-2019 LIBRARY; T=293.16K
Neutron emission for (n,4n)

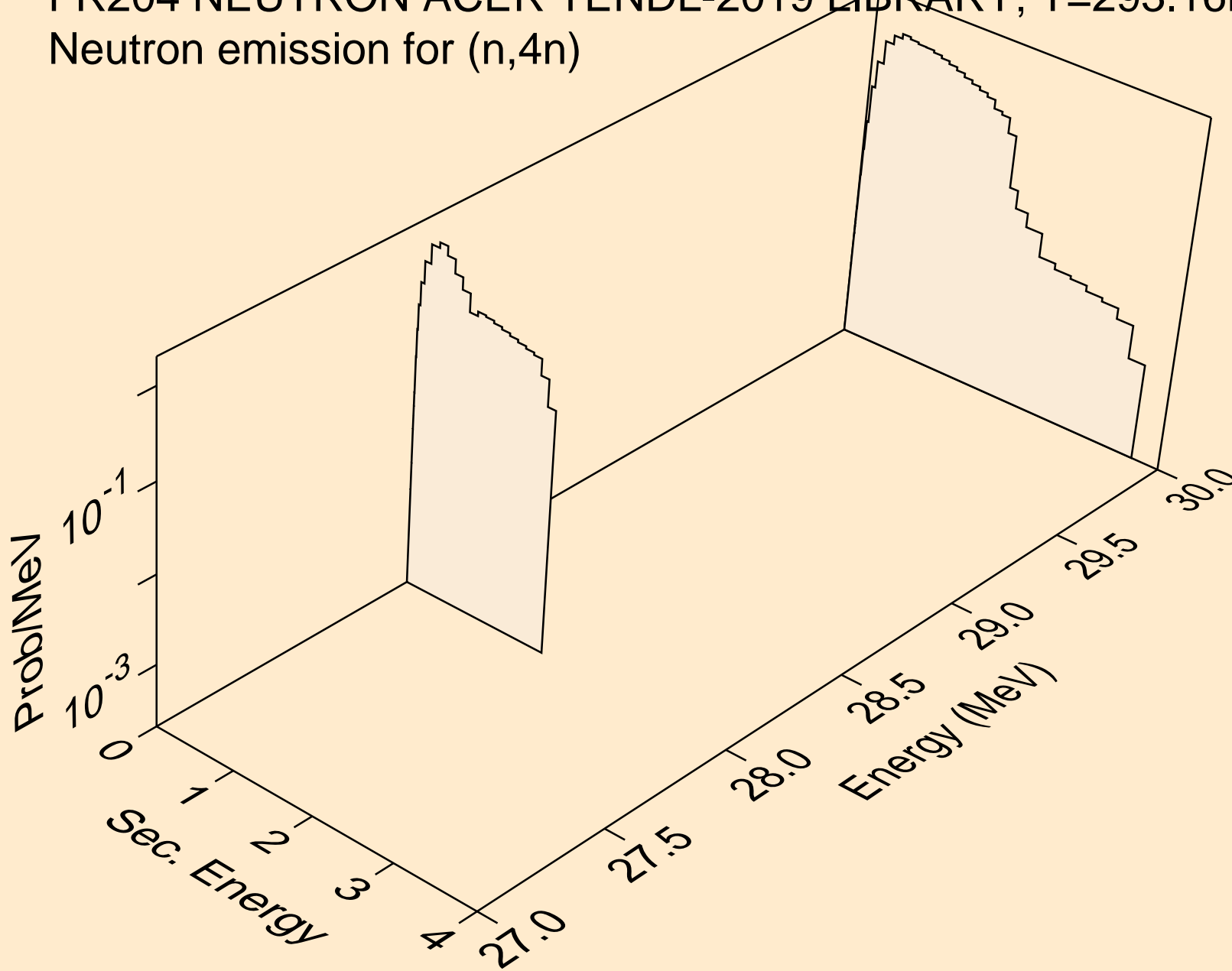

FR204 NEUTRON ACER TENDL-2019 LIBRARY; T=293.16K
Neutron emission for (n,2np)

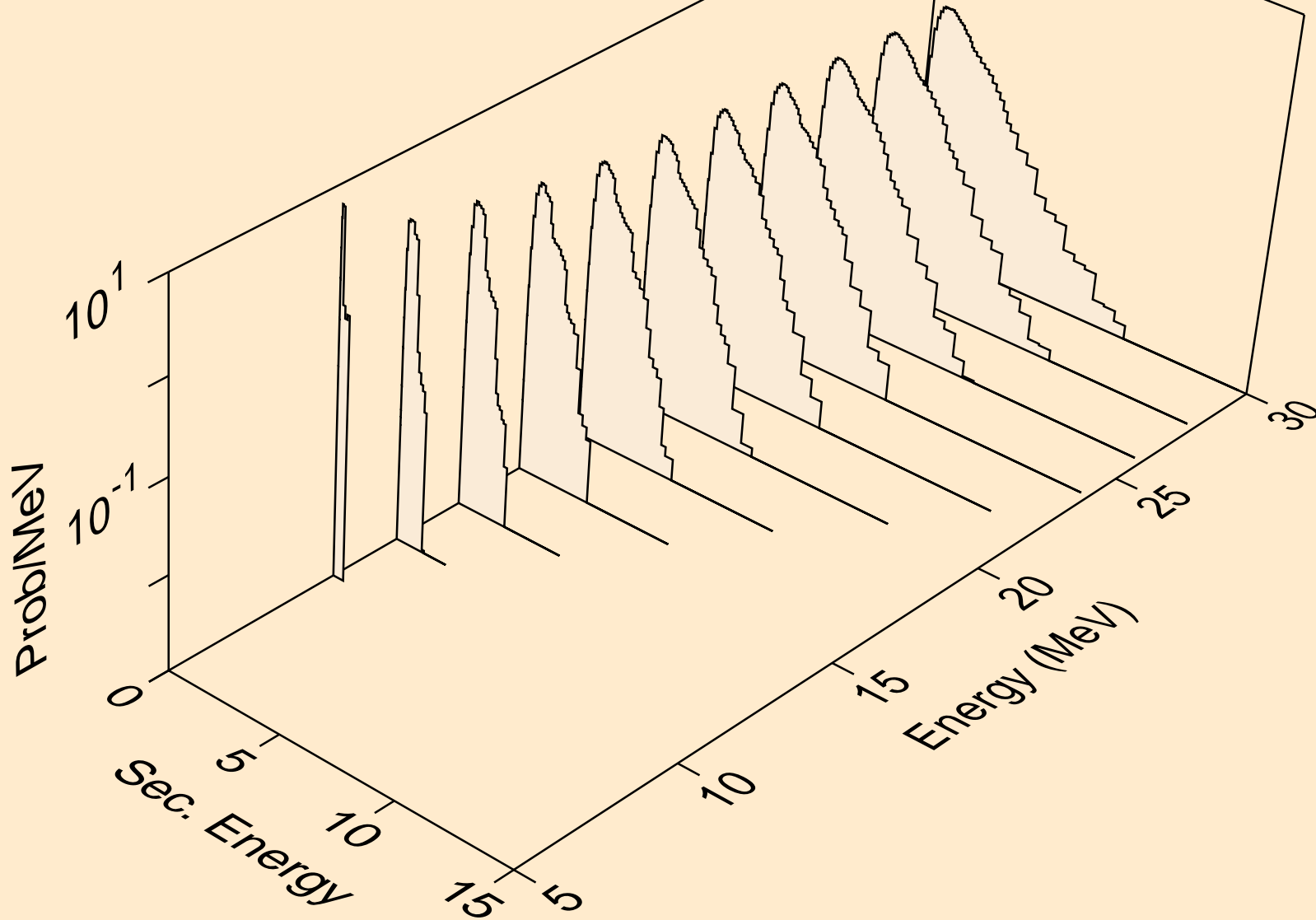

FR204 NEUTRON ACER TENDL-2019 LIBRARY; T=293.16K
Neutron emission for (n,3np)

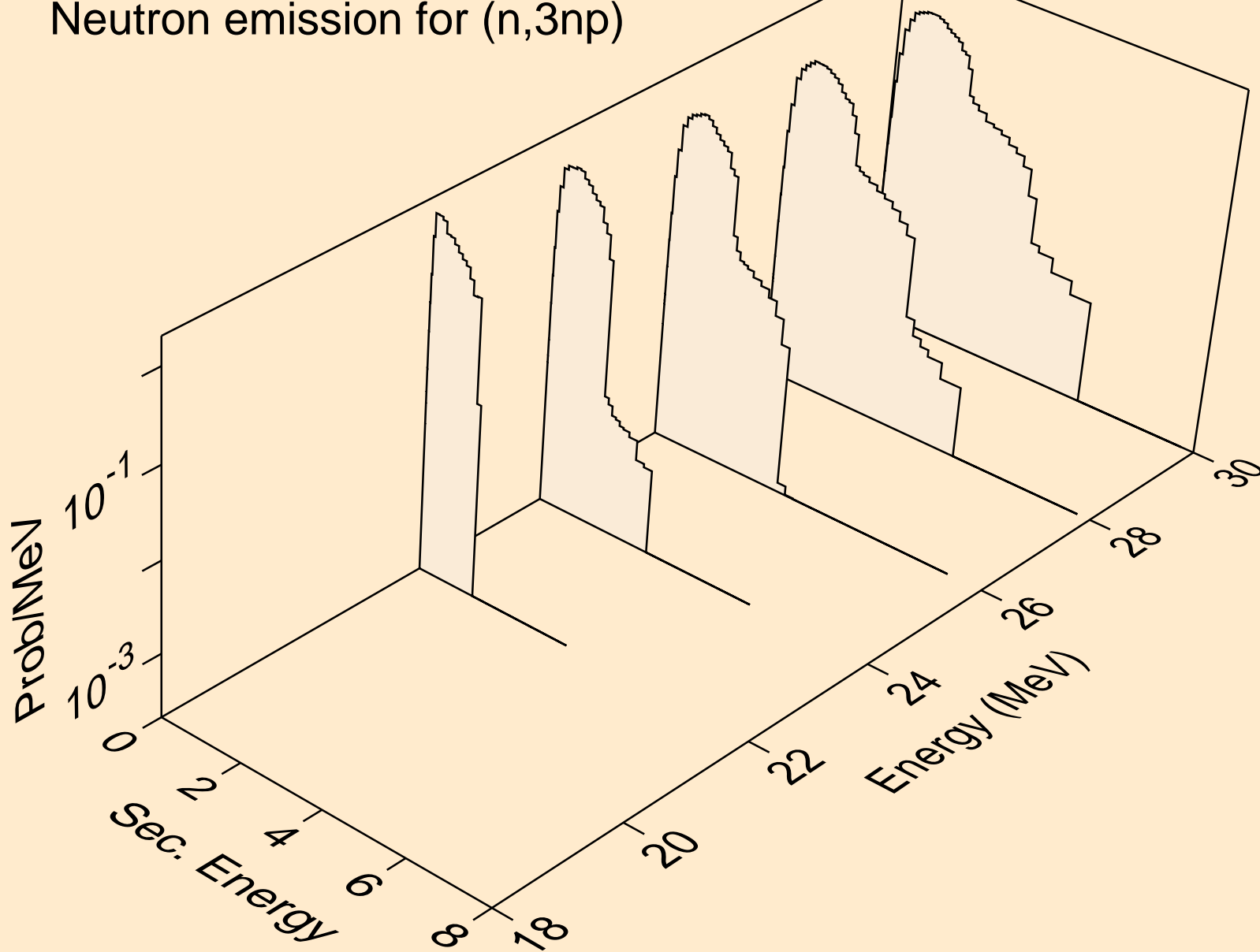

FR204 NEUTRON ACER TENDL-2019 LIBRARY; T=293.16K
Neutron emission for (n,2np)

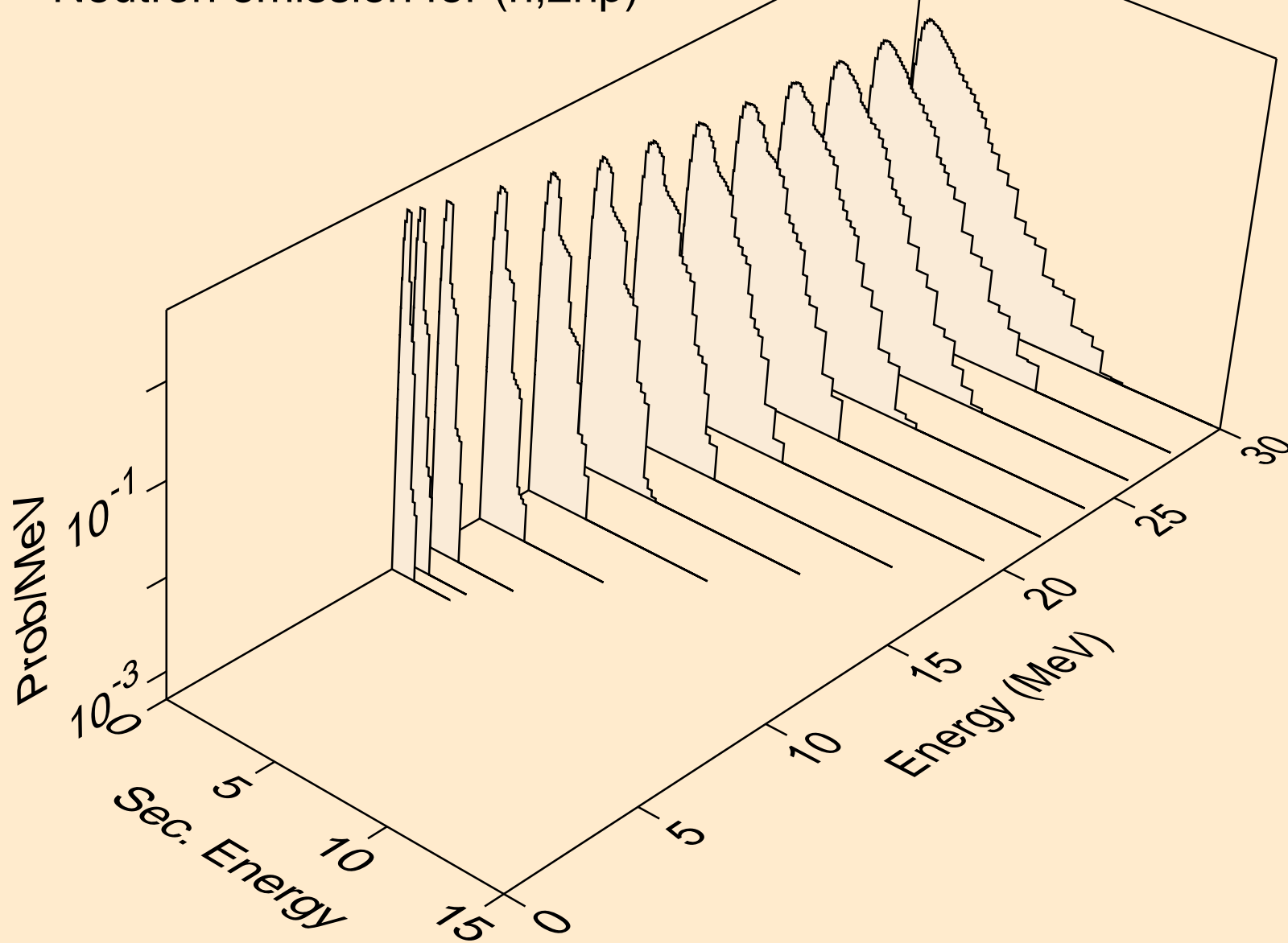

FR204 NEUTRON ACER TENDL-2019 LIBRARY; T=293.16K
Neutron emission for (n,npa)

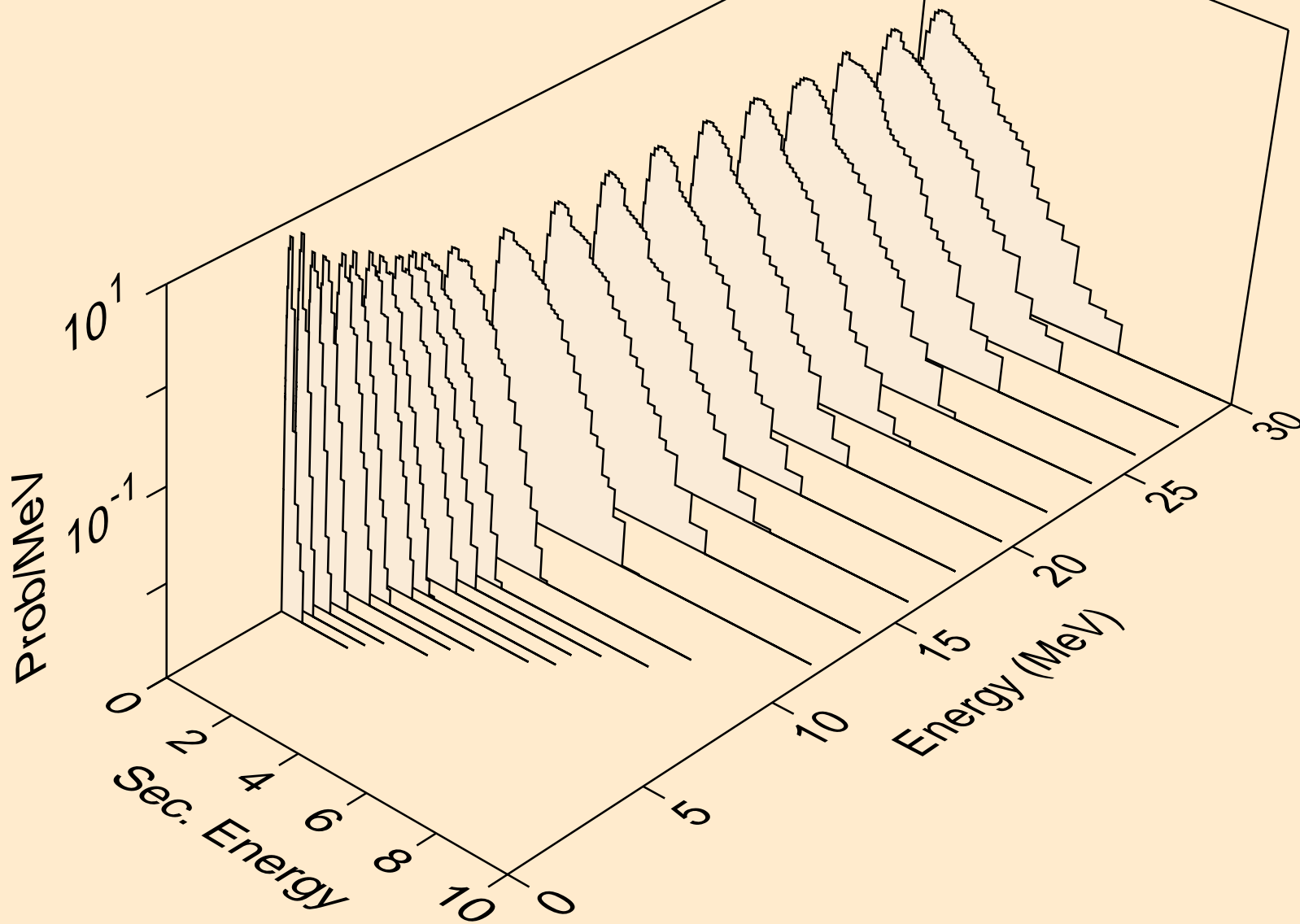

FR204 NEUTRON ACER TENDL-2019 LIBRARY; T=293.16K
Neutron emission for (n,n*c)

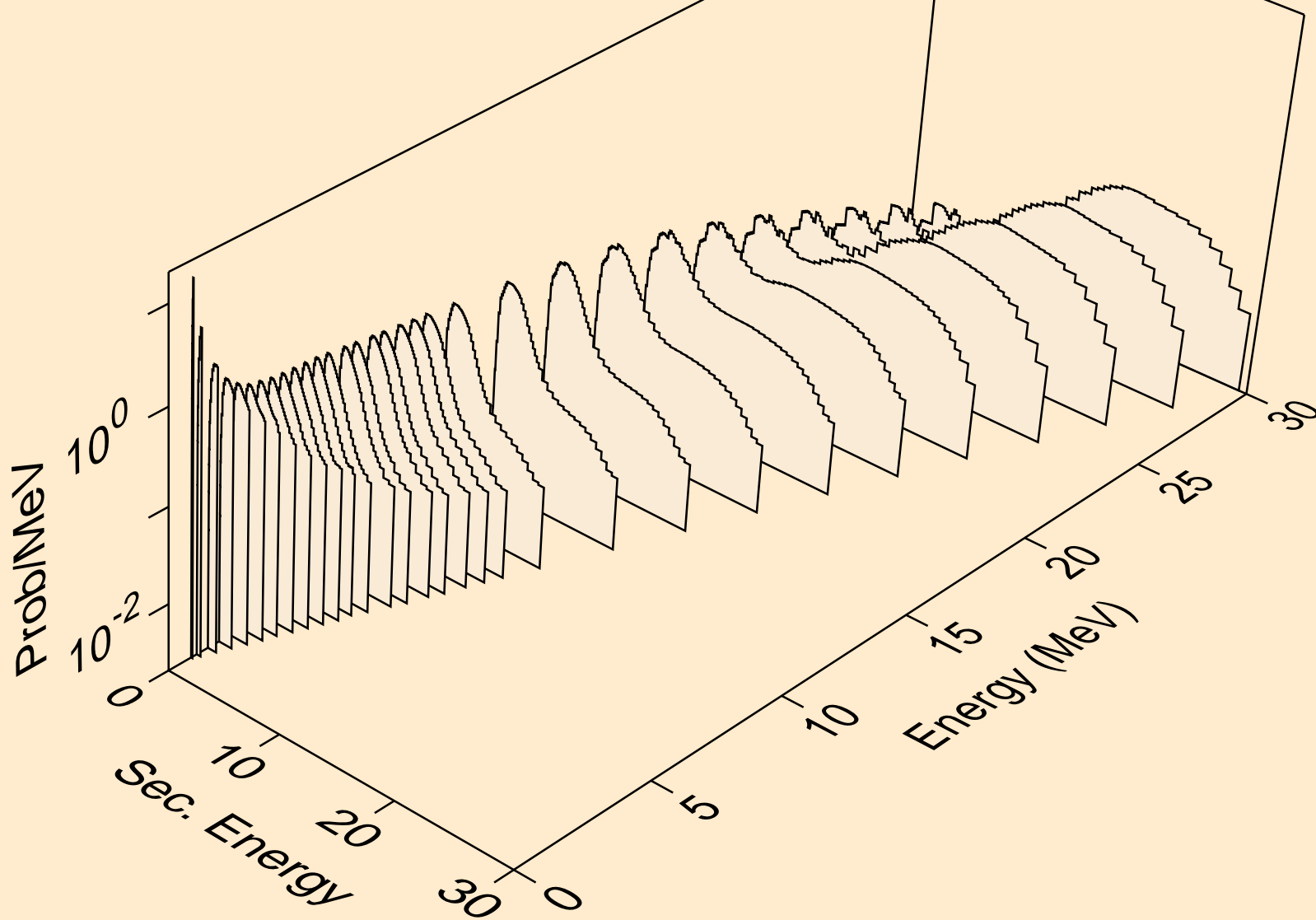

FR204 NEUTRON ACER TENDL-2019 LIBRARY; T=293.16K
Photon emission for (n,x)

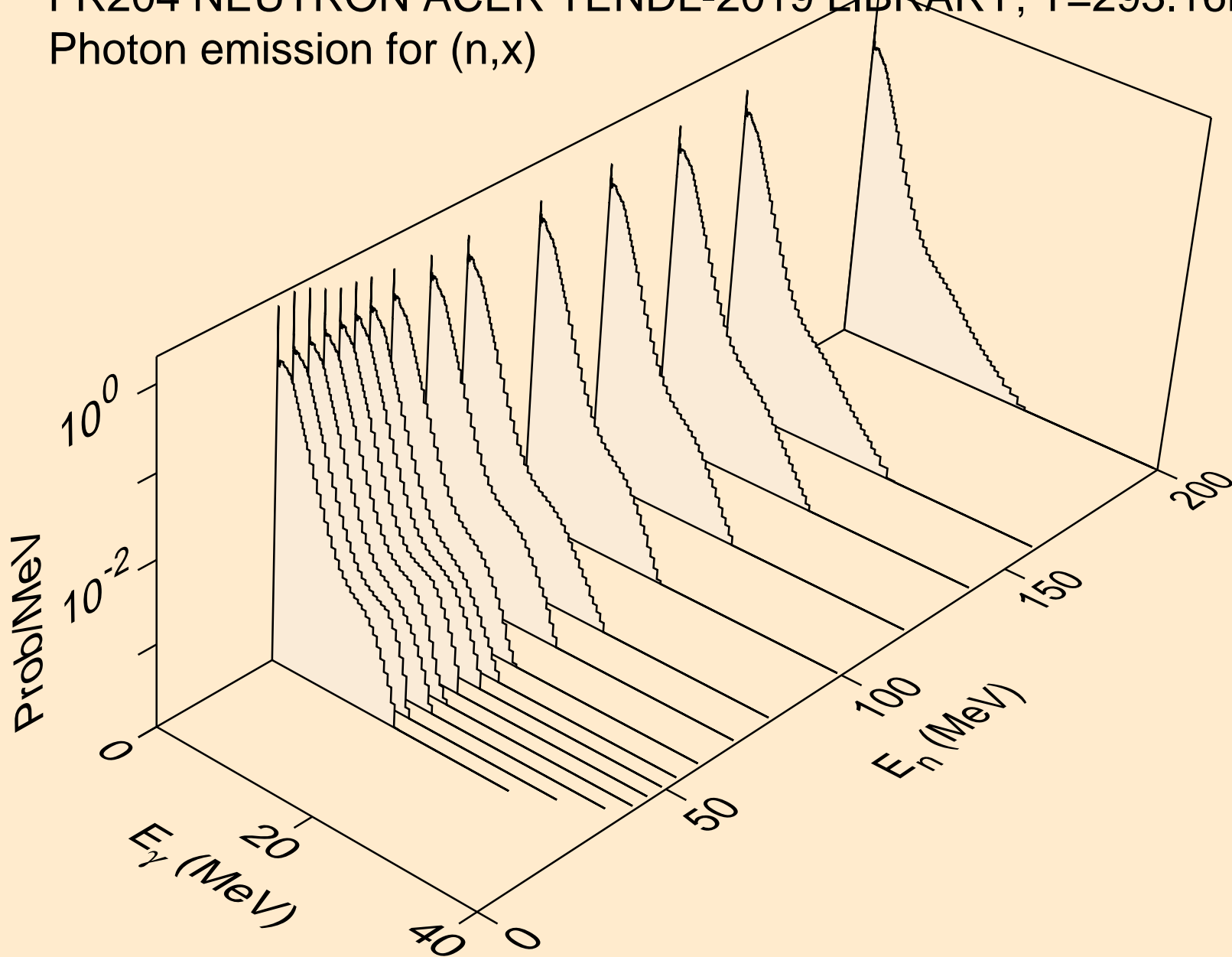

FR204 NEUTRON ACER TENDL-2019 LIBRARY; T=293.16K
Photon emission for (n,2nd)

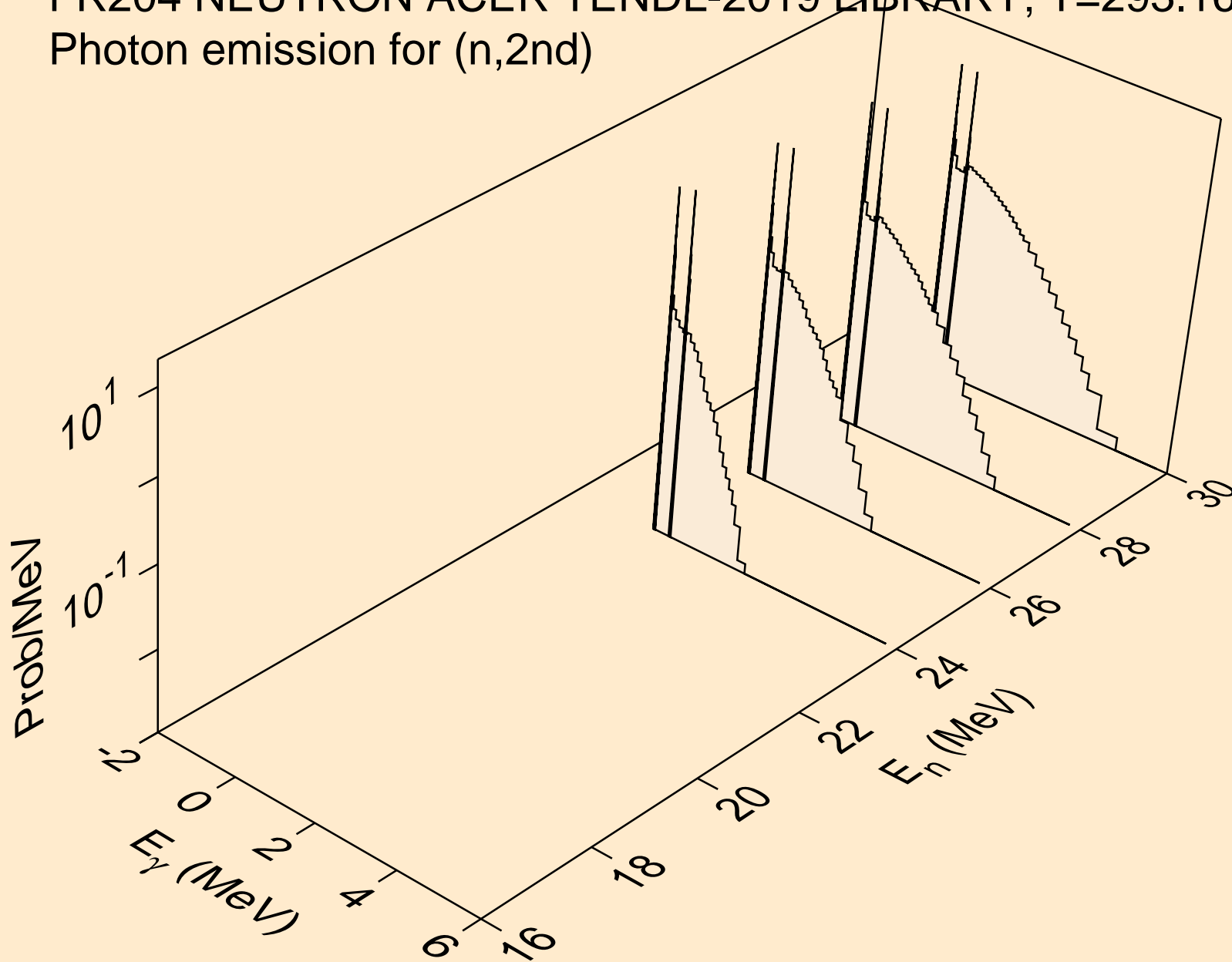

FR204 NEUTRON ACER TENDL-2019 LIBRARY; T=293.16K
Photon emission for (n,2n)

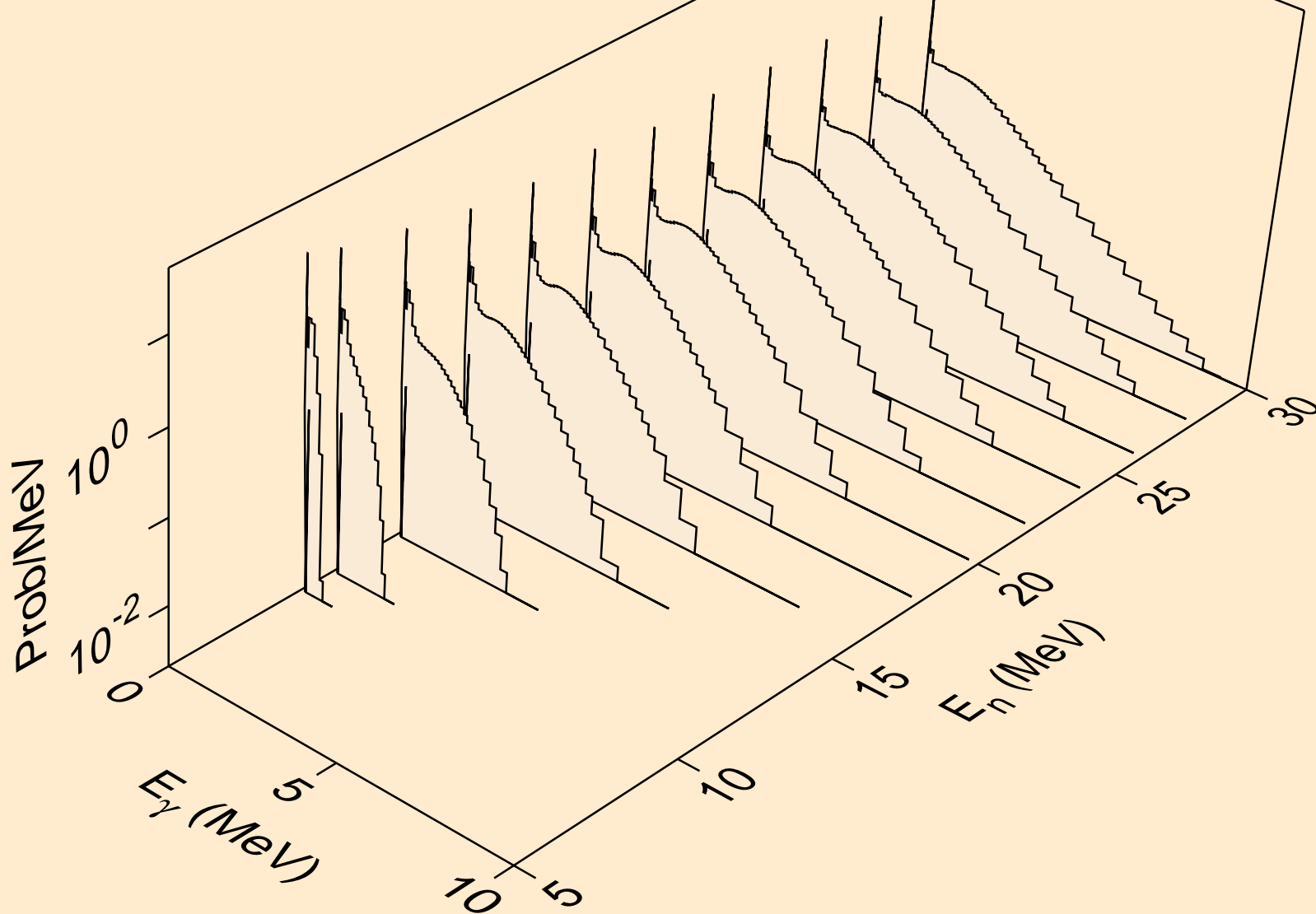

FR204 NEUTRON ACER TENDL-2019 LIBRARY; T=293.16K
Photon emission for (n,3n)

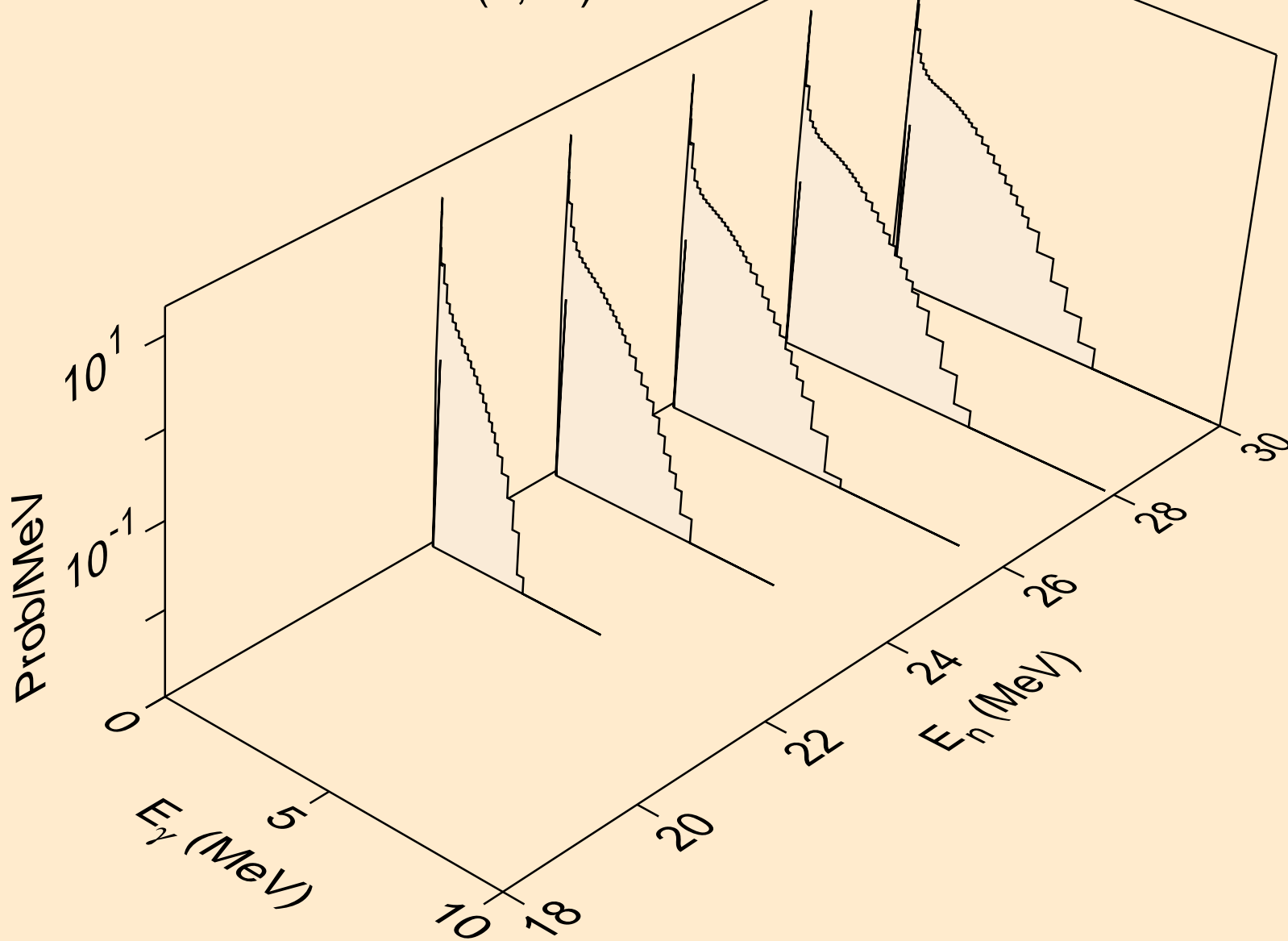

FR204 NEUTRON ACER TENDL-2019 LIBRARY; T=293.16K
Photon emission for (n,n*)a

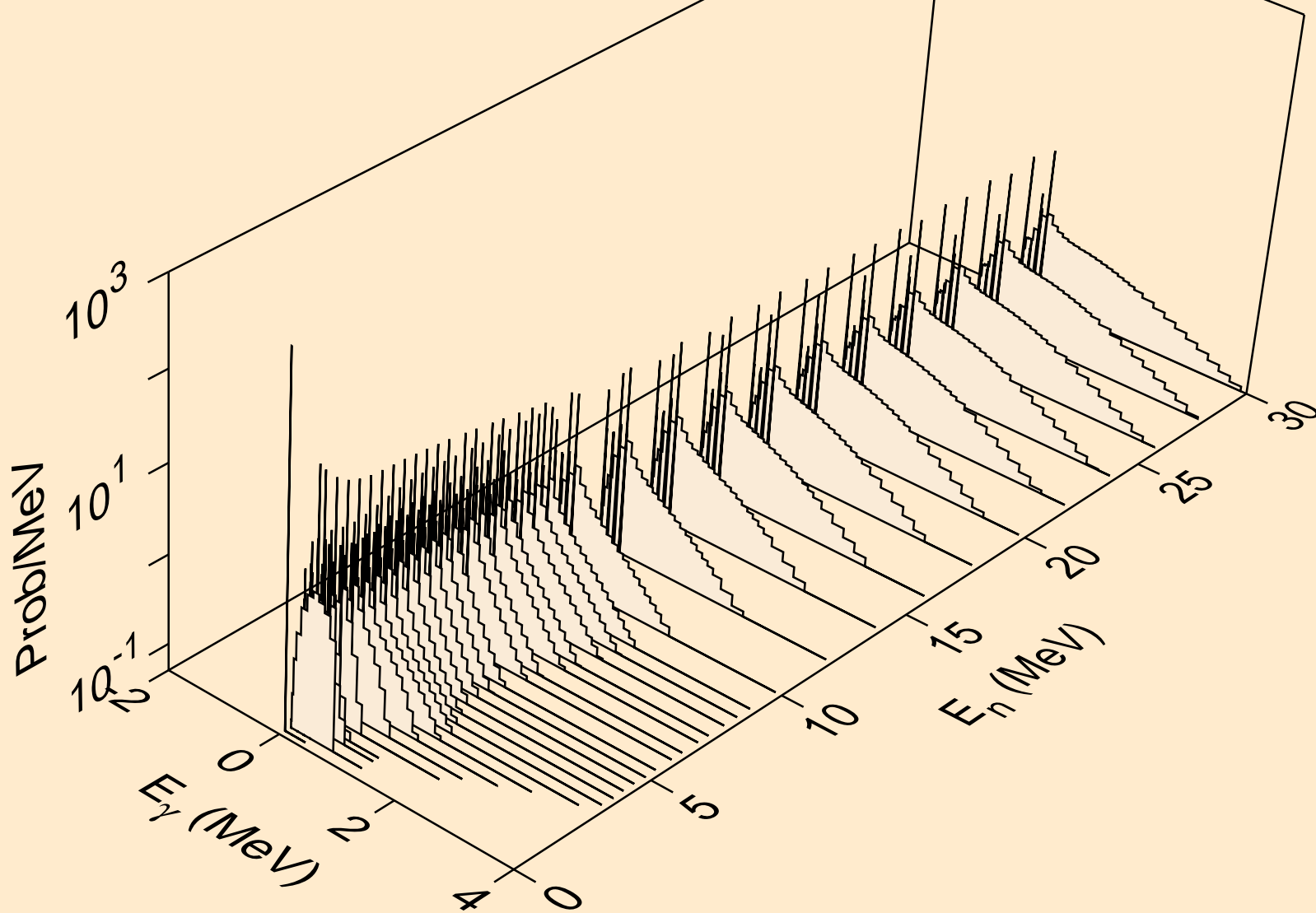

FR204 NEUTRON ACER TENDL-2019 LIBRARY; T=293.16K
Photon emission for (n,2n)a

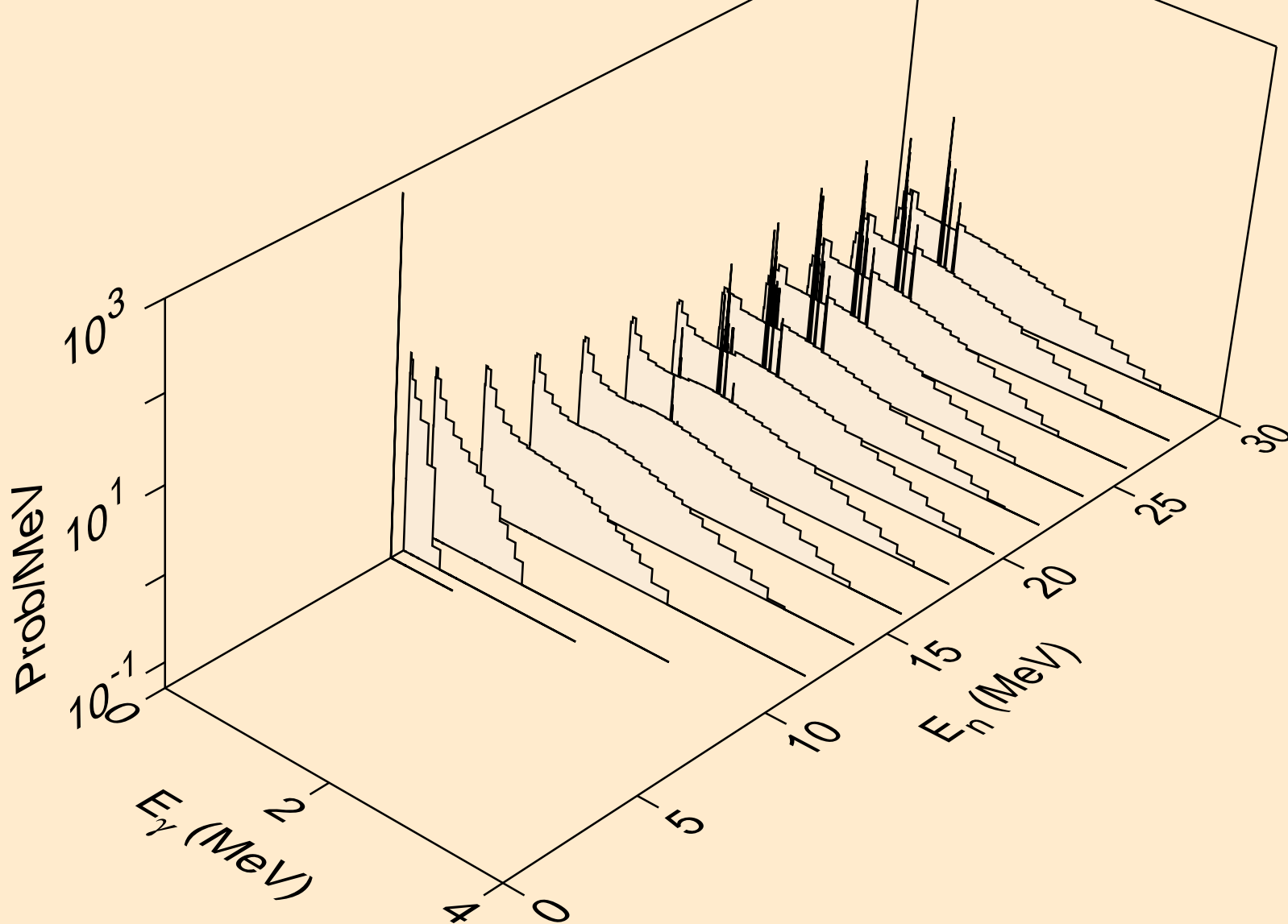

FR204 NEUTRON ACER TENDL-2019 LIBRARY; T=293.16K
Photon emission for (n,3n)a

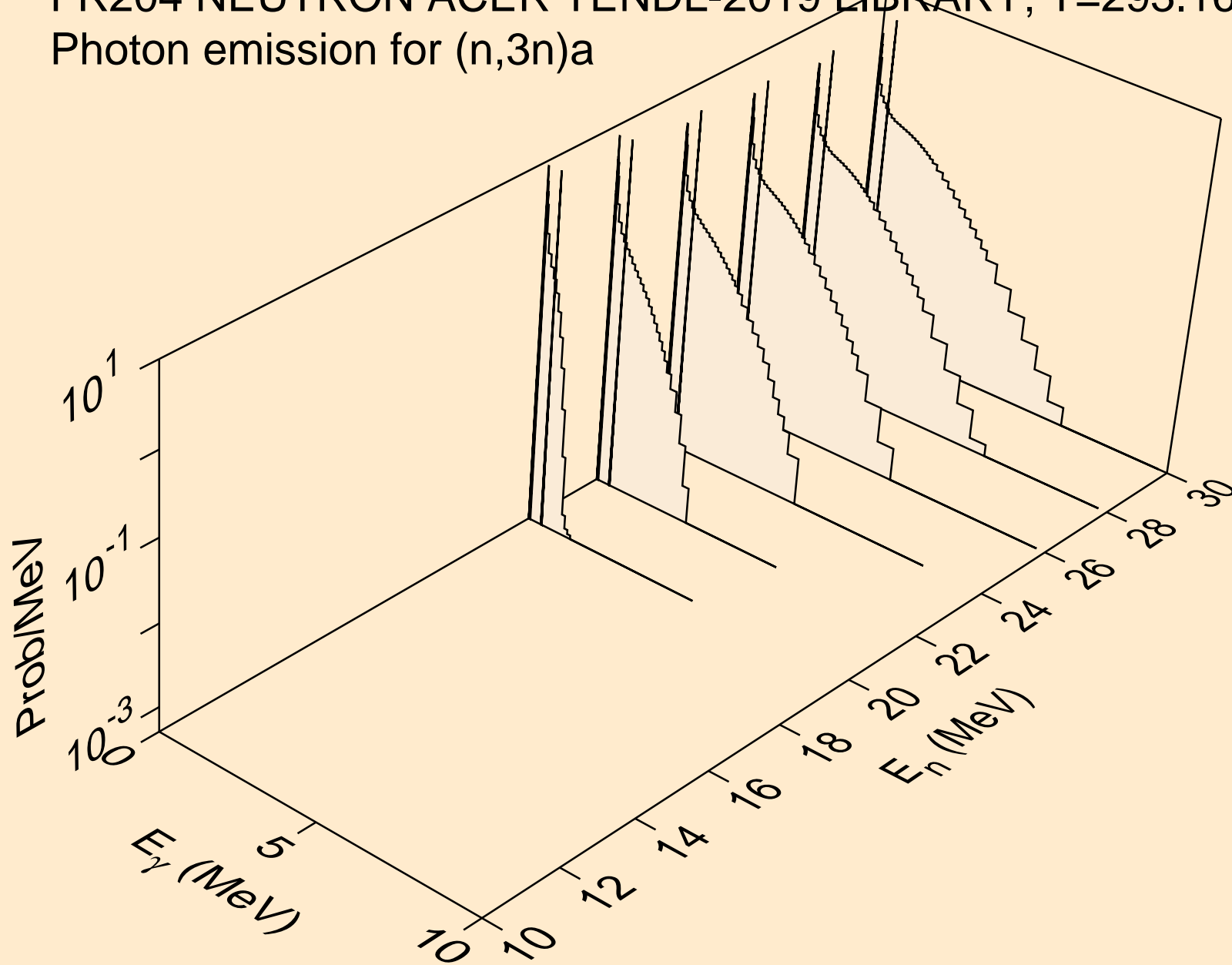

FR204 NEUTRON ACER TENDL-2019 LIBRARY; T=293.16K
Photon emission for (n,n*)p

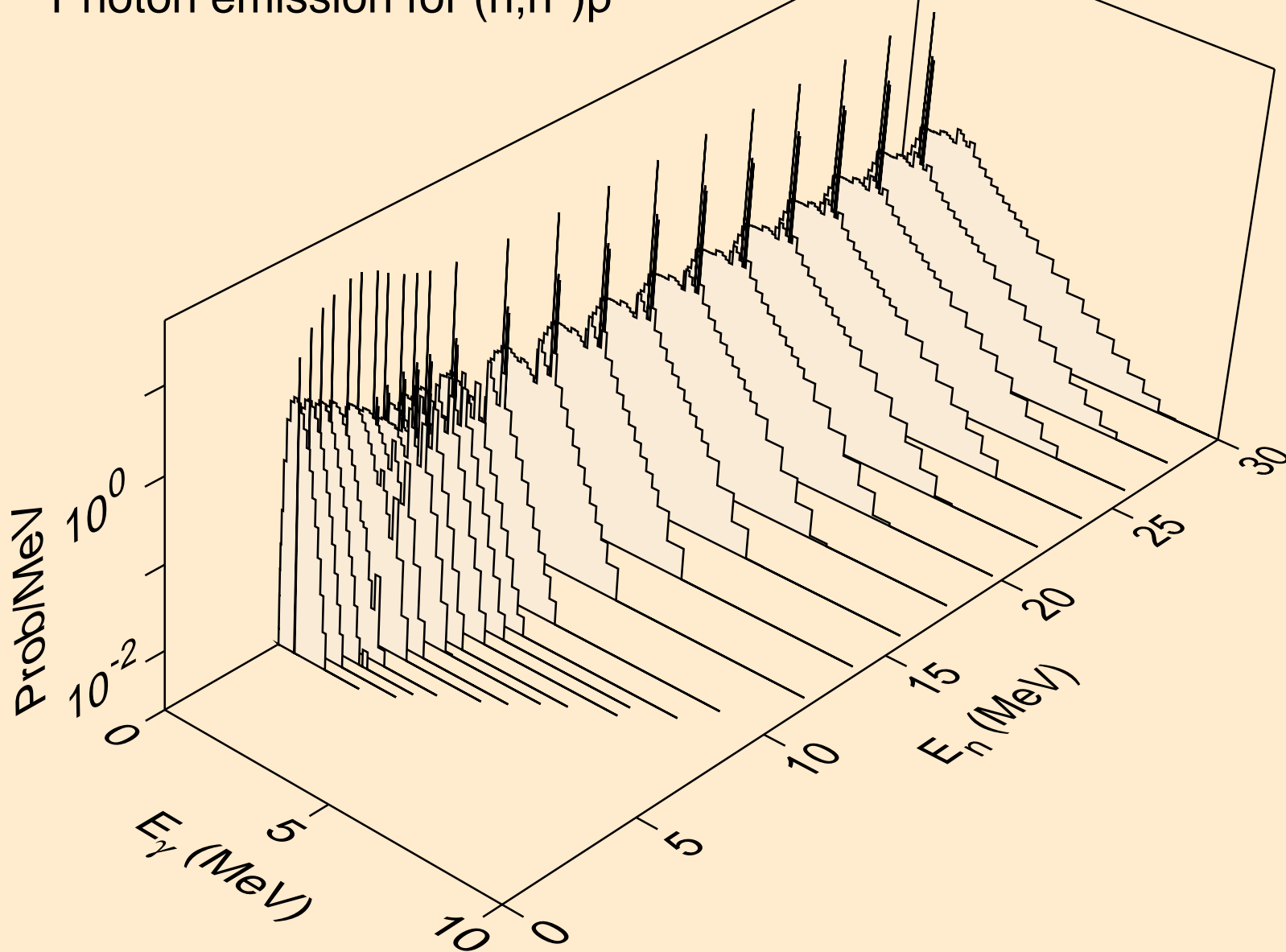

FR204 NEUTRON ACER TENDL-2019 LIBRARY; T=293.16K
Photon emission for (n,n*)2a

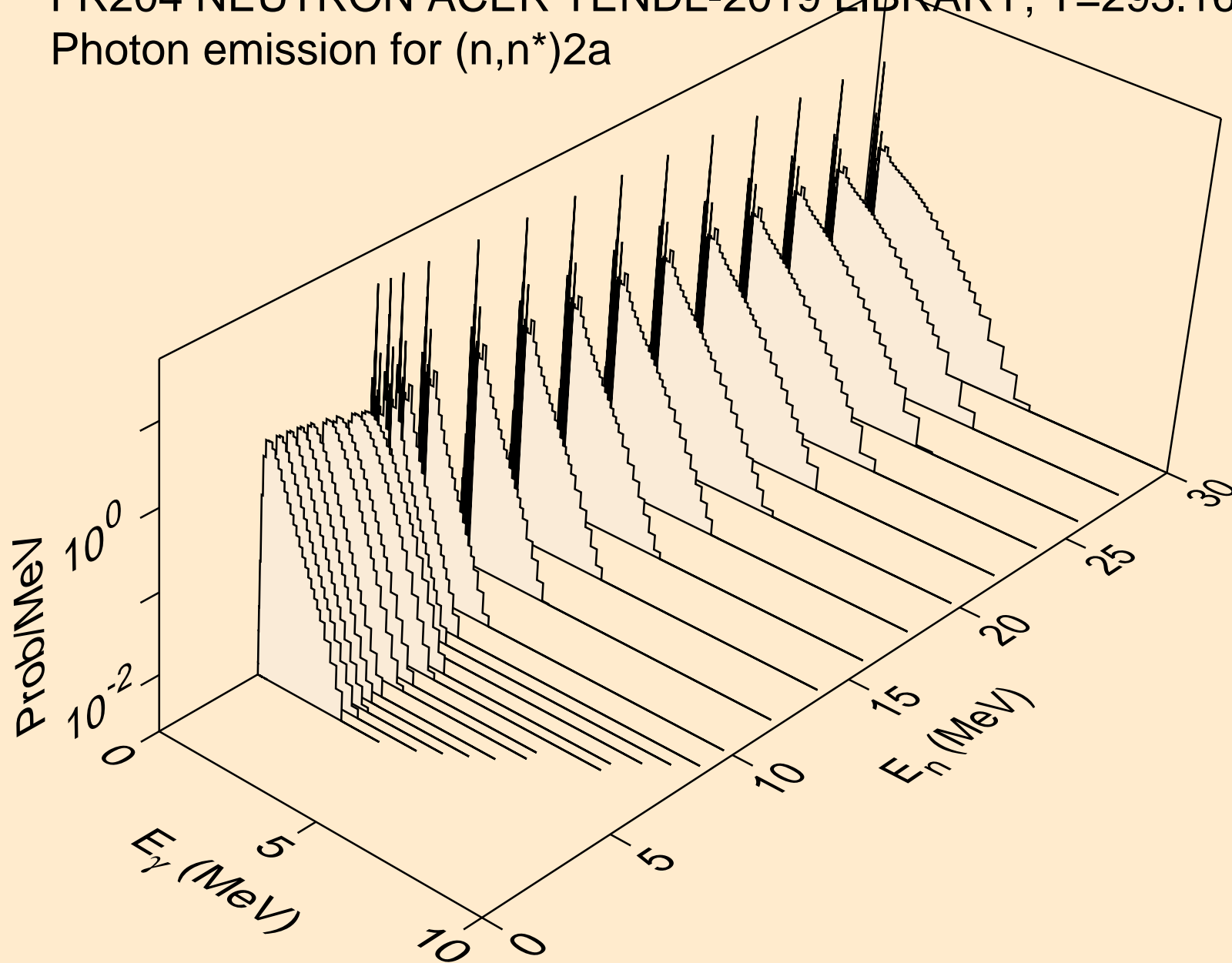

FR204 NEUTRON ACER TENDL-2019 LIBRARY; T=293.16K
Photon emission for (n,2n)2a

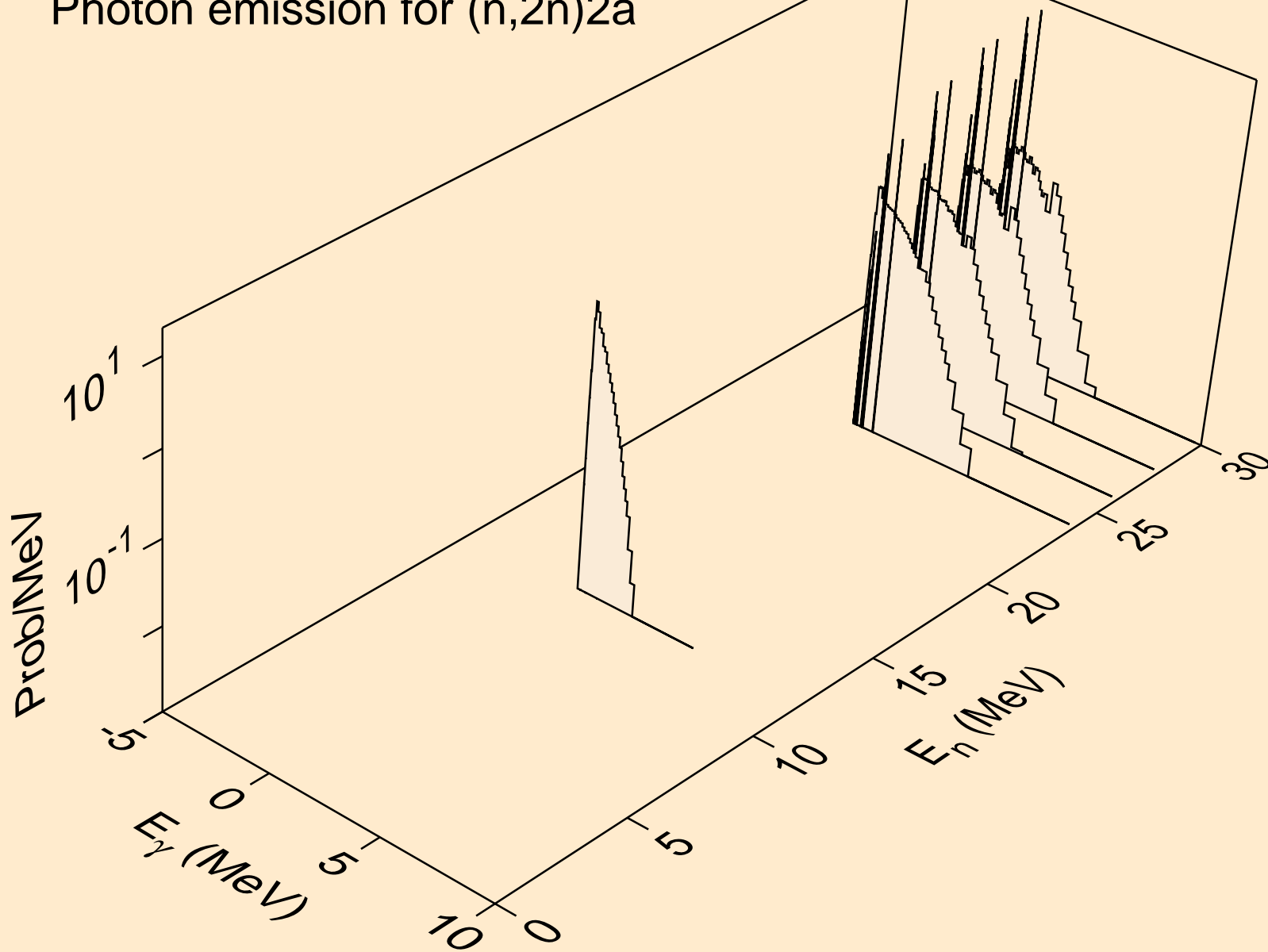

FR204 NEUTRON ACER TENDL-2019 LIBRARY; T=293.16K
Photon emission for (n,n*)d

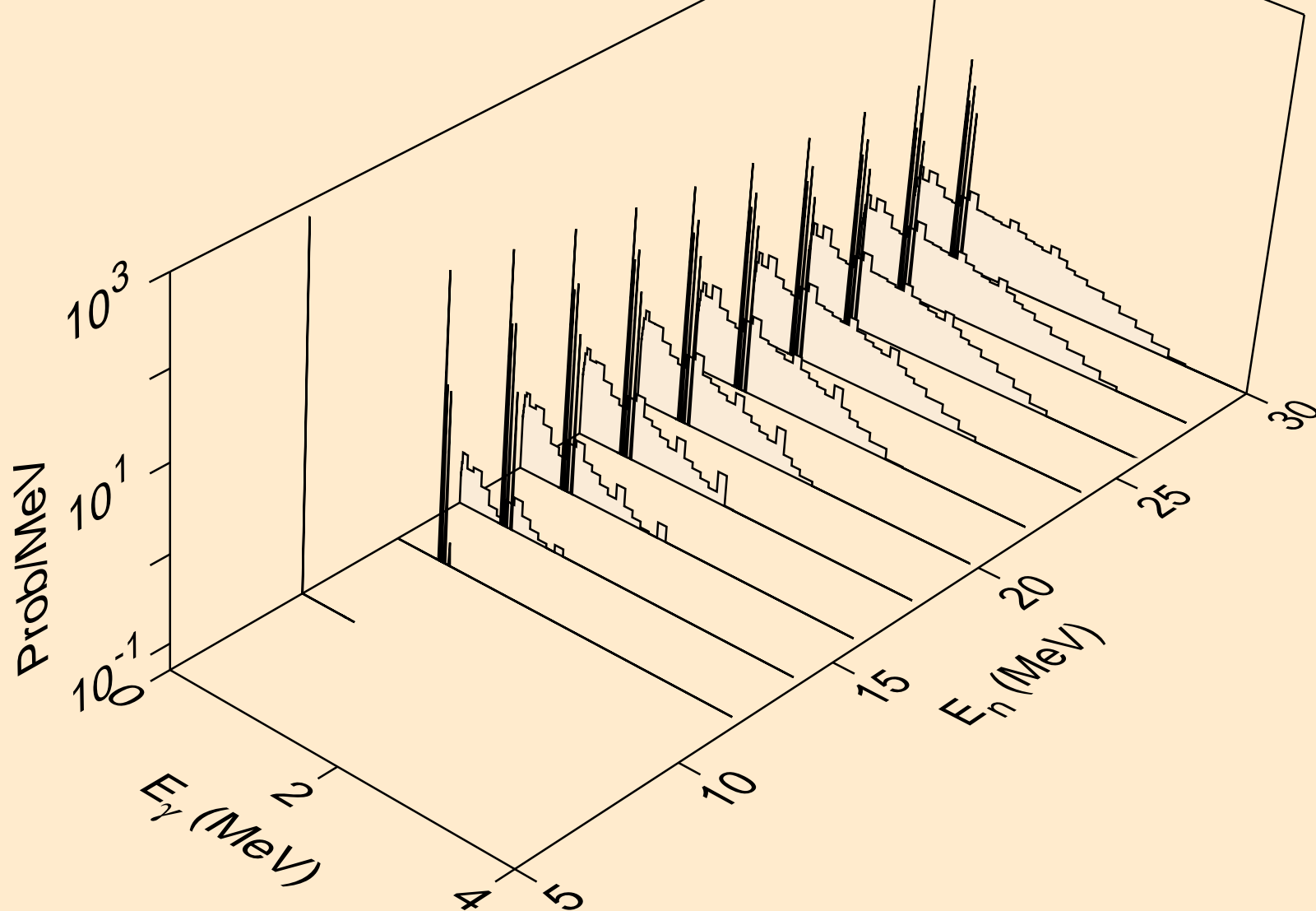

FR204 NEUTRON ACER TENDL-2019 LIBRARY; T=293.16K
Photon emission for (n,n*)t

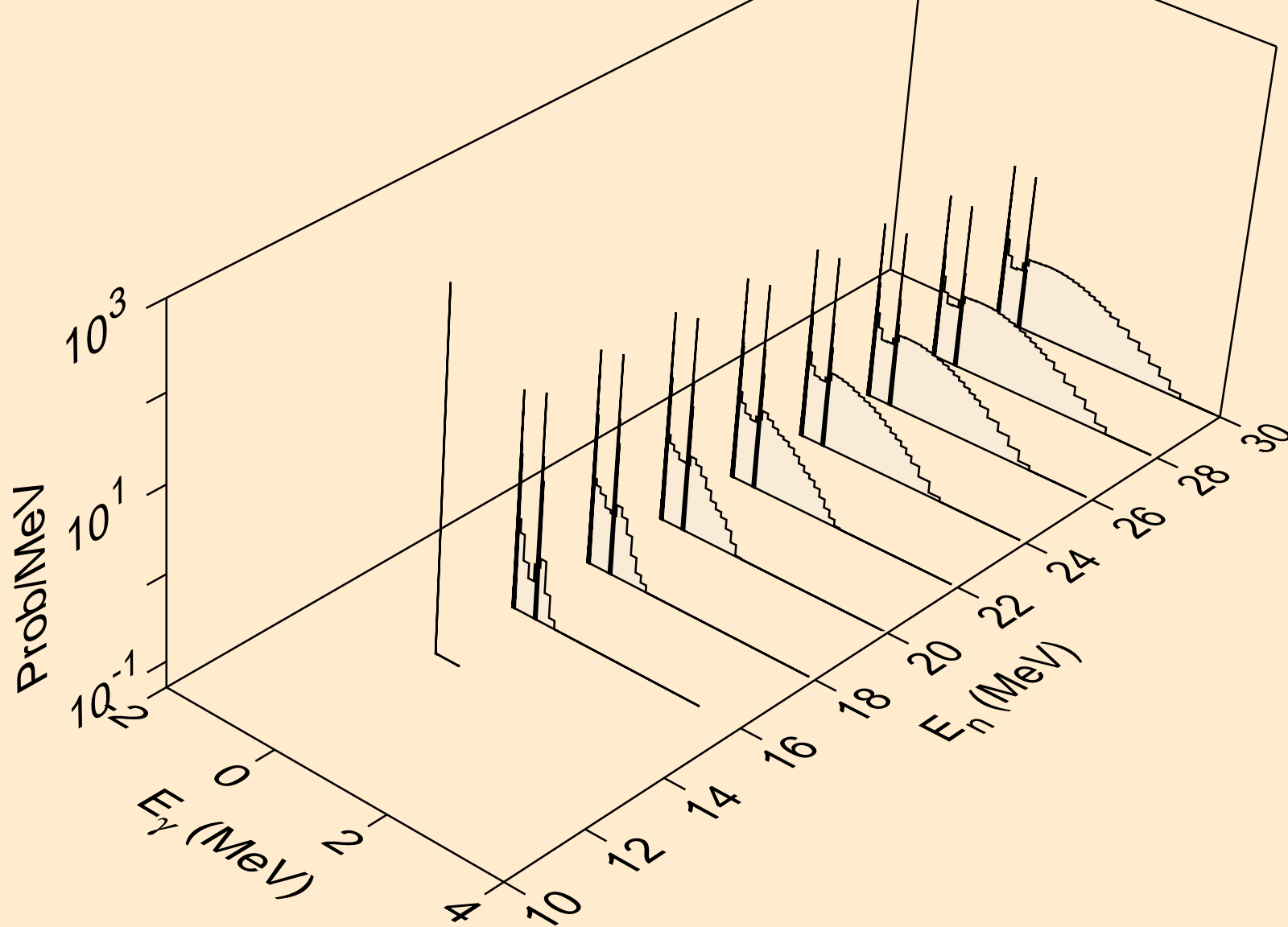

FR204 NEUTRON ACER TENDL-2019 LIBRARY; T=293.16K
Photon emission for (n,n*)he3

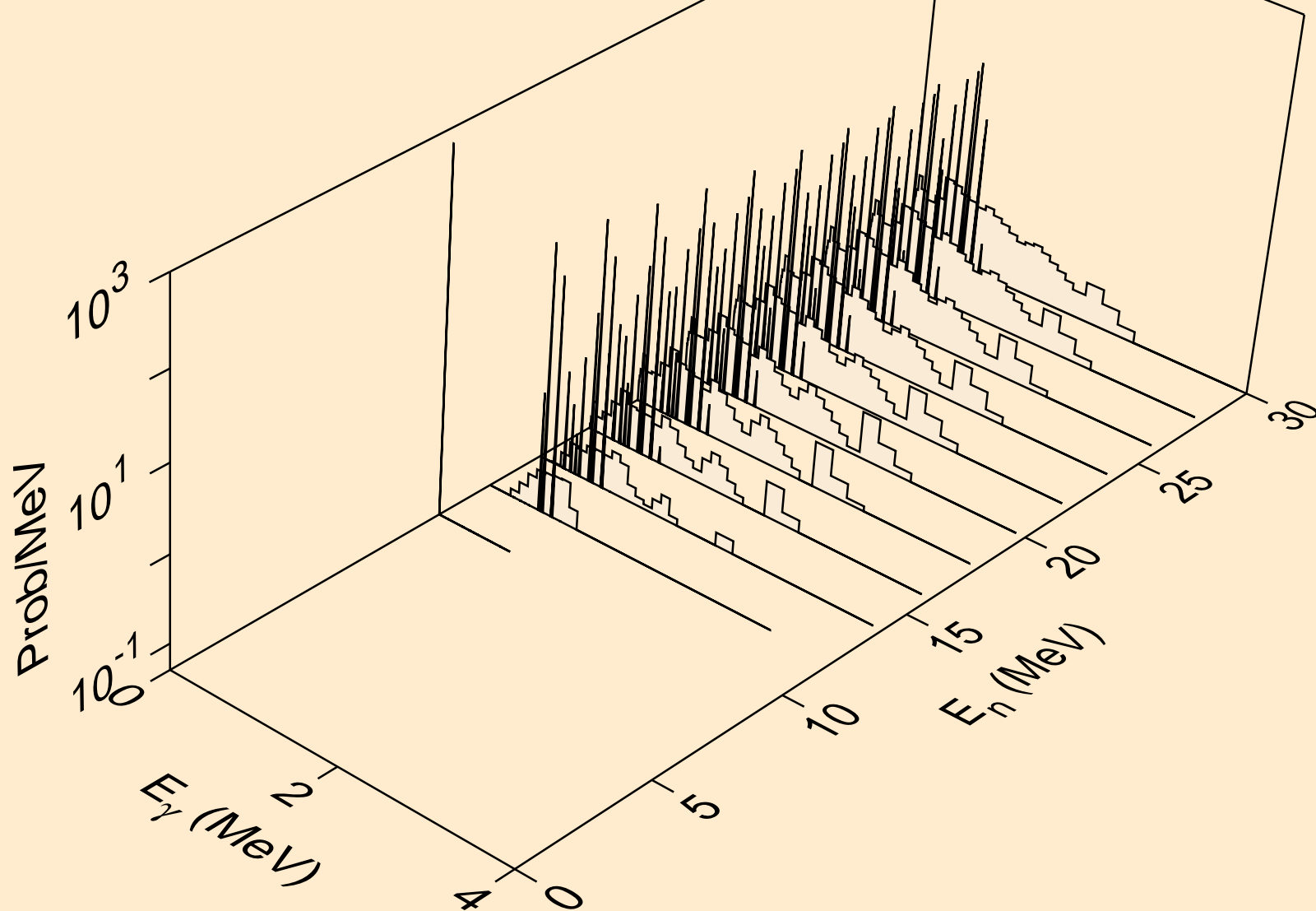

FR204 NEUTRON ACER TENDL-2019 LIBRARY; T=293.16K
Photon emission for (n,4n)

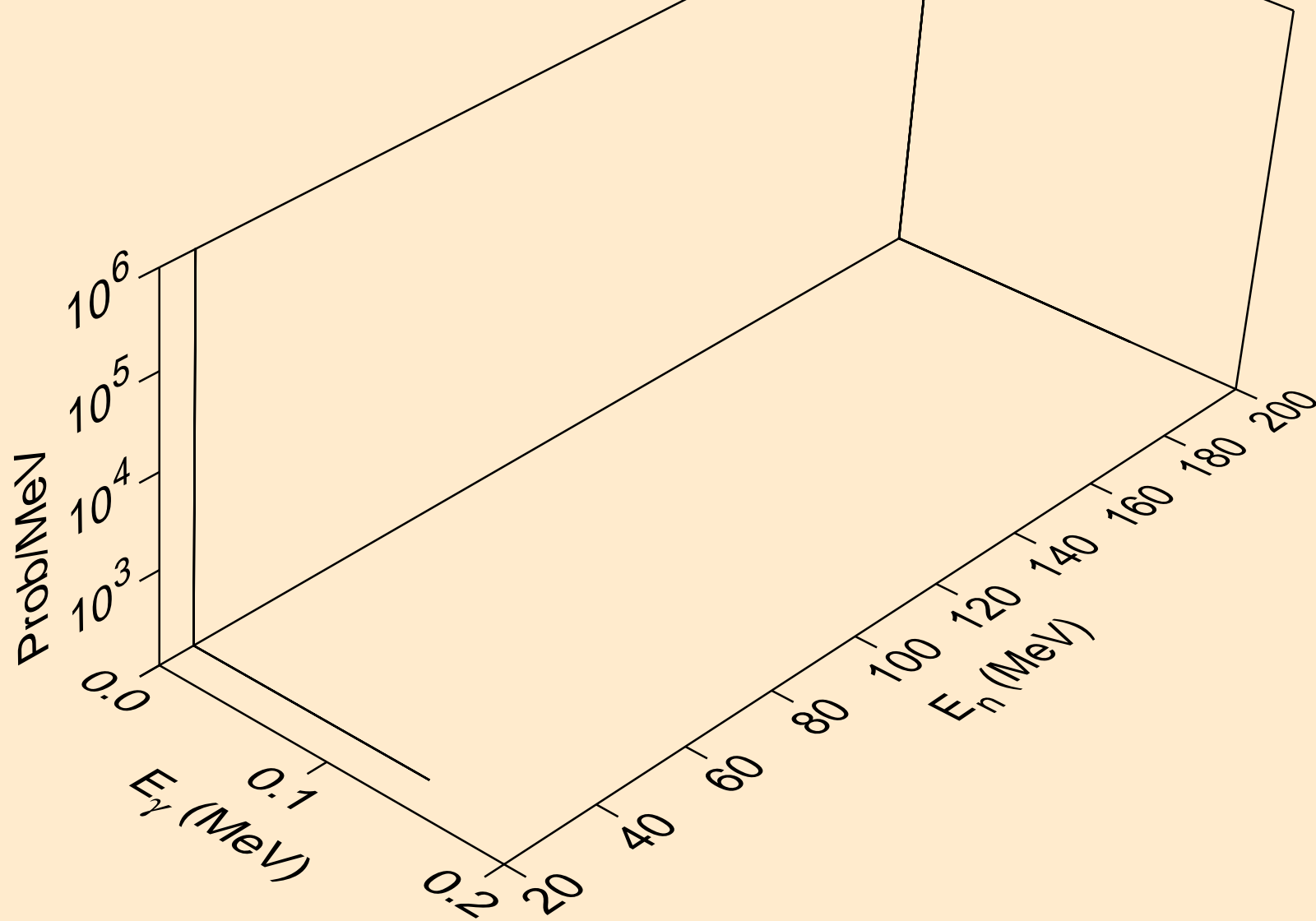

FR204 NEUTRON ACER TENDL-2019 LIBRARY; T=293.16K
Photon emission for (n,2np)

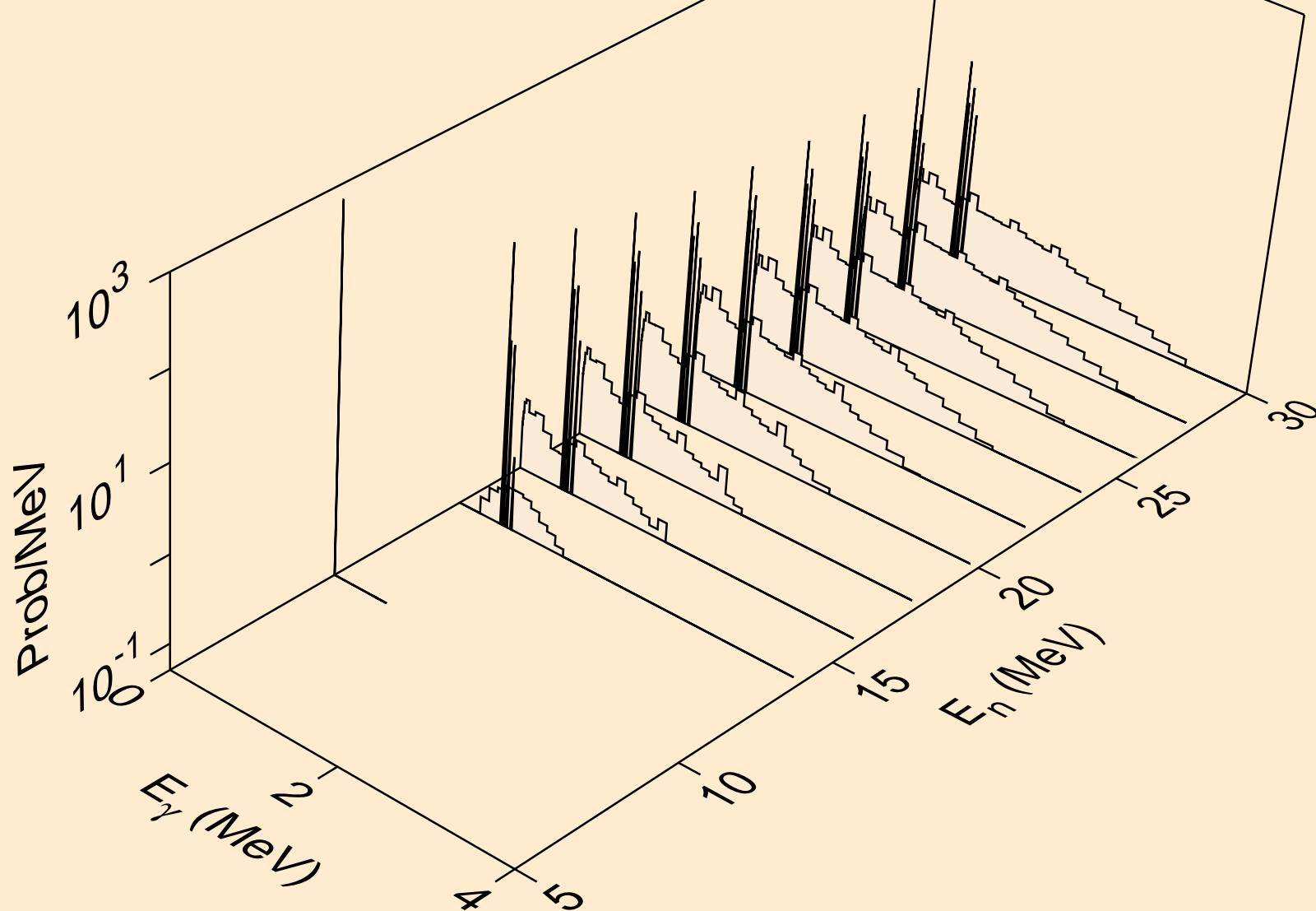

FR204 NEUTRON ACER TENDL-2019 LIBRARY; T=293.16K
Photon emission for (n,3np)

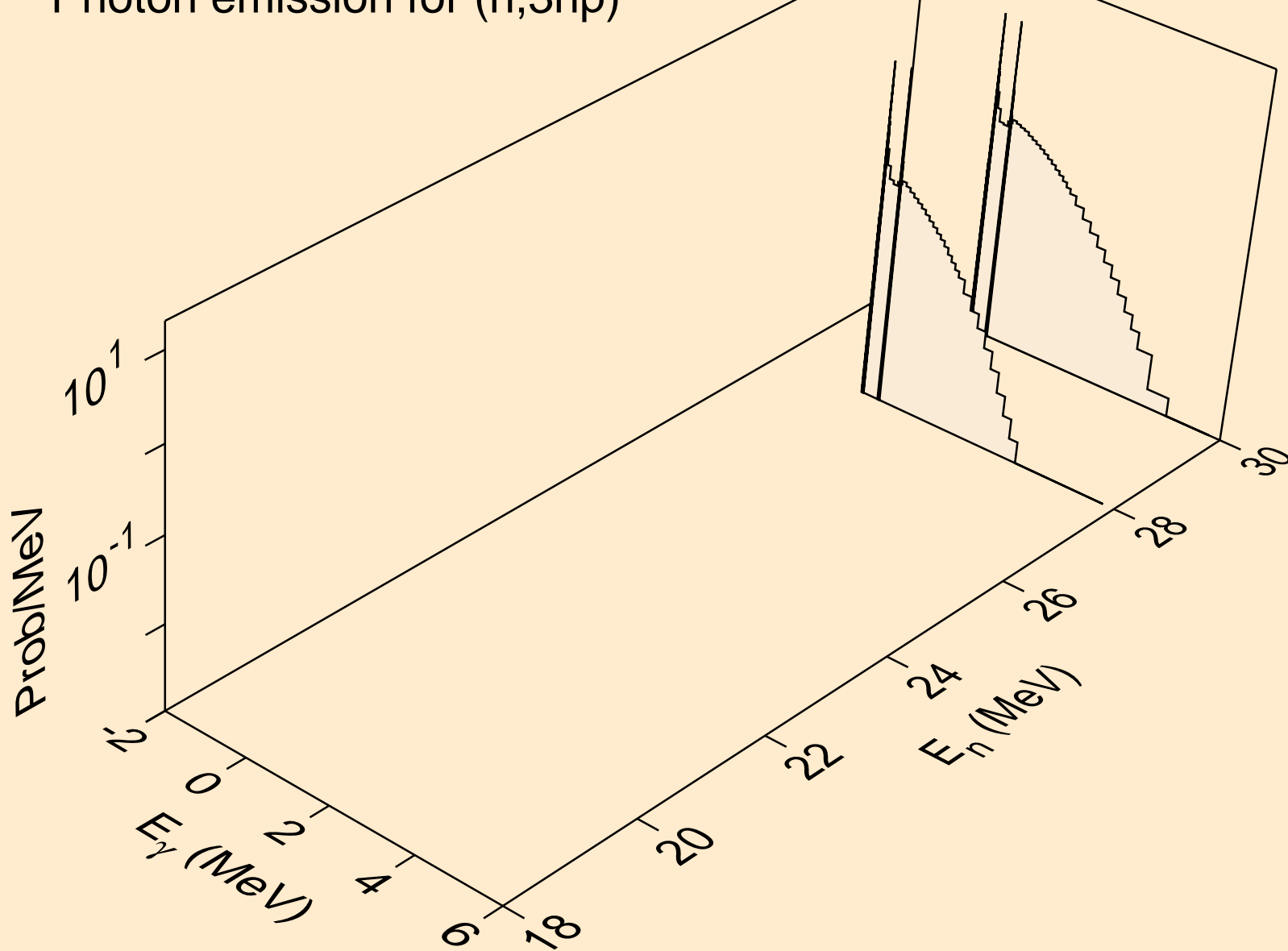

FR204 NEUTRON ACER TENDL-2019 LIBRARY; T=293.16K
Photon emission for (n,2np)

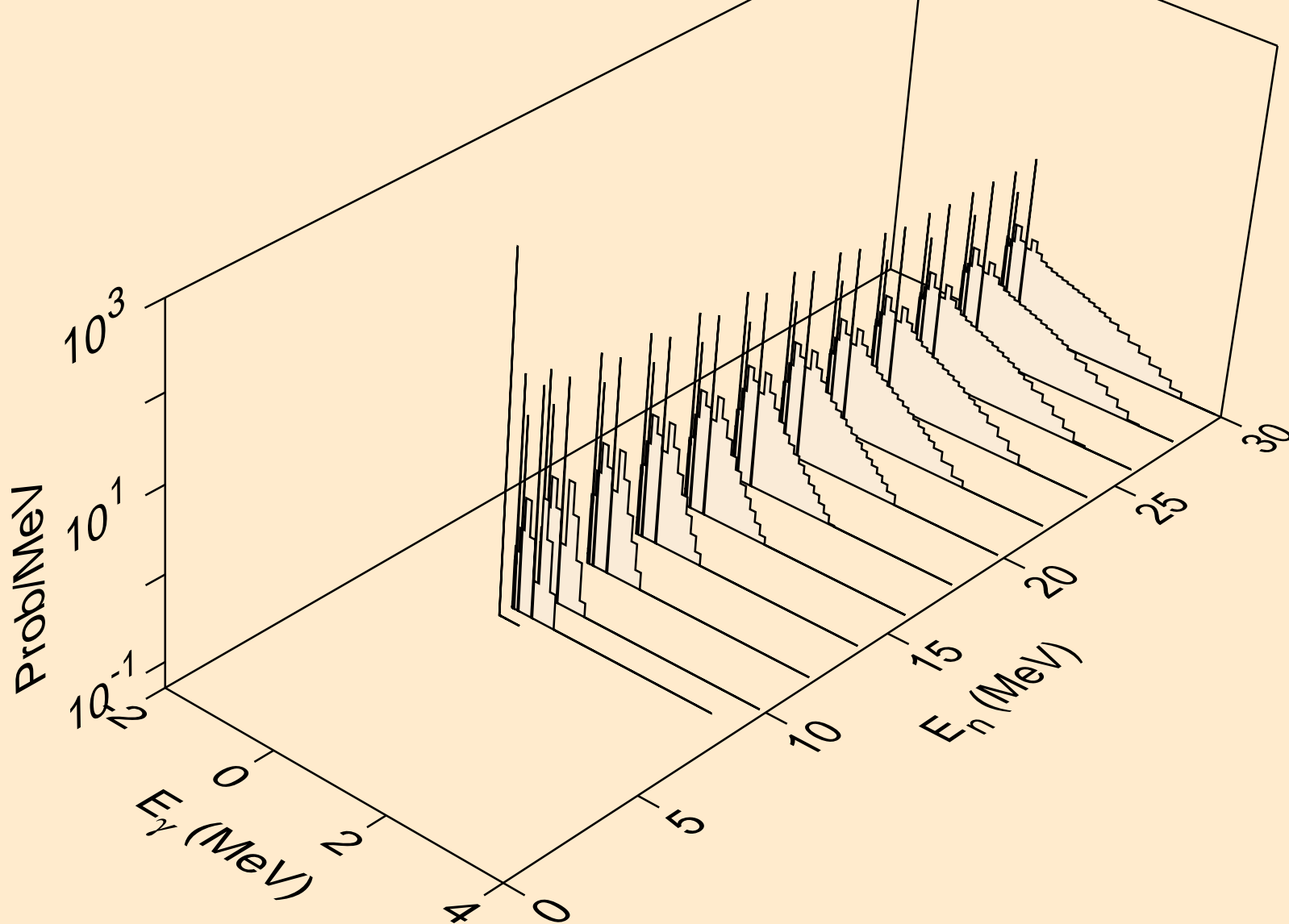

FR204 NEUTRON ACER TENDL-2019 LIBRARY; T=293.16K
Photon emission for (n,npa)

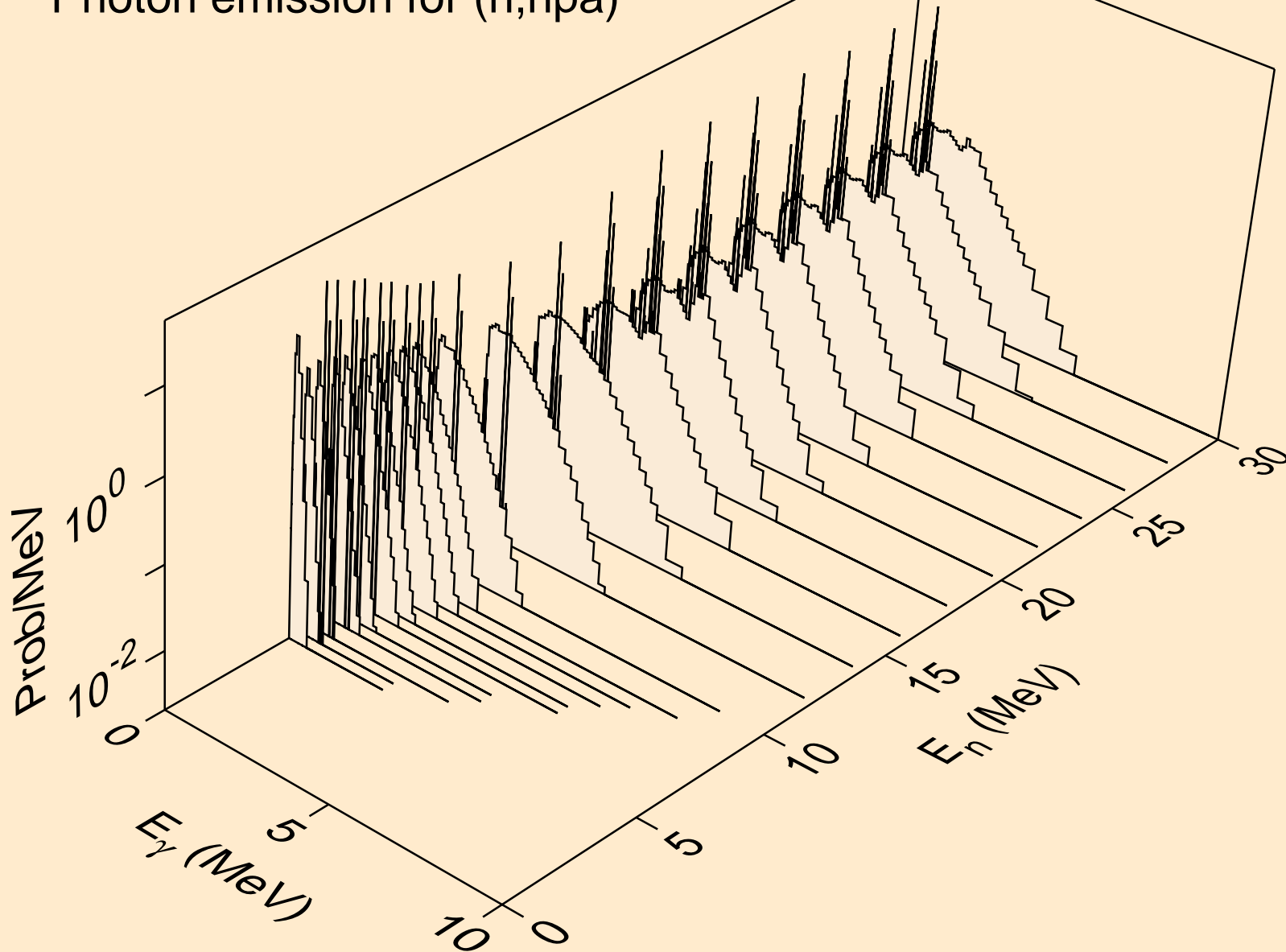

FR204 NEUTRON ACER TENDL-2019 LIBRARY; T=293.16K
Photon emission for (n,n*c)

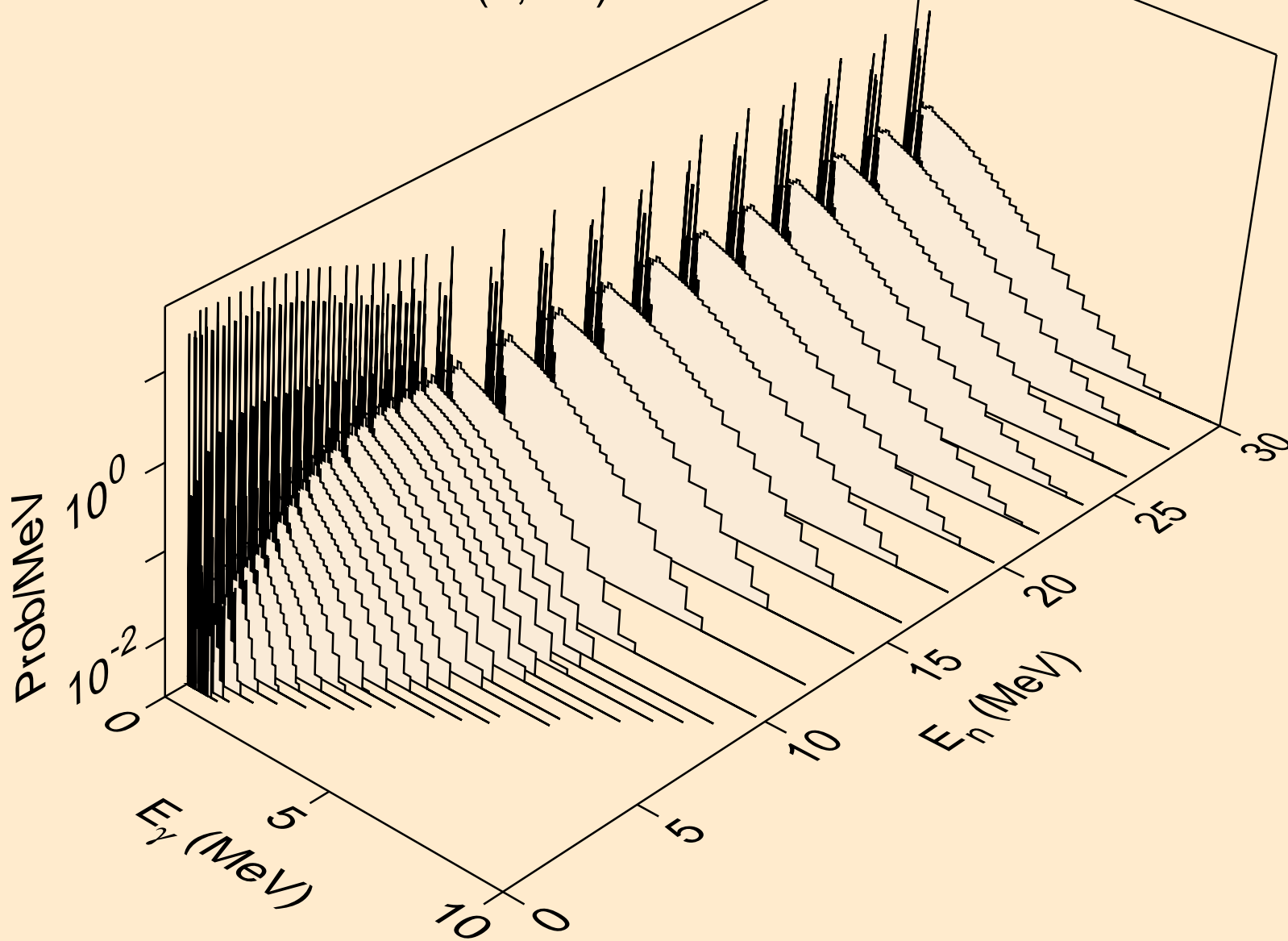

FR204 NEUTRON ACER TENDL-2019 LIBRARY; T=293.16K
Photon emission for (n,gma)

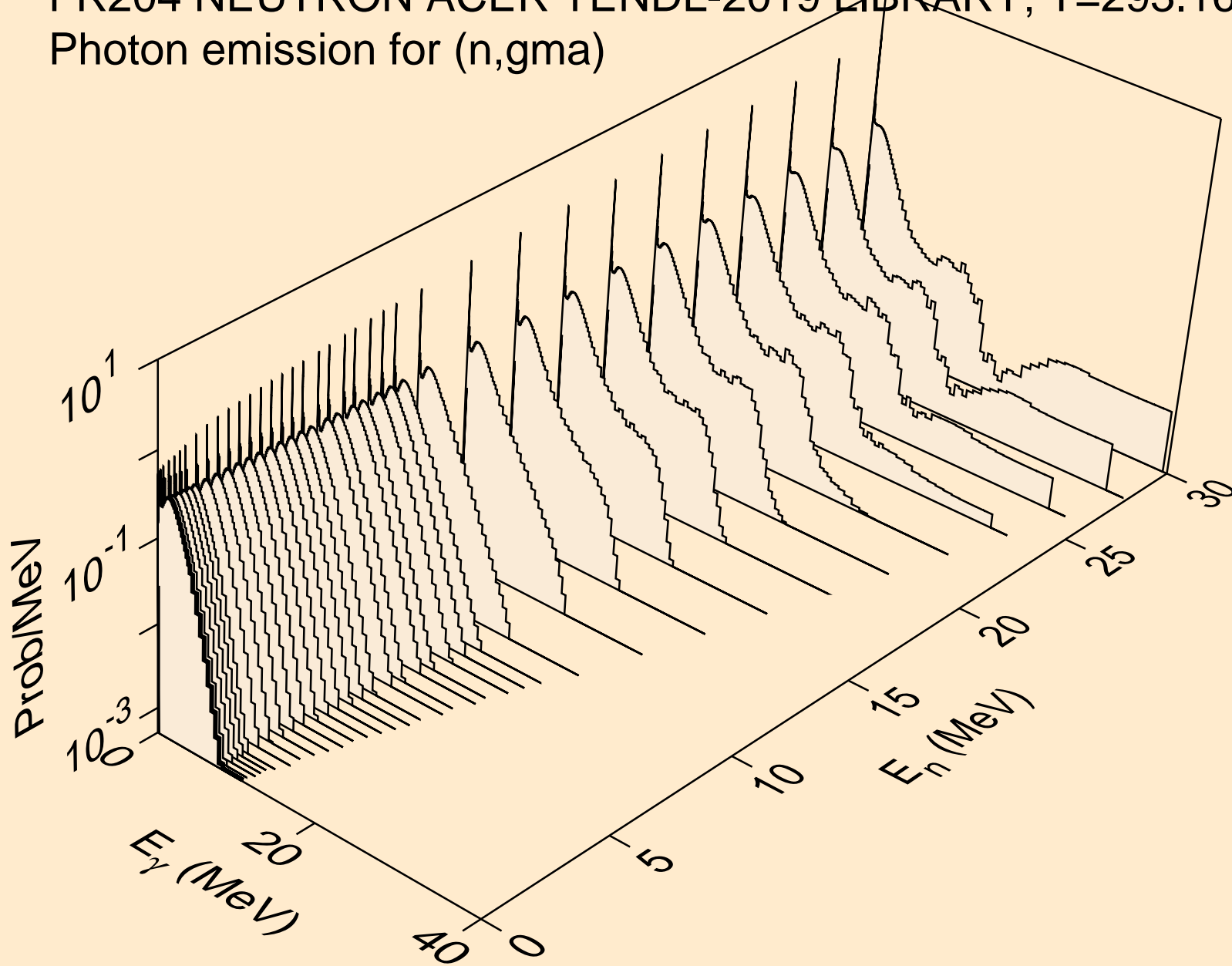

FR204 NEUTRON ACER TENDL-2019 LIBRARY; T=293.16K
Photon emission for (n,p)

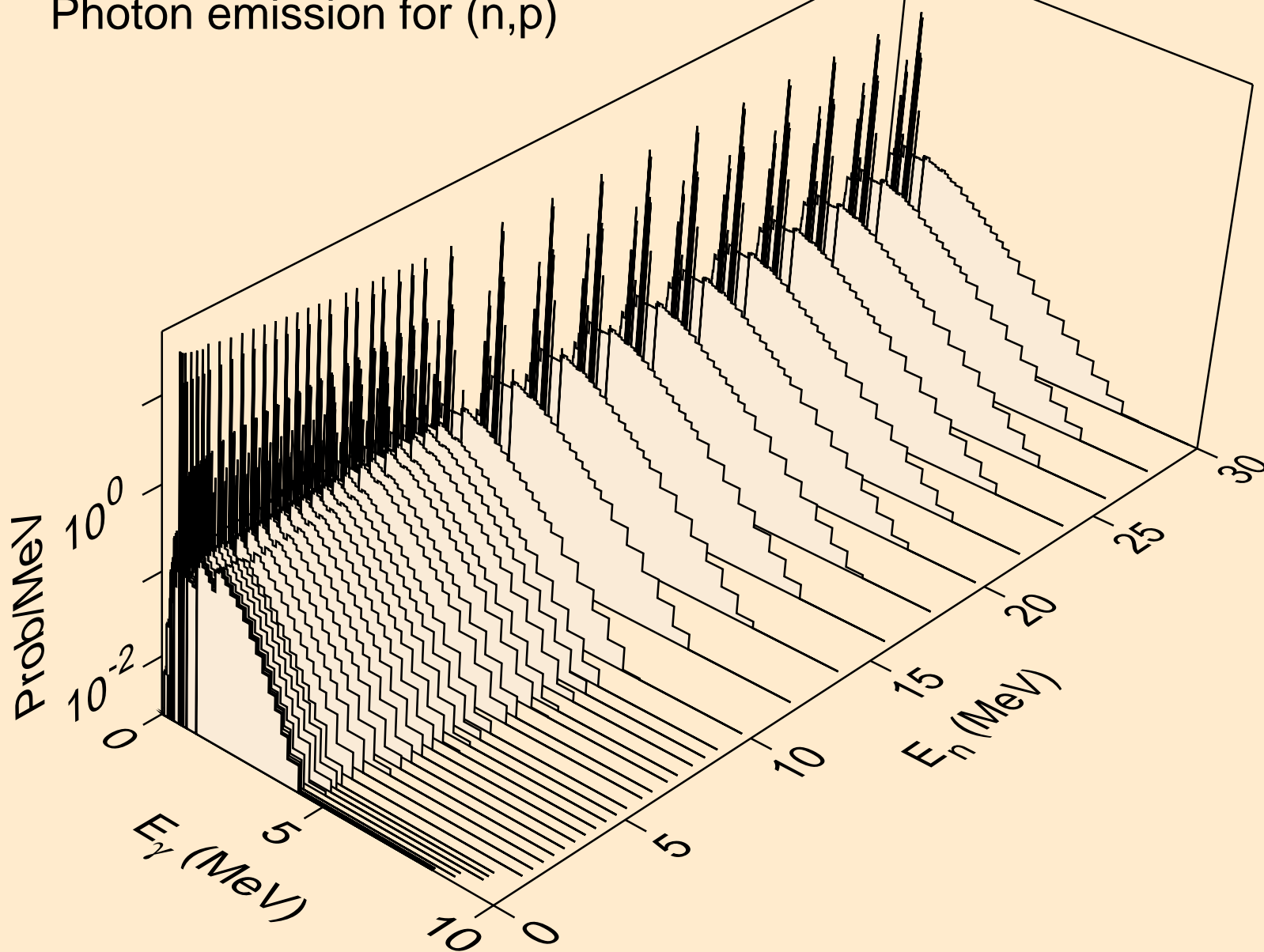

FR204 NEUTRON ACER TENDL-2019 LIBRARY; T=293.16K
Photon emission for (n,d)

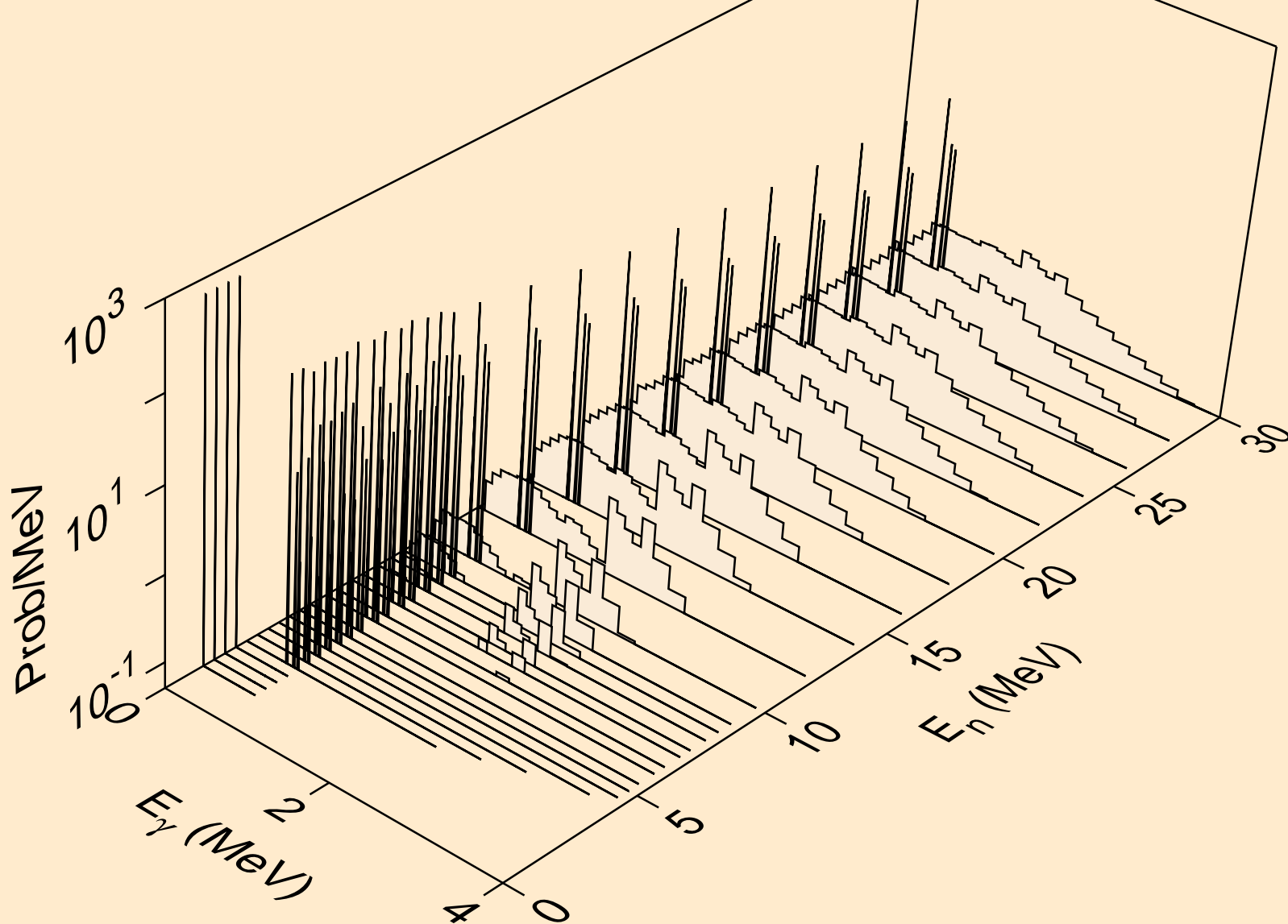

FR204 NEUTRON ACER TENDL-2019 LIBRARY; T=293.16K
Photon emission for (n,t)

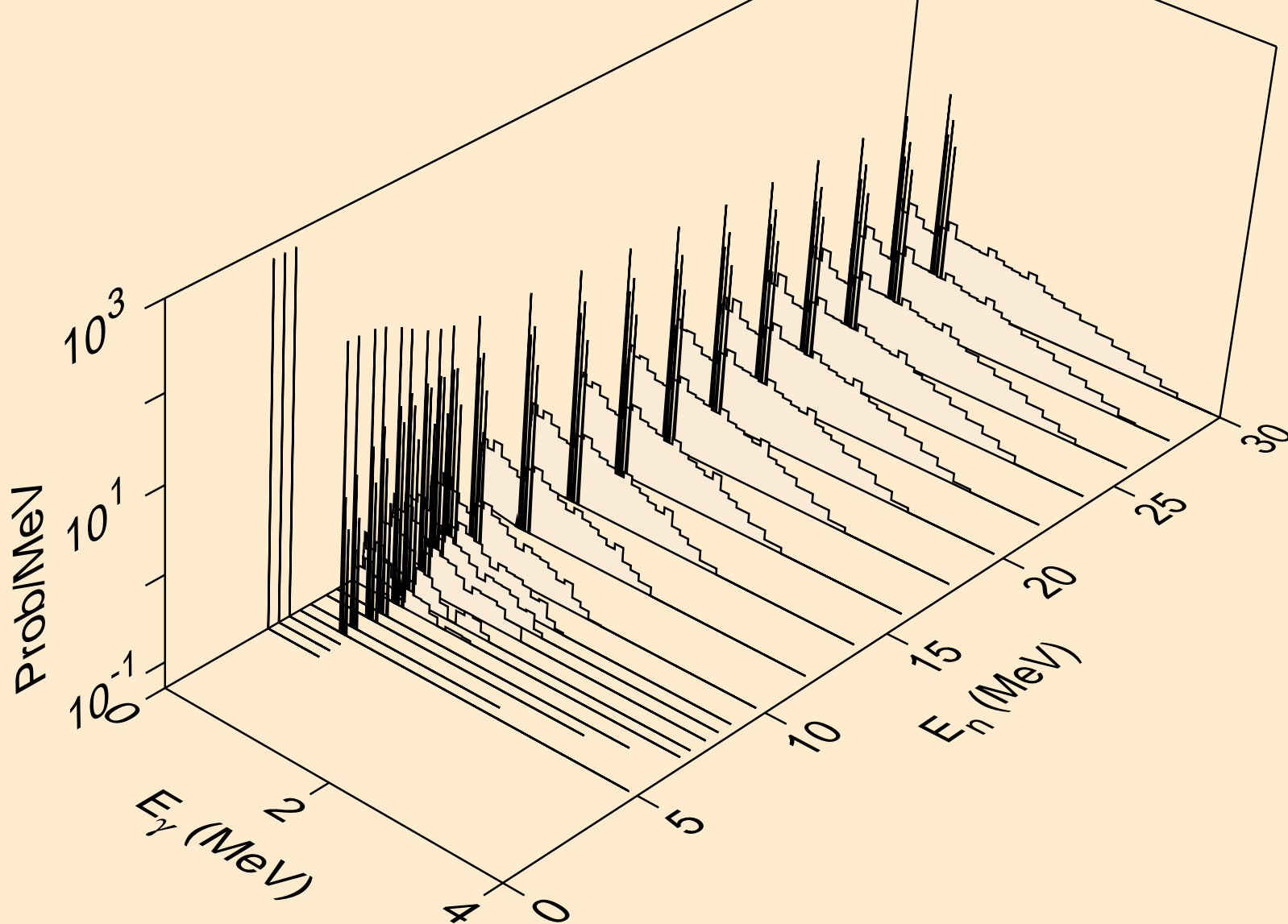

FR204 NEUTRON ACER TENDL-2019 LIBRARY; T=293.16K
Photon emission for (n,he3)

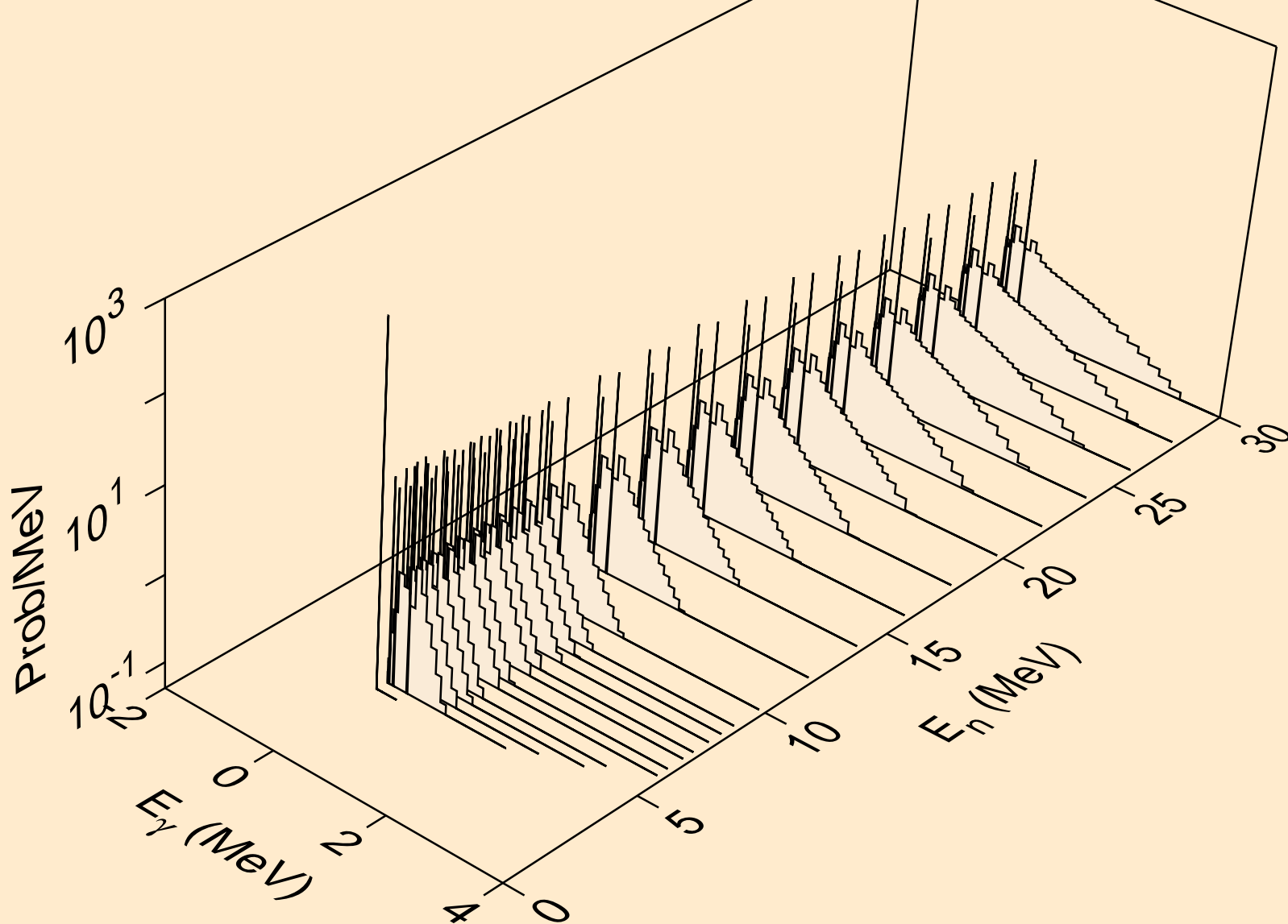

FR204 NEUTRON ACER TENDL-2019 LIBRARY; T=293.16K
Photon emission for (n,a)

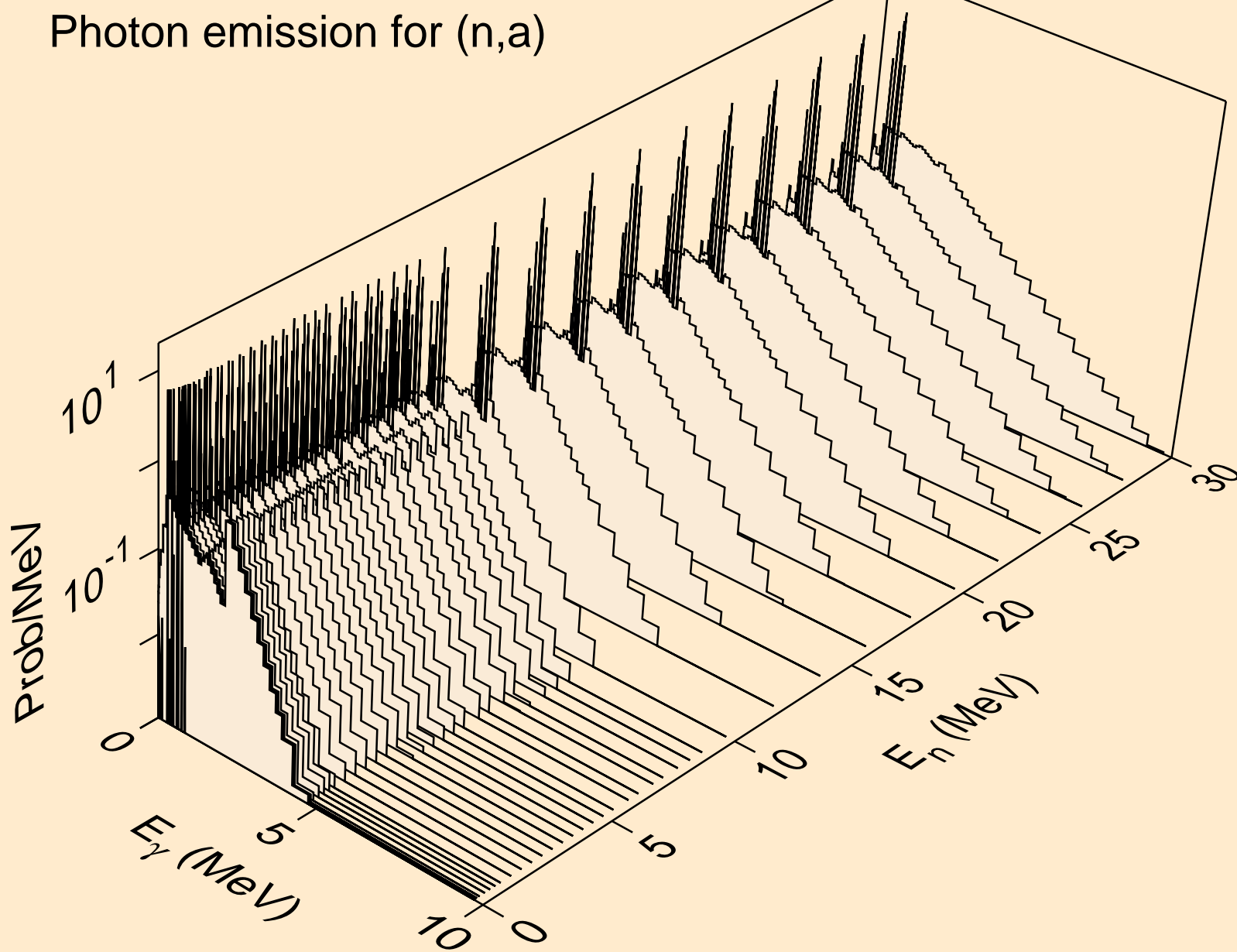

FR204 NEUTRON ACER TENDL-2019 LIBRARY; T=293.16K
Photon emission for (n,2a)

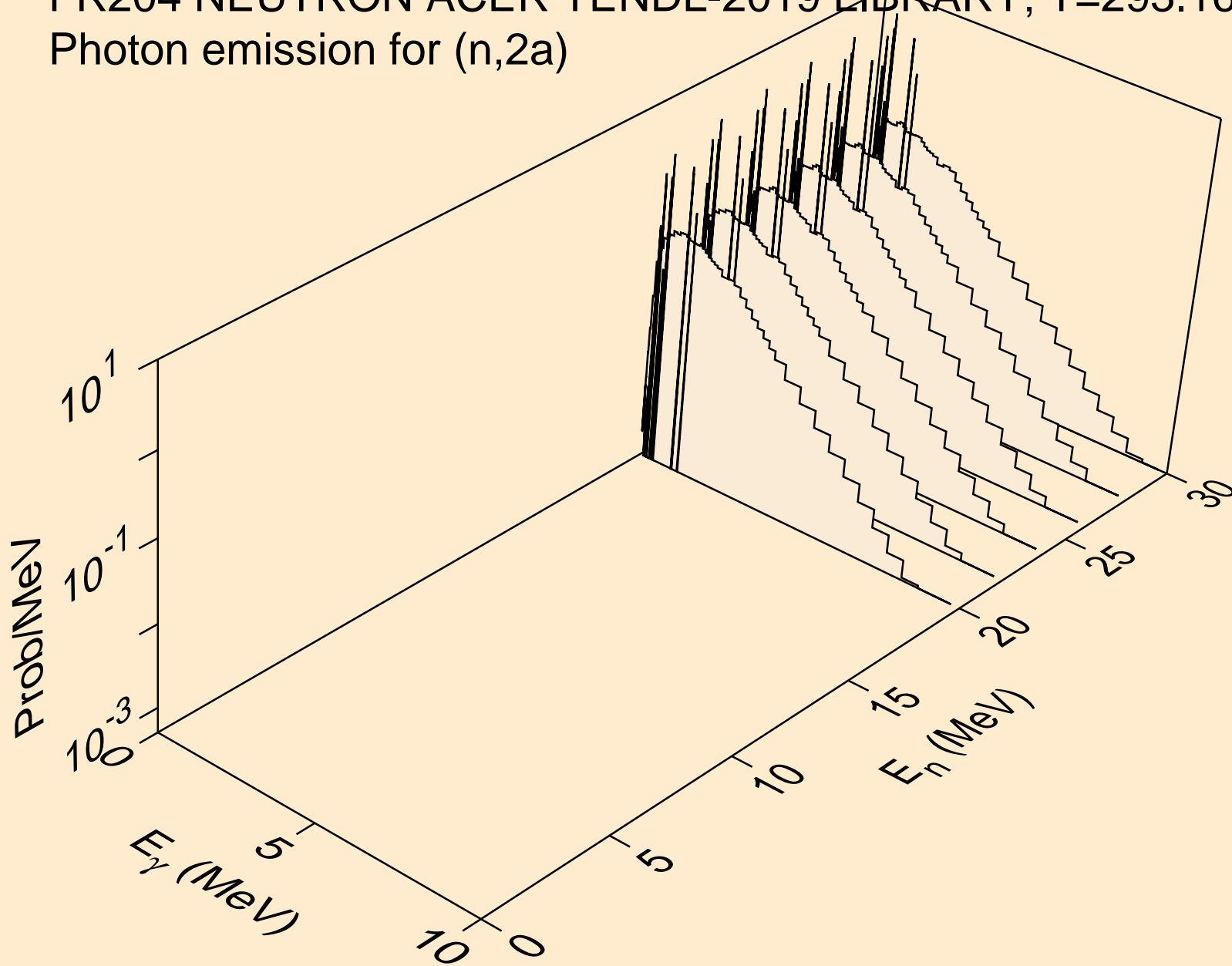

FR204 NEUTRON ACER TENDL-2019 LIBRARY; T=293.16K
Photon emission for (n,3a)

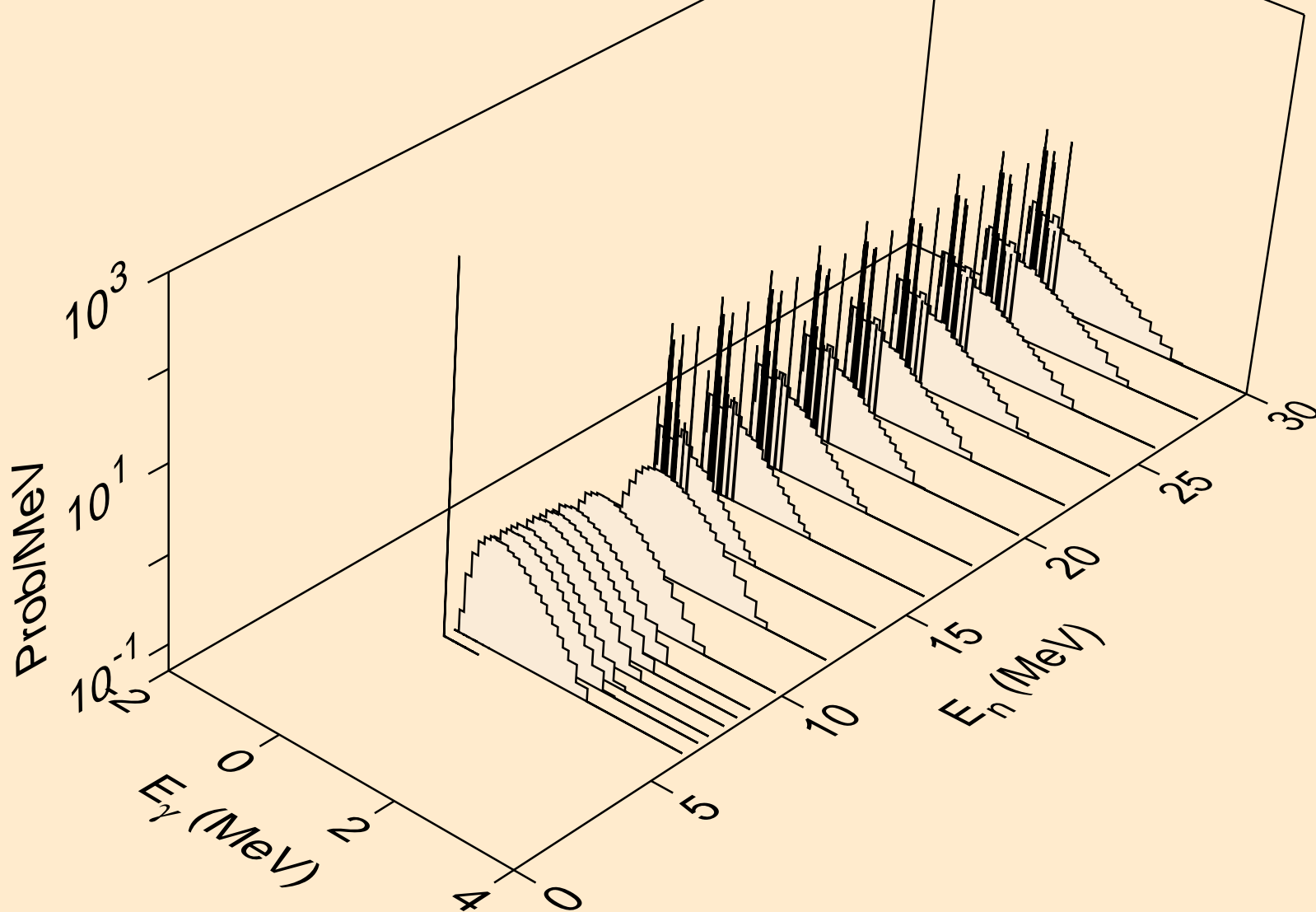

FR204 NEUTRON ACER TENDL-2019 LIBRARY; T=293.16K
Photon emission for (n,2p)

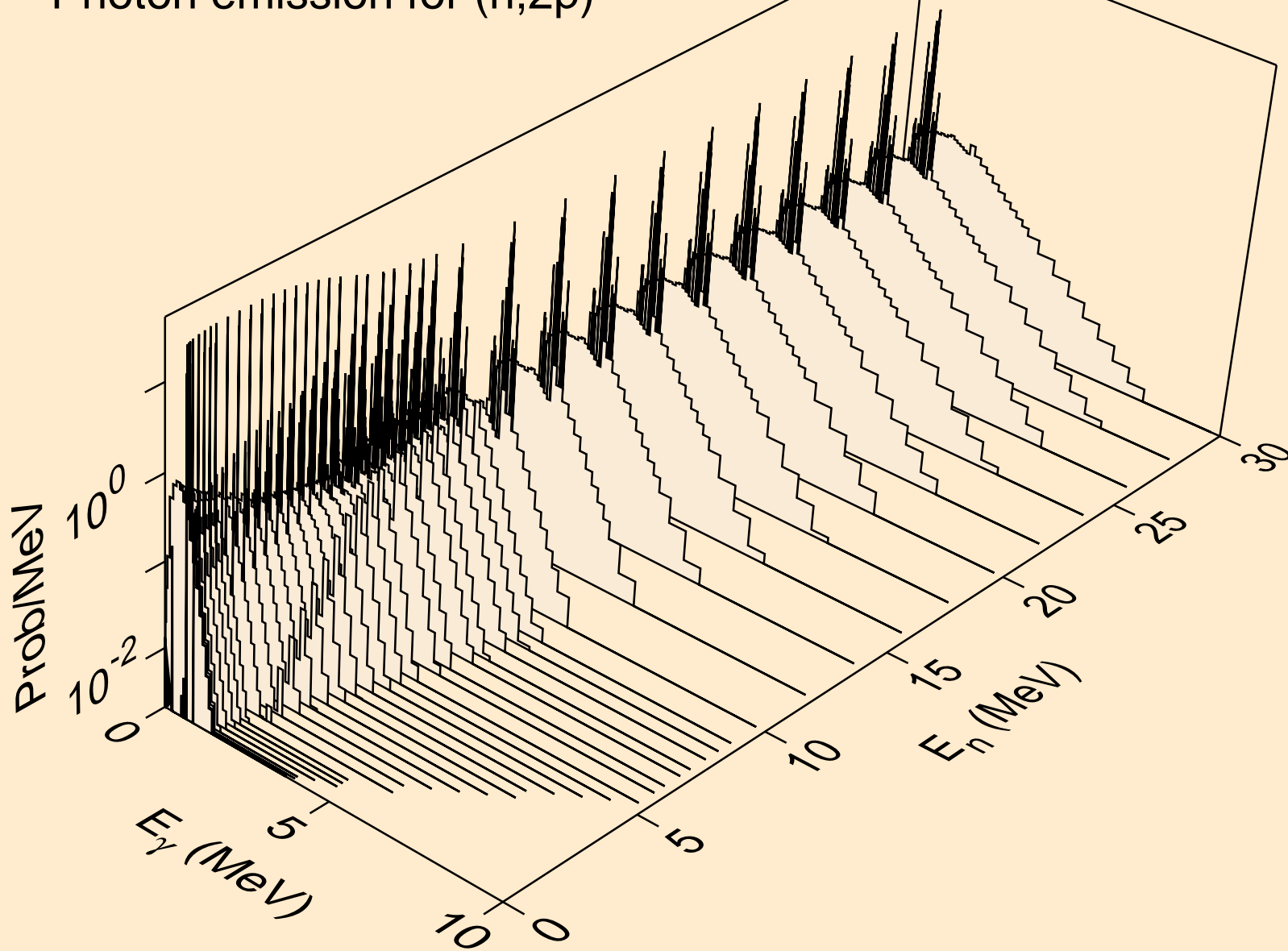

FR204 NEUTRON ACER TENDL-2019 LIBRARY; T=293.16K
Photon emission for (n,p α)

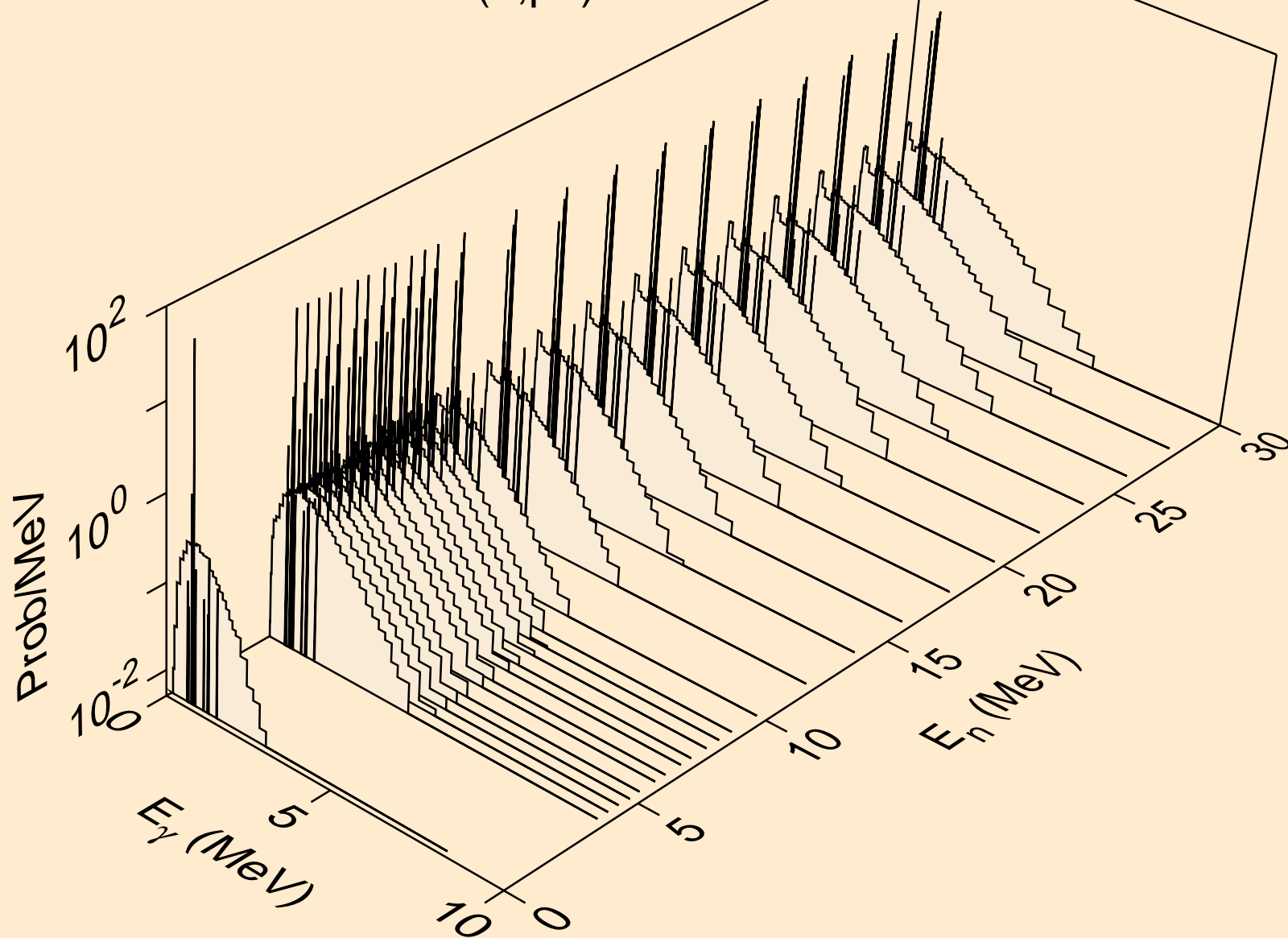

FR204 NEUTRON ACER TENDL-2019 LIBRARY; T=293.16K
Photon emission for (n,pd)

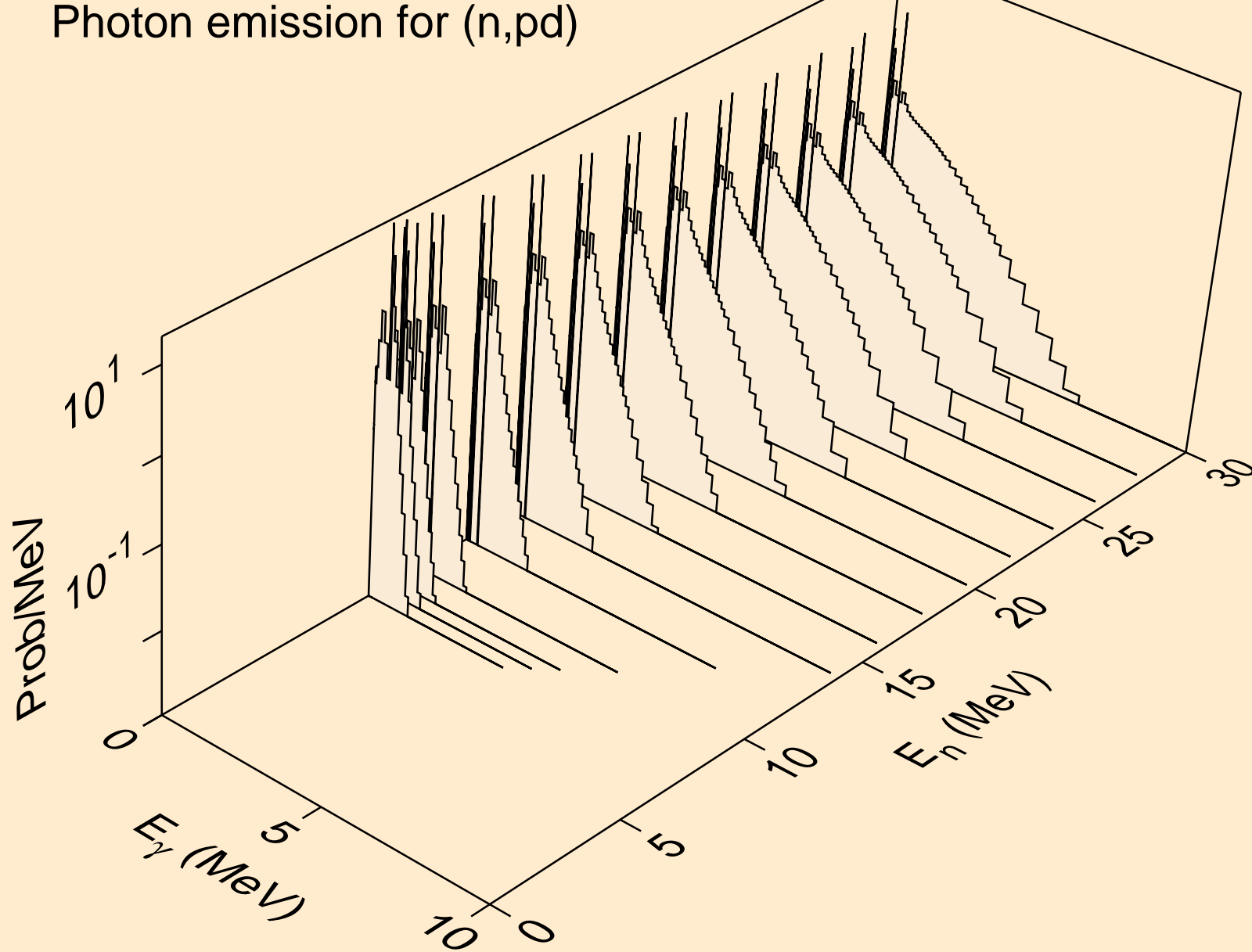

FR204 NEUTRON ACER TENDL-2019 LIBRARY; T=293.16K
Photon emission for (n,pt)

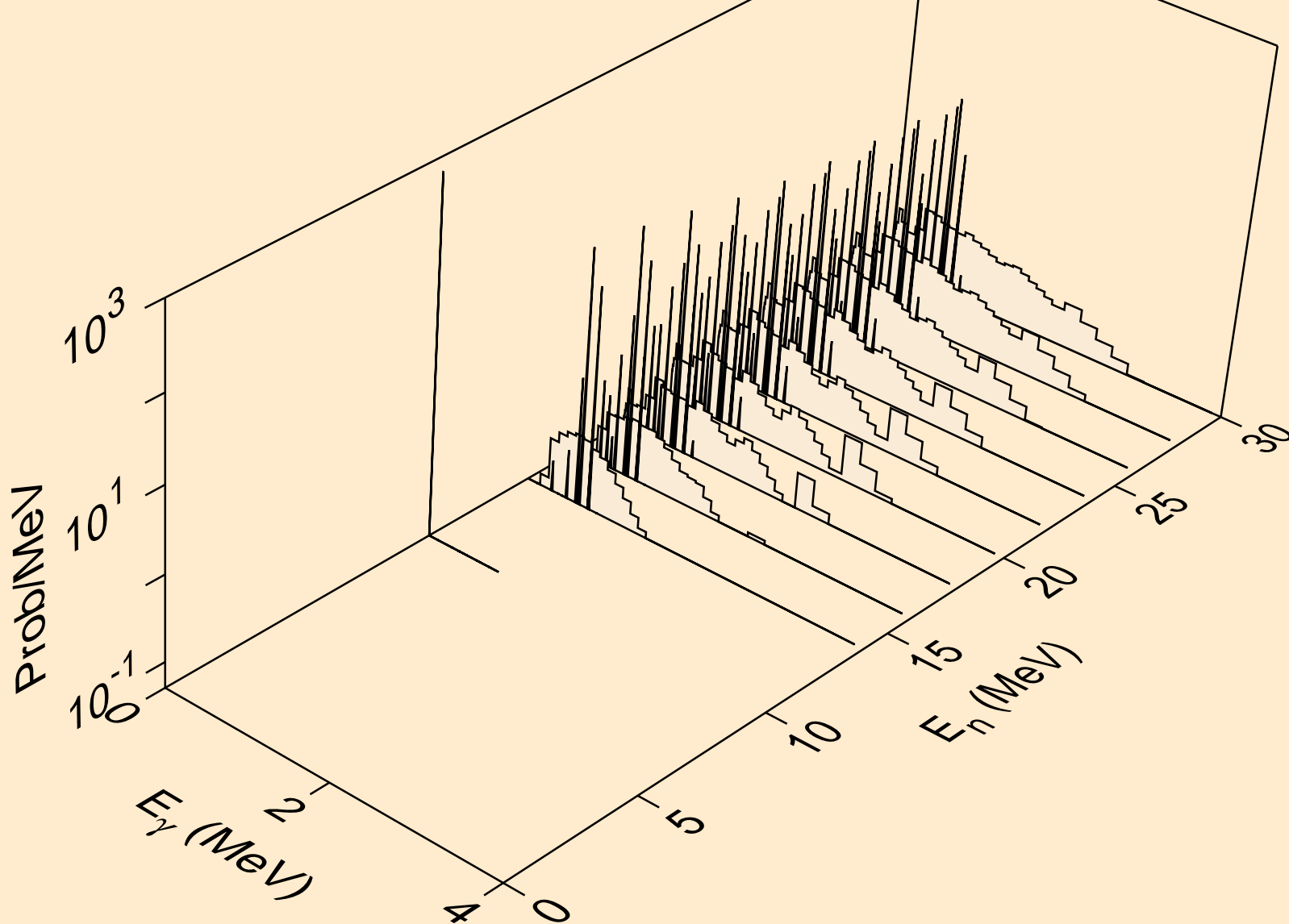

FR204 NEUTRON ACER TENDL-2019 LIBRARY; T=293.16K
Photon emission for (n,da)

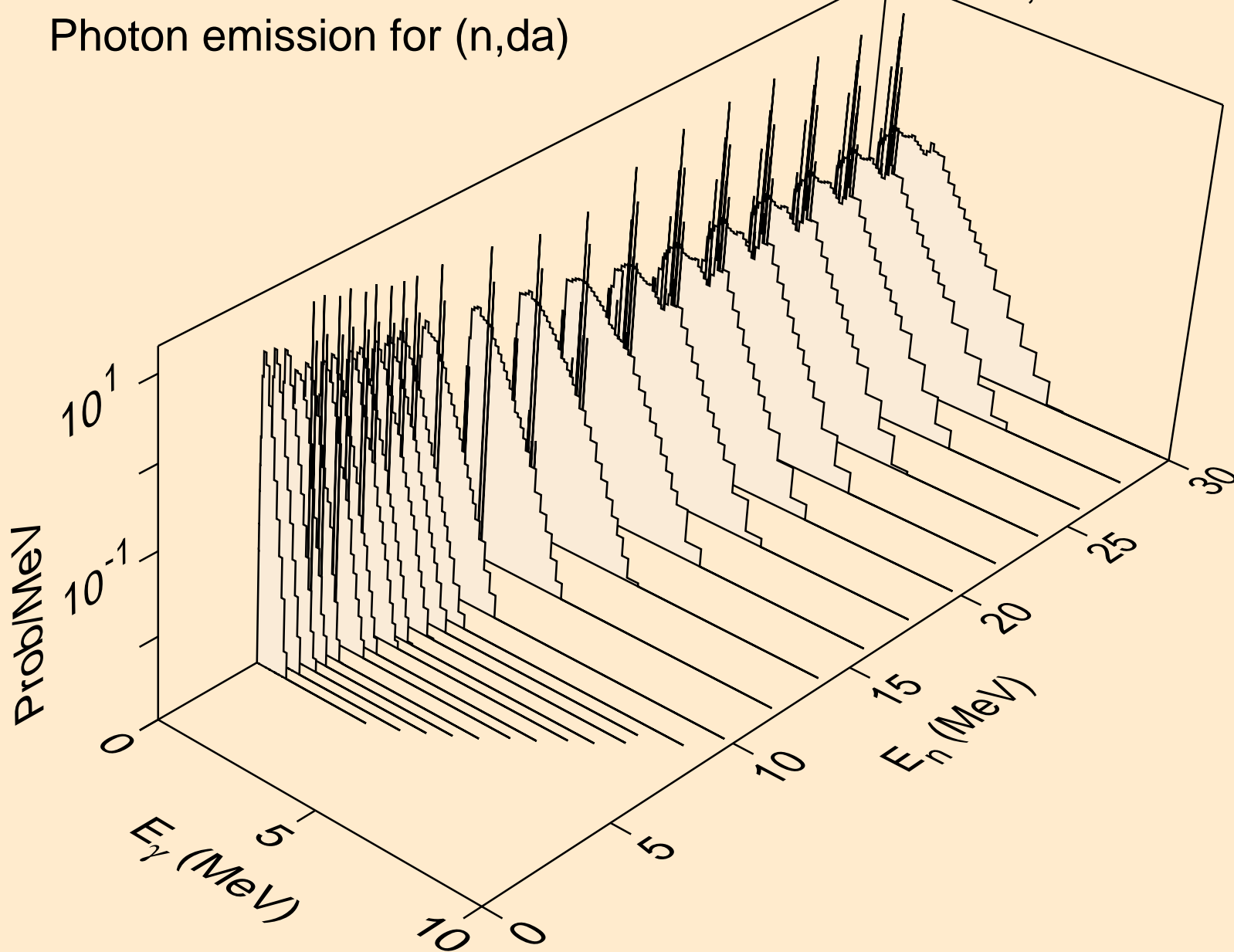

FR204 NEUTRON ACER TENDL-2019 LIBRARY; T=293.16K
thermal capture photon spectrum

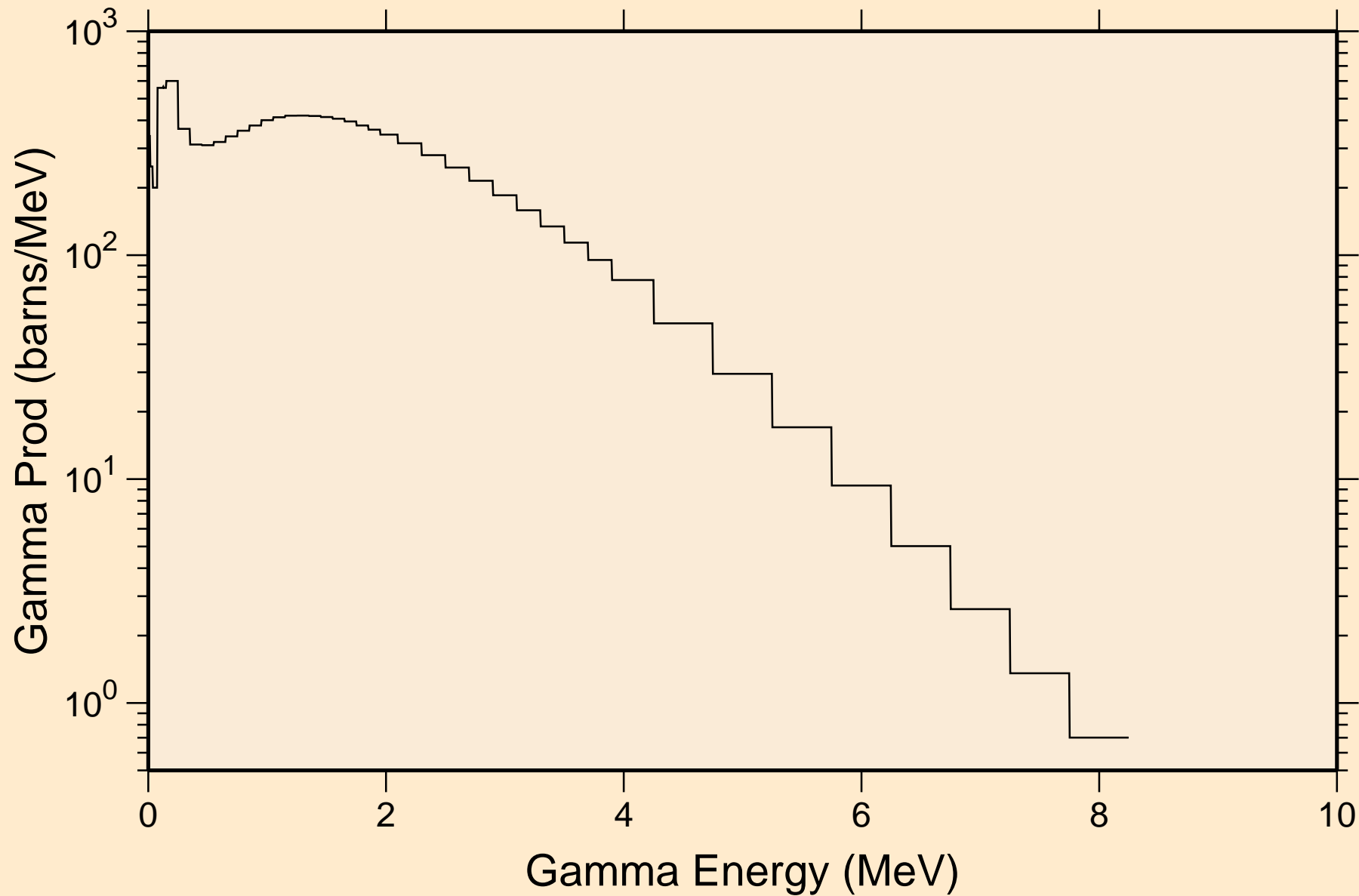

FR204 NEUTRON ACER TENDL-2019 LIBRARY; T=293.16K
14 MeV photon spectrum

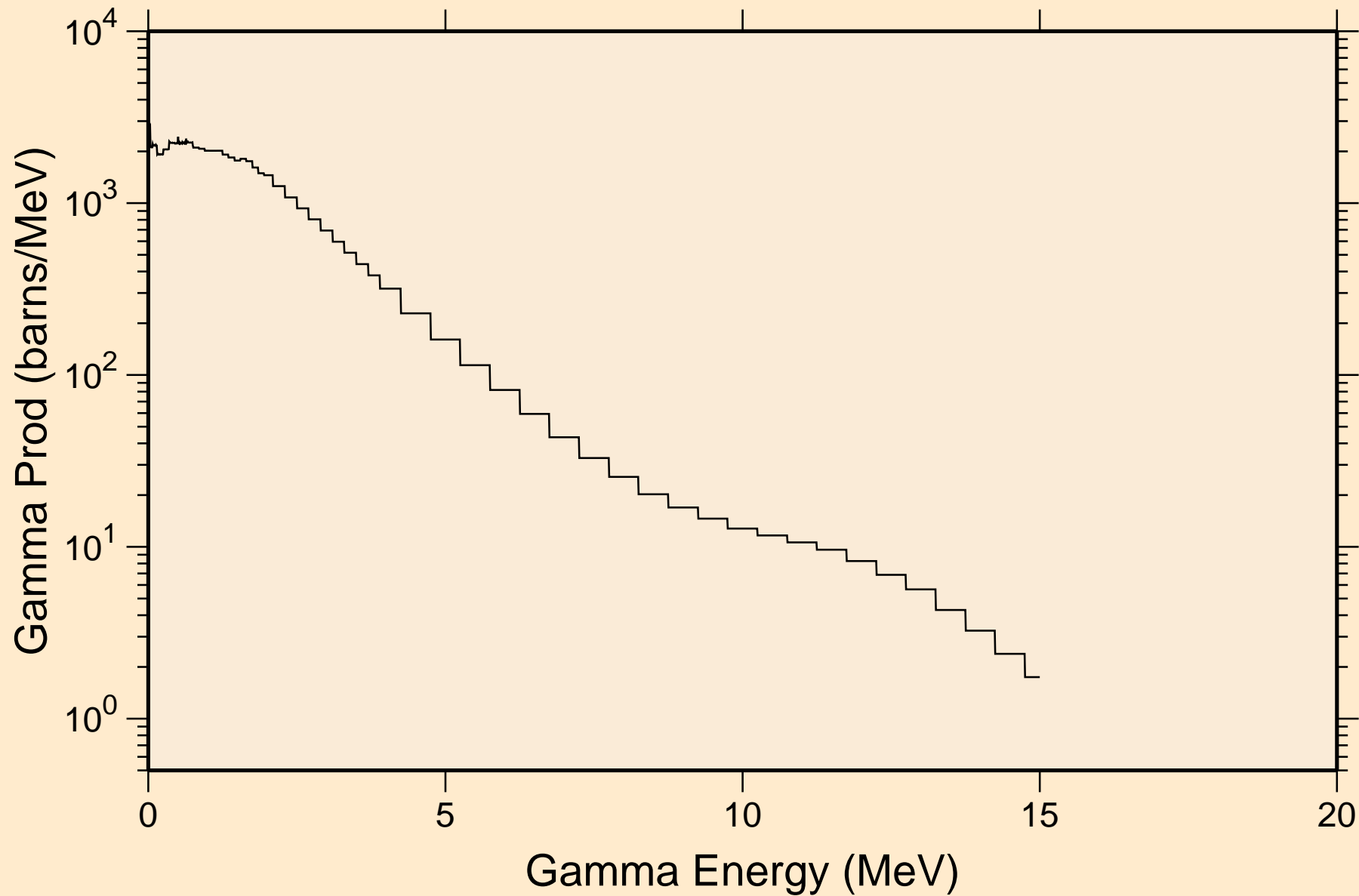

FR204 NEUTRON ACER TENDL-2019 LIBRARY; T=293.16K

Particle heating contributions

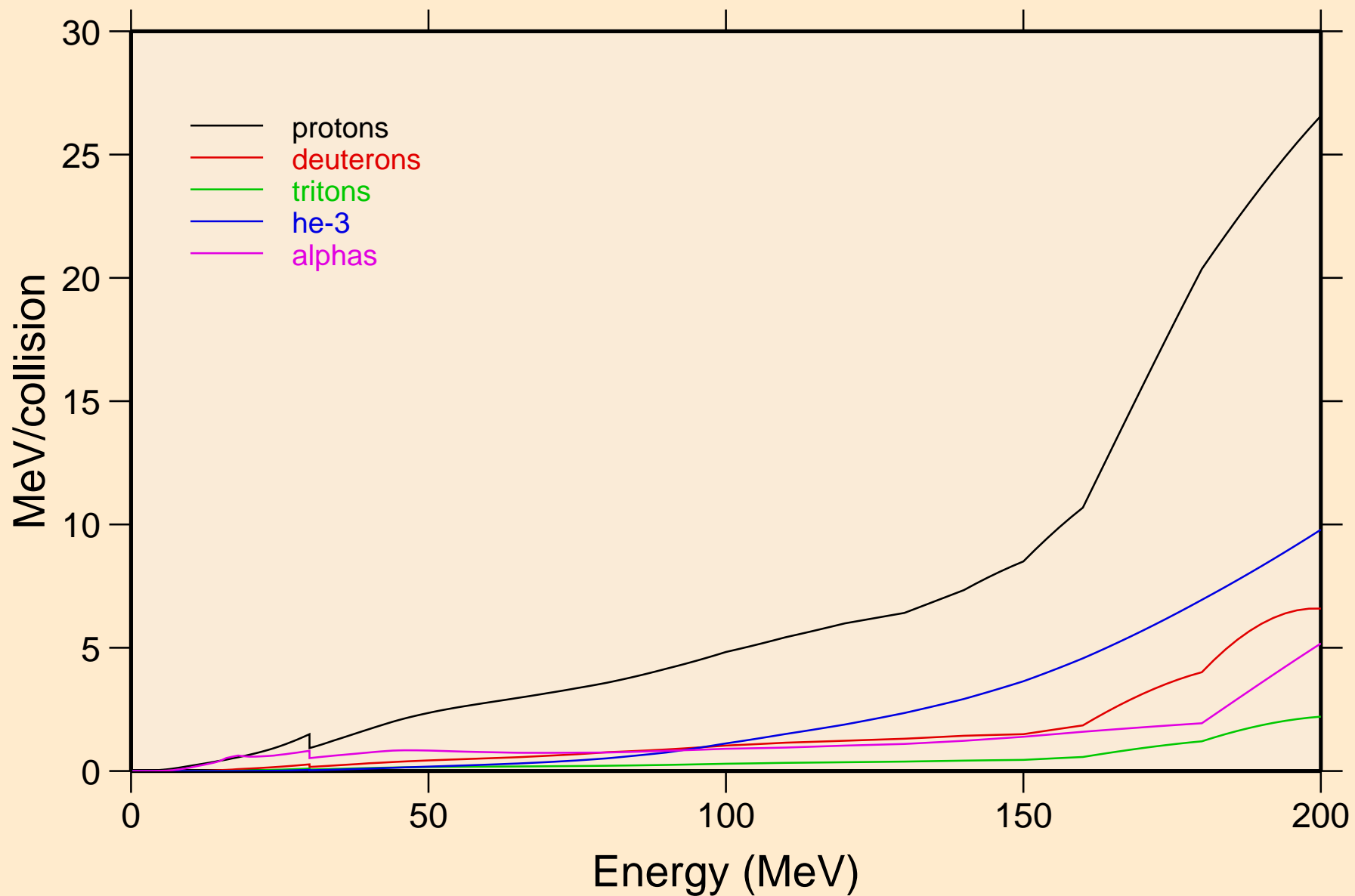

FR204 NEUTRON ACER TENDL-2019 LIBRARY; T=293.16K
Recoil Heating

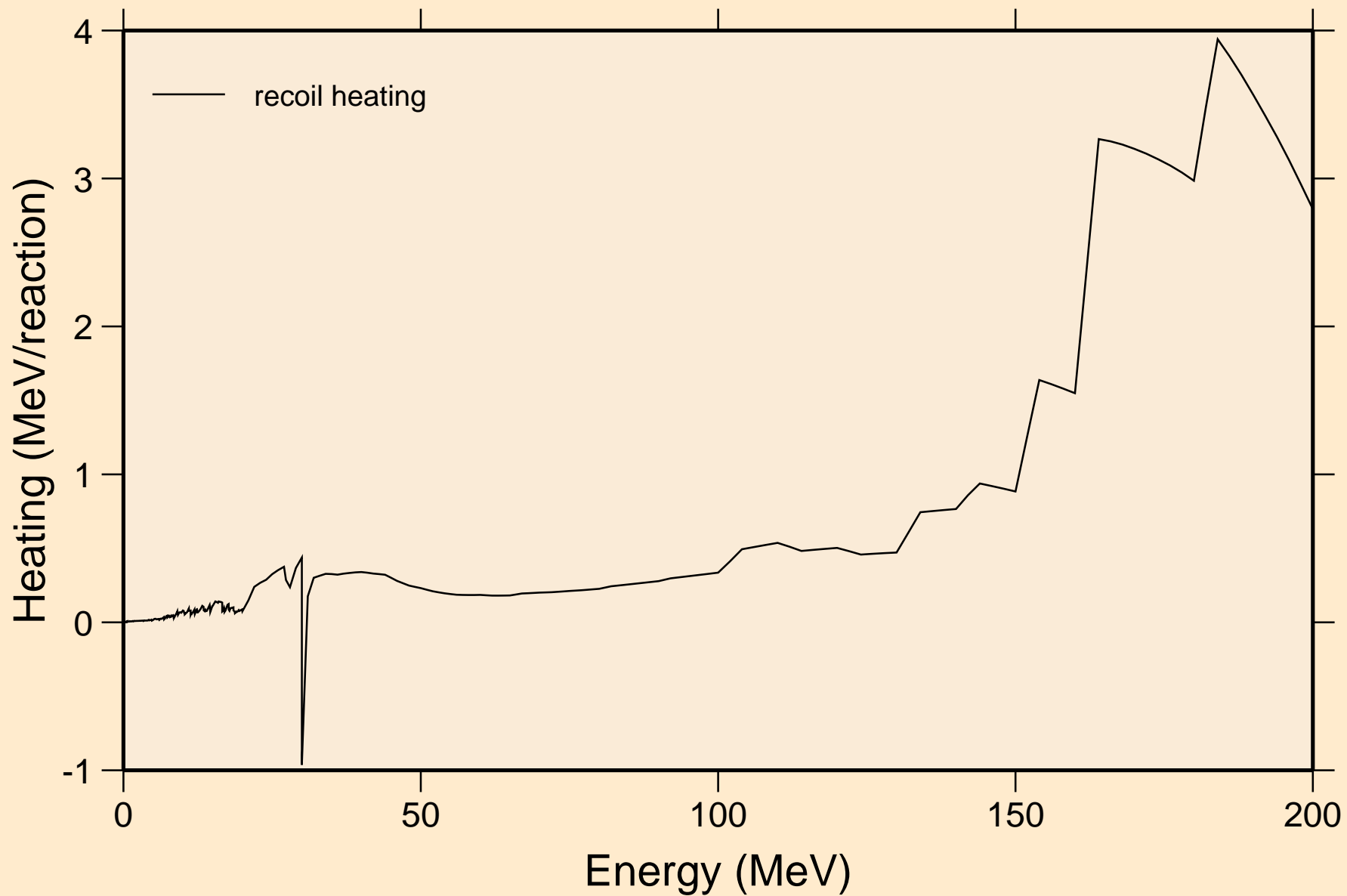

FR204 NEUTRON ACER TENDL-2019 LIBRARY; T=293.16K
Particle production cross sections

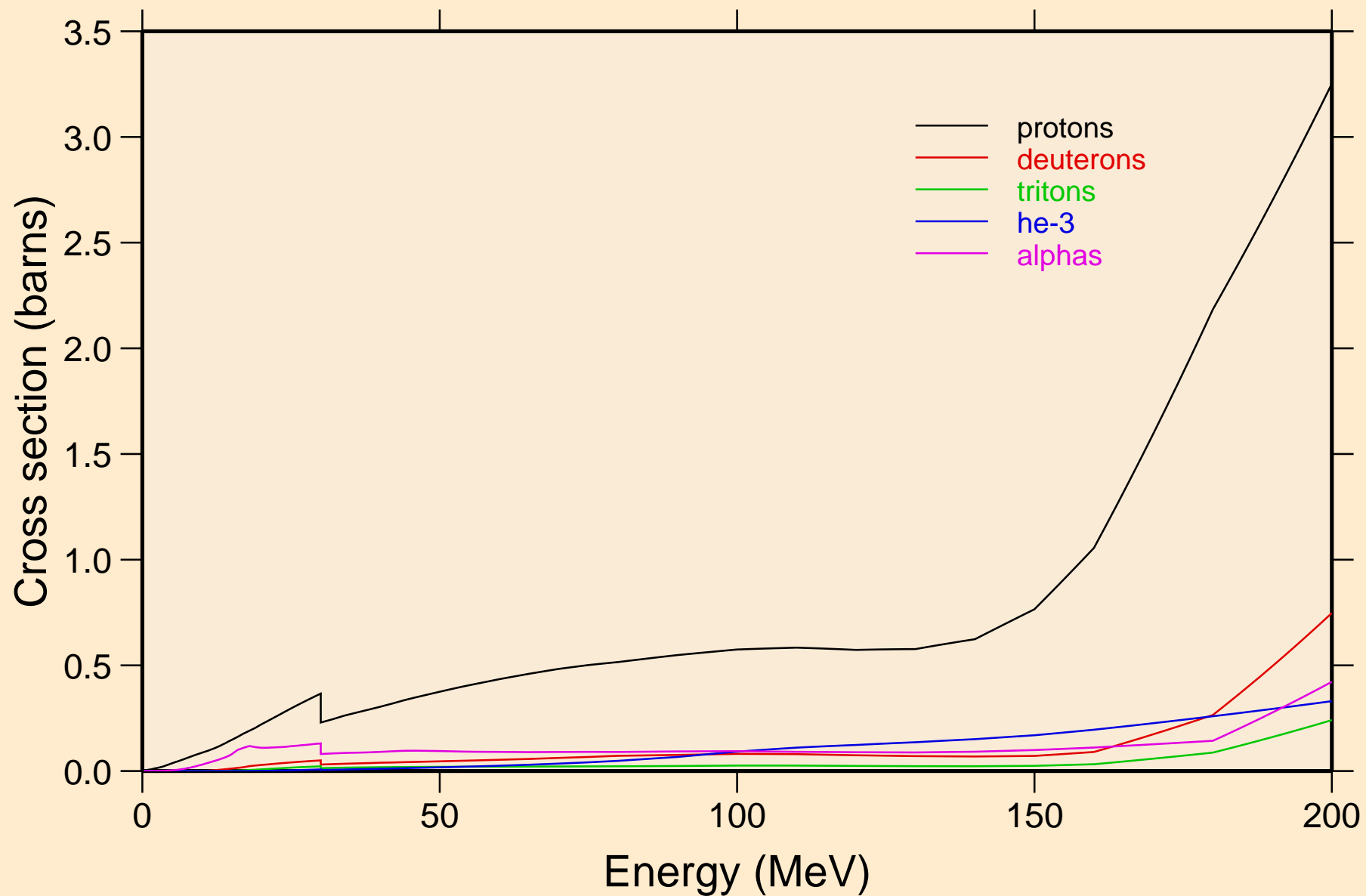

FR204 NEUTRON ACER TENDL-2019 LIBRARY; T=293.16K
protons from (n,x)

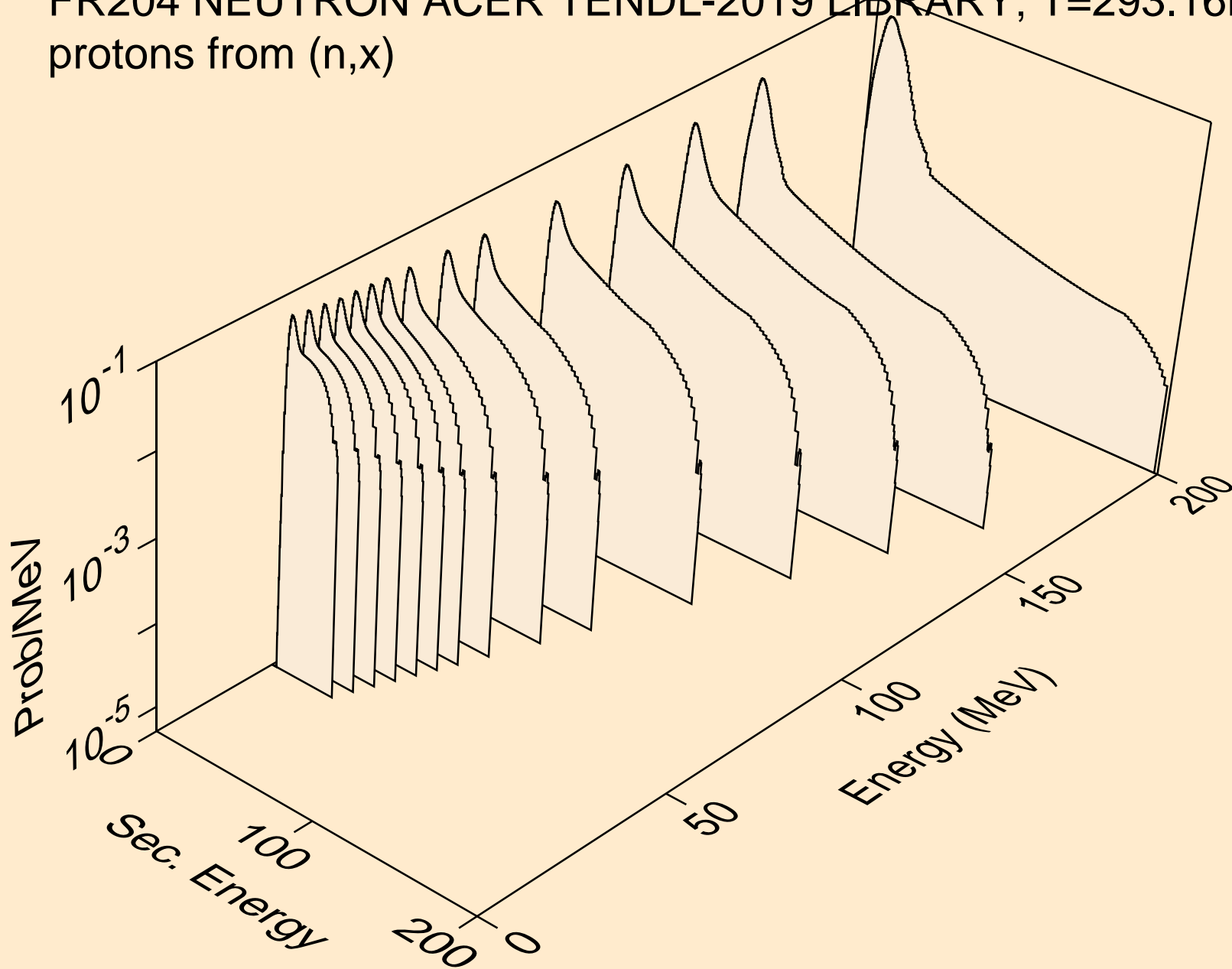

FR204 NEUTRON ACER TENDL-2019 LIBRARY; T=293.16K
protons from (n,n*)p

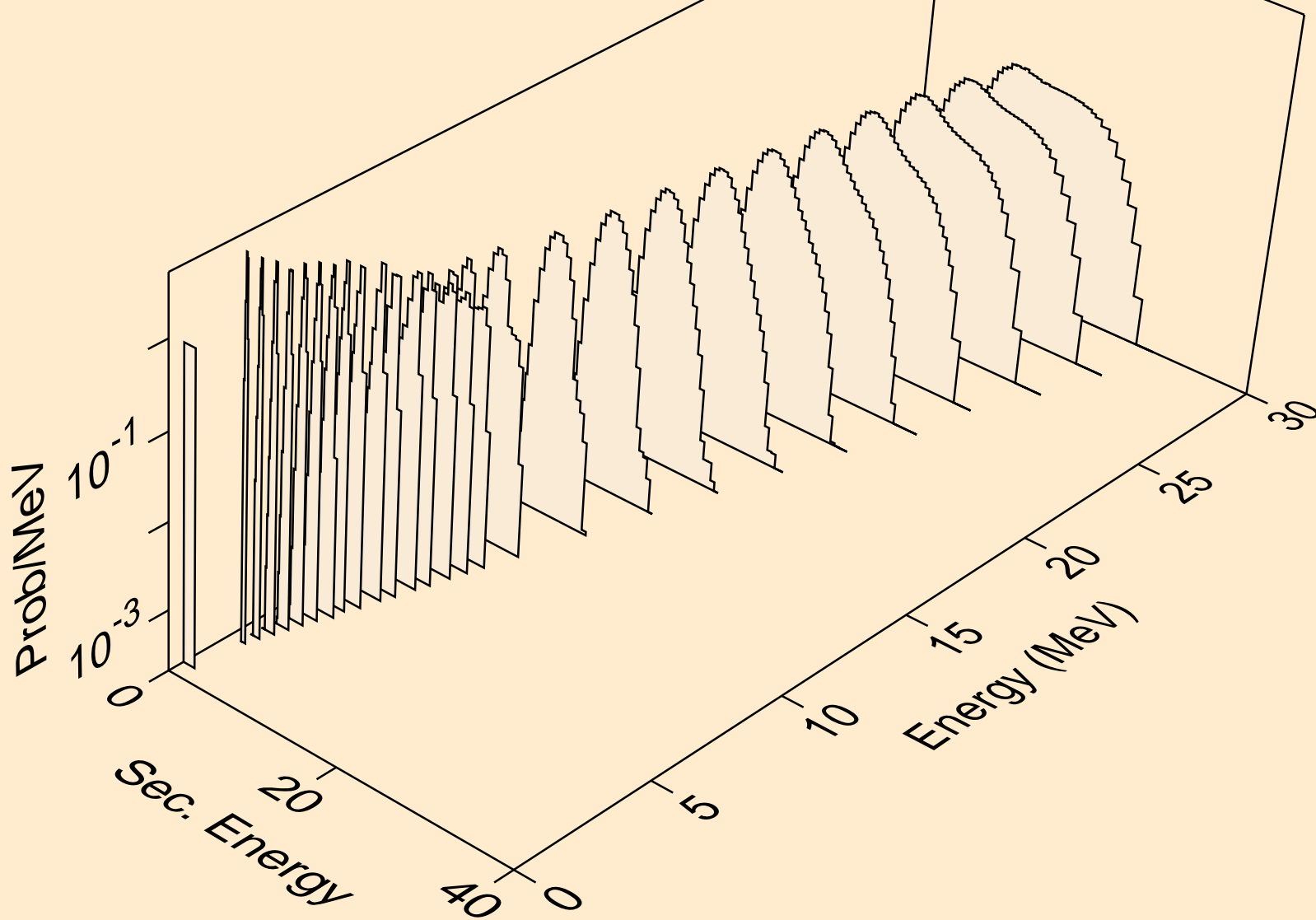

FR204 NEUTRON ACER TENDL-2019 LIBRARY; T=293.16K
protons from (n,2np)

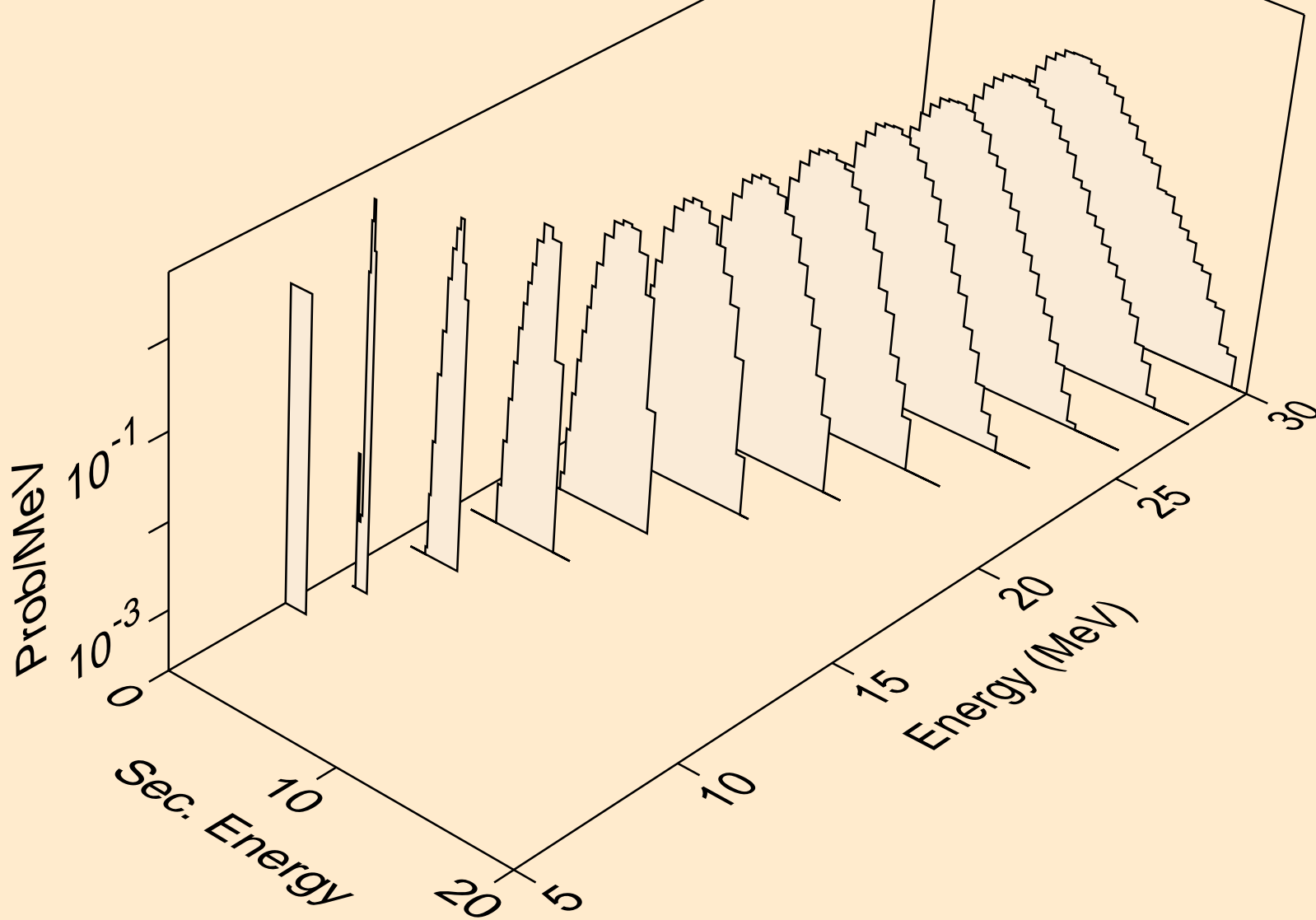

FR204 NEUTRON ACER TENDL-2019 LIBRARY; T=293.16K
protons from (n,3np)

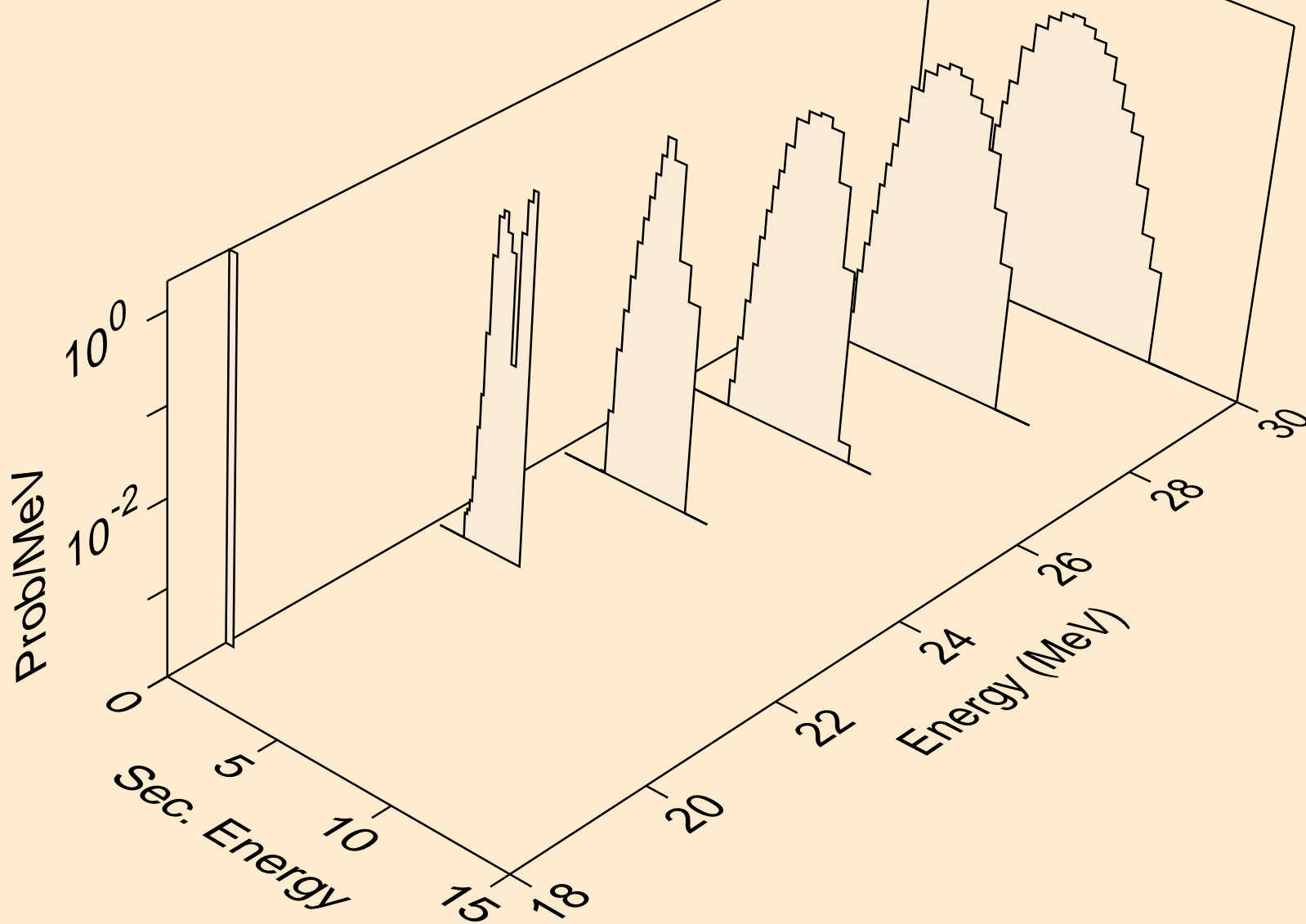

FR204 NEUTRON ACER TENDL-2019 LIBRARY; T=293.16K
protons from (n,2np)

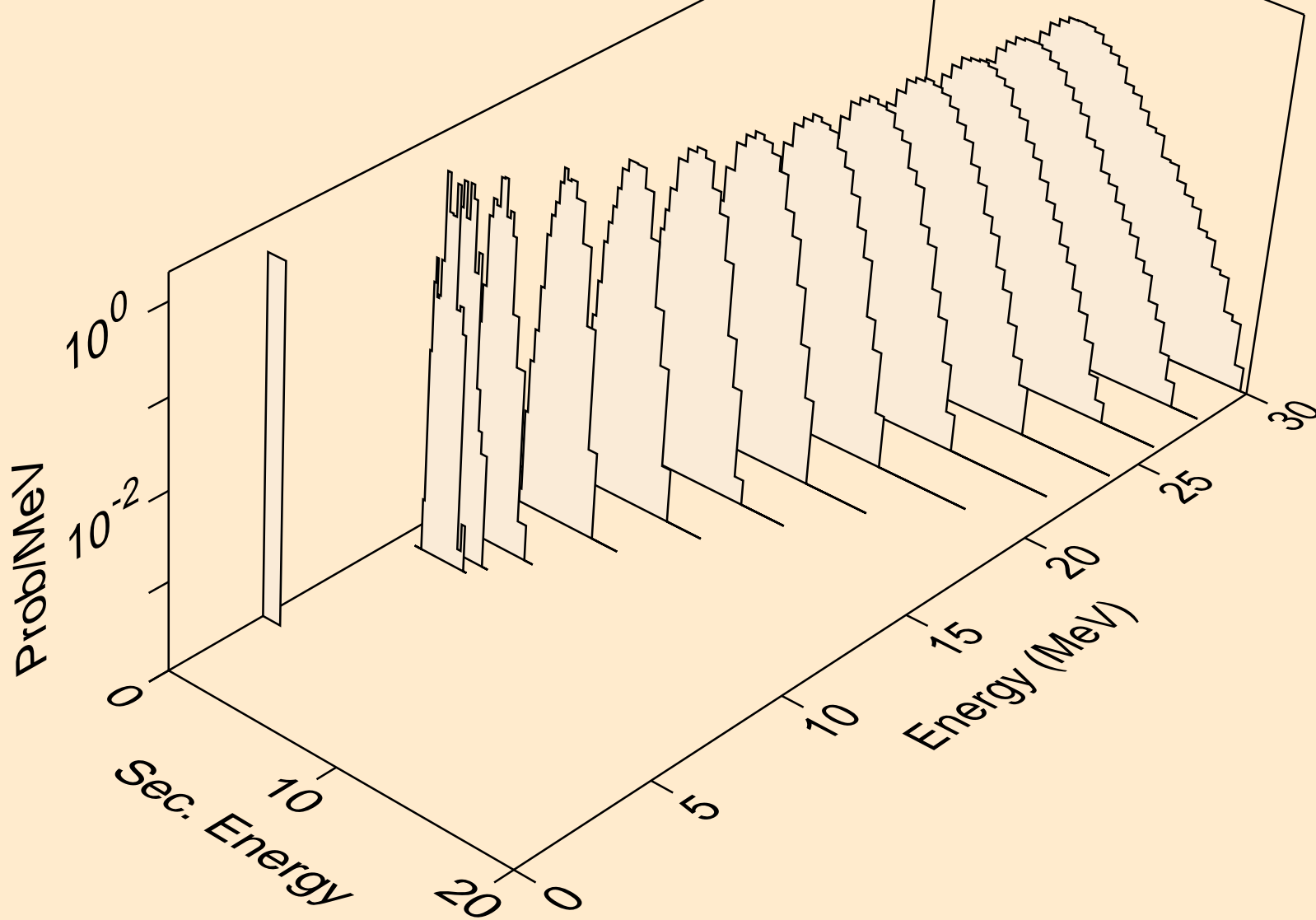

FR204 NEUTRON ACER TENDL-2019 LIBRARY; T=293.16K
protons from (n,npa)

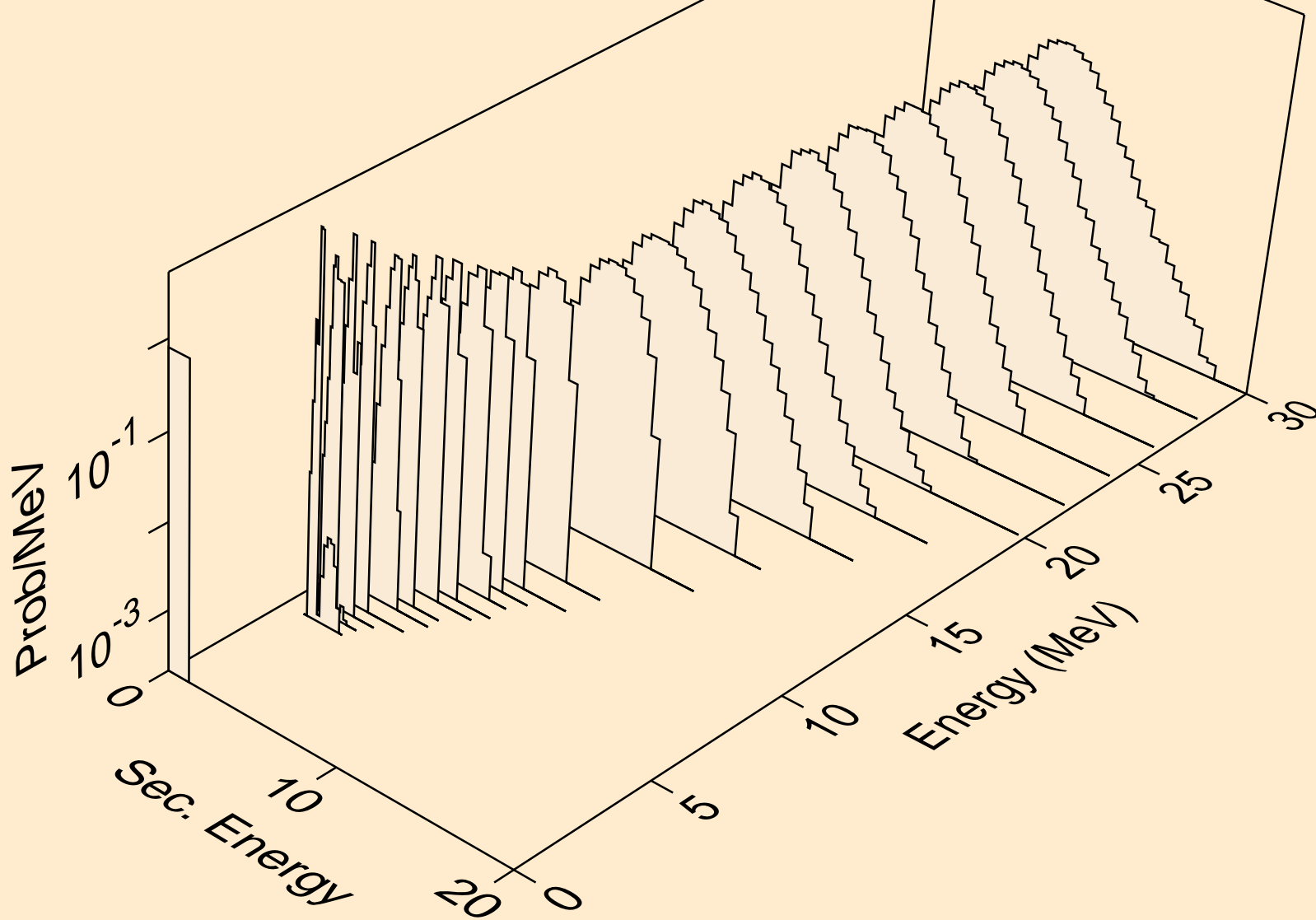

FR204 NEUTRON ACER TENDL-2019 LIBRARY; T=293.16K
protons from (n,p)

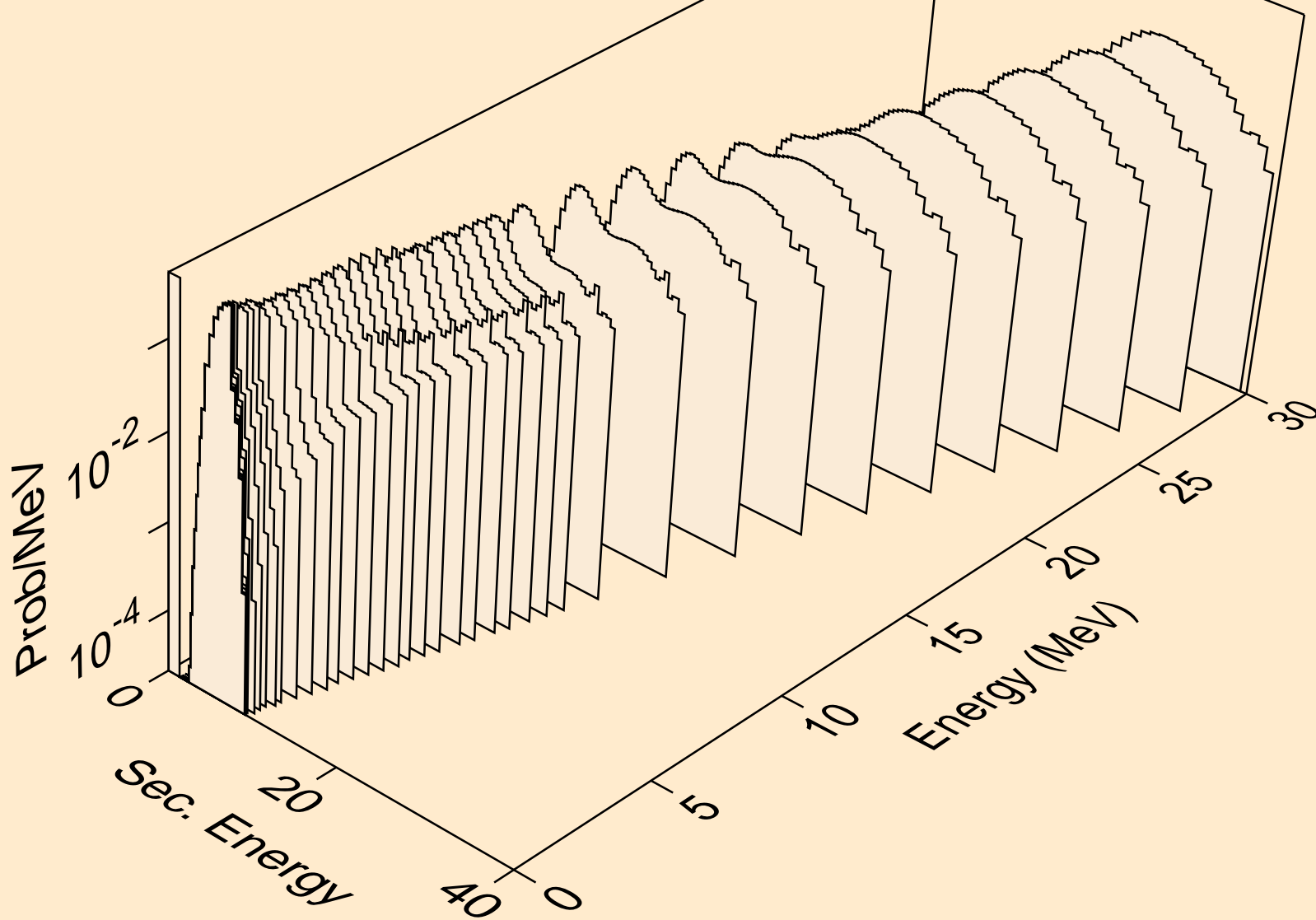

FR204 NEUTRON ACER TENDL-2019 LIBRARY; T=293.16K
protons from (n,2p)

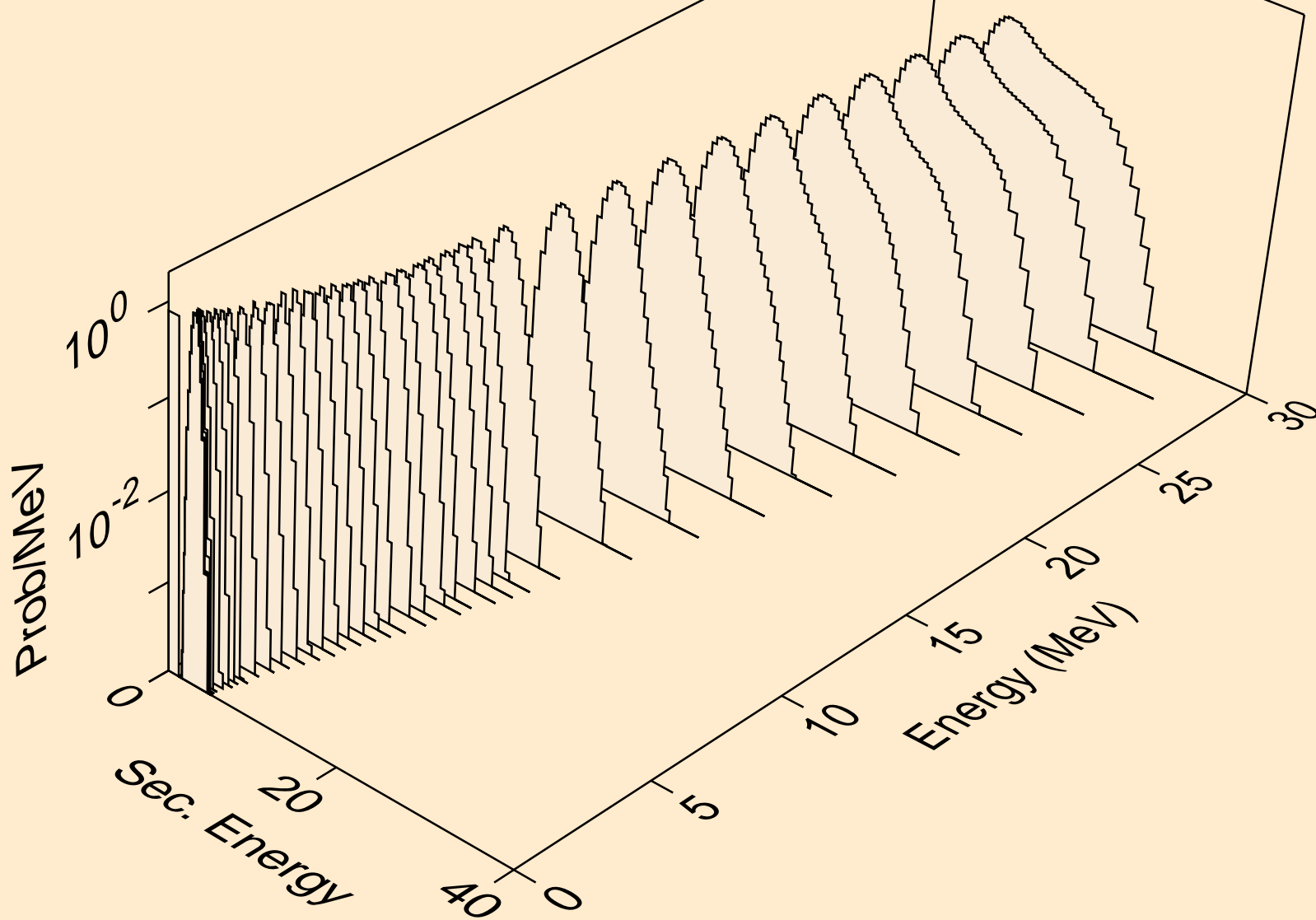

FR204 NEUTRON ACER TENDL-2019 LIBRARY; T=293.16K
protons from (n,p)

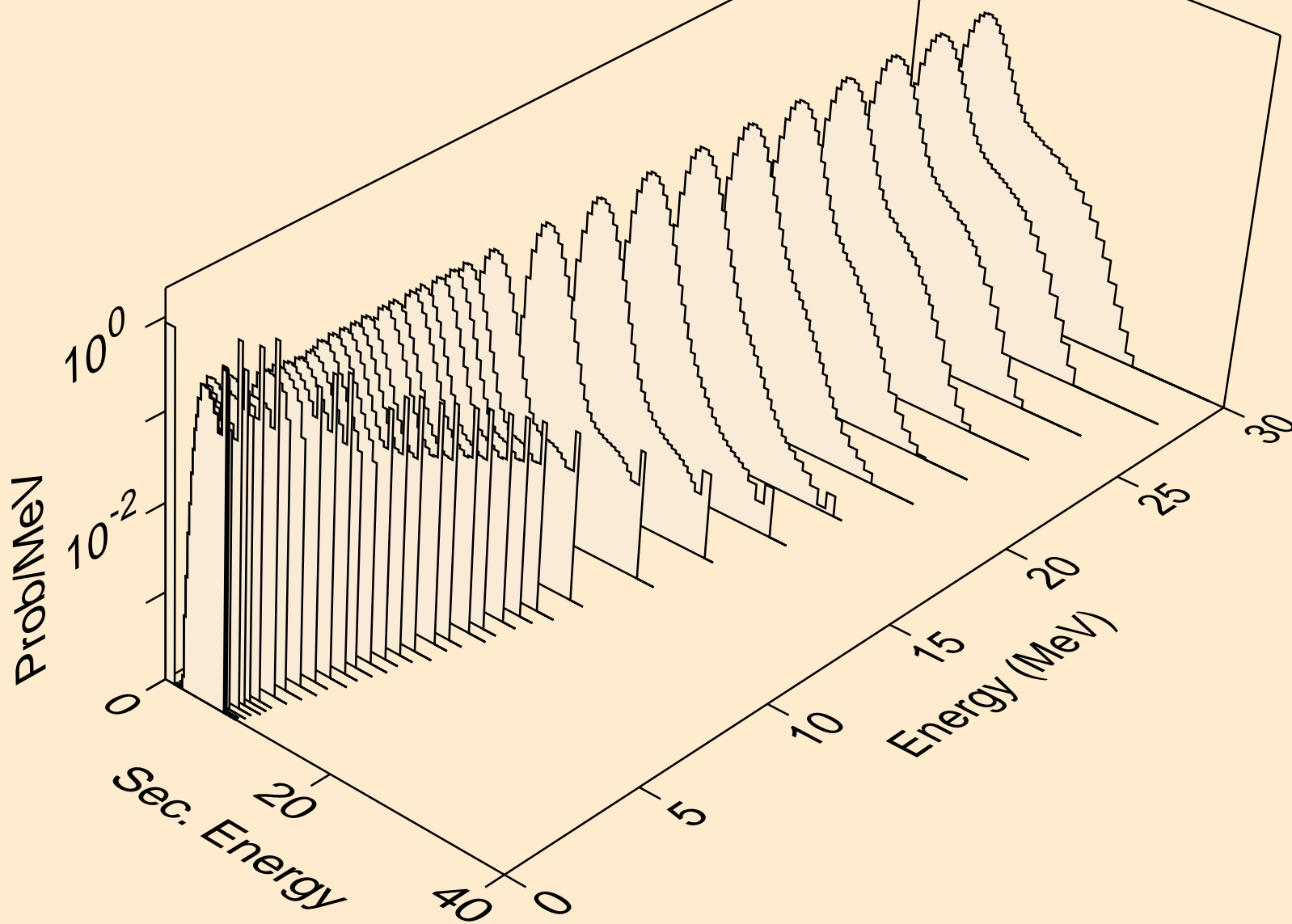

FR204 NEUTRON ACER TENDL-2019 LIBRARY; T=293.16K
protons from (n,pd)

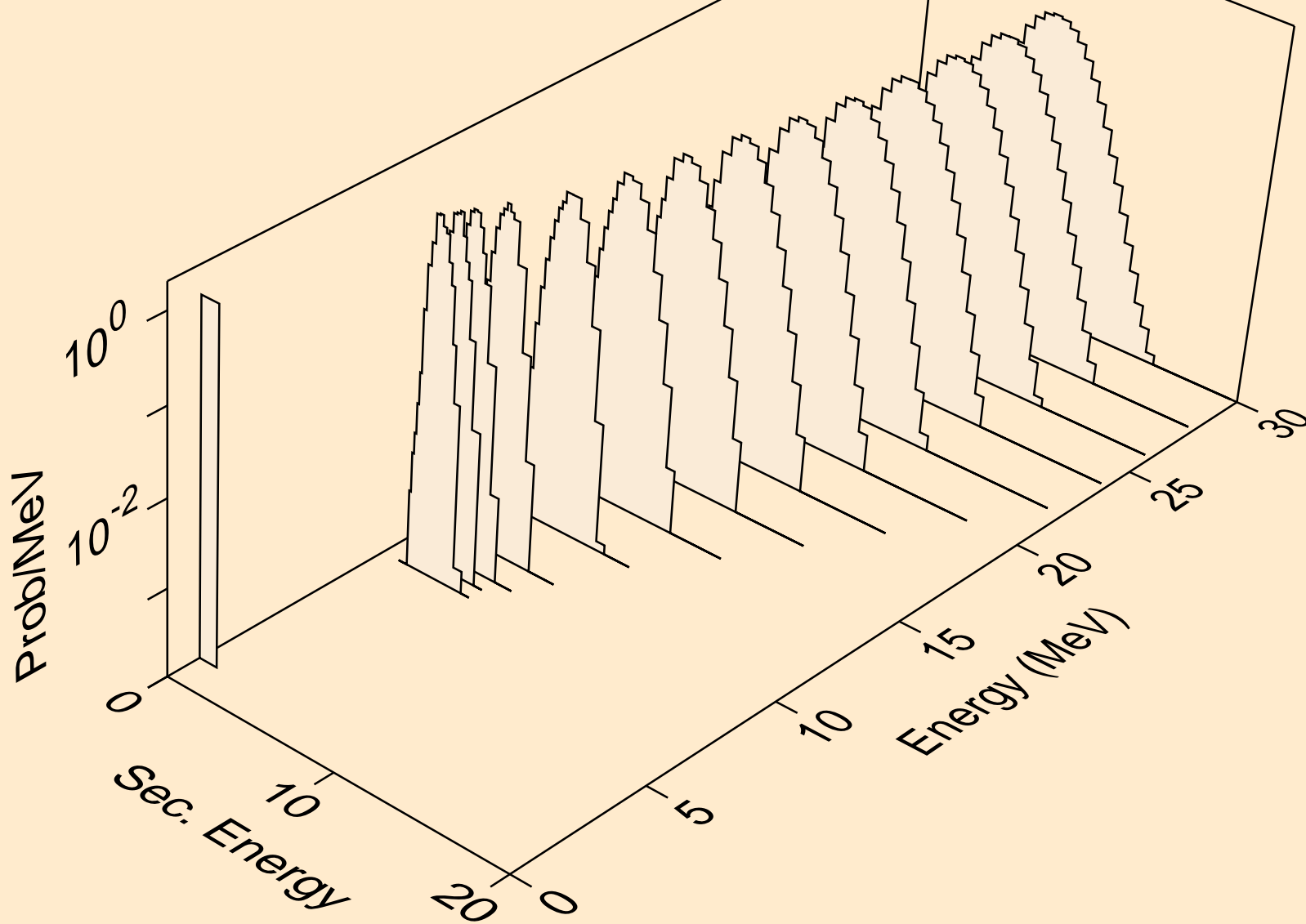

FR204 NEUTRON ACER TENDL-2019 LIBRARY; T=293.16K
protons from (n,pt)

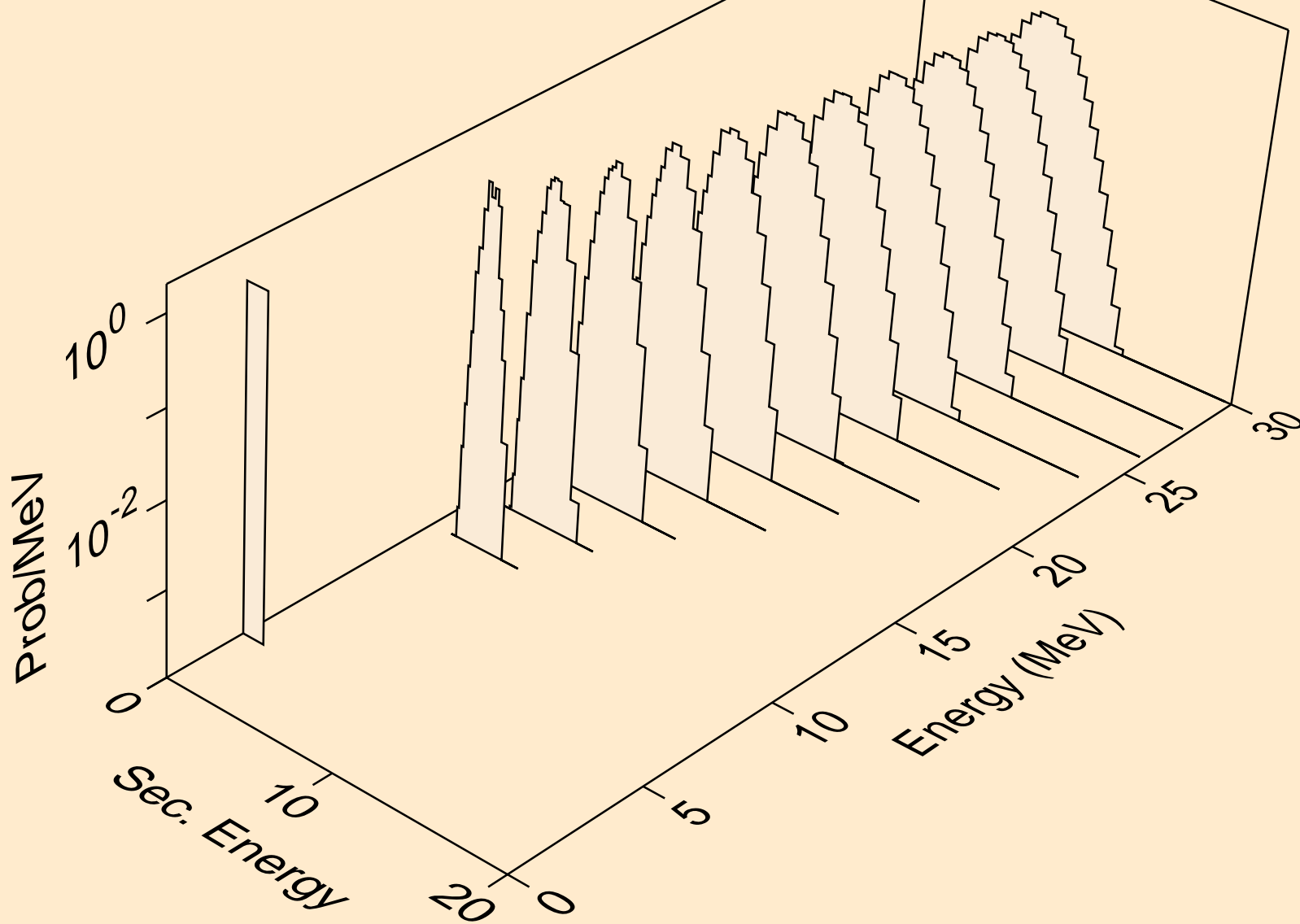

FR204 NEUTRON ACER TENDL-2019 LIBRARY; T=293.16K
deuterons from (n,x)

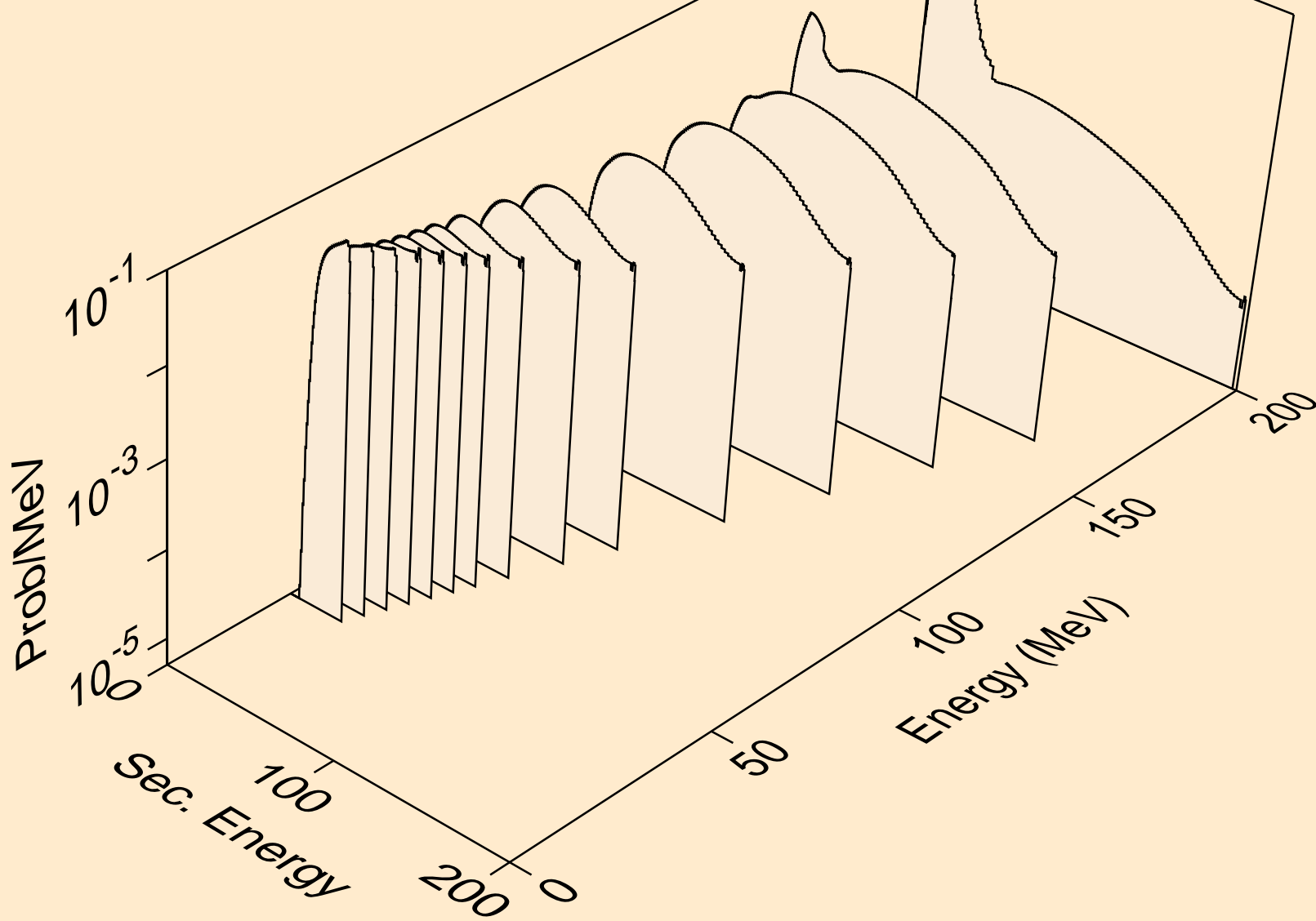

FR204 NEUTRON ACER TENDL-2019 LIBRARY; T=293.16K
deuterons from (n,2nd)

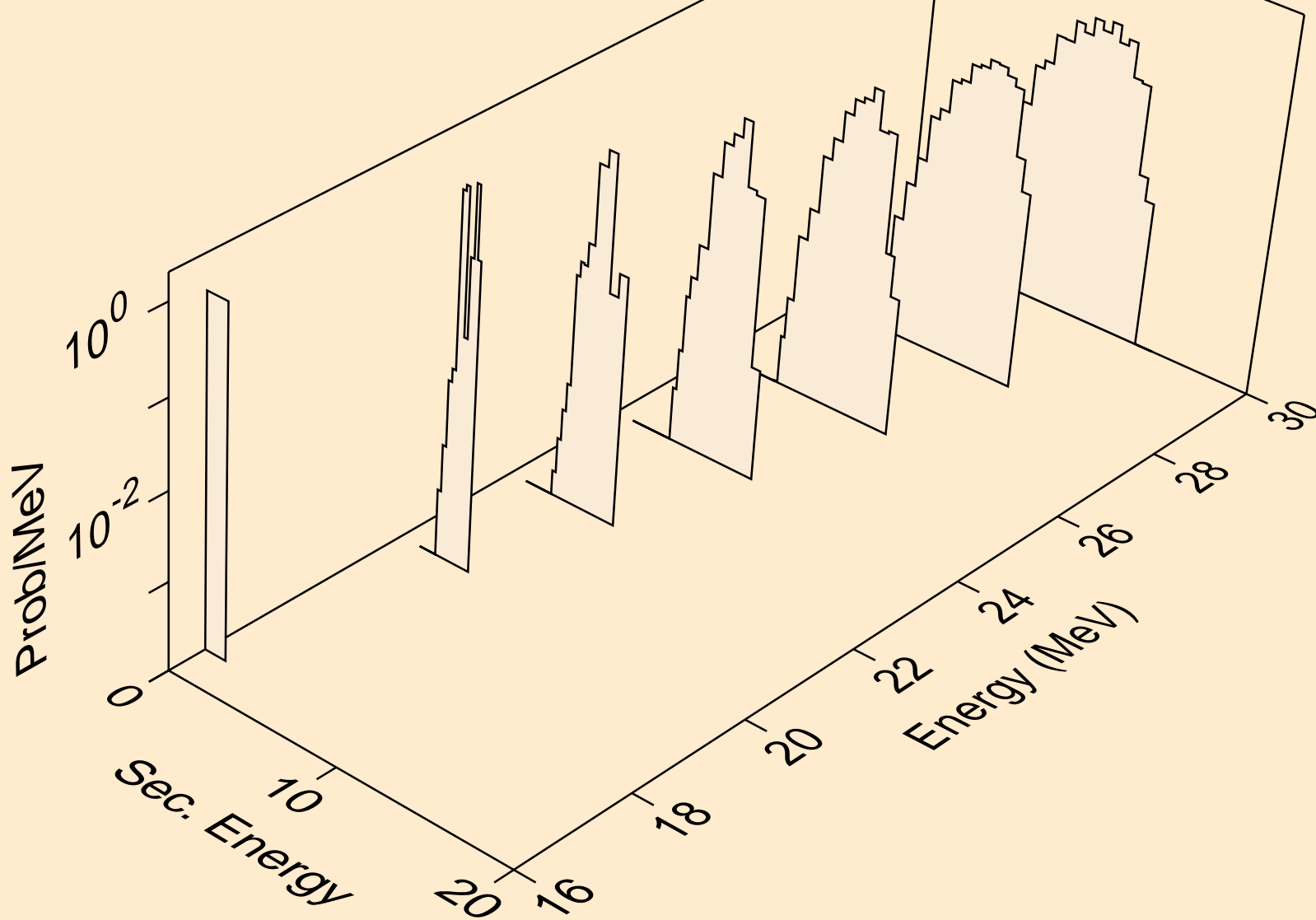

FR204 NEUTRON ACER TENDL-2019 LIBRARY; T=293.16K
deuterons from (n,n*)d

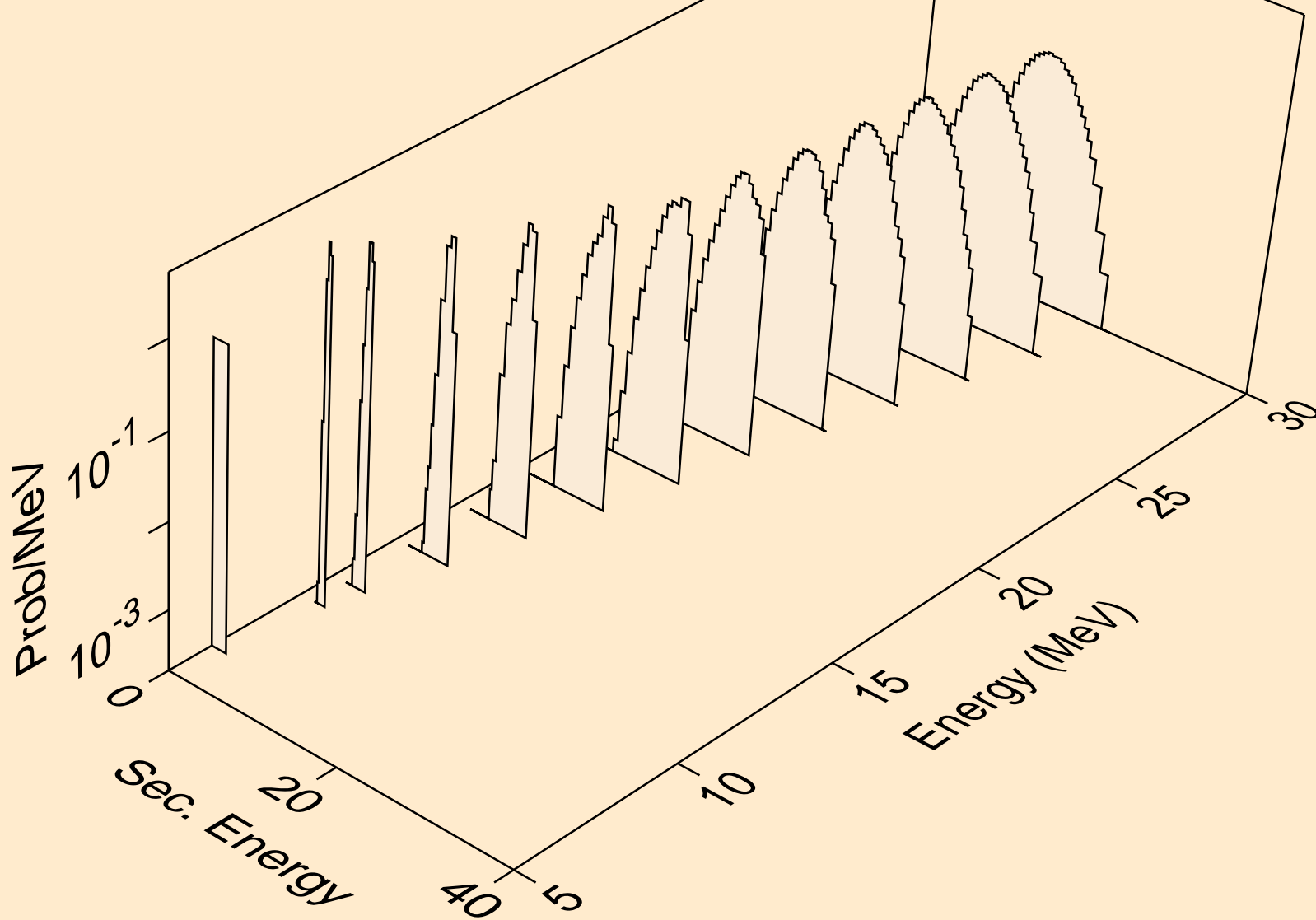

FR204 NEUTRON ACER TENDL-2019 LIBRARY; T=293.16K
deuterons from (n,d)

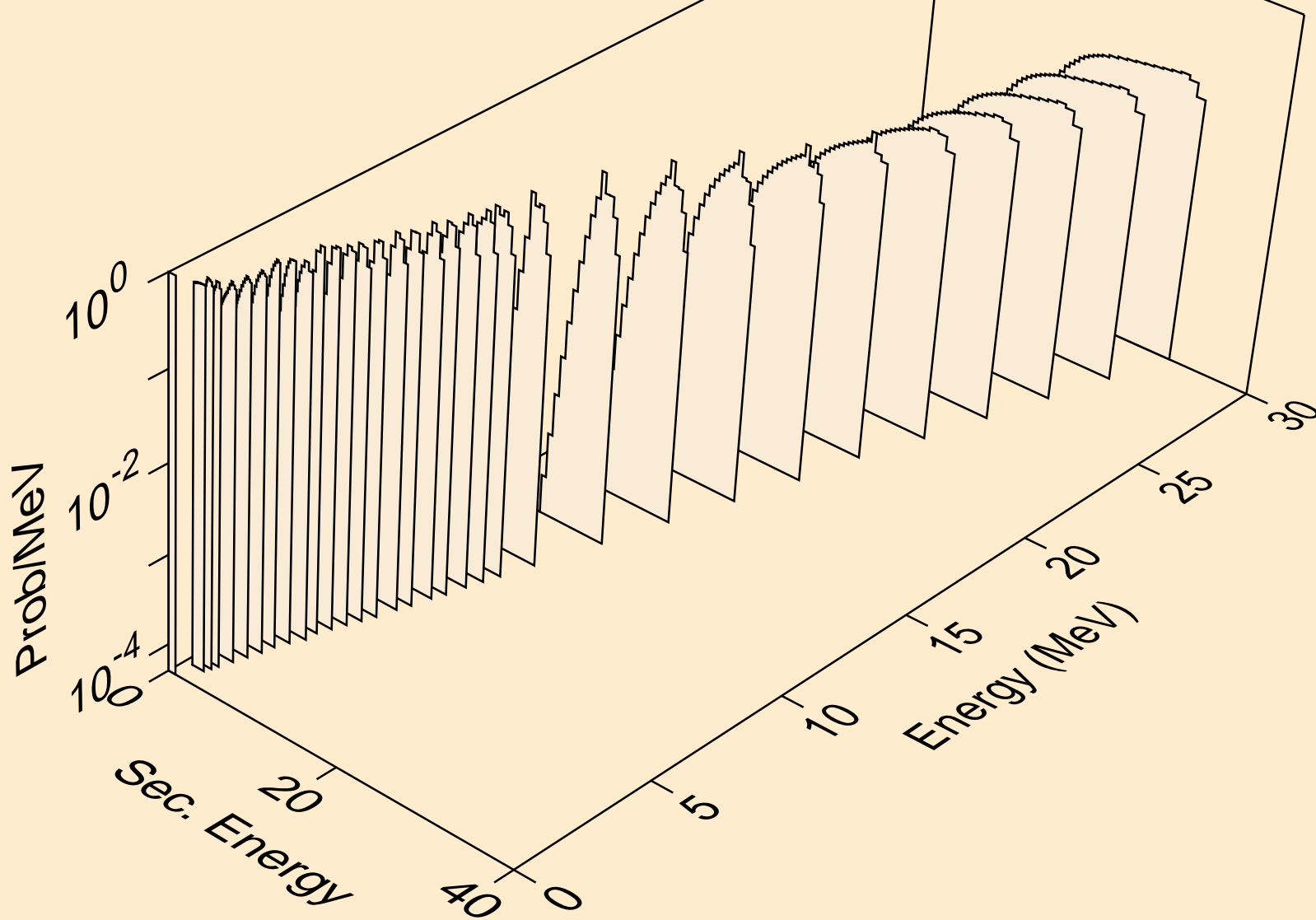

FR204 NEUTRON ACER TENDL-2019 LIBRARY; T=293.16K
deuterons from (n,pd)

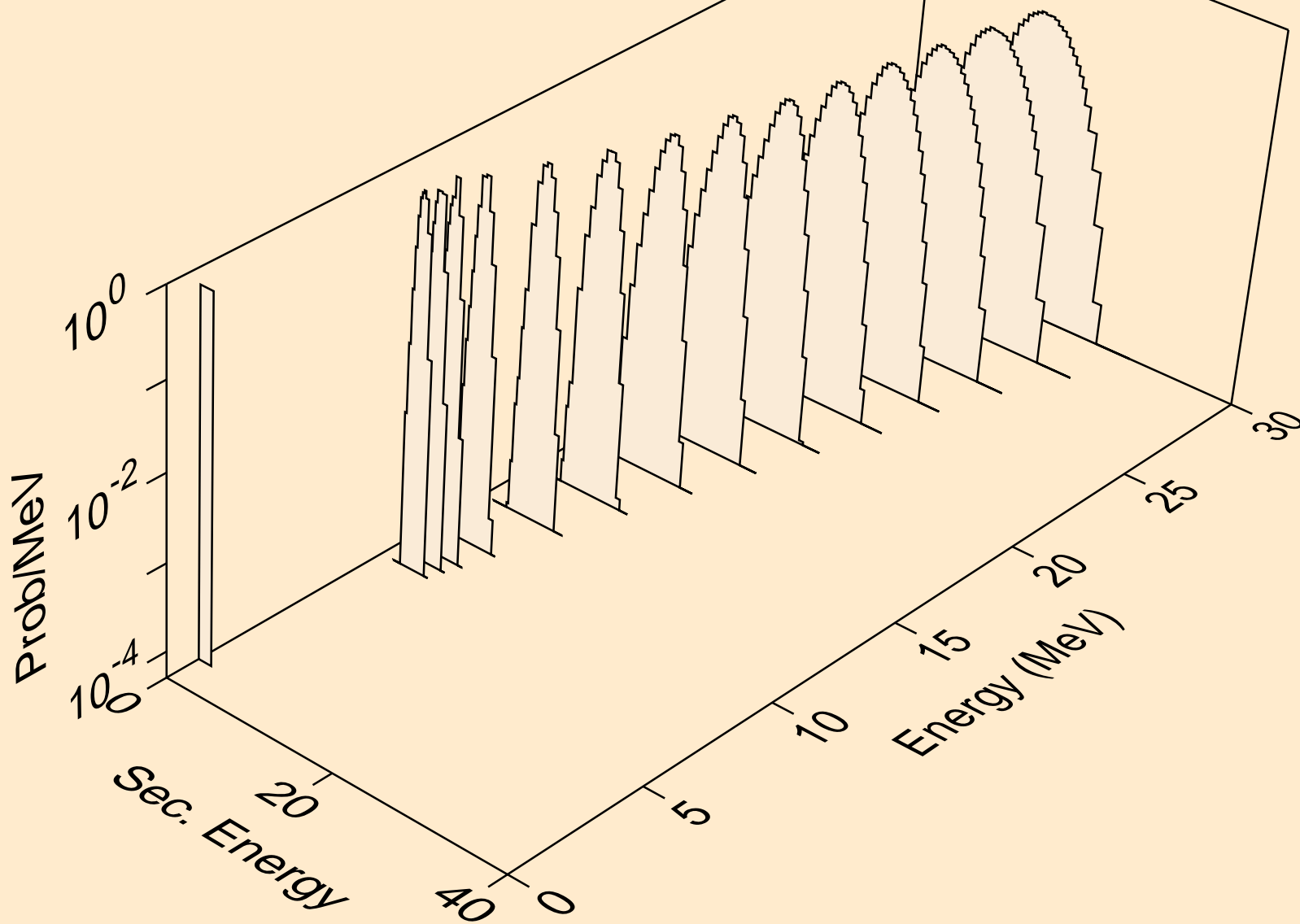

FR204 NEUTRON ACER TENDL-2019 LIBRARY; T=293.16K
deuterons from (n,da)

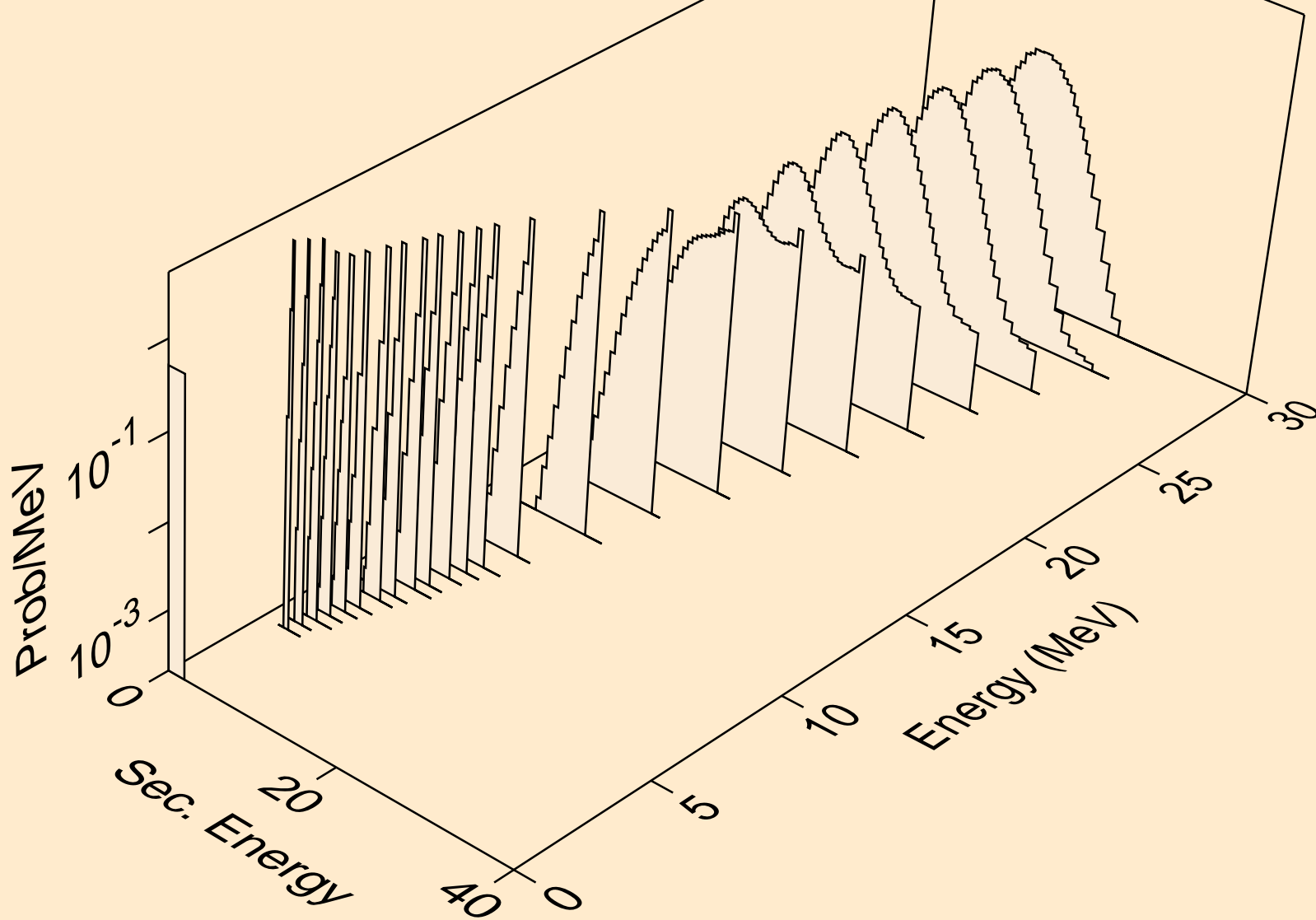

FR204 NEUTRON ACER TENDL-2019 LIBRARY; T=293.16K
tritons from (n,x)

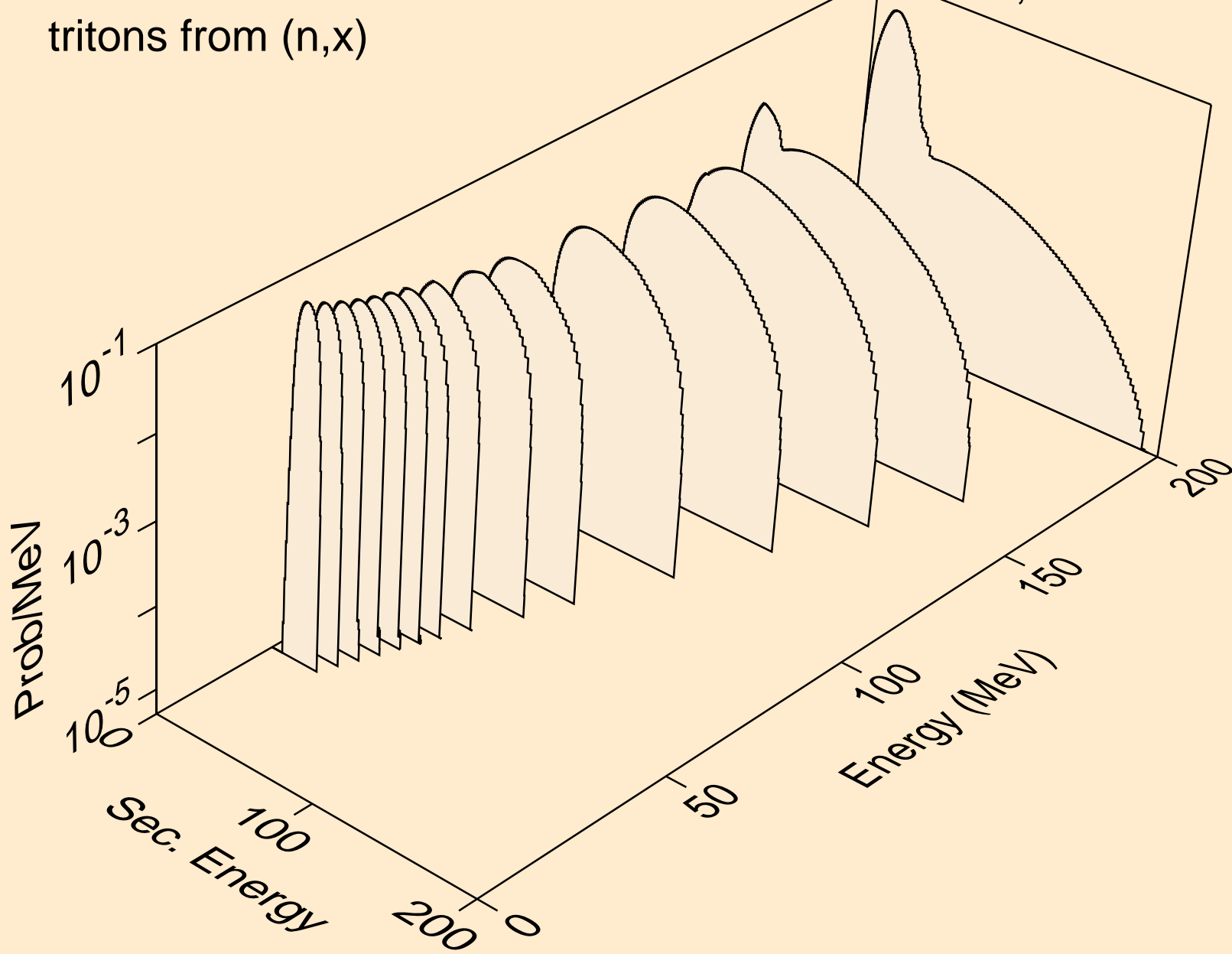

FR204 NEUTRON ACER TENDL-2019 LIBRARY; T=293.16K
tritons from (n,n*)t

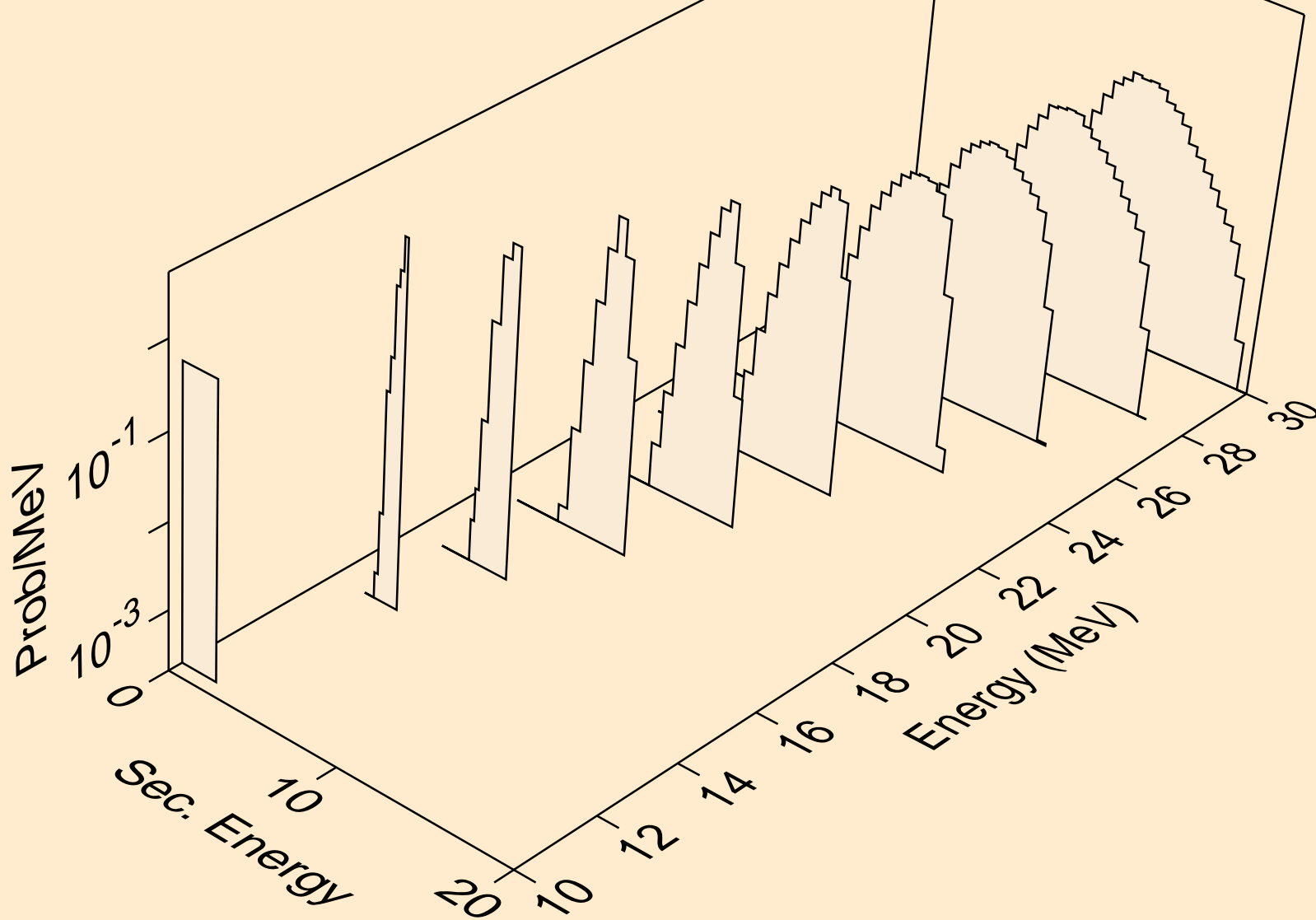

FR204 NEUTRON ACER TENDL-2019 LIBRARY; T=293.16K
tritons from (n,t)

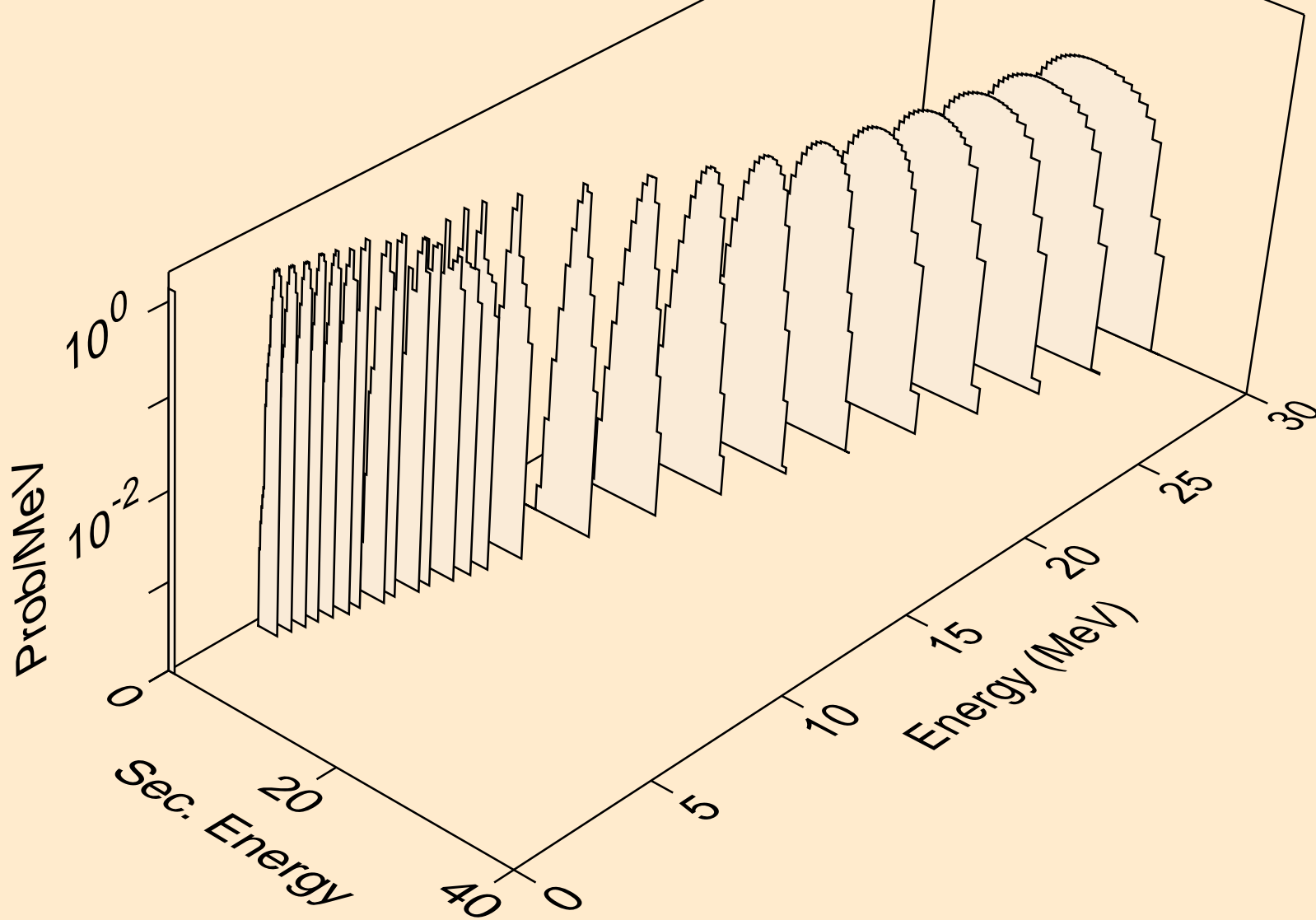

FR204 NEUTRON ACER TENDL-2019 LIBRARY; T=293.16K
tritons from (n,pt)

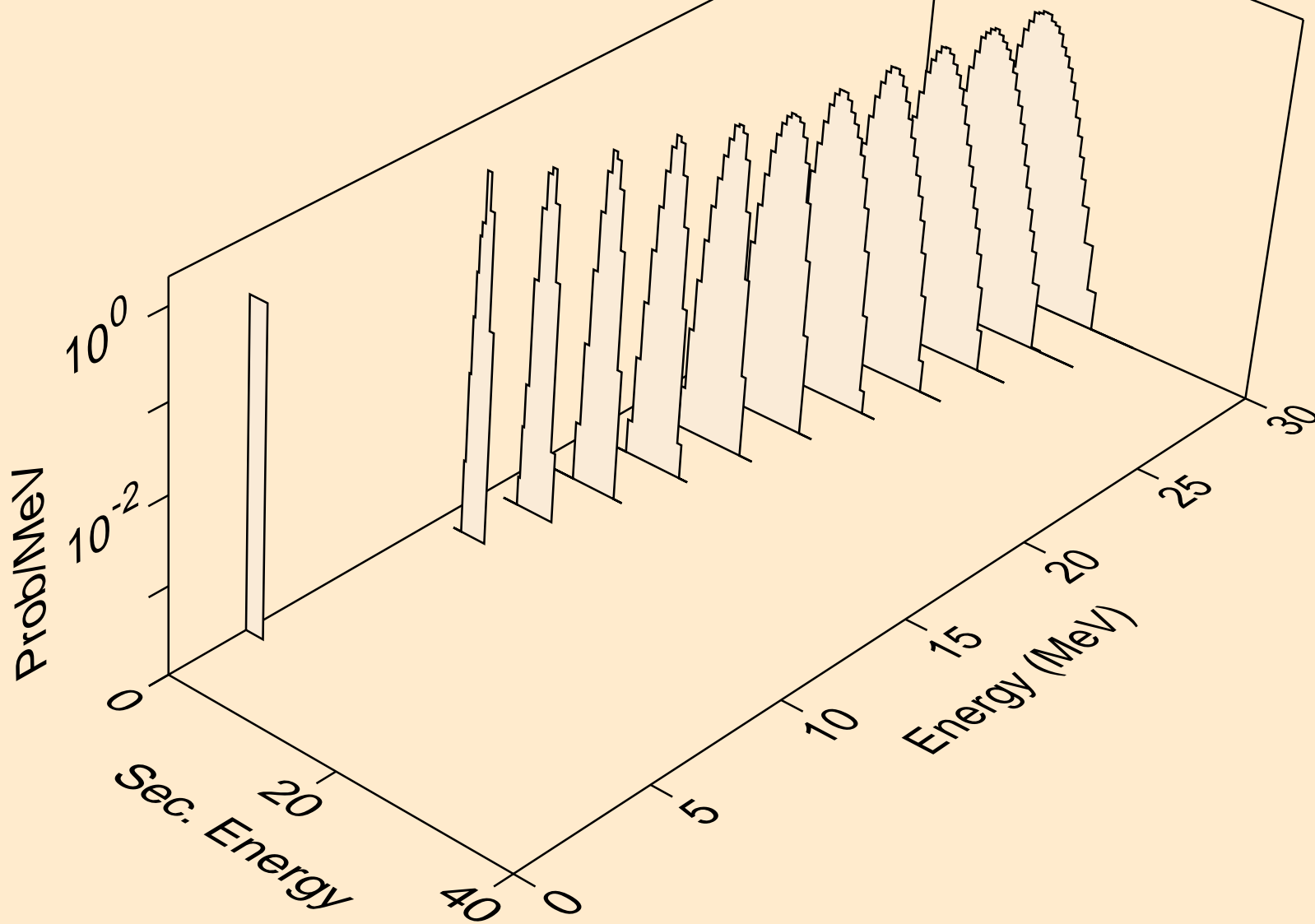

FR204 NEUTRON ACER TENDL-2019 LIBRARY; T=293.16K
he3s from (n,x)

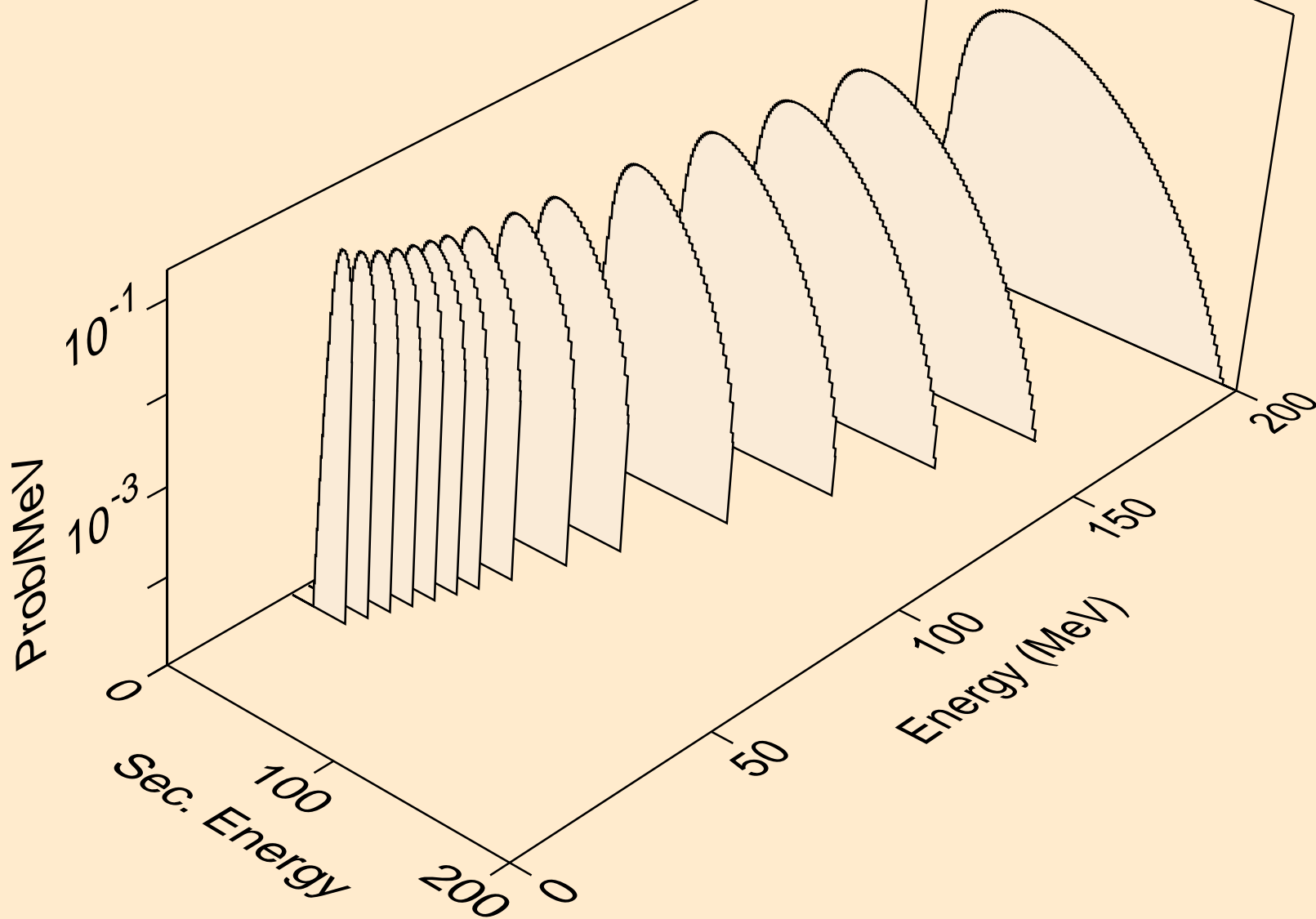

FR204 NEUTRON ACER TENDL-2019 LIBRARY; T=293.16K
he3s from (n,n*)he3

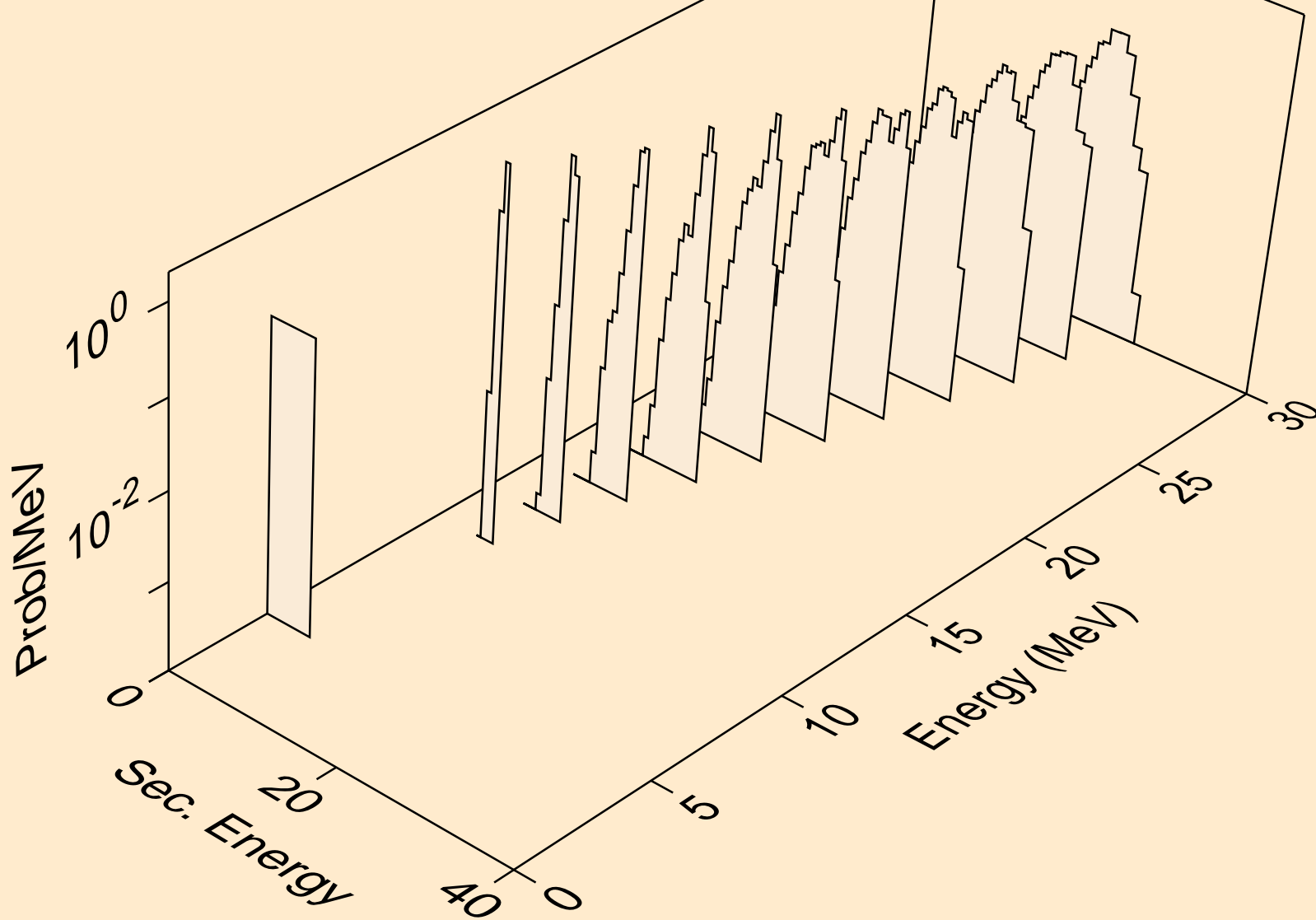

FR204 NEUTRON ACER TENDL-2019 LIBRARY; T=293.16K
he3s from (n,he3)

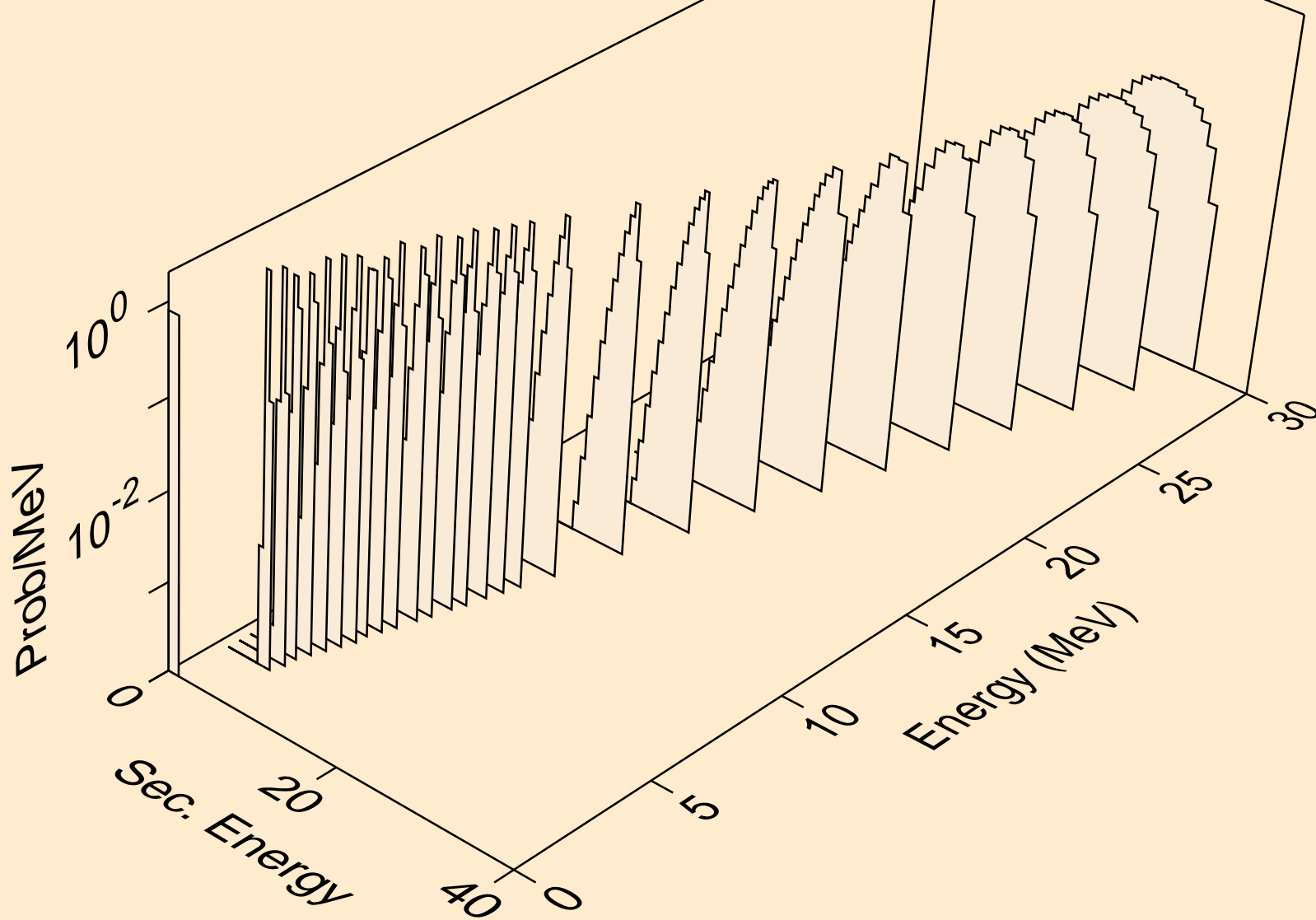

FR204 NEUTRON ACER TENDL-2019 LIBRARY; T=293.16K
alphas from (n,x)

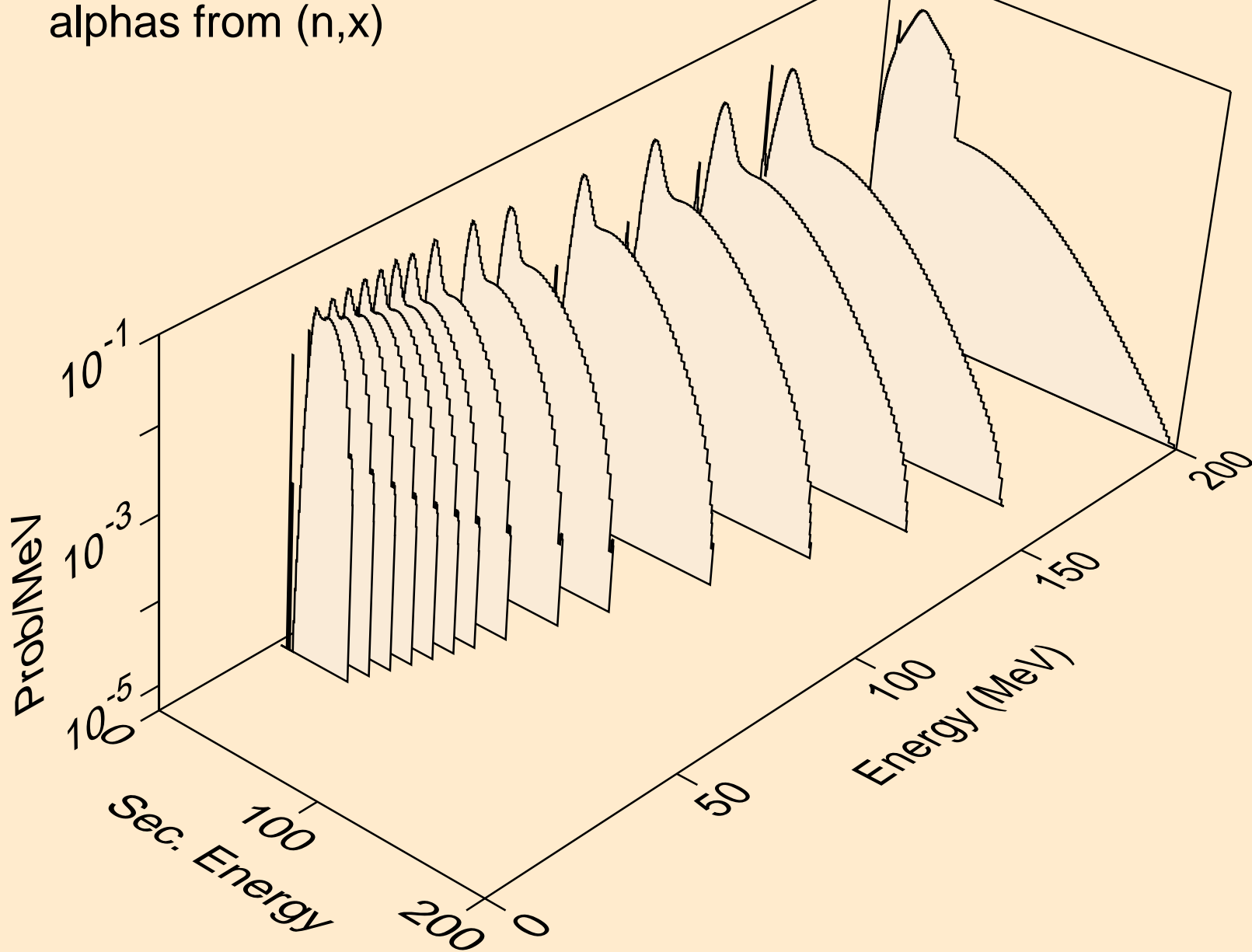

FR204 NEUTRON ACER TENDL-2019 LIBRARY; T=293.16K
alphas from (n,n*)a

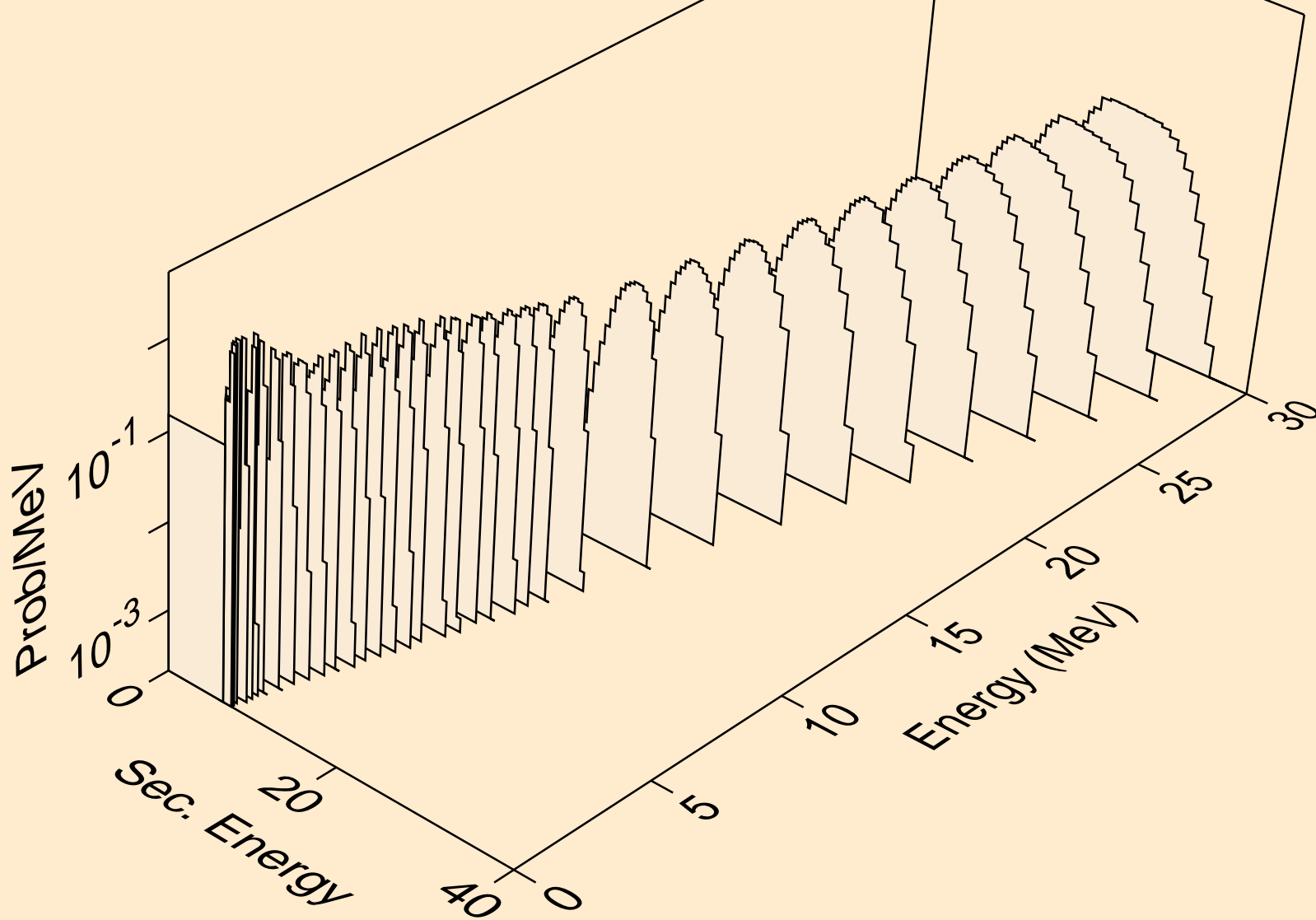

FR204 NEUTRON ACER TENDL-2019 LIBRARY; T=293.16K
alphas from (n,2n)a

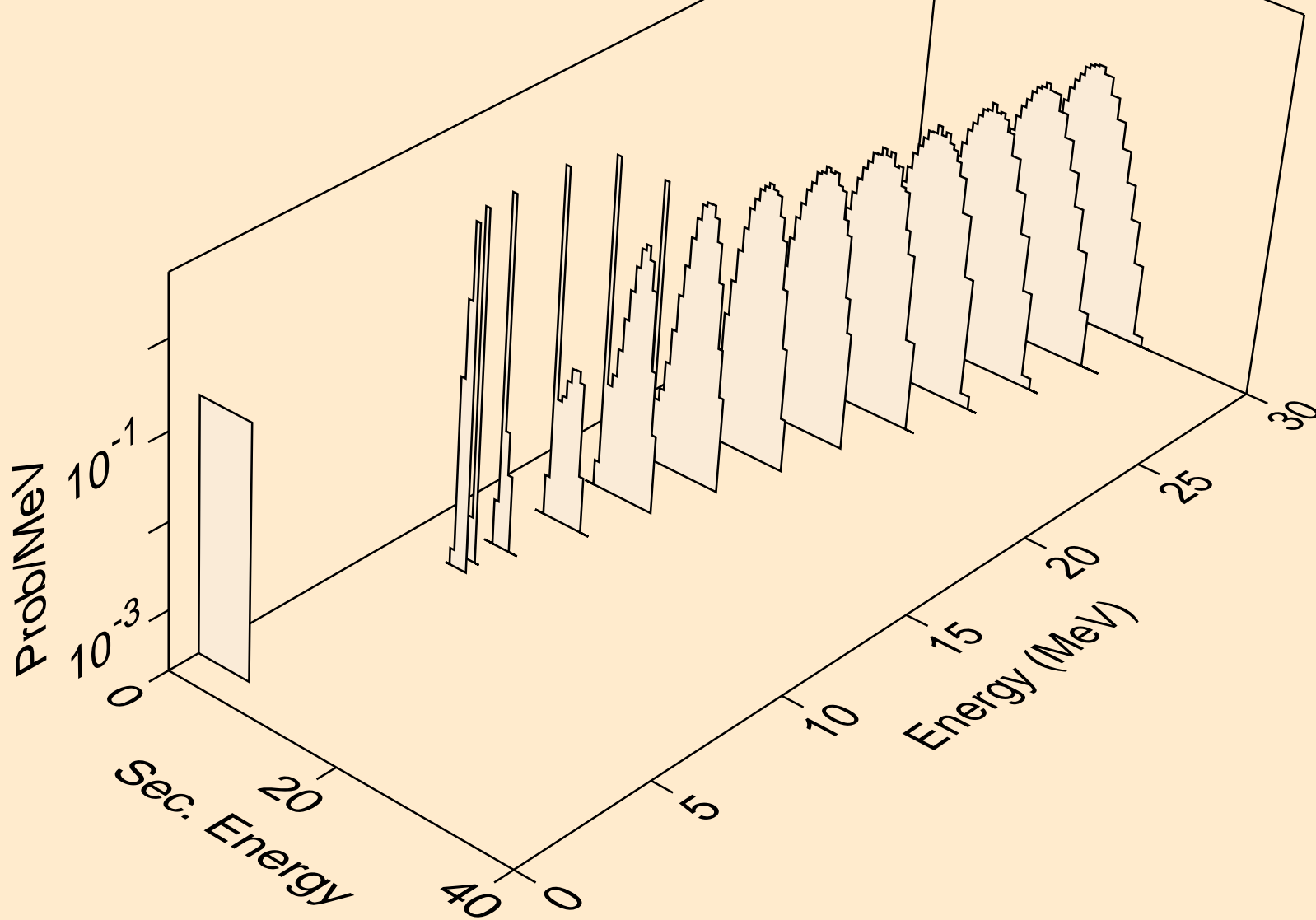

FR204 NEUTRON ACER TENDL-2019 LIBRARY; T=293.16K
alphas from (n,3n)a

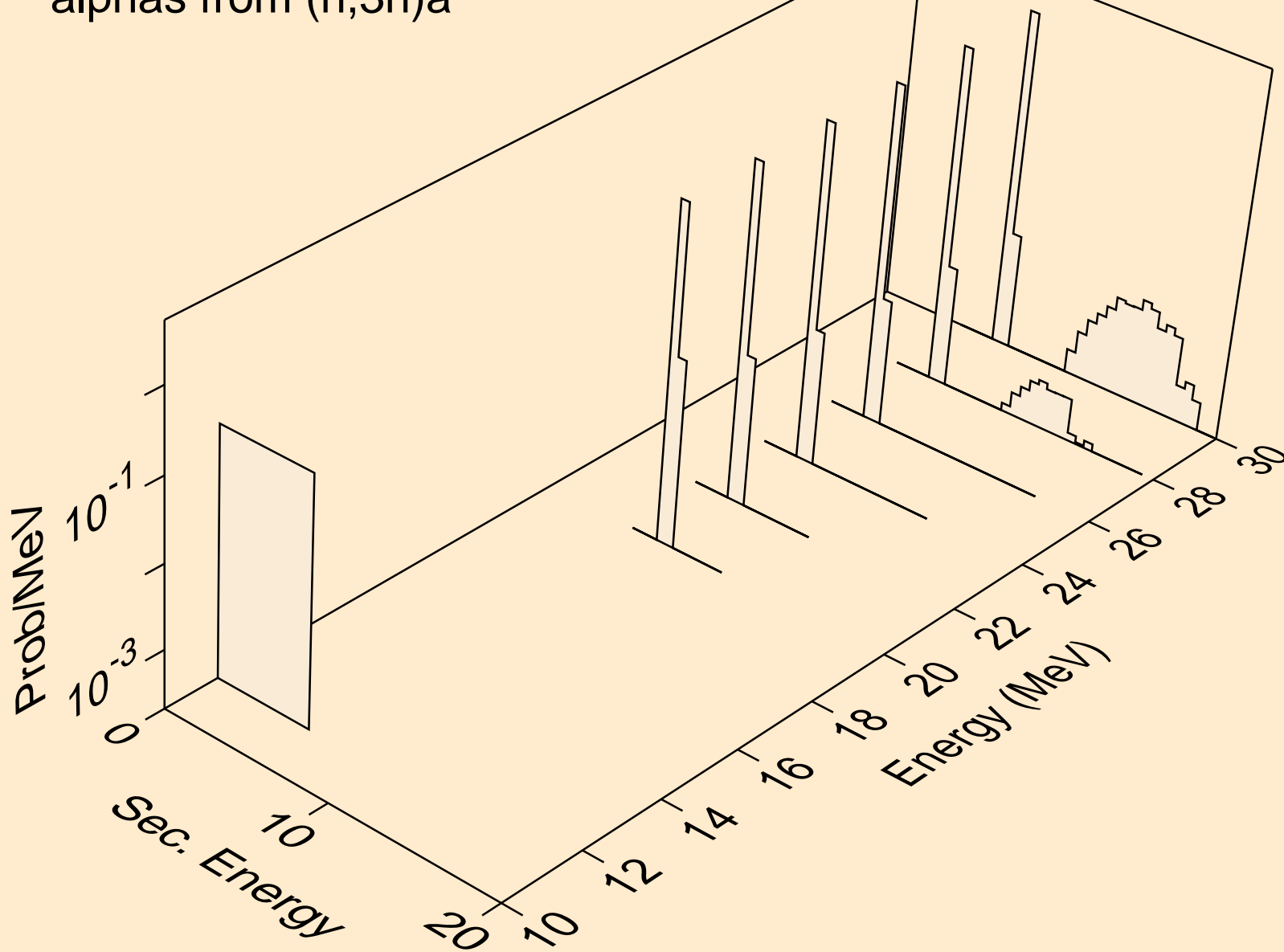

FR204 NEUTRON ACER TENDL-2019 LIBRARY; T=293.16K
alphas from (n,n*)2a

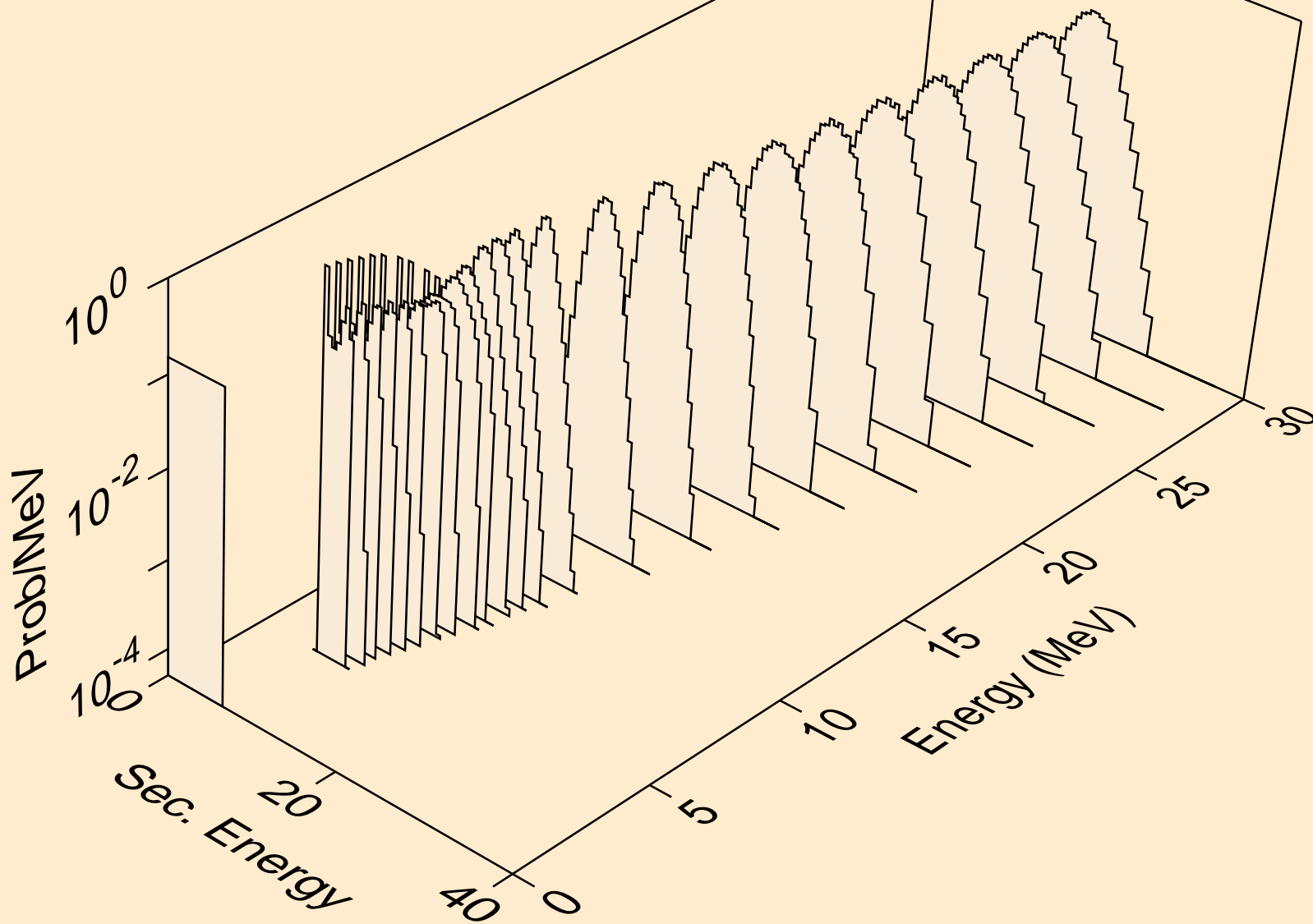

FR204 NEUTRON ACER TENDL-2019 LIBRARY; T=293.16K
alphas from (n,2n)2a

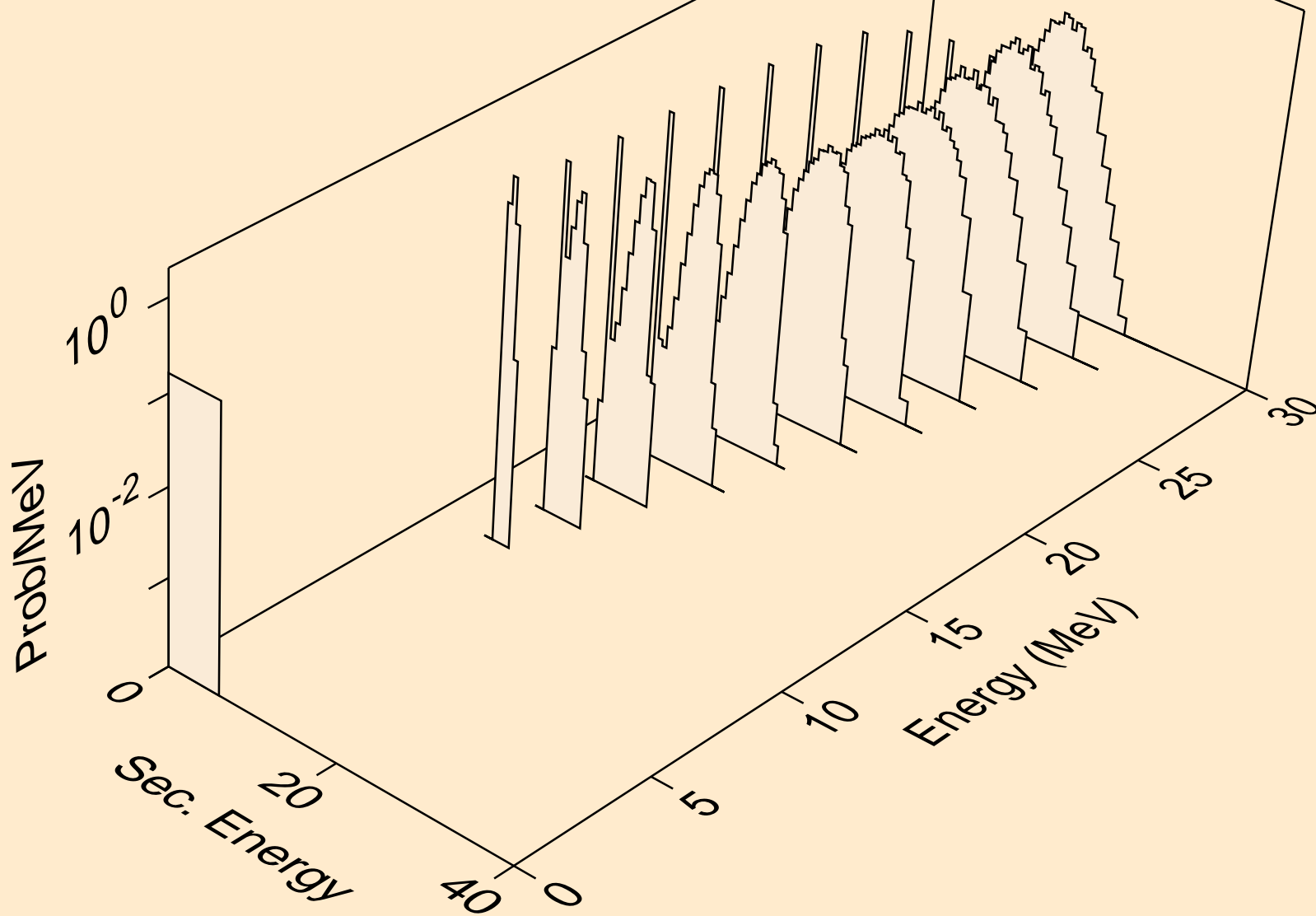

FR204 NEUTRON ACER TENDL-2019 LIBRARY; T=293.16K
alphas from (n,npa)

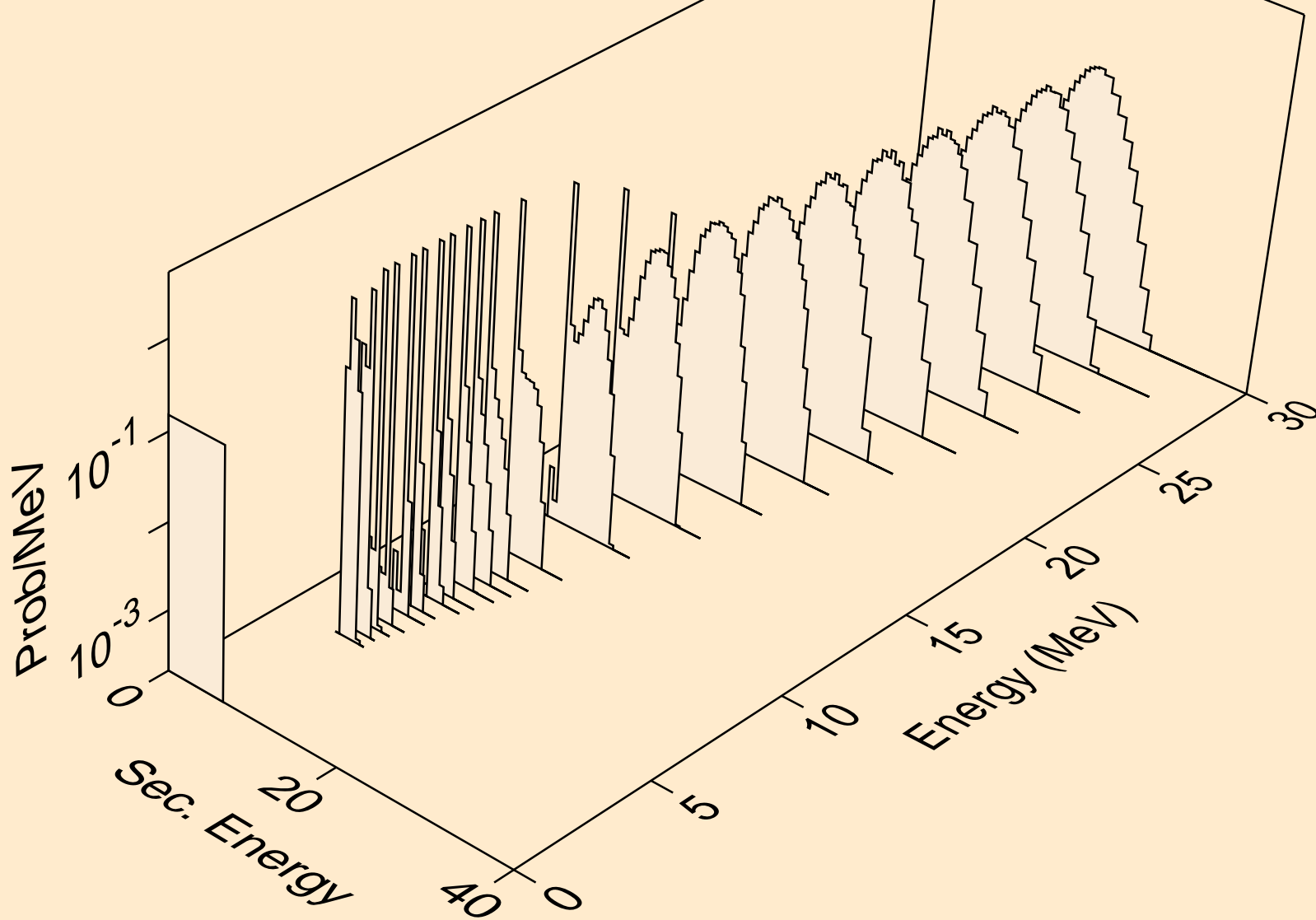

FR204 NEUTRON ACER TENDL-2019 LIBRARY; T=293.16K
alphas from (n,a)

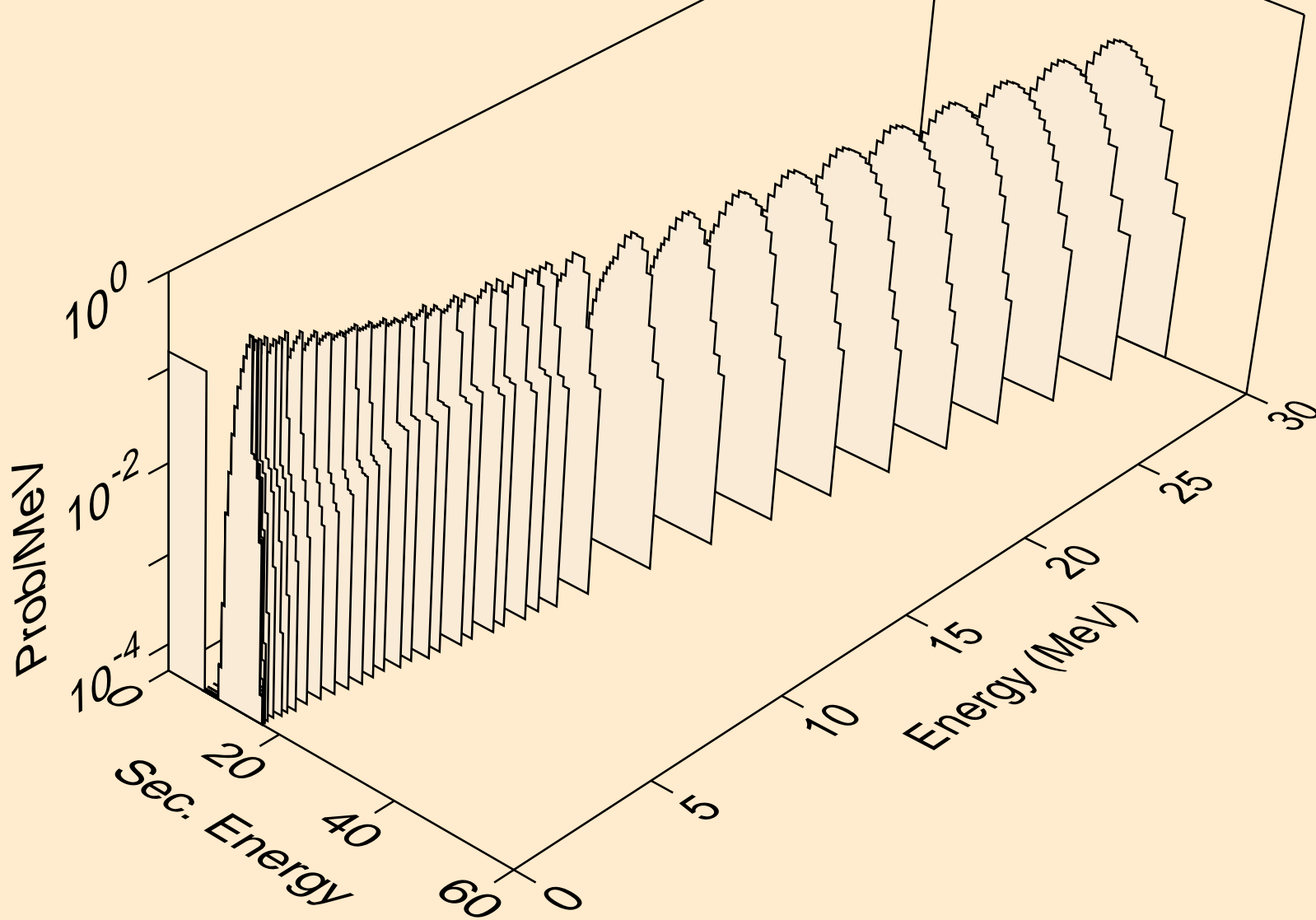

FR204 NEUTRON ACER TENDL-2019 LIBRARY; T=293.16K
alphas from (n,2a)

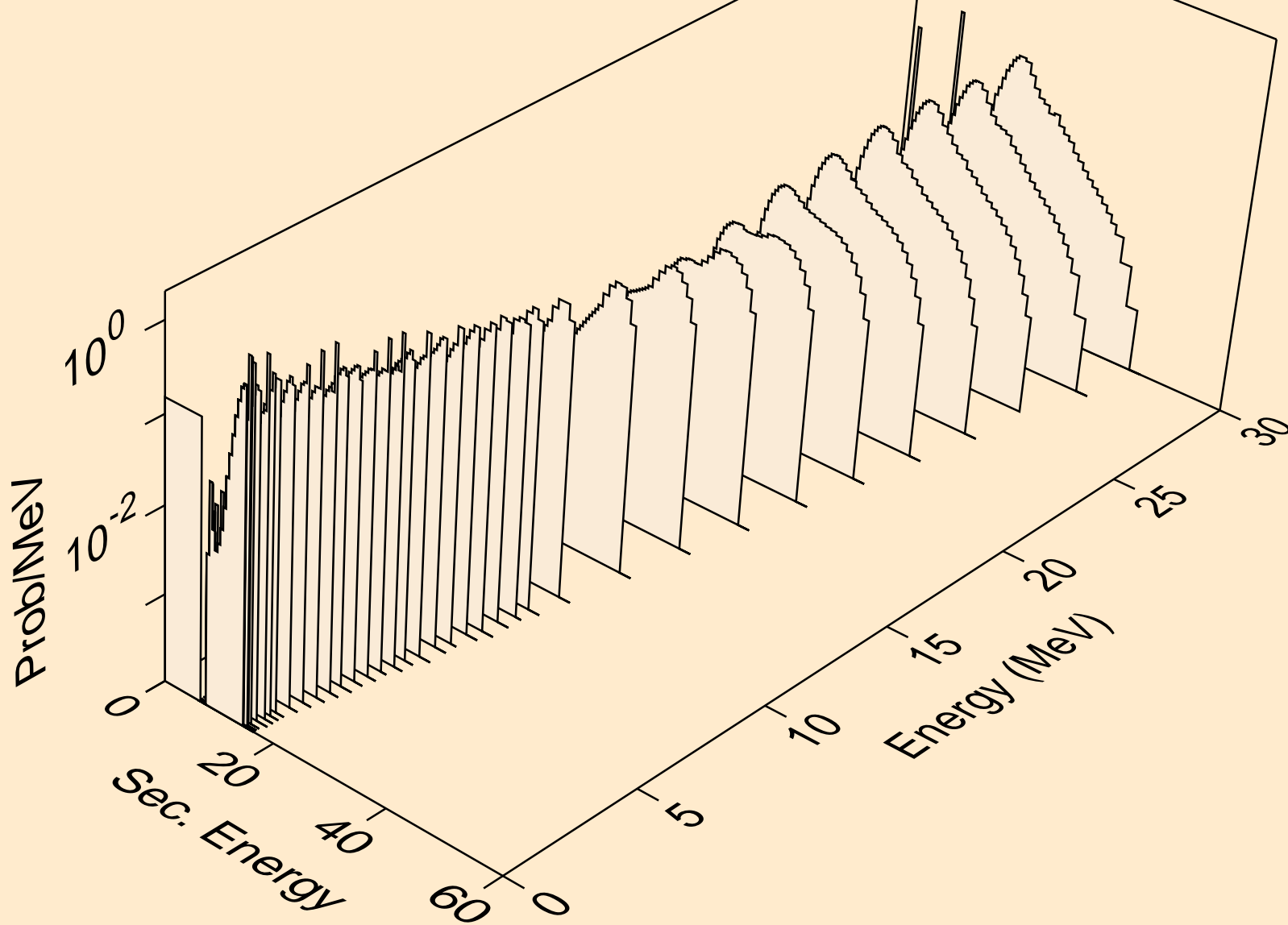

FR204 NEUTRON ACER TENDL-2019 LIBRARY; T=293.16K
alphas from (n,3a)

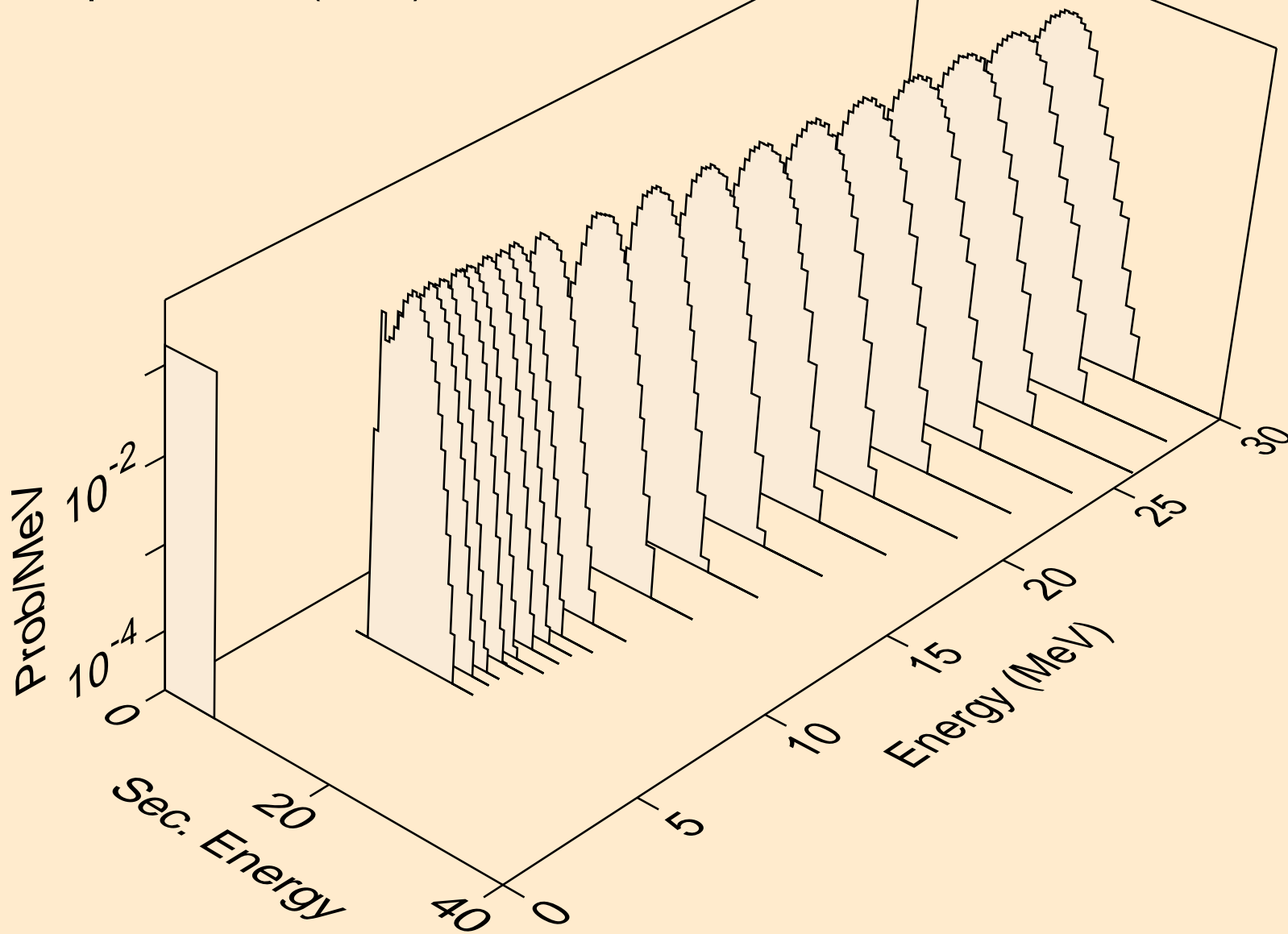

FR204 NEUTRON ACER TENDL-2019 LIBRARY; T=293.16K
alphas from (n,pa)

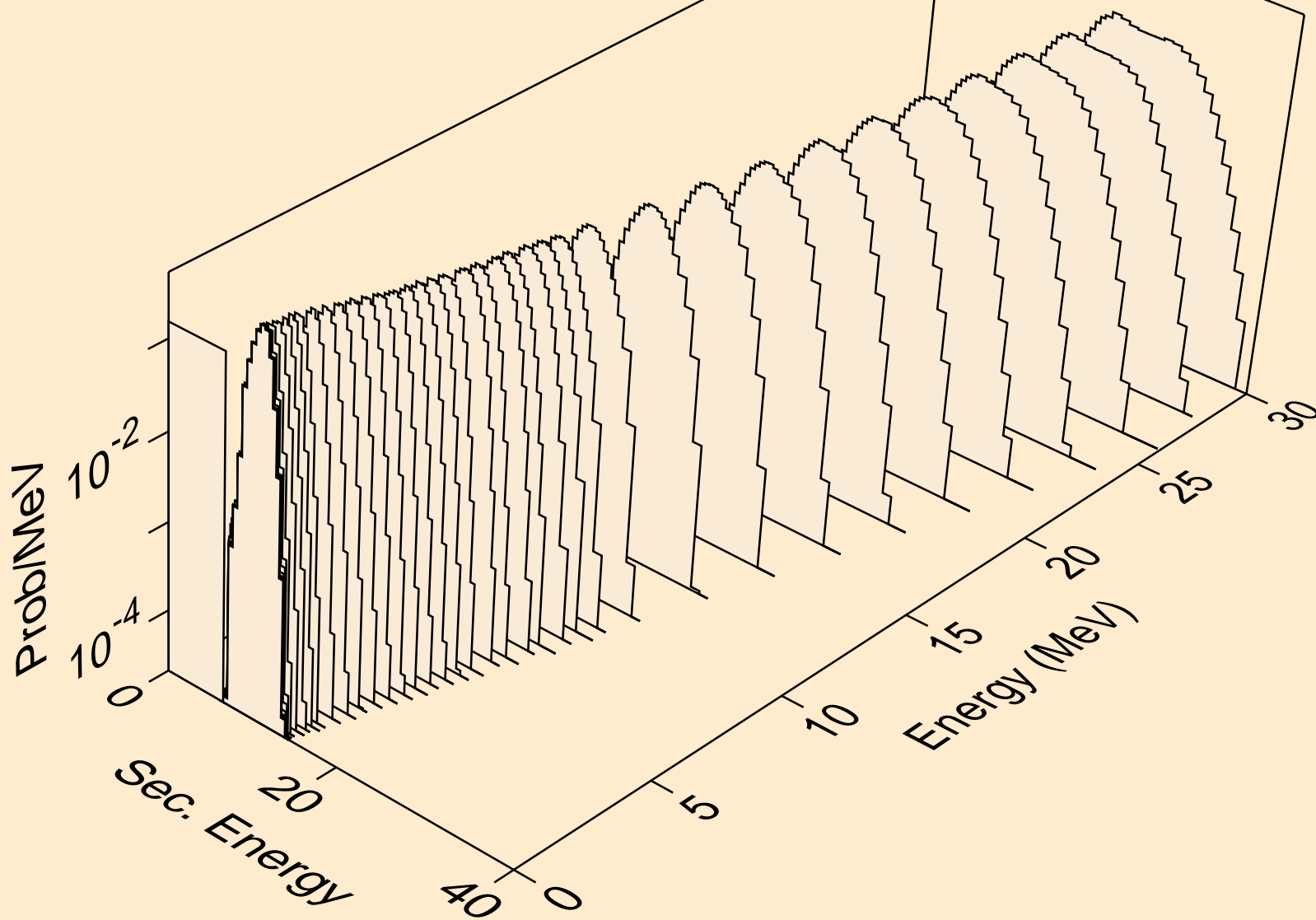

FR204 NEUTRON ACER TENDL-2019 LIBRARY; T=293.16K
alphas from (n,da)

