

FR205 NEUTRON ACER TENDL-2019 LIBRARY; T=293.16K
Principal cross sections

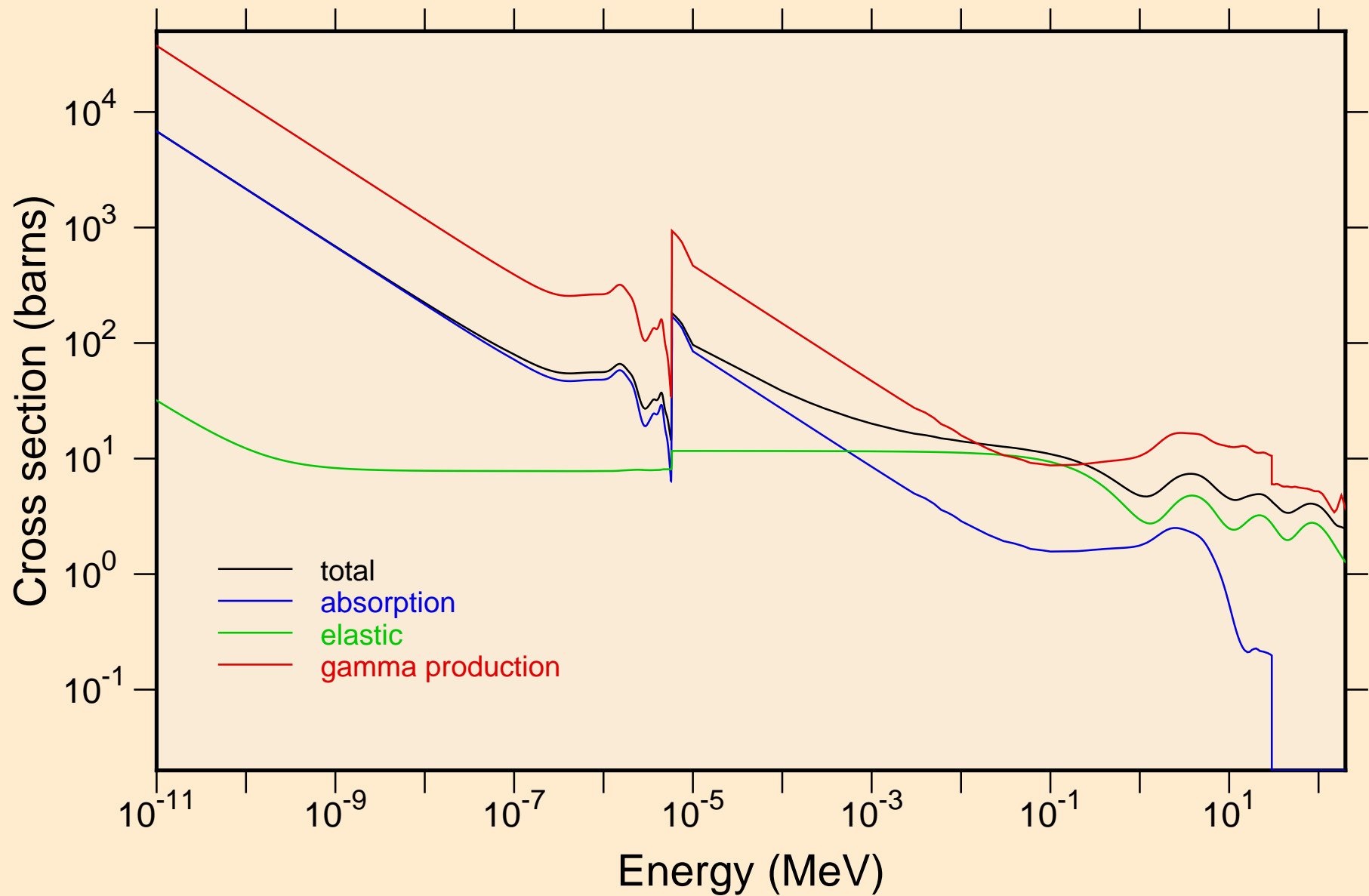

FR205 NEUTRON ACER TENDL-2019 LIBRARY; T=293.16K
Heating

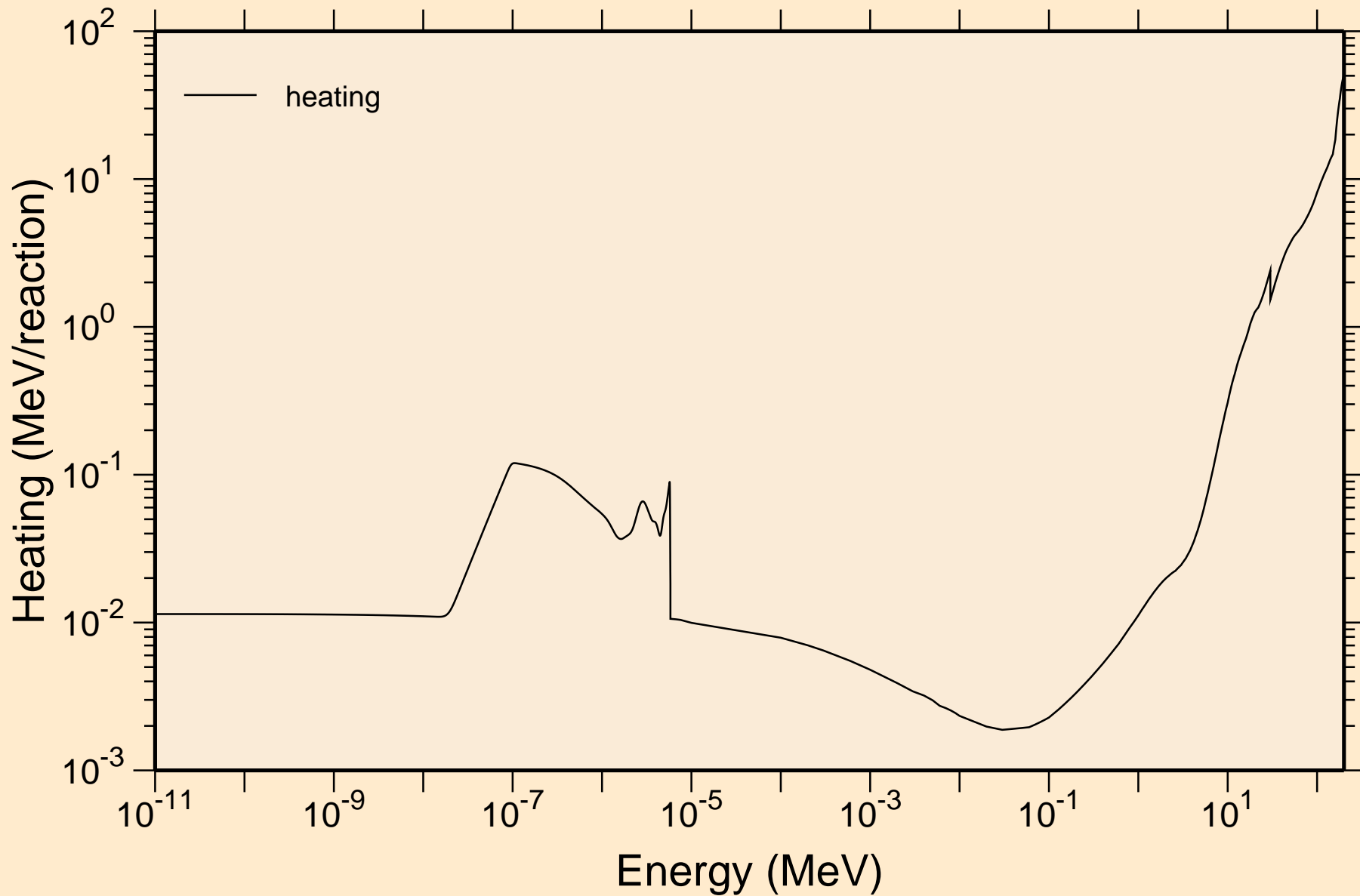

FR205 NEUTRON ACER TENDL-2019 LIBRARY; T=293.16K
Damage

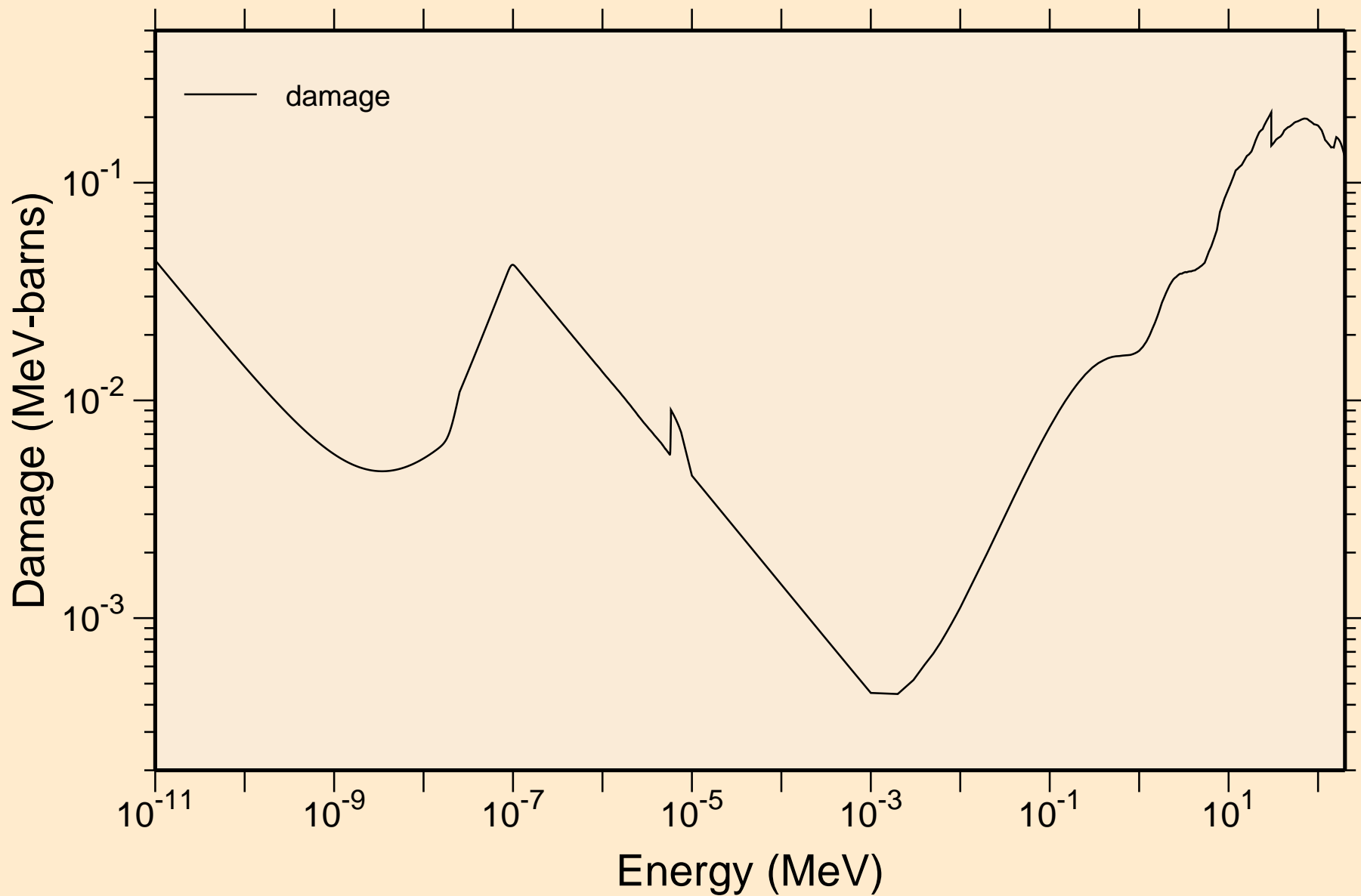

FR205 NEUTRON ACER TENDL-2019 LIBRARY; T=293.16K
Non-threshold reactions

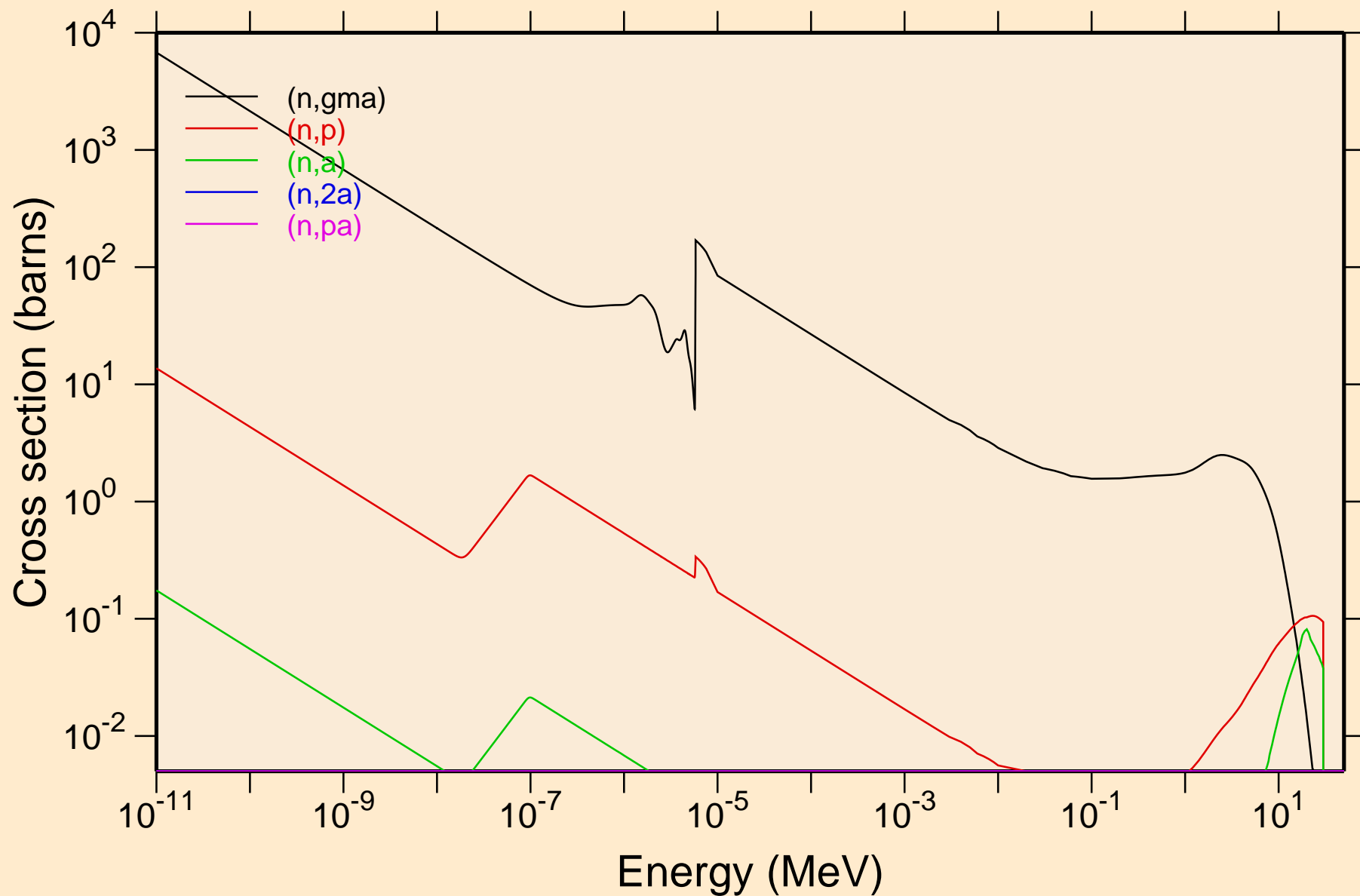

FR205 NEUTRON ACER TENDL-2019 LIBRARY; T=293.16K
Non-threshold reactions

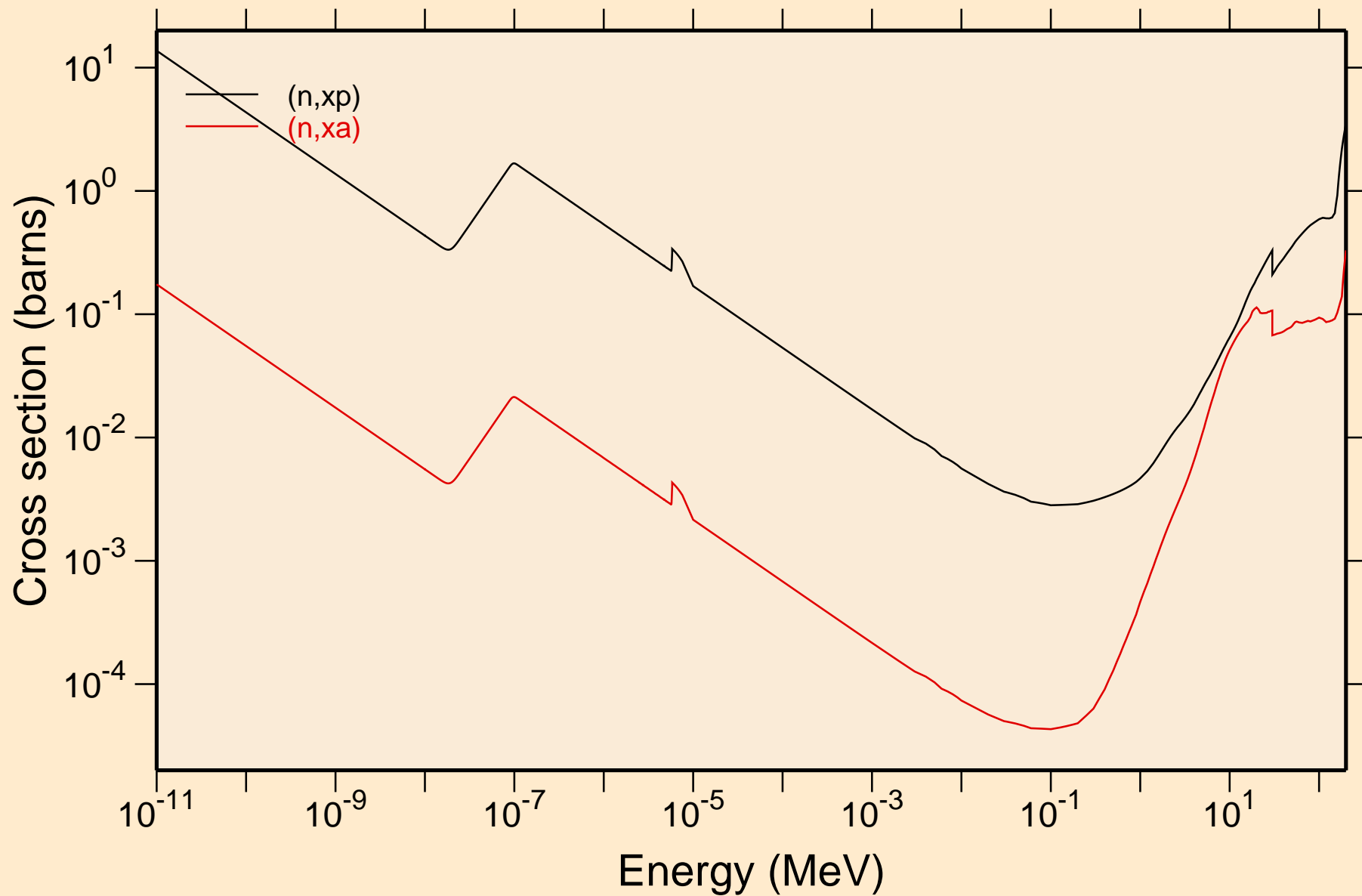

FR205 NEUTRON ACER TENDL-2019 LIBRARY; T=293.16K
Principal cross sections

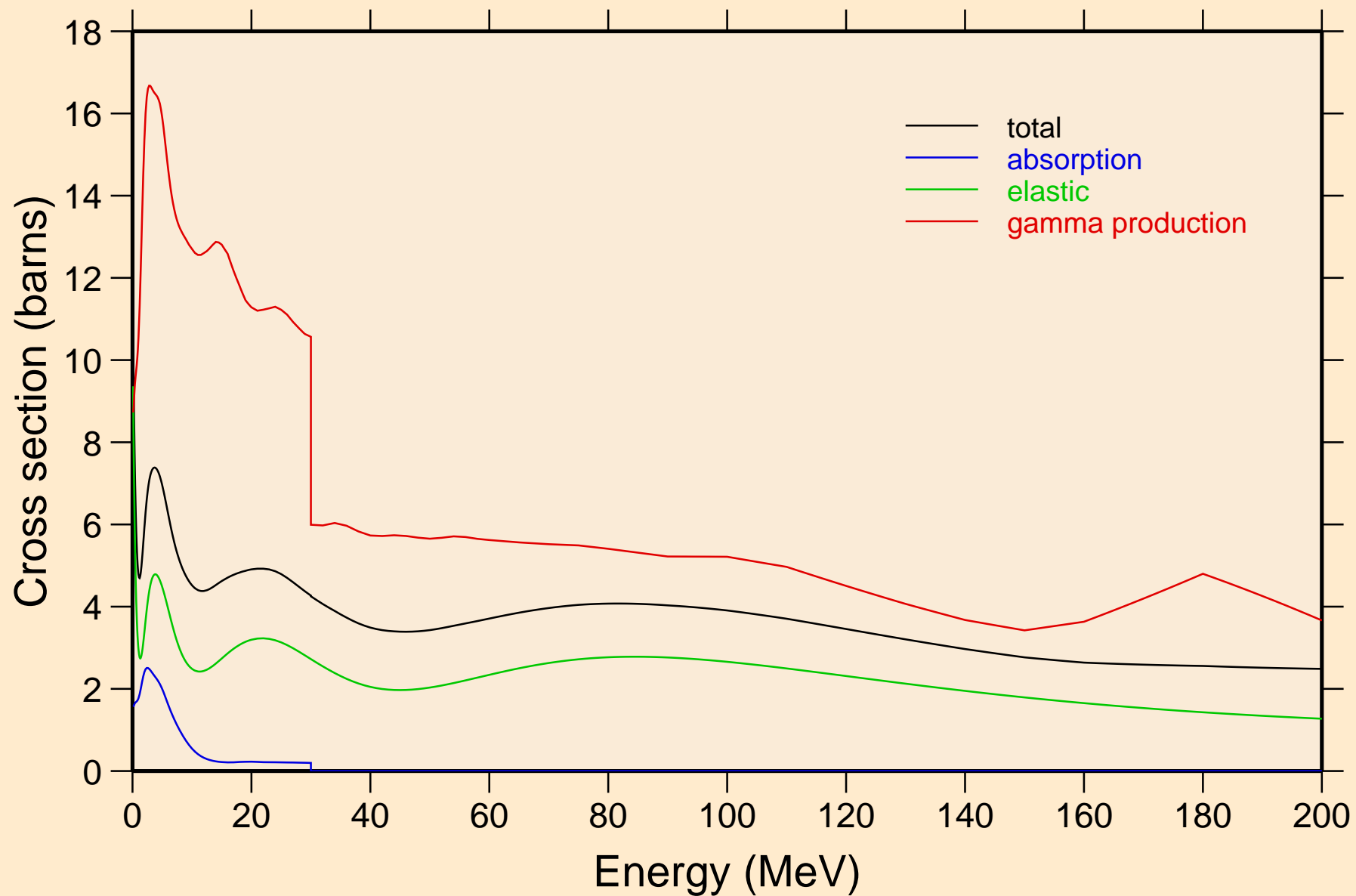

FR205 NEUTRON ACER TENDL-2019 LIBRARY; T=293.16K
Heating

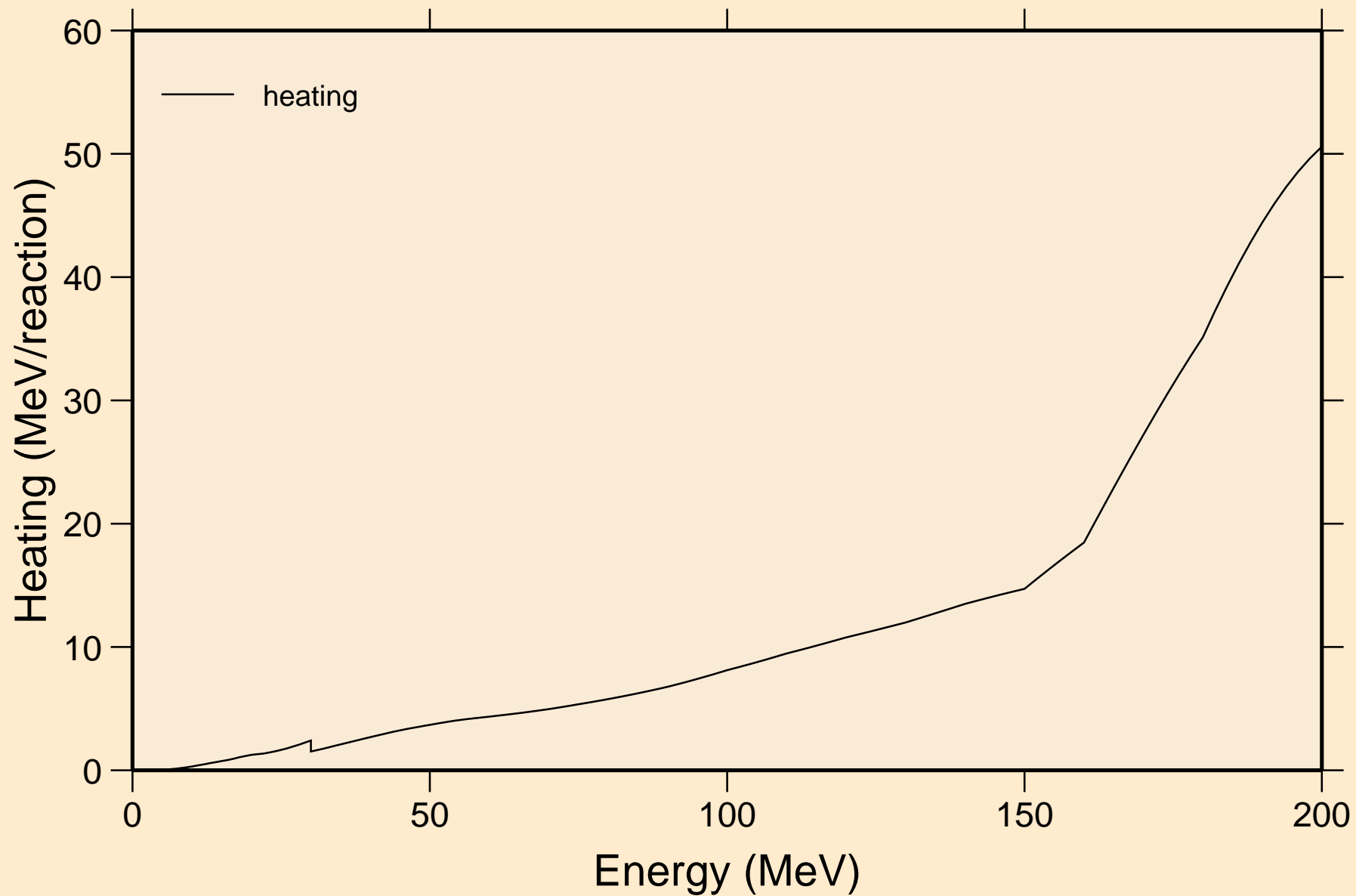

FR205 NEUTRON ACER TENDL-2019 LIBRARY; T=293.16K
Damage

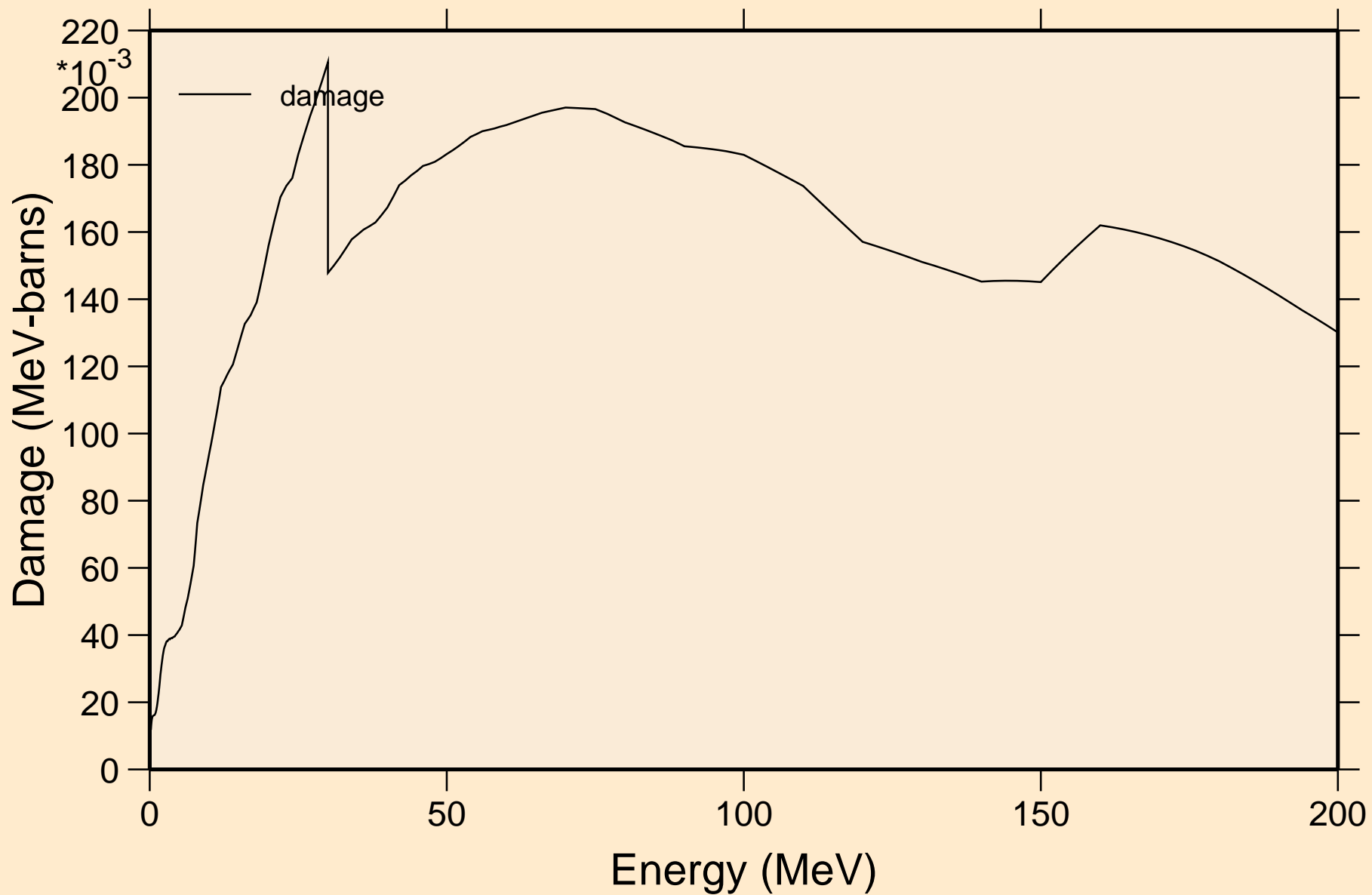

FR205 NEUTRON ACER TENDL-2019 LIBRARY; T=293.16K
Non-threshold reactions

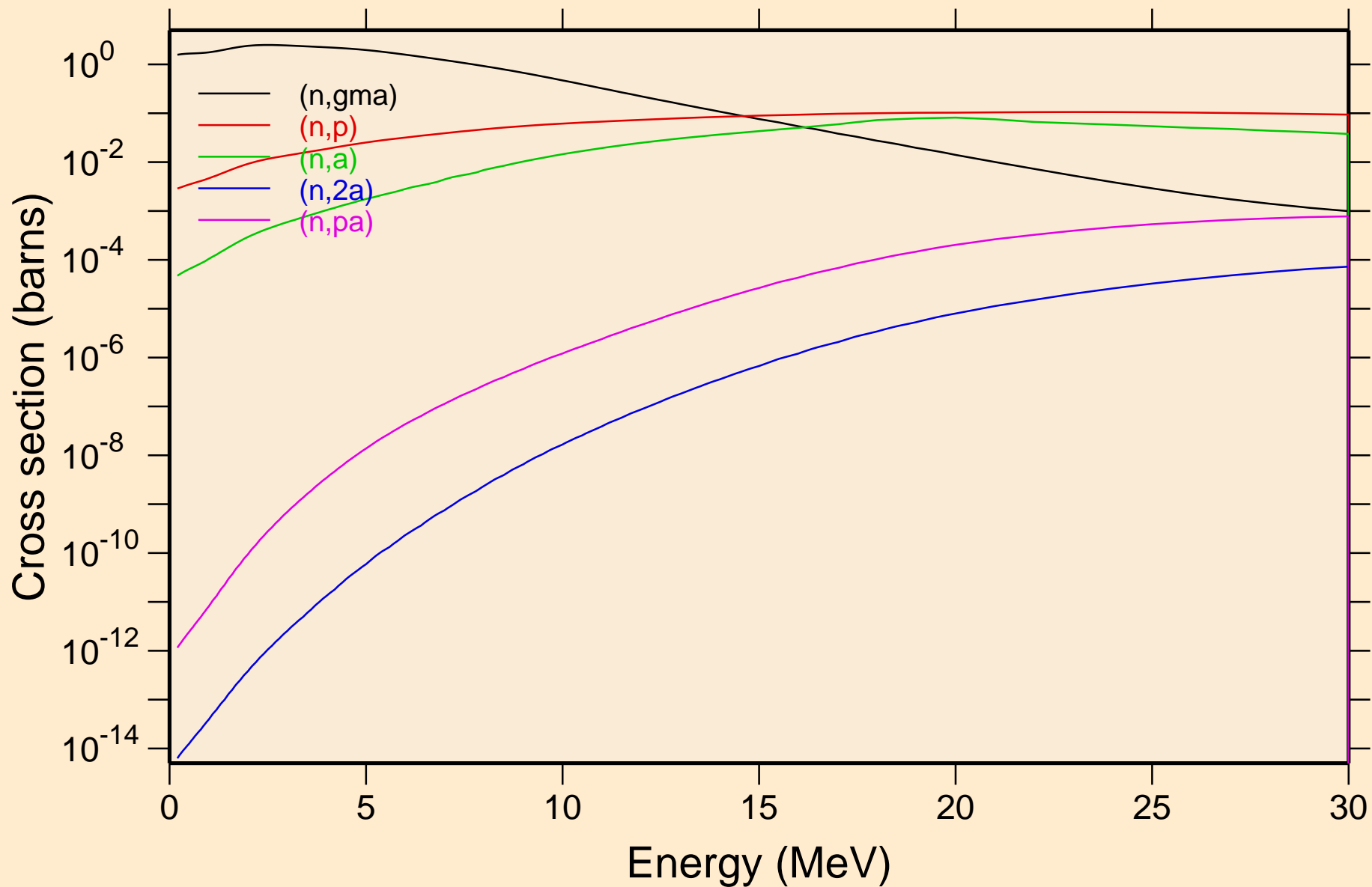

FR205 NEUTRON ACER TENDL-2019 LIBRARY; T=293.16K
Non-threshold reactions

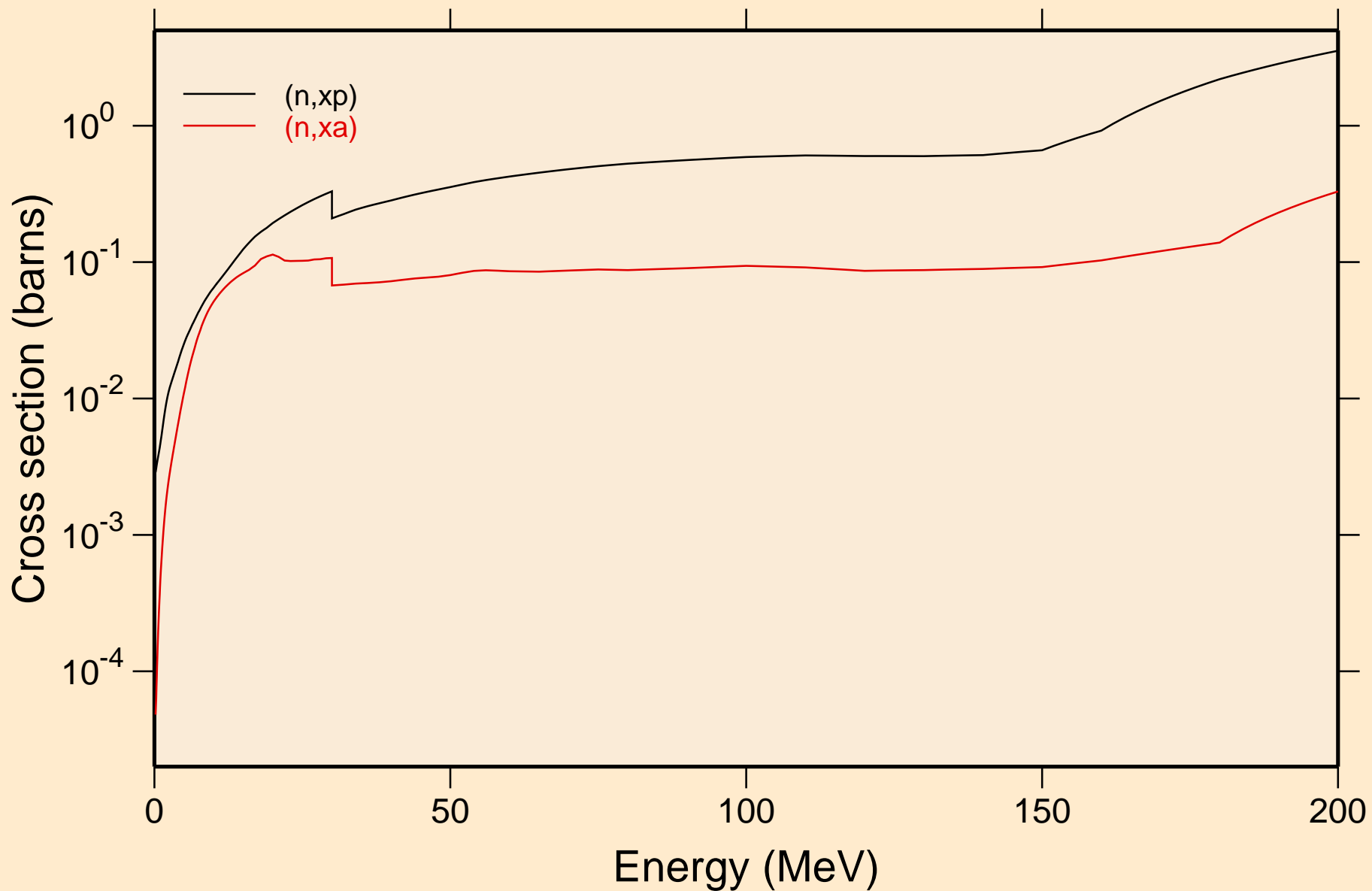

FR205 NEUTRON ACER TENDL-2019 LIBRARY; T=293.16K
Inelastic levels

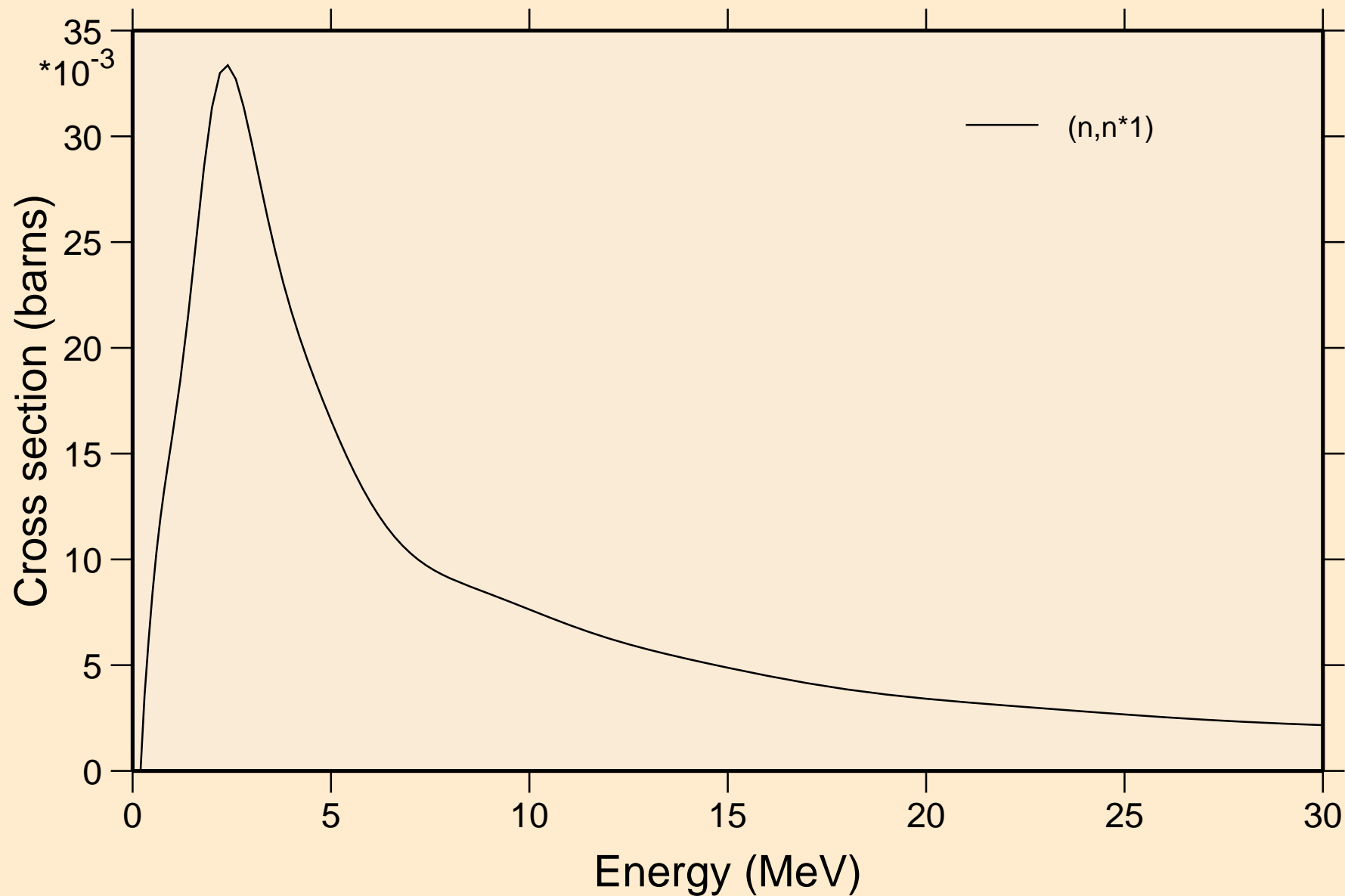

FR205 NEUTRON ACER TENDL-2019 LIBRARY; T=293.16K
Threshold reactions

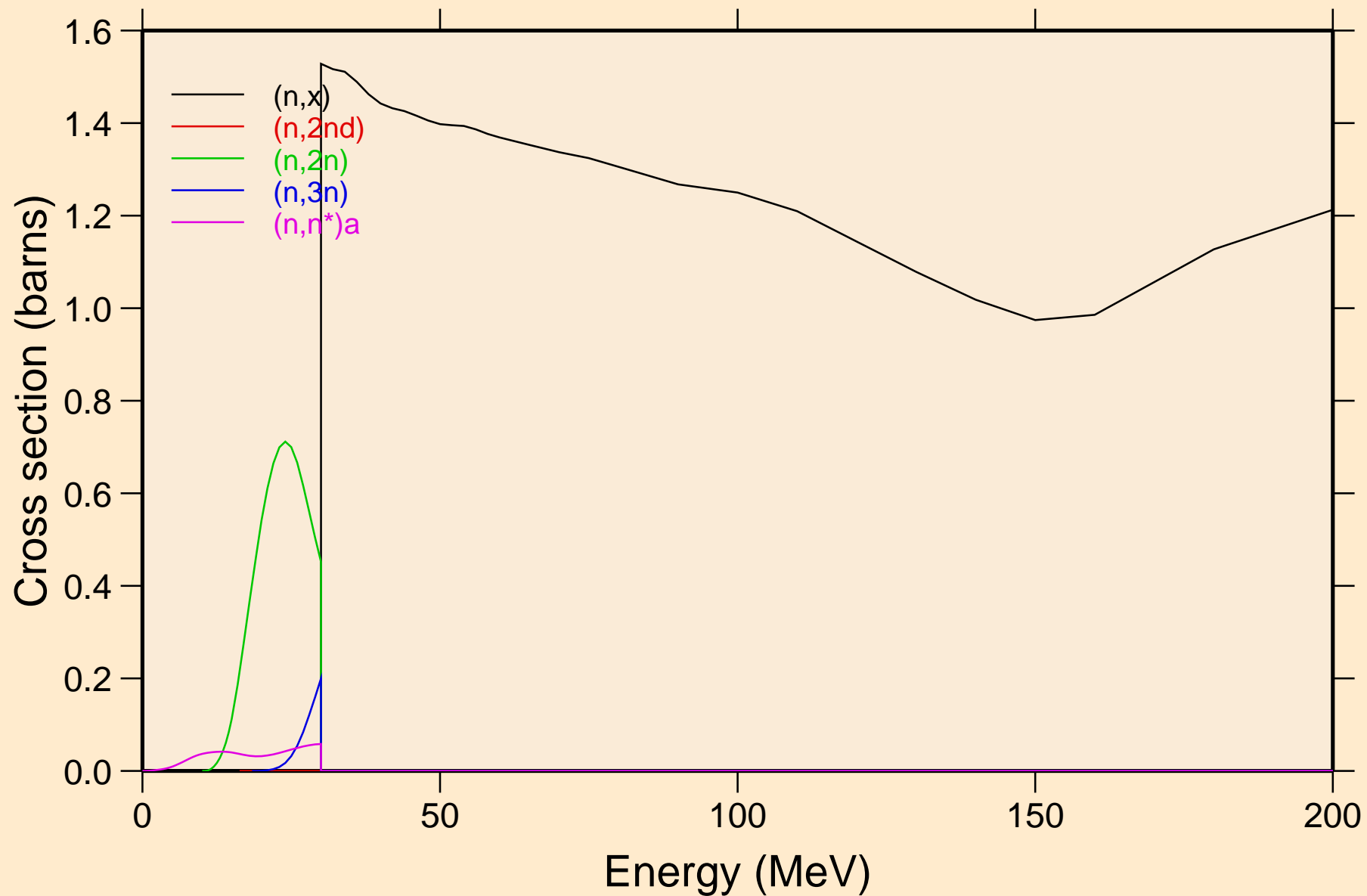

FR205 NEUTRON ACER TENDL-2019 LIBRARY; T=293.16K
Threshold reactions

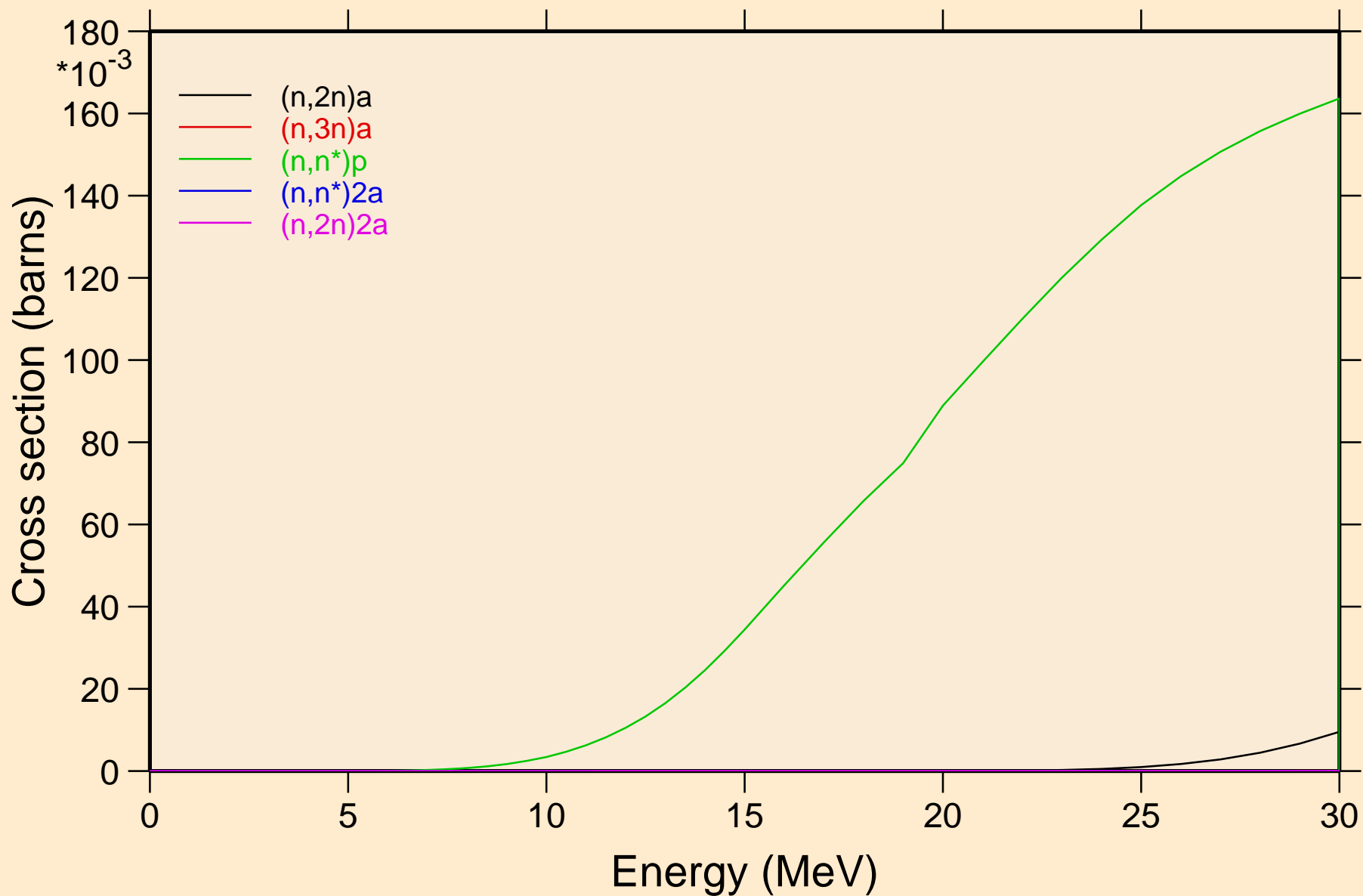

FR205 NEUTRON ACER TENDL-2019 LIBRARY; T=293.16K
Threshold reactions

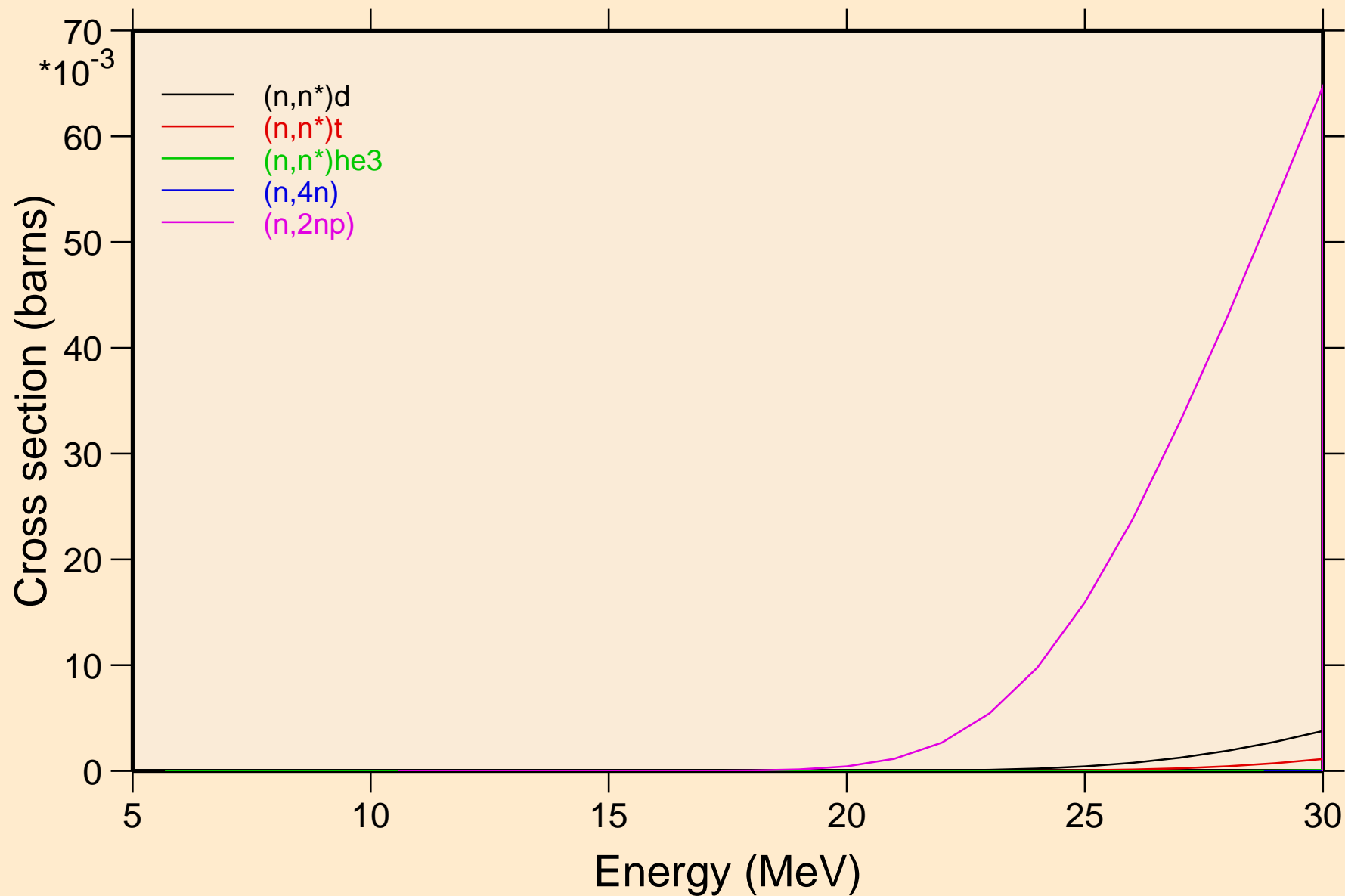

FR205 NEUTRON ACER TENDL-2019 LIBRARY; T=293.16K
Threshold reactions

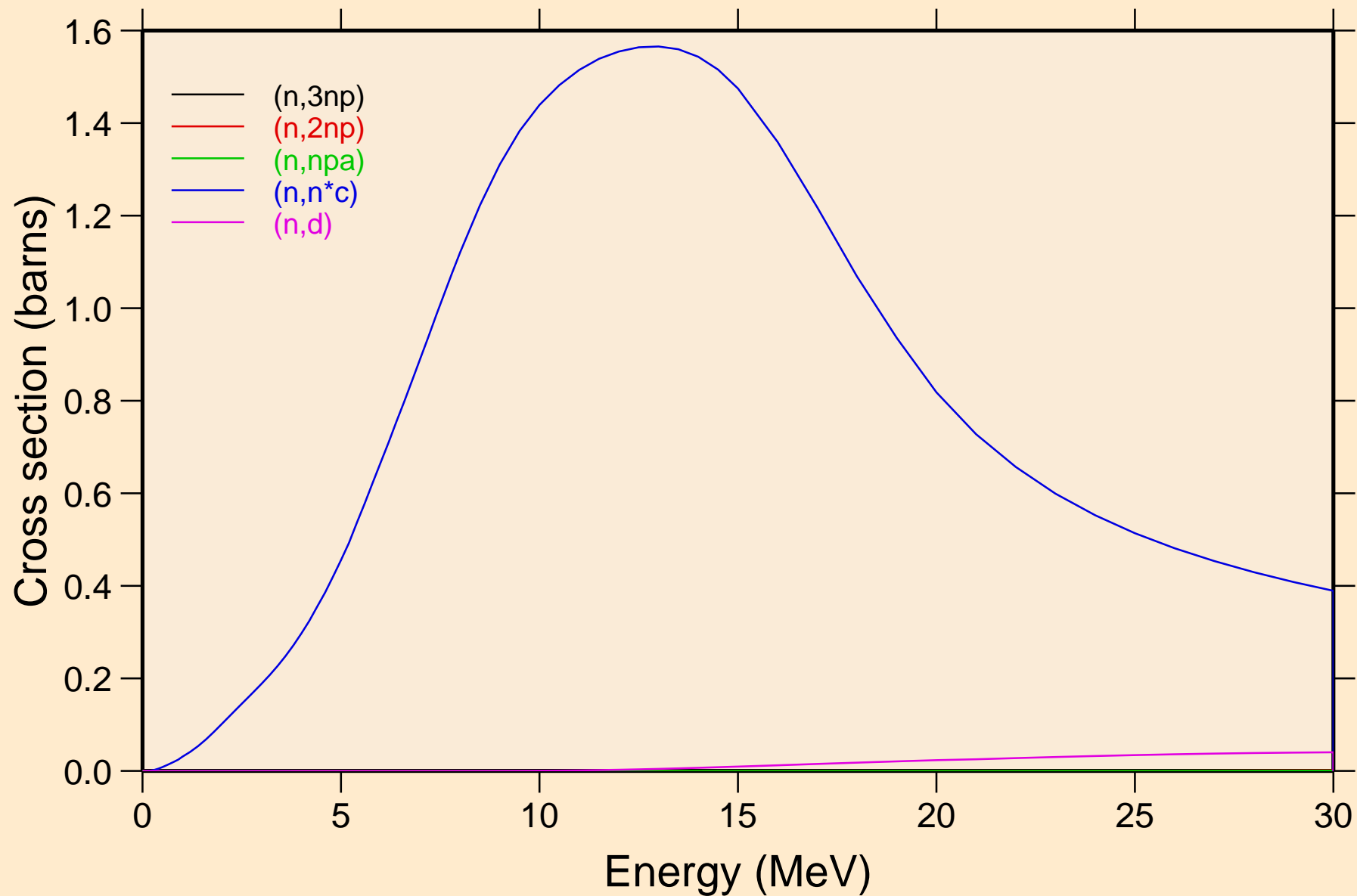

FR205 NEUTRON ACER TENDL-2019 LIBRARY; T=293.16K
Threshold reactions

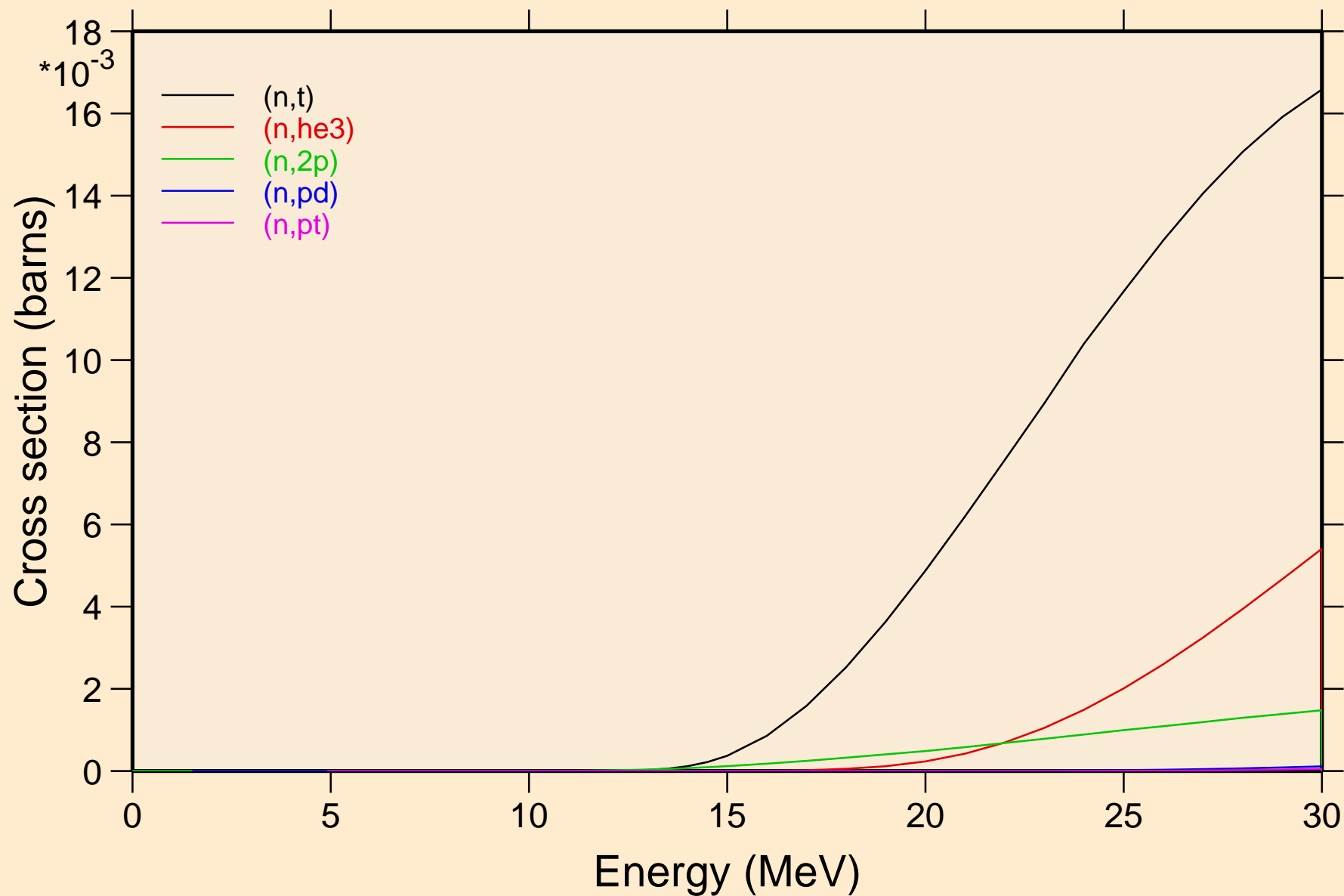

FR205 NEUTRON ACER TENDL-2019 LIBRARY; T=293.16K
Threshold reactions

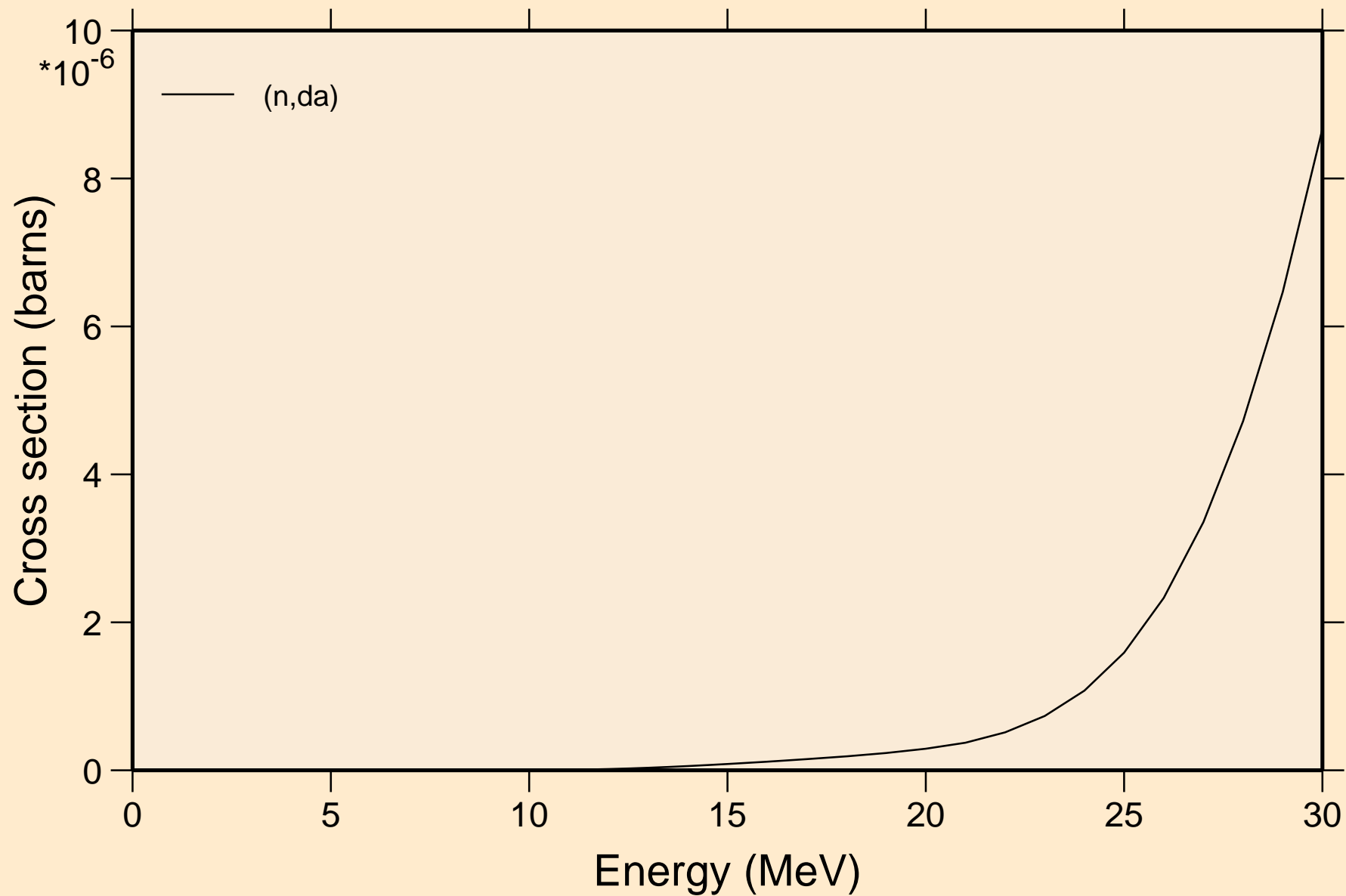

FR205 NEUTRON ACER TENDL-2019 LIBRARY; T=293.16K
Threshold reactions

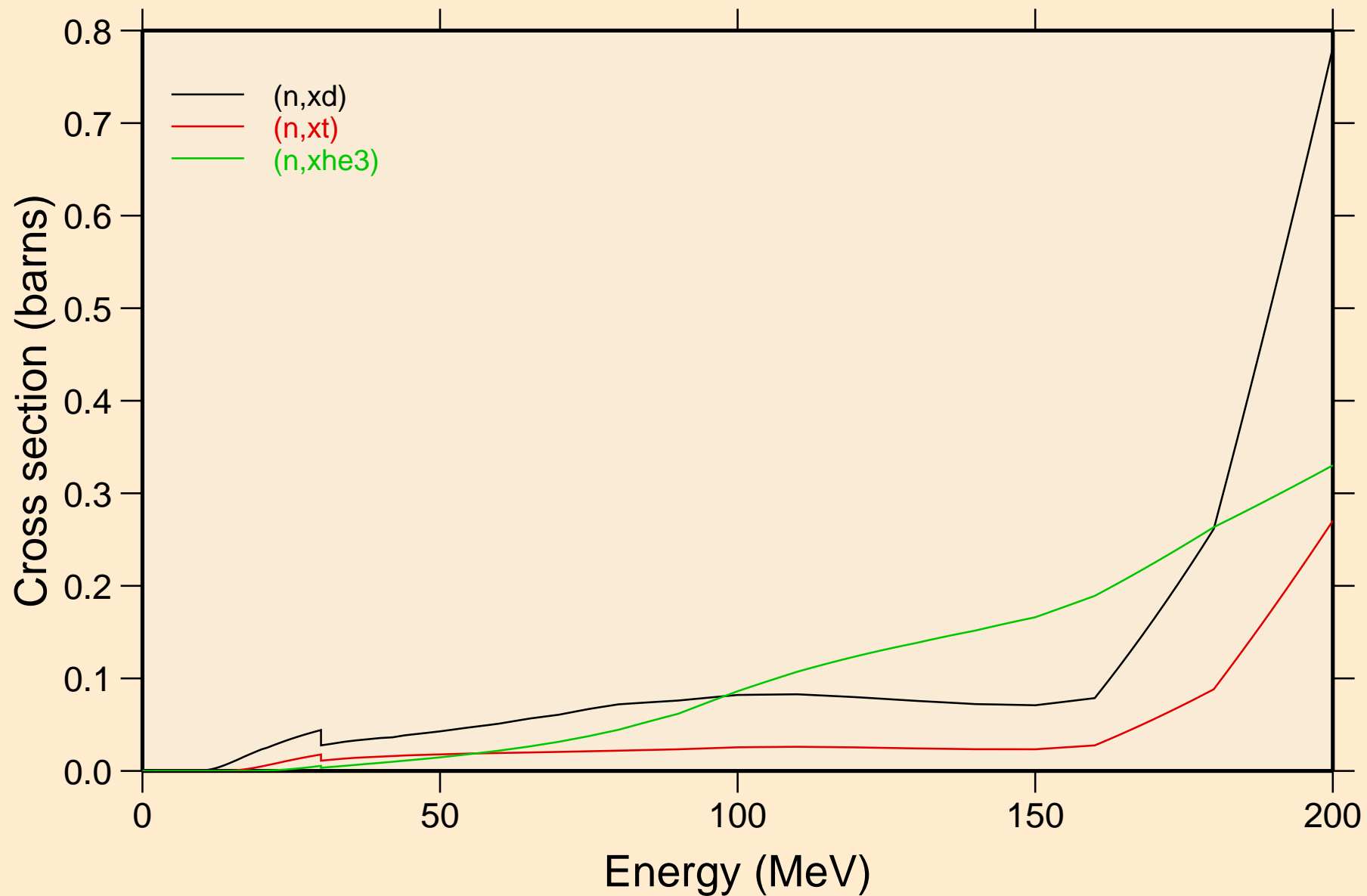

FR205 NEUTRON ACER TENDL-2019 LIBRARY; T=293.16K
angular distribution for elastic

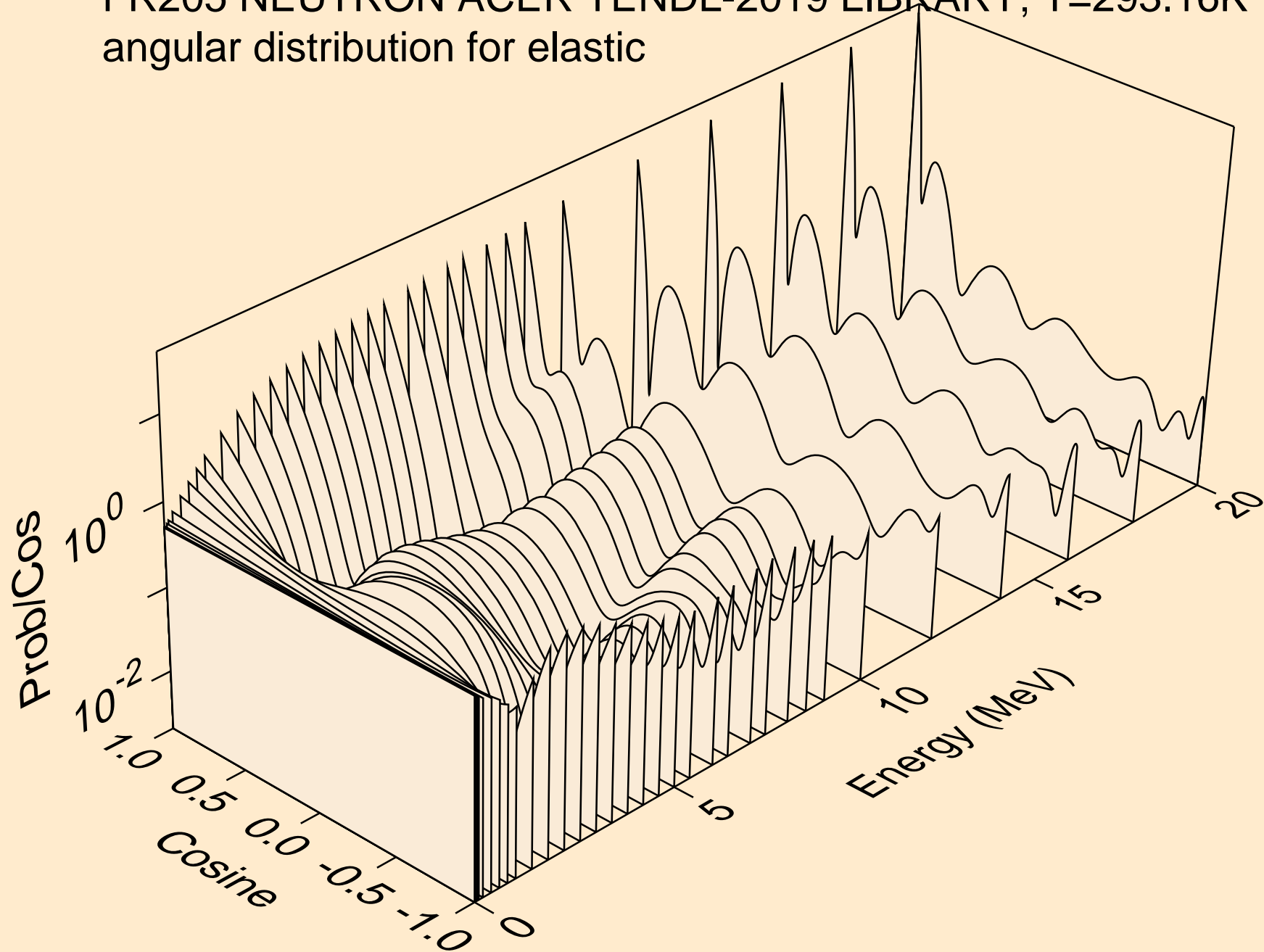

FR205 NEUTRON ACER TENDL-2019 LIBRARY; T=293.16K
angular distribution for elastic

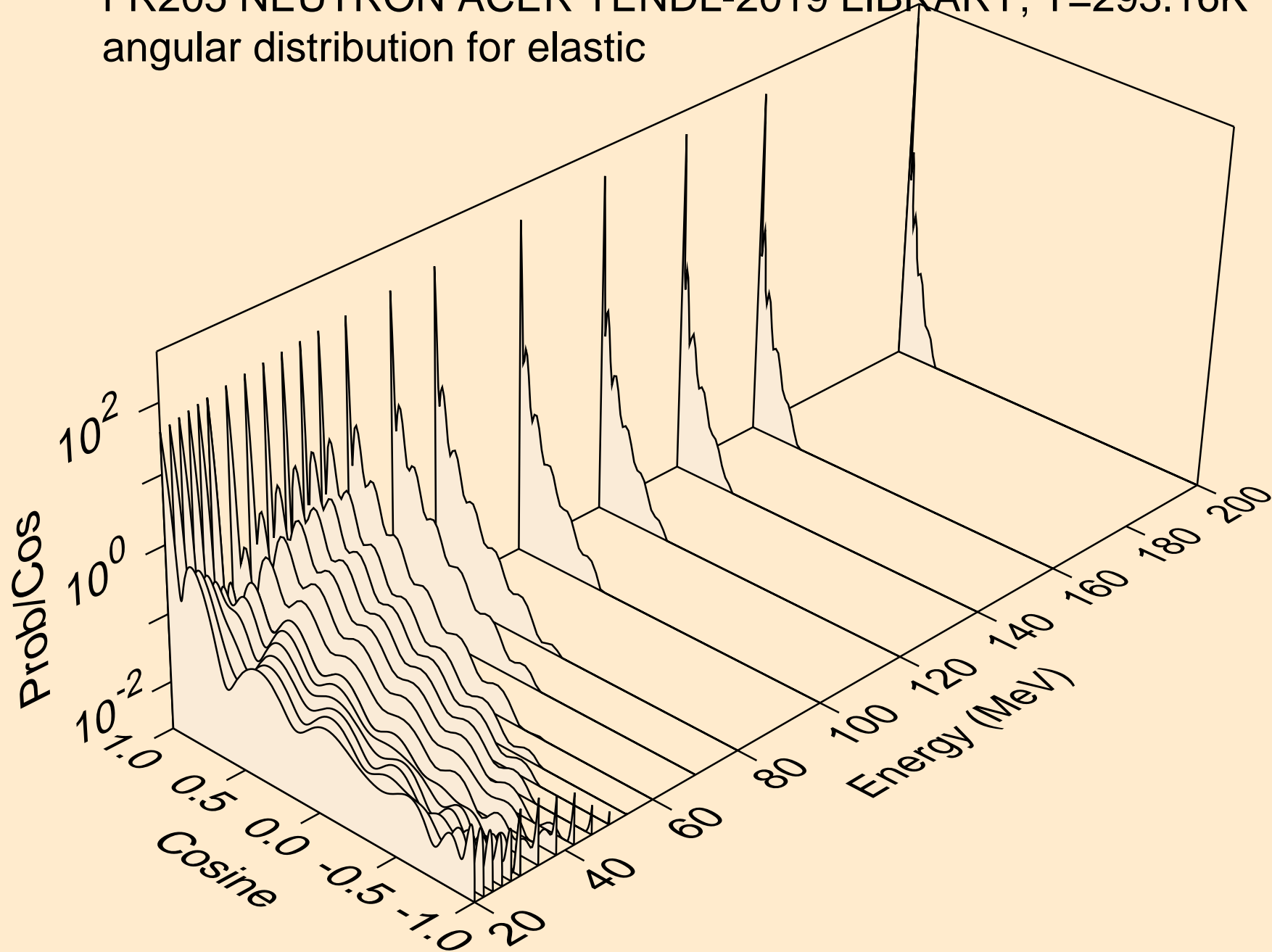

FR205 NEUTRON ACER TENDL-2019 LIBRARY; T=293.16K
angular distribution for (n,n*1)

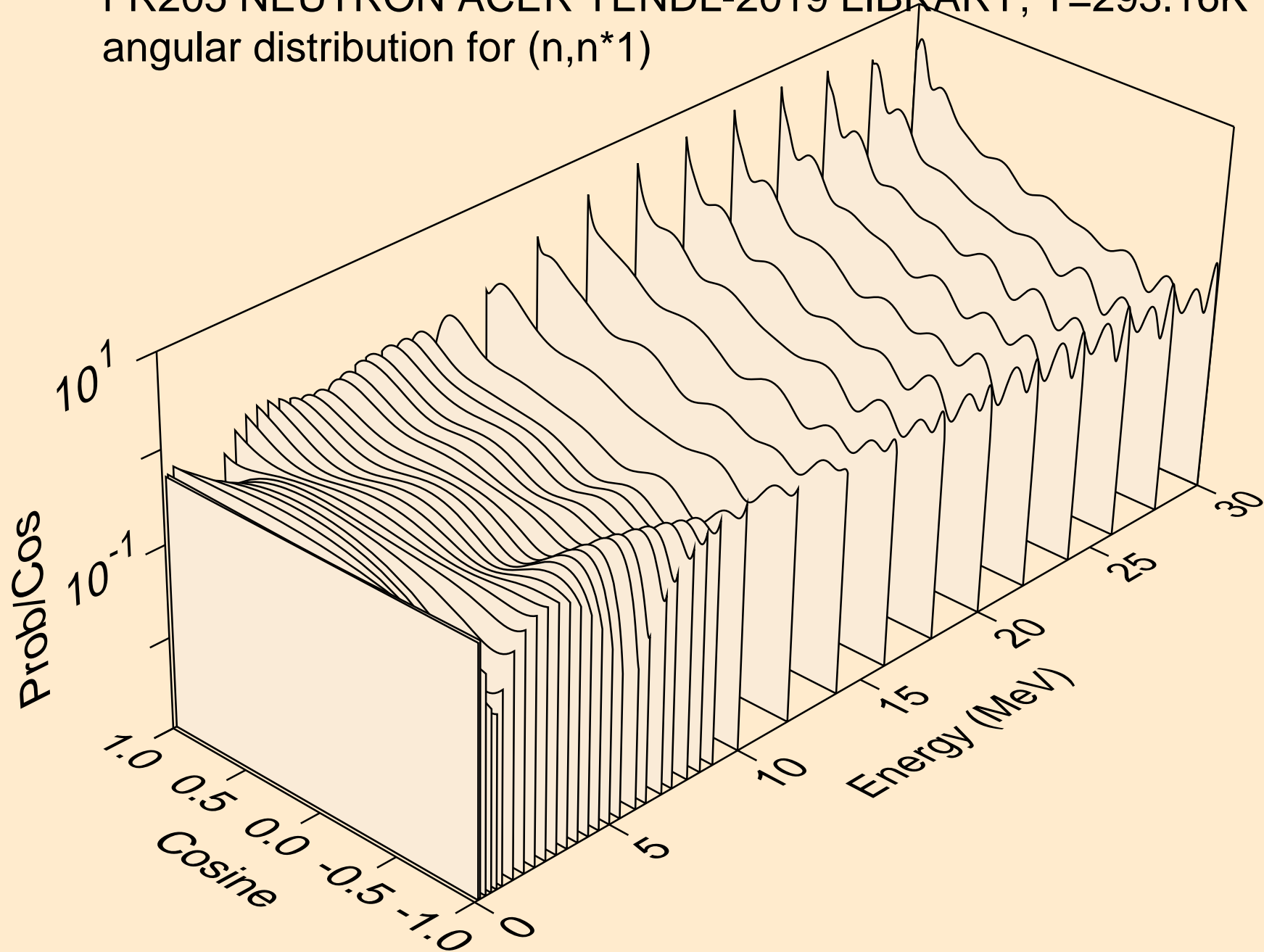

FR205 NEUTRON ACER TENDL-2019 LIBRARY; T=293.16K
Neutron emission for (n,x)

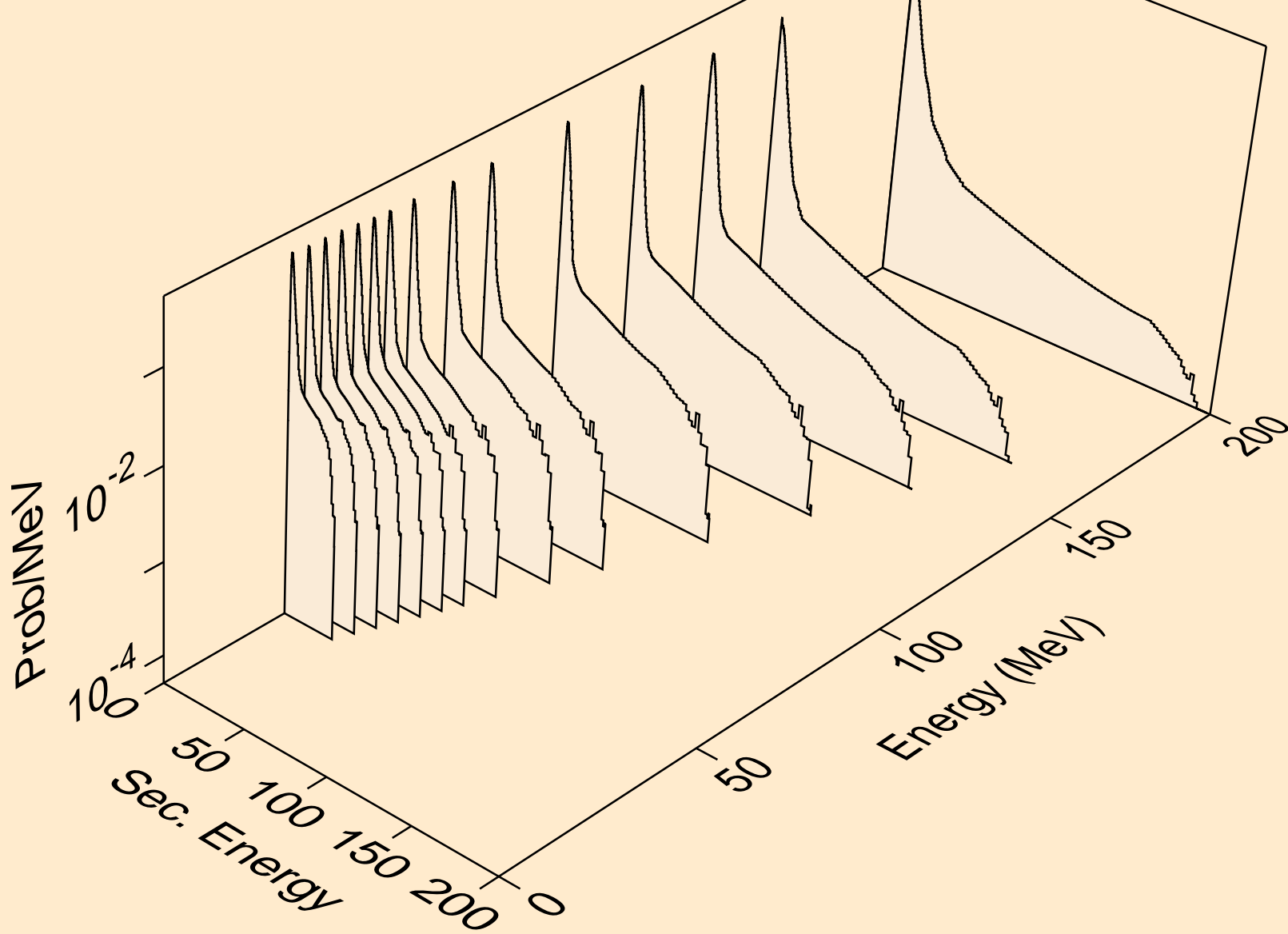

FR205 NEUTRON ACER TENDL-2019 LIBRARY; T=293.16K
Neutron emission for (n,2nd)

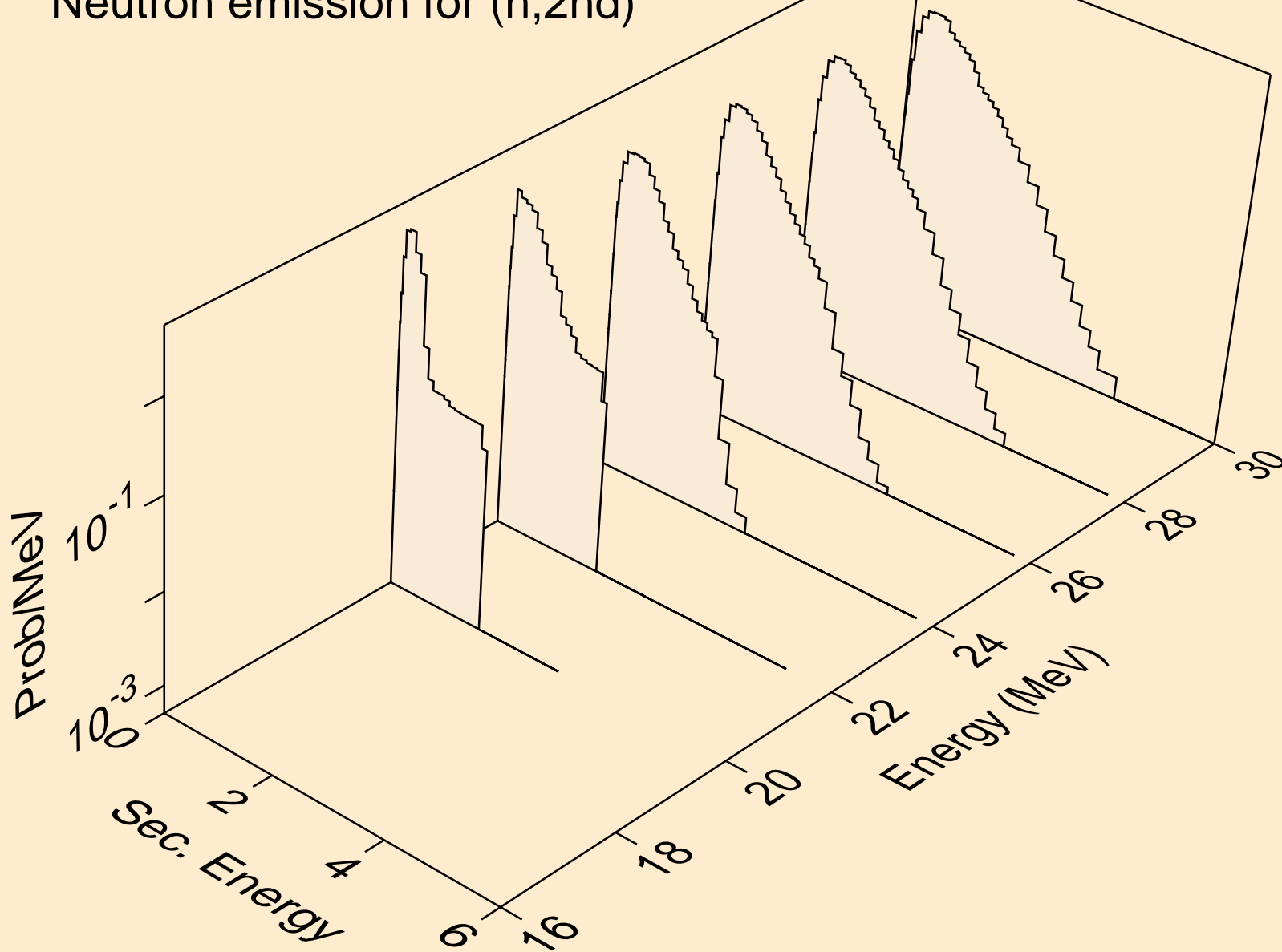

FR205 NEUTRON ACER TENDL-2019 LIBRARY; T=293.16K
Neutron emission for (n,2n)

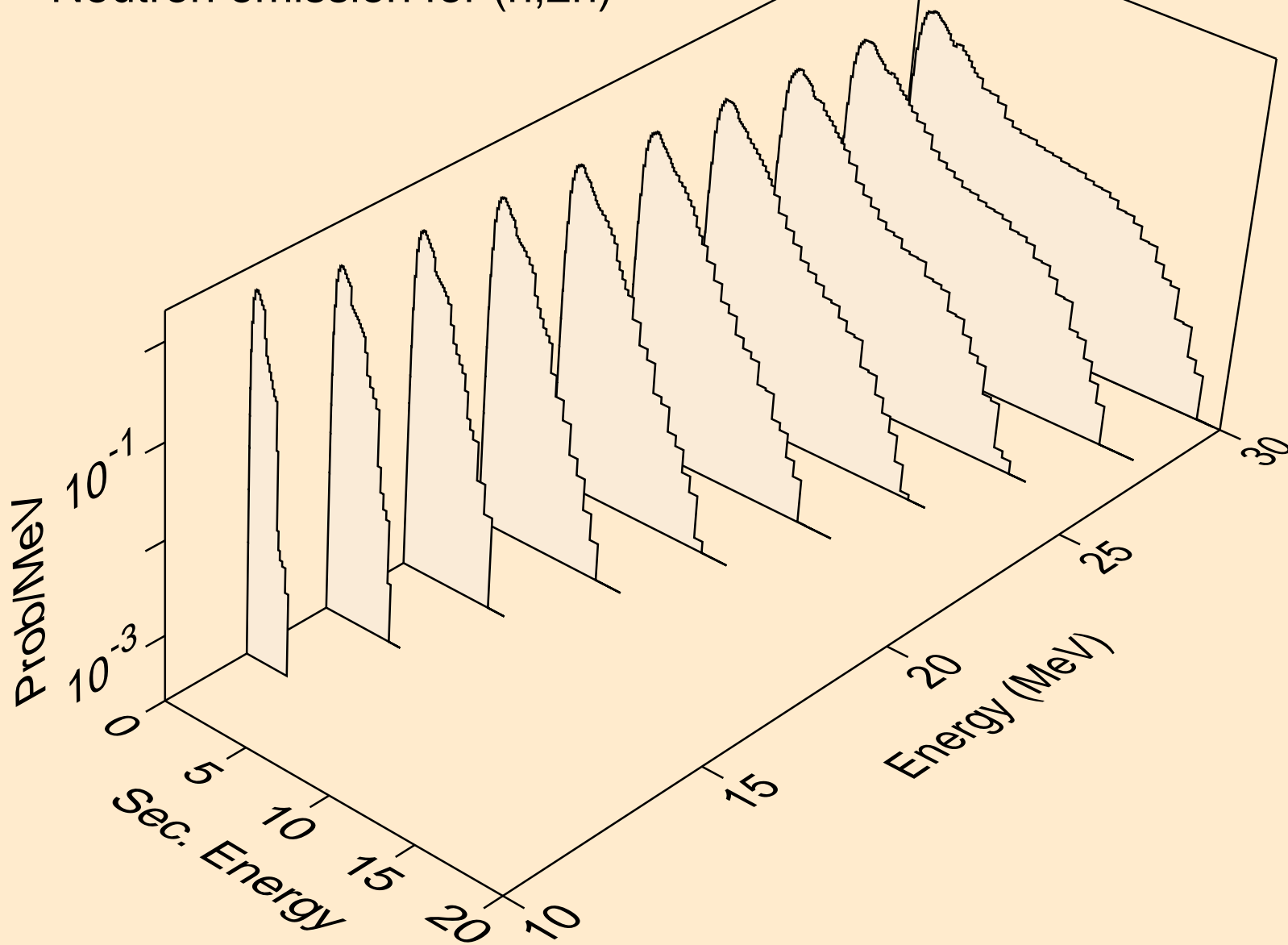

FR205 NEUTRON ACER TENDL-2019 LIBRARY; T=293.16K
Neutron emission for (n,3n)

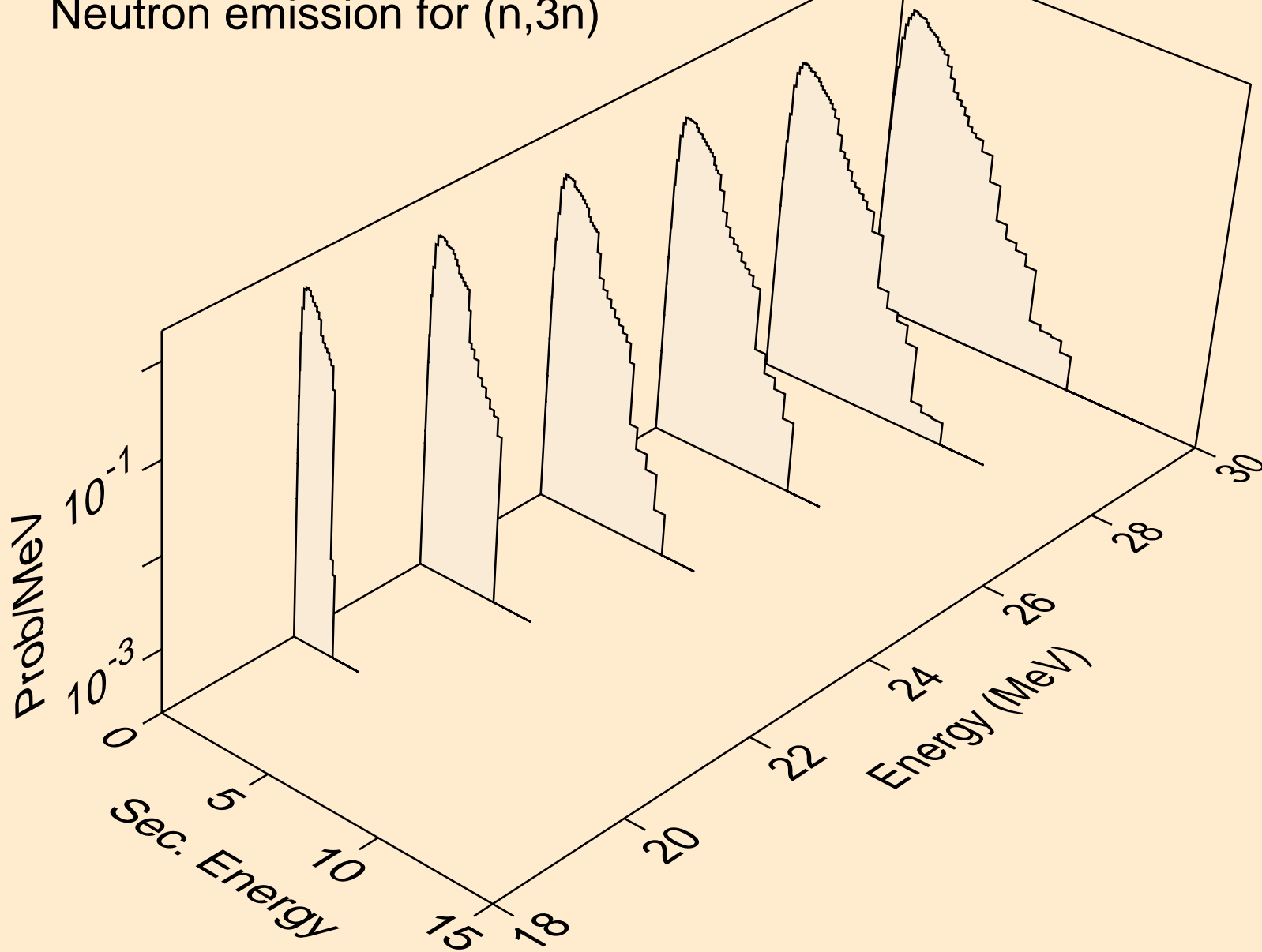

FR205 NEUTRON ACER TENDL-2019 LIBRARY; T=293.16K
Neutron emission for (n,n*)a

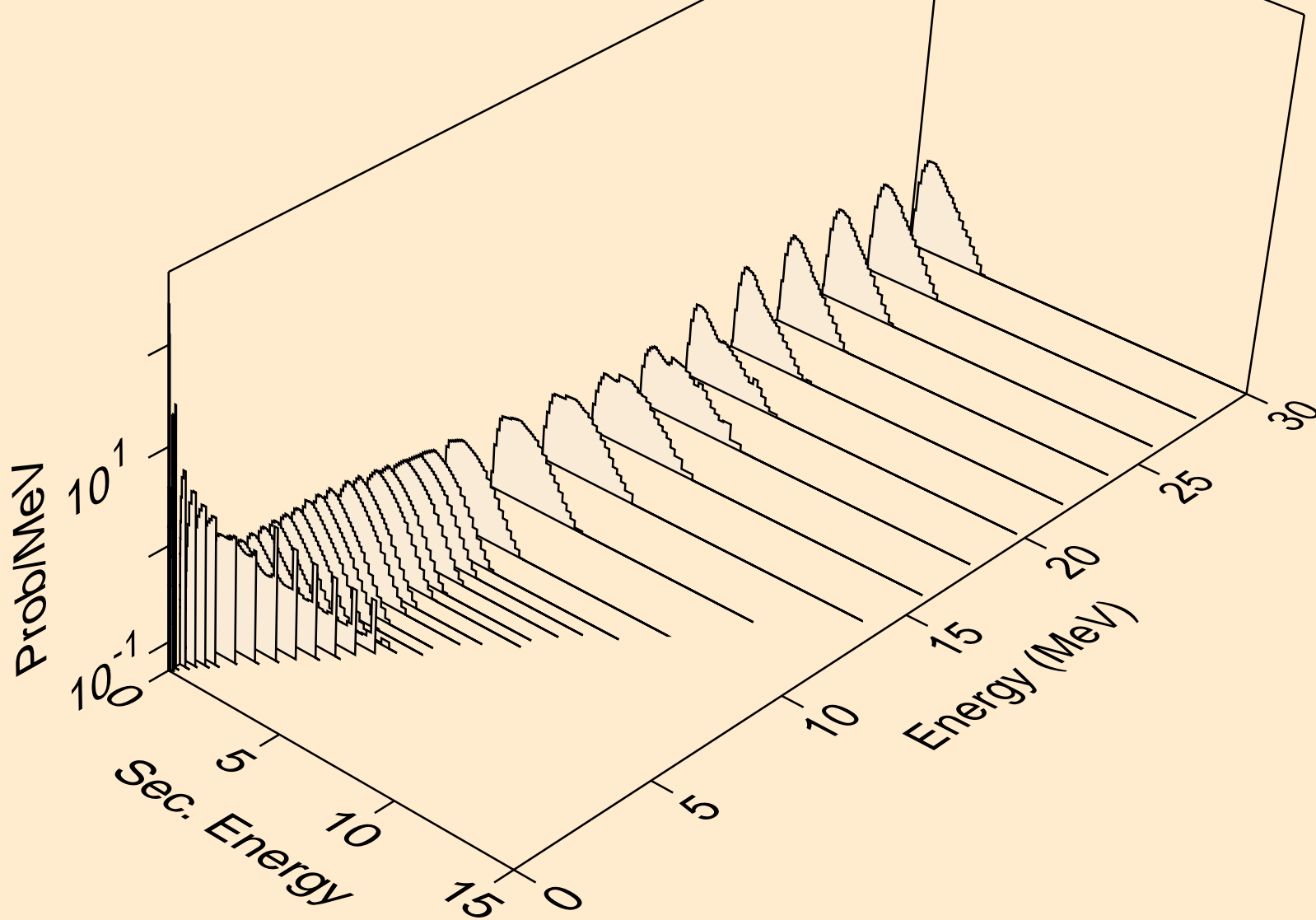

FR205 NEUTRON ACER TENDL-2019 LIBRARY; T=293.16K
Neutron emission for (n,2n)a

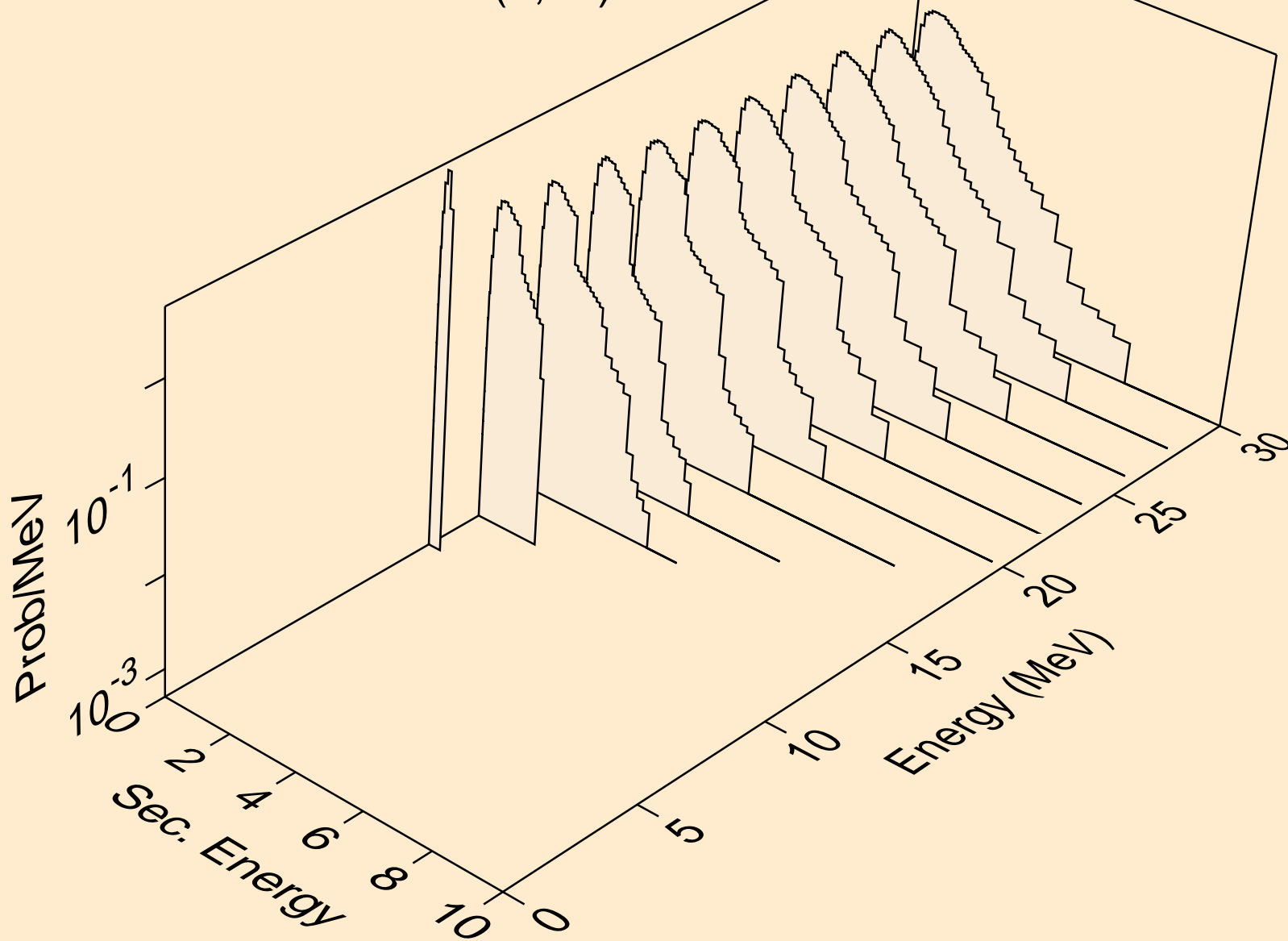

FR205 NEUTRON ACER TENDL-2019 LIBRARY; T=293.16K
Neutron emission for (n,3n)a

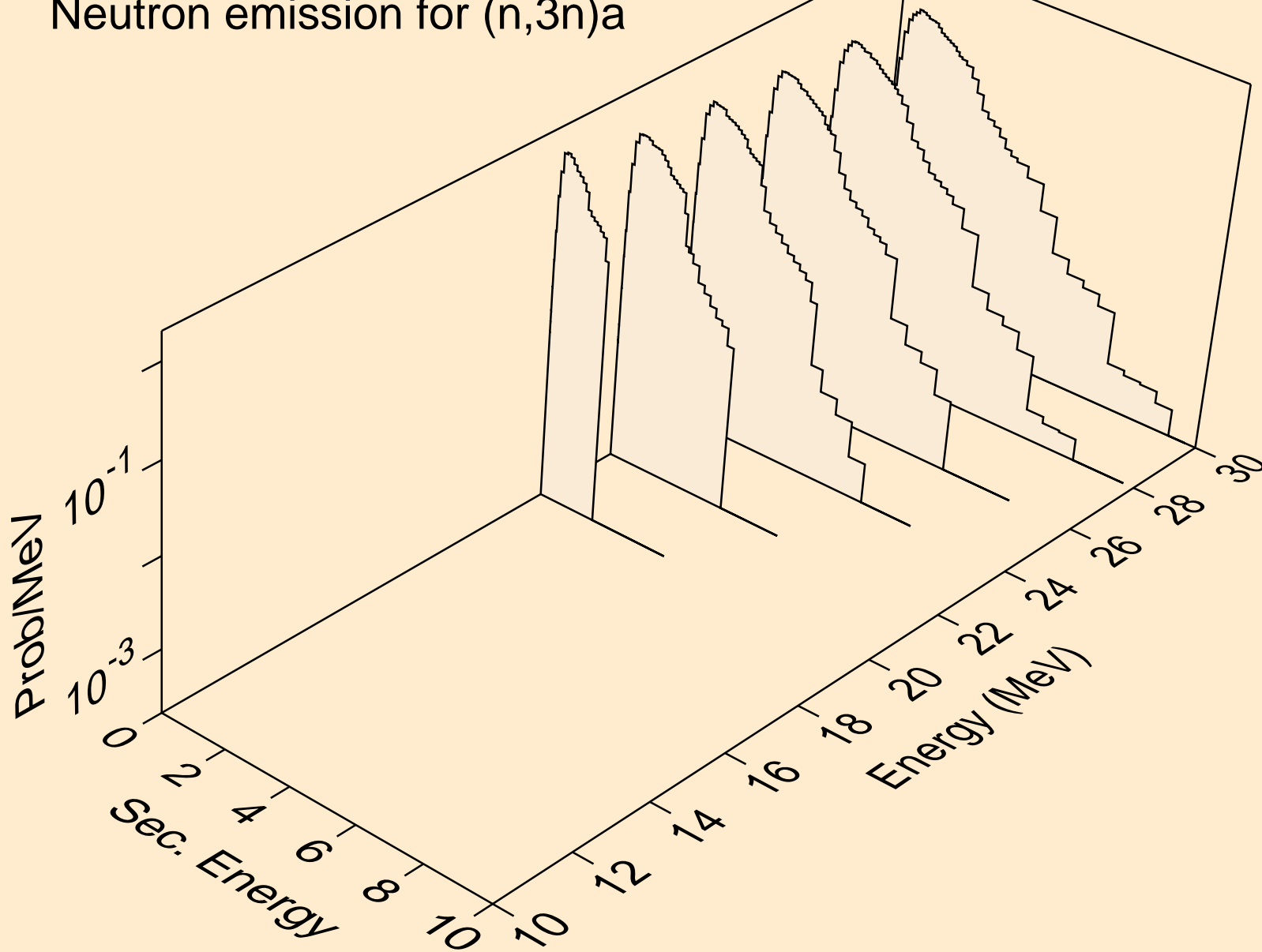

FR205 NEUTRON ACER TENDL-2019 LIBRARY; T=293.16K
Neutron emission for (n,n*)p

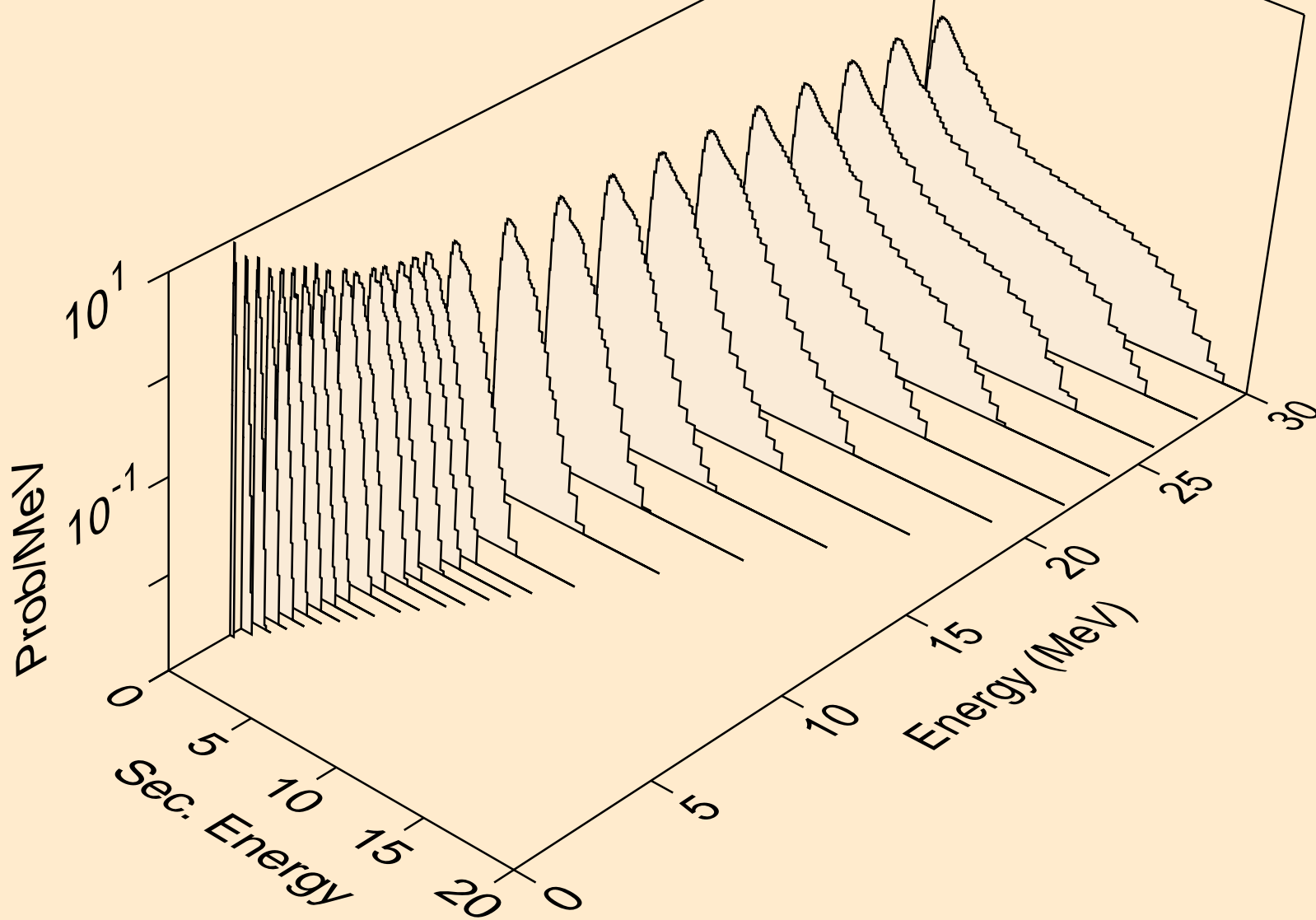

FR205 NEUTRON ACER TENDL-2019 LIBRARY; T=293.16K
Neutron emission for (n,n*)2a

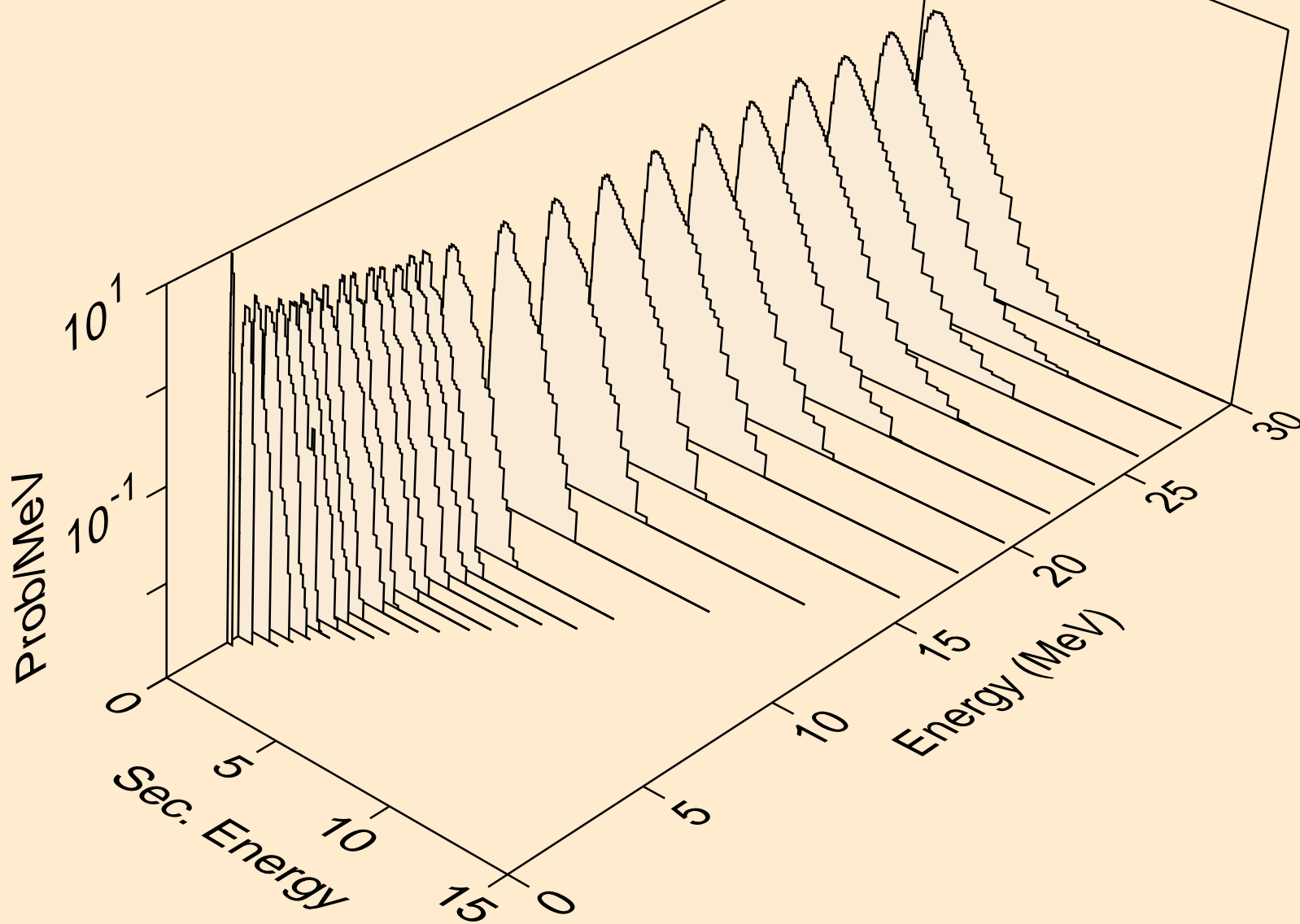

FR205 NEUTRON ACER TENDL-2019 LIBRARY; T=293.16K
Neutron emission for (n,2n)2a

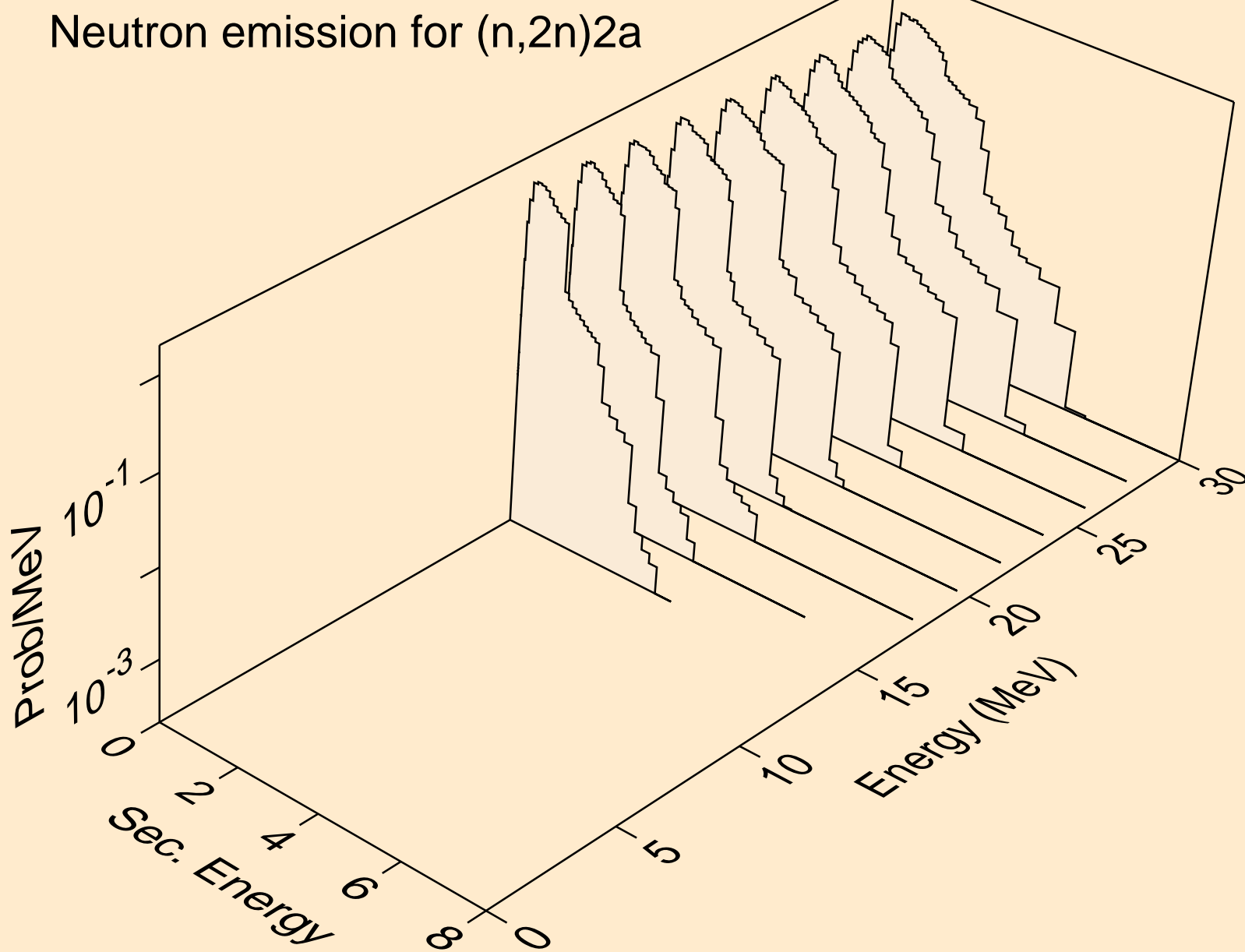

FR205 NEUTRON ACER TENDL-2019 LIBRARY; T=293.16K
Neutron emission for (n,n*)d

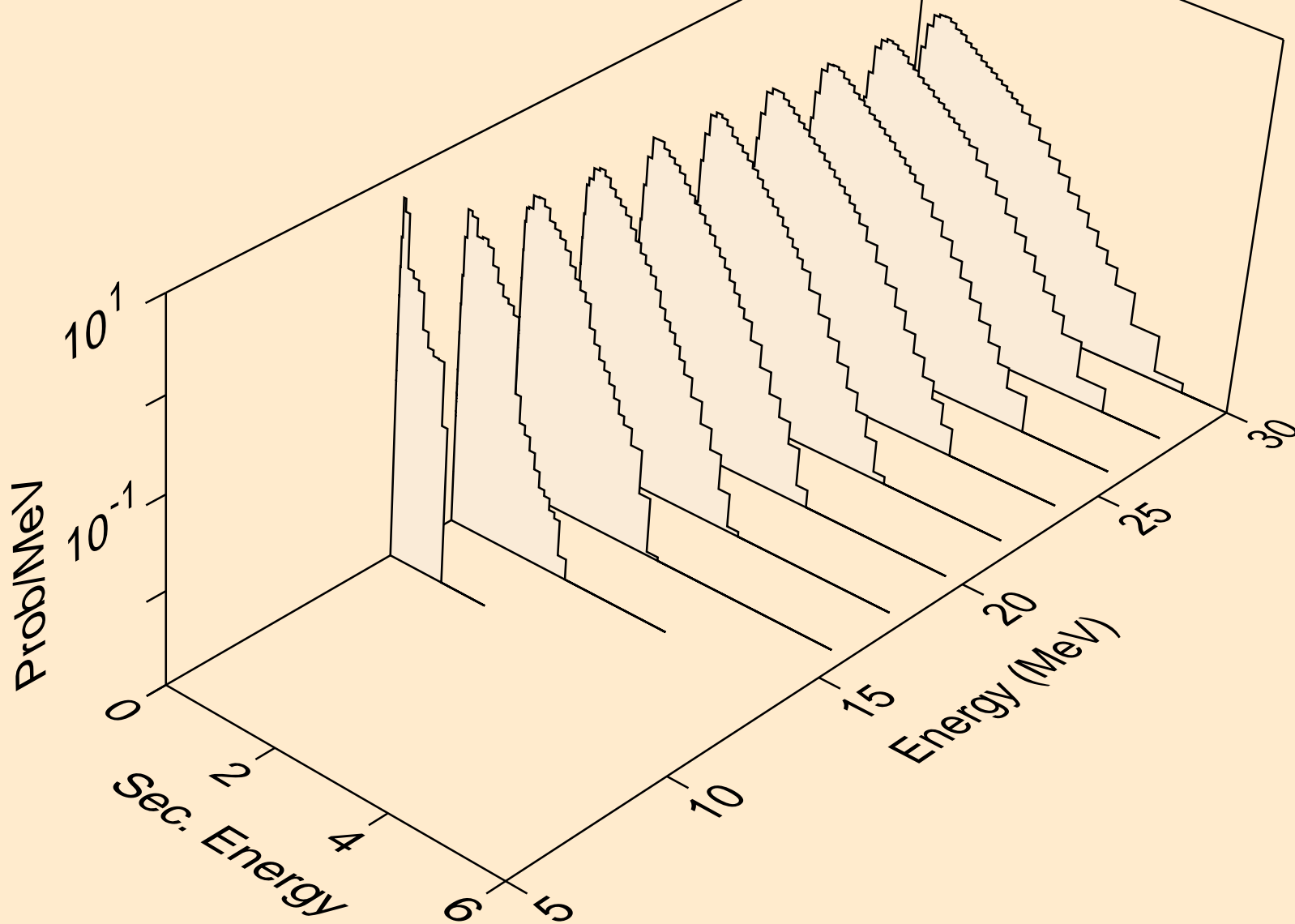

FR205 NEUTRON ACER TENDL-2019 LIBRARY; T=293.16K
Neutron emission for (n,n*)t

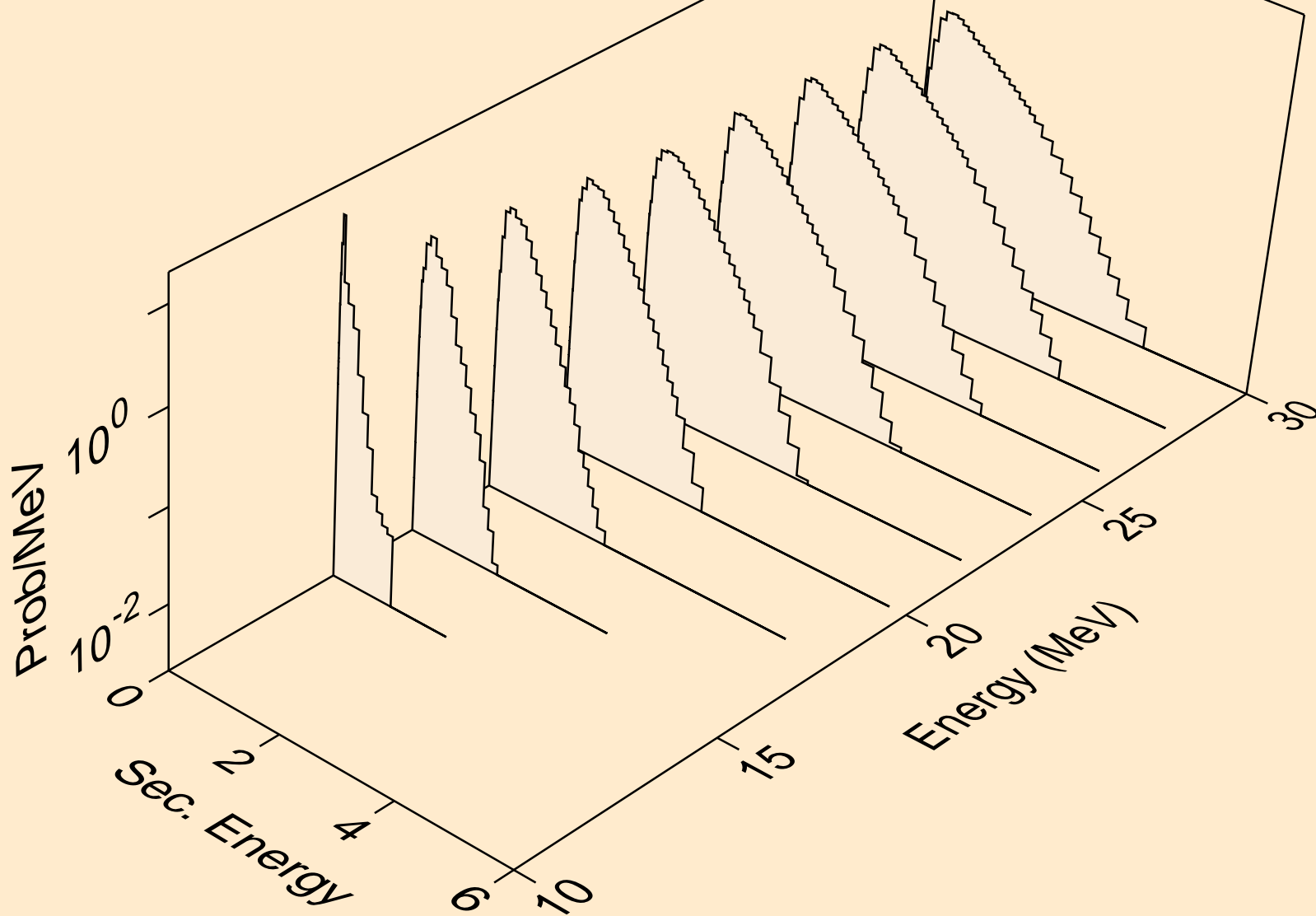

FR205 NEUTRON ACER TENDL-2019 LIBRARY; T=293.16K
Neutron emission for (n,n*)he3

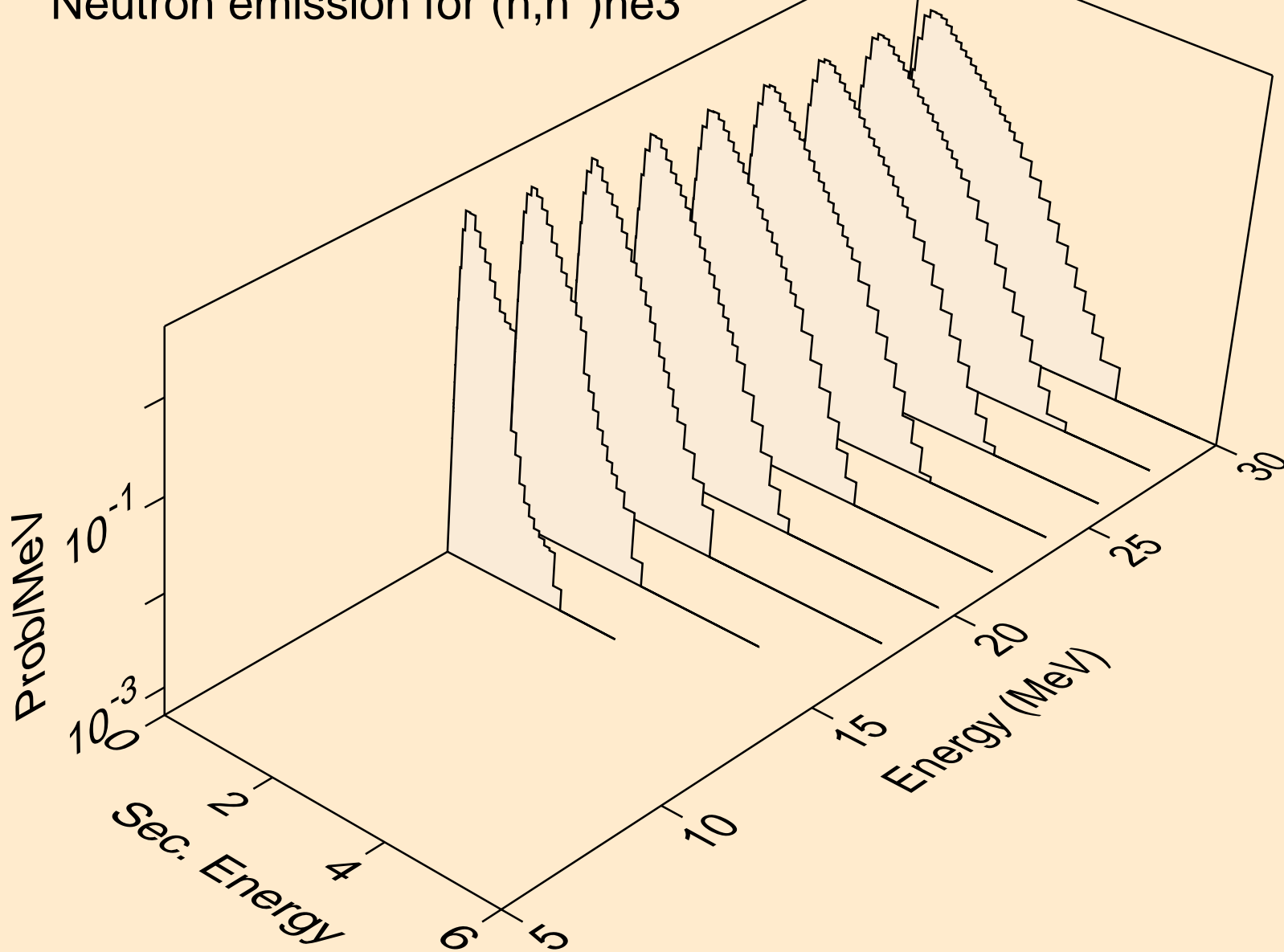

FR205 NEUTRON ACER TENDL-2019 LIBRARY; T=293.16K
Neutron emission for (n,4n)

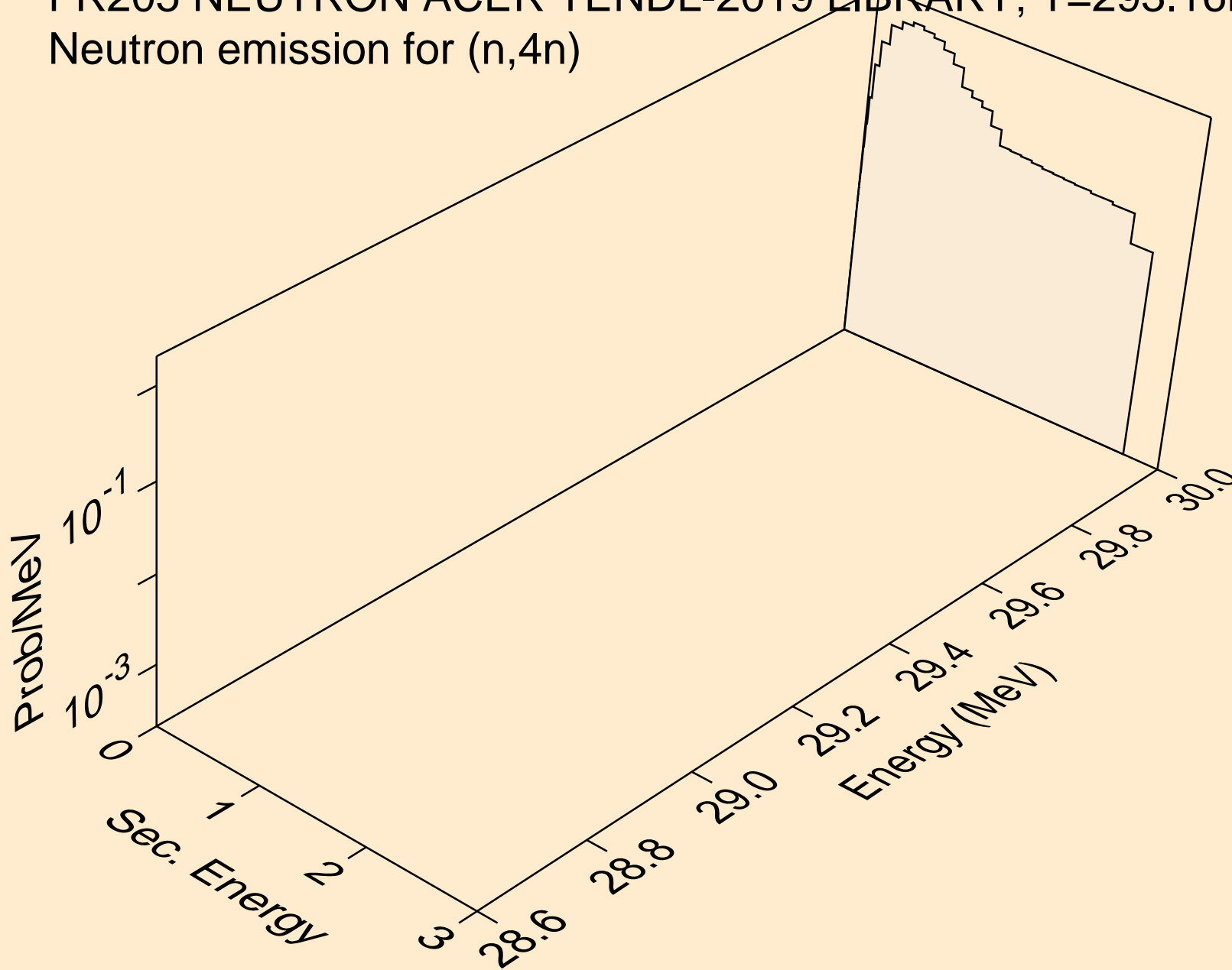

FR205 NEUTRON ACER TENDL-2019 LIBRARY; T=293.16K
Neutron emission for (n,2np)

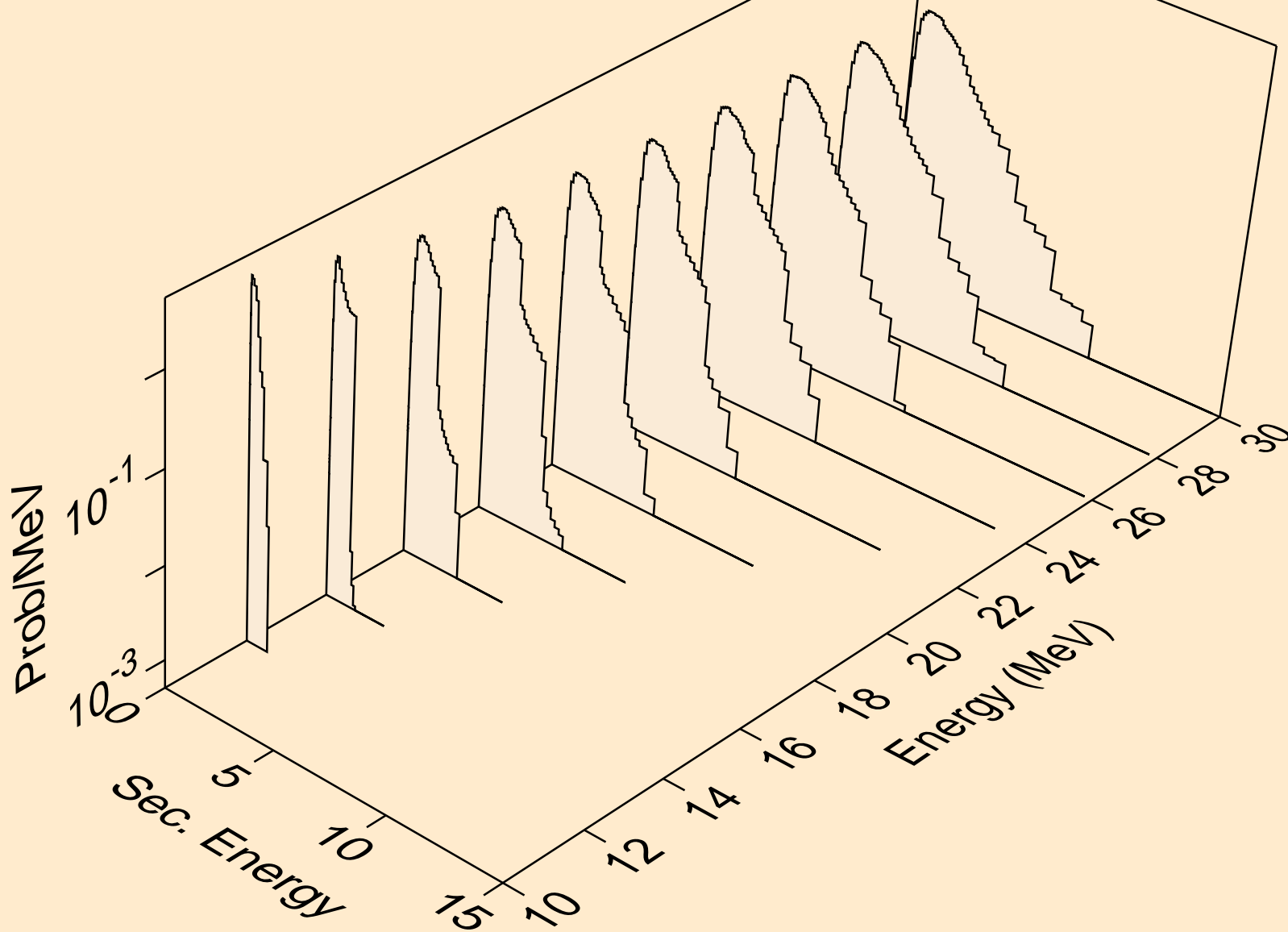

FR205 NEUTRON ACER TENDL-2019 LIBRARY; T=293.16K
Neutron emission for (n,3np)

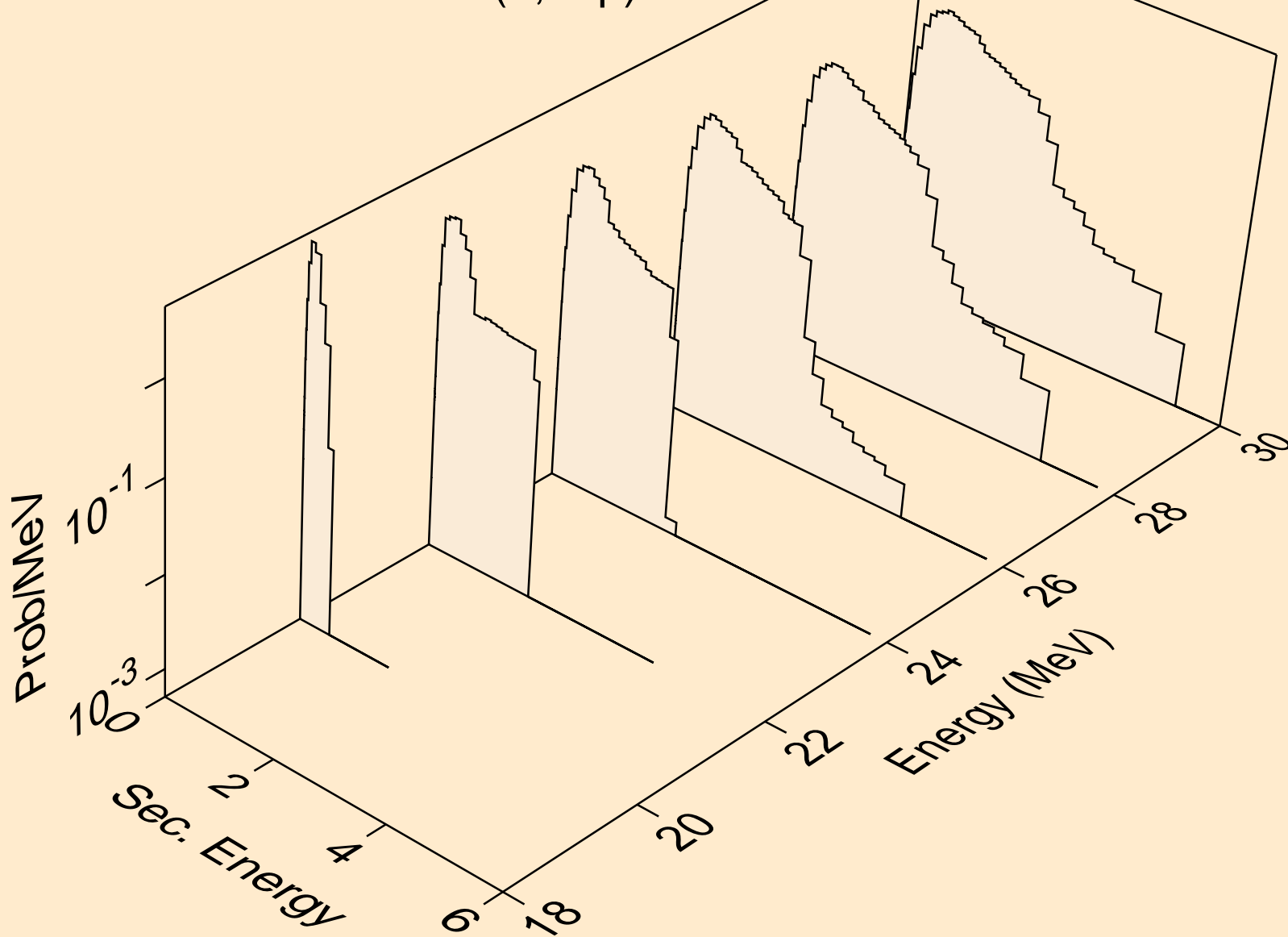

FR205 NEUTRON ACER TENDL-2019 LIBRARY; T=293.16K
Neutron emission for (n,2np)

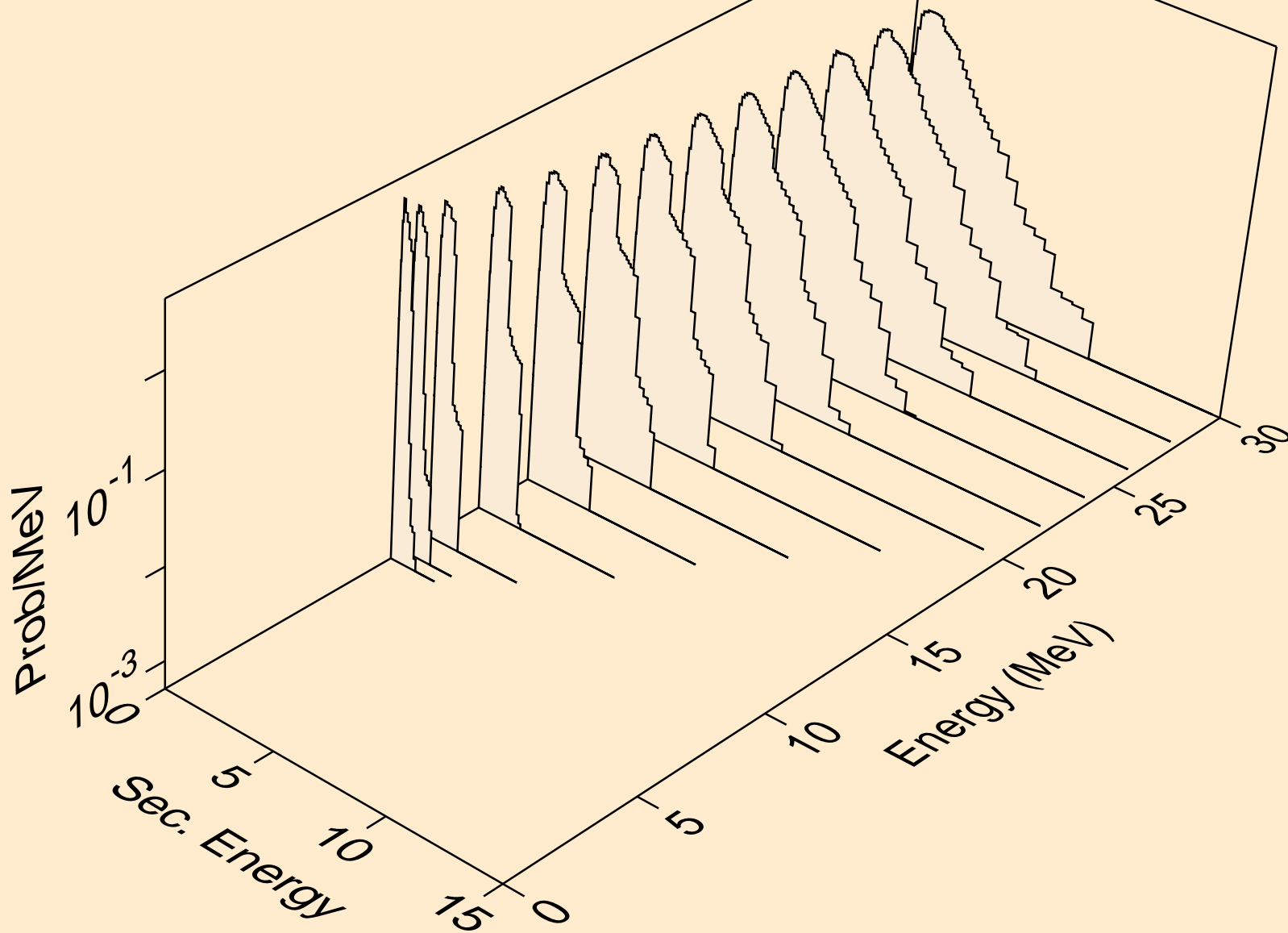

FR205 NEUTRON ACER TENDL-2019 LIBRARY; T=293.16K
Neutron emission for (n,npa)

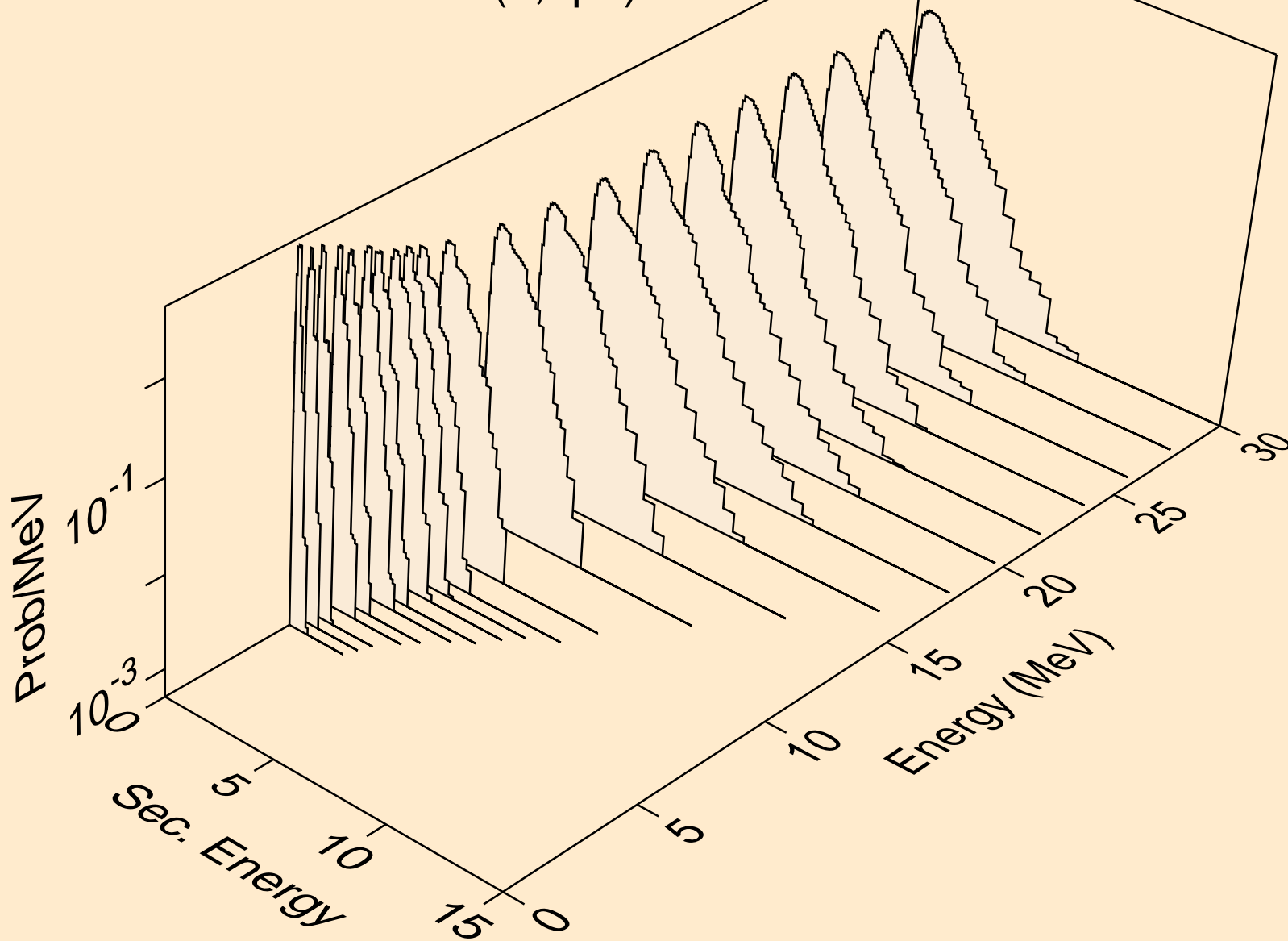

FR205 NEUTRON ACER TENDL-2019 LIBRARY; T=293.16K
Neutron emission for (n,n*c)

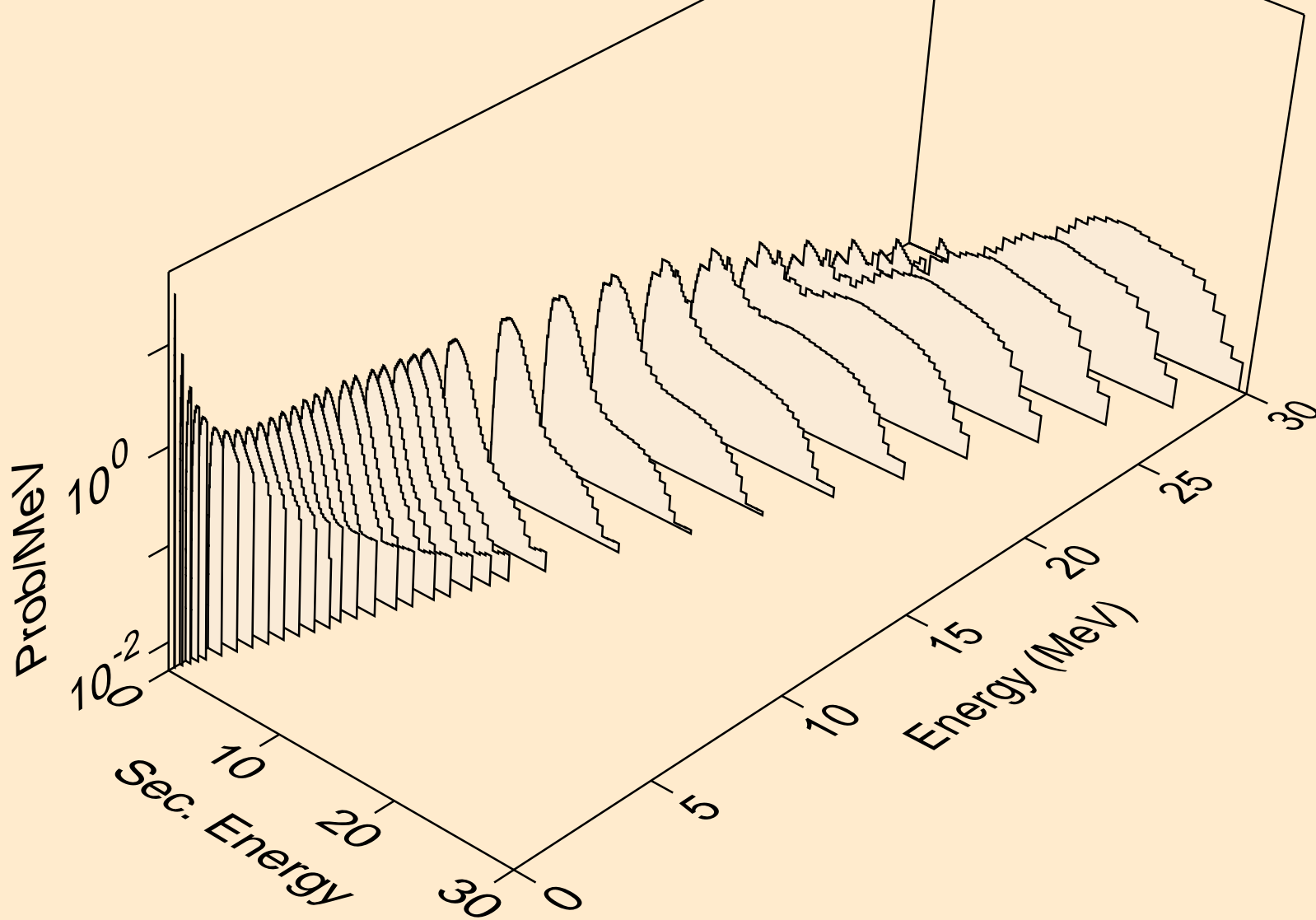

FR205 NEUTRON ACER TENDL-2019 LIBRARY; T=293.16K
Photon emission for (n,x)

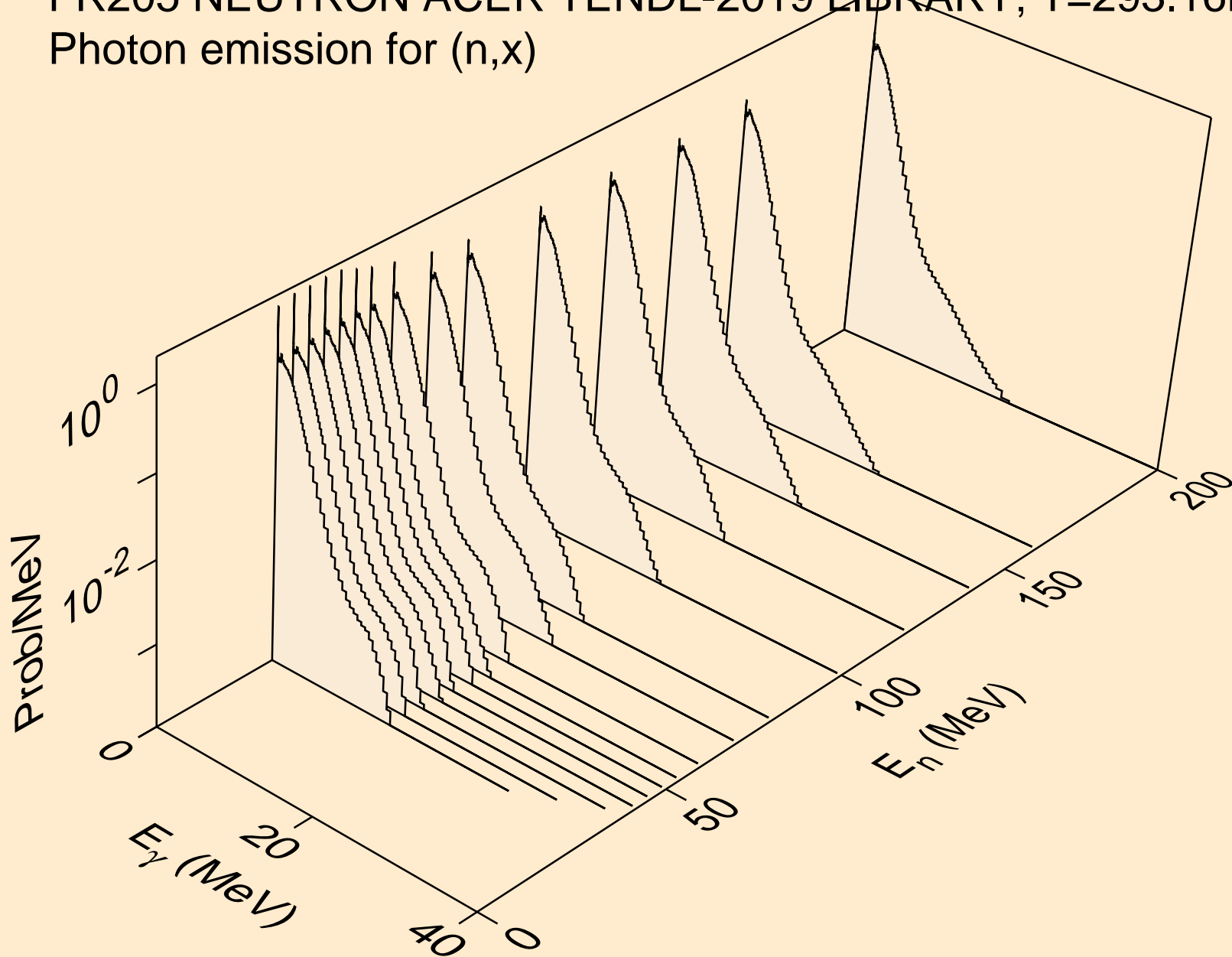

FR205 NEUTRON ACER TENDL-2019 LIBRARY; T=293.16K
Photon emission for (n,2nd)

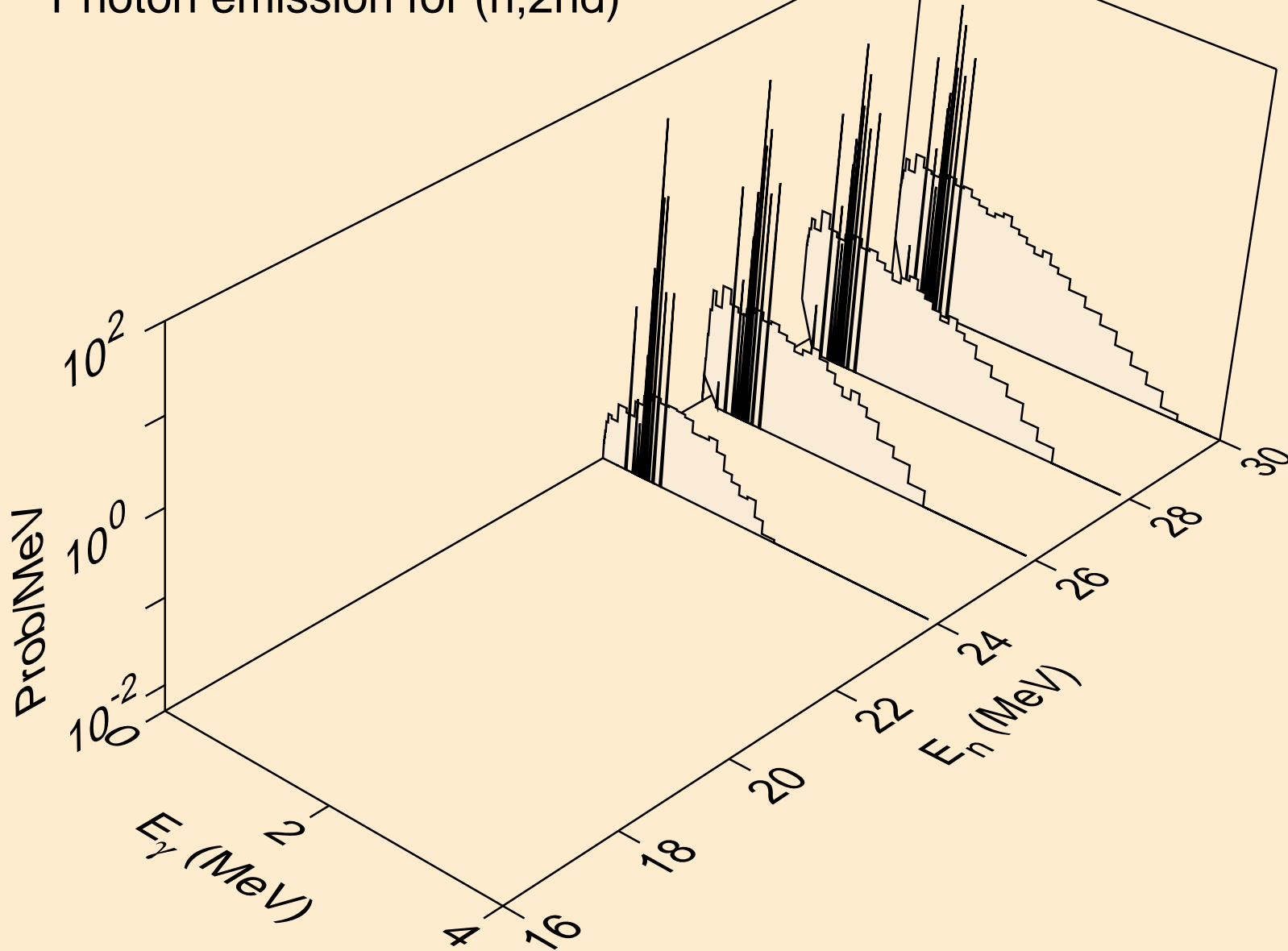

FR205 NEUTRON ACER TENDL-2019 LIBRARY; T=293.16K
Photon emission for (n,2n)

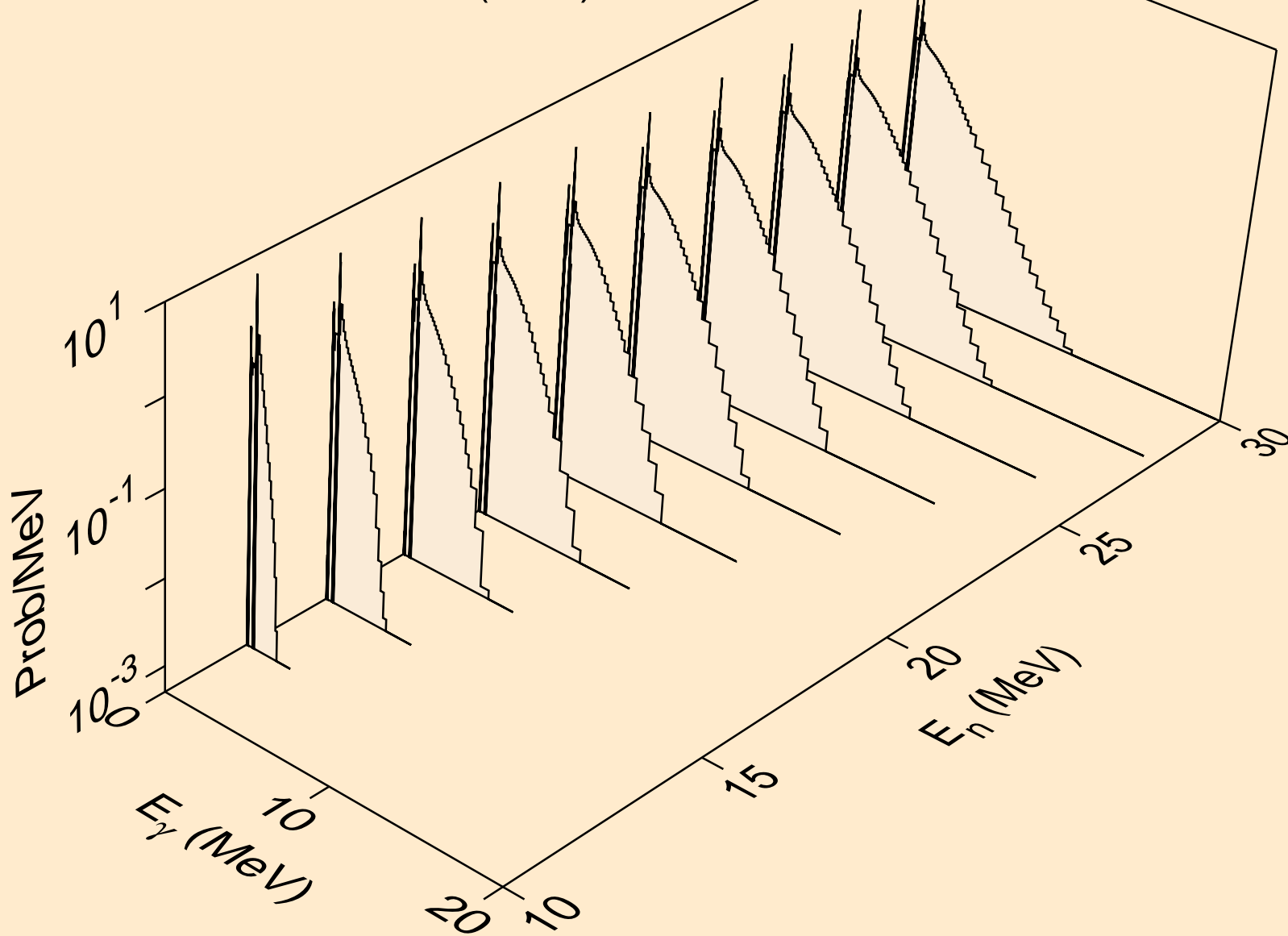

FR205 NEUTRON ACER TENDL-2019 LIBRARY; T=293.16K
Photon emission for (n,3n)

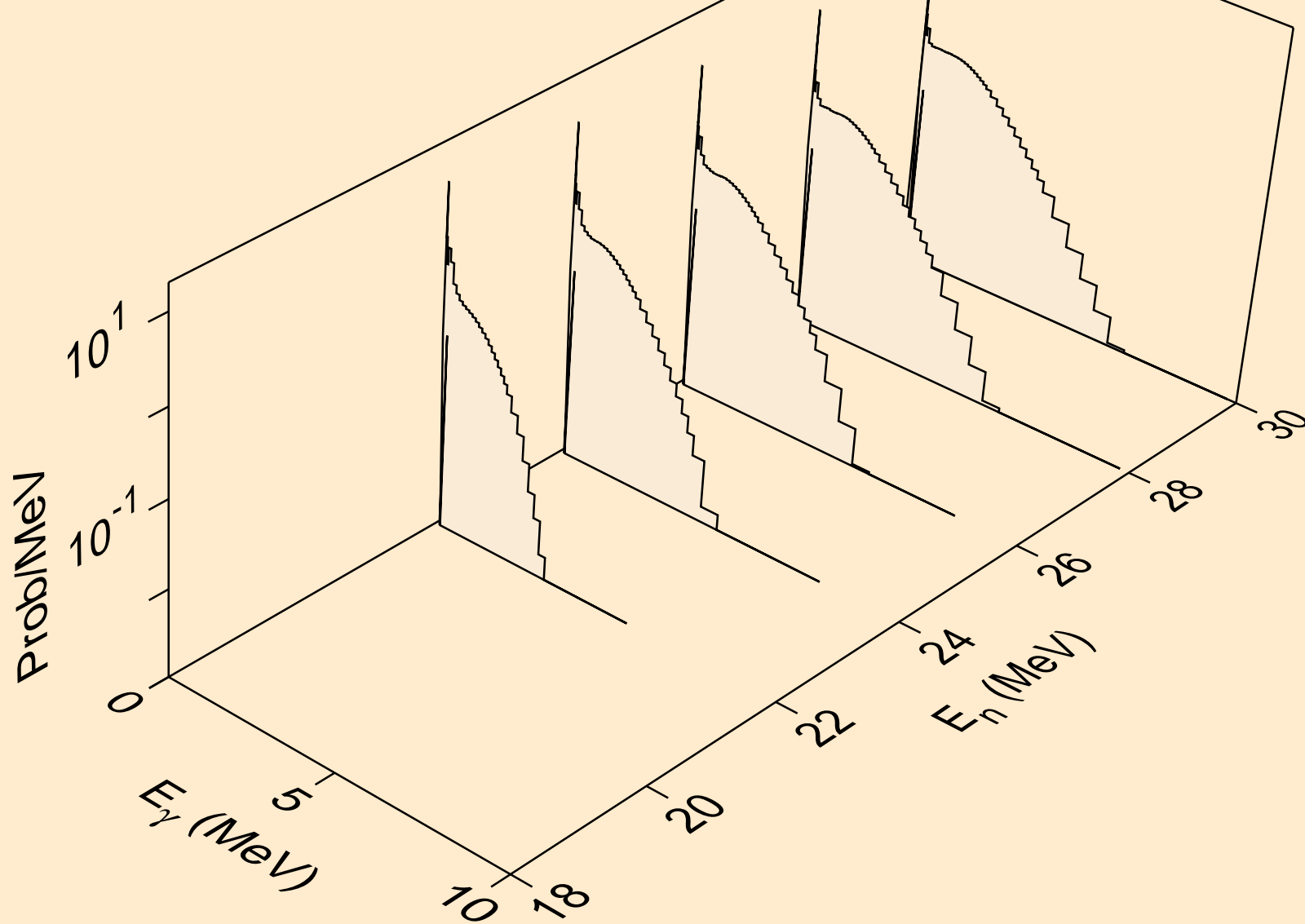

FR205 NEUTRON ACER TENDL-2019 LIBRARY; T=293.16K
Photon emission for (n,n*)a

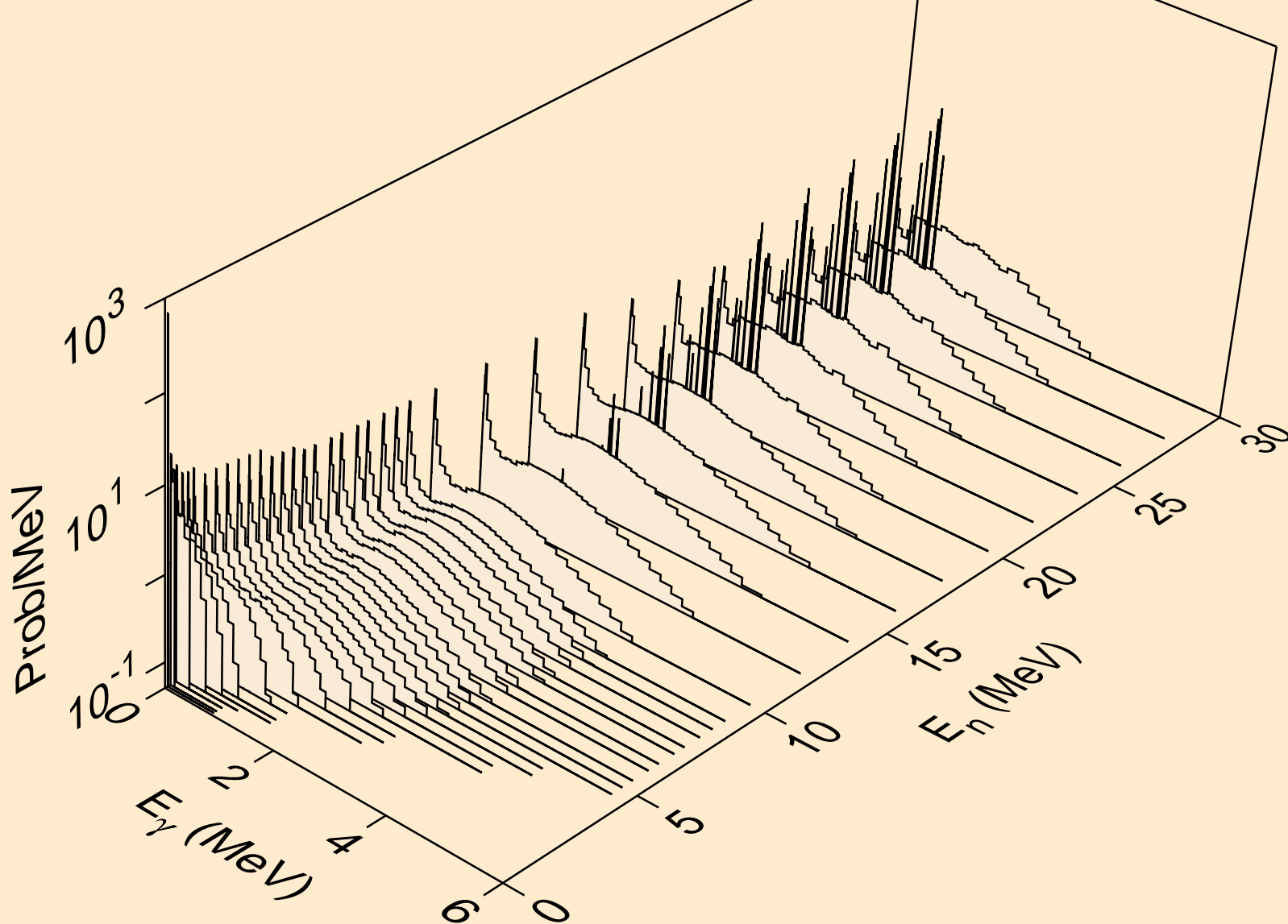

FR205 NEUTRON ACER TENDL-2019 LIBRARY; T=293.16K
Photon emission for (n,2n) α

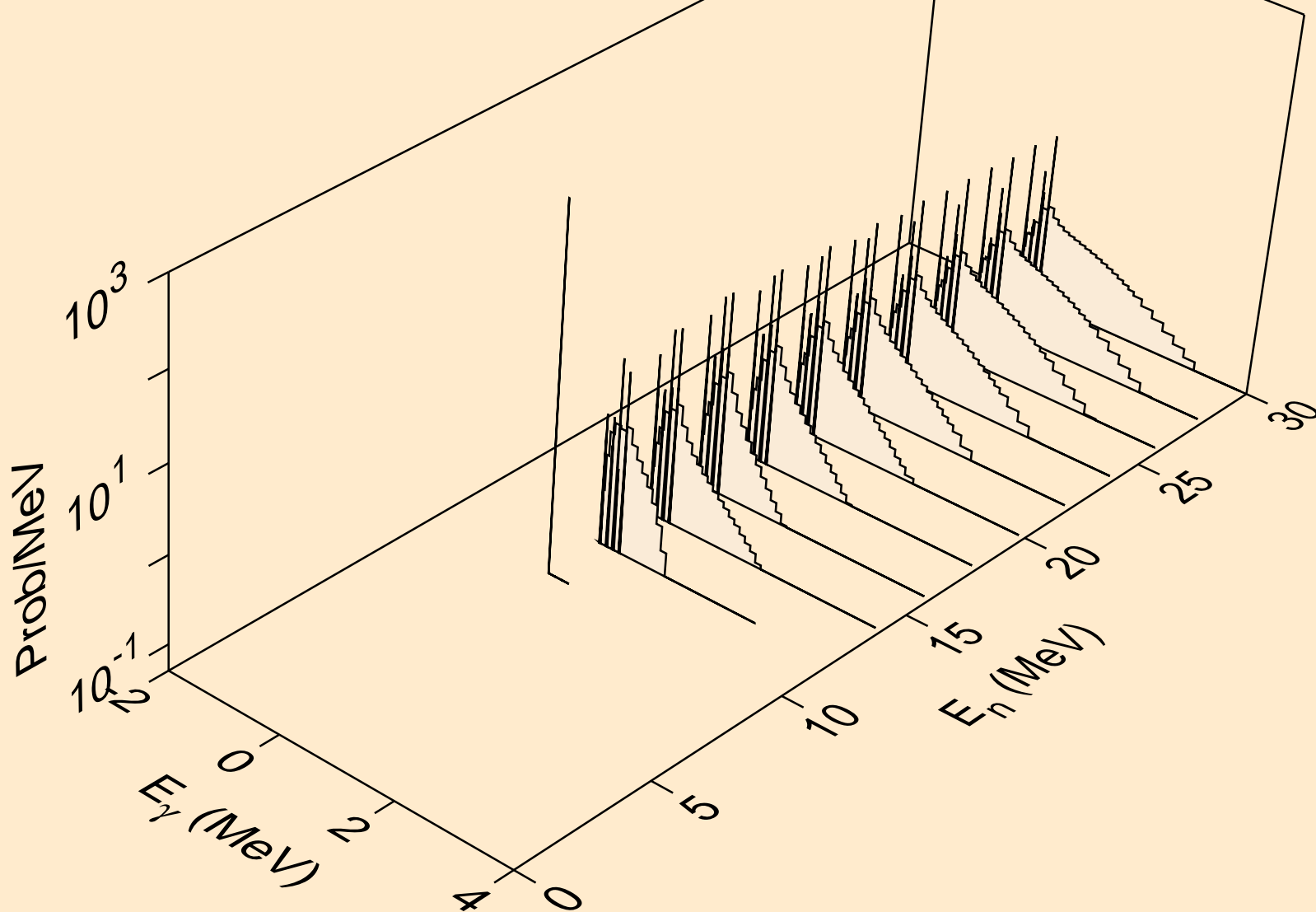

FR205 NEUTRON ACER TENDL-2019 LIBRARY; T=293.16K
Photon emission for (n,3n)a

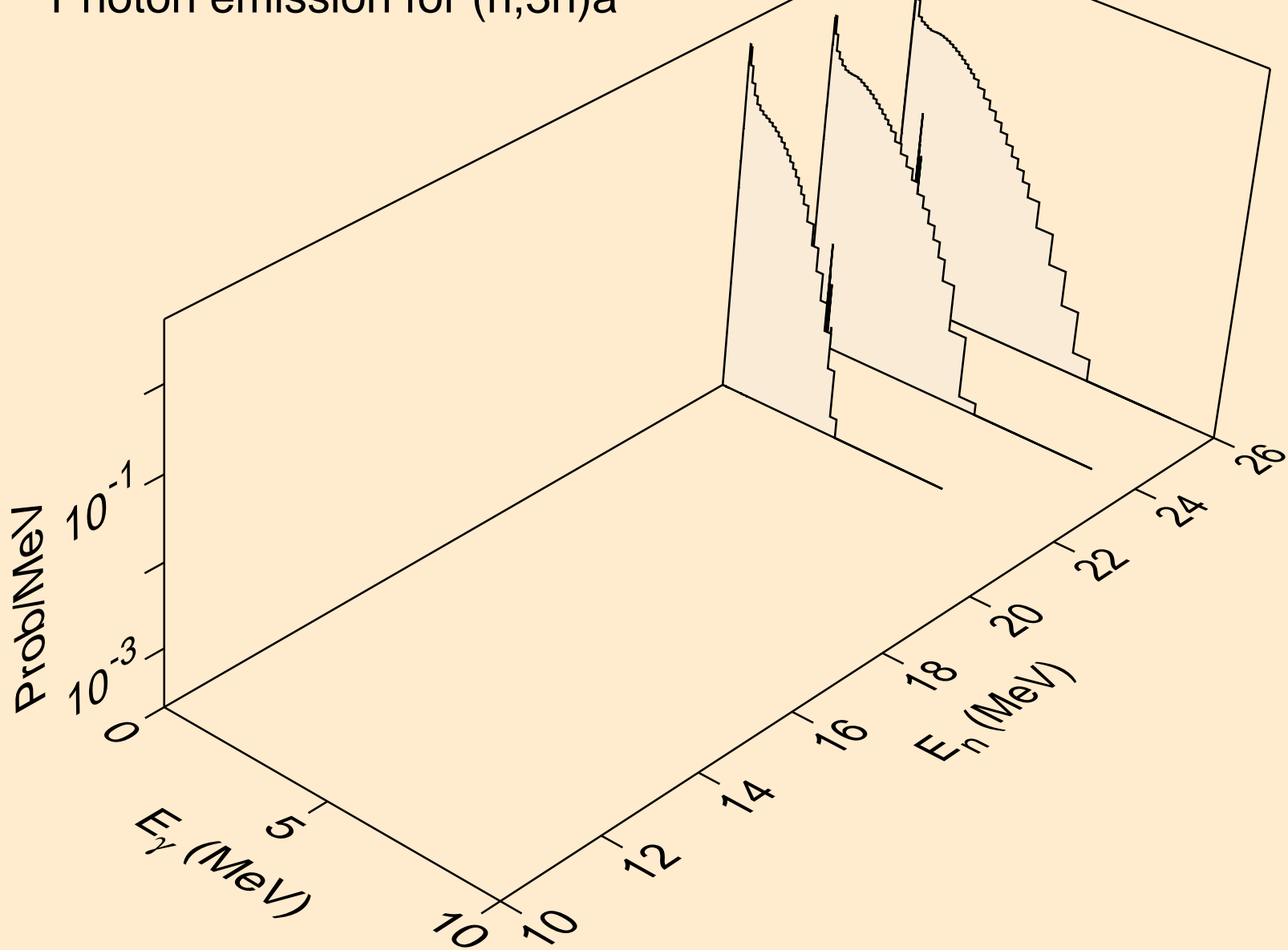

FR205 NEUTRON ACER TENDL-2019 LIBRARY; T=293.16K
Photon emission for (n,n*)p

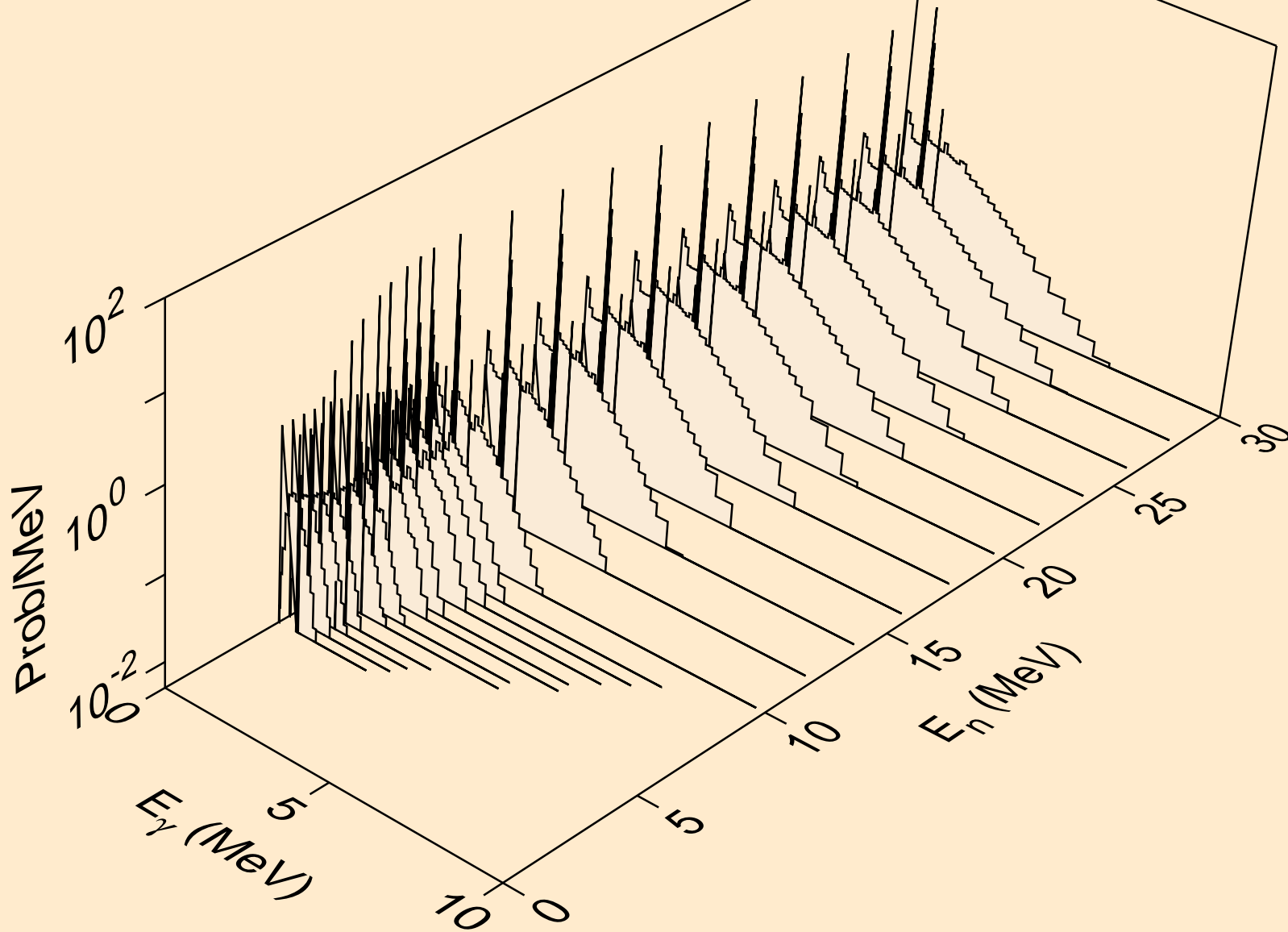

FR205 NEUTRON ACER TENDL-2019 LIBRARY; T=293.16K
Photon emission for (n,n*)2a

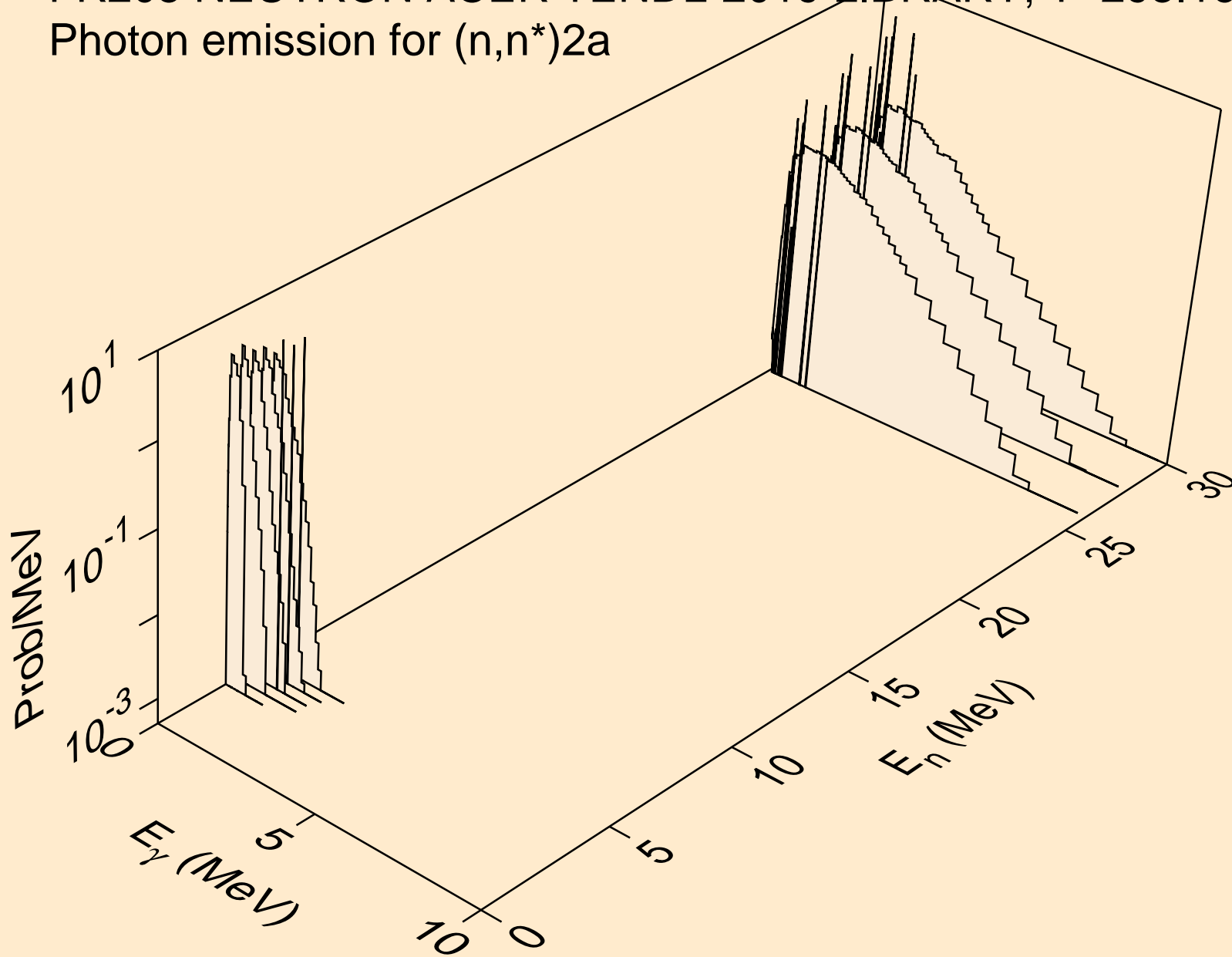

FR205 NEUTRON ACER TENDL-2019 LIBRARY; T=293.16K
Photon emission for (n,2n)2a

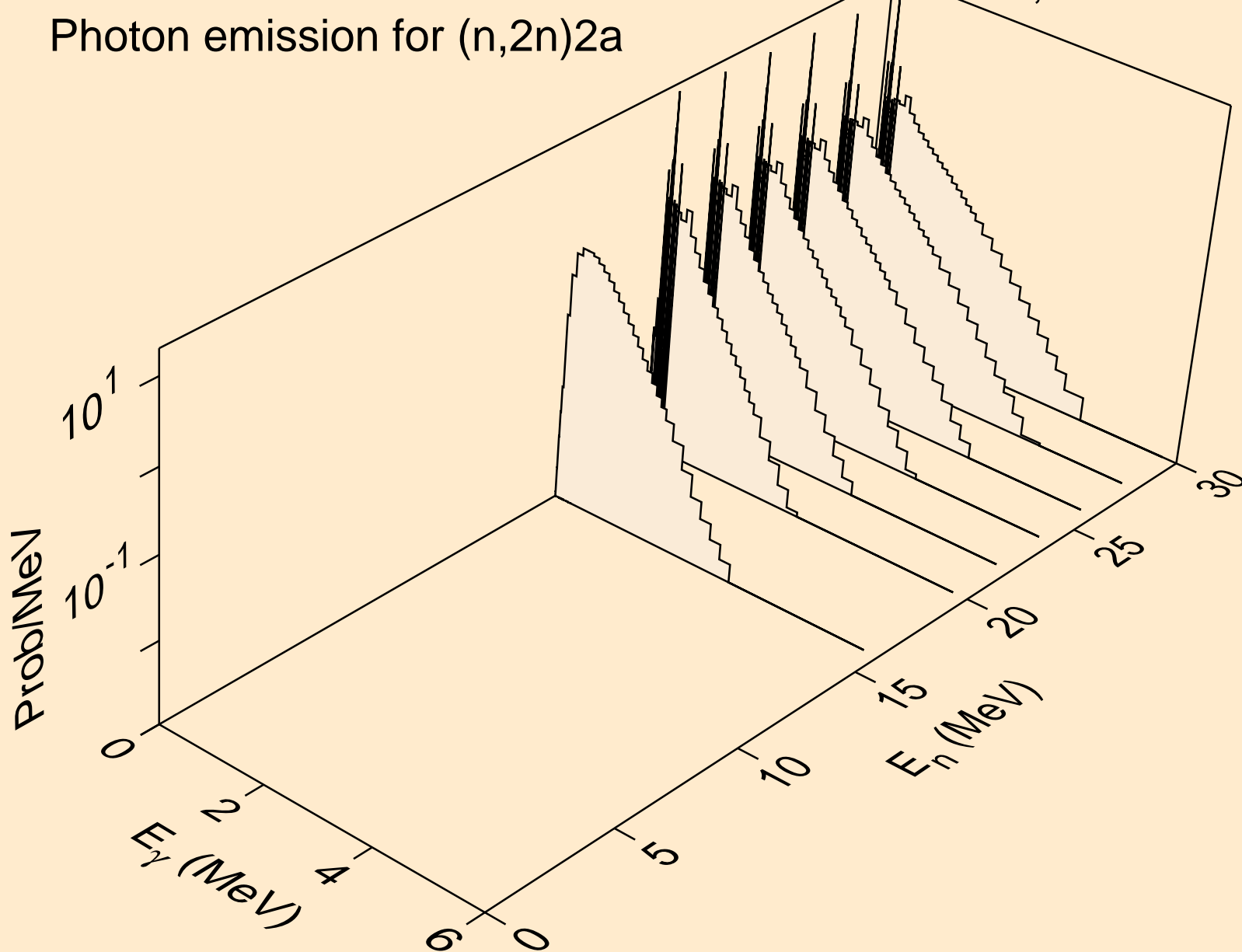

FR205 NEUTRON ACER TENDL-2019 LIBRARY; T=293.16K
Photon emission for (n,n*)d

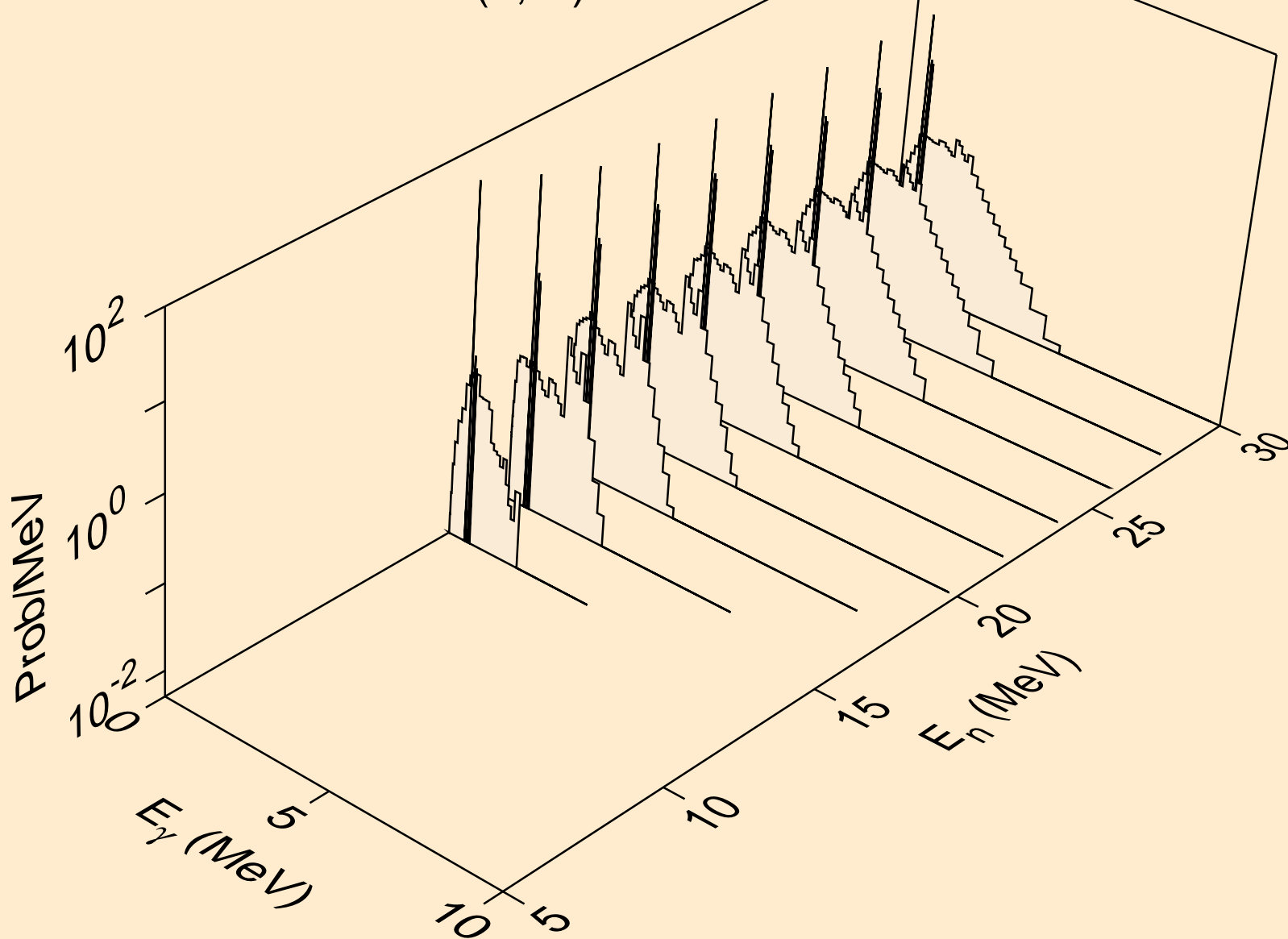

FR205 NEUTRON ACER TENDL-2019 LIBRARY; T=293.16K
Photon emission for (n,n*)t

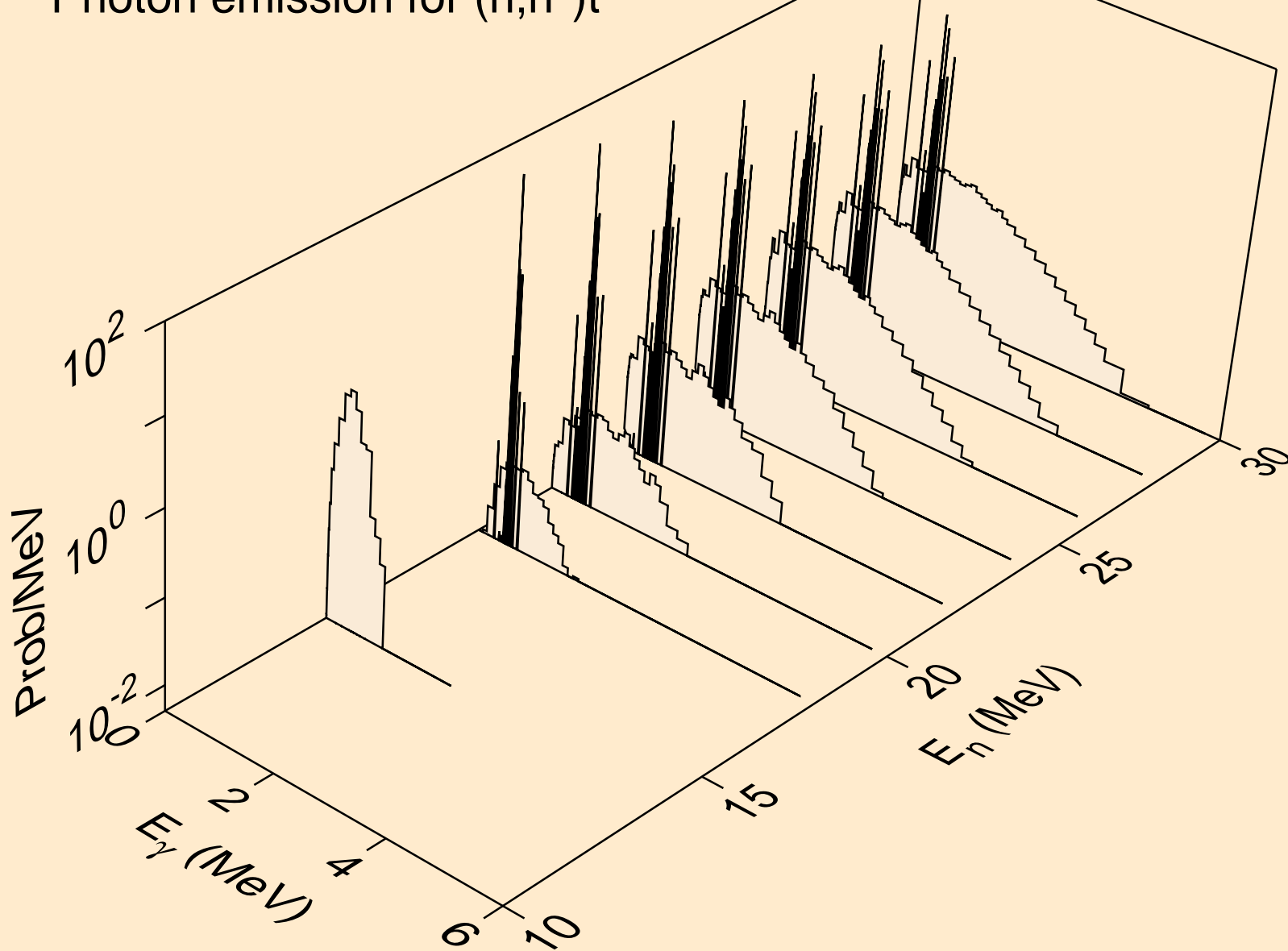

FR205 NEUTRON ACER TENDL-2019 LIBRARY; T=293.16K
Photon emission for (n,n*)he3

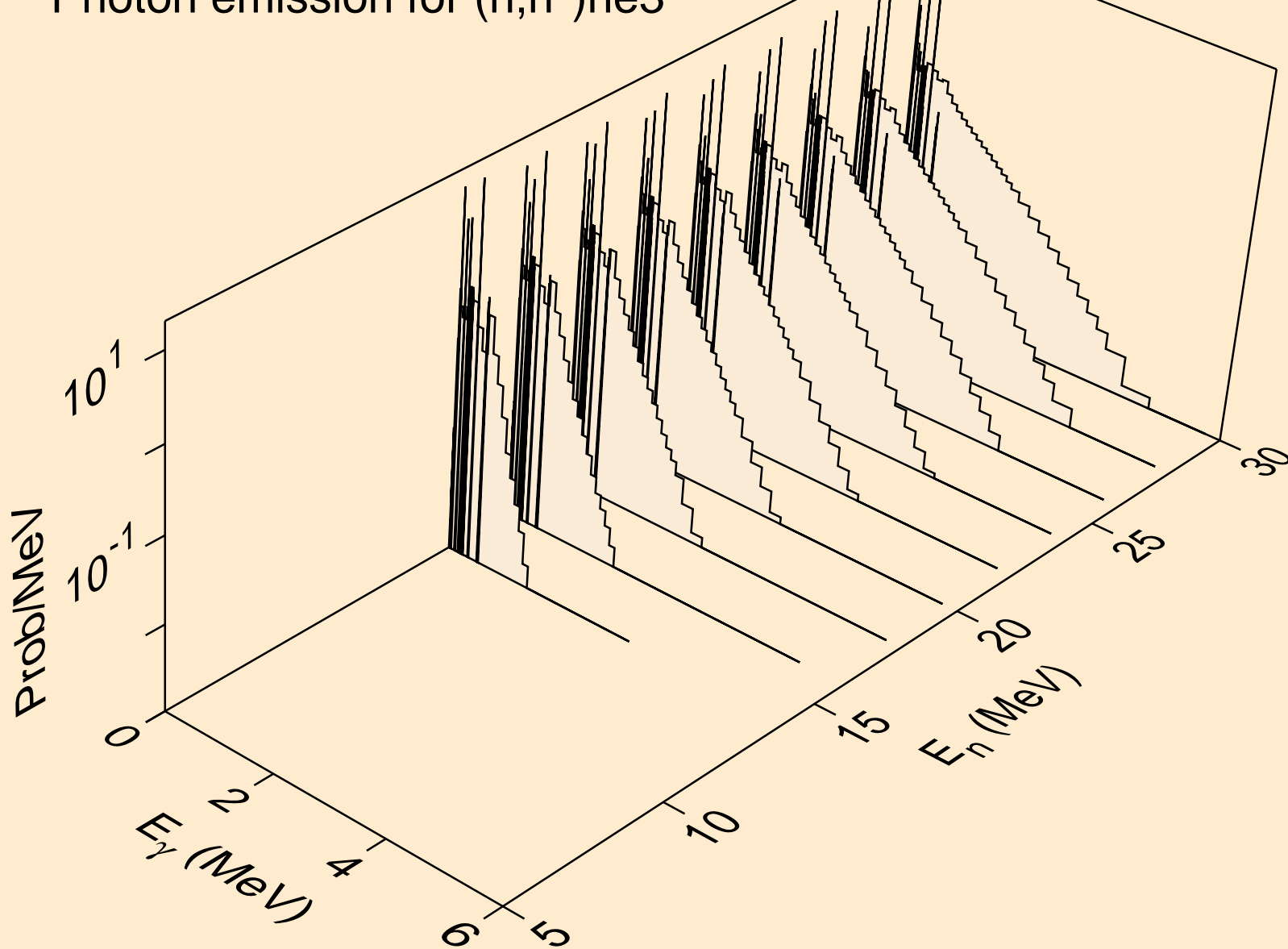

FR205 NEUTRON ACER TENDL-2019 LIBRARY; T=293.16K
Photon emission for (n,4n)

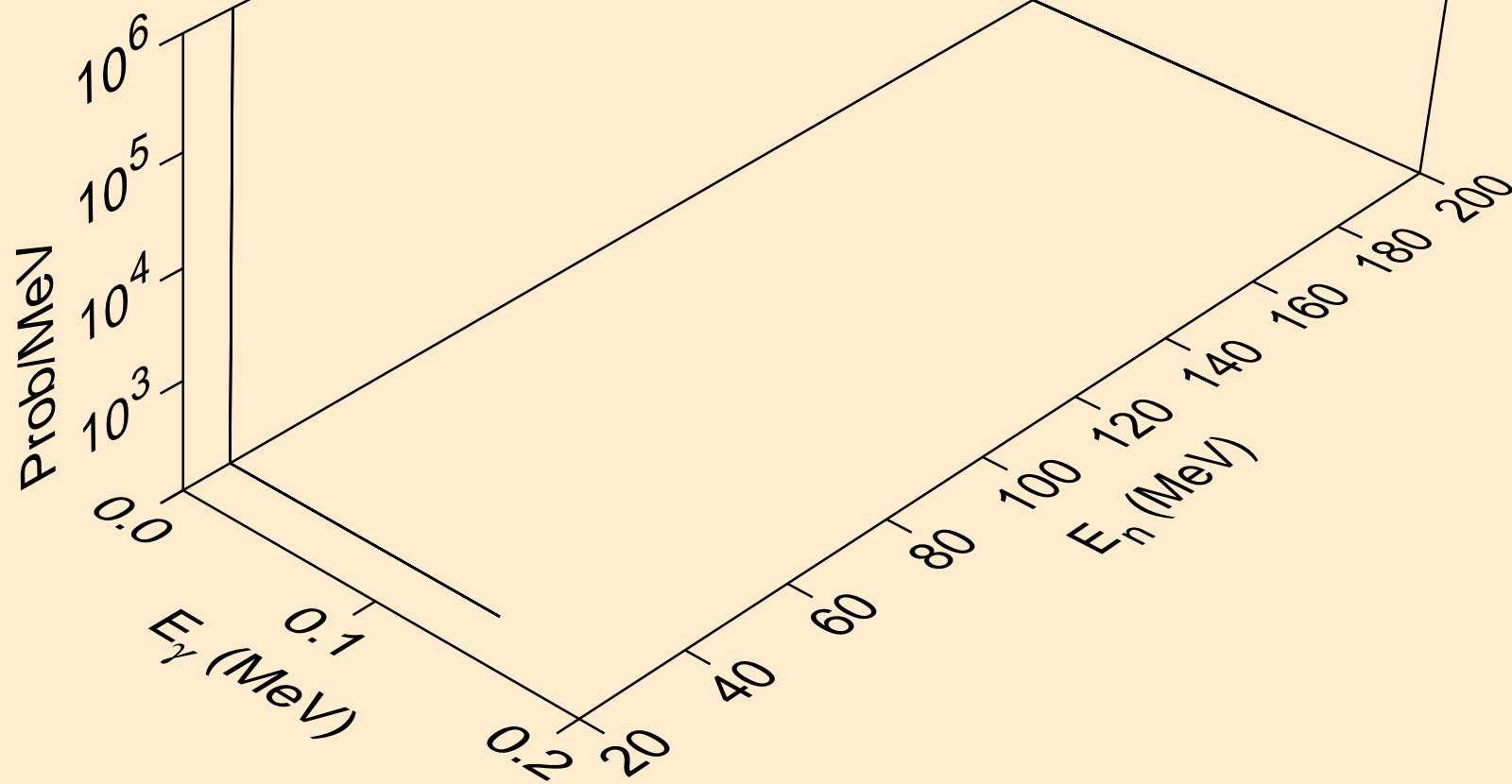

FR205 NEUTRON ACER TENDL-2019 LIBRARY; T=293.16K
Photon emission for (n,2np)

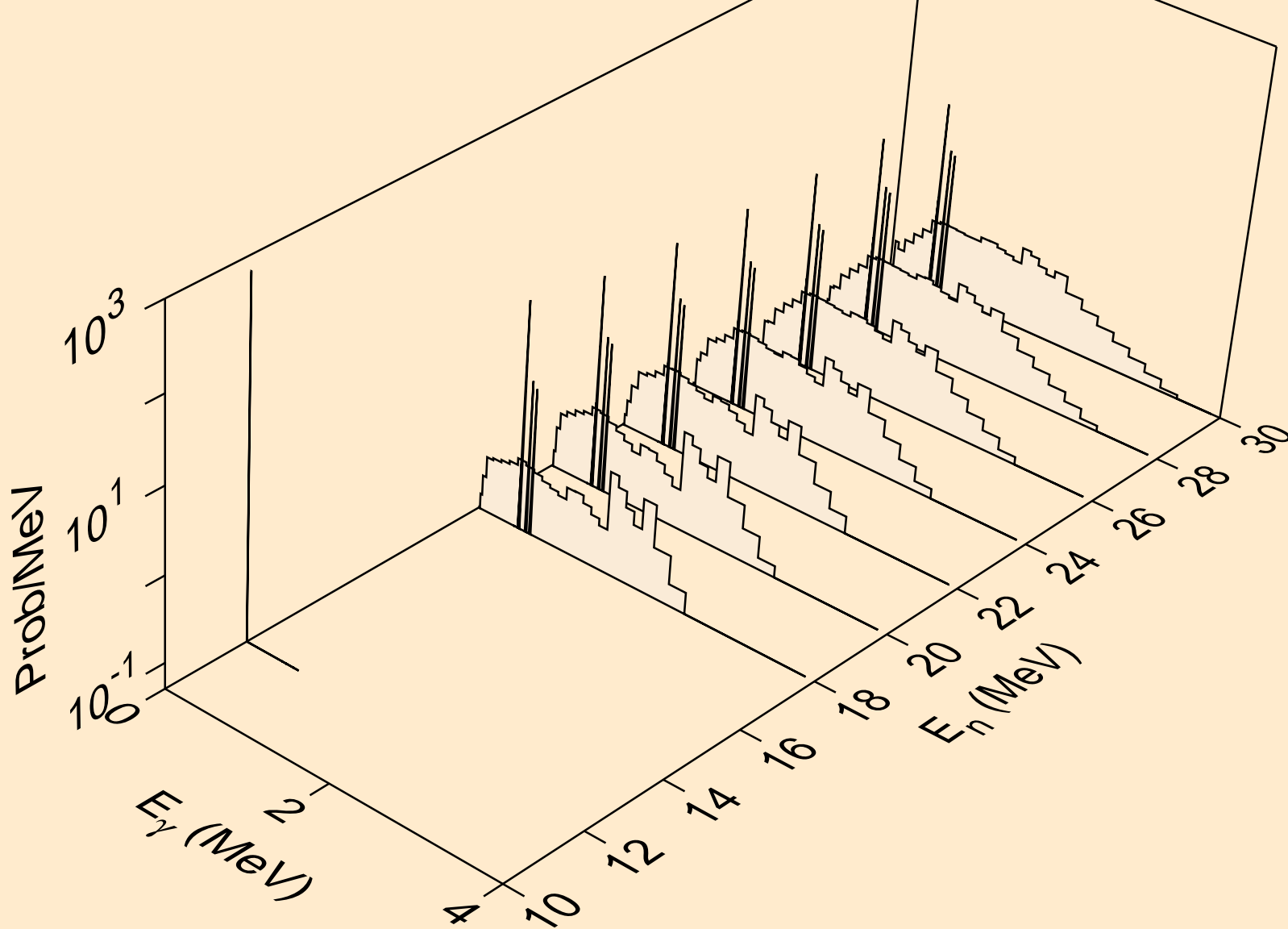

FR205 NEUTRON ACER TENDL-2019 LIBRARY; T=293.16K
Photon emission for (n,3np)

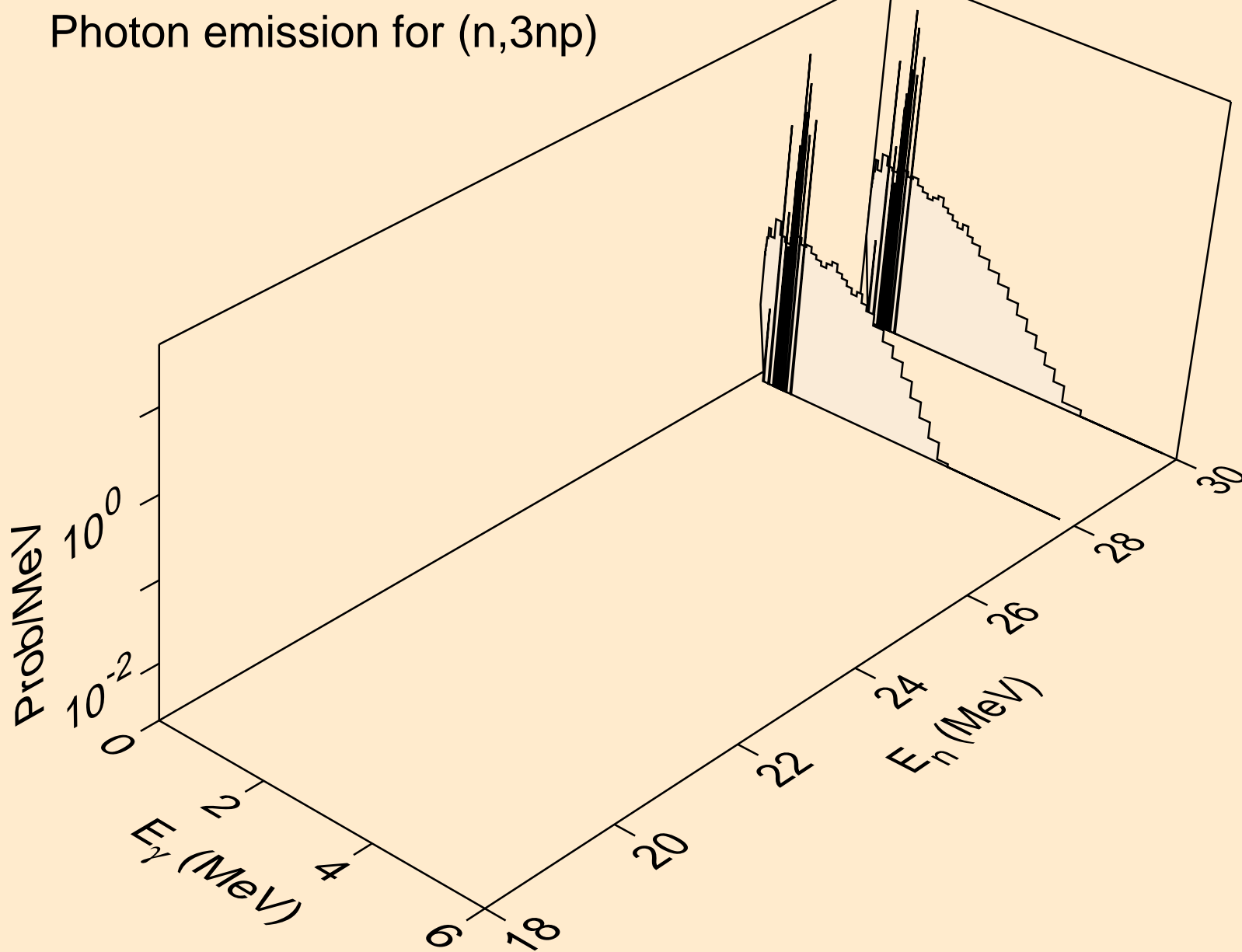

FR205 NEUTRON ACER TENDL-2019 LIBRARY; T=293.16K
Photon emission for (n,2np)

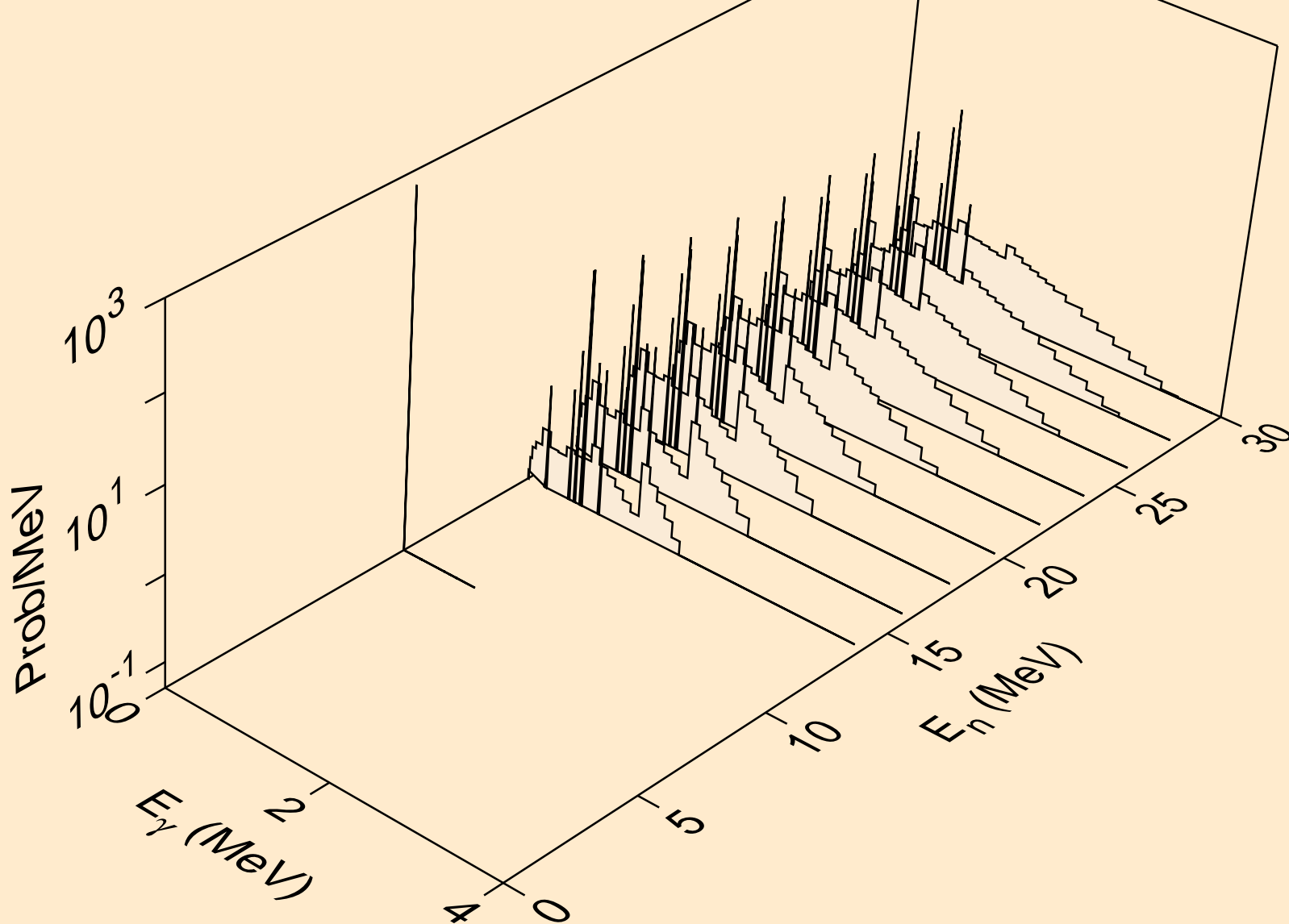

FR205 NEUTRON ACER TENDL-2019 LIBRARY; T=293.16K
Photon emission for (n,npa)

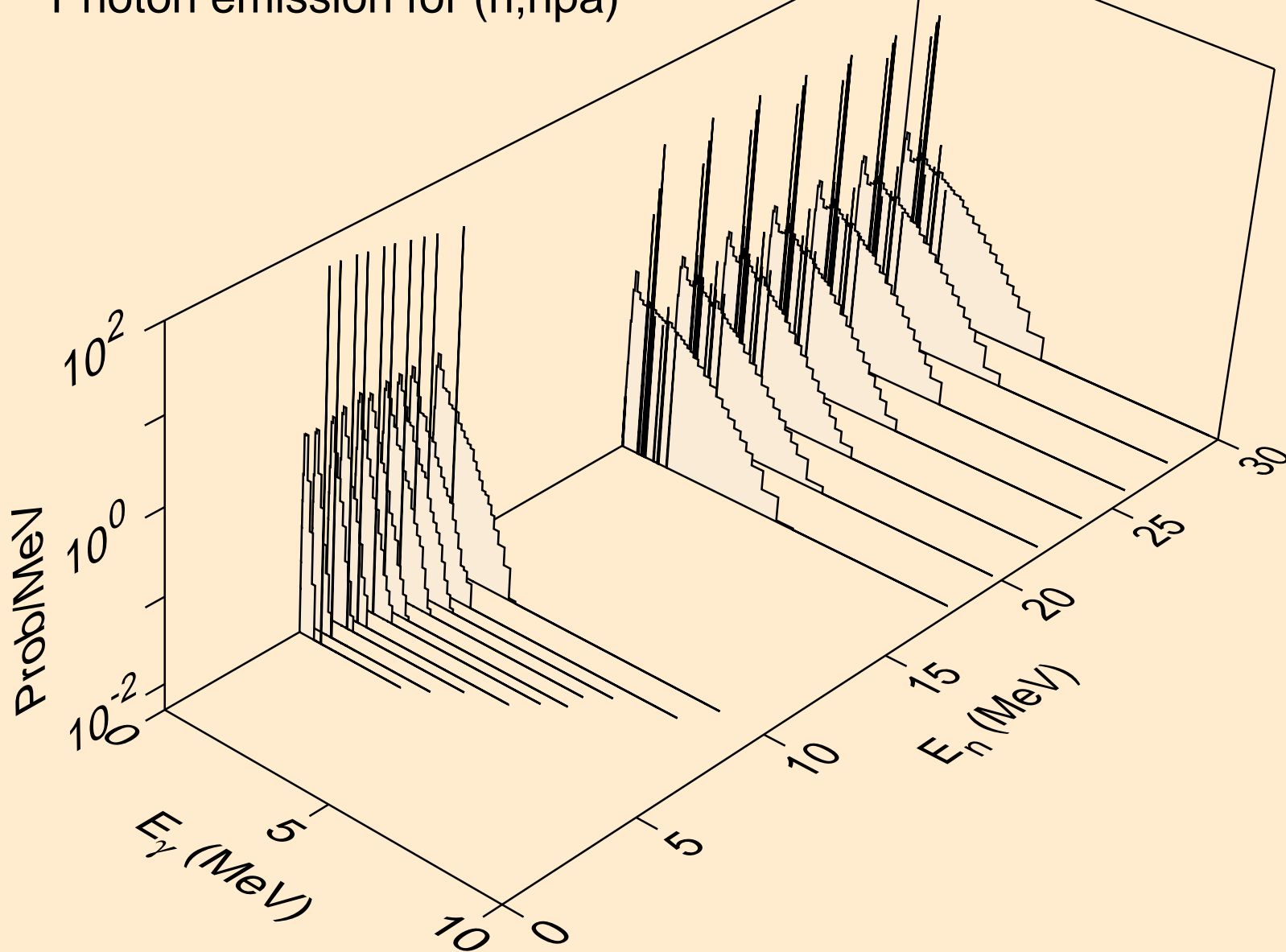

FR205 NEUTRON ACER TENDL-2019 LIBRARY; T=293.16K
Photon emission for (n,n*c)

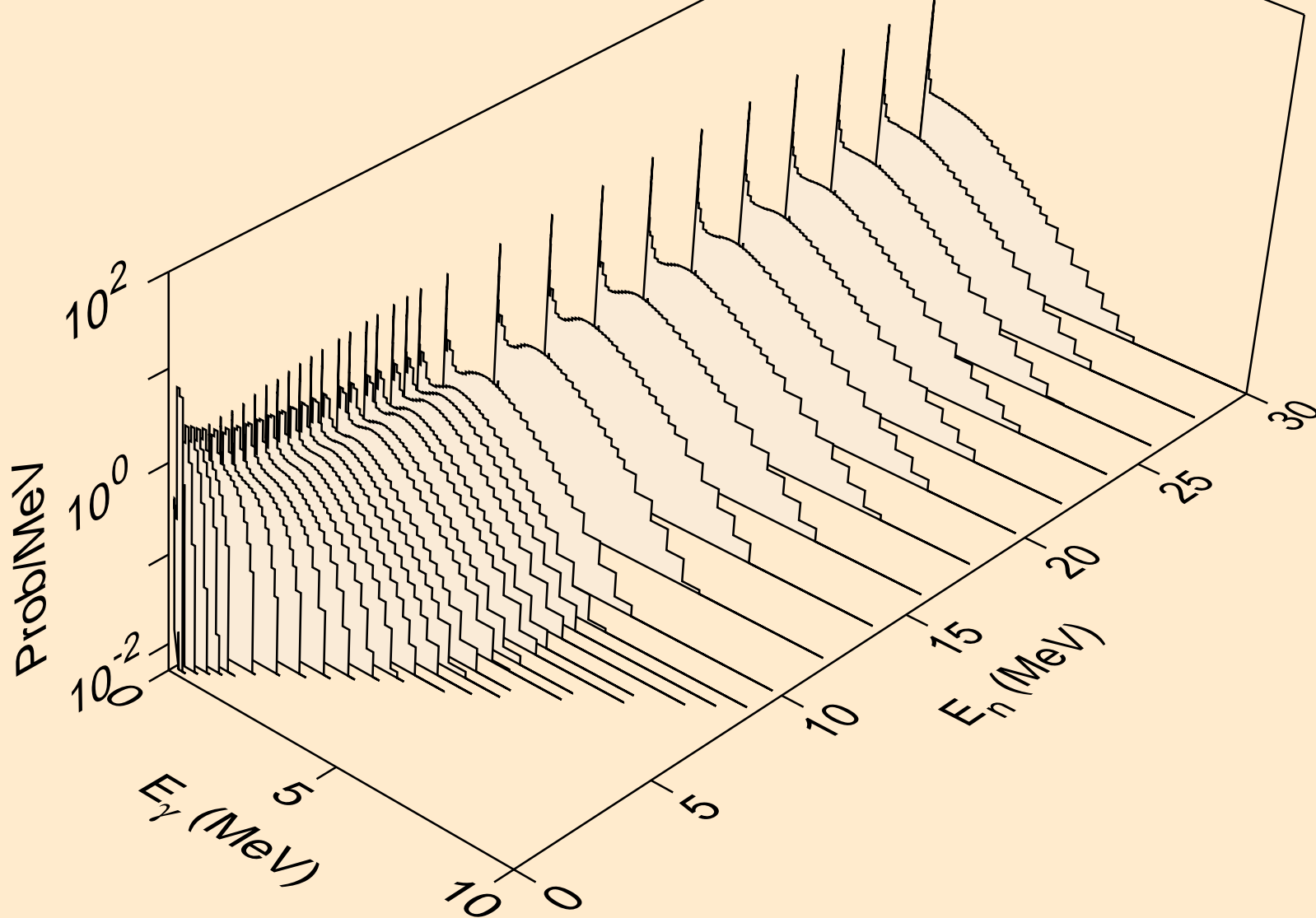

FR205 NEUTRON ACER TENDL-2019 LIBRARY; T=293.16K
Photon emission for (n,gma)

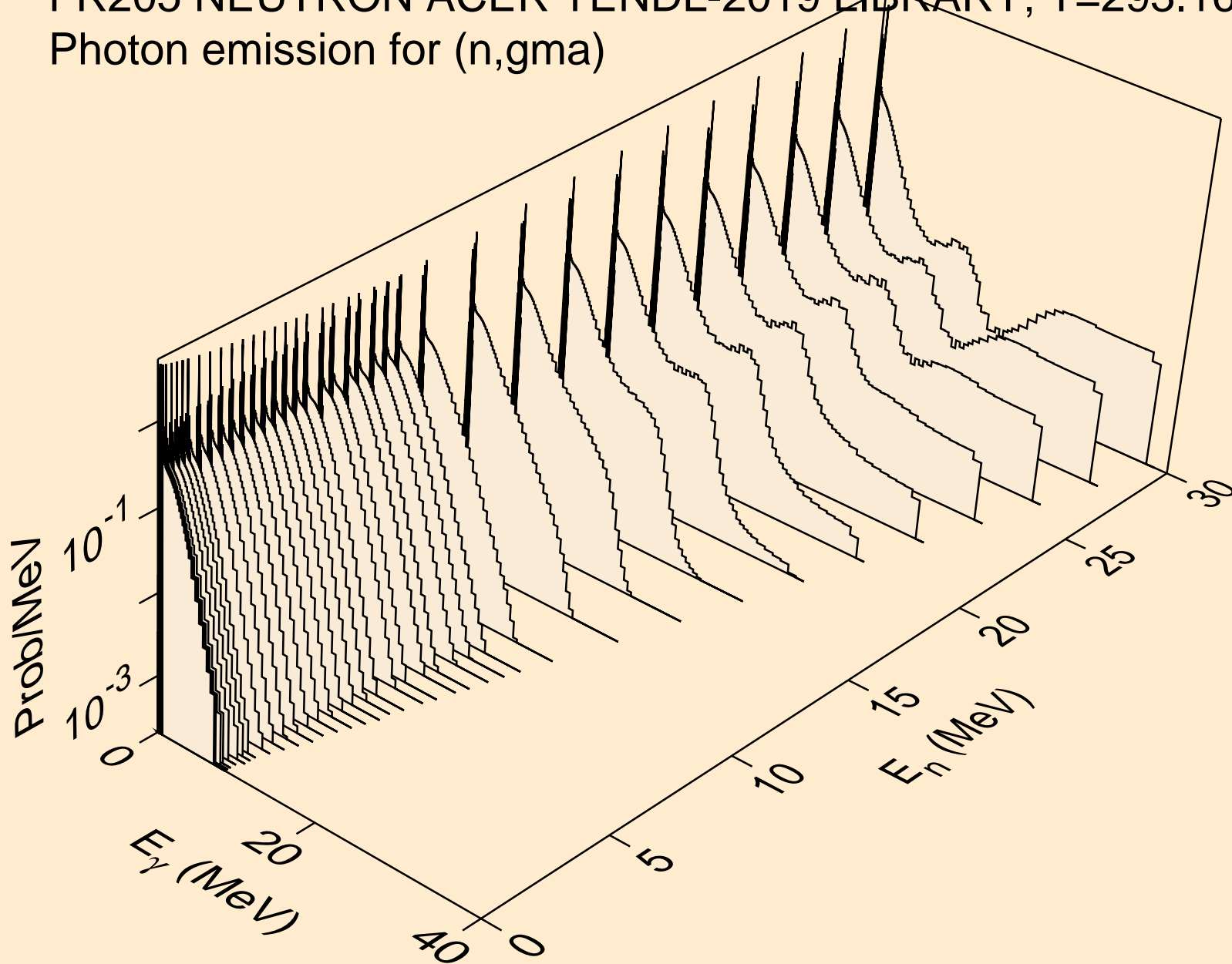

FR205 NEUTRON ACER TENDL-2019 LIBRARY; T=293.16K
Photon emission for (n,p)

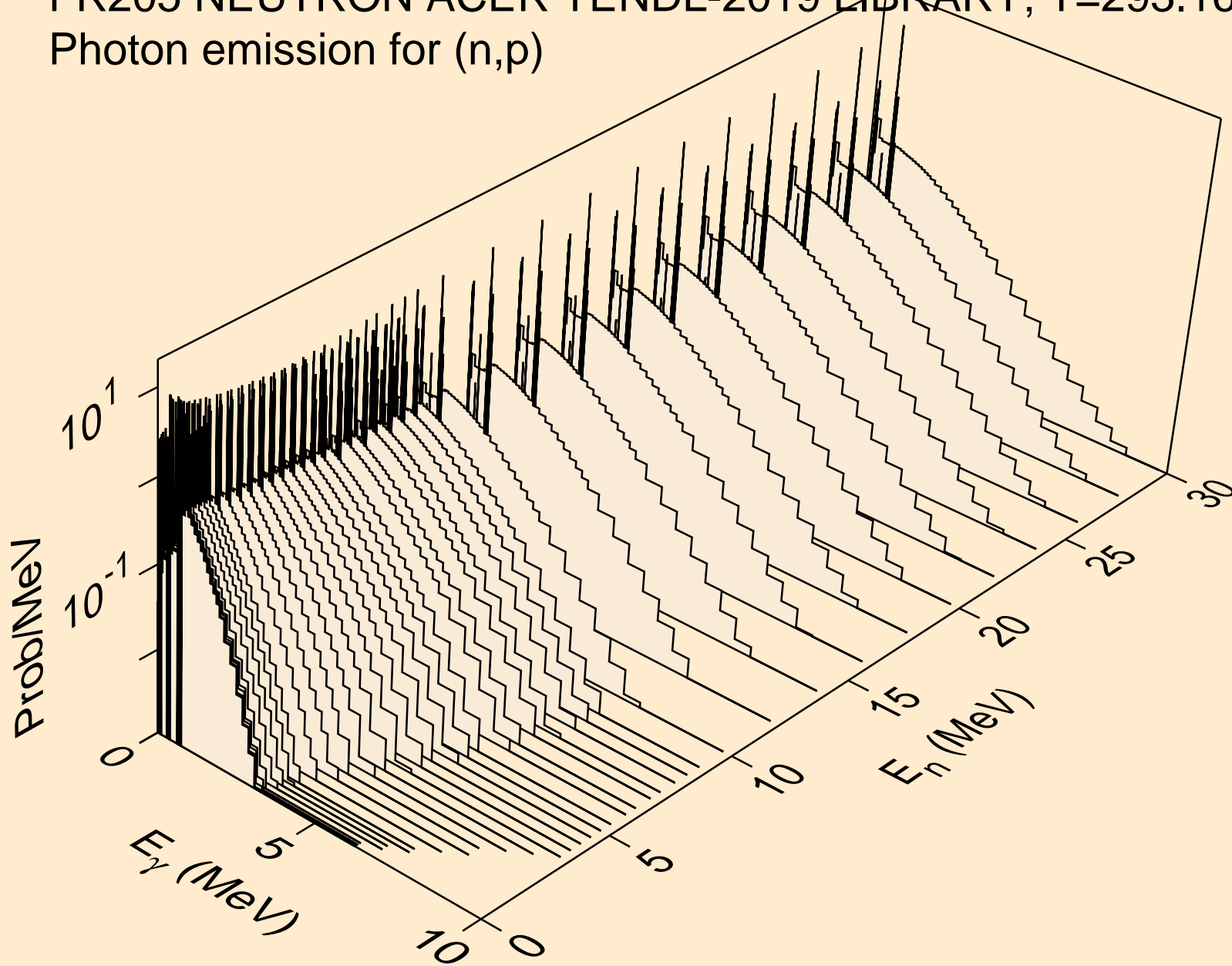

FR205 NEUTRON ACER TENDL-2019 LIBRARY; T=293.16K
Photon emission for (n,d)

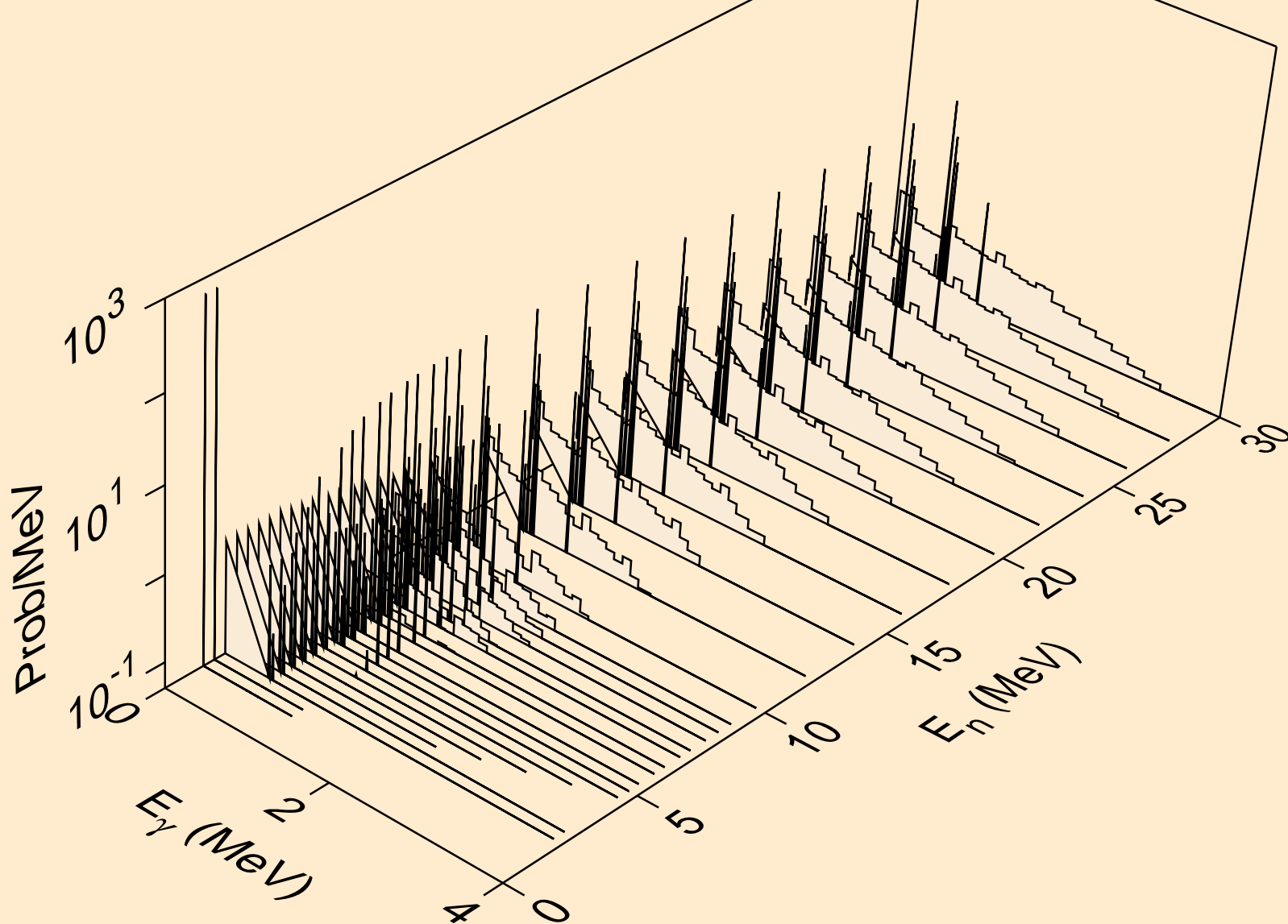

FR205 NEUTRON ACER TENDL-2019 LIBRARY; T=293.16K
Photon emission for (n,t)

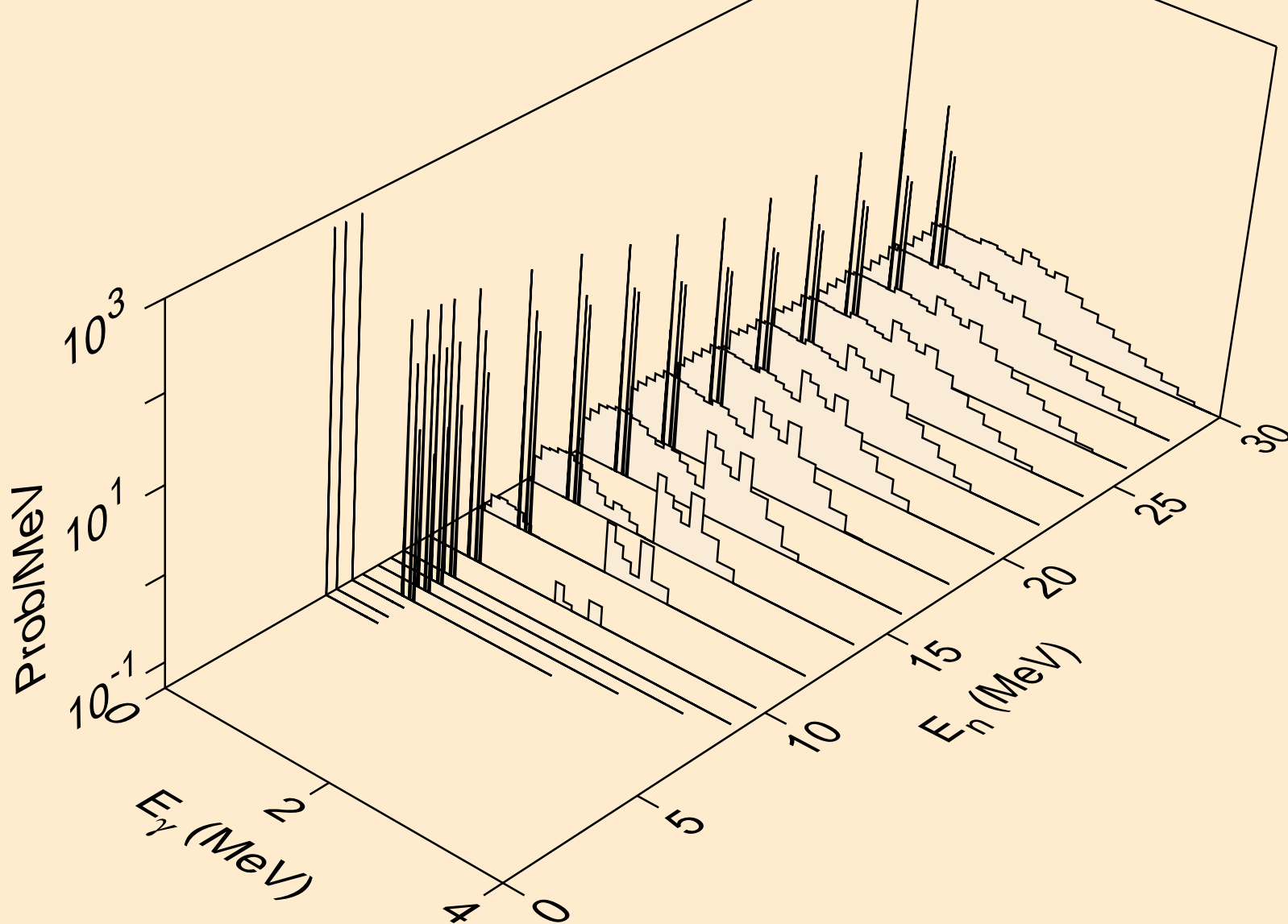

FR205 NEUTRON ACER TENDL-2019 LIBRARY; T=293.16K
Photon emission for (n,he3)

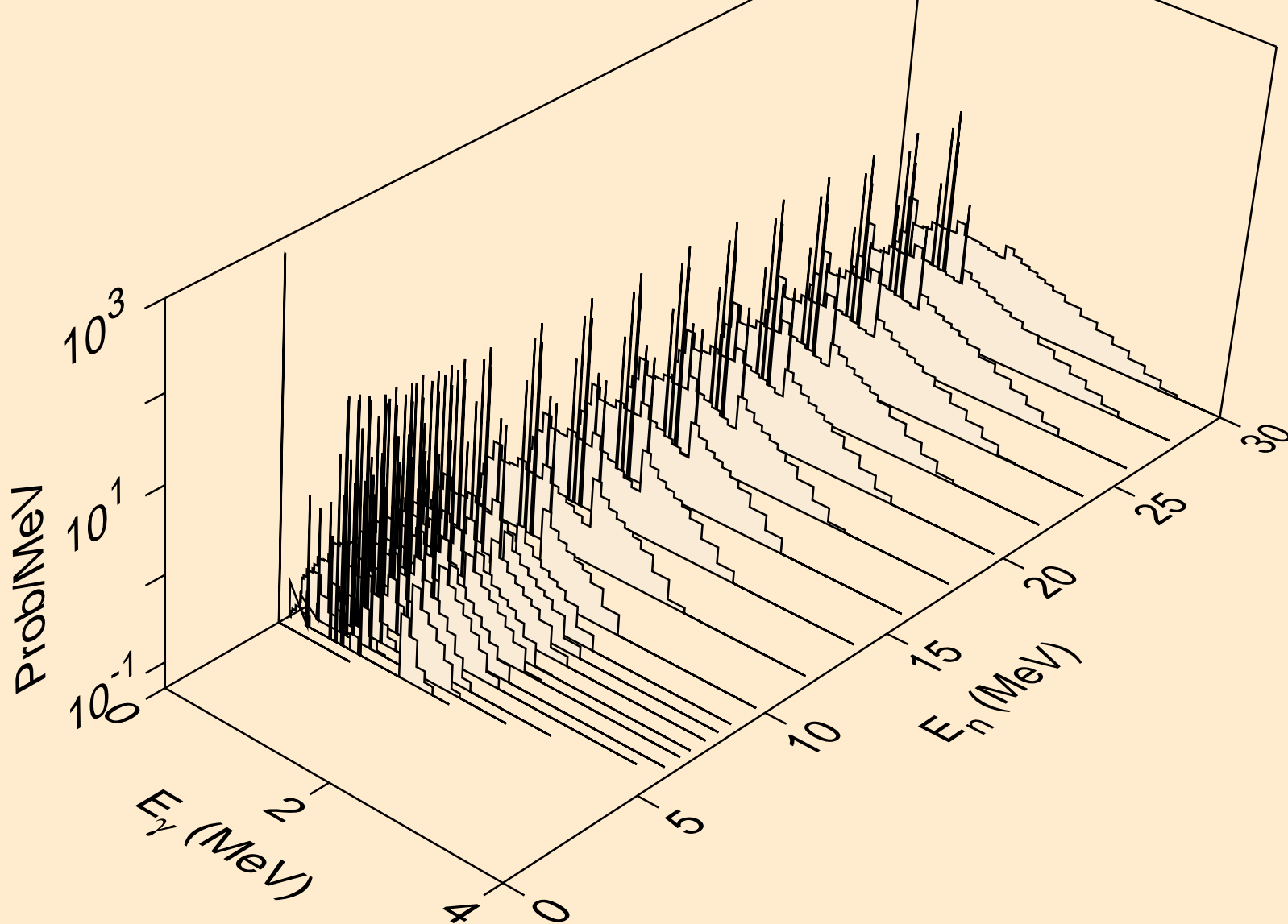

FR205 NEUTRON ACER TENDL-2019 LIBRARY; T=293.16K
Photon emission for (n,a)

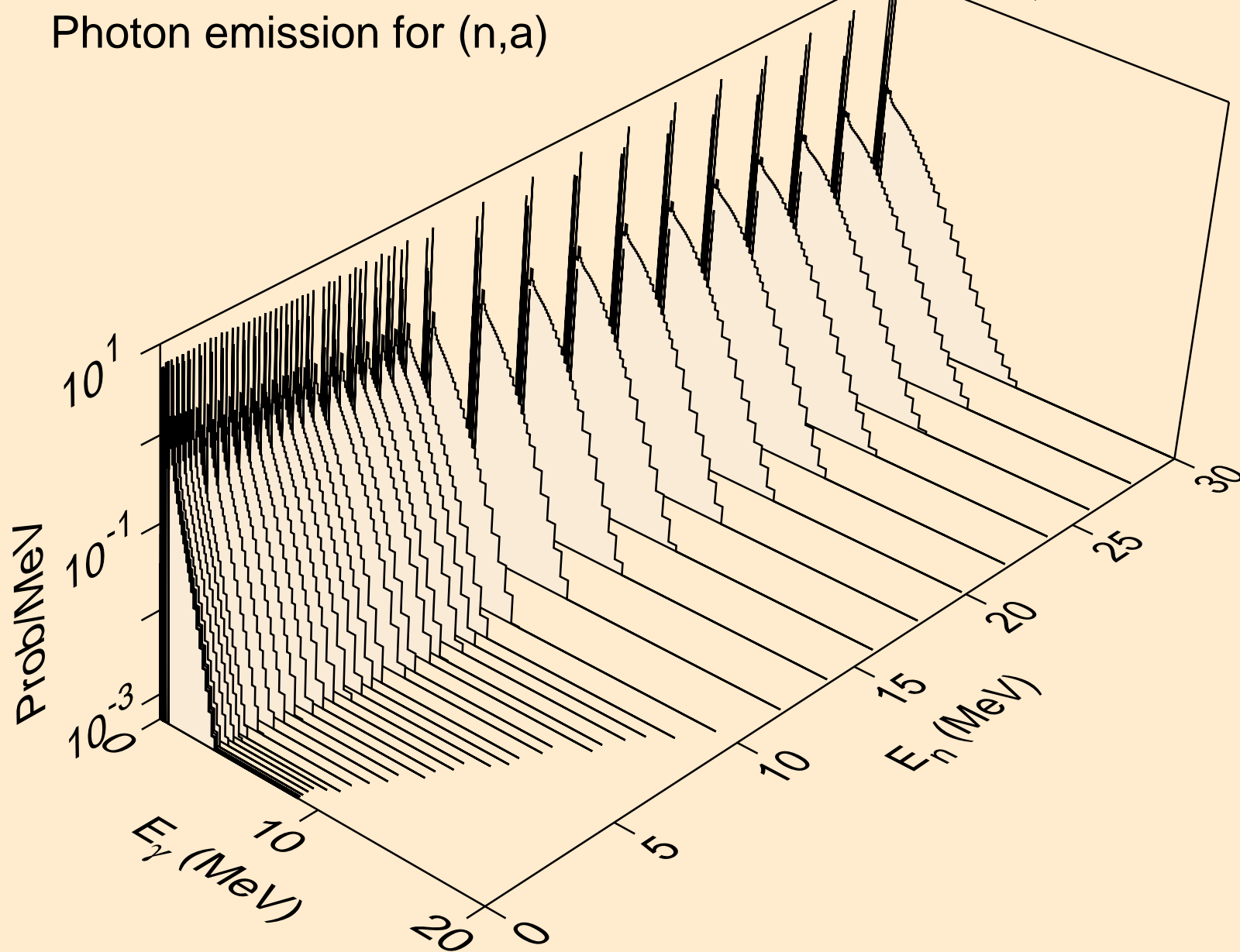

FR205 NEUTRON ACER TENDL-2019 LIBRARY; T=293.16K
Photon emission for (n,2a)

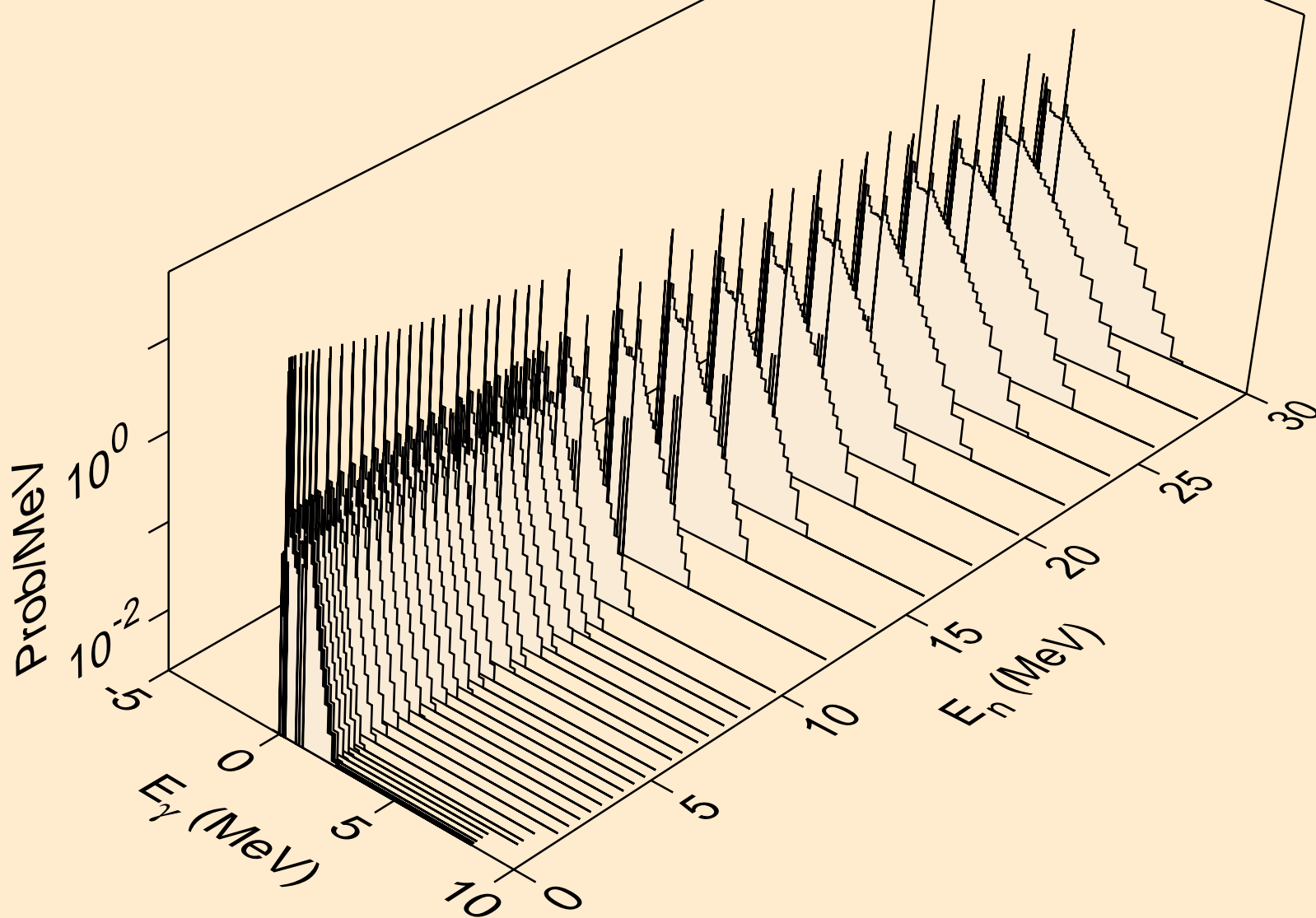

FR205 NEUTRON ACER TENDL-2019 LIBRARY; T=293.16K
Photon emission for (n,2p)

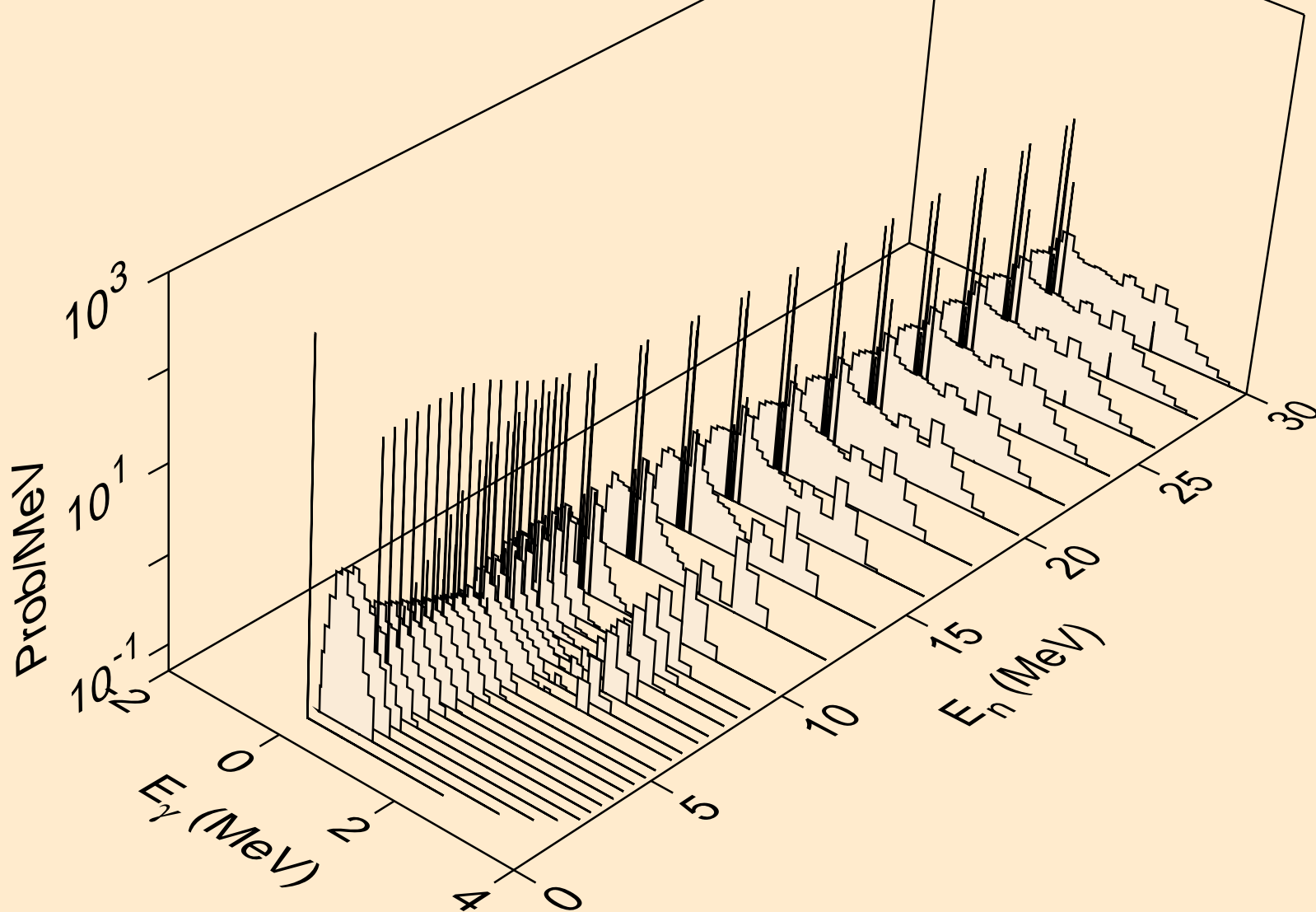

FR205 NEUTRON ACER TENDL-2019 LIBRARY; T=293.16K
Photon emission for (n,p α)

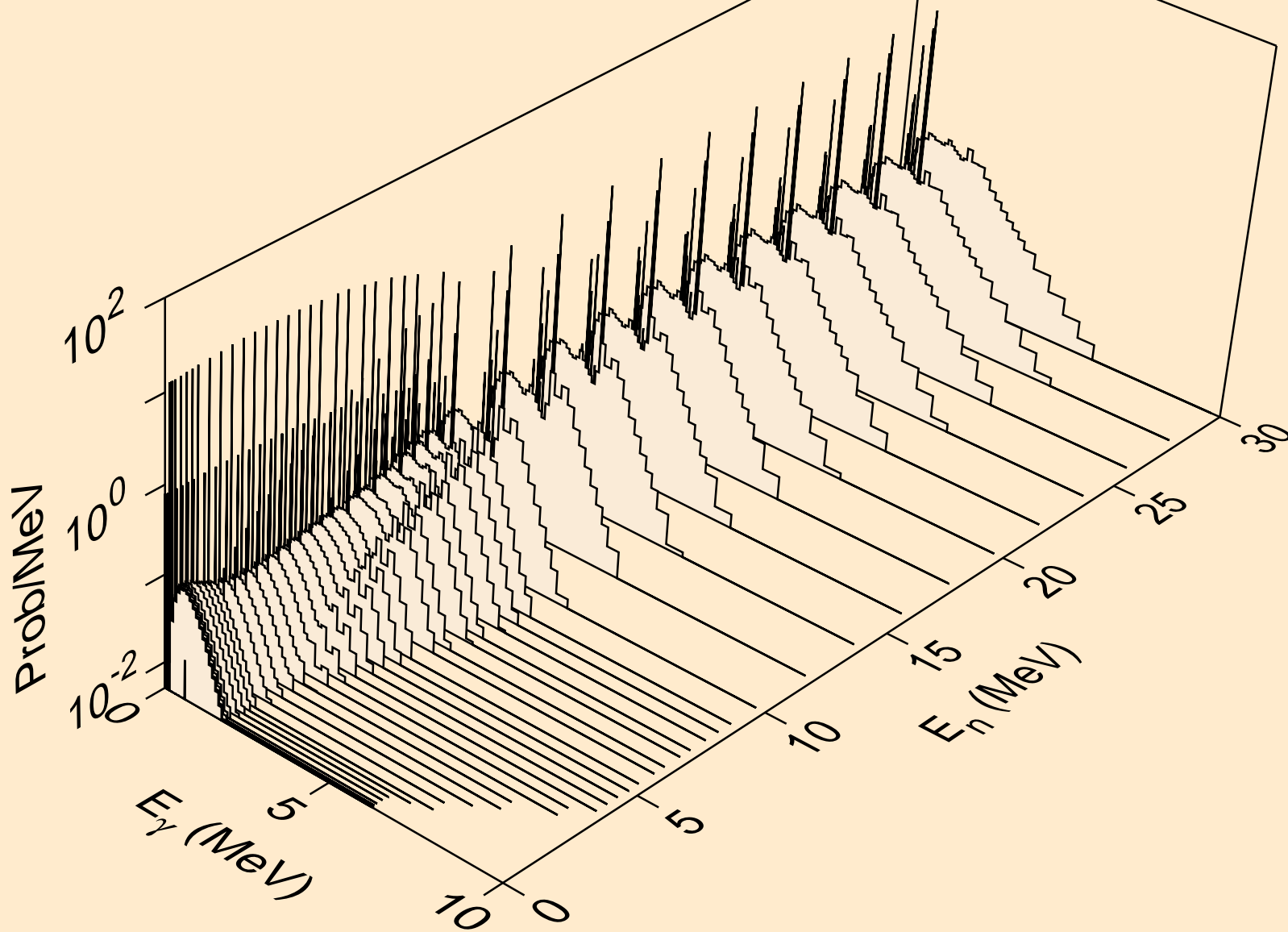

FR205 NEUTRON ACER TENDL-2019 LIBRARY; T=293.16K
Photon emission for (n,pd)

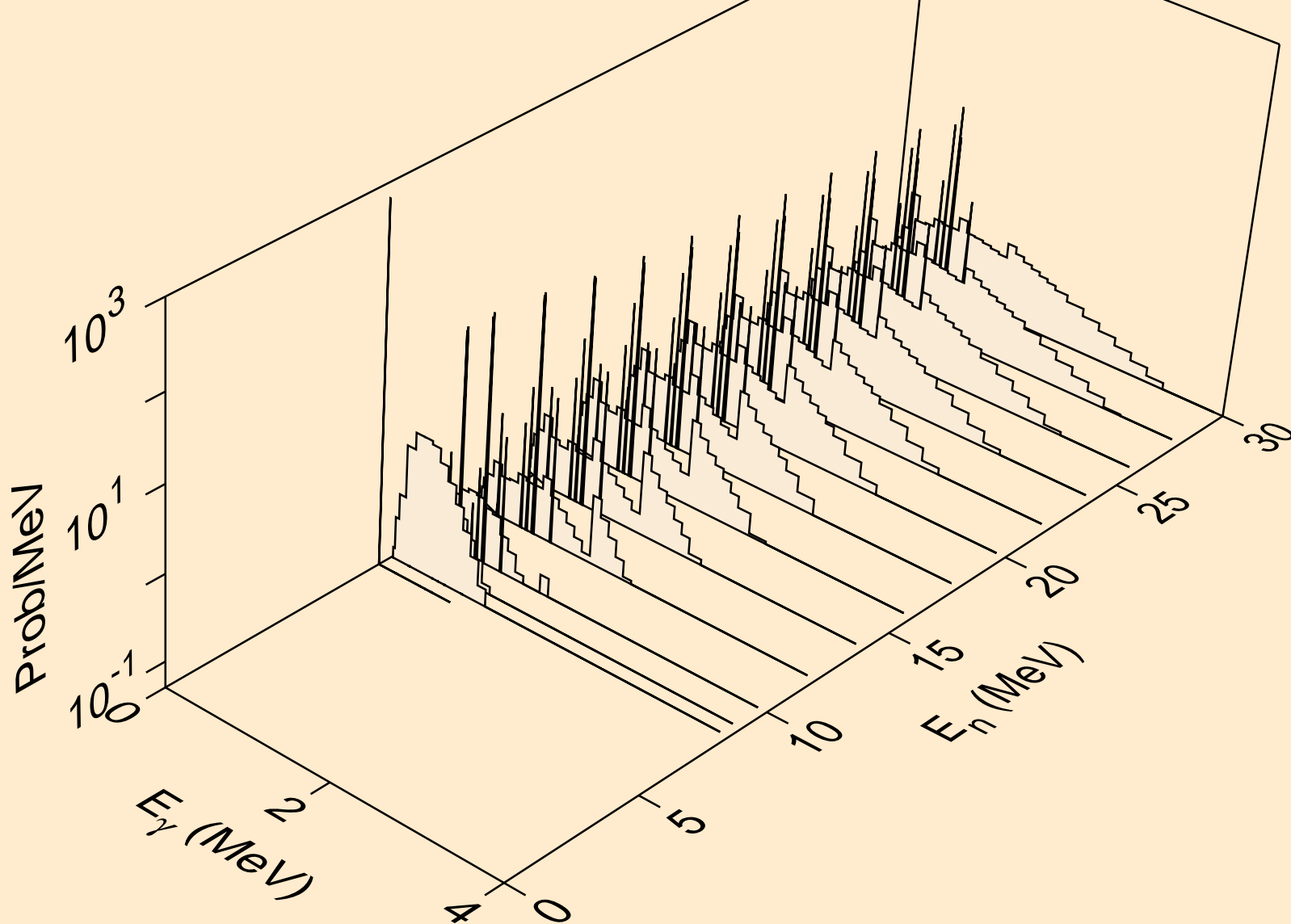

FR205 NEUTRON ACER TENDL-2019 LIBRARY; T=293.16K
Photon emission for (n,pt)

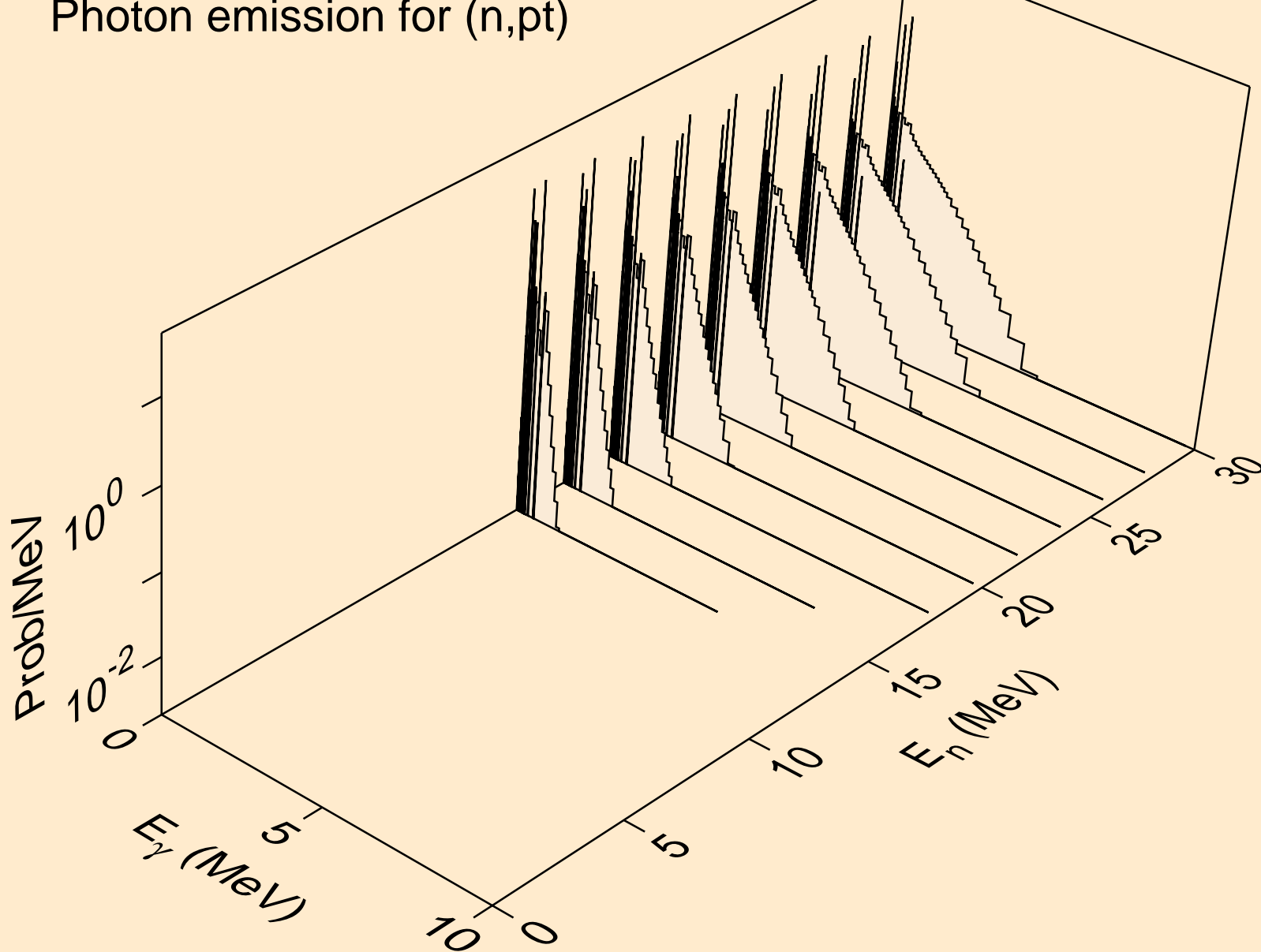

FR205 NEUTRON ACER TENDL-2019 LIBRARY; T=293.16K
Photon emission for (n,da)

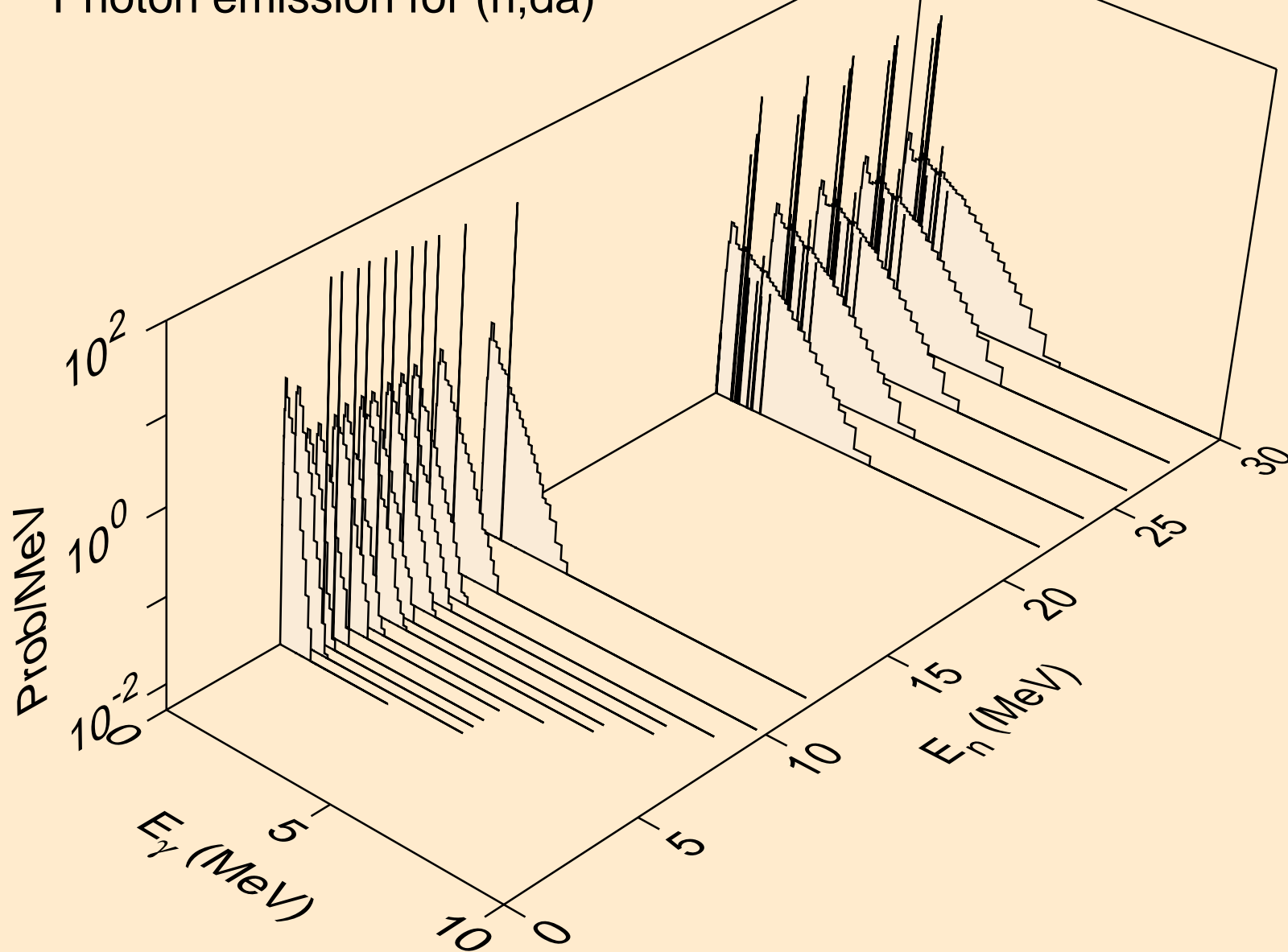

FR205 NEUTRON ACER TENDL-2019 LIBRARY; T=293.16K
thermal capture photon spectrum

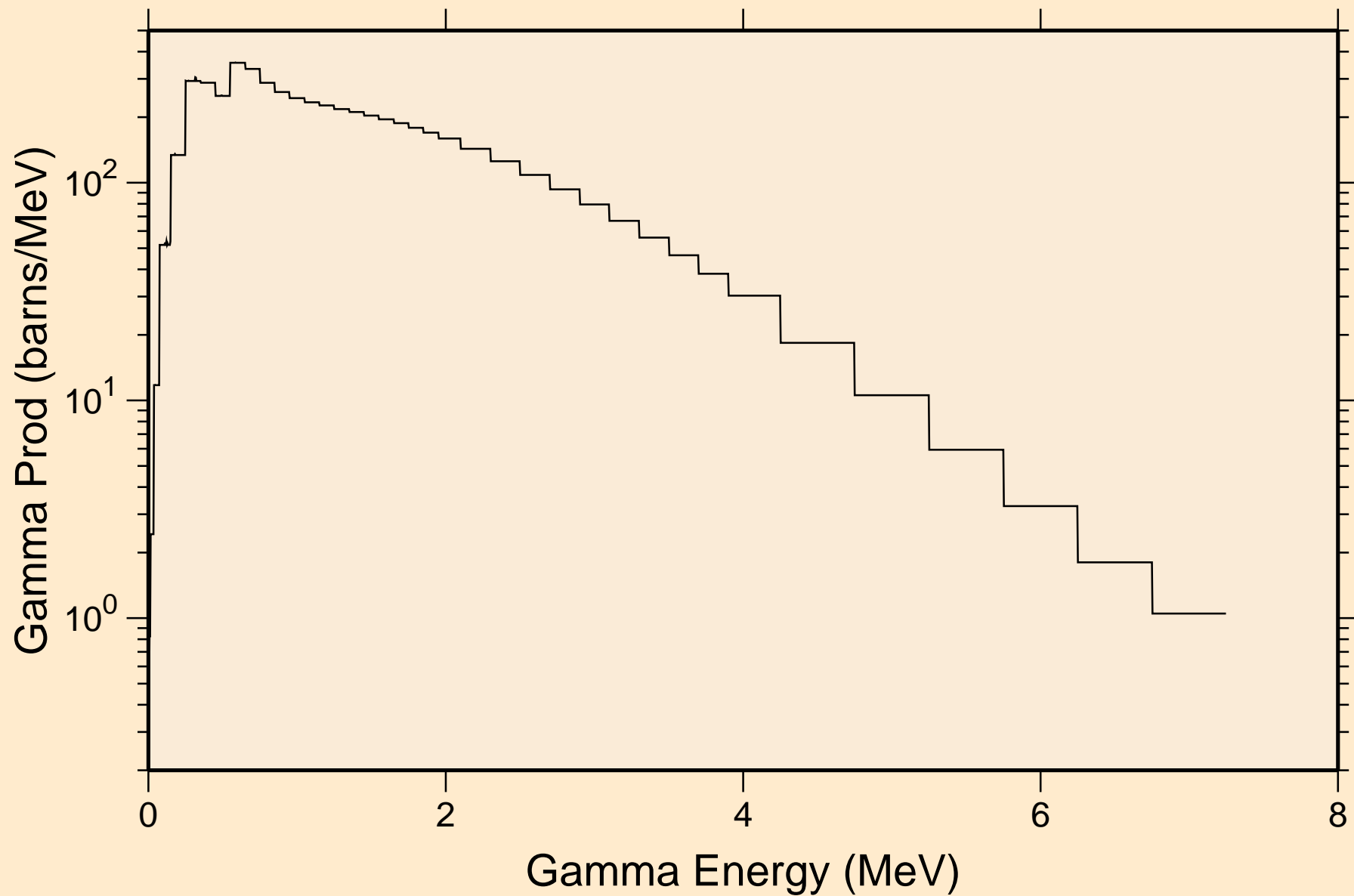

FR205 NEUTRON ACER TENDL-2019 LIBRARY; T=293.16K
14 MeV photon spectrum

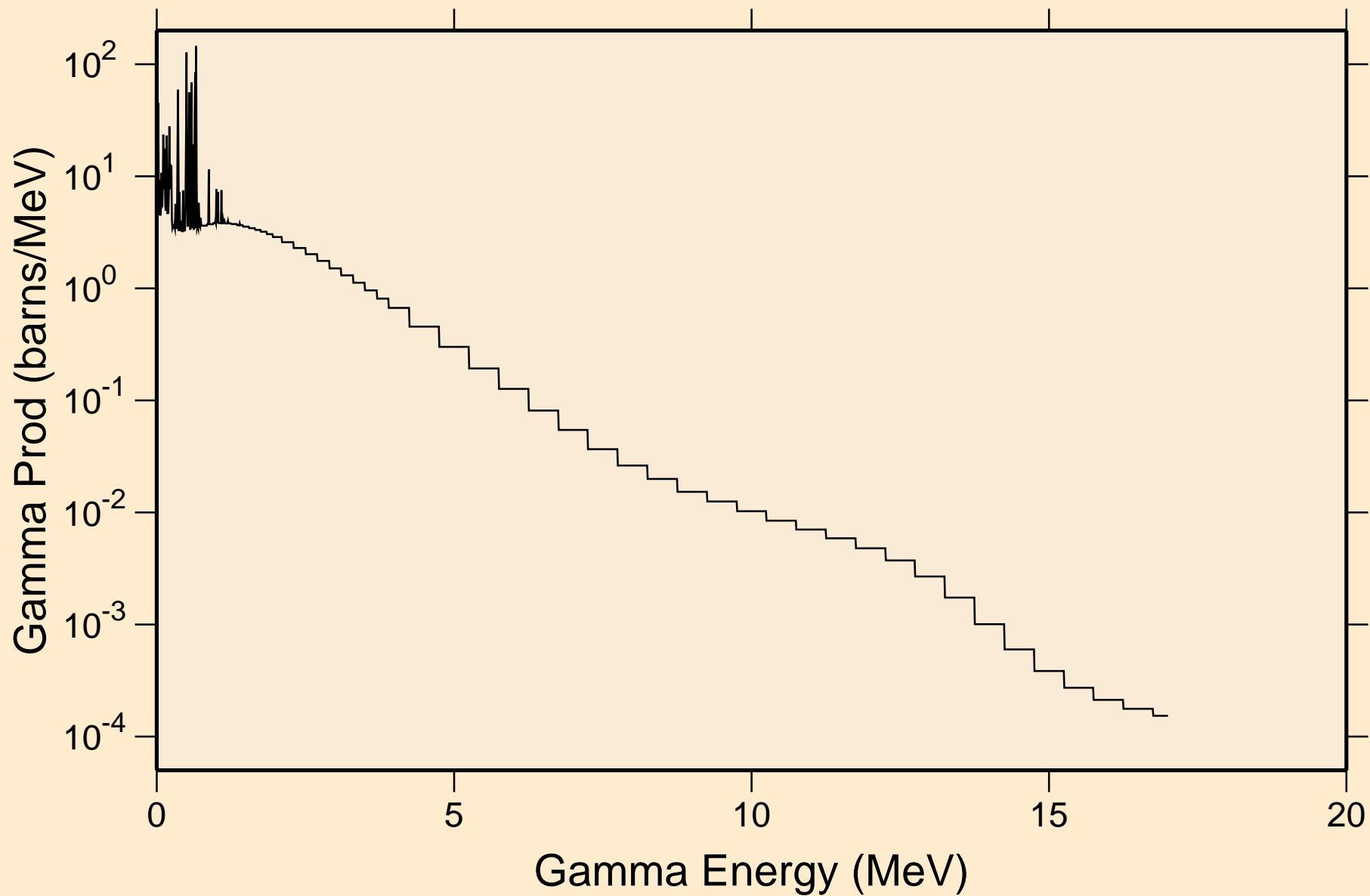

FR205 NEUTRON ACER TENDL-2019 LIBRARY; T=293.16K

Particle heating contributions

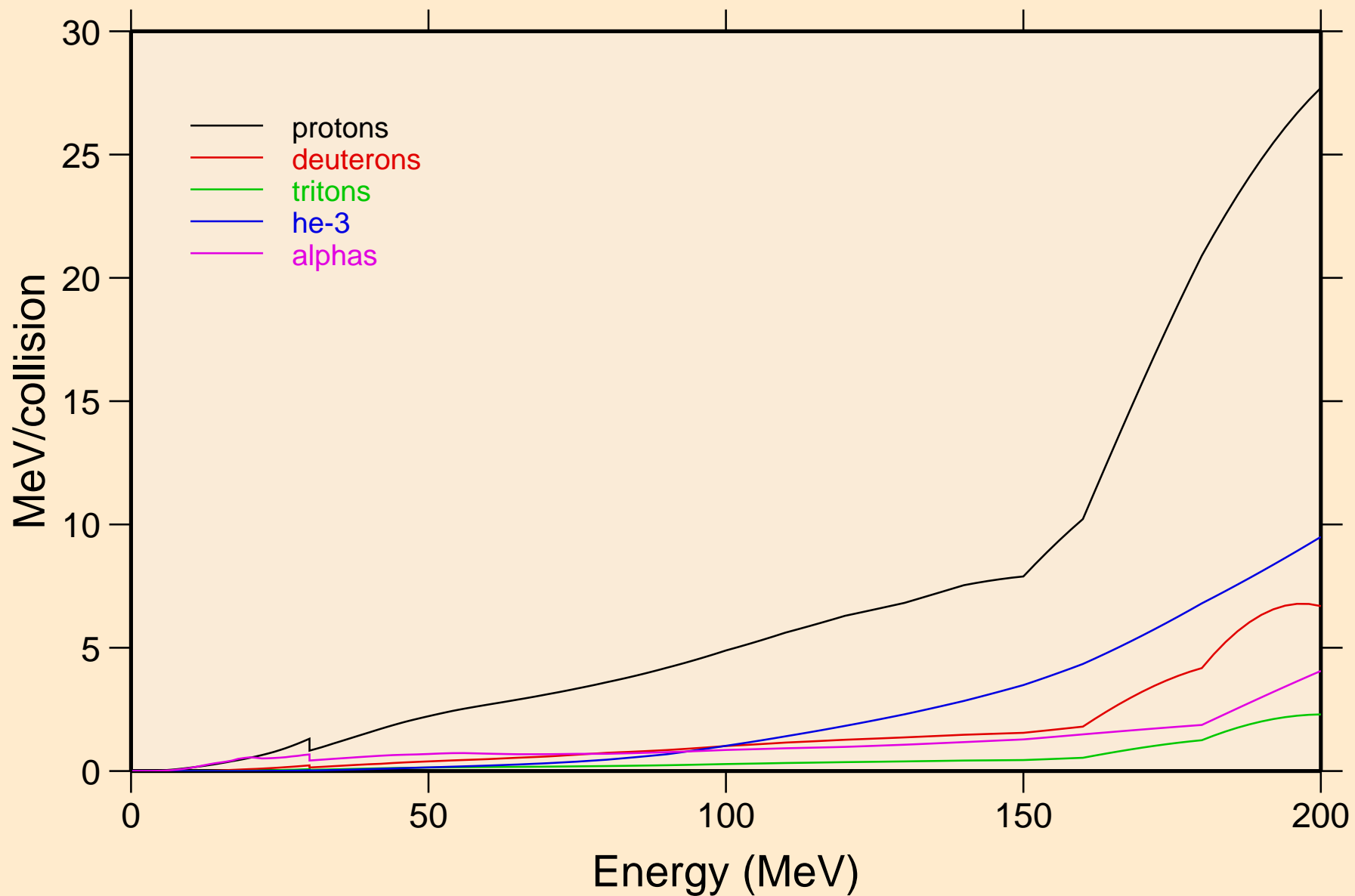

FR205 NEUTRON ACER TENDL-2019 LIBRARY; T=293.16K
Recoil Heating

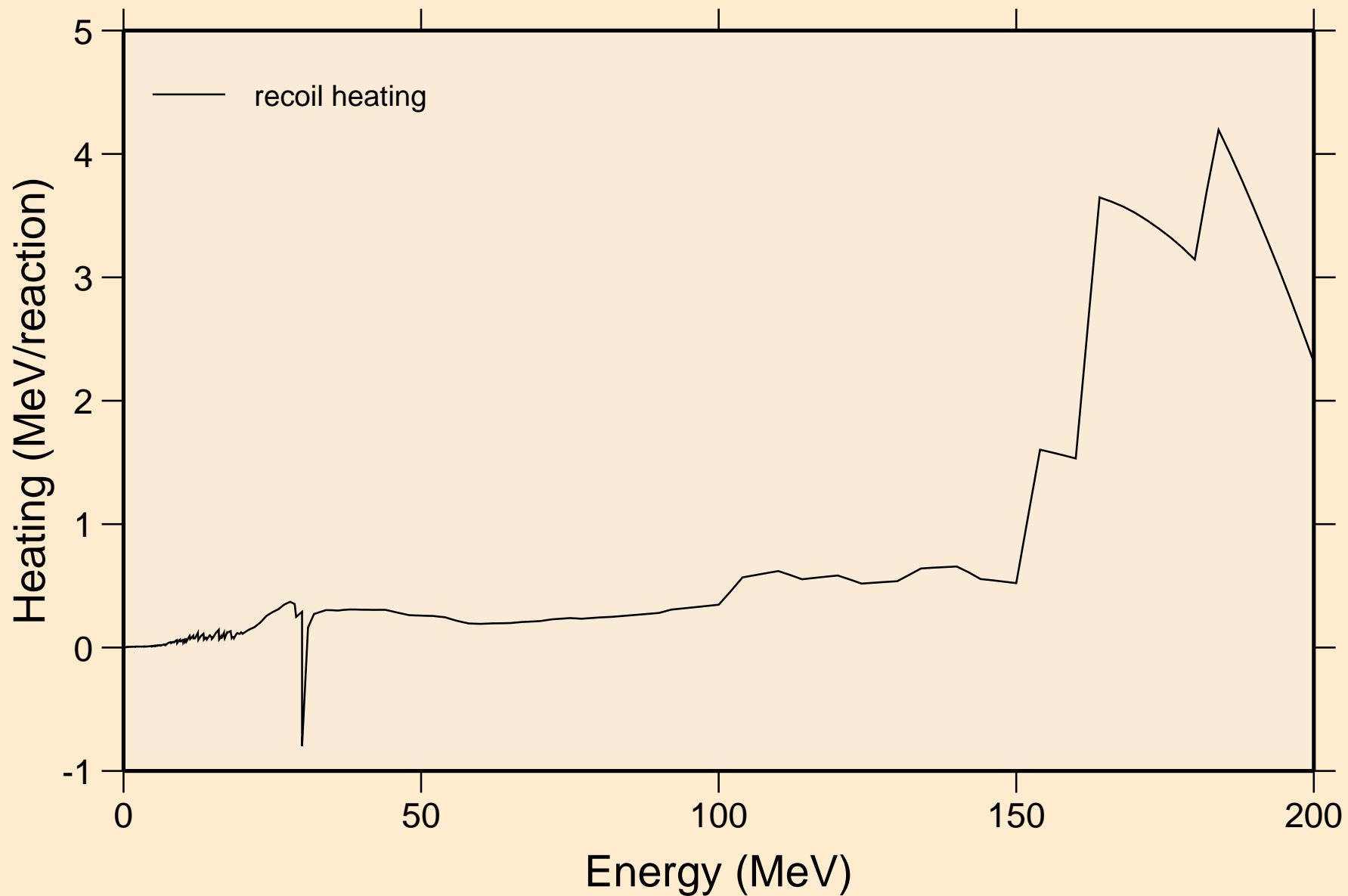

FR205 NEUTRON ACER TENDL-2019 LIBRARY; T=293.16K
Particle production cross sections

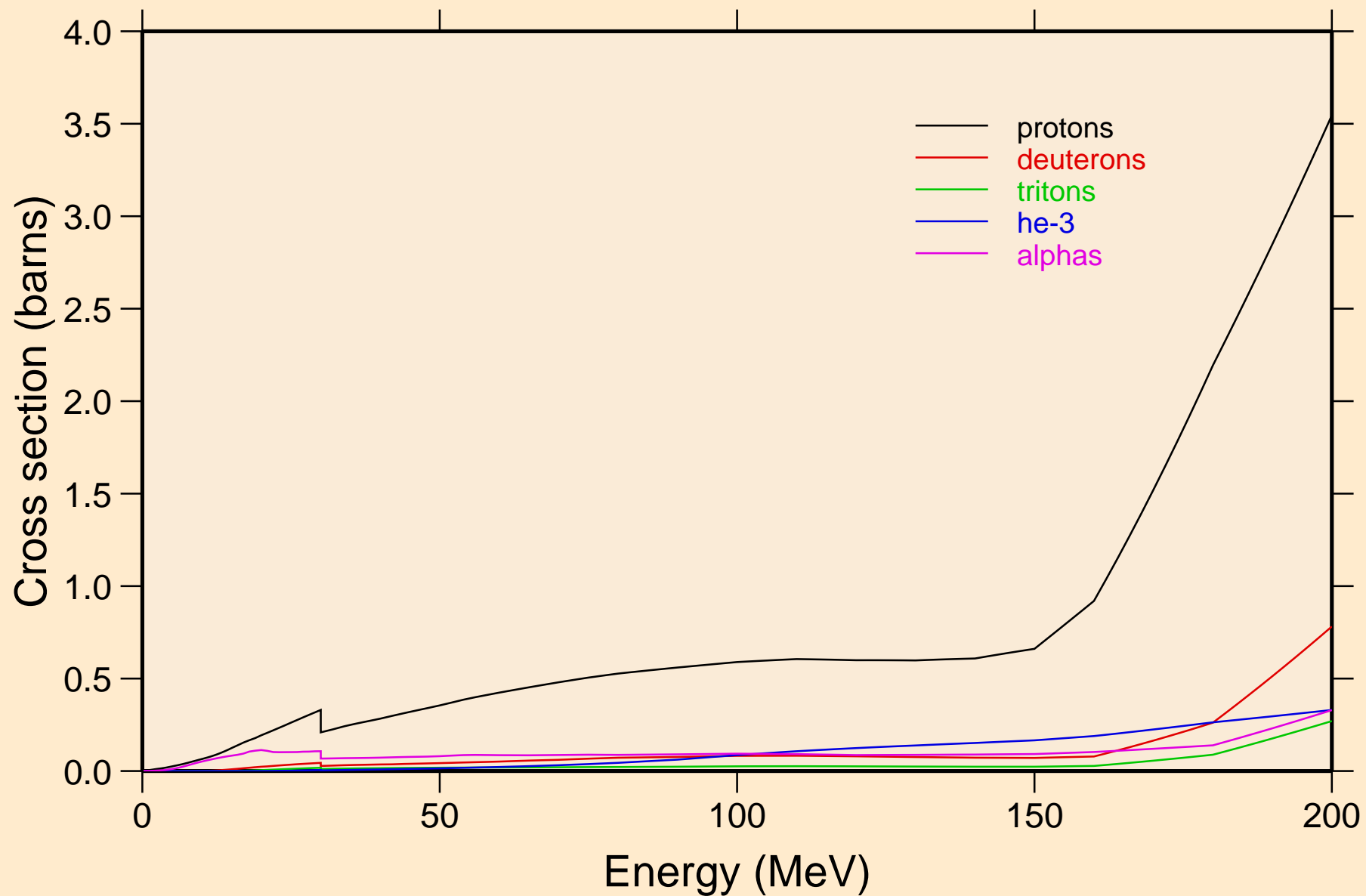

FR205 NEUTRON ACER TENDL-2019 LIBRARY; T=293.16K
protons from (n,x)

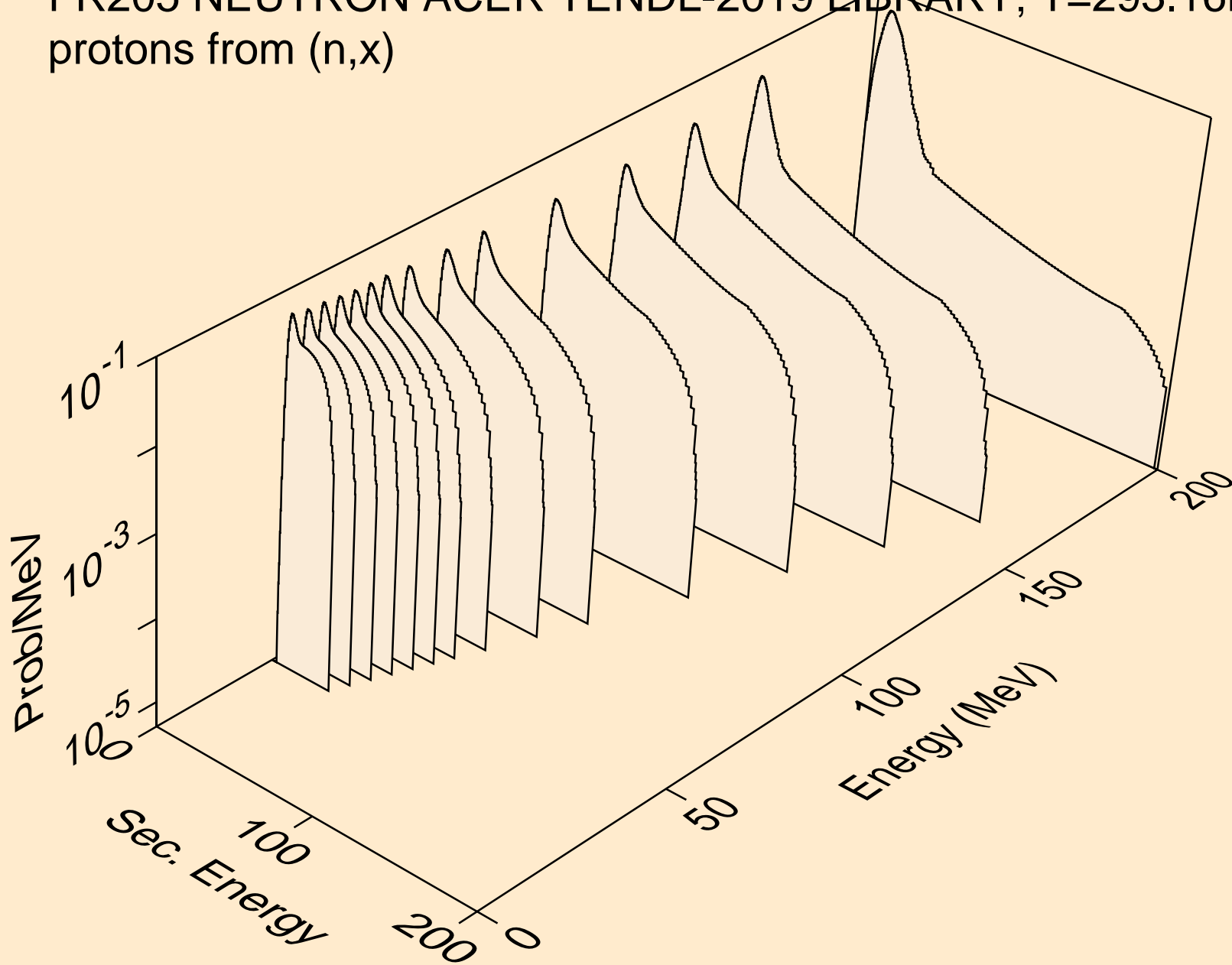

FR205 NEUTRON ACER TENDL-2019 LIBRARY; T=293.16K
protons from (n,n*)p

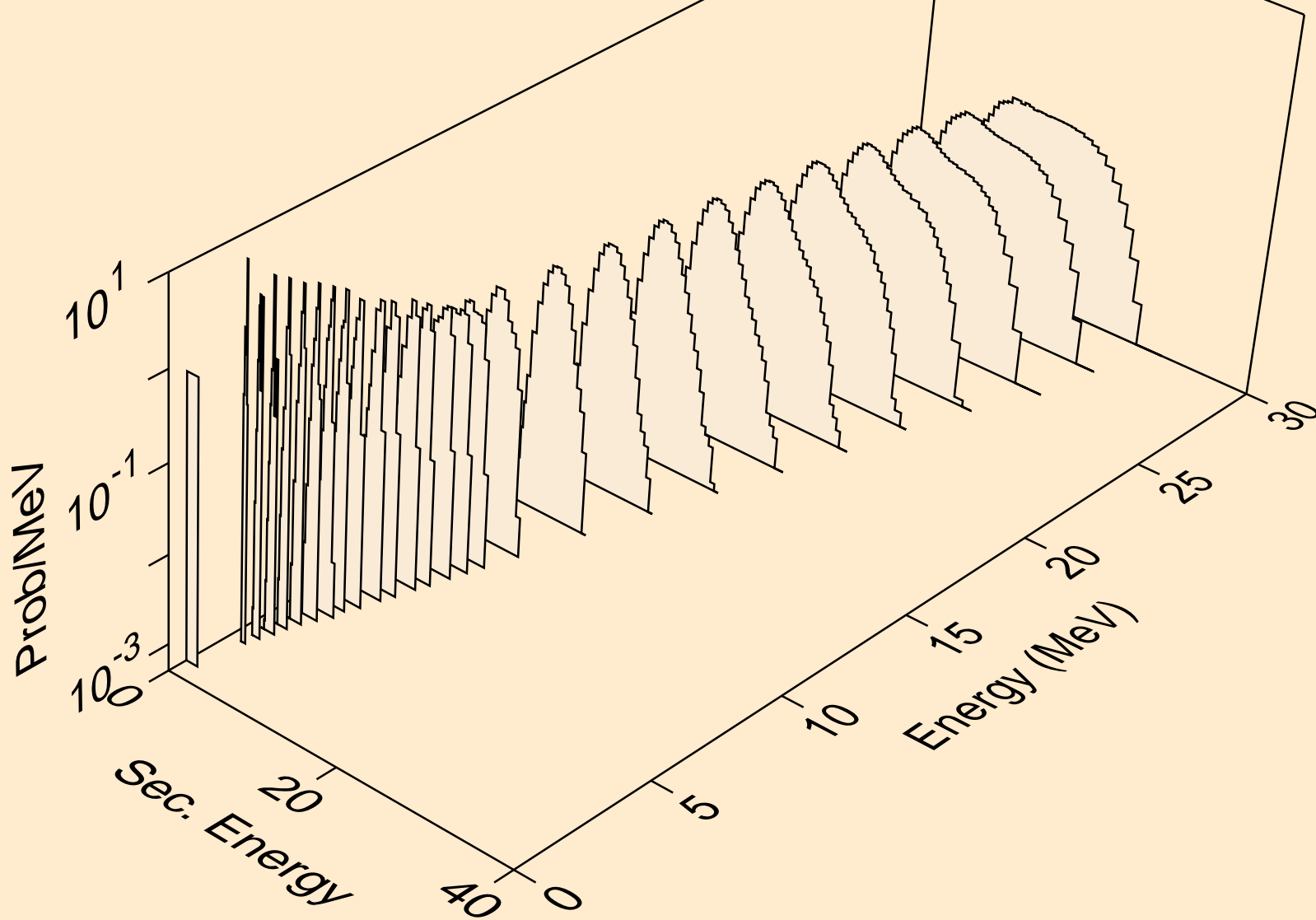

FR205 NEUTRON ACER TENDL-2019 LIBRARY; T=293.16K
protons from (n,2np)

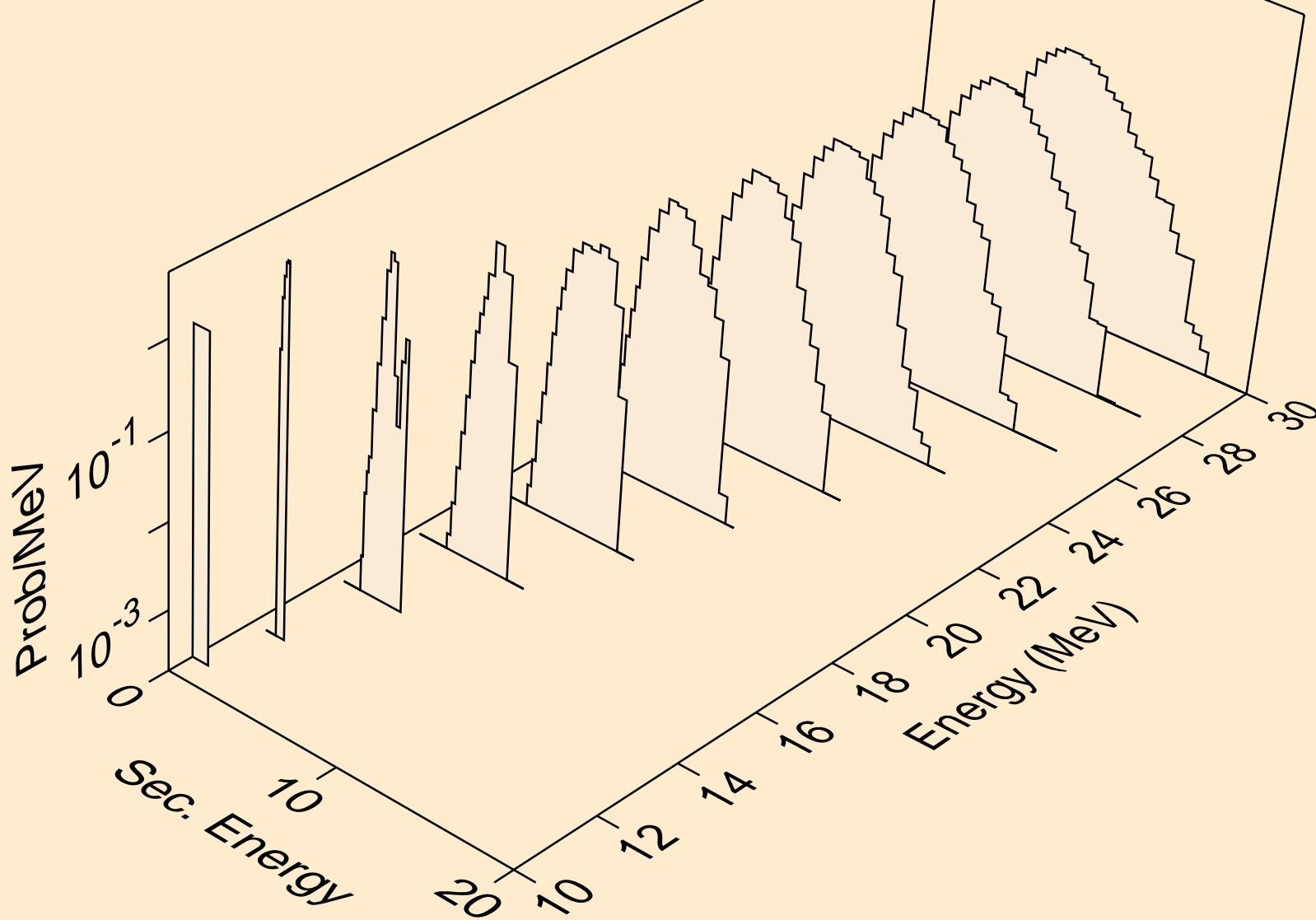

FR205 NEUTRON ACER TENDL-2019 LIBRARY; T=293.16K
protons from (n,3np)

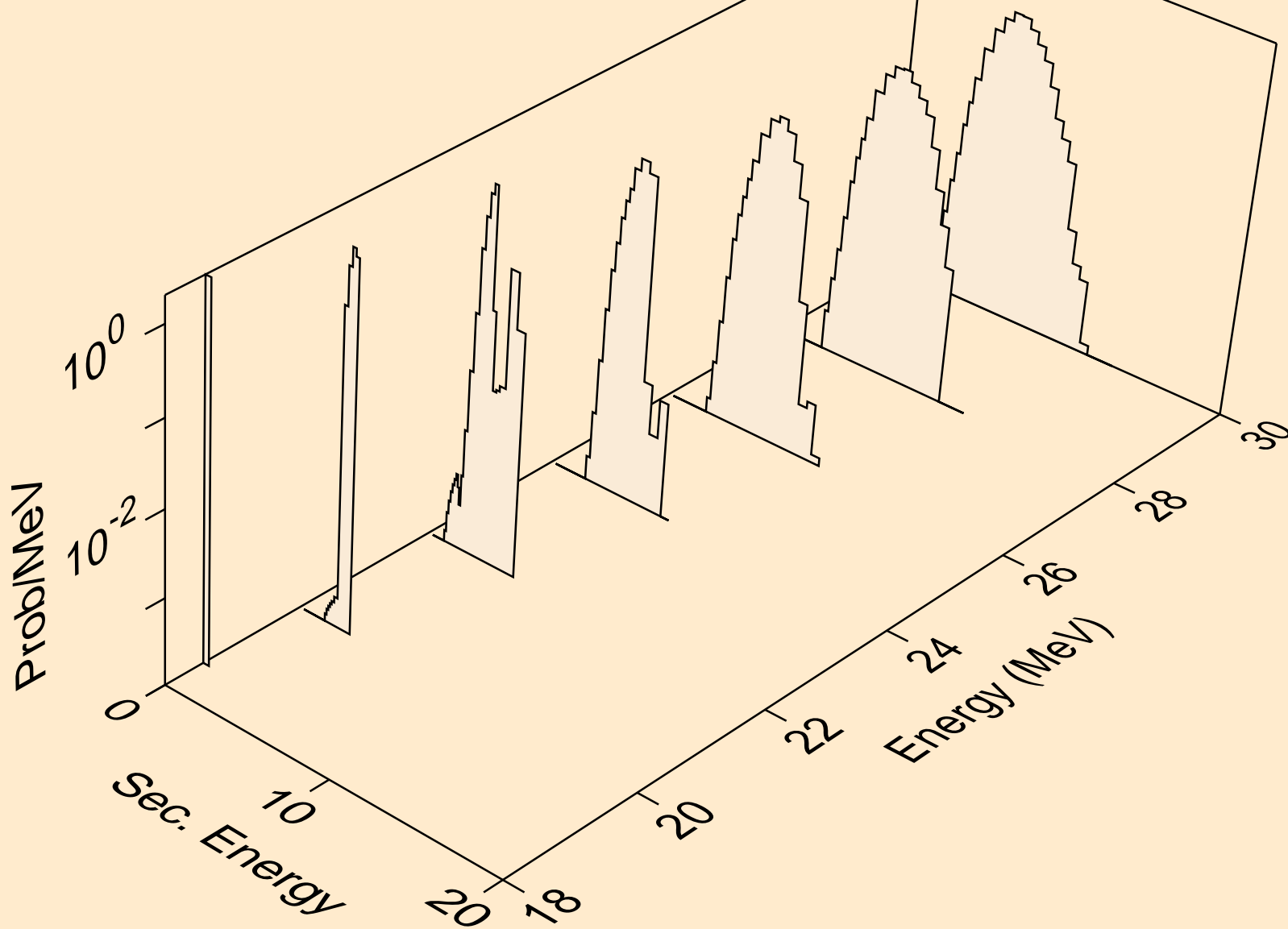

FR205 NEUTRON ACER TENDL-2019 LIBRARY; T=293.16K
protons from (n,2np)

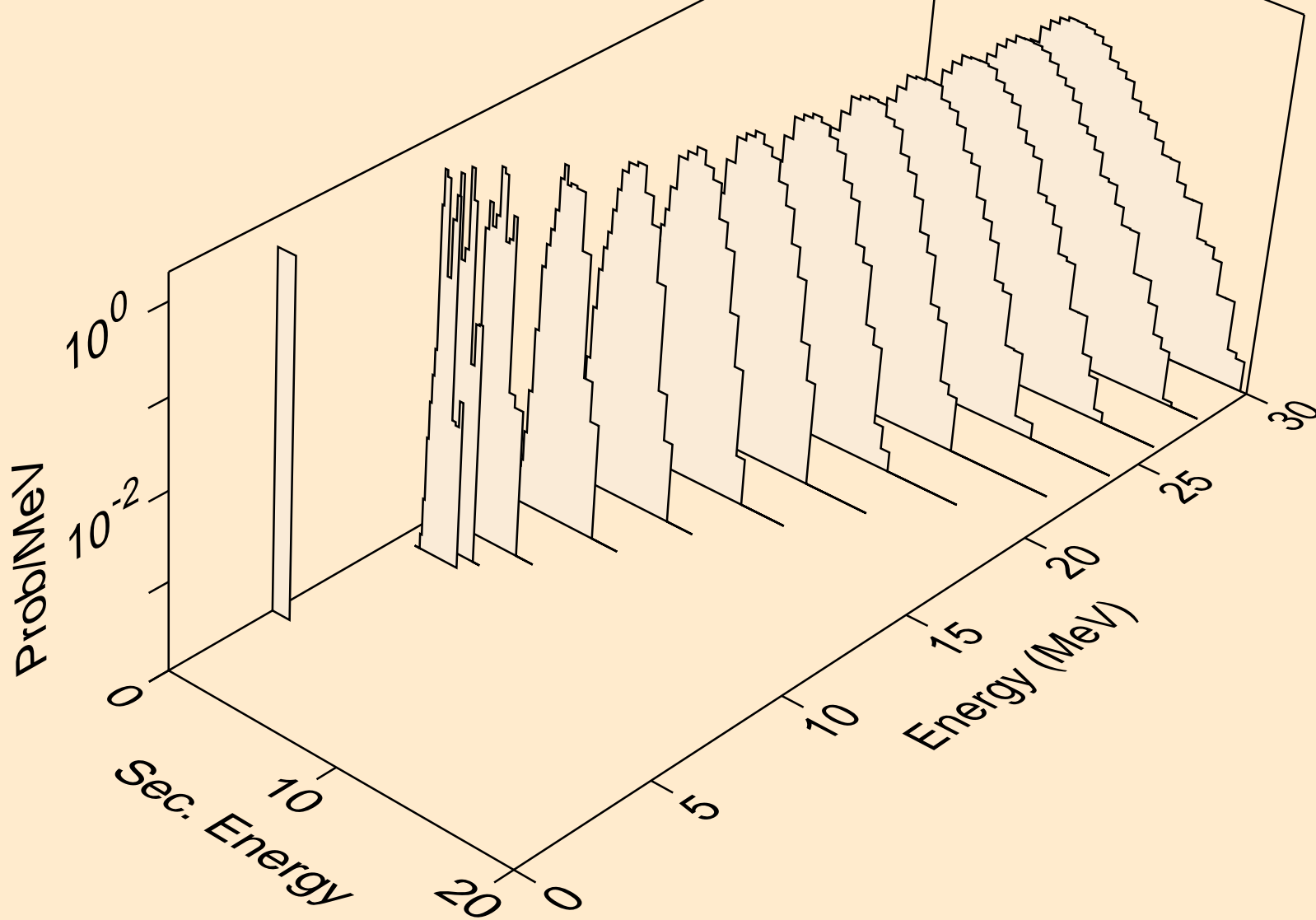

FR205 NEUTRON ACER TENDL-2019 LIBRARY; T=293.16K
protons from (n,npa)

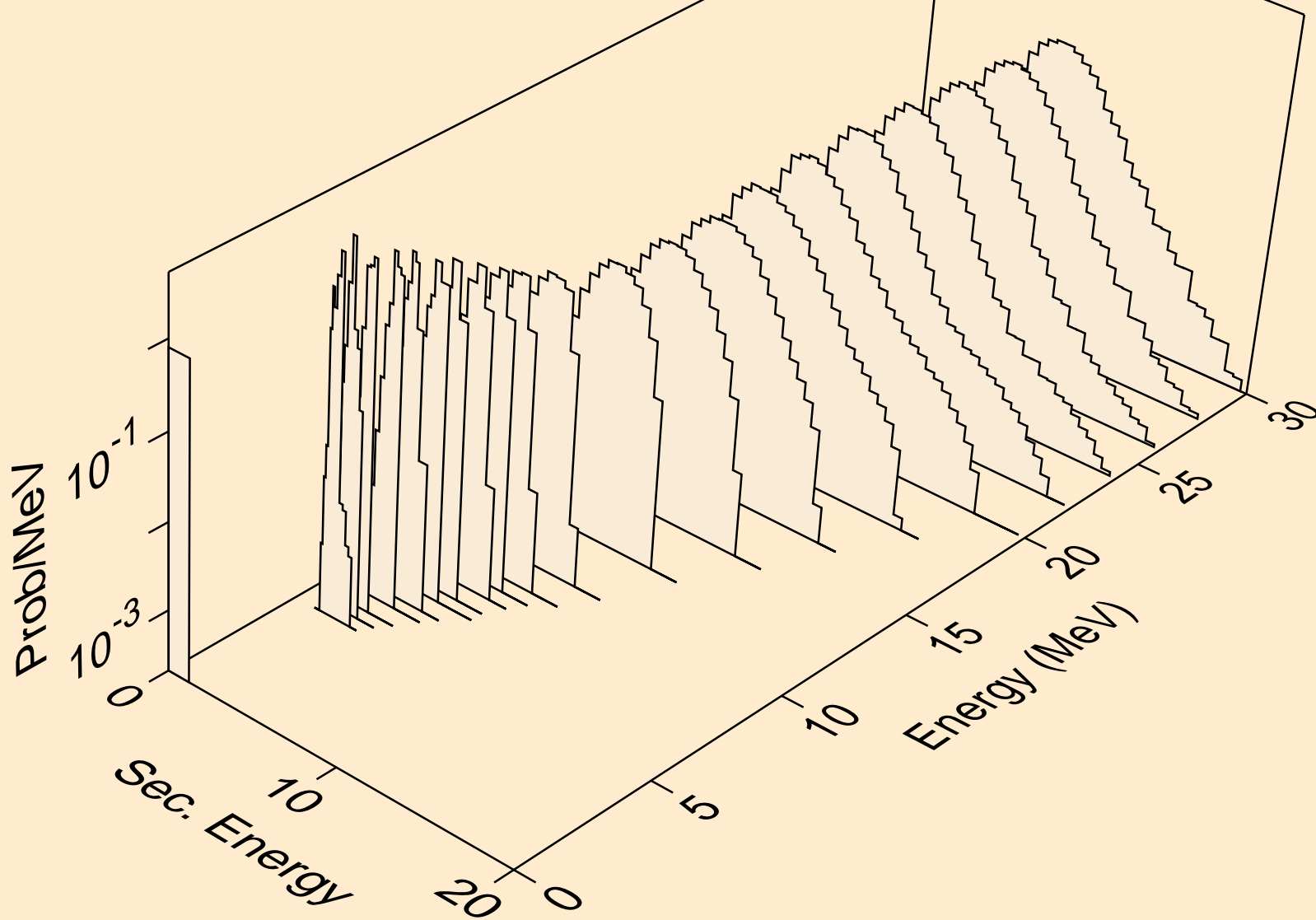

FR205 NEUTRON ACER TENDL-2019 LIBRARY; T=293.16K
protons from (n,p)

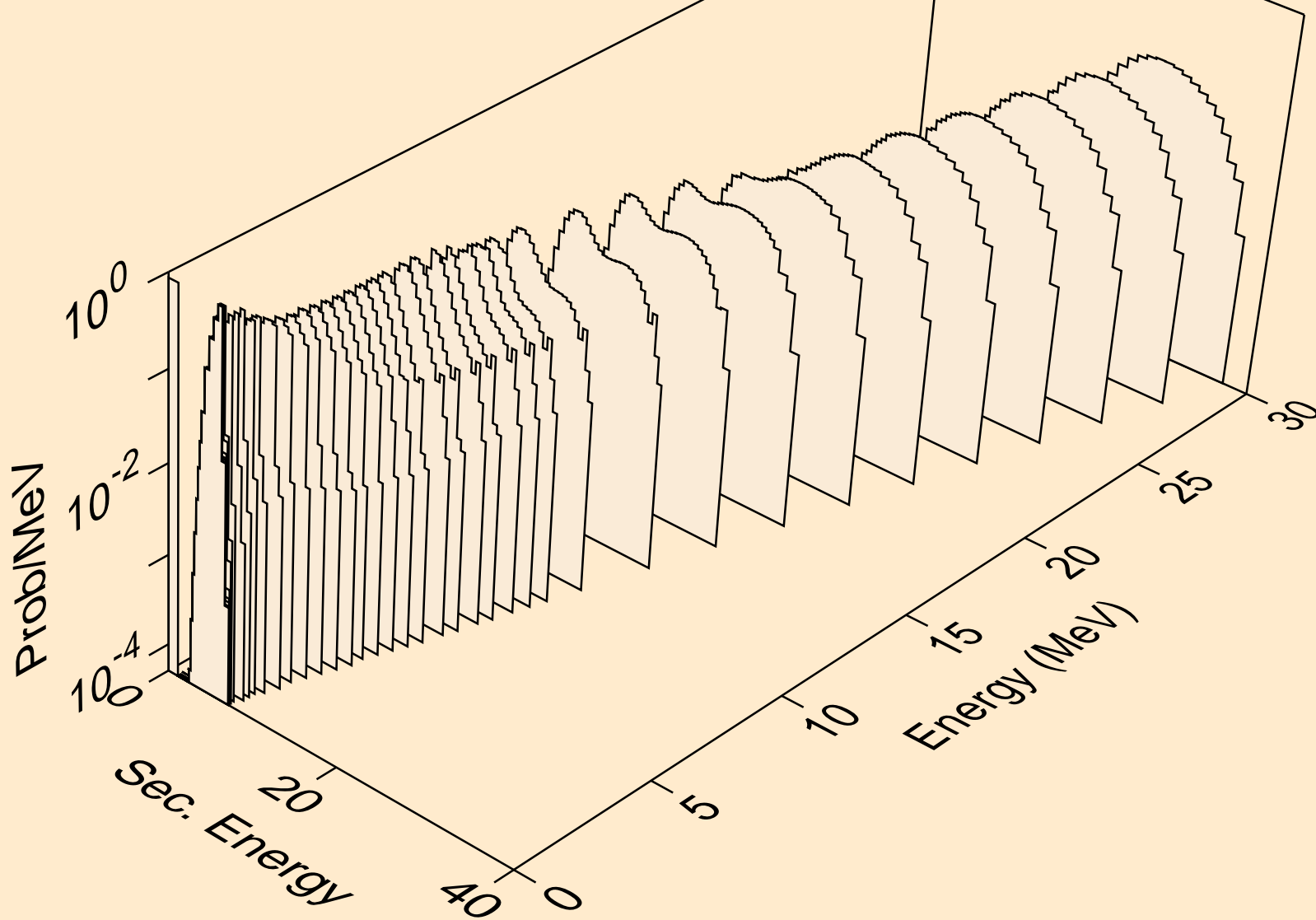

FR205 NEUTRON ACER TENDL-2019 LIBRARY; T=293.16K
protons from (n,2p)

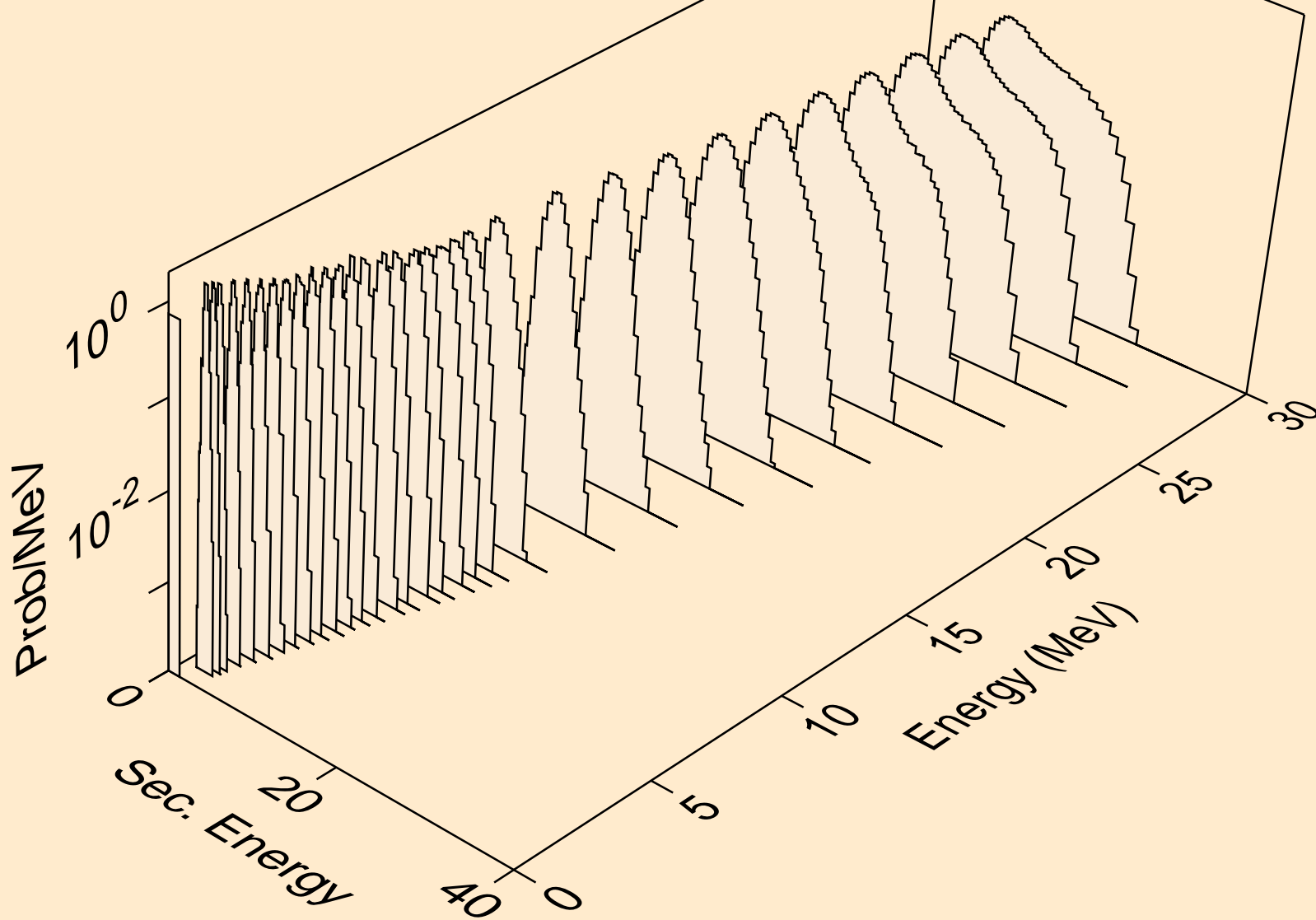

FR205 NEUTRON ACER TENDL-2019 LIBRARY; T=293.16K
protons from (n,p)

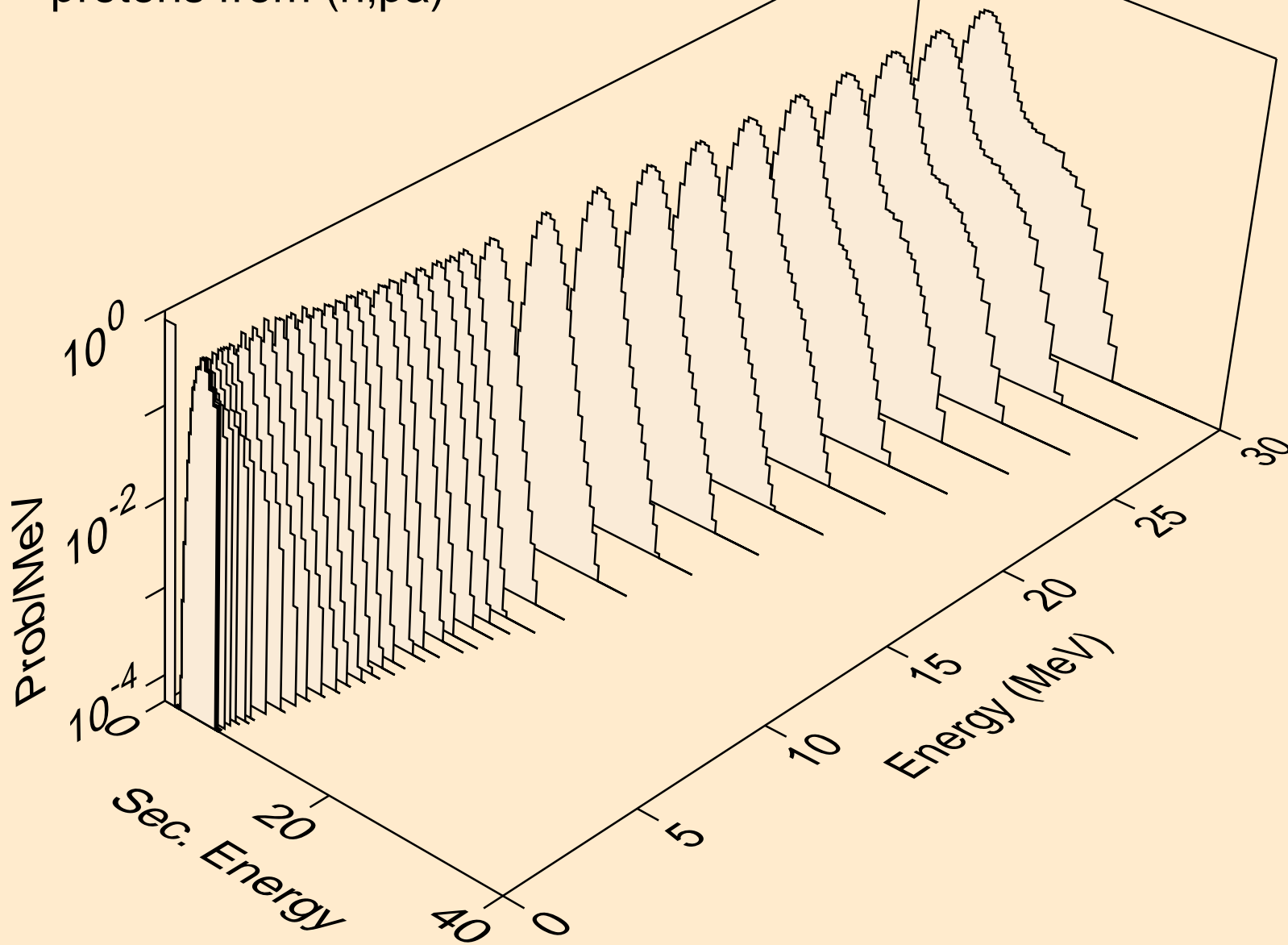

FR205 NEUTRON ACER TENDL-2019 LIBRARY; T=293.16K
protons from (n,pd)

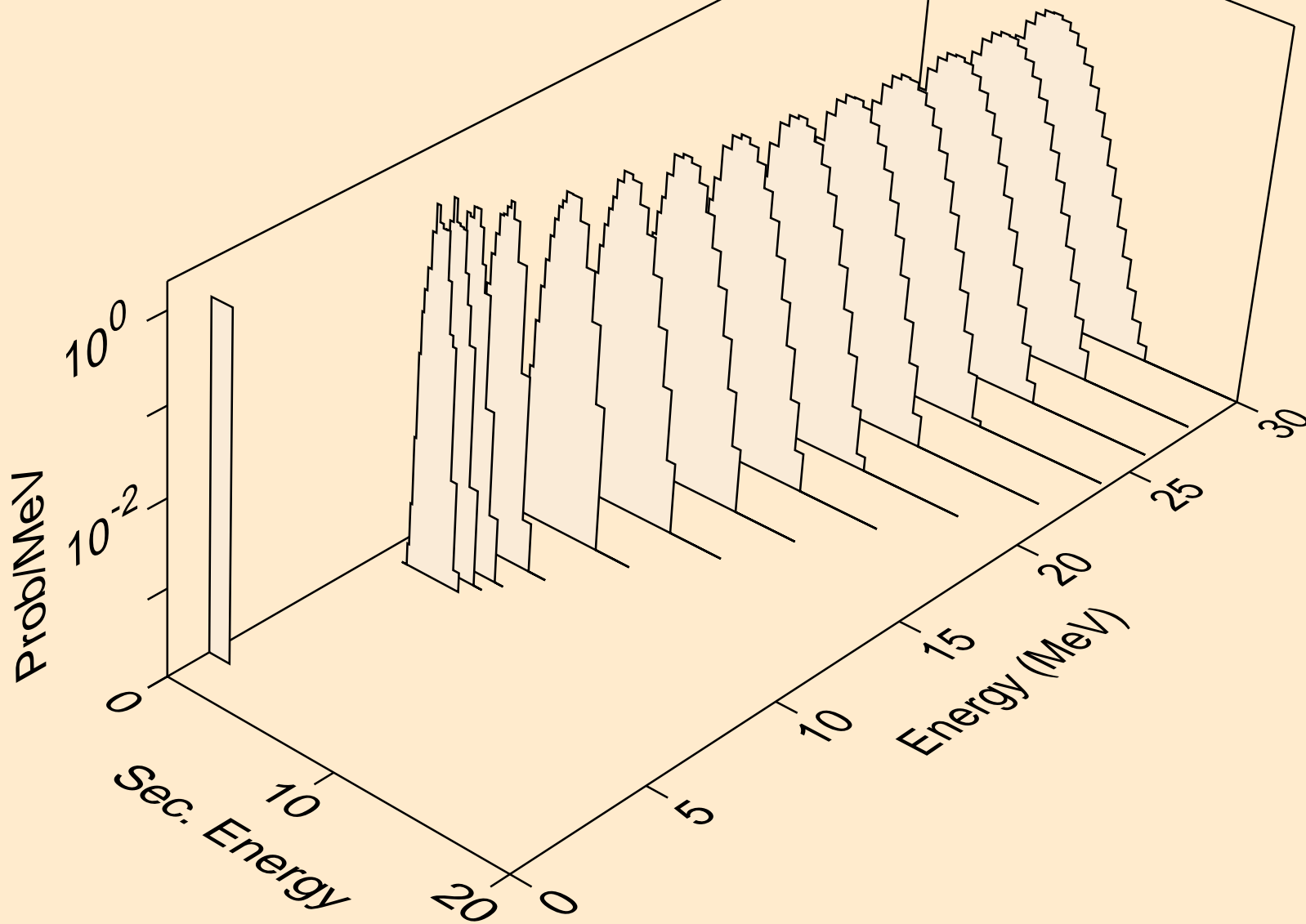

FR205 NEUTRON ACER TENDL-2019 LIBRARY; T=293.16K
protons from (n,pt)

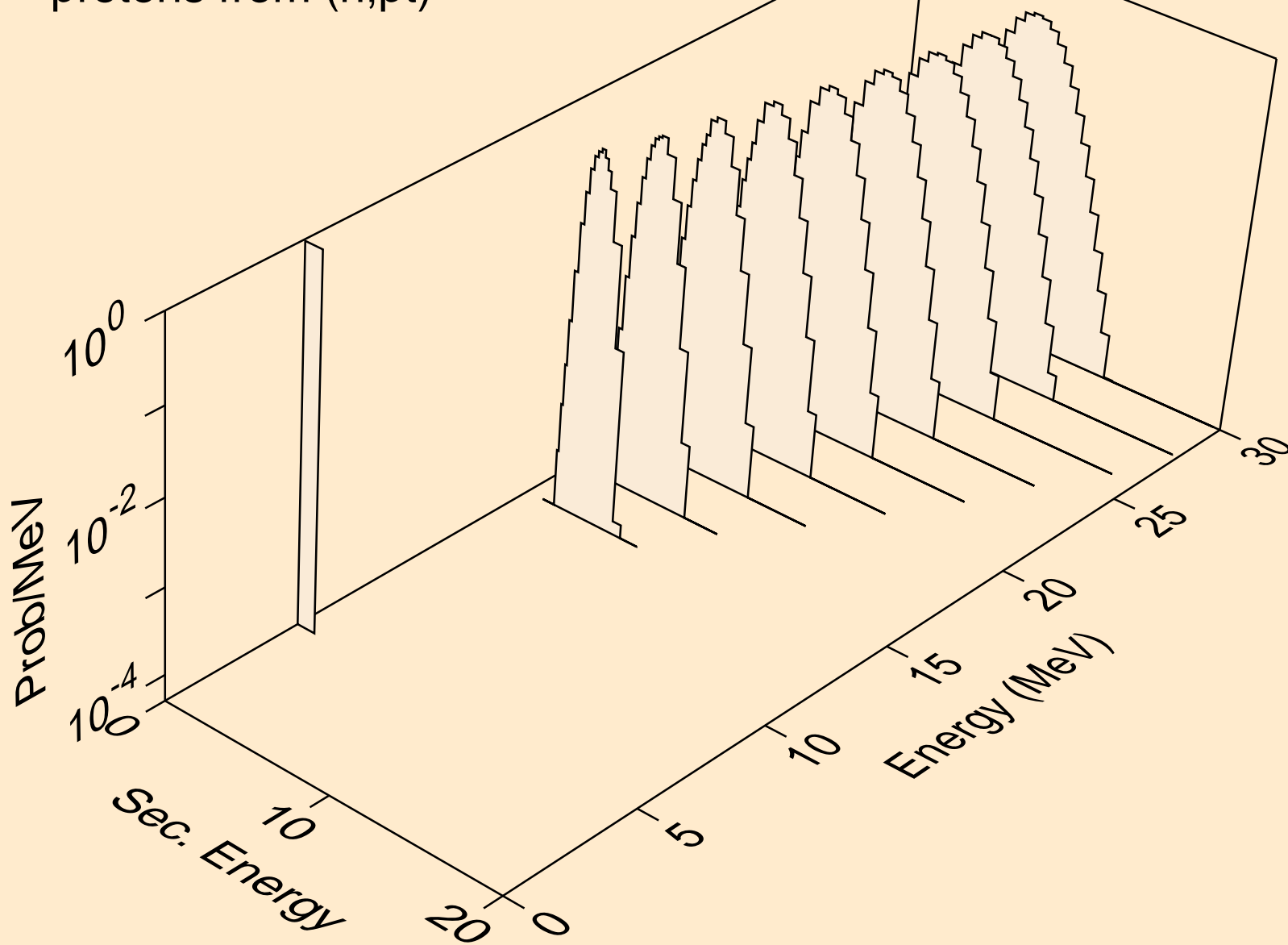

FR205 NEUTRON ACER TENDL-2019 LIBRARY; T=293.16K
deuterons from (n,x)

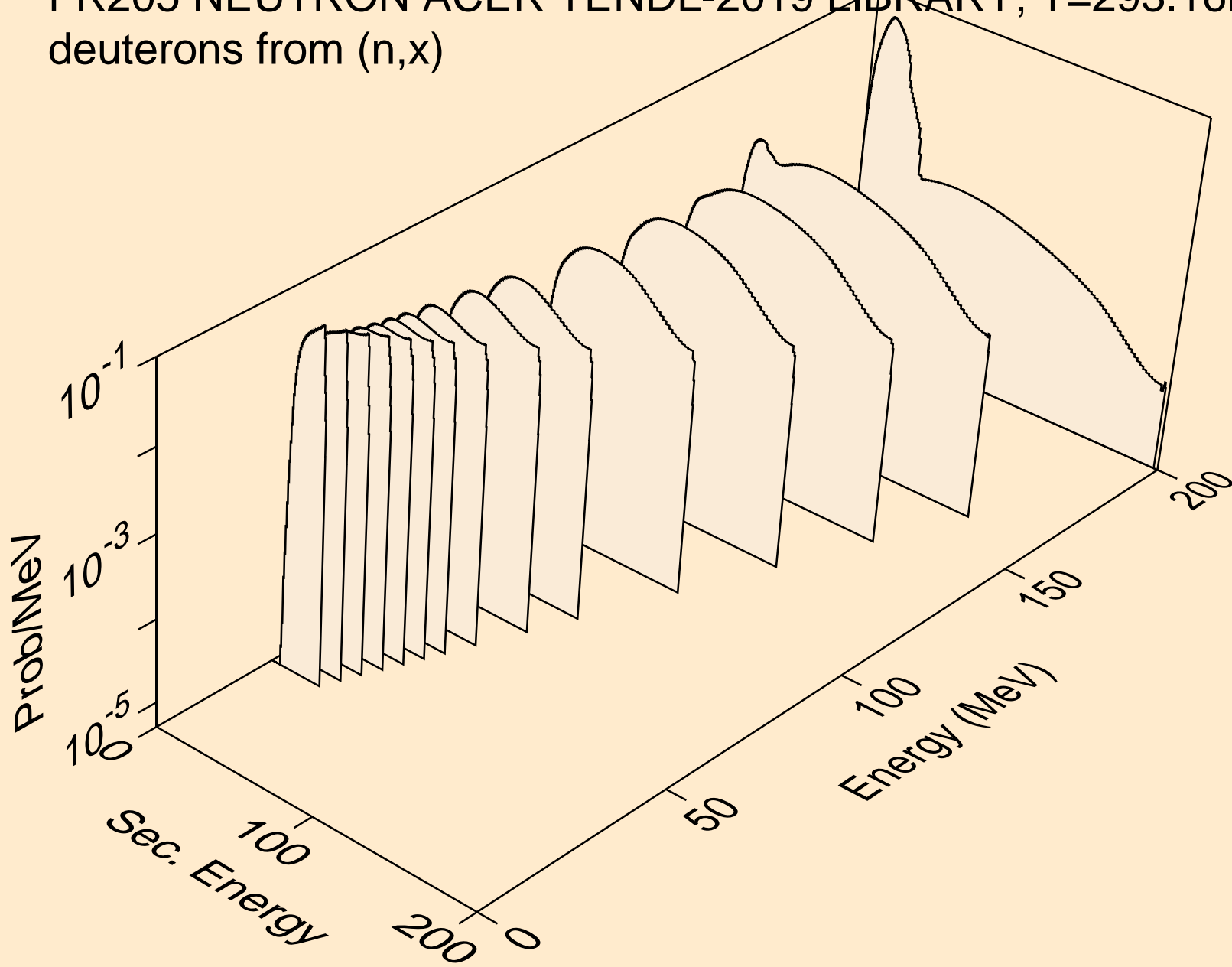

FR205 NEUTRON ACER TENDL-2019 LIBRARY; T=293.16K
deuterons from (n,2nd)

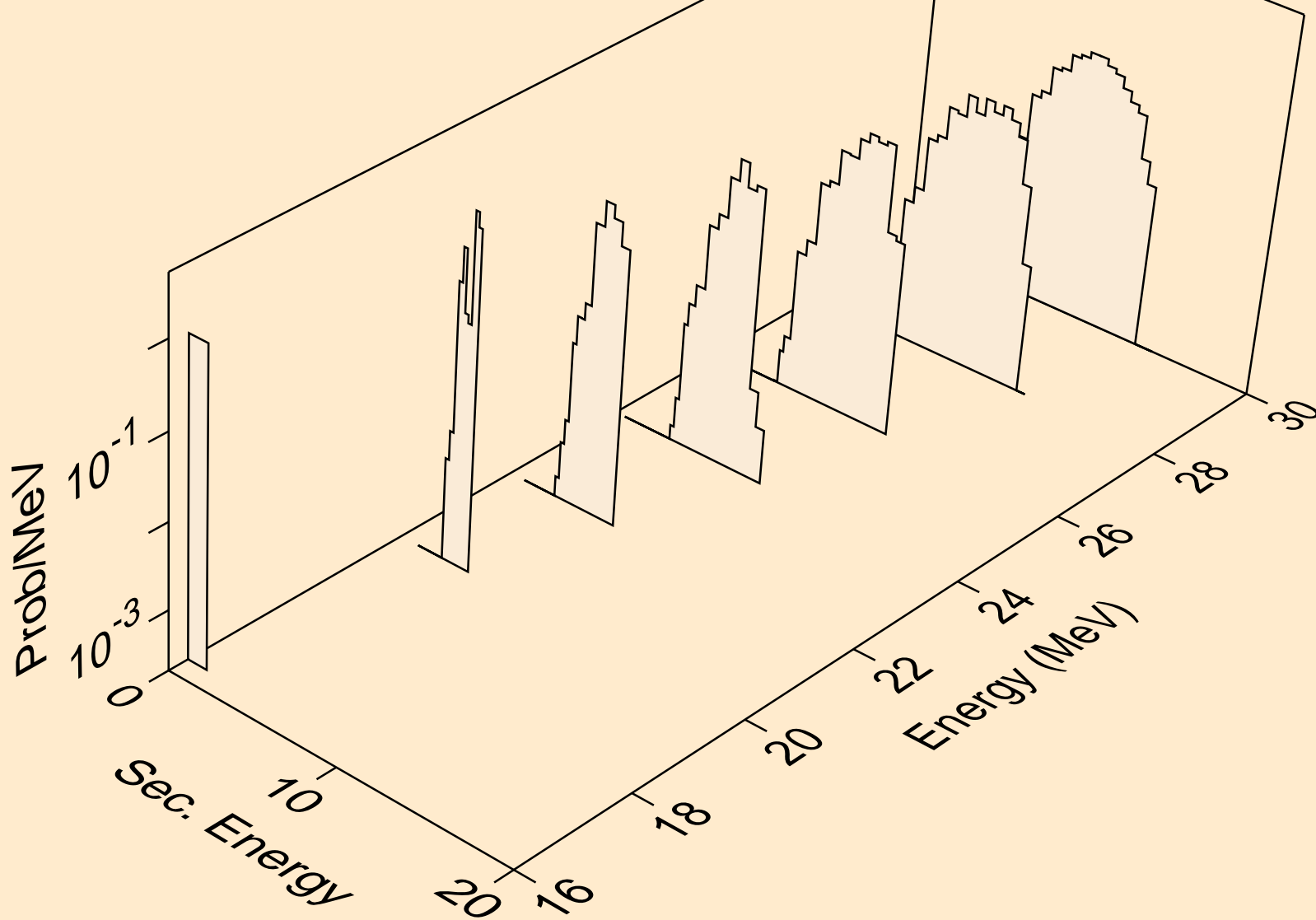

FR205 NEUTRON ACER TENDL-2019 LIBRARY; T=293.16K
deuterons from (n,n*)d

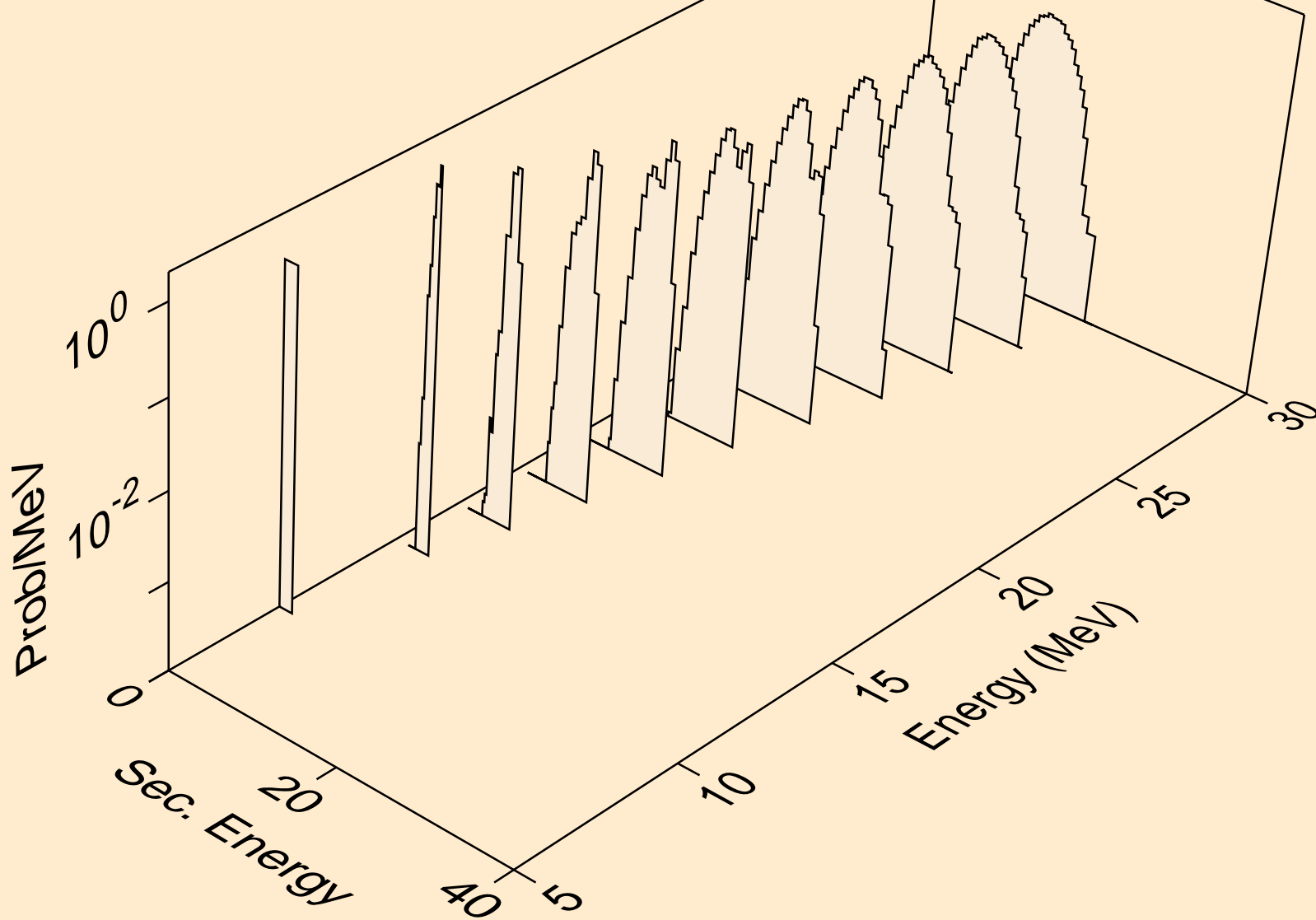

FR205 NEUTRON ACER TENDL-2019 LIBRARY; T=293.16K
deuterons from (n,d)

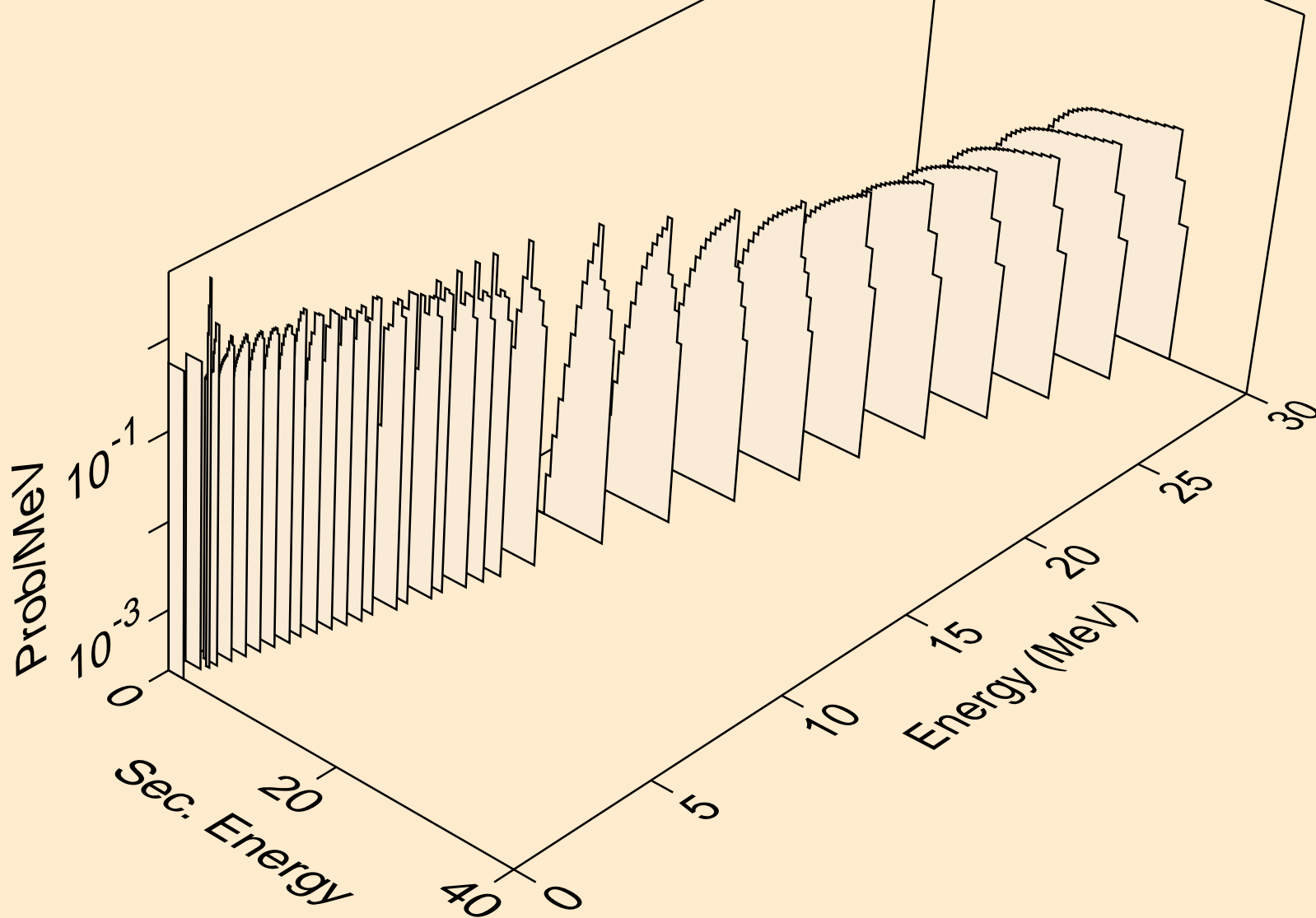

FR205 NEUTRON ACER TENDL-2019 LIBRARY; T=293.16K
deuterons from (n,pd)

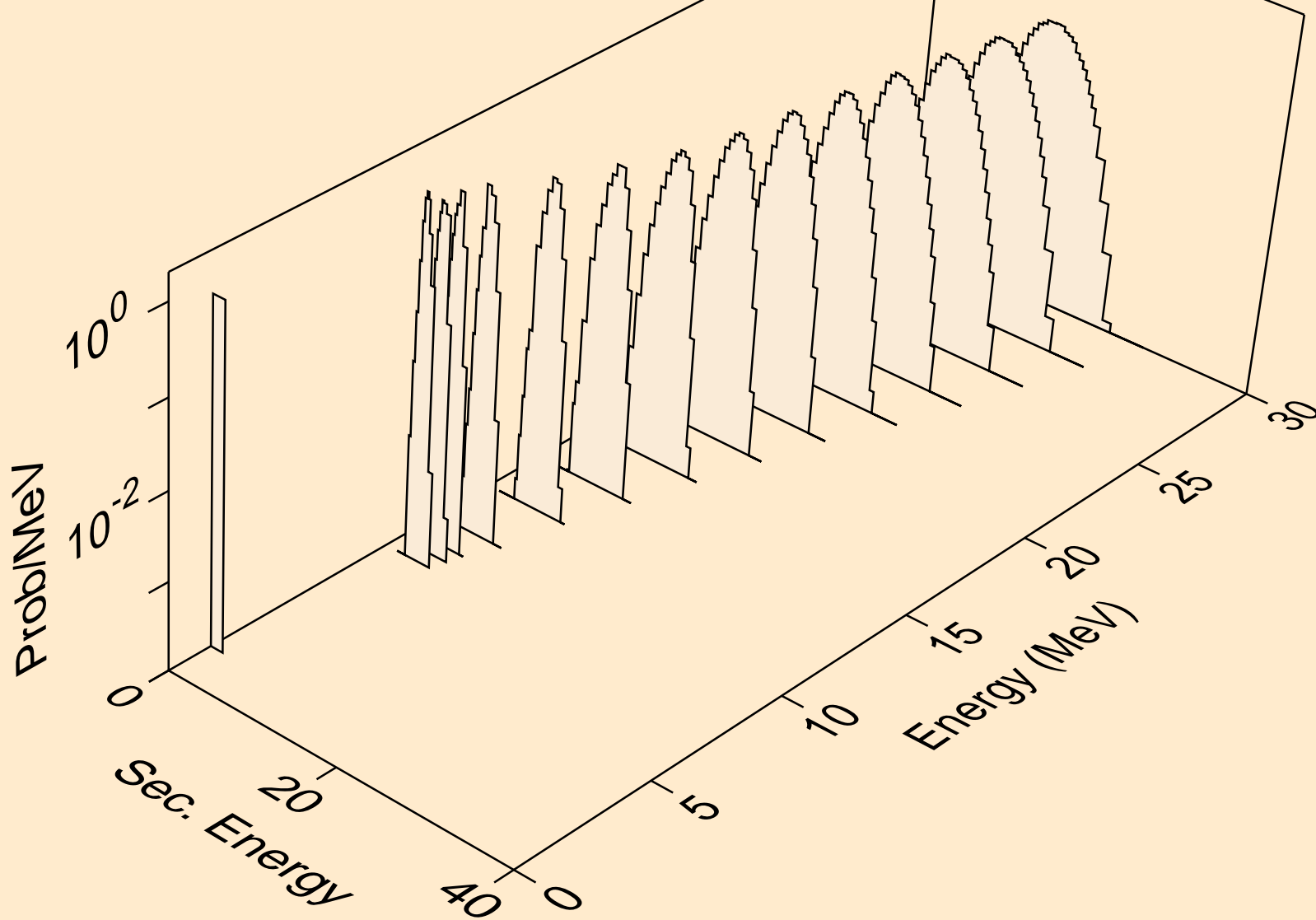

FR205 NEUTRON ACER TENDL-2019 LIBRARY; T=293.16K
deuterons from (n,da)

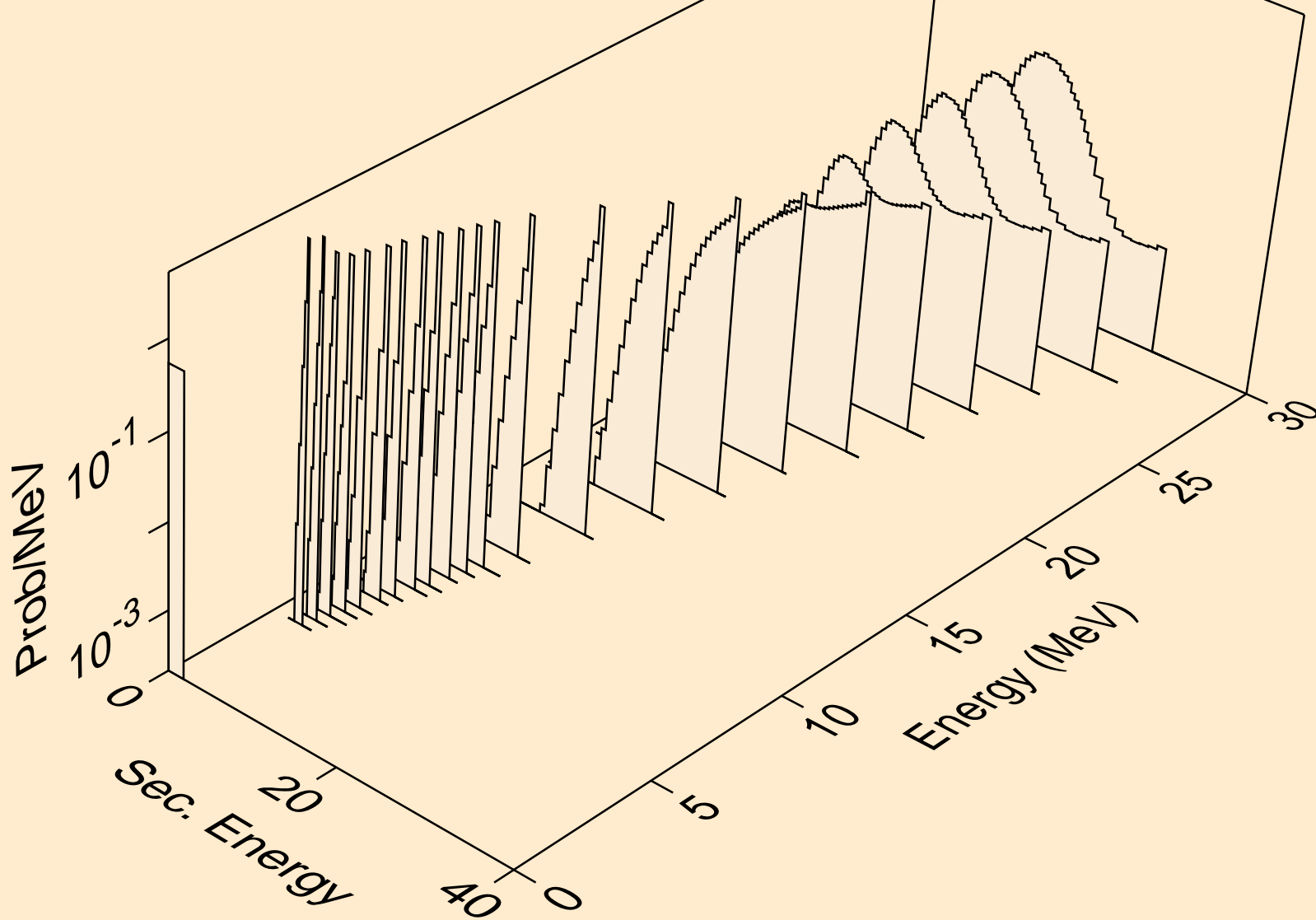

FR205 NEUTRON ACER TENDL-2019 LIBRARY; T=293.16K
tritons from (n,x)

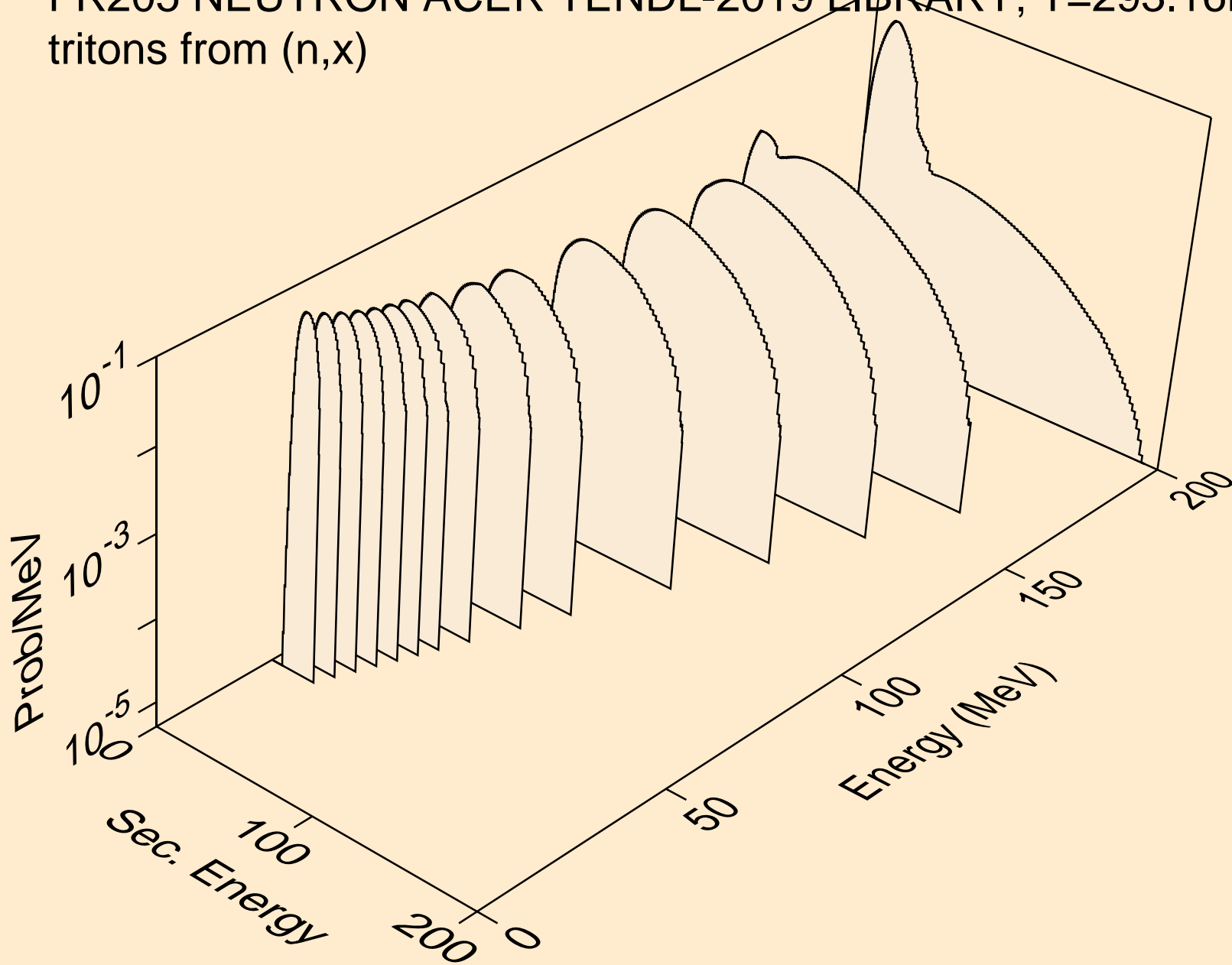

FR205 NEUTRON ACER TENDL-2019 LIBRARY; T=293.16K
tritons from (n,n*)t

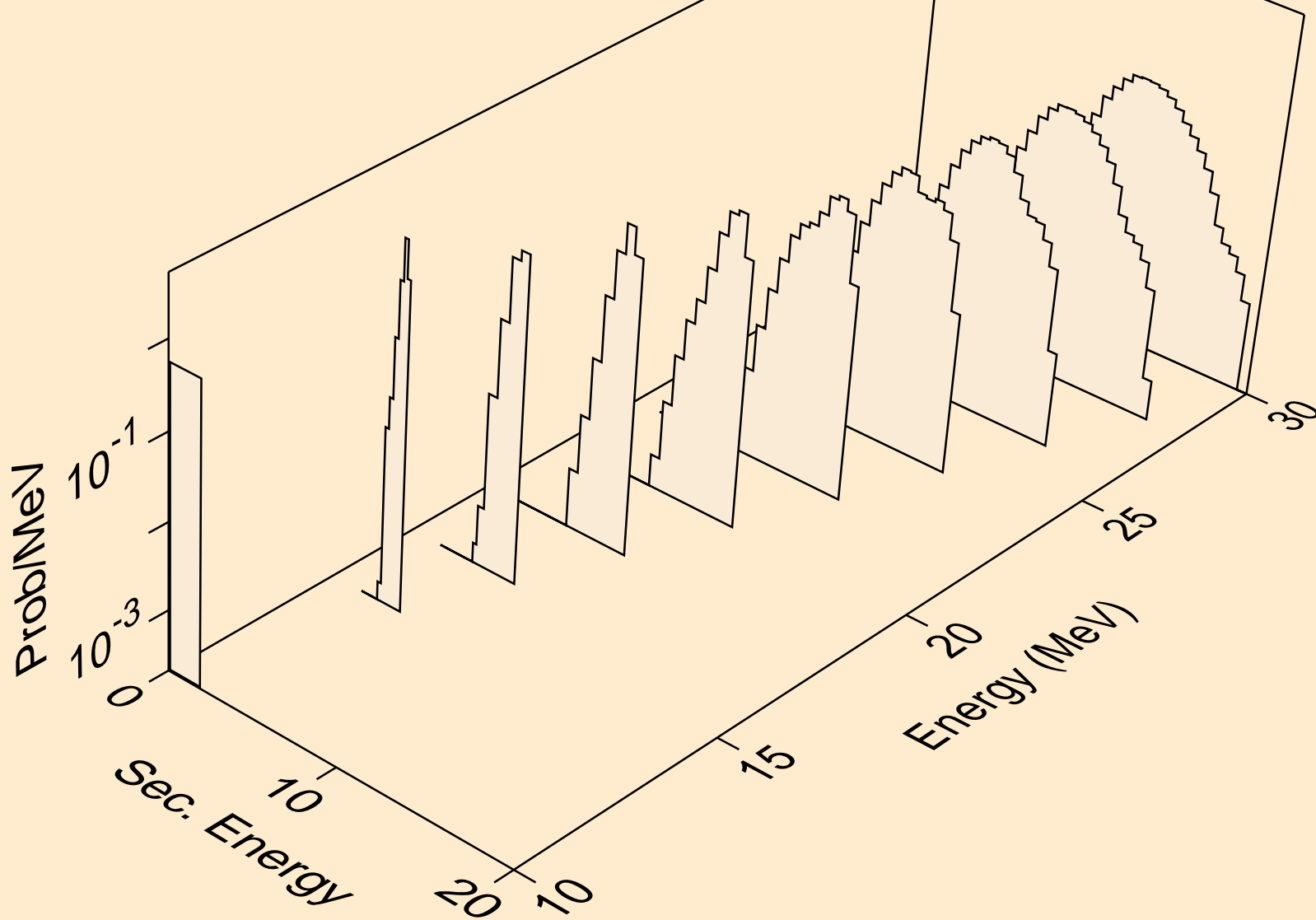

FR205 NEUTRON ACER TENDL-2019 LIBRARY; T=293.16K
tritons from (n,t)

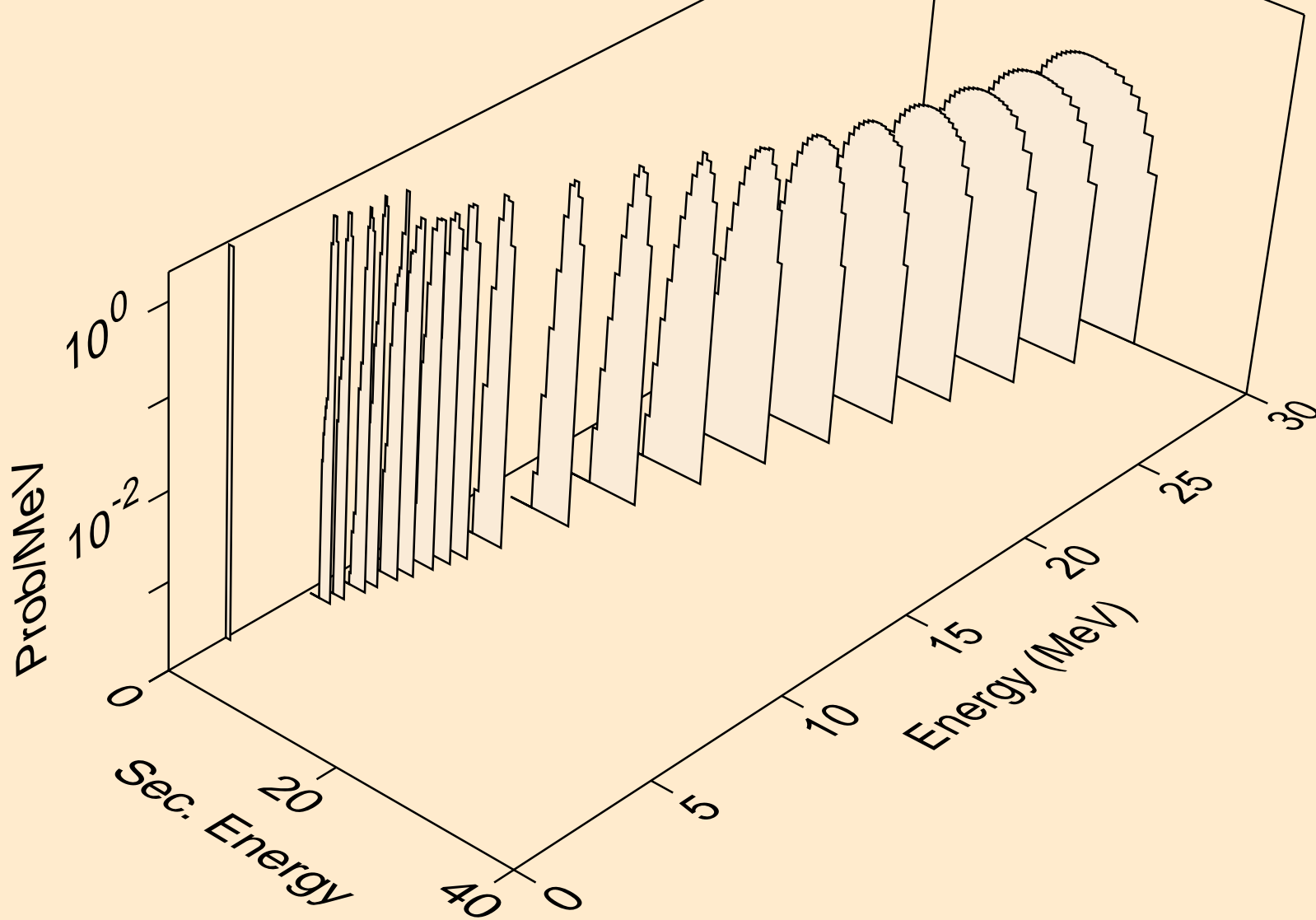

FR205 NEUTRON ACER TENDL-2019 LIBRARY; T=293.16K
tritons from (n,pt)

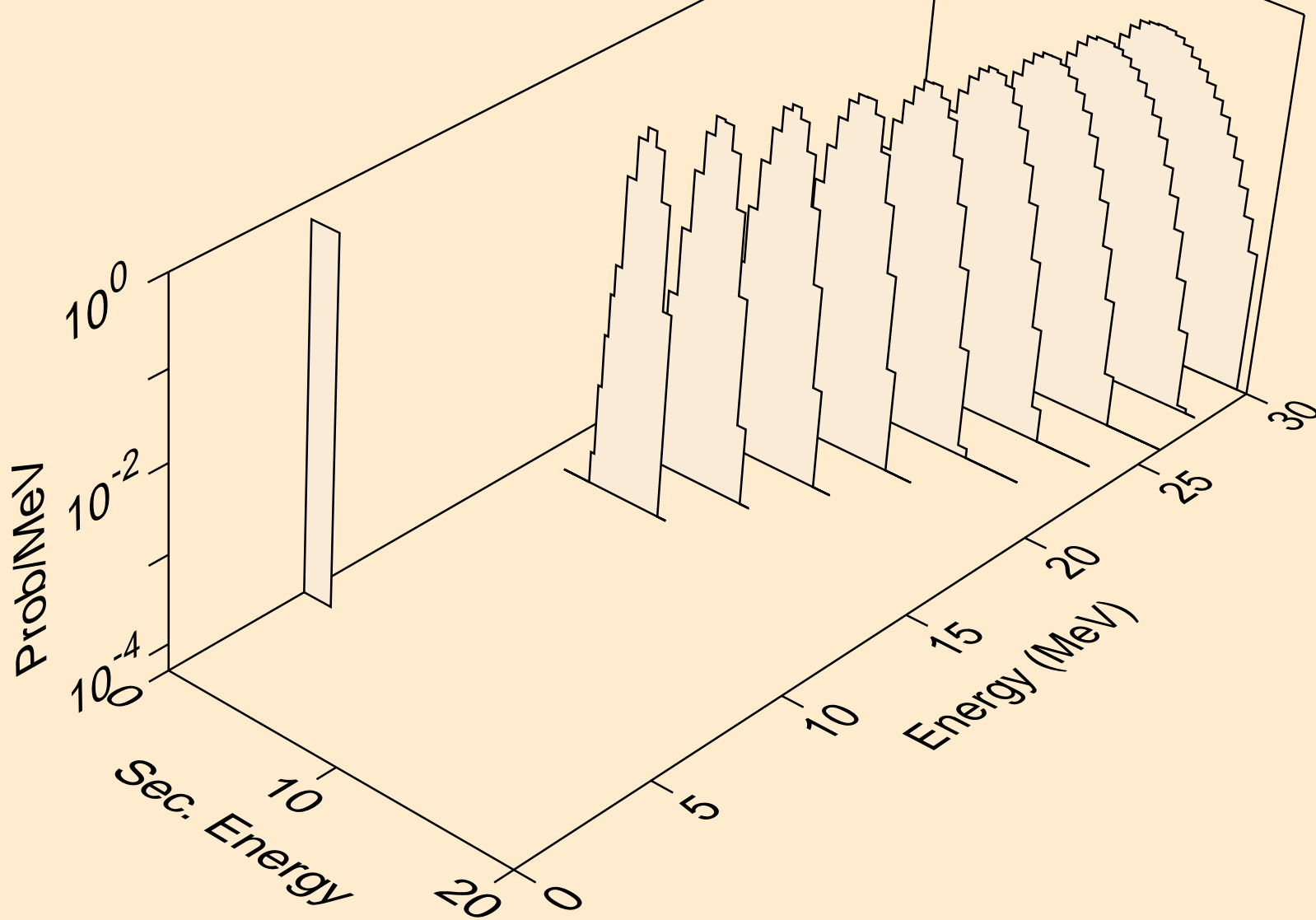

FR205 NEUTRON ACER TENDL-2019 LIBRARY; T=293.16K
he3s from (n,x)

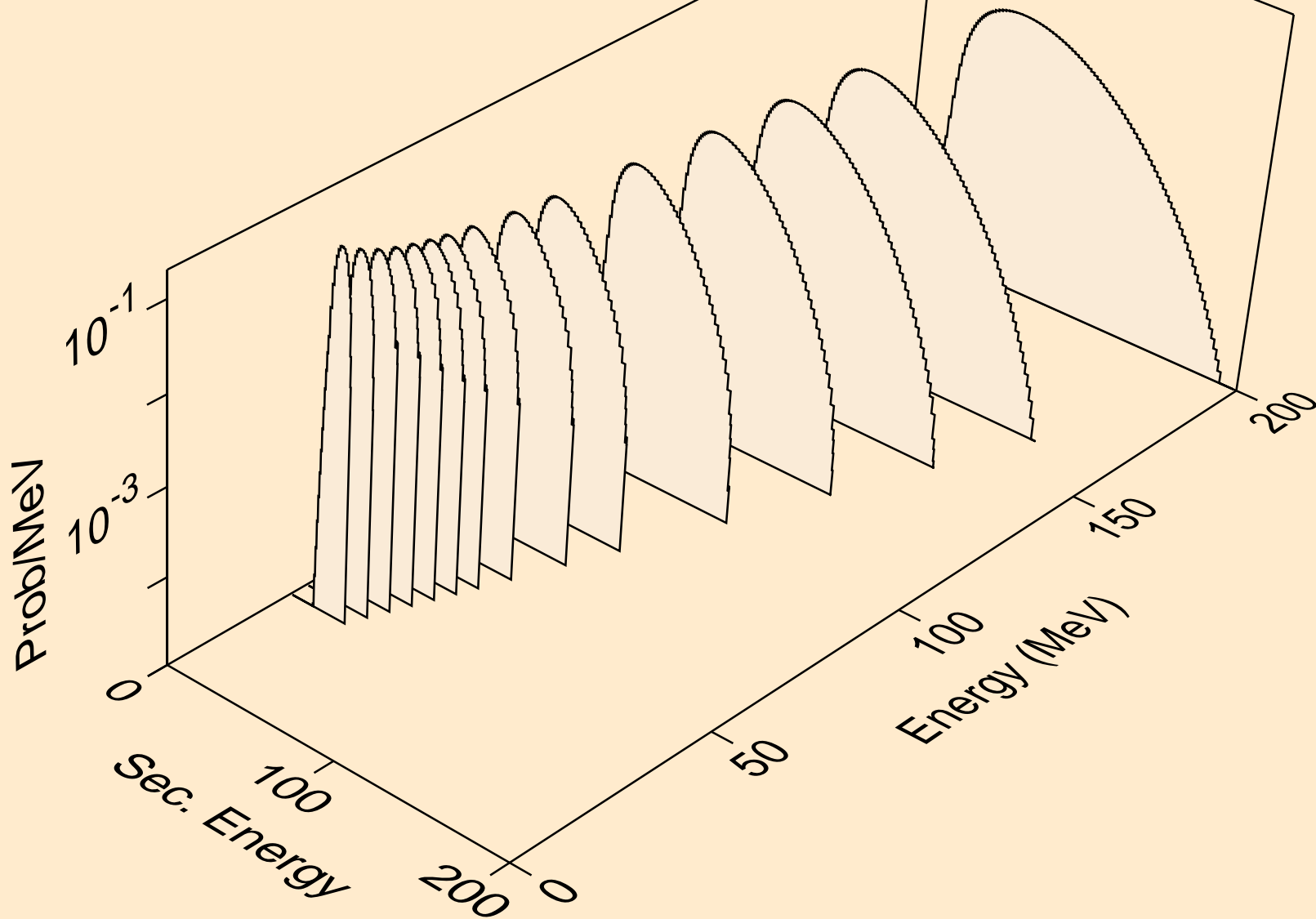

FR205 NEUTRON ACER TENDL-2019 LIBRARY; T=293.16K
he3s from (n,n*)he3

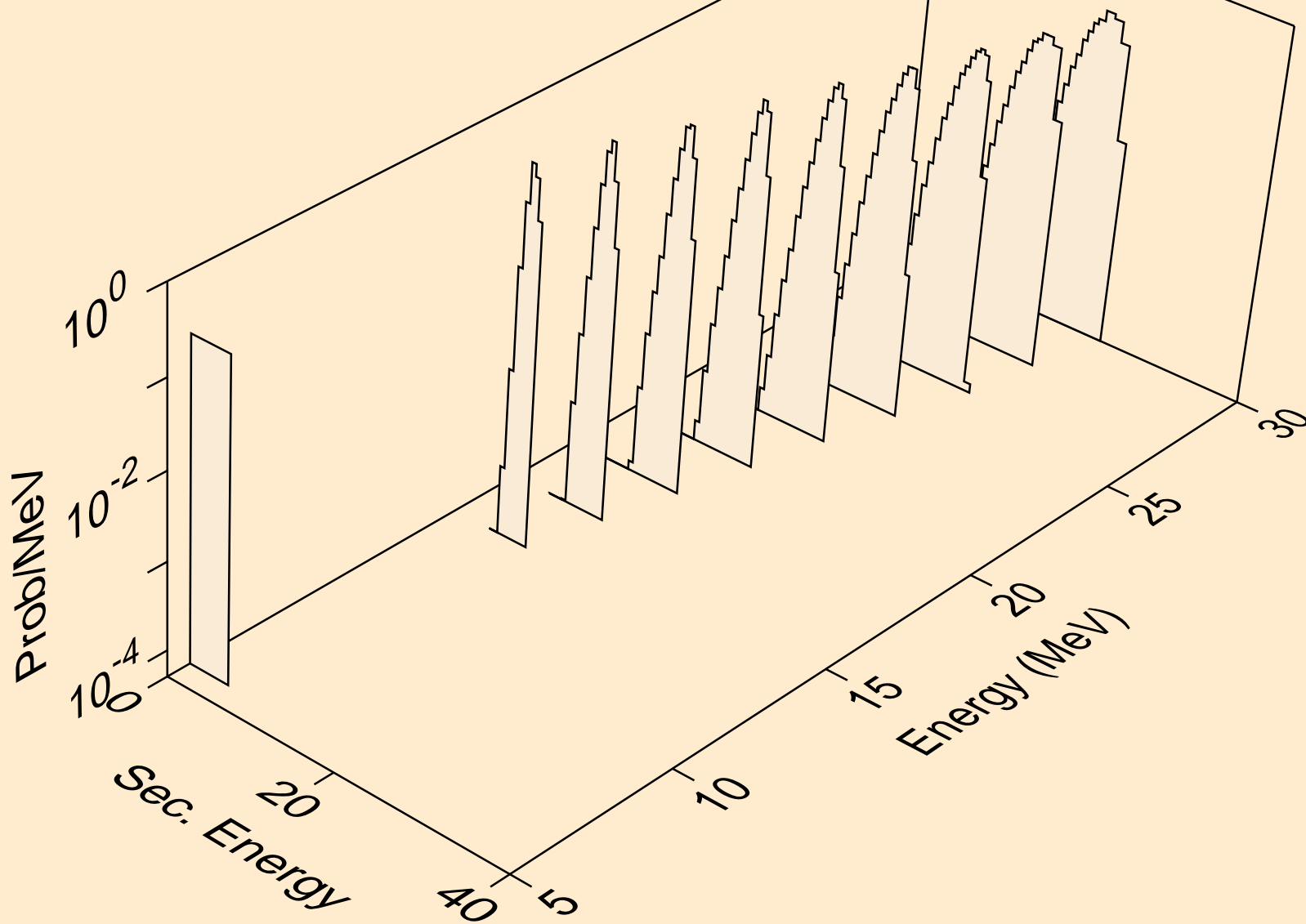

FR205 NEUTRON ACER TENDL-2019 LIBRARY; T=293.16K
he3s from (n,he3)

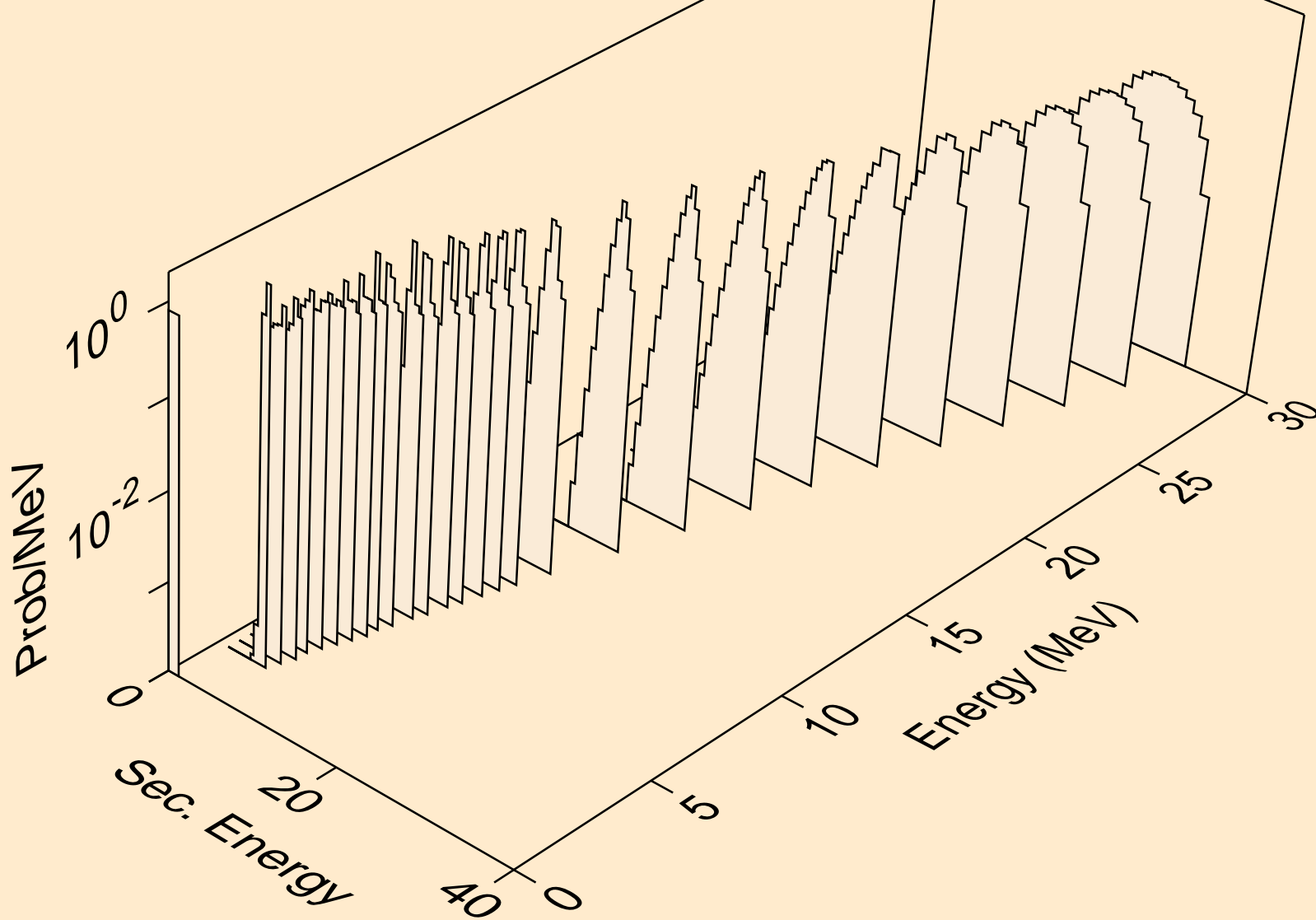

FR205 NEUTRON ACER TENDL-2019 LIBRARY; T=293.16K
alphas from (n,x)

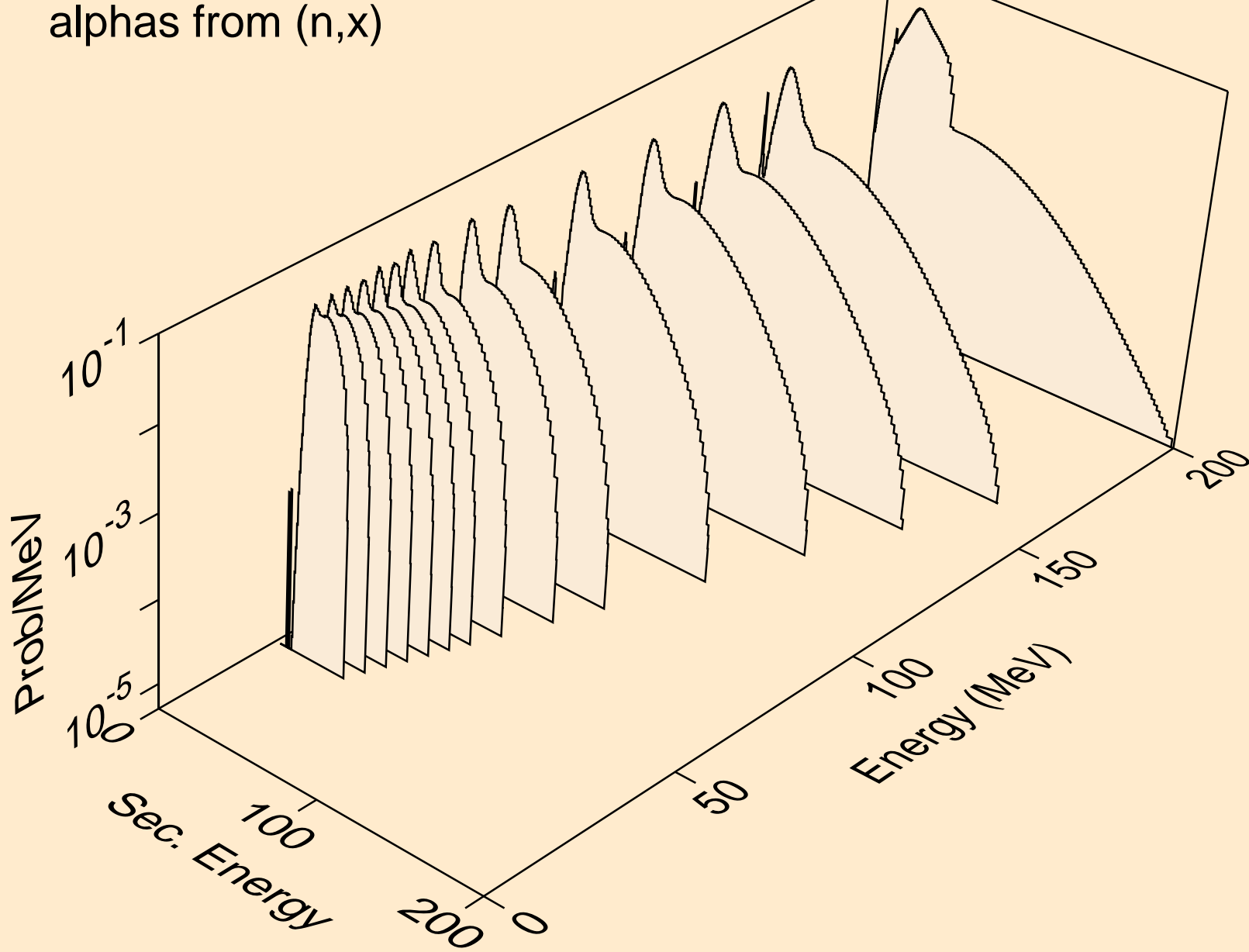

FR205 NEUTRON ACER TENDL-2019 LIBRARY; T=293.16K
alphas from (n,n*)a

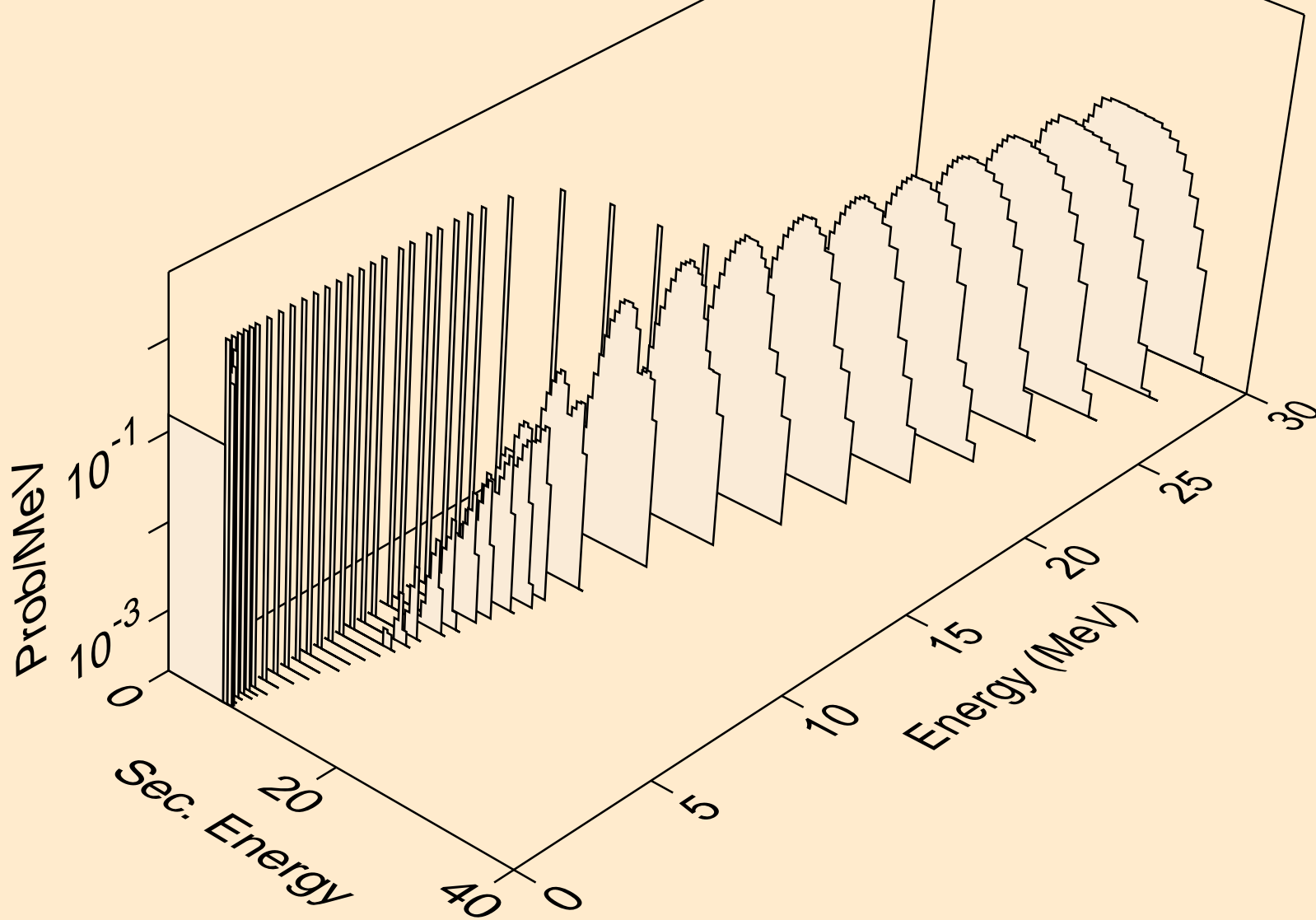

FR205 NEUTRON ACER TENDL-2019 LIBRARY; T=293.16K
alphas from (n,2n)a

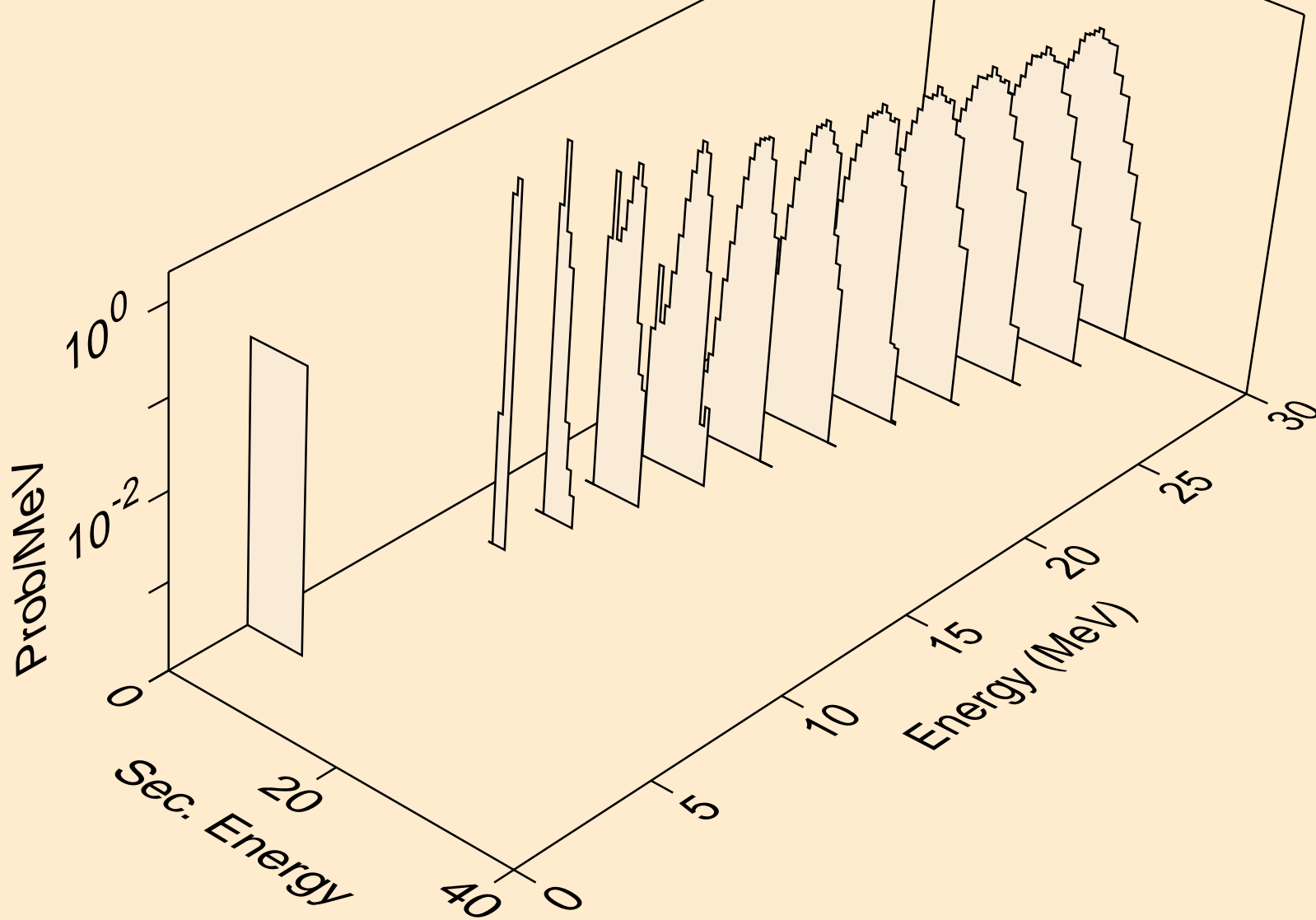

FR205 NEUTRON ACER TENDL-2019 LIBRARY; T=293.16K
alphas from (n,3n)a

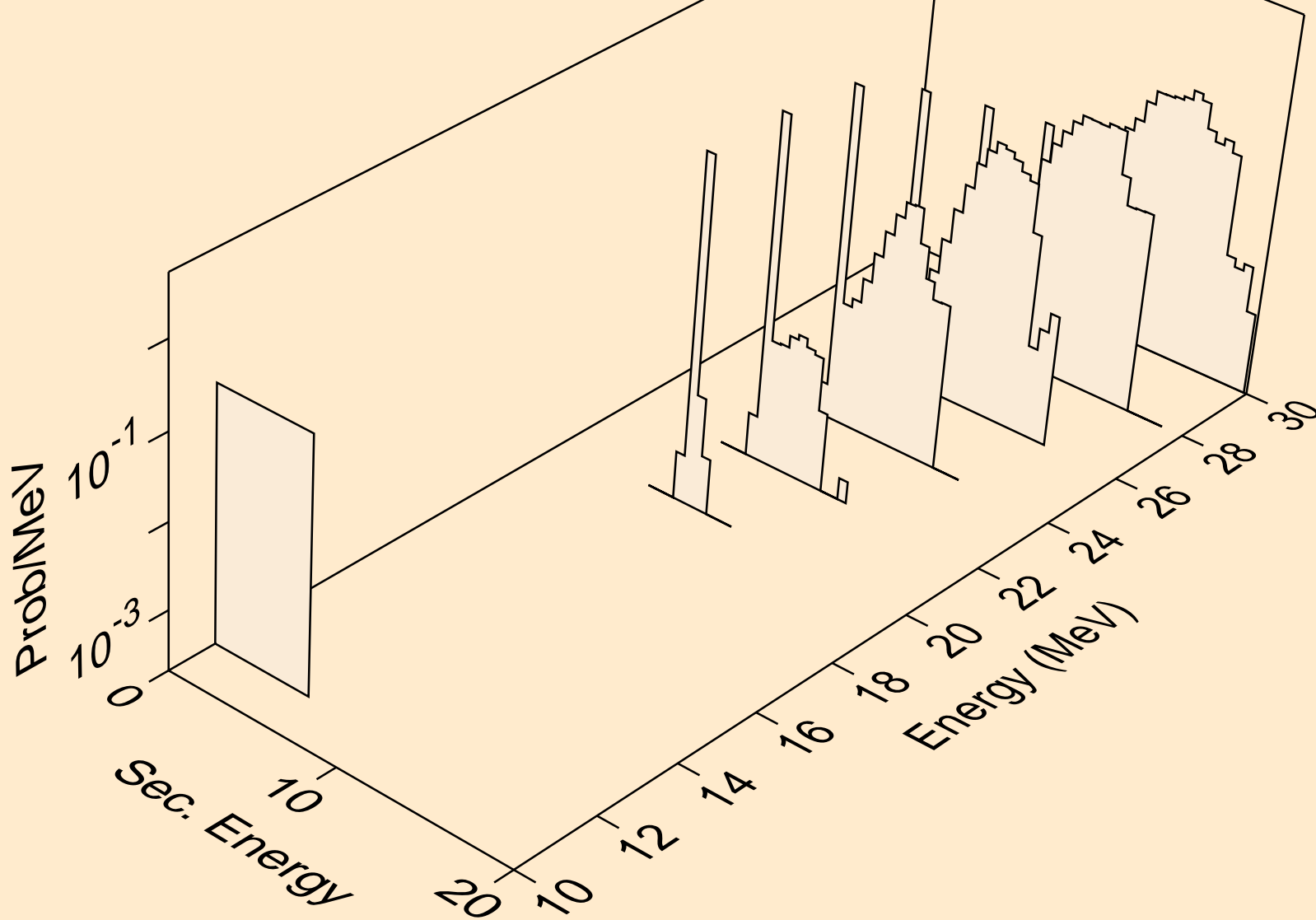

FR205 NEUTRON ACER TENDL-2019 LIBRARY; T=293.16K
alphas from (n,n*)2a

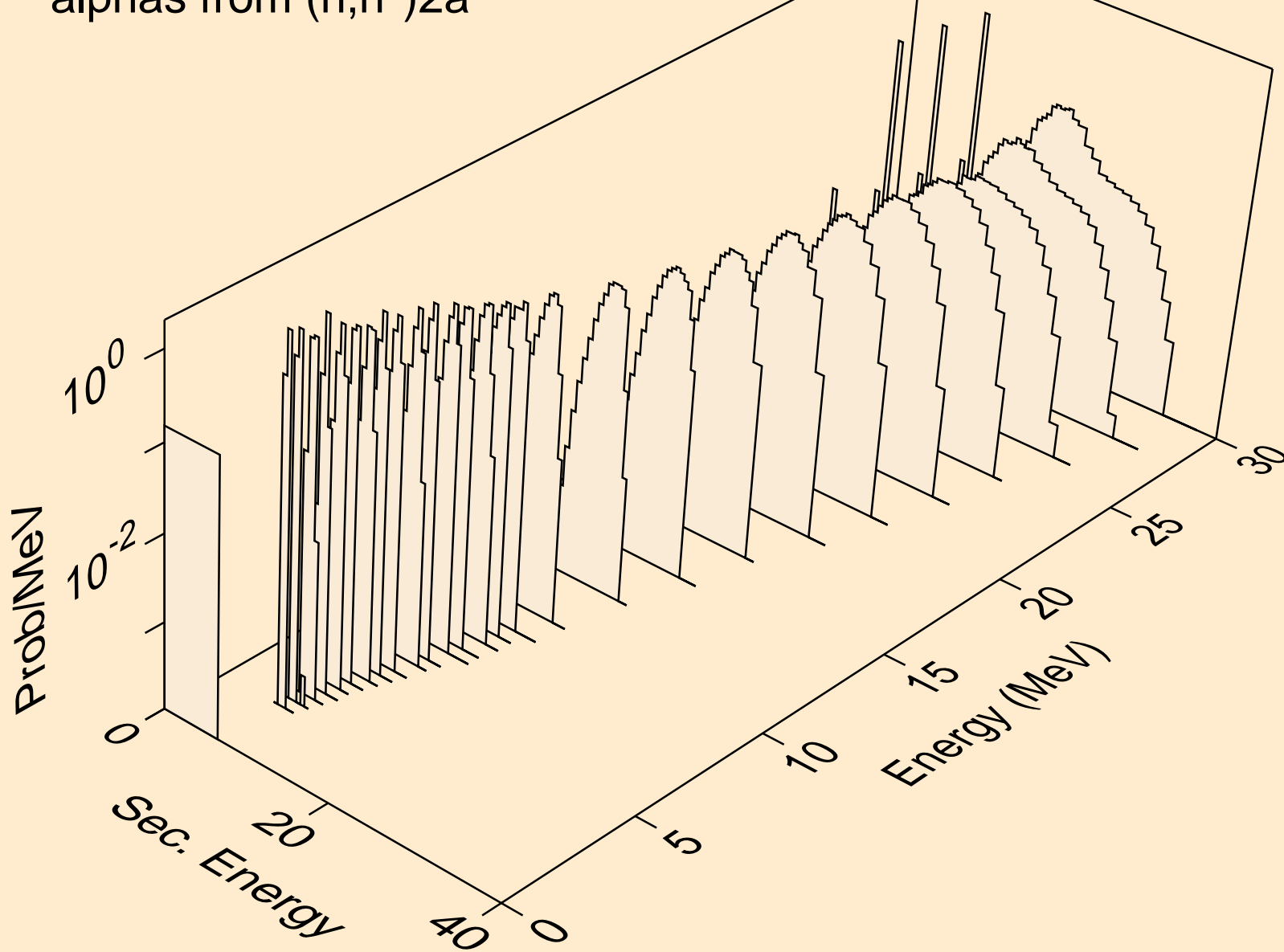

FR205 NEUTRON ACER TENDL-2019 LIBRARY; T=293.16K
alphas from (n,2n)2a

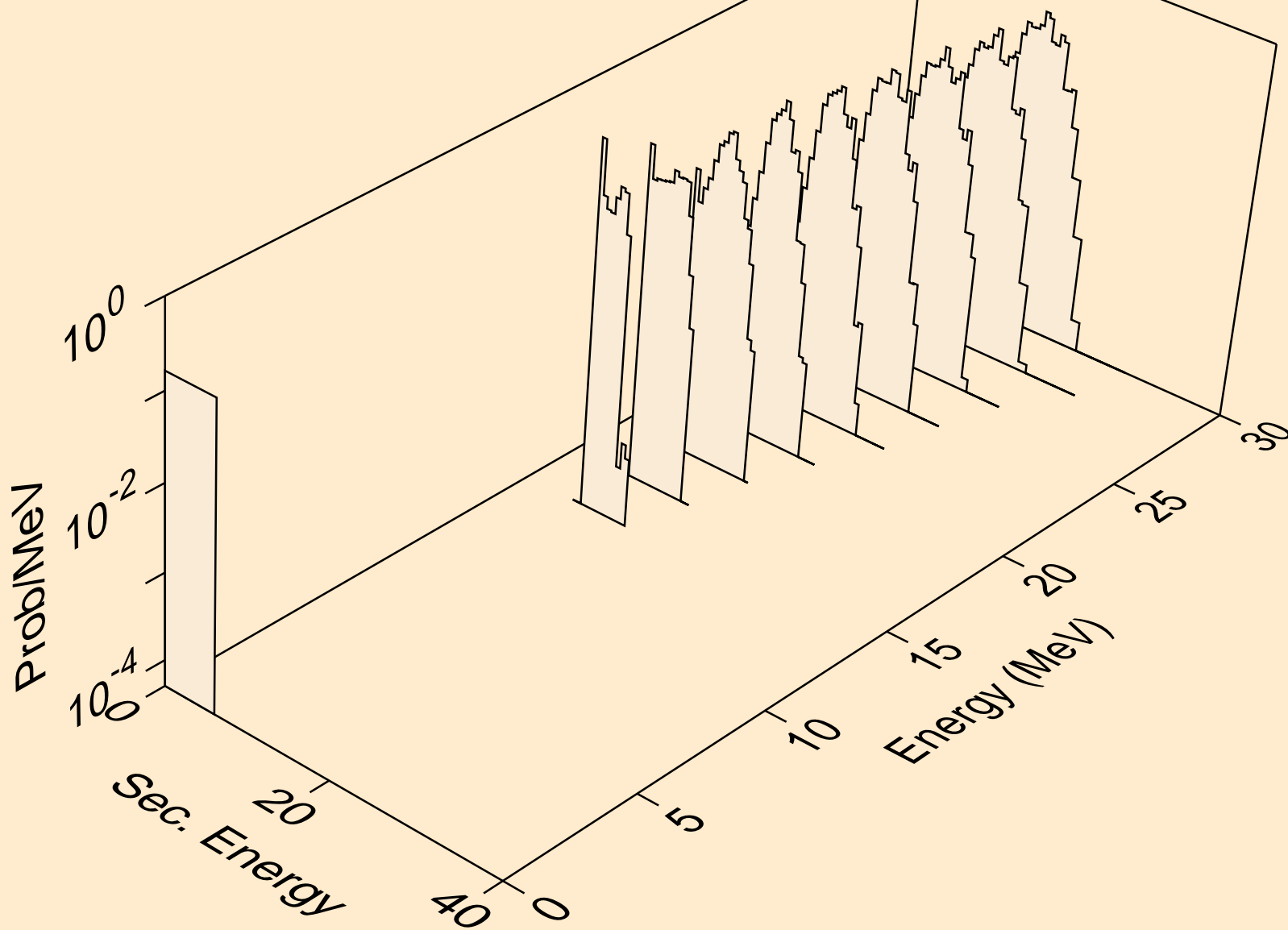

FR205 NEUTRON ACER TENDL-2019 LIBRARY; T=293.16K
alphas from (n,npa)

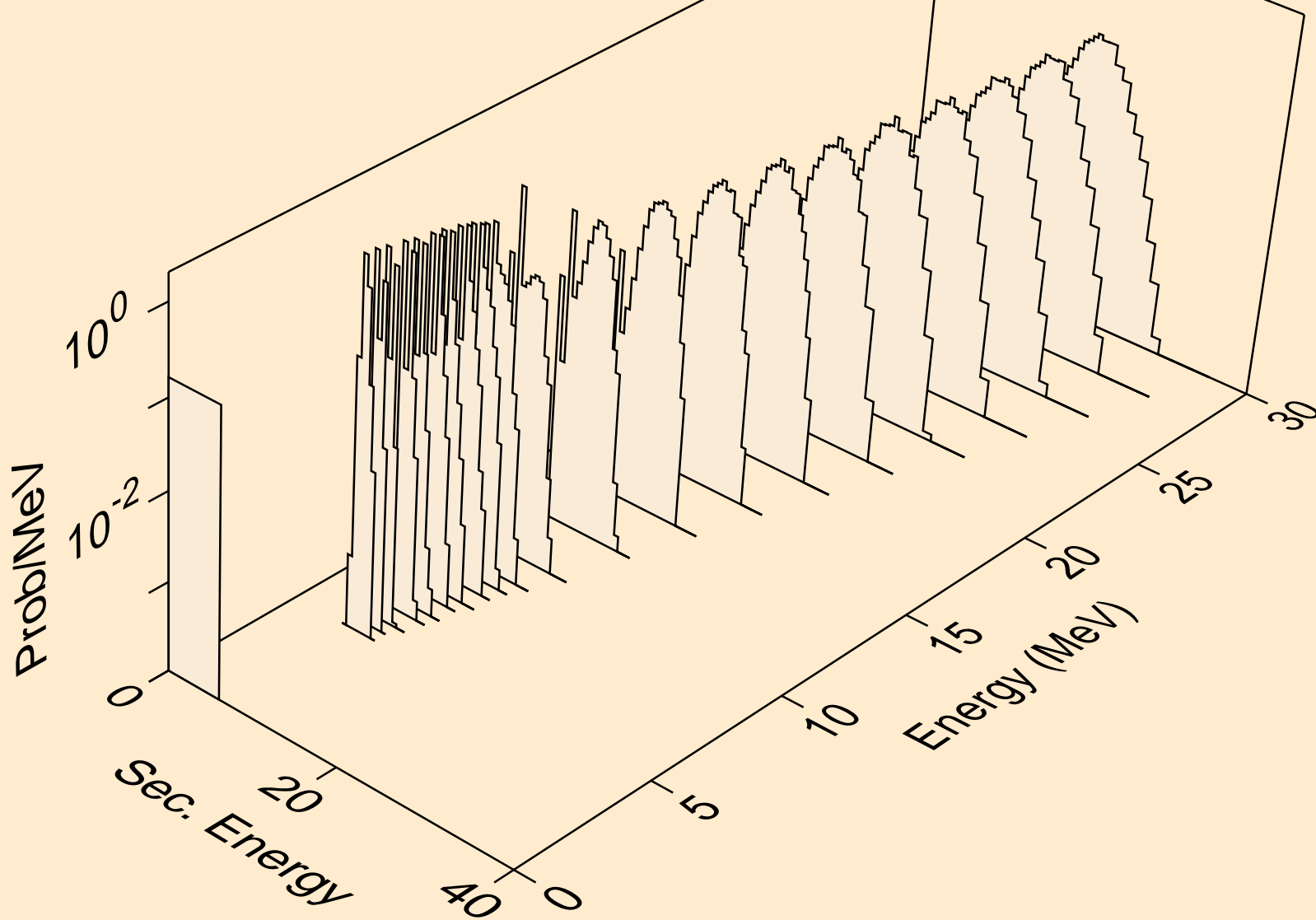

FR205 NEUTRON ACER TENDL-2019 LIBRARY; T=293.16K
alphas from (n,a)

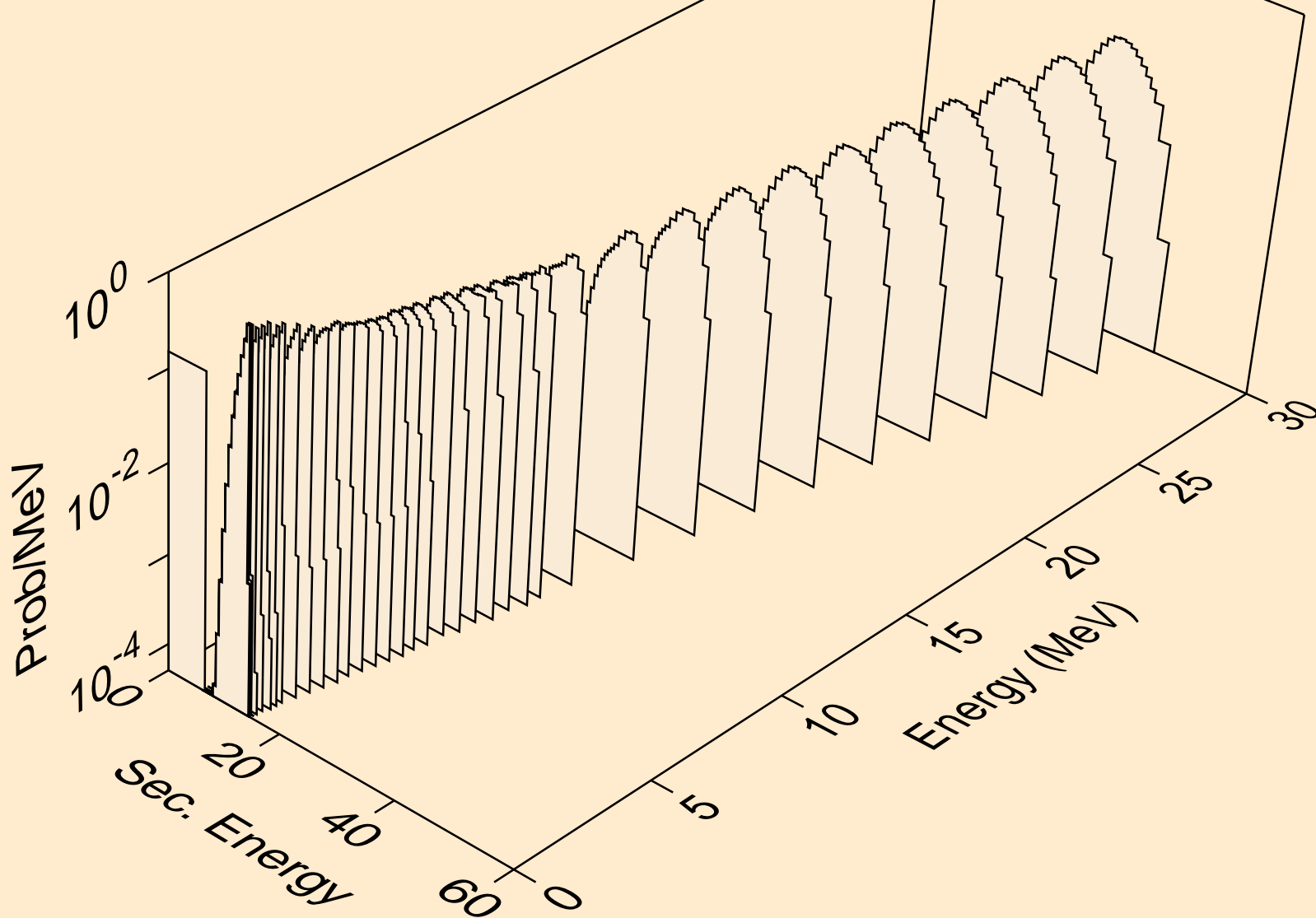

FR205 NEUTRON ACER TENDL-2019 LIBRARY; T=293.16K
alphas from (n,2a)

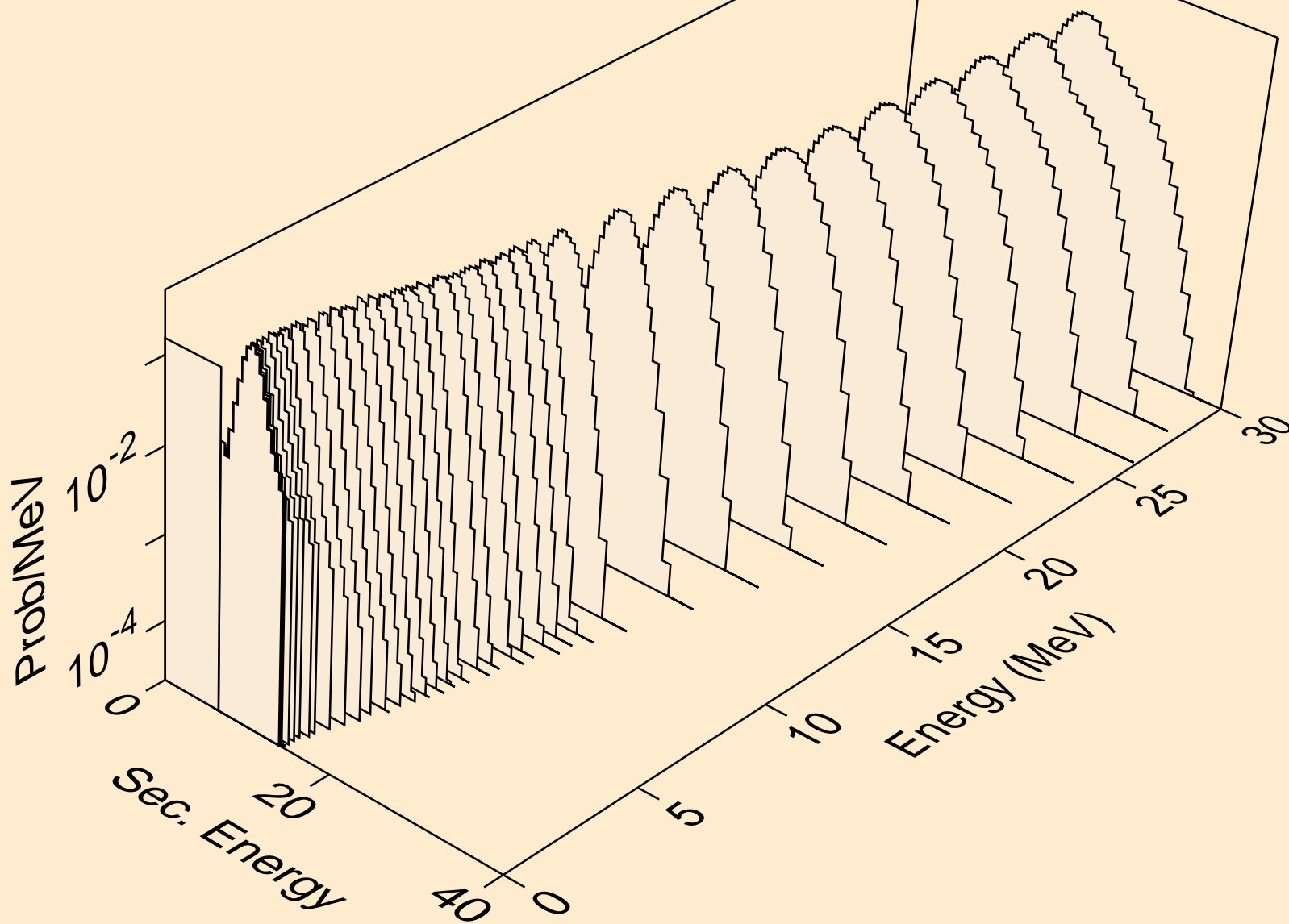

FR205 NEUTRON ACER TENDL-2019 LIBRARY; T=293.16K
alphas from (n,pa)

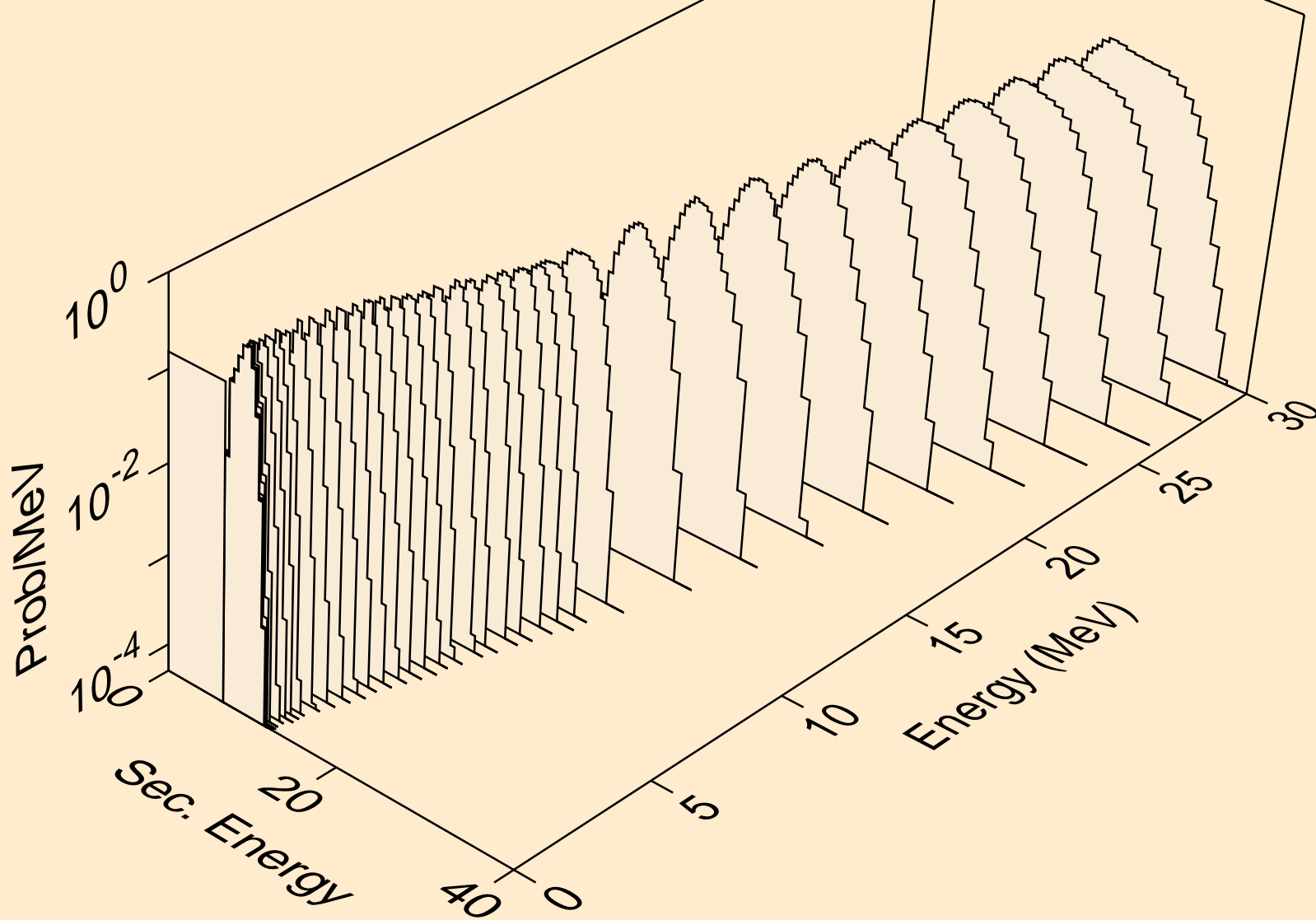

FR205 NEUTRON ACER TENDL-2019 LIBRARY; T=293.16K
alphas from (n,da)

