

FR208 NEUTRON ACER TENDL-2019 LIBRARY; T=293.16K  
Principal cross sections

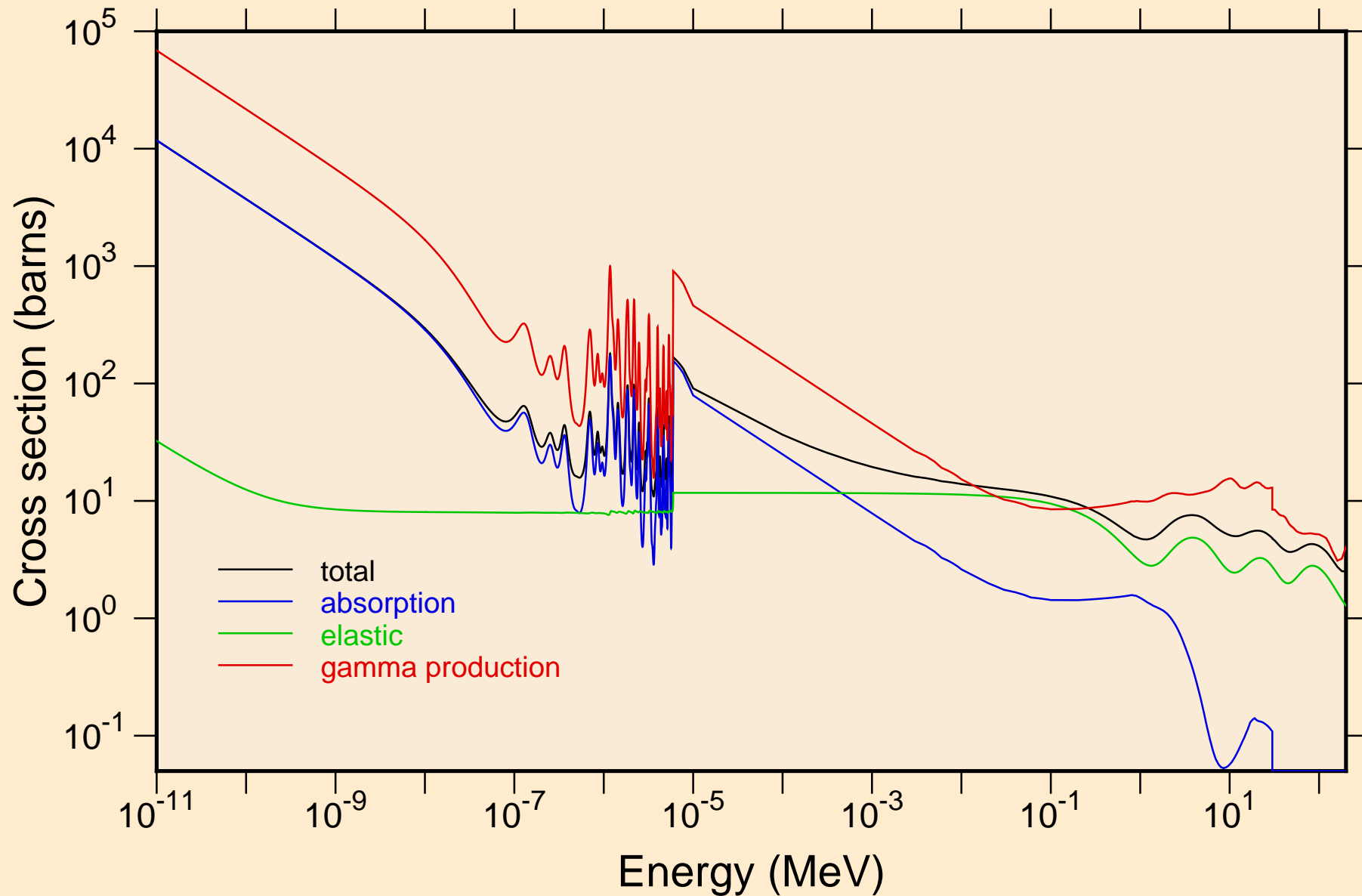

FR208 NEUTRON ACER TENDL-2019 LIBRARY; T=293.16K  
resonance total cross section

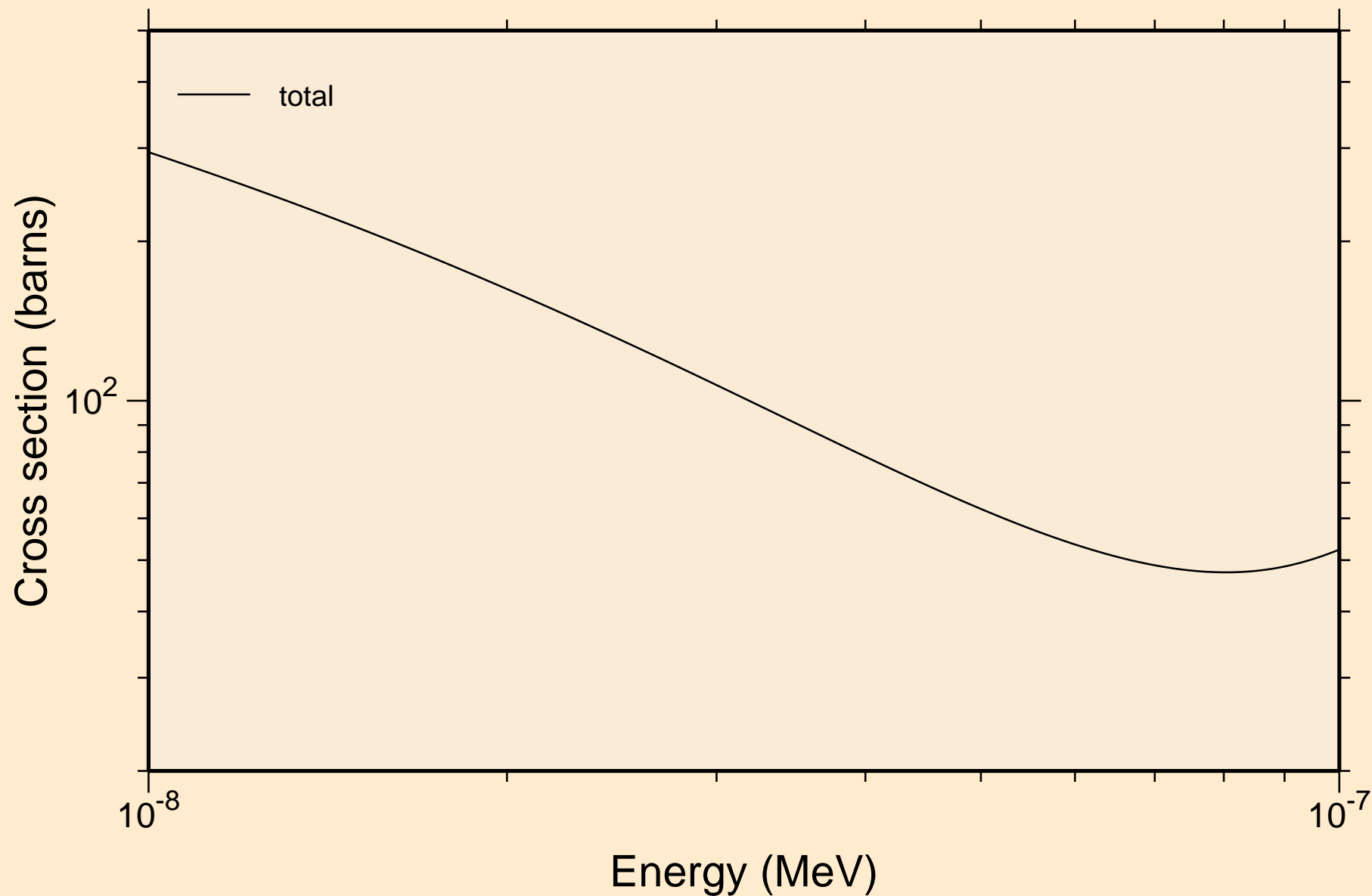

FR208 NEUTRON ACER TENDL-2019 LIBRARY; T=293.16K  
resonance total cross section

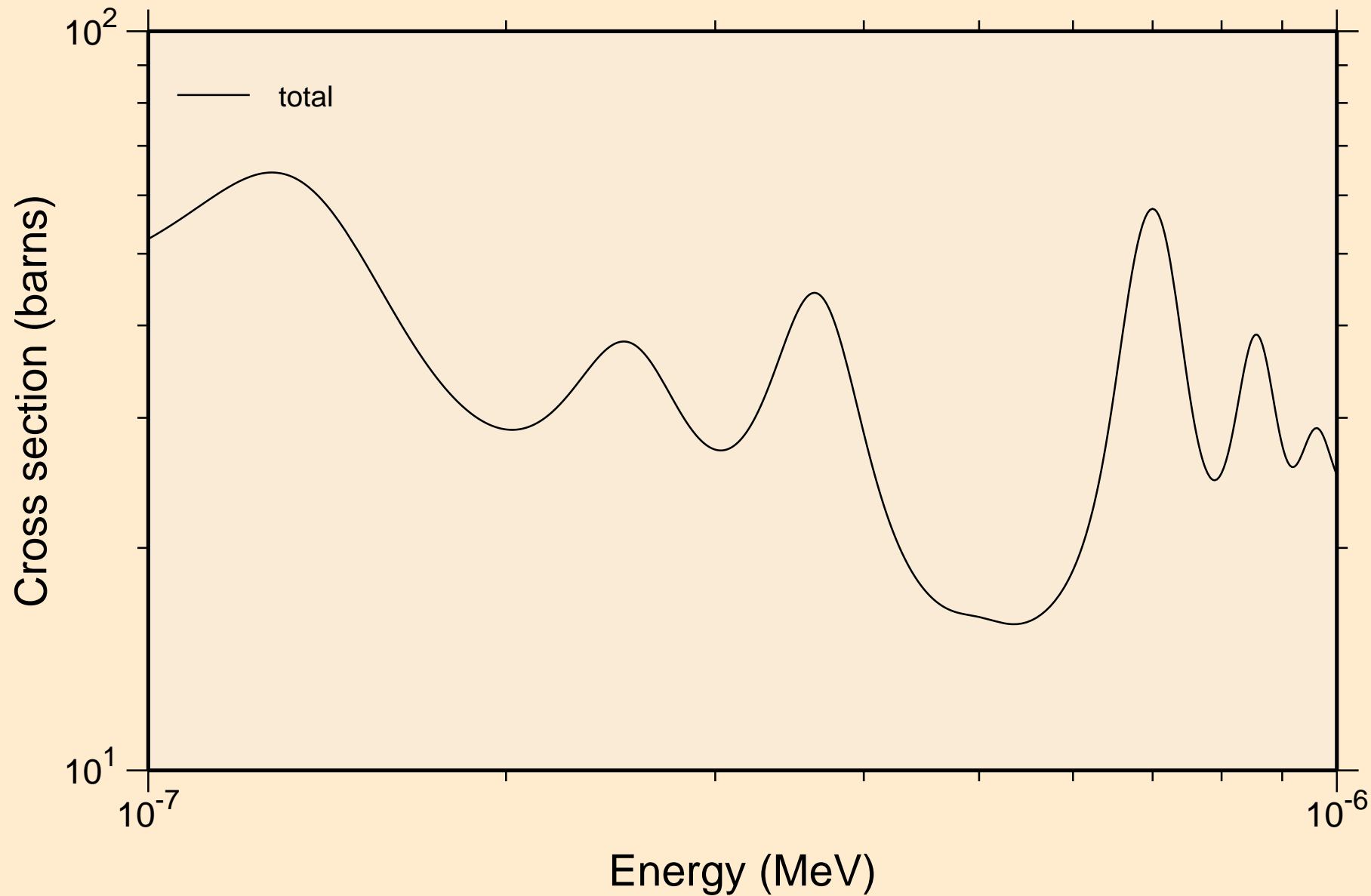

FR208 NEUTRON ACER TENDL-2019 LIBRARY; T=293.16K  
resonance total cross section

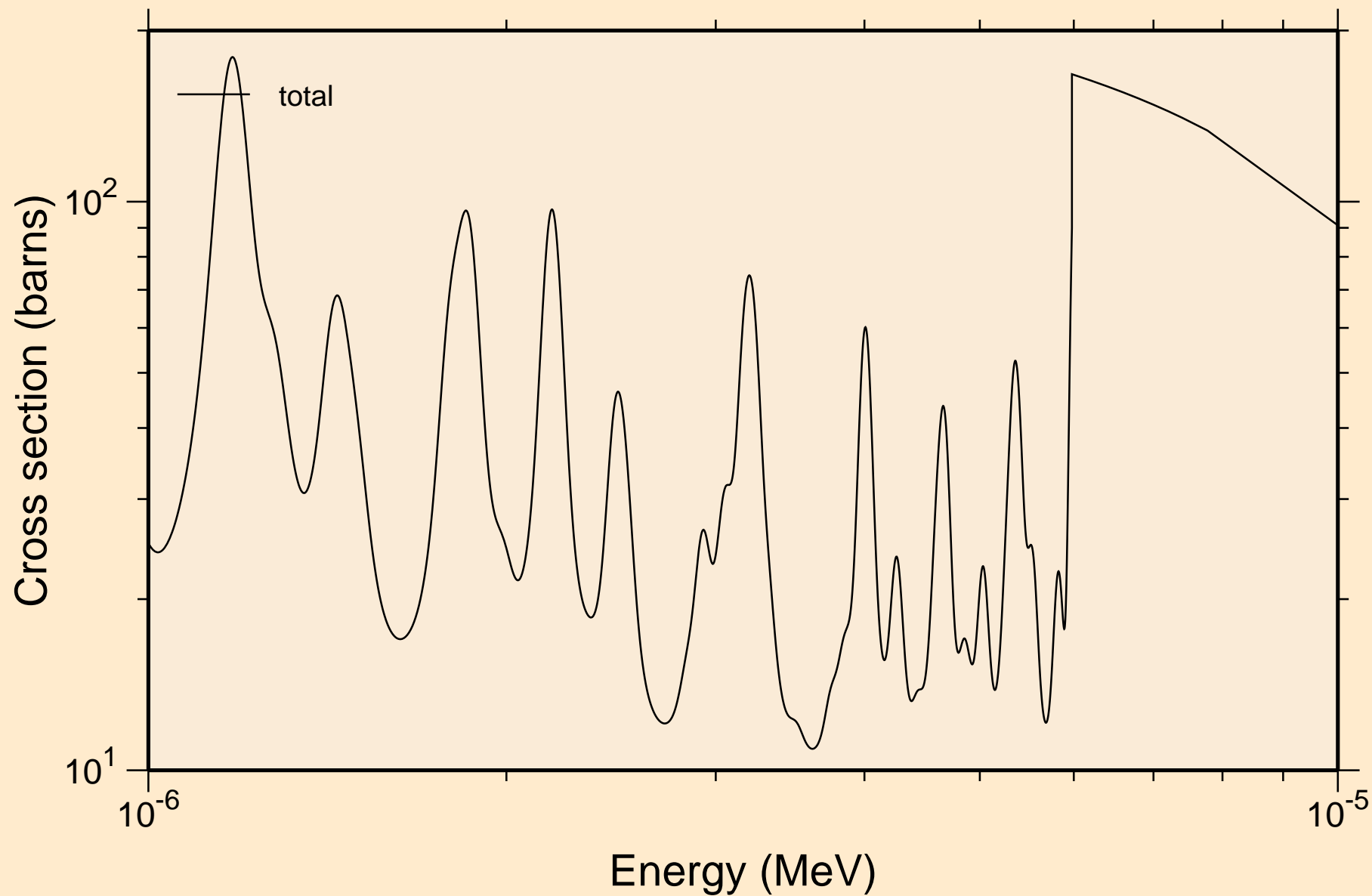

FR208 NEUTRON ACER TENDL-2019 LIBRARY; T=293.16K  
resonance total cross section

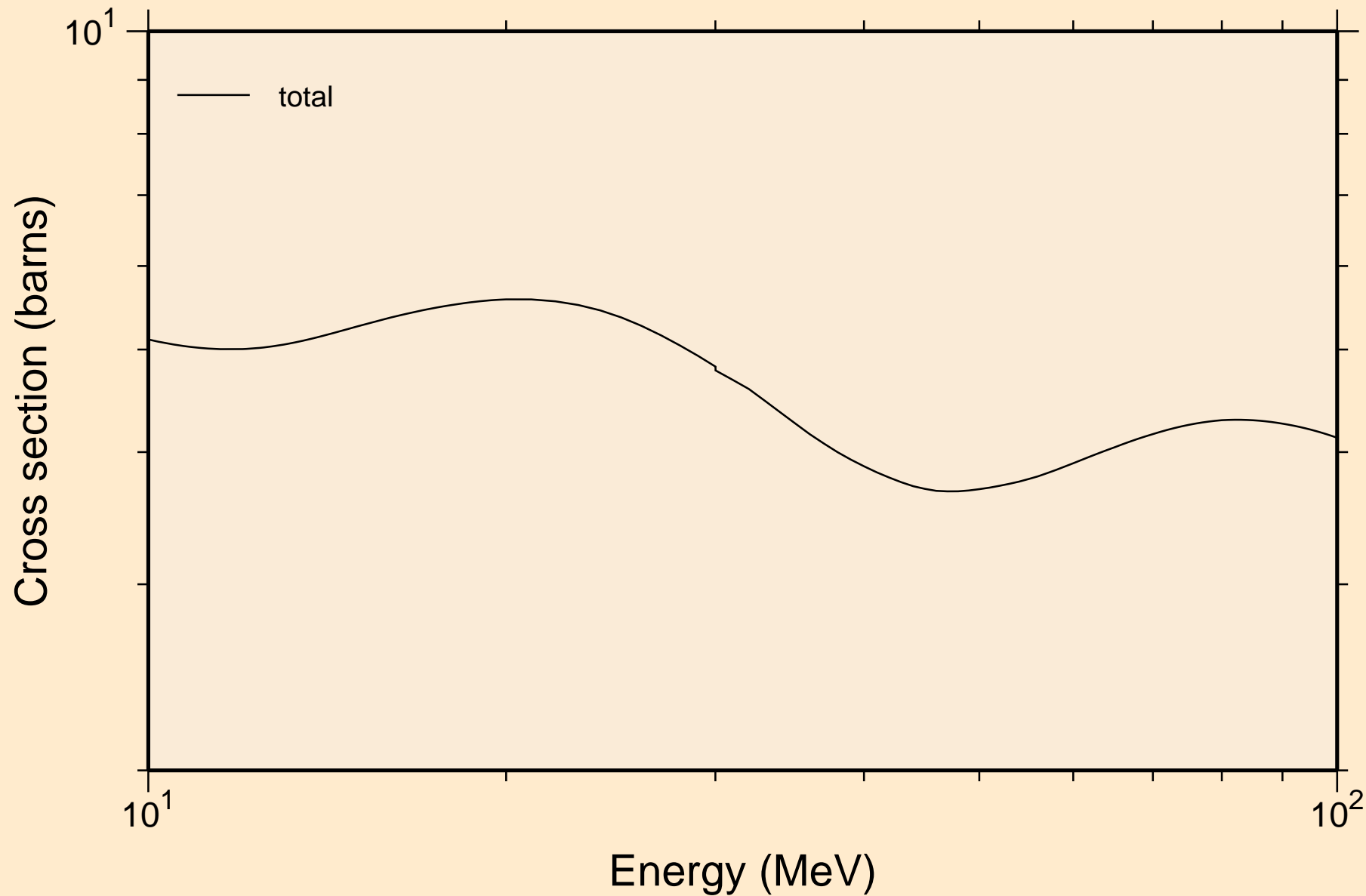

FR208 NEUTRON ACER TENDL-2019 LIBRARY; T=293.16K  
resonance absorption cross sections

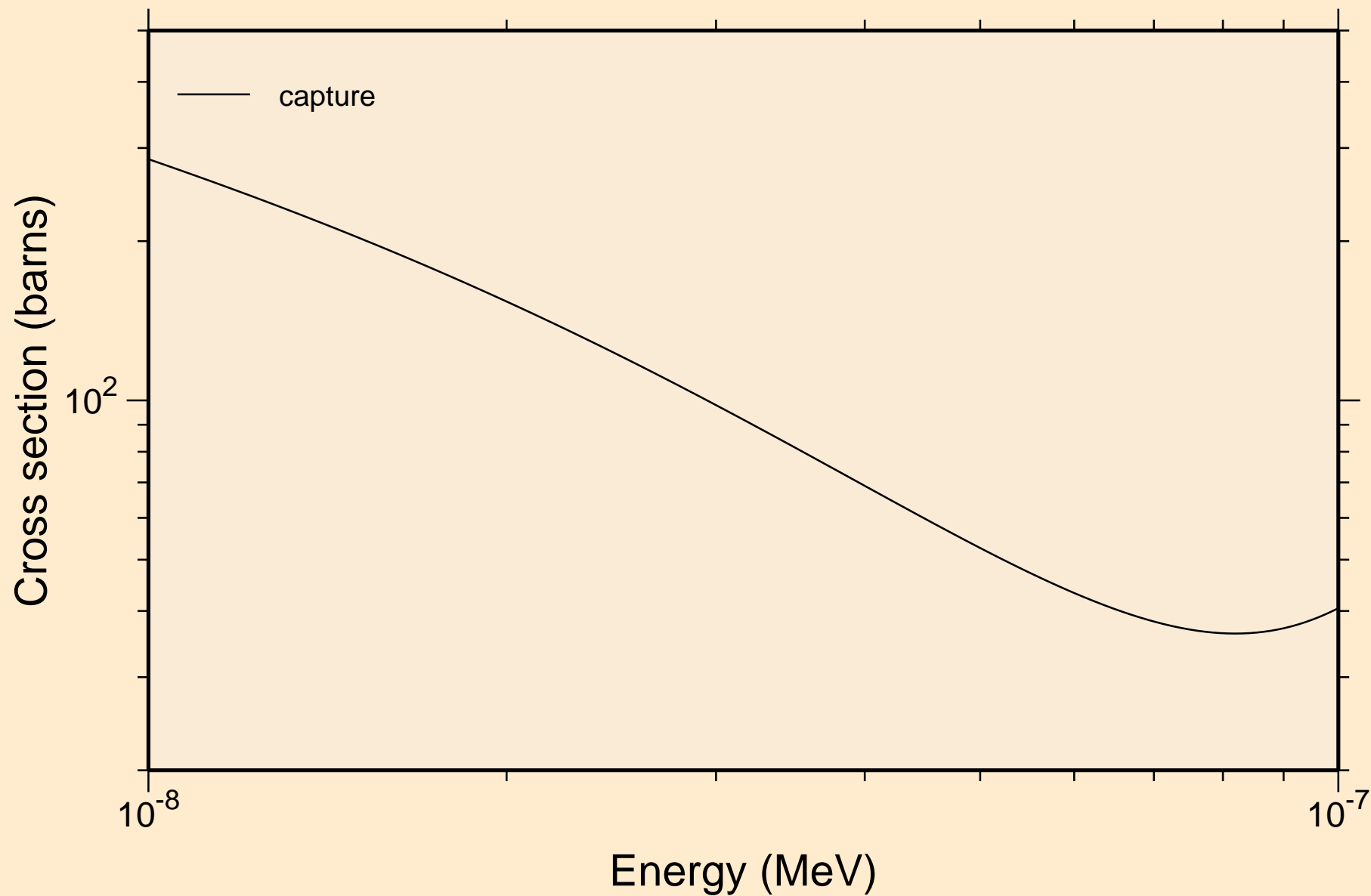

FR208 NEUTRON ACER TENDL-2019 LIBRARY; T=293.16K  
resonance absorption cross sections

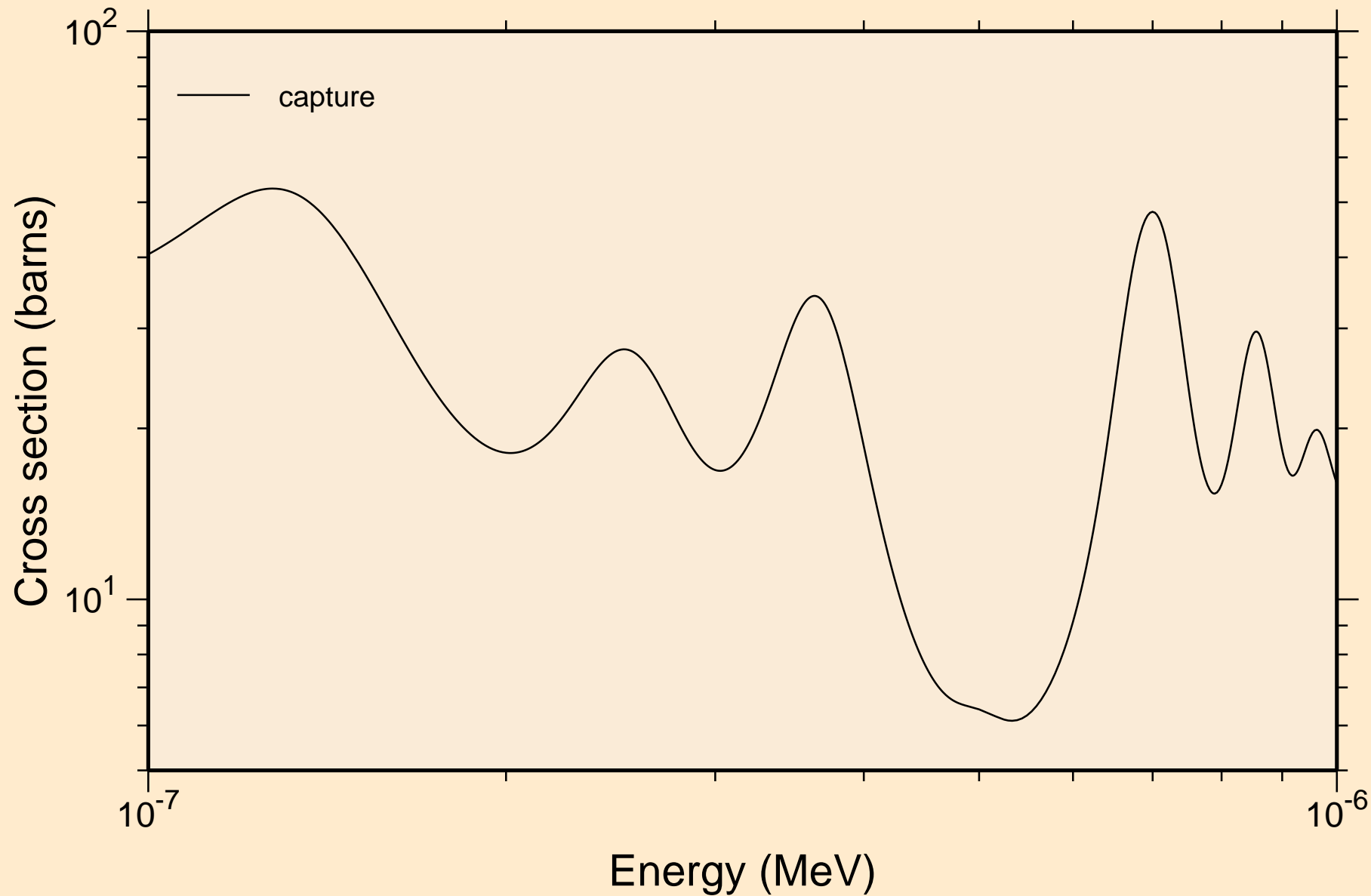

FR208 NEUTRON ACER TENDL-2019 LIBRARY; T=293.16K  
resonance absorption cross sections

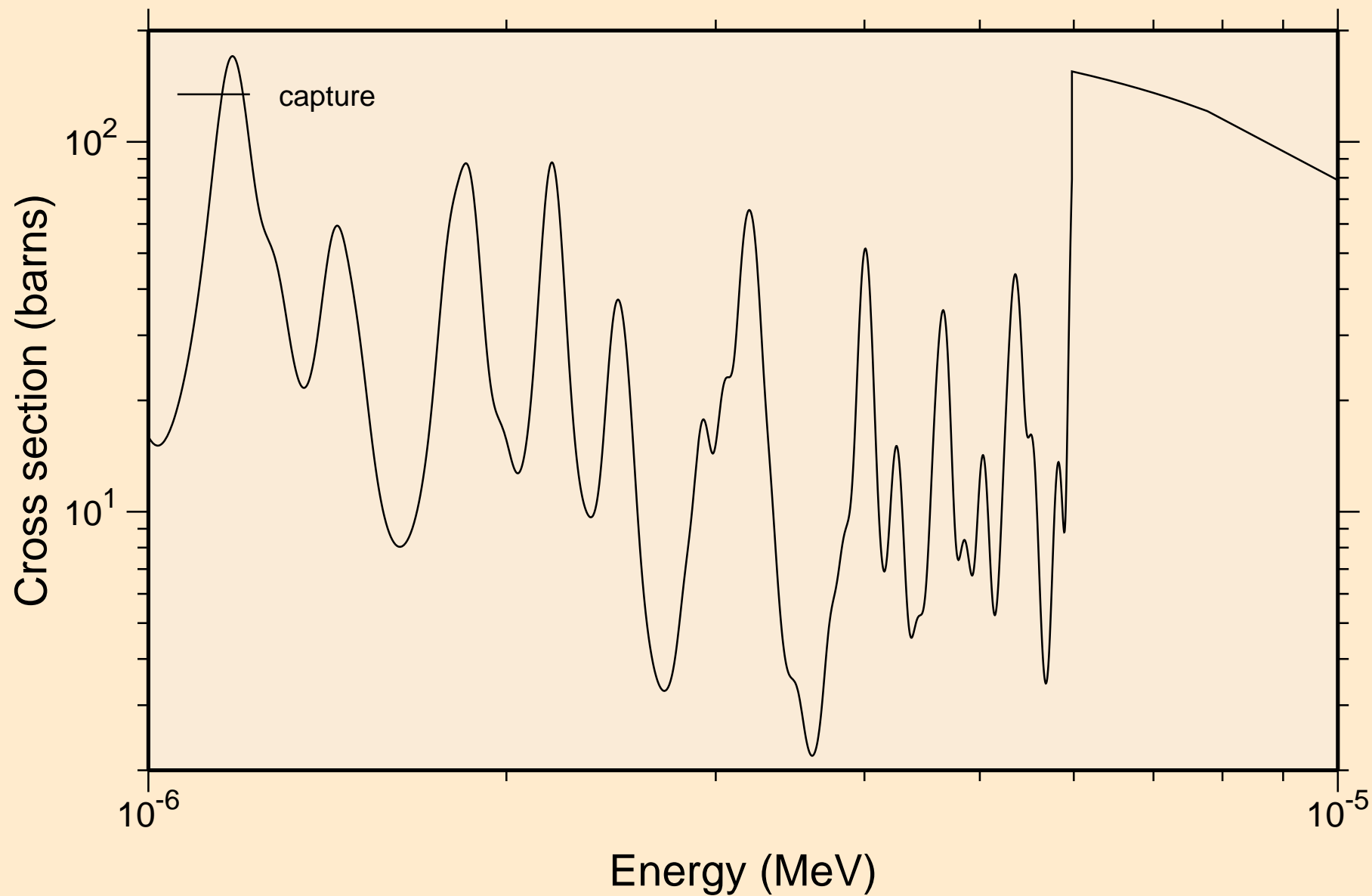



FR208 NEUTRON ACER TENDL-2019 LIBRARY; T=293.16K  
resonance absorption cross sections

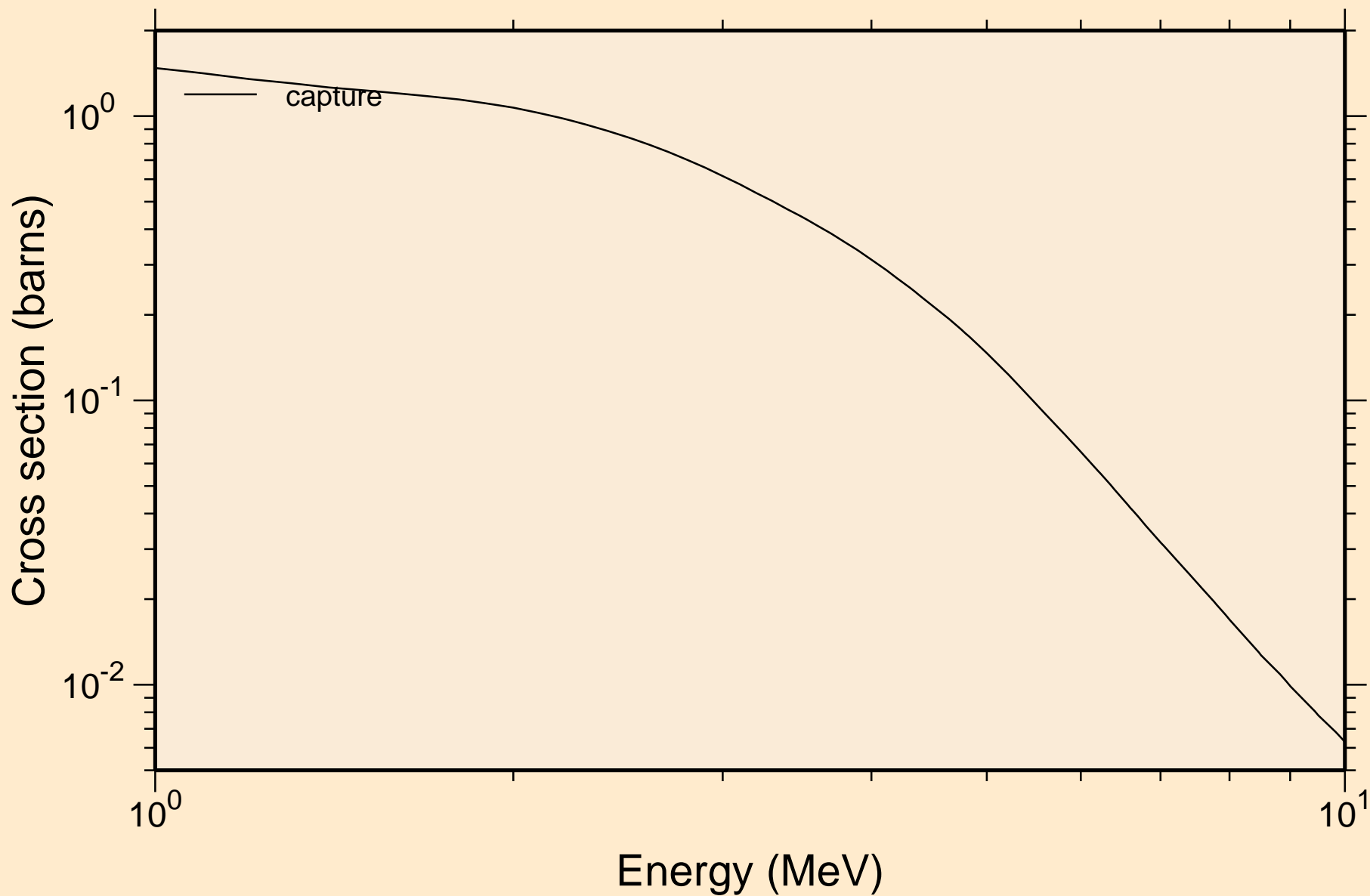

FR208 NEUTRON ACER TENDL-2019 LIBRARY; T=293.16K  
Heating

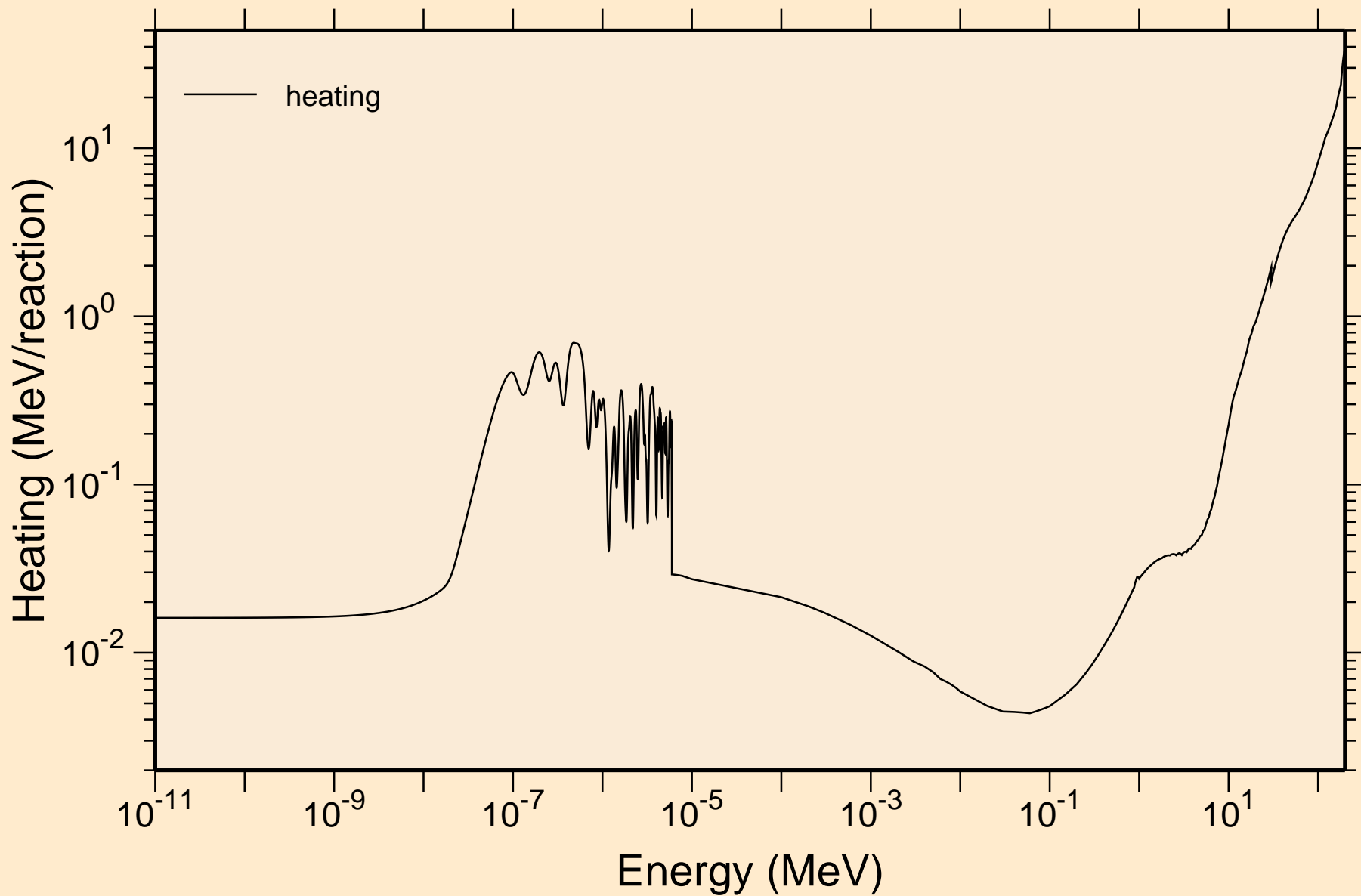

FR208 NEUTRON ACER TENDL-2019 LIBRARY; T=293.16K  
Damage

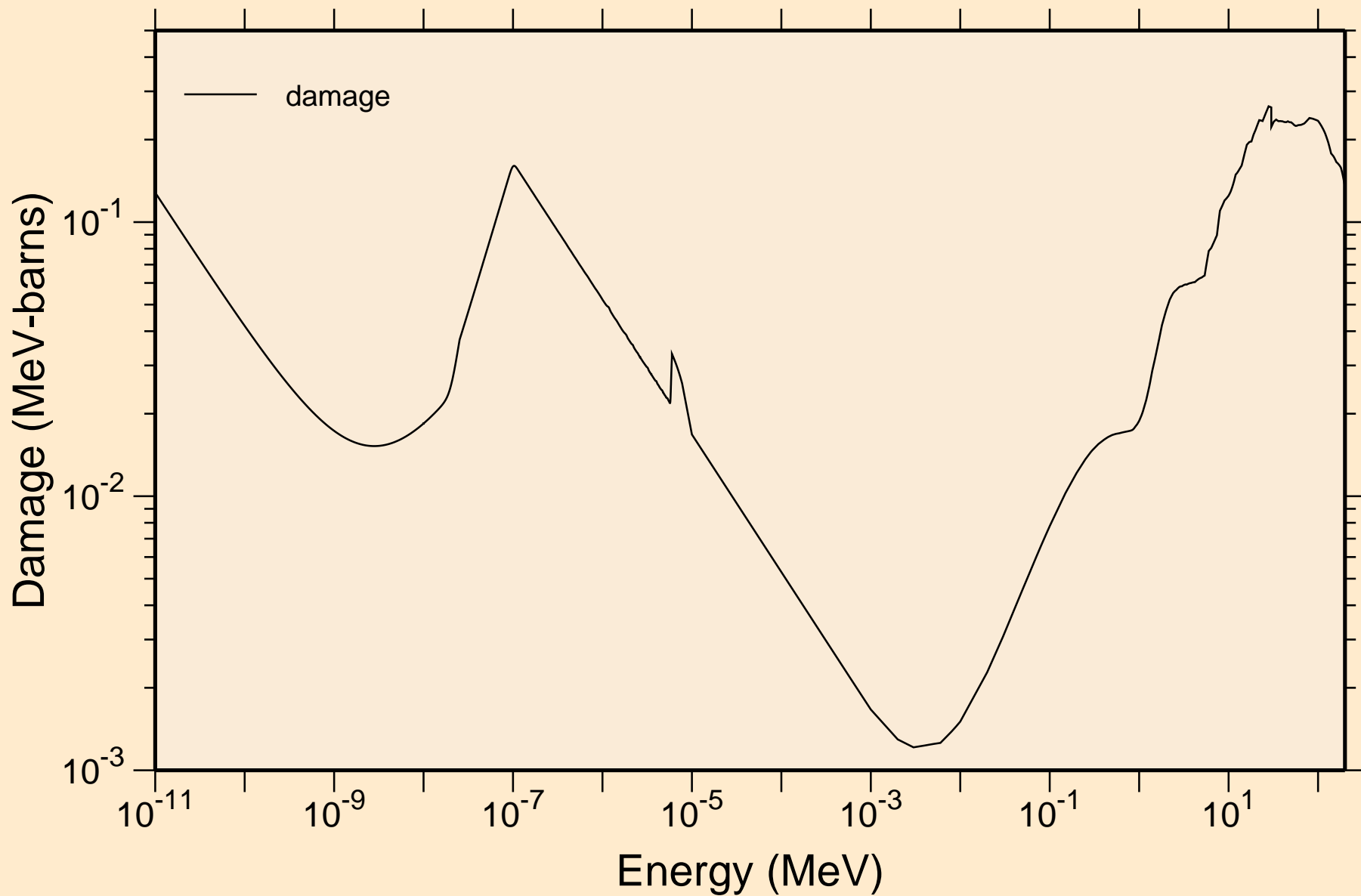

FR208 NEUTRON ACER TENDL-2019 LIBRARY; T=293.16K  
Non-threshold reactions

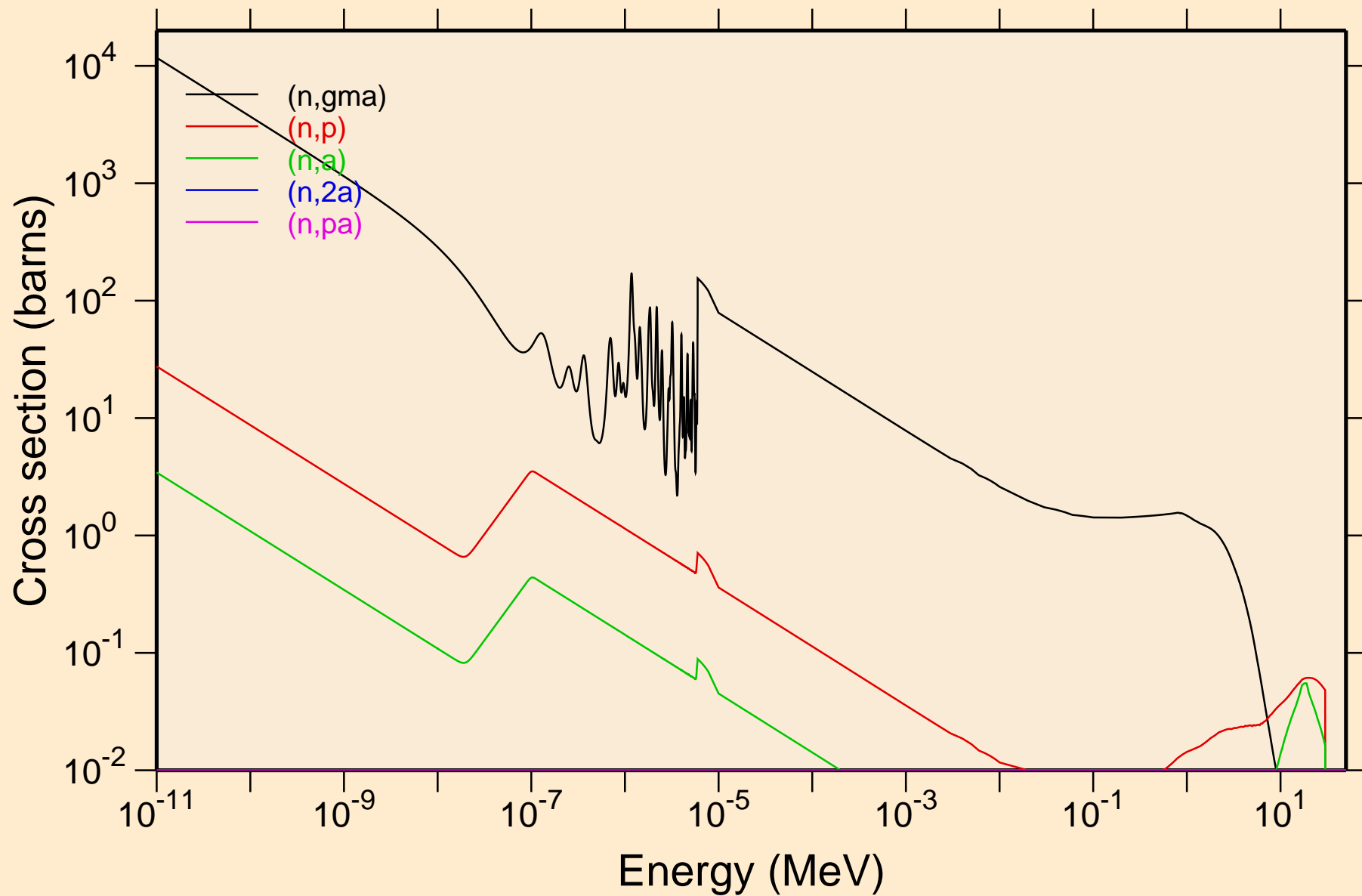

FR208 NEUTRON ACER TENDL-2019 LIBRARY; T=293.16K  
Non-threshold reactions

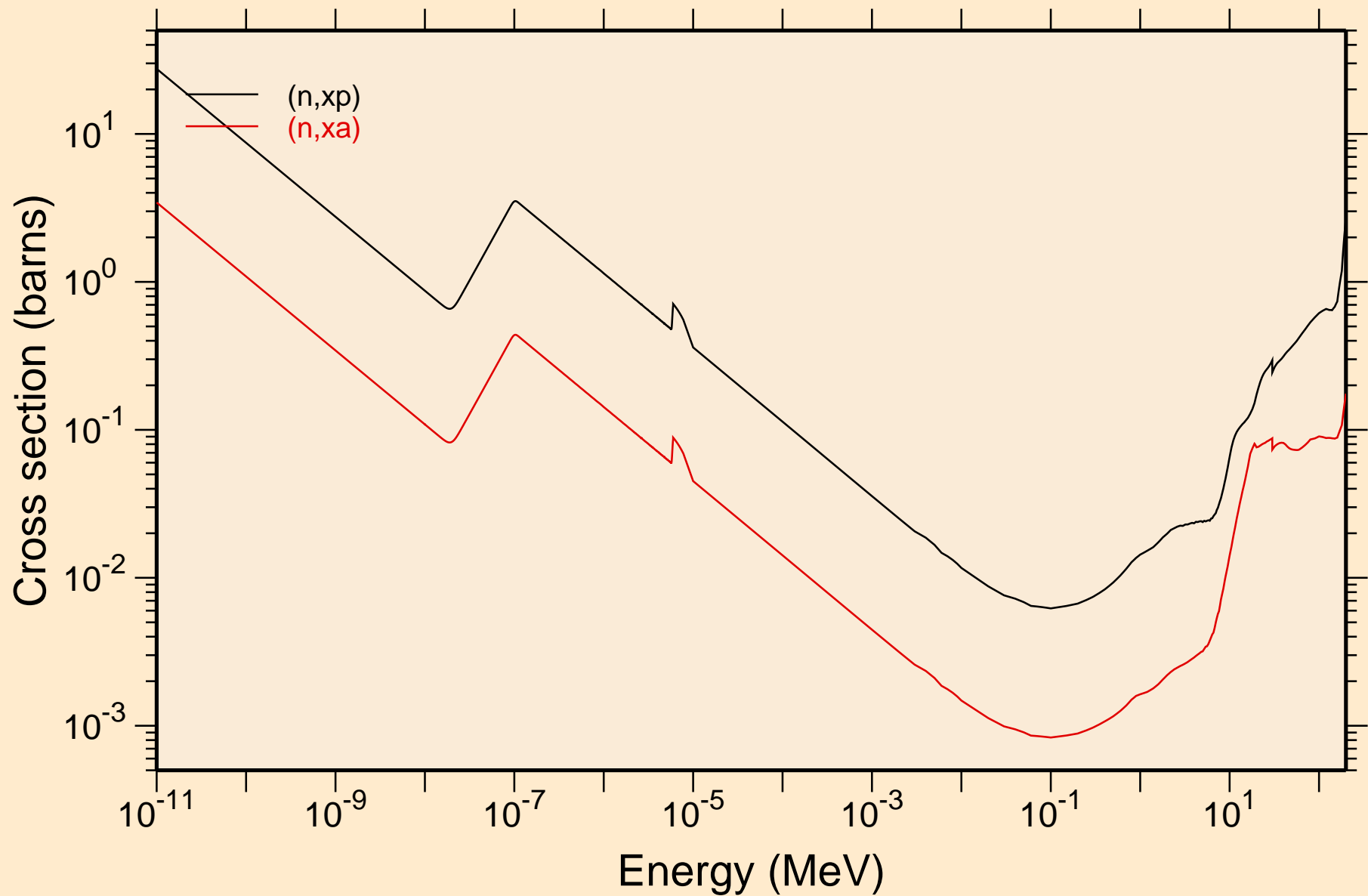

FR208 NEUTRON ACER TENDL-2019 LIBRARY; T=293.16K  
Principal cross sections

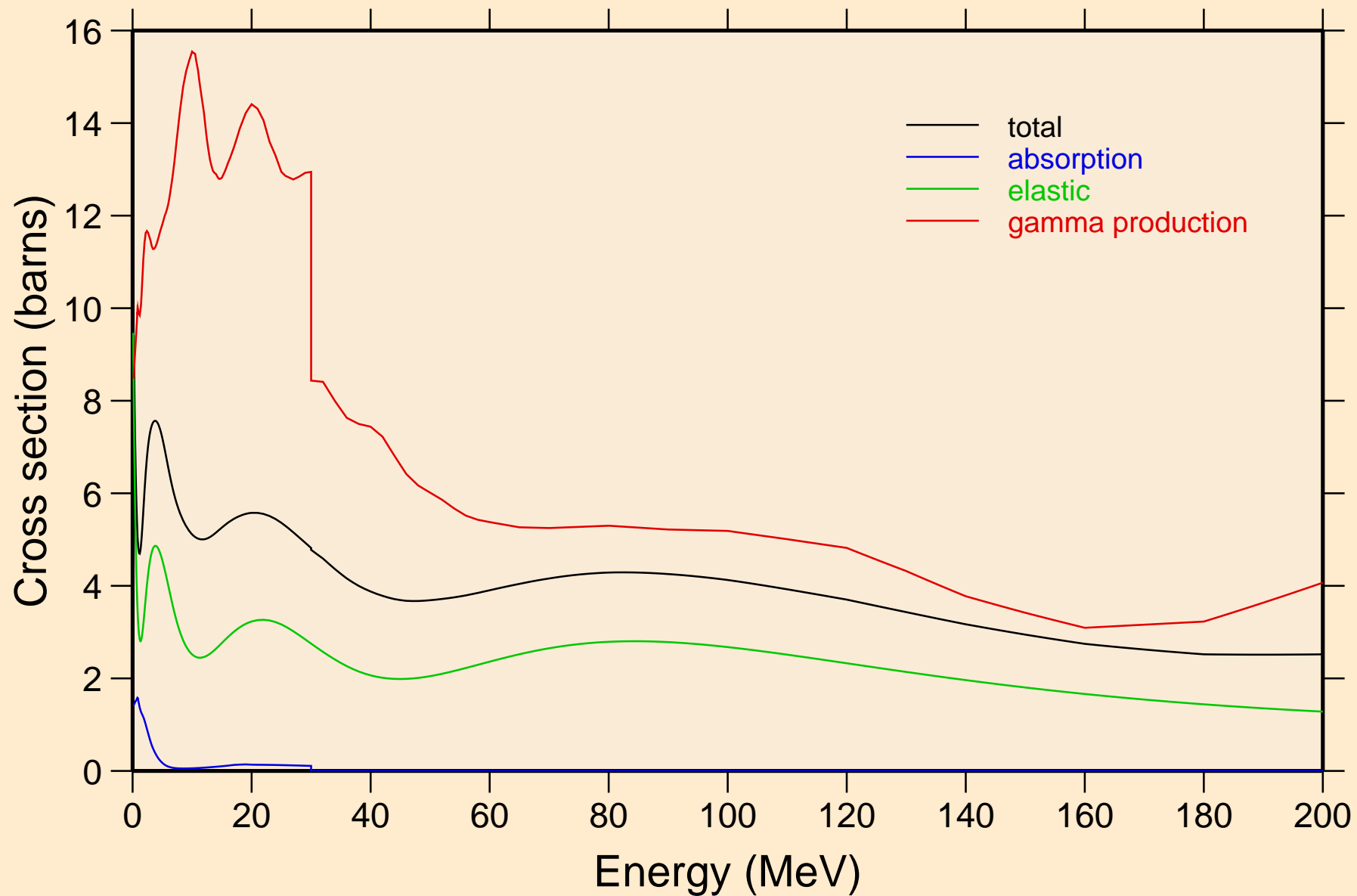

FR208 NEUTRON ACER TENDL-2019 LIBRARY; T=293.16K  
Heating

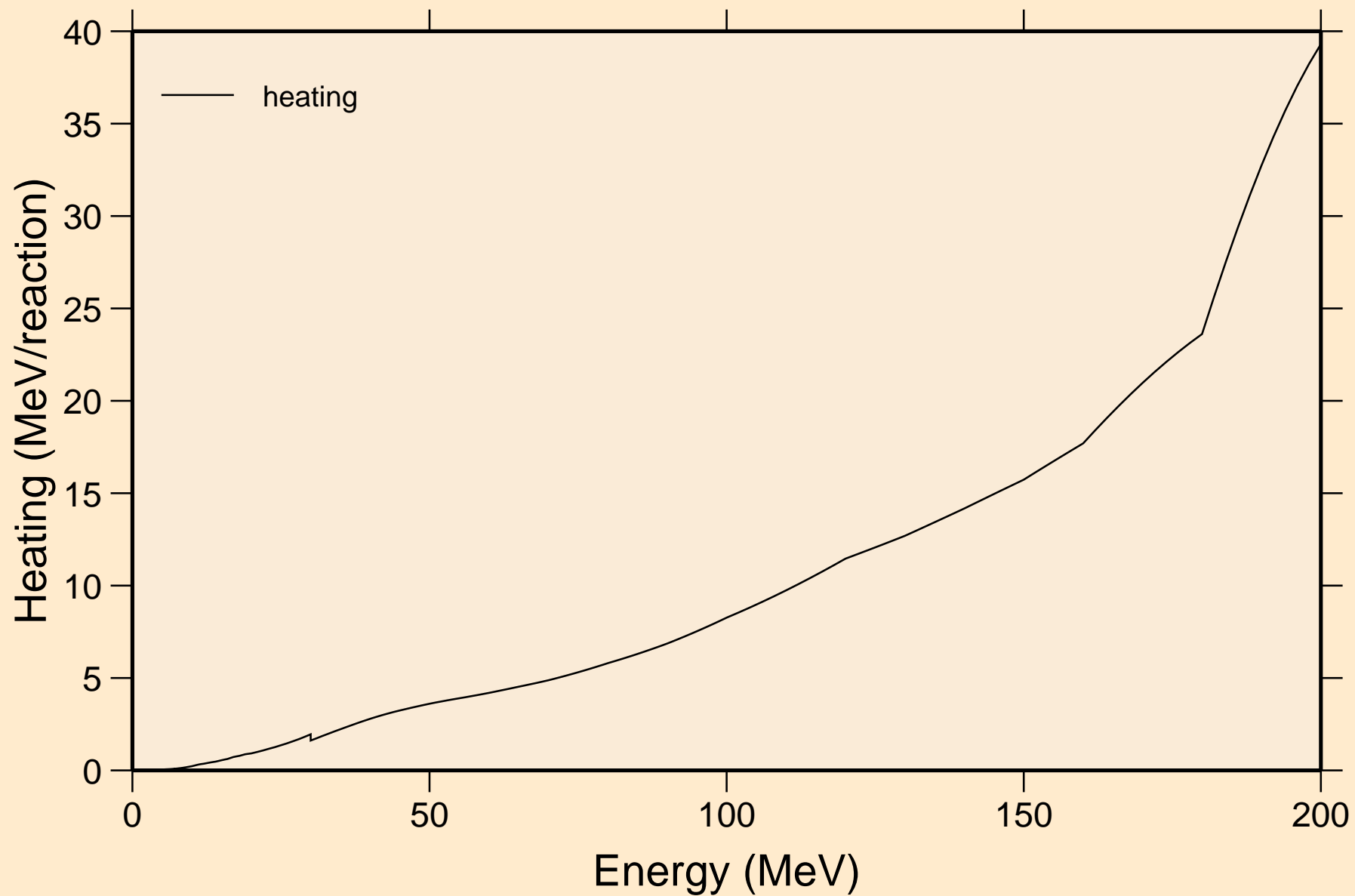

FR208 NEUTRON ACER TENDL-2019 LIBRARY; T=293.16K  
Damage

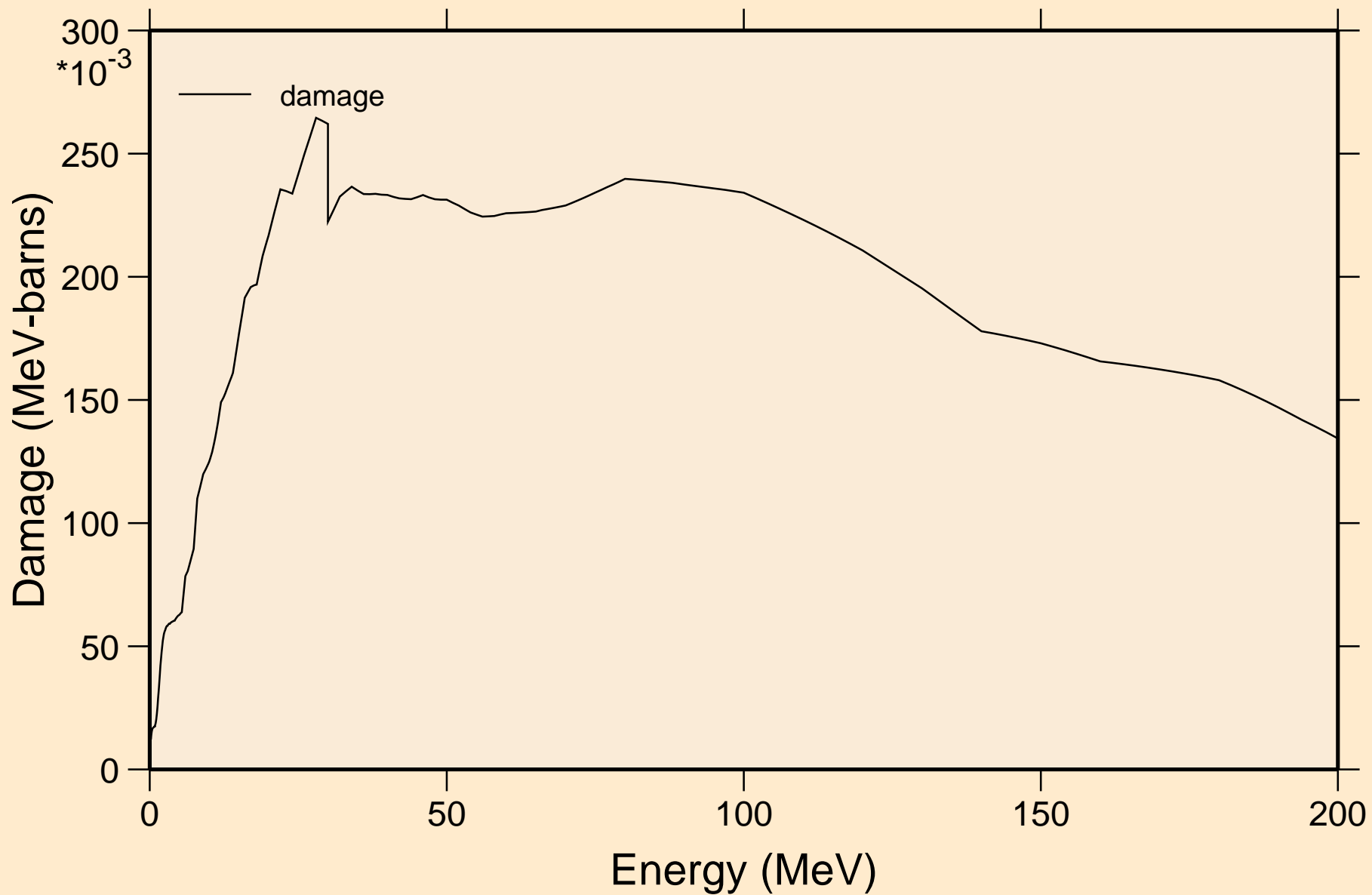



FR208 NEUTRON ACER TENDL-2019 LIBRARY; T=293.16K  
Non-threshold reactions

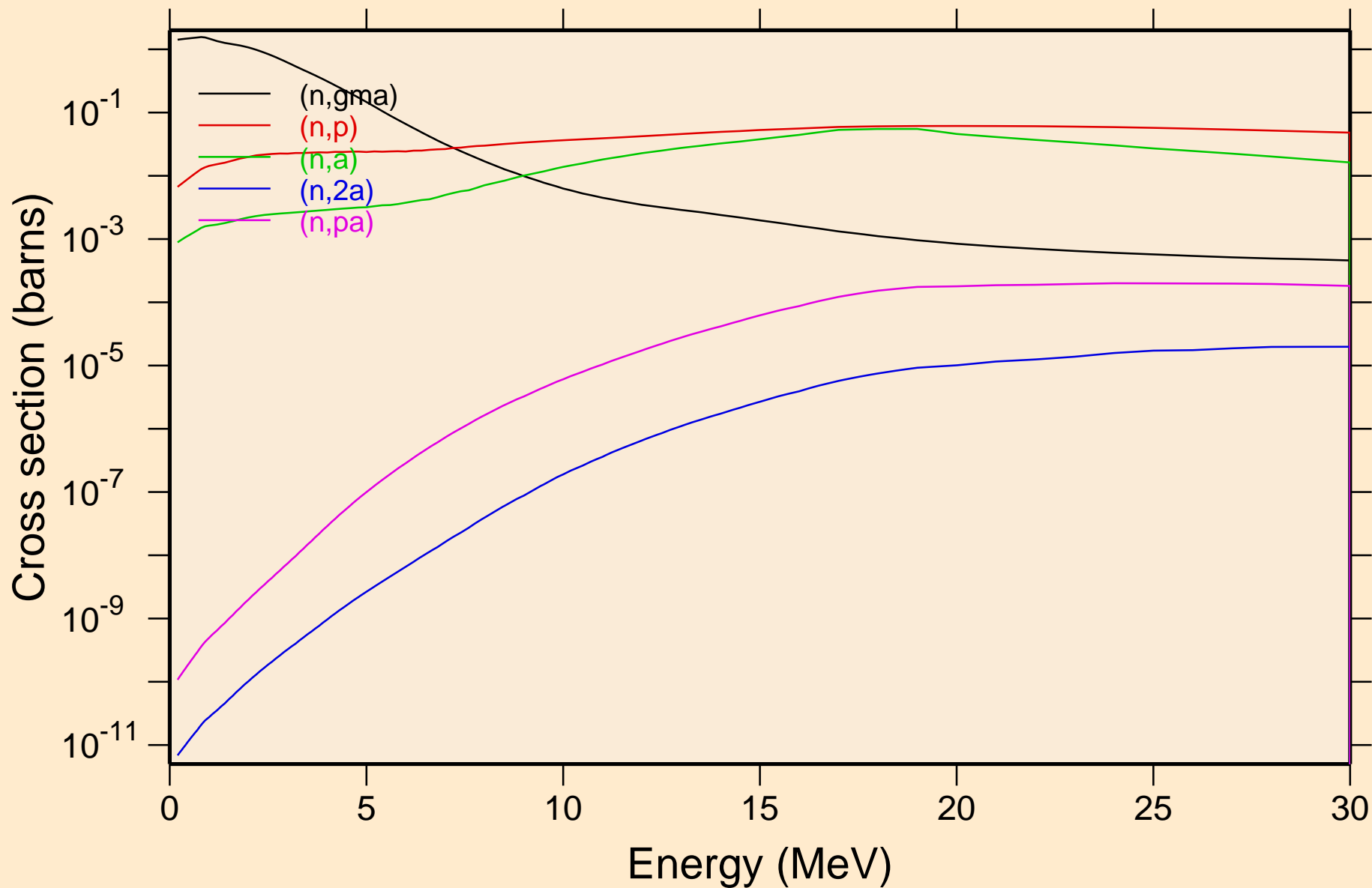

FR208 NEUTRON ACER TENDL-2019 LIBRARY; T=293.16K  
Non-threshold reactions

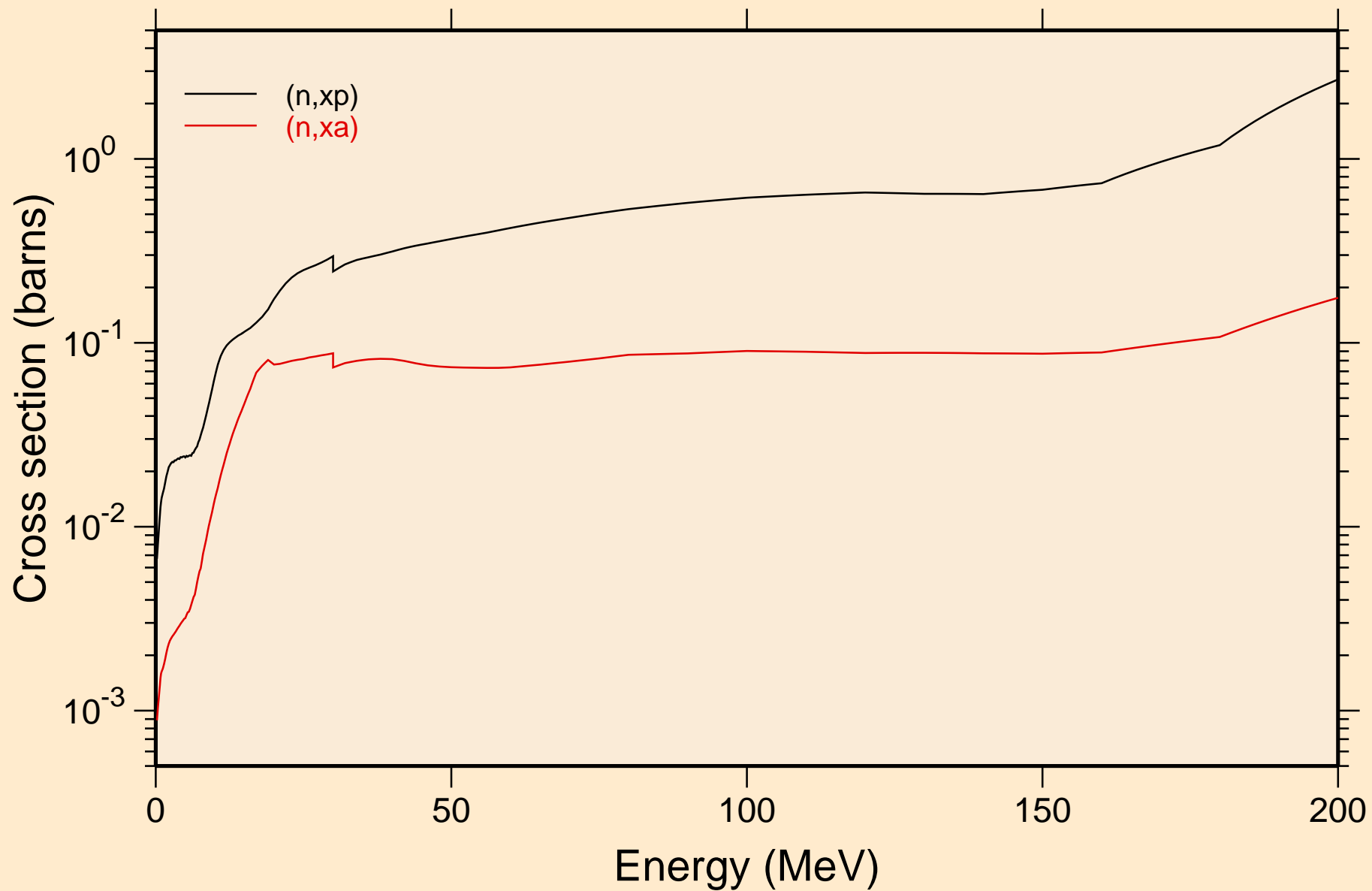

FR208 NEUTRON ACER TENDL-2019 LIBRARY; T=293.16K  
Inelastic levels

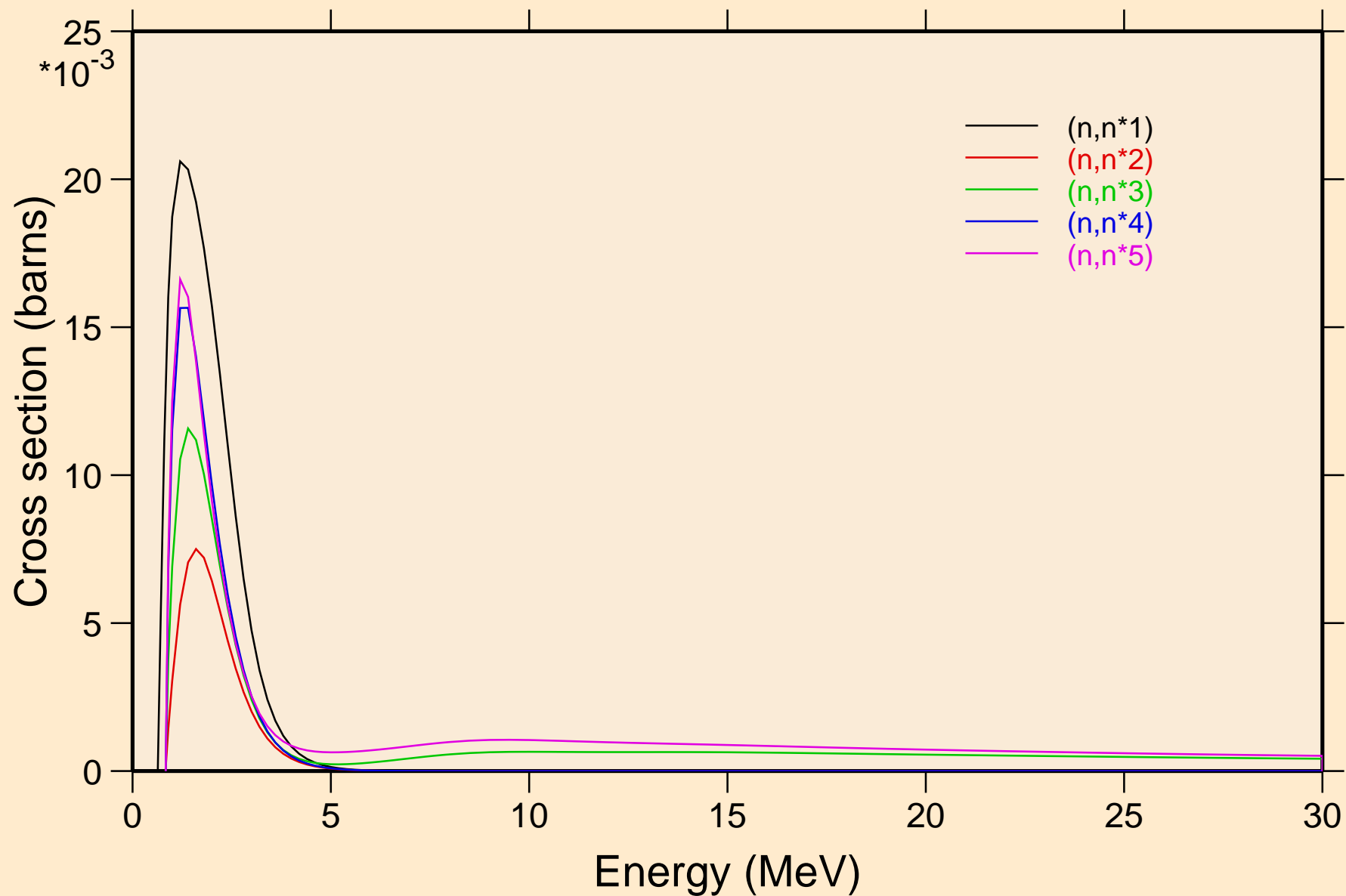

FR208 NEUTRON ACER TENDL-2019 LIBRARY; T=293.16K  
Inelastic levels

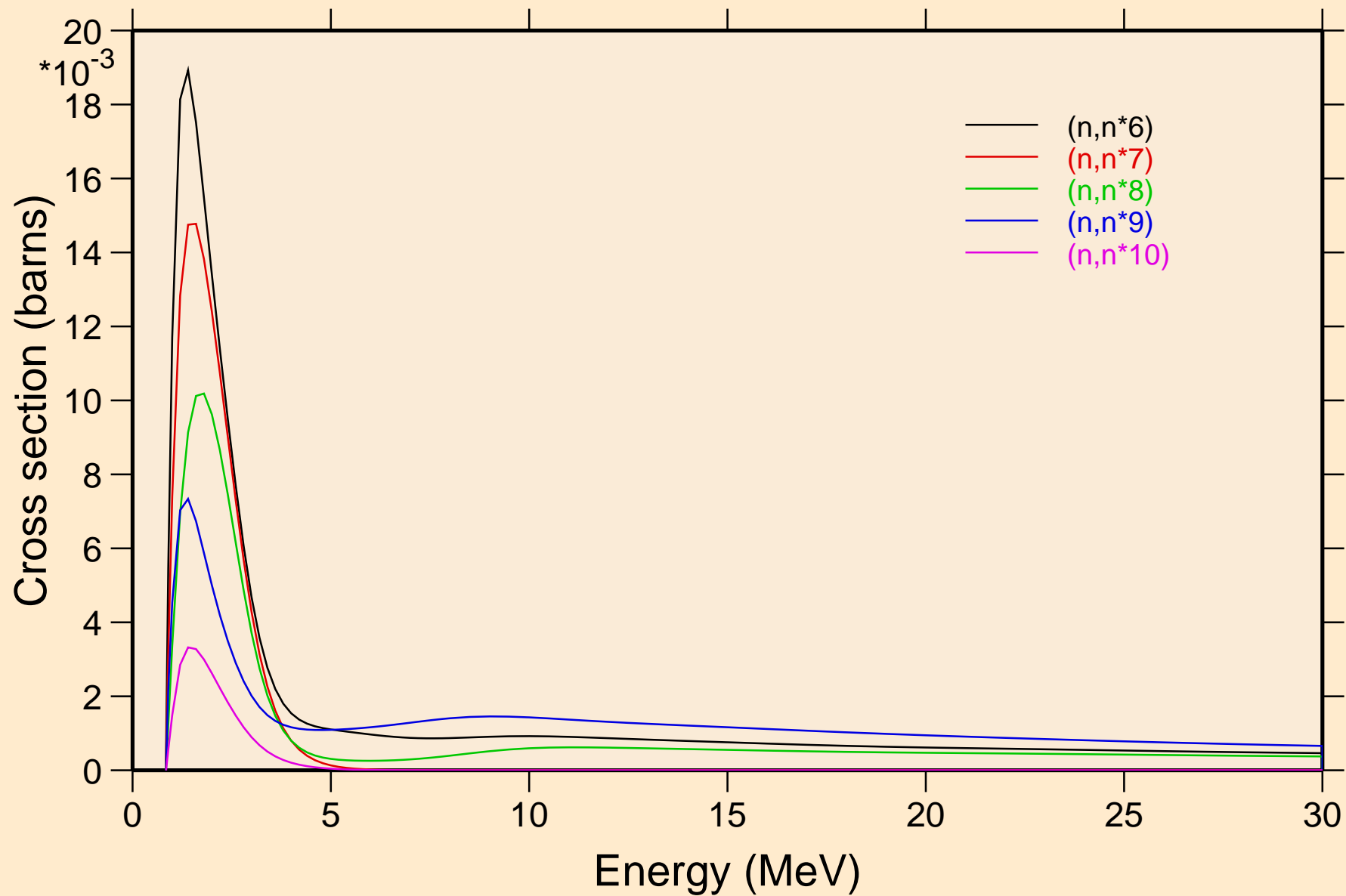

FR208 NEUTRON ACER TENDL-2019 LIBRARY; T=293.16K  
Inelastic levels

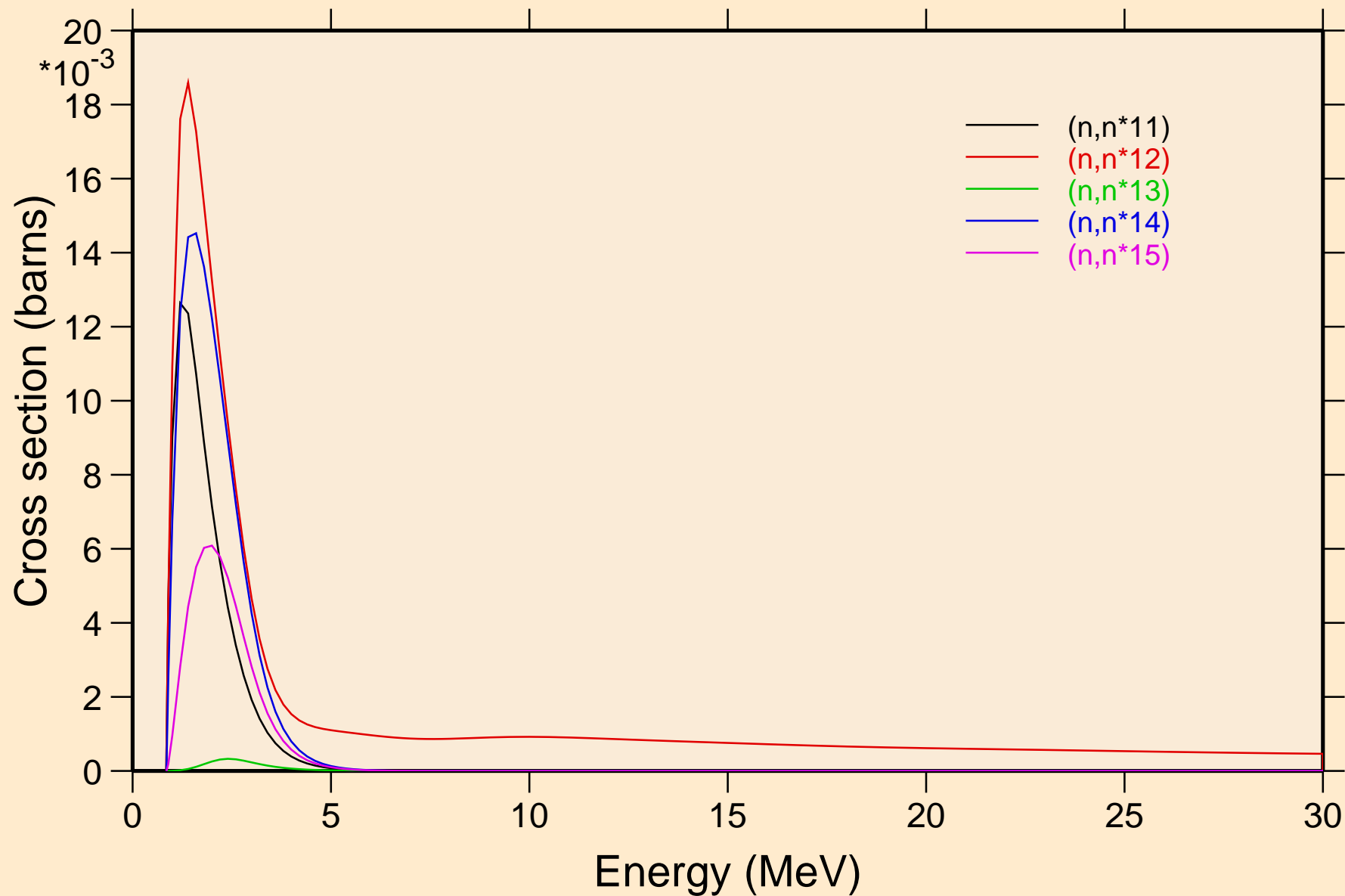

FR208 NEUTRON ACER TENDL-2019 LIBRARY; T=293.16K  
Inelastic levels

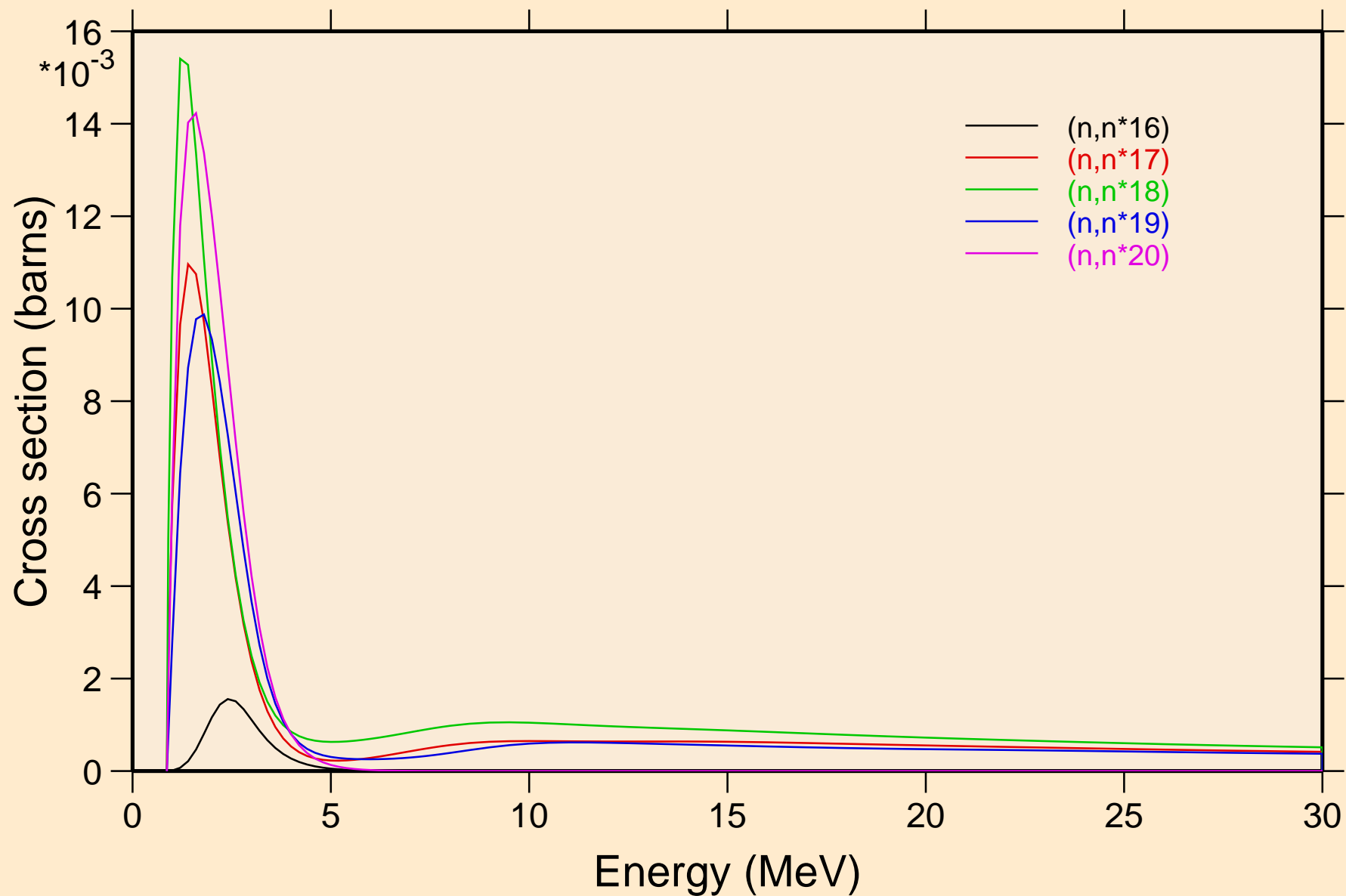

FR208 NEUTRON ACER TENDL-2019 LIBRARY; T=293.16K  
Inelastic levels

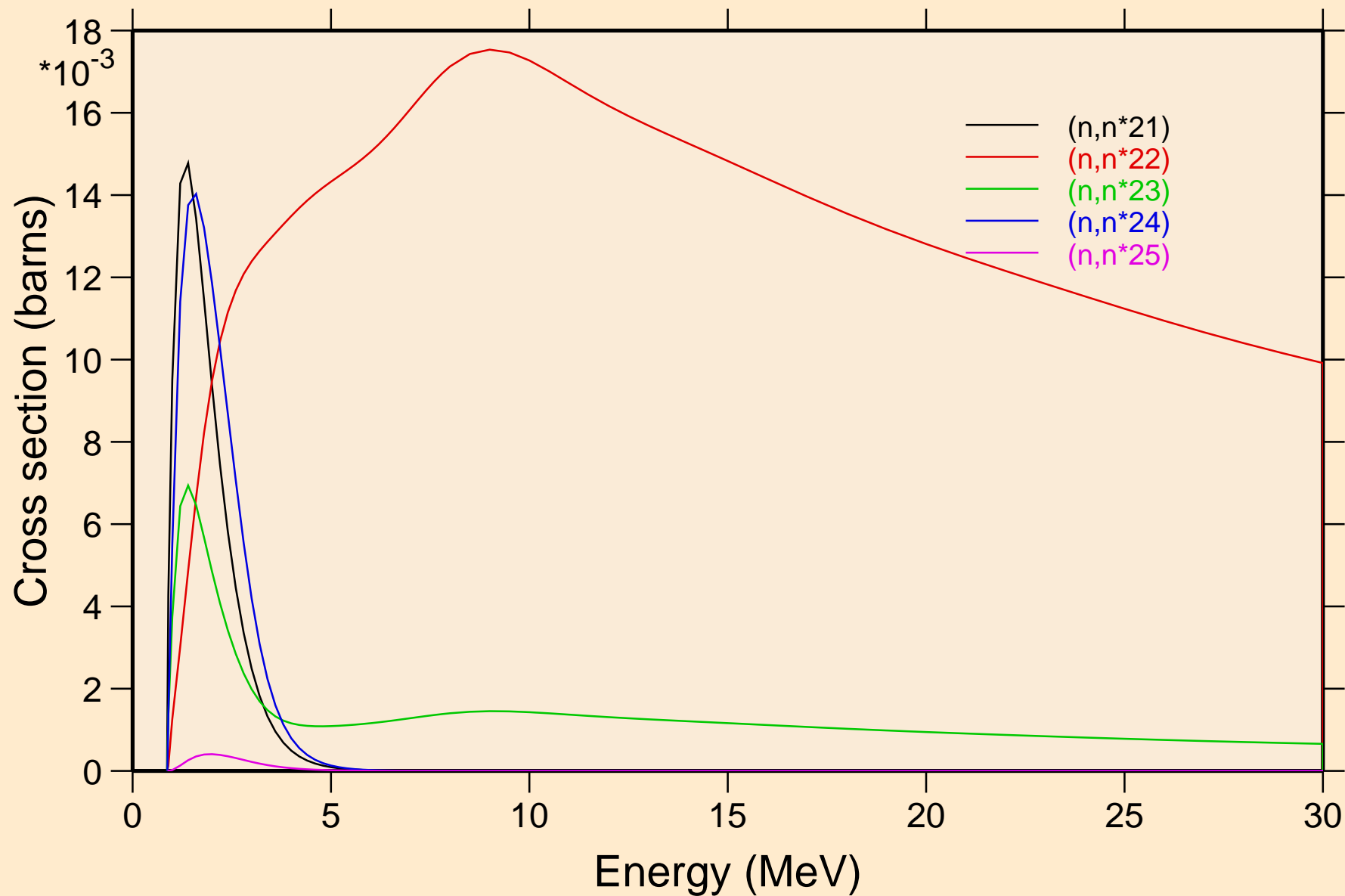

FR208 NEUTRON ACER TENDL-2019 LIBRARY; T=293.16K  
Inelastic levels

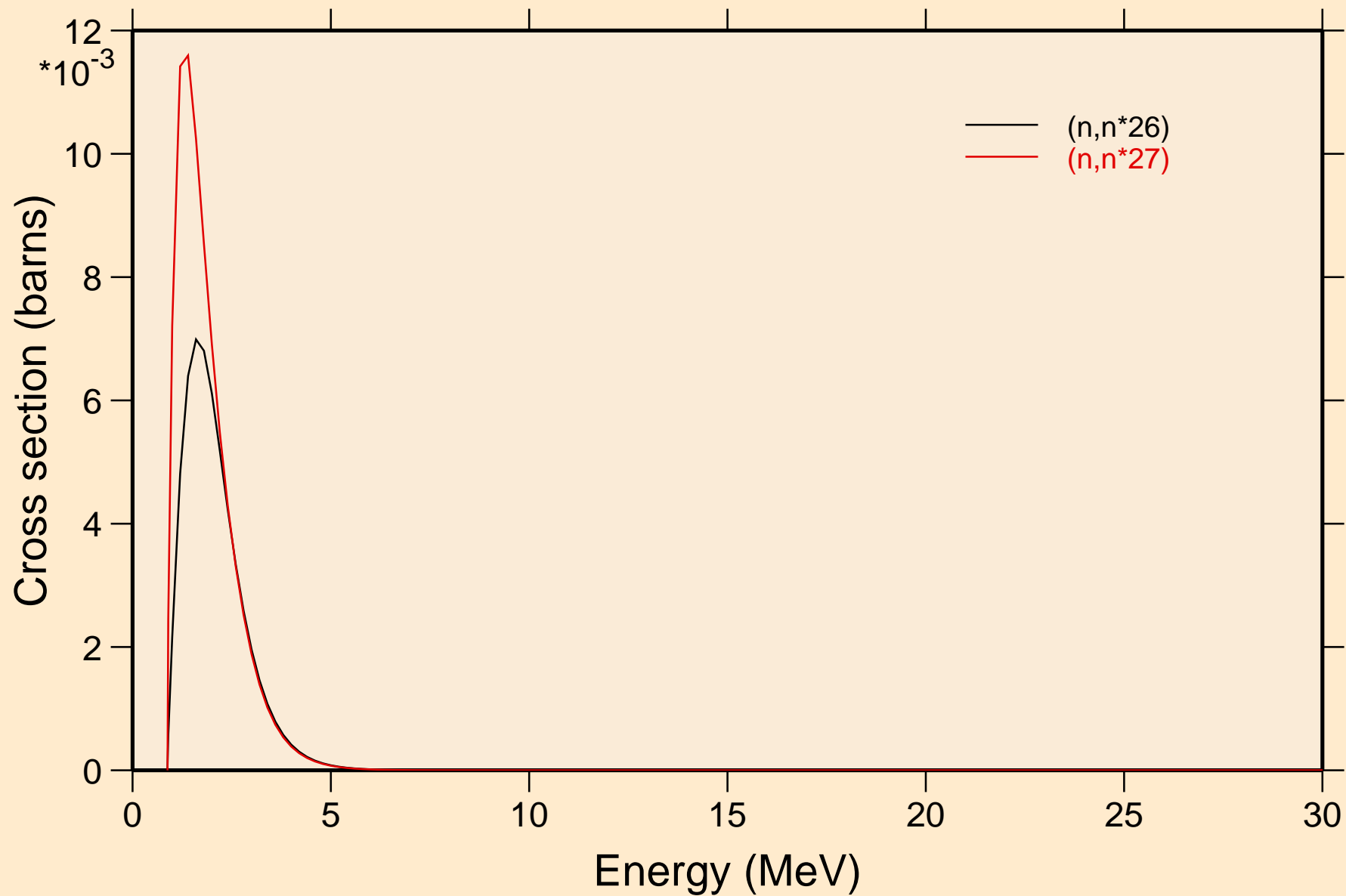



FR208 NEUTRON ACER TENDL-2019 LIBRARY; T=293.16K  
Threshold reactions

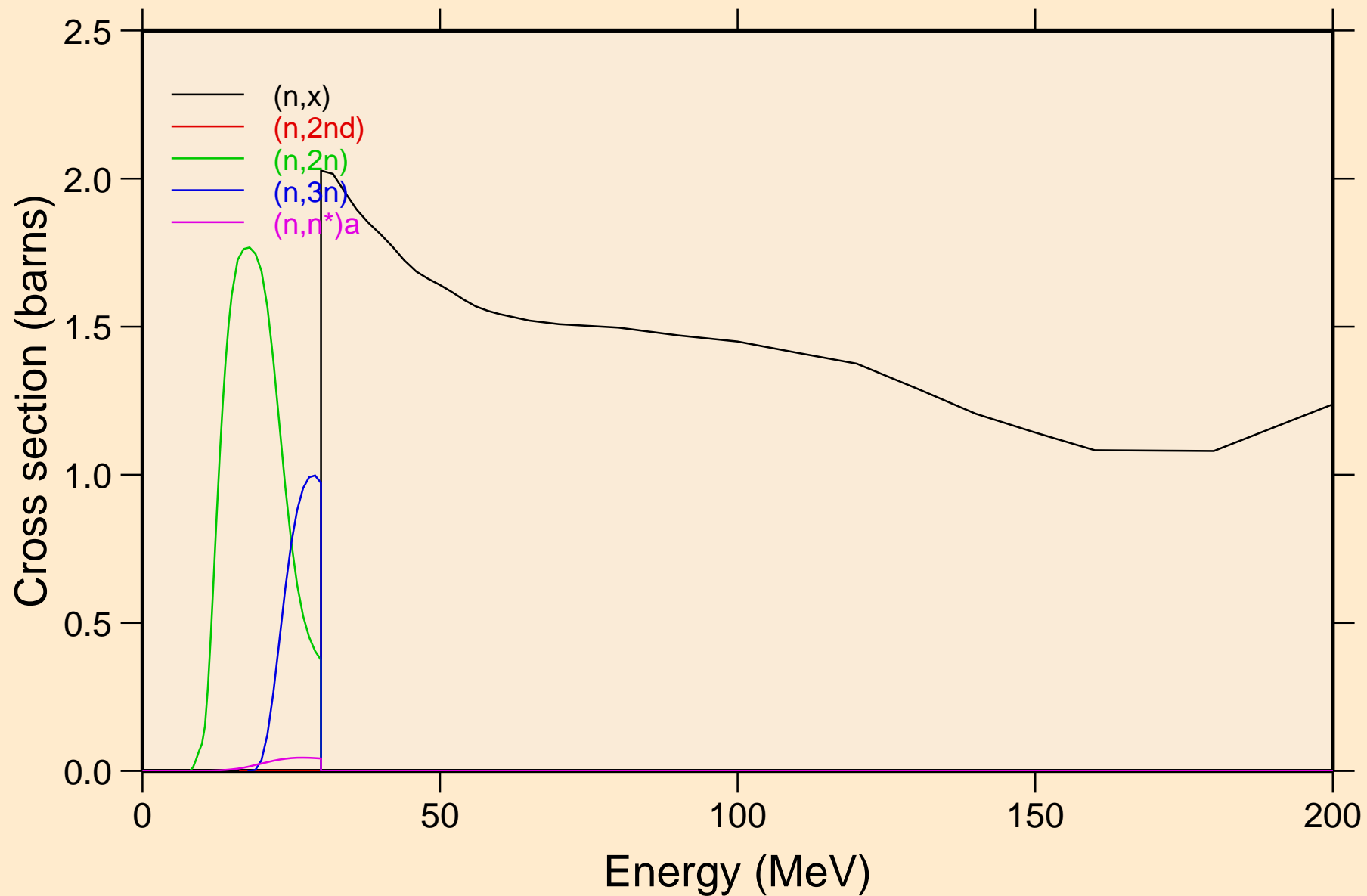

FR208 NEUTRON ACER TENDL-2019 LIBRARY; T=293.16K  
Threshold reactions

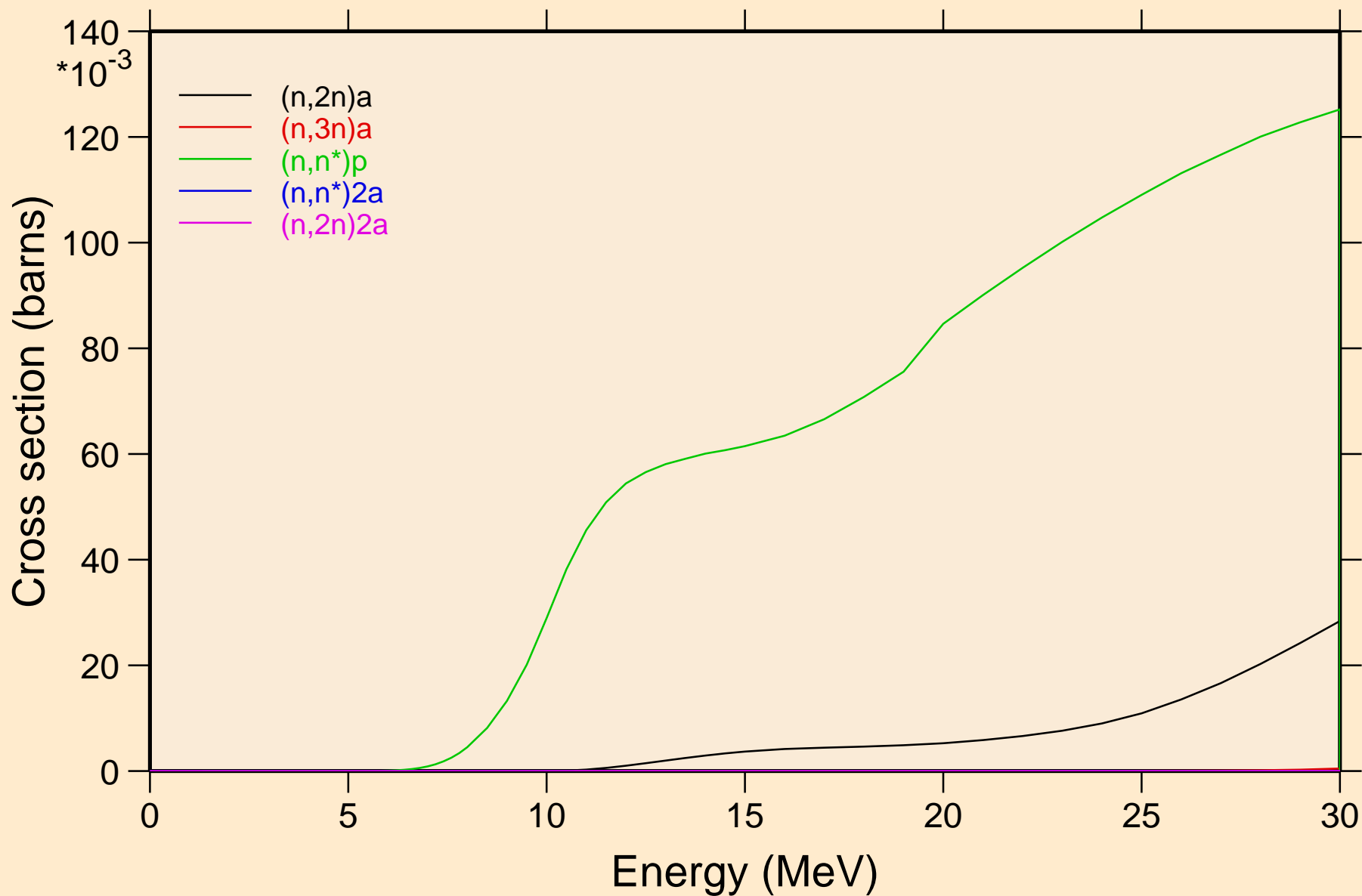

FR208 NEUTRON ACER TENDL-2019 LIBRARY; T=293.16K  
Threshold reactions

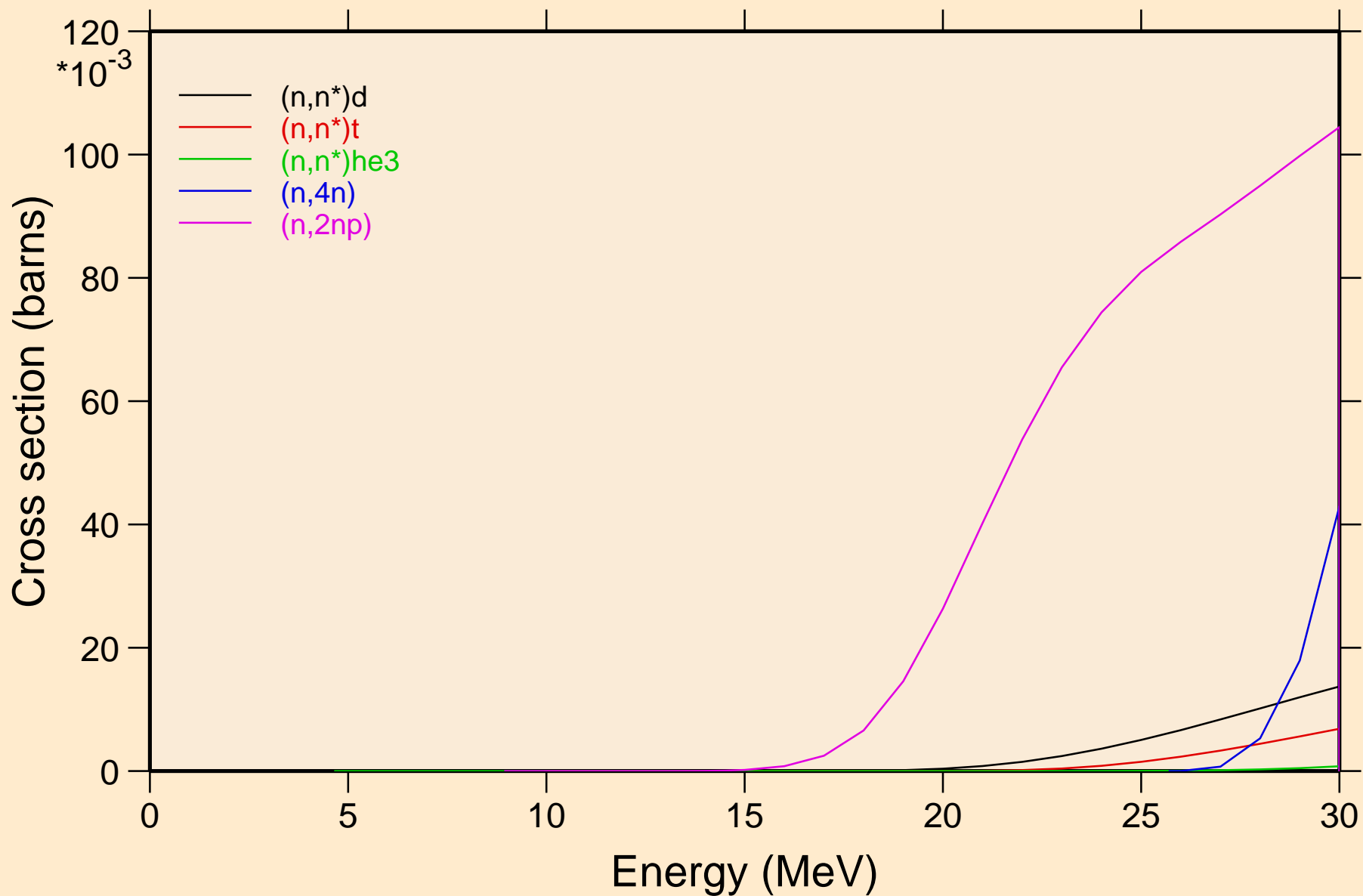

FR208 NEUTRON ACER TENDL-2019 LIBRARY; T=293.16K  
Threshold reactions

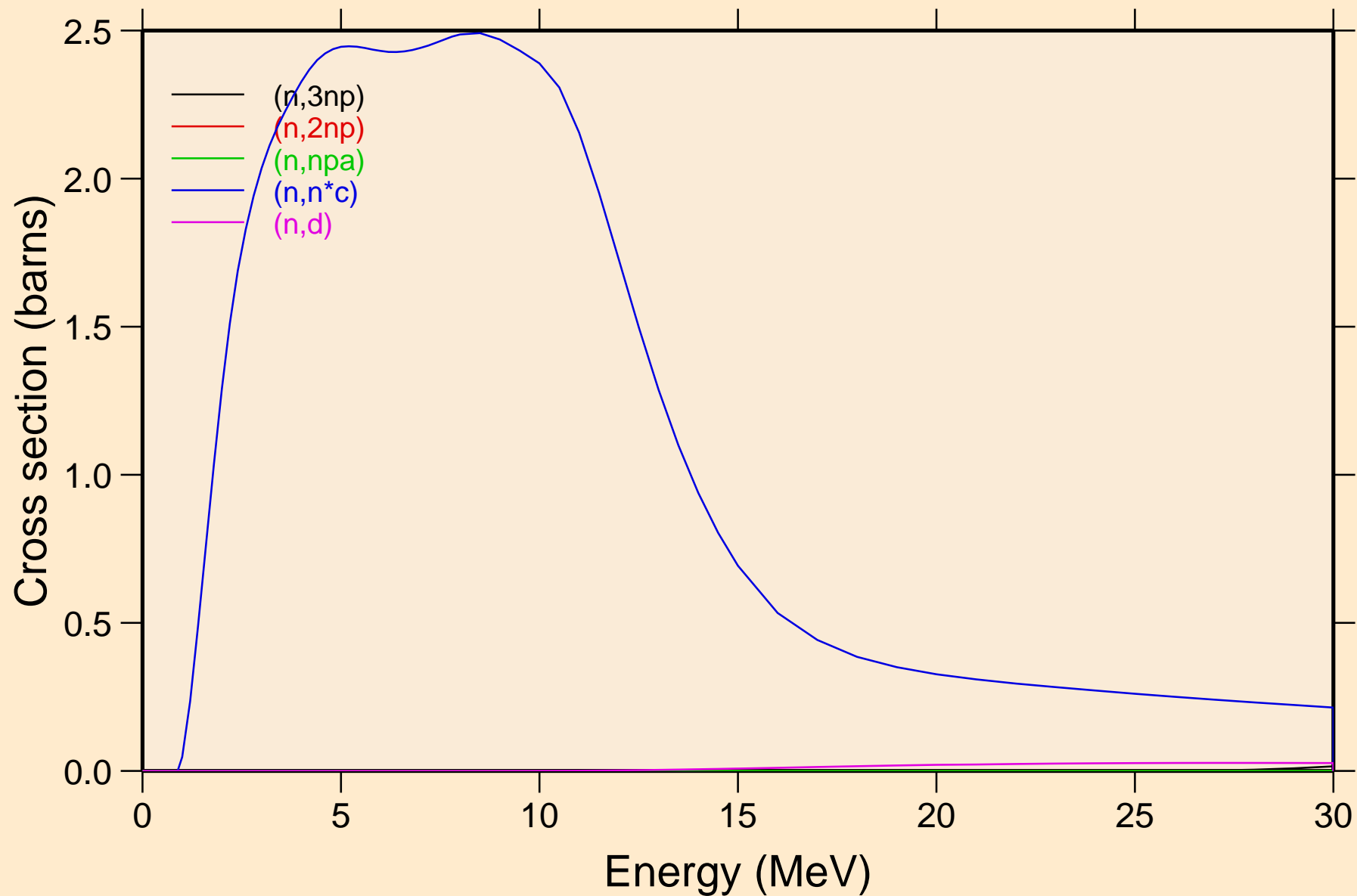

FR208 NEUTRON ACER TENDL-2019 LIBRARY; T=293.16K  
Threshold reactions

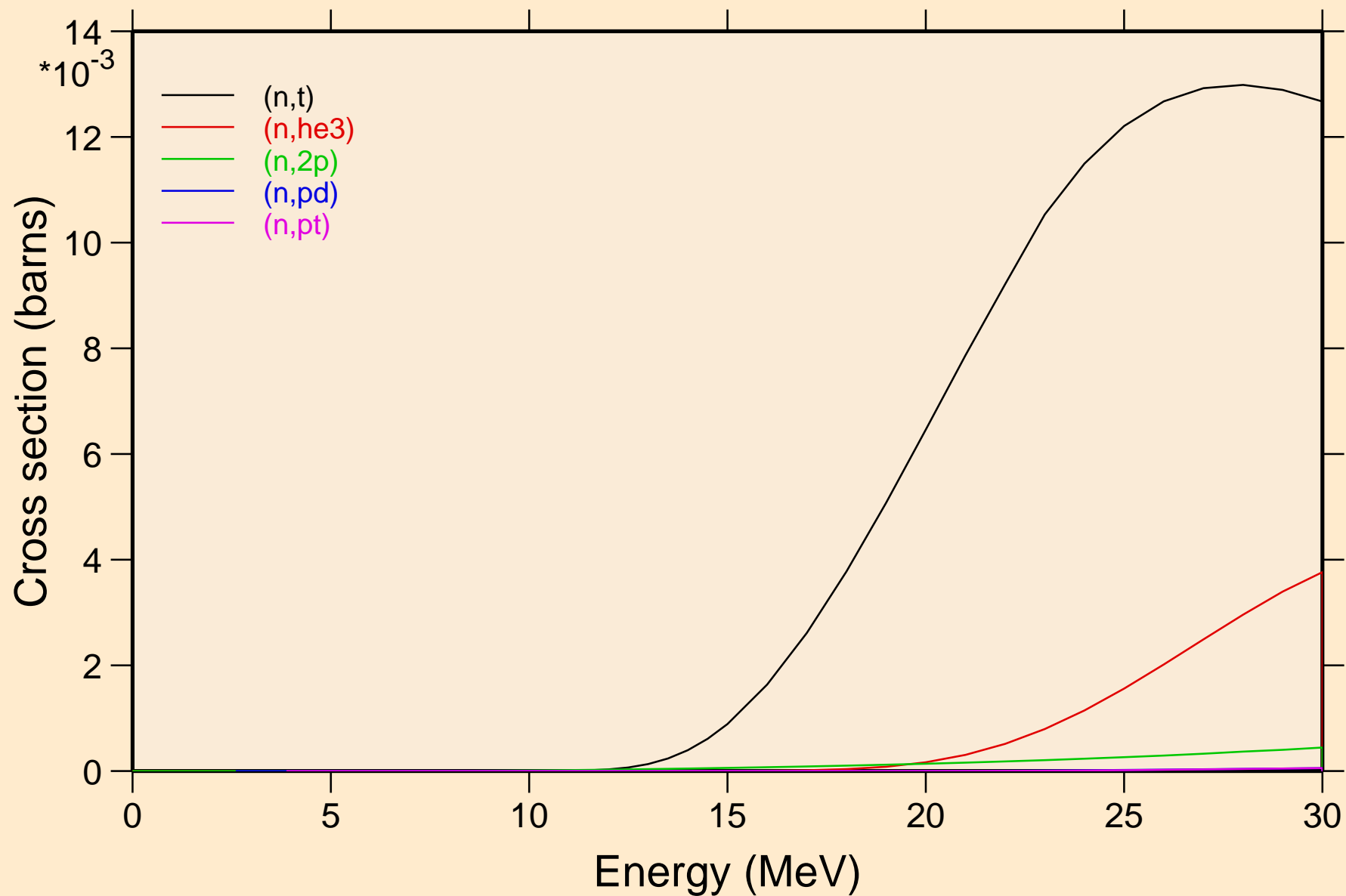

FR208 NEUTRON ACER TENDL-2019 LIBRARY; T=293.16K  
Threshold reactions

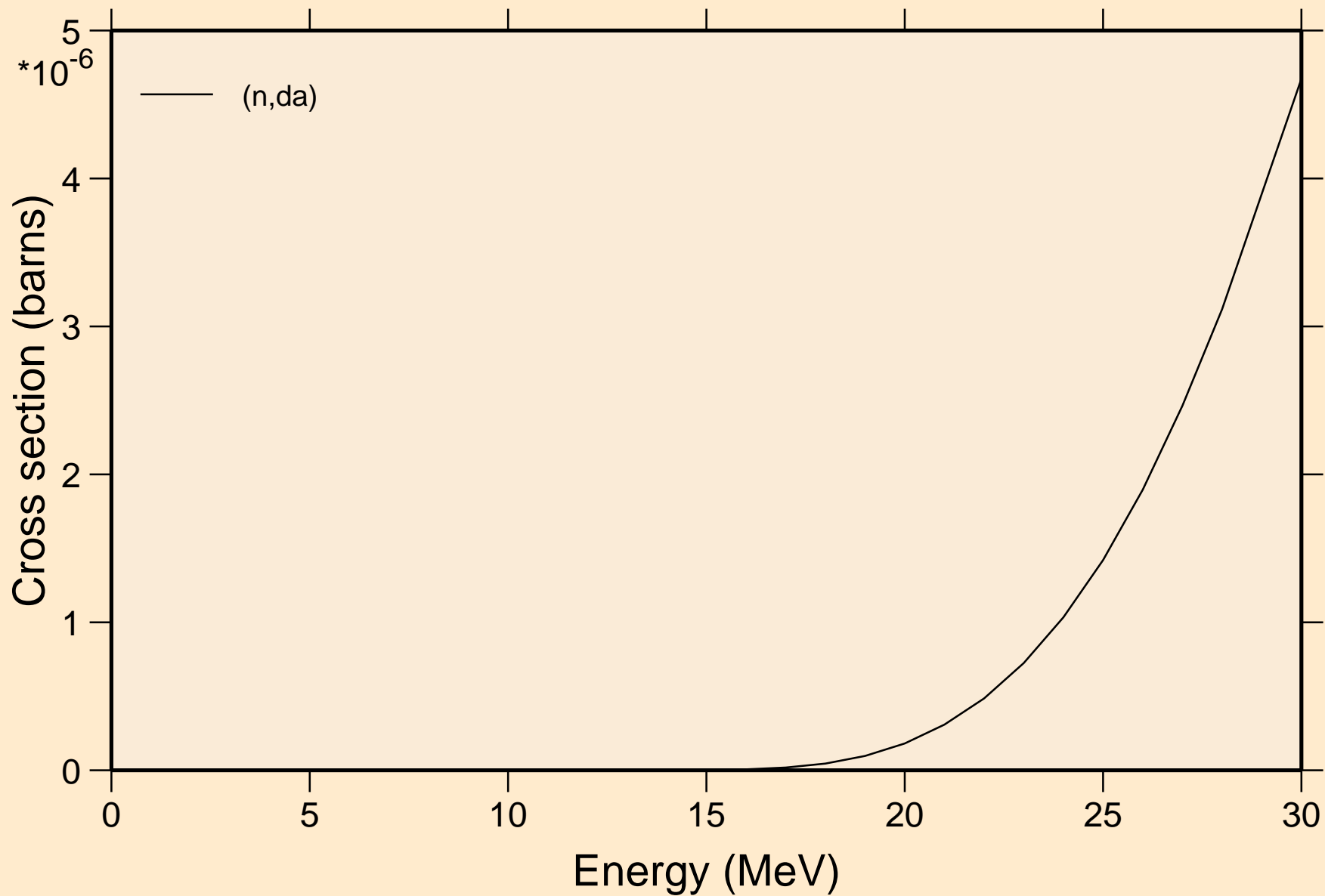

FR208 NEUTRON ACER TENDL-2019 LIBRARY; T=293.16K  
Threshold reactions

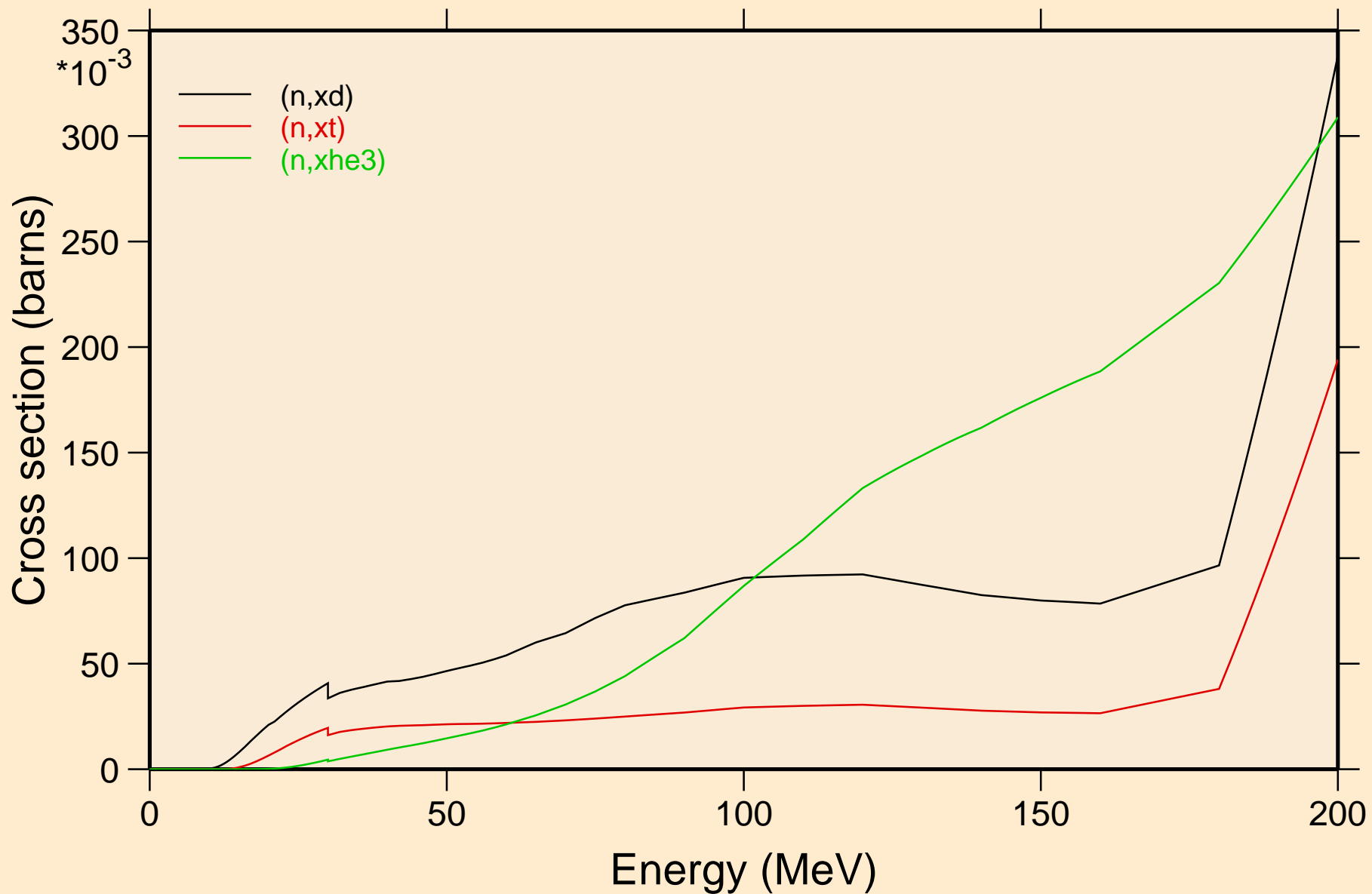

FR208 NEUTRON ACER TENDL-2019 LIBRARY; T=293.16K  
angular distribution for elastic

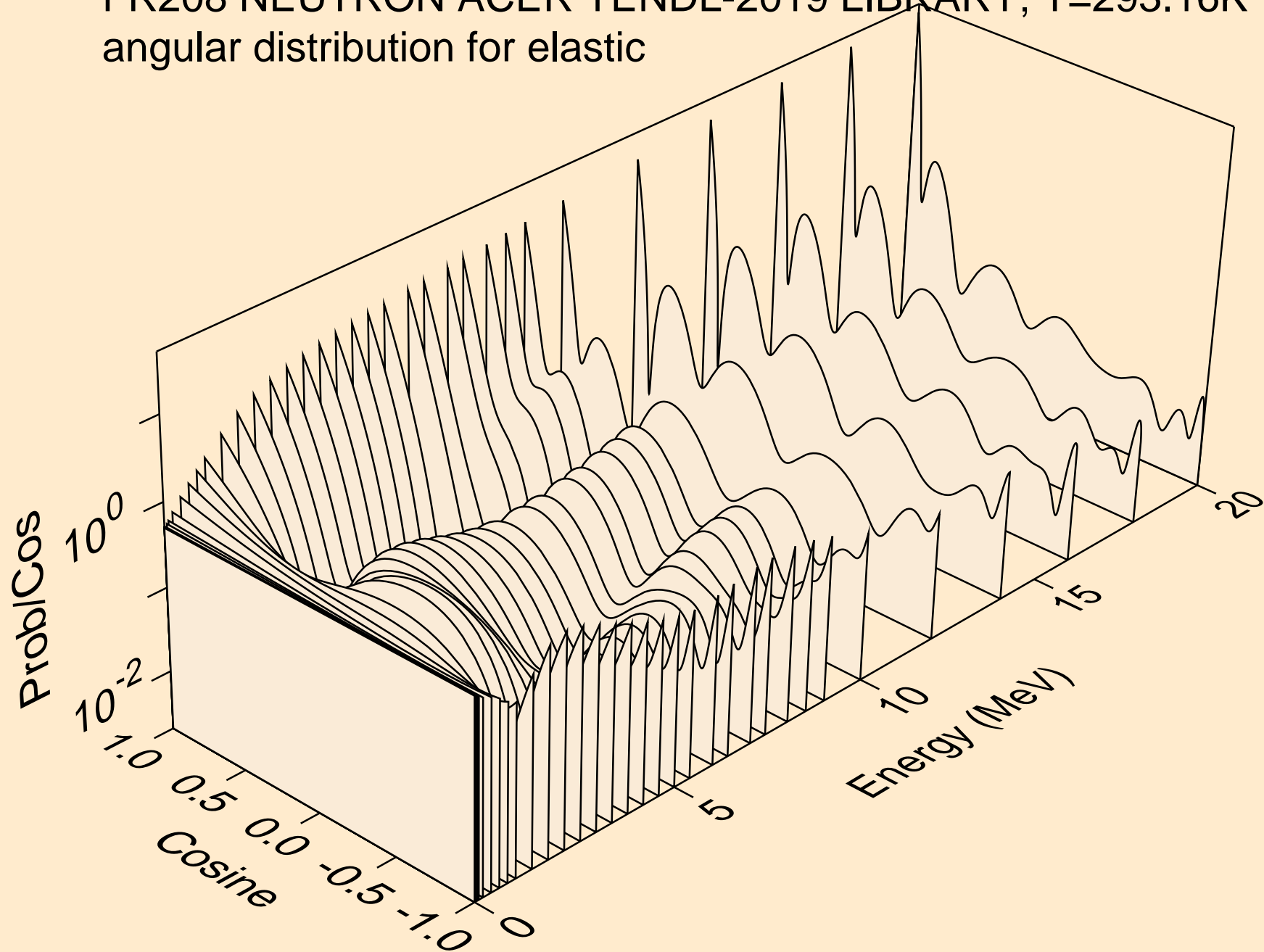



FR208 NEUTRON ACER TENDL-2019 LIBRARY; T=293.16K  
angular distribution for elastic

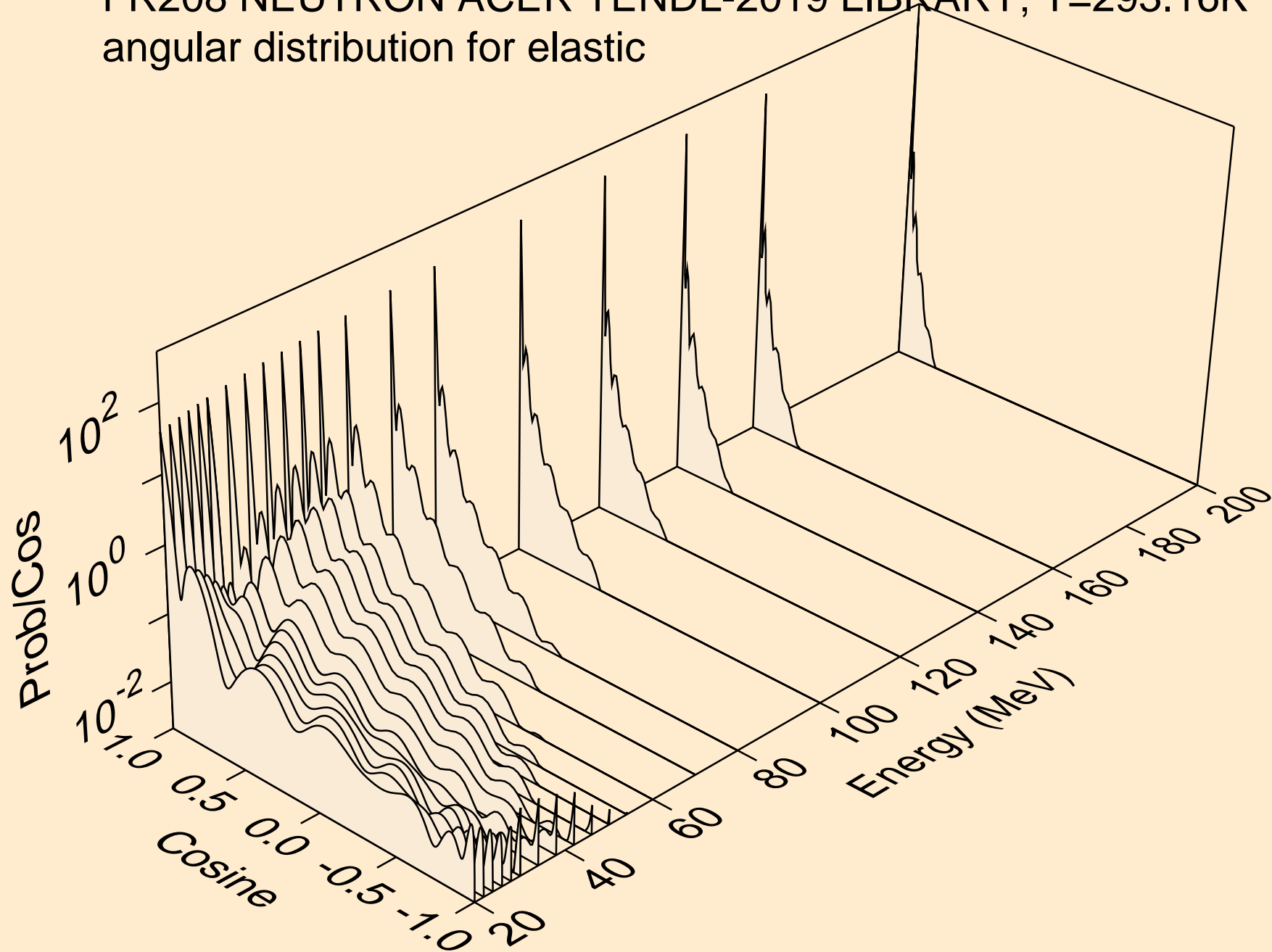

FR208 NEUTRON ACER TENDL-2019 LIBRARY; T=293.16K  
angular distribution for (n,n\*1)

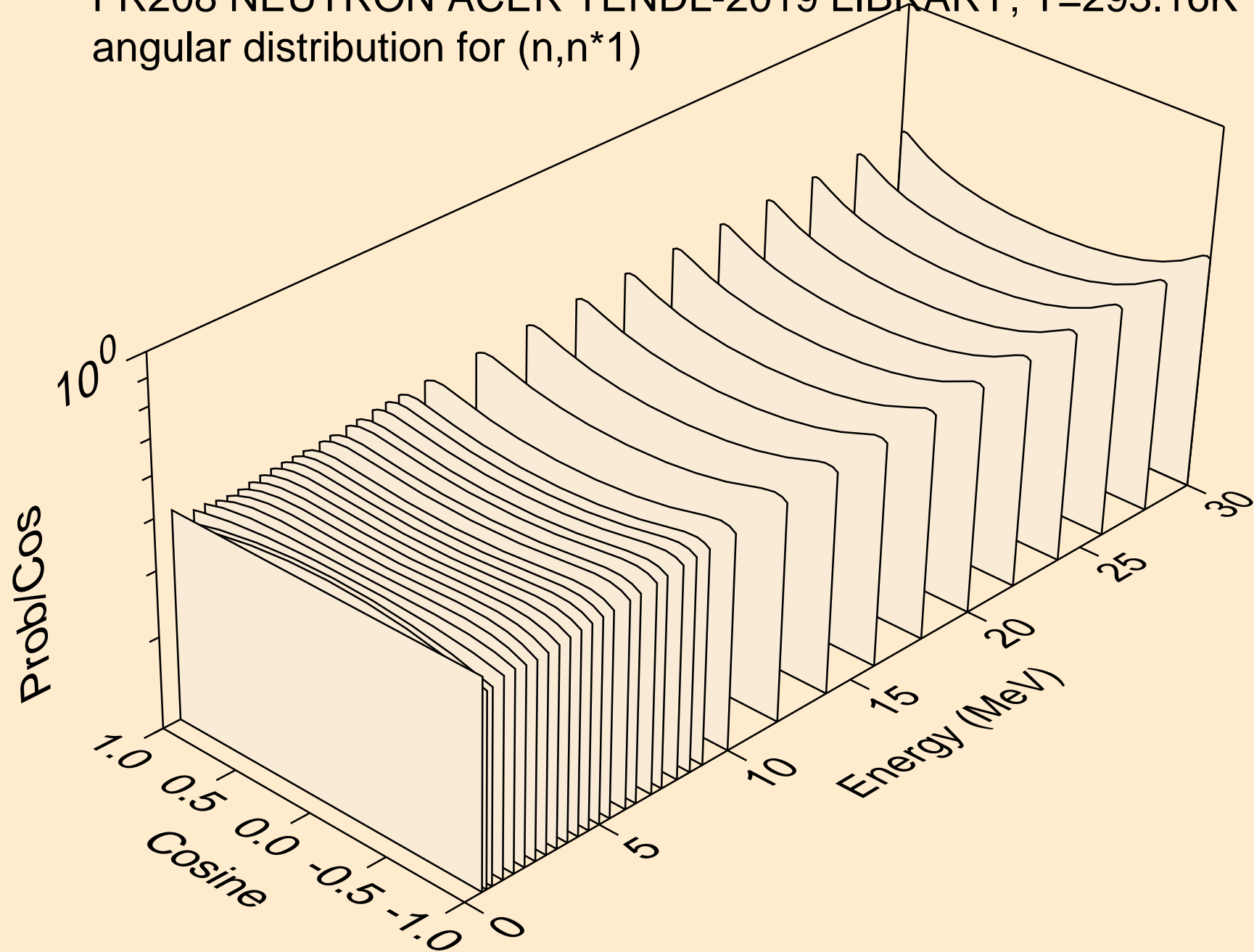

FR208 NEUTRON ACER TENDL-2019 LIBRARY; T=293.16K  
angular distribution for (n,n\*2)

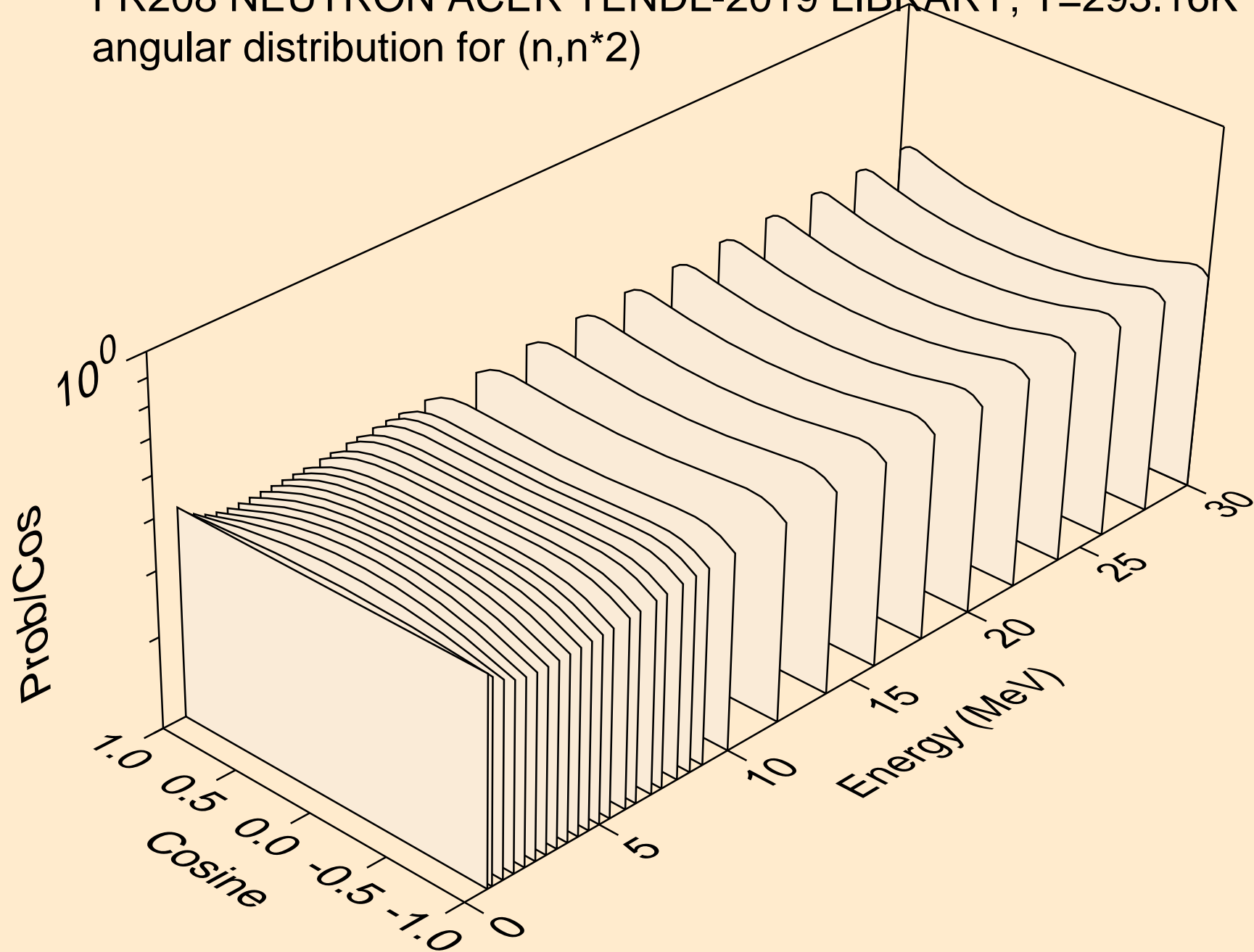

FR208 NEUTRON ACER TENDL-2019 LIBRARY; T=293.16K  
angular distribution for (n,n\*3)

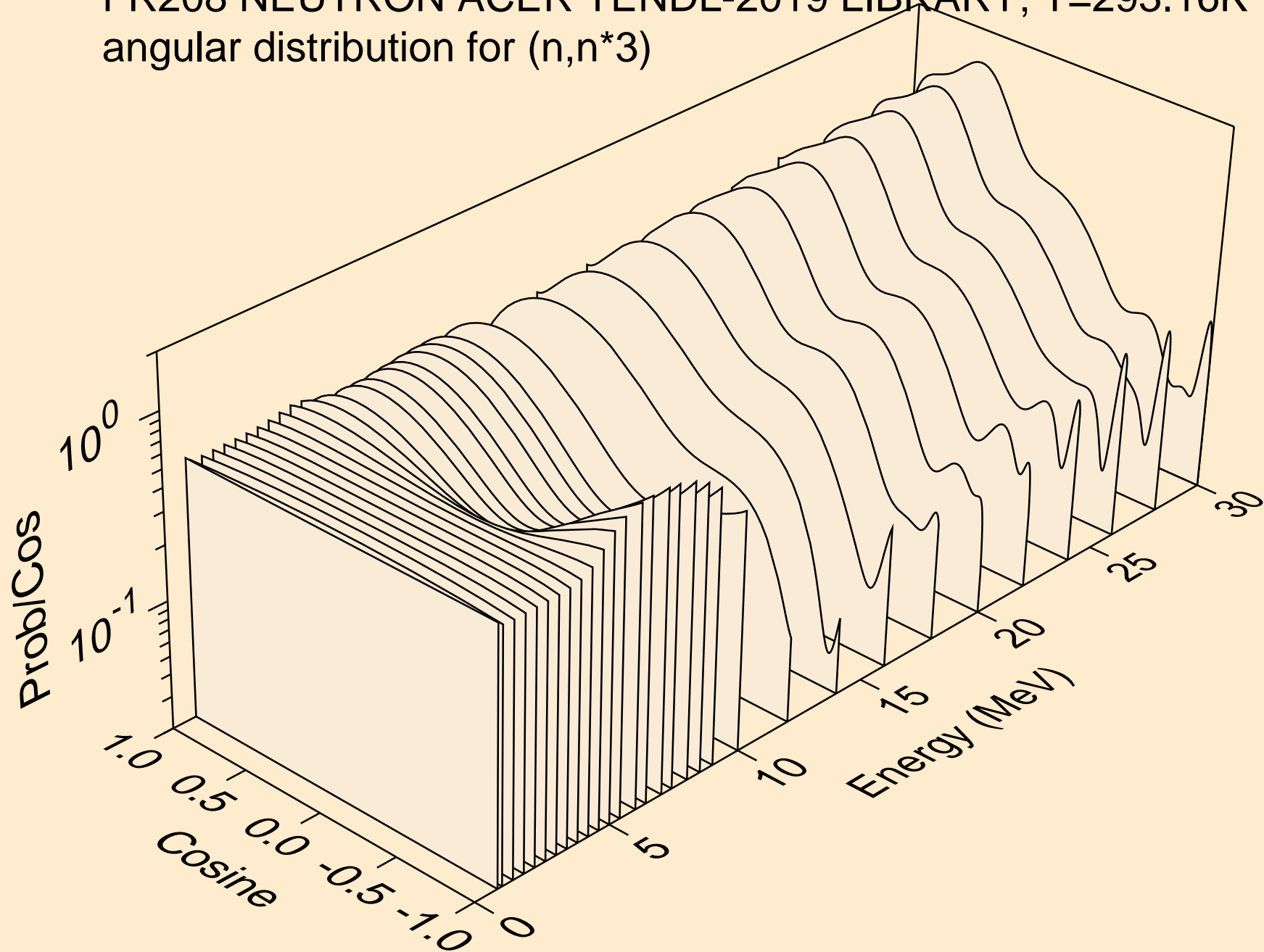

FR208 NEUTRON ACER TENDL-2019 LIBRARY; T=293.16K  
angular distribution for (n,n\*4)

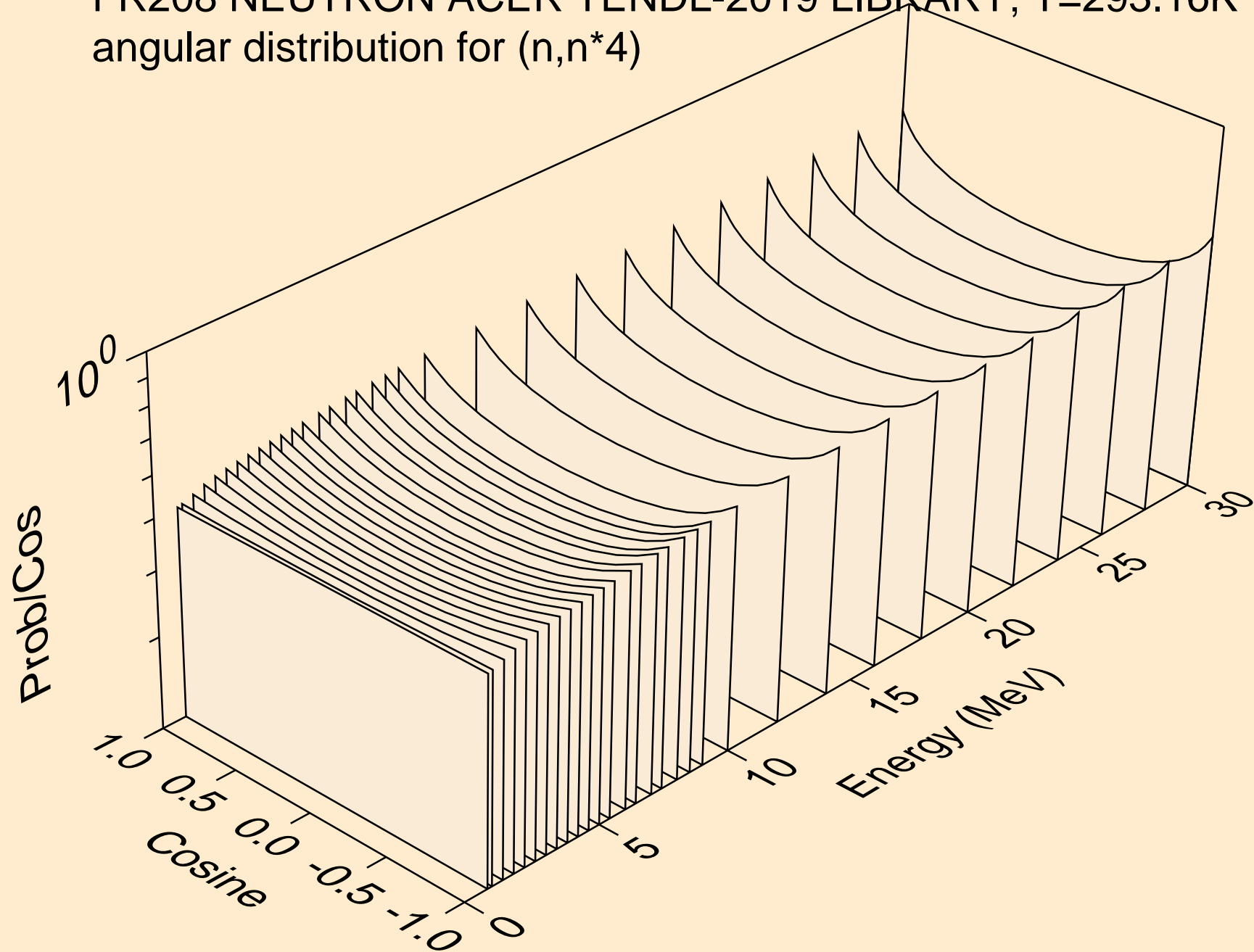

FR208 NEUTRON ACER TENDL-2019 LIBRARY; T=293.16K  
angular distribution for (n,n\*5)

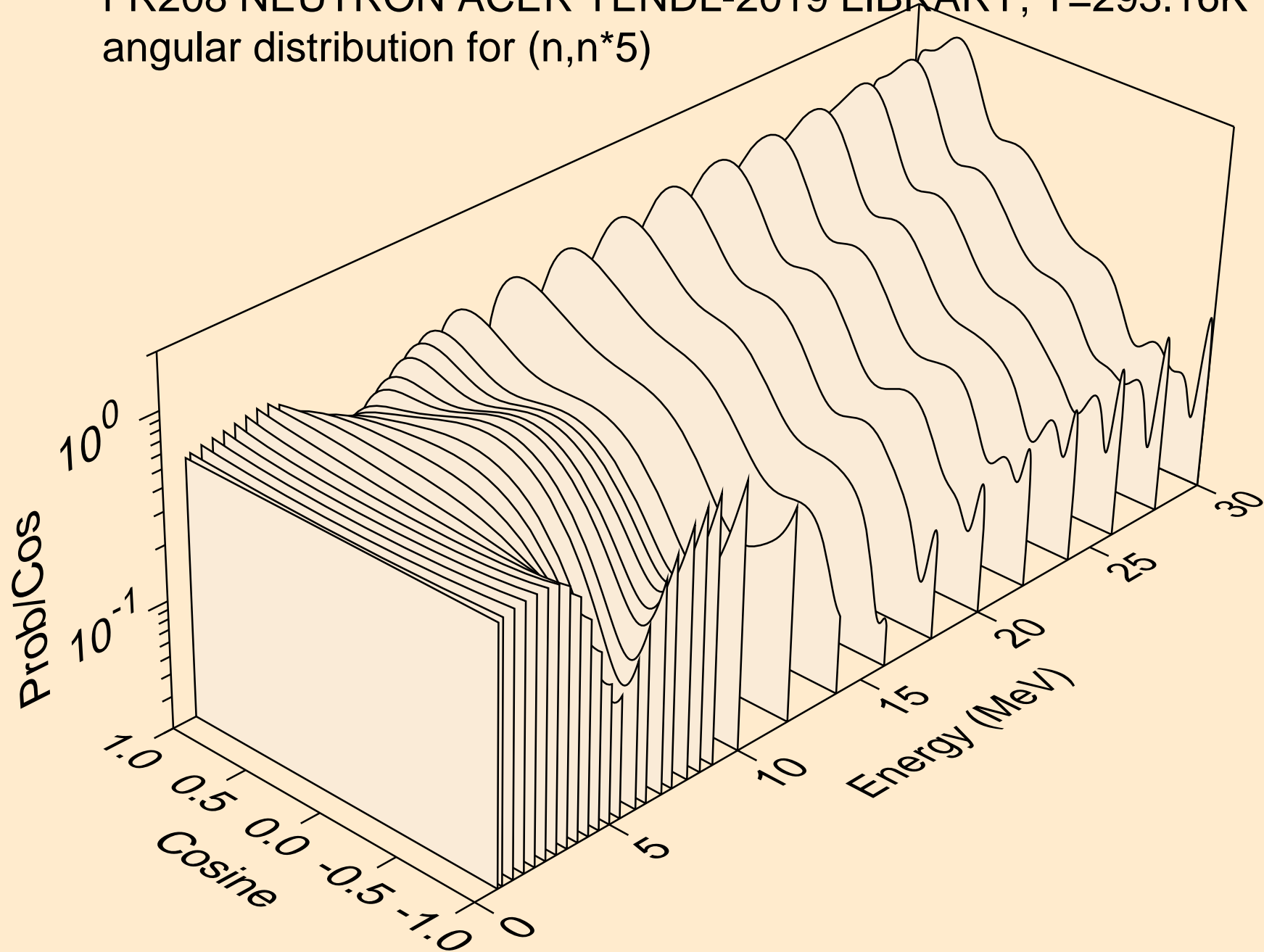

FR208 NEUTRON ACER TENDL-2019 LIBRARY; T=293.16K  
angular distribution for (n,n\*6)

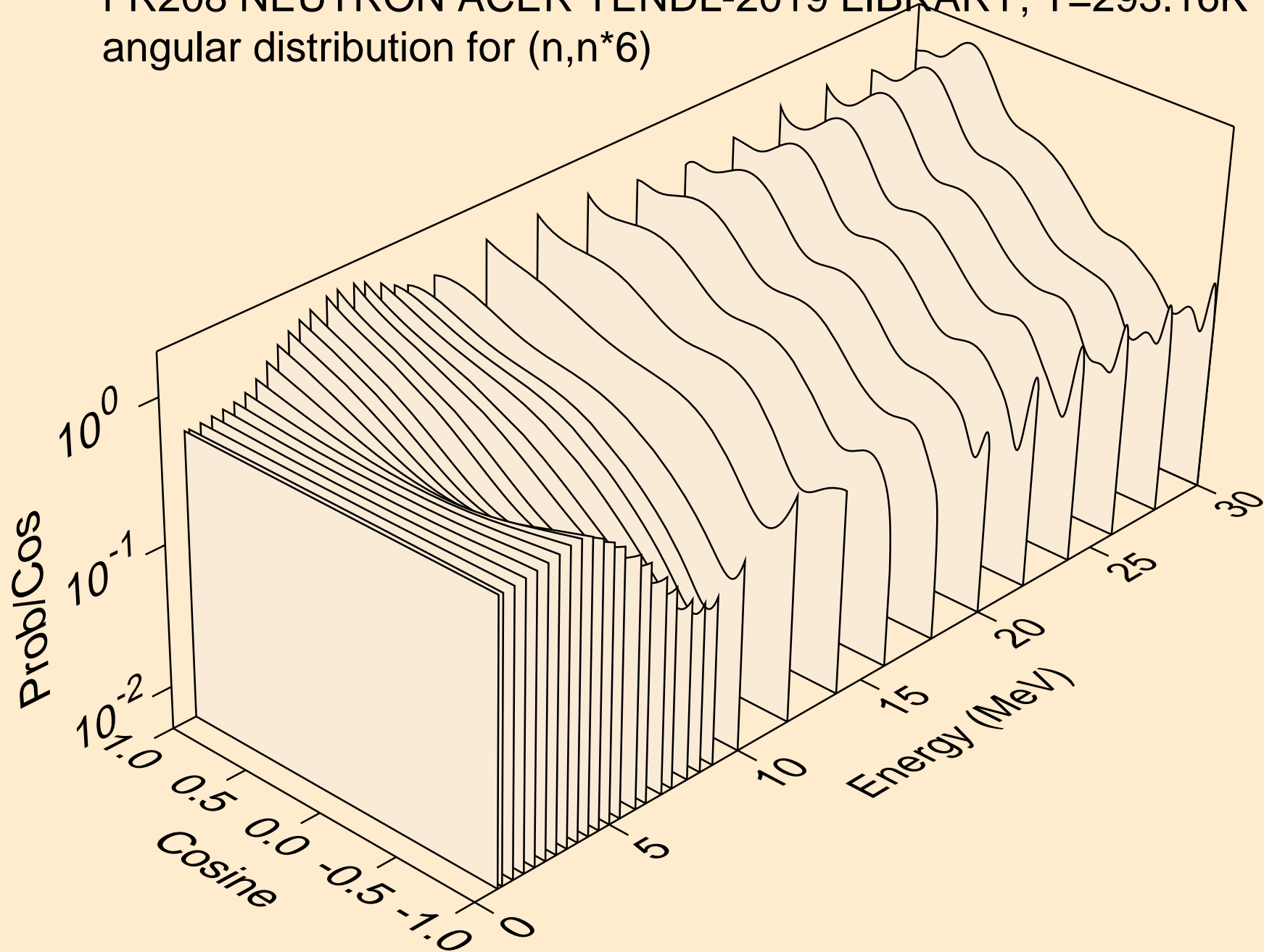

FR208 NEUTRON ACER TENDL-2019 LIBRARY; T=293.16K  
angular distribution for (n,n\*7)

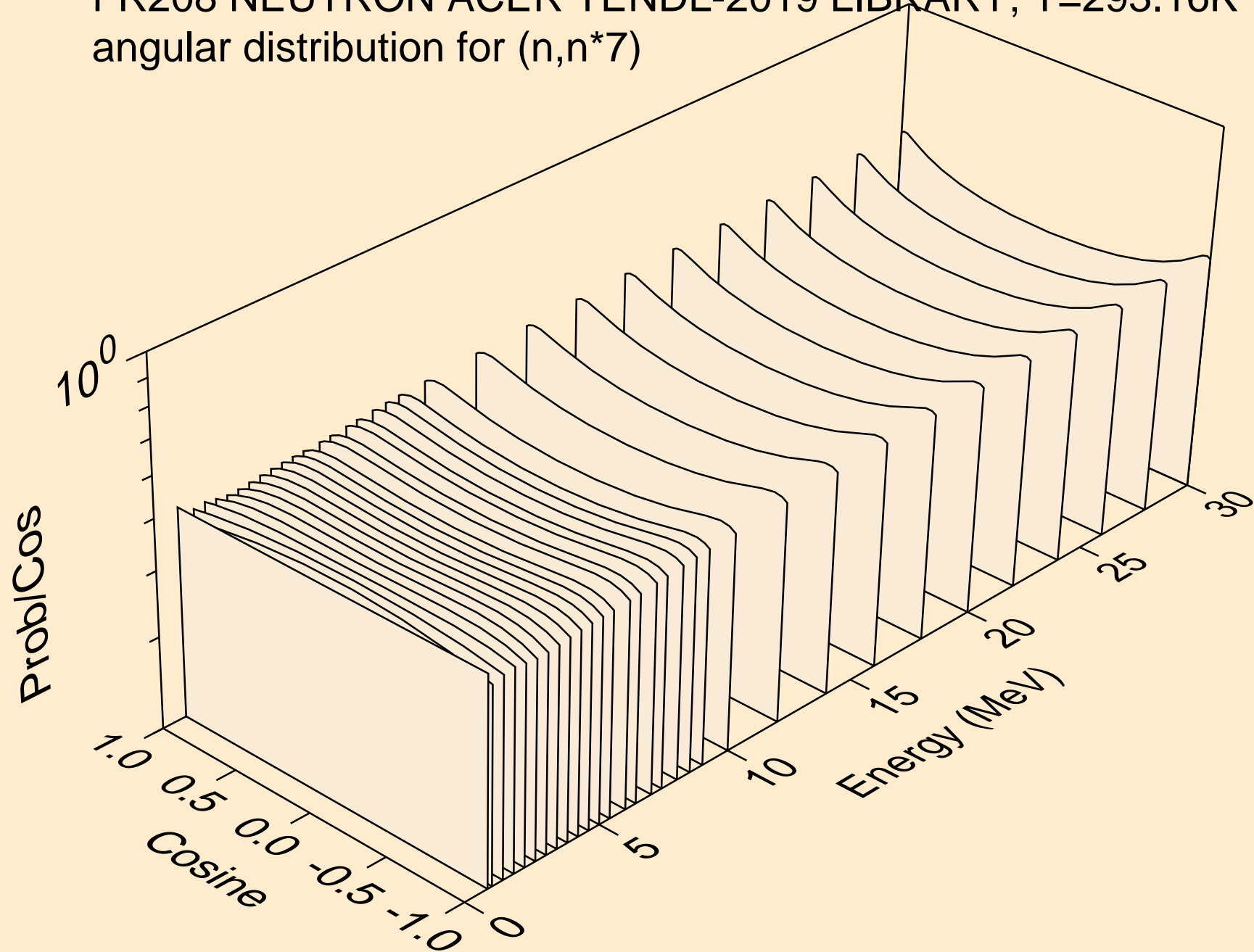



FR208 NEUTRON ACER TENDL-2019 LIBRARY; T=293.16K  
angular distribution for (n,n\*8)

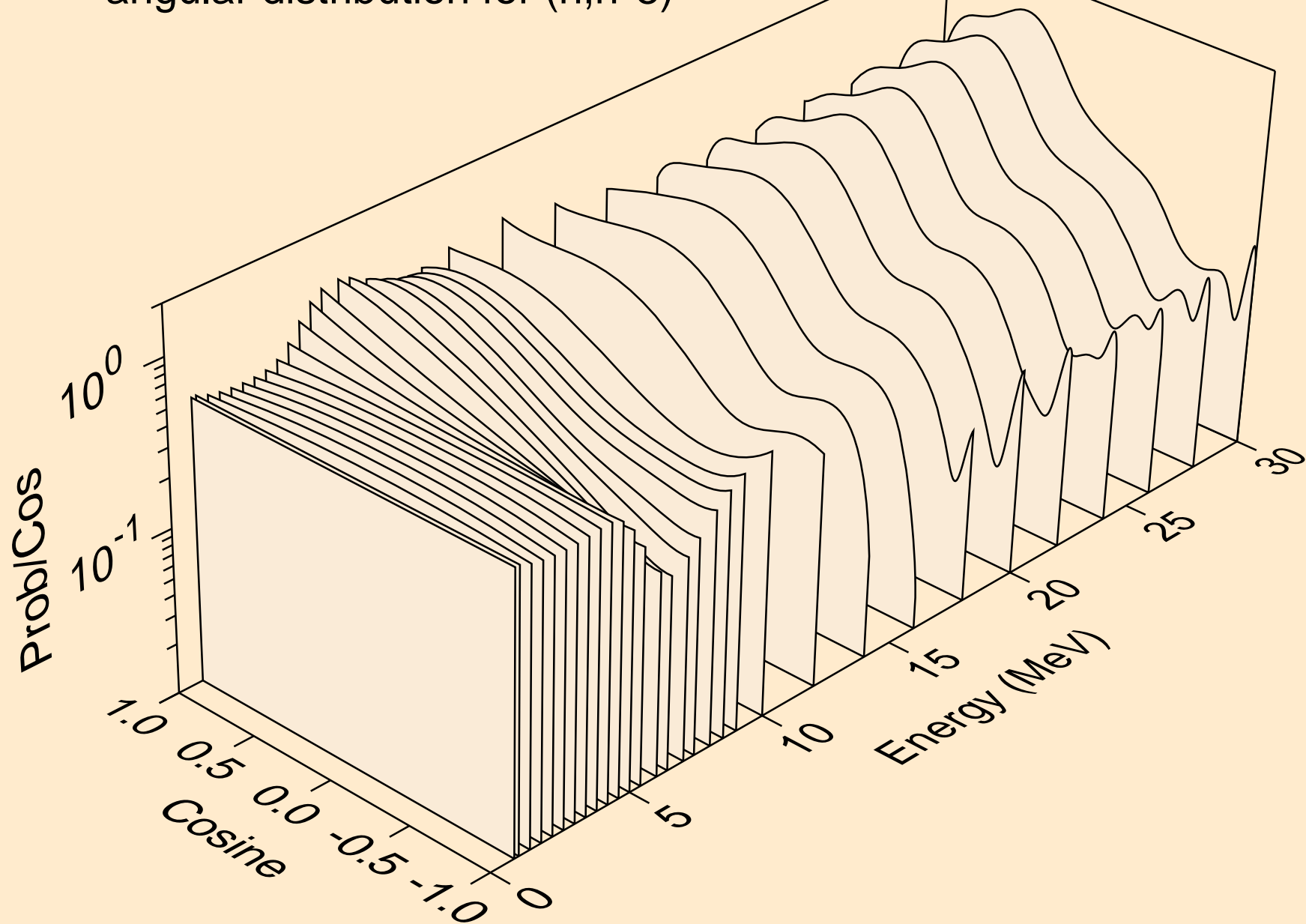

FR208 NEUTRON ACER TENDL-2019 LIBRARY; T=293.16K  
angular distribution for (n,n\*9)

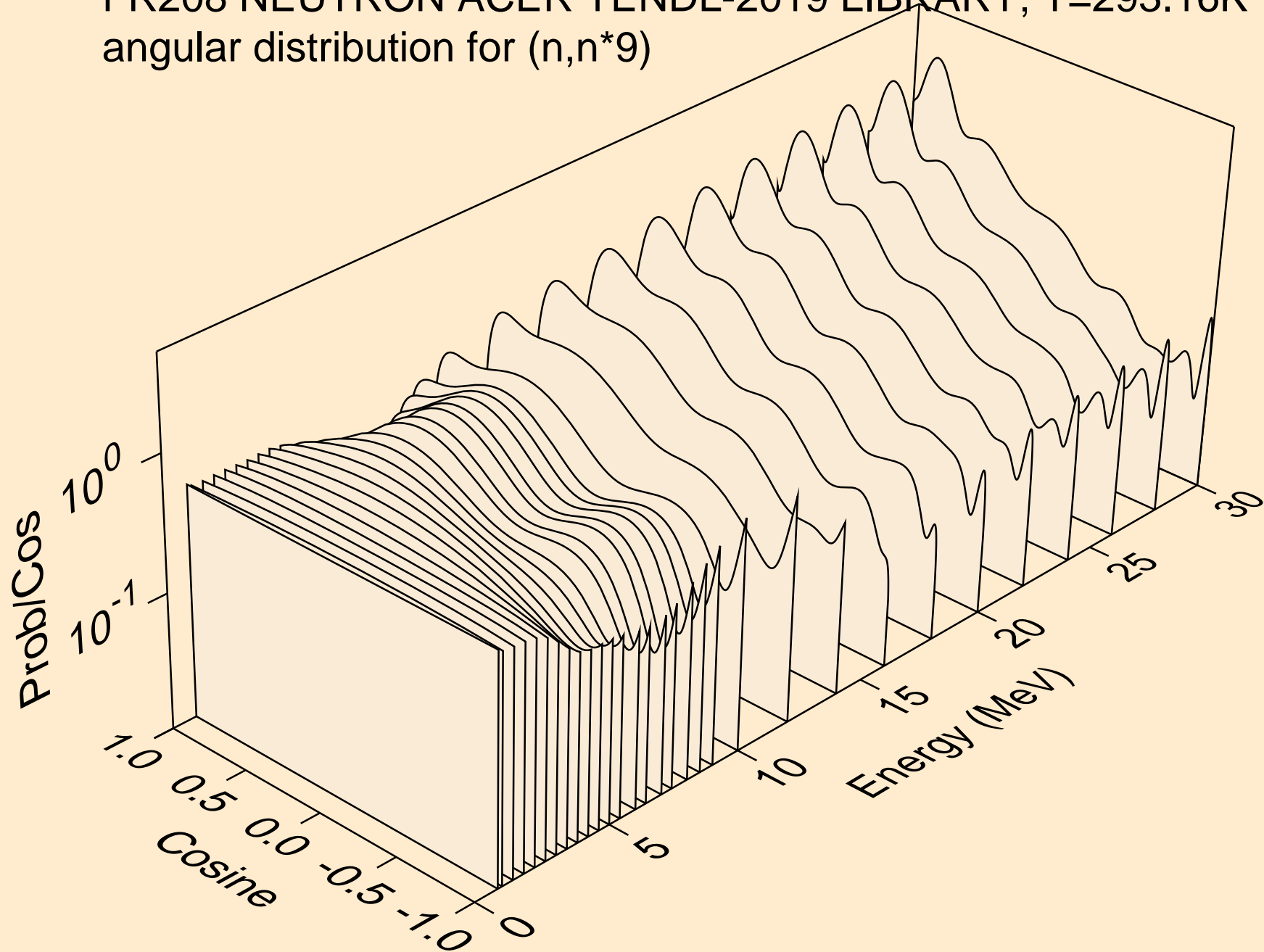

FR208 NEUTRON ACER TENDL-2019 LIBRARY; T=293.16K  
angular distribution for (n,n\*10)

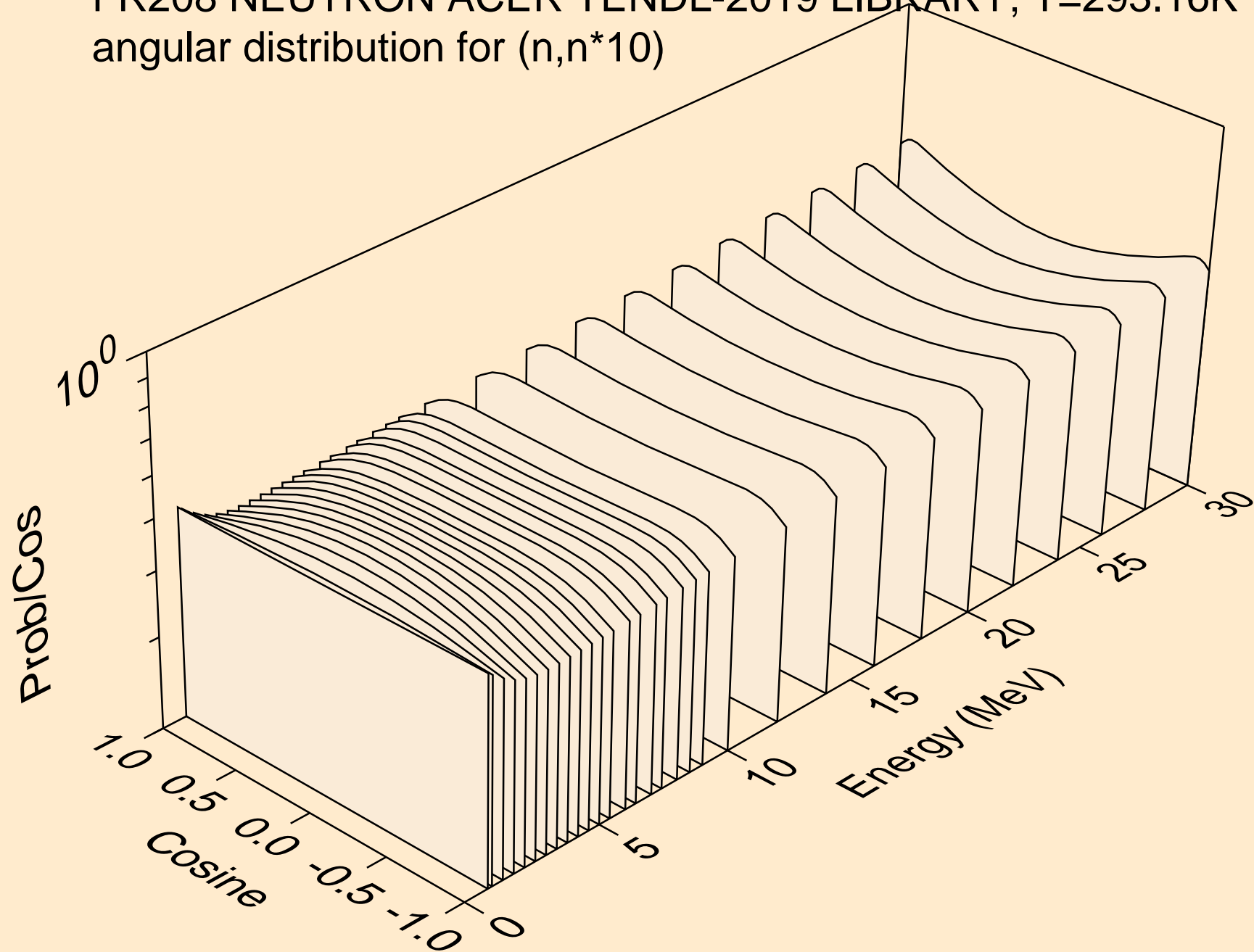

FR208 NEUTRON ACER TENDL-2019 LIBRARY; T=293.16K  
angular distribution for (n,n\*11)

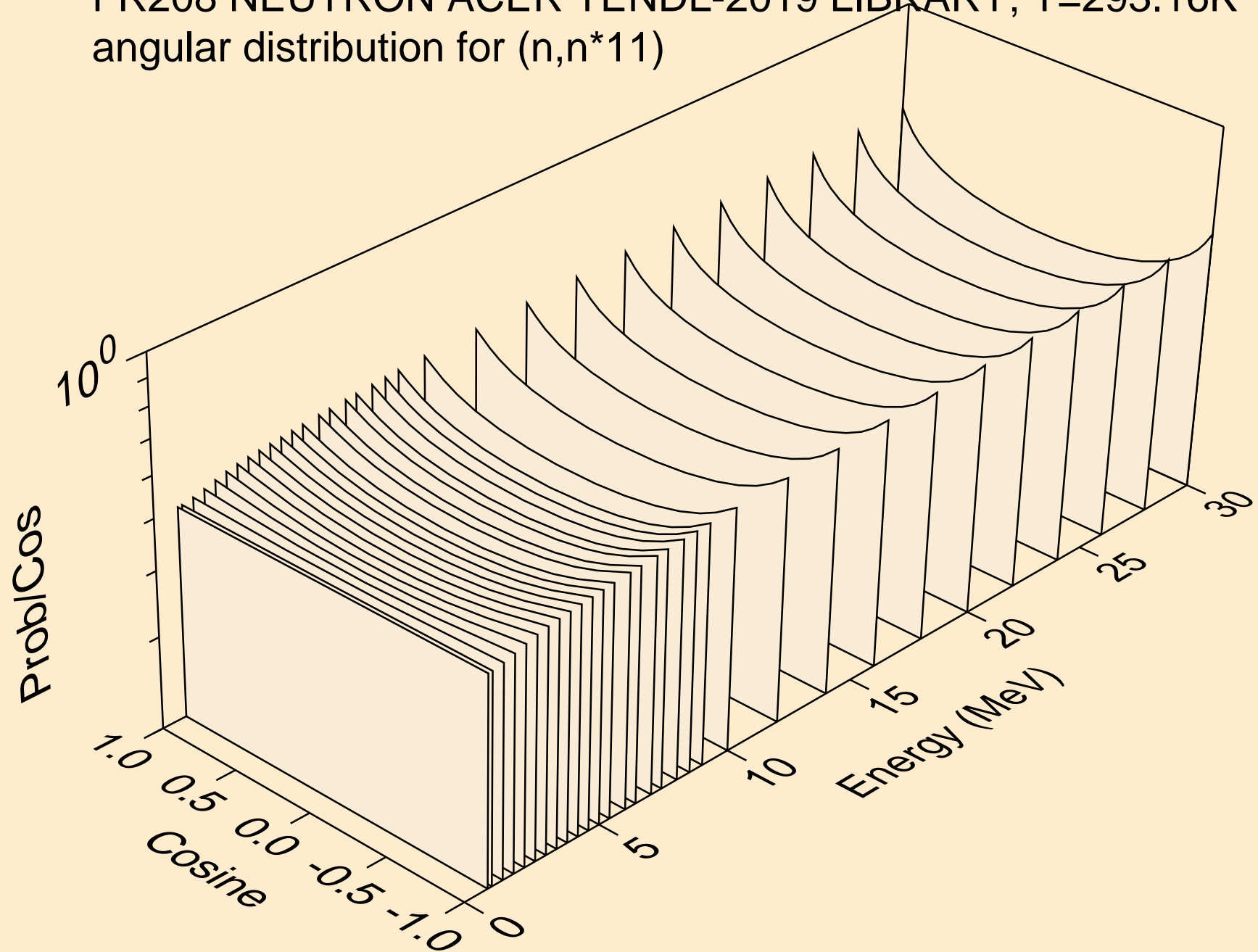

FR208 NEUTRON ACER TENDL-2019 LIBRARY; T=293.16K  
angular distribution for (n,n\*12)

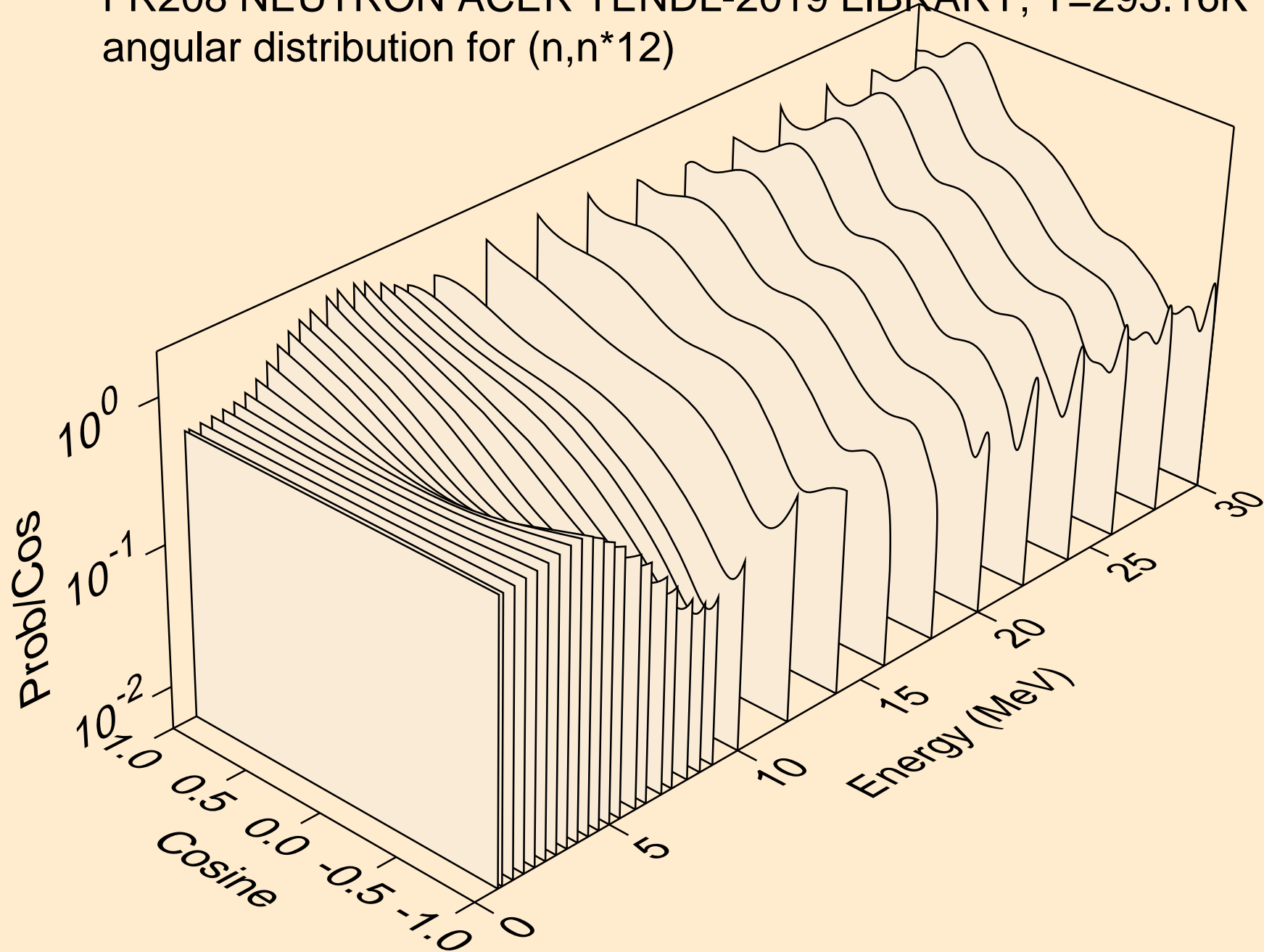

FR208 NEUTRON ACER TENDL-2019 LIBRARY; T=293.16K  
angular distribution for (n,n\*13)

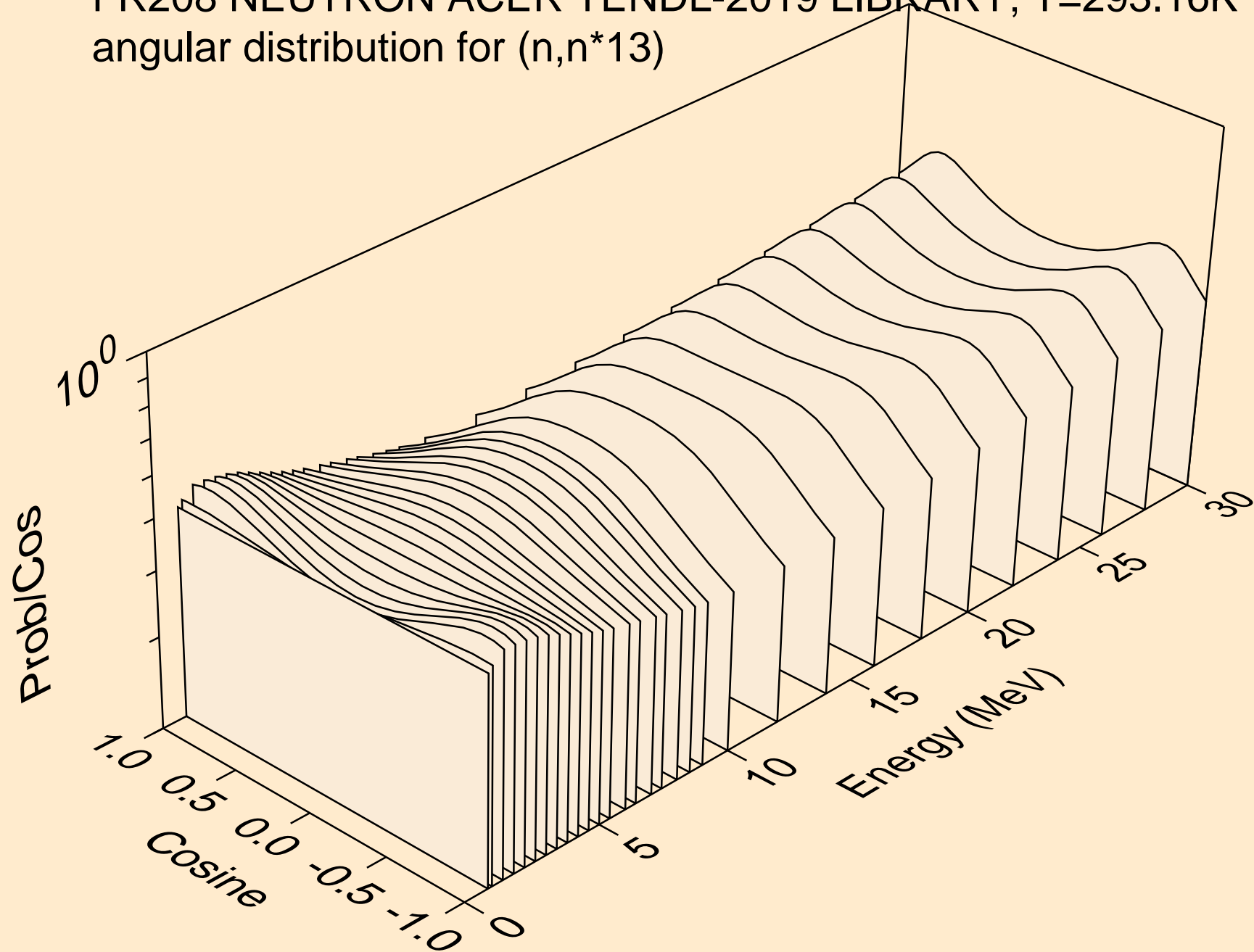

FR208 NEUTRON ACER TENDL-2019 LIBRARY; T=293.16K  
angular distribution for (n,n\*14)

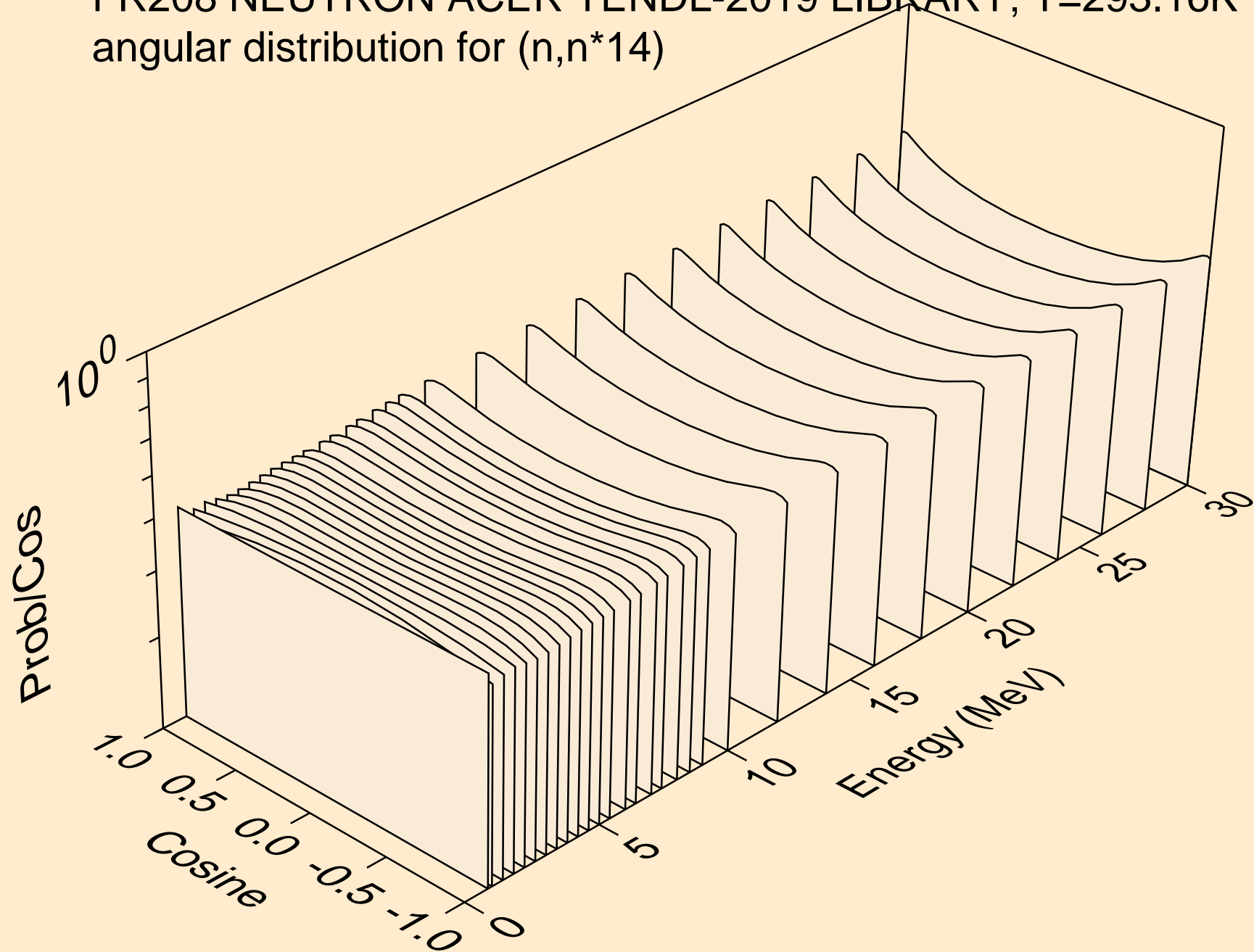

FR208 NEUTRON ACER TENDL-2019 LIBRARY; T=293.16K  
angular distribution for (n,n\*15)

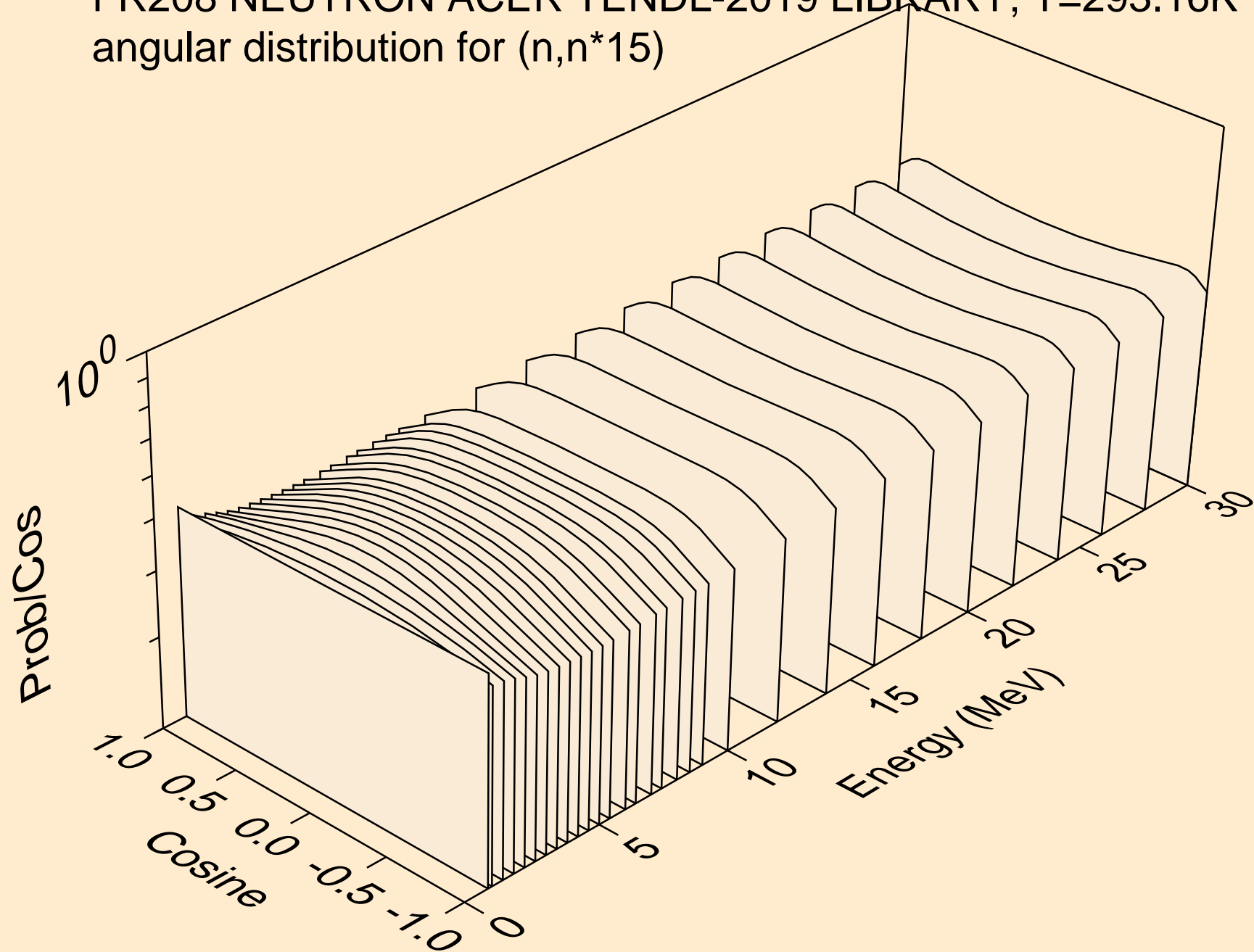



FR208 NEUTRON ACER TENDL-2019 LIBRARY; T=293.16K  
angular distribution for (n,n\*16)

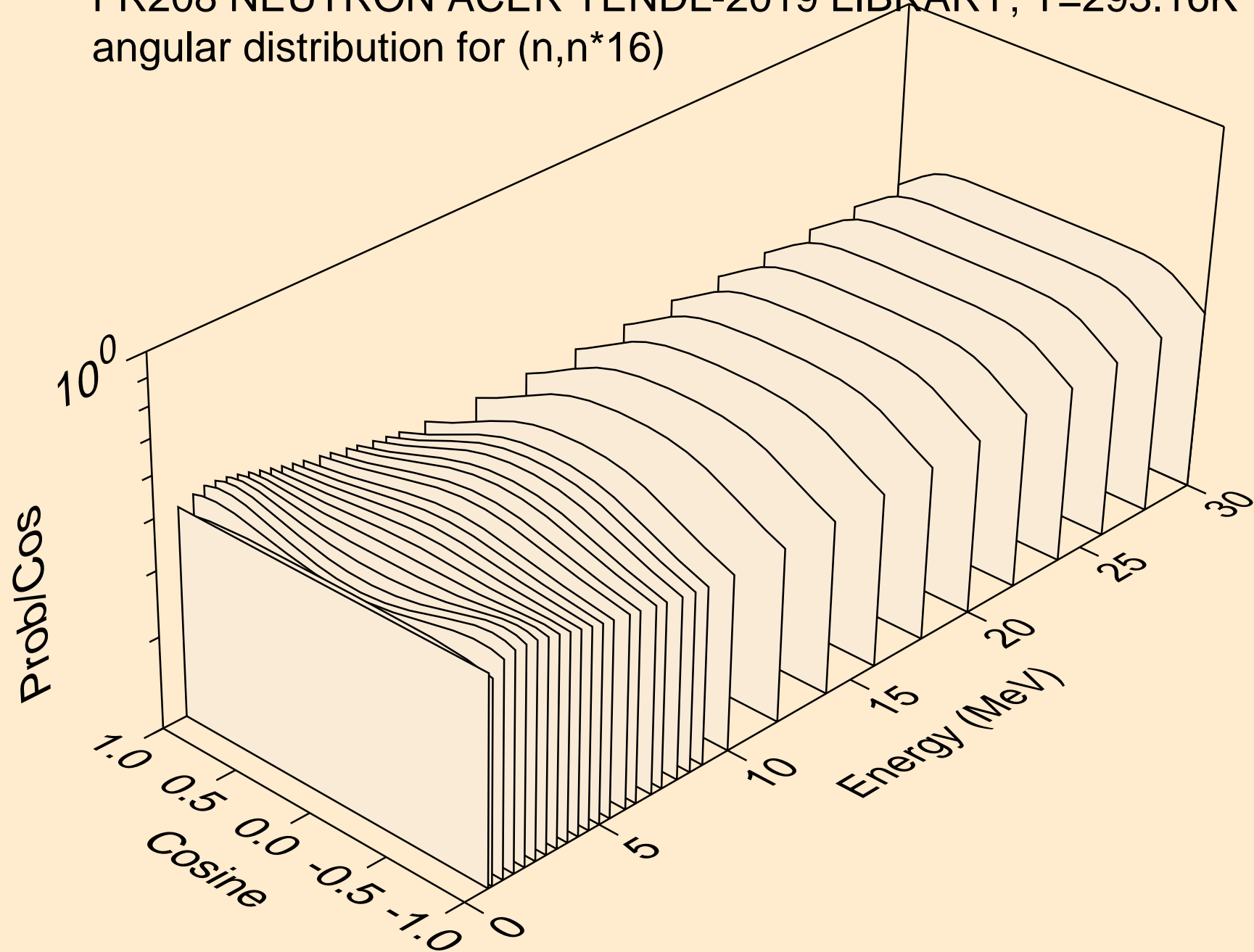

FR208 NEUTRON ACER TENDL-2019 LIBRARY; T=293.16K  
angular distribution for (n,n\*17)

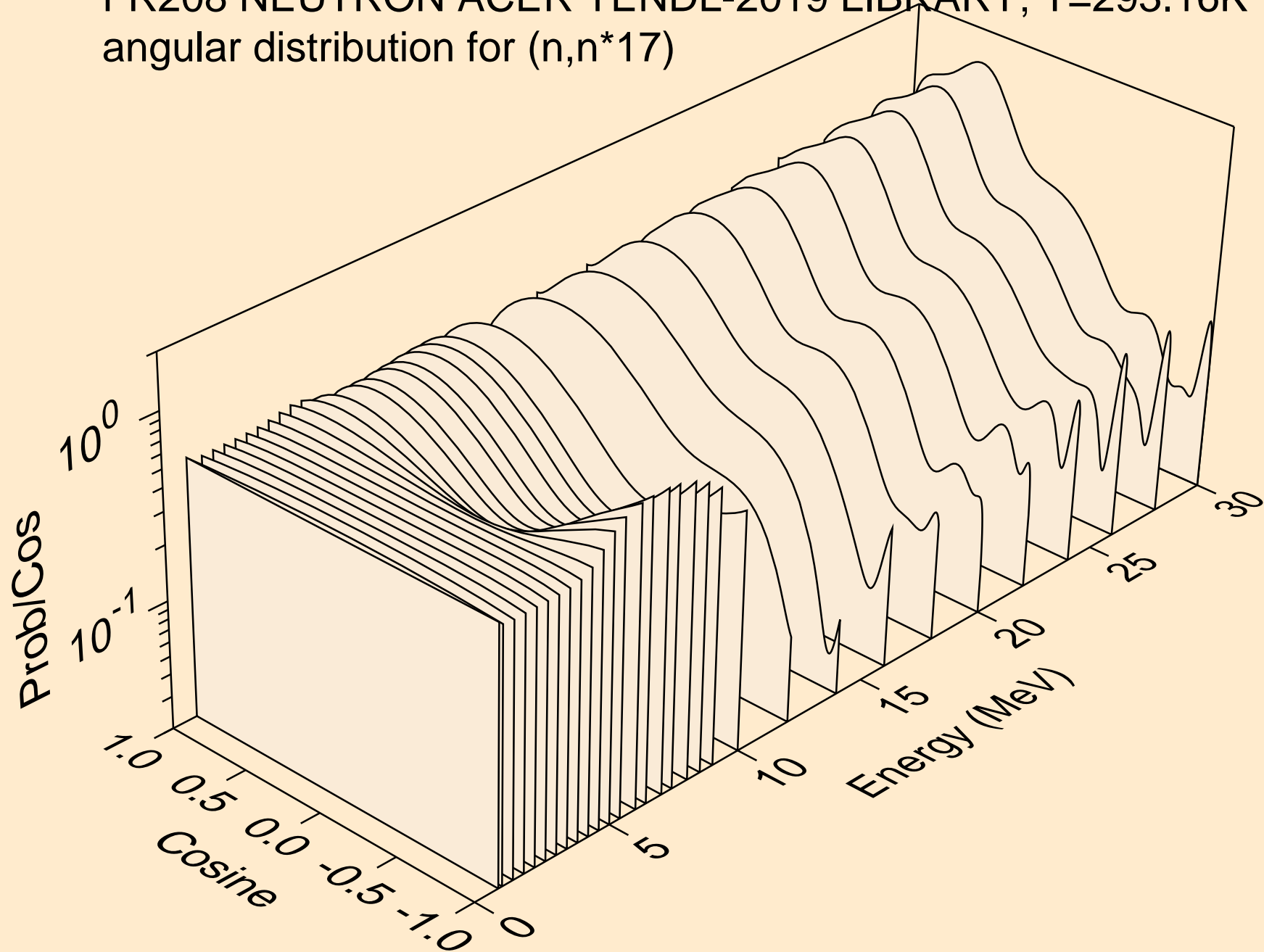

FR208 NEUTRON ACER TENDL-2019 LIBRARY; T=293.16K  
angular distribution for (n,n\*18)

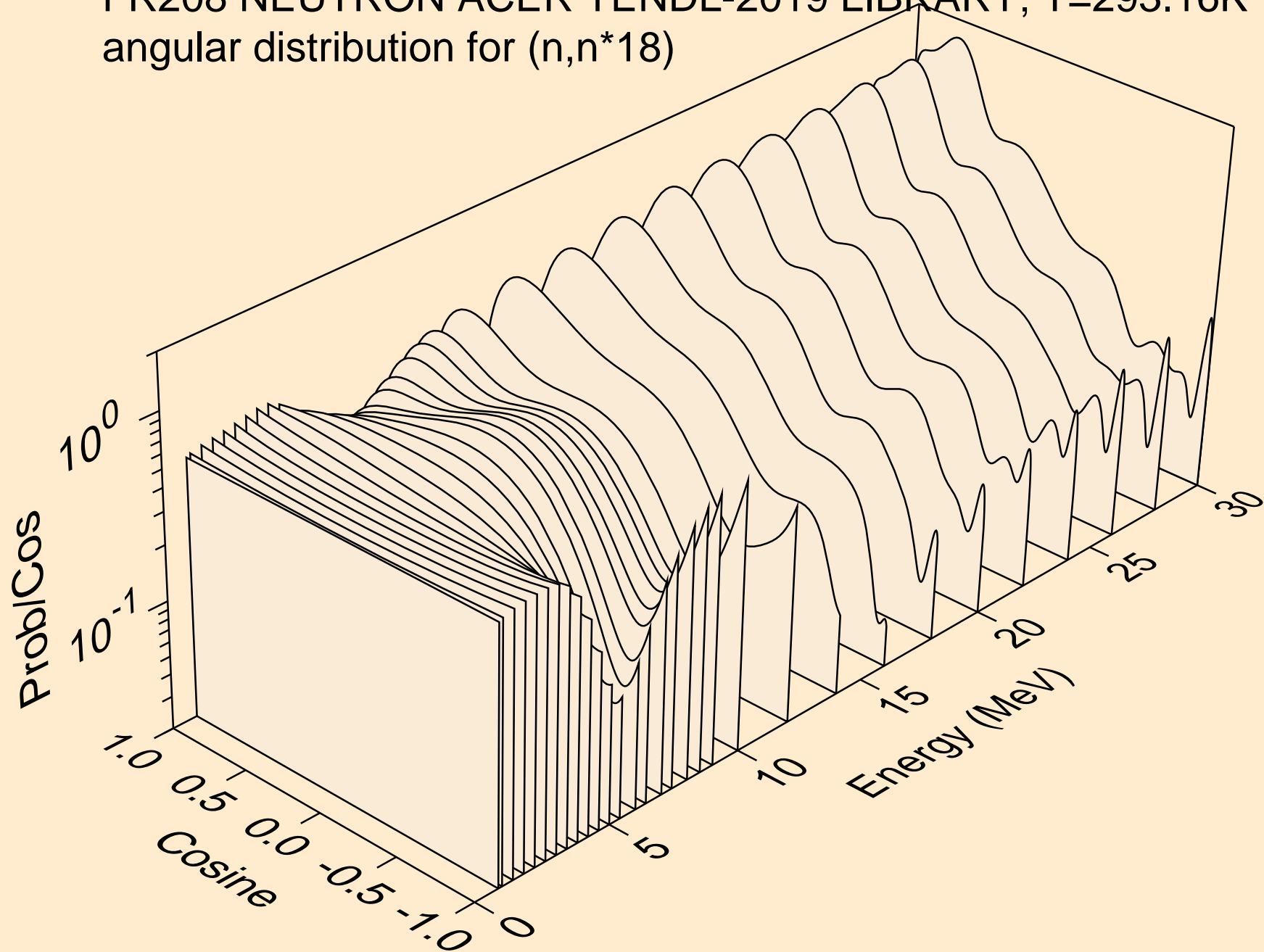

FR208 NEUTRON ACER TENDL-2019 LIBRARY; T=293.16K  
angular distribution for (n,n\*19)

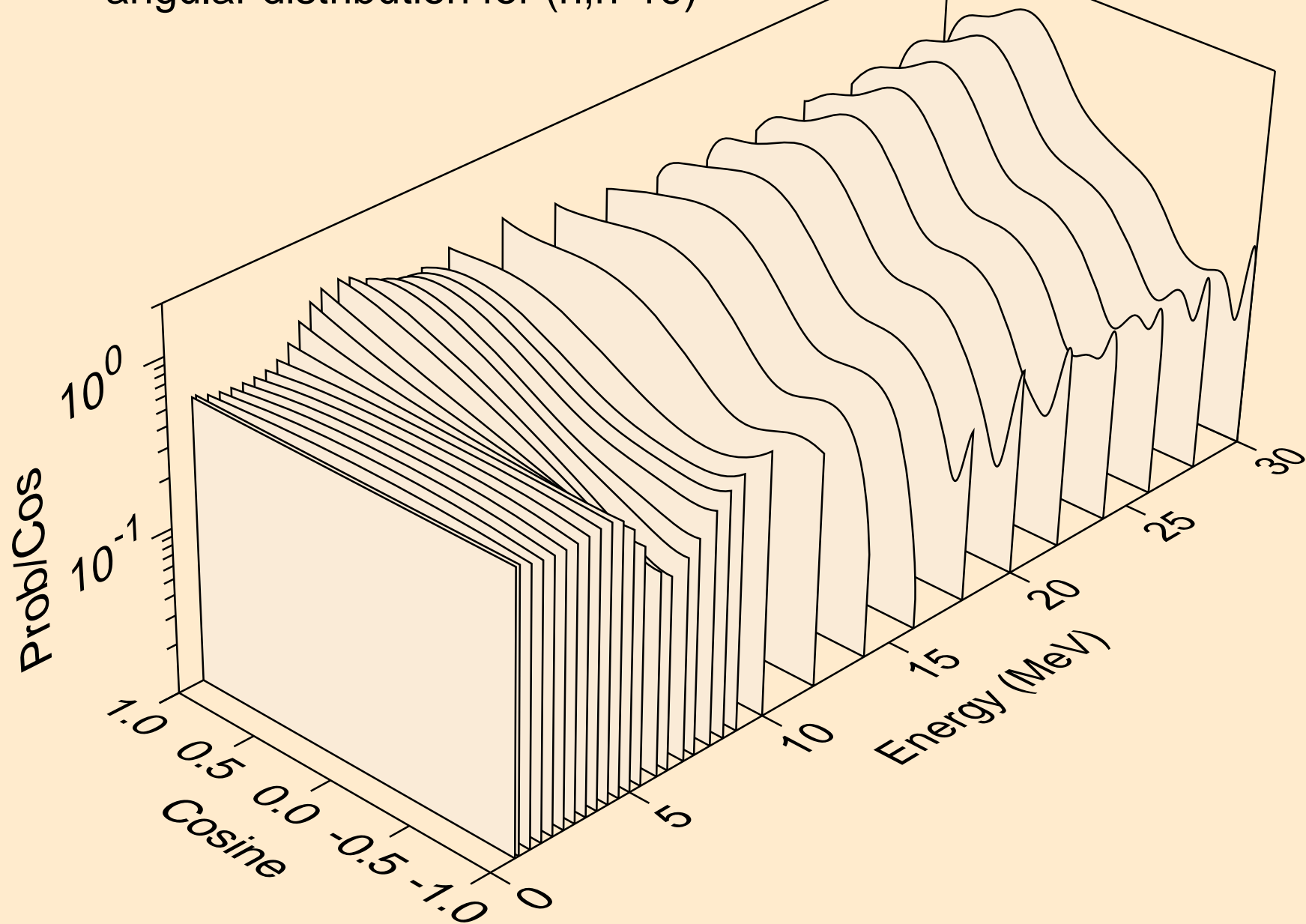

FR208 NEUTRON ACER TENDL-2019 LIBRARY; T=293.16K  
angular distribution for (n,n\*20)

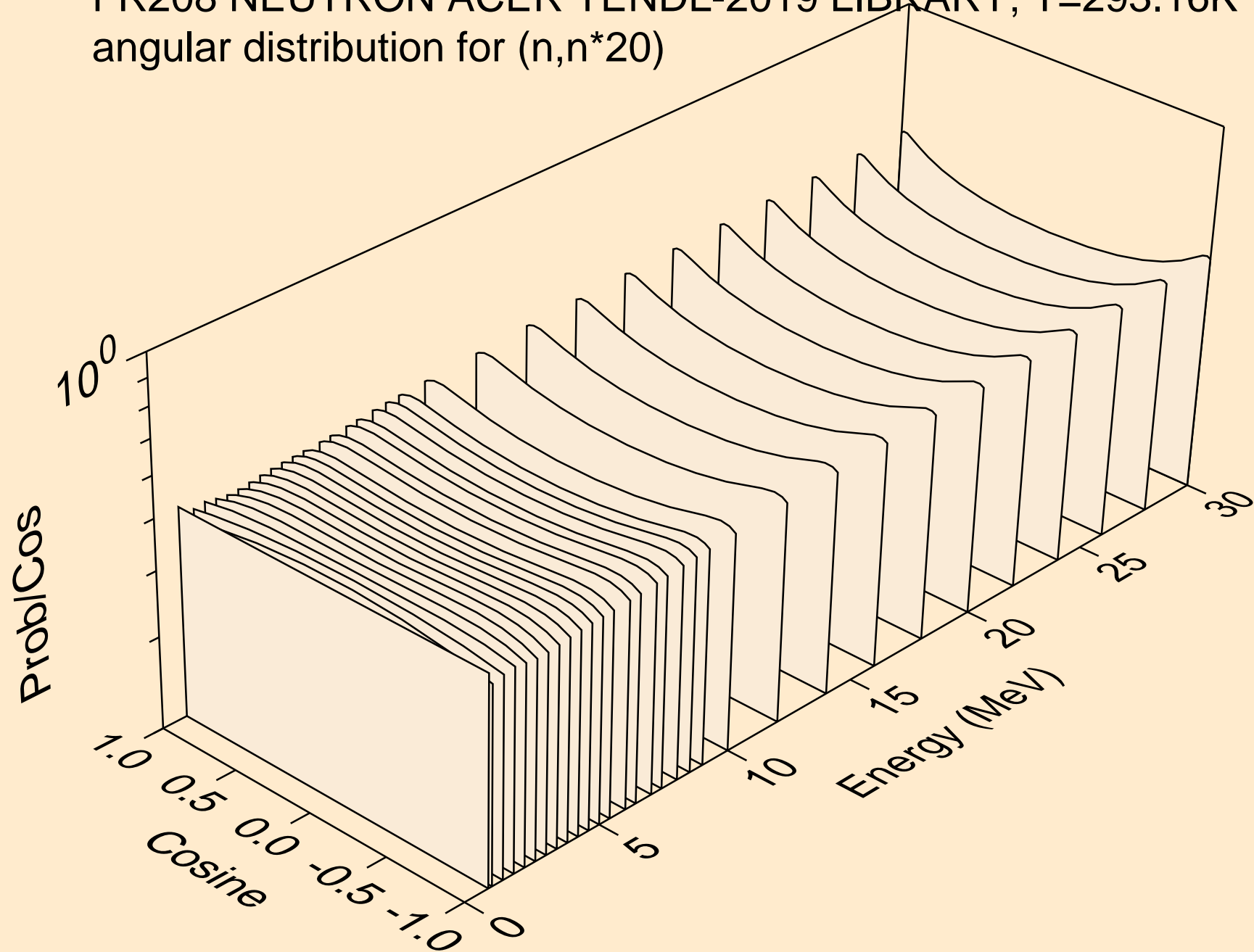

FR208 NEUTRON ACER TENDL-2019 LIBRARY; T=293.16K  
angular distribution for (n,n\*21)

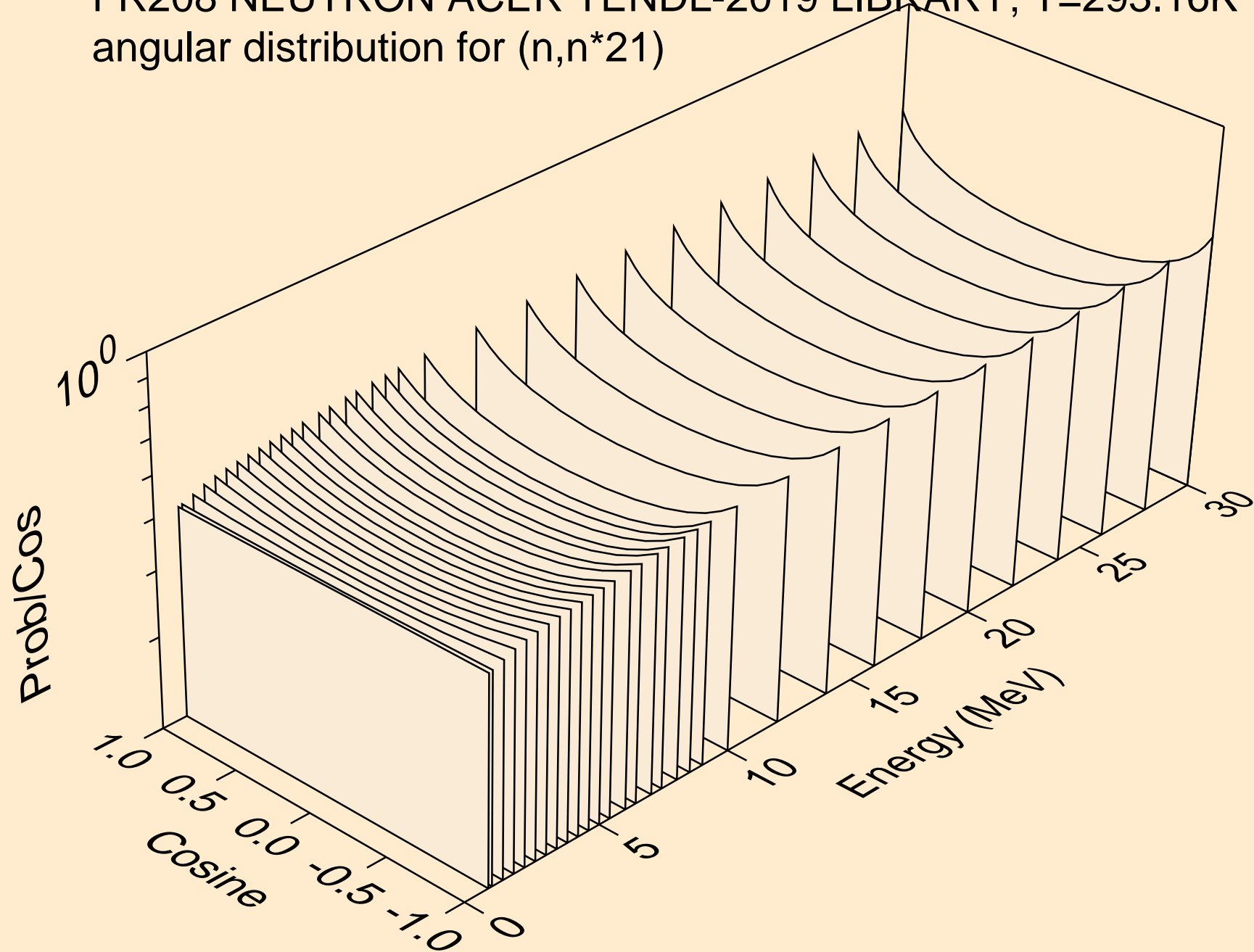

FR208 NEUTRON ACER TENDL-2019 LIBRARY; T=293.16K  
angular distribution for (n,n\*22)

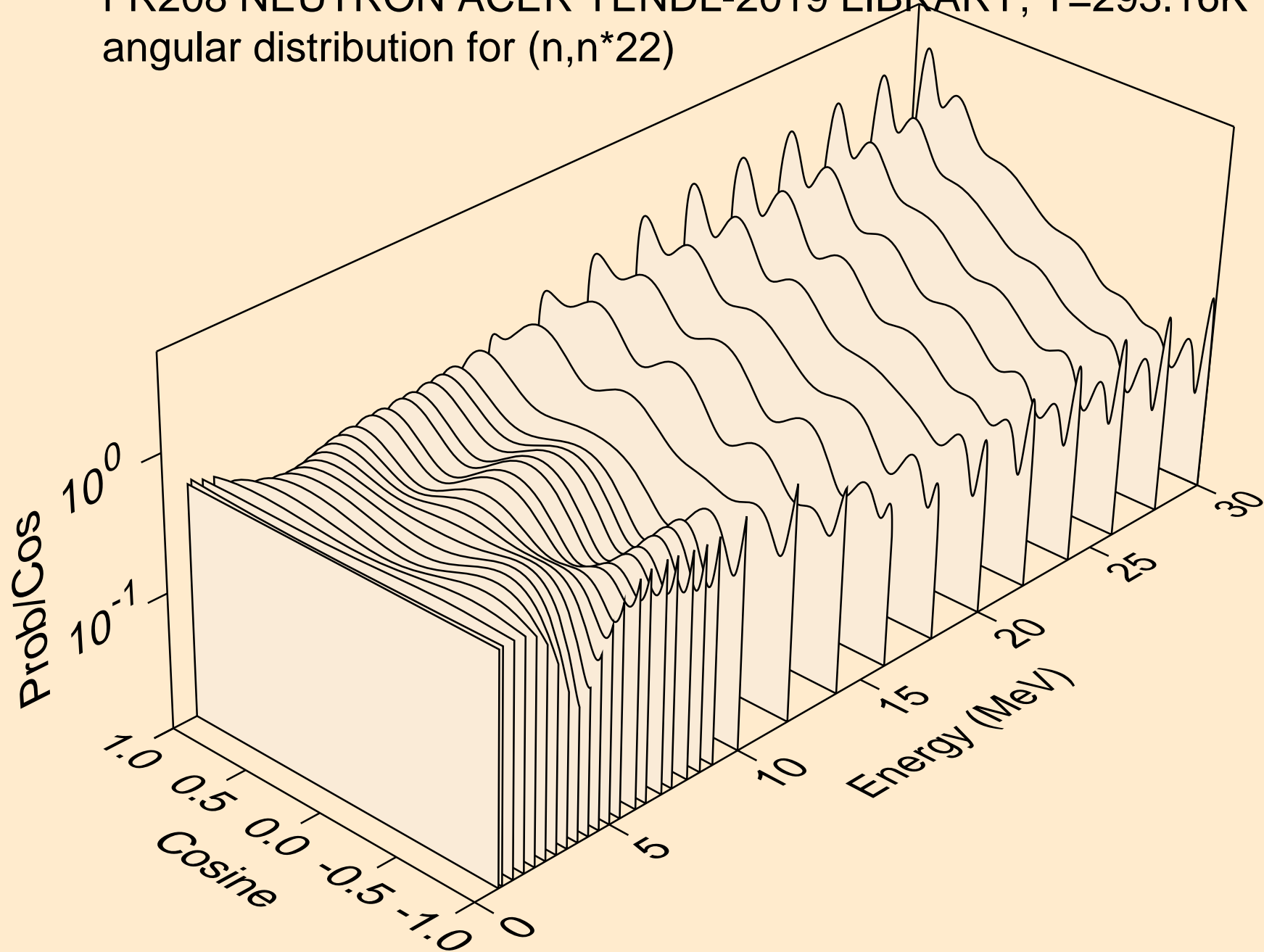

FR208 NEUTRON ACER TENDL-2019 LIBRARY; T=293.16K  
angular distribution for (n,n\*23)

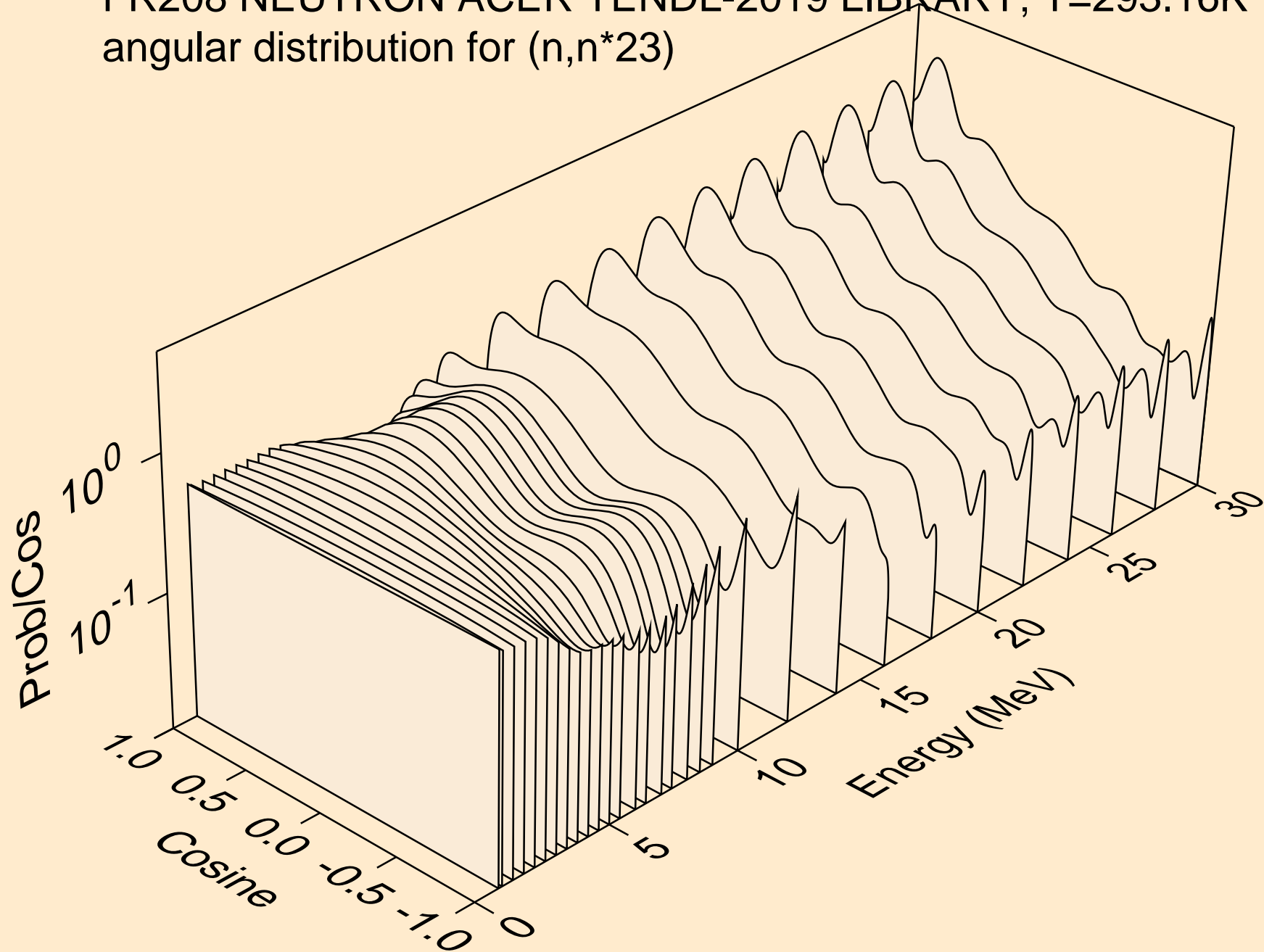



FR208 NEUTRON ACER TENDL-2019 LIBRARY; T=293.16K  
angular distribution for (n,n\*24)

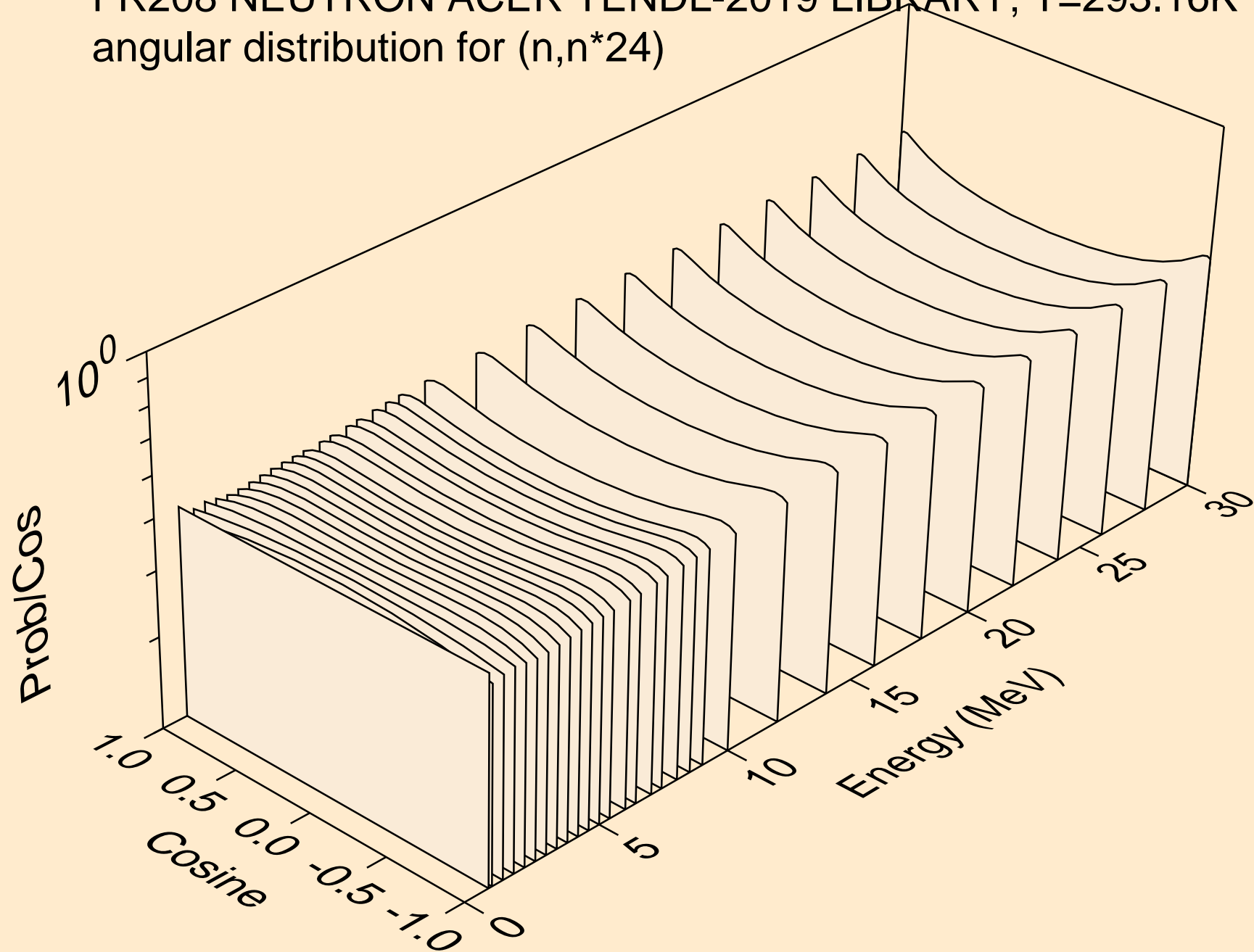

FR208 NEUTRON ACER TENDL-2019 LIBRARY; T=293.16K  
angular distribution for (n,n\*25)

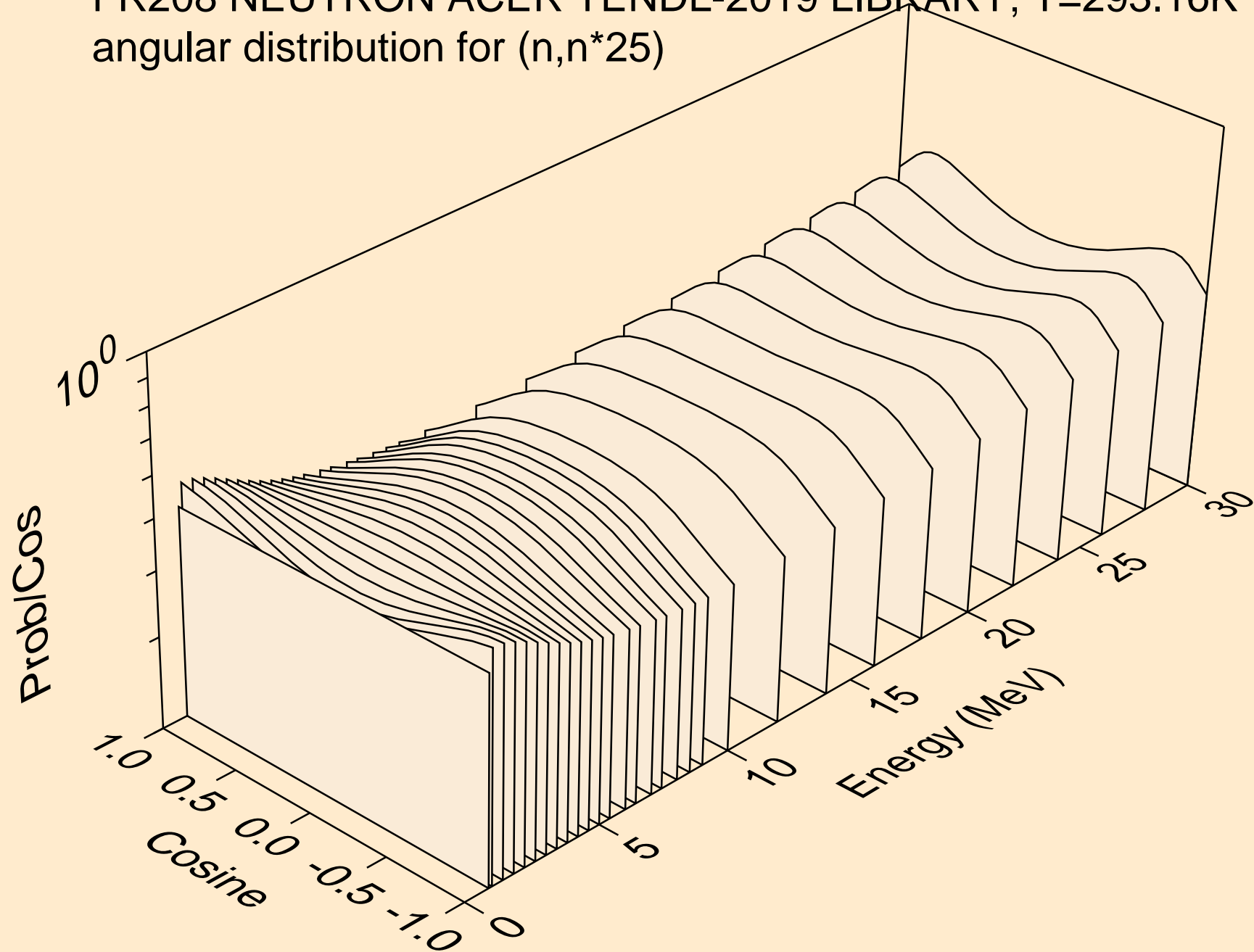

FR208 NEUTRON ACER TENDL-2019 LIBRARY; T=293.16K  
angular distribution for (n,n\*26)

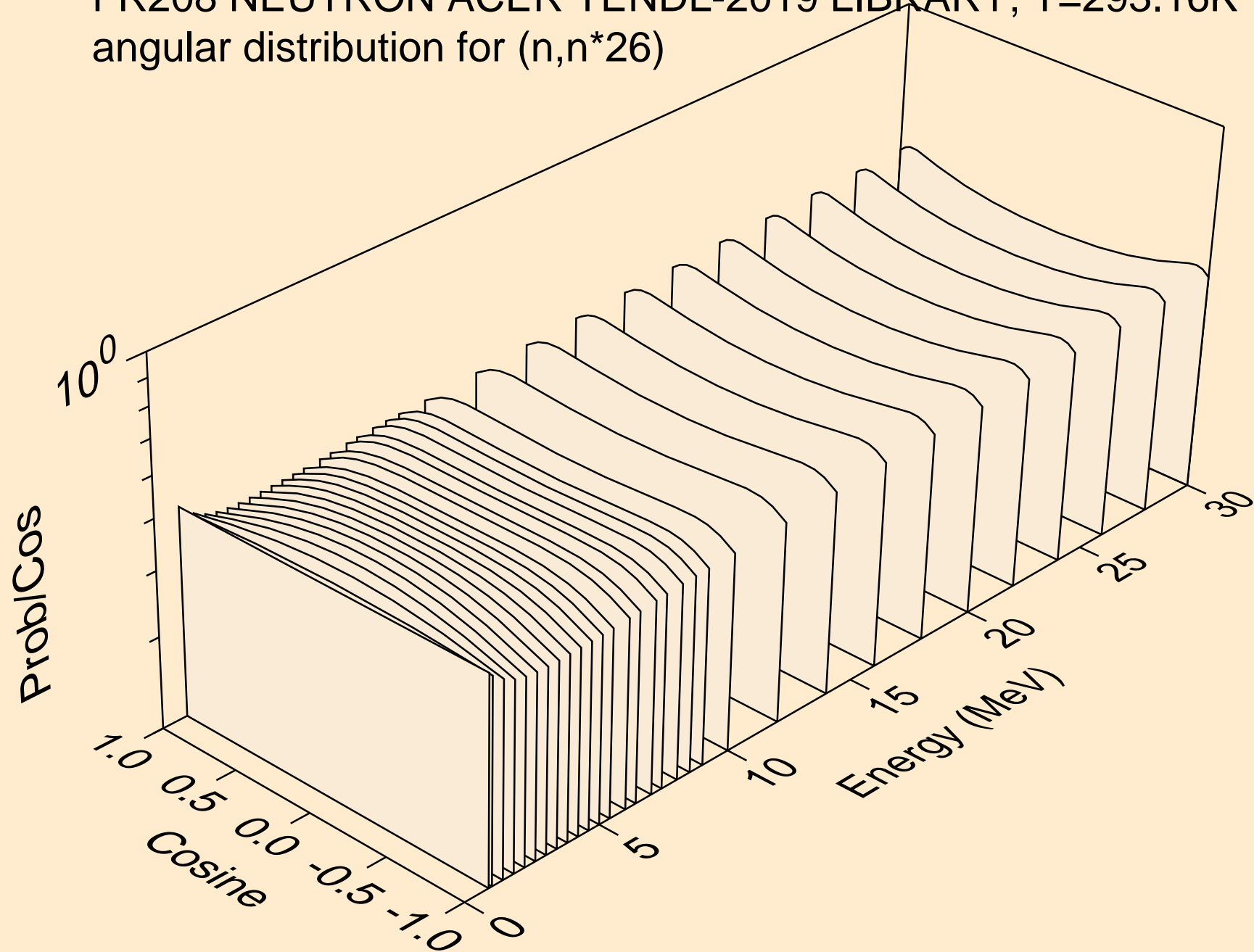

FR208 NEUTRON ACER TENDL-2019 LIBRARY; T=293.16K  
angular distribution for (n,n\*27)

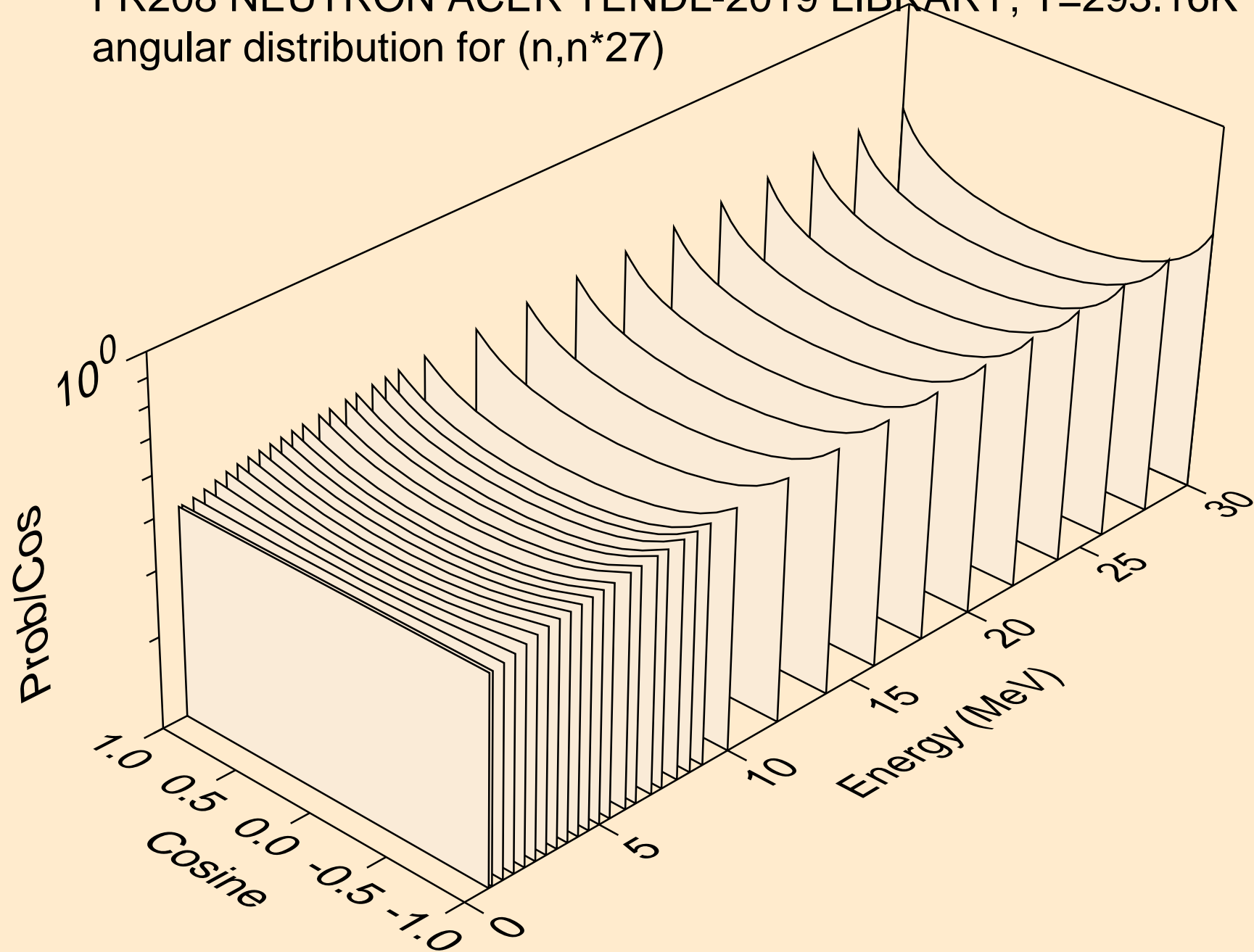

FR208 NEUTRON ACER TENDL-2019 LIBRARY; T=293.16K  
Neutron emission for (n,x)

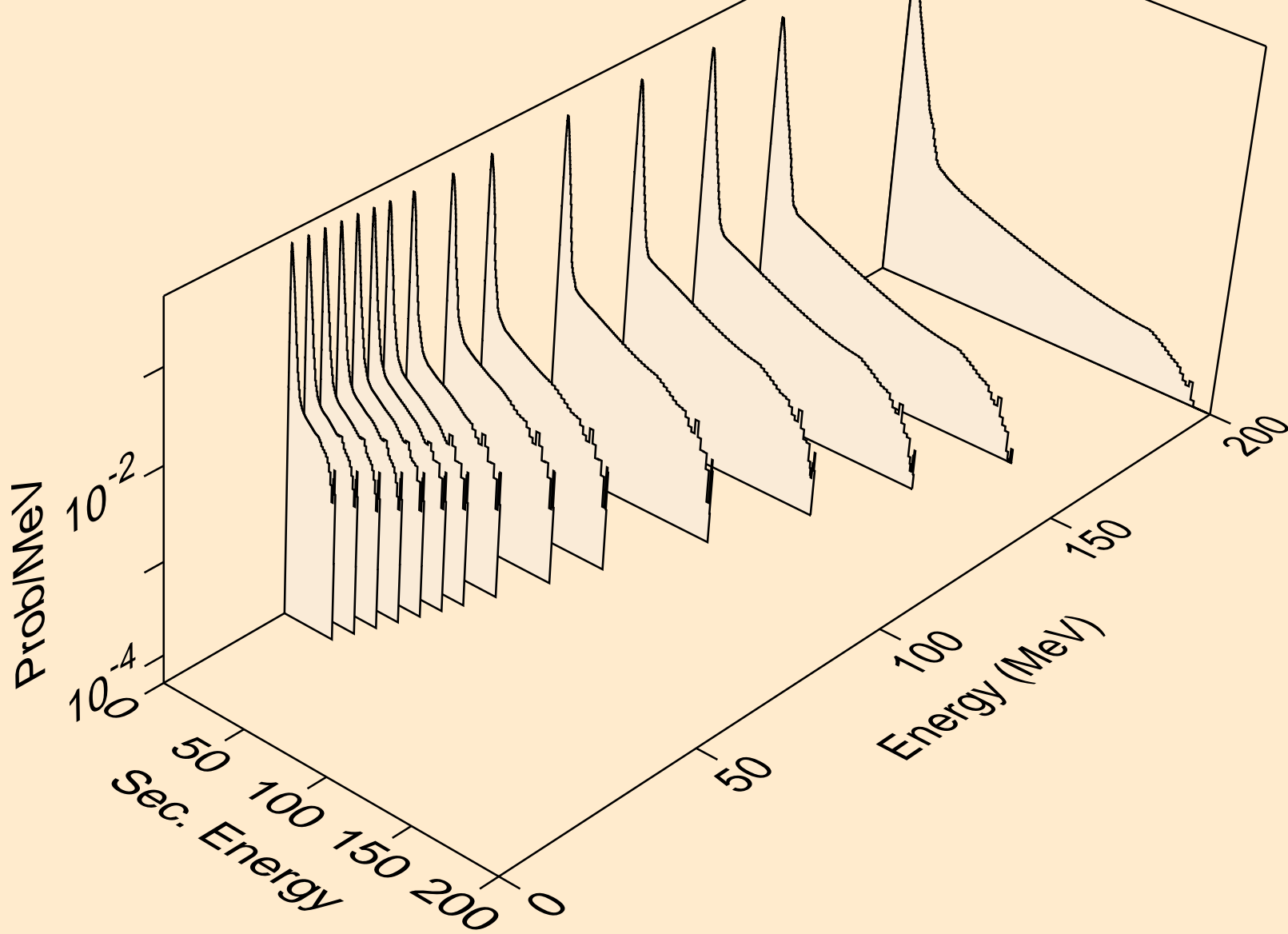

FR208 NEUTRON ACER TENDL-2019 LIBRARY; T=293.16K  
Neutron emission for (n,2nd)

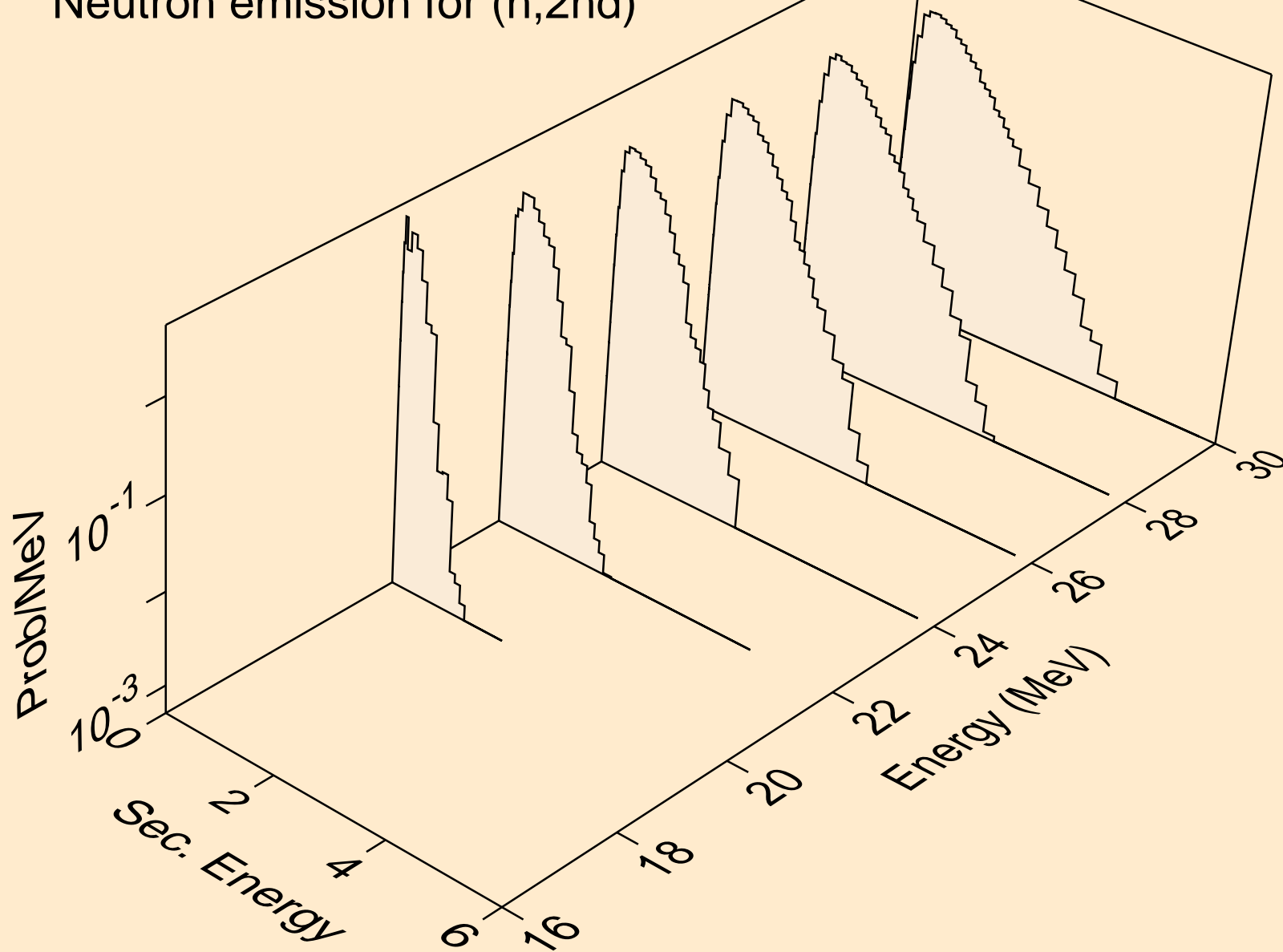

FR208 NEUTRON ACER TENDL-2019 LIBRARY; T=293.16K  
Neutron emission for (n,2n)

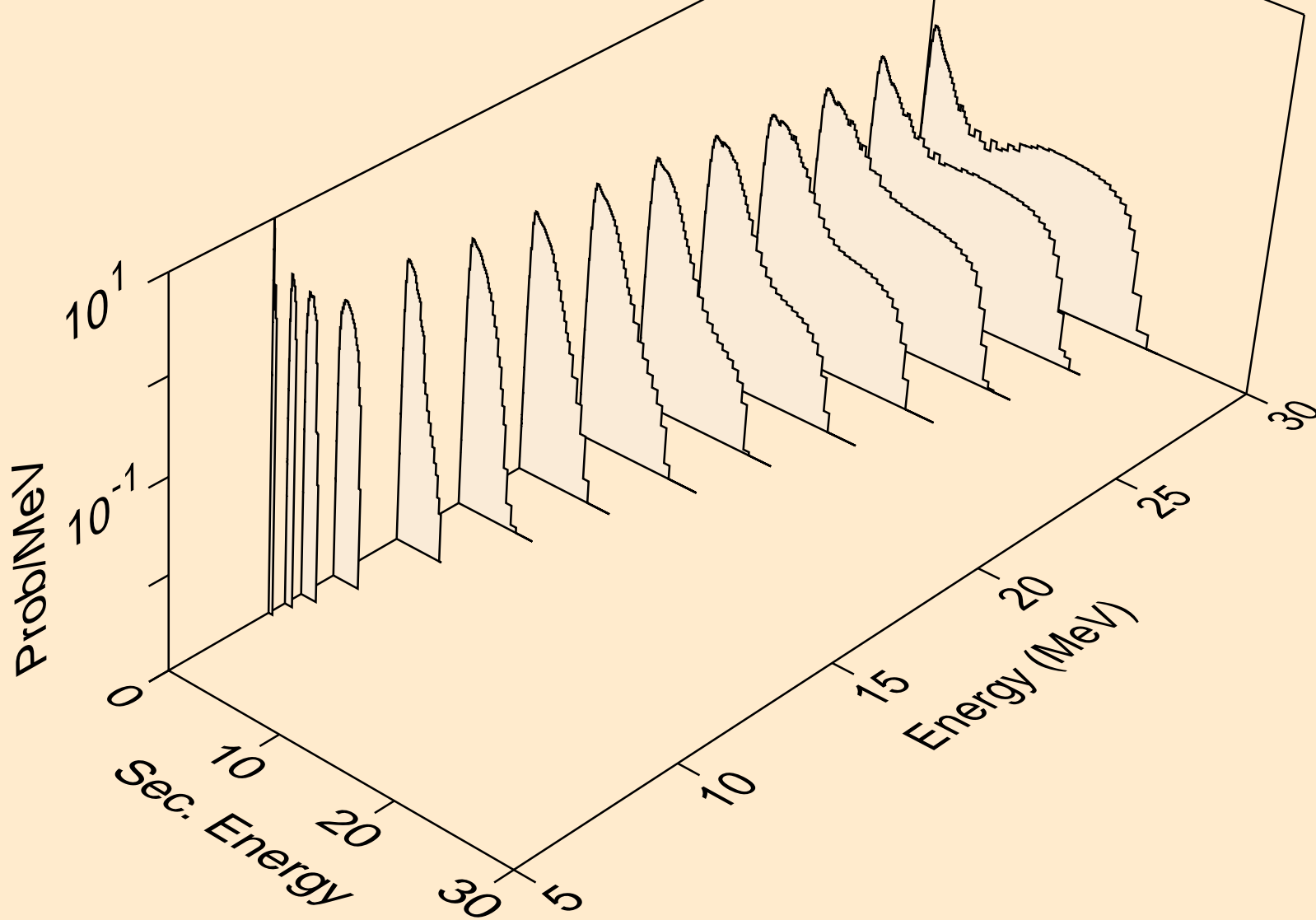

FR208 NEUTRON ACER TENDL-2019 LIBRARY; T=293.16K  
Neutron emission for (n,3n)

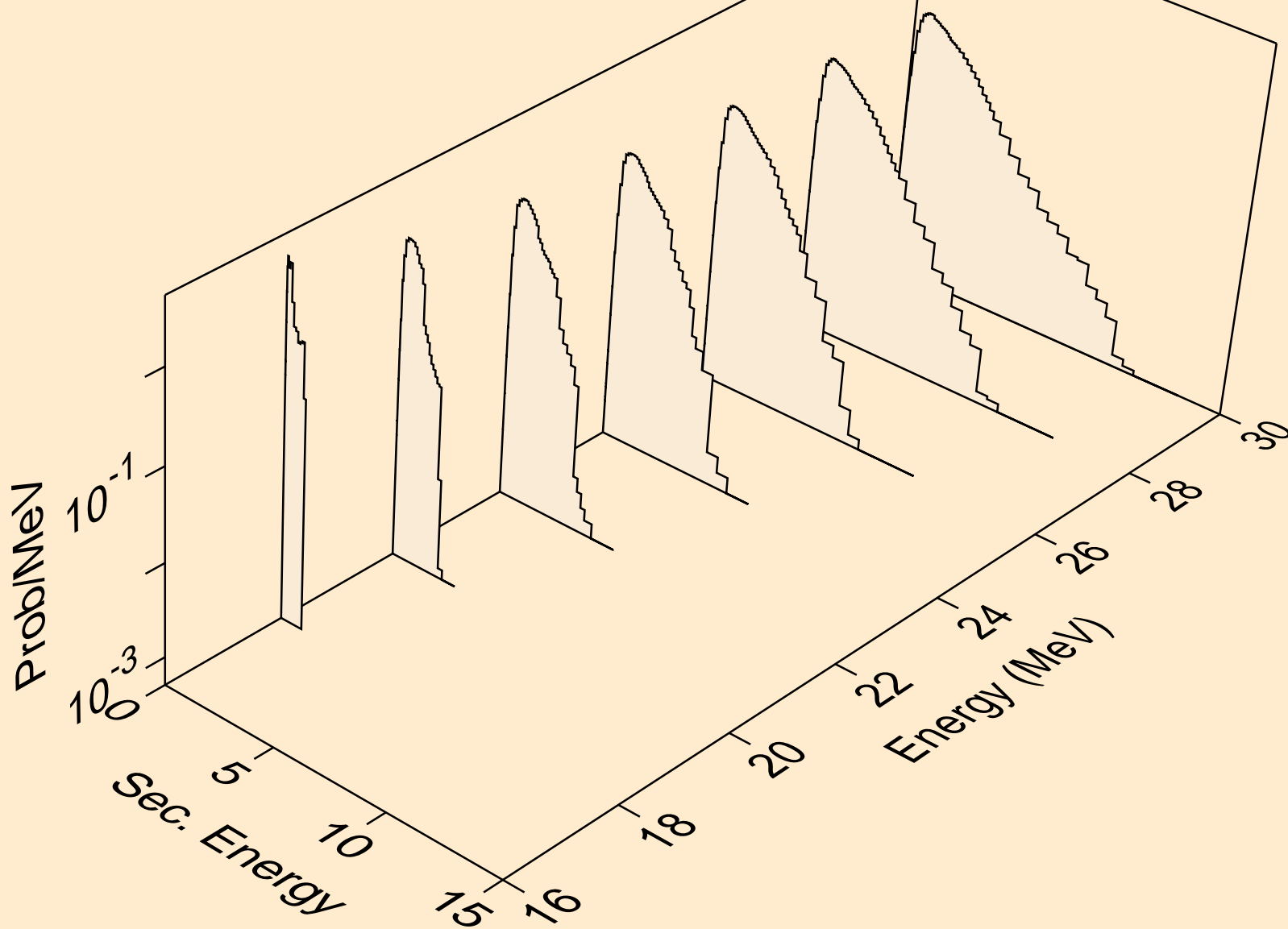



FR208 NEUTRON ACER TENDL-2019 LIBRARY; T=293.16K  
Neutron emission for (n,n\*)a

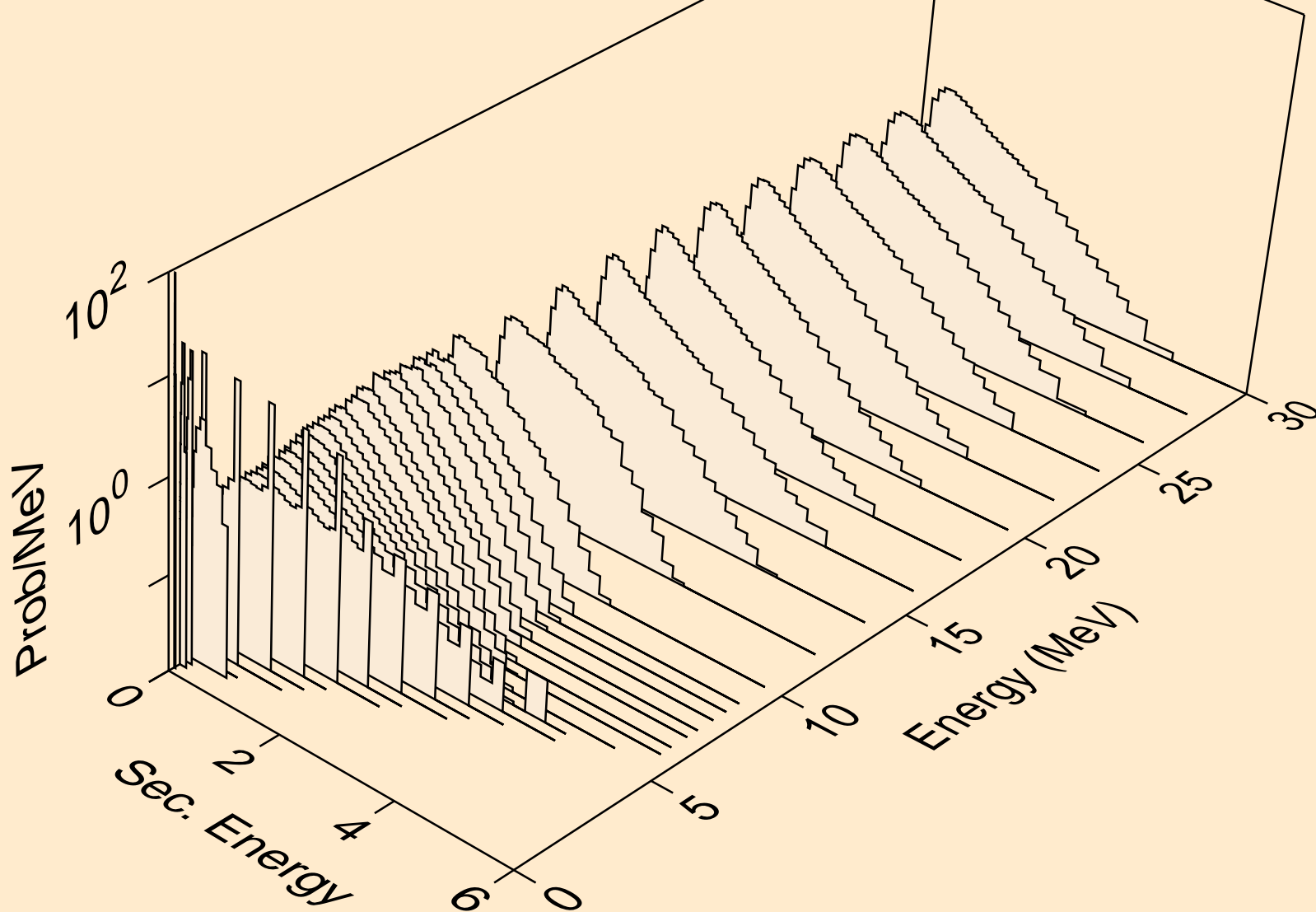

FR208 NEUTRON ACER TENDL-2019 LIBRARY; T=293.16K  
Neutron emission for (n,2n)a

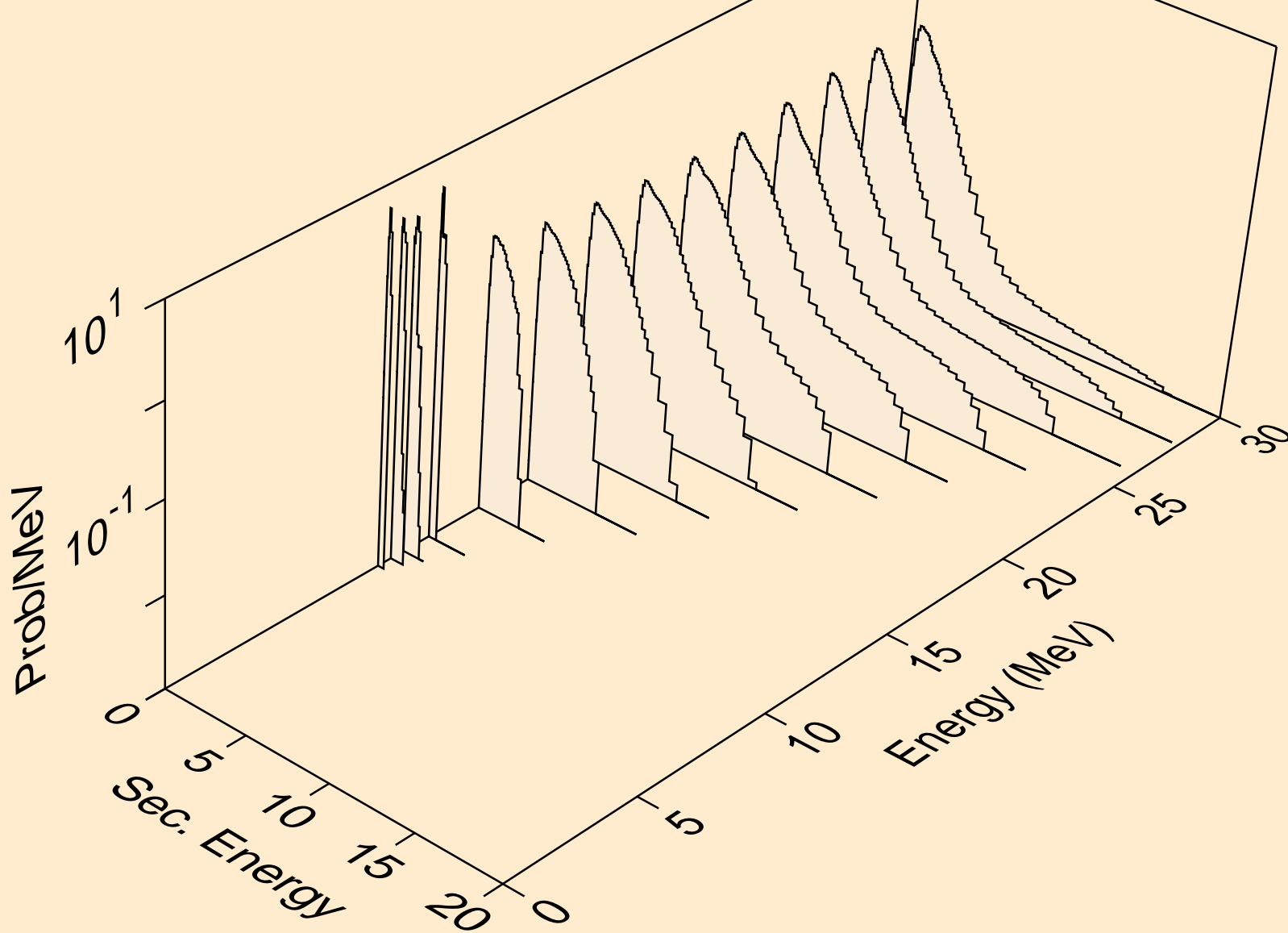

FR208 NEUTRON ACER TENDL-2019 LIBRARY; T=293.16K  
Neutron emission for (n,3n)a

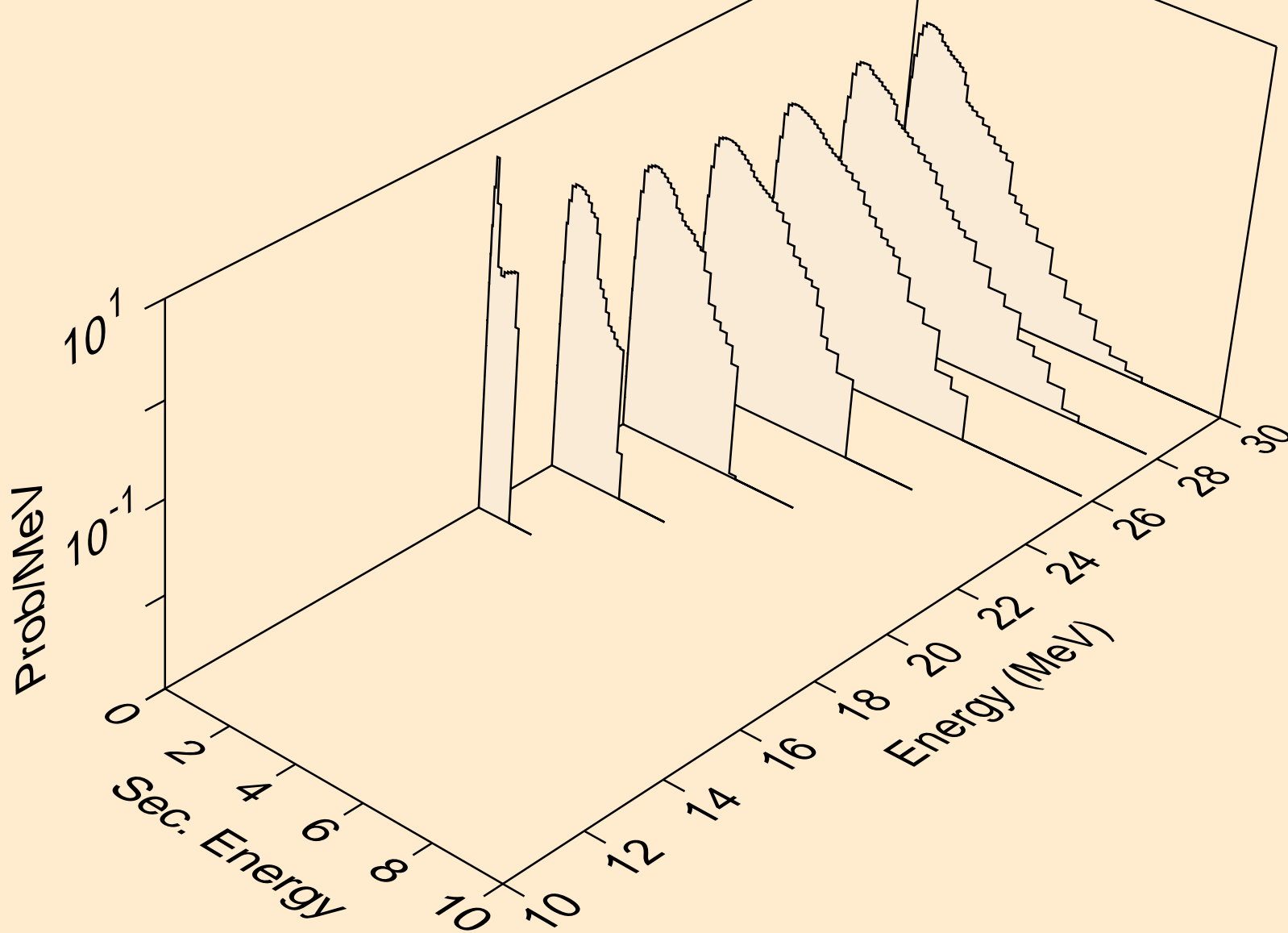

FR208 NEUTRON ACER TENDL-2019 LIBRARY; T=293.16K  
Neutron emission for (n,n\*)p

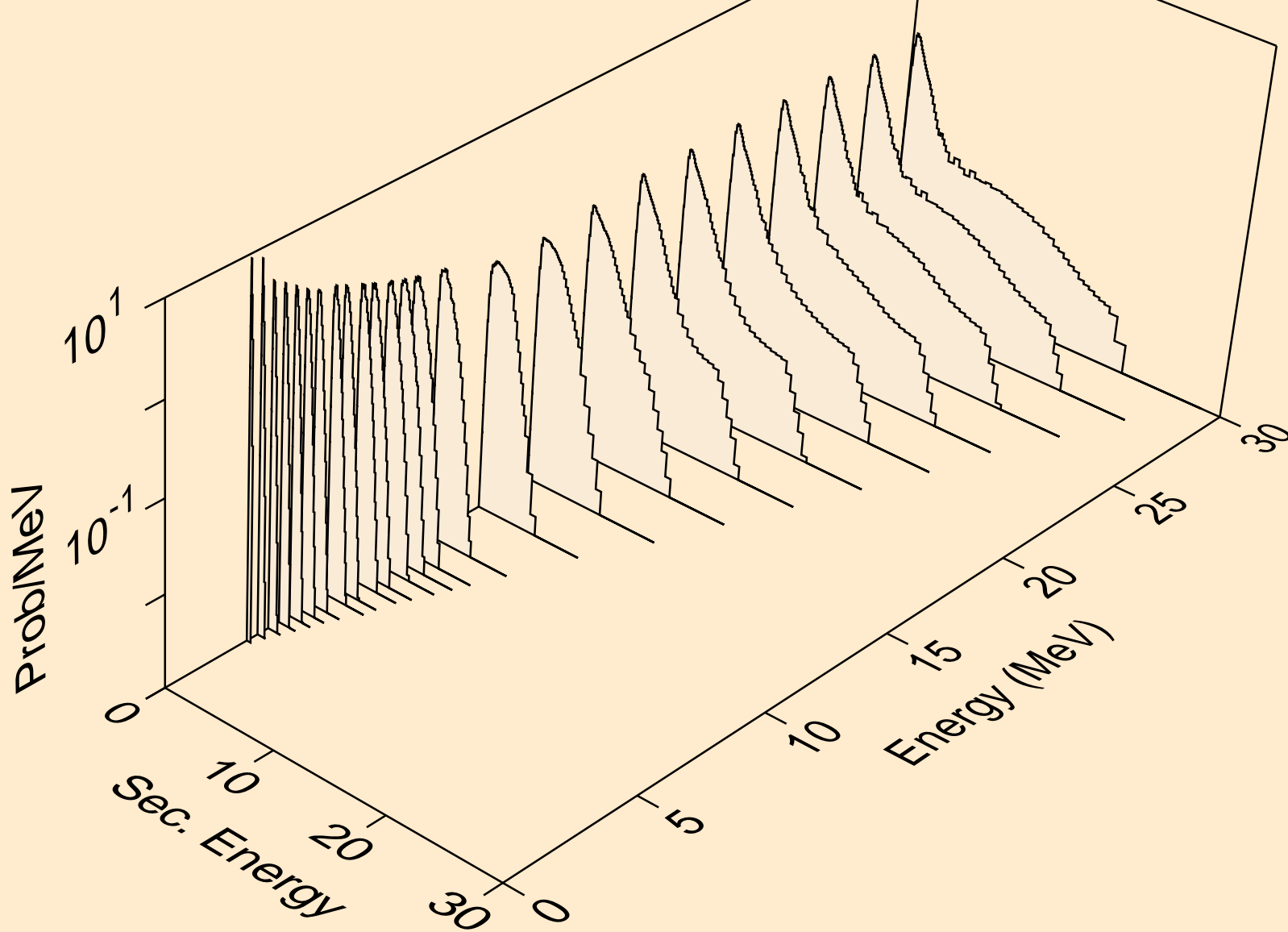

FR208 NEUTRON ACER TENDL-2019 LIBRARY; T=293.16K  
Neutron emission for (n,n\*)2a

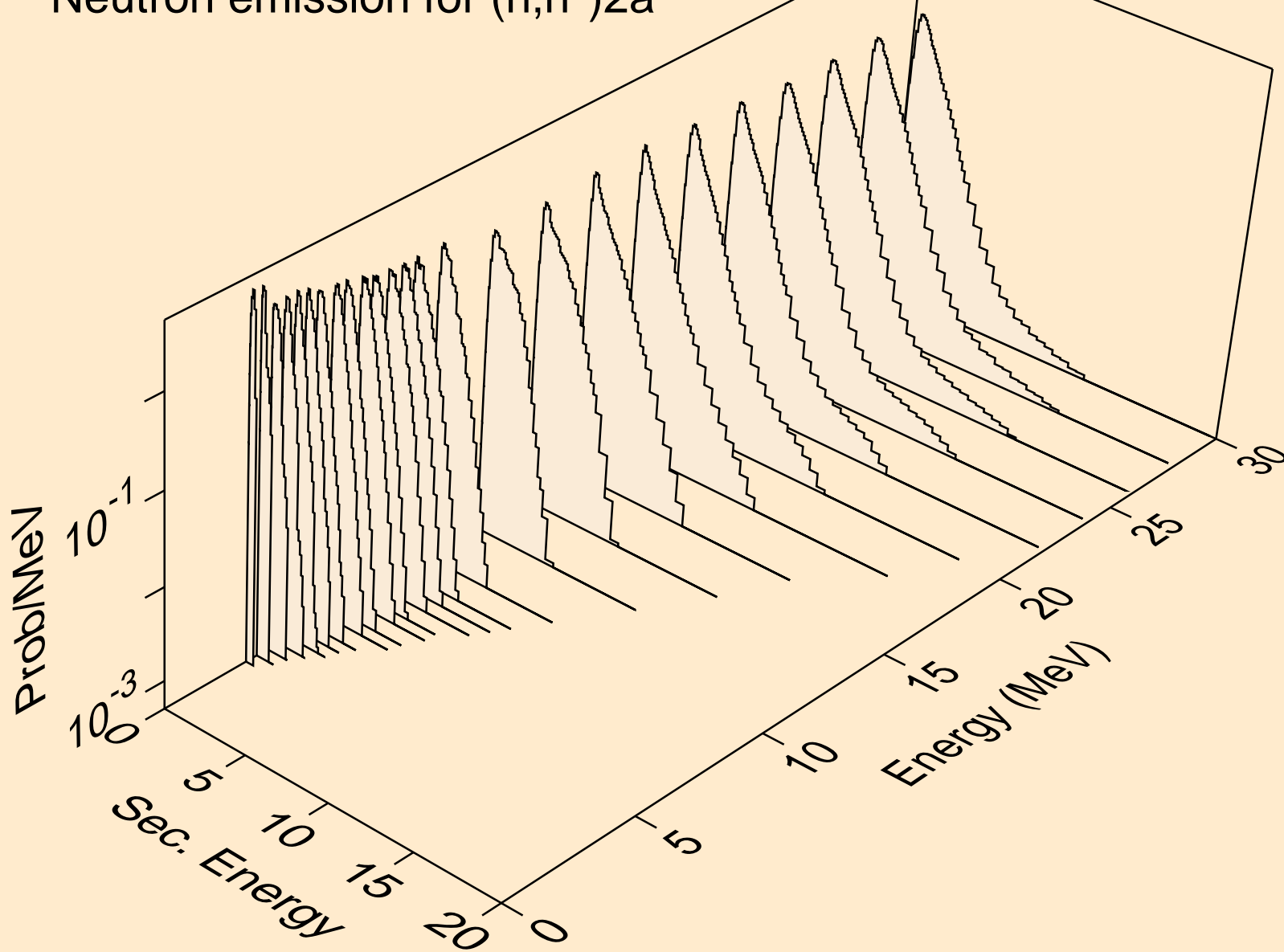

FR208 NEUTRON ACER TENDL-2019 LIBRARY; T=293.16K  
Neutron emission for (n,2n)2a

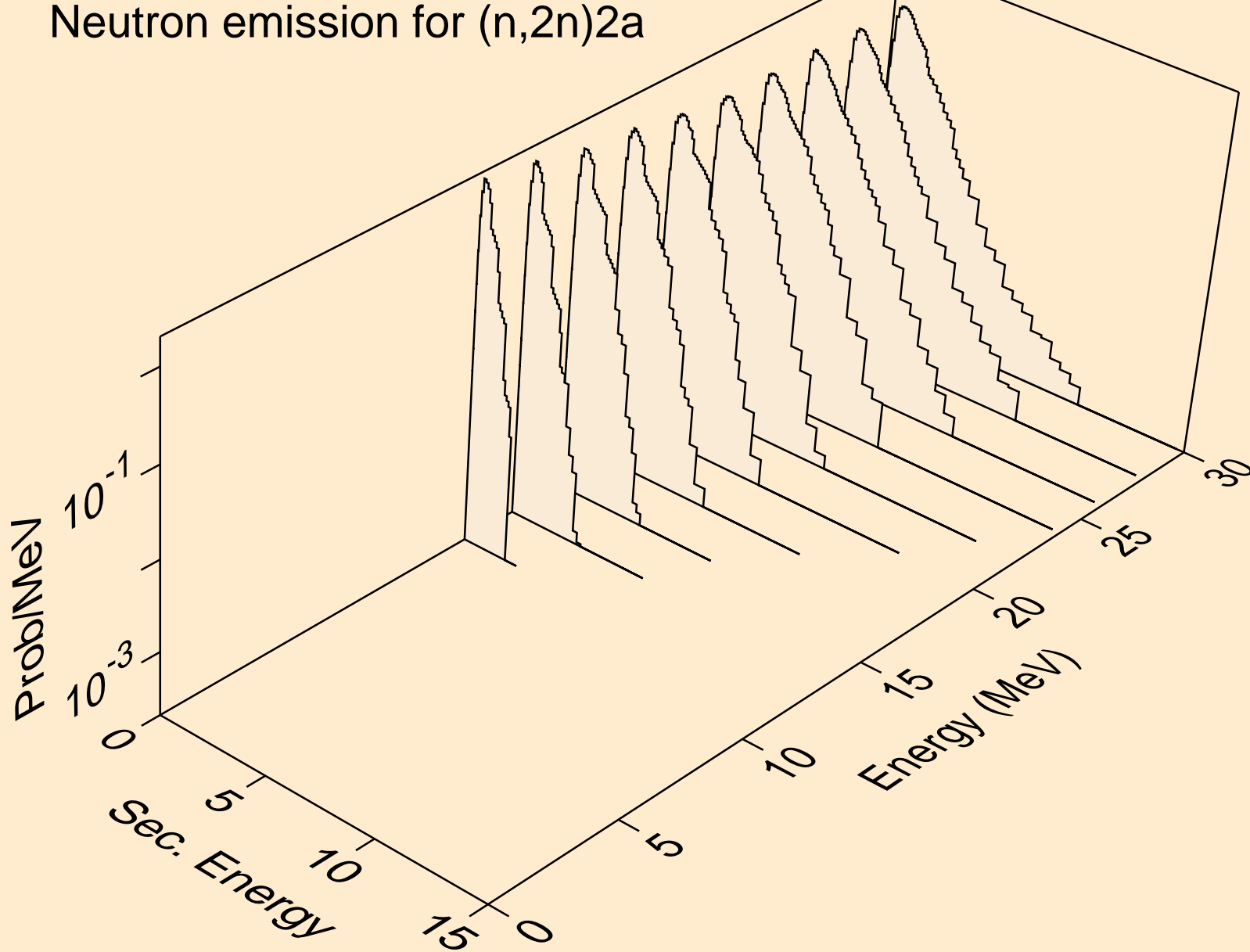

FR208 NEUTRON ACER TENDL-2019 LIBRARY; T=293.16K  
Neutron emission for (n,n\*)d

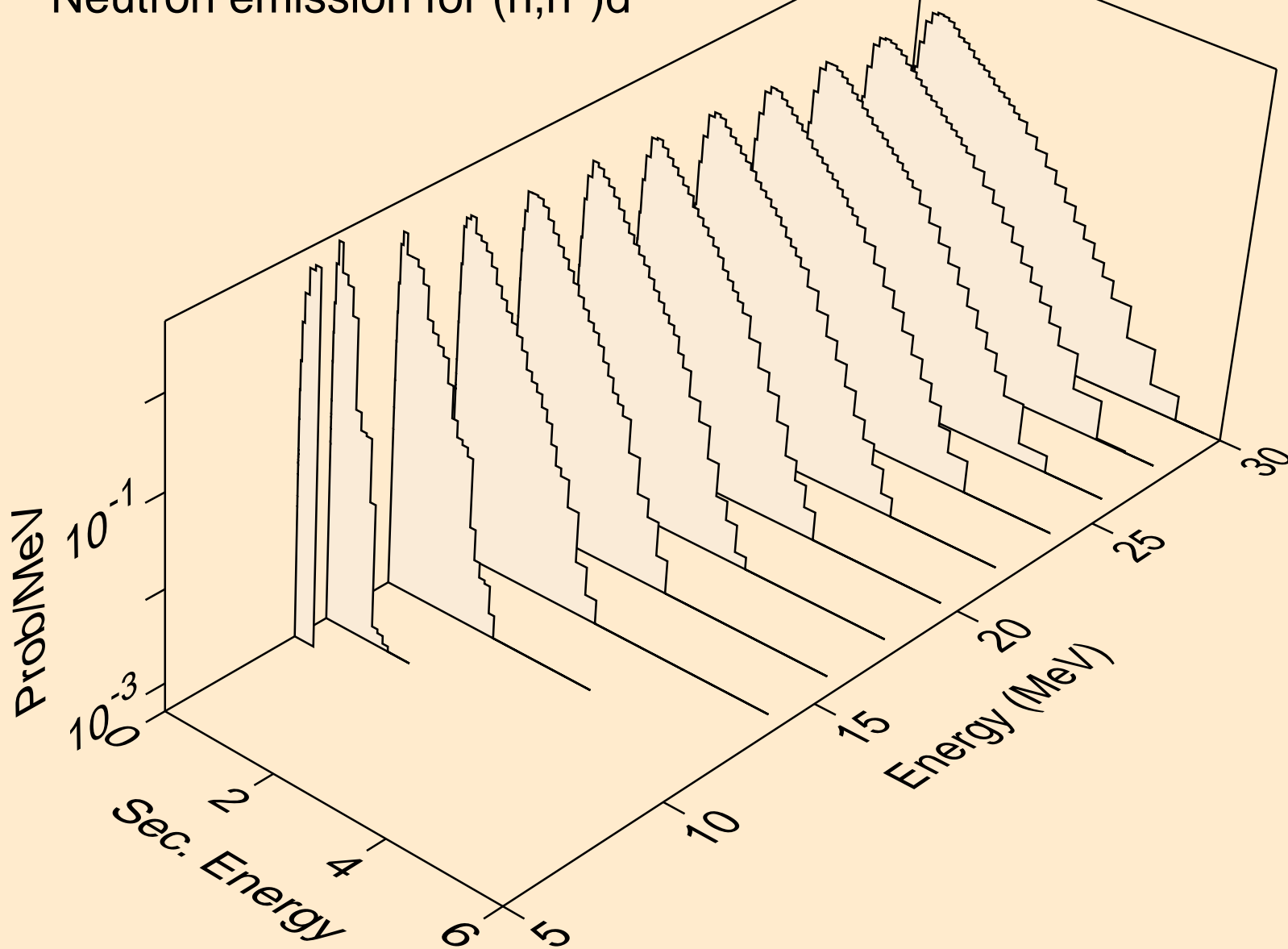

FR208 NEUTRON ACER TENDL-2019 LIBRARY; T=293.16K  
Neutron emission for (n,n\*)t

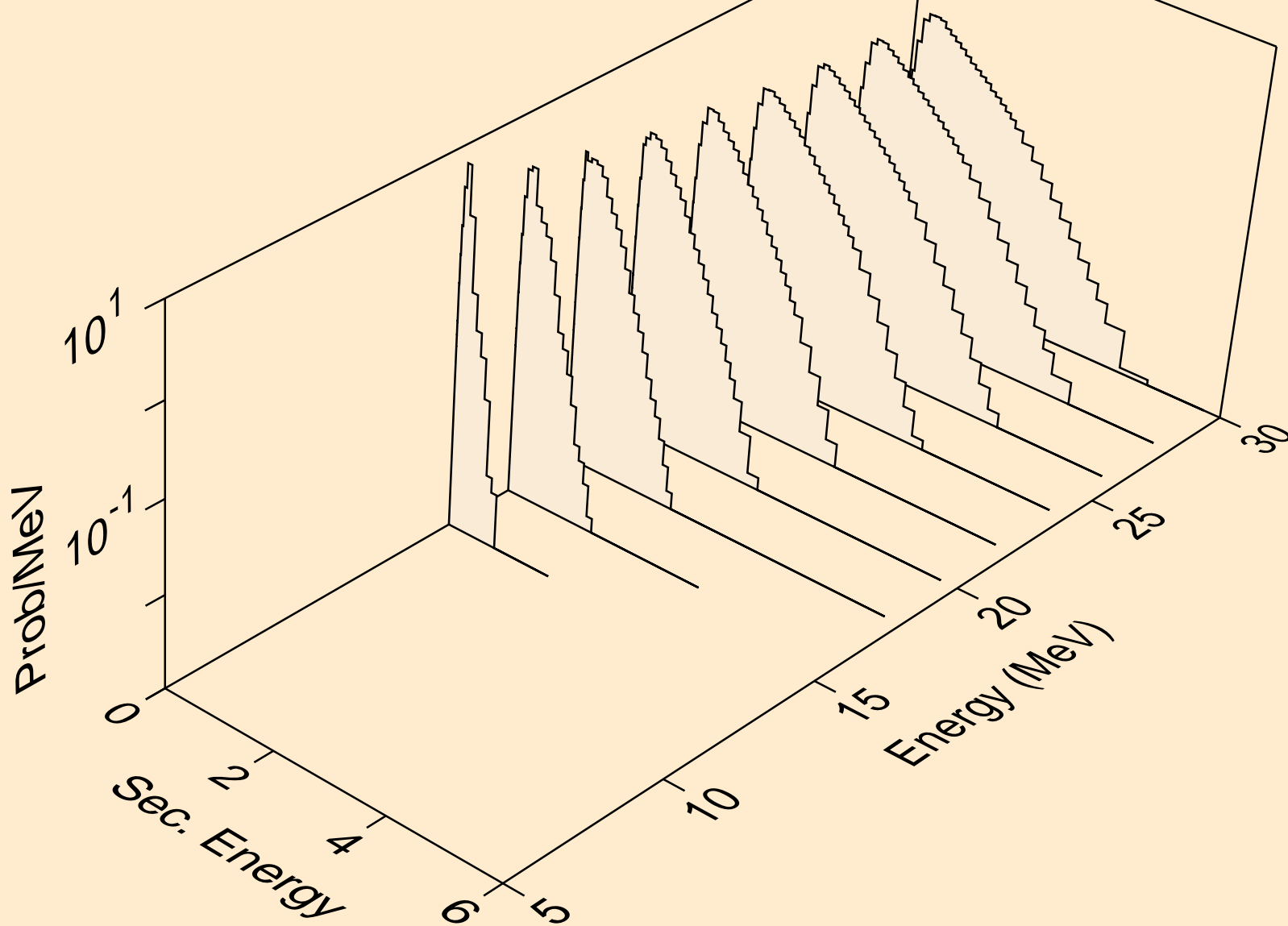



FR208 NEUTRON ACER TENDL-2019 LIBRARY; T=293.16K  
Neutron emission for (n,n\*)he3

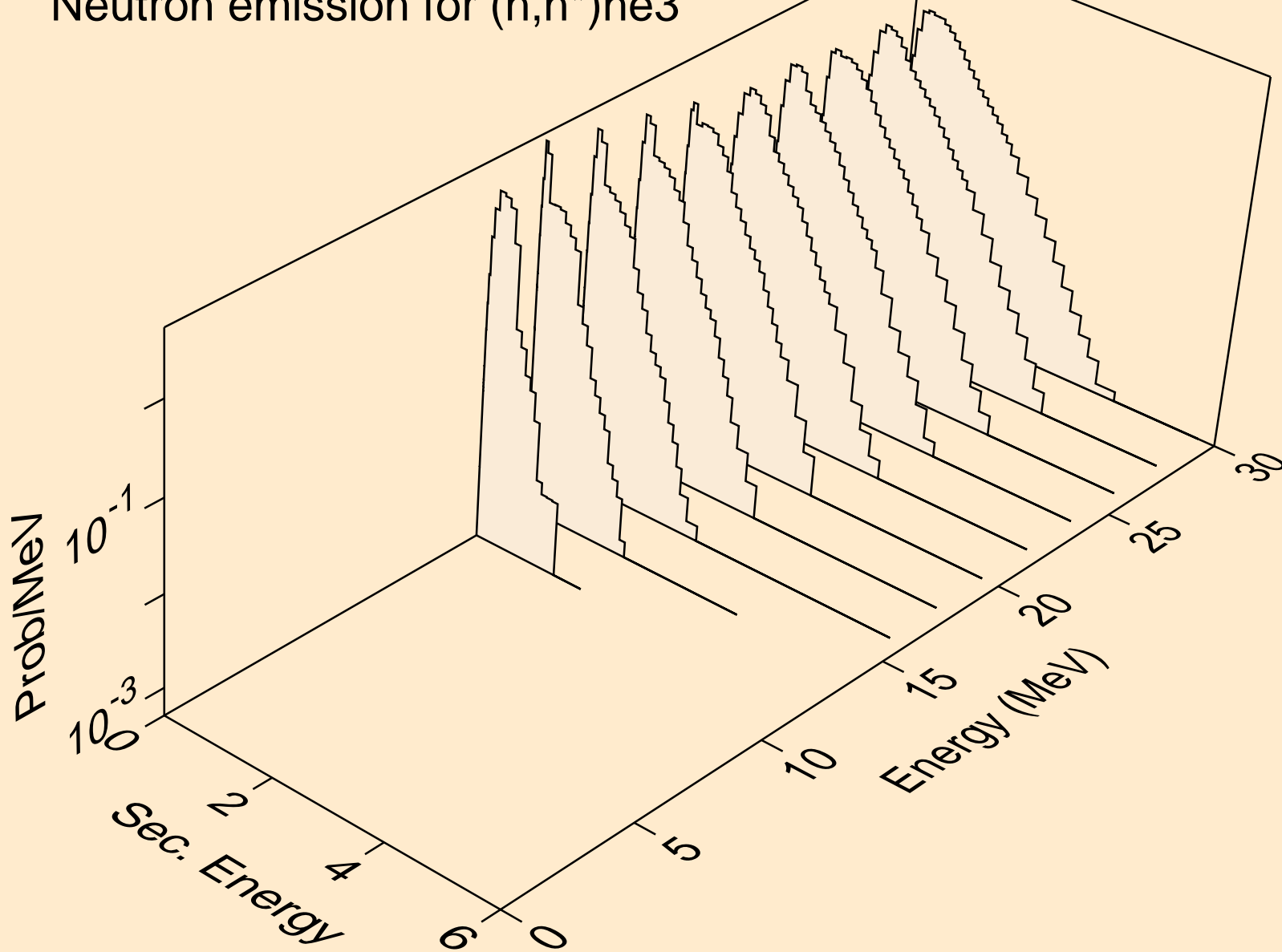

FR208 NEUTRON ACER TENDL-2019 LIBRARY; T=293.16K  
Neutron emission for (n,4n)

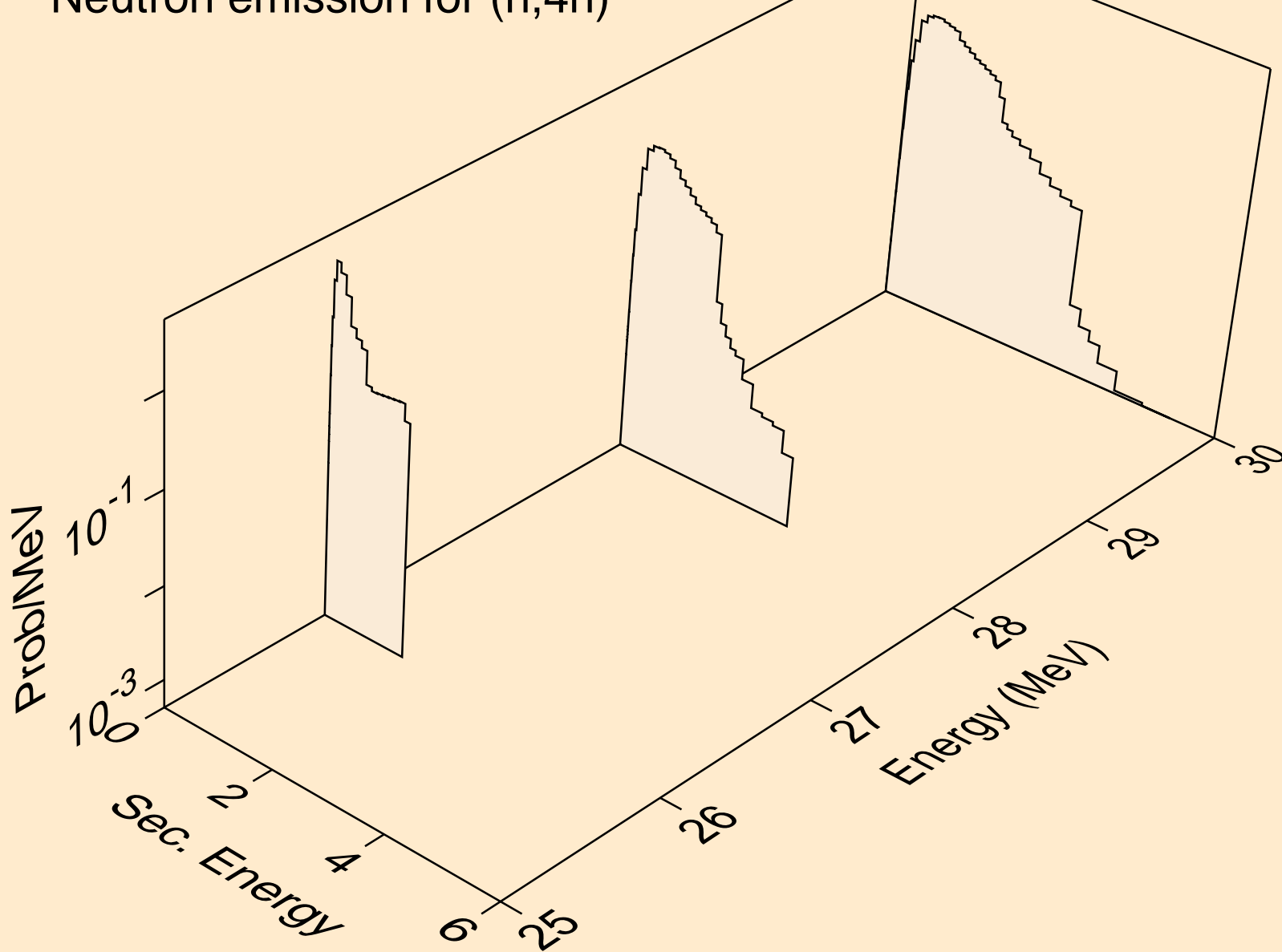

FR208 NEUTRON ACER TENDL-2019 LIBRARY; T=293.16K  
Neutron emission for (n,2np)

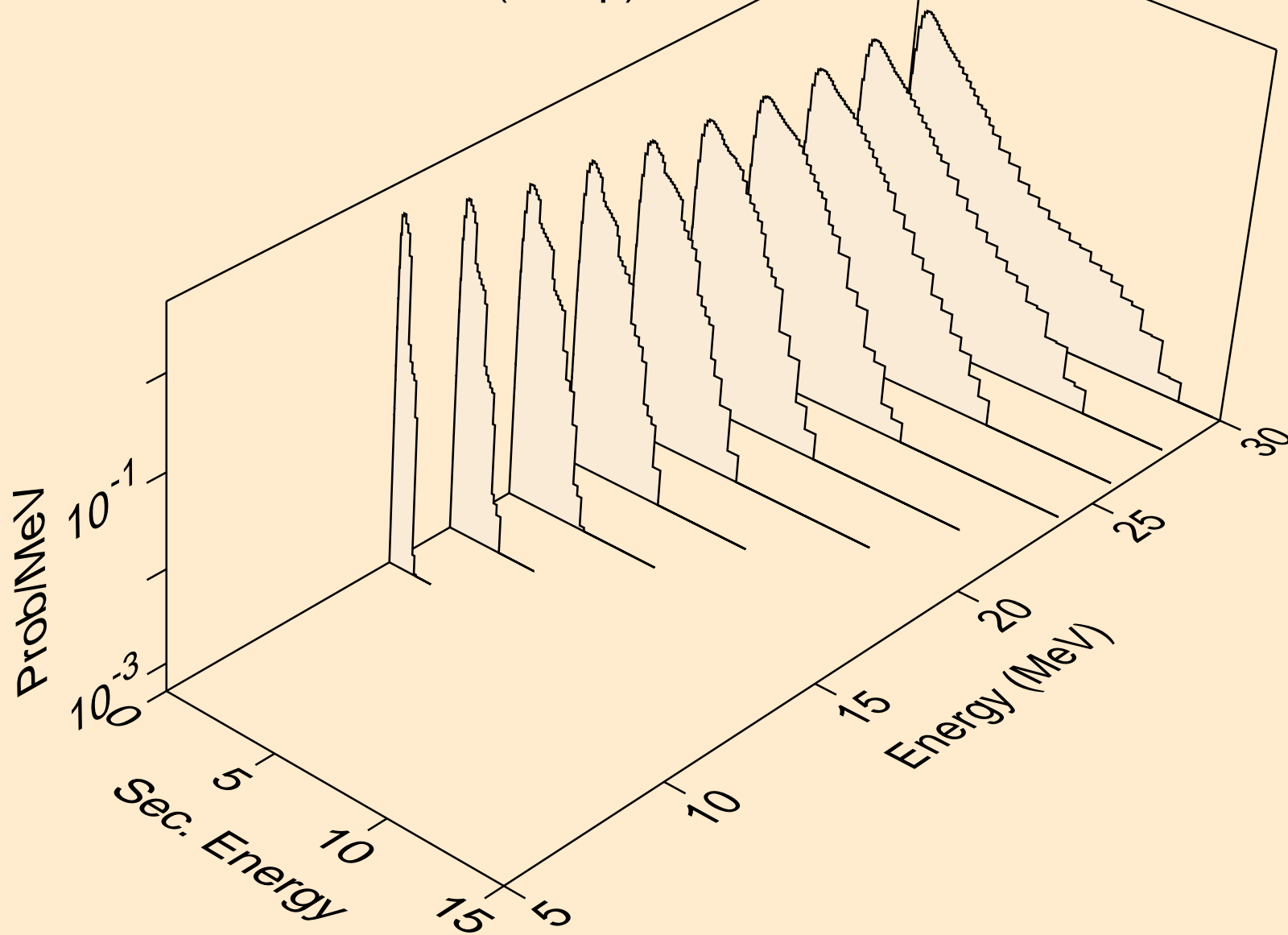

FR208 NEUTRON ACER TENDL-2019 LIBRARY; T=293.16K  
Neutron emission for (n,3np)

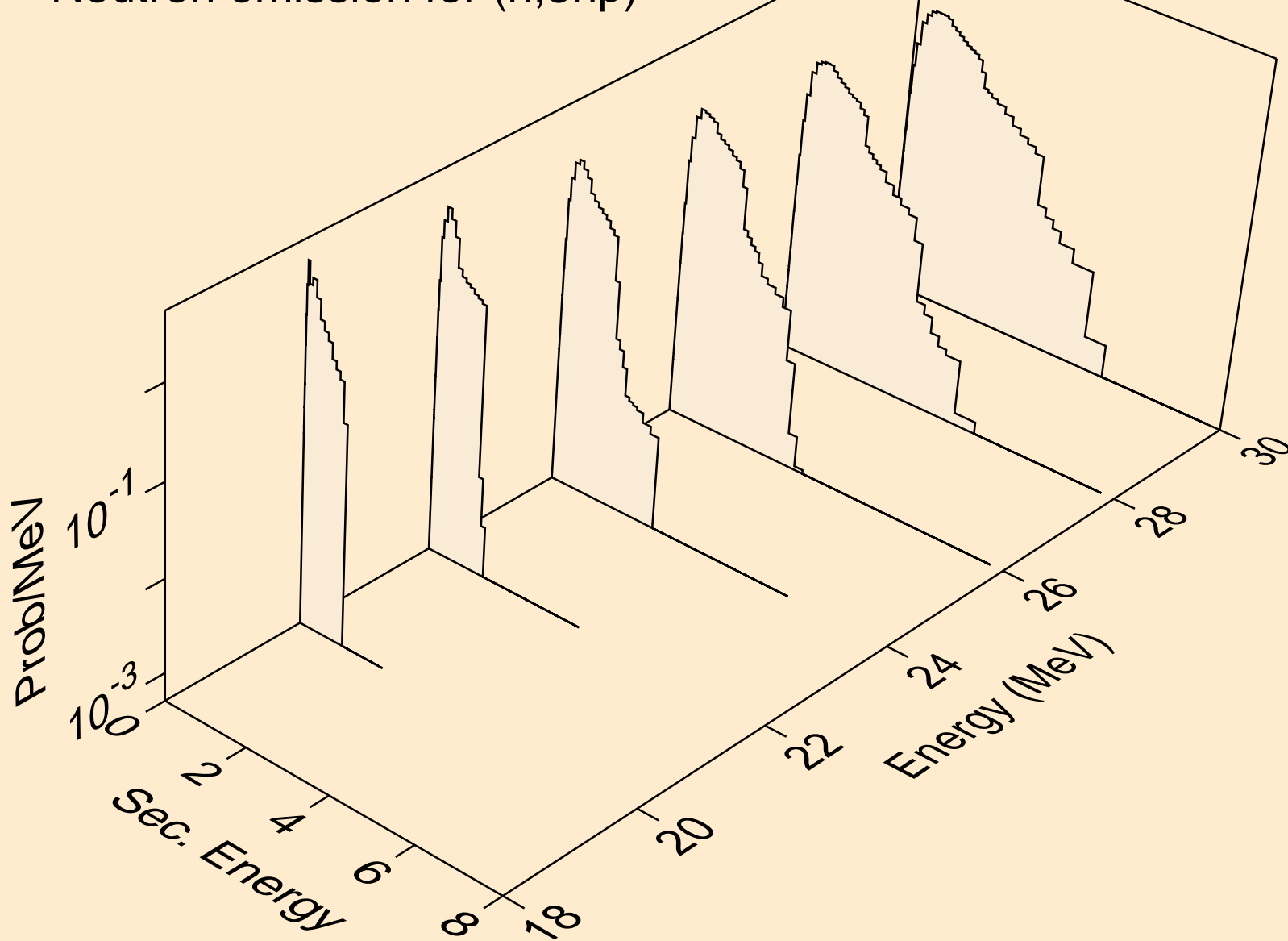

FR208 NEUTRON ACER TENDL-2019 LIBRARY; T=293.16K  
Neutron emission for (n,2np)

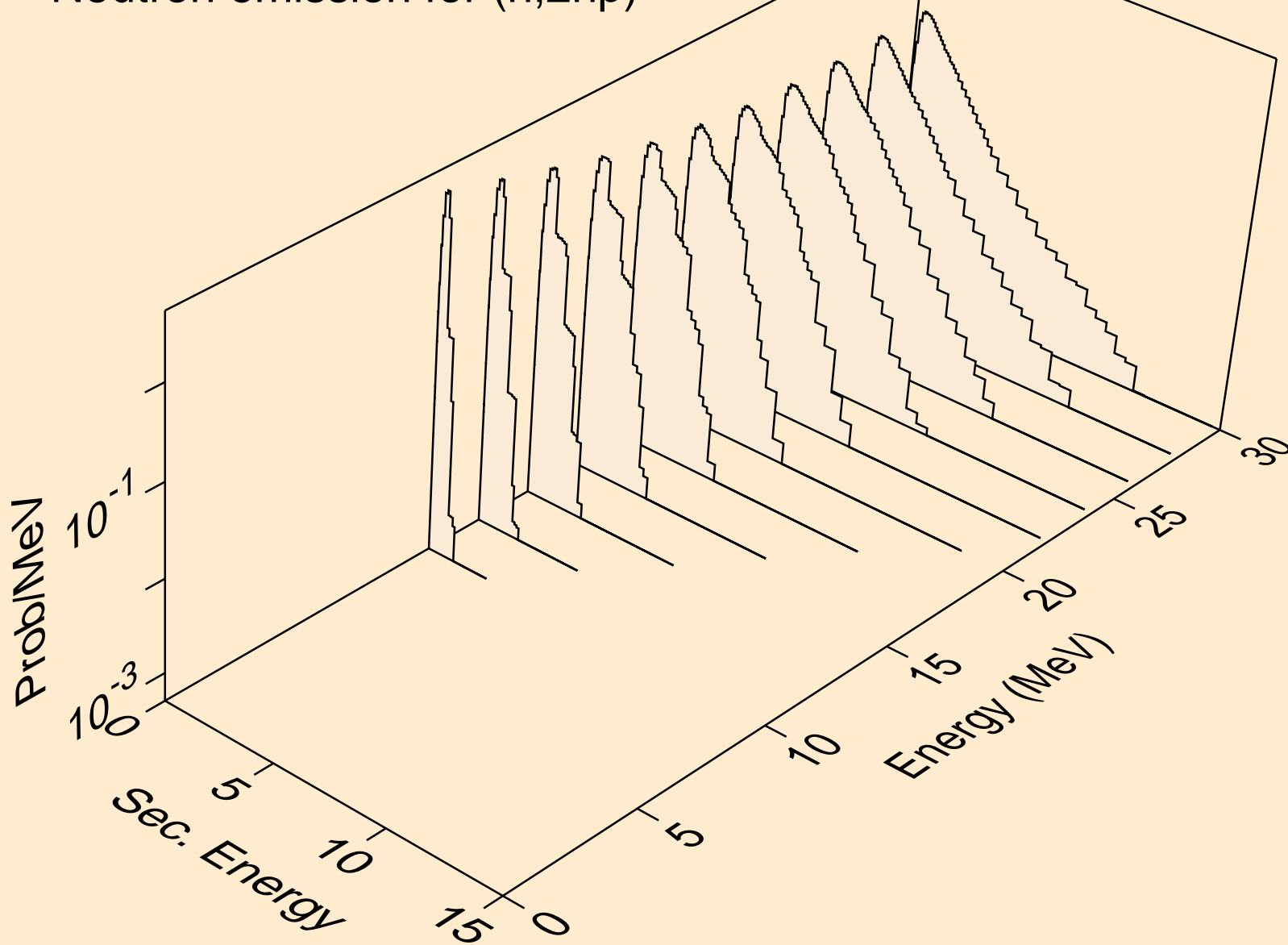

FR208 NEUTRON ACER TENDL-2019 LIBRARY; T=293.16K  
Neutron emission for (n,npa)

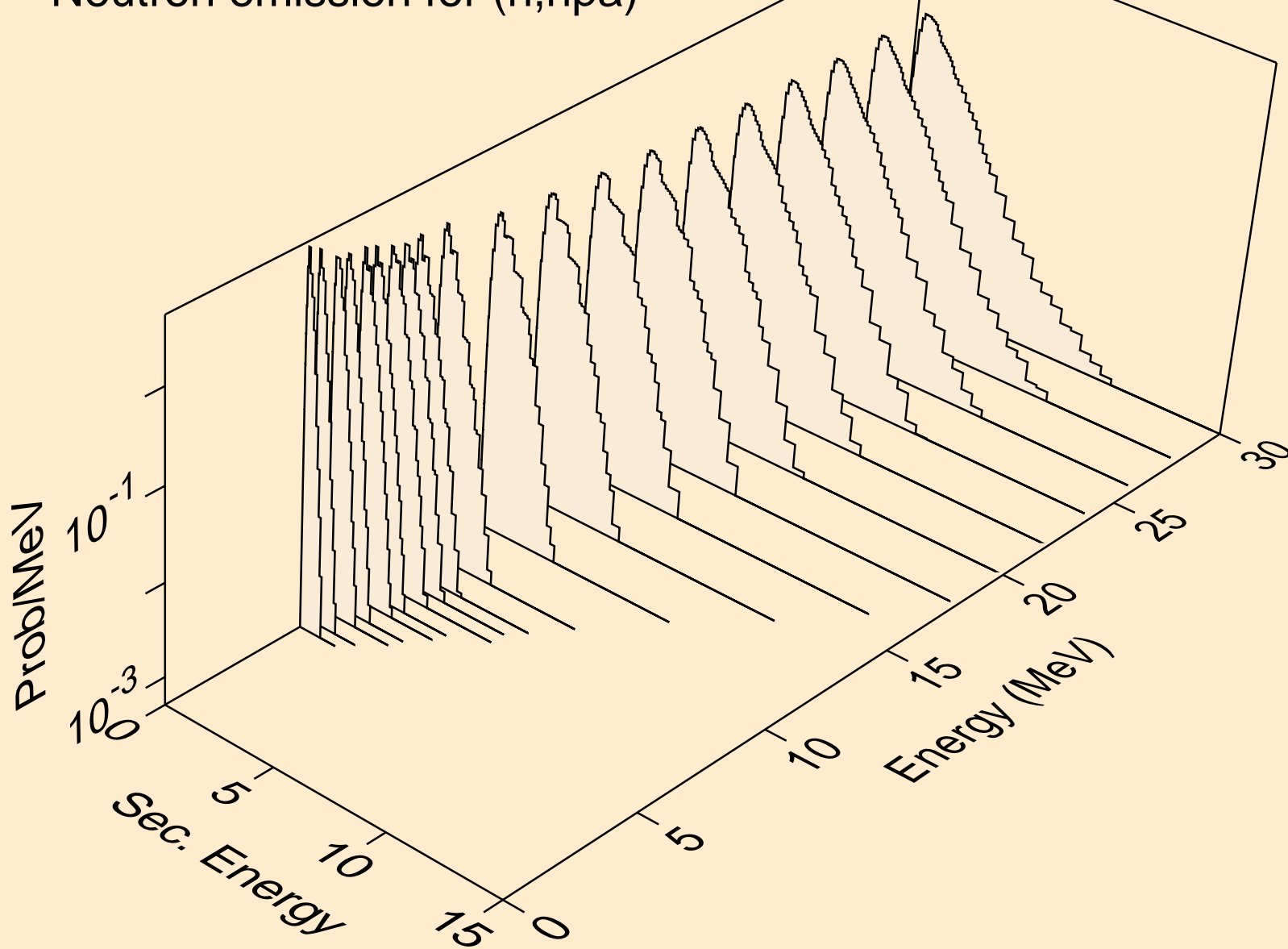

FR208 NEUTRON ACER TENDL-2019 LIBRARY; T=293.16K  
Neutron emission for (n,n\*c)

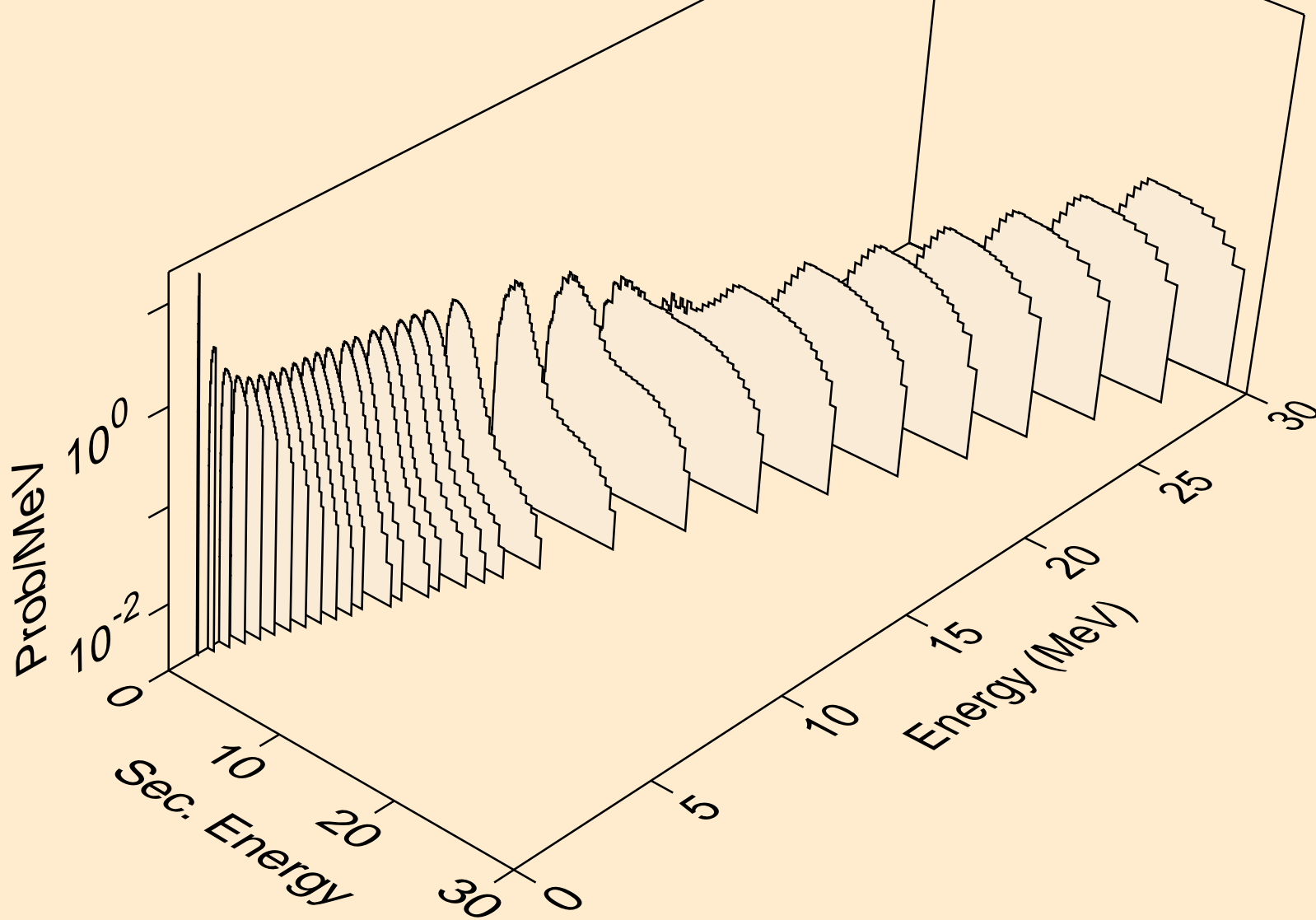

FR208 NEUTRON ACER TENDL-2019 LIBRARY; T=293.16K  
Photon emission for (n,x)

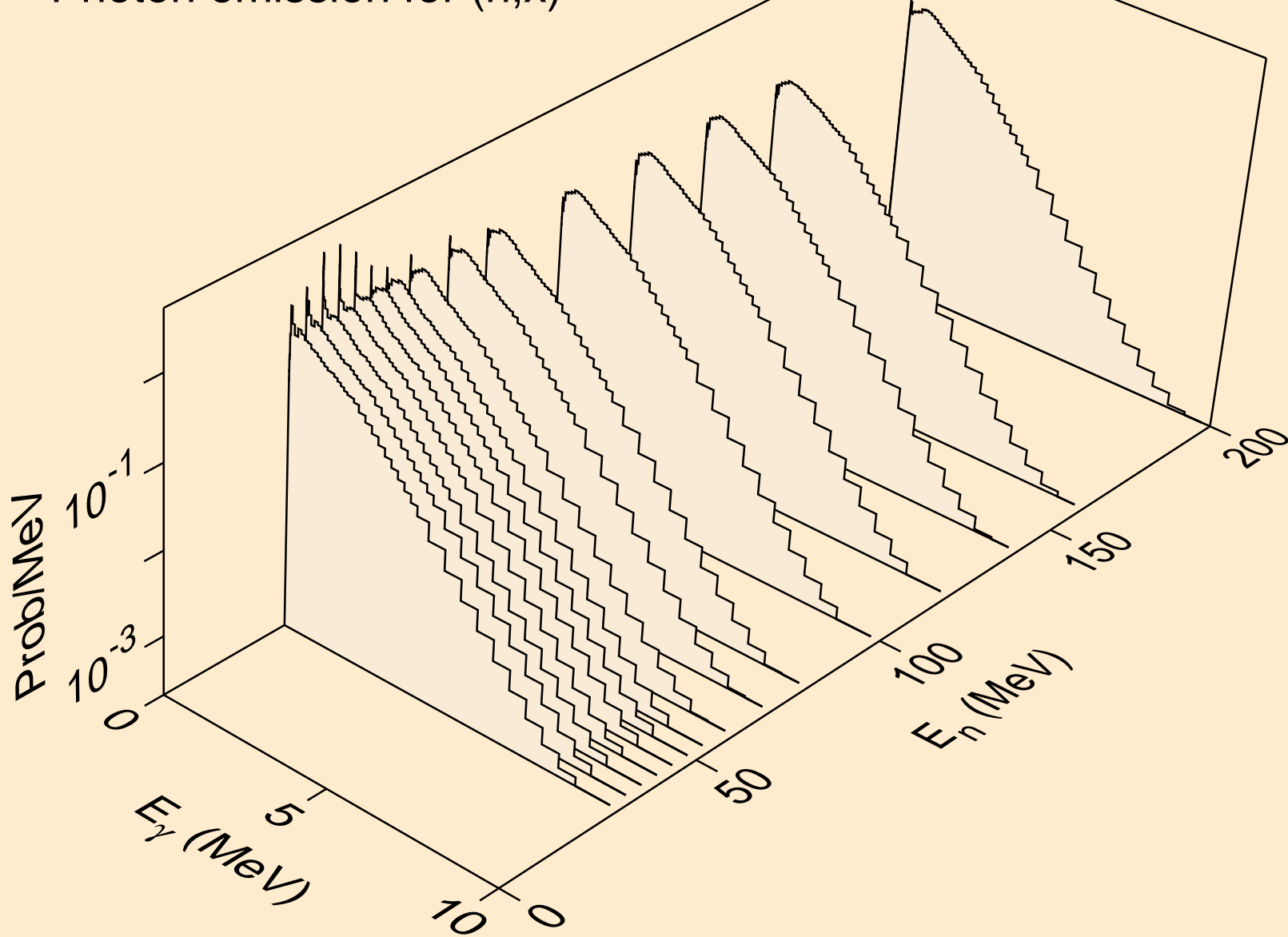



FR208 NEUTRON ACER TENDL-2019 LIBRARY; T=293.16K  
Photon emission for (n,2nd)

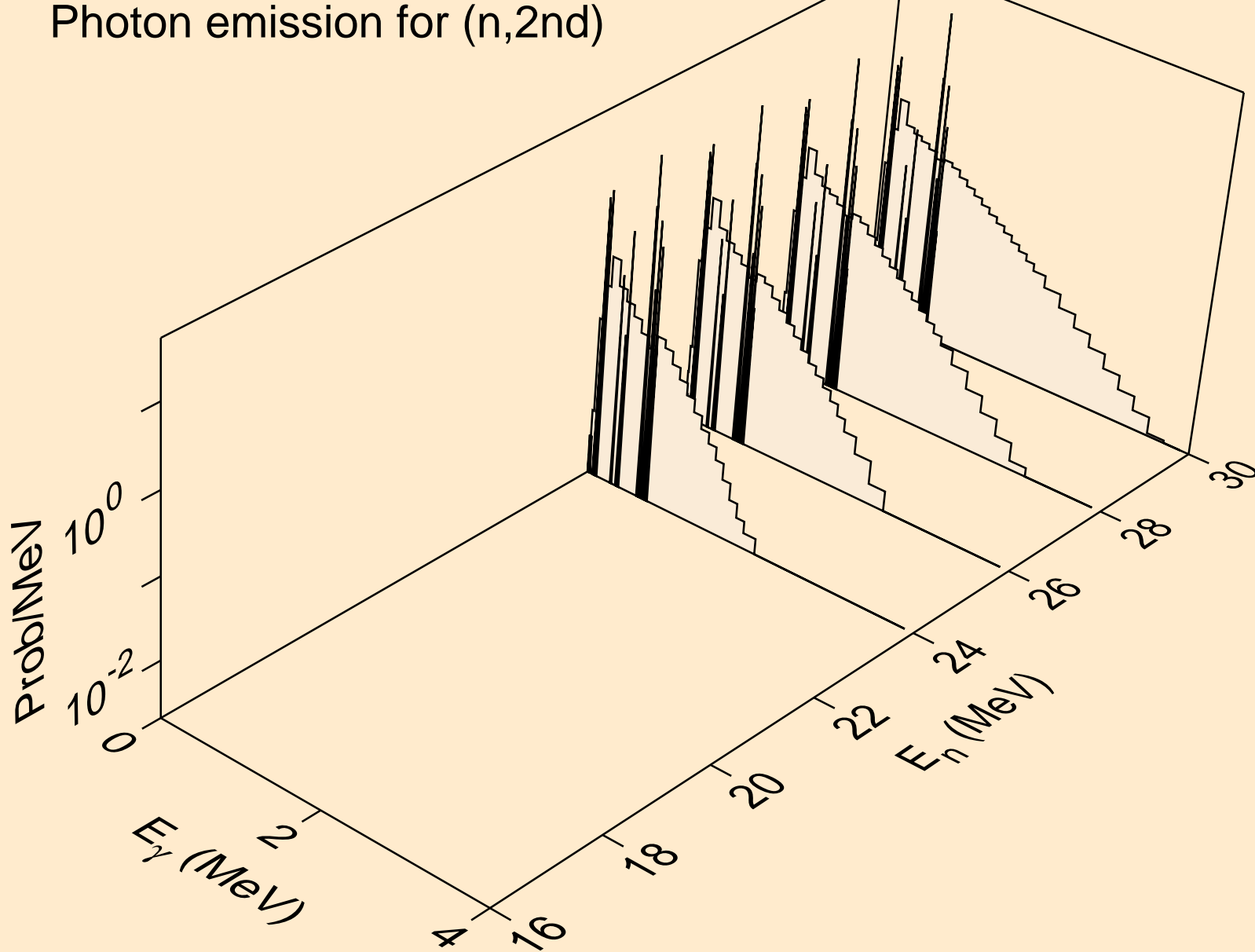

FR208 NEUTRON ACER TENDL-2019 LIBRARY; T=293.16K  
Photon emission for (n,2n)

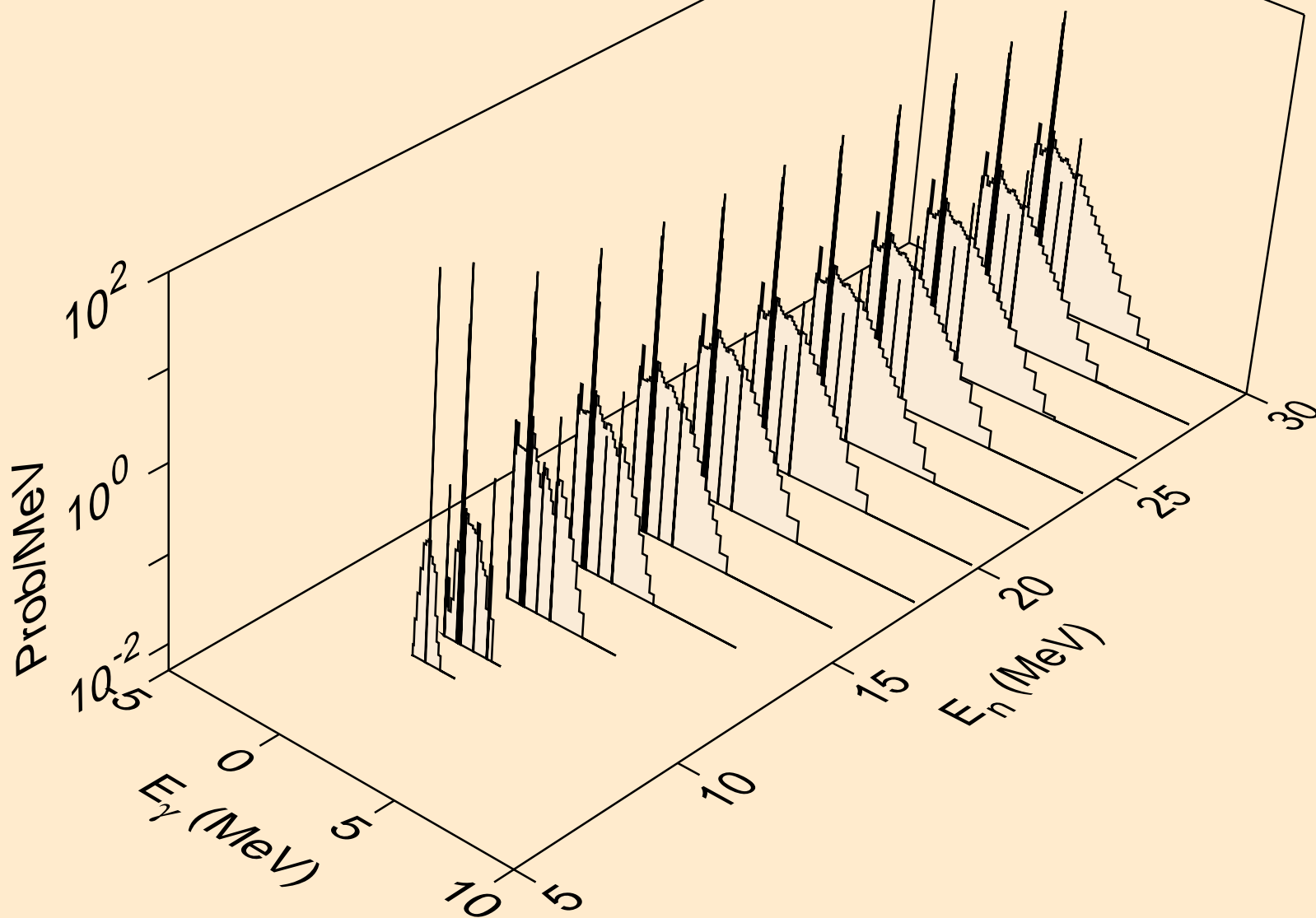

FR208 NEUTRON ACER TENDL-2019 LIBRARY; T=293.16K  
Photon emission for (n,3n)

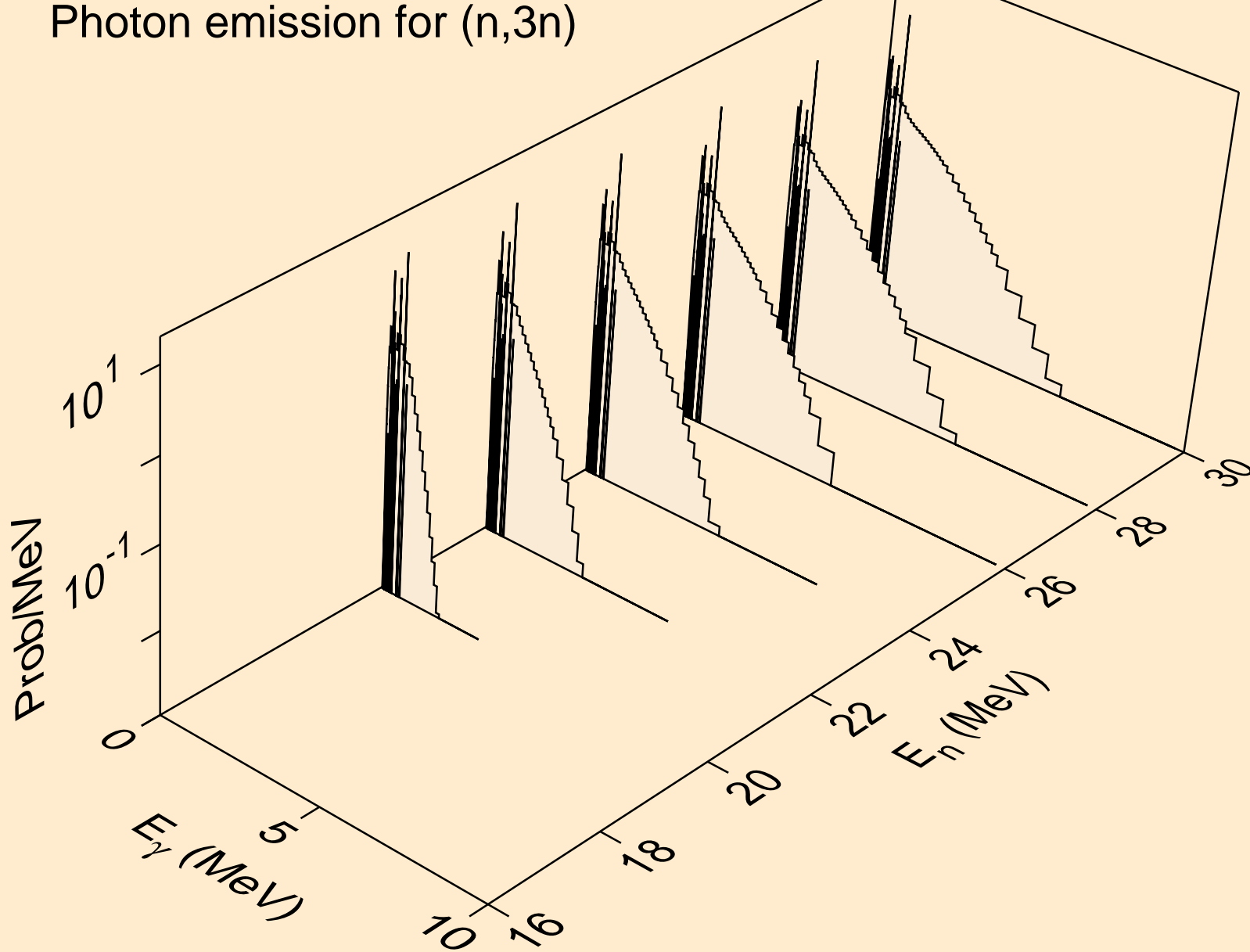

FR208 NEUTRON ACER TENDL-2019 LIBRARY; T=293.16K  
Photon emission for (n,n\*)a

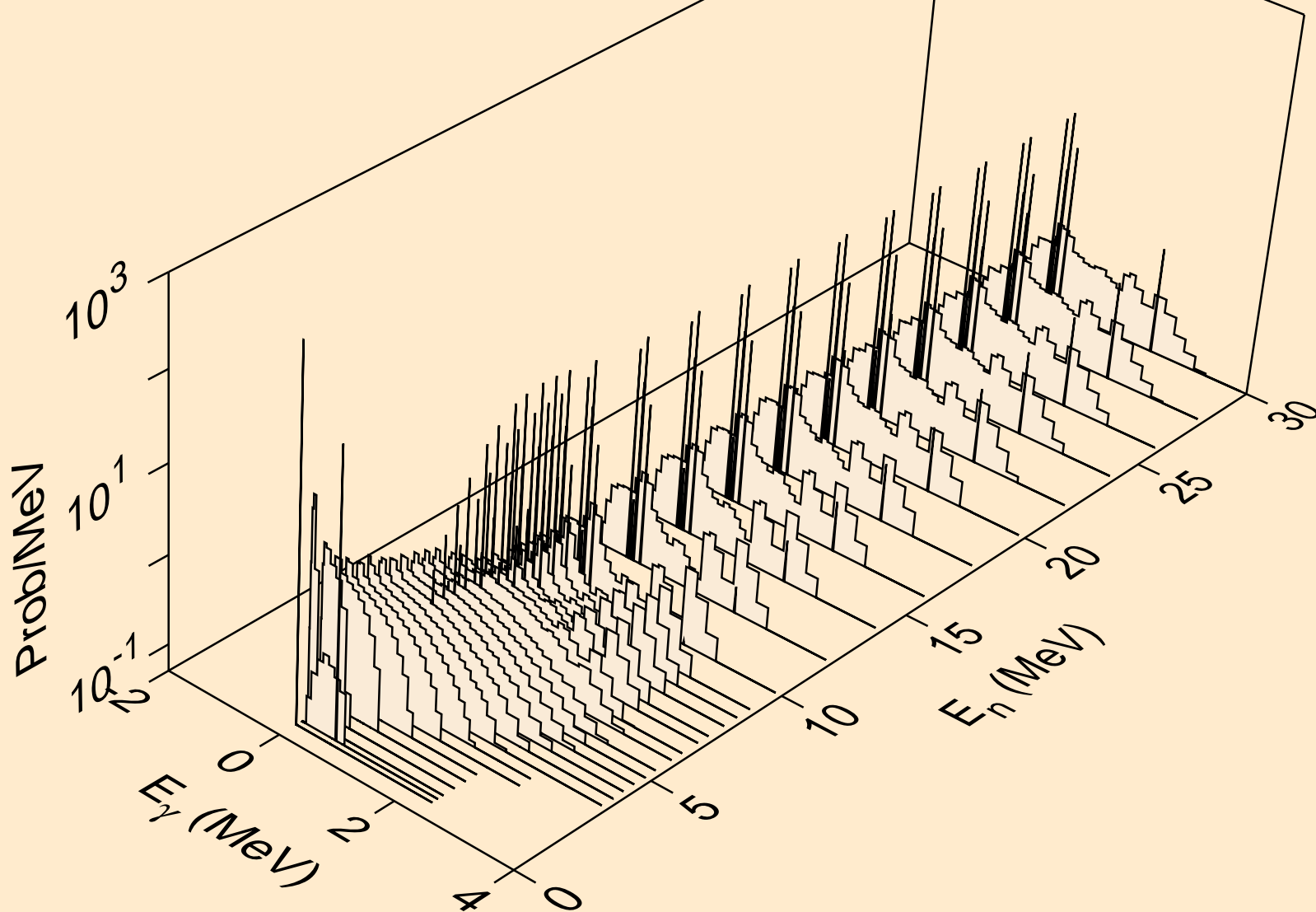

FR208 NEUTRON ACER TENDL-2019 LIBRARY; T=293.16K  
Photon emission for (n,2n)a

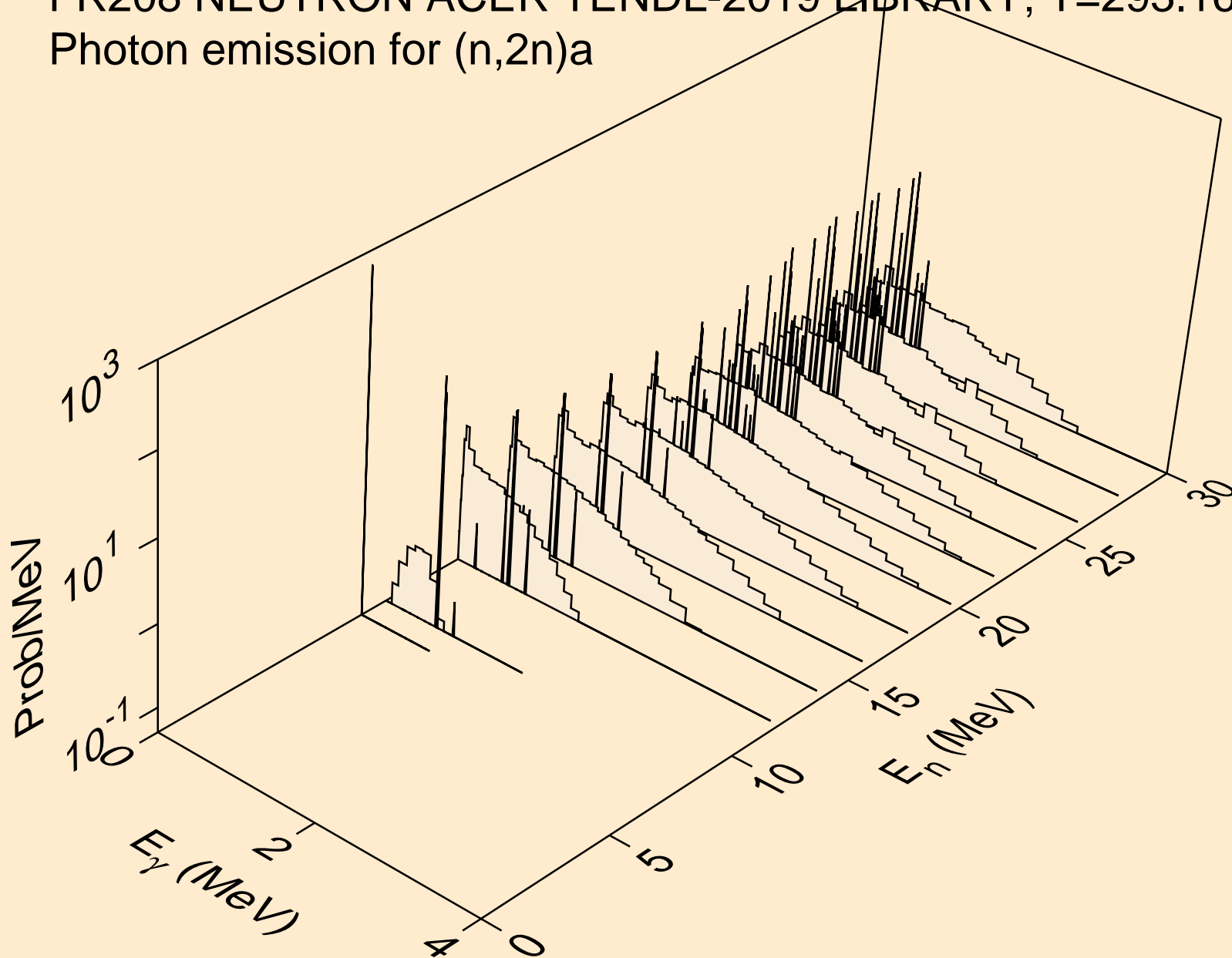

FR208 NEUTRON ACER TENDL-2019 LIBRARY; T=293.16K  
Photon emission for (n,3n)a

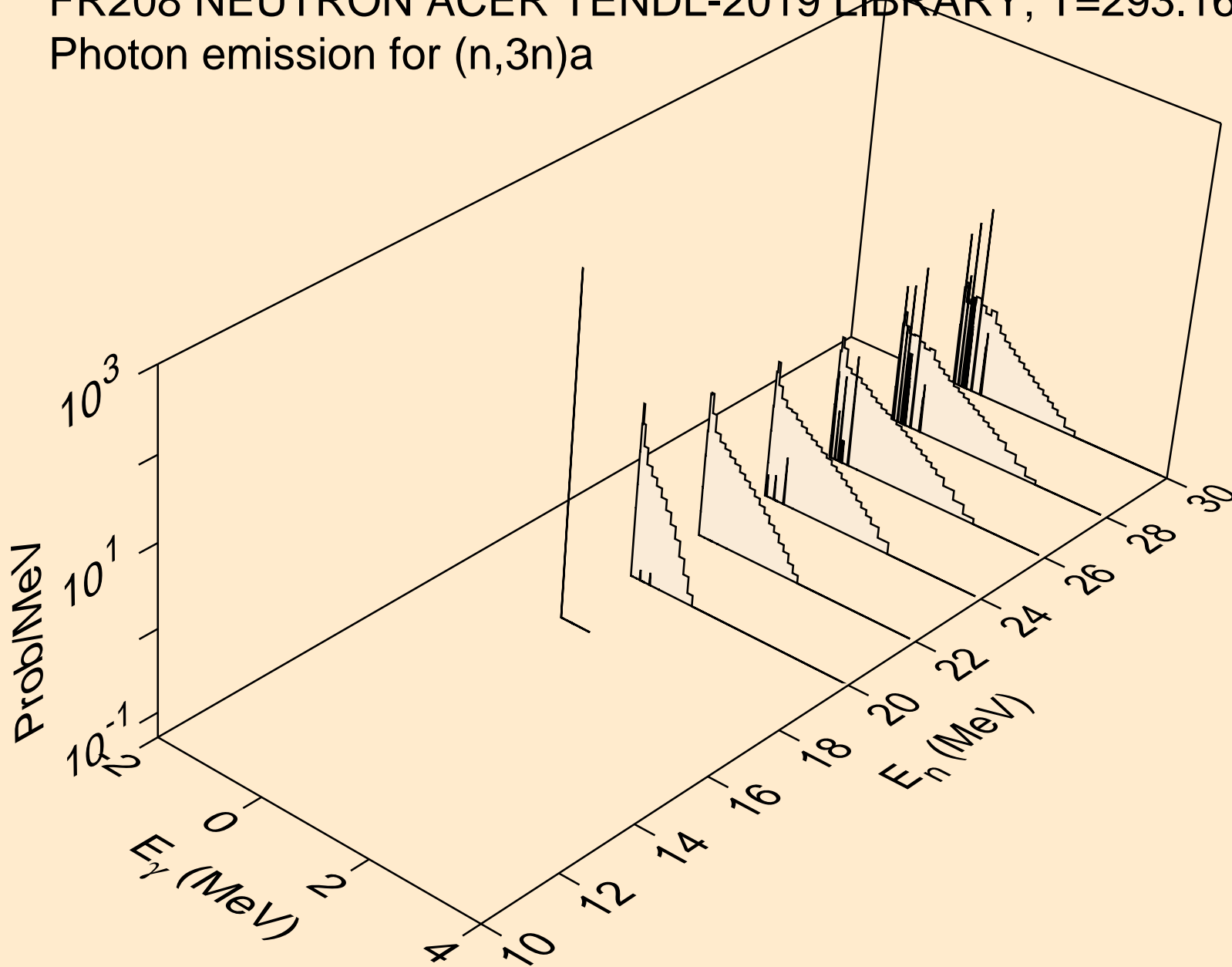

FR208 NEUTRON ACER TENDL-2019 LIBRARY; T=293.16K  
Photon emission for (n,n\*)p

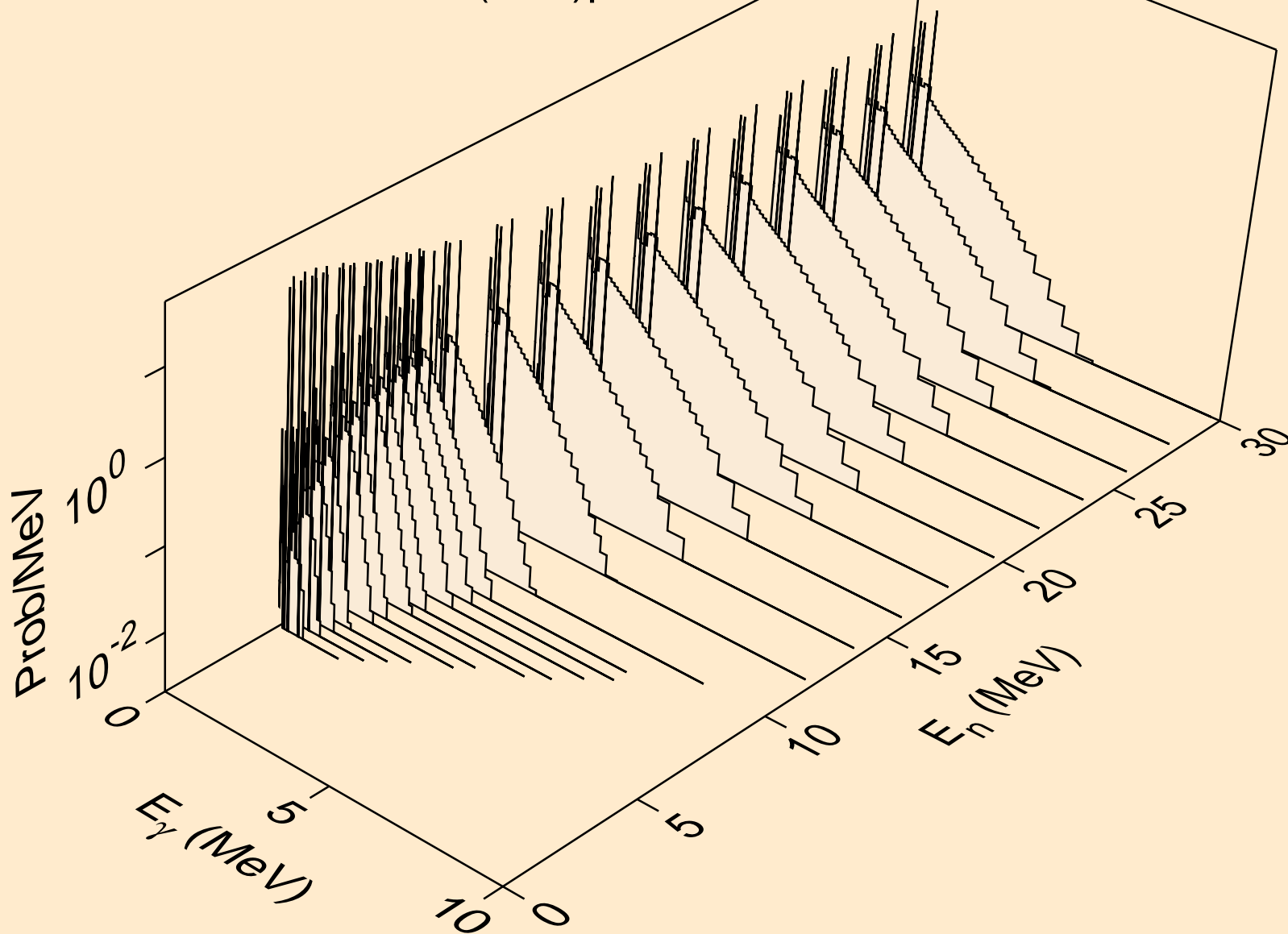

FR208 NEUTRON ACER TENDL-2019 LIBRARY; T=293.16K  
Photon emission for (n,n\*)2a

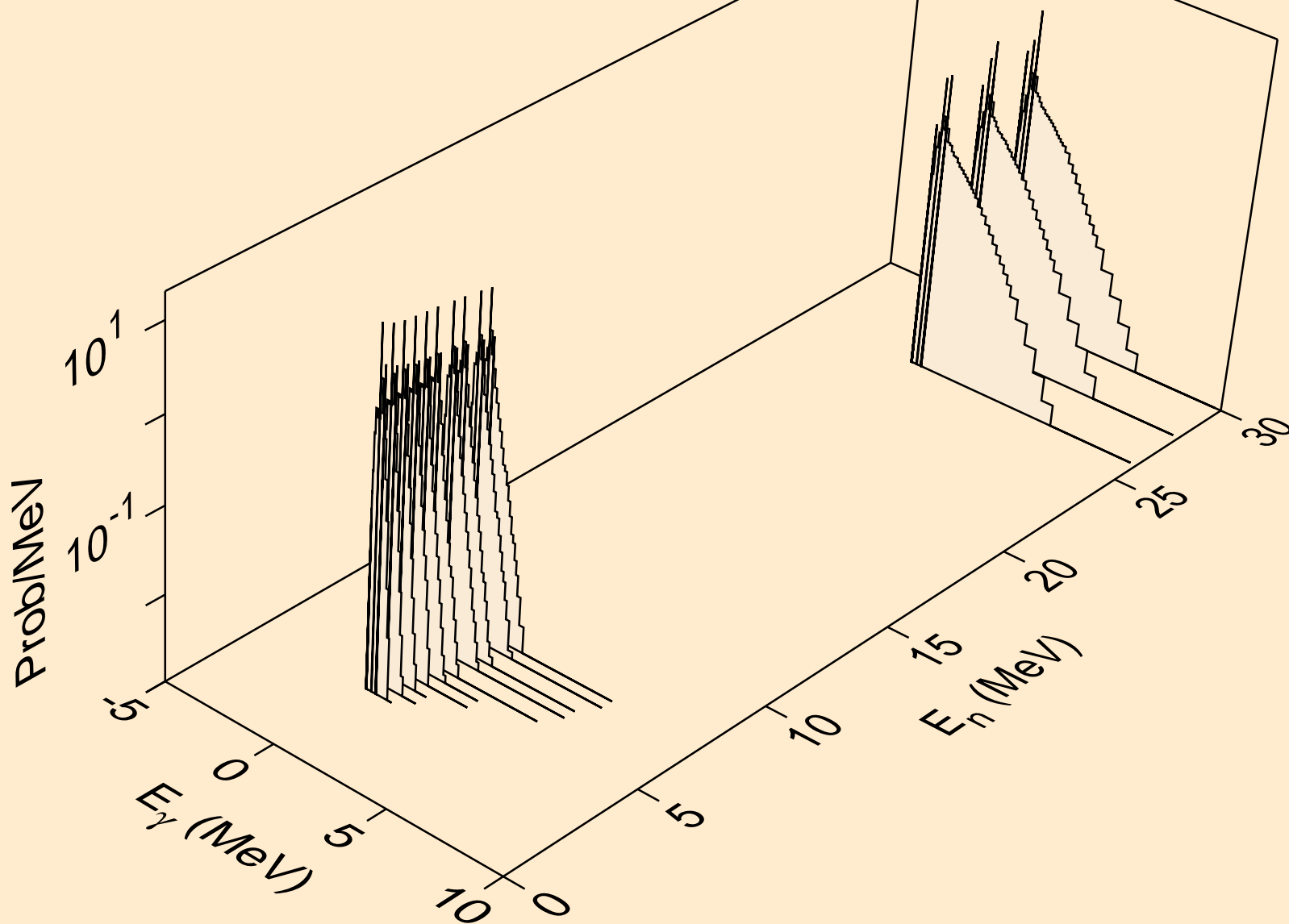



FR208 NEUTRON ACER TENDL-2019 LIBRARY; T=293.16K  
Photon emission for (n,2n)2a

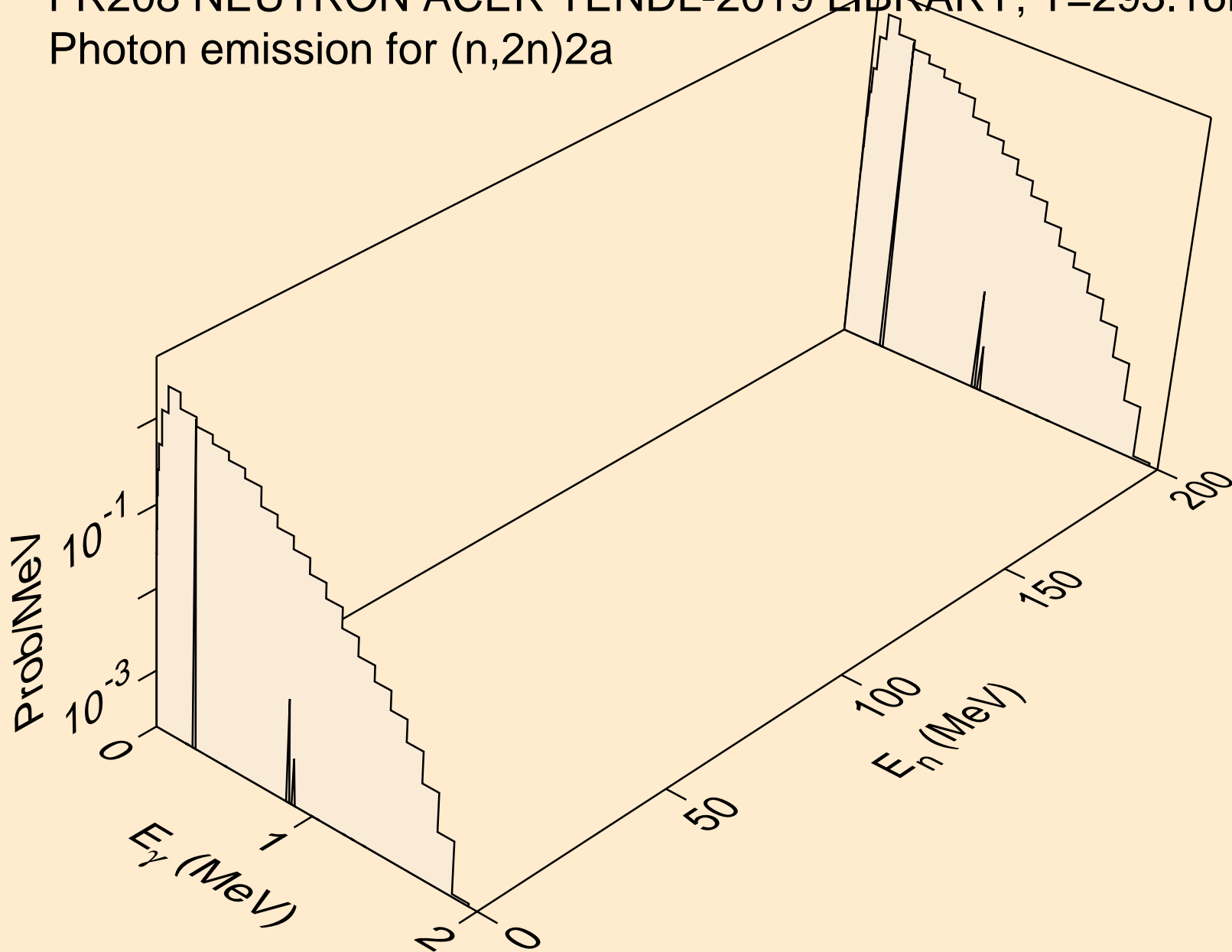

FR208 NEUTRON ACER TENDL-2019 LIBRARY; T=293.16K  
Photon emission for (n,n\*)d

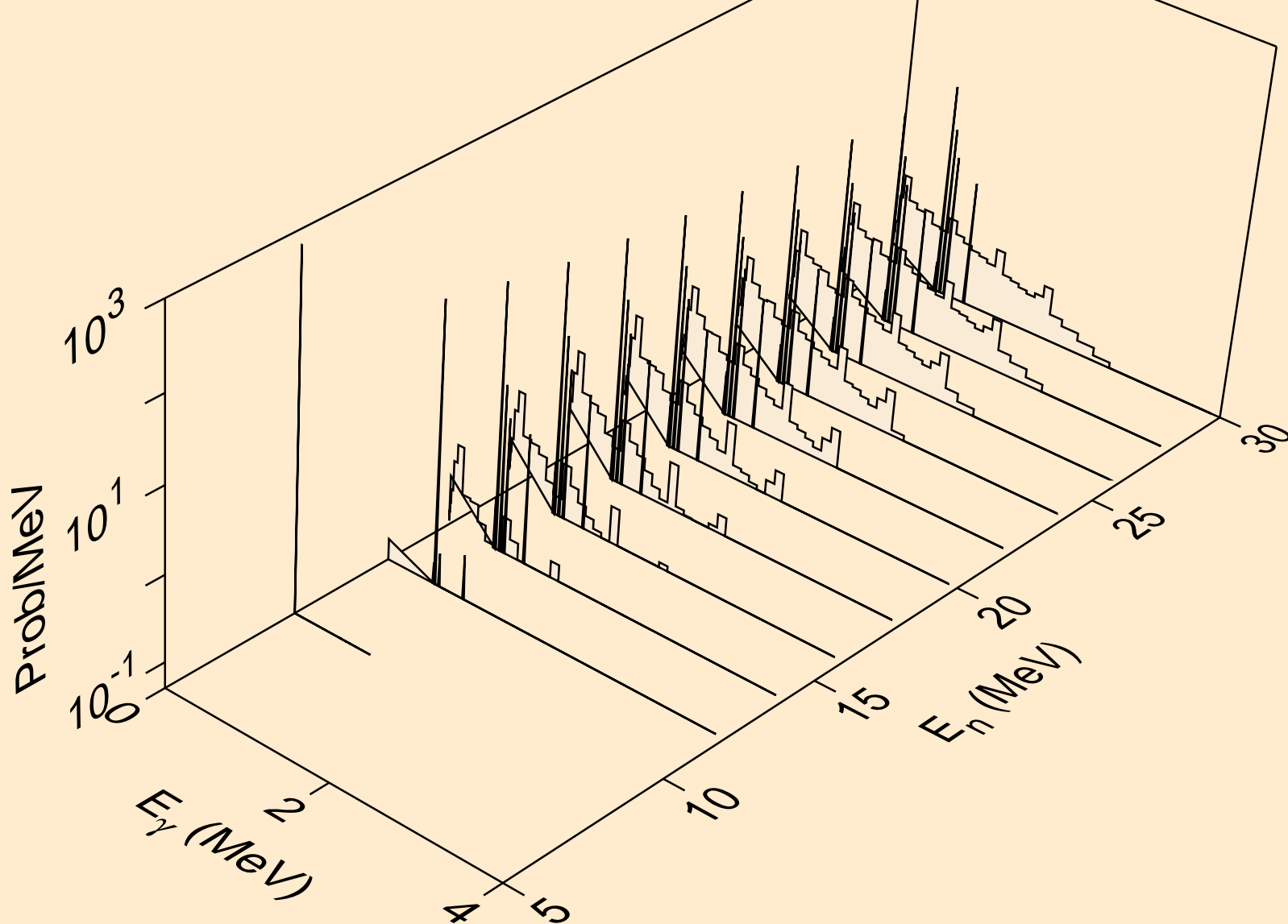

FR208 NEUTRON ACER TENDL-2019 LIBRARY; T=293.16K  
Photon emission for (n,n\*)t

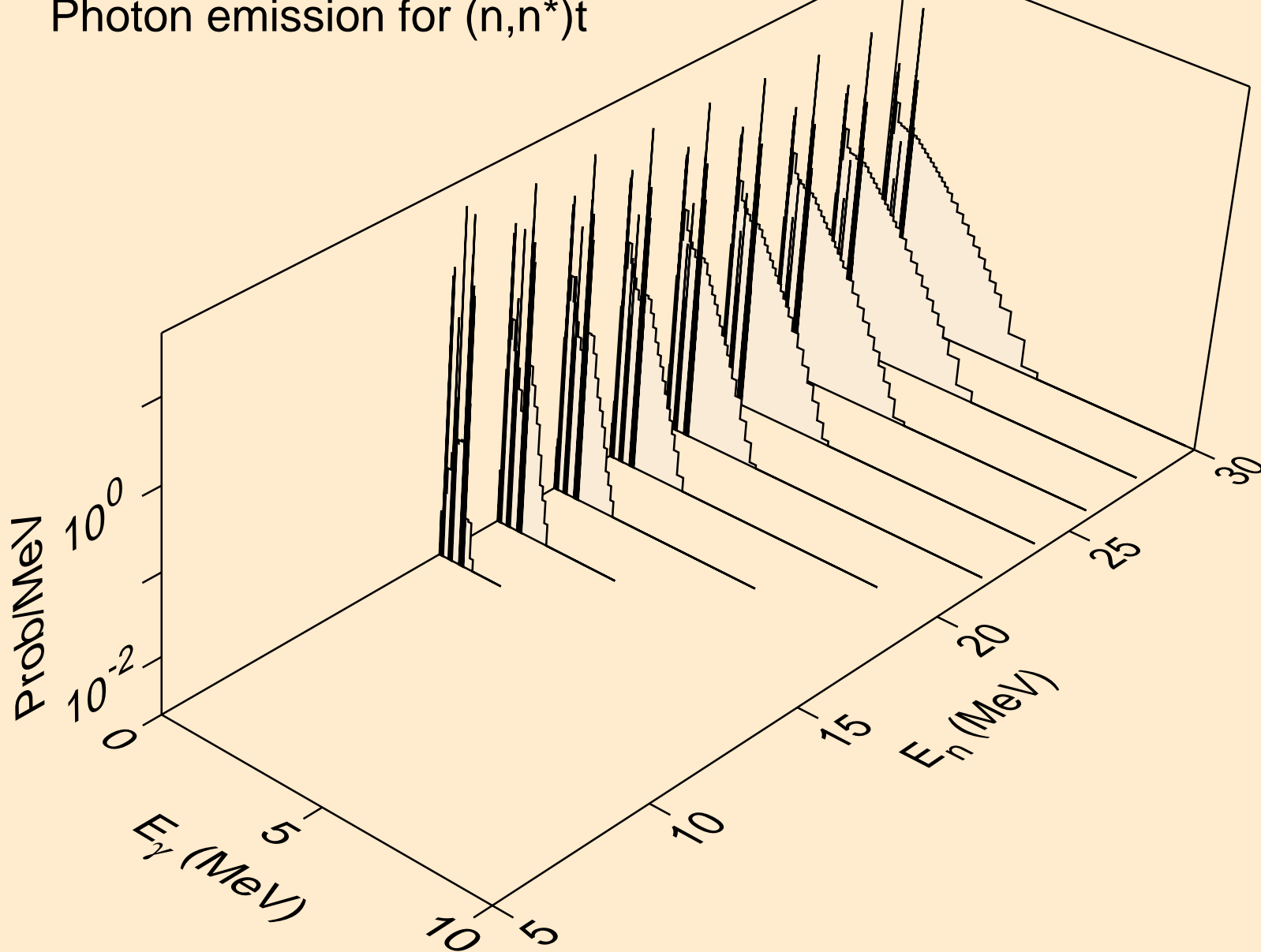

FR208 NEUTRON ACER TENDL-2019 LIBRARY; T=293.16K  
Photon emission for (n,n\*)he3

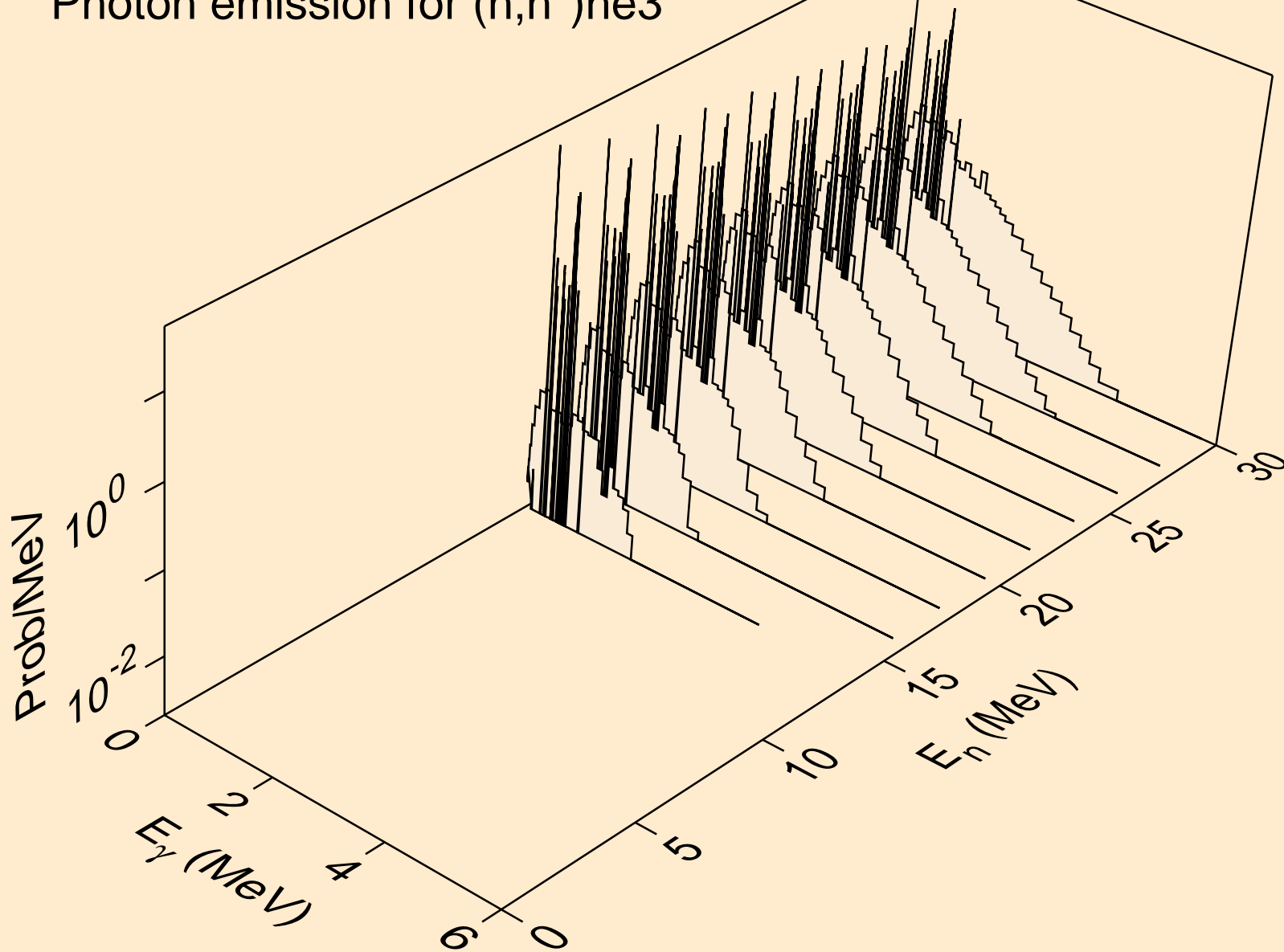

FR208 NEUTRON ACER TENDL-2019 LIBRARY; T=293.16K  
Photon emission for (n,4n)

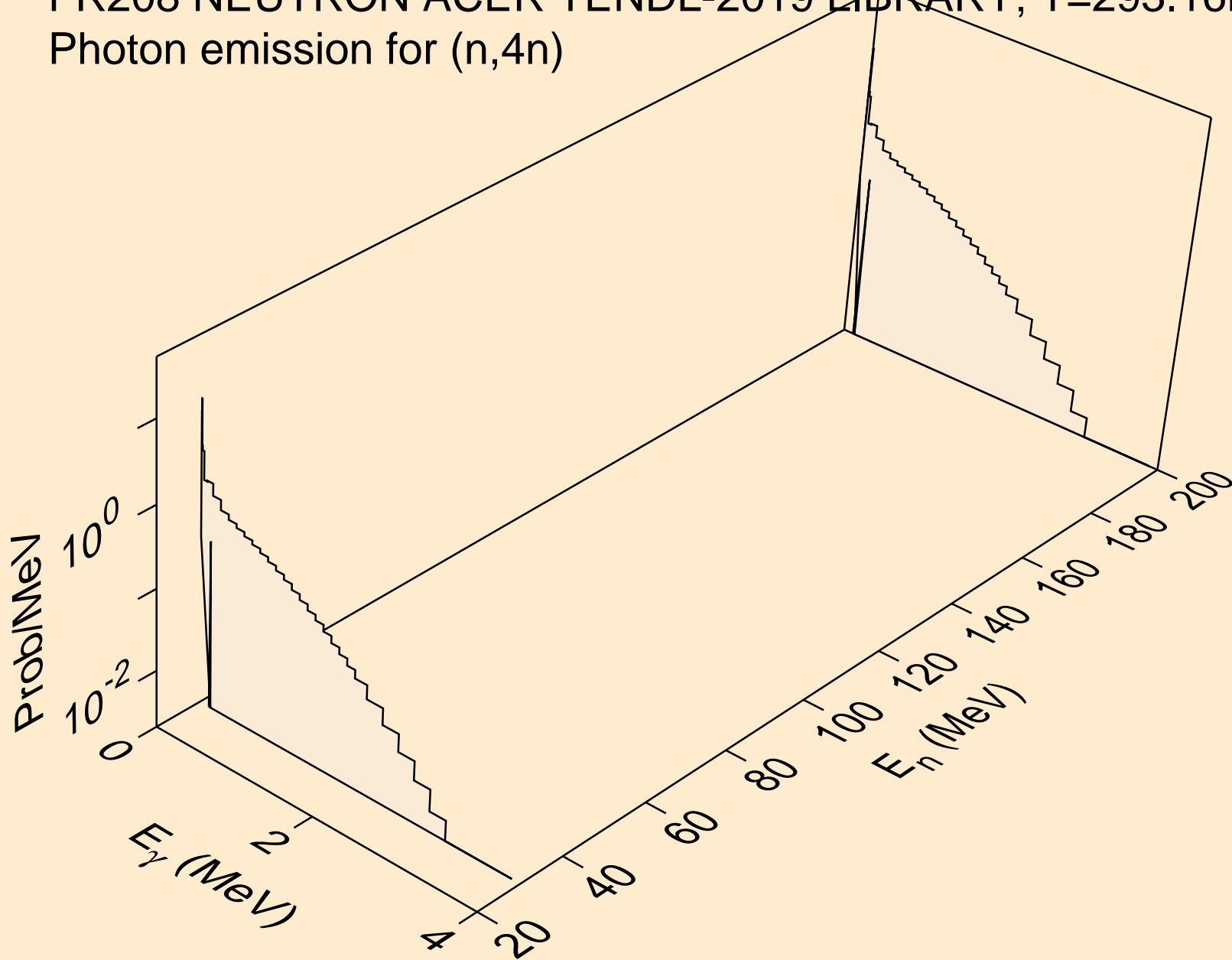

FR208 NEUTRON ACER TENDL-2019 LIBRARY; T=293.16K  
Photon emission for (n,2np)

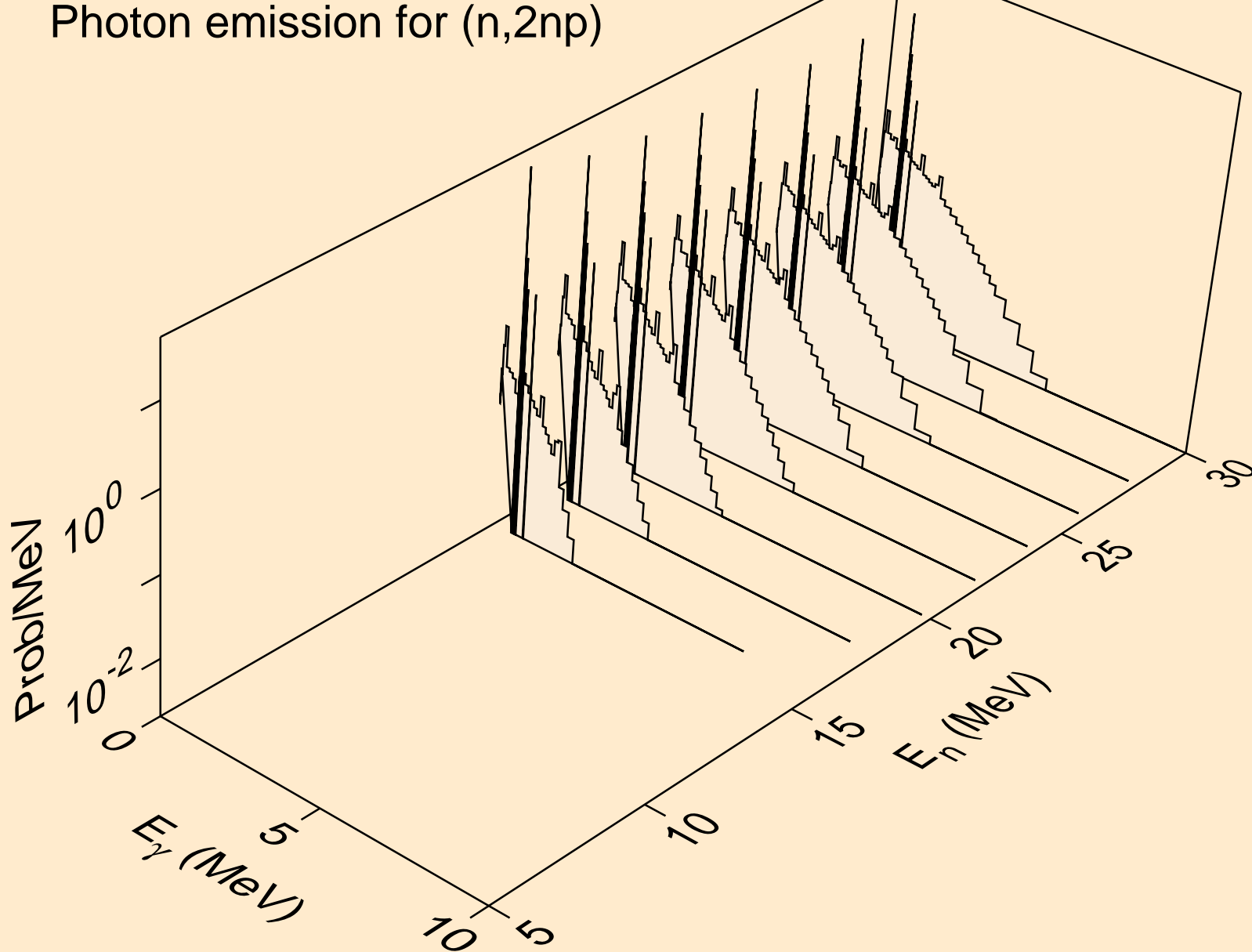

FR208 NEUTRON ACER TENDL-2019 LIBRARY; T=293.16K  
Photon emission for (n,3np)

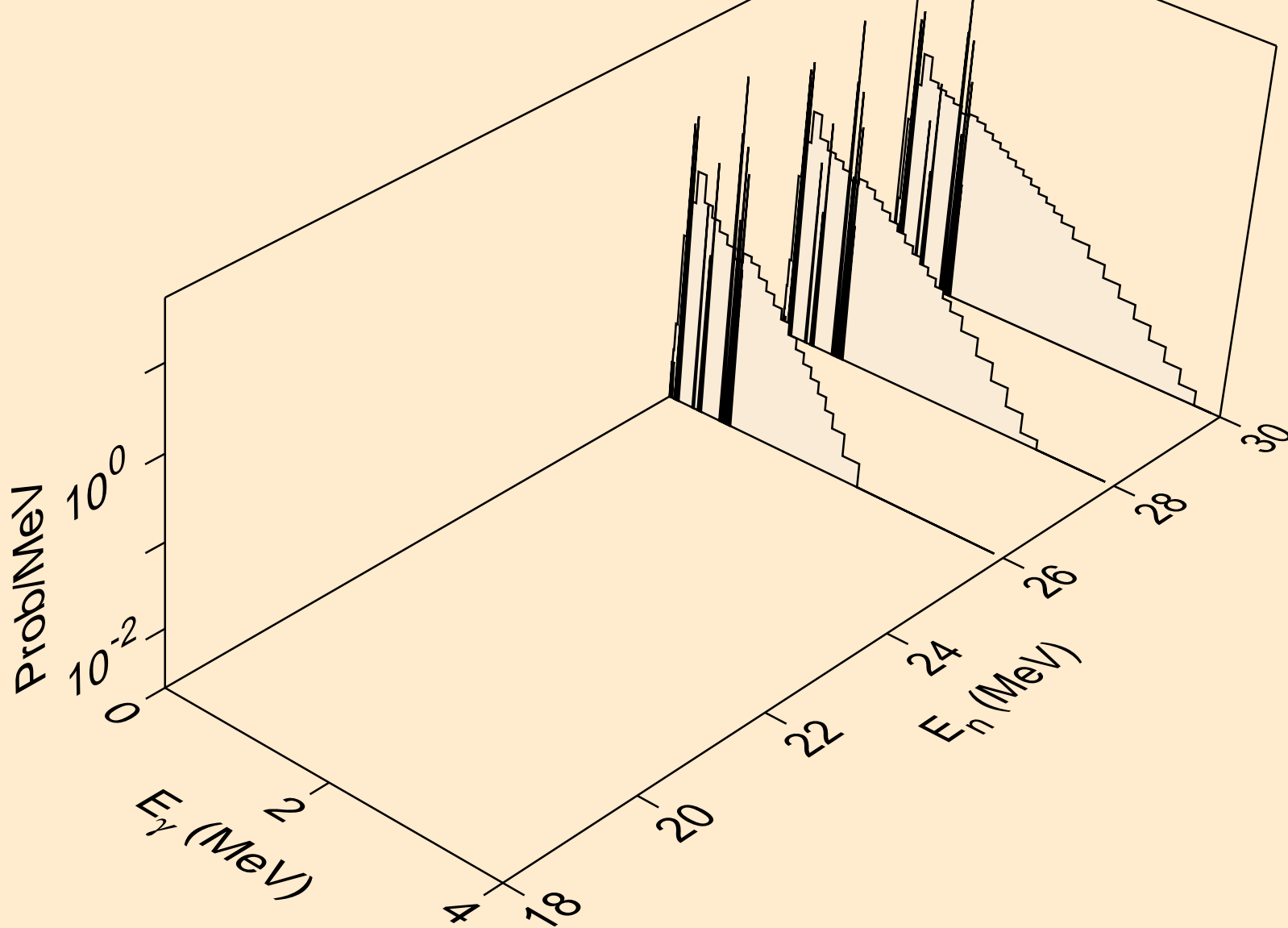

FR208 NEUTRON ACER TENDL-2019 LIBRARY; T=293.16K  
Photon emission for (n,2np)

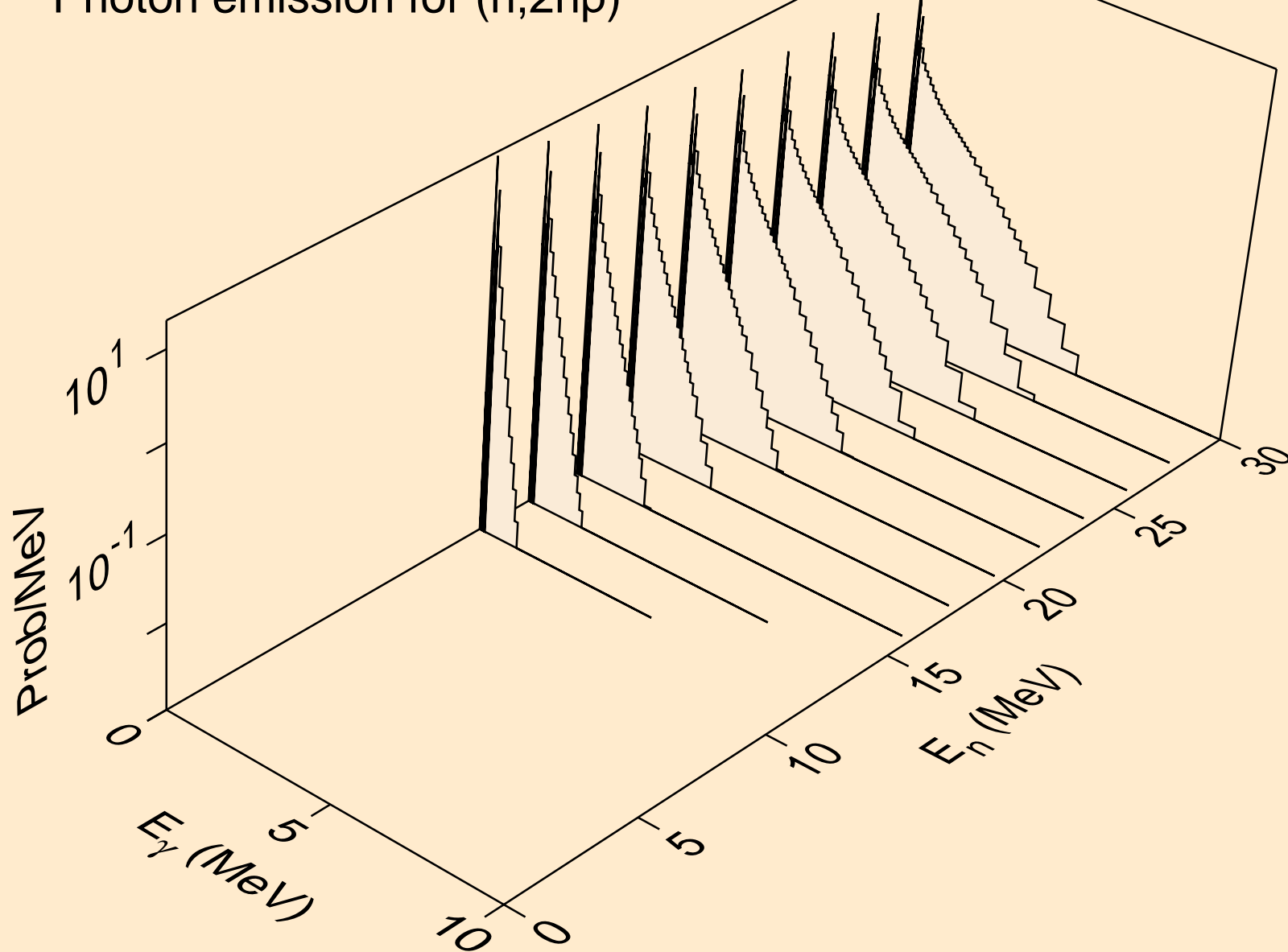



FR208 NEUTRON ACER TENDL-2019 LIBRARY; T=293.16K  
Photon emission for (n,npa)

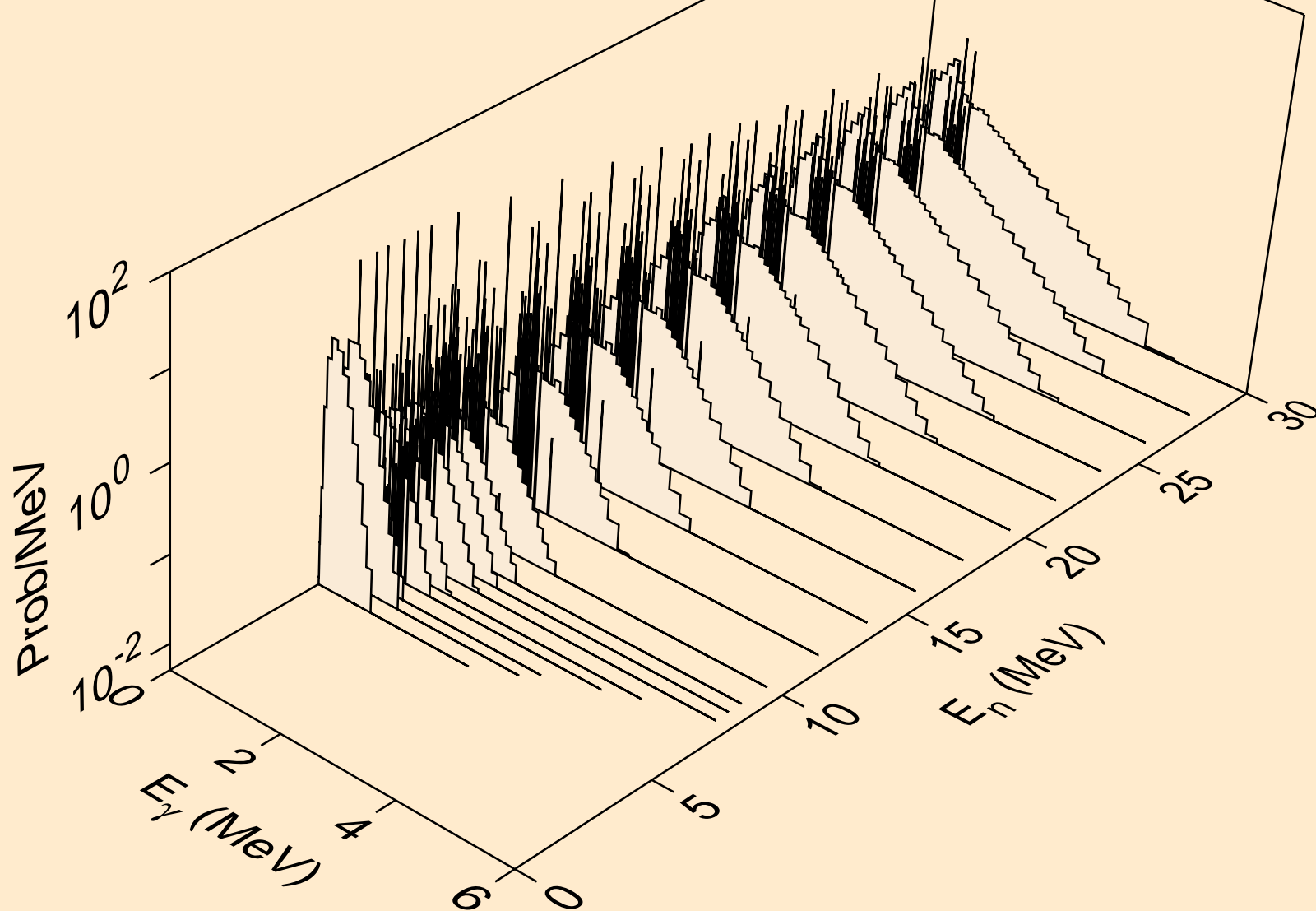

FR208 NEUTRON ACER TENDL-2019 LIBRARY; T=293.16K  
Photon emission for (n,n\*c)

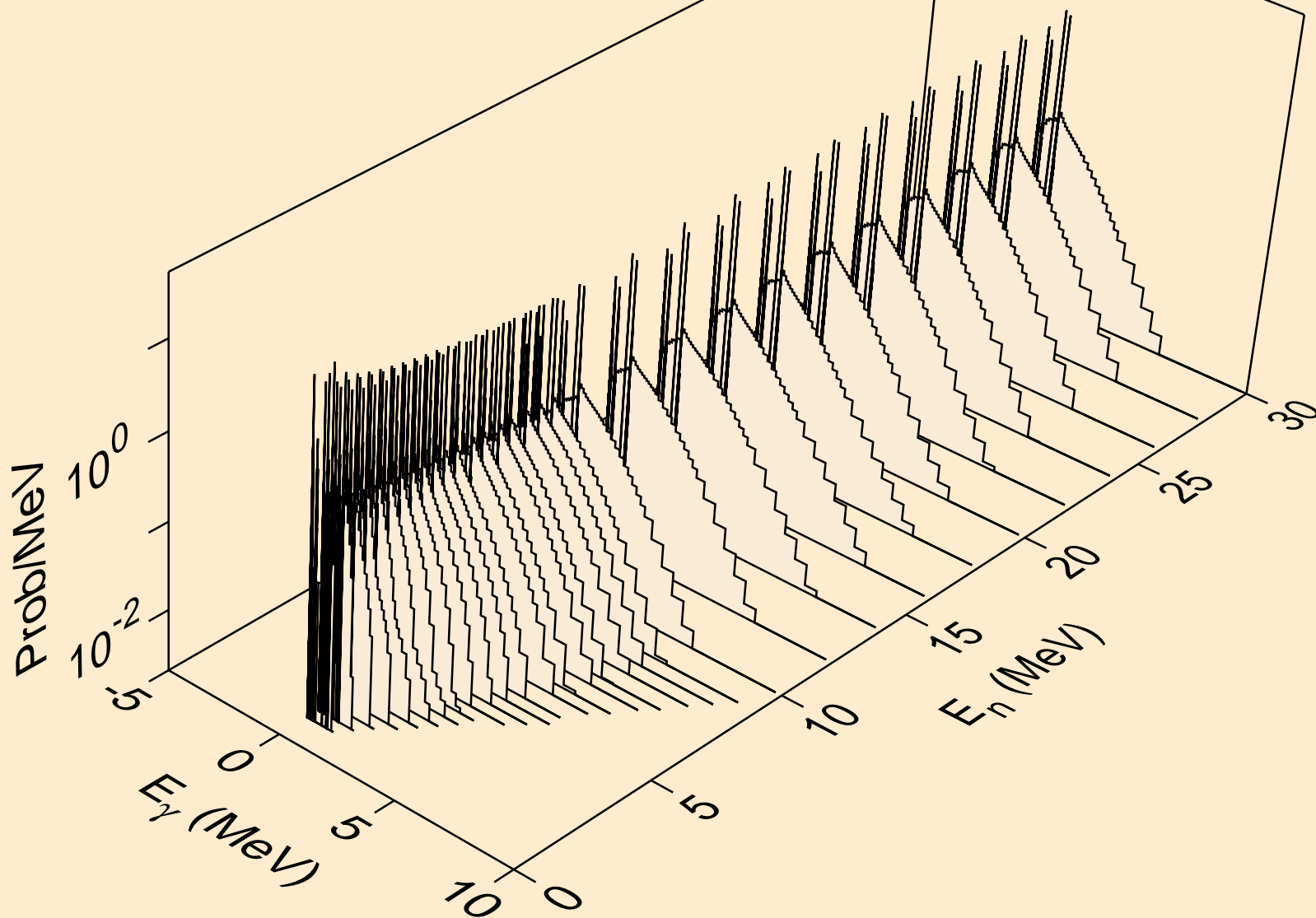

FR208 NEUTRON ACER TENDL-2019 LIBRARY; T=293.16K  
Photon emission for (n,gma)

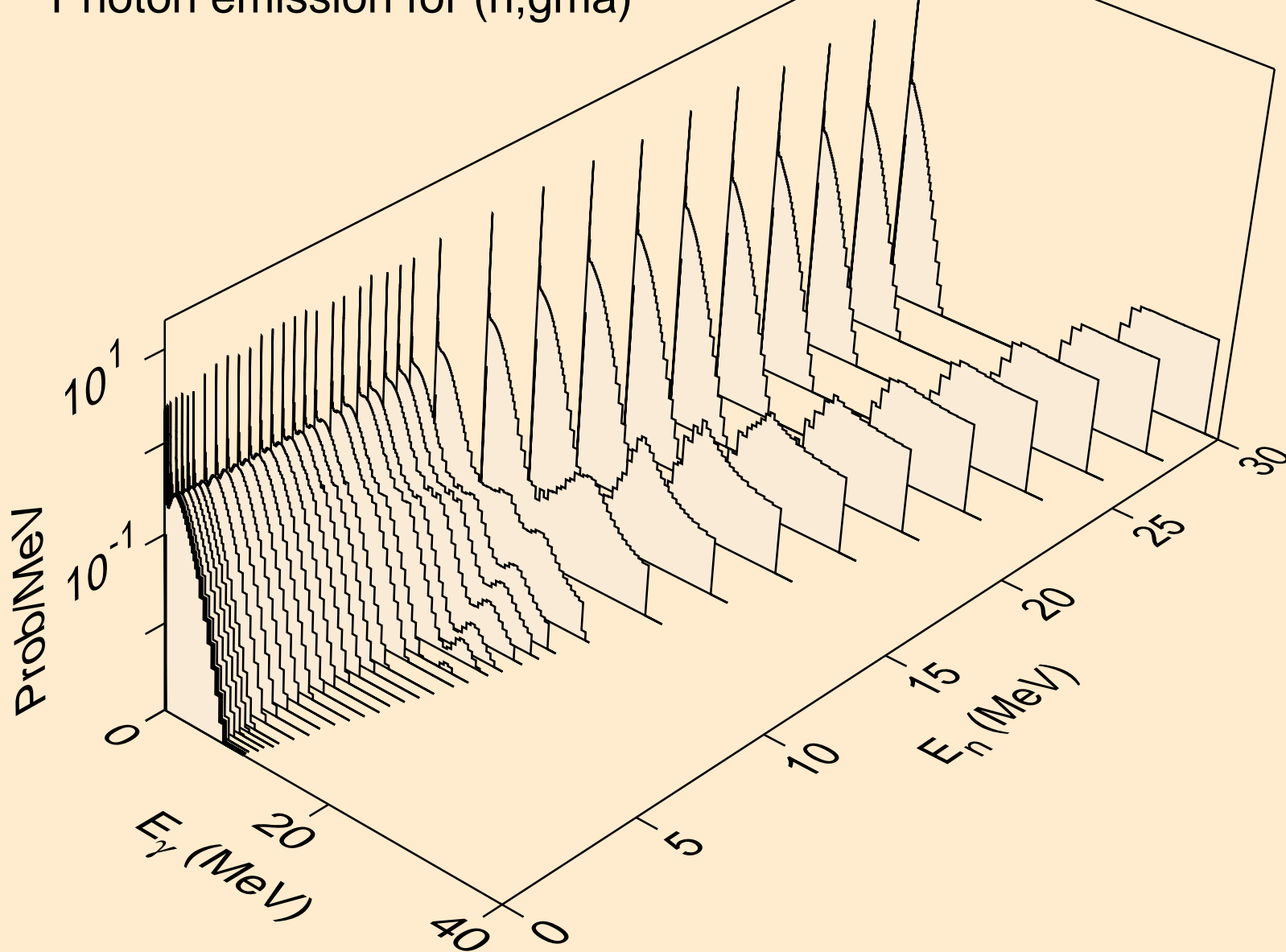

FR208 NEUTRON ACER TENDL-2019 LIBRARY; T=293.16K  
Photon emission for (n,p)

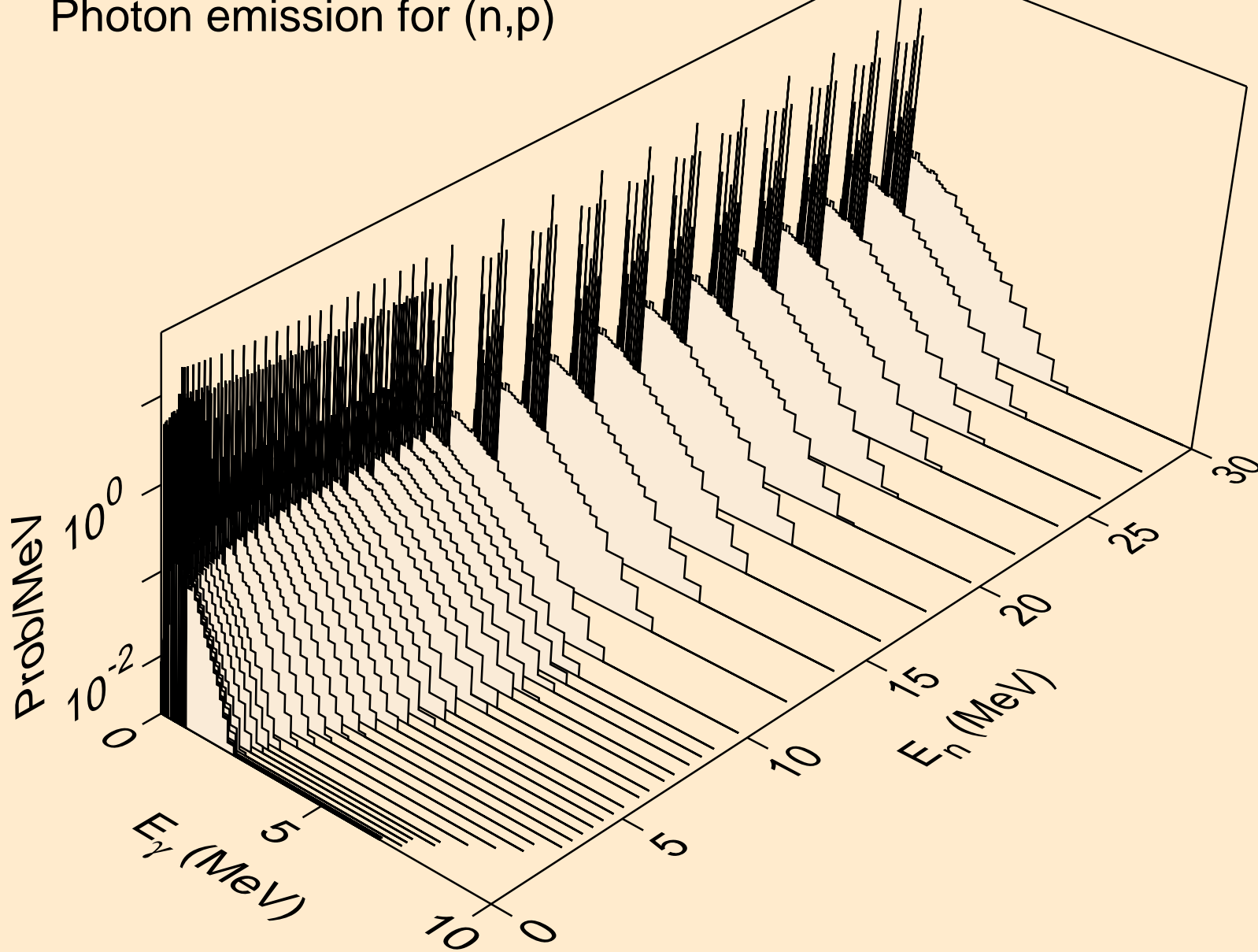

FR208 NEUTRON ACER TENDL-2019 LIBRARY; T=293.16K  
Photon emission for (n,d)

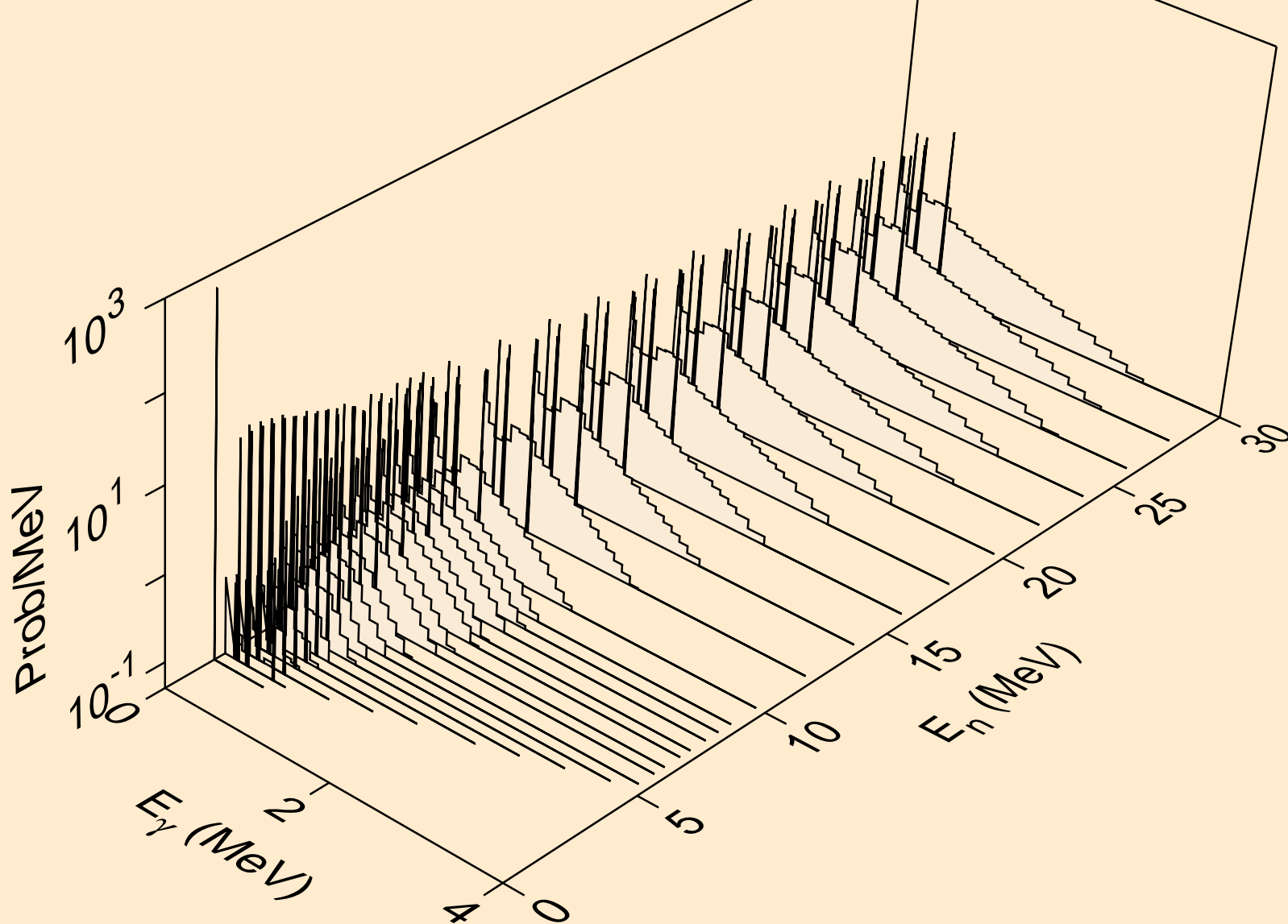

FR208 NEUTRON ACER TENDL-2019 LIBRARY; T=293.16K  
Photon emission for (n,t)

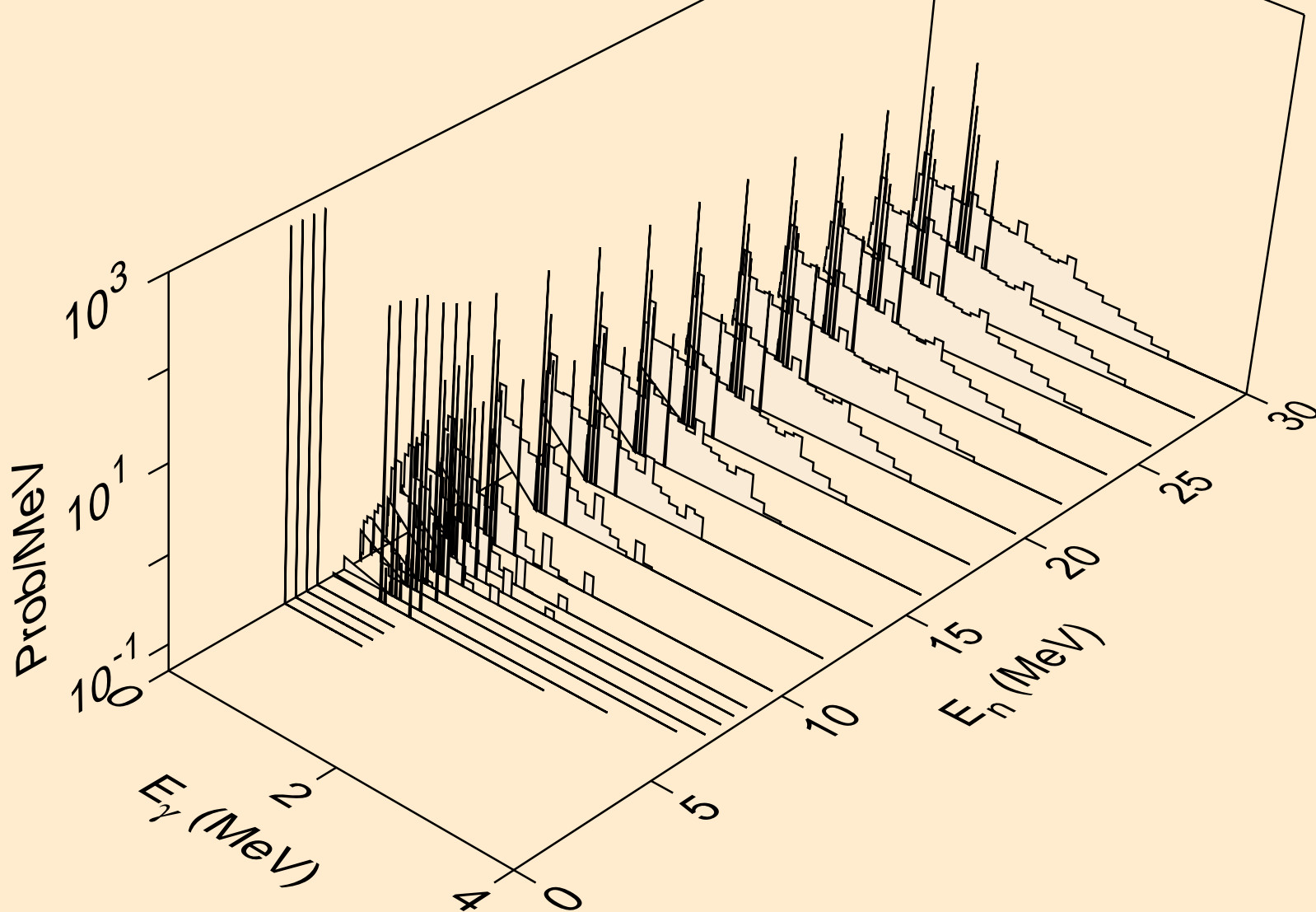

FR208 NEUTRON ACER TENDL-2019 LIBRARY; T=293.16K  
Photon emission for (n,he3)

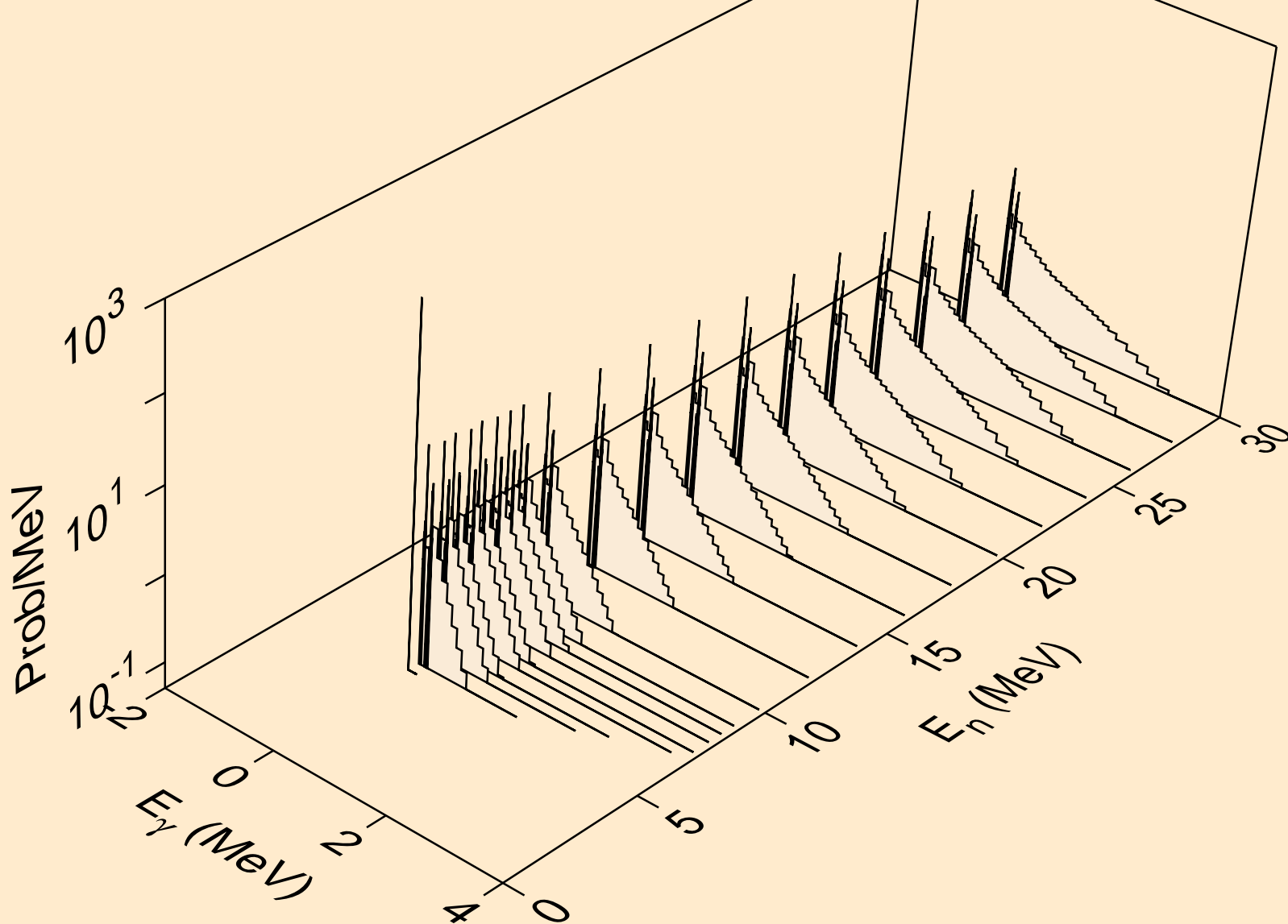

FR208 NEUTRON ACER TENDL-2019 LIBRARY; T=293.16K  
Photon emission for (n,a)

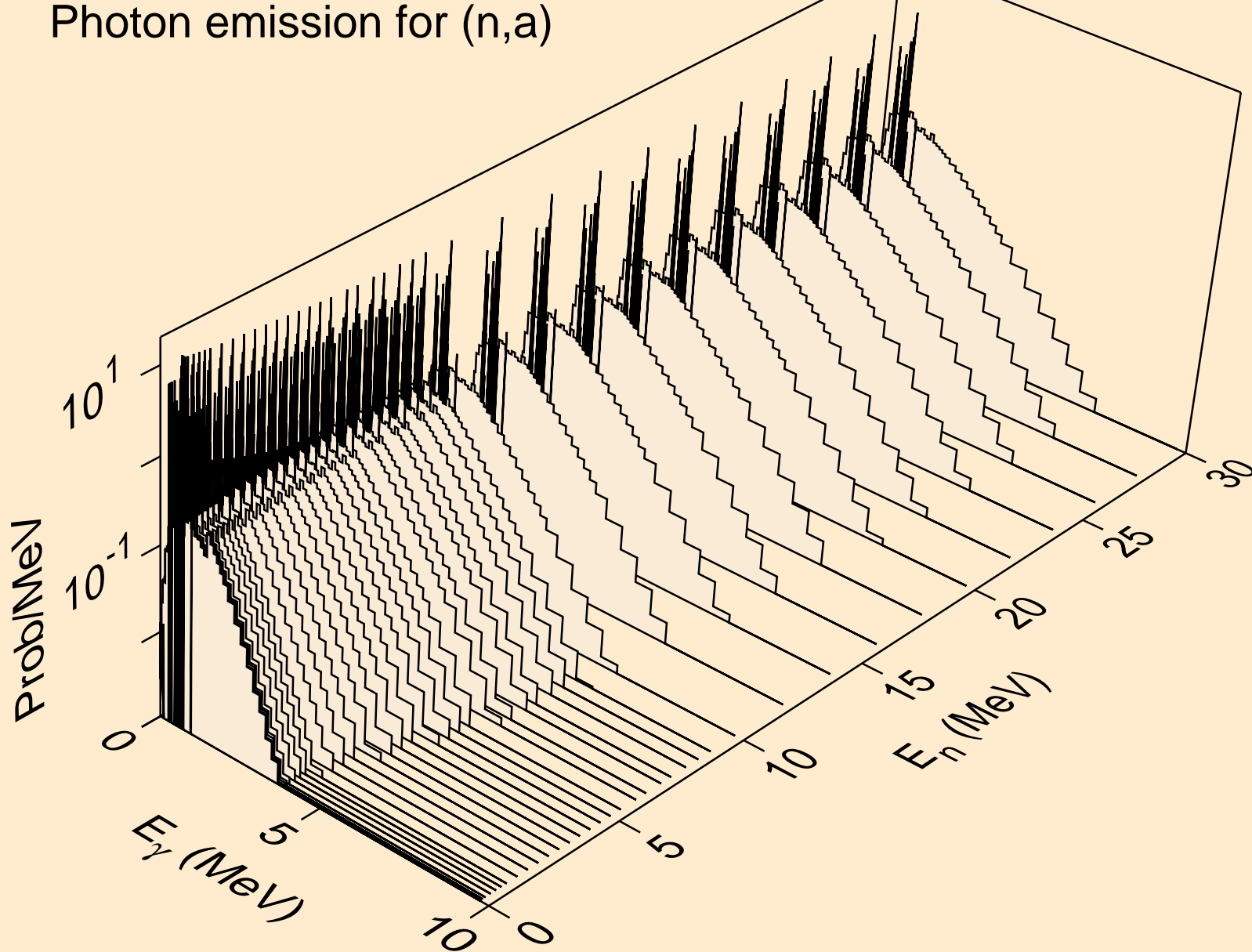



FR208 NEUTRON ACER TENDL-2019 LIBRARY; T=293.16K  
Photon emission for (n,2a)

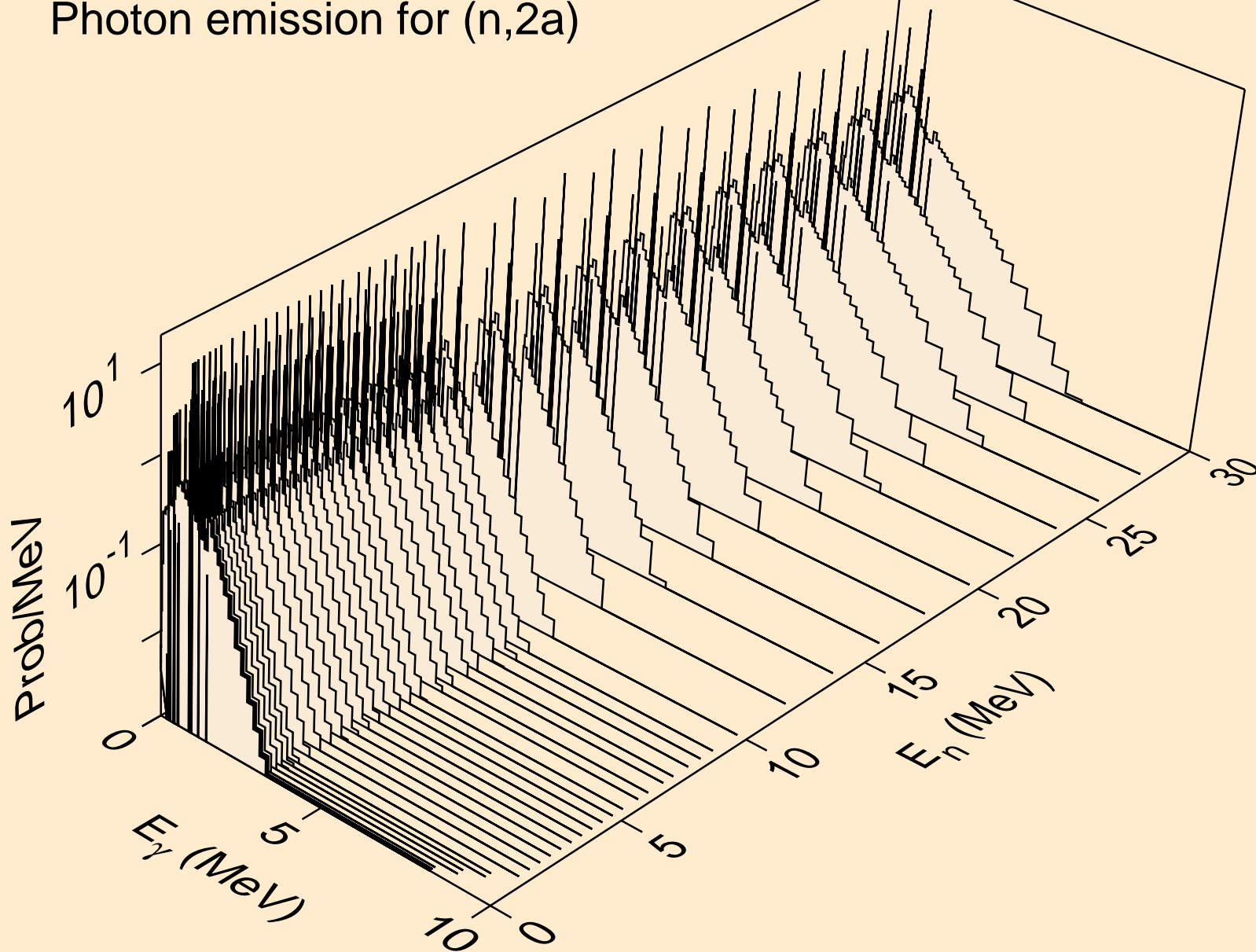

FR208 NEUTRON ACER TENDL-2019 LIBRARY; T=293.16K  
Photon emission for (n,2p)

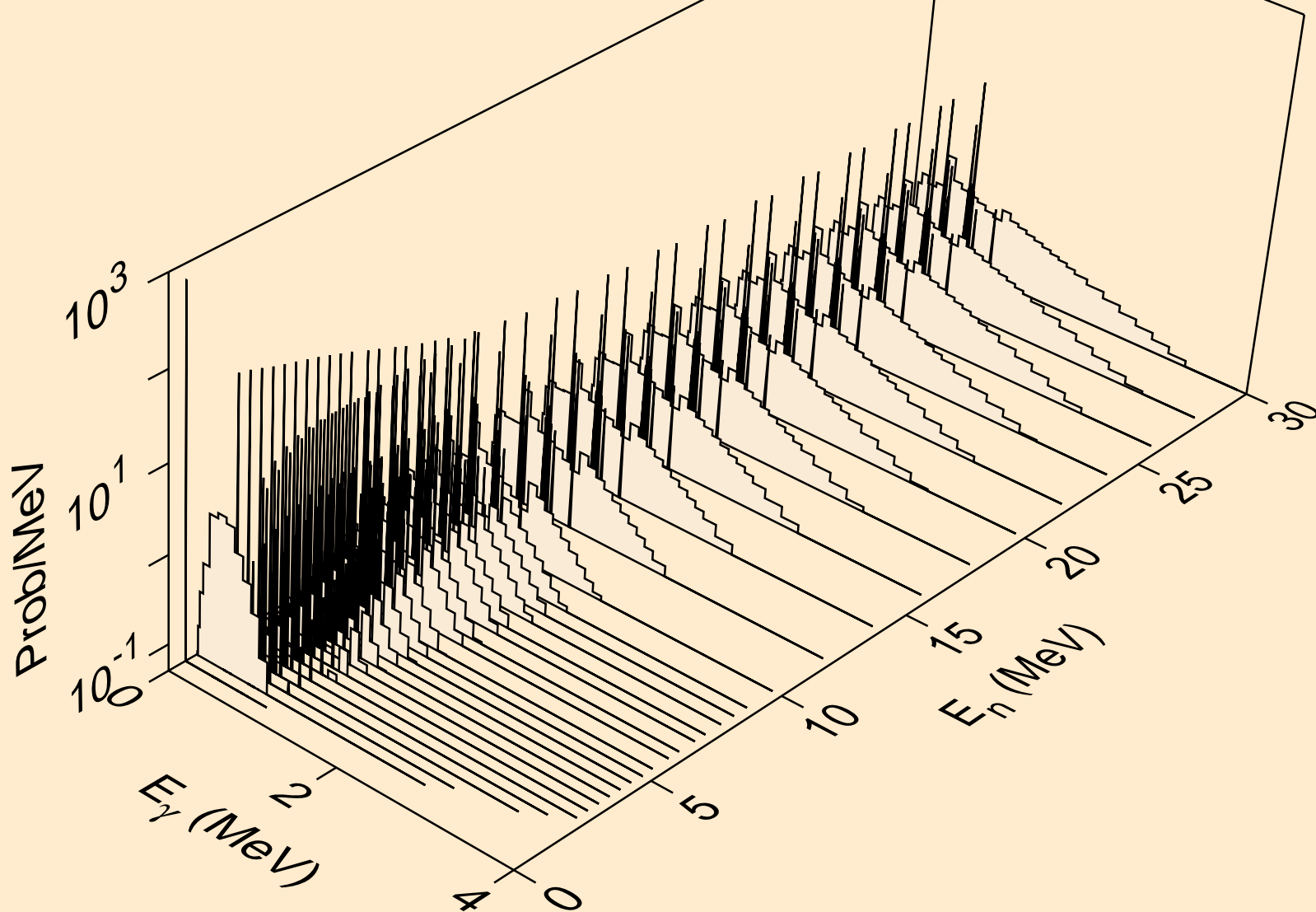

FR208 NEUTRON ACER TENDL-2019 LIBRARY; T=293.16K  
Photon emission for (n,p $\alpha$ )

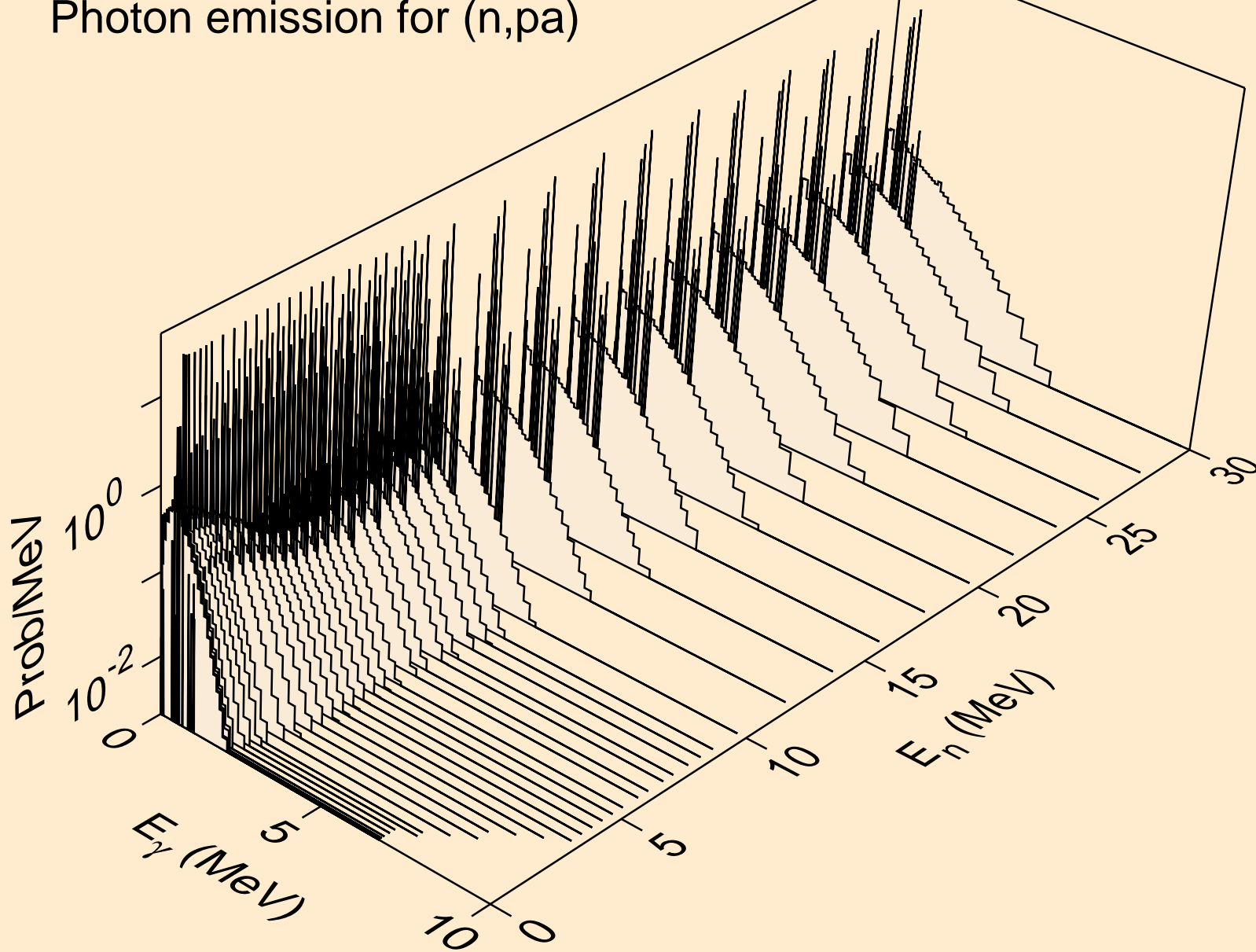

FR208 NEUTRON ACER TENDL-2019 LIBRARY; T=293.16K  
Photon emission for (n,pd)

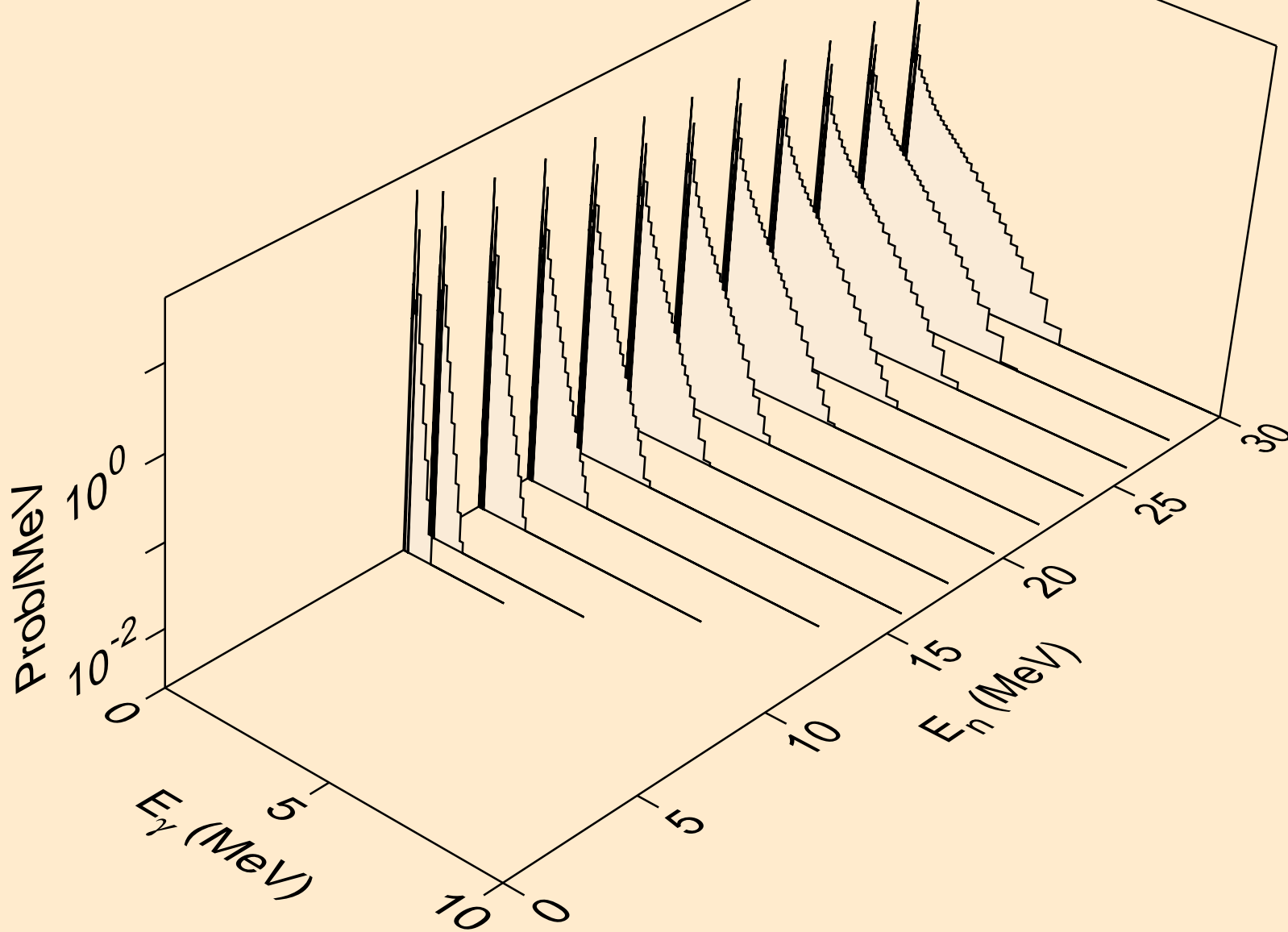

FR208 NEUTRON ACER TENDL-2019 LIBRARY; T=293.16K  
Photon emission for (n,pt)

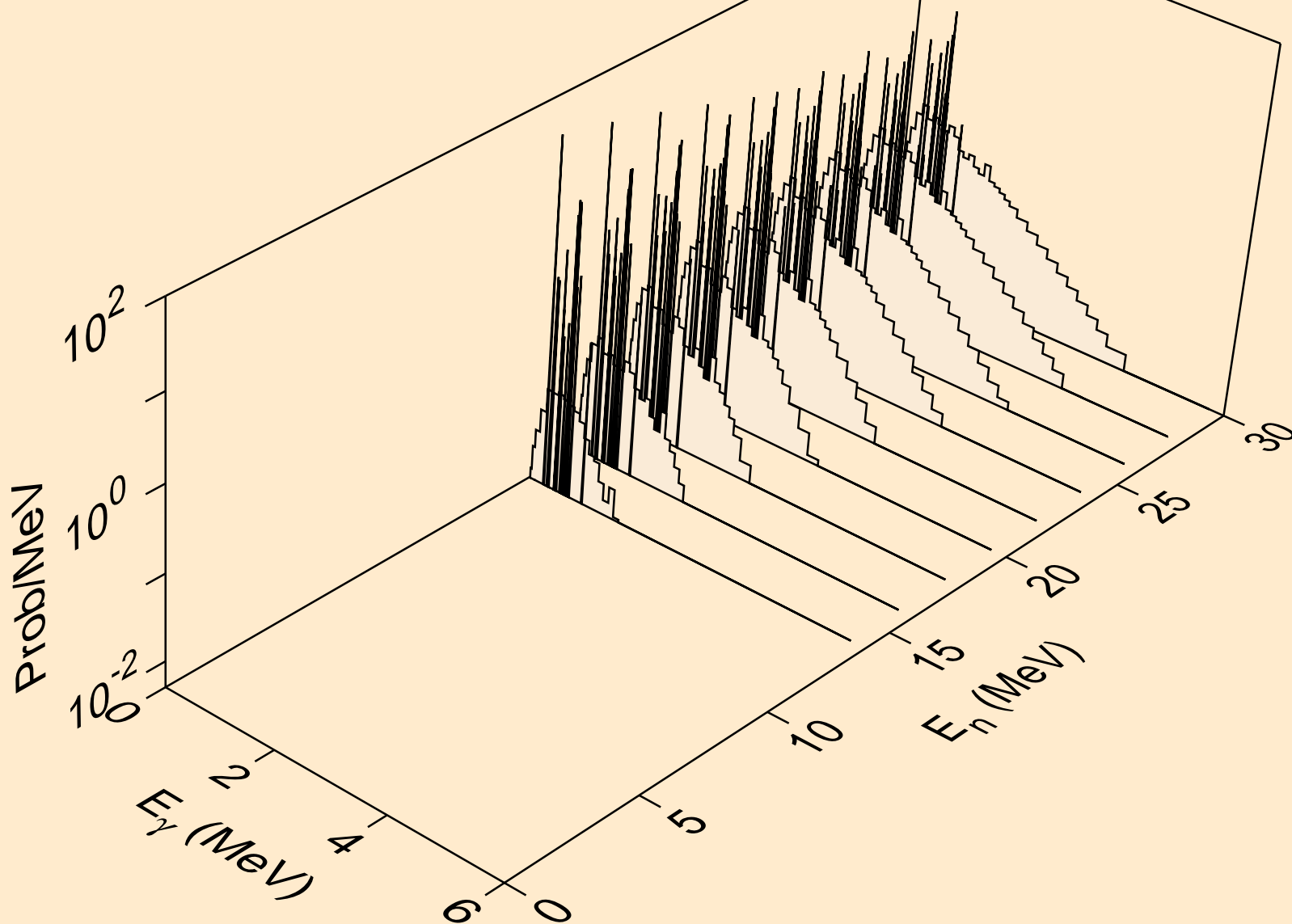

FR208 NEUTRON ACER TENDL-2019 LIBRARY; T=293.16K  
Photon emission for (n,da)

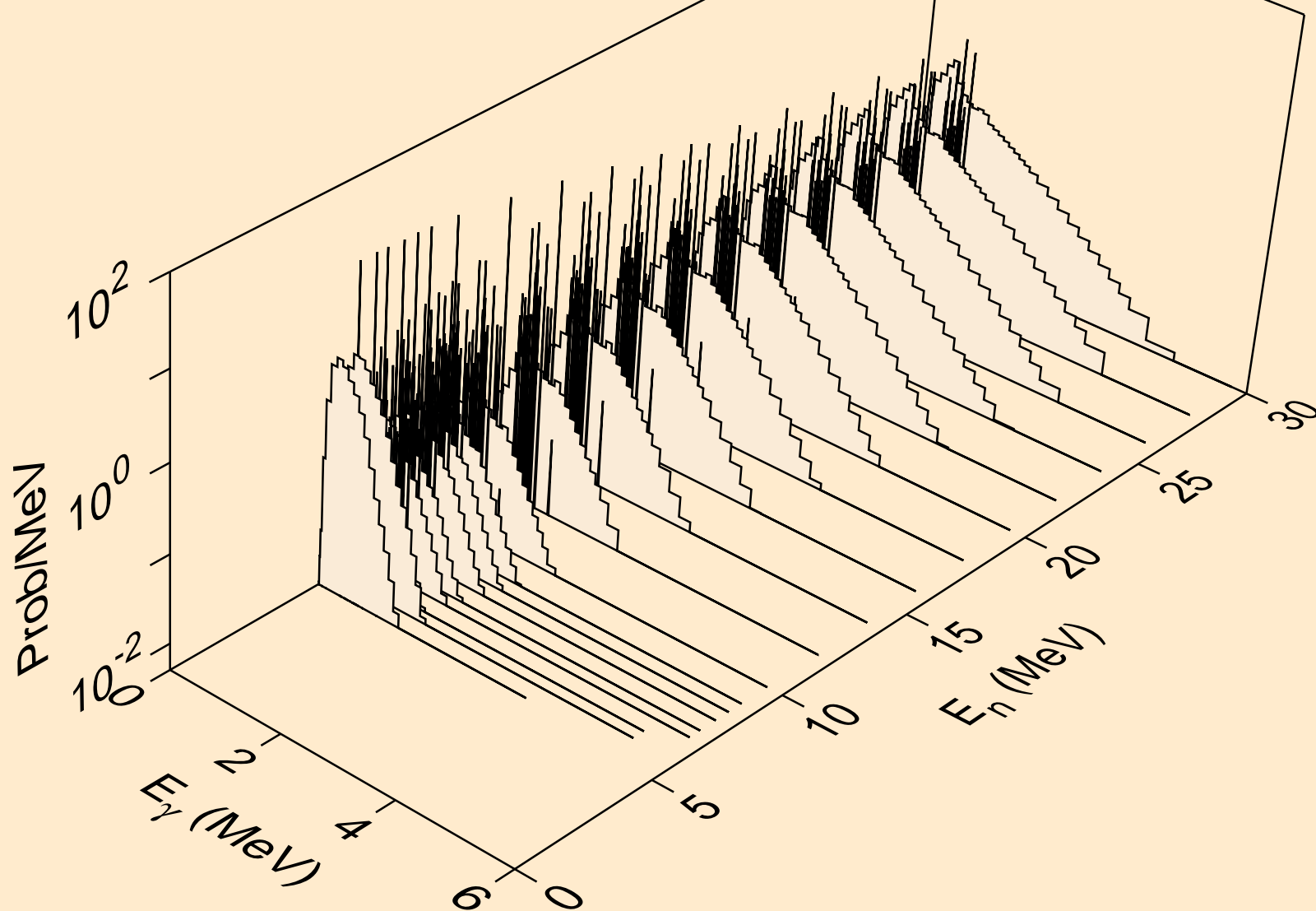

FR208 NEUTRON ACER TENDL-2019 LIBRARY; T=293.16K  
thermal capture photon spectrum

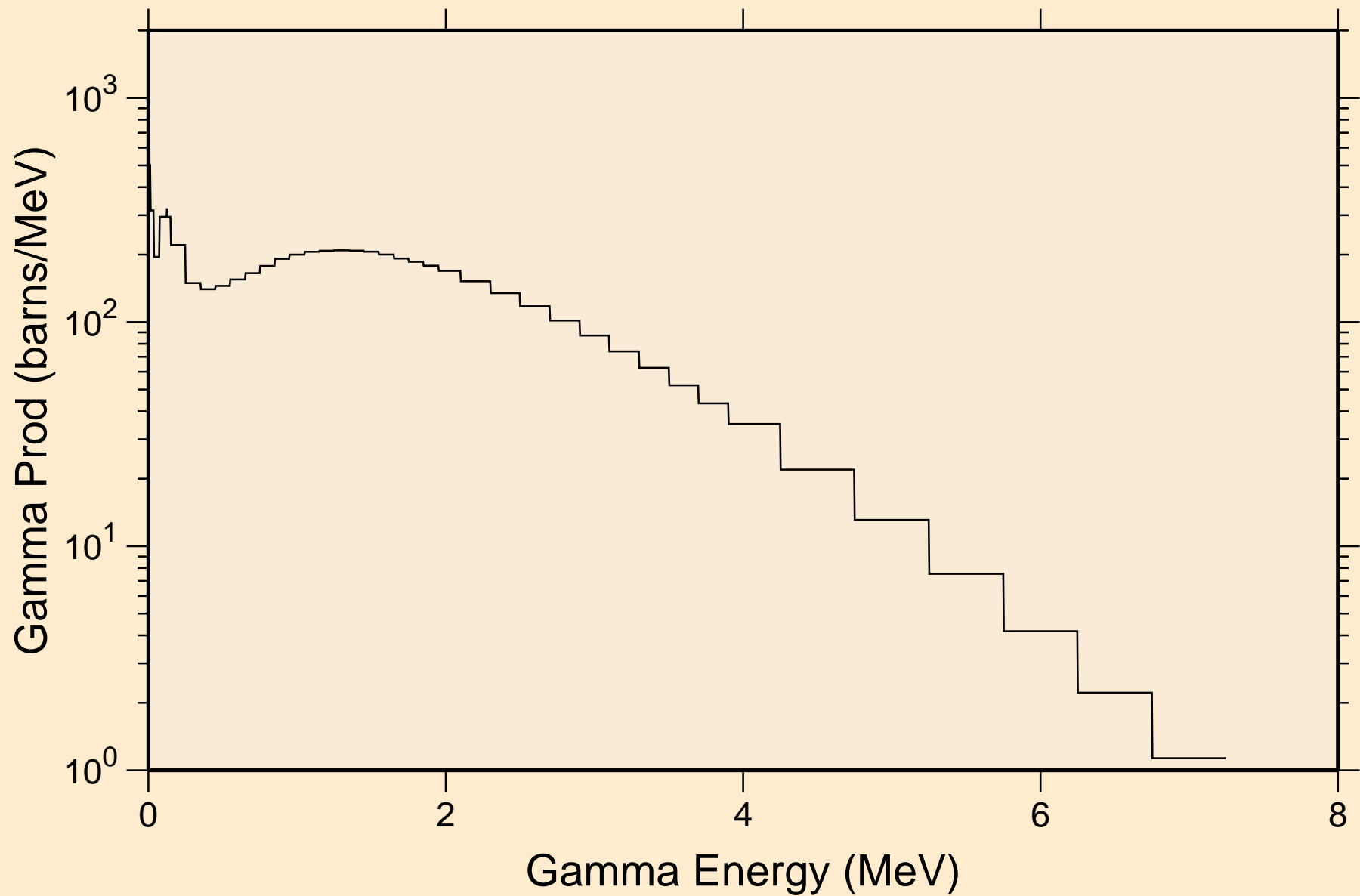

FR208 NEUTRON ACER TENDL-2019 LIBRARY; T=293.16K  
14 MeV photon spectrum

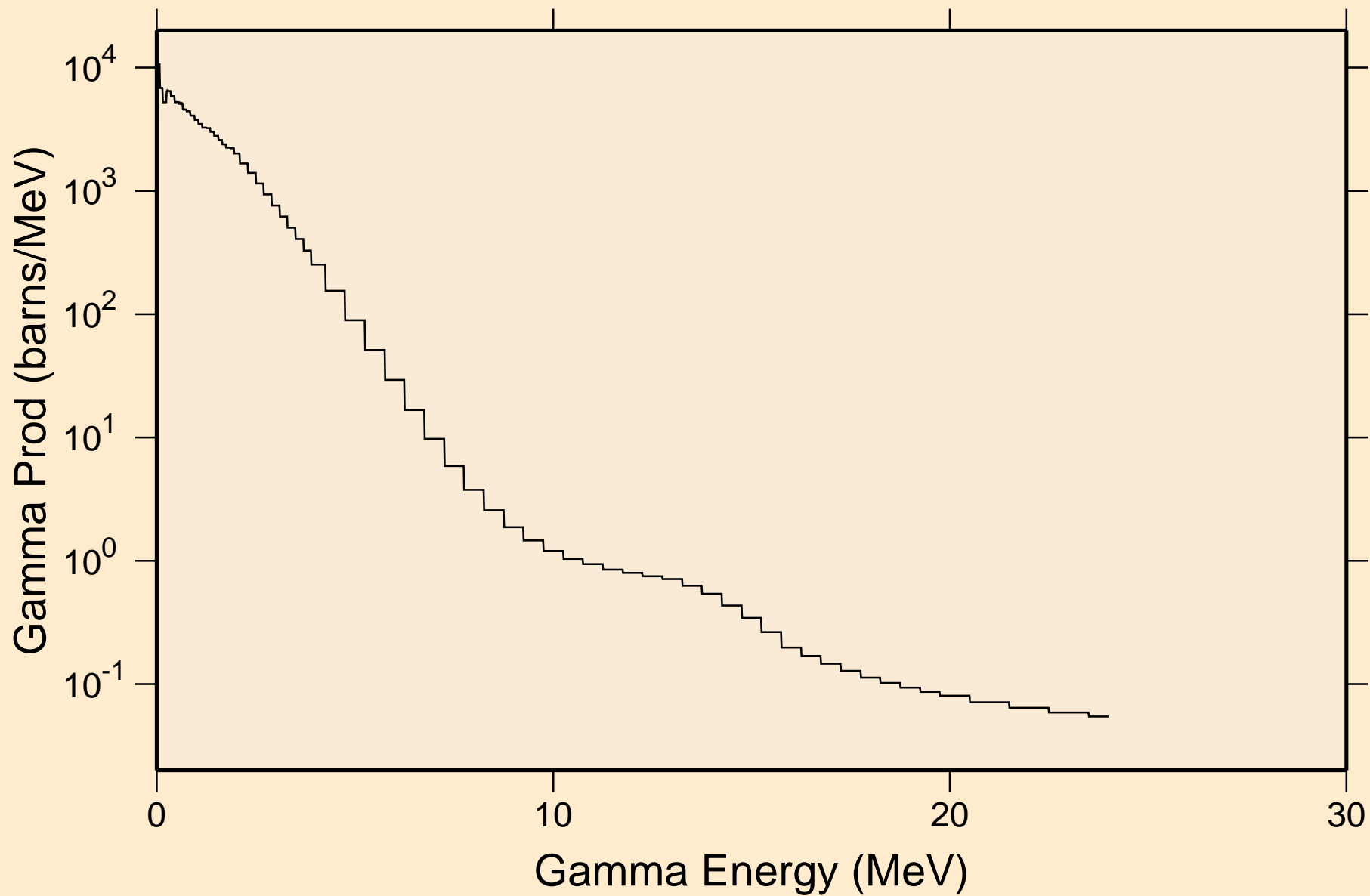



FR208 NEUTRON ACER TENDL-2019 LIBRARY; T=293.16K  
Particle heating contributions

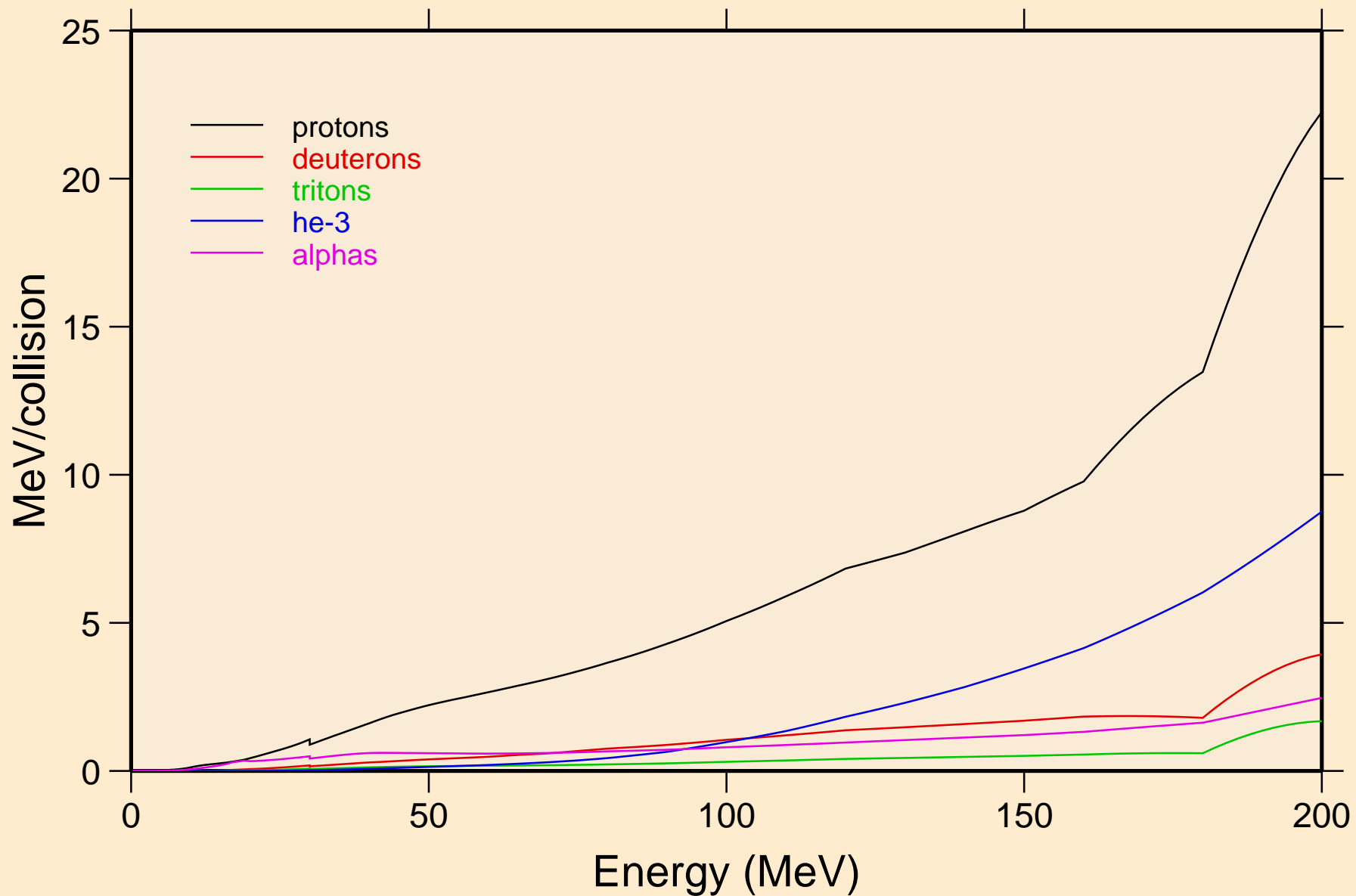

FR208 NEUTRON ACER TENDL-2019 LIBRARY; T=293.16K  
Recoil Heating

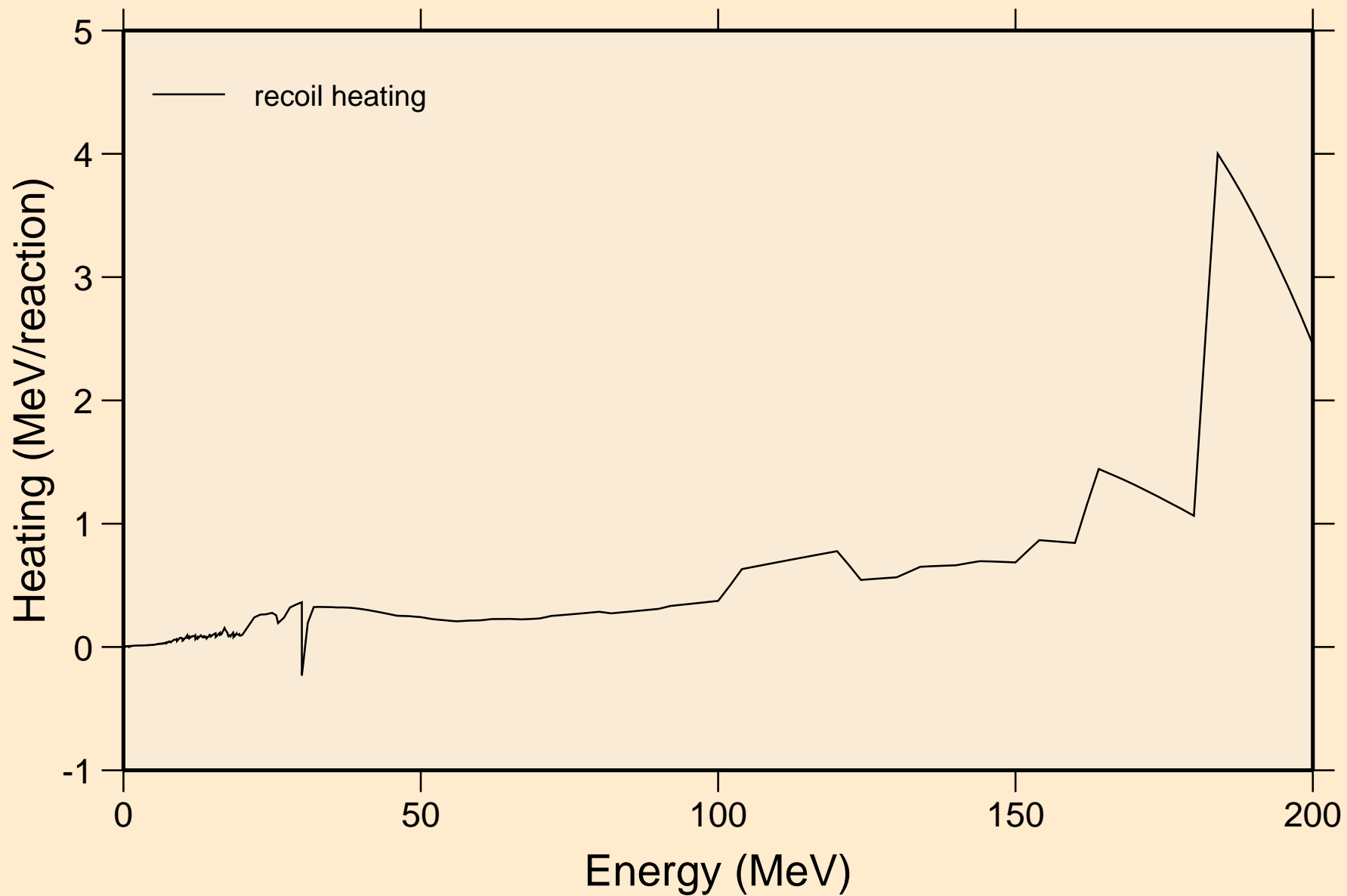

FR208 NEUTRON ACER TENDL-2019 LIBRARY; T=293.16K  
Particle production cross sections

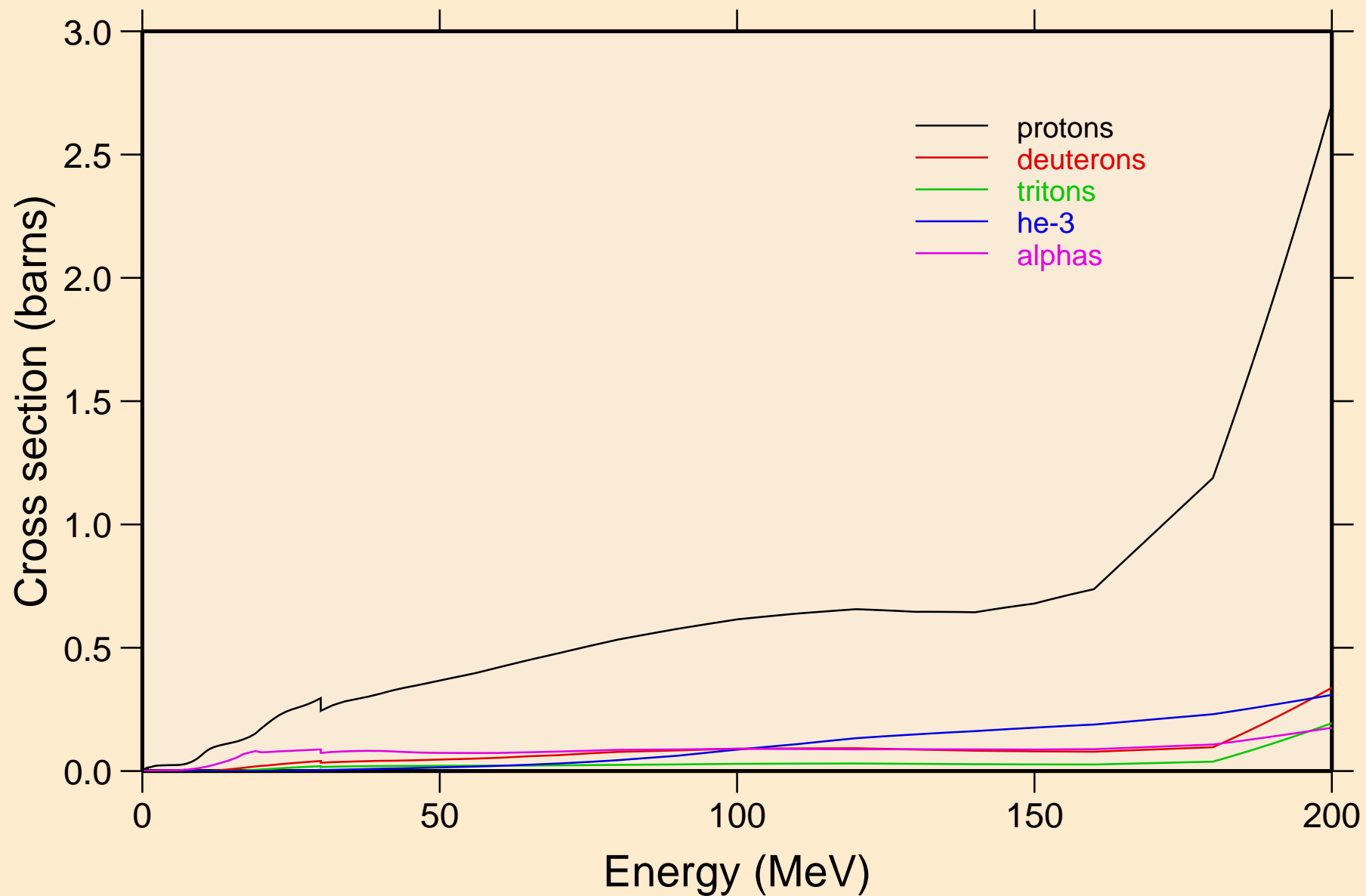

FR208 NEUTRON ACER TENDL-2019 LIBRARY; T=293.16K  
protons from (n,x)

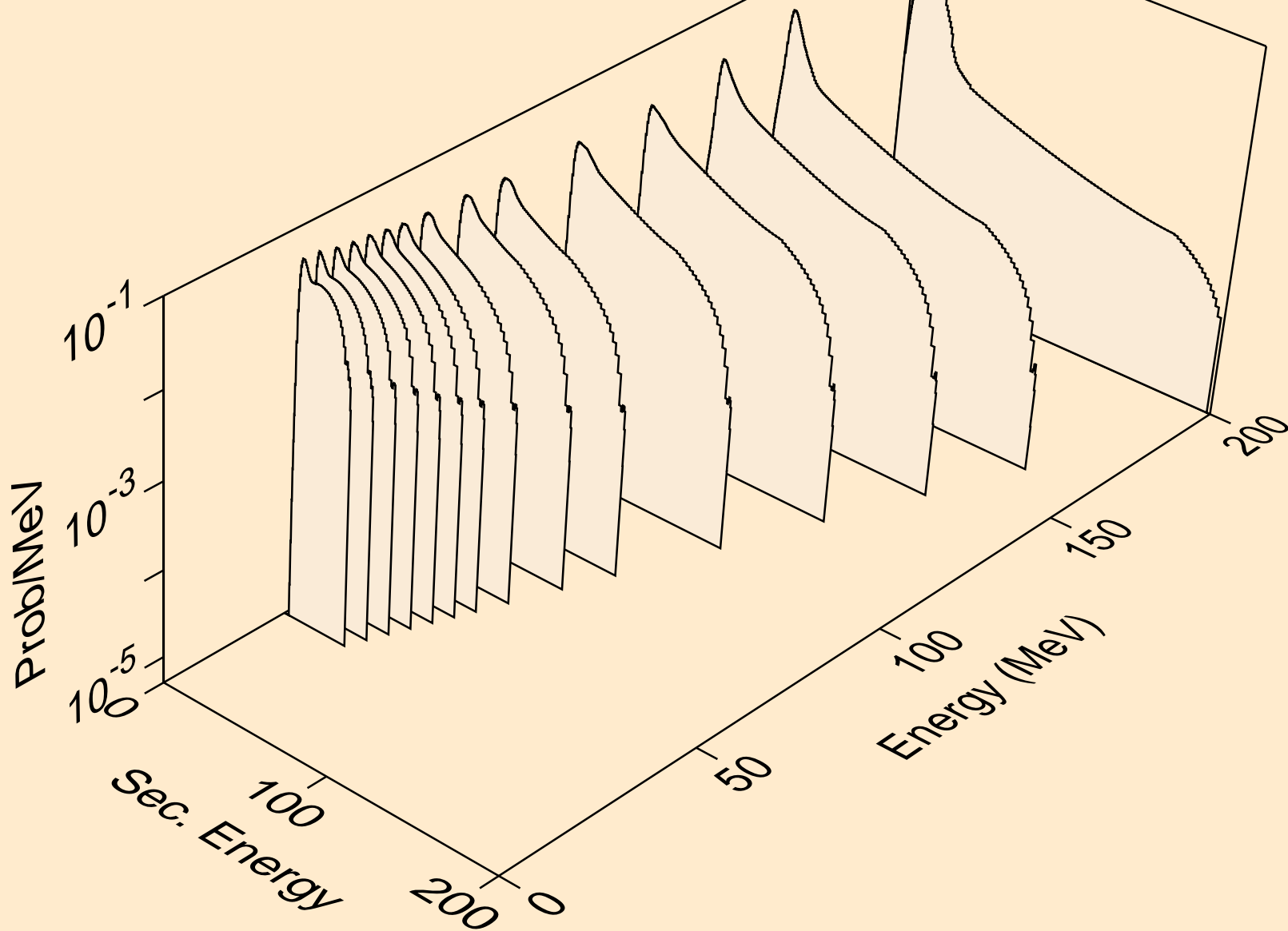

FR208 NEUTRON ACER TENDL-2019 LIBRARY; T=293.16K  
protons from (n,n\*)p

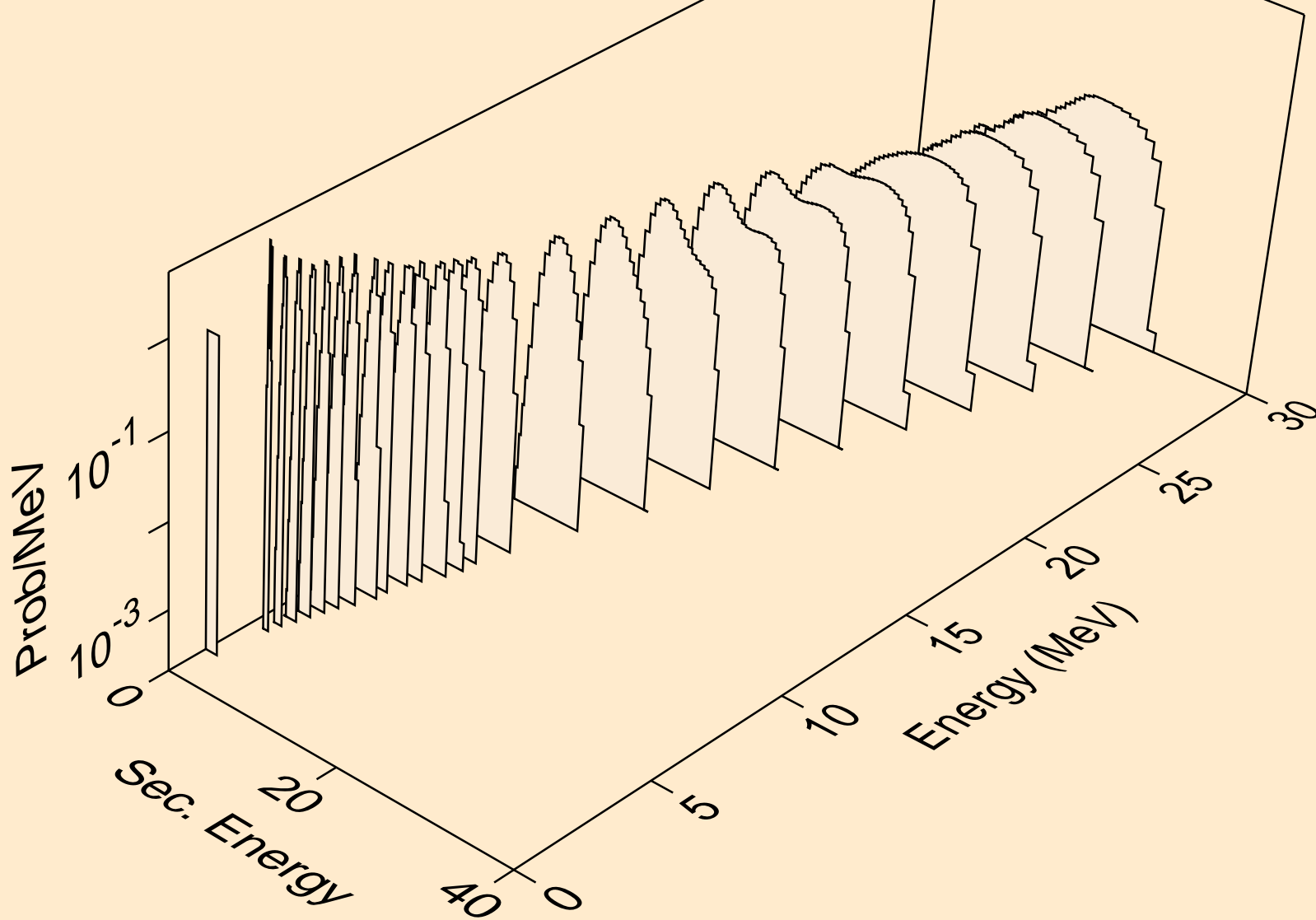

FR208 NEUTRON ACER TENDL-2019 LIBRARY; T=293.16K  
protons from (n,2np)

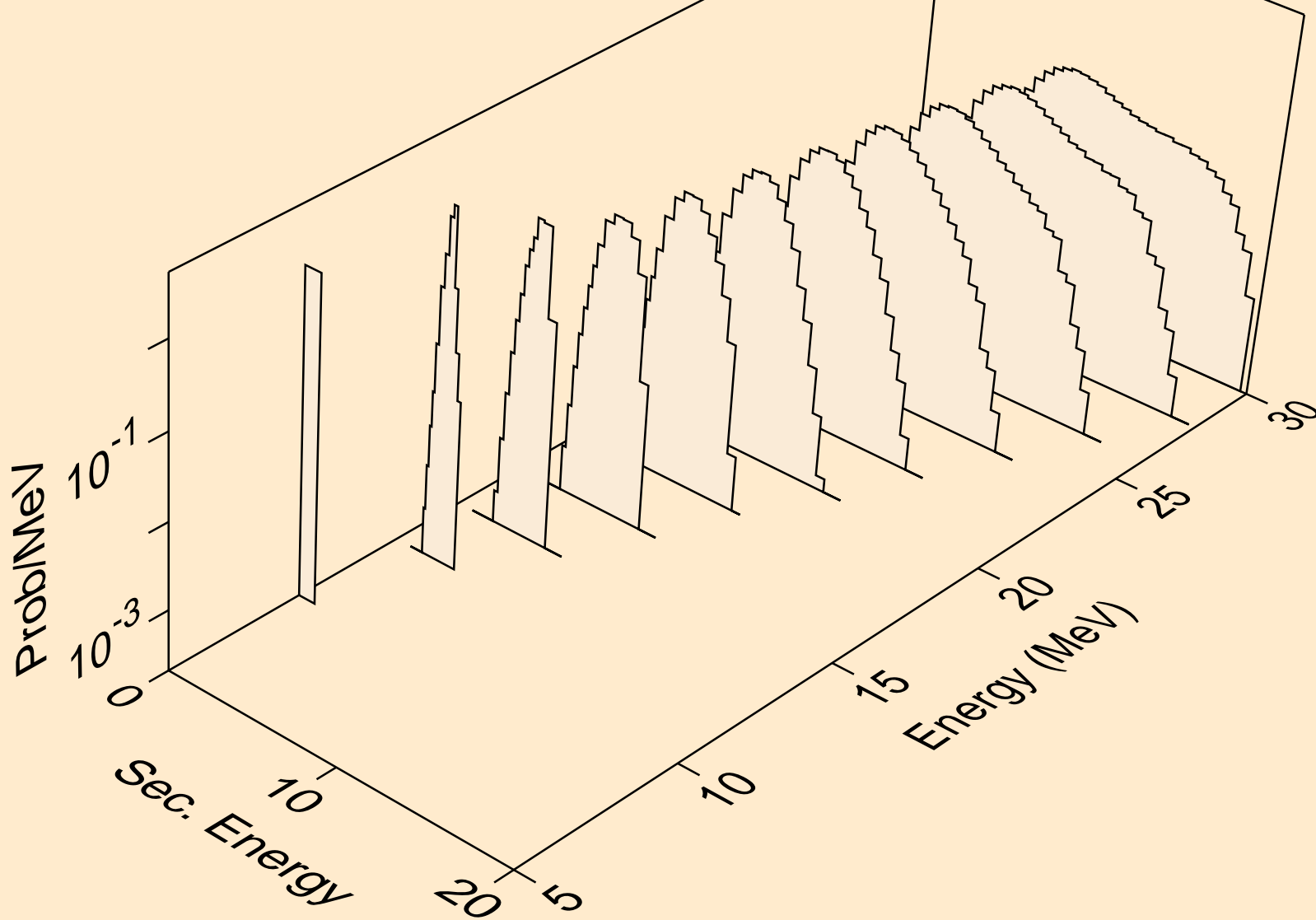

FR208 NEUTRON ACER TENDL-2019 LIBRARY; T=293.16K  
protons from (n,3np)

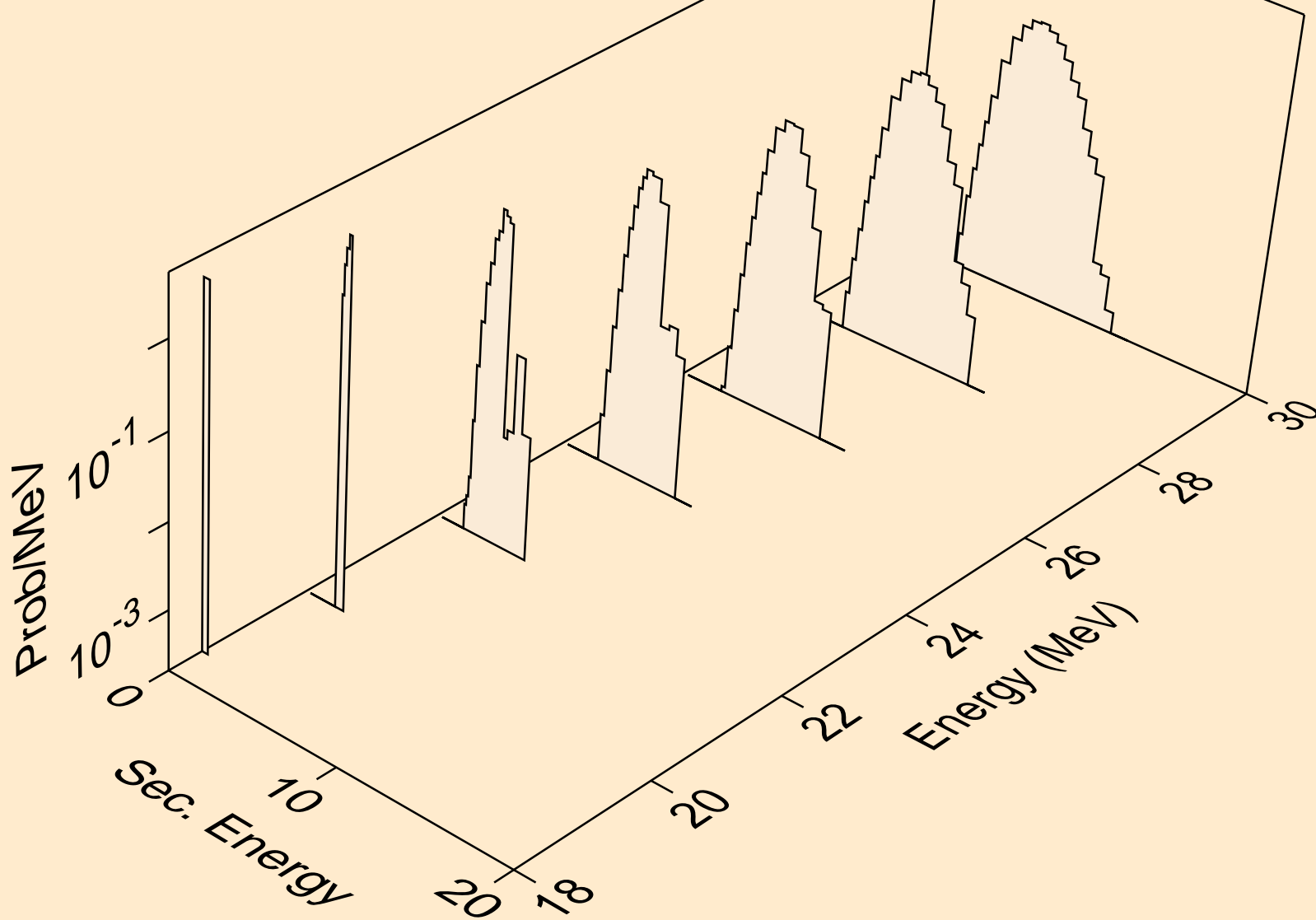

FR208 NEUTRON ACER TENDL-2019 LIBRARY; T=293.16K  
protons from (n,2np)

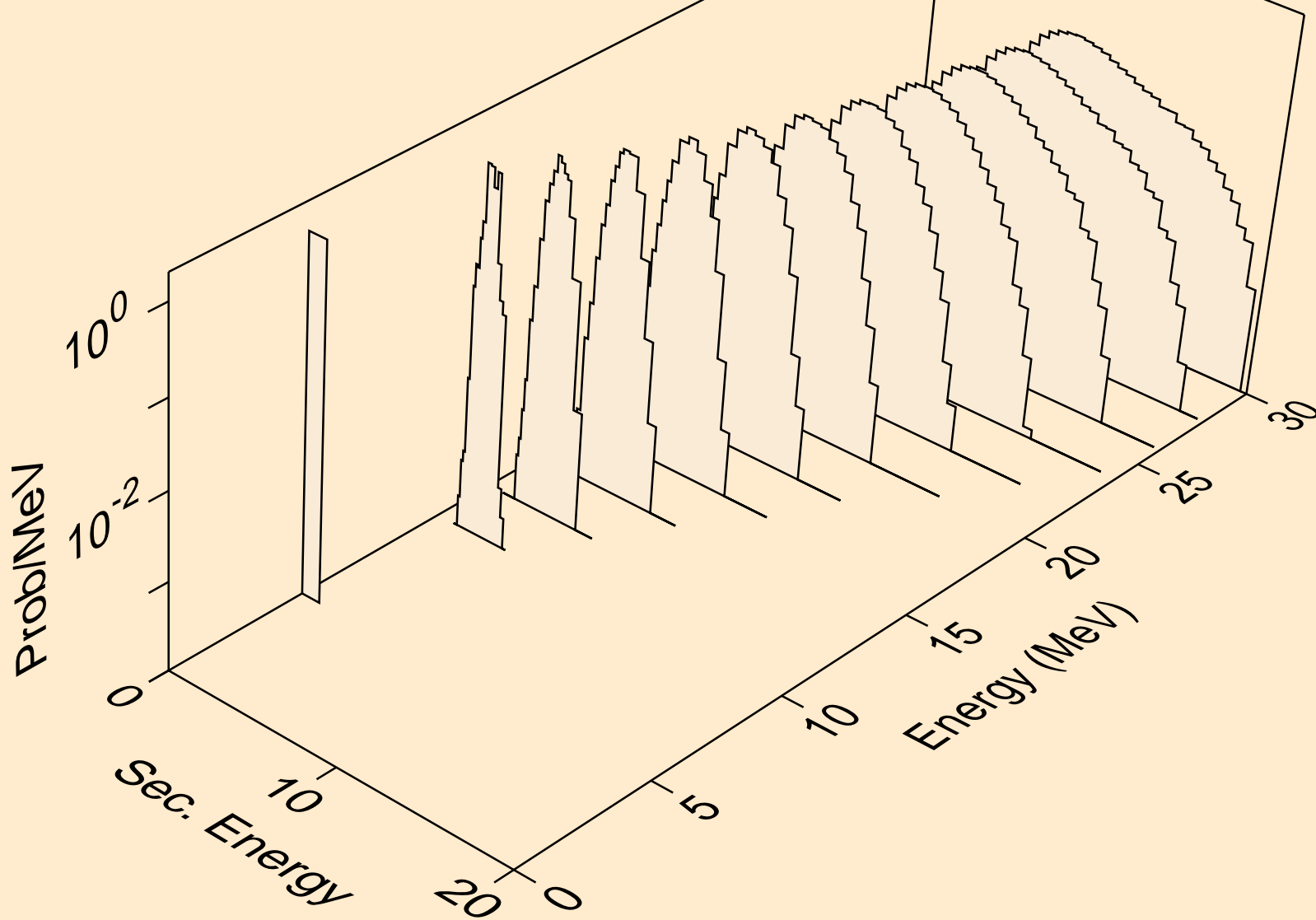



FR208 NEUTRON ACER TENDL-2019 LIBRARY; T=293.16K  
protons from (n,npa)

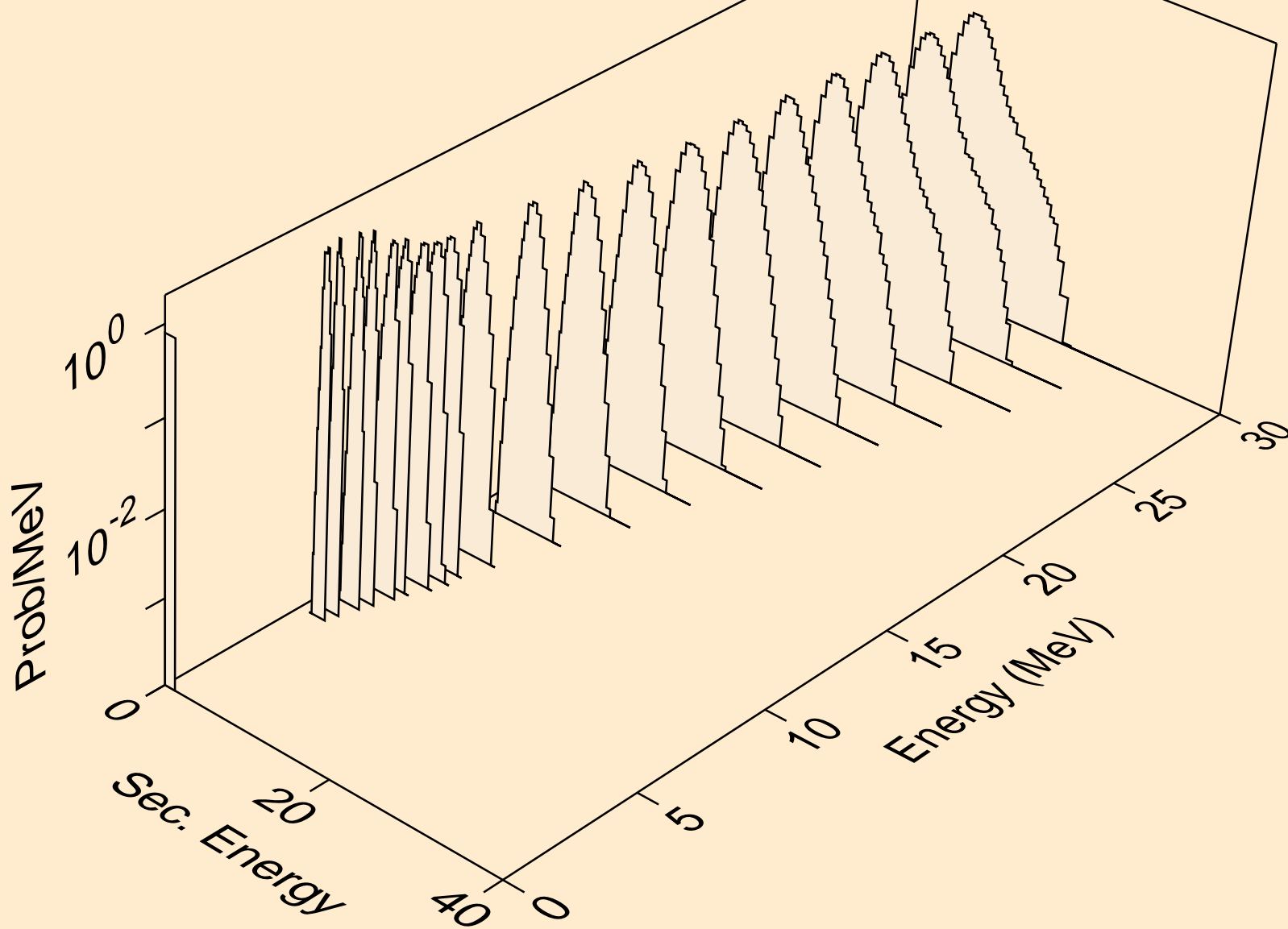

FR208 NEUTRON ACER TENDL-2019 LIBRARY; T=293.16K  
protons from (n,p)

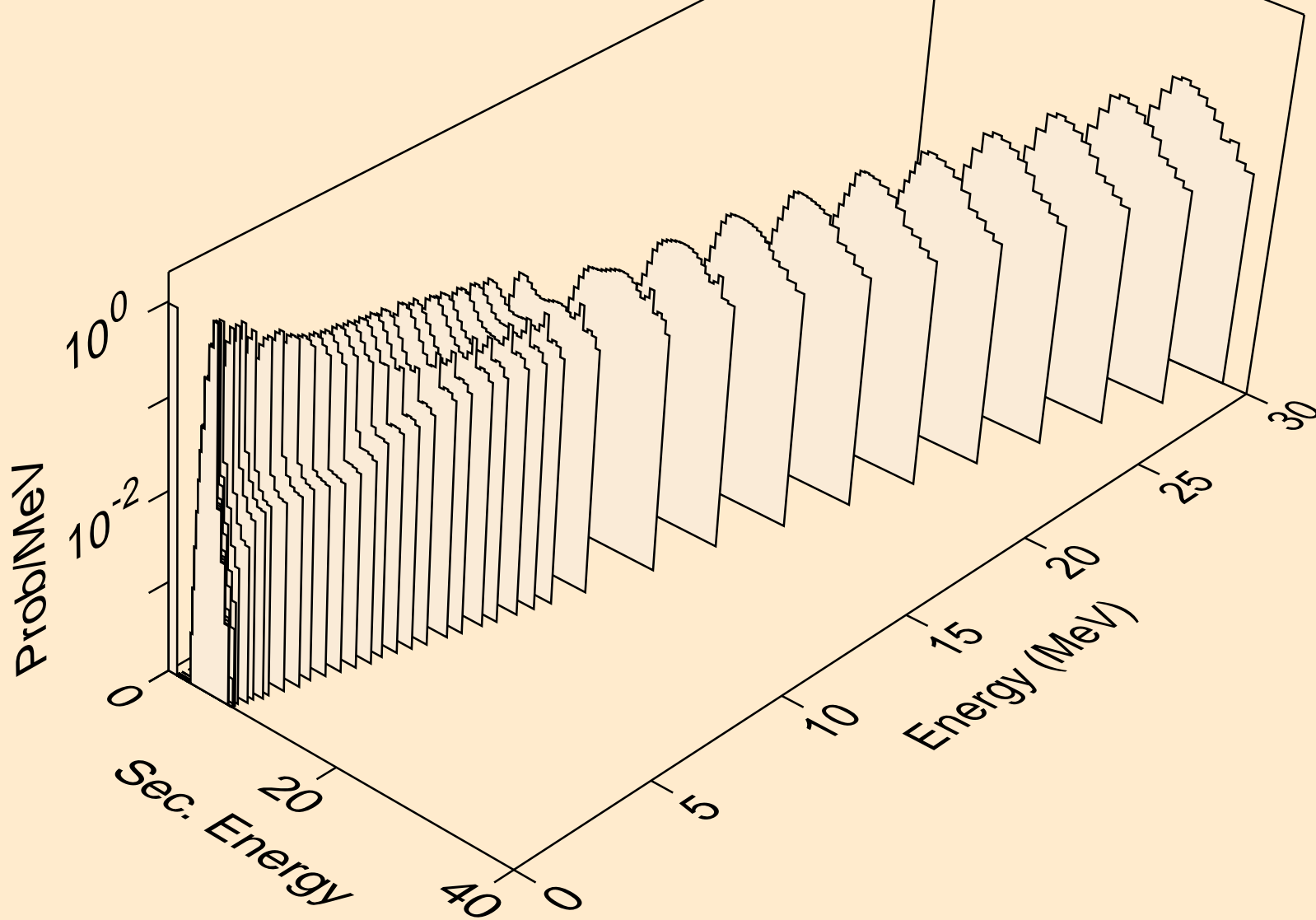

FR208 NEUTRON ACER TENDL-2019 LIBRARY; T=293.16K  
protons from (n,2p)

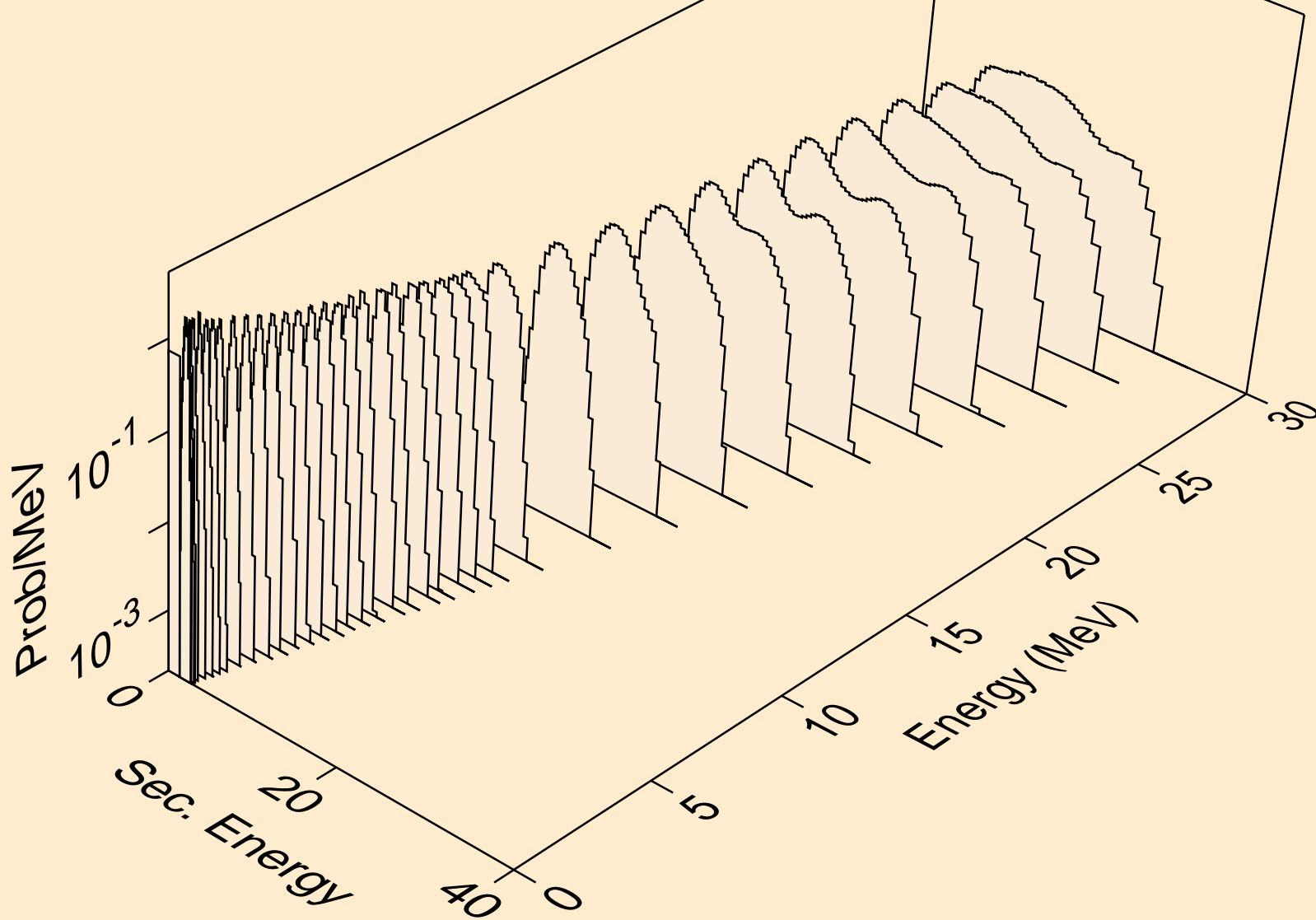

FR208 NEUTRON ACER TENDL-2019 LIBRARY; T=293.16K  
protons from (n,p)

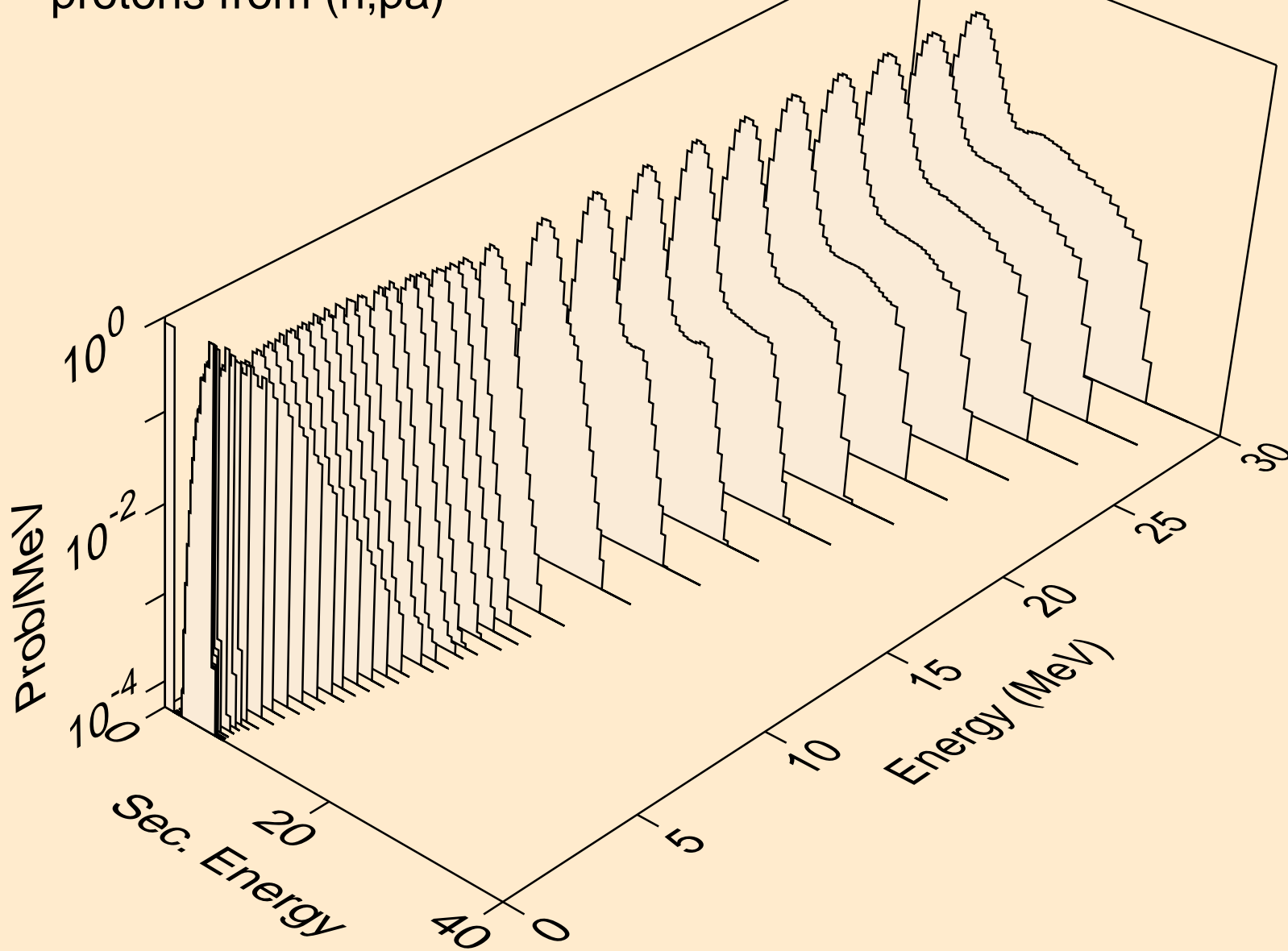

FR208 NEUTRON ACER TENDL-2019 LIBRARY; T=293.16K  
protons from (n,pd)

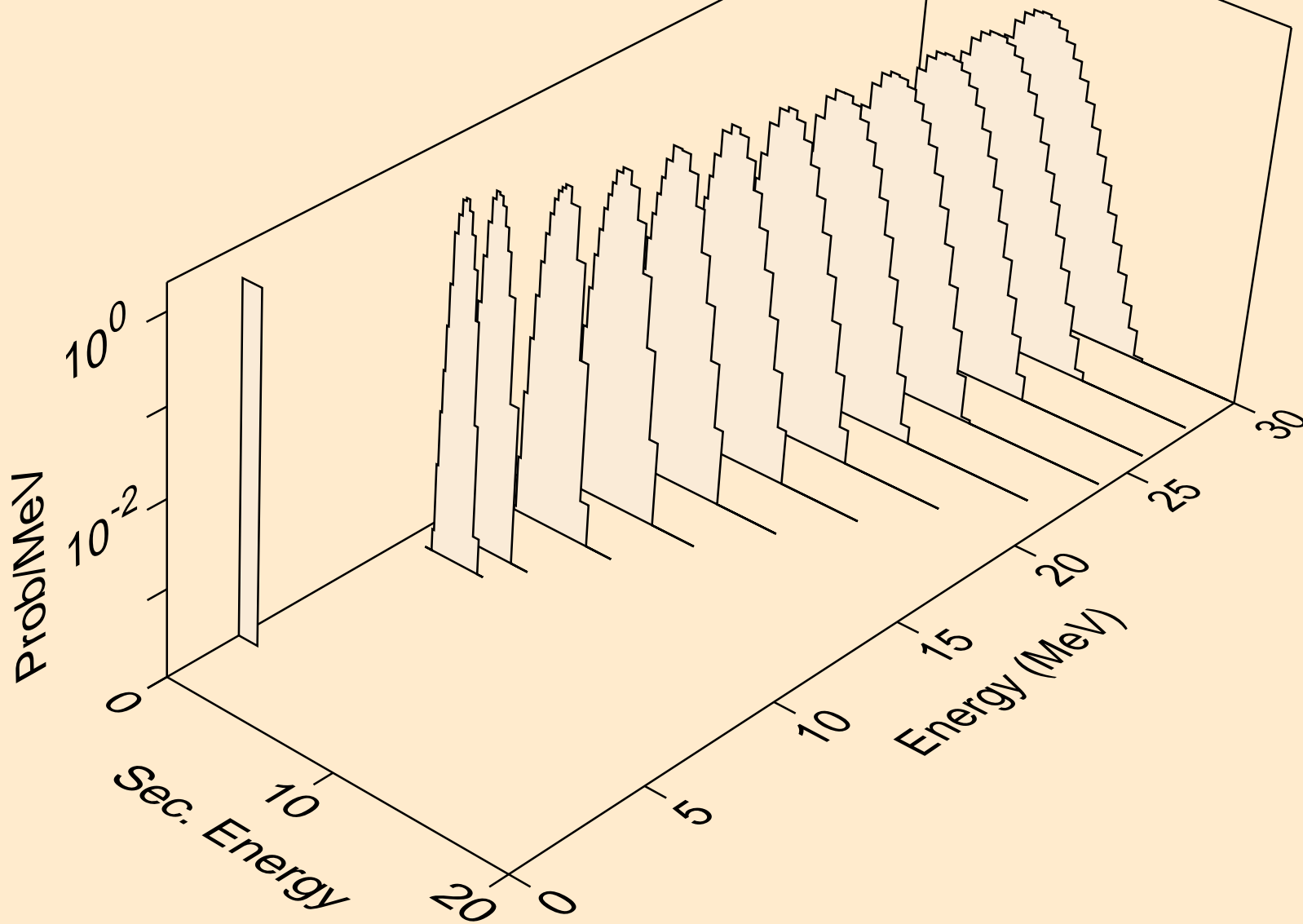

FR208 NEUTRON ACER TENDL-2019 LIBRARY; T=293.16K  
protons from (n,pt)

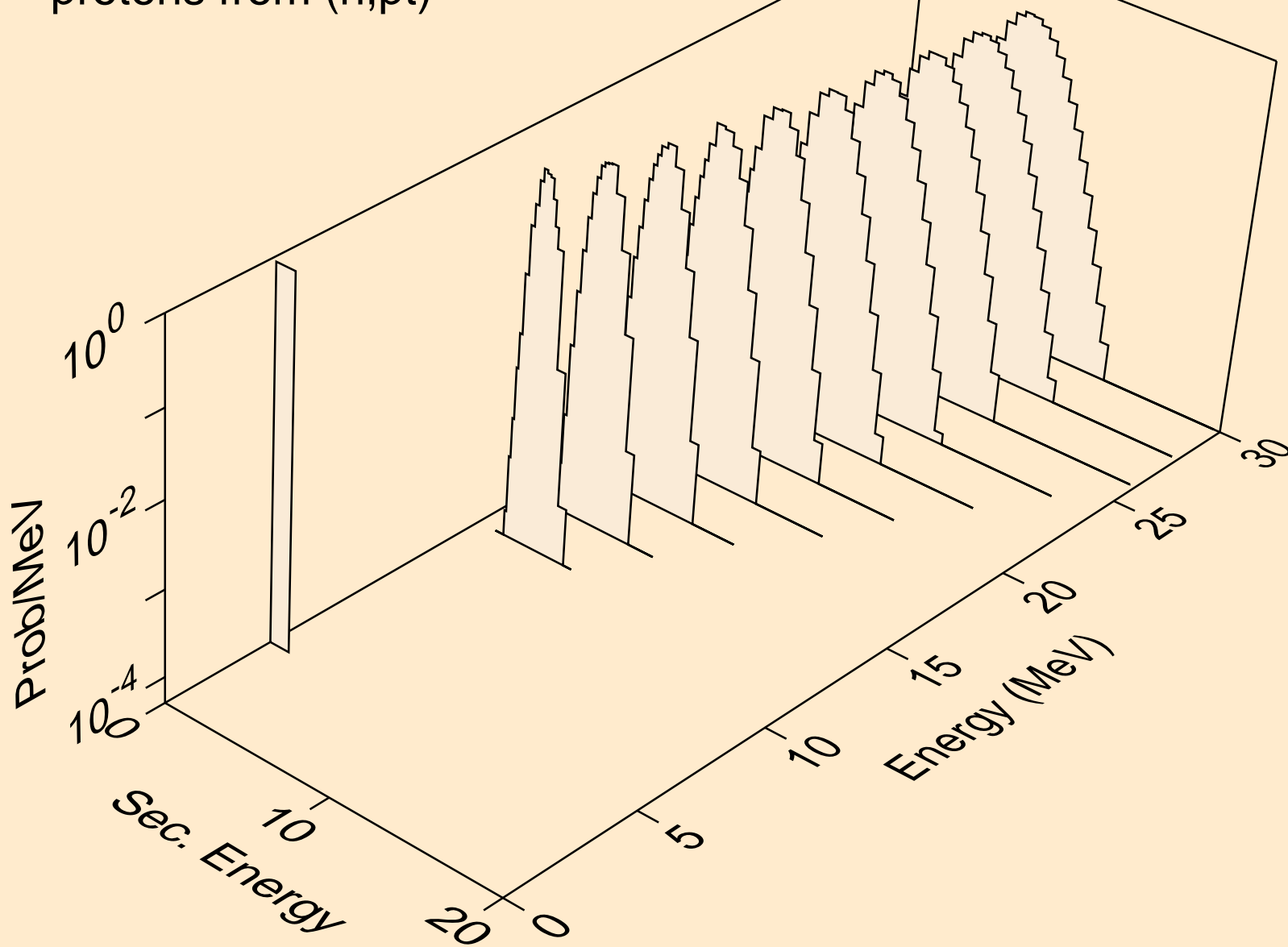

FR208 NEUTRON ACER TENDL-2019 LIBRARY; T=293.16K  
deuterons from (n,x)

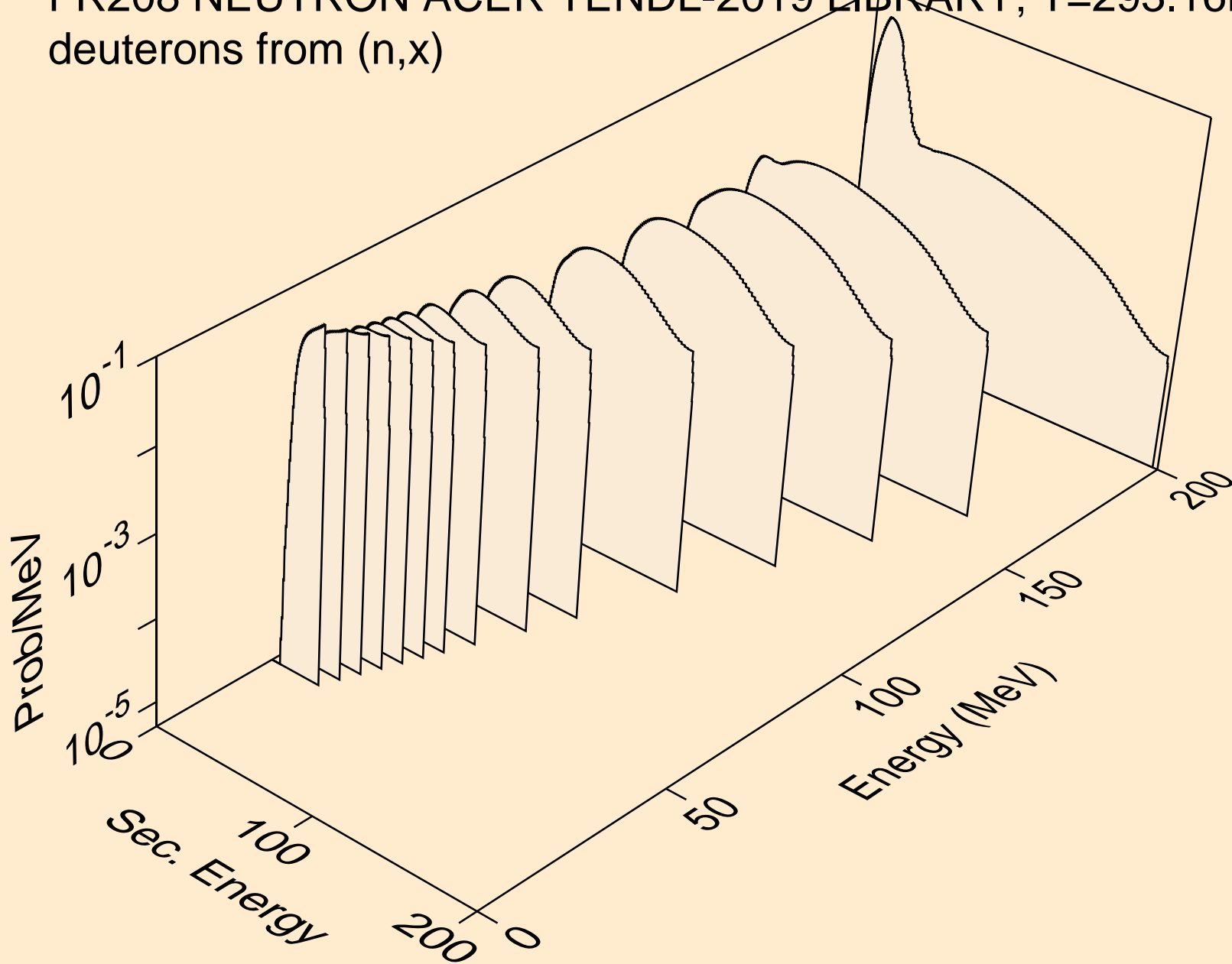

FR208 NEUTRON ACER TENDL-2019 LIBRARY; T=293.16K  
deuterons from (n,2nd)

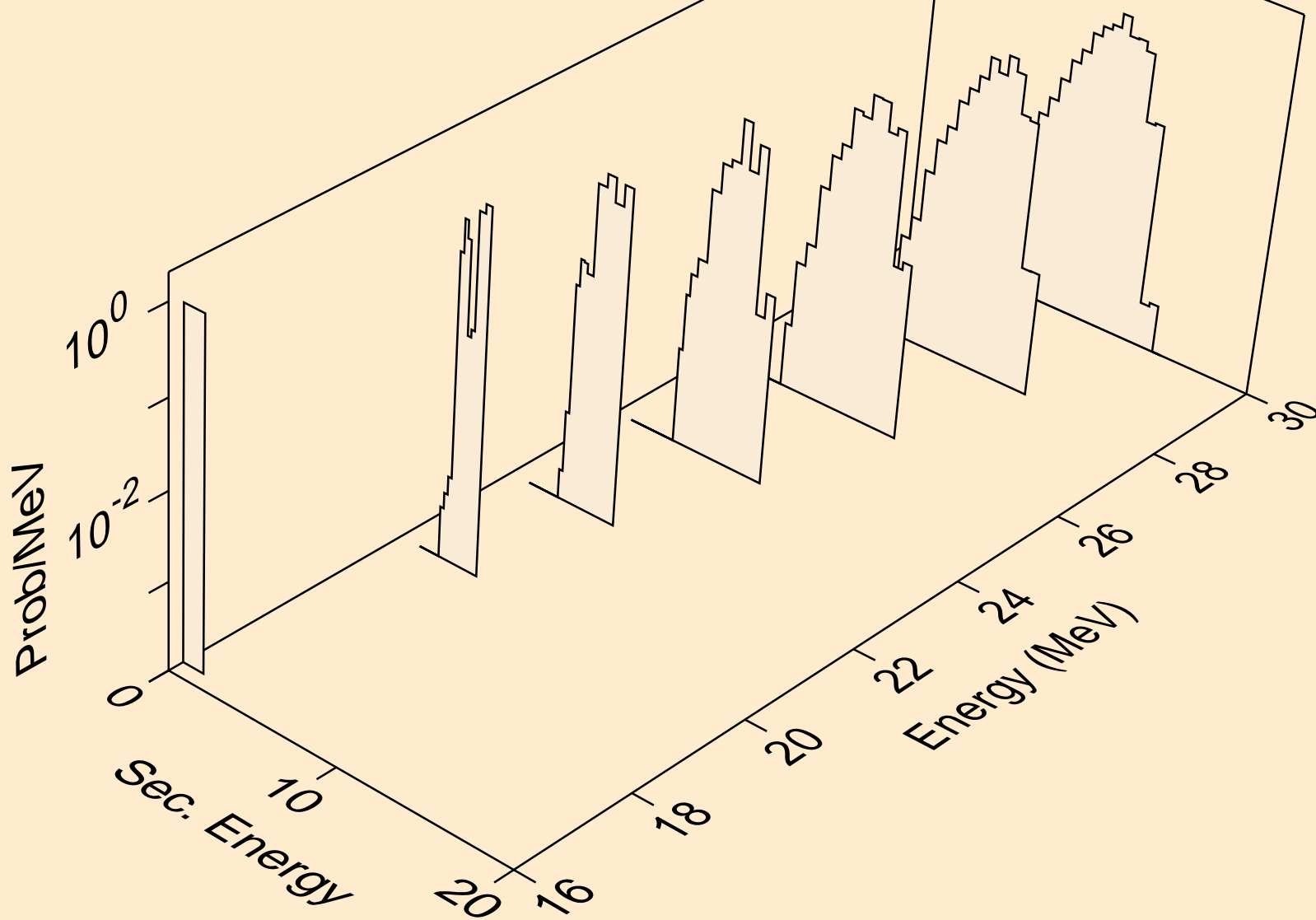



FR208 NEUTRON ACER TENDL-2019 LIBRARY; T=293.16K  
deuterons from (n,n\*)d

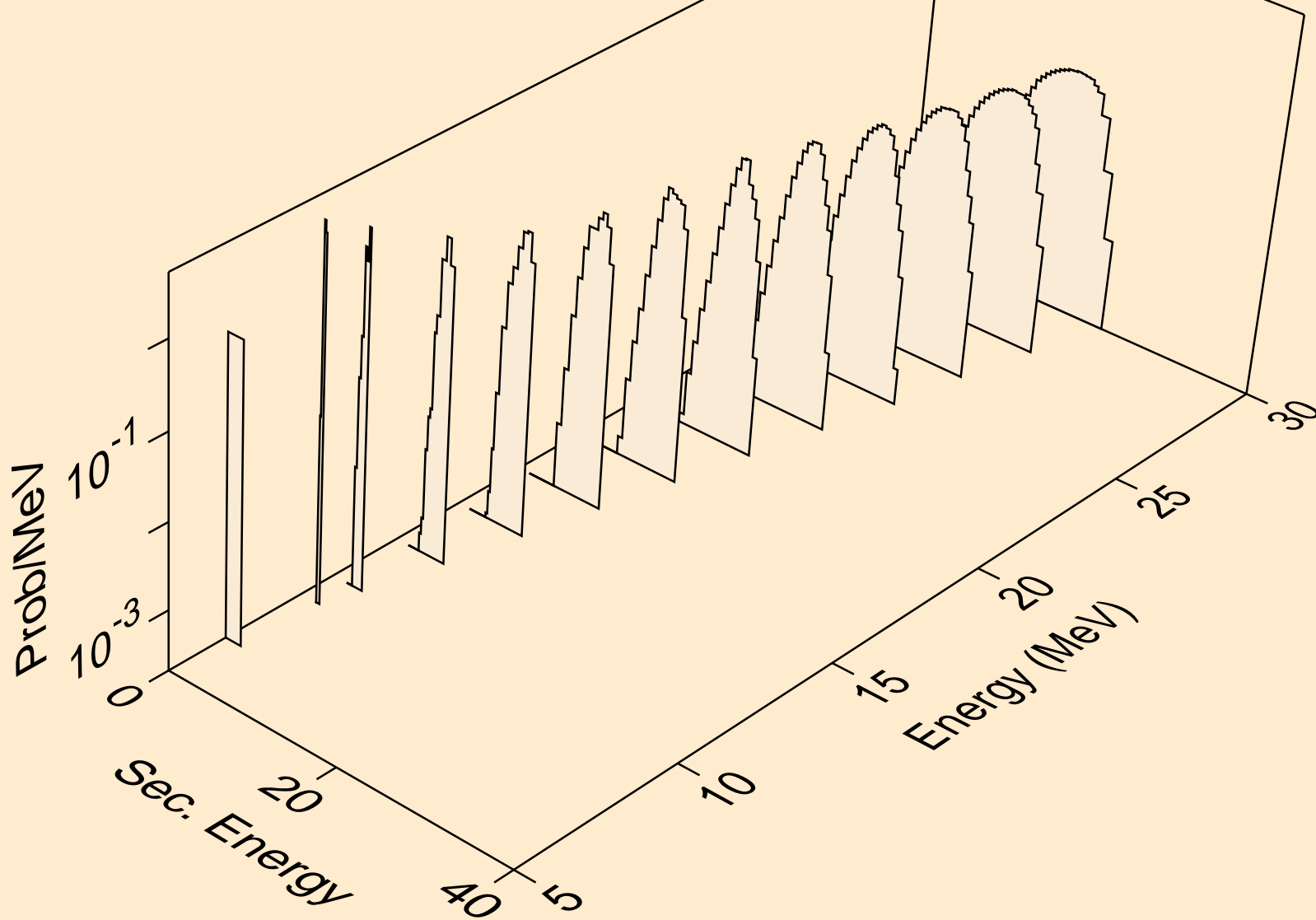

FR208 NEUTRON ACER TENDL-2019 LIBRARY; T=293.16K  
deuterons from (n,d)

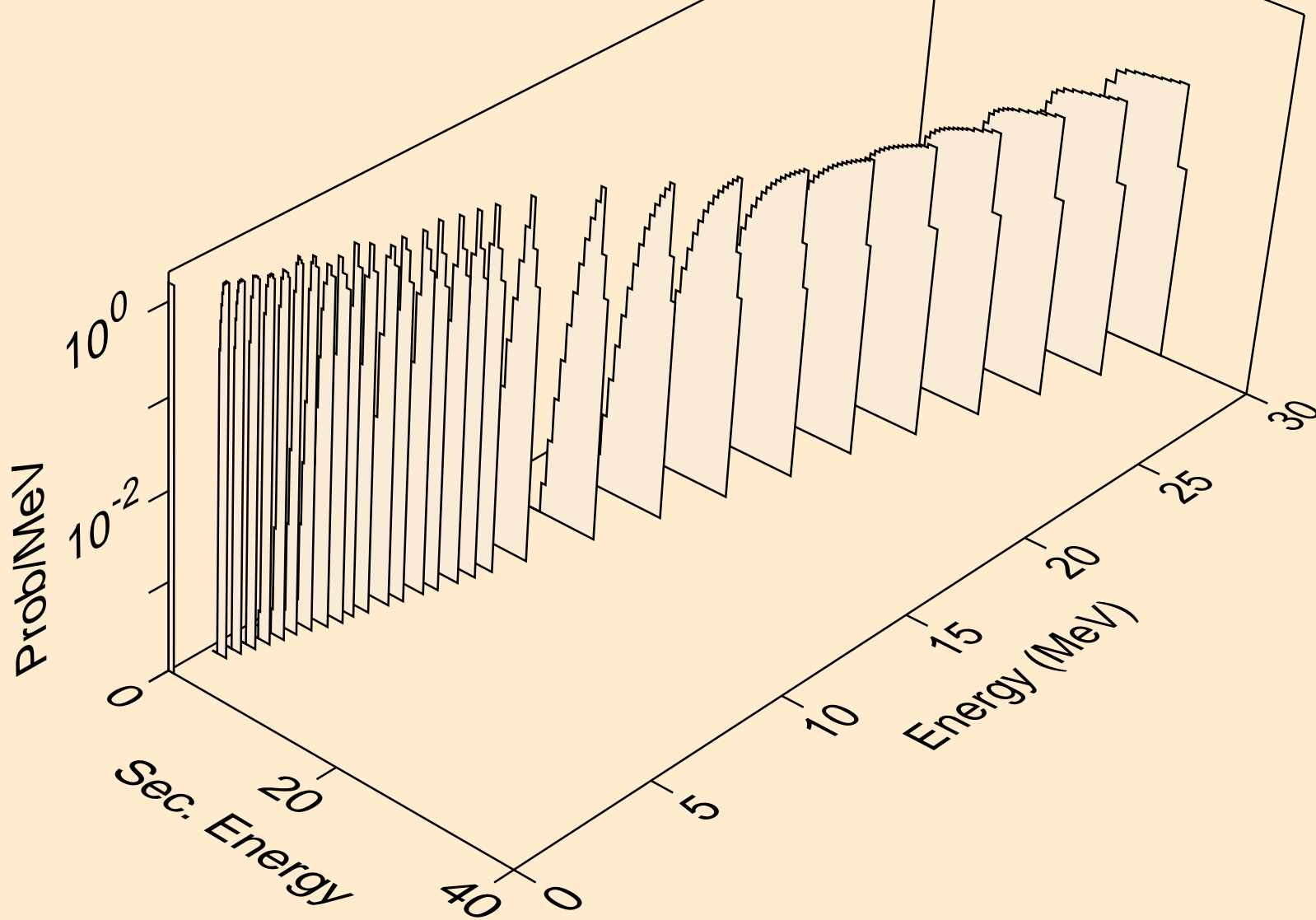

FR208 NEUTRON ACER TENDL-2019 LIBRARY; T=293.16K  
deuterons from (n,pd)

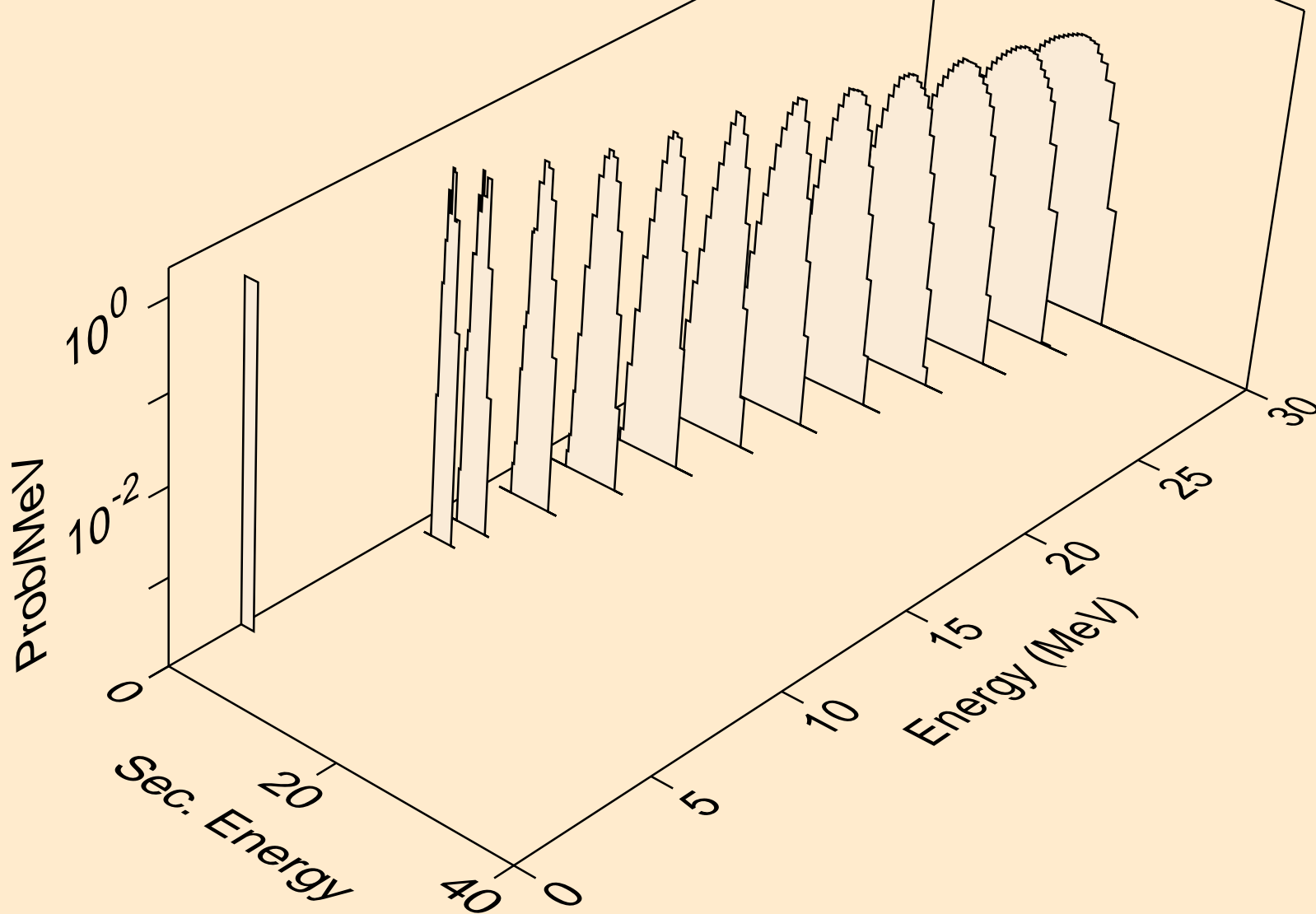

FR208 NEUTRON ACER TENDL-2019 LIBRARY; T=293.16K  
deuterons from (n,da)

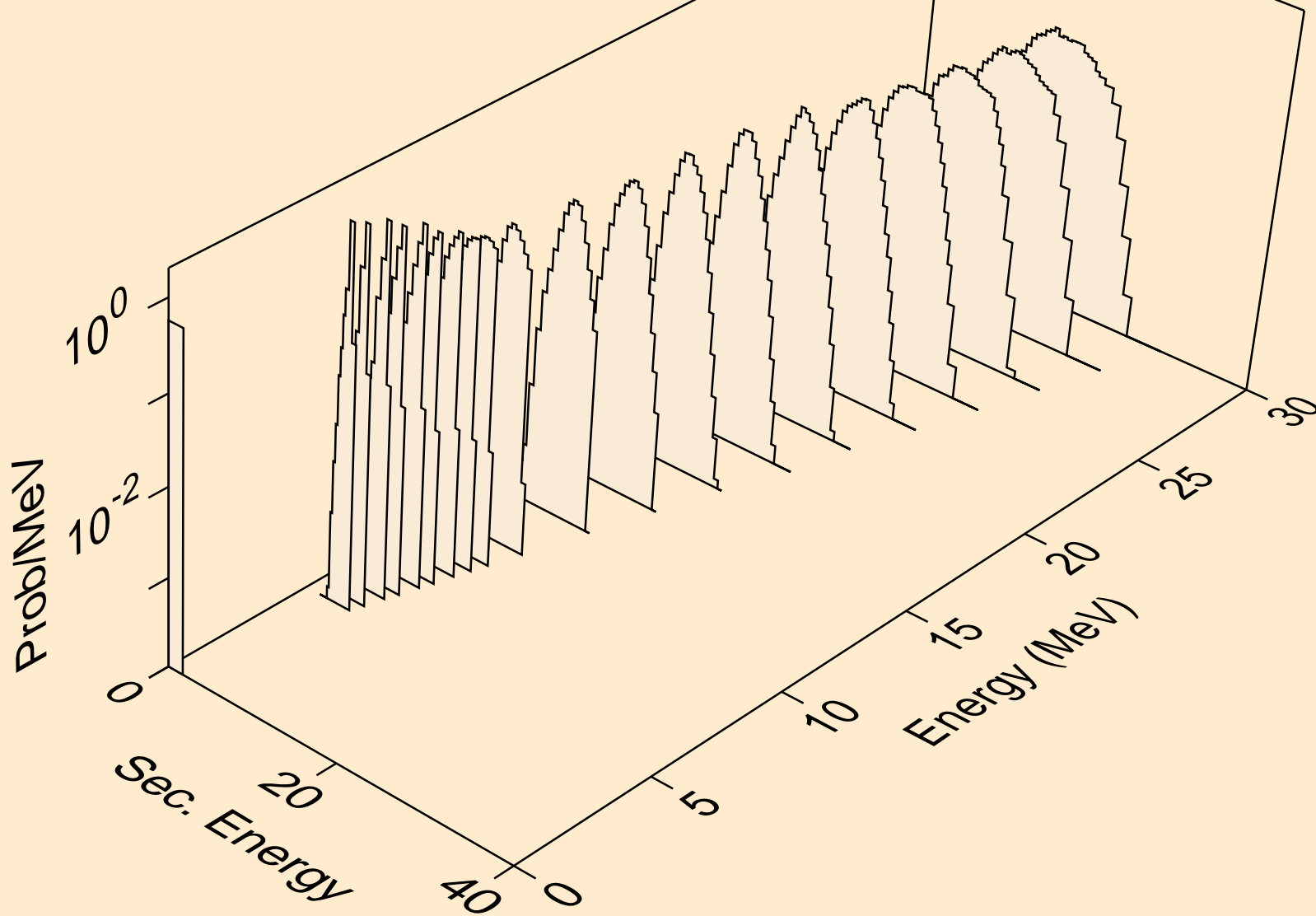

FR208 NEUTRON ACER TENDL-2019 LIBRARY; T=293.16K  
tritons from (n,x)

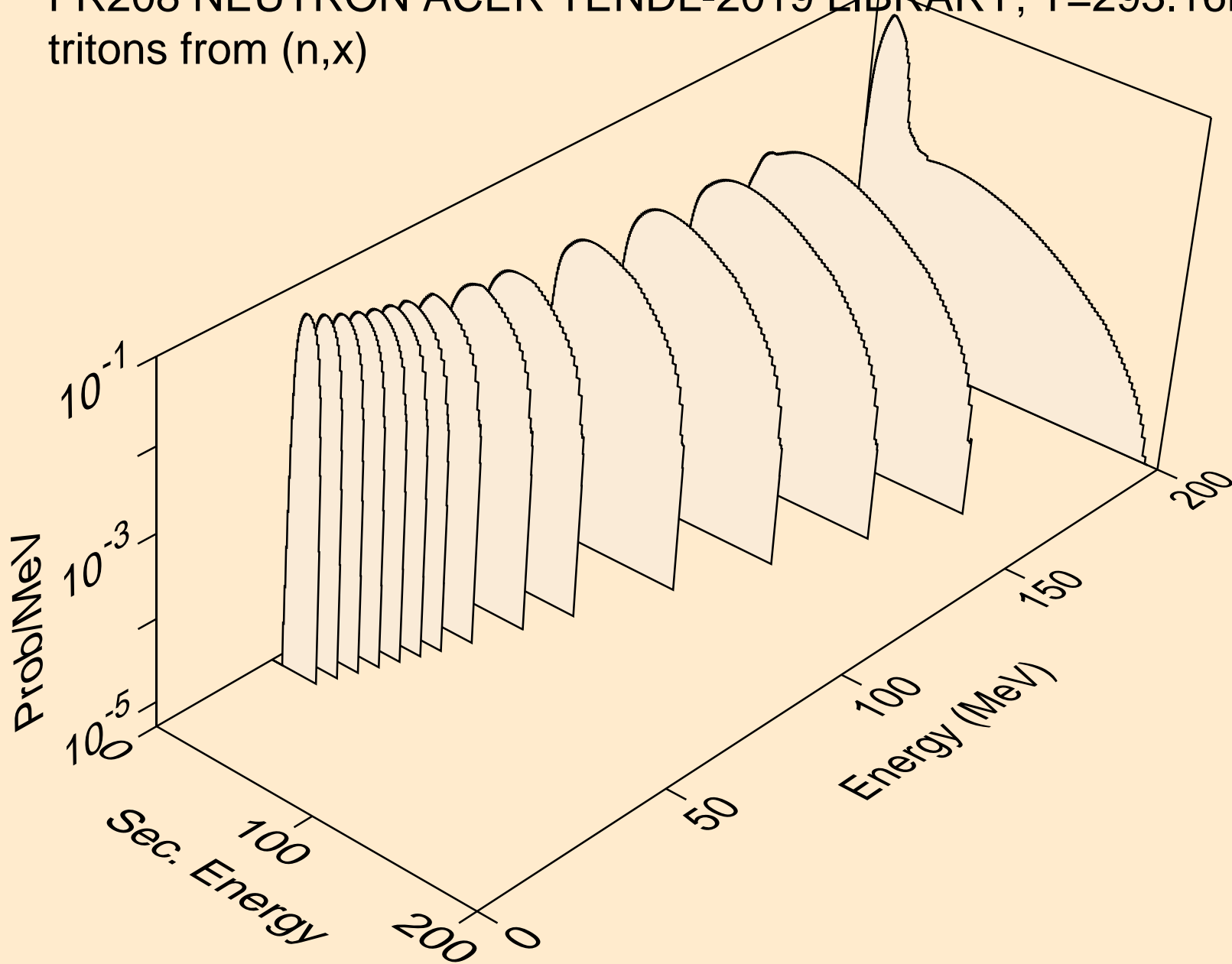

FR208 NEUTRON ACER TENDL-2019 LIBRARY; T=293.16K  
tritons from (n,n\*)t

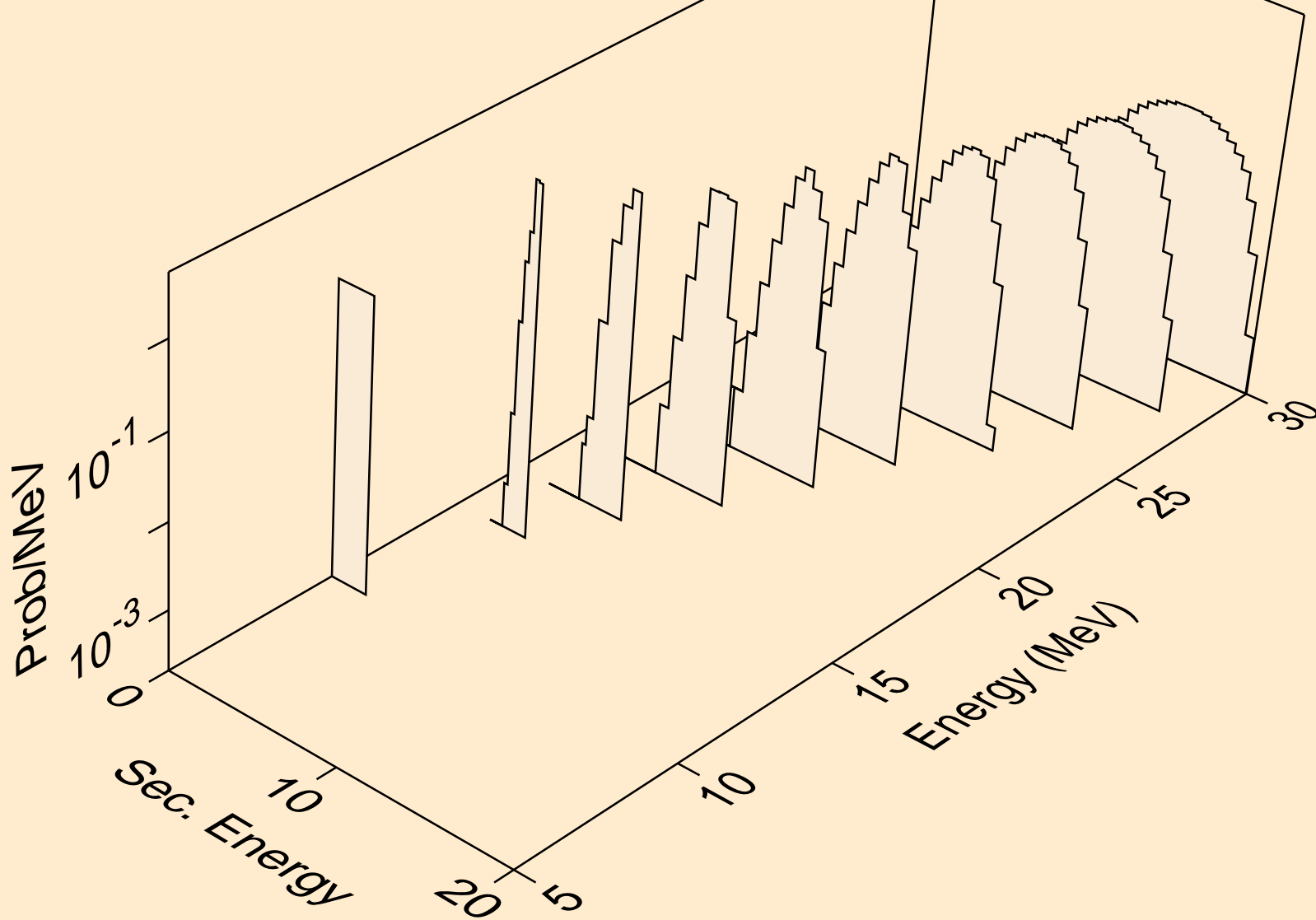

FR208 NEUTRON ACER TENDL-2019 LIBRARY; T=293.16K  
tritons from (n,t)

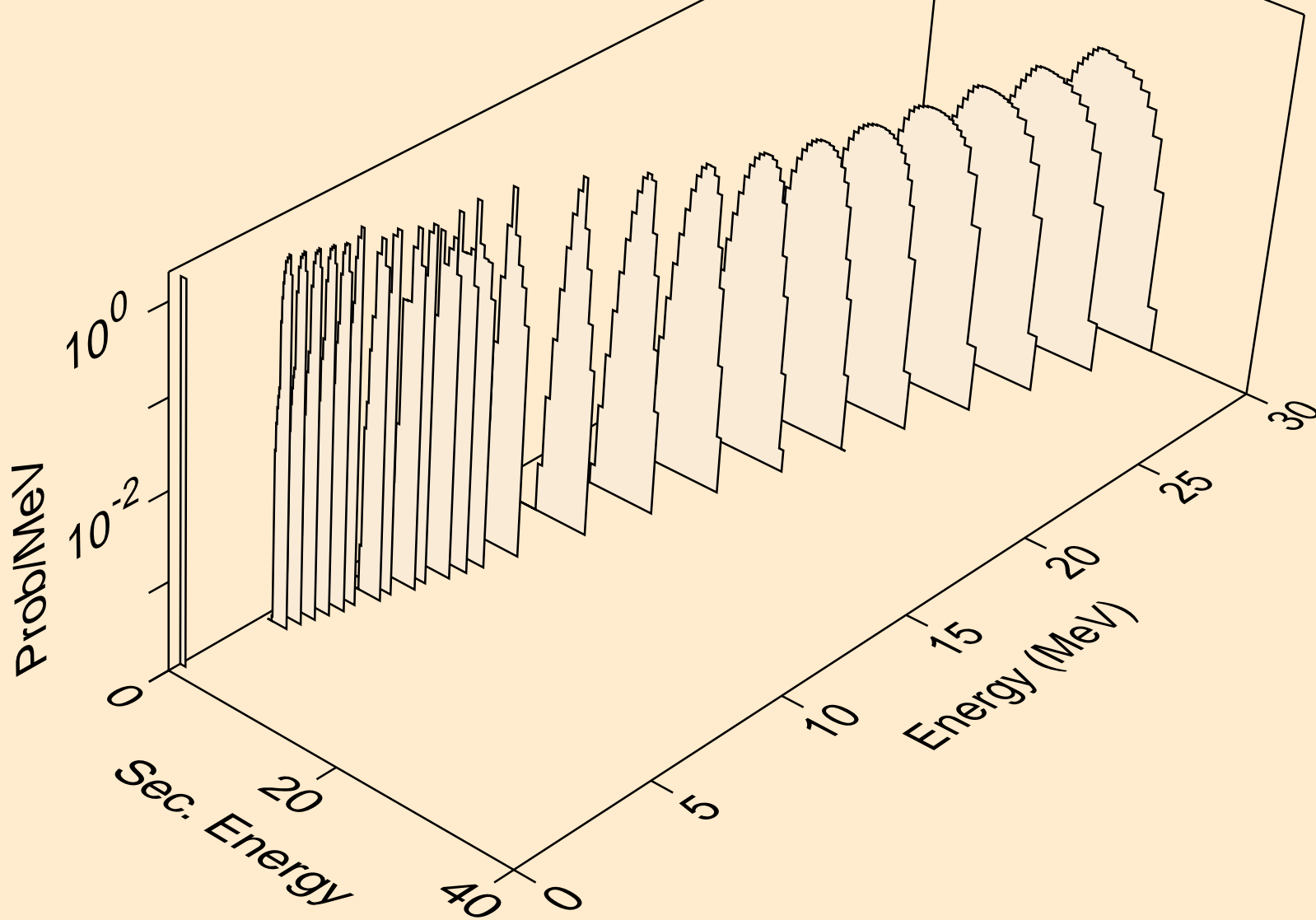

FR208 NEUTRON ACER TENDL-2019 LIBRARY; T=293.16K  
tritons from (n,pt)

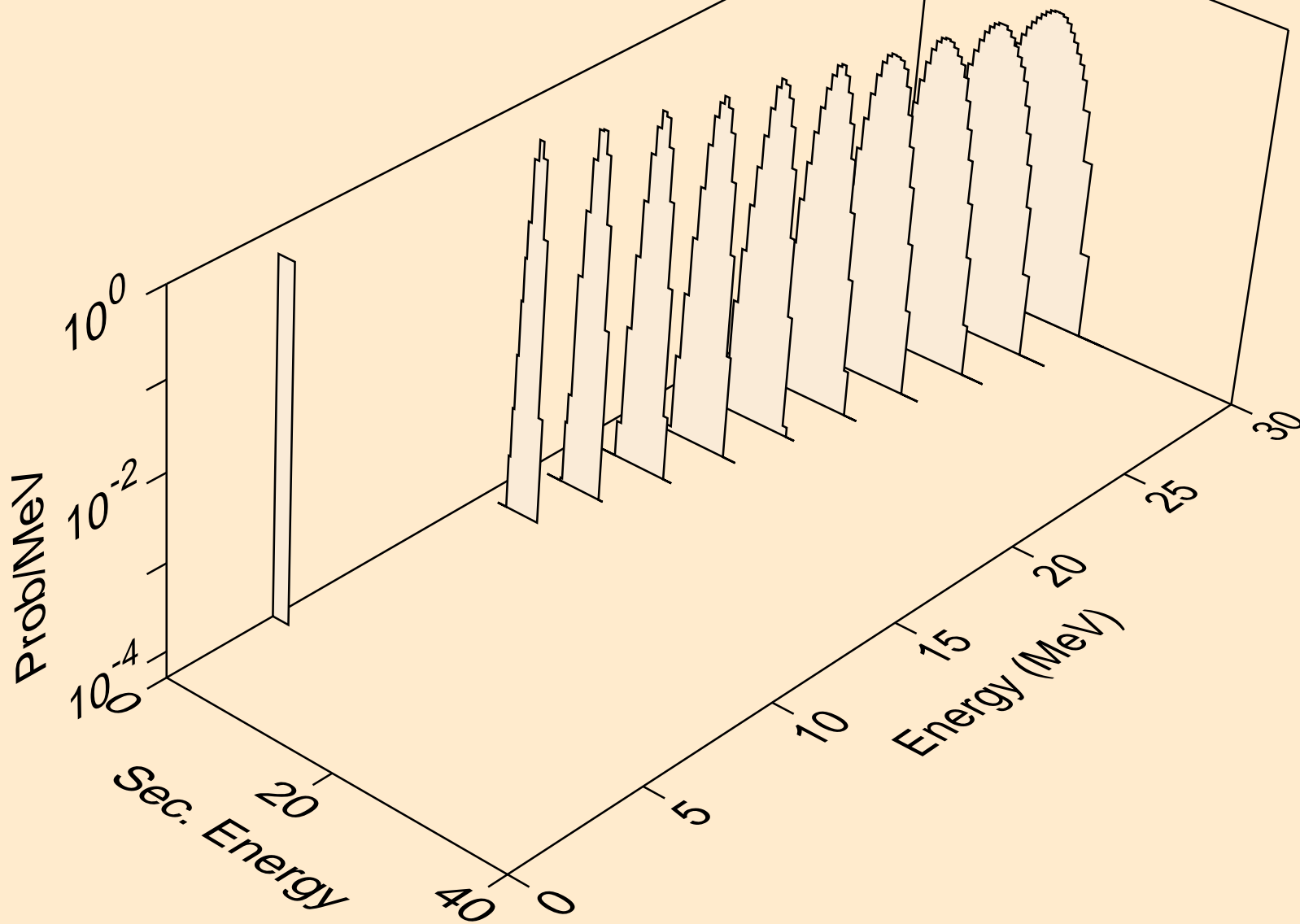



FR208 NEUTRON ACER TENDL-2019 LIBRARY; T=293.16K  
he3s from (n,x)

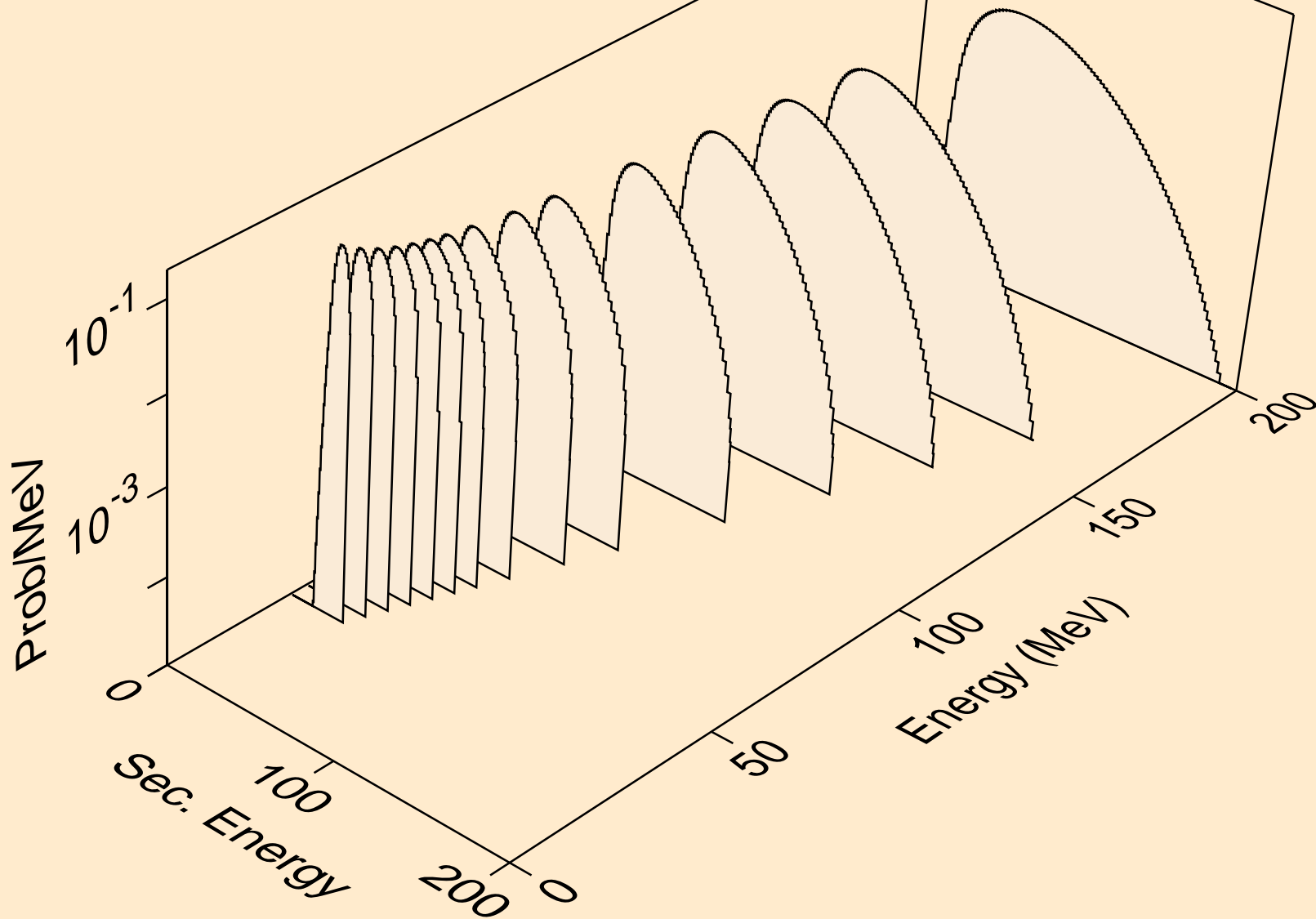

FR208 NEUTRON ACER TENDL-2019 LIBRARY; T=293.16K  
he3s from (n,n\*)he3

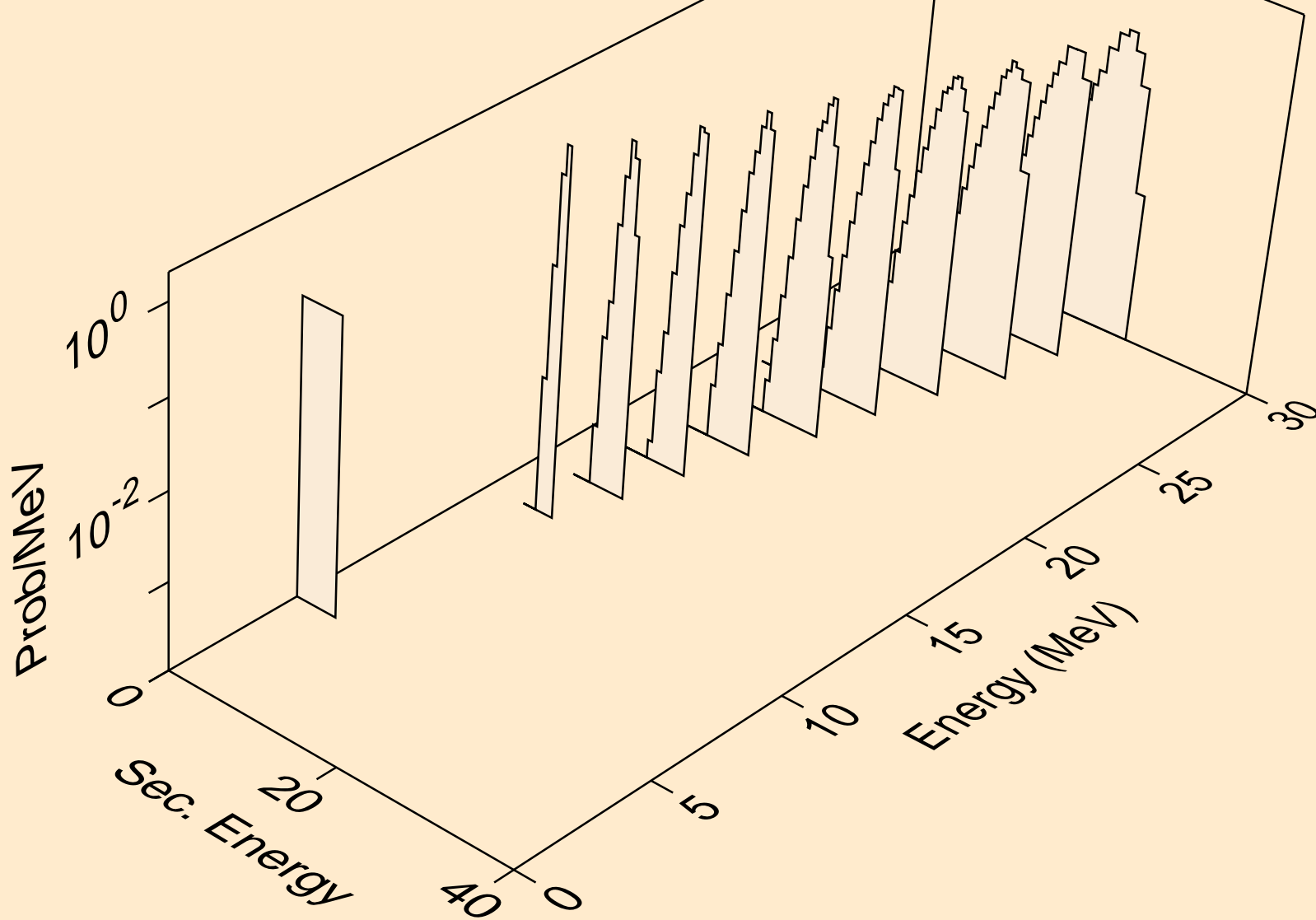

FR208 NEUTRON ACER TENDL-2019 LIBRARY; T=293.16K  
he3s from (n,he3)

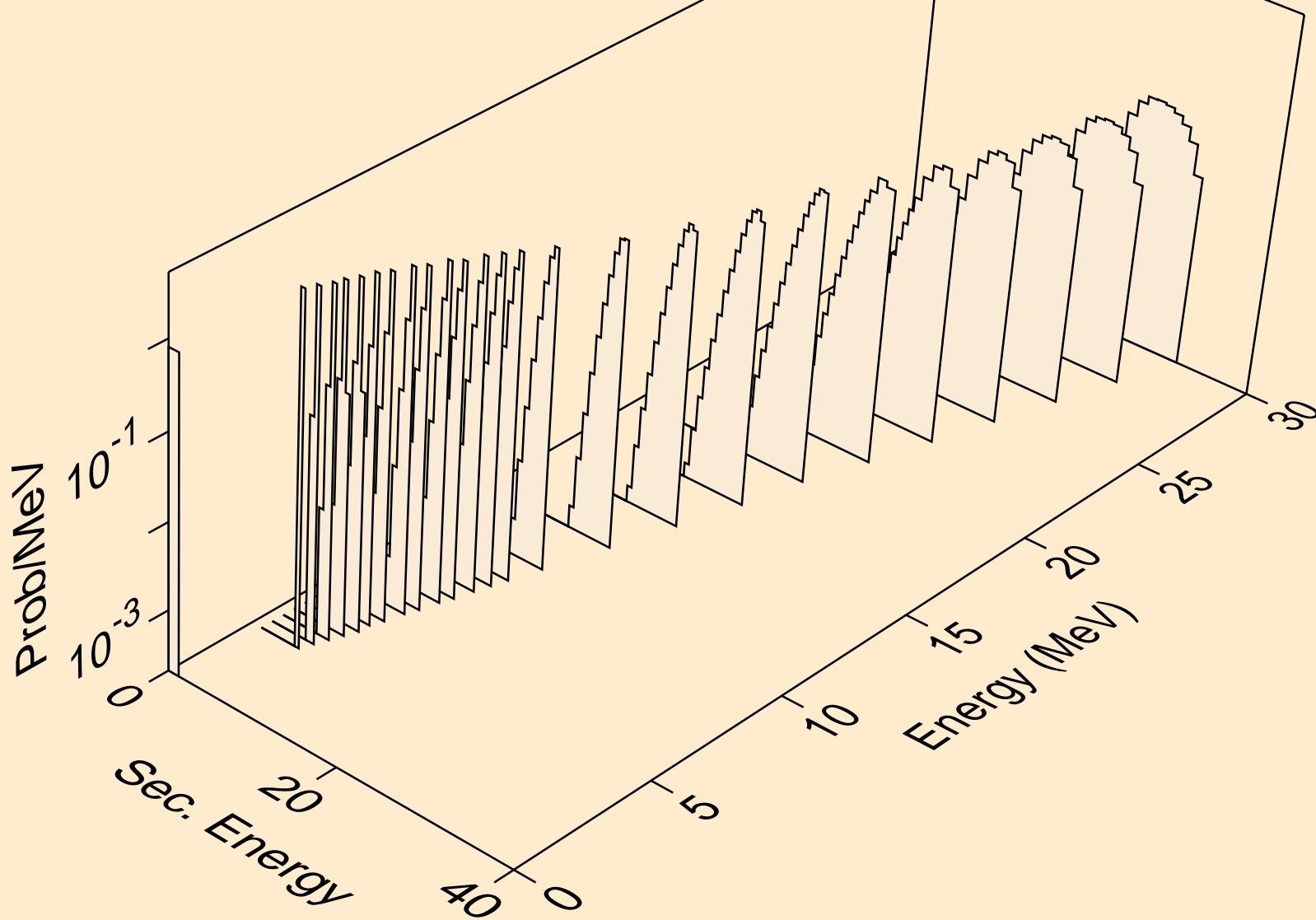

FR208 NEUTRON ACER TENDL-2019 LIBRARY; T=293.16K  
alphas from (n,x)

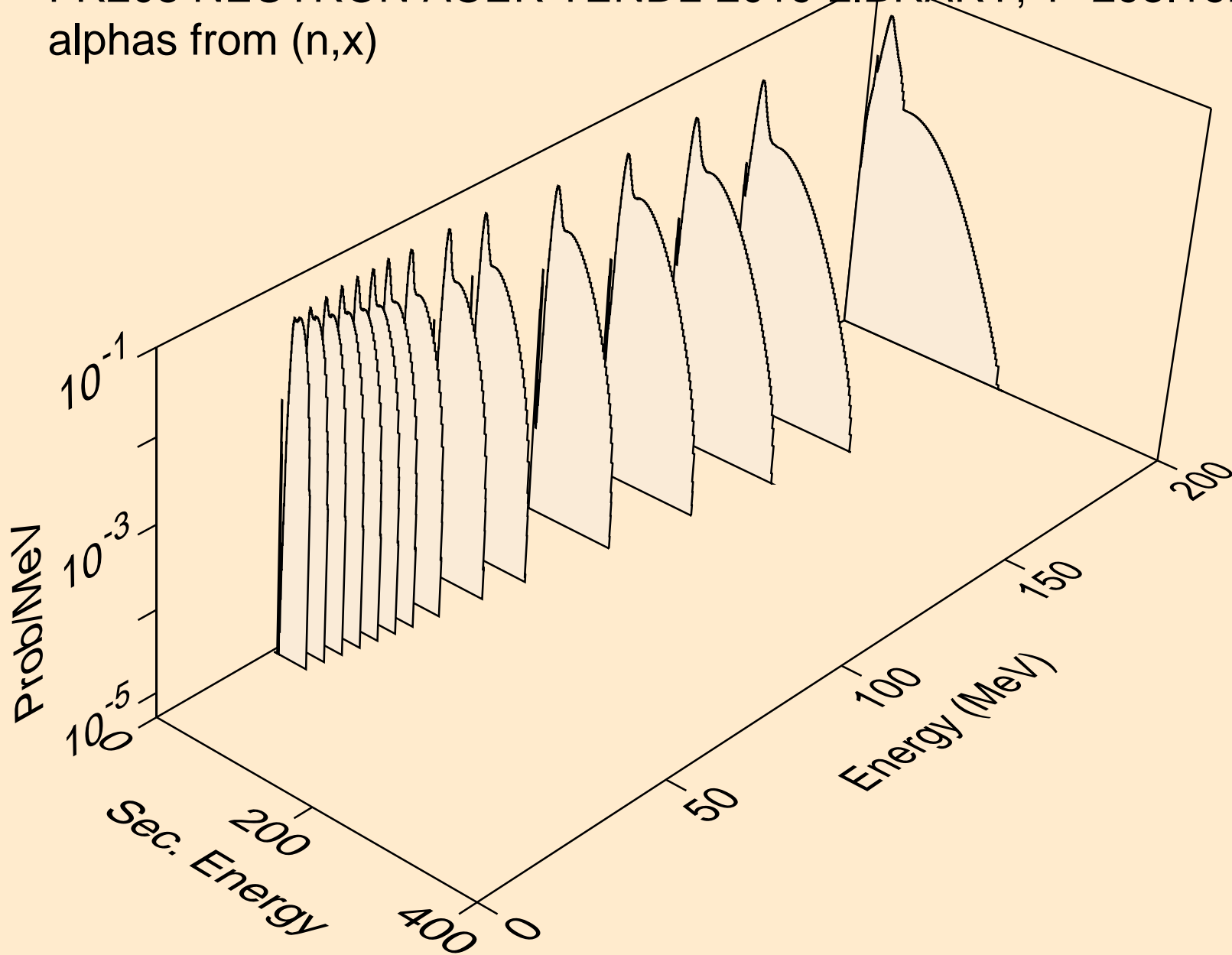

FR208 NEUTRON ACER TENDL-2019 LIBRARY; T=293.16K  
alphas from (n,n\*)a

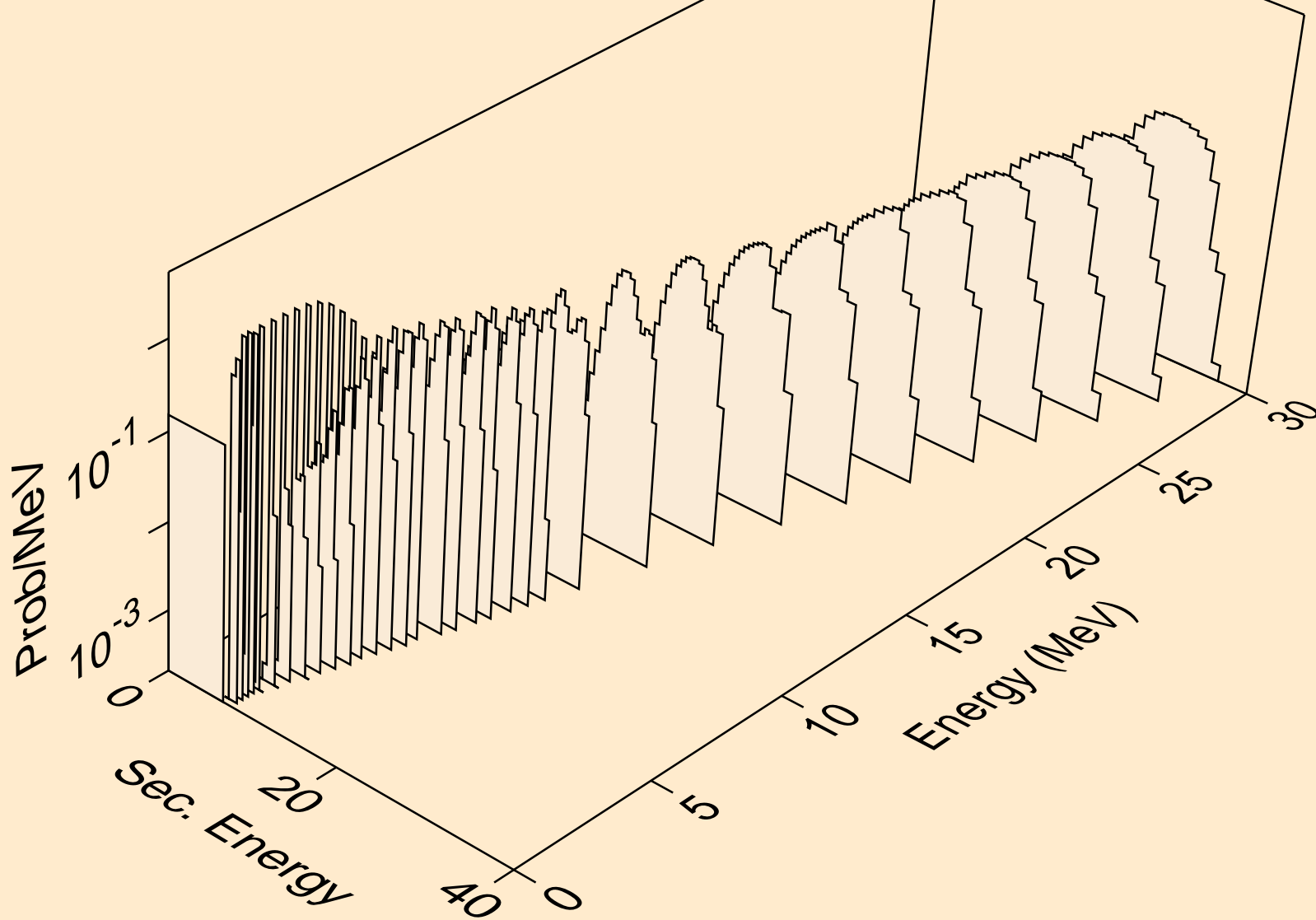

FR208 NEUTRON ACER TENDL-2019 LIBRARY; T=293.16K  
alphas from (n,2n)a

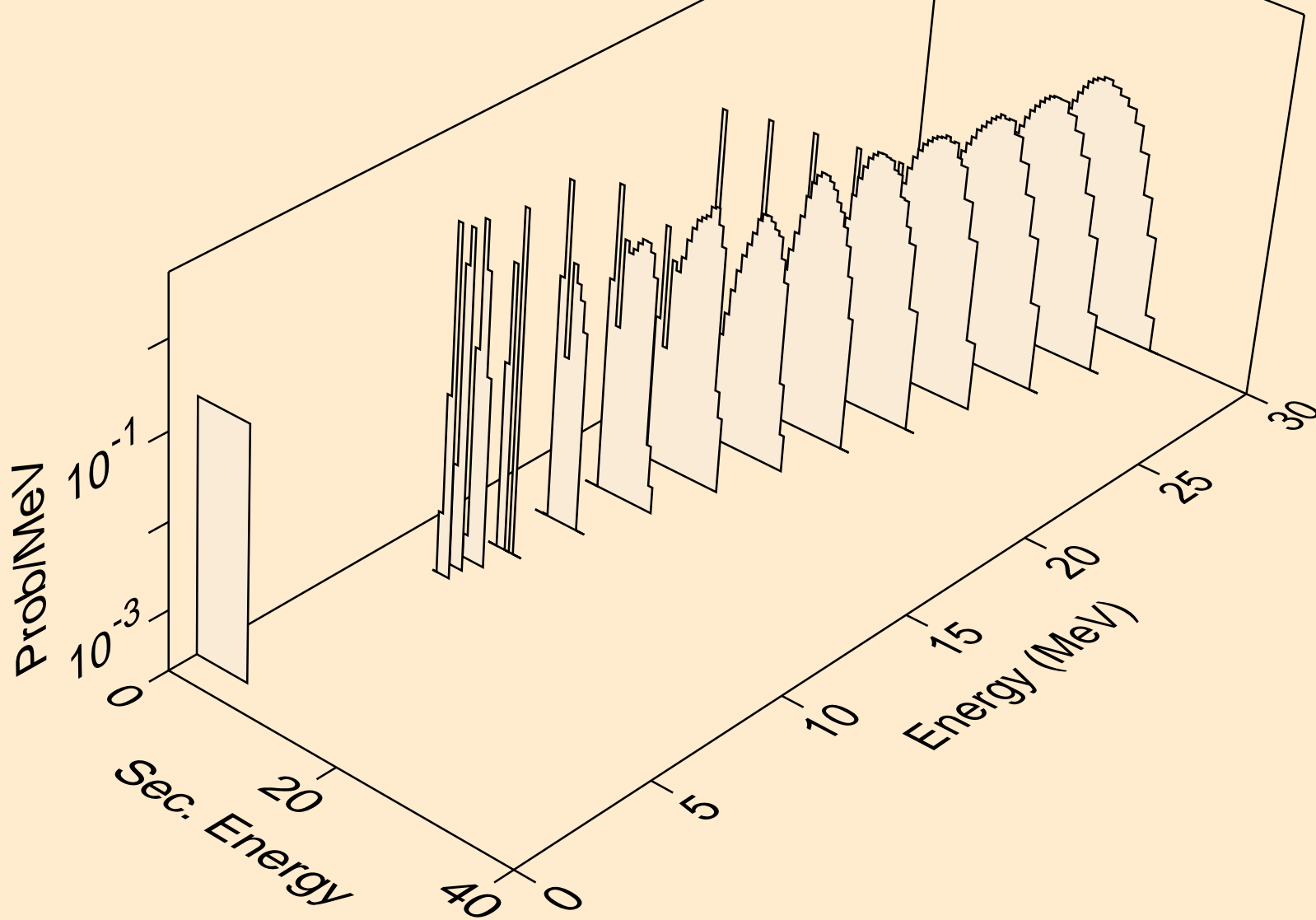

FR208 NEUTRON ACER TENDL-2019 LIBRARY; T=293.16K  
alphas from (n,3n)a

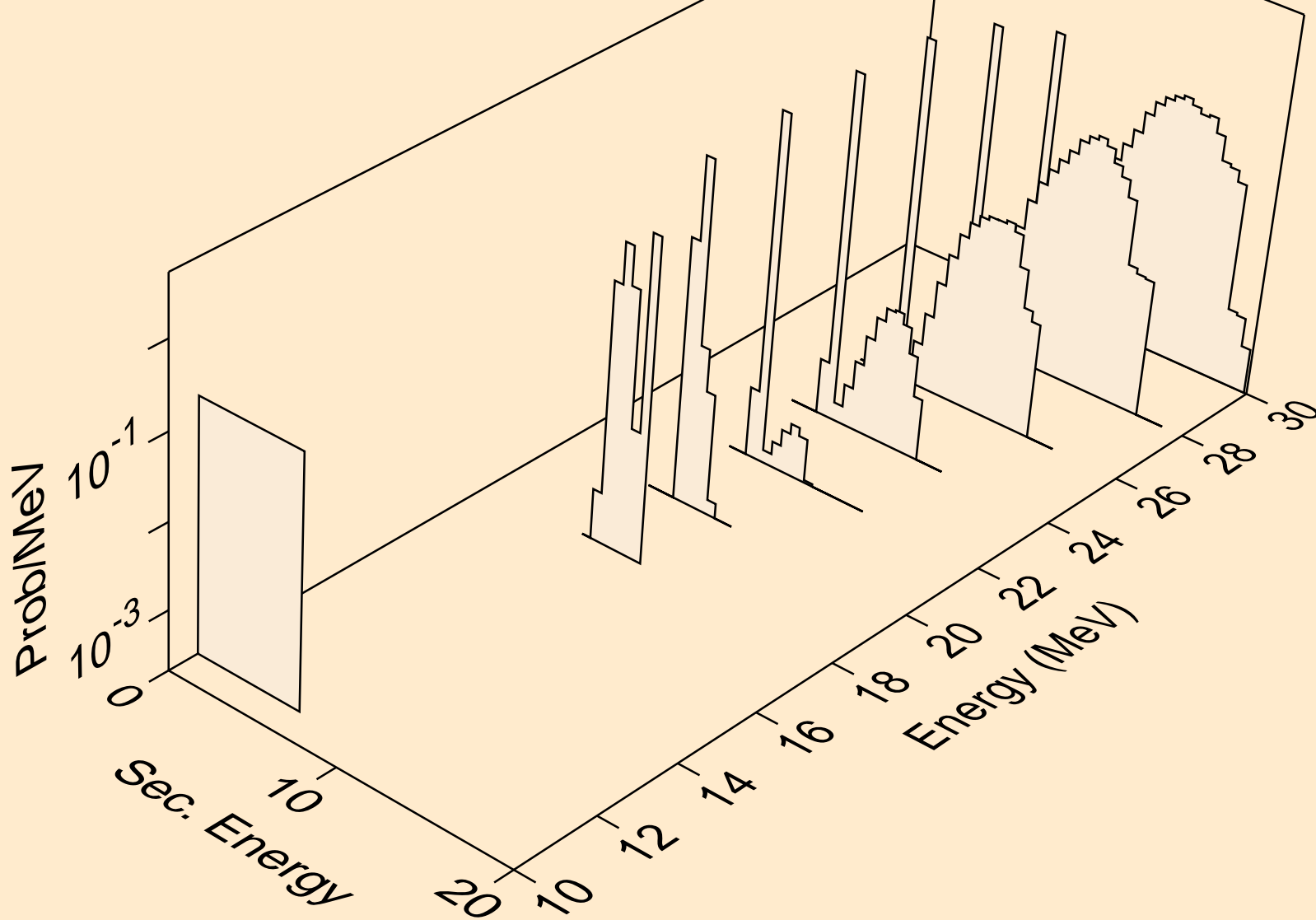

FR208 NEUTRON ACER TENDL-2019 LIBRARY; T=293.16K  
alphas from (n,n\*)2a

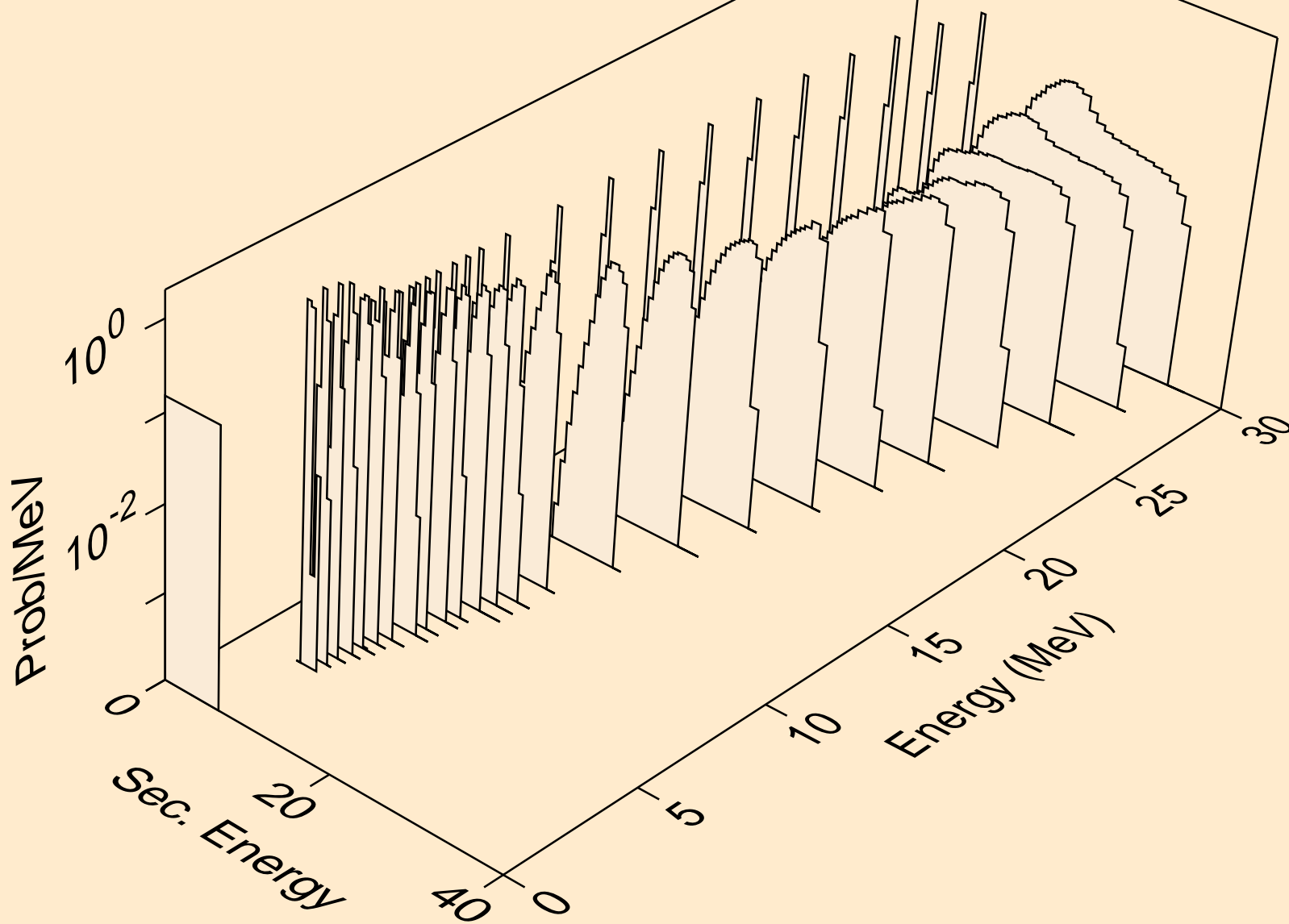



FR208 NEUTRON ACER TENDL-2019 LIBRARY; T=293.16K  
alphas from (n,2n)2a

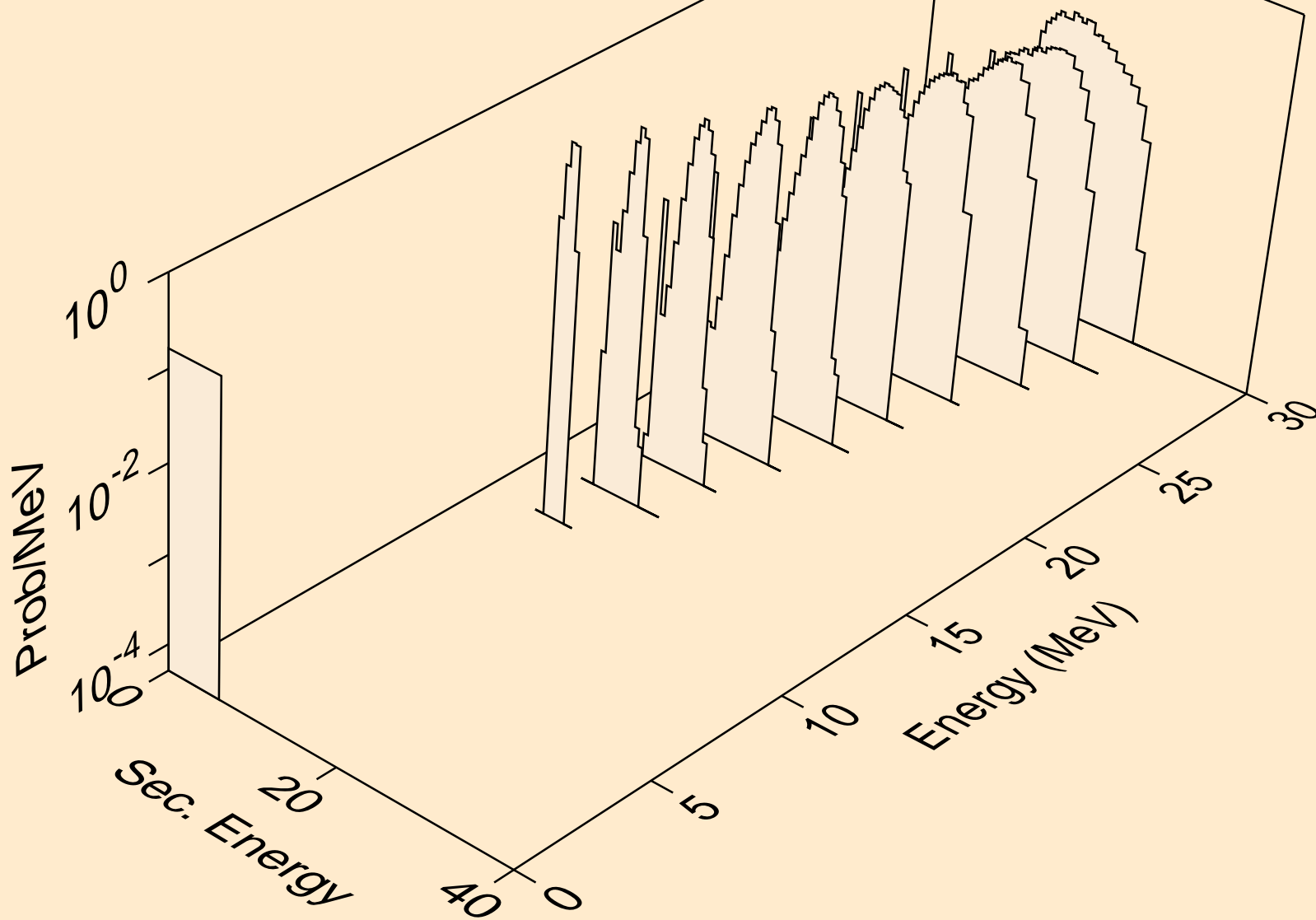

FR208 NEUTRON ACER TENDL-2019 LIBRARY; T=293.16K  
alphas from (n,npa)

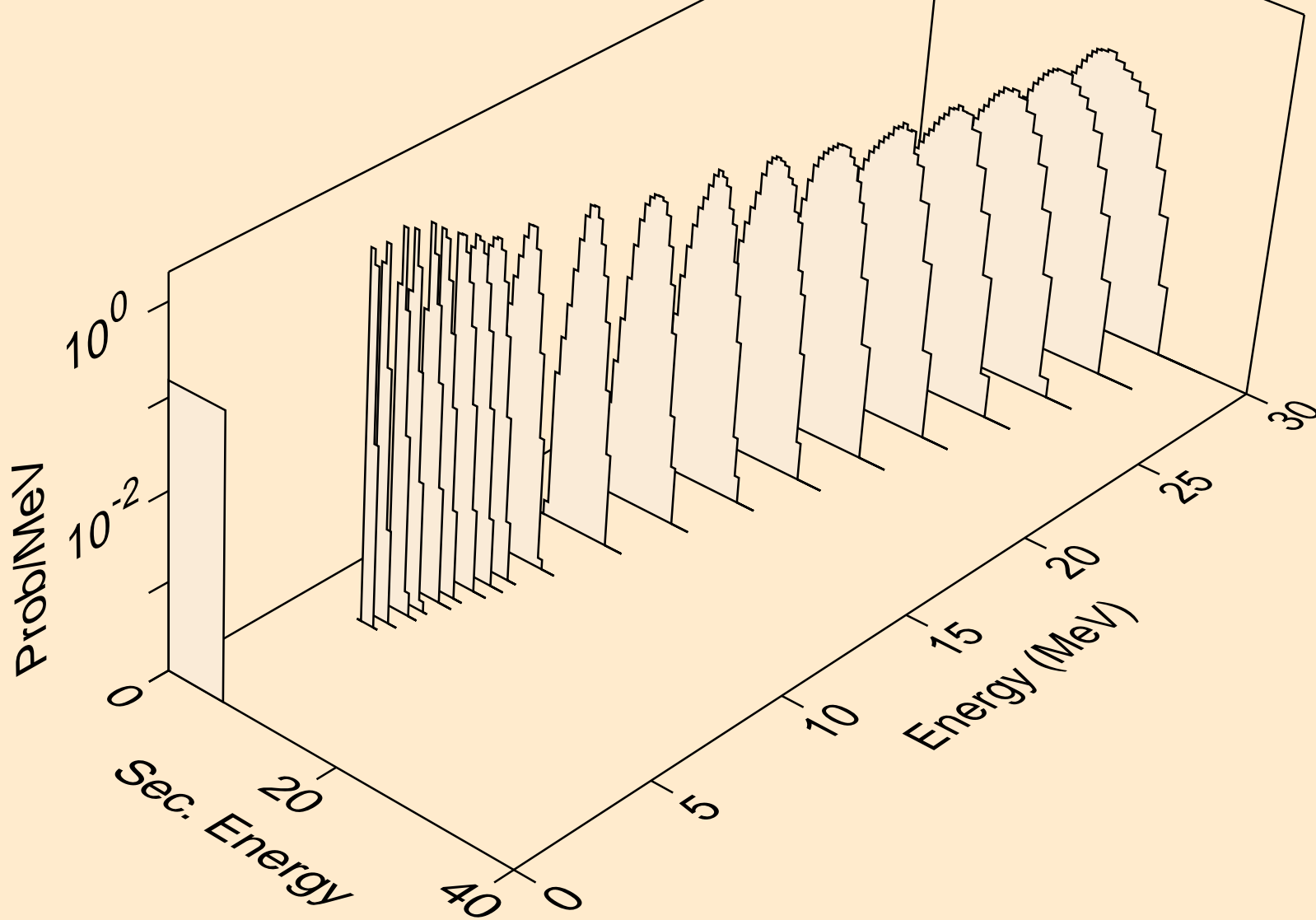

FR208 NEUTRON ACER TENDL-2019 LIBRARY; T=293.16K  
alphas from (n,a)

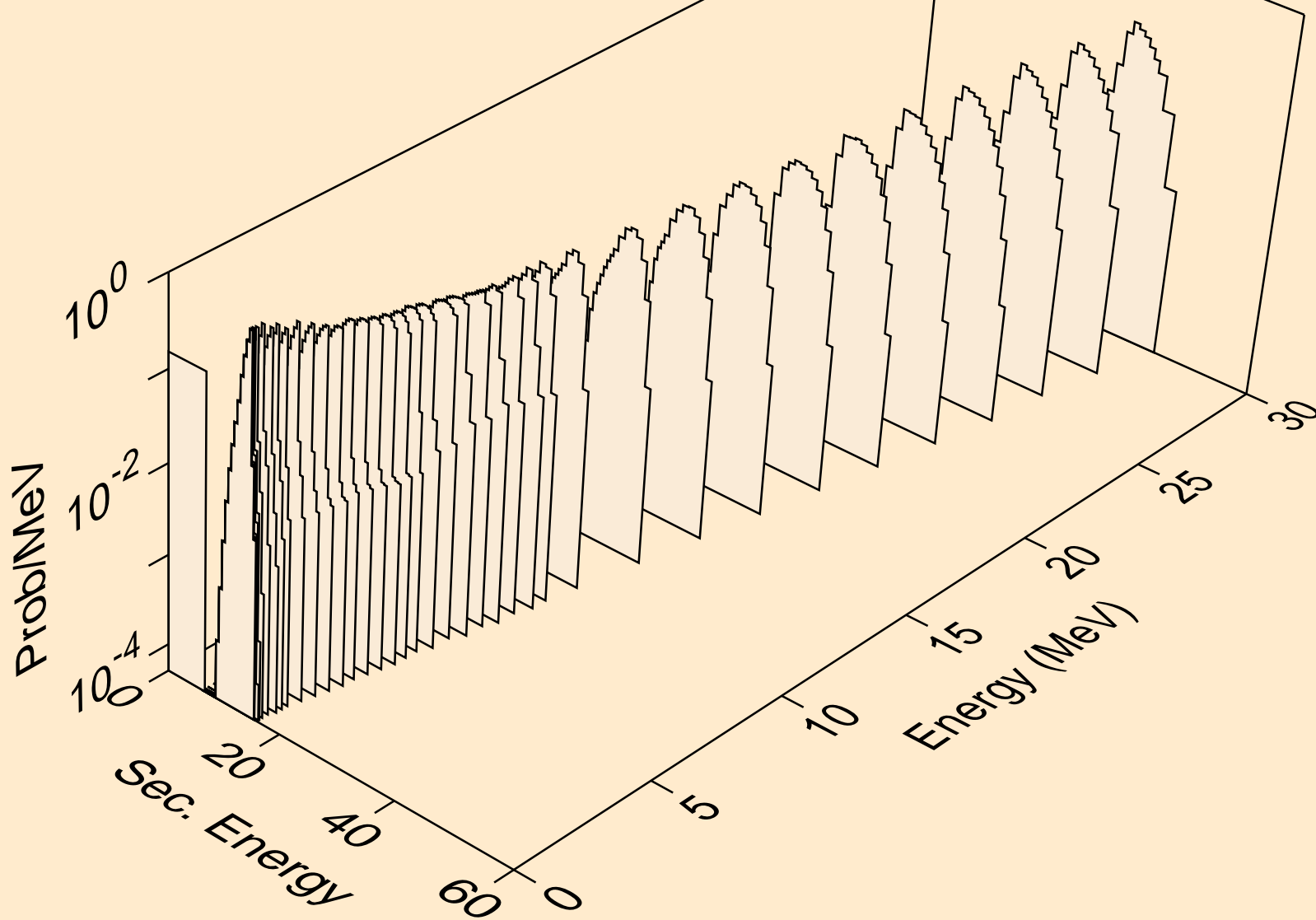

FR208 NEUTRON ACER TENDL-2019 LIBRARY; T=293.16K  
alphas from (n,2a)

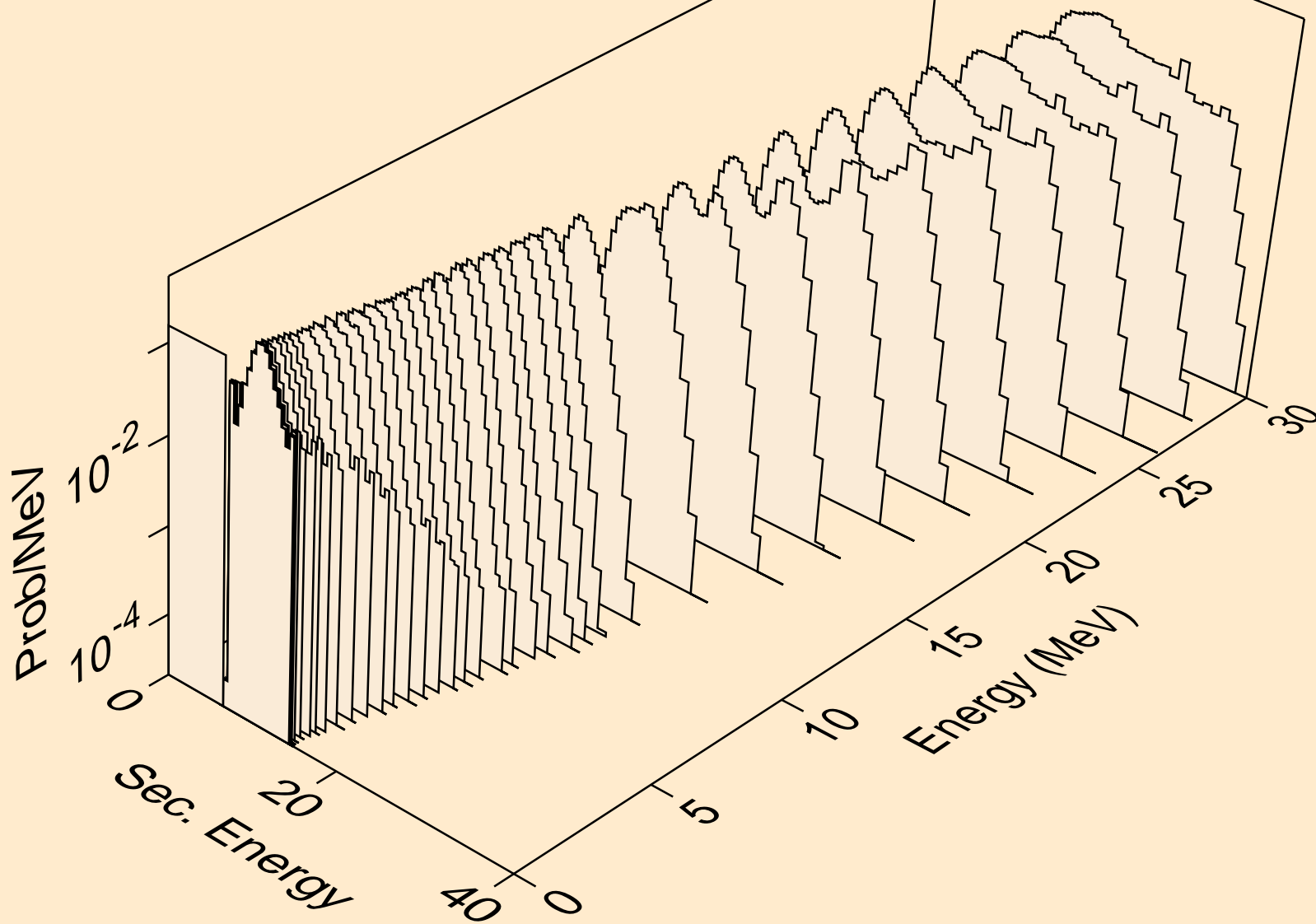

FR208 NEUTRON ACER TENDL-2019 LIBRARY; T=293.16K  
alphas from (n,pa)

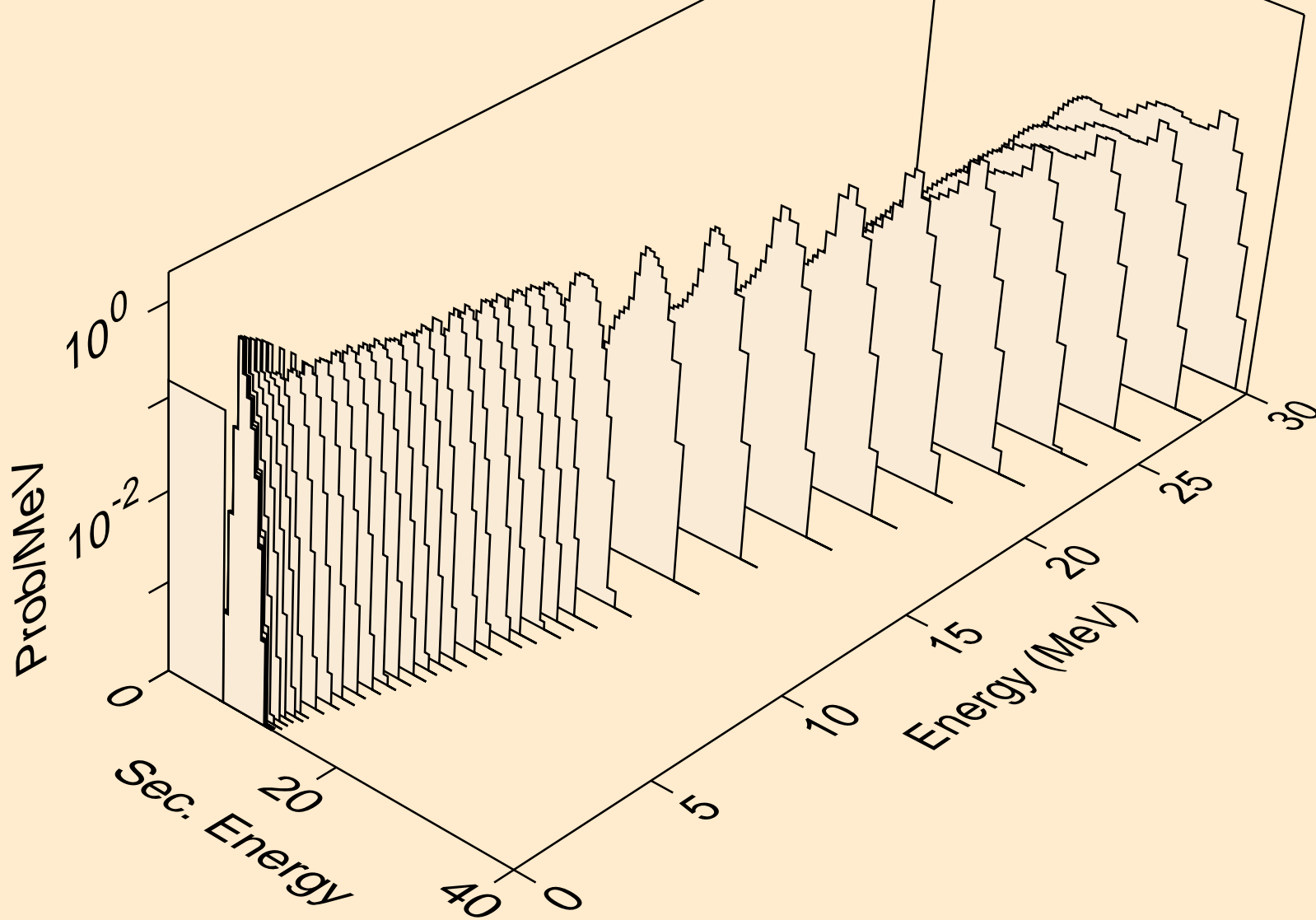

FR208 NEUTRON ACER TENDL-2019 LIBRARY; T=293.16K  
alphas from (n,da)

