

FR224 NEUTRON ACER TENDL-2019 LIBRARY; T=293.16K
Principal cross sections

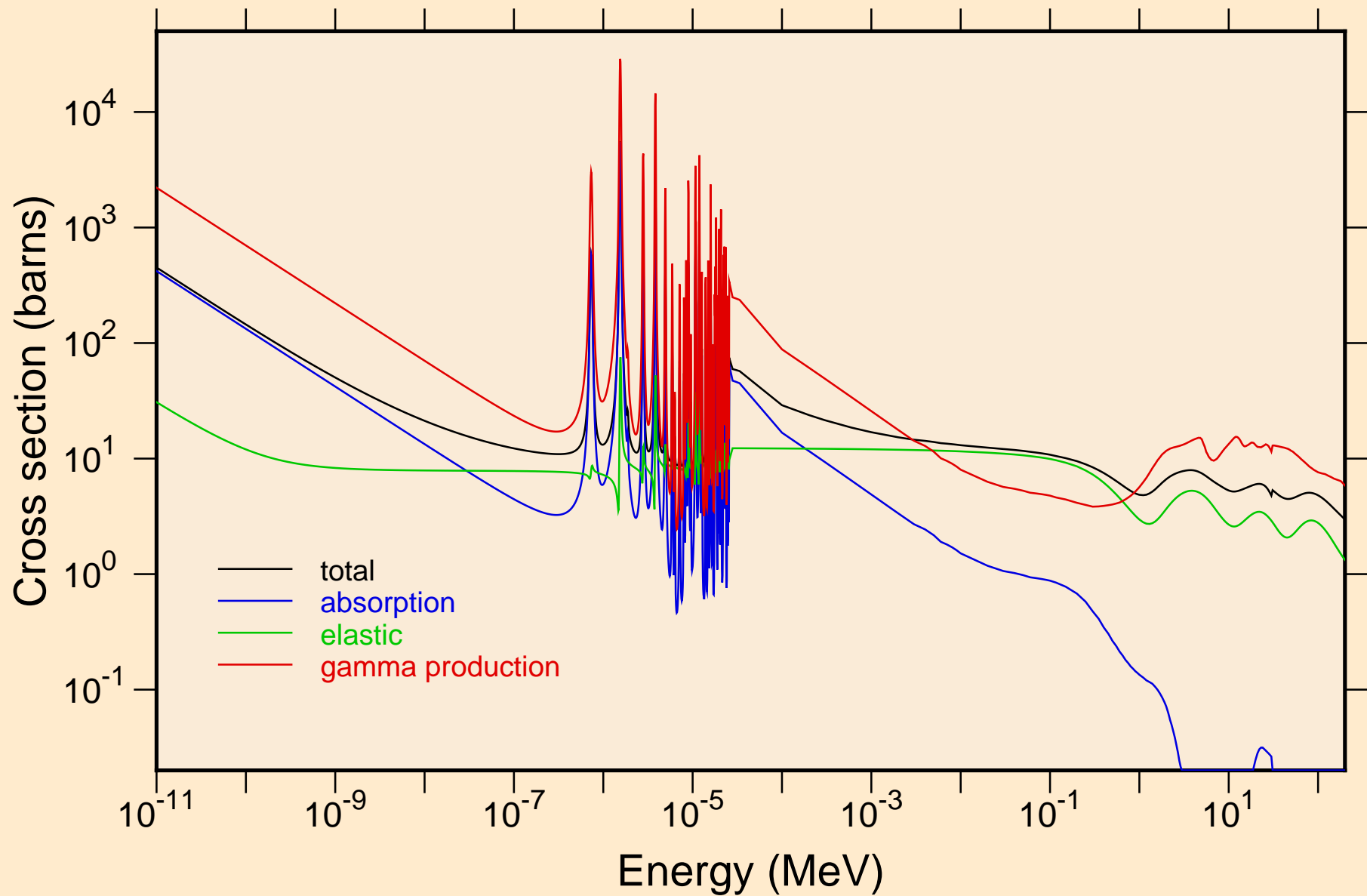

FR224 NEUTRON ACER TENDL-2019 LIBRARY; T=293.16K
resonance total cross section

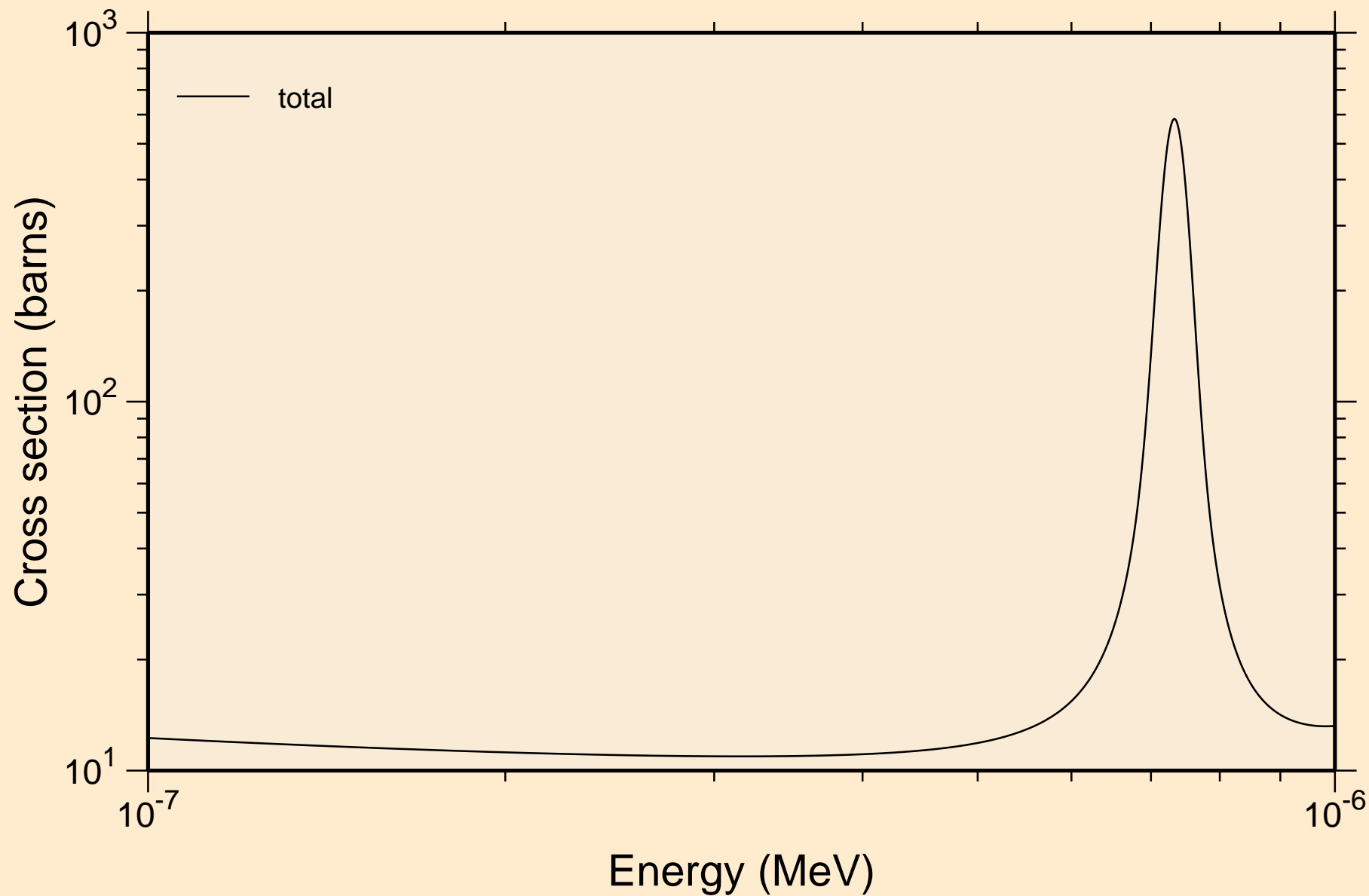

FR224 NEUTRON ACER TENDL-2019 LIBRARY; T=293.16K
resonance total cross section

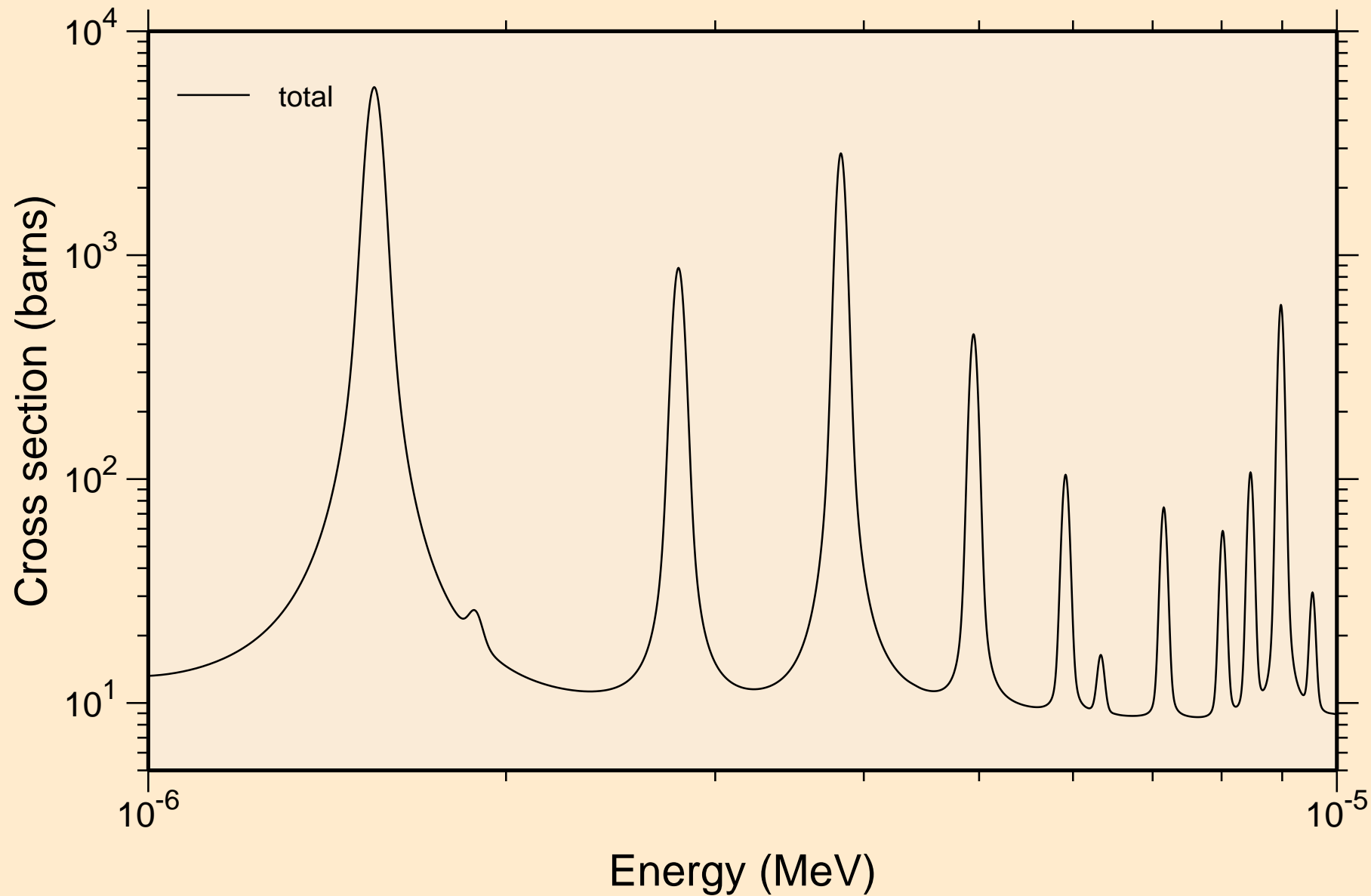

FR224 NEUTRON ACER TENDL-2019 LIBRARY; T=293.16K
resonance total cross section

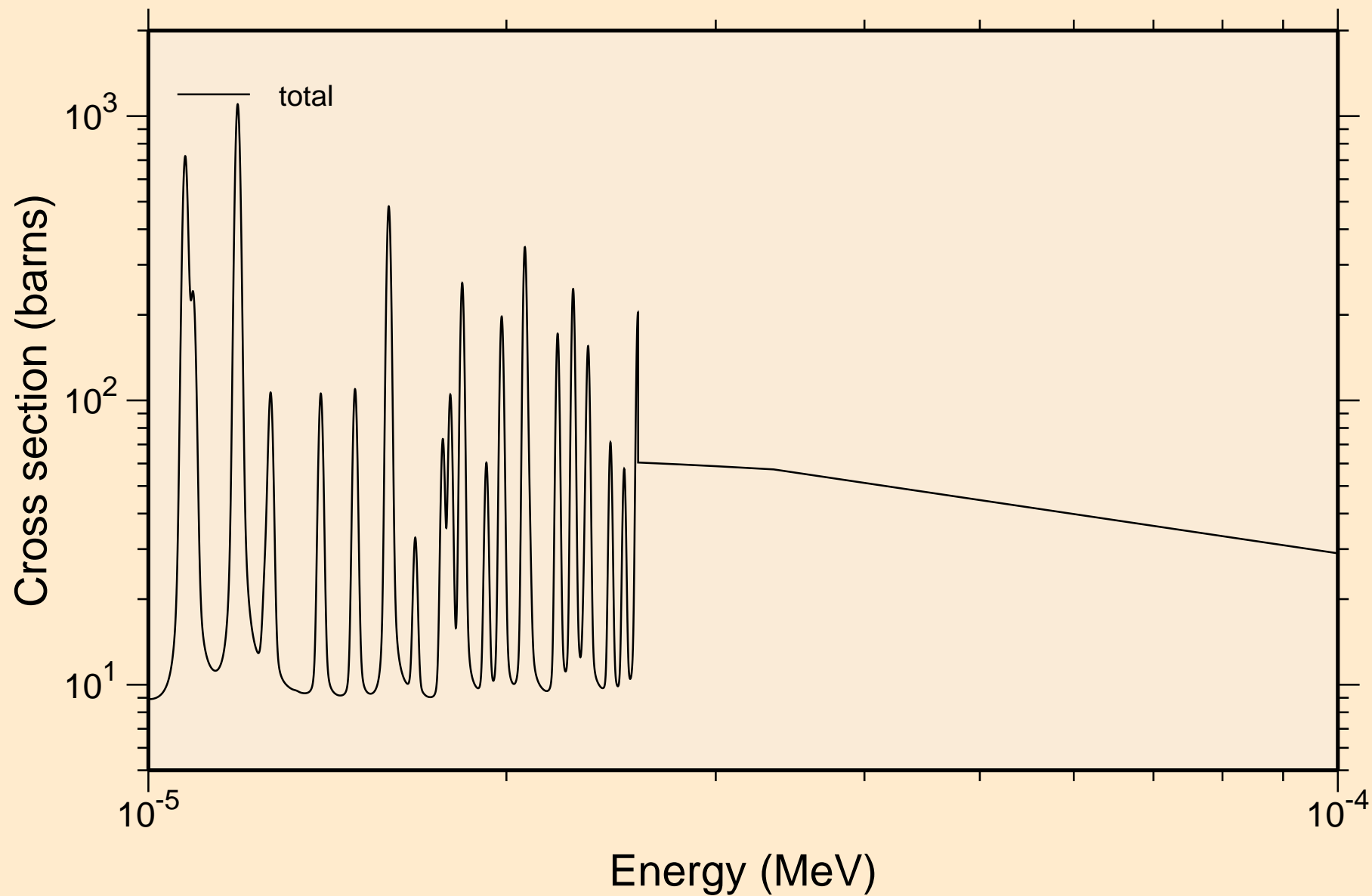

FR224 NEUTRON ACER TENDL-2019 LIBRARY; T=293.16K
resonance total cross section

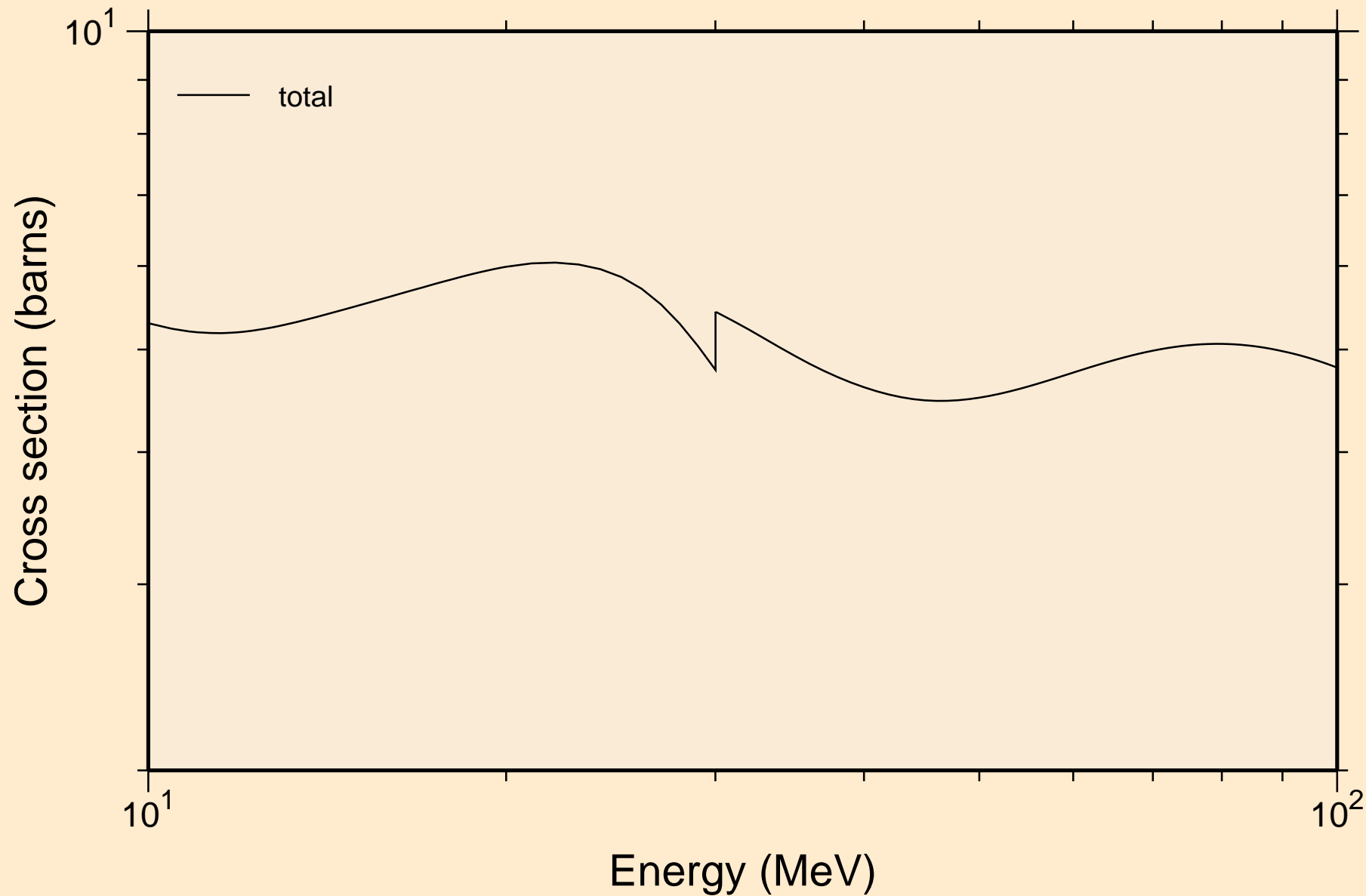

FR224 NEUTRON ACER TENDL-2019 LIBRARY; T=293.16K
resonance absorption cross sections

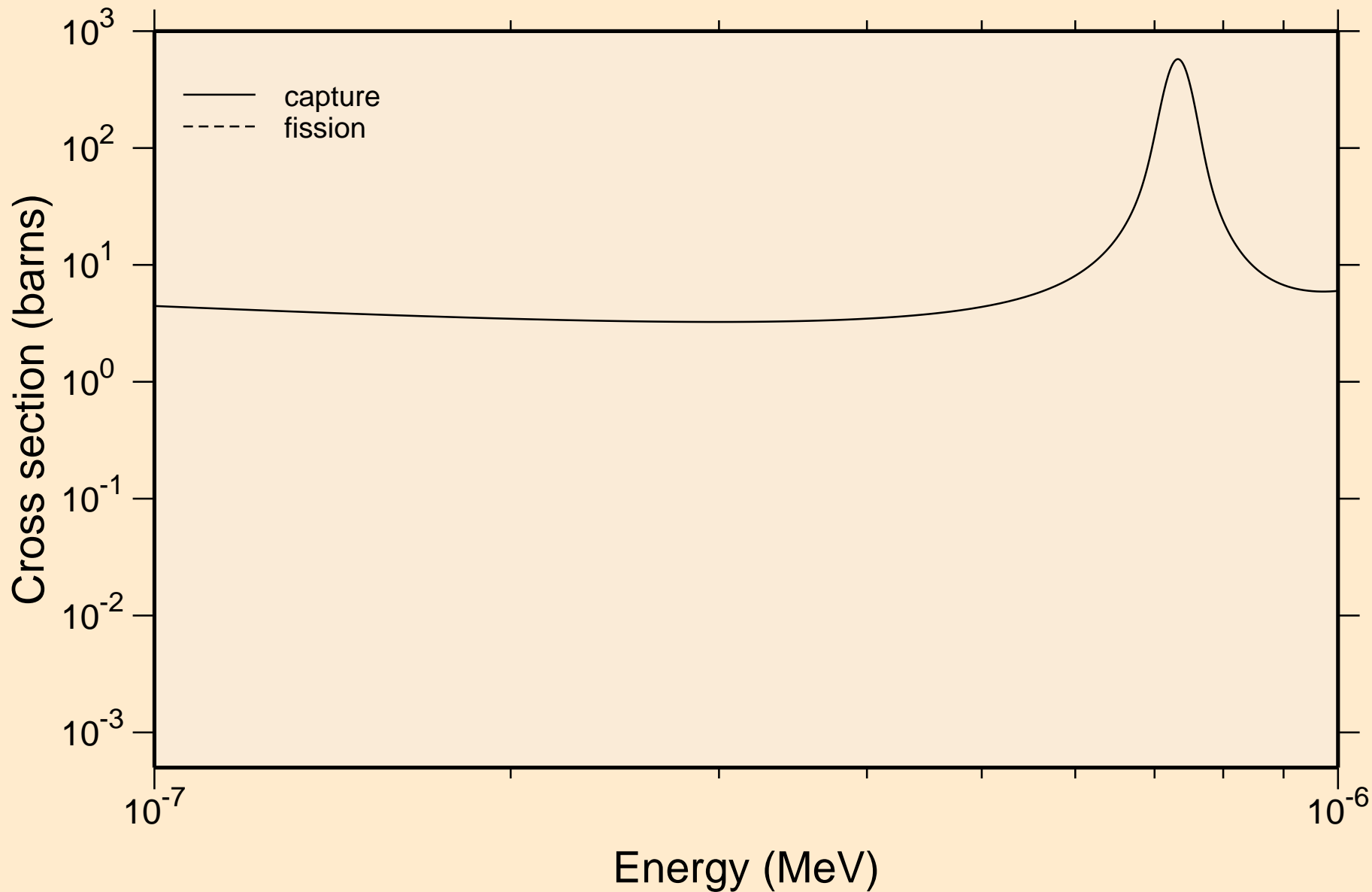

FR224 NEUTRON ACER TENDL-2019 LIBRARY; T=293.16K
resonance absorption cross sections

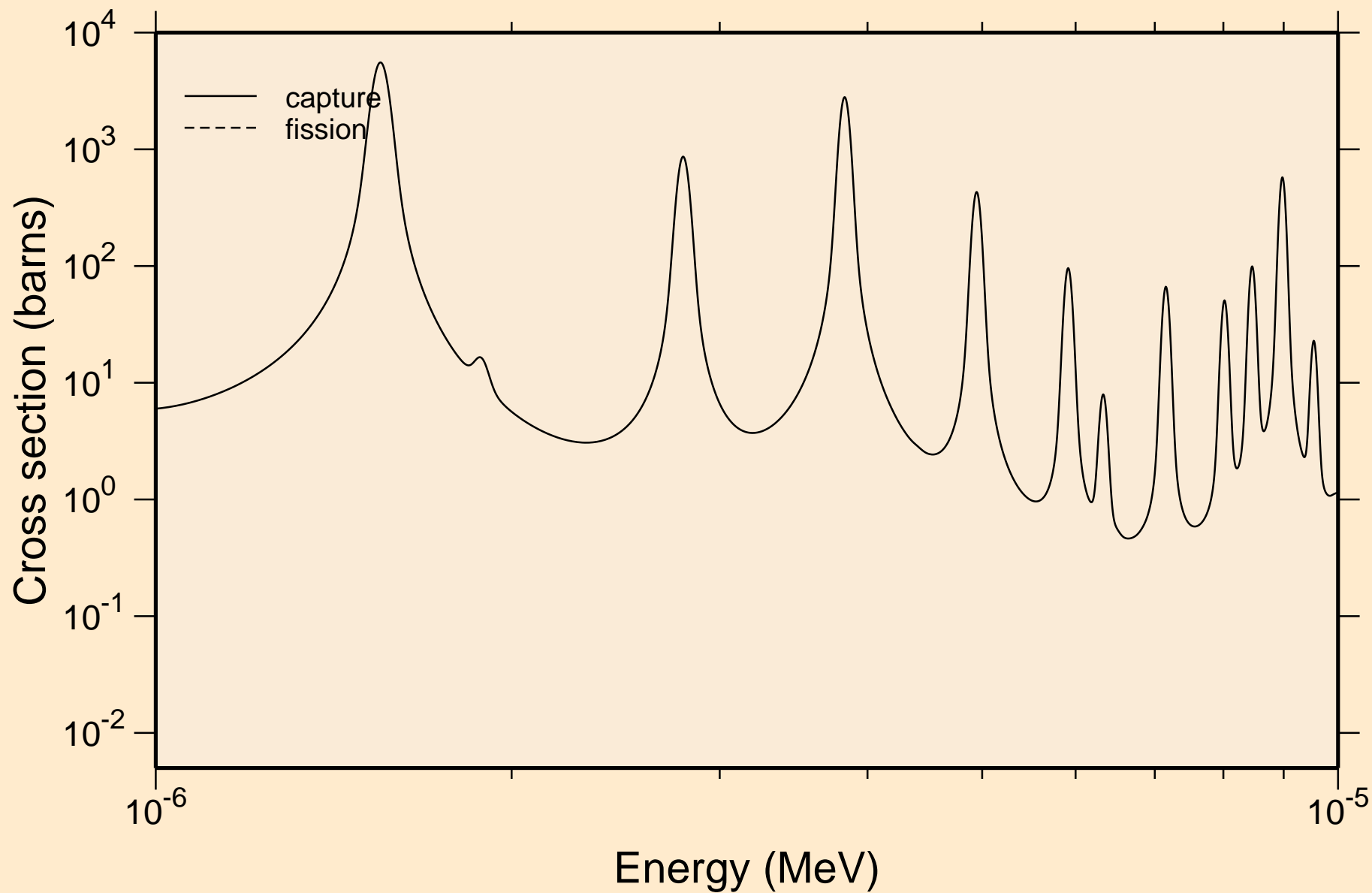

FR224 NEUTRON ACER TENDL-2019 LIBRARY; T=293.16K
resonance absorption cross sections

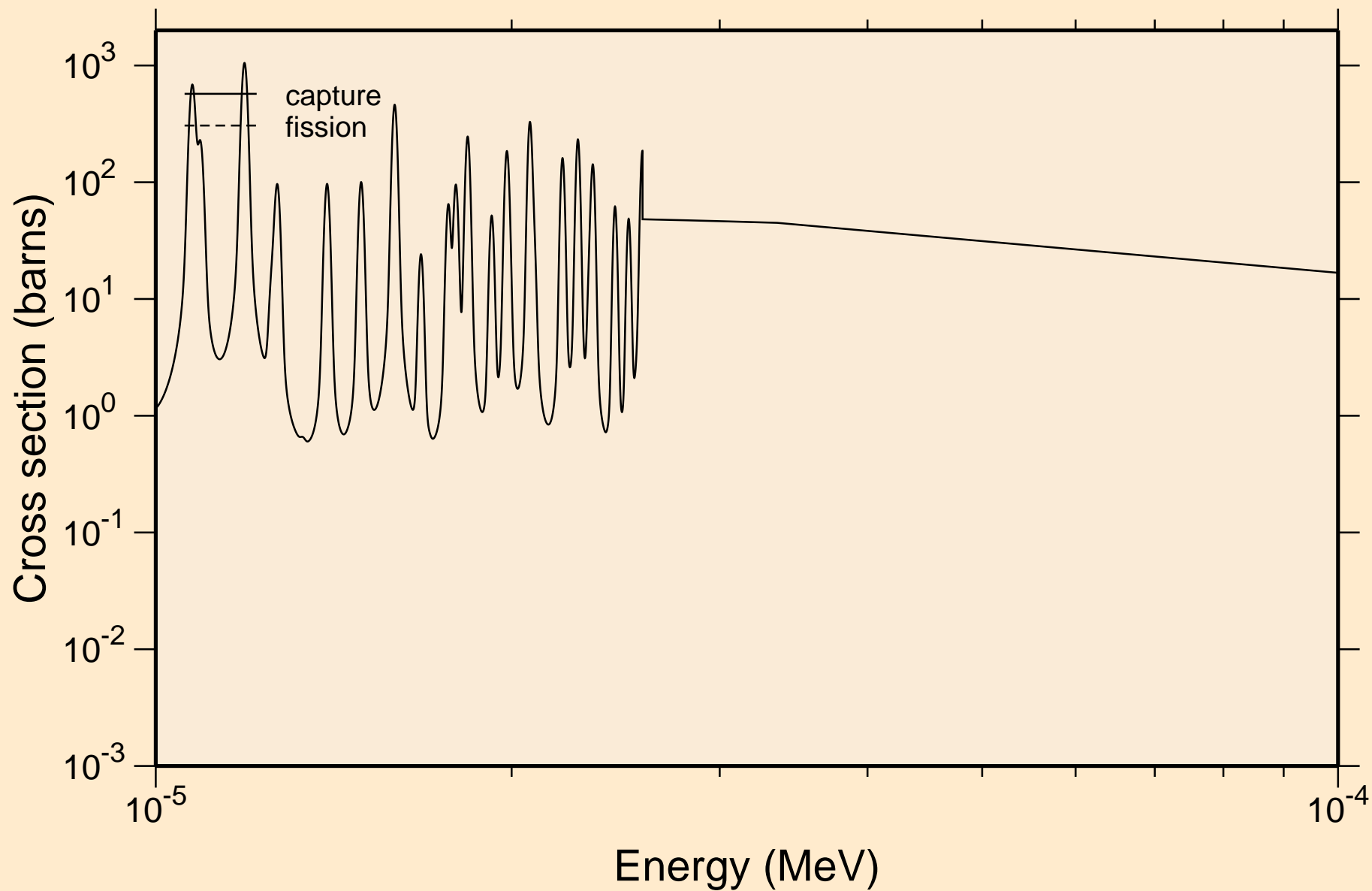

FR224 NEUTRON ACER TENDL-2019 LIBRARY; T=293.16K
resonance absorption cross sections

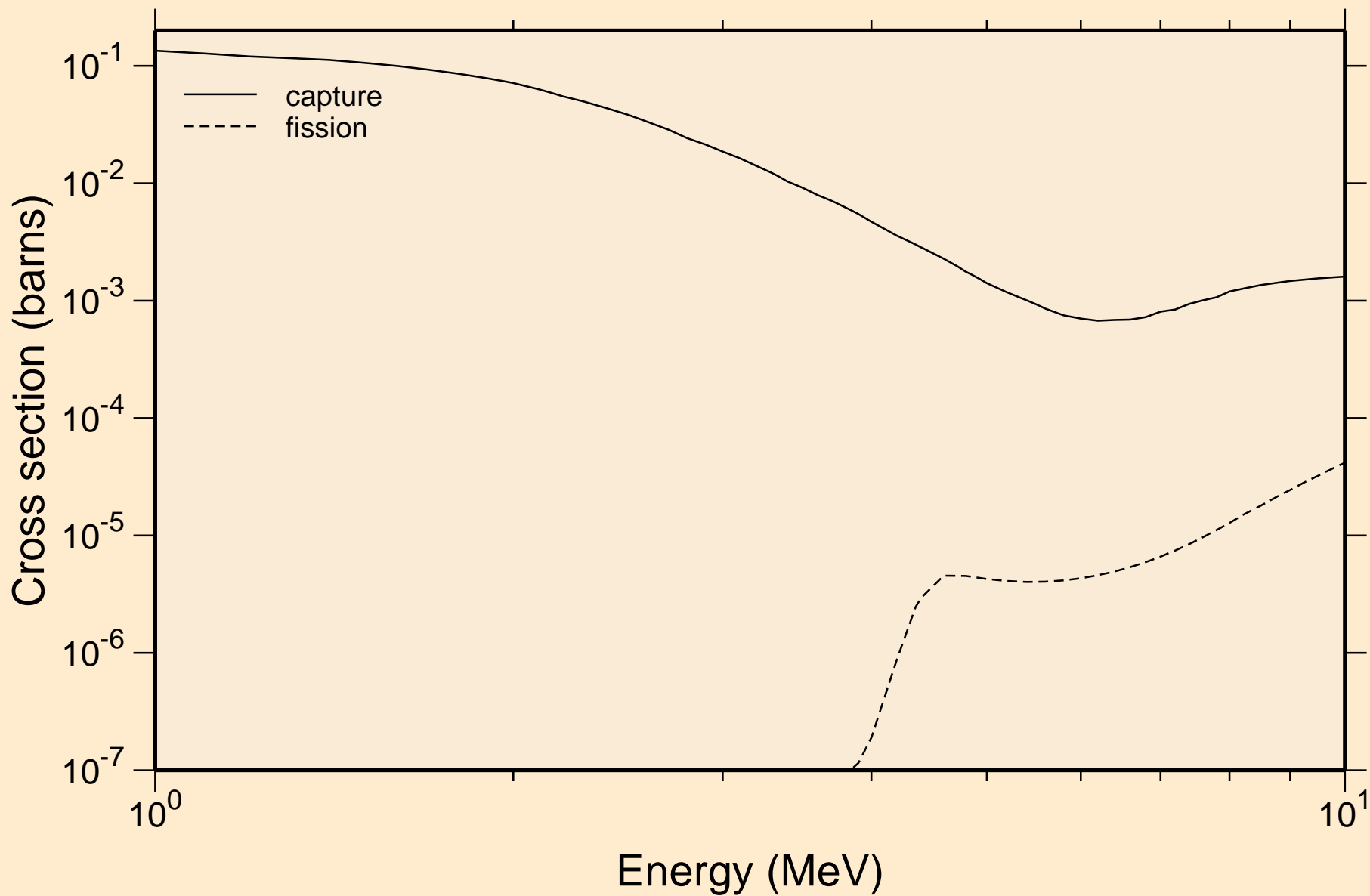

FR224 NEUTRON ACER TENDL-2019 LIBRARY; T=293.16K
Heating

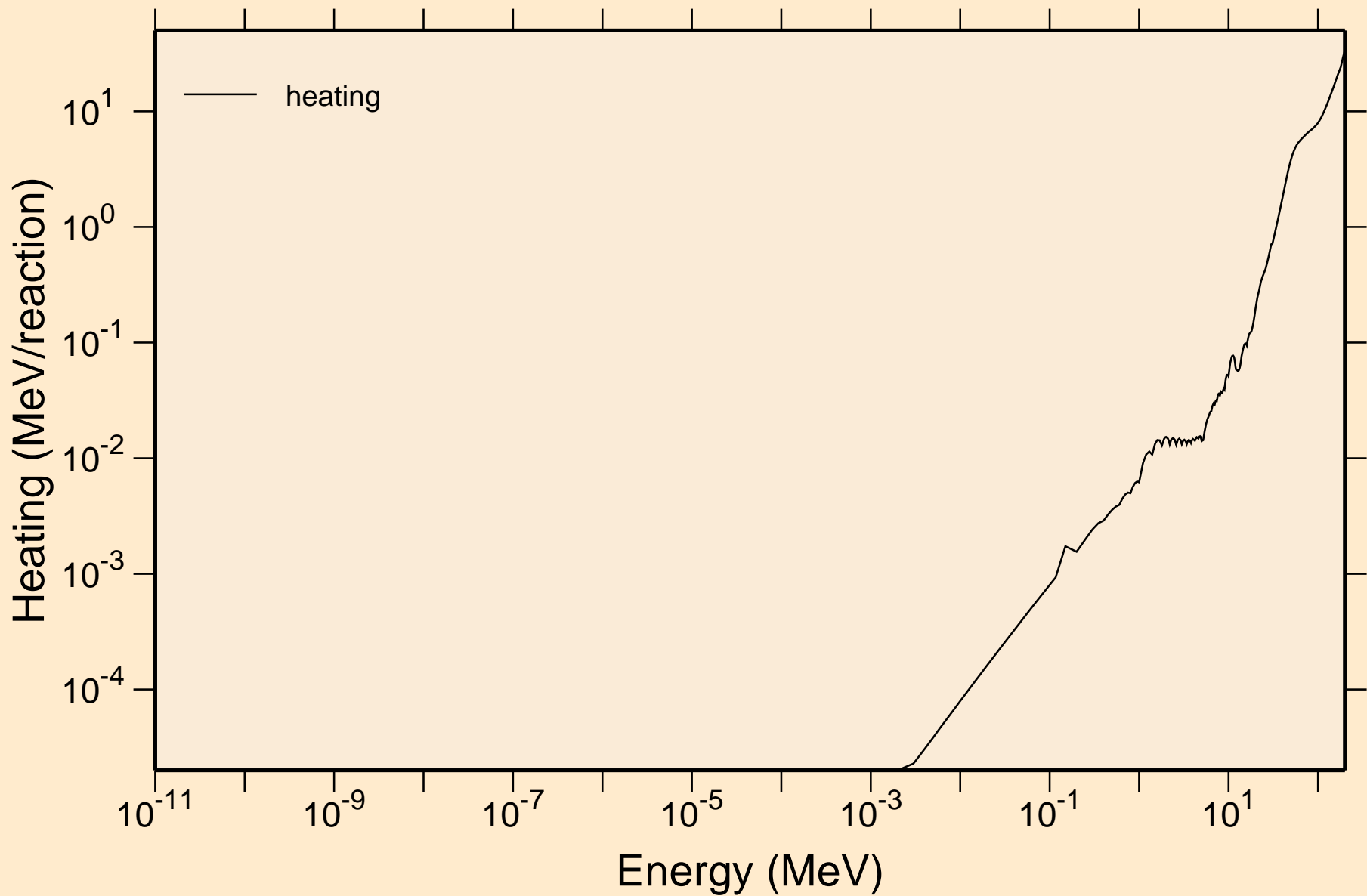

FR224 NEUTRON ACER TENDL-2019 LIBRARY; T=293.16K
Damage

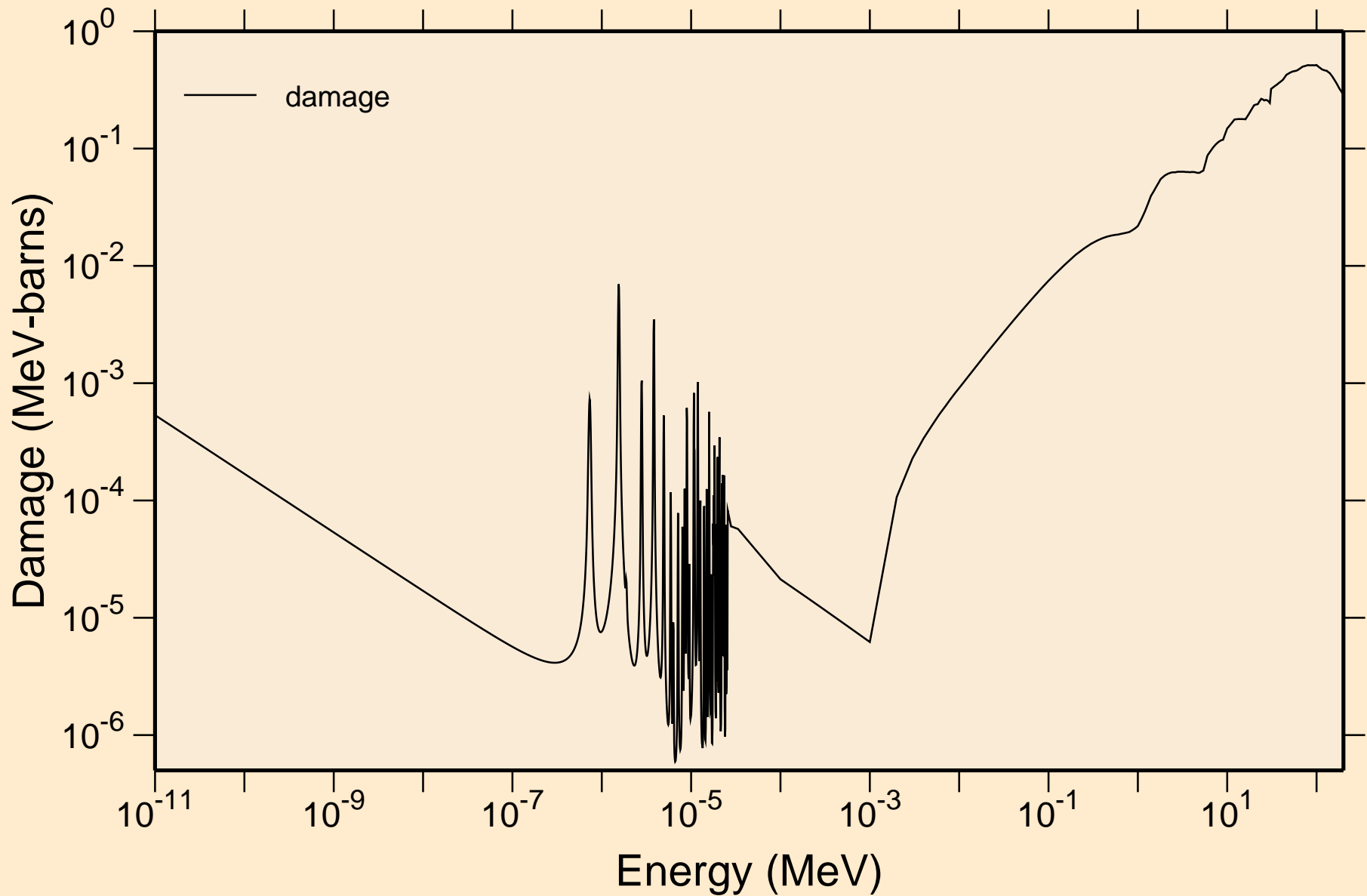

FR224 NEUTRON ACER TENDL-2019 LIBRARY; T=293.16K
Non-threshold reactions

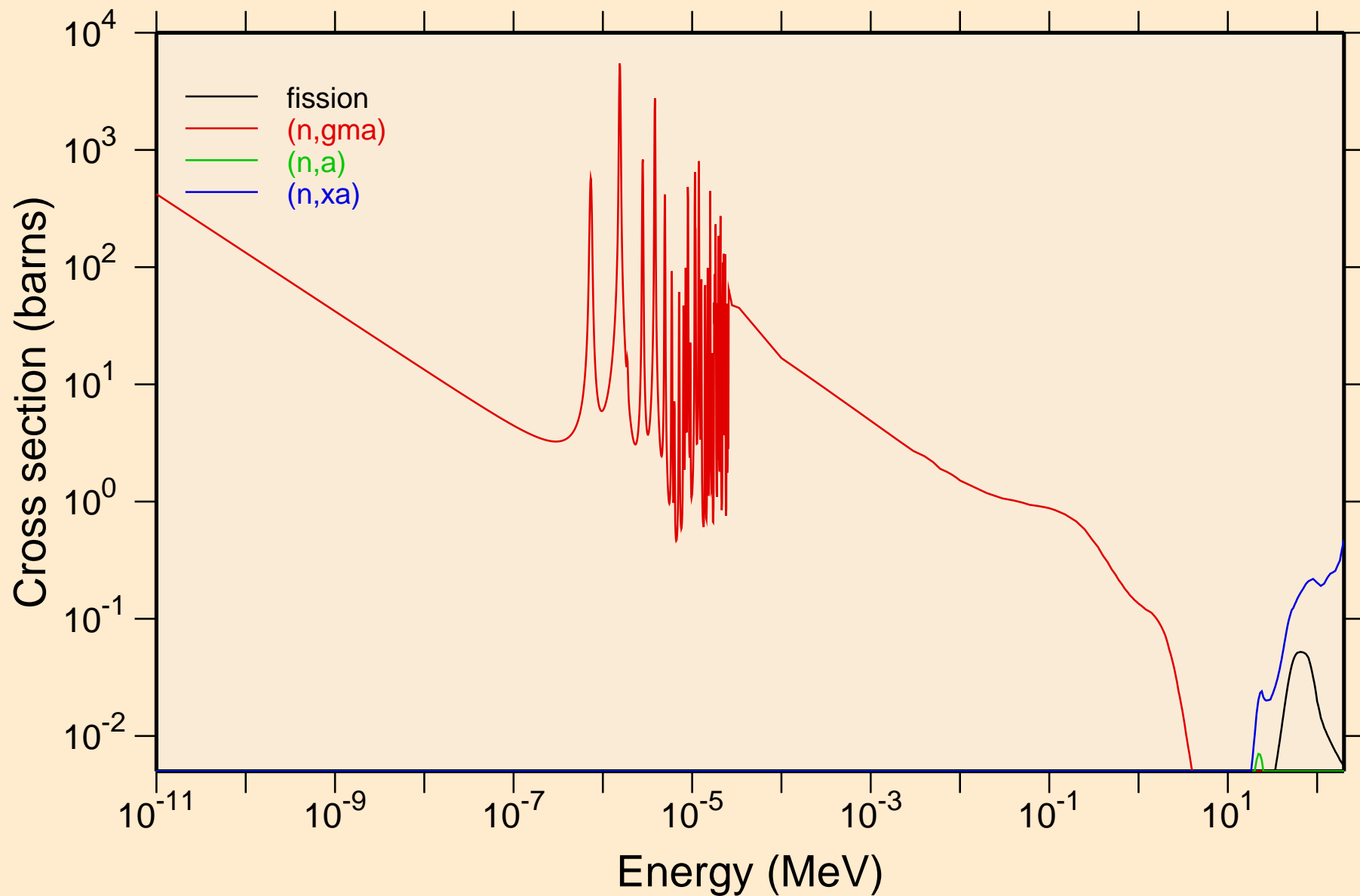

FR224 NEUTRON ACER TENDL-2019 LIBRARY; T=293.16K

Principal cross sections

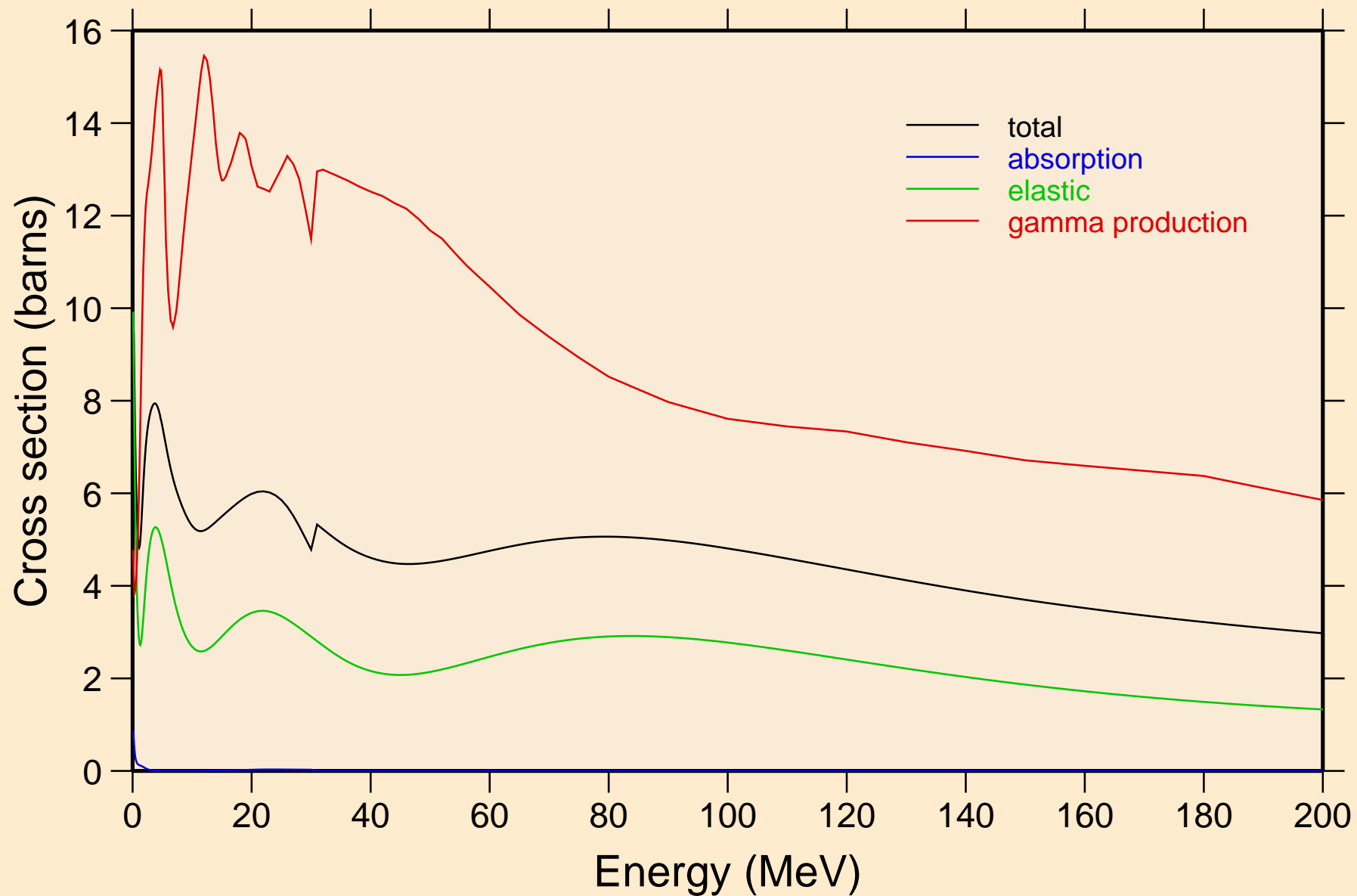

FR224 NEUTRON ACER TENDL-2019 LIBRARY; T=293.16K
Heating

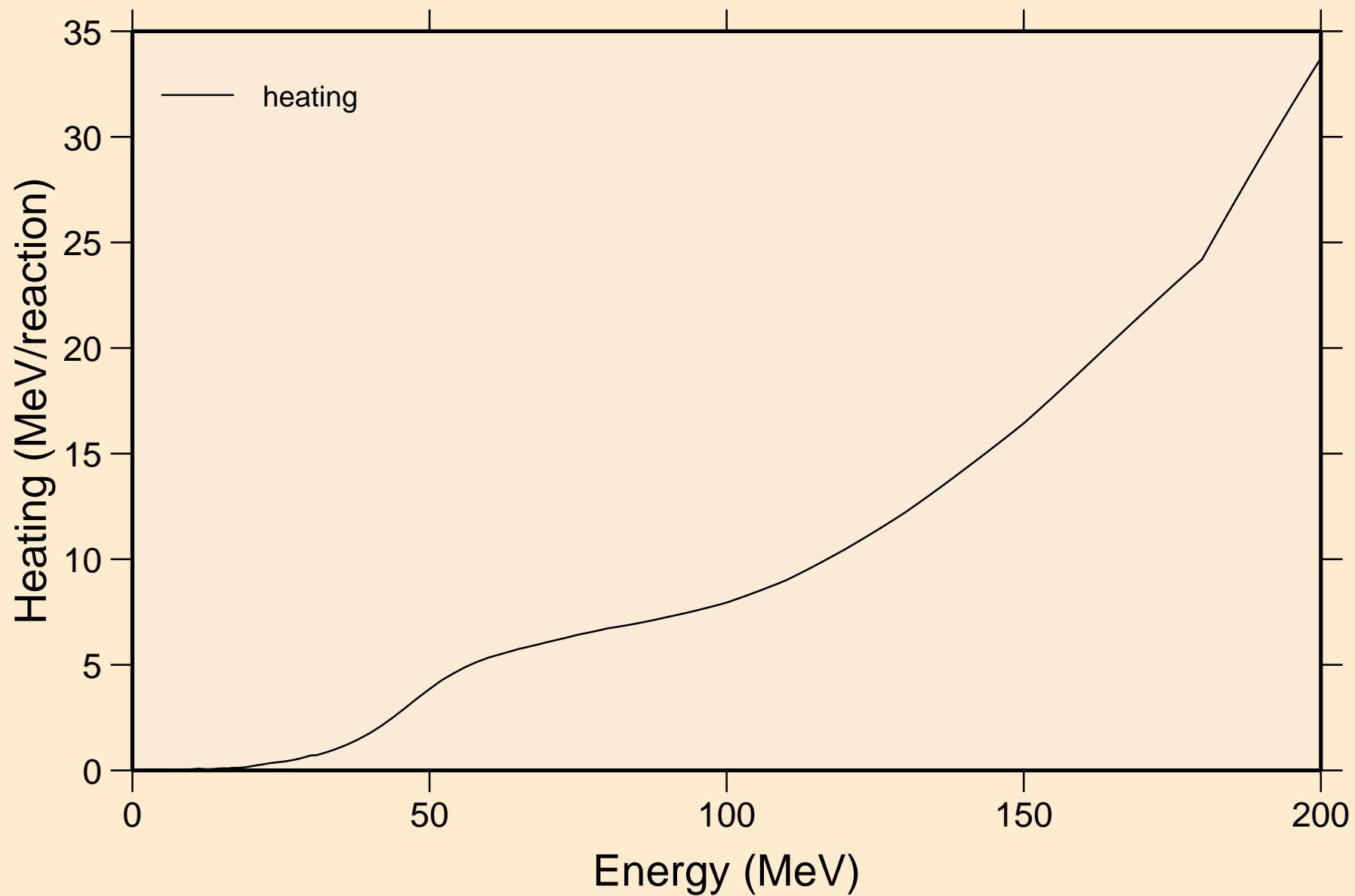

FR224 NEUTRON ACER TENDL-2019 LIBRARY; T=293.16K
Damage

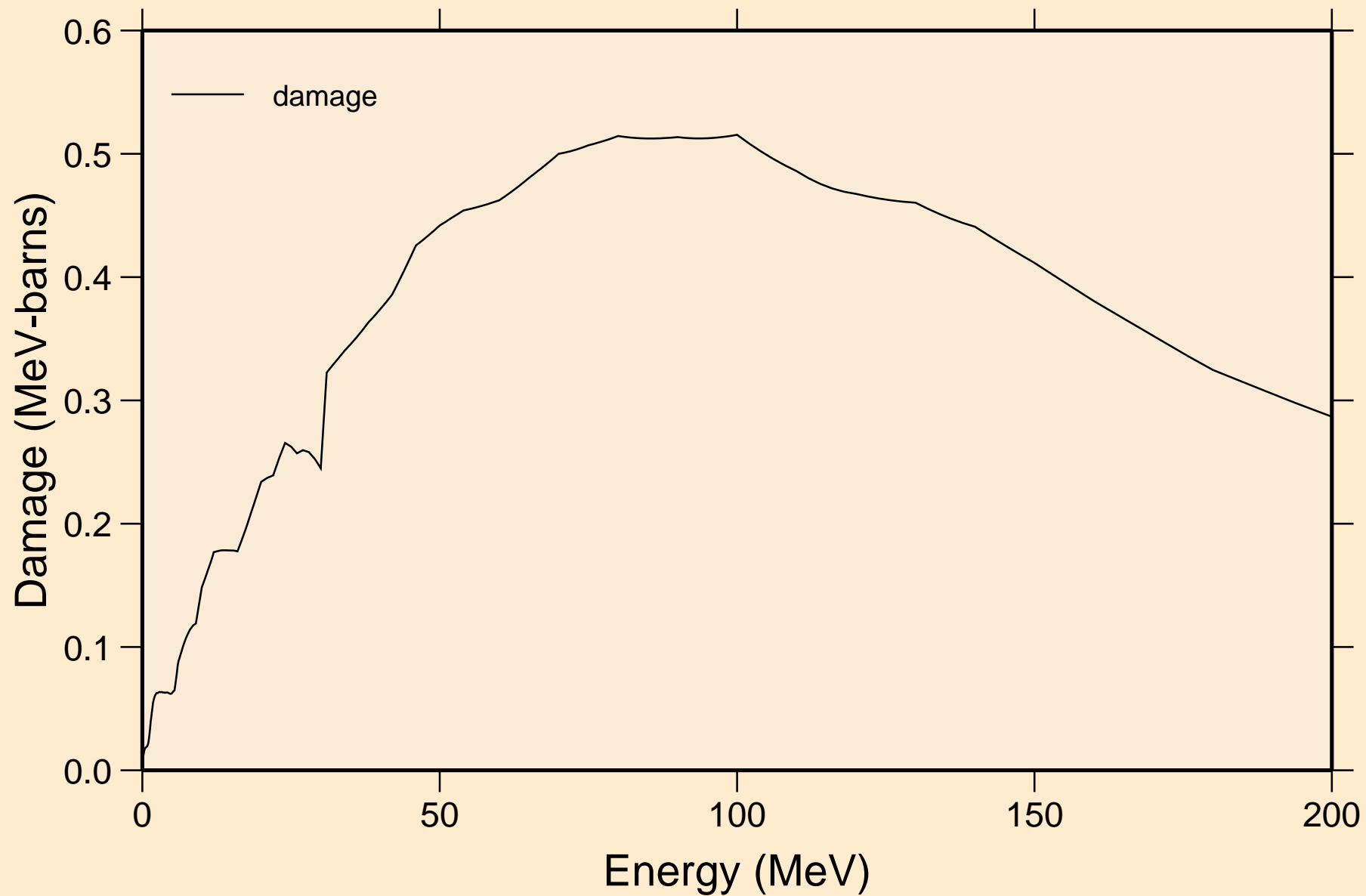

FR224 NEUTRON ACER TENDL-2019 LIBRARY; T=293.16K
Non-threshold reactions

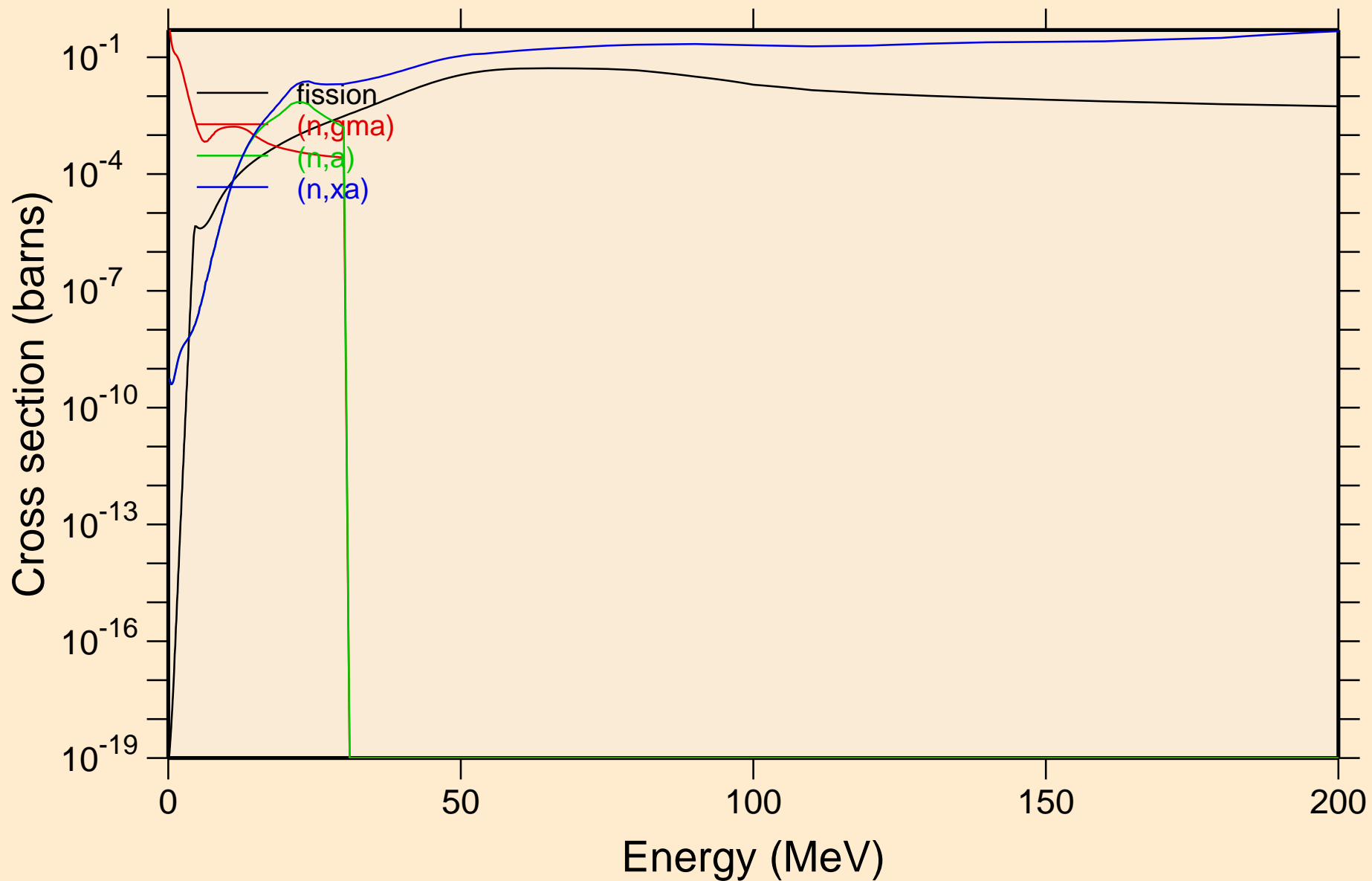

FR224 NEUTRON ACER TENDL-2019 LIBRARY; T=293.16K
Inelastic levels

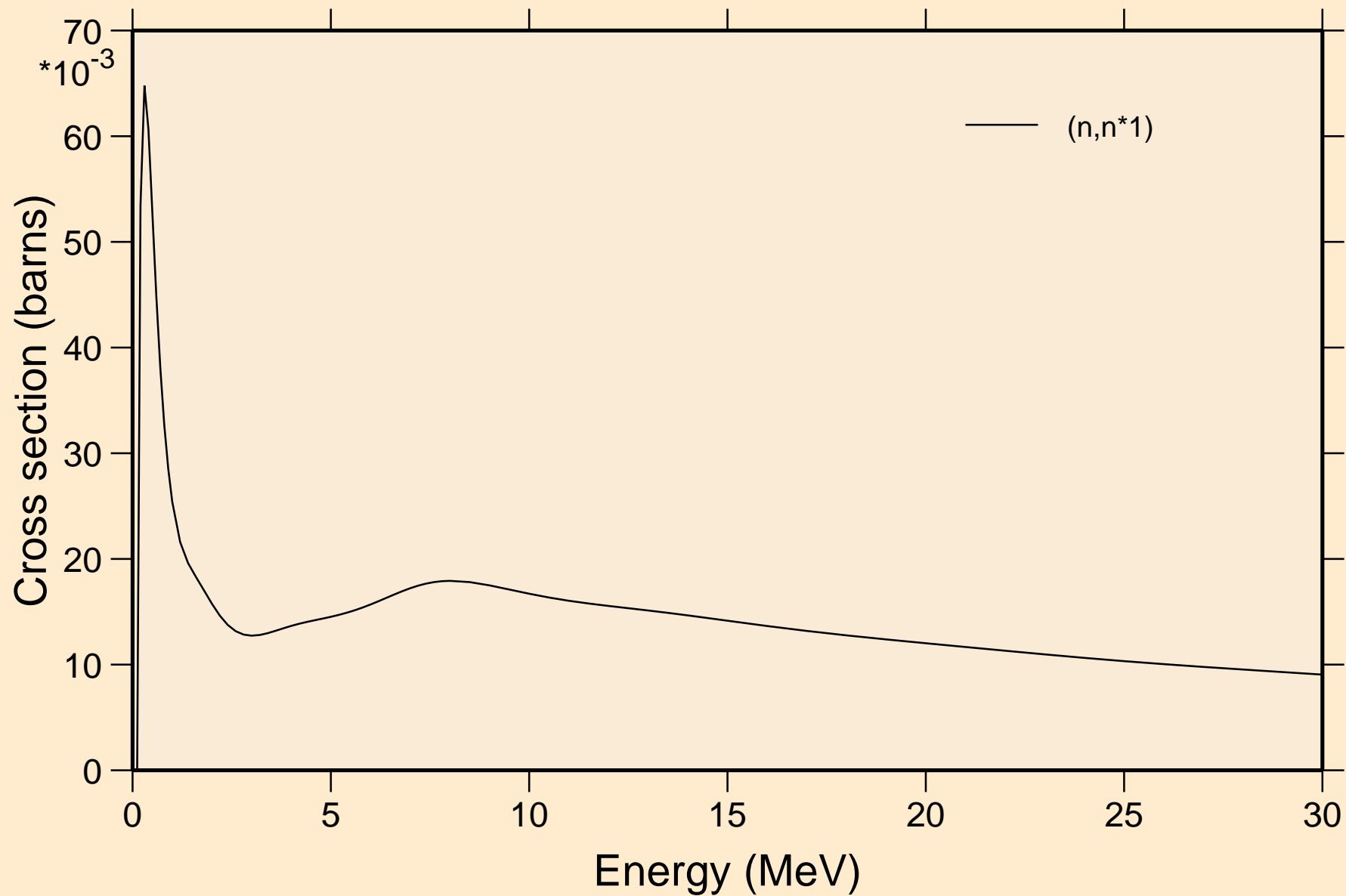

FR224 NEUTRON ACER TENDL-2019 LIBRARY; T=293.16K
Threshold reactions

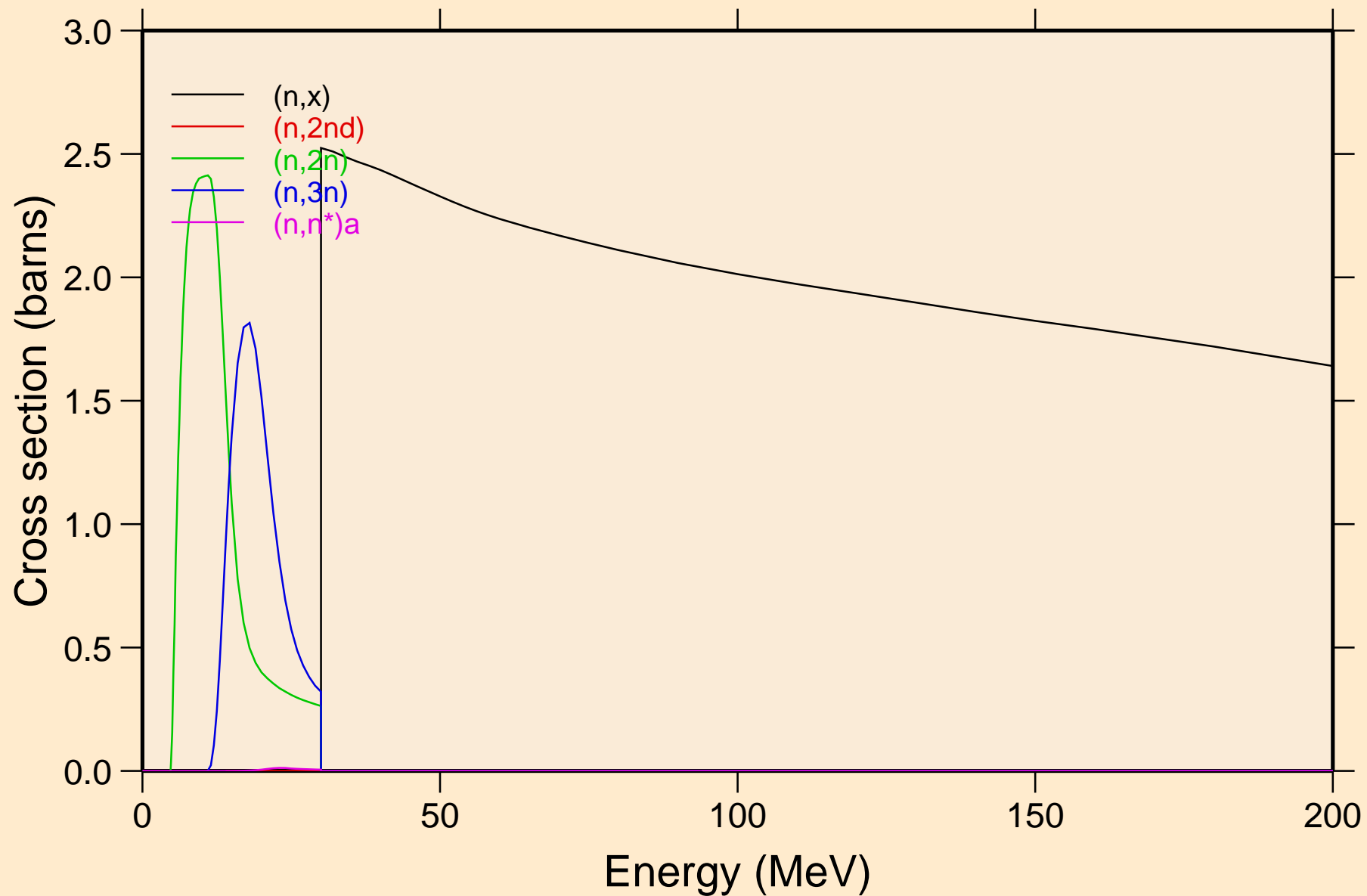

FR224 NEUTRON ACER TENDL-2019 LIBRARY; T=293.16K
Threshold reactions

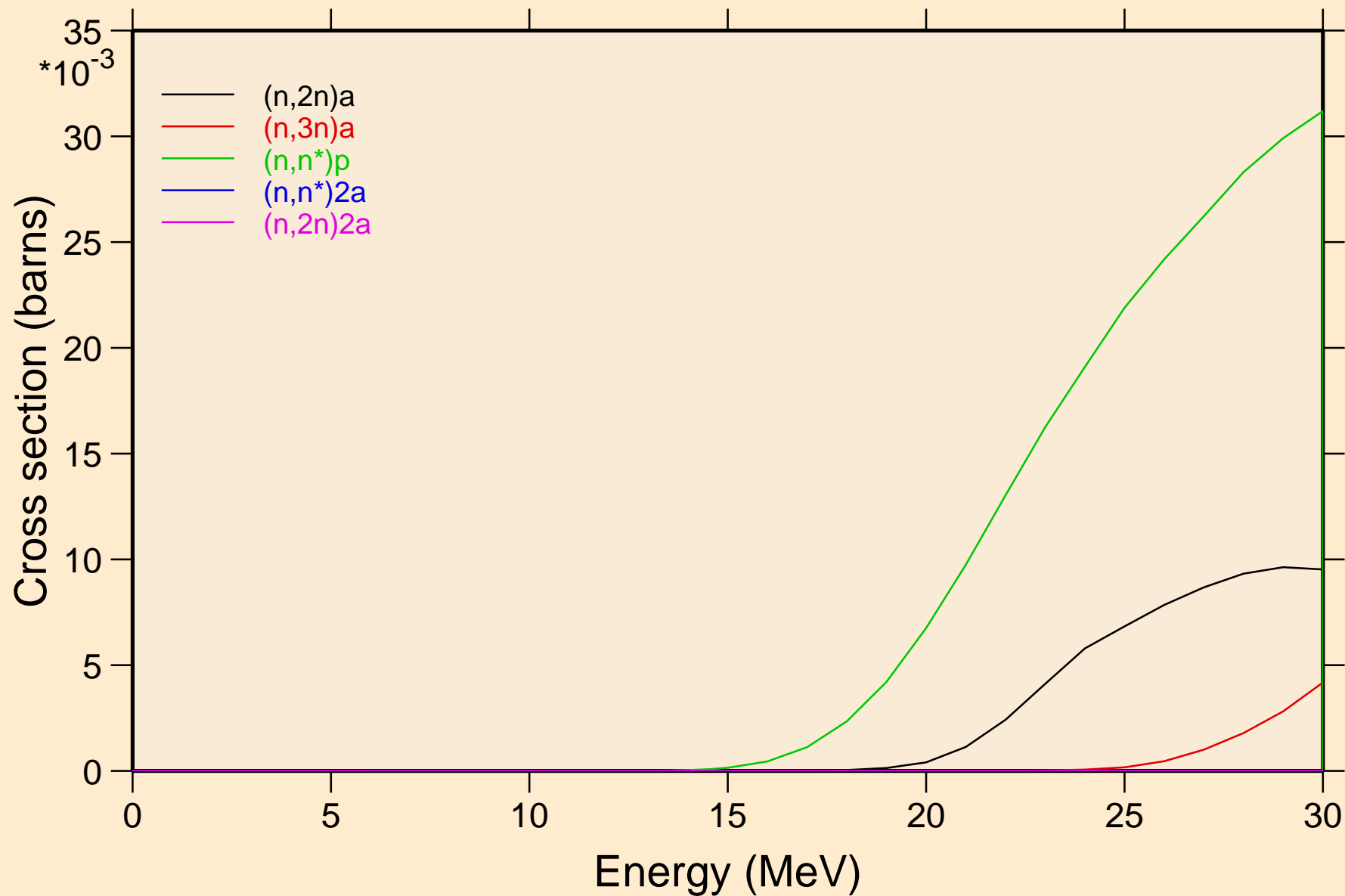

FR224 NEUTRON ACER TENDL-2019 LIBRARY; T=293.16K
Threshold reactions

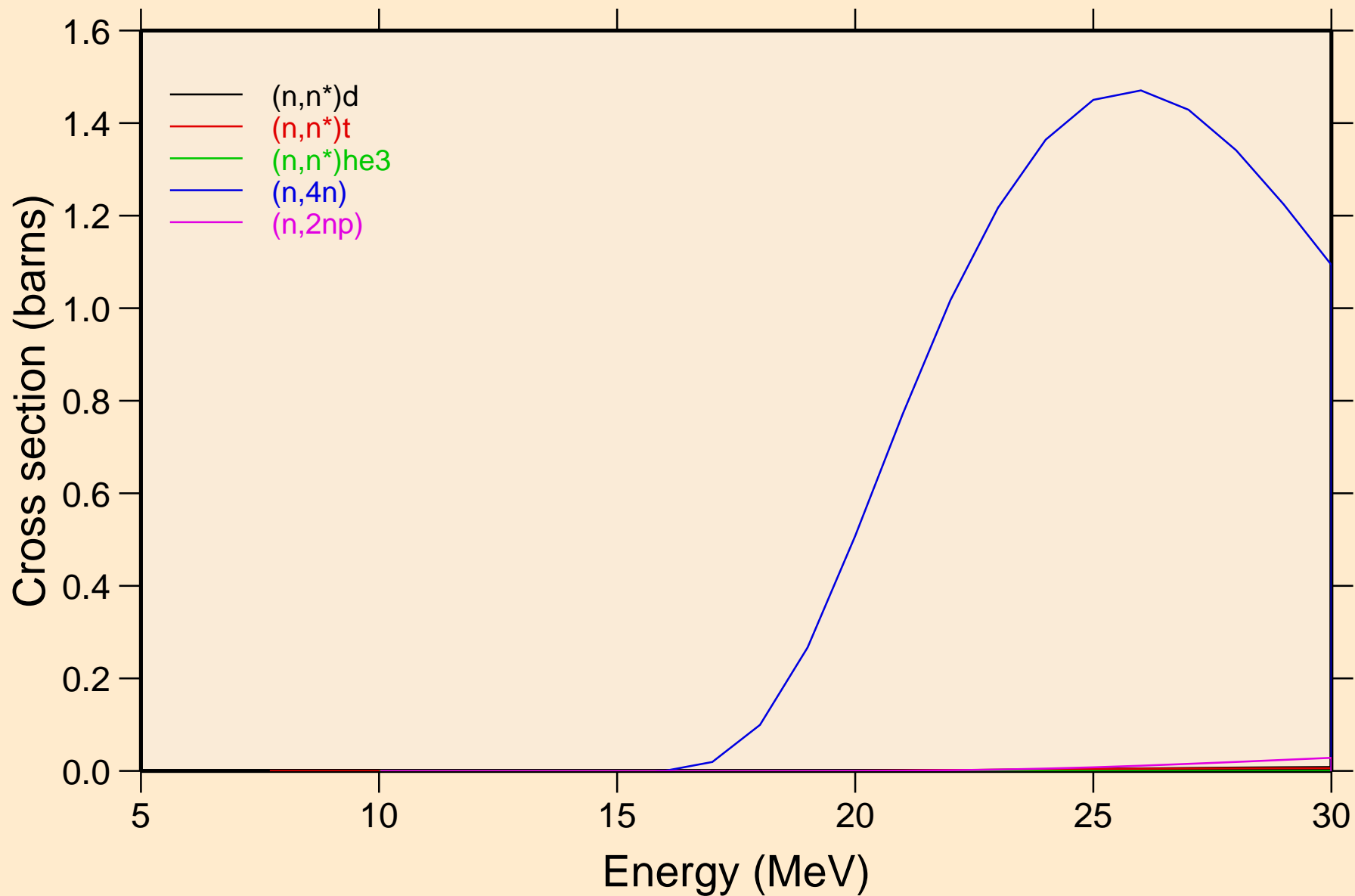

FR224 NEUTRON ACER TENDL-2019 LIBRARY; T=293.16K
Threshold reactions

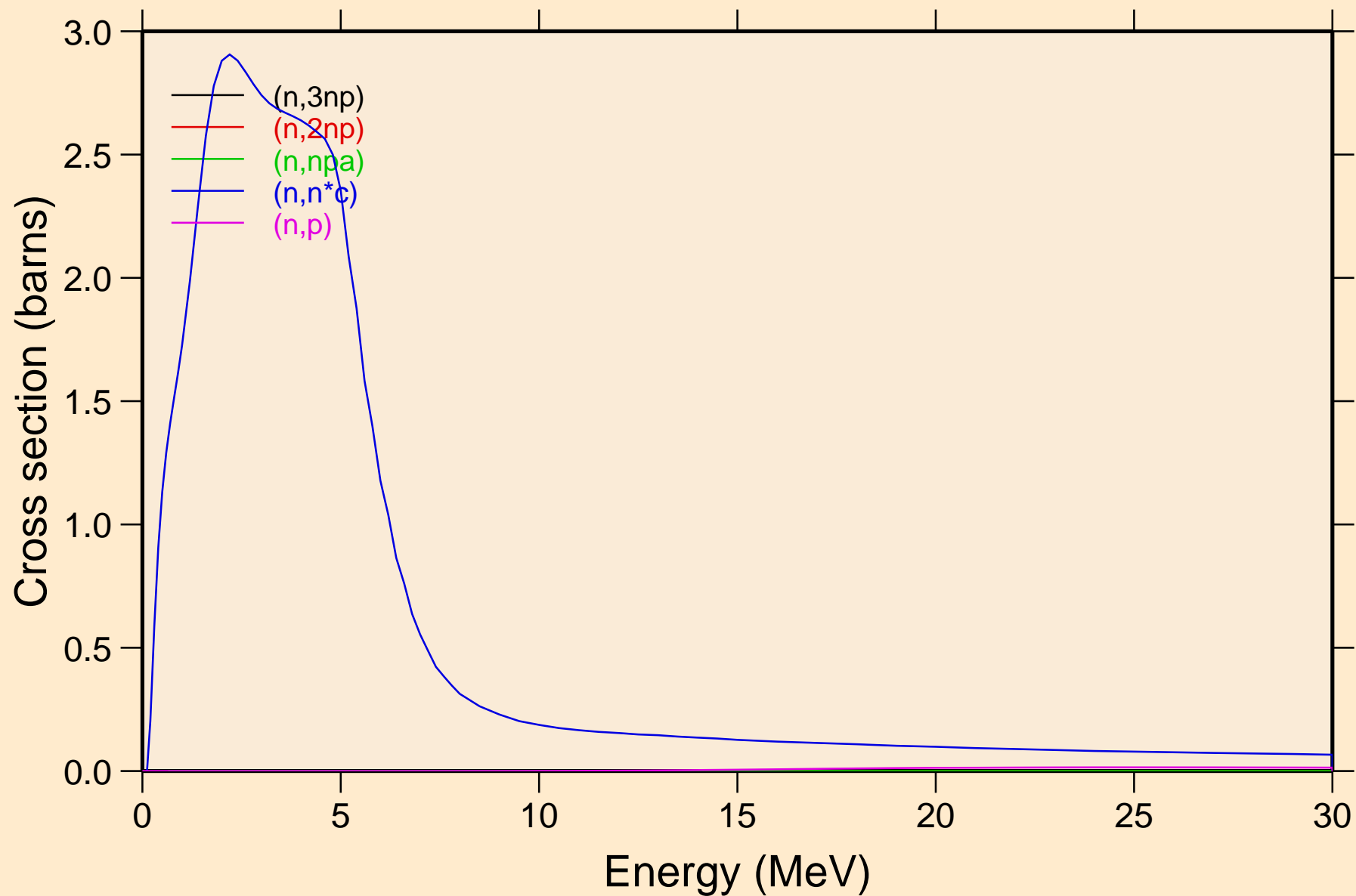

FR224 NEUTRON ACER TENDL-2019 LIBRARY; T=293.16K
Threshold reactions

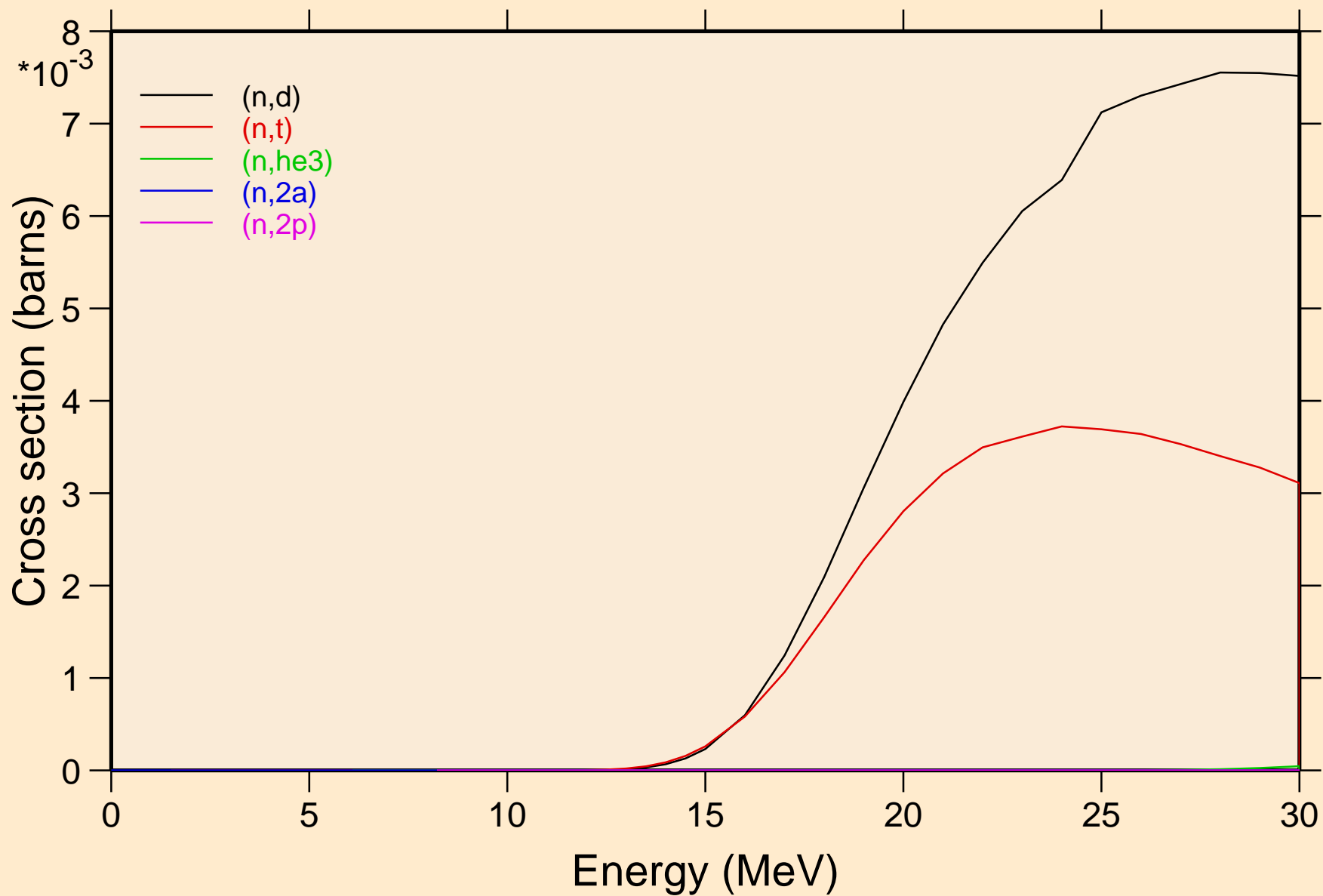

FR224 NEUTRON ACER TENDL-2019 LIBRARY; T=293.16K
Threshold reactions

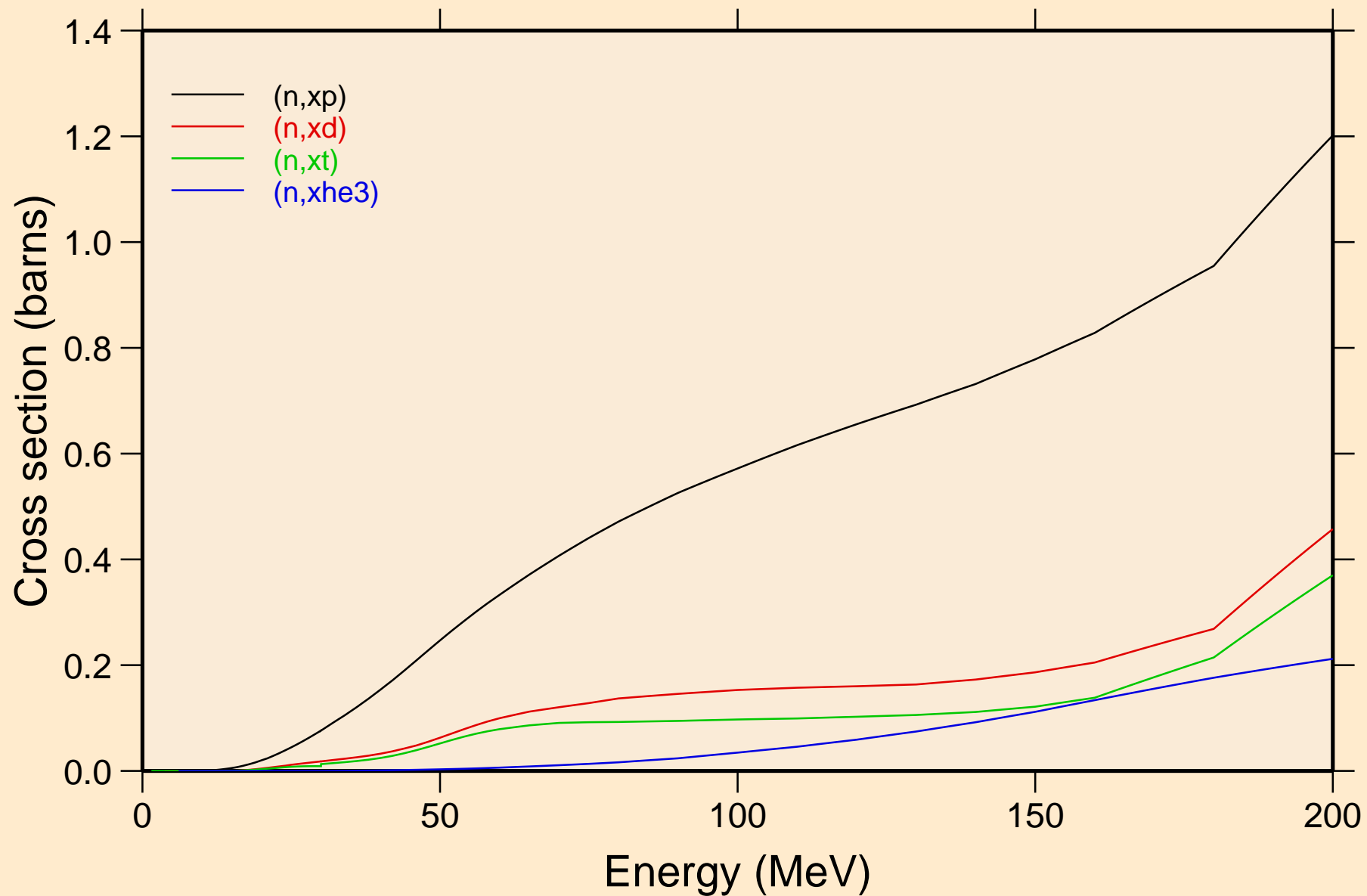

FR224 NEUTRON ACER TENDL-2019 LIBRARY; T=293.16K
angular distribution for elastic

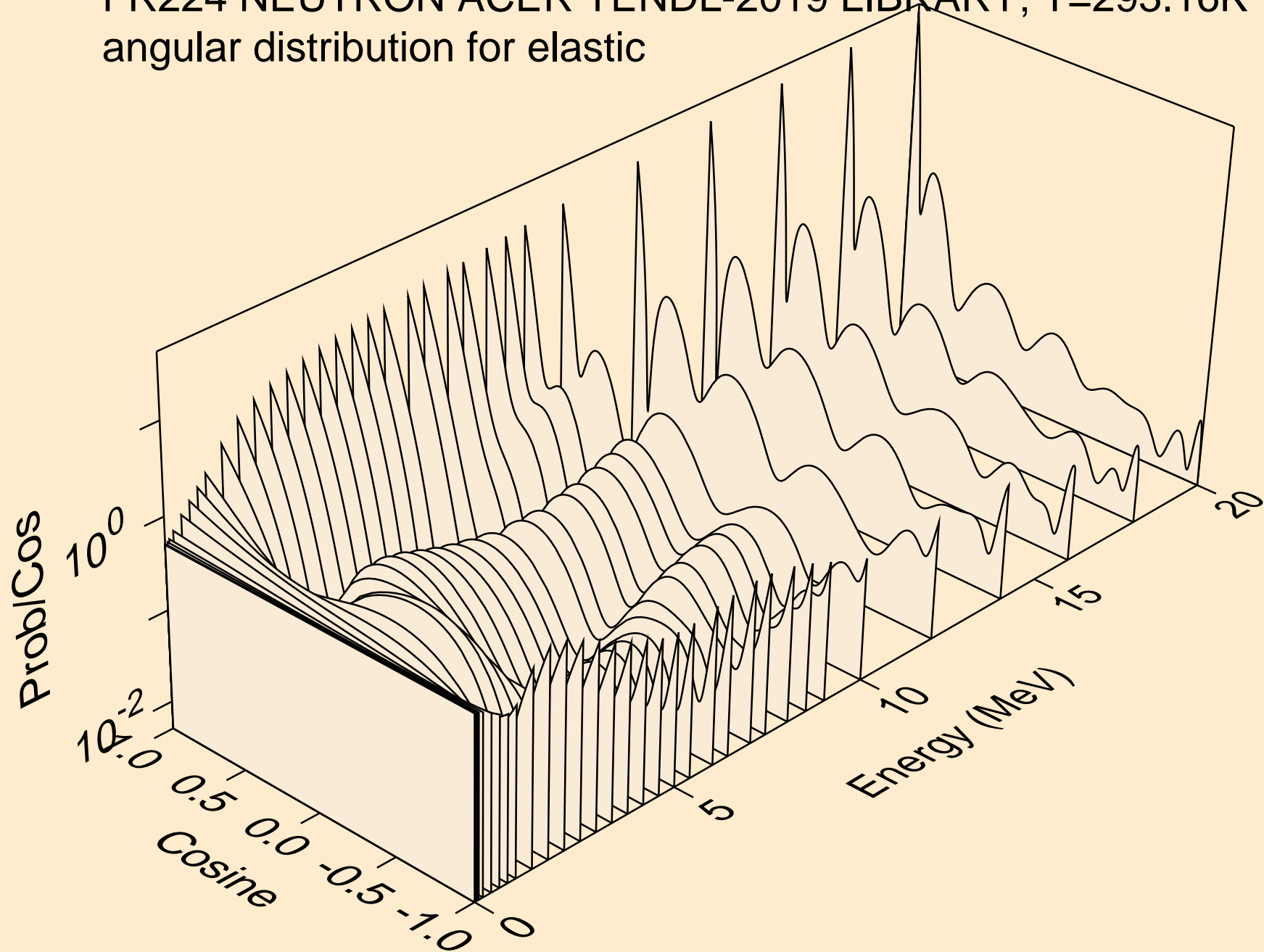

FR224 NEUTRON ACER TENDL-2019 LIBRARY; T=293.16K
angular distribution for elastic

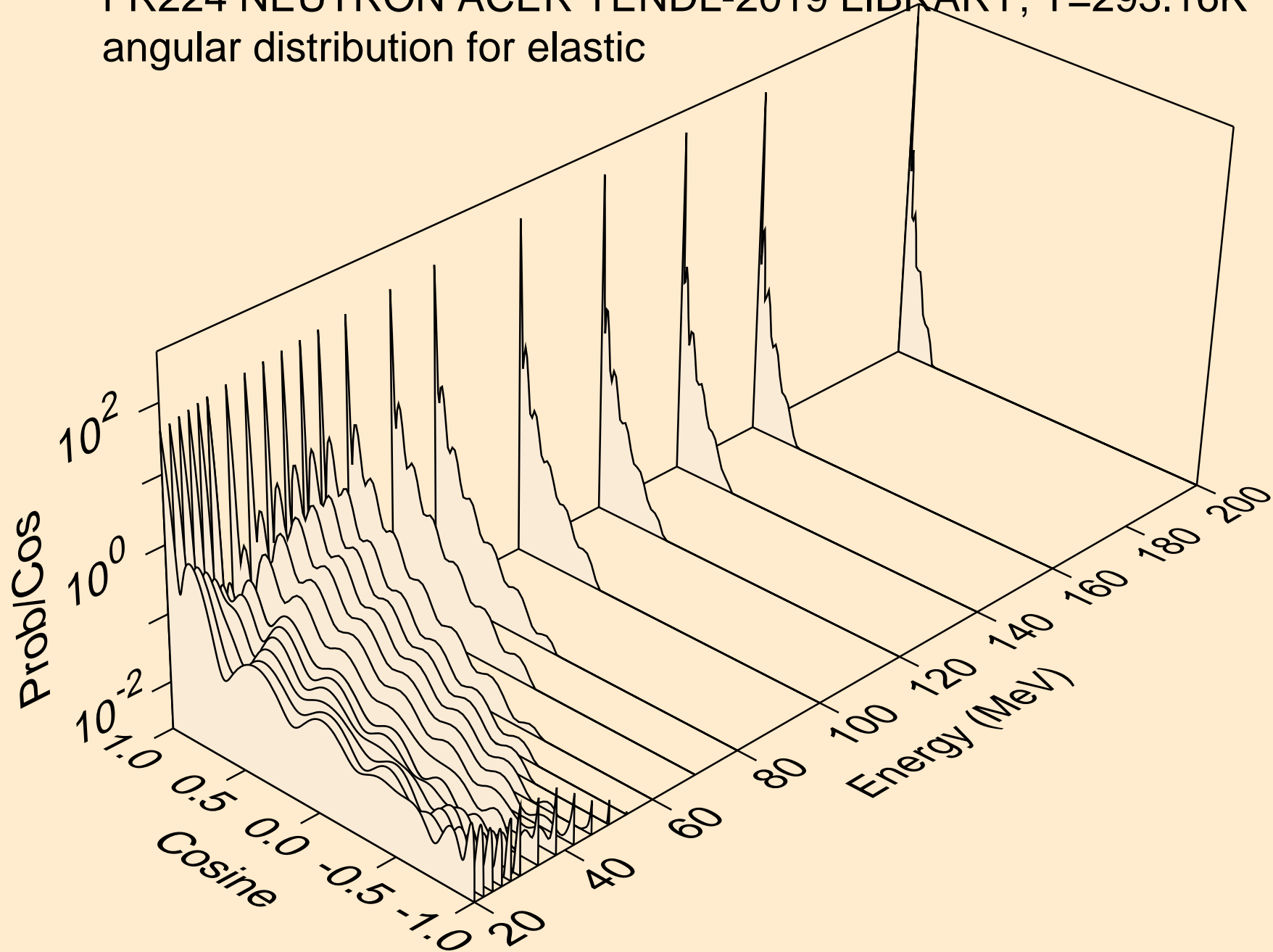

FR224 NEUTRON ACER TENDL-2019 LIBRARY; T=293.16K
angular distribution for (n,n*1)

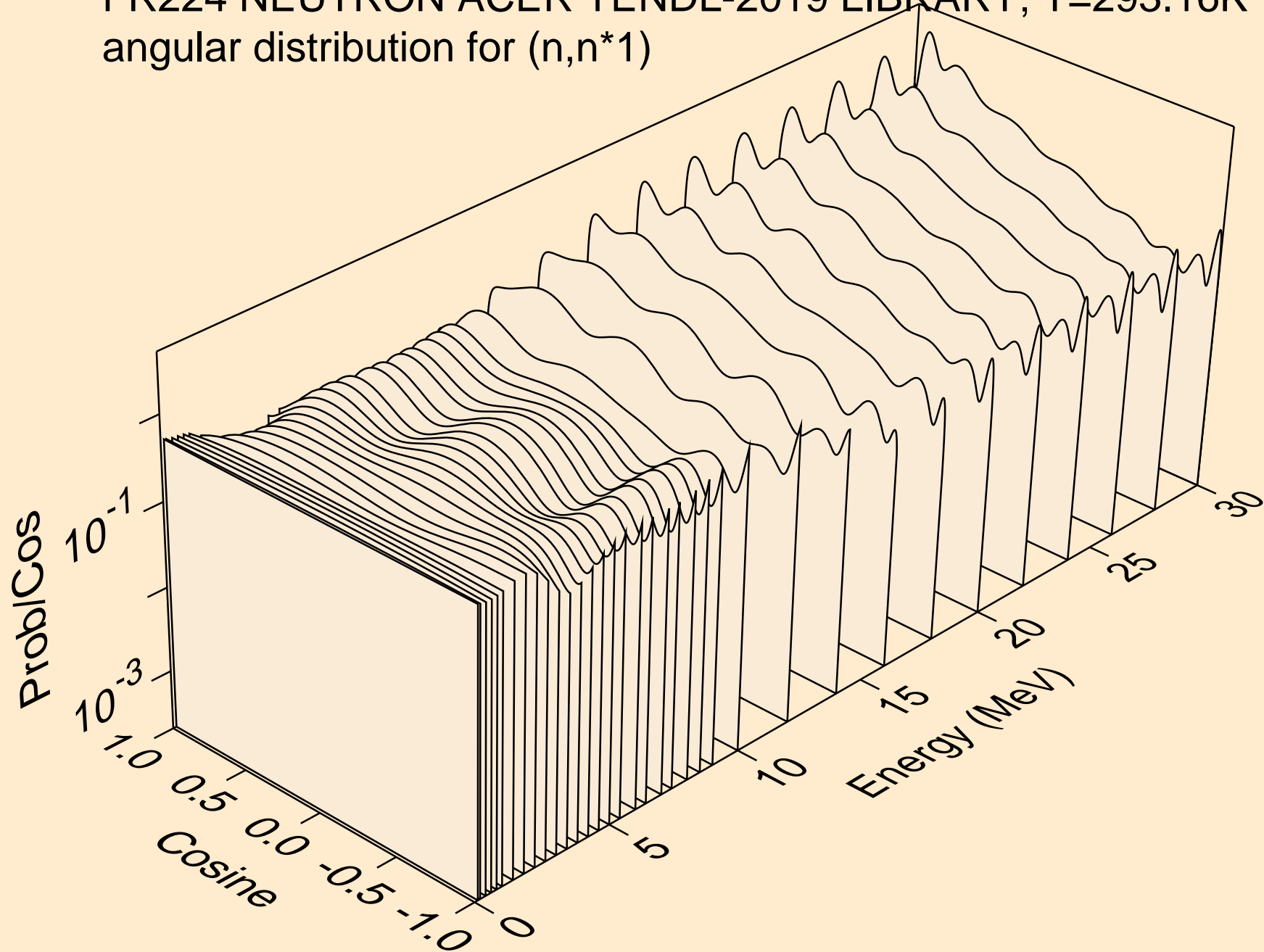

FR224 NEUTRON ACER TENDL-2019 LIBRARY; T=293.16K
Total fission nubar

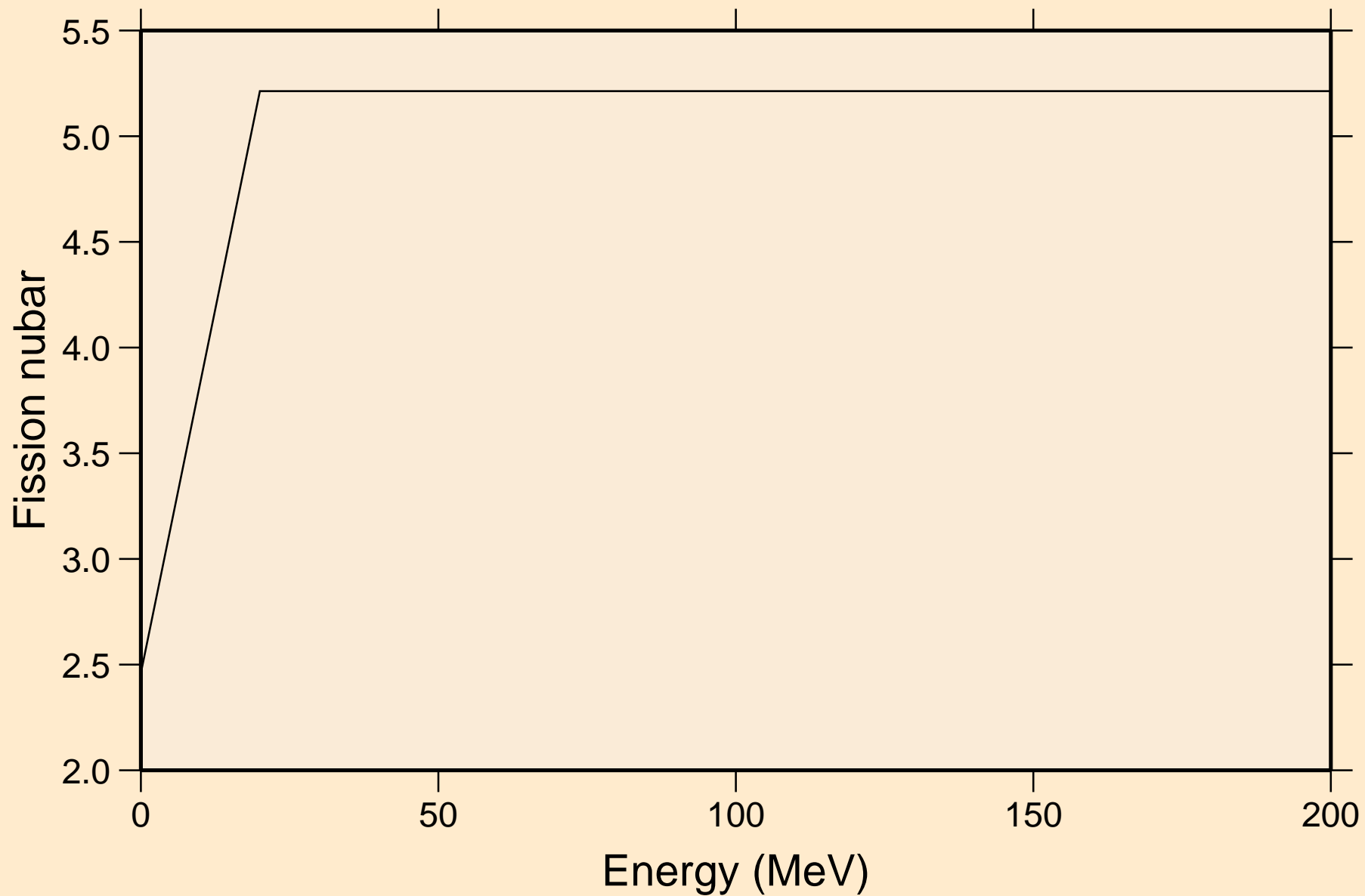

FR224 NEUTRON ACER TENDL-2019 LIBRARY; T=293.16K
Neutron emission for (n,x)

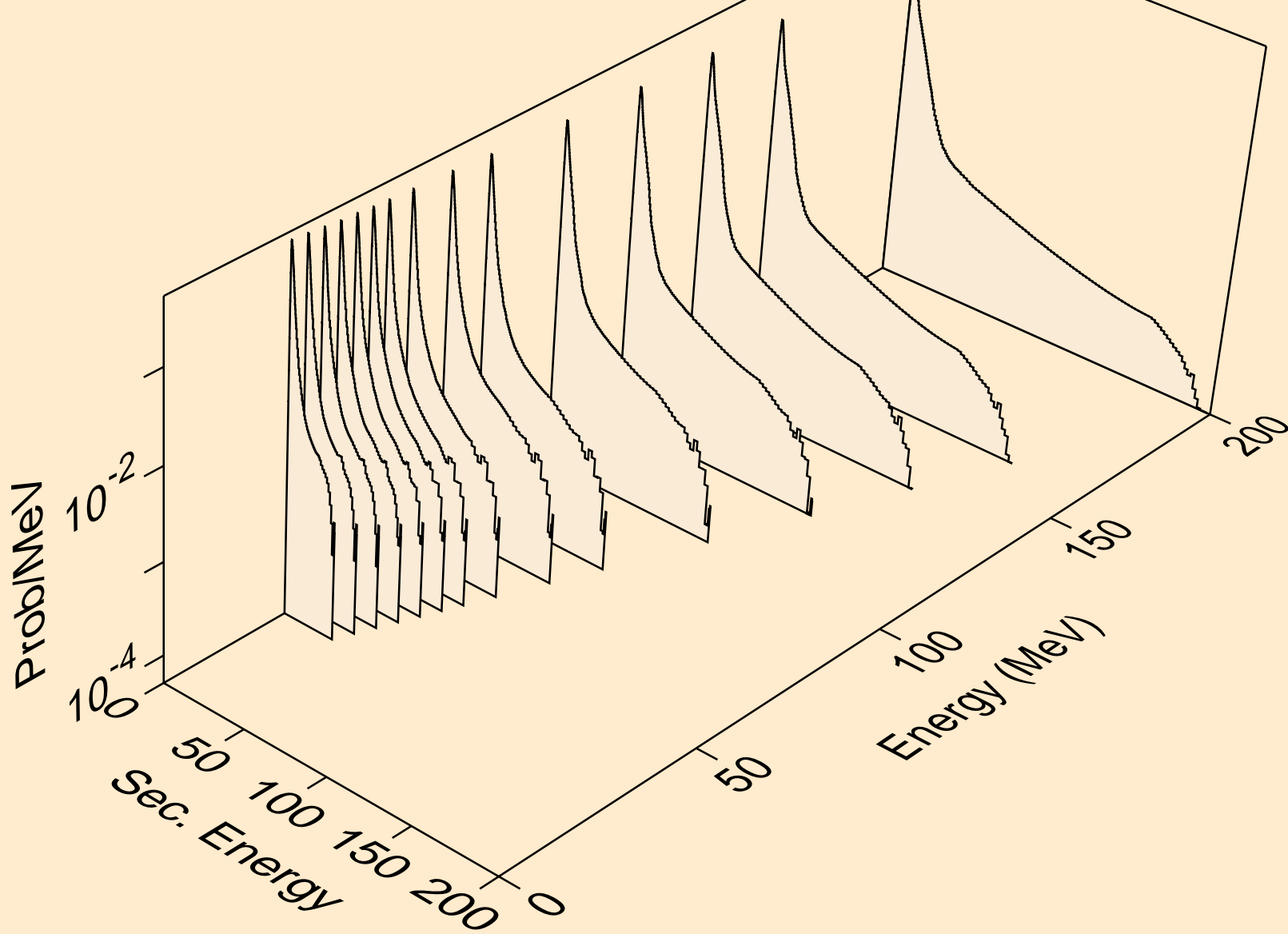

FR224 NEUTRON ACER TENDL-2019 LIBRARY; T=293.16K
Neutron emission for (n,2nd)

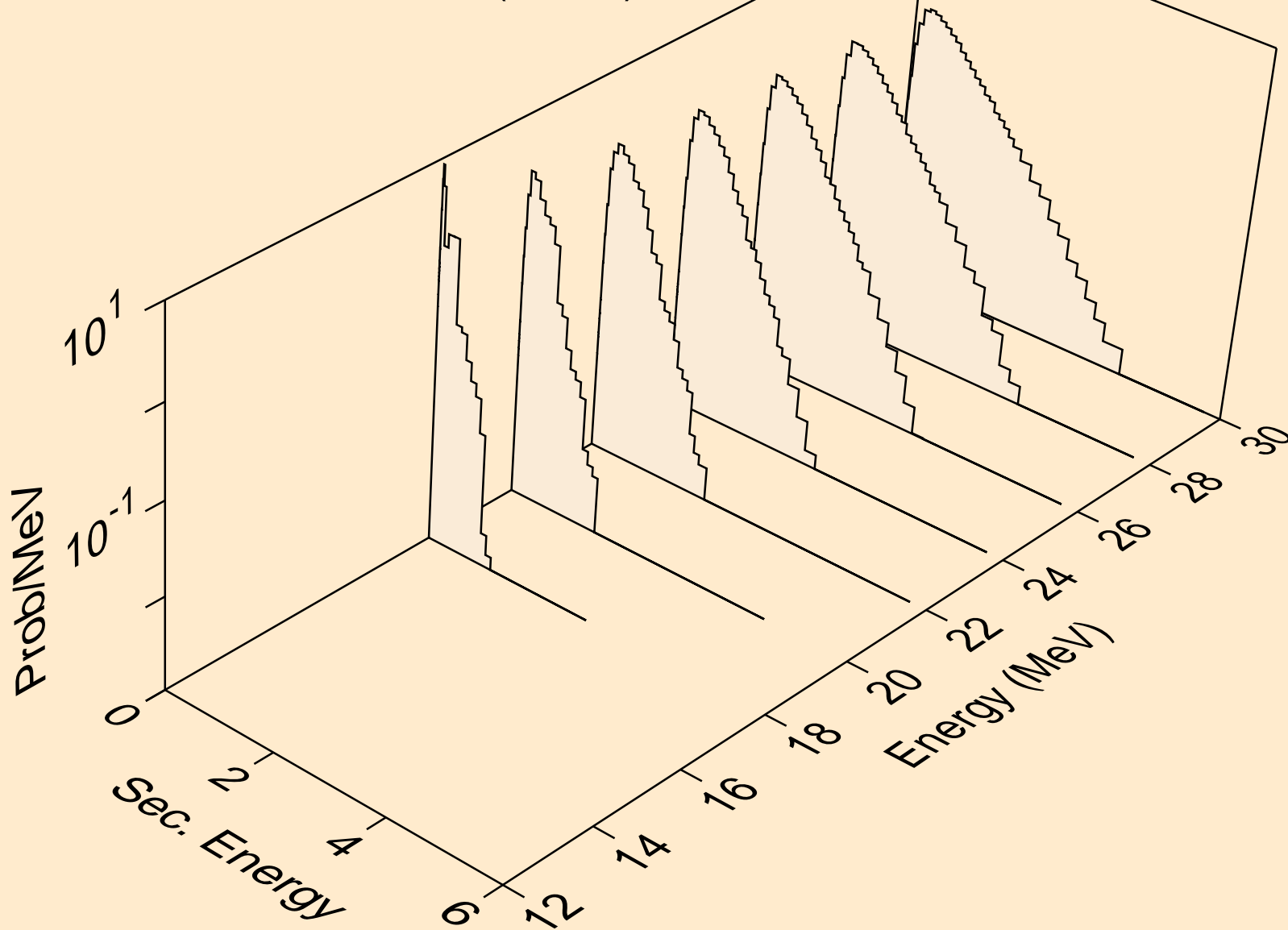

FR224 NEUTRON ACER TENDL-2019 LIBRARY; T=293.16K
Neutron emission for (n,2n)

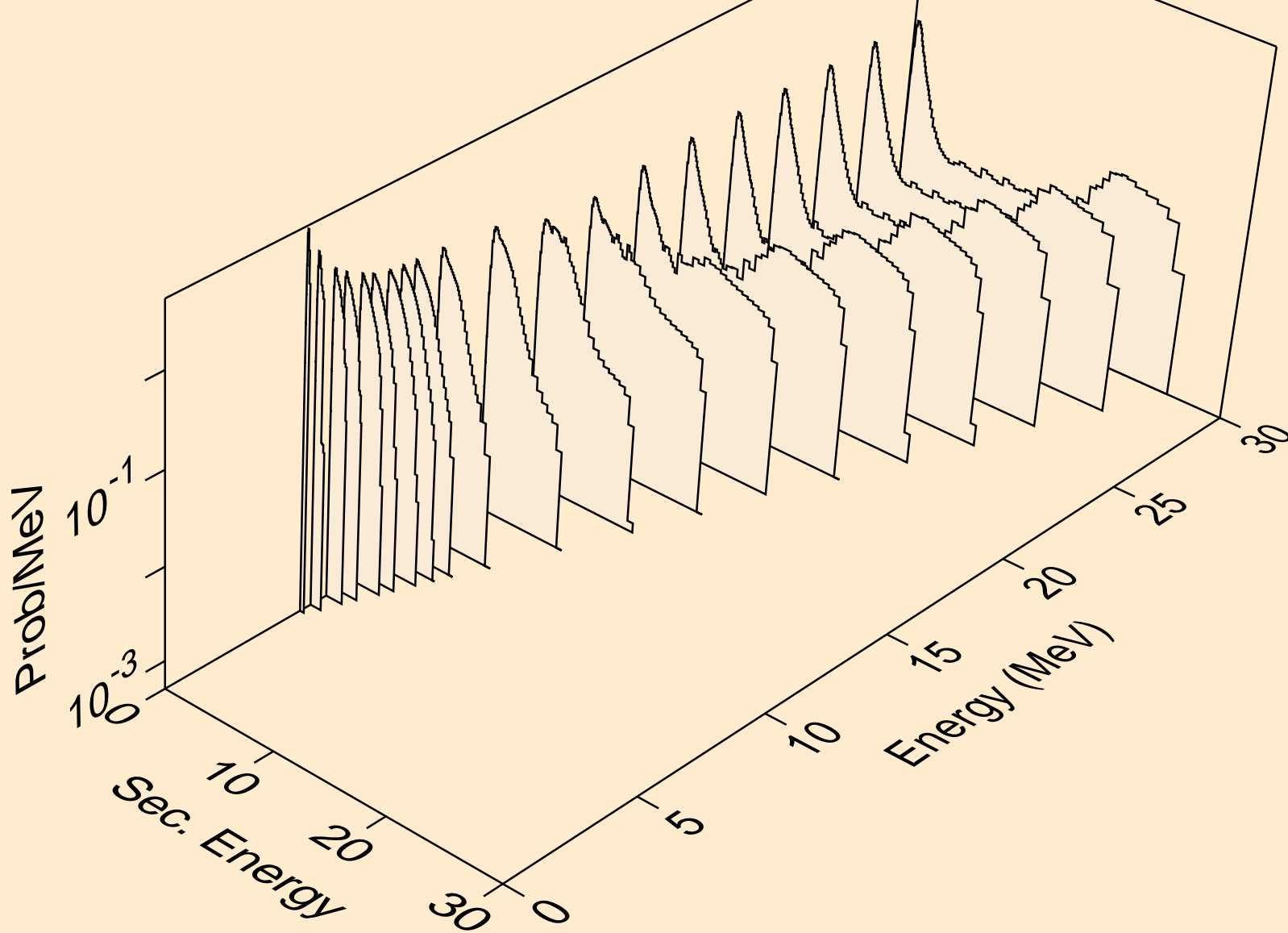

FR224 NEUTRON ACER TENDL-2019 LIBRARY; T=293.16K
Neutron emission for (n,3n)

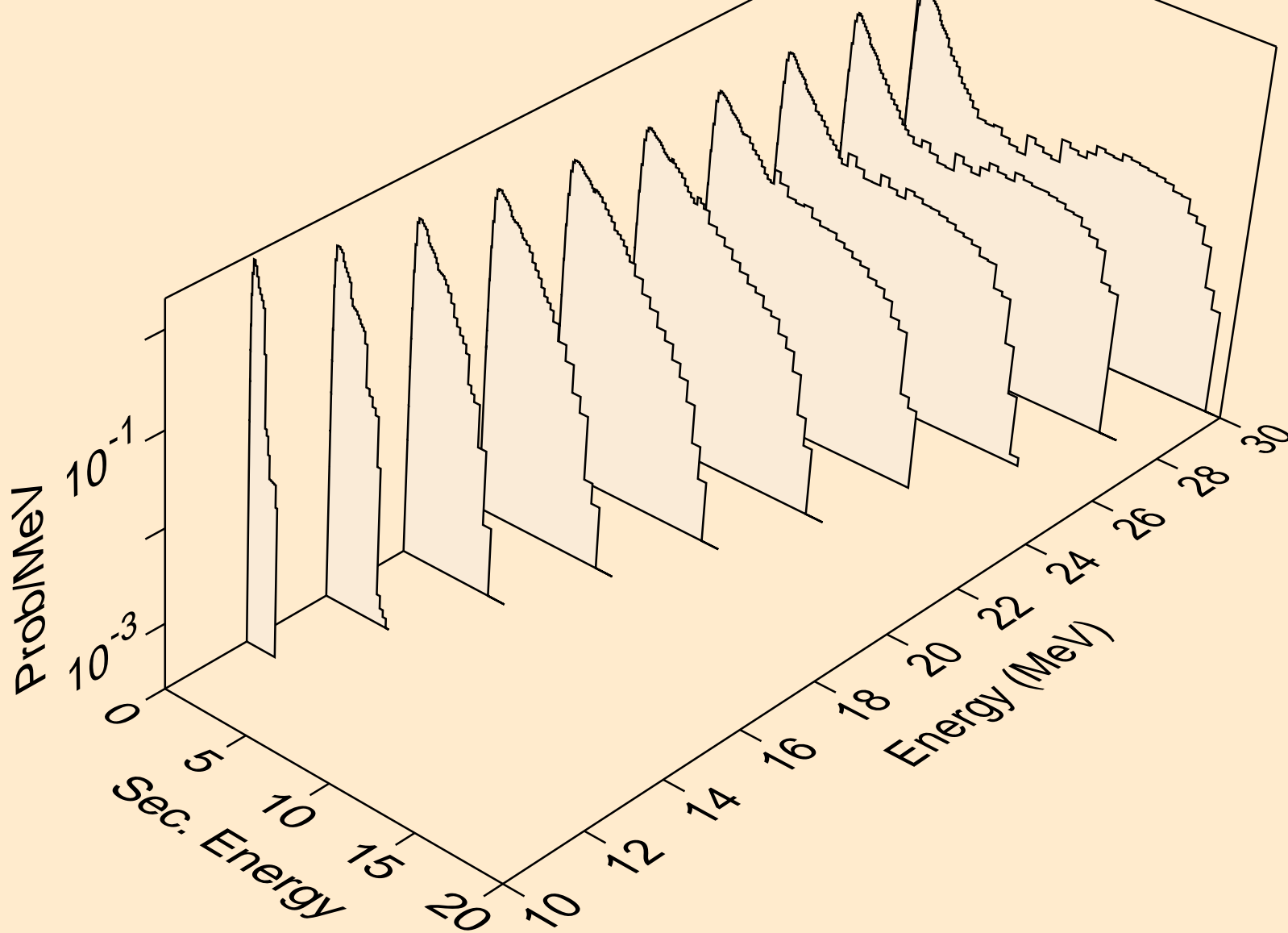

FR224 NEUTRON ACER TENDL-2019 LIBRARY; T=293.16K
Neutron emission for fission

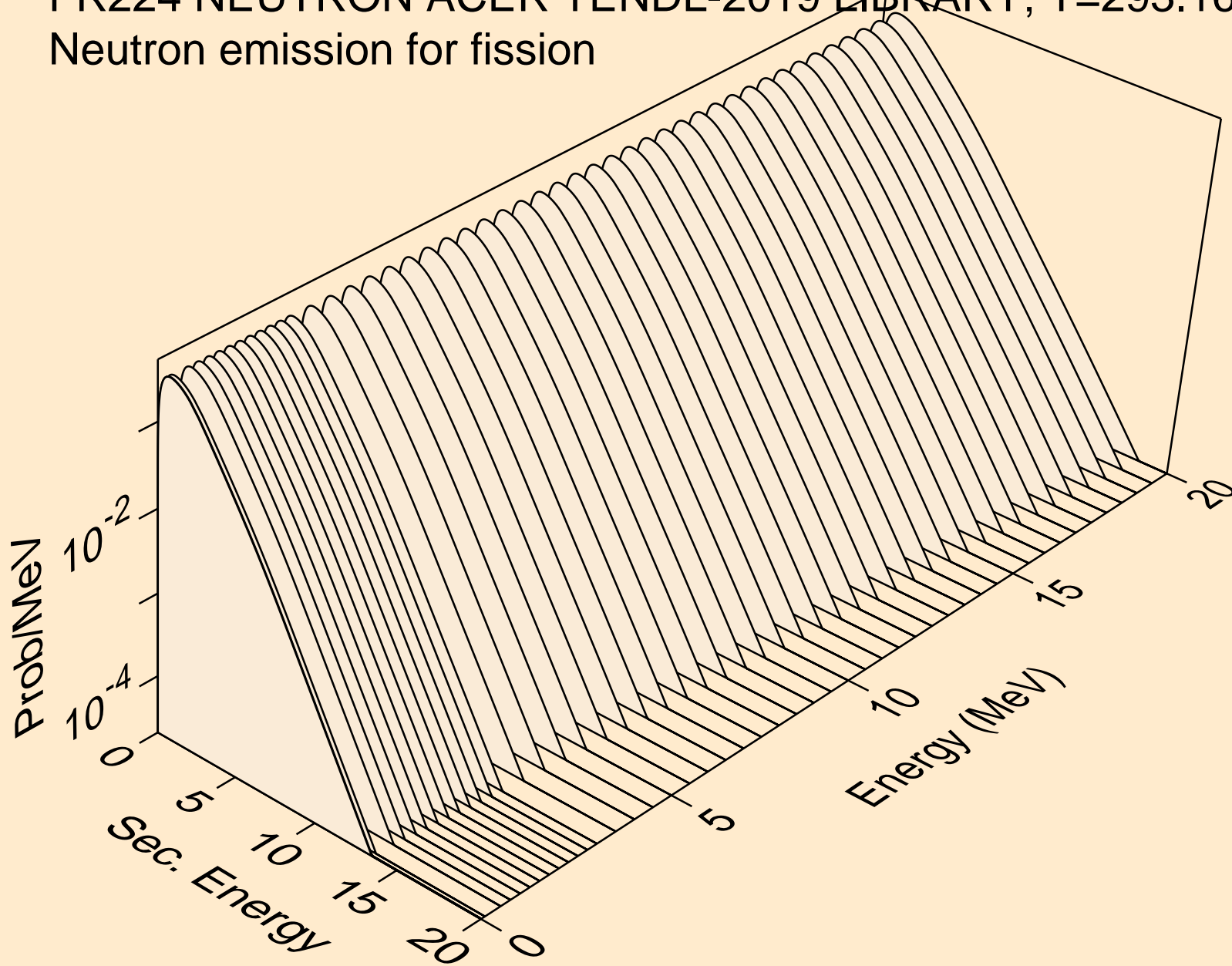

FR224 NEUTRON ACER TENDL-2019 LIBRARY; T=293.16K
Neutron emission for (n,n*)a

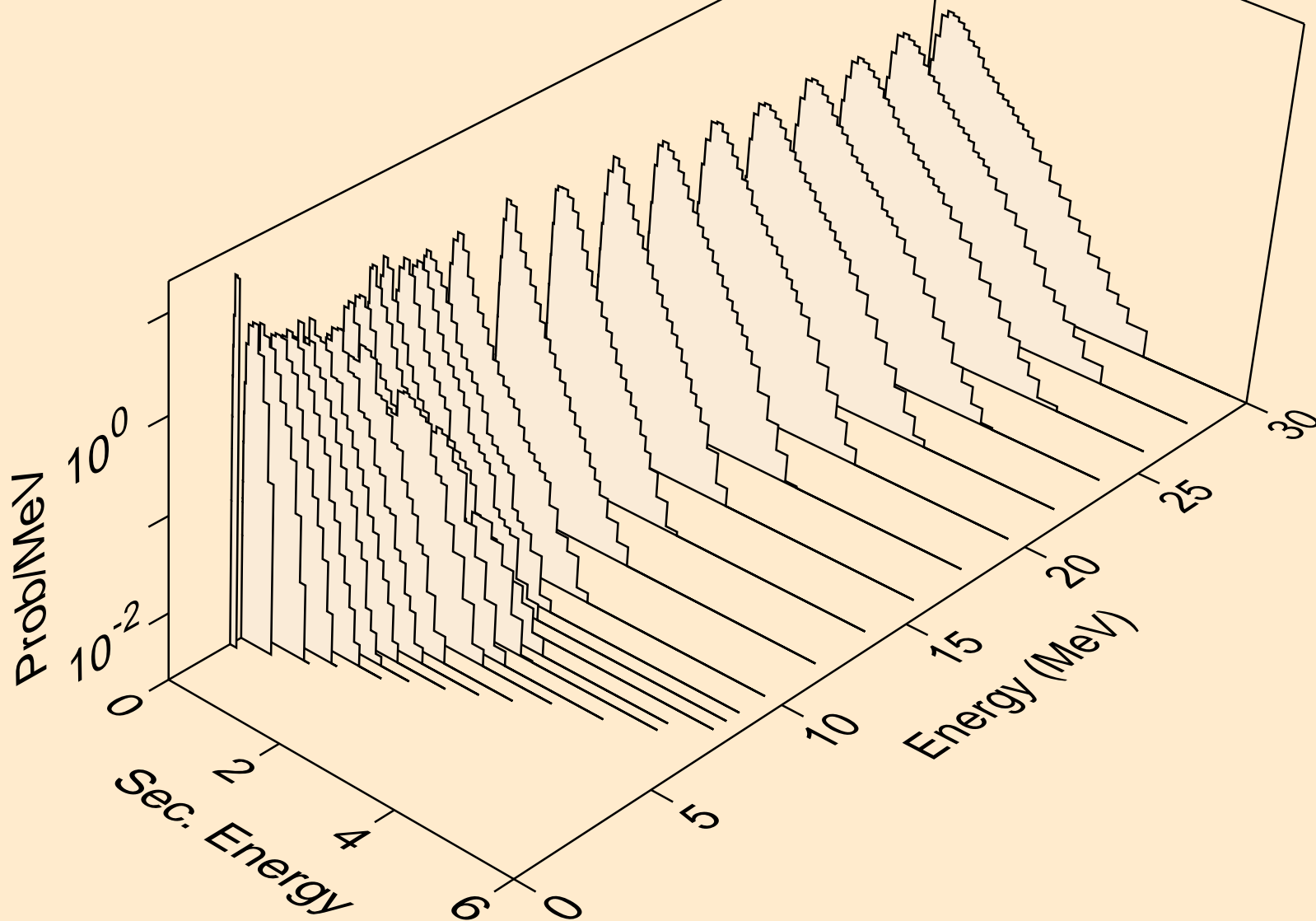

FR224 NEUTRON ACER TENDL-2019 LIBRARY; T=293.16K
Neutron emission for (n,2n)a

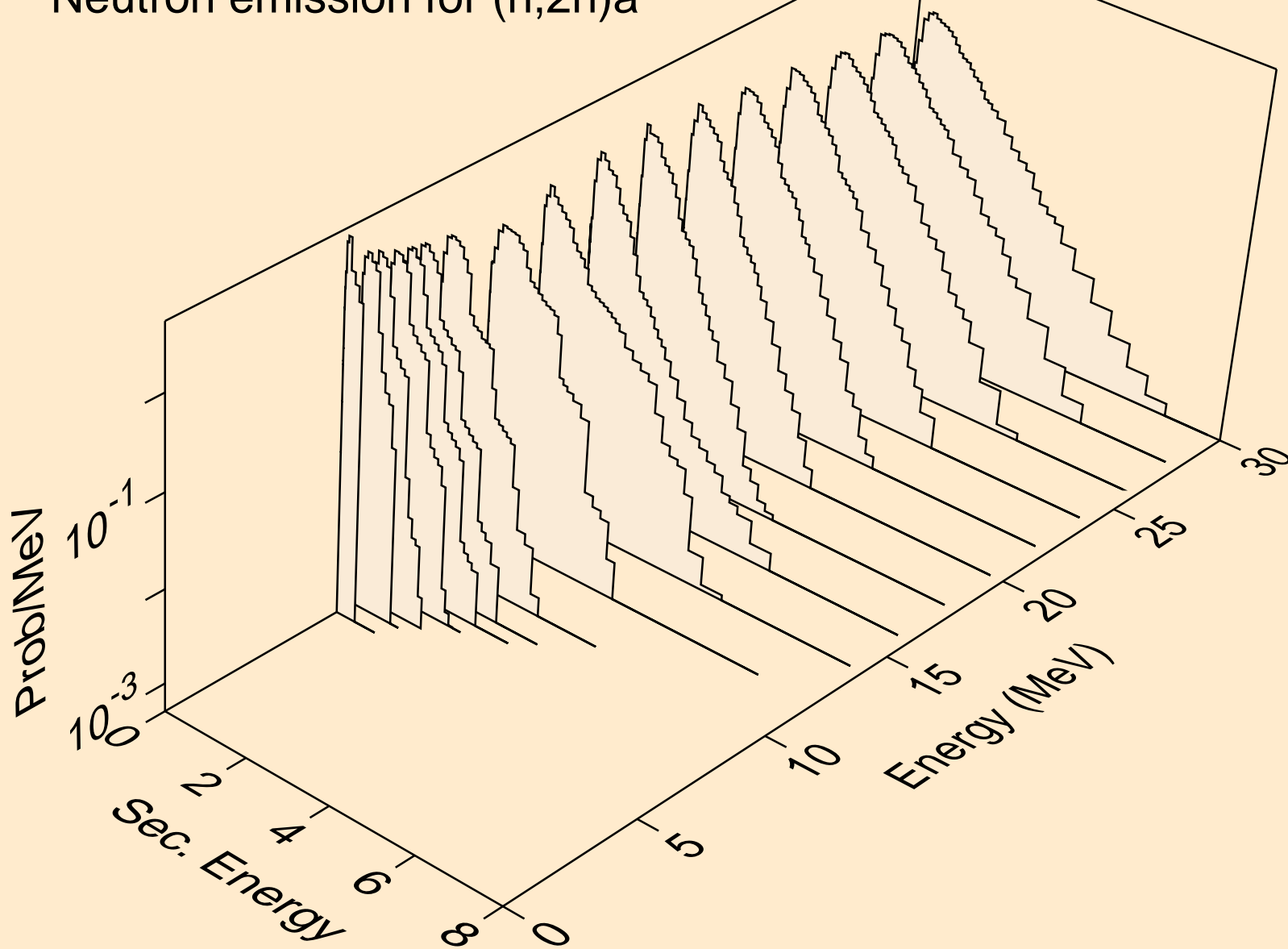

FR224 NEUTRON ACER TENDL-2019 LIBRARY; T=293.16K
Neutron emission for (n,3n)a

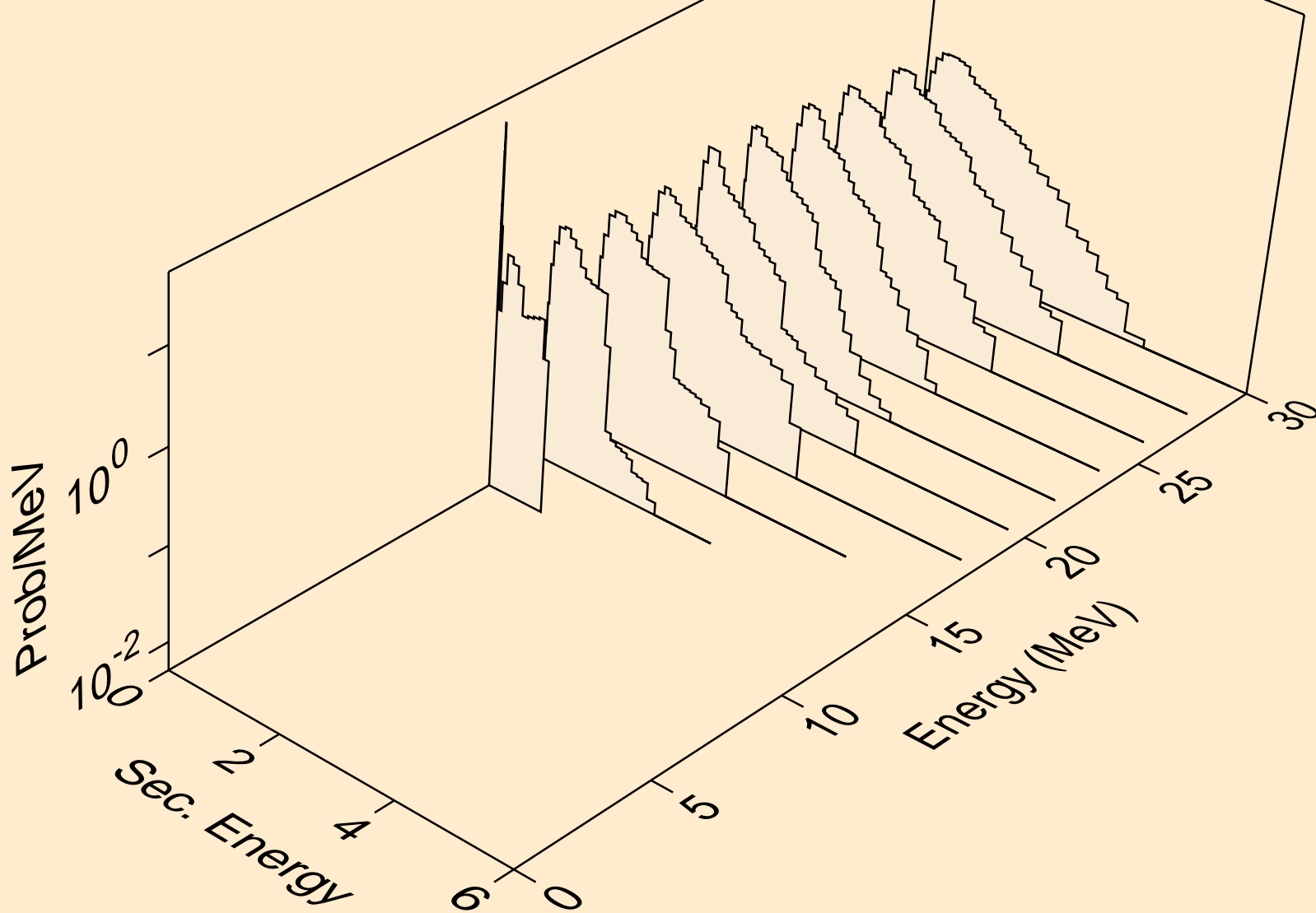

FR224 NEUTRON ACER TENDL-2019 LIBRARY; T=293.16K
Neutron emission for (n,n*)p

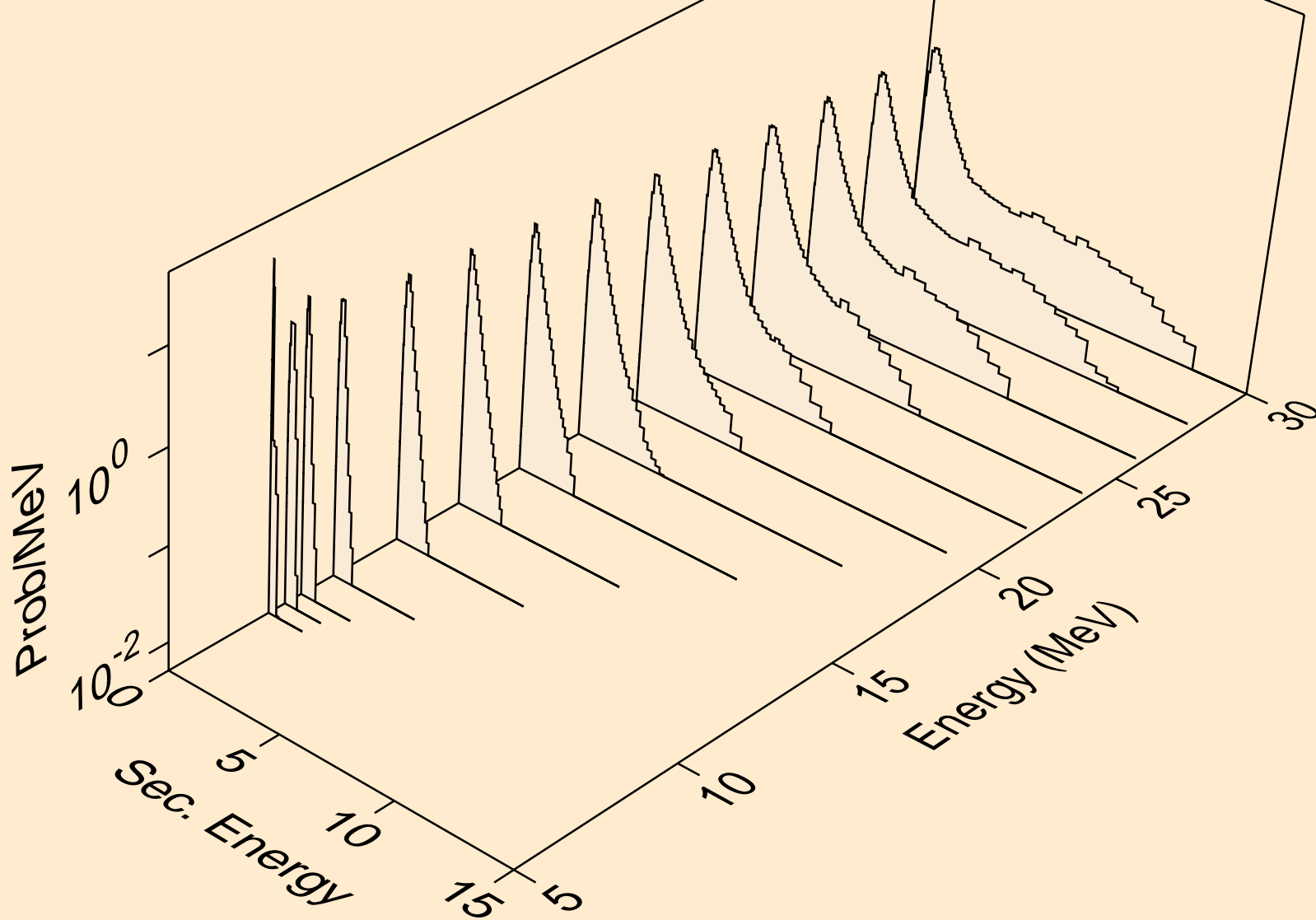

FR224 NEUTRON ACER TENDL-2019 LIBRARY; T=293.16K
Neutron emission for (n,n*)2a

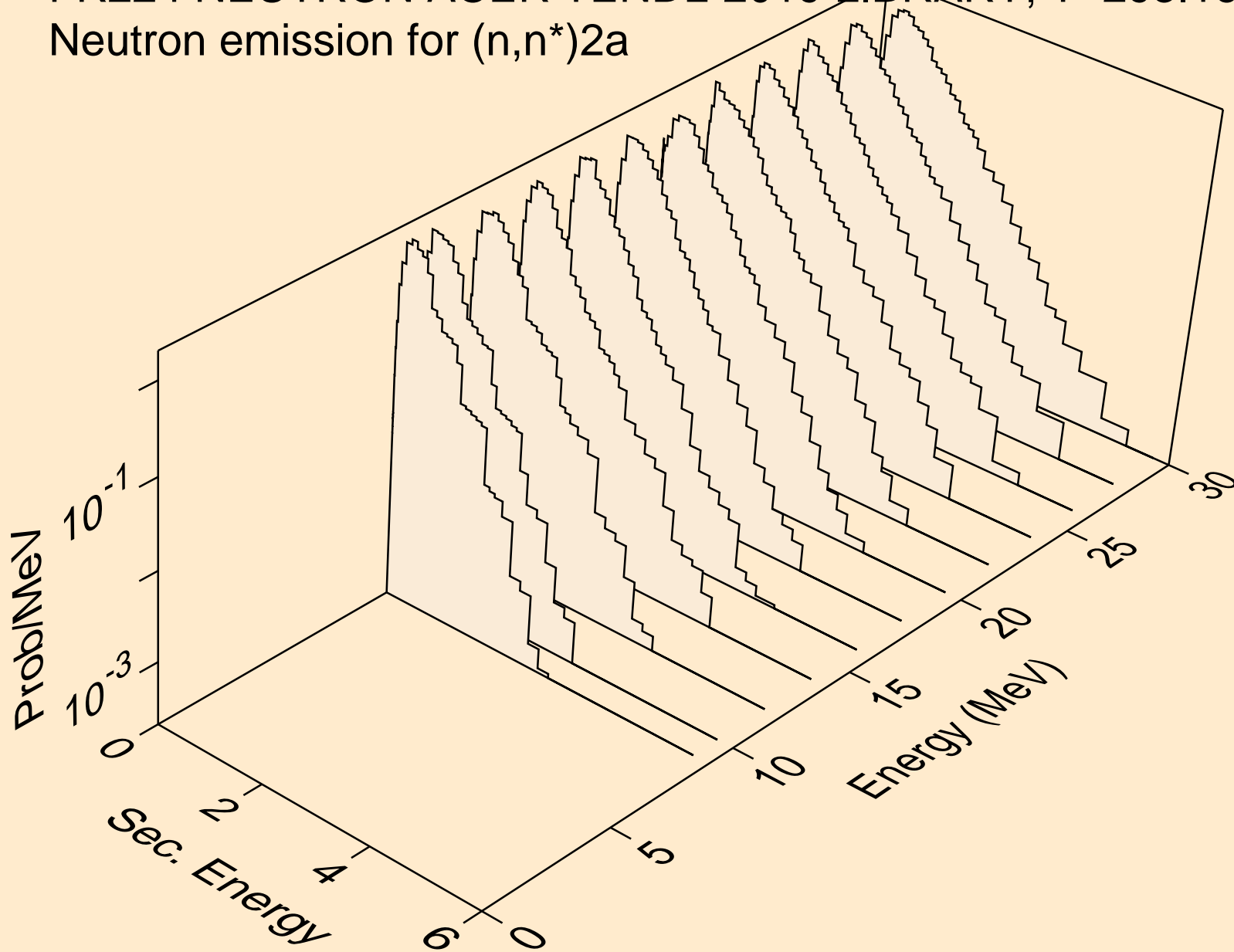

FR224 NEUTRON ACER TENDL-2019 LIBRARY; T=293.16K
Neutron emission for (n,2n)2a

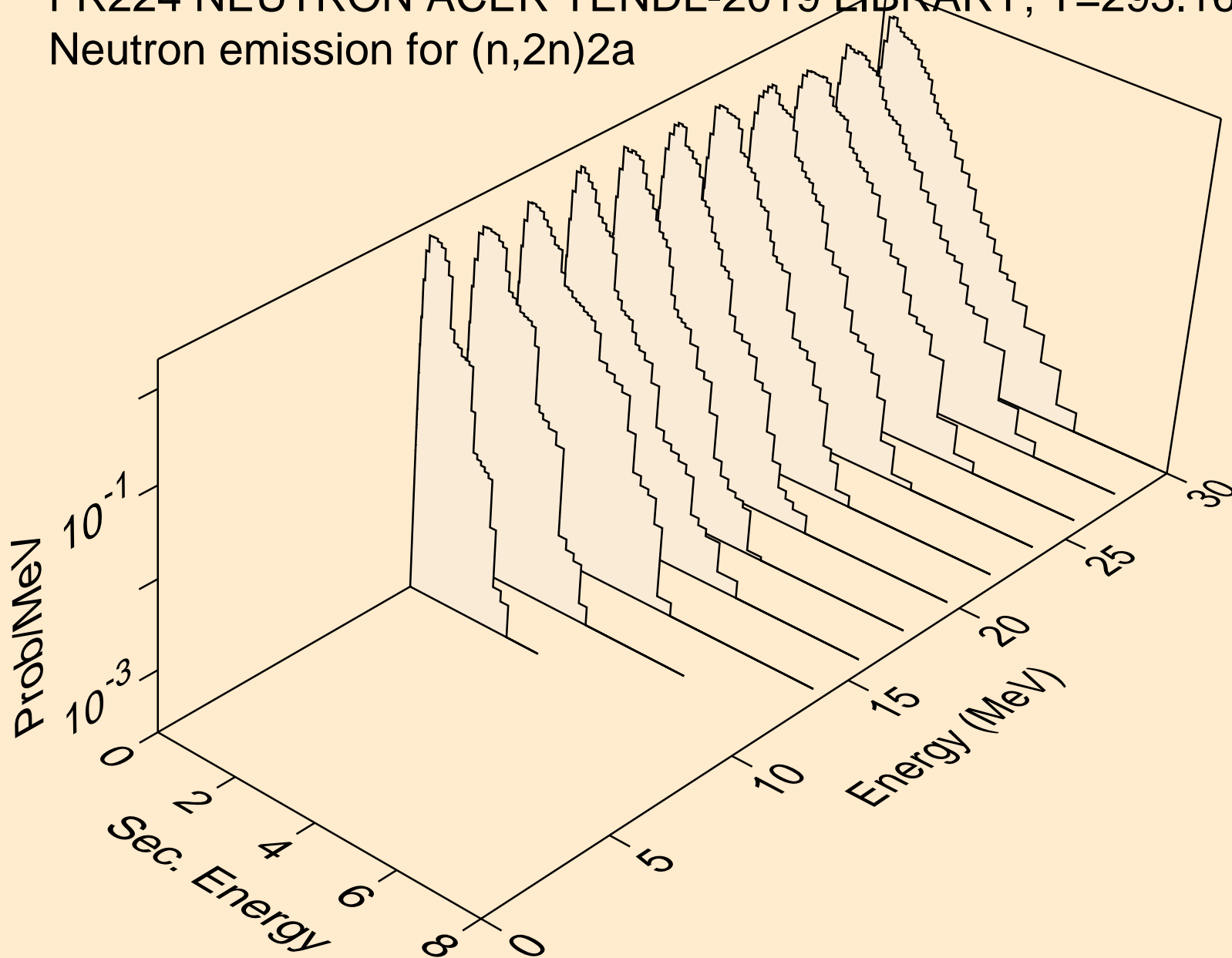

FR224 NEUTRON ACER TENDL-2019 LIBRARY; T=293.16K
Neutron emission for (n,n*)d

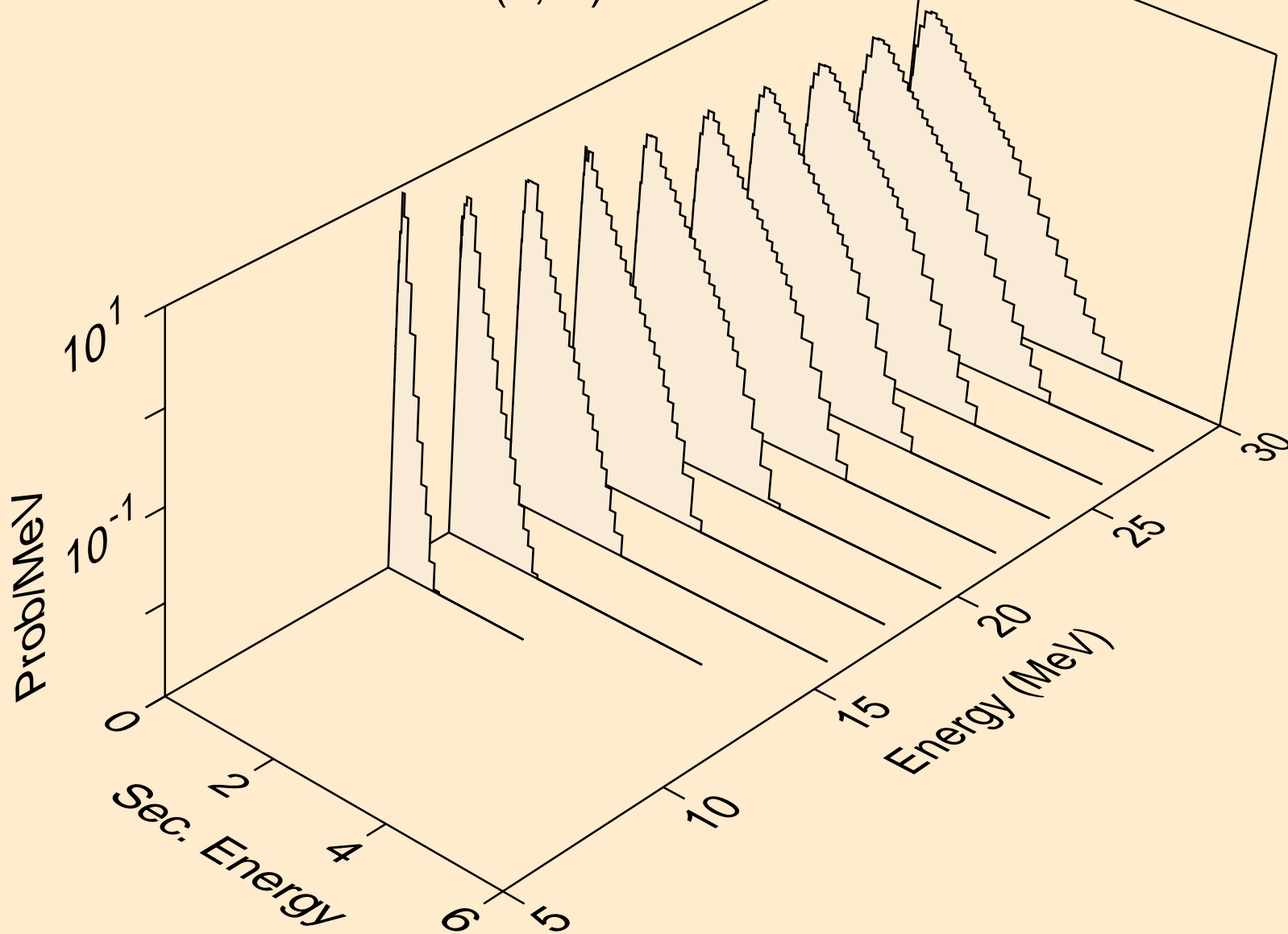

FR224 NEUTRON ACER TENDL-2019 LIBRARY; T=293.16K
Neutron emission for (n,n*)t

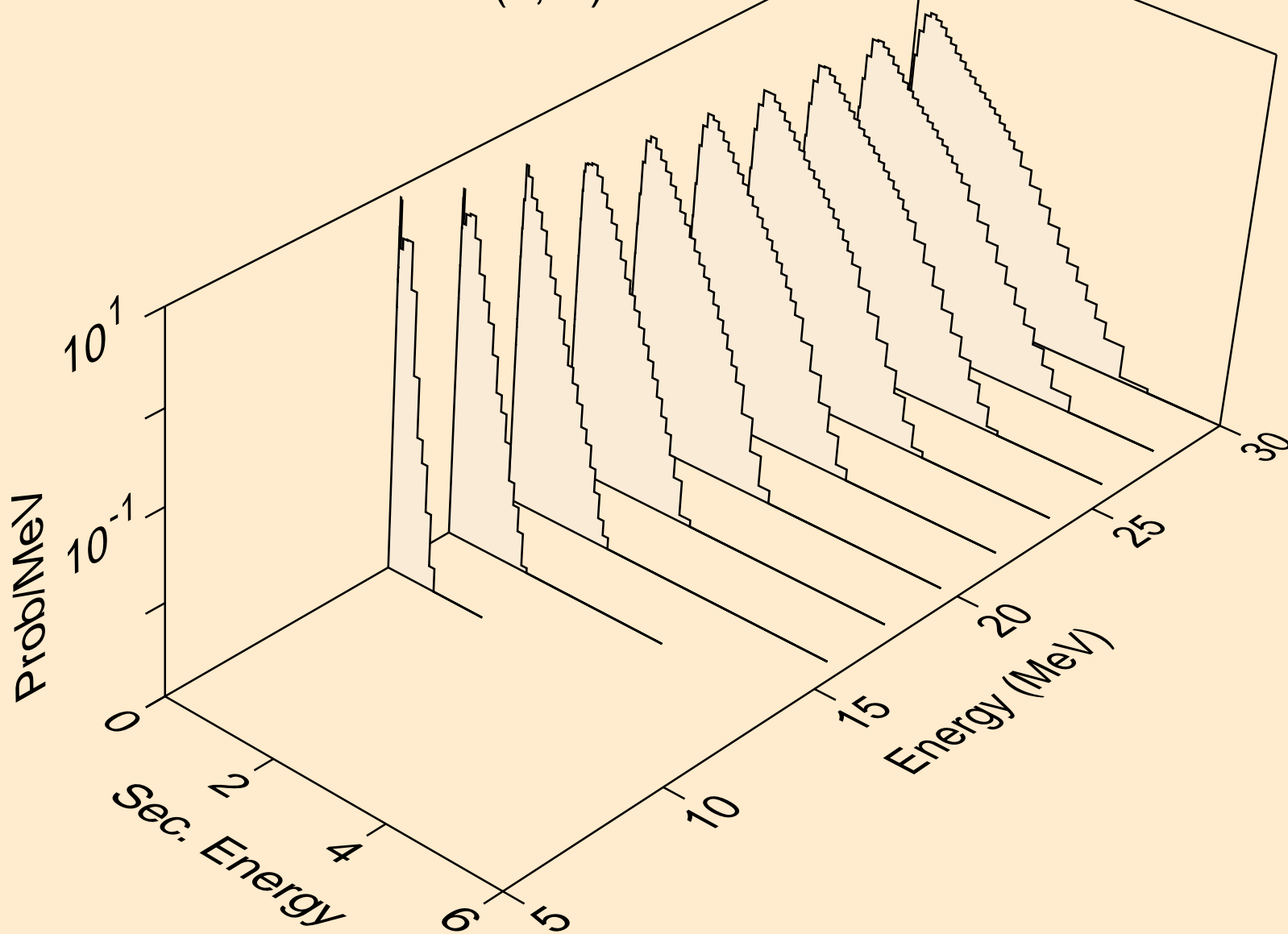

FR224 NEUTRON ACER TENDL-2019 LIBRARY; T=293.16K
Neutron emission for (n,n*)he3

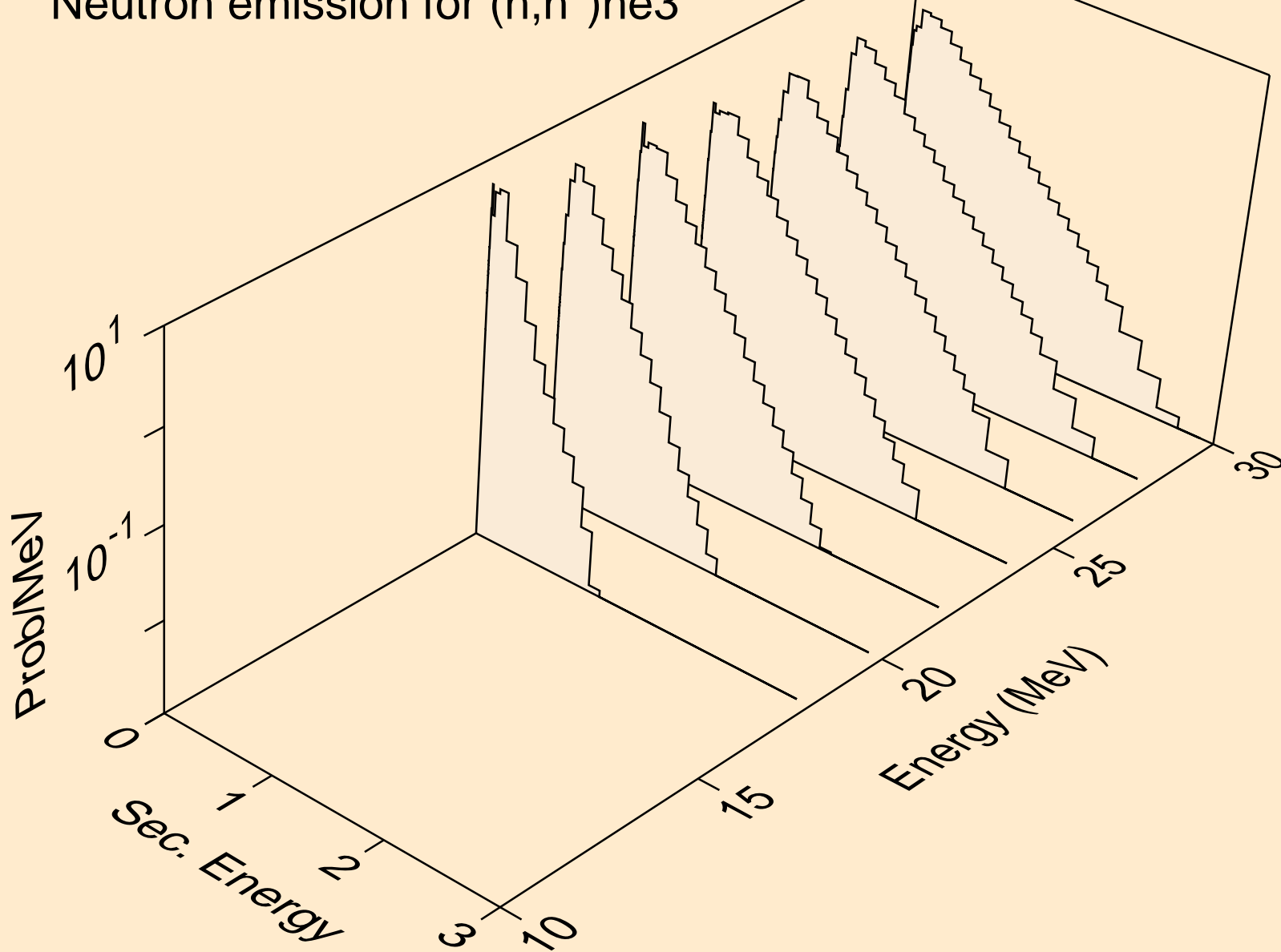

FR224 NEUTRON ACER TENDL-2019 LIBRARY; T=293.16K
Neutron emission for (n,4n)

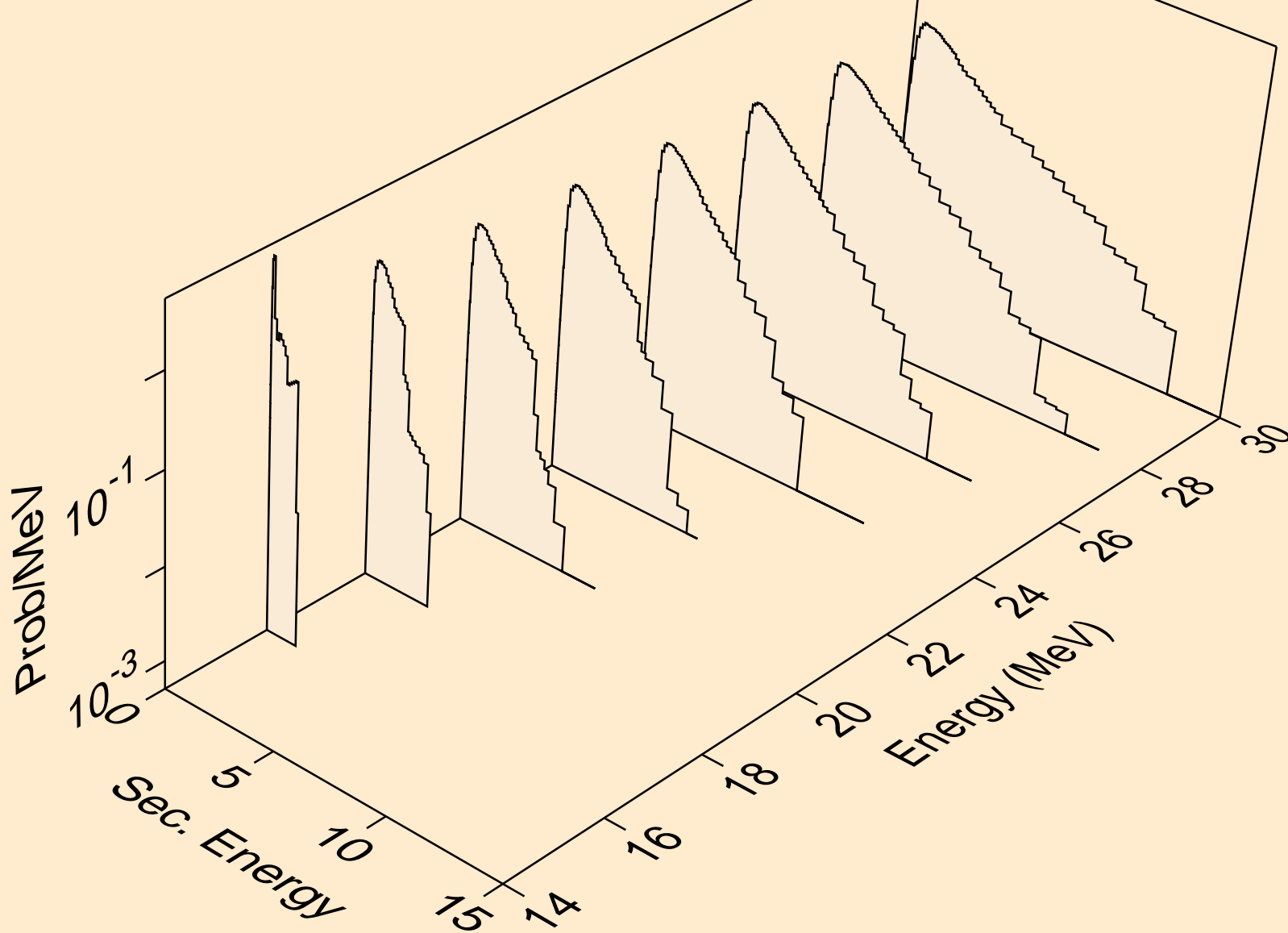

FR224 NEUTRON ACER TENDL-2019 LIBRARY; T=293.16K
Neutron emission for (n,2np)

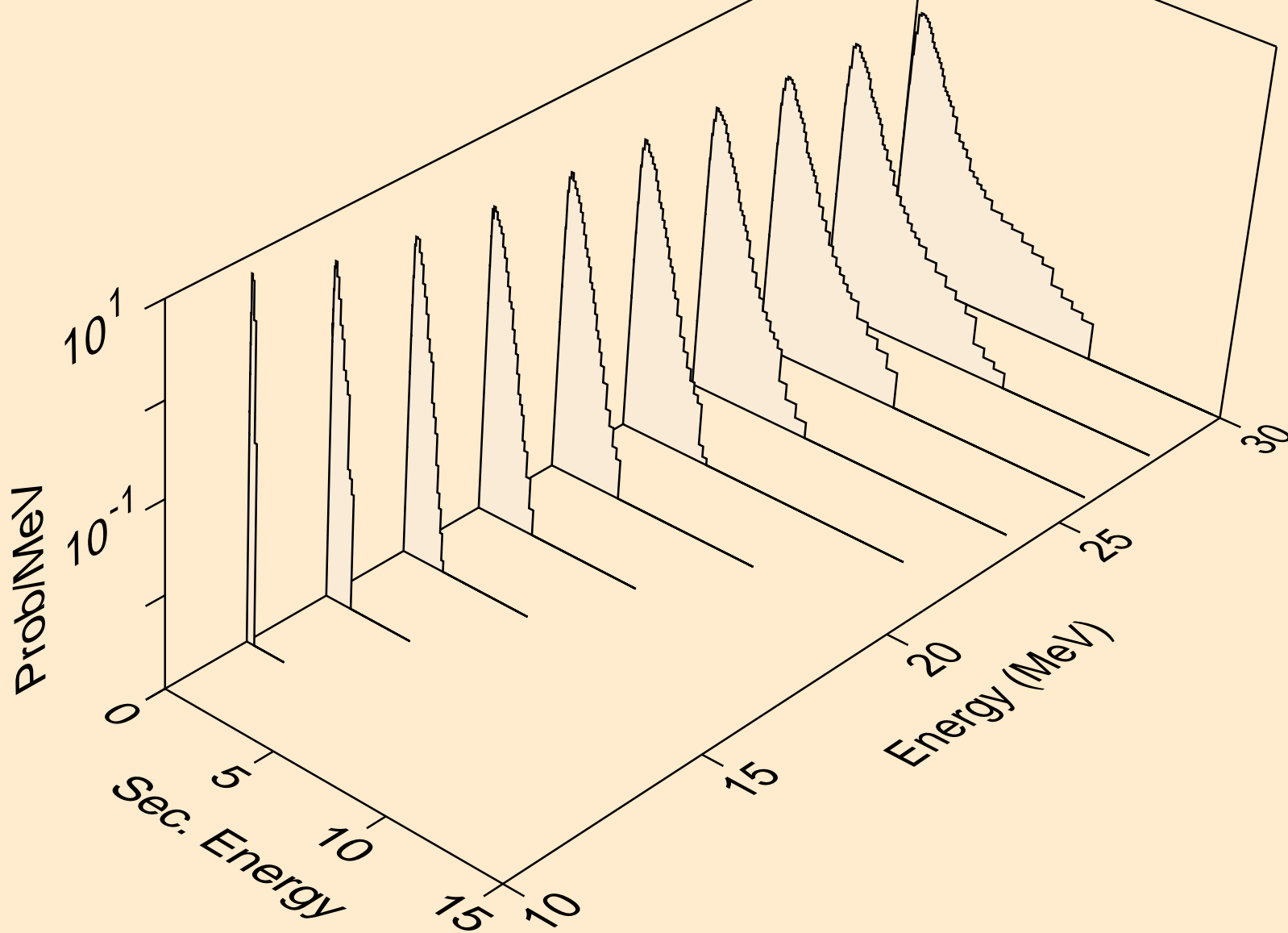

FR224 NEUTRON ACER TENDL-2019 LIBRARY; T=293.16K
Neutron emission for (n,3np)

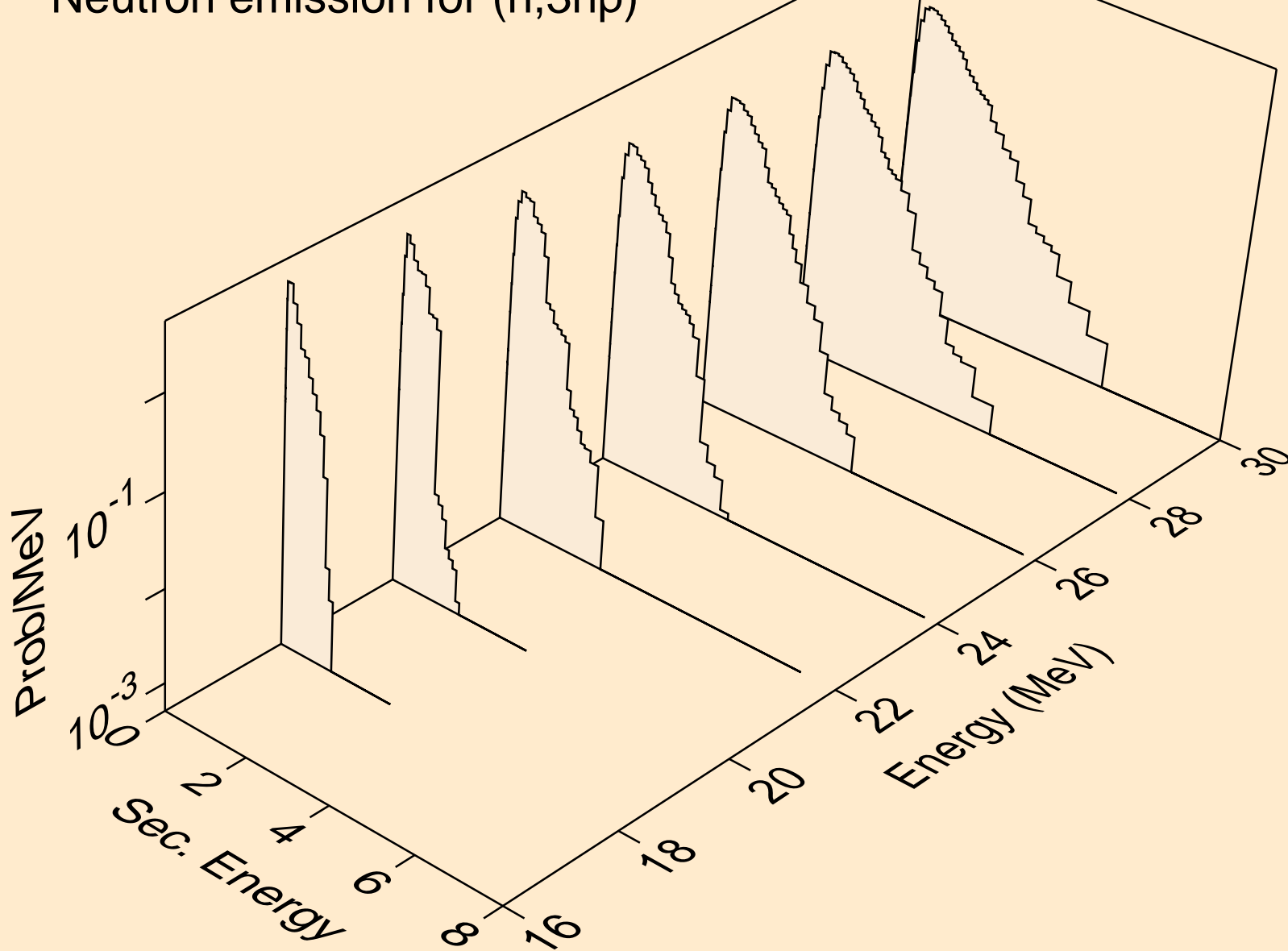

FR224 NEUTRON ACER TENDL-2019 LIBRARY; T=293.16K
Neutron emission for (n,2np)

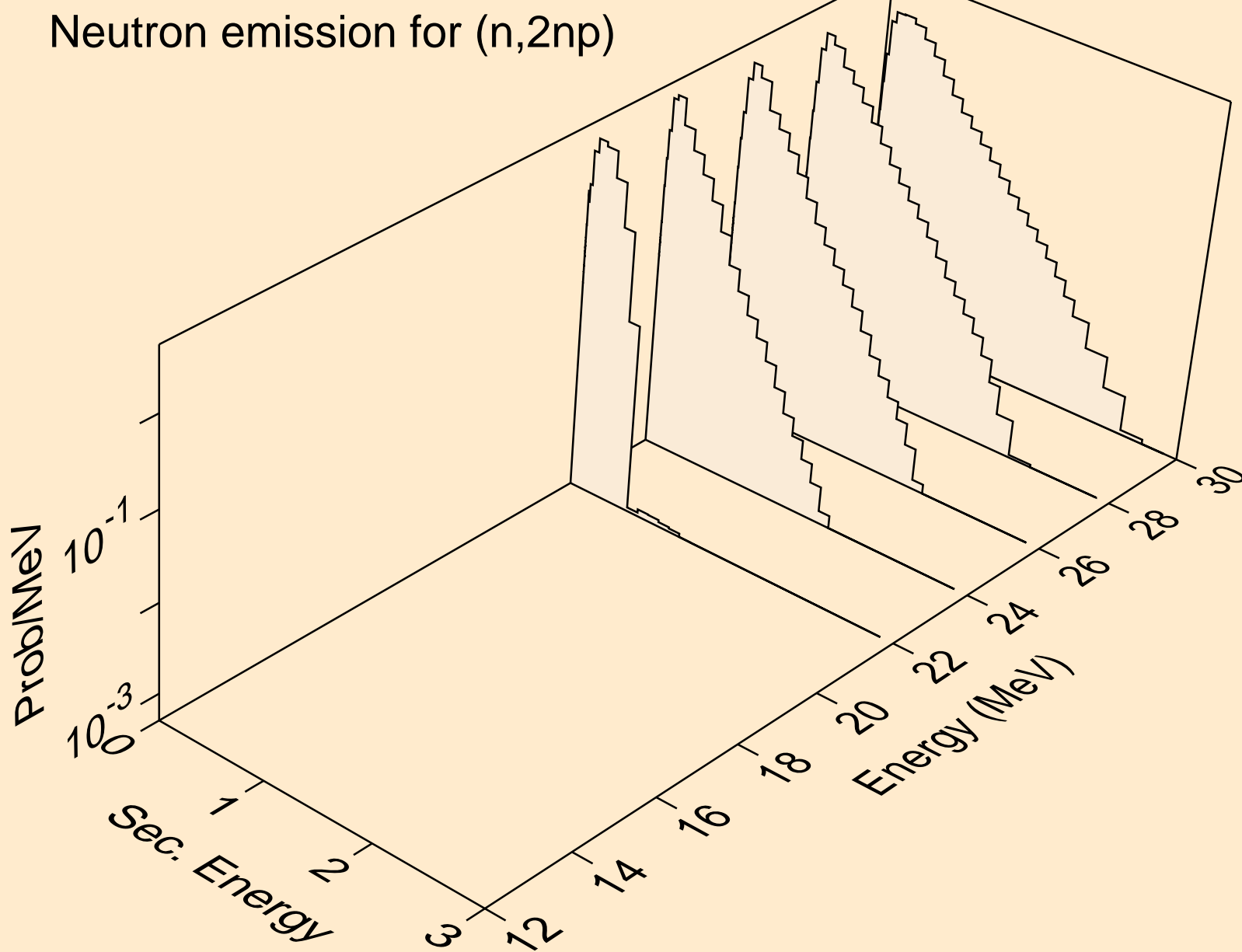

FR224 NEUTRON ACER TENDL-2019 LIBRARY; T=293.16K
Neutron emission for (n,npa)

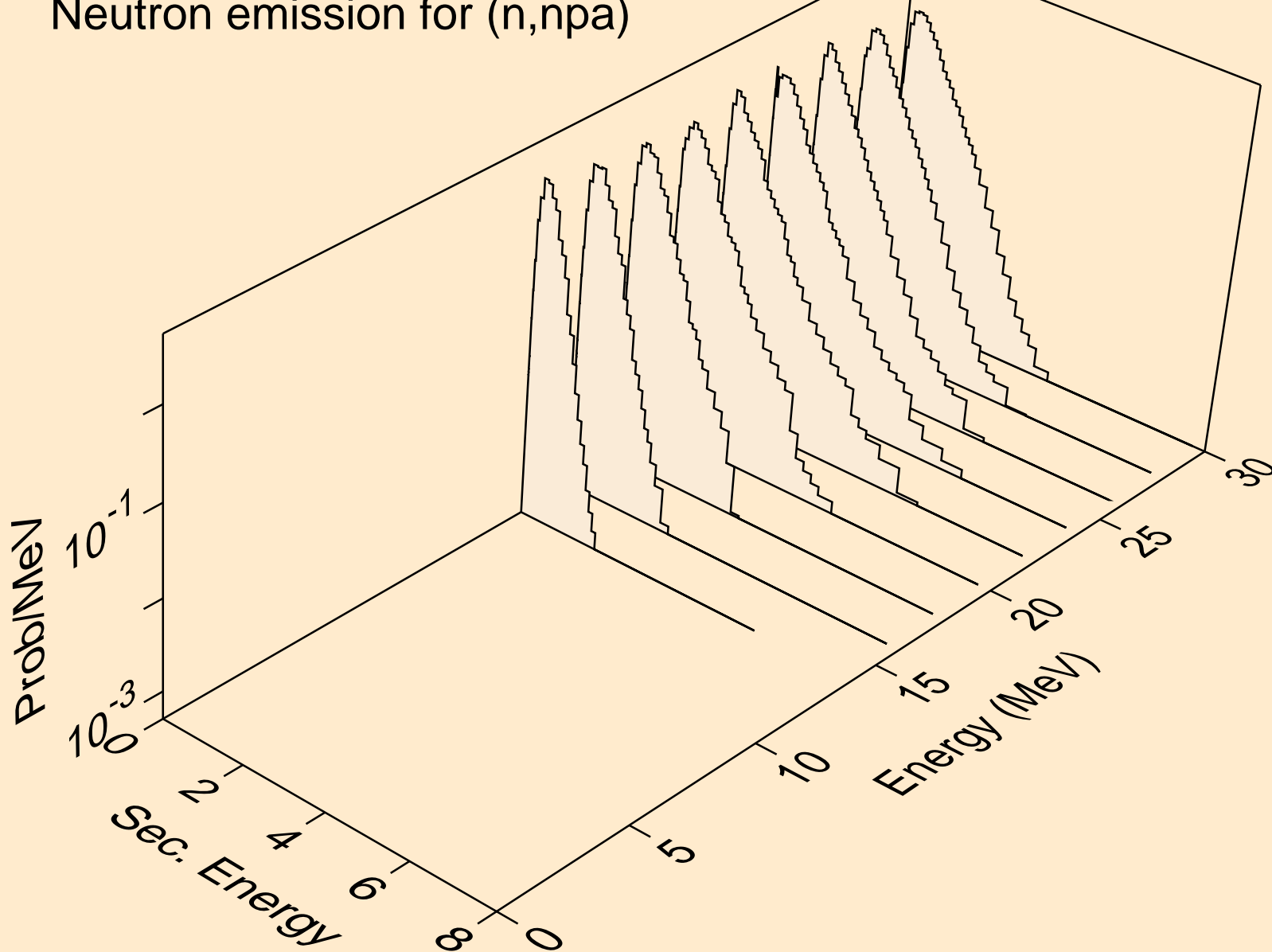

FR224 NEUTRON ACER TENDL-2019 LIBRARY; T=293.16K
Neutron emission for (n,n*c)

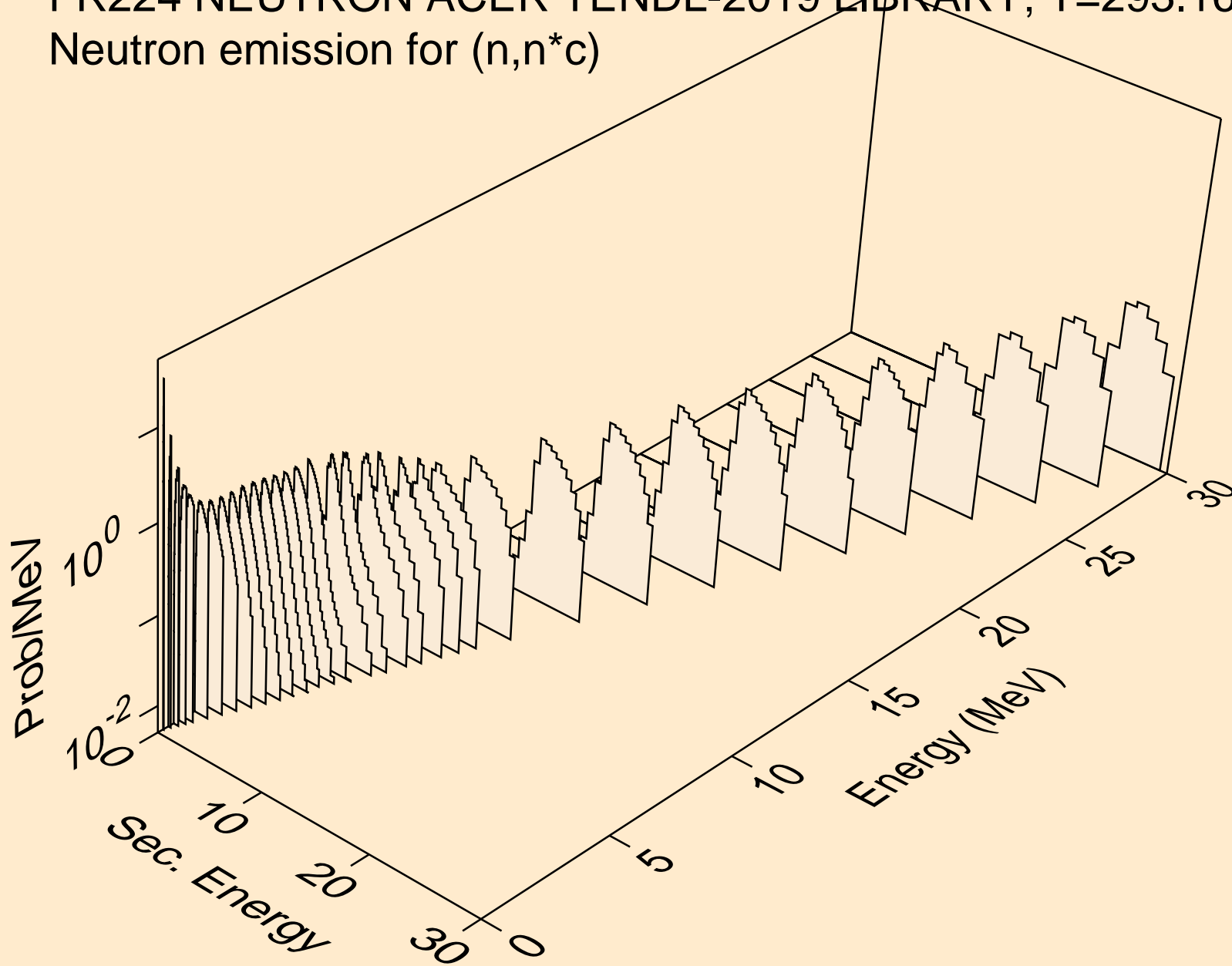

FR224 NEUTRON ACER TENDL-2019 LIBRARY; T=293.16K
Delayed nubar

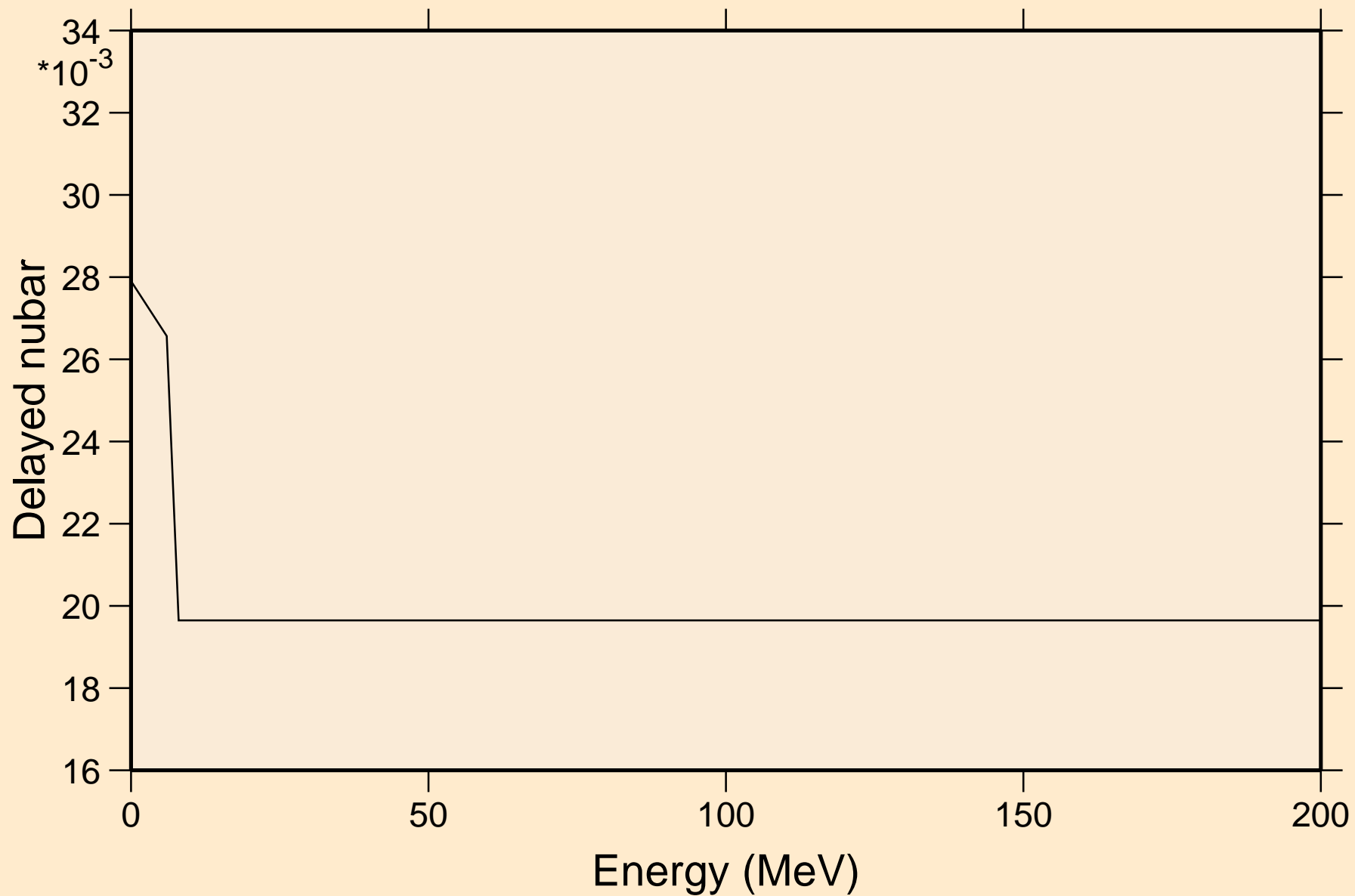

FR224 NEUTRON ACER TENDL-2019 LIBRARY; T=293.16K

Delayed neutron spectra

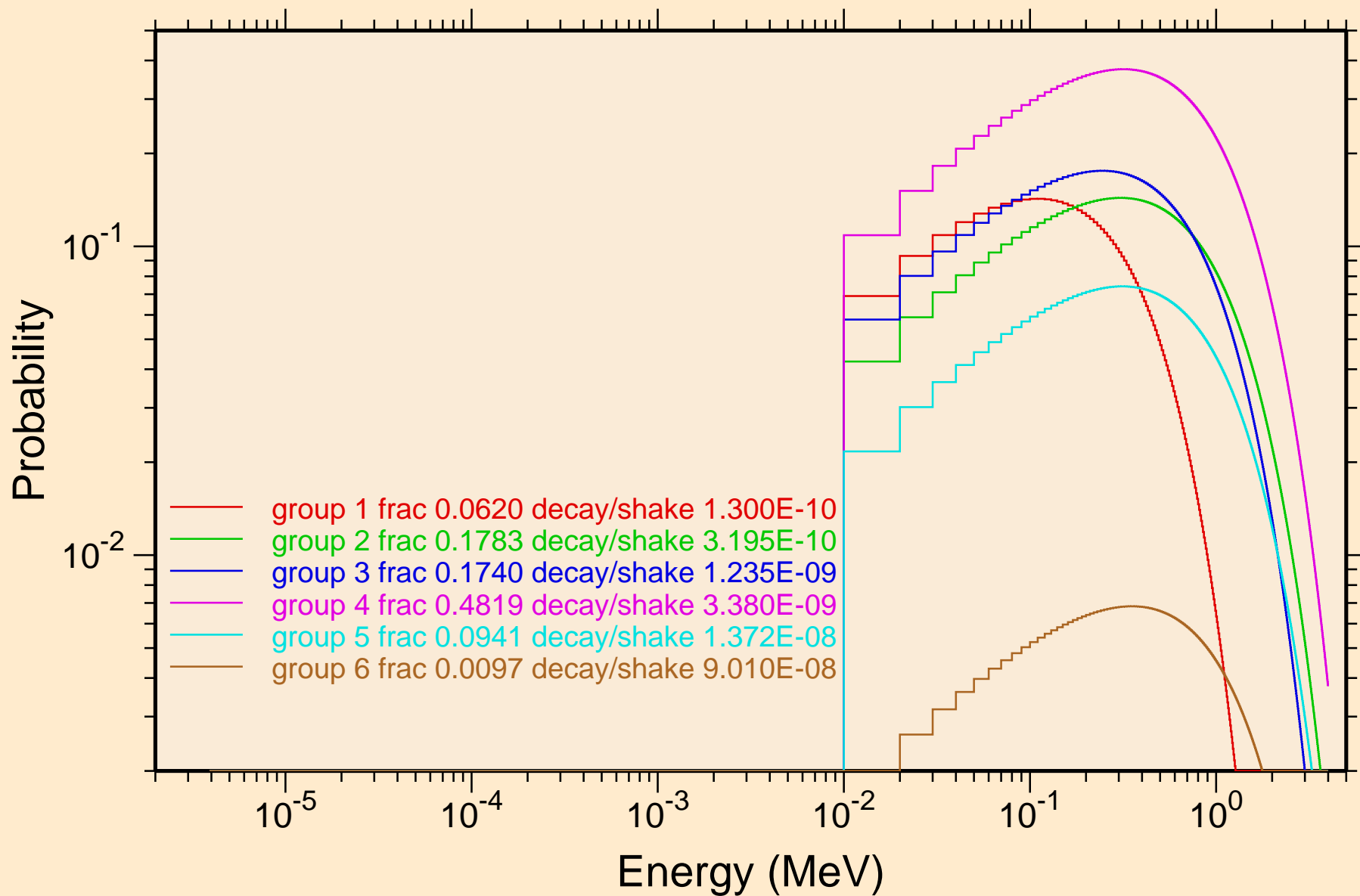

FR224 NEUTRON ACER TENDL-2019 LIBRARY; T=293.16K
Photon emission for (n,x)

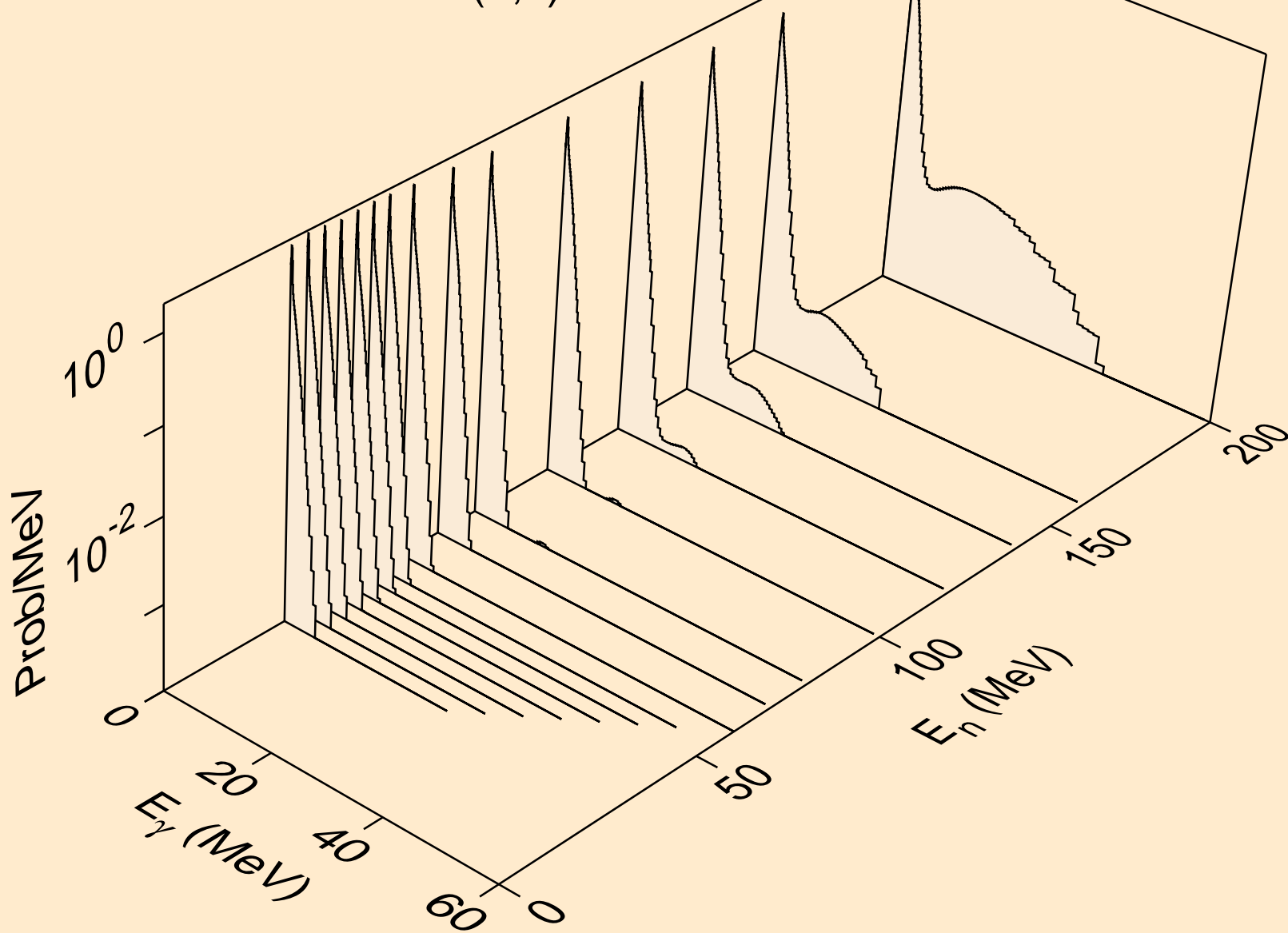

FR224 NEUTRON ACER TENDL-2019 LIBRARY; T=293.16K
Photon emission for (n,2nd)

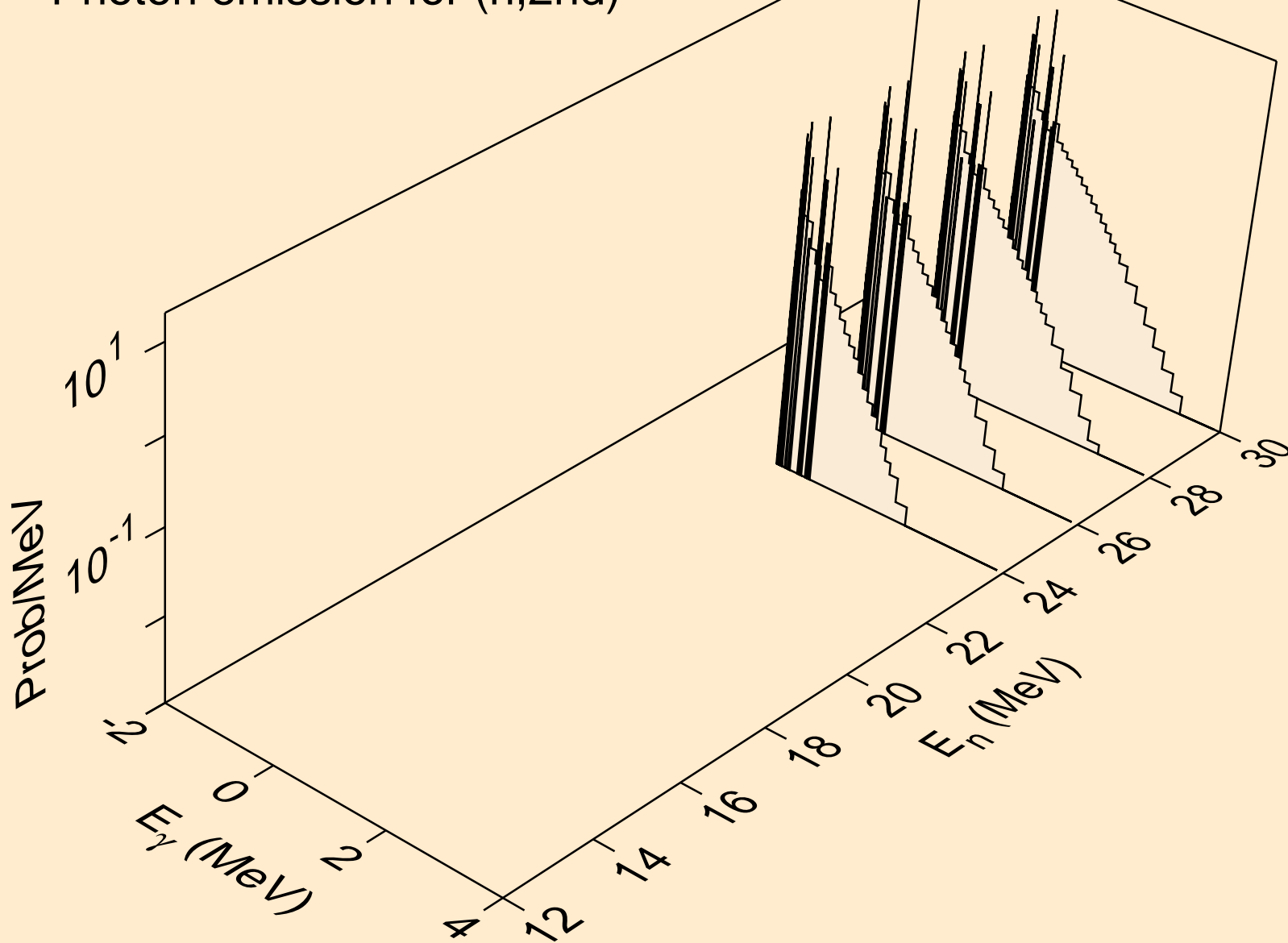

FR224 NEUTRON ACER TENDL-2019 LIBRARY; T=293.16K
Photon emission for (n,2n)

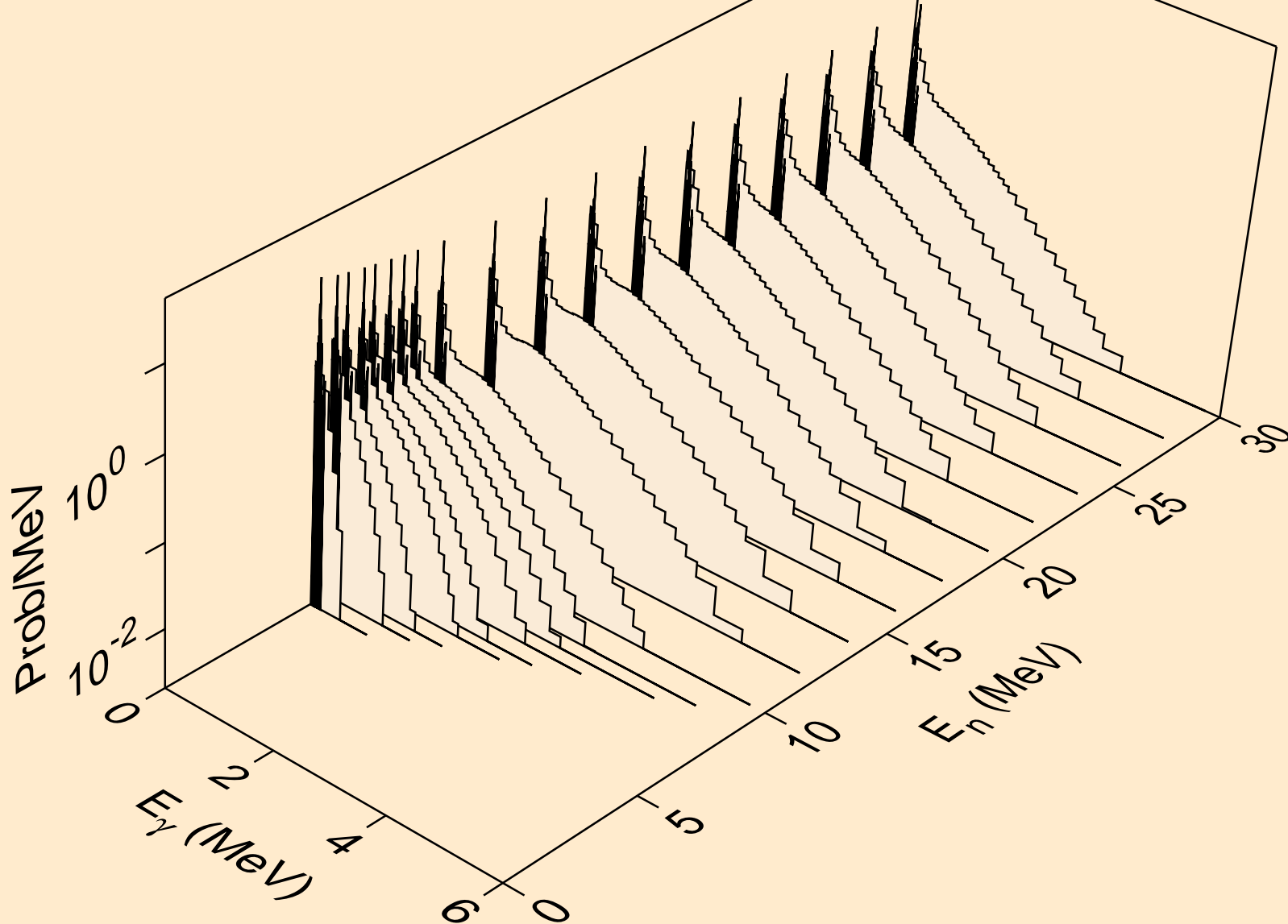

FR224 NEUTRON ACER TENDL-2019 LIBRARY; T=293.16K
Photon emission for (n,3n)

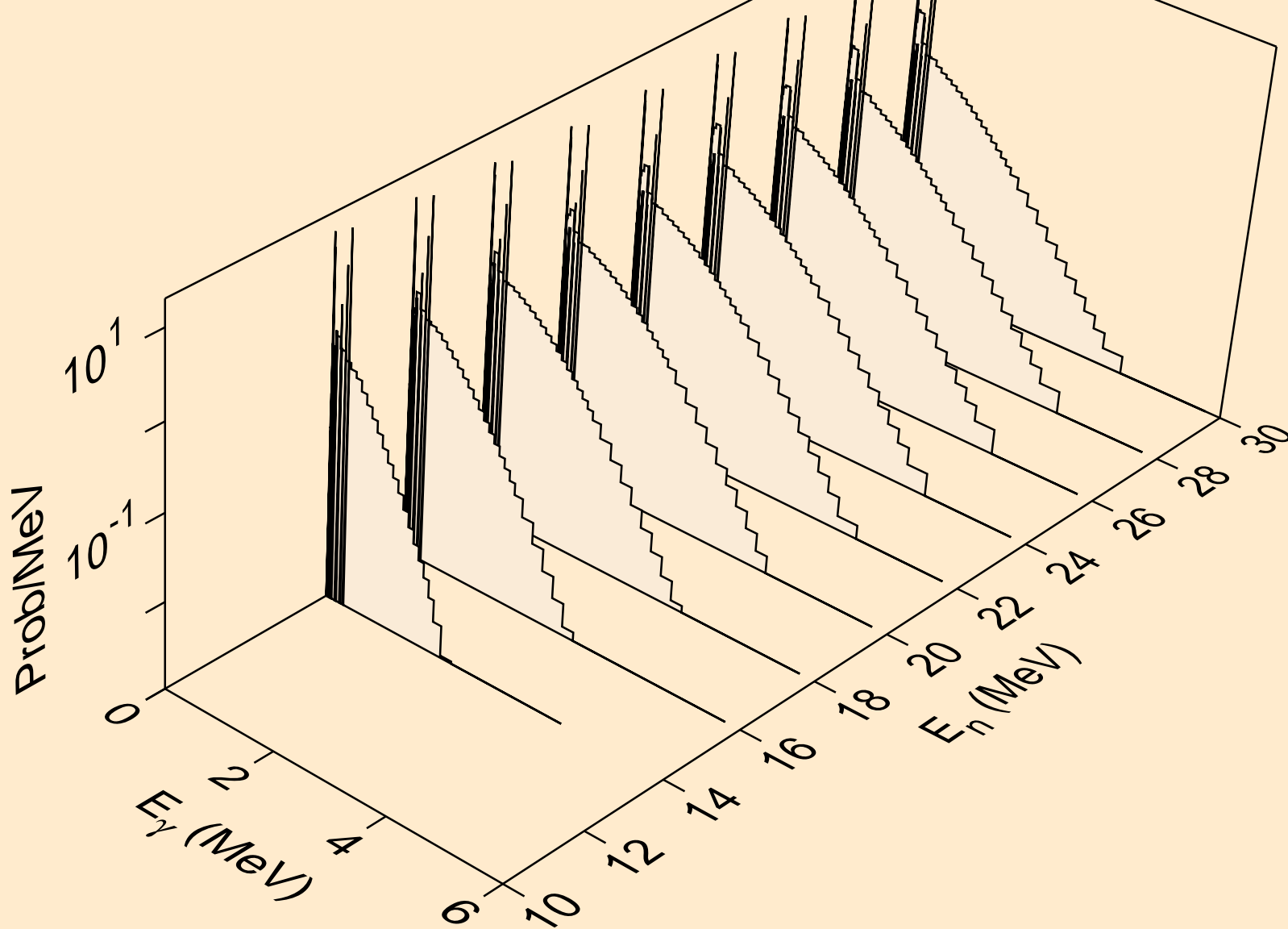

FR224 NEUTRON ACER TENDL-2019 LIBRARY; T=293.16K
Photon emission for (n,n*)a

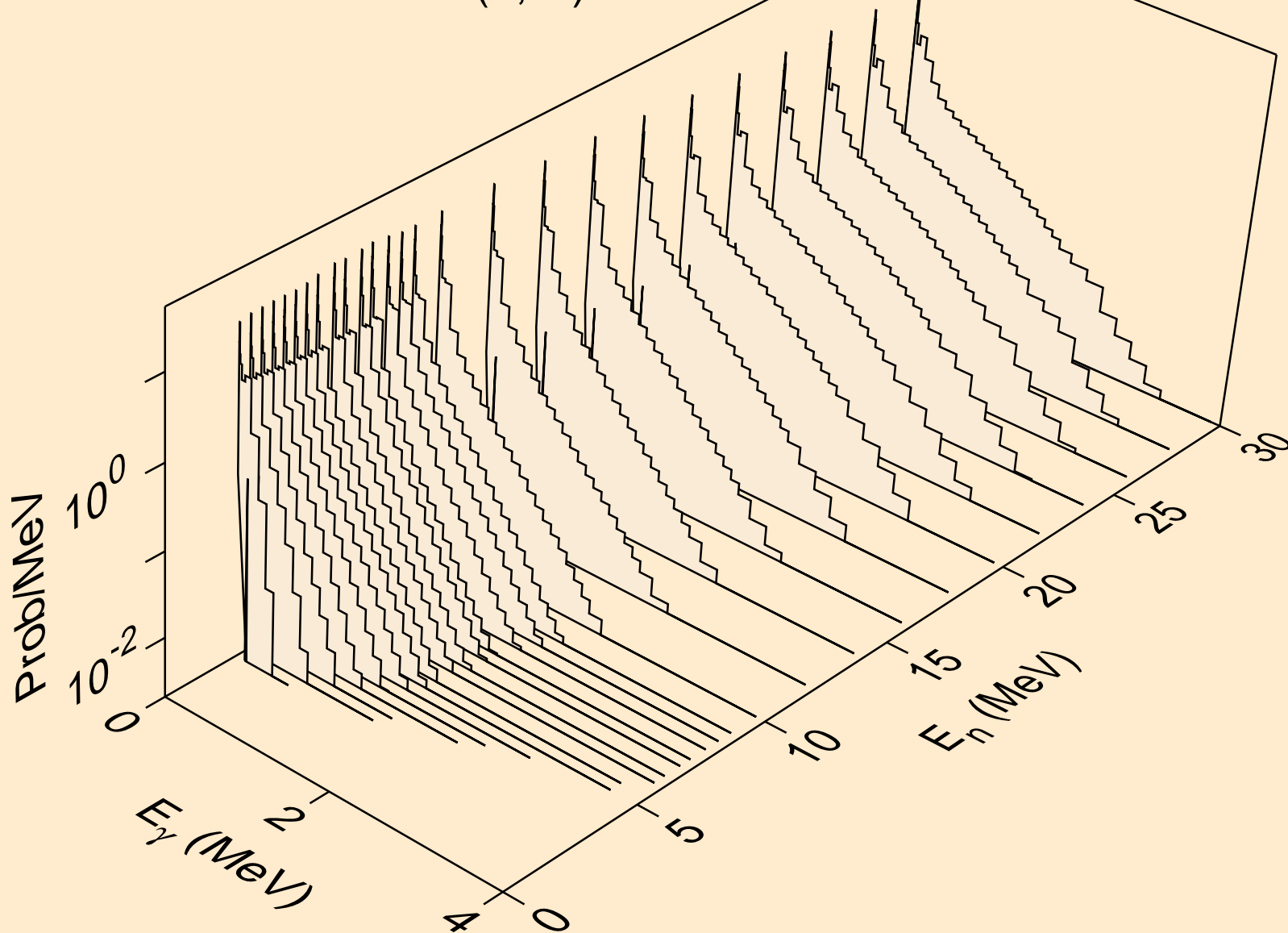

FR224 NEUTRON ACER TENDL-2019 LIBRARY; T=293.16K
Photon emission for (n,2n) α

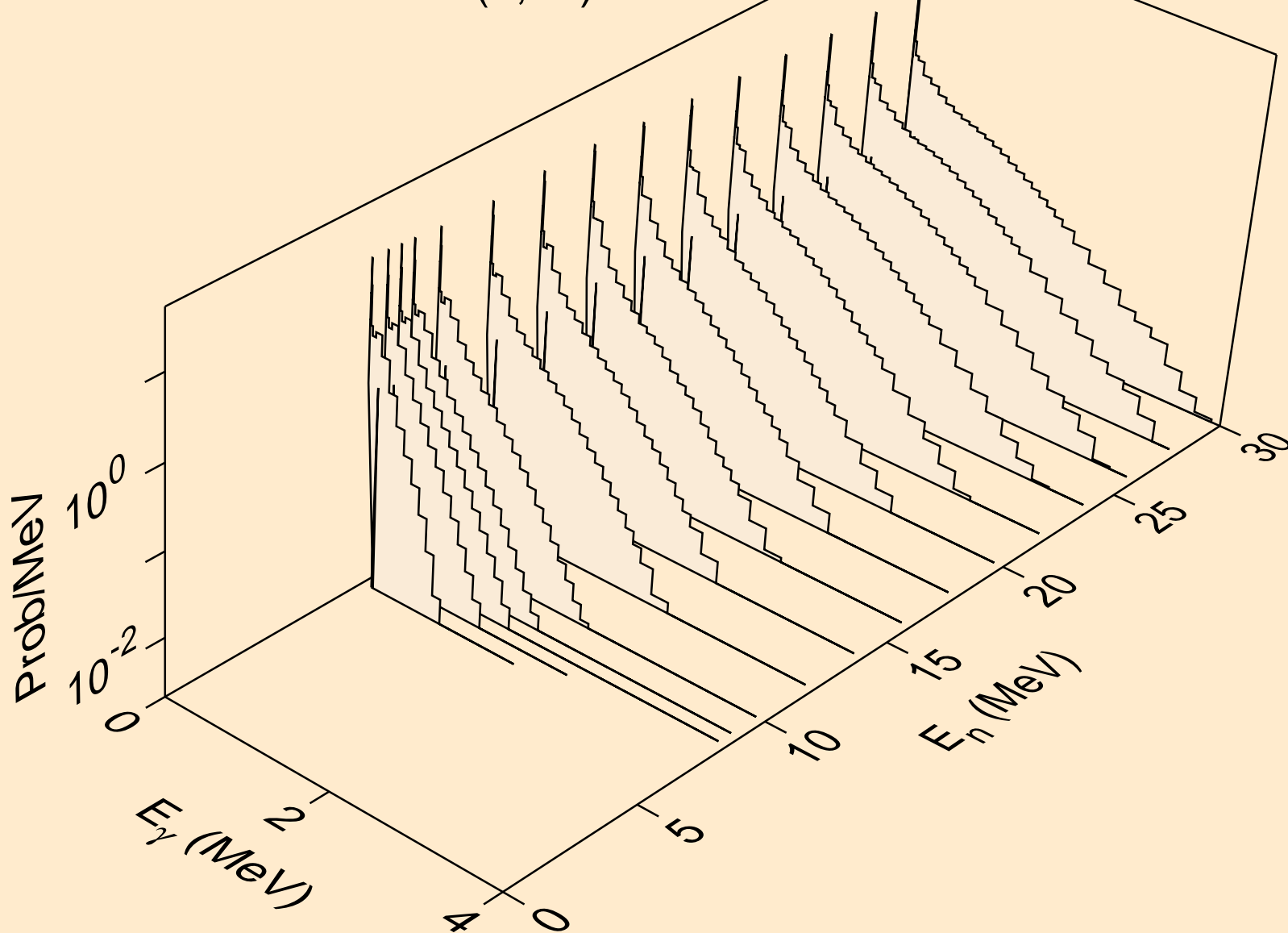

FR224 NEUTRON ACER TENDL-2019 LIBRARY; T=293.16K
Photon emission for (n,3n)a

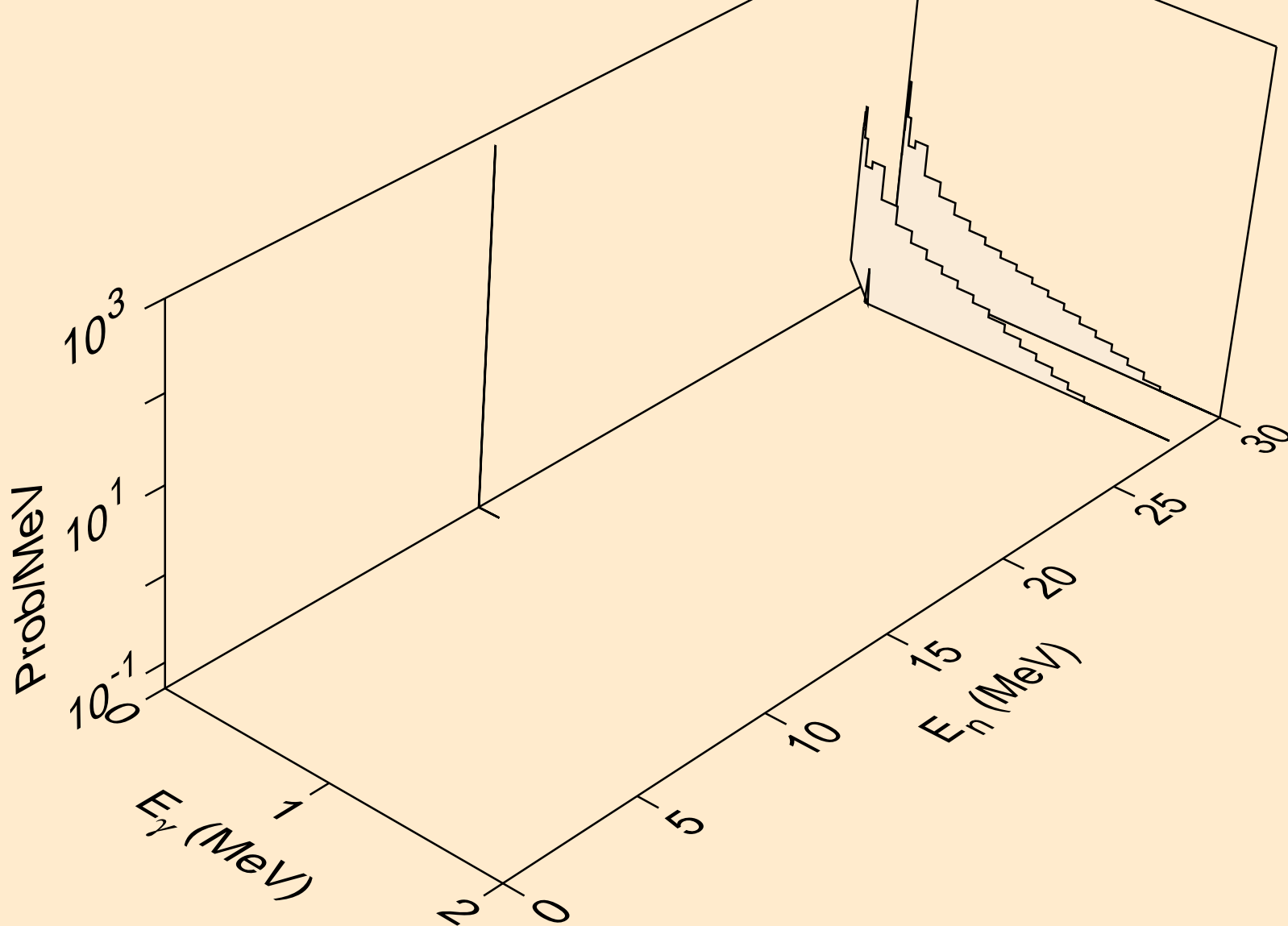

FR224 NEUTRON ACER TENDL-2019 LIBRARY; T=293.16K
Photon emission for (n,n*)p

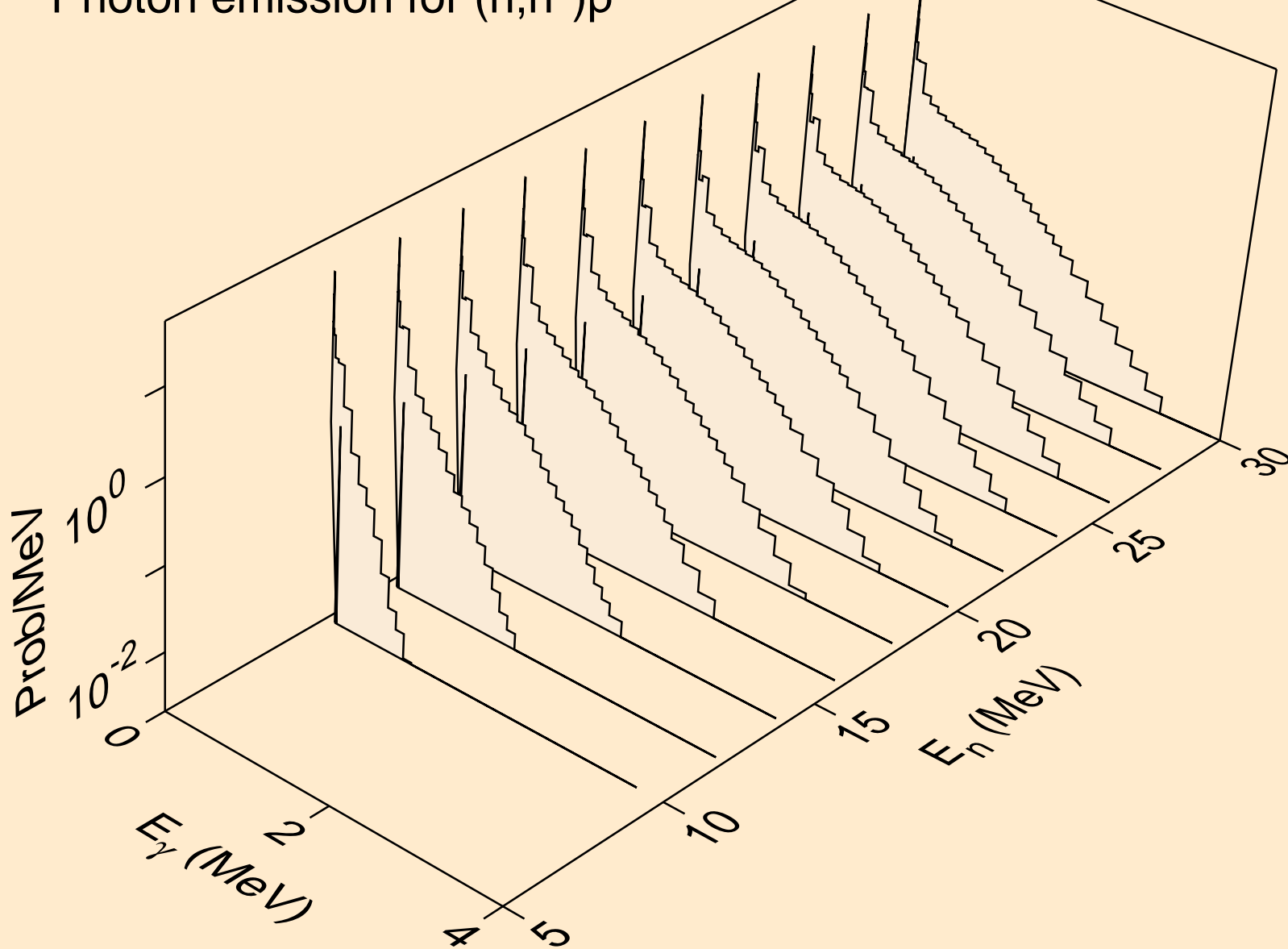

FR224 NEUTRON ACER TENDL-2019 LIBRARY; T=293.16K
Photon emission for (n,n*)2a

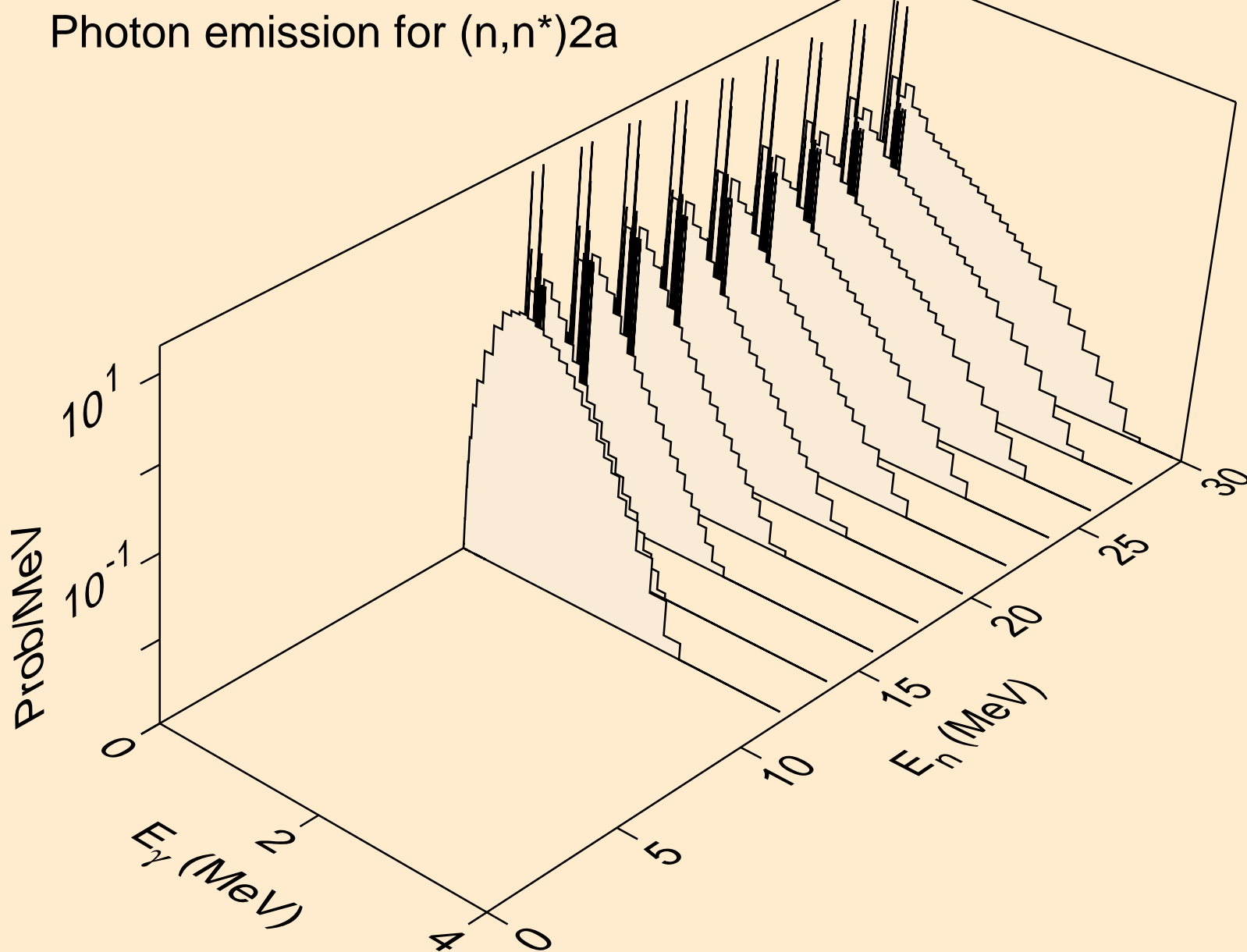

FR224 NEUTRON ACER TENDL-2019 LIBRARY; T=293.16K
Photon emission for (n,2n)2a

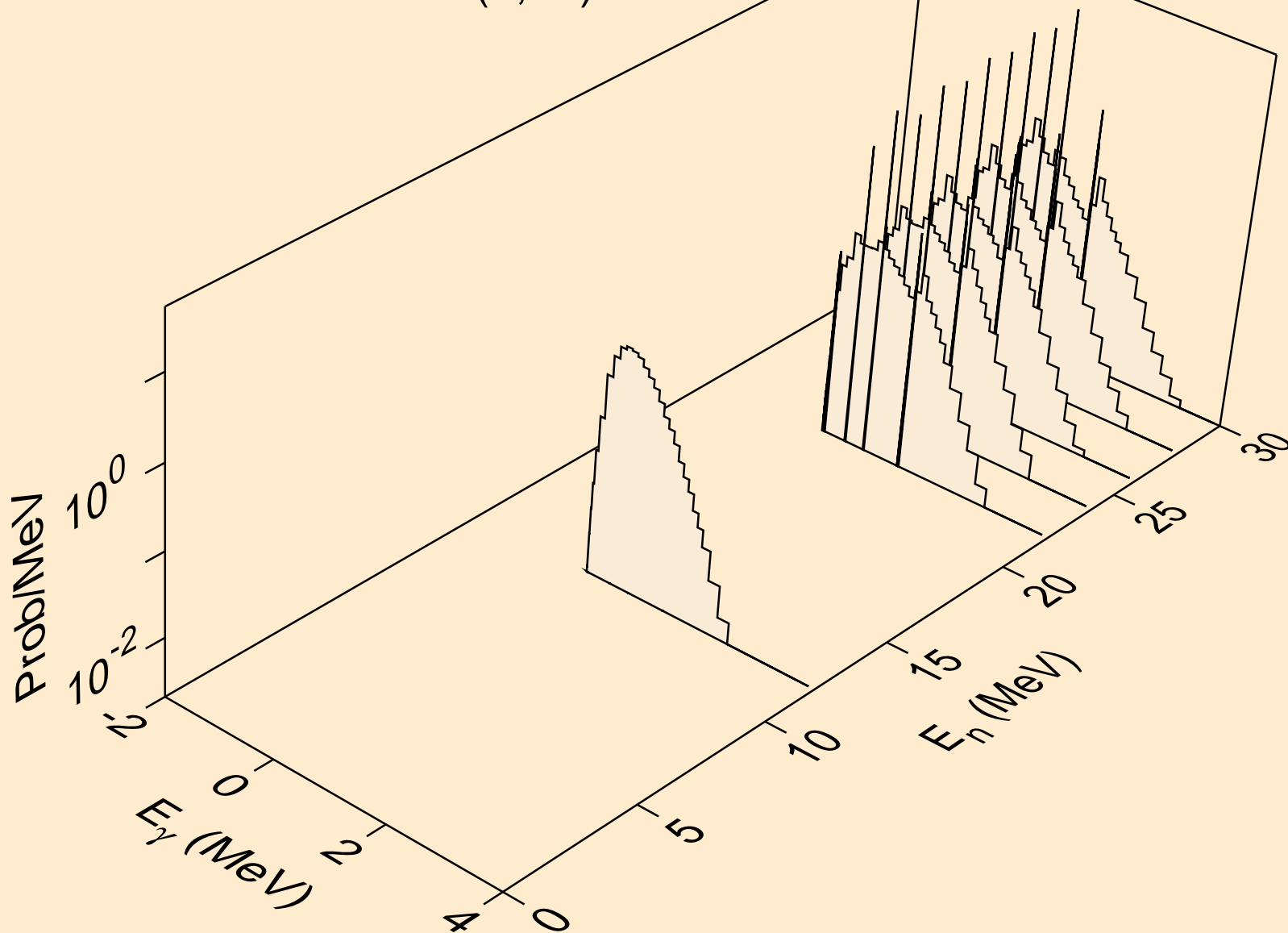

FR224 NEUTRON ACER TENDL-2019 LIBRARY; T=293.16K
Photon emission for (n,n*)d

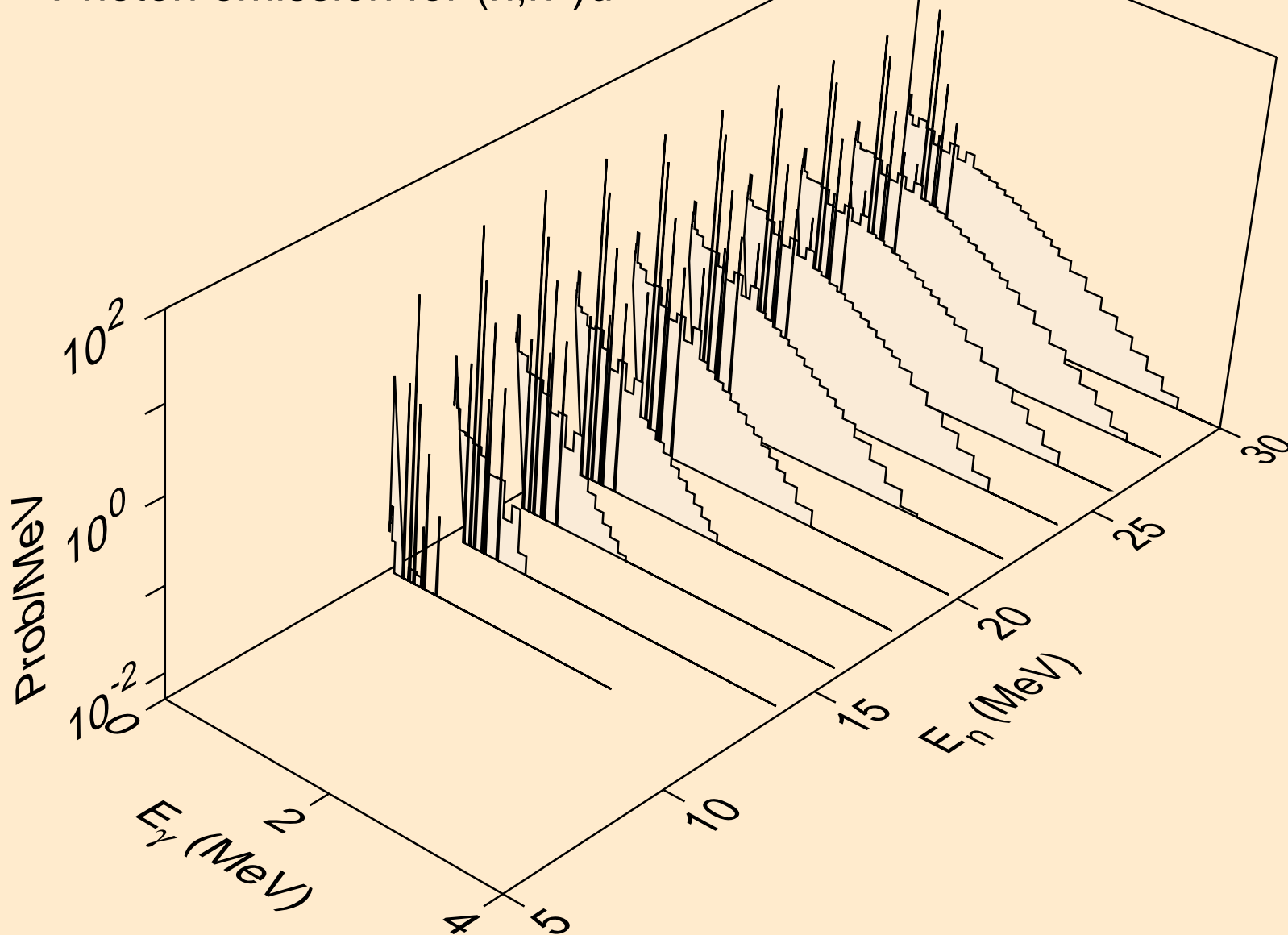

FR224 NEUTRON ACER TENDL-2019 LIBRARY; T=293.16K
Photon emission for (n,n*)t

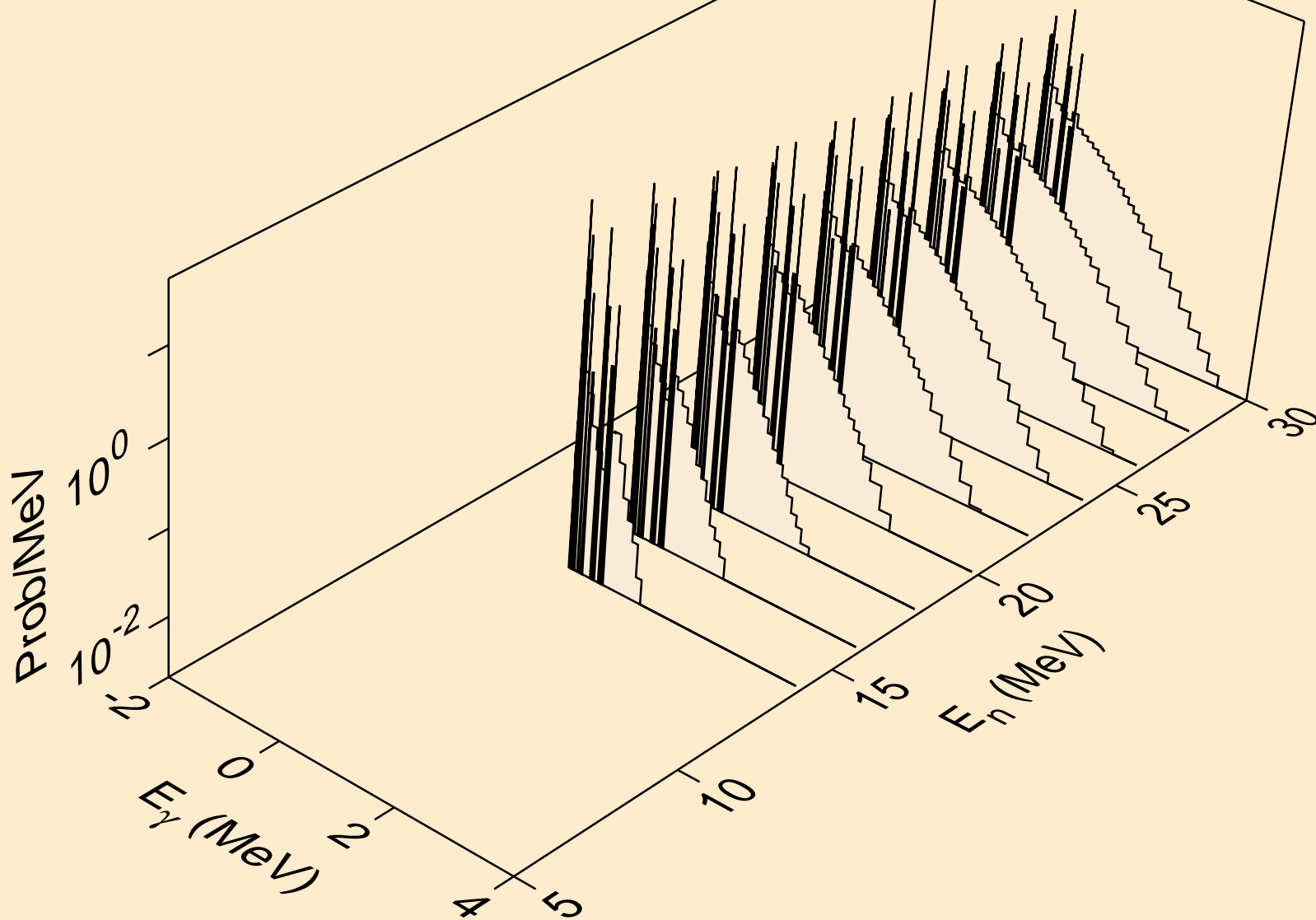

FR224 NEUTRON ACER TENDL-2019 LIBRARY; T=293.16K
Photon emission for (n,n*)he3

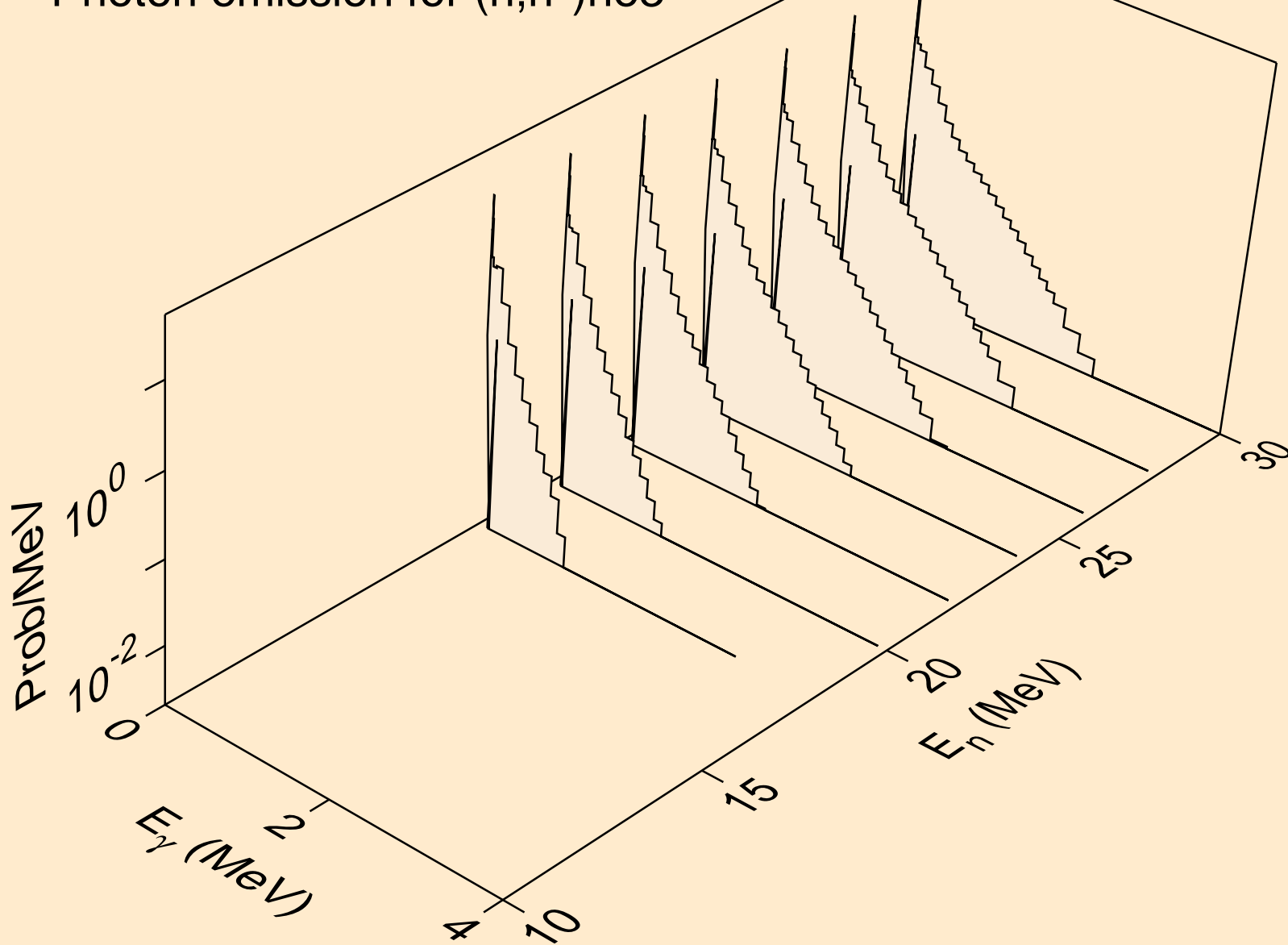

FR224 NEUTRON ACER TENDL-2019 LIBRARY; T=293.16K
Photon emission for (n,4n)

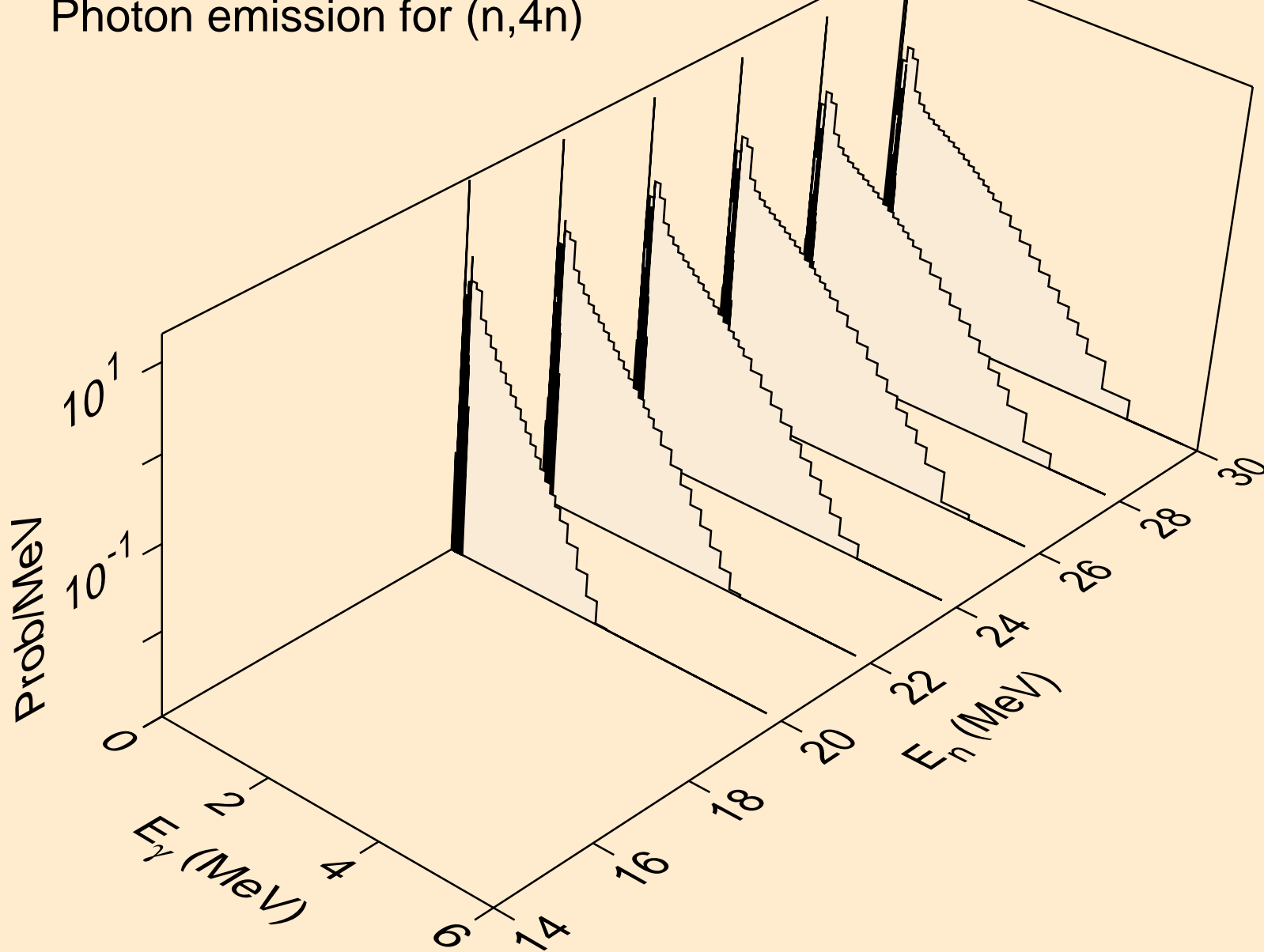

FR224 NEUTRON ACER TENDL-2019 LIBRARY; T=293.16K
Photon emission for (n,2np)

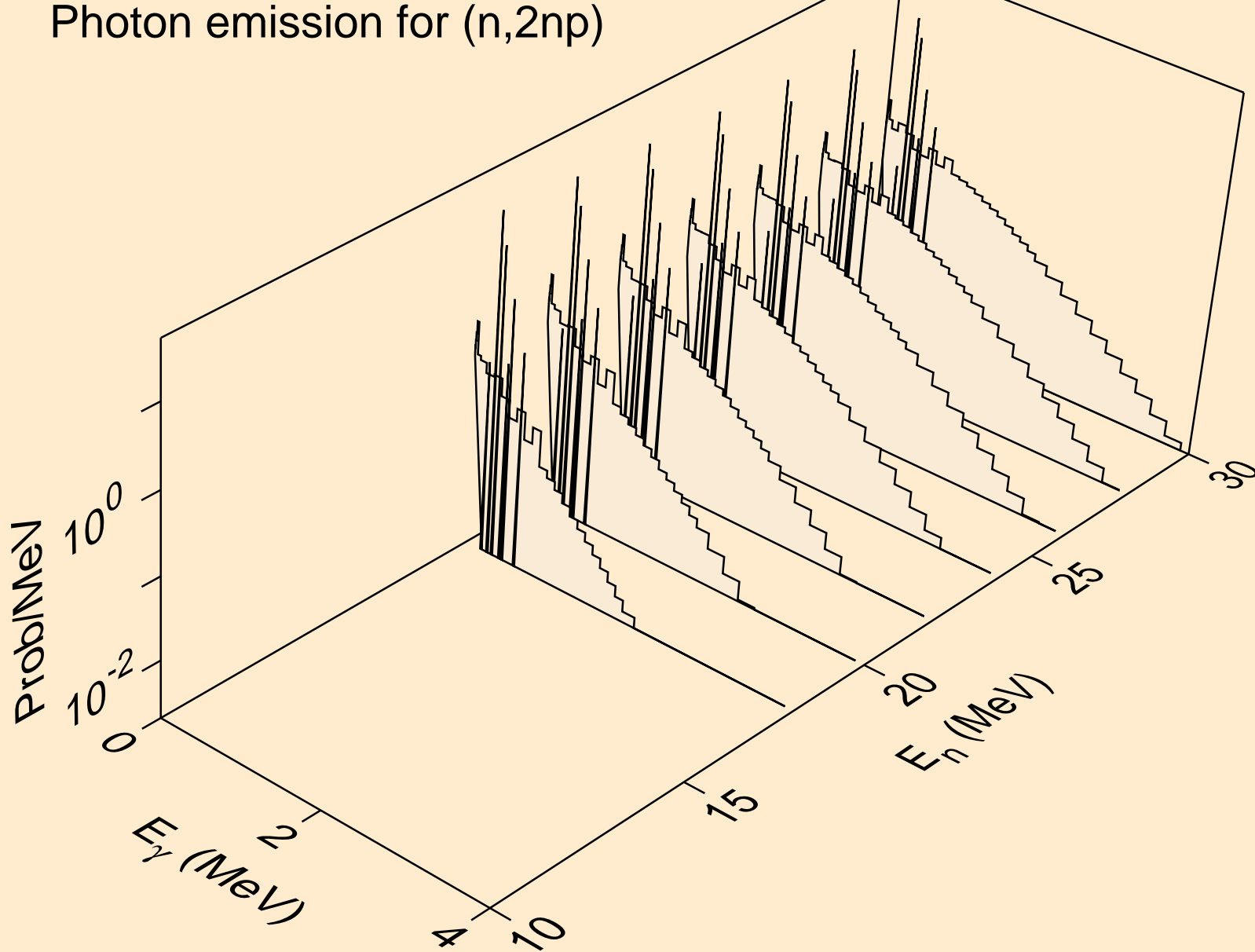

FR224 NEUTRON ACER TENDL-2019 LIBRARY; T=293.16K
Photon emission for (n,3np)

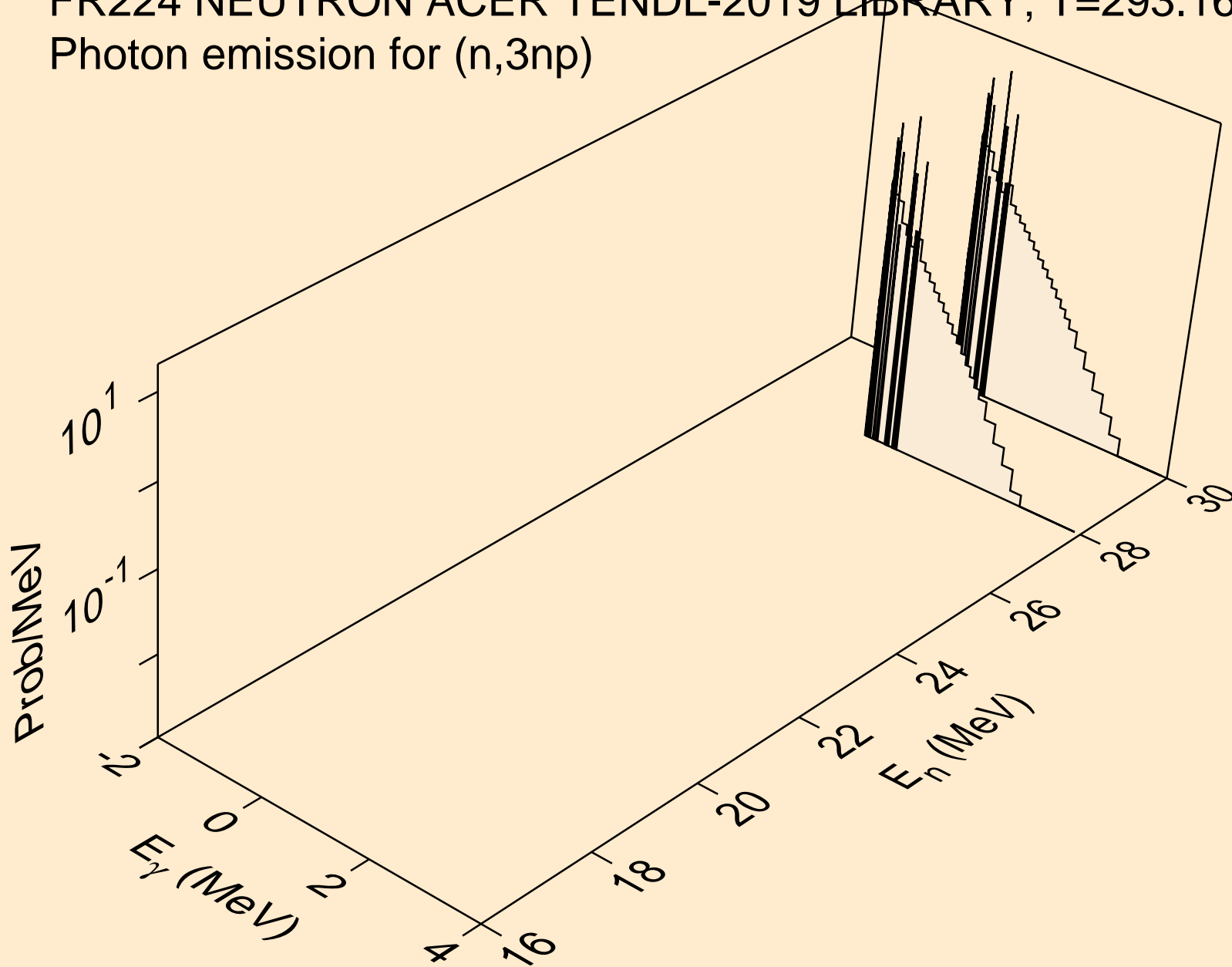

FR224 NEUTRON ACER TENDL-2019 LIBRARY; T=293.16K
Photon emission for (n,2np)

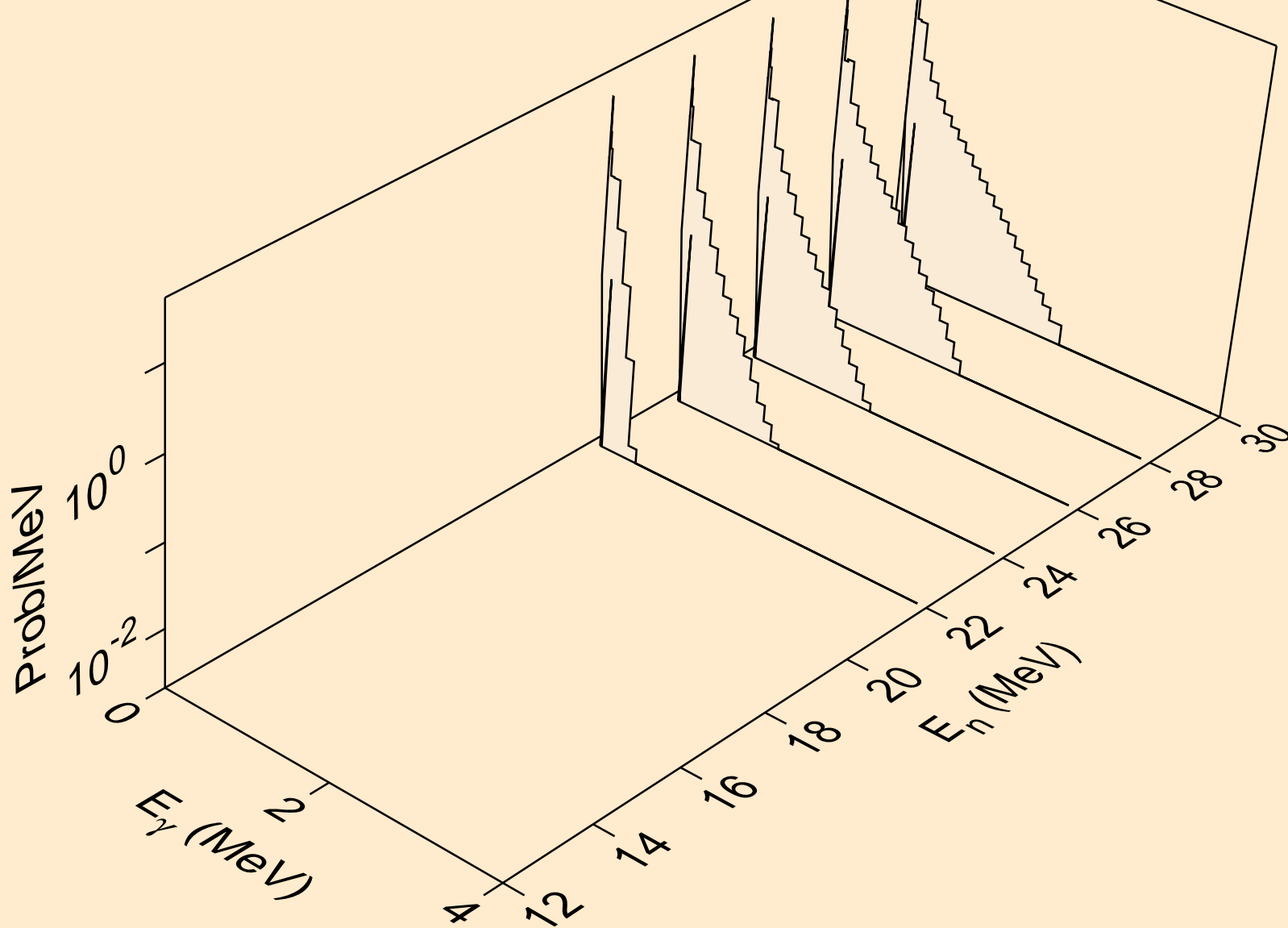

FR224 NEUTRON ACER TENDL-2019 LIBRARY; T=293.16K
Photon emission for (n,npa)

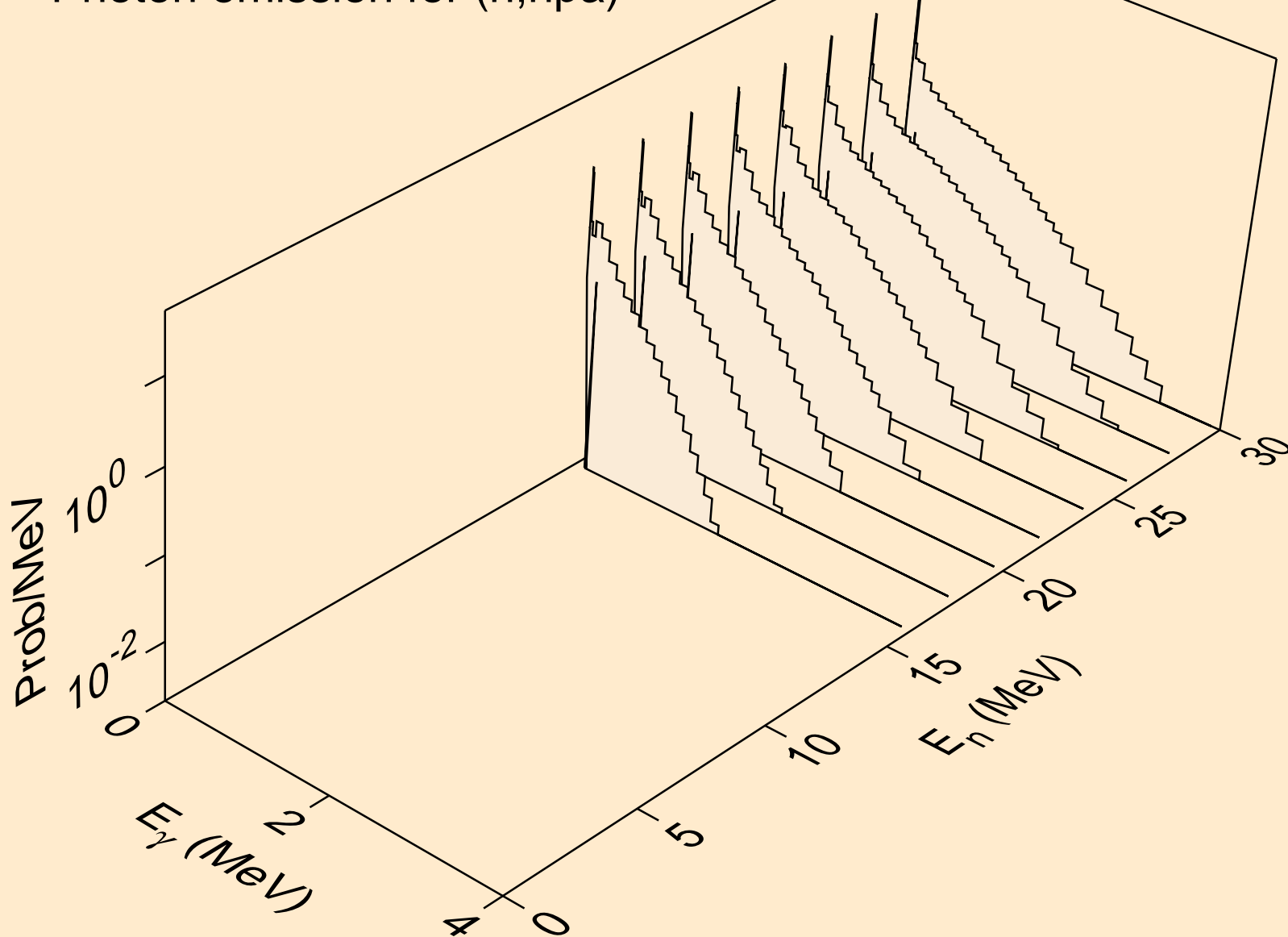

FR224 NEUTRON ACER TENDL-2019 LIBRARY; T=293.16K
Photon emission for (n,n*c)

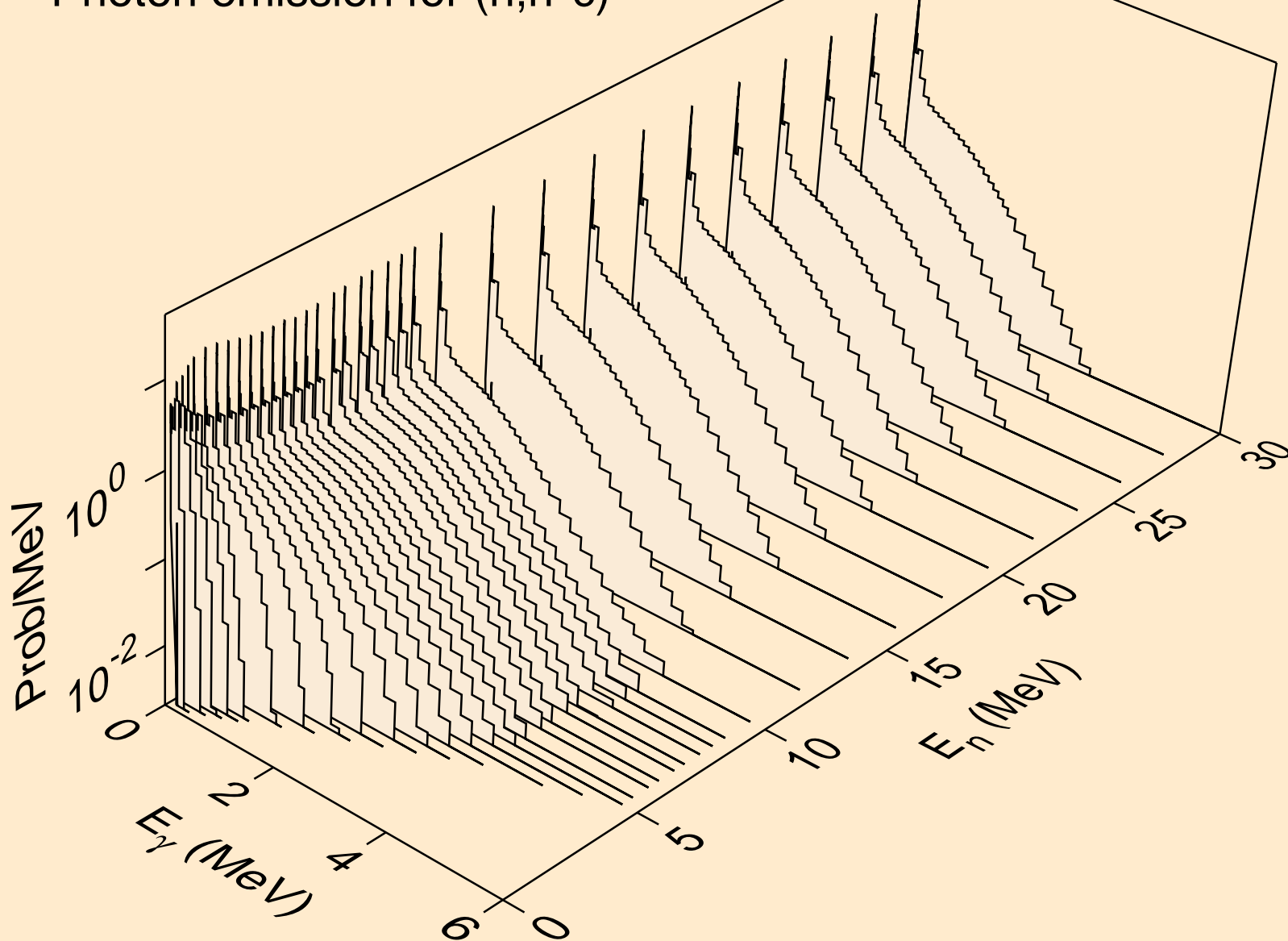

FR224 NEUTRON ACER TENDL-2019 LIBRARY; T=293.16K
Photon emission for (n,gma)

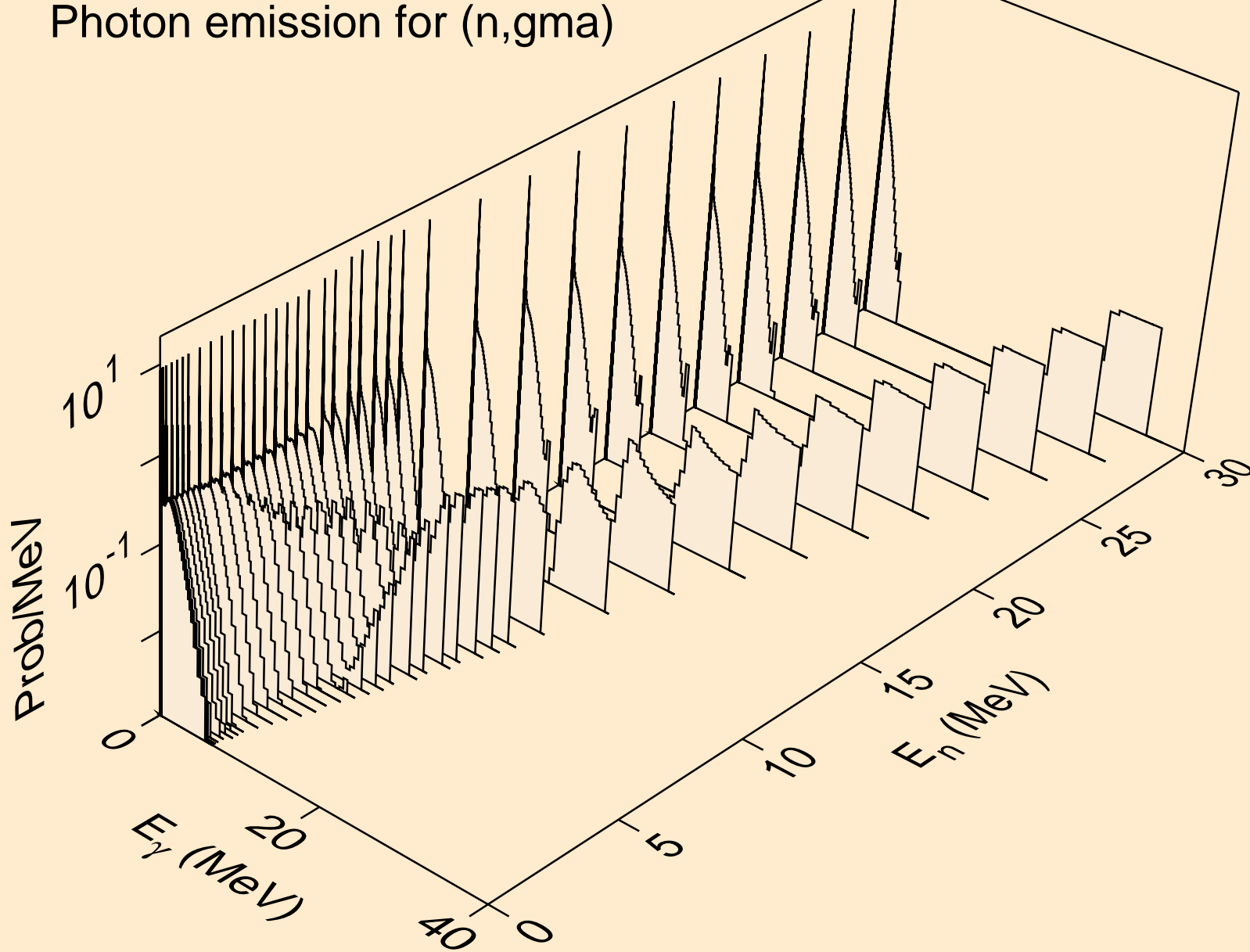

FR224 NEUTRON ACER TENDL-2019 LIBRARY; T=293.16K
Photon emission for (n,p)

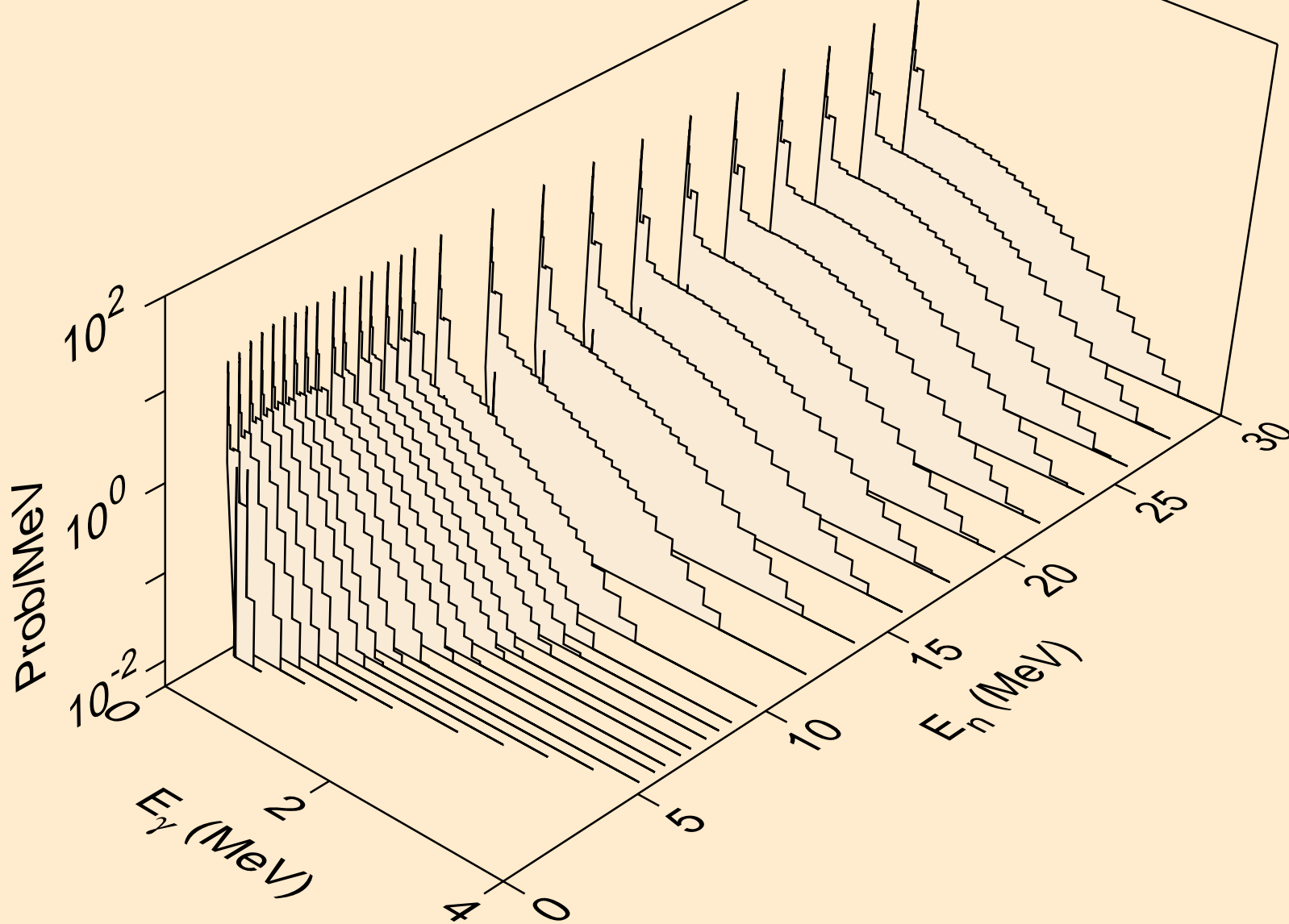

FR224 NEUTRON ACER TENDL-2019 LIBRARY; T=293.16K
Photon emission for (n,d)

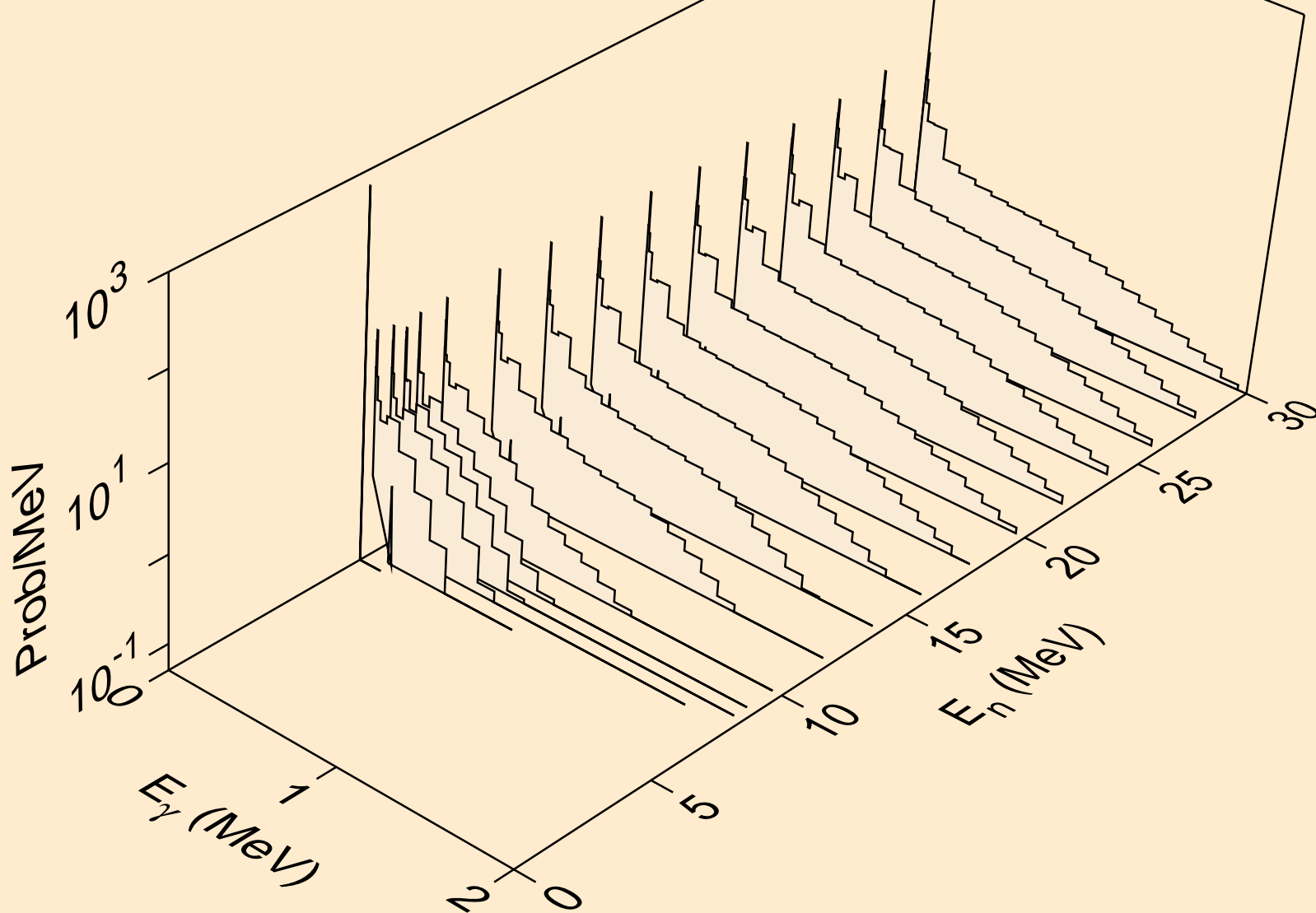

FR224 NEUTRON ACER TENDL-2019 LIBRARY; T=293.16K
Photon emission for (n,t)

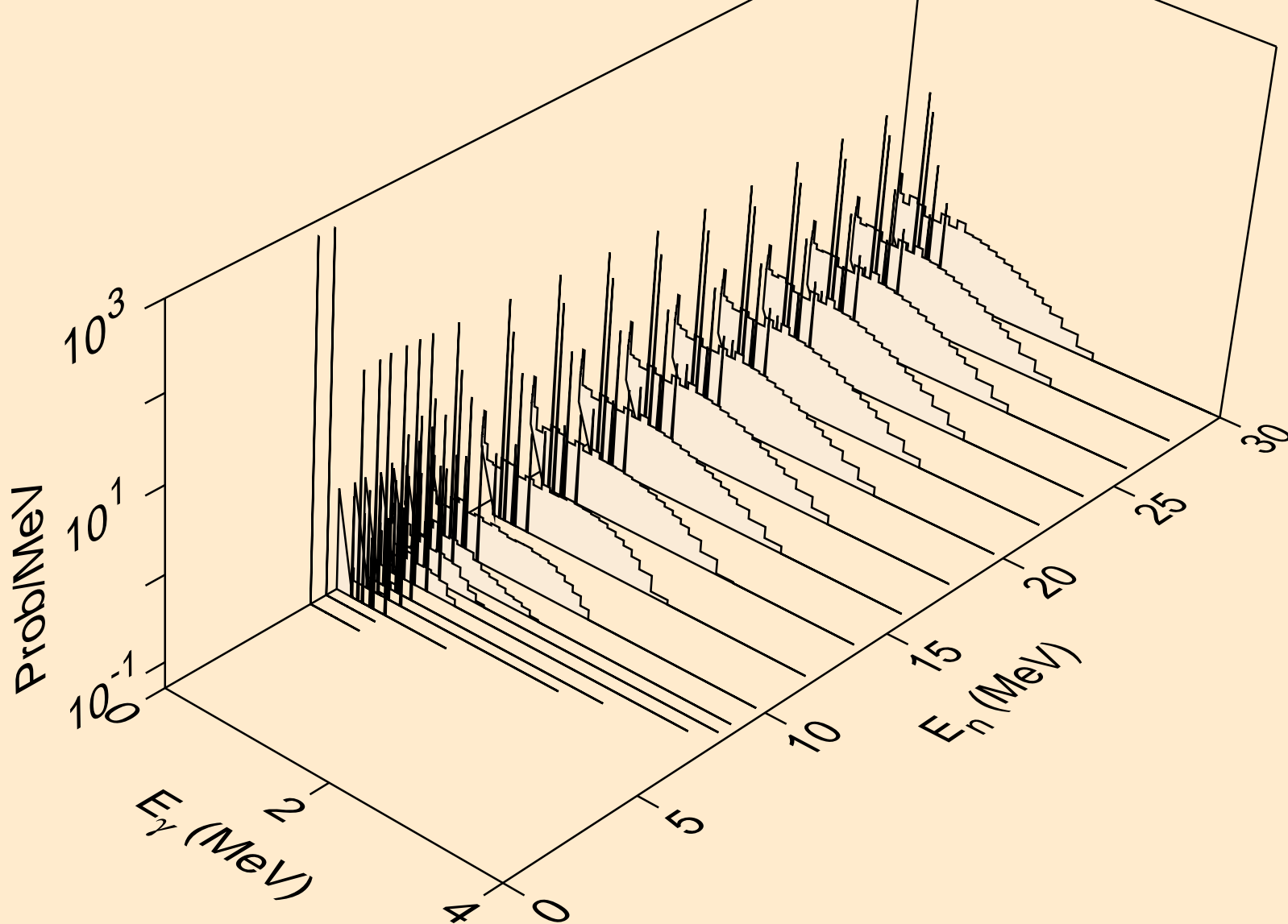

FR224 NEUTRON ACER TENDL-2019 LIBRARY; T=293.16K
Photon emission for (n,he3)

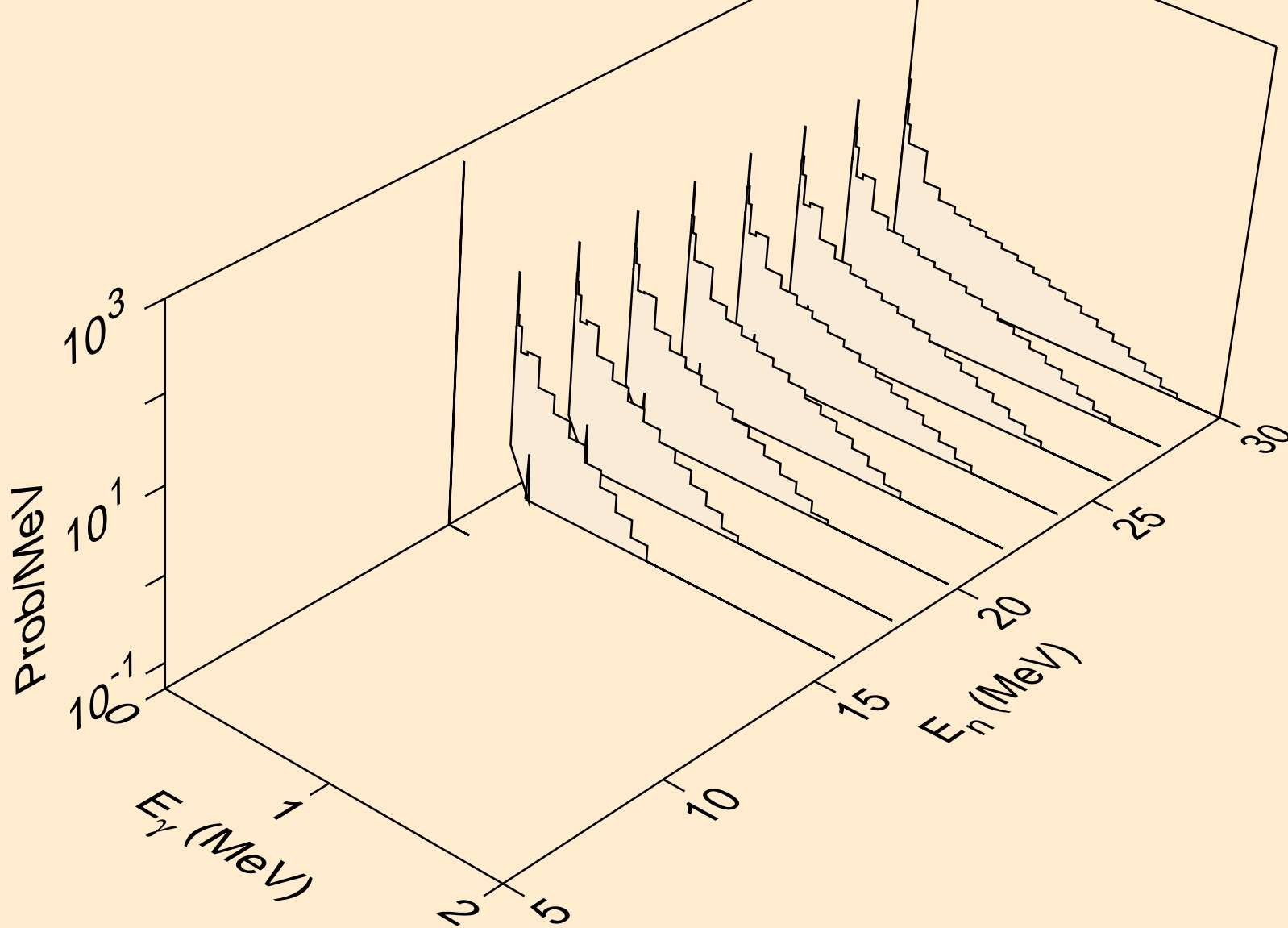

FR224 NEUTRON ACER TENDL-2019 LIBRARY; T=293.16K
Photon emission for (n,a)

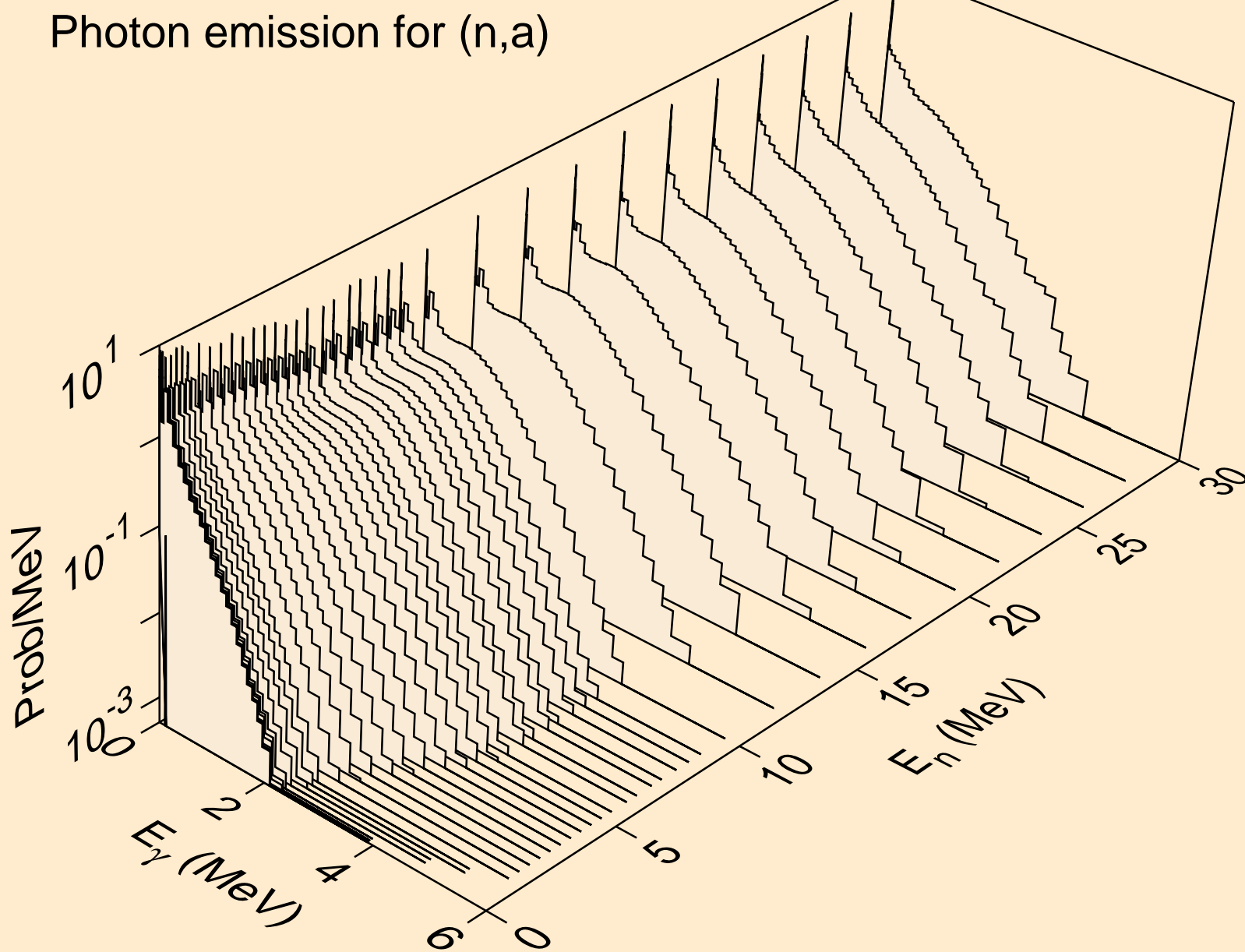

FR224 NEUTRON ACER TENDL-2019 LIBRARY; T=293.16K
Photon emission for (n,2a)

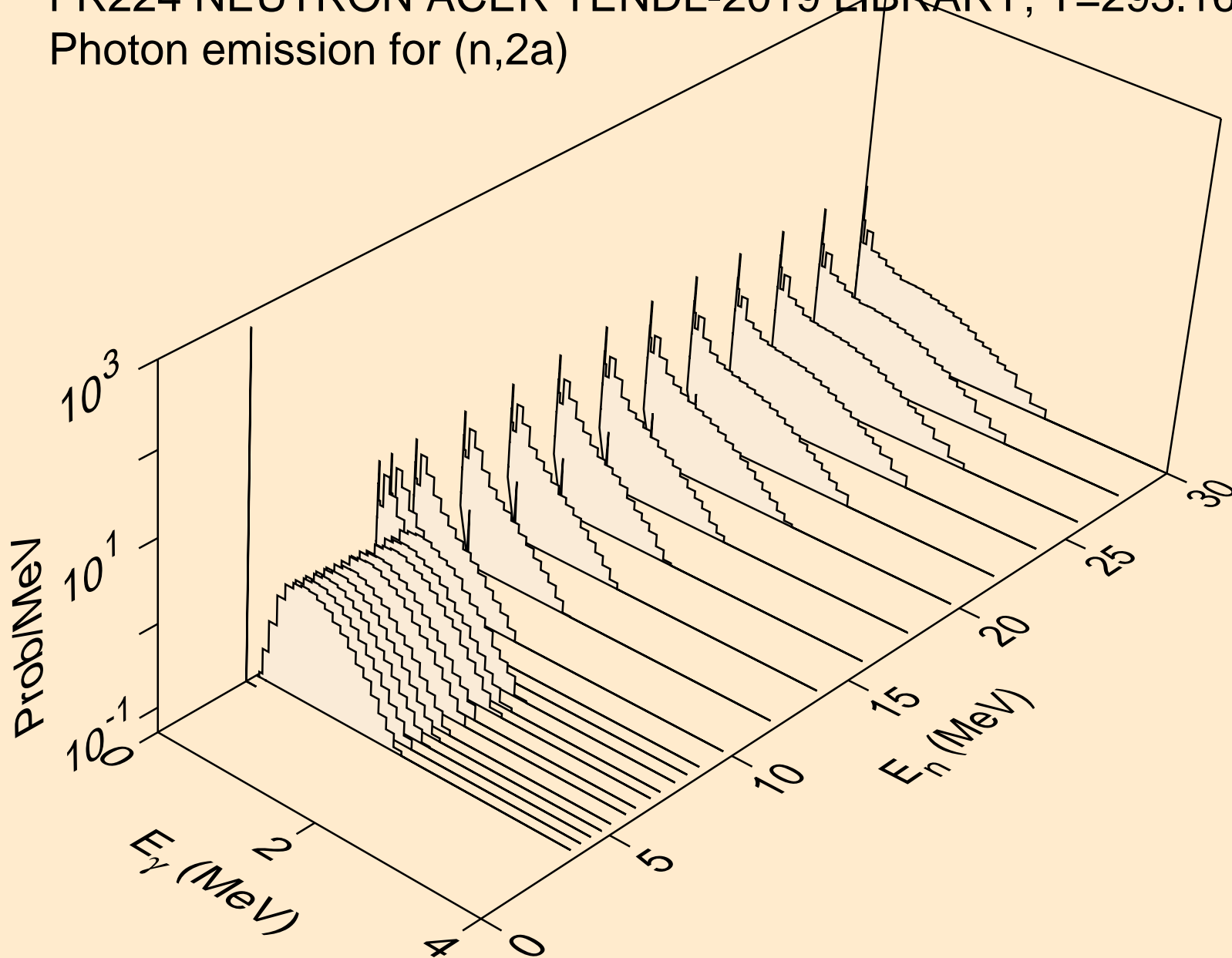

FR224 NEUTRON ACER TENDL-2019 LIBRARY; T=293.16K
Photon emission for (n,2p)

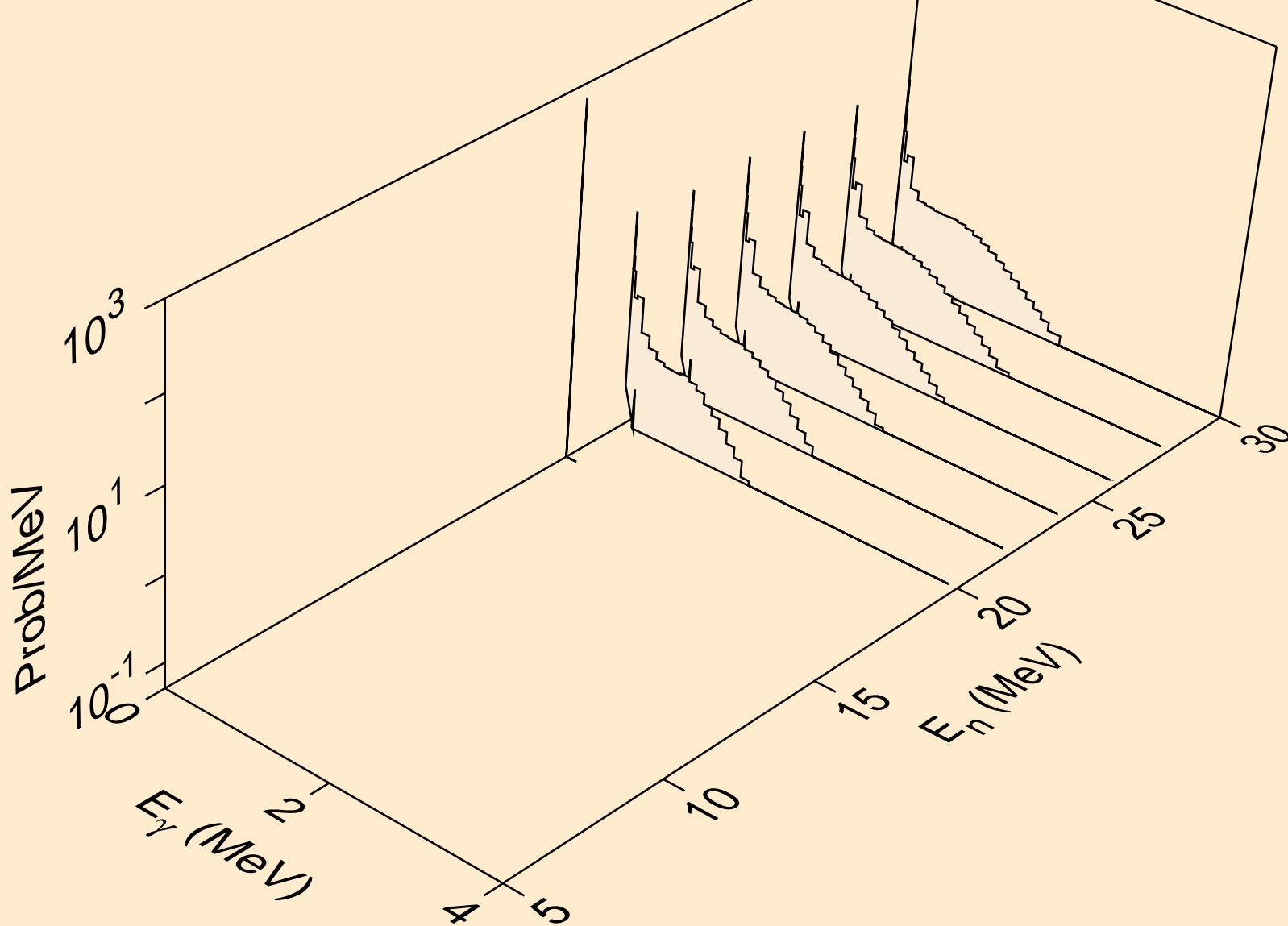

FR224 NEUTRON ACER TENDL-2019 LIBRARY; T=293.16K
thermal capture photon spectrum

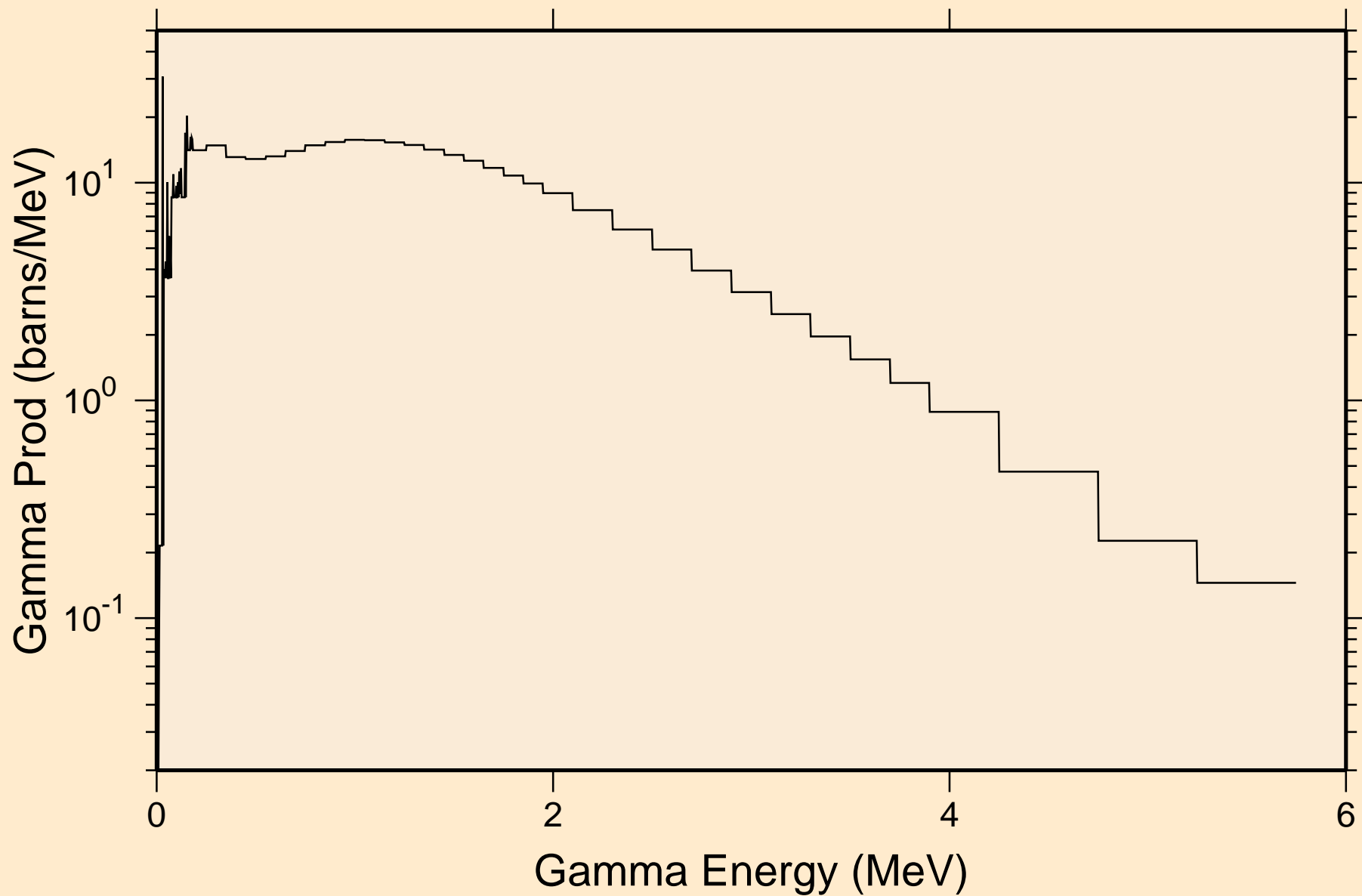

FR224 NEUTRON ACER TENDL-2019 LIBRARY; T=293.16K
14 MeV photon spectrum

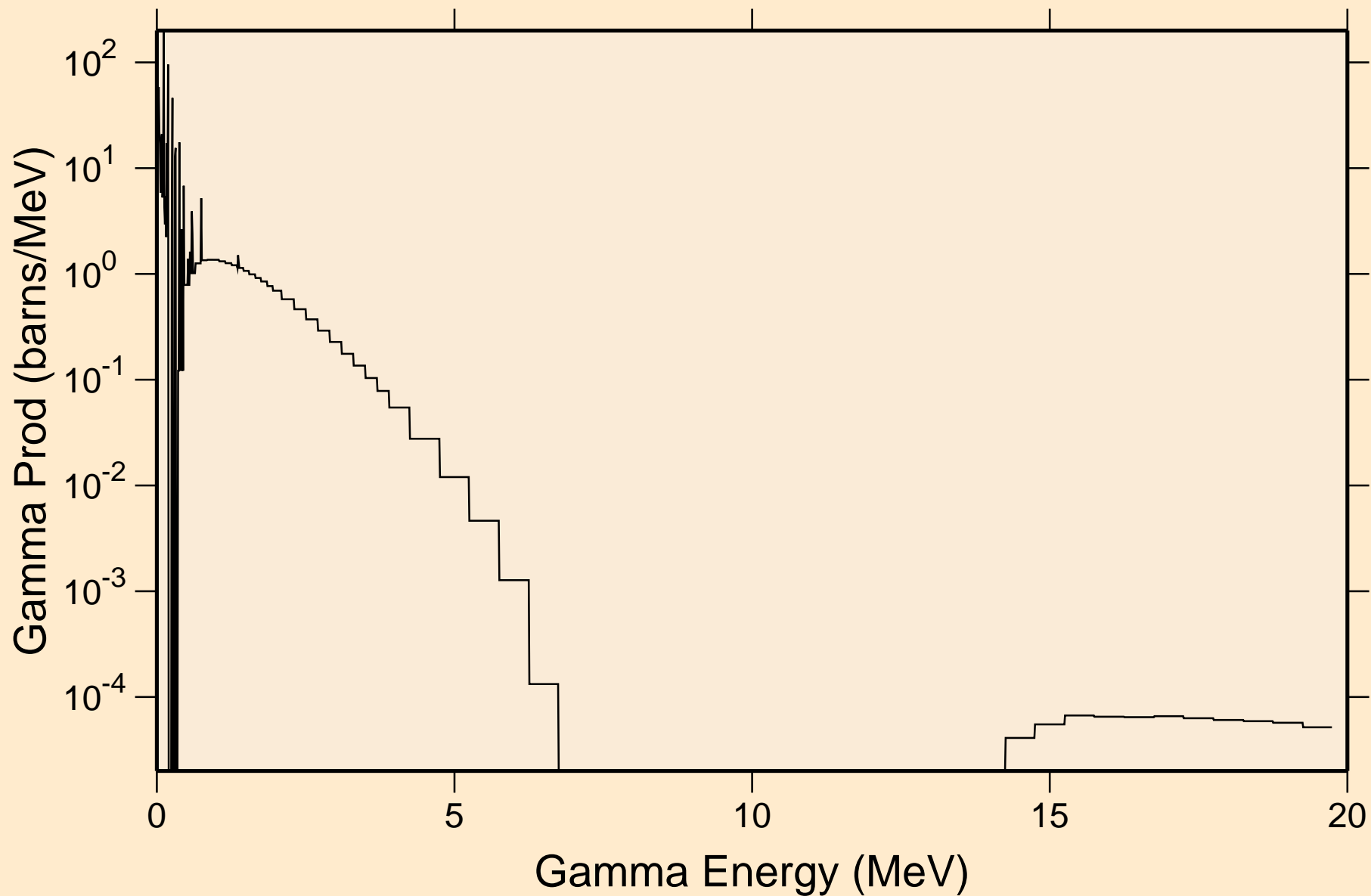

FR224 NEUTRON ACER TENDL-2019 LIBRARY; T=293.16K
Particle heating contributions

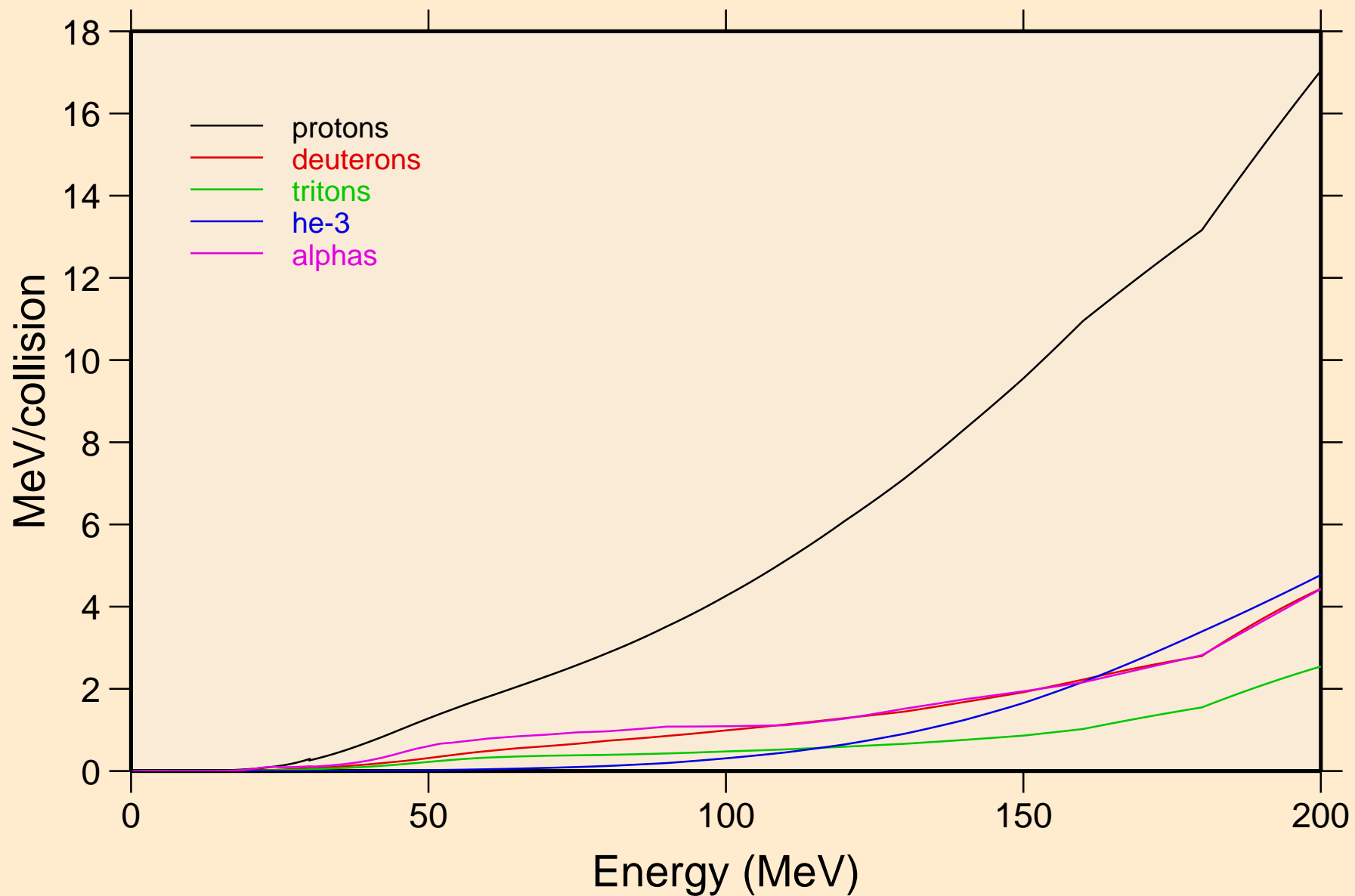

FR224 NEUTRON ACER TENDL-2019 LIBRARY; T=293.16K
Recoil Heating

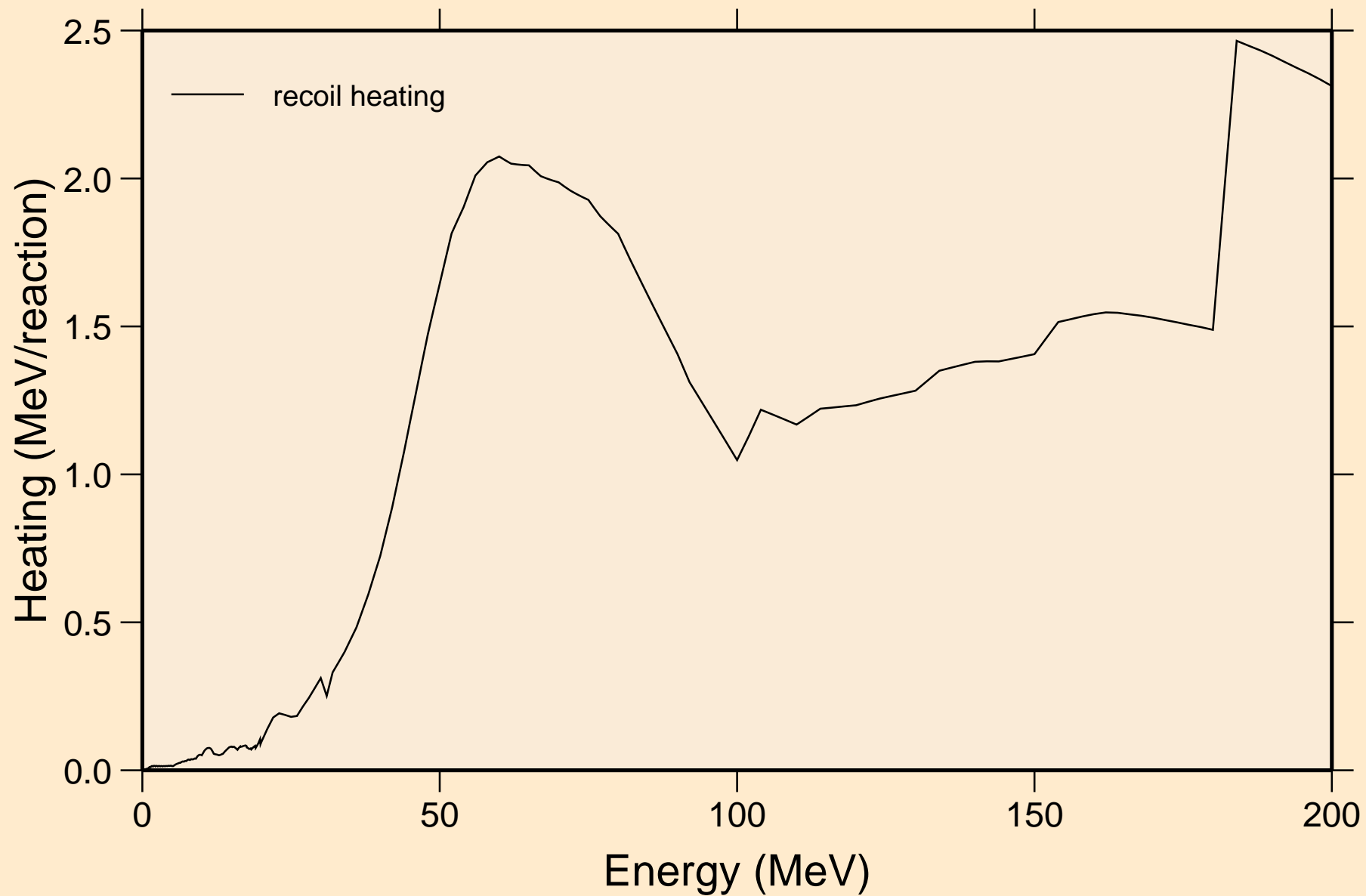

FR224 NEUTRON ACER TENDL-2019 LIBRARY; T=293.16K
Particle production cross sections

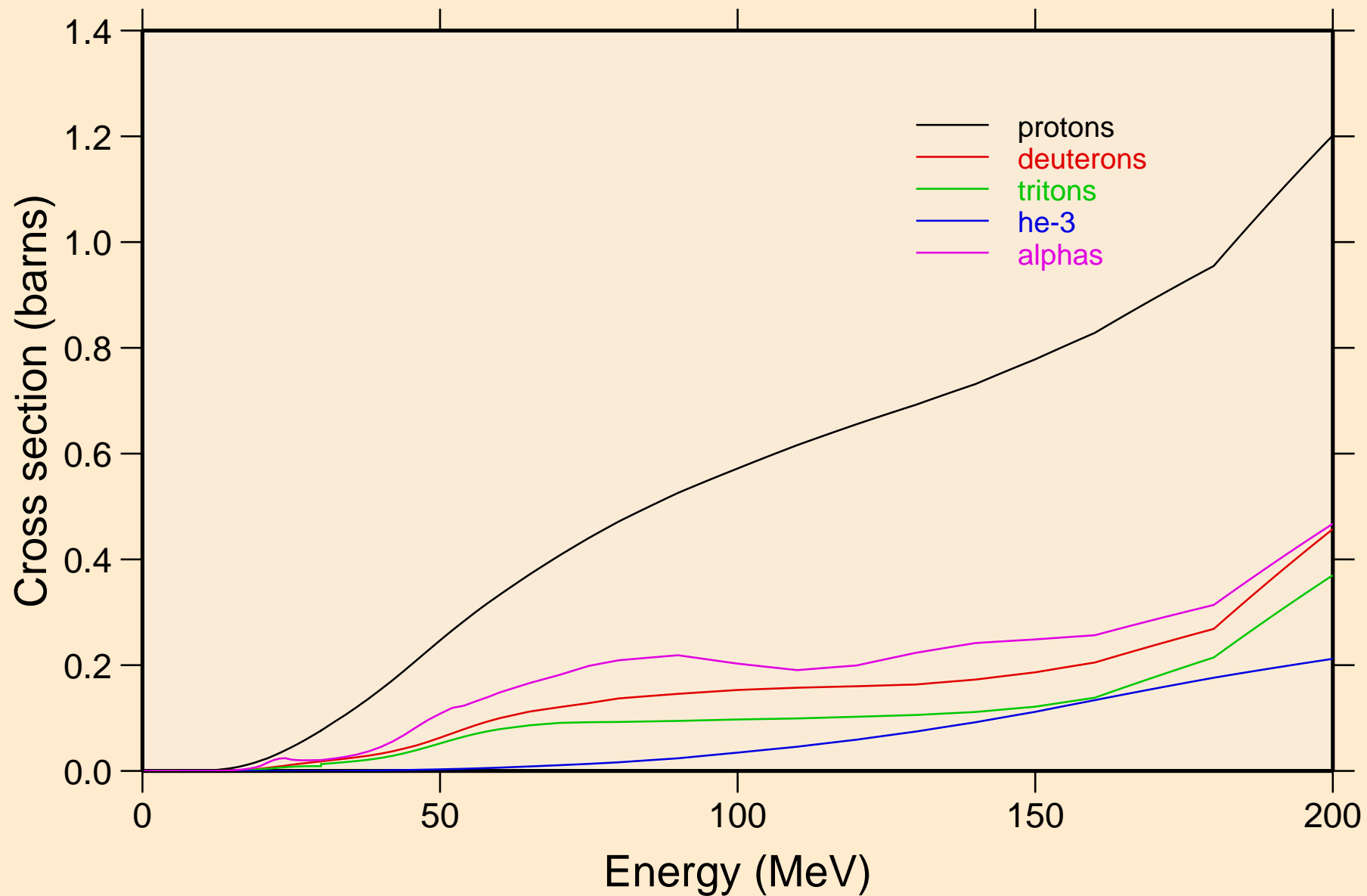

FR224 NEUTRON ACER TENDL-2019 LIBRARY; T=293.16K
protons from (n,x)

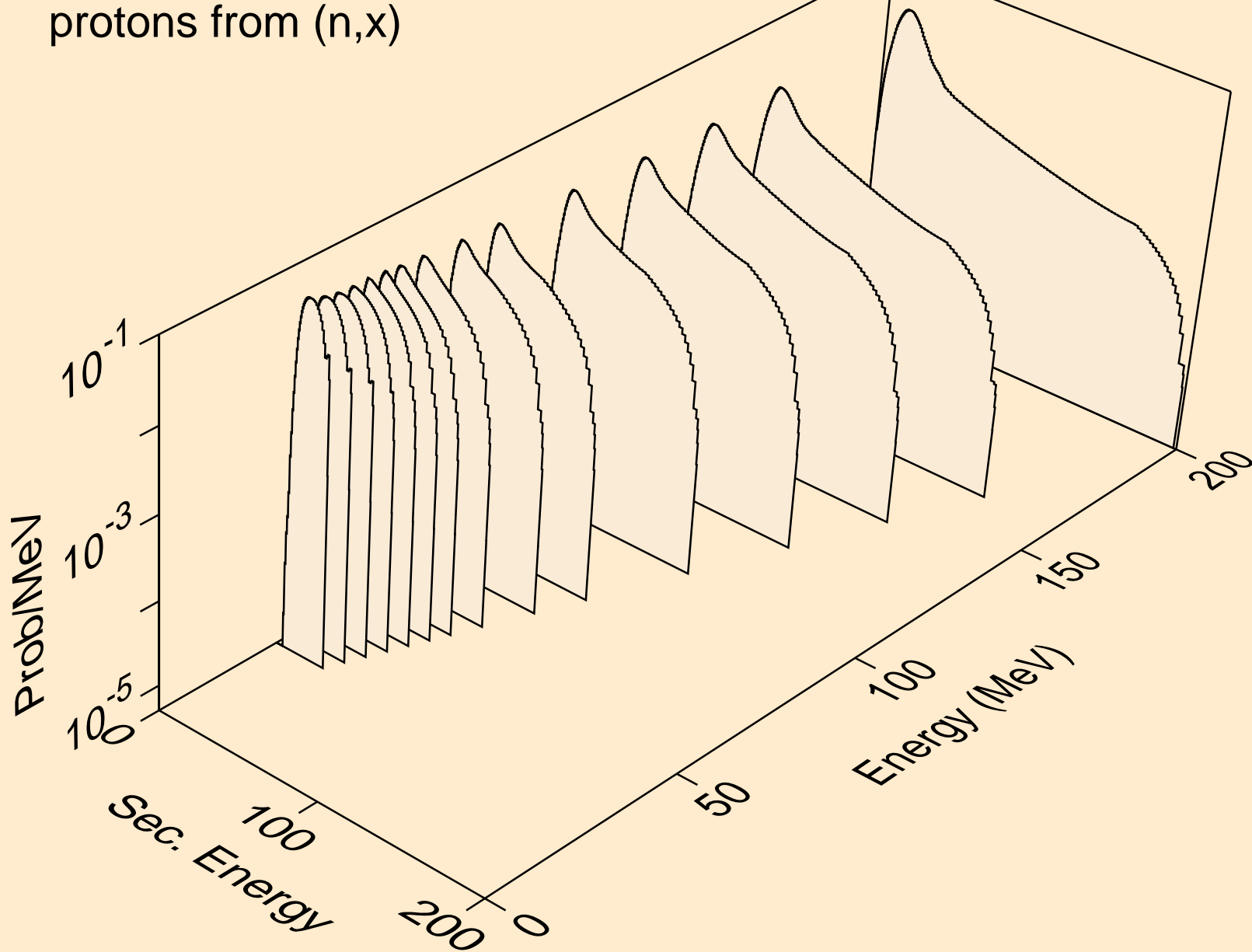

FR224 NEUTRON ACER TENDL-2019 LIBRARY; T=293.16K
protons from (n,n*)p

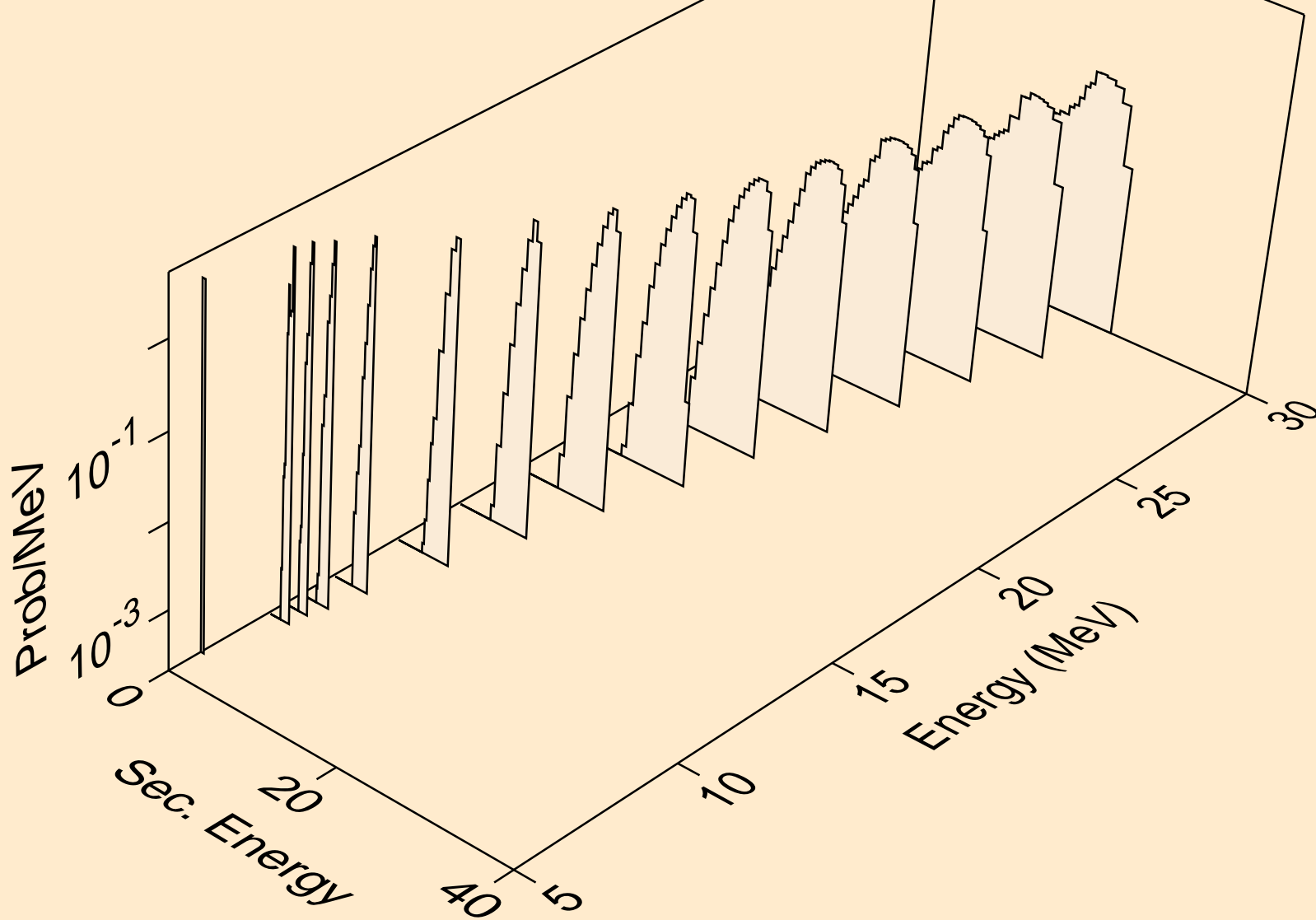

FR224 NEUTRON ACER TENDL-2019 LIBRARY; T=293.16K
protons from (n,2np)

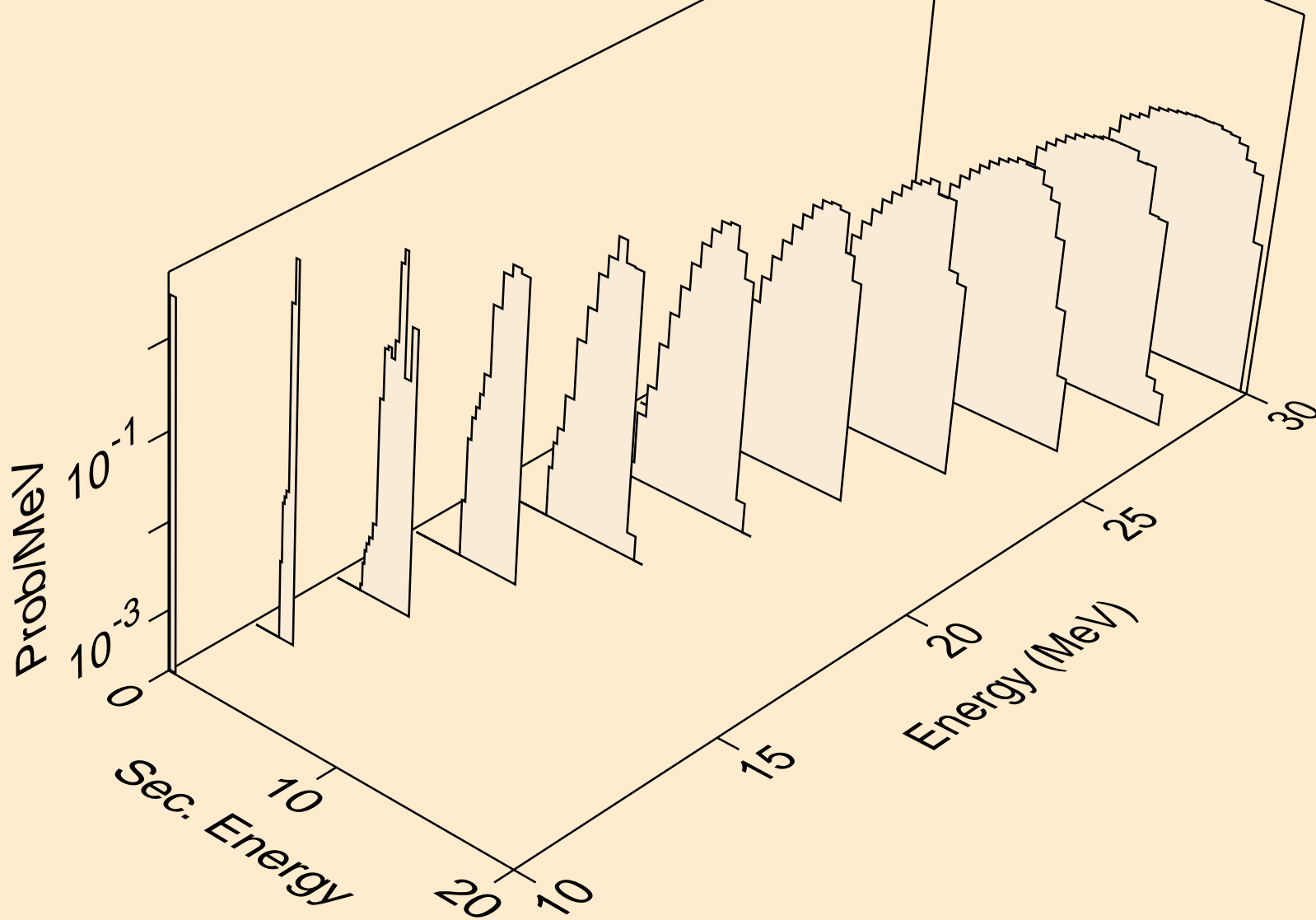

FR224 NEUTRON ACER TENDL-2019 LIBRARY; T=293.16K
protons from (n,3np)

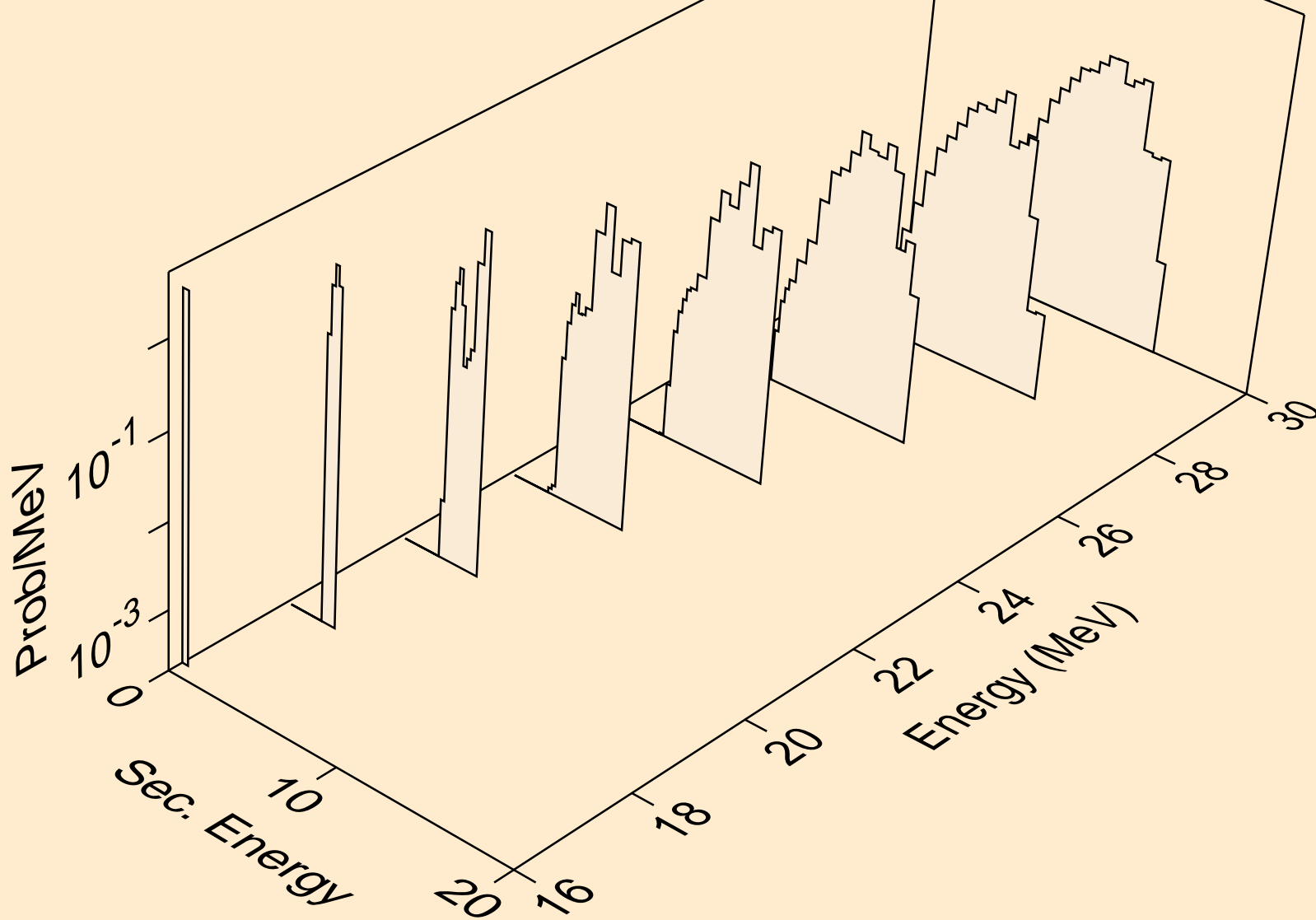

FR224 NEUTRON ACER TENDL-2019 LIBRARY; T=293.16K
protons from (n,2np)

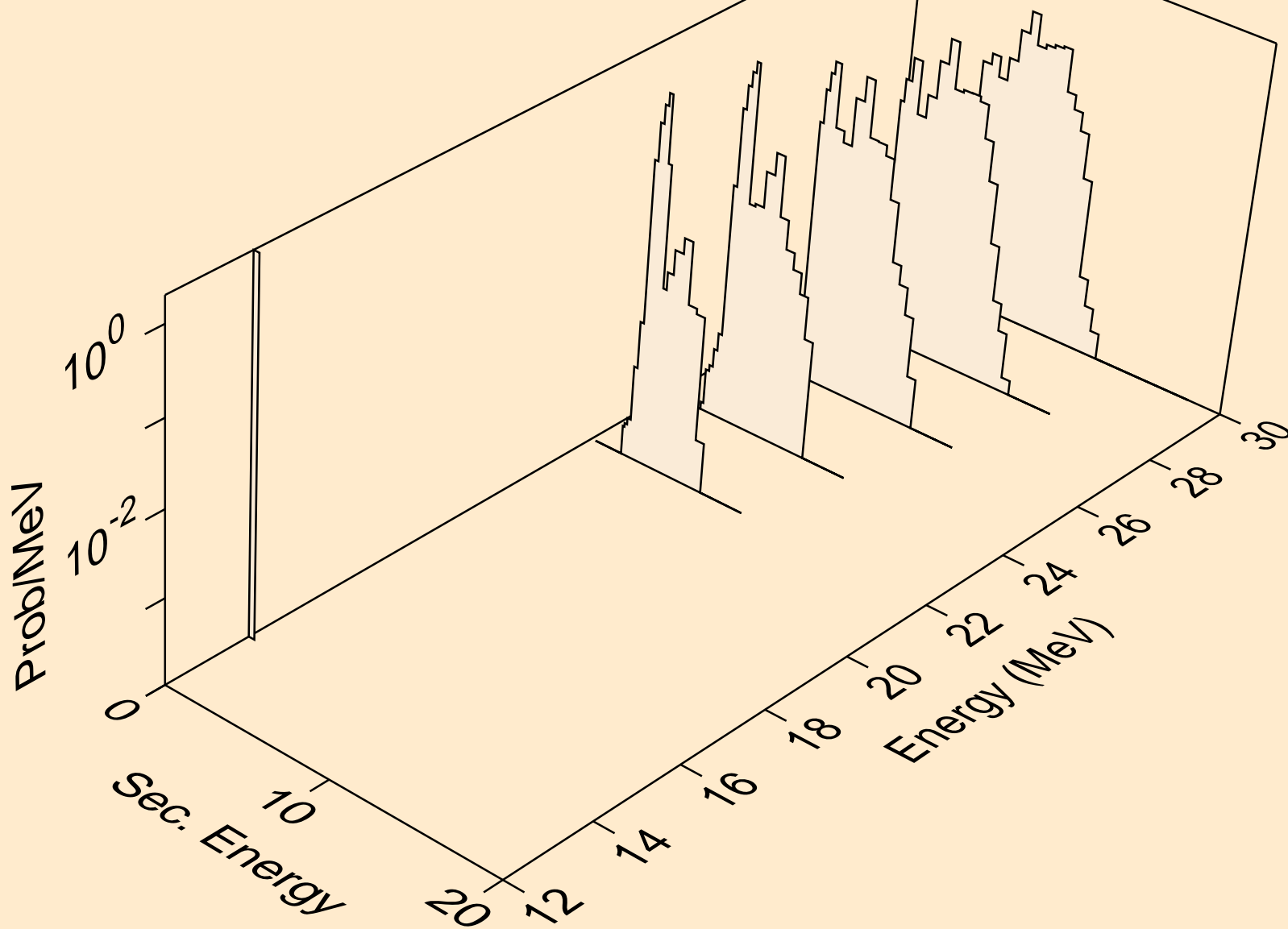

FR224 NEUTRON ACER TENDL-2019 LIBRARY; T=293.16K
protons from (n,npa)

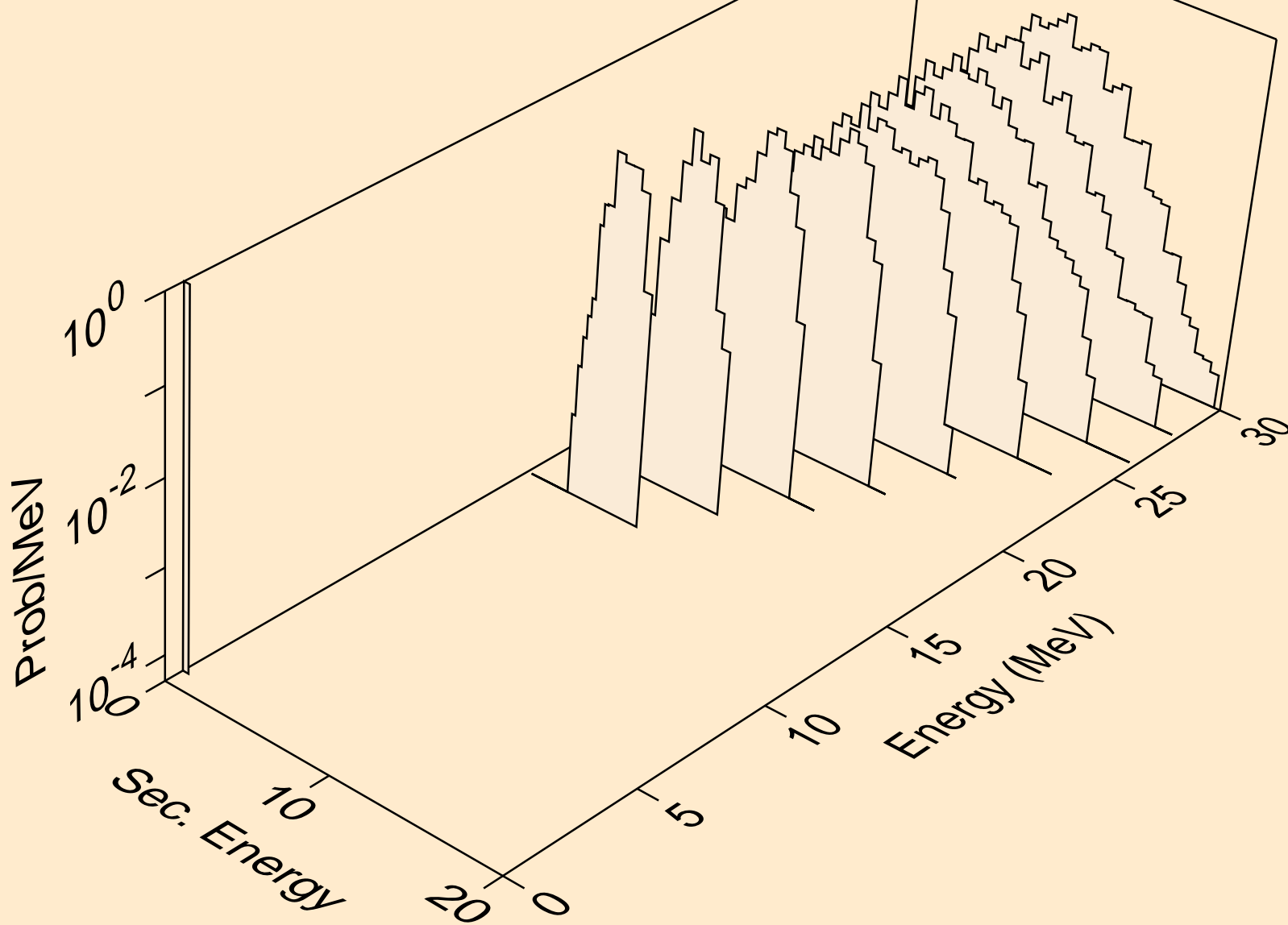

FR224 NEUTRON ACER TENDL-2019 LIBRARY; T=293.16K
protons from (n,p)

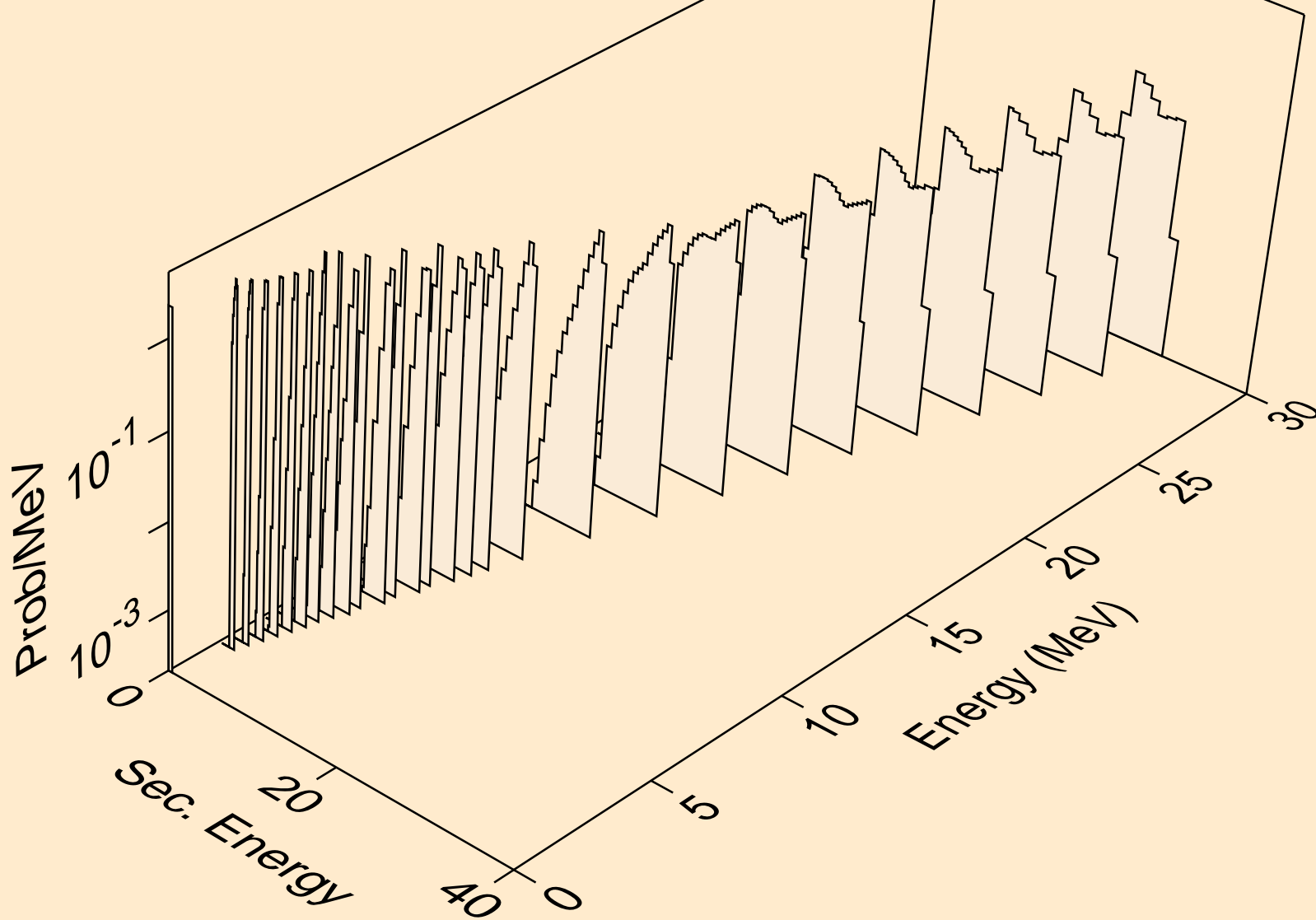

FR224 NEUTRON ACER TENDL-2019 LIBRARY; T=293.16K
protons from (n,2p)

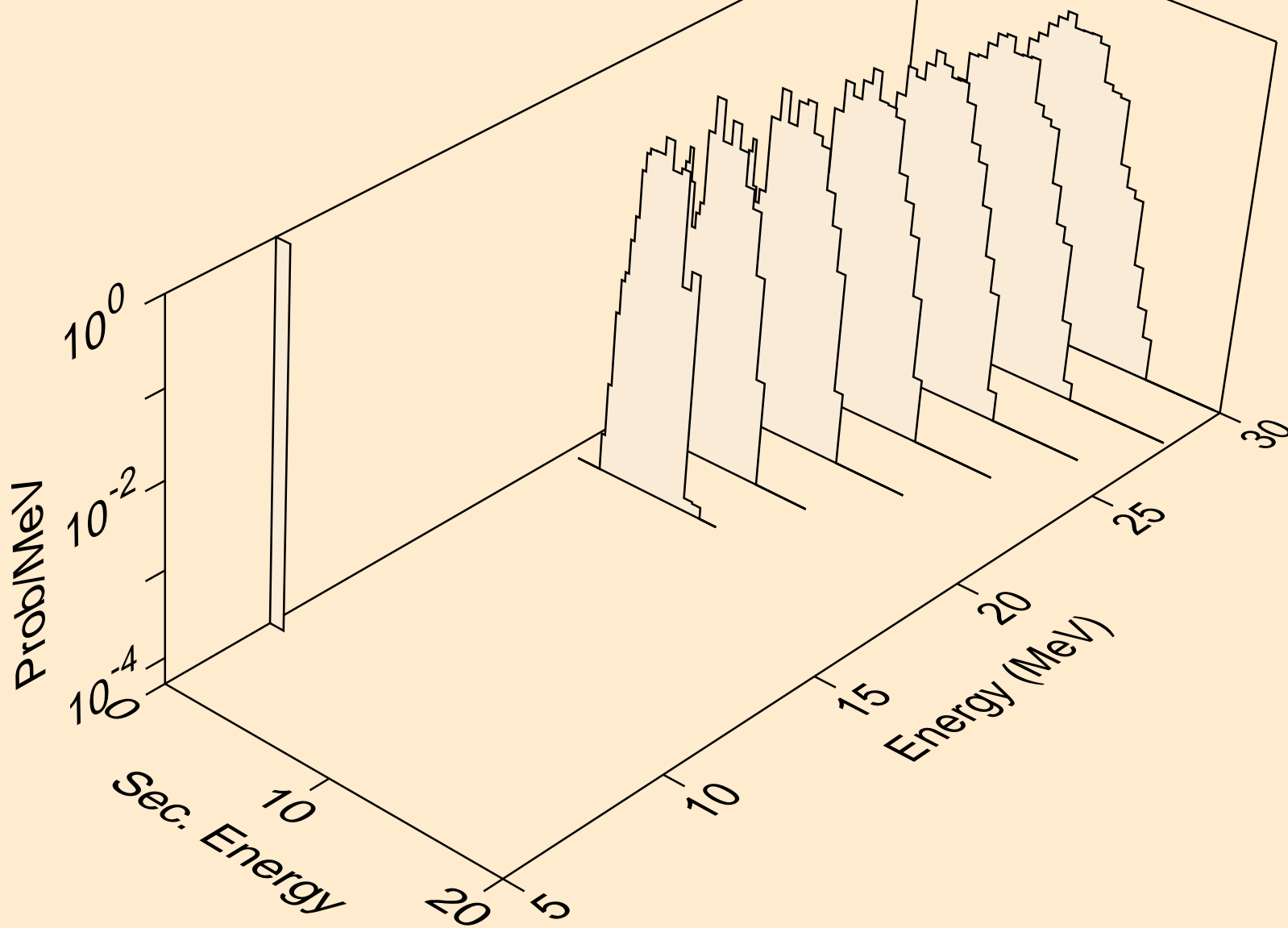

FR224 NEUTRON ACER TENDL-2019 LIBRARY; T=293.16K
deuterons from (n,x)

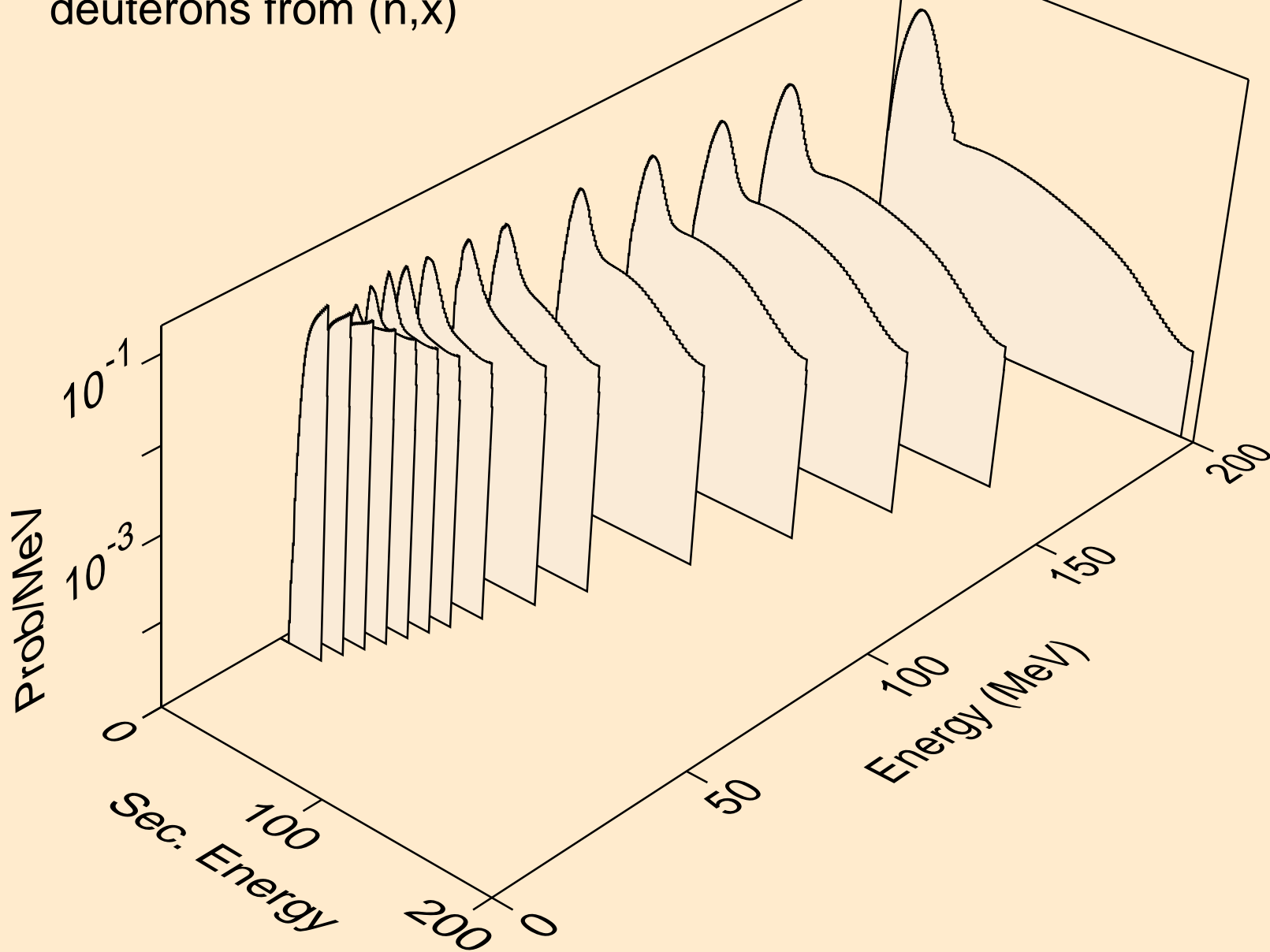

FR224 NEUTRON ACER TENDL-2019 LIBRARY; T=293.16K
deuterons from (n,2nd)

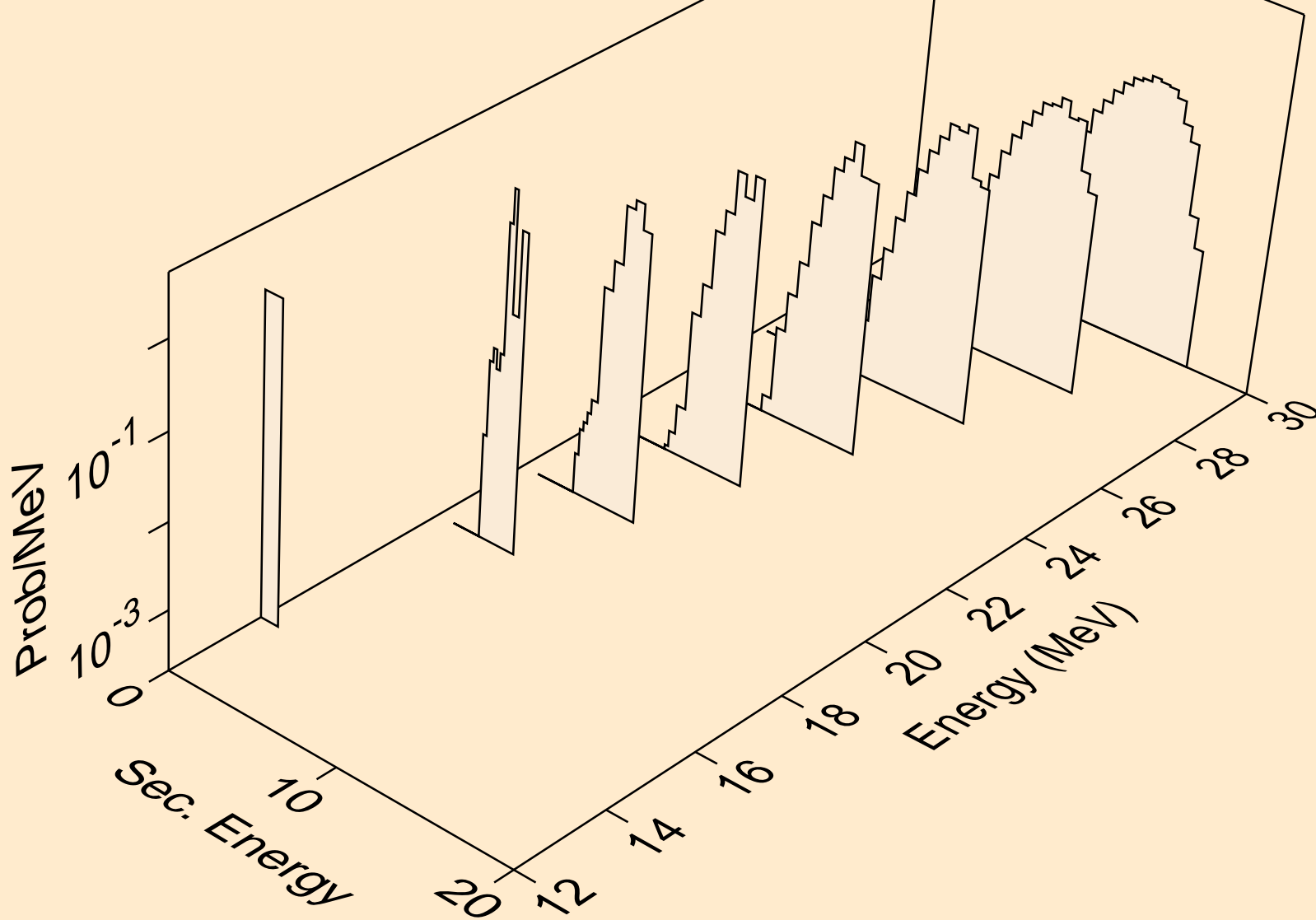

FR224 NEUTRON ACER TENDL-2019 LIBRARY; T=293.16K
deuterons from (n,n*)d

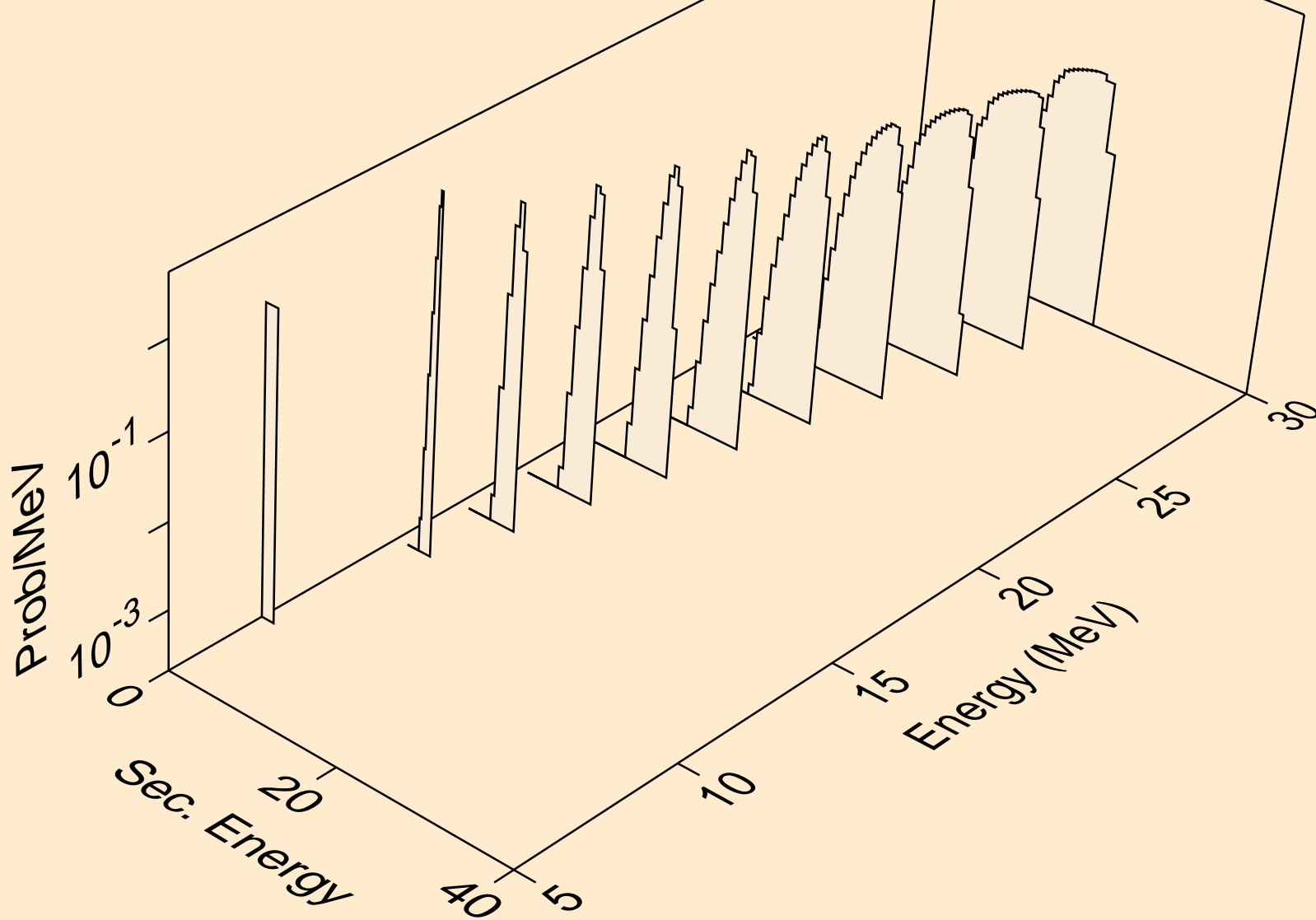

FR224 NEUTRON ACER TENDL-2019 LIBRARY; T=293.16K
deuterons from (n,d)

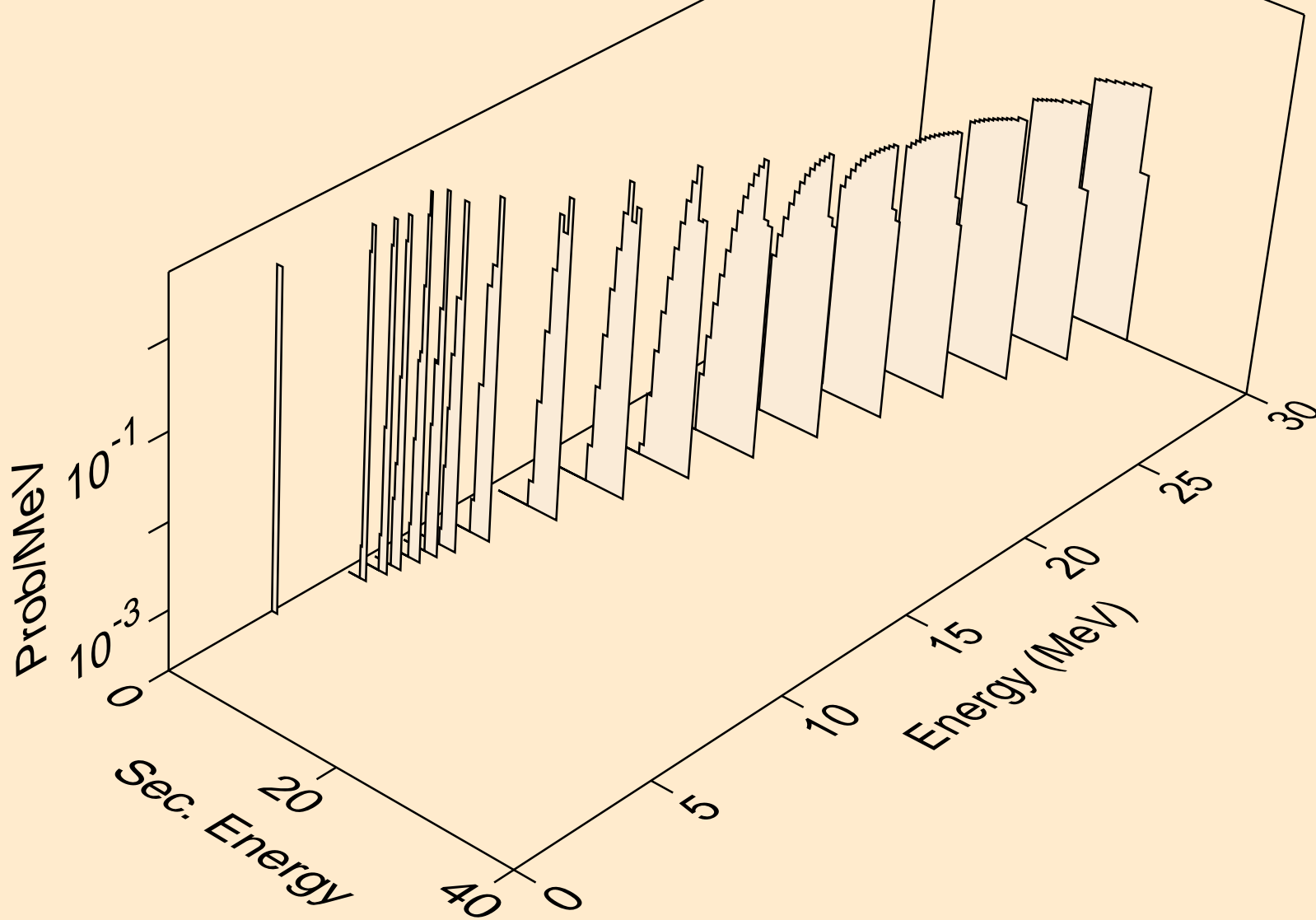

FR224 NEUTRON ACER TENDL-2019 LIBRARY; T=293.16K
tritons from (n,x)

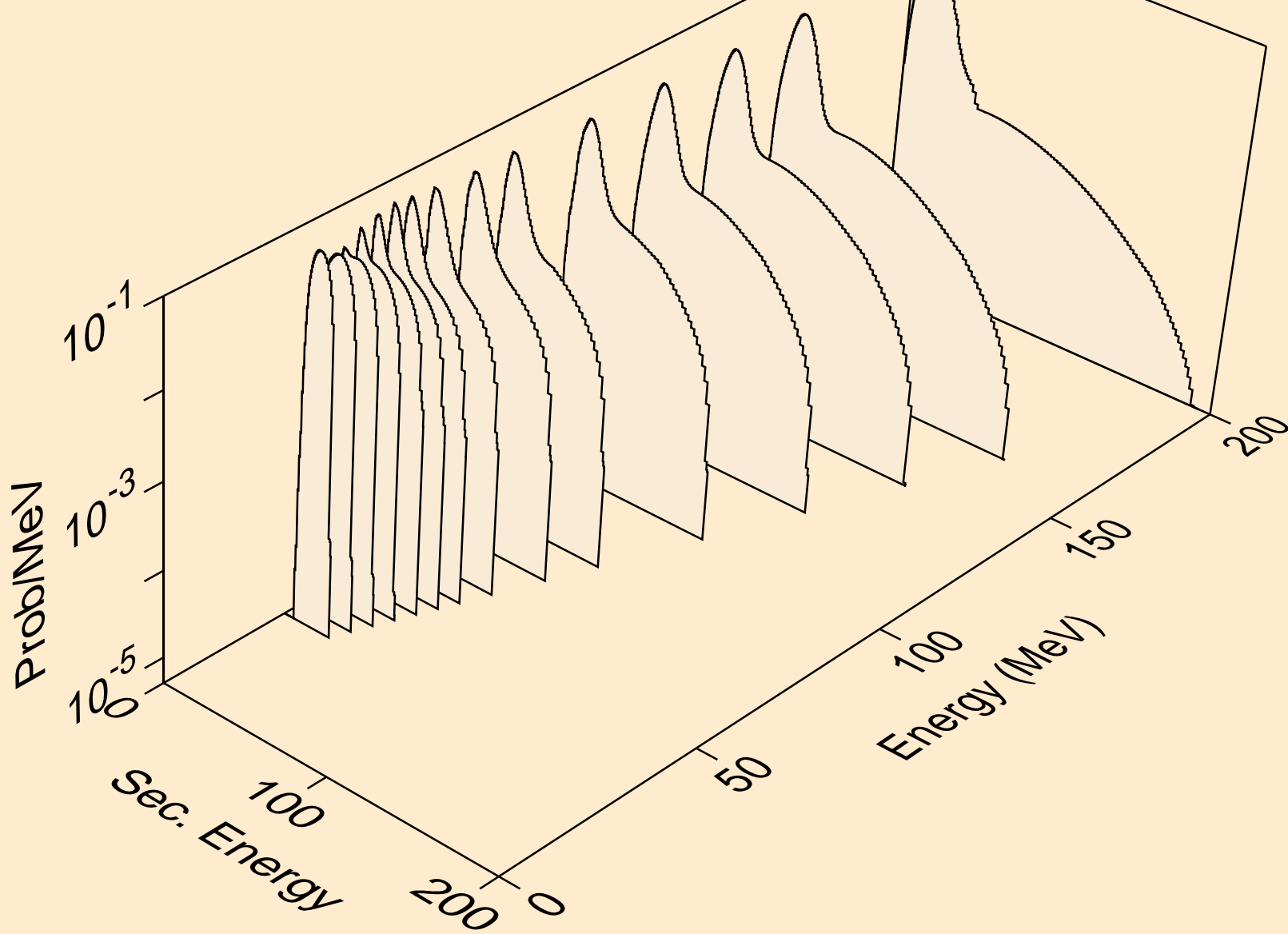

FR224 NEUTRON ACER TENDL-2019 LIBRARY; T=293.16K
tritons from (n,n*)t

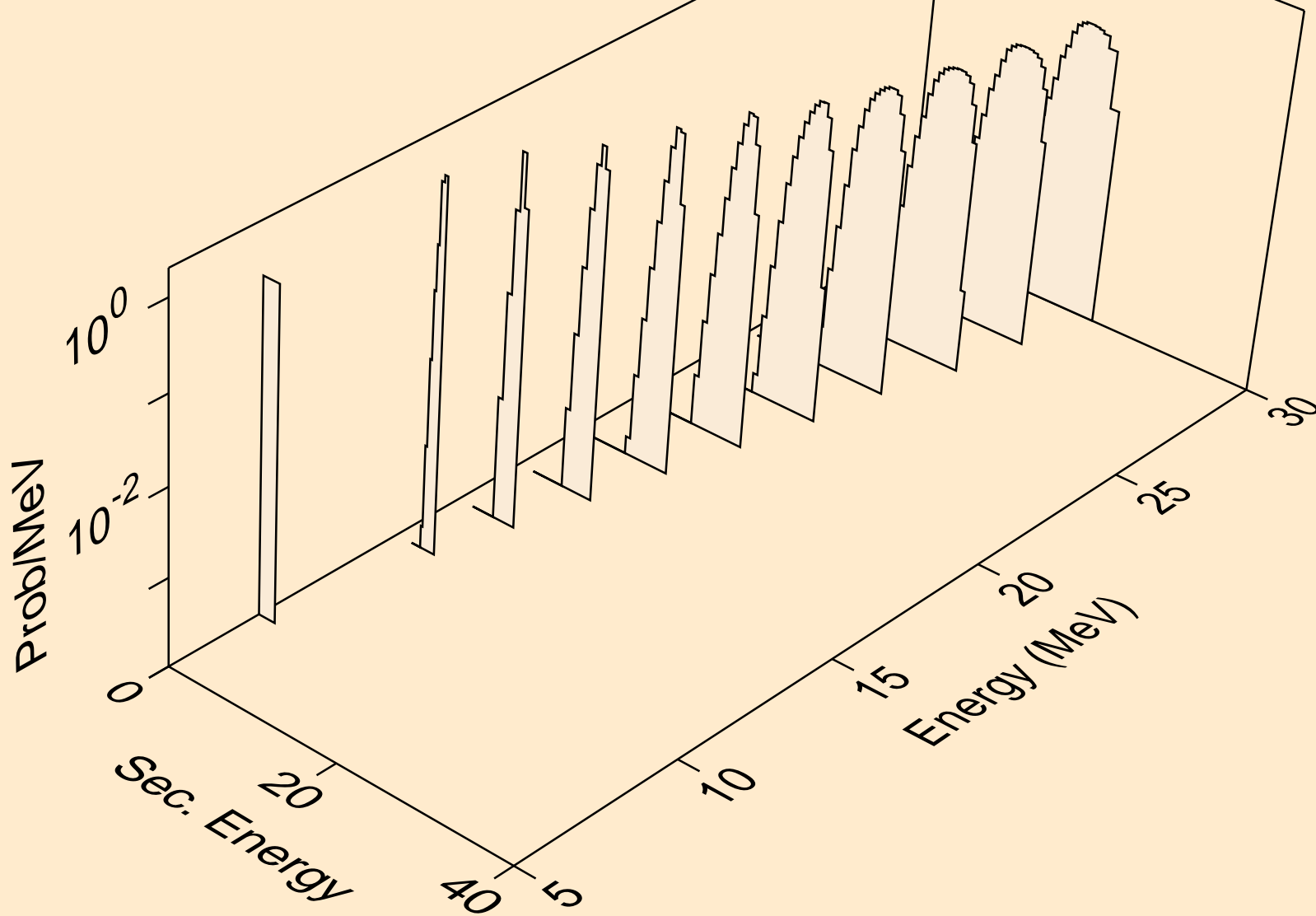

FR224 NEUTRON ACER TENDL-2019 LIBRARY; T=293.16K
tritons from (n,t)

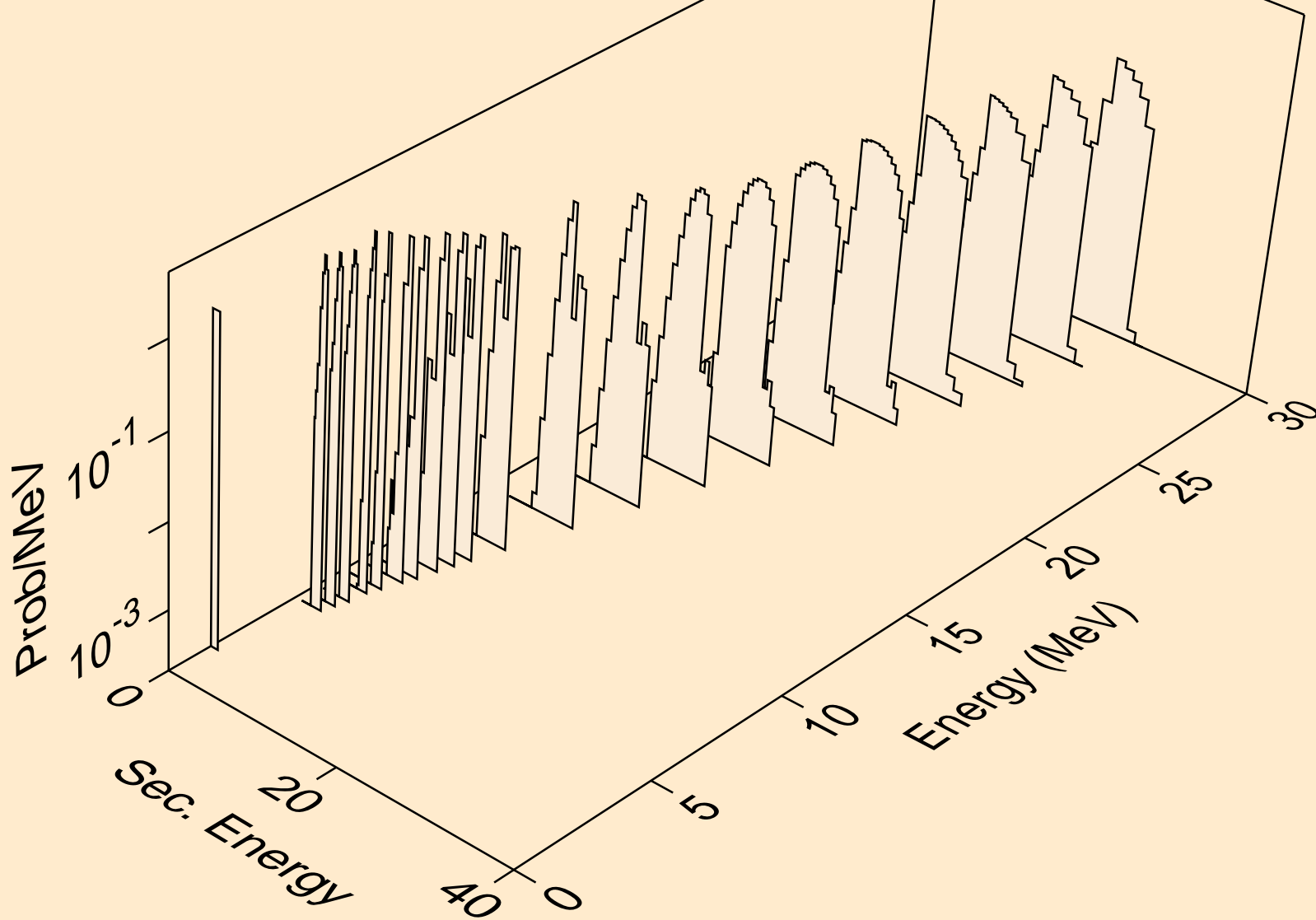

FR224 NEUTRON ACER TENDL-2019 LIBRARY; T=293.16K
he3s from (n,x)

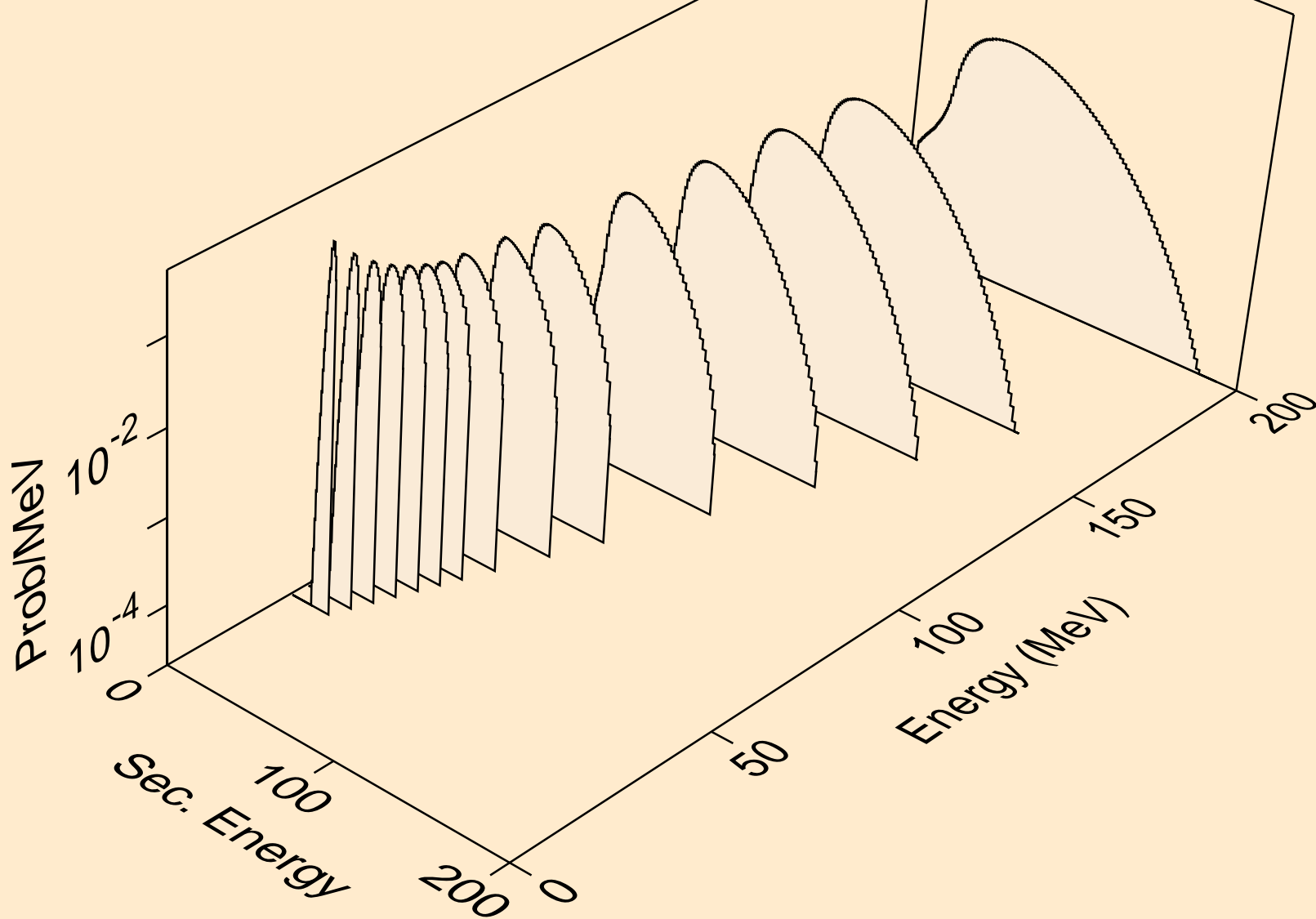

FR224 NEUTRON ACER TENDL-2019 LIBRARY; T=293.16K
he3s from (n,n*)he3

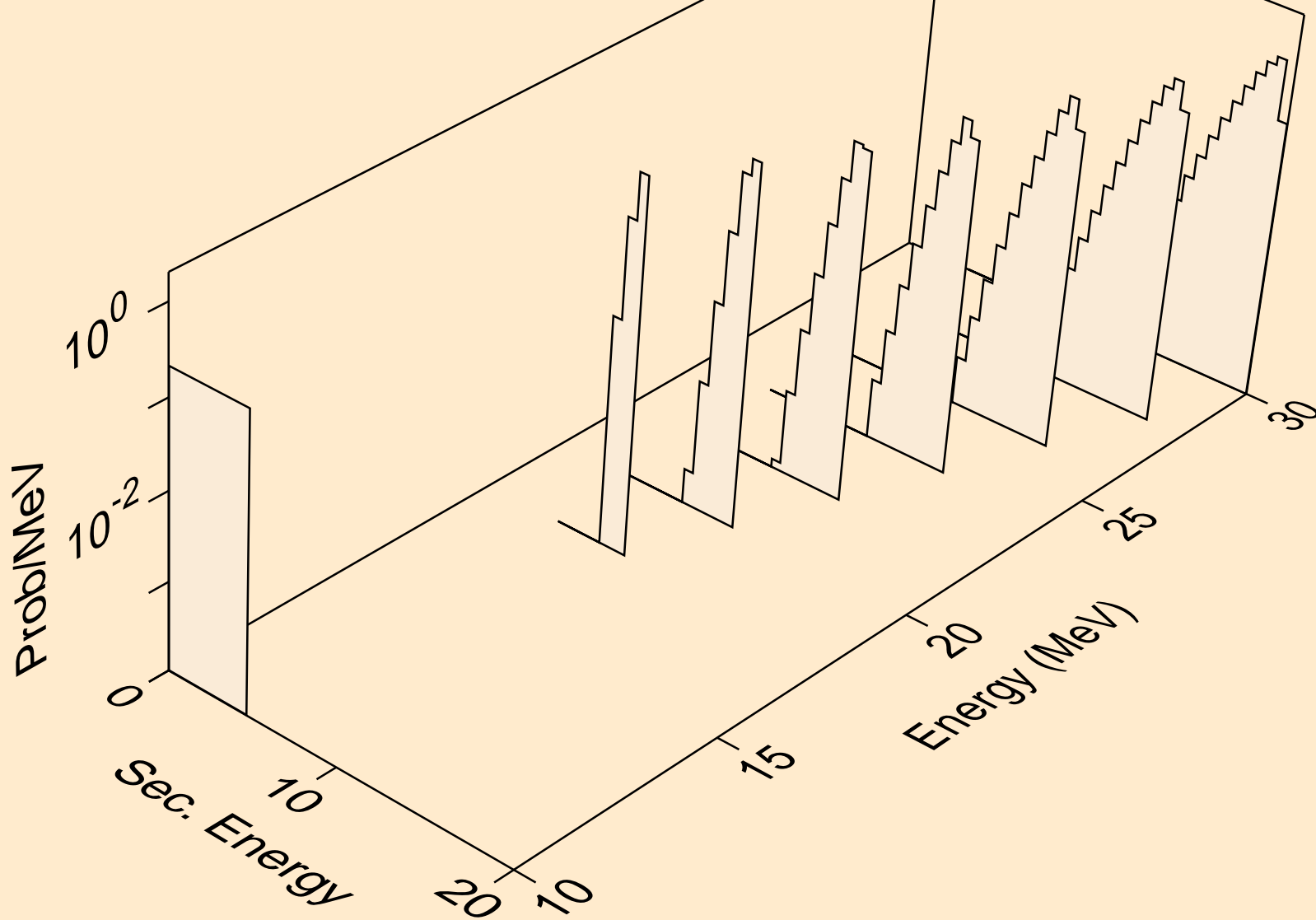

FR224 NEUTRON ACER TENDL-2019 LIBRARY; T=293.16K
he3s from (n,he3)

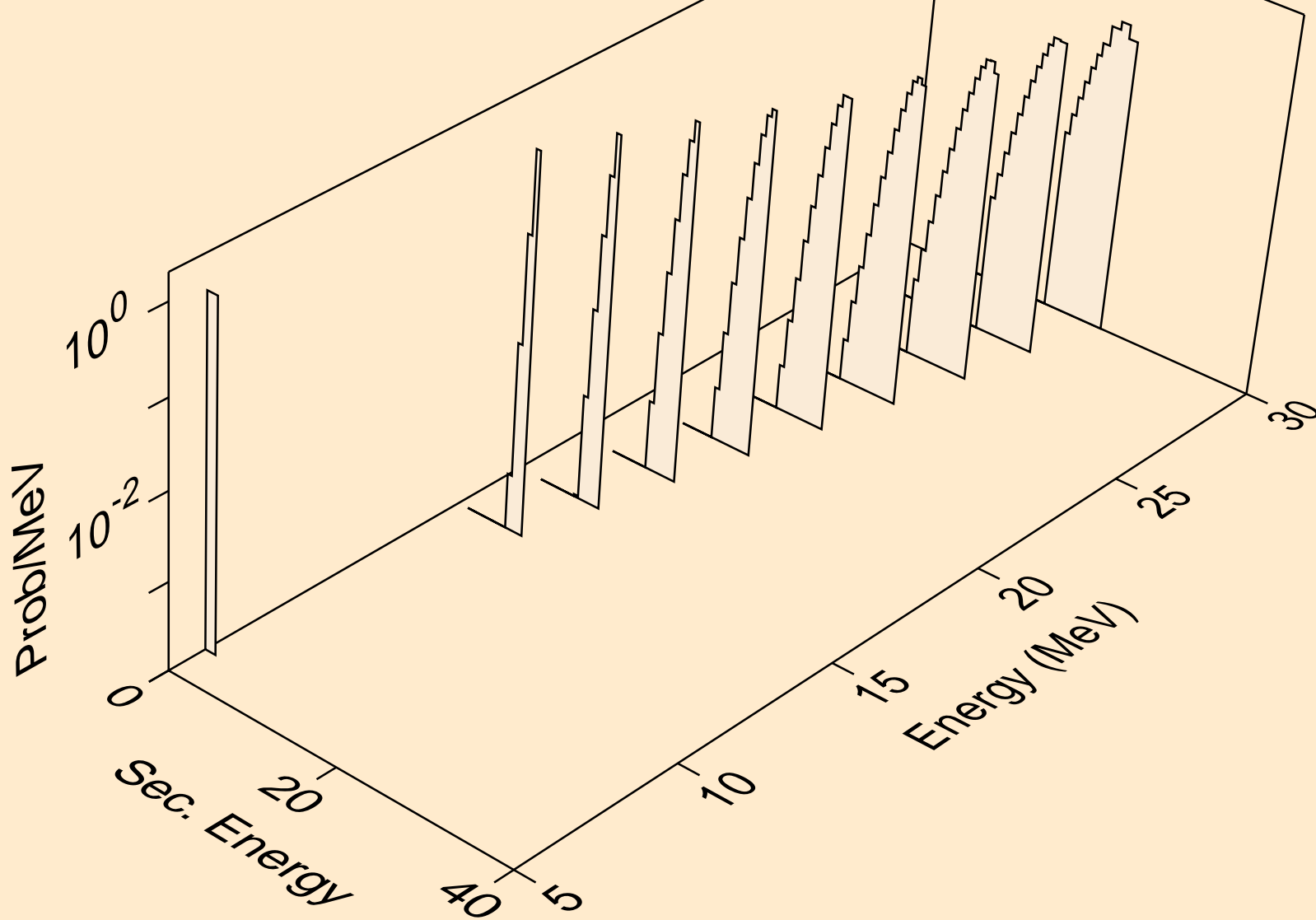

FR224 NEUTRON ACER TENDL-2019 LIBRARY; T=293.16K
alphas from (n,x)

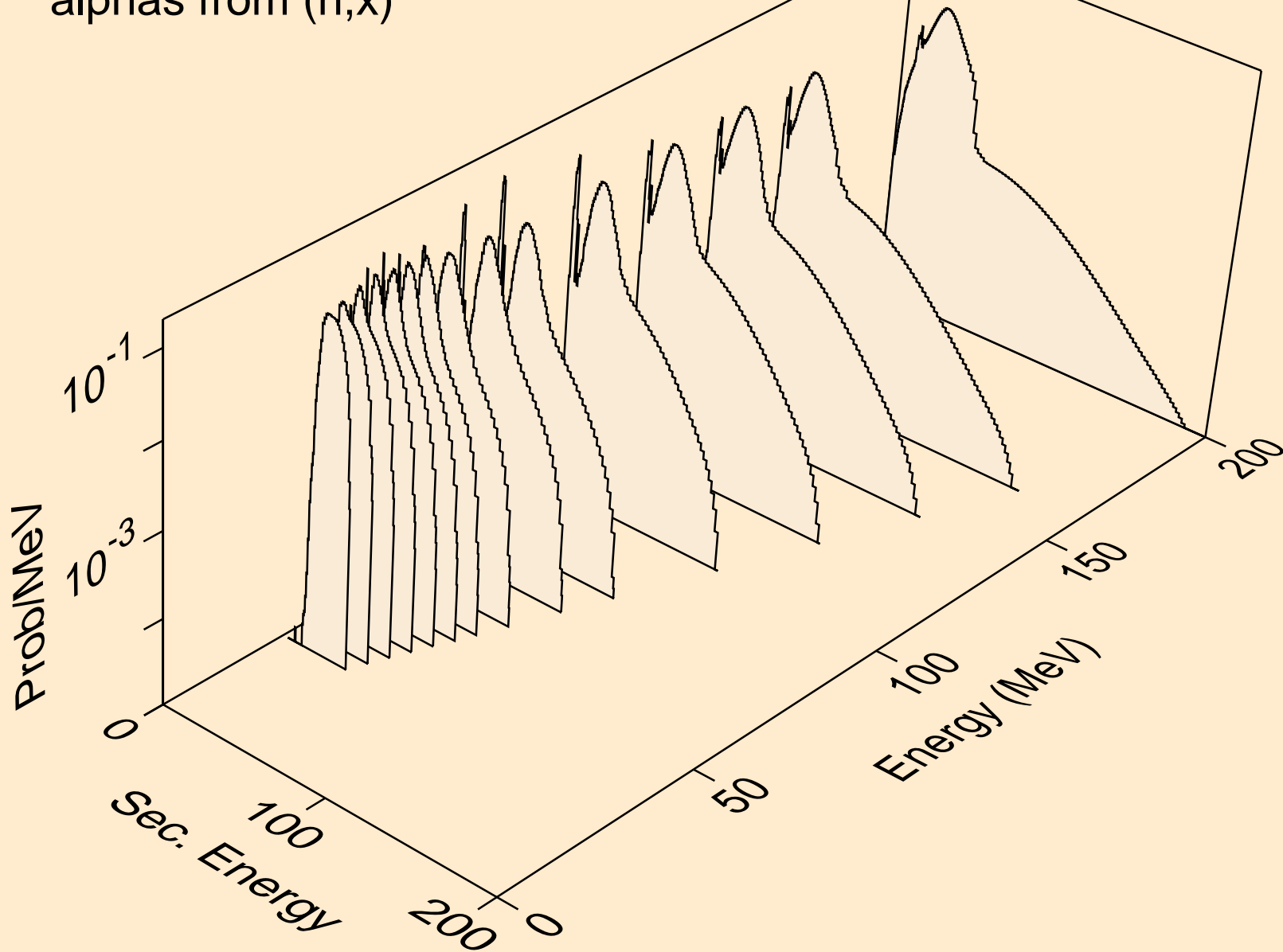

FR224 NEUTRON ACER TENDL-2019 LIBRARY; T=293.16K
alphas from (n,n*)a

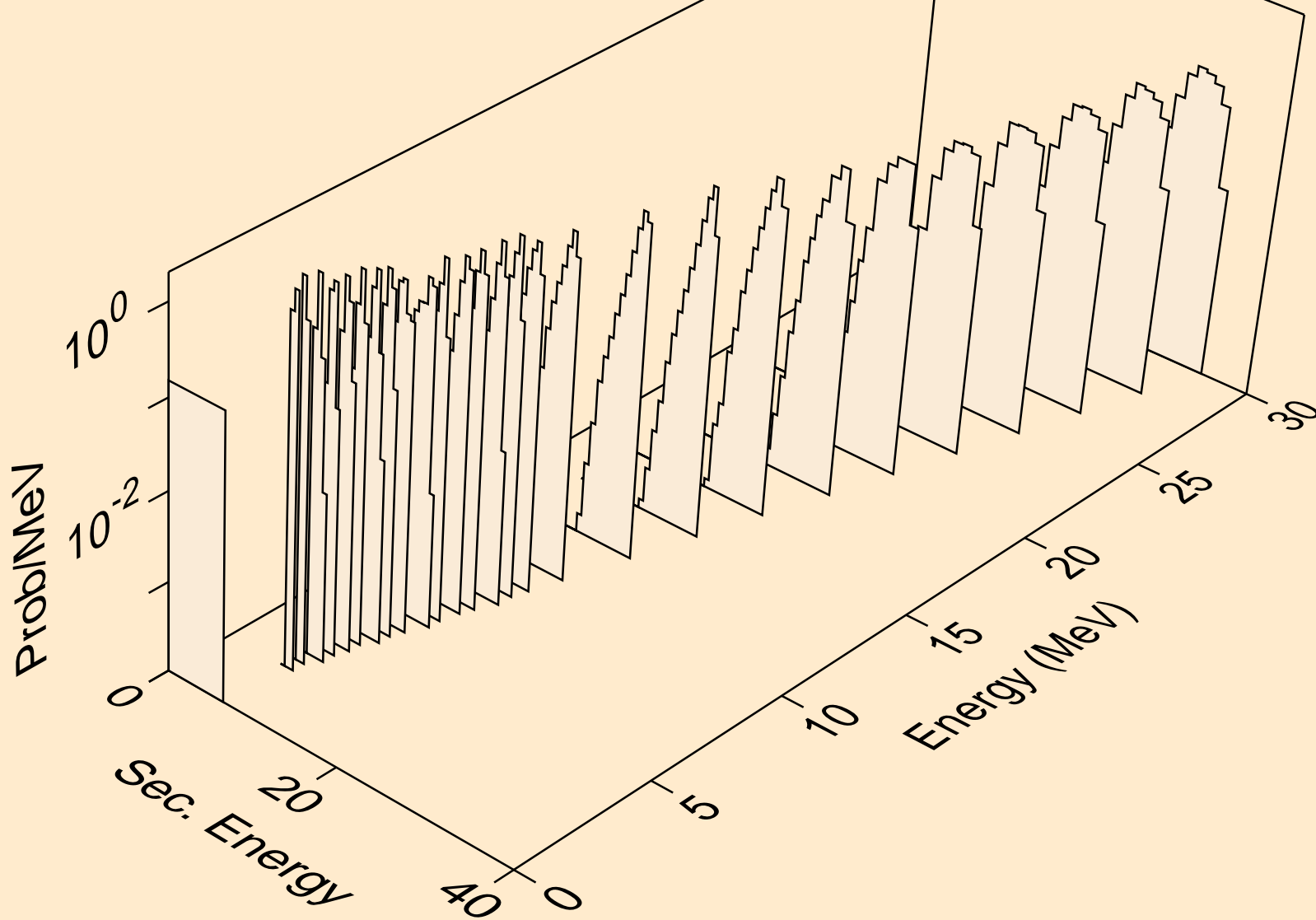

FR224 NEUTRON ACER TENDL-2019 LIBRARY; T=293.16K
alphas from (n,2n)a

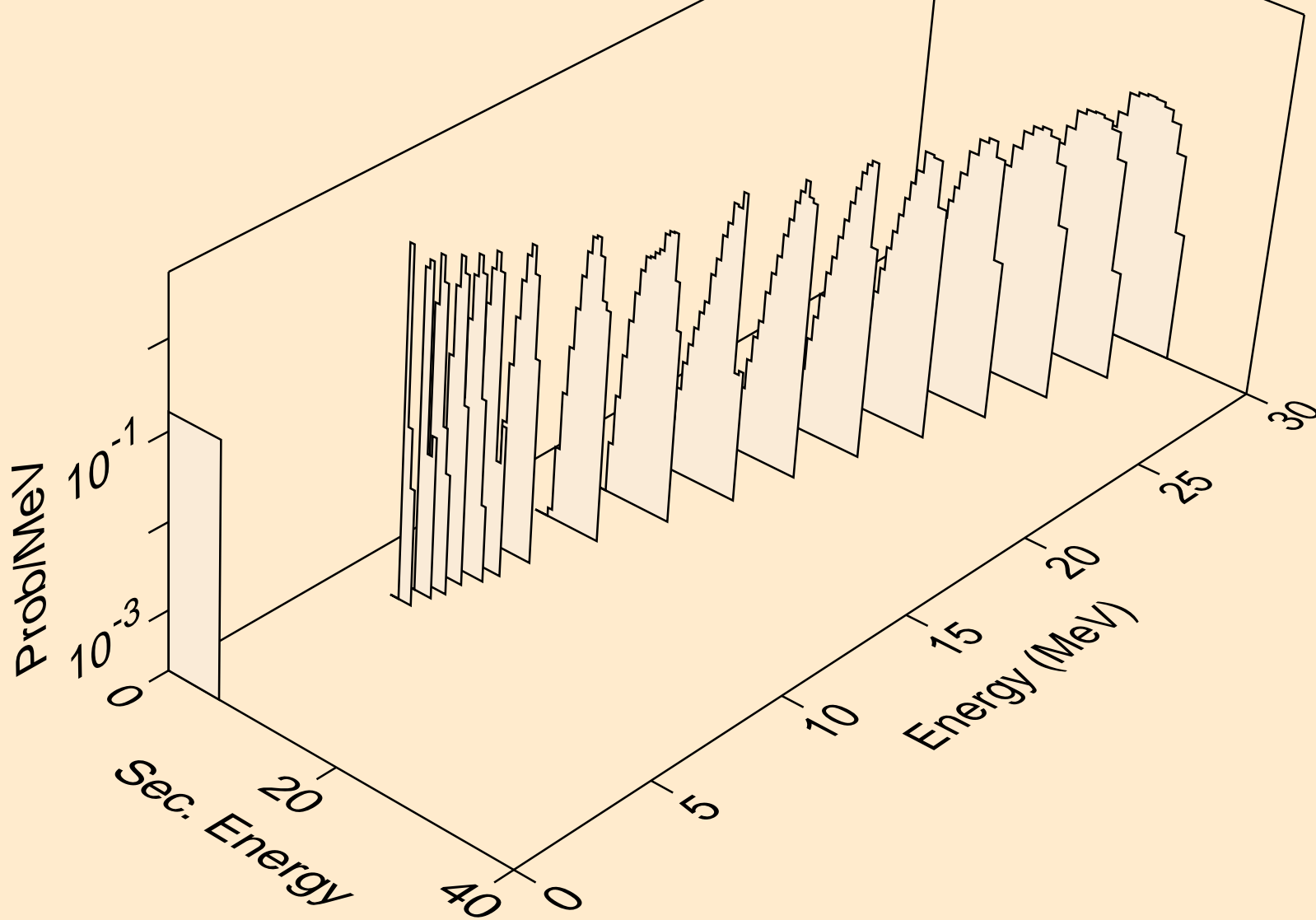

FR224 NEUTRON ACER TENDL-2019 LIBRARY; T=293.16K
alphas from (n,3n)a

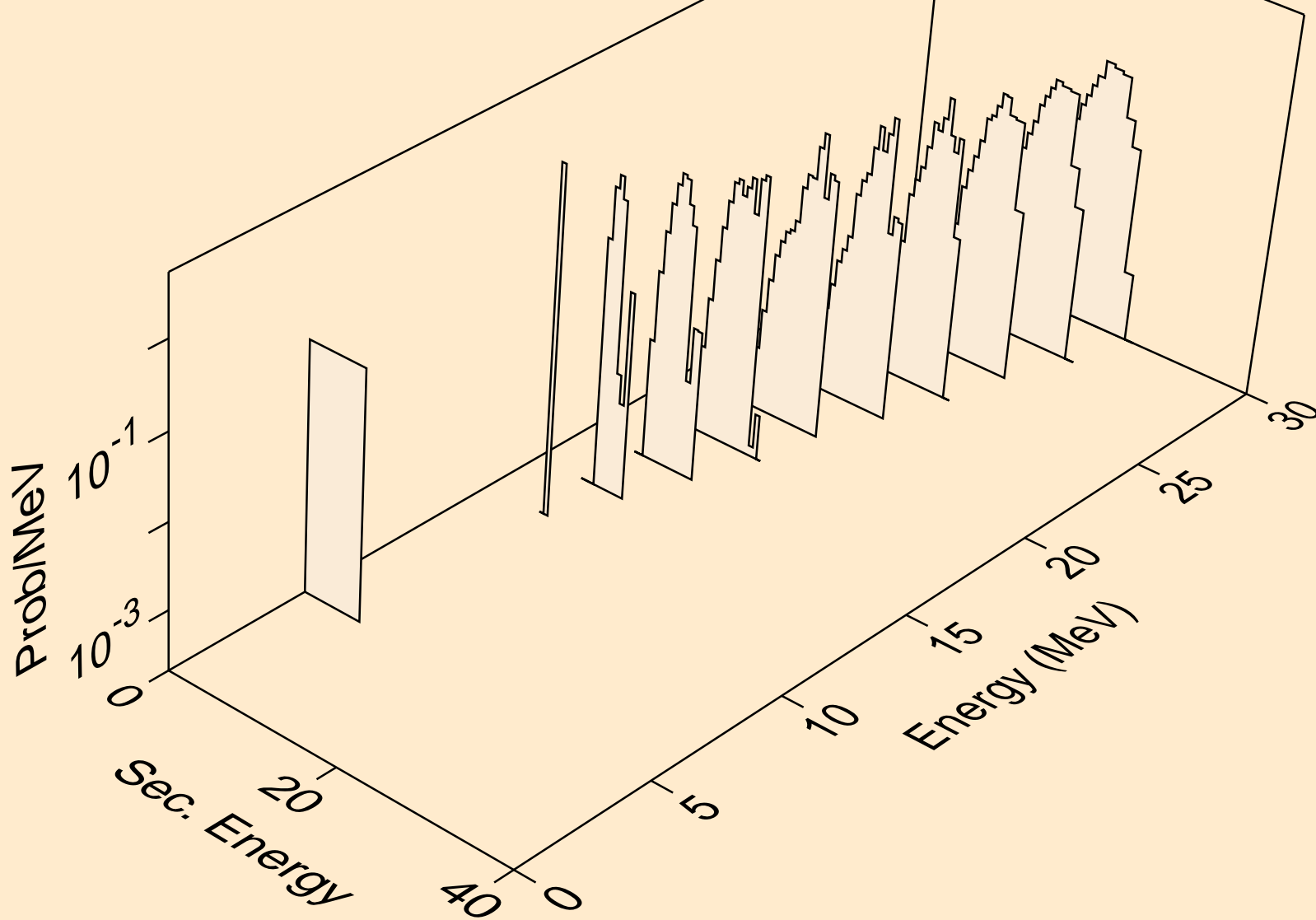

FR224 NEUTRON ACER TENDL-2019 LIBRARY; T=293.16K
alphas from (n,n*)2a

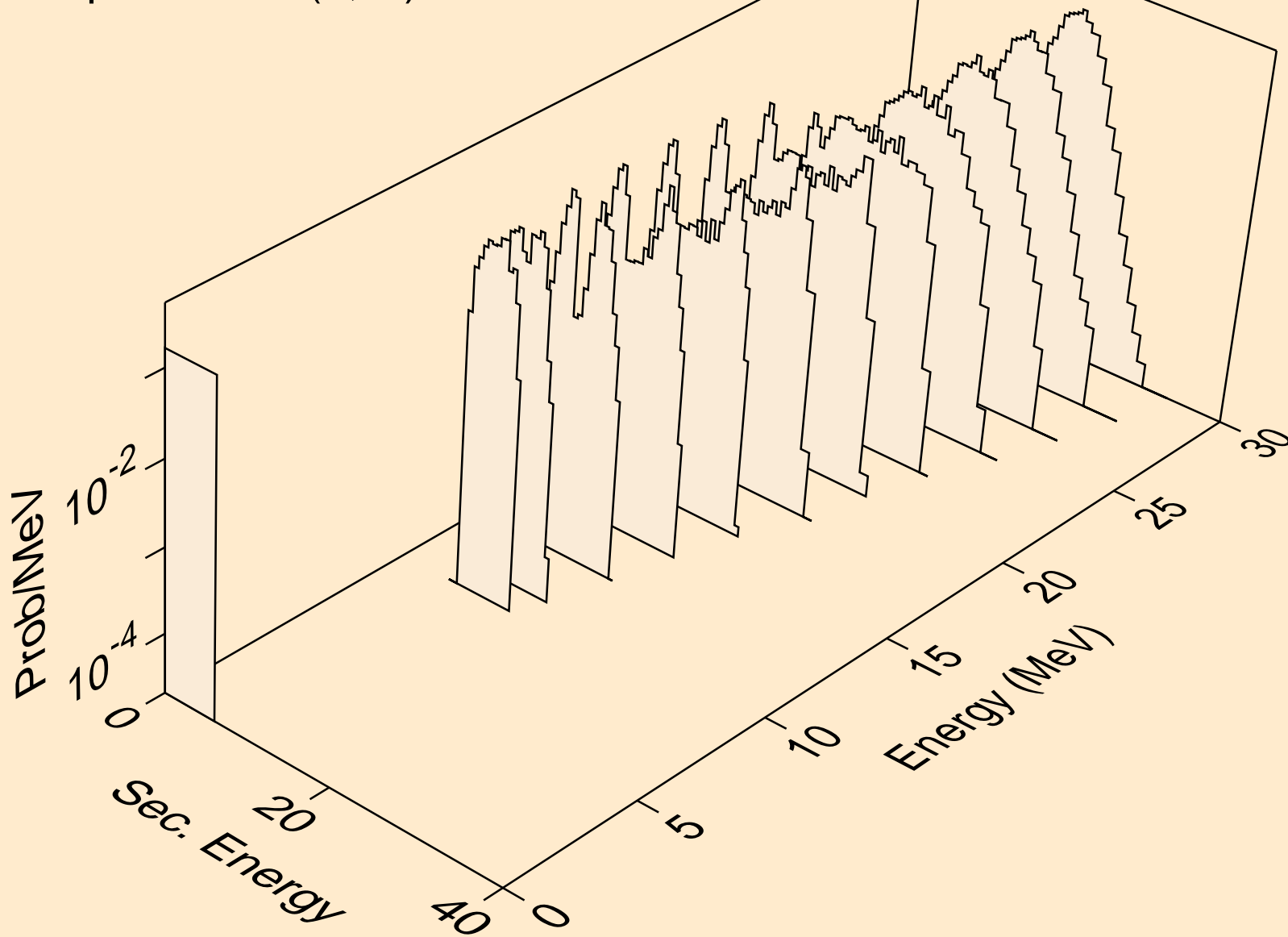

FR224 NEUTRON ACER TENDL-2019 LIBRARY; T=293.16K
alphas from (n,2n)2a

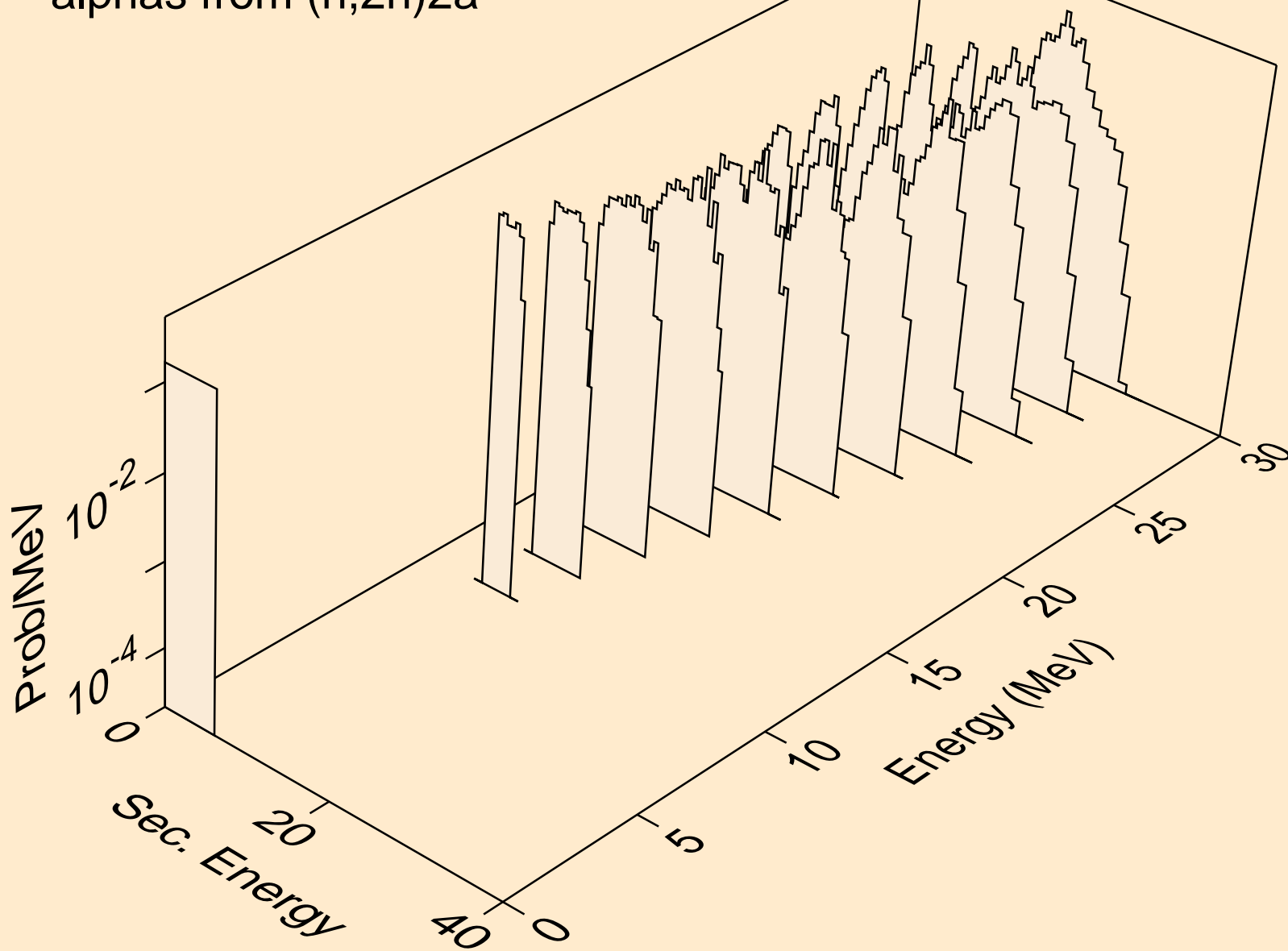

FR224 NEUTRON ACER TENDL-2019 LIBRARY; T=293.16K
alphas from (n,npa)

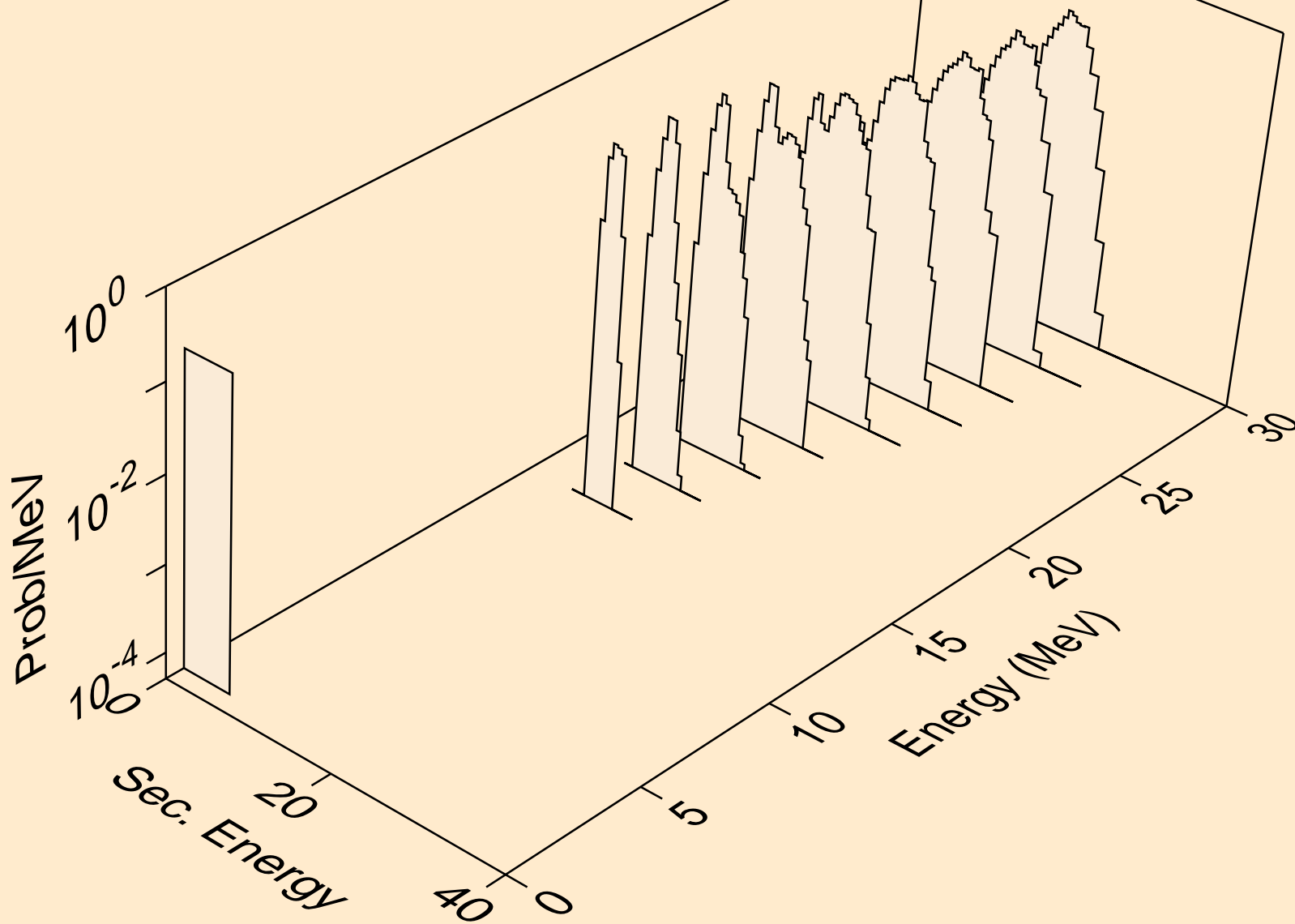

FR224 NEUTRON ACER TENDL-2019 LIBRARY; T=293.16K
alphas from (n,a)

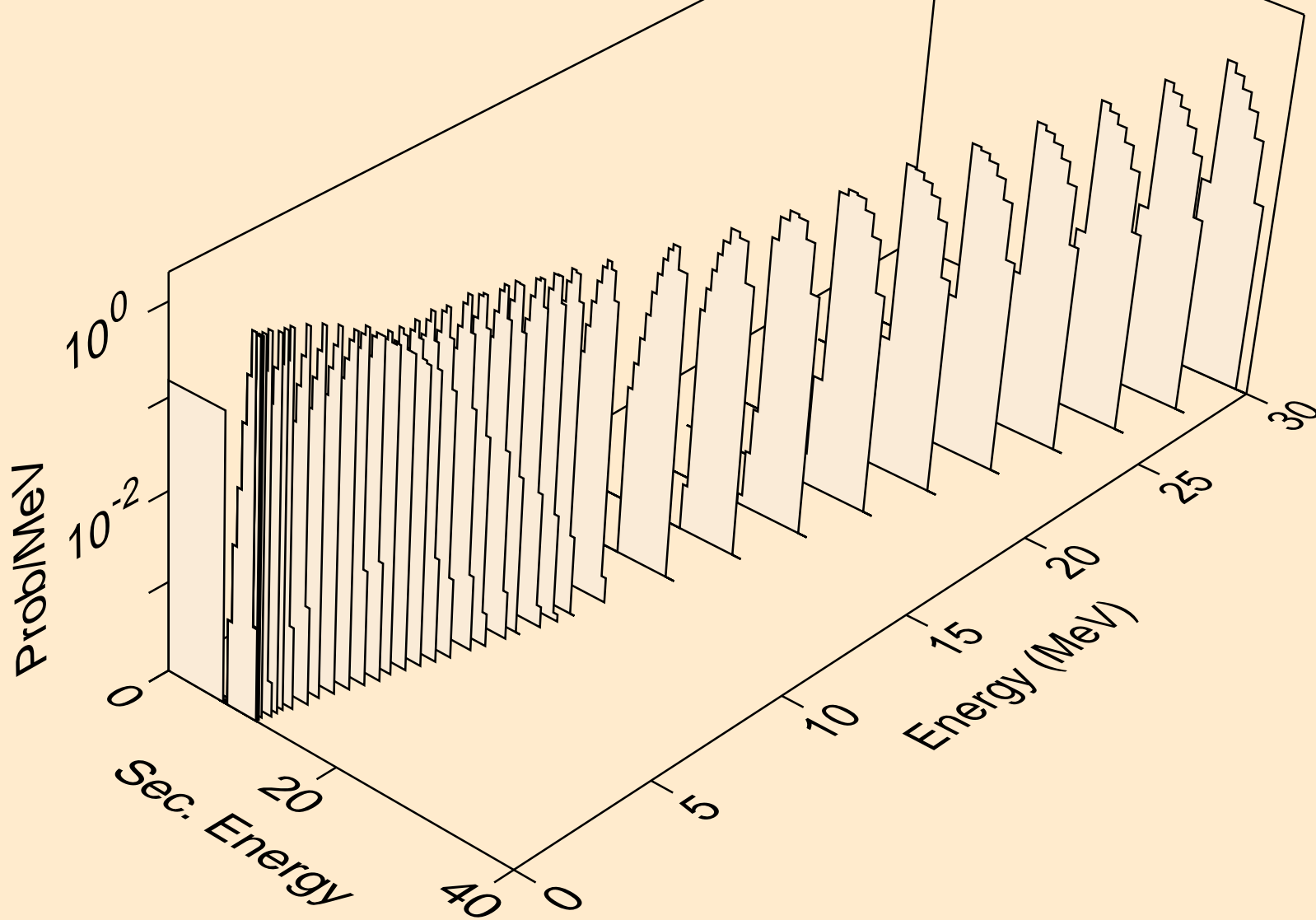

FR224 NEUTRON ACER TENDL-2019 LIBRARY; T=293.16K
alphas from (n,2a)

