

FR226 NEUTRON ACER TENDL-2019 LIBRARY; T=293.16K  
Principal cross sections

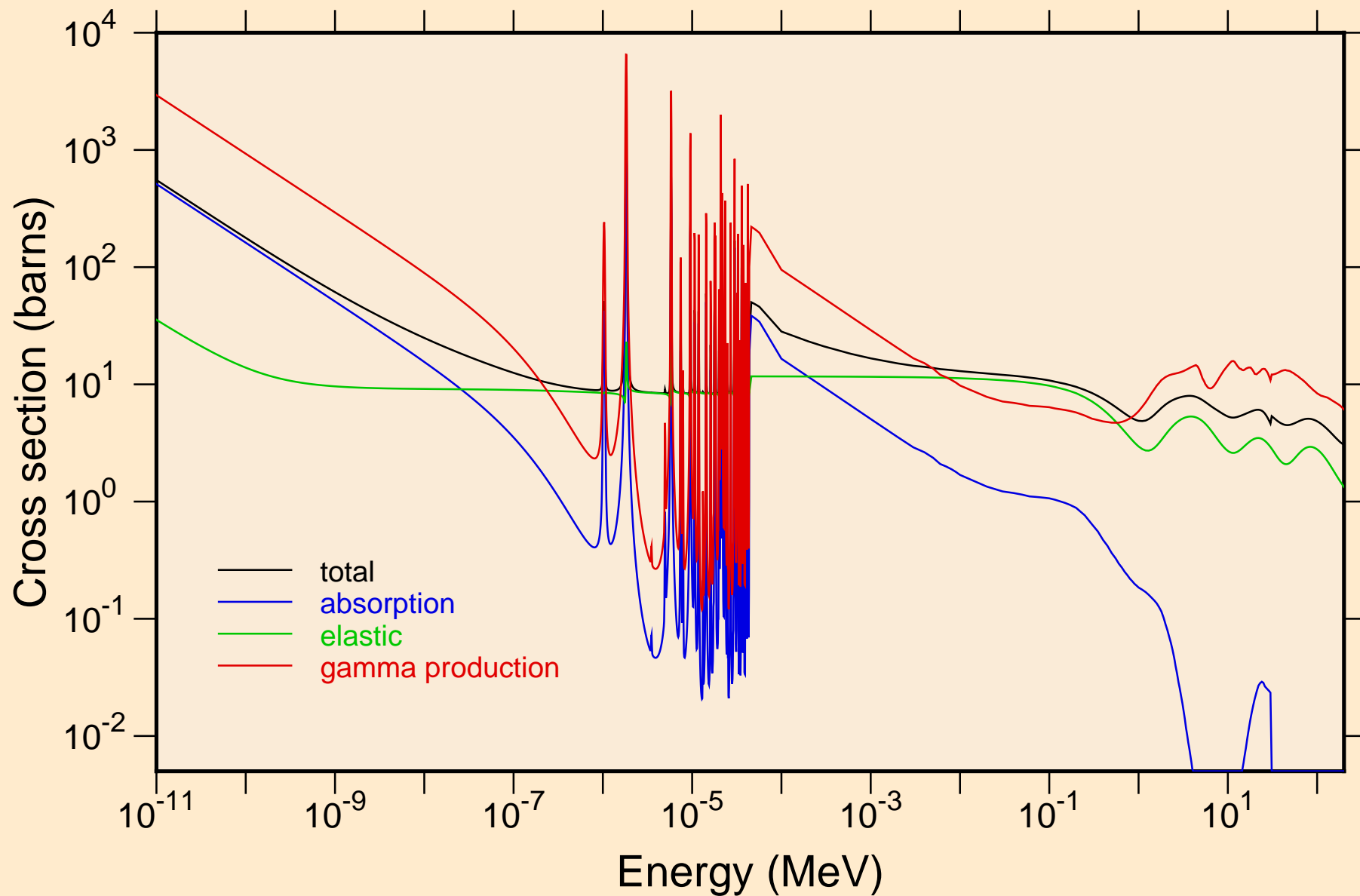

FR226 NEUTRON ACER TENDL-2019 LIBRARY; T=293.16K  
resonance total cross section

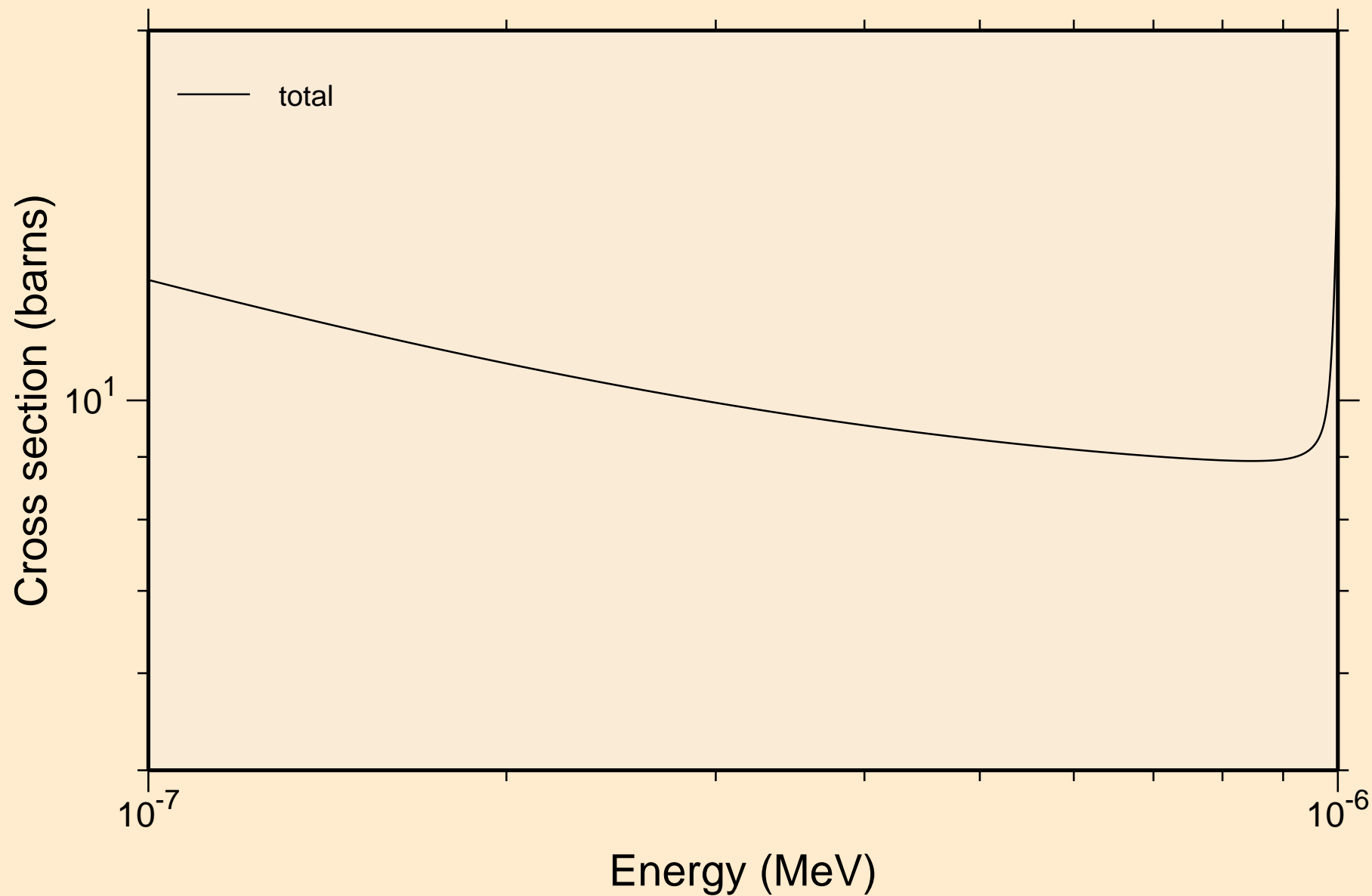

FR226 NEUTRON ACER TENDL-2019 LIBRARY; T=293.16K  
resonance total cross section

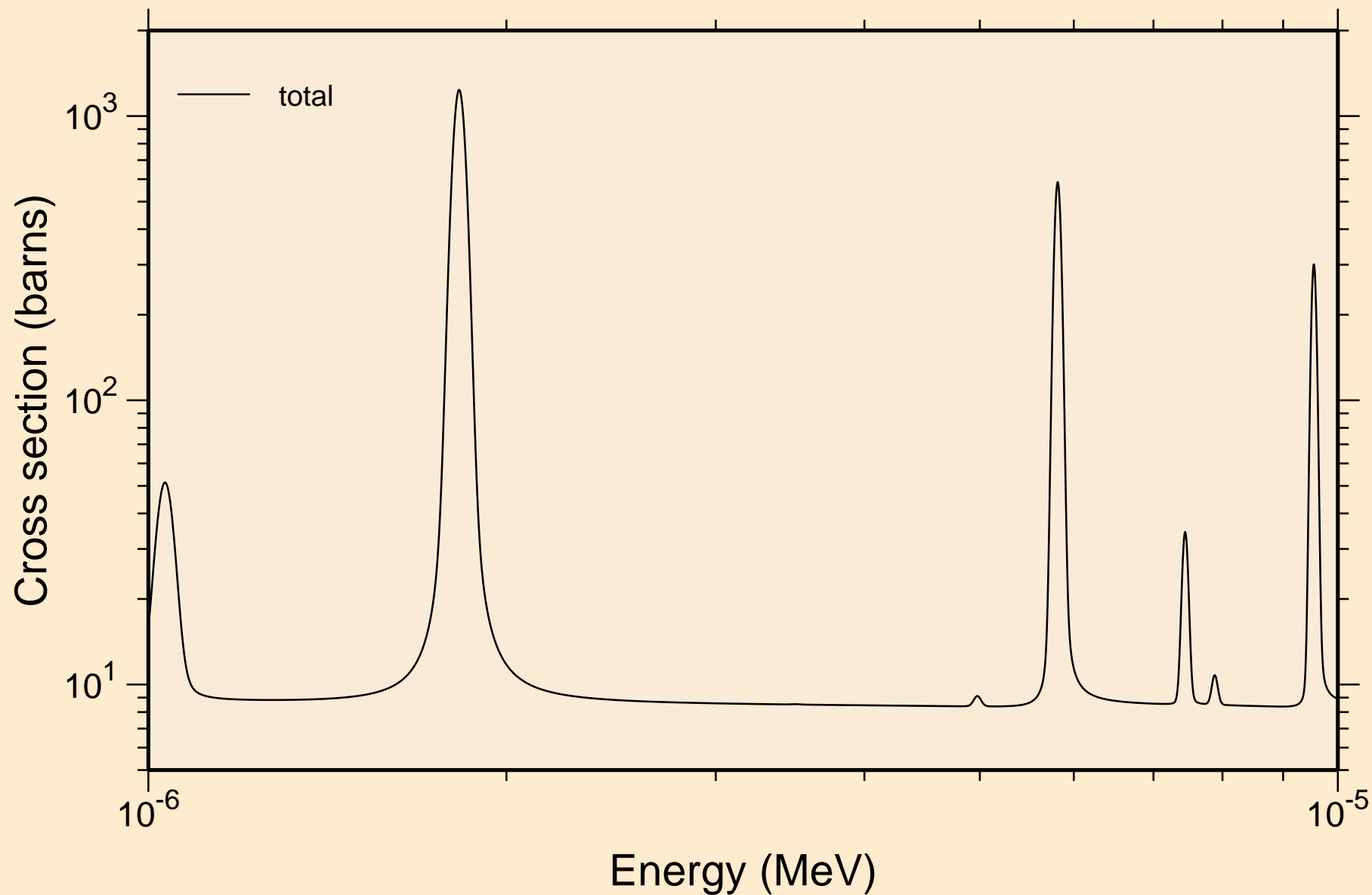

FR226 NEUTRON ACER TENDL-2019 LIBRARY; T=293.16K  
resonance total cross section

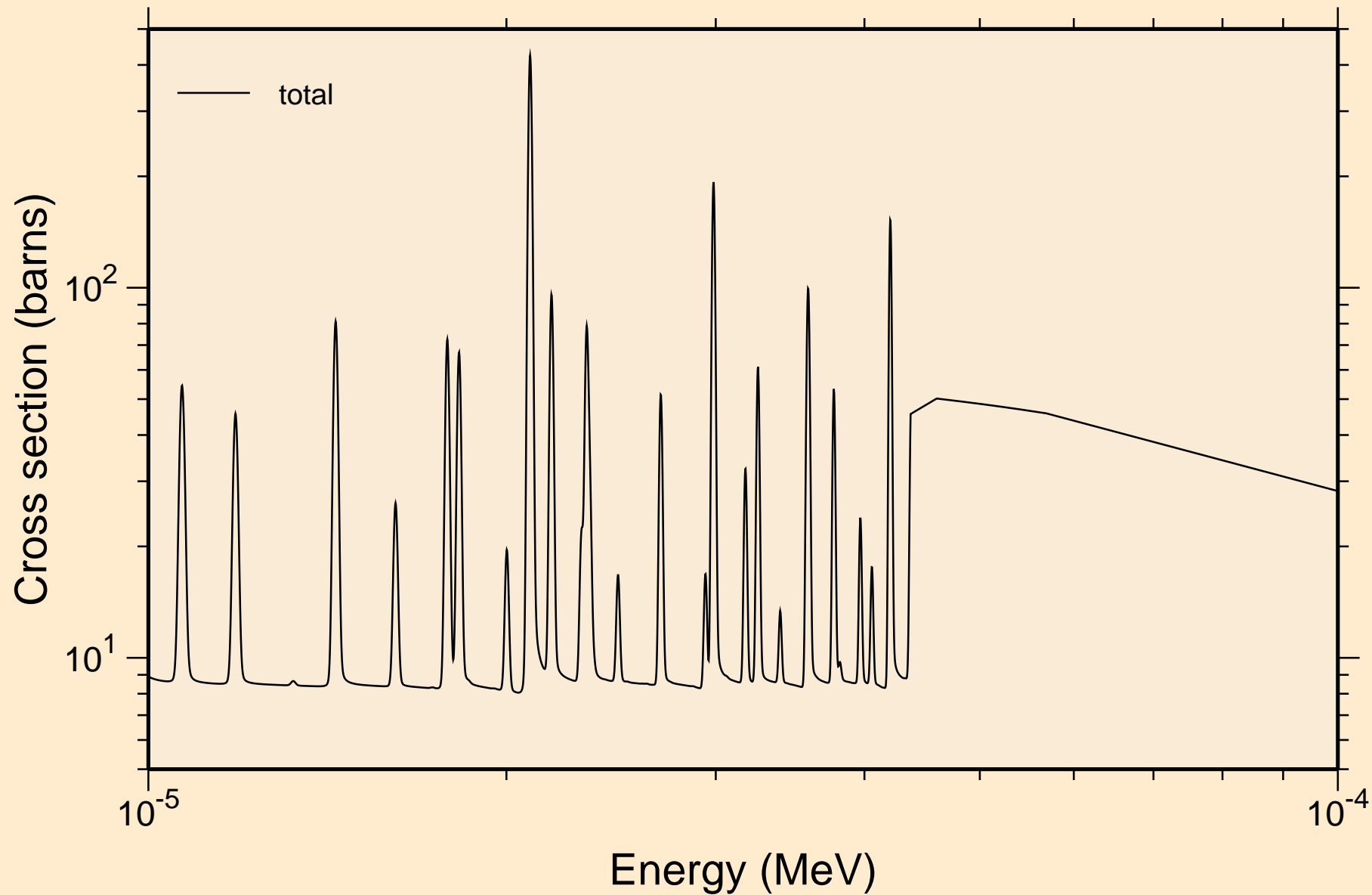

FR226 NEUTRON ACER TENDL-2019 LIBRARY; T=293.16K  
resonance total cross section

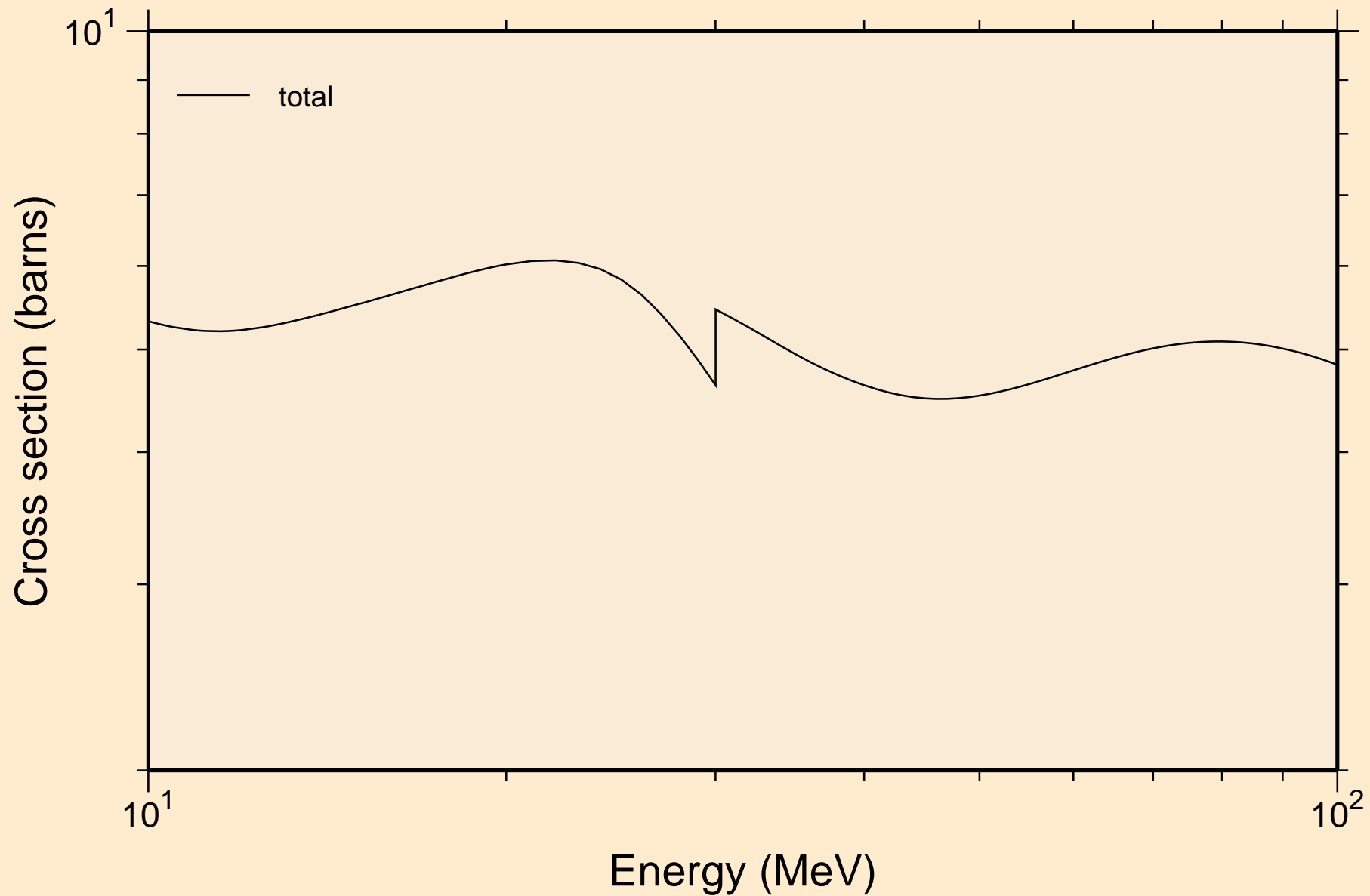

FR226 NEUTRON ACER TENDL-2019 LIBRARY; T=293.16K  
resonance absorption cross sections

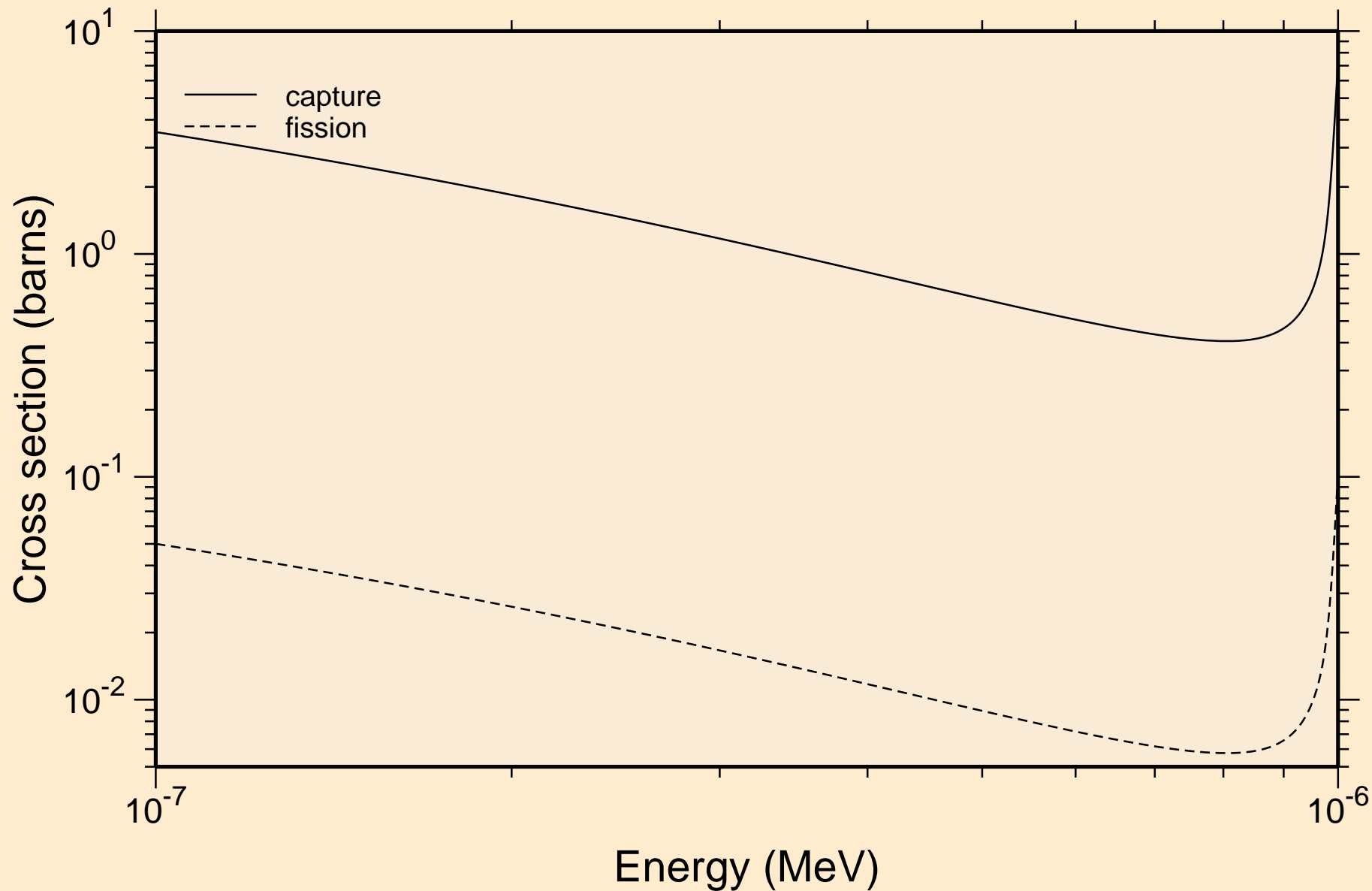

FR226 NEUTRON ACER TENDL-2019 LIBRARY; T=293.16K  
resonance absorption cross sections

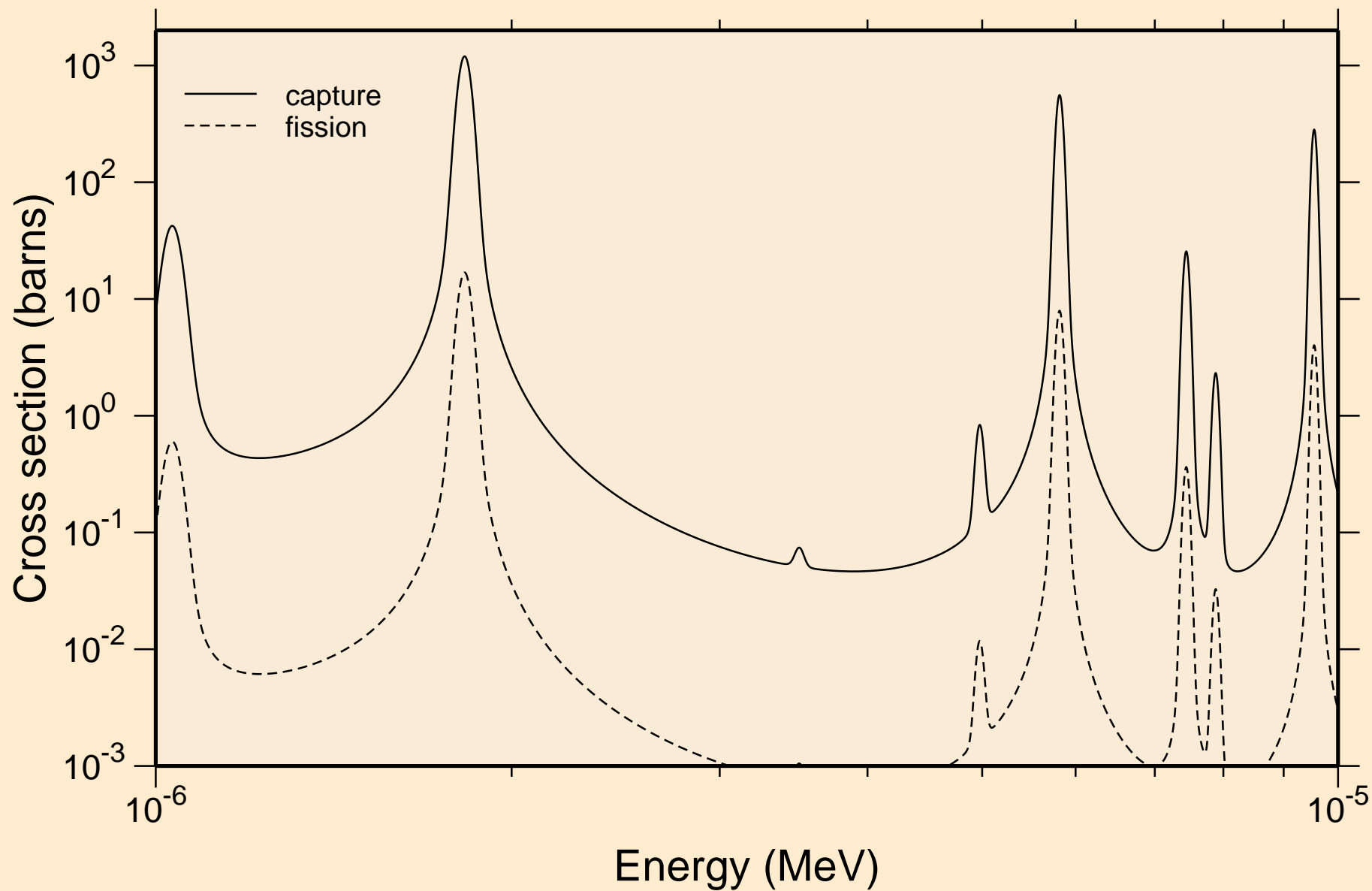

FR226 NEUTRON ACER TENDL-2019 LIBRARY; T=293.16K  
resonance absorption cross sections

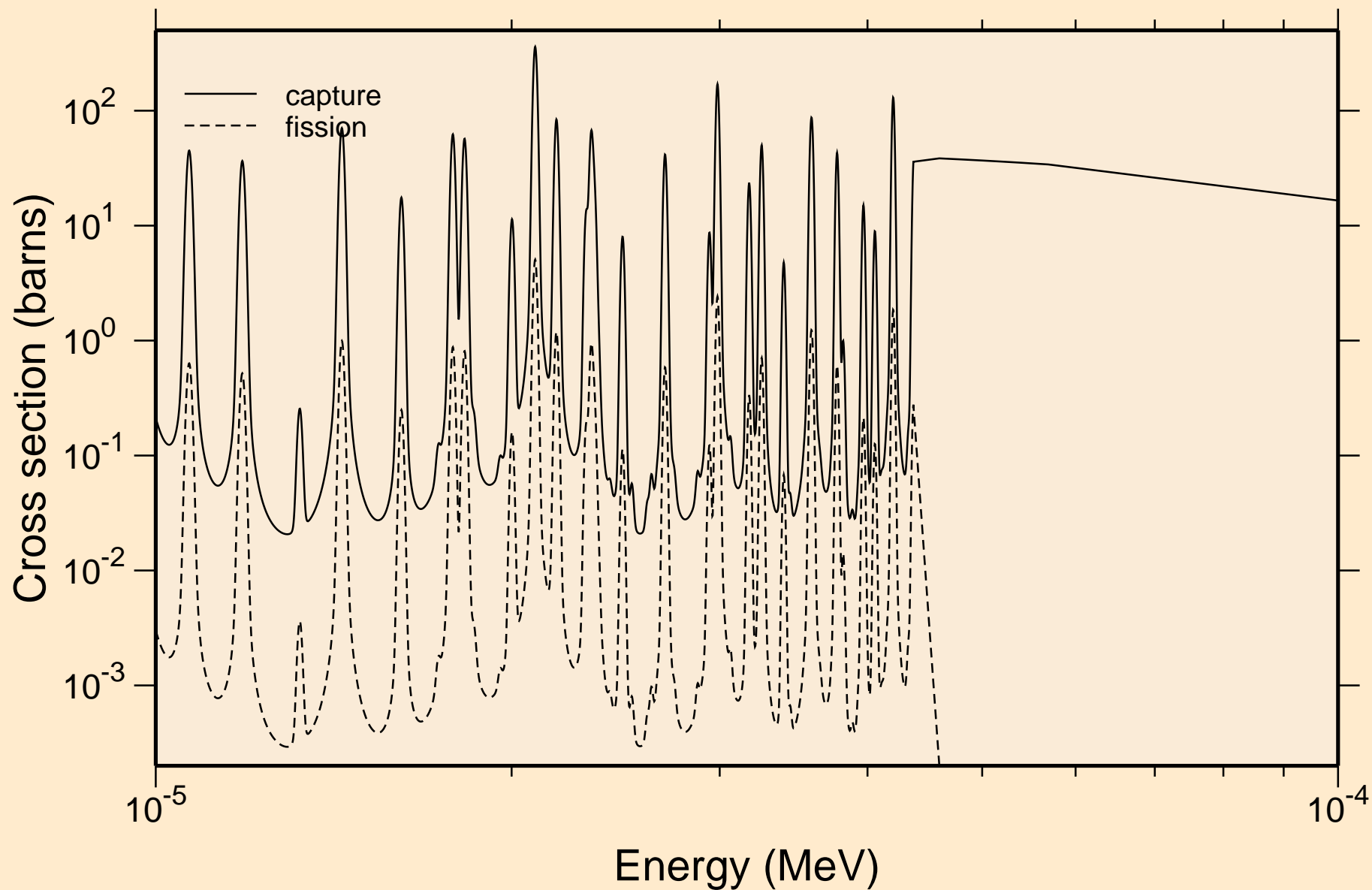



FR226 NEUTRON ACER TENDL-2019 LIBRARY; T=293.16K  
resonance absorption cross sections

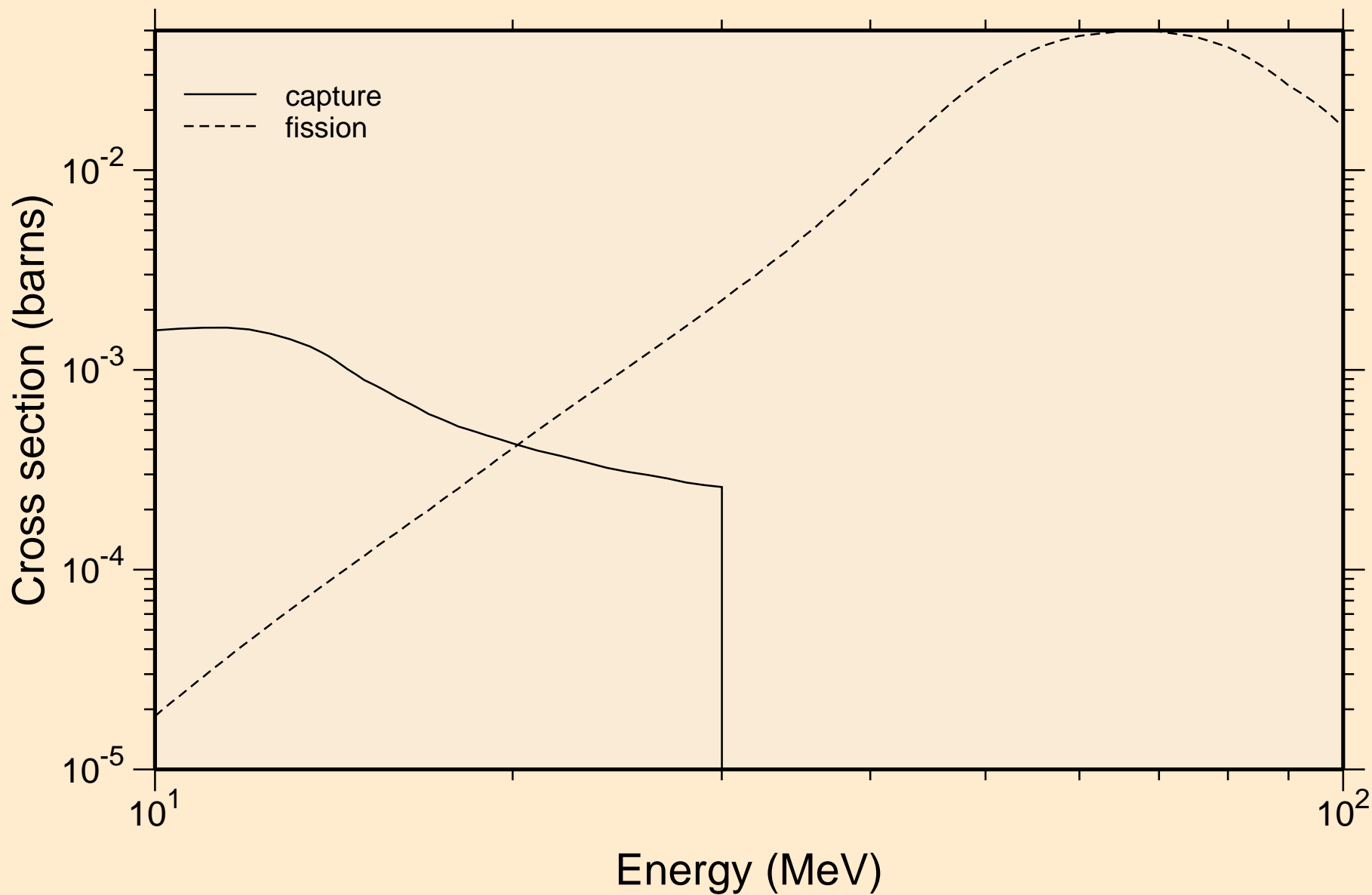

FR226 NEUTRON ACER TENDL-2019 LIBRARY; T=293.16K  
Heating

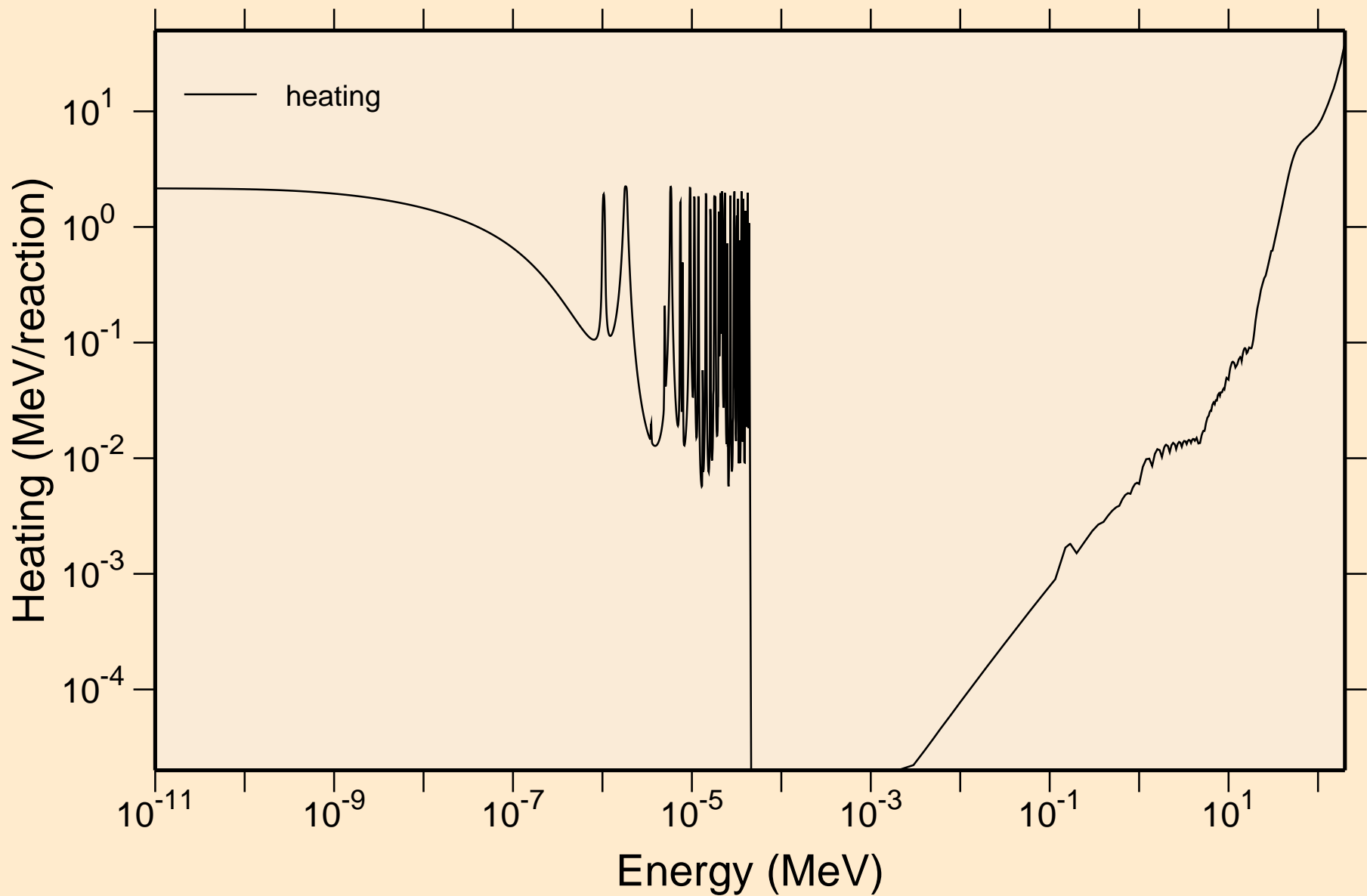

FR226 NEUTRON ACER TENDL-2019 LIBRARY; T=293.16K  
Damage

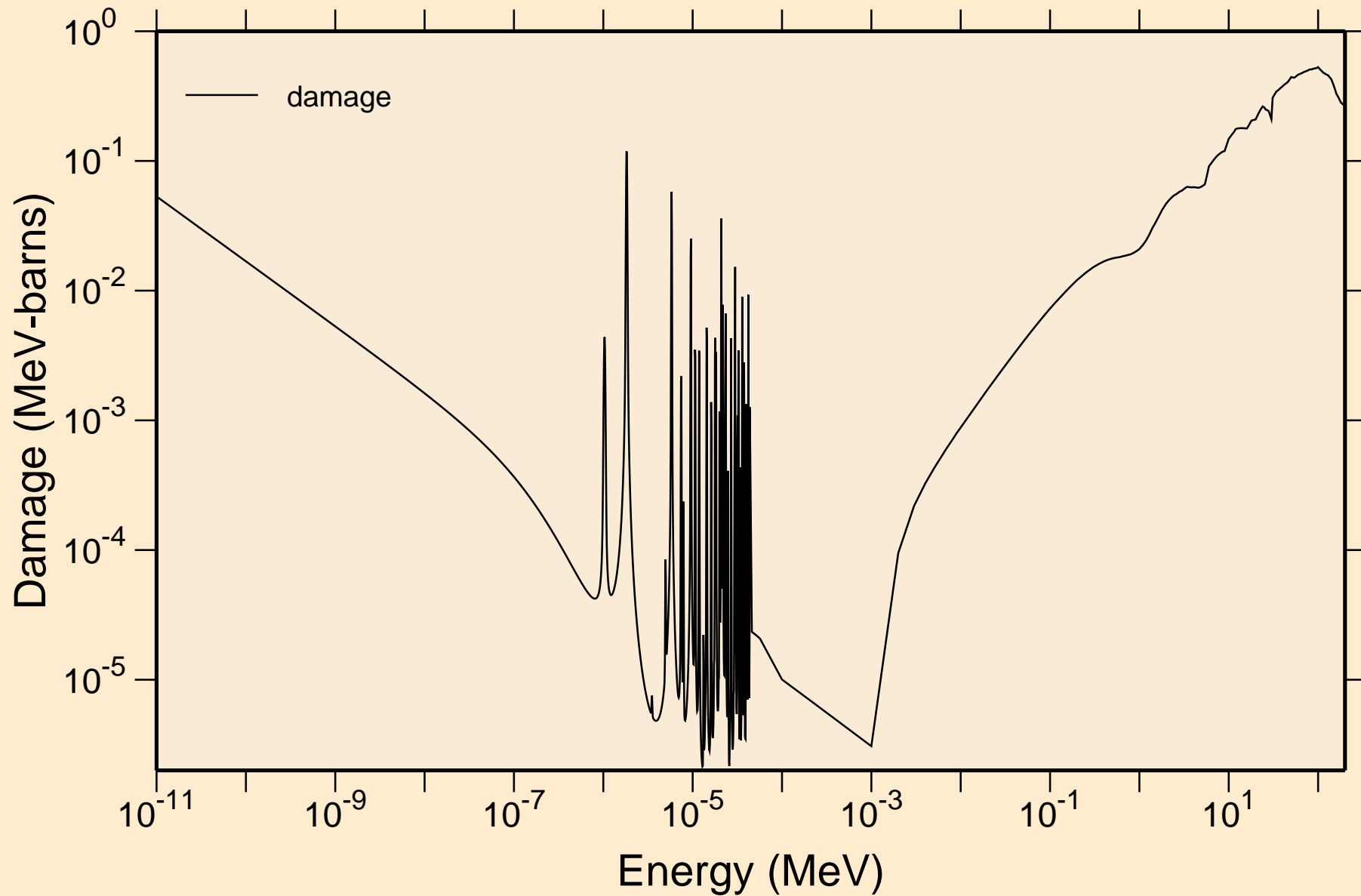

FR226 NEUTRON ACER TENDL-2019 LIBRARY; T=293.16K  
Non-threshold reactions

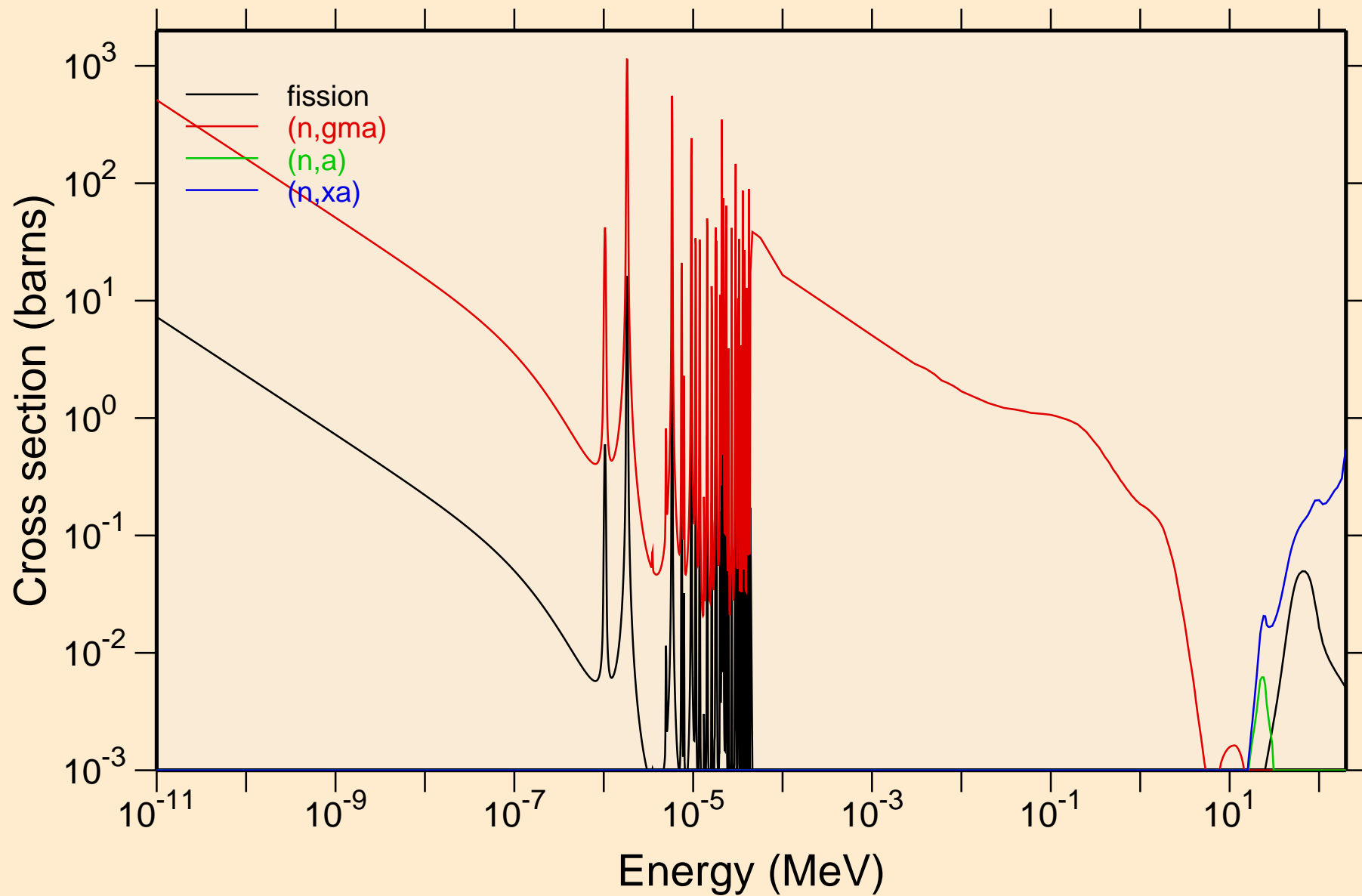

FR226 NEUTRON ACER TENDL-2019 LIBRARY; T=293.16K  
Principal cross sections

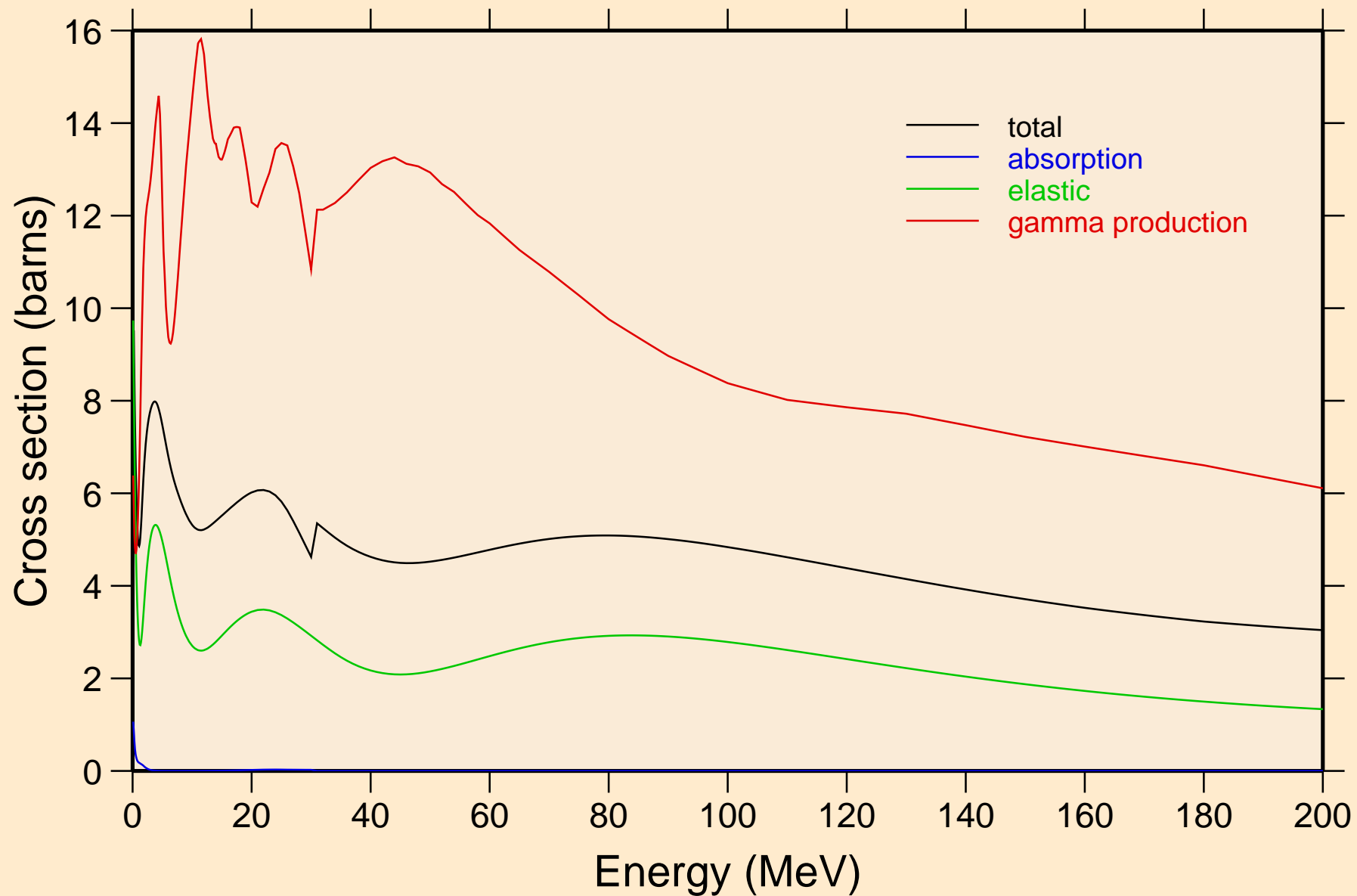

FR226 NEUTRON ACER TENDL-2019 LIBRARY; T=293.16K  
Heating

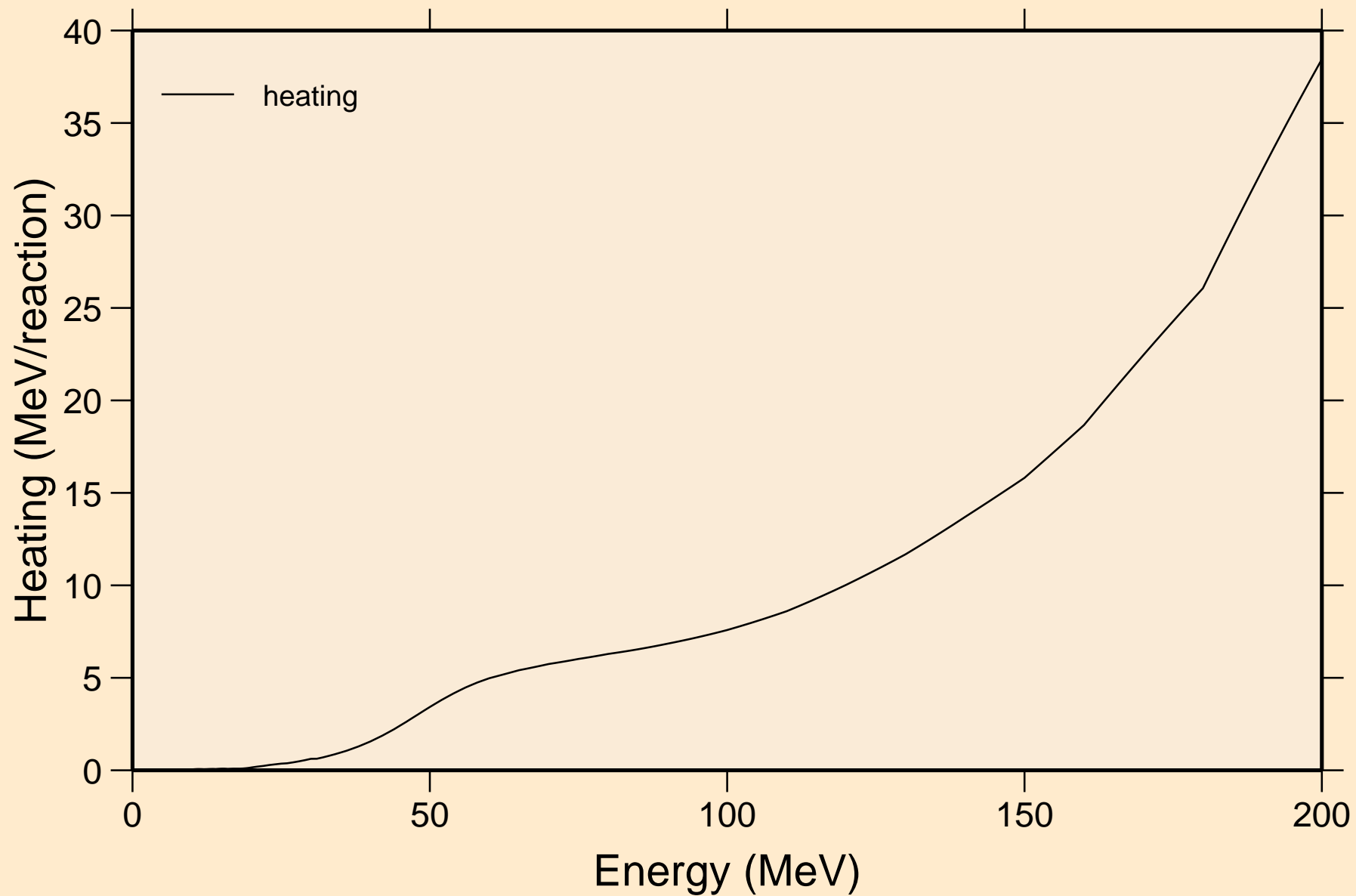

FR226 NEUTRON ACER TENDL-2019 LIBRARY; T=293.16K  
Damage

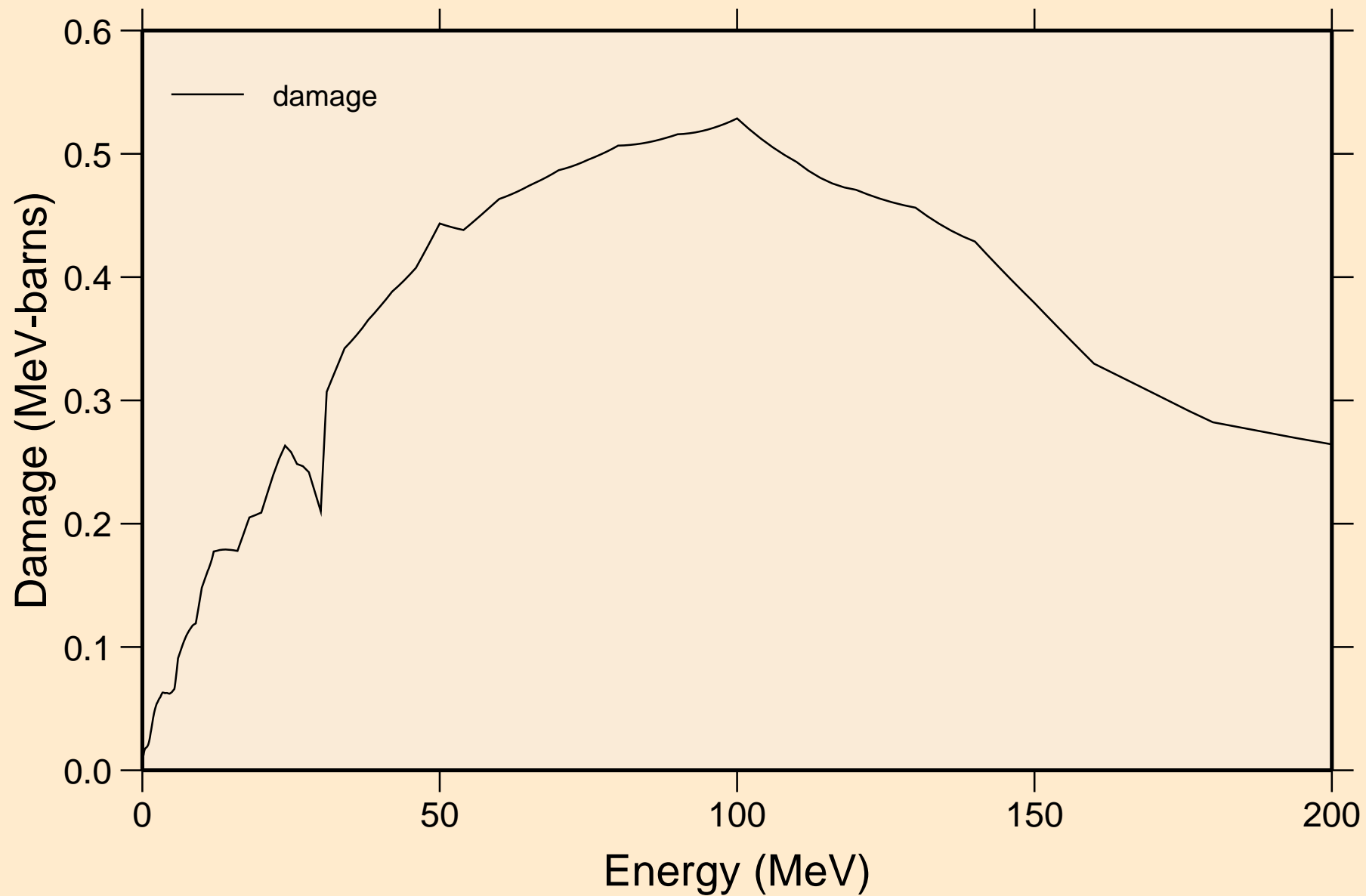

FR226 NEUTRON ACER TENDL-2019 LIBRARY; T=293.16K  
Non-threshold reactions

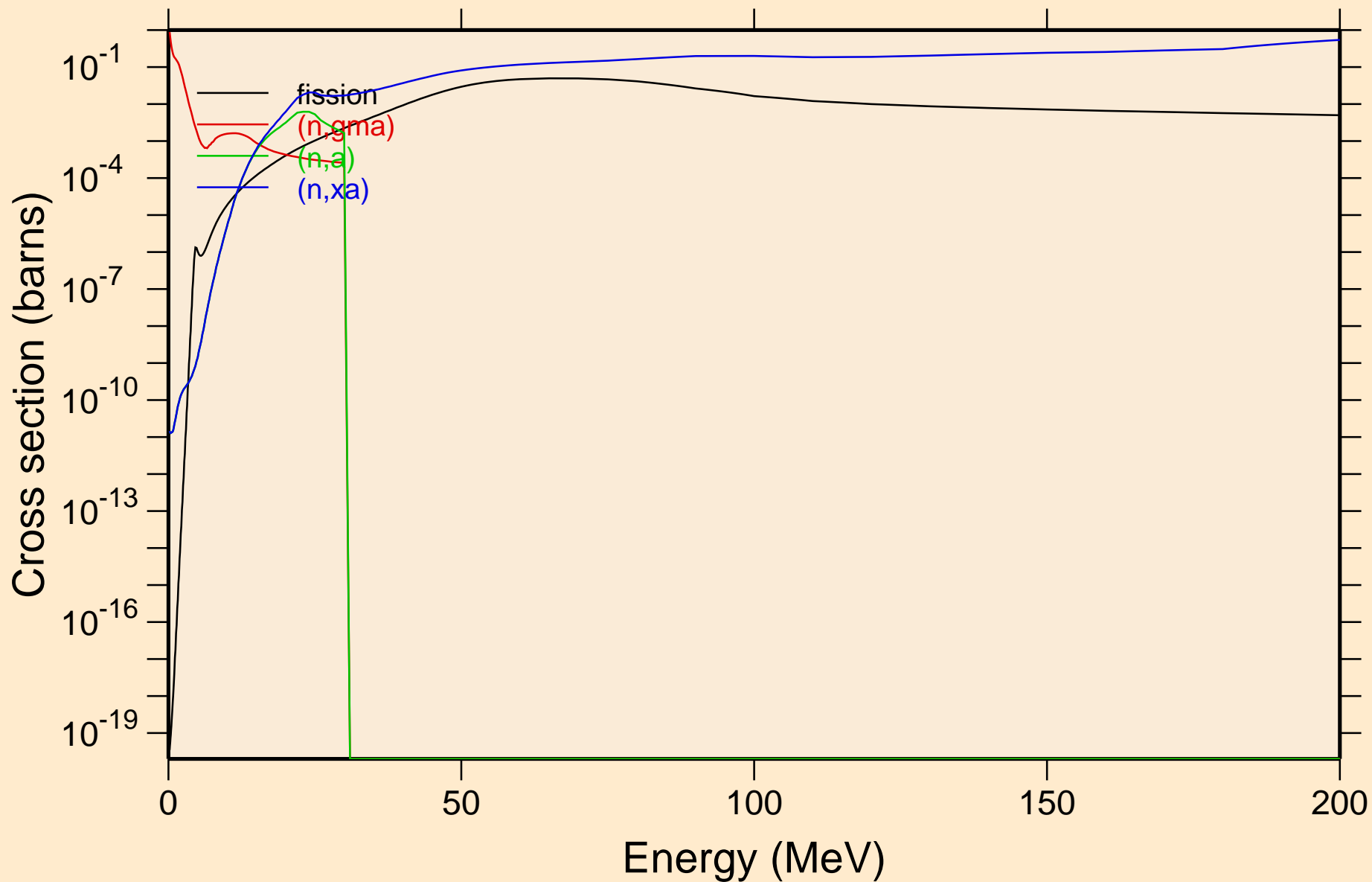



FR226 NEUTRON ACER TENDL-2019 LIBRARY; T=293.16K  
Inelastic levels

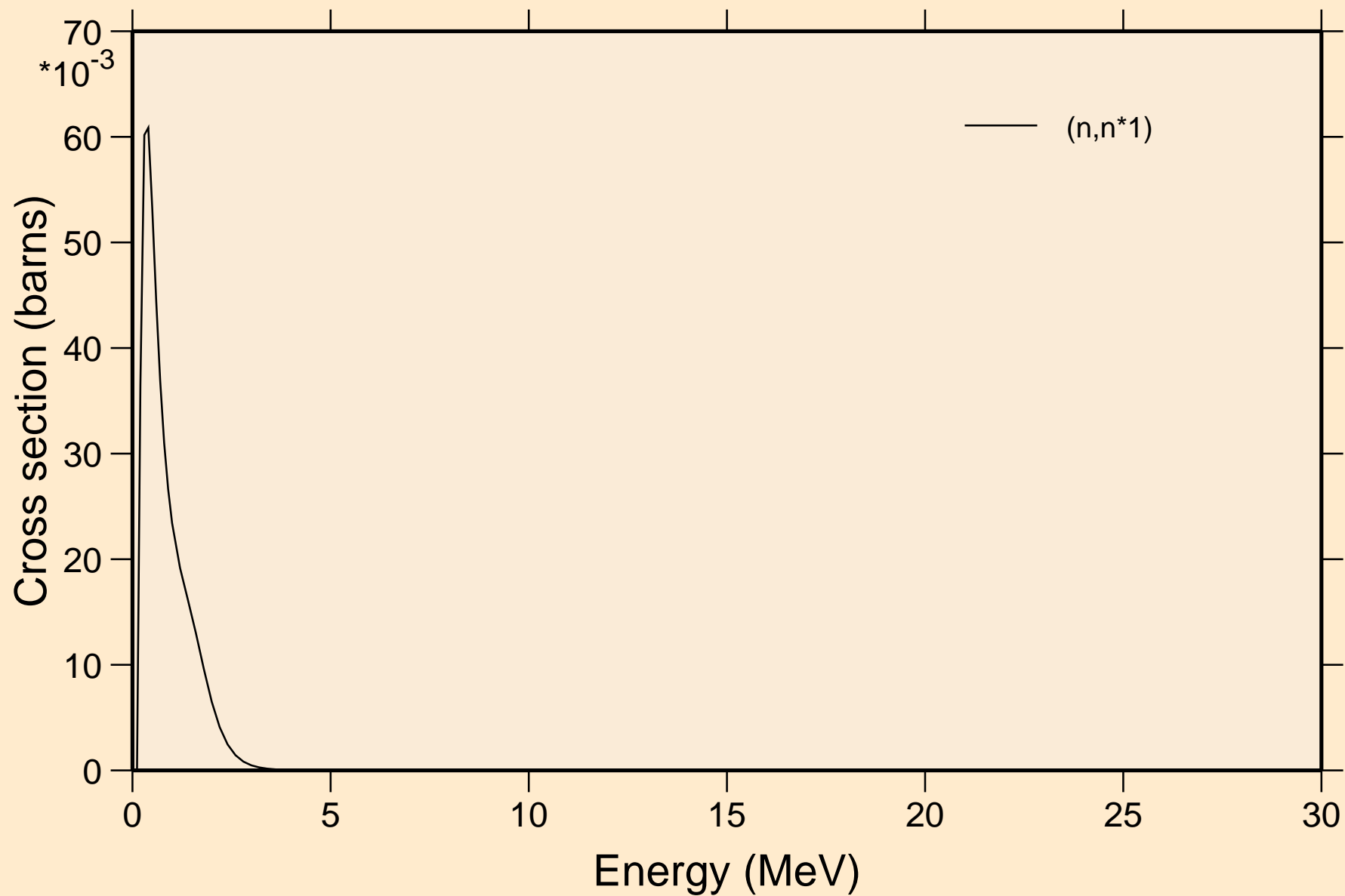

FR226 NEUTRON ACER TENDL-2019 LIBRARY; T=293.16K  
Threshold reactions

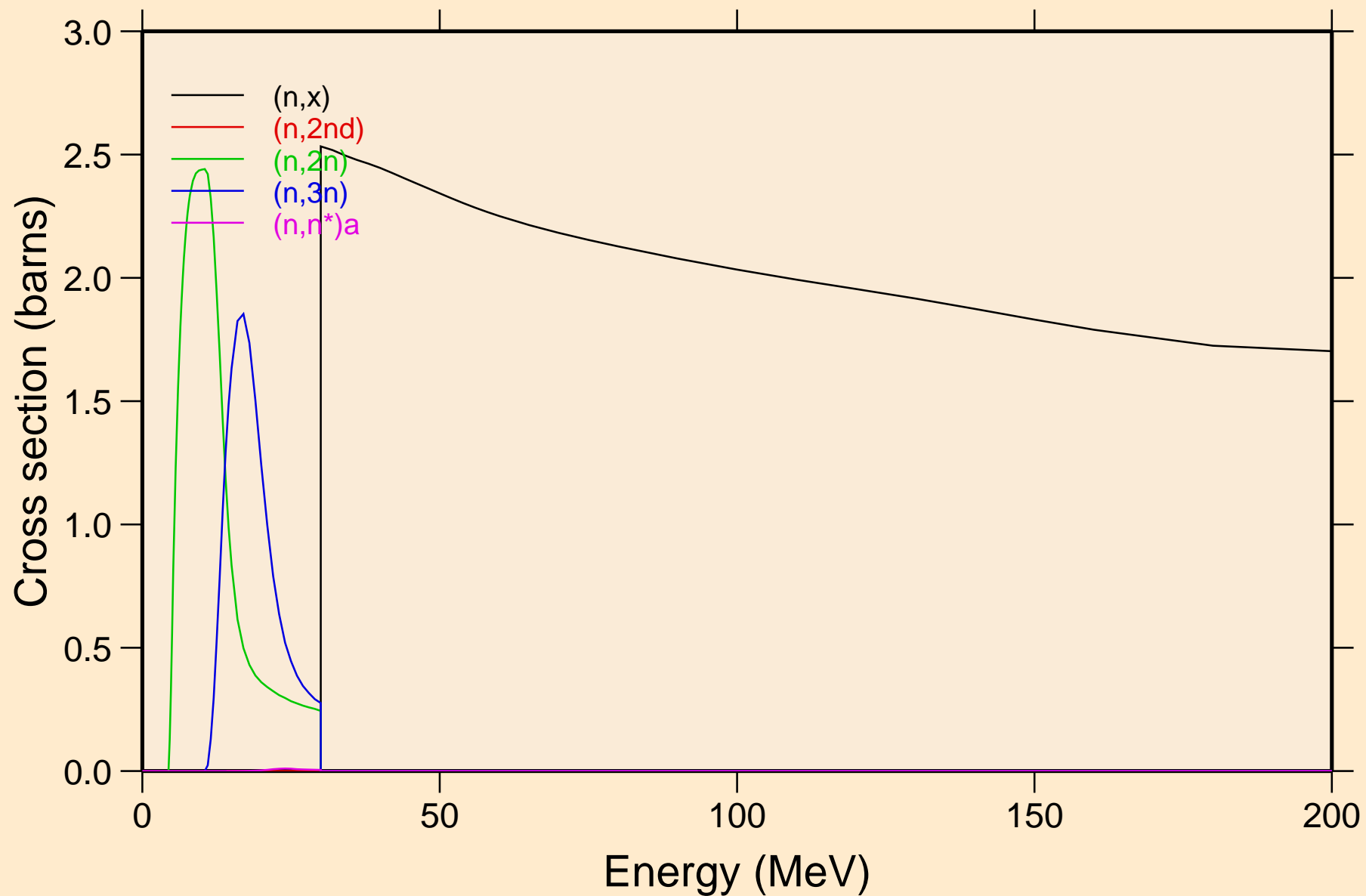

FR226 NEUTRON ACER TENDL-2019 LIBRARY; T=293.16K  
Threshold reactions

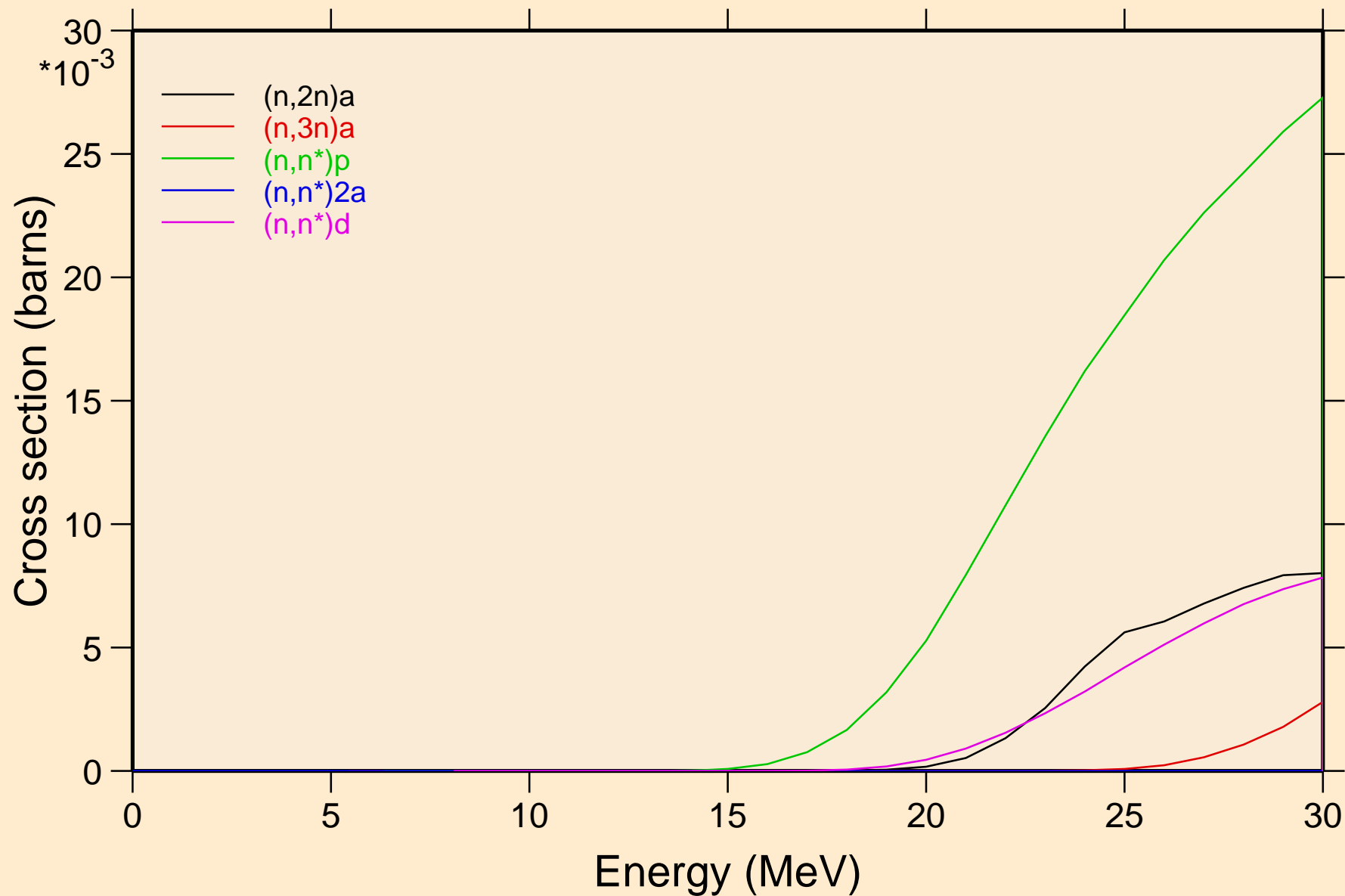

FR226 NEUTRON ACER TENDL-2019 LIBRARY; T=293.16K  
Threshold reactions

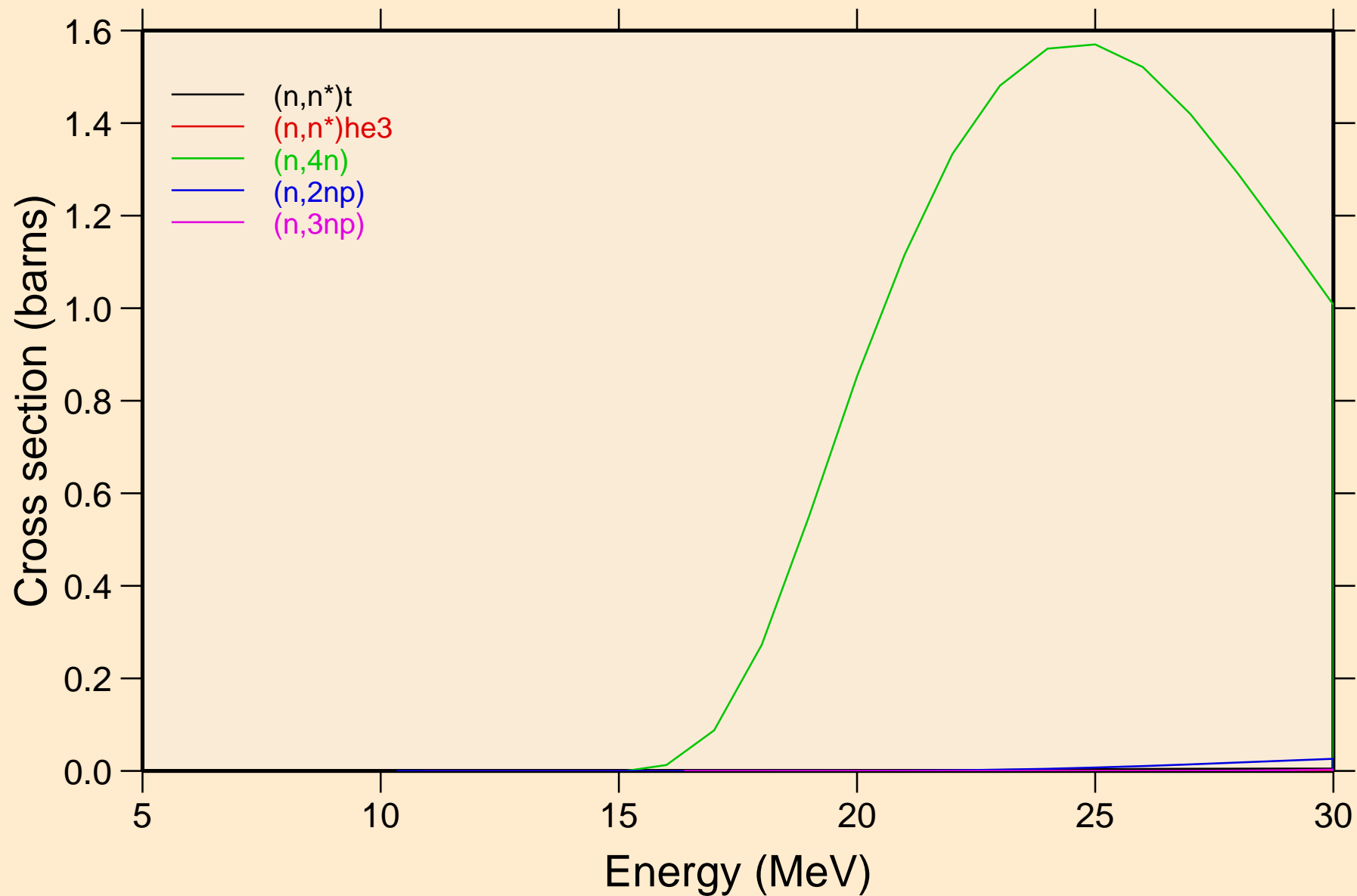

FR226 NEUTRON ACER TENDL-2019 LIBRARY; T=293.16K  
Threshold reactions

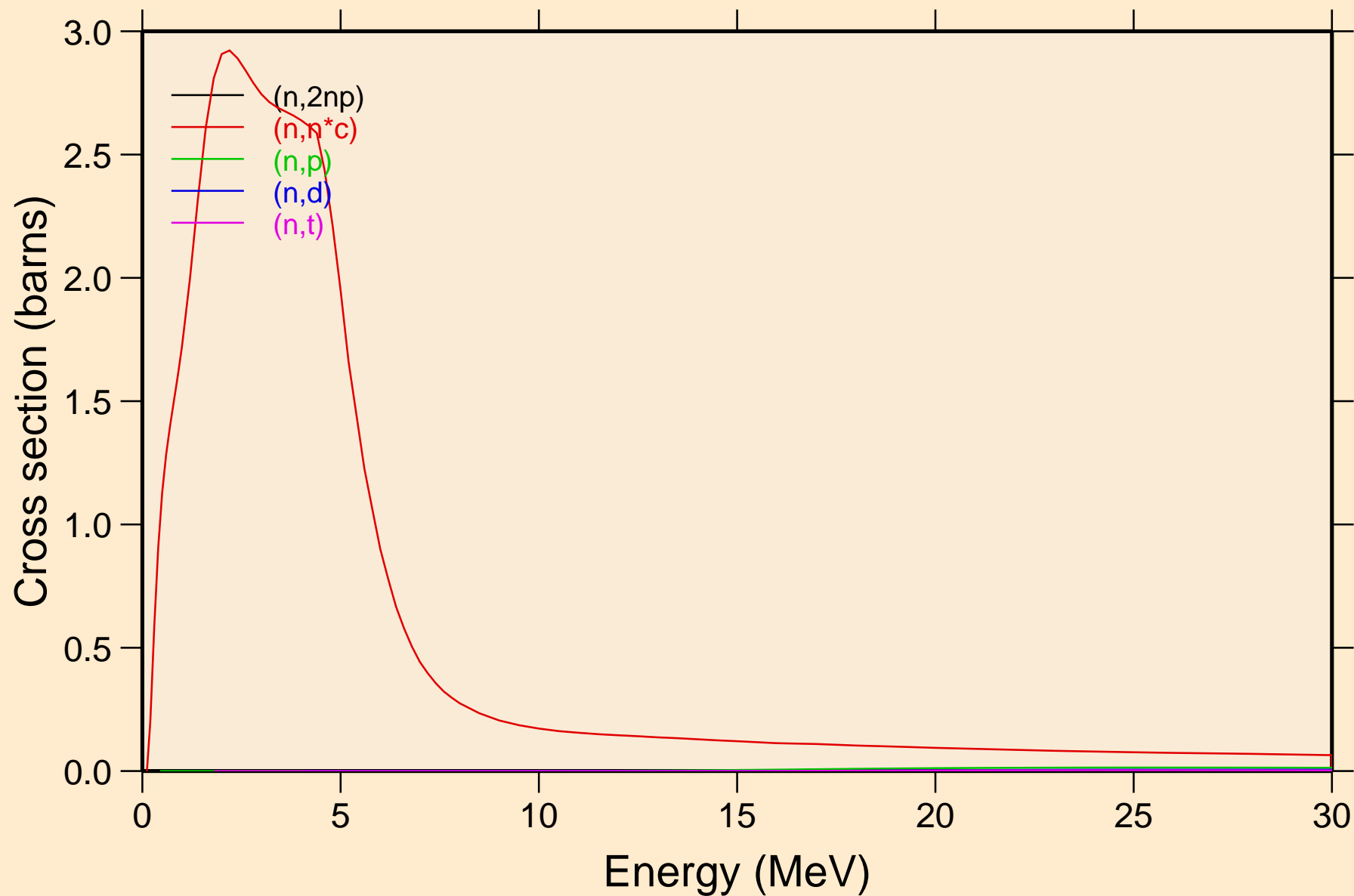

FR226 NEUTRON ACER TENDL-2019 LIBRARY; T=293.16K  
Threshold reactions

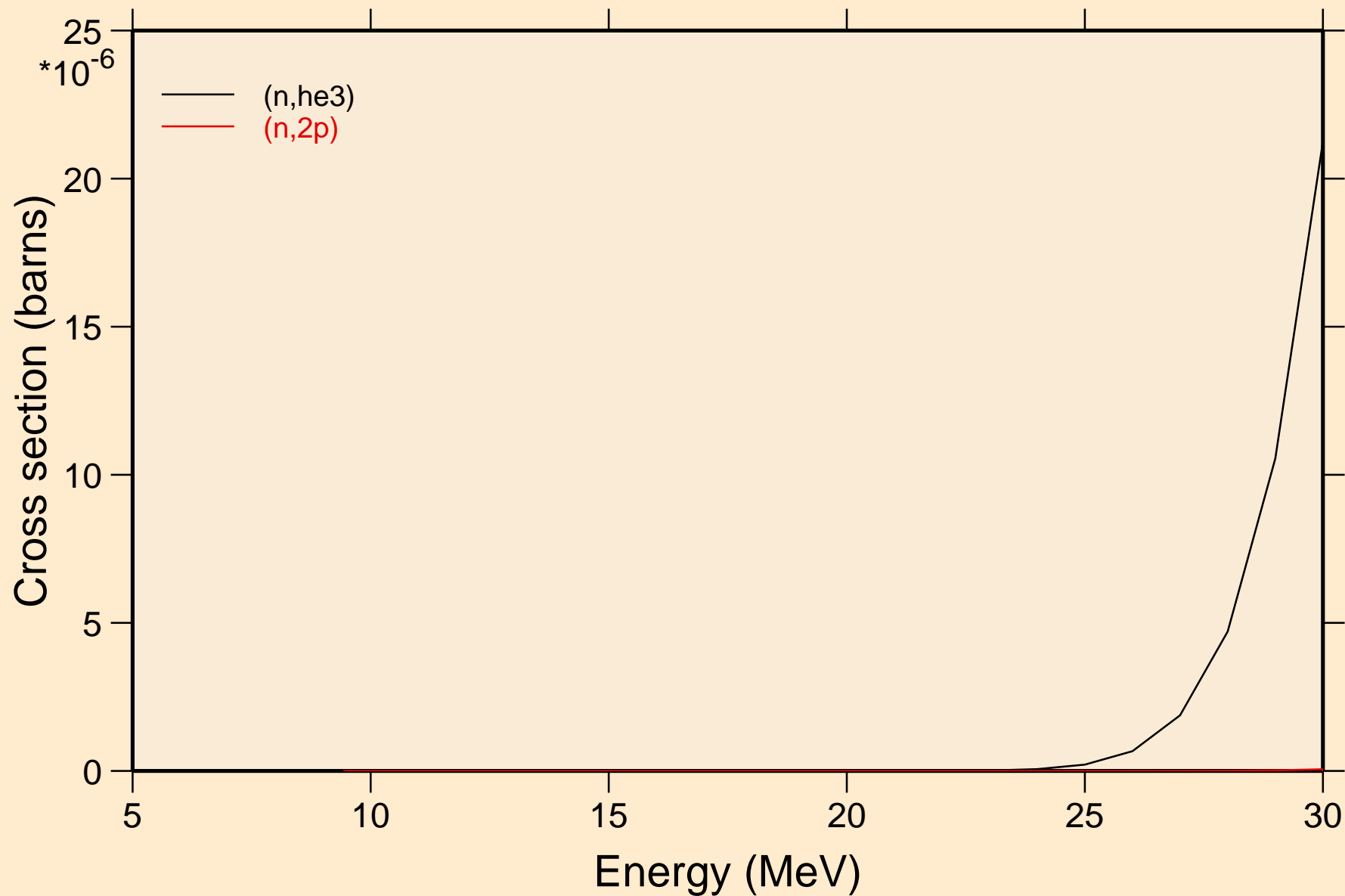

FR226 NEUTRON ACER TENDL-2019 LIBRARY; T=293.16K  
Threshold reactions

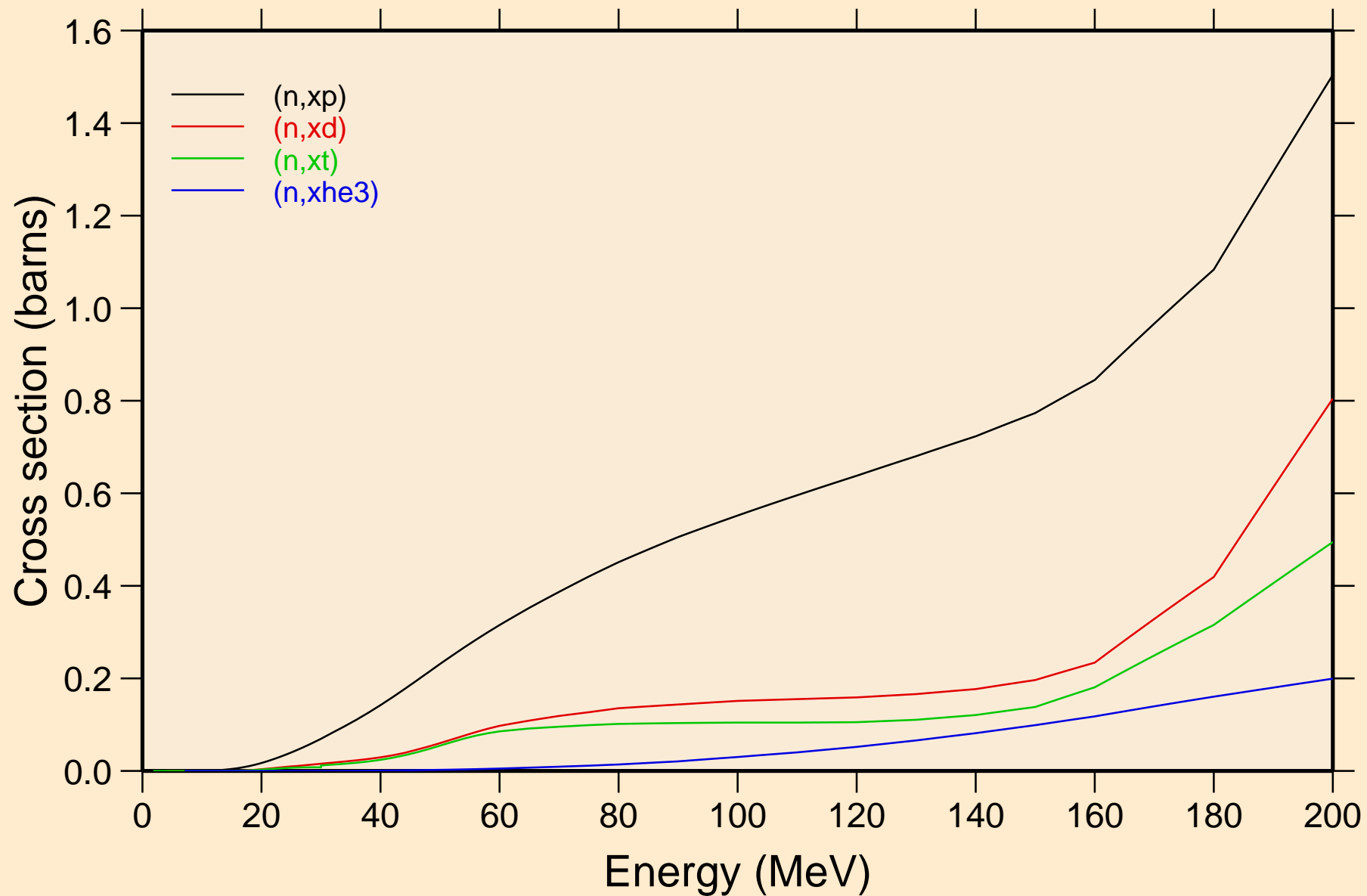

FR226 NEUTRON ACER TENDL-2019 LIBRARY; T=293.16K  
angular distribution for elastic

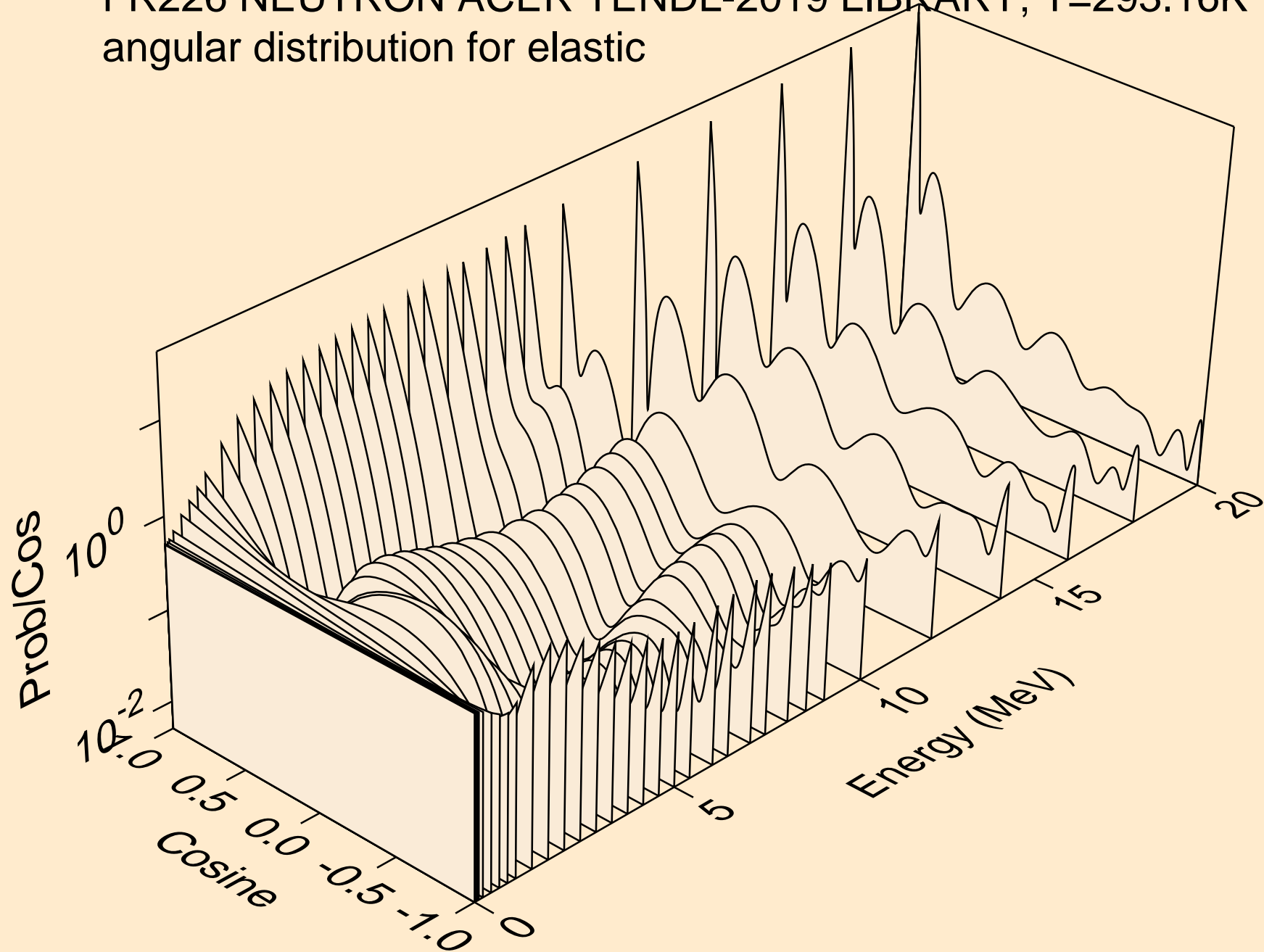



FR226 NEUTRON ACER TENDL-2019 LIBRARY; T=293.16K  
angular distribution for elastic

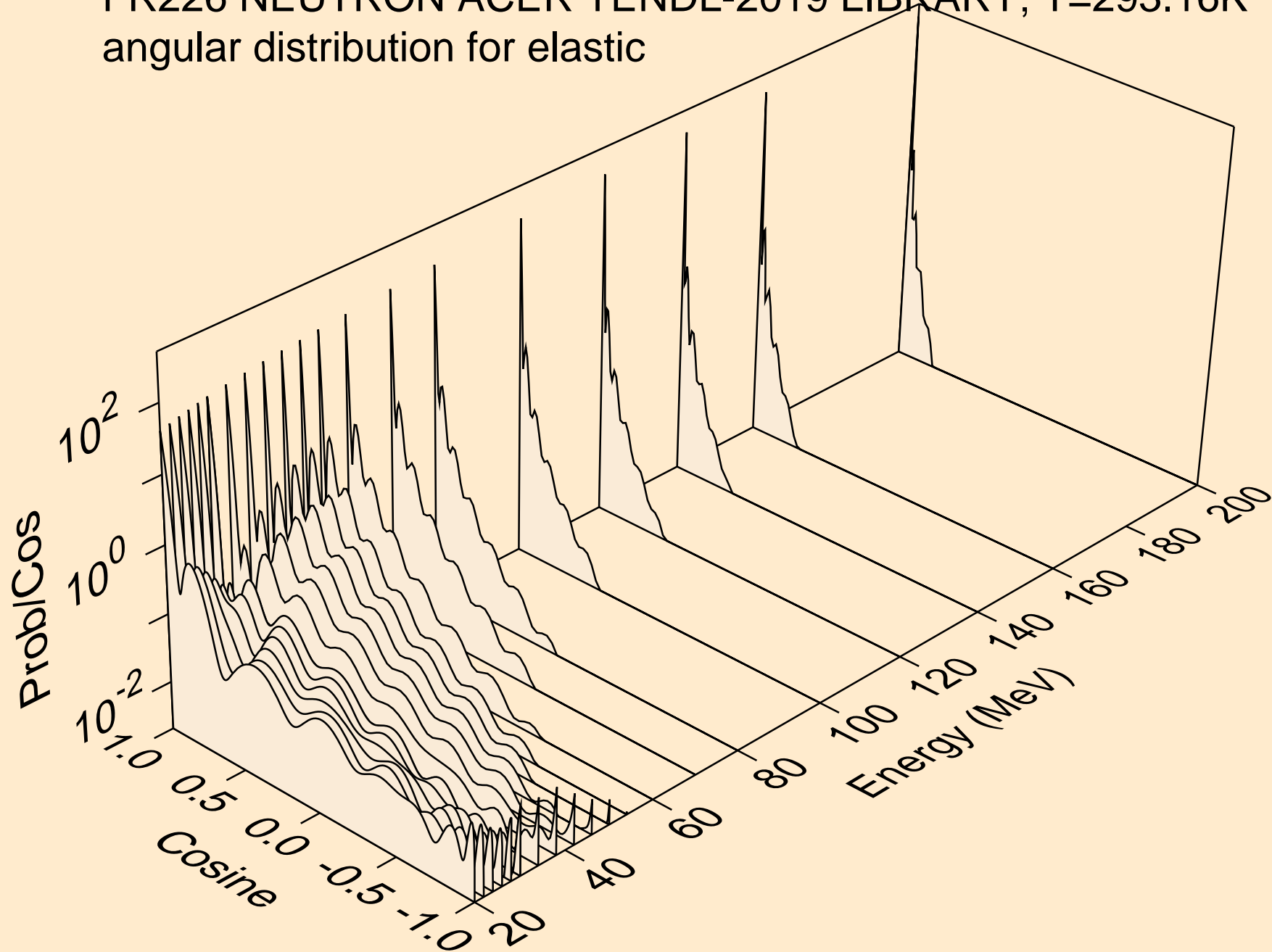

FR226 NEUTRON ACER TENDL-2019 LIBRARY; T=293.16K  
angular distribution for (n,n\*1)

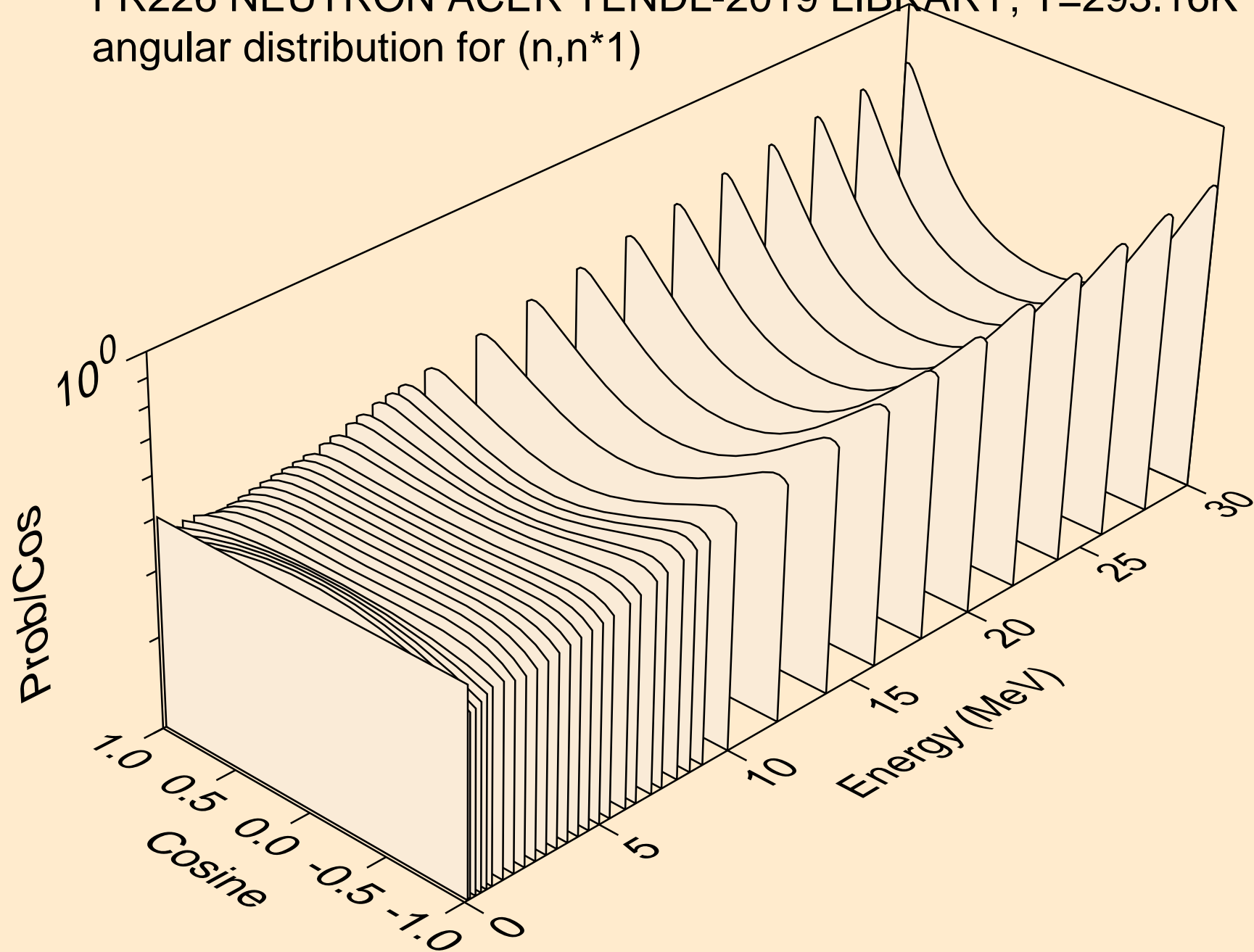

FR226 NEUTRON ACER TENDL-2019 LIBRARY; T=293.16K  
Total fission nubar

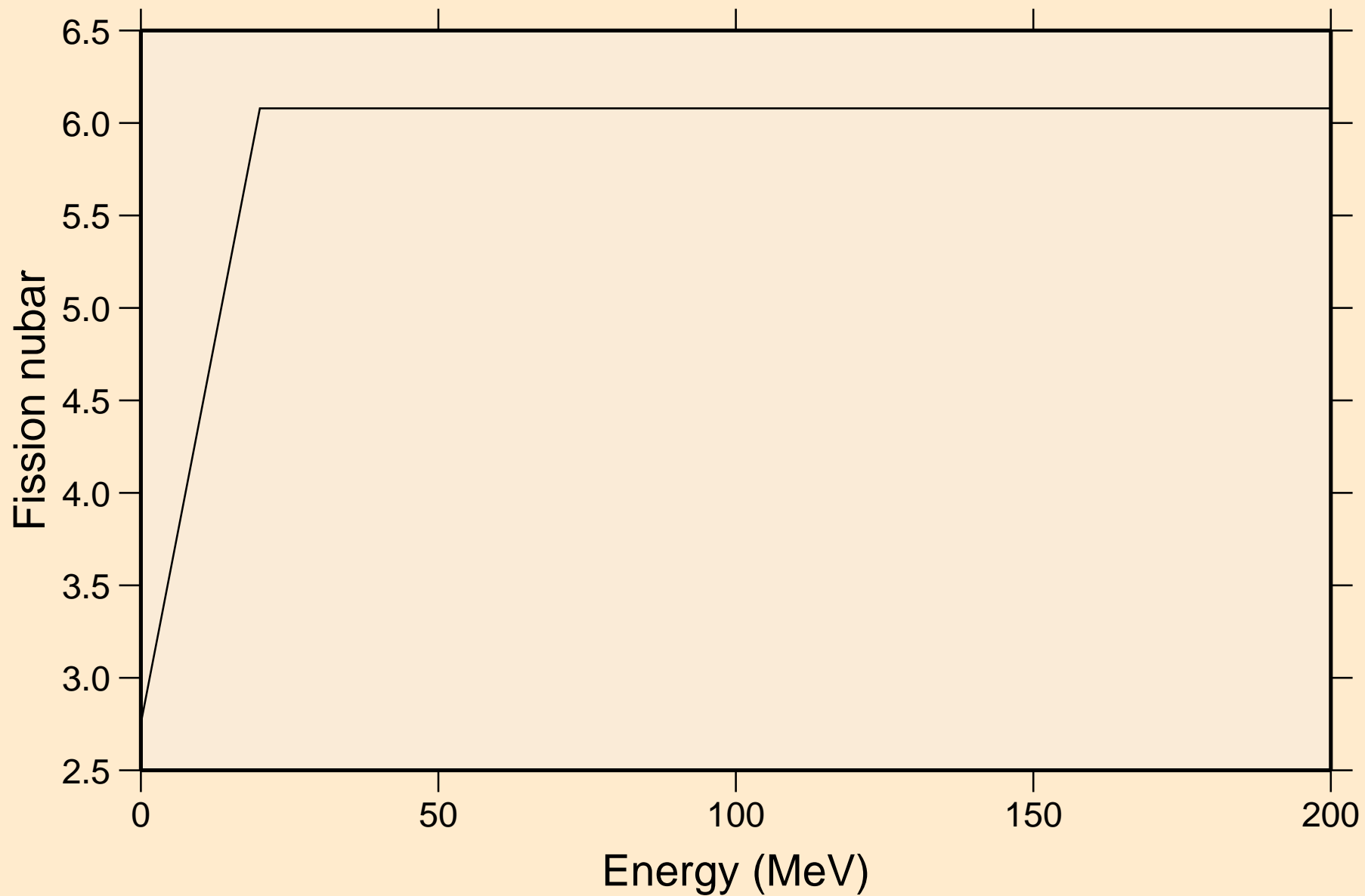

FR226 NEUTRON ACER TENDL-2019 LIBRARY; T=293.16K  
Neutron emission for (n,x)

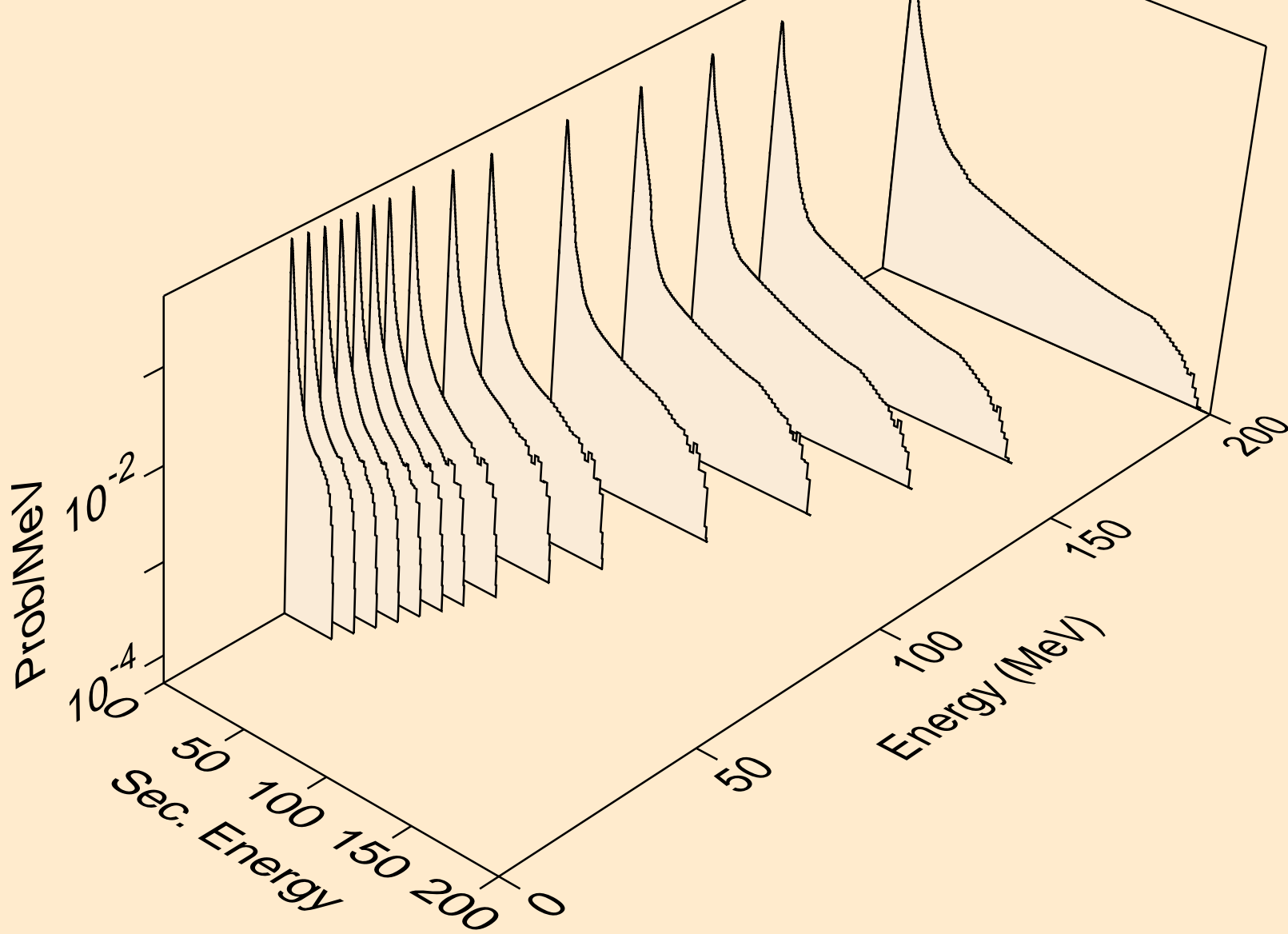

FR226 NEUTRON ACER TENDL-2019 LIBRARY; T=293.16K  
Neutron emission for (n,2nd)

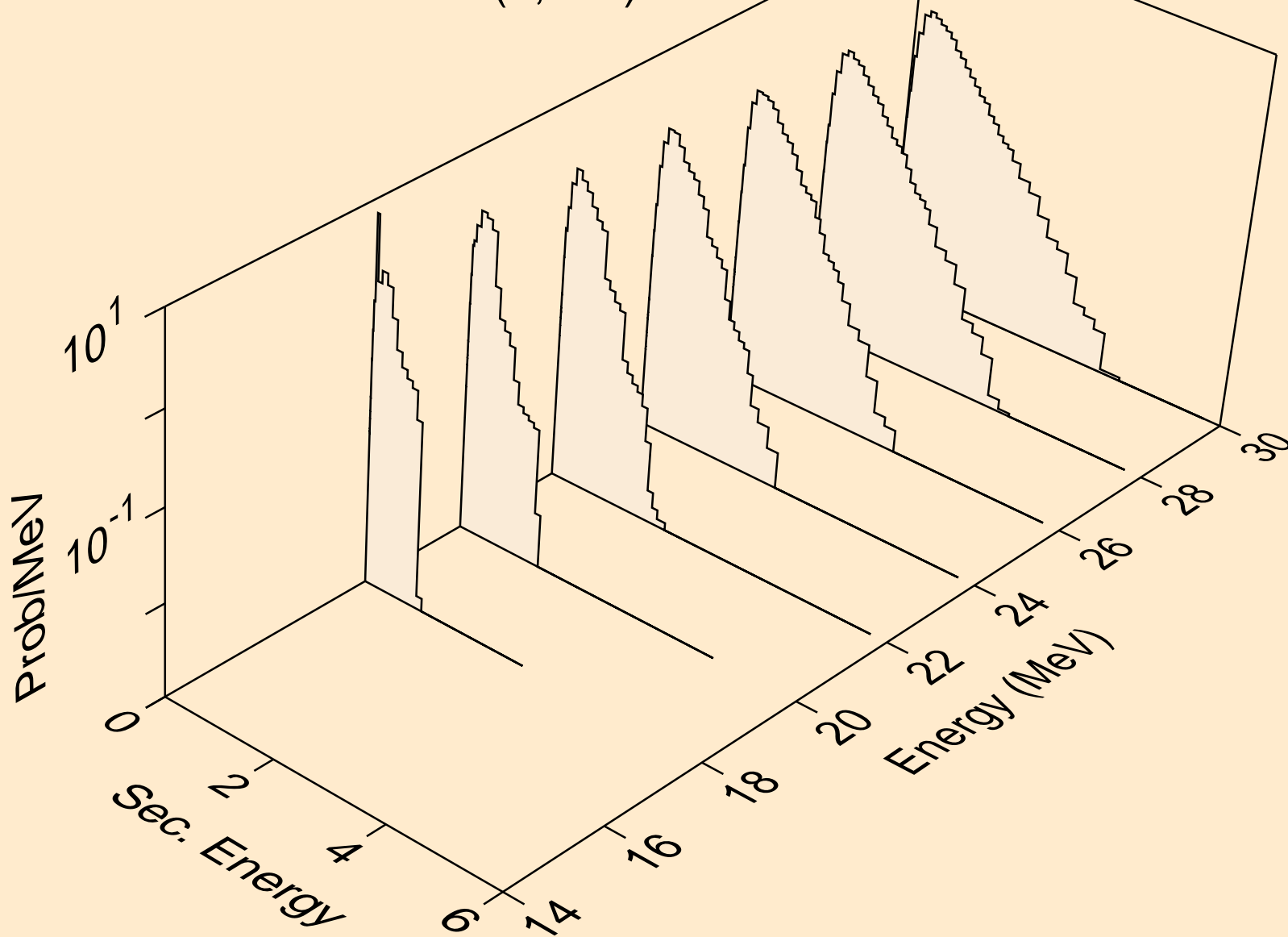

FR226 NEUTRON ACER TENDL-2019 LIBRARY; T=293.16K  
Neutron emission for (n,2n)

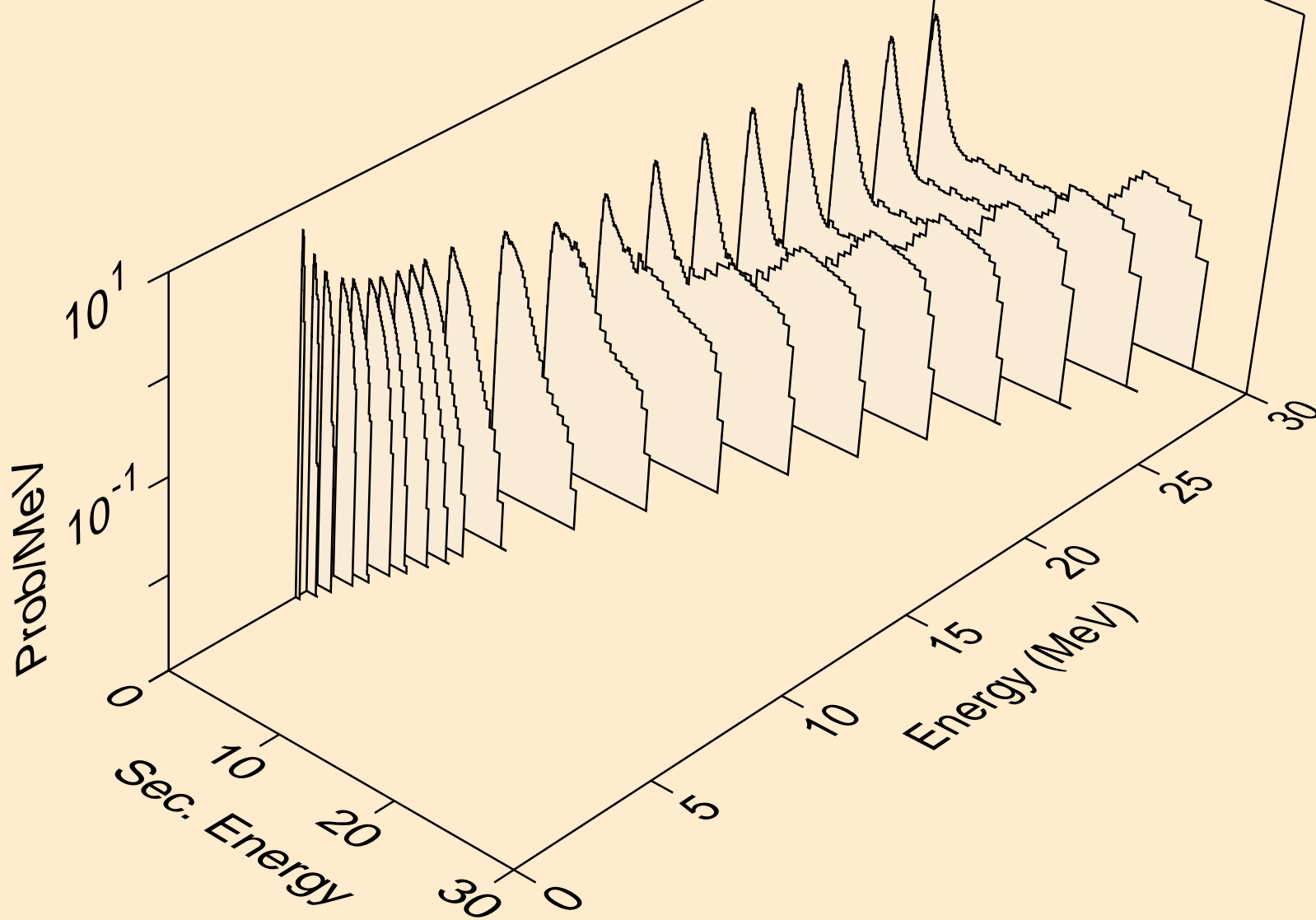

FR226 NEUTRON ACER TENDL-2019 LIBRARY; T=293.16K  
Neutron emission for (n,3n)

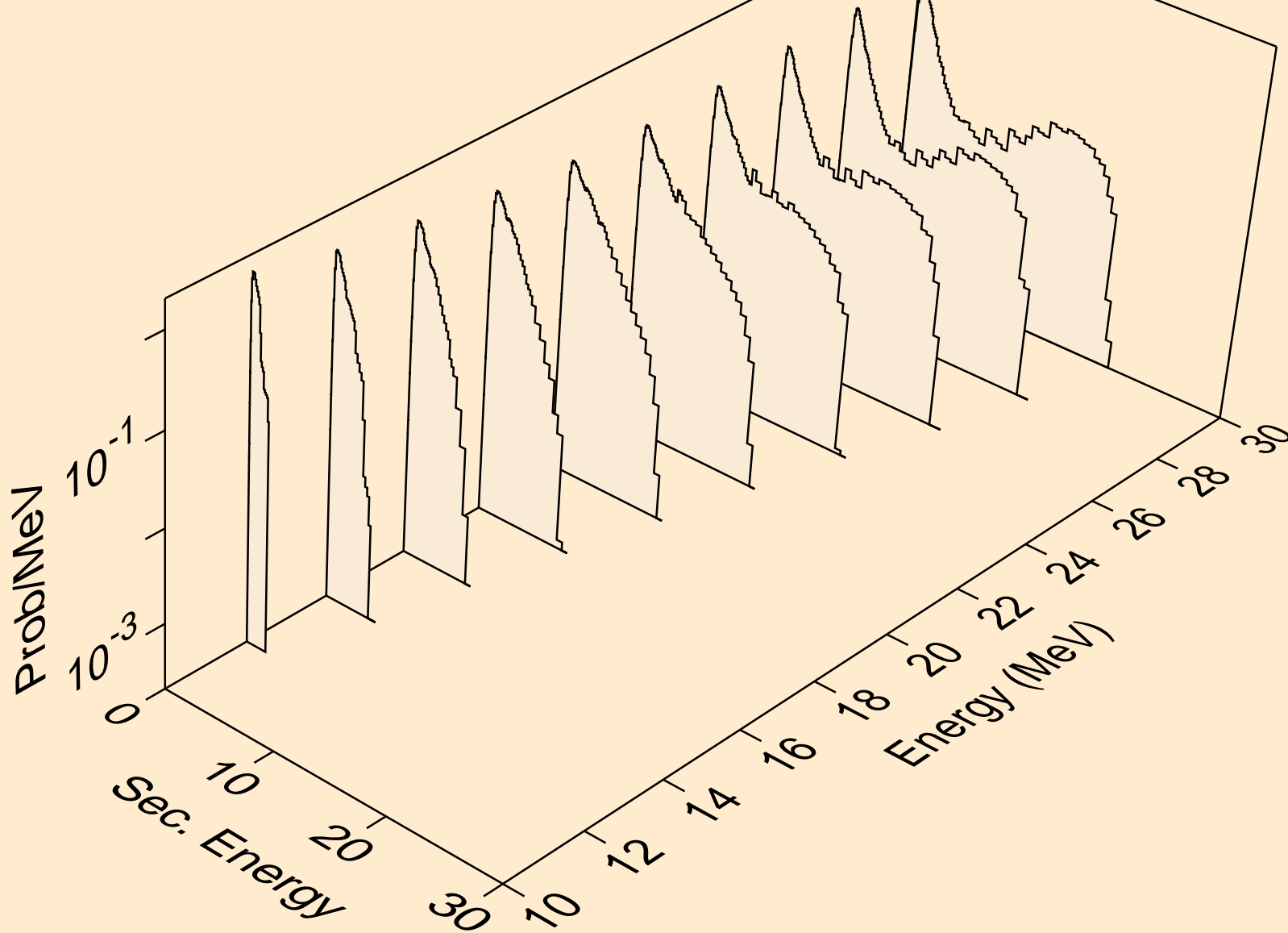

FR226 NEUTRON ACER TENDL-2019 LIBRARY; T=293.16K  
Neutron emission for fission

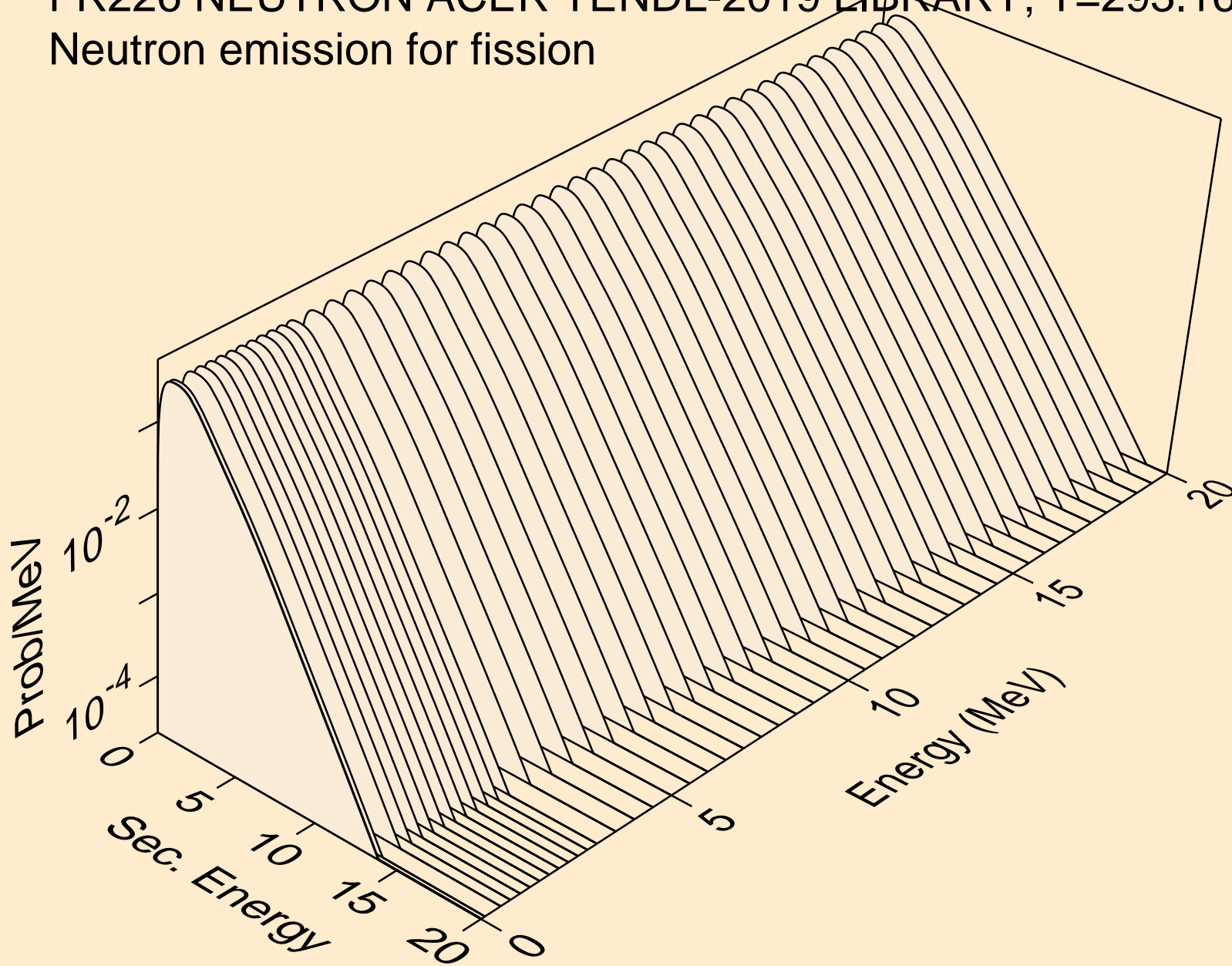



FR226 NEUTRON ACER TENDL-2019 LIBRARY; T=293.16K  
Neutron emission for (n,n\*)a

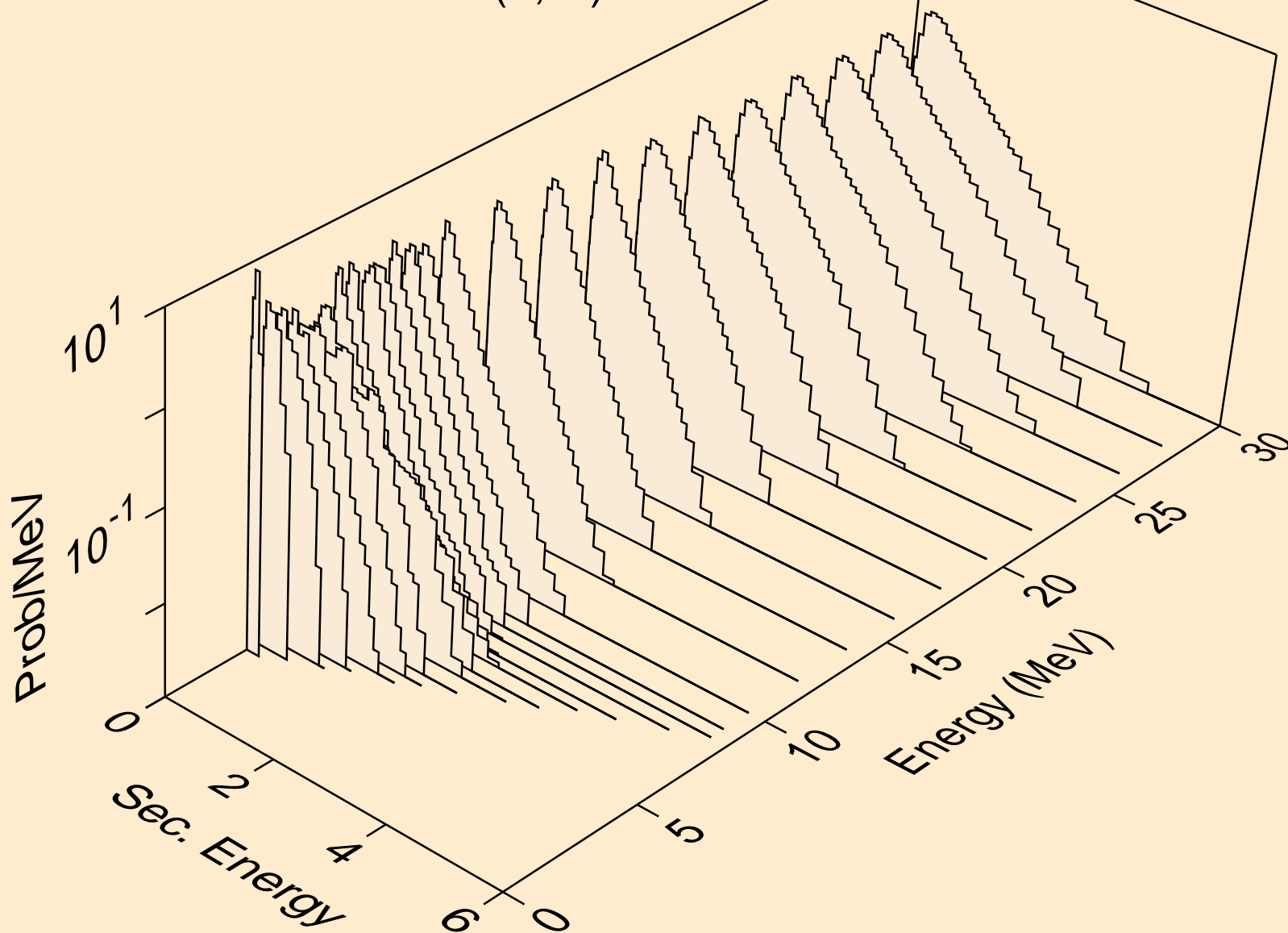

FR226 NEUTRON ACER TENDL-2019 LIBRARY; T=293.16K  
Neutron emission for (n,2n)a

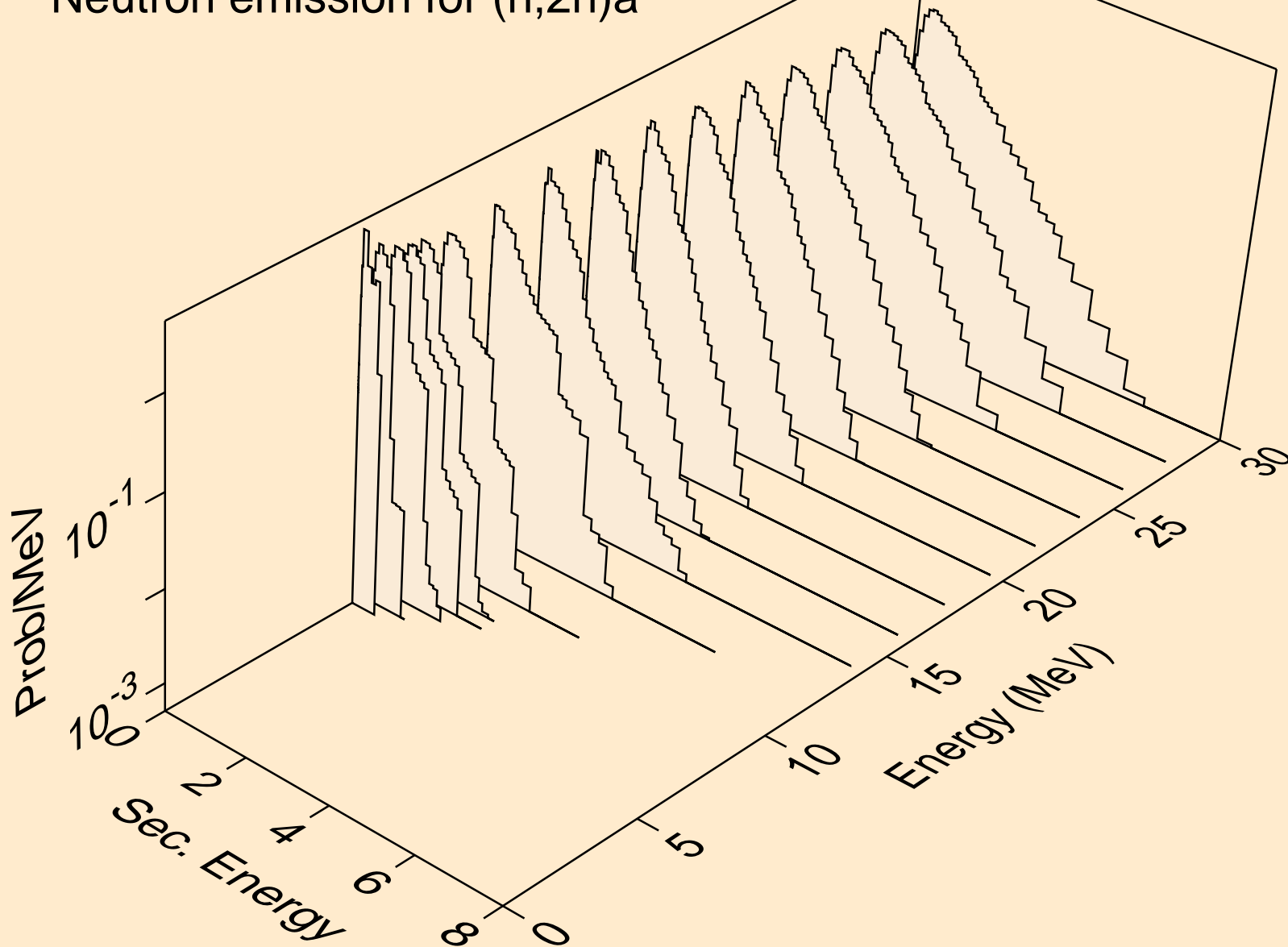

FR226 NEUTRON ACER TENDL-2019 LIBRARY; T=293.16K  
Neutron emission for (n,3n)a

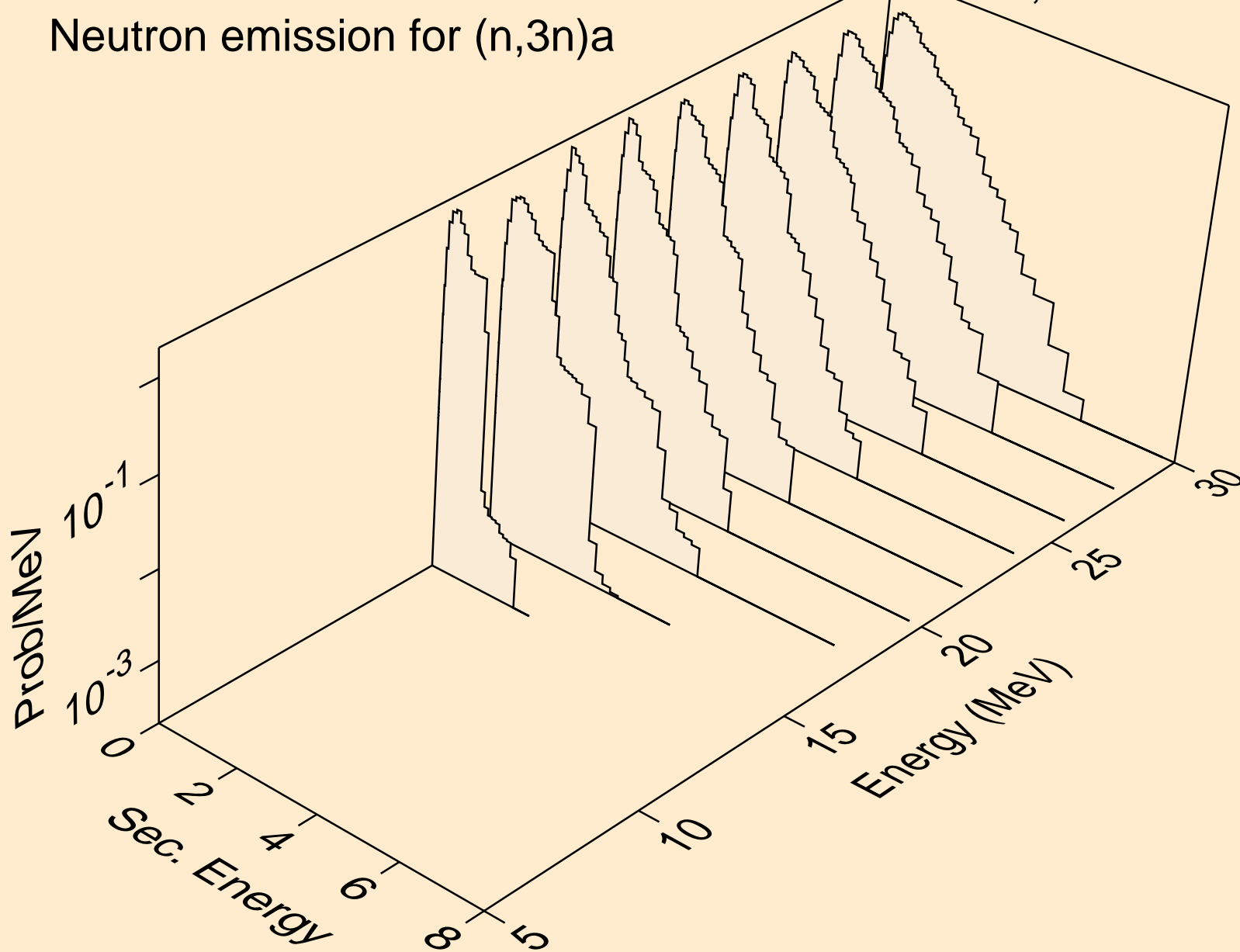

FR226 NEUTRON ACER TENDL-2019 LIBRARY; T=293.16K  
Neutron emission for (n,n\*)p

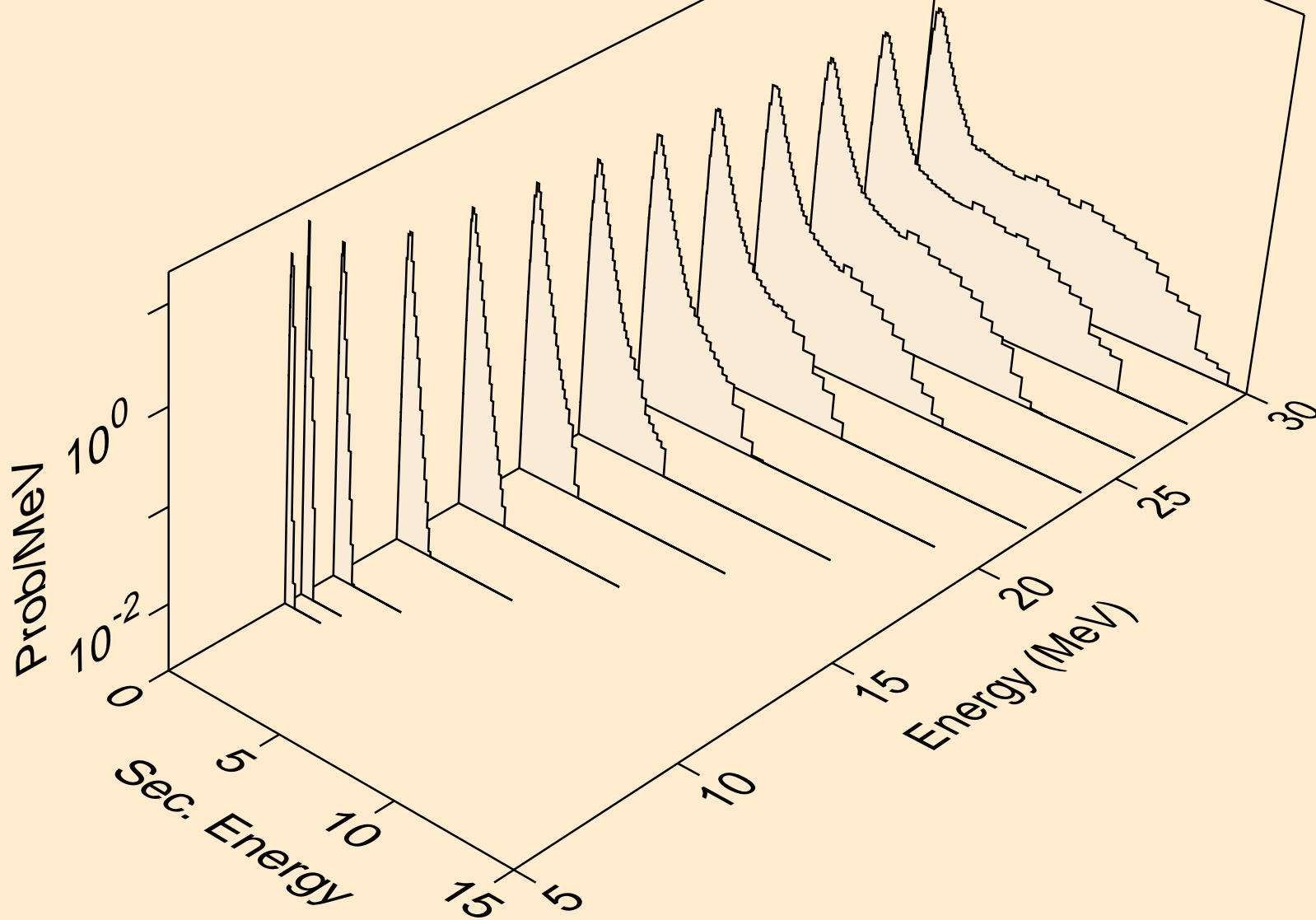

FR226 NEUTRON ACER TENDL-2019 LIBRARY; T=293.16K  
Neutron emission for (n,n\*)2a

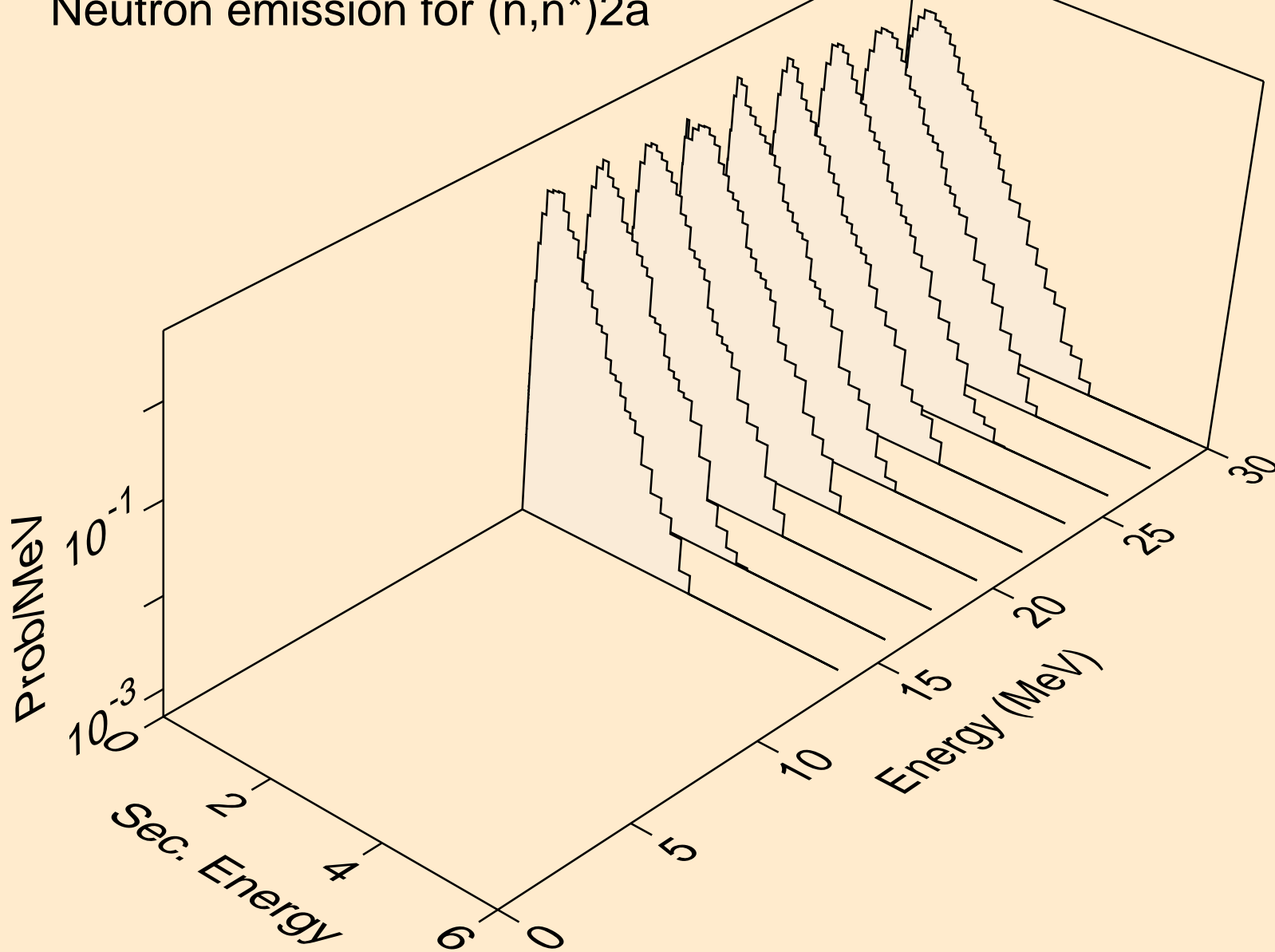

FR226 NEUTRON ACER TENDL-2019 LIBRARY; T=293.16K  
Neutron emission for (n,n\*)d

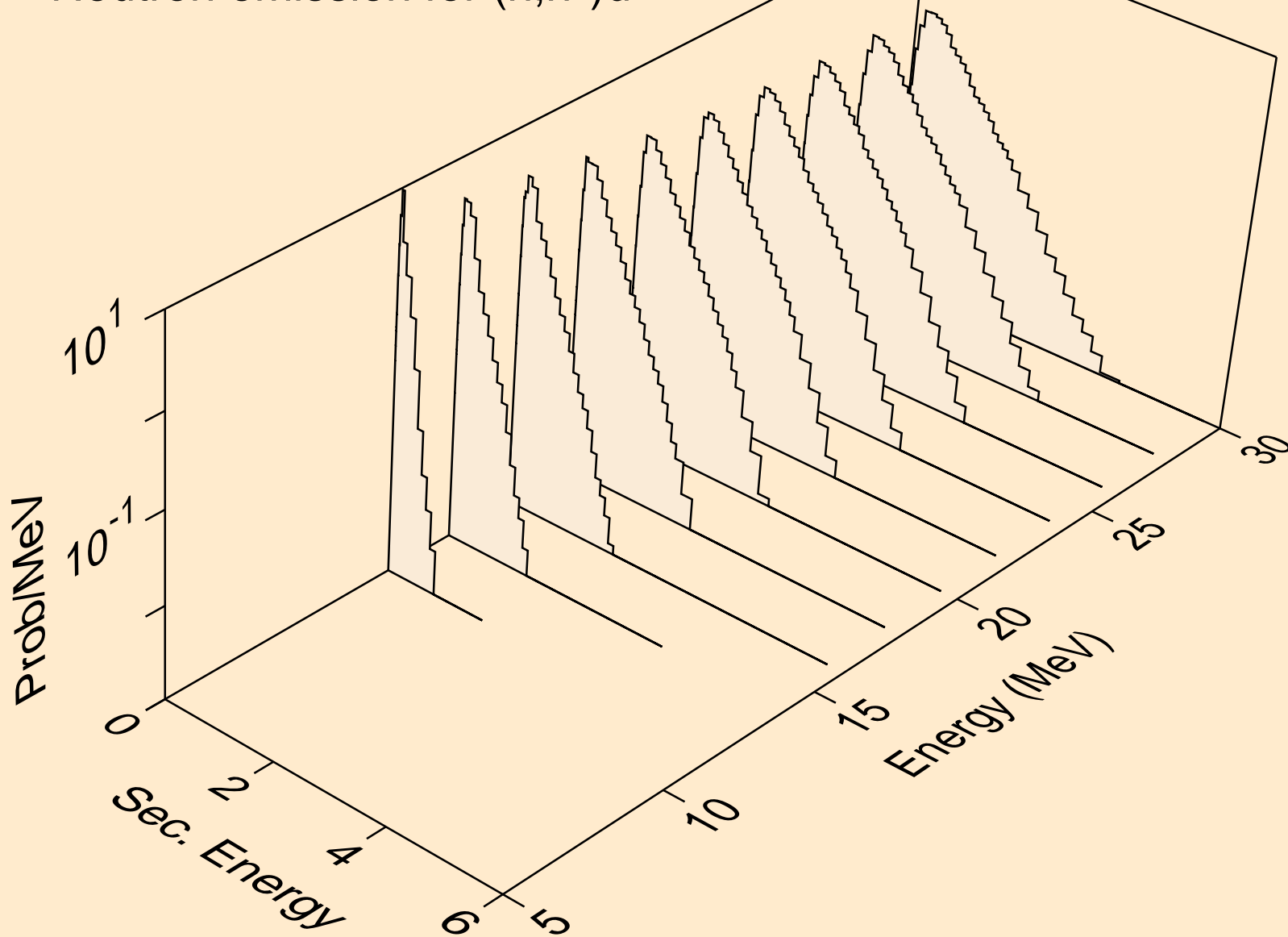

FR226 NEUTRON ACER TENDL-2019 LIBRARY; T=293.16K  
Neutron emission for (n,n\*)t

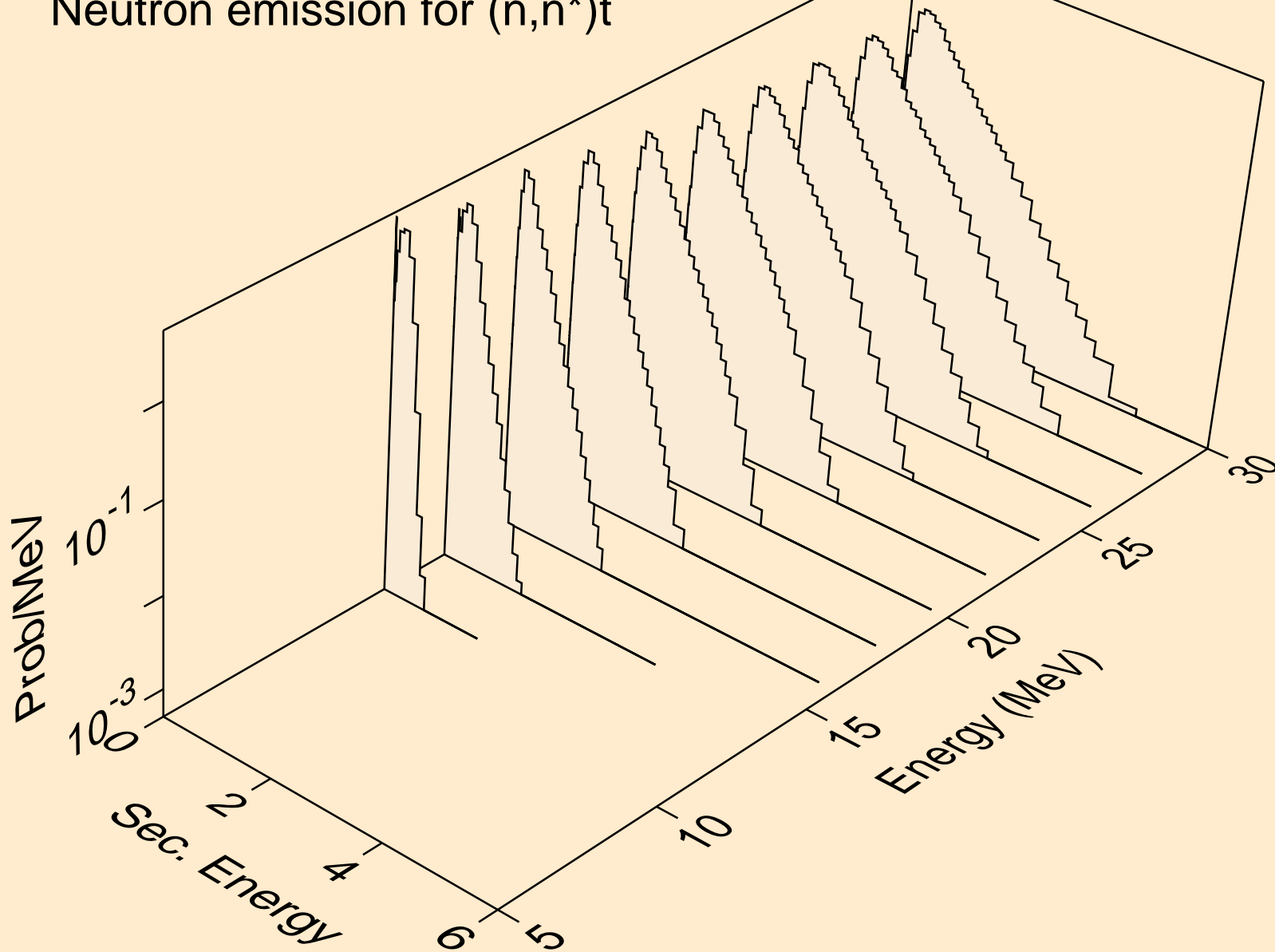

FR226 NEUTRON ACER TENDL-2019 LIBRARY; T=293.16K  
Neutron emission for (n,n\*)he3

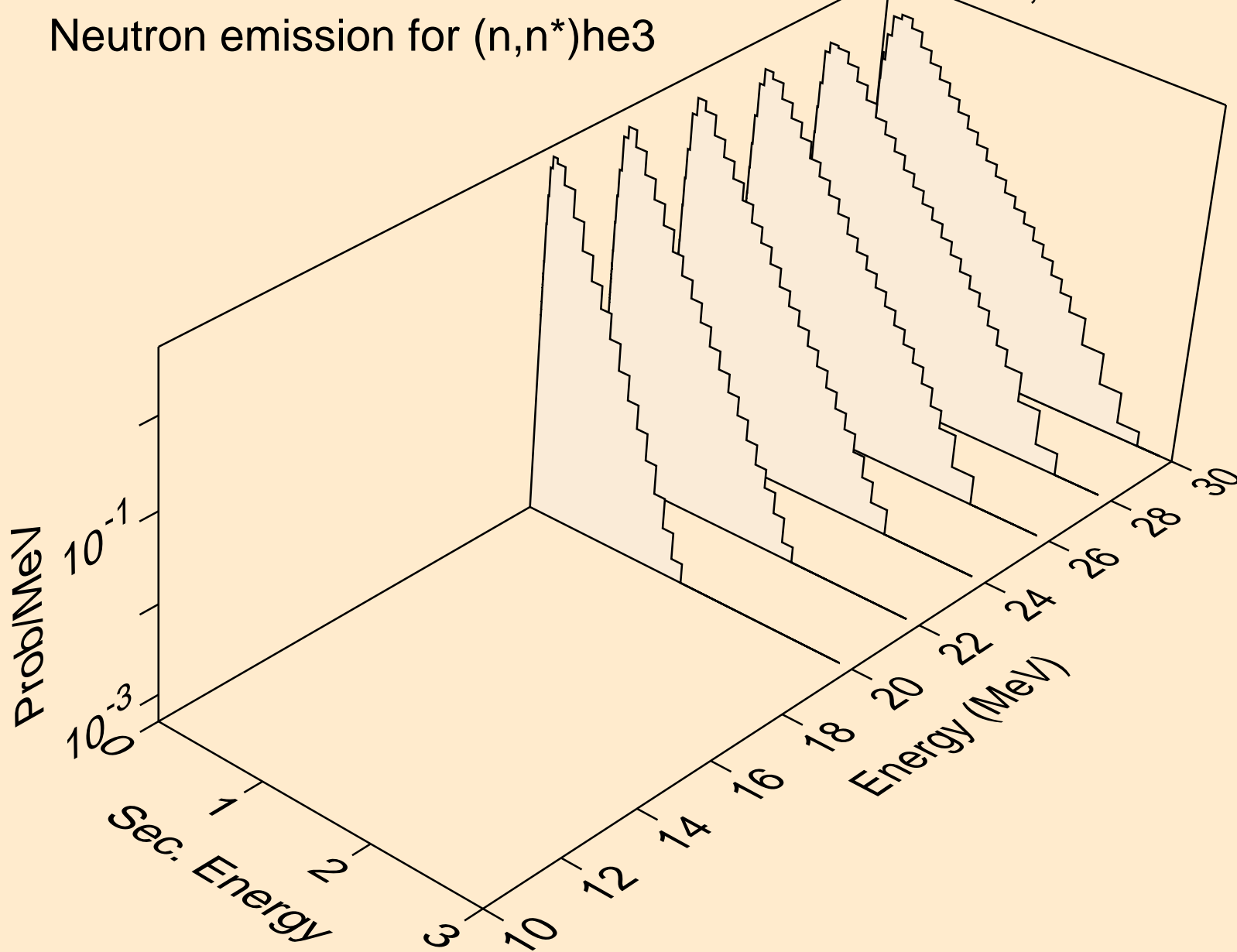



FR226 NEUTRON ACER TENDL-2019 LIBRARY; T=293.16K  
Neutron emission for (n,4n)

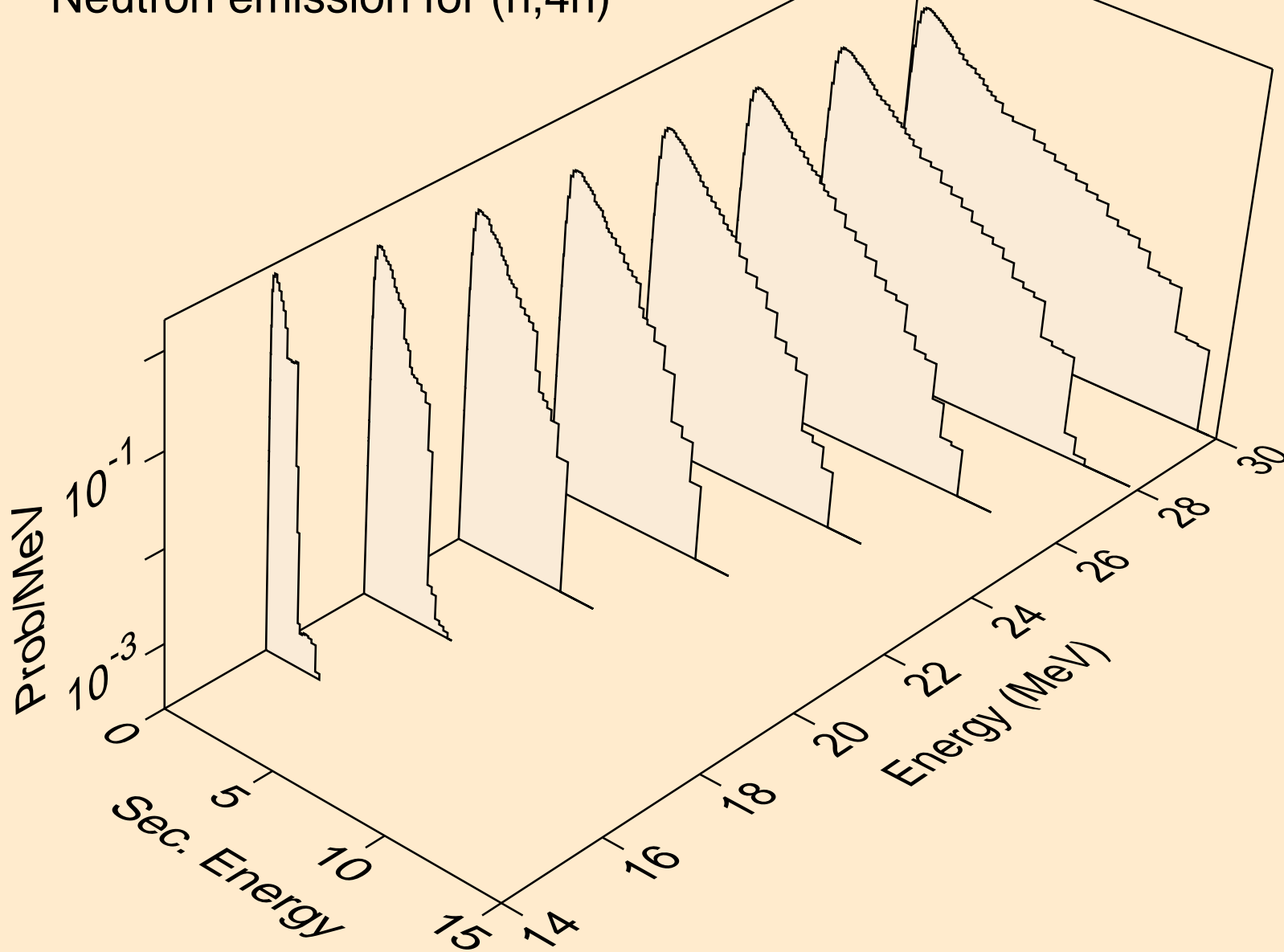

FR226 NEUTRON ACER TENDL-2019 LIBRARY; T=293.16K  
Neutron emission for (n,2np)

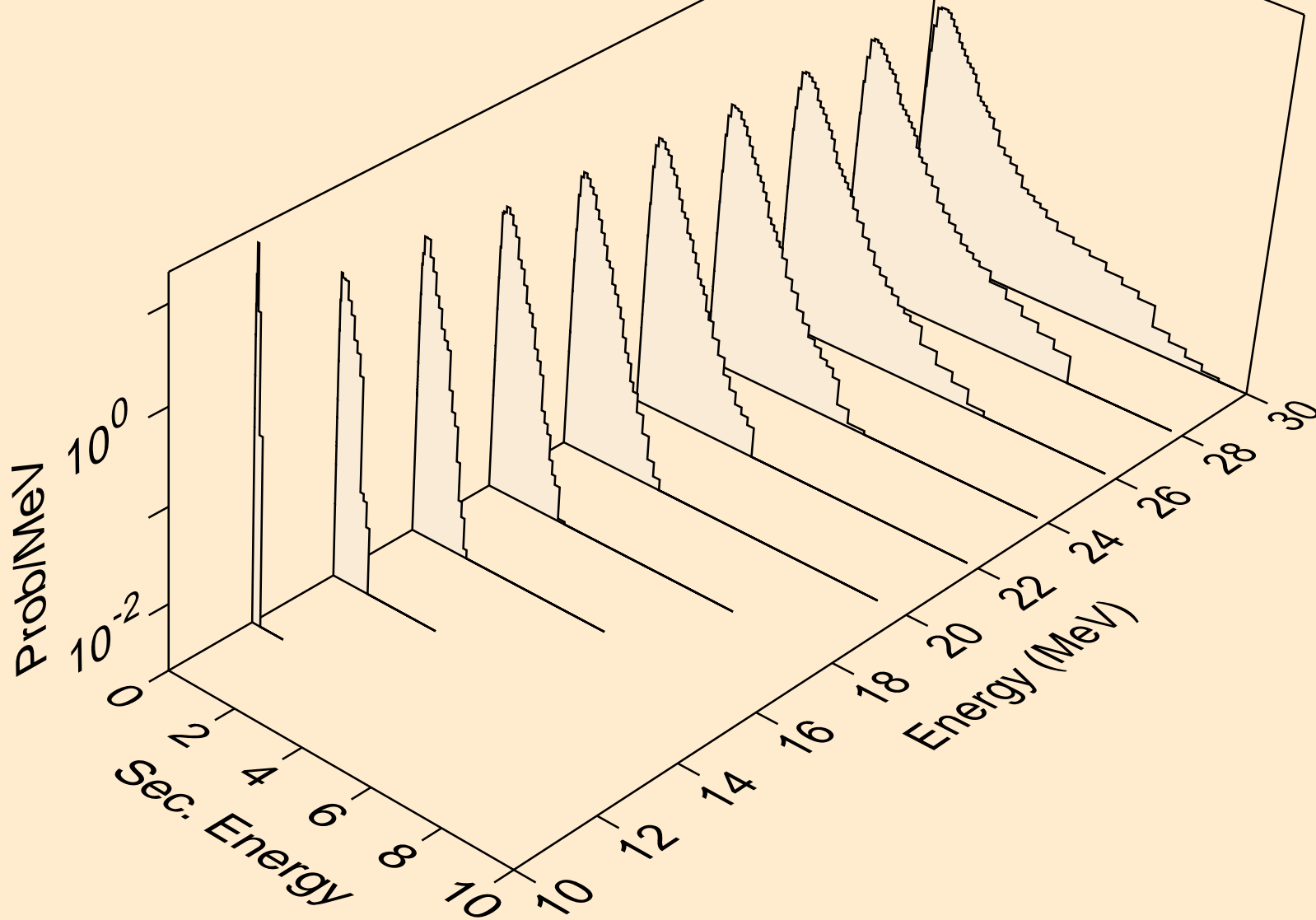

FR226 NEUTRON ACER TENDL-2019 LIBRARY; T=293.16K  
Neutron emission for (n,3np)

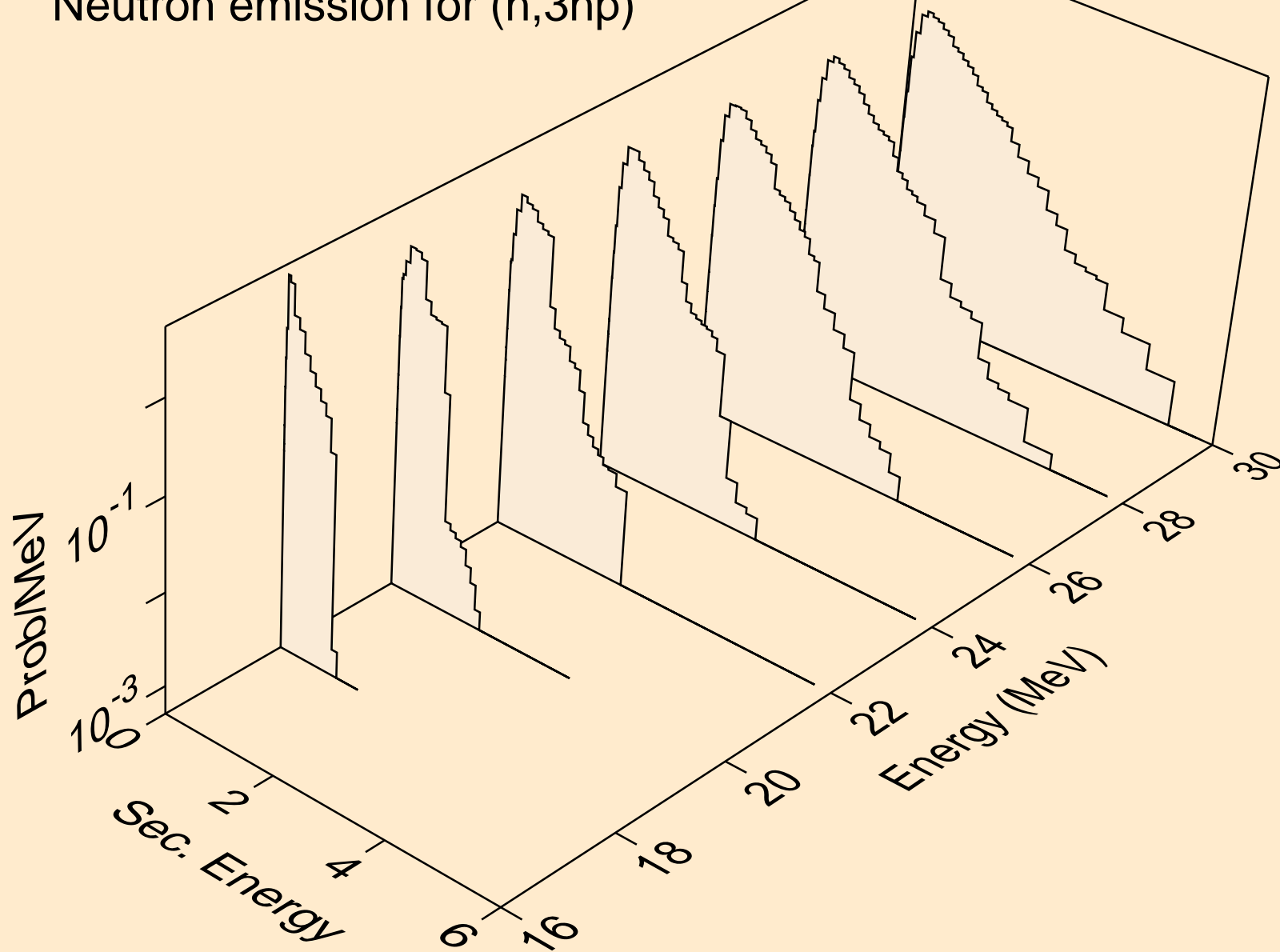

FR226 NEUTRON ACER TENDL-2019 LIBRARY; T=293.16K  
Neutron emission for (n,2np)

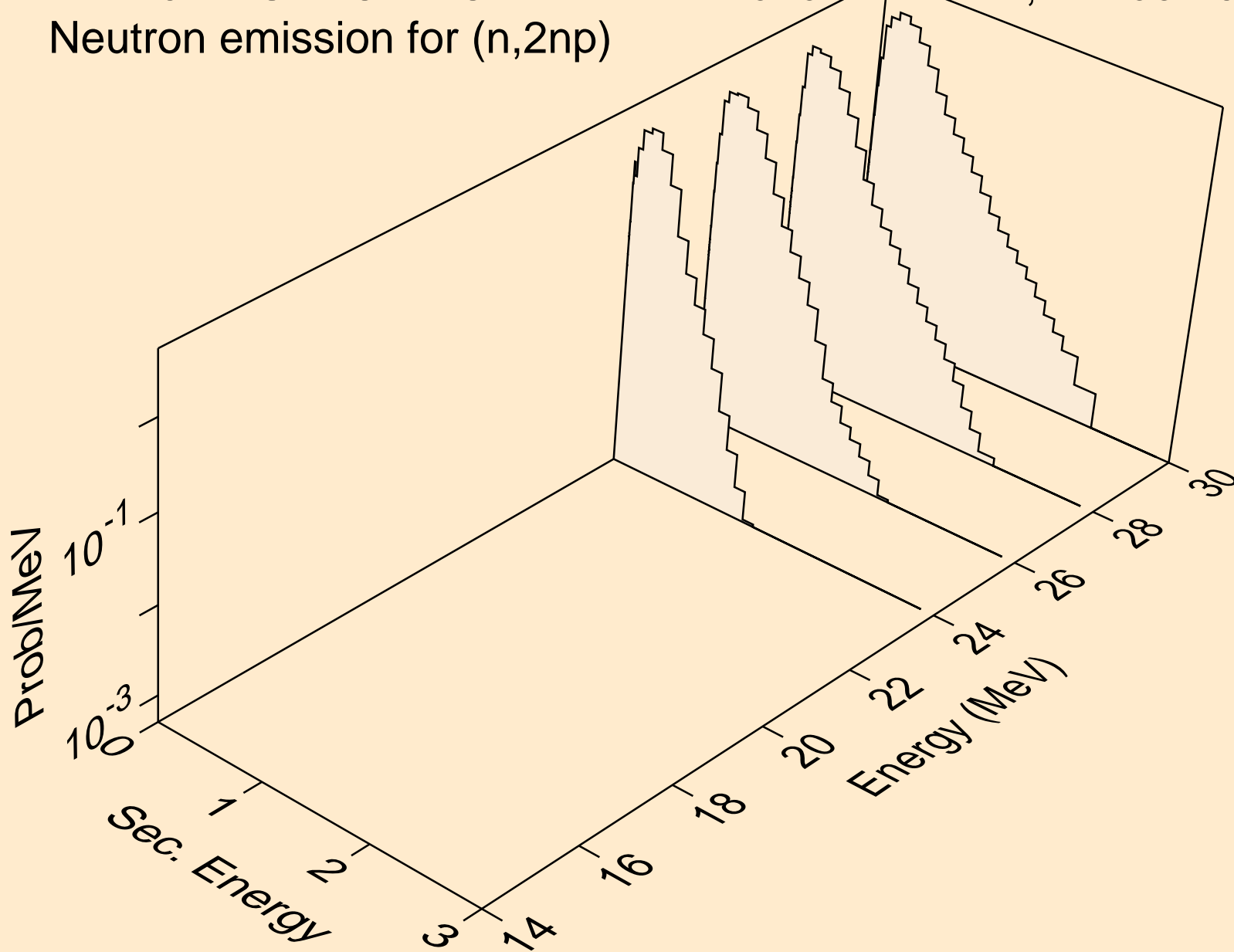

FR226 NEUTRON ACER TENDL-2019 LIBRARY; T=293.16K  
Neutron emission for (n,n\*c)

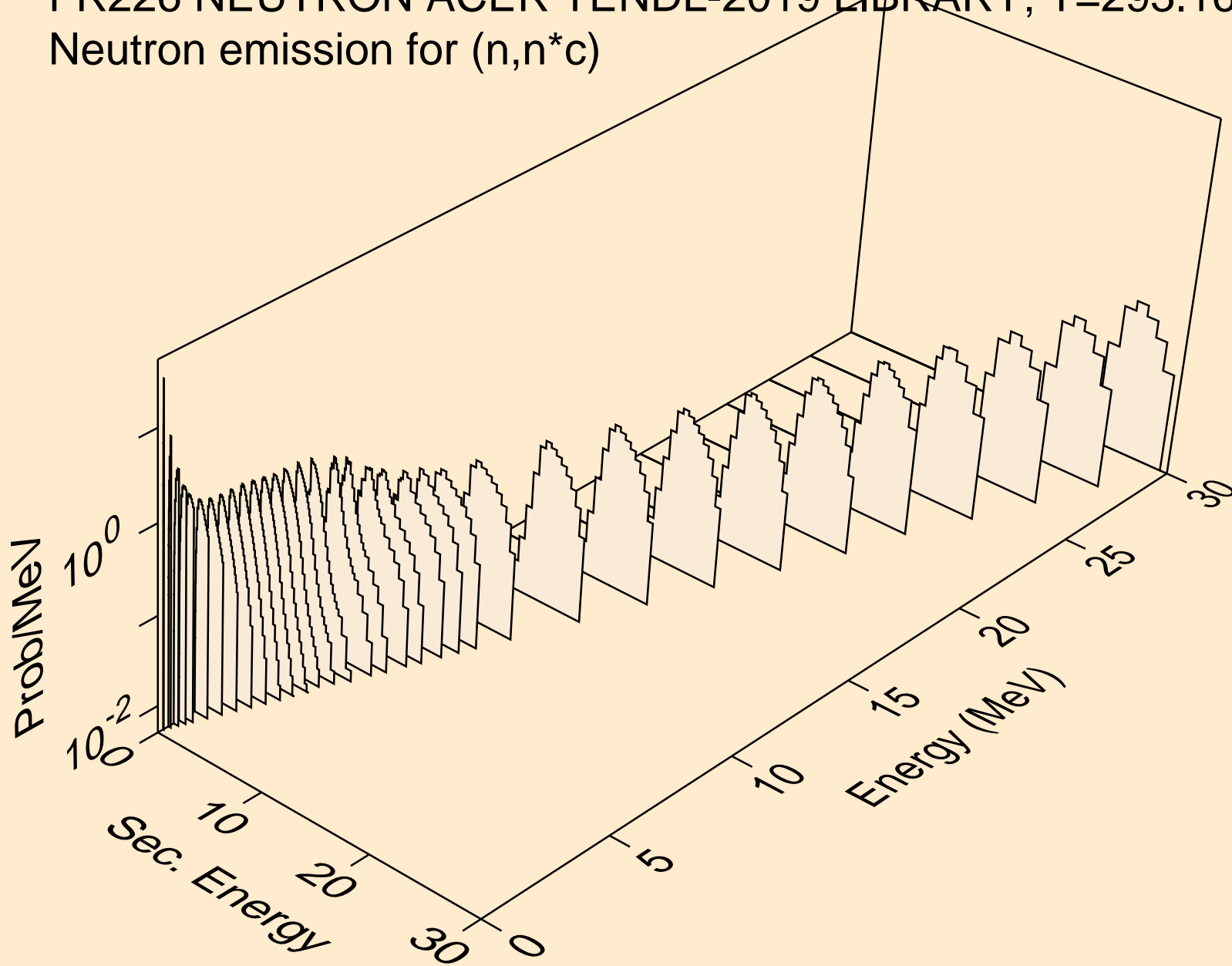

FR226 NEUTRON ACER TENDL-2019 LIBRARY; T=293.16K

Delayed nubar

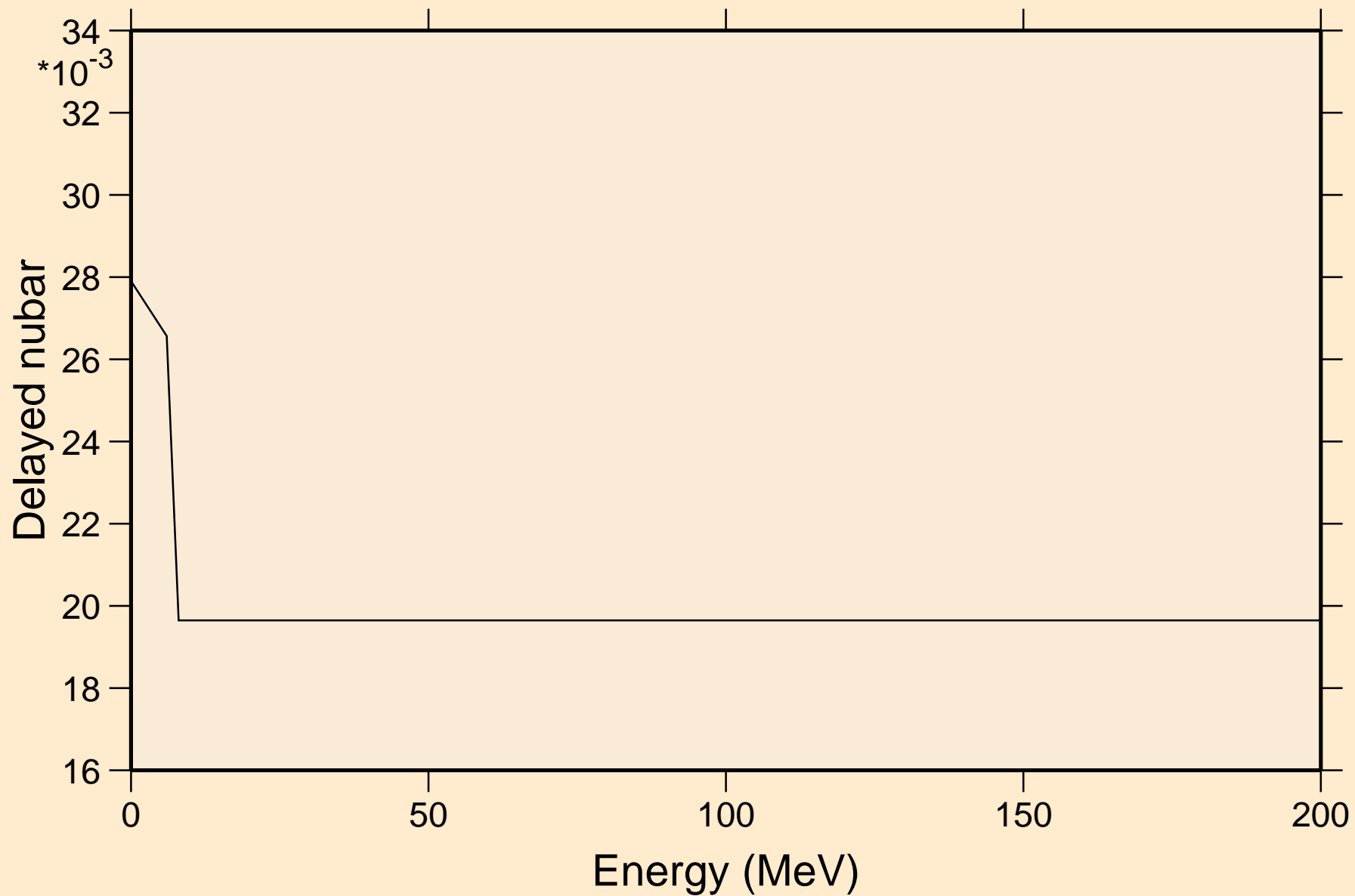

# FR226 NEUTRON ACER TENDL-2019 LIBRARY; T=293.16K

## Delayed neutron spectra

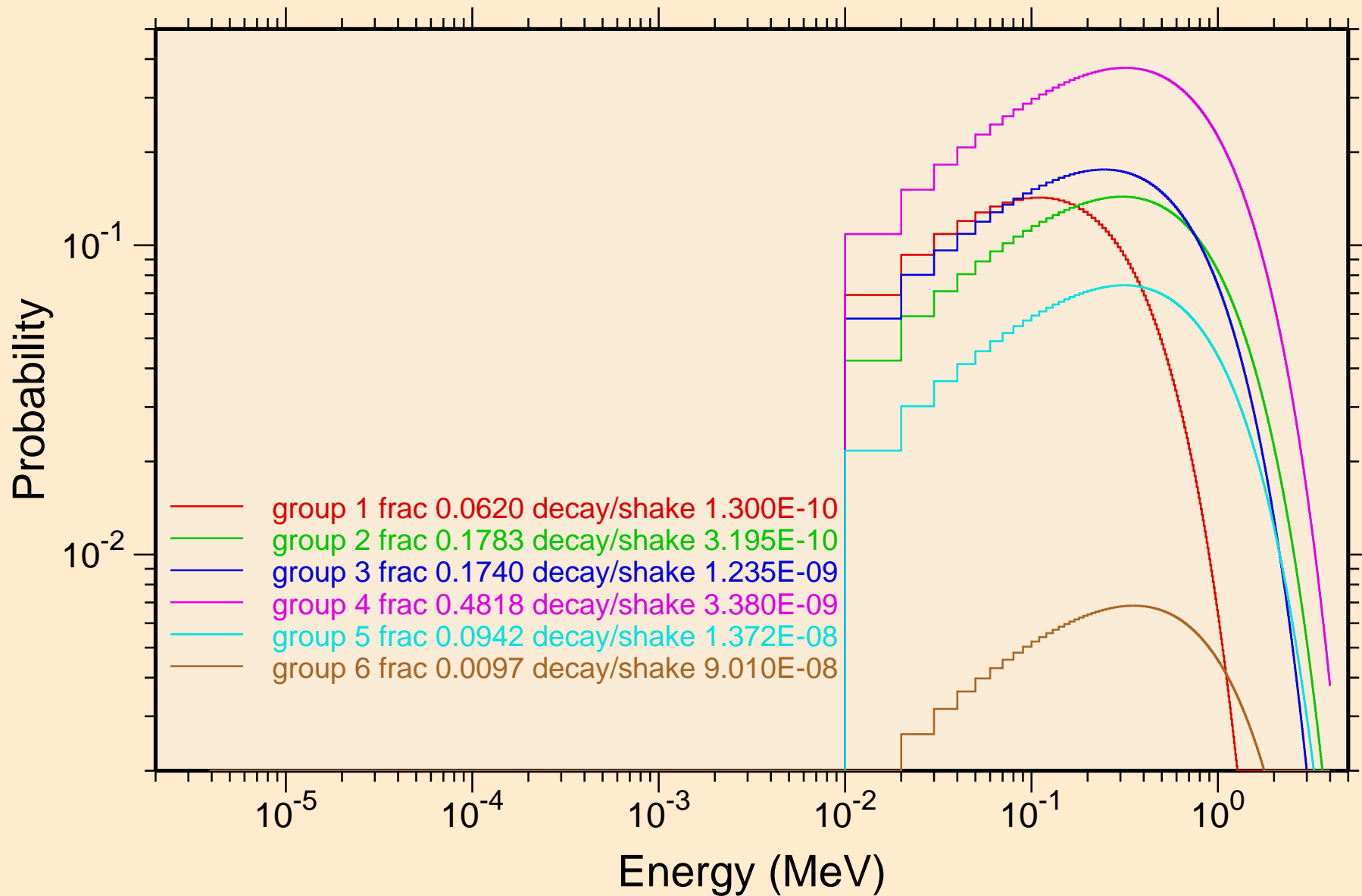

FR226 NEUTRON ACER TENDL-2019 LIBRARY; T=293.16K  
Photon emission for (n,x)

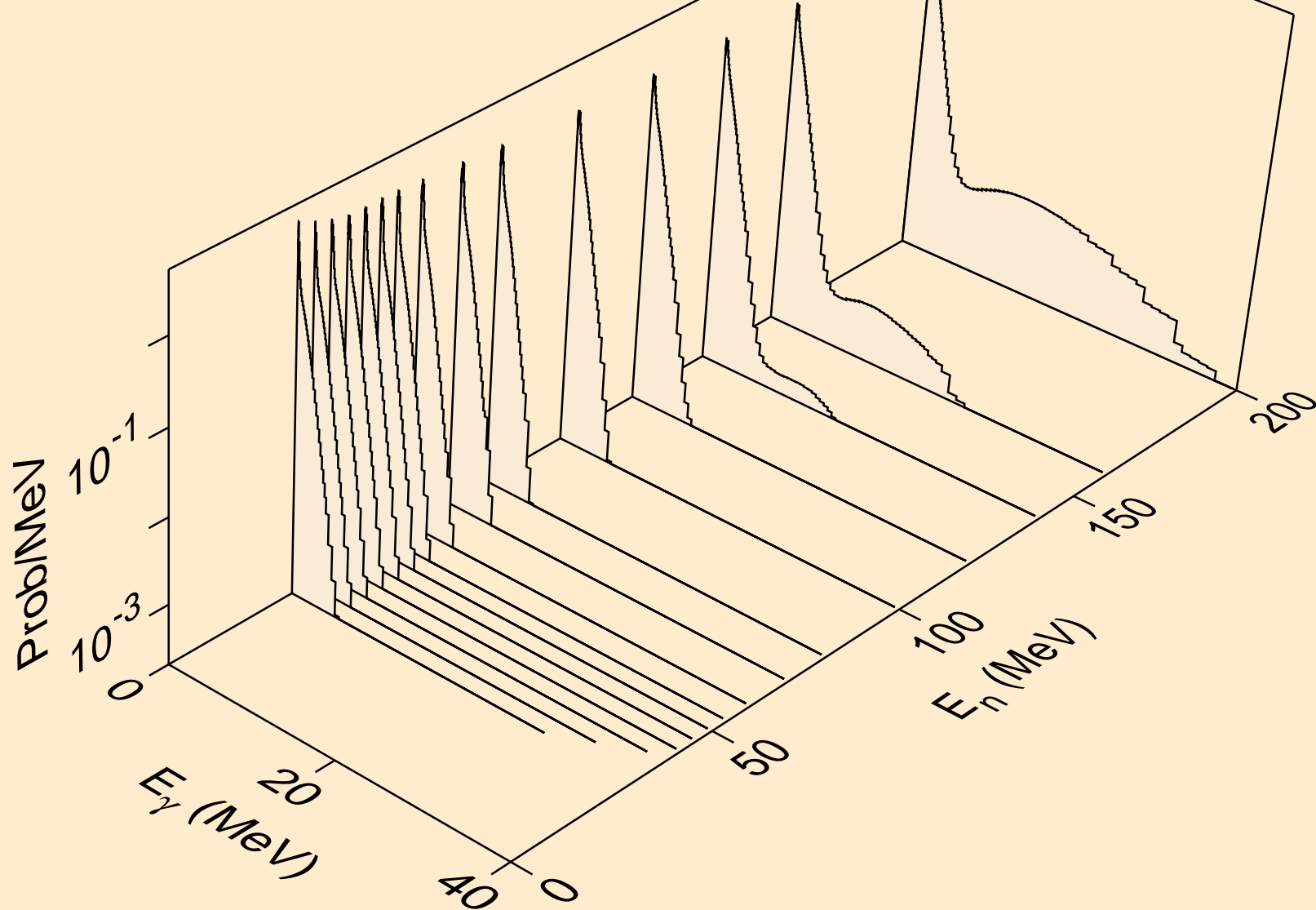



FR226 NEUTRON ACER TENDL-2019 LIBRARY; T=293.16K  
Photon emission for (n,2nd)

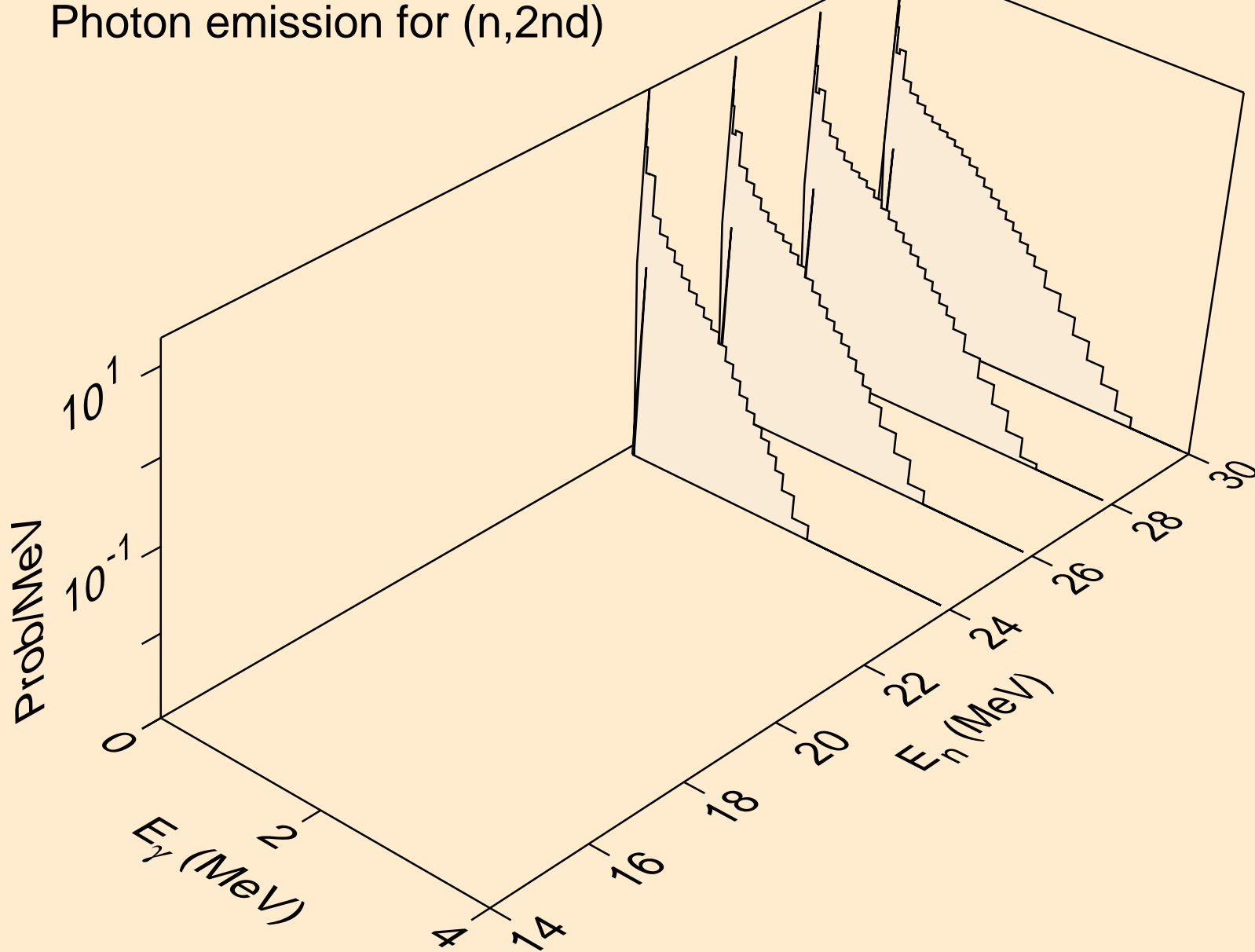

FR226 NEUTRON ACER TENDL-2019 LIBRARY; T=293.16K  
Photon emission for (n,2n)

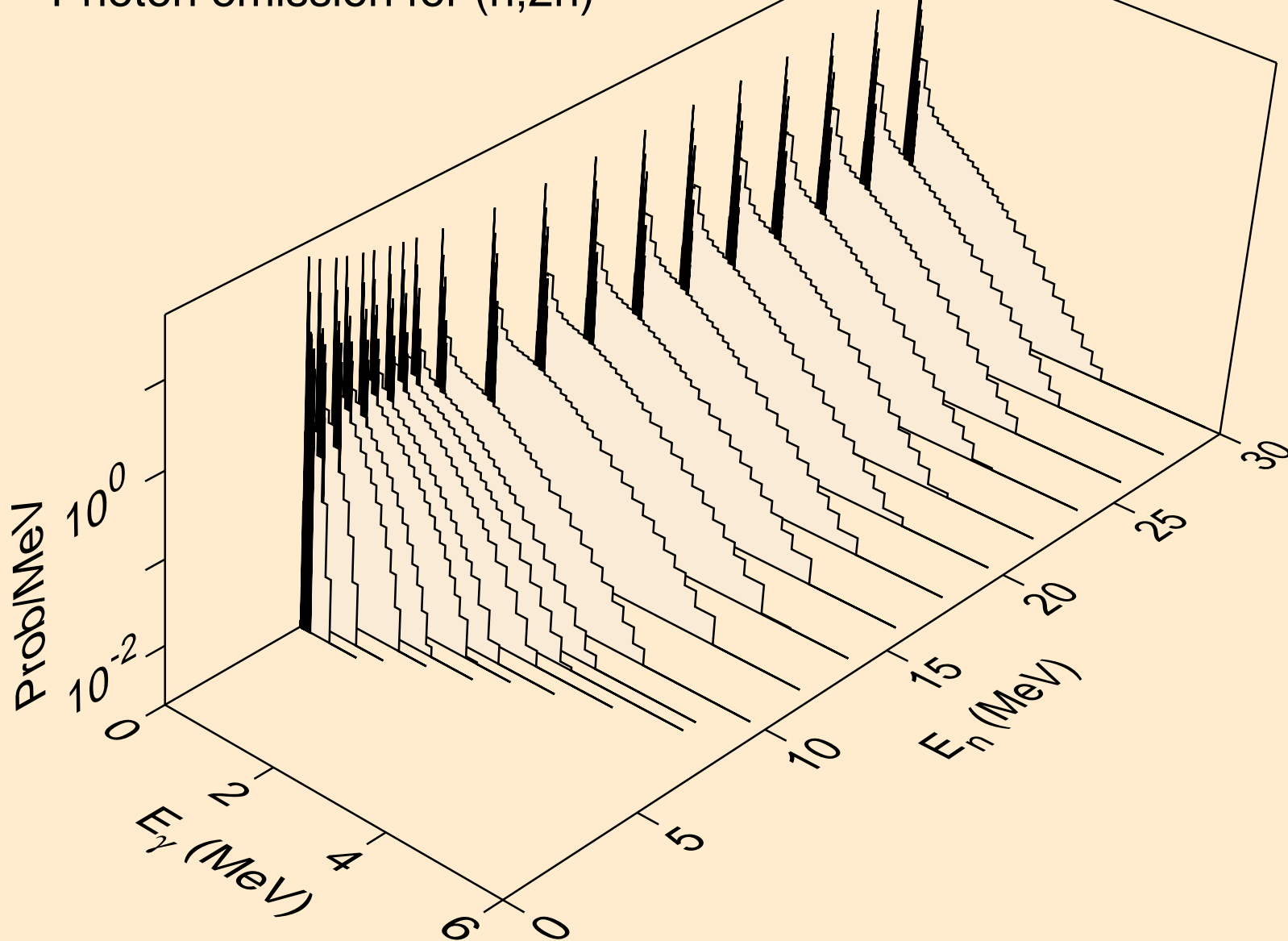

FR226 NEUTRON ACER TENDL-2019 LIBRARY; T=293.16K  
Photon emission for (n,3n)

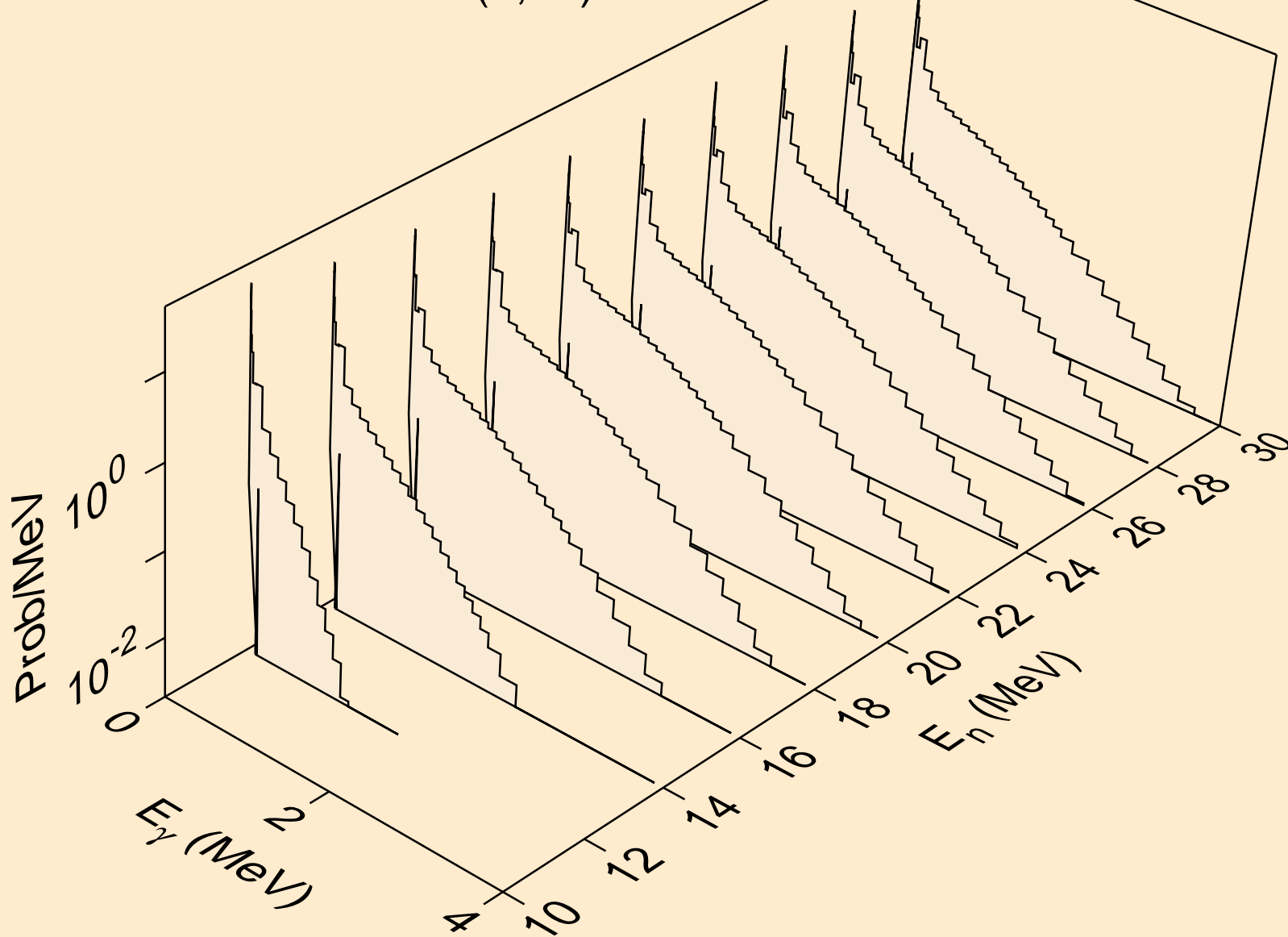

FR226 NEUTRON ACER TENDL-2019 LIBRARY; T=293.16K  
Photon emission for (n,n\*)a

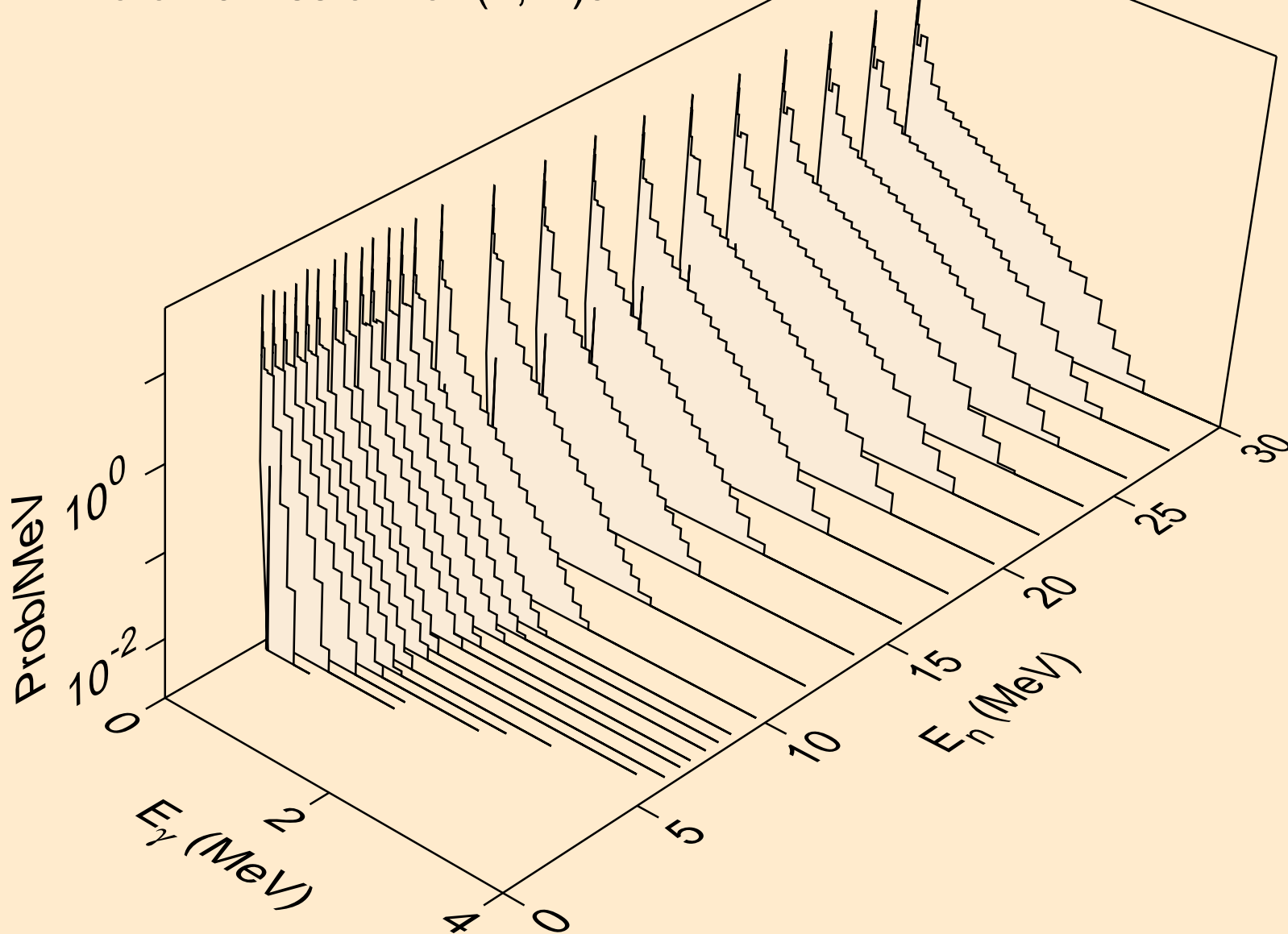

FR226 NEUTRON ACER TENDL-2019 LIBRARY; T=293.16K  
Photon emission for (n,2n)a

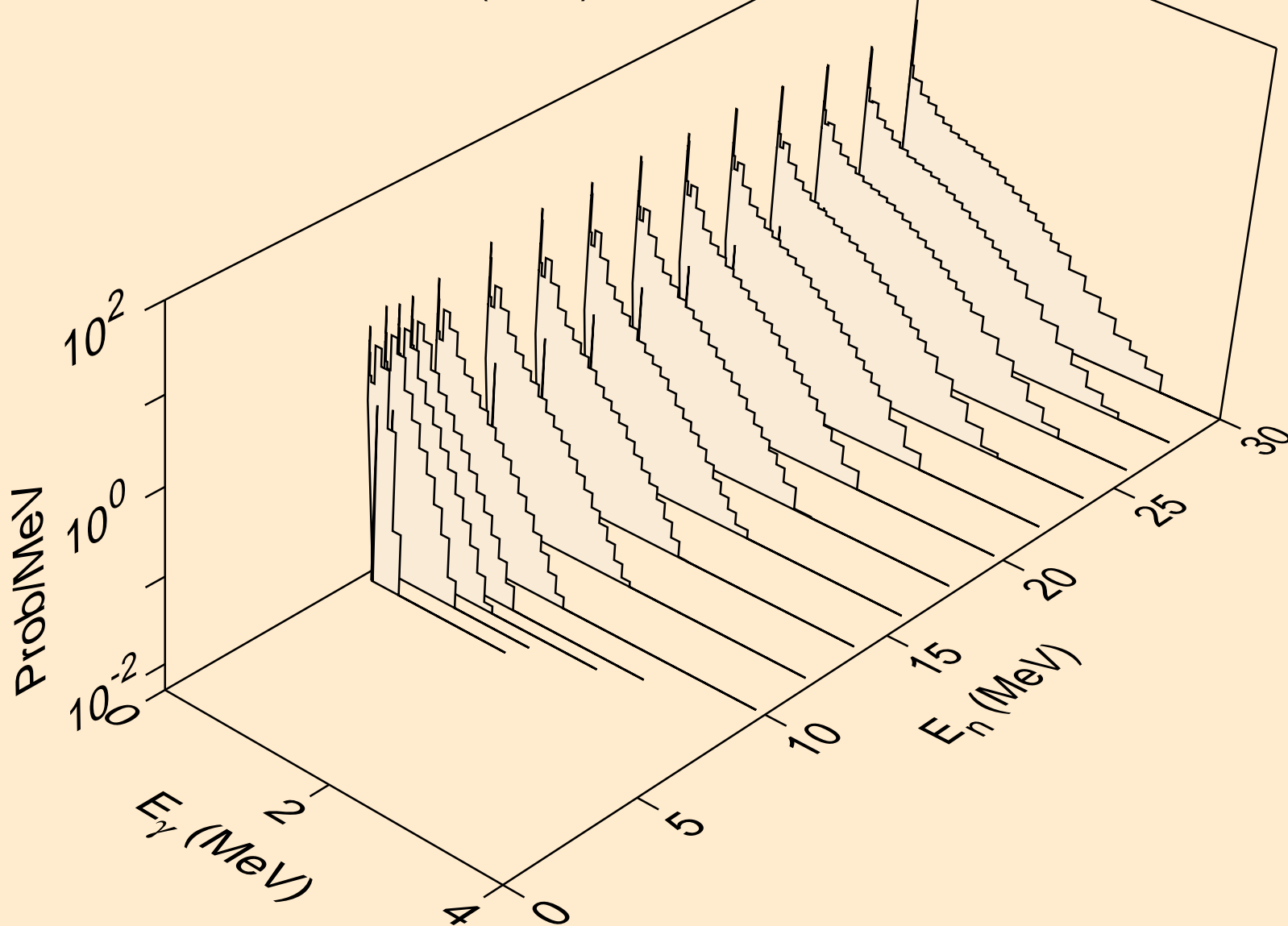

FR226 NEUTRON ACER TENDL-2019 LIBRARY; T=293.16K  
Photon emission for (n,3n)a

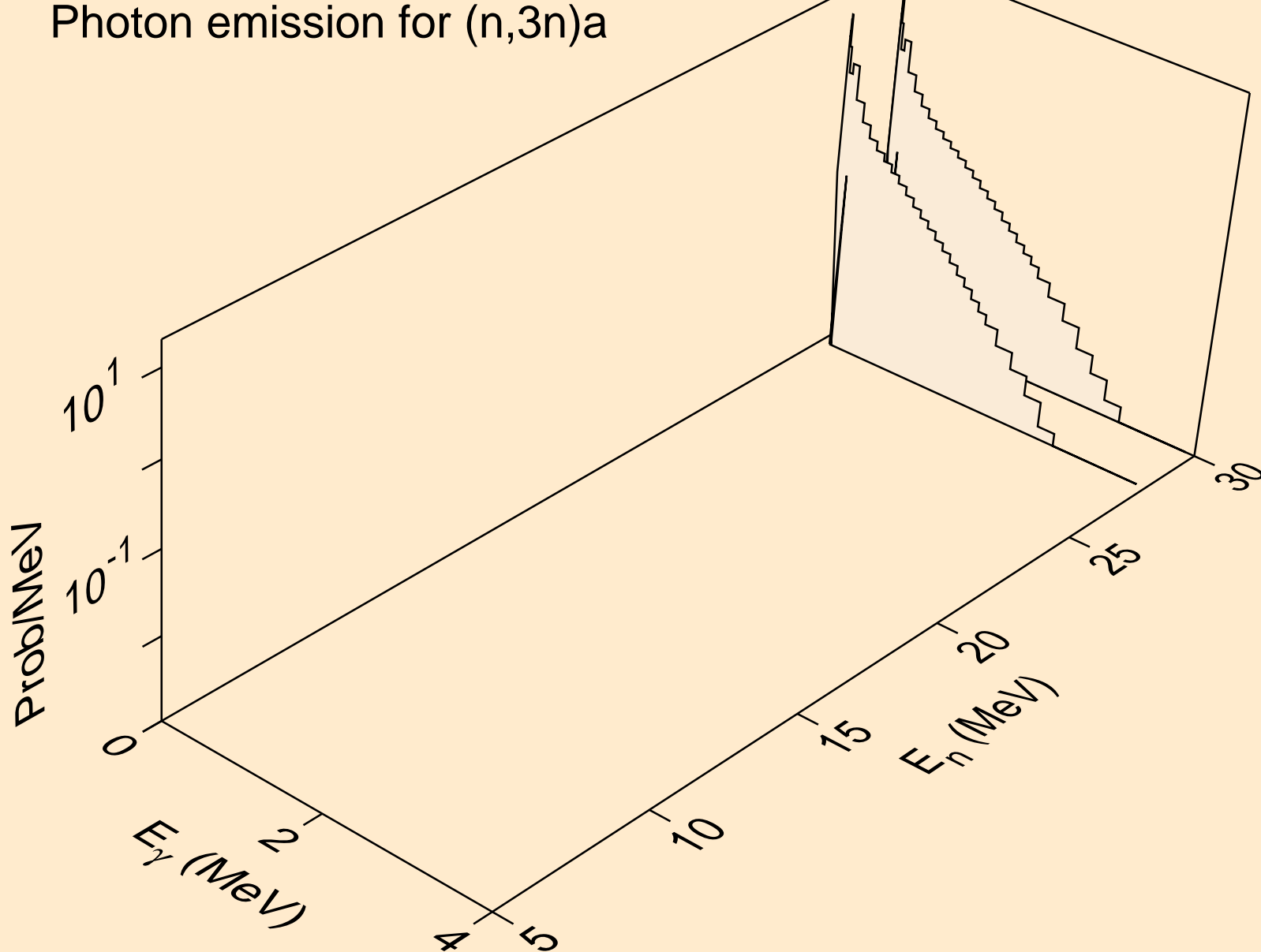

FR226 NEUTRON ACER TENDL-2019 LIBRARY; T=293.16K  
Photon emission for (n,n\*)p

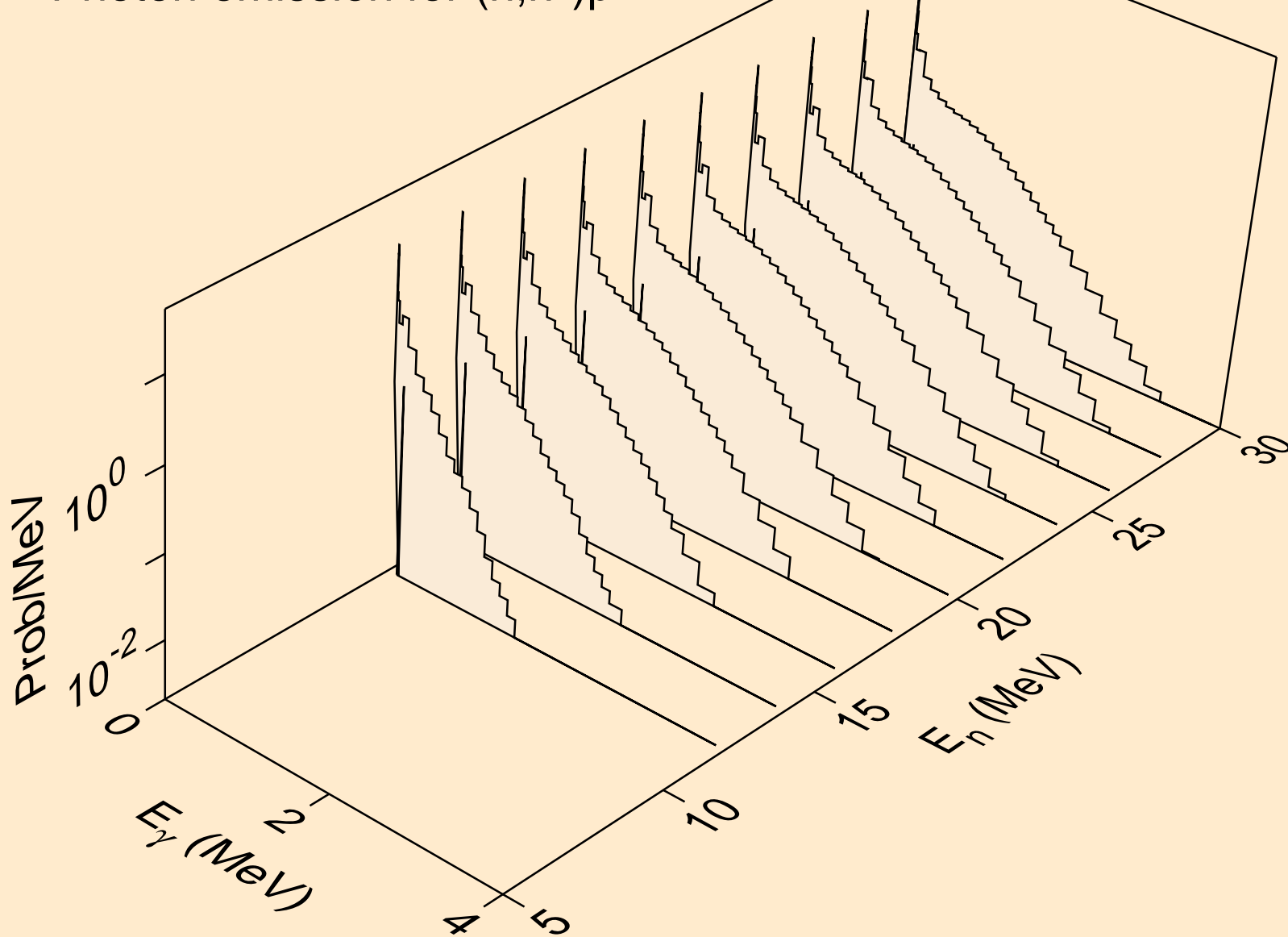

FR226 NEUTRON ACER TENDL-2019 LIBRARY; T=293.16K  
Photon emission for (n,n\*)2a

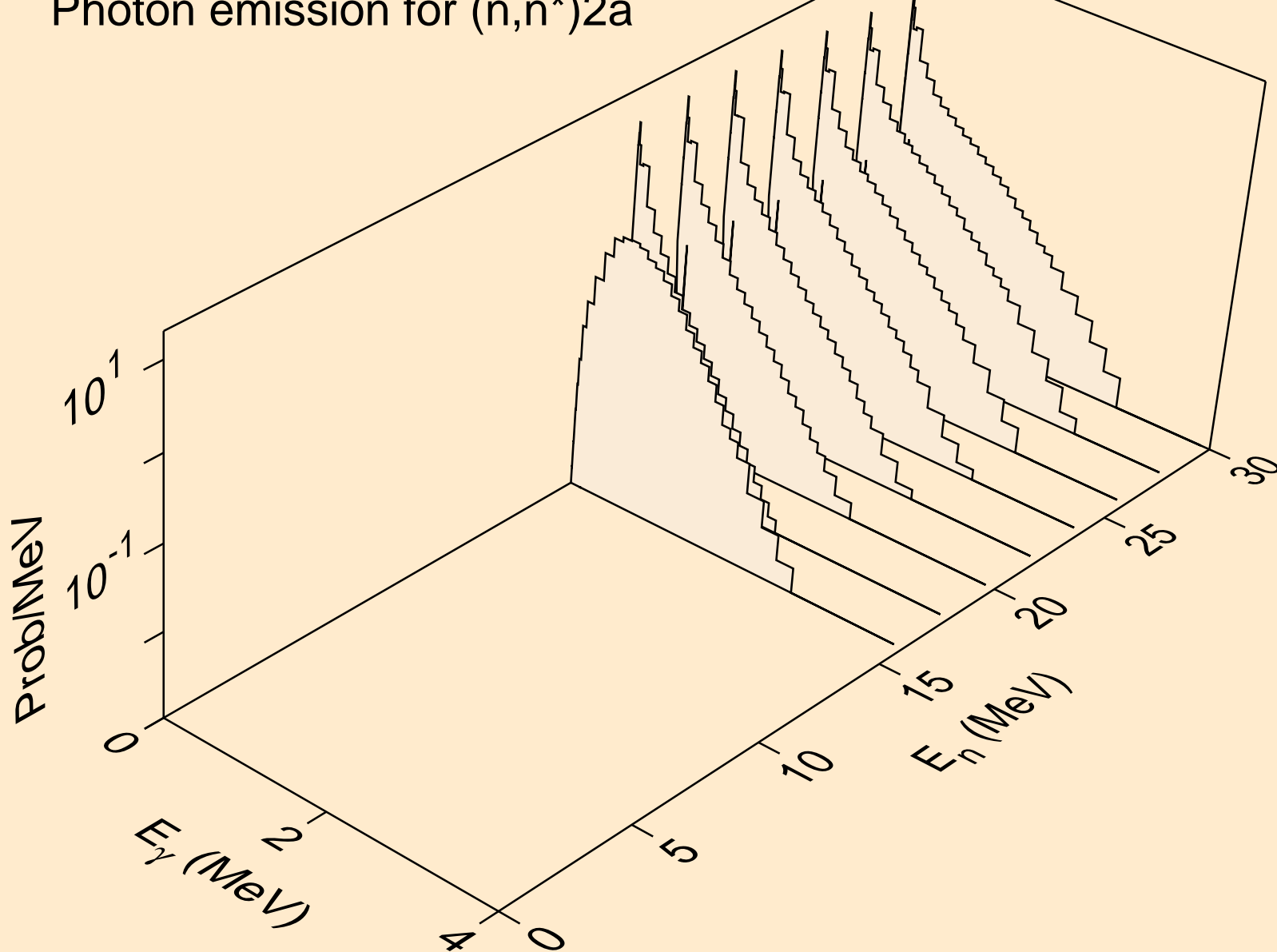



FR226 NEUTRON ACER TENDL-2019 LIBRARY; T=293.16K  
Photon emission for (n,n\*)d

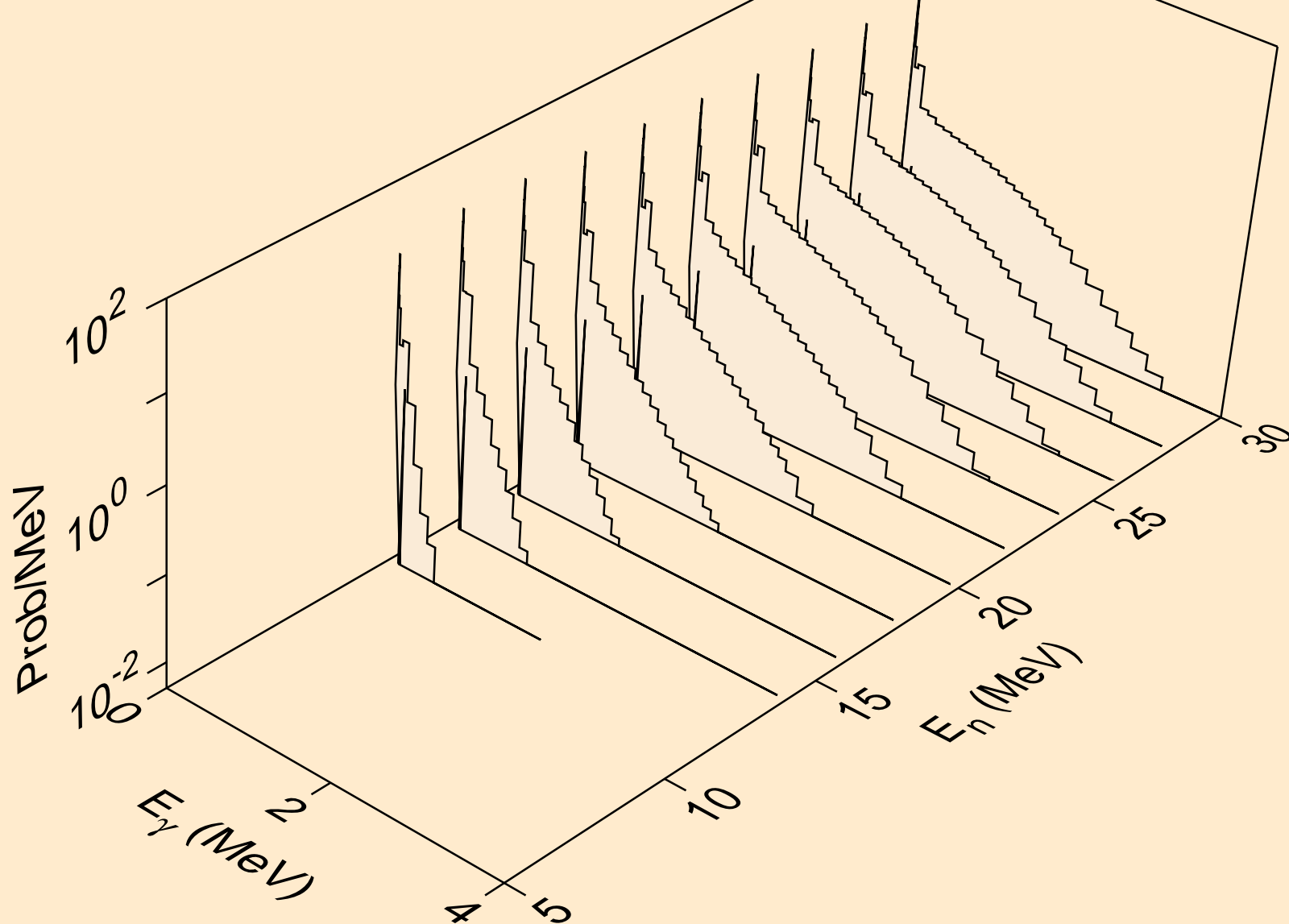

FR226 NEUTRON ACER TENDL-2019 LIBRARY; T=293.16K  
Photon emission for (n,n\*)t

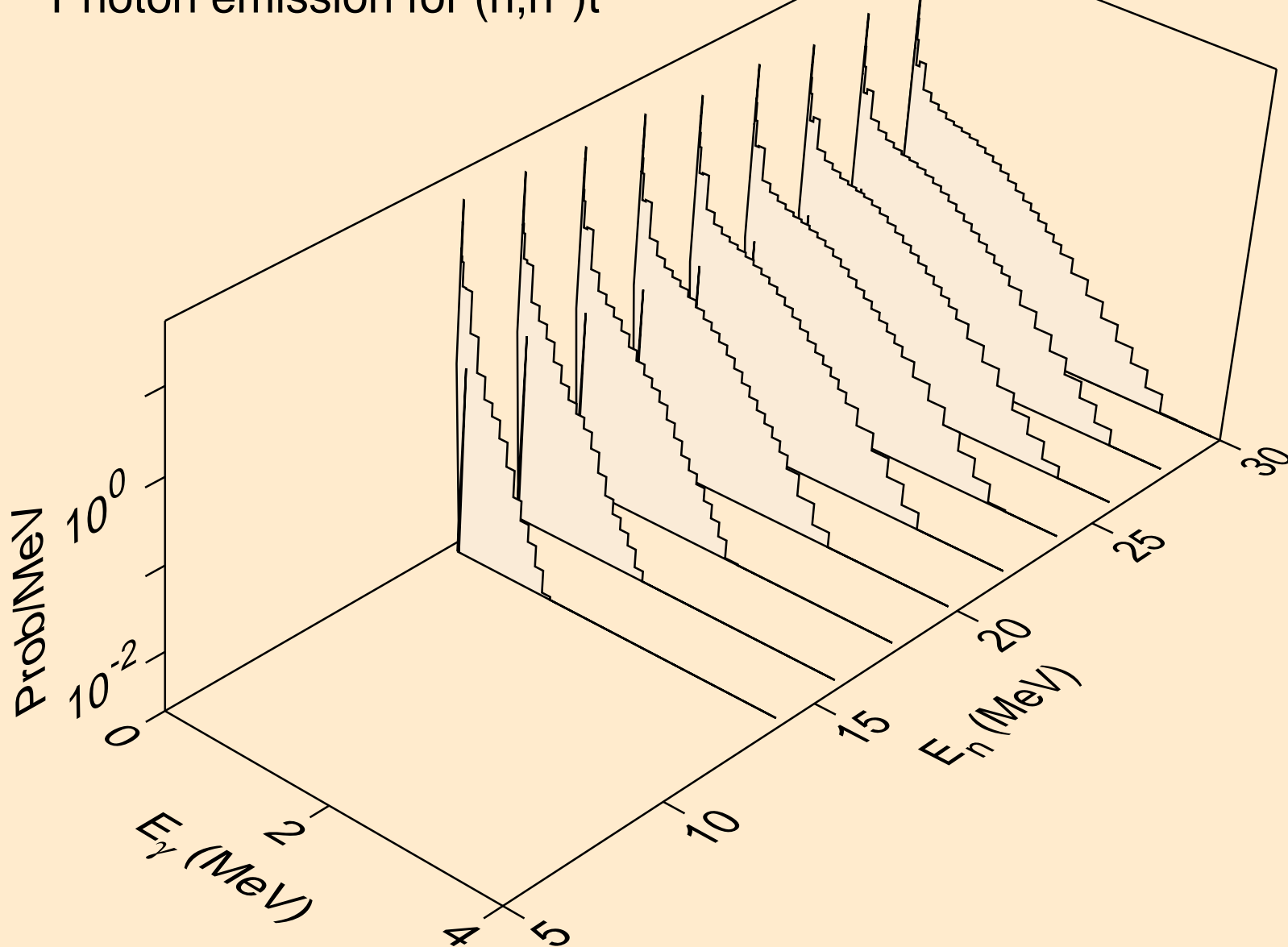

FR226 NEUTRON ACER TENDL-2019 LIBRARY; T=293.16K  
Photon emission for (n,n\*)he3

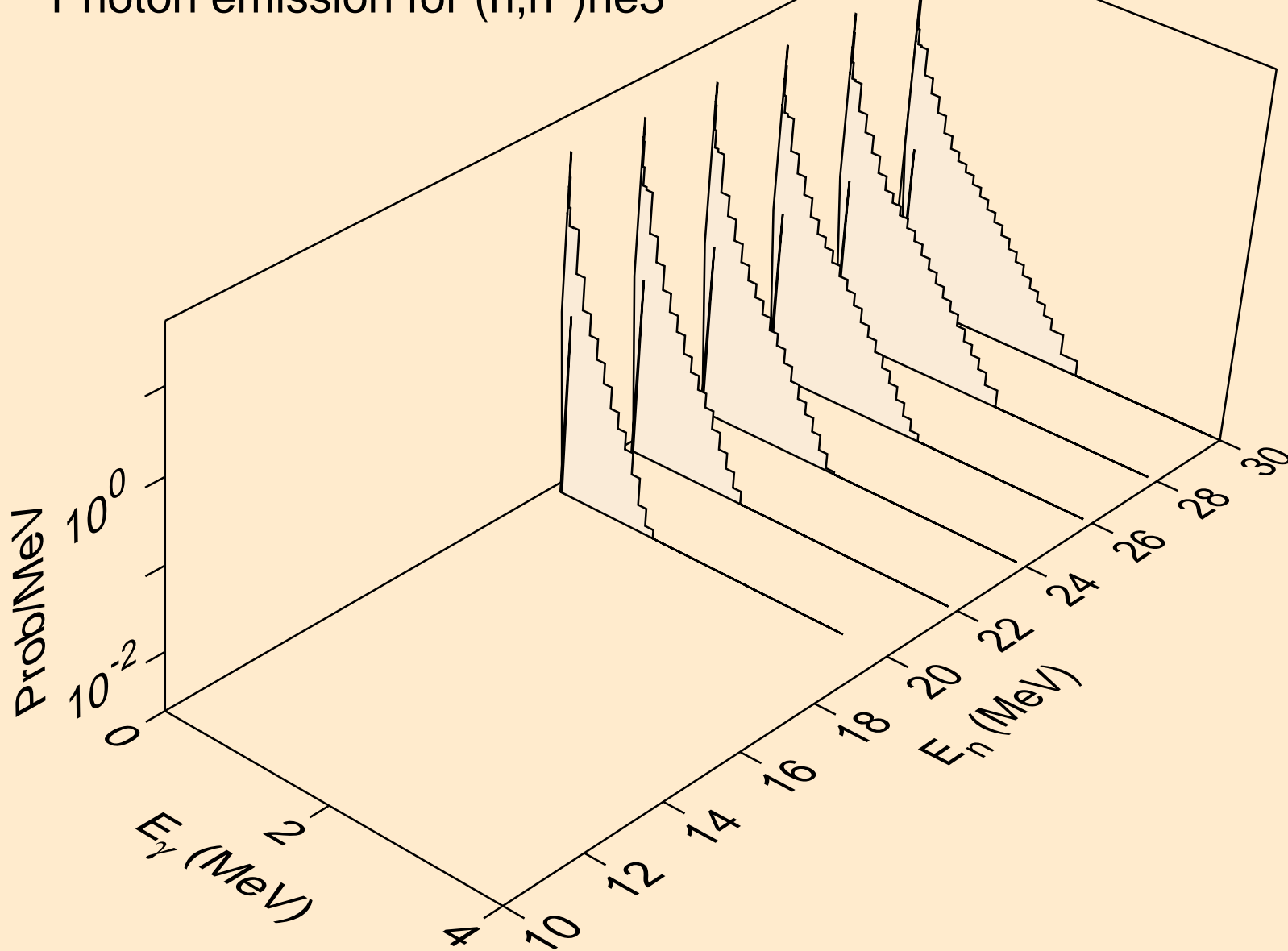

FR226 NEUTRON ACER TENDL-2019 LIBRARY; T=293.16K  
Photon emission for (n,4n)

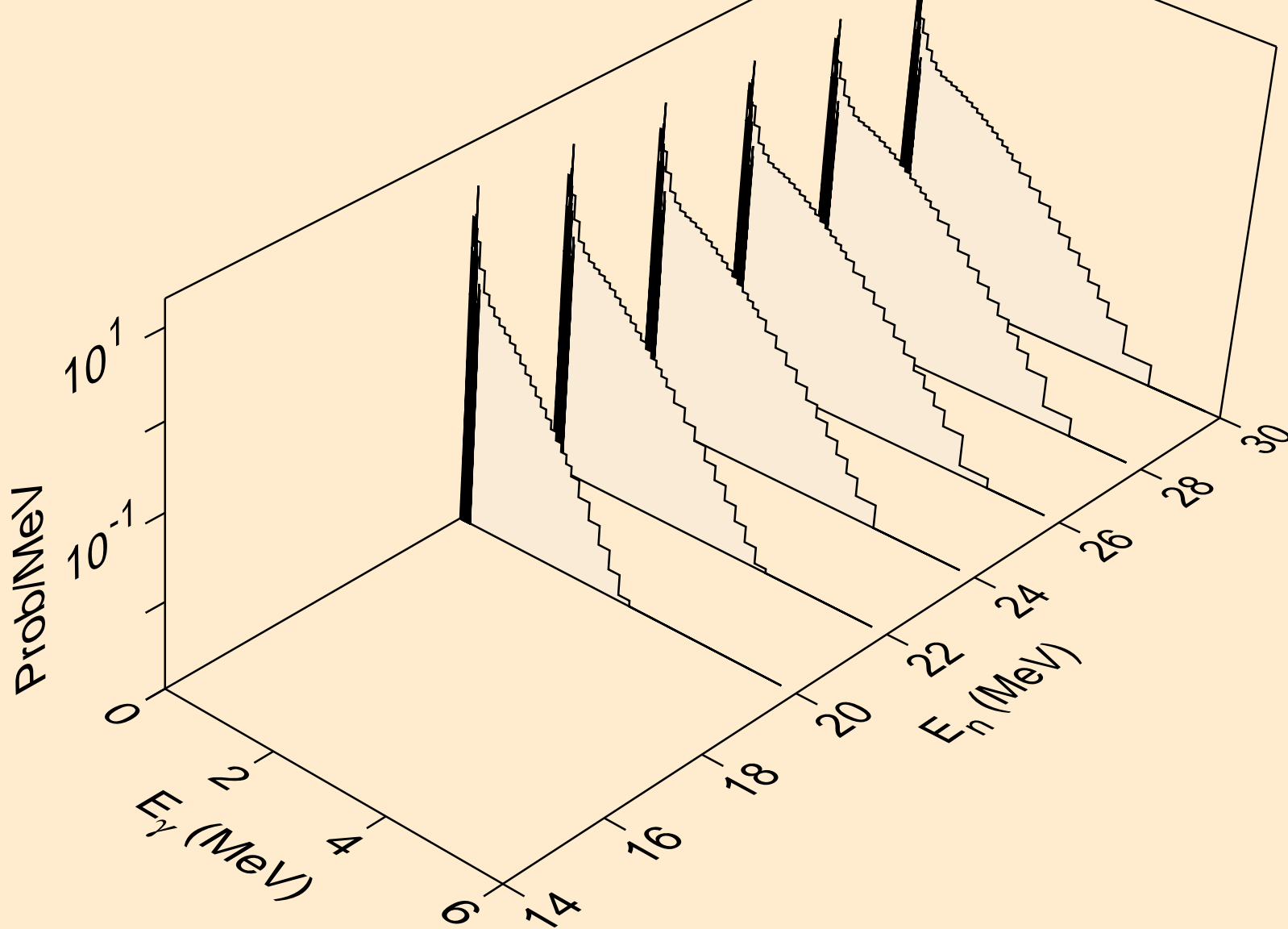

FR226 NEUTRON ACER TENDL-2019 LIBRARY; T=293.16K  
Photon emission for (n,2np)

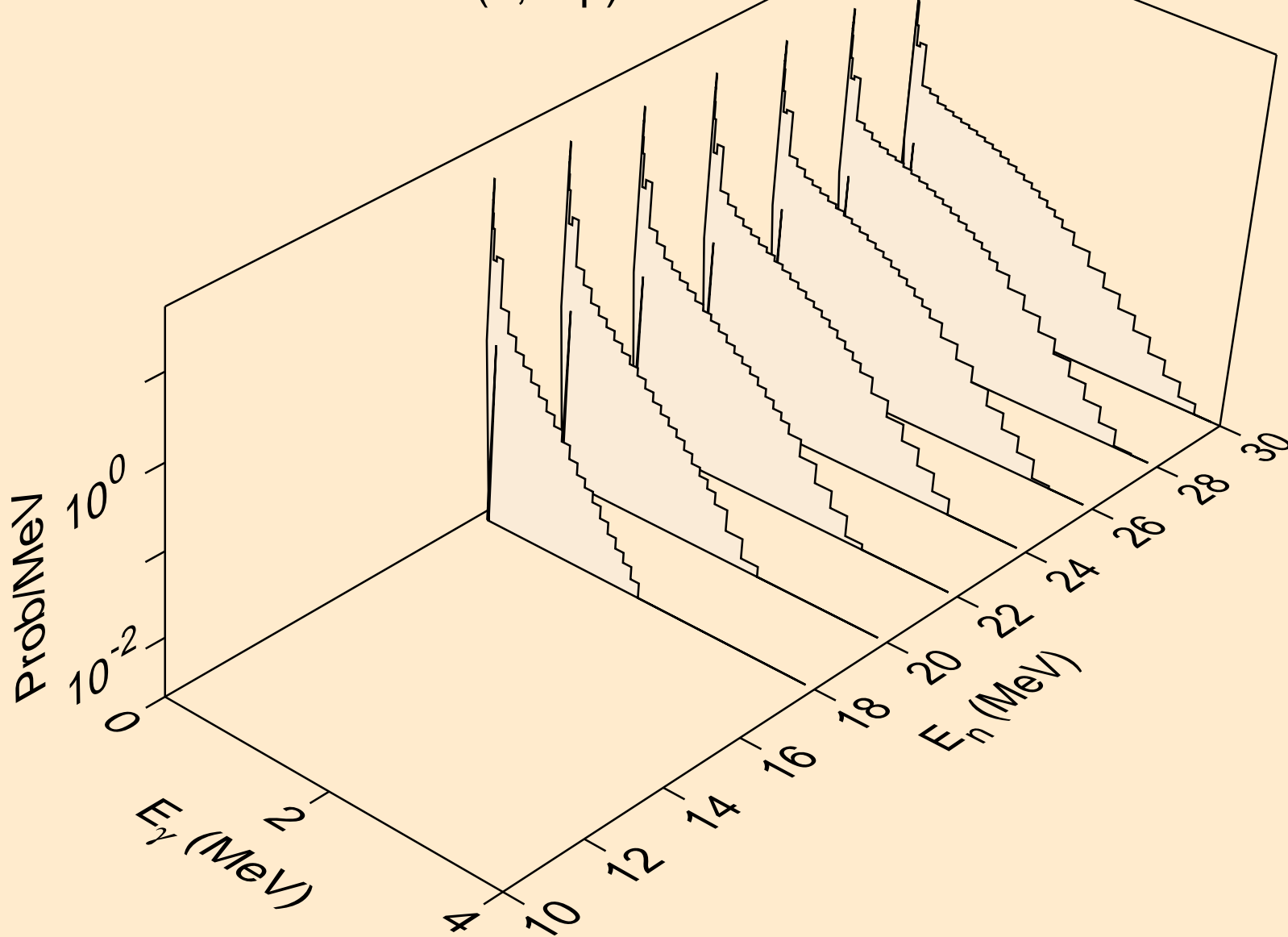

FR226 NEUTRON ACER TENDL-2019 LIBRARY; T=293.16K  
Photon emission for (n,3np)

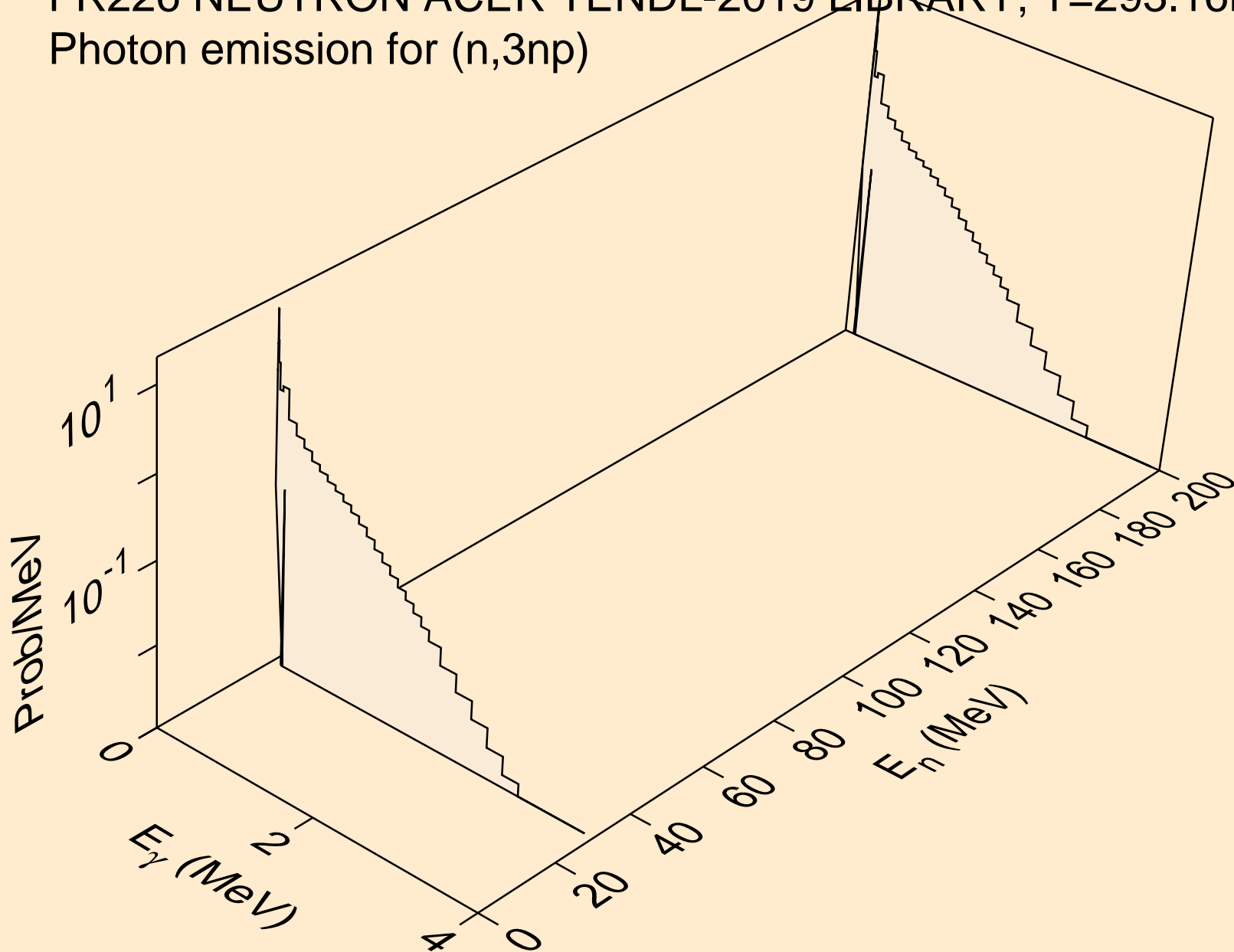

FR226 NEUTRON ACER TENDL-2019 LIBRARY; T=293.16K  
Photon emission for (n,2np)

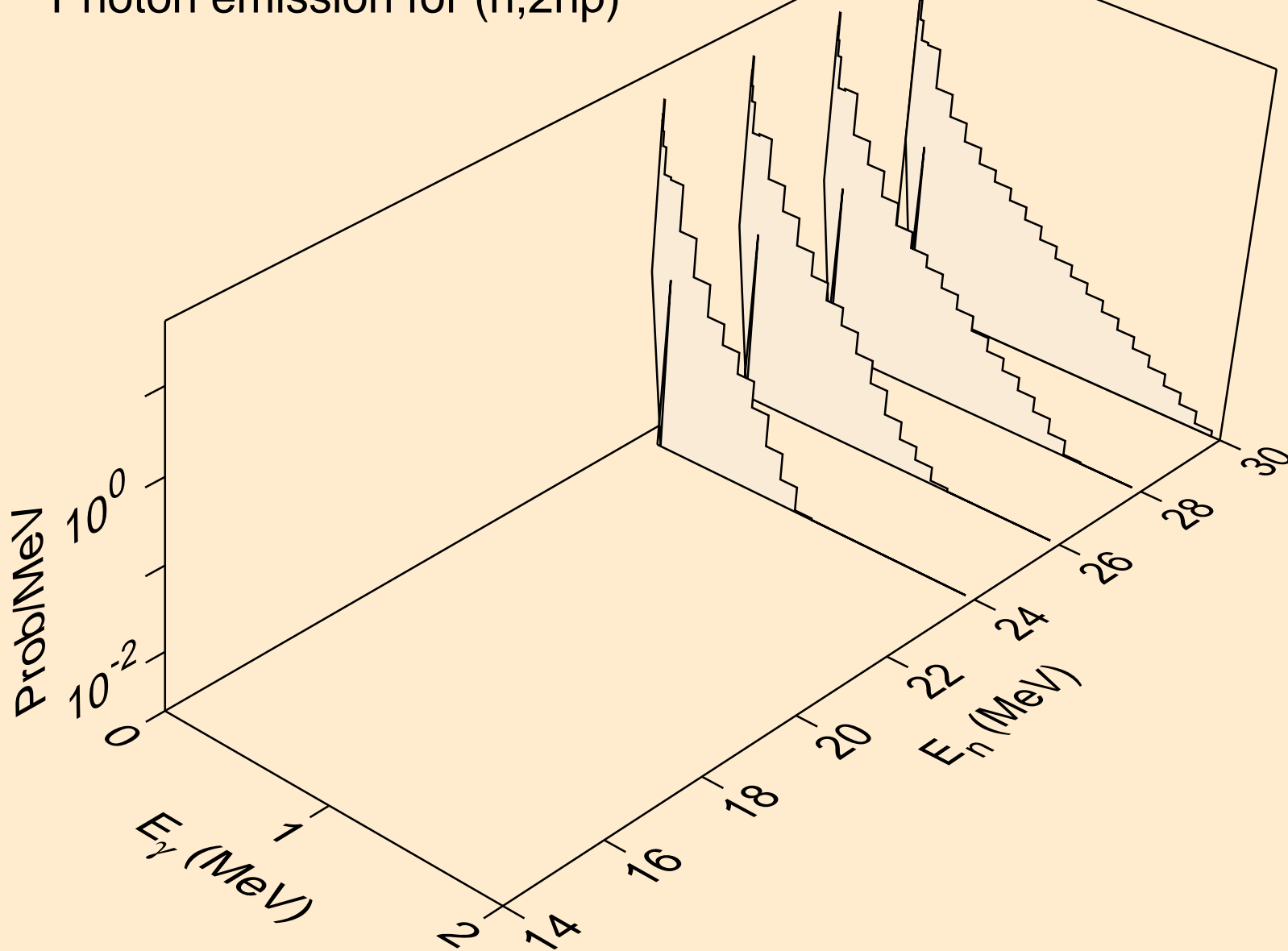

FR226 NEUTRON ACER TENDL-2019 LIBRARY; T=293.16K  
Photon emission for (n,n\*c)

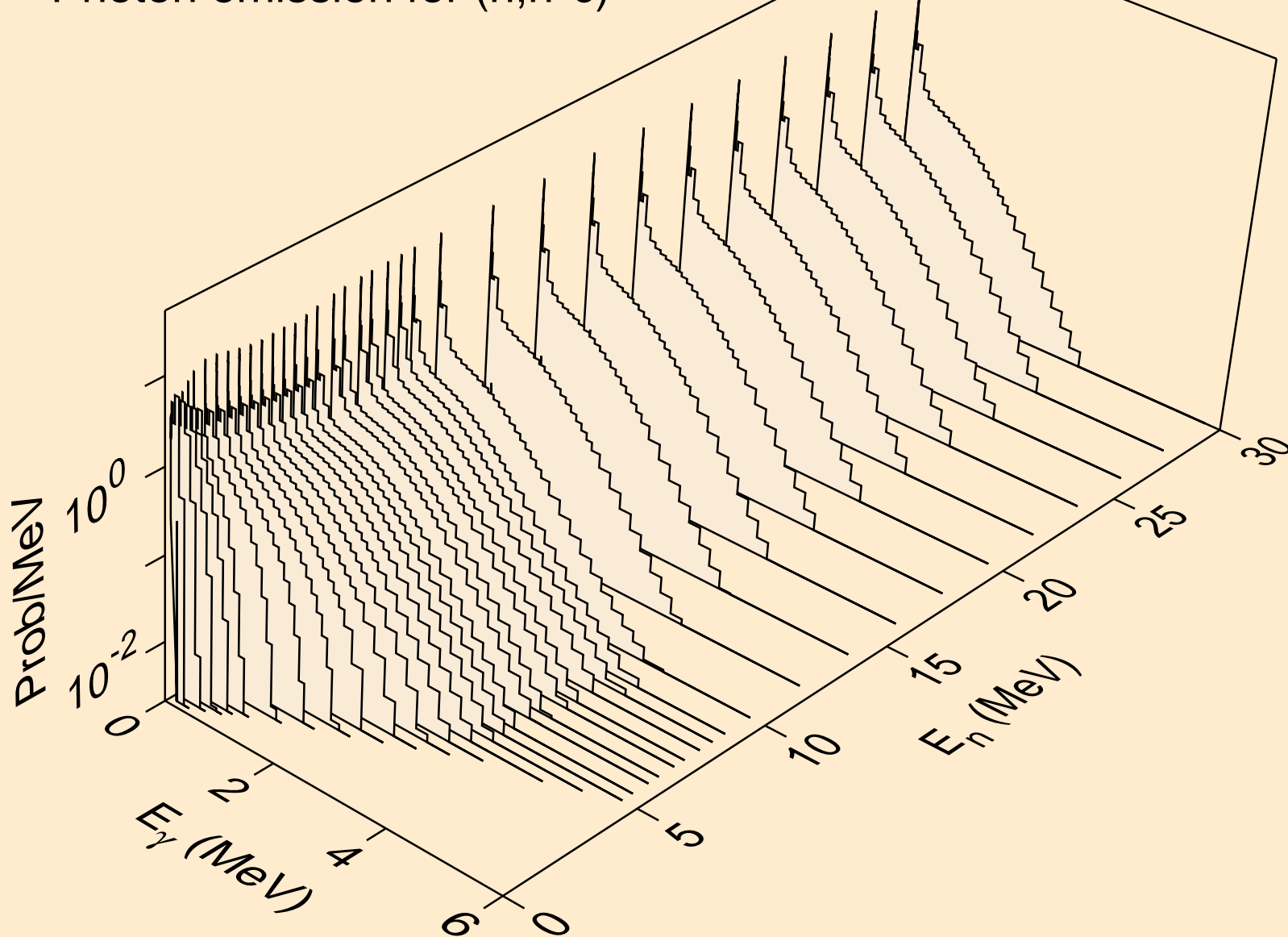



FR226 NEUTRON ACER TENDL-2019 LIBRARY; T=293.16K  
Photon emission for (n,gma)

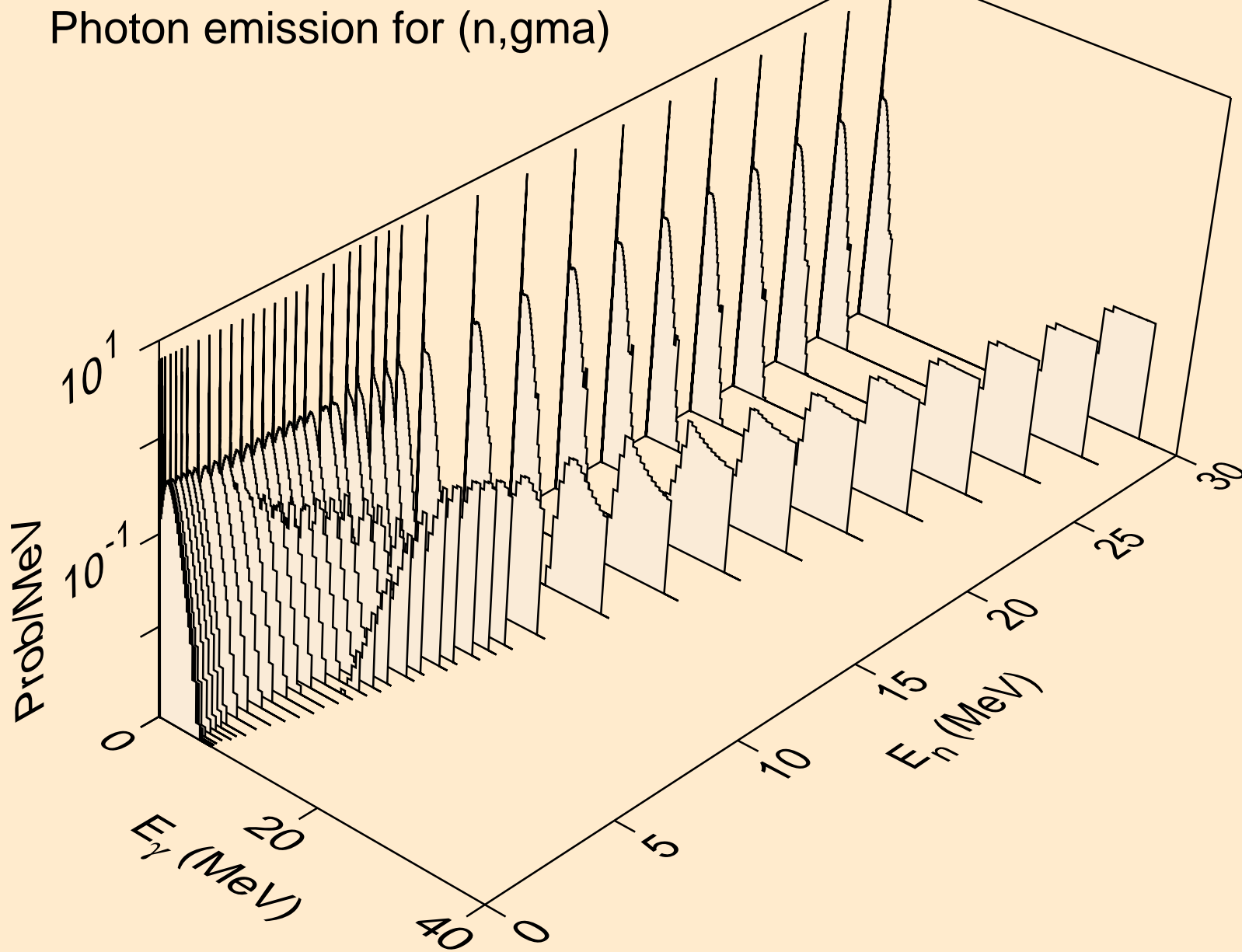

FR226 NEUTRON ACER TENDL-2019 LIBRARY; T=293.16K  
Photon emission for (n,p)

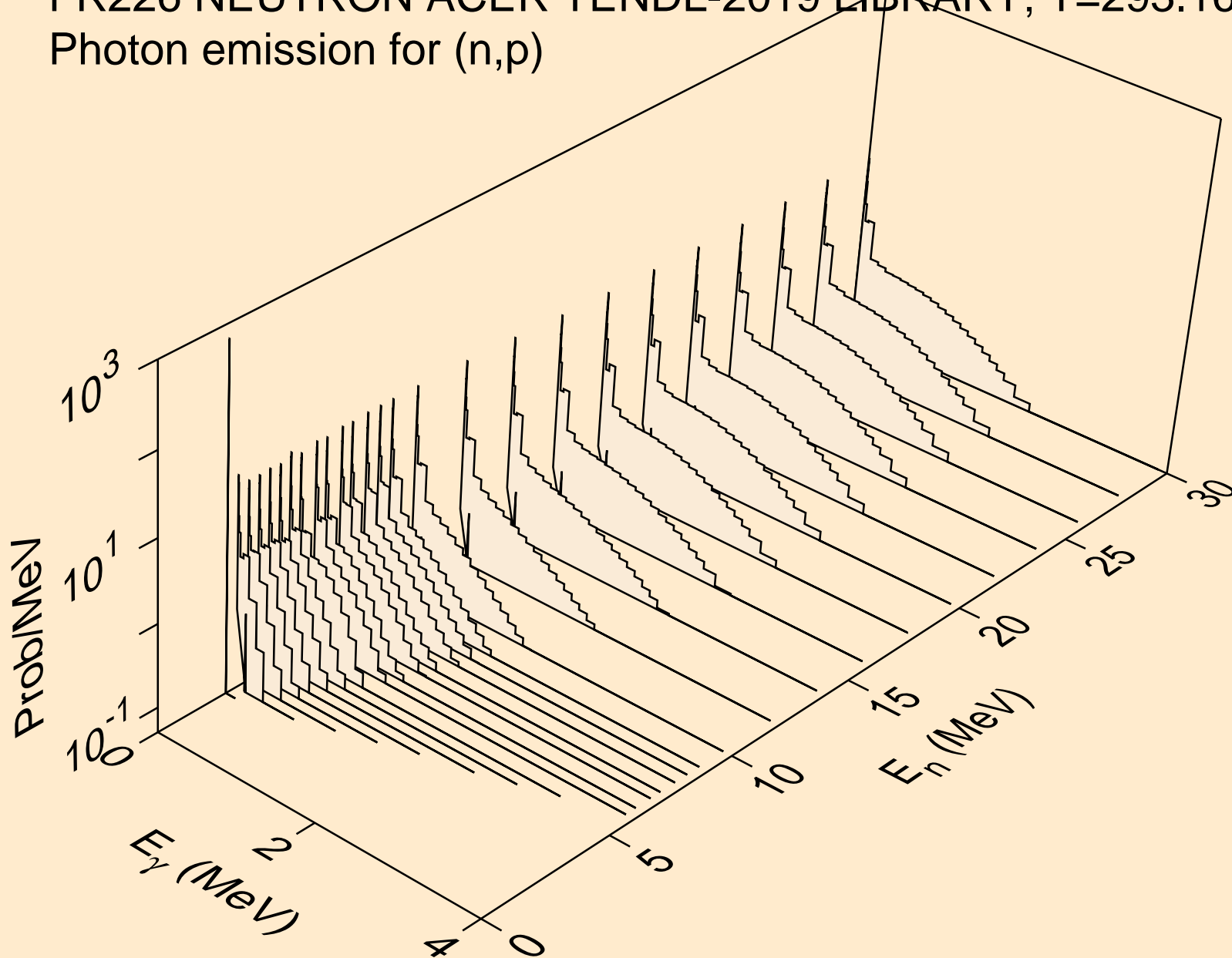

FR226 NEUTRON ACER TENDL-2019 LIBRARY; T=293.16K  
Photon emission for (n,d)

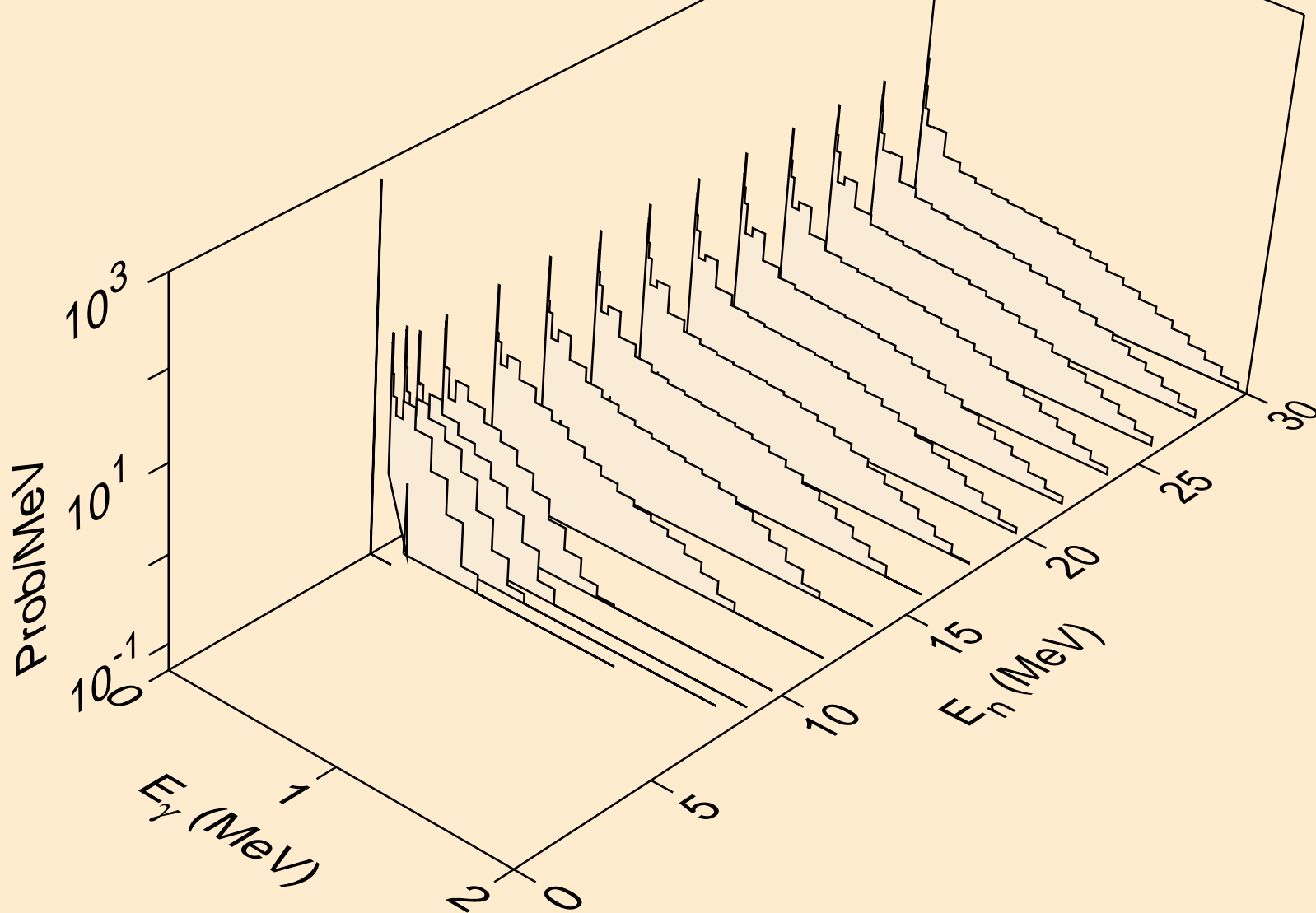

FR226 NEUTRON ACER TENDL-2019 LIBRARY; T=293.16K  
Photon emission for (n,t)

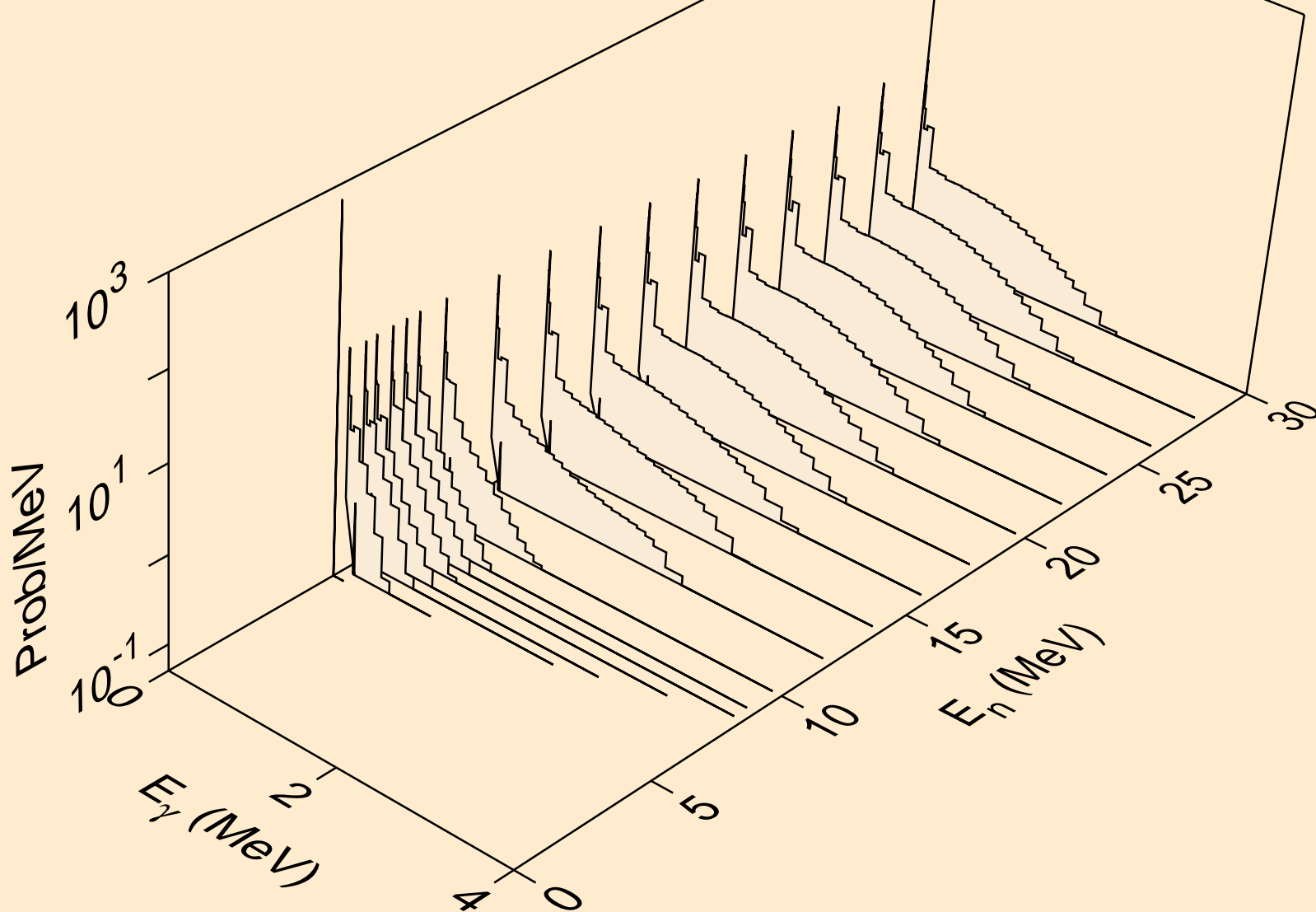

FR226 NEUTRON ACER TENDL-2019 LIBRARY; T=293.16K  
Photon emission for (n,he3)

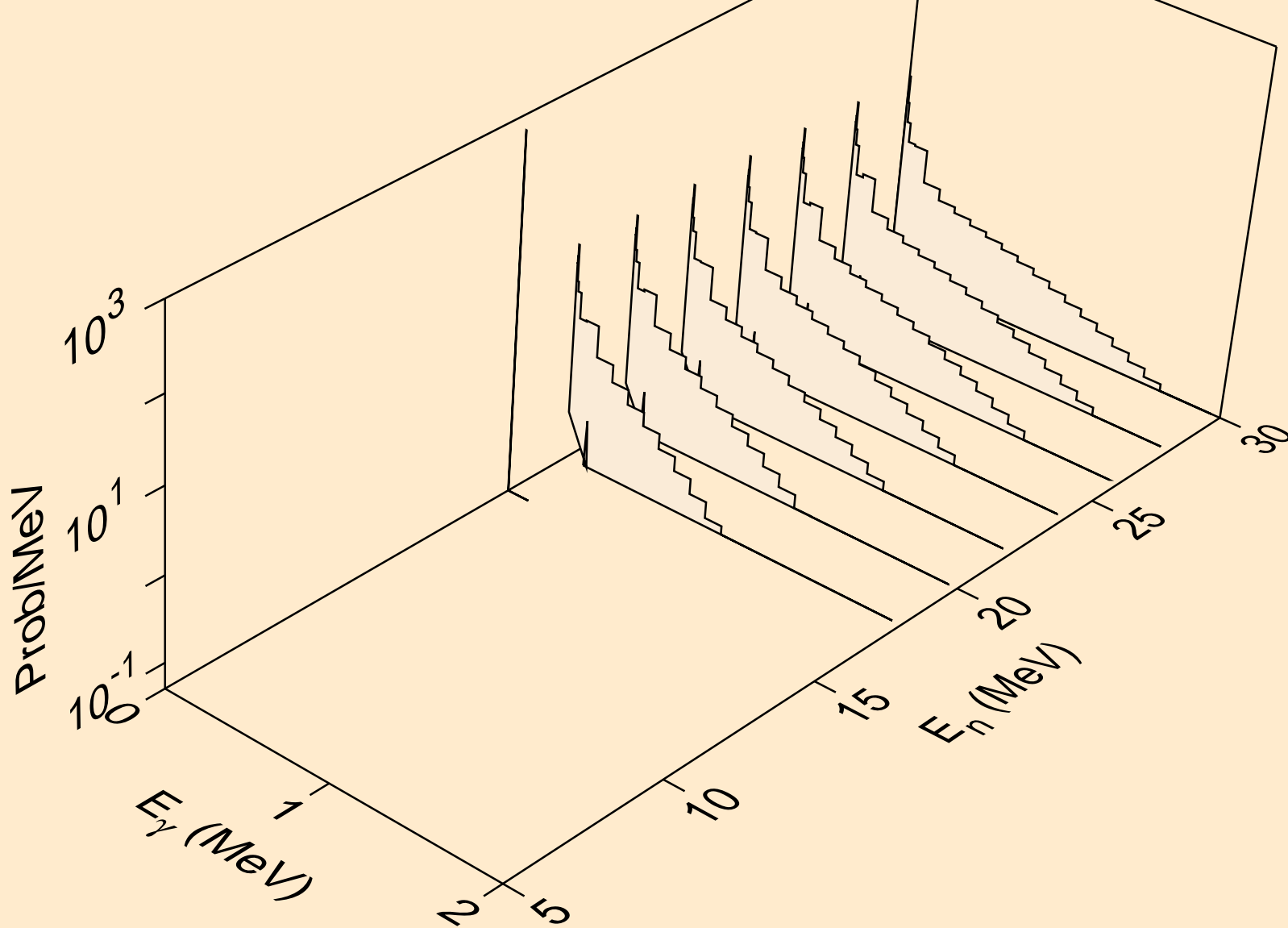

FR226 NEUTRON ACER TENDL-2019 LIBRARY; T=293.16K  
Photon emission for (n,a)

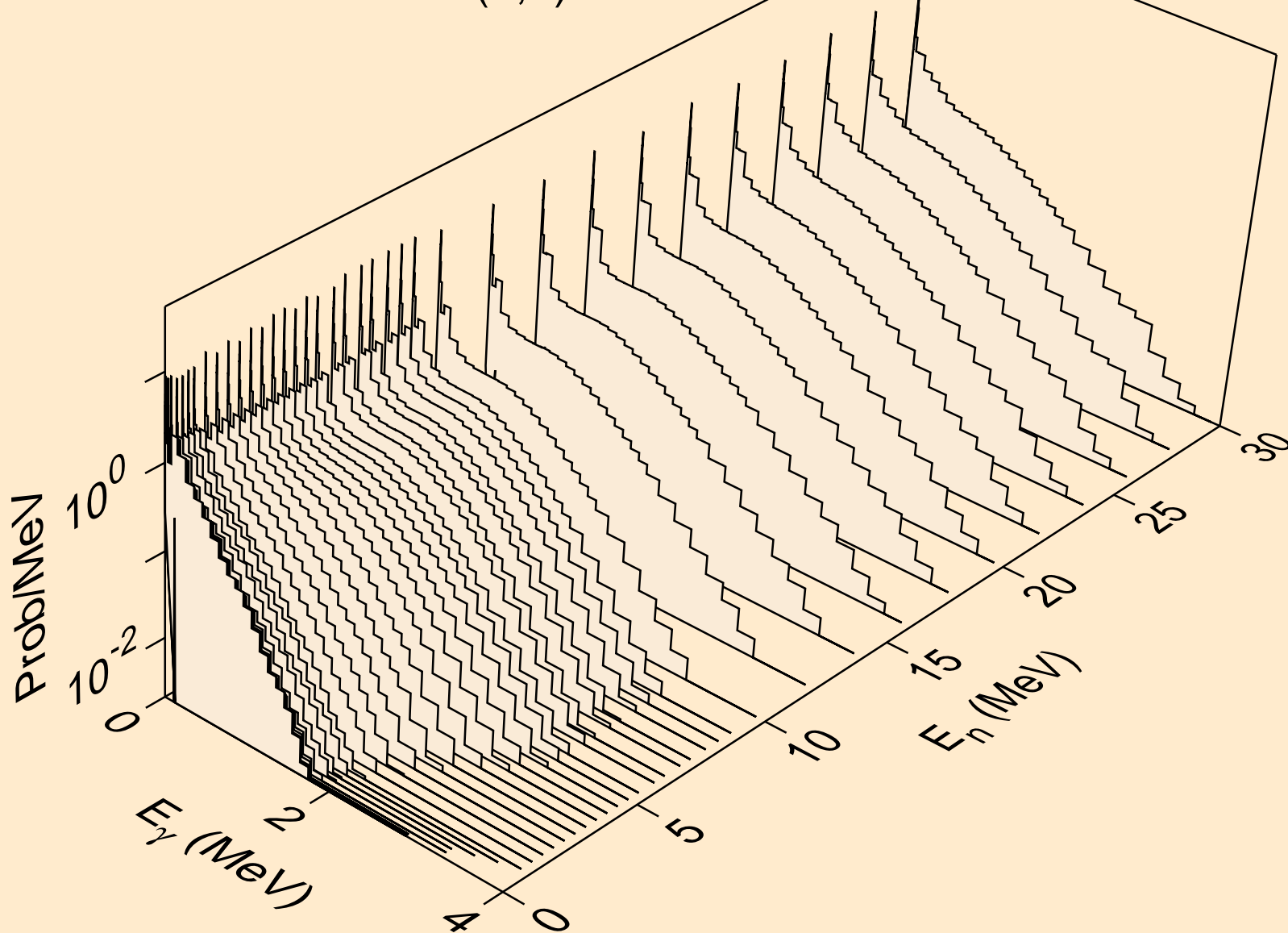

FR226 NEUTRON ACER TENDL-2019 LIBRARY; T=293.16K  
Photon emission for (n,2p)

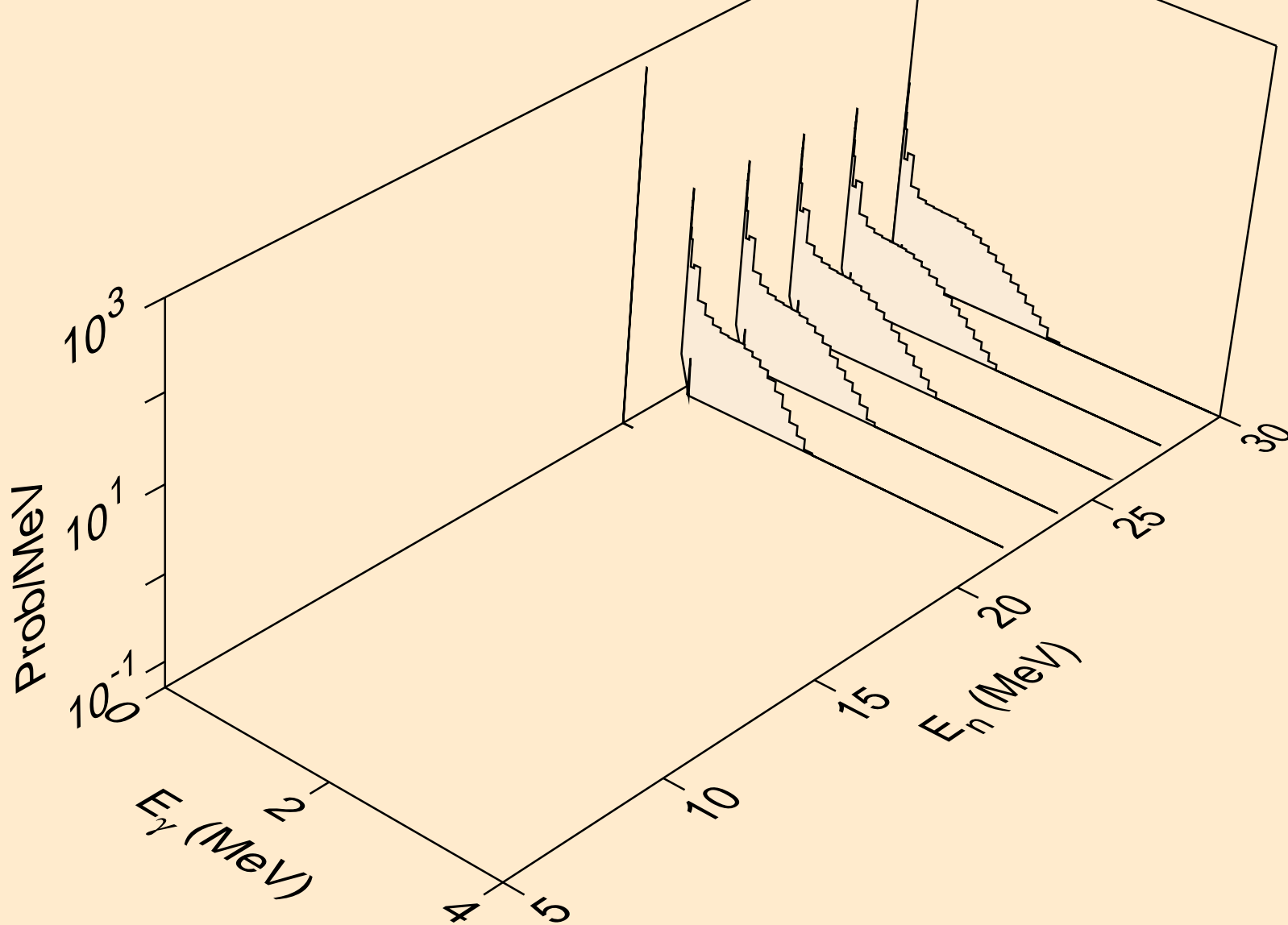

FR226 NEUTRON ACER TENDL-2019 LIBRARY; T=293.16K  
thermal capture photon spectrum

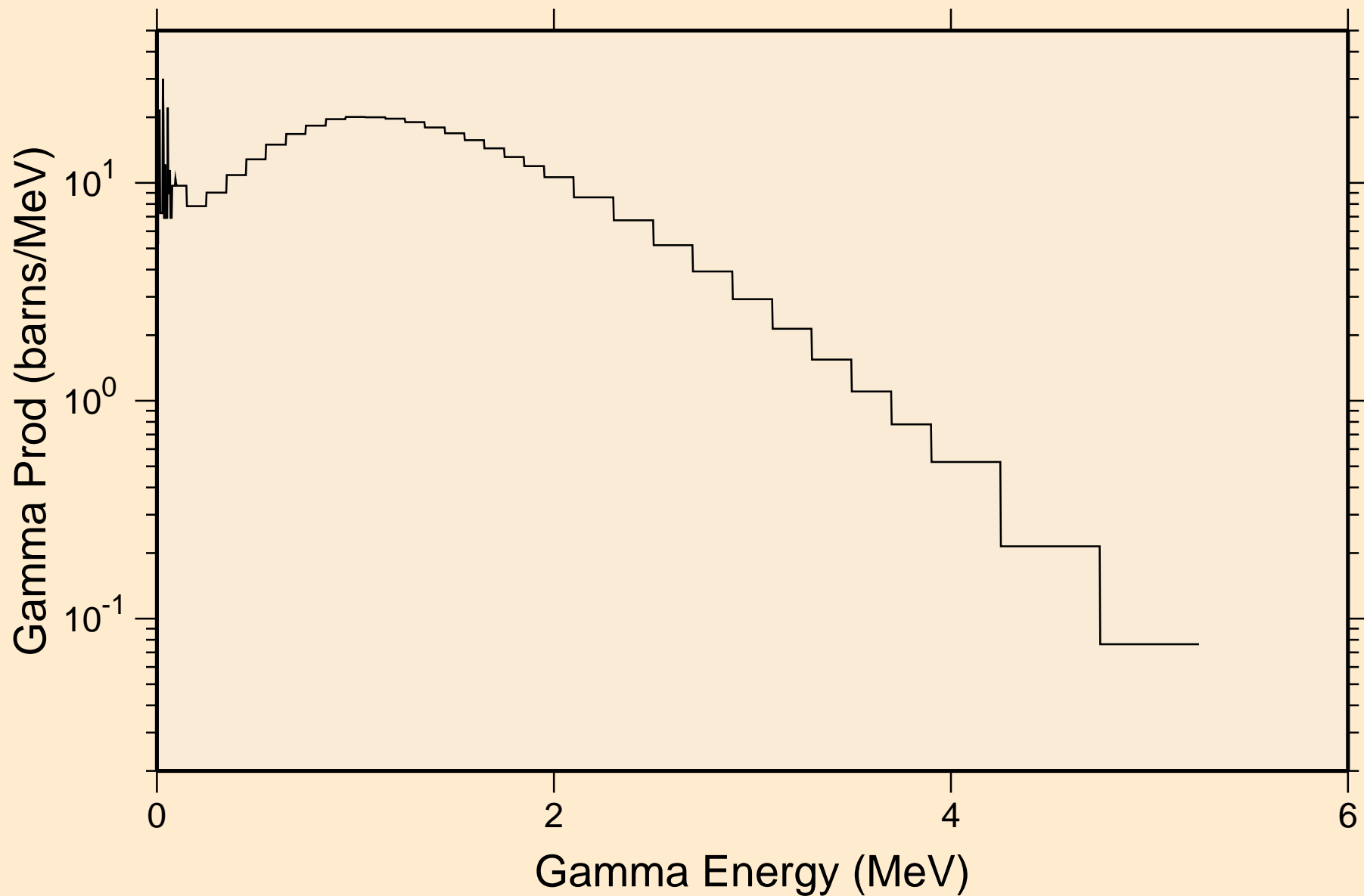



FR226 NEUTRON ACER TENDL-2019 LIBRARY; T=293.16K  
14 MeV photon spectrum

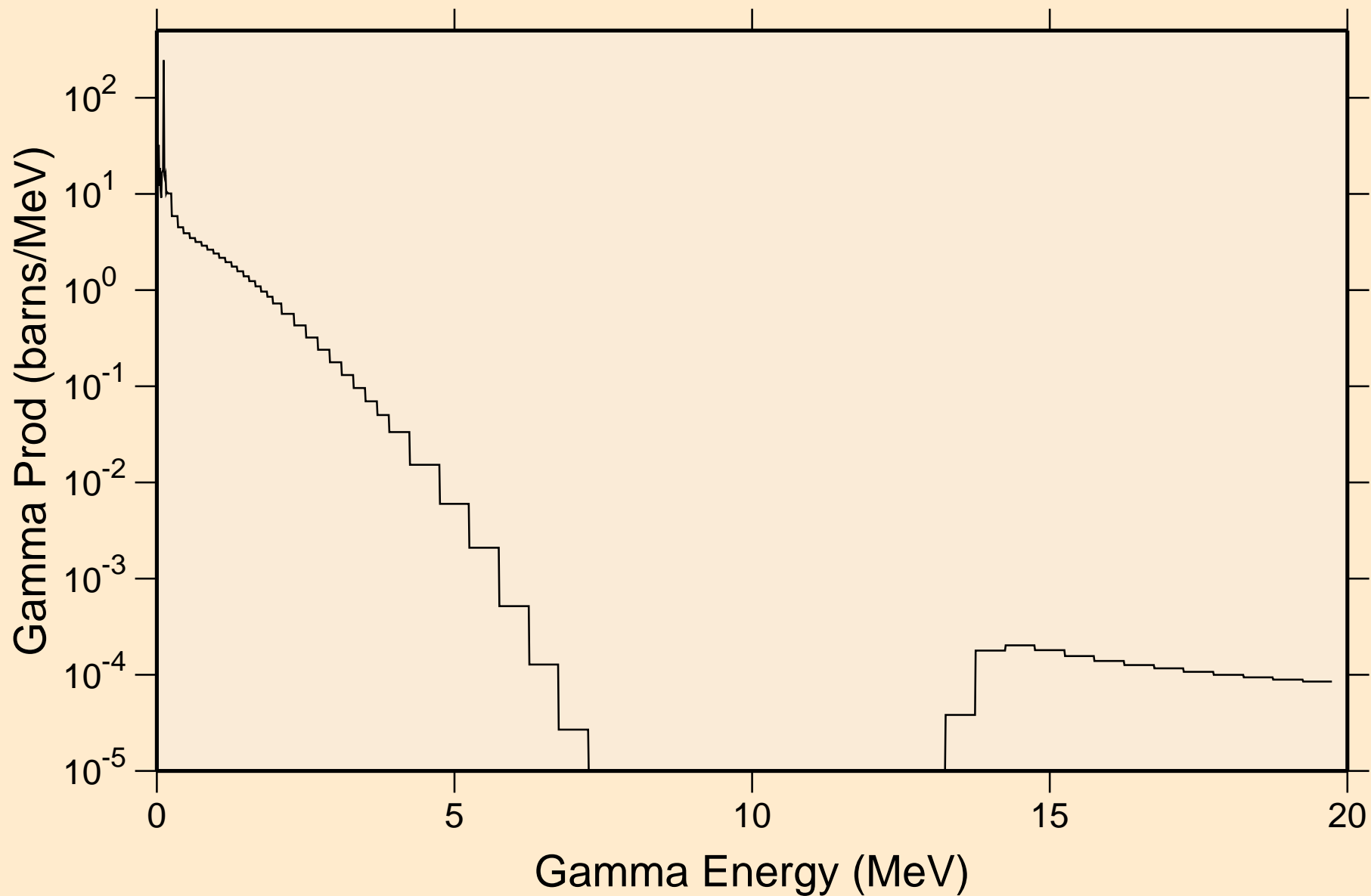

FR226 NEUTRON ACER TENDL-2019 LIBRARY; T=293.16K  
Particle heating contributions

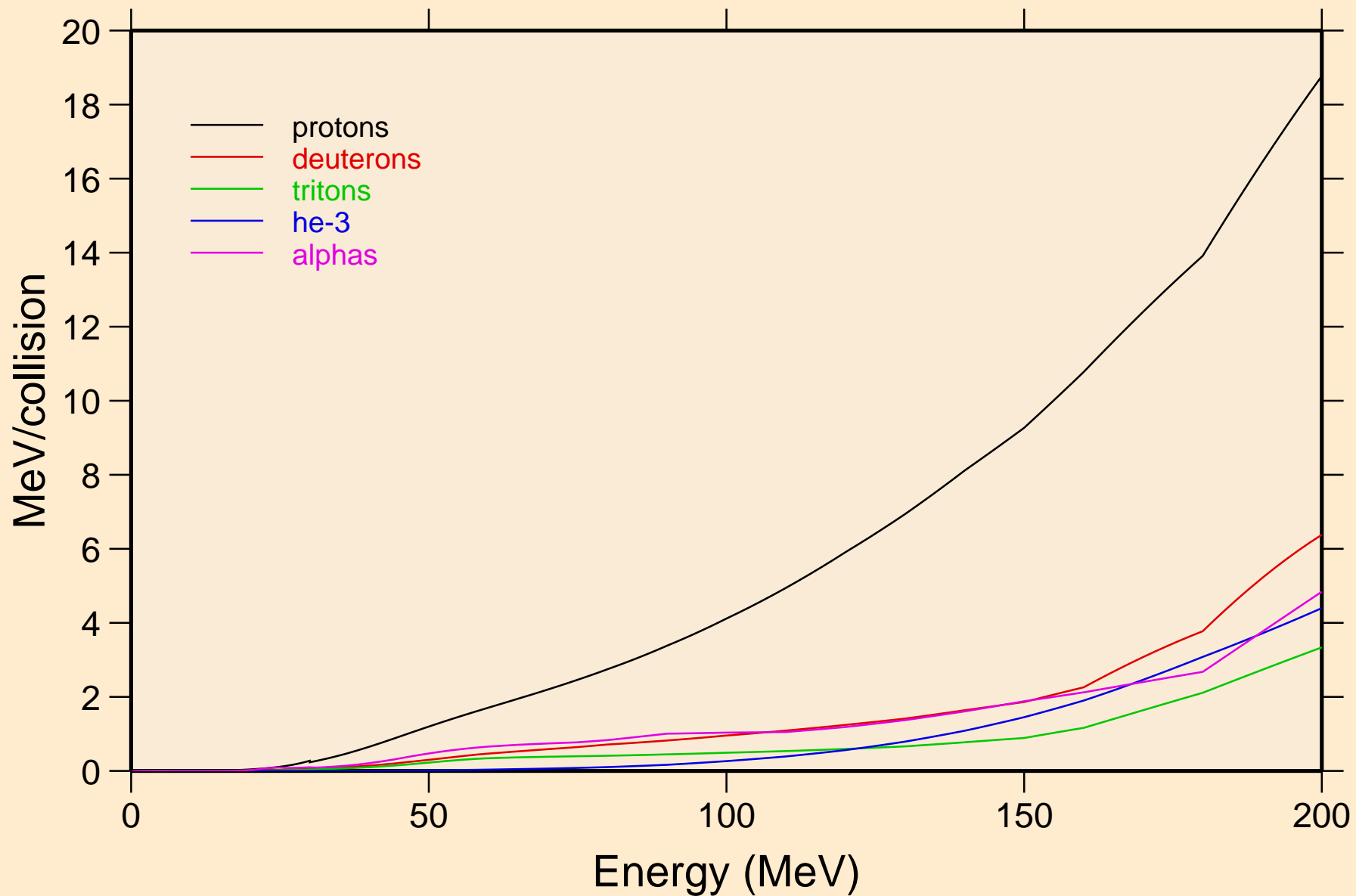

FR226 NEUTRON ACER TENDL-2019 LIBRARY; T=293.16K  
Recoil Heating

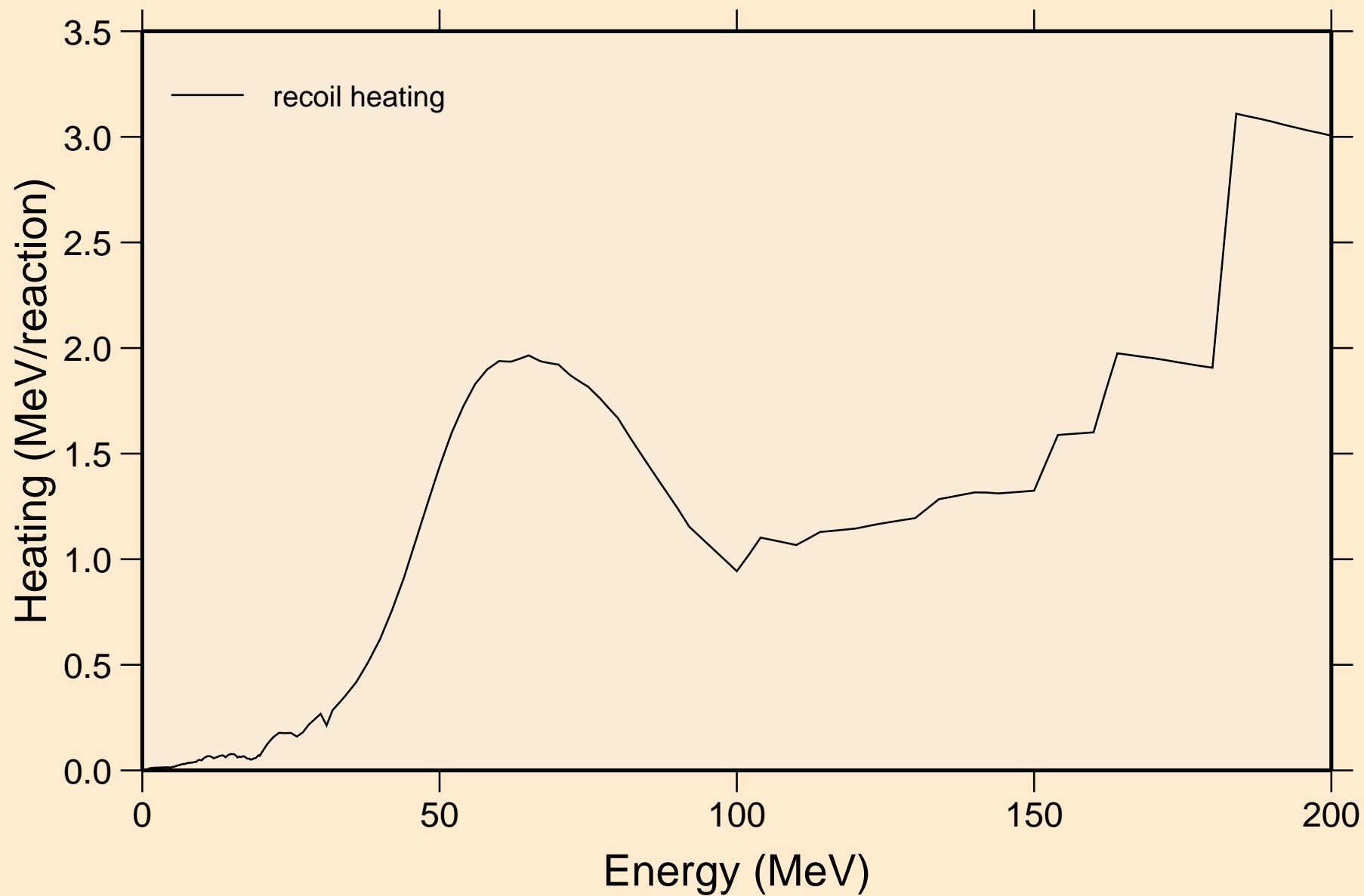

FR226 NEUTRON ACER TENDL-2019 LIBRARY; T=293.16K  
Particle production cross sections

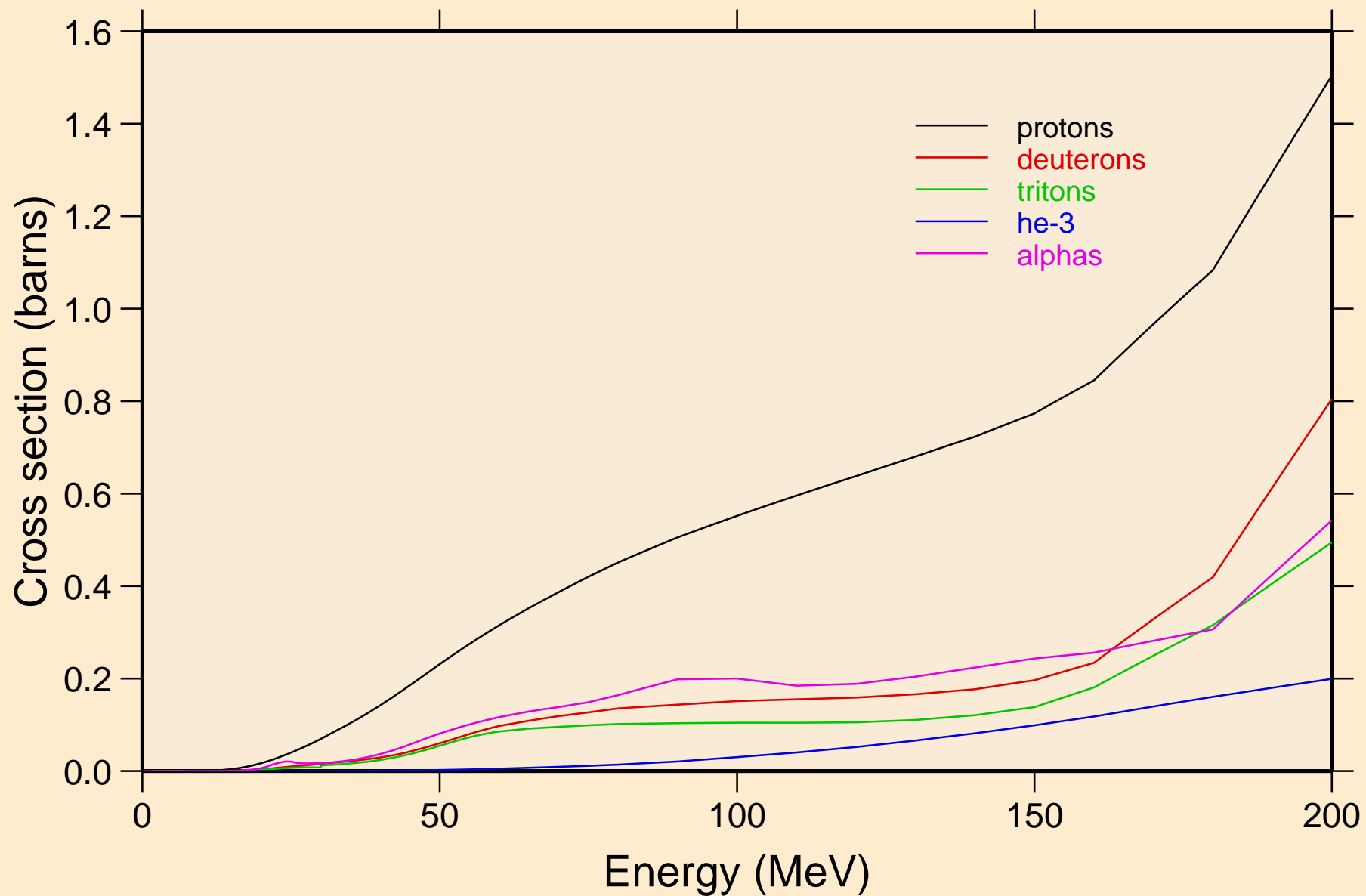

FR226 NEUTRON ACER TENDL-2019 LIBRARY; T=293.16K  
protons from (n,x)

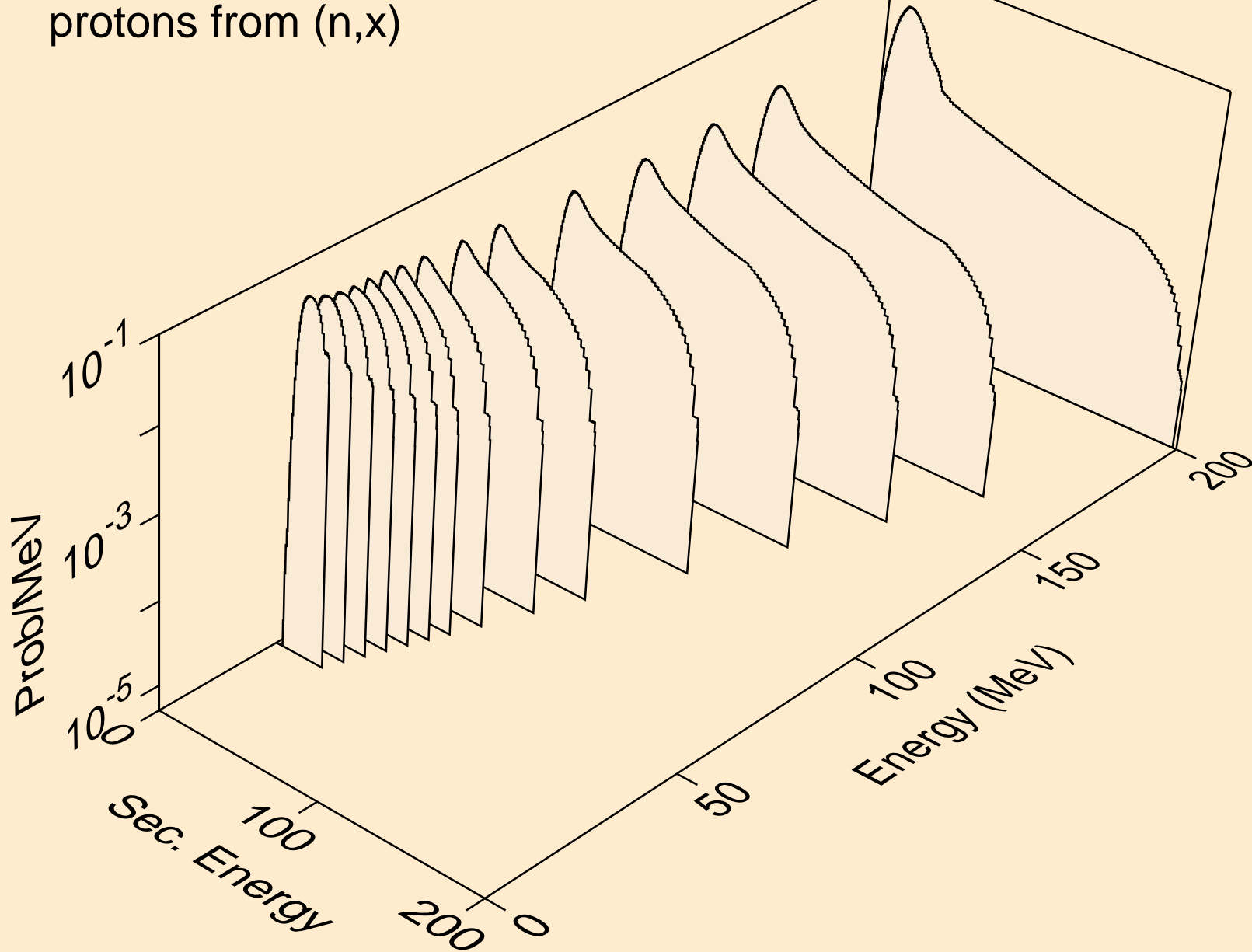

FR226 NEUTRON ACER TENDL-2019 LIBRARY; T=293.16K  
protons from (n,n\*)p

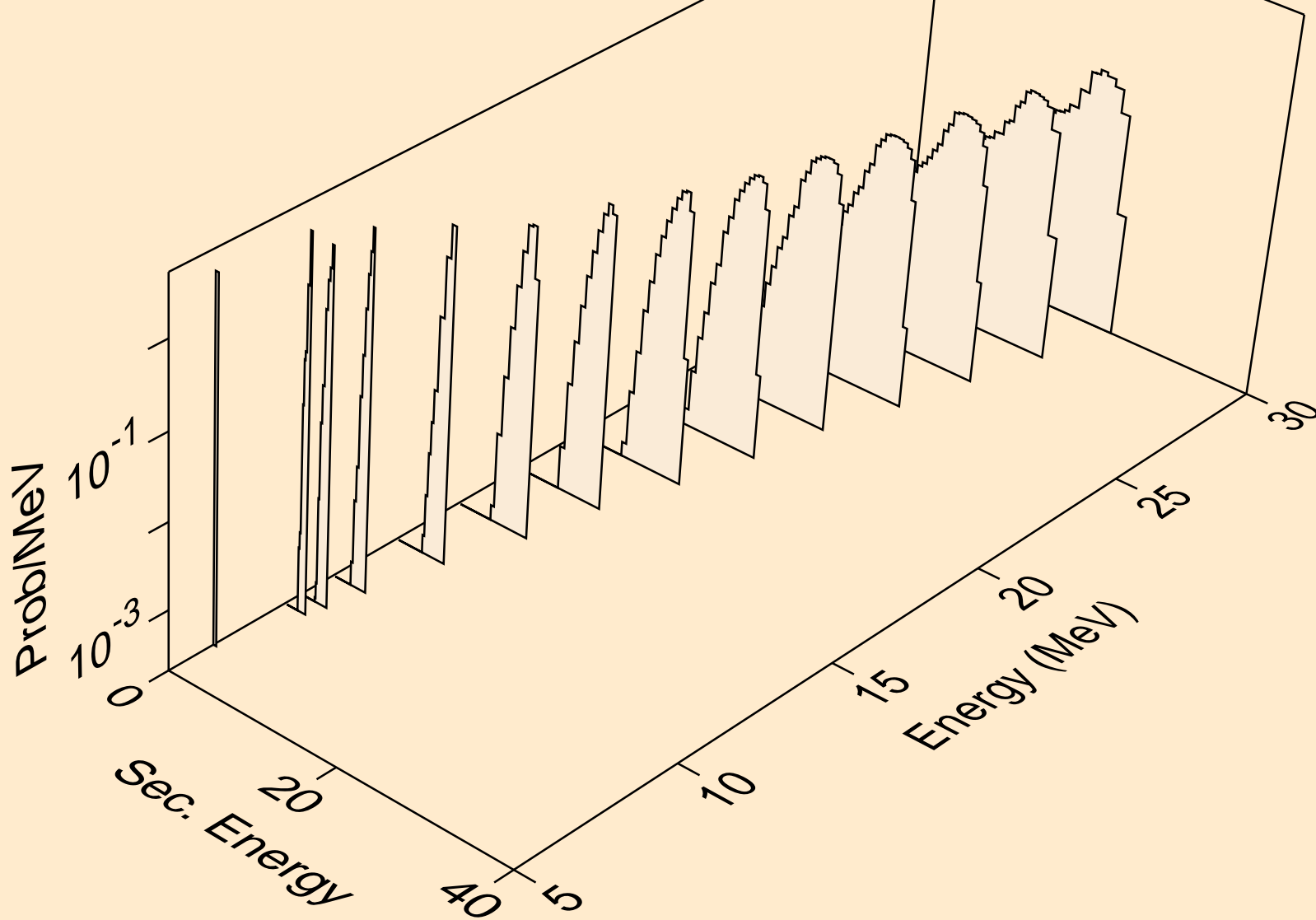

FR226 NEUTRON ACER TENDL-2019 LIBRARY; T=293.16K  
protons from (n,2np)

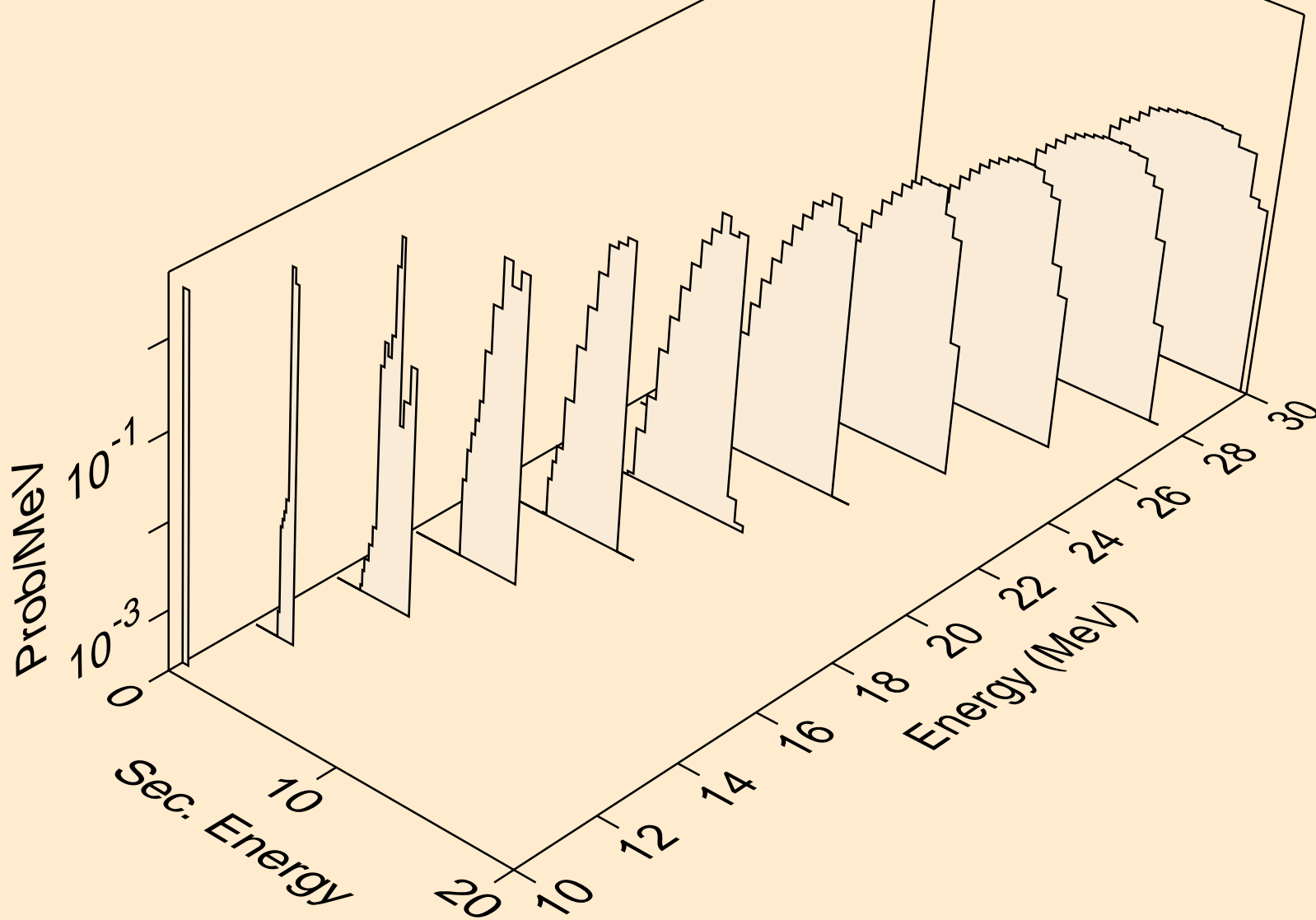

FR226 NEUTRON ACER TENDL-2019 LIBRARY; T=293.16K  
protons from (n,3np)

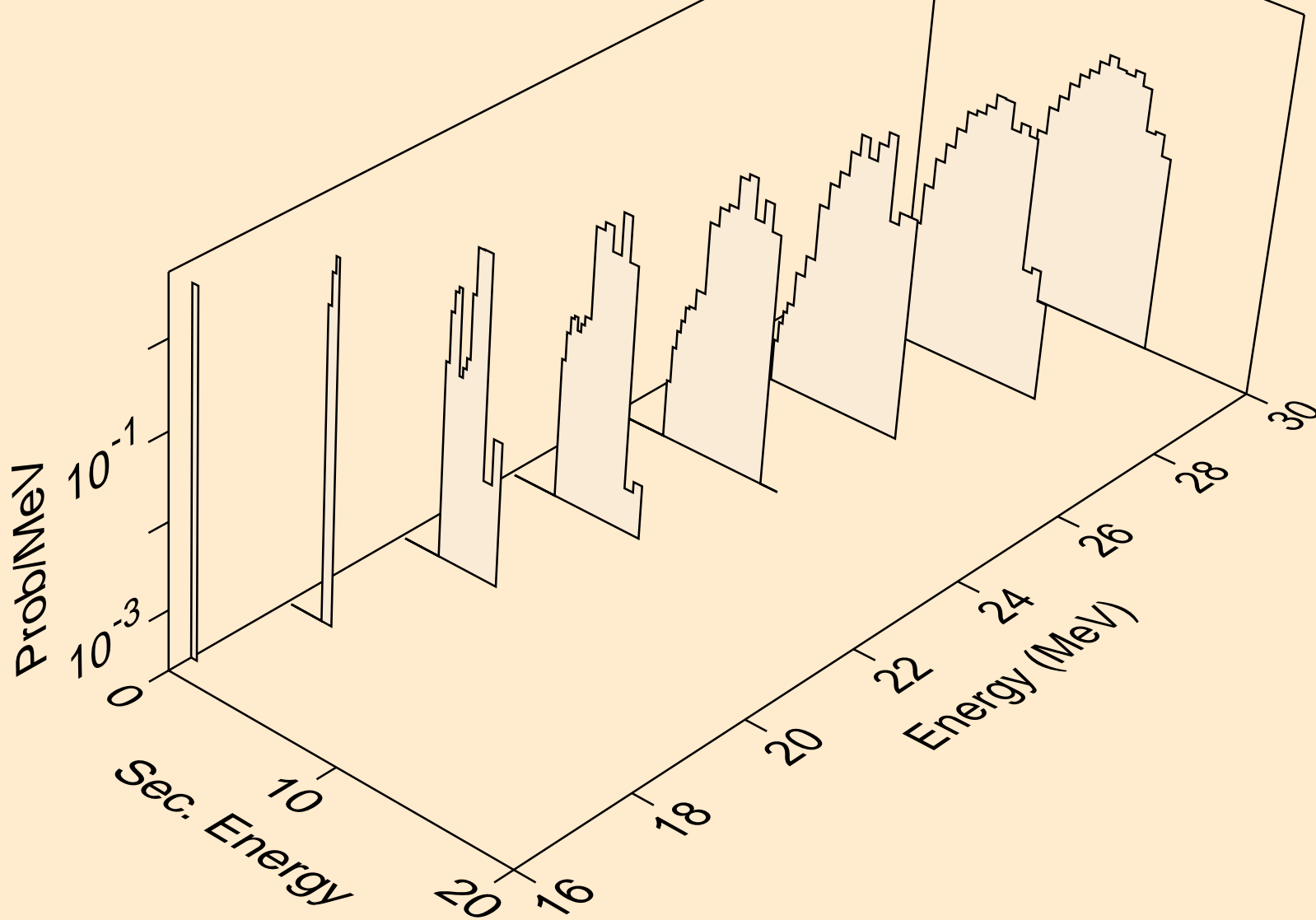



FR226 NEUTRON ACER TENDL-2019 LIBRARY; T=293.16K  
protons from (n,2np)

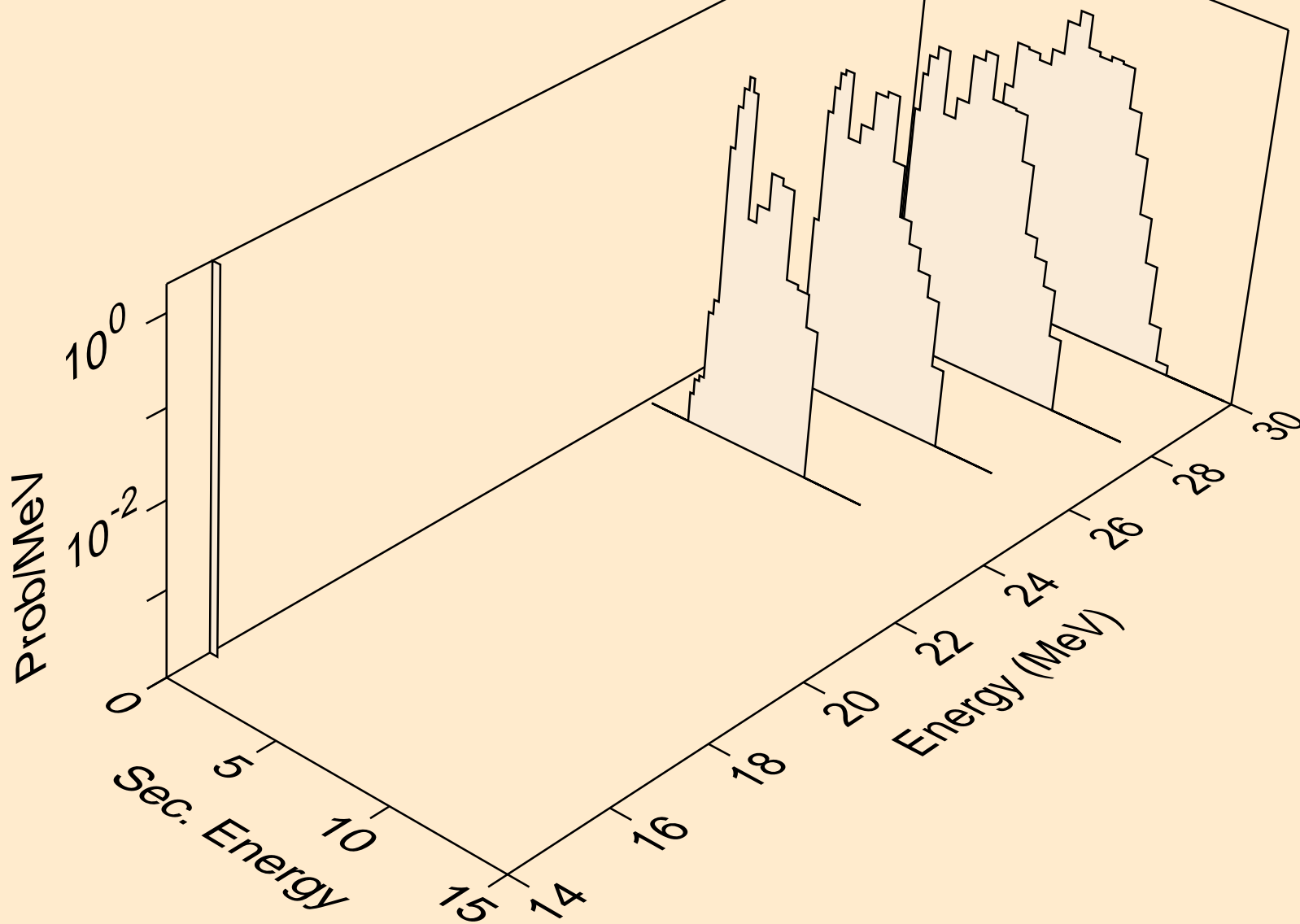

FR226 NEUTRON ACER TENDL-2019 LIBRARY; T=293.16K  
protons from (n,p)

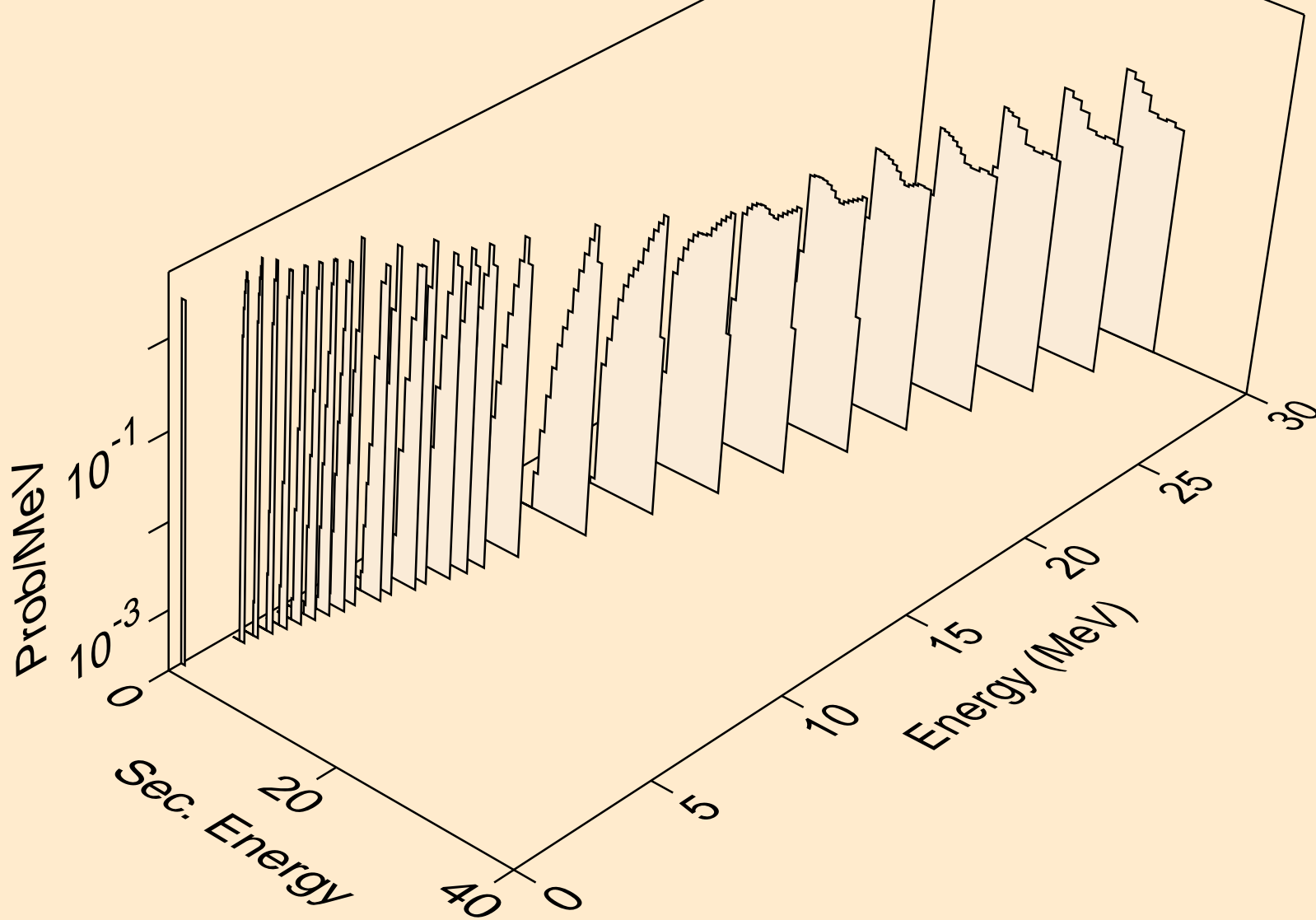

FR226 NEUTRON ACER TENDL-2019 LIBRARY; T=293.16K  
protons from (n,2p)

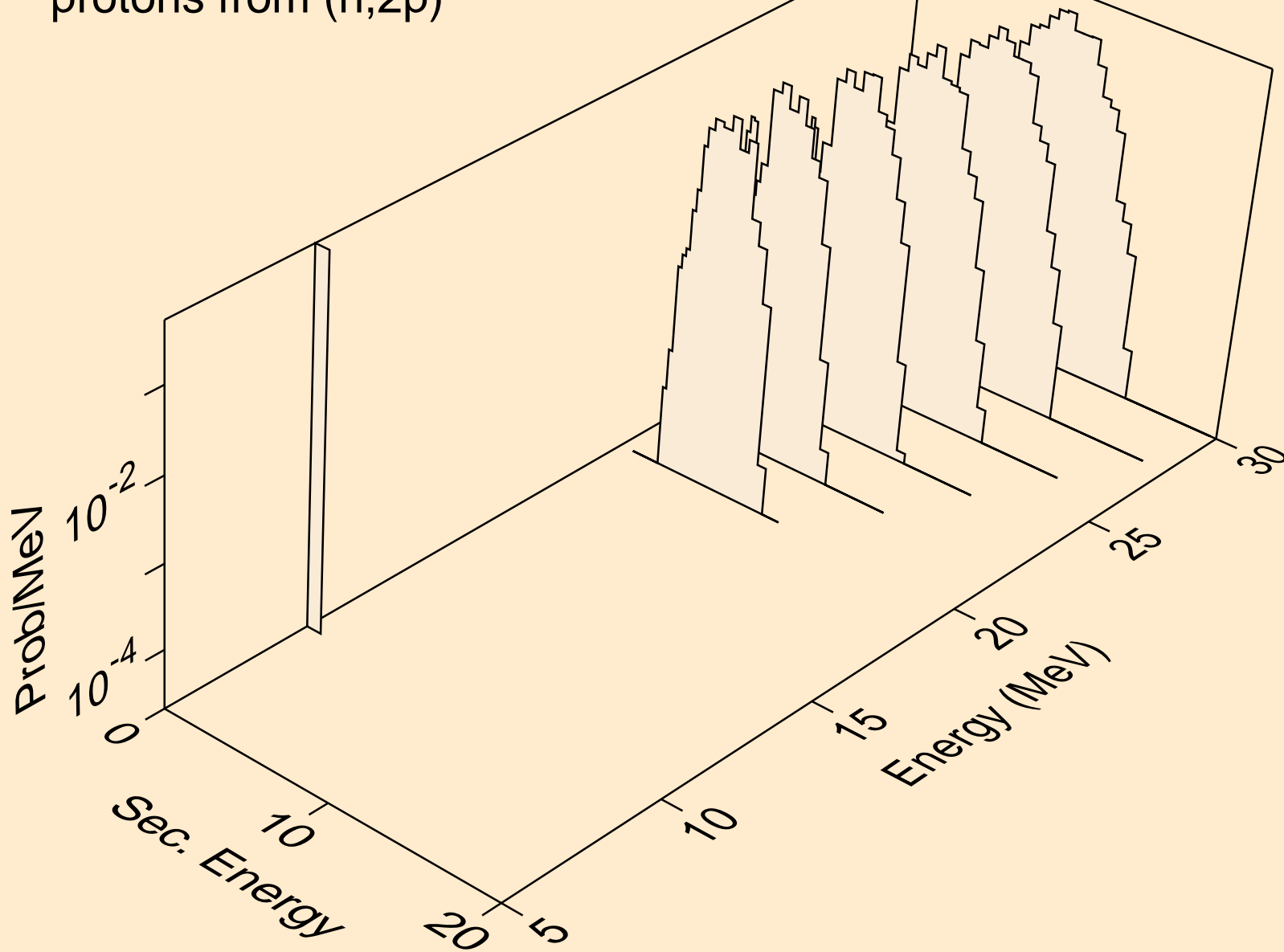

FR226 NEUTRON ACER TENDL-2019 LIBRARY; T=293.16K  
deuterons from (n,x)

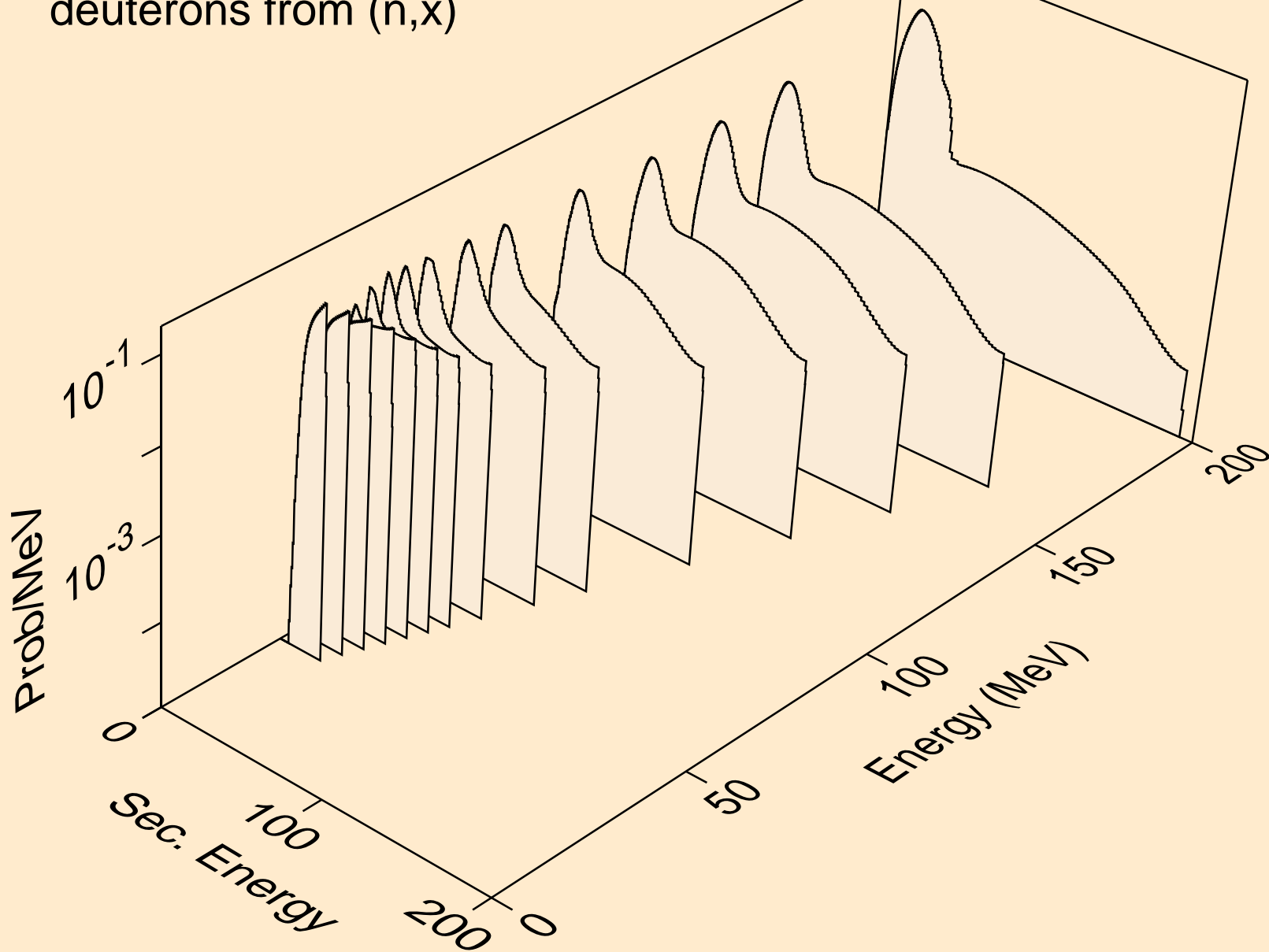

FR226 NEUTRON ACER TENDL-2019 LIBRARY; T=293.16K  
deuterons from (n,2nd)

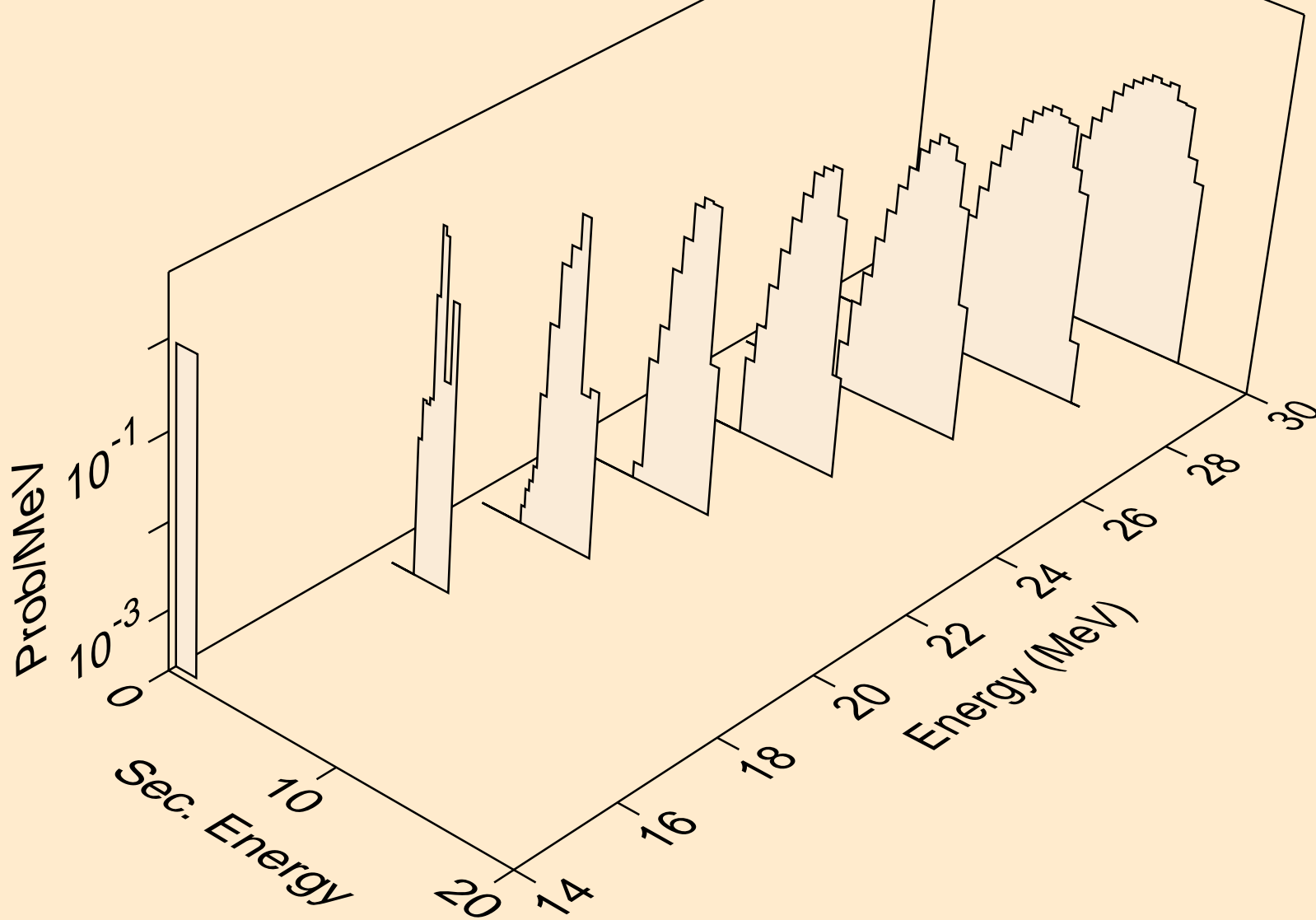

FR226 NEUTRON ACER TENDL-2019 LIBRARY; T=293.16K  
deuterons from (n,n\*)d

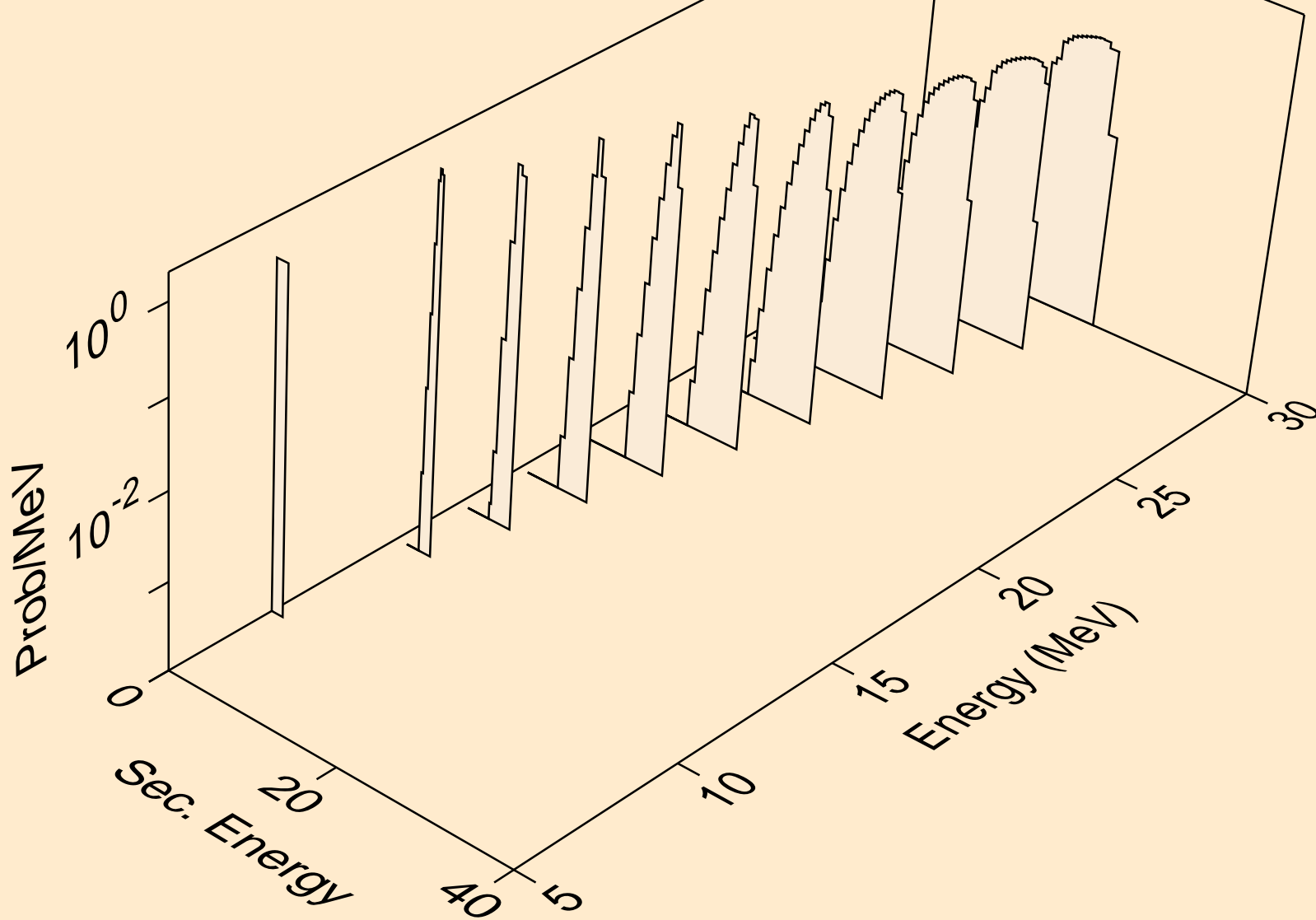

FR226 NEUTRON ACER TENDL-2019 LIBRARY; T=293.16K  
deuterons from (n,d)

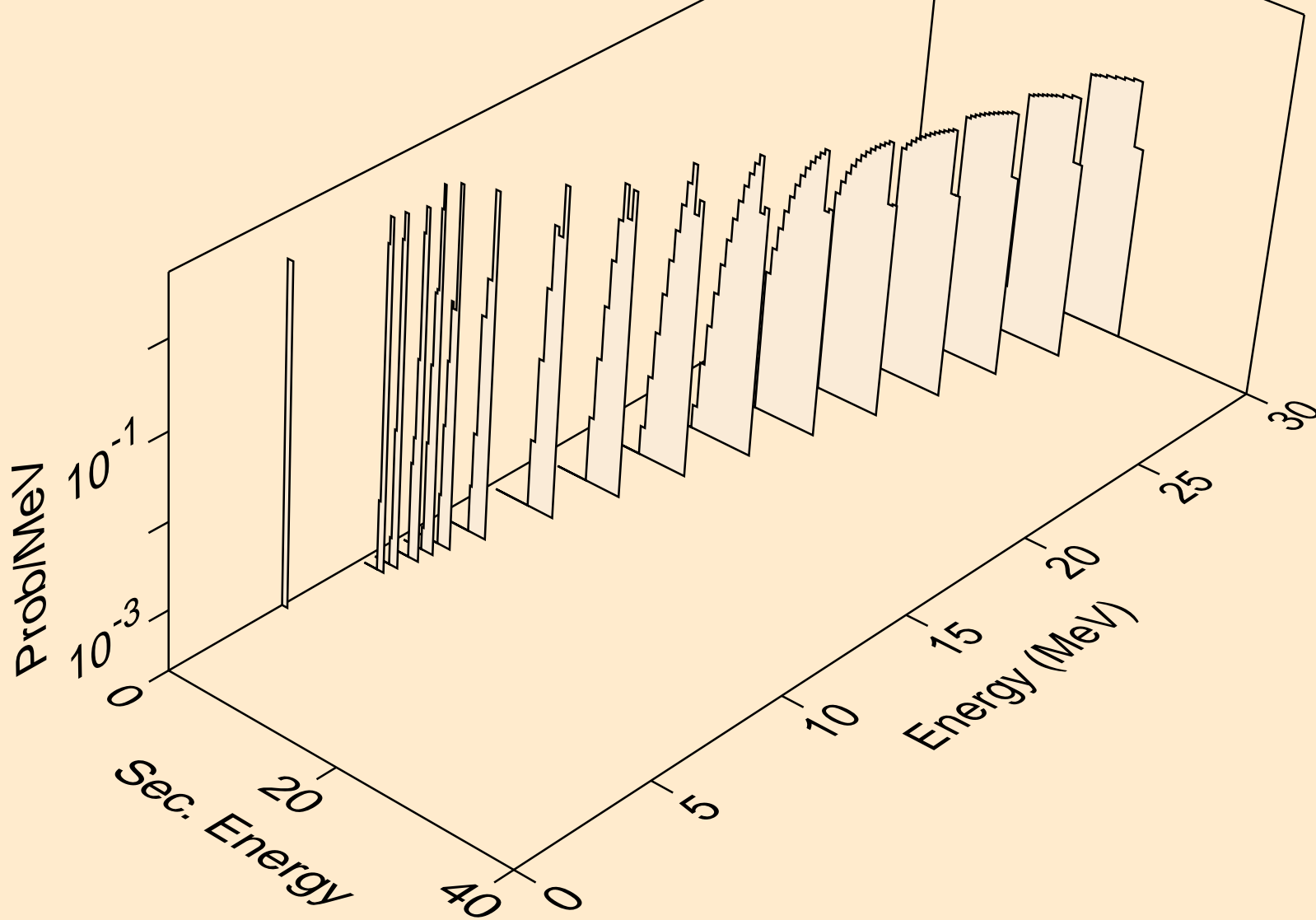

FR226 NEUTRON ACER TENDL-2019 LIBRARY; T=293.16K  
tritons from (n,x)

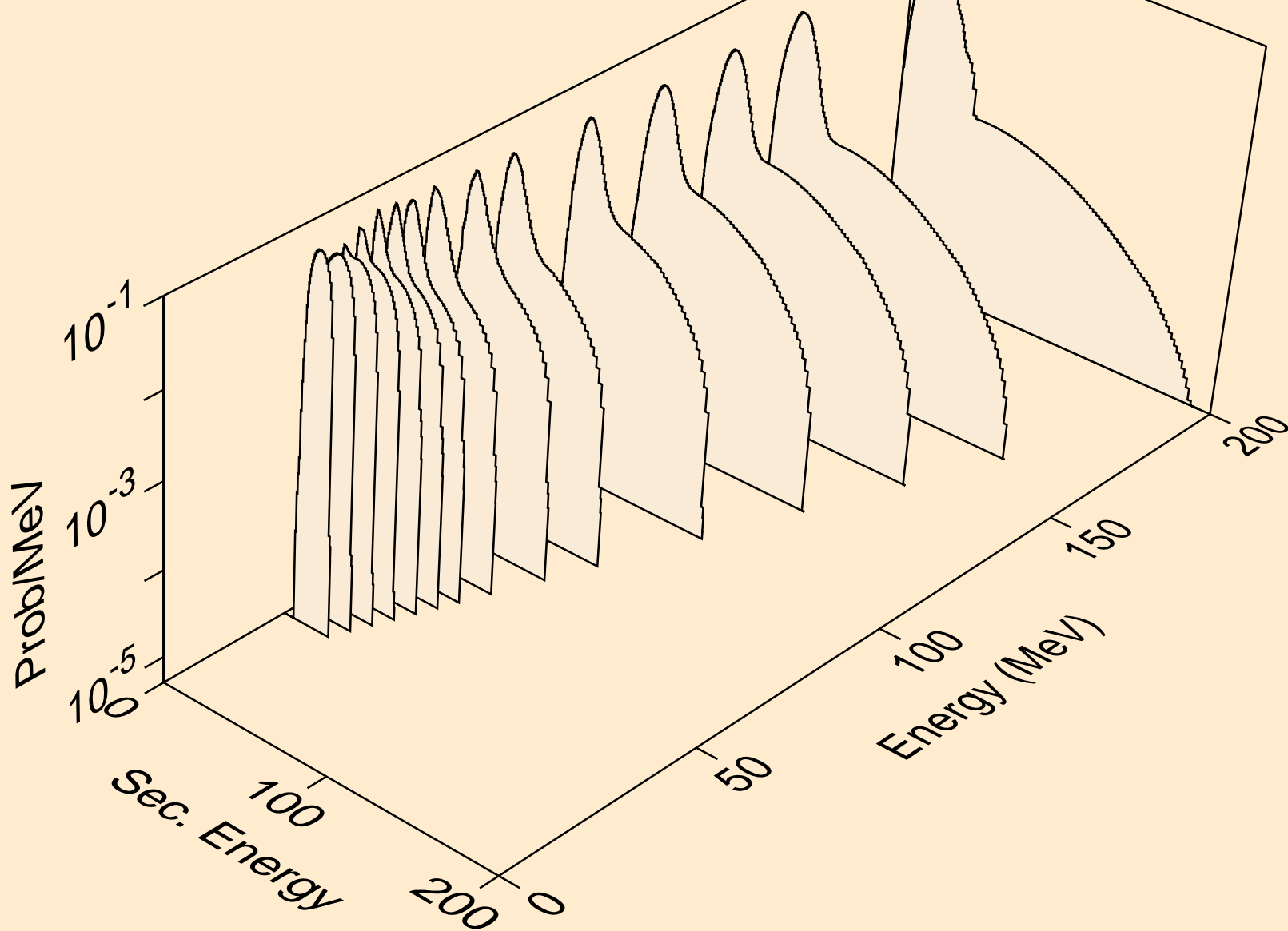



FR226 NEUTRON ACER TENDL-2019 LIBRARY; T=293.16K  
tritons from (n,n\*)t

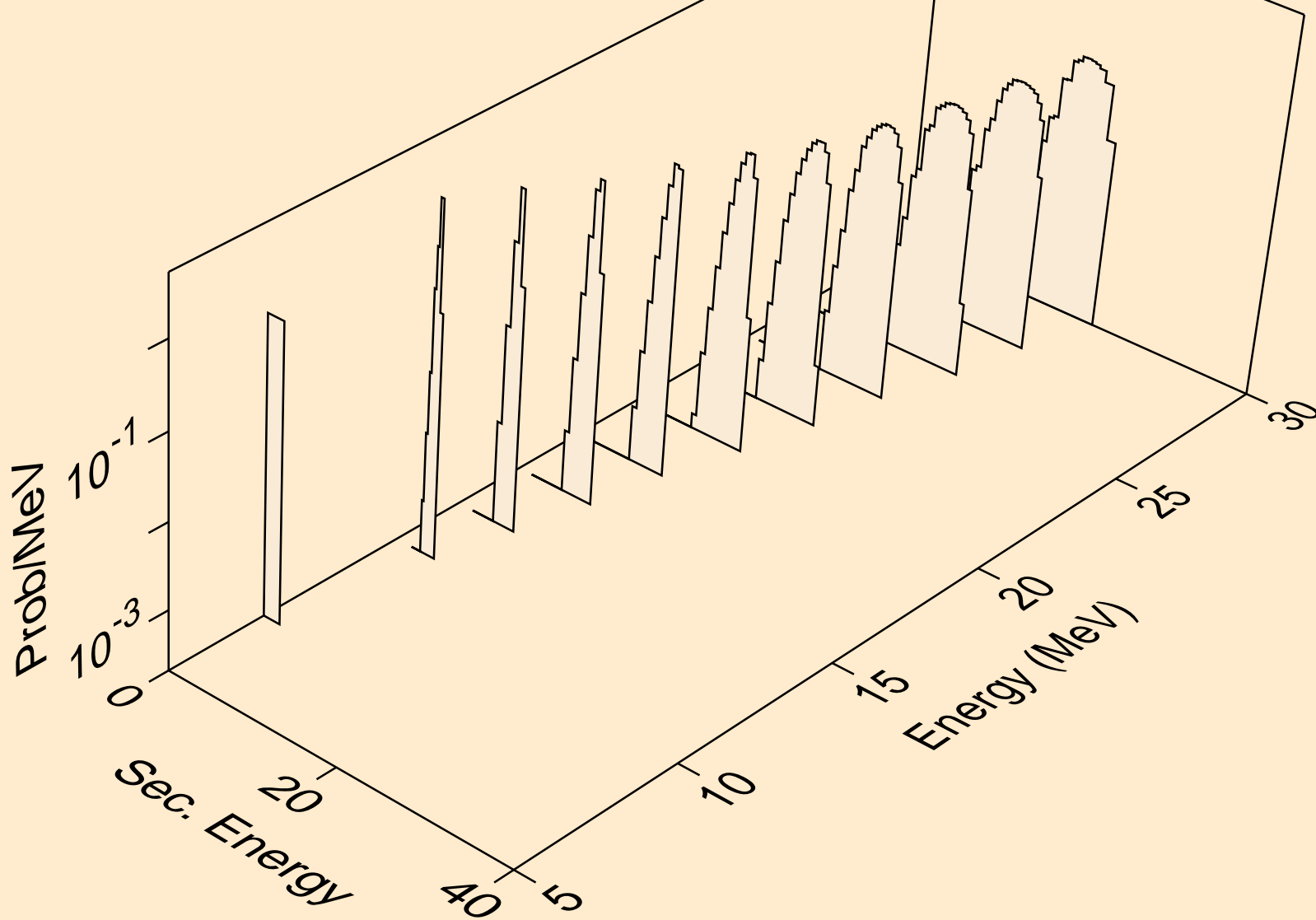

FR226 NEUTRON ACER TENDL-2019 LIBRARY; T=293.16K  
tritons from (n,t)

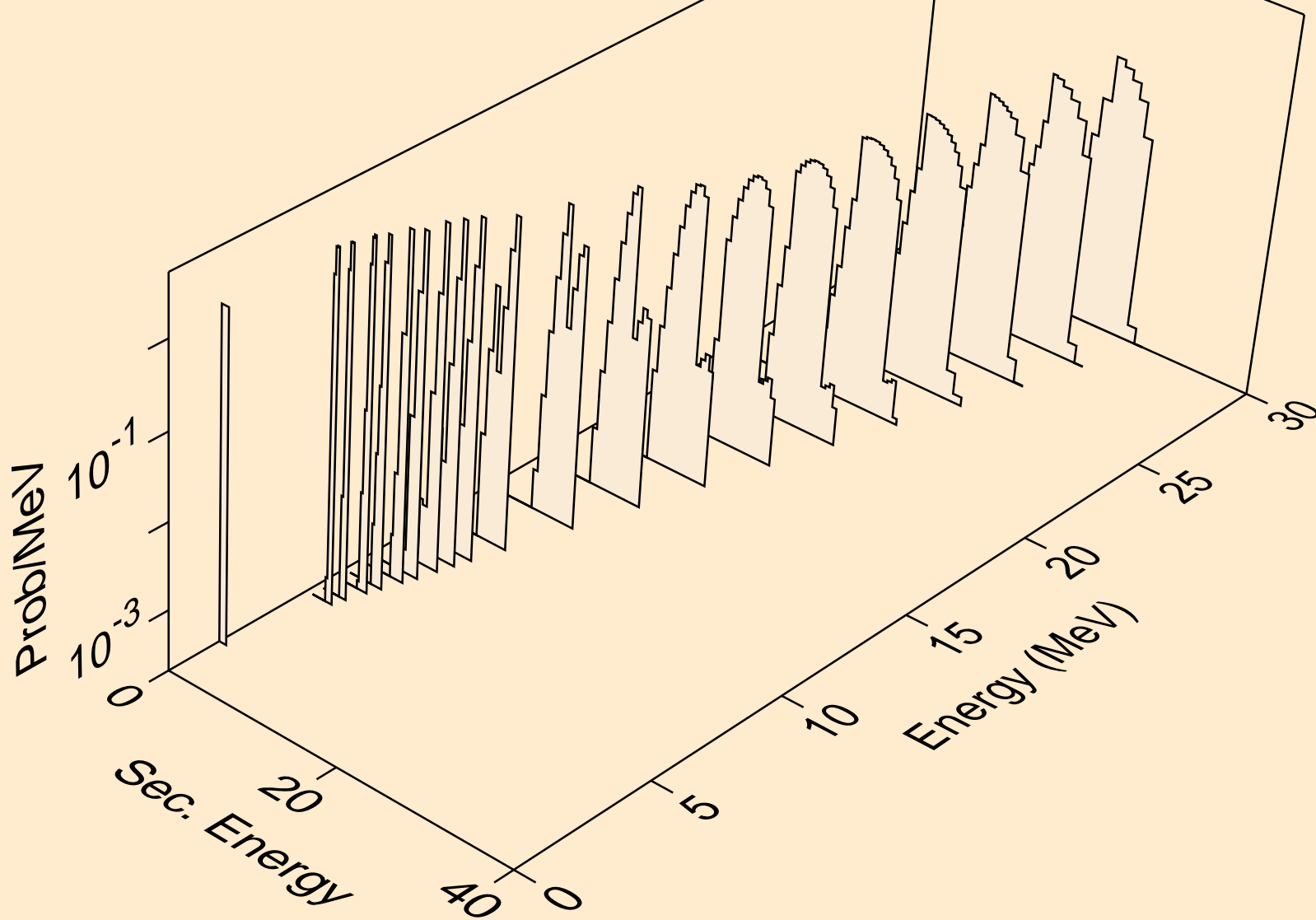

FR226 NEUTRON ACER TENDL-2019 LIBRARY; T=293.16K  
he3s from (n,x)

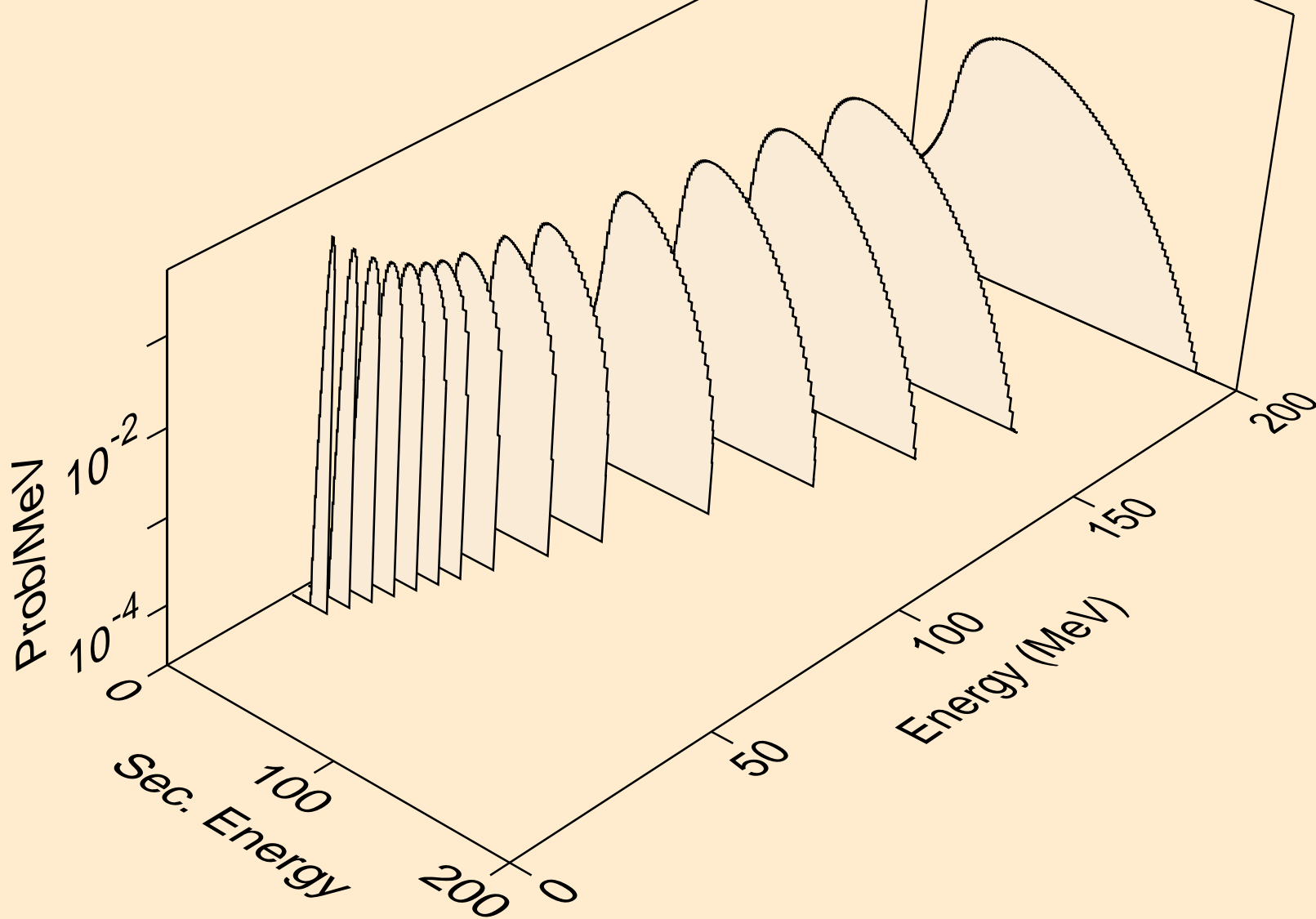

FR226 NEUTRON ACER TENDL-2019 LIBRARY; T=293.16K  
he3s from (n,n\*)he3

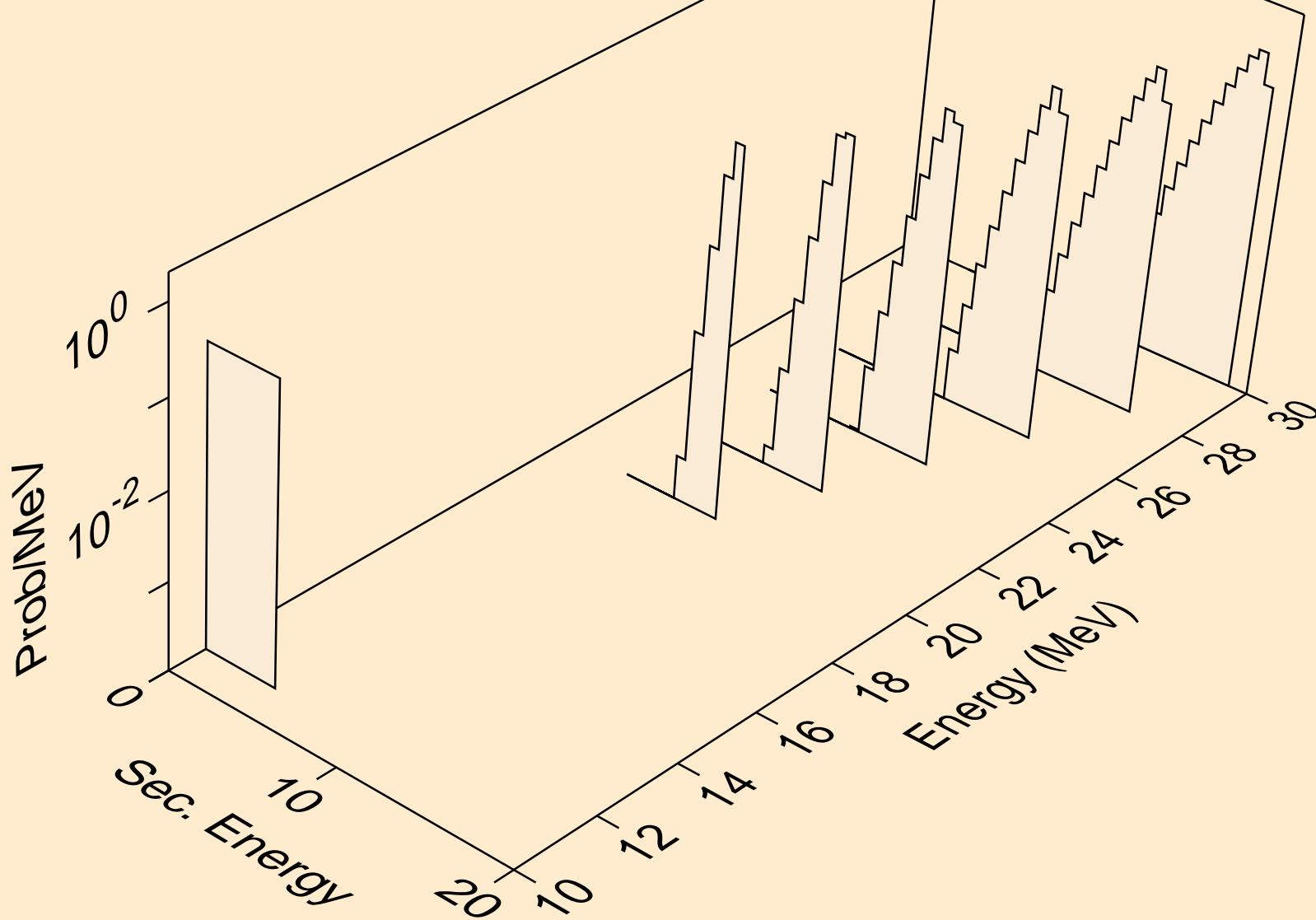

FR226 NEUTRON ACER TENDL-2019 LIBRARY; T=293.16K  
he3s from (n,he3)

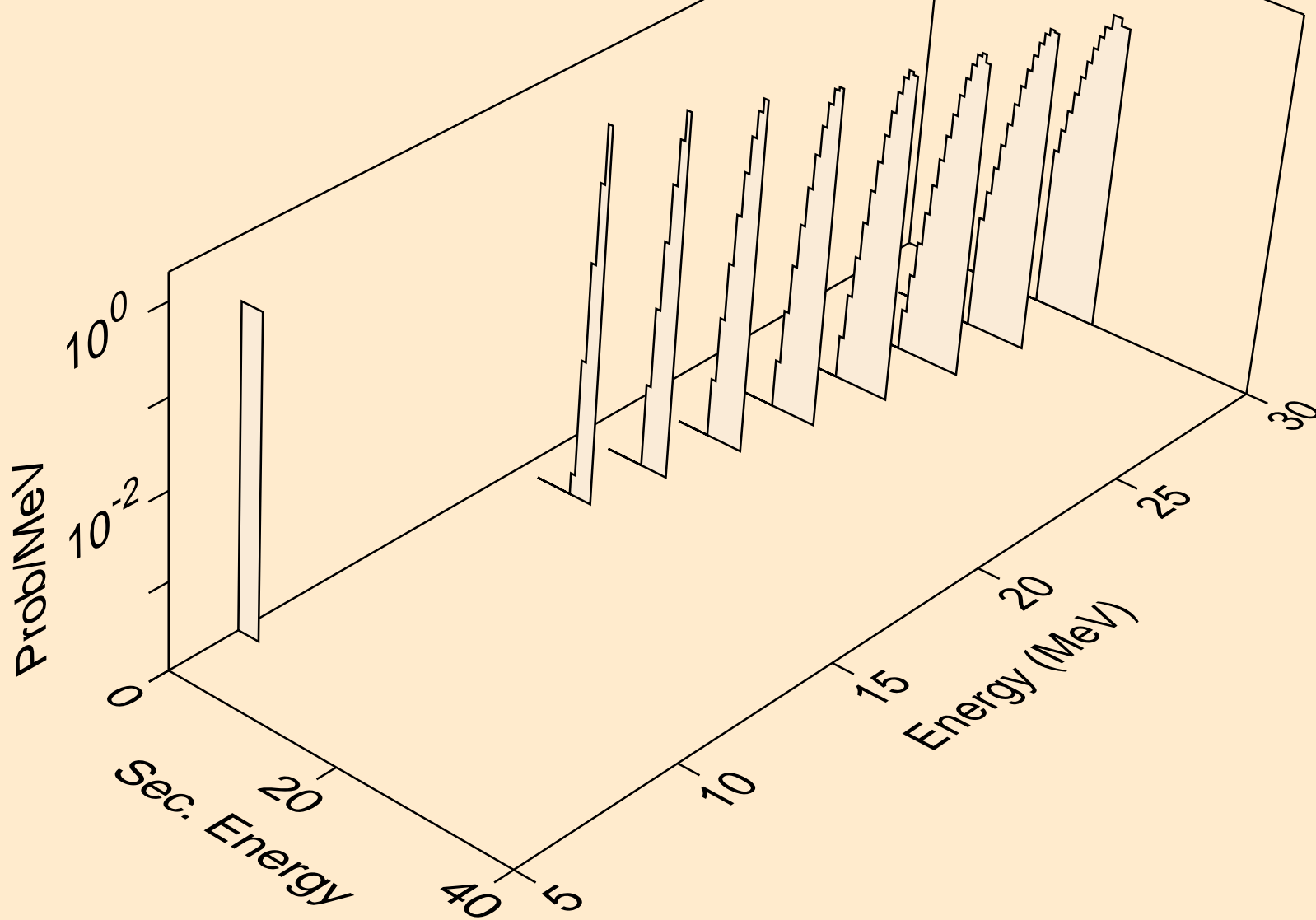

FR226 NEUTRON ACER TENDL-2019 LIBRARY; T=293.16K  
alphas from (n,x)

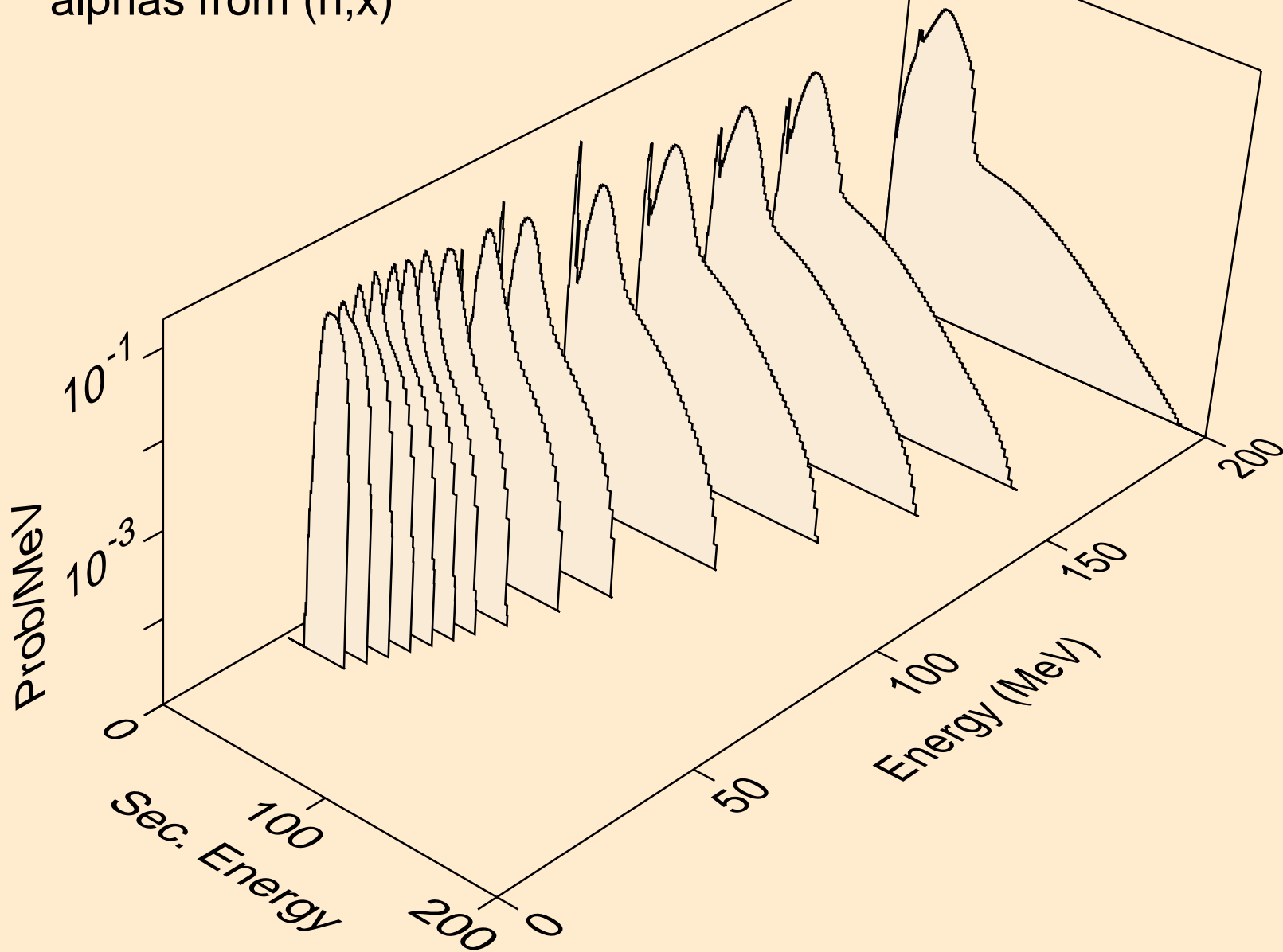

FR226 NEUTRON ACER TENDL-2019 LIBRARY; T=293.16K  
alphas from (n,n\*)a

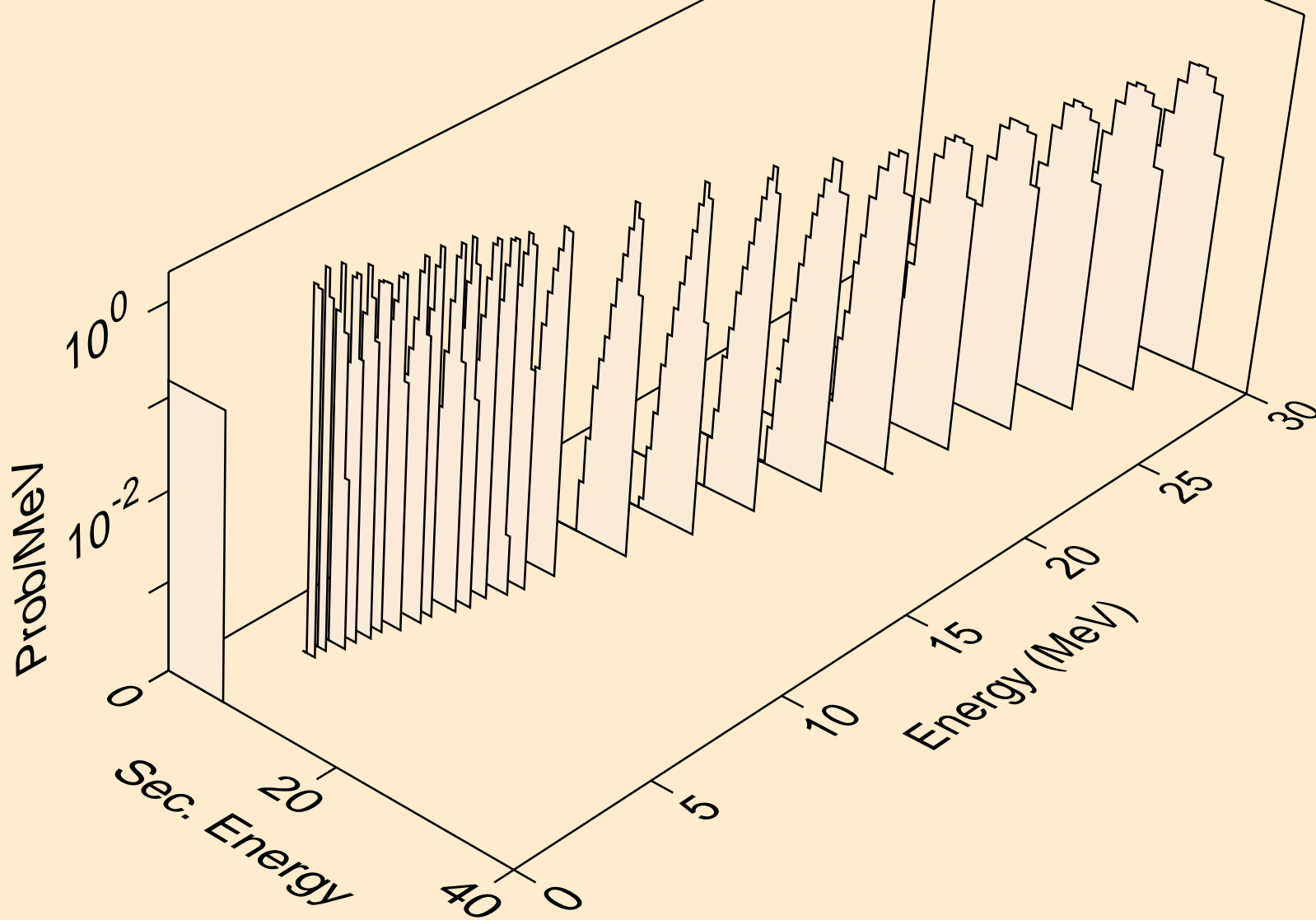

FR226 NEUTRON ACER TENDL-2019 LIBRARY; T=293.16K  
alphas from (n,2n)a

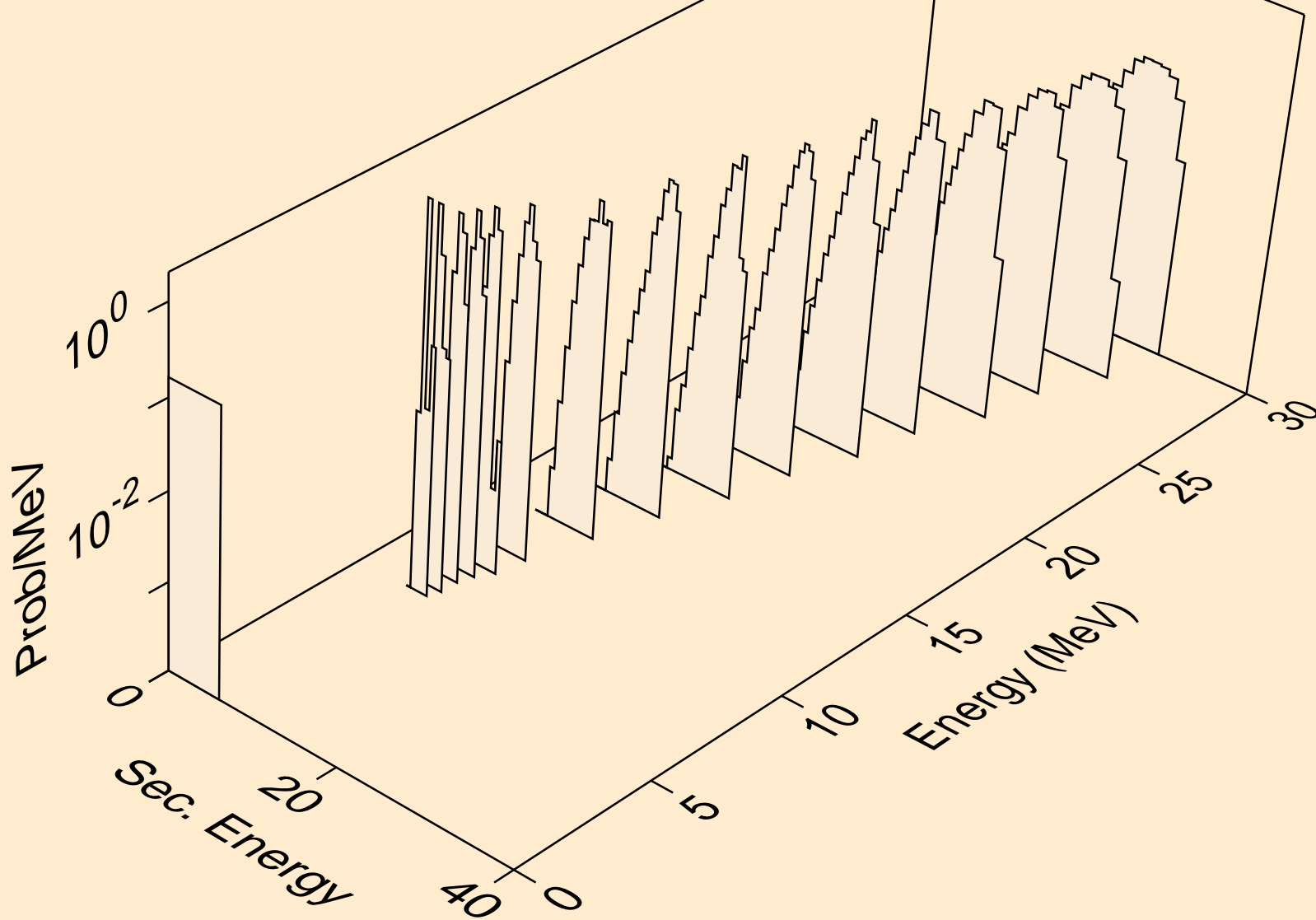



FR226 NEUTRON ACER TENDL-2019 LIBRARY; T=293.16K  
alphas from (n,3n)a

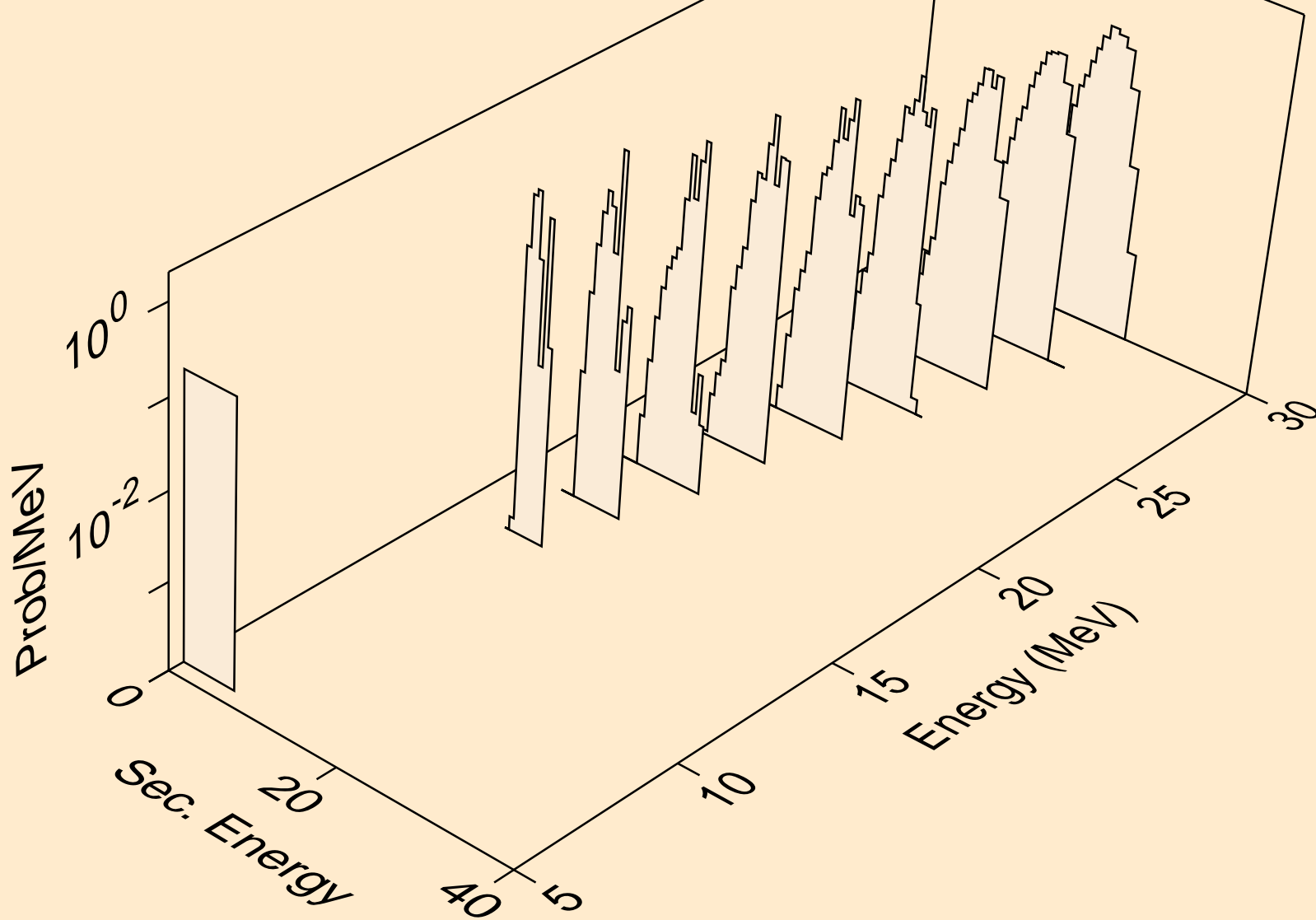

FR226 NEUTRON ACER TENDL-2019 LIBRARY; T=293.16K  
alphas from (n,n\*)2a

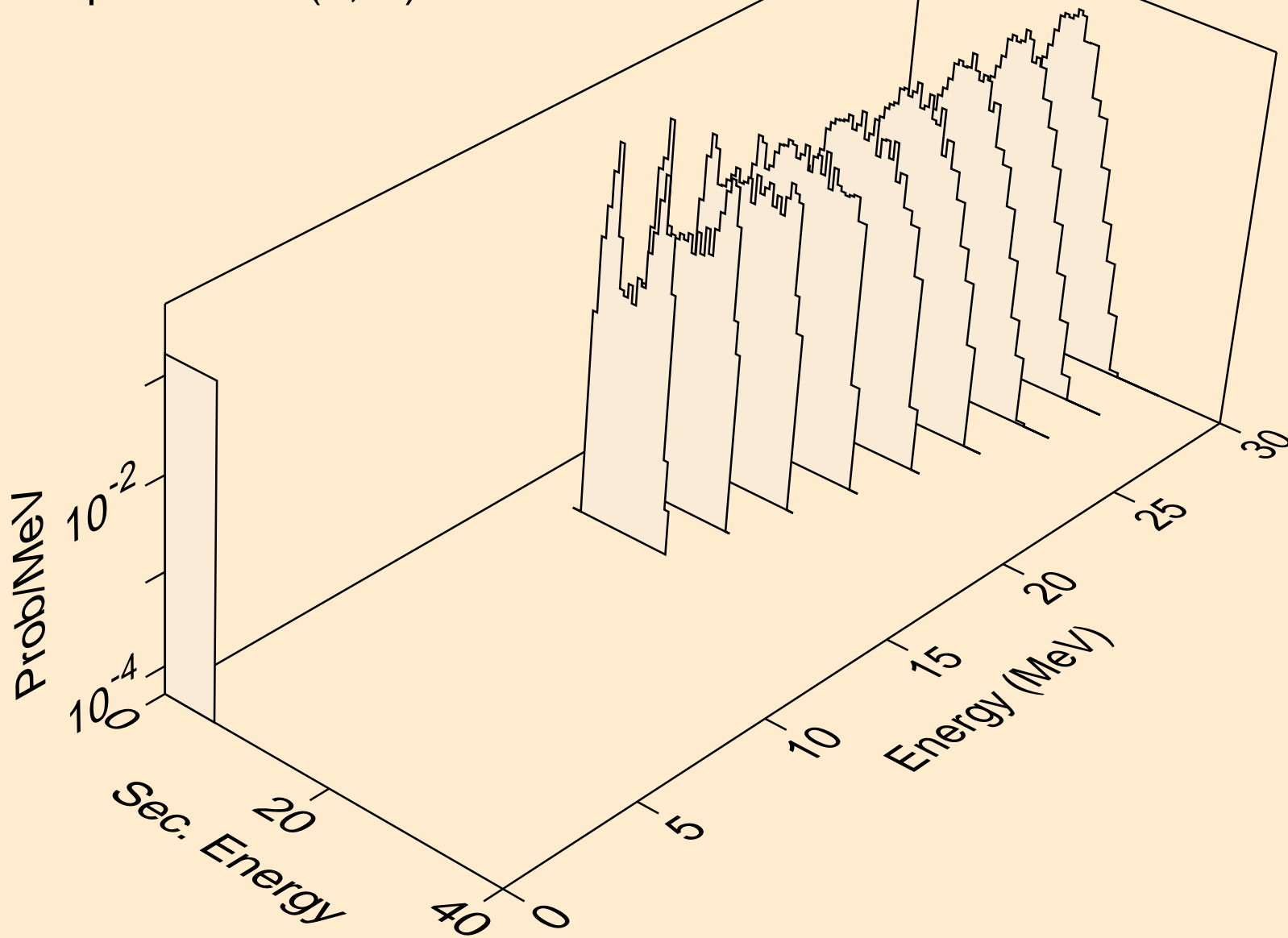

FR226 NEUTRON ACER TENDL-2019 LIBRARY; T=293.16K  
alphas from (n,a)

