

GE081 NEUTRON ACER TENDL-2019 LIBRARY; T=293.16K
Principal cross sections

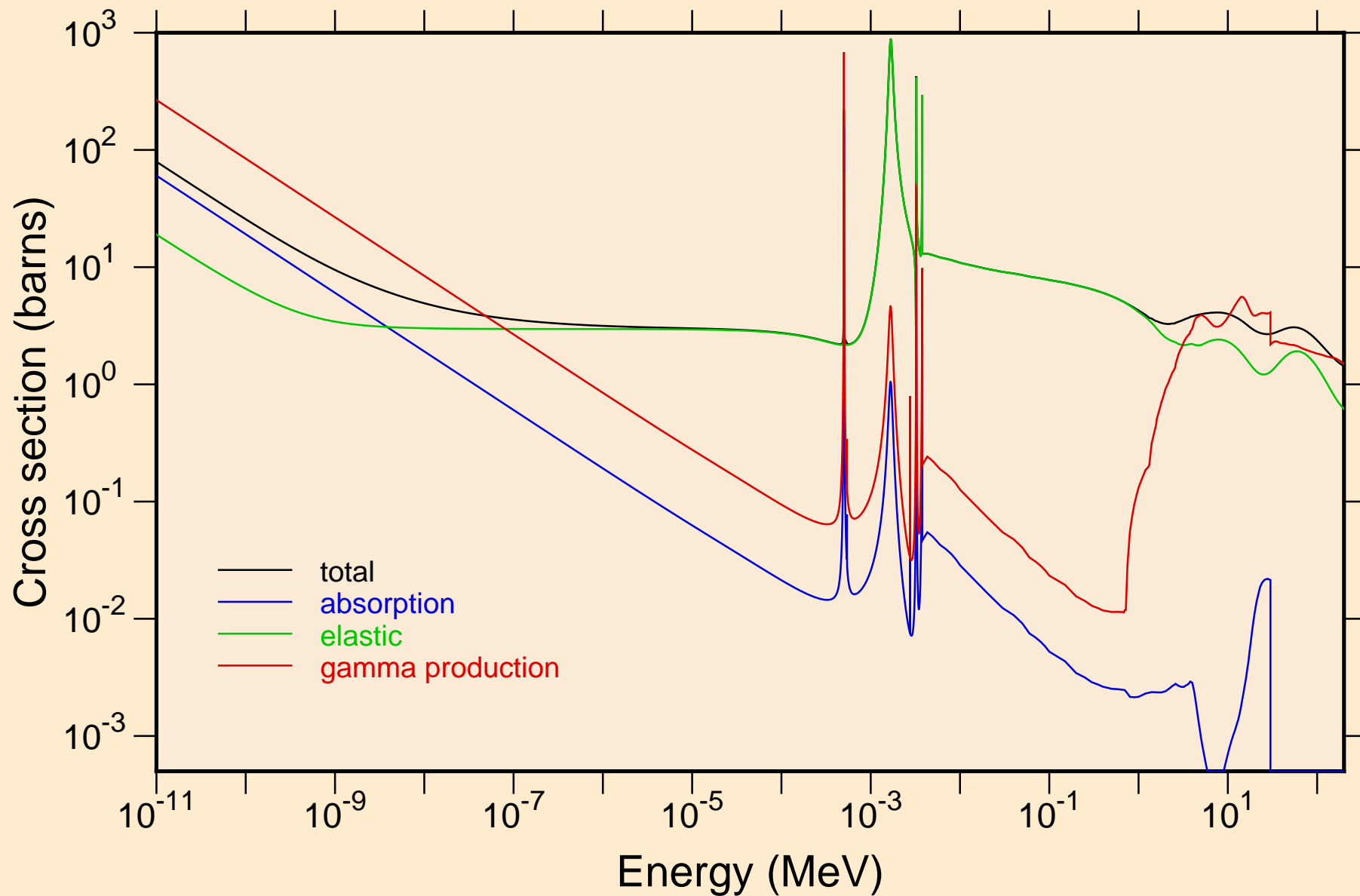

GE081 NEUTRON ACER TENDL-2019 LIBRARY; T=293.16K
resonance total cross section

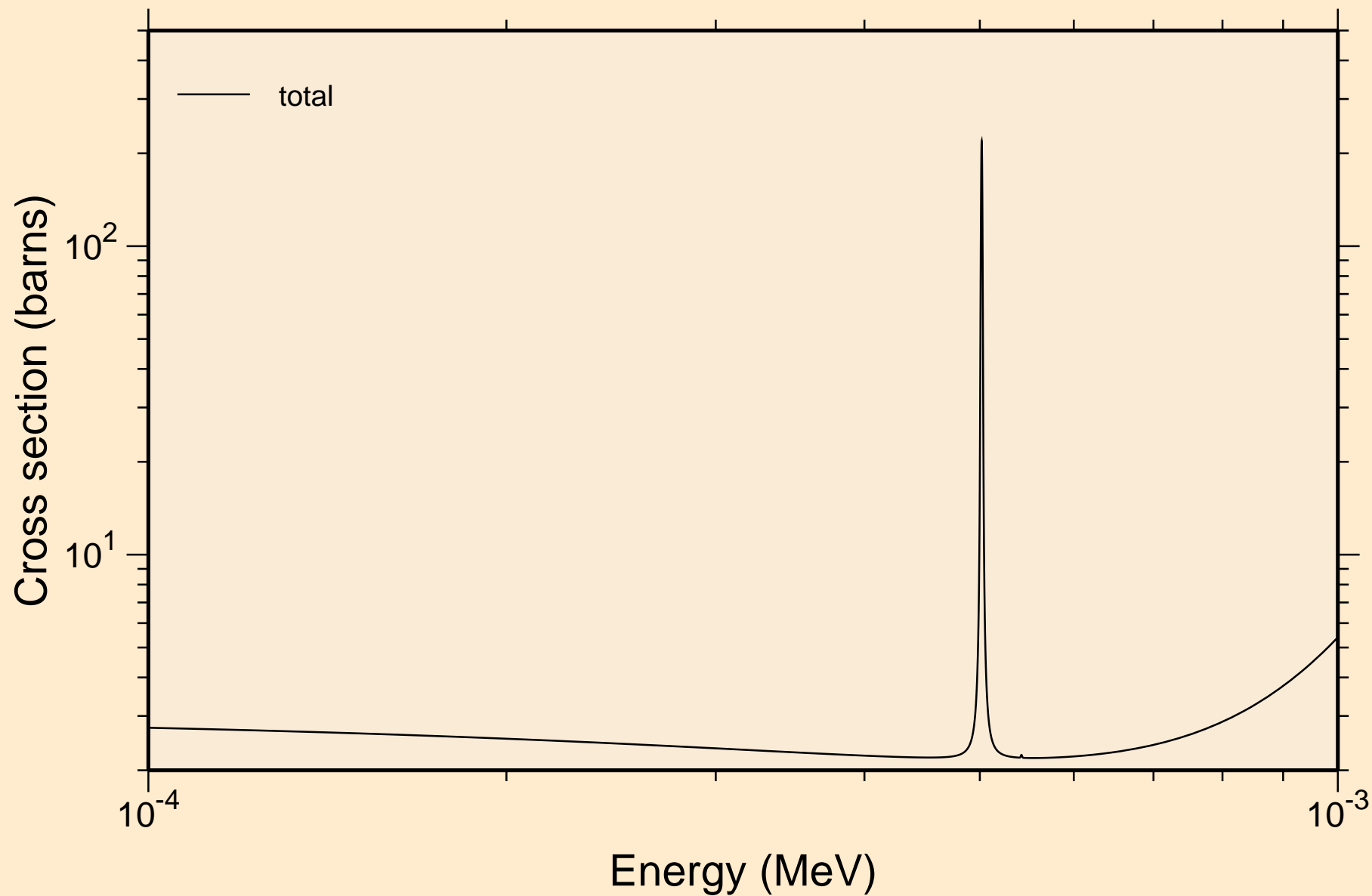

GE081 NEUTRON ACER TENDL-2019 LIBRARY; T=293.16K
resonance total cross section

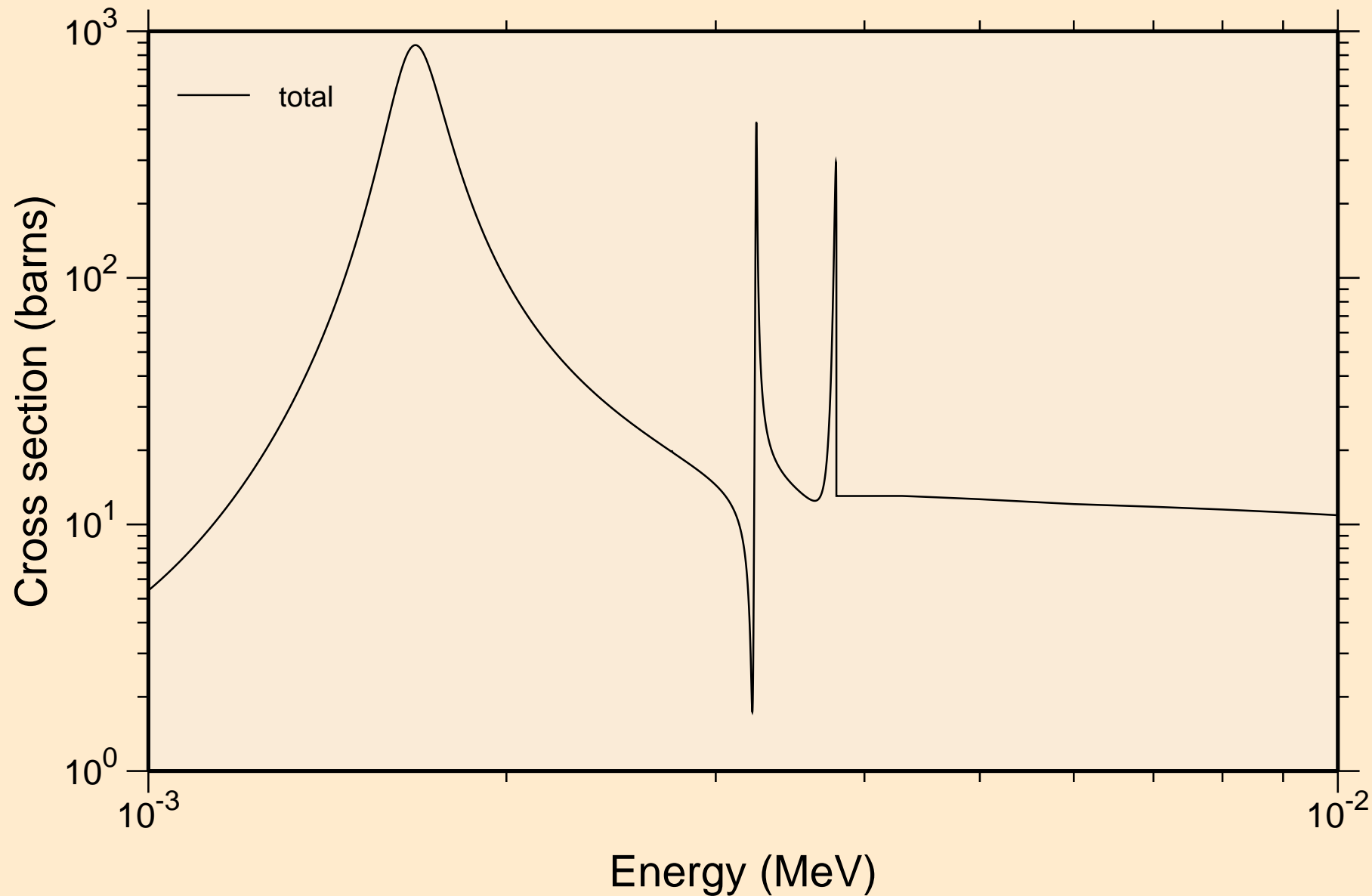

GE081 NEUTRON ACER TENDL-2019 LIBRARY; T=293.16K
resonance total cross section

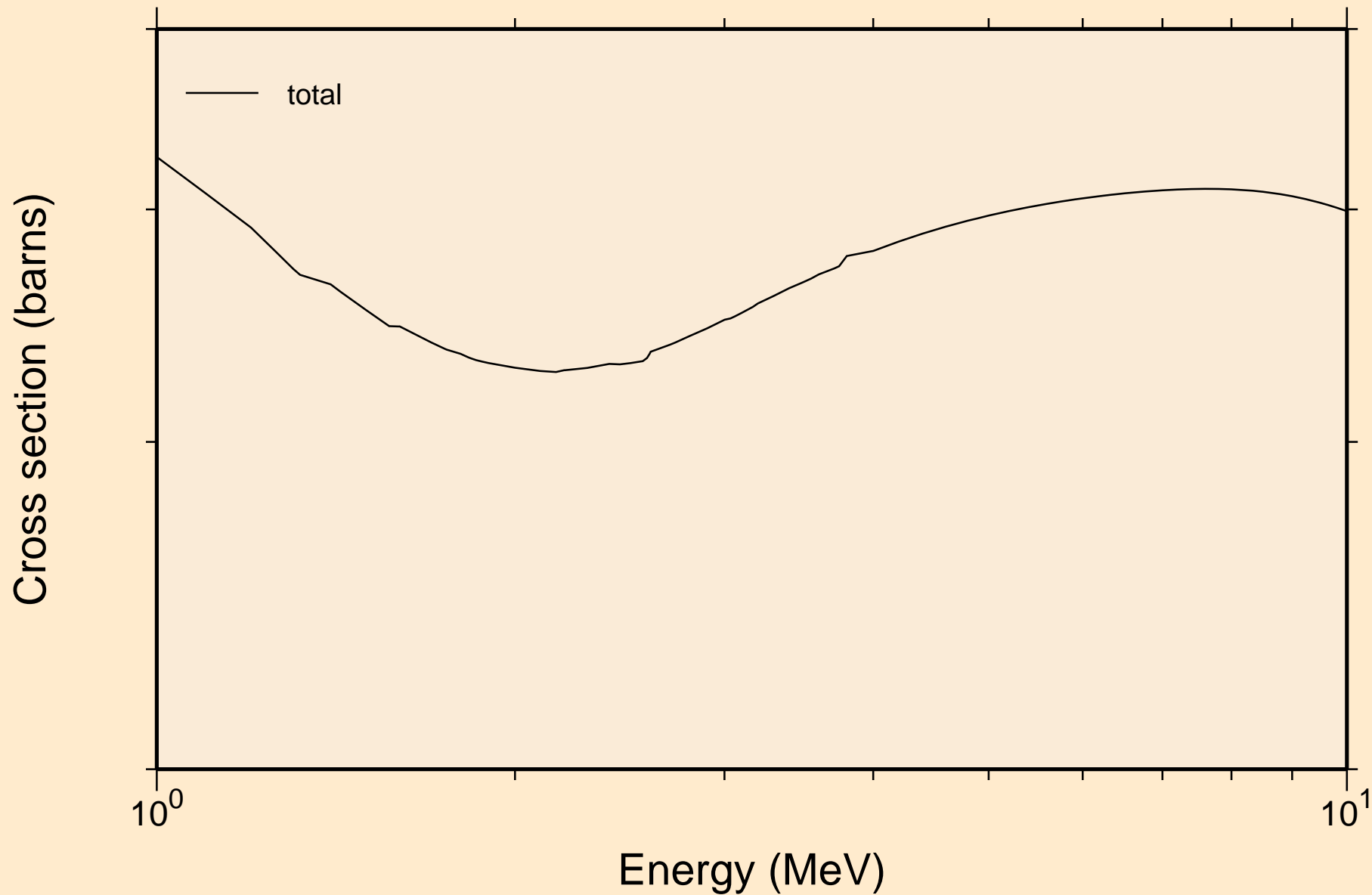

GE081 NEUTRON ACER TENDL-2019 LIBRARY; T=293.16K
resonance absorption cross sections

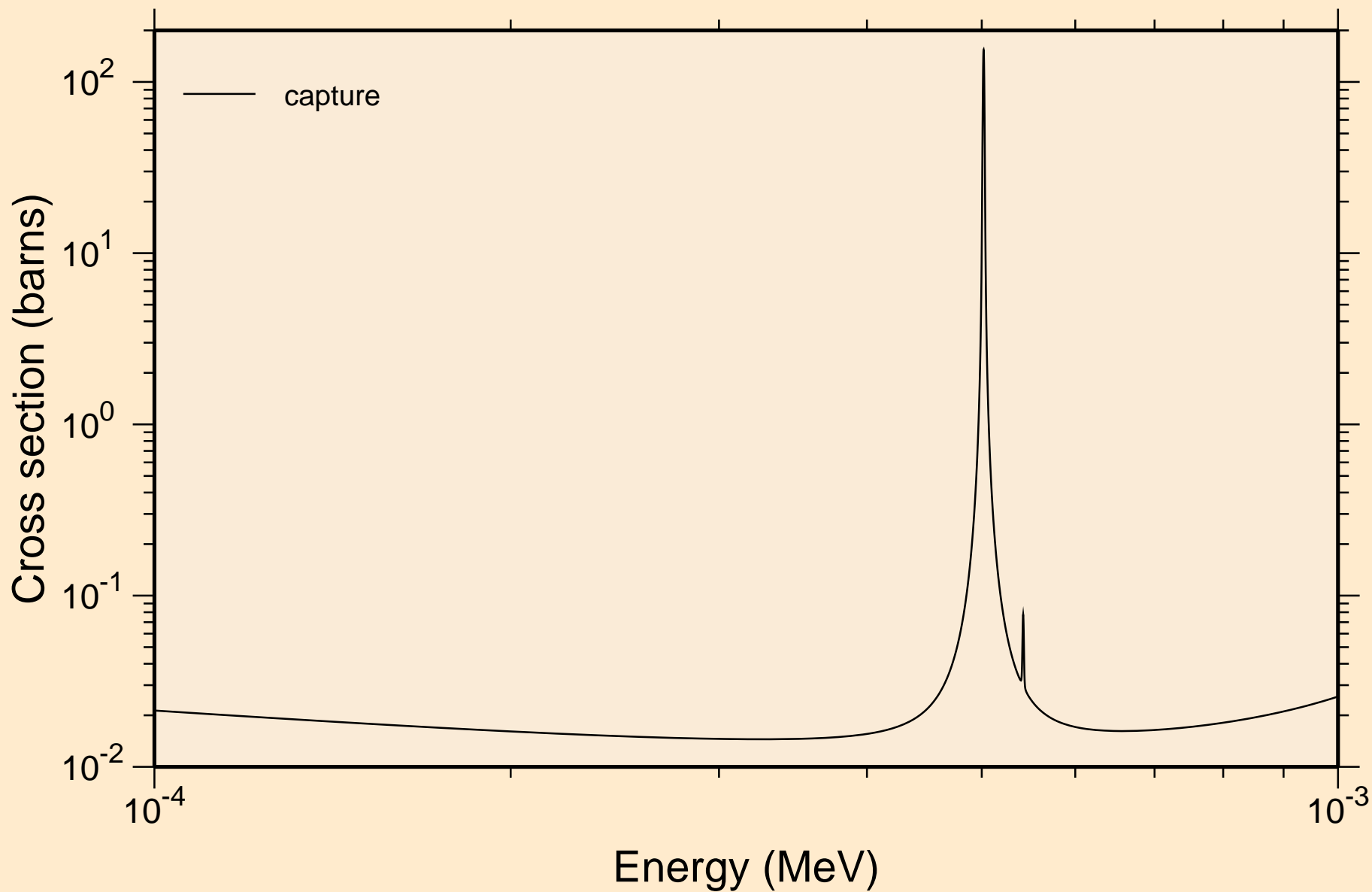

GE081 NEUTRON ACER TENDL-2019 LIBRARY; T=293.16K
resonance absorption cross sections

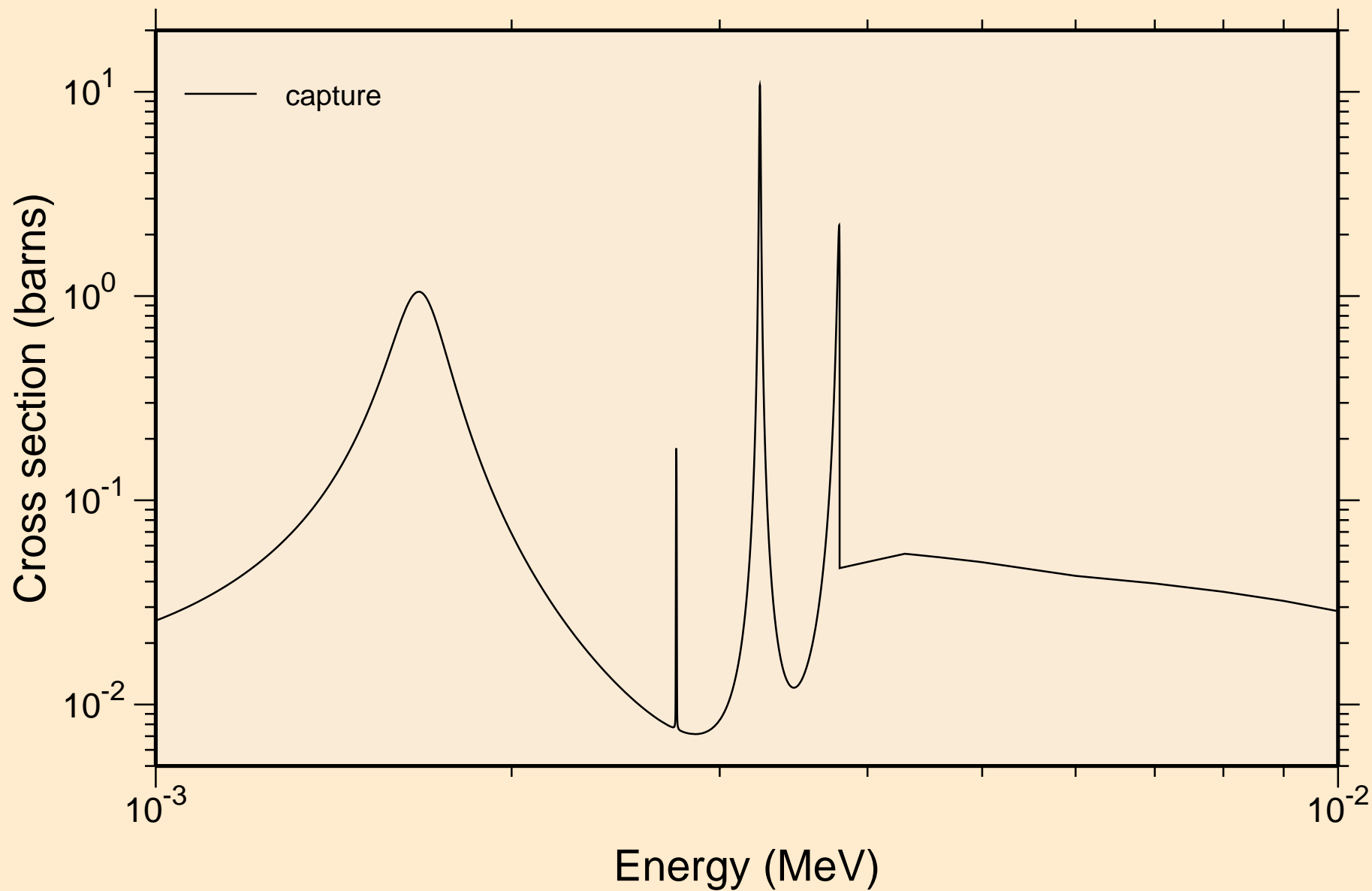

GE081 NEUTRON ACER TENDL-2019 LIBRARY; T=293.16K
resonance absorption cross sections

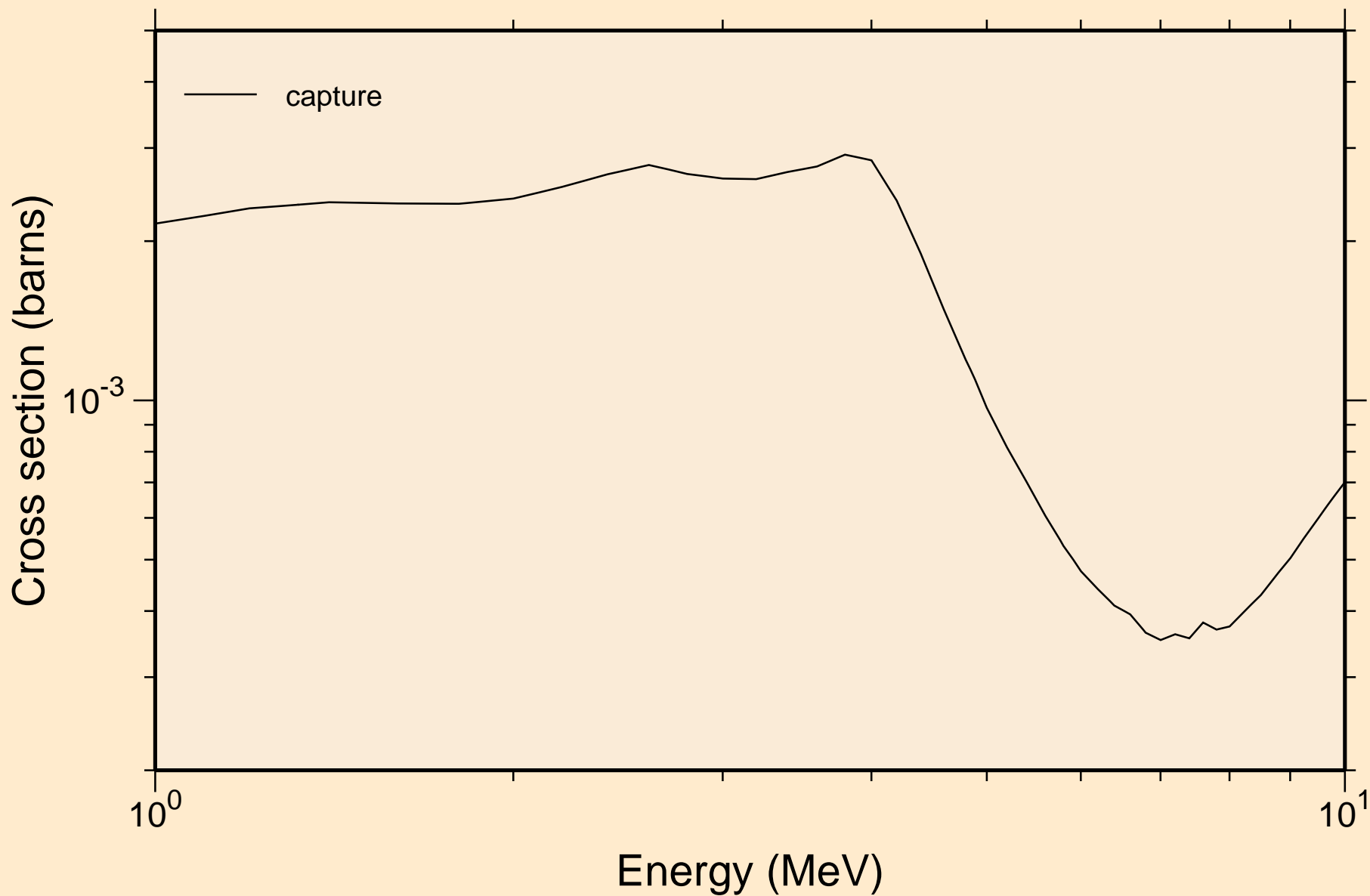

GE081 NEUTRON ACER TENDL-2019 LIBRARY; T=293.16K
Heating

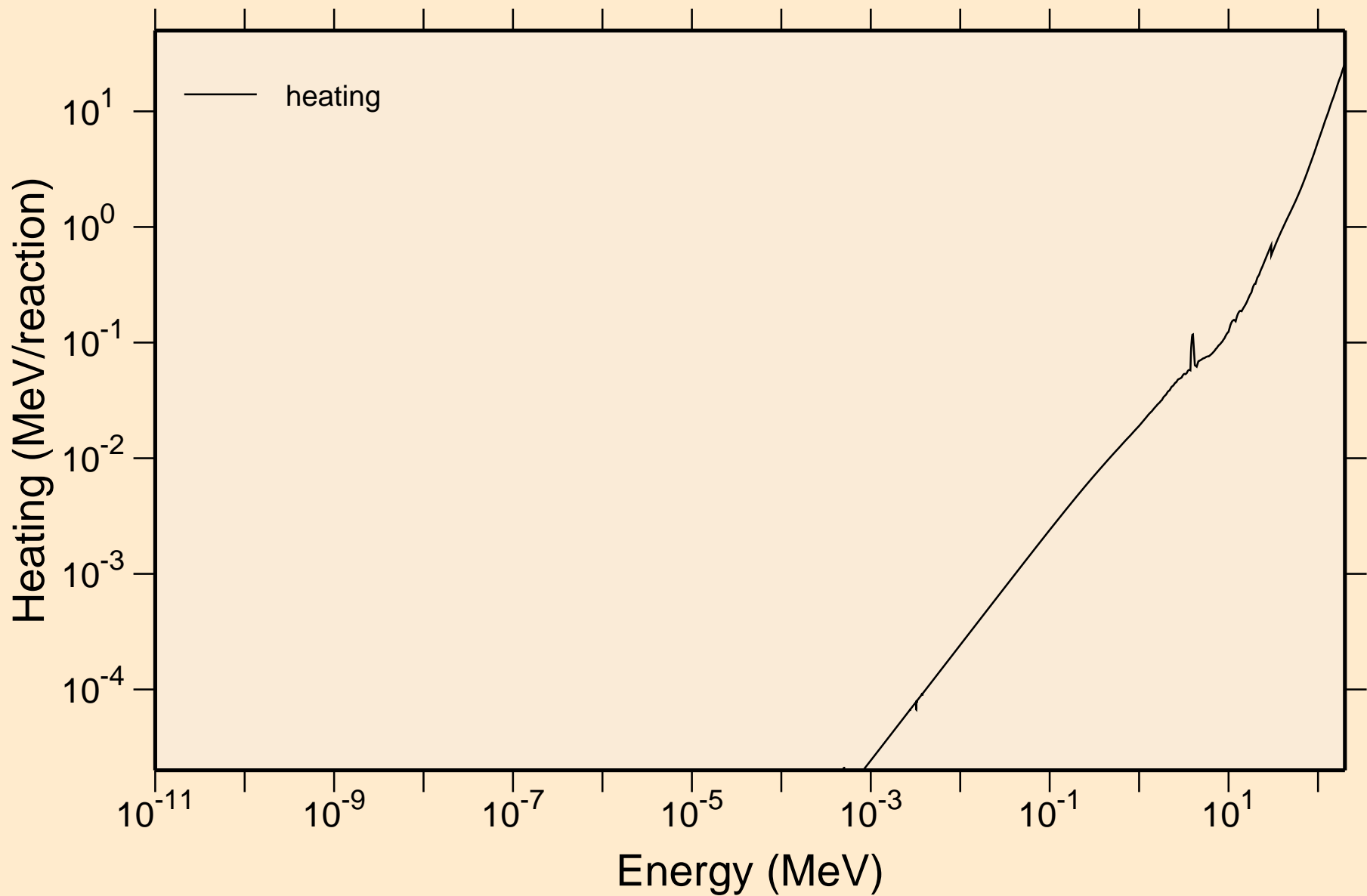

GE081 NEUTRON ACER TENDL-2019 LIBRARY; T=293.16K
Damage

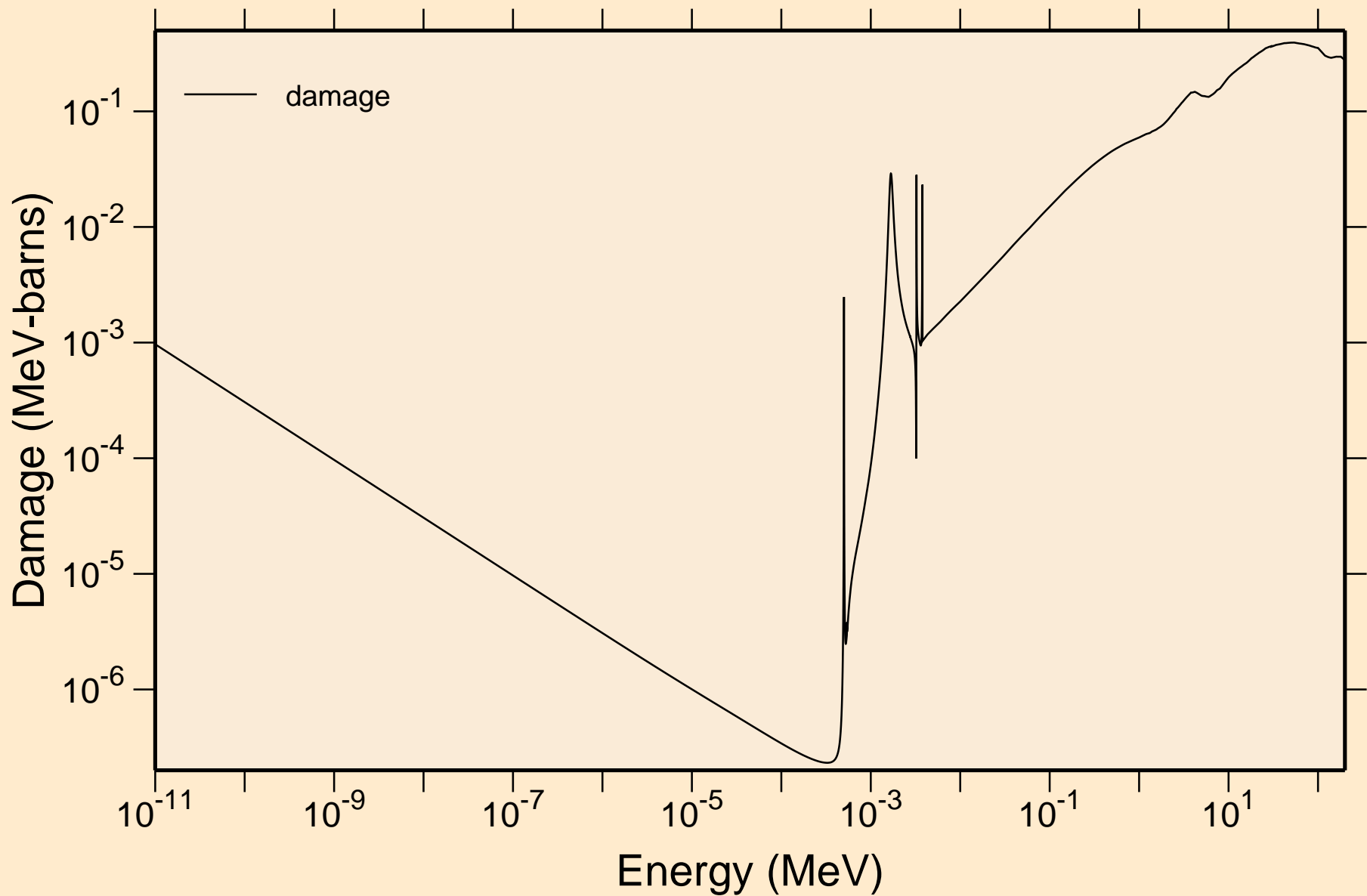

GE081 NEUTRON ACER TENDL-2019 LIBRARY; T=293.16K
Non-threshold reactions

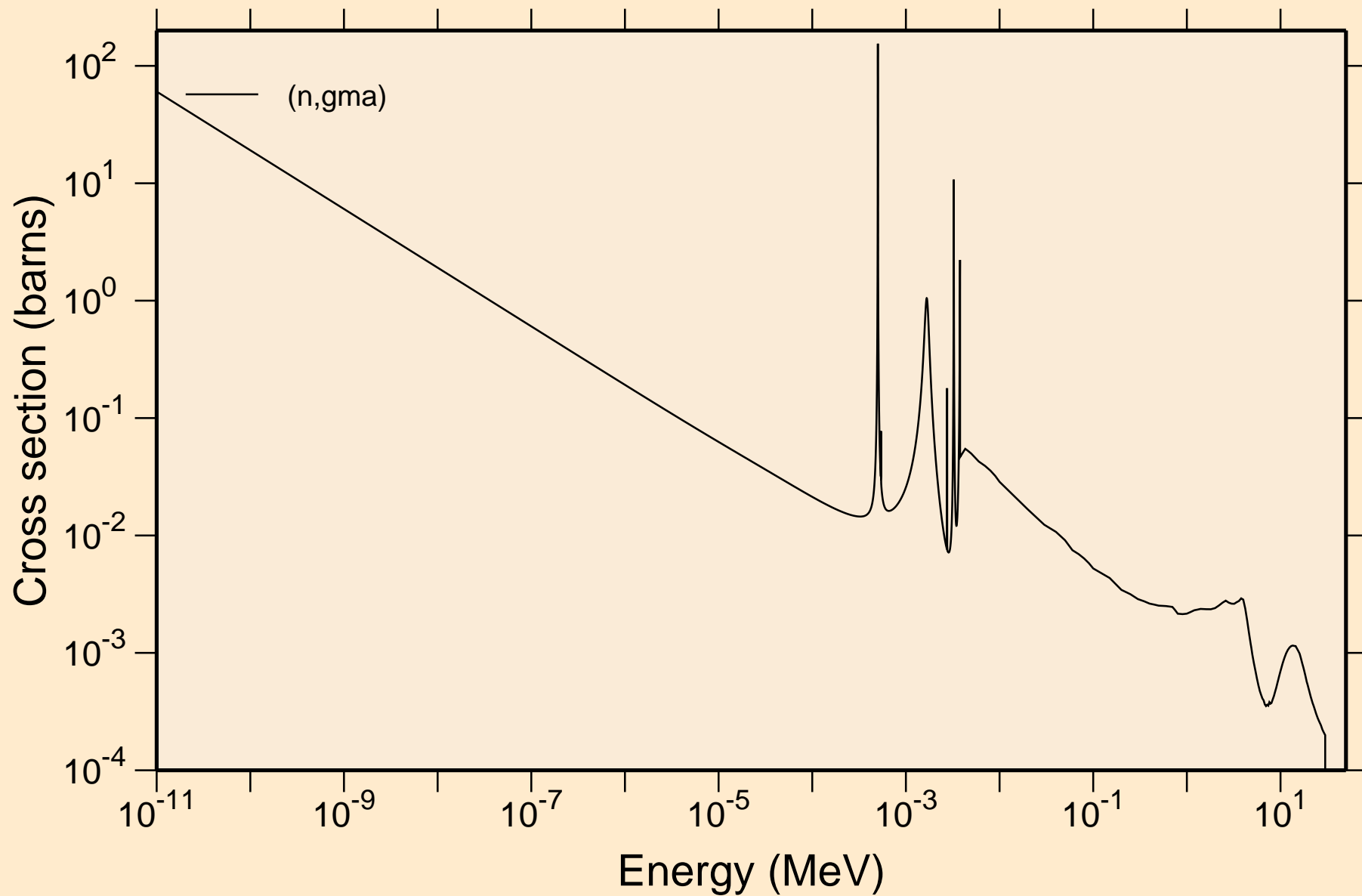

GE081 NEUTRON ACER TENDL-2019 LIBRARY; T=293.16K

Principal cross sections

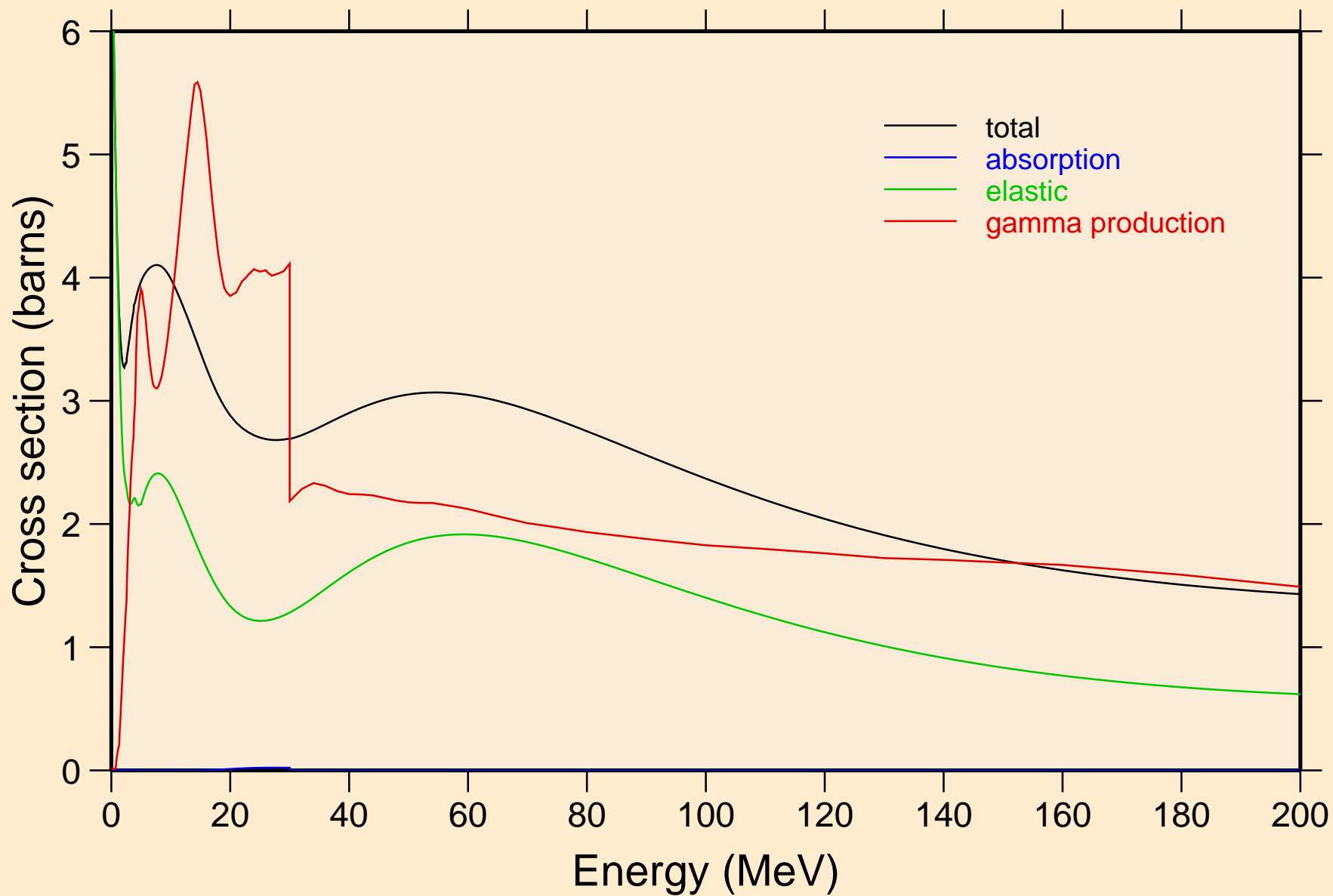

GE081 NEUTRON ACER TENDL-2019 LIBRARY; T=293.16K
Heating

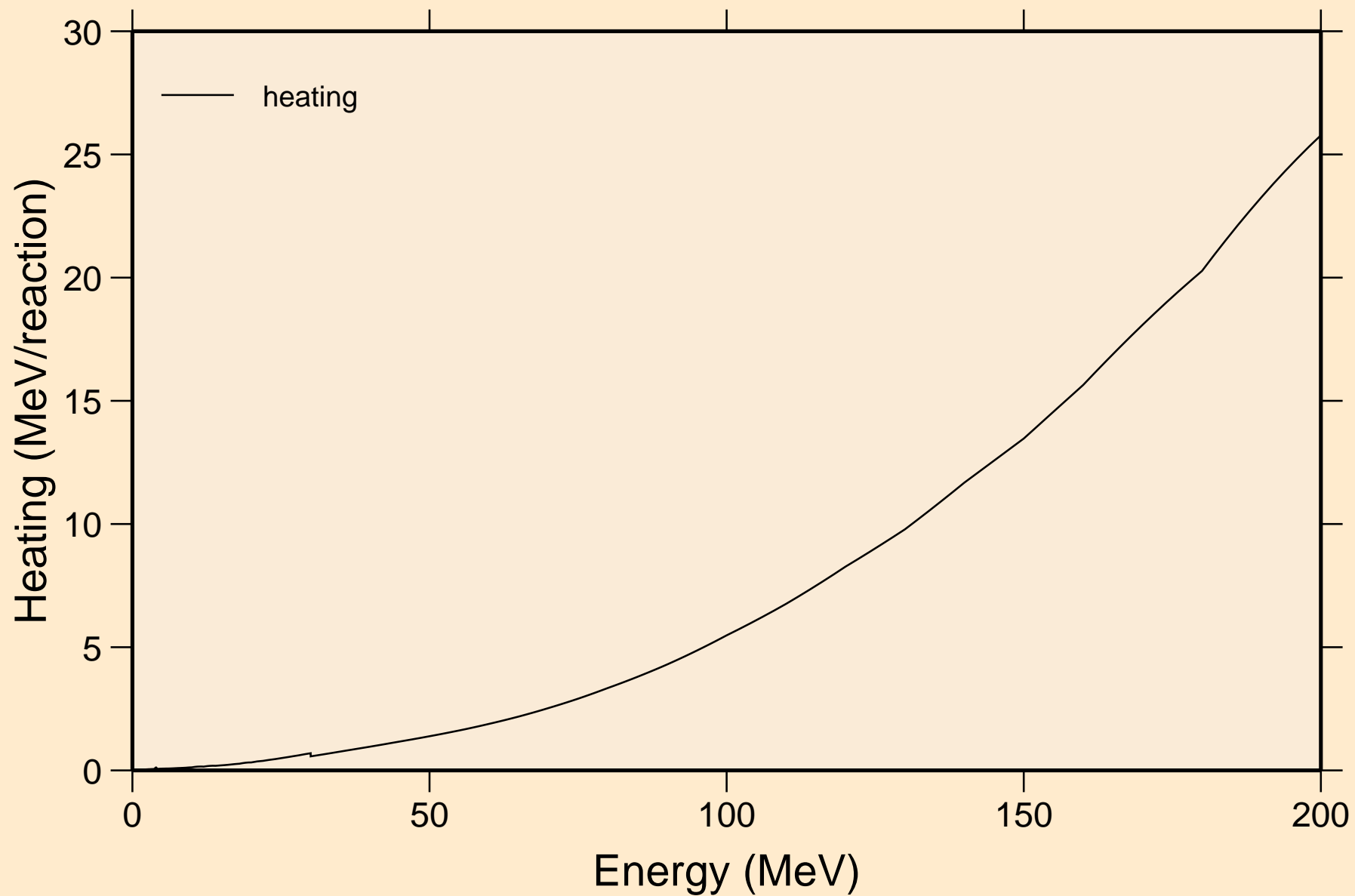

GE081 NEUTRON ACER TENDL-2019 LIBRARY; T=293.16K
Damage

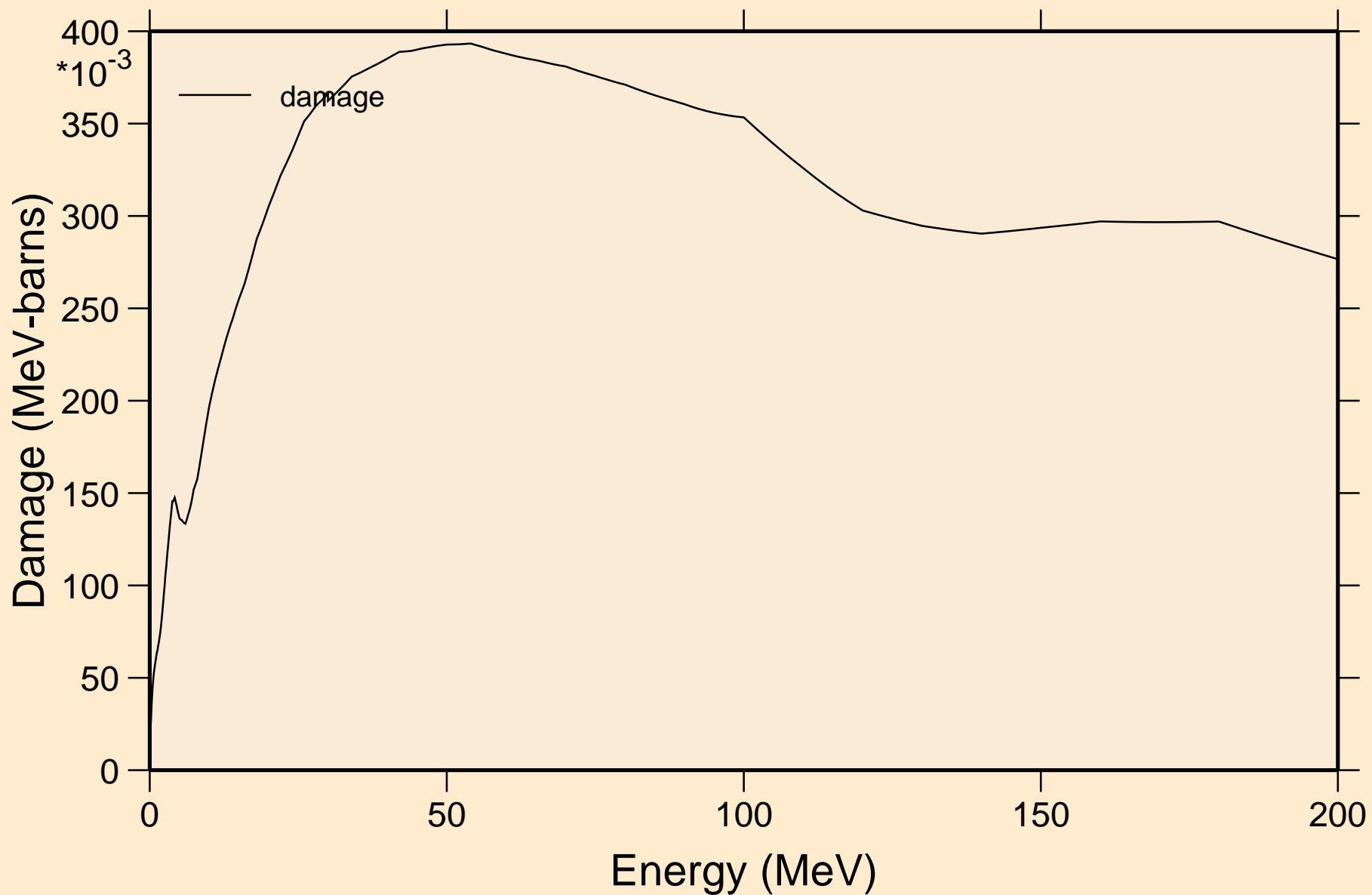

GE081 NEUTRON ACER TENDL-2019 LIBRARY; T=293.16K
Non-threshold reactions

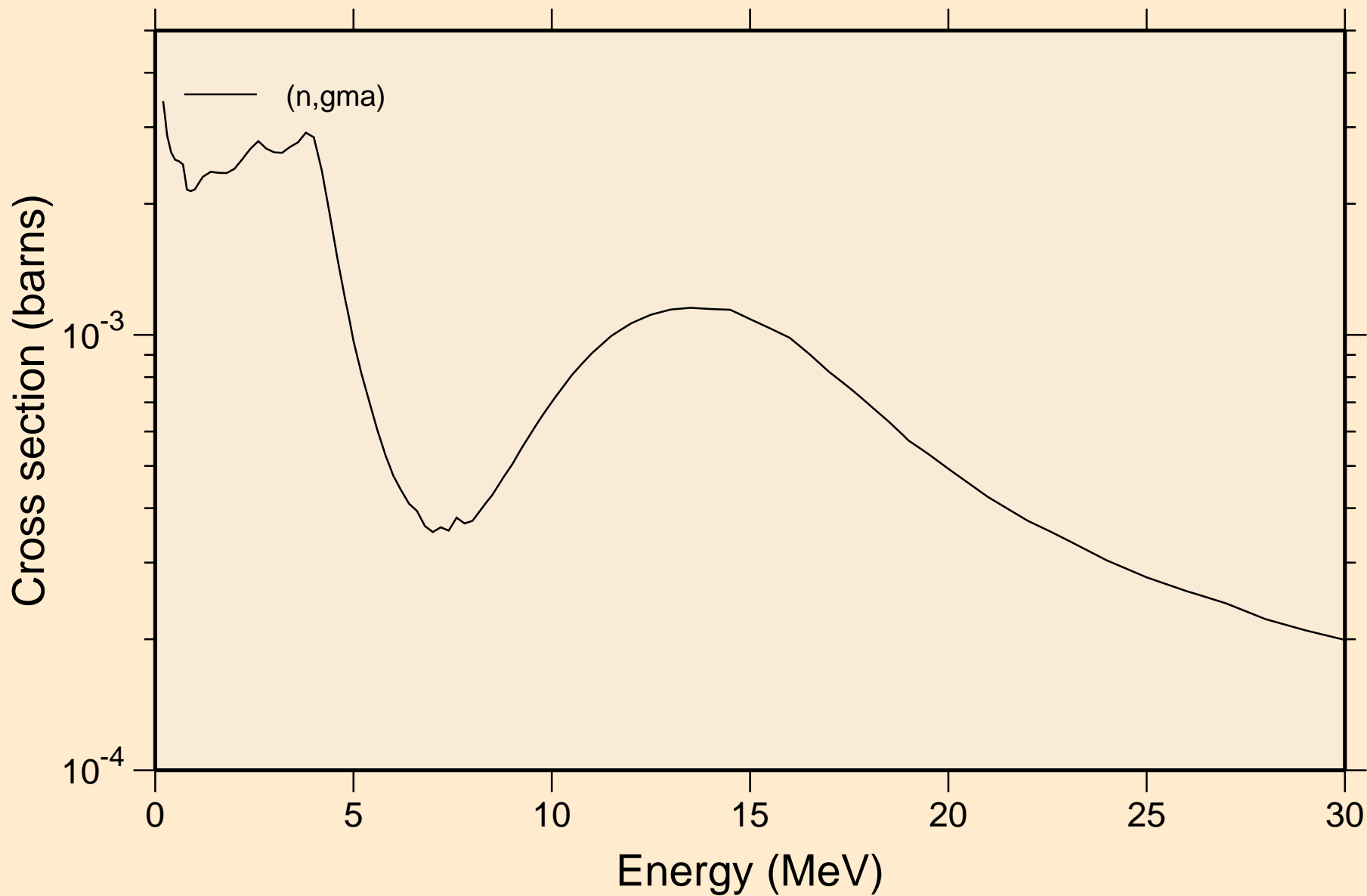

GE081 NEUTRON ACER TENDL-2019 LIBRARY; T=293.16K
Inelastic levels

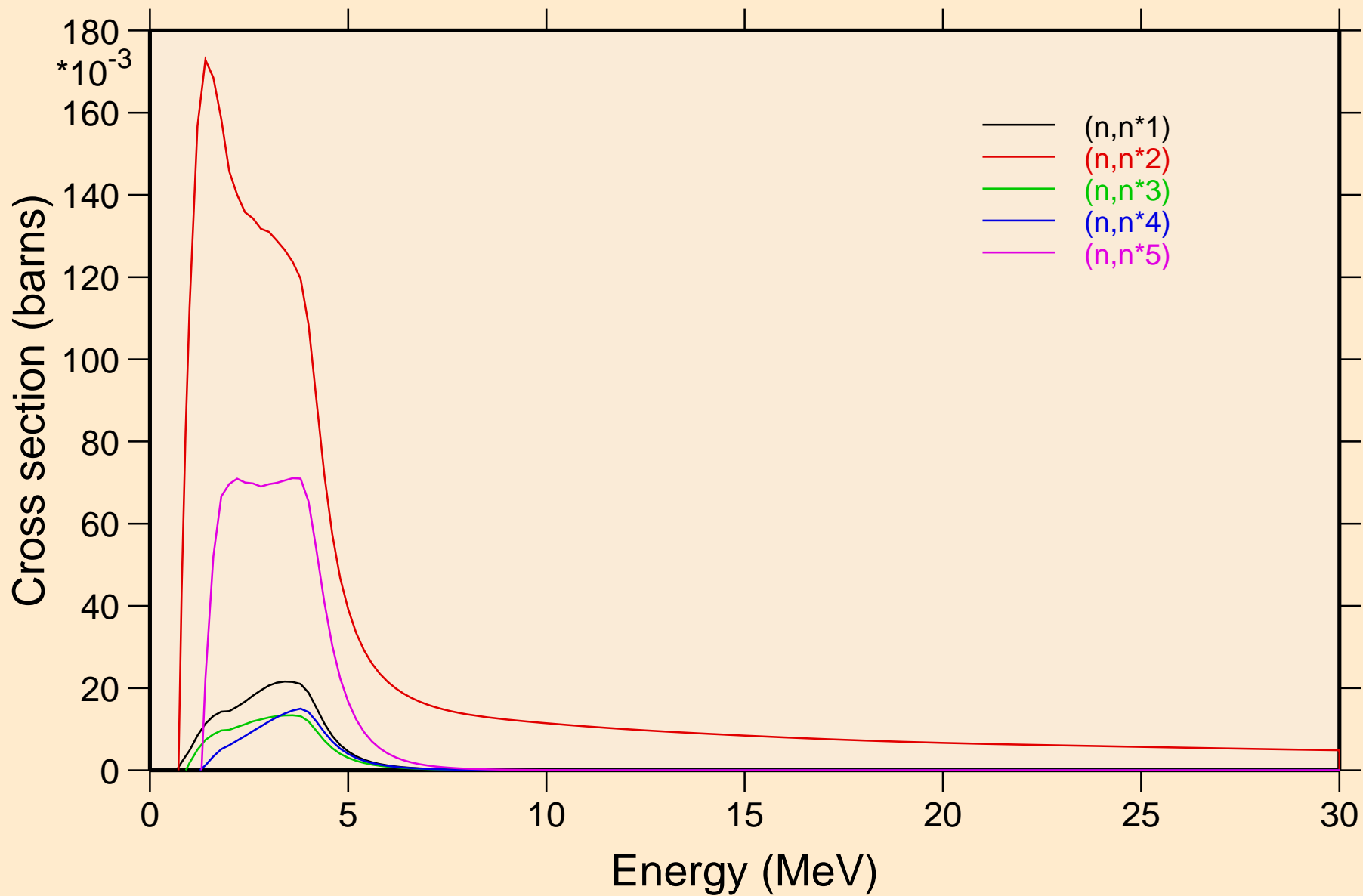

GE081 NEUTRON ACER TENDL-2019 LIBRARY; T=293.16K

Inelastic levels

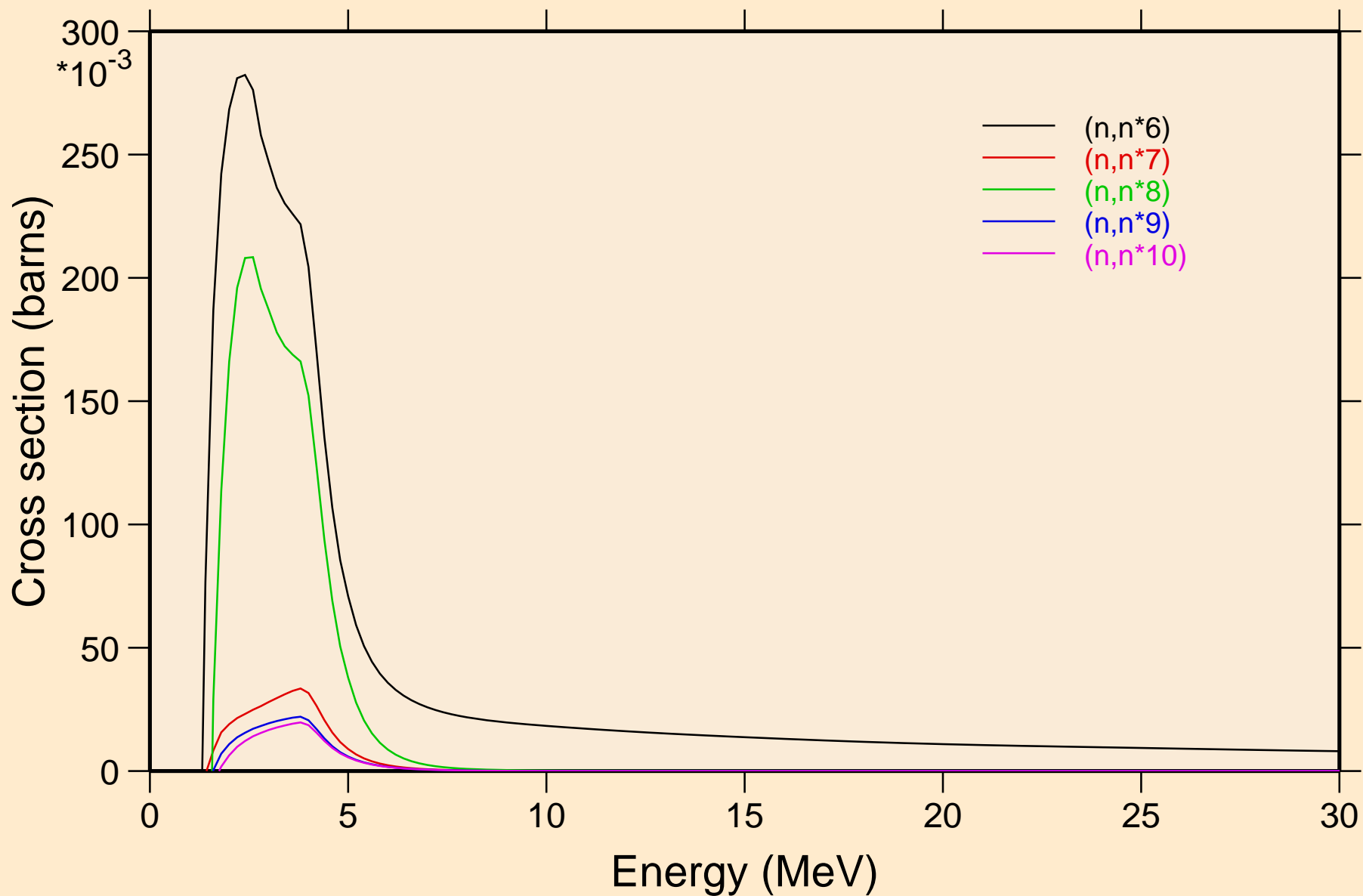

GE081 NEUTRON ACER TENDL-2019 LIBRARY; T=293.16K
Inelastic levels

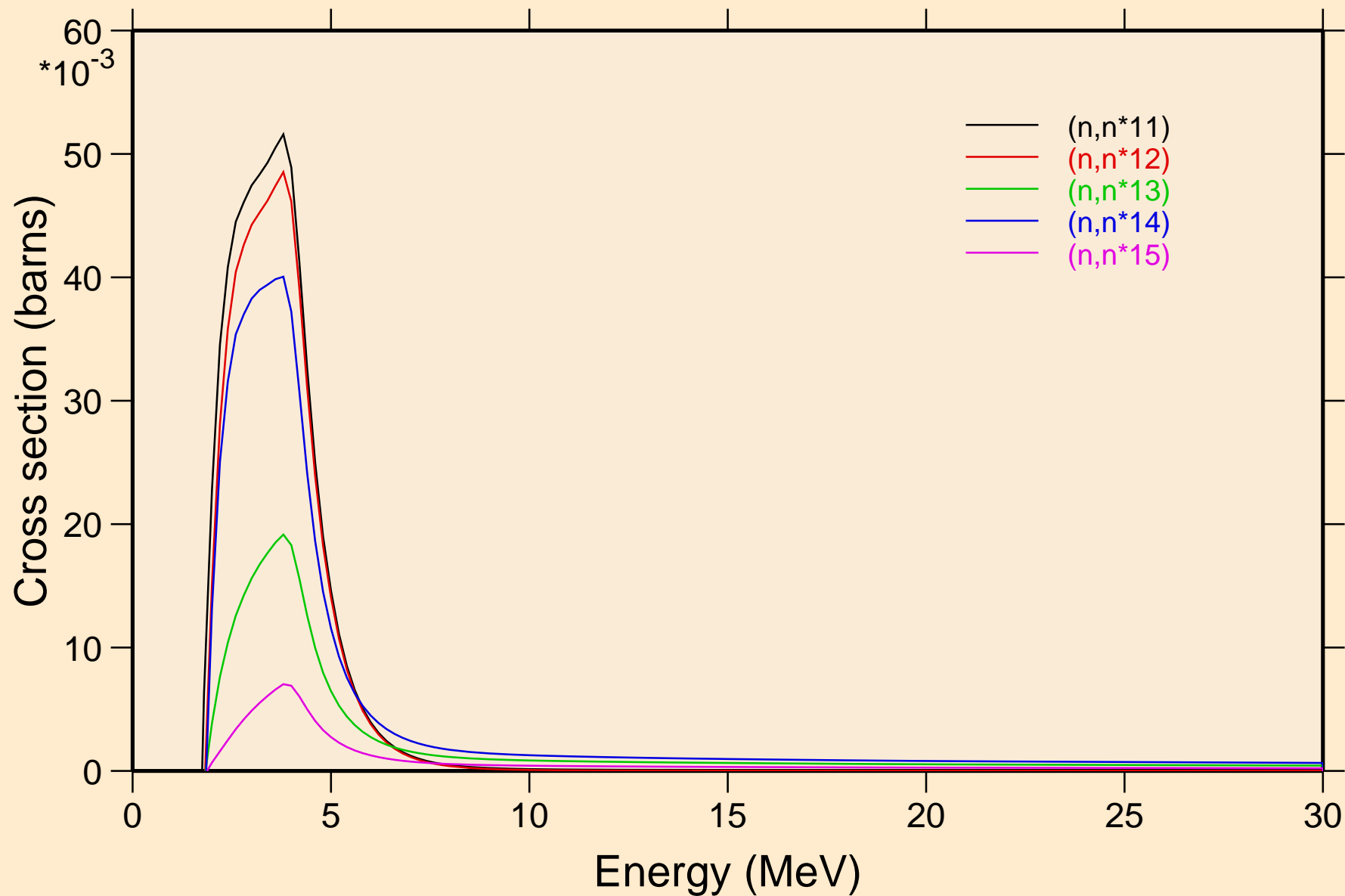

GE081 NEUTRON ACER TENDL-2019 LIBRARY; T=293.16K
Inelastic levels

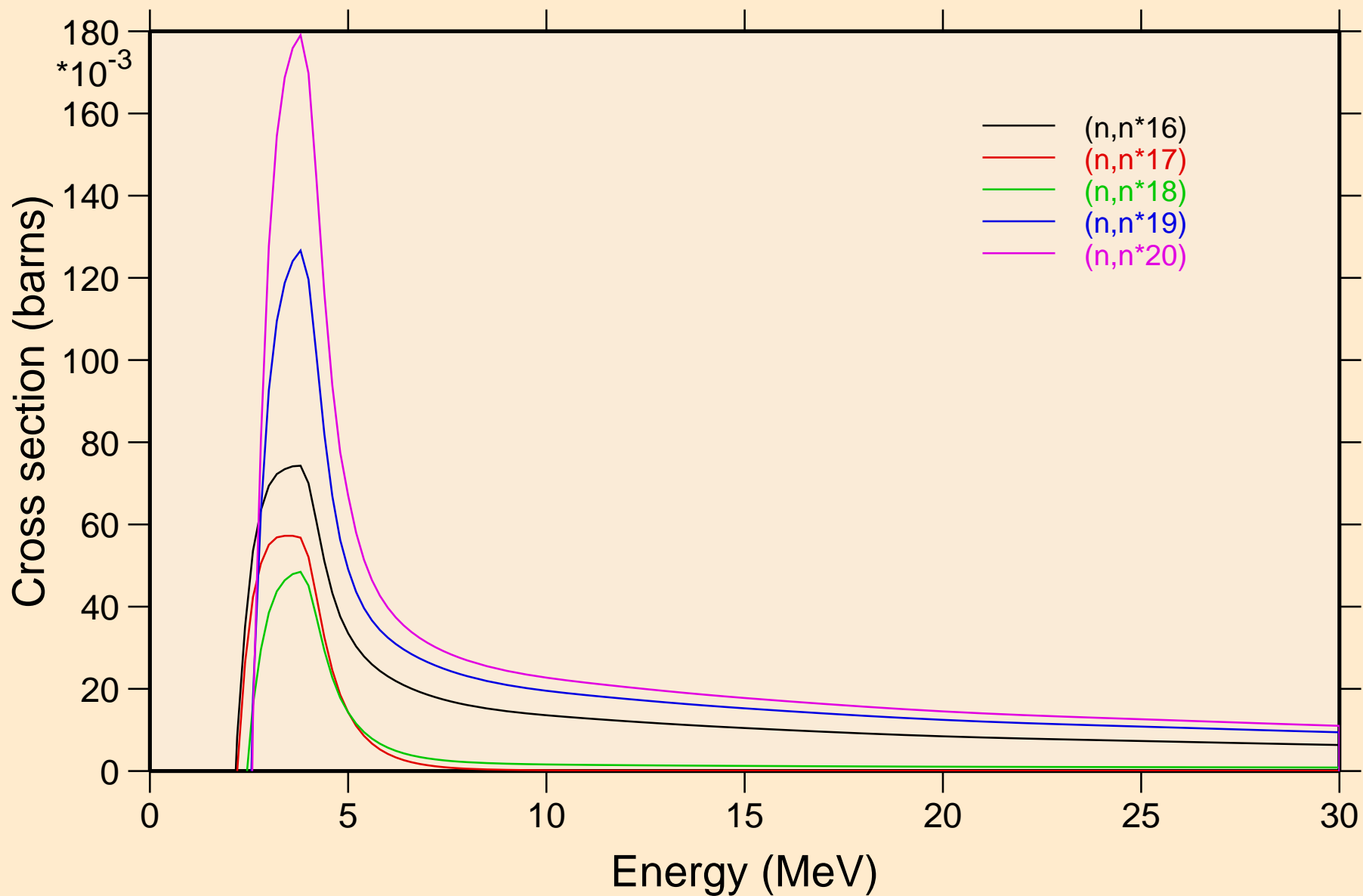

GE081 NEUTRON ACER TENDL-2019 LIBRARY; T=293.16K
Inelastic levels

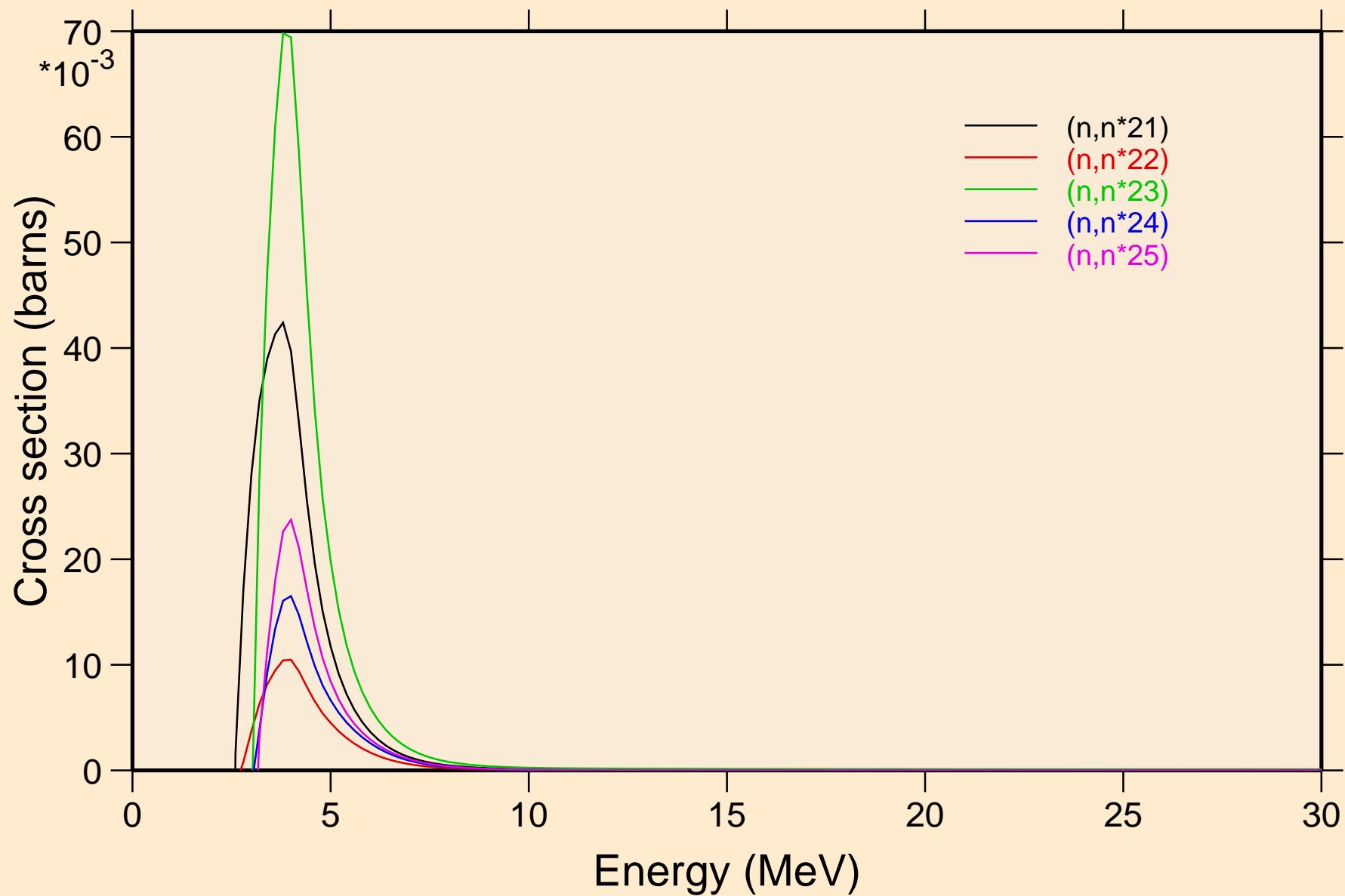

GE081 NEUTRON ACER TENDL-2019 LIBRARY; T=293.16K
Inelastic levels

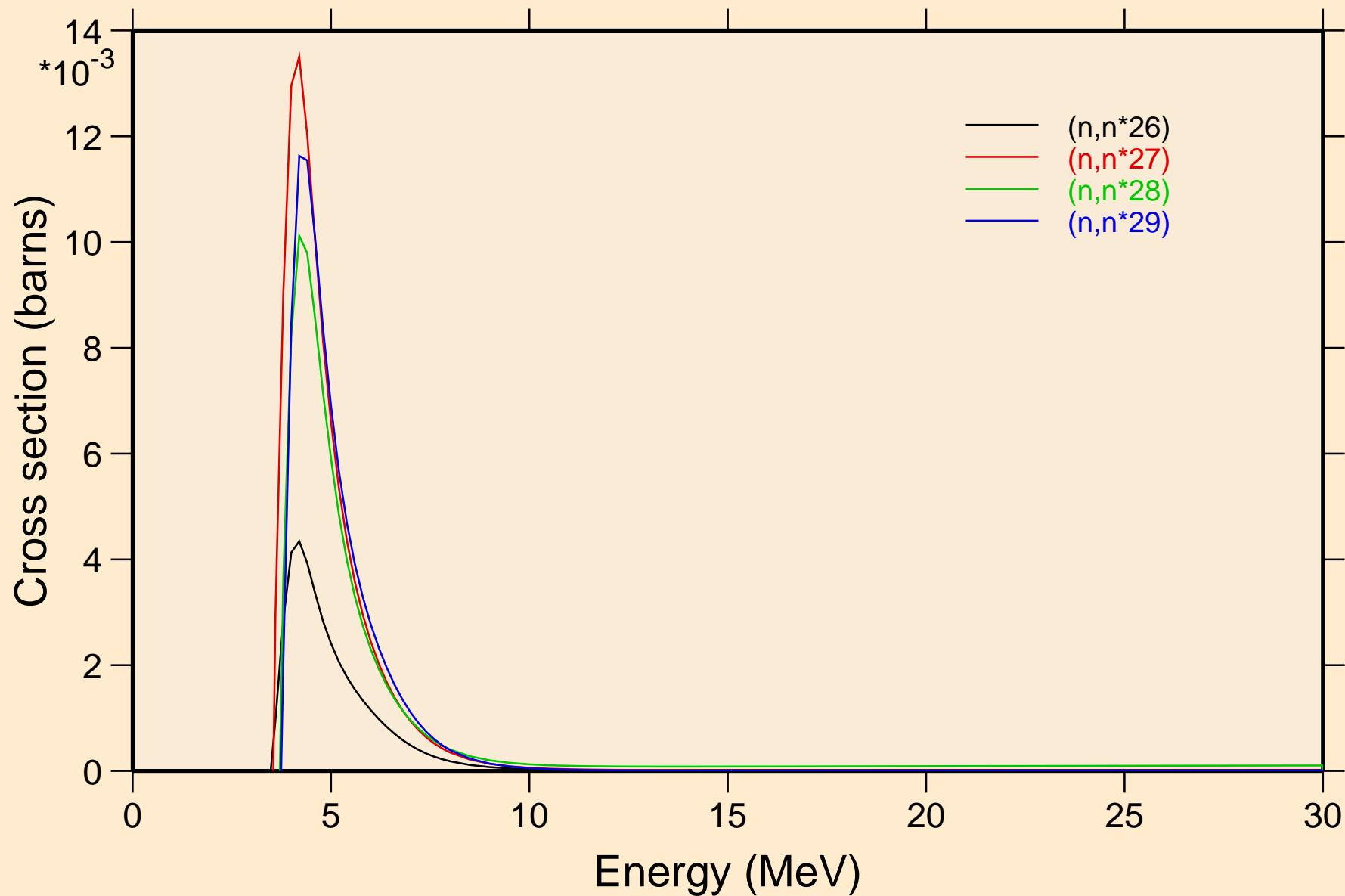

GE081 NEUTRON ACER TENDL-2019 LIBRARY; T=293.16K

Threshold reactions

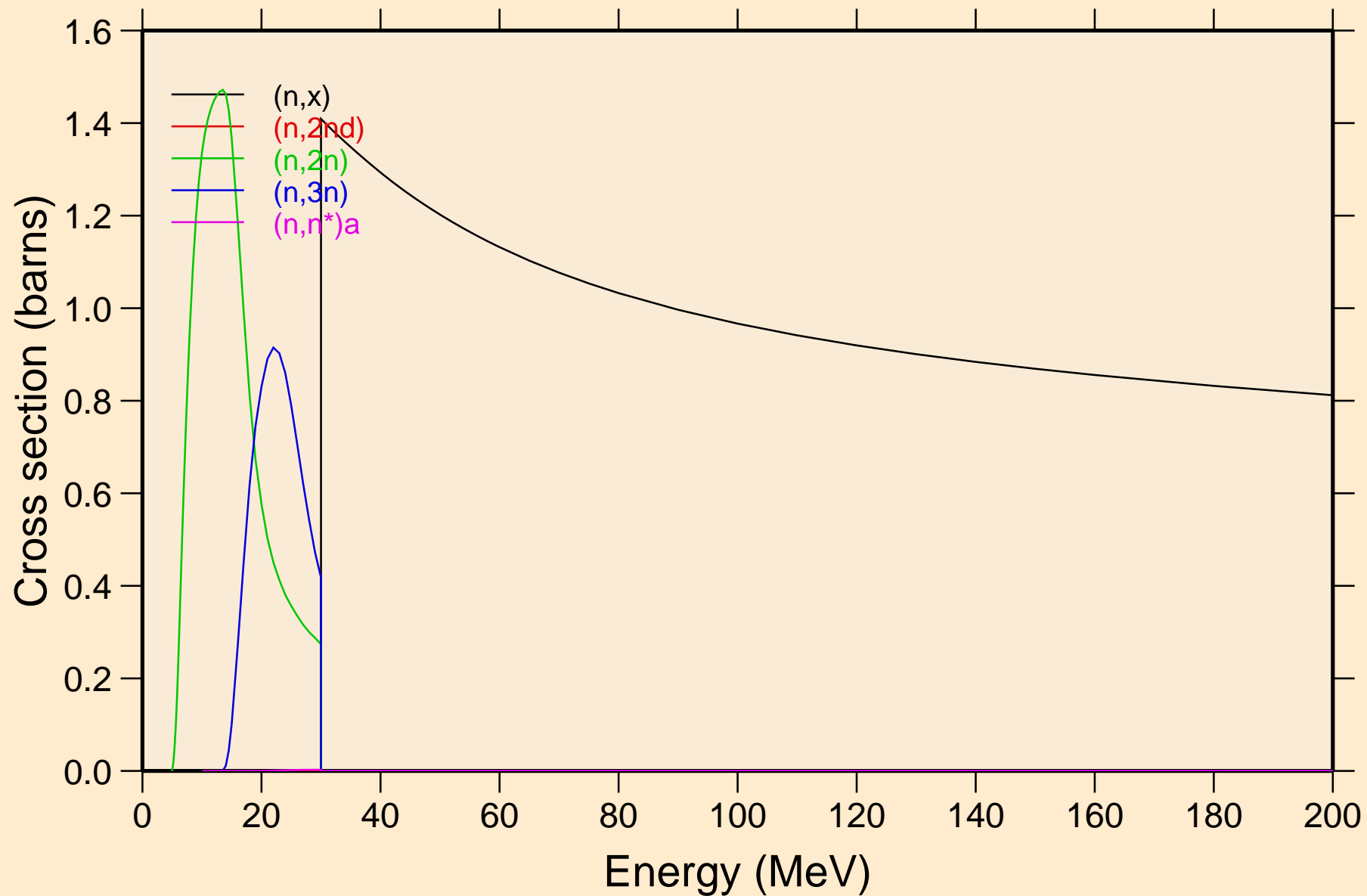

GE081 NEUTRON ACER TENDL-2019 LIBRARY; T=293.16K
Threshold reactions

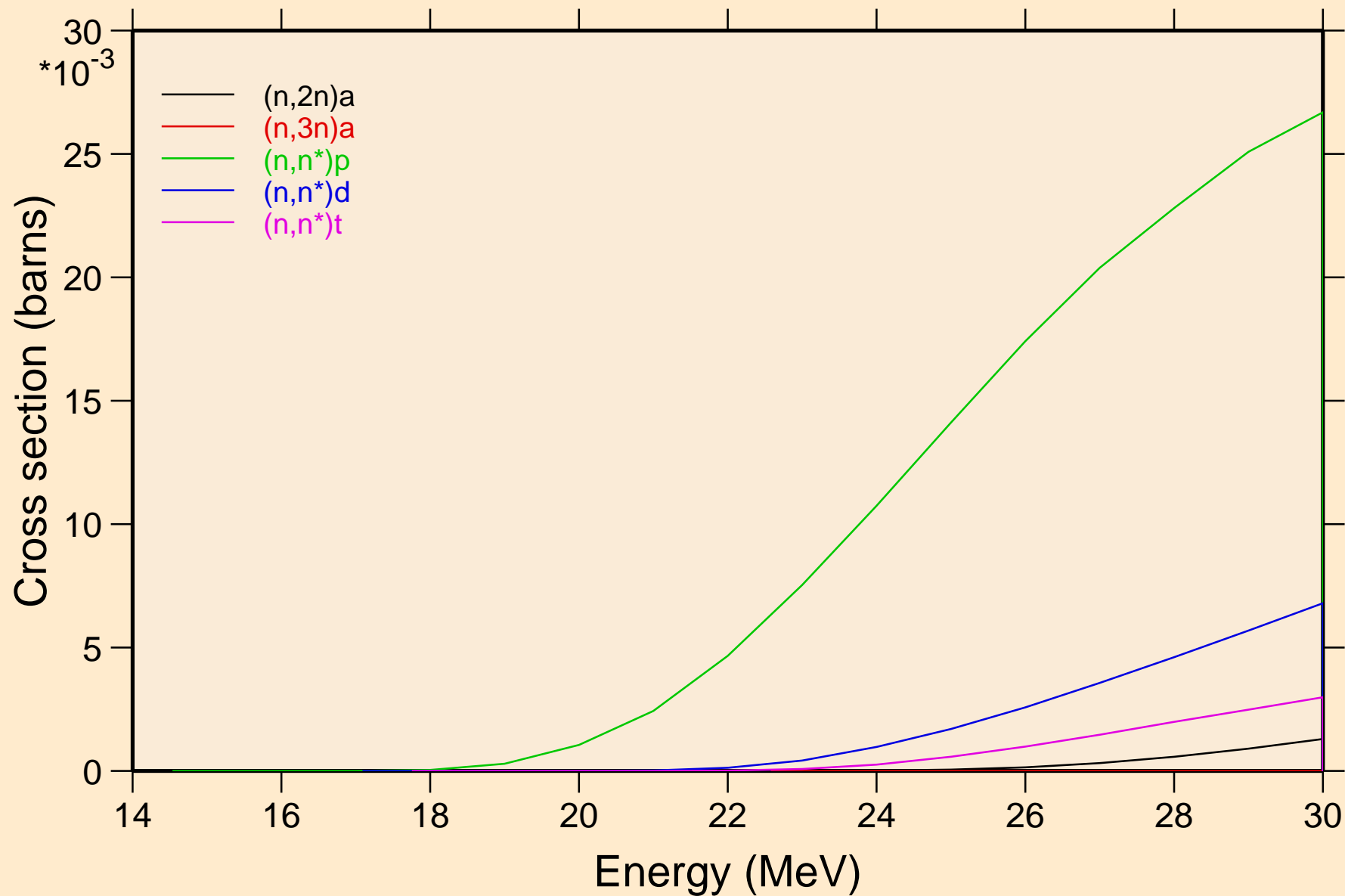

GE081 NEUTRON ACER TENDL-2019 LIBRARY; T=293.16K
Threshold reactions

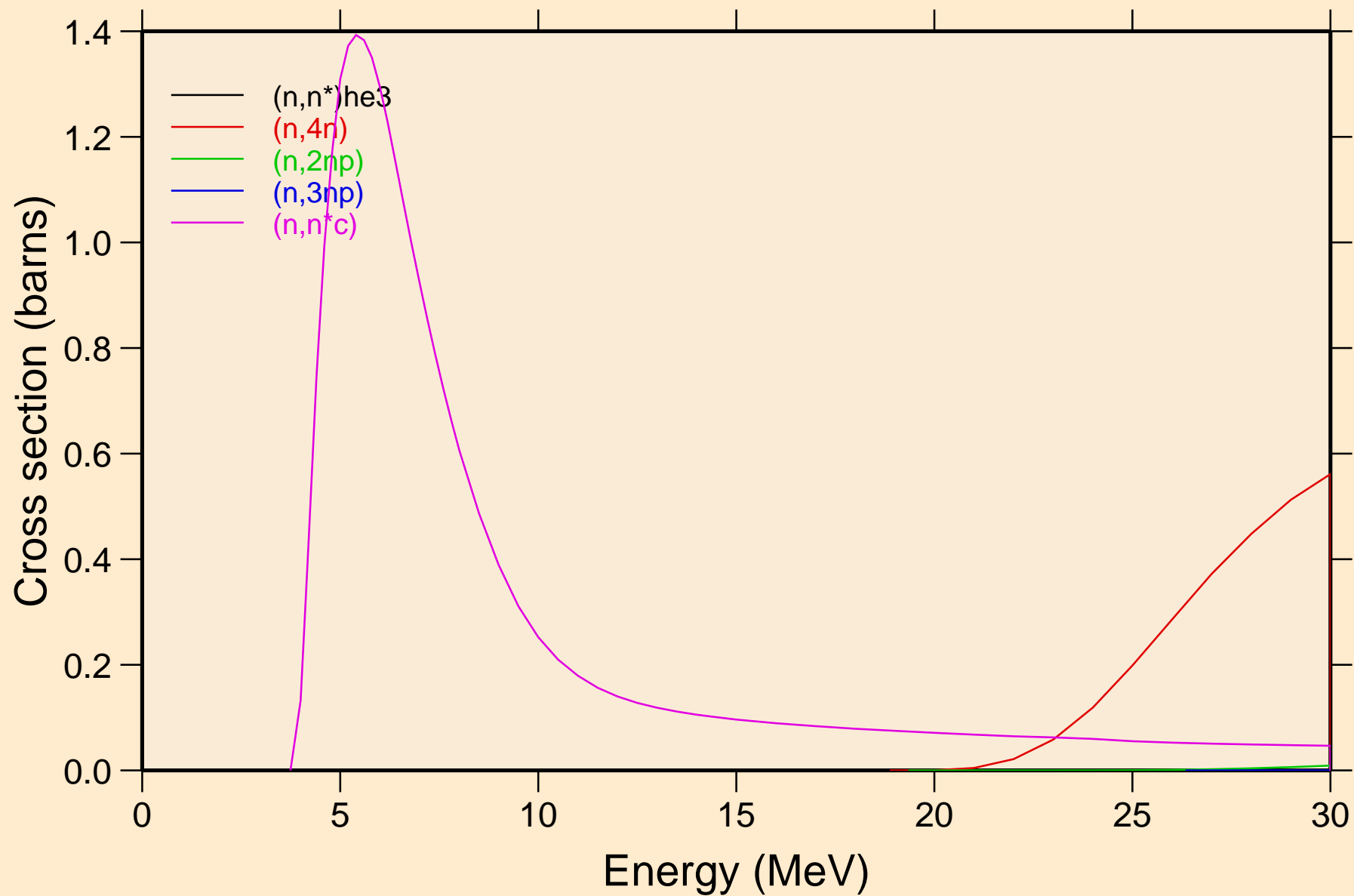

GE081 NEUTRON ACER TENDL-2019 LIBRARY; T=293.16K
Threshold reactions

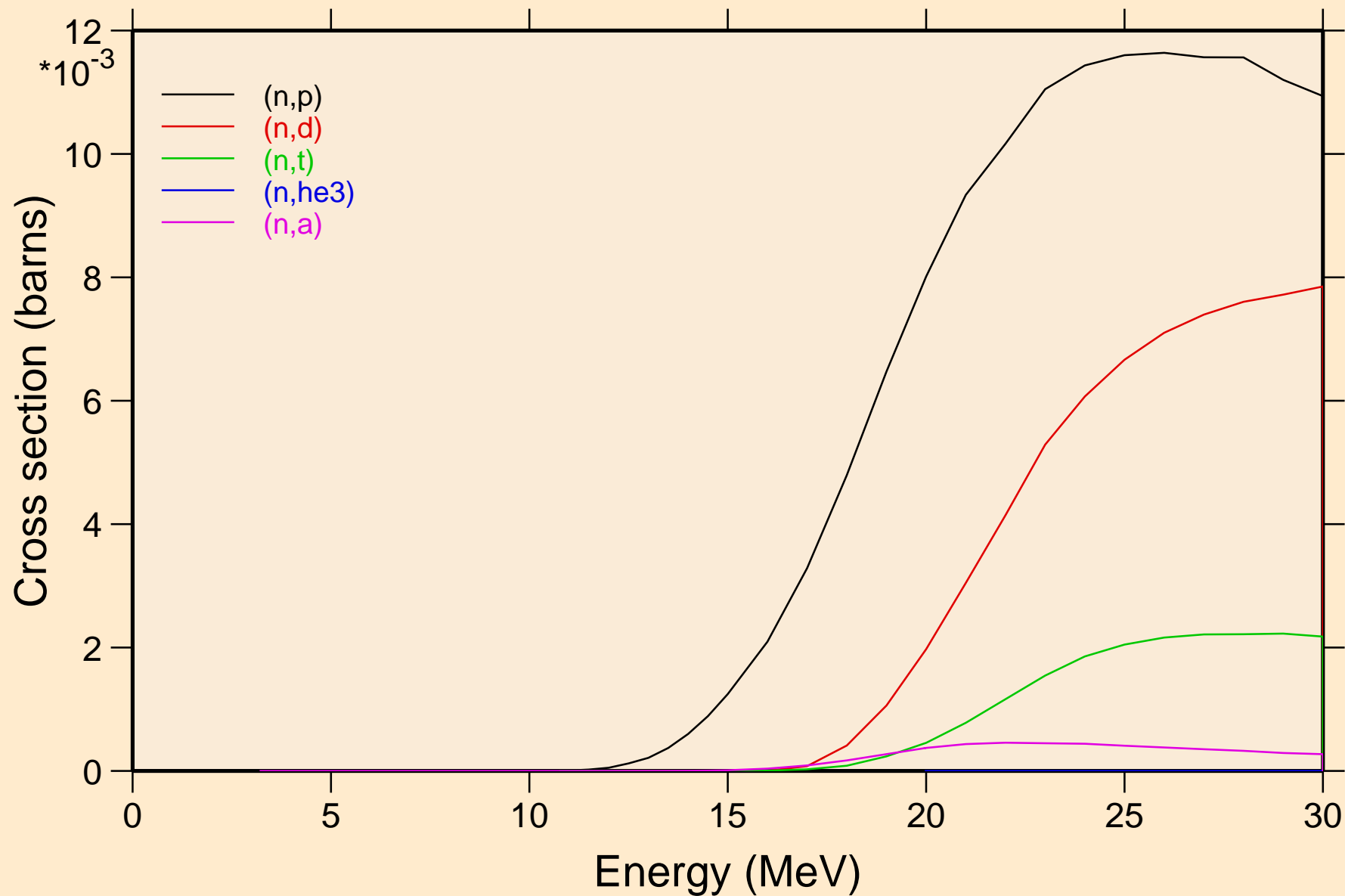

GE081 NEUTRON ACER TENDL-2019 LIBRARY; T=293.16K
Threshold reactions

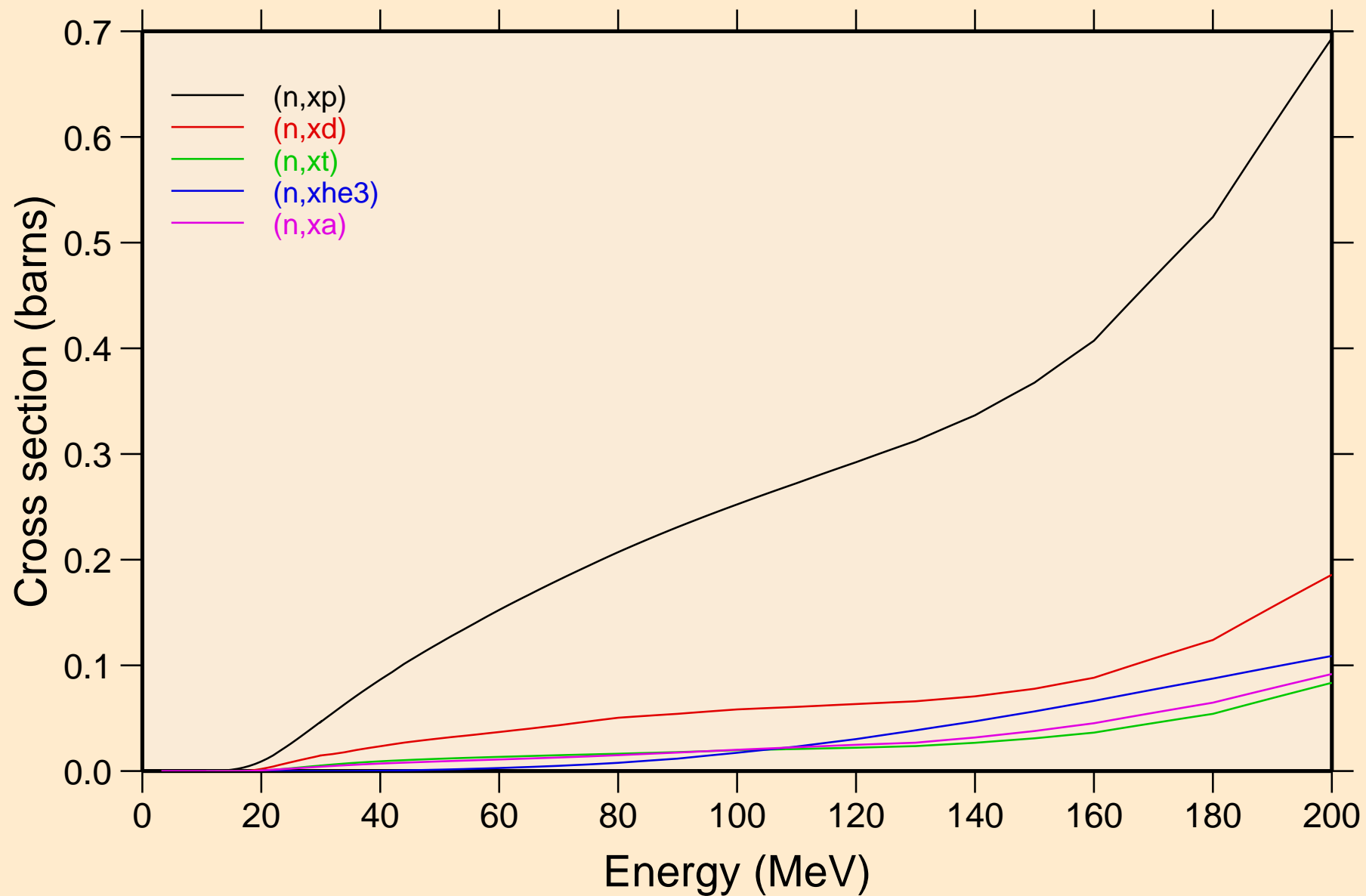

GE081 NEUTRON ACER TENDL-2019 LIBRARY; T=293.16K
angular distribution for elastic

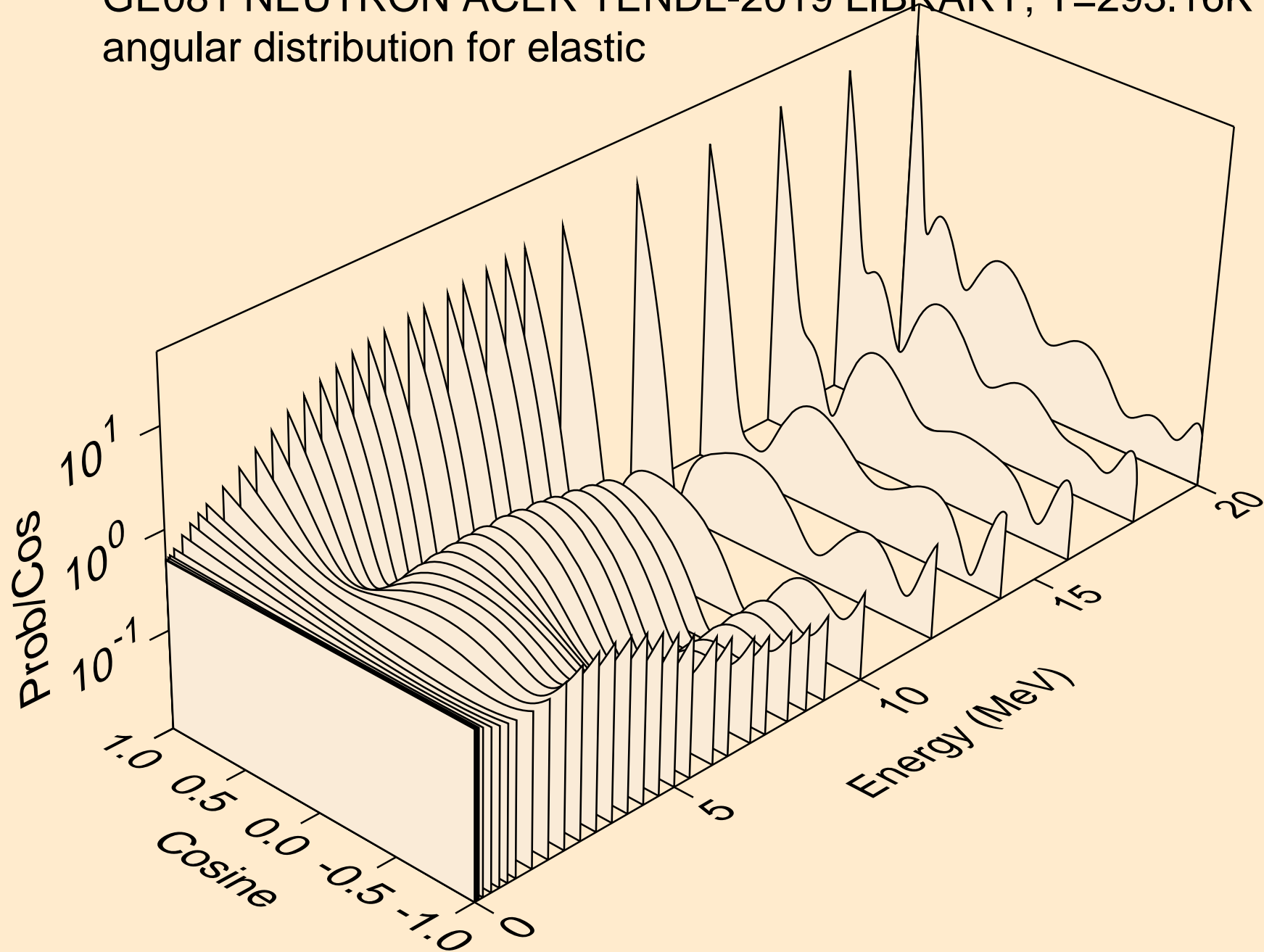

GE081 NEUTRON ACER TENDL-2019 LIBRARY; T=293.16K
angular distribution for elastic

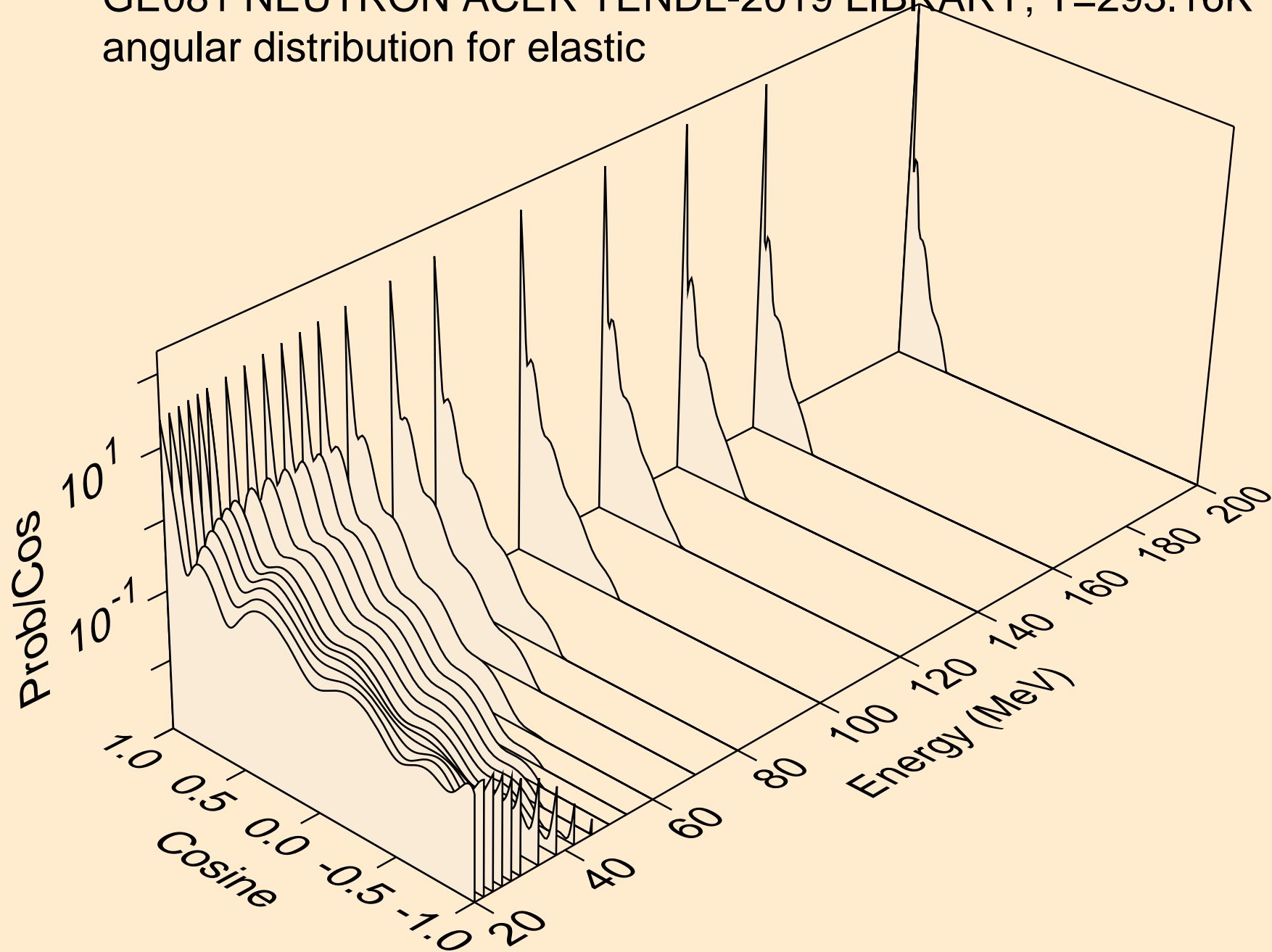

GE081 NEUTRON ACER TENDL-2019 LIBRARY; T=293.16K
angular distribution for (n,n*1)

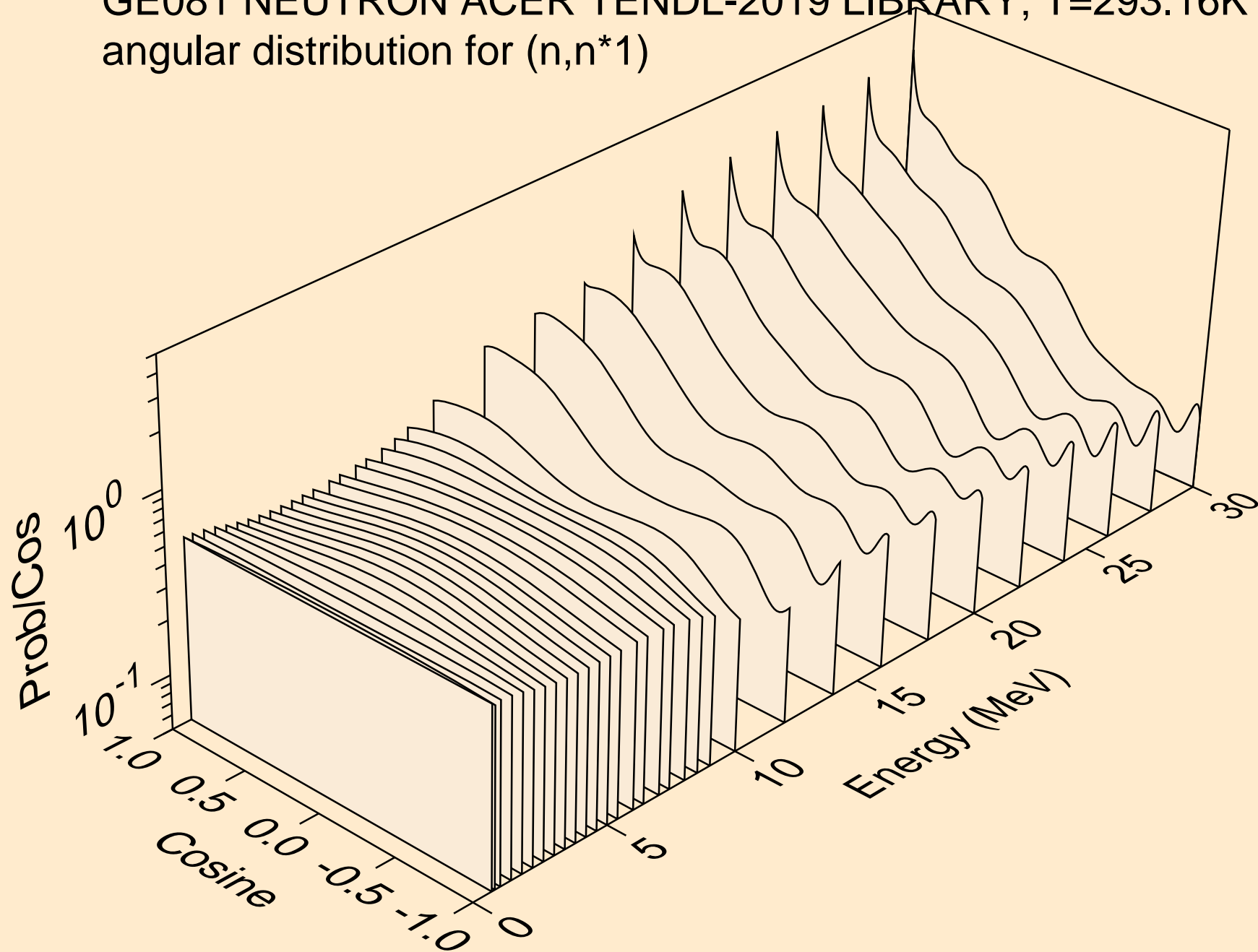

GE081 NEUTRON ACER TENDL-2019 LIBRARY; T=293.16K
angular distribution for (n,n*2)

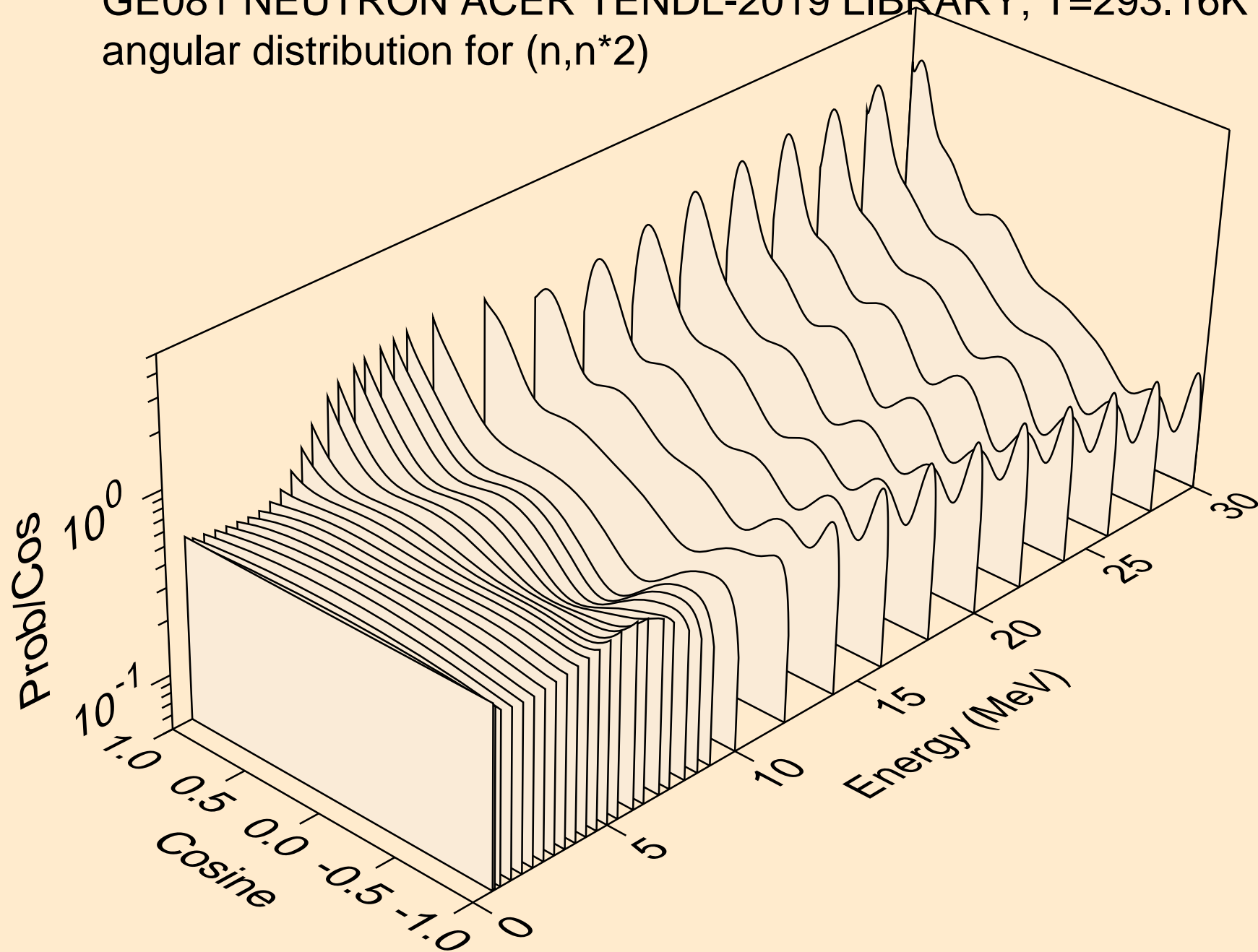

GE081 NEUTRON ACER TENDL-2019 LIBRARY; T=293.16K
angular distribution for (n,n*3)

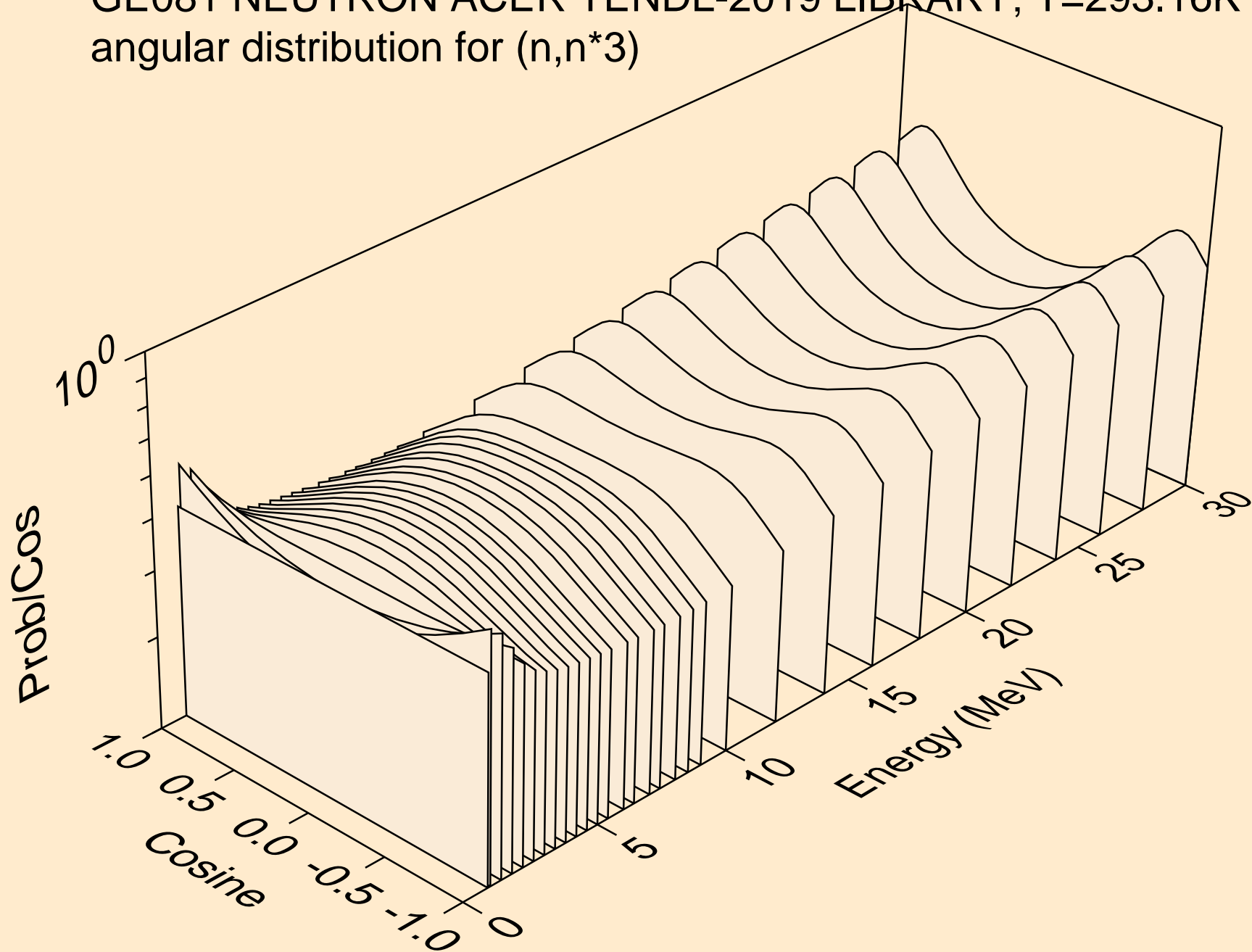

GE081 NEUTRON ACER TENDL-2019 LIBRARY; T=293.16K
angular distribution for (n,n*4)

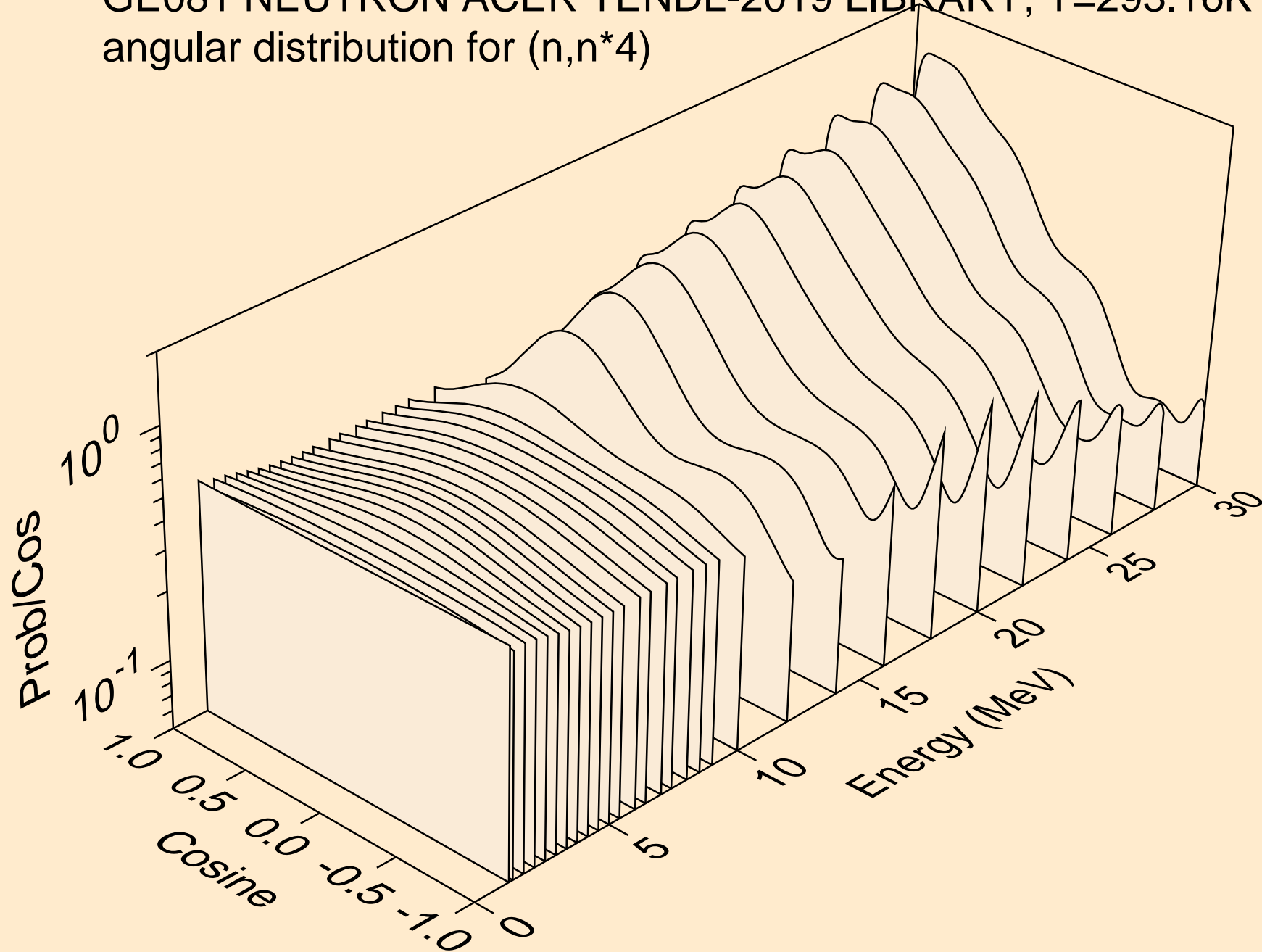

GE081 NEUTRON ACER TENDL-2019 LIBRARY; T=293.16K
angular distribution for (n,n*5)

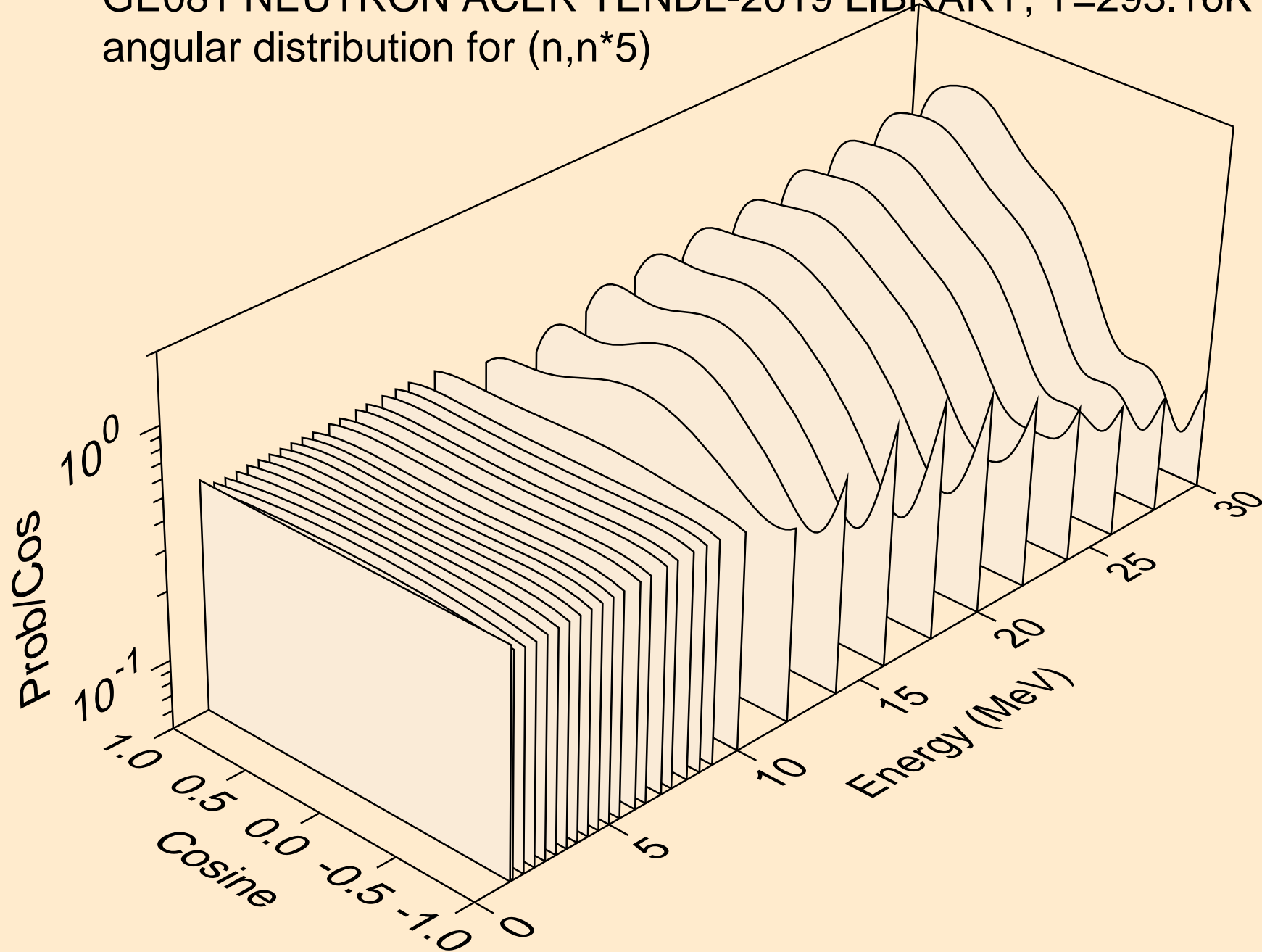

GE081 NEUTRON ACER TENDL-2019 LIBRARY; T=293.16K
angular distribution for (n,n*6)

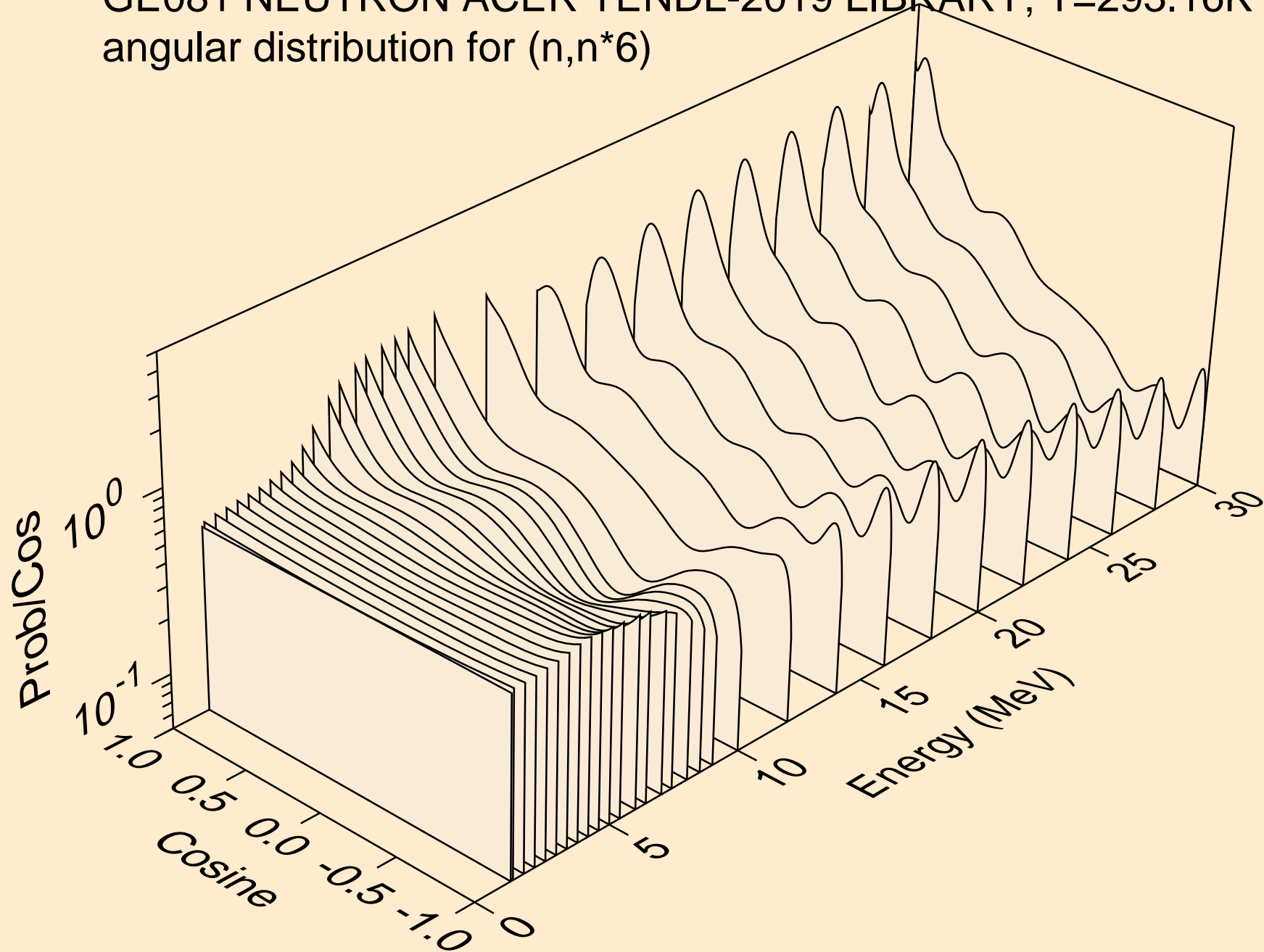

GE081 NEUTRON ACER TENDL-2019 LIBRARY; T=293.16K
angular distribution for (n,n*7)

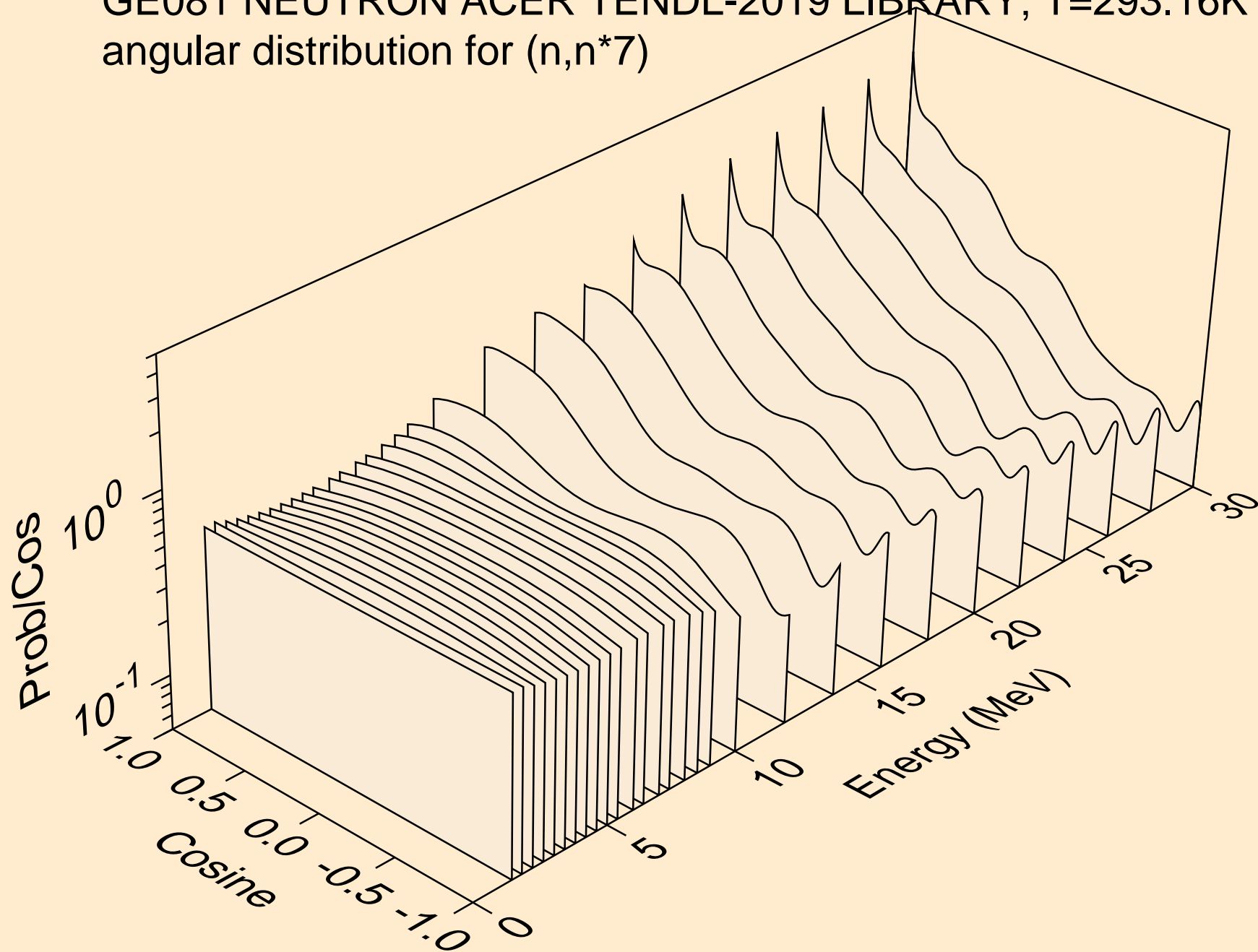

GE081 NEUTRON ACER TENDL-2019 LIBRARY; T=293.16K
angular distribution for (n,n*8)

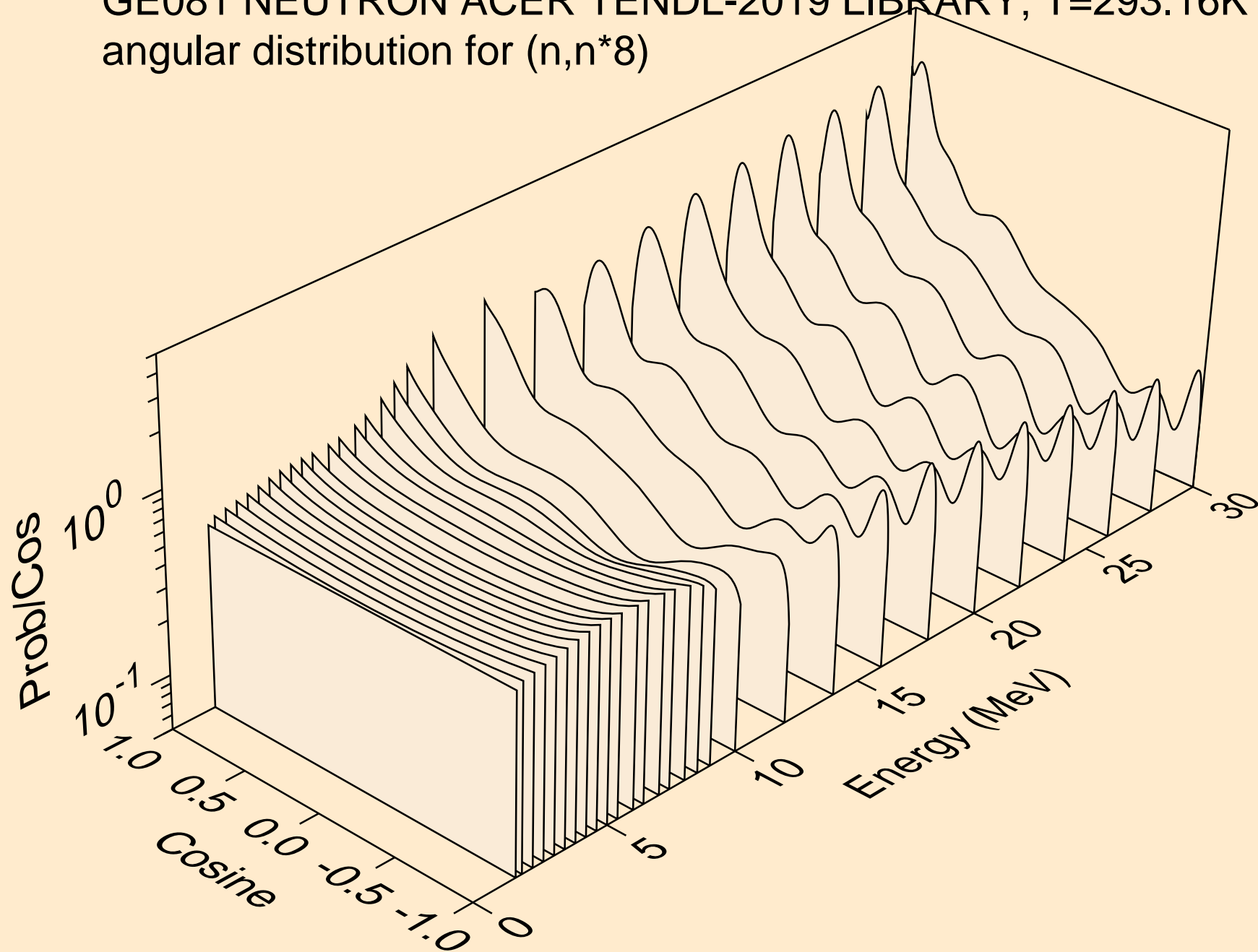

GE081 NEUTRON ACER TENDL-2019 LIBRARY; T=293.16K
angular distribution for (n,n*9)

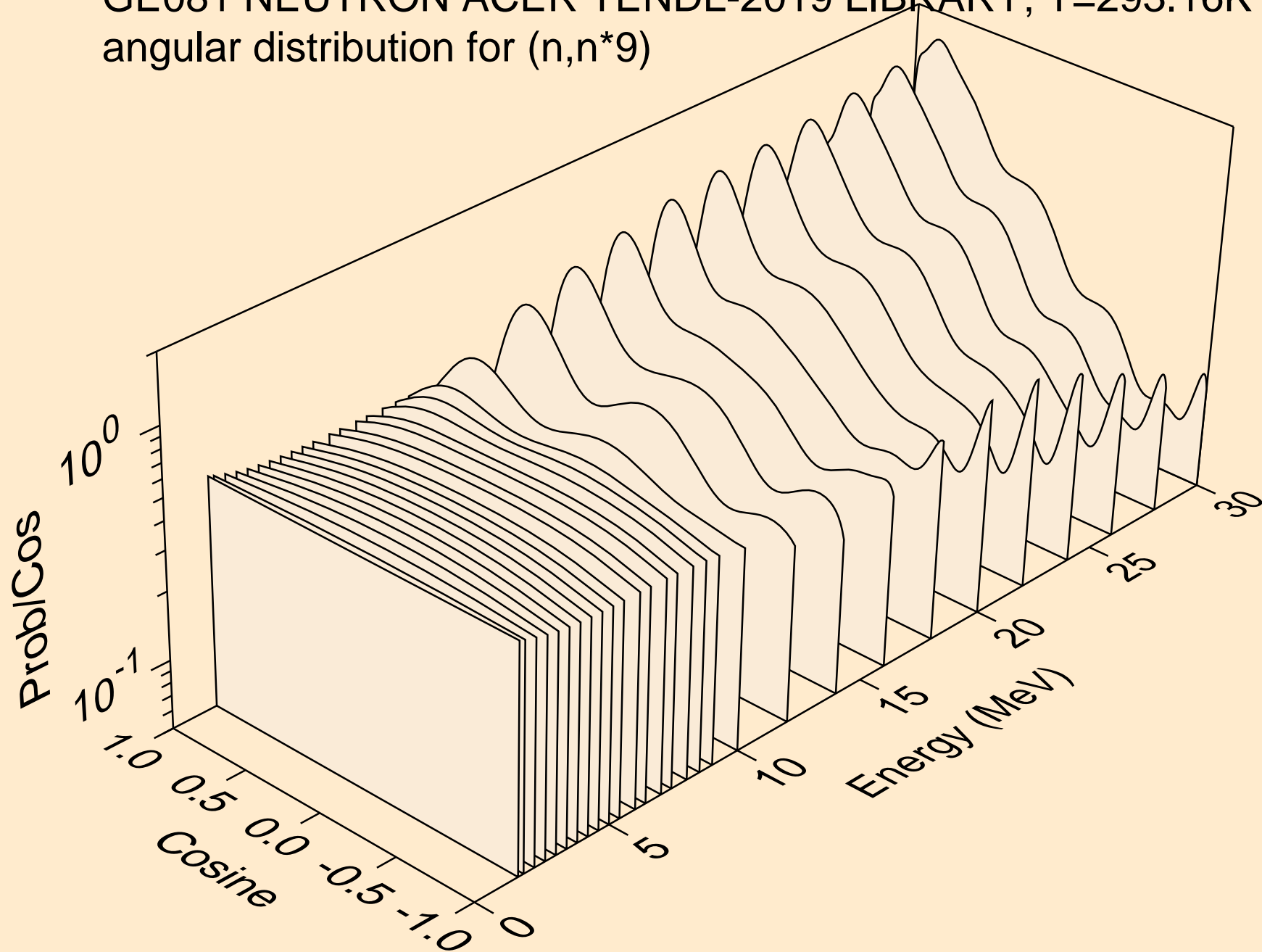

GE081 NEUTRON ACER TENDL-2019 LIBRARY; T=293.16K
angular distribution for (n,n*10)

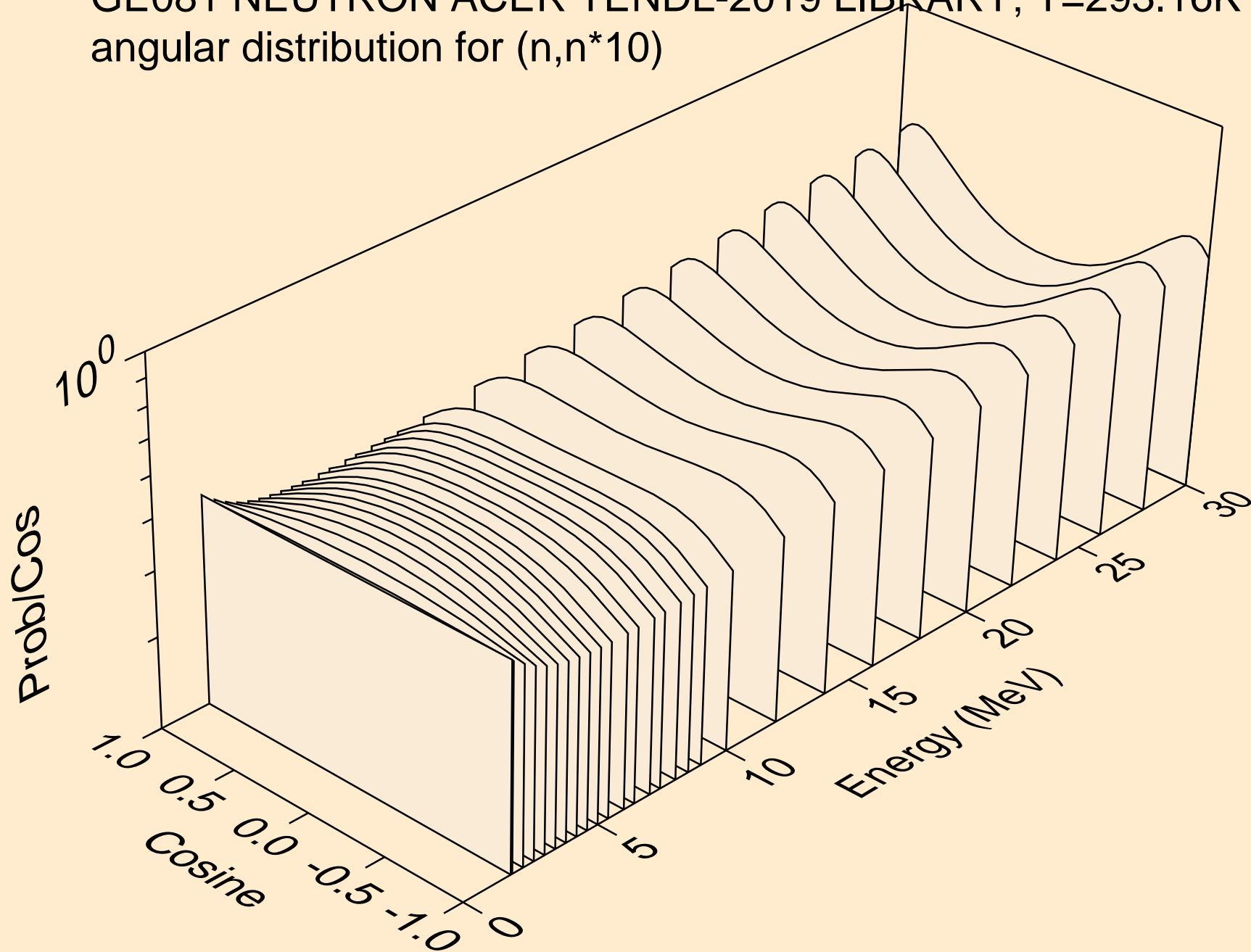

GE081 NEUTRON ACER TENDL-2019 LIBRARY; T=293.16K
angular distribution for (n,n*11)

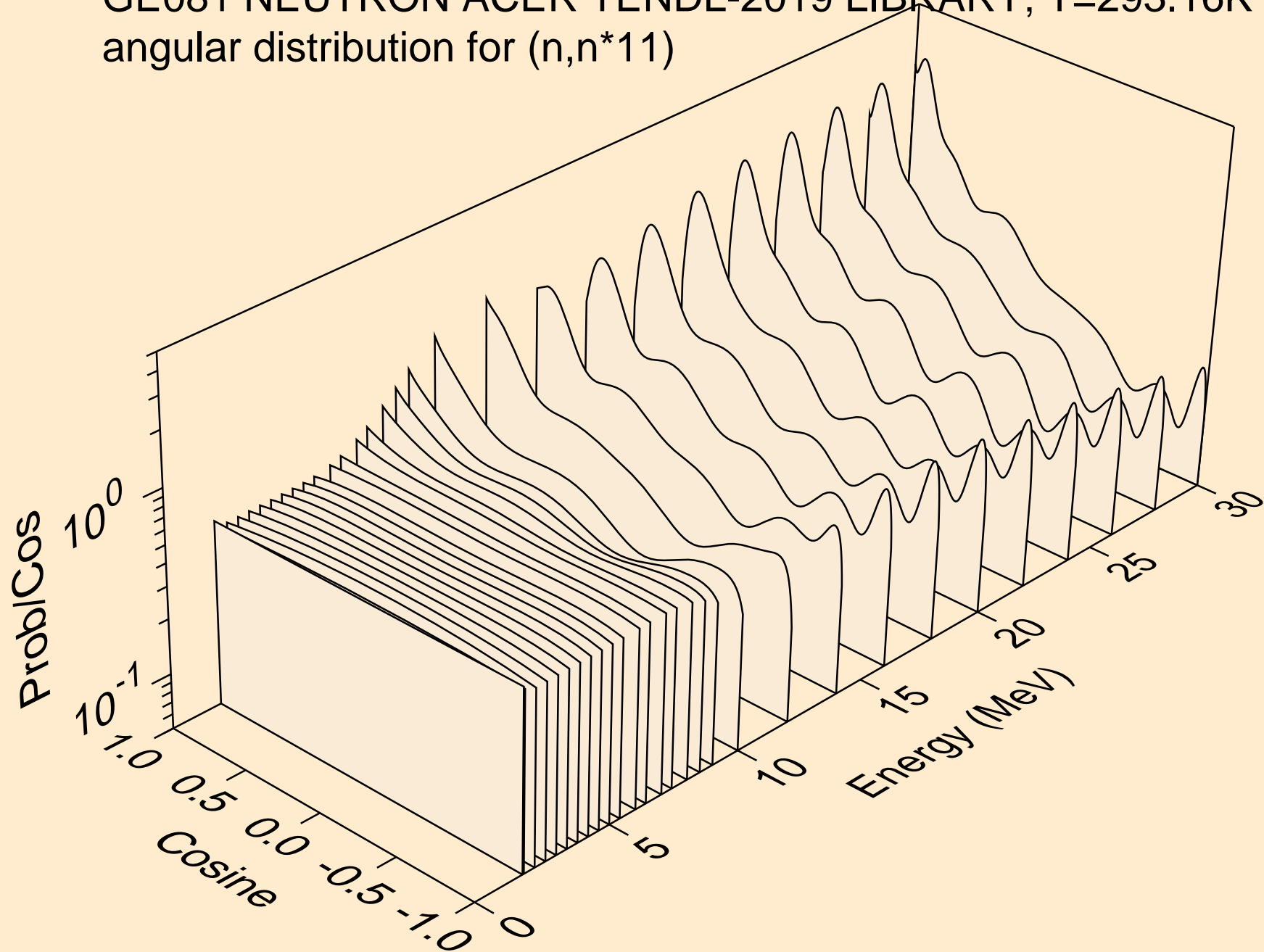

GE081 NEUTRON ACER TENDL-2019 LIBRARY; T=293.16K
angular distribution for (n,n*12)

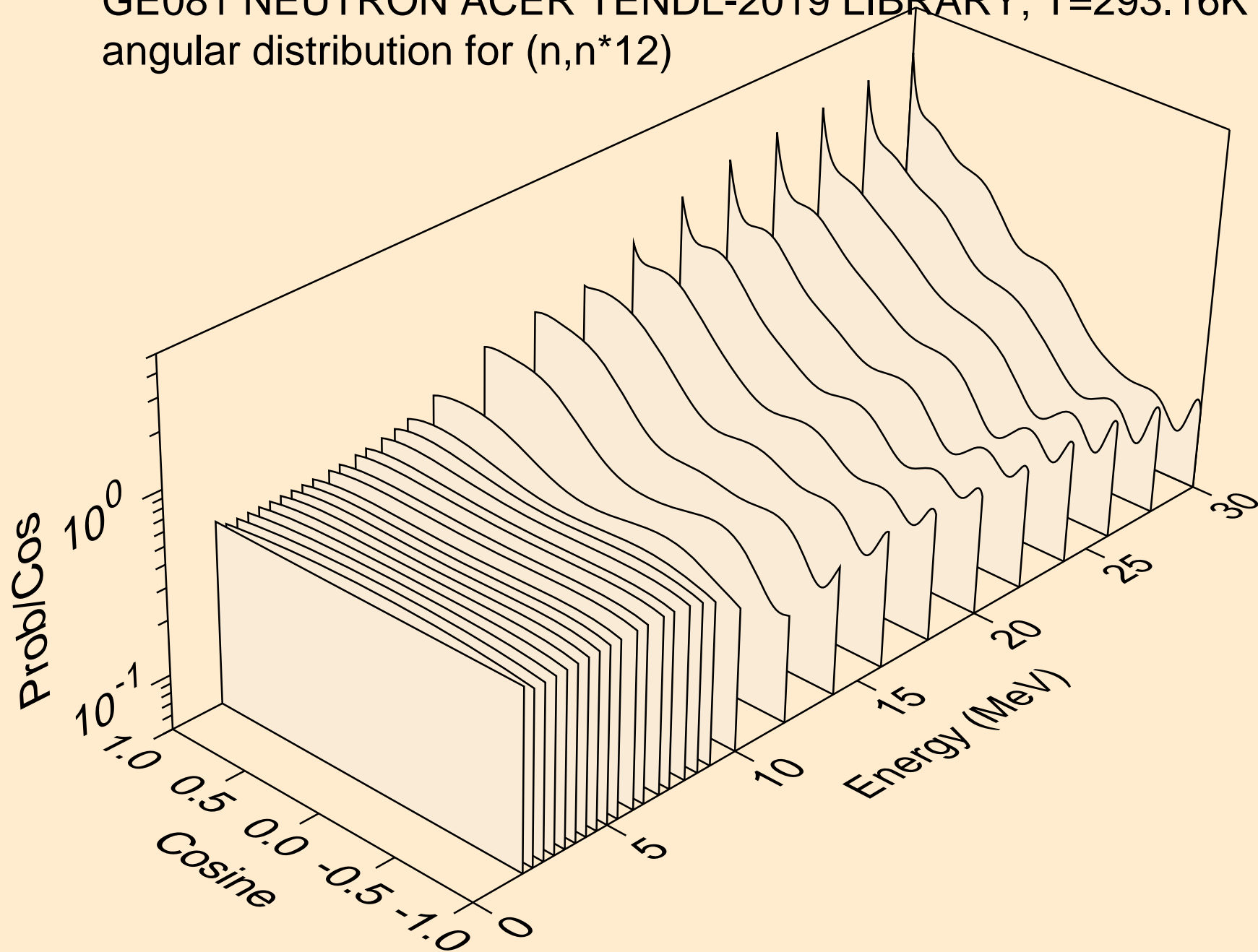

GE081 NEUTRON ACER TENDL-2019 LIBRARY; T=293.16K
angular distribution for (n,n*13)

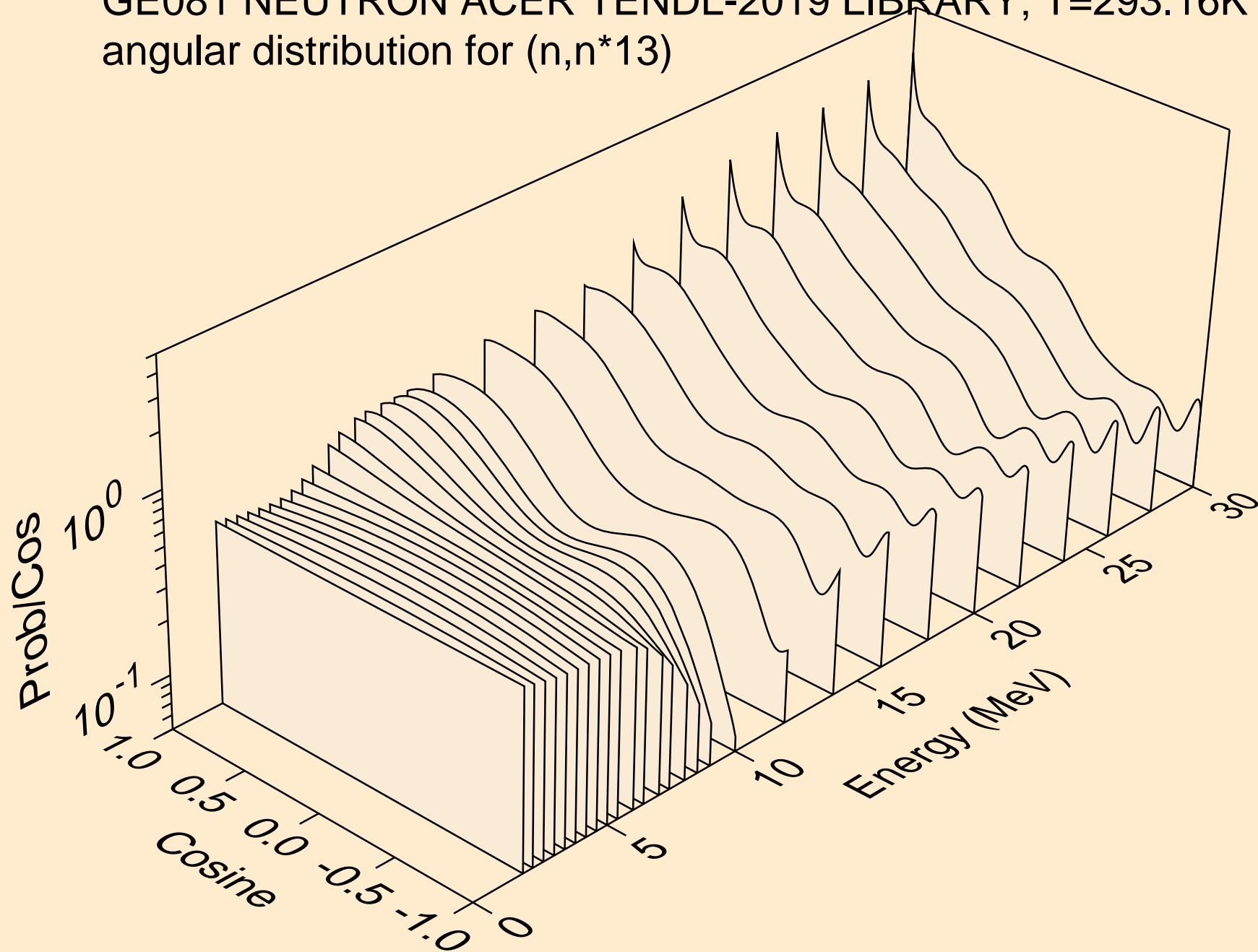

GE081 NEUTRON ACER TENDL-2019 LIBRARY; T=293.16K
angular distribution for (n,n*14)

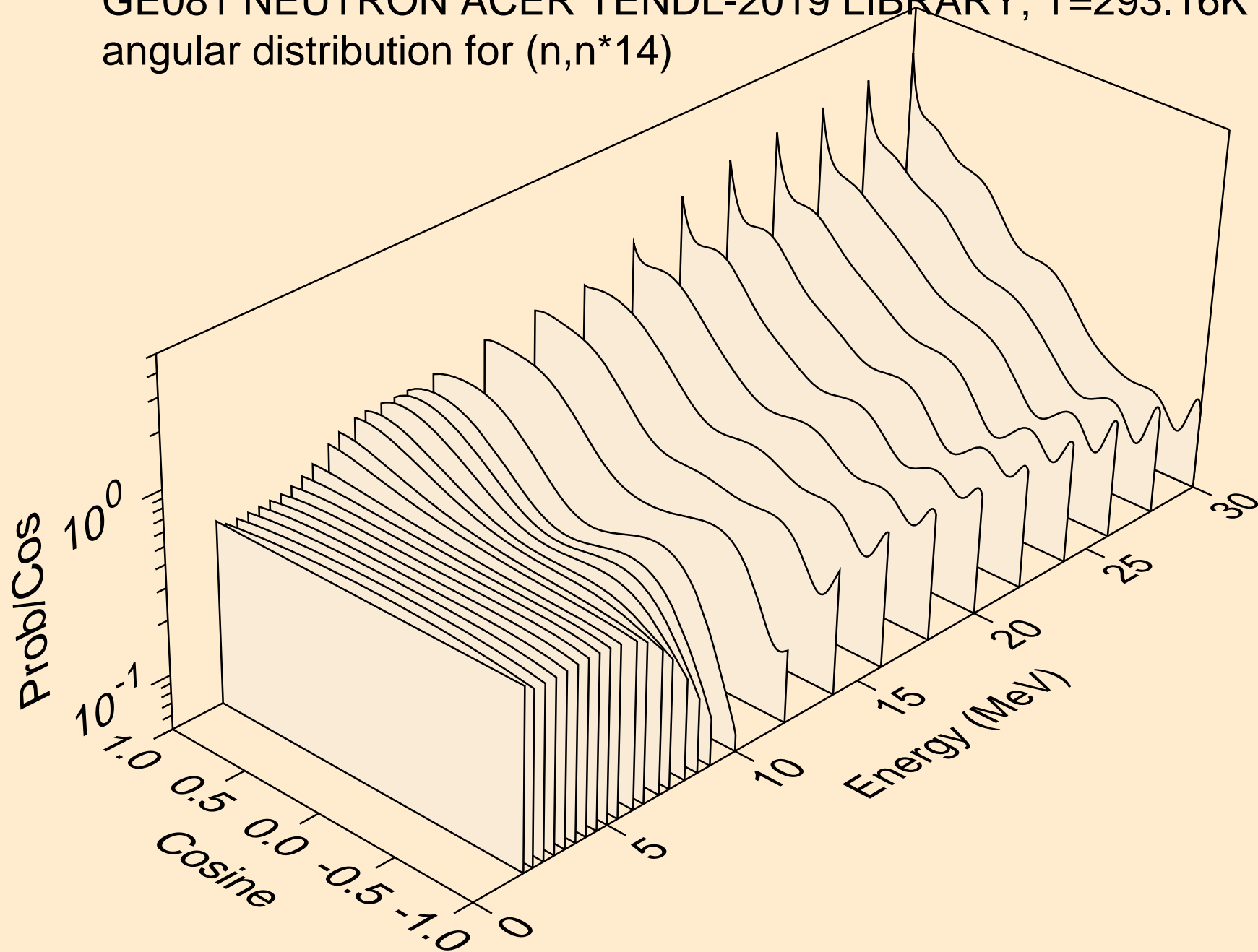

GE081 NEUTRON ACER TENDL-2019 LIBRARY; T=293.16K
angular distribution for (n,n*15)

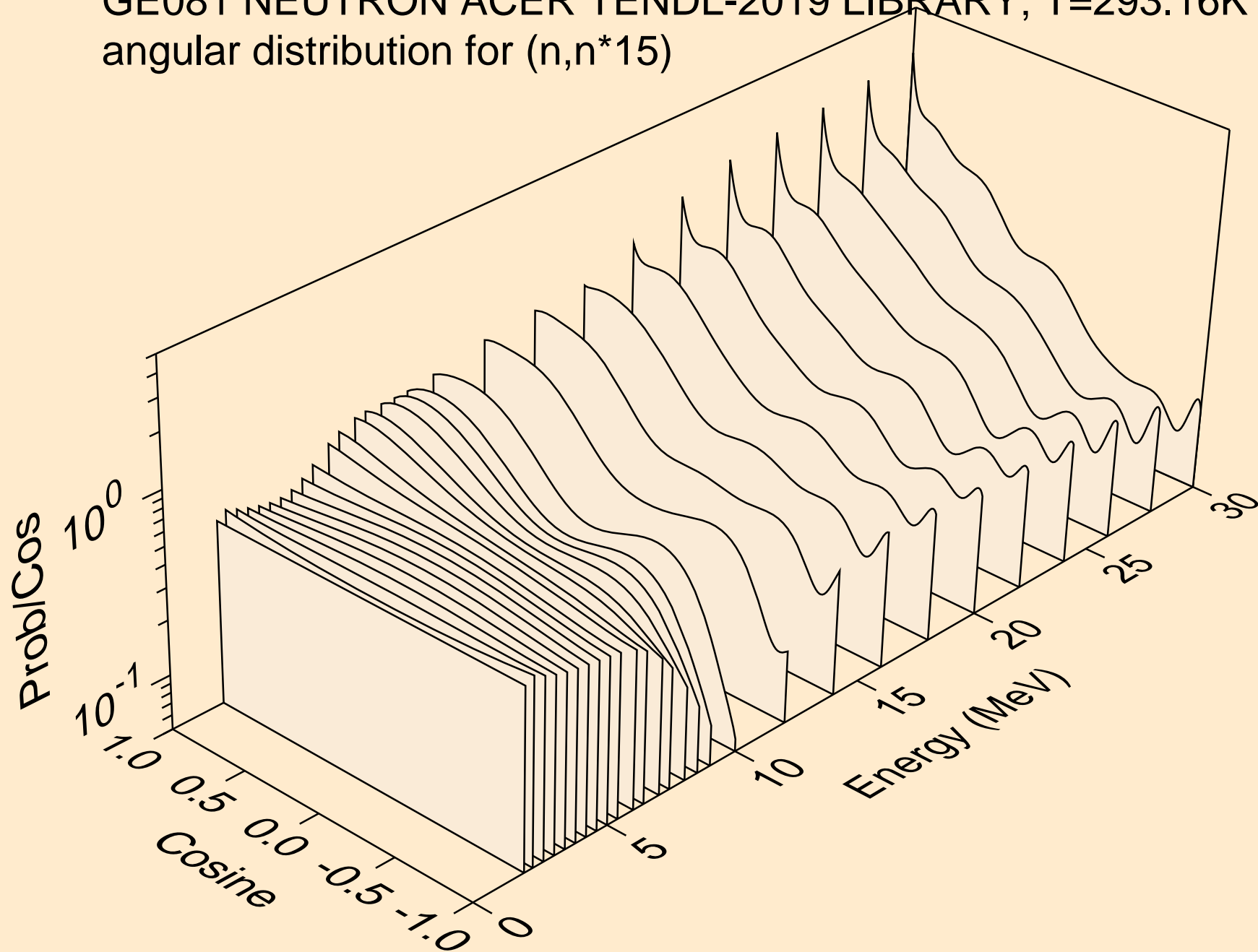

GE081 NEUTRON ACER TENDL-2019 LIBRARY; T=293.16K
angular distribution for (n,n*16)

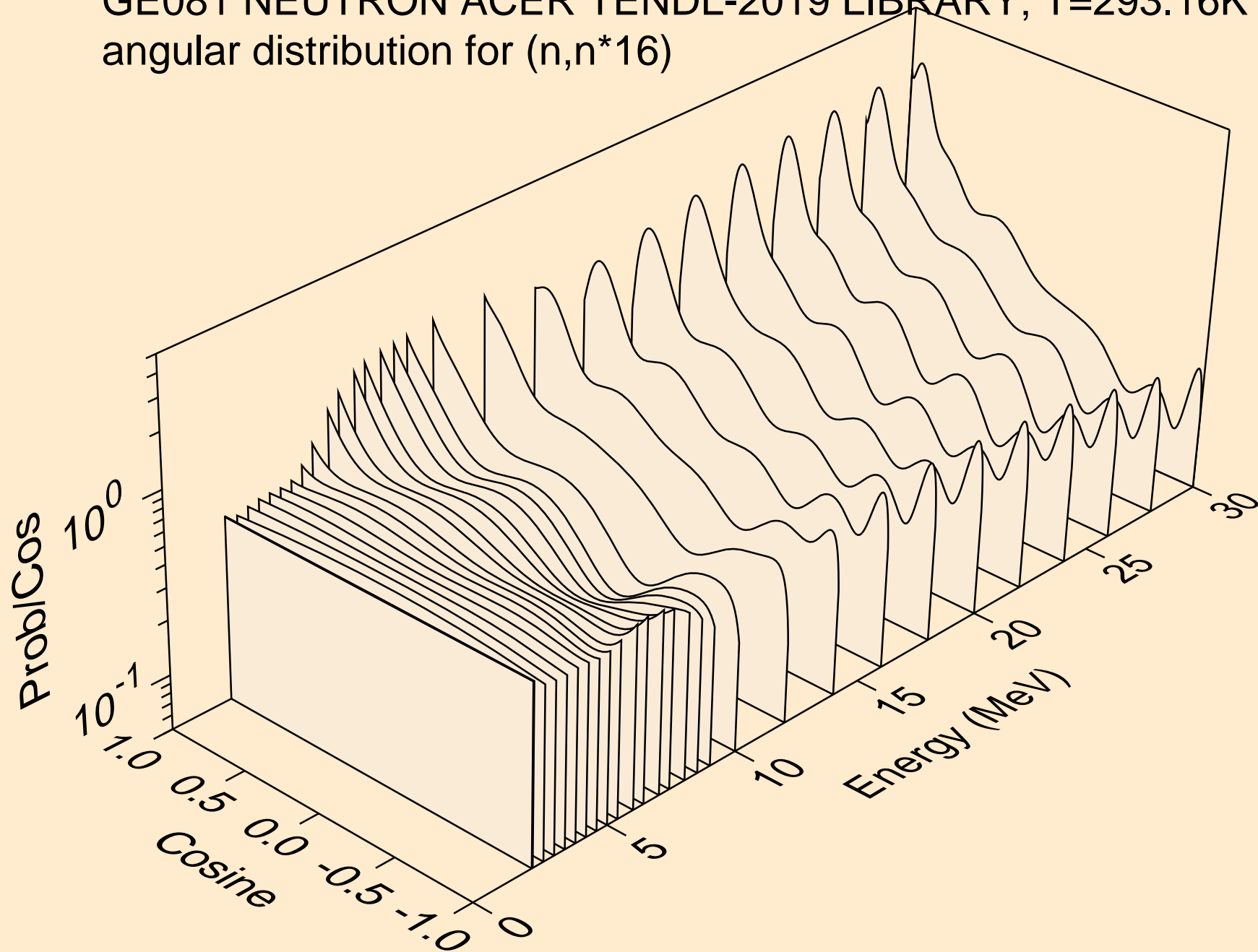

GE081 NEUTRON ACER TENDL-2019 LIBRARY; T=293.16K
angular distribution for (n,n*17)

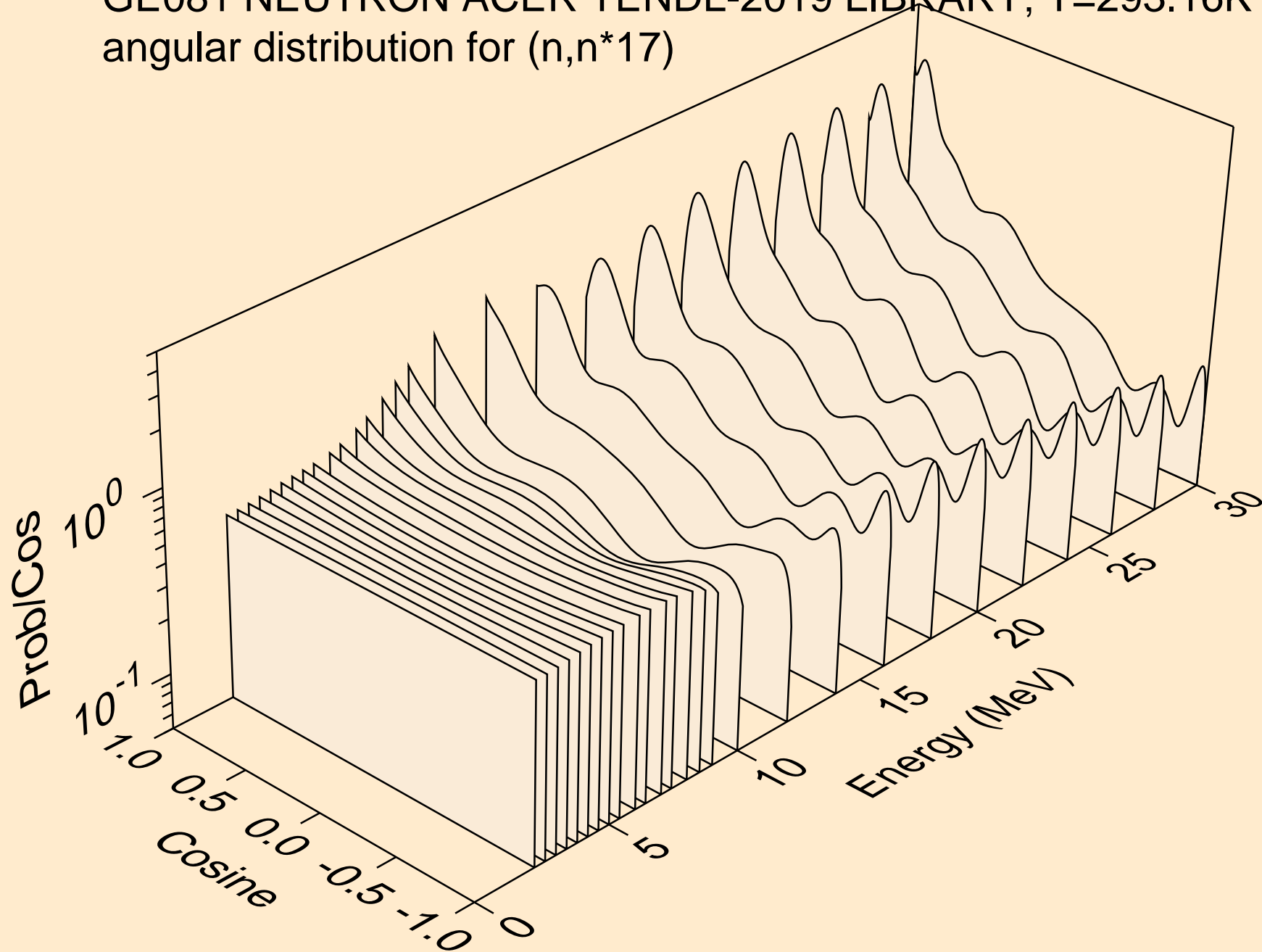

GE081 NEUTRON ACER TENDL-2019 LIBRARY; T=293.16K
angular distribution for (n,n*18)

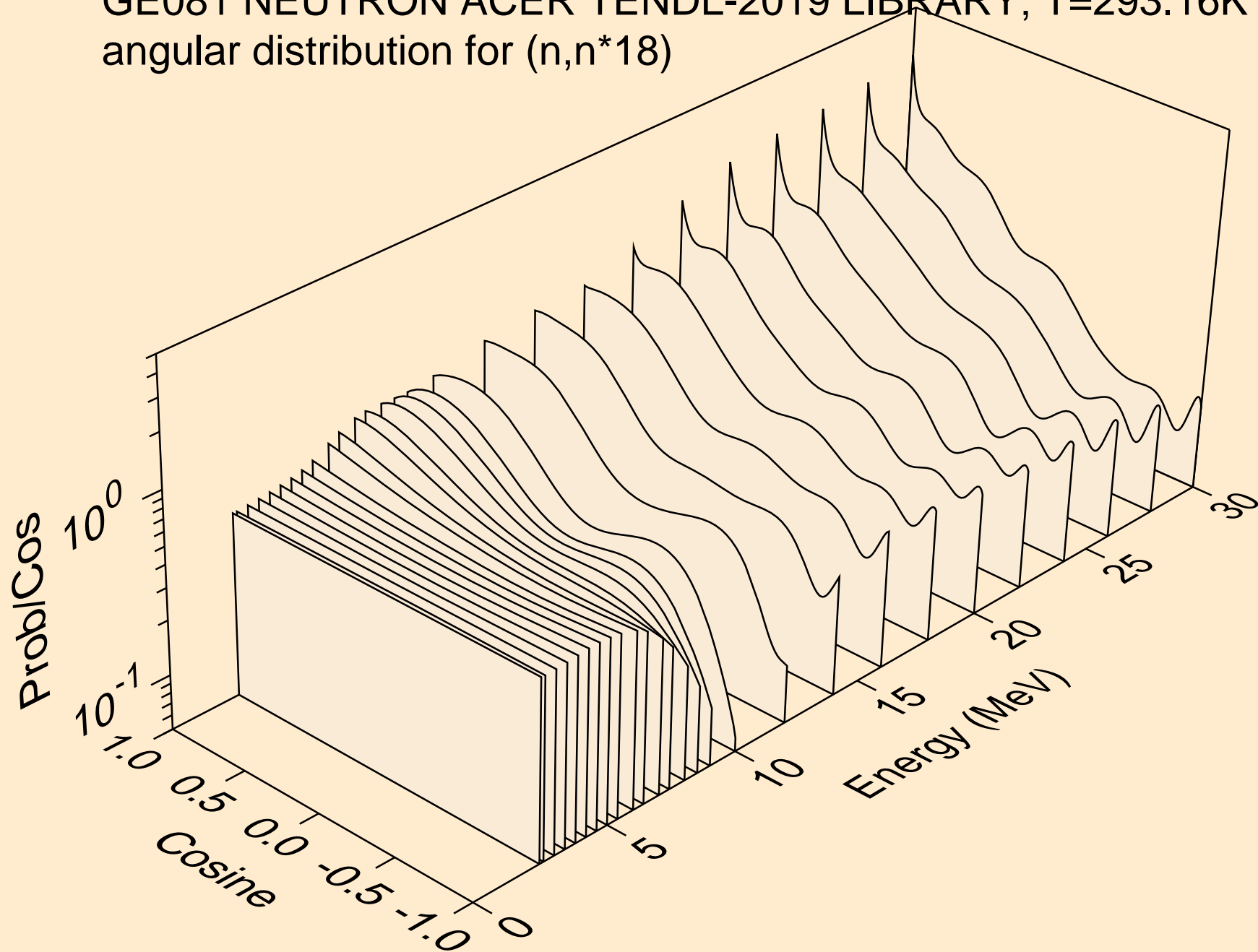

GE081 NEUTRON ACER TENDL-2019 LIBRARY; T=293.16K
angular distribution for (n,n*19)

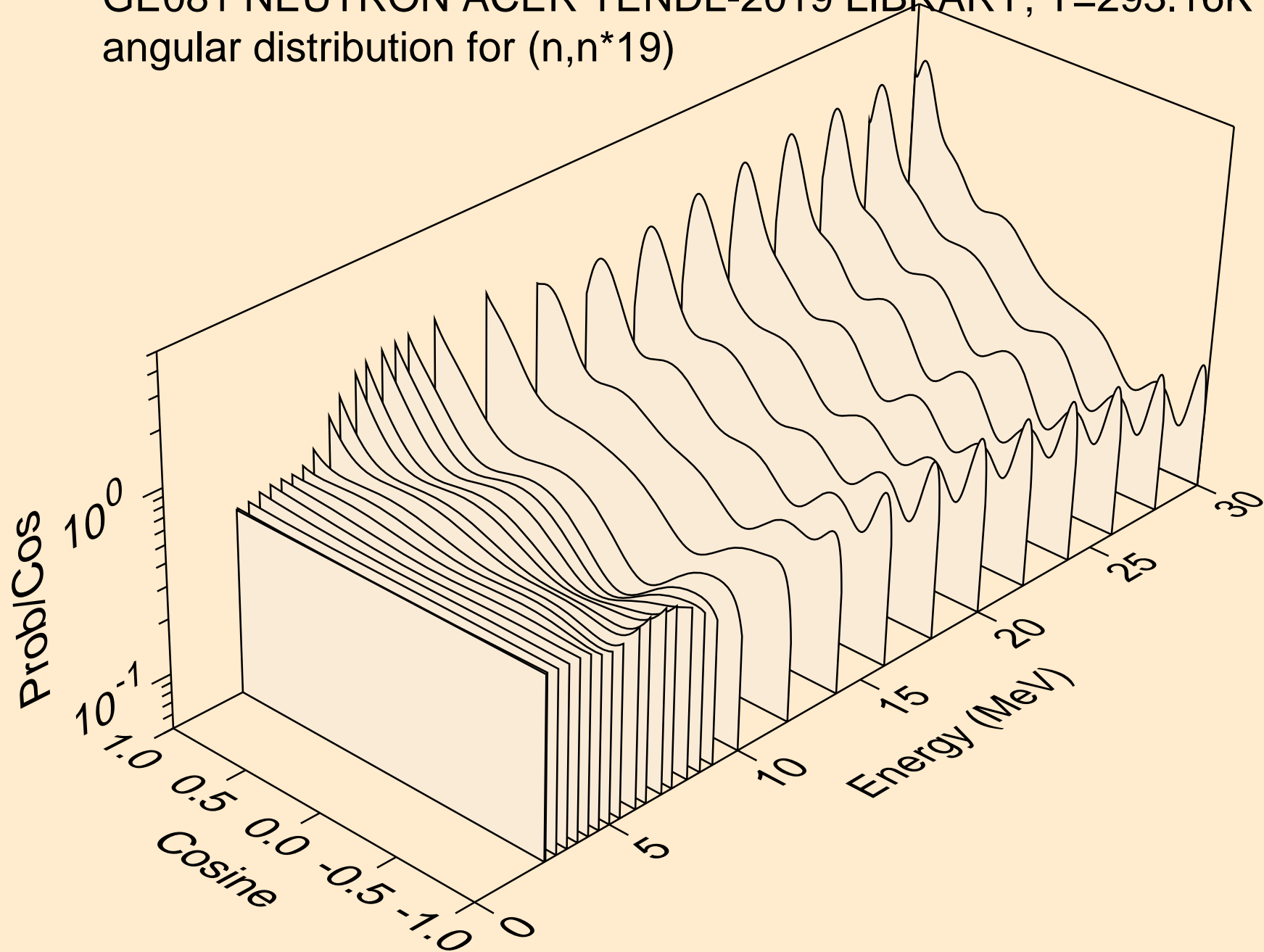

GE081 NEUTRON ACER TENDL-2019 LIBRARY; T=293.16K
angular distribution for (n,n*20)

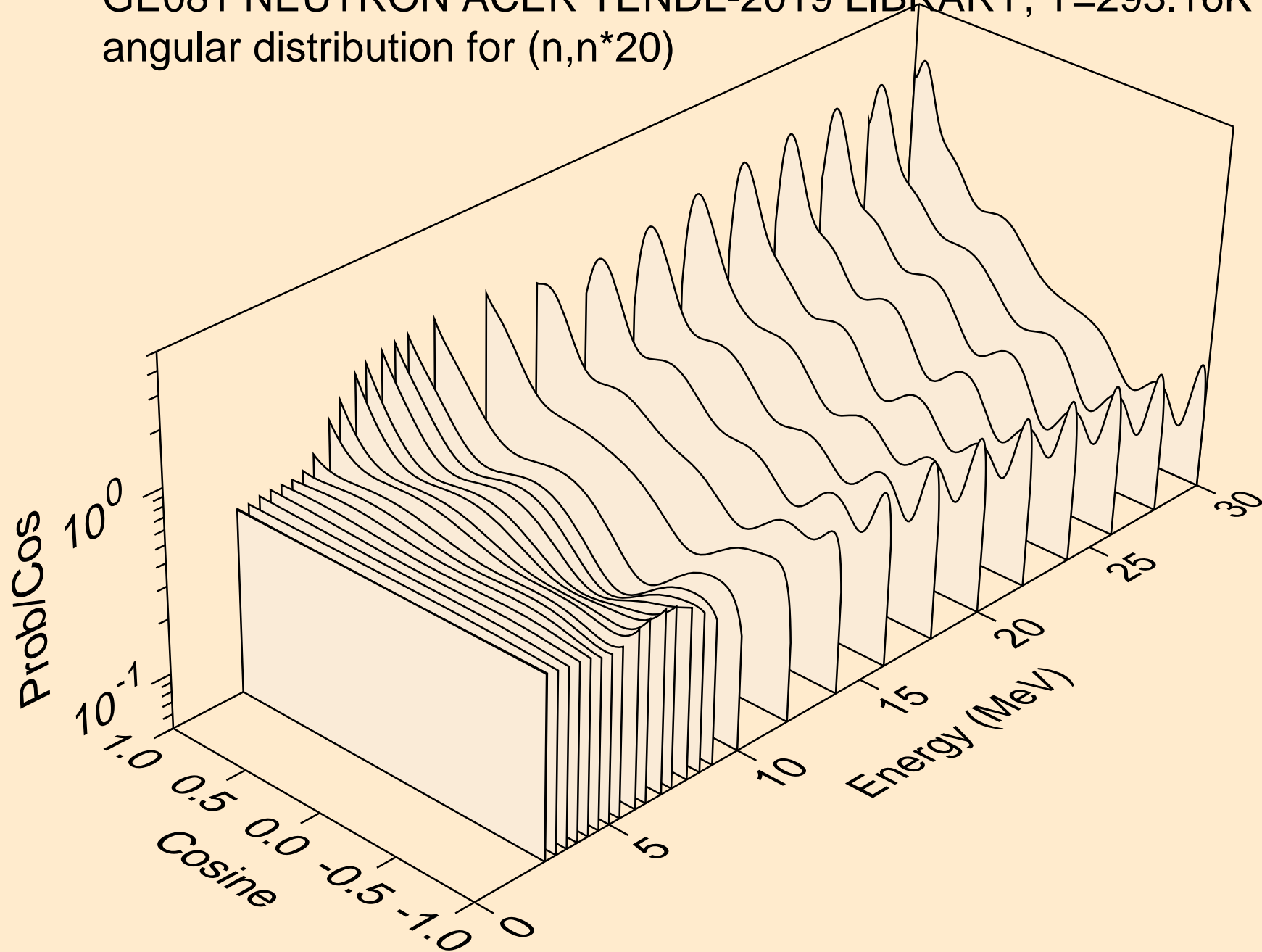

GE081 NEUTRON ACER TENDL-2019 LIBRARY; T=293.16K
angular distribution for (n,n*21)

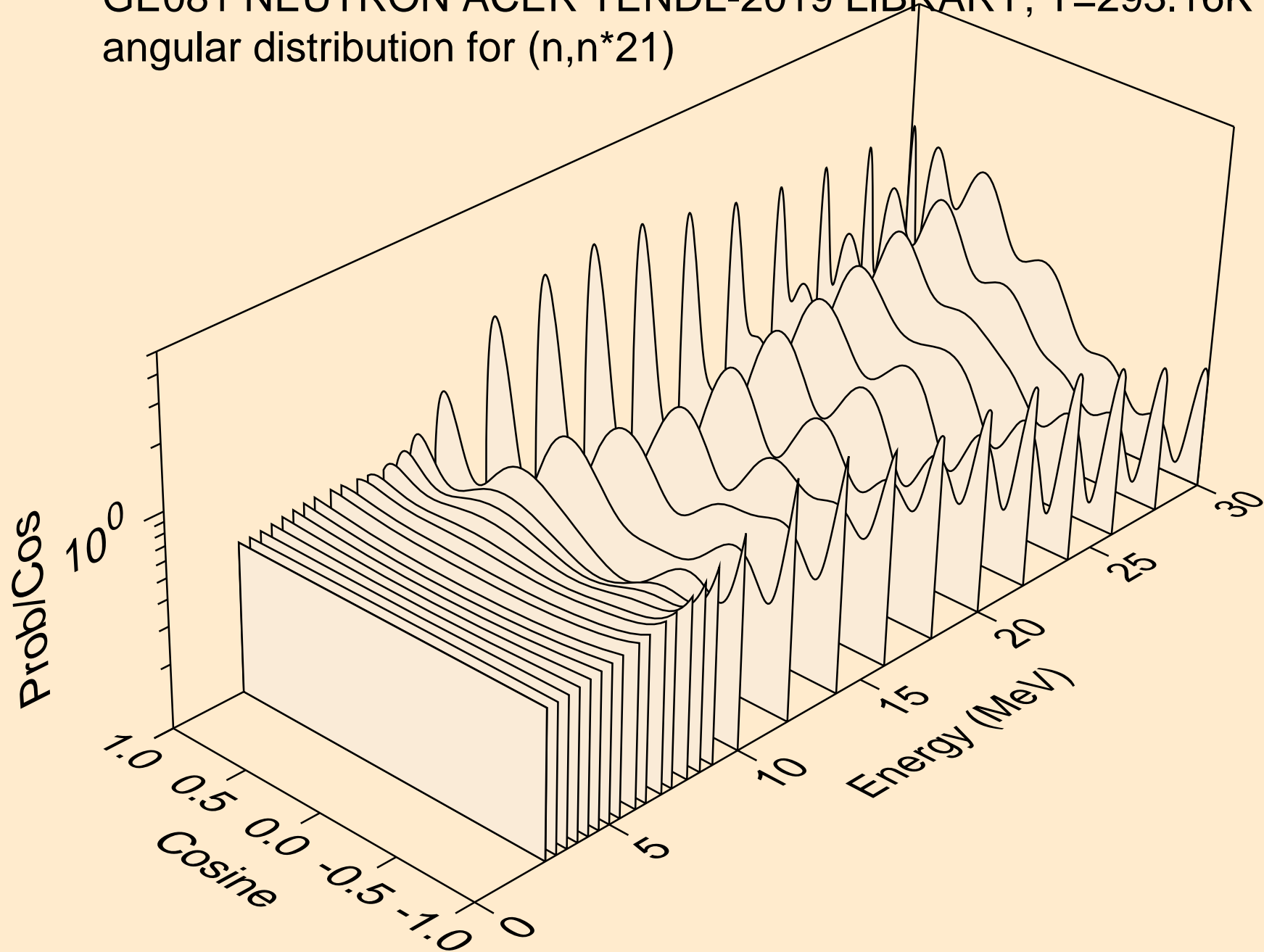

GE081 NEUTRON ACER TENDL-2019 LIBRARY; T=293.16K
angular distribution for (n,n*22)

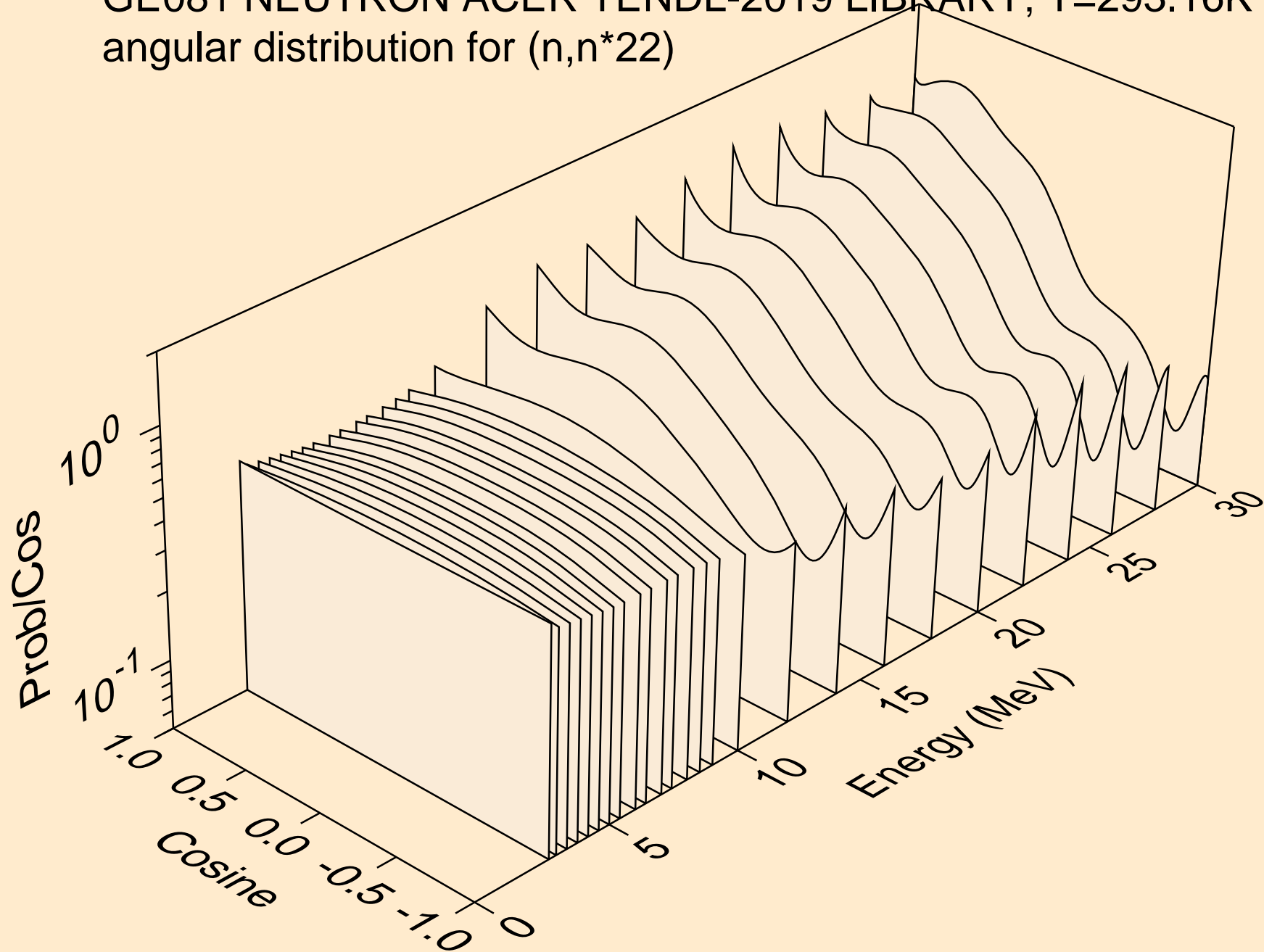

GE081 NEUTRON ACER TENDL-2019 LIBRARY; T=293.16K
angular distribution for (n,n*23)

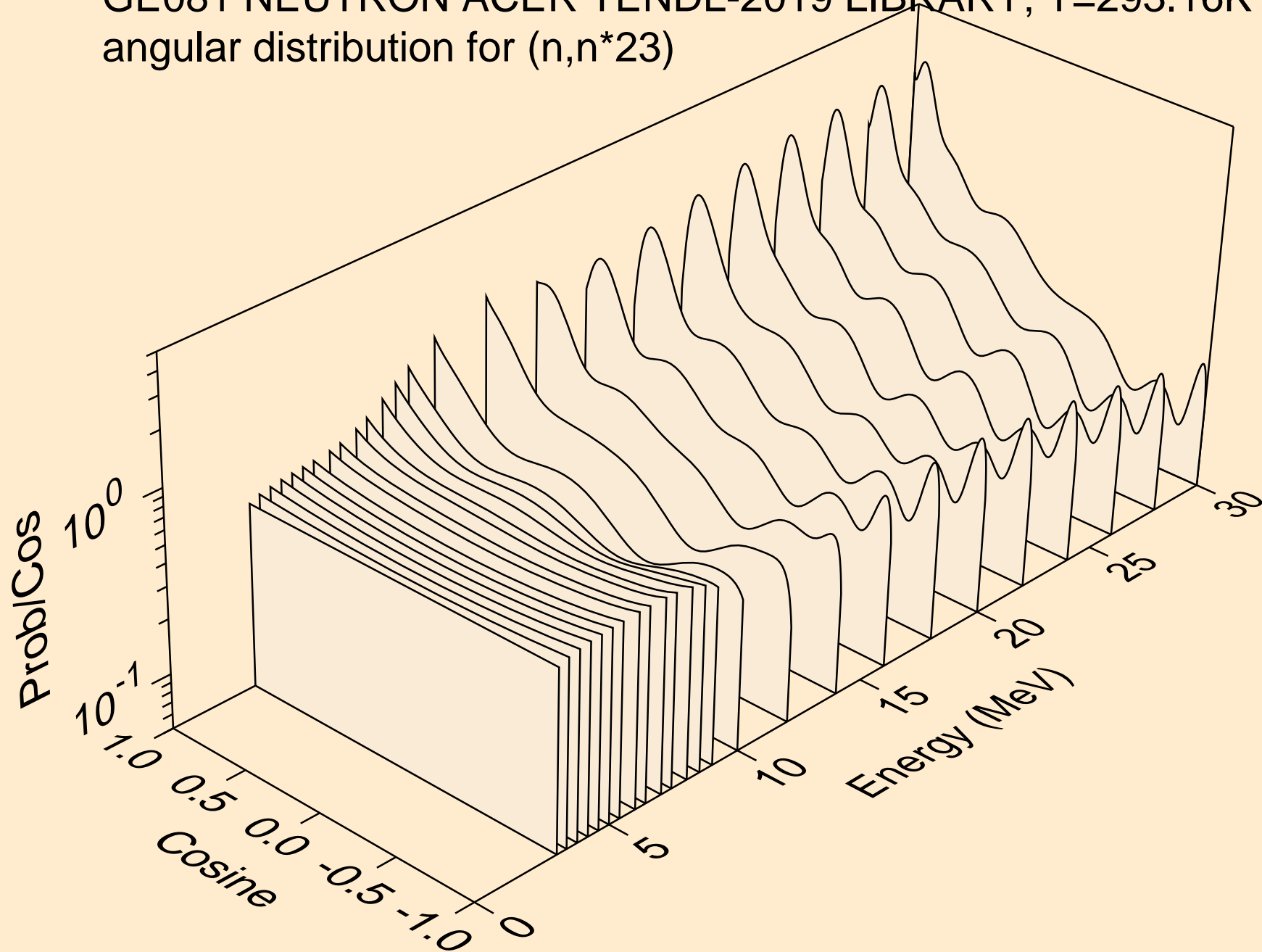

GE081 NEUTRON ACER TENDL-2019 LIBRARY; T=293.16K
angular distribution for (n,n*24)

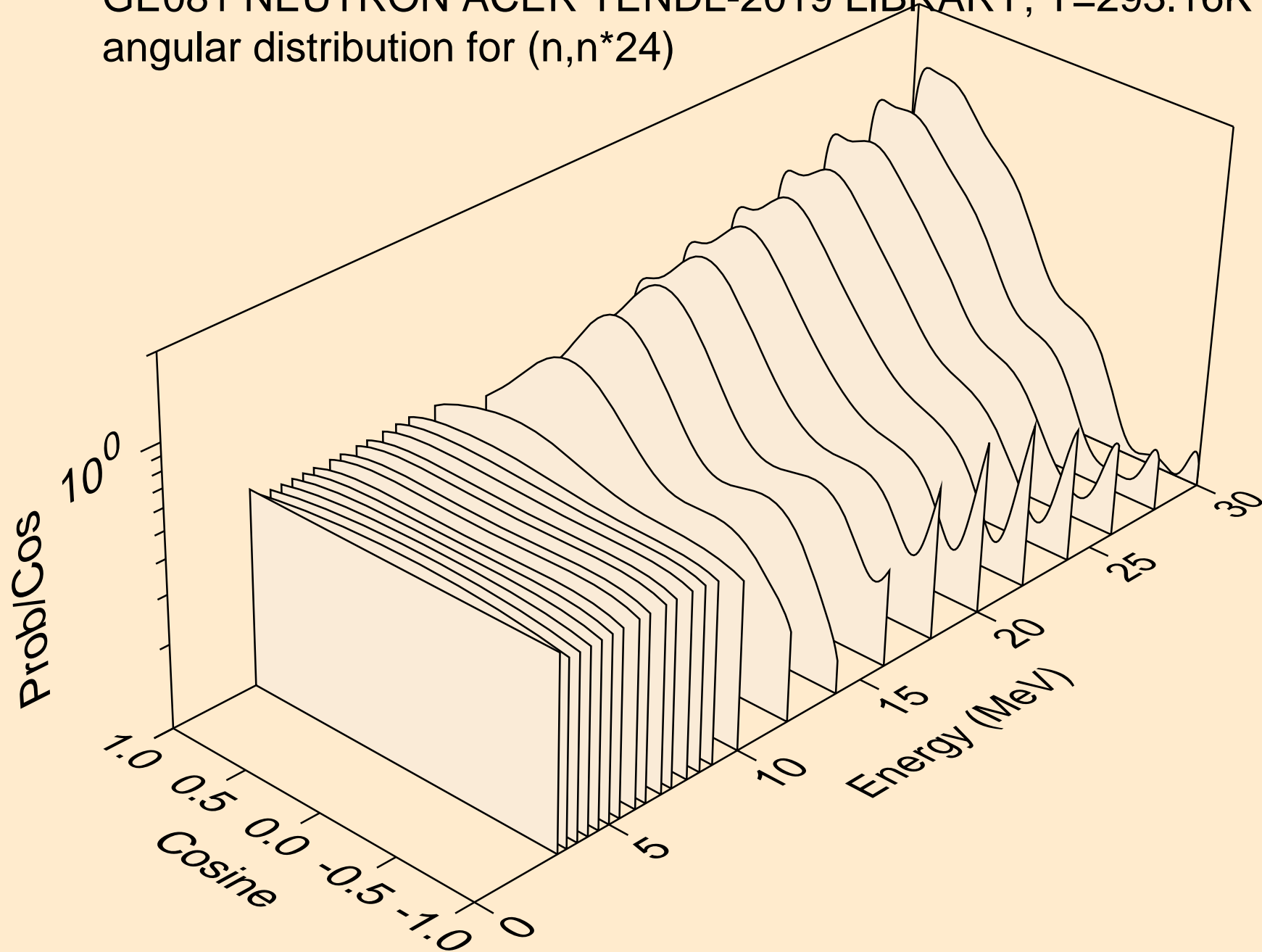

GE081 NEUTRON ACER TENDL-2019 LIBRARY; T=293.16K
angular distribution for (n,n*25)

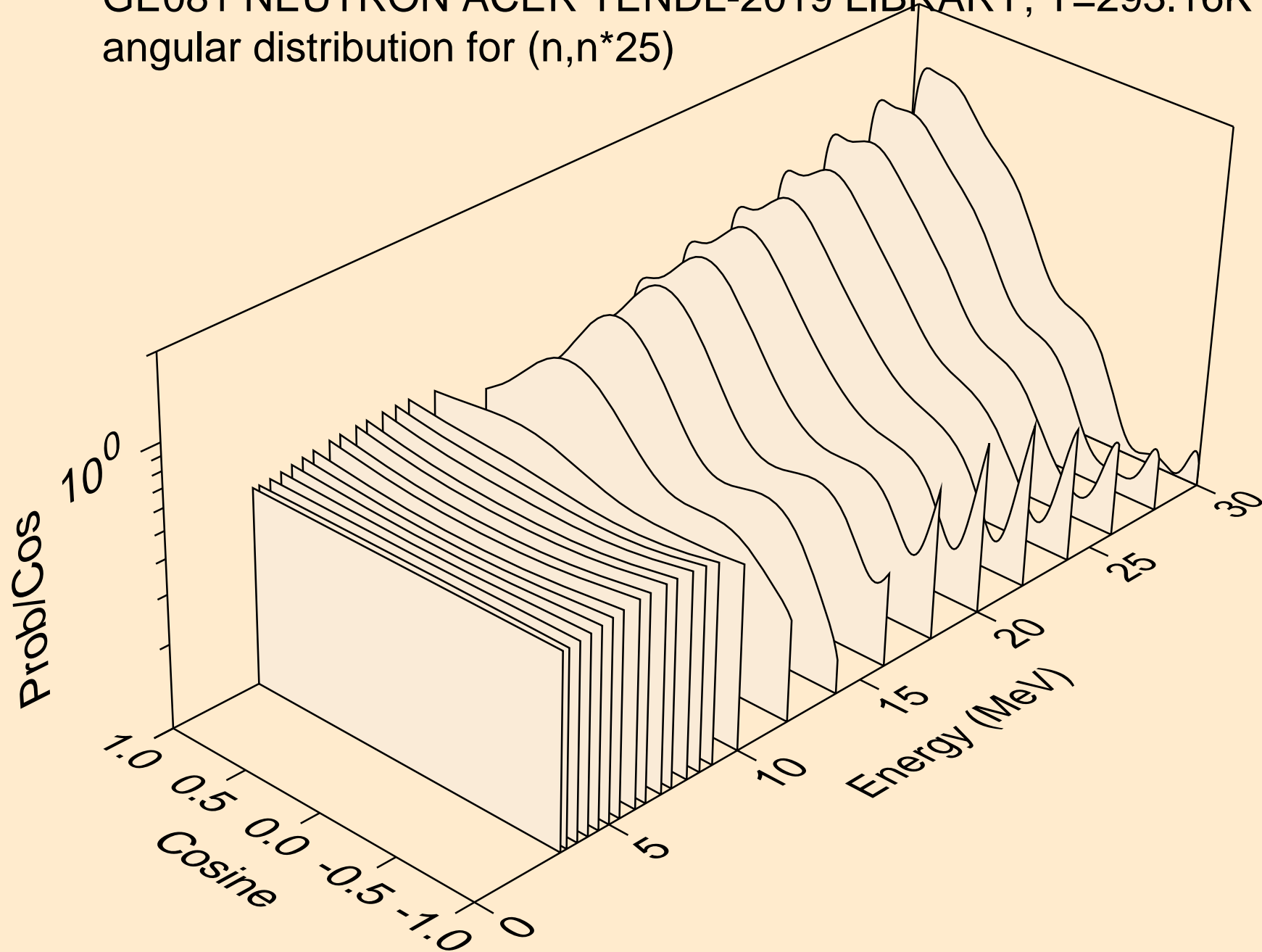

GE081 NEUTRON ACER TENDL-2019 LIBRARY; T=293.16K
angular distribution for (n,n*26)

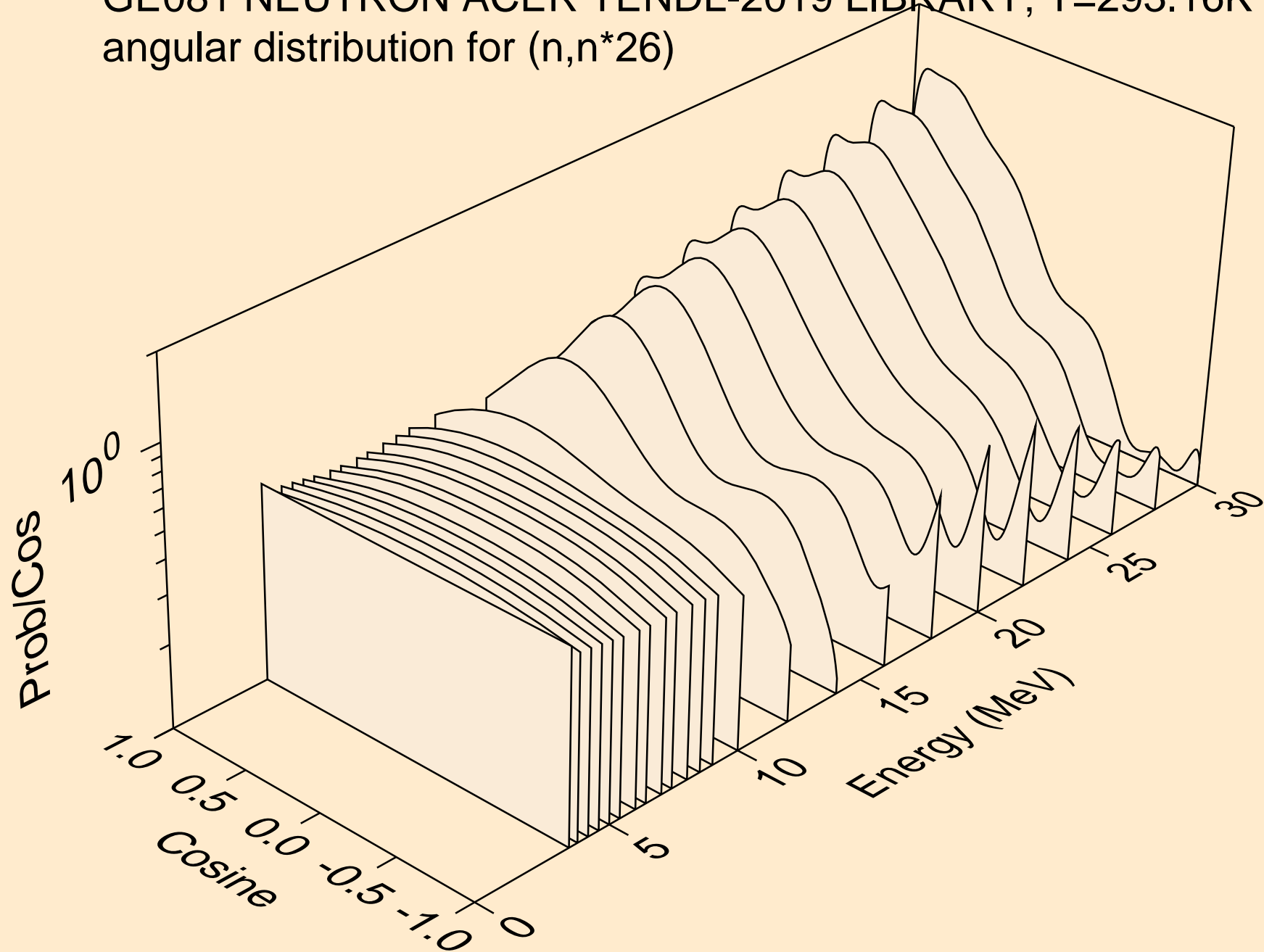

GE081 NEUTRON ACER TENDL-2019 LIBRARY; T=293.16K
angular distribution for (n,n*27)

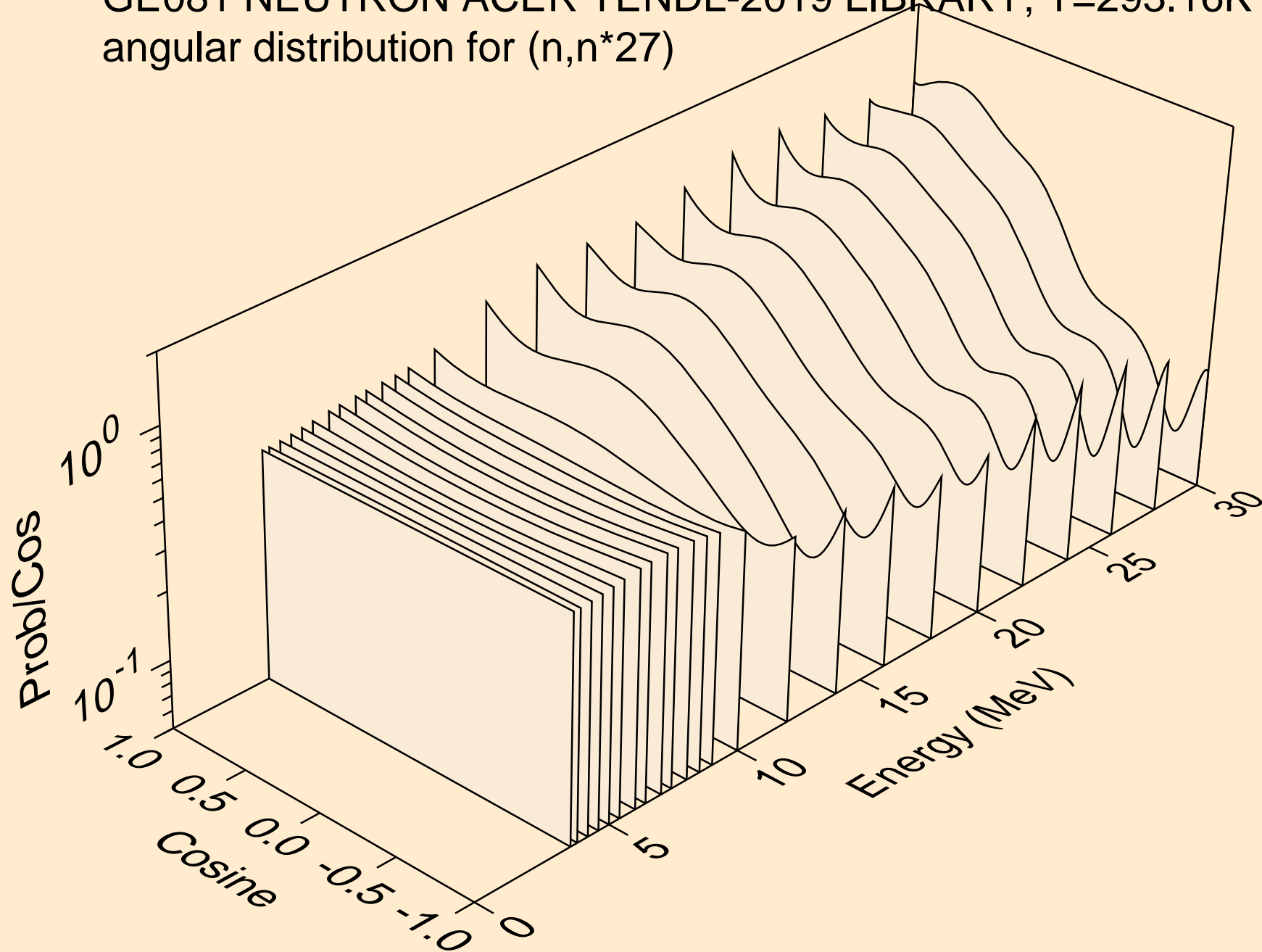

GE081 NEUTRON ACER TENDL-2019 LIBRARY; T=293.16K
angular distribution for (n,n*28)

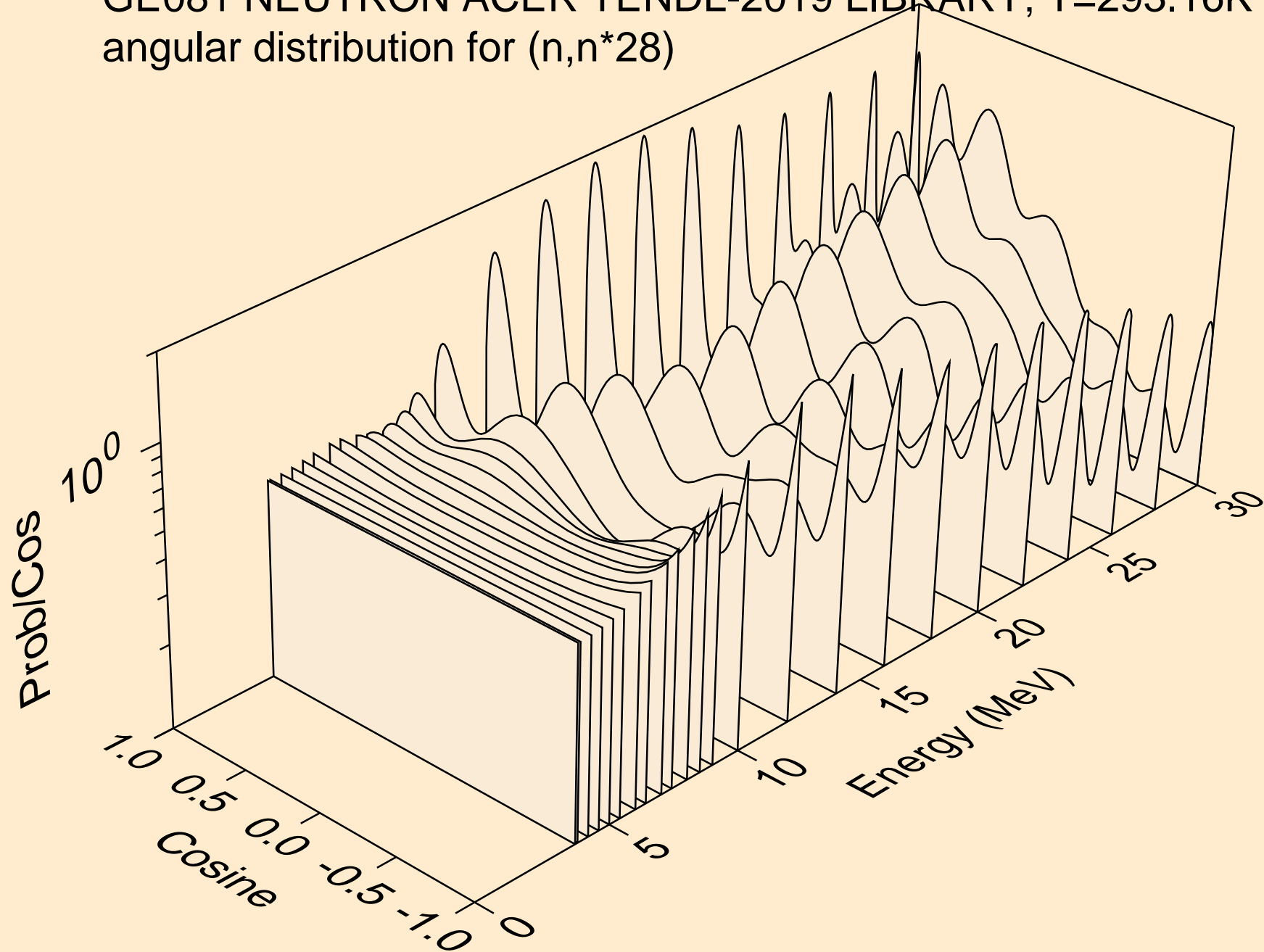

GE081 NEUTRON ACER TENDL-2019 LIBRARY; T=293.16K
angular distribution for (n,n*29)

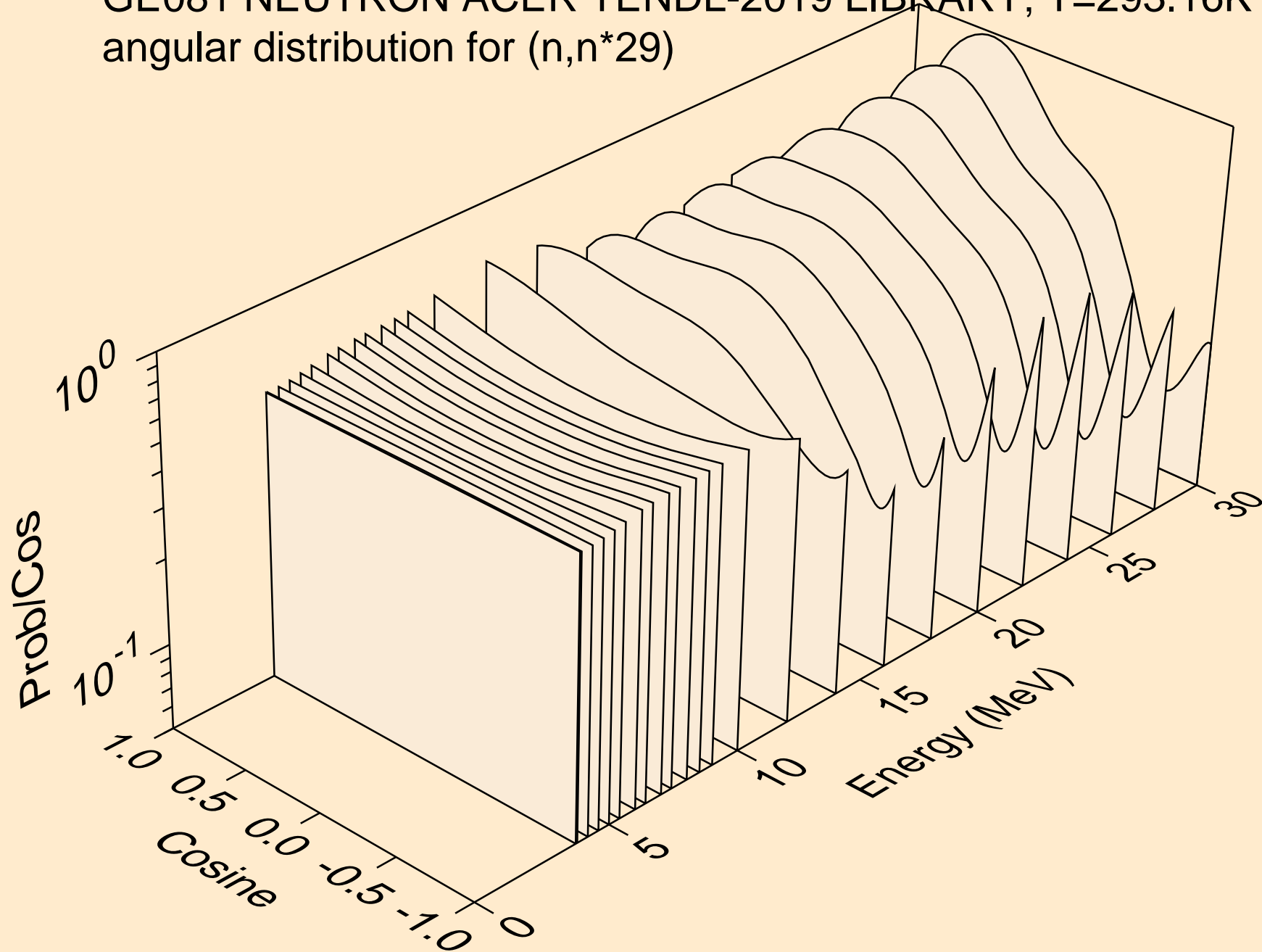

GE081 NEUTRON ACER TENDL-2019 LIBRARY; T=293.16K
Neutron emission for (n,x)

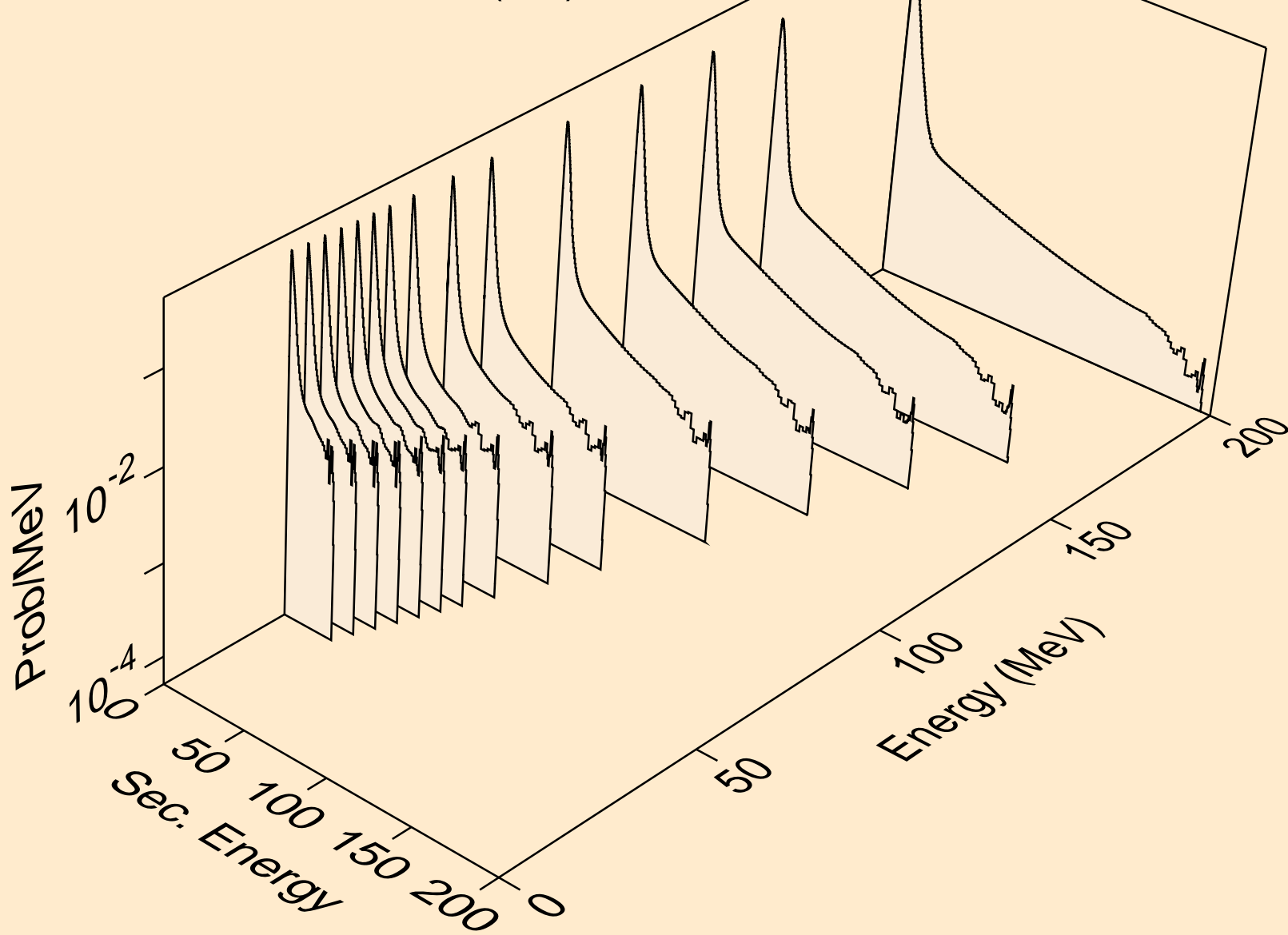

GE081 NEUTRON ACER TENDL-2019 LIBRARY; T=293.16K
Neutron emission for (n,2nd)

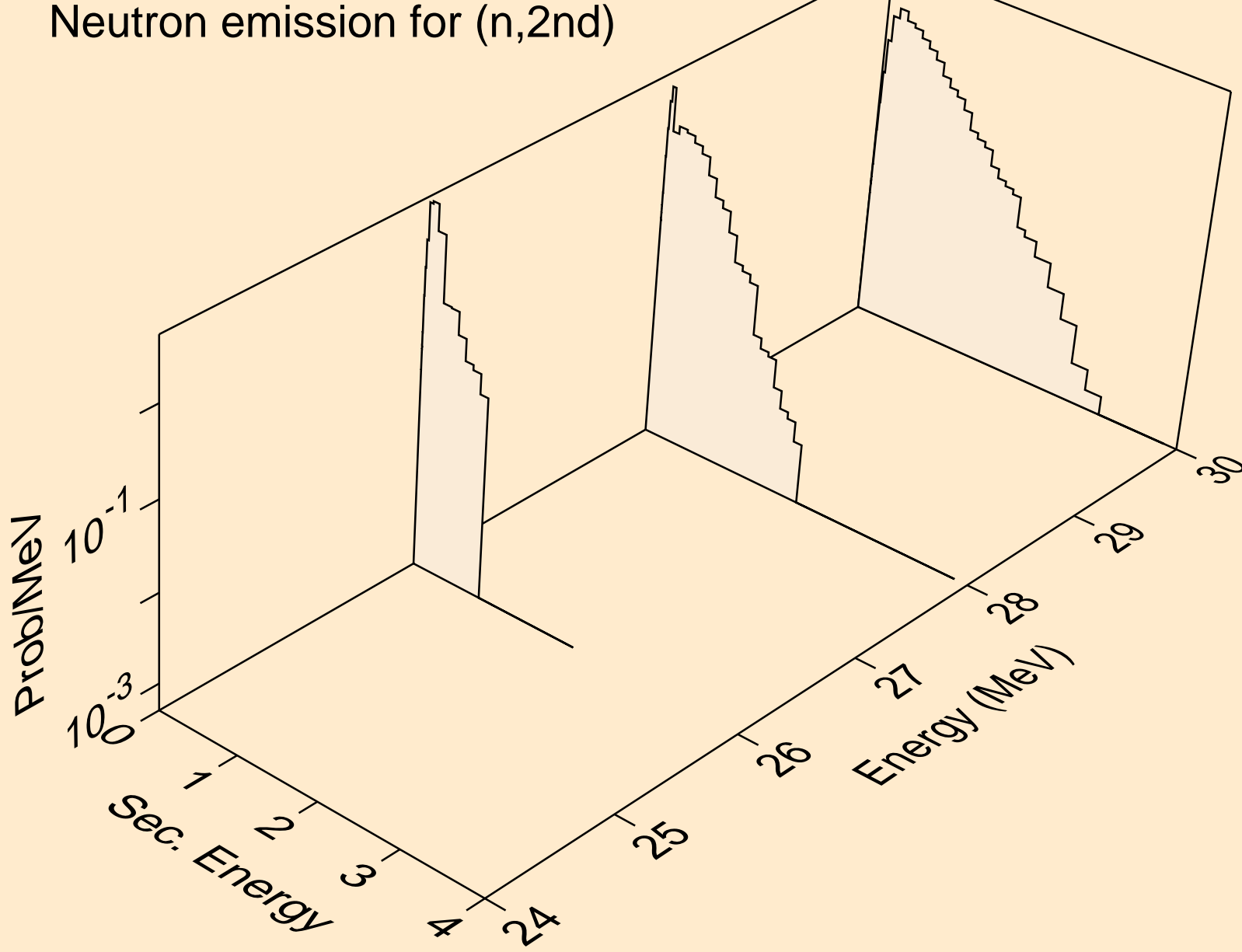

GE081 NEUTRON ACER TENDL-2019 LIBRARY; T=293.16K
Neutron emission for (n,2n)

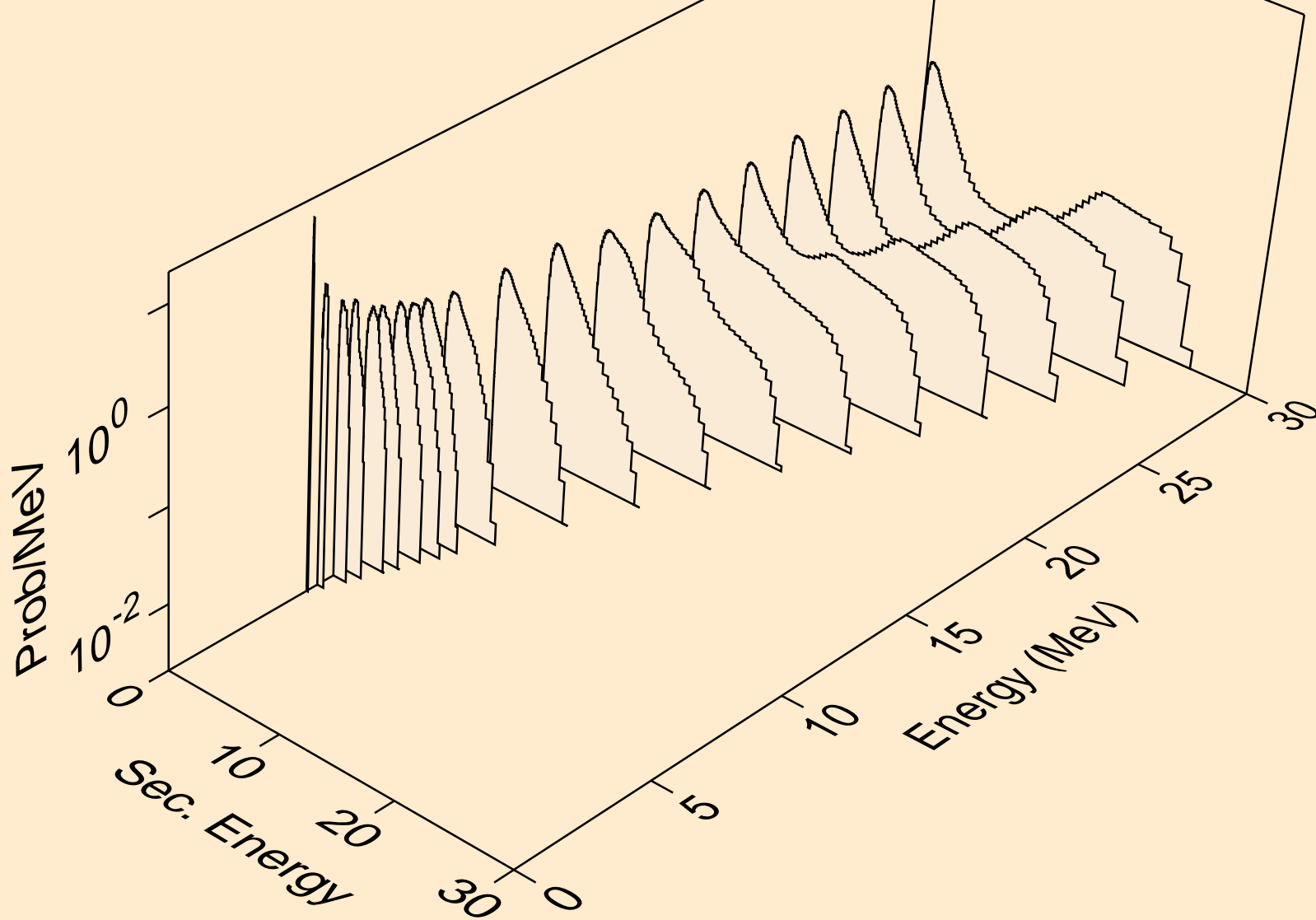

GE081 NEUTRON ACER TENDL-2019 LIBRARY; T=293.16K
Neutron emission for (n,3n)

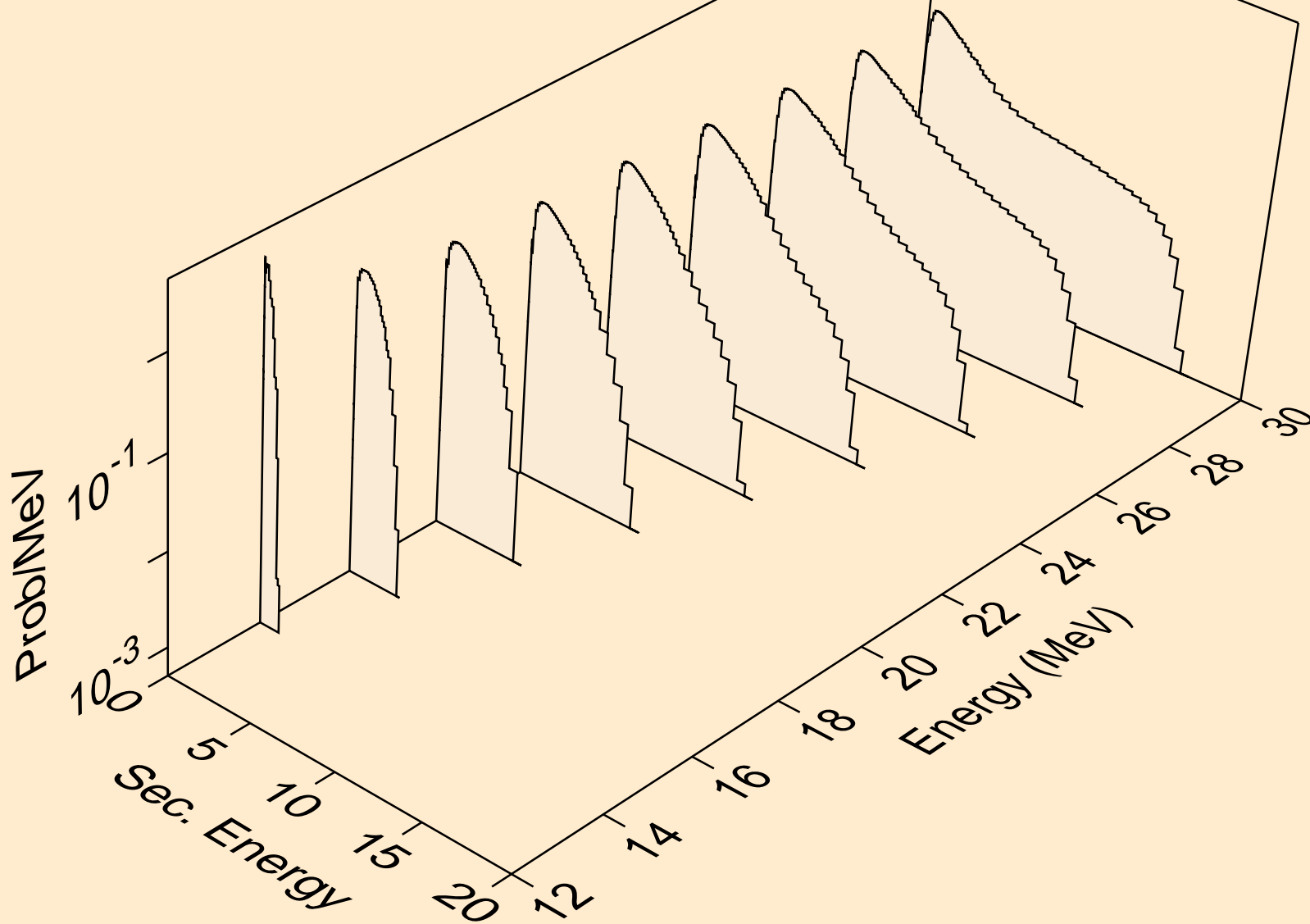

GE081 NEUTRON ACER TENDL-2019 LIBRARY; T=293.16K
Neutron emission for (n,n*)a

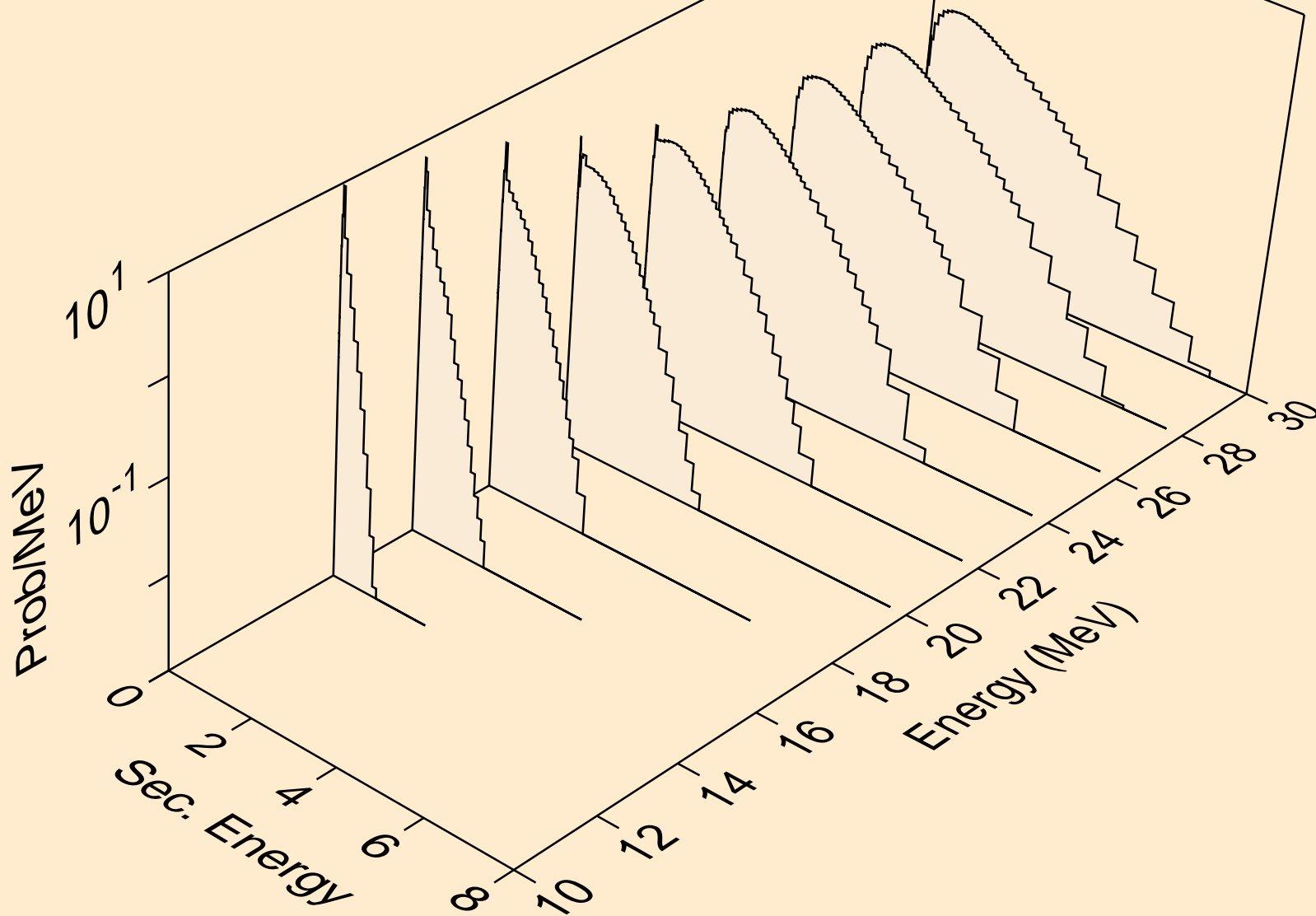

GE081 NEUTRON ACER TENDL-2019 LIBRARY; T=293.16K
Neutron emission for (n,2n)a

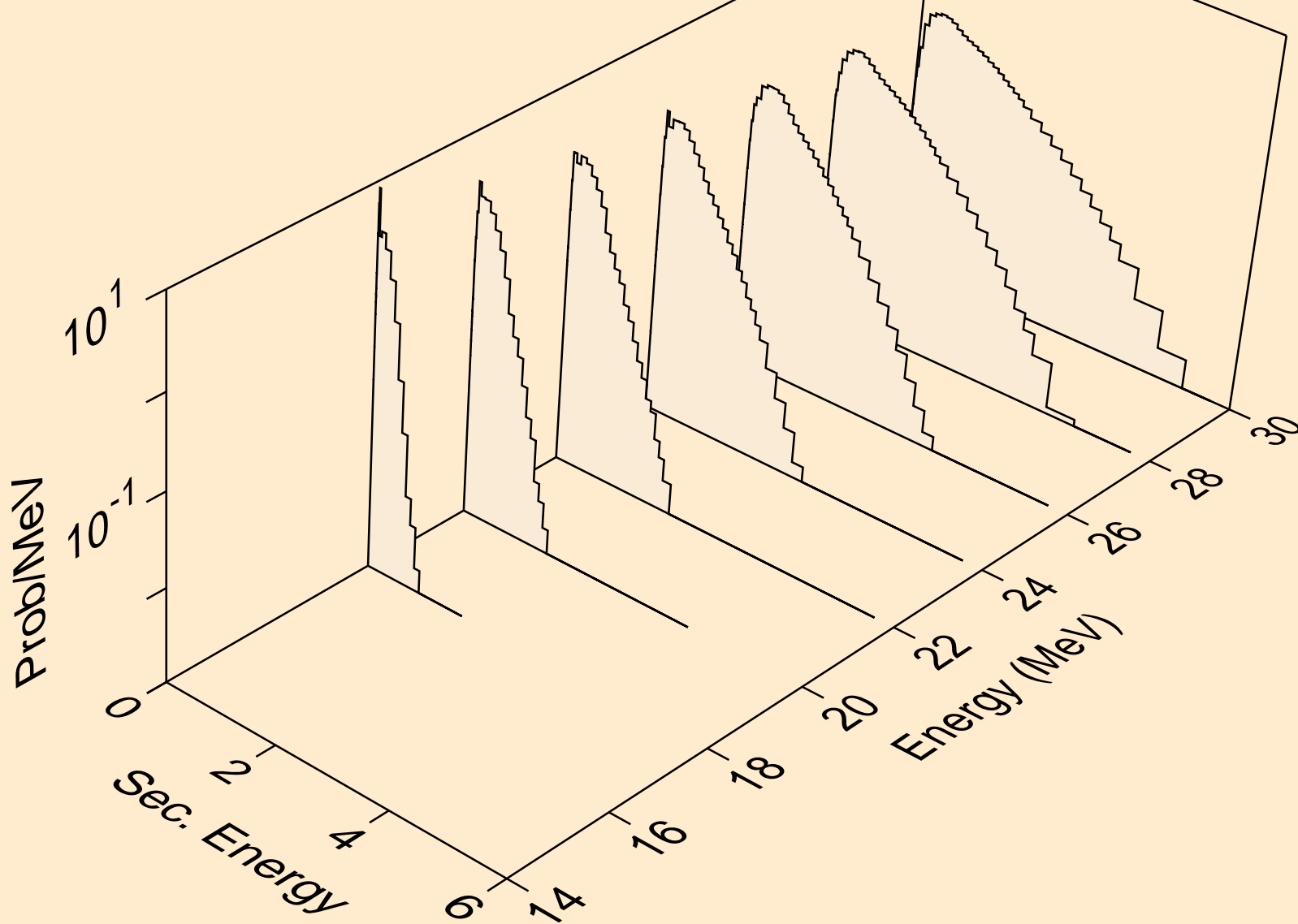

GE081 NEUTRON ACER TENDL-2019 LIBRARY; T=293.16K
Neutron emission for (n,3n)a

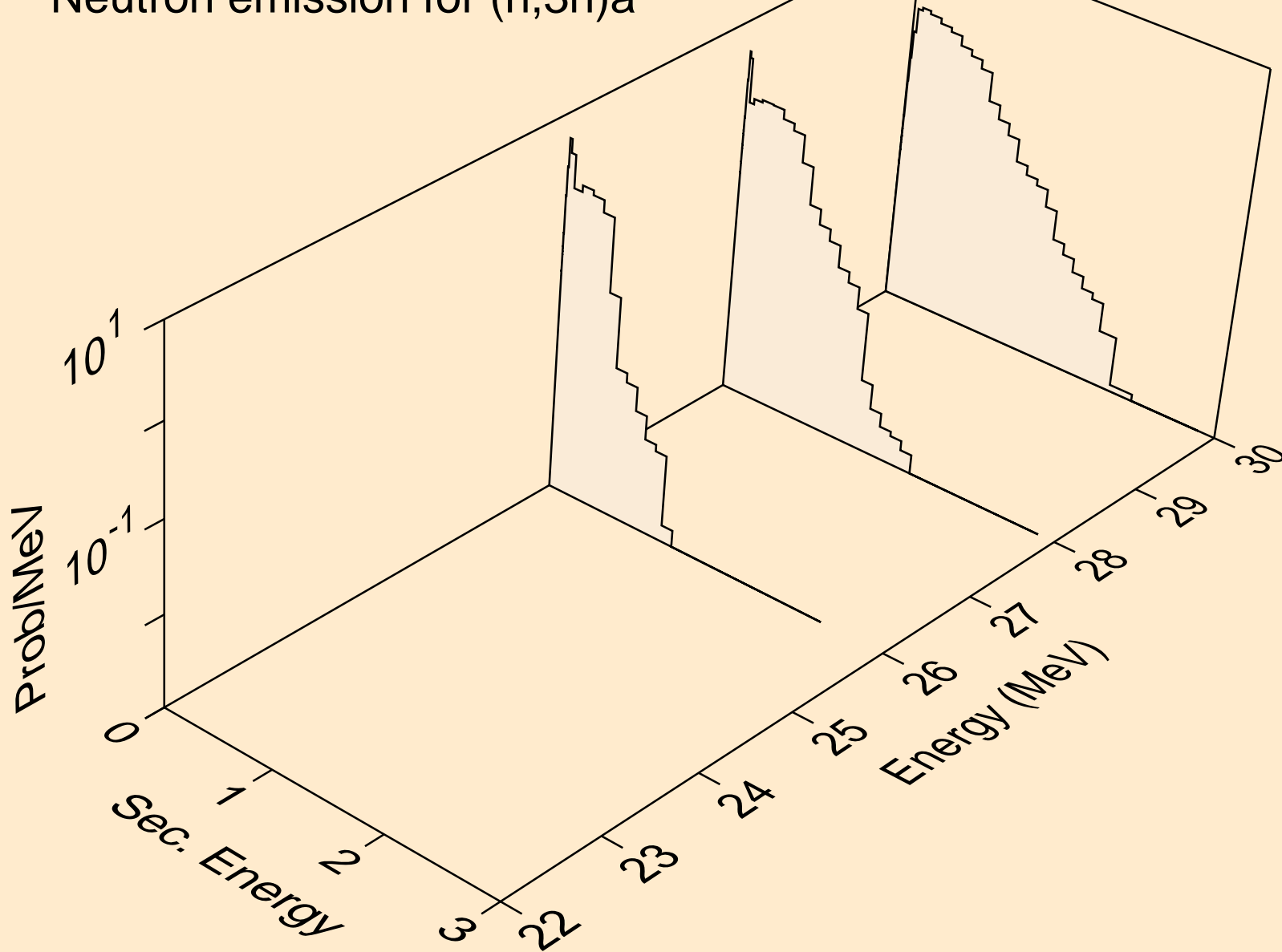

GE081 NEUTRON ACER TENDL-2019 LIBRARY; T=293.16K
Neutron emission for (n,n*)p

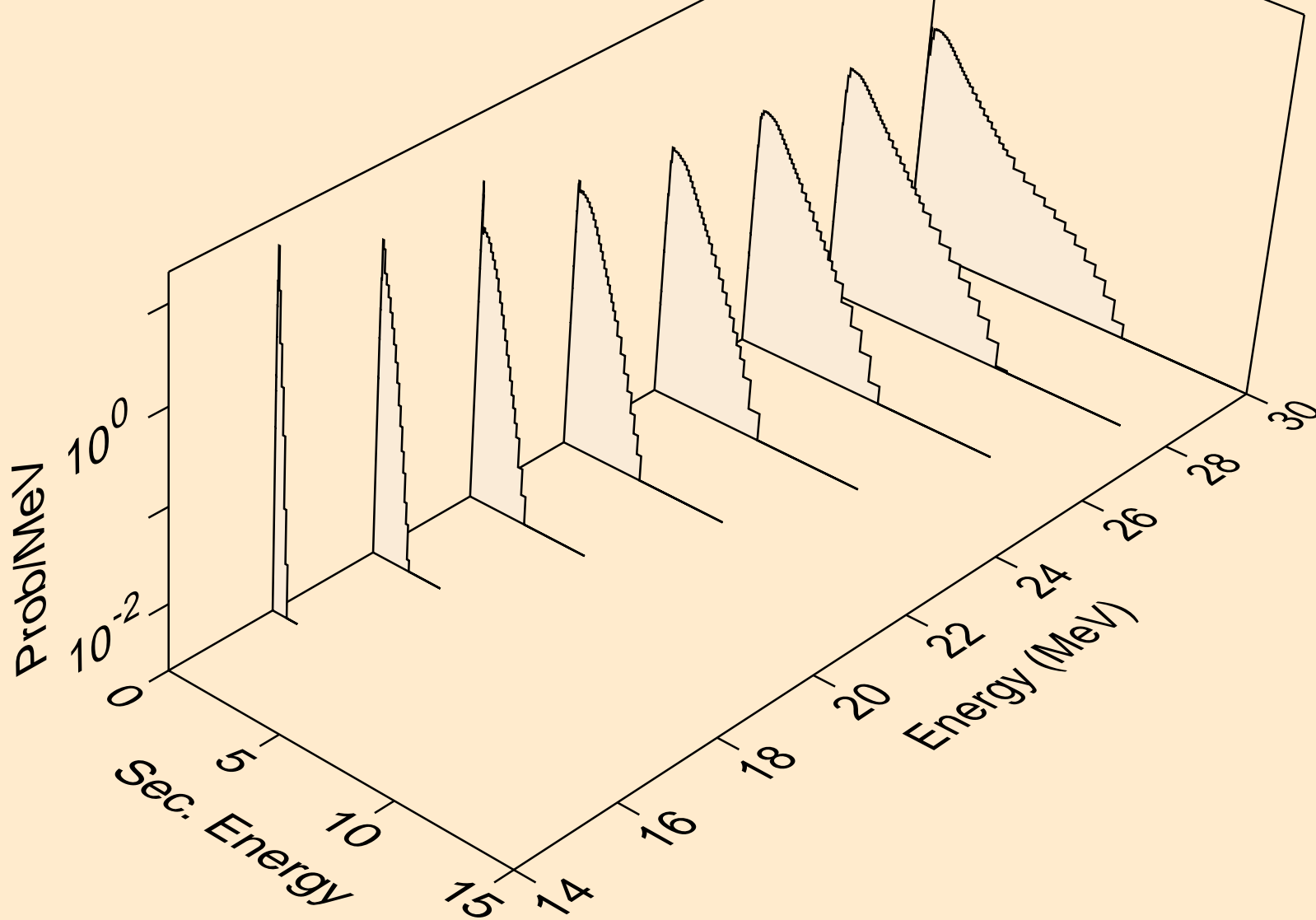

GE081 NEUTRON ACER TENDL-2019 LIBRARY; T=293.16K
Neutron emission for (n,n*)d

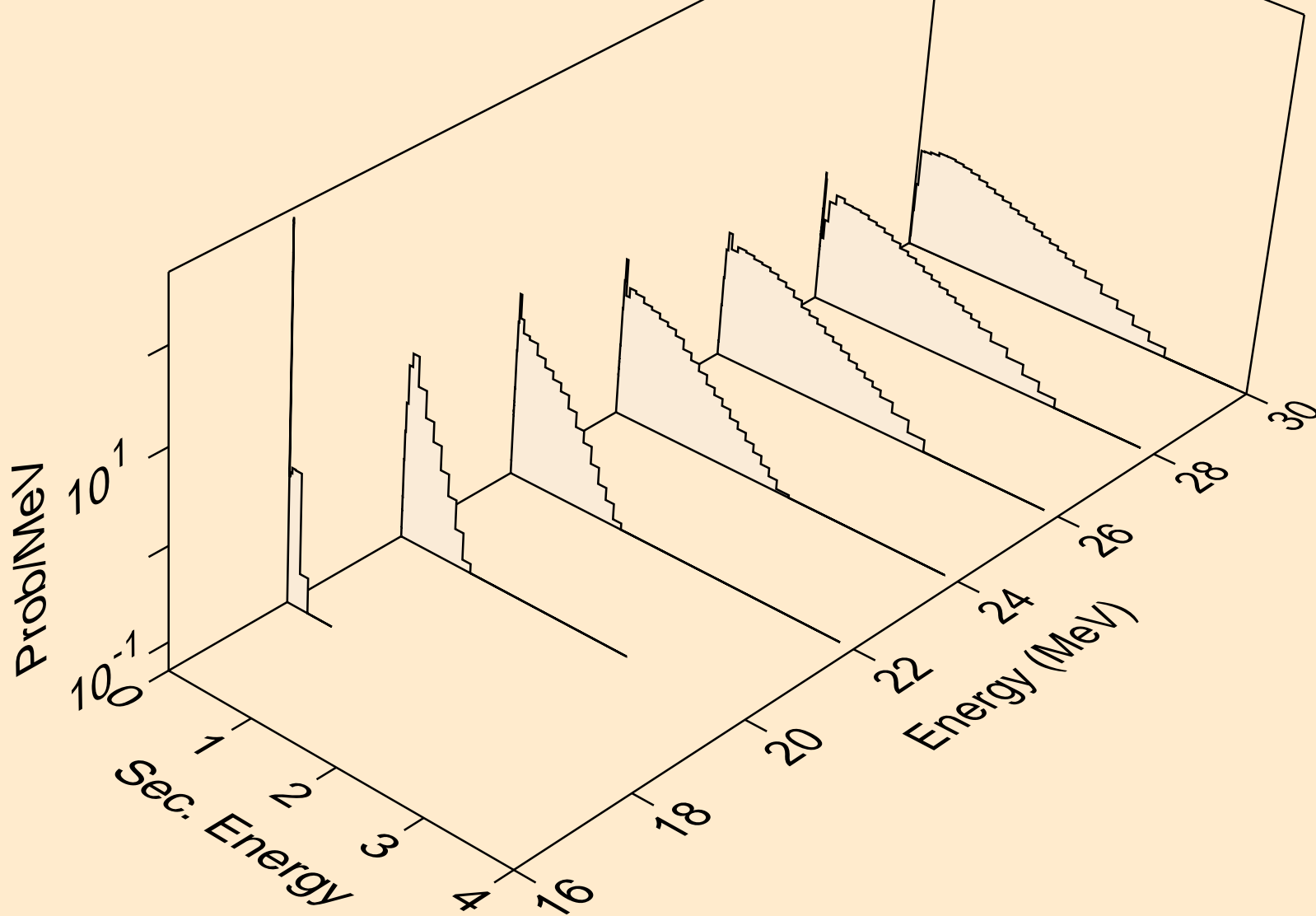

GE081 NEUTRON ACER TENDL-2019 LIBRARY; T=293.16K
Neutron emission for (n,n*)t

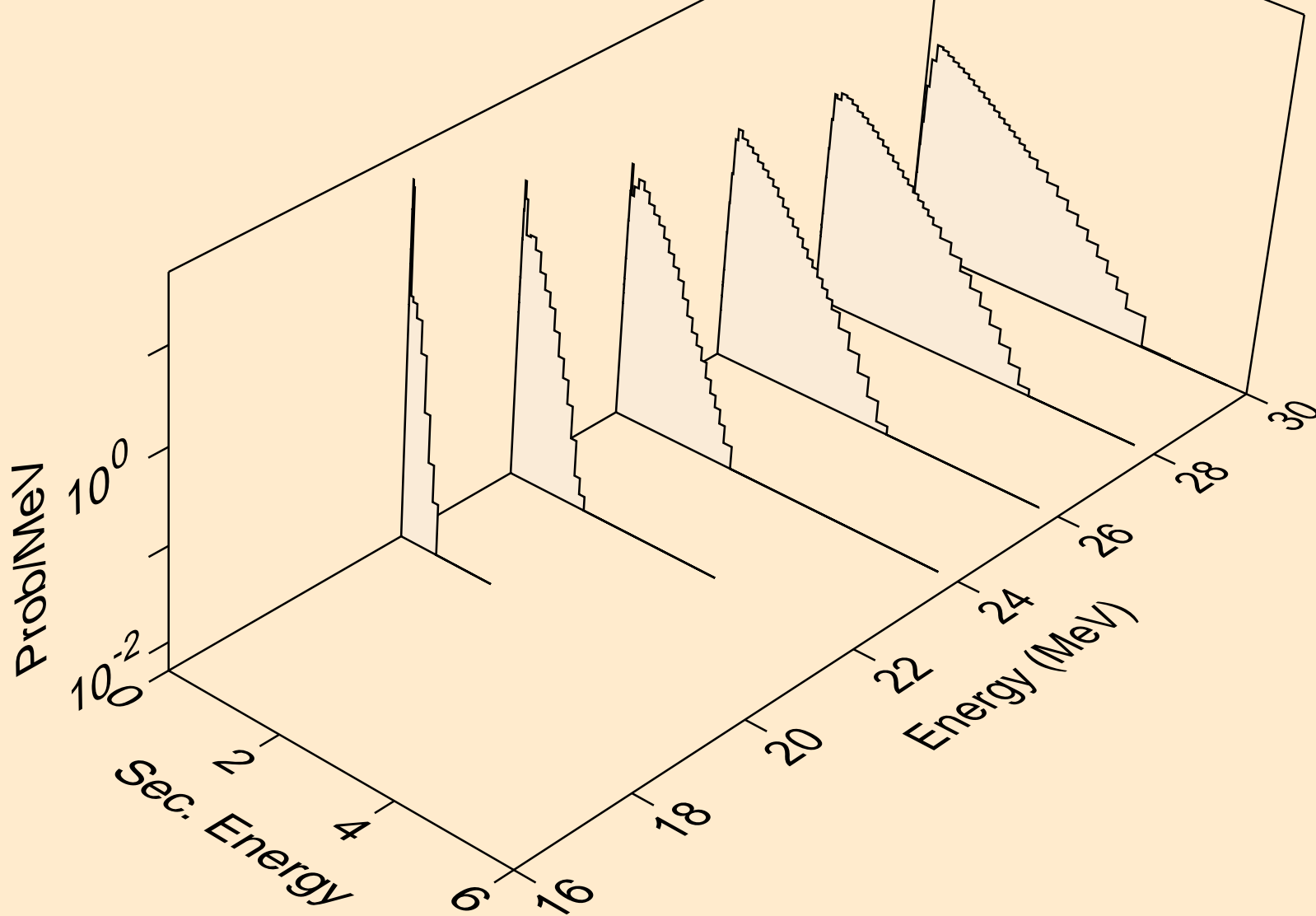

GE081 NEUTRON ACER TENDL-2019 LIBRARY; T=293.16K
Neutron emission for (n,n*)he3

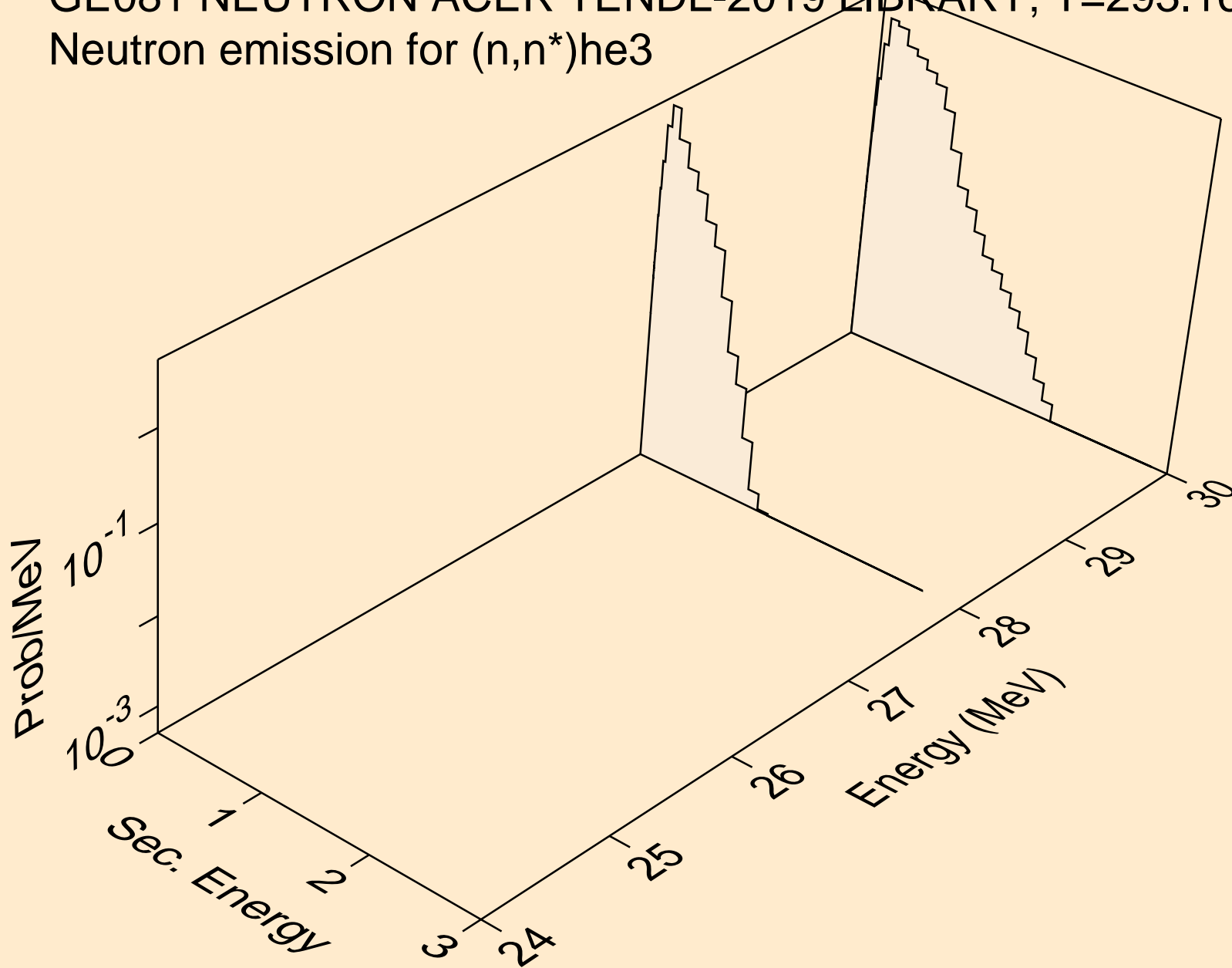

GE081 NEUTRON ACER TENDL-2019 LIBRARY; T=293.16K
Neutron emission for (n,4n)

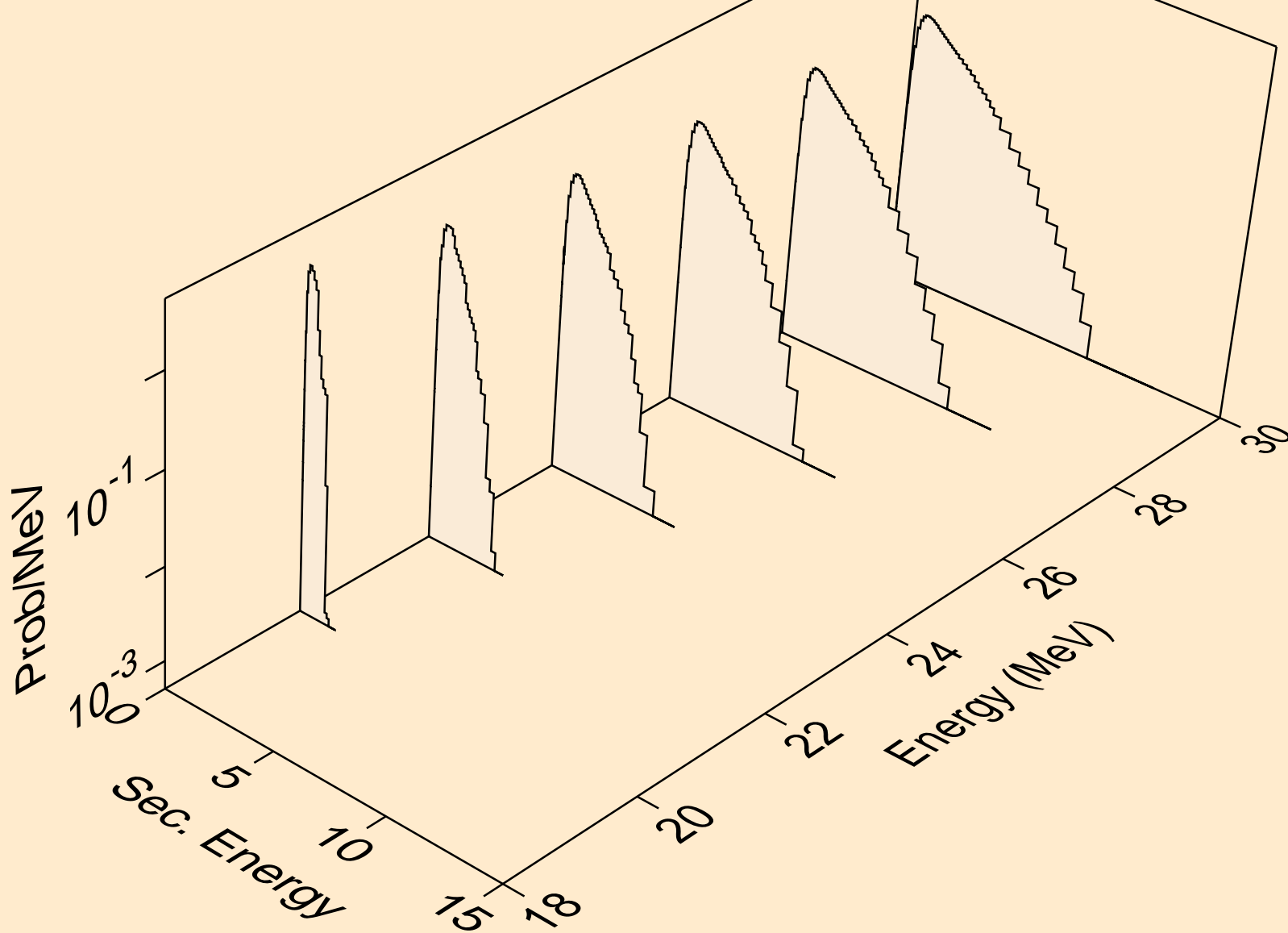

GE081 NEUTRON ACER TENDL-2019 LIBRARY; T=293.16K
Neutron emission for (n,2np)

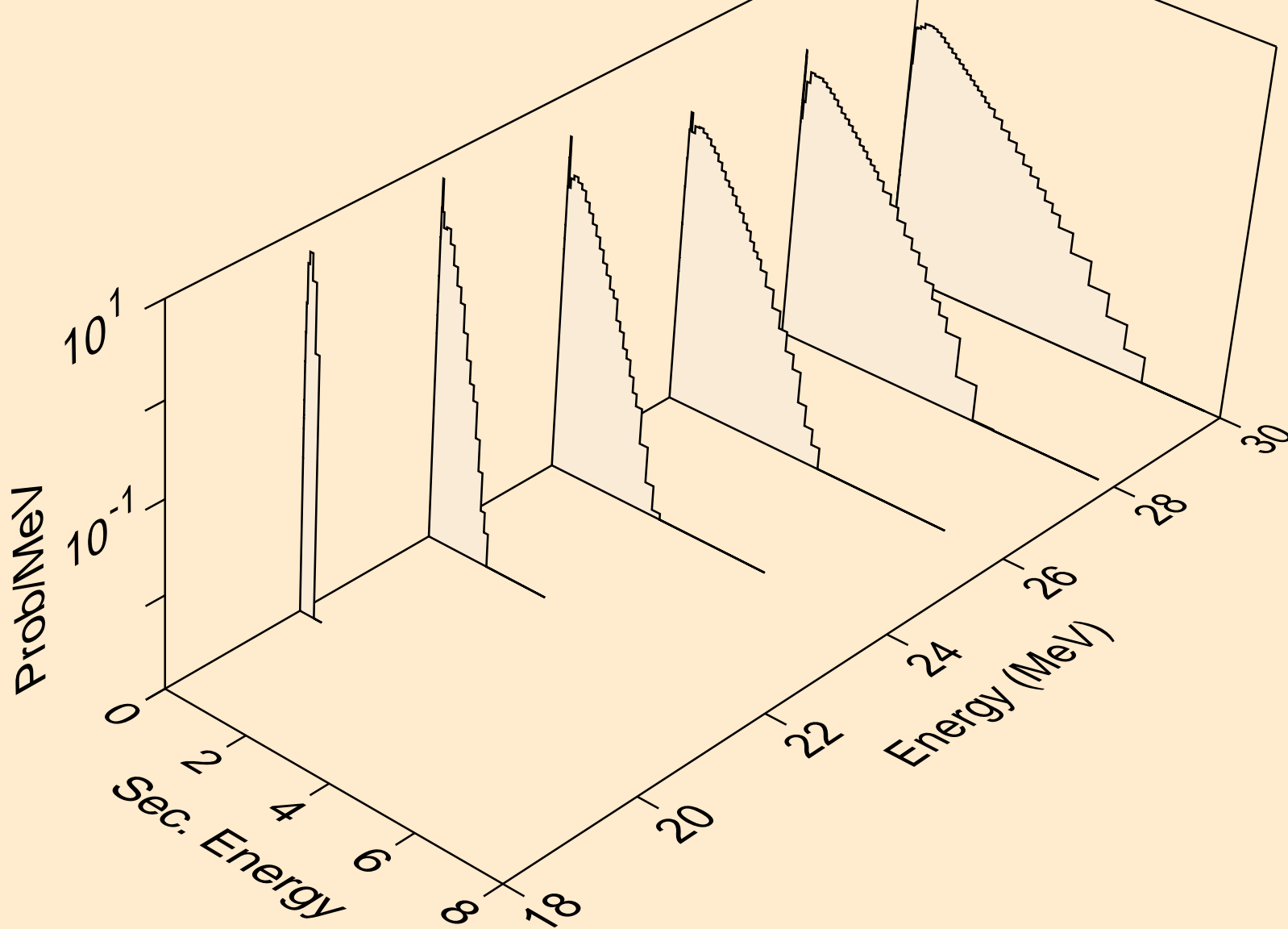

GE081 NEUTRON ACER TENDL-2019 LIBRARY; T=293.16K
Neutron emission for (n,3np)

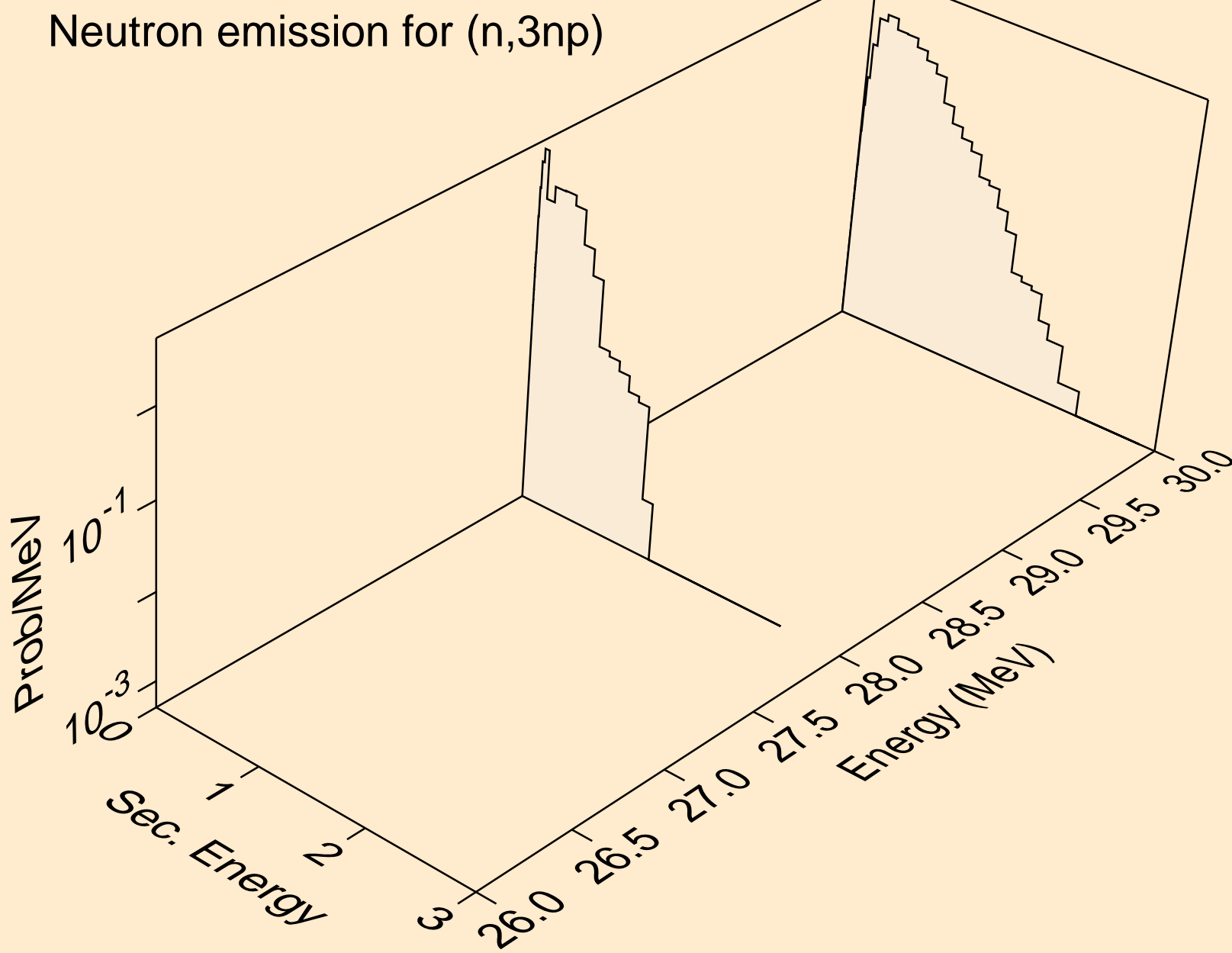

GE081 NEUTRON ACER TENDL-2019 LIBRARY; T=293.16K
Neutron emission for (n,n*c)

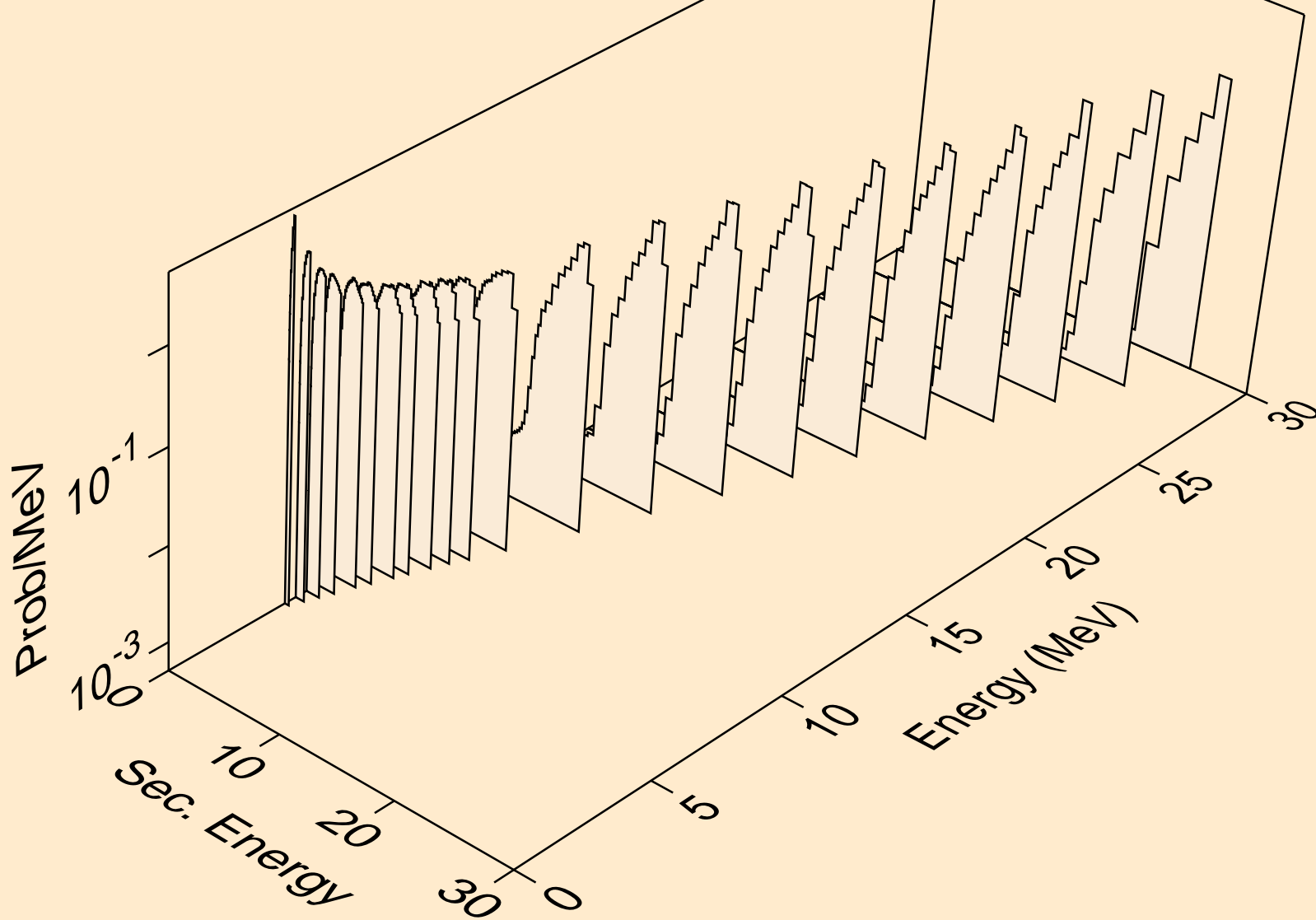

GE081 NEUTRON ACER TENDL-2019 LIBRARY; T=293.16K
Photon emission for (n,x)

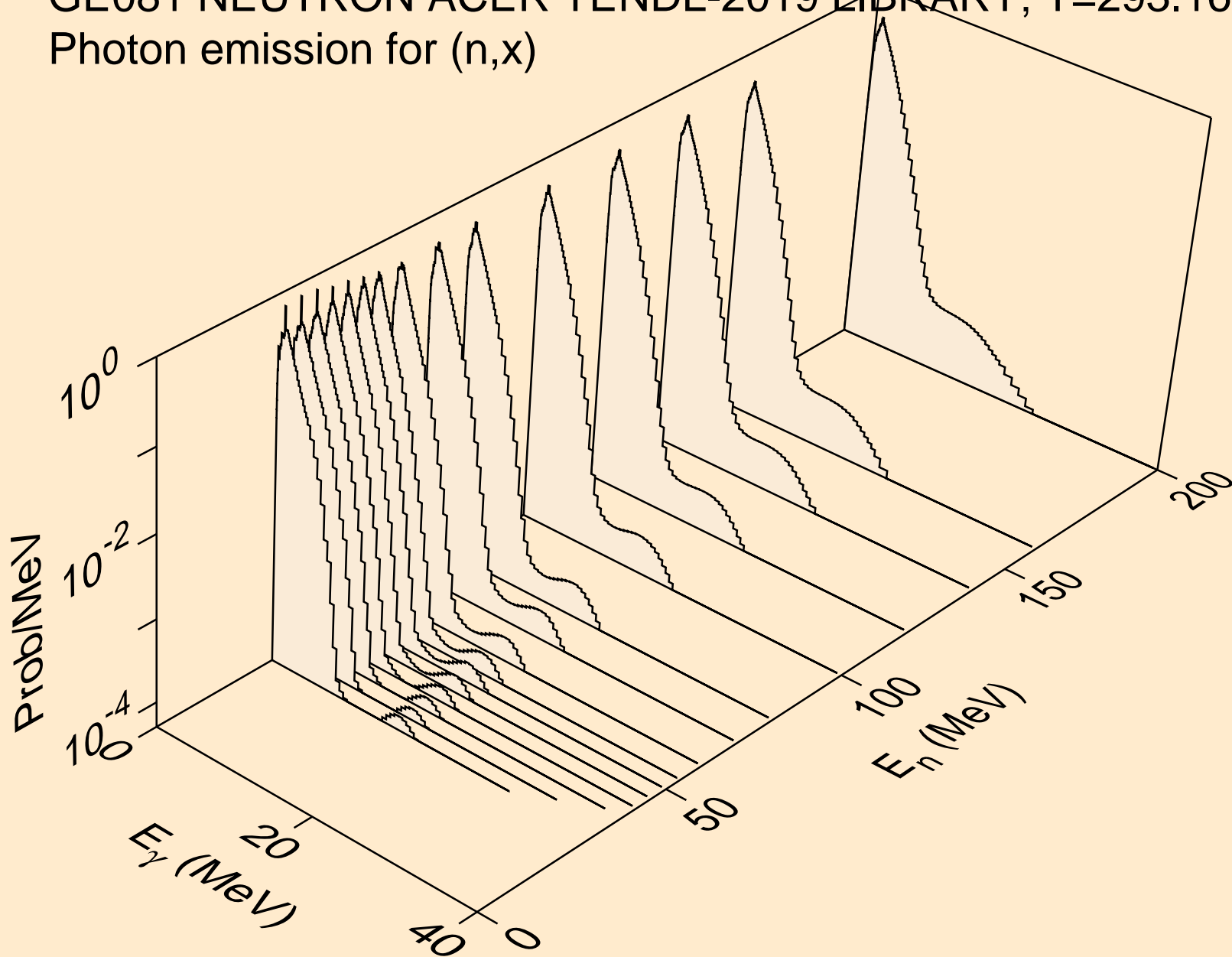

GE081 NEUTRON ACER TENDL-2019 LIBRARY; T=293.16K
Photon emission for (n,2nd)

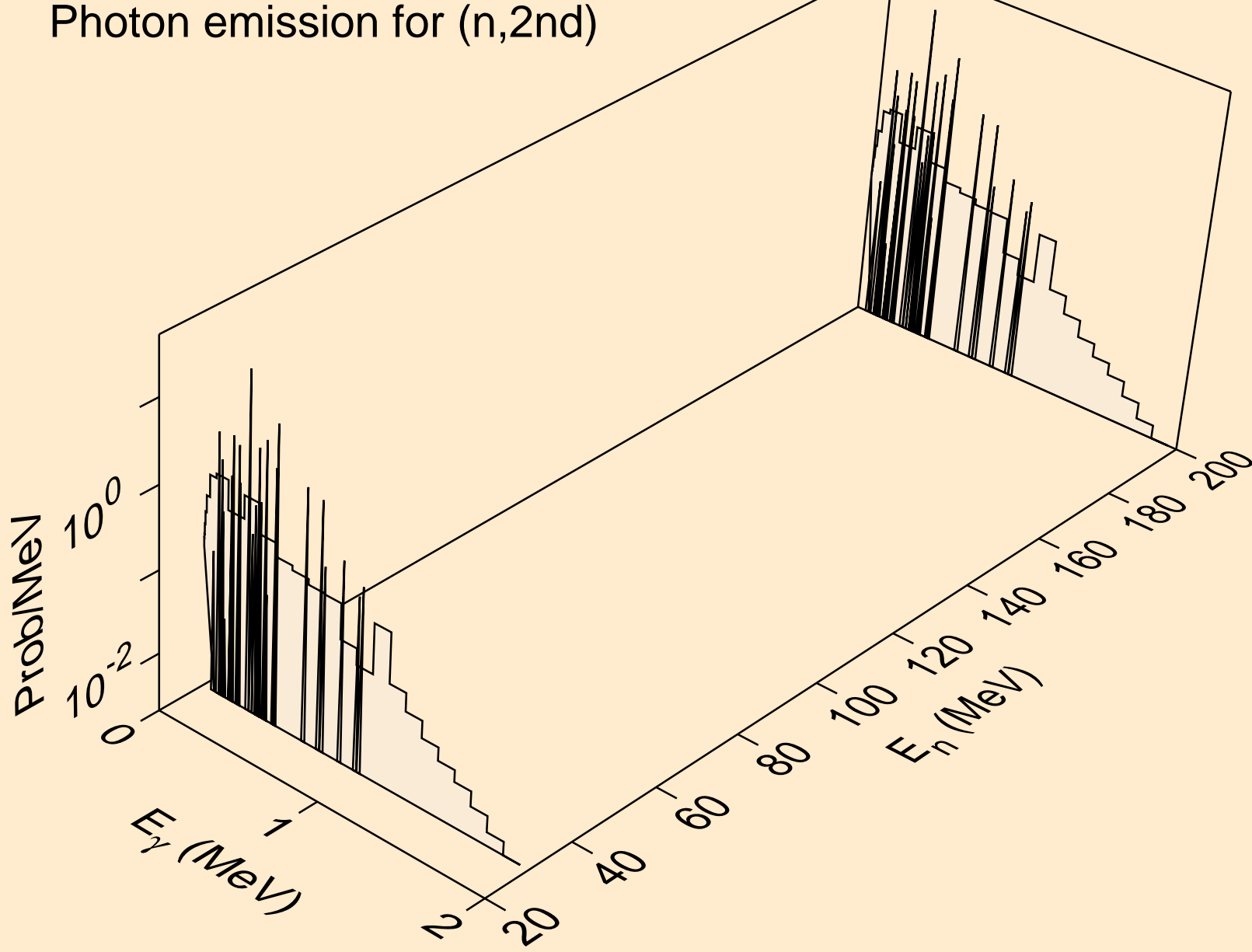

GE081 NEUTRON ACER TENDL-2019 LIBRARY; T=293.16K
Photon emission for (n,2n)

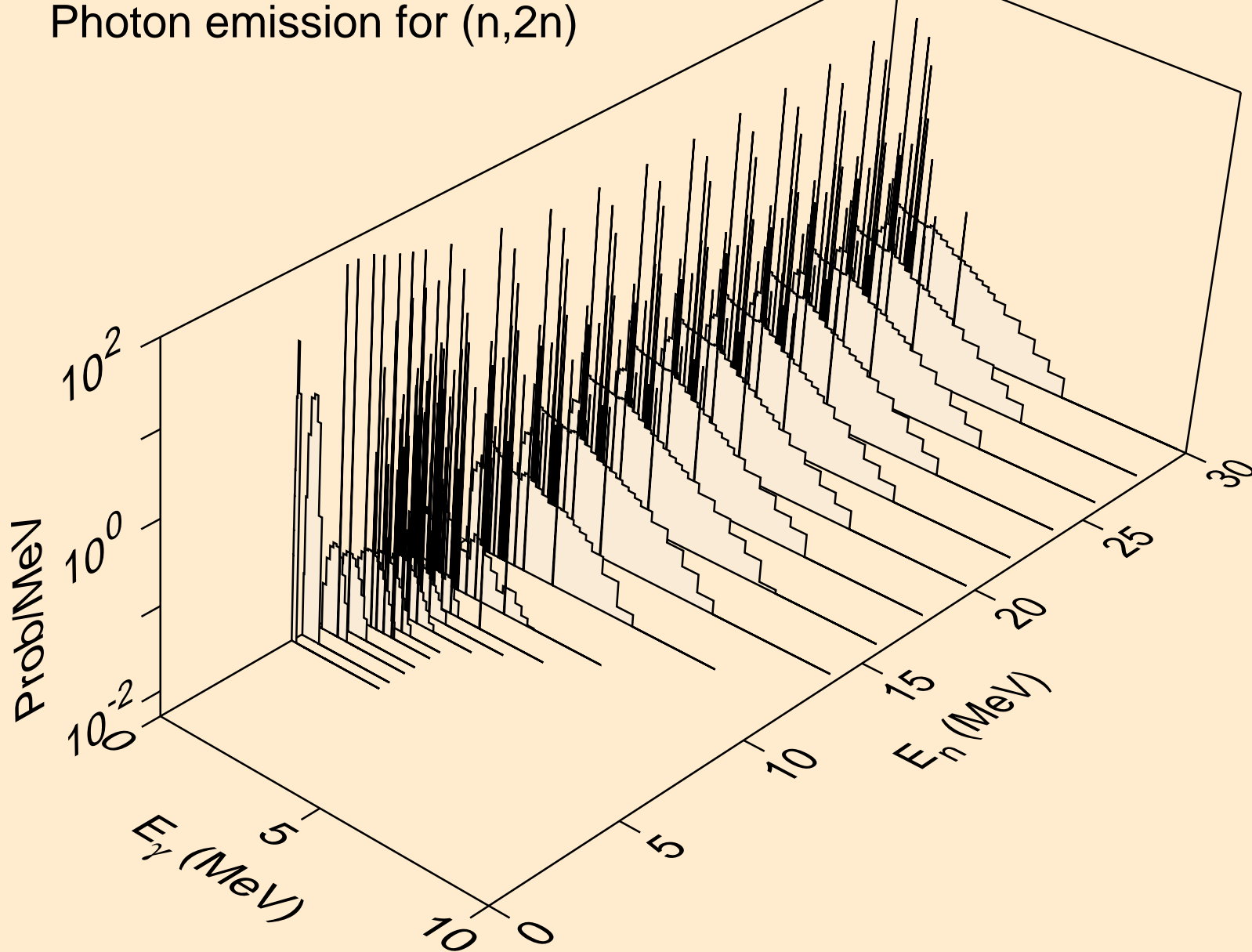

GE081 NEUTRON ACER TENDL-2019 LIBRARY; T=293.16K
Photon emission for (n,3n)

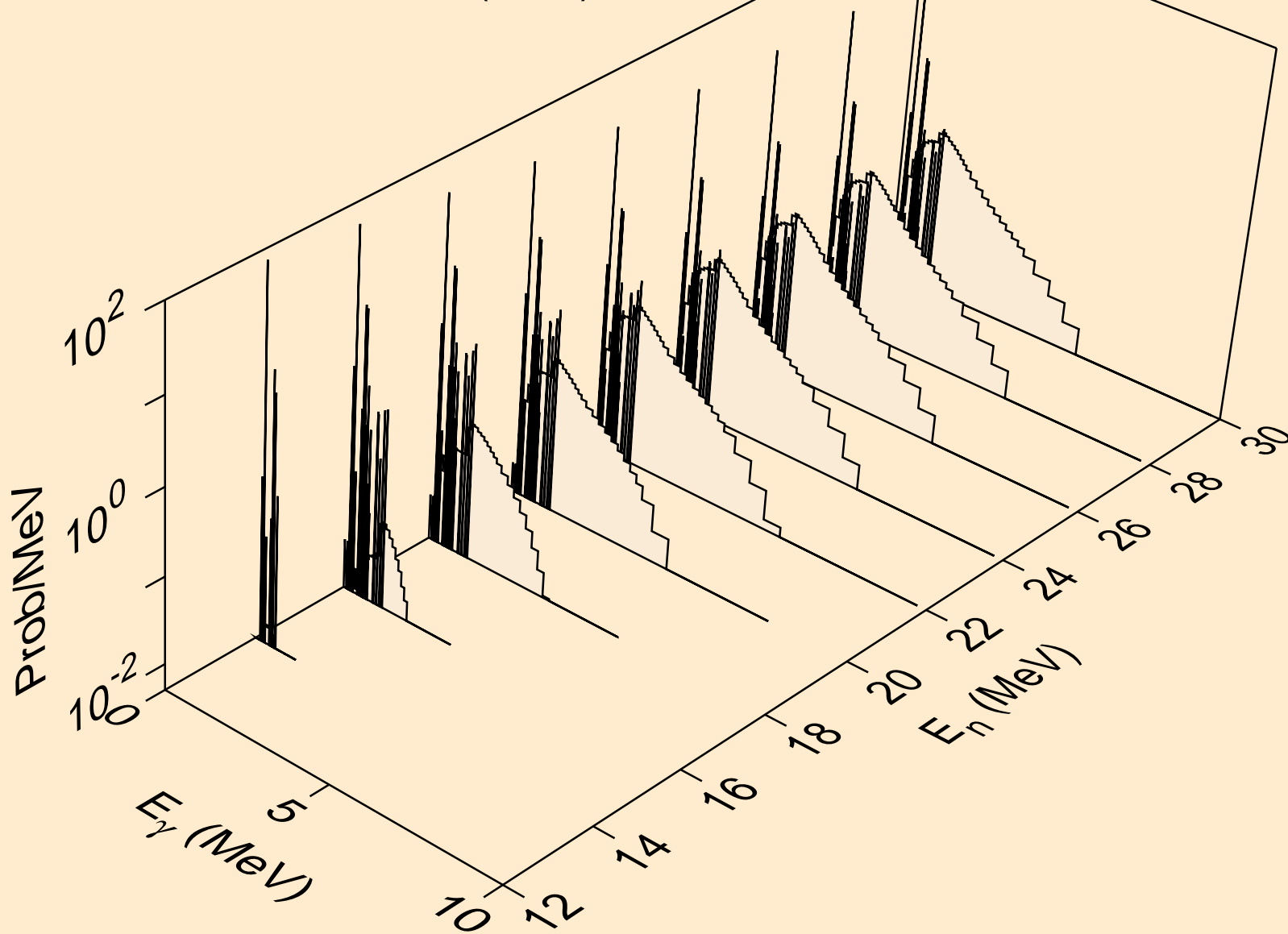

GE081 NEUTRON ACER TENDL-2019 LIBRARY; T=293.16K
Photon emission for (n,n*)a

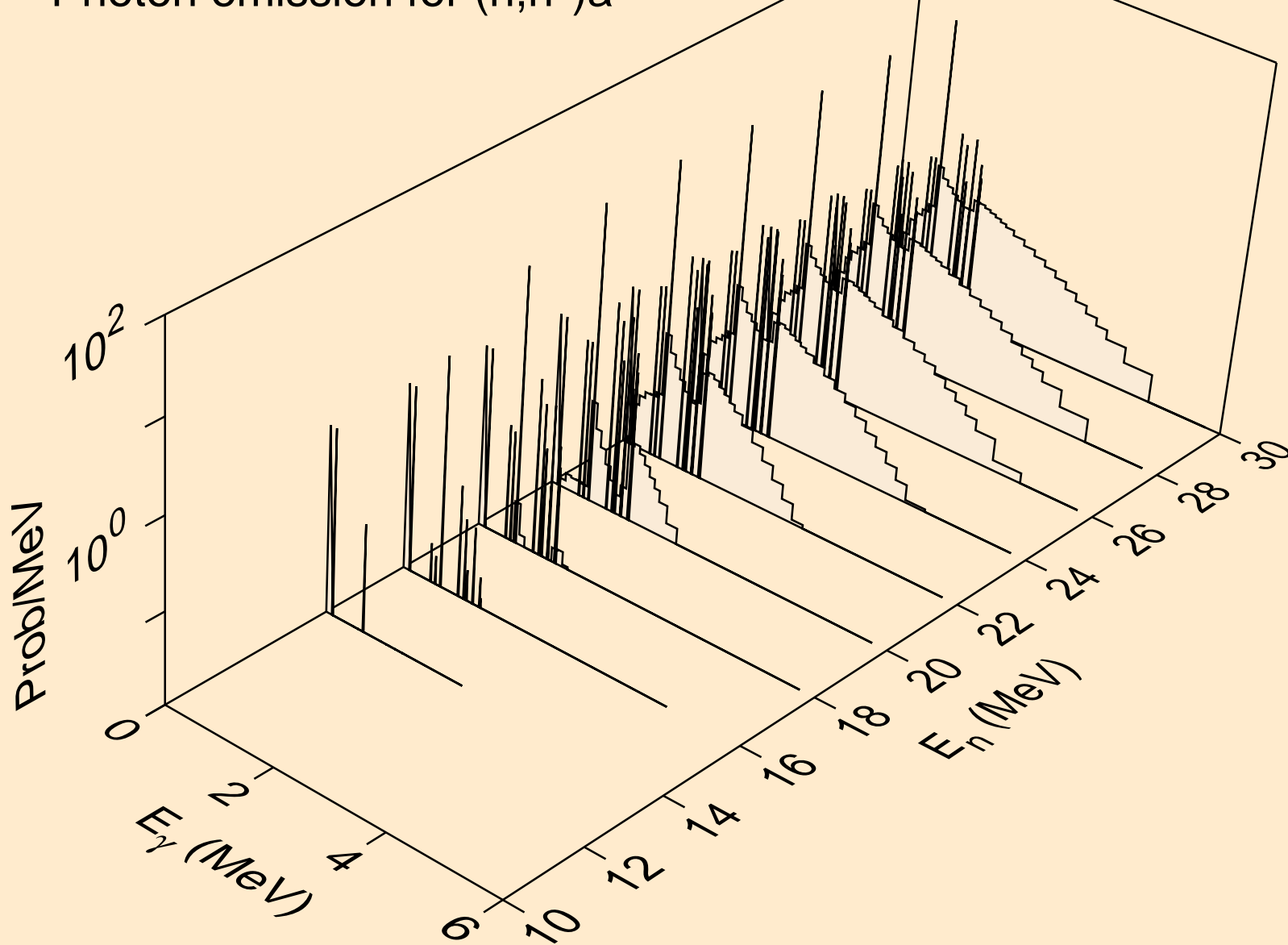

GE081 NEUTRON ACER TENDL-2019 LIBRARY; T=293.16K
Photon emission for (n,2n)a

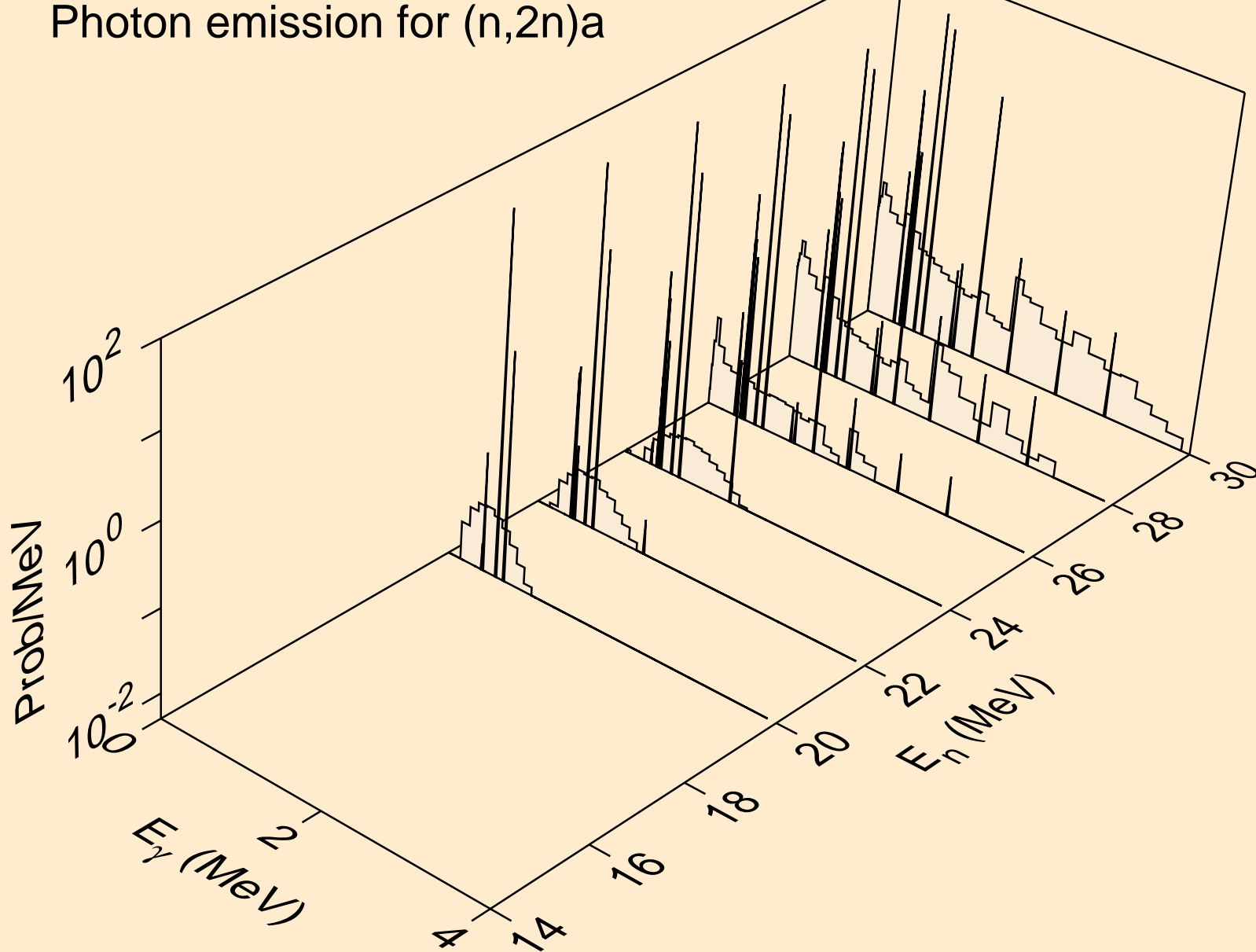

GE081 NEUTRON ACER TENDL-2019 LIBRARY; T=293.16K
Photon emission for (n,3n)a

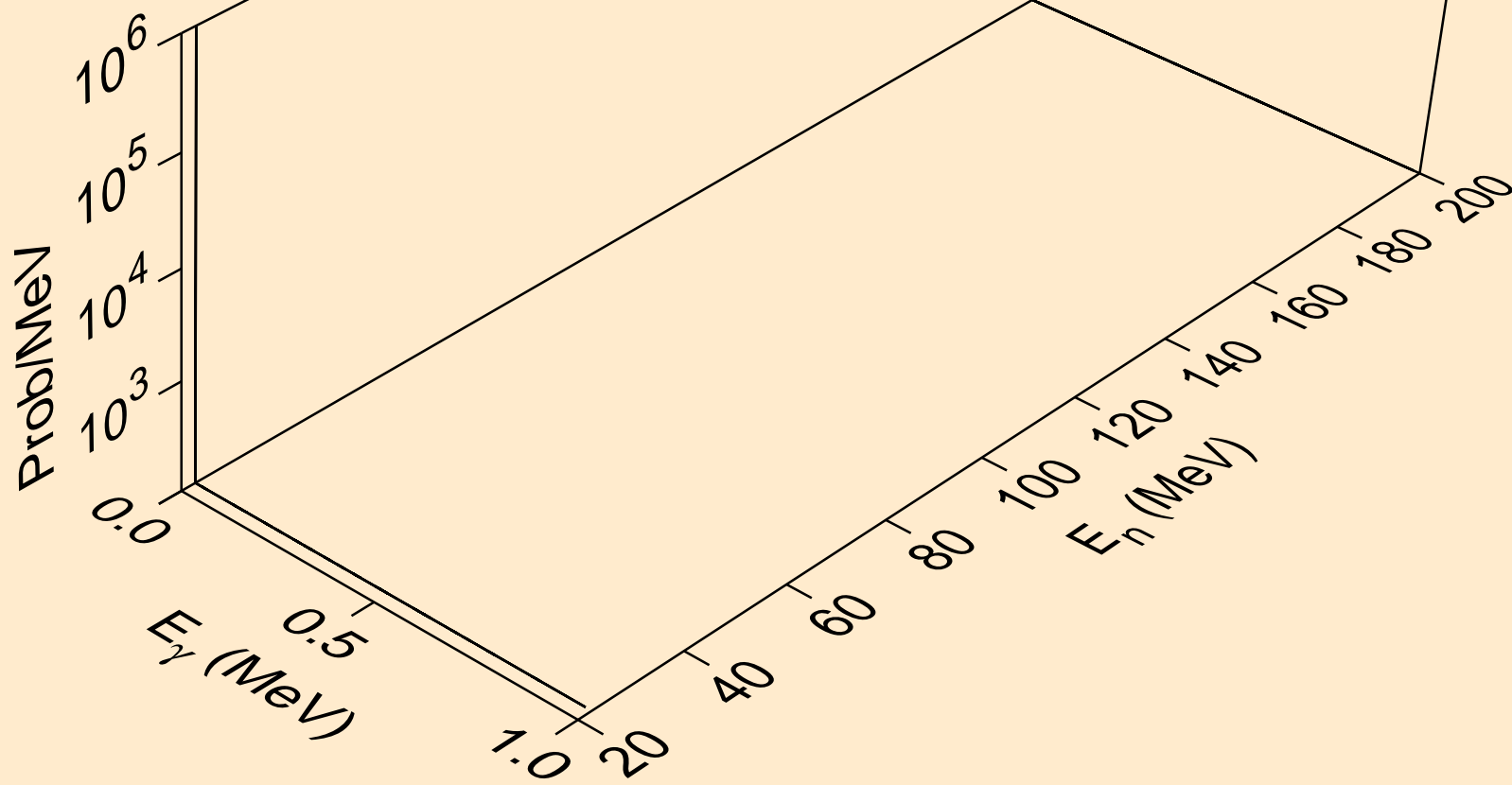

GE081 NEUTRON ACER TENDL-2019 LIBRARY; T=293.16K
Photon emission for (n,n*)p

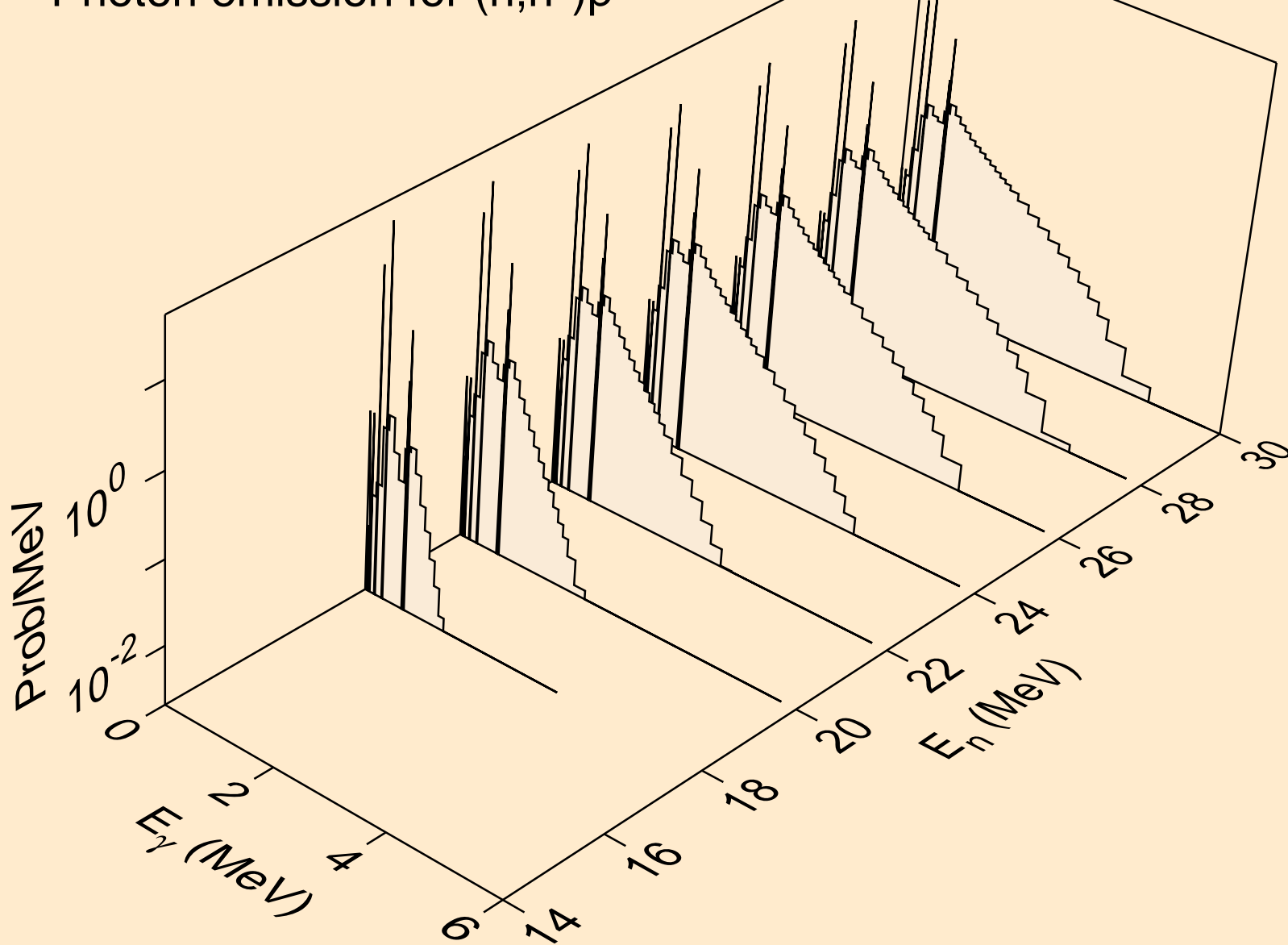

GE081 NEUTRON ACER TENDL-2019 LIBRARY; T=293.16K
Photon emission for (n,n*)d

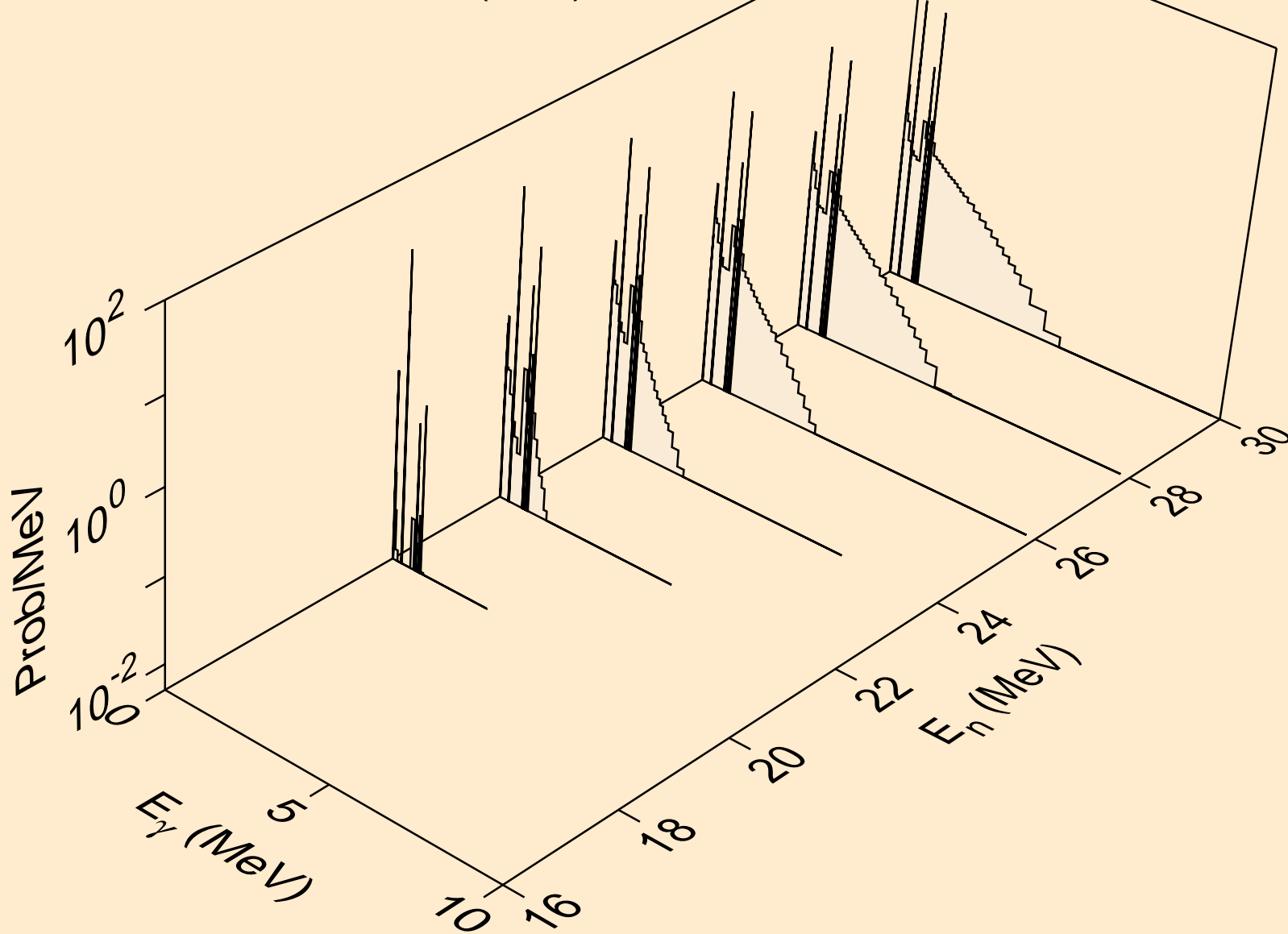

GE081 NEUTRON ACER TENDL-2019 LIBRARY; T=293.16K
Photon emission for (n,n*)t

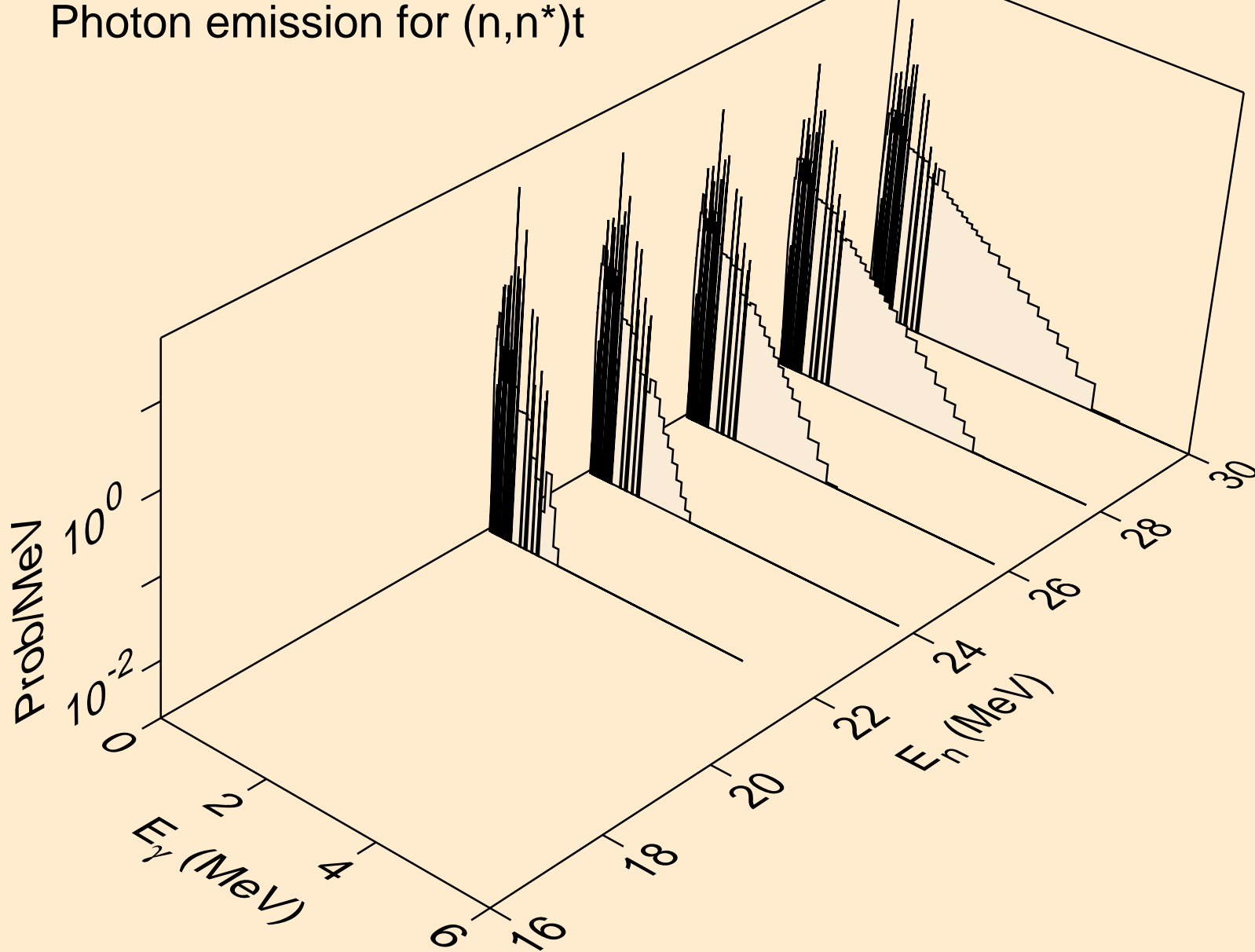

GE081 NEUTRON ACER TENDL-2019 LIBRARY; T=293.16K
Photon emission for (n,n*)he3

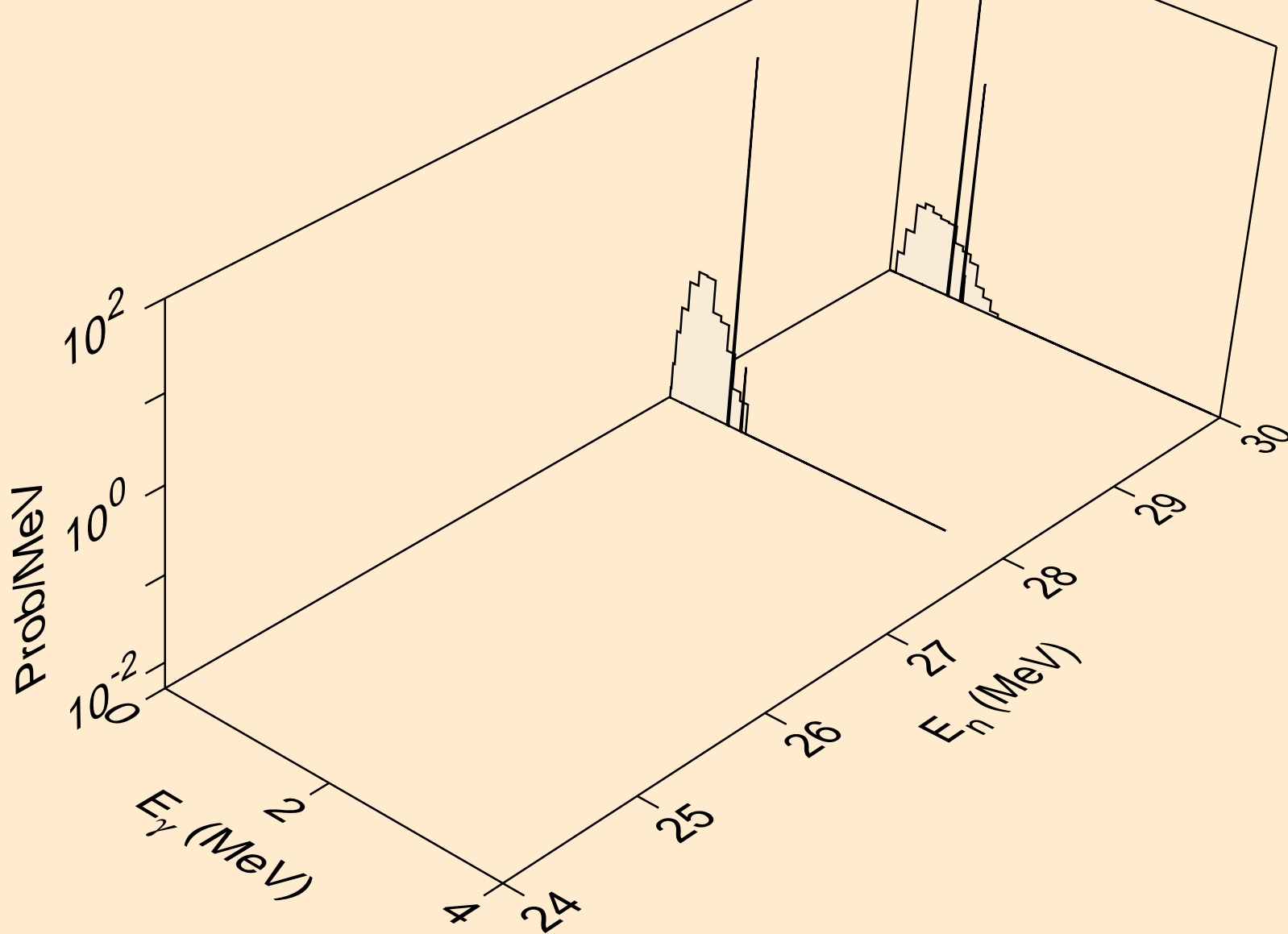

GE081 NEUTRON ACER TENDL-2019 LIBRARY; T=293.16K
Photon emission for (n,4n)

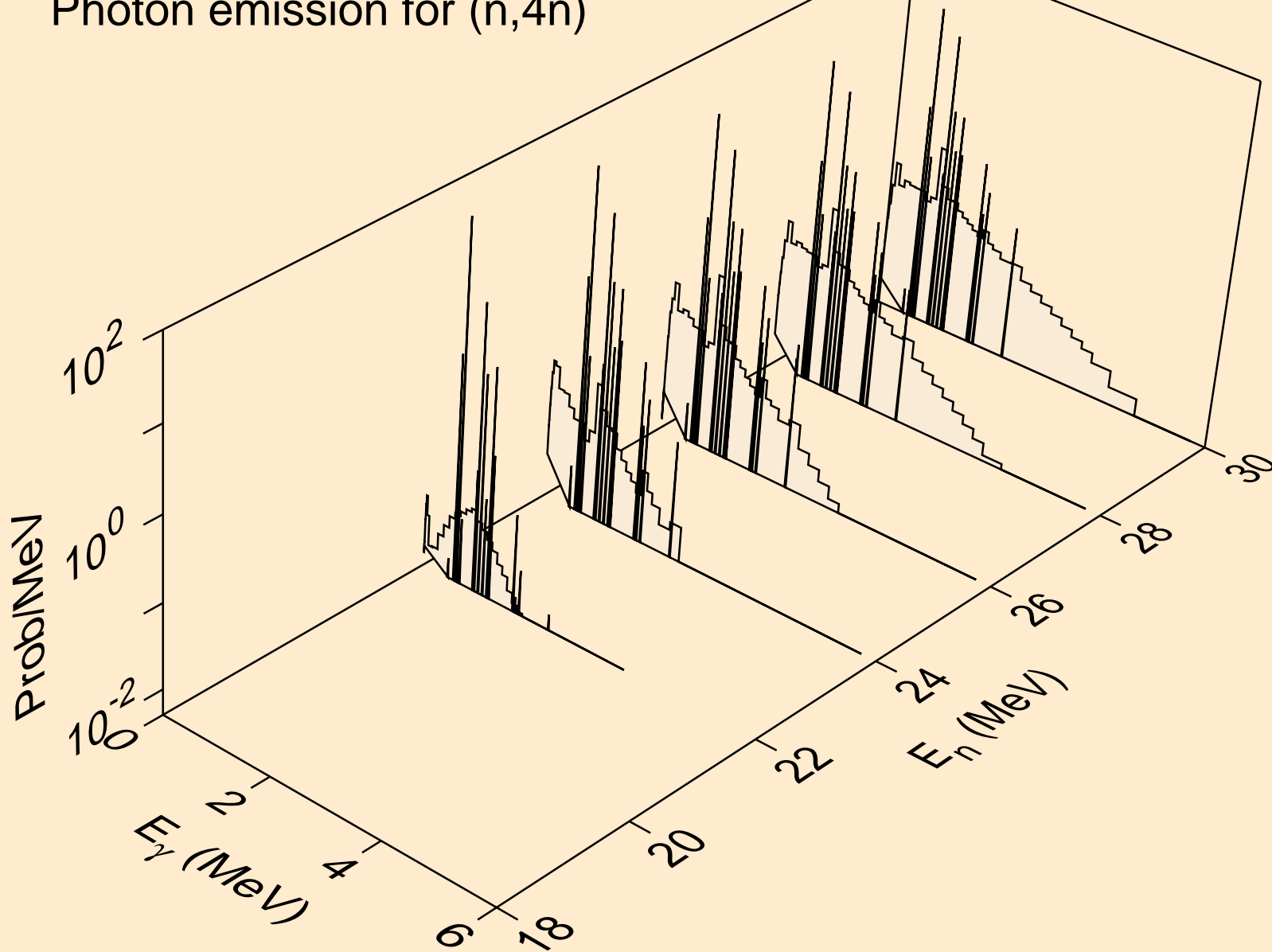

GE081 NEUTRON ACER TENDL-2019 LIBRARY; T=293.16K
Photon emission for (n,2np)

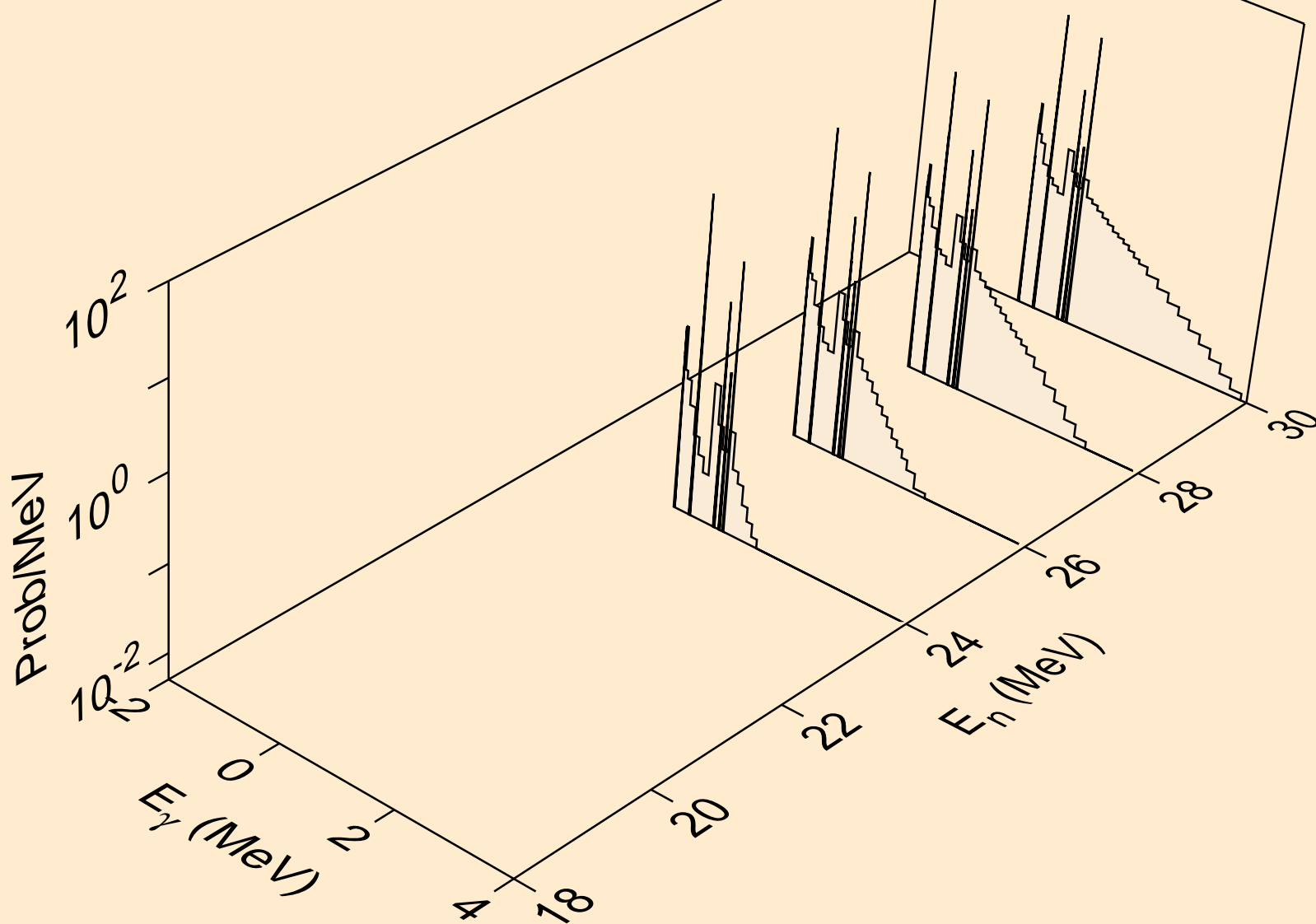

GE081 NEUTRON ACER TENDL-2019 LIBRARY; T=293.16K
Photon emission for (n,3np)

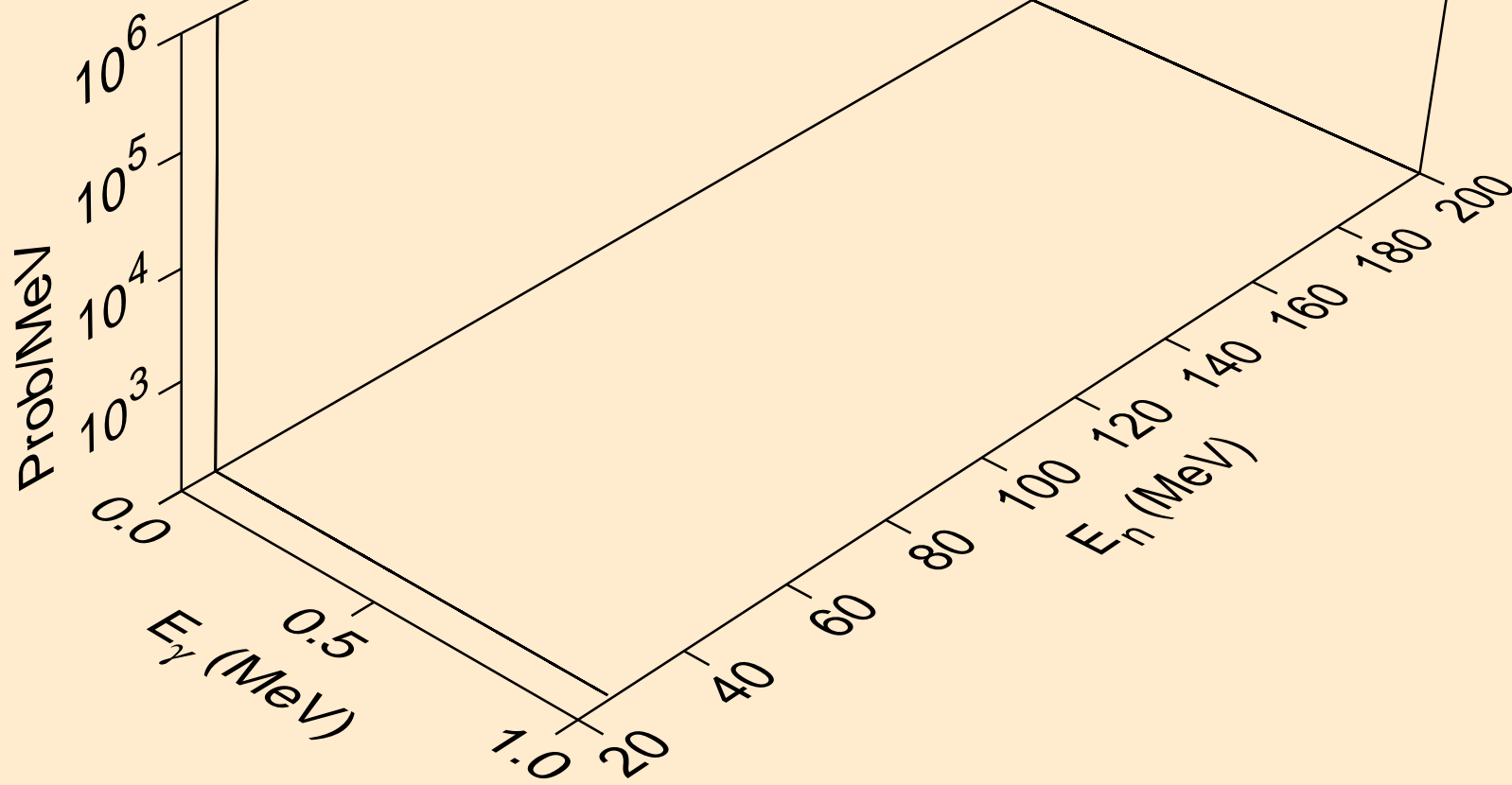

GE081 NEUTRON ACER TENDL-2019 LIBRARY; T=293.16K
Photon emission for (n,n*c)

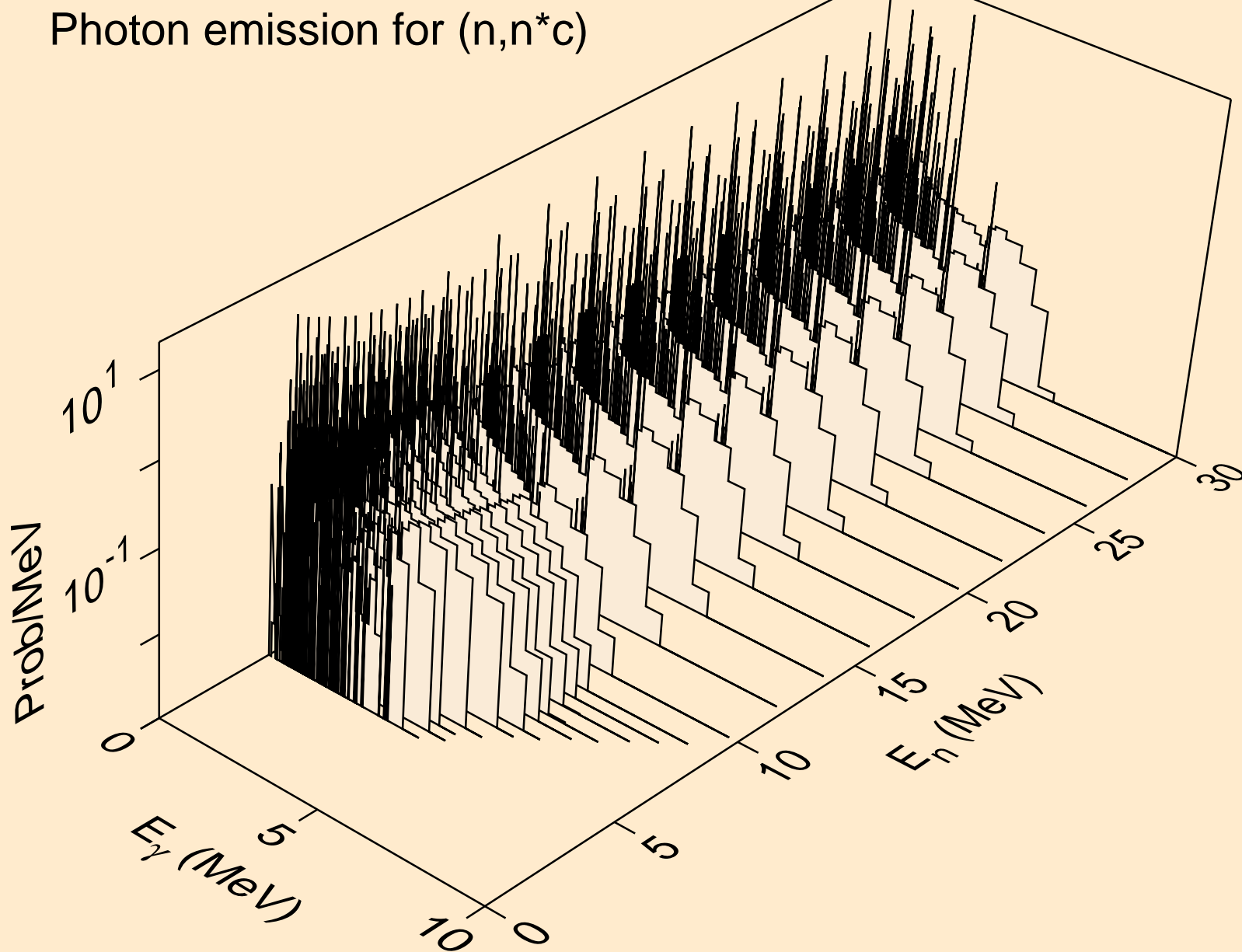

GE081 NEUTRON ACER TENDL-2019 LIBRARY; T=293.16K
Photon emission for (n,gma)

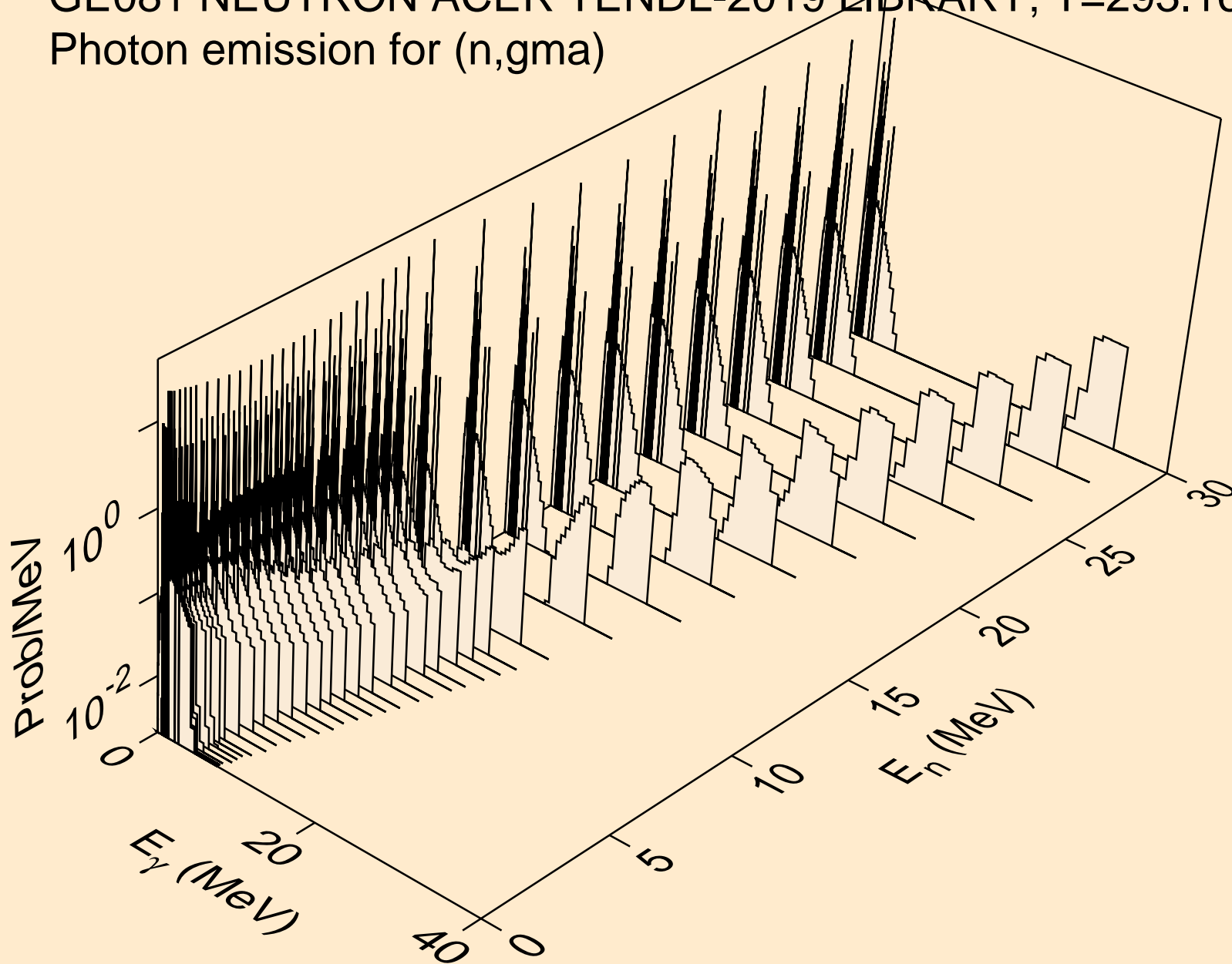

GE081 NEUTRON ACER TENDL-2019 LIBRARY; T=293.16K
Photon emission for (n,p)

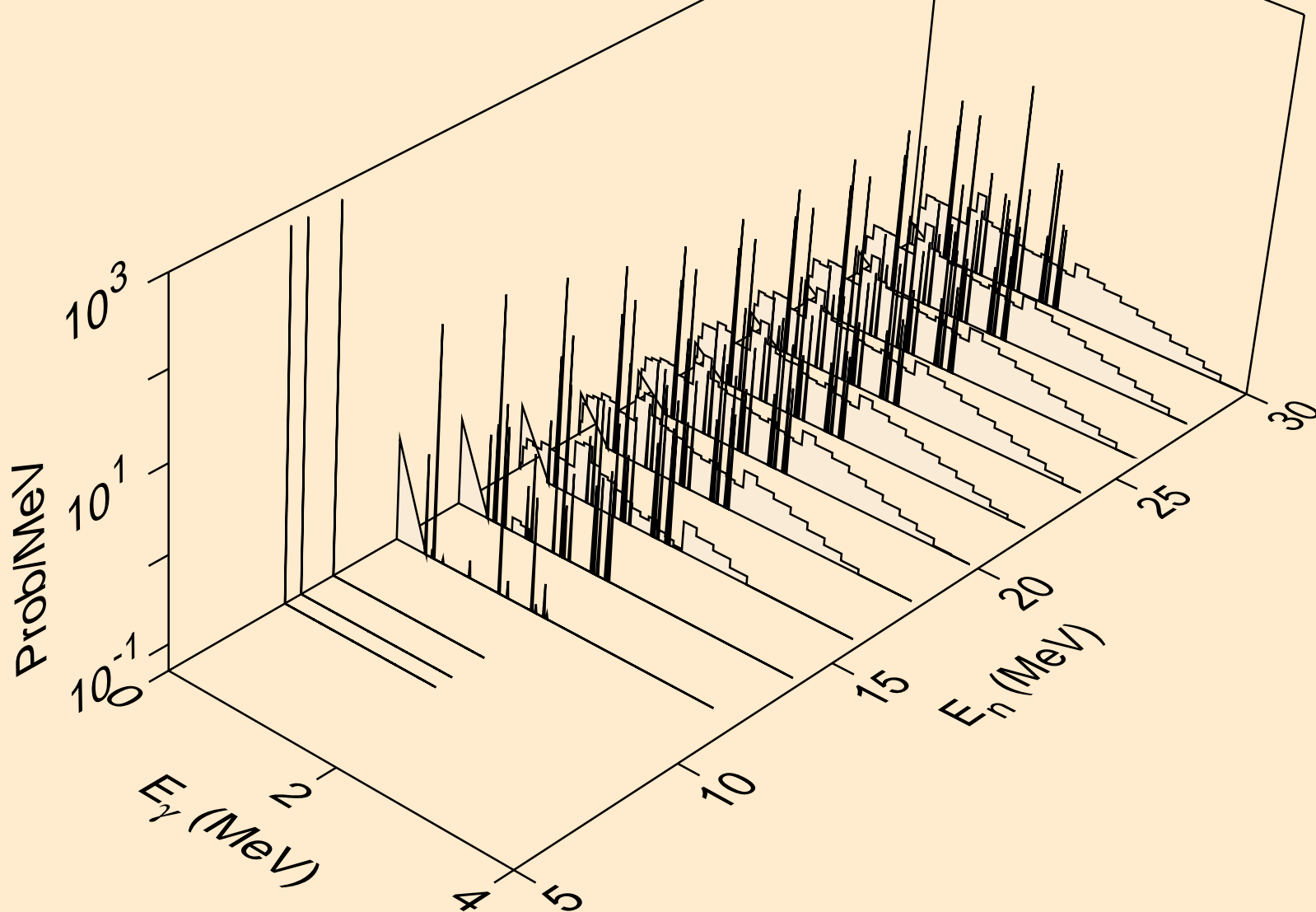

GE081 NEUTRON ACER TENDL-2019 LIBRARY; T=293.16K
Photon emission for (n,d)

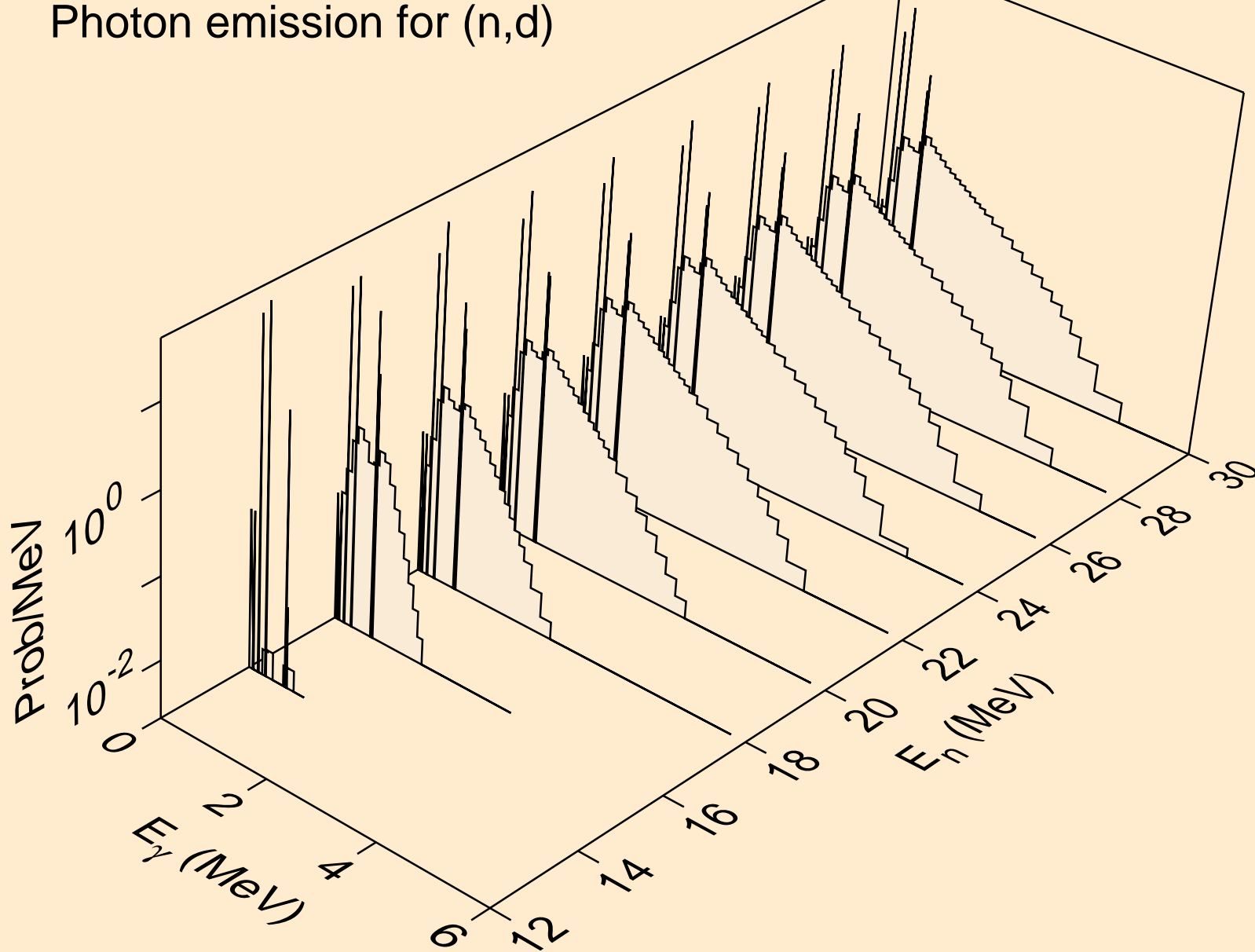

GE081 NEUTRON ACER TENDL-2019 LIBRARY; T=293.16K
Photon emission for (n,t)

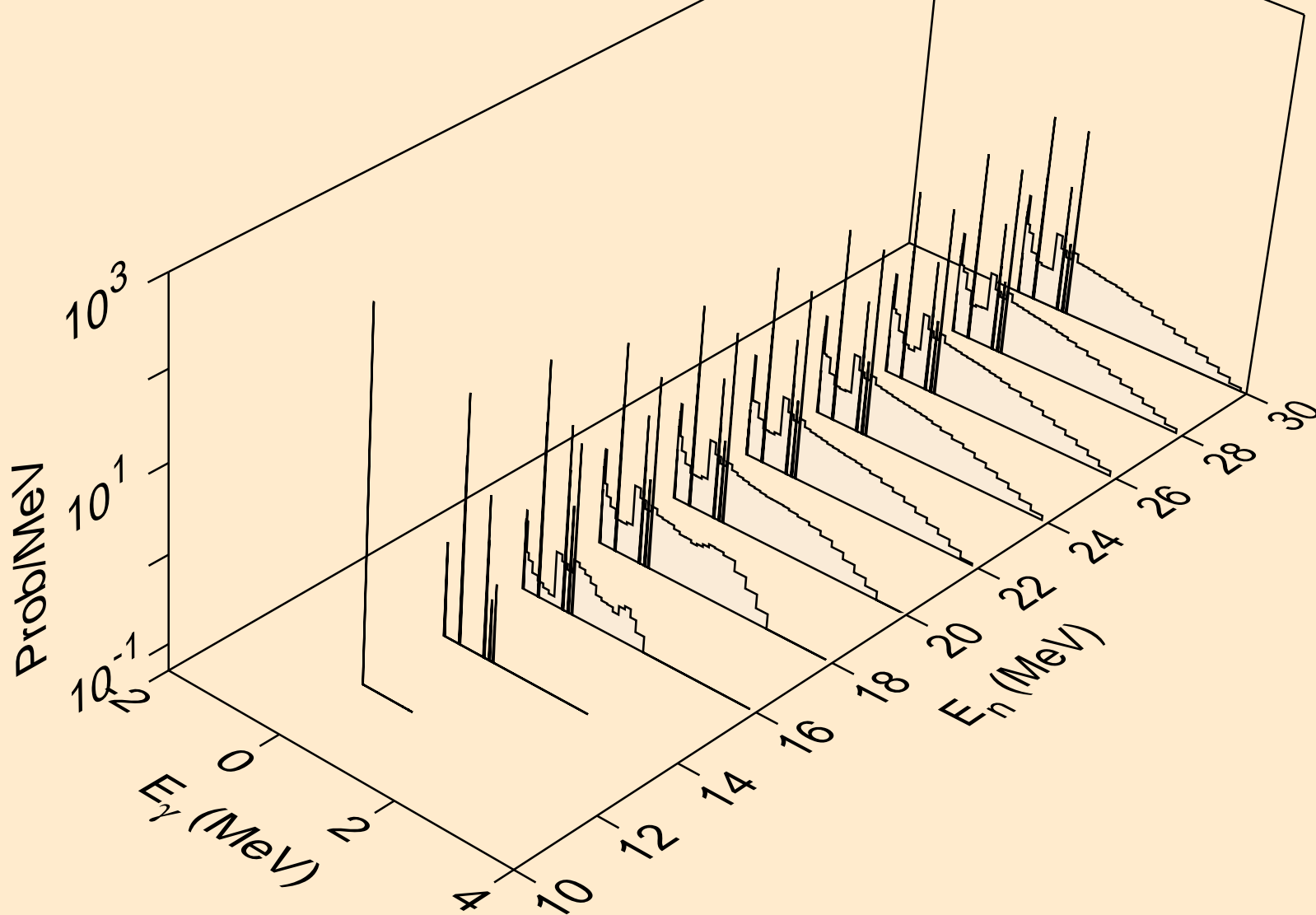

GE081 NEUTRON ACER TENDL-2019 LIBRARY; T=293.16K
Photon emission for (n,he3)

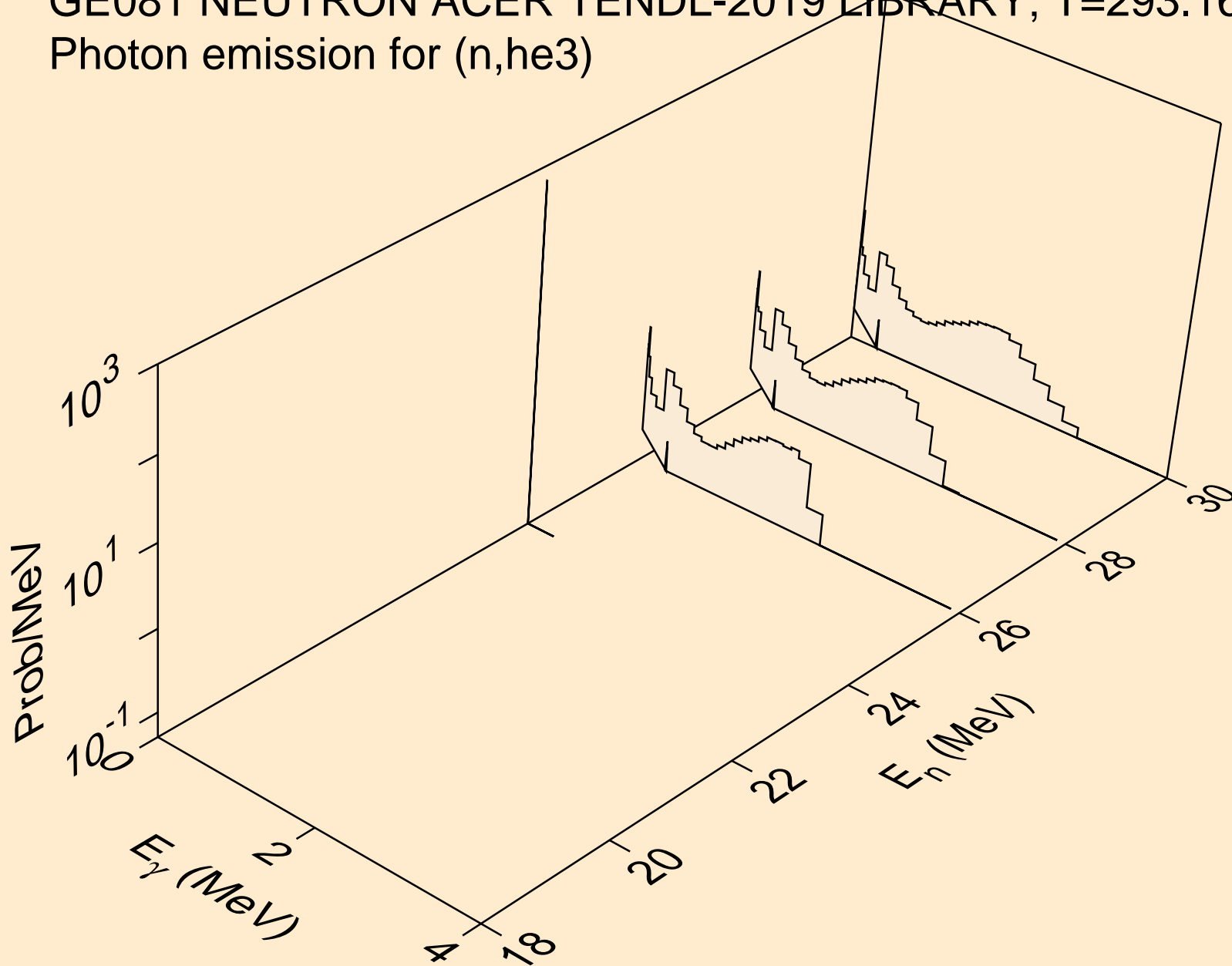

GE081 NEUTRON ACER TENDL-2019 LIBRARY; T=293.16K
Photon emission for (n,a)

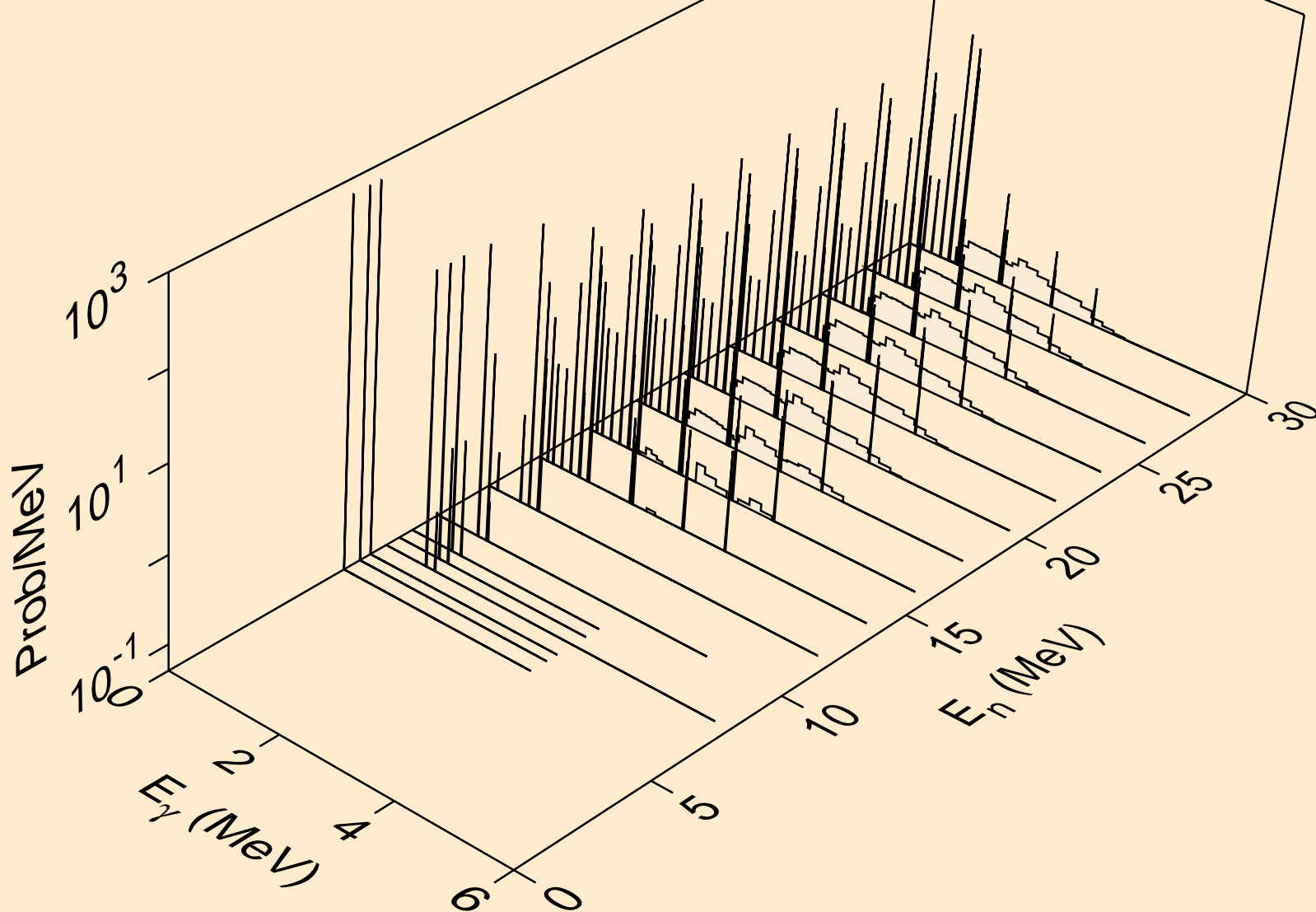

GE081 NEUTRON ACER TENDL-2019 LIBRARY; T=293.16K
thermal capture photon spectrum

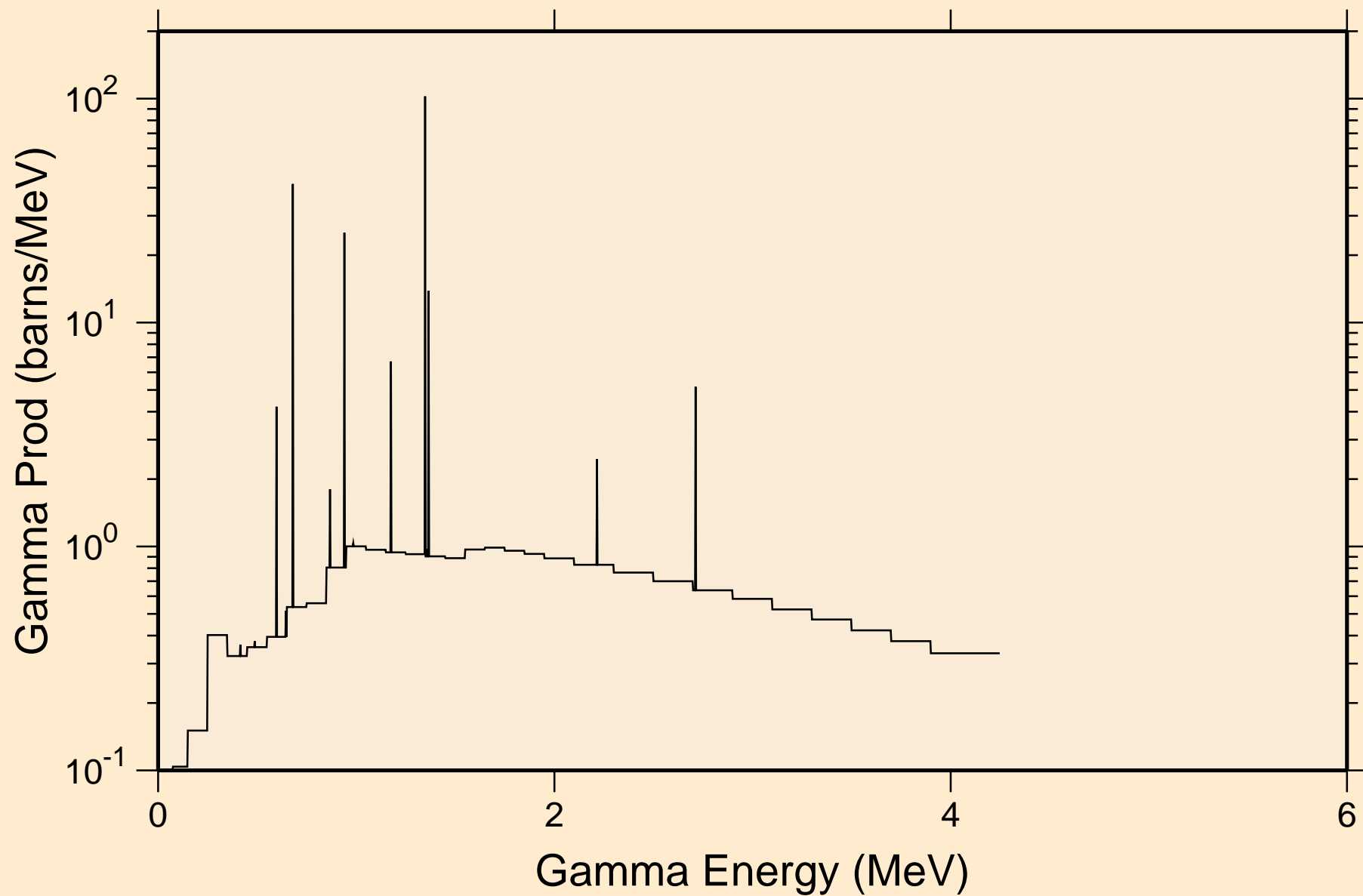

GE081 NEUTRON ACER TENDL-2019 LIBRARY; T=293.16K
14 MeV photon spectrum

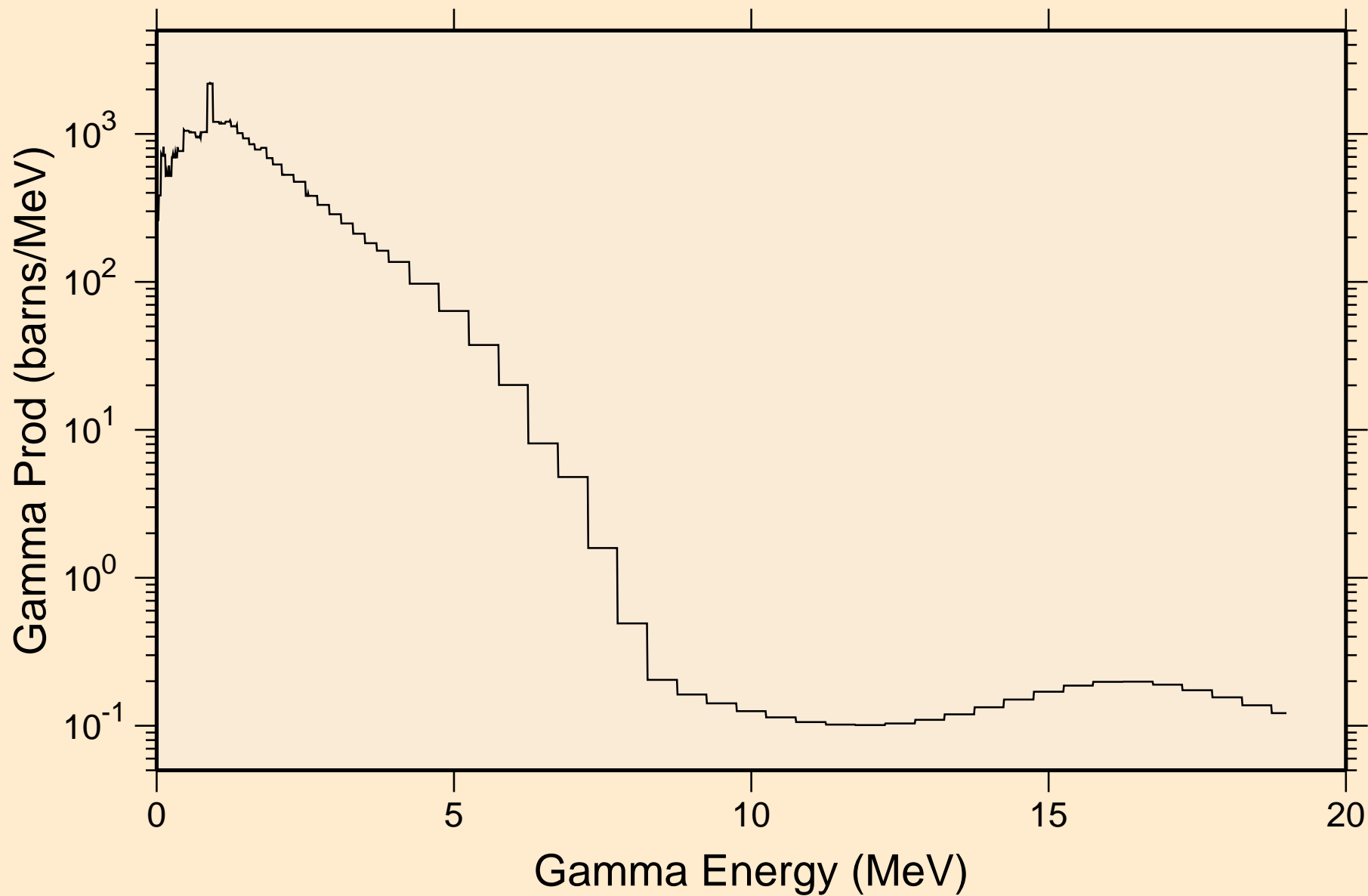

GE081 NEUTRON ACER TENDL-2019 LIBRARY; T=293.16K

Particle heating contributions

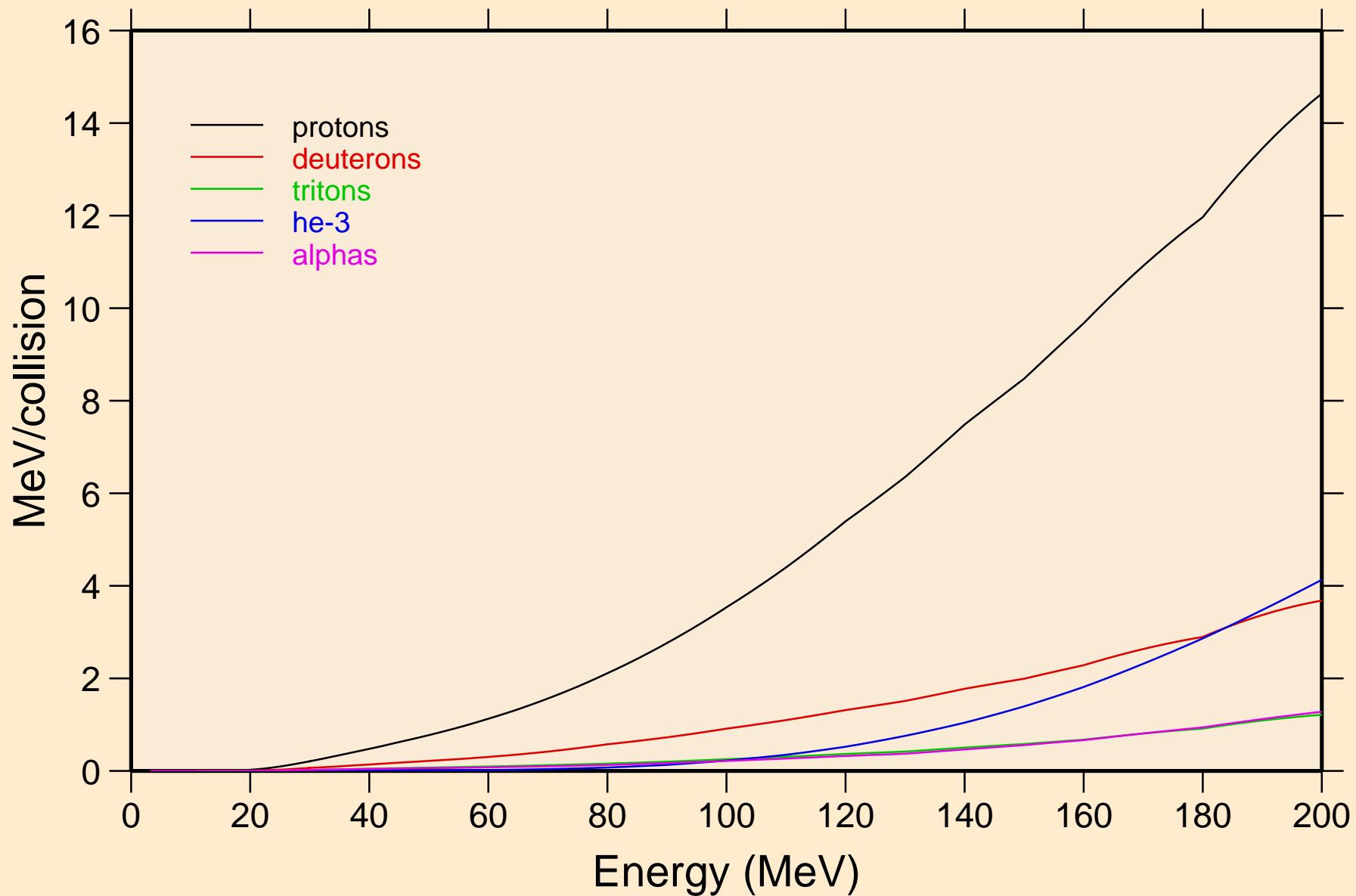

GE081 NEUTRON ACER TENDL-2019 LIBRARY; T=293.16K
Recoil Heating

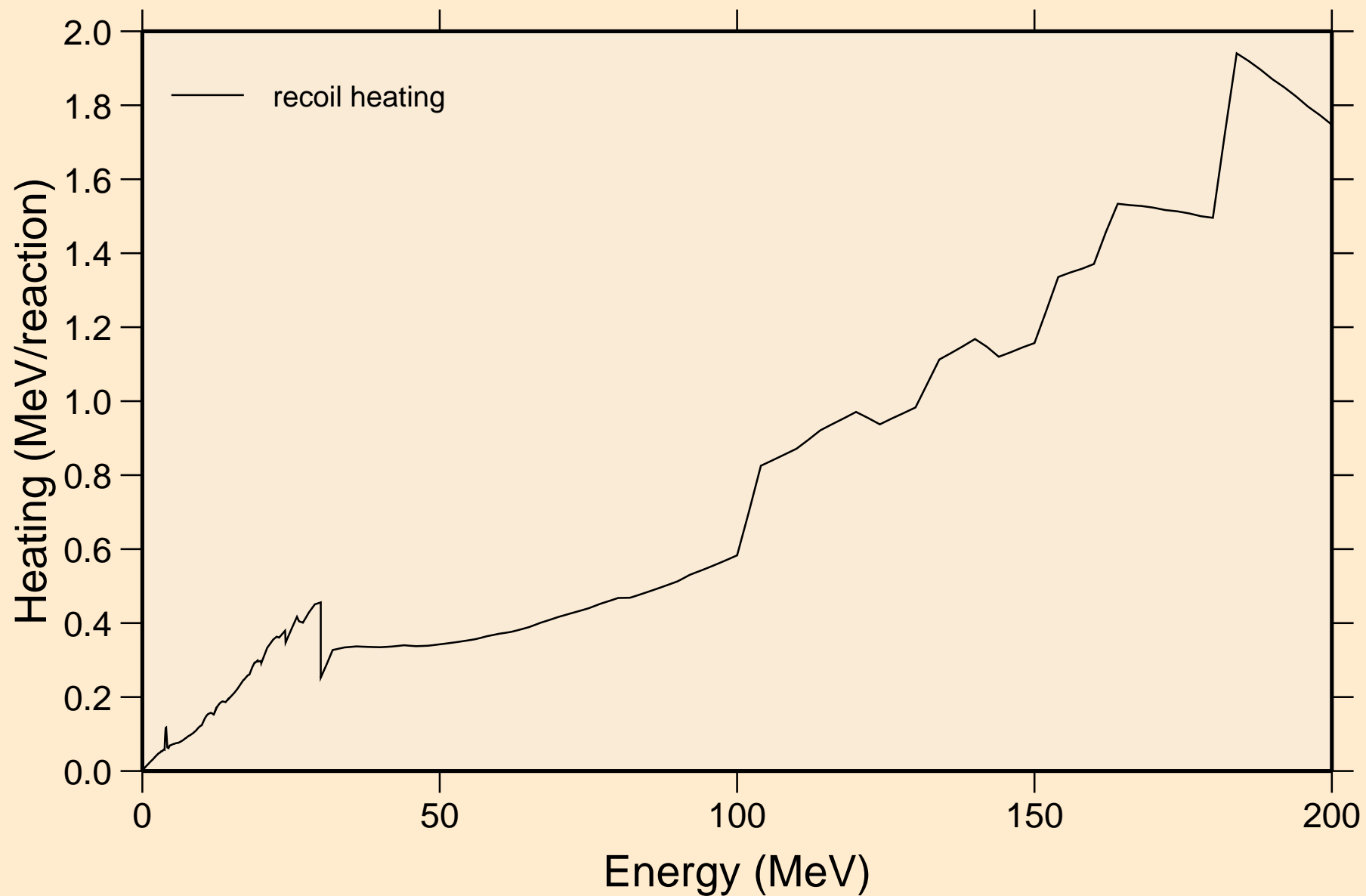

GE081 NEUTRON ACER TENDL-2019 LIBRARY; T=293.16K
Particle production cross sections

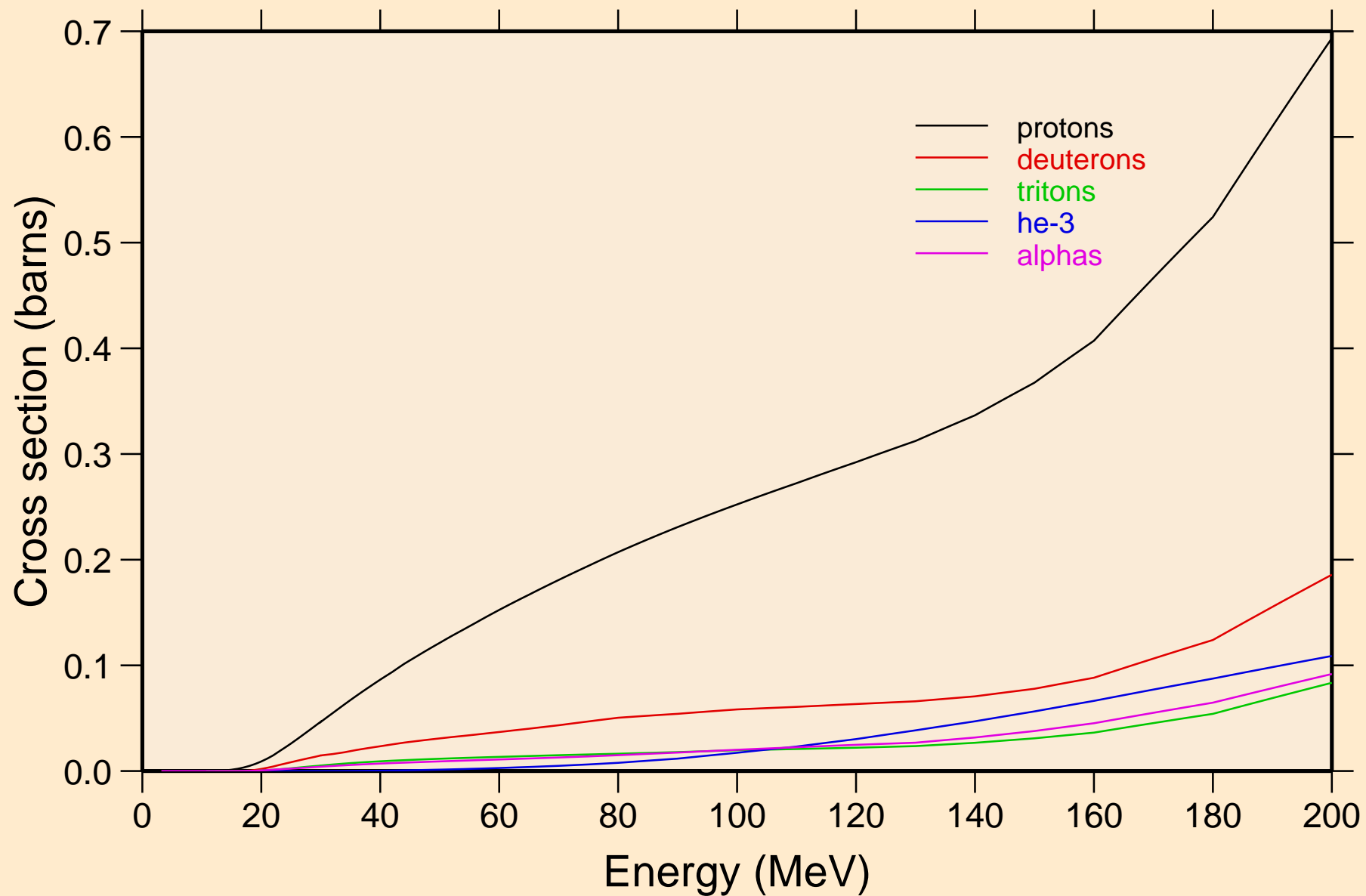

GE081 NEUTRON ACER TENDL-2019 LIBRARY; T=293.16K
protons from (n,x)

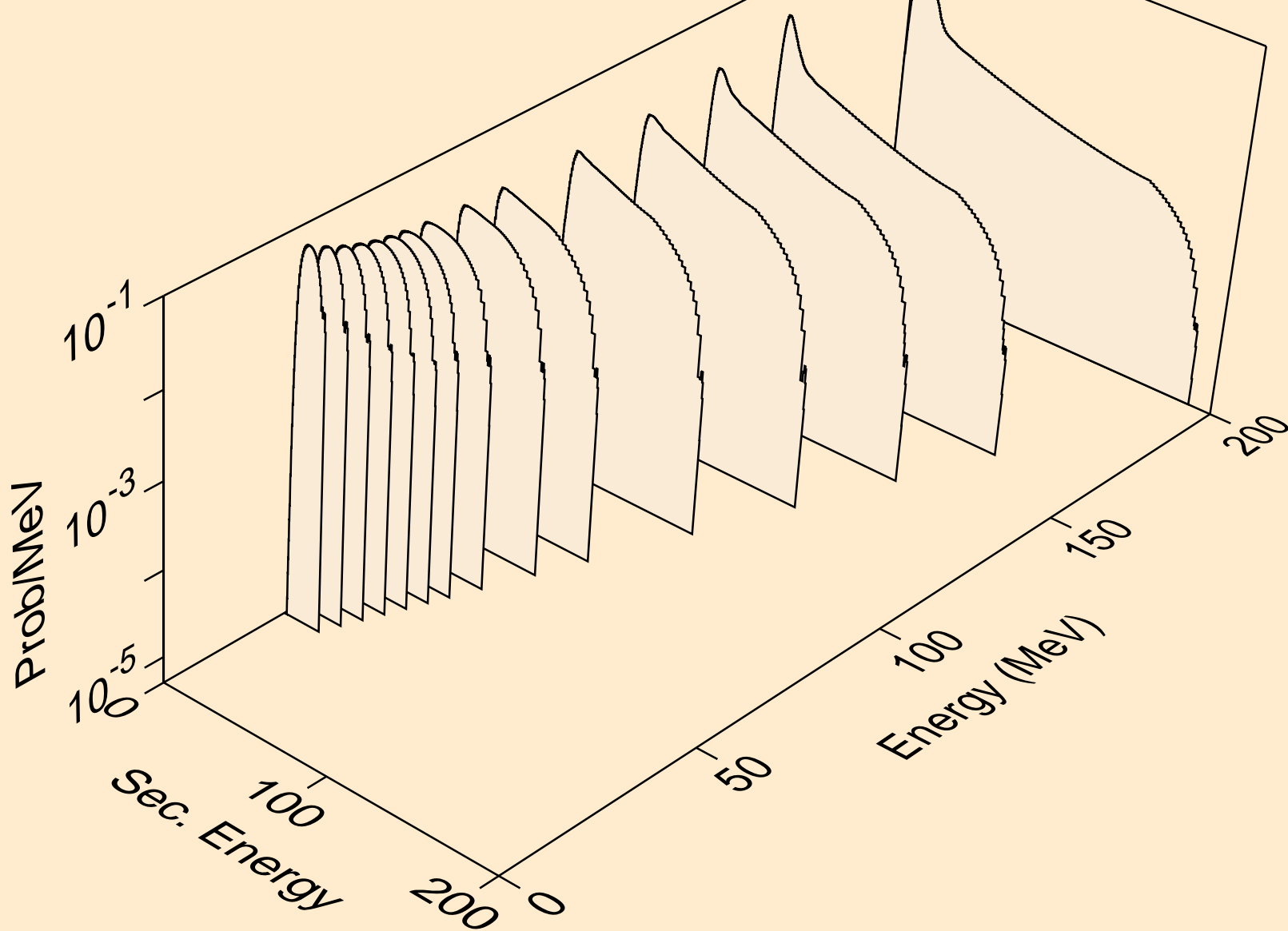

GE081 NEUTRON ACER TENDL-2019 LIBRARY; T=293.16K
protons from (n,n*)p

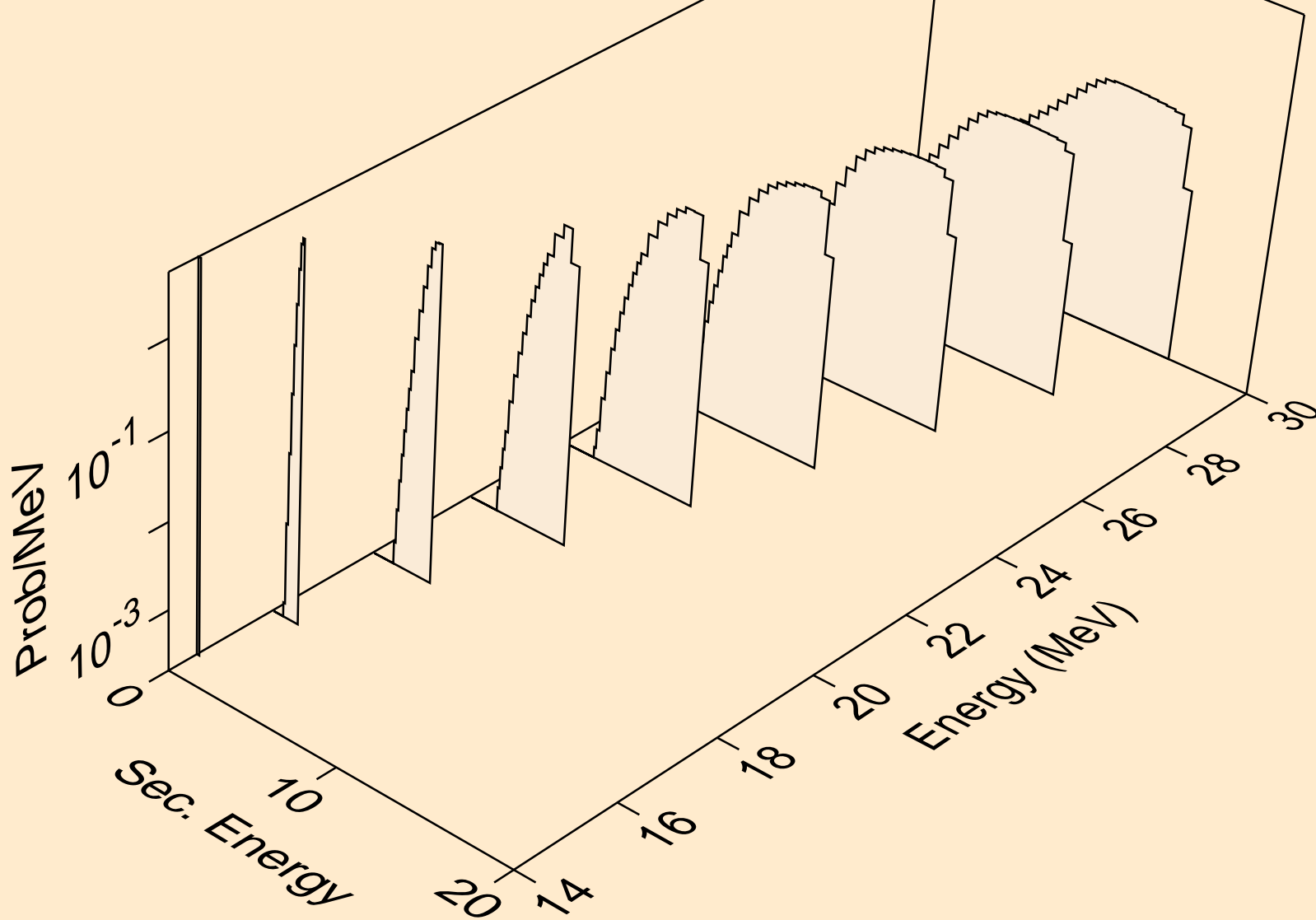

GE081 NEUTRON ACER TENDL-2019 LIBRARY; T=293.16K
protons from (n,2np)

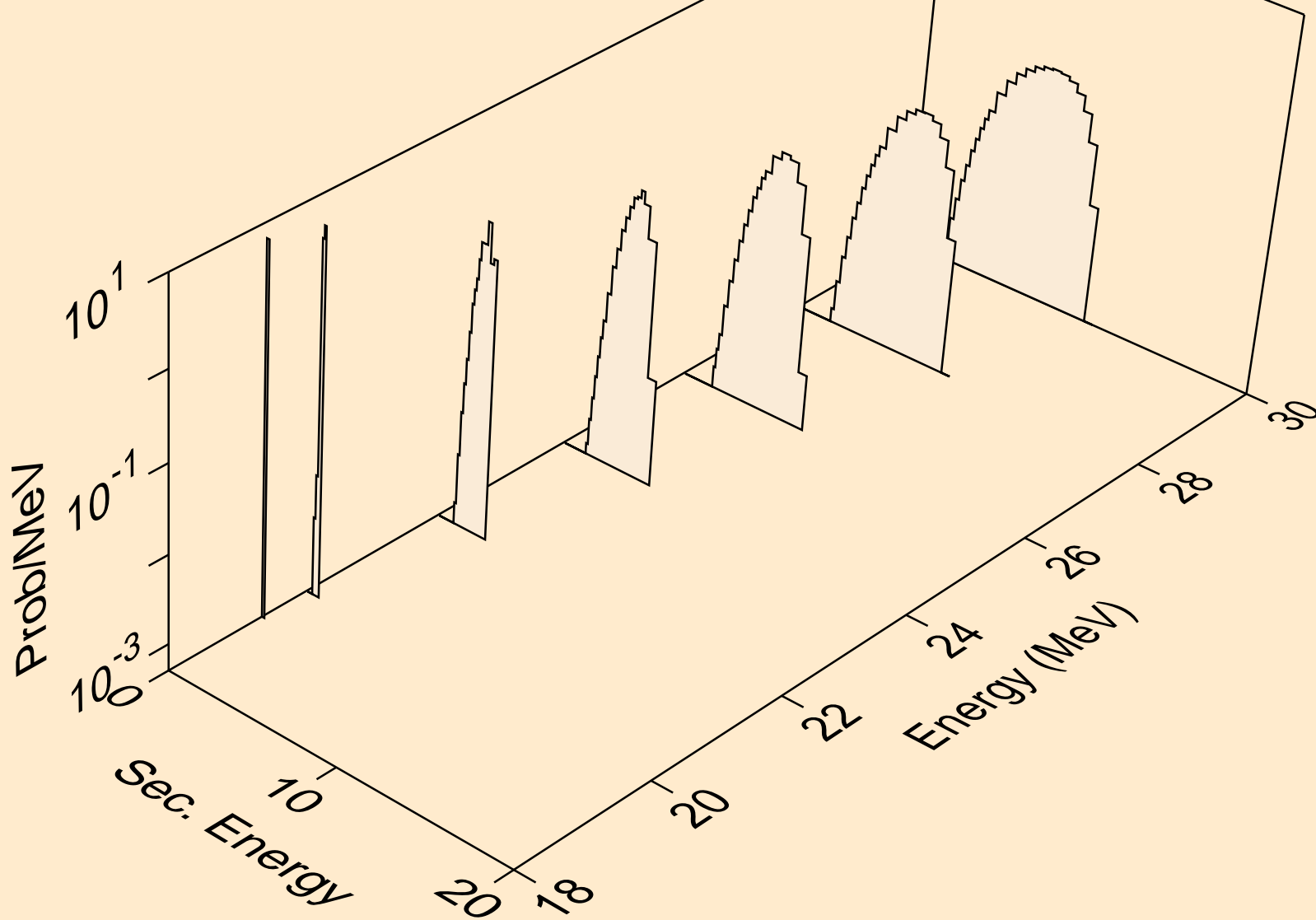

GE081 NEUTRON ACER TENDL-2019 LIBRARY; T=293.16K
protons from (n,3np)

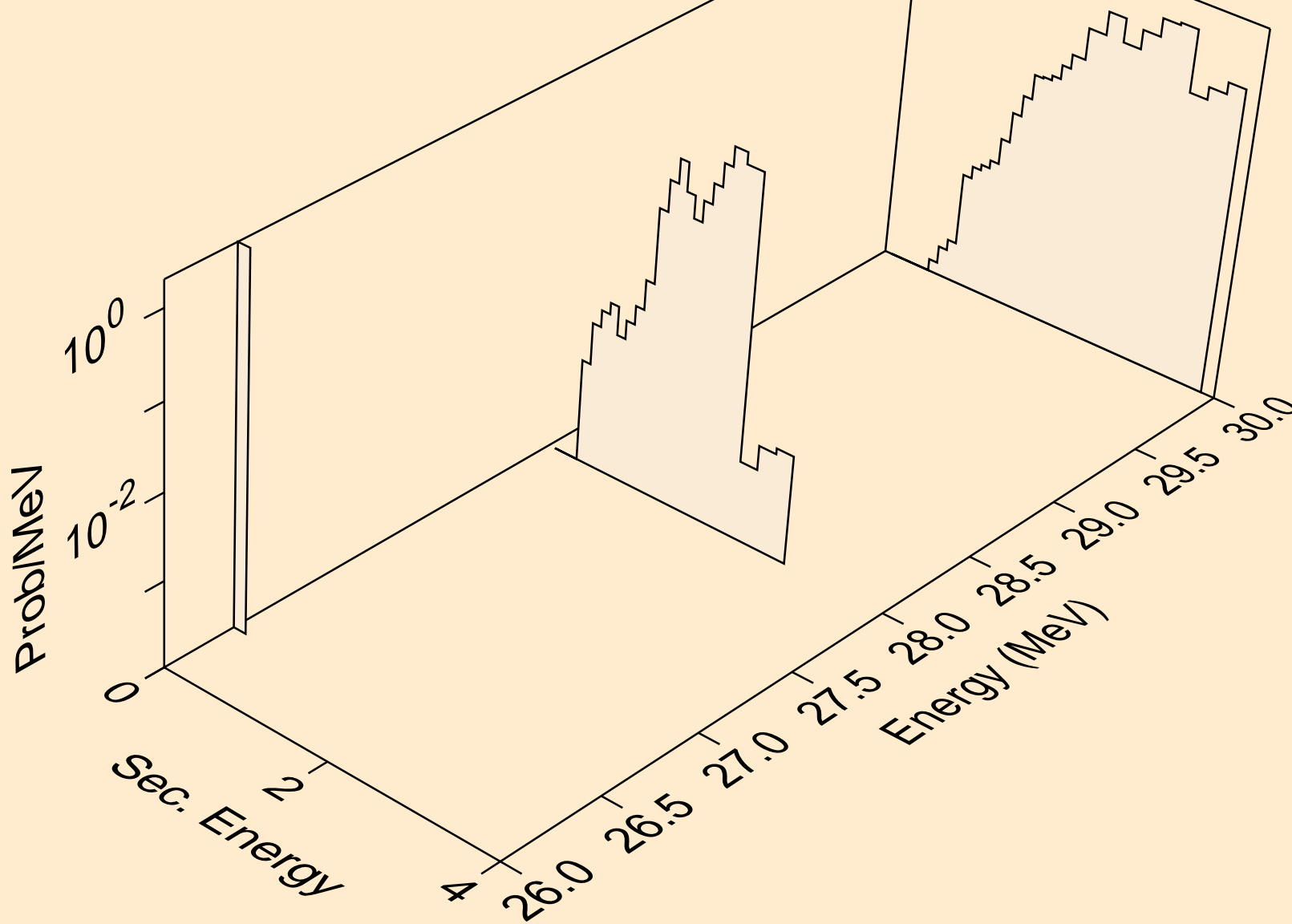

GE081 NEUTRON ACER TENDL-2019 LIBRARY; T=293.16K
protons from (n,p)

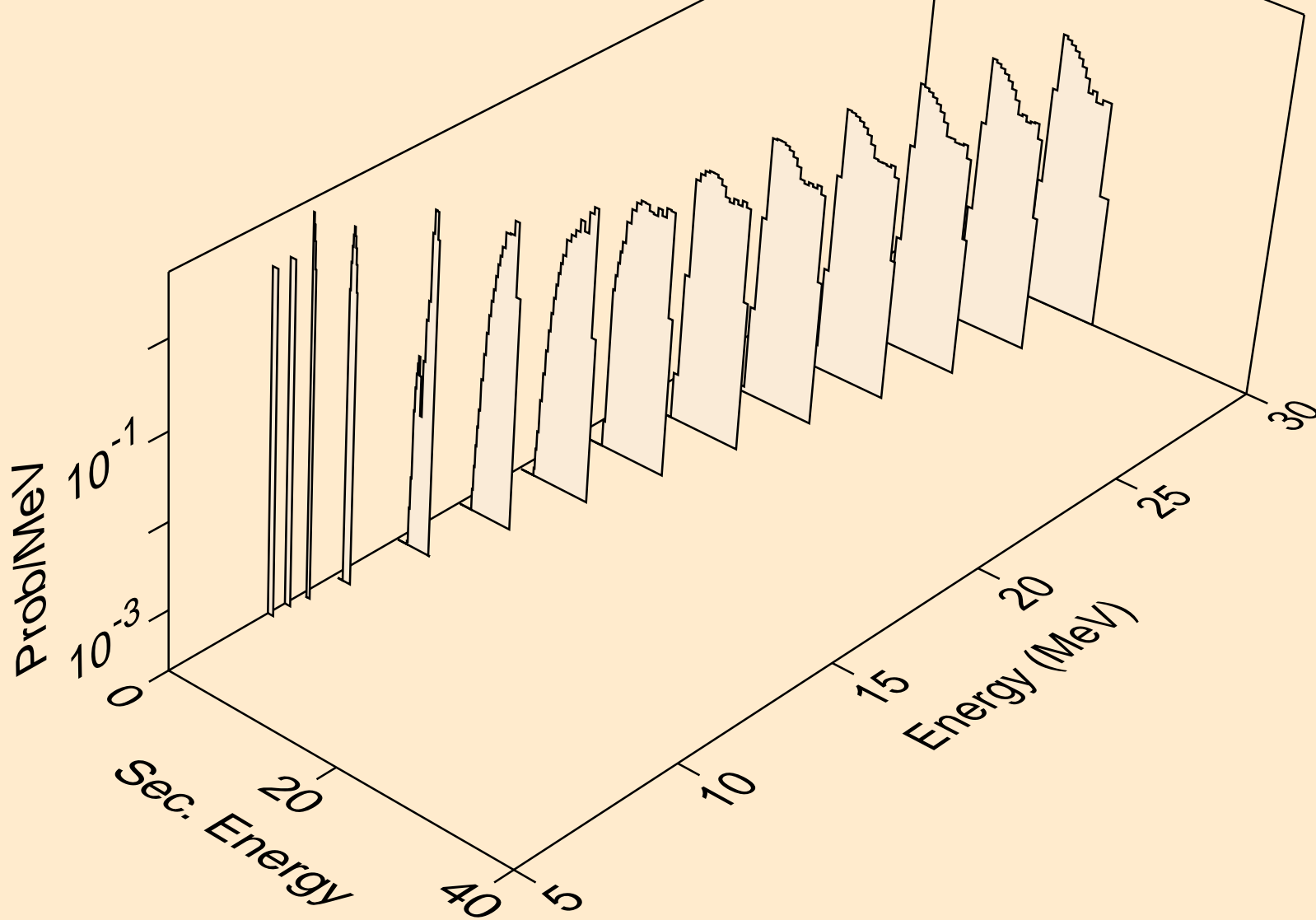

GE081 NEUTRON ACER TENDL-2019 LIBRARY; T=293.16K
deuterons from (n,x)

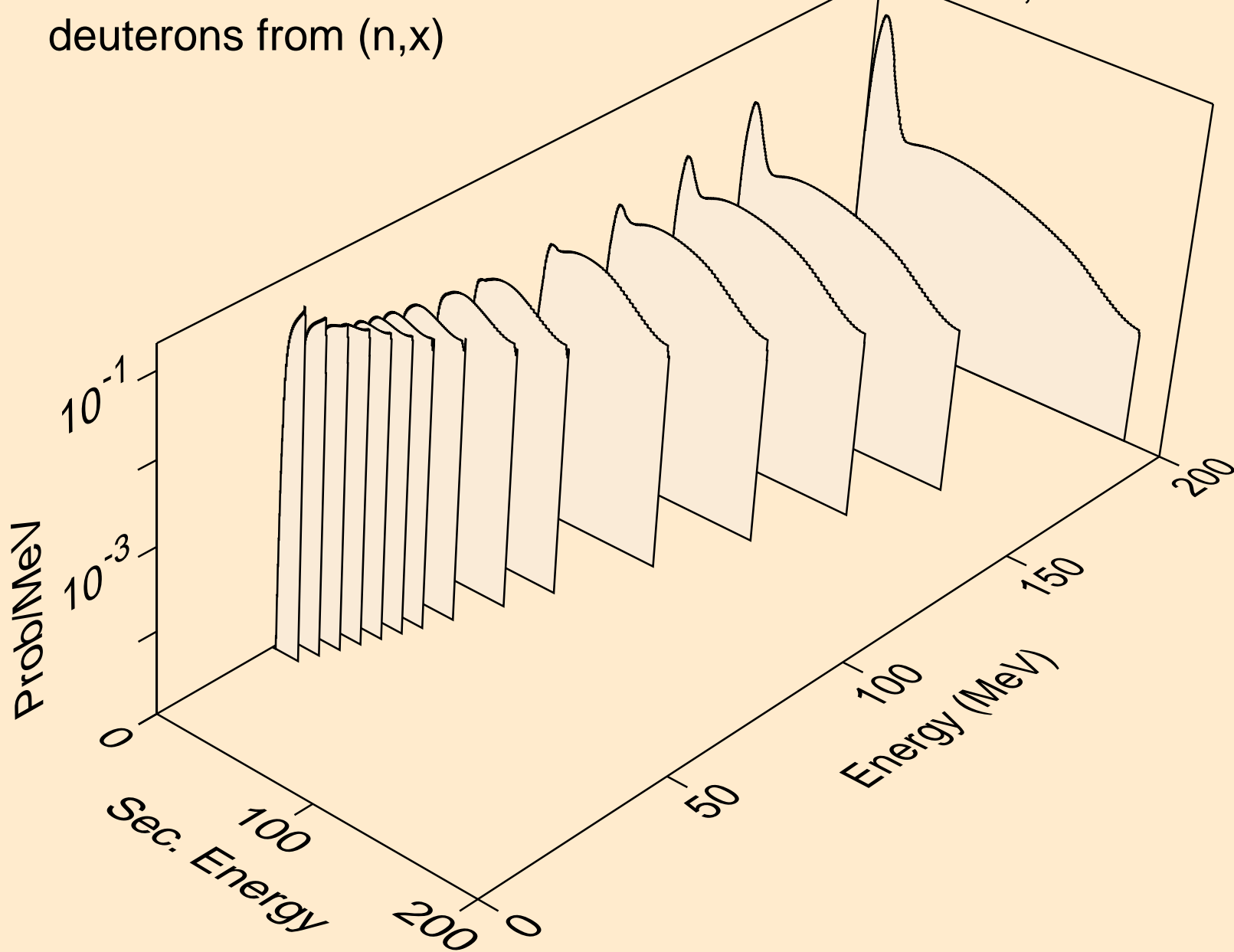

GE081 NEUTRON ACER TENDL-2019 LIBRARY; T=293.16K
deuterons from (n,2nd)

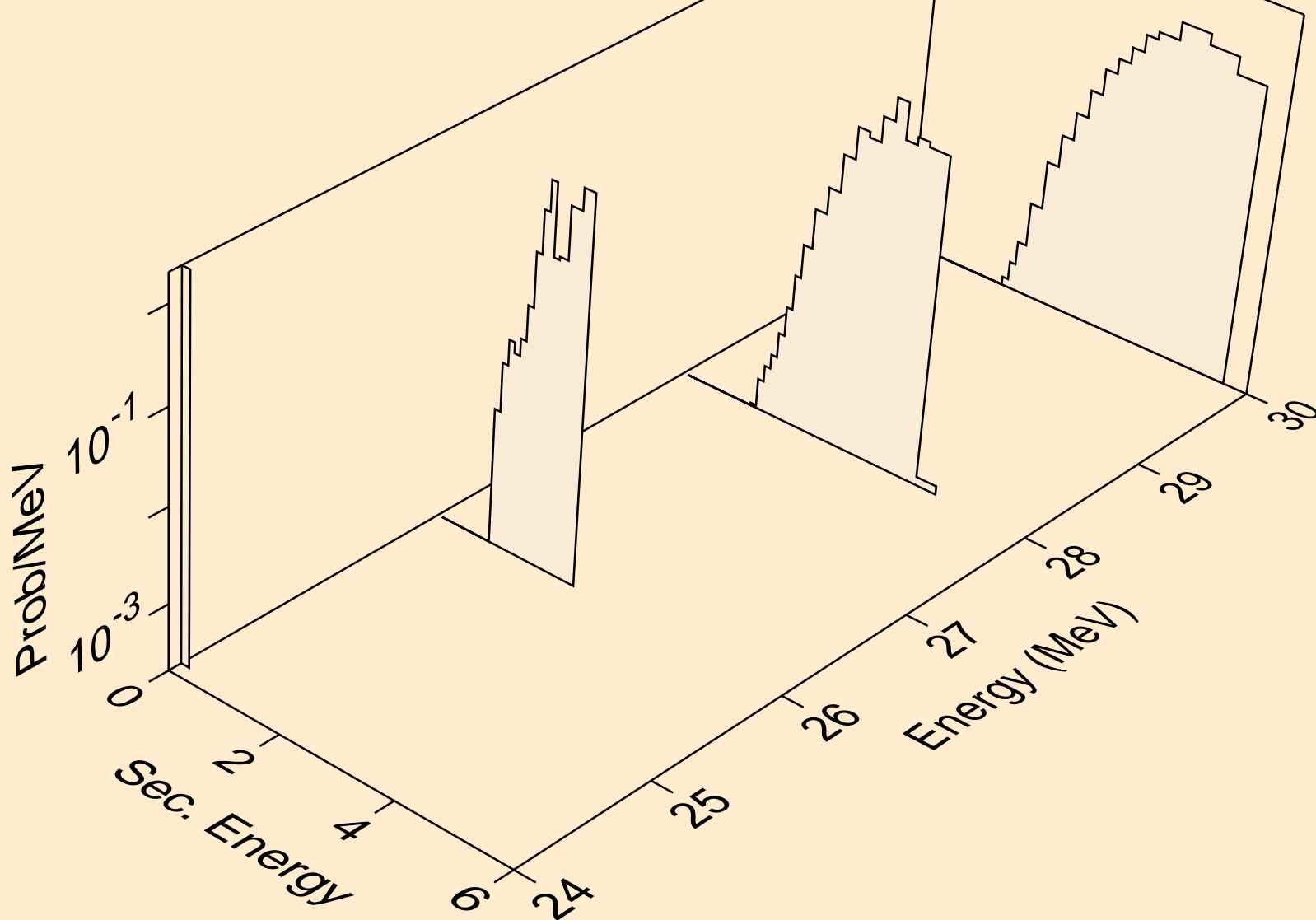

GE081 NEUTRON ACER TENDL-2019 LIBRARY; T=293.16K
deuterons from (n,n*)d

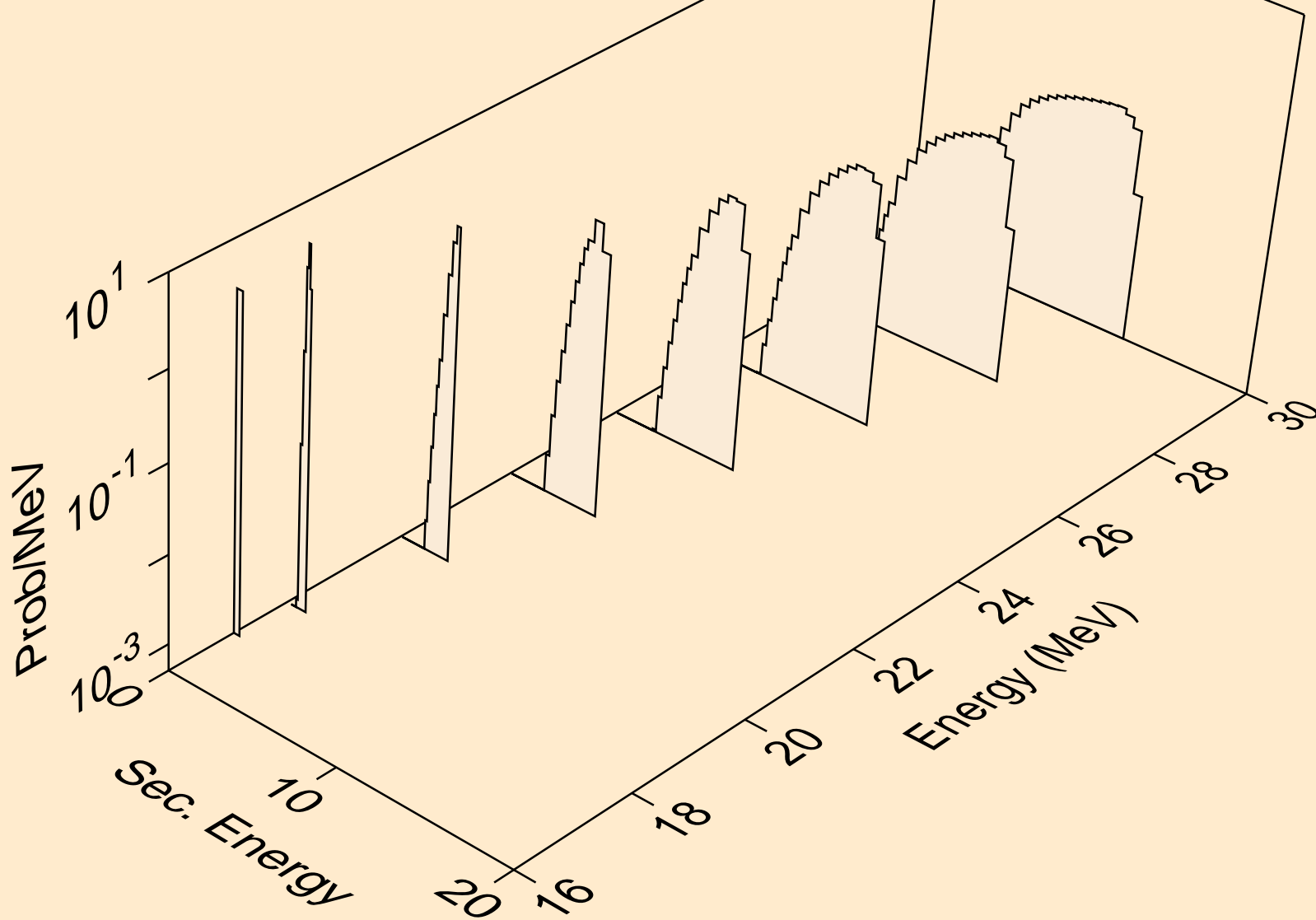

GE081 NEUTRON ACER TENDL-2019 LIBRARY; T=293.16K
deuterons from (n,d)

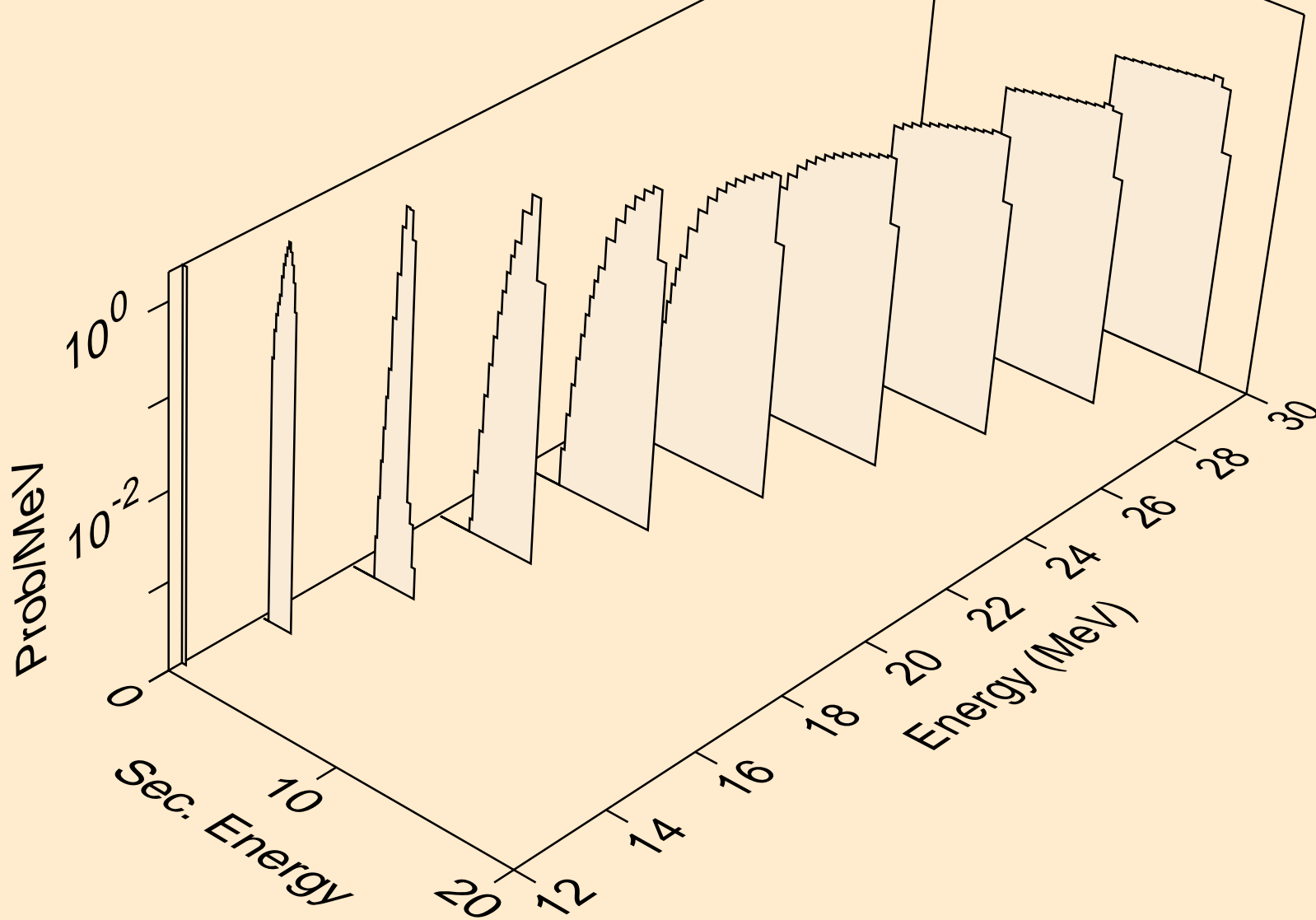

GE081 NEUTRON ACER TENDL-2019 LIBRARY; T=293.16K
tritons from (n,x)

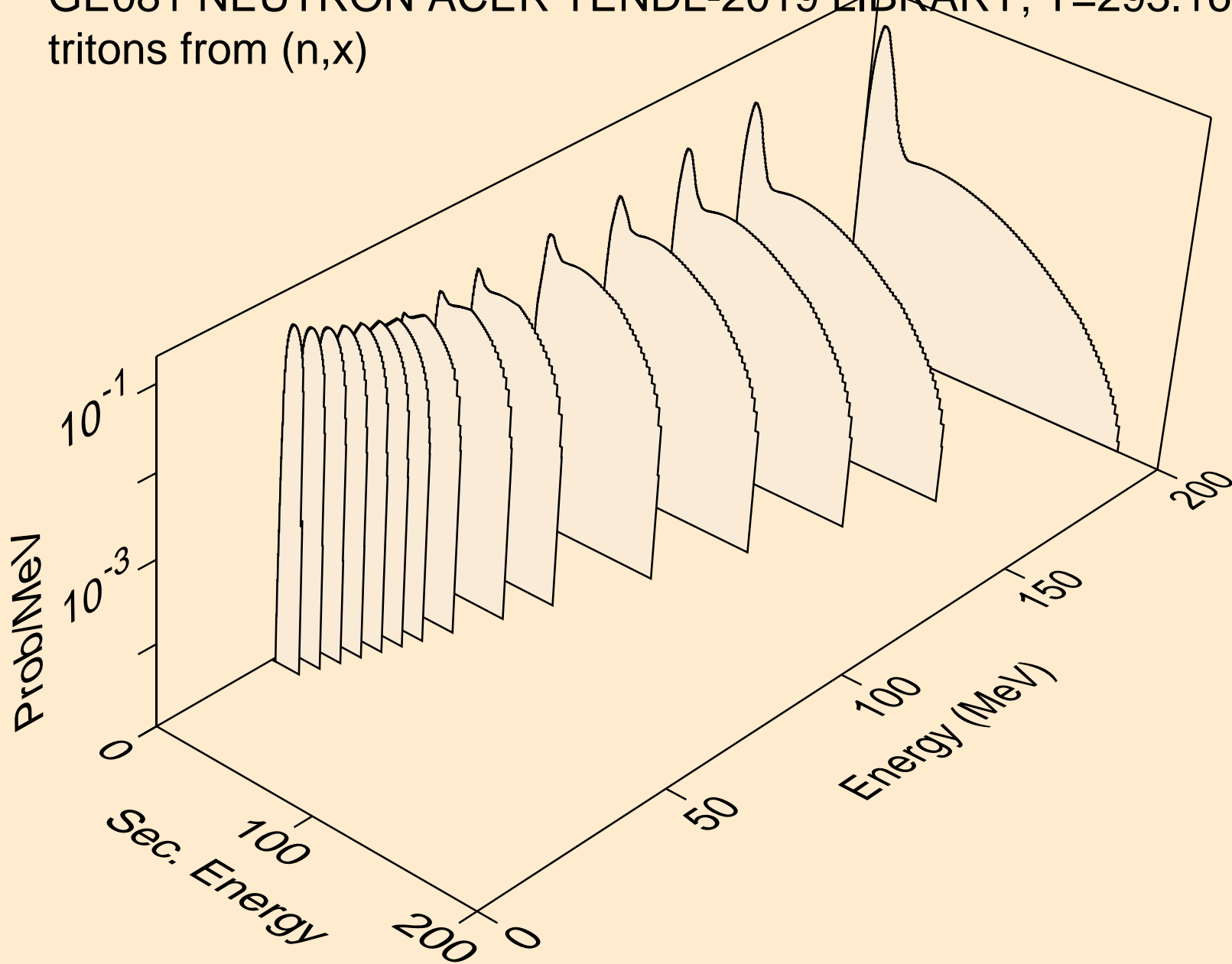

GE081 NEUTRON ACER TENDL-2019 LIBRARY; T=293.16K
tritons from (n,n*)t

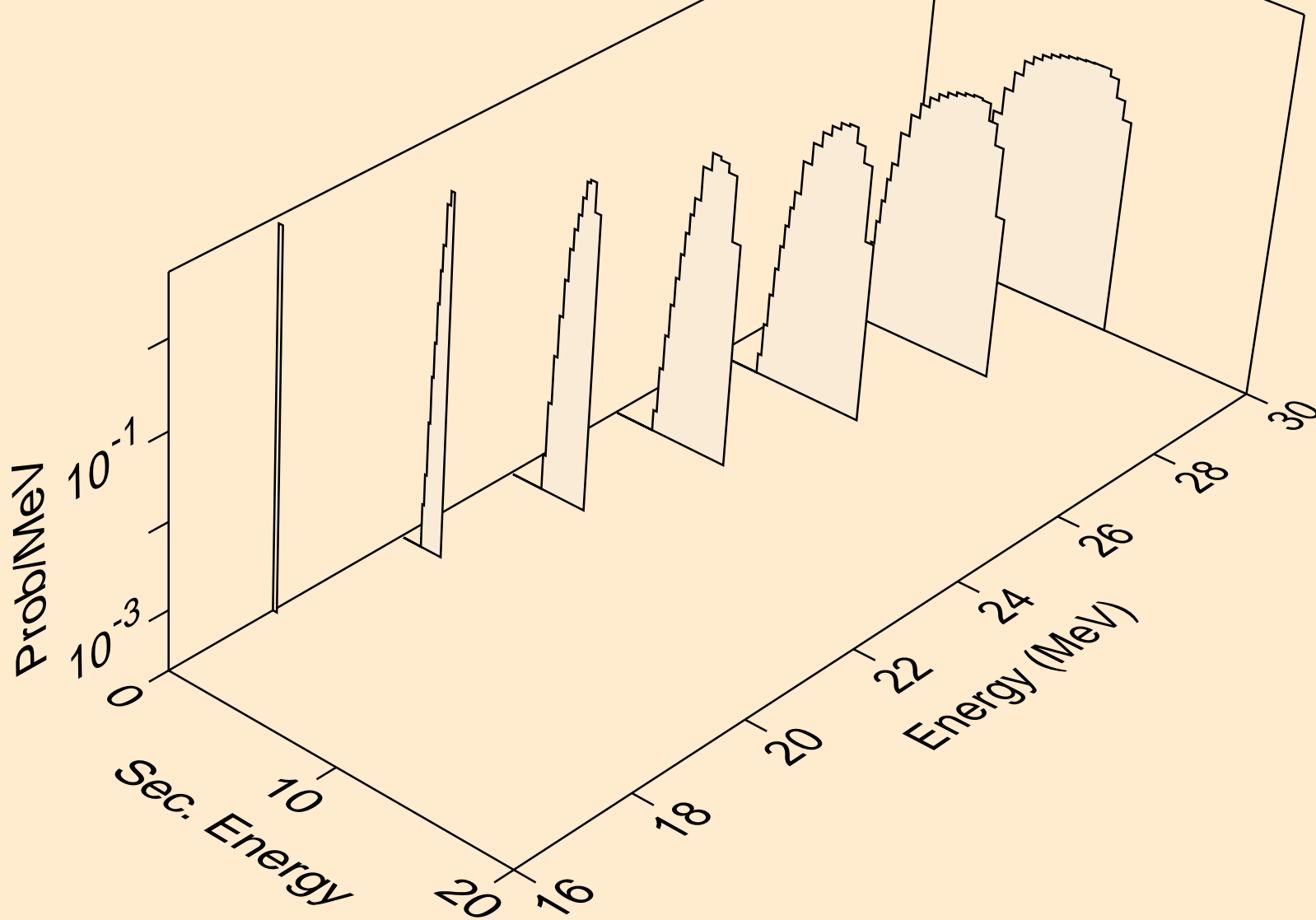

GE081 NEUTRON ACER TENDL-2019 LIBRARY; T=293.16K
tritons from (n,t)

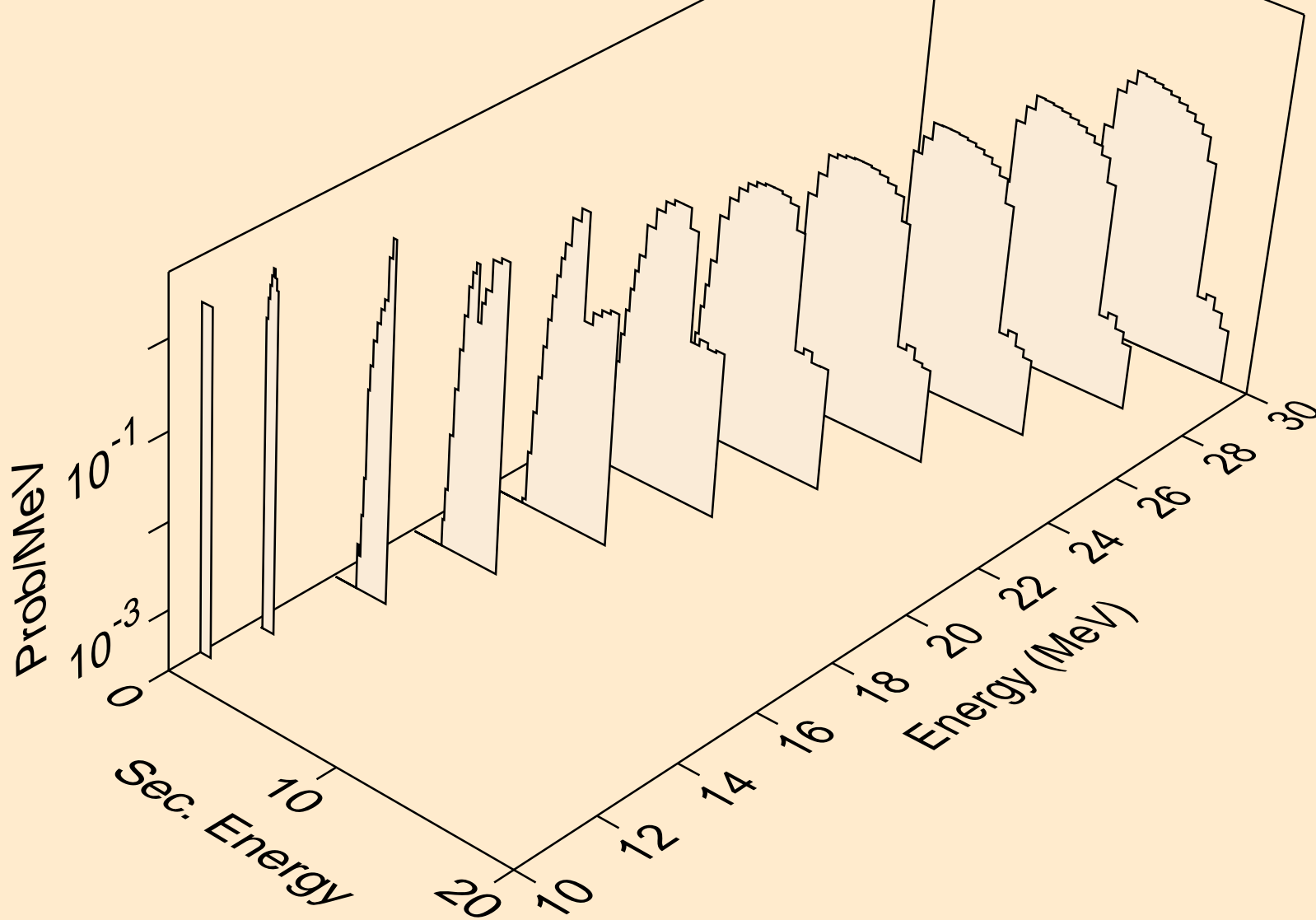

GE081 NEUTRON ACER TENDL-2019 LIBRARY; T=293.16K
he3s from (n,x)

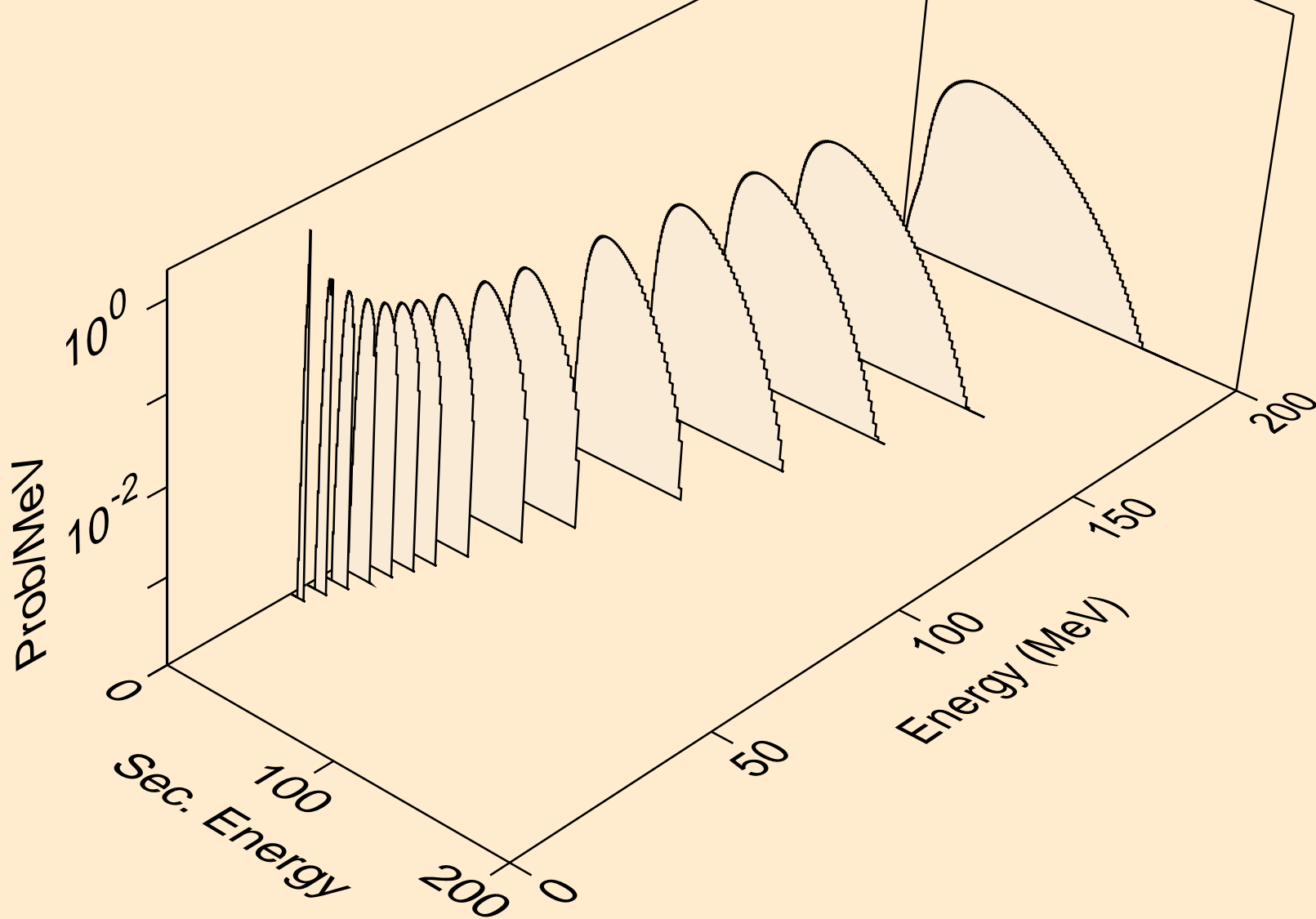

GE081 NEUTRON ACER TENDL-2019 LIBRARY; T=293.16K
he3s from (n,n*)he3

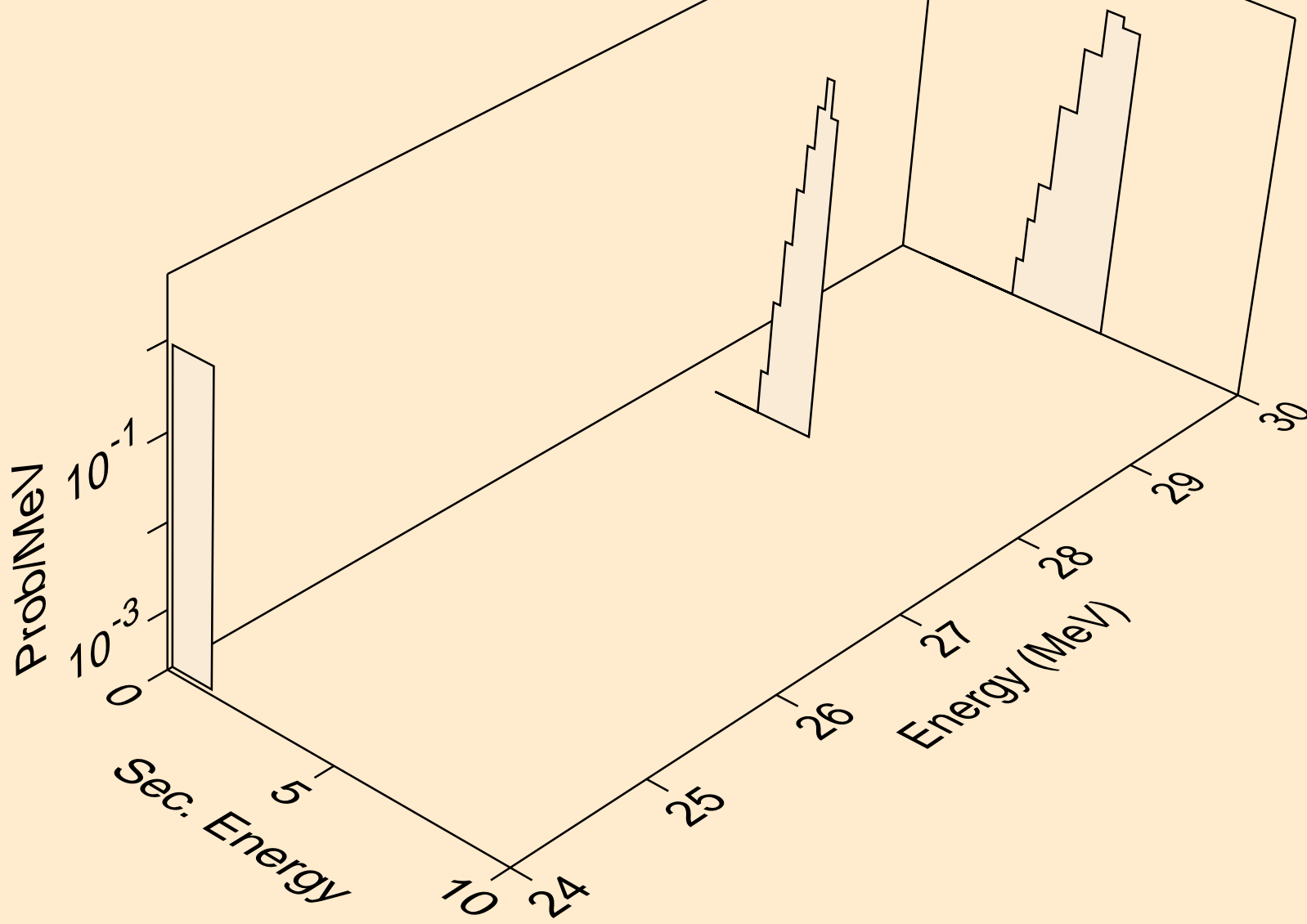

GE081 NEUTRON ACER TENDL-2019 LIBRARY; T=293.16K
he3s from (n,he3)

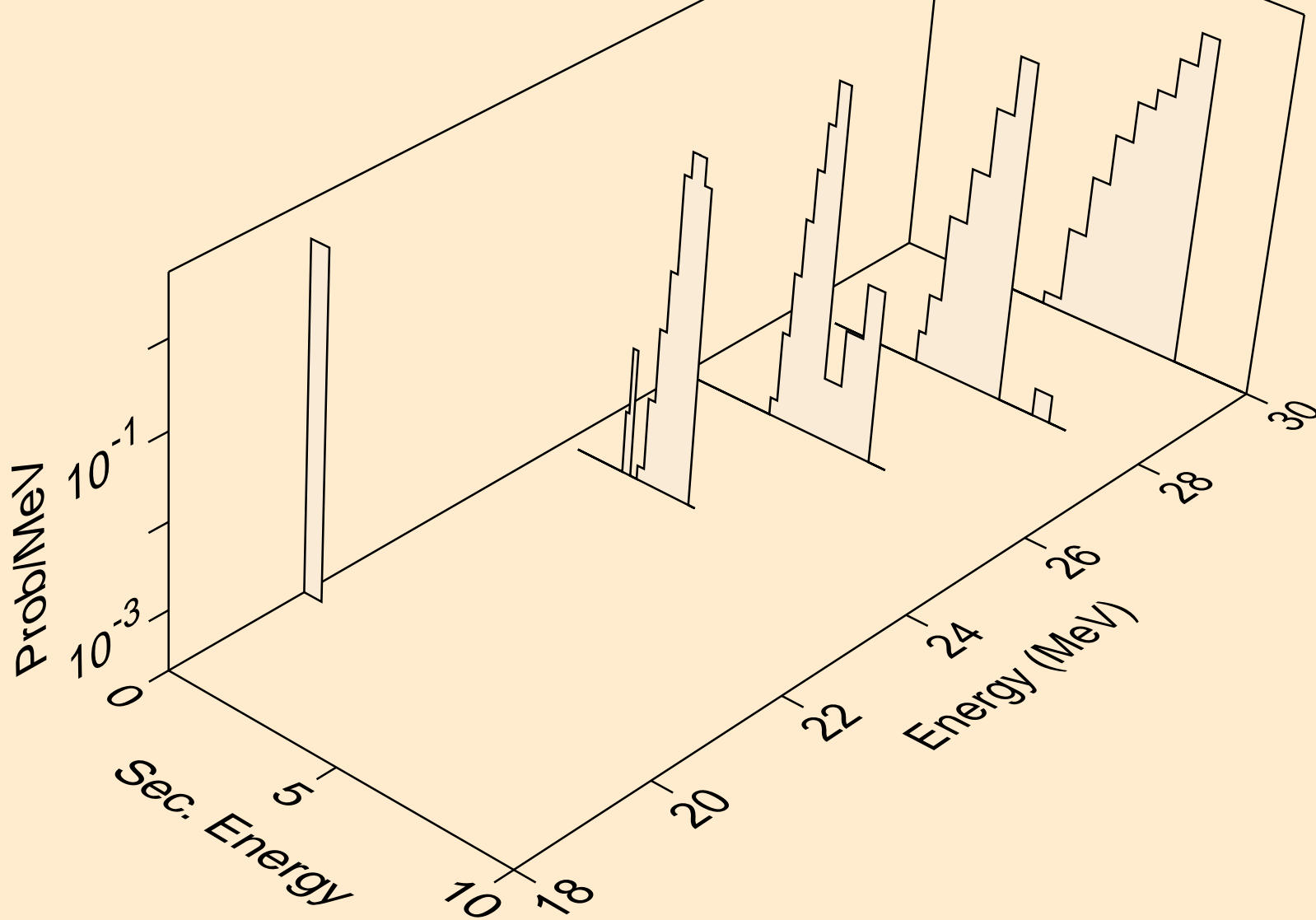

GE081 NEUTRON ACER TENDL-2019 LIBRARY; T=293.16K
alphas from (n,x)

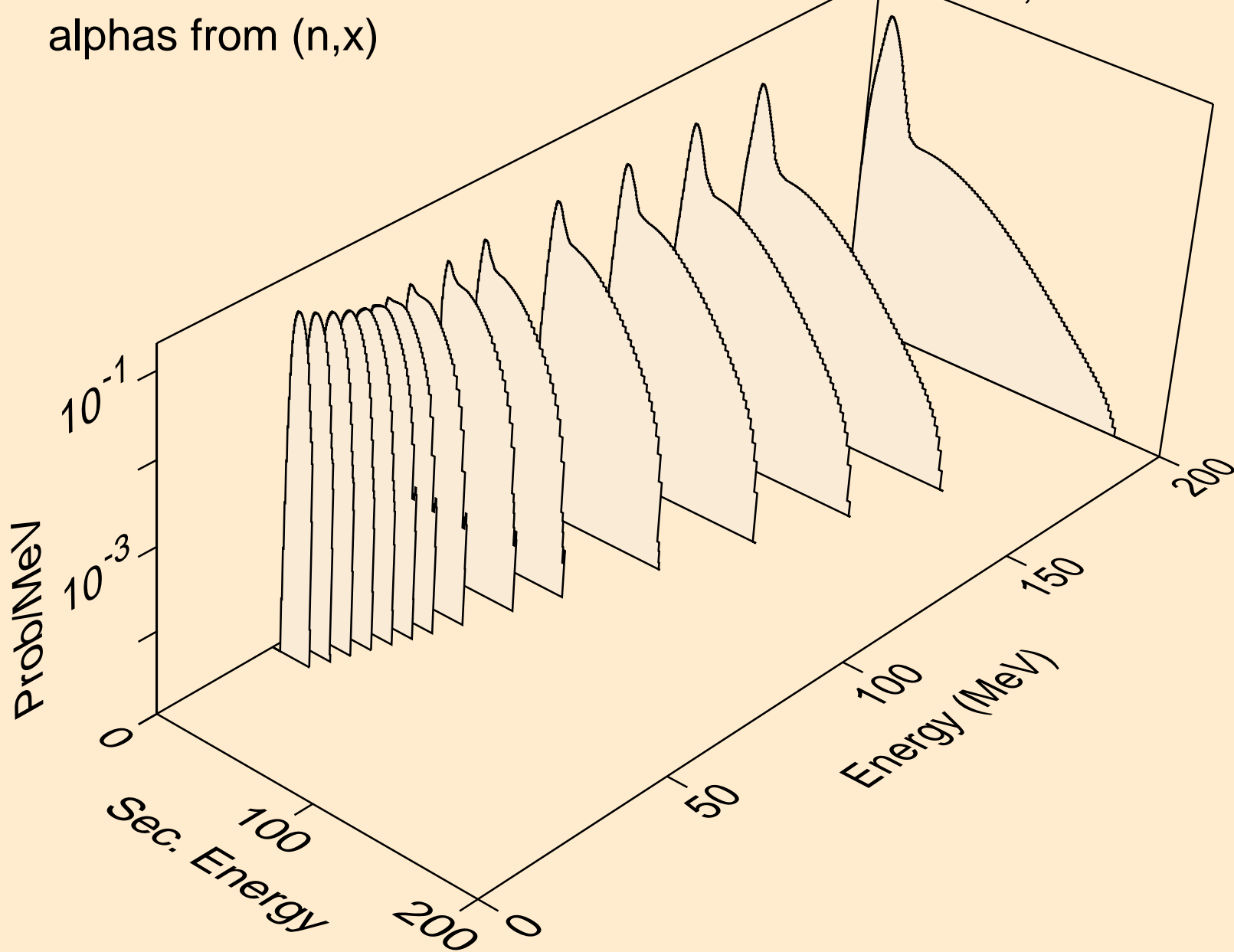

GE081 NEUTRON ACER TENDL-2019 LIBRARY; T=293.16K
alphas from (n,n*)a

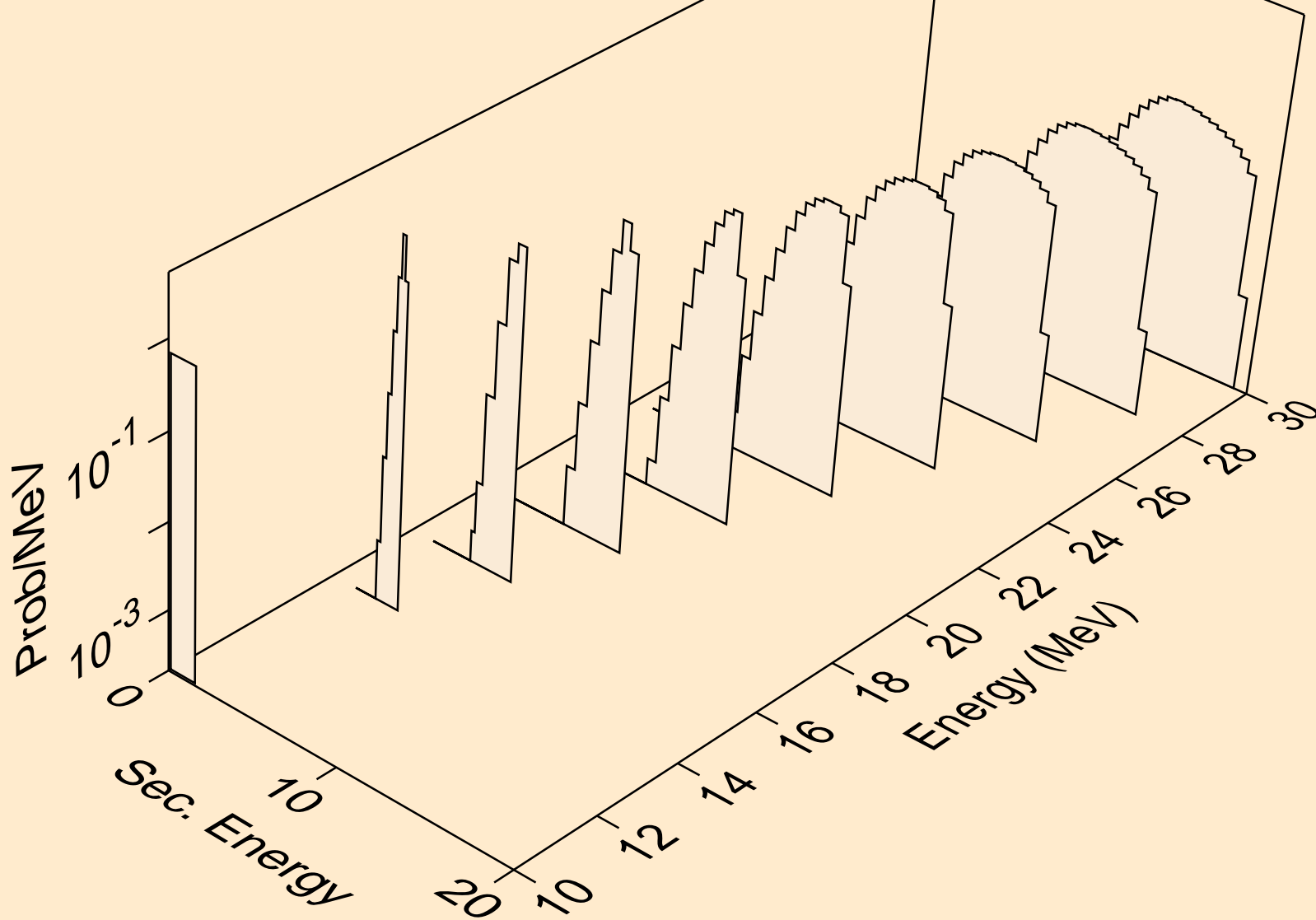

GE081 NEUTRON ACER TENDL-2019 LIBRARY; T=293.16K
alphas from (n,2n)a

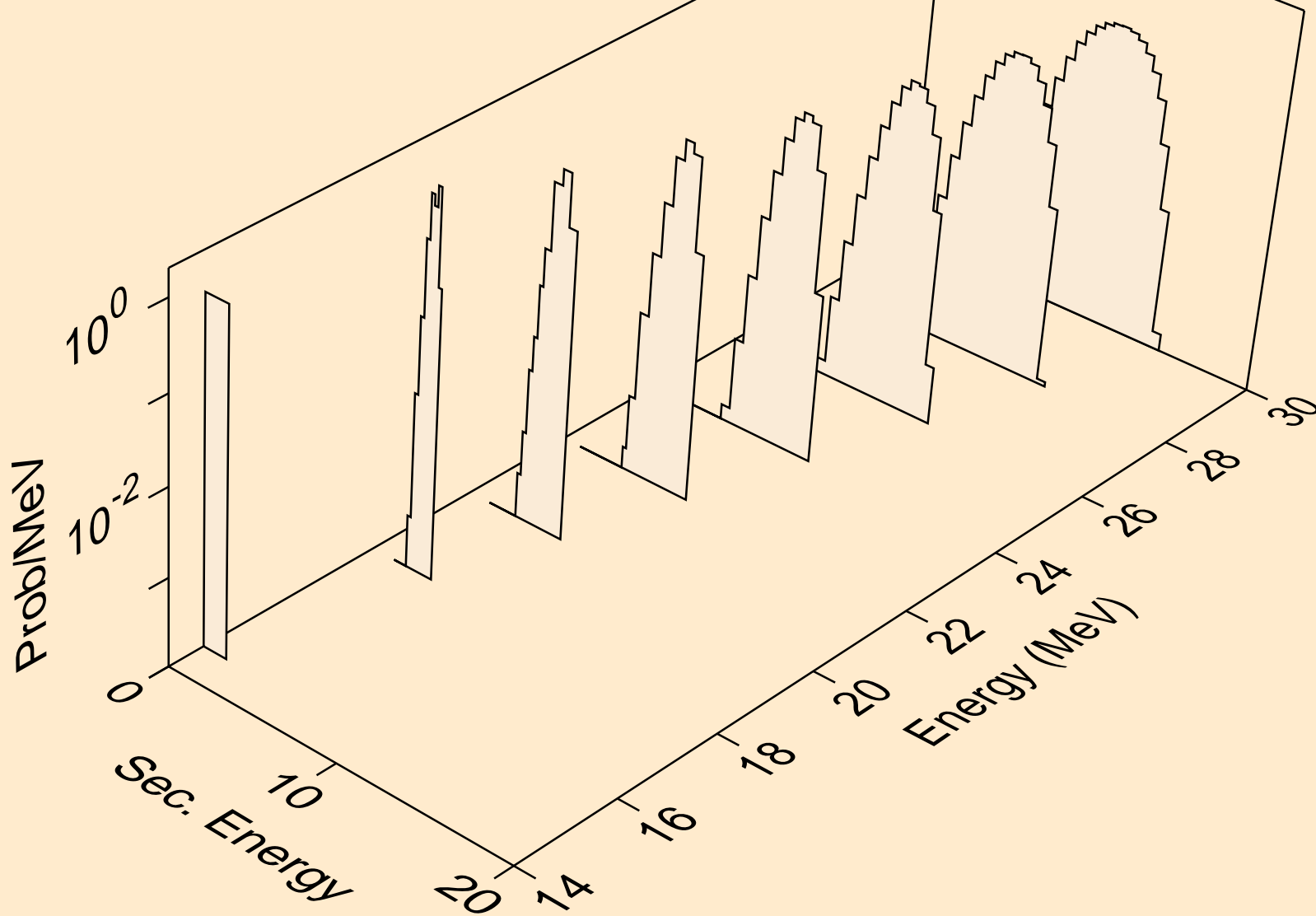

GE081 NEUTRON ACER TENDL-2019 LIBRARY; T=293.16K
alphas from (n,3n)a

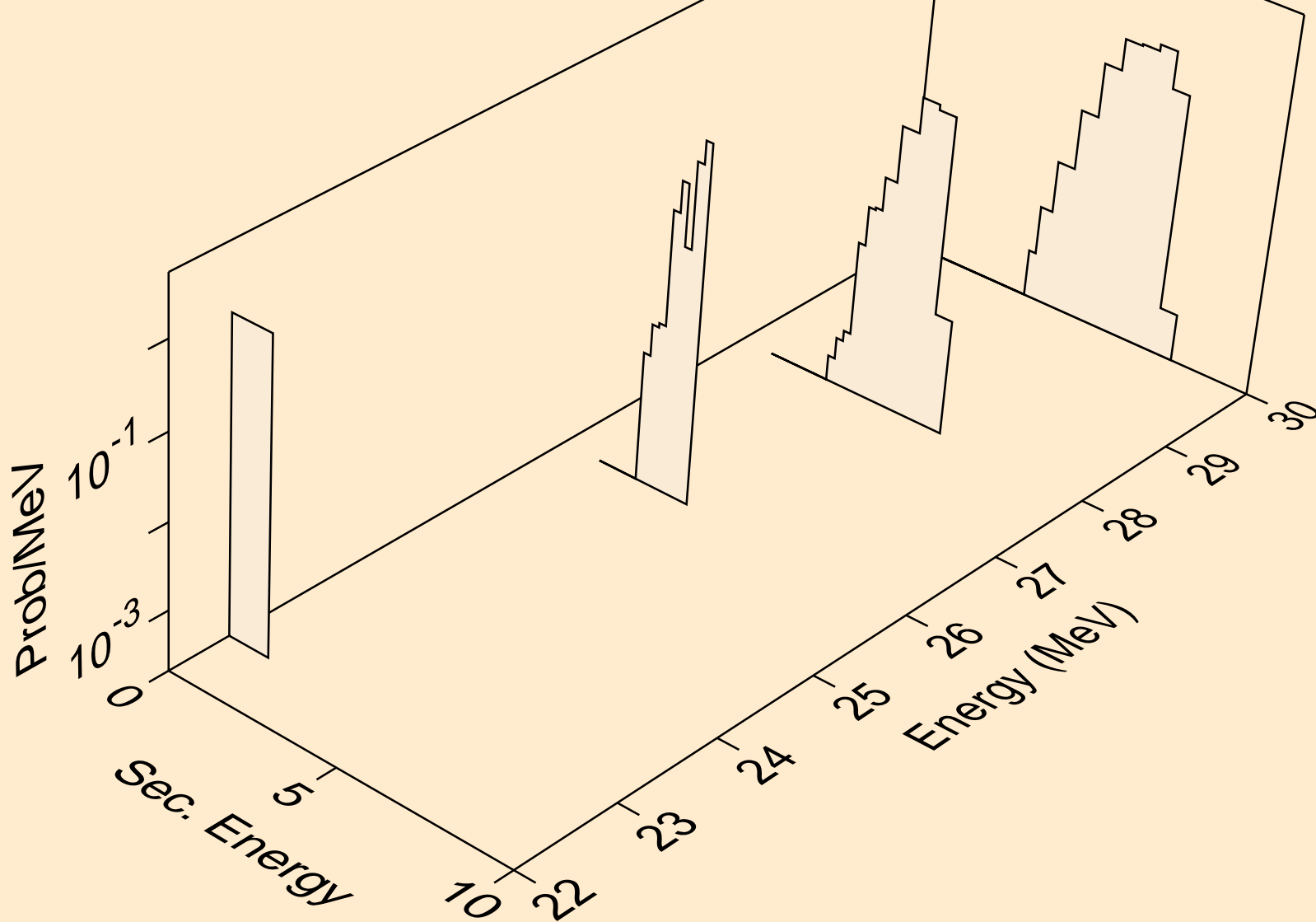

GE081 NEUTRON ACER TENDL-2019 LIBRARY; T=293.16K
alphas from (n,a)

