

# HF159 NEUTRON ACER TENDL-2019 LIBRARY; T=293.16K

## Principal cross sections

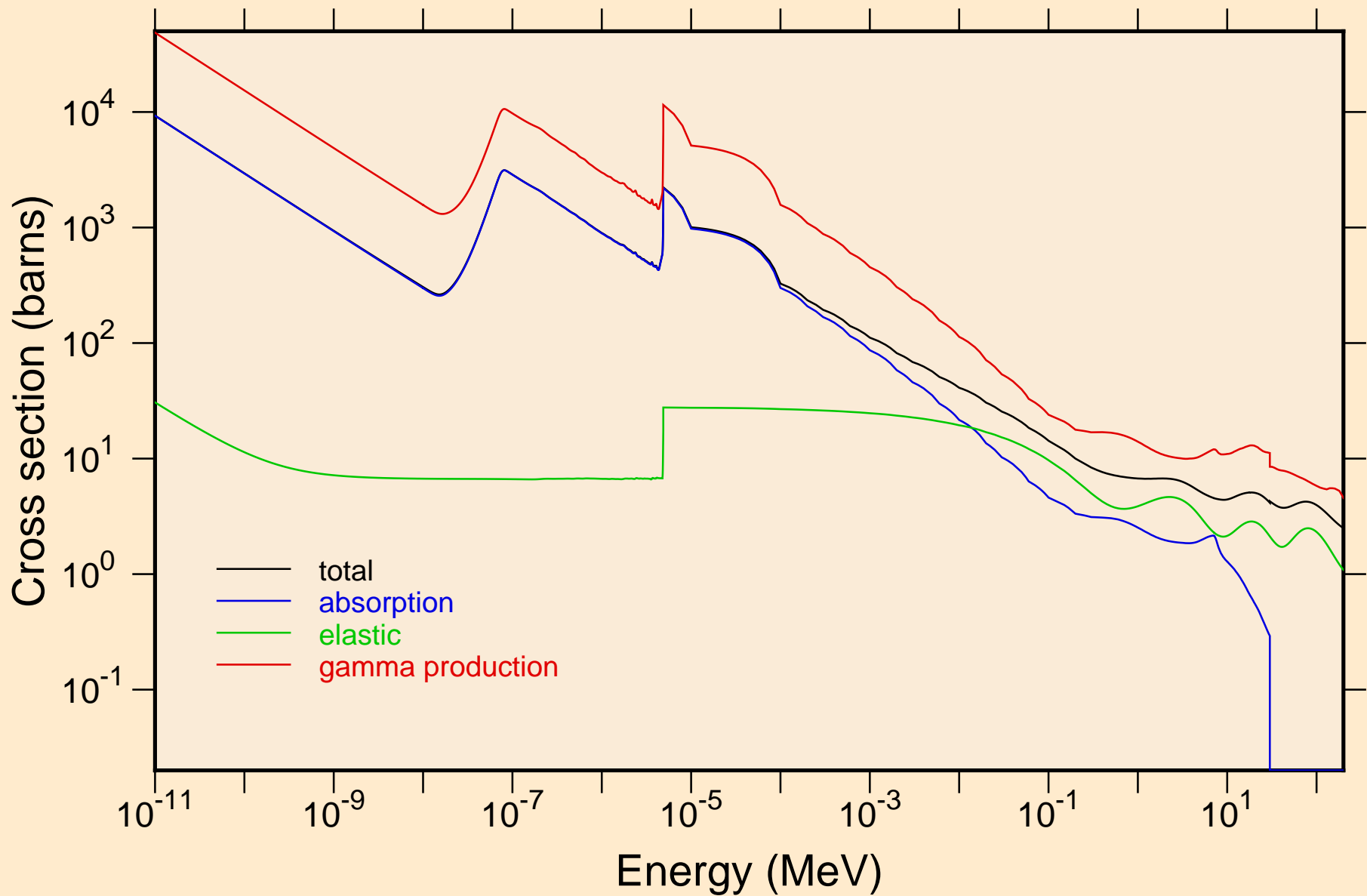

HF159 NEUTRON ACER TENDL-2019 LIBRARY; T=293.16K  
resonance total cross section

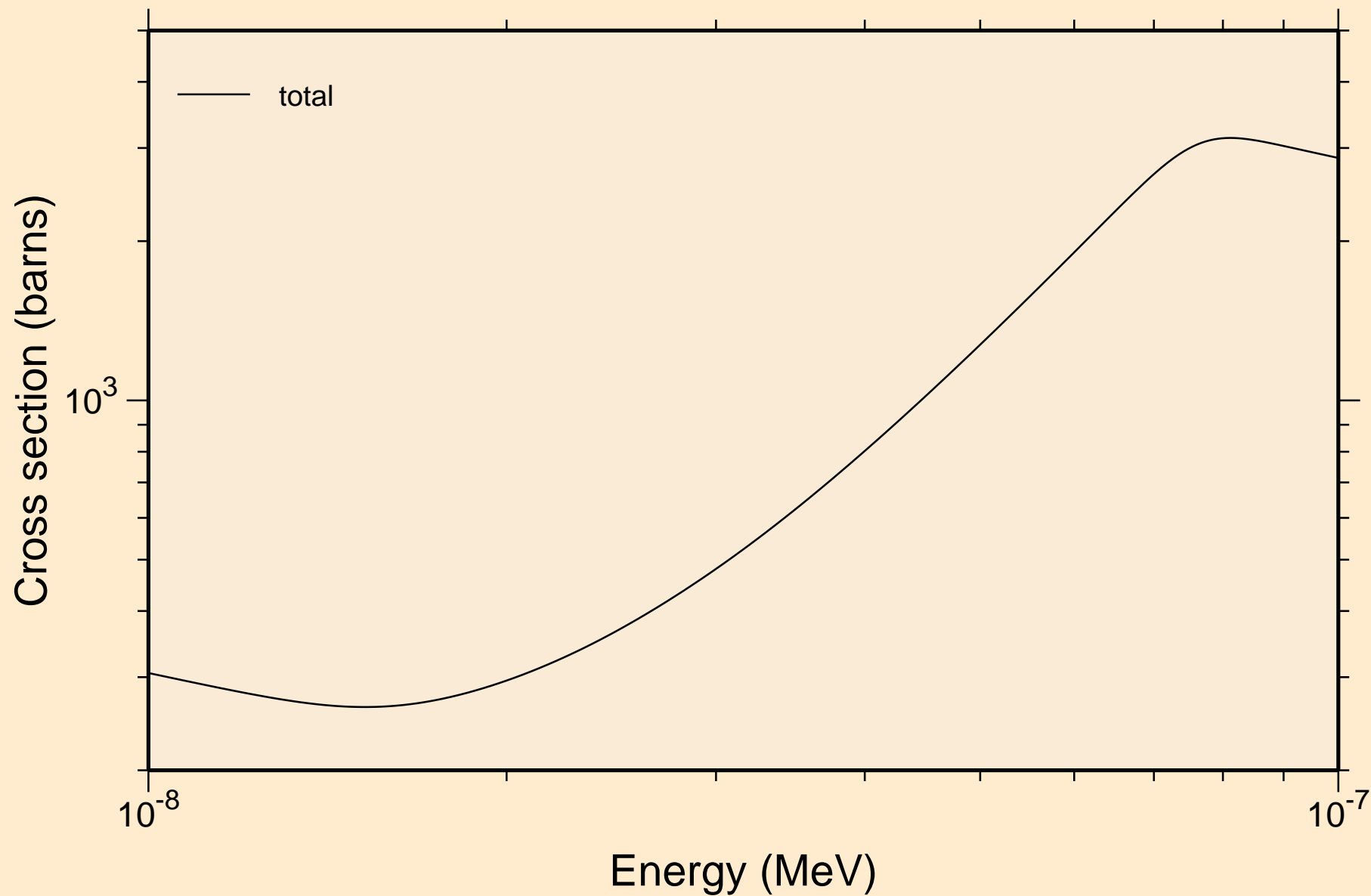

HF159 NEUTRON ACER TENDL-2019 LIBRARY; T=293.16K  
resonance total cross section

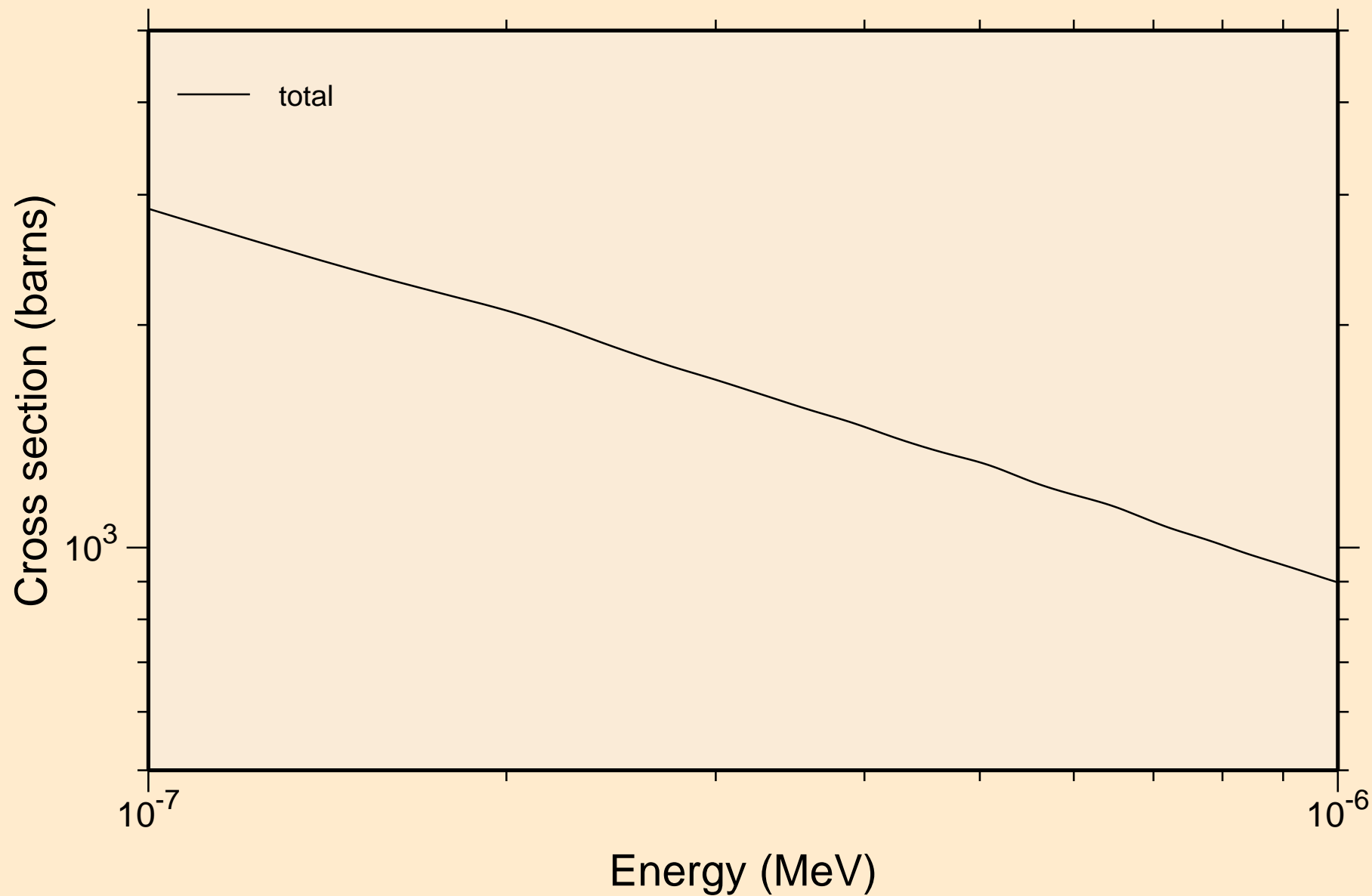

HF159 NEUTRON ACER TENDL-2019 LIBRARY; T=293.16K  
resonance total cross section

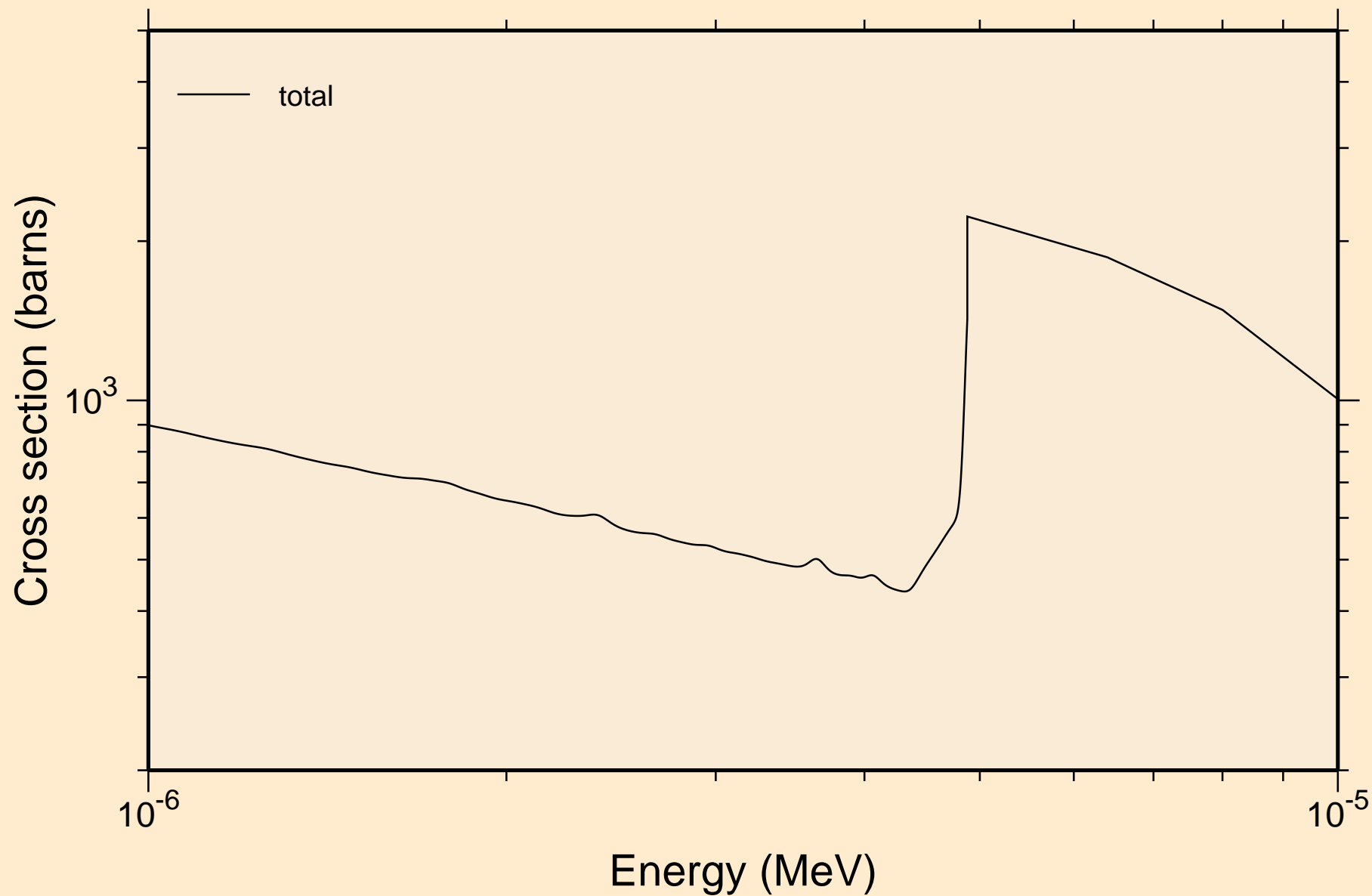

HF159 NEUTRON ACER TENDL-2019 LIBRARY; T=293.16K  
resonance total cross section

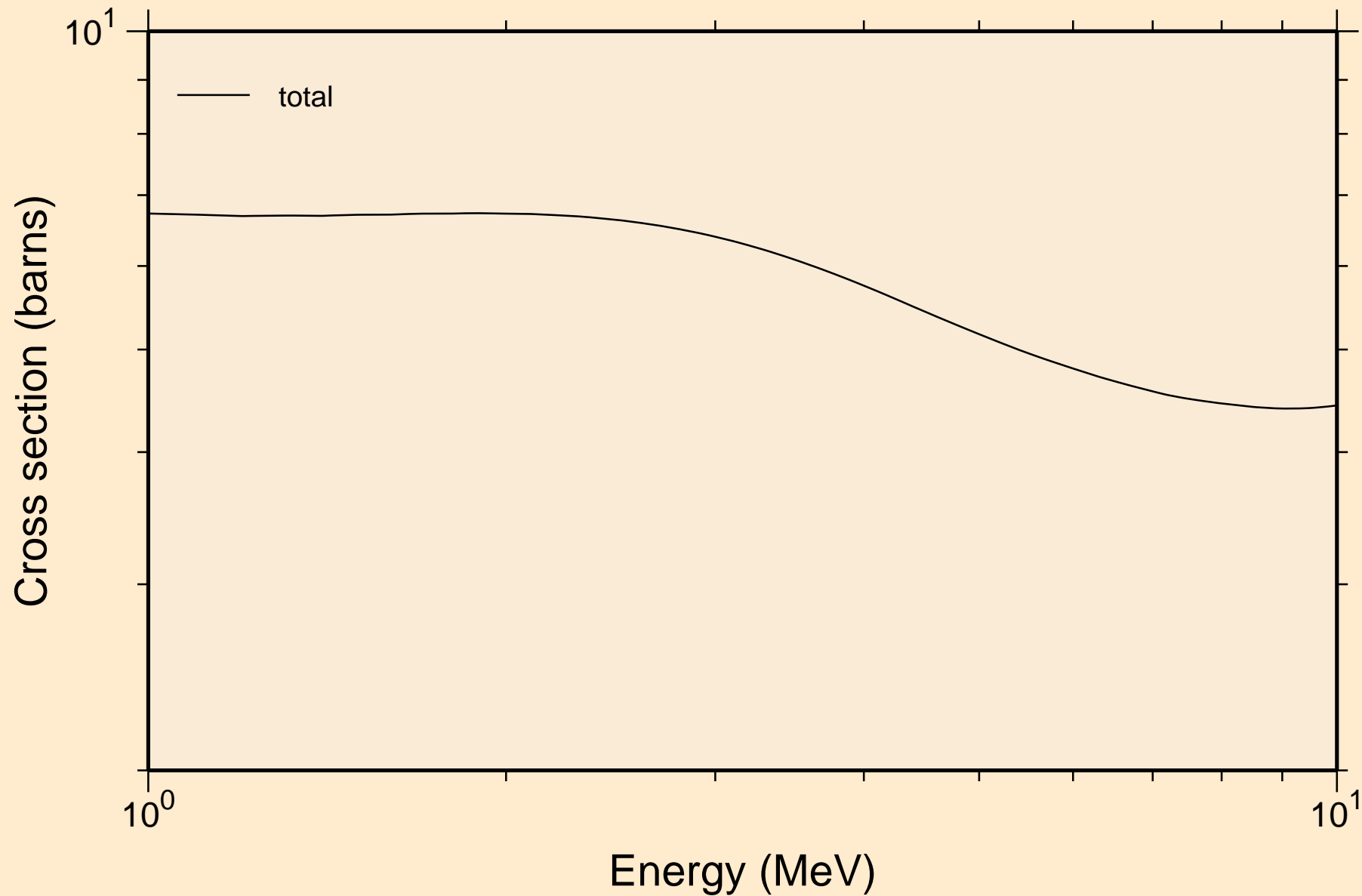

HF159 NEUTRON ACER TENDL-2019 LIBRARY; T=293.16K  
resonance absorption cross sections

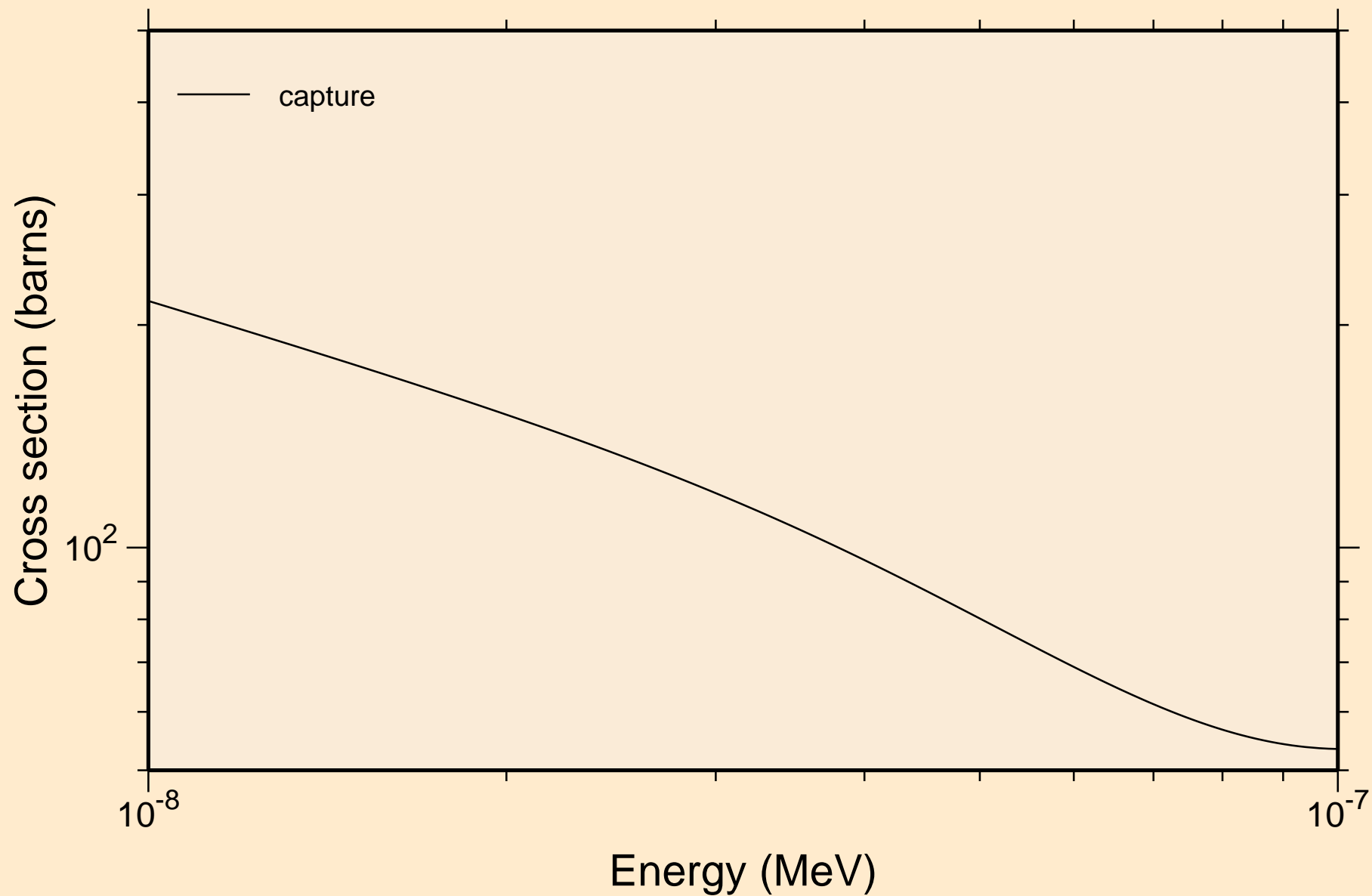

HF159 NEUTRON ACER TENDL-2019 LIBRARY; T=293.16K  
resonance absorption cross sections

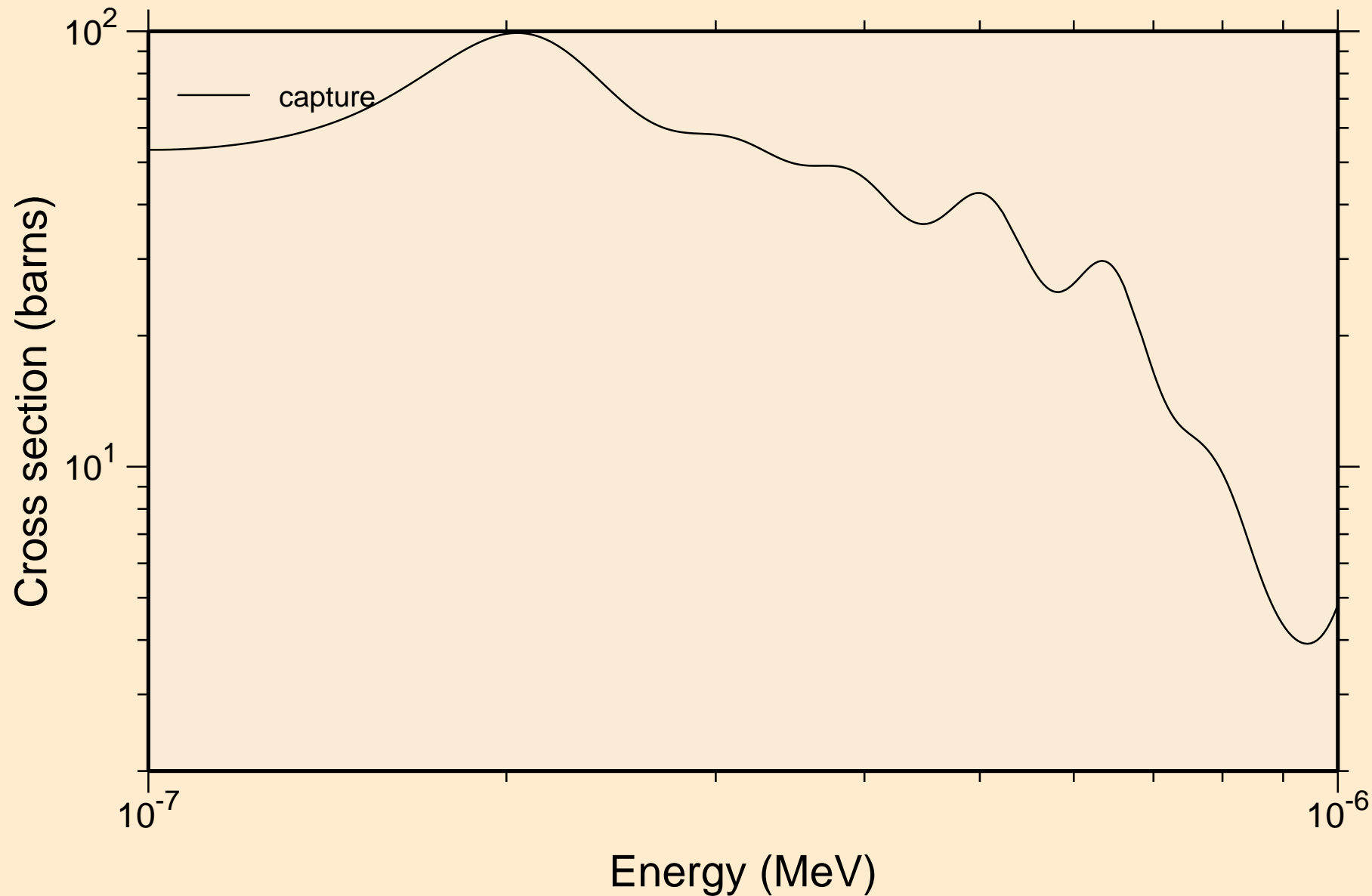

HF159 NEUTRON ACER TENDL-2019 LIBRARY; T=293.16K  
resonance absorption cross sections

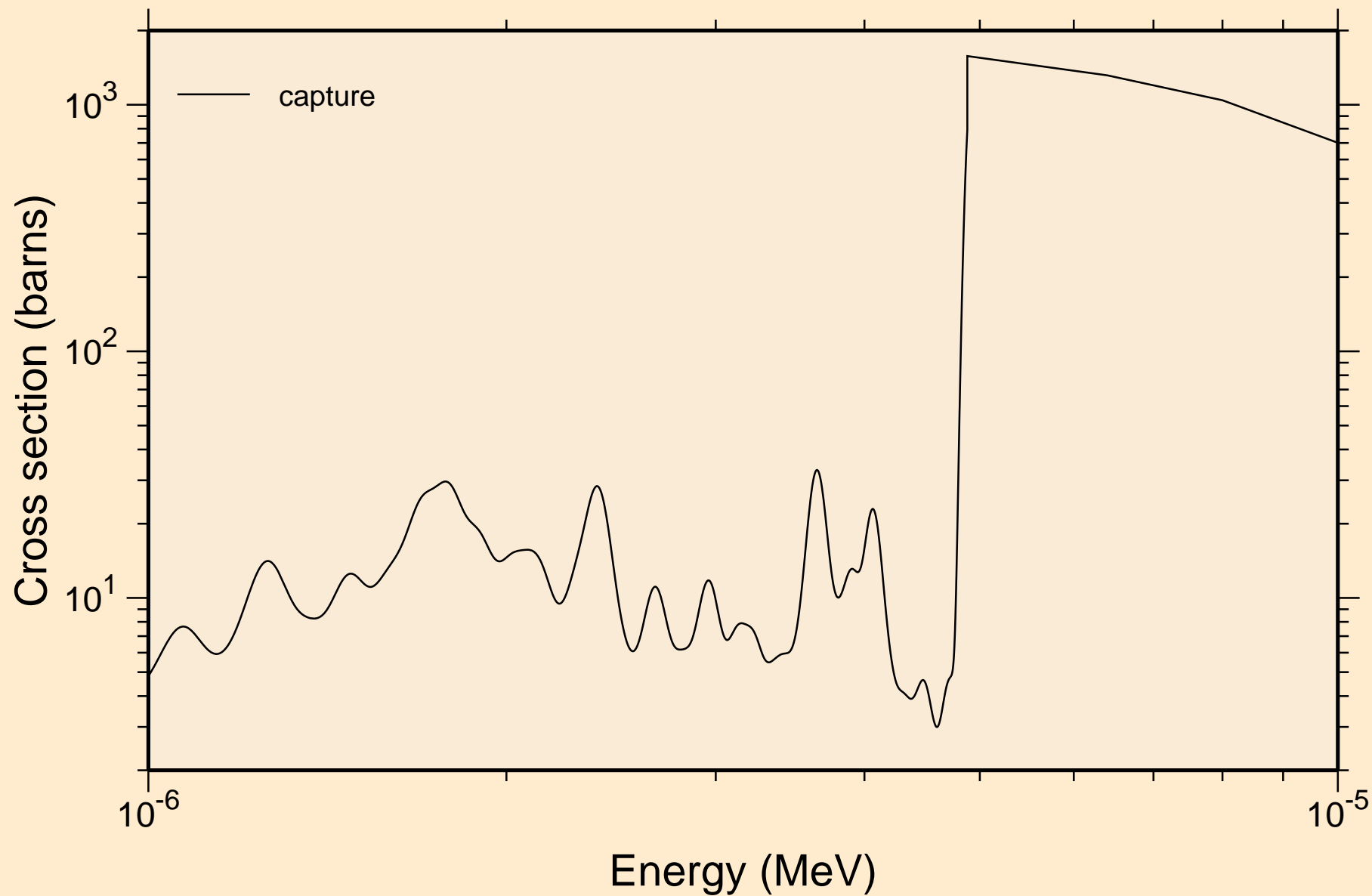



HF159 NEUTRON ACER TENDL-2019 LIBRARY; T=293.16K  
resonance absorption cross sections

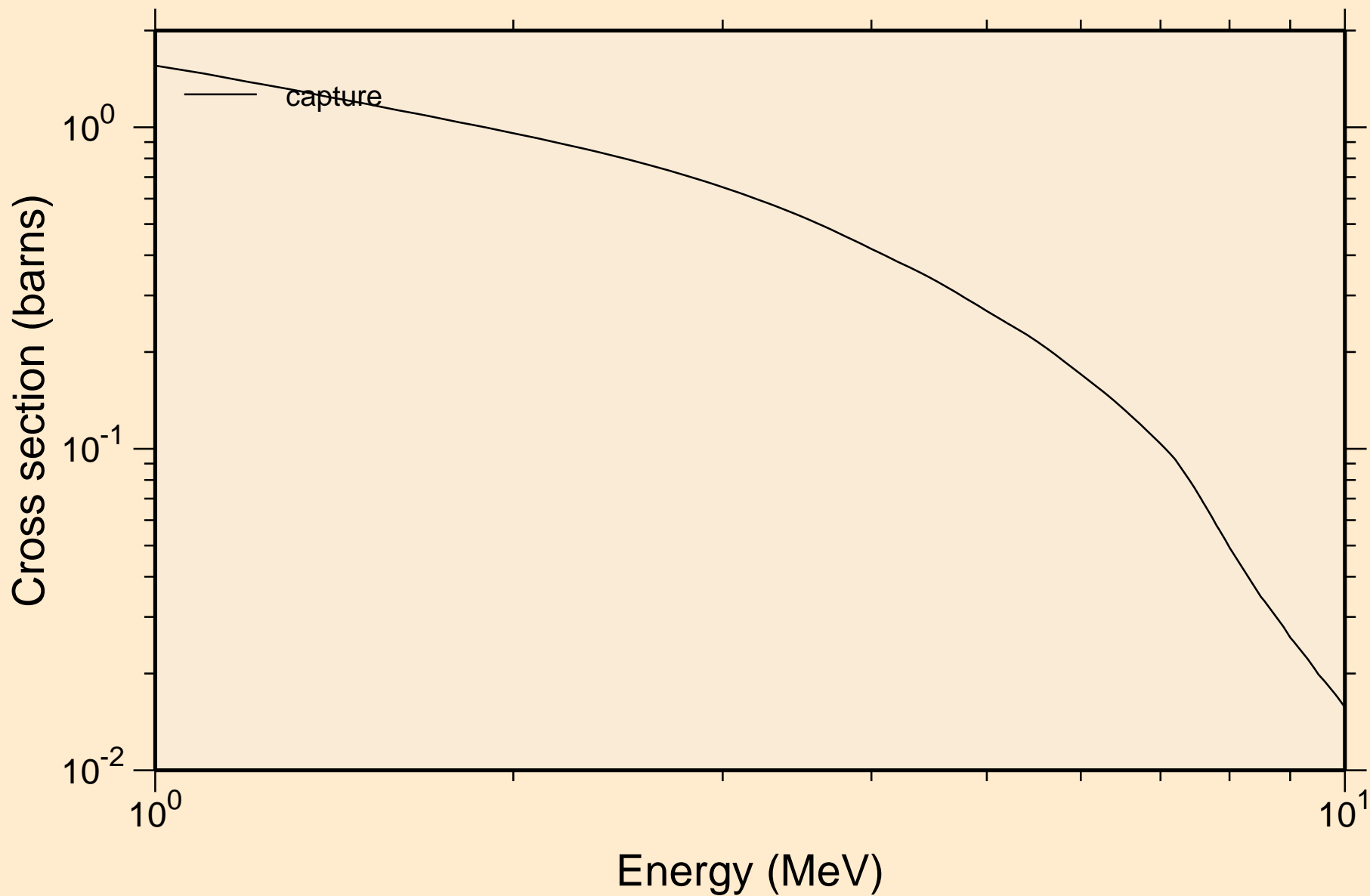

HF159 NEUTRON ACER TENDL-2019 LIBRARY; T=293.16K  
Heating

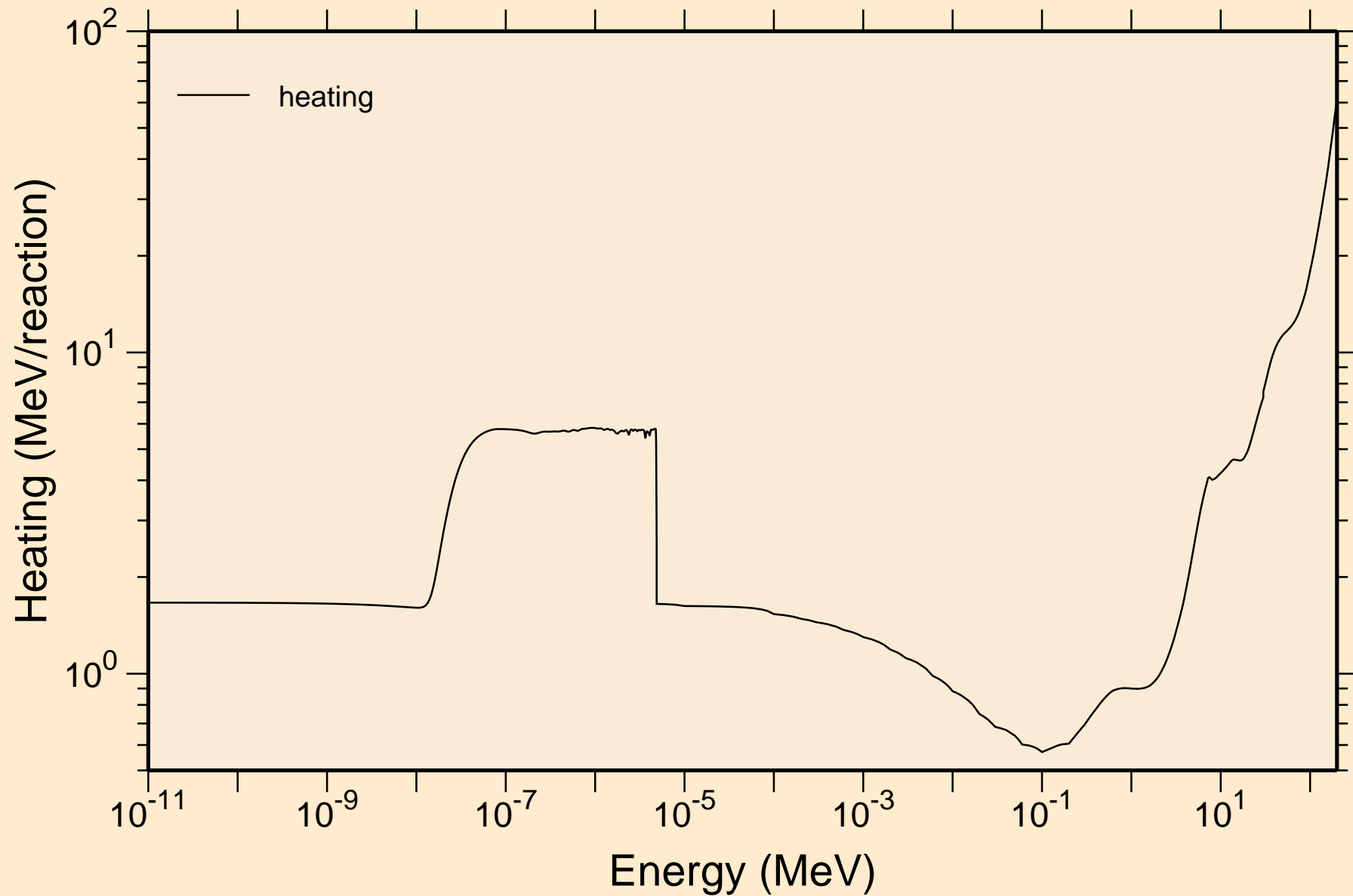

# HF159 NEUTRON ACER TENDL-2019 LIBRARY; T=293.16K

## Damage

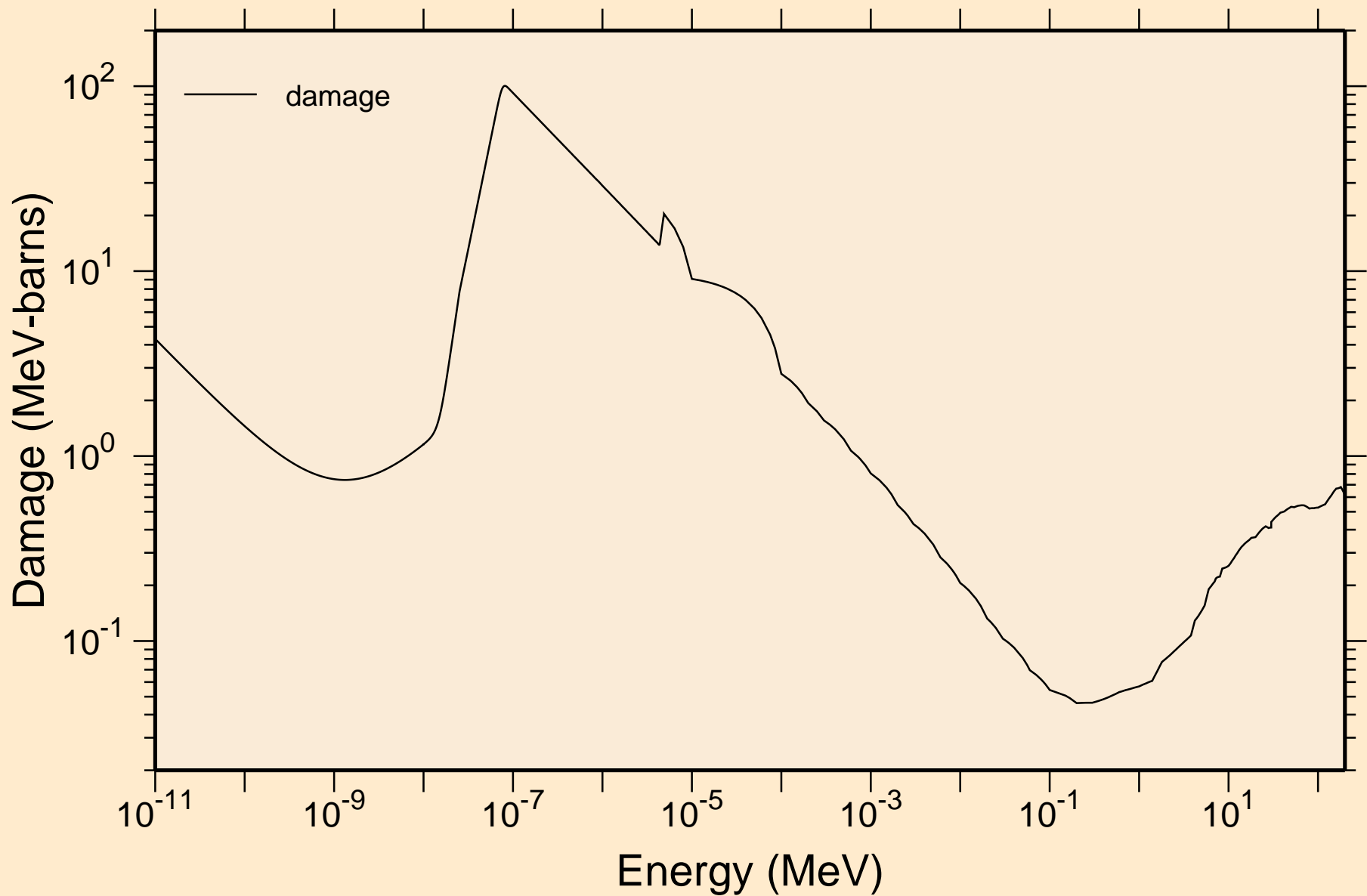

# HF159 NEUTRON ACER TENDL-2019 LIBRARY; T=293.16K

## Non-threshold reactions

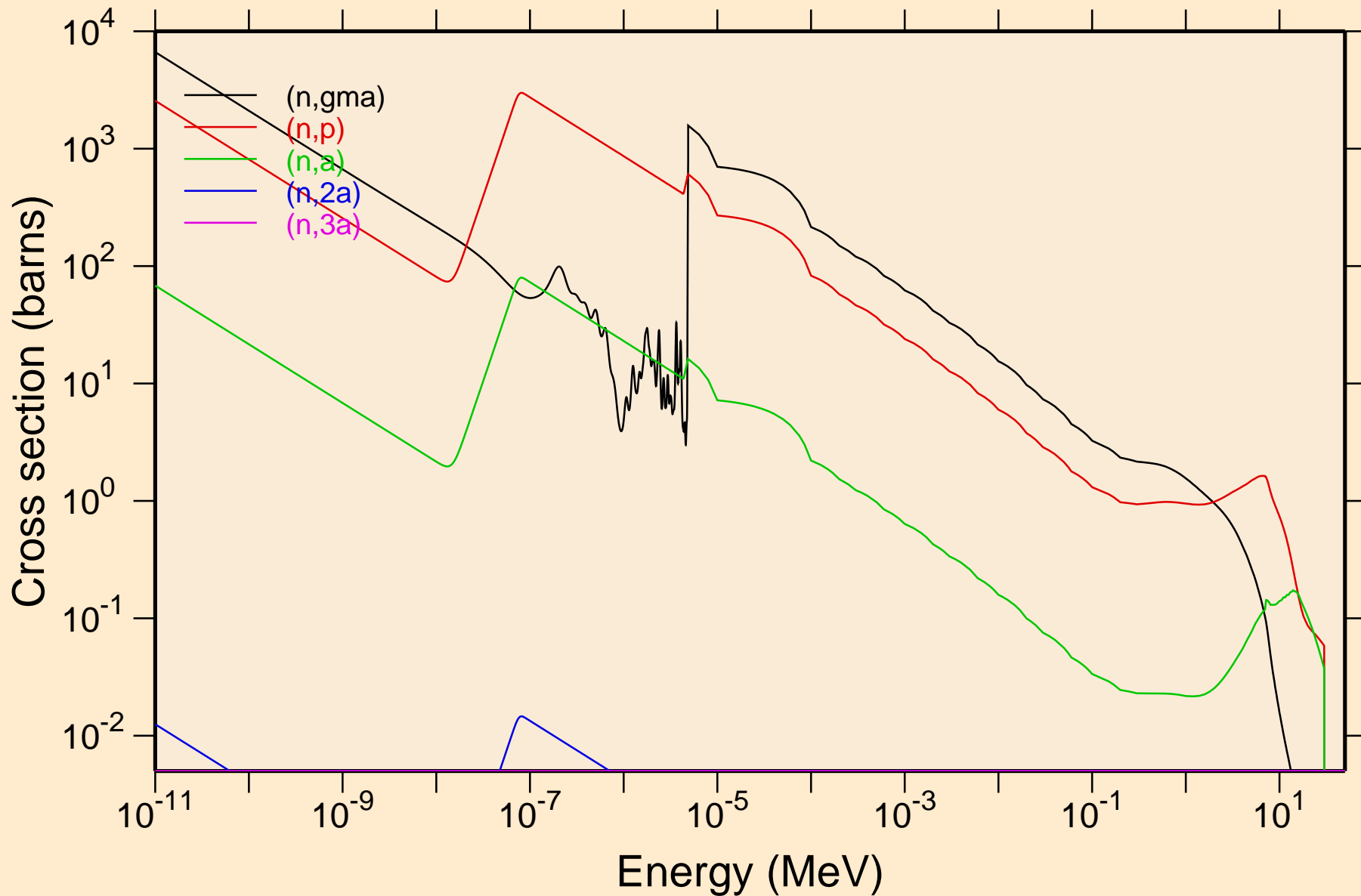

HF159 NEUTRON ACER TENDL-2019 LIBRARY; T=293.16K  
Non-threshold reactions

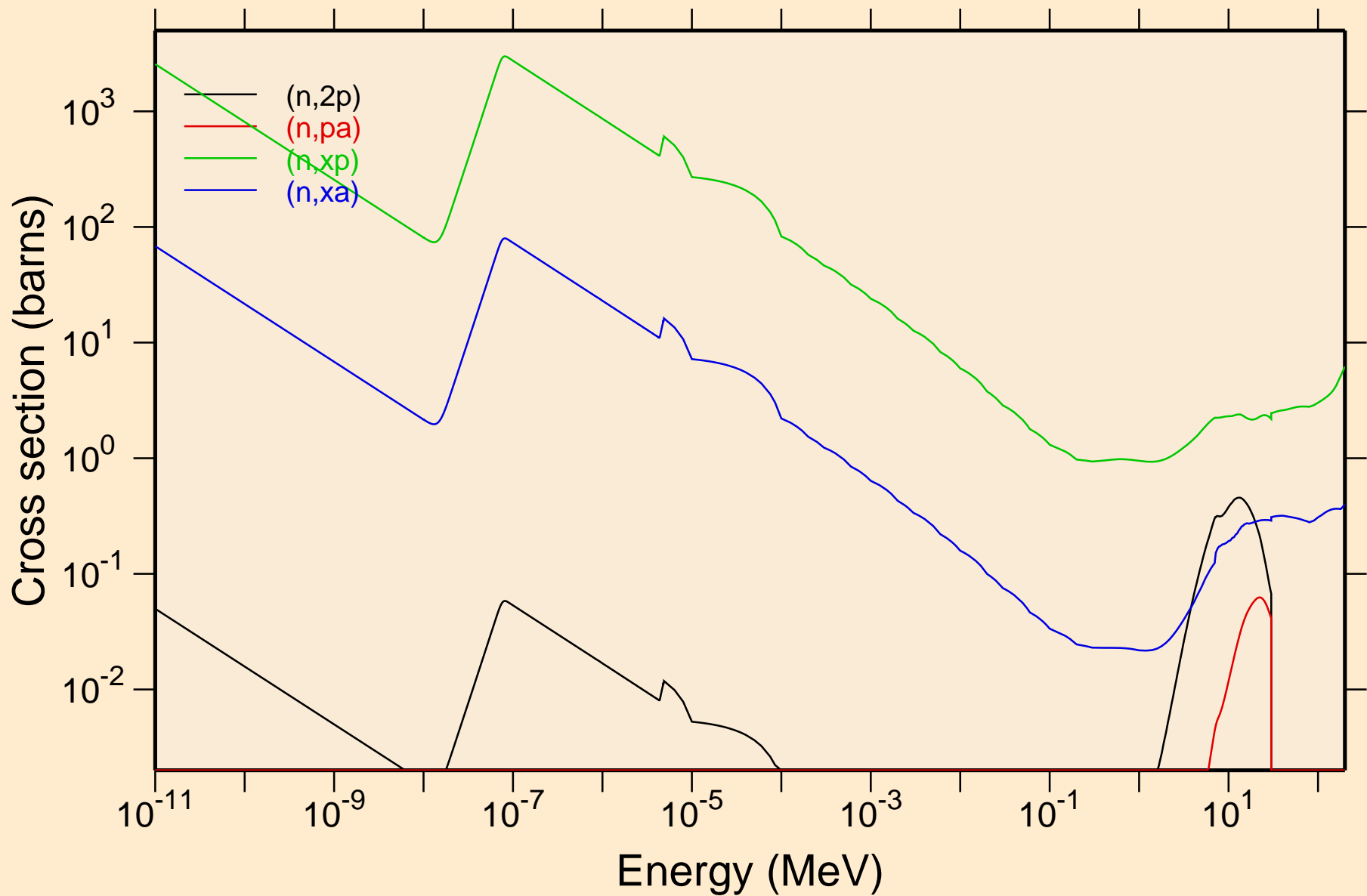

# HF159 NEUTRON ACER TENDL-2019 LIBRARY; T=293.16K

## Principal cross sections

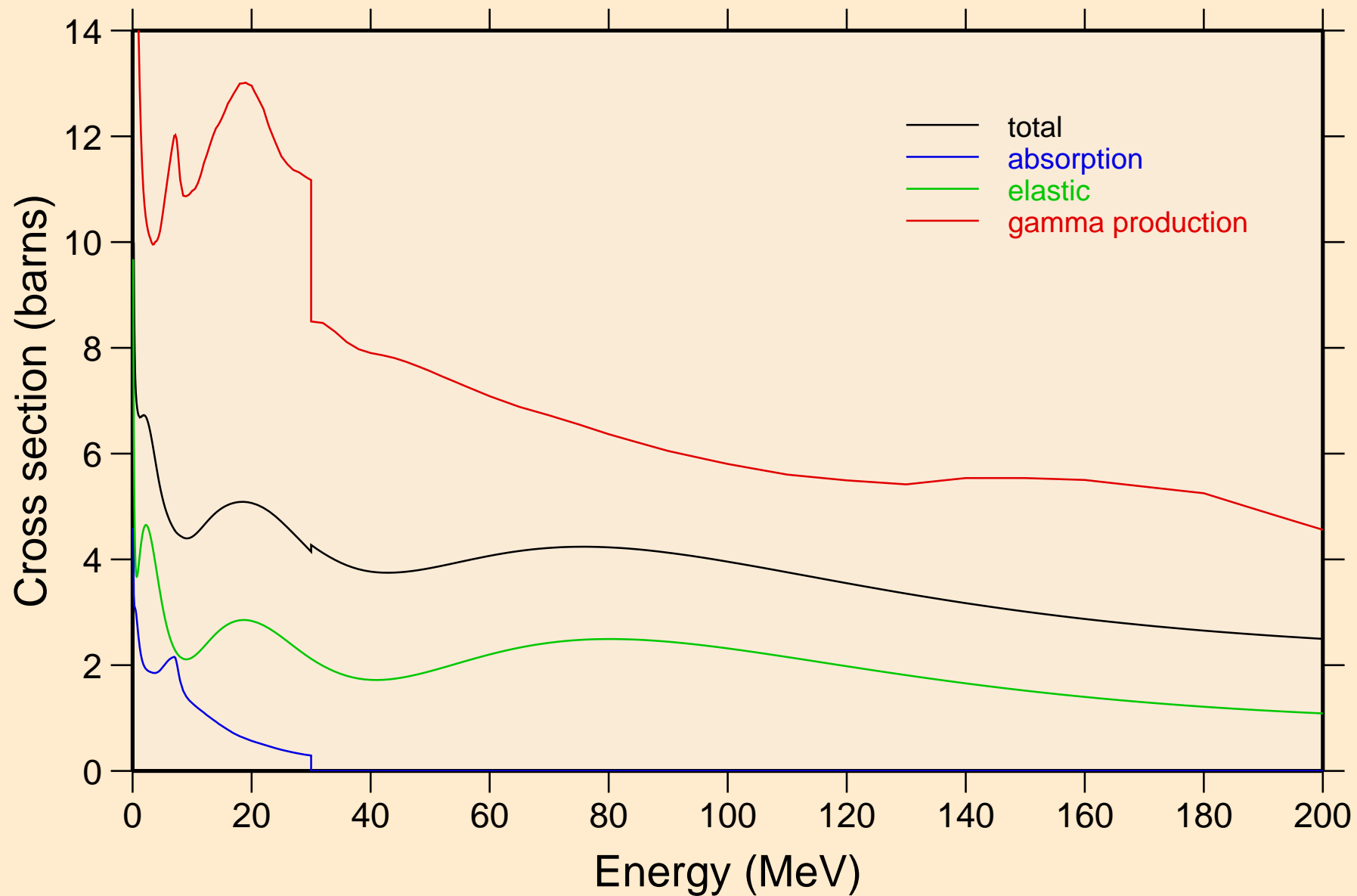

HF159 NEUTRON ACER TENDL-2019 LIBRARY; T=293.16K  
Heating

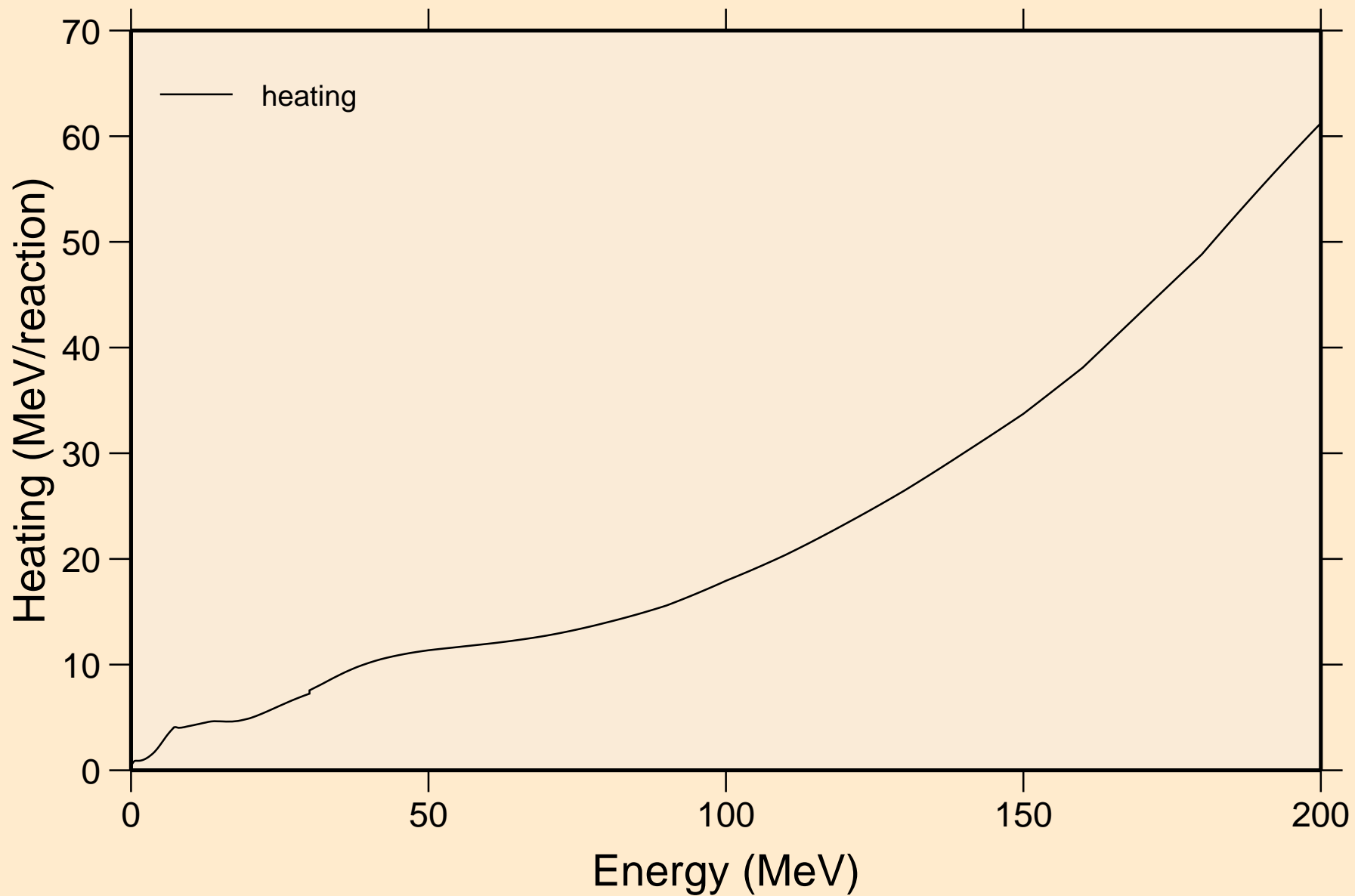

HF159 NEUTRON ACER TENDL-2019 LIBRARY; T=293.16K  
Damage

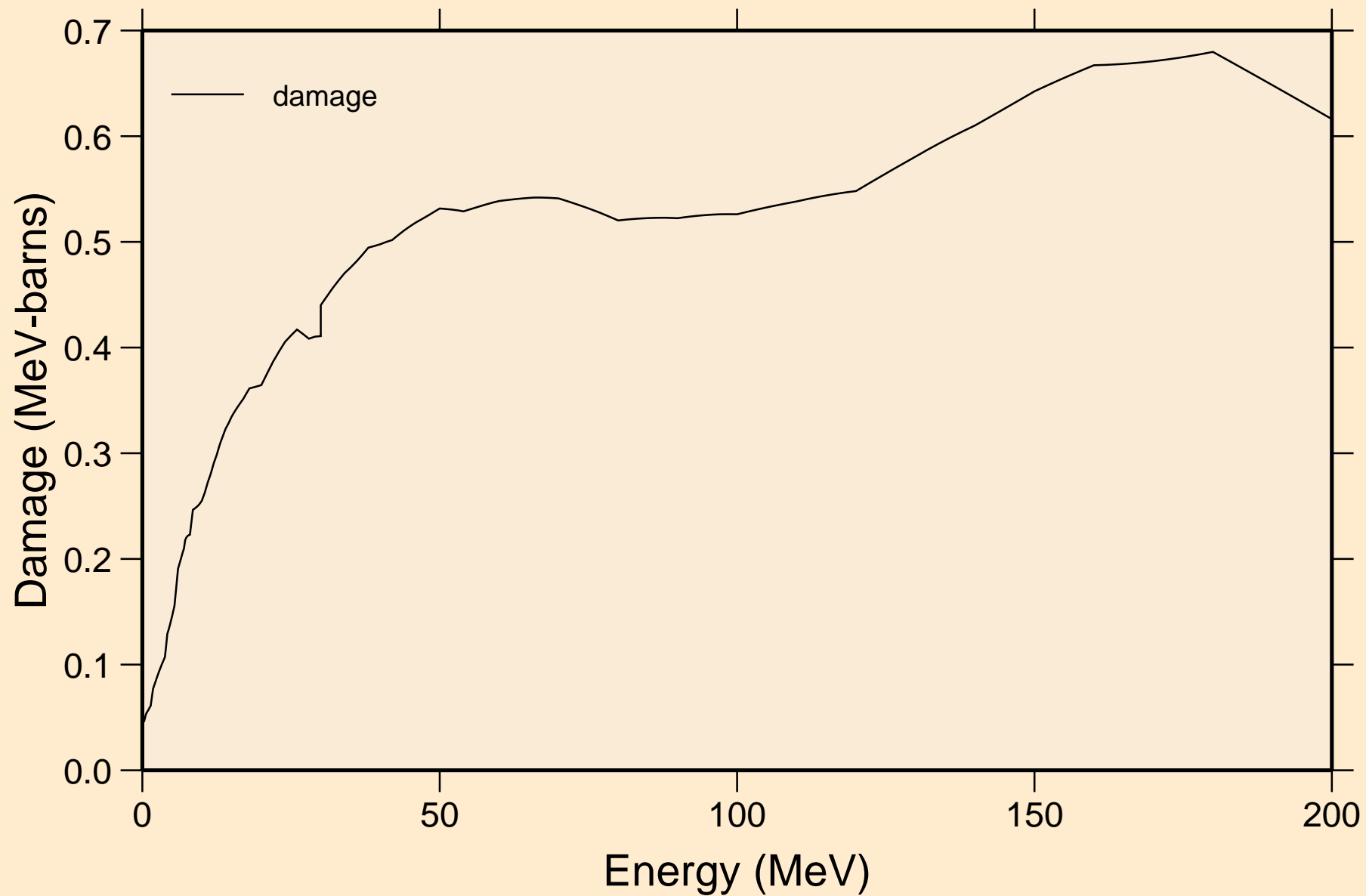



# HF159 NEUTRON ACER TENDL-2019 LIBRARY; T=293.16K

## Non-threshold reactions

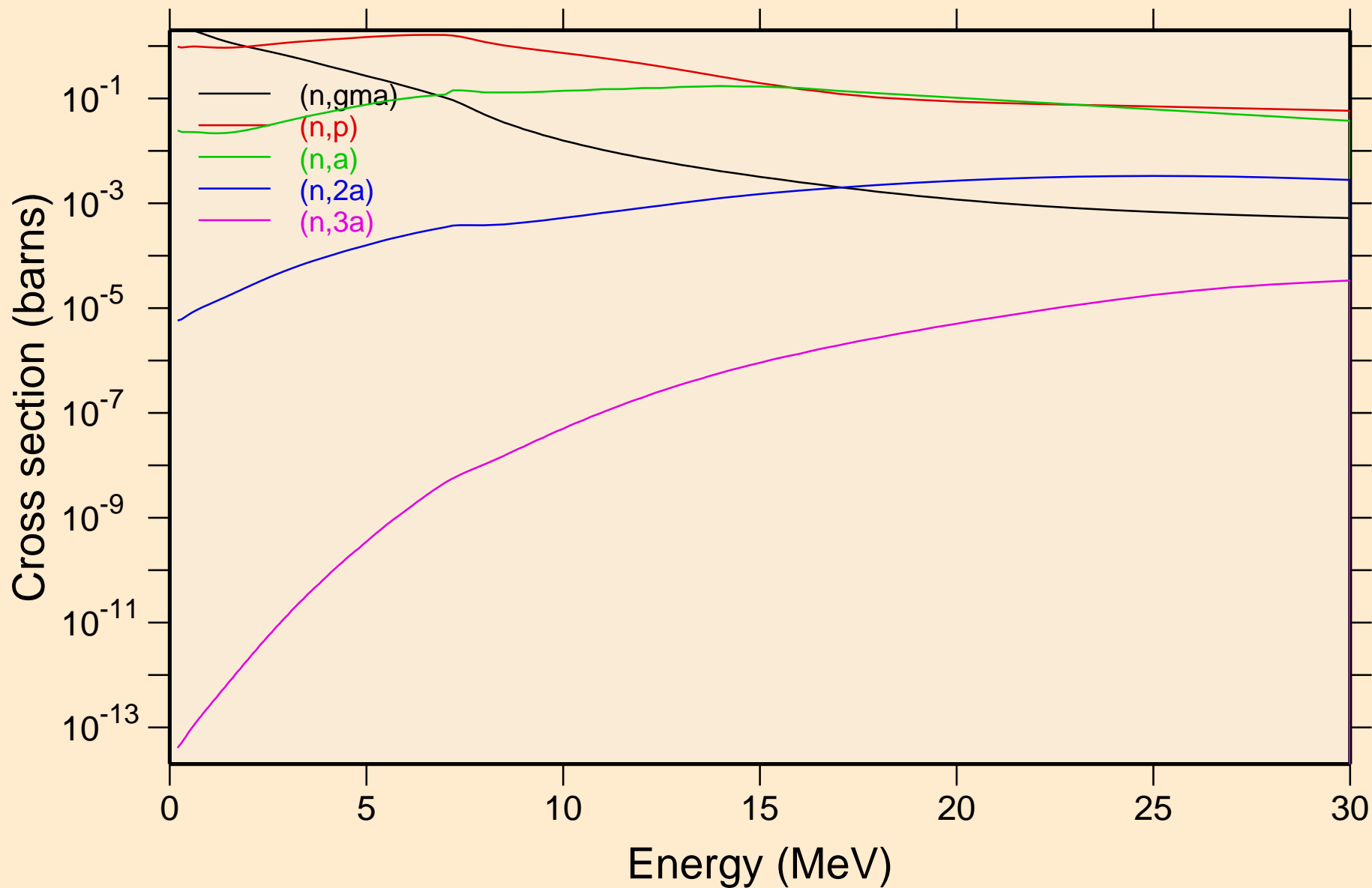

HF159 NEUTRON ACER TENDL-2019 LIBRARY; T=293.16K  
Non-threshold reactions

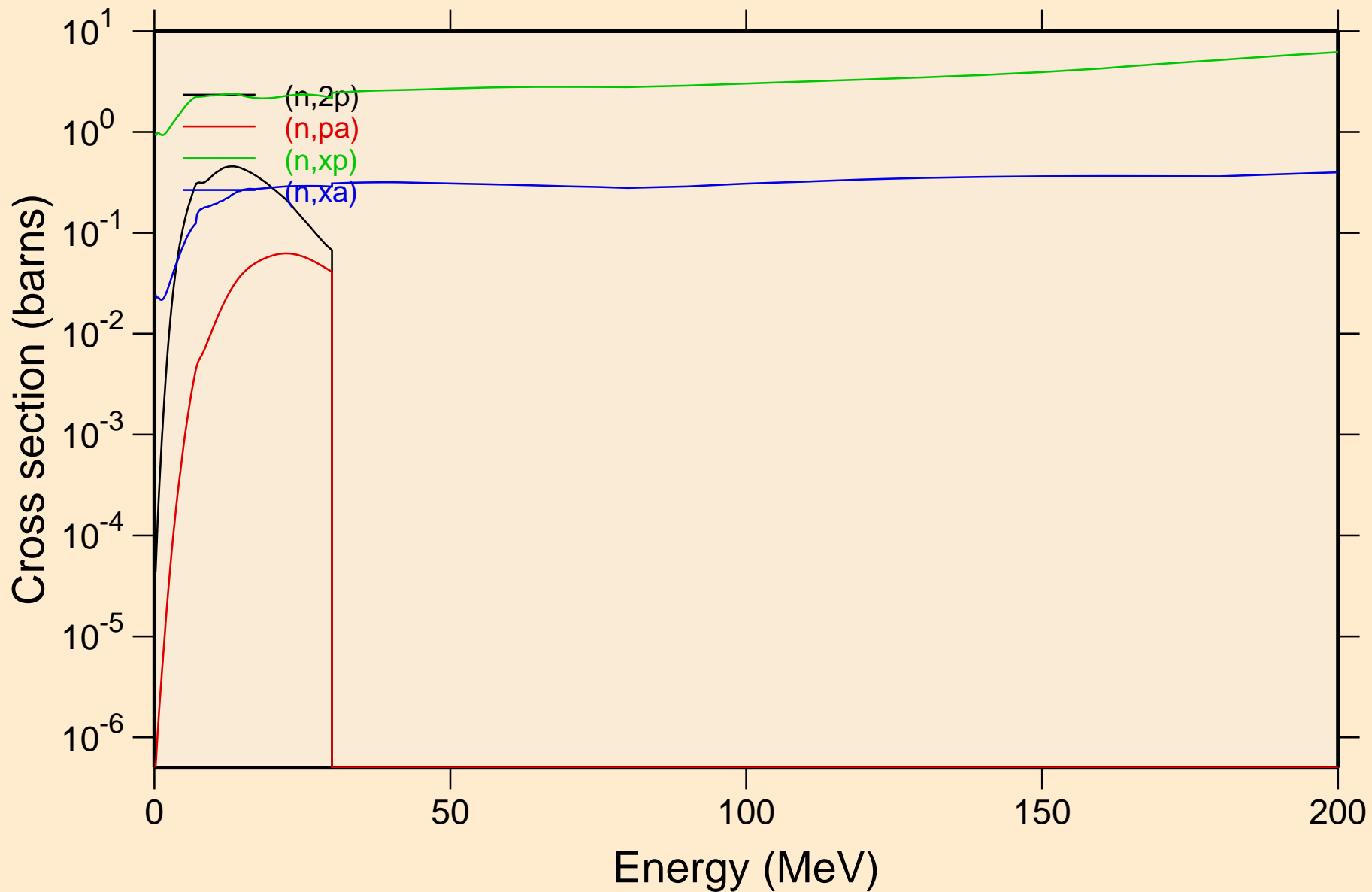

HF159 NEUTRON ACER TENDL-2019 LIBRARY; T=293.16K  
Inelastic levels

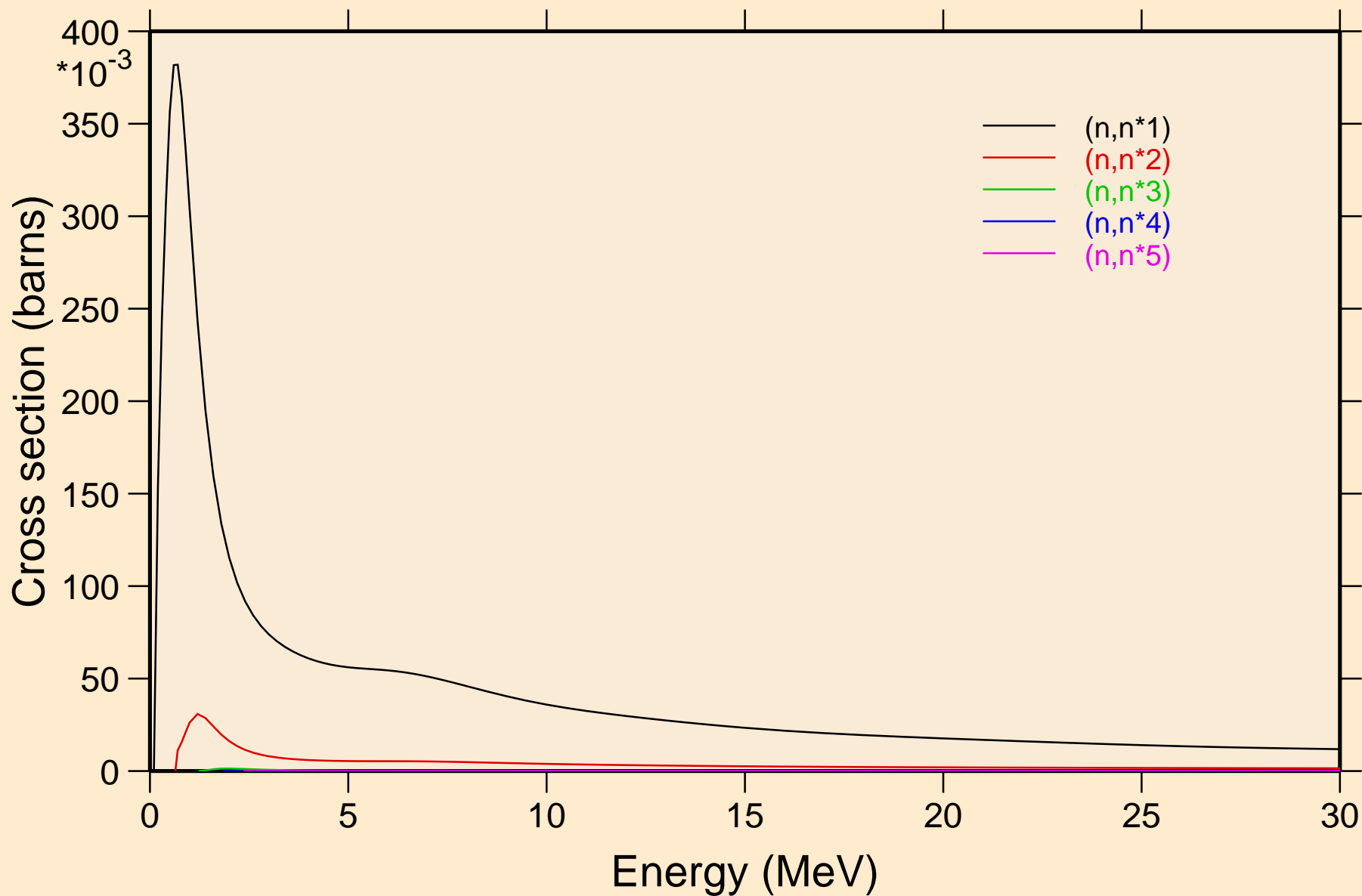

HF159 NEUTRON ACER TENDL-2019 LIBRARY; T=293.16K  
Inelastic levels

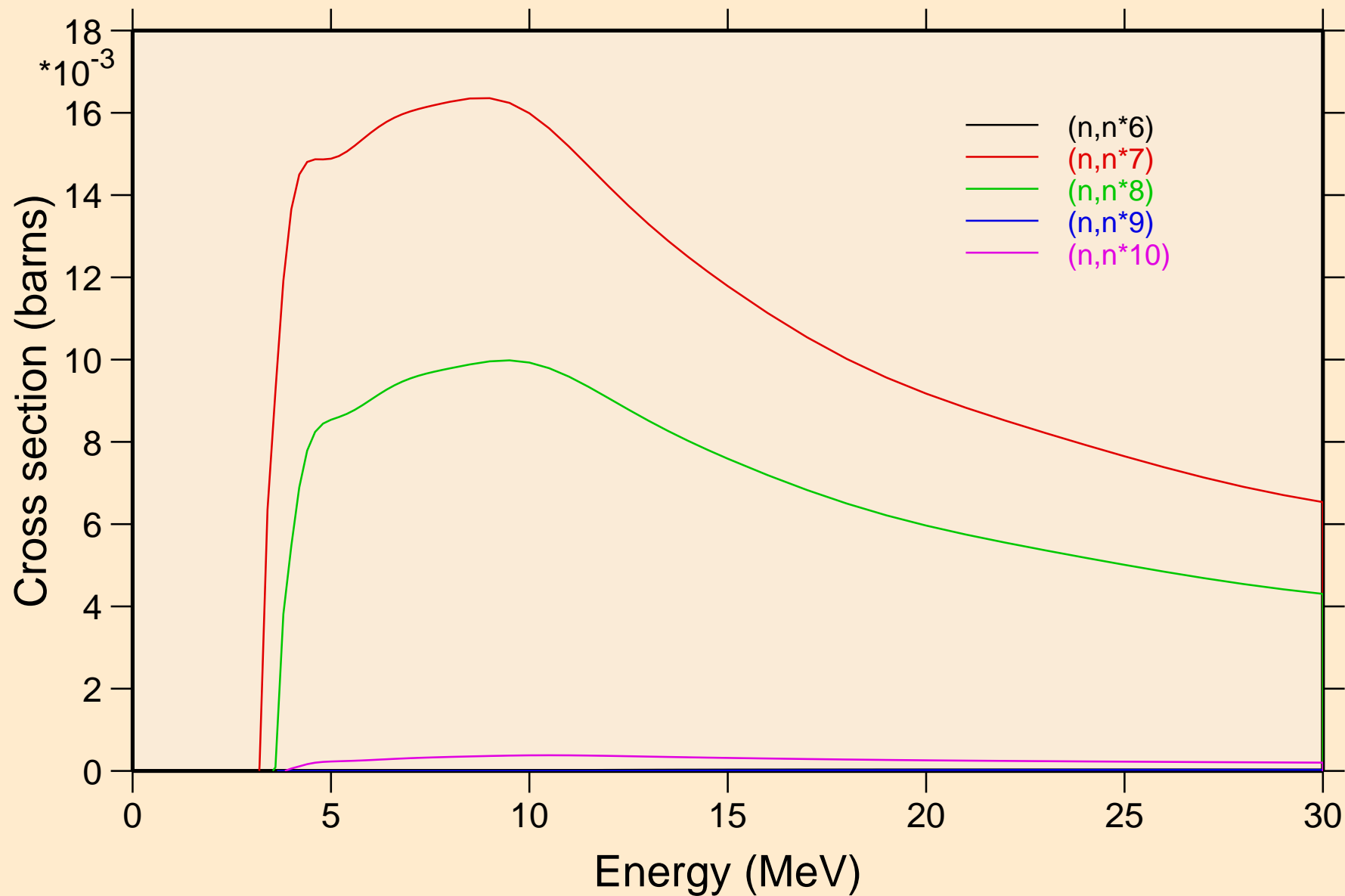

HF159 NEUTRON ACER TENDL-2019 LIBRARY; T=293.16K  
Inelastic levels

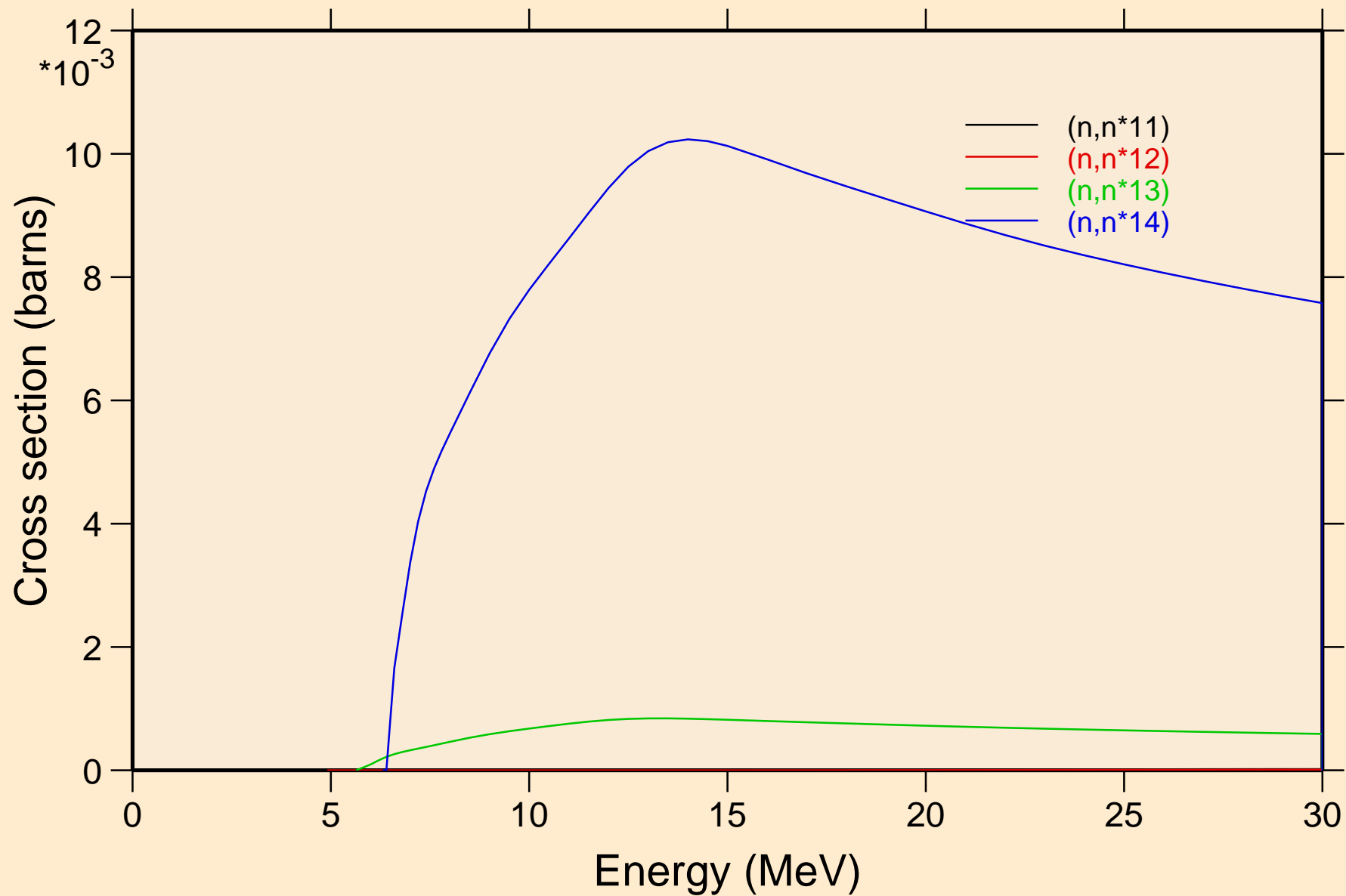

# HF159 NEUTRON ACER TENDL-2019 LIBRARY; T=293.16K

## Threshold reactions

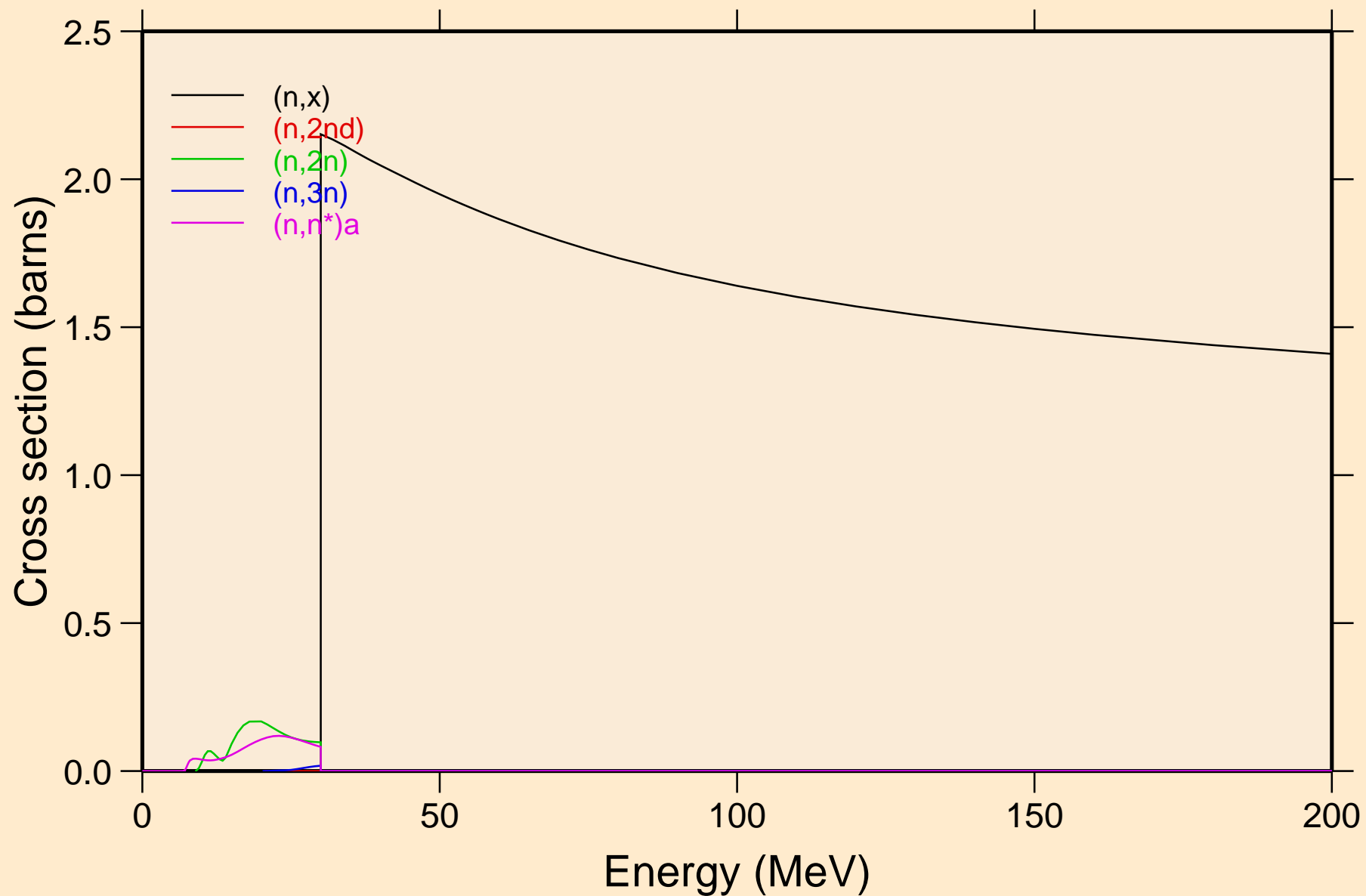

HF159 NEUTRON ACER TENDL-2019 LIBRARY; T=293.16K  
Threshold reactions

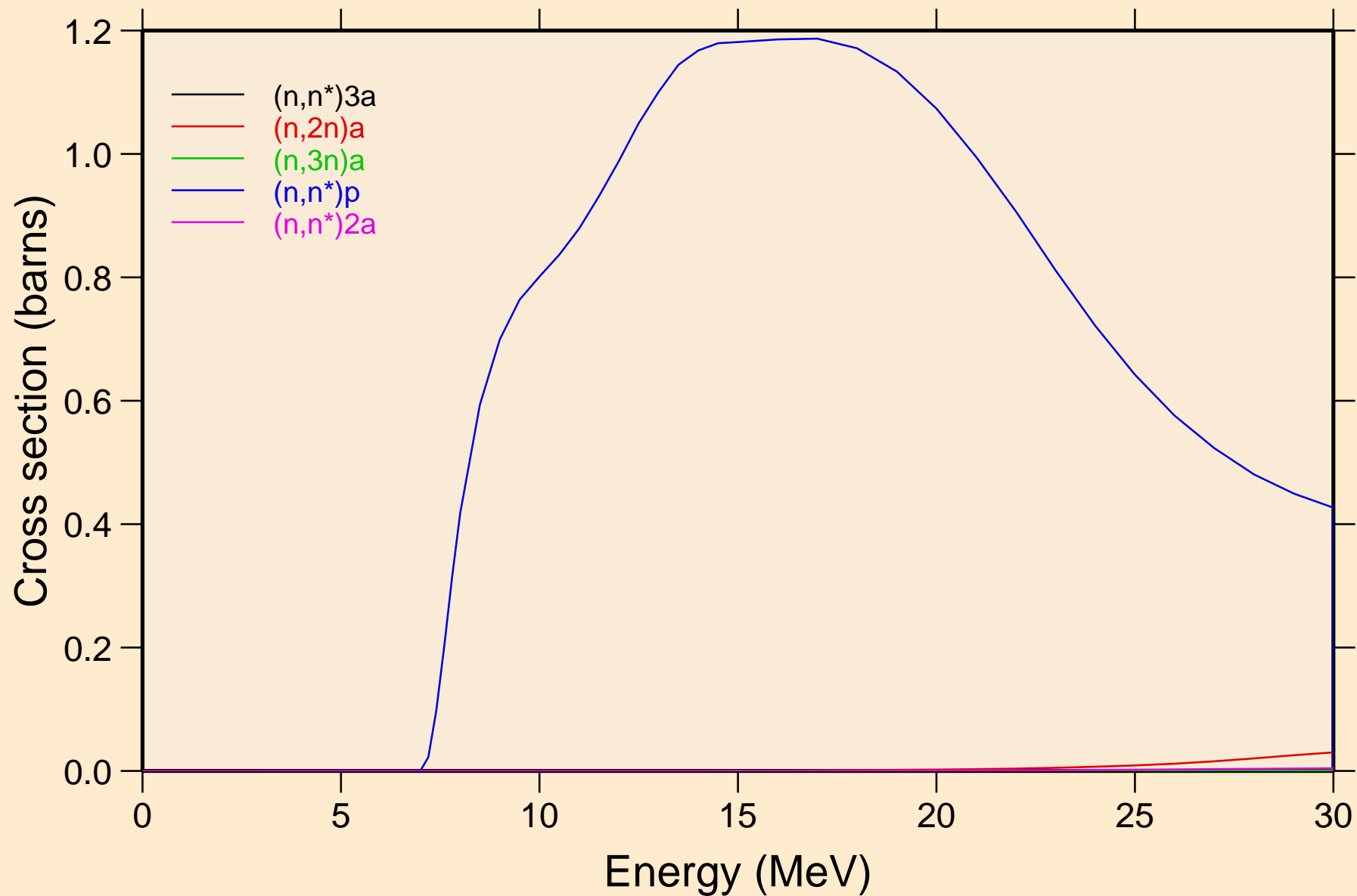

# HF159 NEUTRON ACER TENDL-2019 LIBRARY; T=293.16K

## Threshold reactions

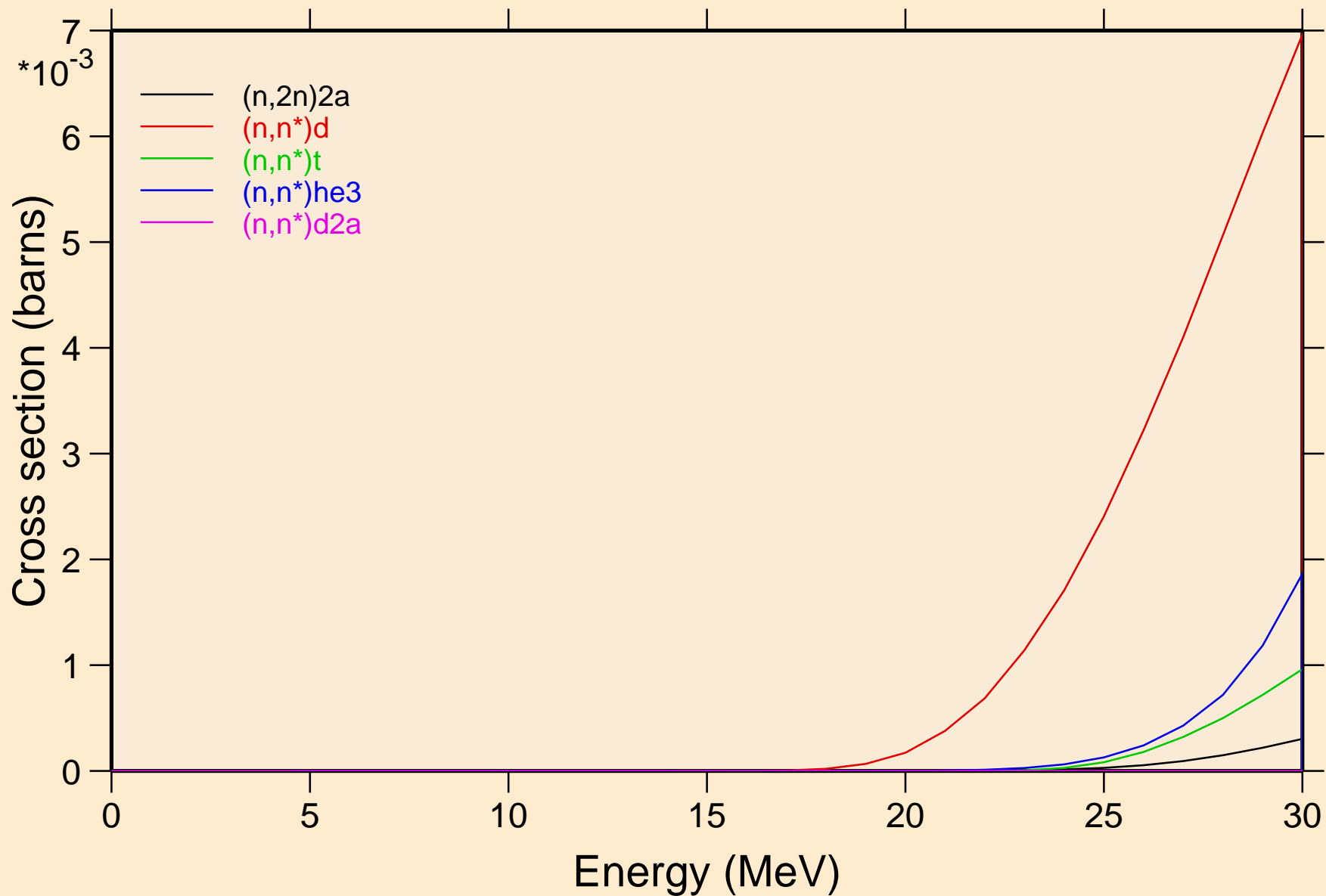



HF159 NEUTRON ACER TENDL-2019 LIBRARY; T=293.16K  
Threshold reactions

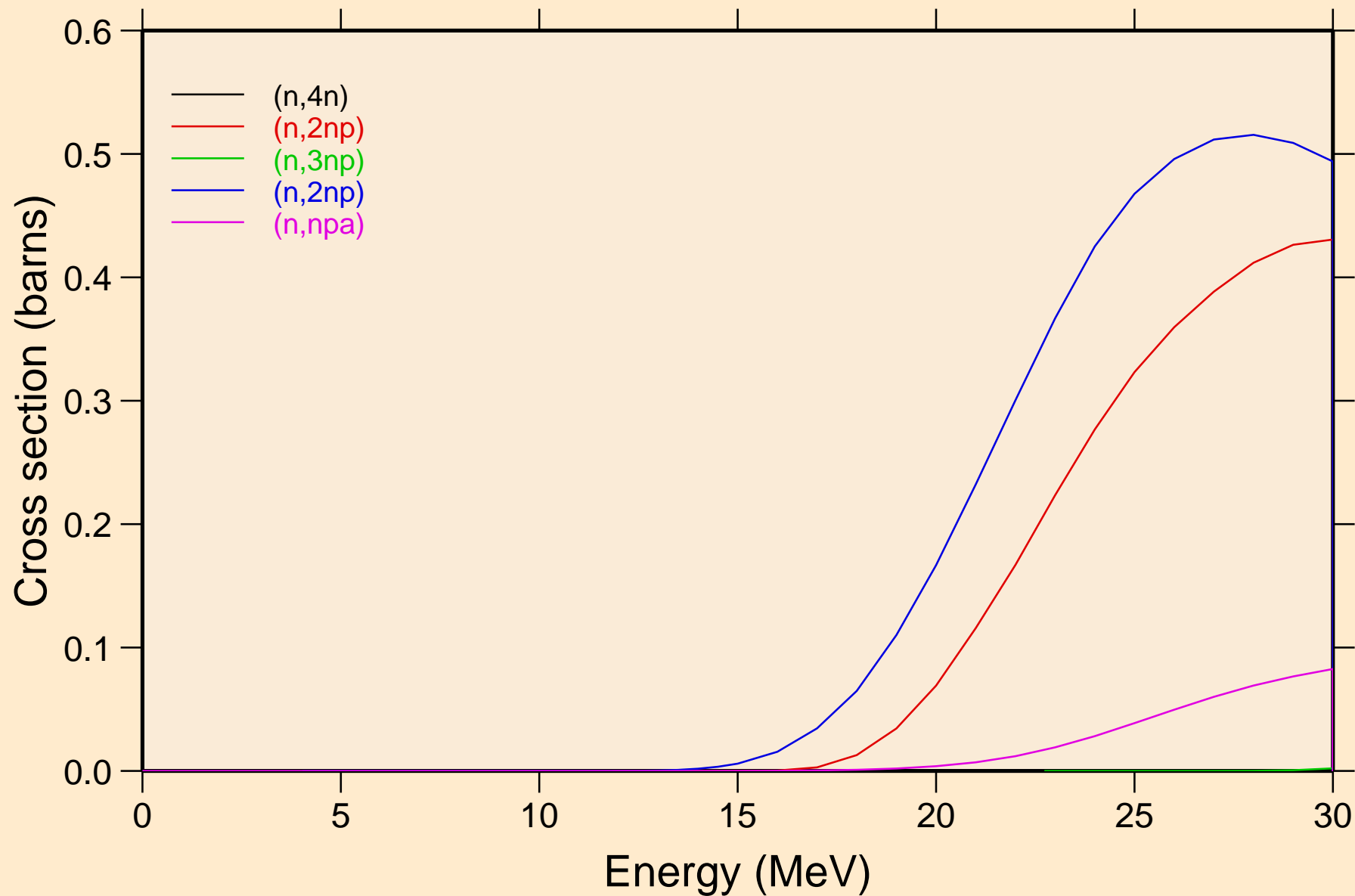

# HF159 NEUTRON ACER TENDL-2019 LIBRARY; T=293.16K

## Threshold reactions

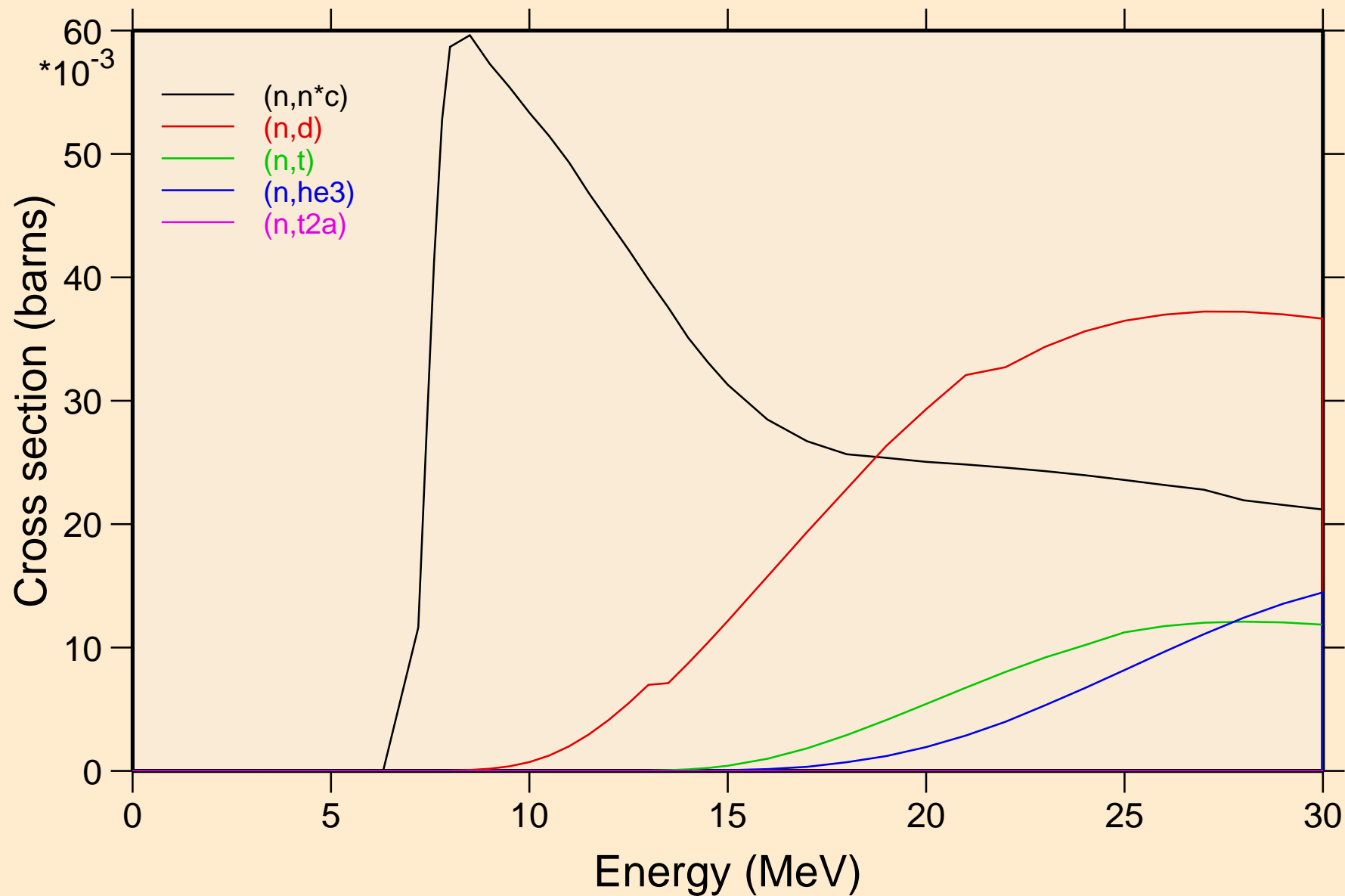

HF159 NEUTRON ACER TENDL-2019 LIBRARY; T=293.16K  
Threshold reactions

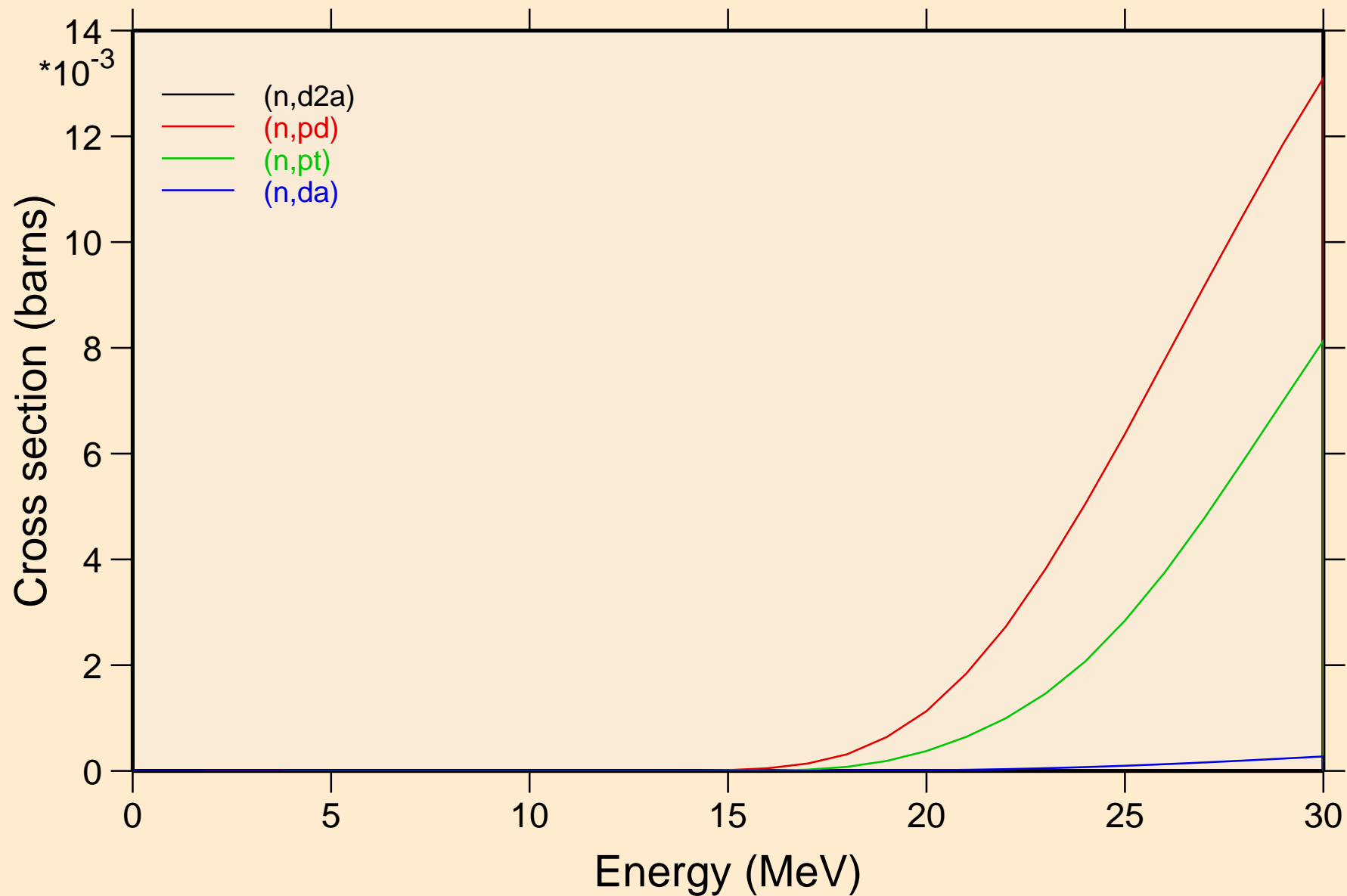

HF159 NEUTRON ACER TENDL-2019 LIBRARY; T=293.16K  
Threshold reactions

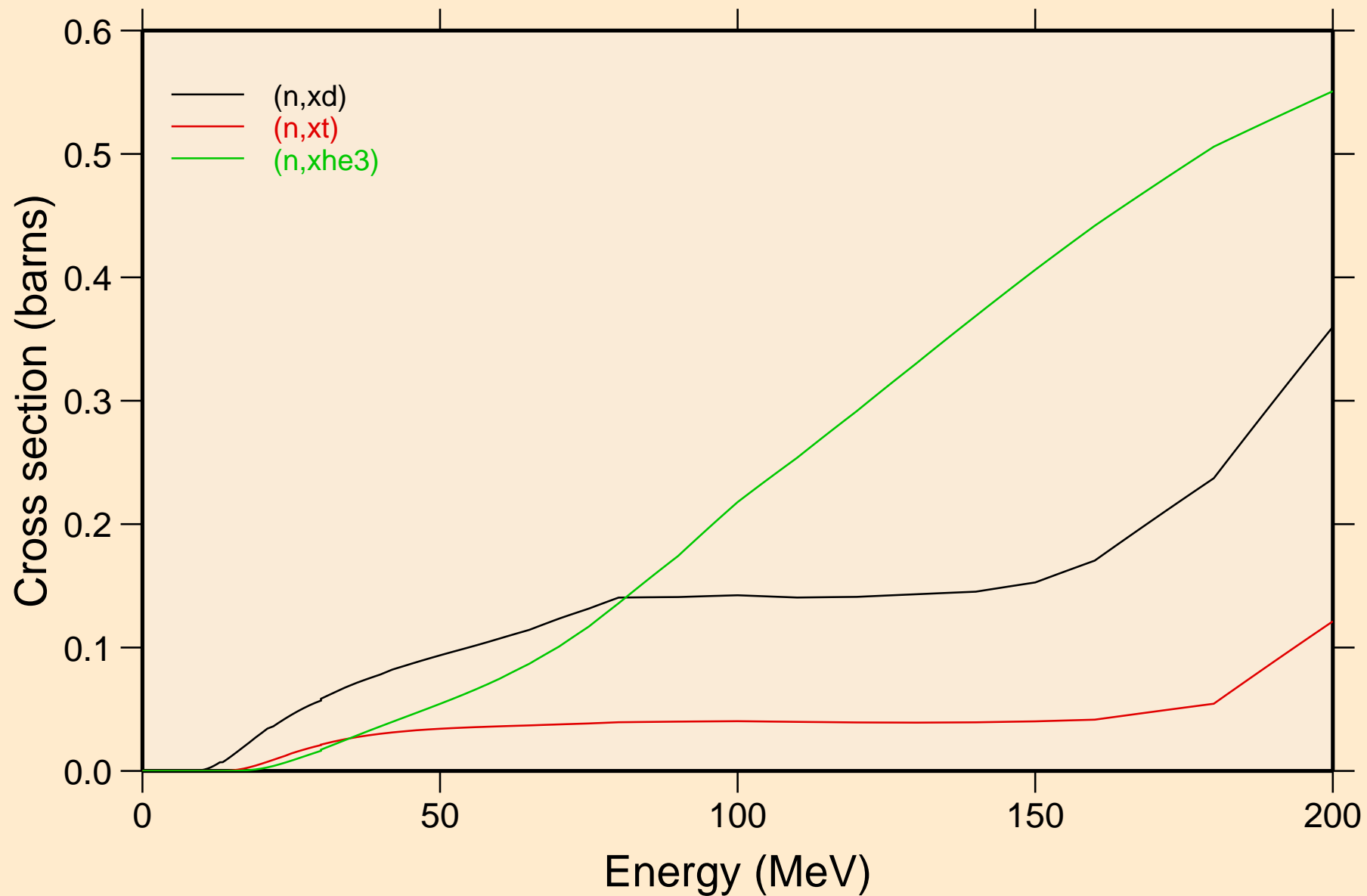

HF159 NEUTRON ACER TENDL-2019 LIBRARY; T=293.16K  
angular distribution for elastic

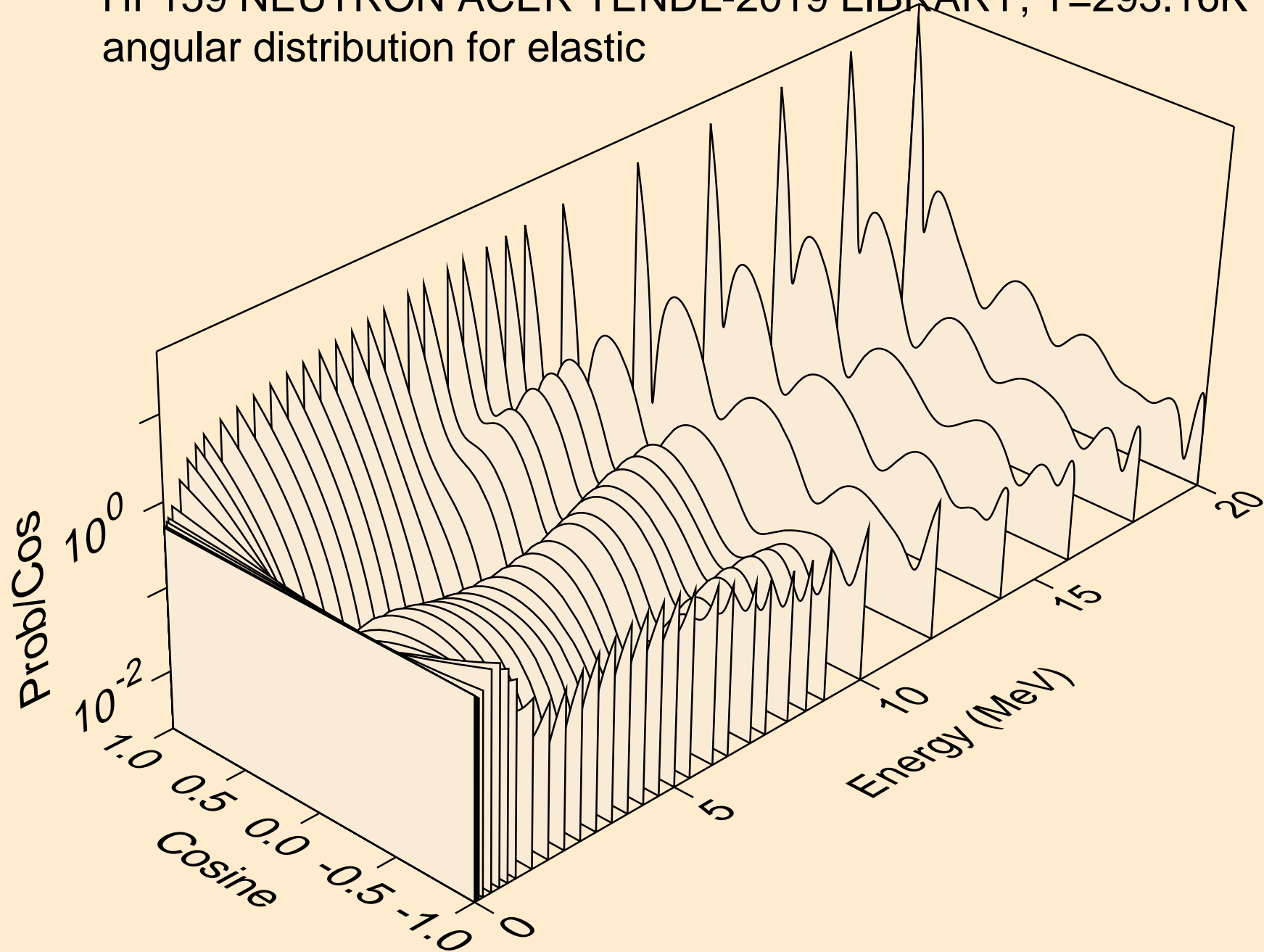

HF159 NEUTRON ACER TENDL-2019 LIBRARY; T=293.16K  
angular distribution for elastic

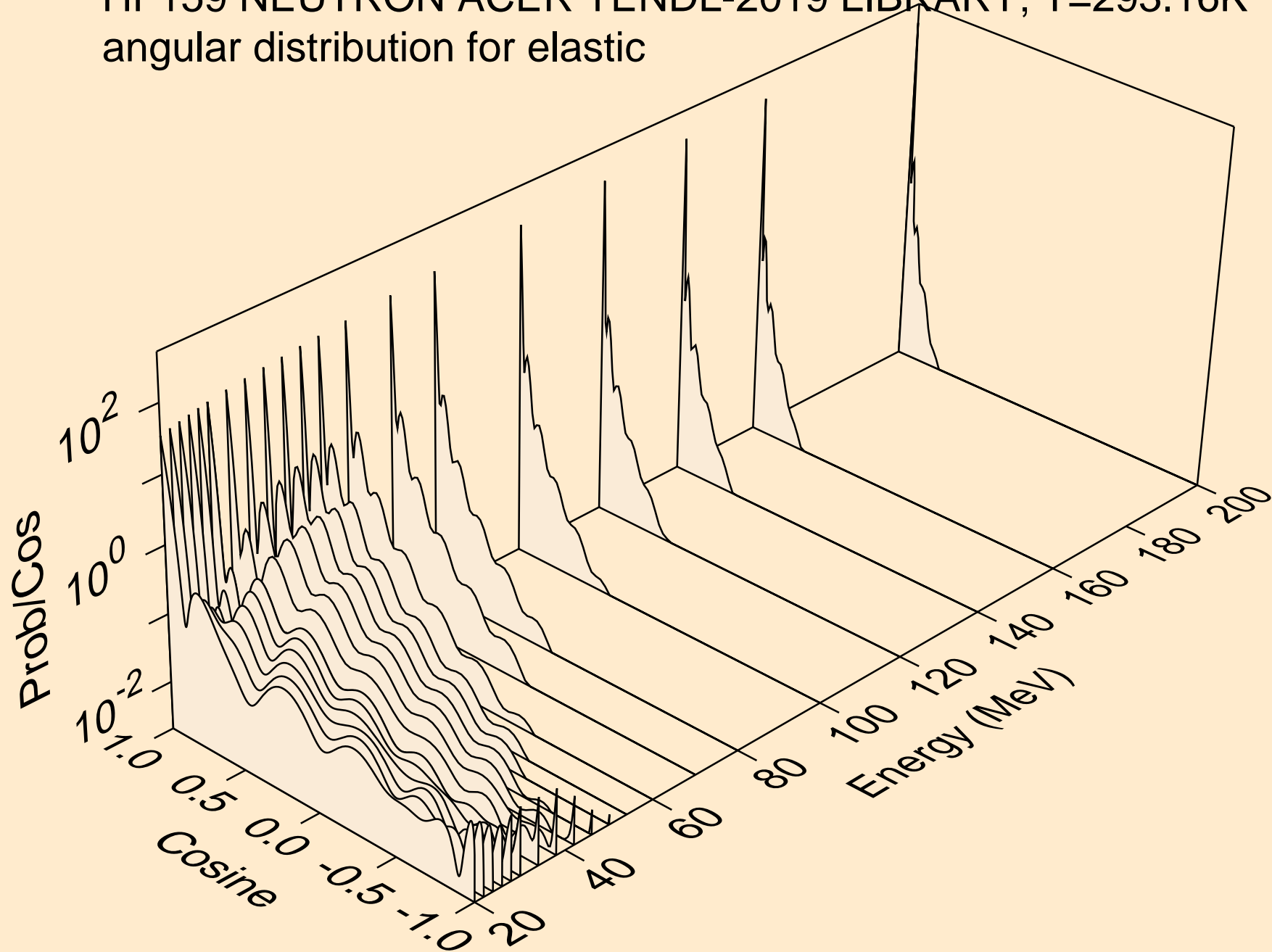

HF159 NEUTRON ACER TENDL-2019 LIBRARY; T=293.16K  
angular distribution for (n,n\*1)

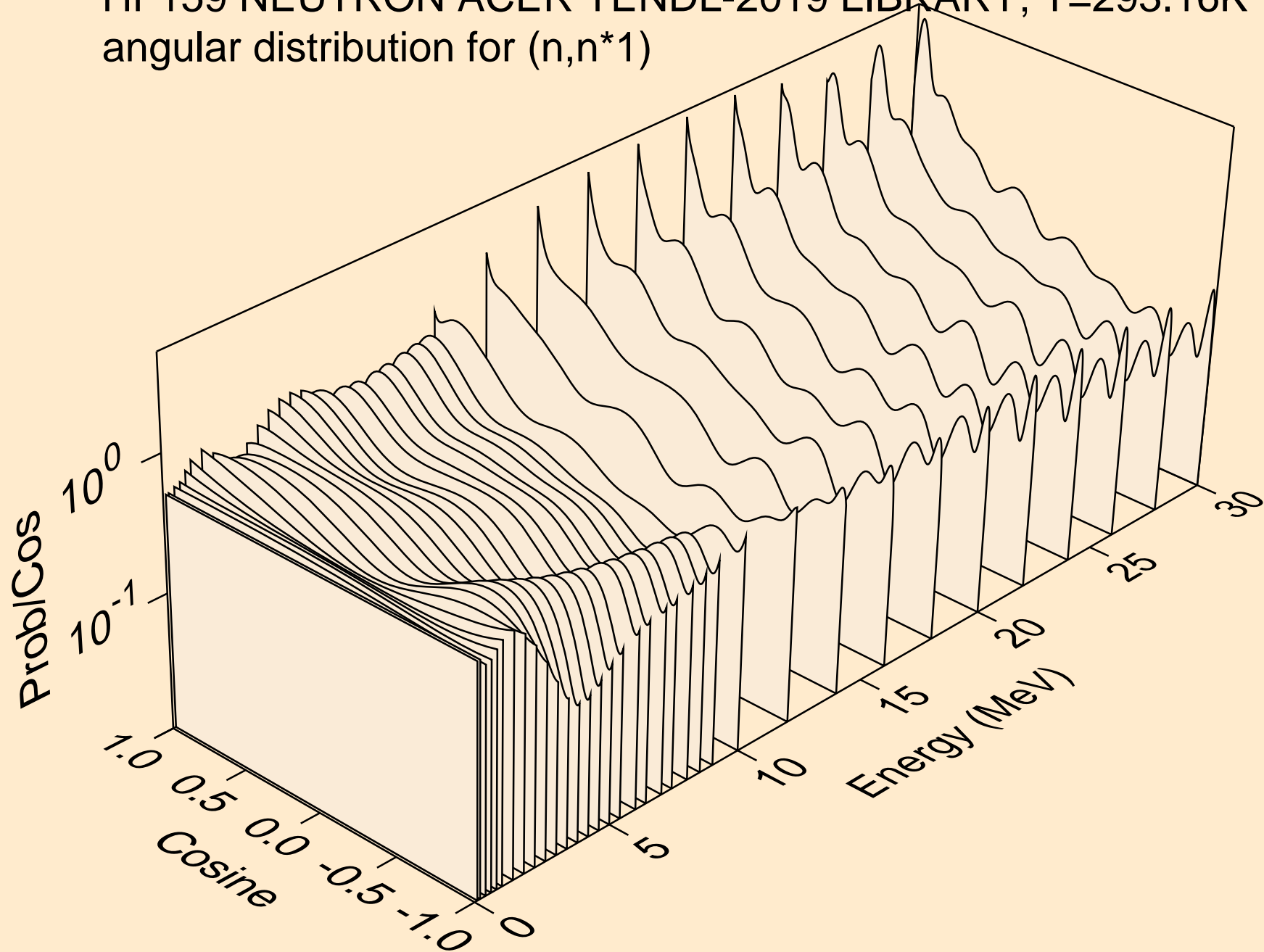

HF159 NEUTRON ACER TENDL-2019 LIBRARY; T=293.16K  
angular distribution for (n,n\*2)

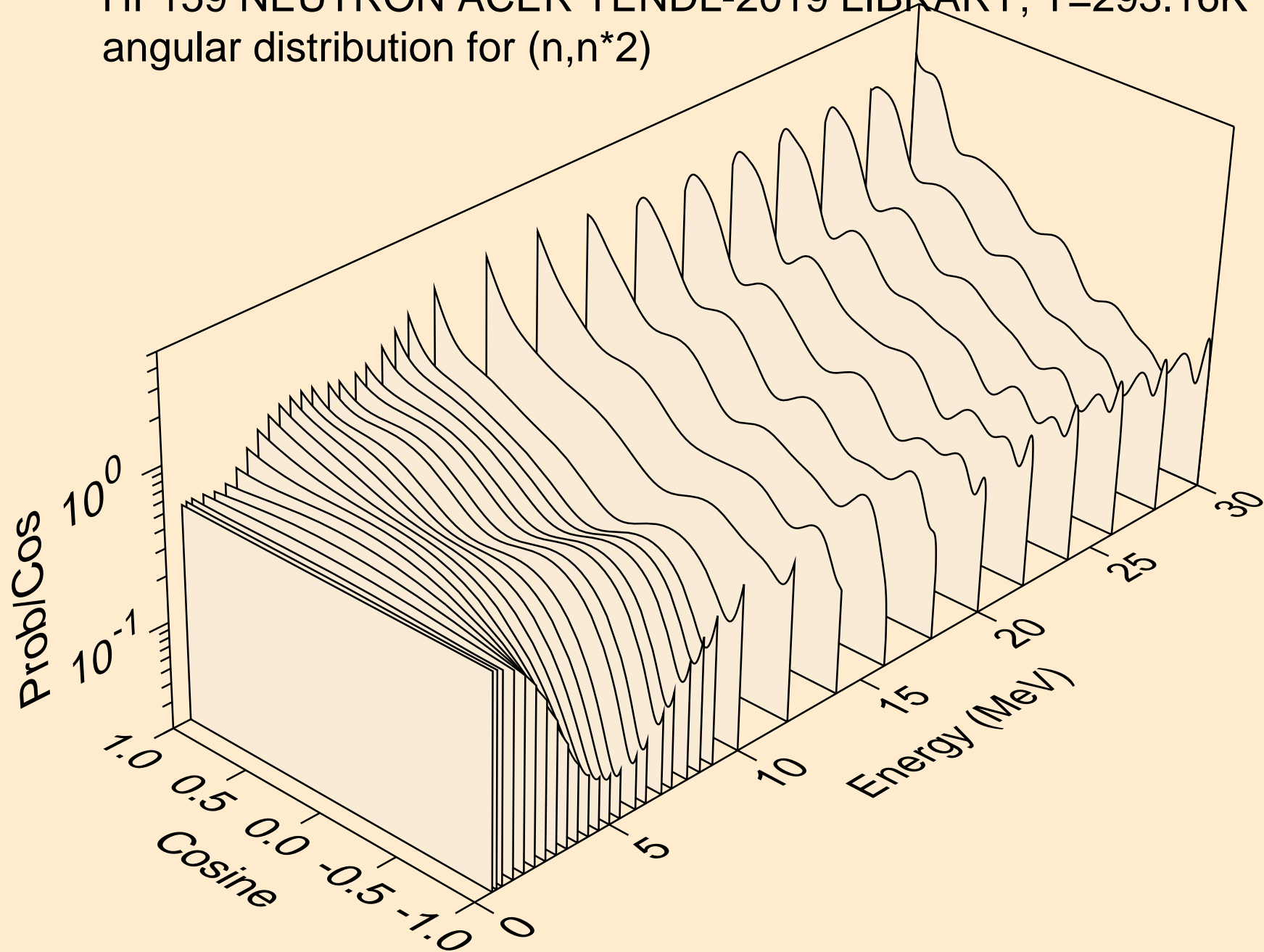



HF159 NEUTRON ACER TENDL-2019 LIBRARY; T=293.16K  
angular distribution for (n,n\*3)

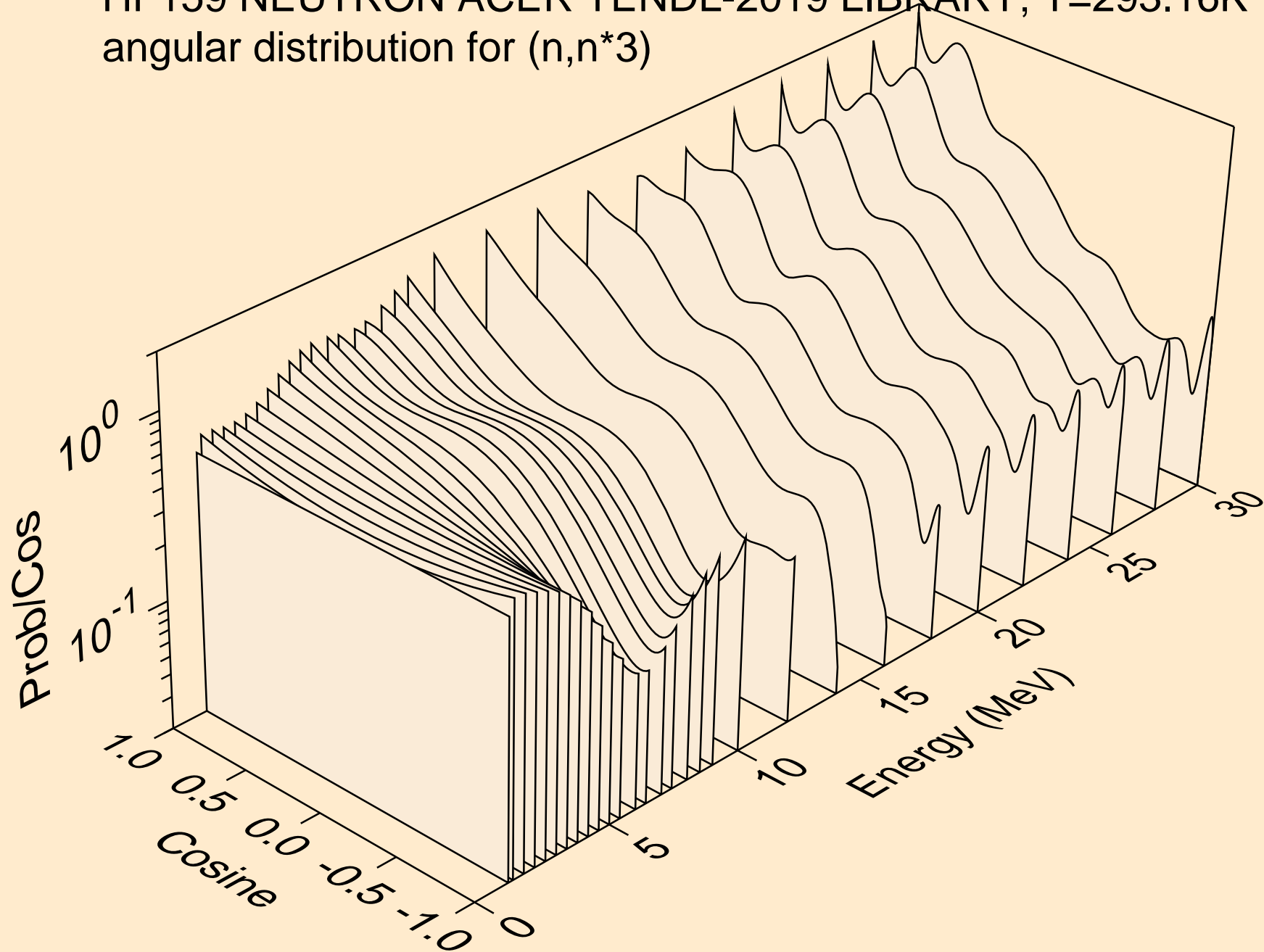

HF159 NEUTRON ACER TENDL-2019 LIBRARY; T=293.16K  
angular distribution for (n,n\*4)

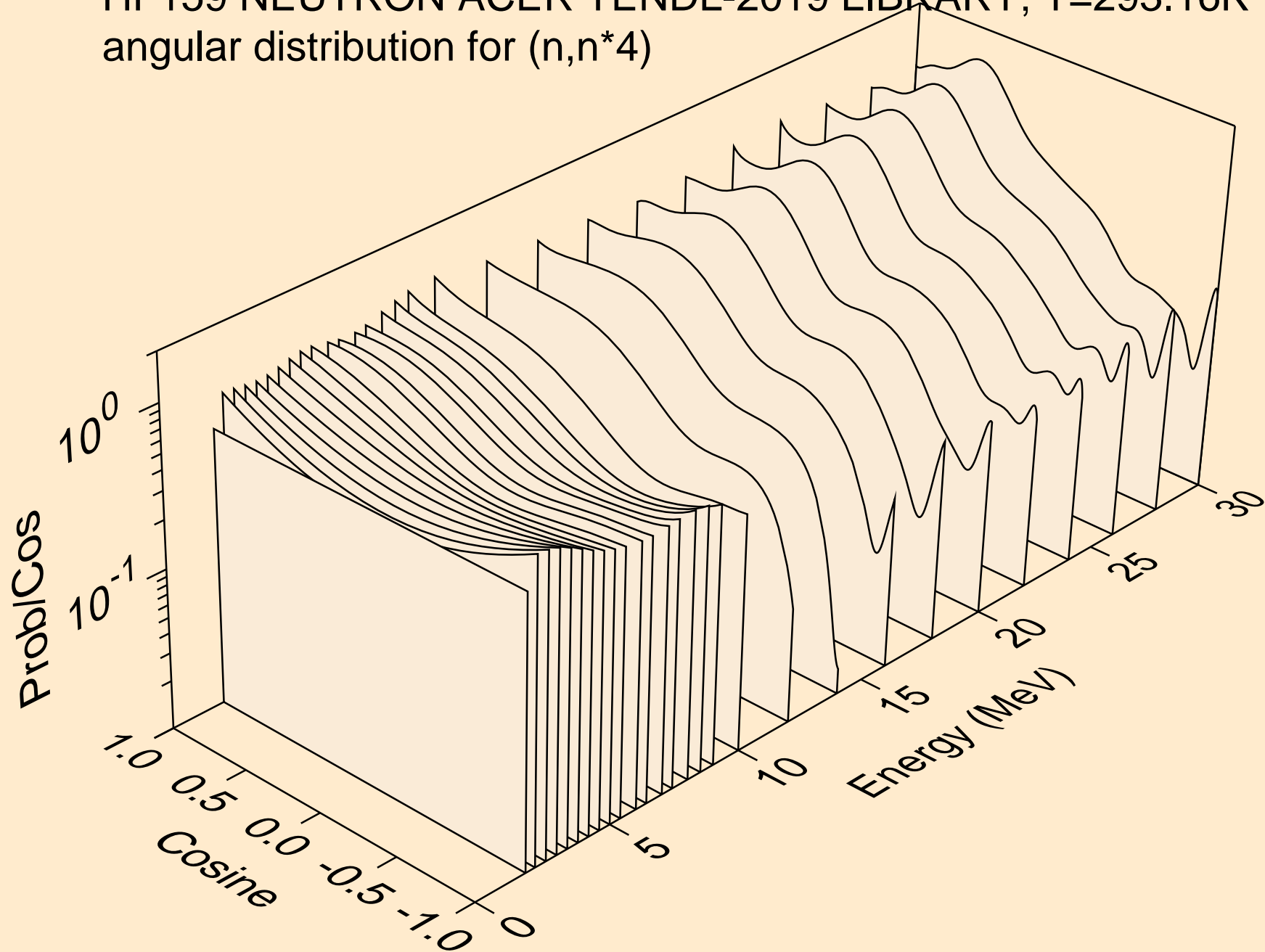

HF159 NEUTRON ACER TENDL-2019 LIBRARY; T=293.16K  
angular distribution for (n,n\*5)

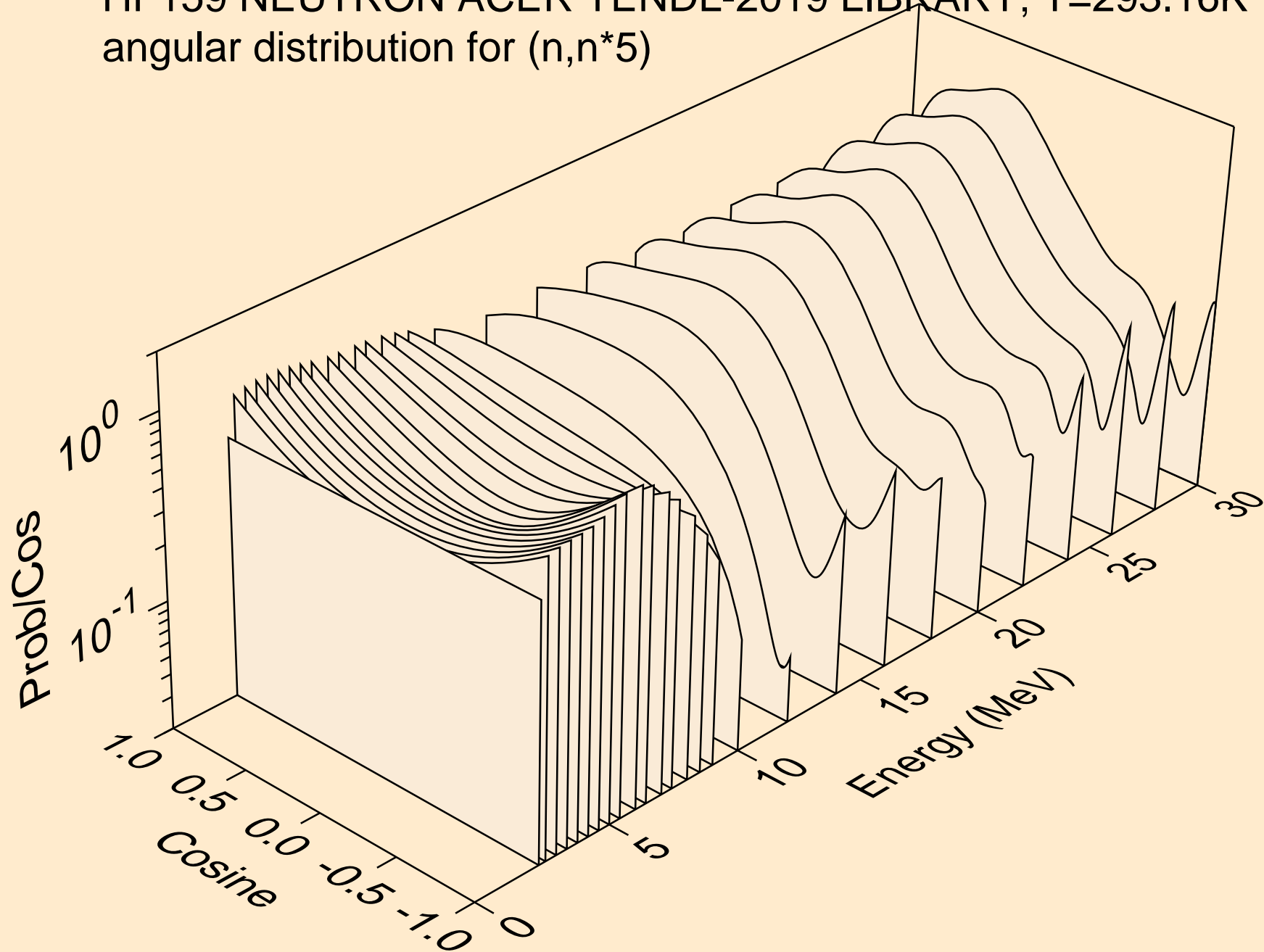

HF159 NEUTRON ACER TENDL-2019 LIBRARY; T=293.16K  
angular distribution for (n,n\*6)

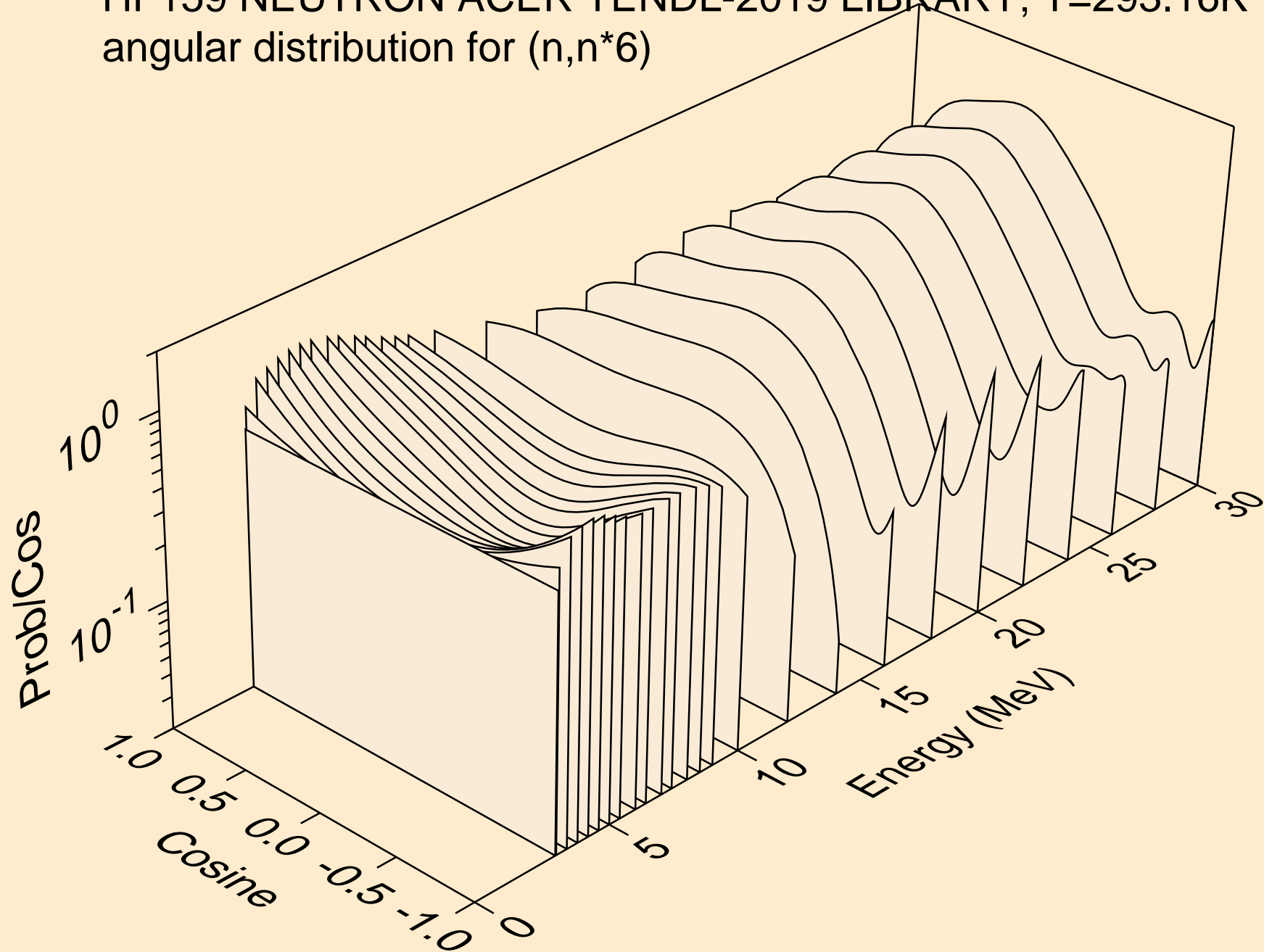

HF159 NEUTRON ACER TENDL-2019 LIBRARY; T=293.16K  
angular distribution for (n,n\*7)

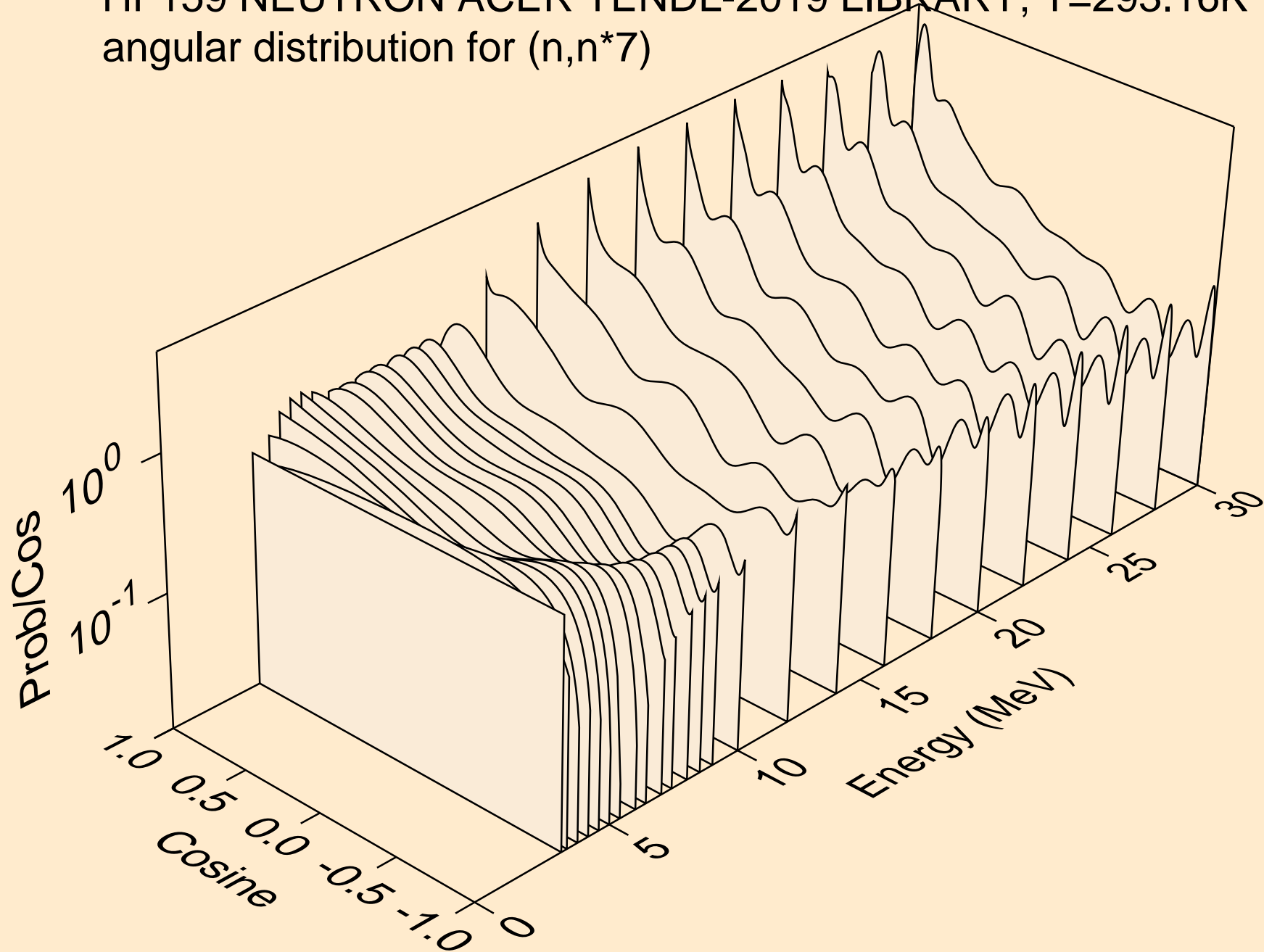

HF159 NEUTRON ACER TENDL-2019 LIBRARY; T=293.16K  
angular distribution for (n,n\*8)

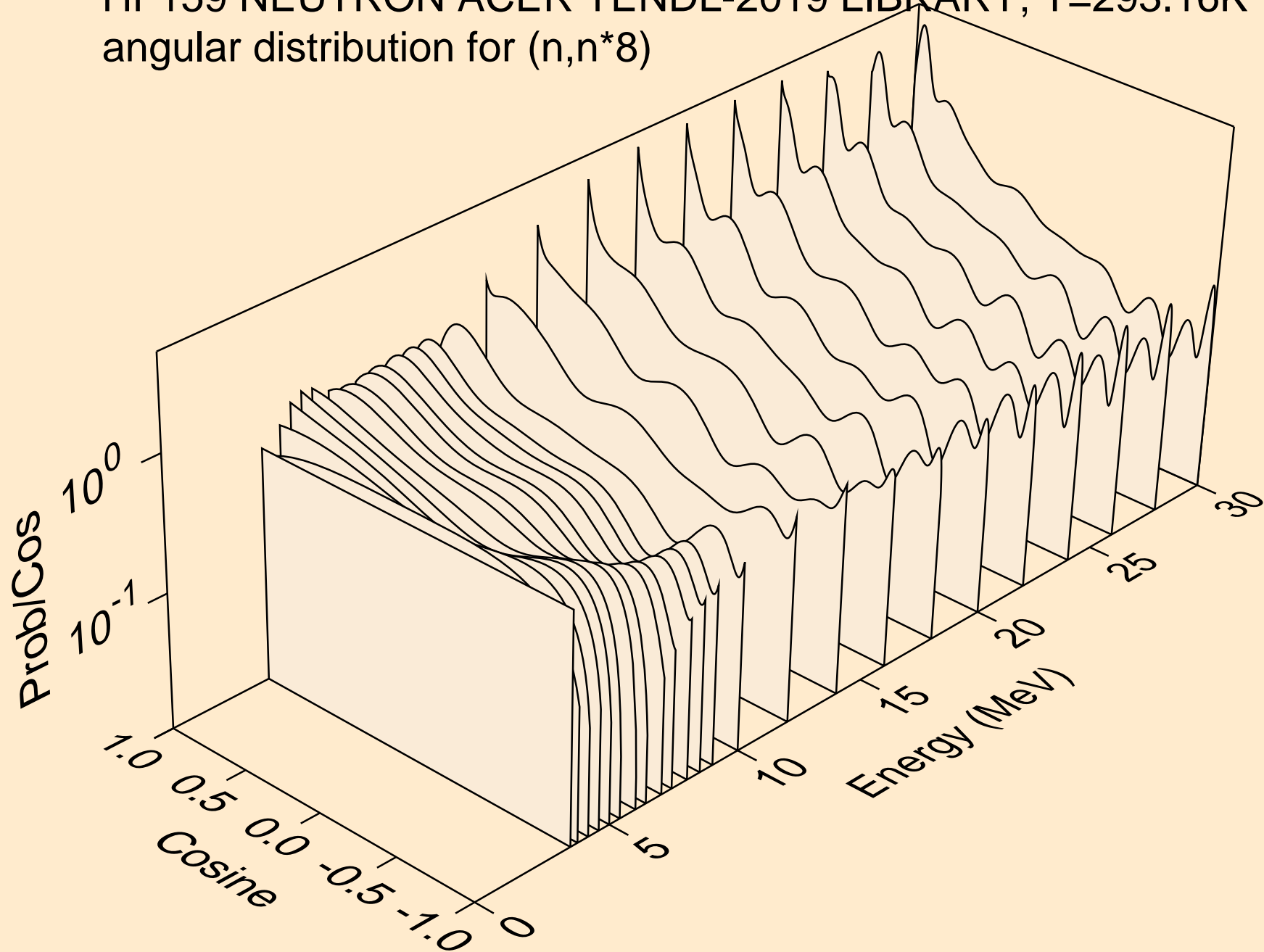

HF159 NEUTRON ACER TENDL-2019 LIBRARY; T=293.16K  
angular distribution for (n,n\*9)

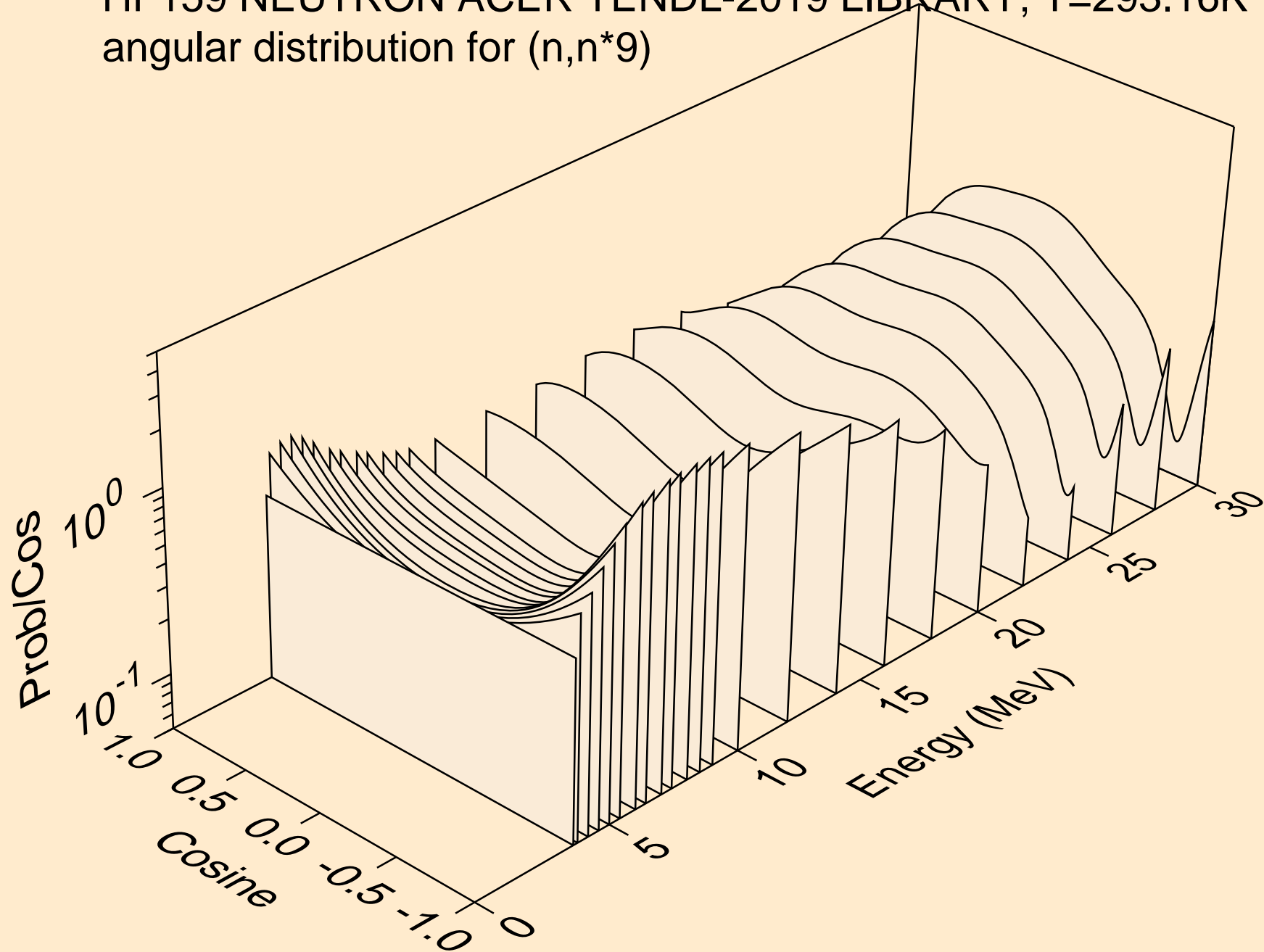

HF159 NEUTRON ACER TENDL-2019 LIBRARY; T=293.16K  
angular distribution for (n,n\*10)

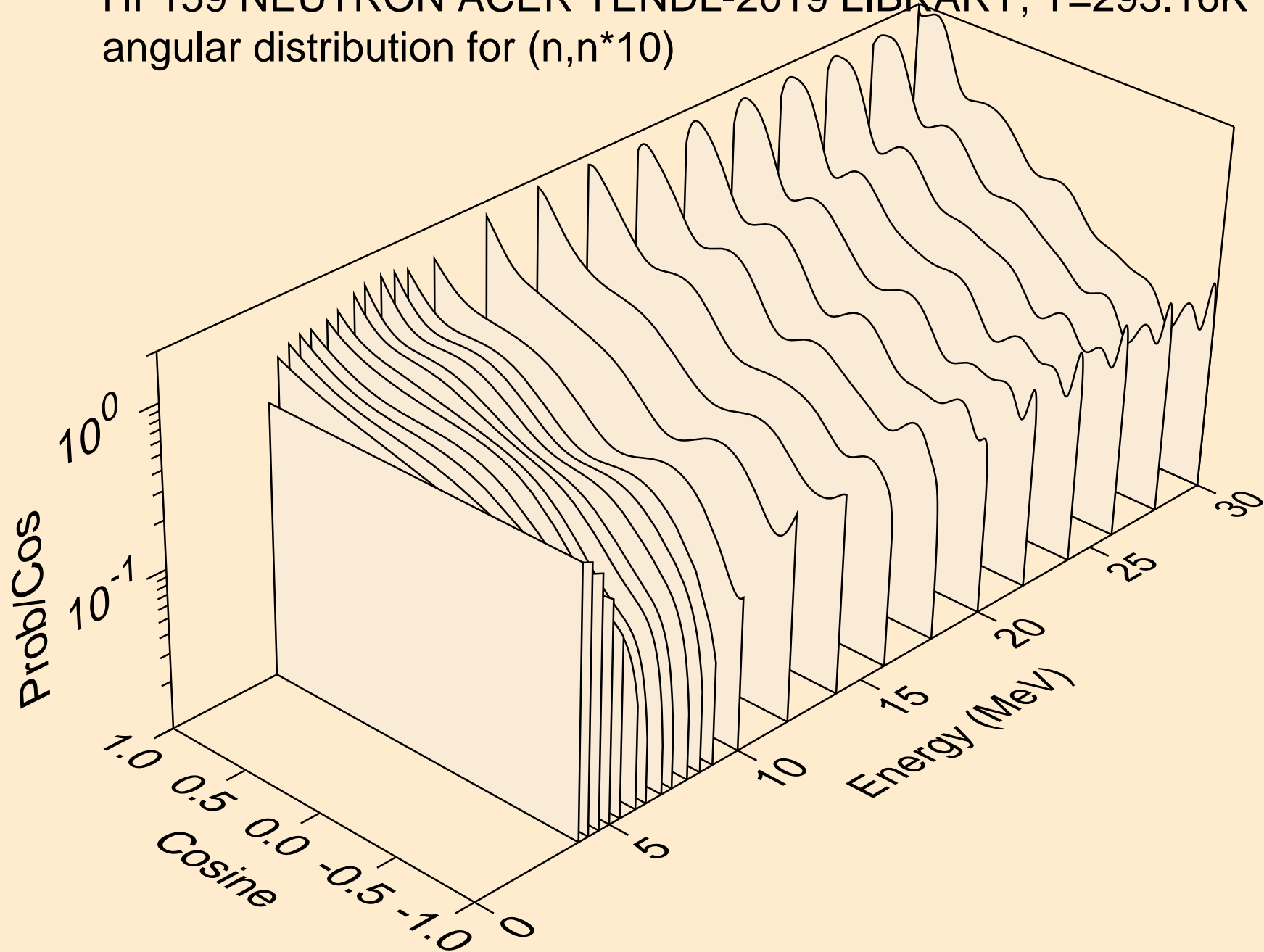



HF159 NEUTRON ACER TENDL-2019 LIBRARY; T=293.16K  
angular distribution for (n,n\*11)

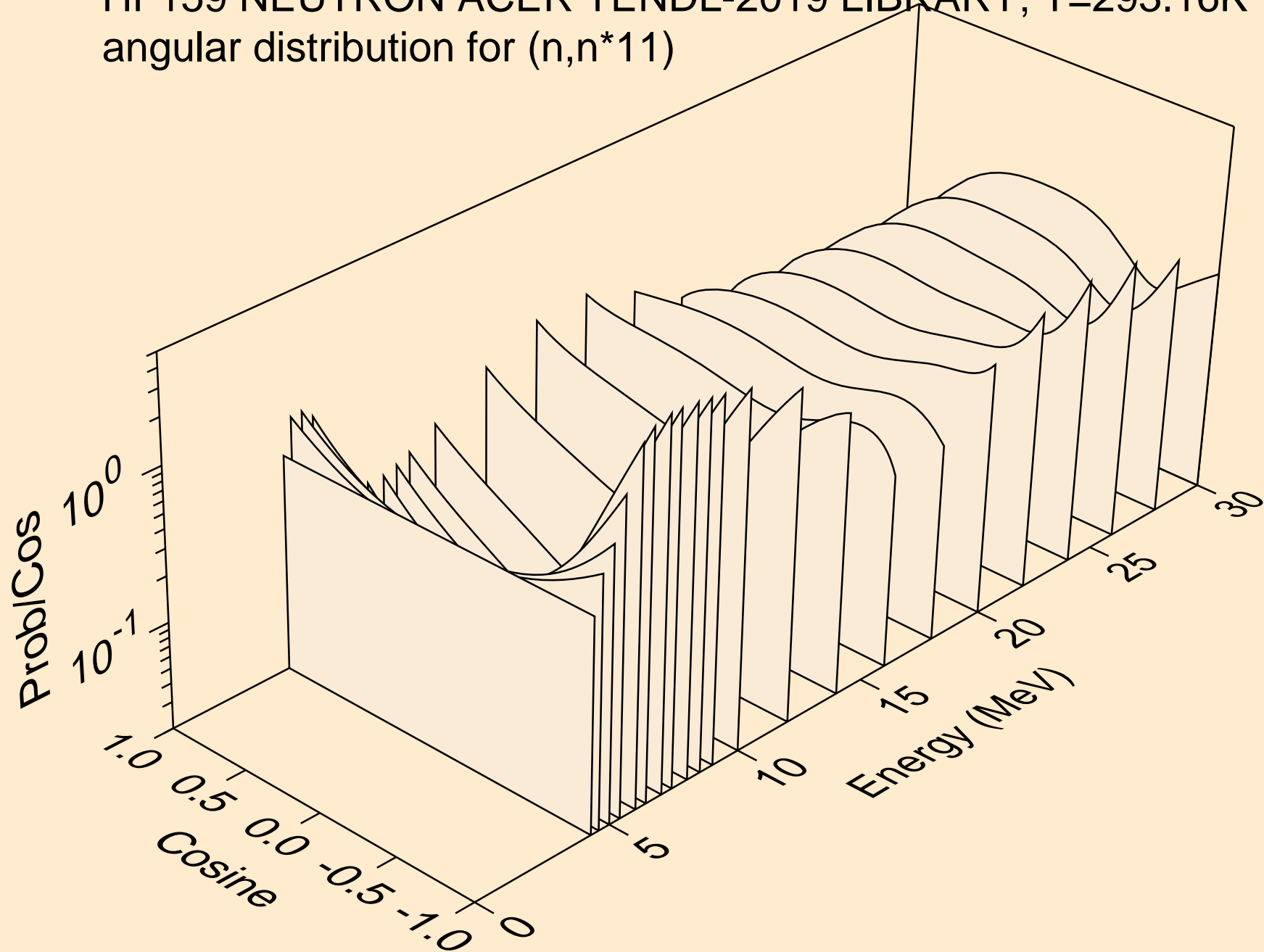

HF159 NEUTRON ACER TENDL-2019 LIBRARY; T=293.16K  
angular distribution for (n,n\*12)

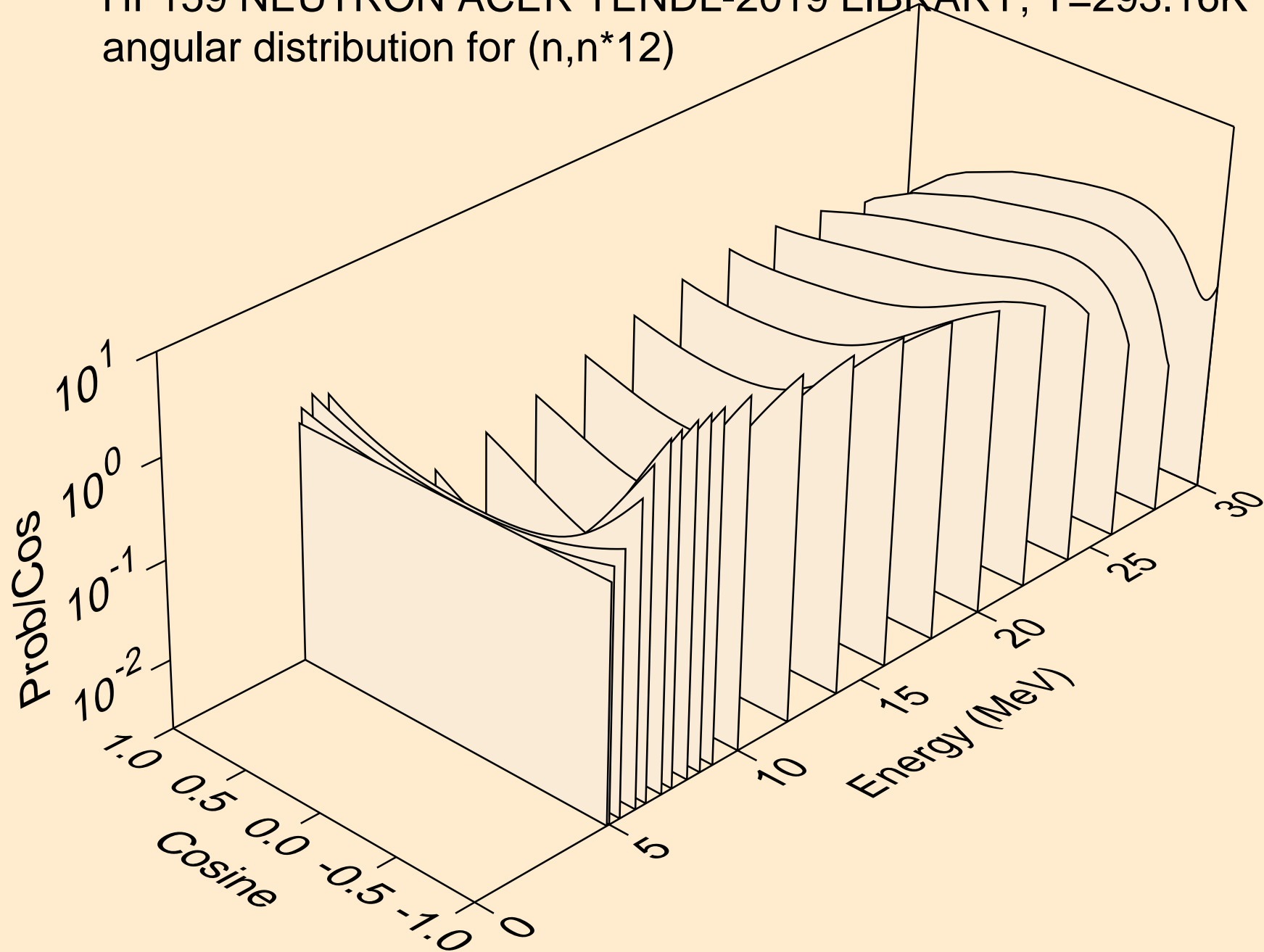

HF159 NEUTRON ACER TENDL-2019 LIBRARY; T=293.16K  
angular distribution for (n,n\*13)

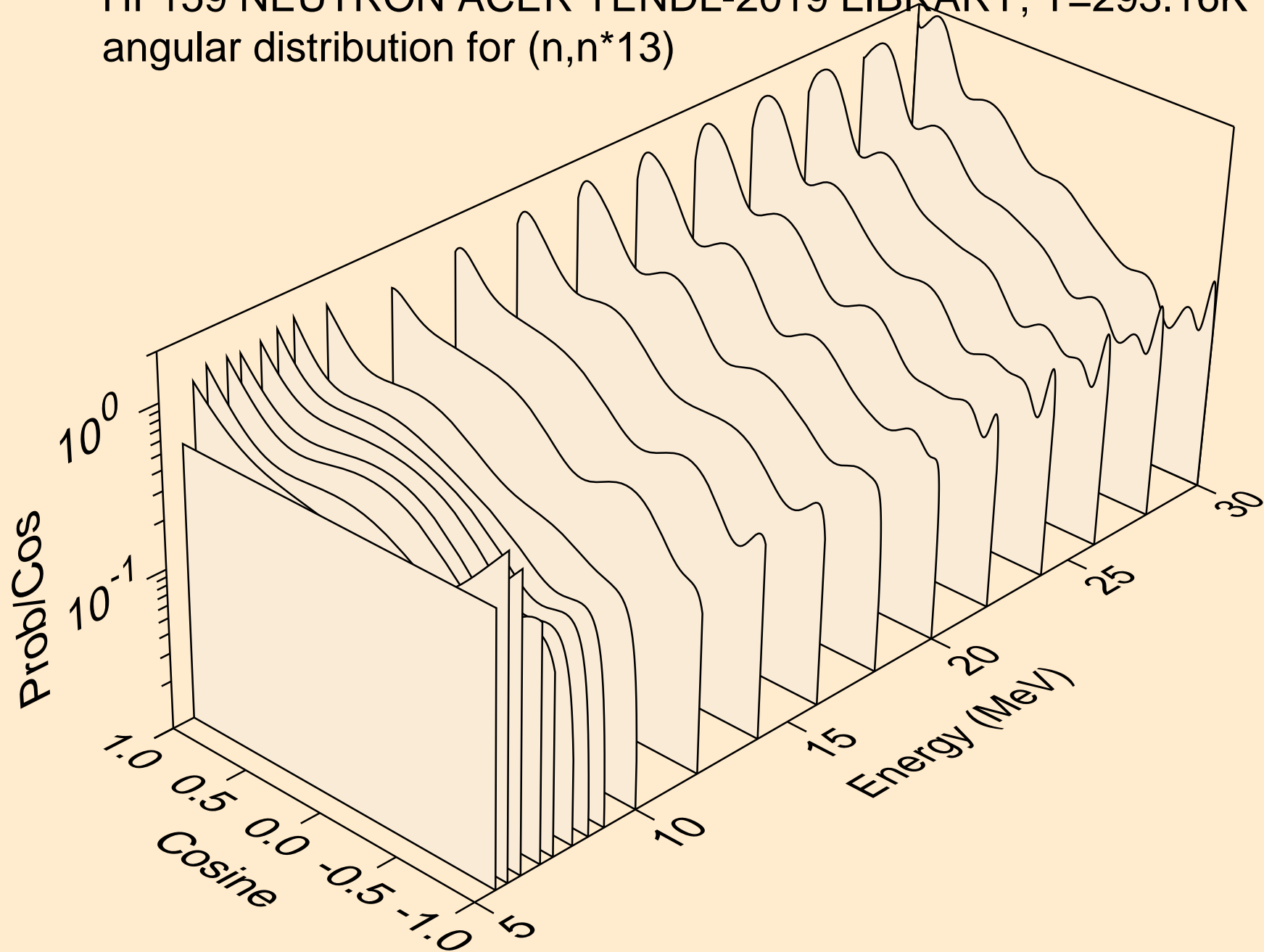

HF159 NEUTRON ACER TENDL-2019 LIBRARY; T=293.16K  
angular distribution for (n,n\*14)

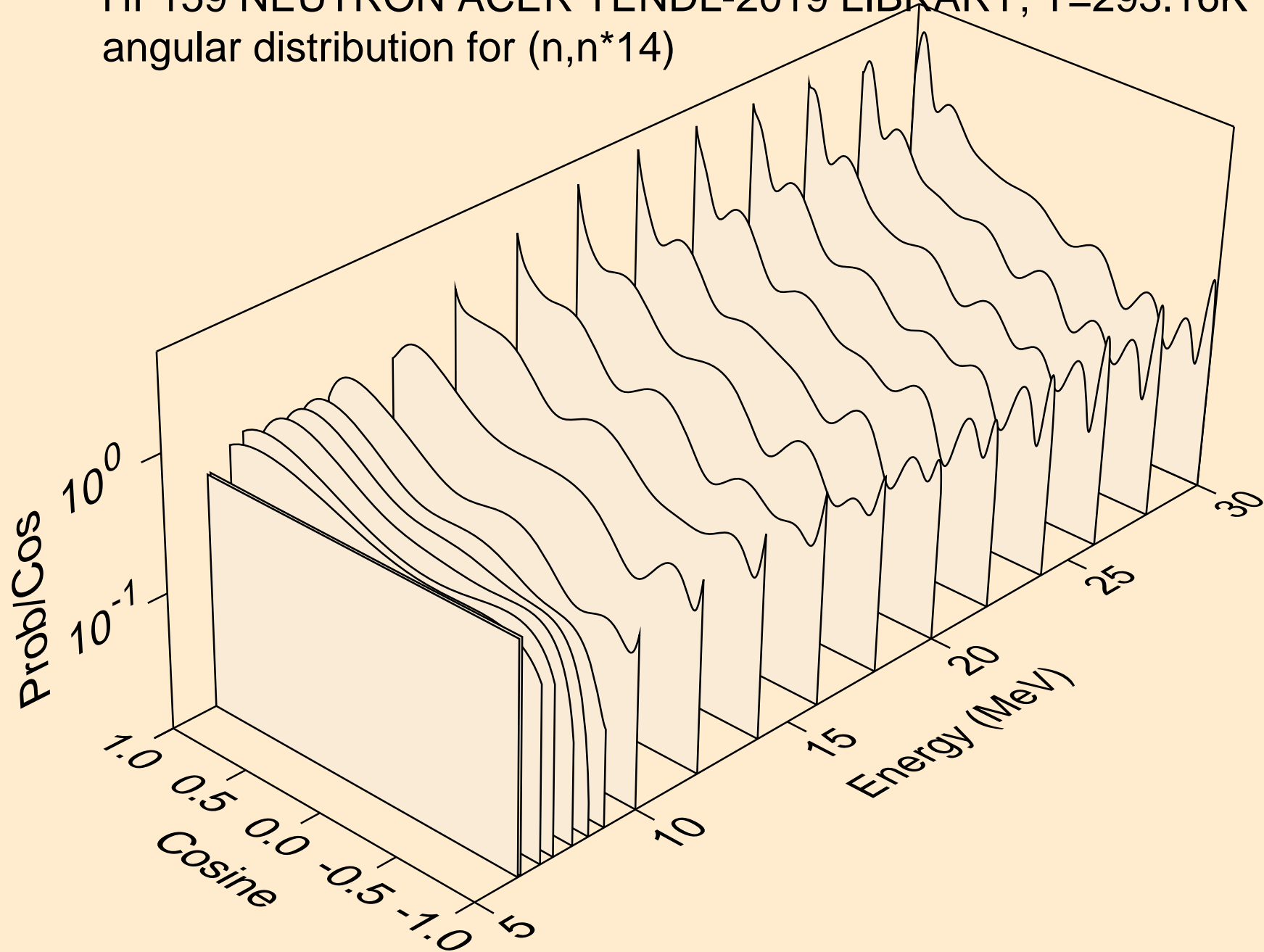

HF159 NEUTRON ACER TENDL-2019 LIBRARY; T=293.16K  
Neutron emission for (n,x)

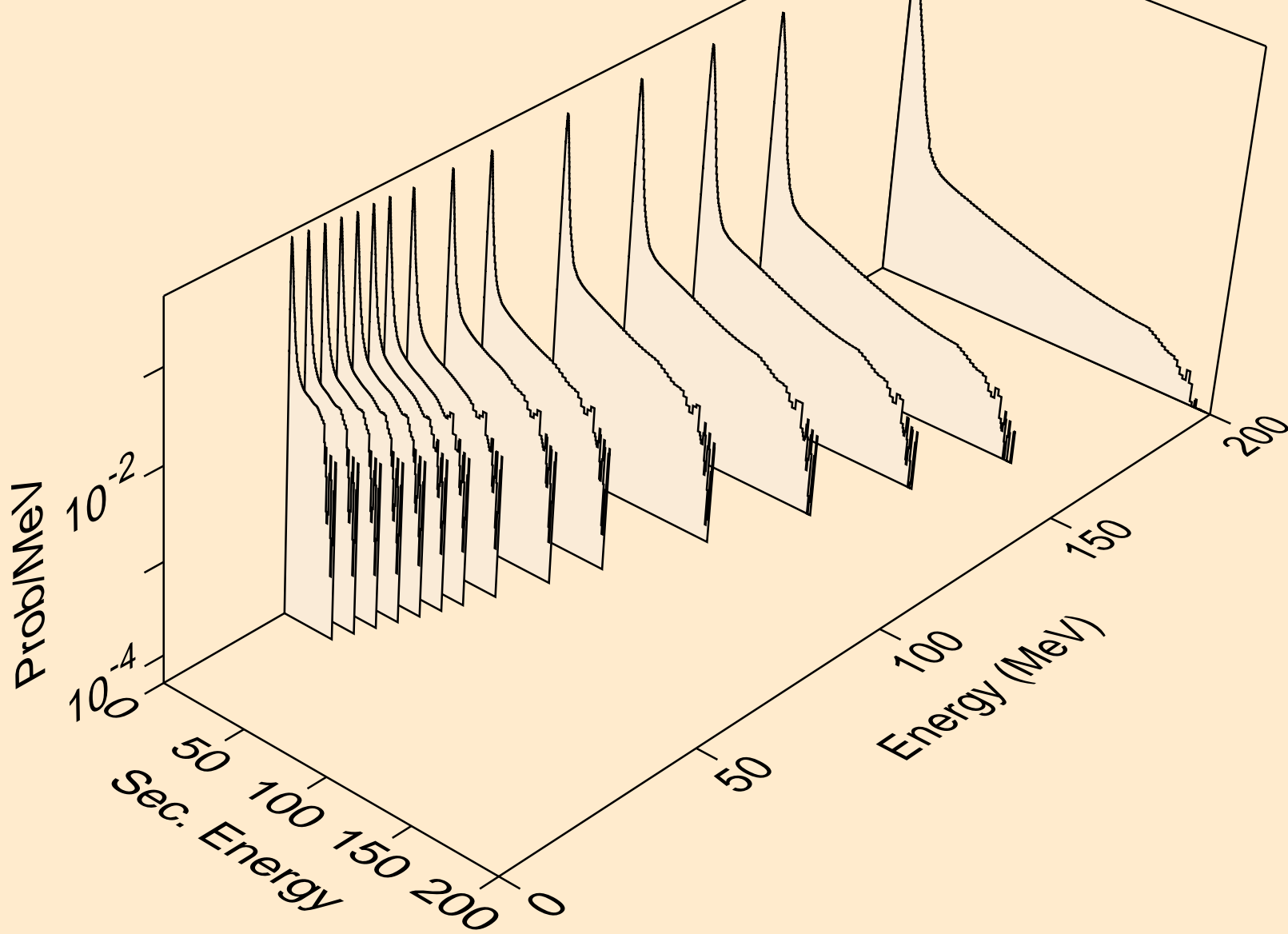

HF159 NEUTRON ACER TENDL-2019 LIBRARY; T=293.16K  
Neutron emission for (n,2nd)

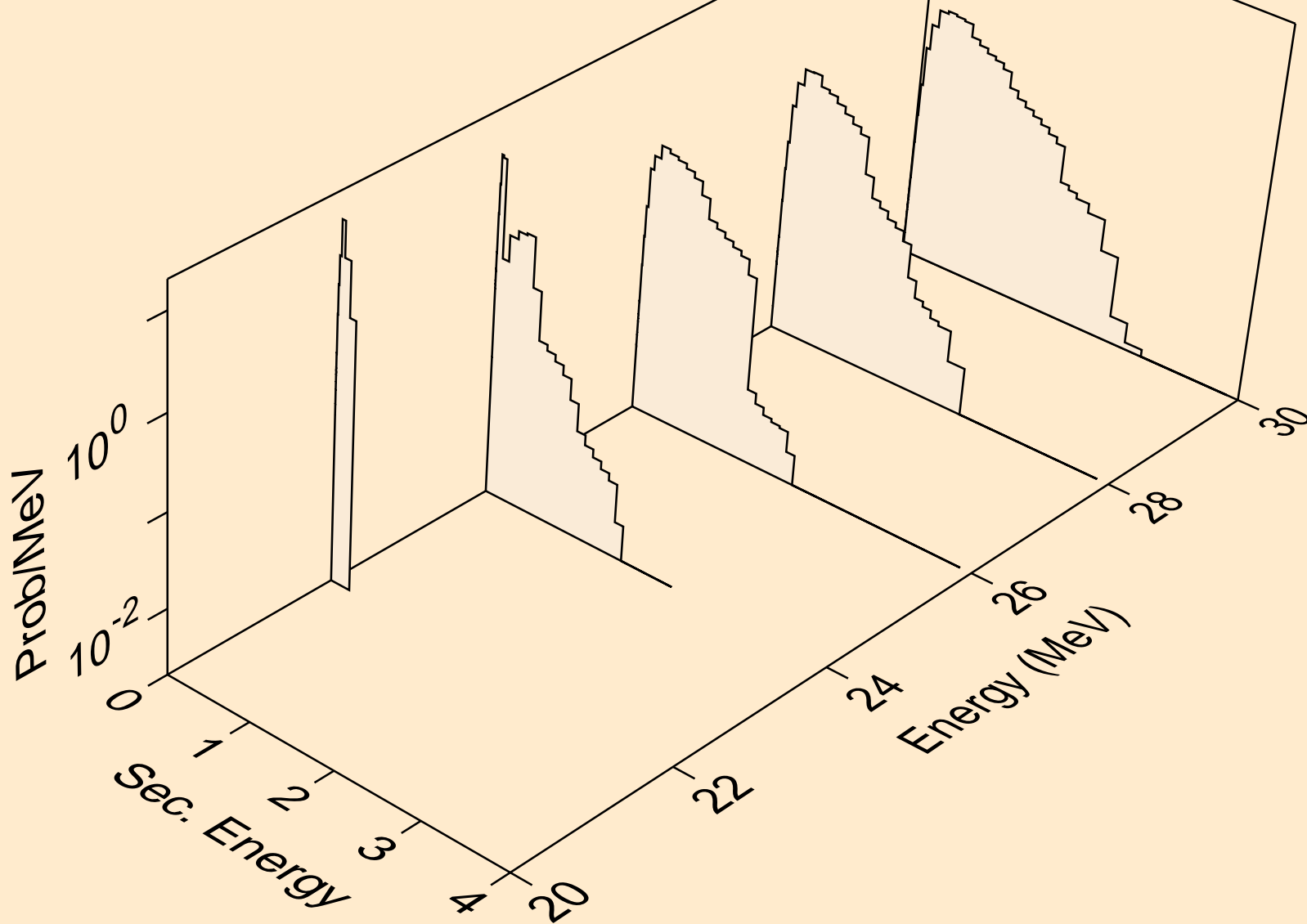

HF159 NEUTRON ACER TENDL-2019 LIBRARY; T=293.16K  
Neutron emission for (n,2n)

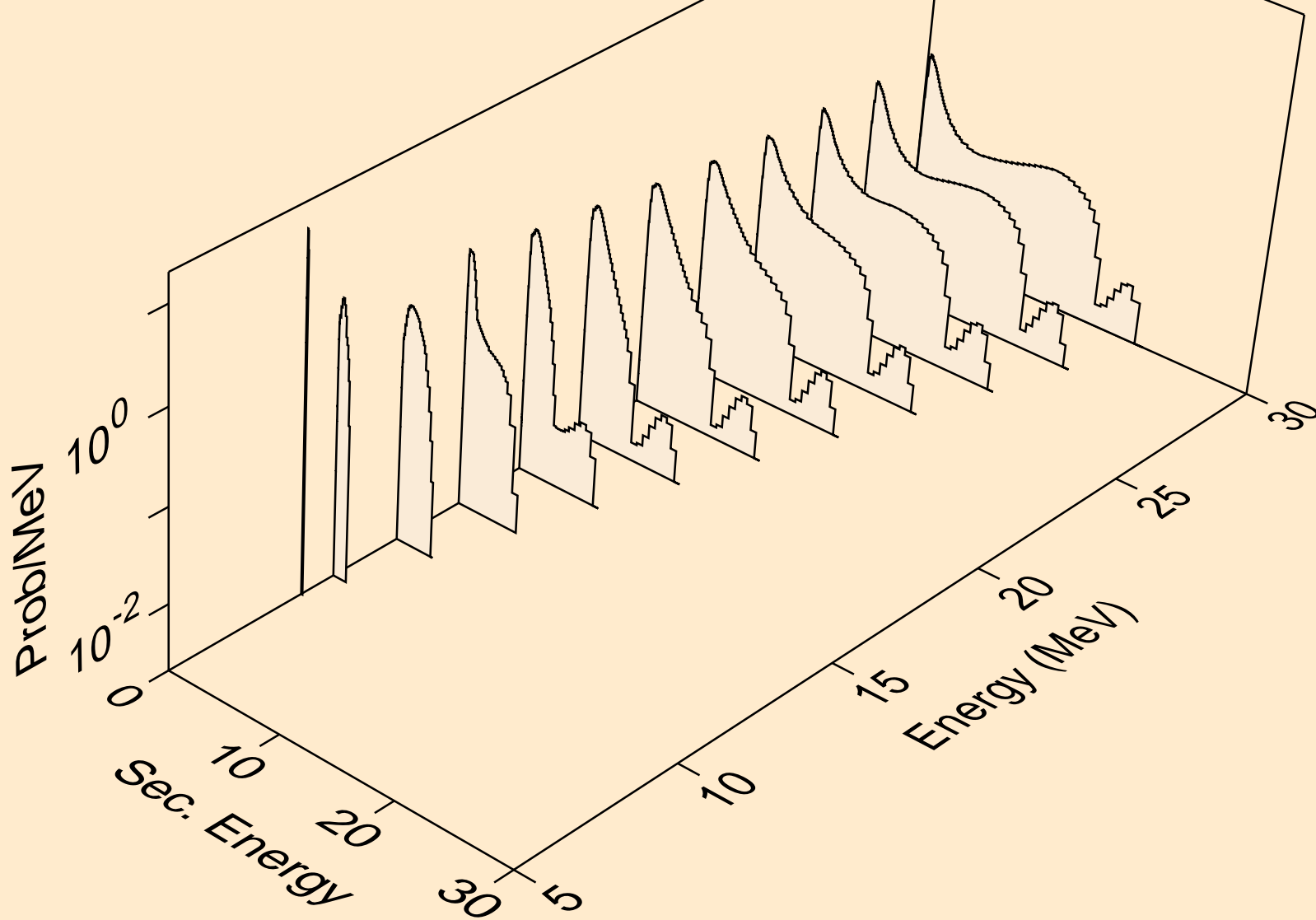

HF159 NEUTRON ACER TENDL-2019 LIBRARY; T=293.16K  
Neutron emission for (n,3n)

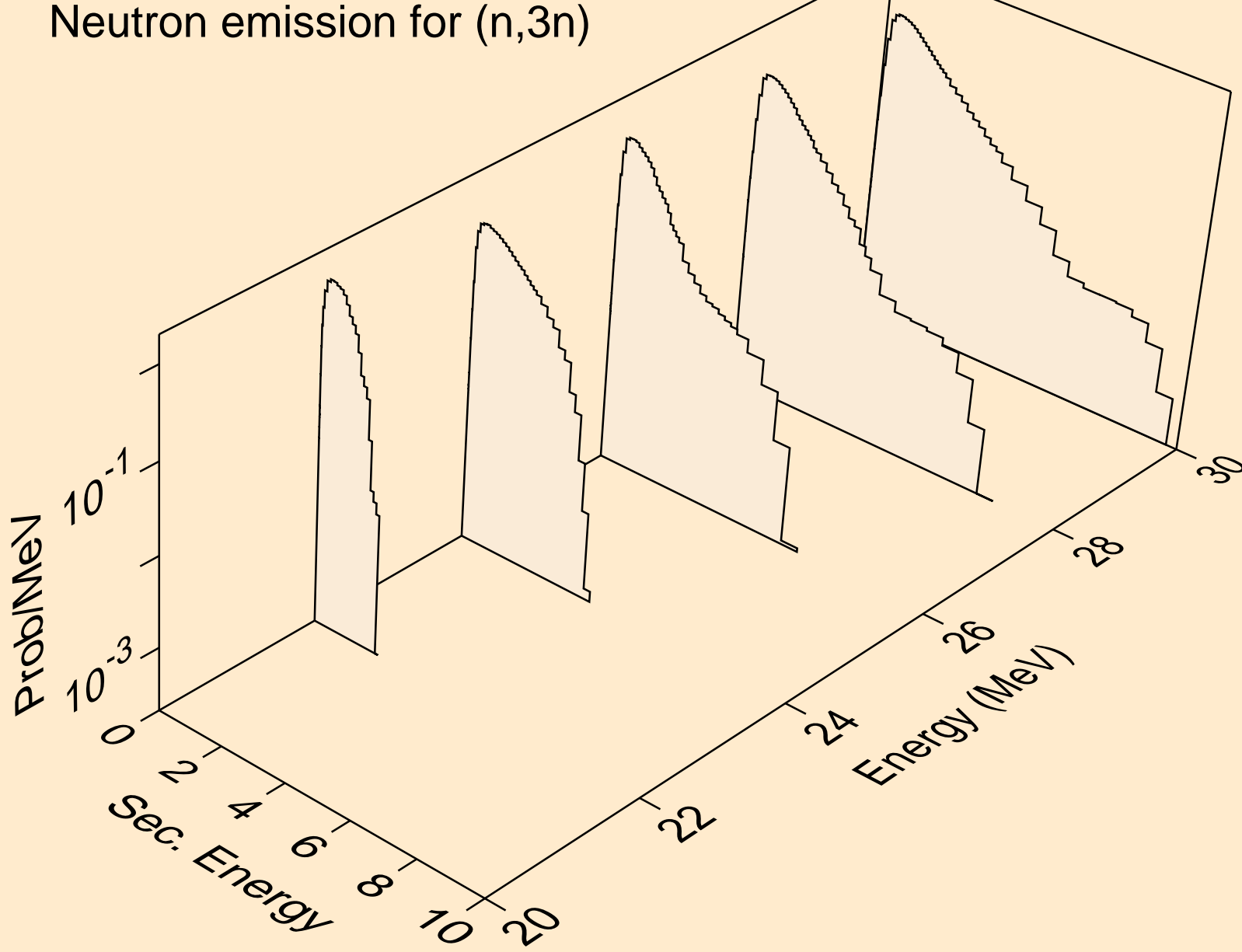



HF159 NEUTRON ACER TENDL-2019 LIBRARY; T=293.16K  
Neutron emission for (n,n\*)a

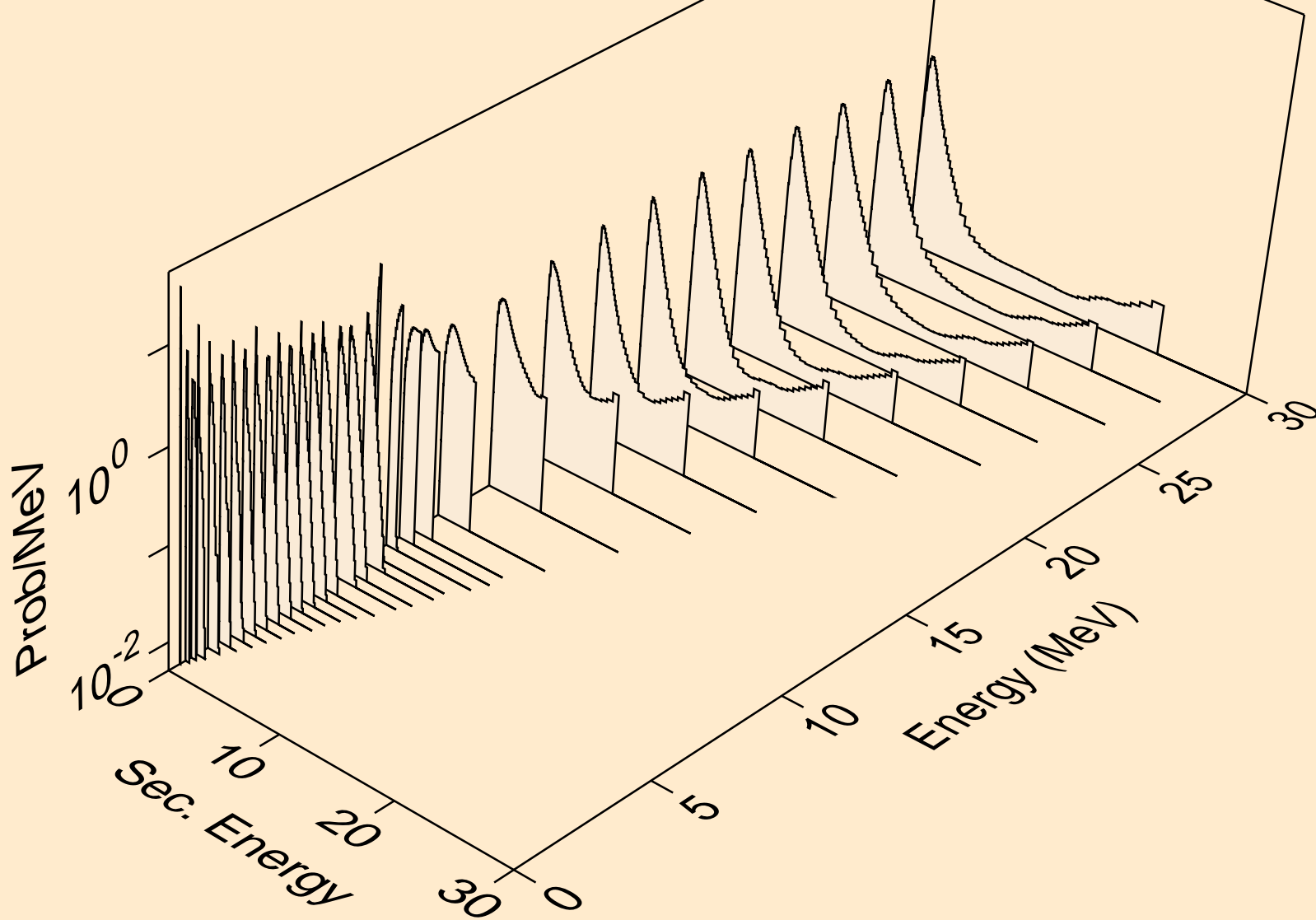

HF159 NEUTRON ACER TENDL-2019 LIBRARY; T=293.16K  
Neutron emission for (n,n\*)3a

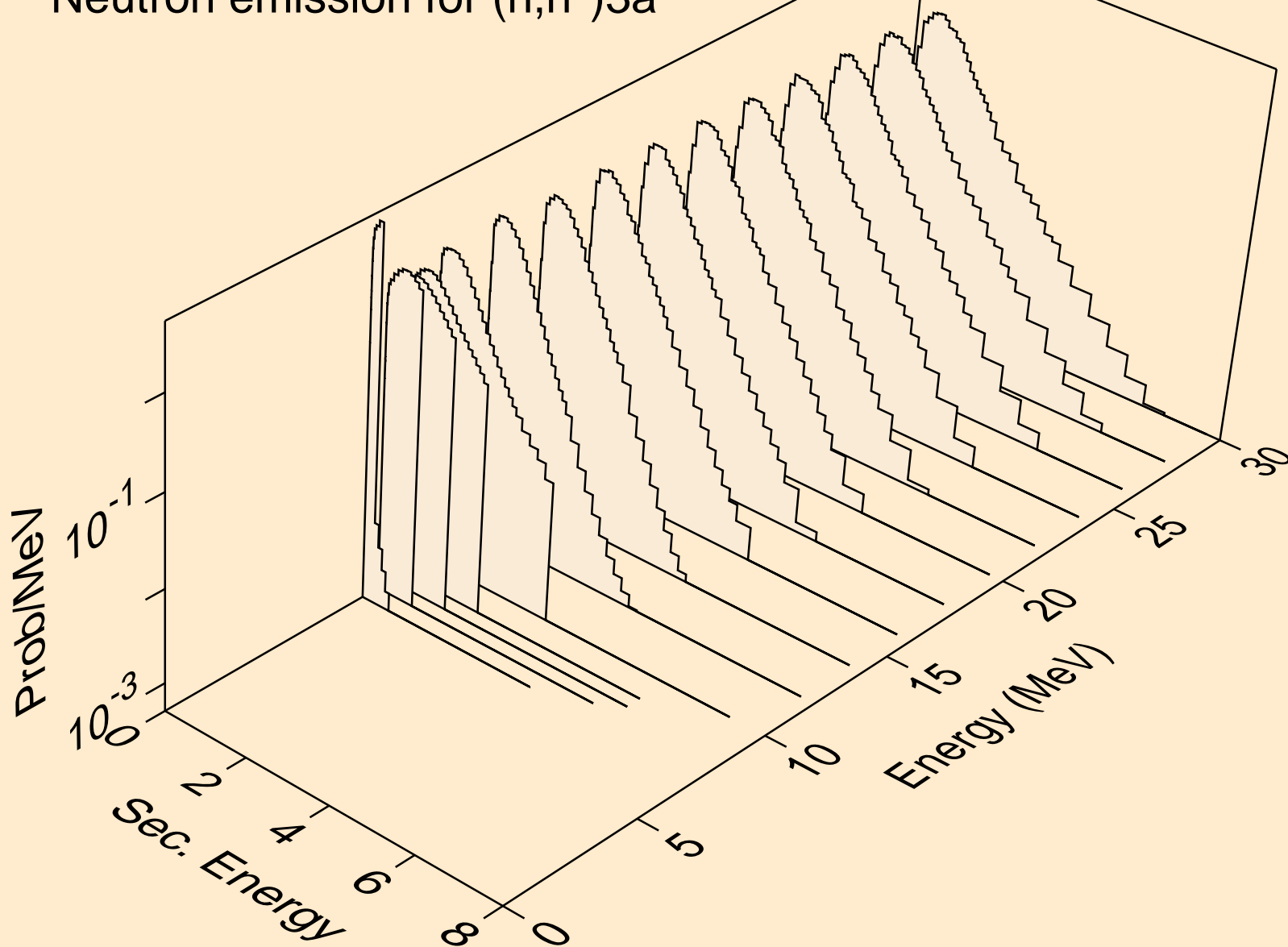

HF159 NEUTRON ACER TENDL-2019 LIBRARY; T=293.16K  
Neutron emission for (n,2n)a

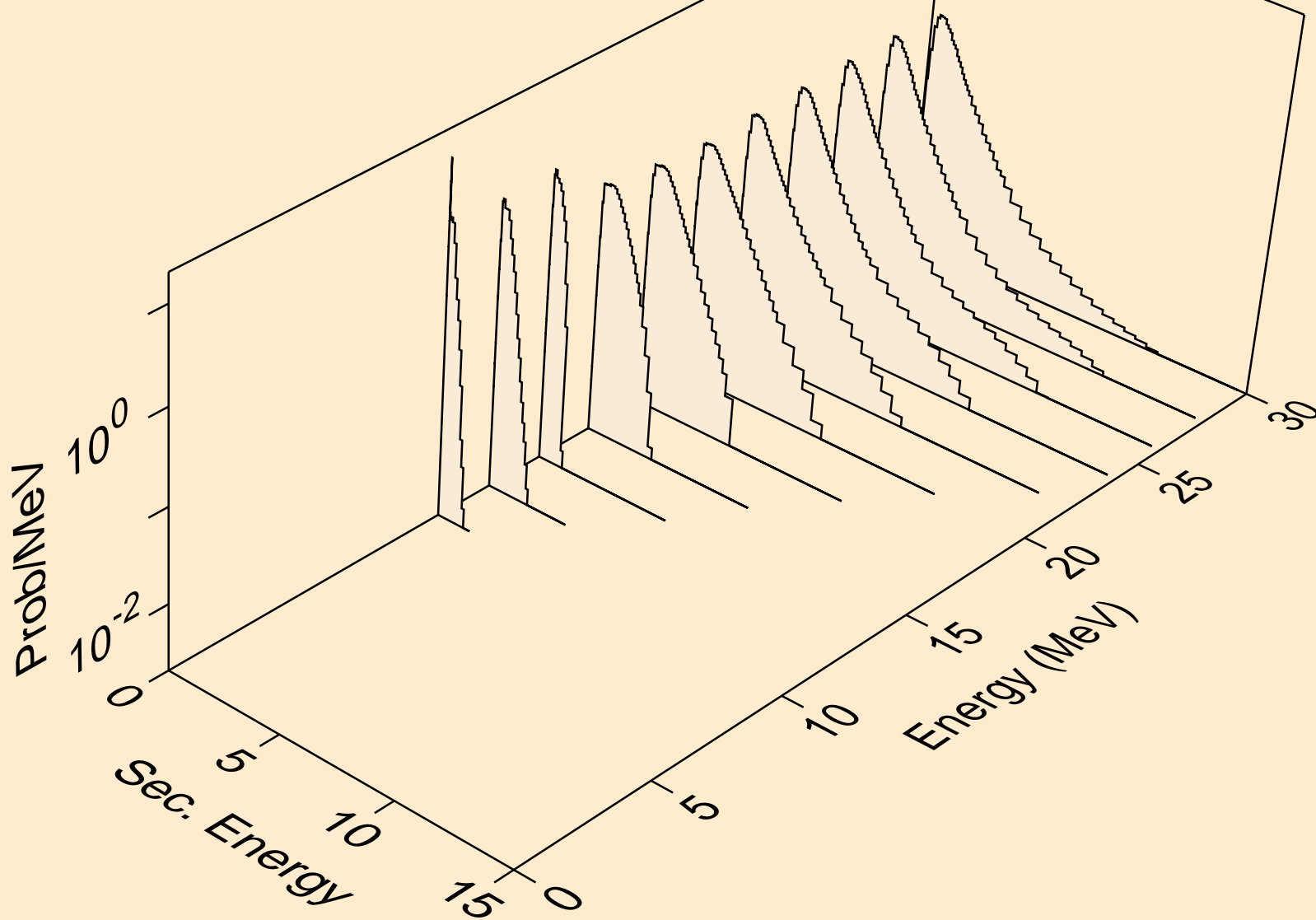

HF159 NEUTRON ACER TENDL-2019 LIBRARY; T=293.16K  
Neutron emission for (n,3n)a

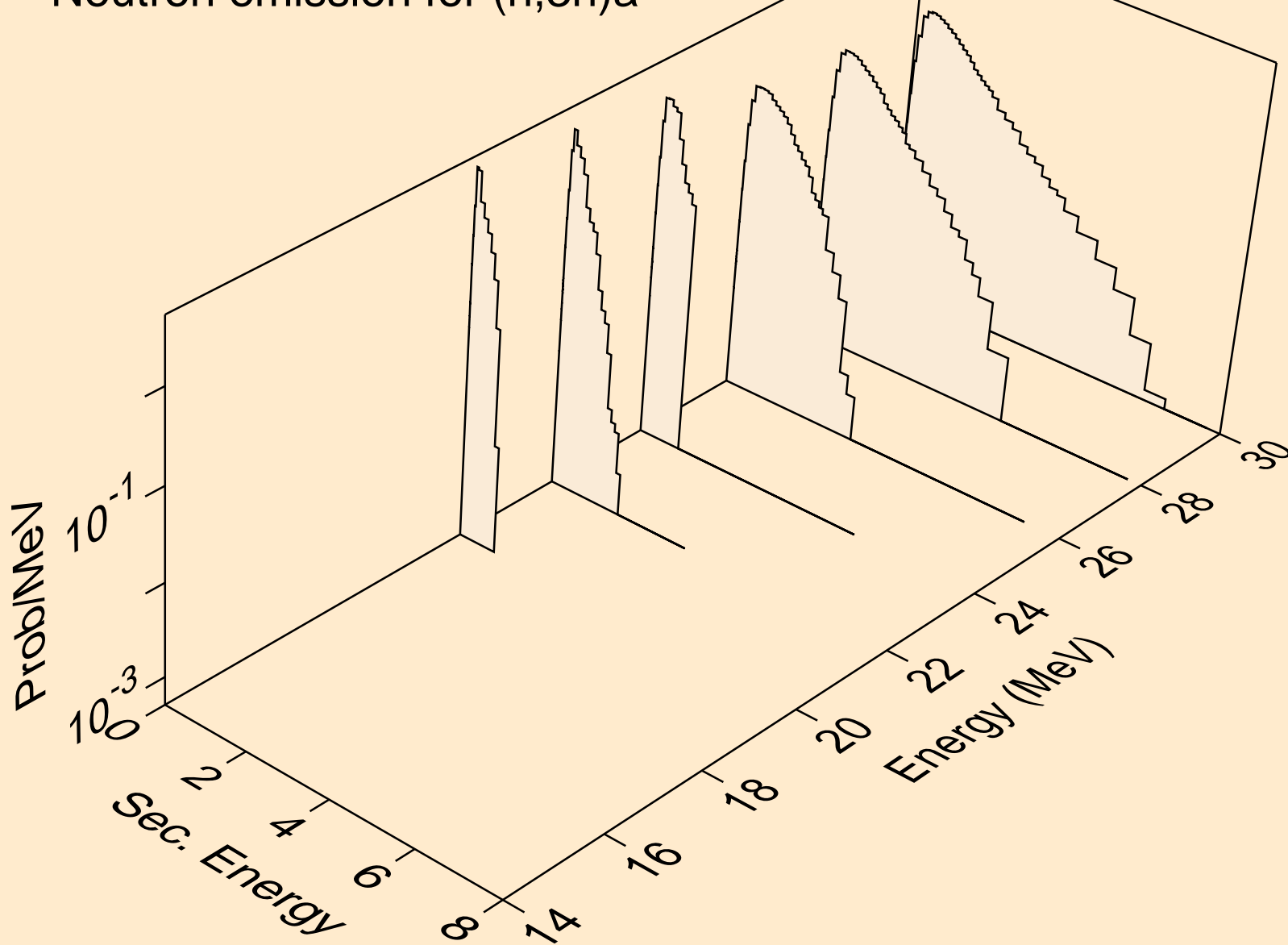

HF159 NEUTRON ACER TENDL-2019 LIBRARY; T=293.16K  
Neutron emission for (n,n\*)p

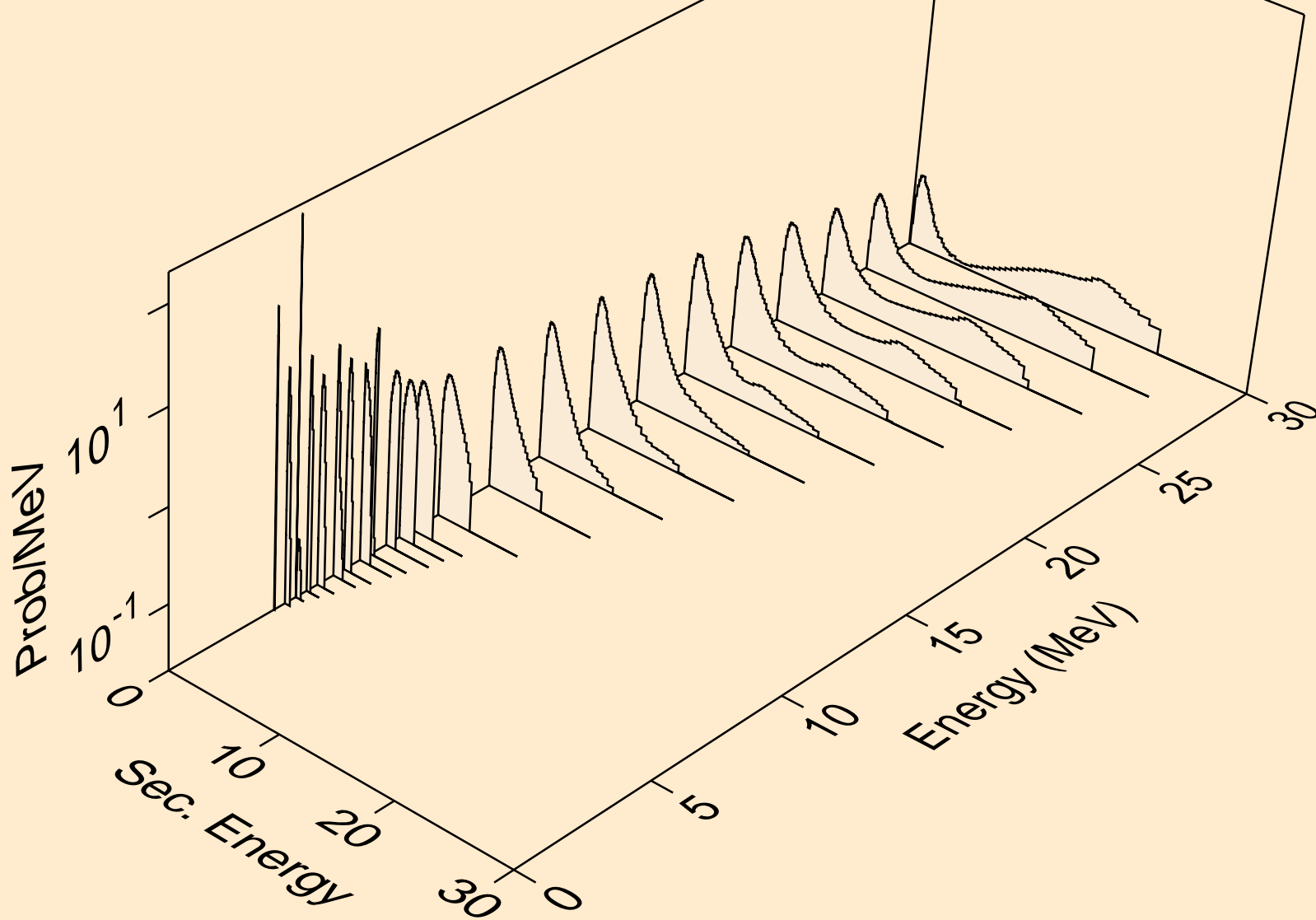

HF159 NEUTRON ACER TENDL-2019 LIBRARY; T=293.16K  
Neutron emission for (n,n\*)2a

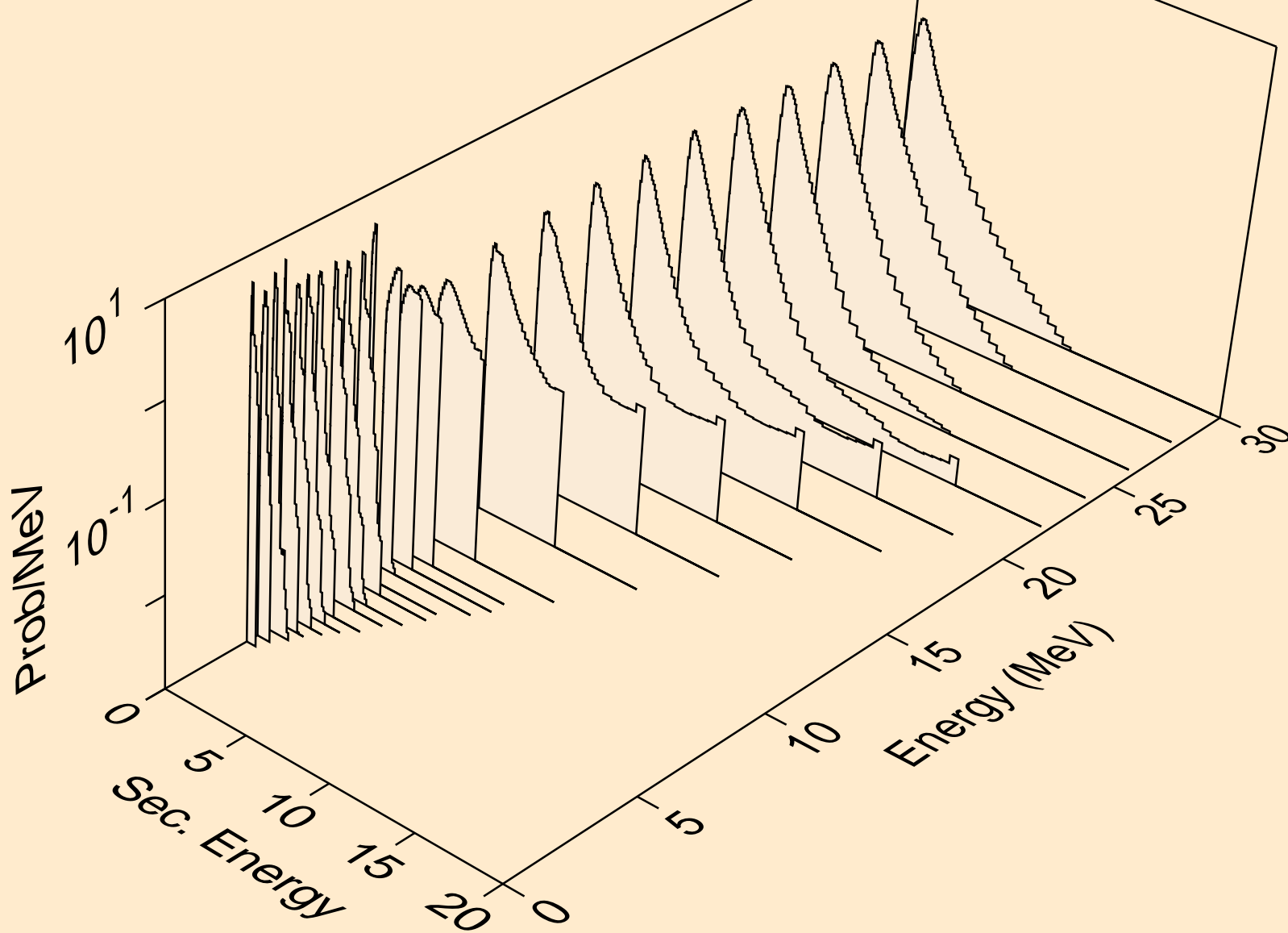

HF159 NEUTRON ACER TENDL-2019 LIBRARY; T=293.16K  
Neutron emission for (n,2n)2a

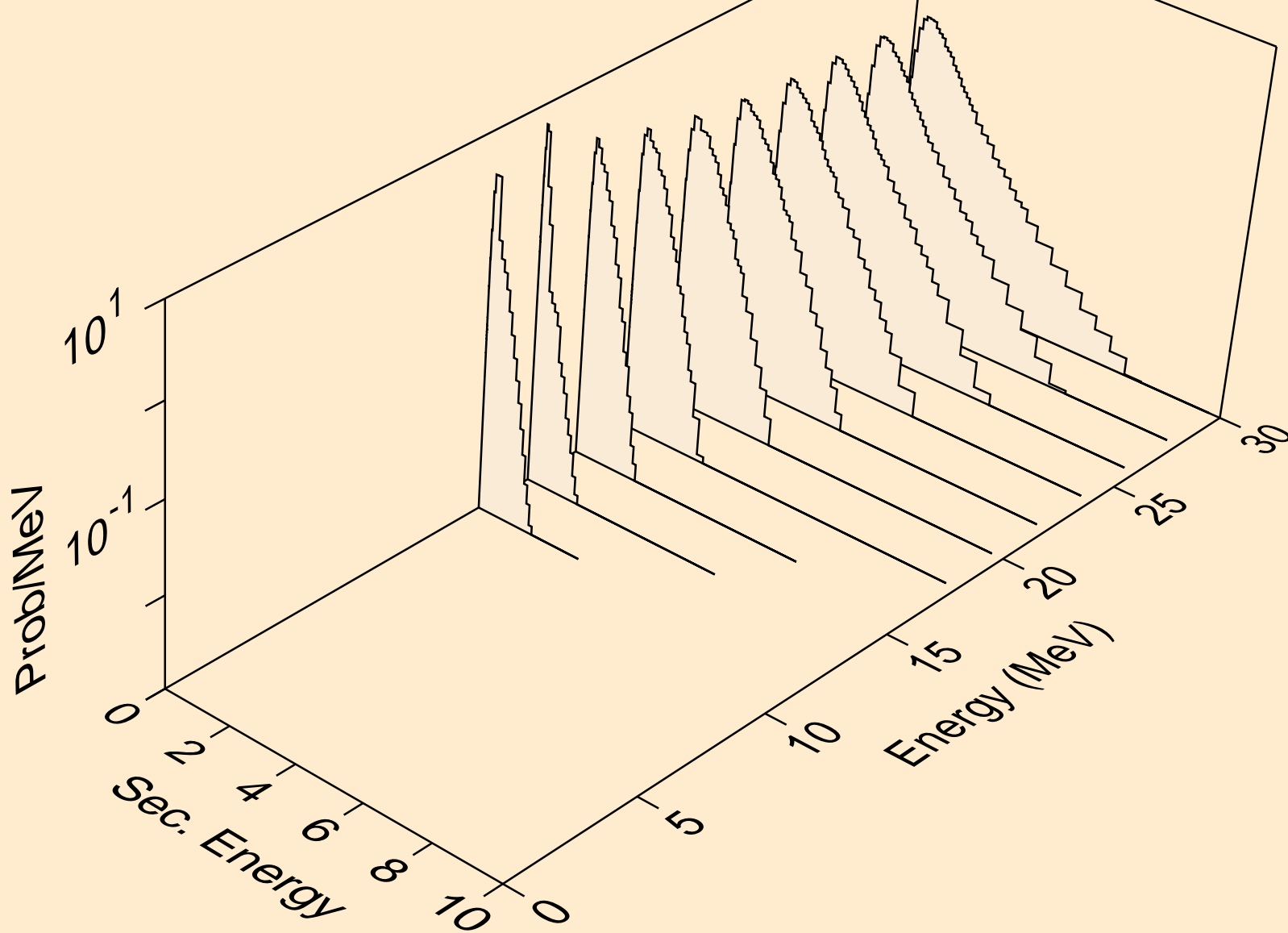

HF159 NEUTRON ACER TENDL-2019 LIBRARY; T=293.16K  
Neutron emission for (n,n\*)d

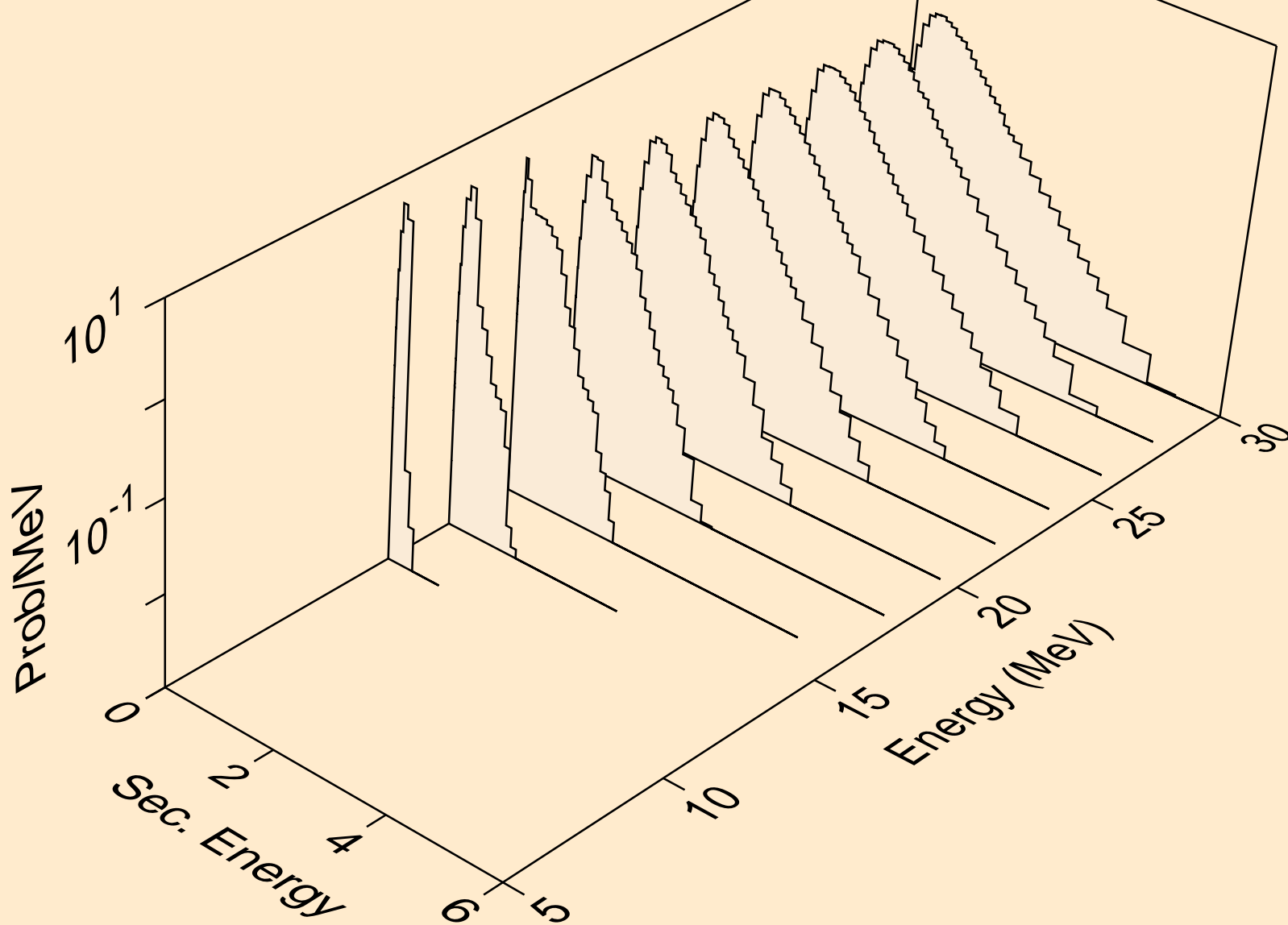



HF159 NEUTRON ACER TENDL-2019 LIBRARY; T=293.16K  
Neutron emission for (n,n\*)t

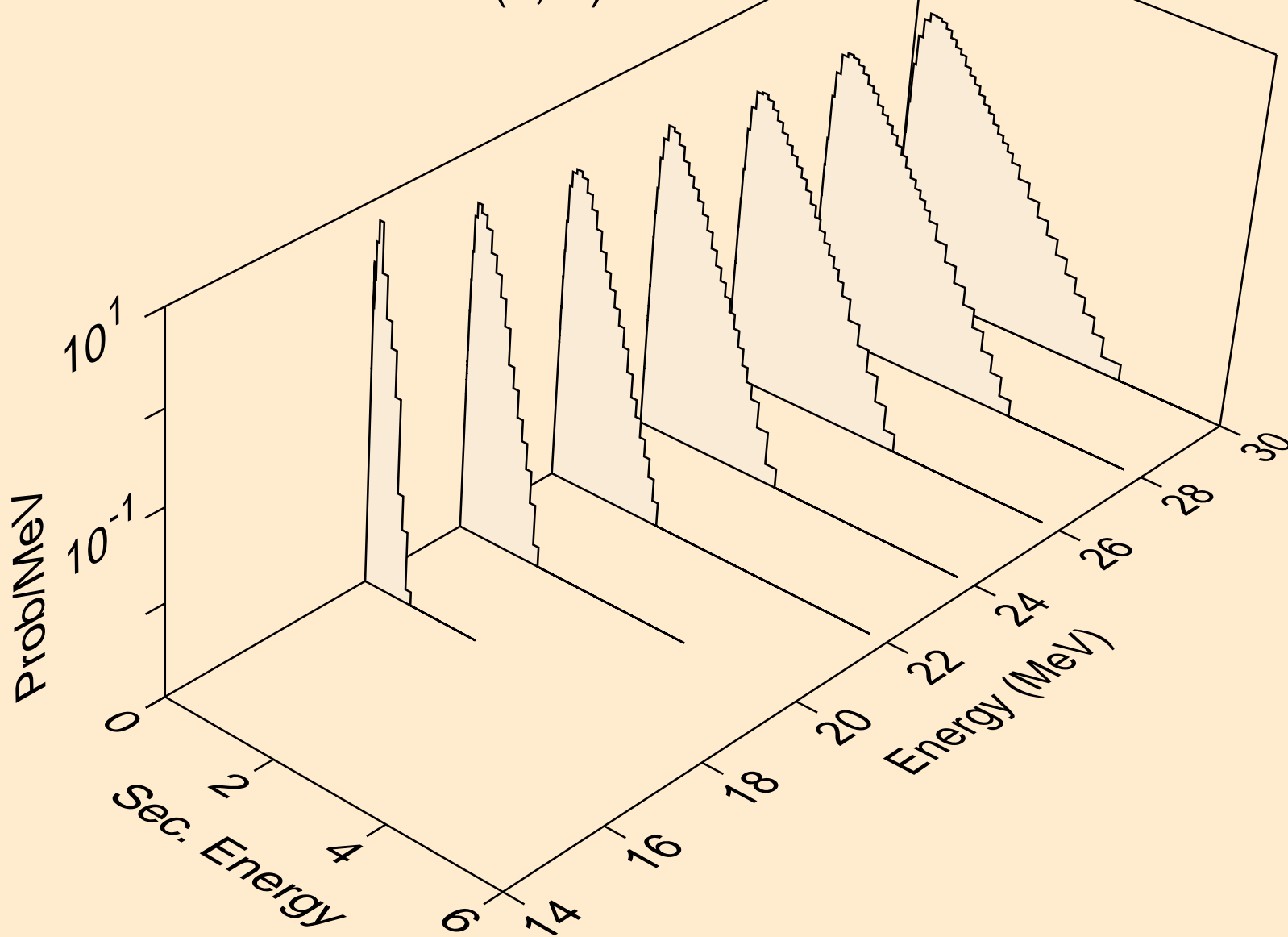

HF159 NEUTRON ACER TENDL-2019 LIBRARY; T=293.16K  
Neutron emission for (n,n\*)he3

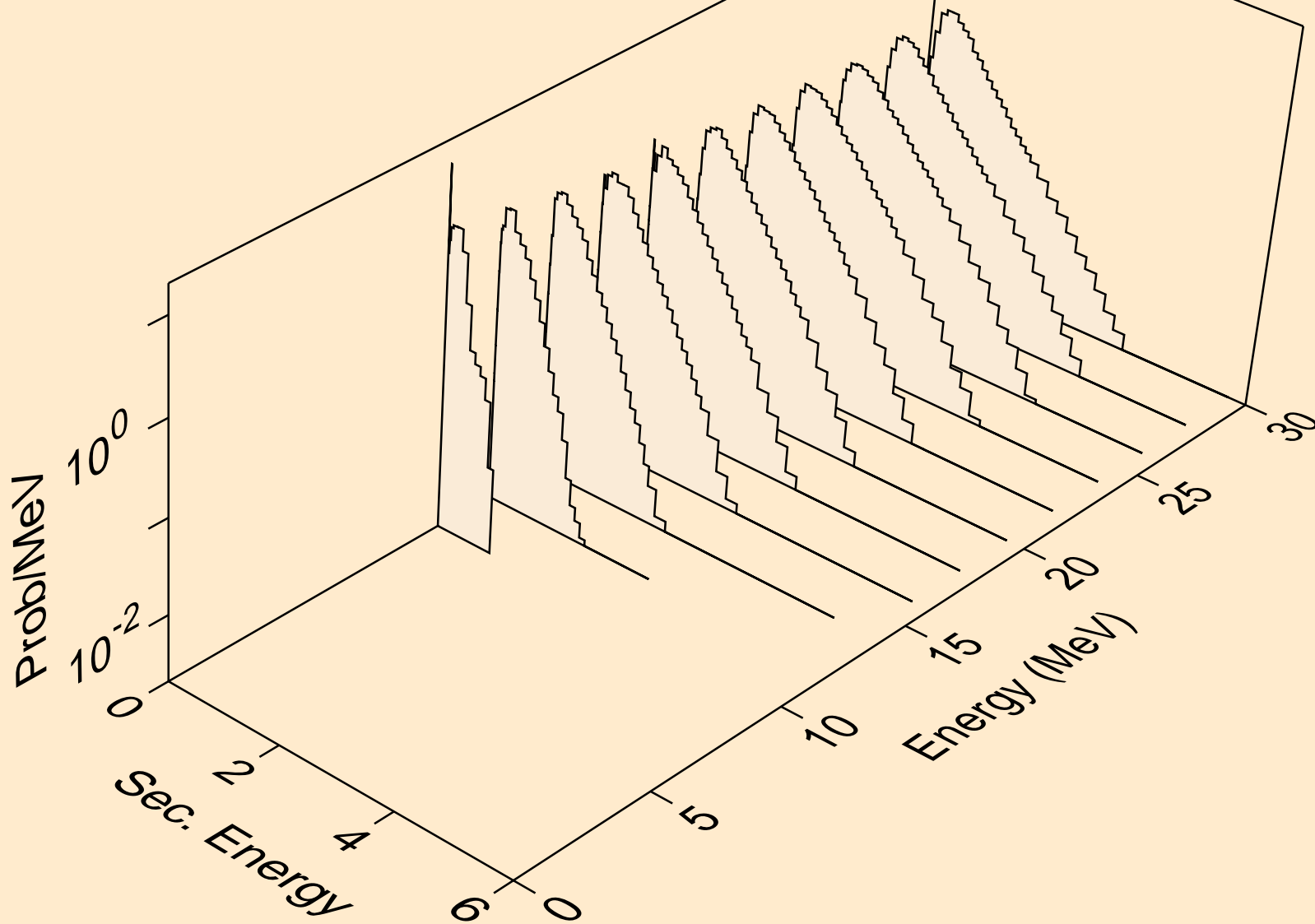

HF159 NEUTRON ACER TENDL-2019 LIBRARY; T=293.16K  
Neutron emission for (n,n\*)d2a

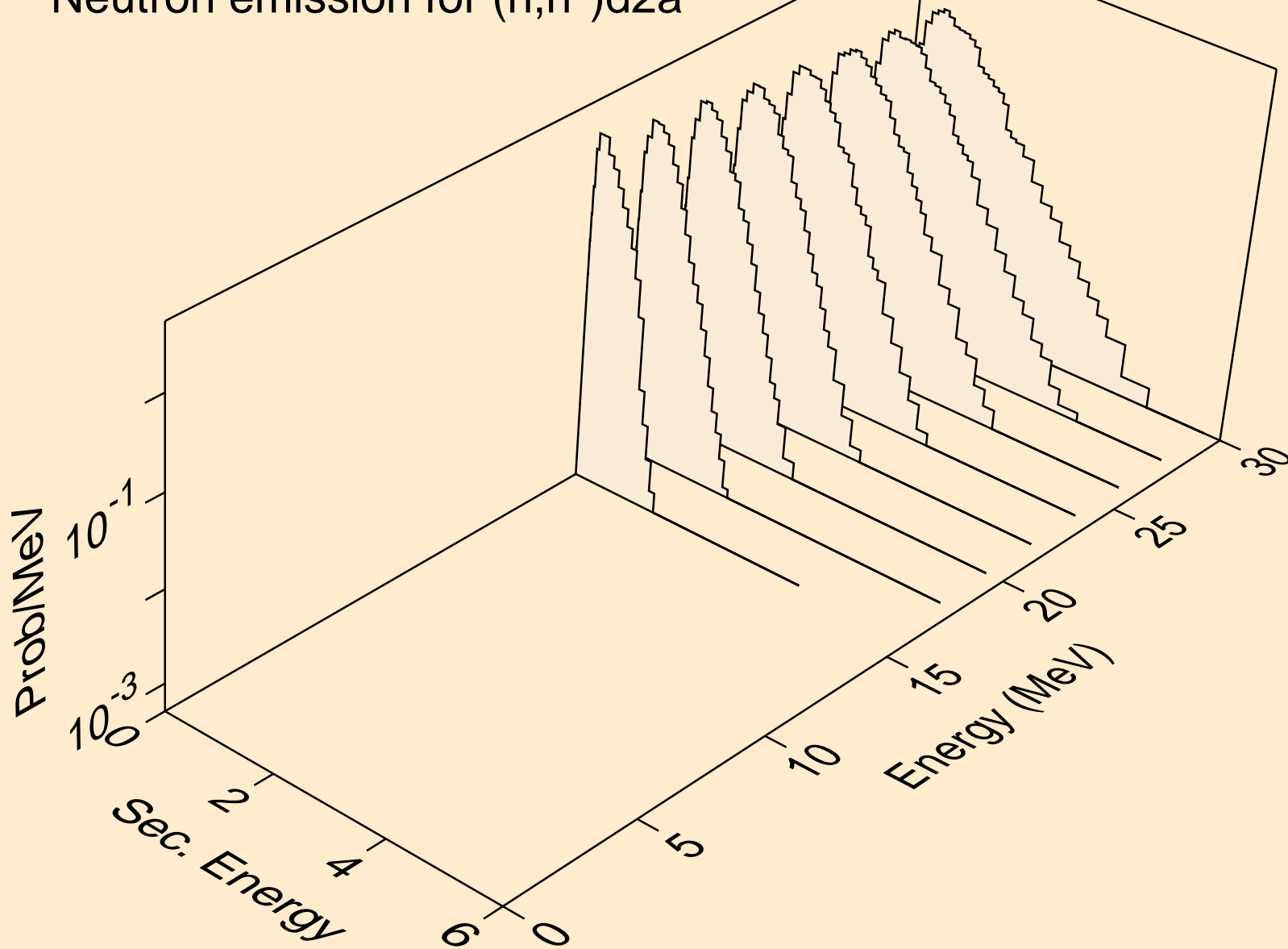

HF159 NEUTRON ACER TENDL-2019 LIBRARY; T=293.16K  
Neutron emission for (n,4n)

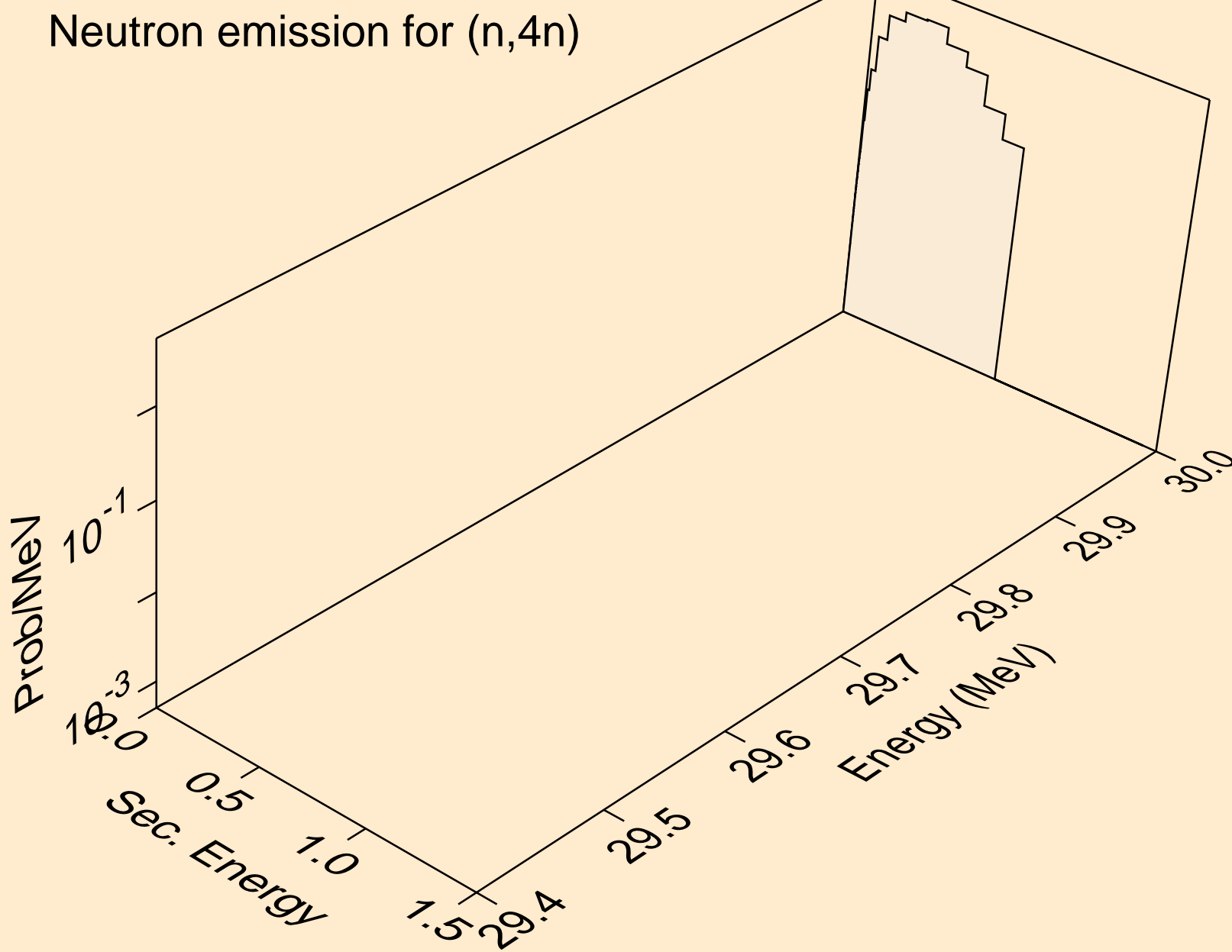

HF159 NEUTRON ACER TENDL-2019 LIBRARY; T=293.16K  
Neutron emission for (n,2np)

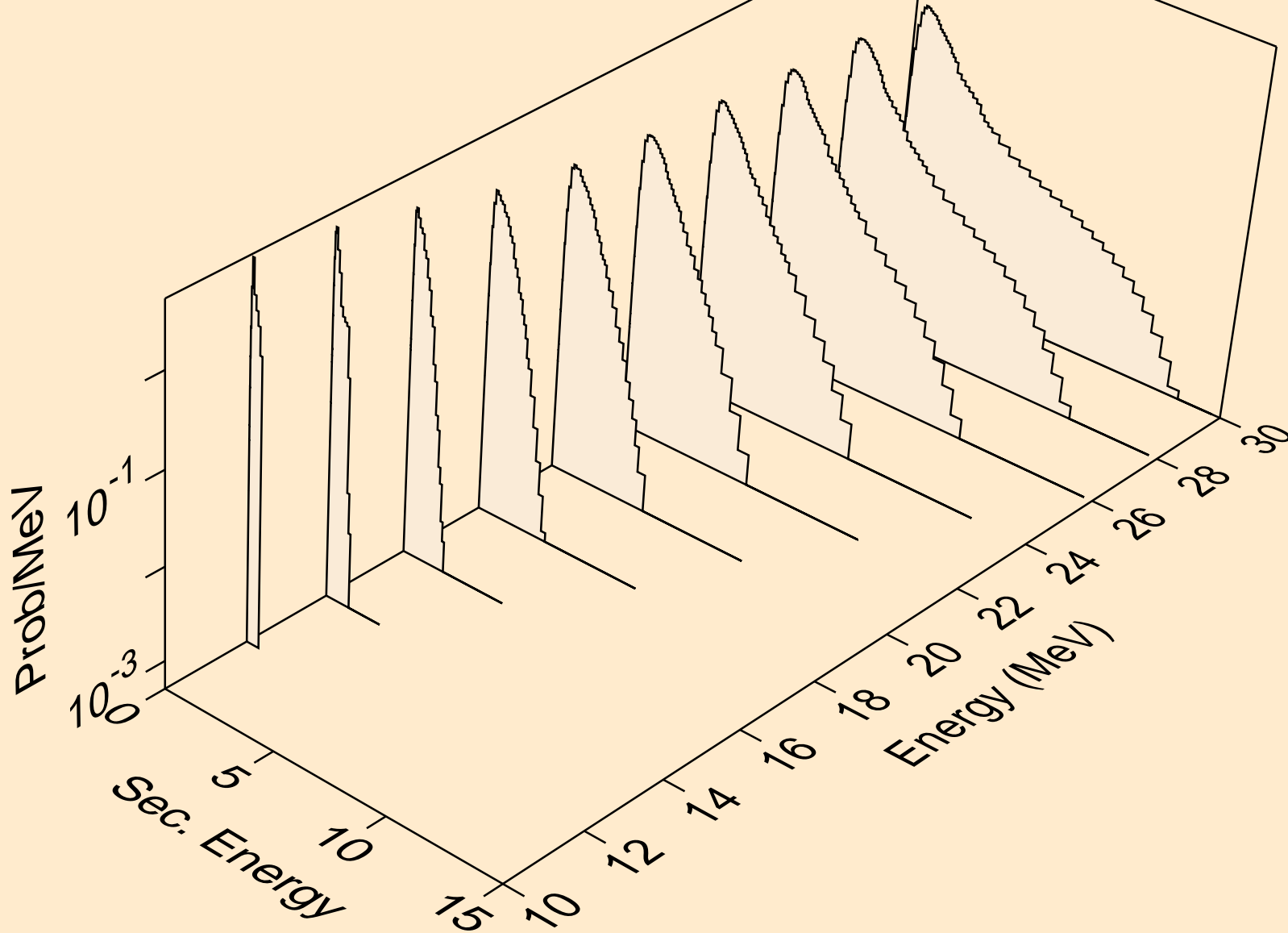

HF159 NEUTRON ACER TENDL-2019 LIBRARY; T=293.16K  
Neutron emission for (n,3np)

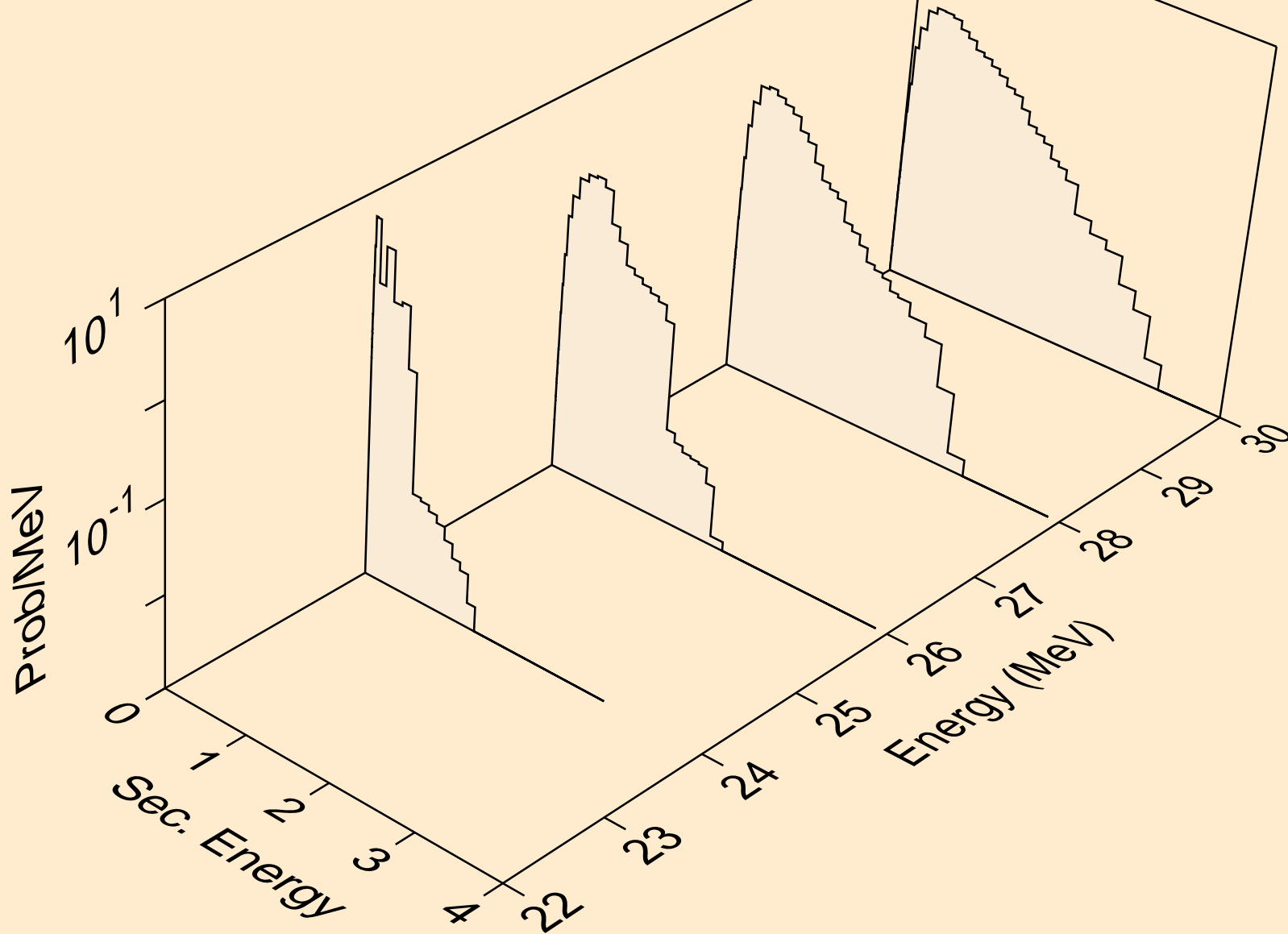

HF159 NEUTRON ACER TENDL-2019 LIBRARY; T=293.16K  
Neutron emission for (n,2np)

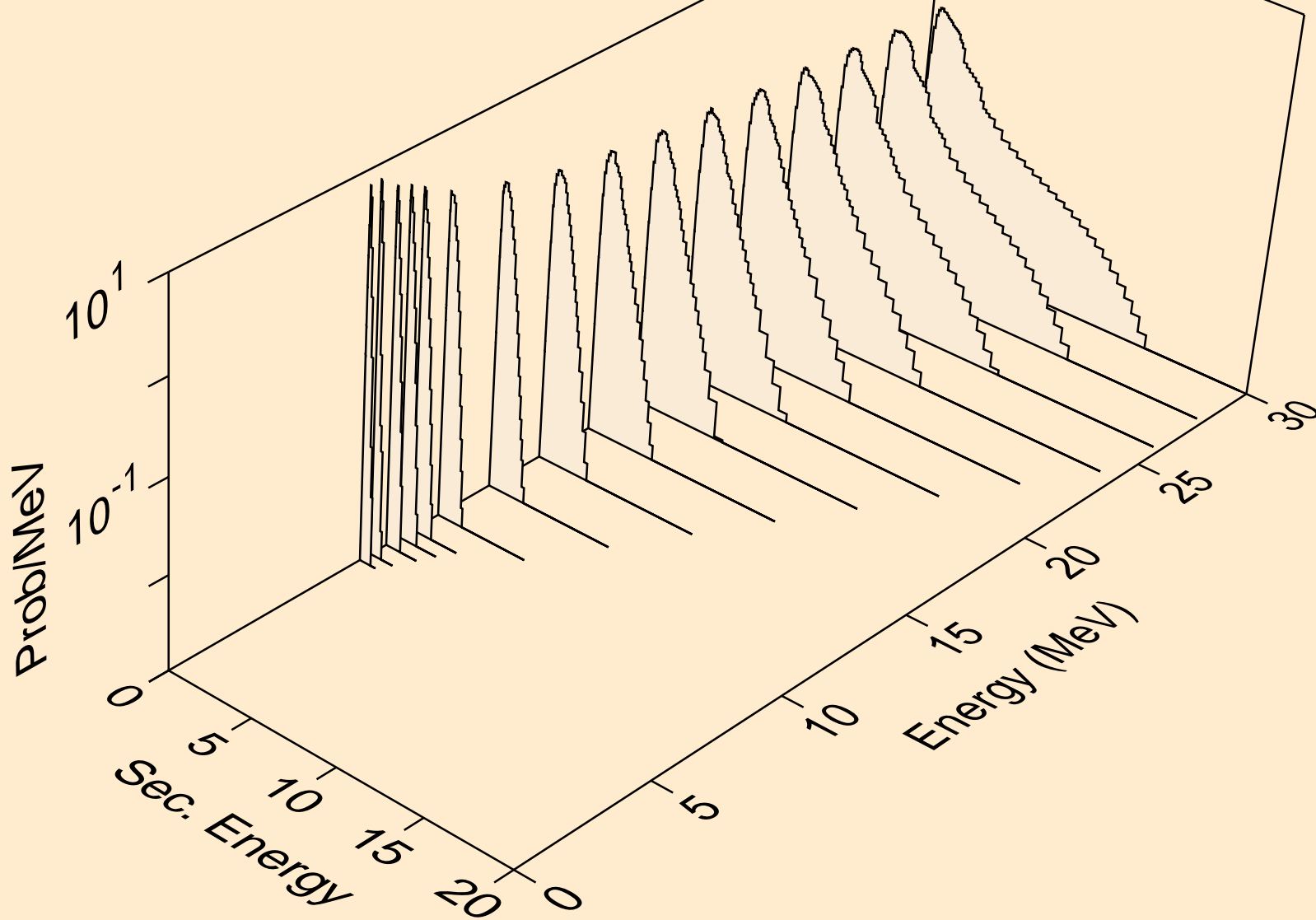

HF159 NEUTRON ACER TENDL-2019 LIBRARY; T=293.16K  
Neutron emission for (n,npa)

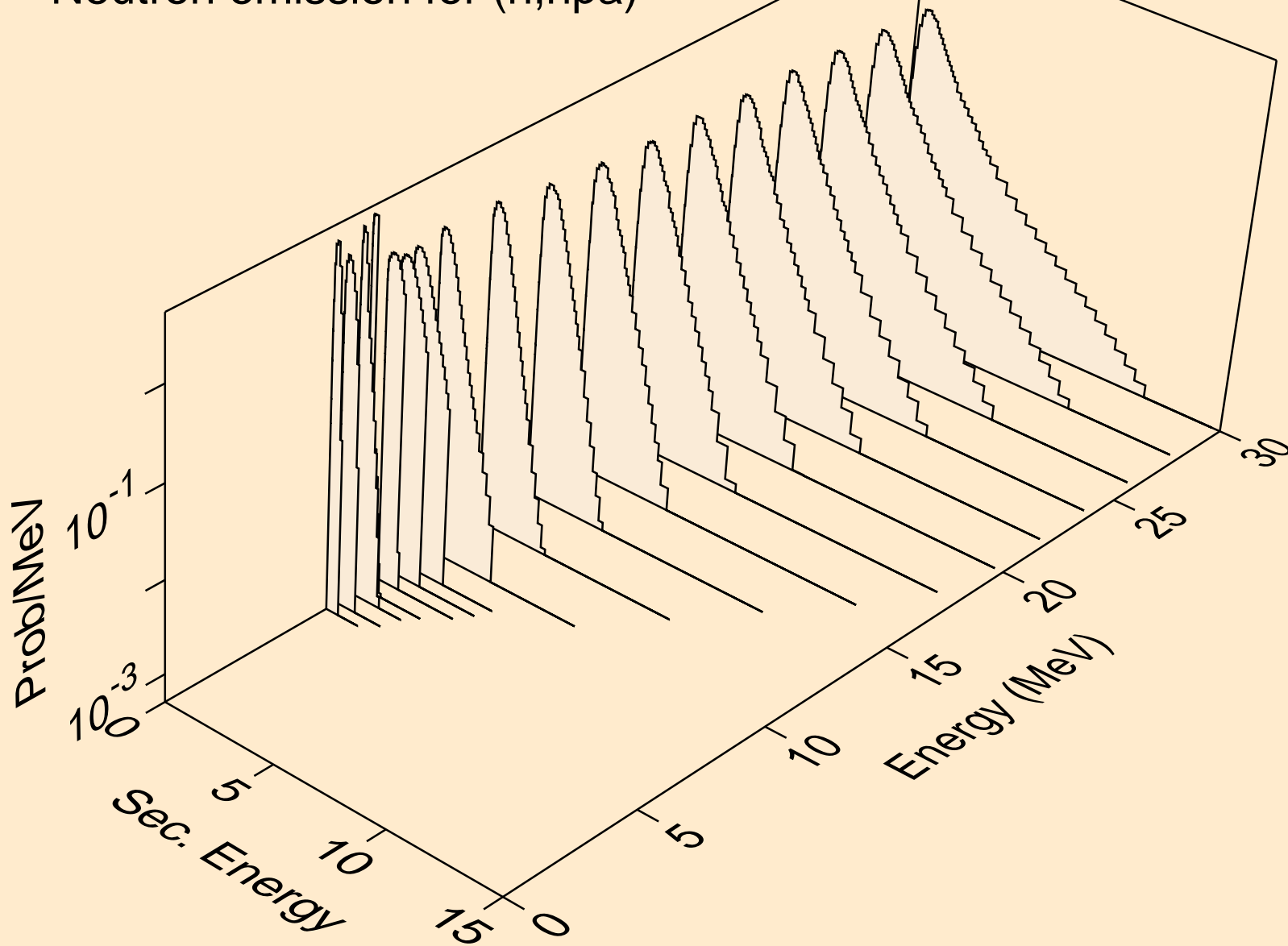



HF159 NEUTRON ACER TENDL-2019 LIBRARY; T=293.16K  
Neutron emission for (n,n\*c)

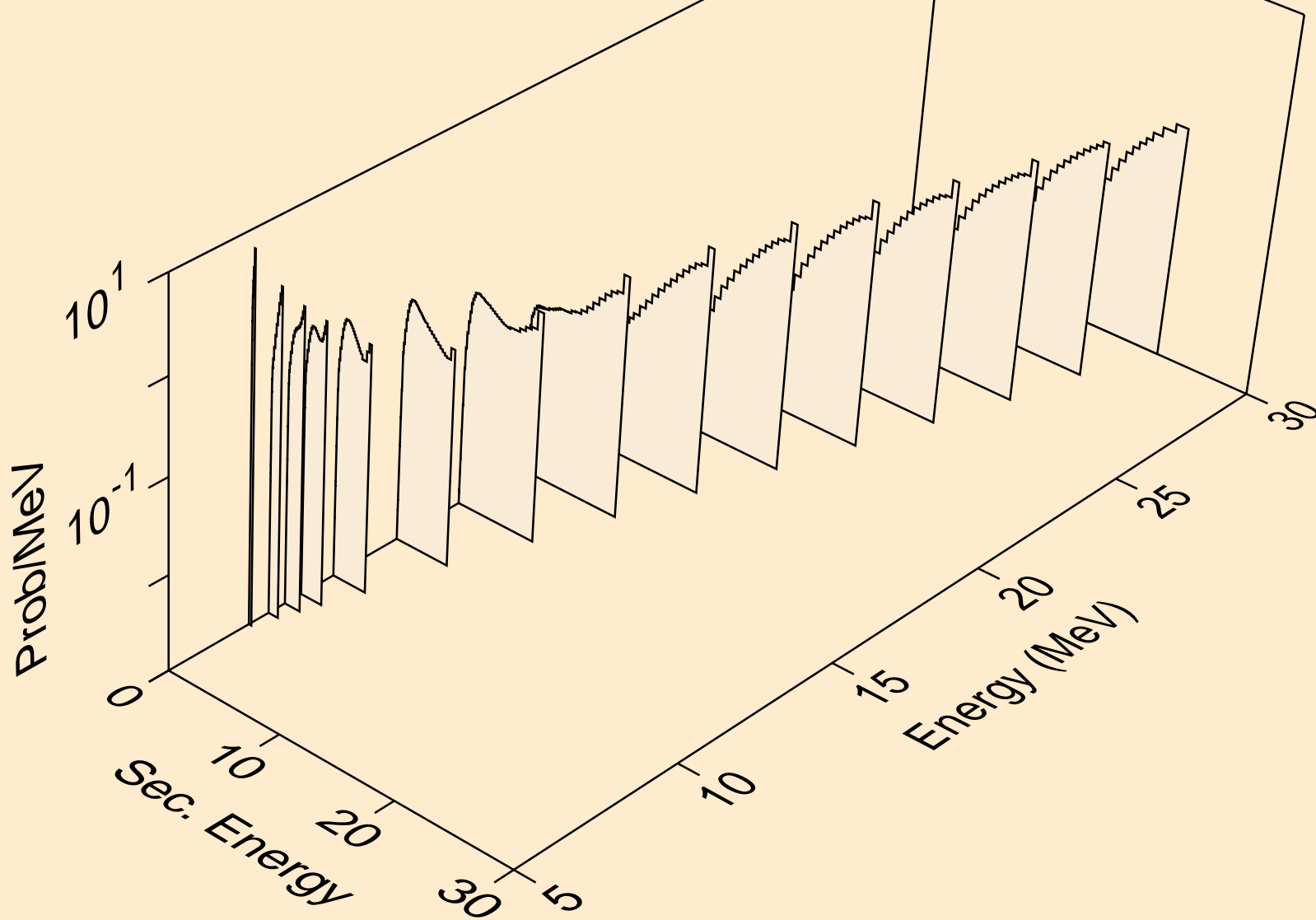

HF159 NEUTRON ACER TENDL-2019 LIBRARY; T=293.16K  
Photon emission for (n,x)

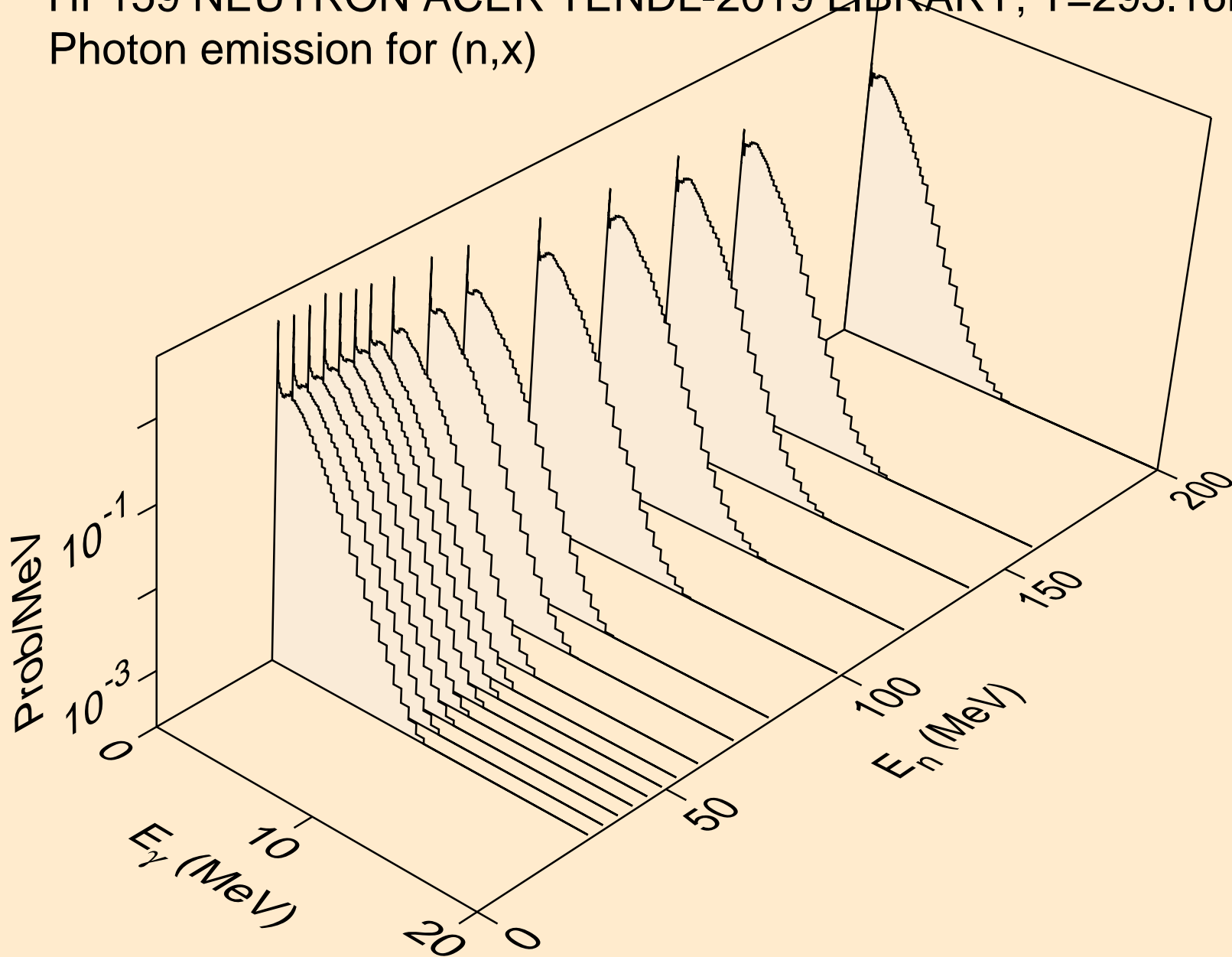

HF159 NEUTRON ACER TENDL-2019 LIBRARY; T=293.16K  
Photon emission for (n,2nd)

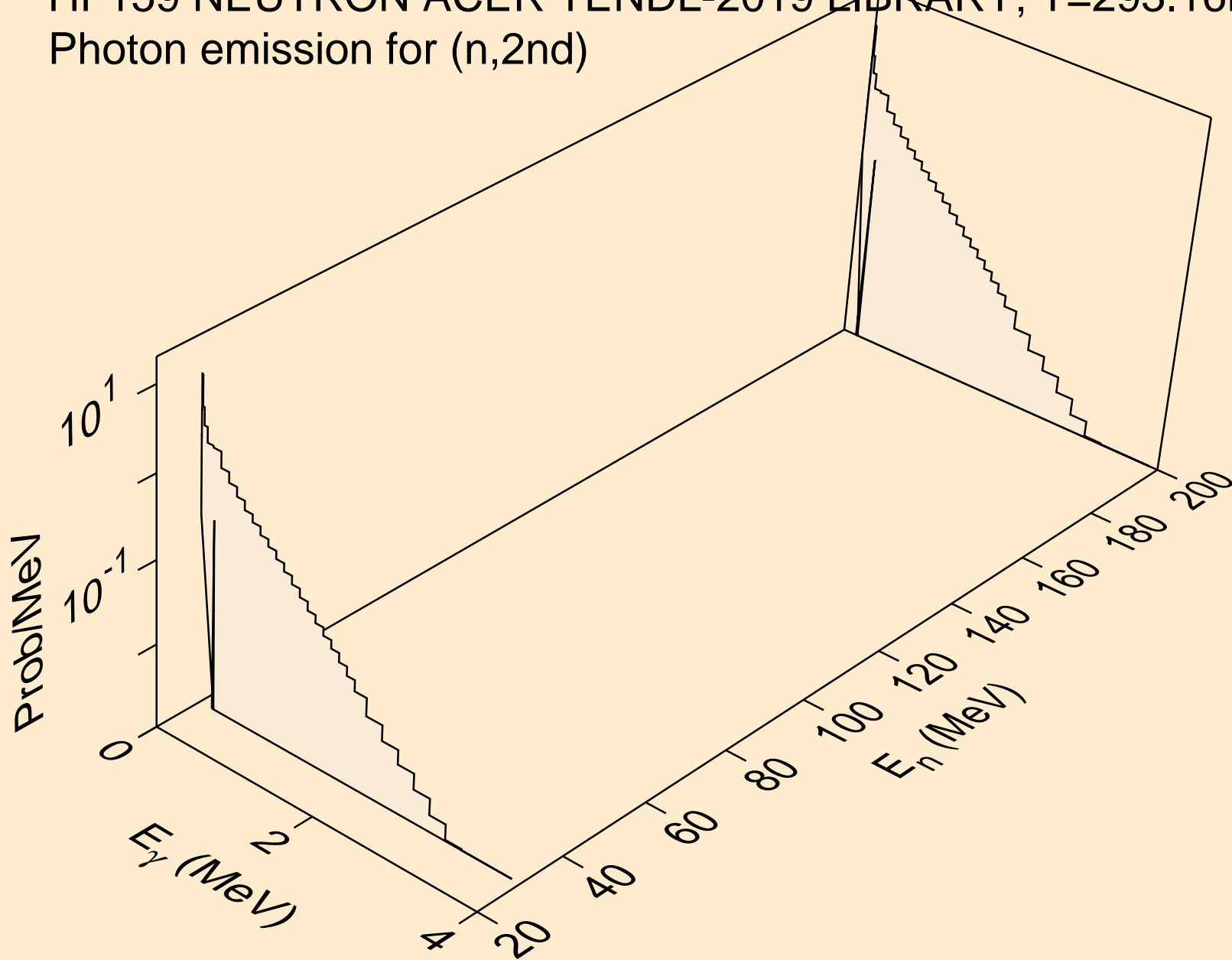

HF159 NEUTRON ACER TENDL-2019 LIBRARY; T=293.16K  
Photon emission for (n,2n)

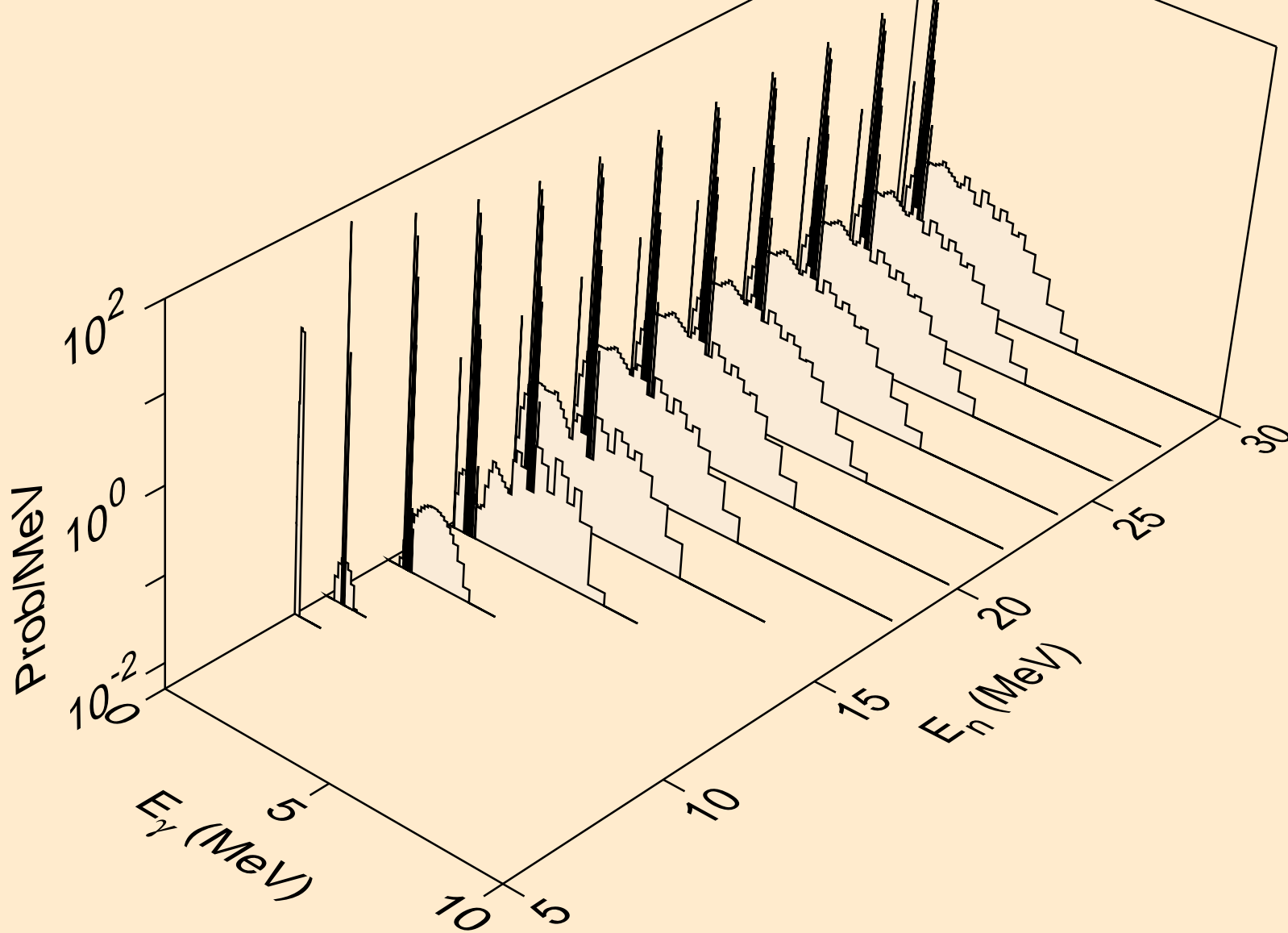

HF159 NEUTRON ACER TENDL-2019 LIBRARY; T=293.16K  
Photon emission for (n,3n)

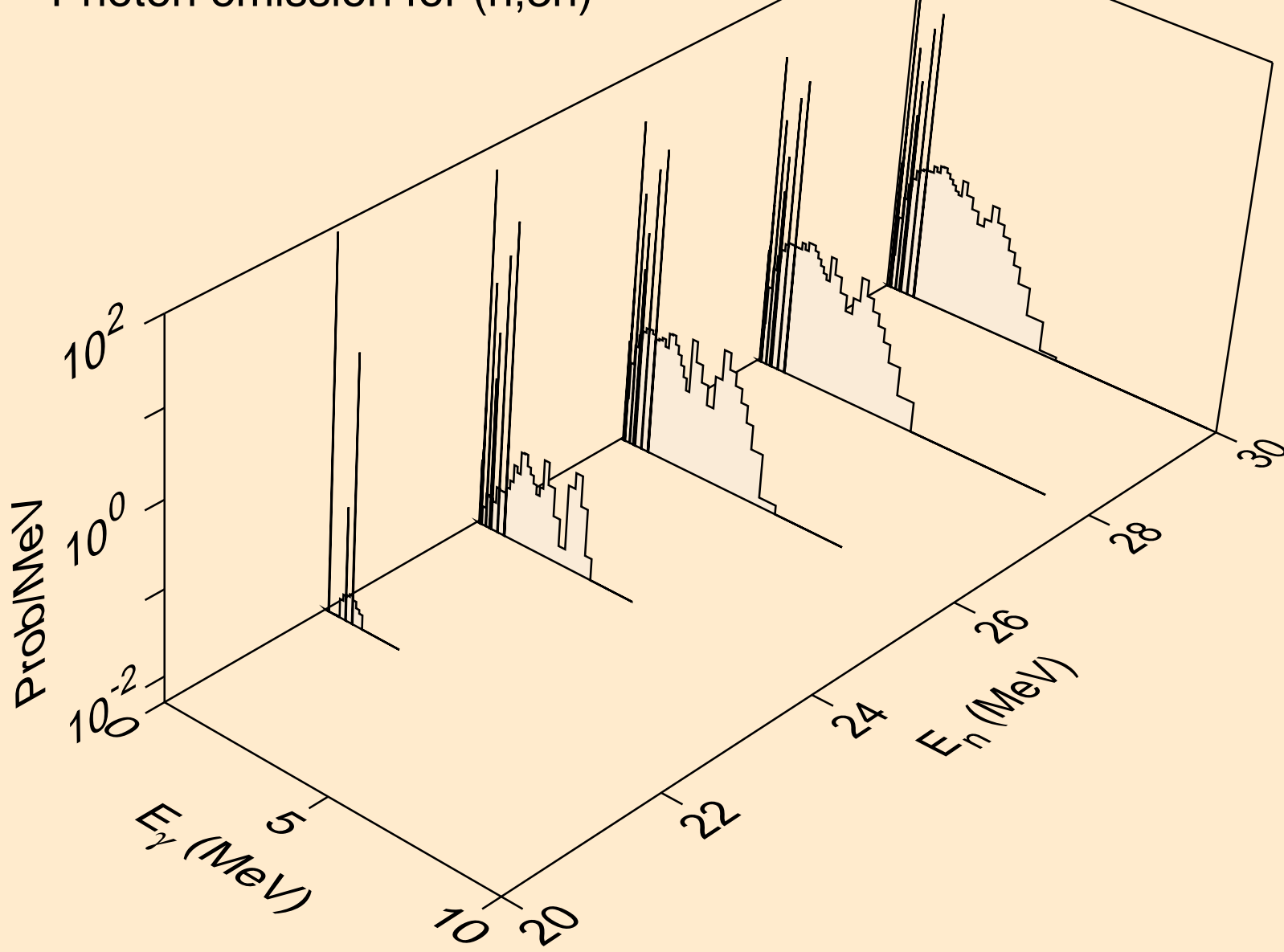

HF159 NEUTRON ACER TENDL-2019 LIBRARY; T=293.16K  
Photon emission for (n,n\*)a

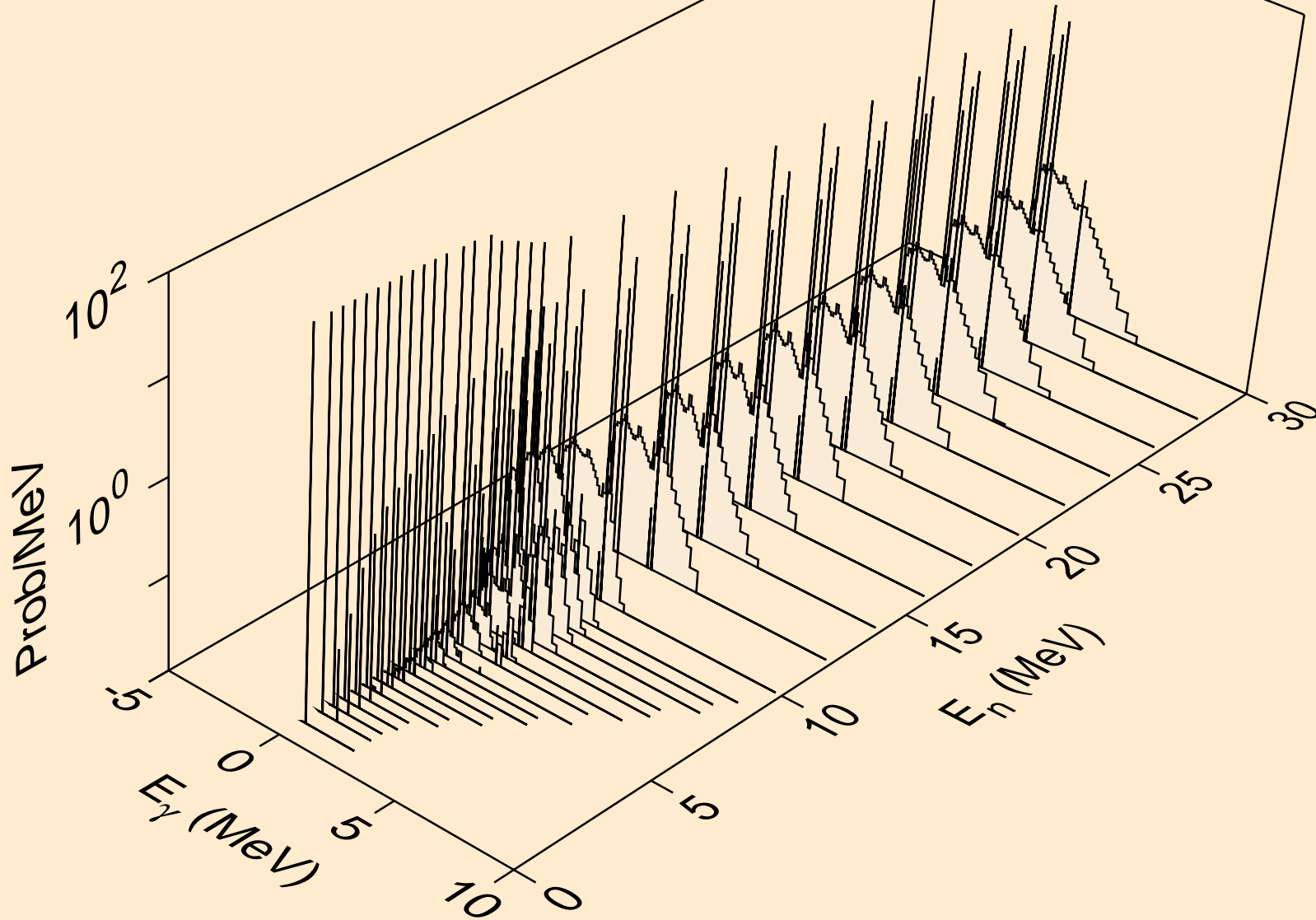

HF159 NEUTRON ACER TENDL-2019 LIBRARY; T=293.16K  
Photon emission for (n,n\*)3a

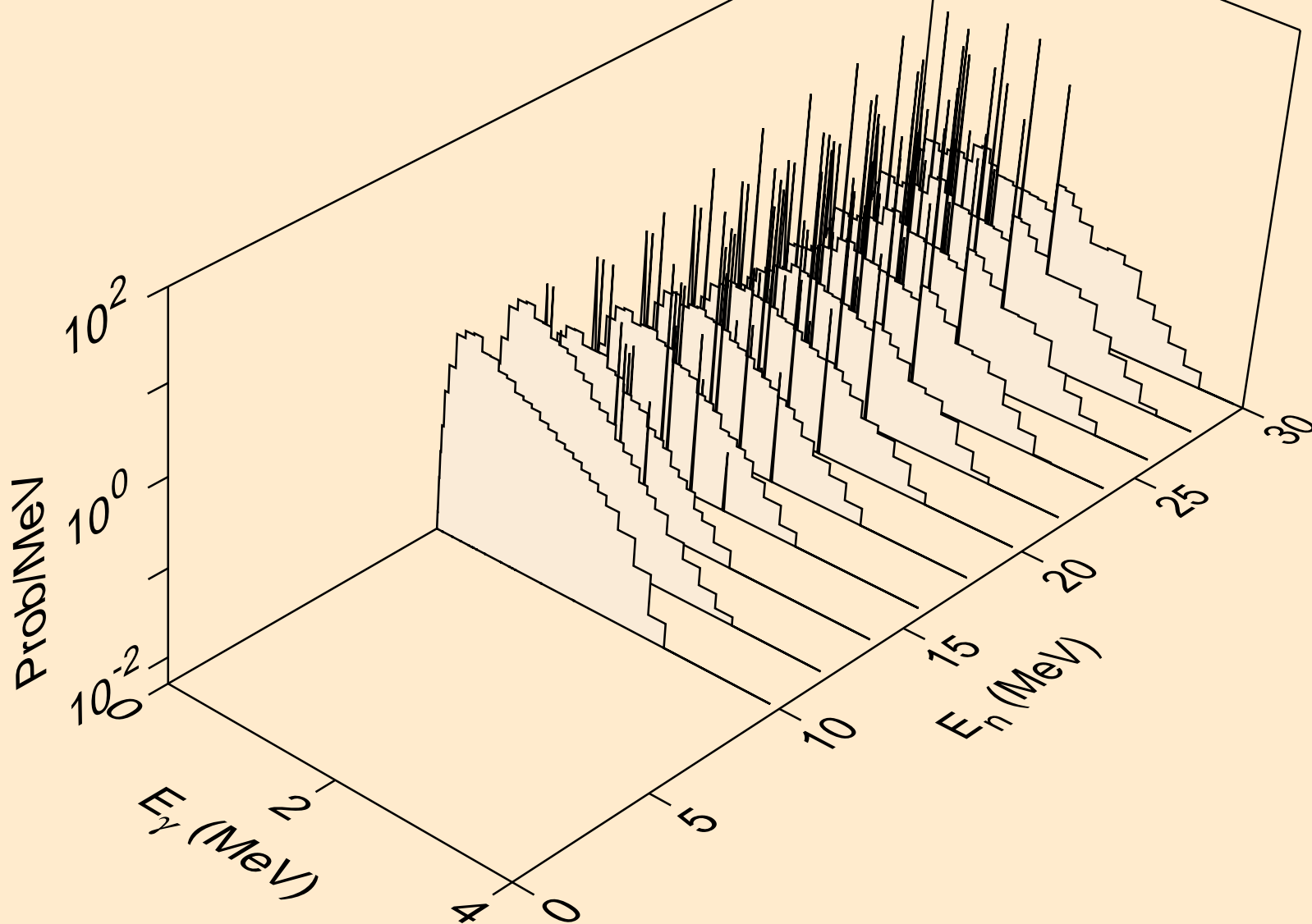

HF159 NEUTRON ACER TENDL-2019 LIBRARY; T=293.16K  
Photon emission for (n,2n)a

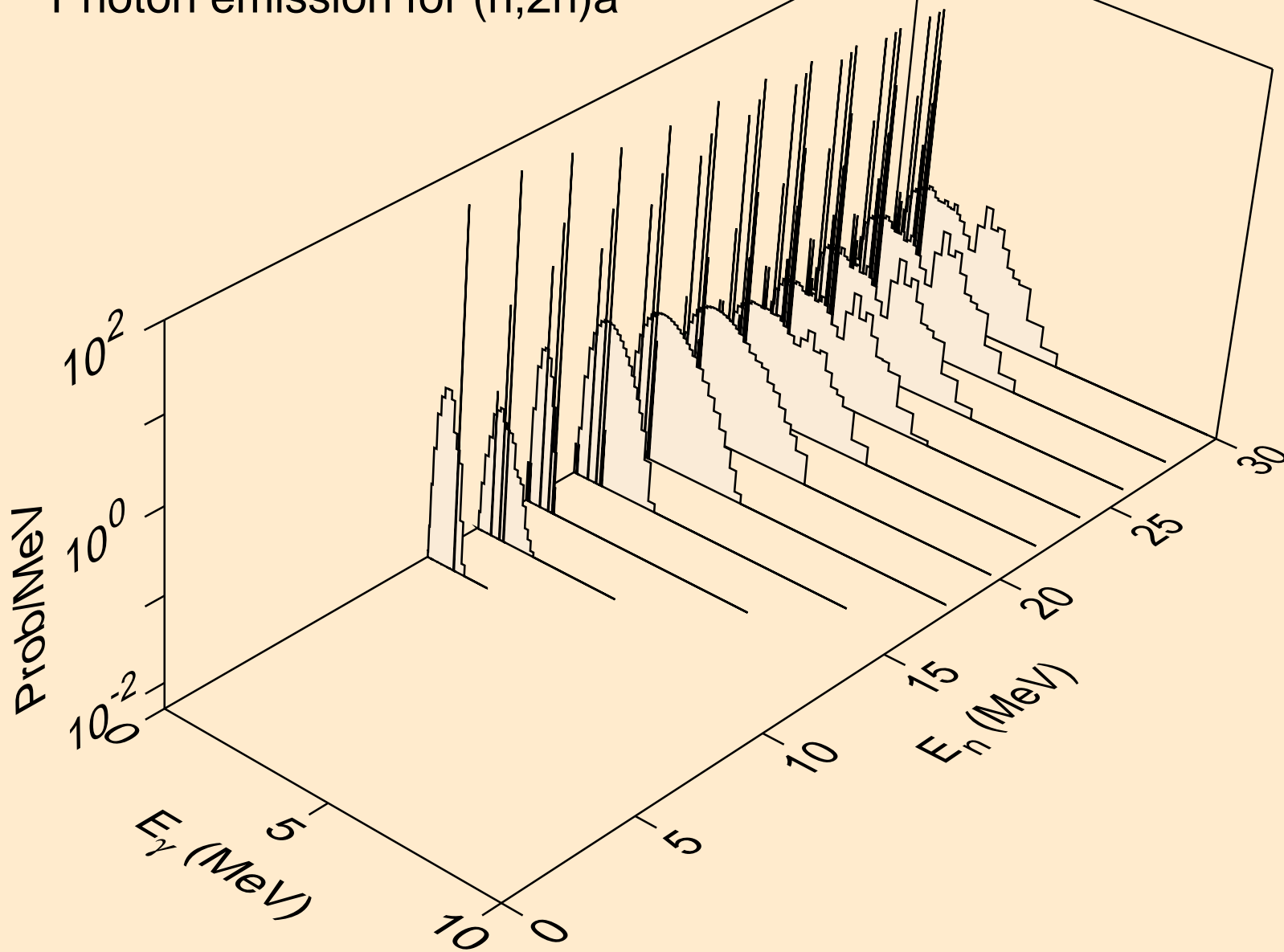



HF159 NEUTRON ACER TENDL-2019 LIBRARY; T=293.16K  
Photon emission for (n,3n)a

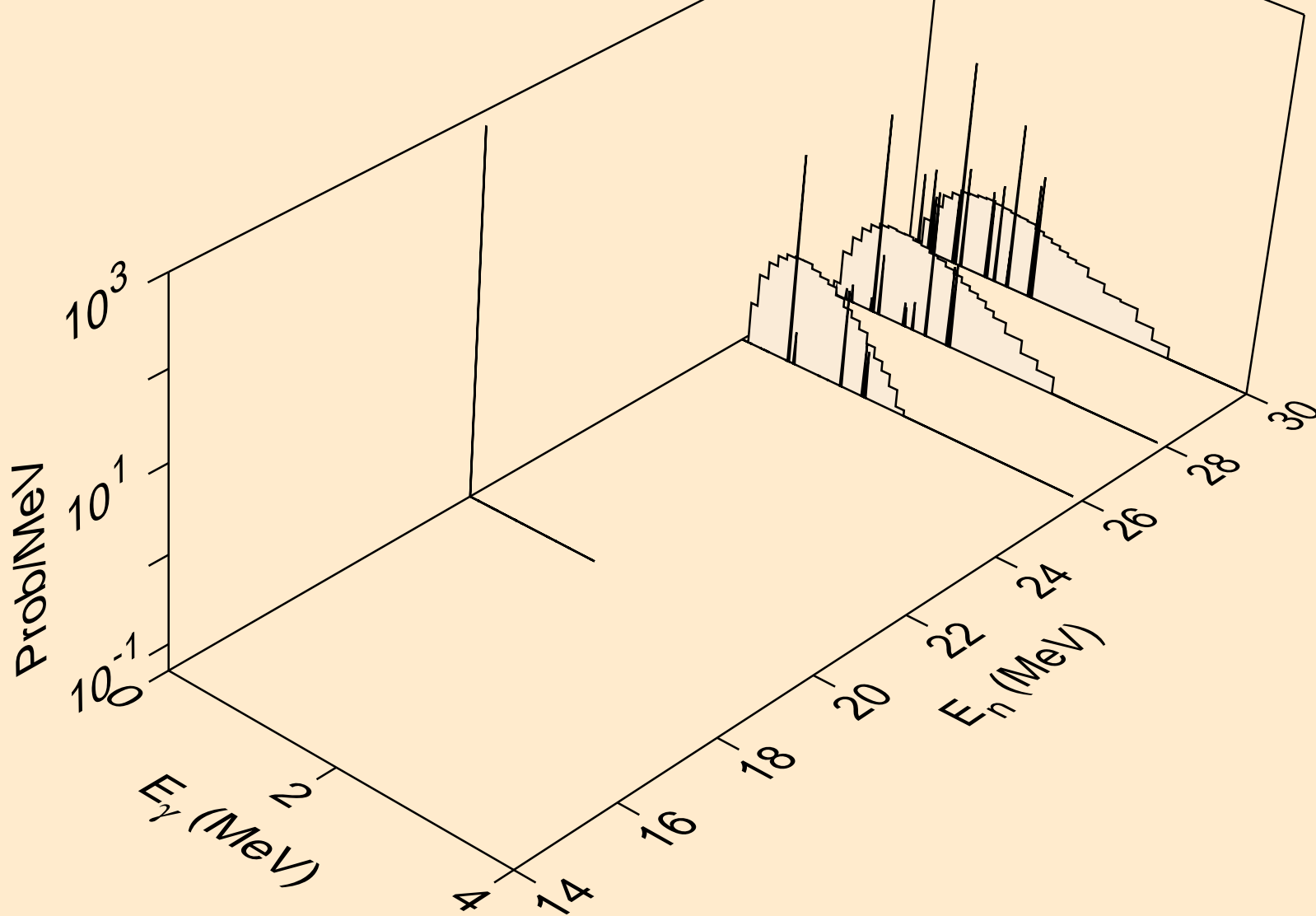

HF159 NEUTRON ACER TENDL-2019 LIBRARY; T=293.16K  
Photon emission for (n,n\*)p

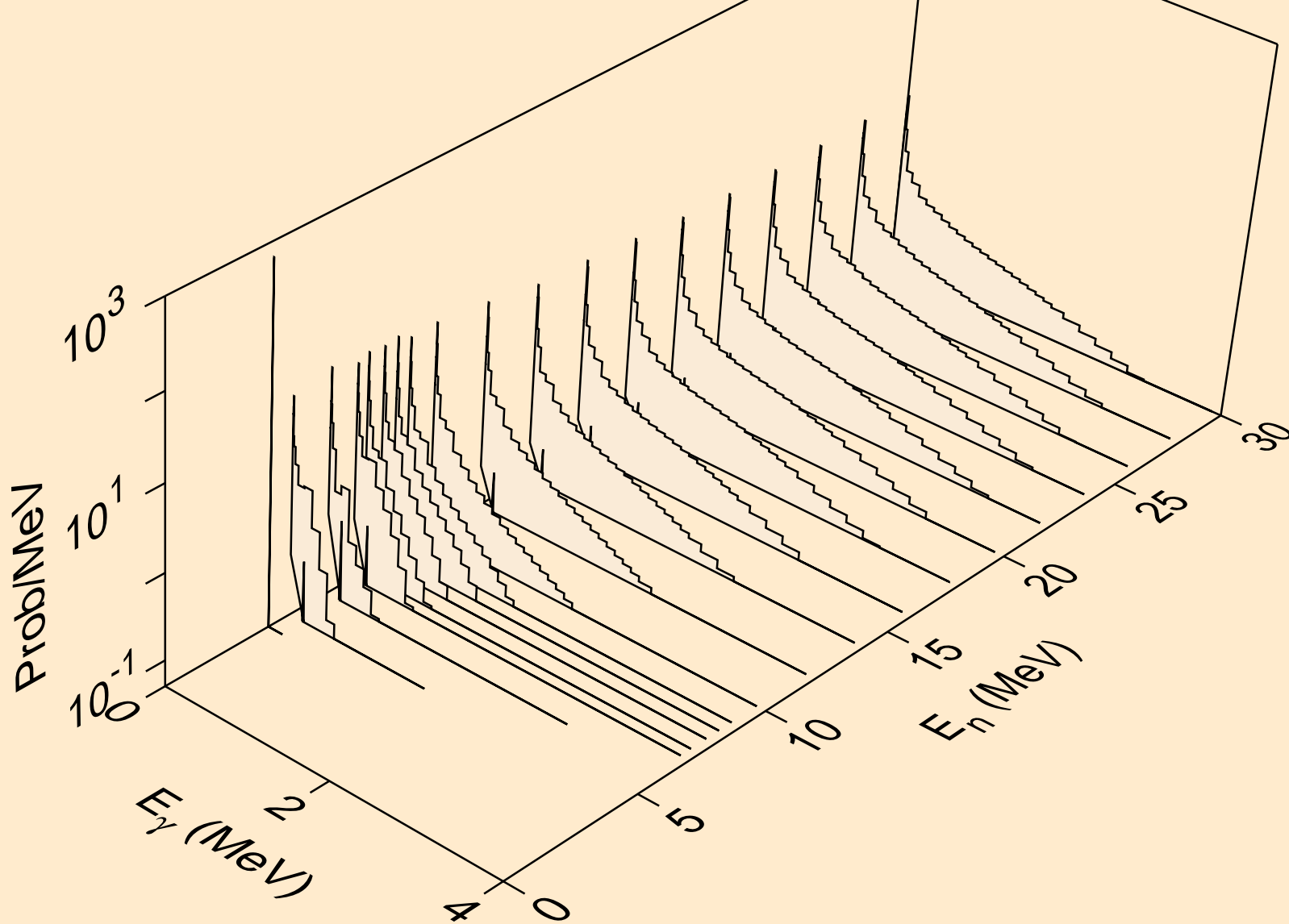

HF159 NEUTRON ACER TENDL-2019 LIBRARY; T=293.16K  
Photon emission for (n,n\*)2a

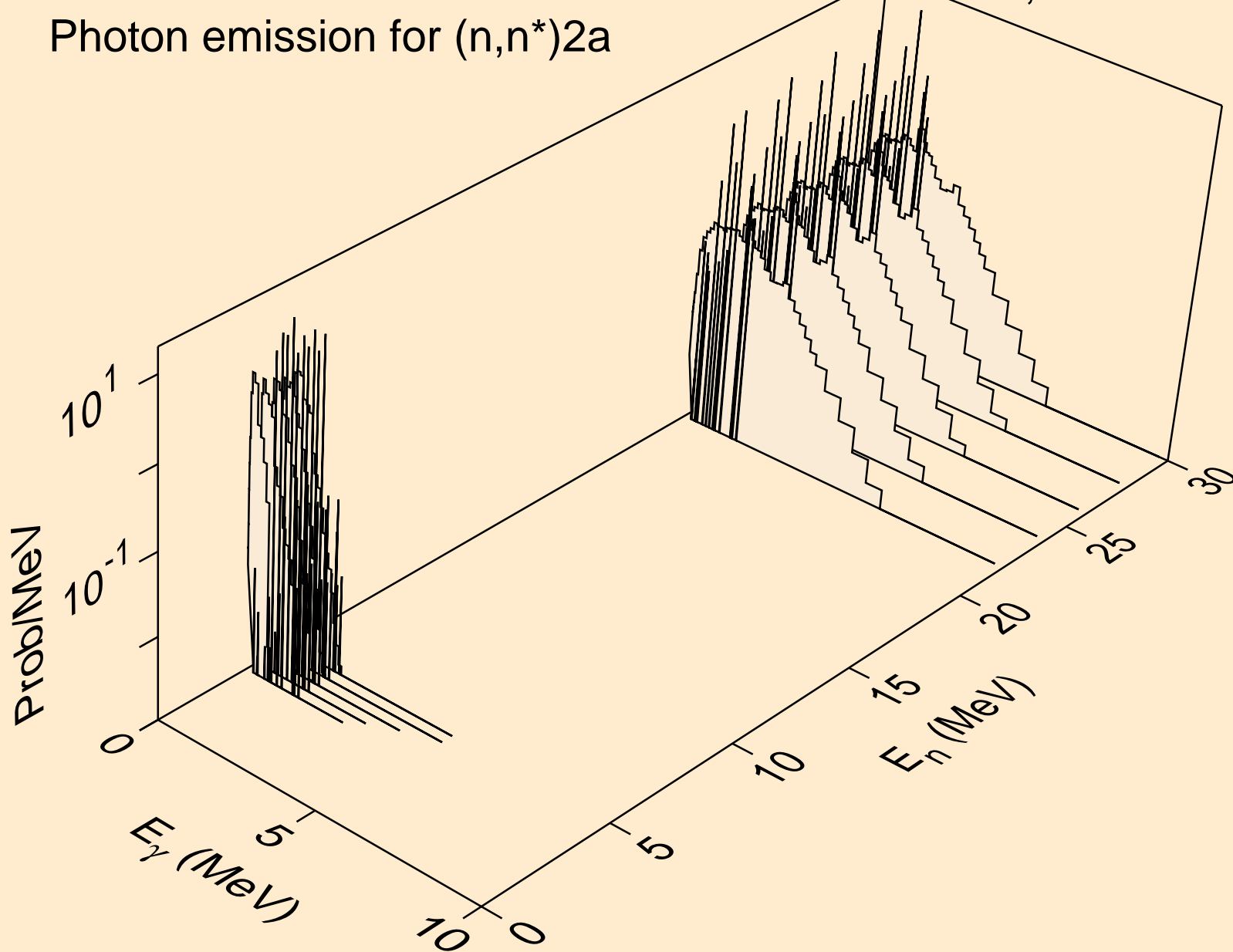

HF159 NEUTRON ACER TENDL-2019 LIBRARY; T=293.16K  
Photon emission for (n,2n)2a

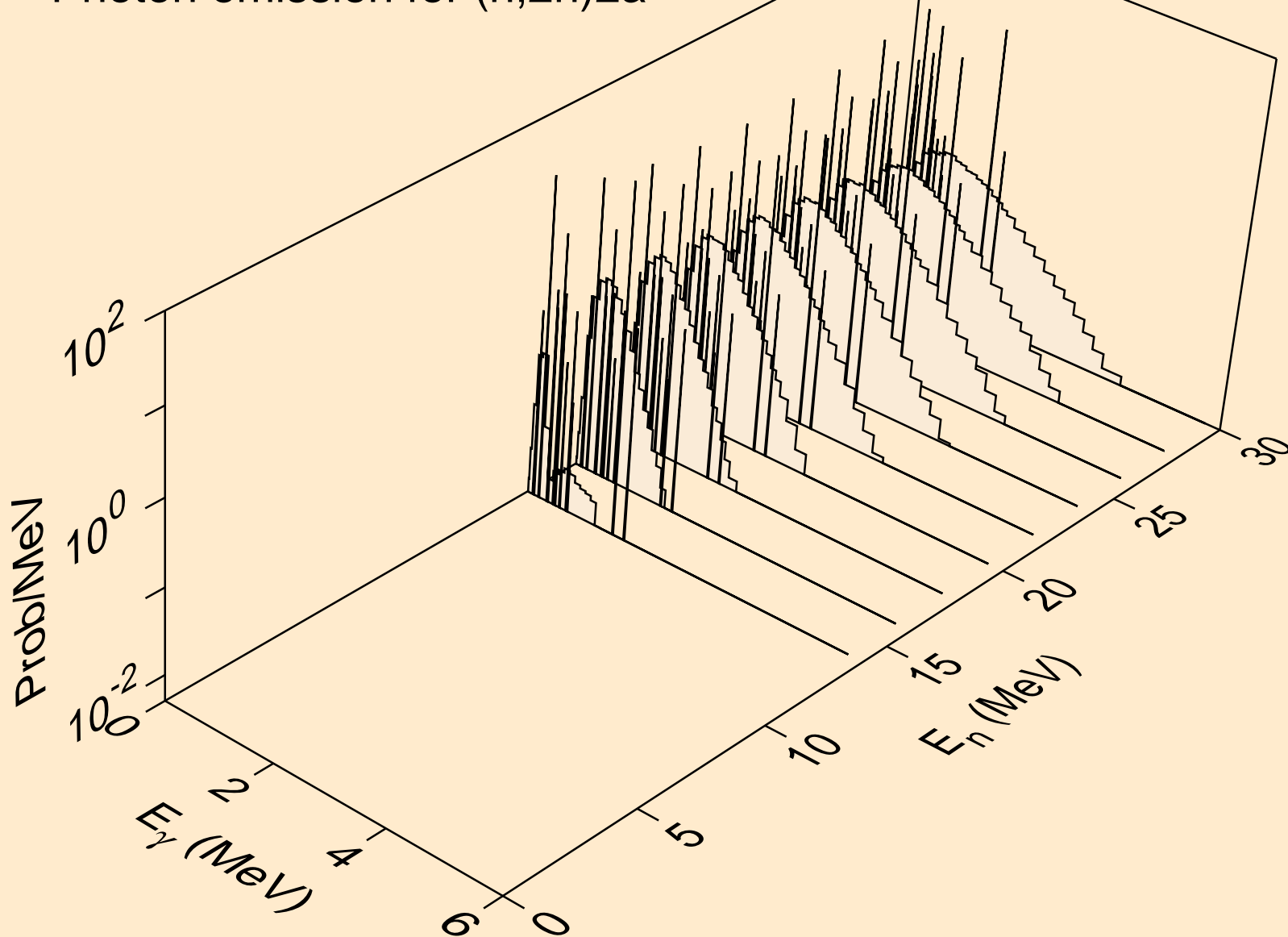

HF159 NEUTRON ACER TENDL-2019 LIBRARY; T=293.16K  
Photon emission for (n,n\*)d

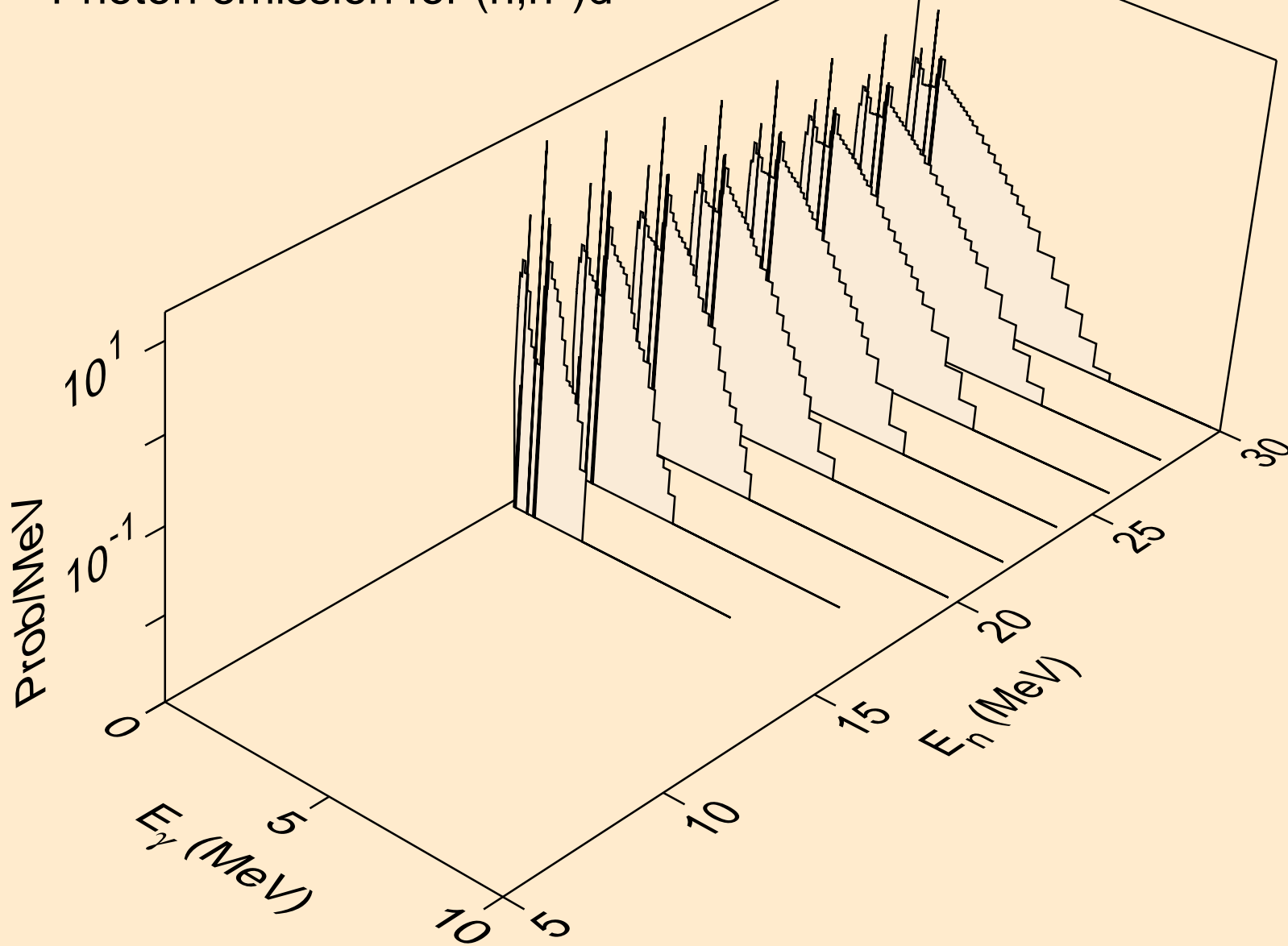

HF159 NEUTRON ACER TENDL-2019 LIBRARY; T=293.16K  
Photon emission for (n,n\*)t

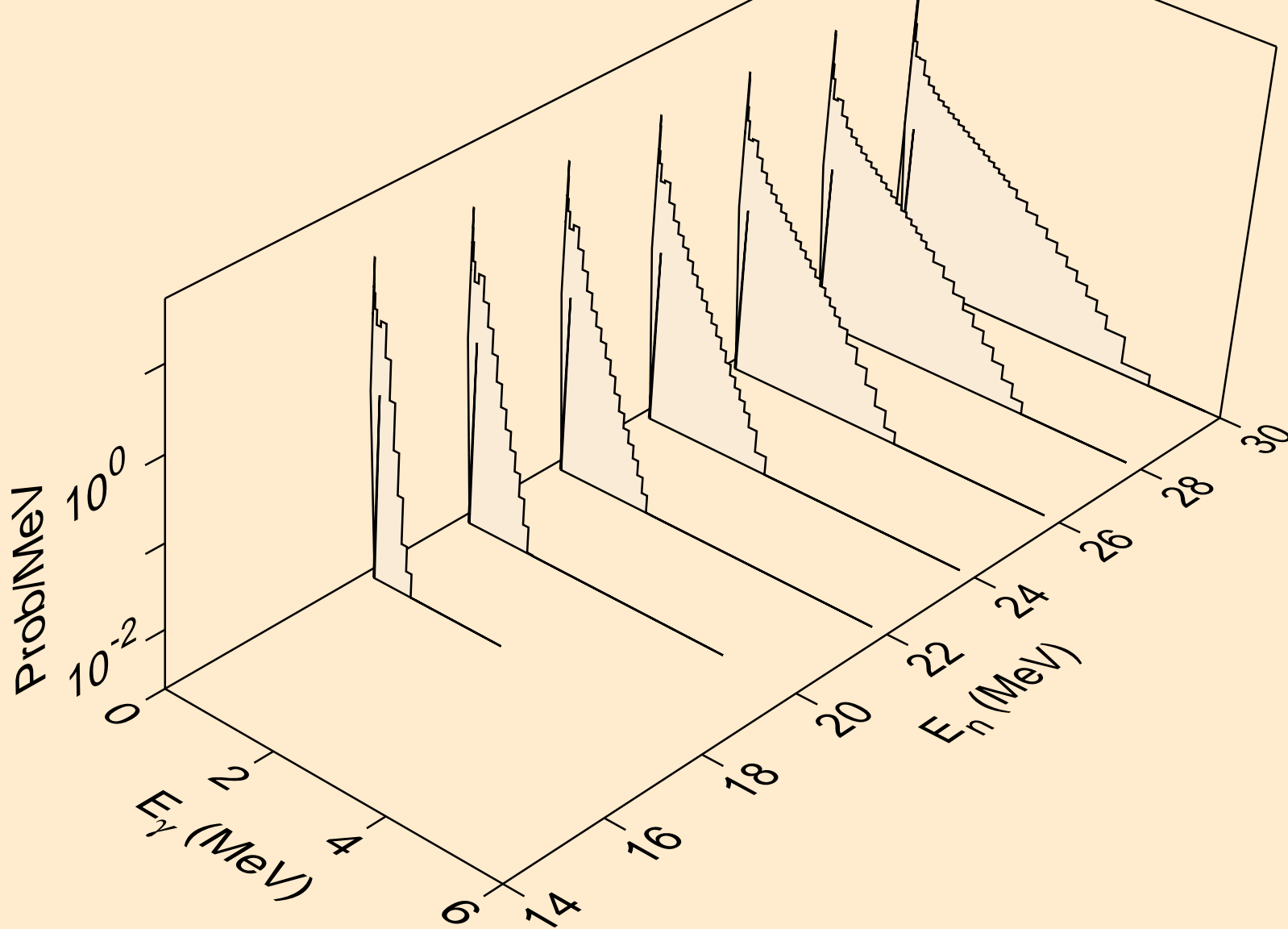

HF159 NEUTRON ACER TENDL-2019 LIBRARY; T=293.16K  
Photon emission for (n,n\*)he3

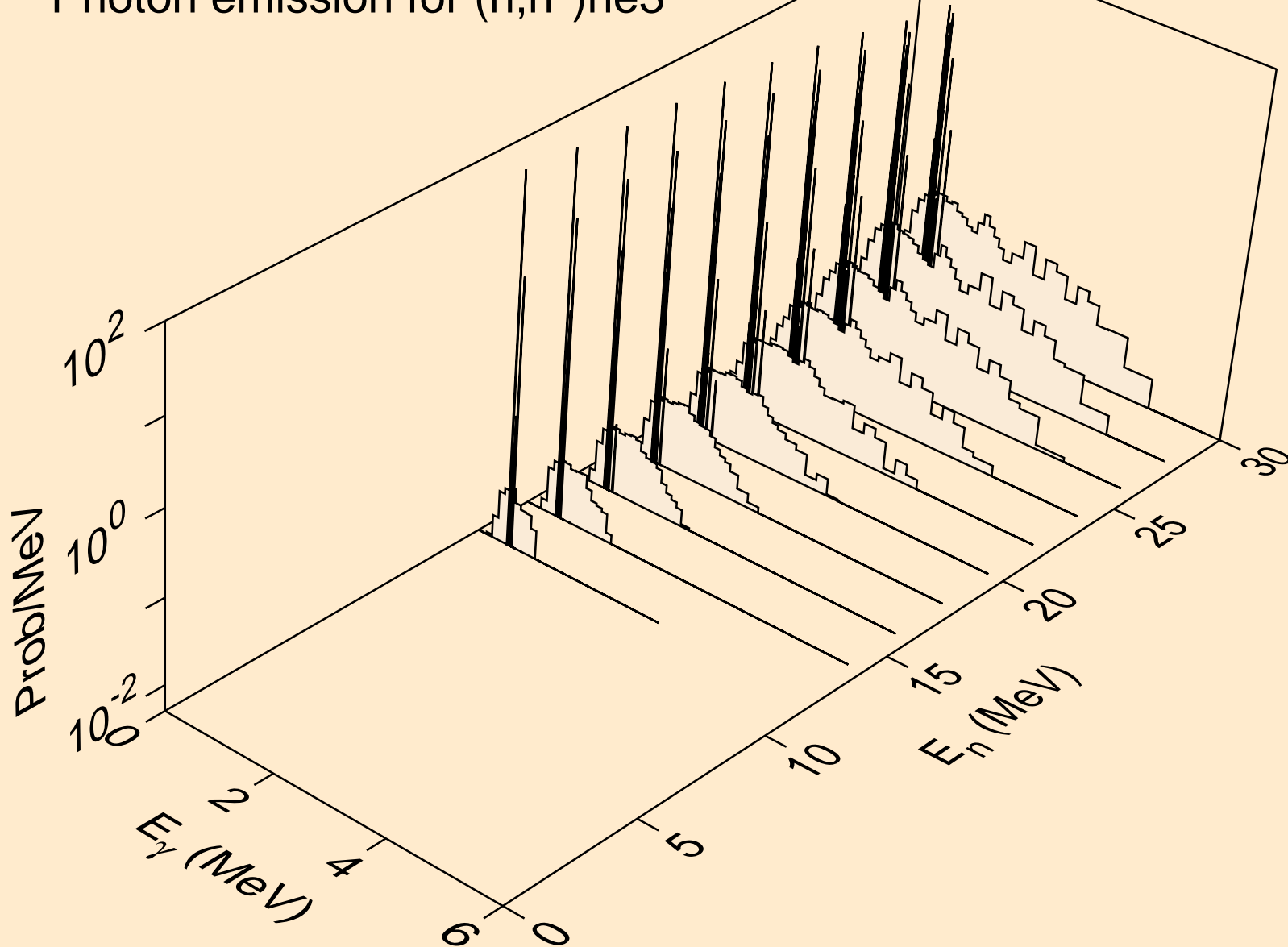

HF159 NEUTRON ACER TENDL-2019 LIBRARY; T=293.16K  
Photon emission for (n,n\*)d2a

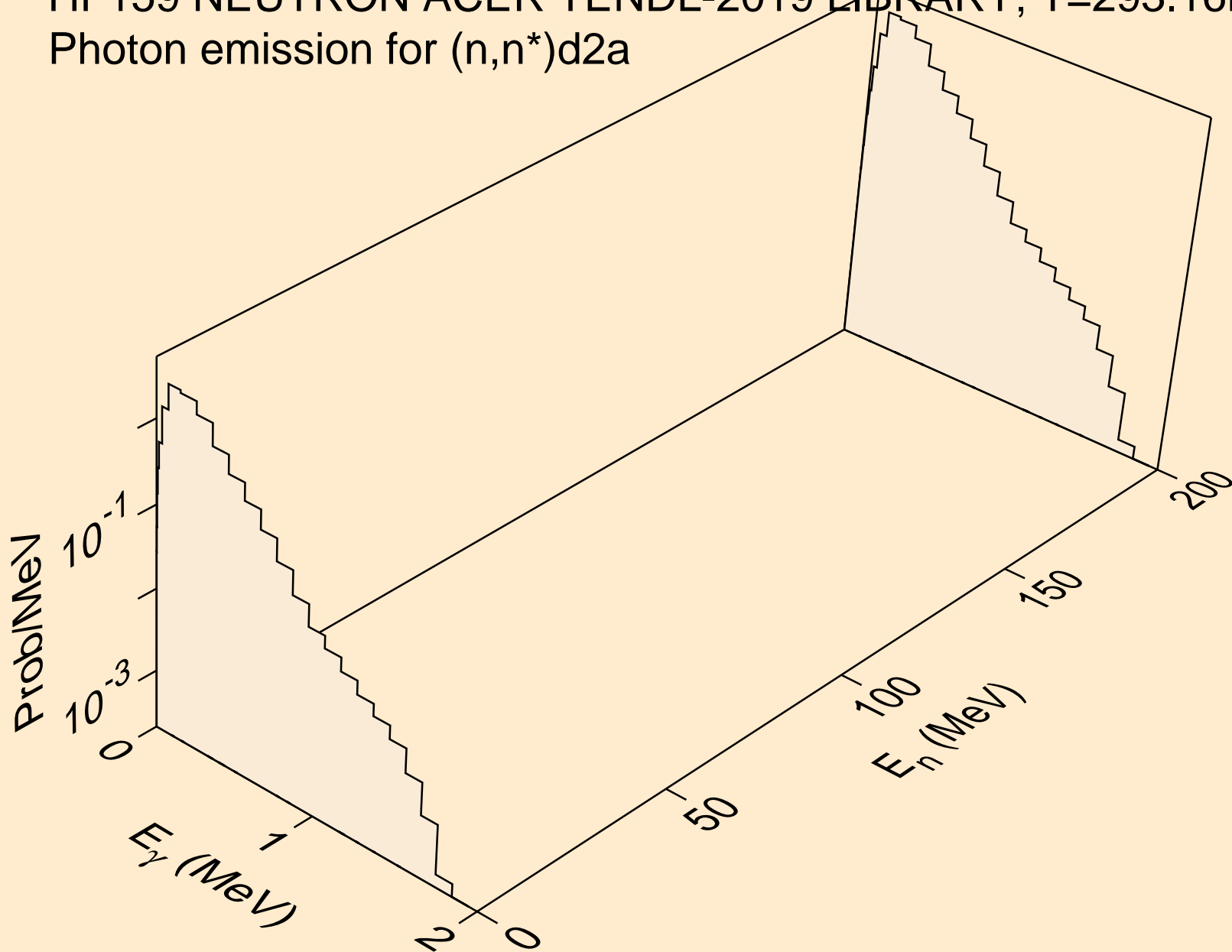



HF159 NEUTRON ACER TENDL-2019 LIBRARY; T=293.16K  
Photon emission for (n,4n)

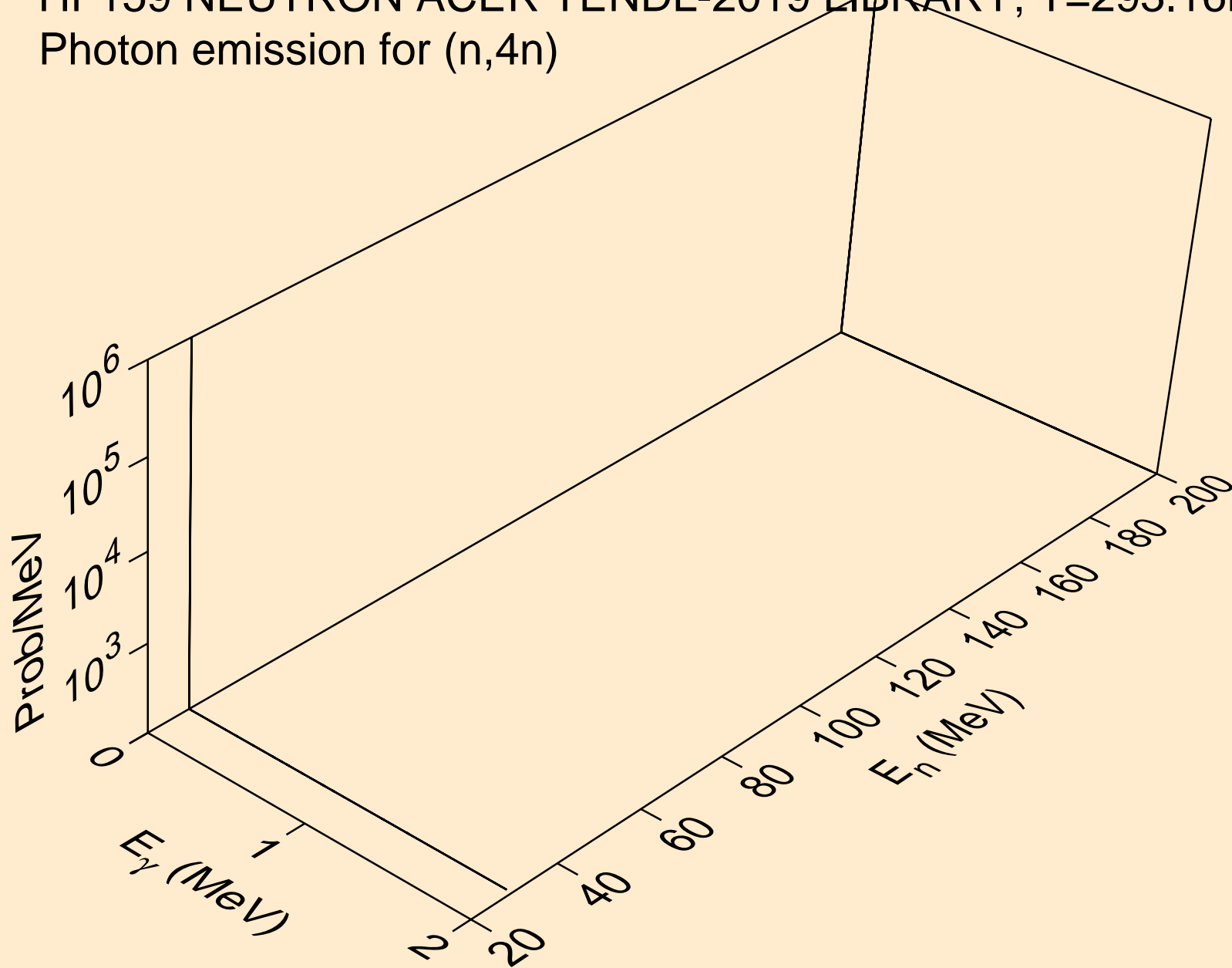

HF159 NEUTRON ACER TENDL-2019 LIBRARY; T=293.16K  
Photon emission for (n,2np)

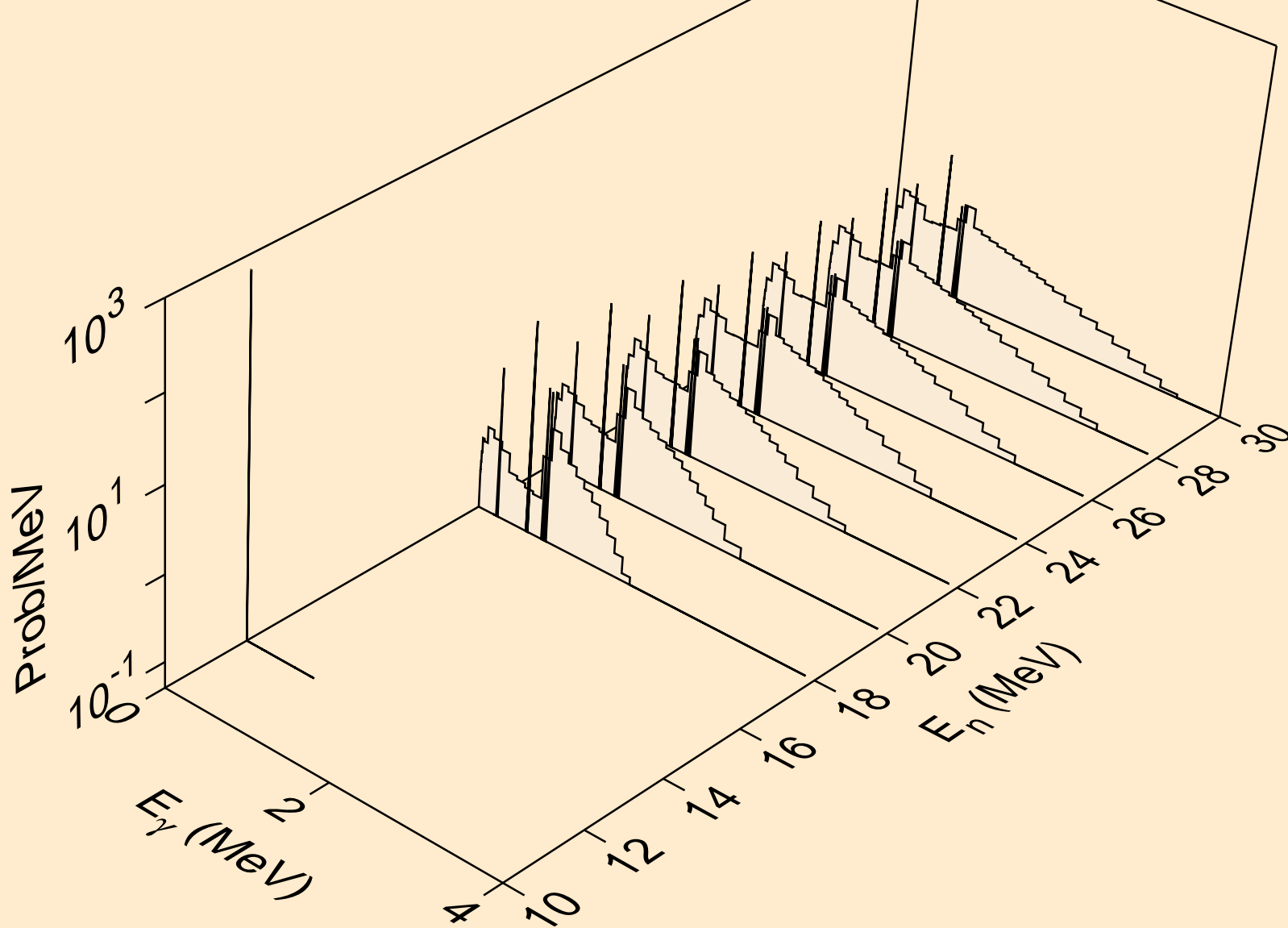

HF159 NEUTRON ACER TENDL-2019 LIBRARY; T=293.16K  
Photon emission for (n,3np)

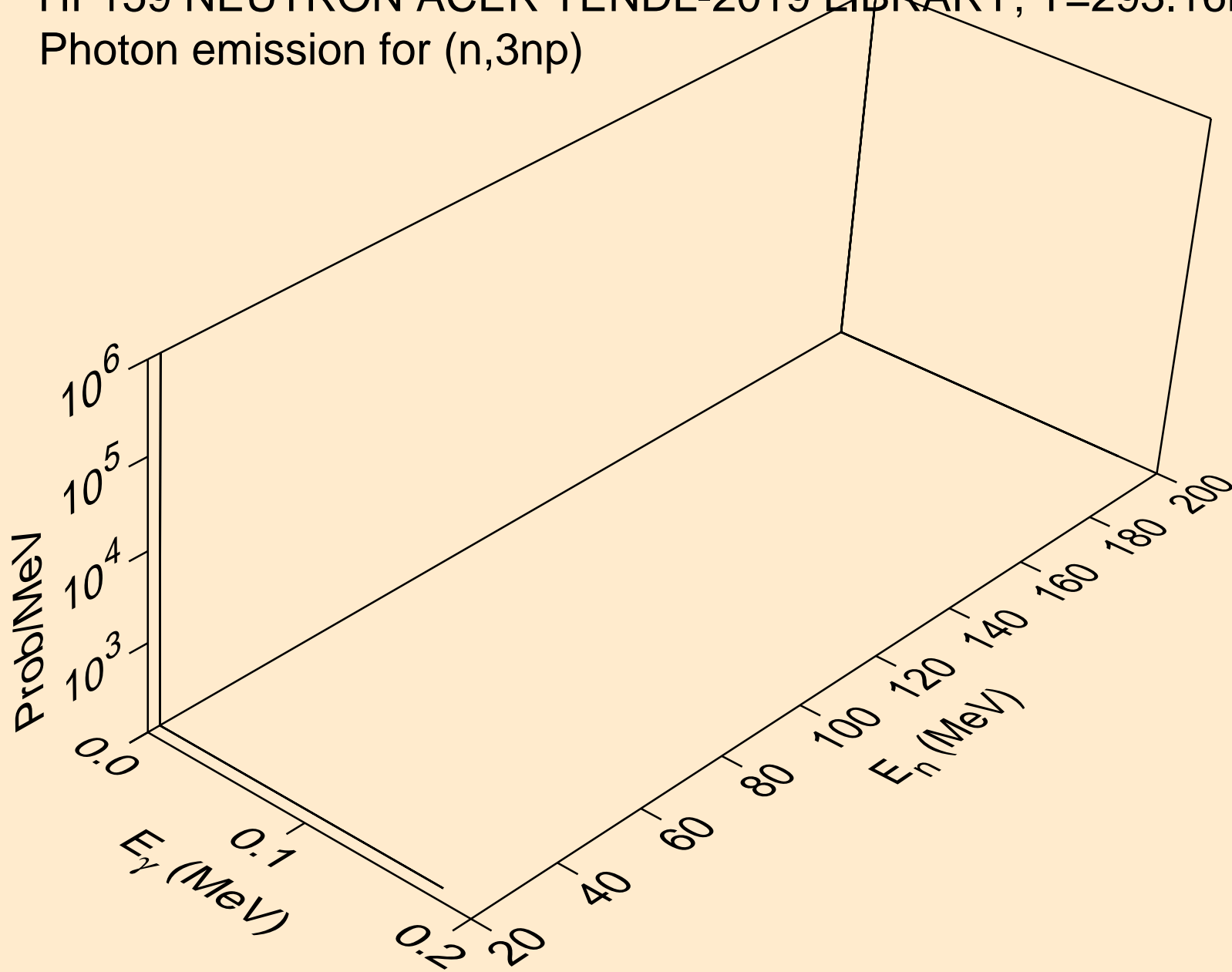

HF159 NEUTRON ACER TENDL-2019 LIBRARY; T=293.16K  
Photon emission for (n,2np)

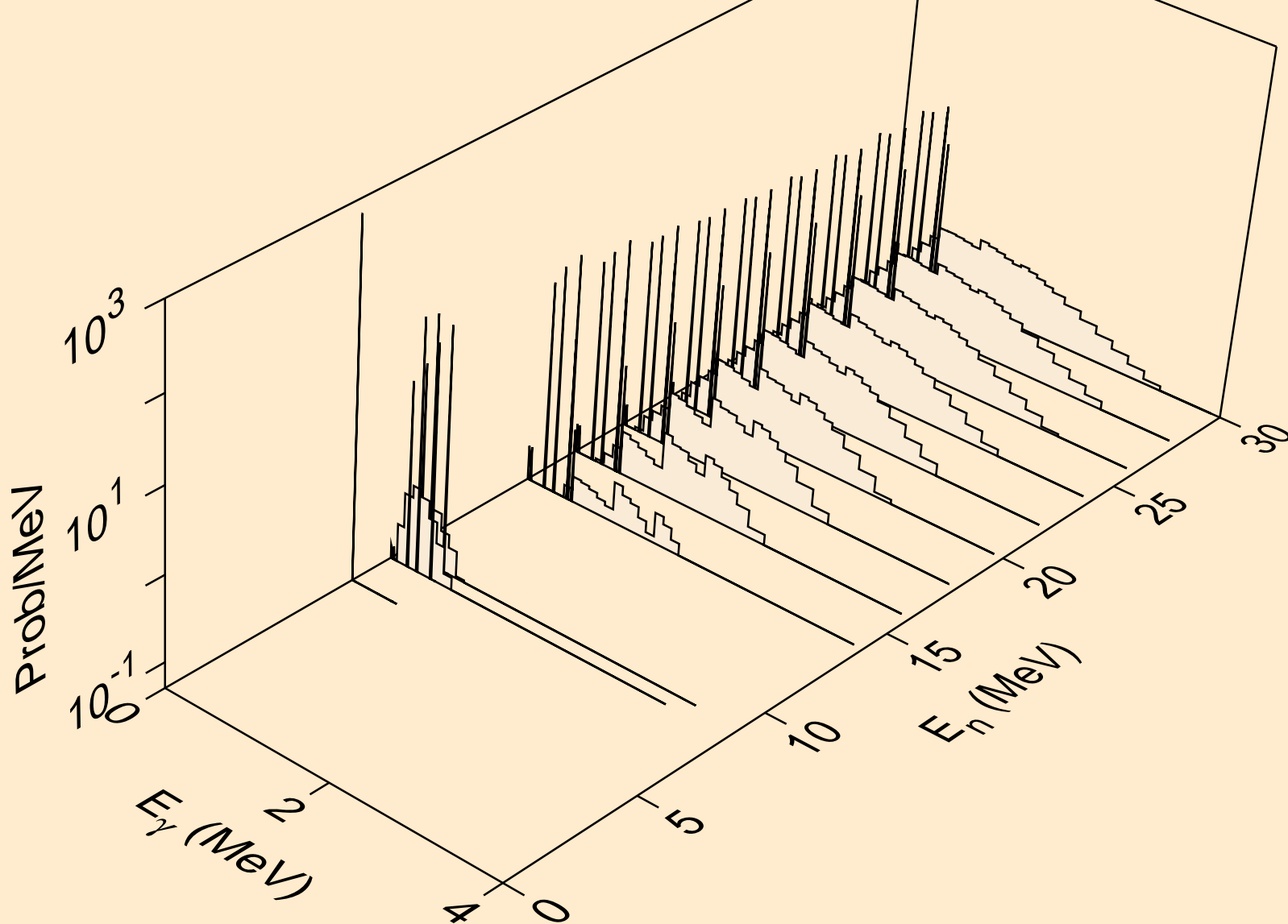

HF159 NEUTRON ACER TENDL-2019 LIBRARY; T=293.16K  
Photon emission for (n,npa)

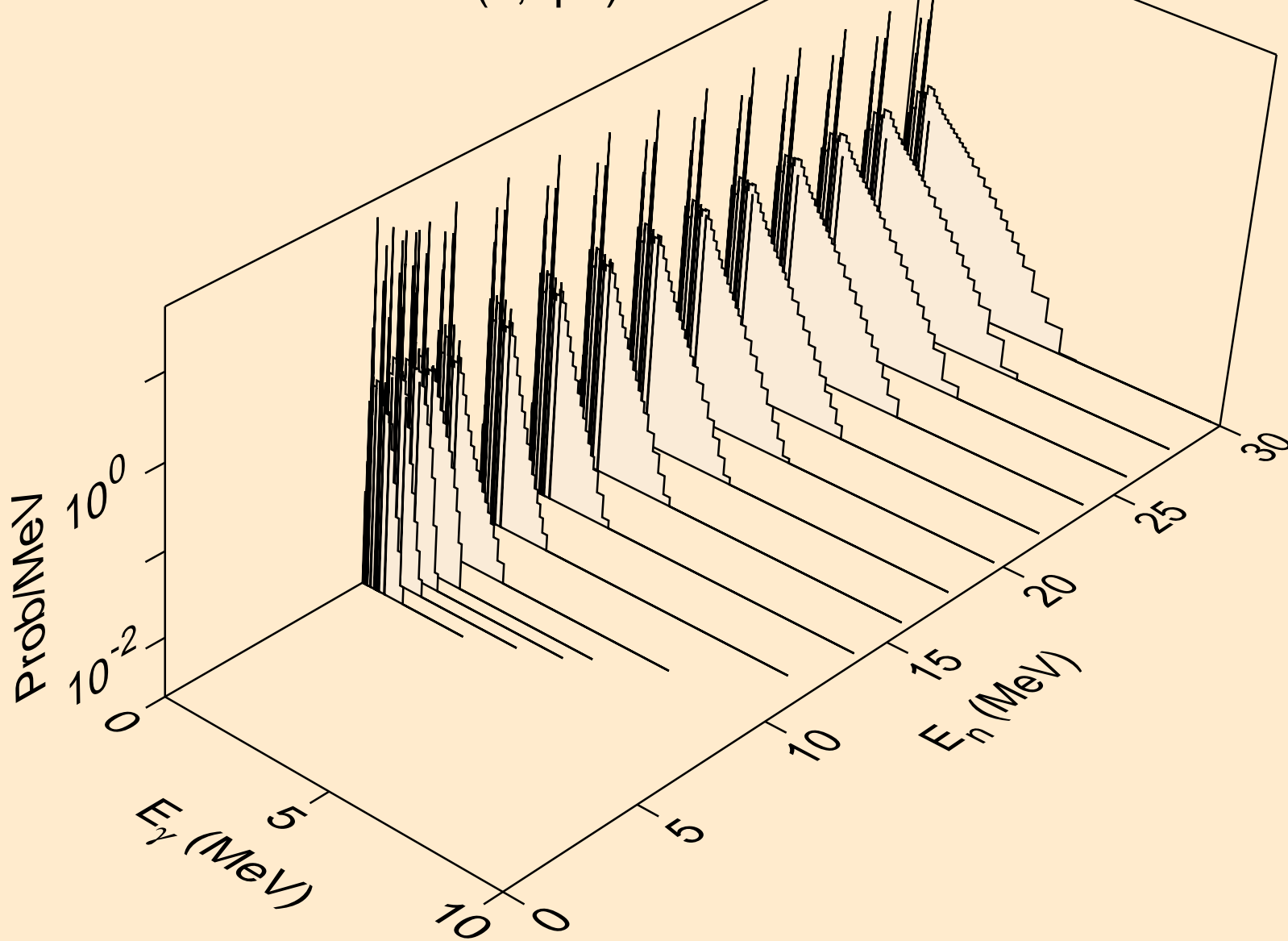

HF159 NEUTRON ACER TENDL-2019 LIBRARY; T=293.16K  
Photon emission for (n,n\*c)

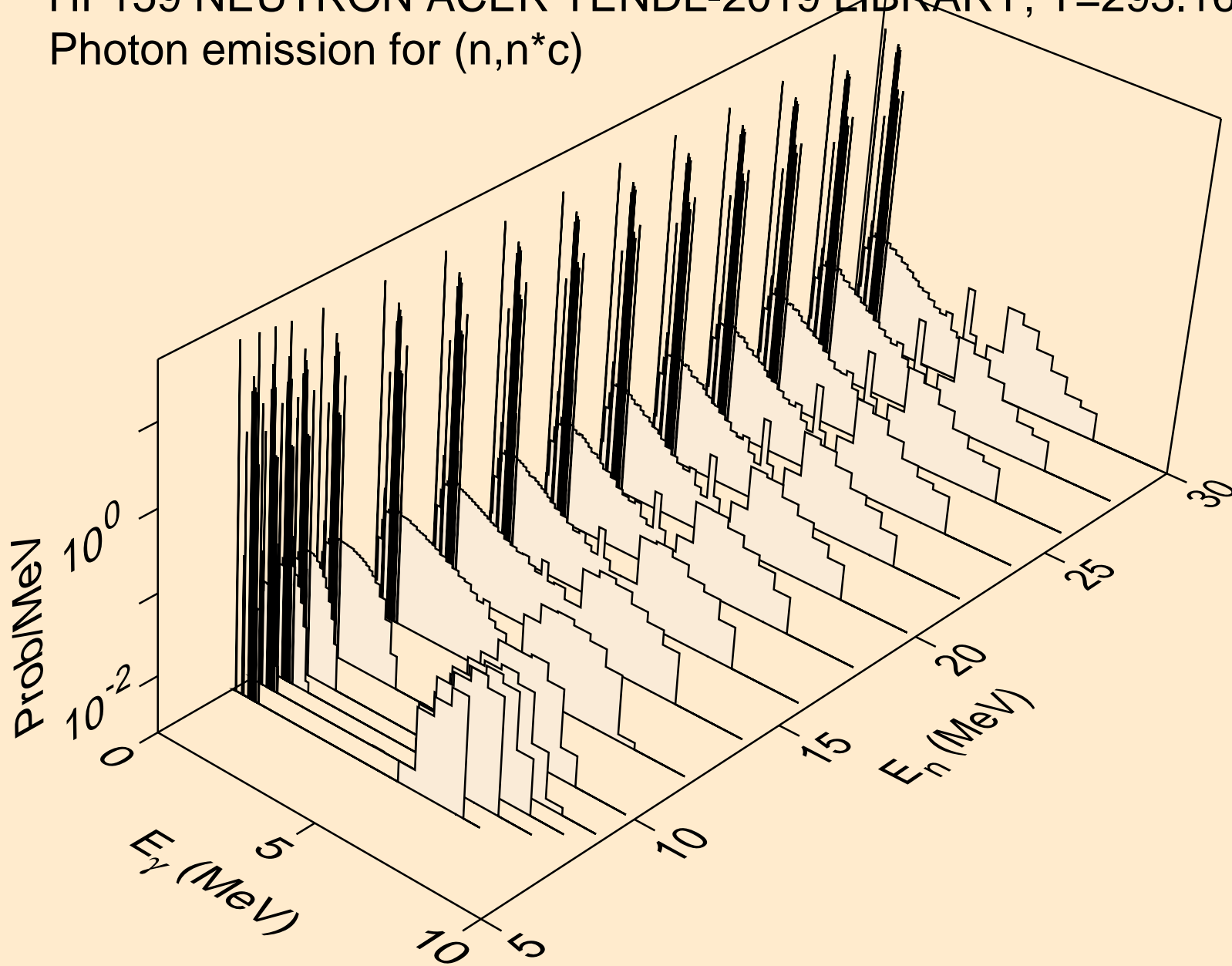

HF159 NEUTRON ACER TENDL-2019 LIBRARY; T=293.16K  
Photon emission for (n,gma)

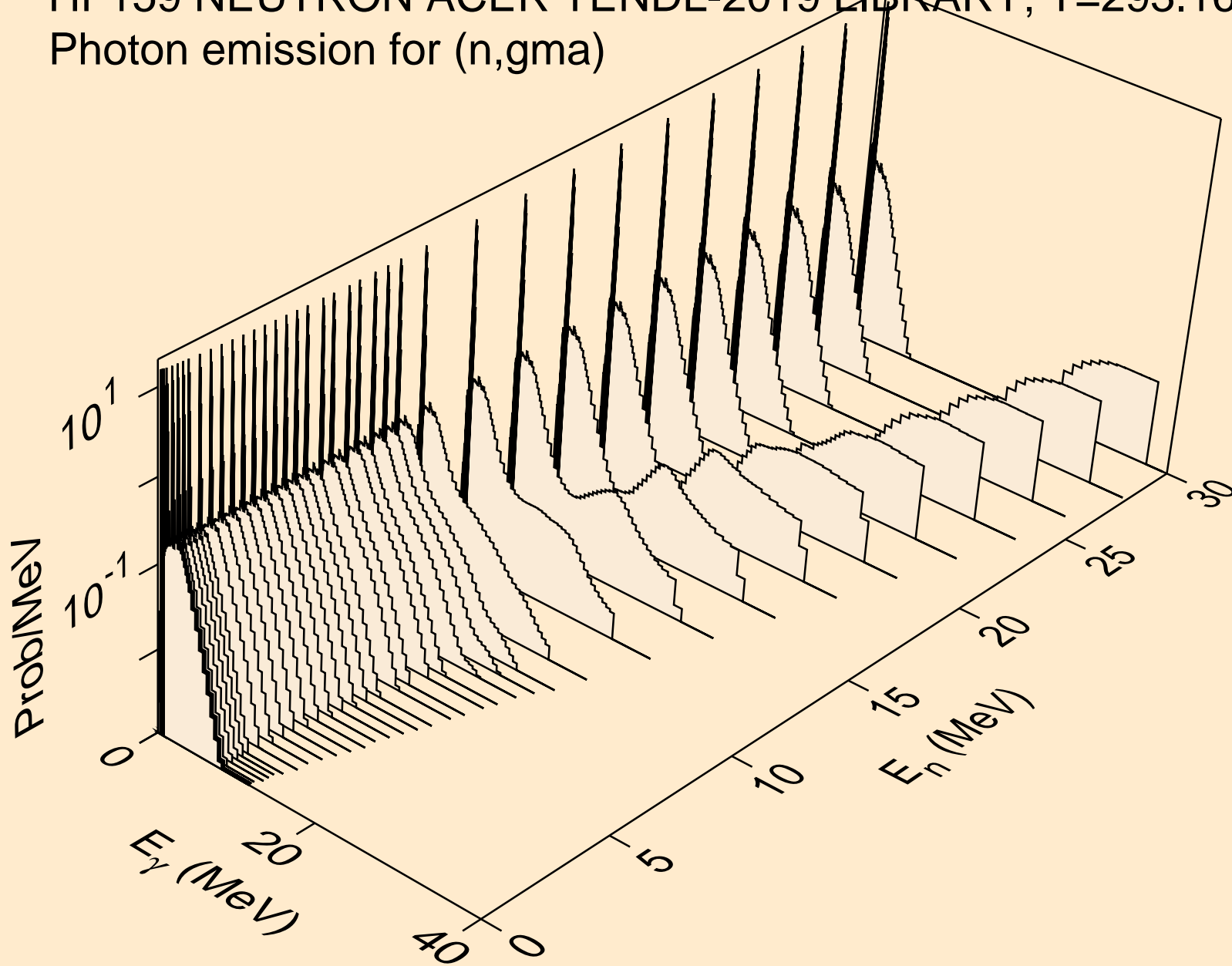

HF159 NEUTRON ACER TENDL-2019 LIBRARY; T=293.16K  
Photon emission for (n,p)

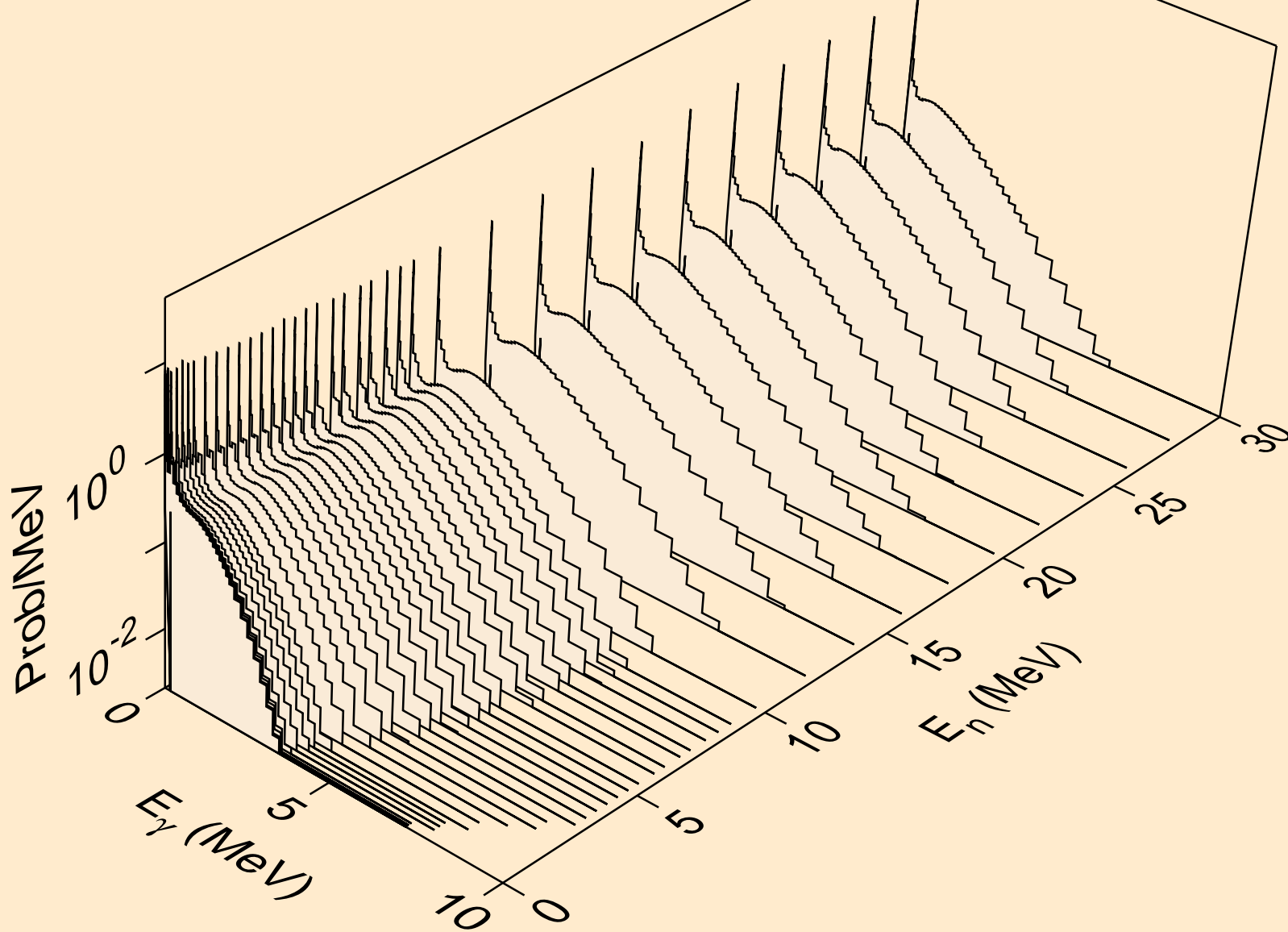



HF159 NEUTRON ACER TENDL-2019 LIBRARY; T=293.16K  
Photon emission for (n,d)

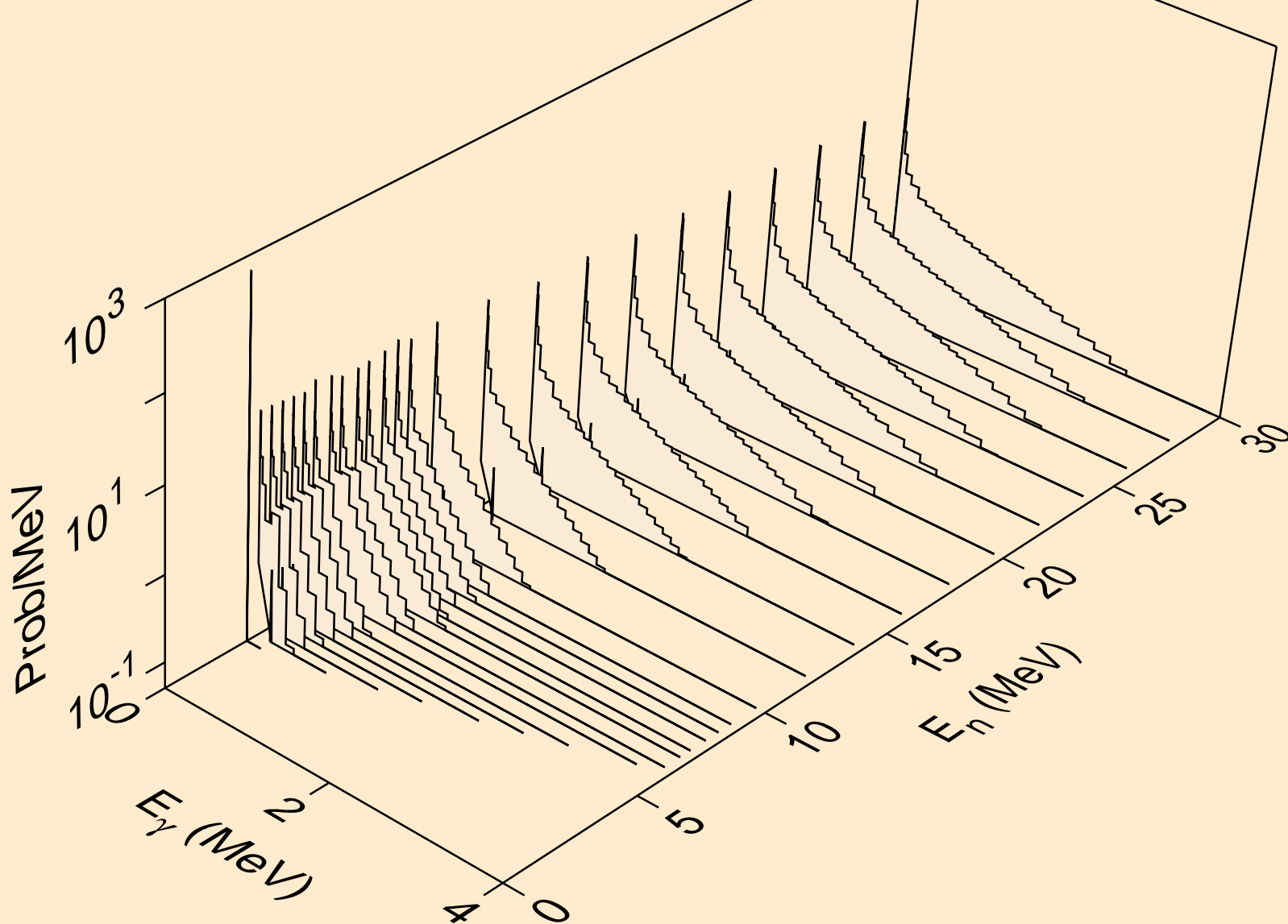

HF159 NEUTRON ACER TENDL-2019 LIBRARY; T=293.16K  
Photon emission for (n,t)

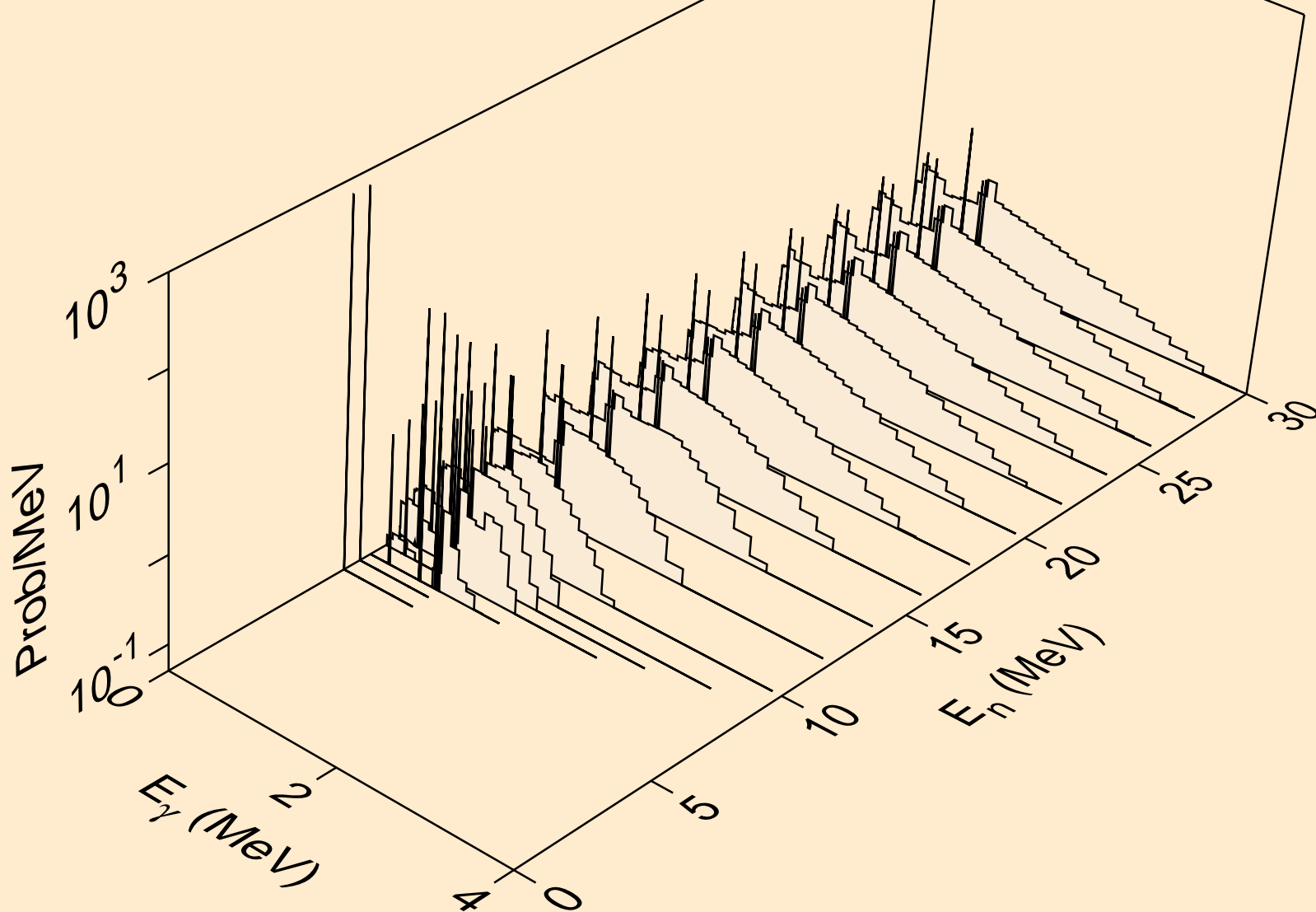

HF159 NEUTRON ACER TENDL-2019 LIBRARY; T=293.16K  
Photon emission for (n,he3)

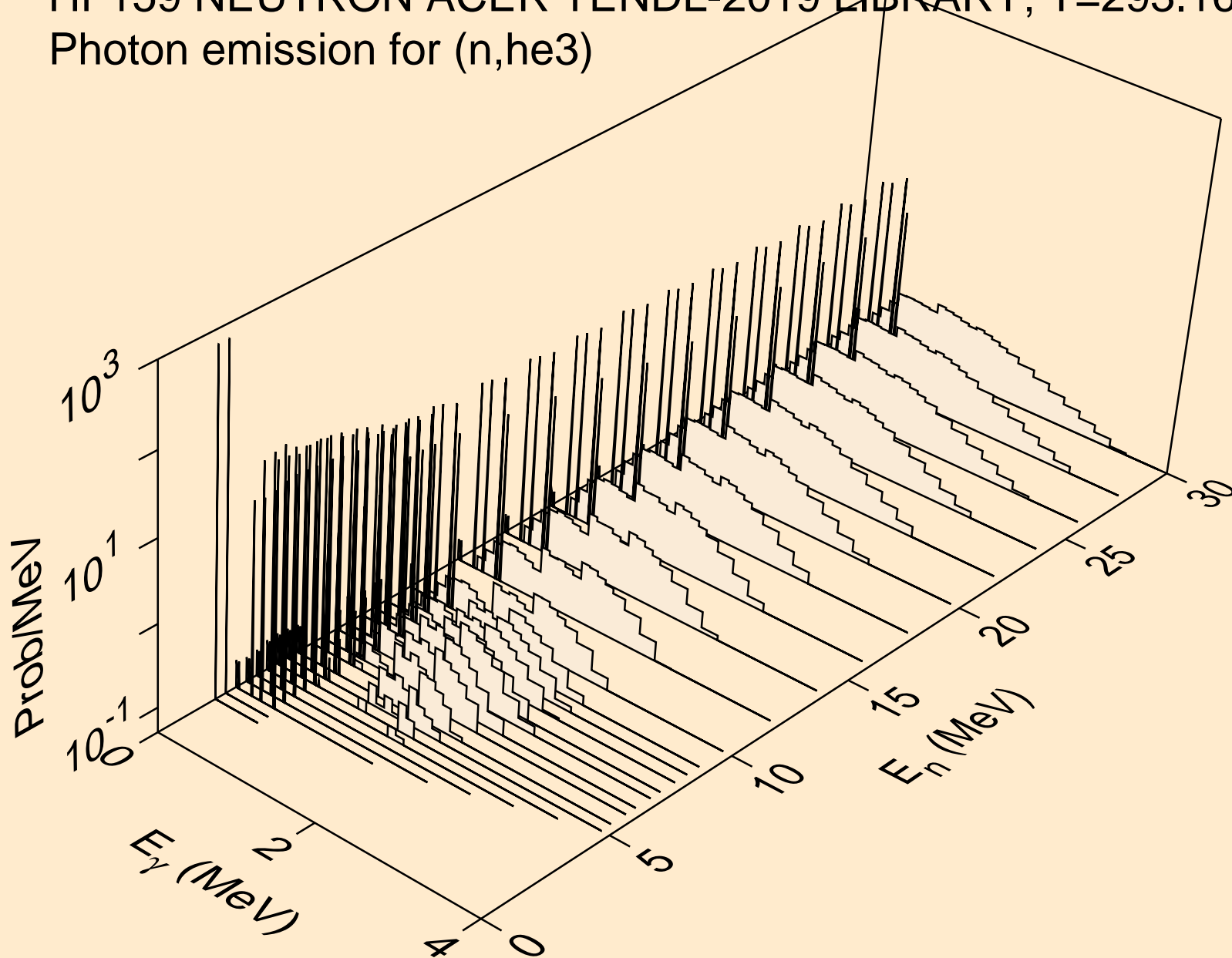

HF159 NEUTRON ACER TENDL-2019 LIBRARY; T=293.16K  
Photon emission for (n,a)

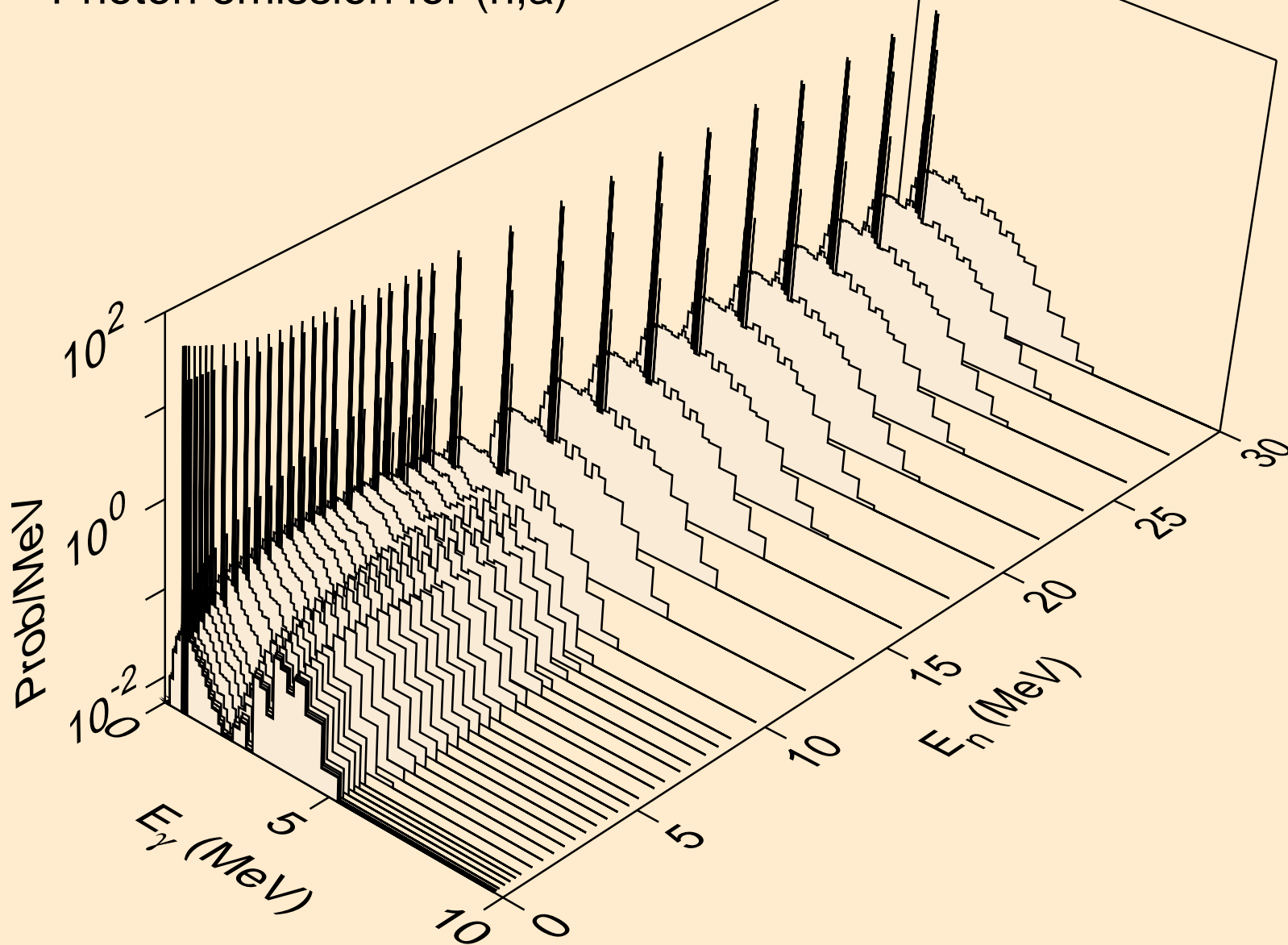

HF159 NEUTRON ACER TENDL-2019 LIBRARY; T=293.16K  
Photon emission for (n,2a)

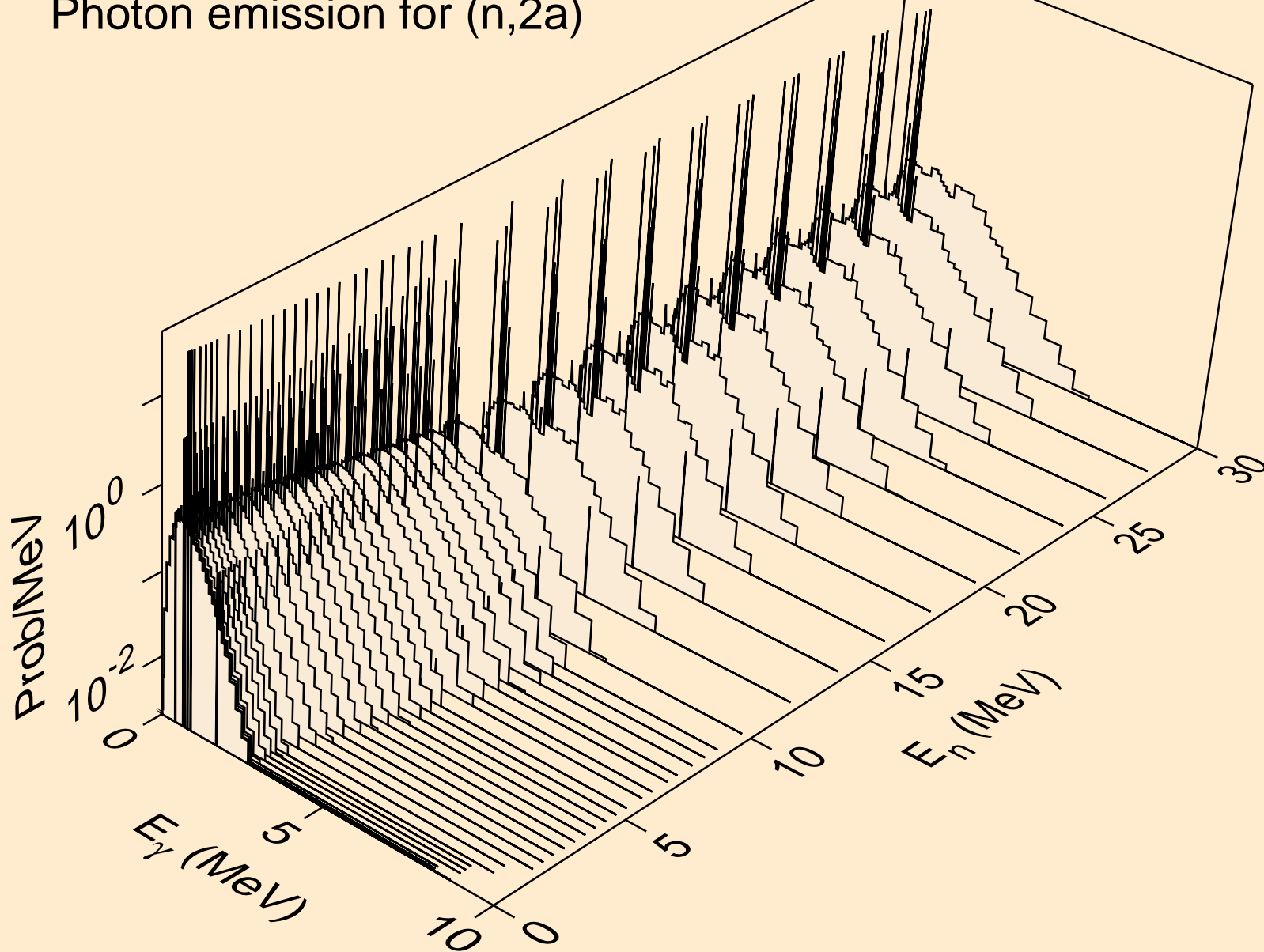

HF159 NEUTRON ACER TENDL-2019 LIBRARY; T=293.16K  
Photon emission for (n,3a)

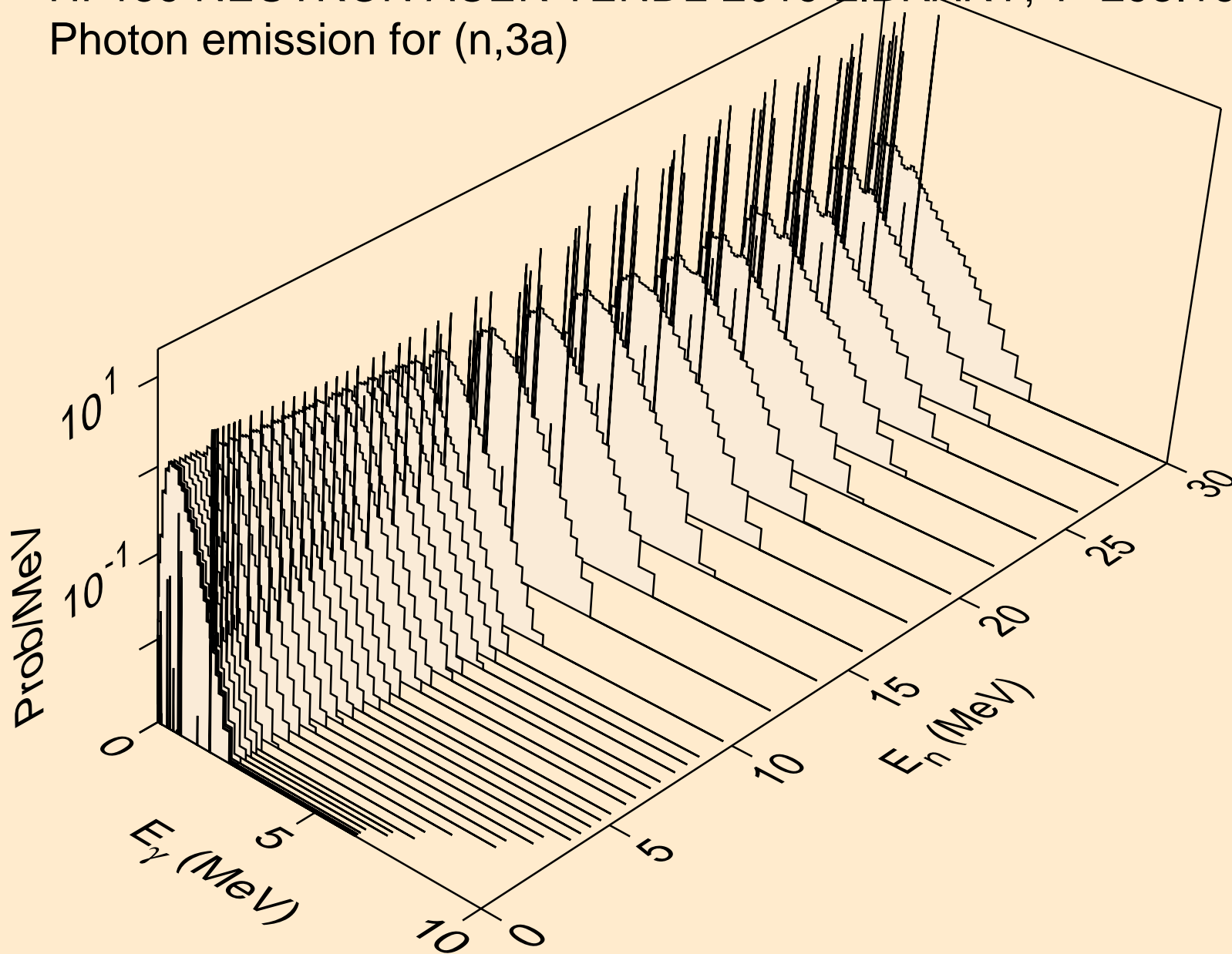

HF159 NEUTRON ACER TENDL-2019 LIBRARY; T=293.16K  
Photon emission for (n,2p)

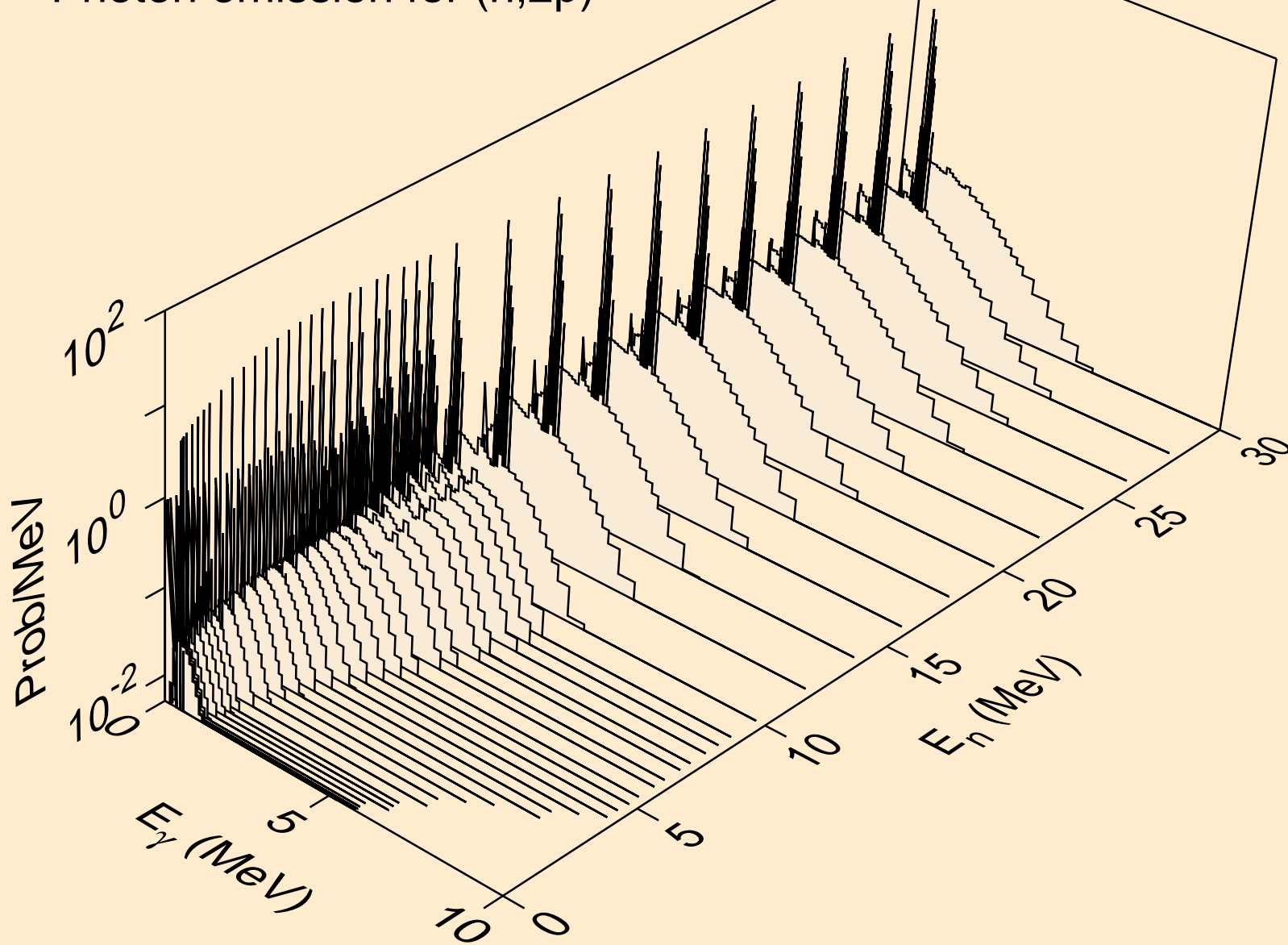

HF159 NEUTRON ACER TENDL-2019 LIBRARY; T=293.16K  
Photon emission for (n,p $\alpha$ )

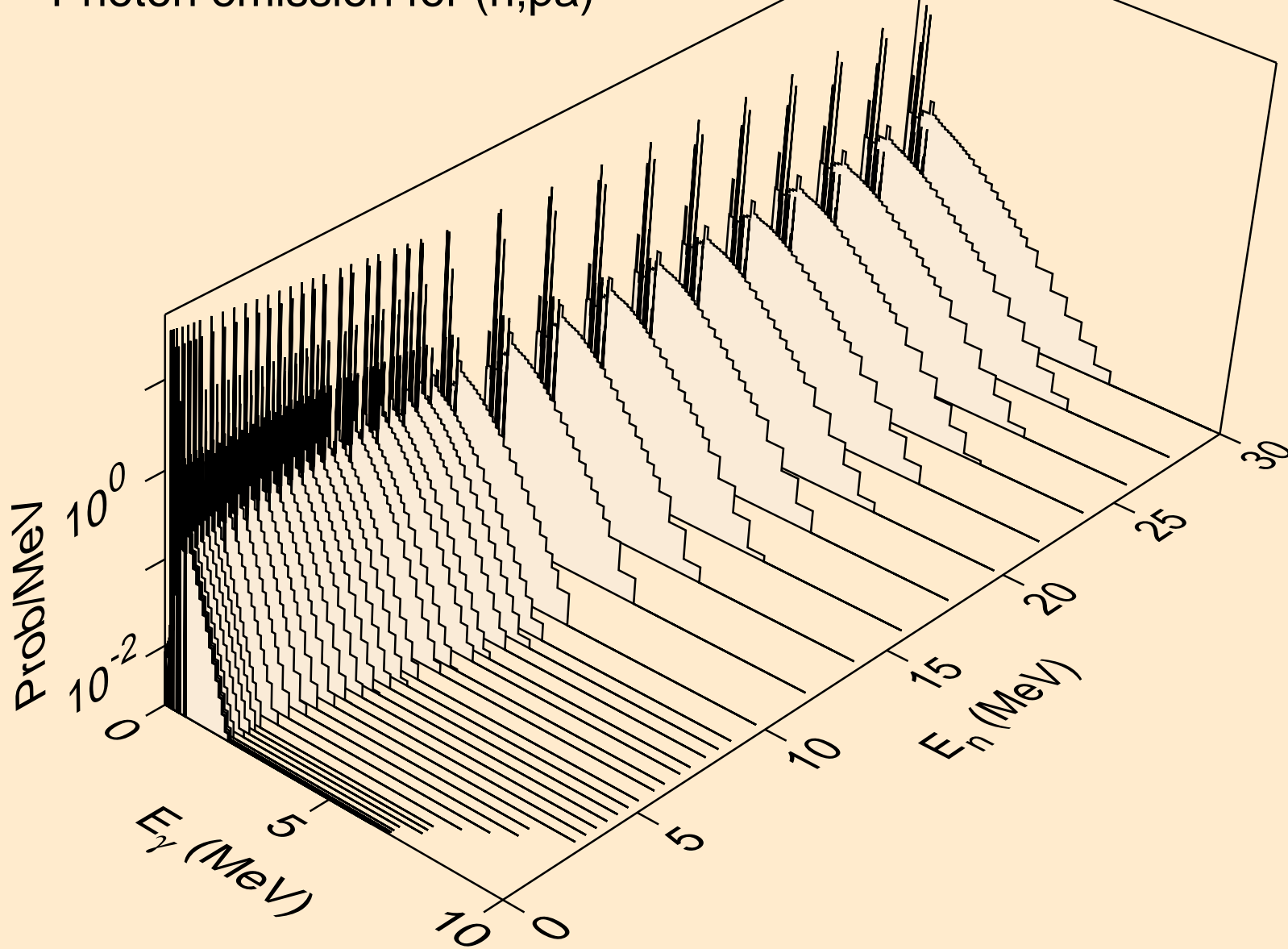



HF159 NEUTRON ACER TENDL-2019 LIBRARY; T=293.16K  
Photon emission for (n,t2a)

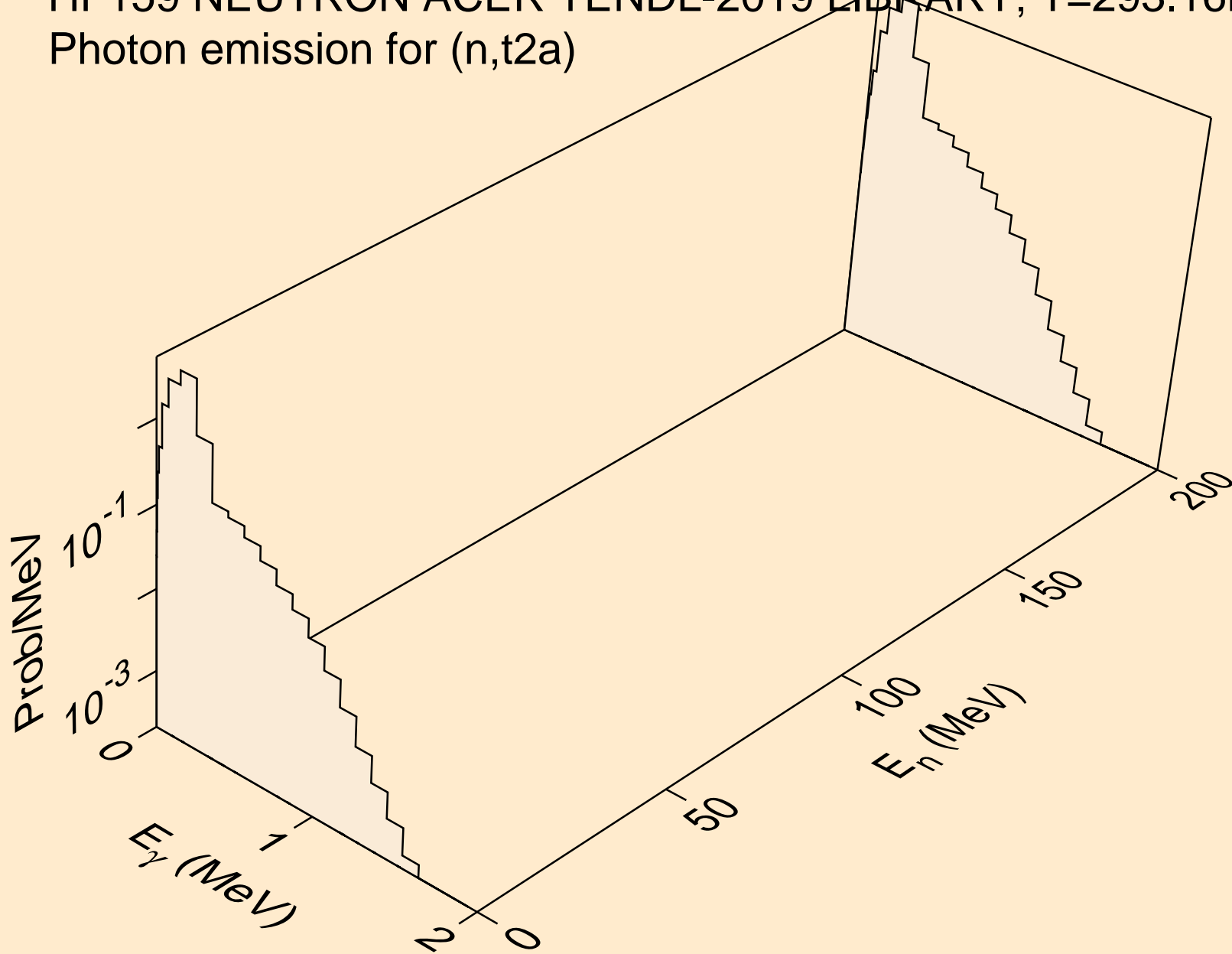

HF159 NEUTRON ACER TENDL-2019 LIBRARY; T=293.16K  
Photon emission for (n,d2a)

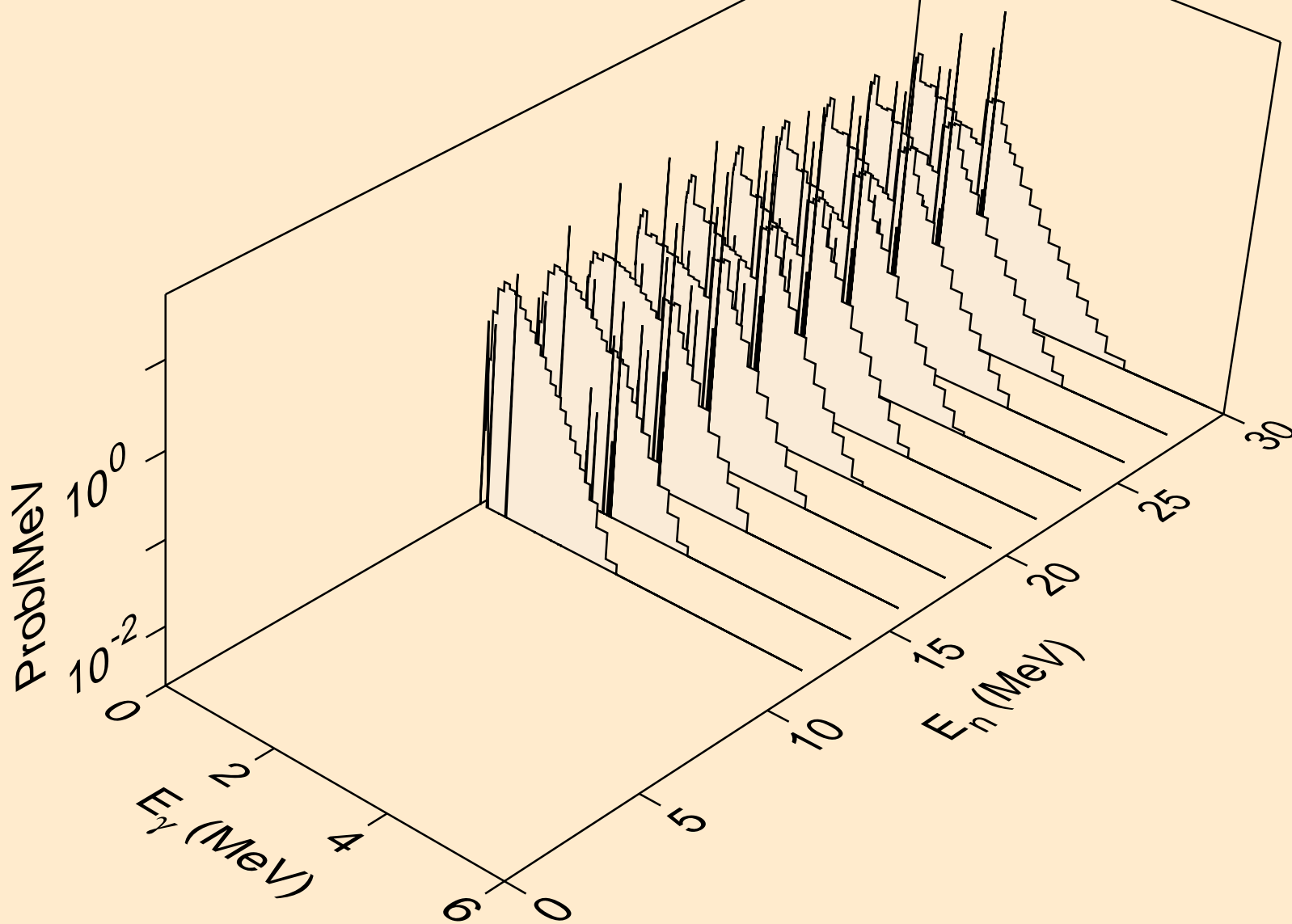

HF159 NEUTRON ACER TENDL-2019 LIBRARY; T=293.16K  
Photon emission for (n,pd)

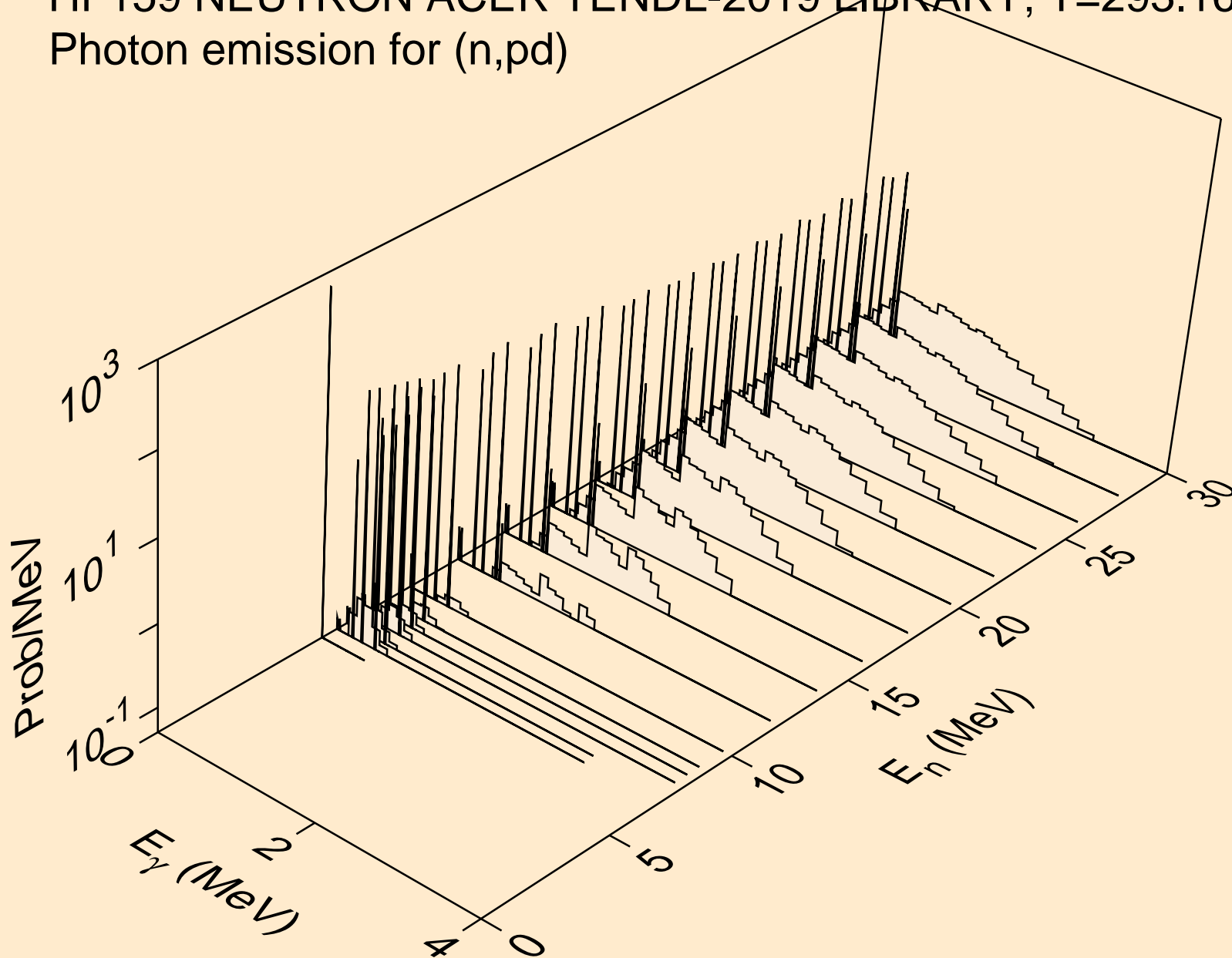

HF159 NEUTRON ACER TENDL-2019 LIBRARY; T=293.16K  
Photon emission for (n,pt)

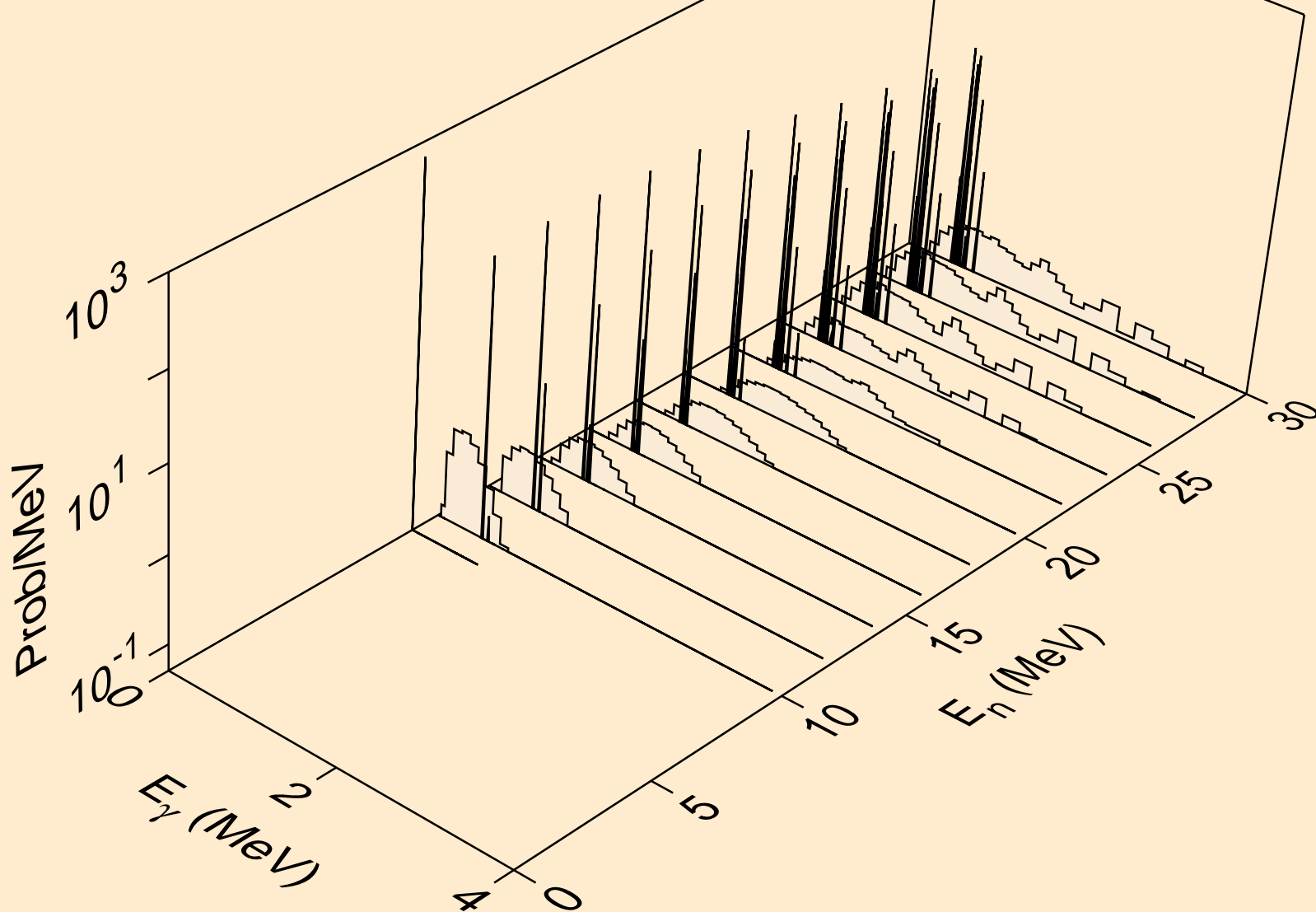

HF159 NEUTRON ACER TENDL-2019 LIBRARY; T=293.16K  
Photon emission for (n,da)

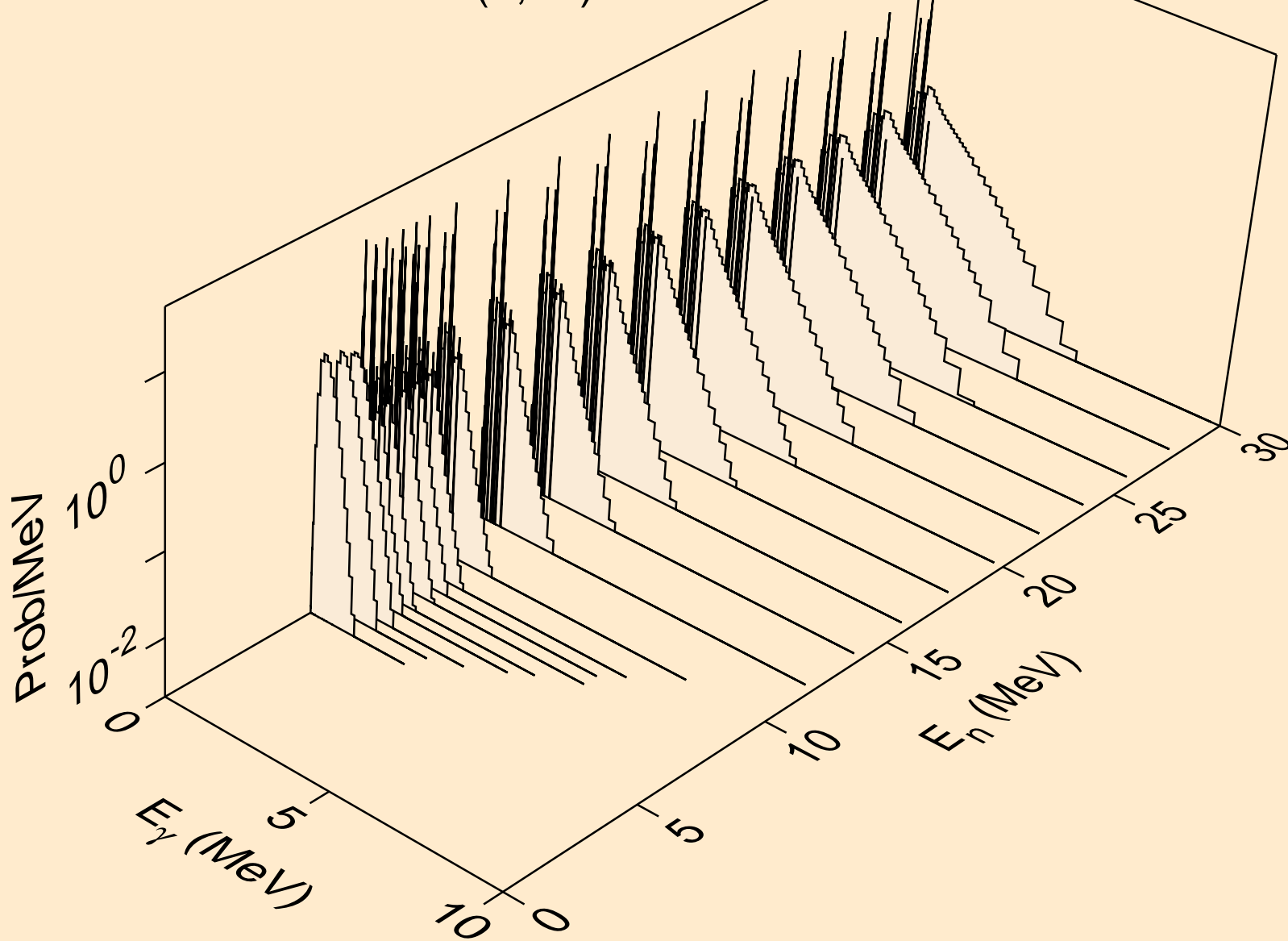

HF159 NEUTRON ACER TENDL-2019 LIBRARY; T=293.16K  
thermal capture photon spectrum

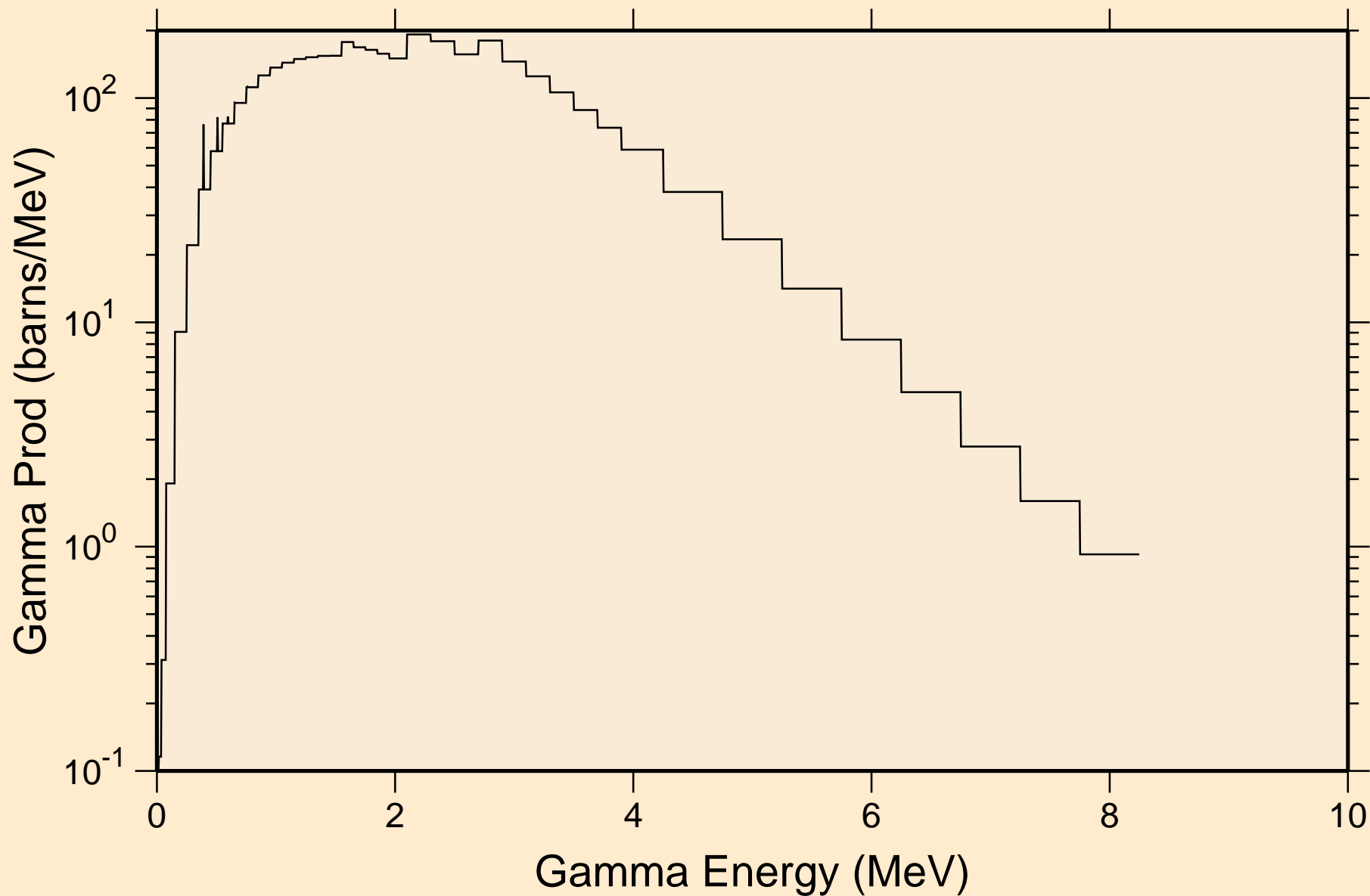

HF159 NEUTRON ACER TENDL-2019 LIBRARY; T=293.16K  
14 MeV photon spectrum

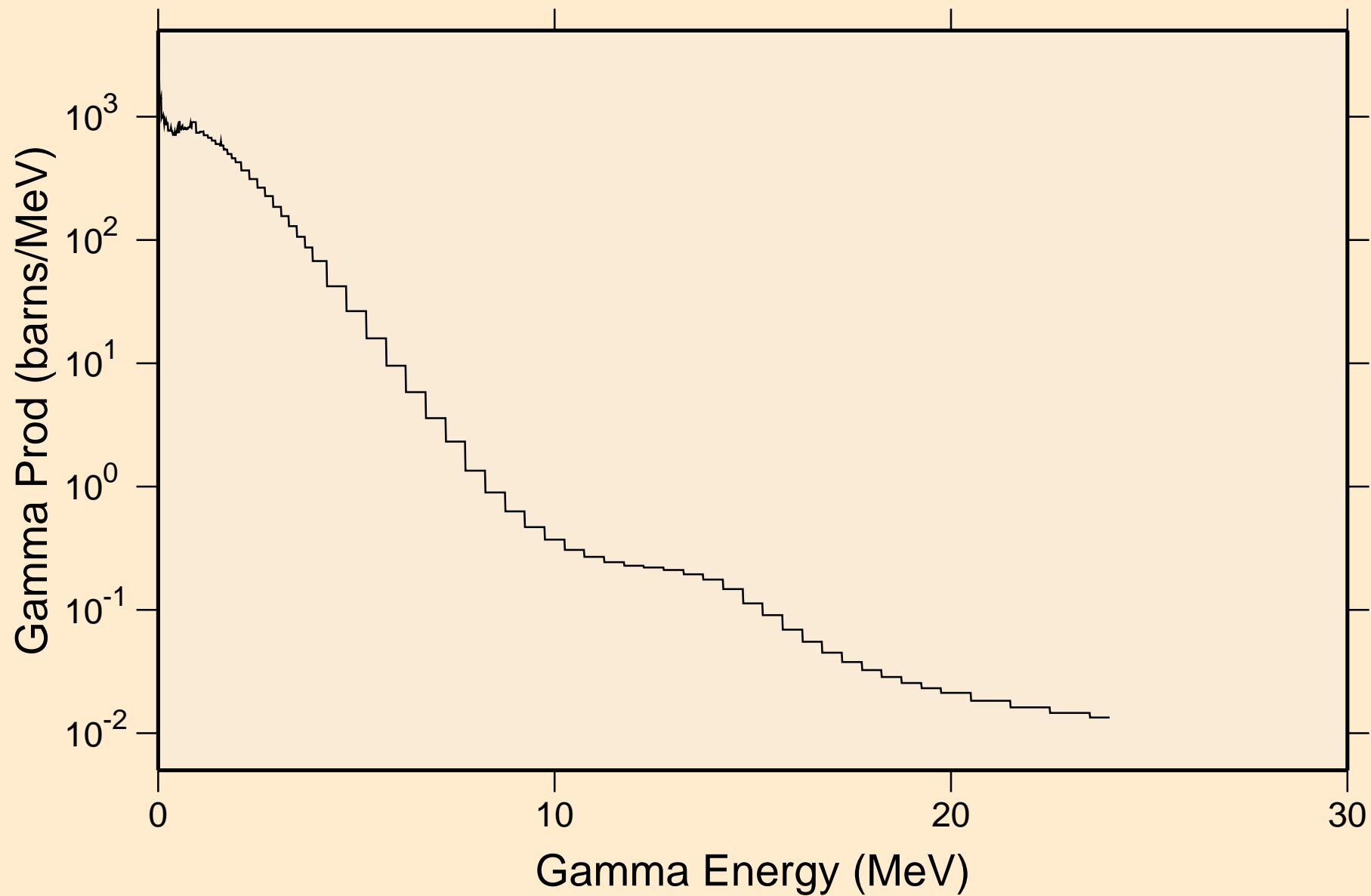

# HF159 NEUTRON ACER TENDL-2019 LIBRARY; T=293.16K

## Particle heating contributions

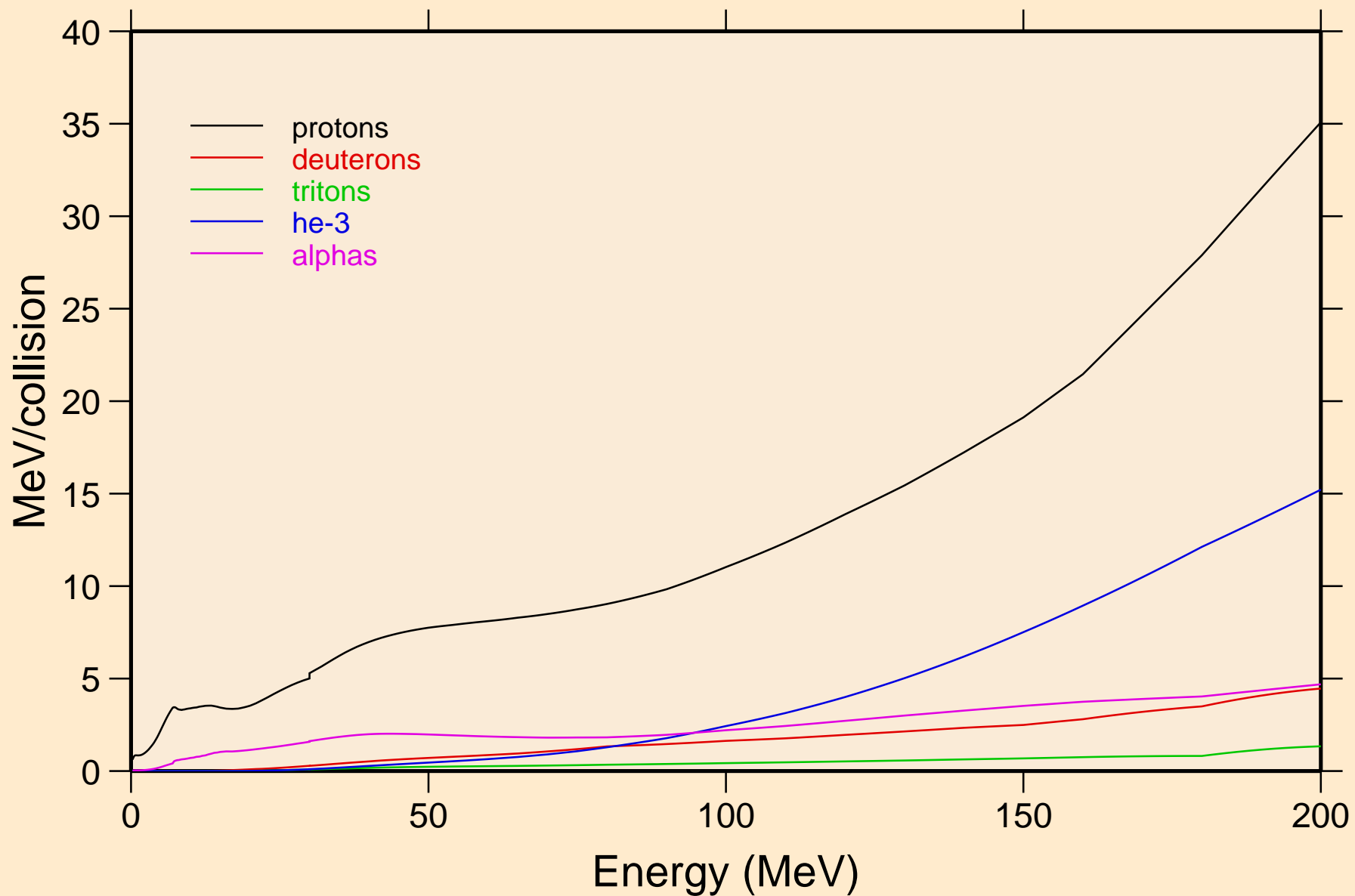



HF159 NEUTRON ACER TENDL-2019 LIBRARY; T=293.16K  
Recoil Heating

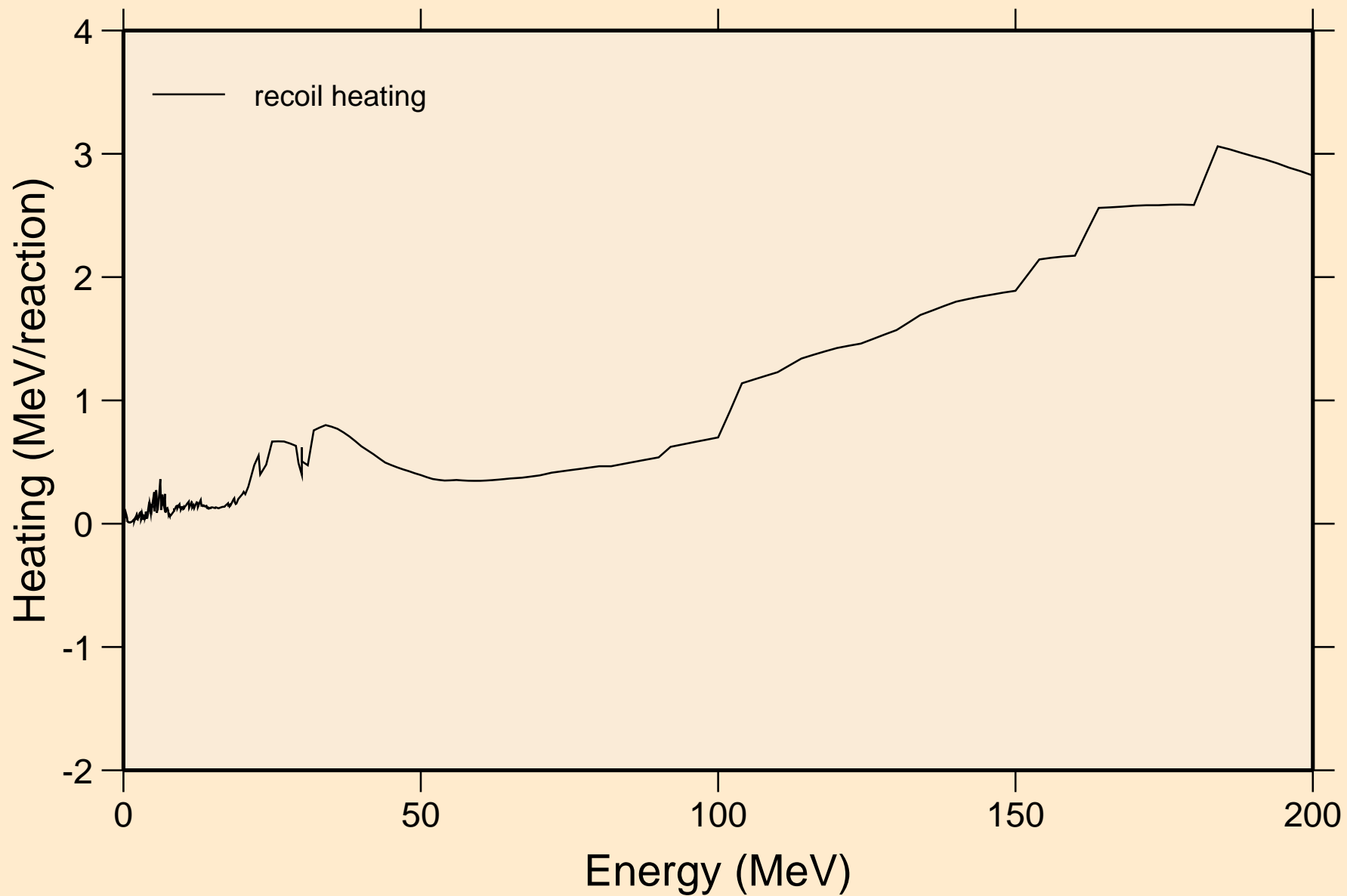

# HF159 NEUTRON ACER TENDL-2019 LIBRARY; T=293.16K

## Particle production cross sections

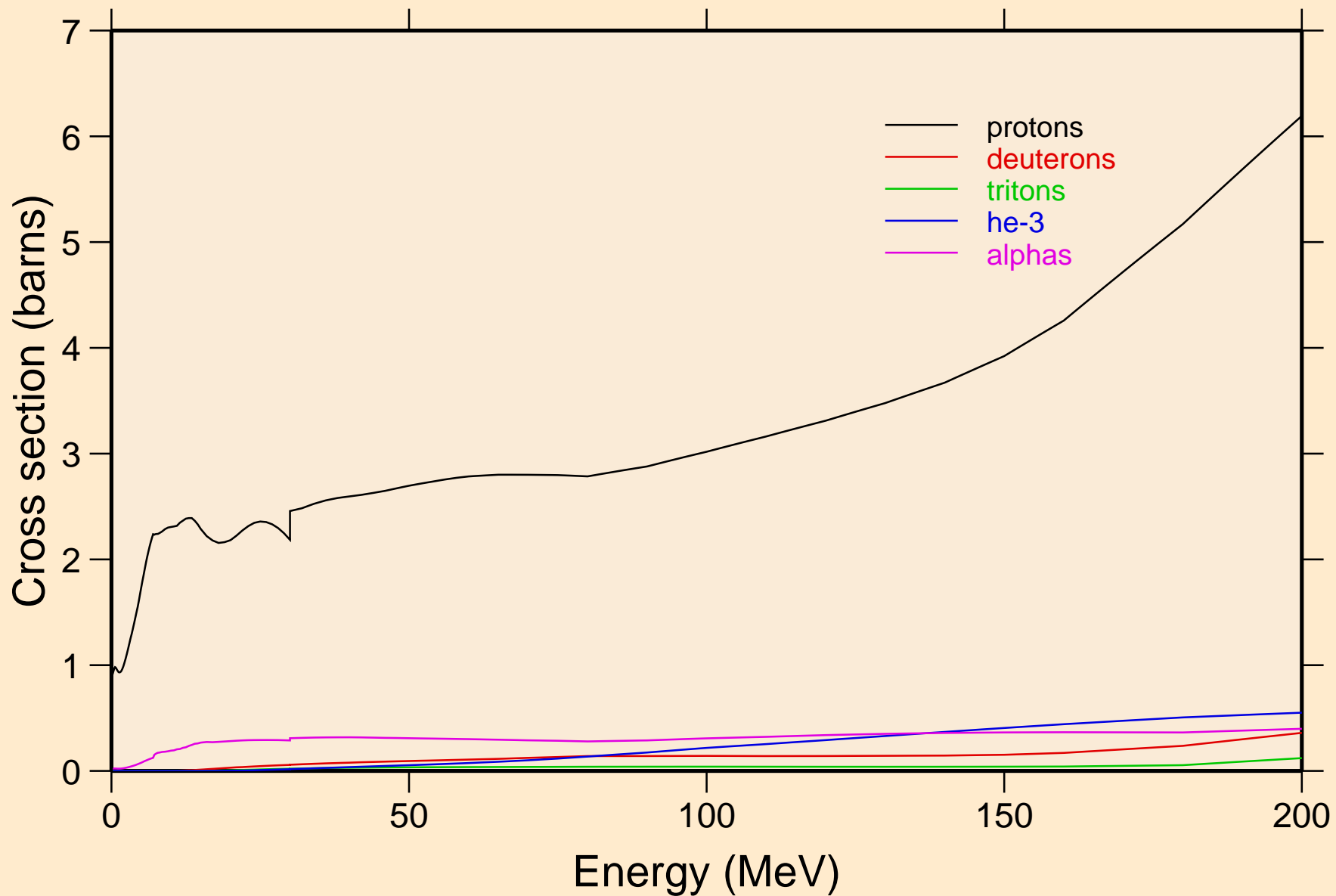

HF159 NEUTRON ACER TENDL-2019 LIBRARY; T=293.16K  
protons from (n,x)

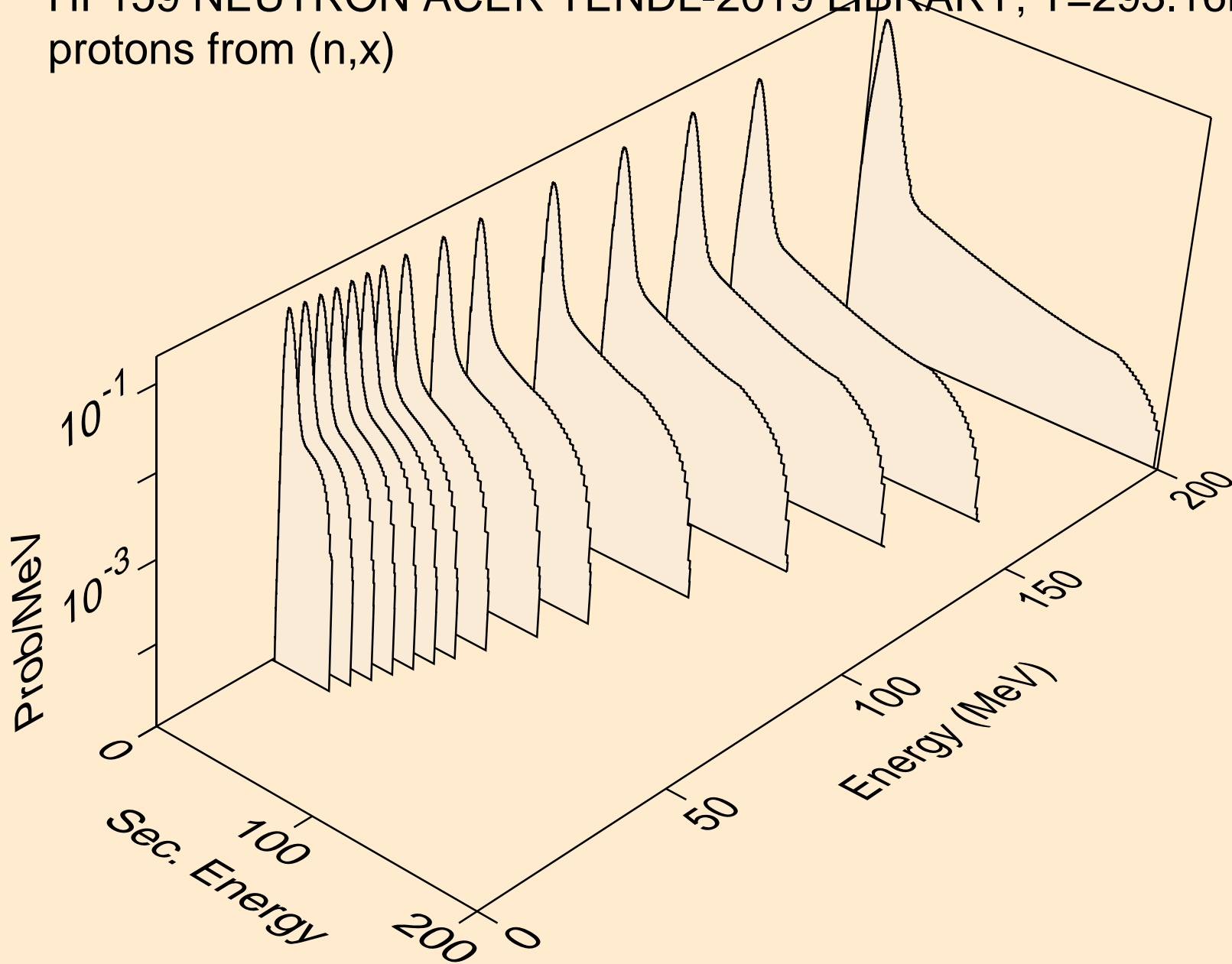

HF159 NEUTRON ACER TENDL-2019 LIBRARY; T=293.16K  
protons from (n,n\*)p

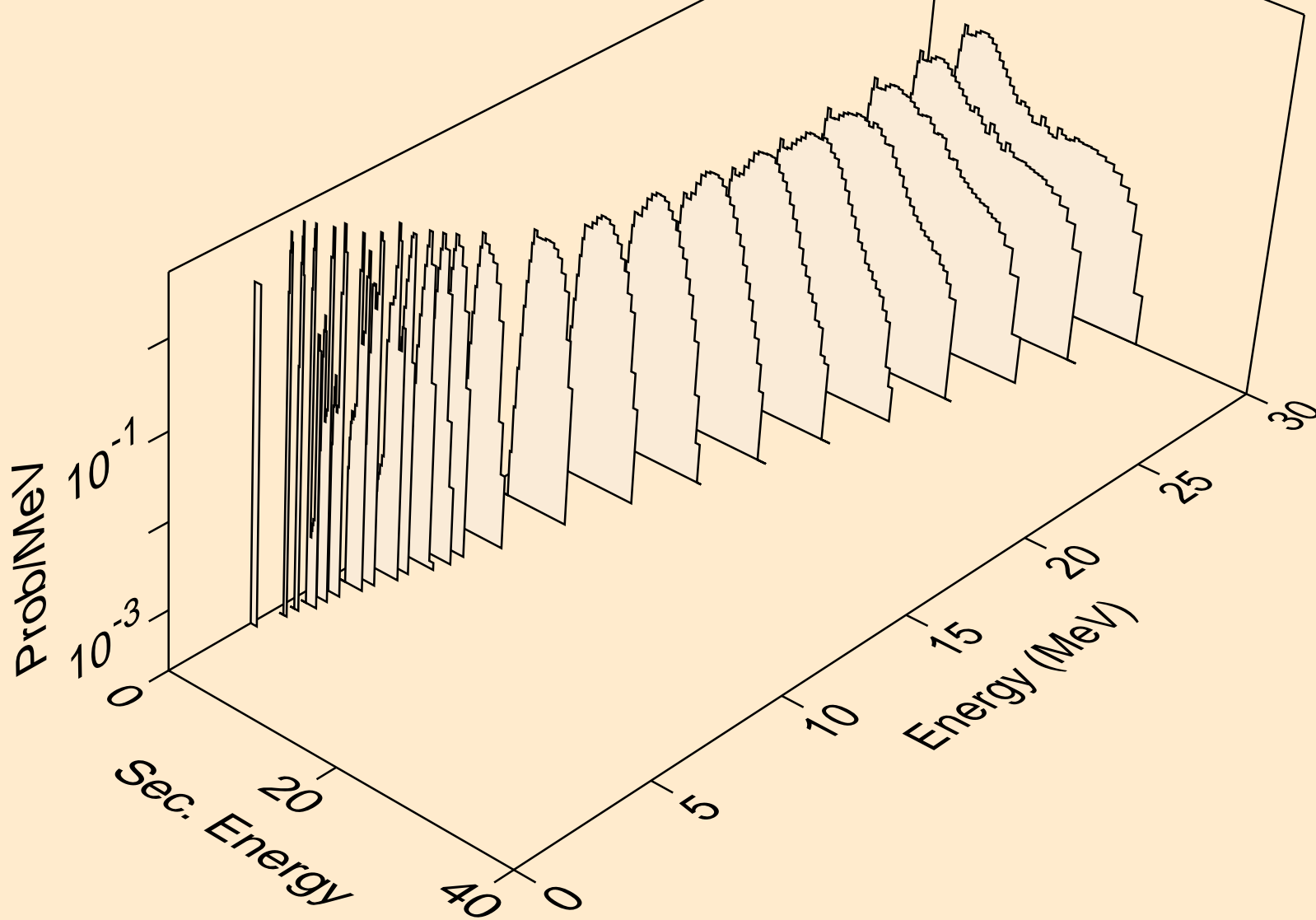

HF159 NEUTRON ACER TENDL-2019 LIBRARY; T=293.16K  
protons from (n,2np)

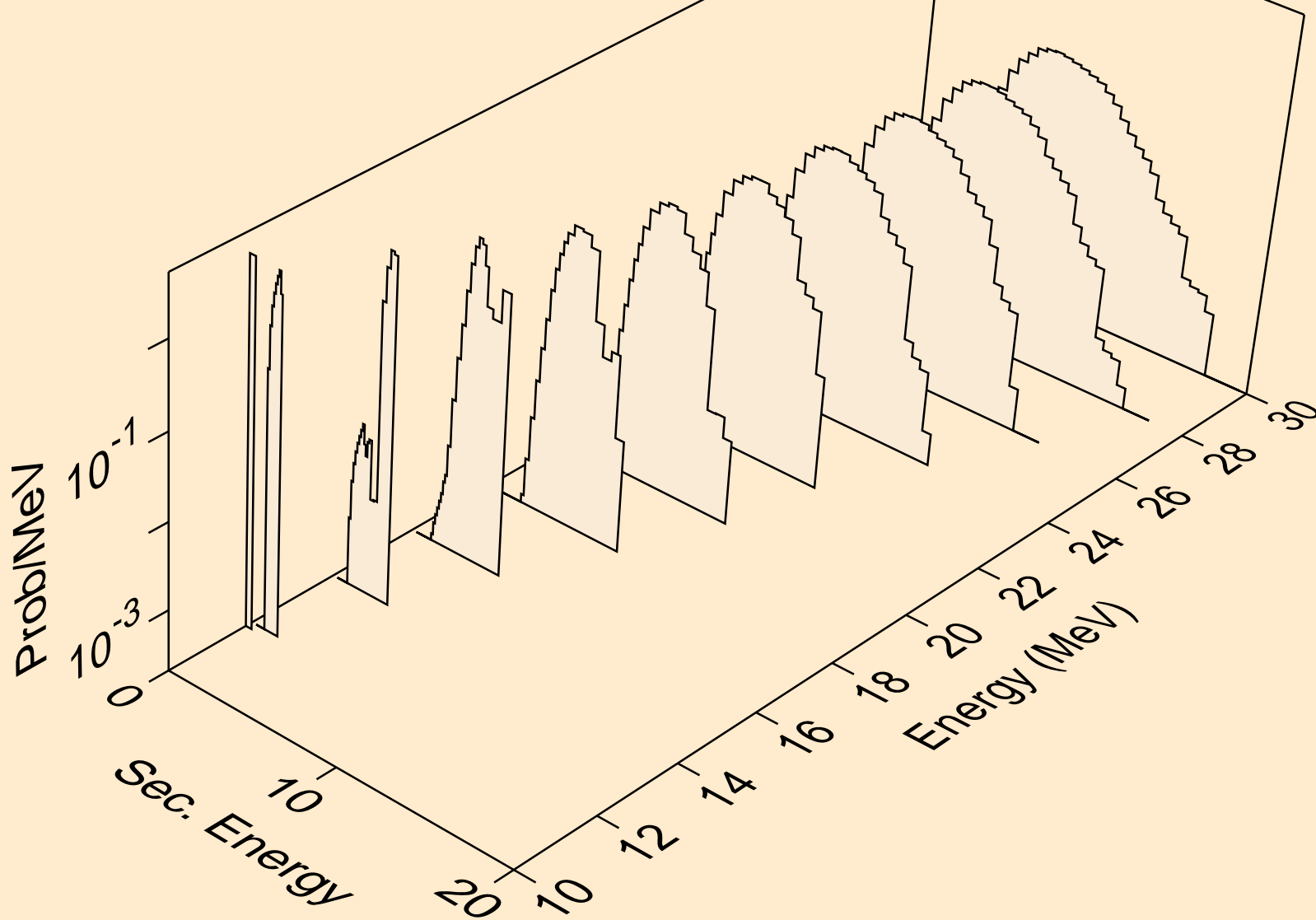

HF159 NEUTRON ACER TENDL-2019 LIBRARY; T=293.16K  
protons from (n,3np)

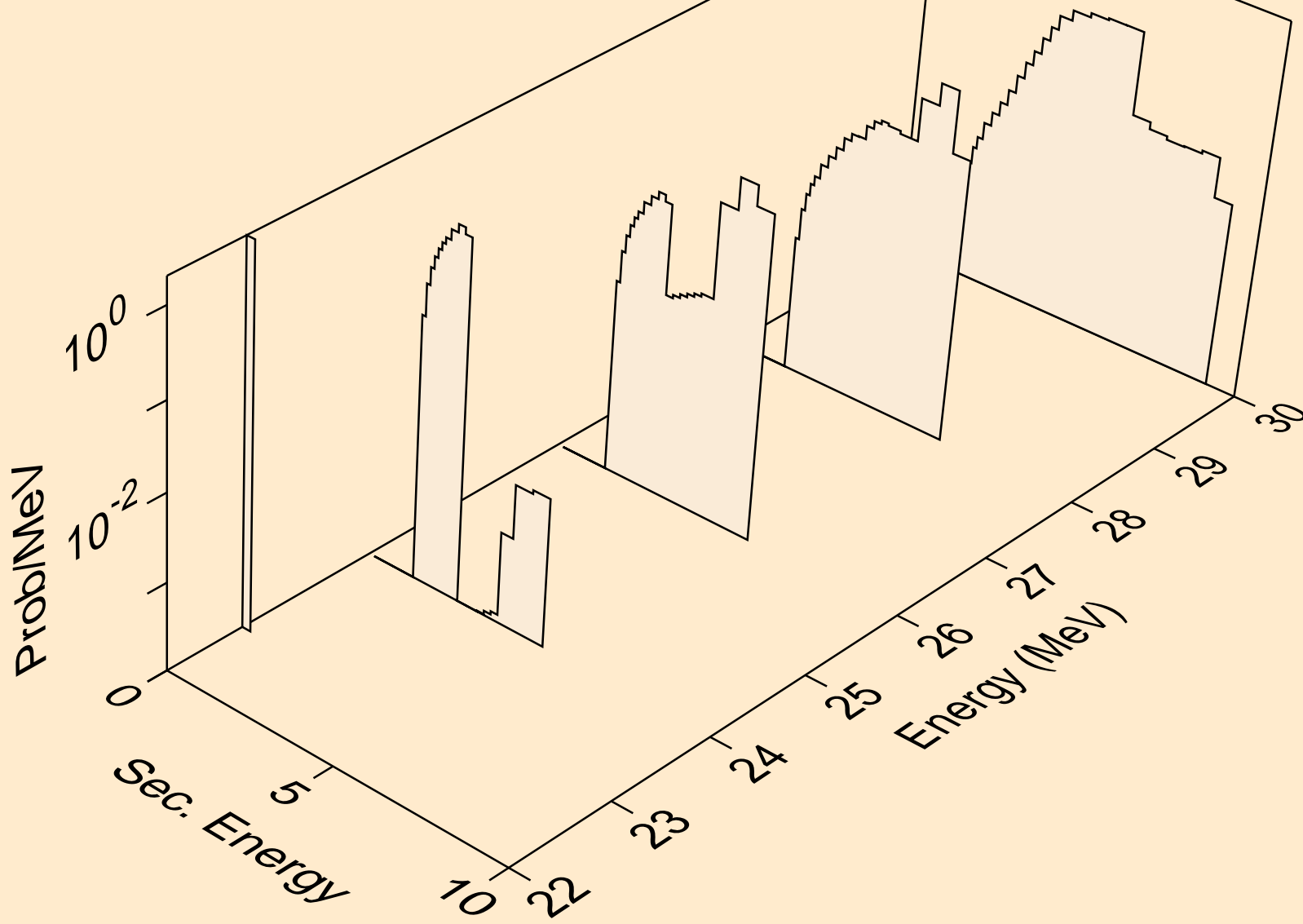

HF159 NEUTRON ACER TENDL-2019 LIBRARY; T=293.16K  
protons from (n,2np)

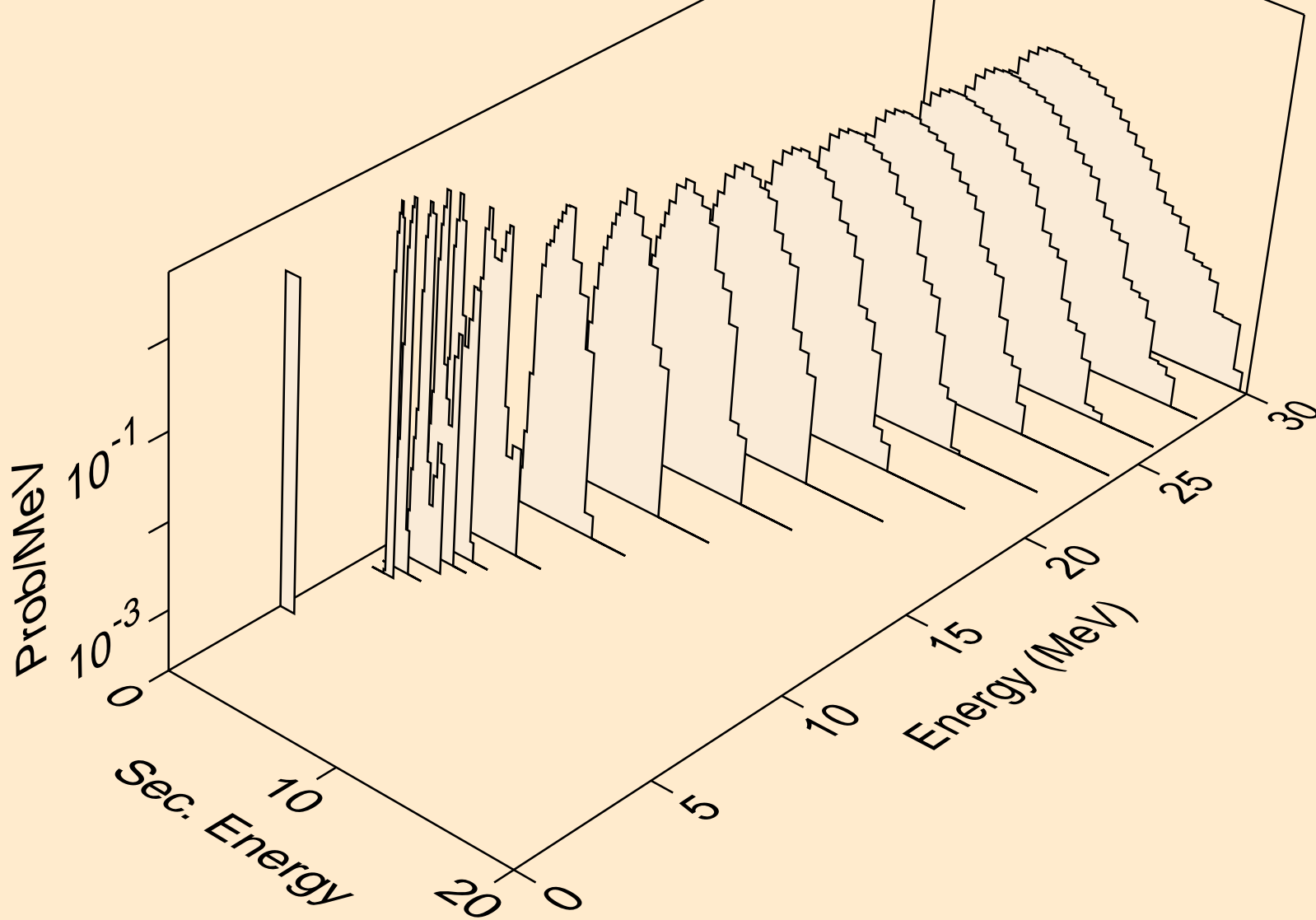

HF159 NEUTRON ACER TENDL-2019 LIBRARY; T=293.16K  
protons from (n,npa)

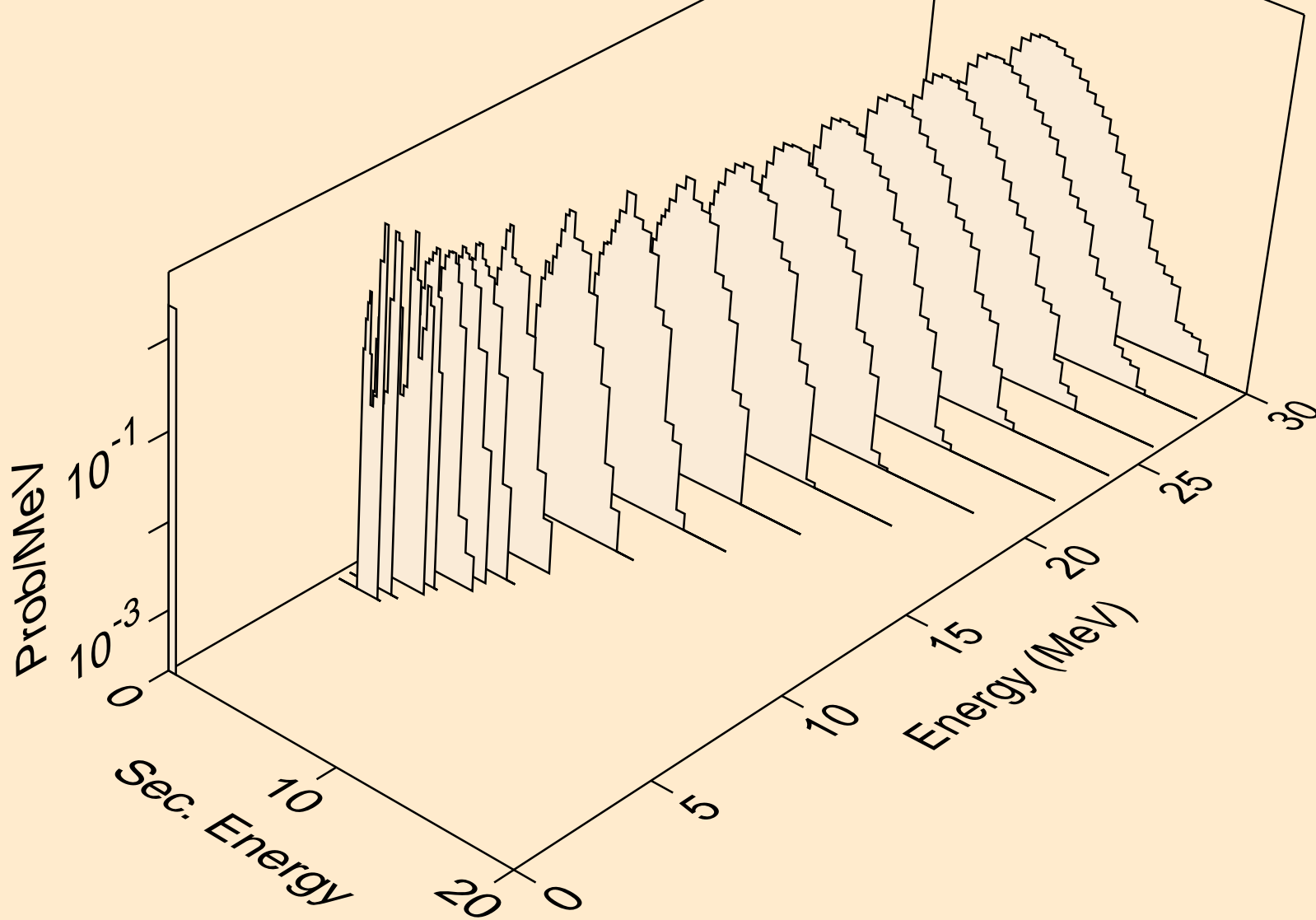



HF159 NEUTRON ACER TENDL-2019 LIBRARY; T=293.16K  
protons from (n,p)

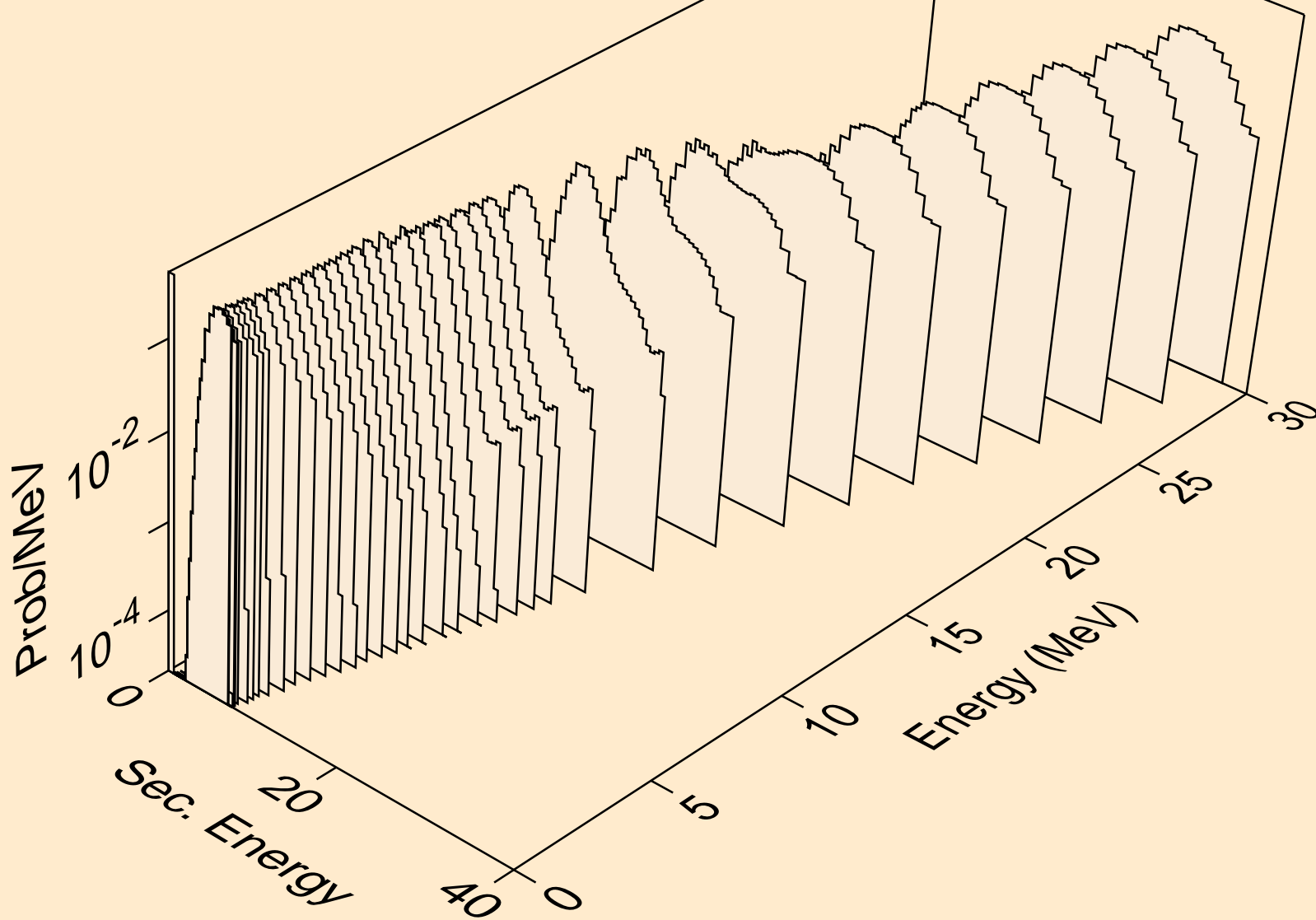

HF159 NEUTRON ACER TENDL-2019 LIBRARY; T=293.16K  
protons from (n,2p)

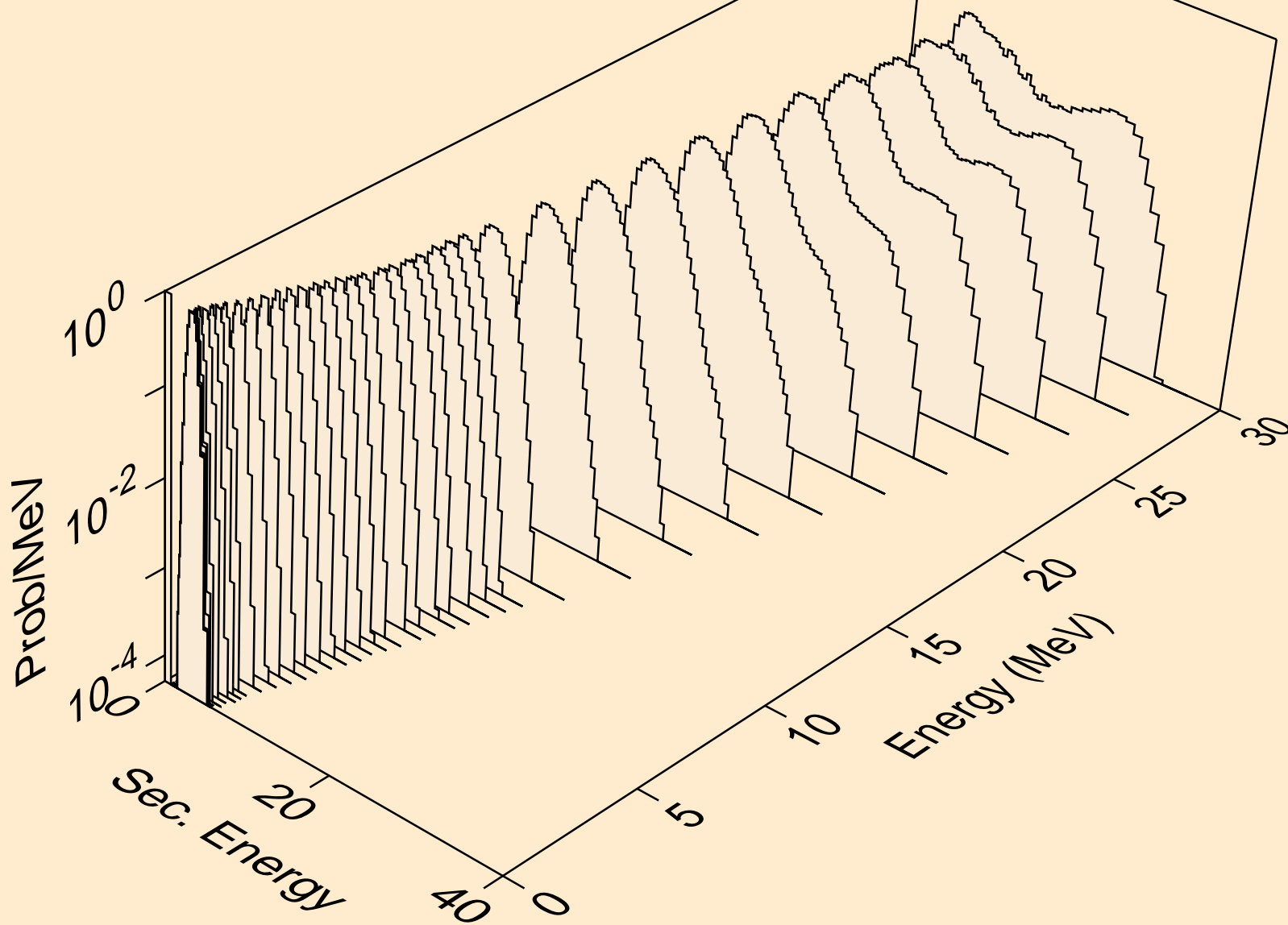

HF159 NEUTRON ACER TENDL-2019 LIBRARY; T=293.16K  
protons from (n,p)

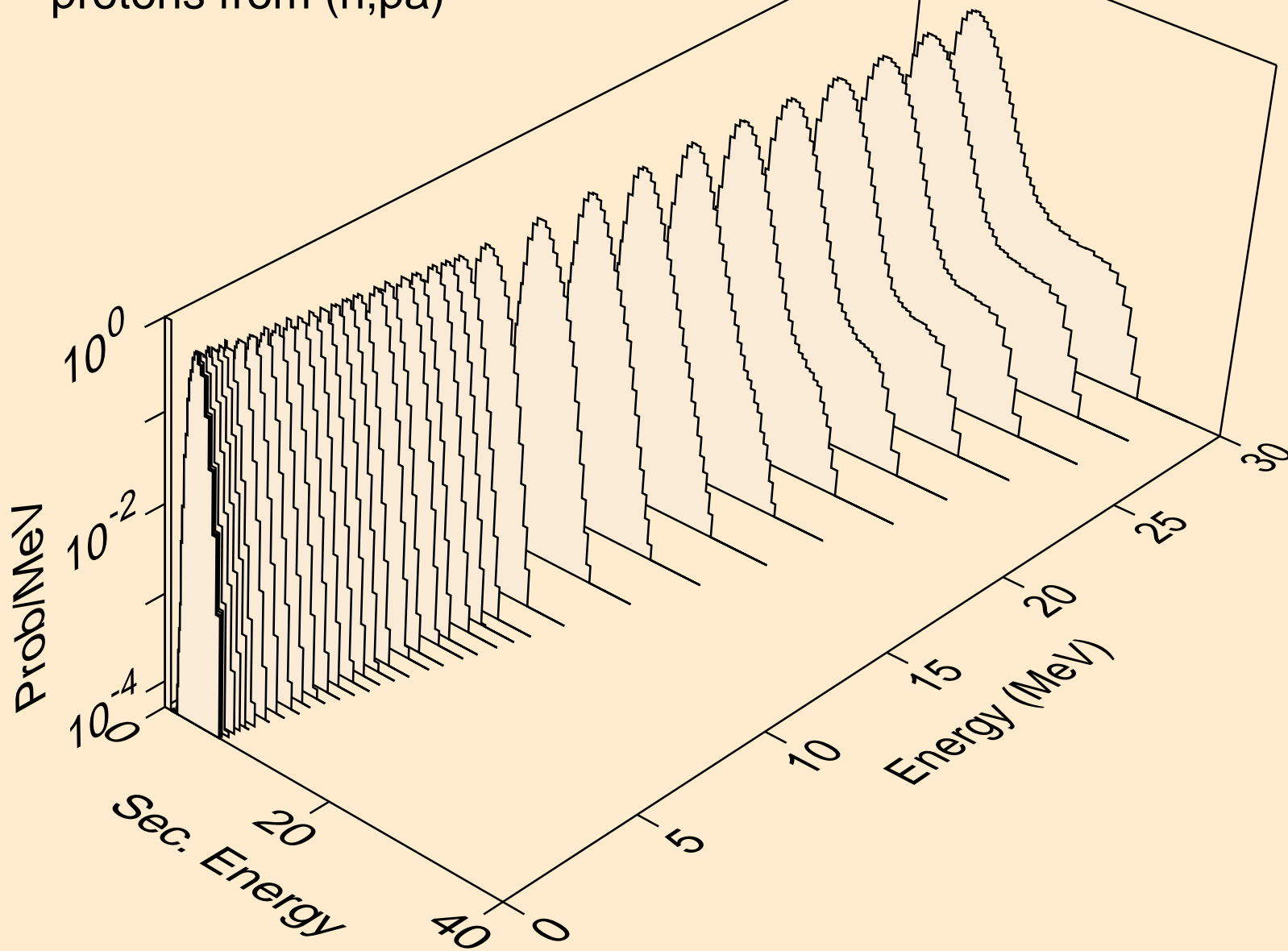

HF159 NEUTRON ACER TENDL-2019 LIBRARY; T=293.16K  
protons from (n,pd)

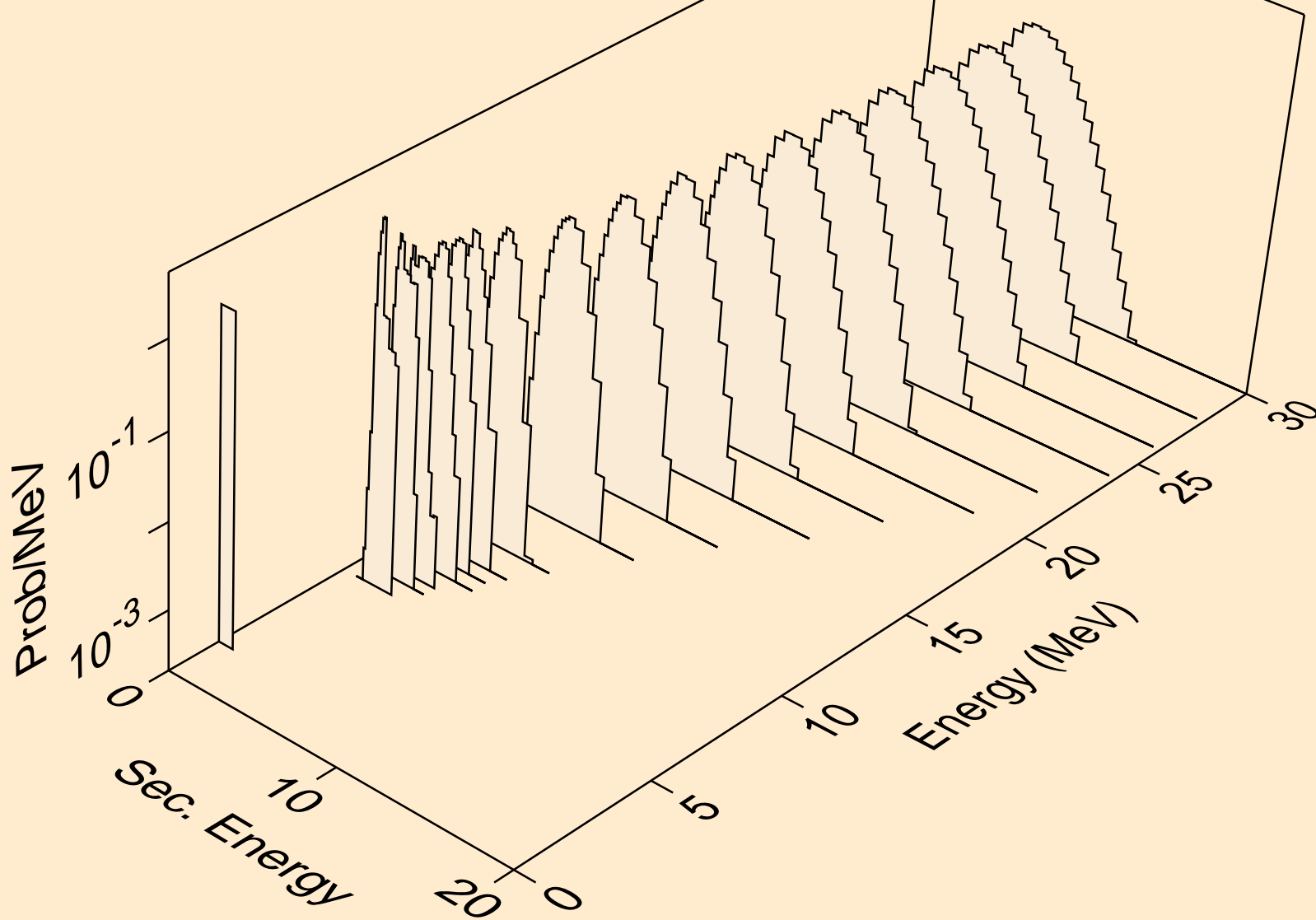

HF159 NEUTRON ACER TENDL-2019 LIBRARY; T=293.16K  
protons from (n,pt)

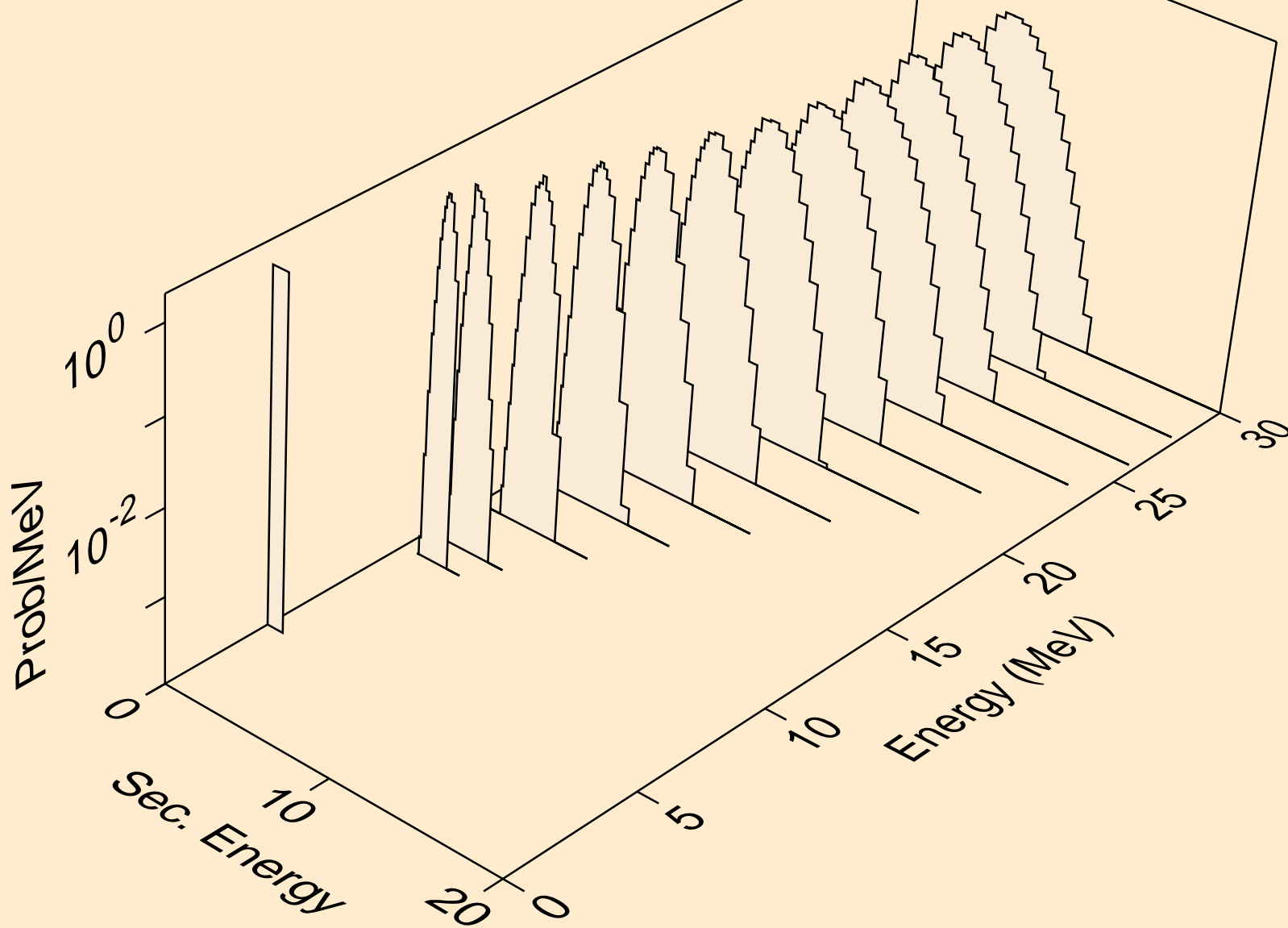

HF159 NEUTRON ACER TENDL-2019 LIBRARY; T=293.16K  
deuterons from (n,x)

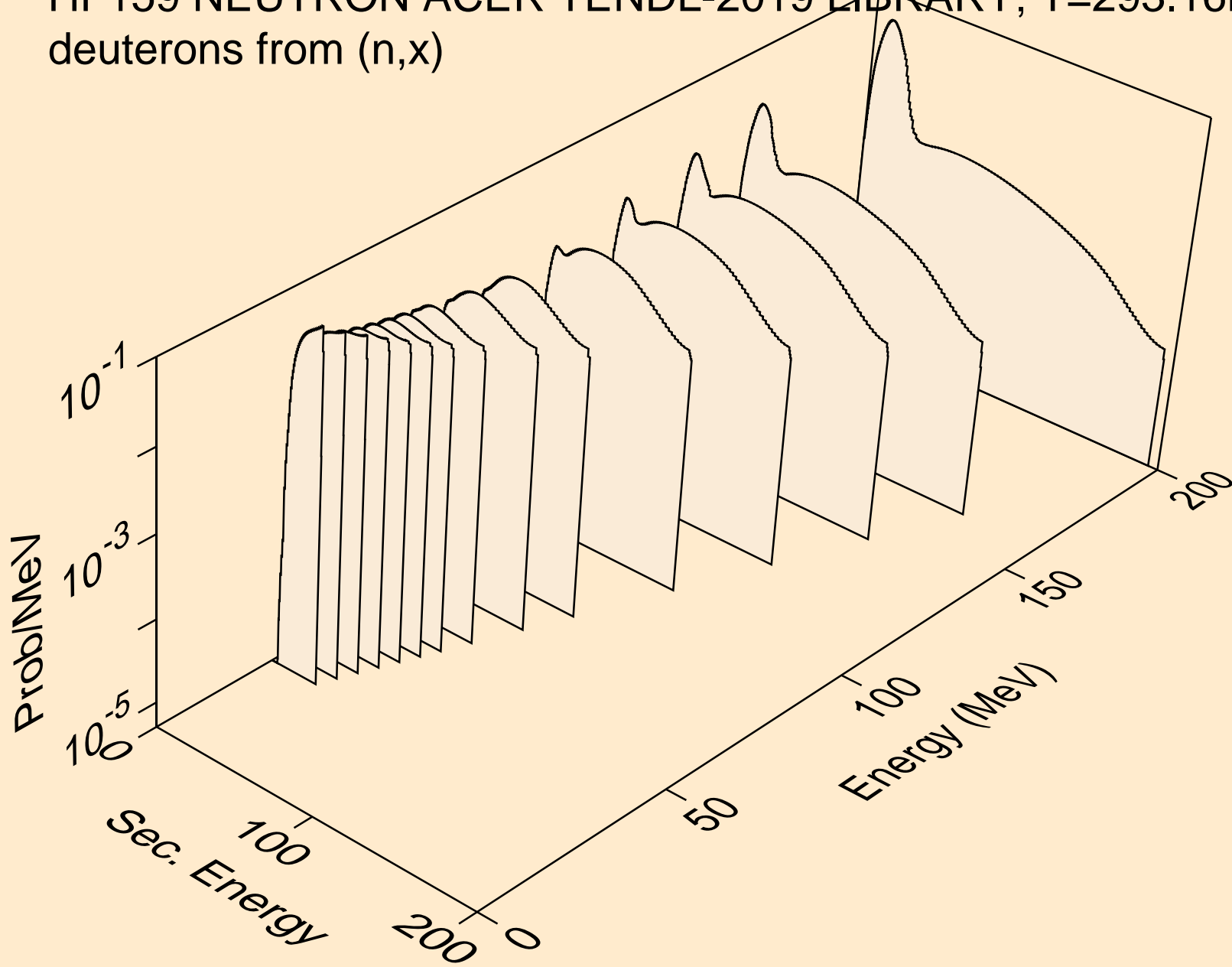

HF159 NEUTRON ACER TENDL-2019 LIBRARY; T=293.16K  
deuterons from (n,2nd)

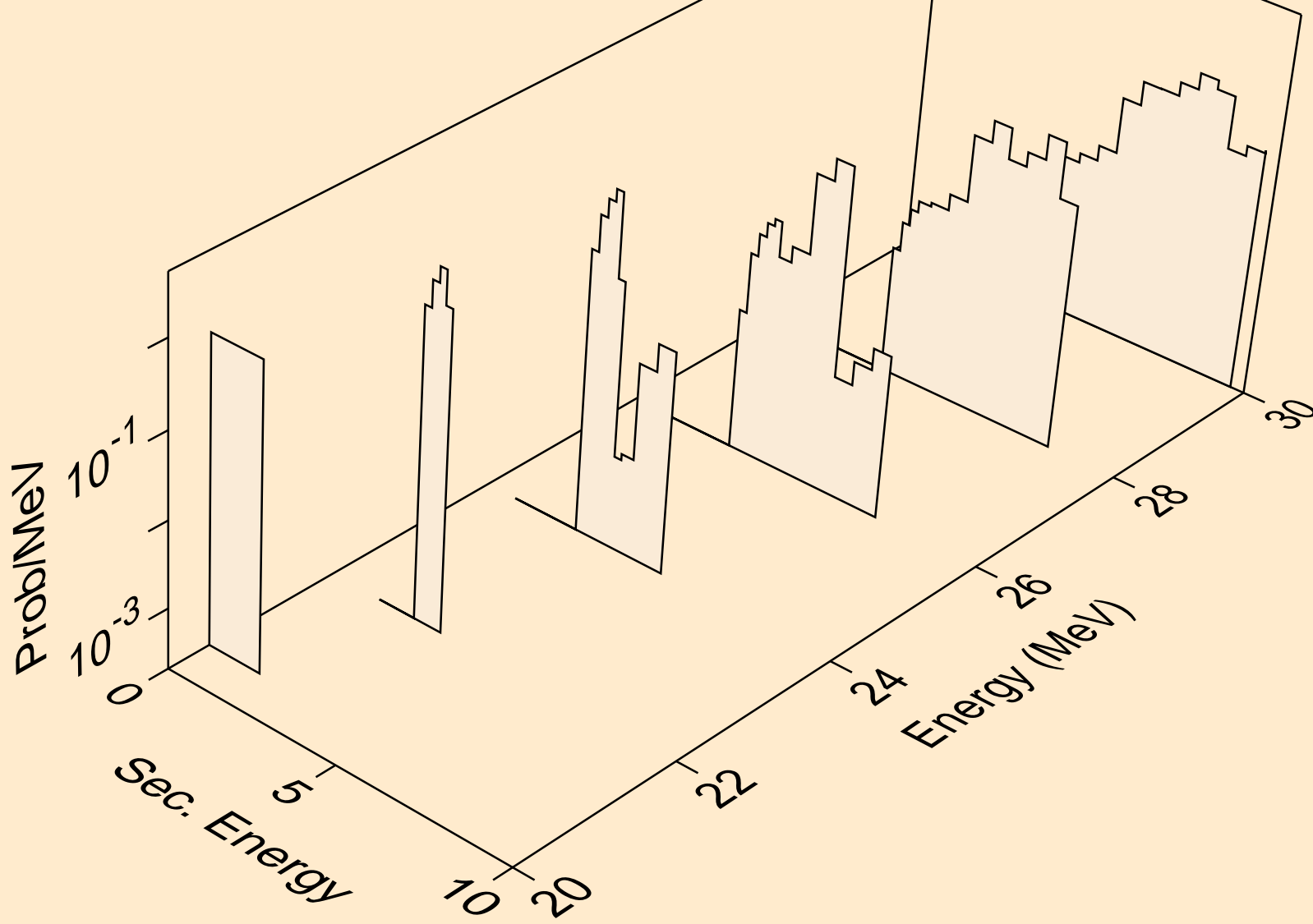

HF159 NEUTRON ACER TENDL-2019 LIBRARY; T=293.16K  
deuterons from (n,n\*)d

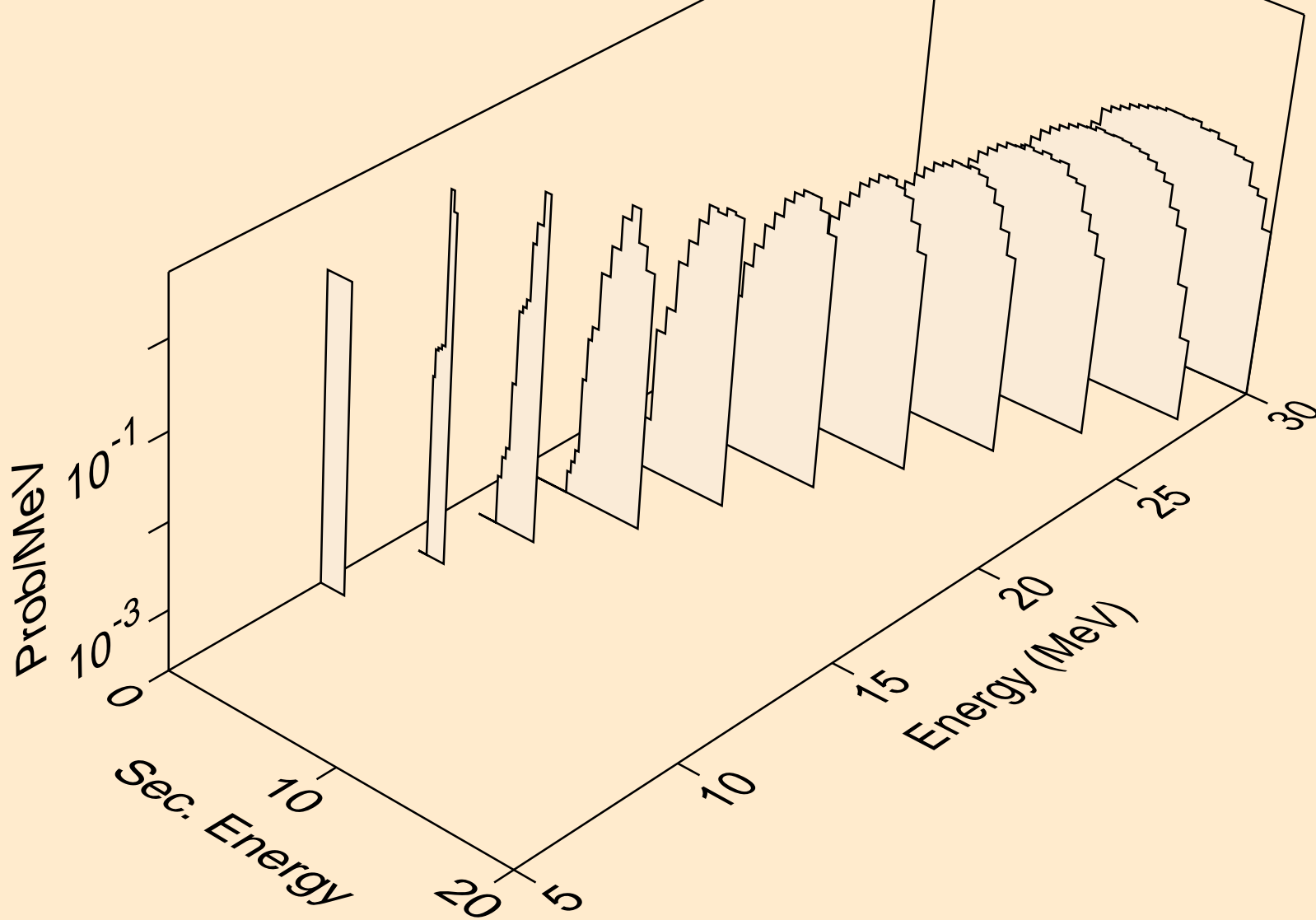



HF159 NEUTRON ACER TENDL-2019 LIBRARY; T=293.16K  
deuterons from (n,n\*)d2a

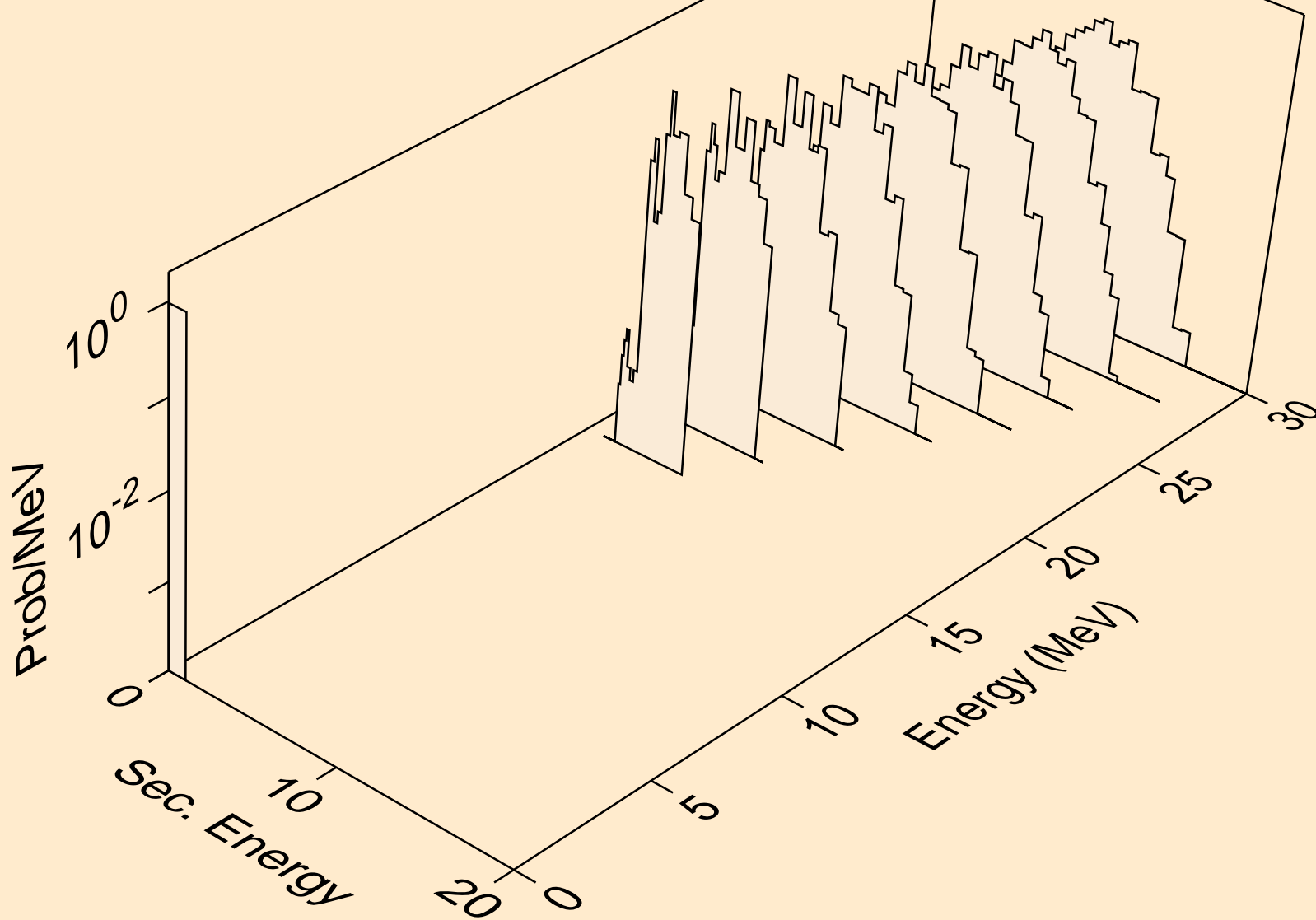

HF159 NEUTRON ACER TENDL-2019 LIBRARY; T=293.16K  
deuterons from (n,d)

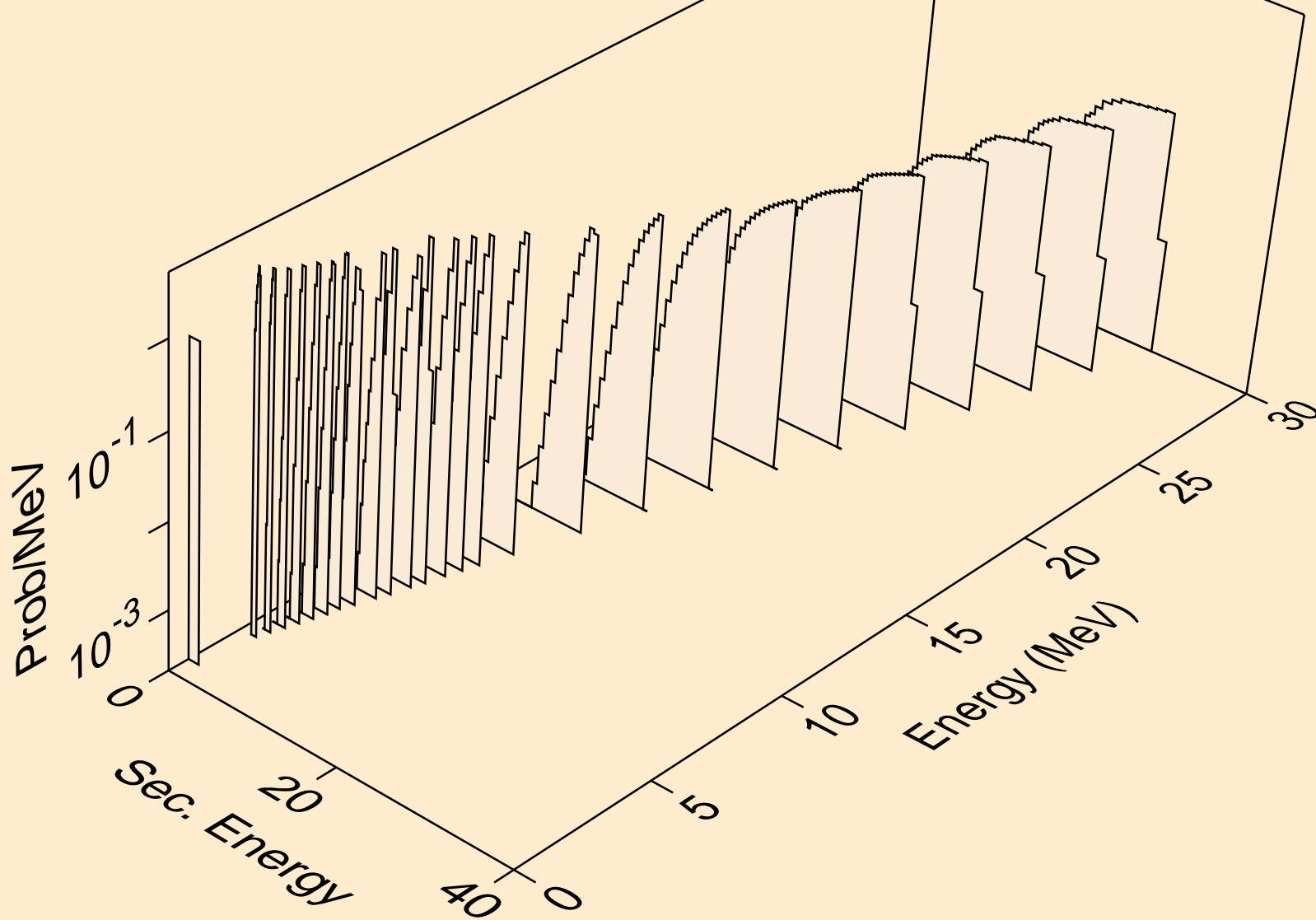

HF159 NEUTRON ACER TENDL-2019 LIBRARY; T=293.16K  
deuterons from (n,d2a)

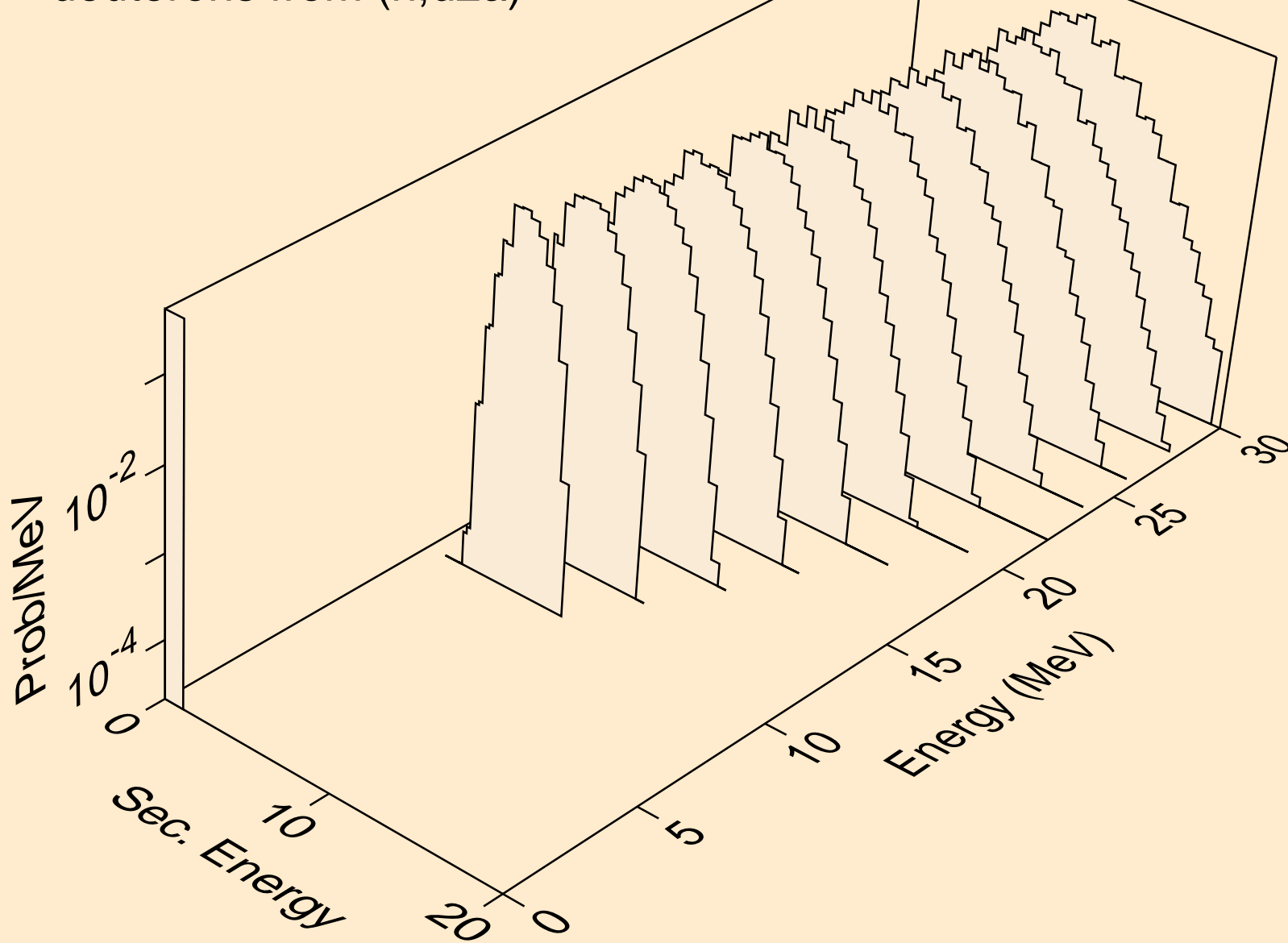

HF159 NEUTRON ACER TENDL-2019 LIBRARY; T=293.16K  
deuterons from (n,pd)

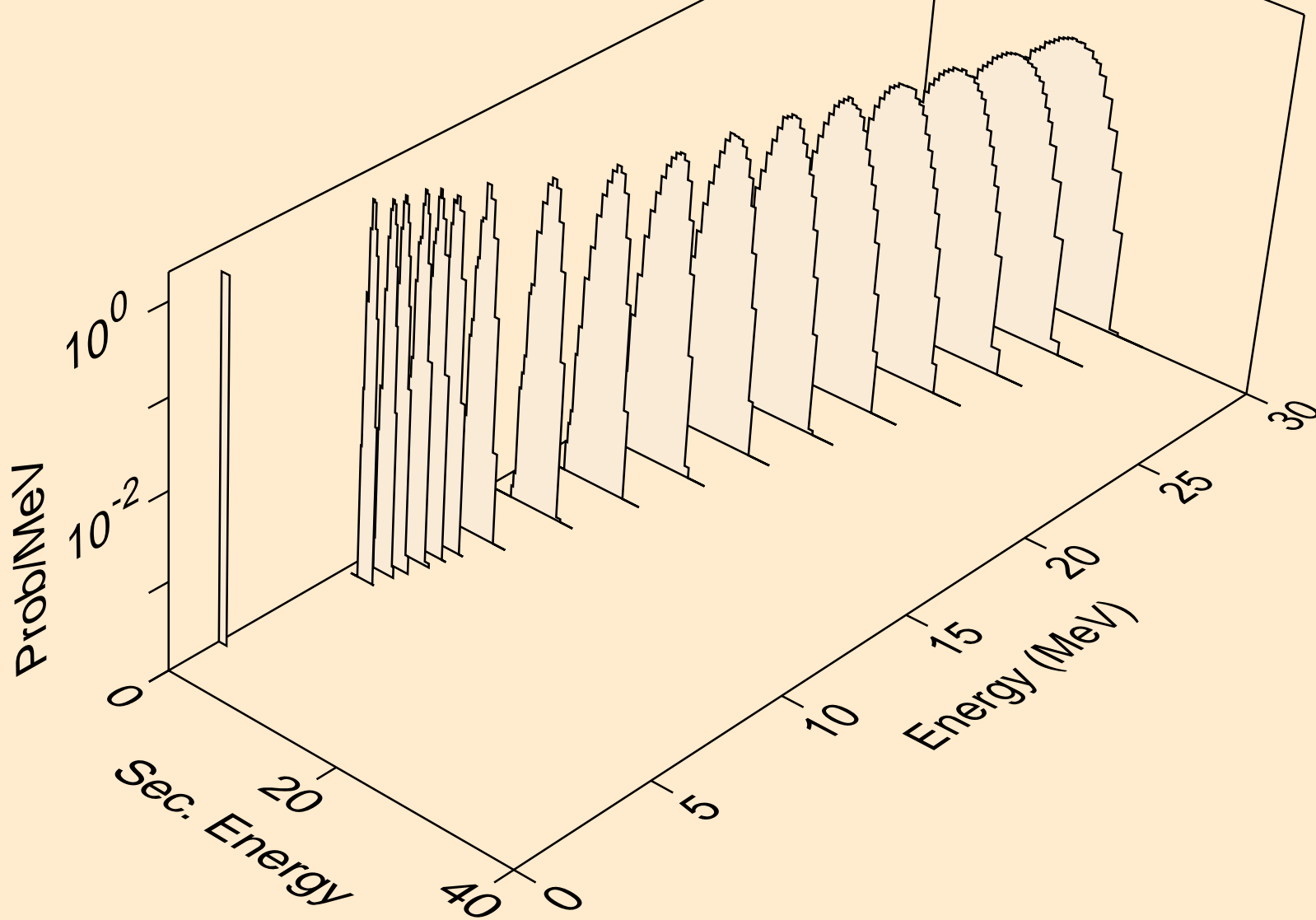

HF159 NEUTRON ACER TENDL-2019 LIBRARY; T=293.16K  
deuterons from (n,da)

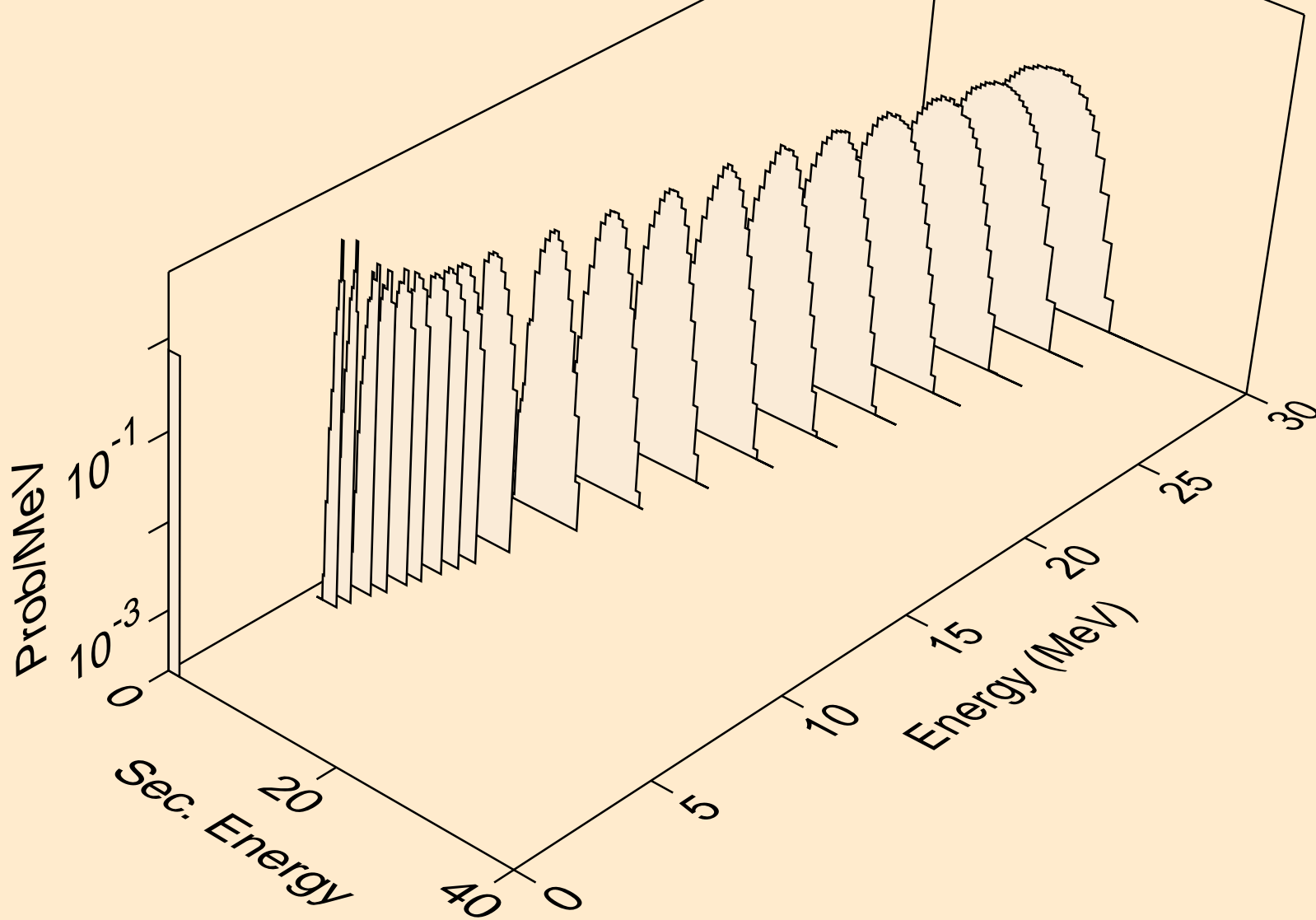

HF159 NEUTRON ACER TENDL-2019 LIBRARY; T=293.16K  
tritons from (n,x)

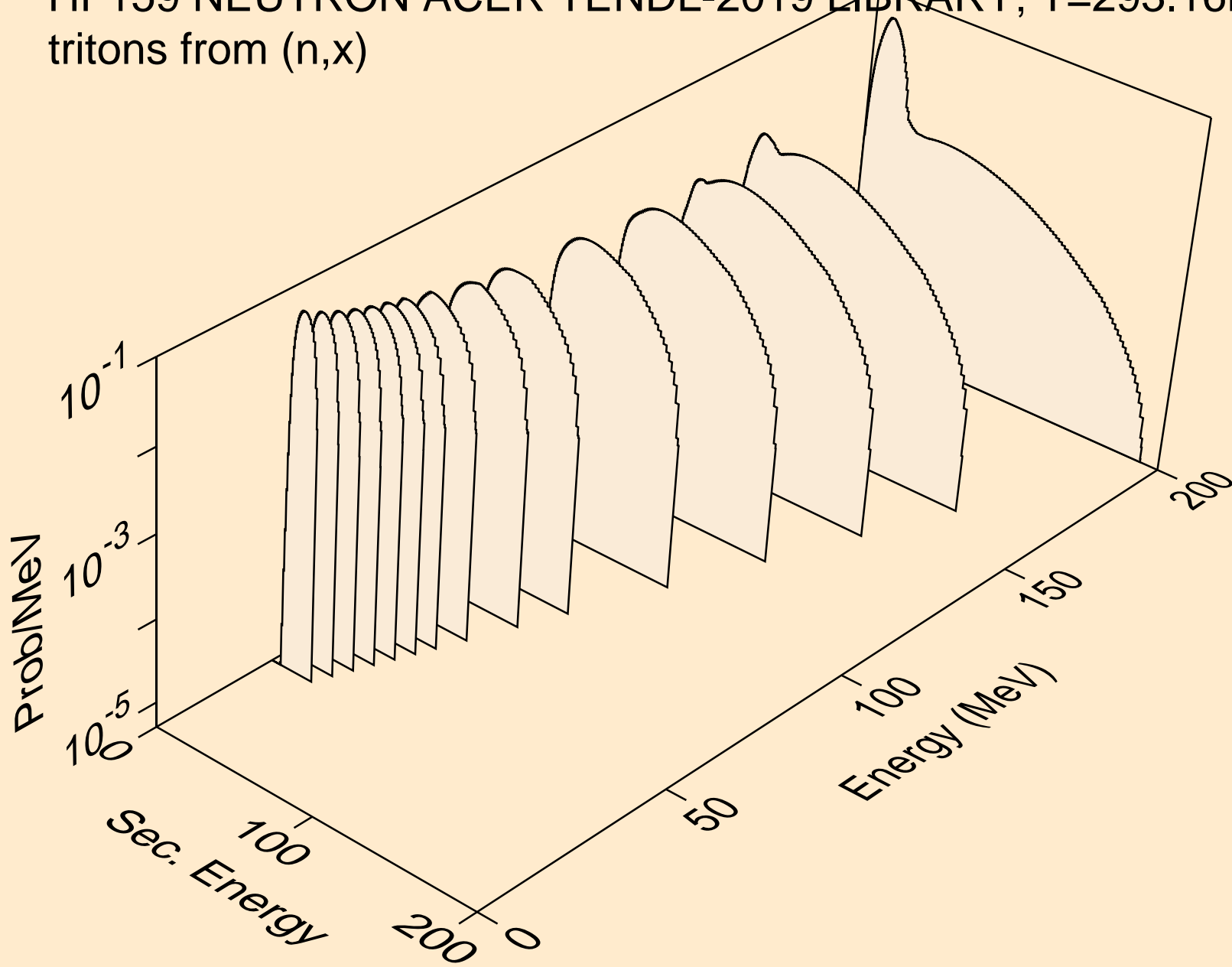

HF159 NEUTRON ACER TENDL-2019 LIBRARY; T=293.16K  
tritons from (n,n\*)t

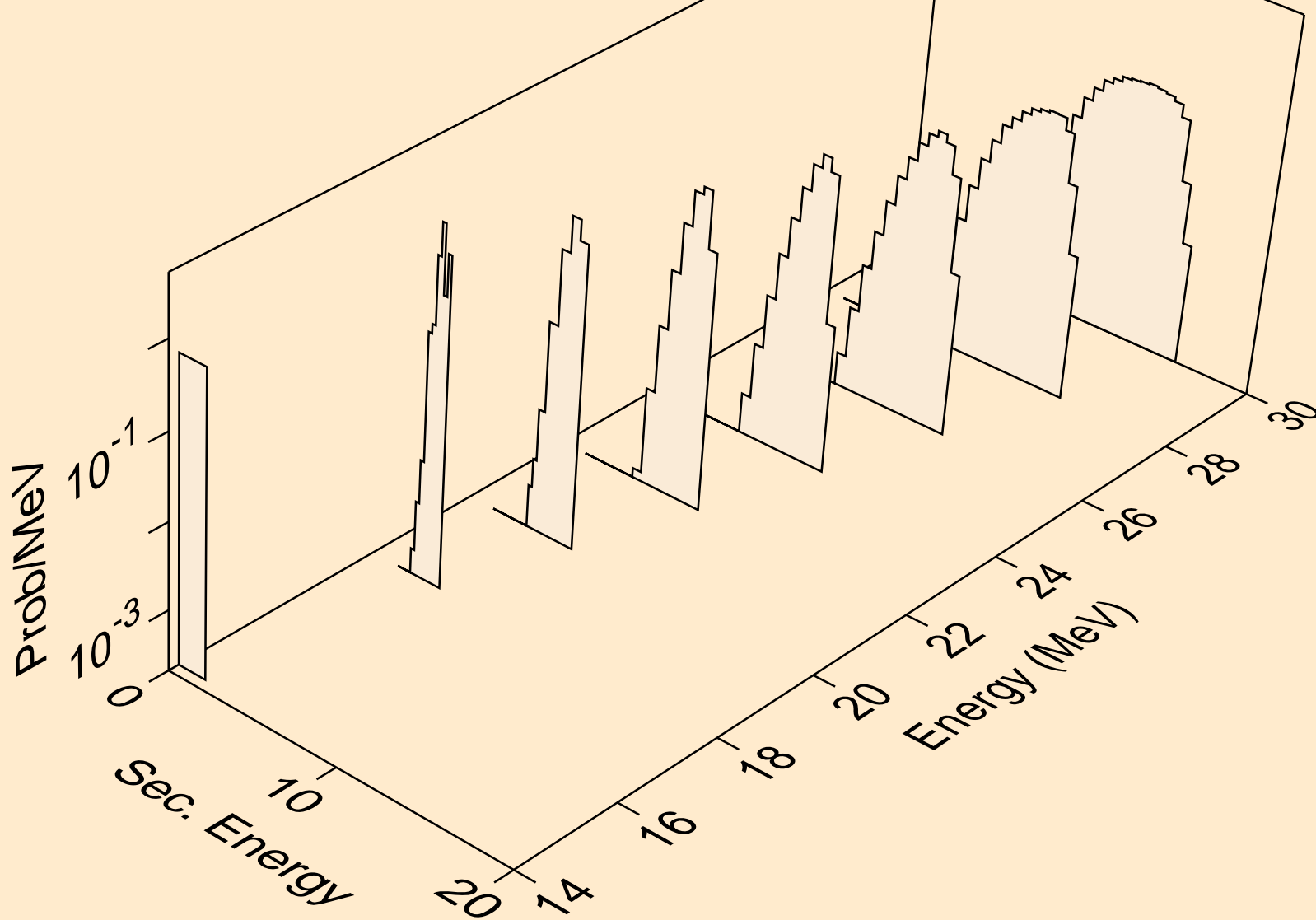

HF159 NEUTRON ACER TENDL-2019 LIBRARY; T=293.16K  
tritons from (n,t)

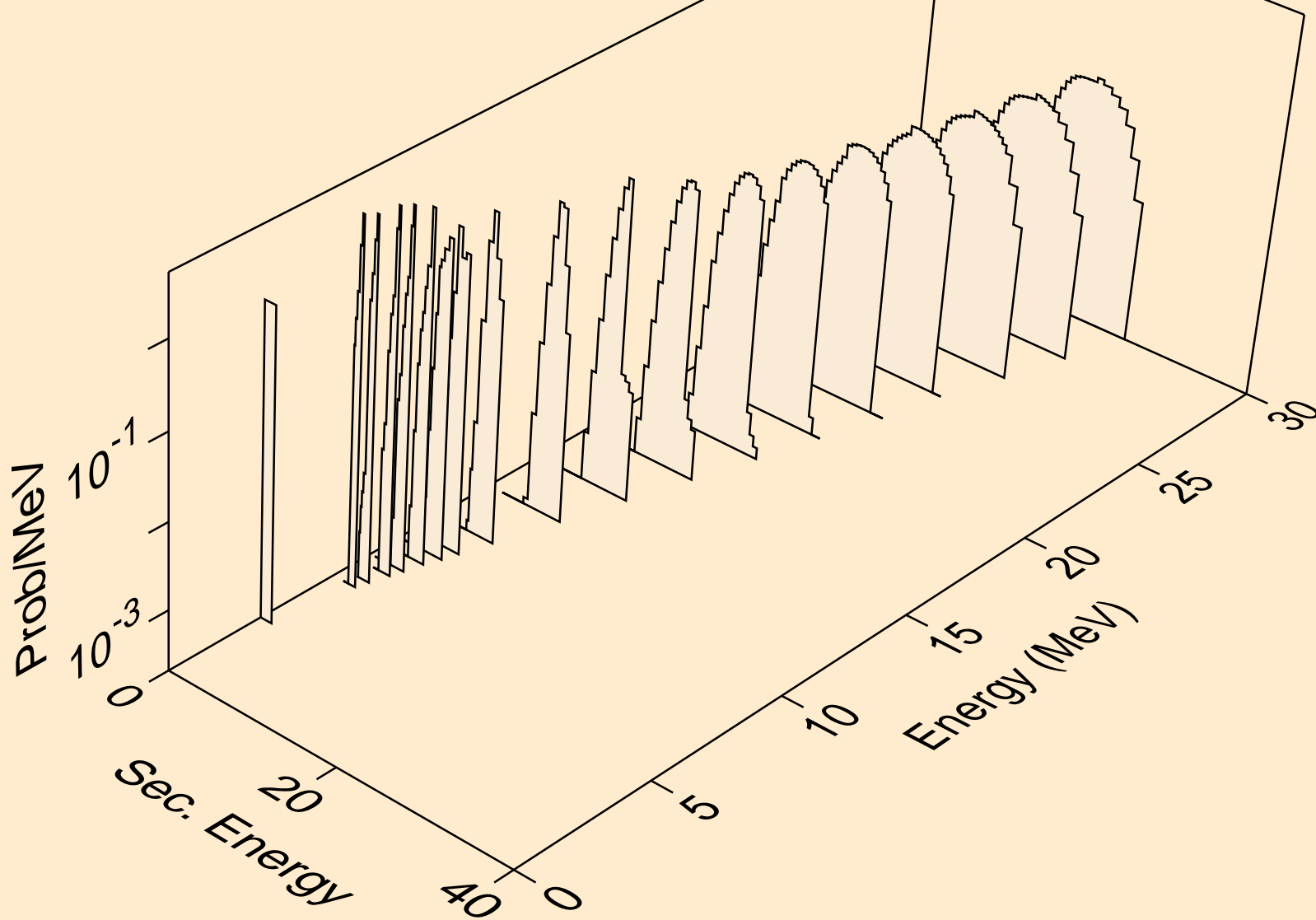



HF159 NEUTRON ACER TENDL-2019 LIBRARY; T=293.16K  
tritons from (n,t2a)

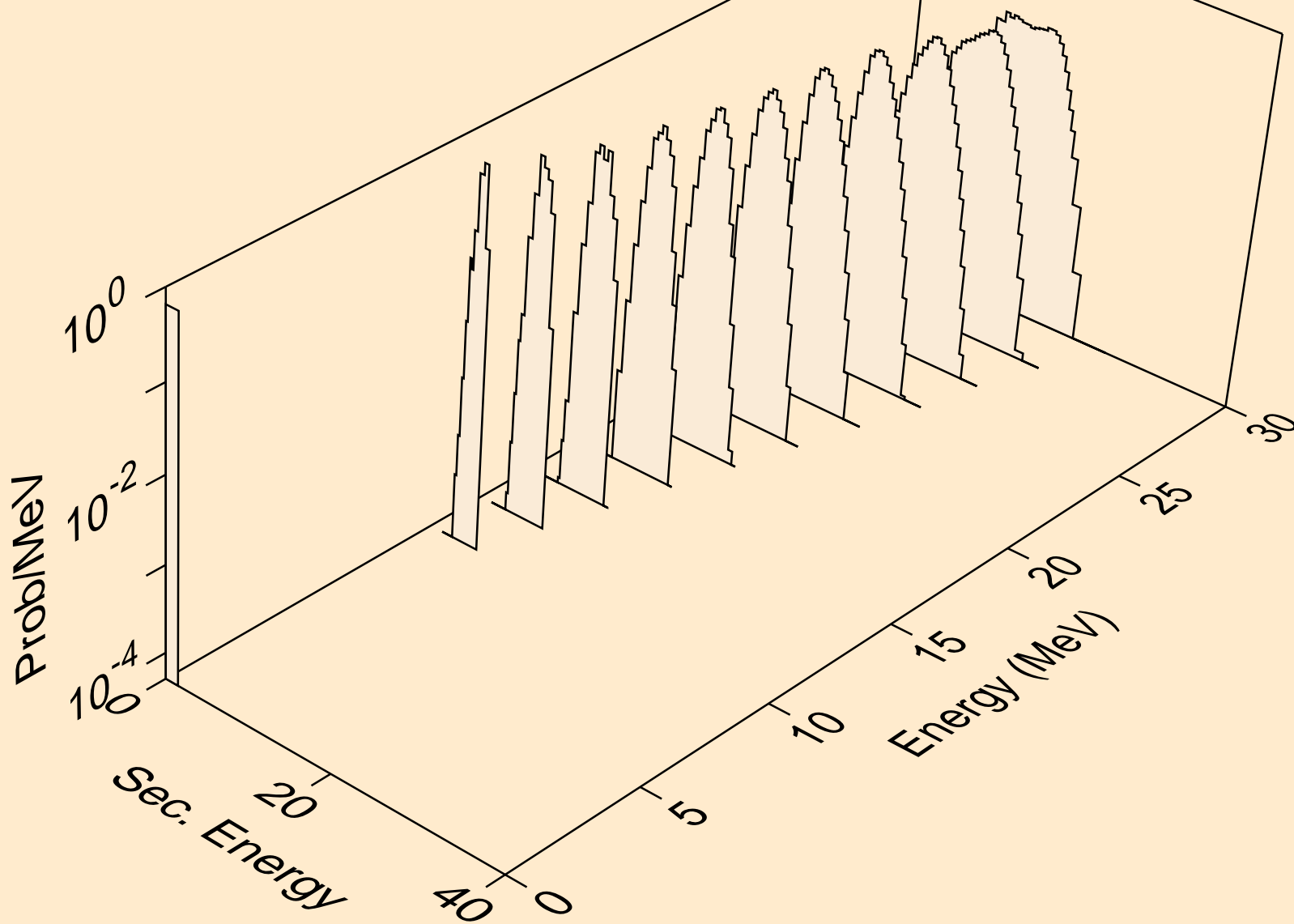

HF159 NEUTRON ACER TENDL-2019 LIBRARY; T=293.16K  
tritons from (n,pt)

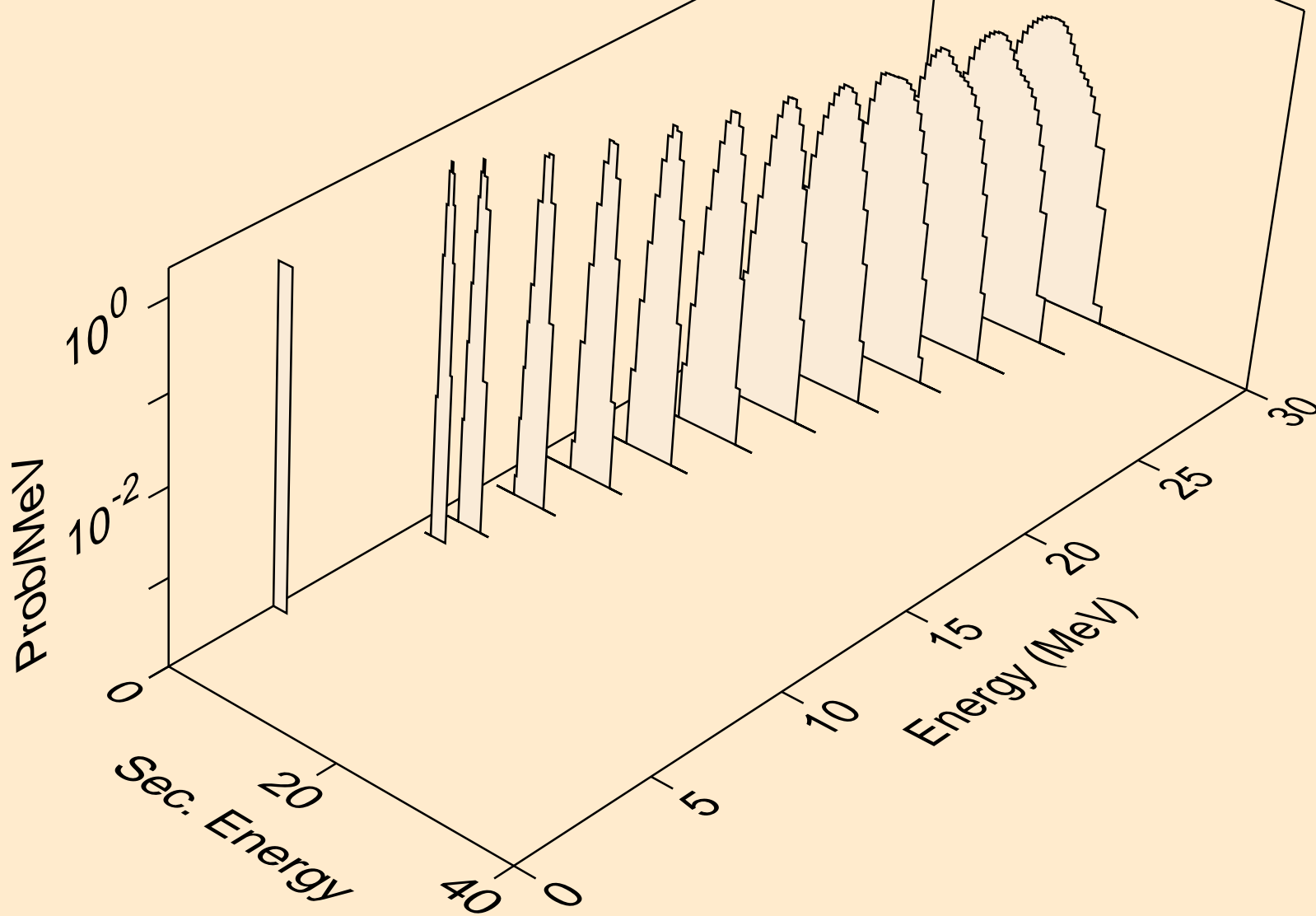

HF159 NEUTRON ACER TENDL-2019 LIBRARY; T=293.16K  
he3s from (n,x)

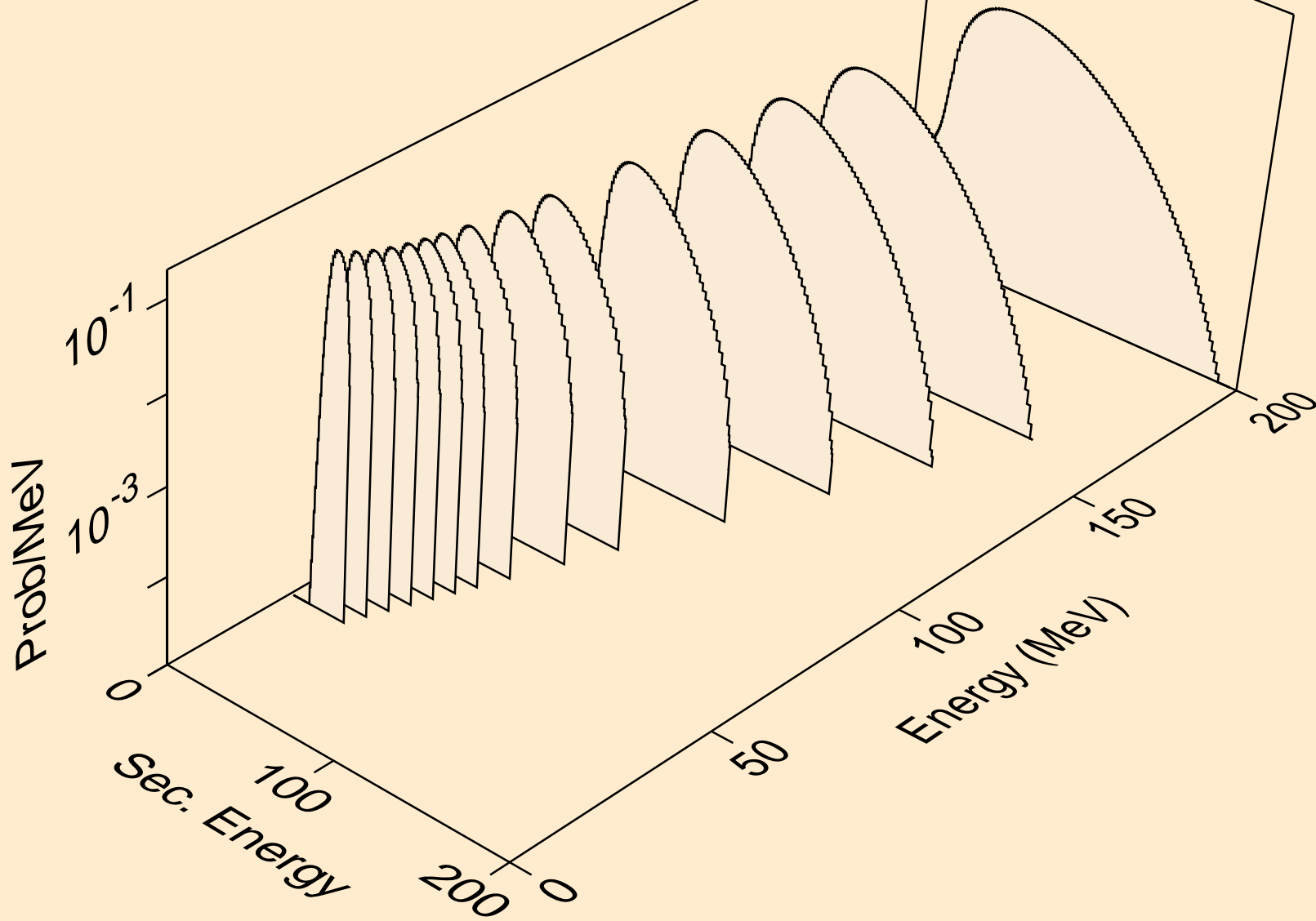

HF159 NEUTRON ACER TENDL-2019 LIBRARY; T=293.16K  
he3s from (n,n\*)he3

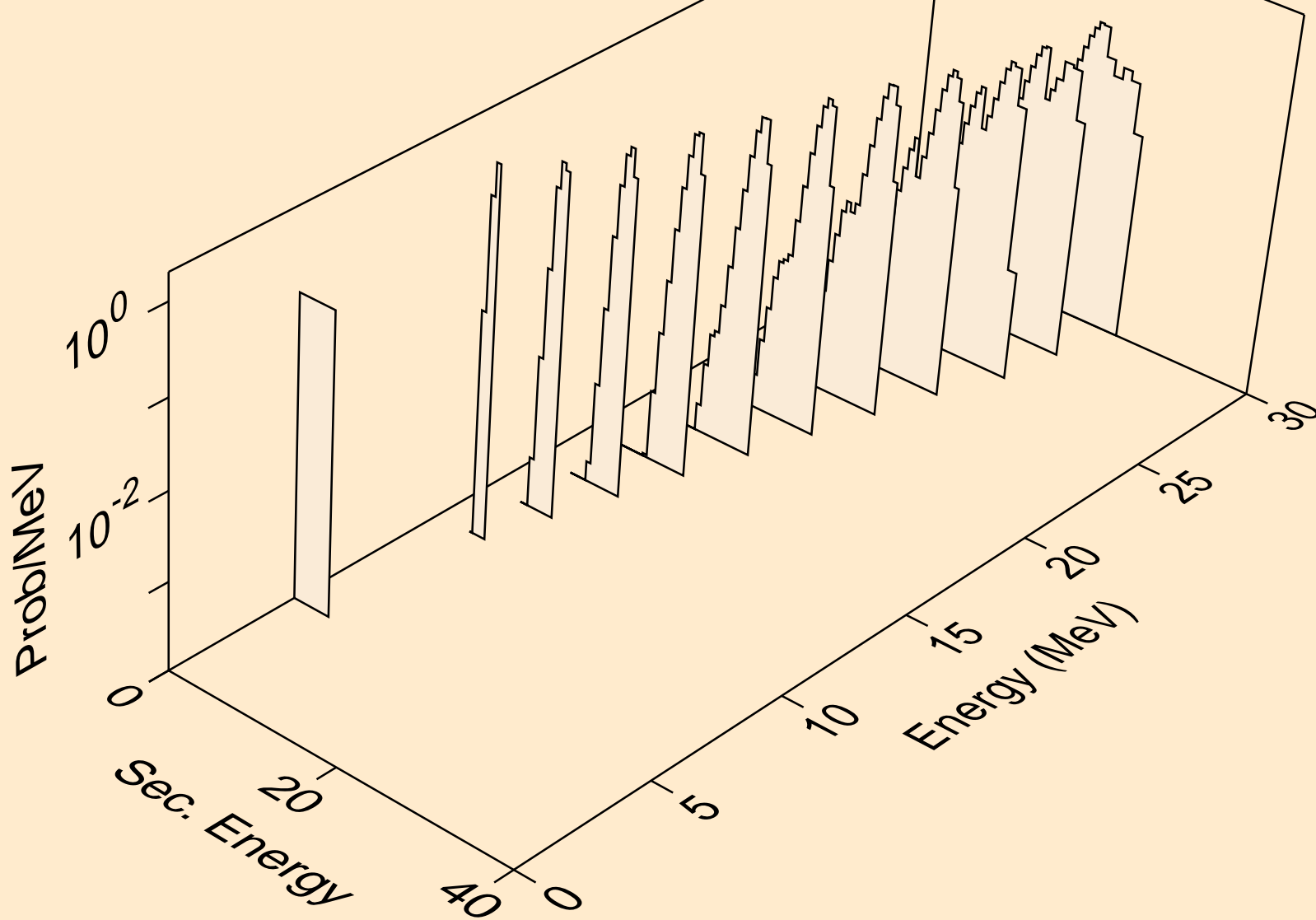

HF159 NEUTRON ACER TENDL-2019 LIBRARY; T=293.16K  
he3s from (n,he3)

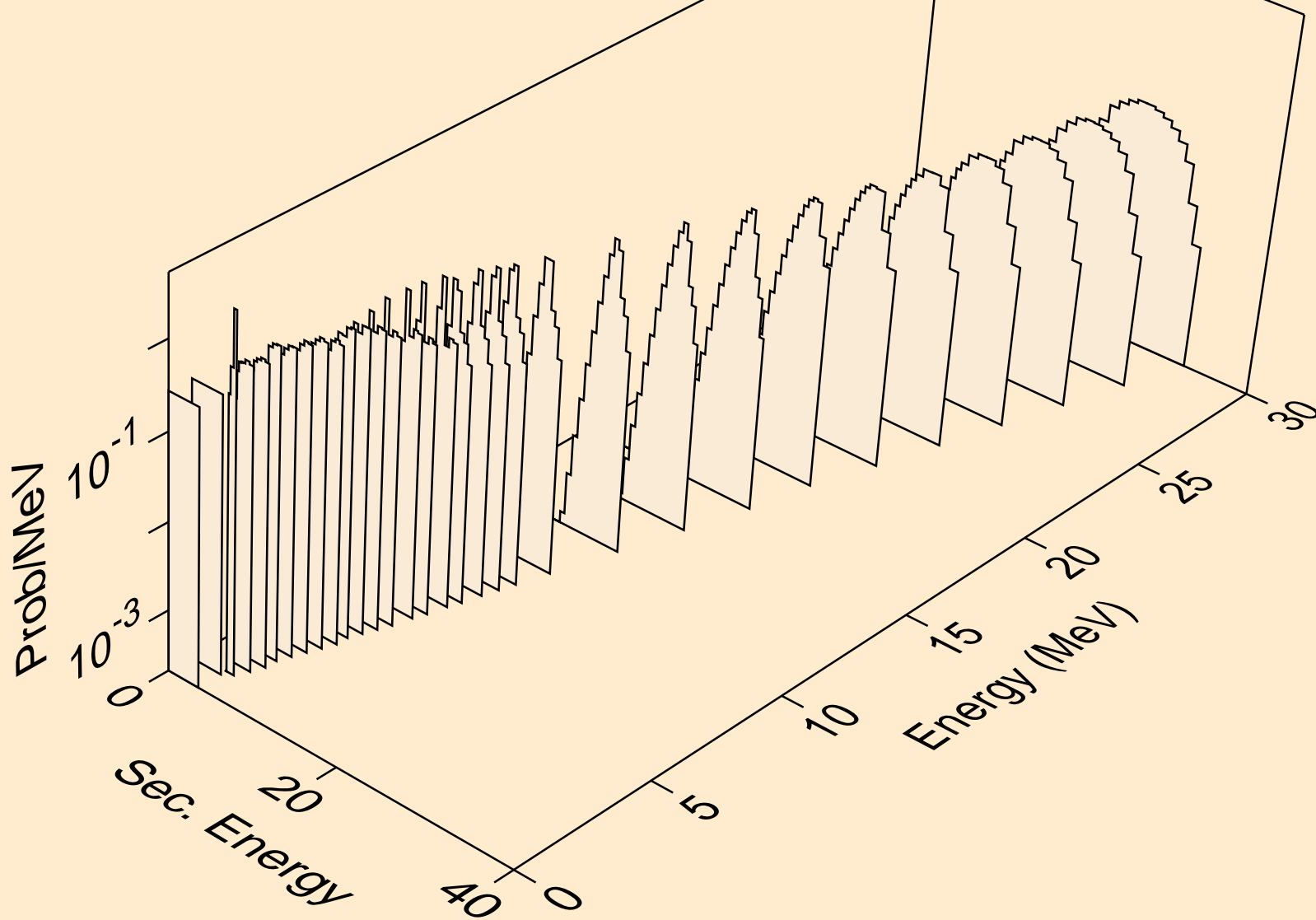

HF159 NEUTRON ACER TENDL-2019 LIBRARY; T=293.16K  
alphas from (n,x)

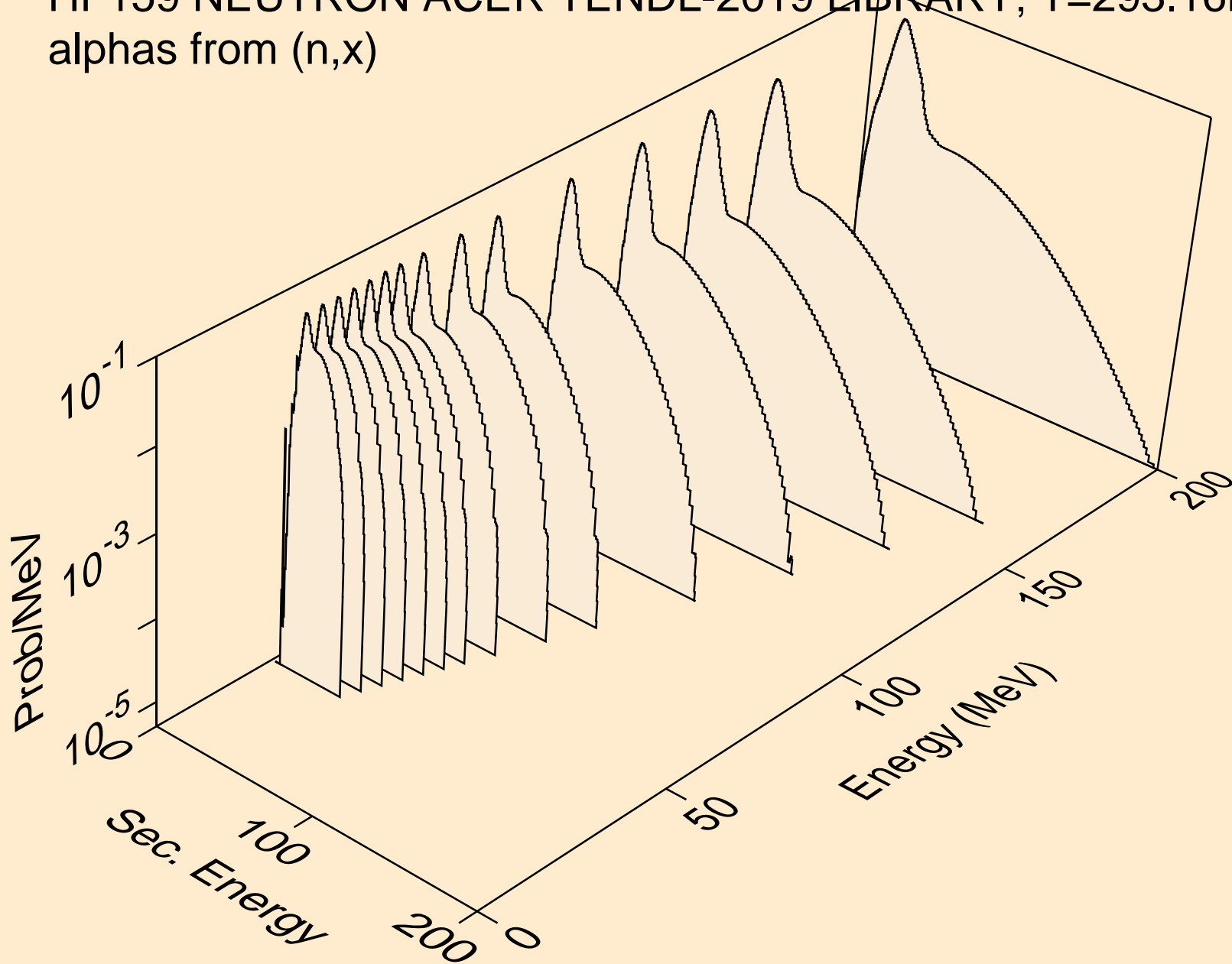

HF159 NEUTRON ACER TENDL-2019 LIBRARY; T=293.16K  
alphas from (n,n\*)a

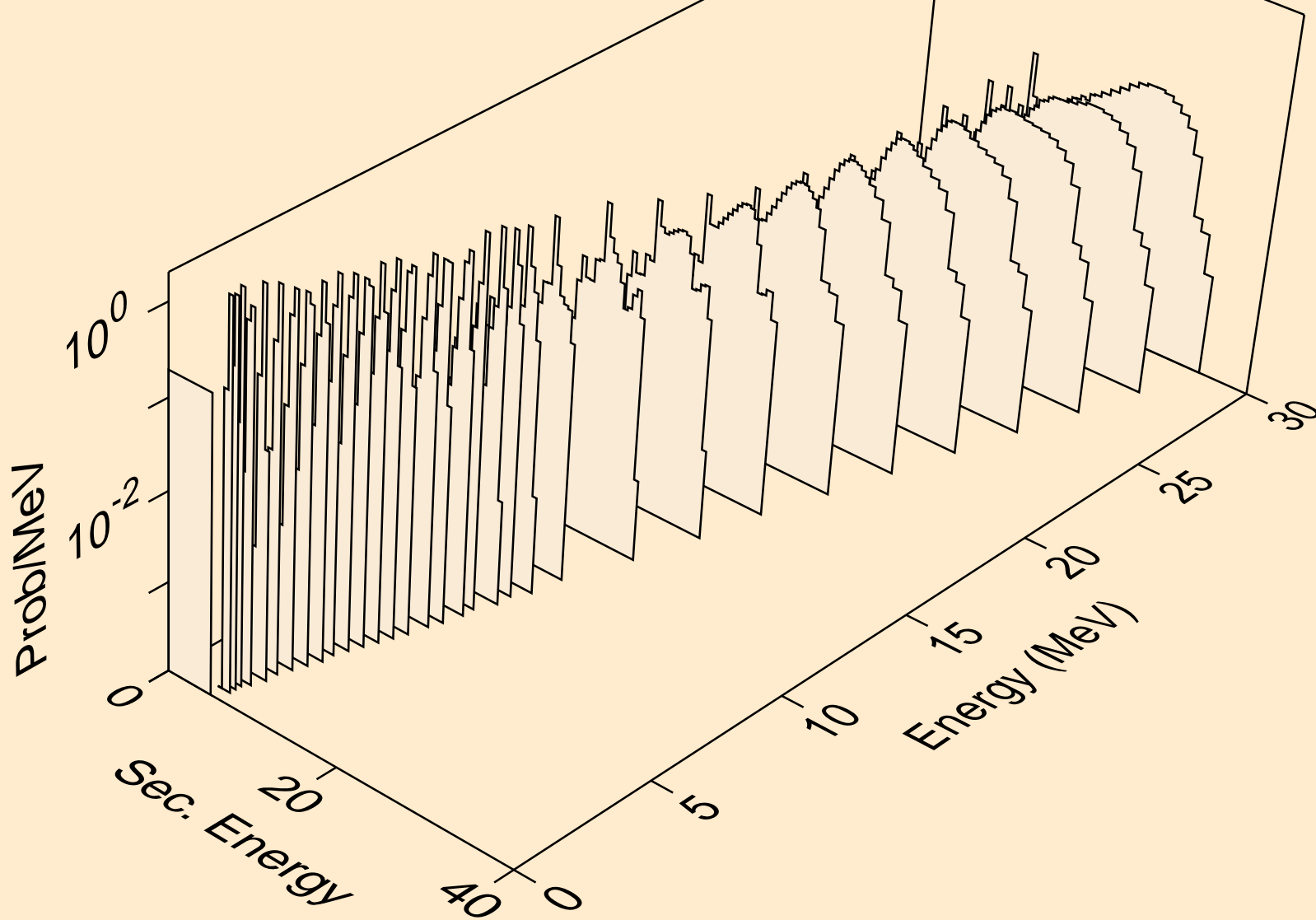

HF159 NEUTRON ACER TENDL-2019 LIBRARY; T=293.16K  
alphas from (n,n\*)3a

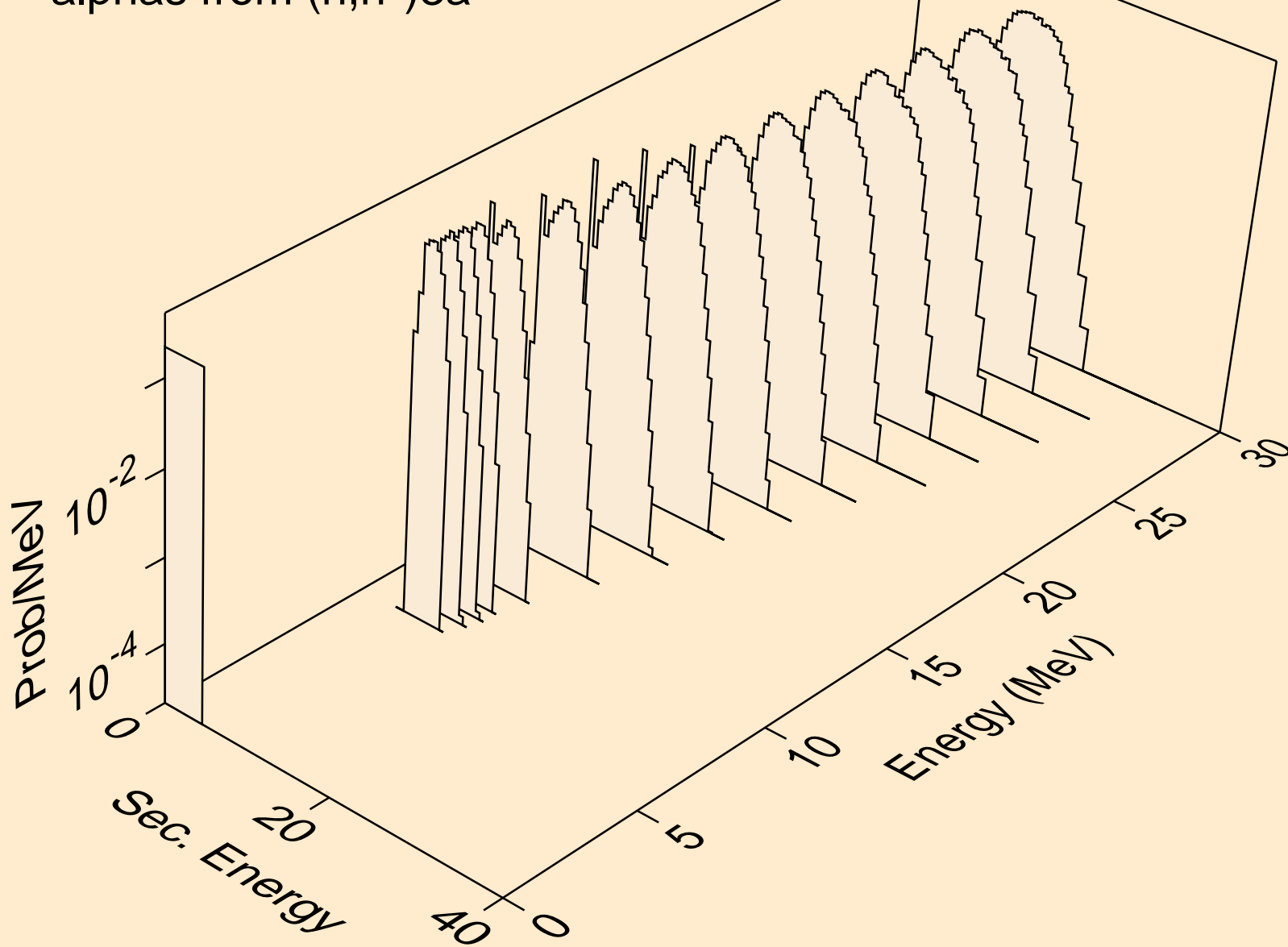



HF159 NEUTRON ACER TENDL-2019 LIBRARY; T=293.16K  
alphas from (n,2n)a

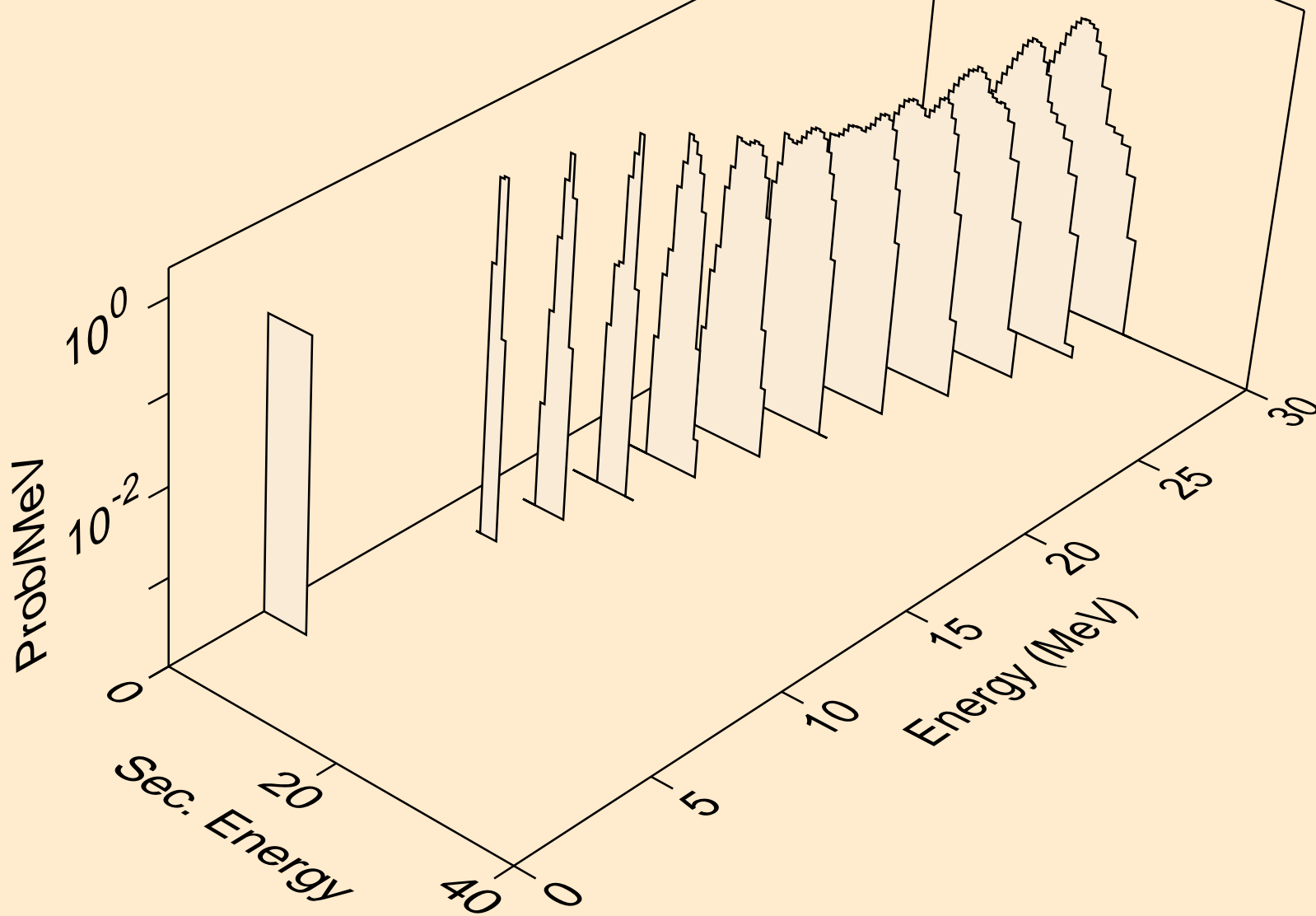

HF159 NEUTRON ACER TENDL-2019 LIBRARY; T=293.16K  
alphas from (n,3n)a

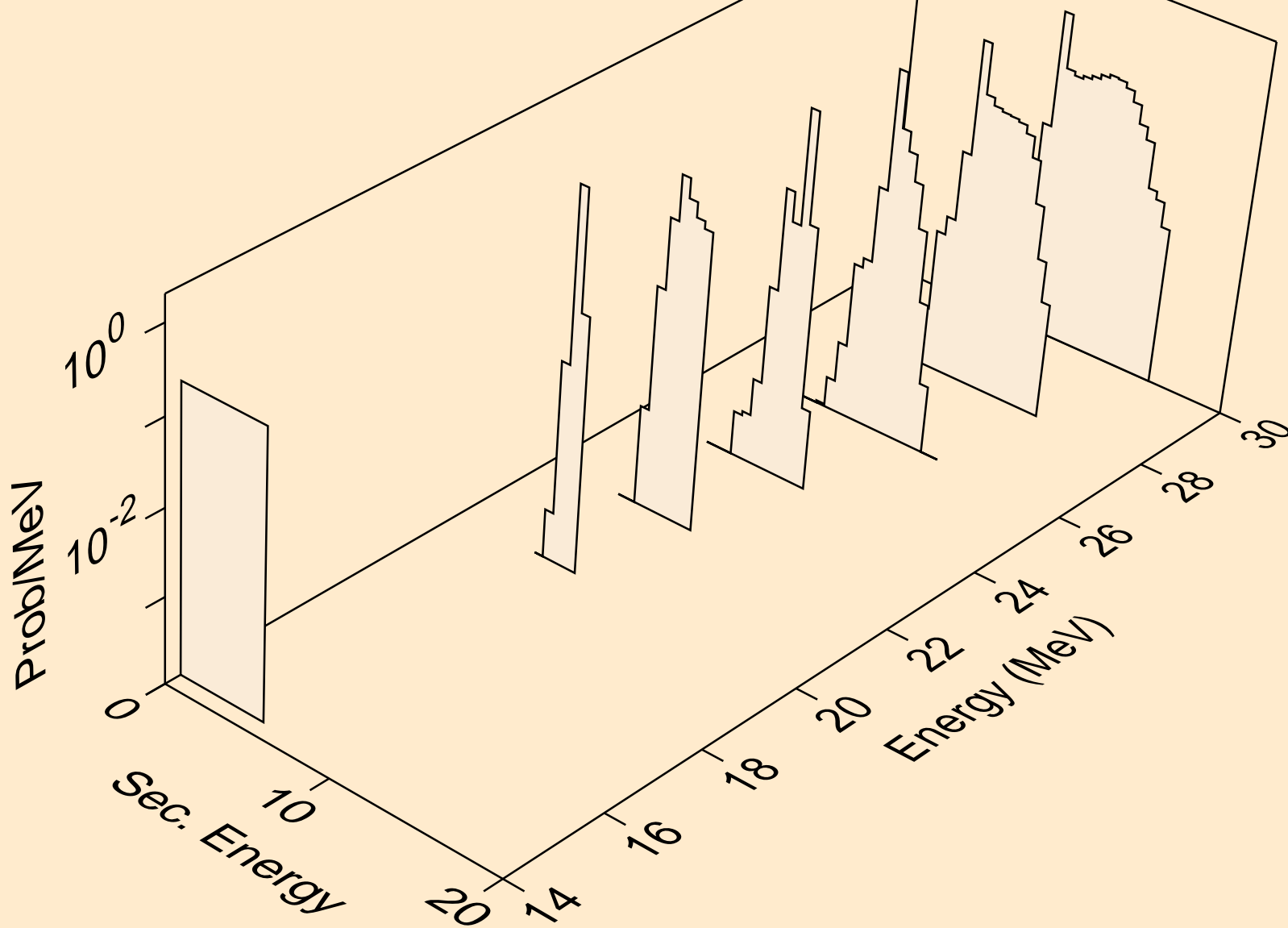

HF159 NEUTRON ACER TENDL-2019 LIBRARY; T=293.16K  
alphas from (n,n\*)2a

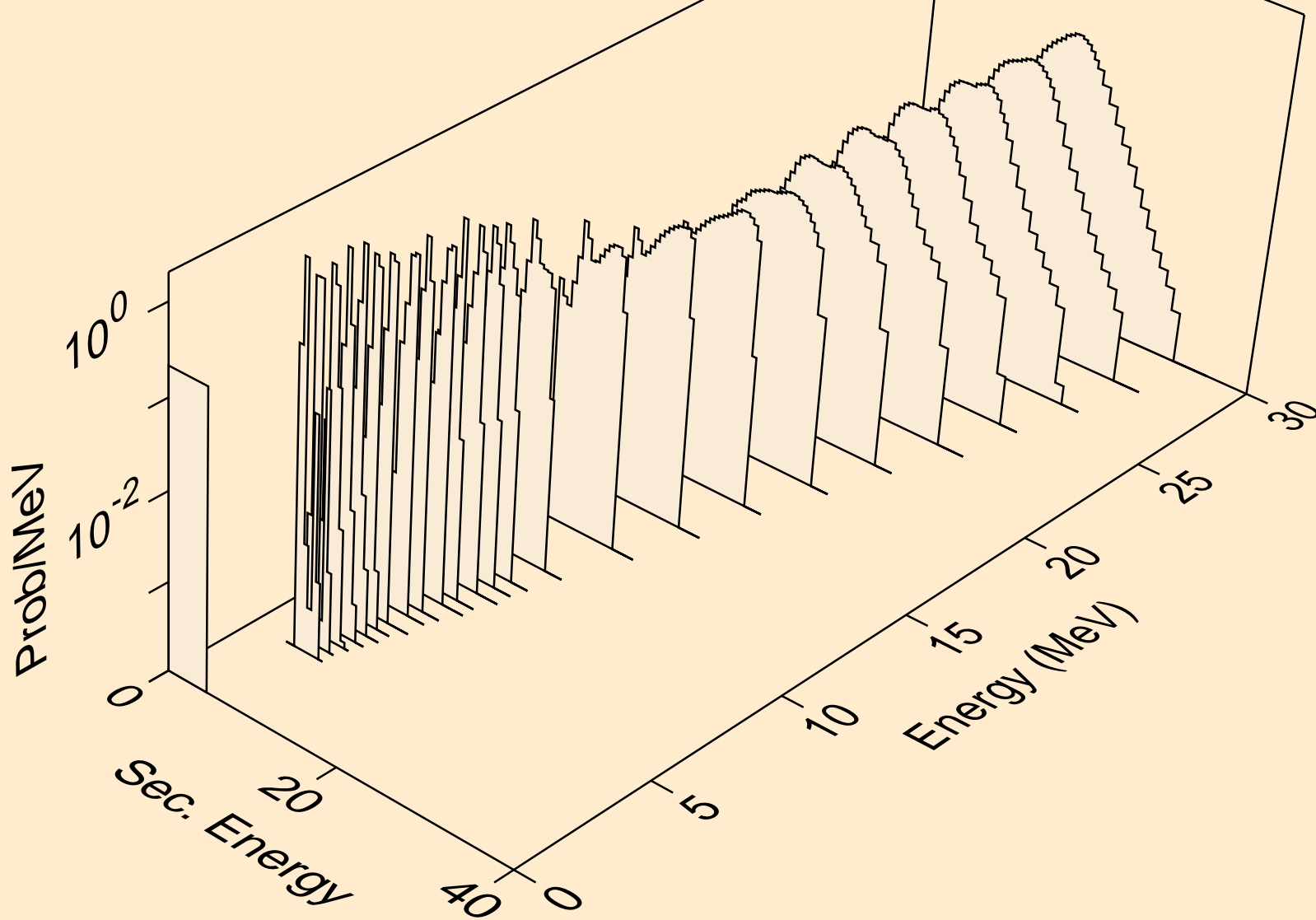

HF159 NEUTRON ACER TENDL-2019 LIBRARY; T=293.16K  
alphas from (n,2n)2a

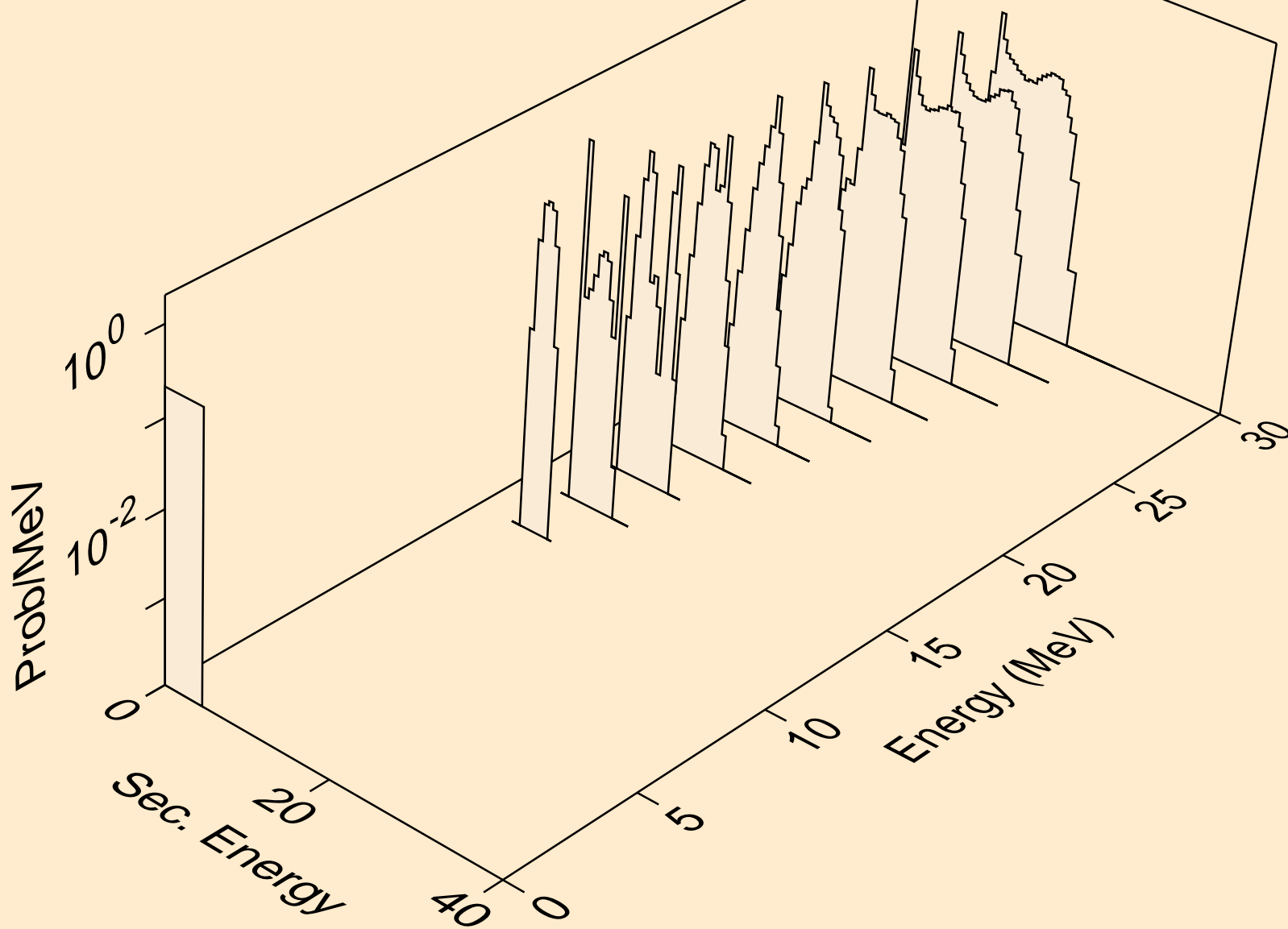

HF159 NEUTRON ACER TENDL-2019 LIBRARY; T=293.16K  
alphas from (n,n\*)d2a

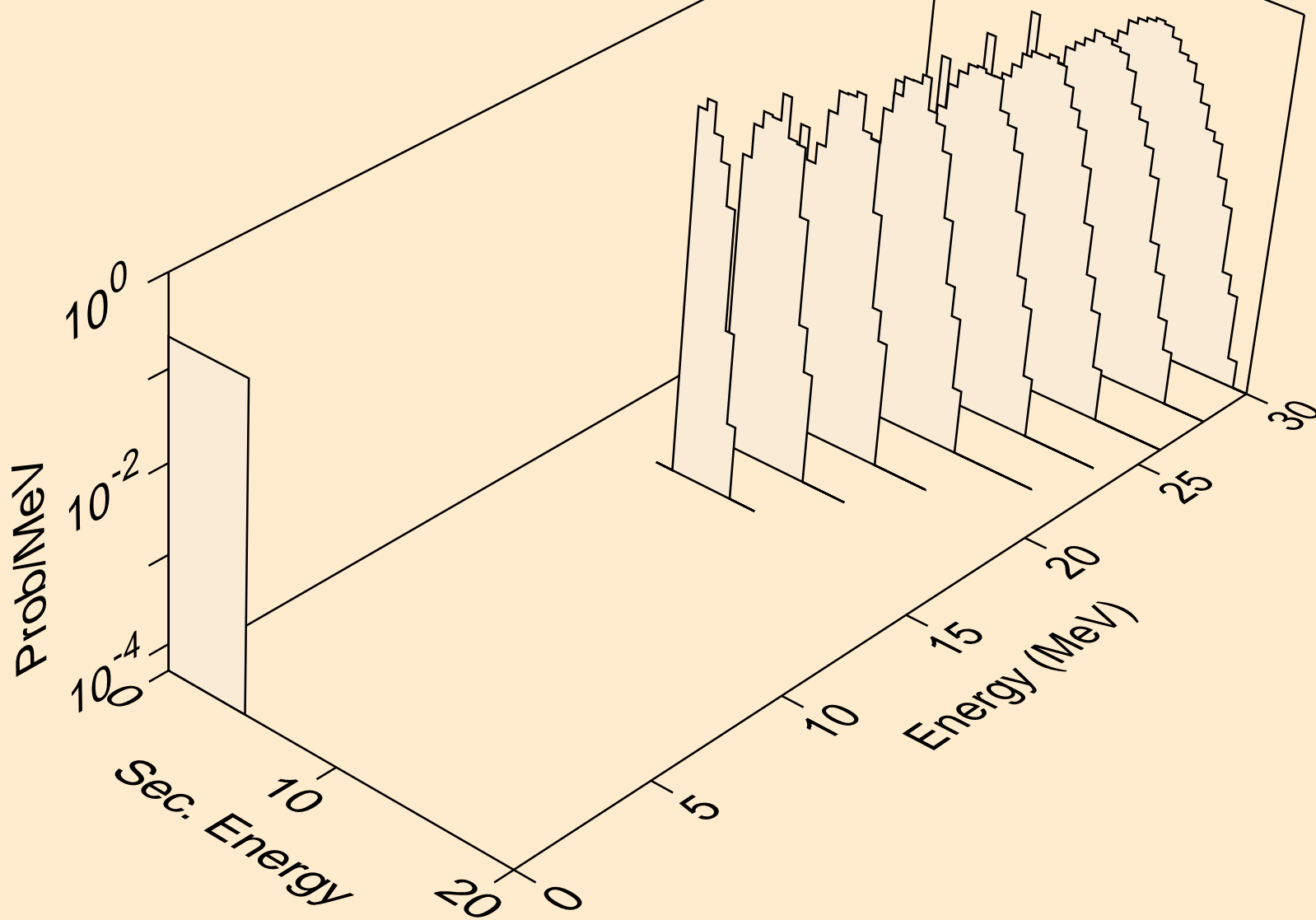

HF159 NEUTRON ACER TENDL-2019 LIBRARY; T=293.16K  
alphas from (n,npa)

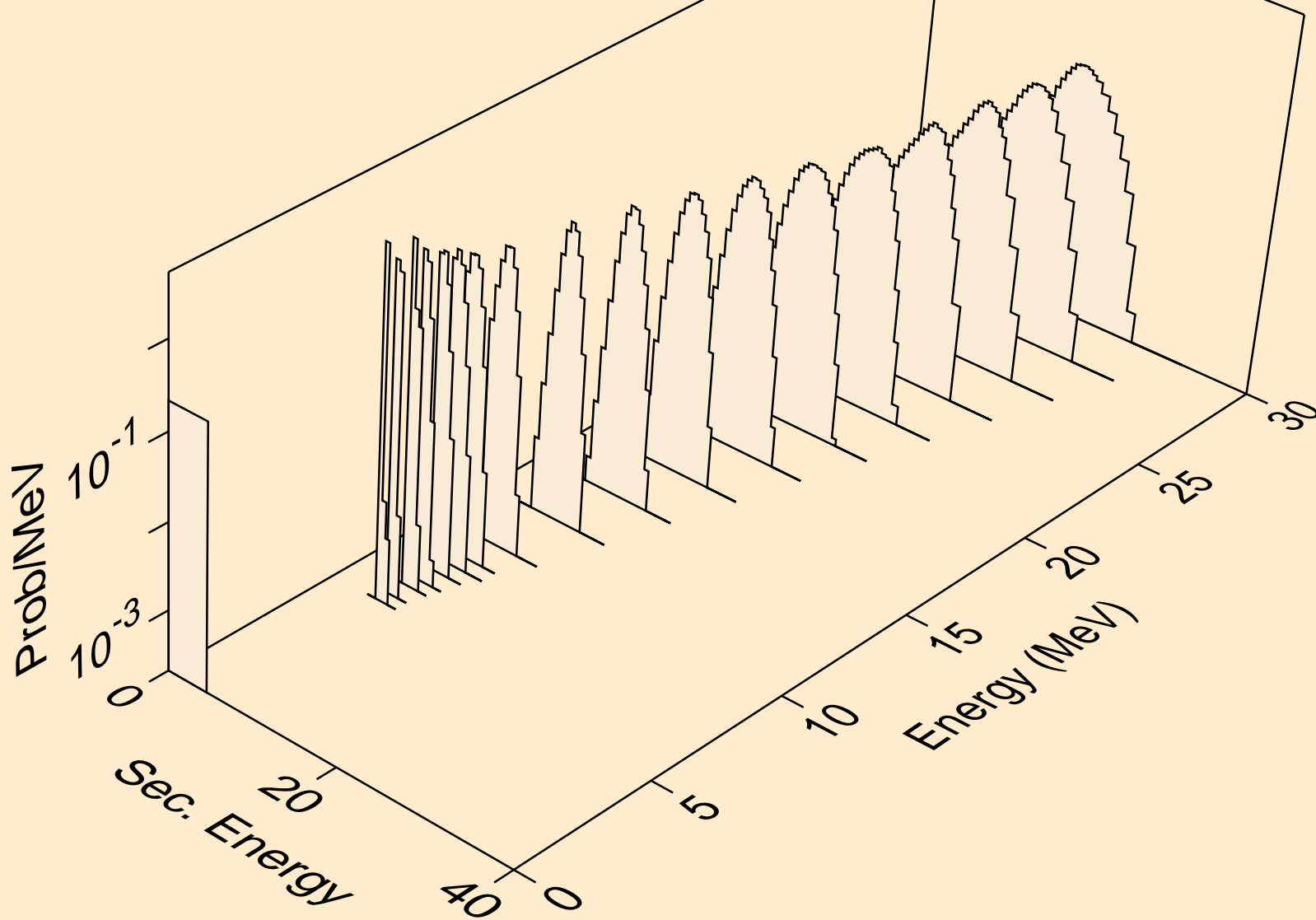

HF159 NEUTRON ACER TENDL-2019 LIBRARY; T=293.16K  
alphas from (n,a)

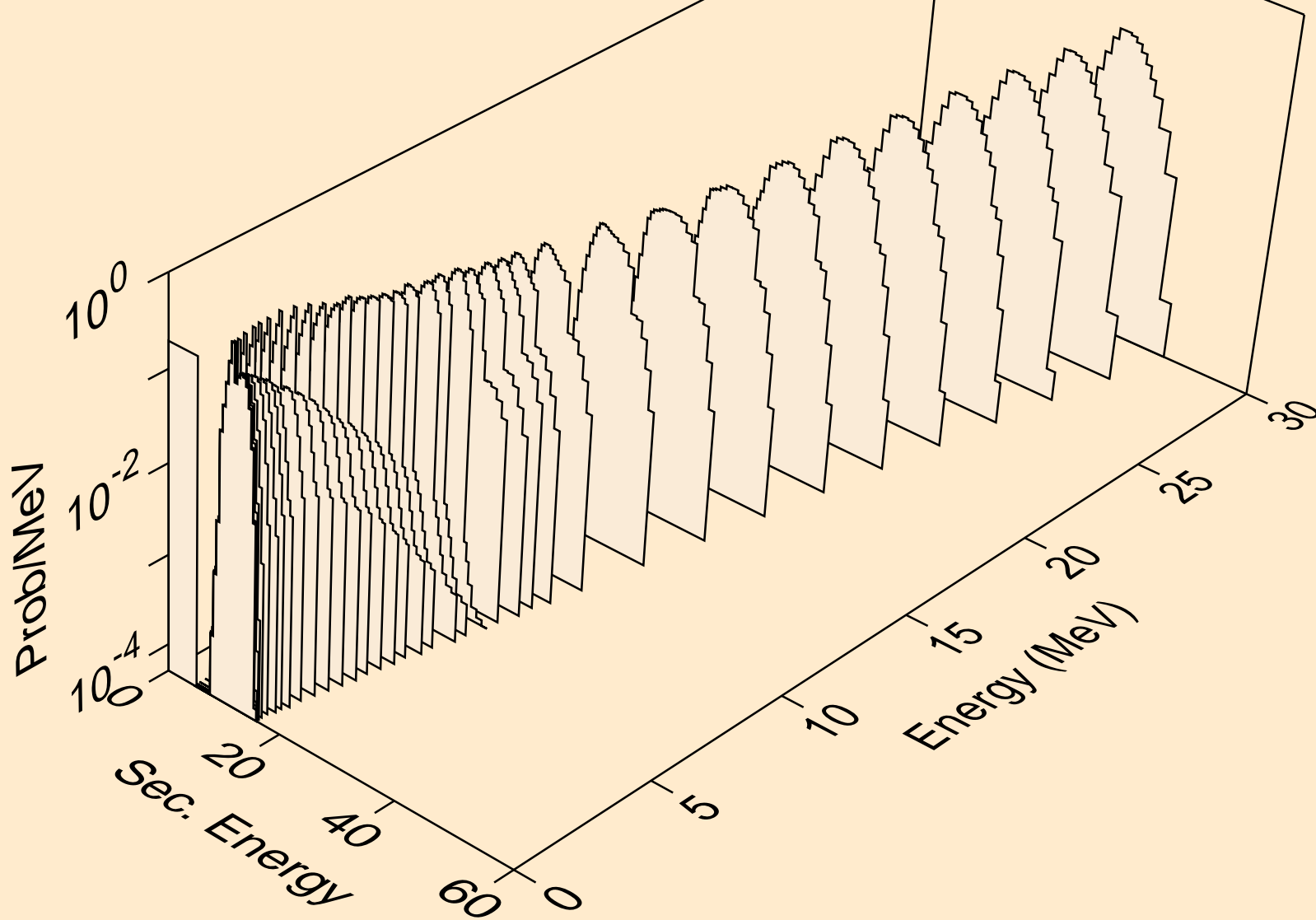

HF159 NEUTRON ACER TENDL-2019 LIBRARY; T=293.16K  
alphas from (n,2a)

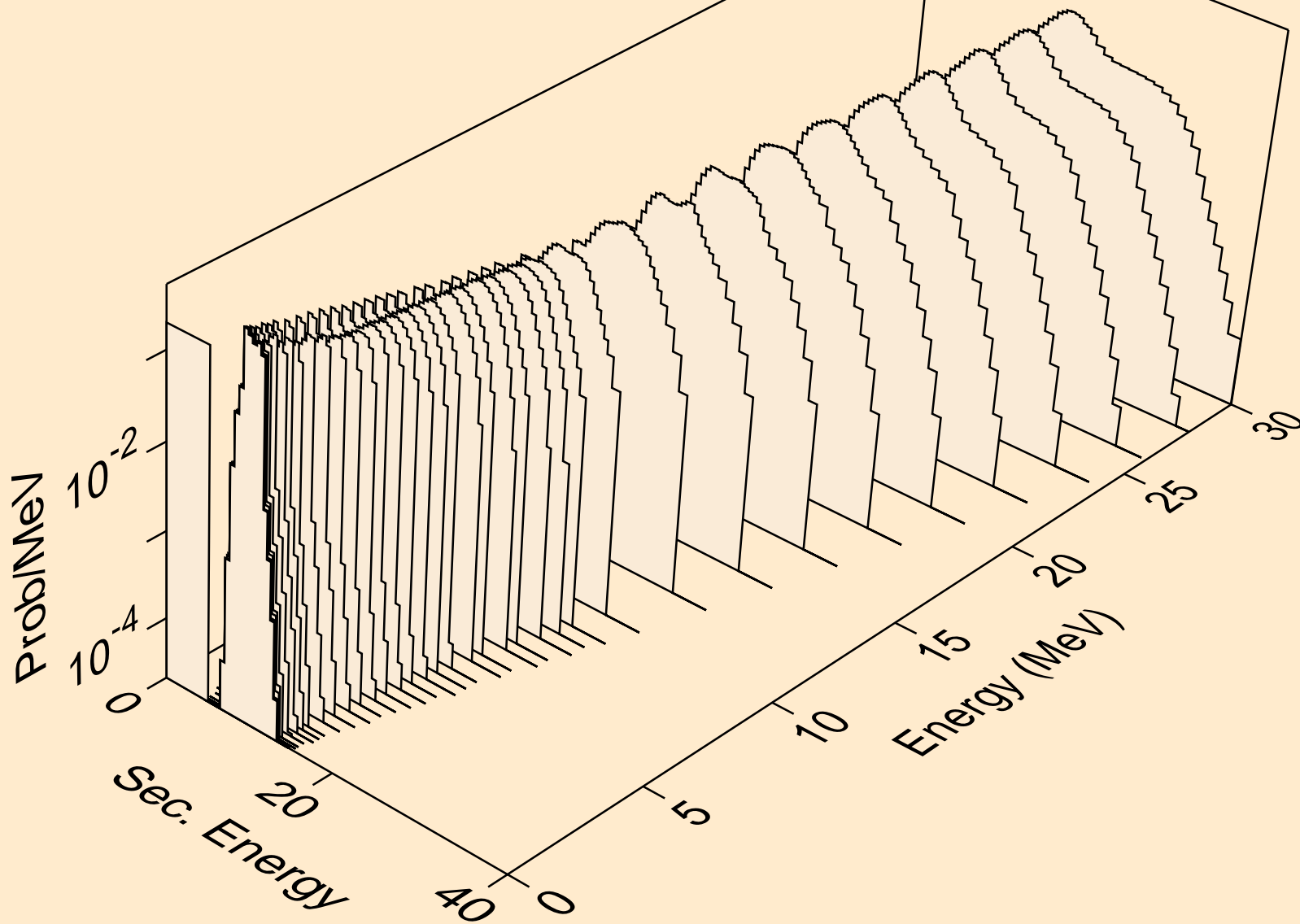



HF159 NEUTRON ACER TENDL-2019 LIBRARY; T=293.16K  
alphas from (n,3a)

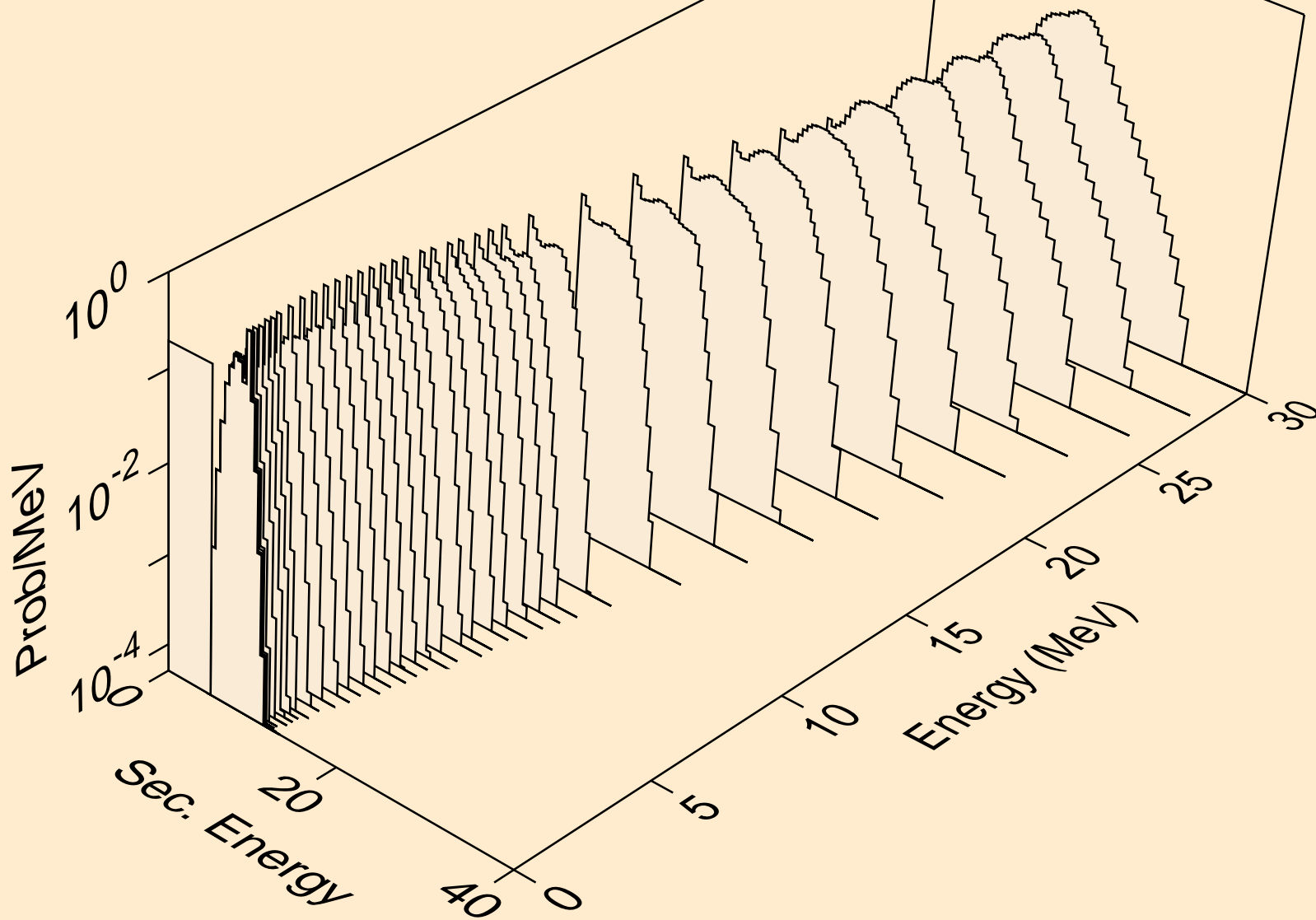

HF159 NEUTRON ACER TENDL-2019 LIBRARY; T=293.16K  
alphas from (n,pa)

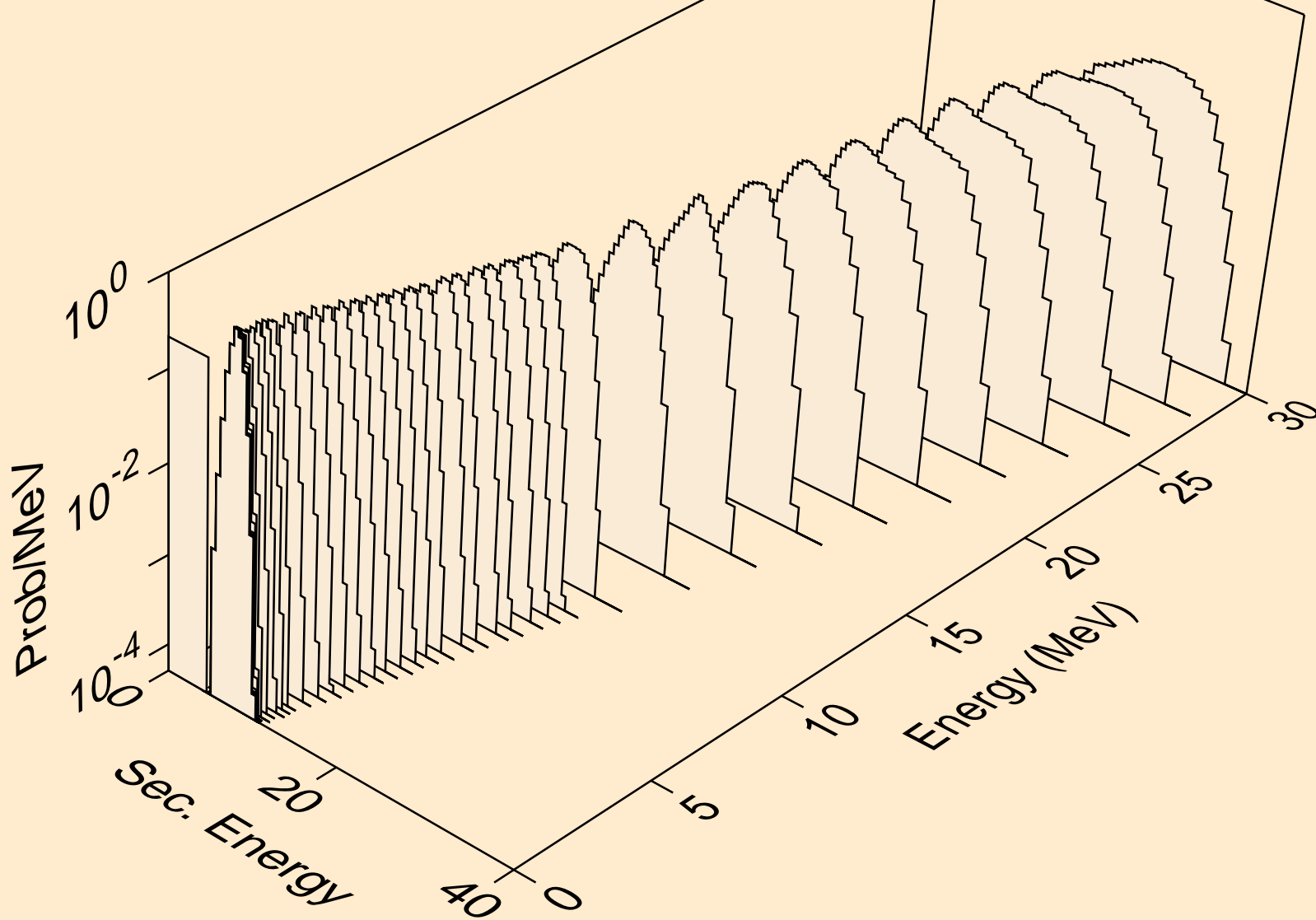

HF159 NEUTRON ACER TENDL-2019 LIBRARY; T=293.16K  
alphas from (n,t2a)

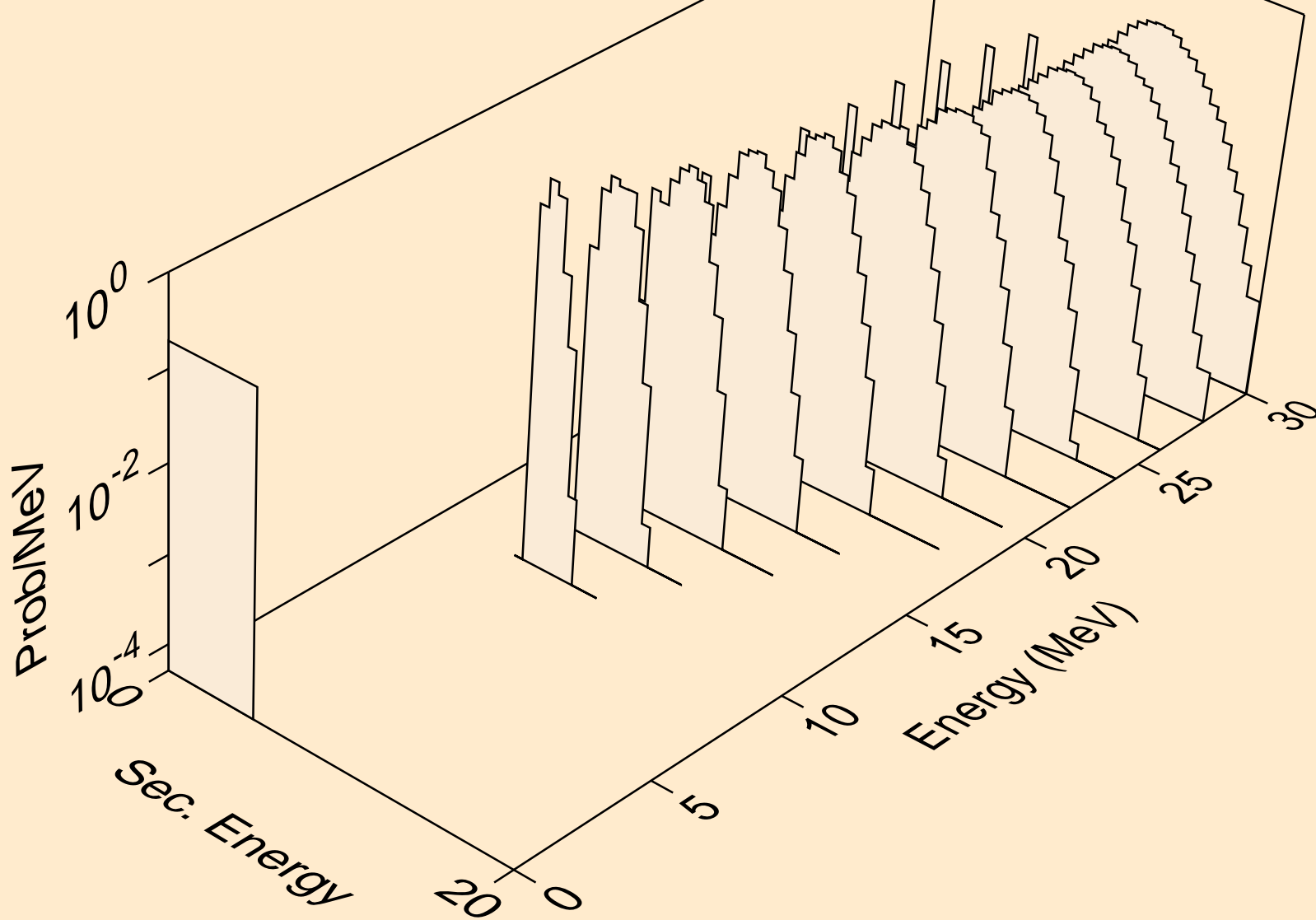

HF159 NEUTRON ACER TENDL-2019 LIBRARY; T=293.16K  
alphas from (n,d2a)

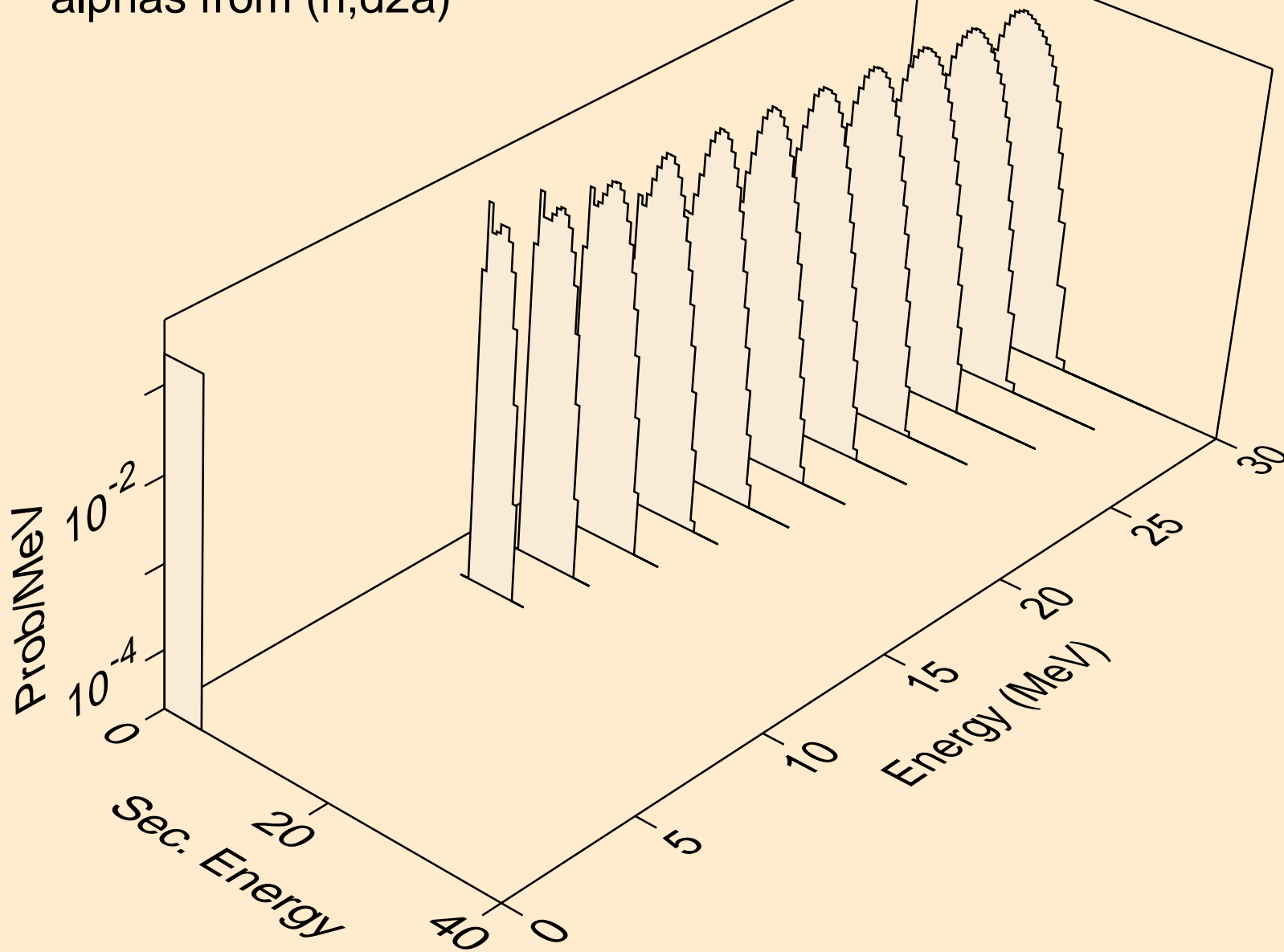

HF159 NEUTRON ACER TENDL-2019 LIBRARY; T=293.16K  
alphas from (n,da)

