

HF171 NEUTRON ACER TENDL-2019 LIBRARY; T=293.16K  
Principal cross sections

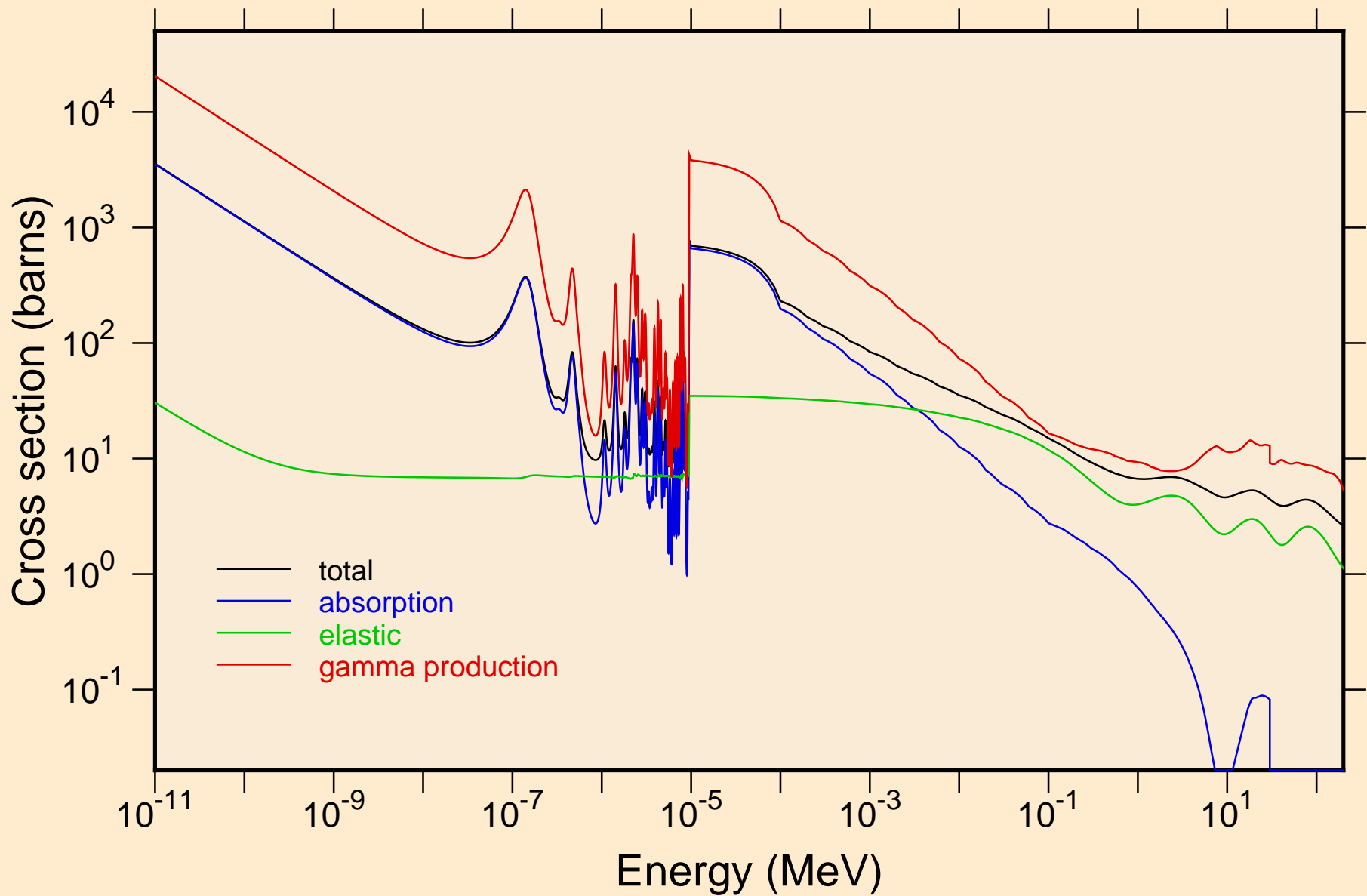

HF171 NEUTRON ACER TENDL-2019 LIBRARY; T=293.16K  
resonance total cross section

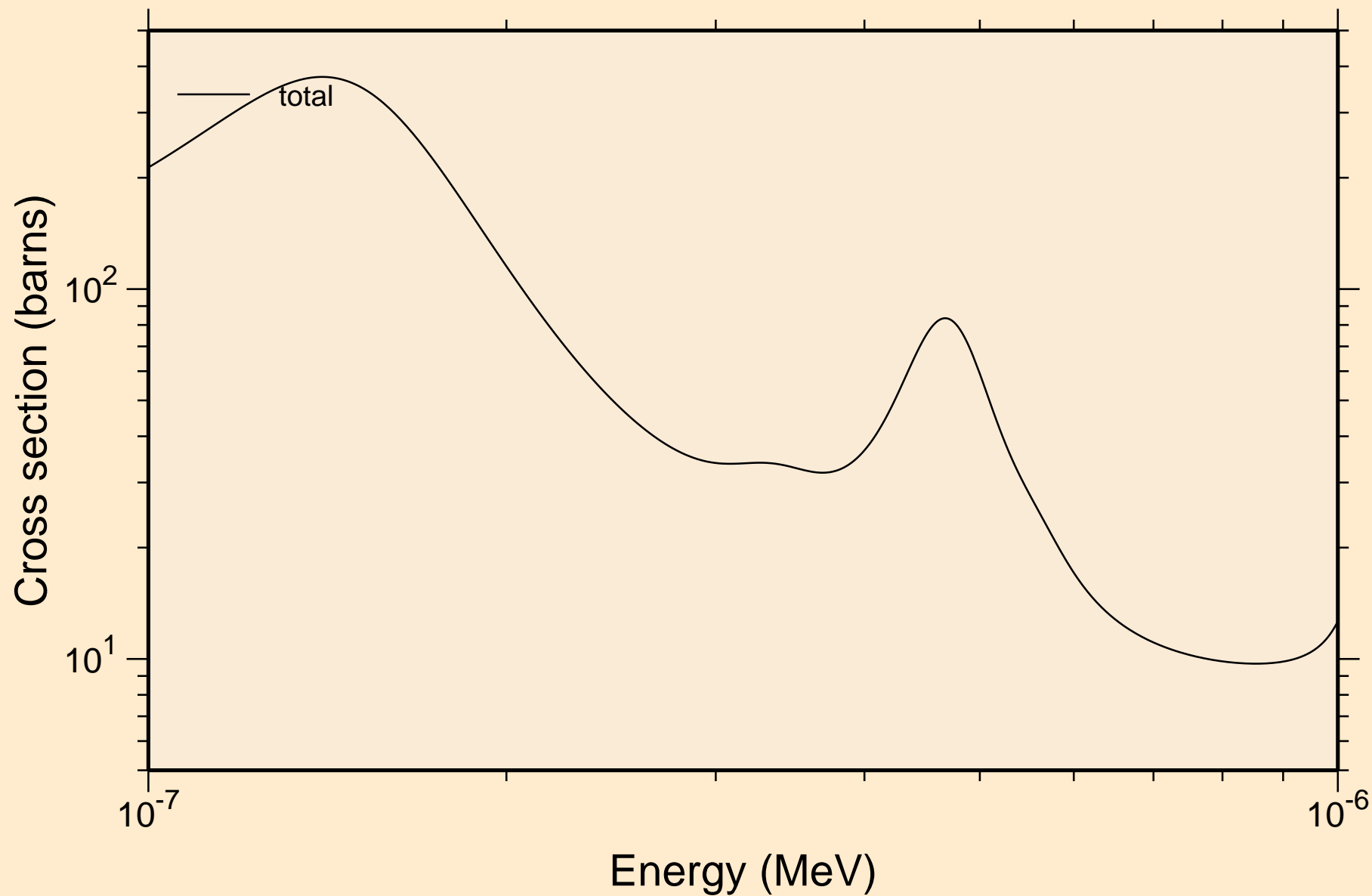

HF171 NEUTRON ACER TENDL-2019 LIBRARY; T=293.16K  
resonance total cross section

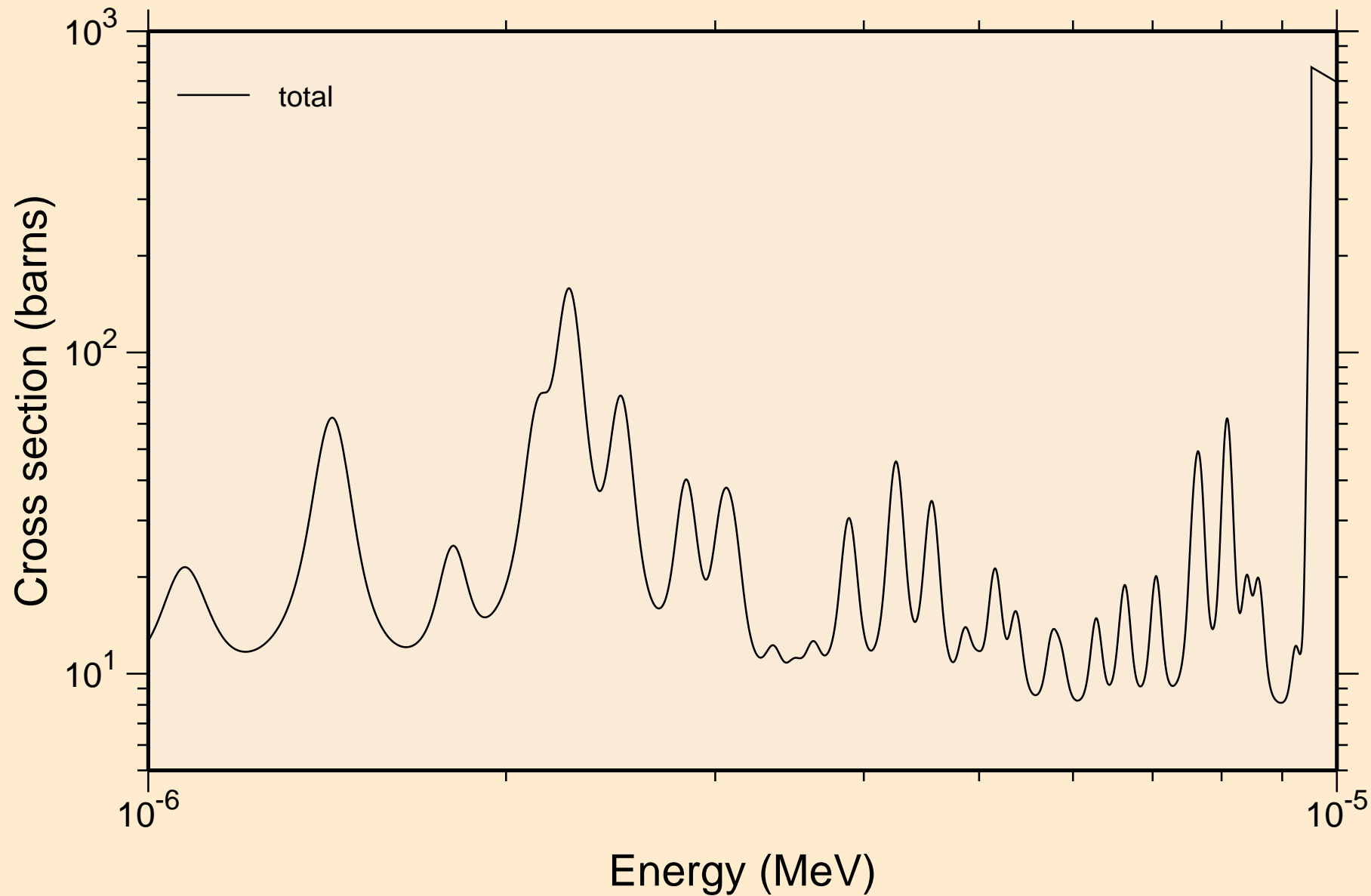

HF171 NEUTRON ACER TENDL-2019 LIBRARY; T=293.16K  
resonance total cross section

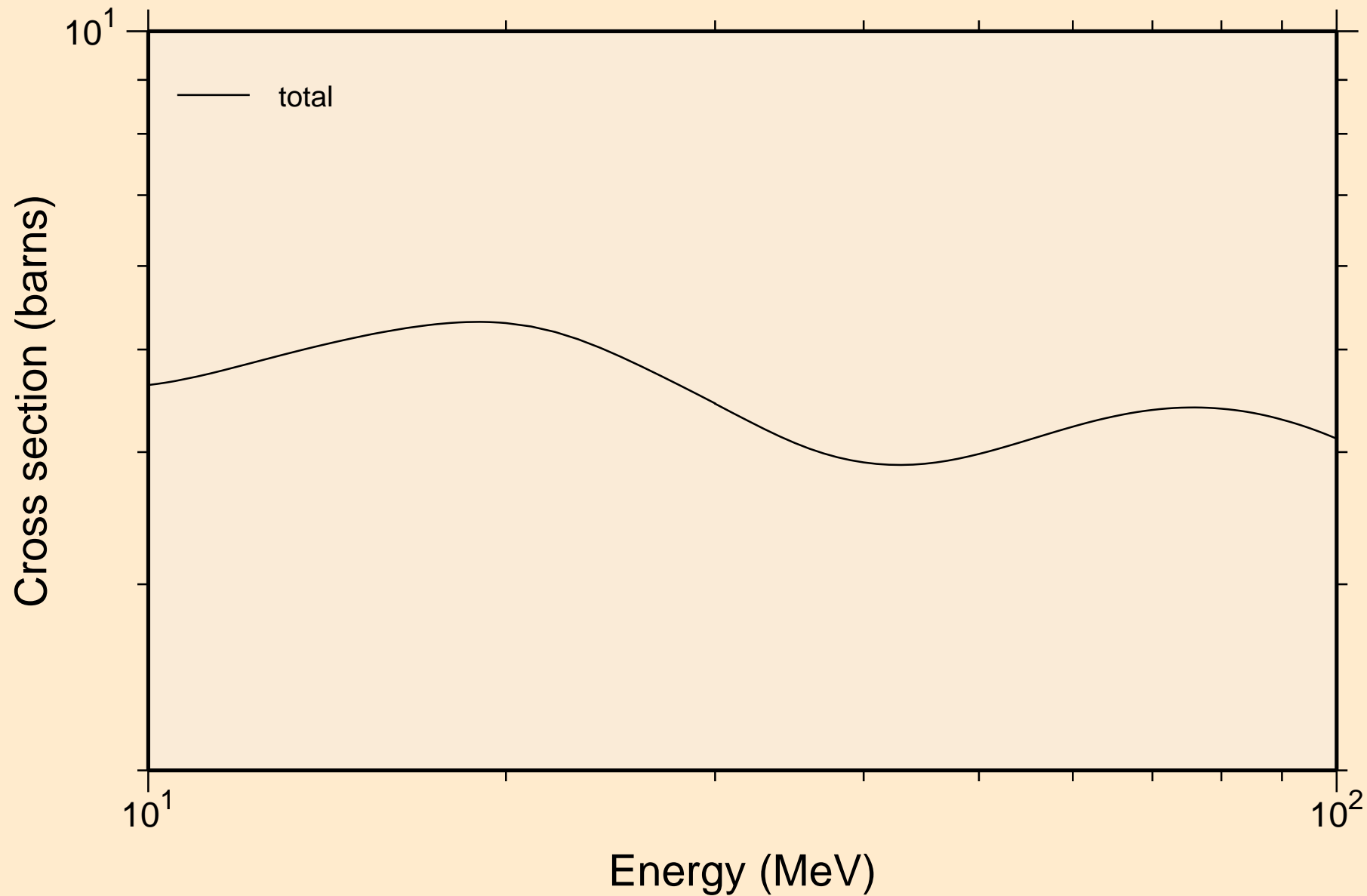

HF171 NEUTRON ACER TENDL-2019 LIBRARY; T=293.16K  
resonance absorption cross sections

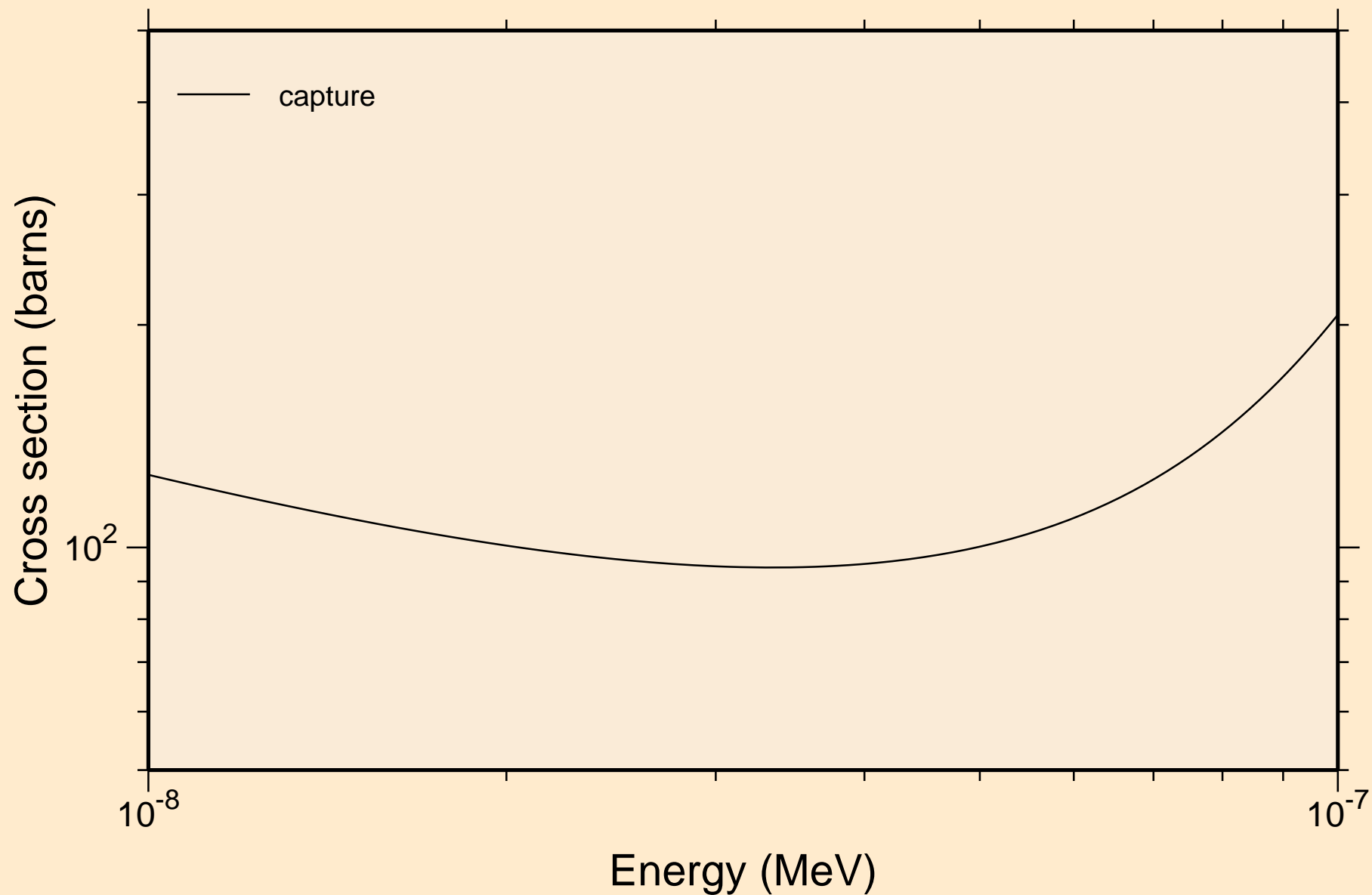

HF171 NEUTRON ACER TENDL-2019 LIBRARY; T=293.16K  
resonance absorption cross sections

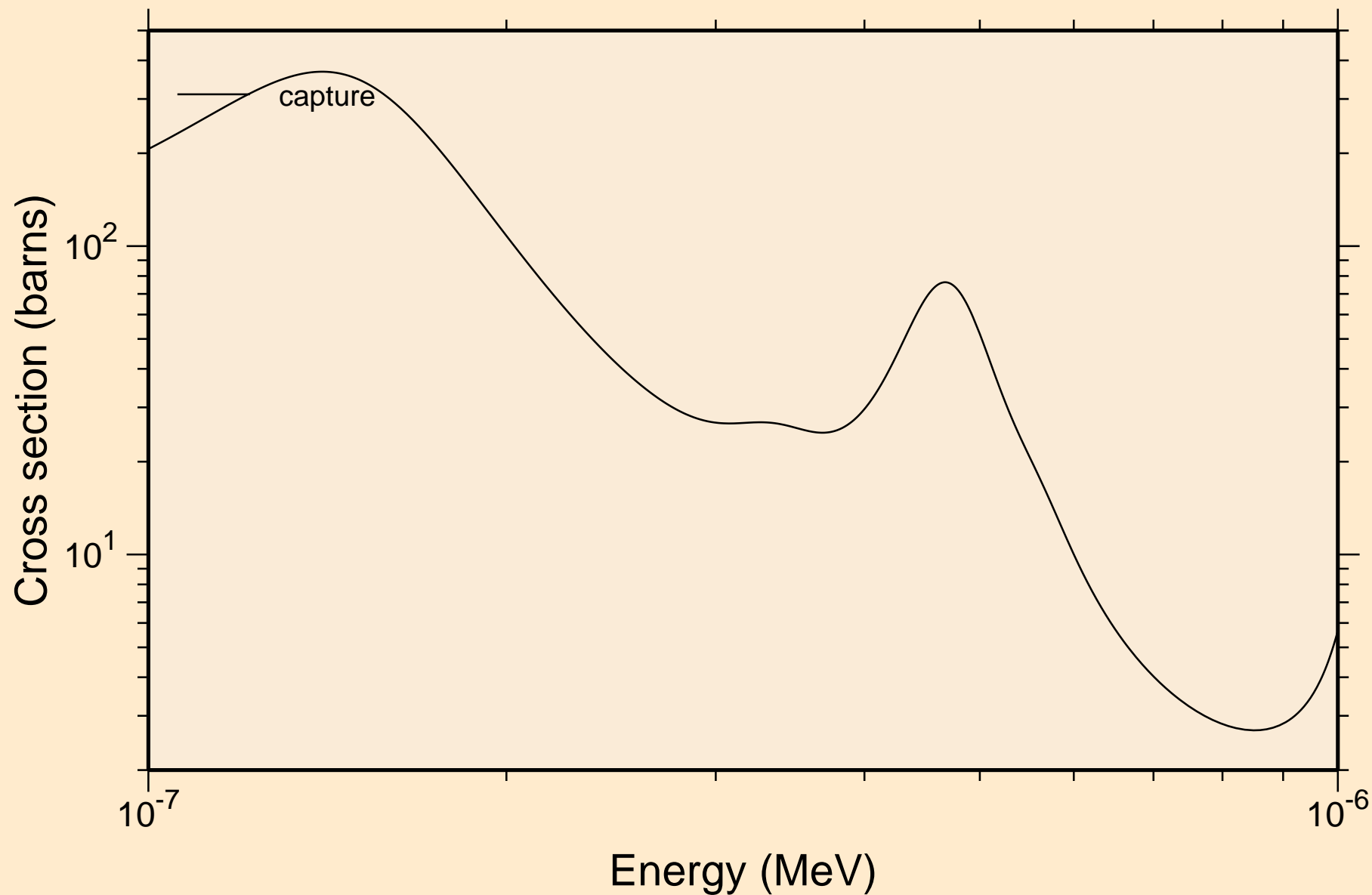

HF171 NEUTRON ACER TENDL-2019 LIBRARY; T=293.16K  
resonance absorption cross sections

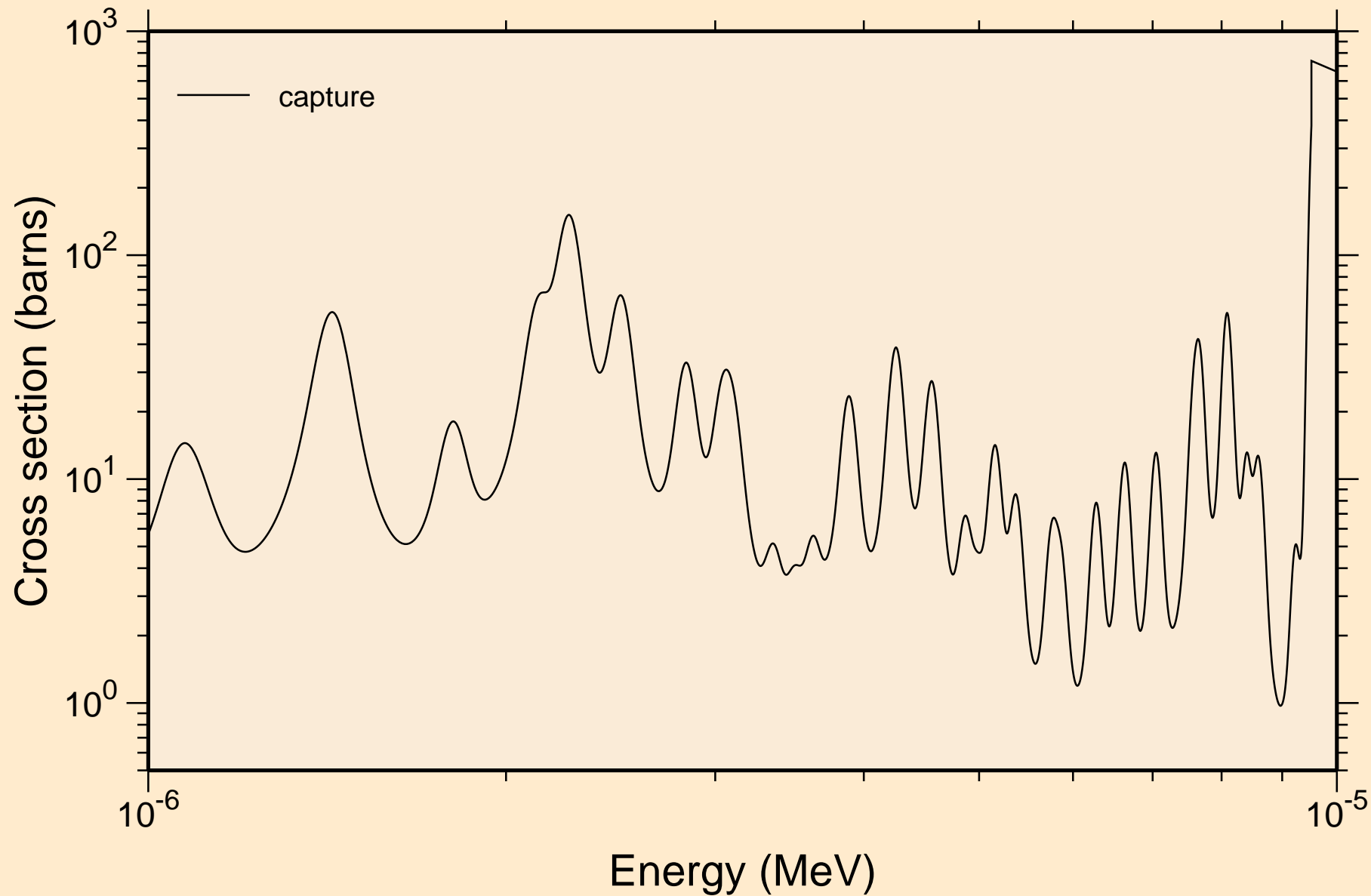

HF171 NEUTRON ACER TENDL-2019 LIBRARY; T=293.16K  
resonance absorption cross sections

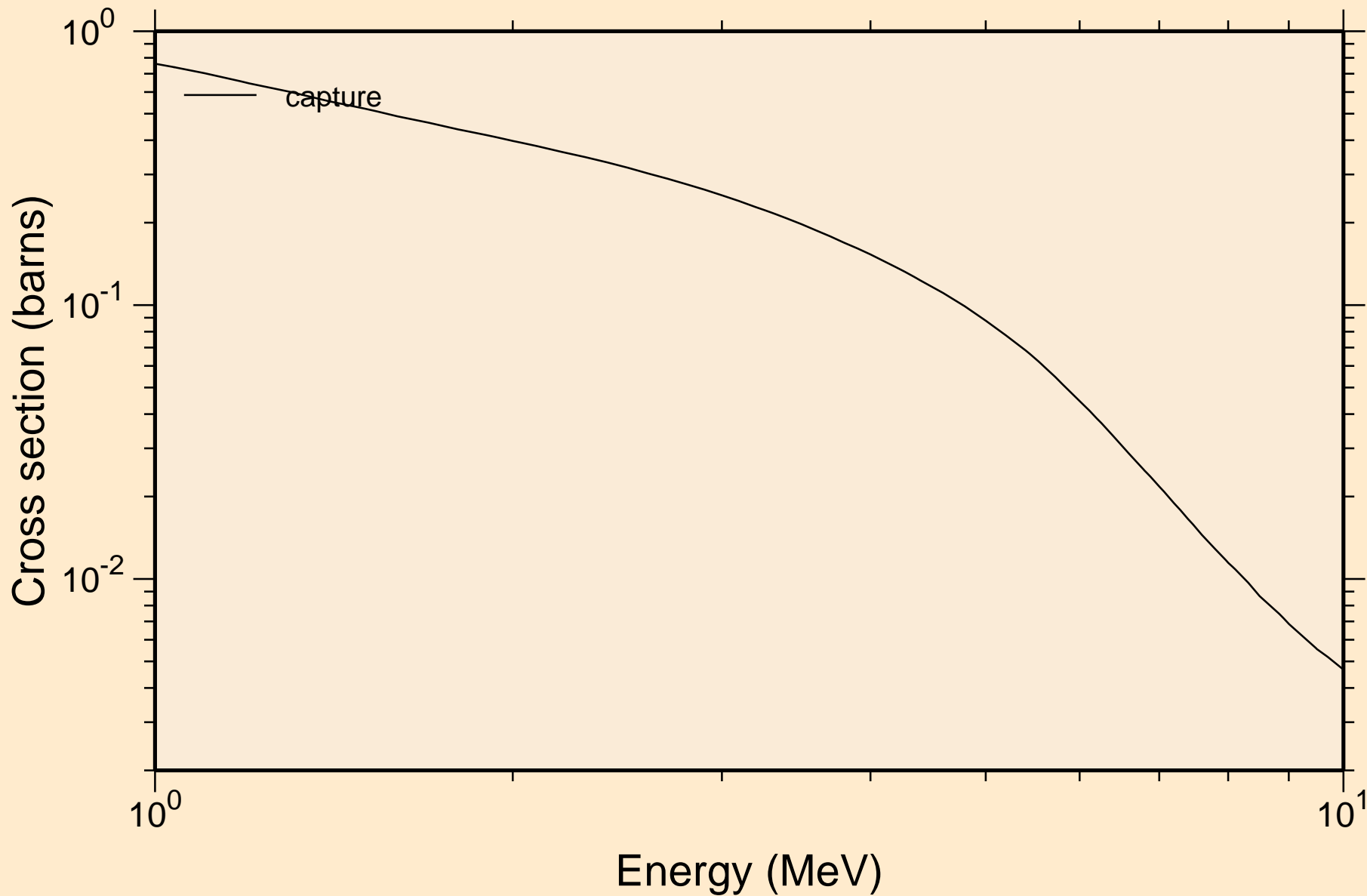



# HF171 NEUTRON ACER TENDL-2019 LIBRARY; T=293.16K

## Heating

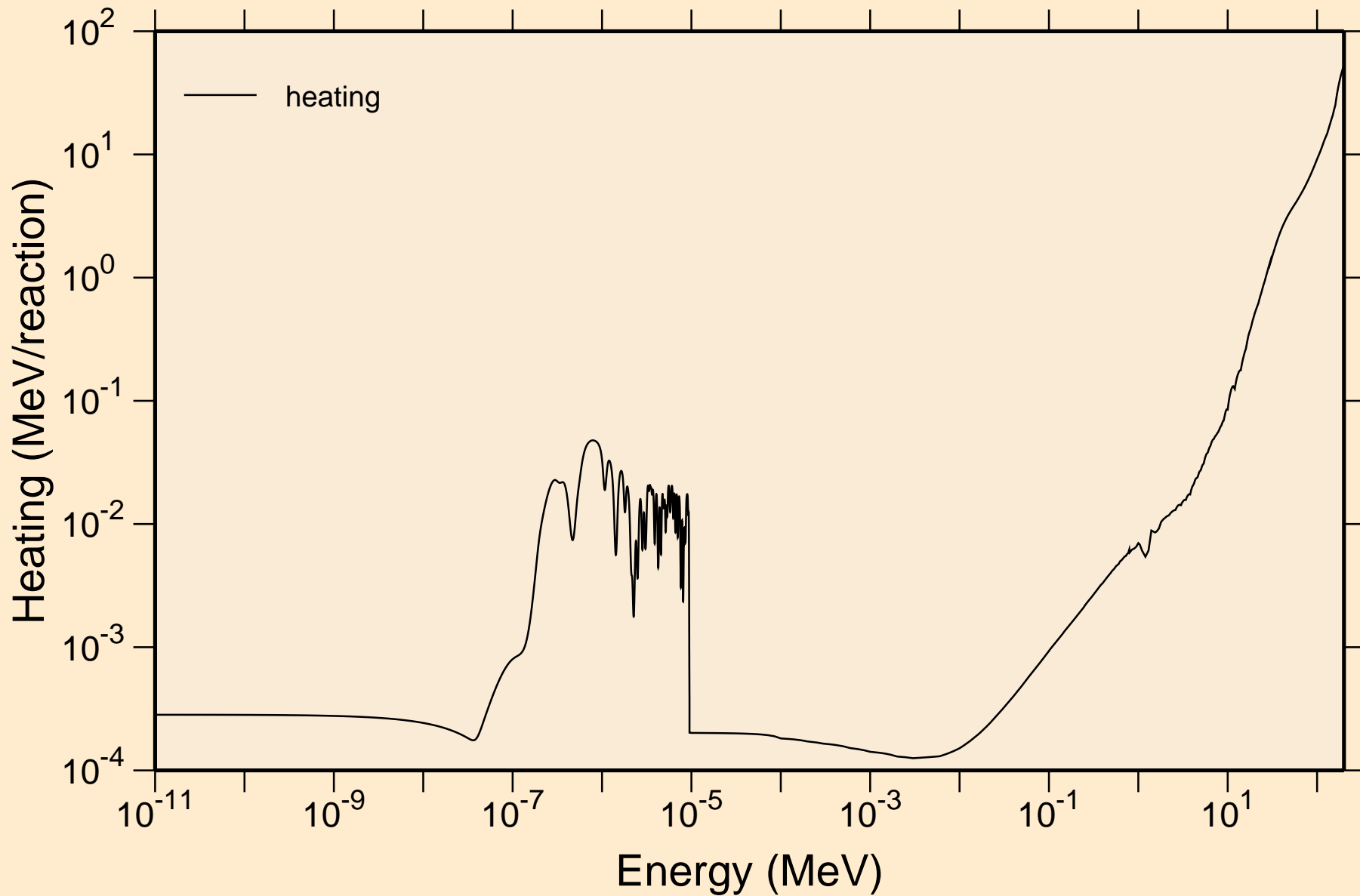

# HF171 NEUTRON ACER TENDL-2019 LIBRARY; T=293.16K

## Damage

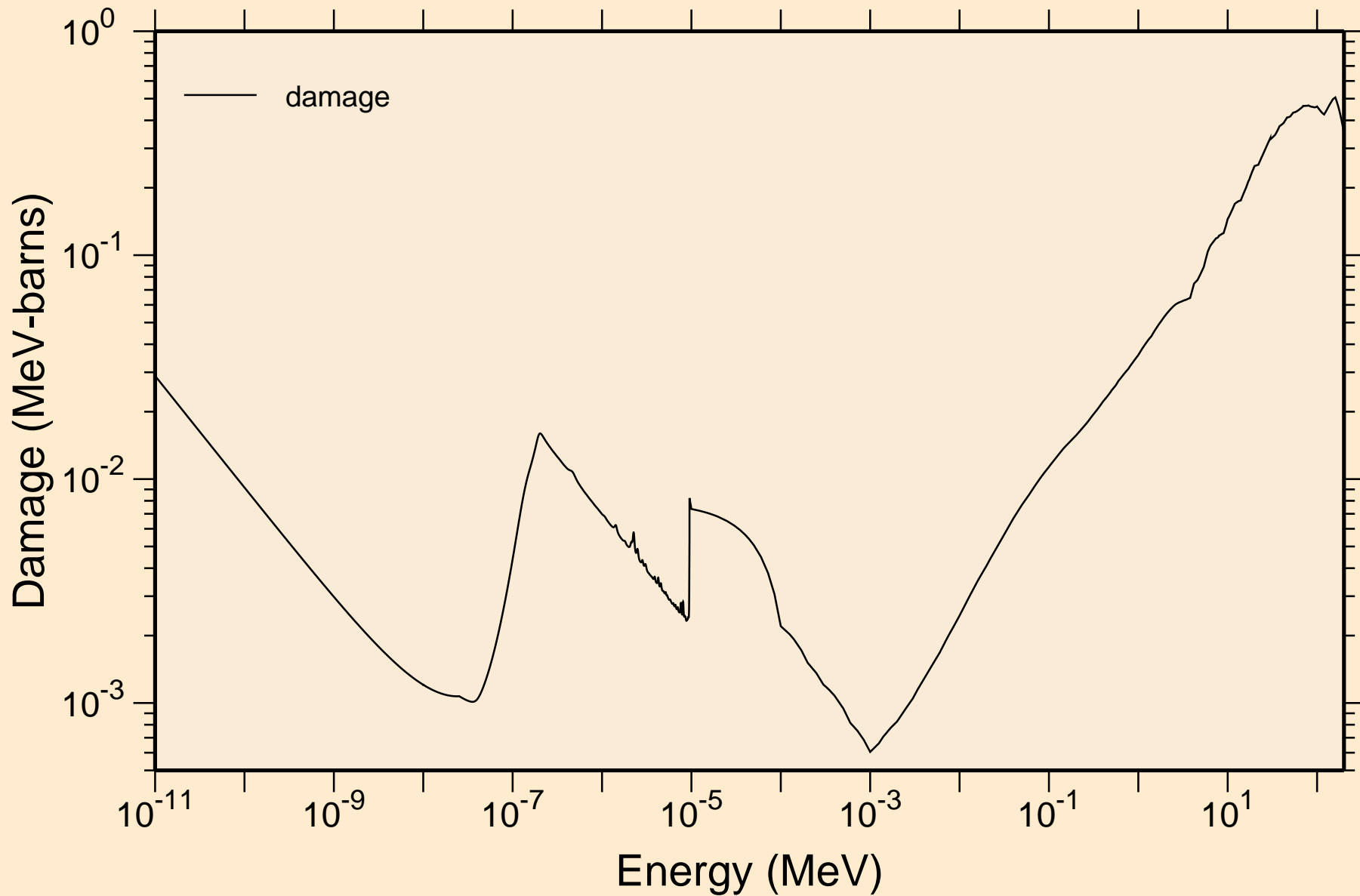

# HF171 NEUTRON ACER TENDL-2019 LIBRARY; T=293.16K

## Non-threshold reactions

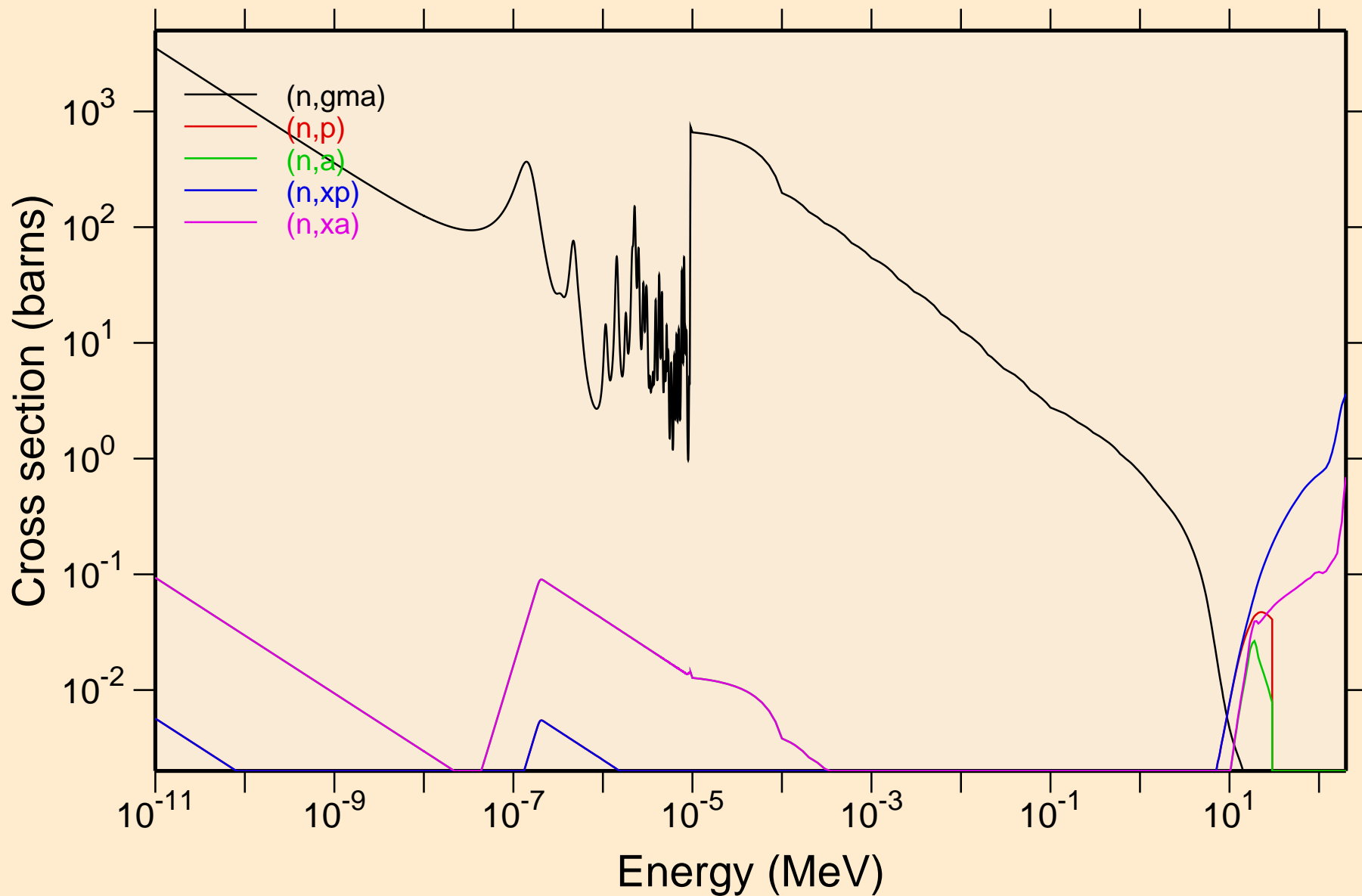

# HF171 NEUTRON ACER TENDL-2019 LIBRARY; T=293.16K

## Principal cross sections

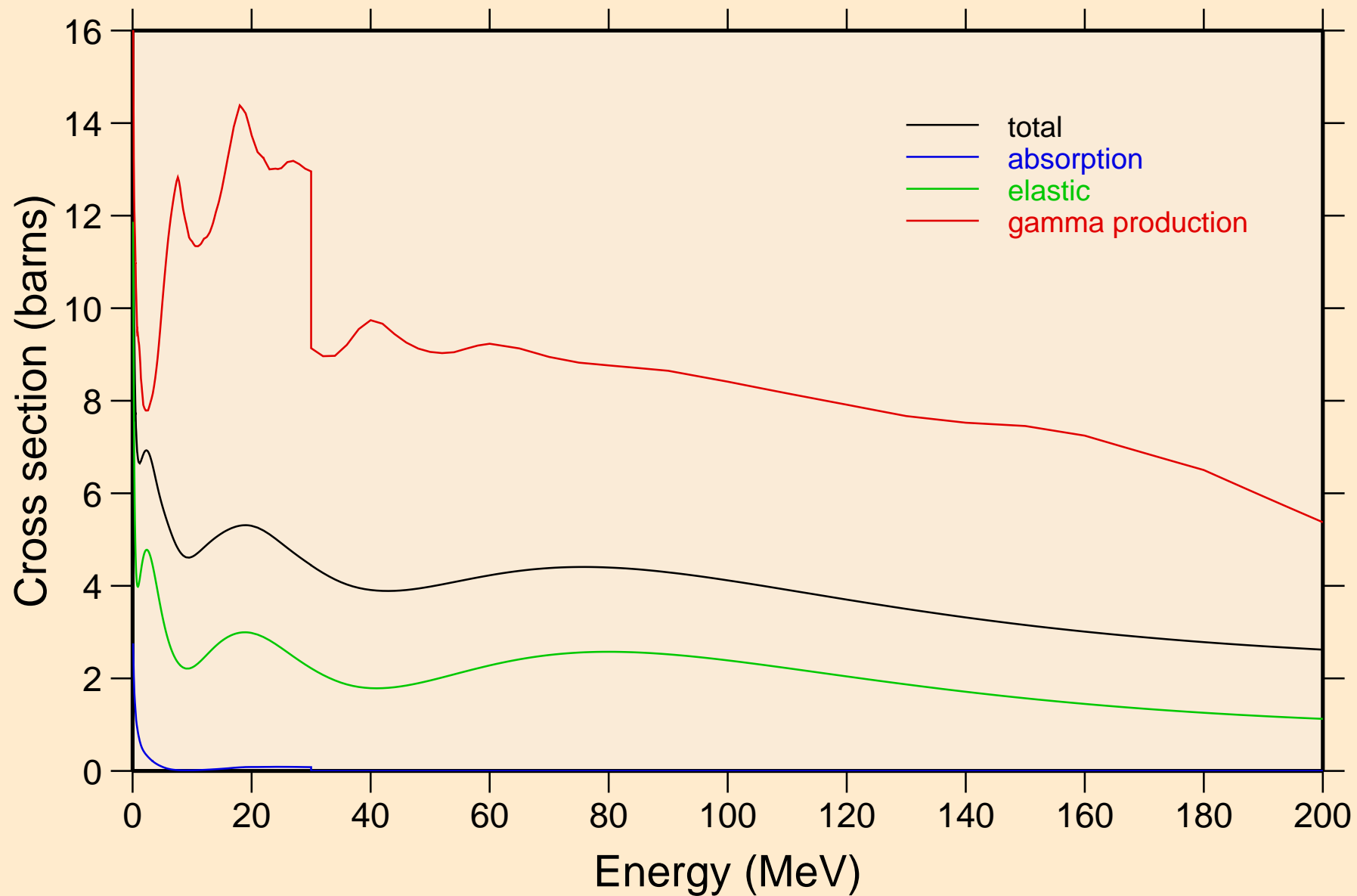

HF171 NEUTRON ACER TENDL-2019 LIBRARY; T=293.16K  
Heating

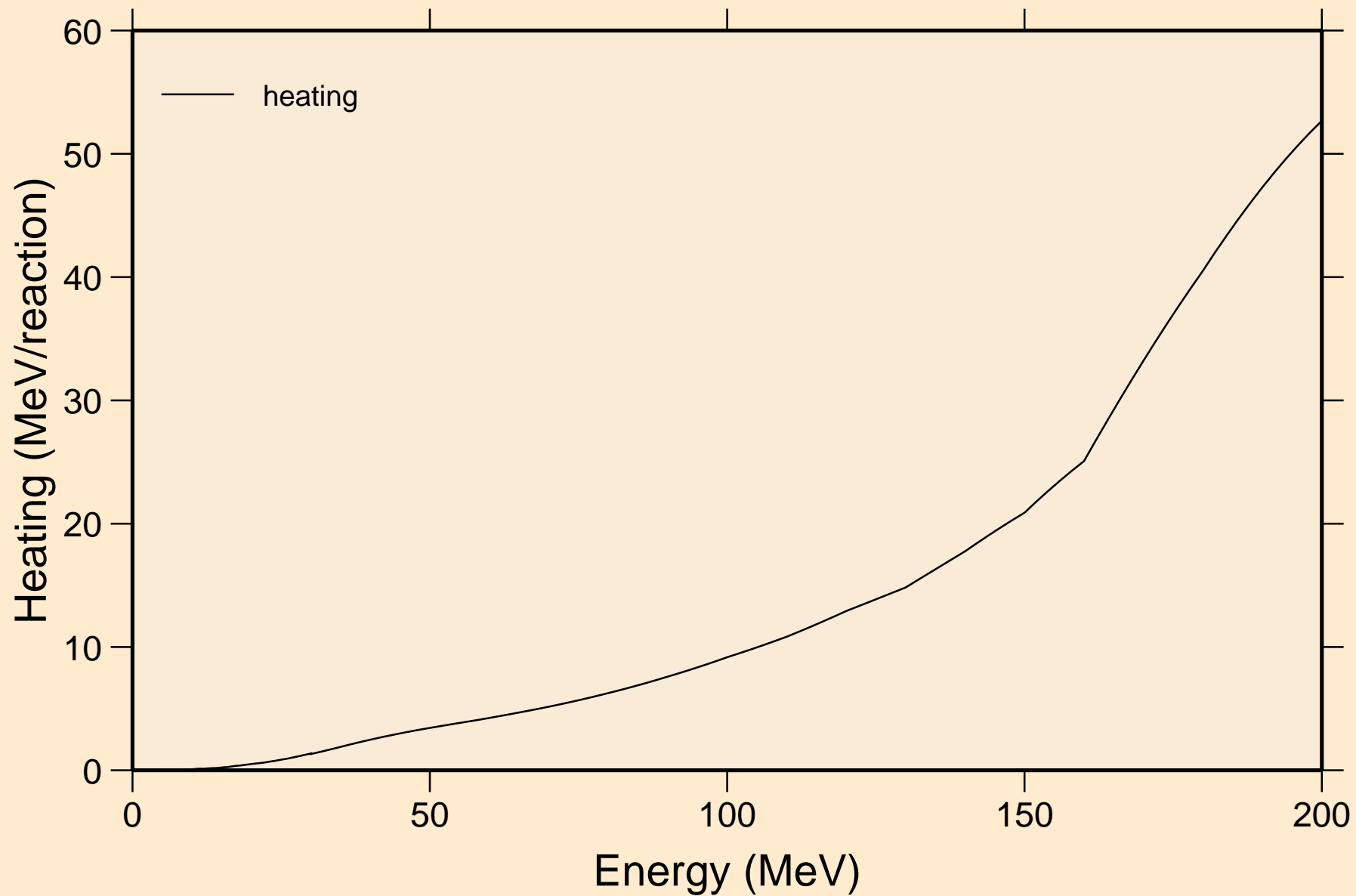

HF171 NEUTRON ACER TENDL-2019 LIBRARY; T=293.16K  
Damage

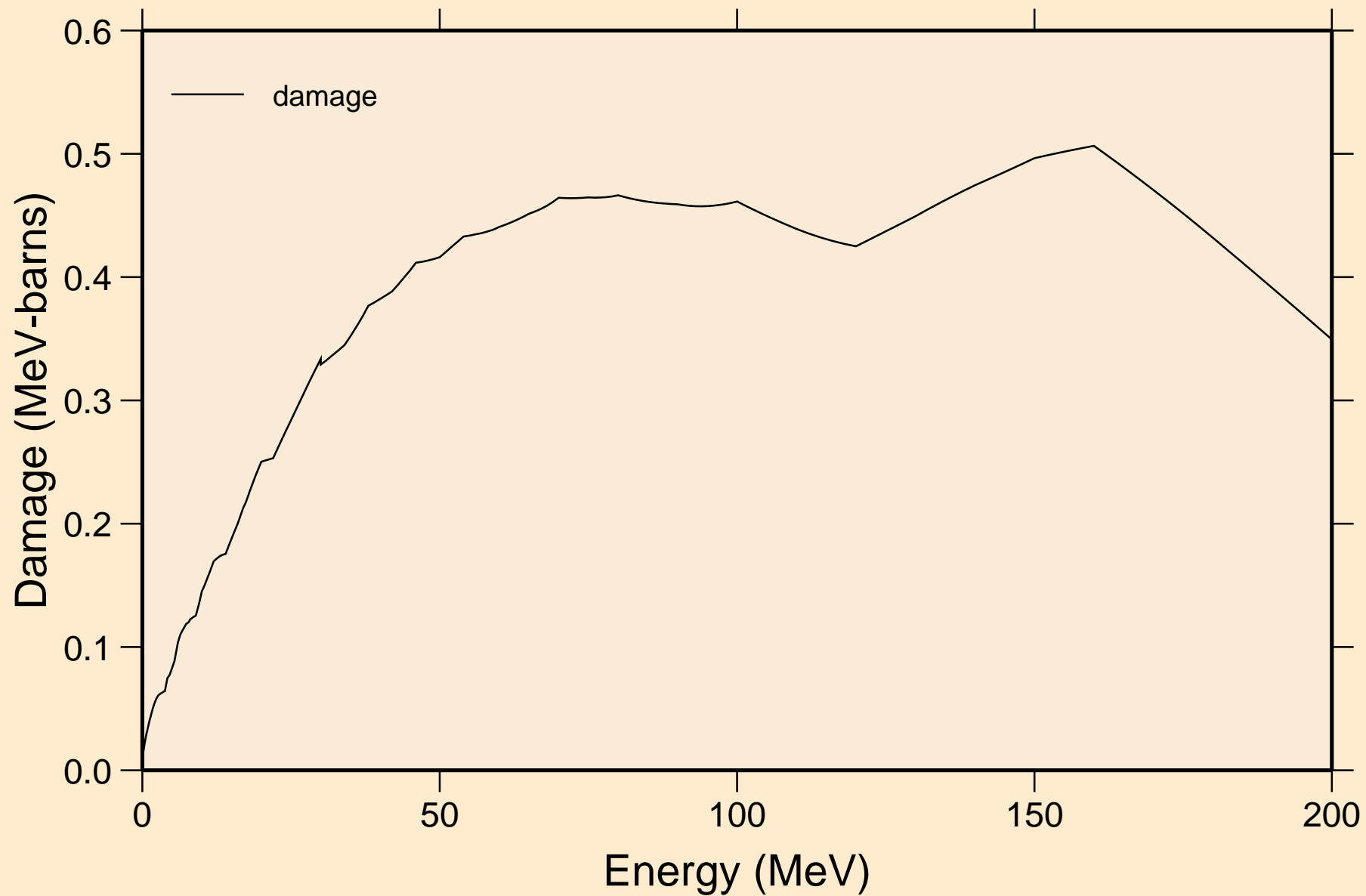

# HF171 NEUTRON ACER TENDL-2019 LIBRARY; T=293.16K

## Non-threshold reactions

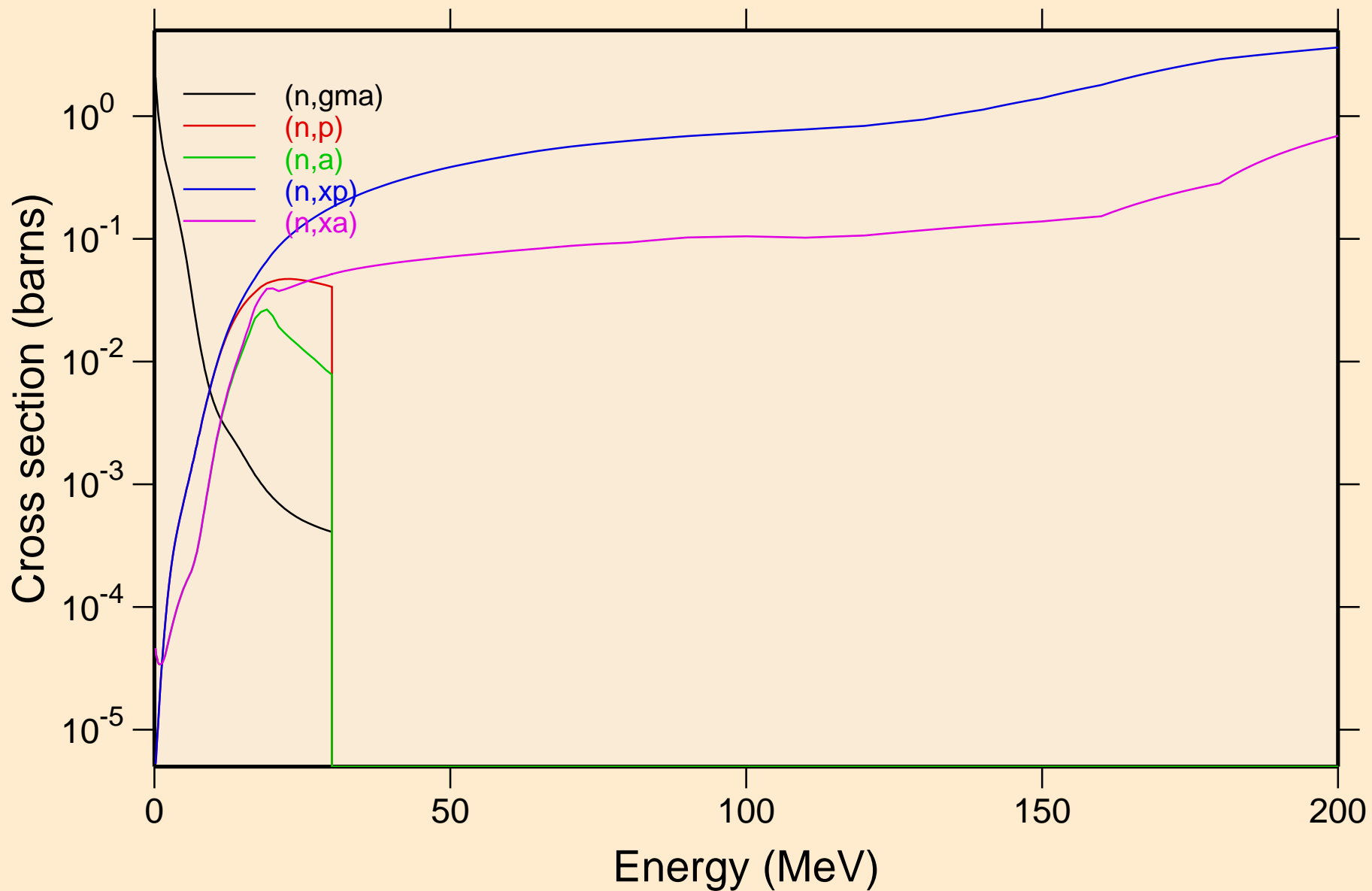

HF171 NEUTRON ACER TENDL-2019 LIBRARY; T=293.16K  
Inelastic levels

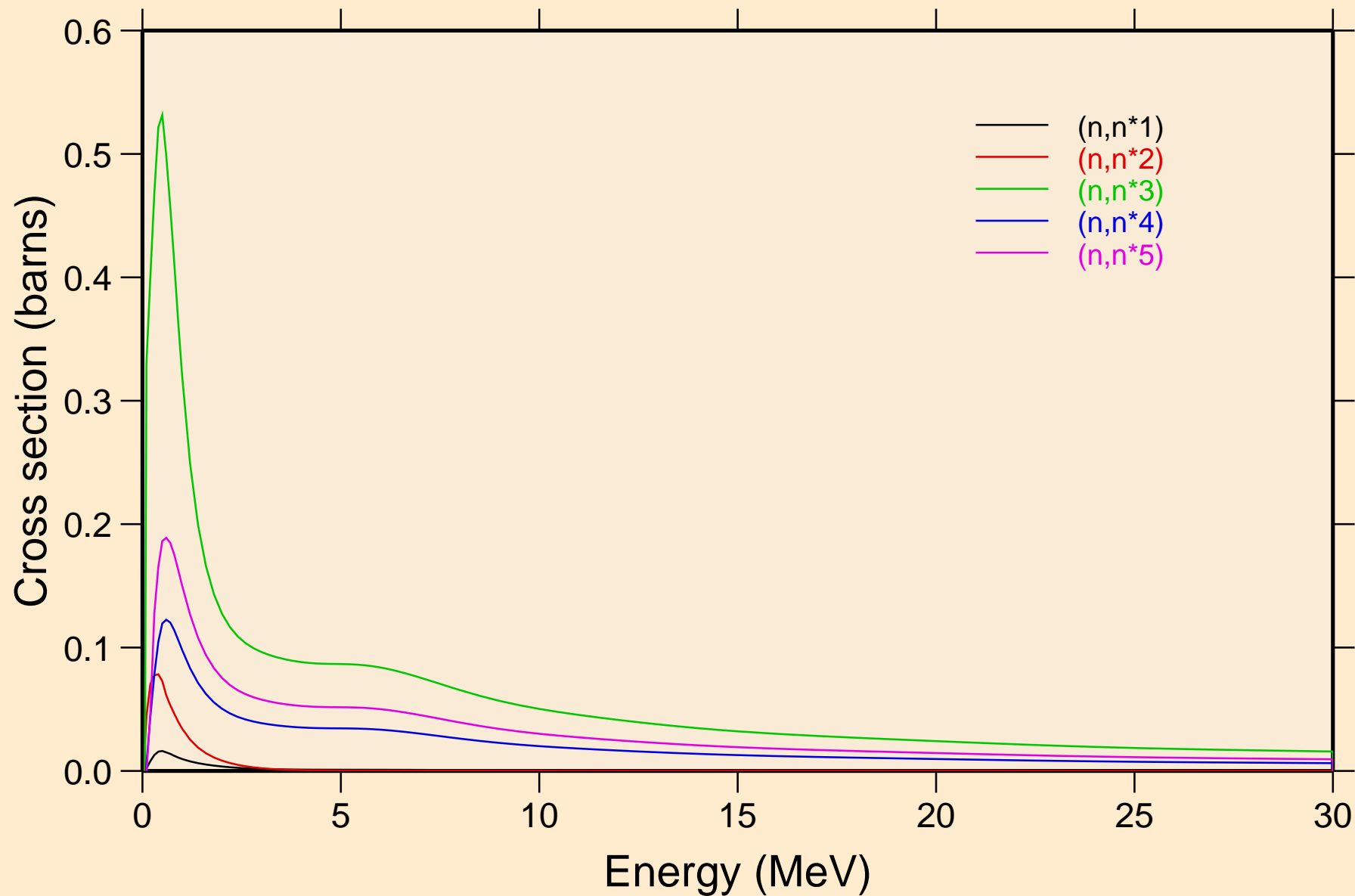



HF171 NEUTRON ACER TENDL-2019 LIBRARY; T=293.16K  
Inelastic levels

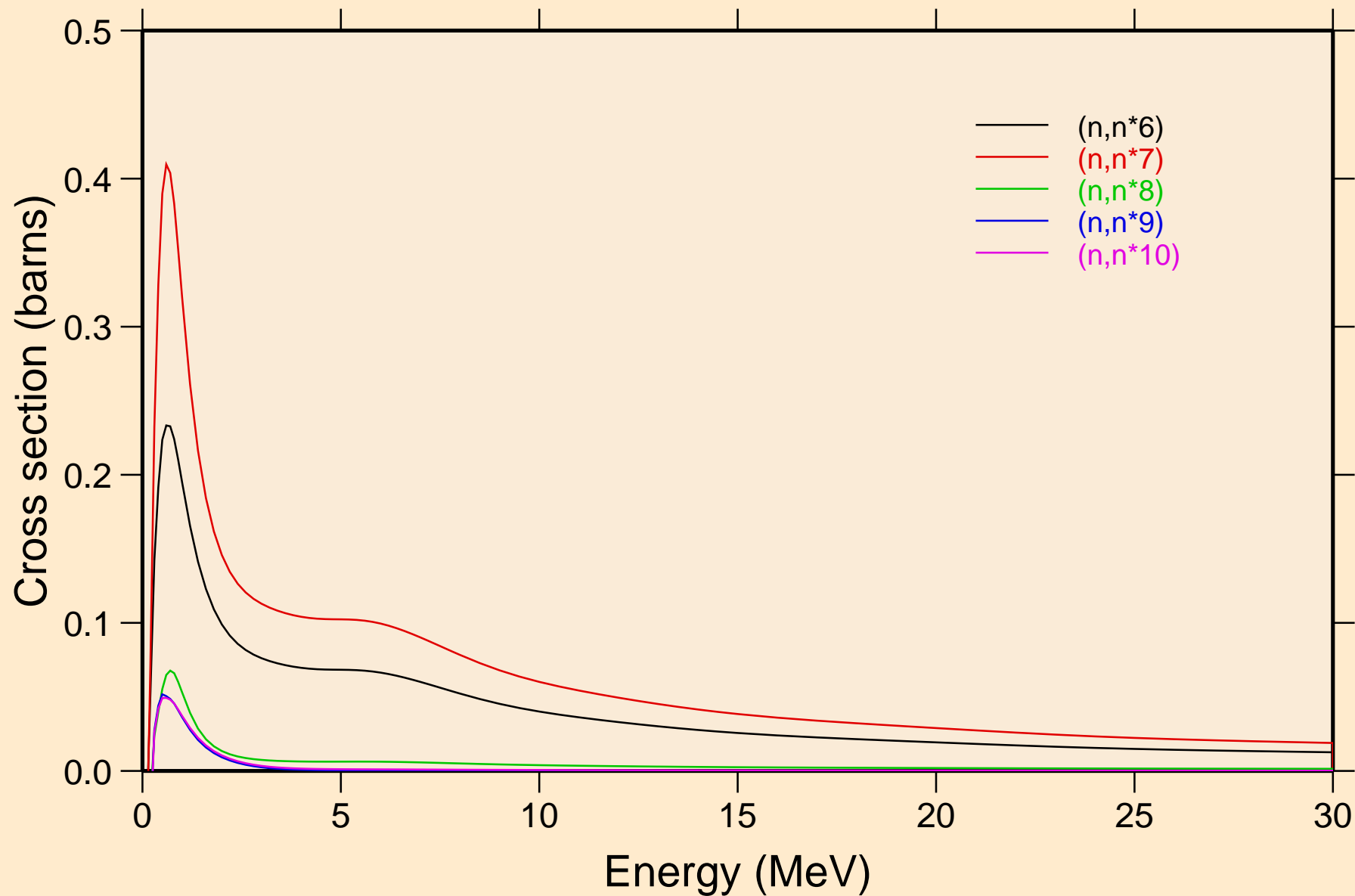

# HF171 NEUTRON ACER TENDL-2019 LIBRARY; T=293.16K

## Inelastic levels

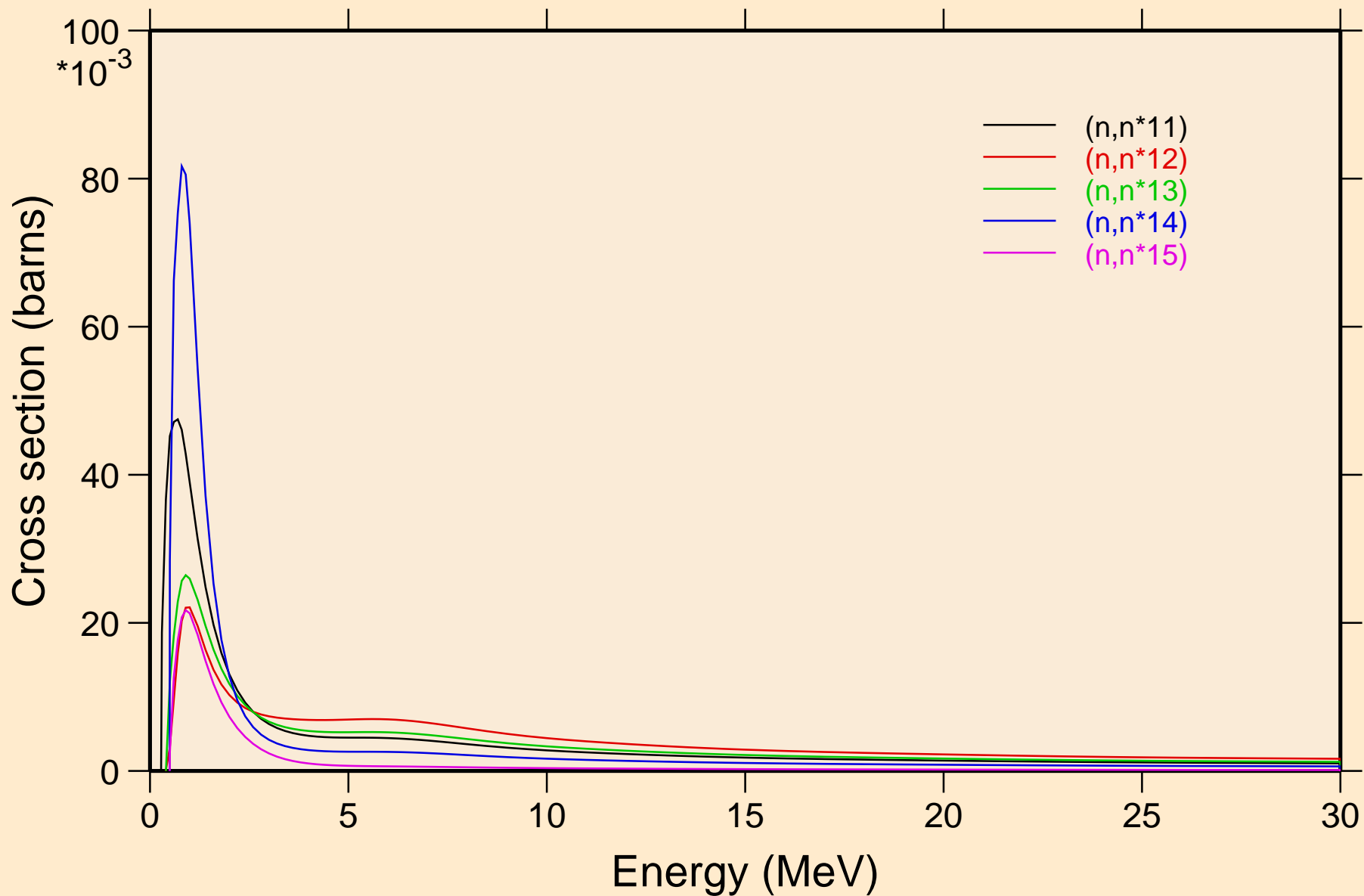

# HF171 NEUTRON ACER TENDL-2019 LIBRARY; T=293.16K

## Inelastic levels

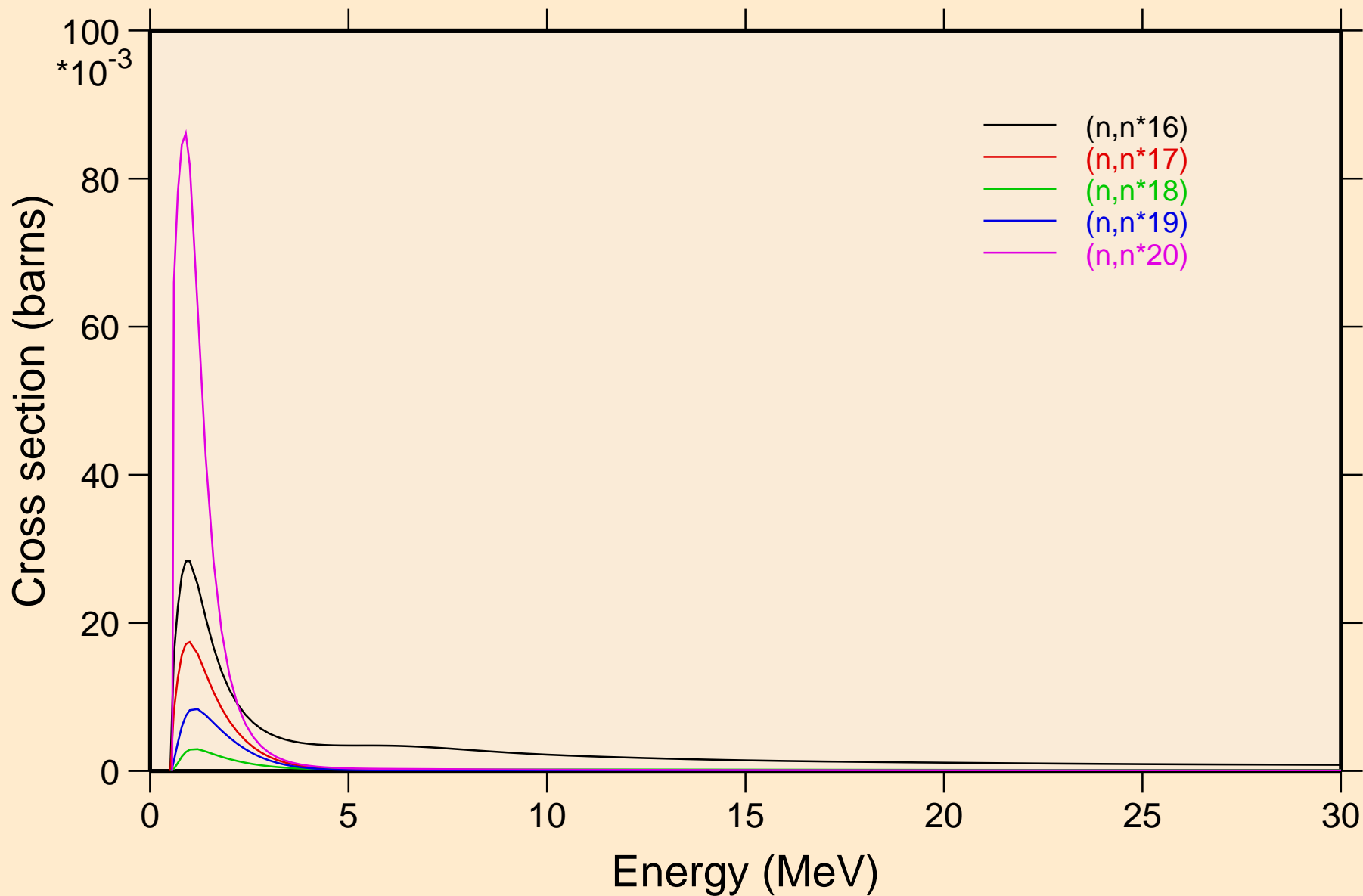

HF171 NEUTRON ACER TENDL-2019 LIBRARY; T=293.16K  
Inelastic levels

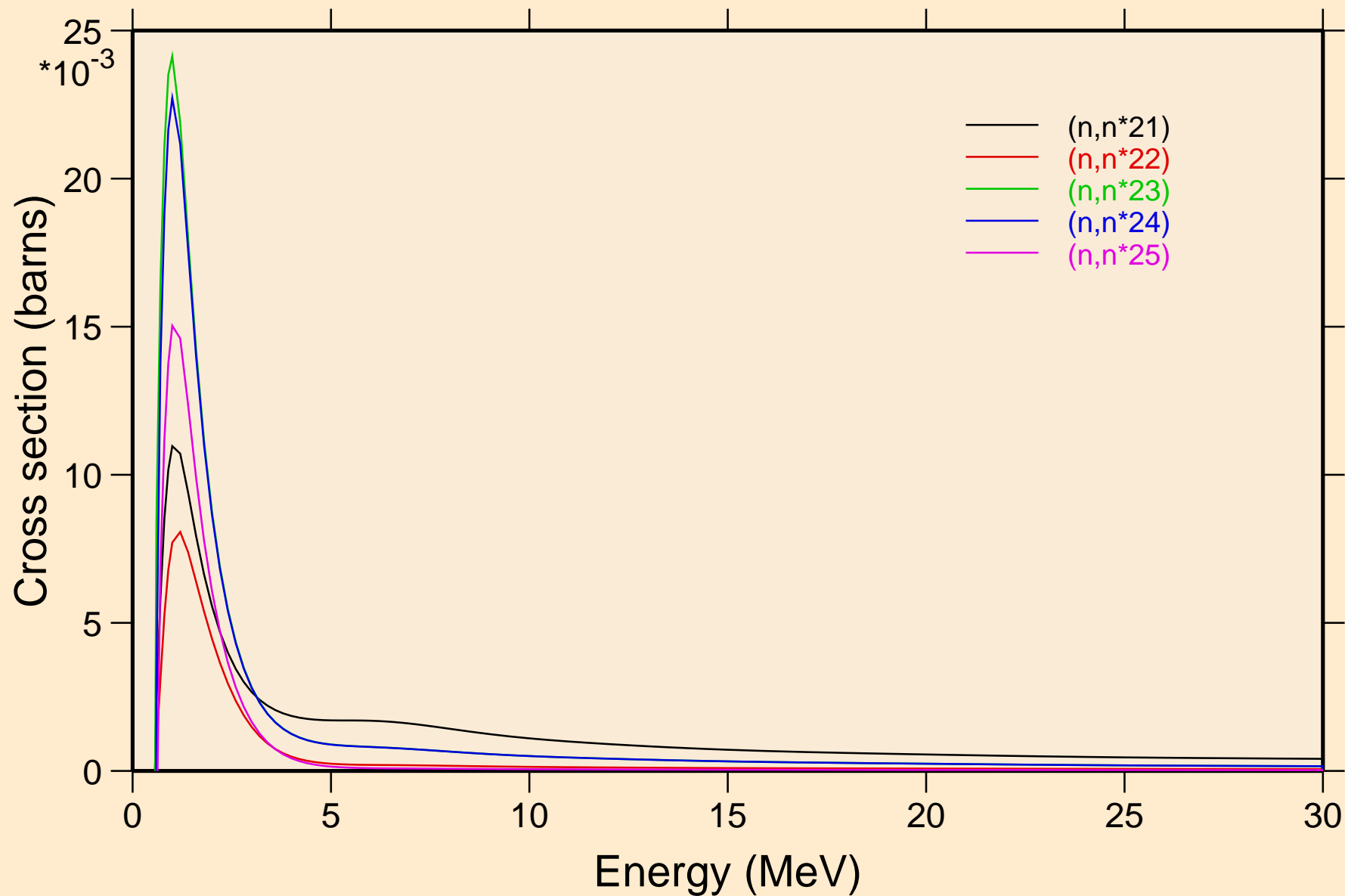

HF171 NEUTRON ACER TENDL-2019 LIBRARY; T=293.16K  
Inelastic levels

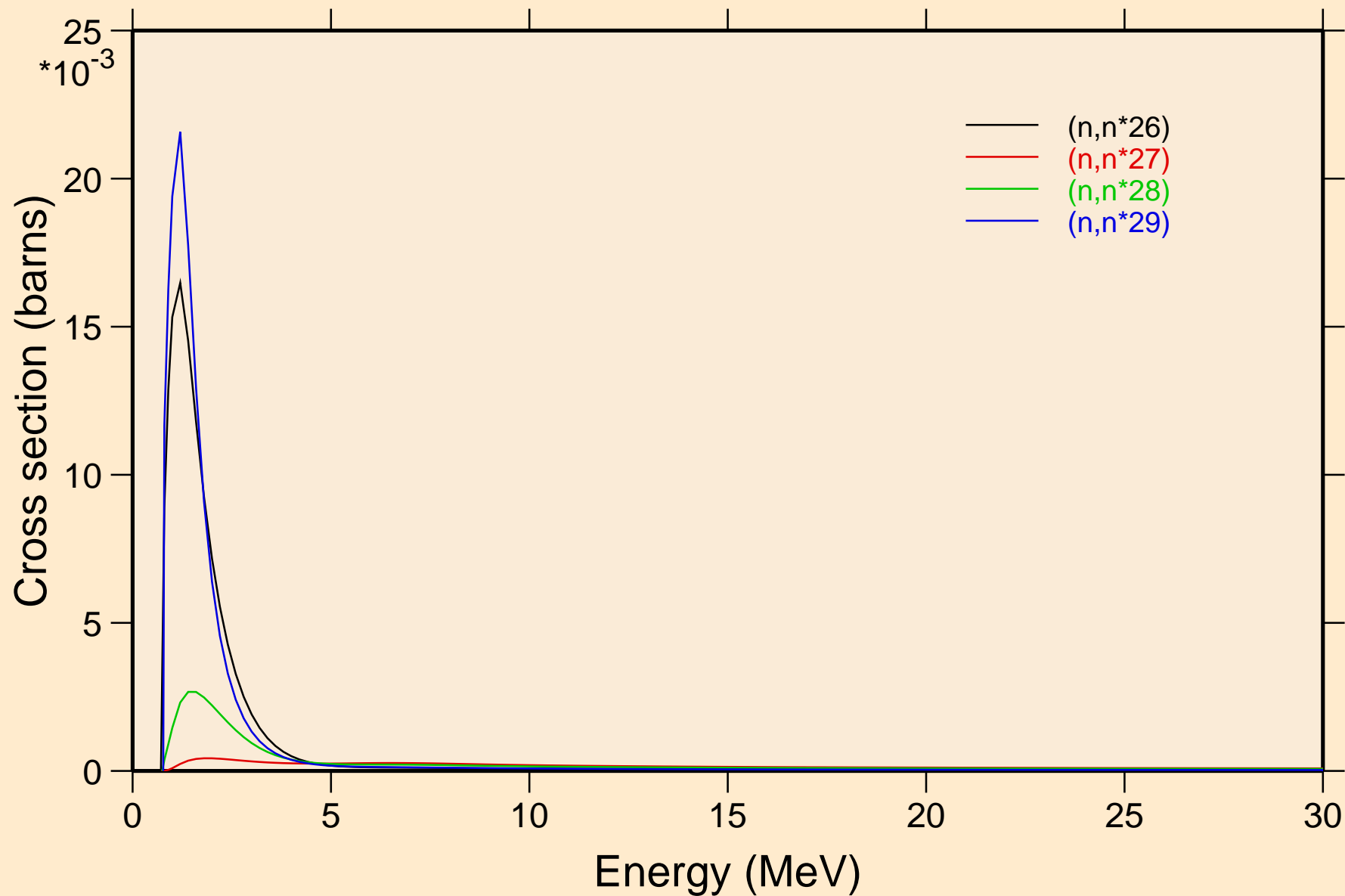

# HF171 NEUTRON ACER TENDL-2019 LIBRARY; T=293.16K

## Threshold reactions

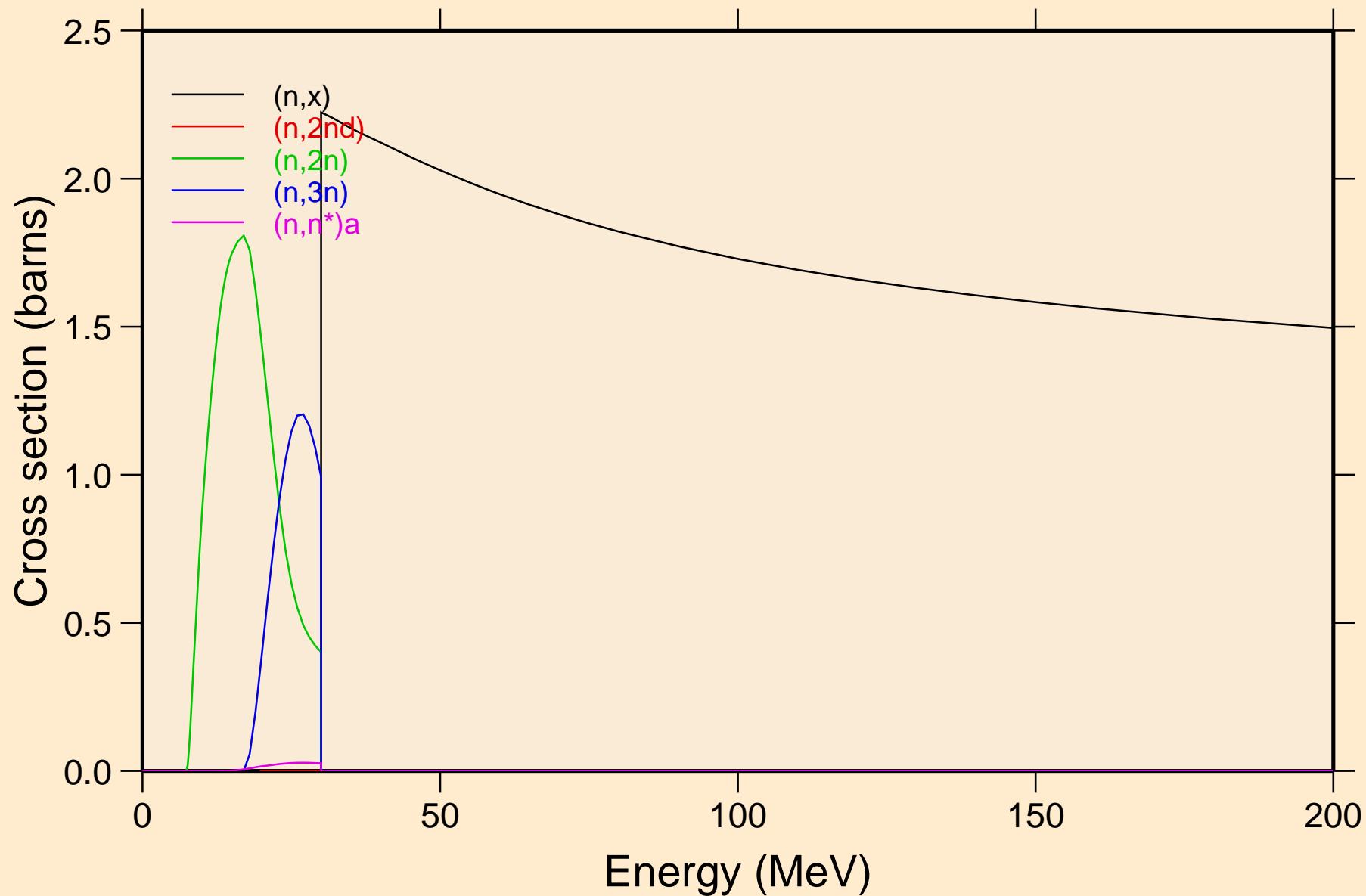

# HF171 NEUTRON ACER TENDL-2019 LIBRARY; T=293.16K

## Threshold reactions

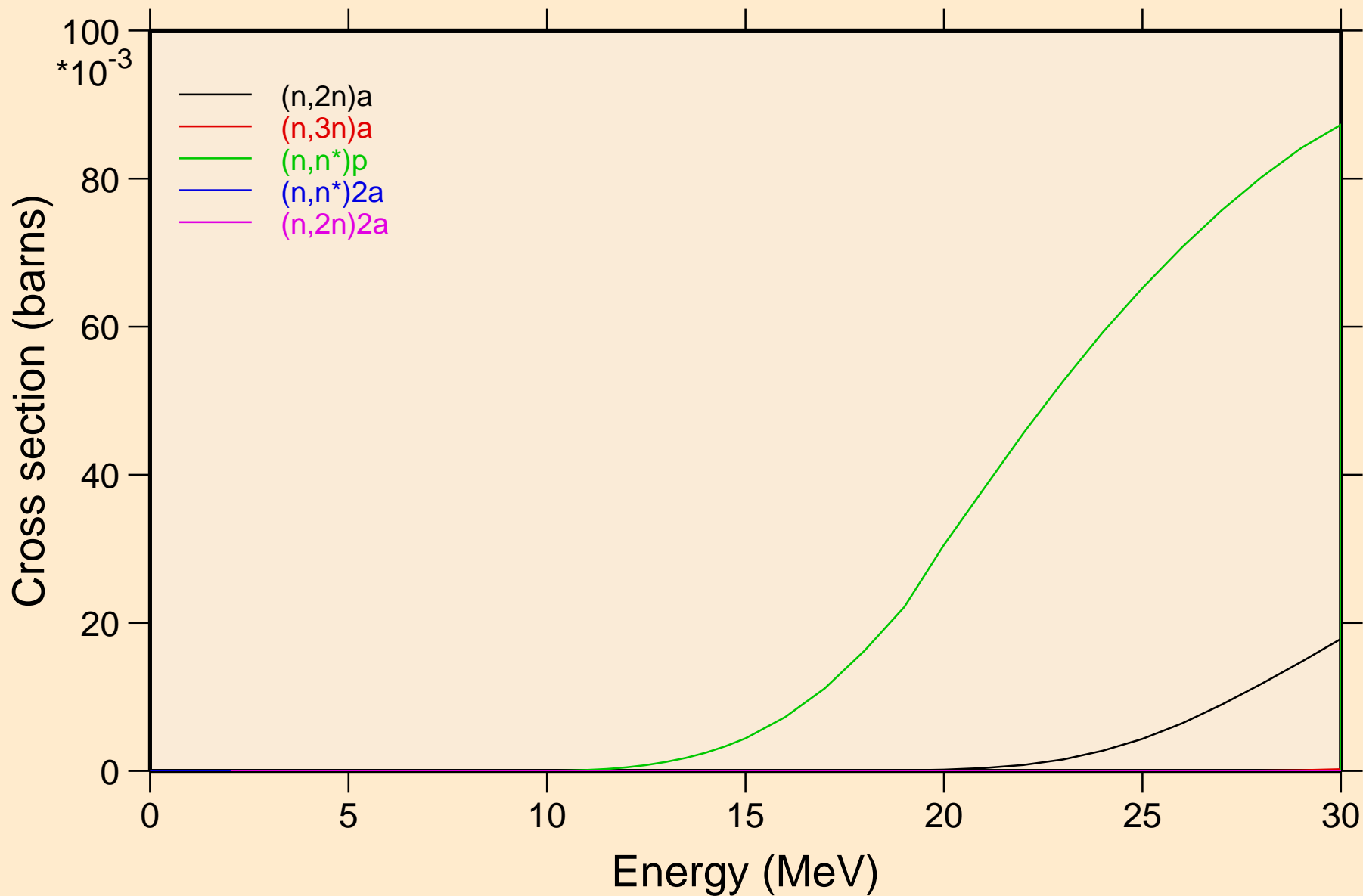

# HF171 NEUTRON ACER TENDL-2019 LIBRARY; T=293.16K

## Threshold reactions

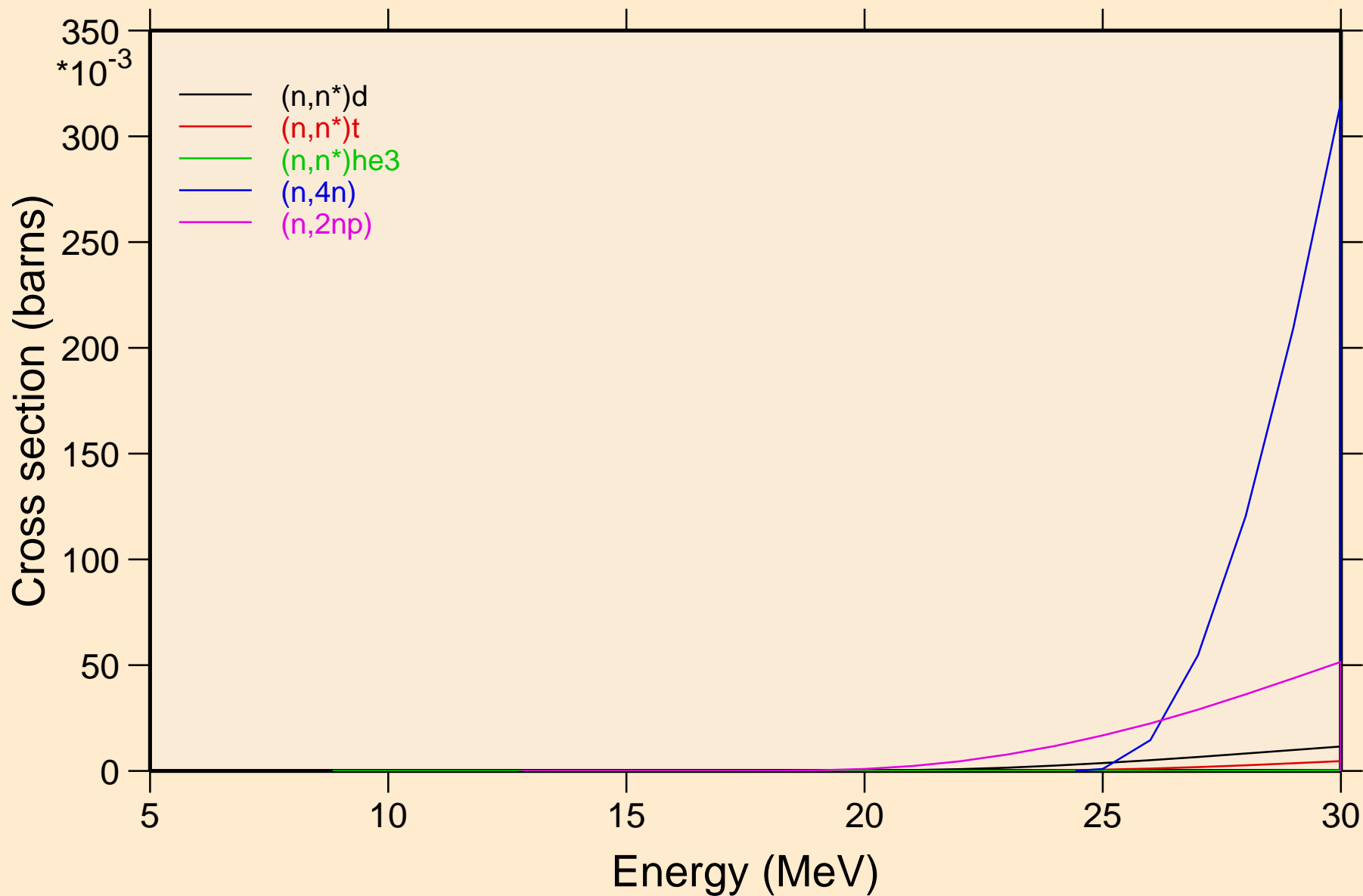



# HF171 NEUTRON ACER TENDL-2019 LIBRARY; T=293.16K

## Threshold reactions

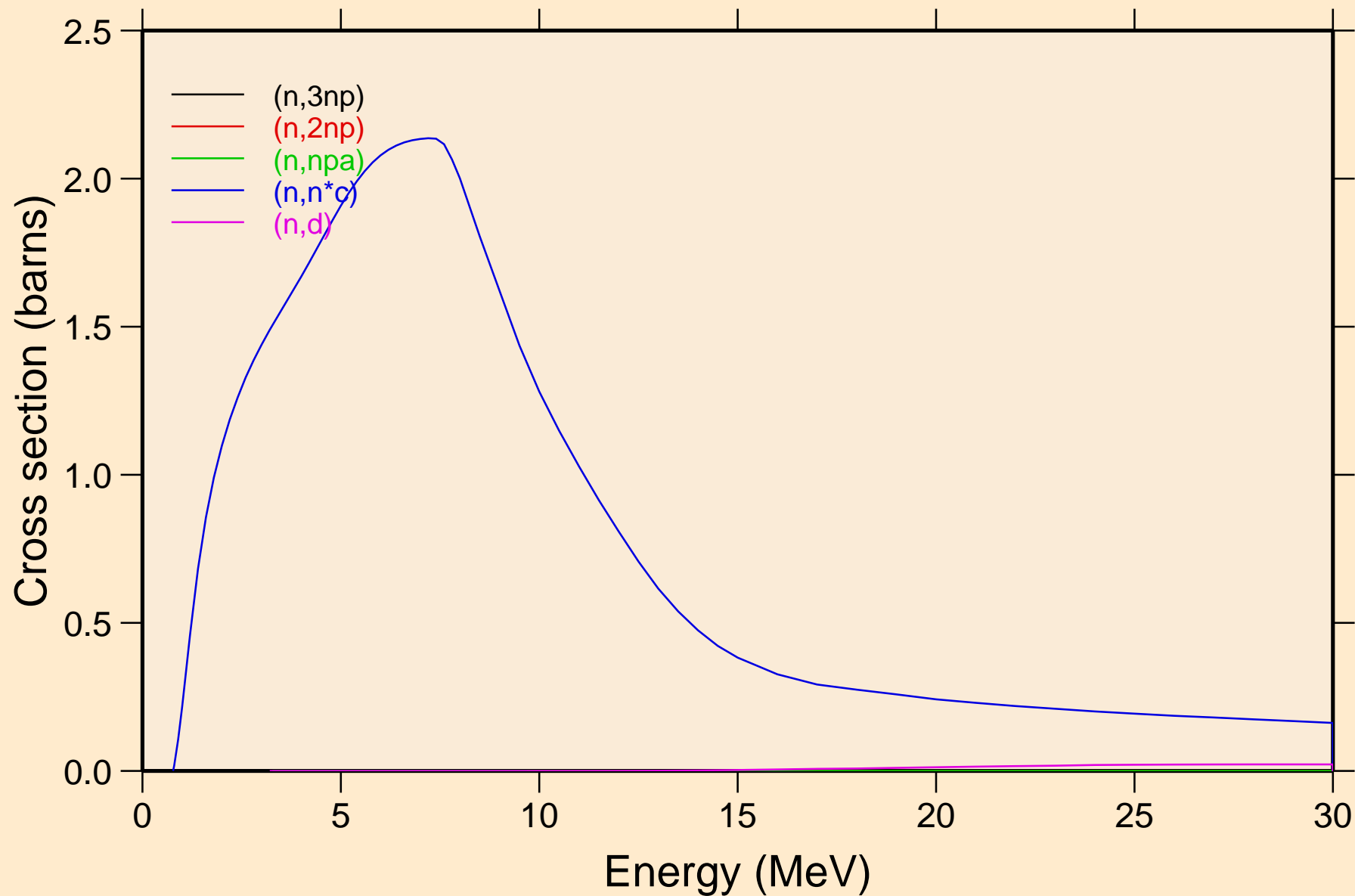

HF171 NEUTRON ACER TENDL-2019 LIBRARY; T=293.16K  
Threshold reactions

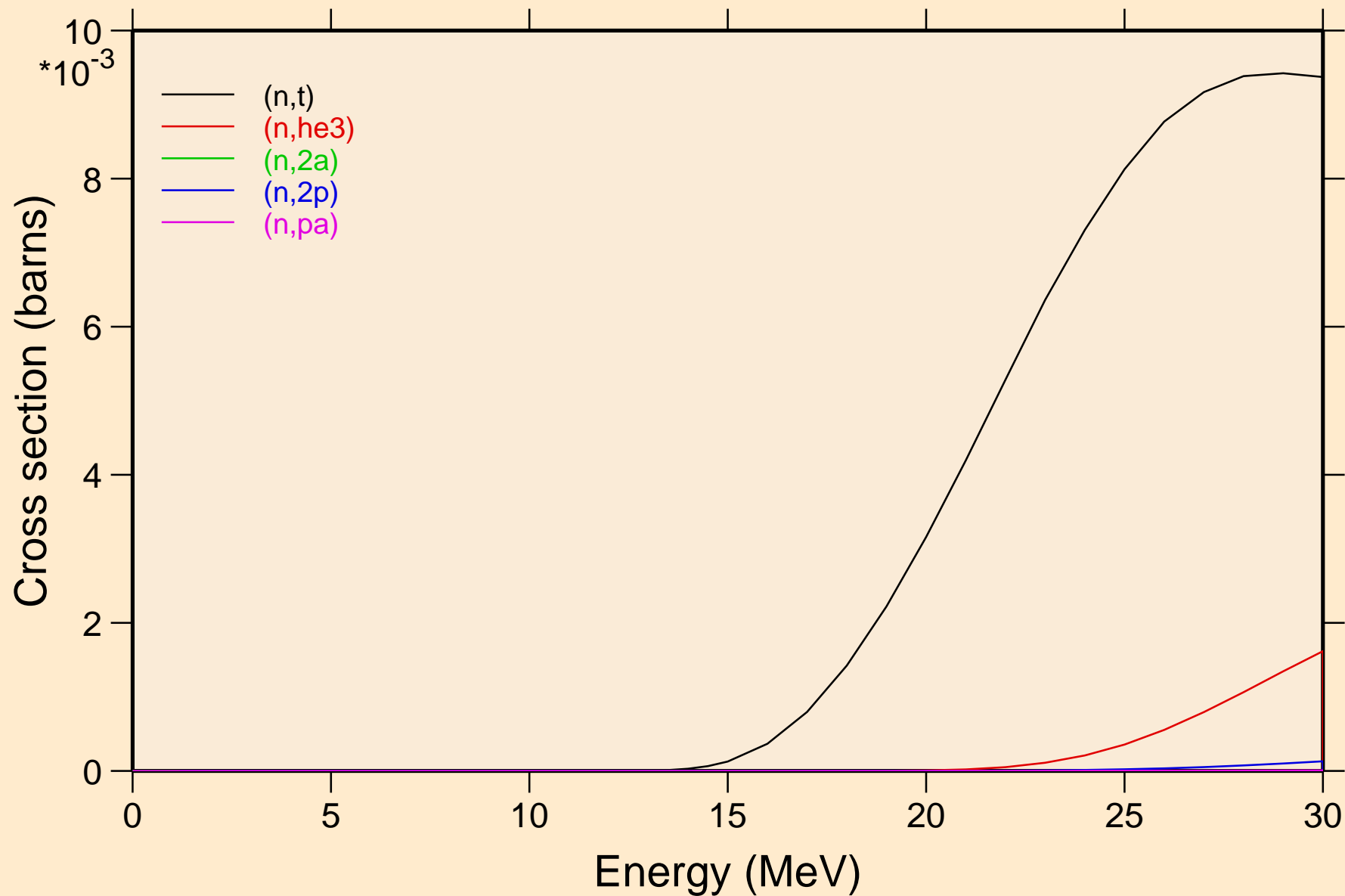

# HF171 NEUTRON ACER TENDL-2019 LIBRARY; T=293.16K

## Threshold reactions

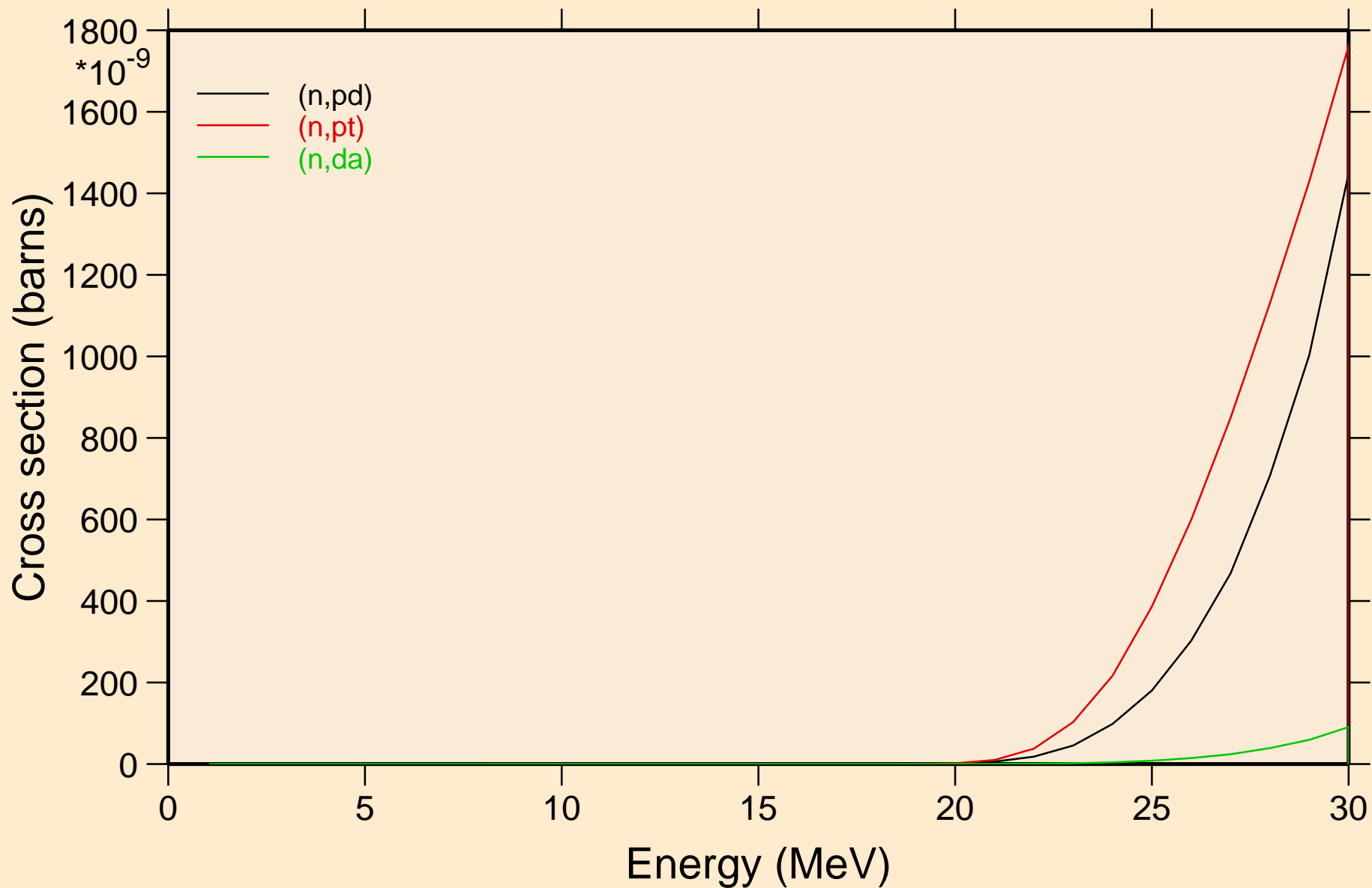

HF171 NEUTRON ACER TENDL-2019 LIBRARY; T=293.16K  
Threshold reactions

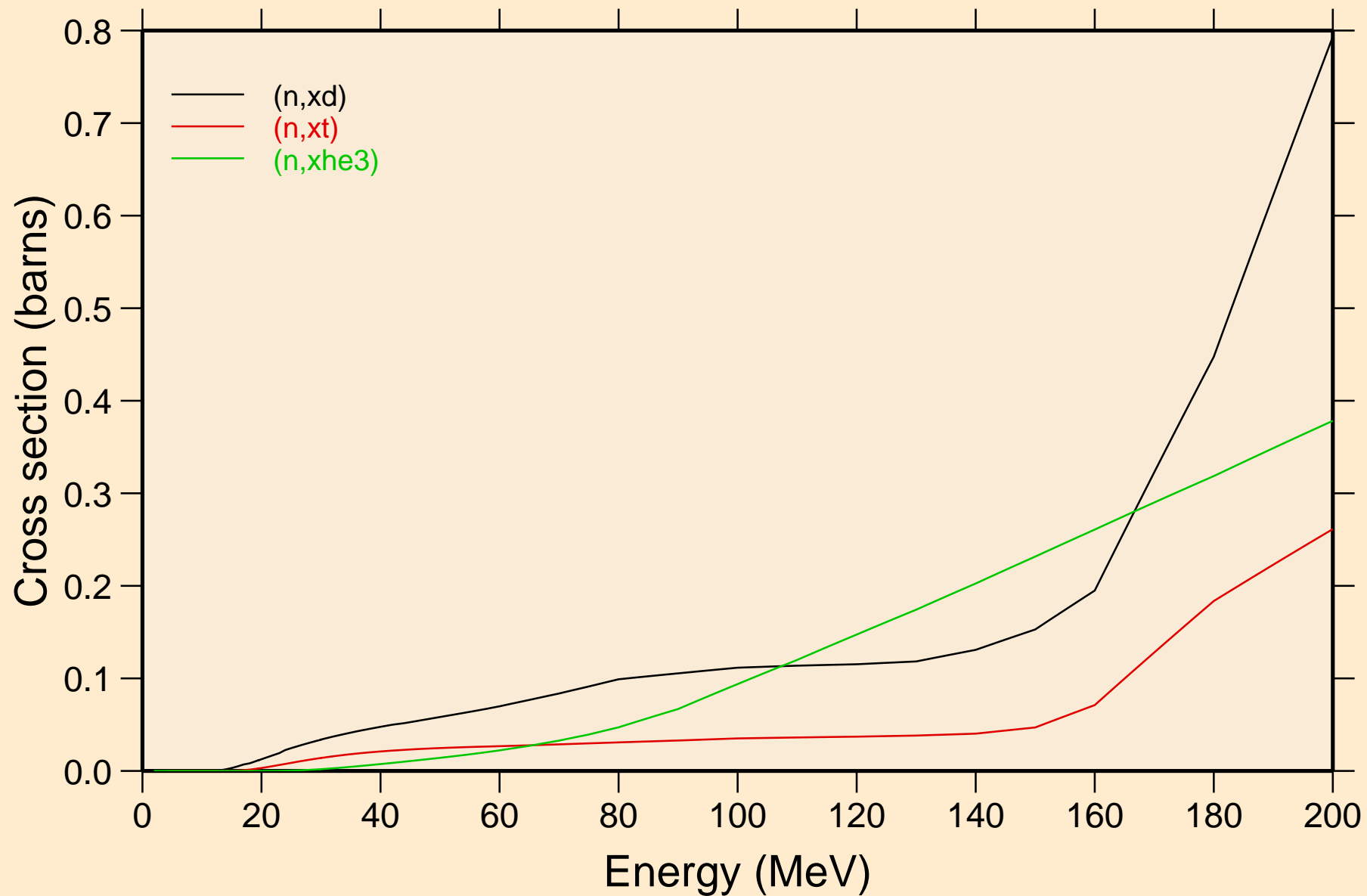

HF171 NEUTRON ACER TENDL-2019 LIBRARY; T=293.16K  
angular distribution for elastic

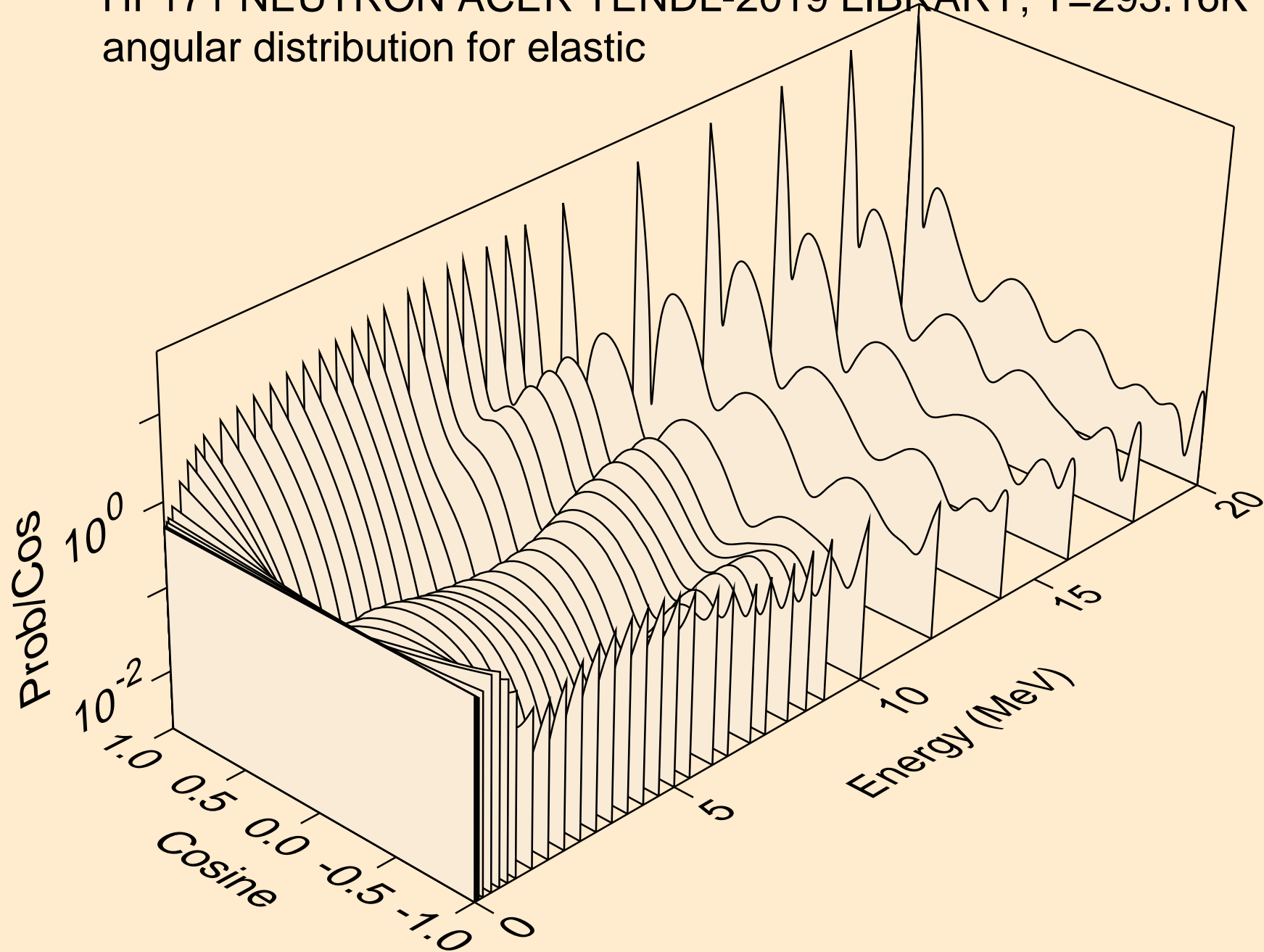

HF171 NEUTRON ACER TENDL-2019 LIBRARY; T=293.16K  
angular distribution for elastic

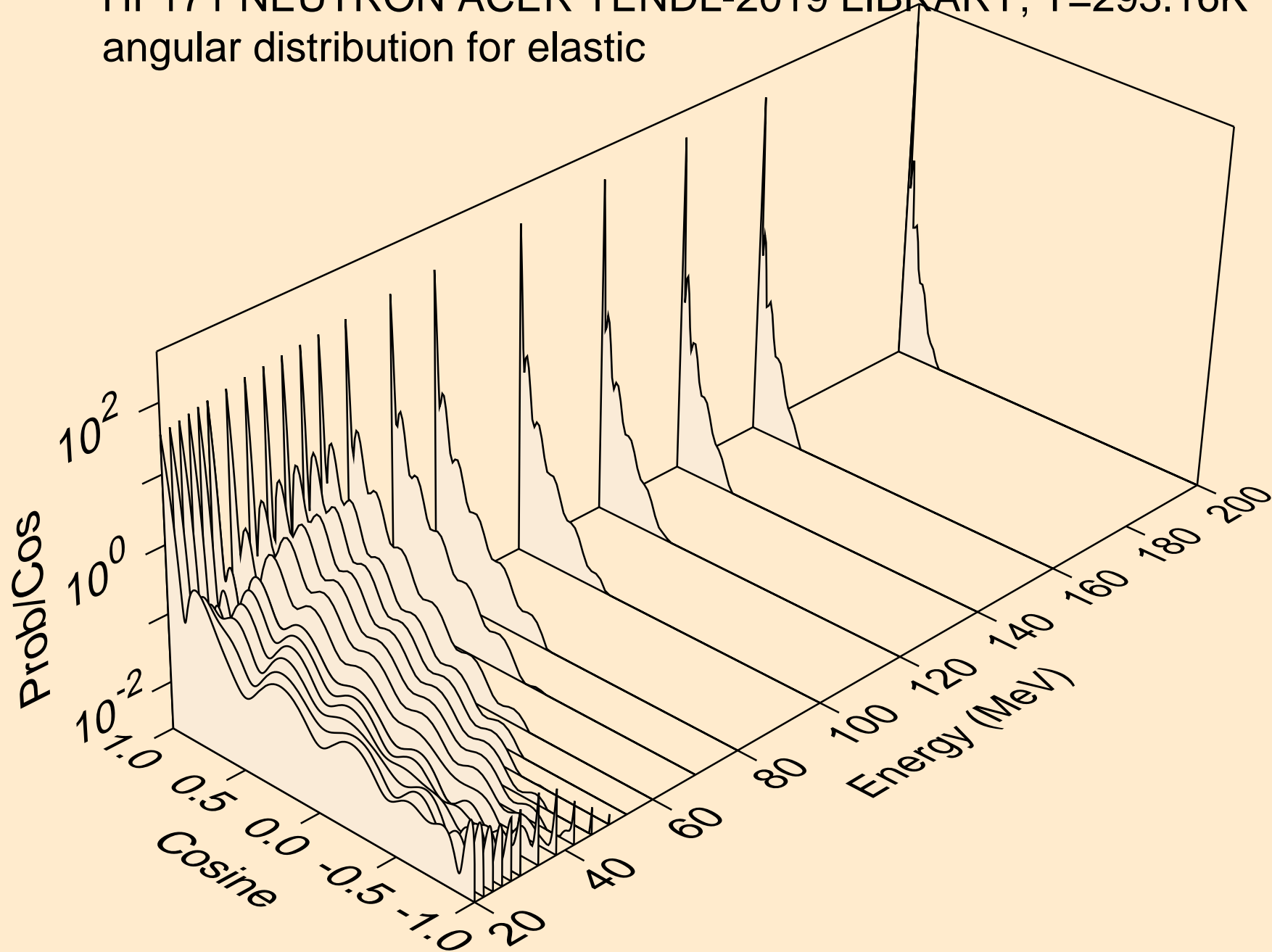

HF171 NEUTRON ACER TENDL-2019 LIBRARY; T=293.16K  
angular distribution for (n,n\*1)

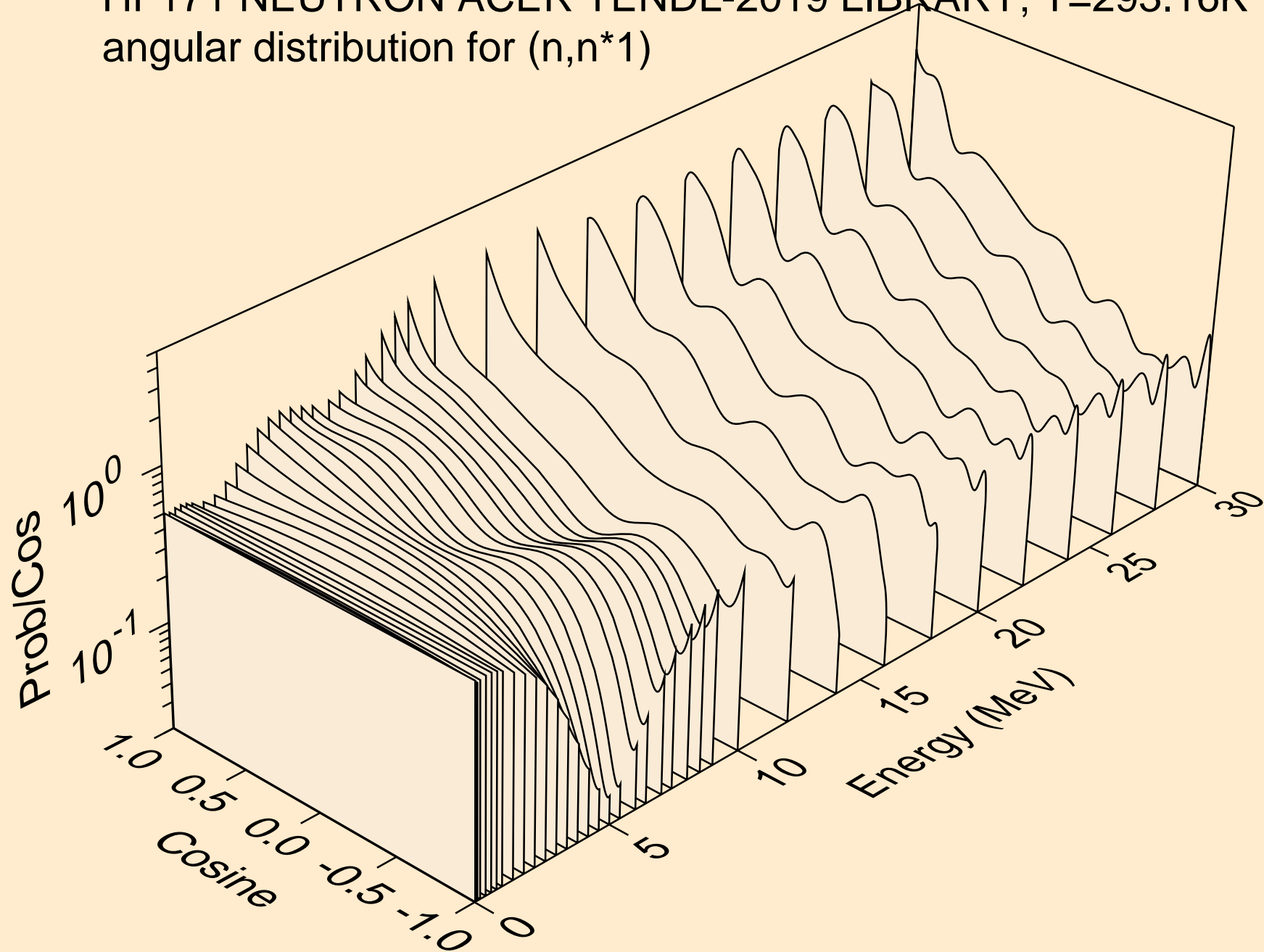

HF171 NEUTRON ACER TENDL-2019 LIBRARY; T=293.16K  
angular distribution for (n,n\*2)

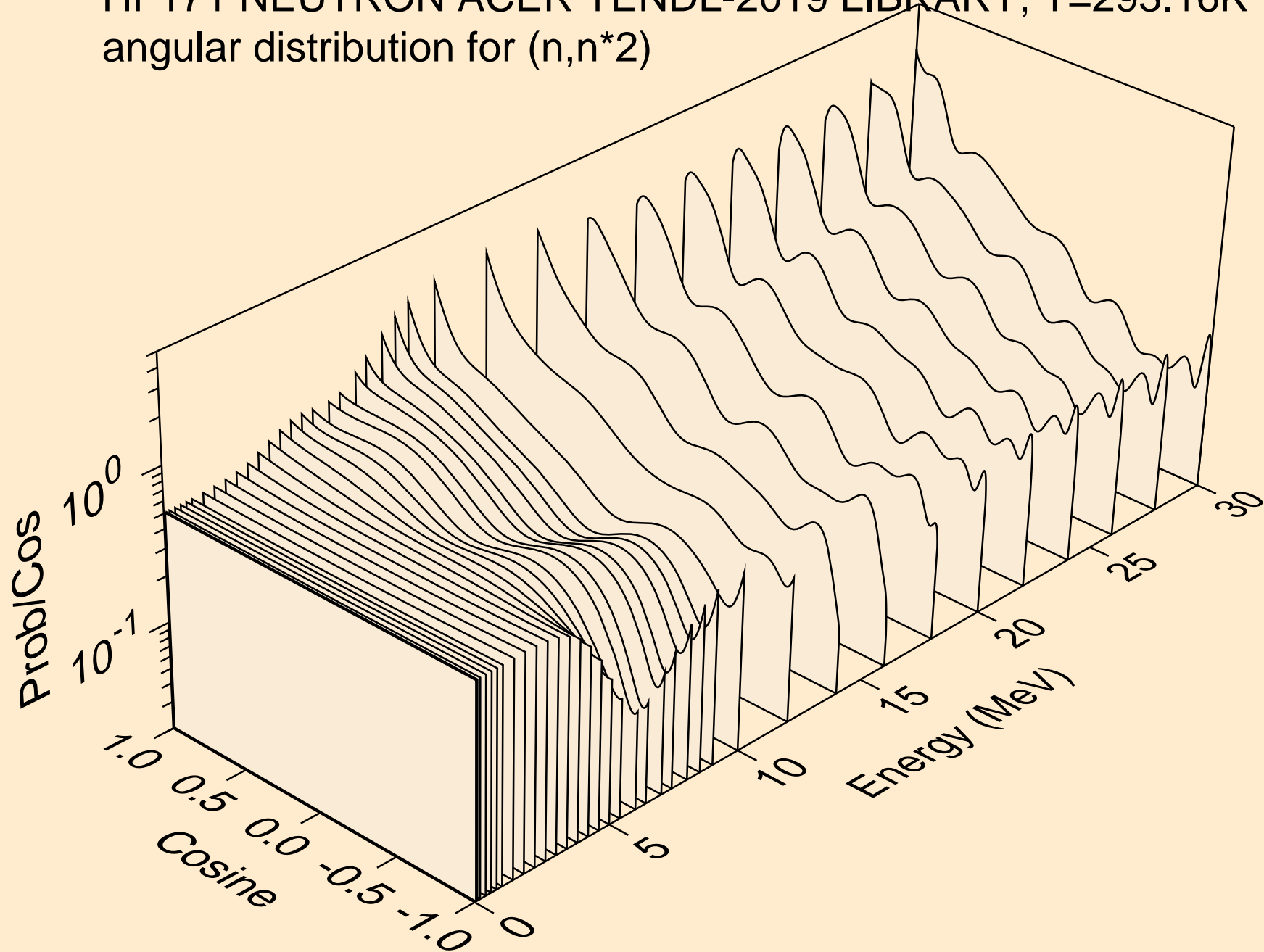



HF171 NEUTRON ACER TENDL-2019 LIBRARY; T=293.16K  
angular distribution for (n,n\*3)

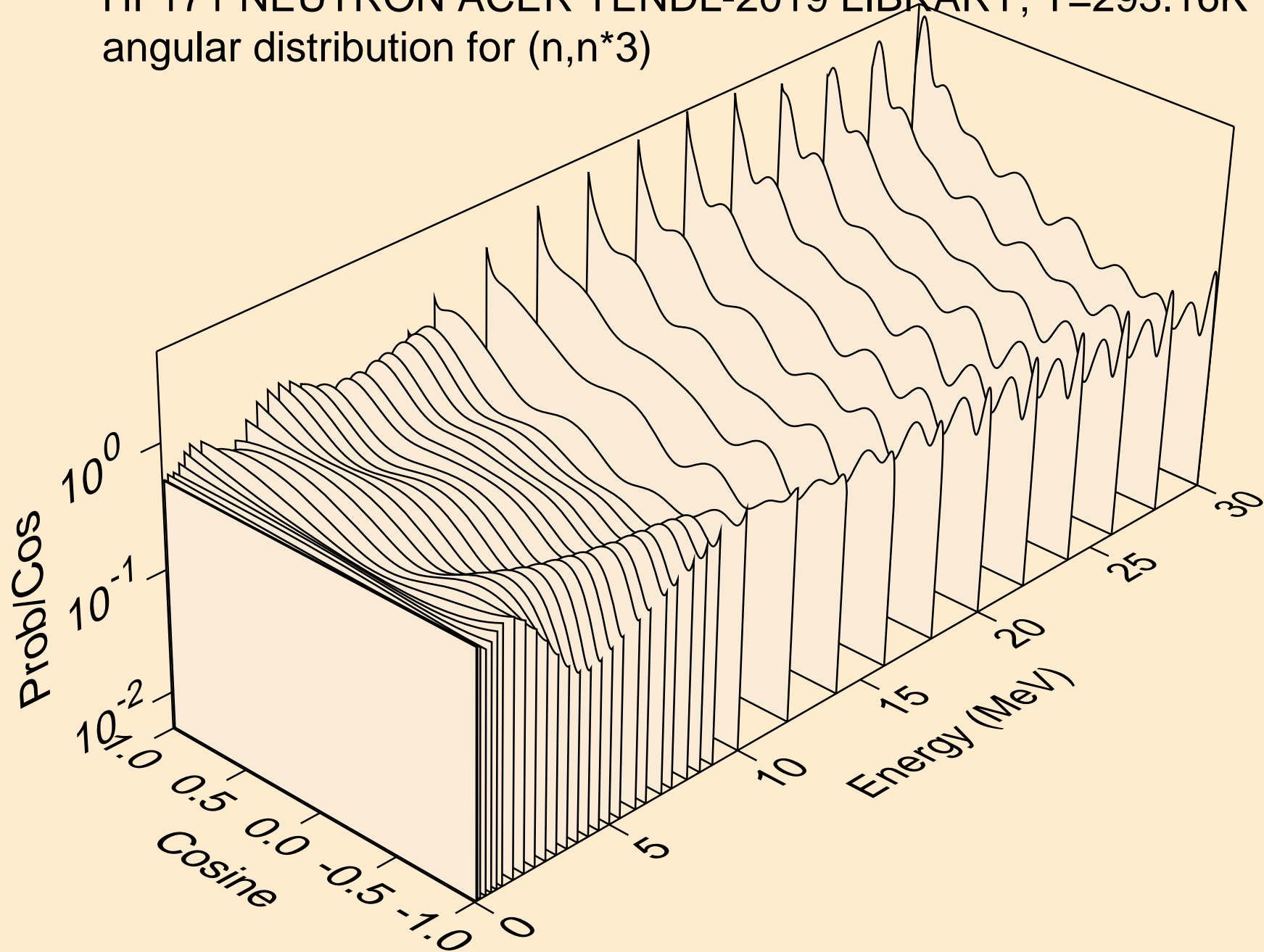

HF171 NEUTRON ACER TENDL-2019 LIBRARY; T=293.16K  
angular distribution for (n,n\*4)

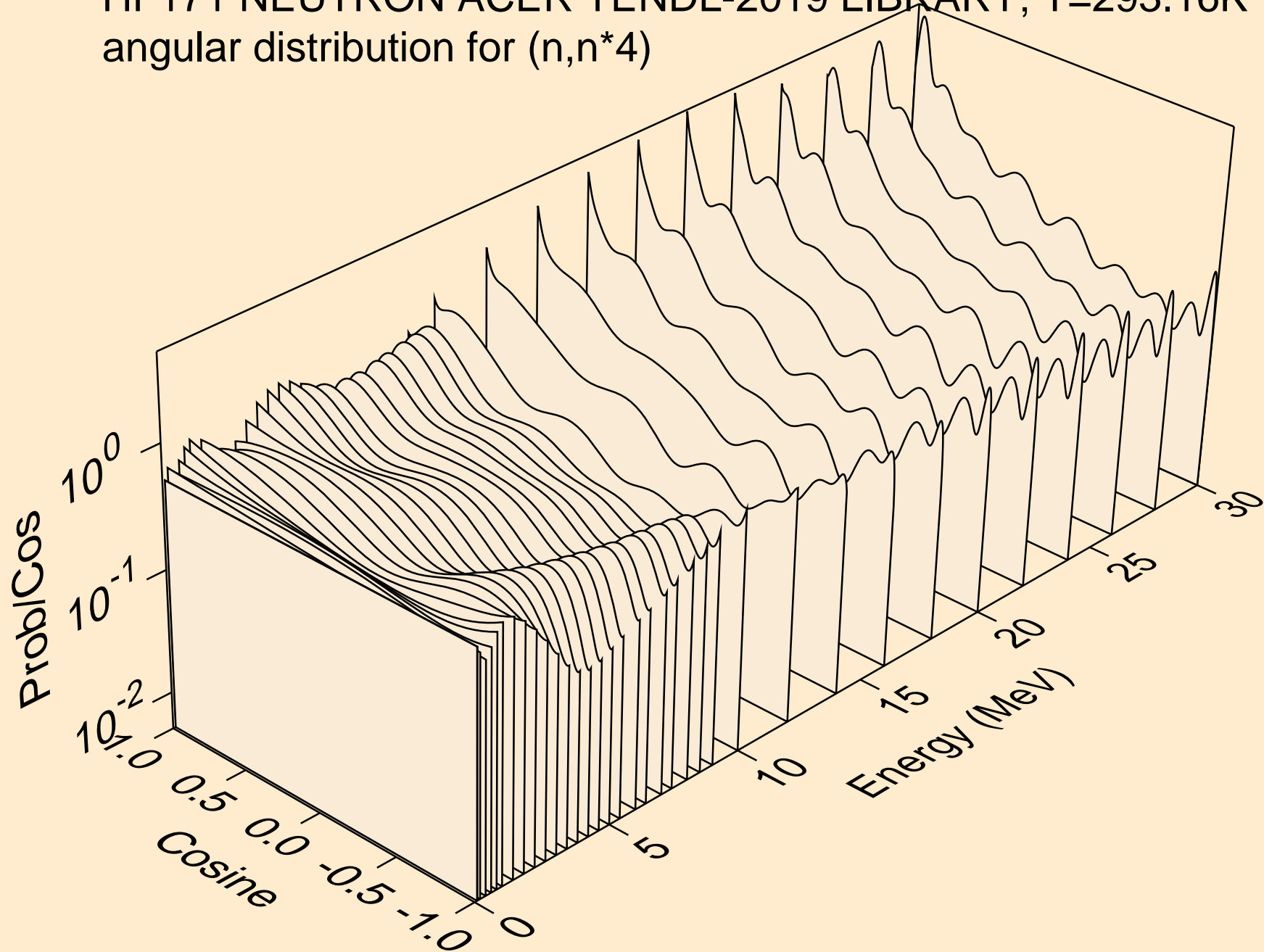

HF171 NEUTRON ACER TENDL-2019 LIBRARY; T=293.16K  
angular distribution for (n,n\*5)

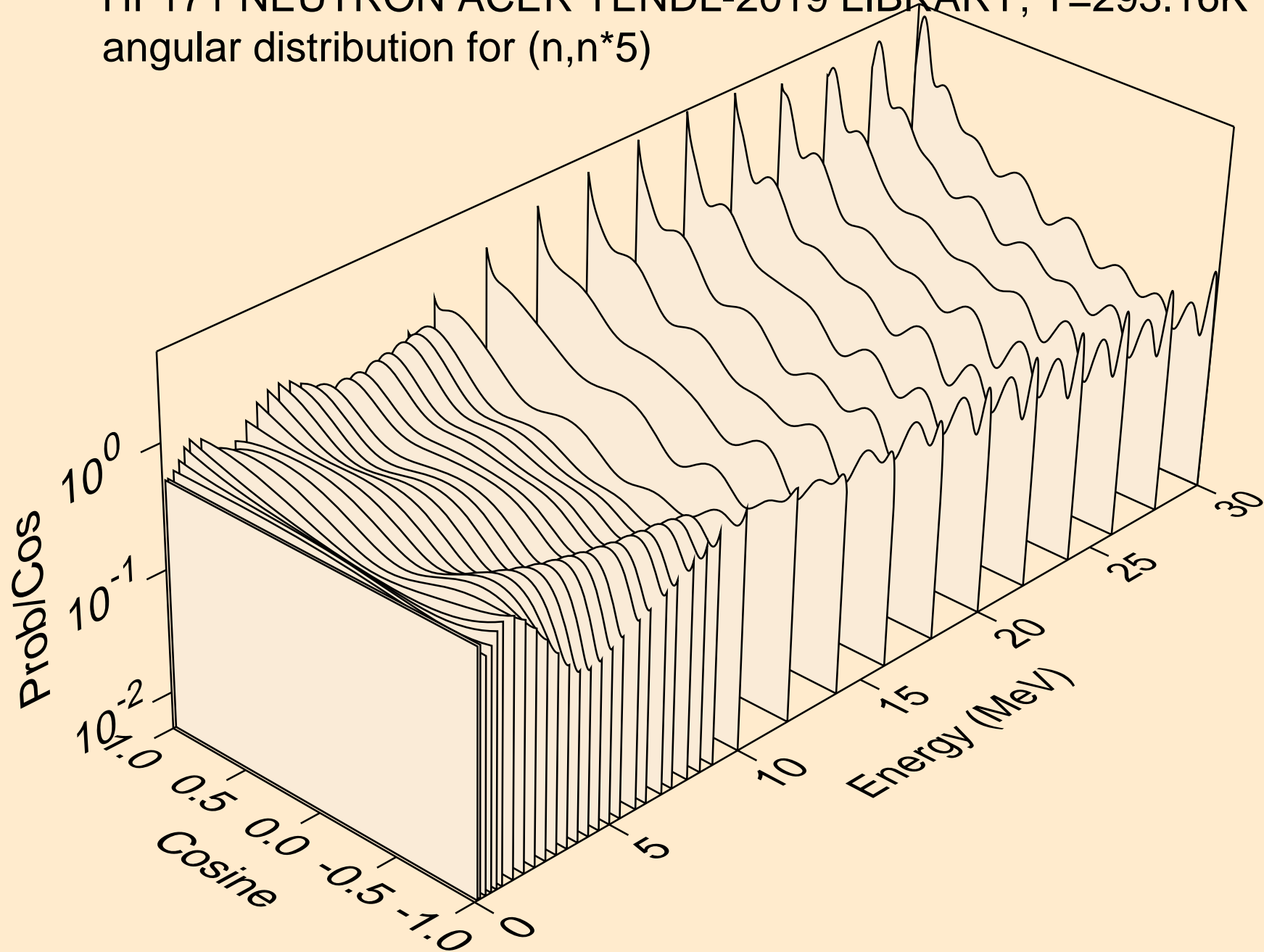

HF171 NEUTRON ACER TENDL-2019 LIBRARY; T=293.16K  
angular distribution for (n,n\*6)

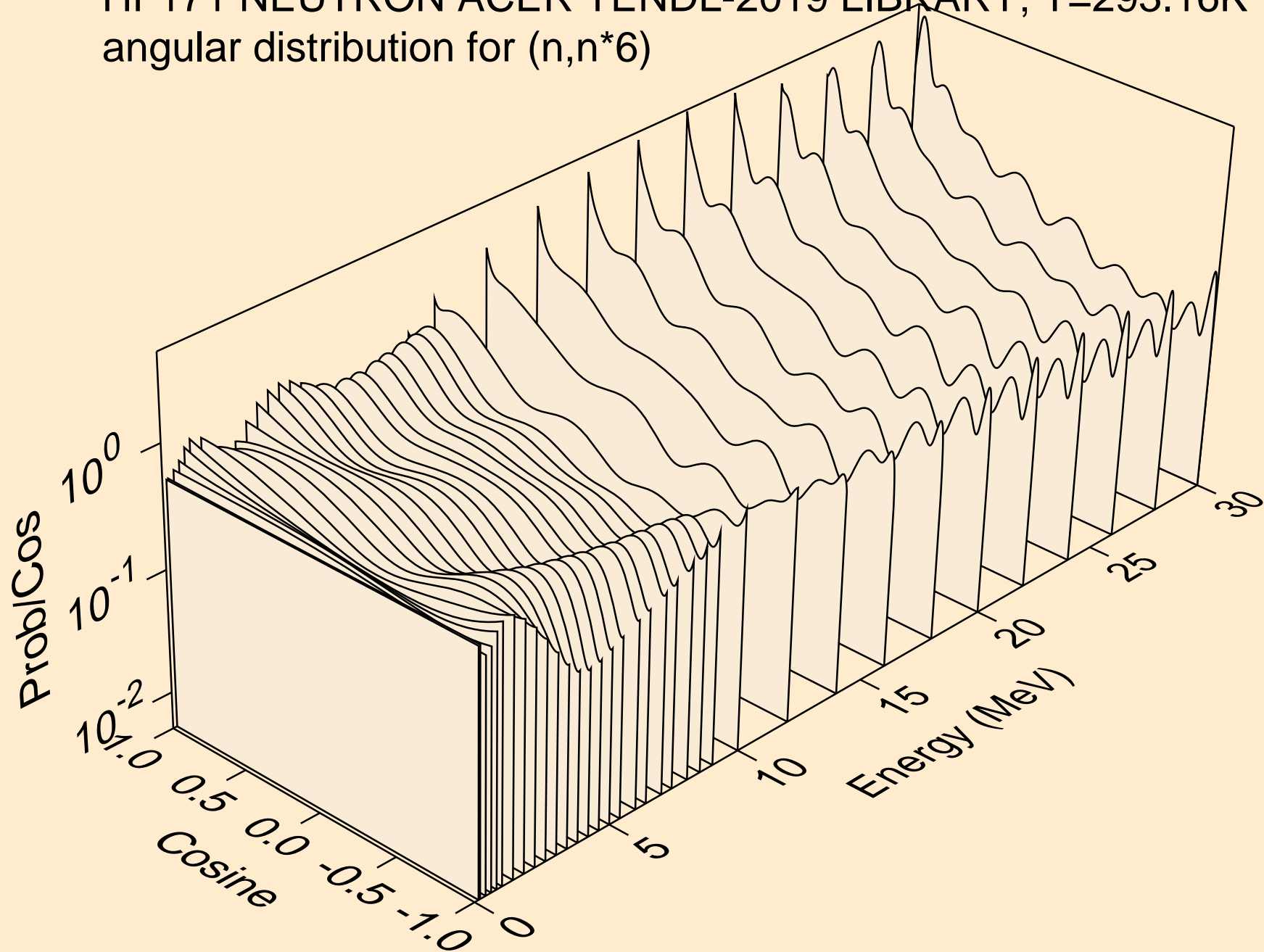

HF171 NEUTRON ACER TENDL-2019 LIBRARY; T=293.16K  
angular distribution for (n,n\*7)

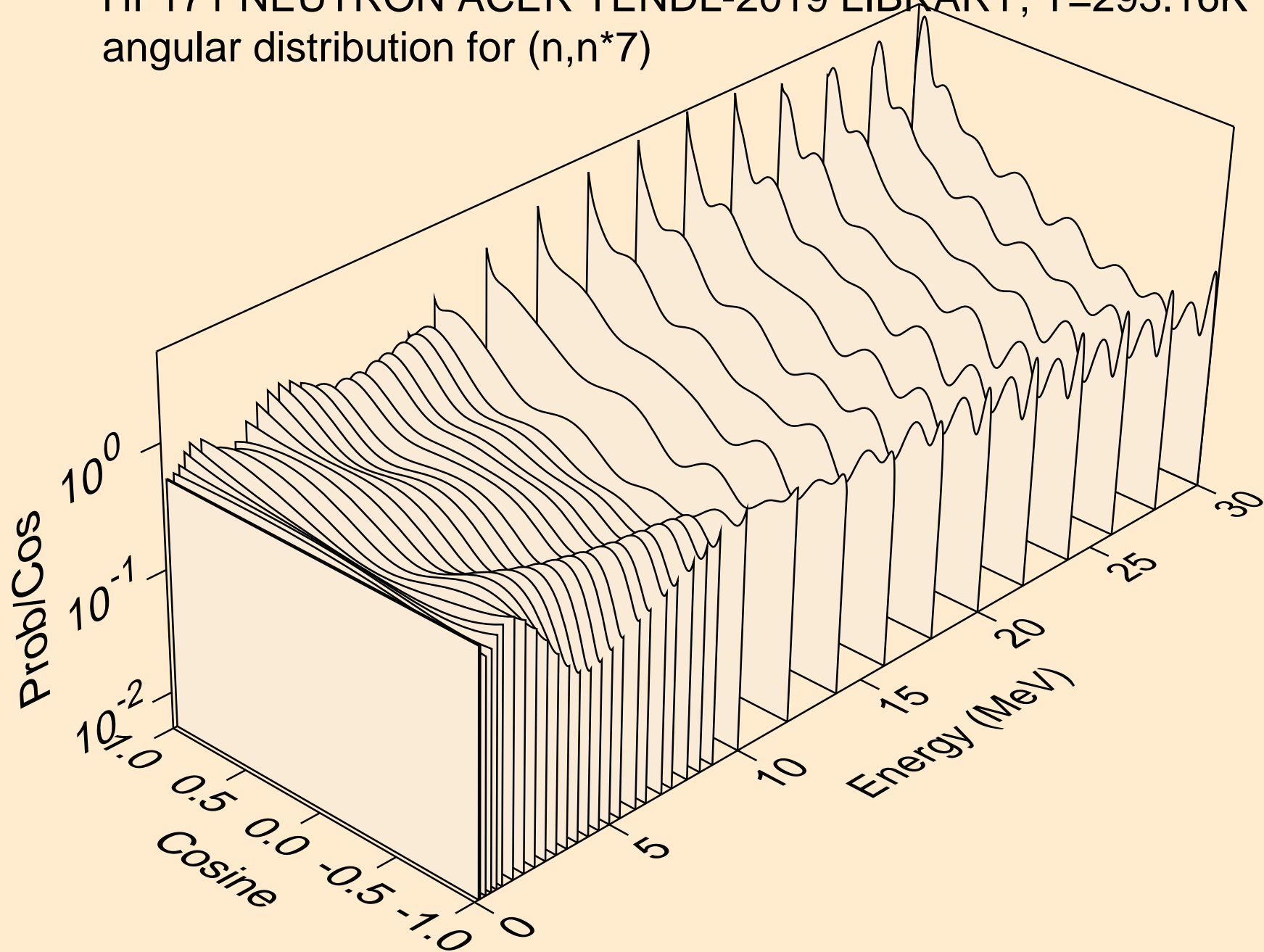

HF171 NEUTRON ACER TENDL-2019 LIBRARY; T=293.16K  
angular distribution for (n,n\*8)

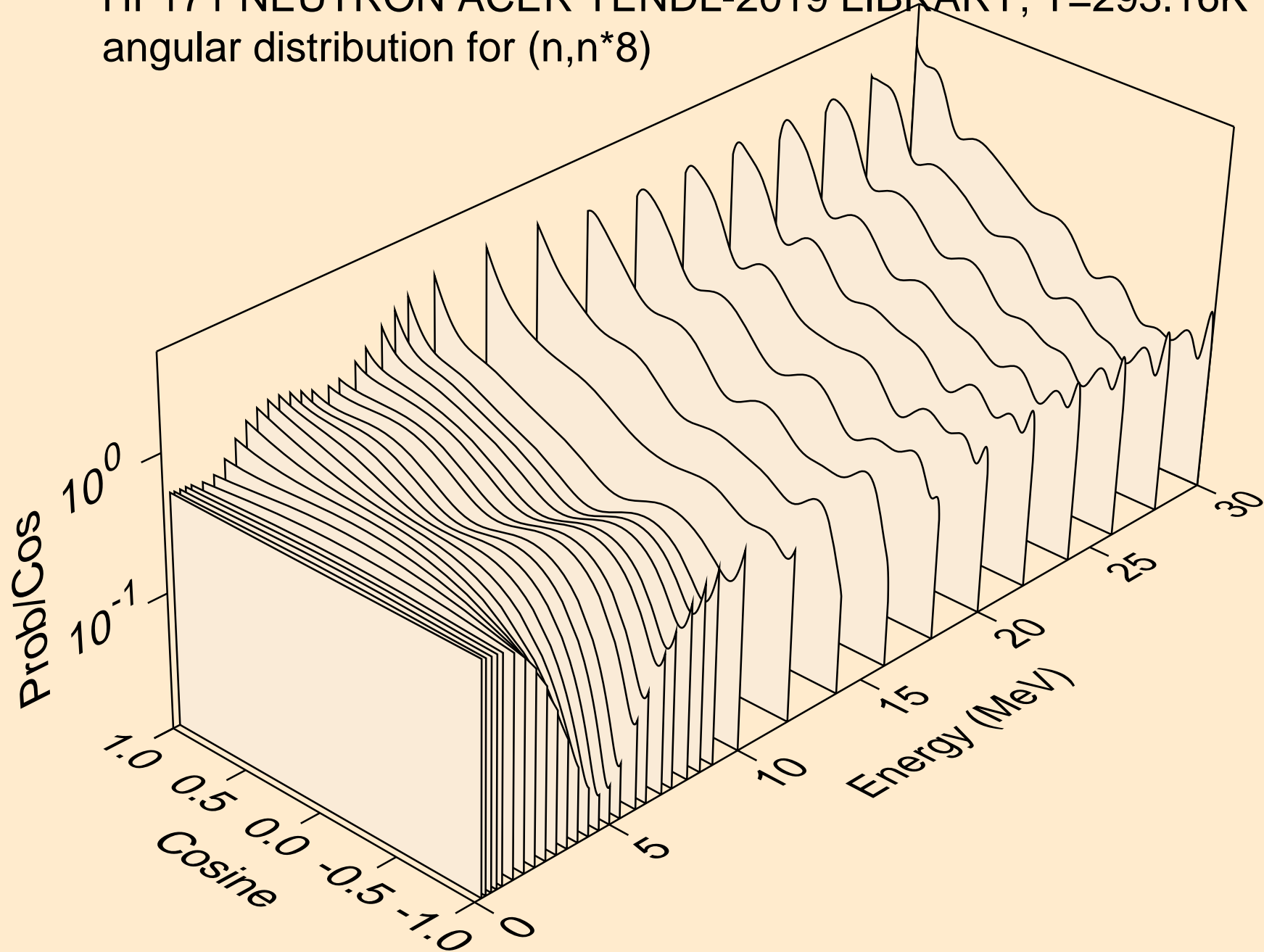

HF171 NEUTRON ACER TENDL-2019 LIBRARY; T=293.16K  
angular distribution for (n,n\*9)

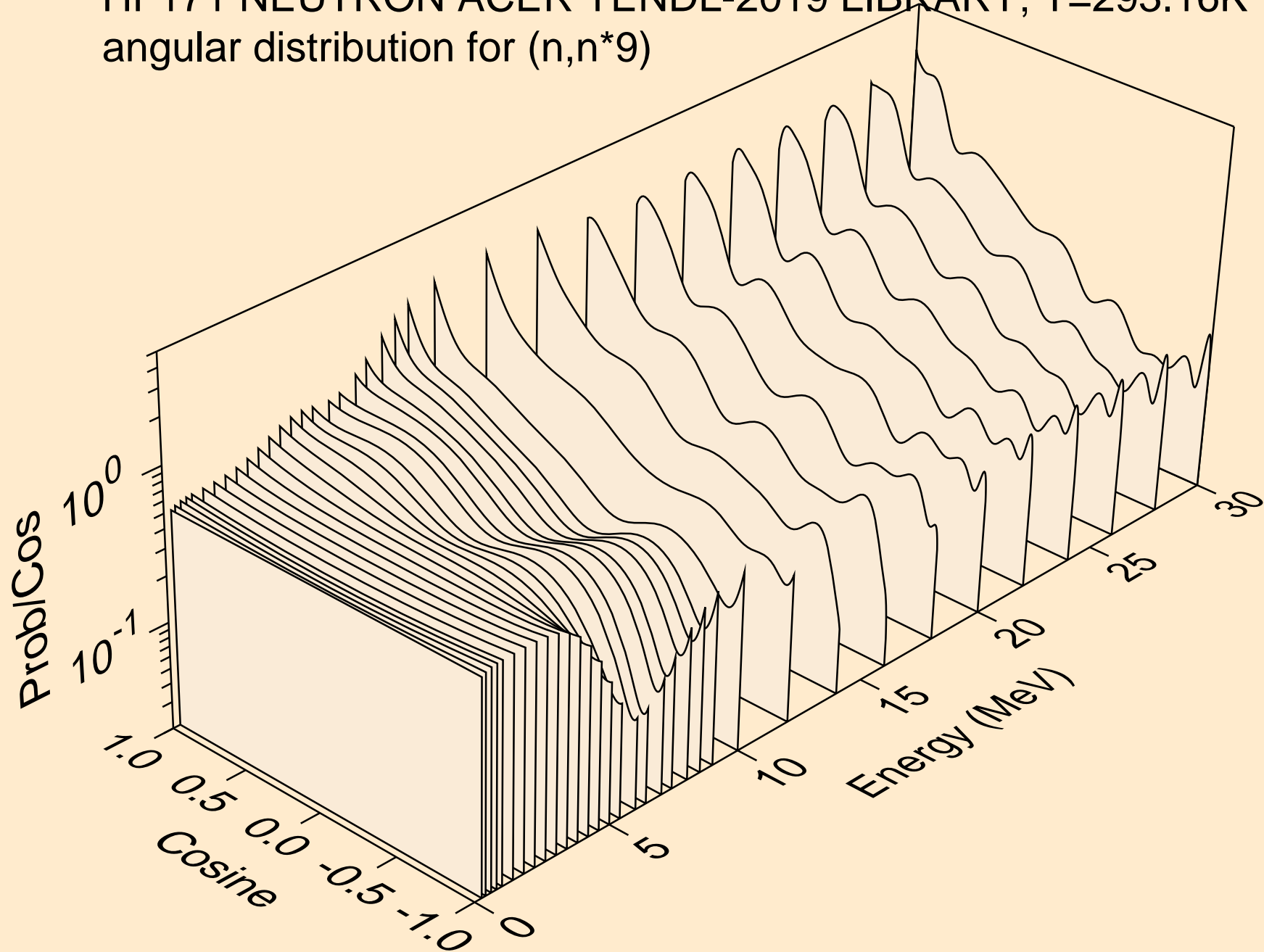

HF171 NEUTRON ACER TENDL-2019 LIBRARY; T=293.16K  
angular distribution for (n,n\*10)

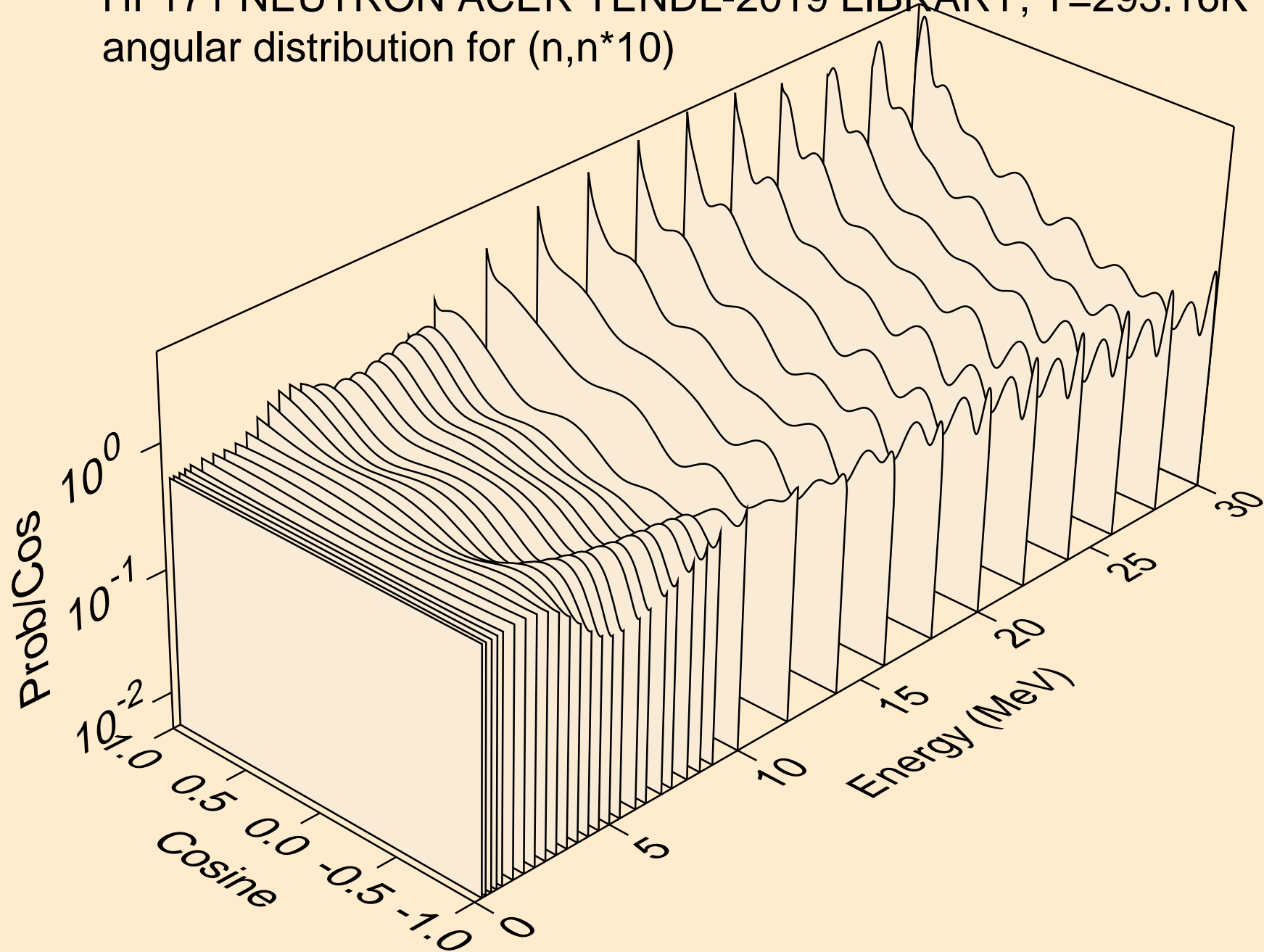



HF171 NEUTRON ACER TENDL-2019 LIBRARY; T=293.16K  
angular distribution for (n,n\*11)

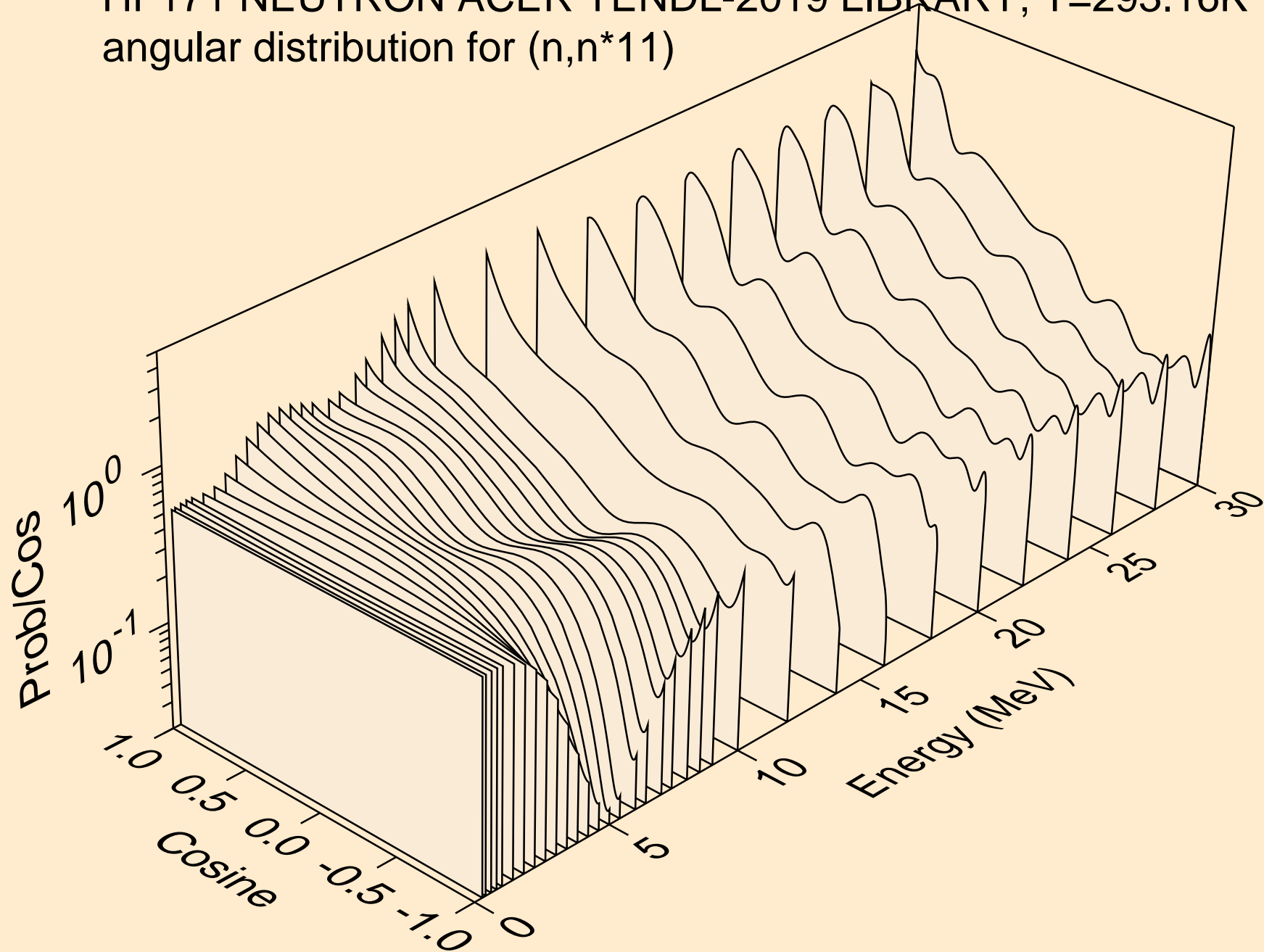

HF171 NEUTRON ACER TENDL-2019 LIBRARY; T=293.16K  
angular distribution for (n,n\*12)

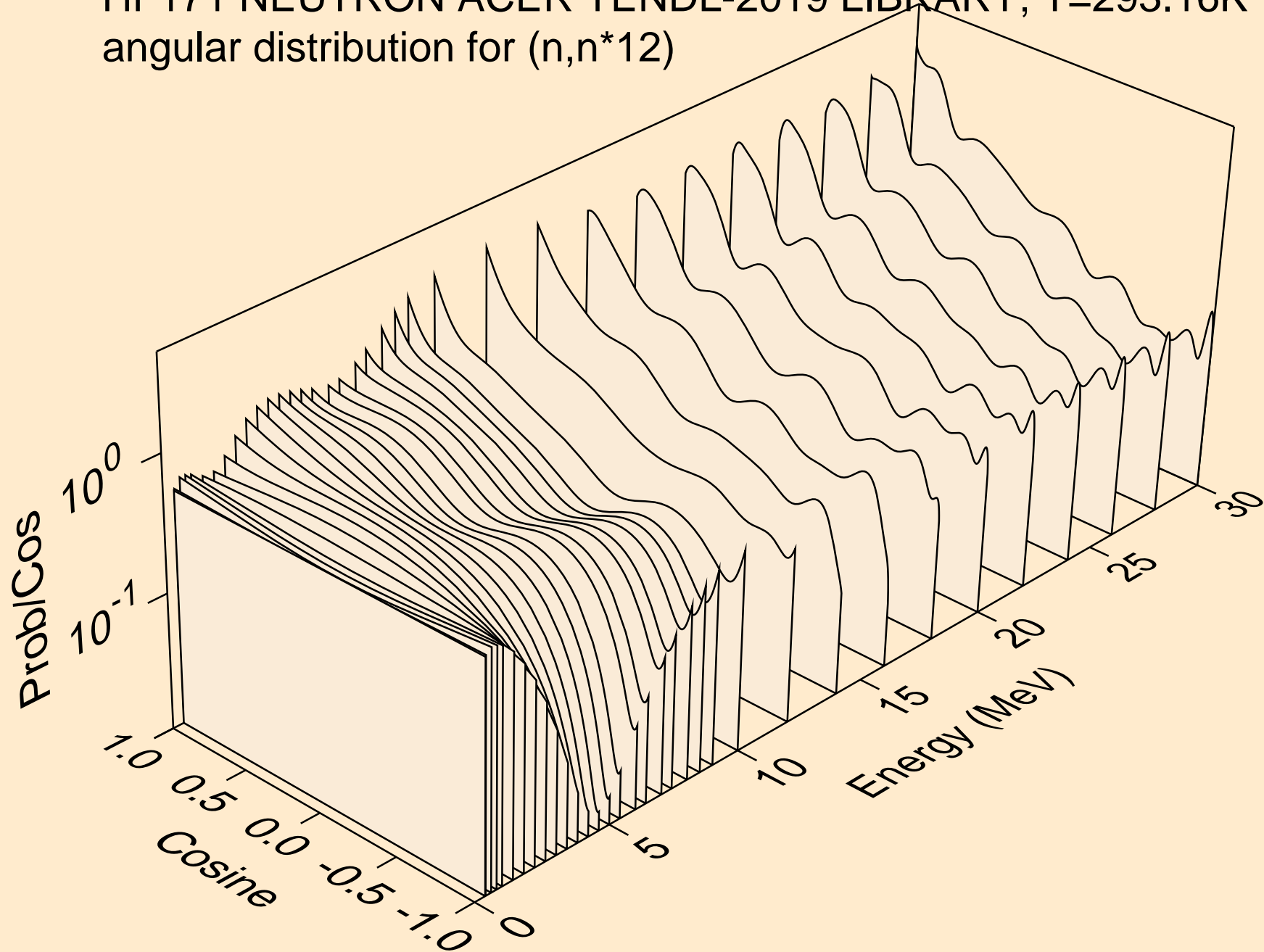

HF171 NEUTRON ACER TENDL-2019 LIBRARY; T=293.16K  
angular distribution for (n,n\*13)

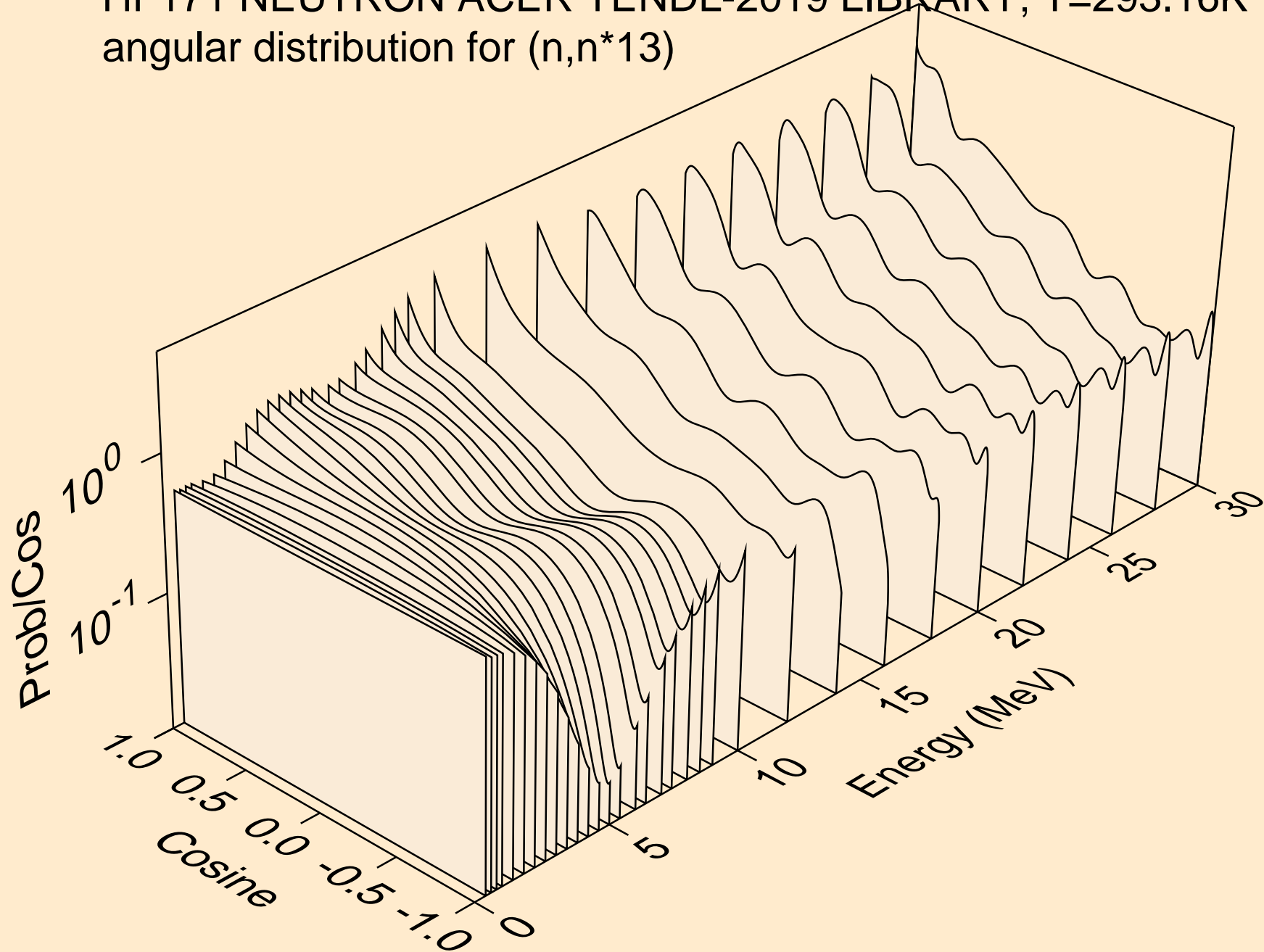

HF171 NEUTRON ACER TENDL-2019 LIBRARY; T=293.16K  
angular distribution for (n,n\*14)

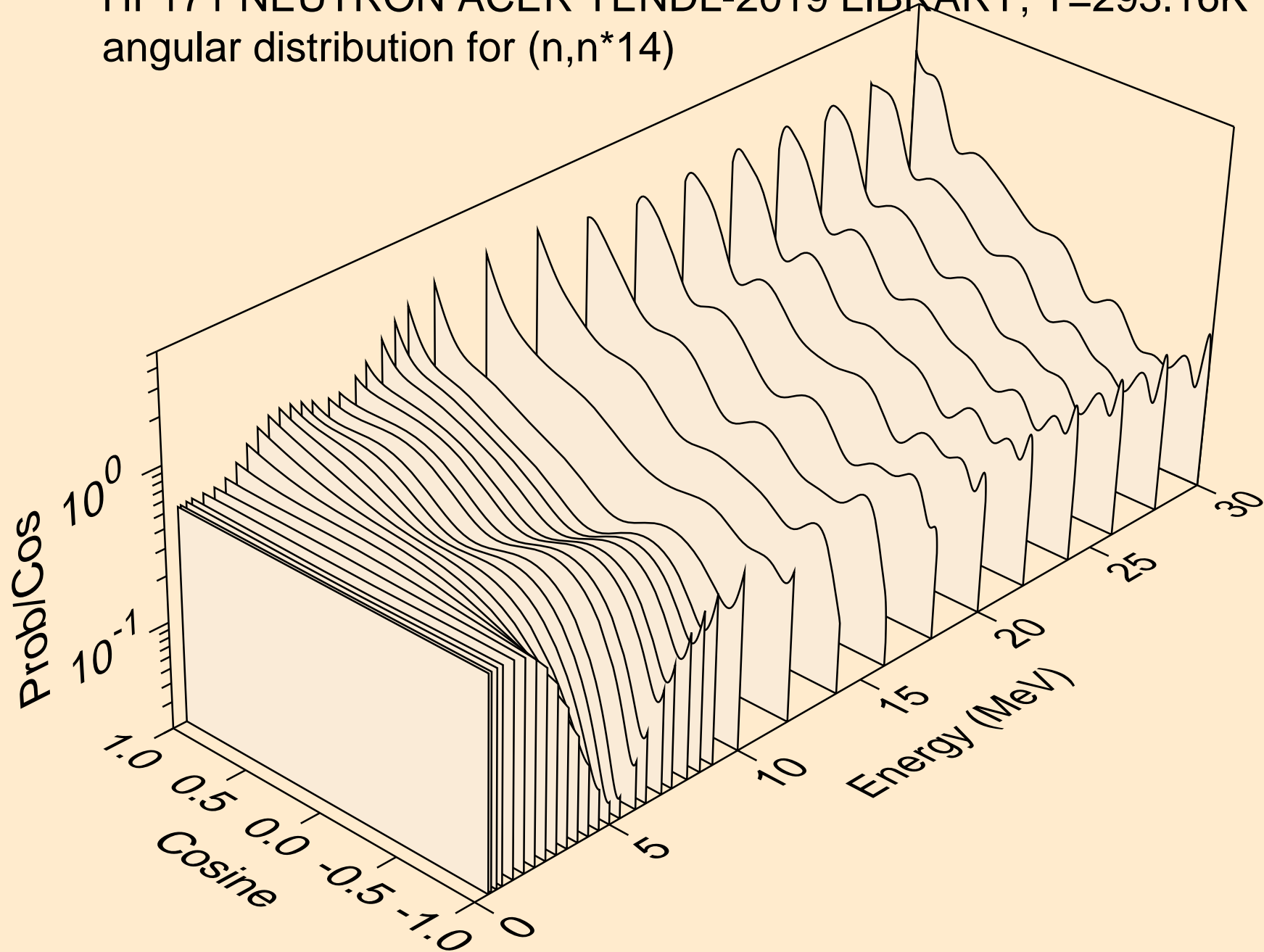

HF171 NEUTRON ACER TENDL-2019 LIBRARY; T=293.16K  
angular distribution for (n,n\*15)

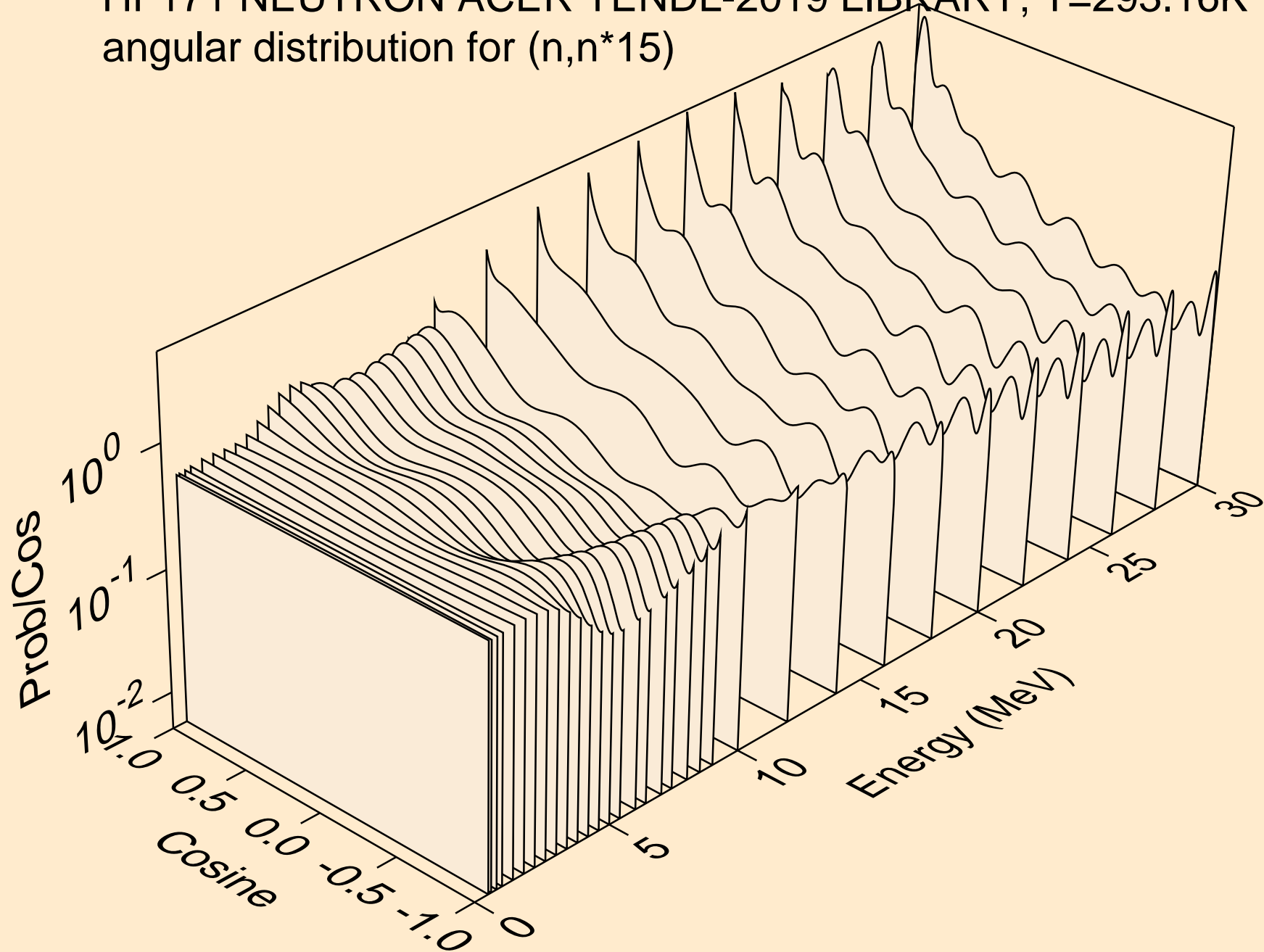

HF171 NEUTRON ACER TENDL-2019 LIBRARY; T=293.16K  
angular distribution for (n,n\*16)

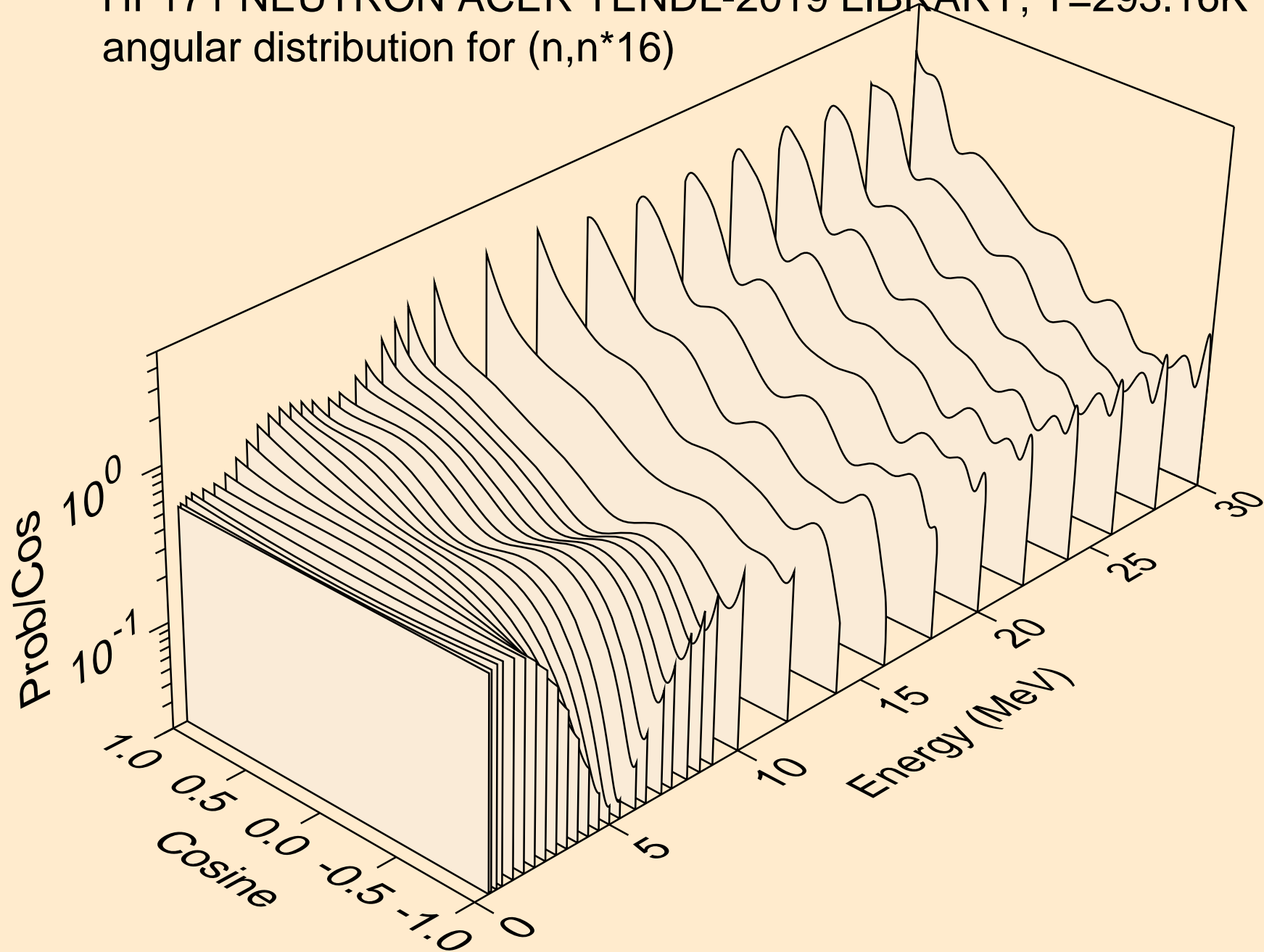

HF171 NEUTRON ACER TENDL-2019 LIBRARY; T=293.16K  
angular distribution for (n,n\*17)

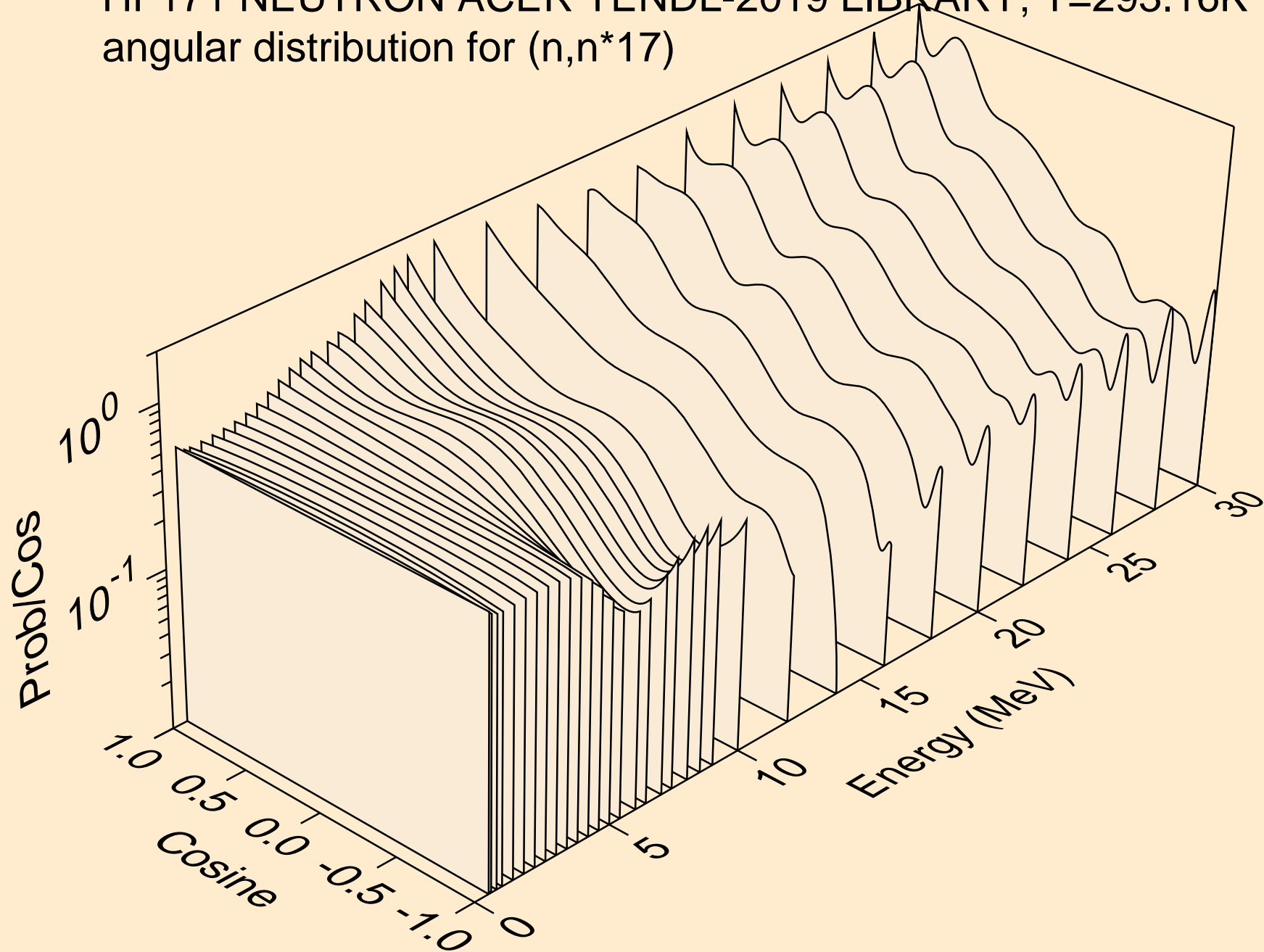

HF171 NEUTRON ACER TENDL-2019 LIBRARY; T=293.16K  
angular distribution for (n,n\*18)

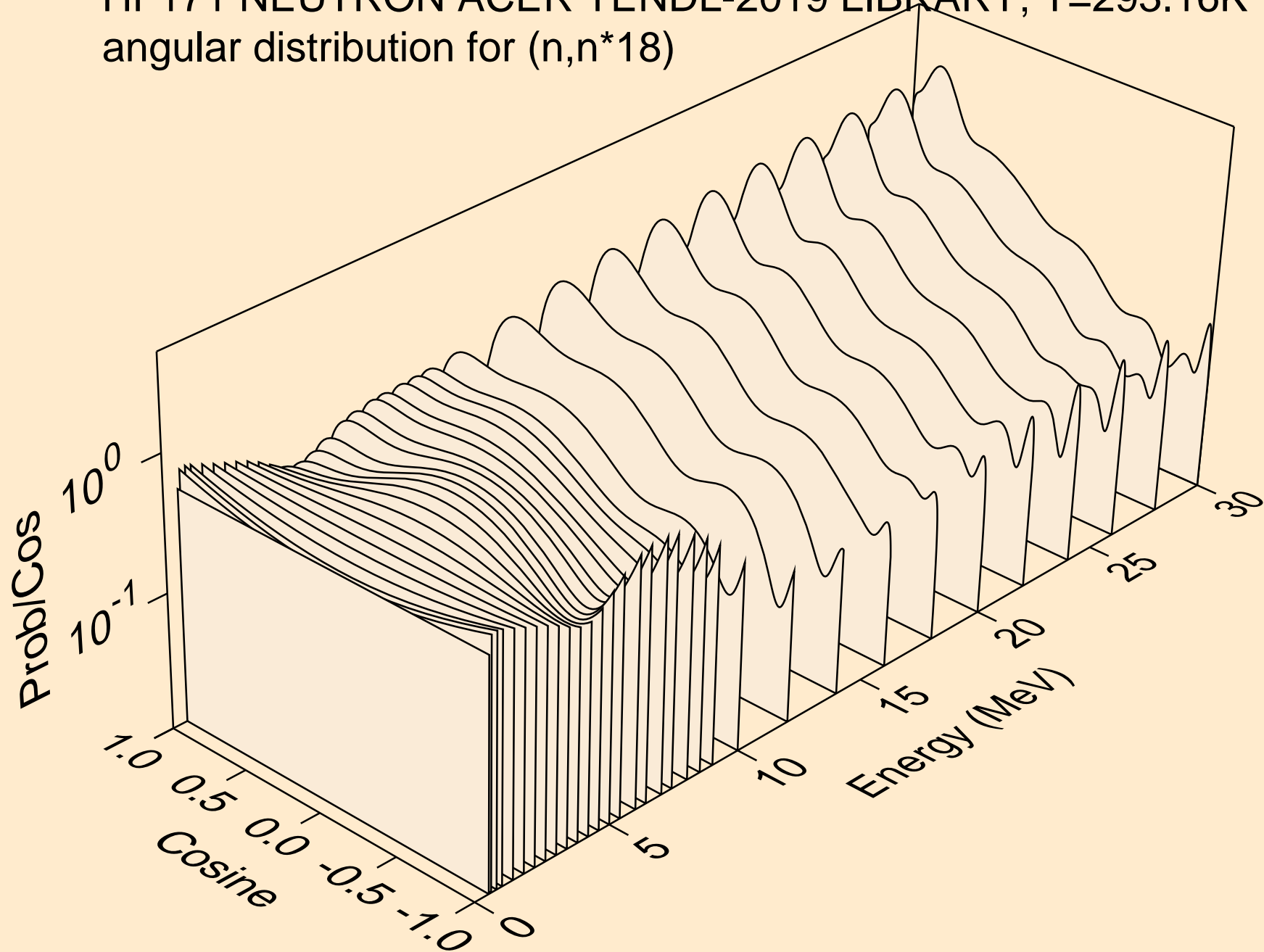



HF171 NEUTRON ACER TENDL-2019 LIBRARY; T=293.16K  
angular distribution for (n,n\*19)

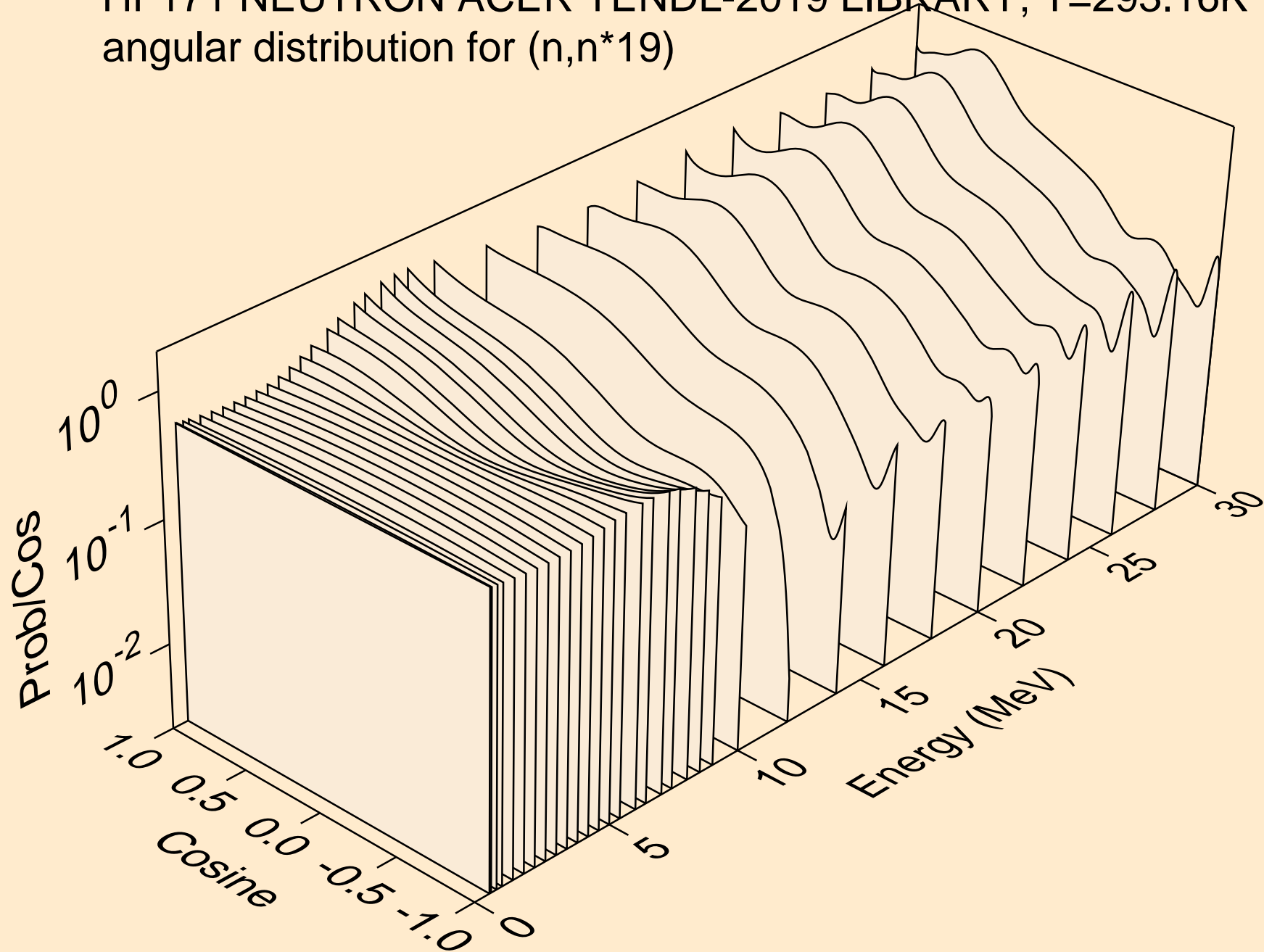

HF171 NEUTRON ACER TENDL-2019 LIBRARY; T=293.16K  
angular distribution for (n,n\*20)

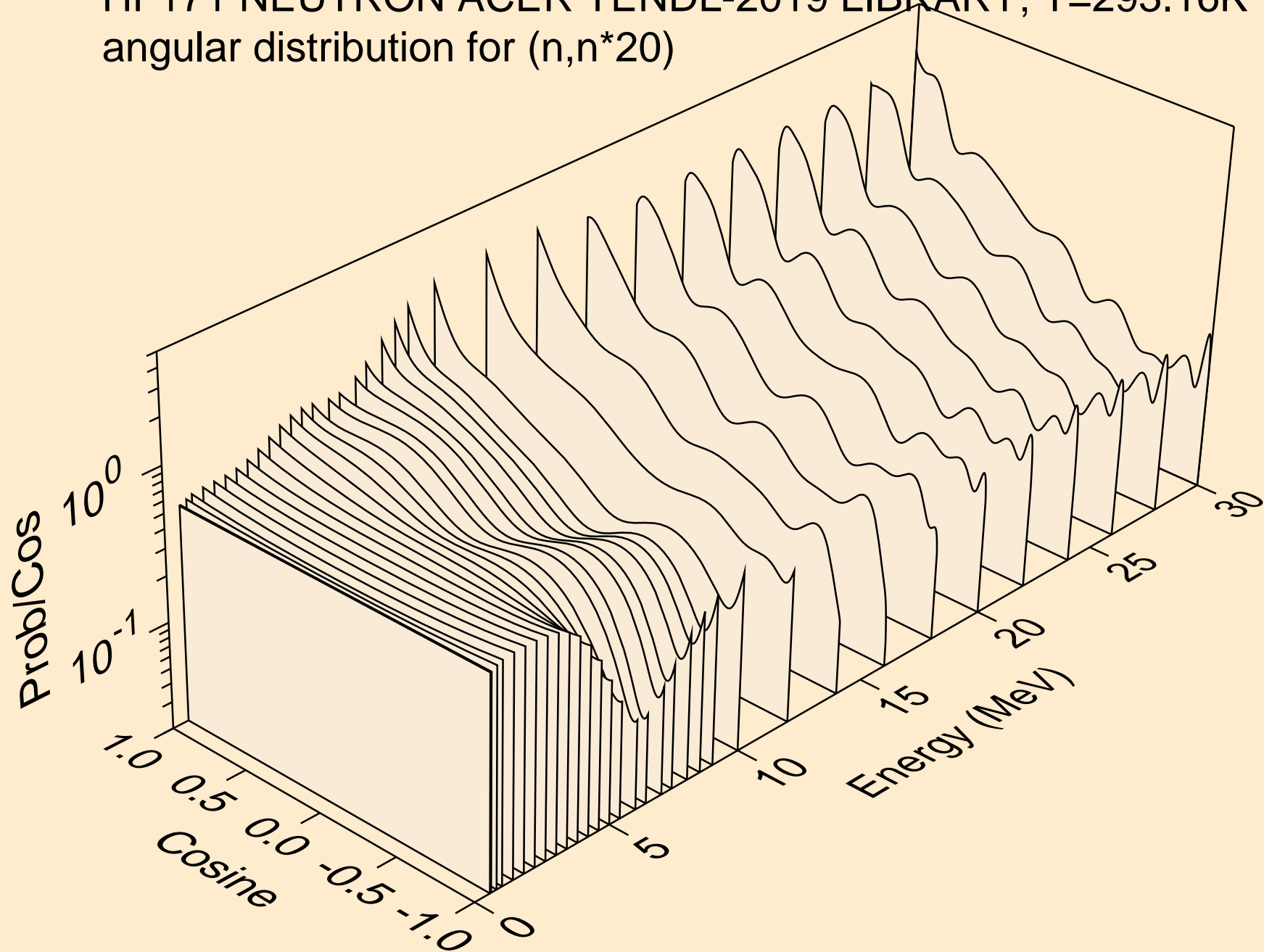

HF171 NEUTRON ACER TENDL-2019 LIBRARY; T=293.16K  
angular distribution for (n,n\*21)

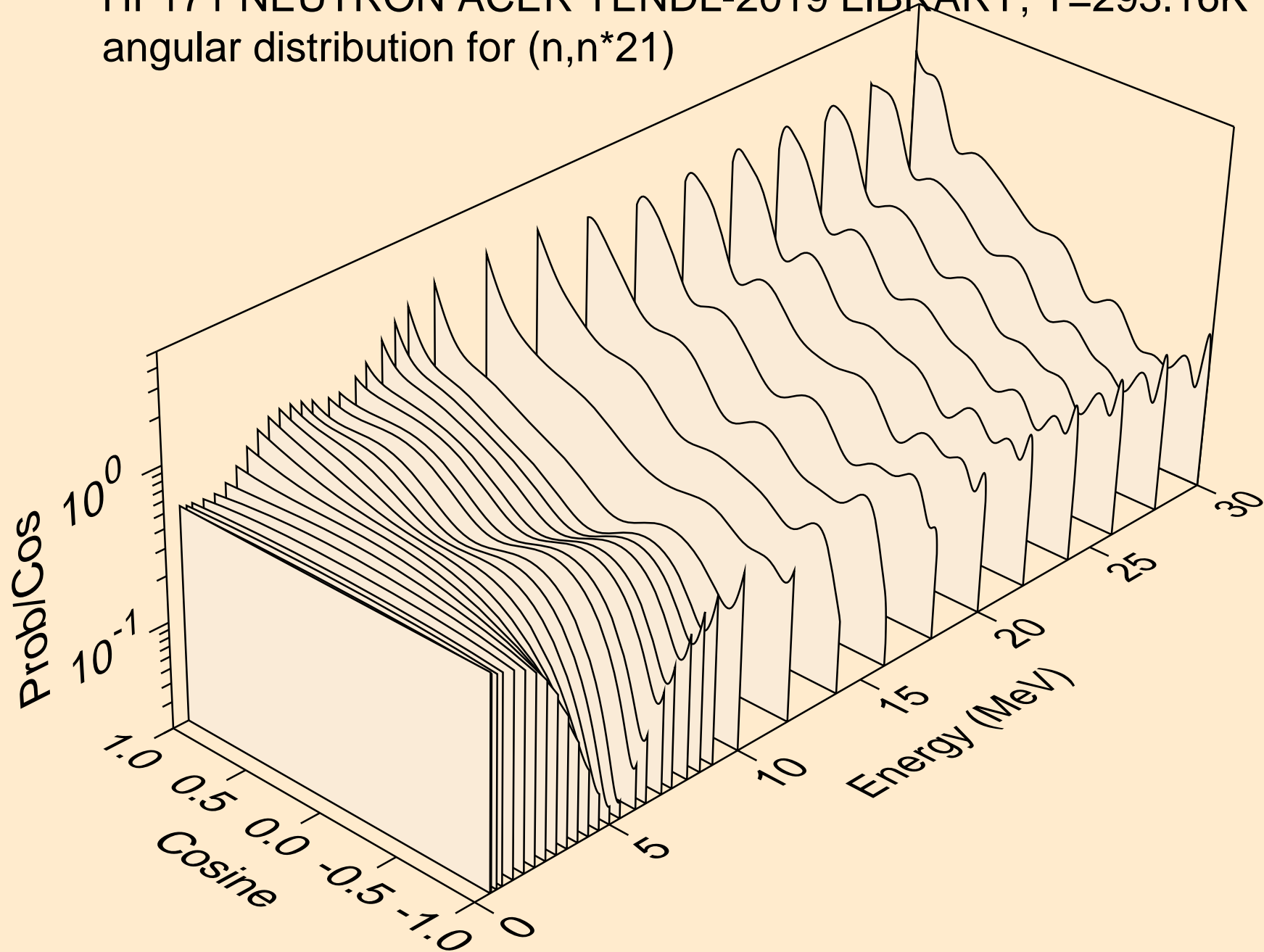

HF171 NEUTRON ACER TENDL-2019 LIBRARY; T=293.16K  
angular distribution for (n,n\*22)

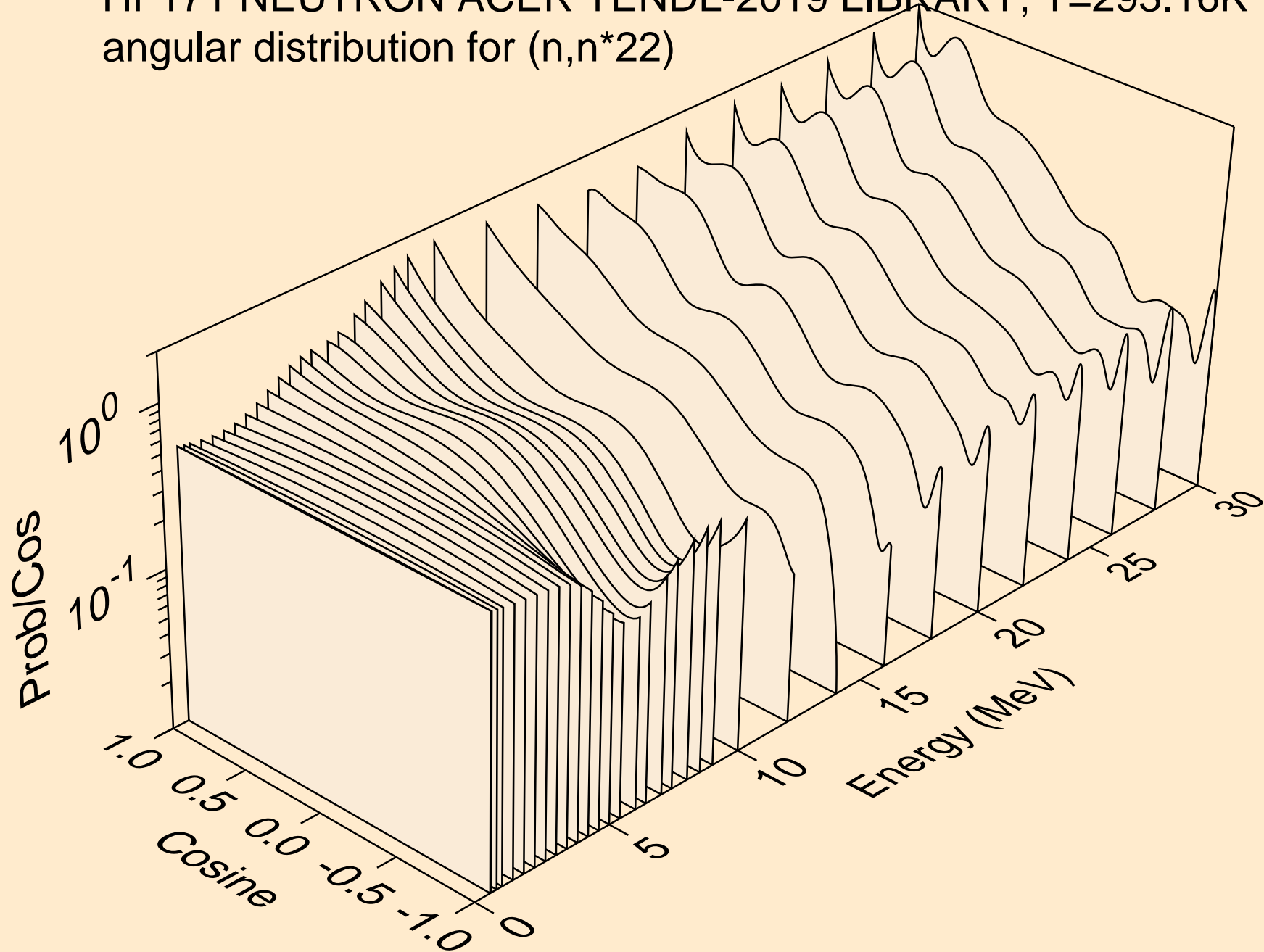

HF171 NEUTRON ACER TENDL-2019 LIBRARY; T=293.16K  
angular distribution for (n,n\*23)

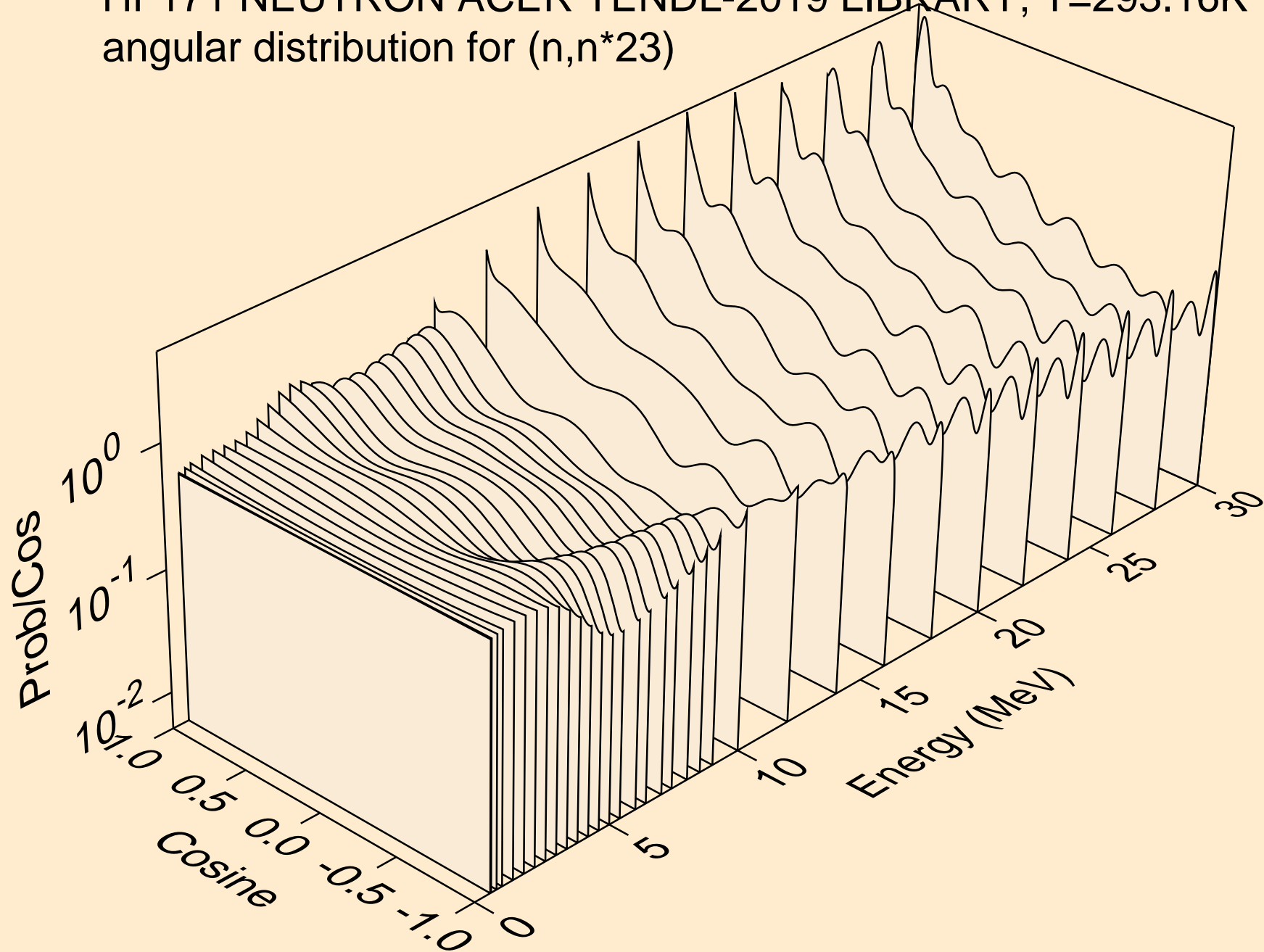

HF171 NEUTRON ACER TENDL-2019 LIBRARY; T=293.16K  
angular distribution for (n,n\*24)

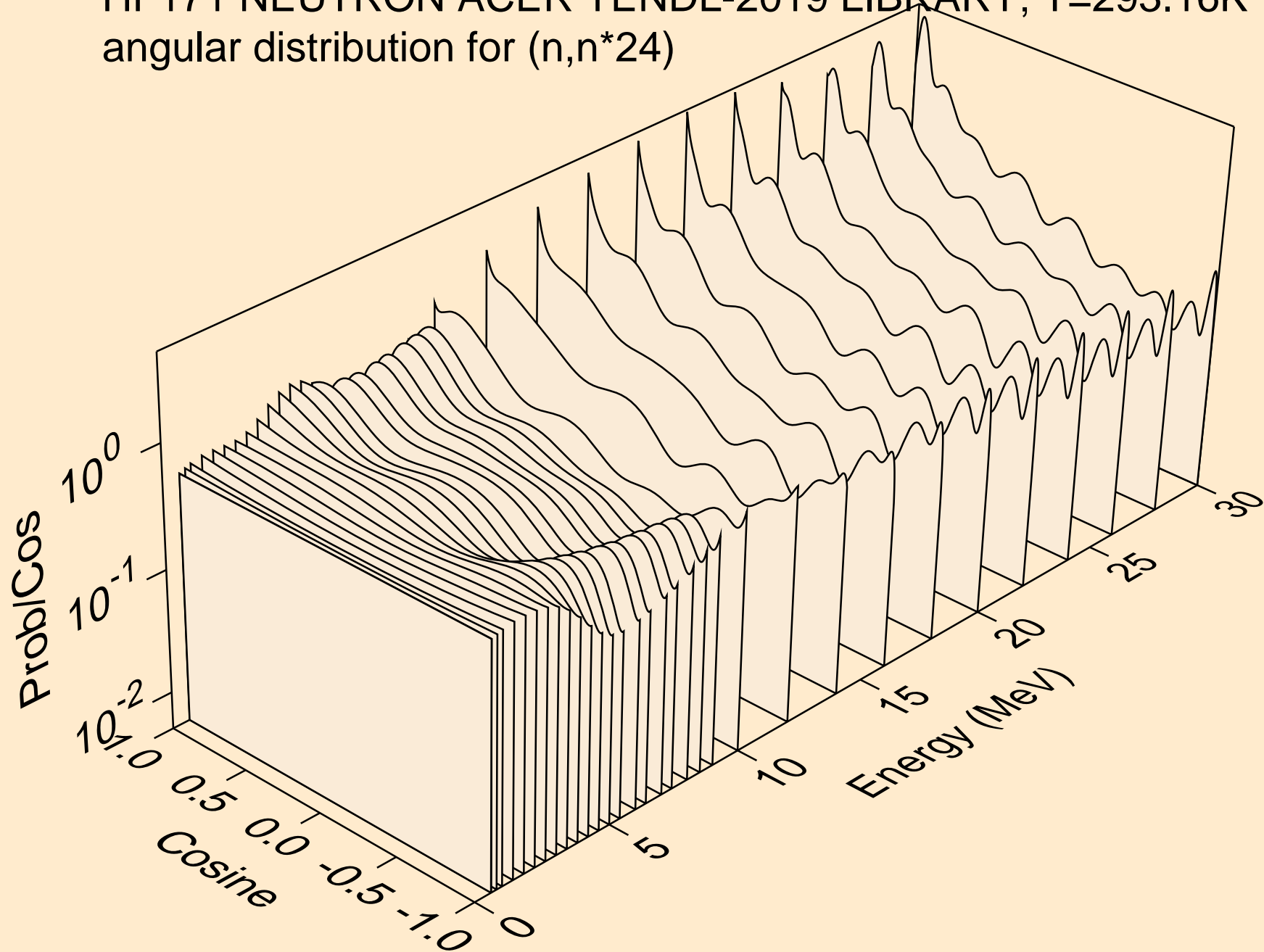

HF171 NEUTRON ACER TENDL-2019 LIBRARY; T=293.16K  
angular distribution for (n,n\*25)

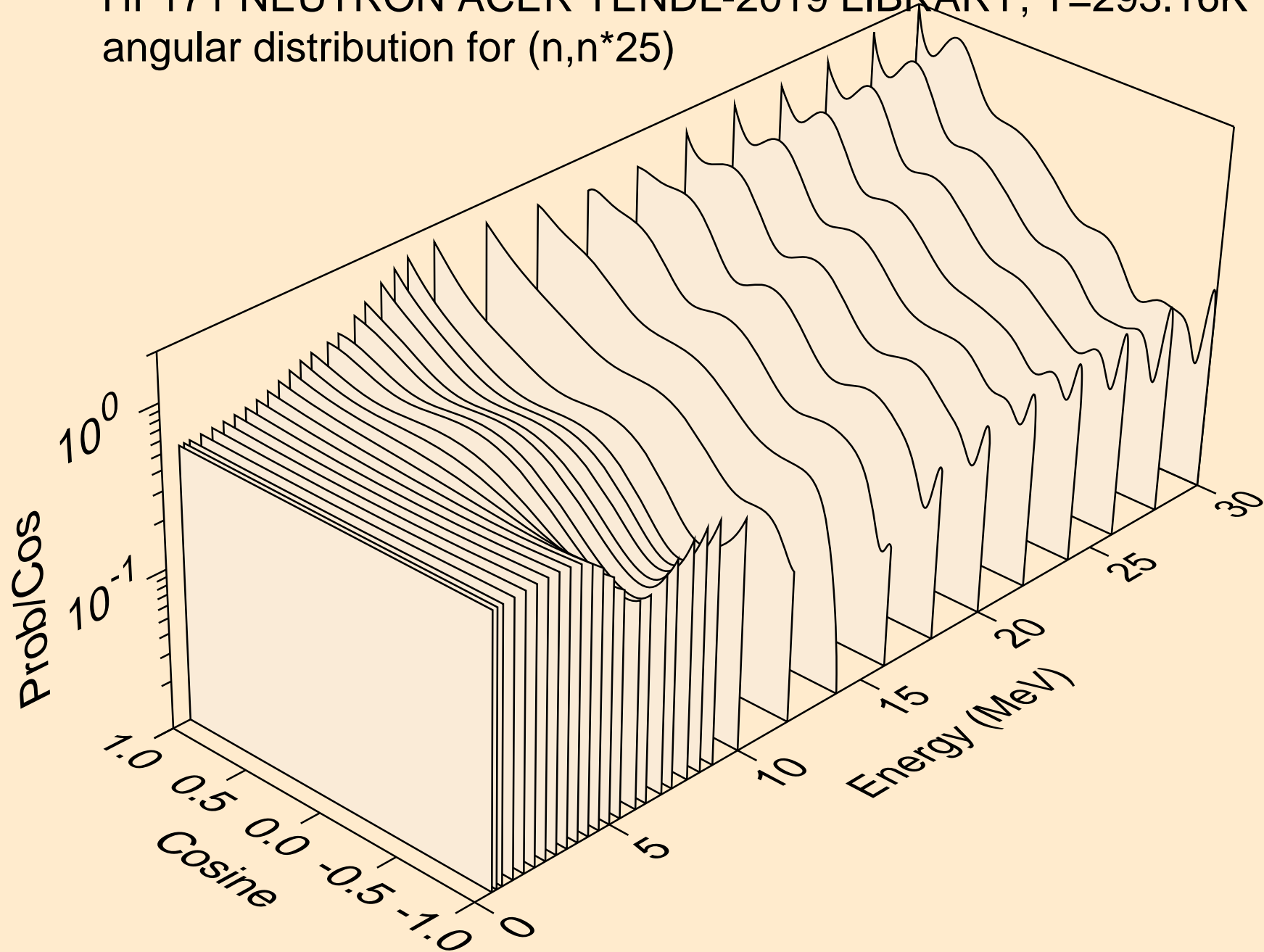

HF171 NEUTRON ACER TENDL-2019 LIBRARY; T=293.16K  
angular distribution for (n,n\*26)

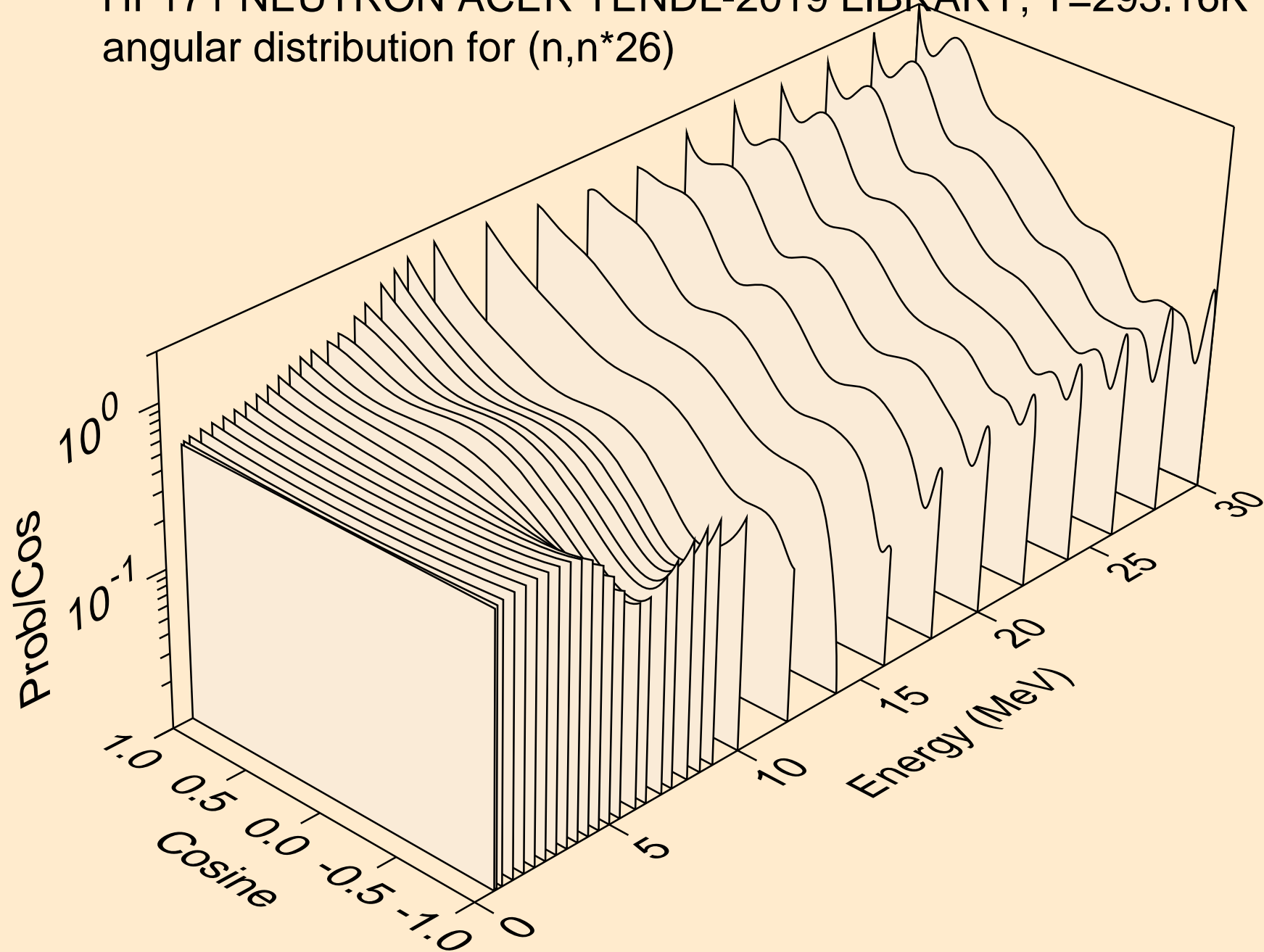



HF171 NEUTRON ACER TENDL-2019 LIBRARY; T=293.16K  
angular distribution for (n,n\*27)

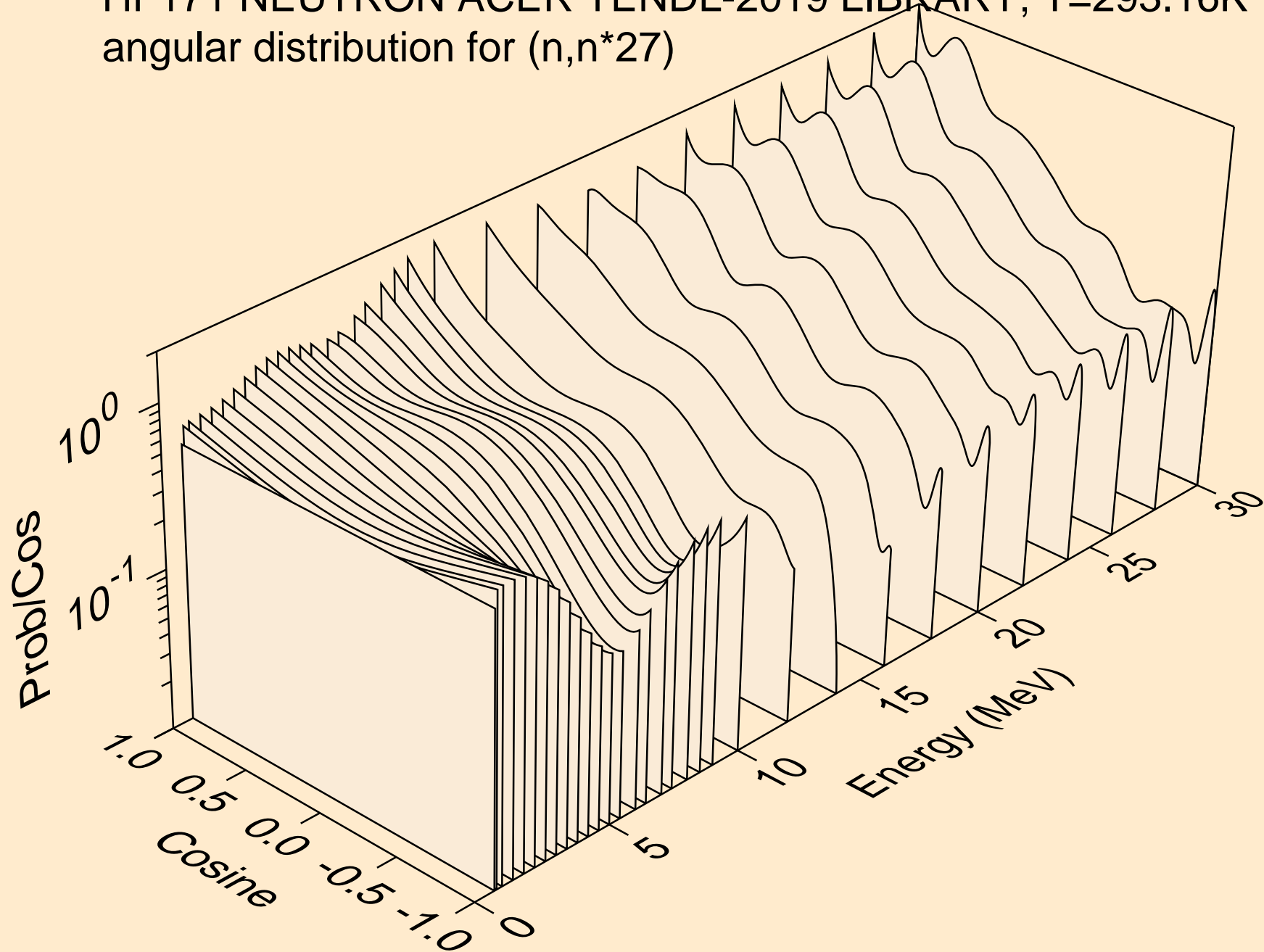

HF171 NEUTRON ACER TENDL-2019 LIBRARY; T=293.16K  
angular distribution for (n,n\*28)

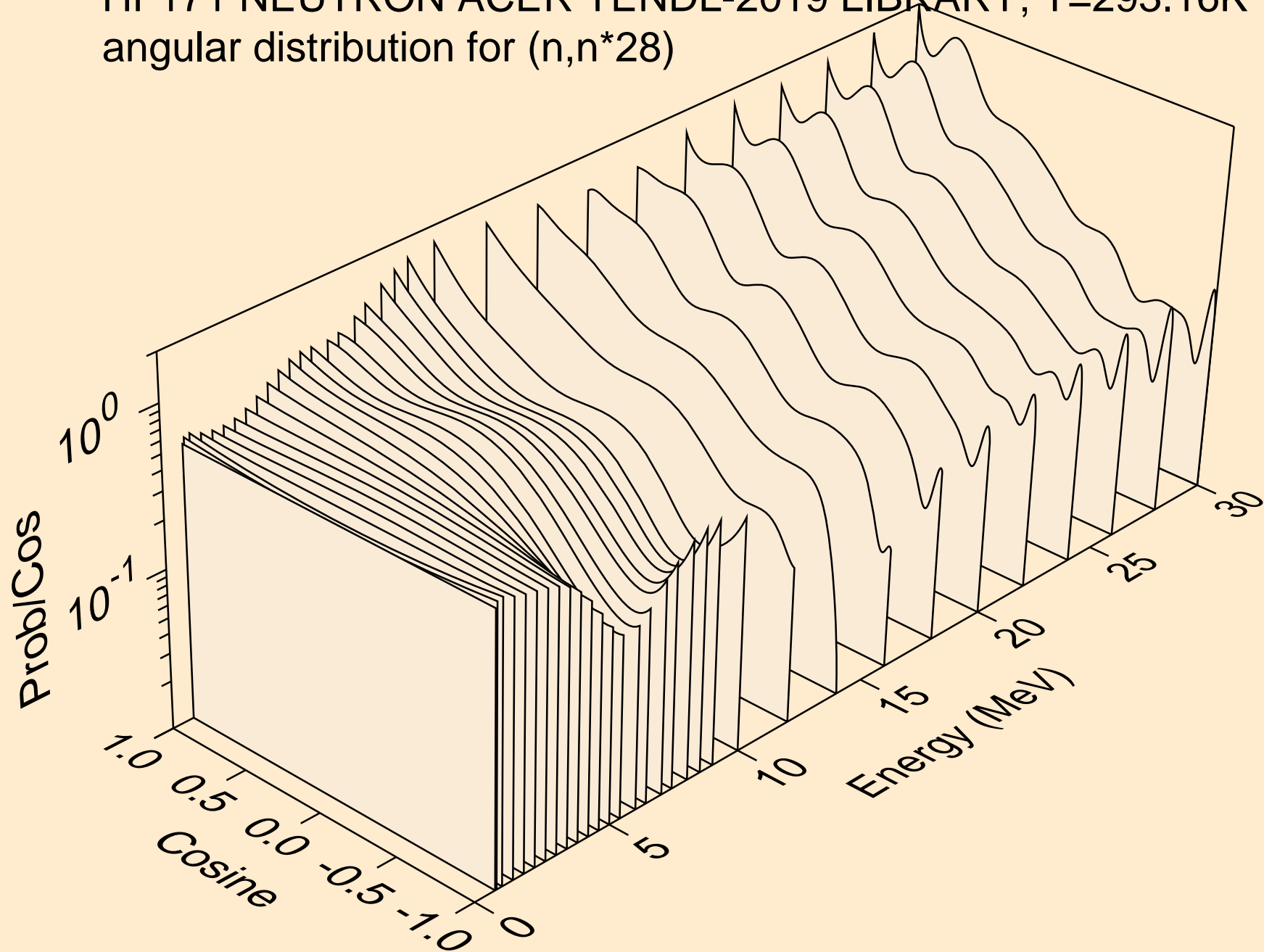

HF171 NEUTRON ACER TENDL-2019 LIBRARY; T=293.16K  
angular distribution for (n,n\*29)

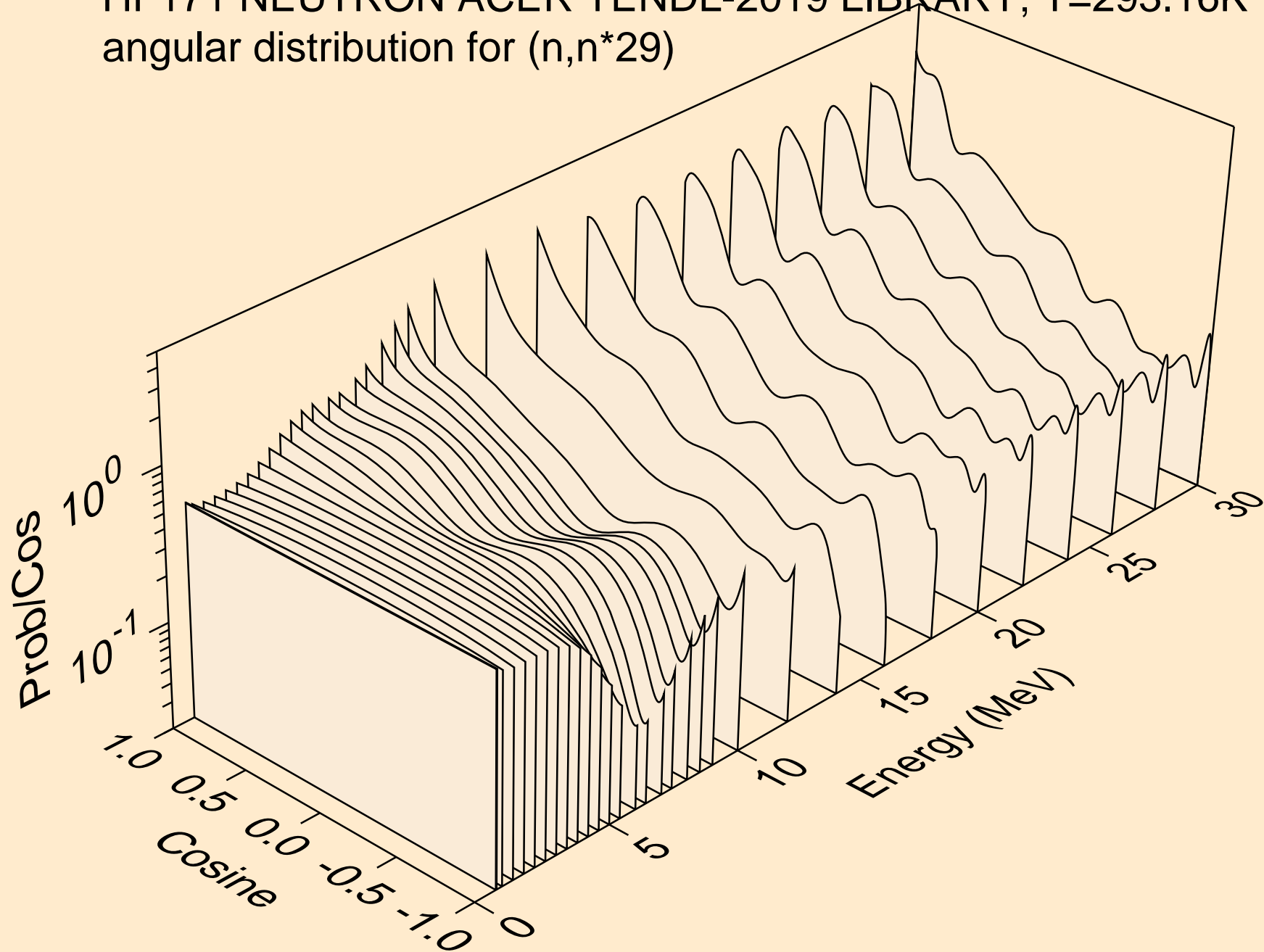

HF171 NEUTRON ACER TENDL-2019 LIBRARY; T=293.16K  
Neutron emission for (n,x)

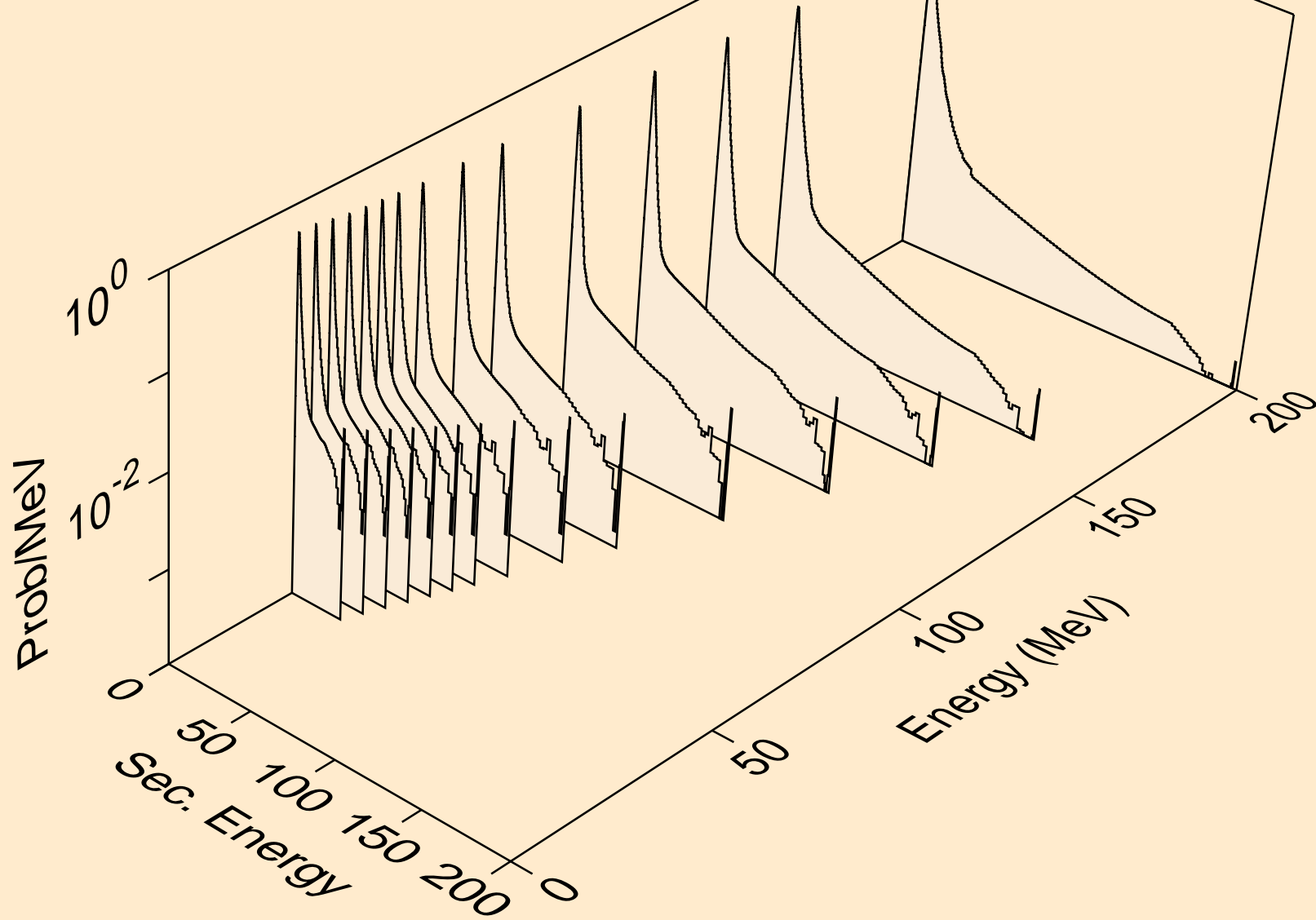

HF171 NEUTRON ACER TENDL-2019 LIBRARY; T=293.16K  
Neutron emission for (n,2nd)

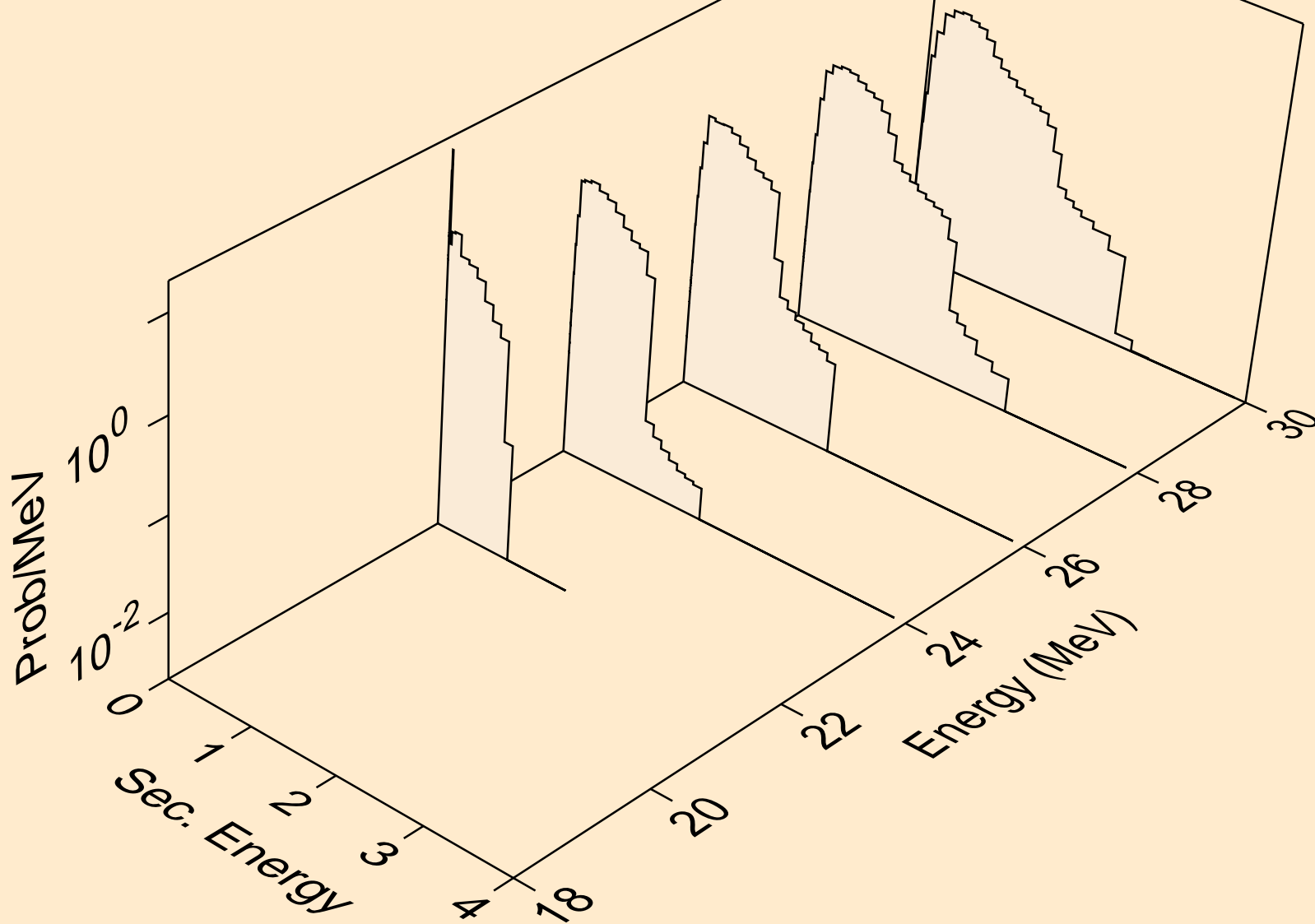

HF171 NEUTRON ACER TENDL-2019 LIBRARY; T=293.16K  
Neutron emission for (n,2n)

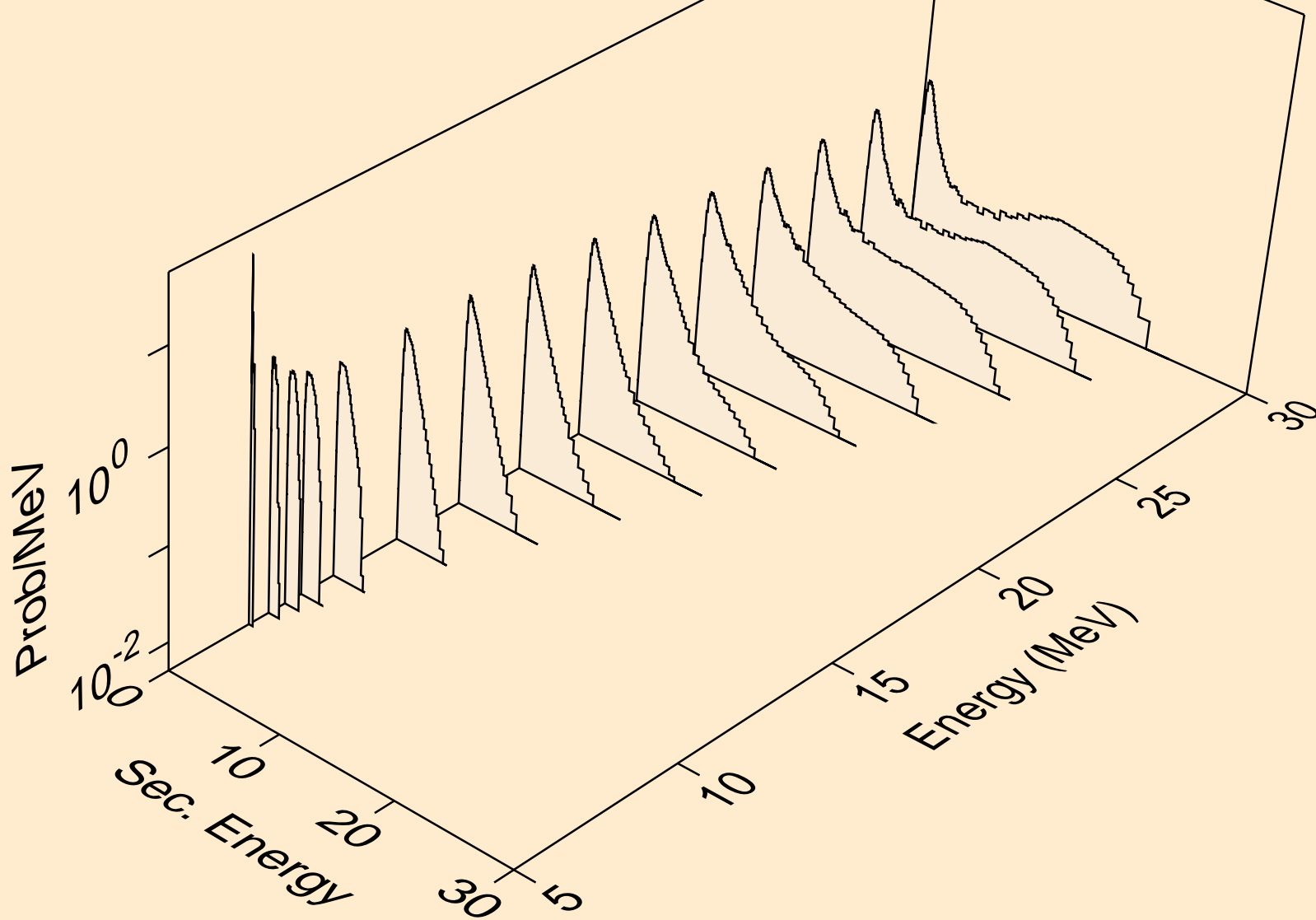

HF171 NEUTRON ACER TENDL-2019 LIBRARY; T=293.16K  
Neutron emission for (n,3n)

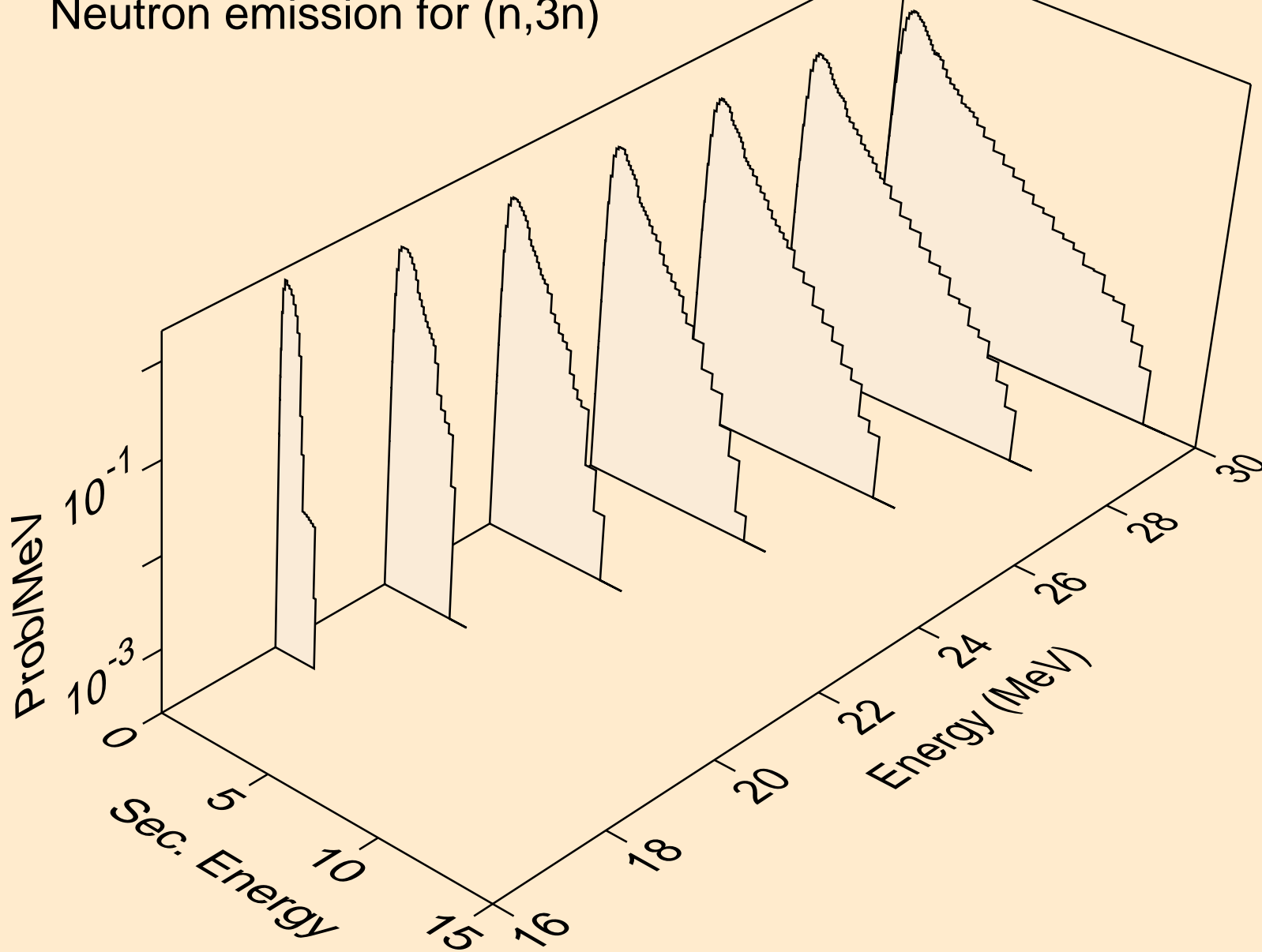

HF171 NEUTRON ACER TENDL-2019 LIBRARY; T=293.16K  
Neutron emission for (n,n\*)a

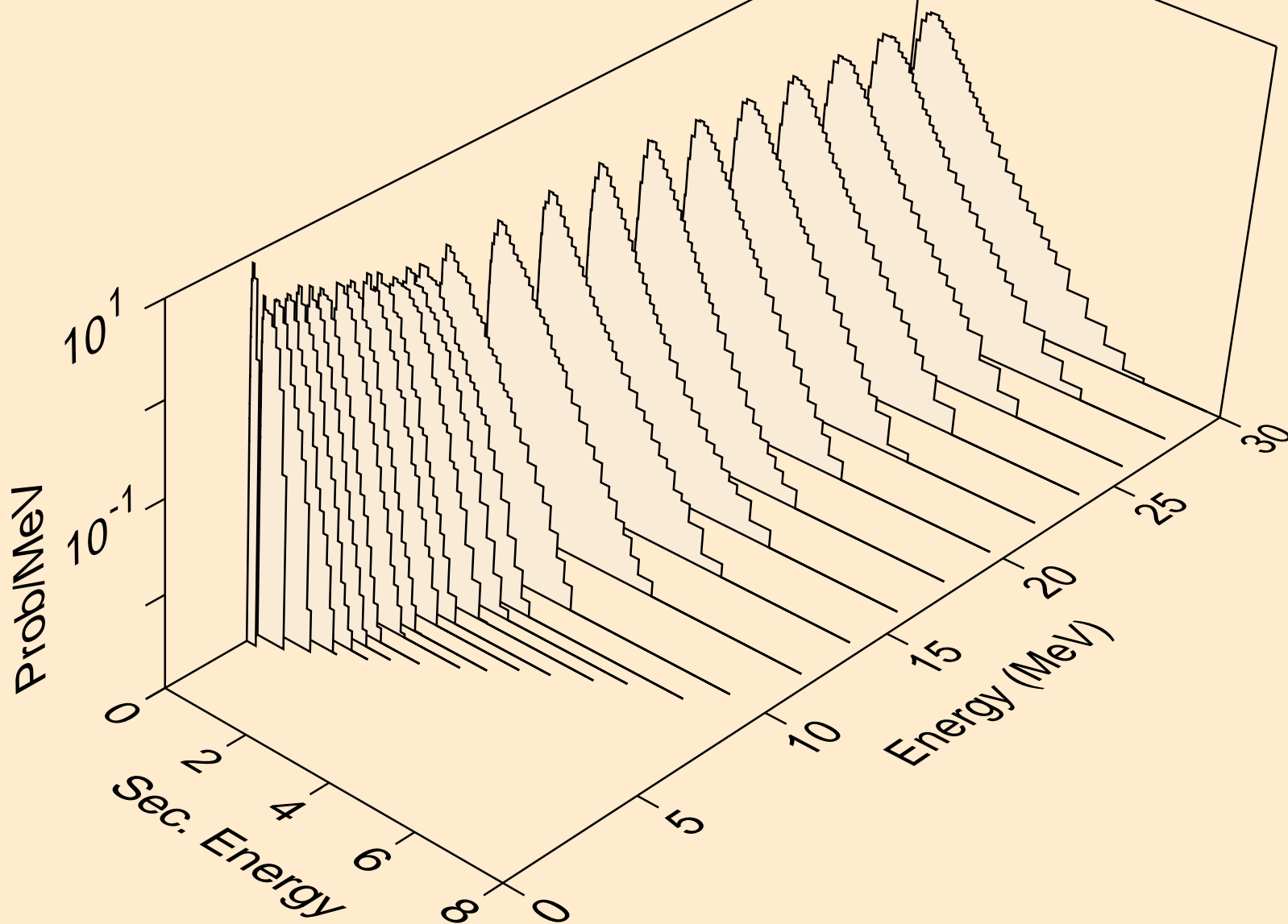



HF171 NEUTRON ACER TENDL-2019 LIBRARY; T=293.16K  
Neutron emission for (n,2n)a

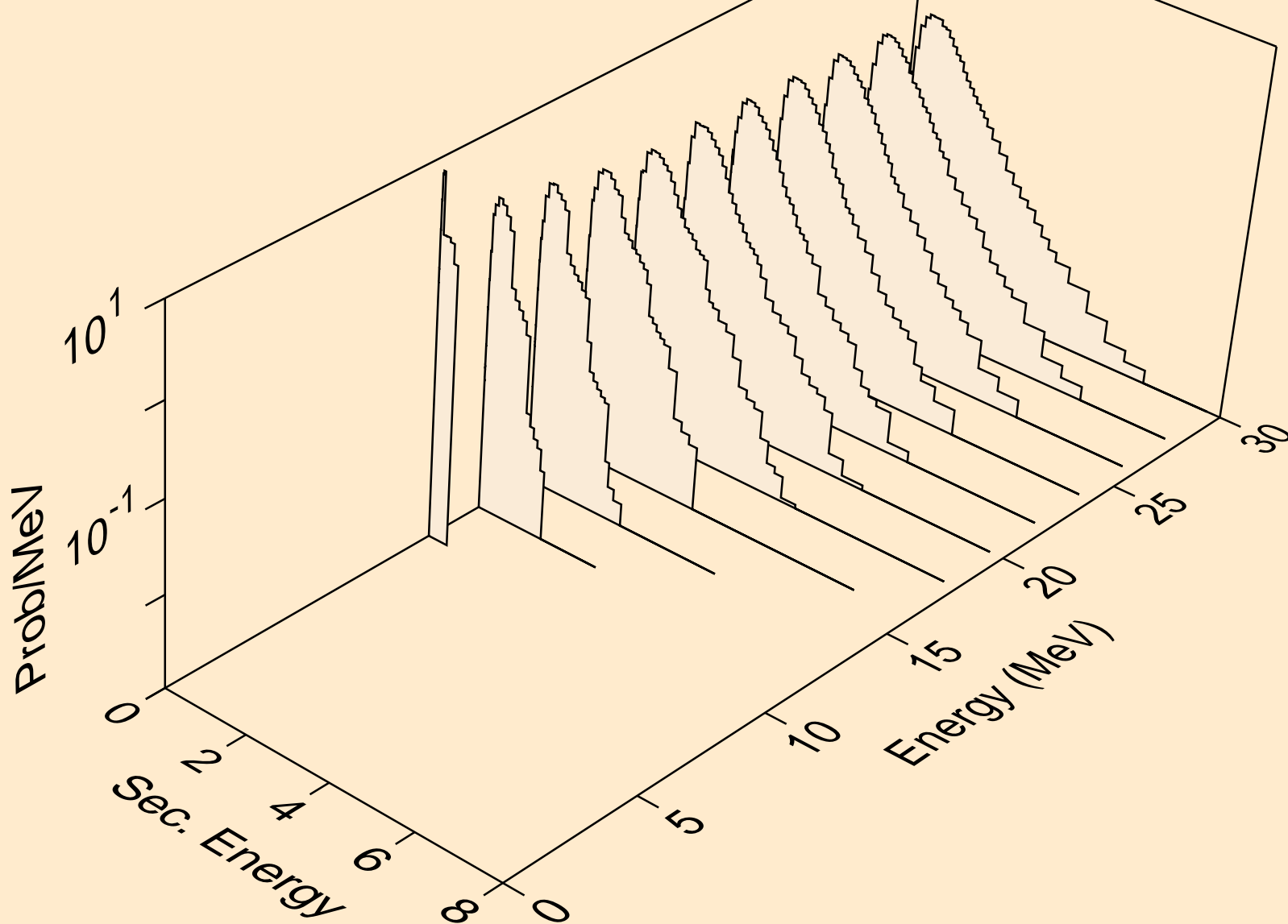

HF171 NEUTRON ACER TENDL-2019 LIBRARY; T=293.16K  
Neutron emission for (n,3n)a

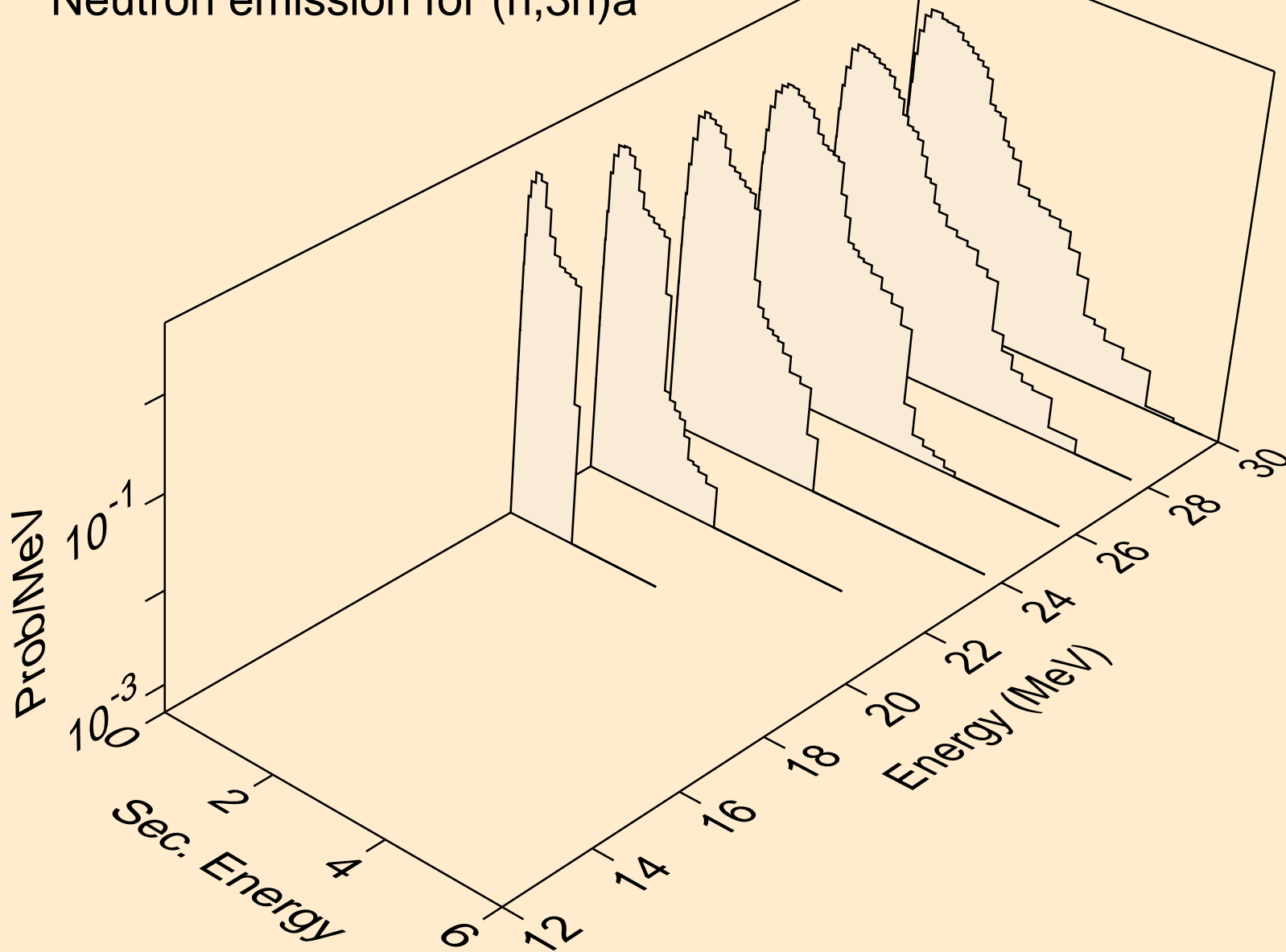

HF171 NEUTRON ACER TENDL-2019 LIBRARY; T=293.16K  
Neutron emission for (n,n\*)p

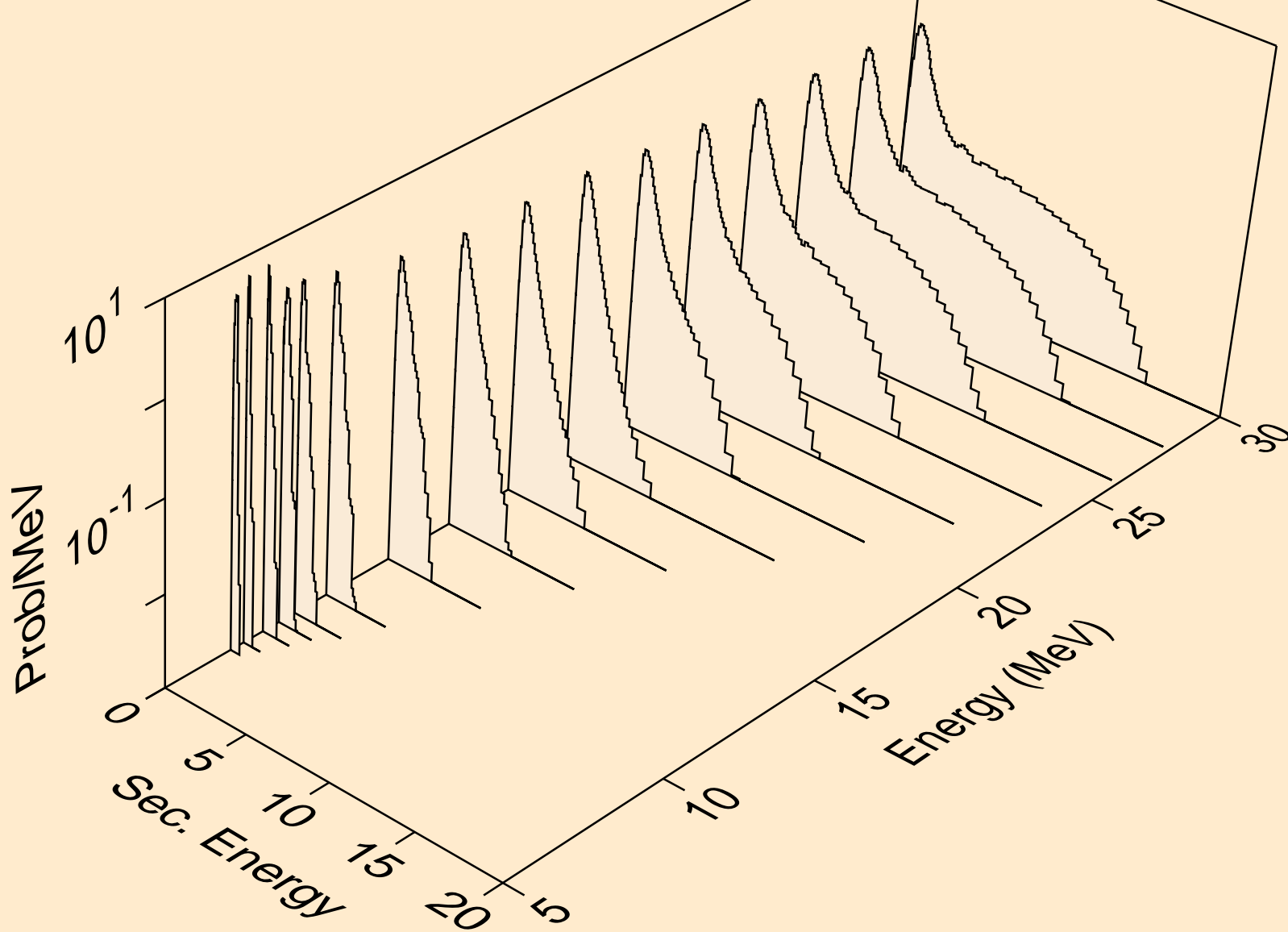

HF171 NEUTRON ACER TENDL-2019 LIBRARY; T=293.16K  
Neutron emission for (n,n\*)2a

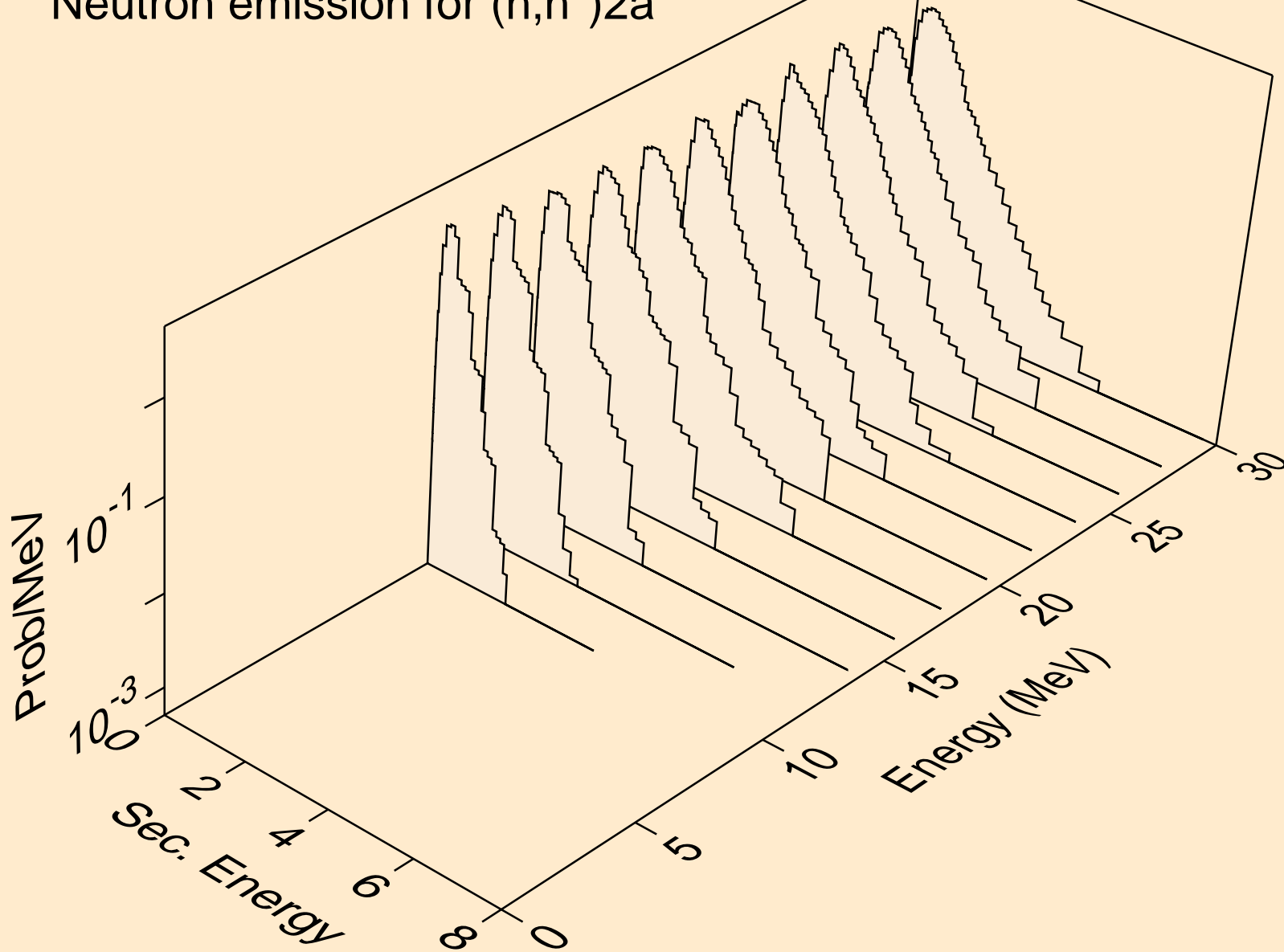

HF171 NEUTRON ACER TENDL-2019 LIBRARY; T=293.16K  
Neutron emission for (n,2n)2a

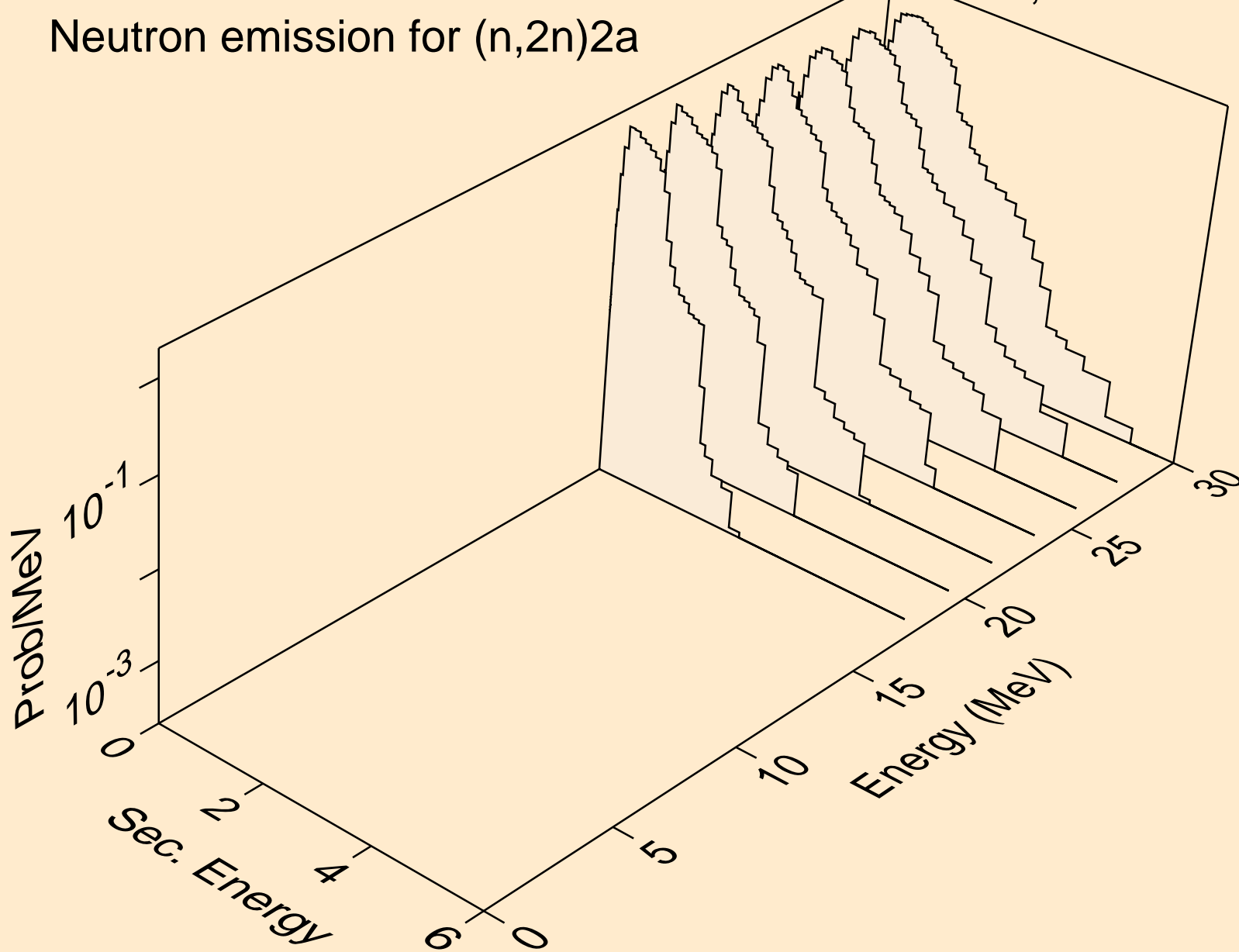

HF171 NEUTRON ACER TENDL-2019 LIBRARY; T=293.16K  
Neutron emission for (n,n\*)d

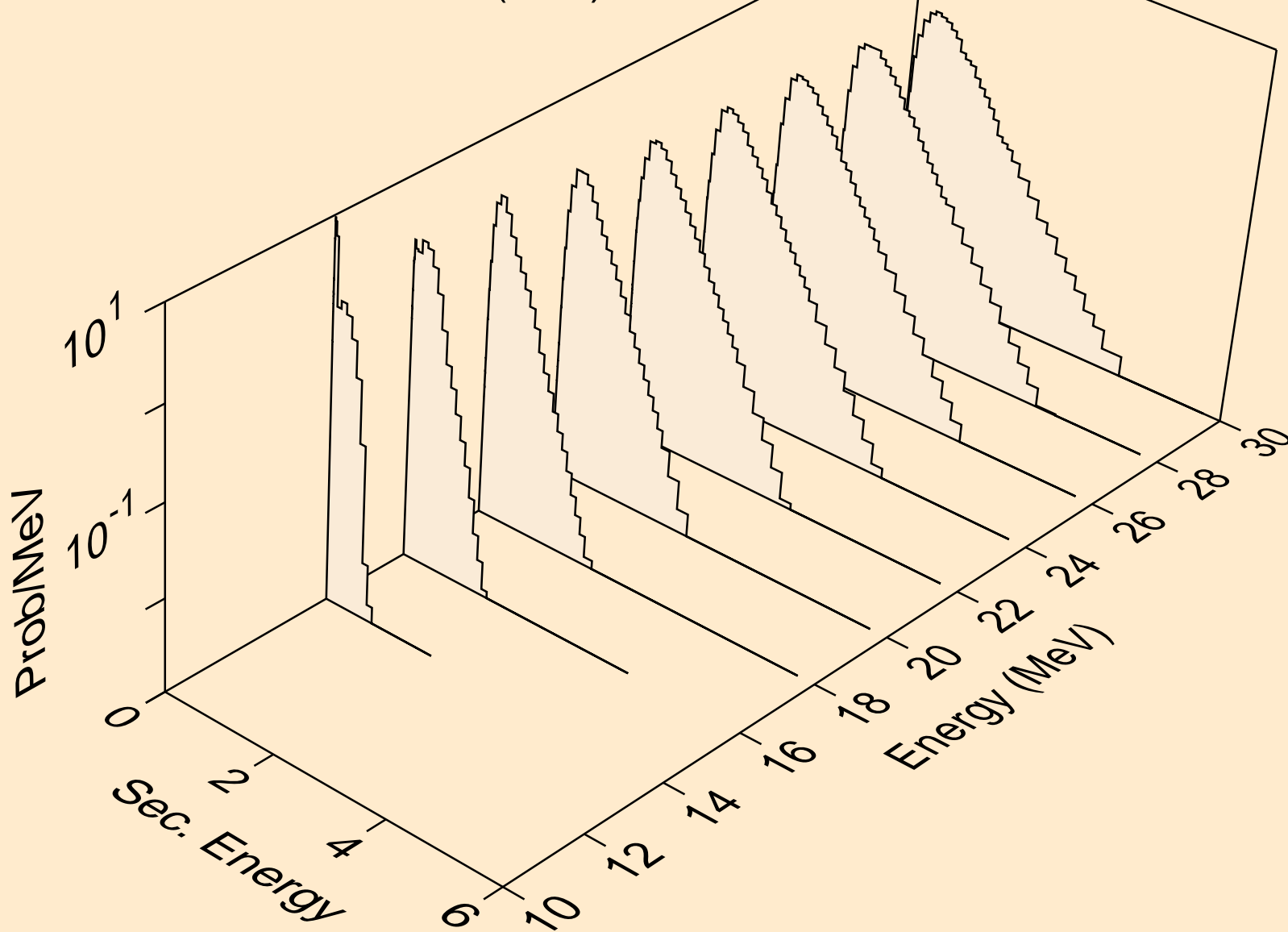

HF171 NEUTRON ACER TENDL-2019 LIBRARY; T=293.16K  
Neutron emission for (n,n\*)t

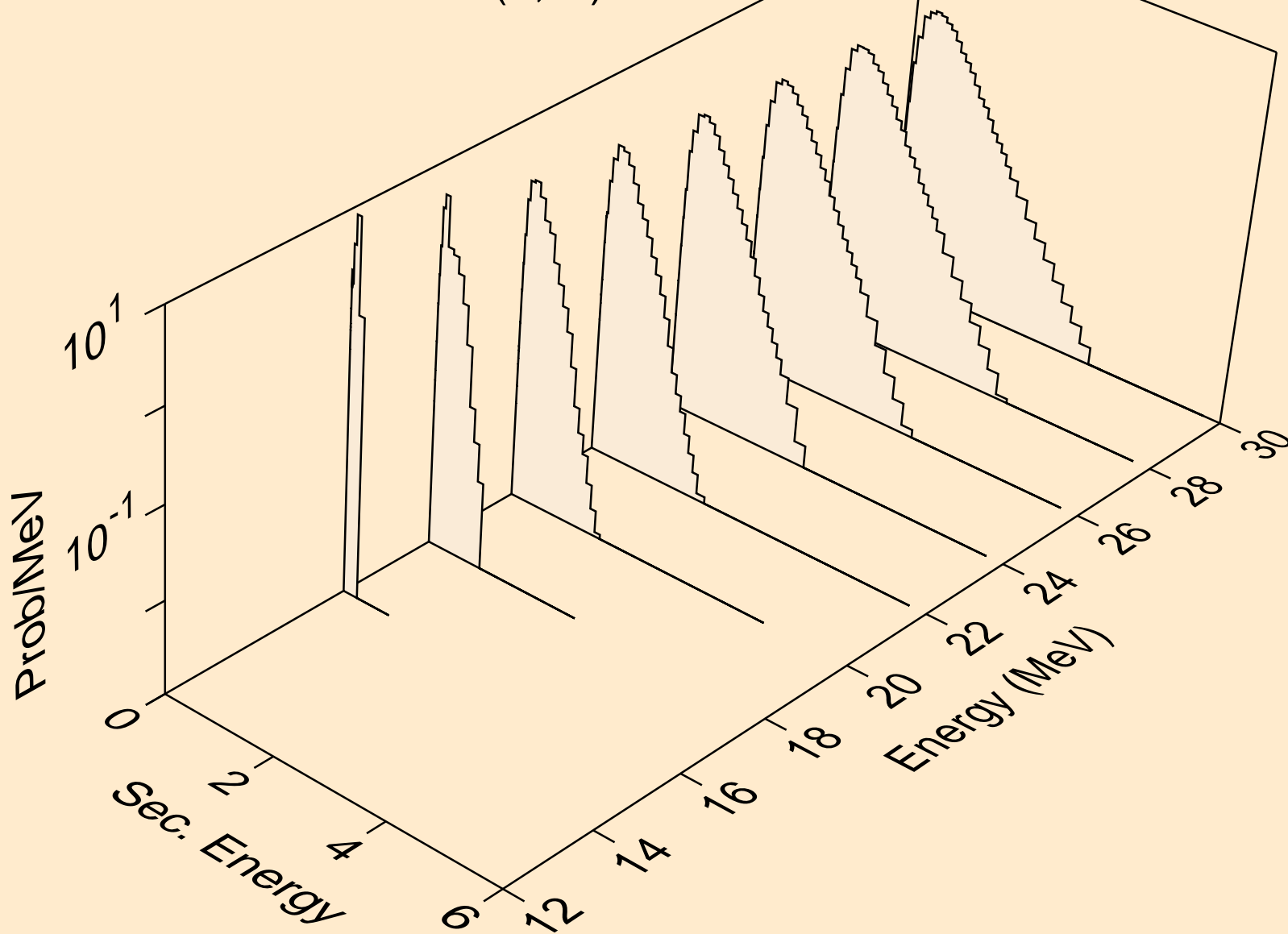

HF171 NEUTRON ACER TENDL-2019 LIBRARY; T=293.16K  
Neutron emission for (n,n\*)he3

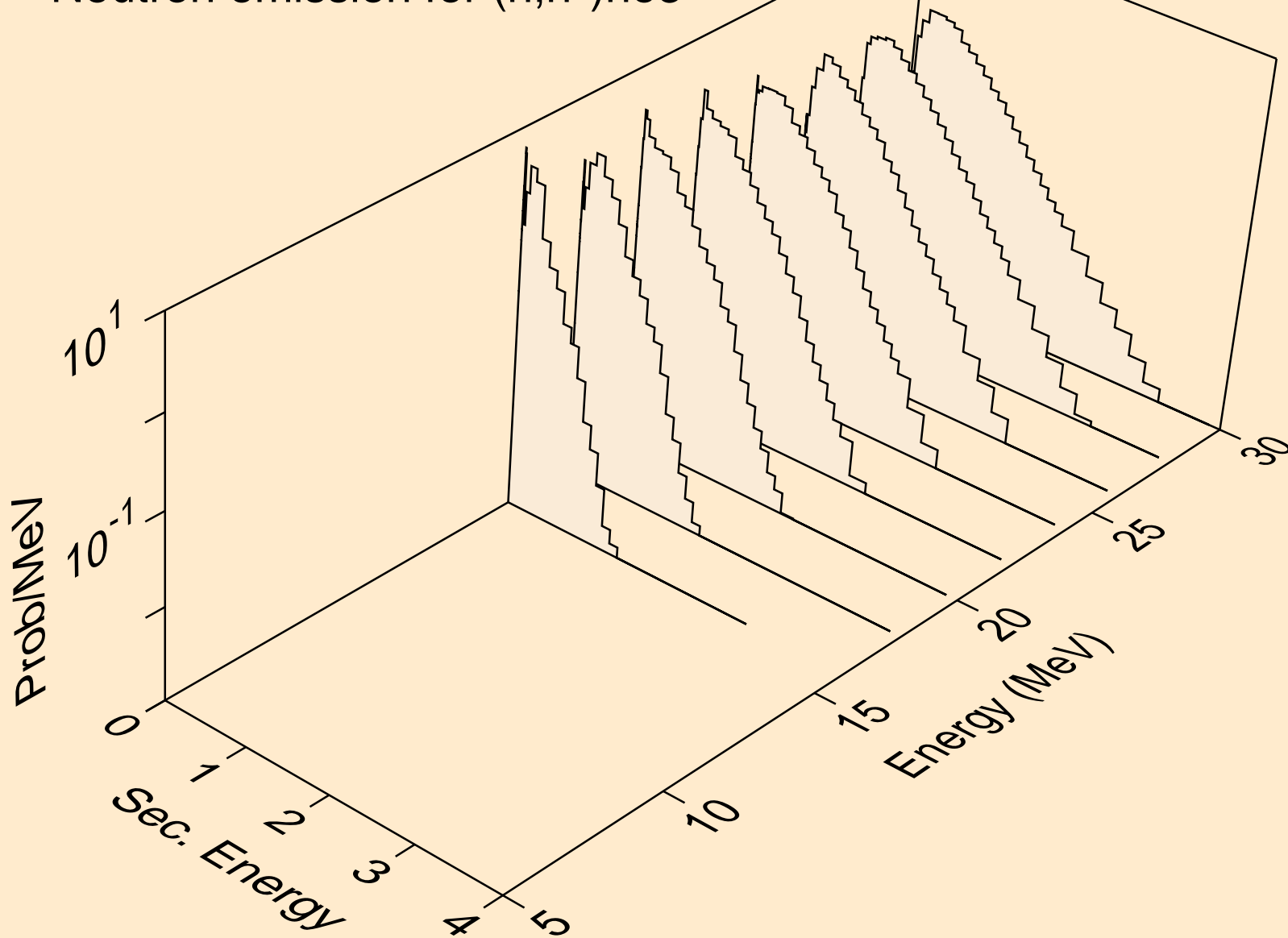



HF171 NEUTRON ACER TENDL-2019 LIBRARY; T=293.16K  
Neutron emission for (n,4n)

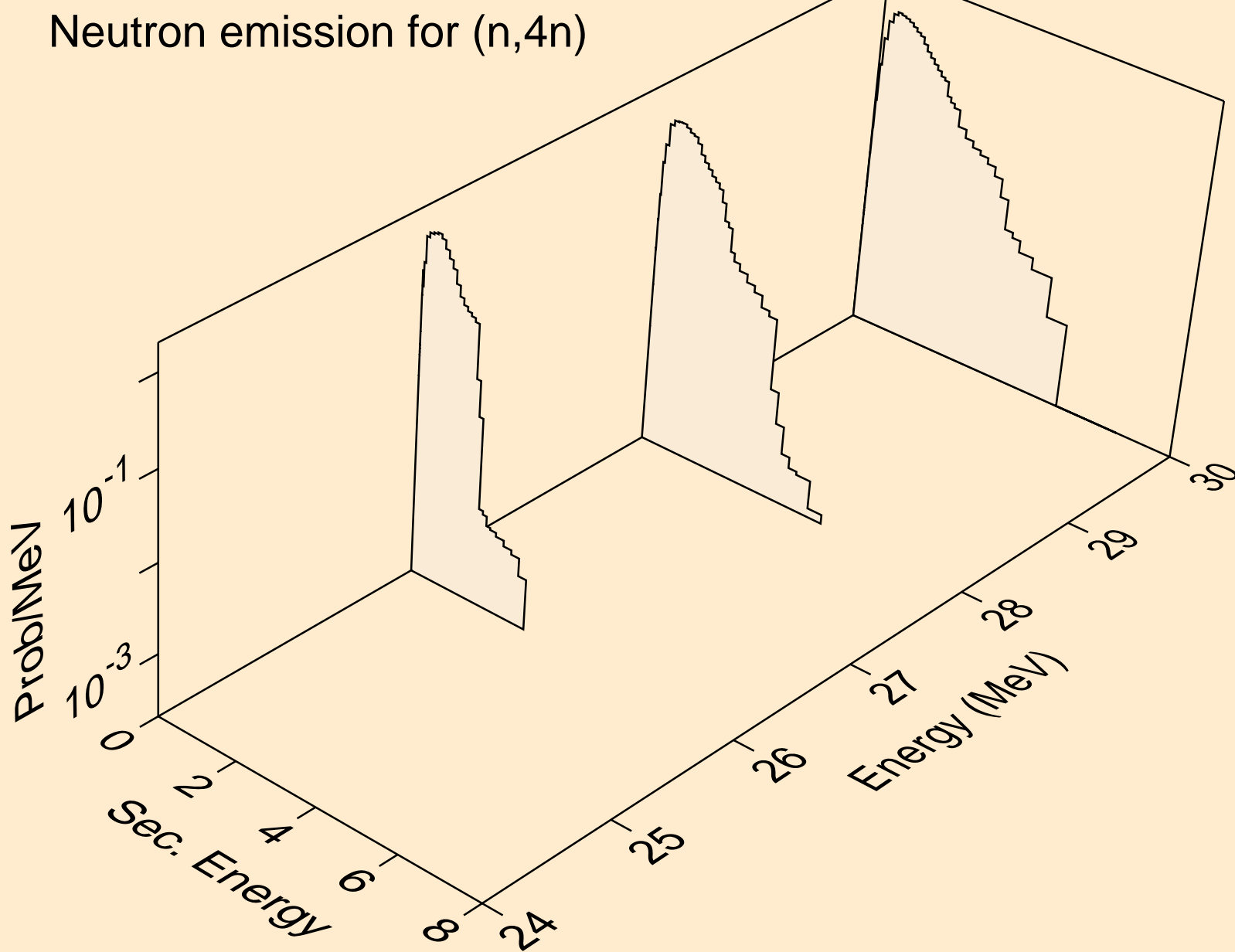

HF171 NEUTRON ACER TENDL-2019 LIBRARY; T=293.16K  
Neutron emission for (n,2np)

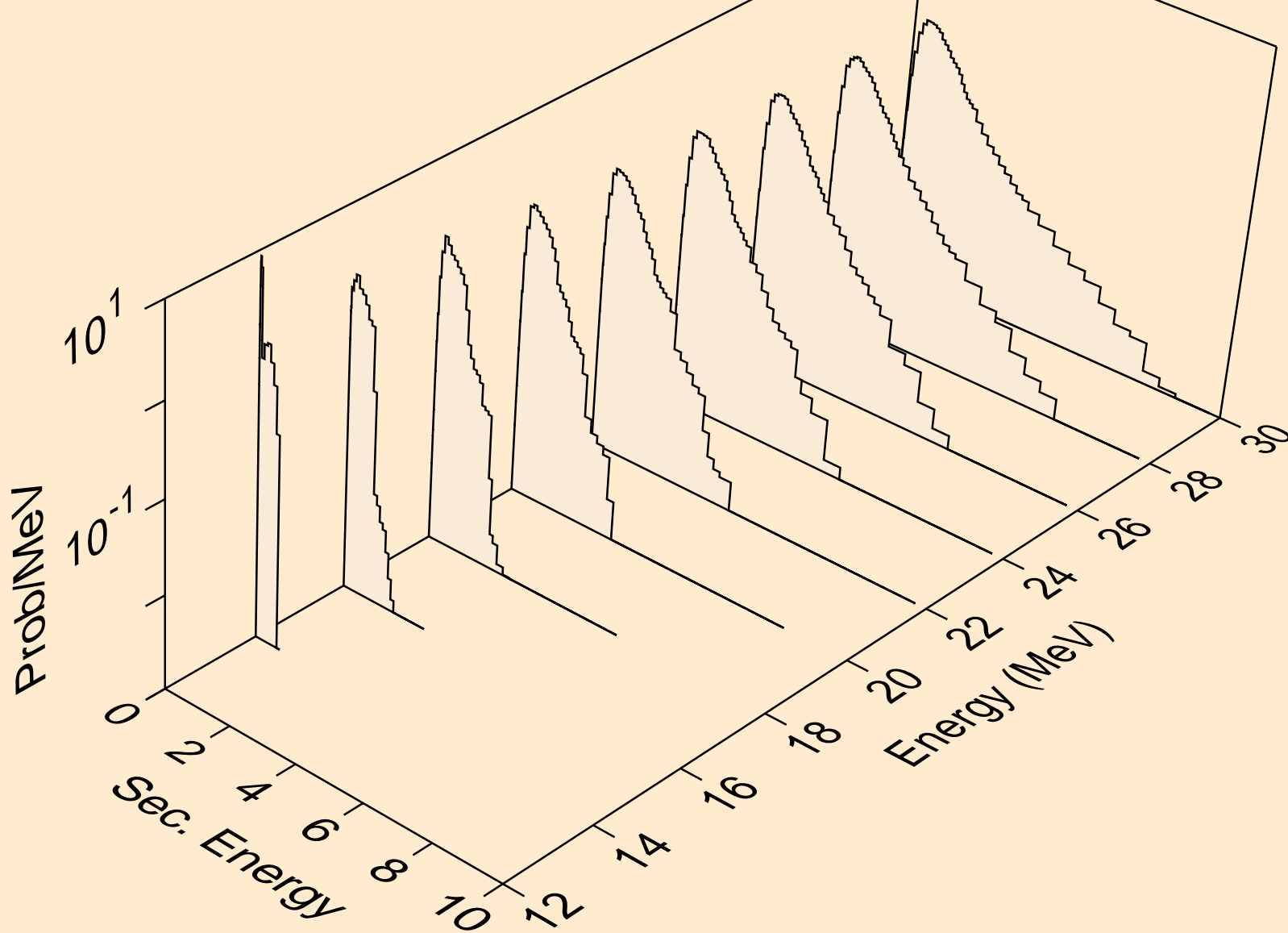

HF171 NEUTRON ACER TENDL-2019 LIBRARY; T=293.16K  
Neutron emission for (n,3np)

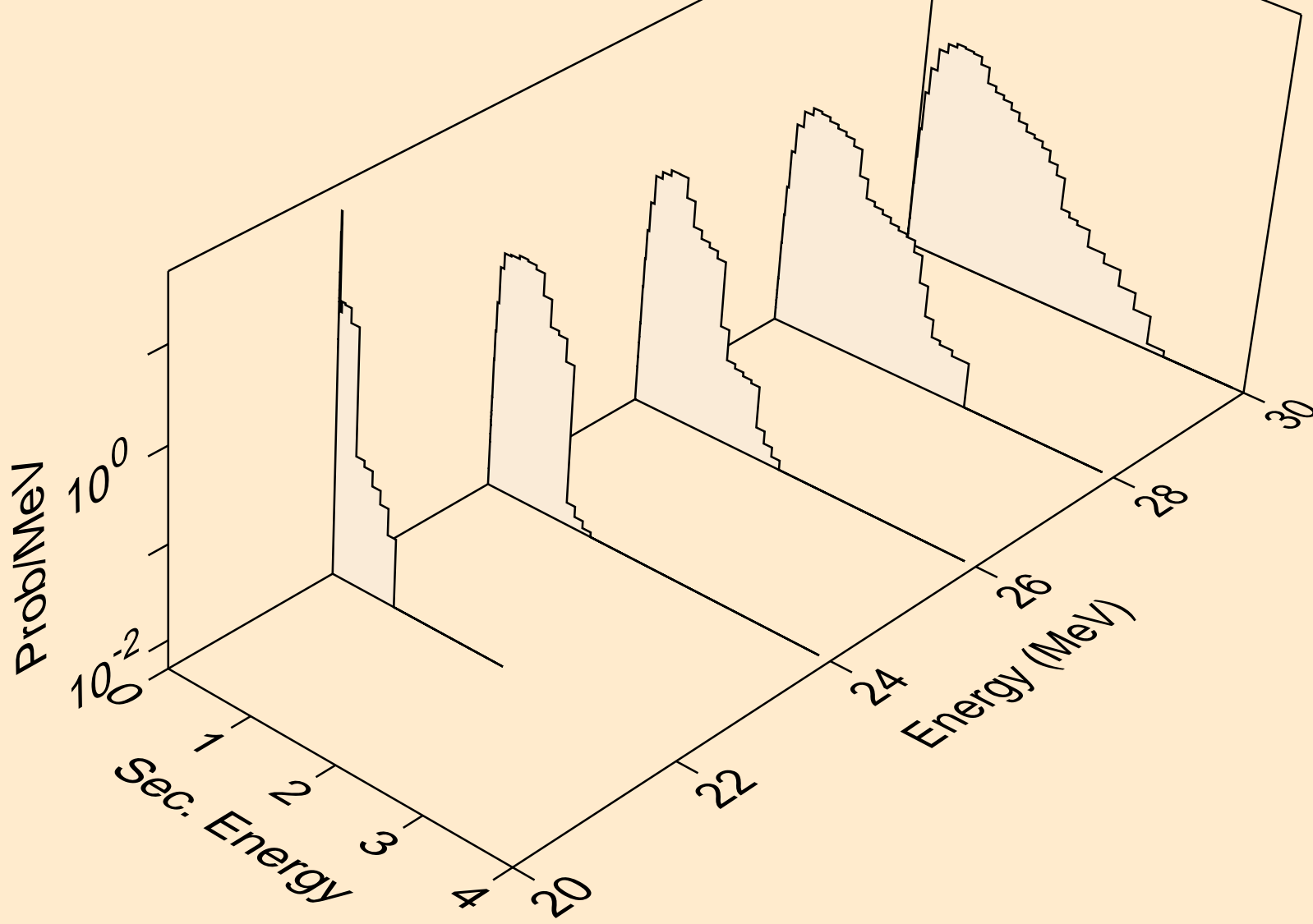

HF171 NEUTRON ACER TENDL-2019 LIBRARY; T=293.16K  
Neutron emission for (n,2np)

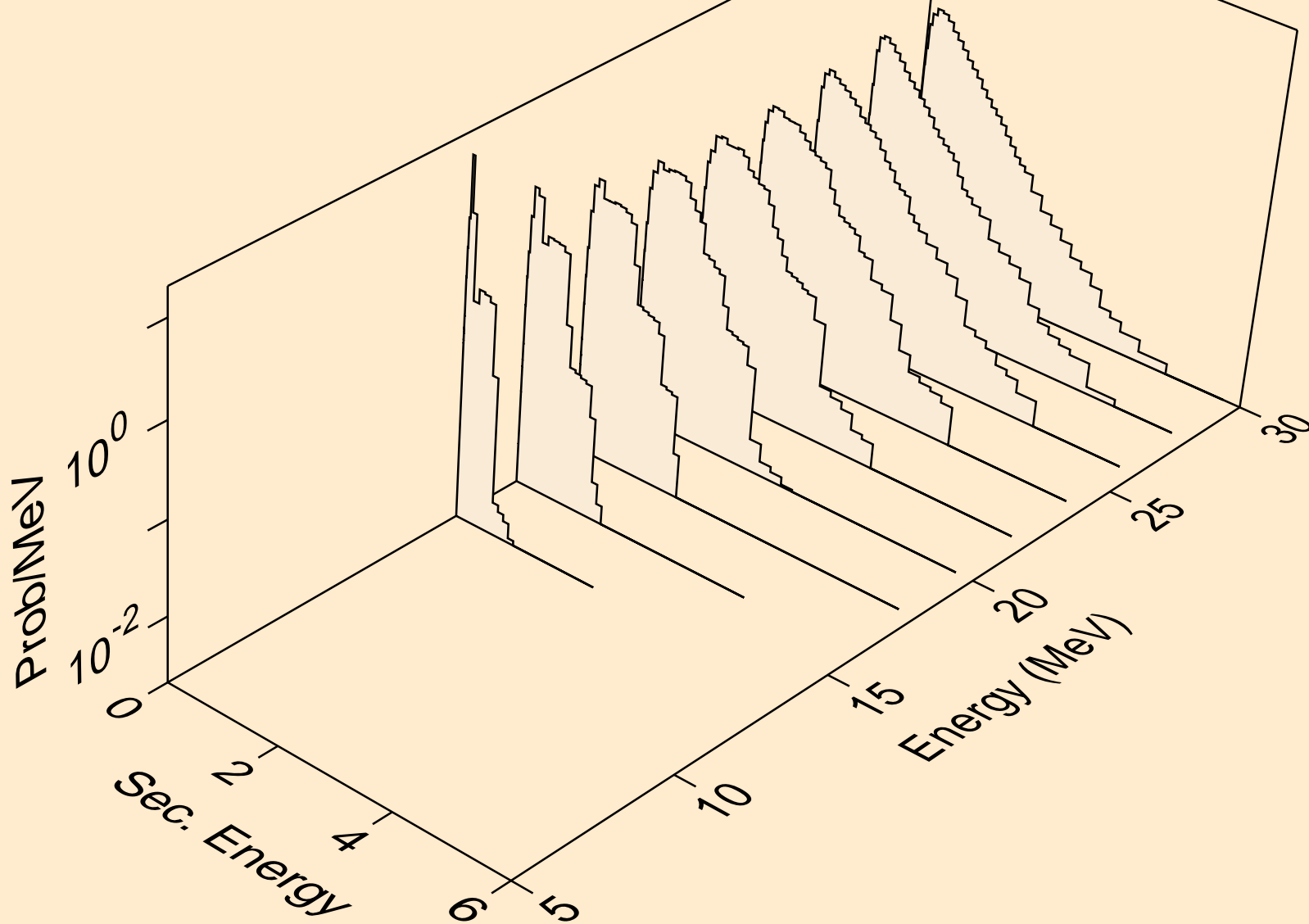

HF171 NEUTRON ACER TENDL-2019 LIBRARY; T=293.16K  
Neutron emission for (n,npa)

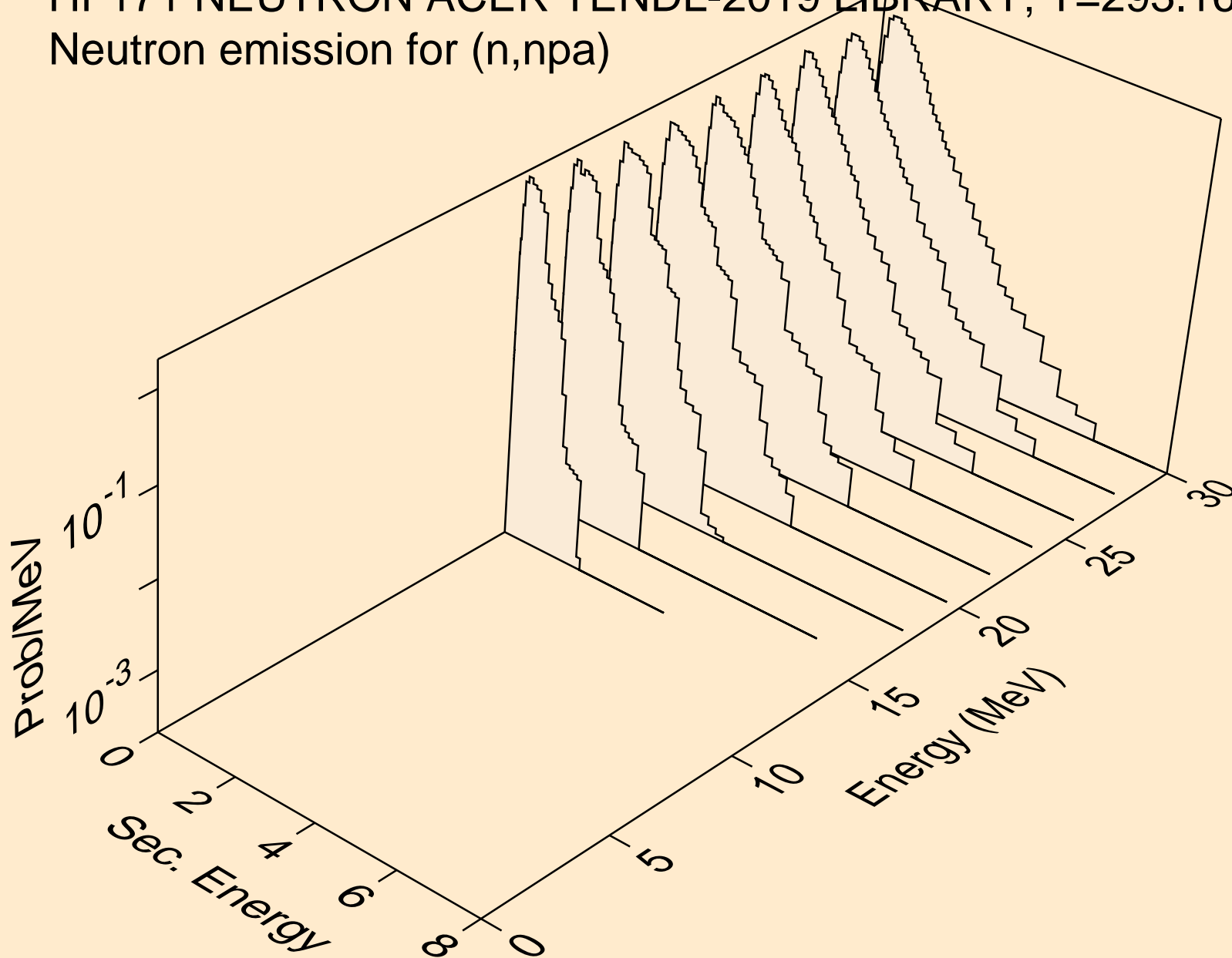

HF171 NEUTRON ACER TENDL-2019 LIBRARY; T=293.16K  
Neutron emission for (n,n\*c)

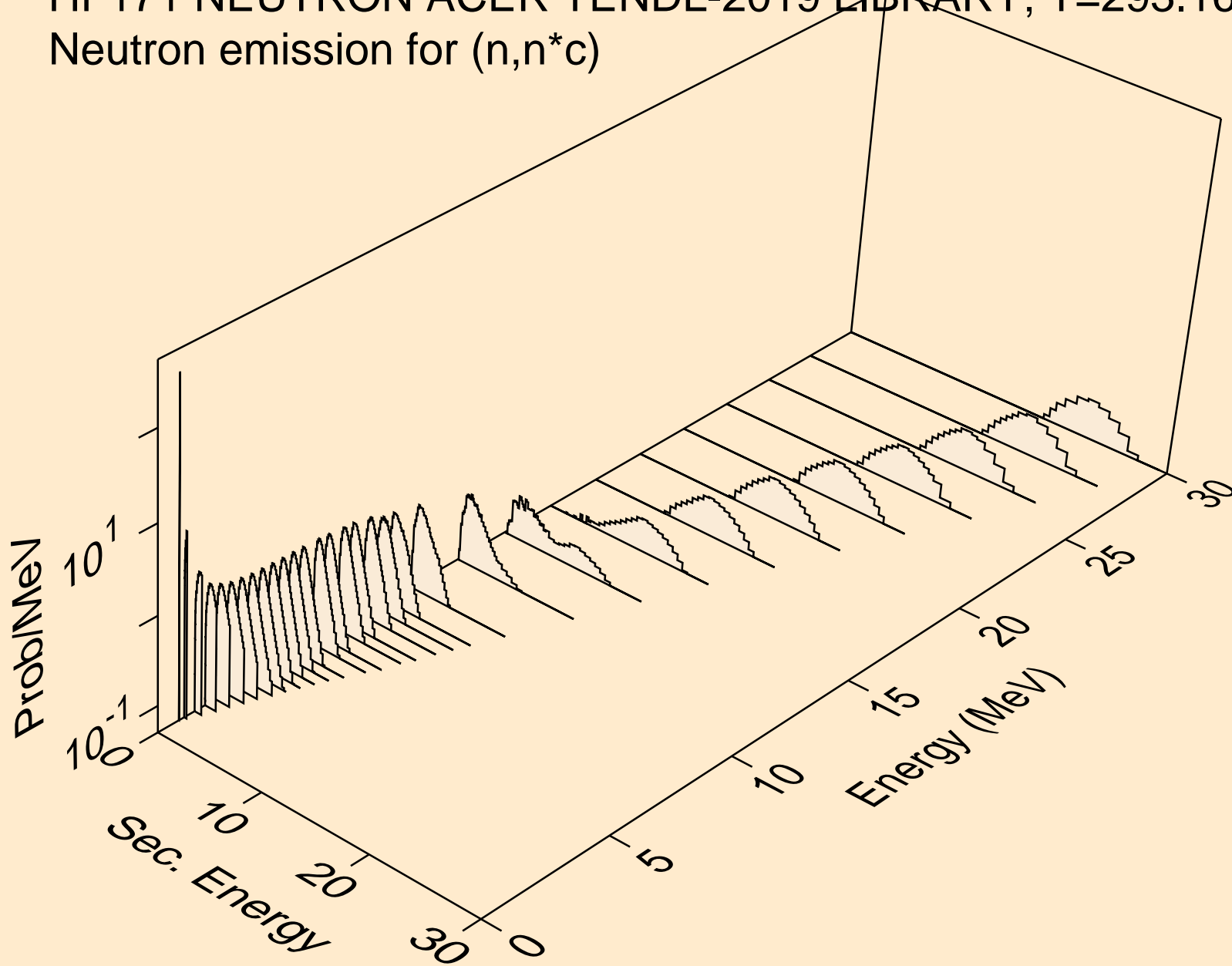

HF171 NEUTRON ACER TENDL-2019 LIBRARY; T=293.16K  
Photon emission for (n,x)

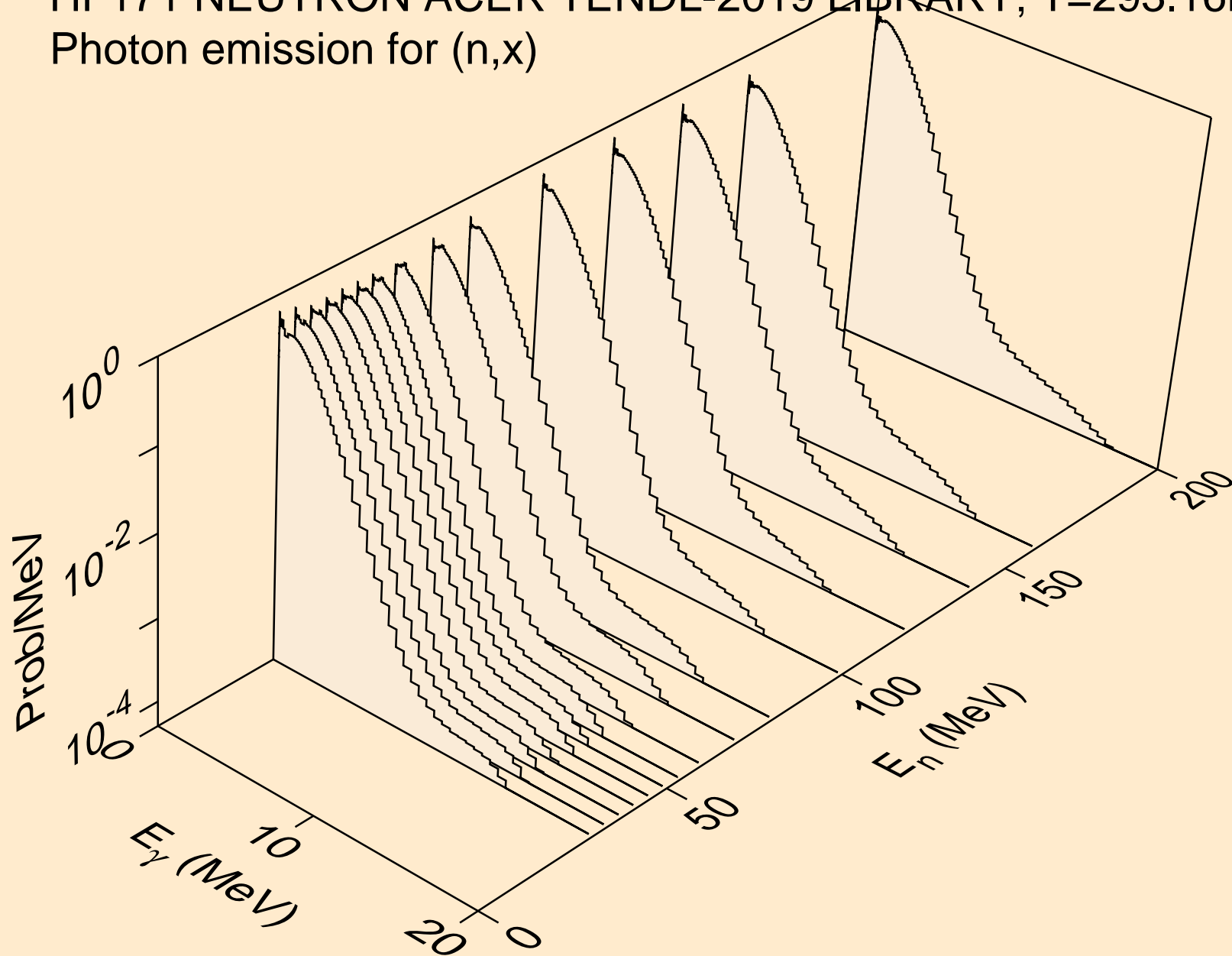

HF171 NEUTRON ACER TENDL-2019 LIBRARY; T=293.16K  
Photon emission for (n,2nd)

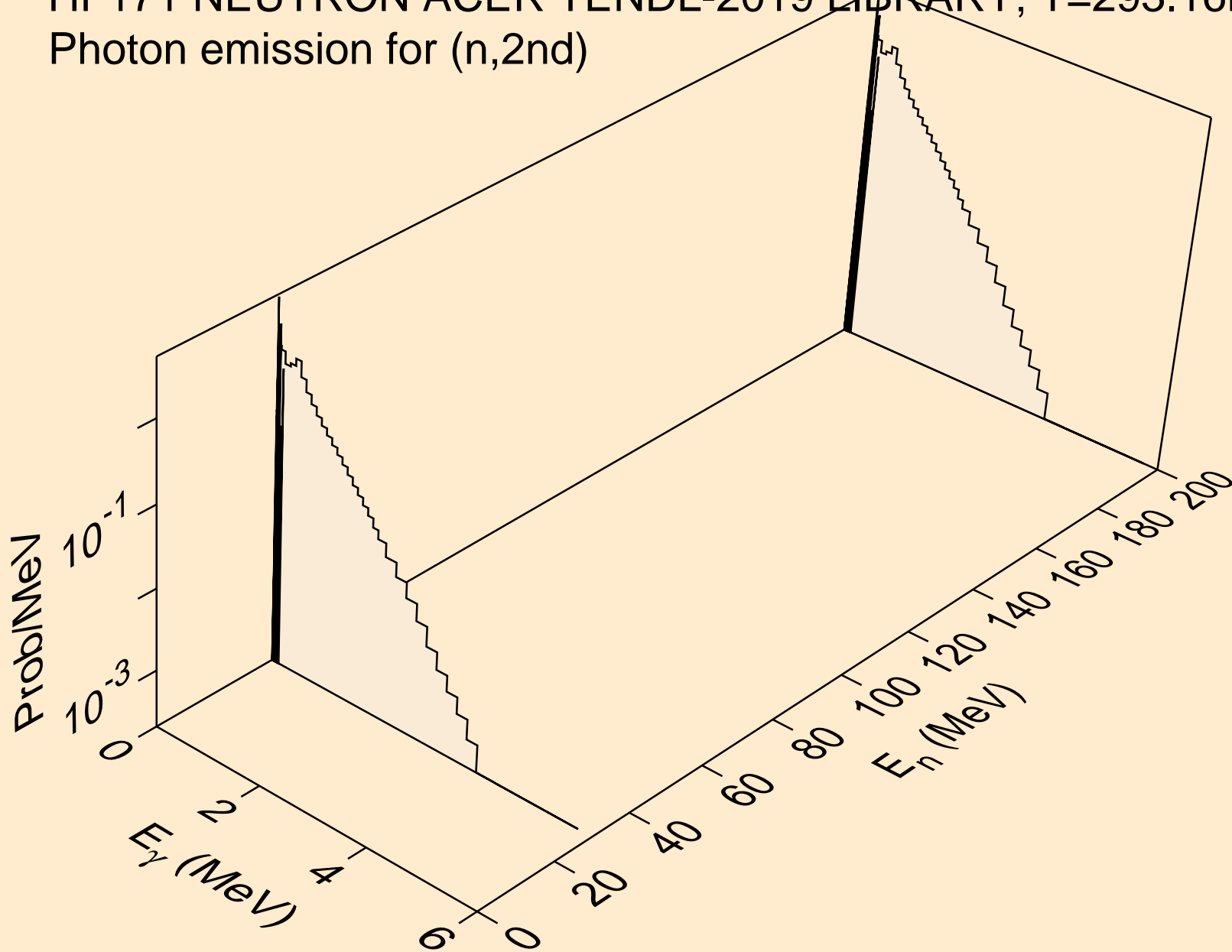



HF171 NEUTRON ACER TENDL-2019 LIBRARY; T=293.16K  
Photon emission for (n,2n)

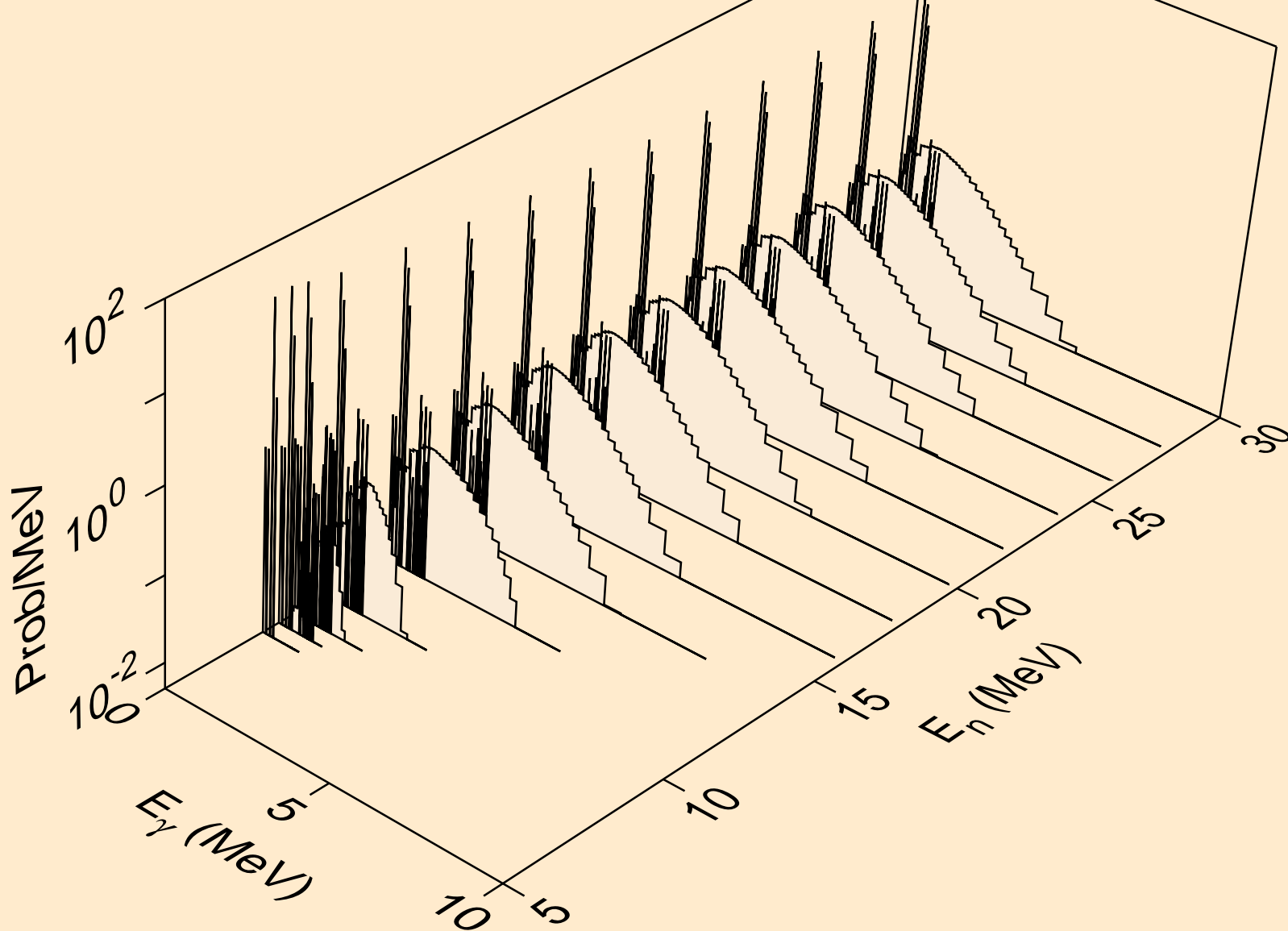

HF171 NEUTRON ACER TENDL-2019 LIBRARY; T=293.16K  
Photon emission for (n,3n)

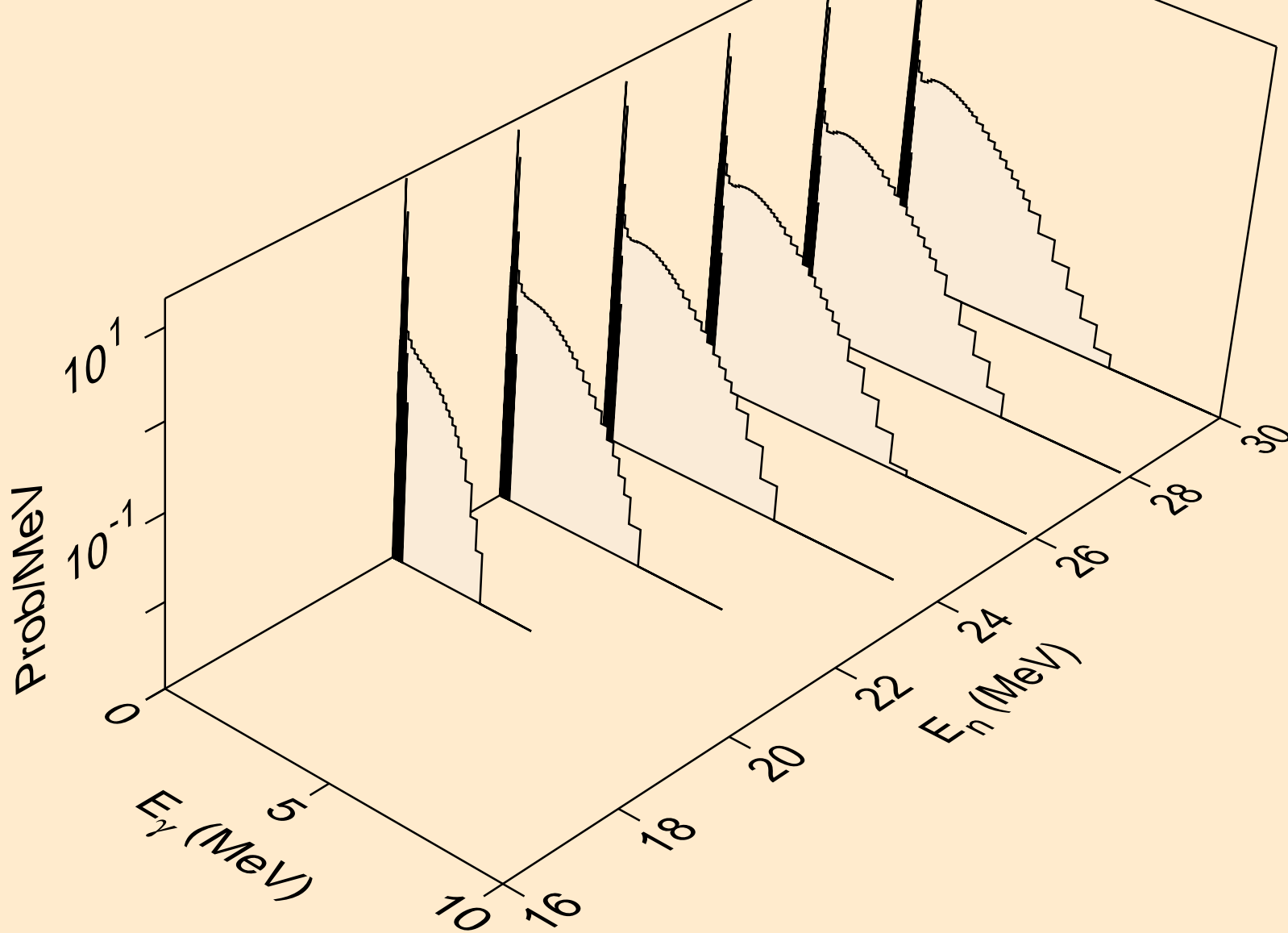

HF171 NEUTRON ACER TENDL-2019 LIBRARY; T=293.16K  
Photon emission for (n,n\*)a

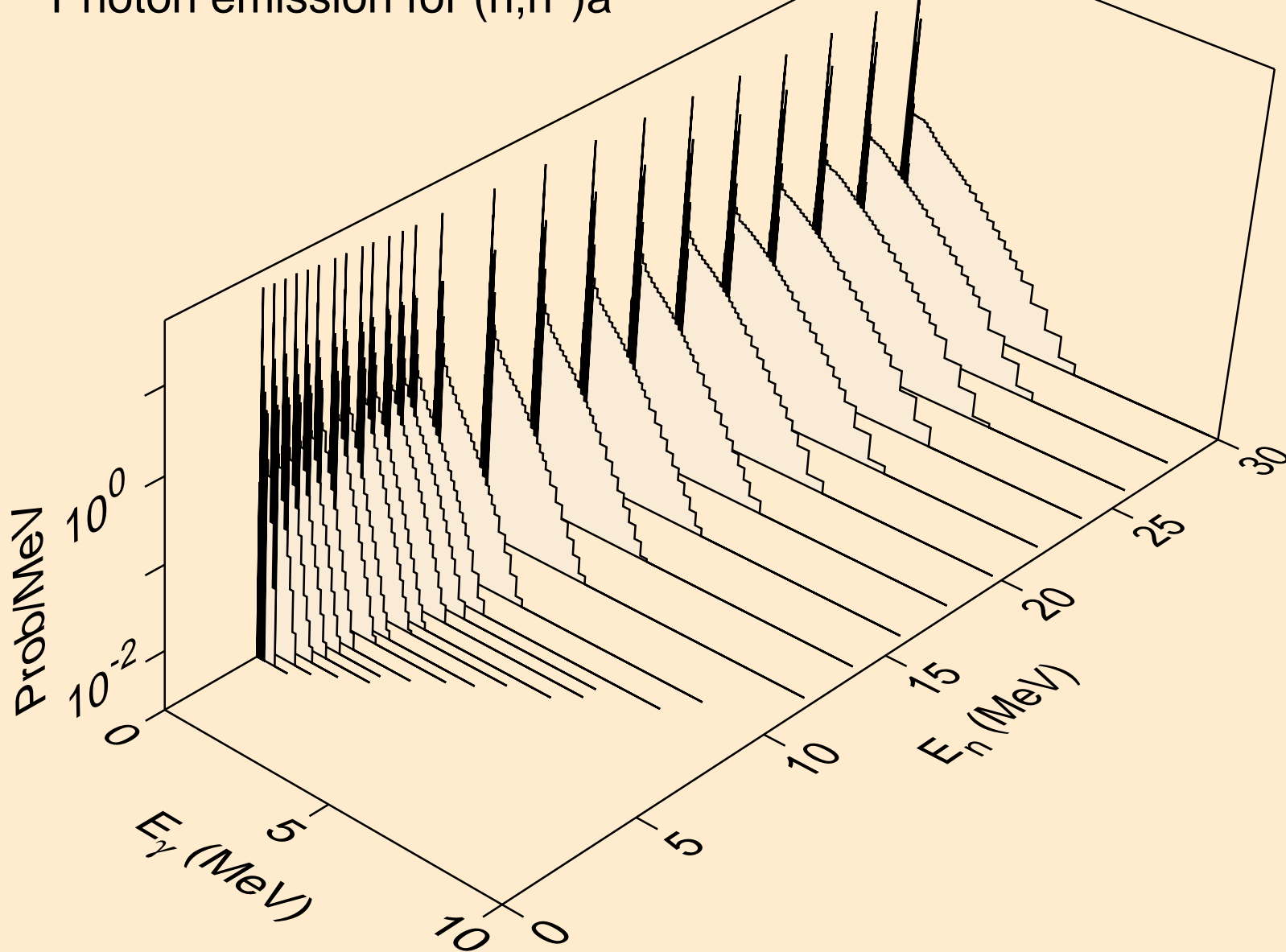

HF171 NEUTRON ACER TENDL-2019 LIBRARY; T=293.16K  
Photon emission for (n,2n)a

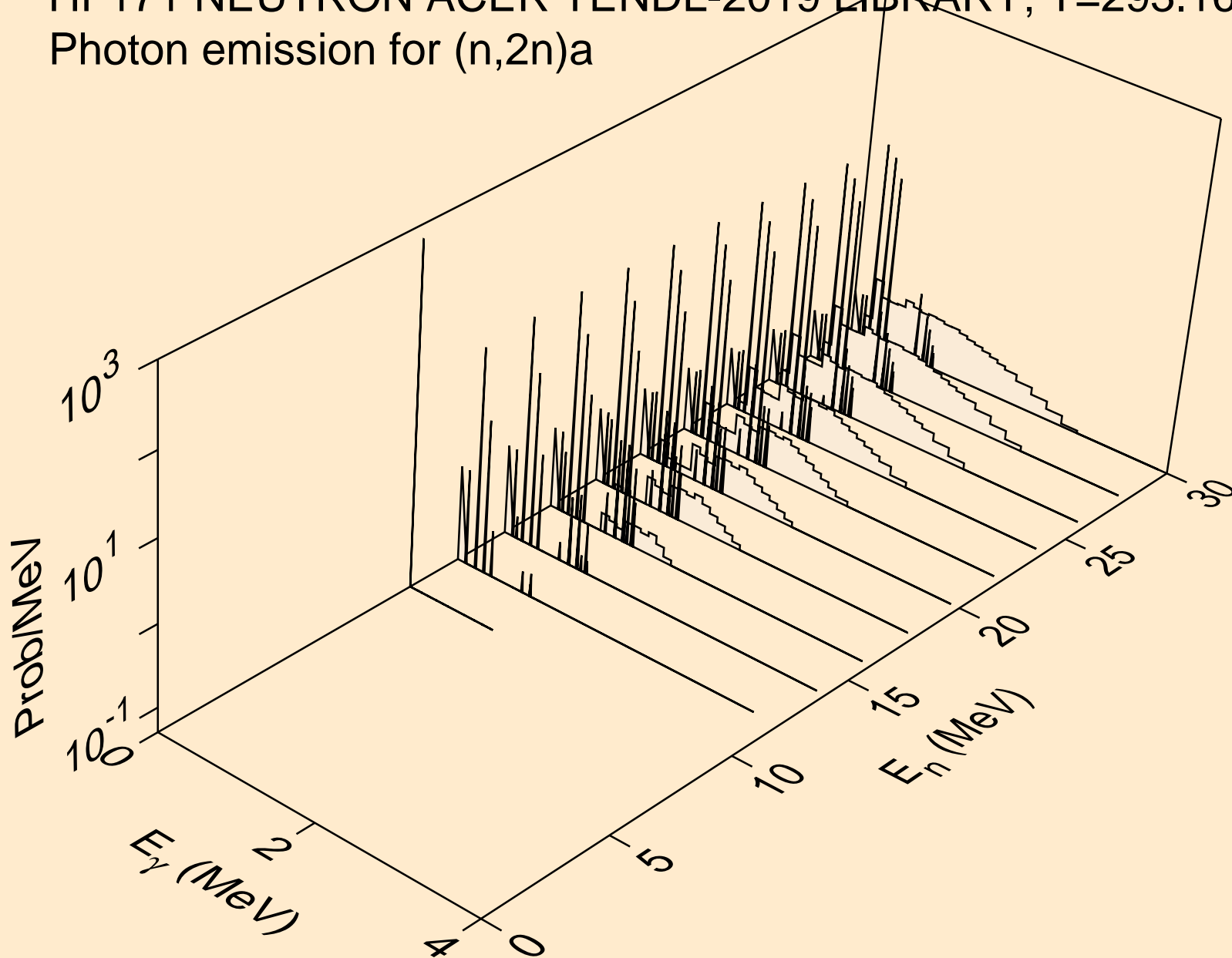

HF171 NEUTRON ACER TENDL-2019 LIBRARY; T=293.16K  
Photon emission for (n,3n)a

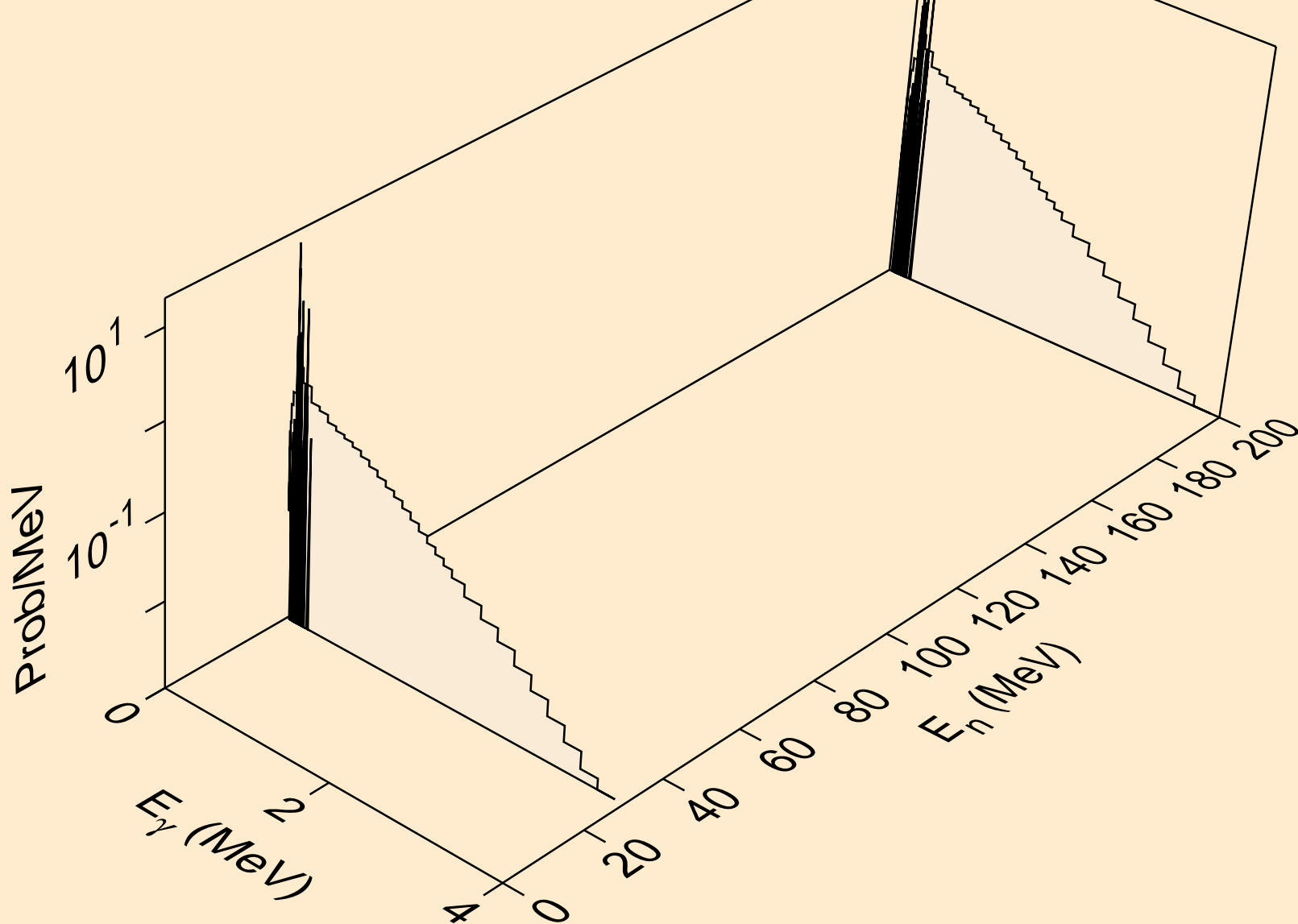

HF171 NEUTRON ACER TENDL-2019 LIBRARY; T=293.16K  
Photon emission for (n,n\*)p

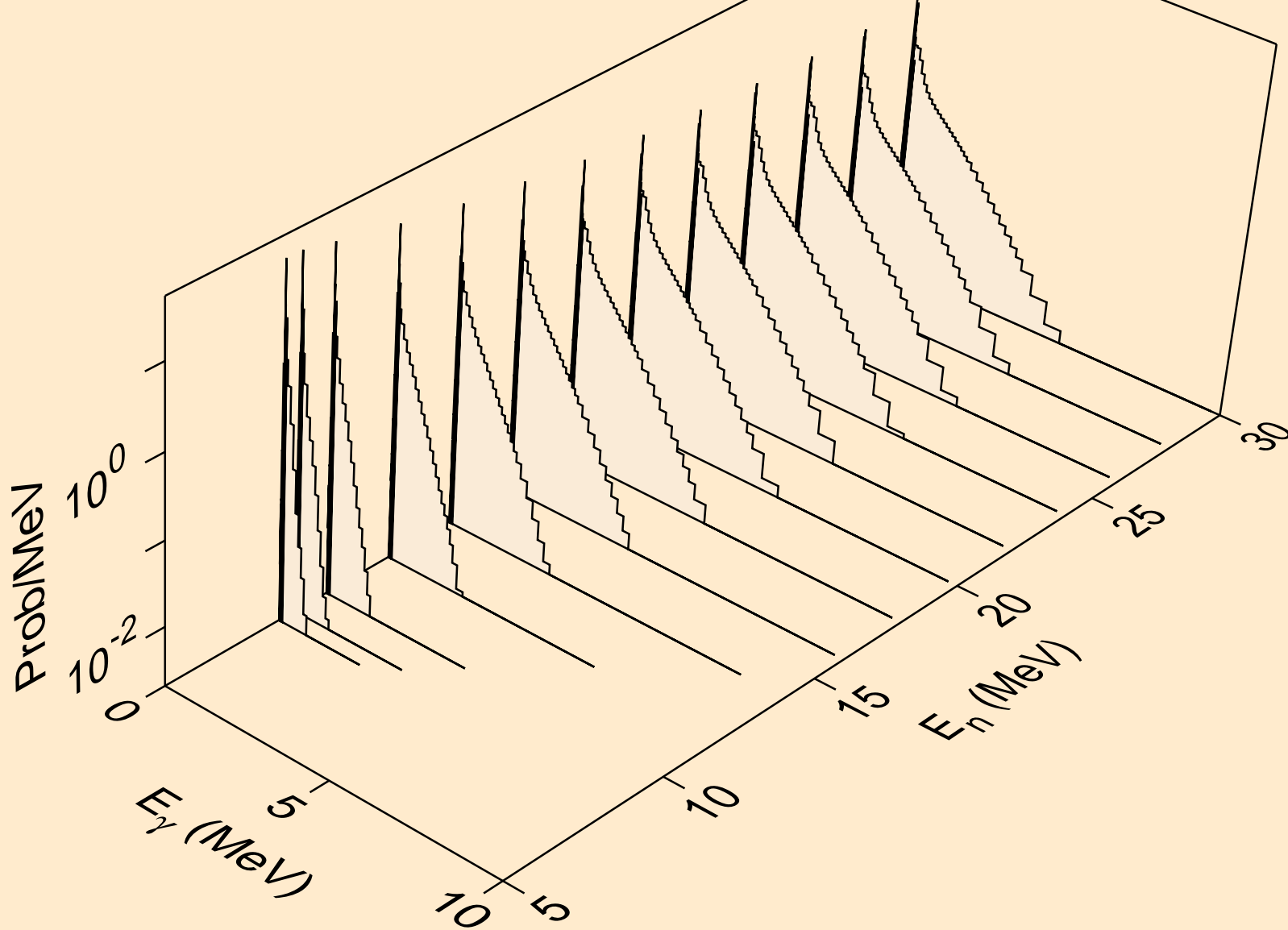

HF171 NEUTRON ACER TENDL-2019 LIBRARY; T=293.16K  
Photon emission for (n,n\*)2a

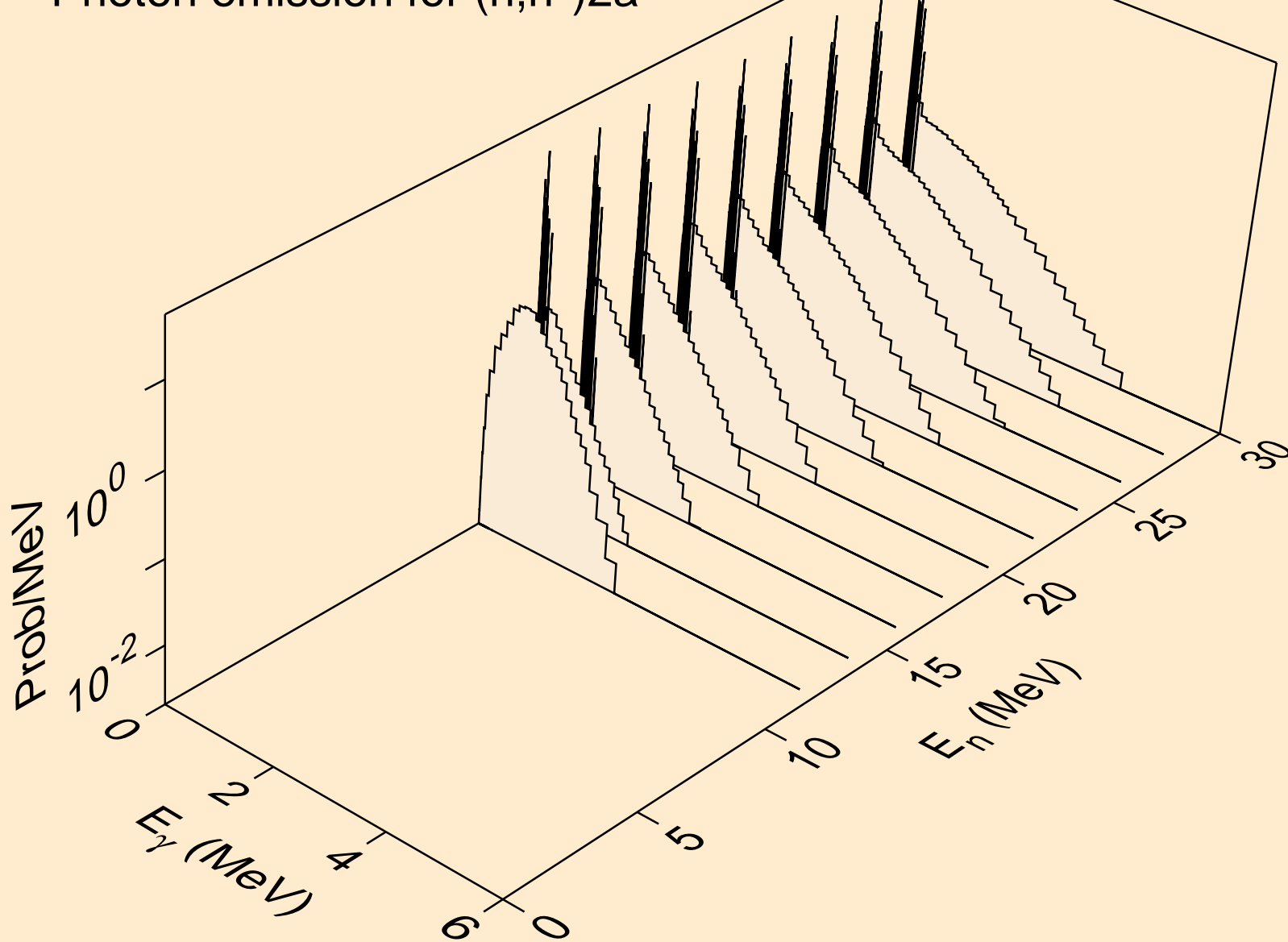

HF171 NEUTRON ACER TENDL-2019 LIBRARY; T=293.16K  
Photon emission for (n,2n)2a

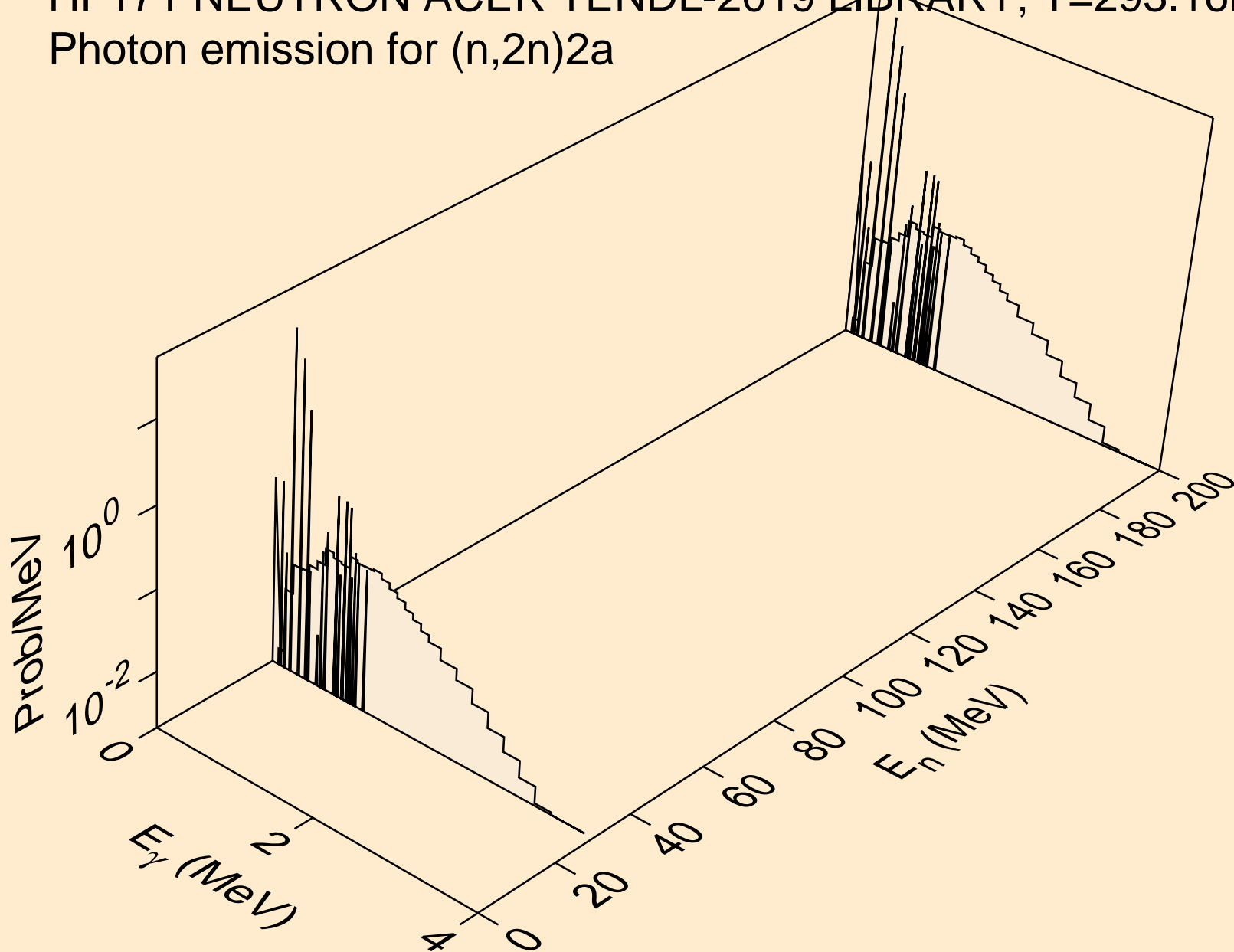



HF171 NEUTRON ACER TENDL-2019 LIBRARY; T=293.16K  
Photon emission for (n,n\*)d

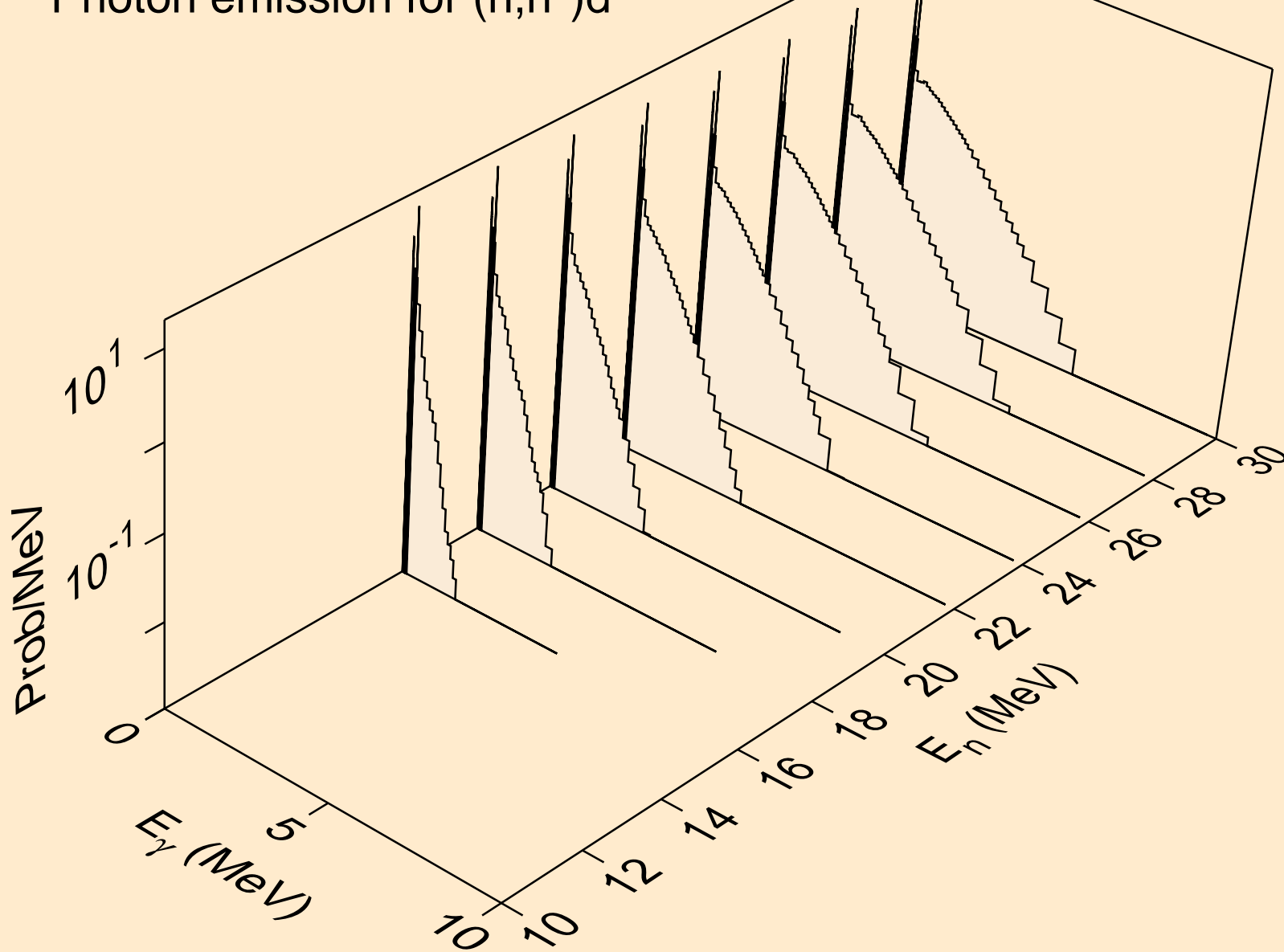

HF171 NEUTRON ACER TENDL-2019 LIBRARY; T=293.16K  
Photon emission for (n,n\*)t

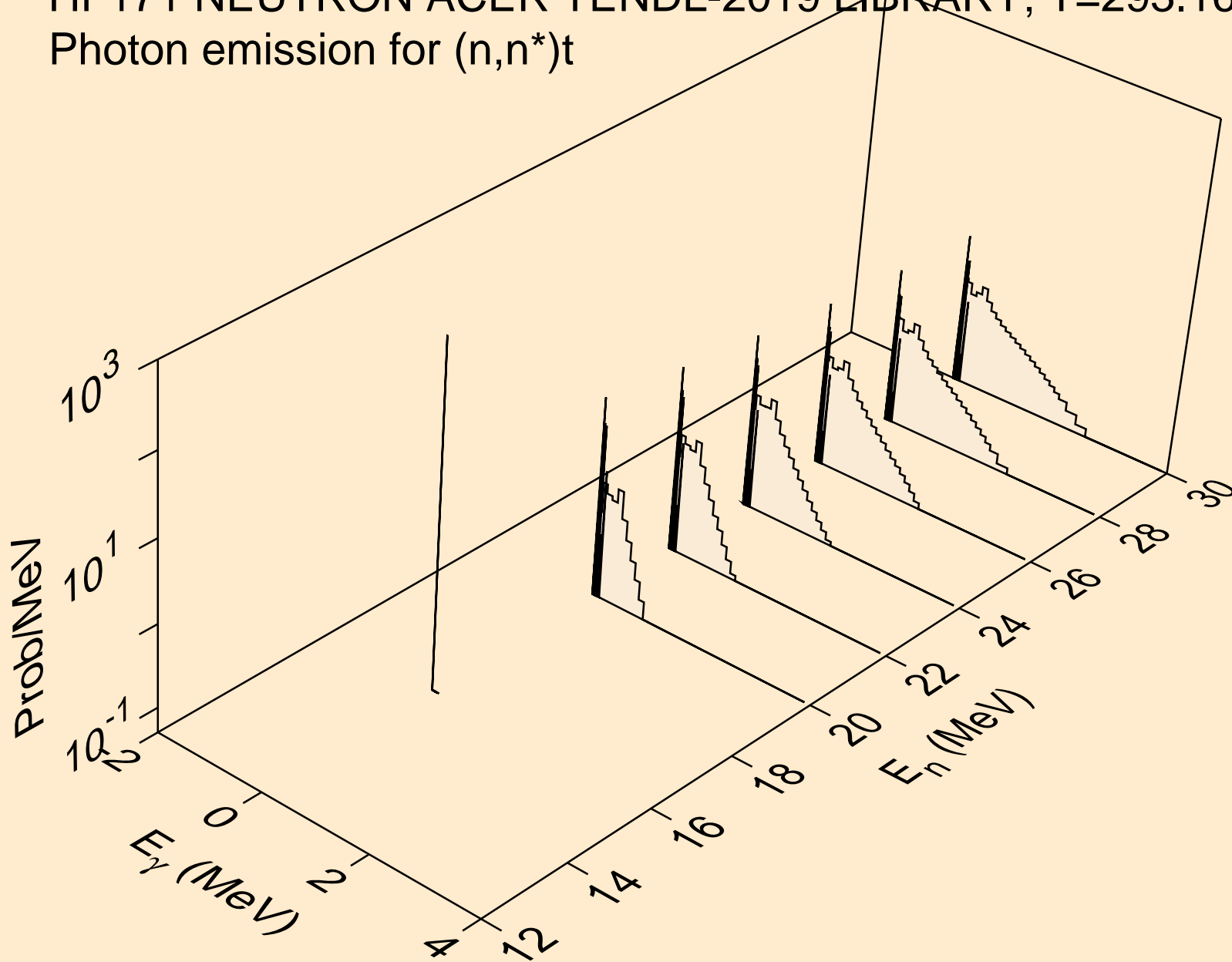

HF171 NEUTRON ACER TENDL-2019 LIBRARY; T=293.16K  
Photon emission for (n,n\*)he3

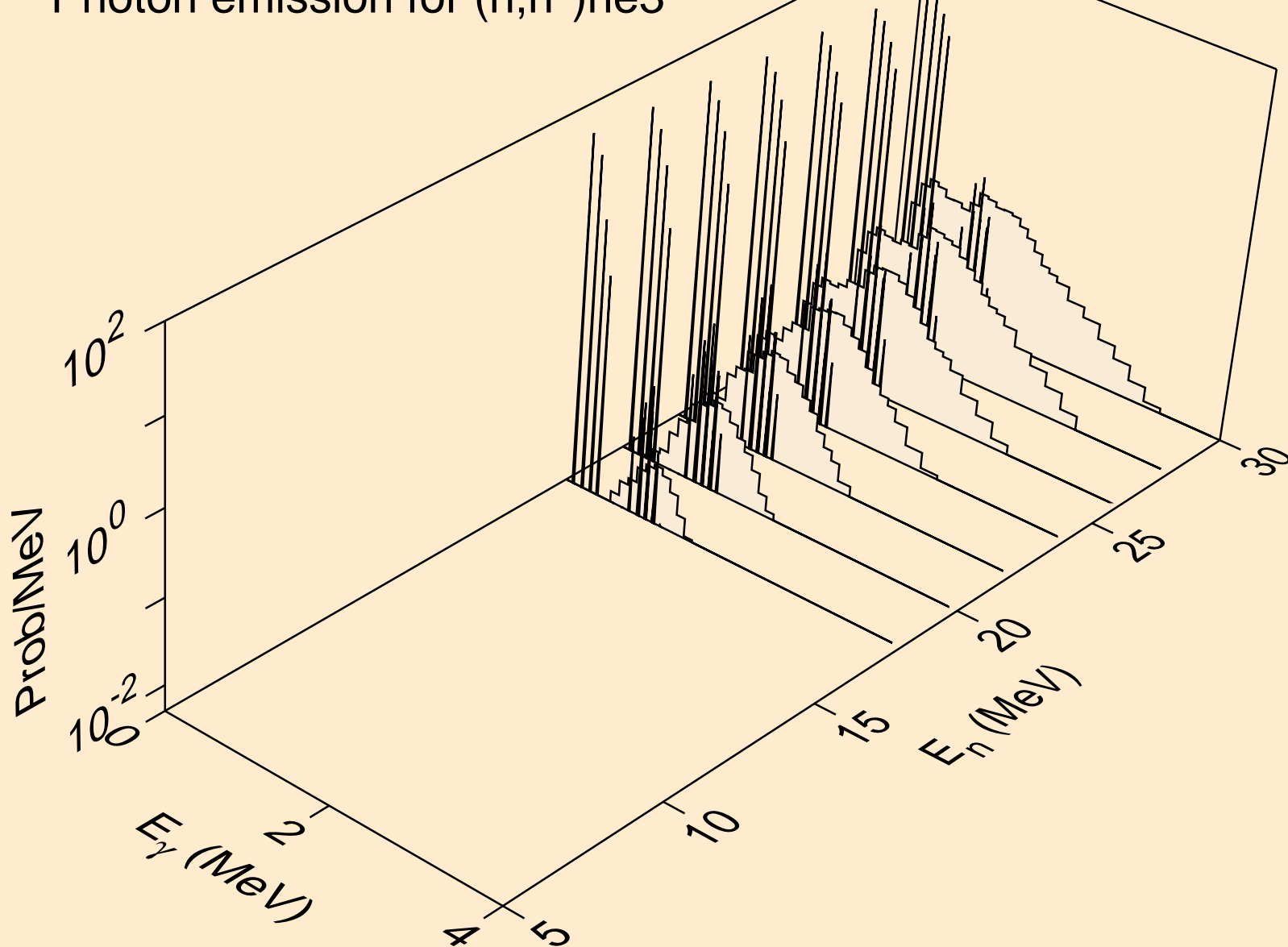

HF171 NEUTRON ACER TENDL-2019 LIBRARY; T=293.16K  
Photon emission for (n,4n)

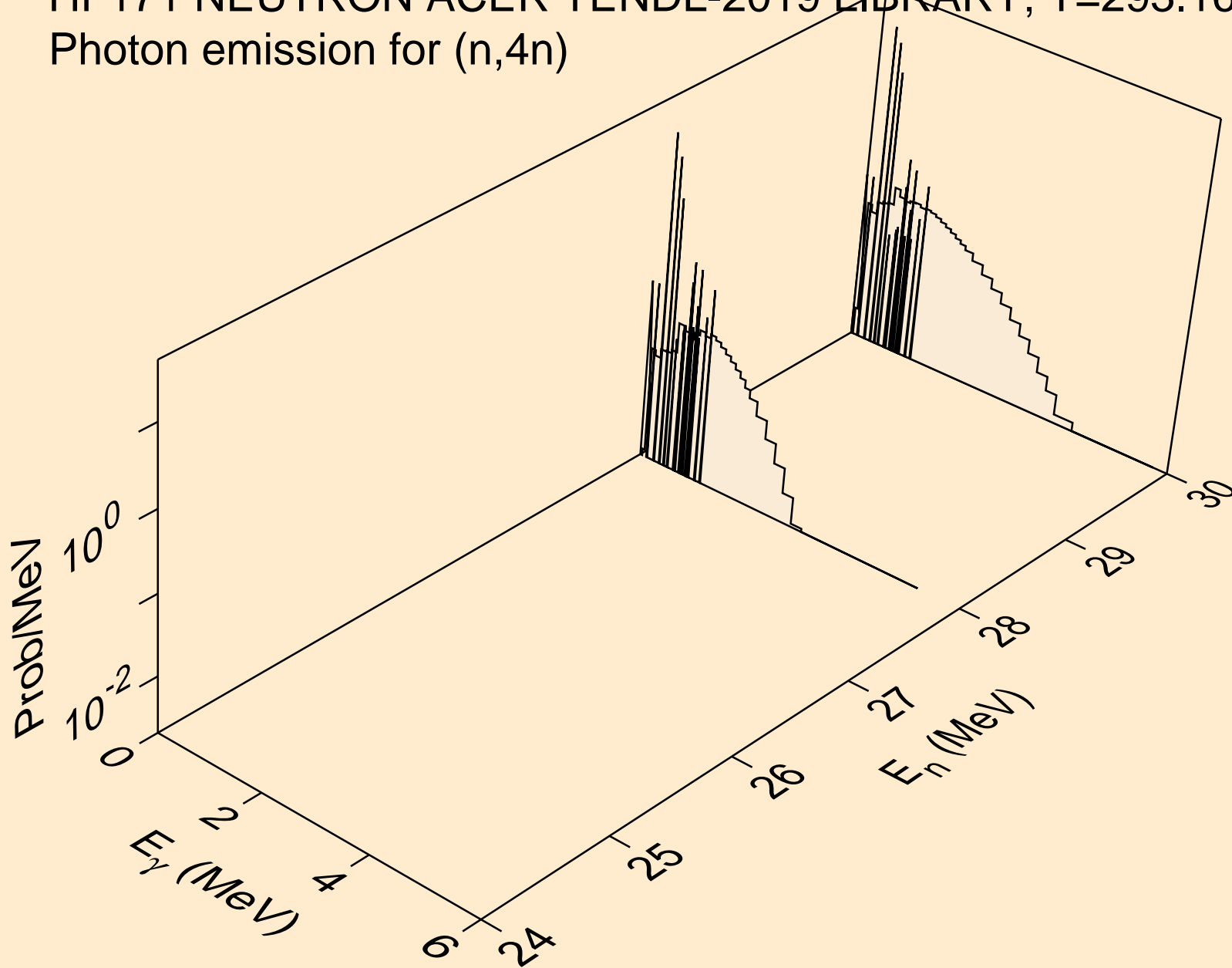

HF171 NEUTRON ACER TENDL-2019 LIBRARY; T=293.16K  
Photon emission for (n,2np)

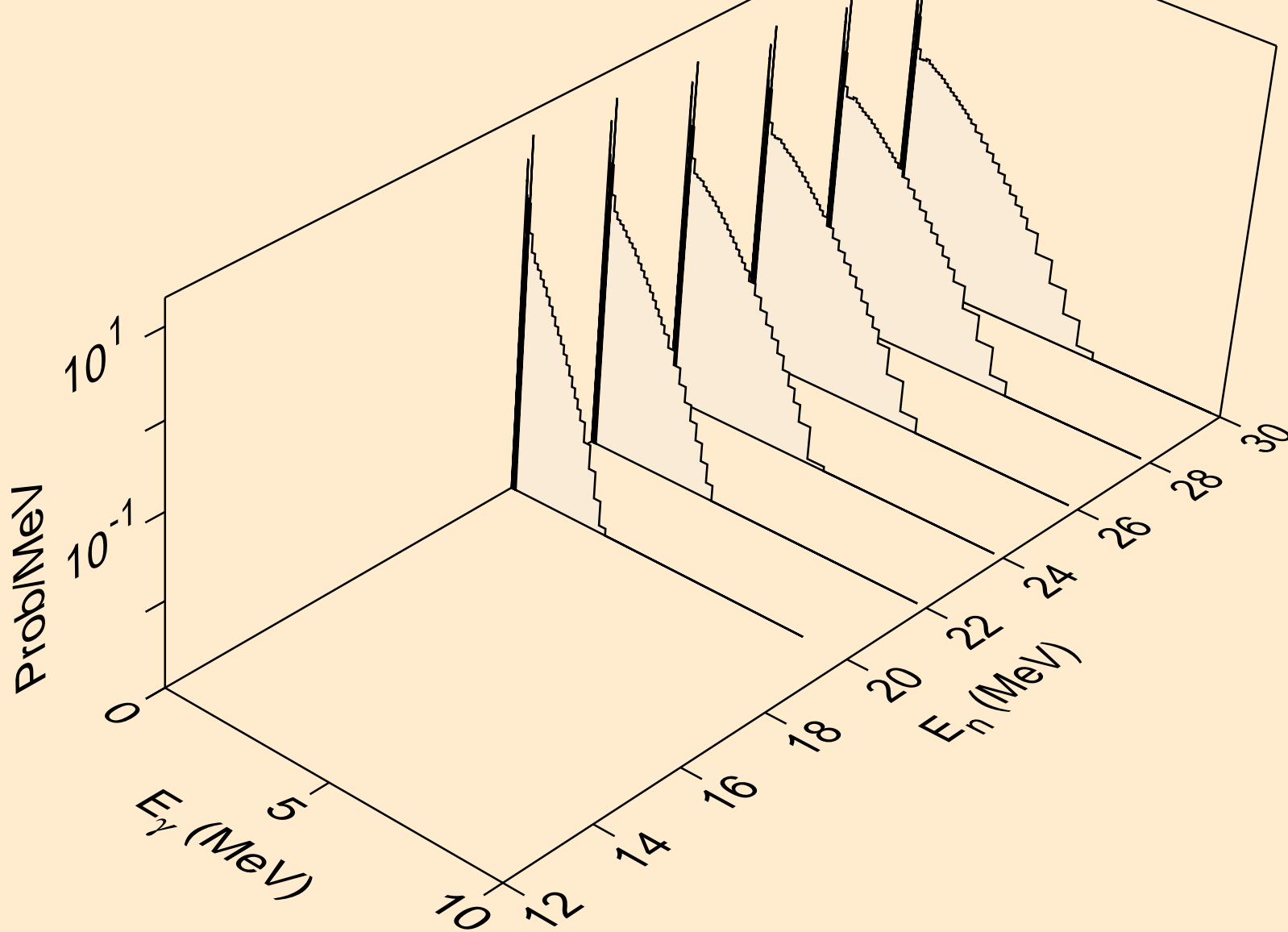

HF171 NEUTRON ACER TENDL-2019 LIBRARY; T=293.16K  
Photon emission for (n,3np)

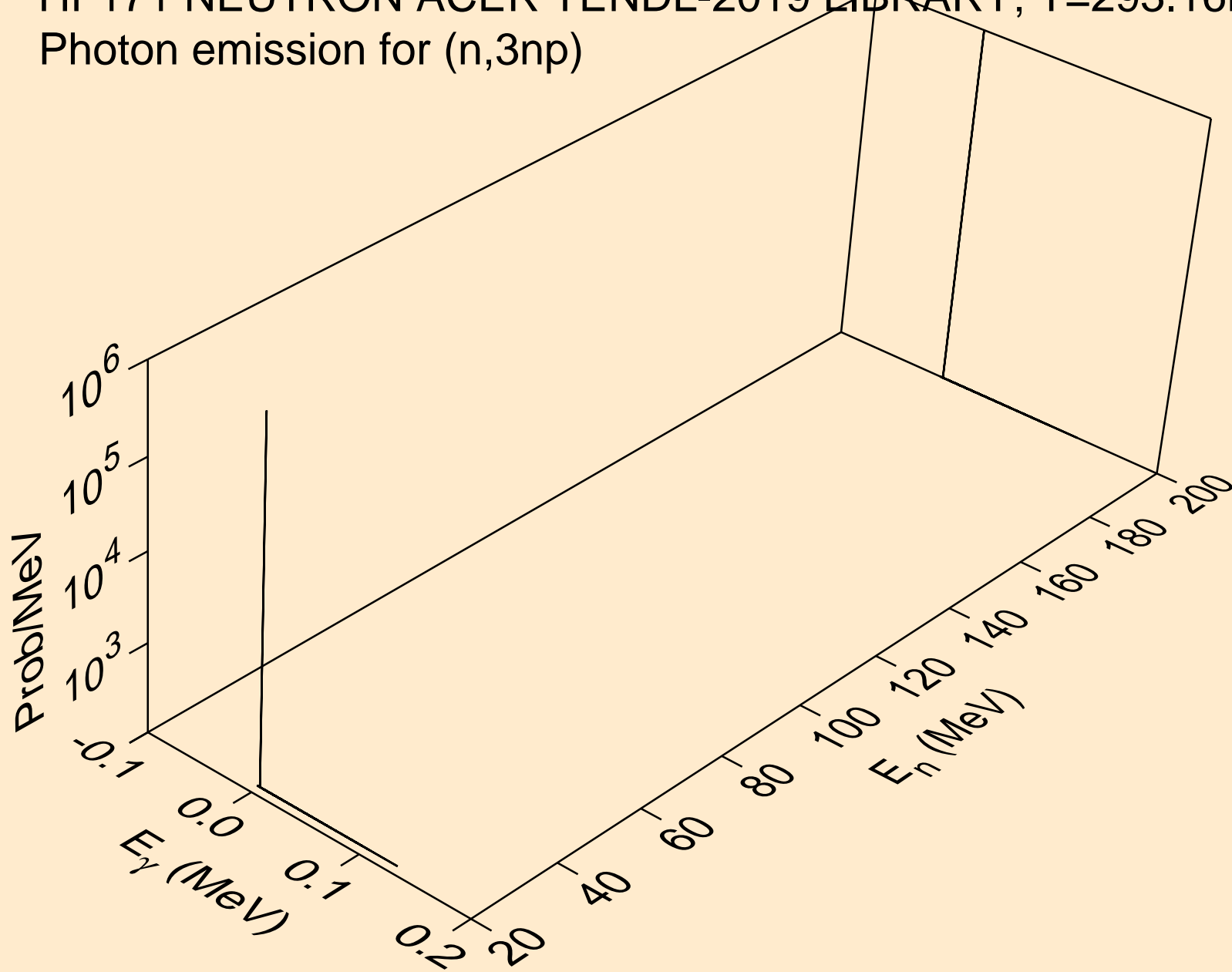

HF171 NEUTRON ACER TENDL-2019 LIBRARY; T=293.16K  
Photon emission for (n,2np)

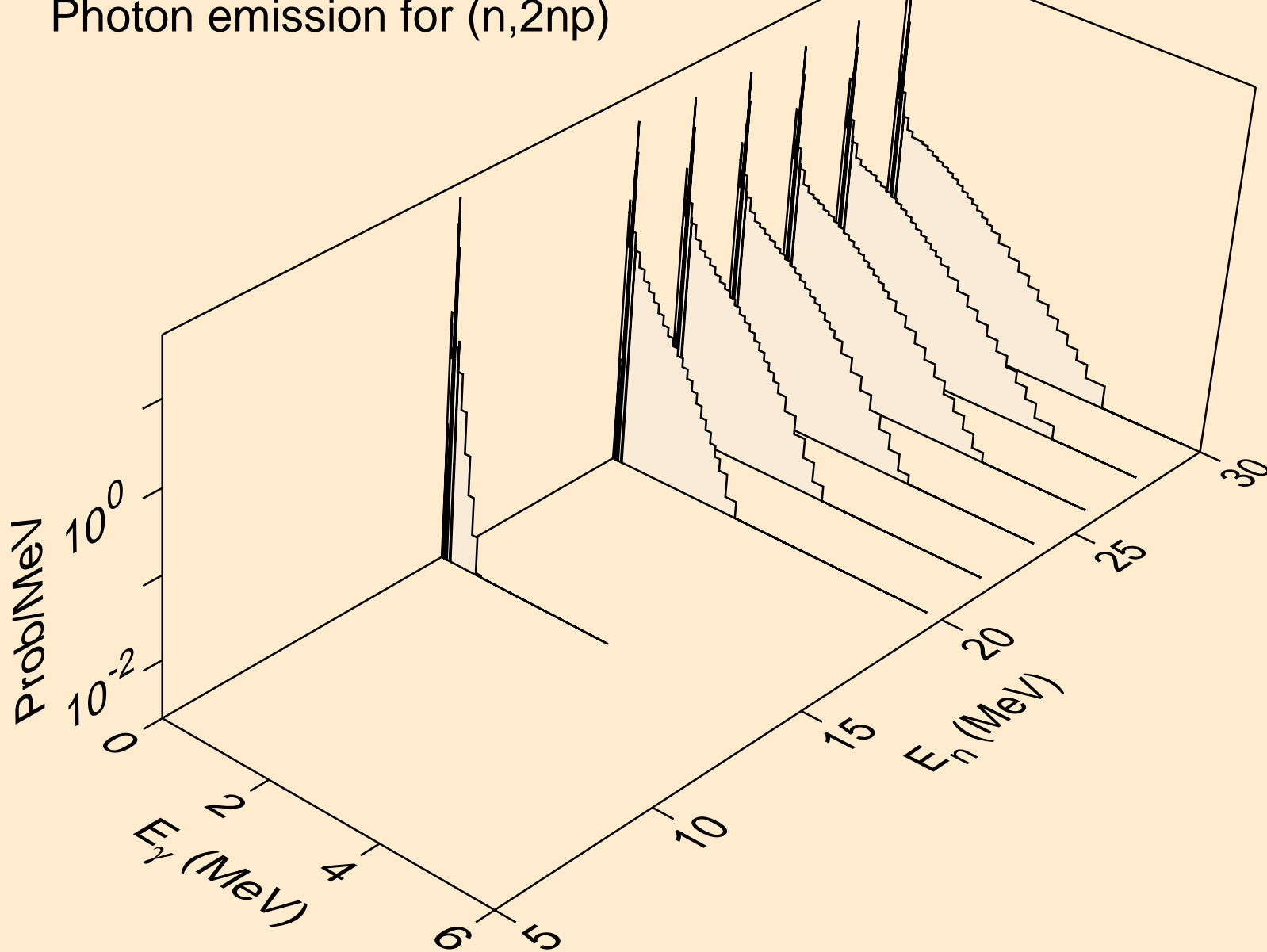

HF171 NEUTRON ACER TENDL-2019 LIBRARY; T=293.16K  
Photon emission for (n,npa)

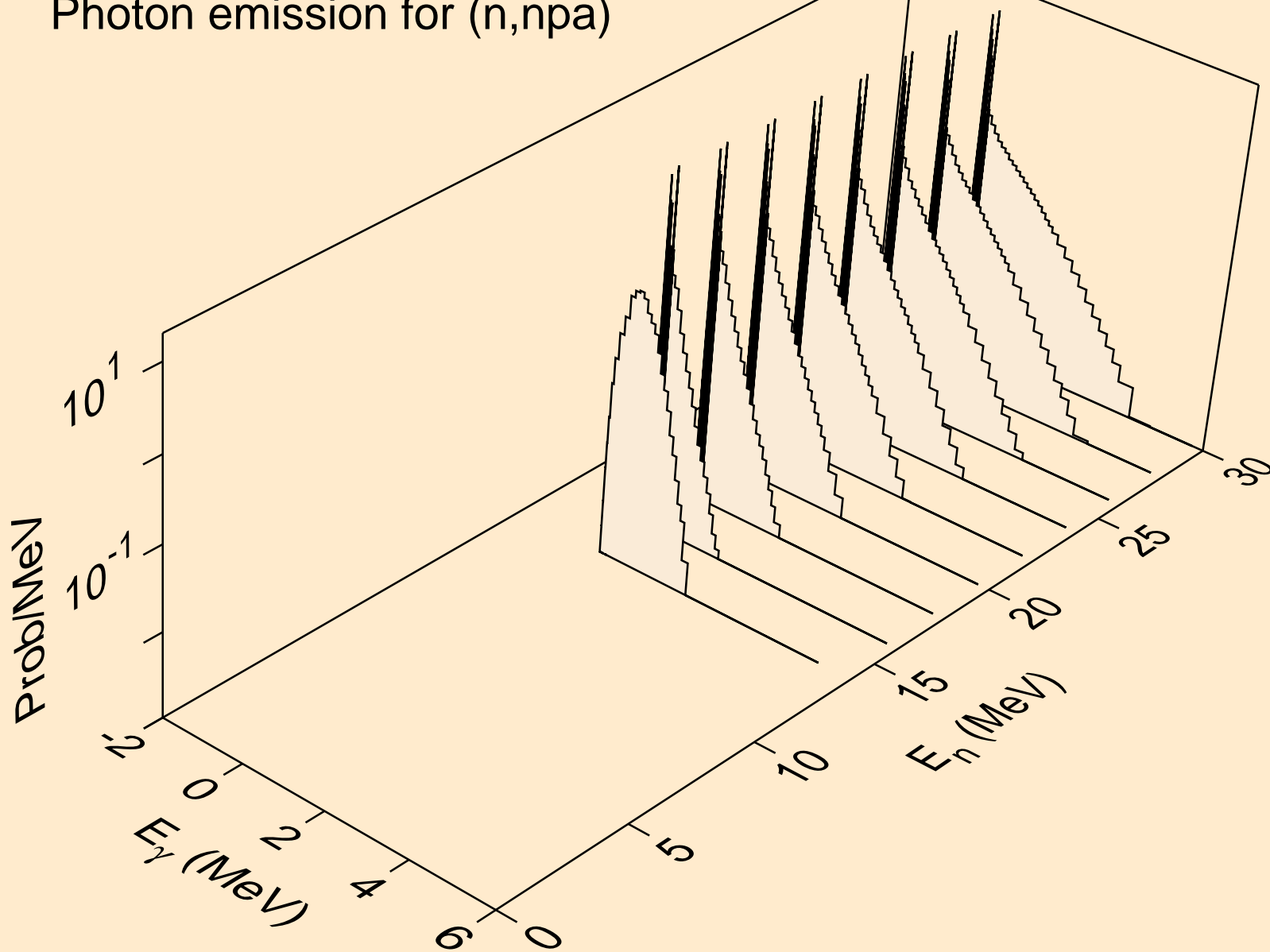



HF171 NEUTRON ACER TENDL-2019 LIBRARY; T=293.16K  
Photon emission for (n,n\*c)

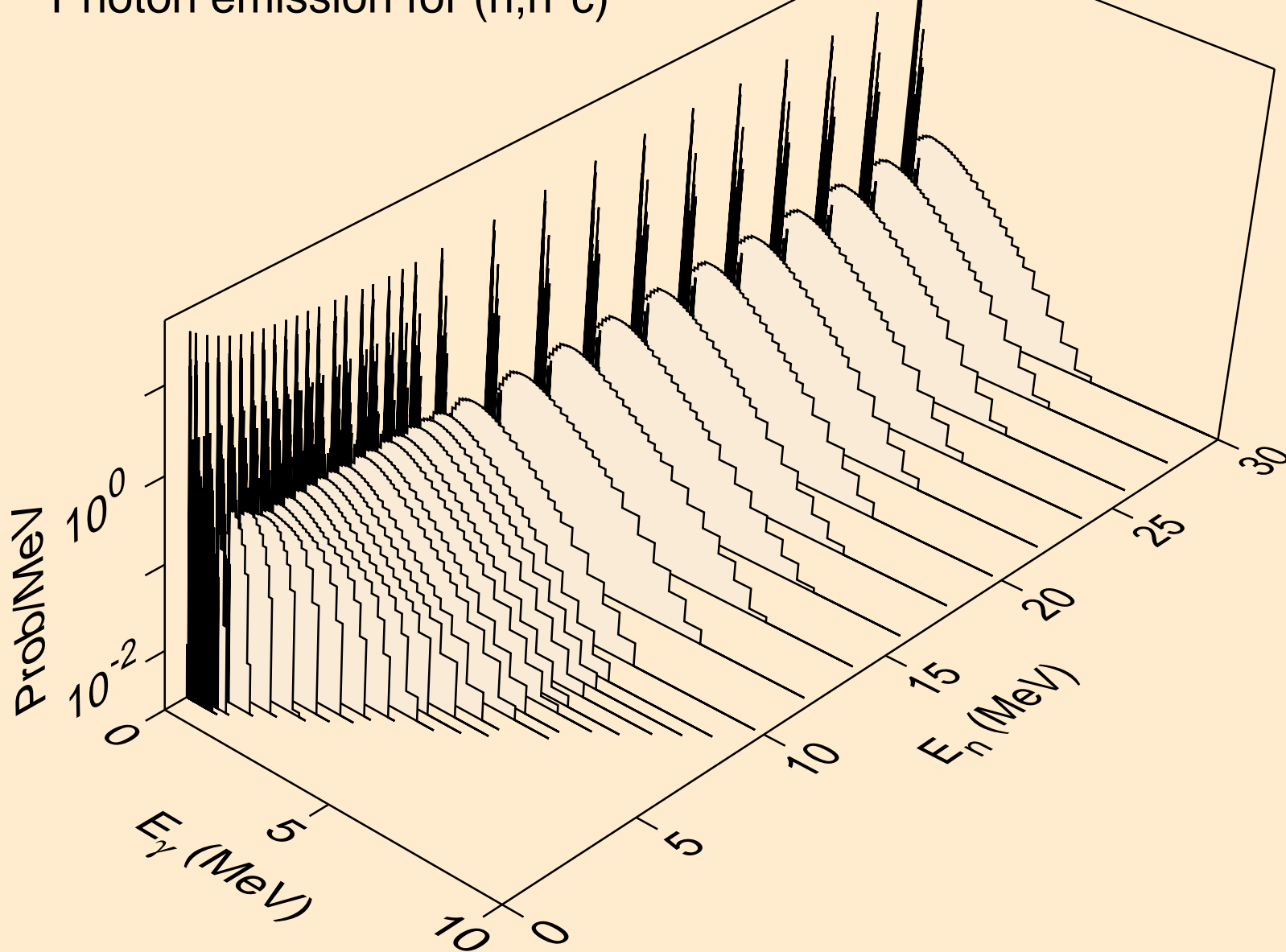

HF171 NEUTRON ACER TENDL-2019 LIBRARY; T=293.16K  
Photon emission for (n,gma)

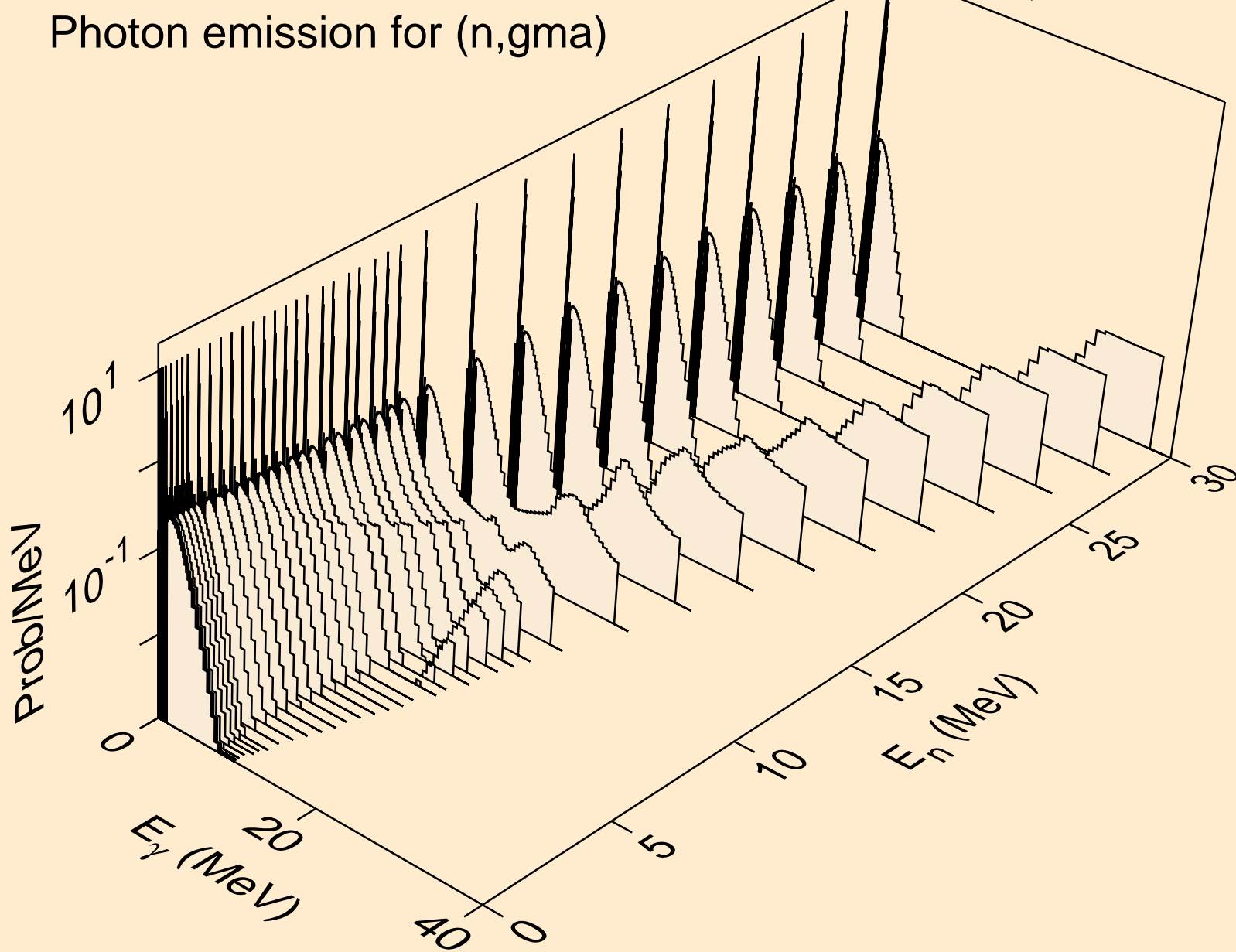

HF171 NEUTRON ACER TENDL-2019 LIBRARY; T=293.16K  
Photon emission for (n,p)

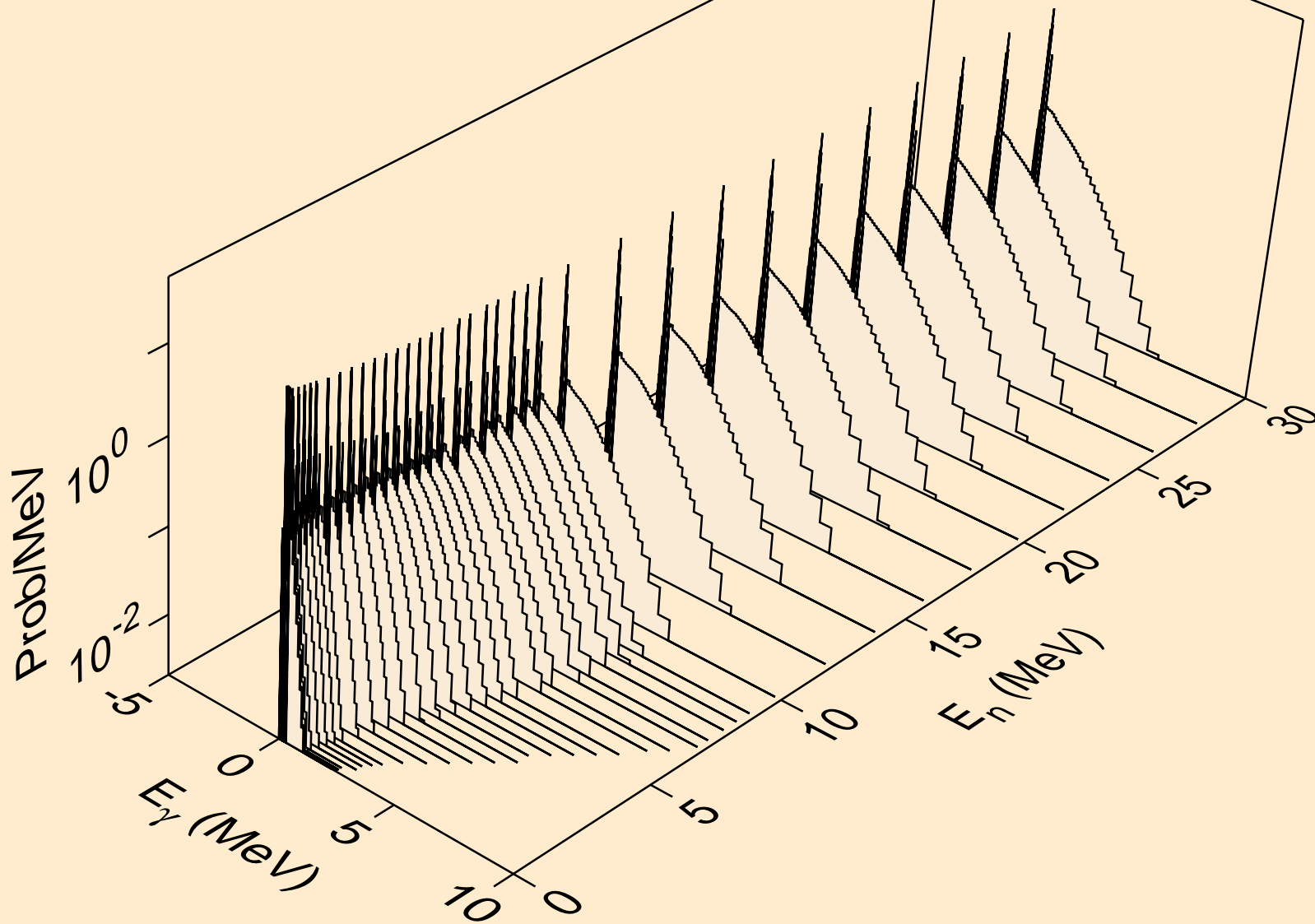

HF171 NEUTRON ACER TENDL-2019 LIBRARY; T=293.16K  
Photon emission for (n,d)

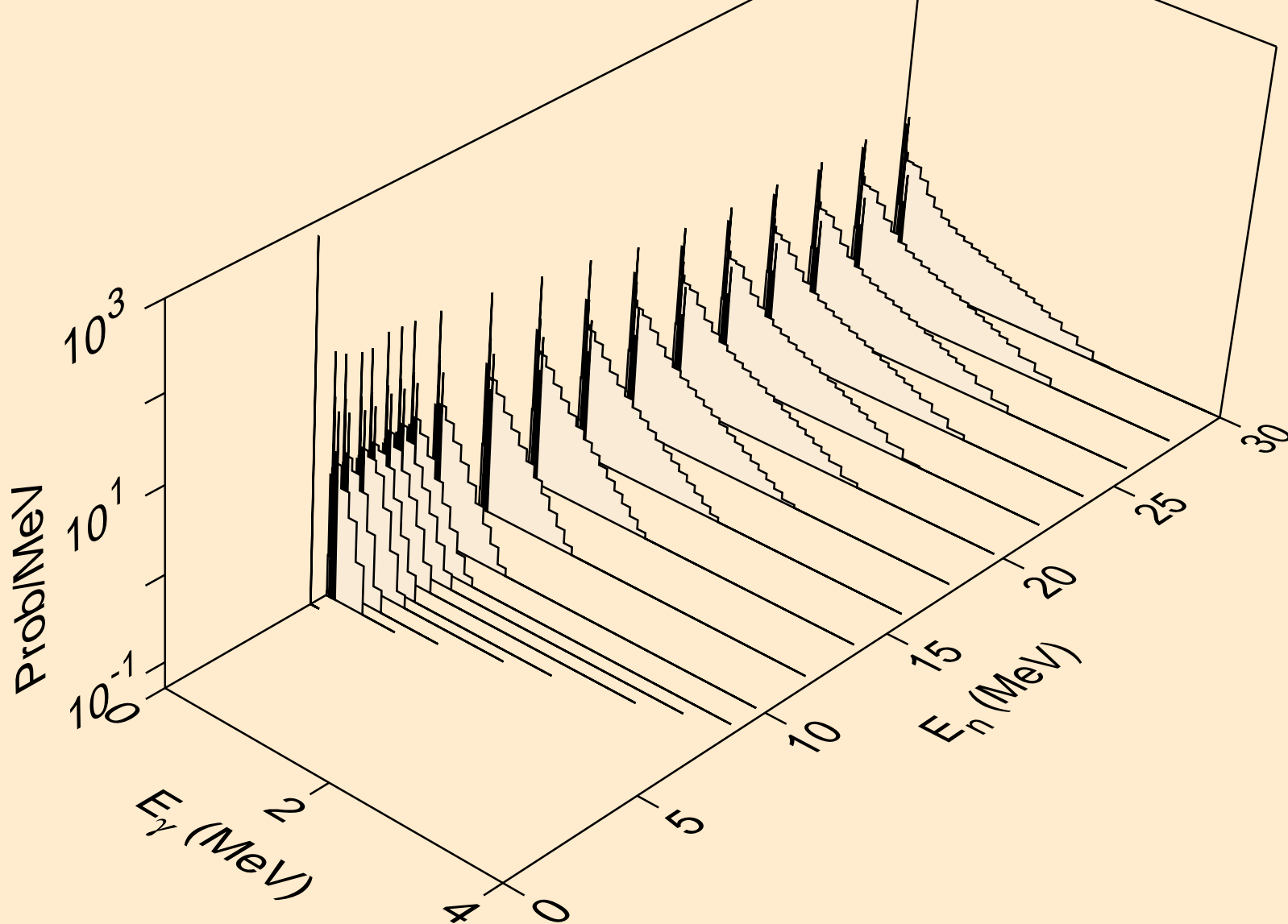

HF171 NEUTRON ACER TENDL-2019 LIBRARY; T=293.16K  
Photon emission for (n,t)

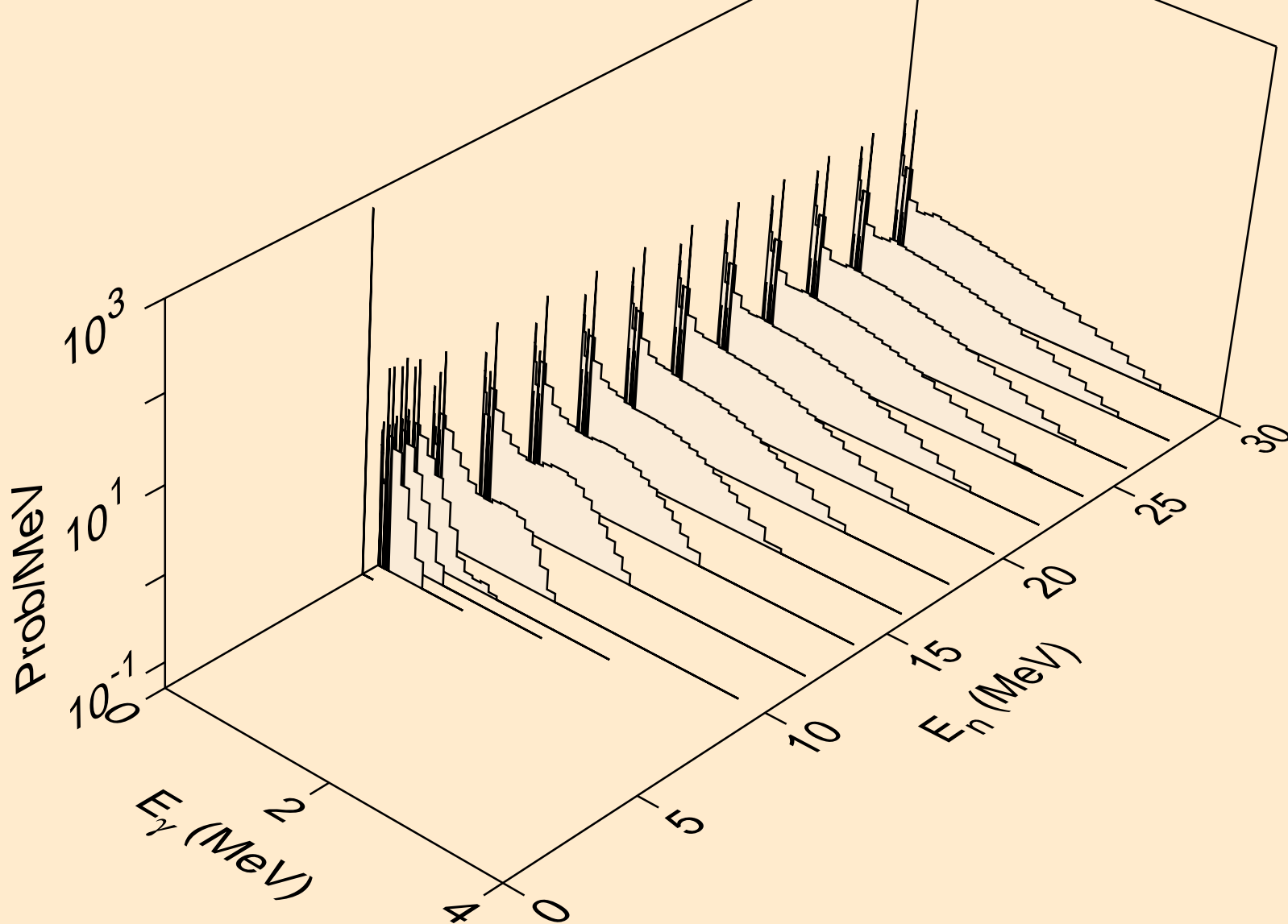

HF171 NEUTRON ACER TENDL-2019 LIBRARY; T=293.16K  
Photon emission for (n,he3)

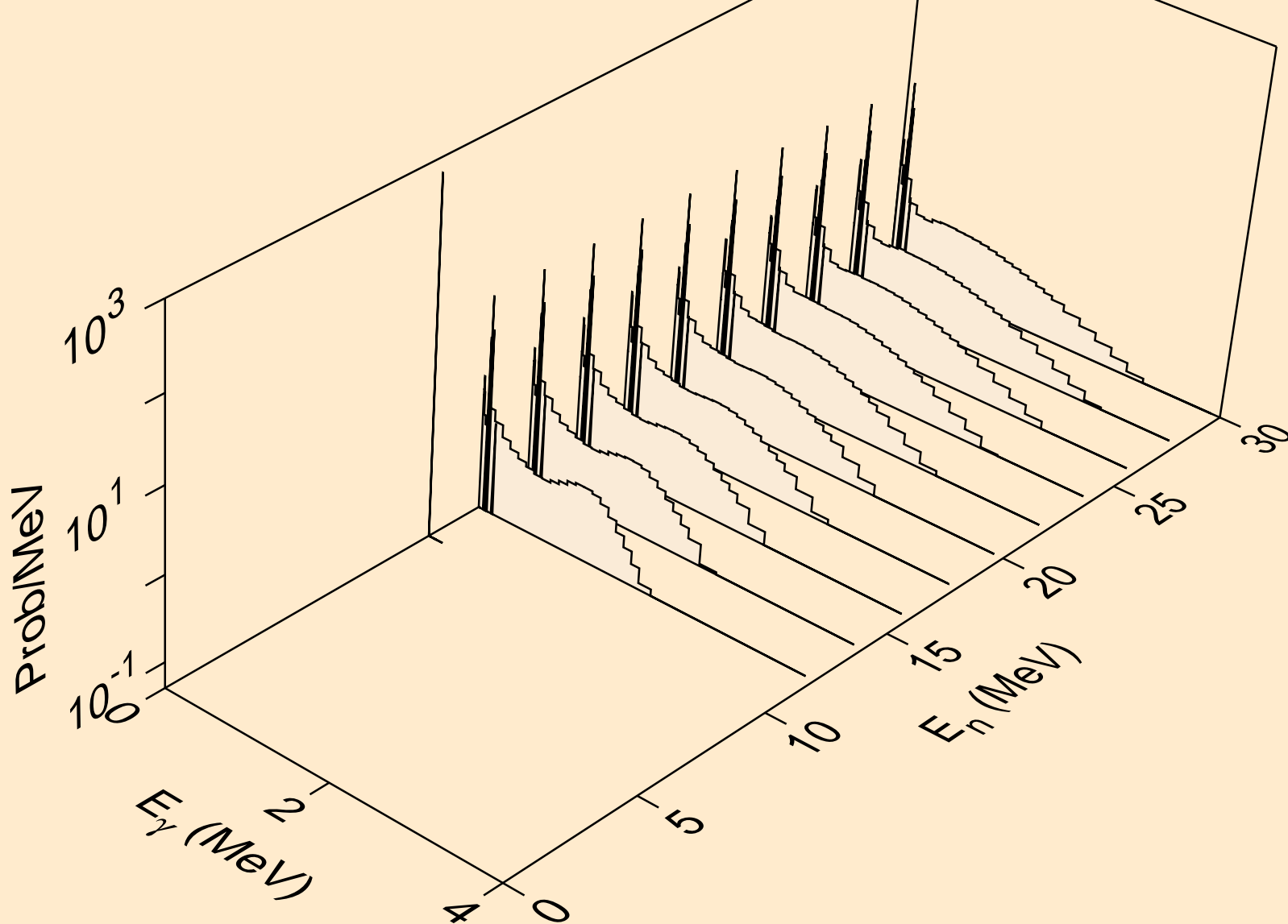

HF171 NEUTRON ACER TENDL-2019 LIBRARY; T=293.16K  
Photon emission for (n,a)

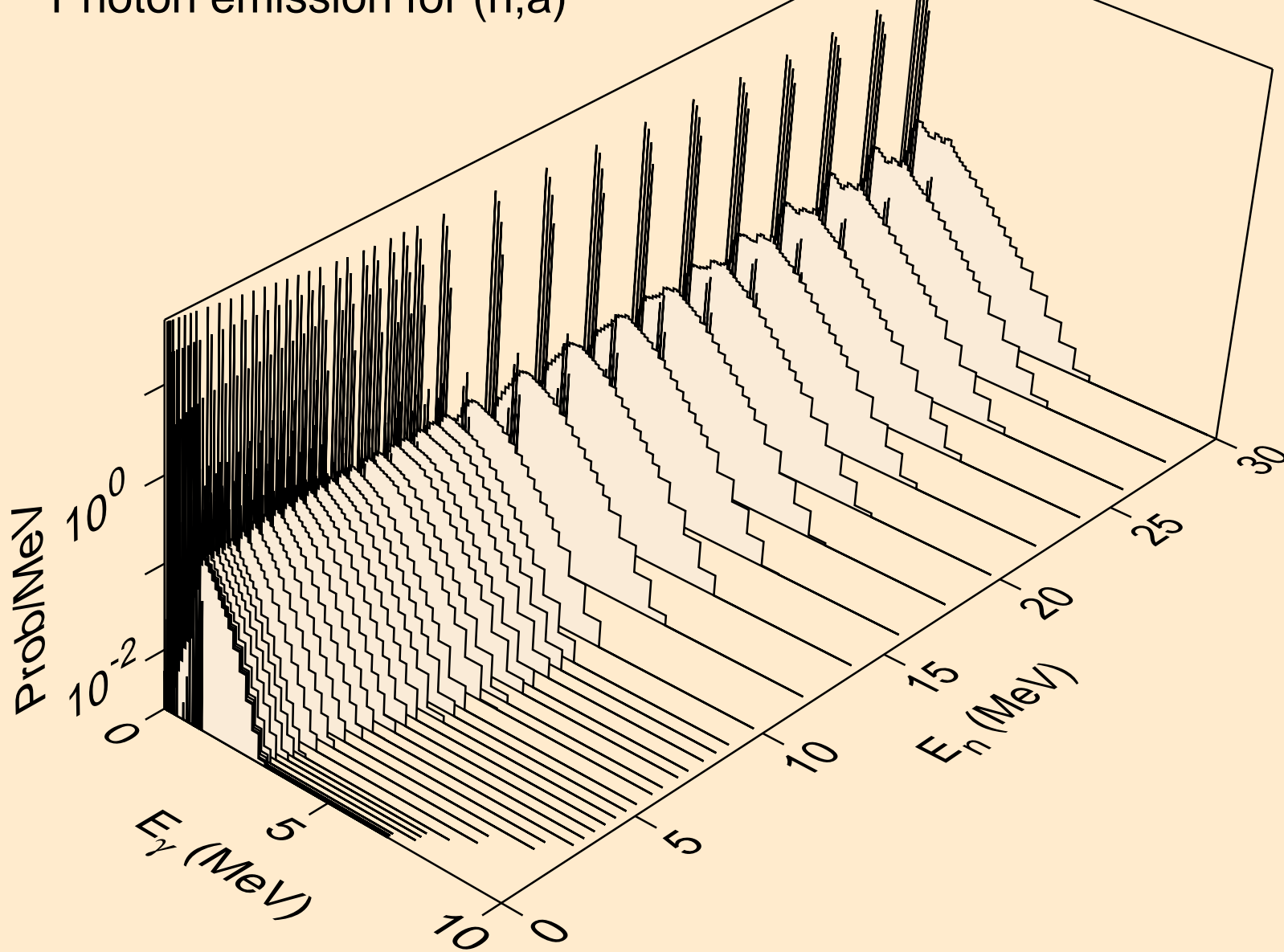

HF171 NEUTRON ACER TENDL-2019 LIBRARY; T=293.16K  
Photon emission for (n,2a)

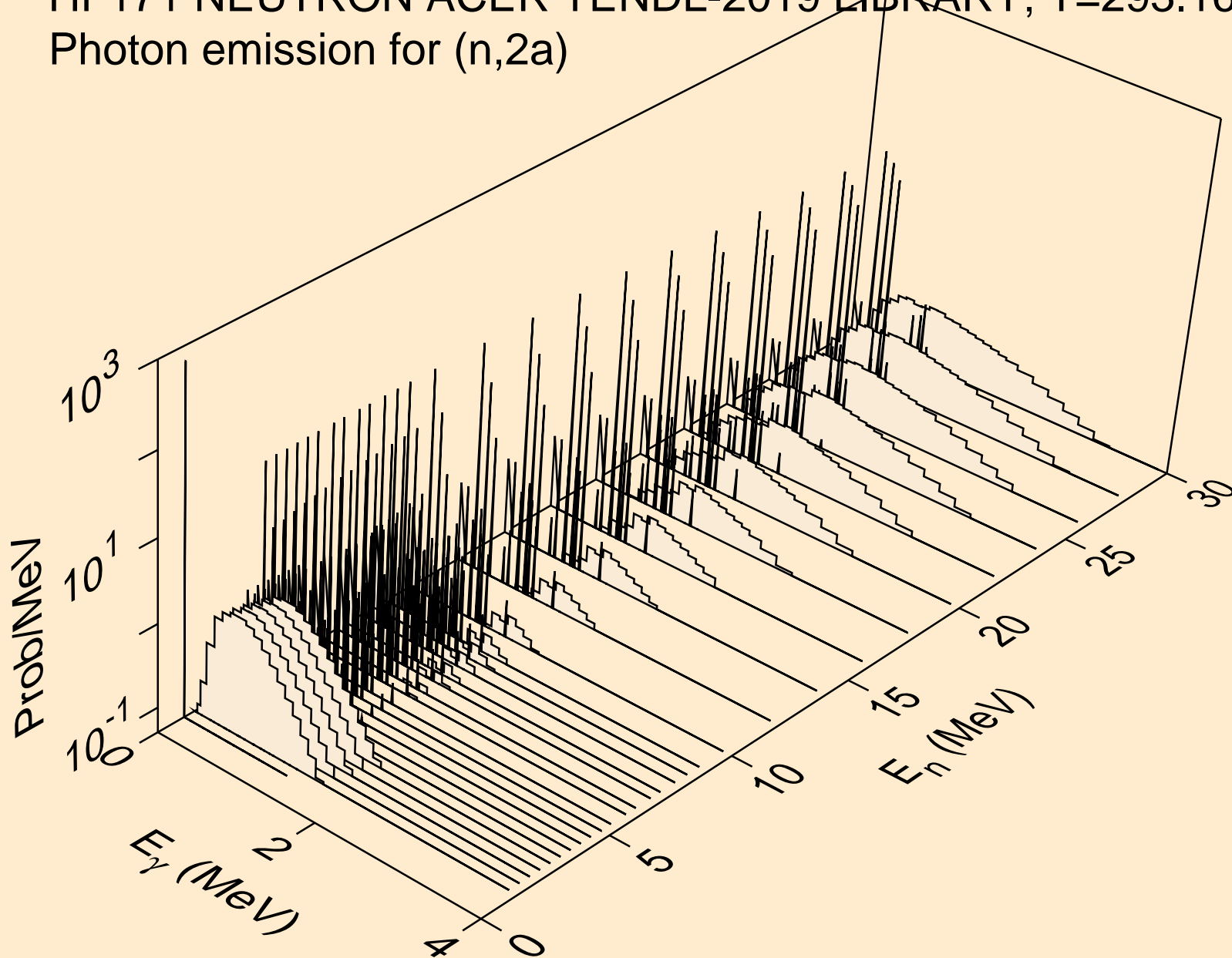



HF171 NEUTRON ACER TENDL-2019 LIBRARY; T=293.16K  
Photon emission for (n,2p)

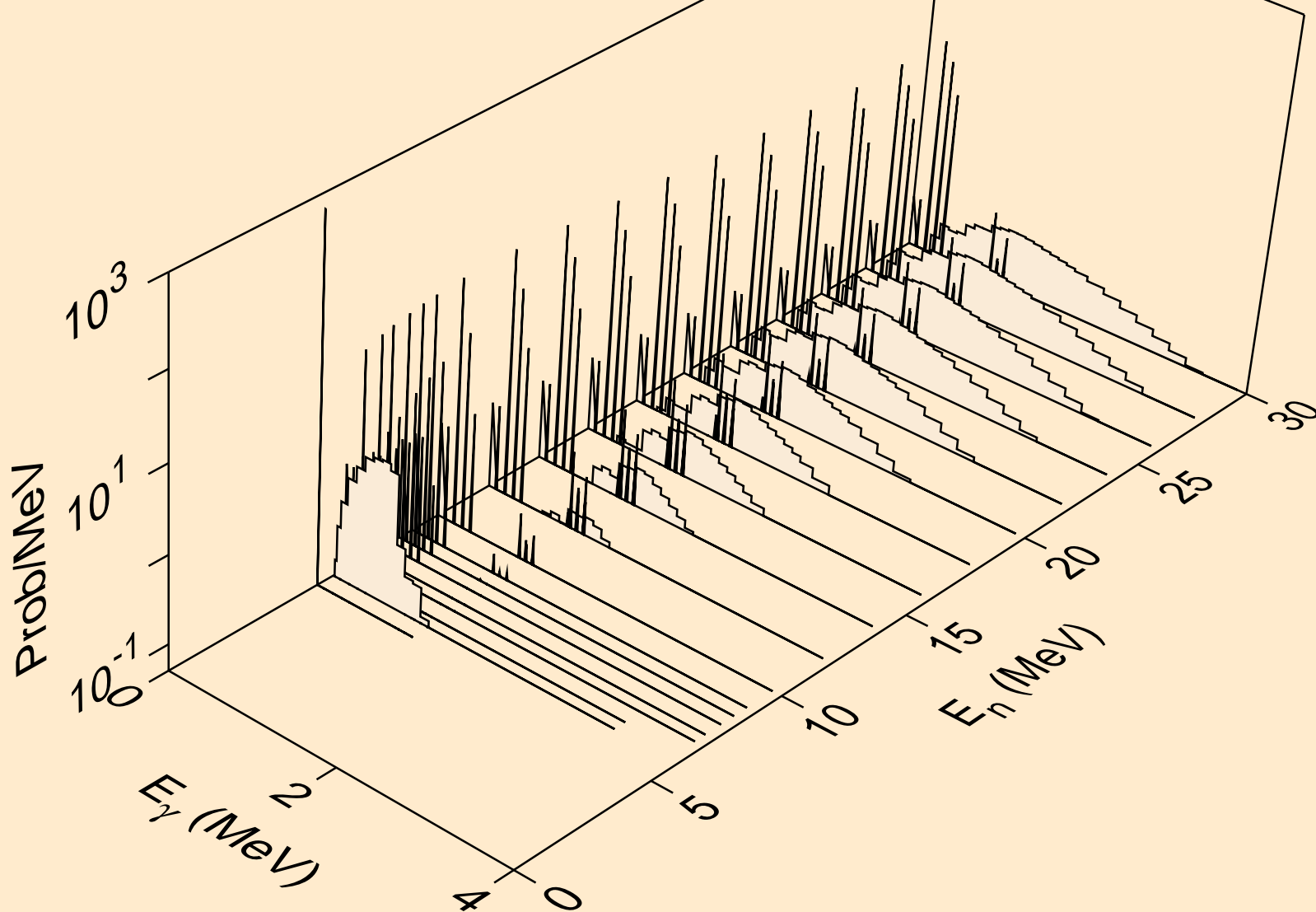

HF171 NEUTRON ACER TENDL-2019 LIBRARY; T=293.16K  
Photon emission for (n,p)

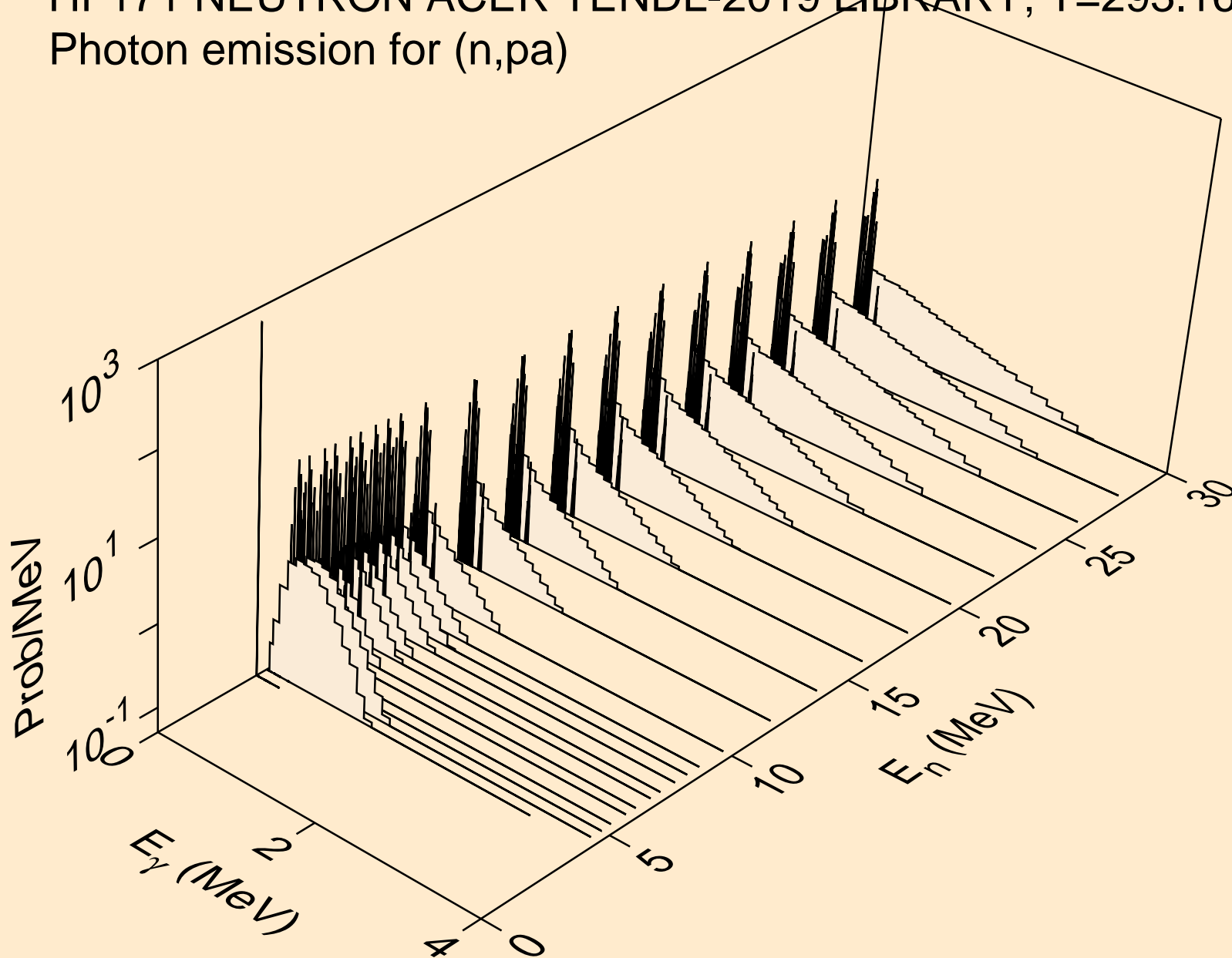

HF171 NEUTRON ACER TENDL-2019 LIBRARY; T=293.16K  
Photon emission for (n,pd)

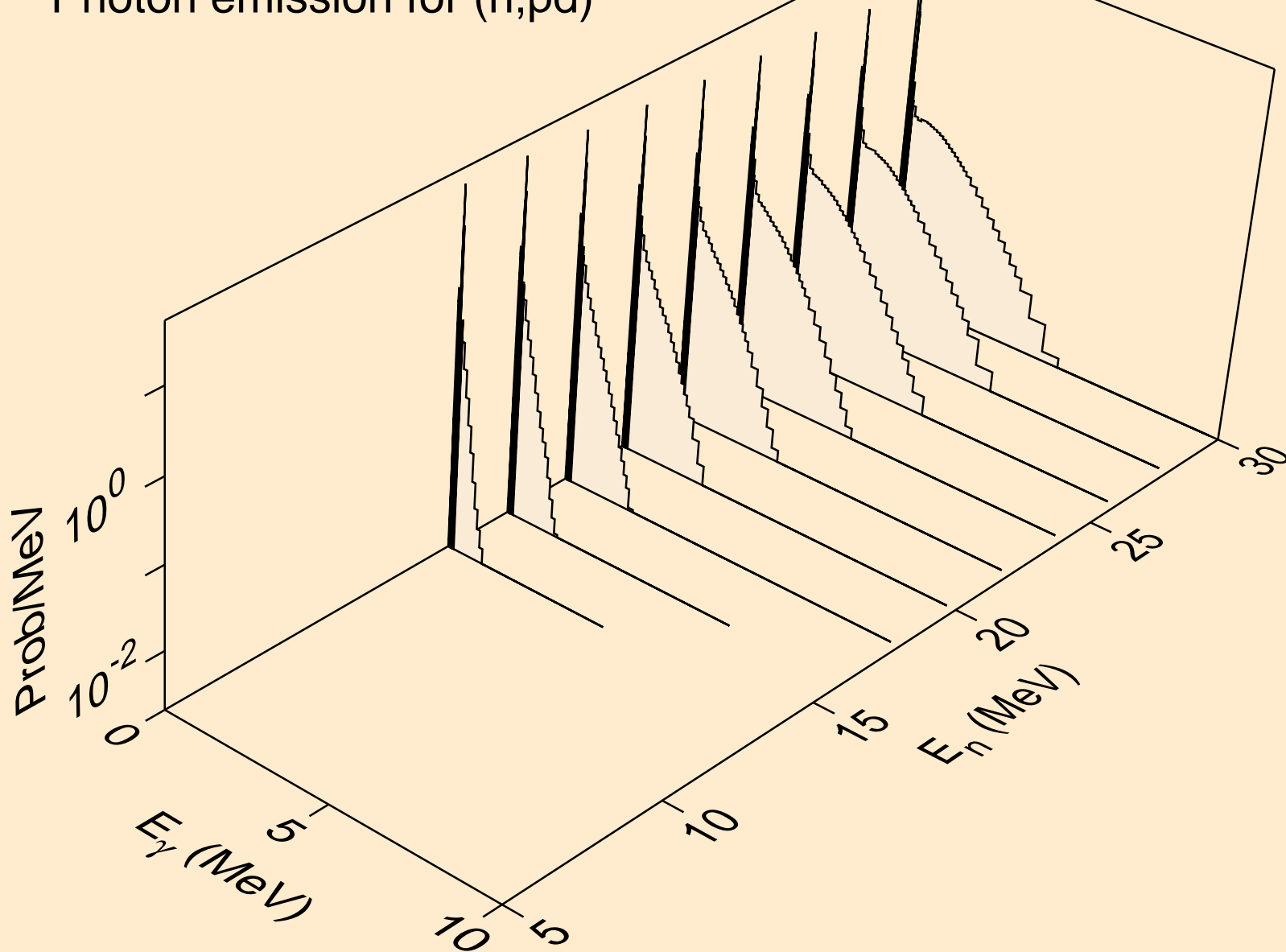

HF171 NEUTRON ACER TENDL-2019 LIBRARY; T=293.16K  
Photon emission for (n,pt)

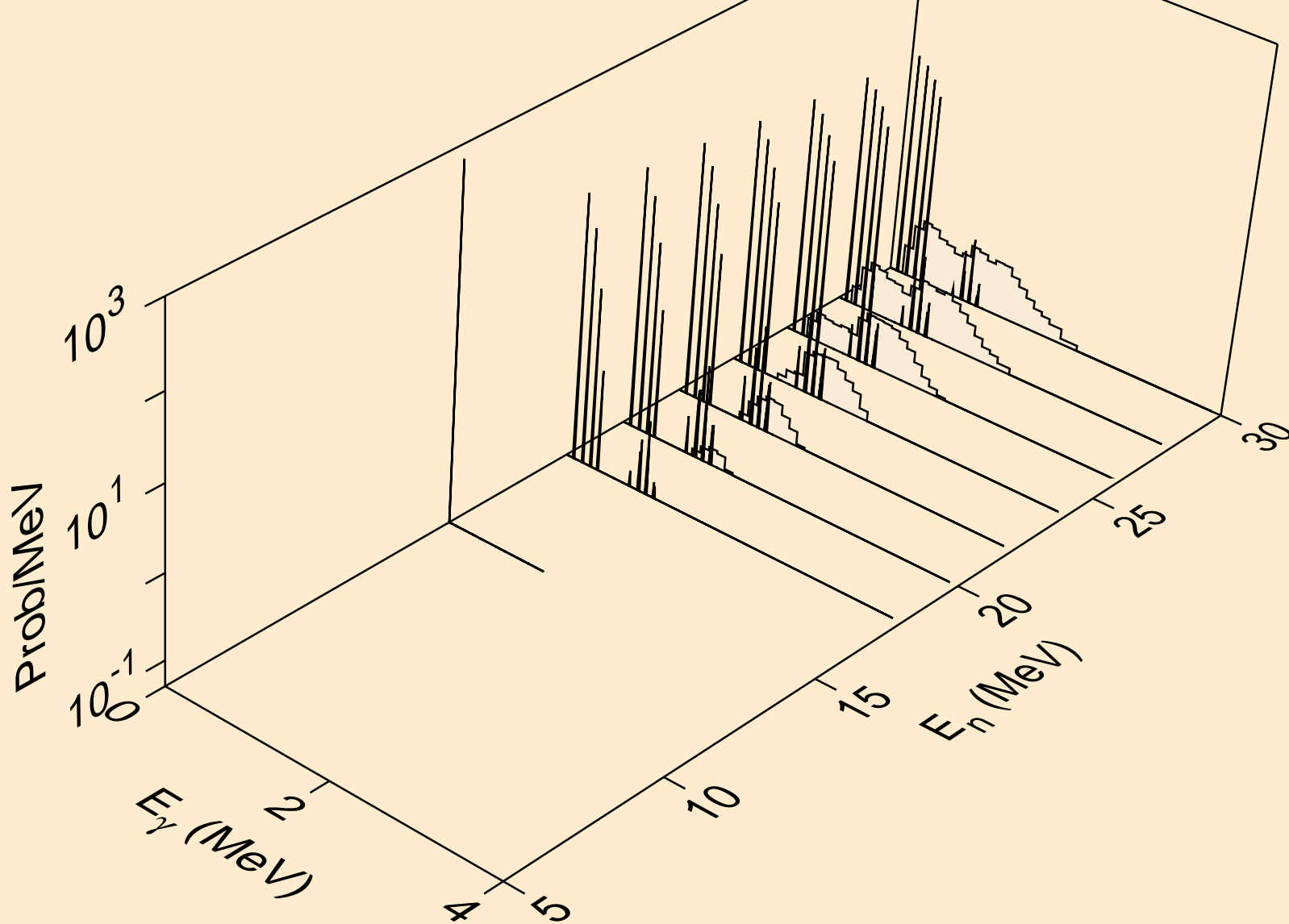

HF171 NEUTRON ACER TENDL-2019 LIBRARY; T=293.16K  
Photon emission for (n,da)

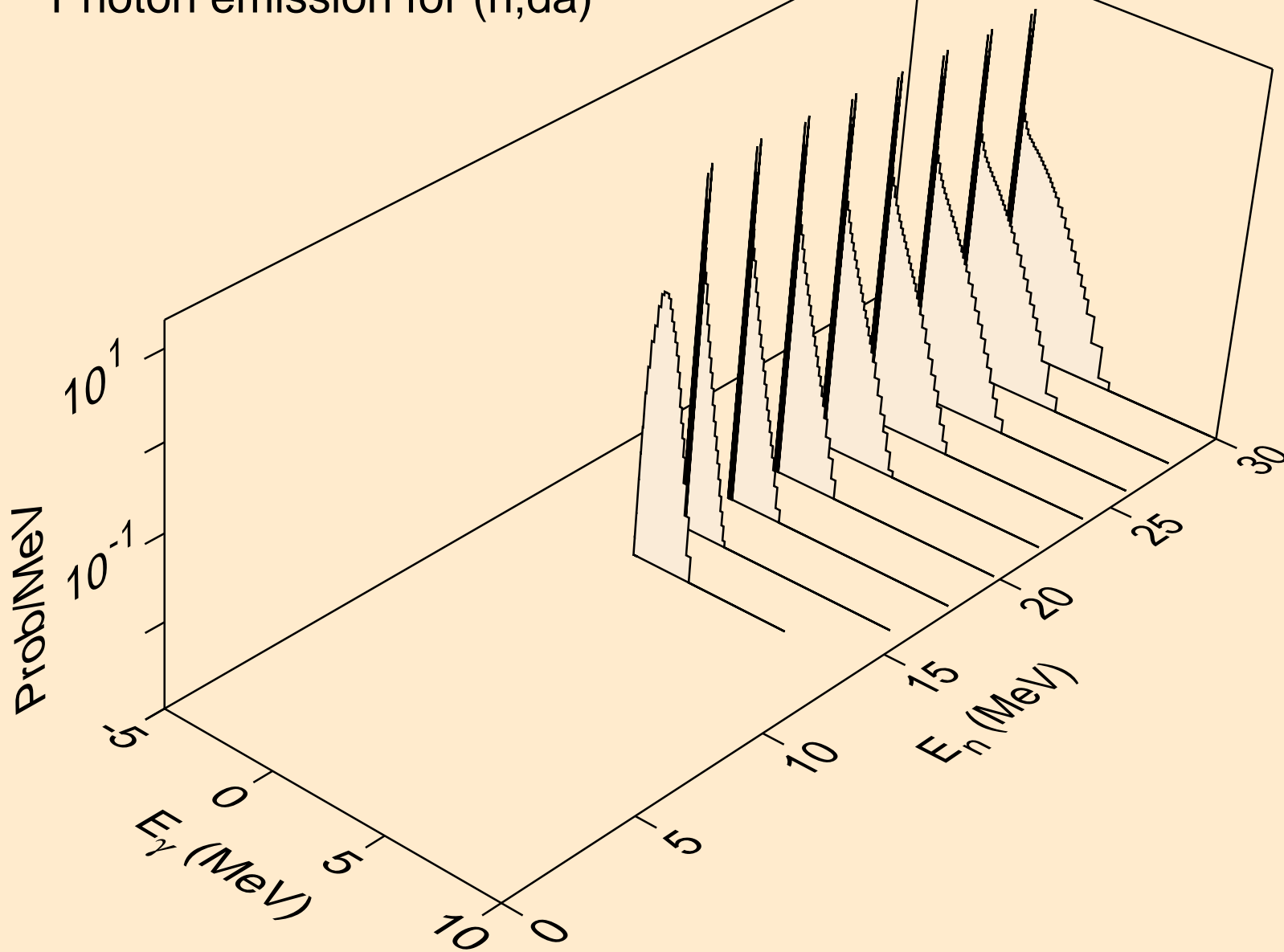

HF171 NEUTRON ACER TENDL-2019 LIBRARY; T=293.16K  
thermal capture photon spectrum

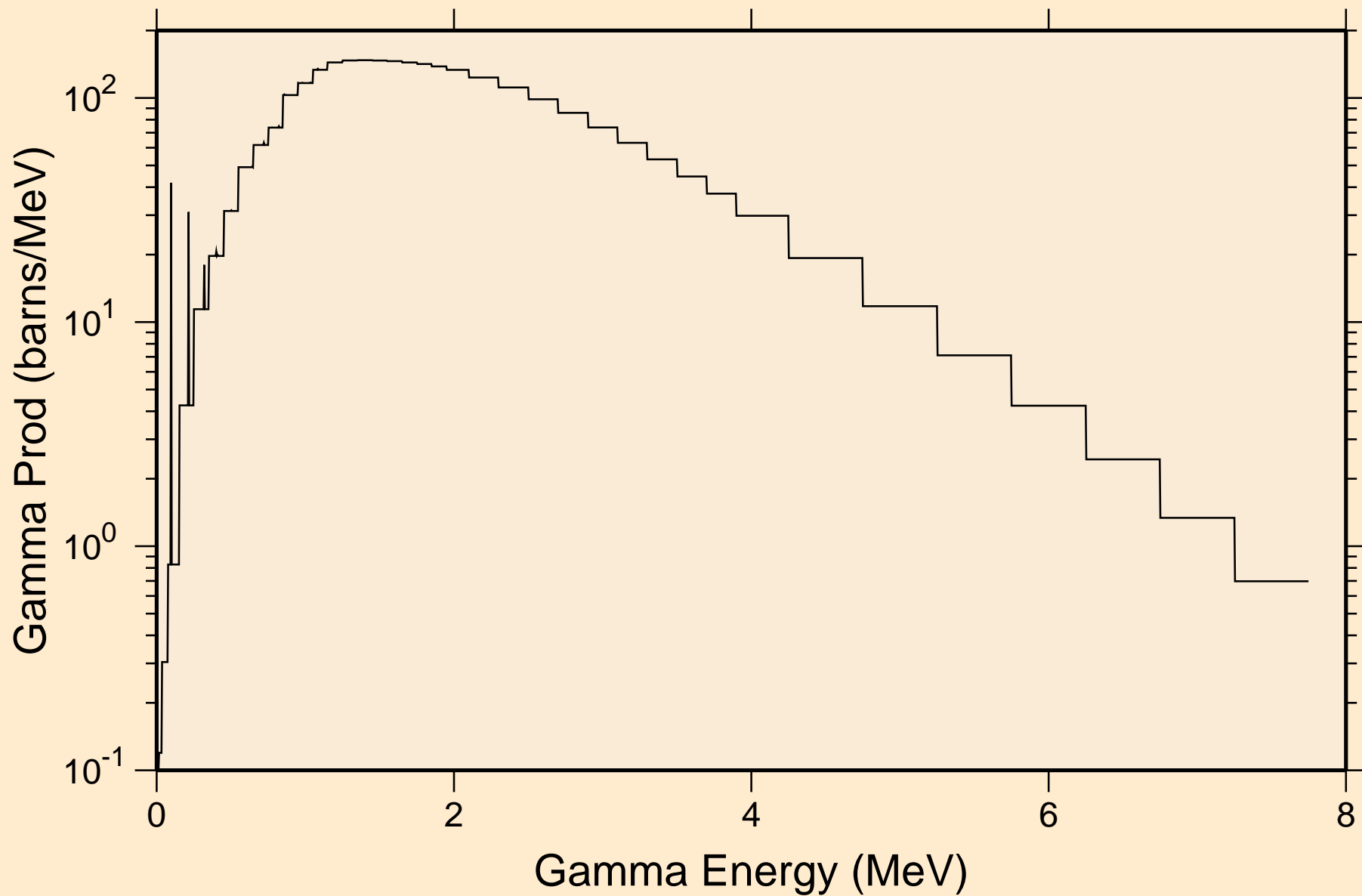

HF171 NEUTRON ACER TENDL-2019 LIBRARY; T=293.16K  
14 MeV photon spectrum

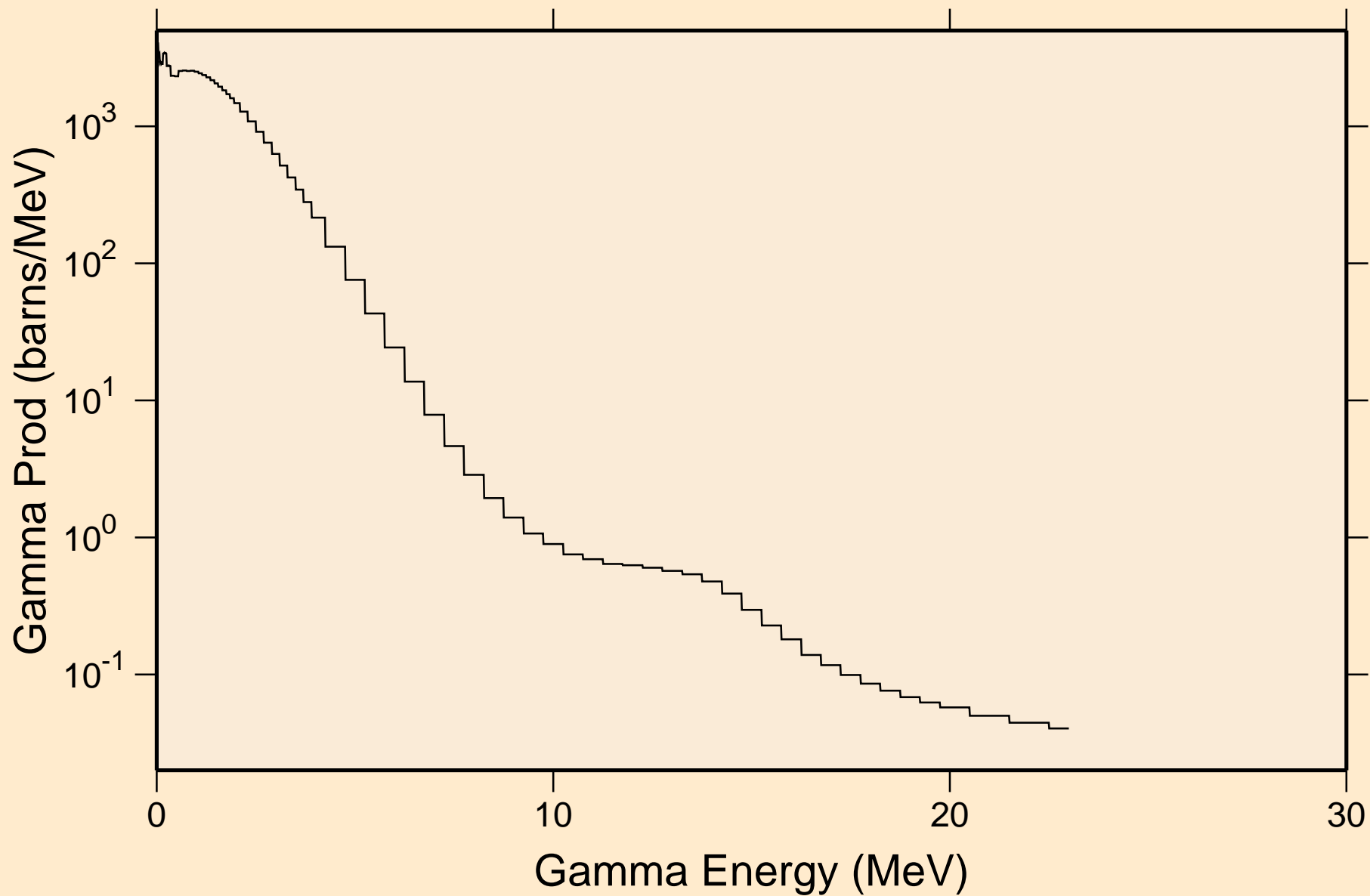

# HF171 NEUTRON ACER TENDL-2019 LIBRARY; T=293.16K

## Particle heating contributions

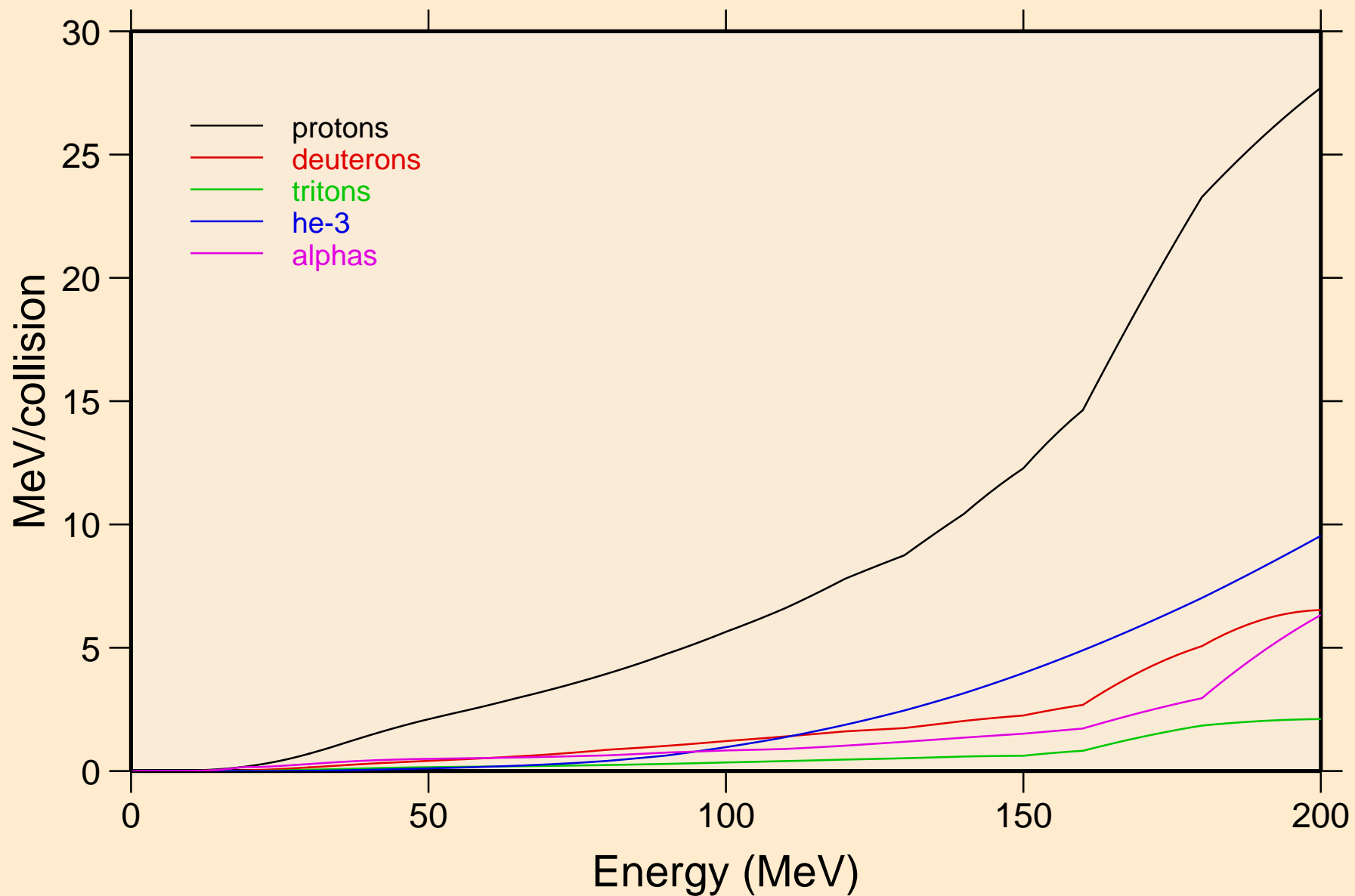



# HF171 NEUTRON ACER TENDL-2019 LIBRARY; T=293.16K

## Recoil Heating

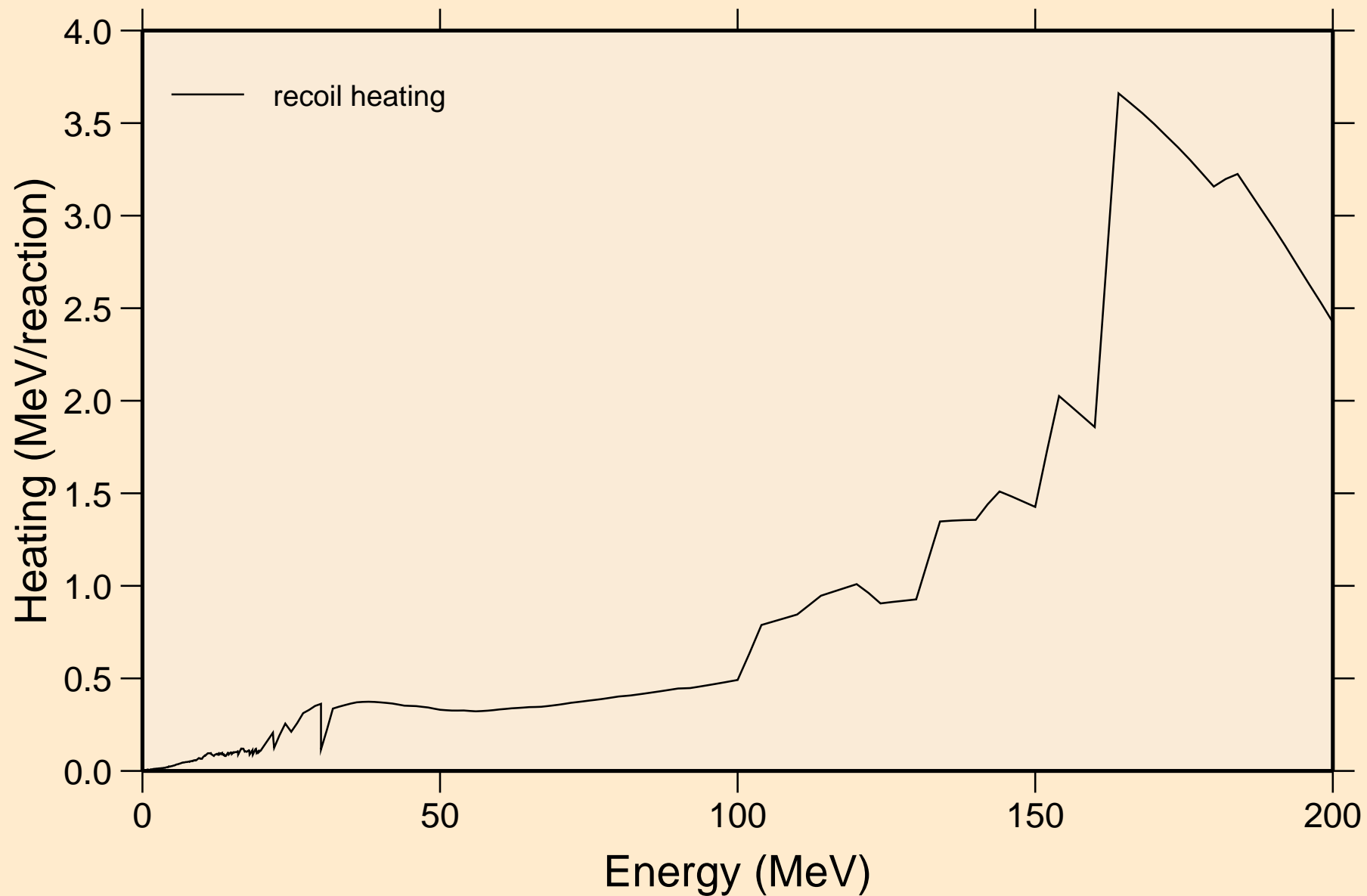

# HF171 NEUTRON ACER TENDL-2019 LIBRARY; T=293.16K

## Particle production cross sections

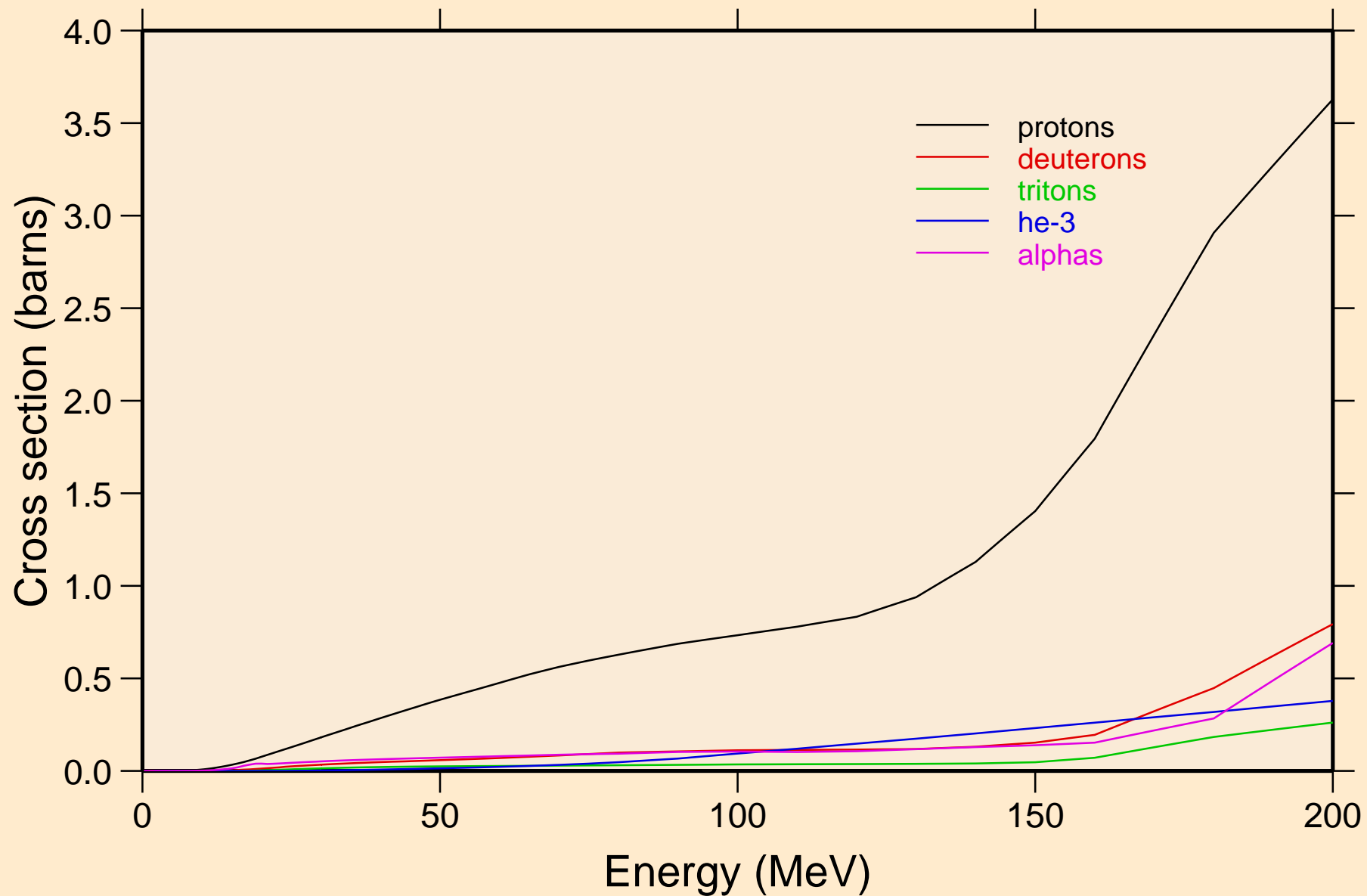

HF171 NEUTRON ACER TENDL-2019 LIBRARY; T=293.16K  
protons from (n,x)

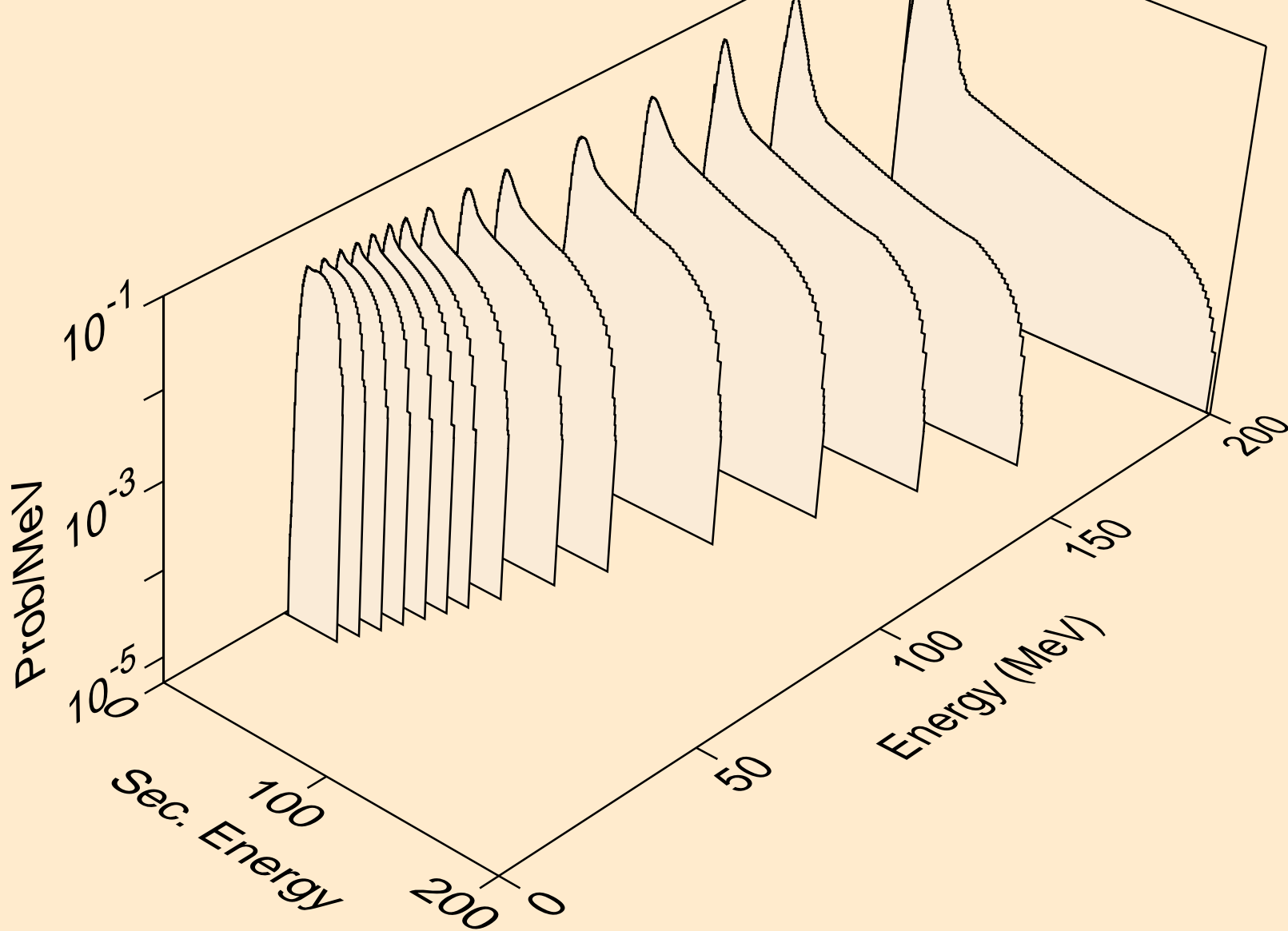

HF171 NEUTRON ACER TENDL-2019 LIBRARY; T=293.16K  
protons from (n,n\*)p

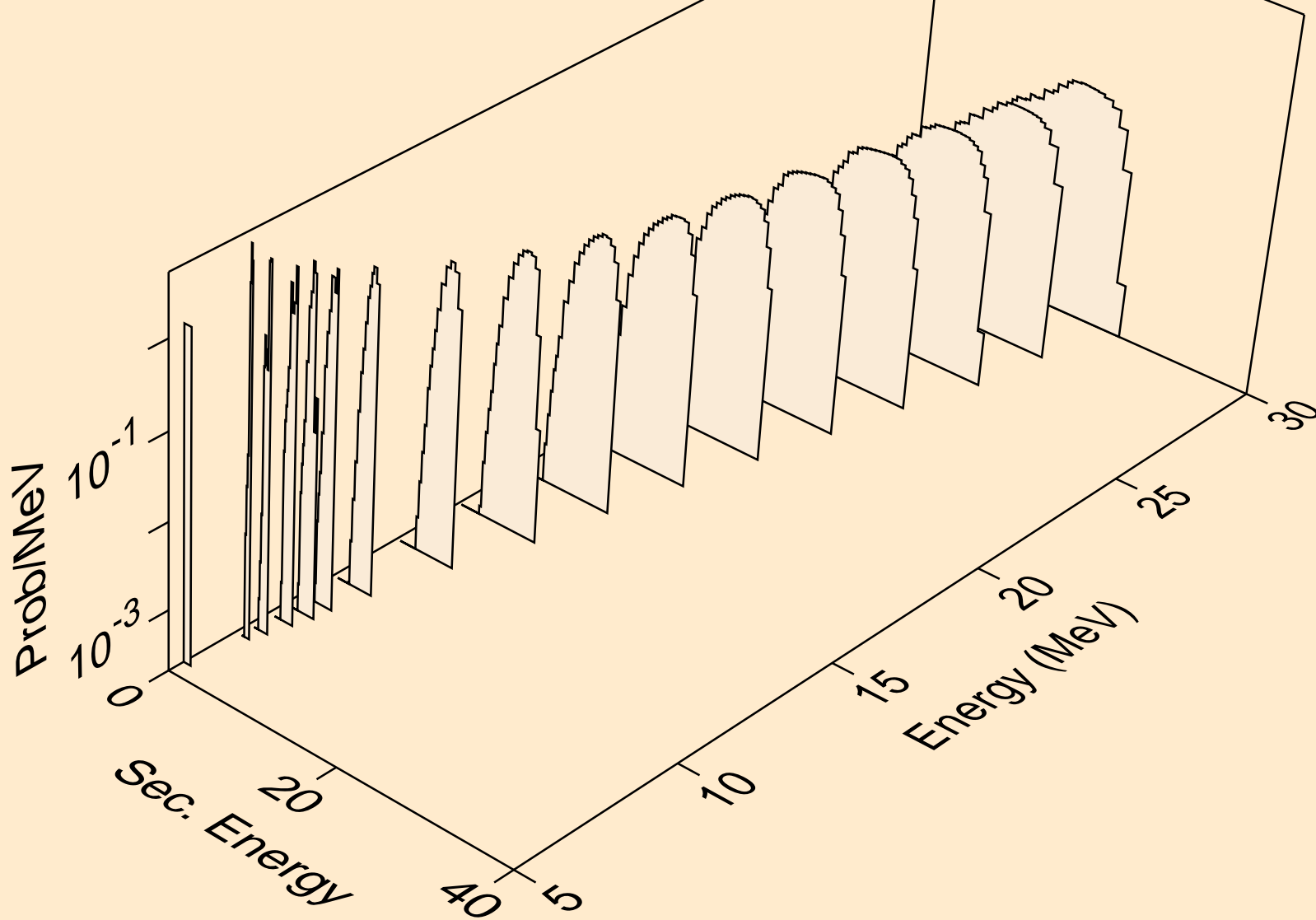

HF171 NEUTRON ACER TENDL-2019 LIBRARY; T=293.16K  
protons from (n,2np)

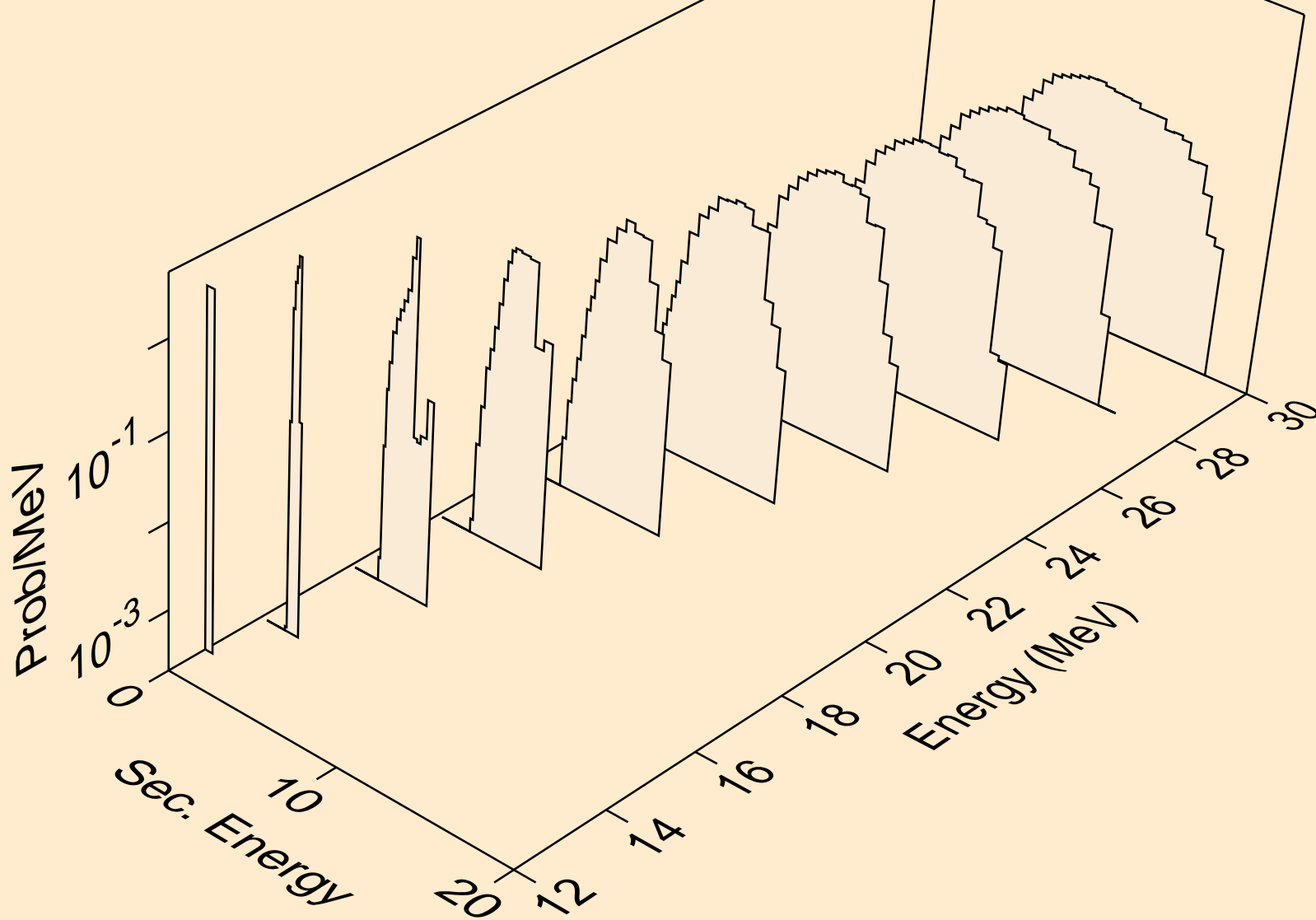

HF171 NEUTRON ACER TENDL-2019 LIBRARY; T=293.16K  
protons from (n,3np)

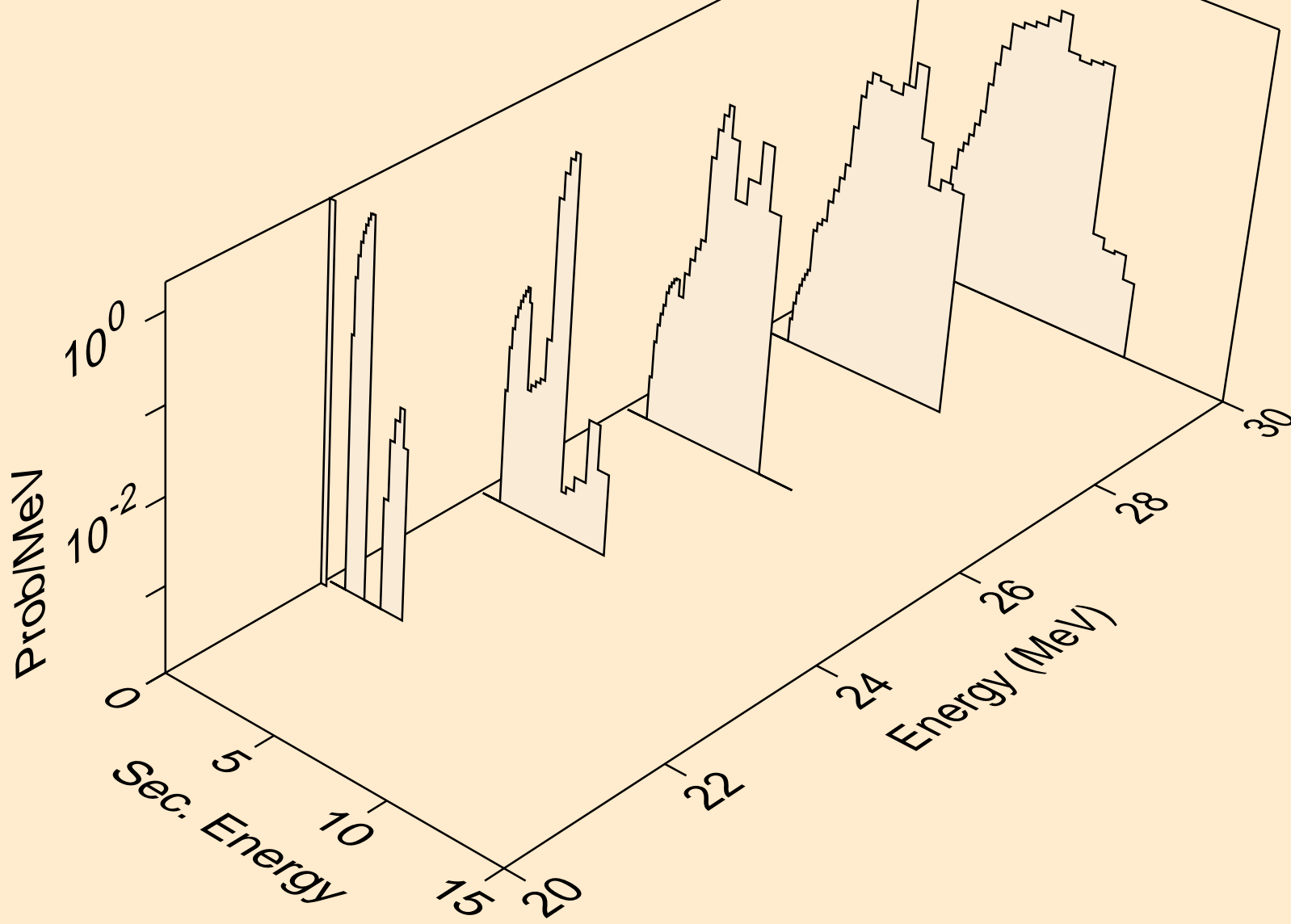

HF171 NEUTRON ACER TENDL-2019 LIBRARY; T=293.16K  
protons from (n,2np)

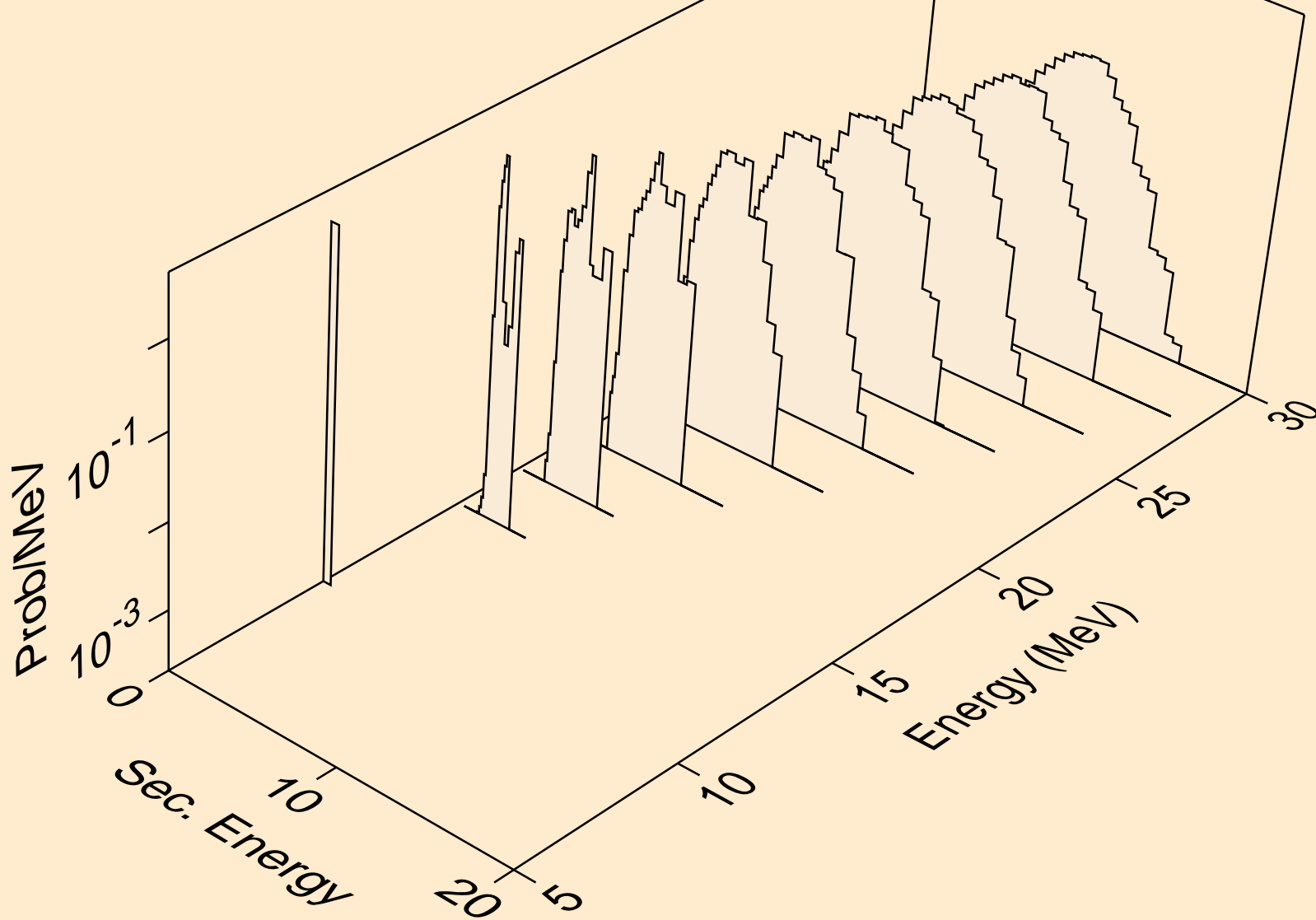

HF171 NEUTRON ACER TENDL-2019 LIBRARY; T=293.16K  
protons from (n,npa)

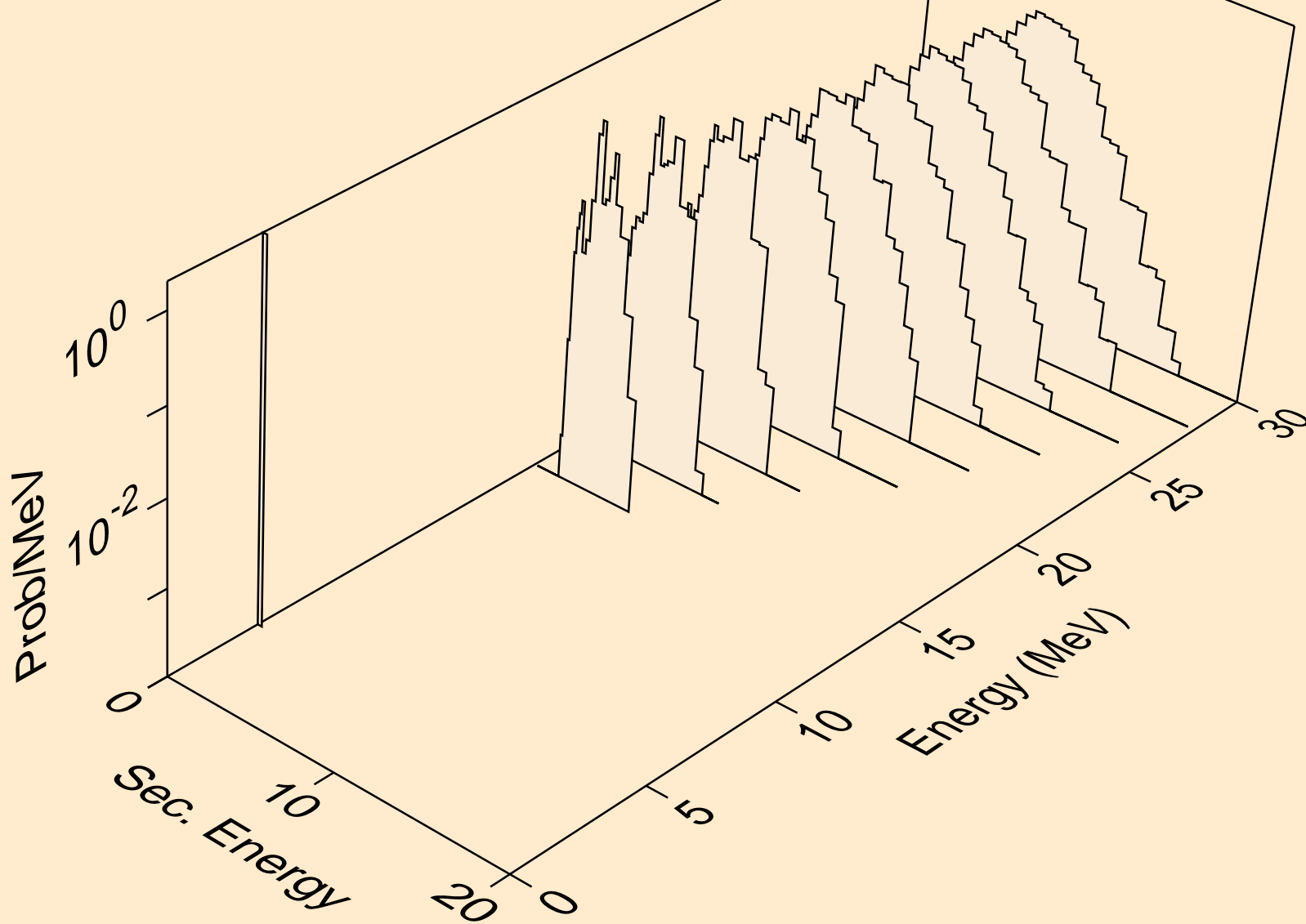



HF171 NEUTRON ACER TENDL-2019 LIBRARY; T=293.16K  
protons from (n,p)

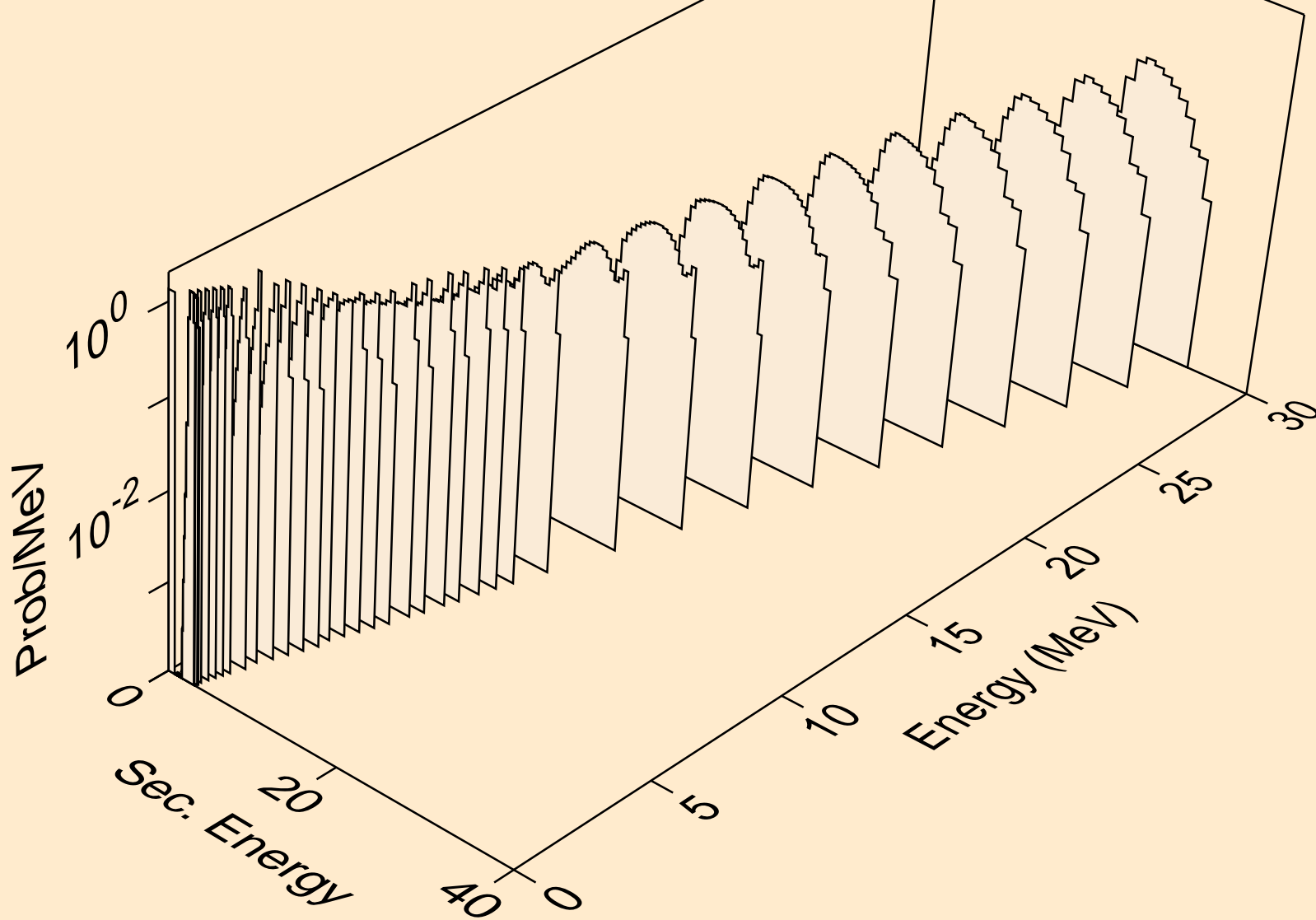

HF171 NEUTRON ACER TENDL-2019 LIBRARY; T=293.16K  
protons from (n,2p)

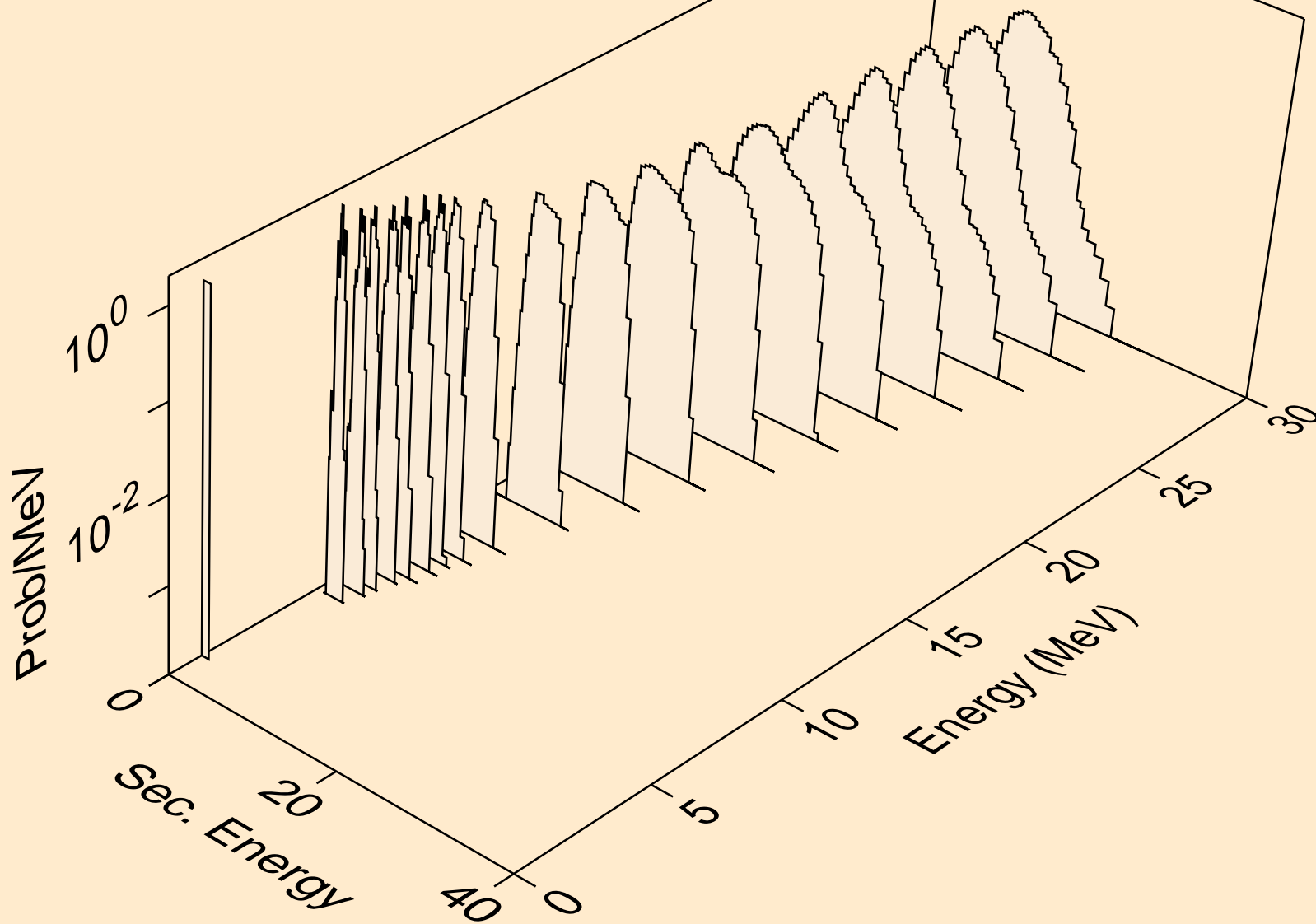

HF171 NEUTRON ACER TENDL-2019 LIBRARY; T=293.16K  
protons from (n,p)

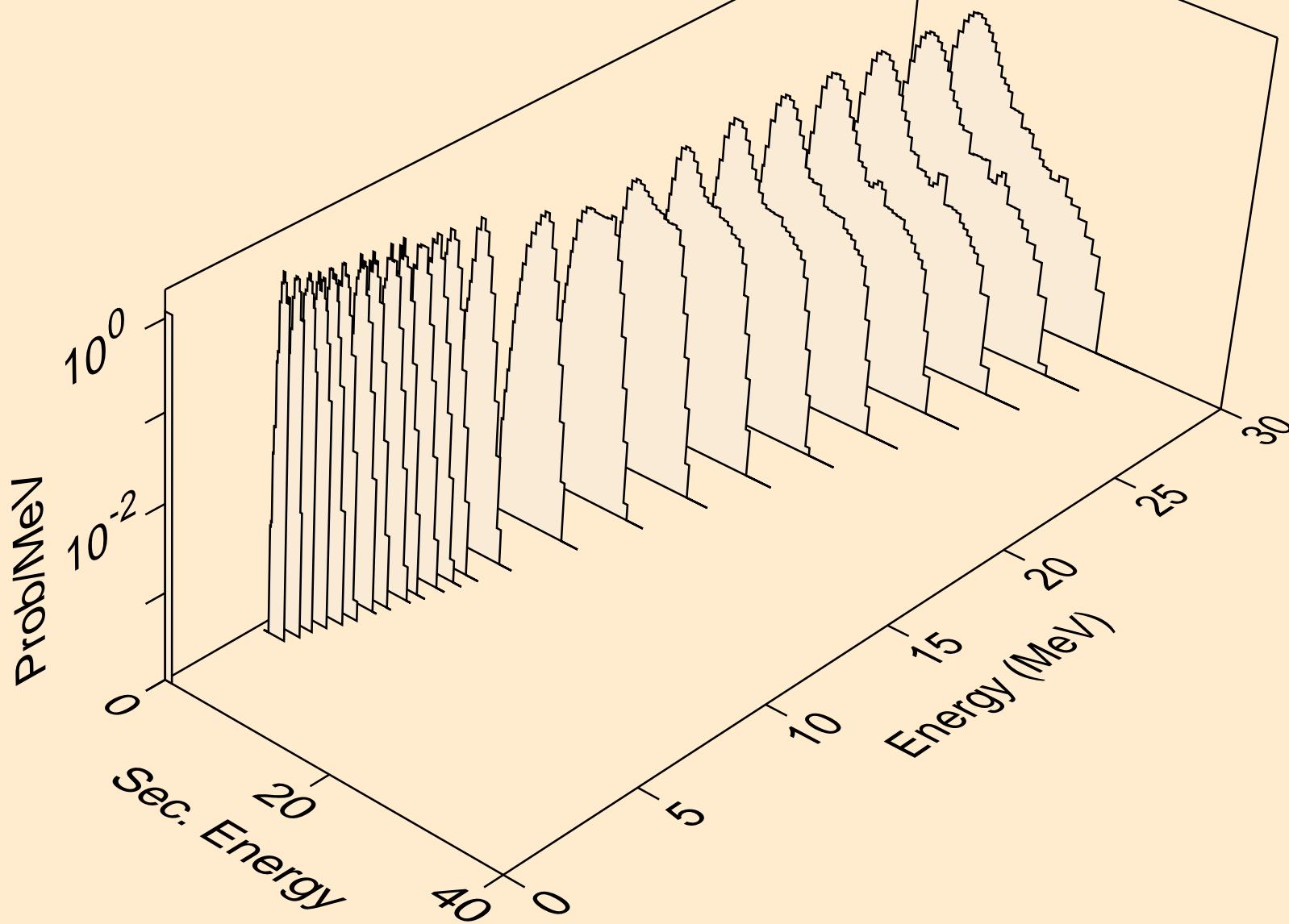

HF171 NEUTRON ACER TENDL-2019 LIBRARY; T=293.16K  
protons from (n,pd)

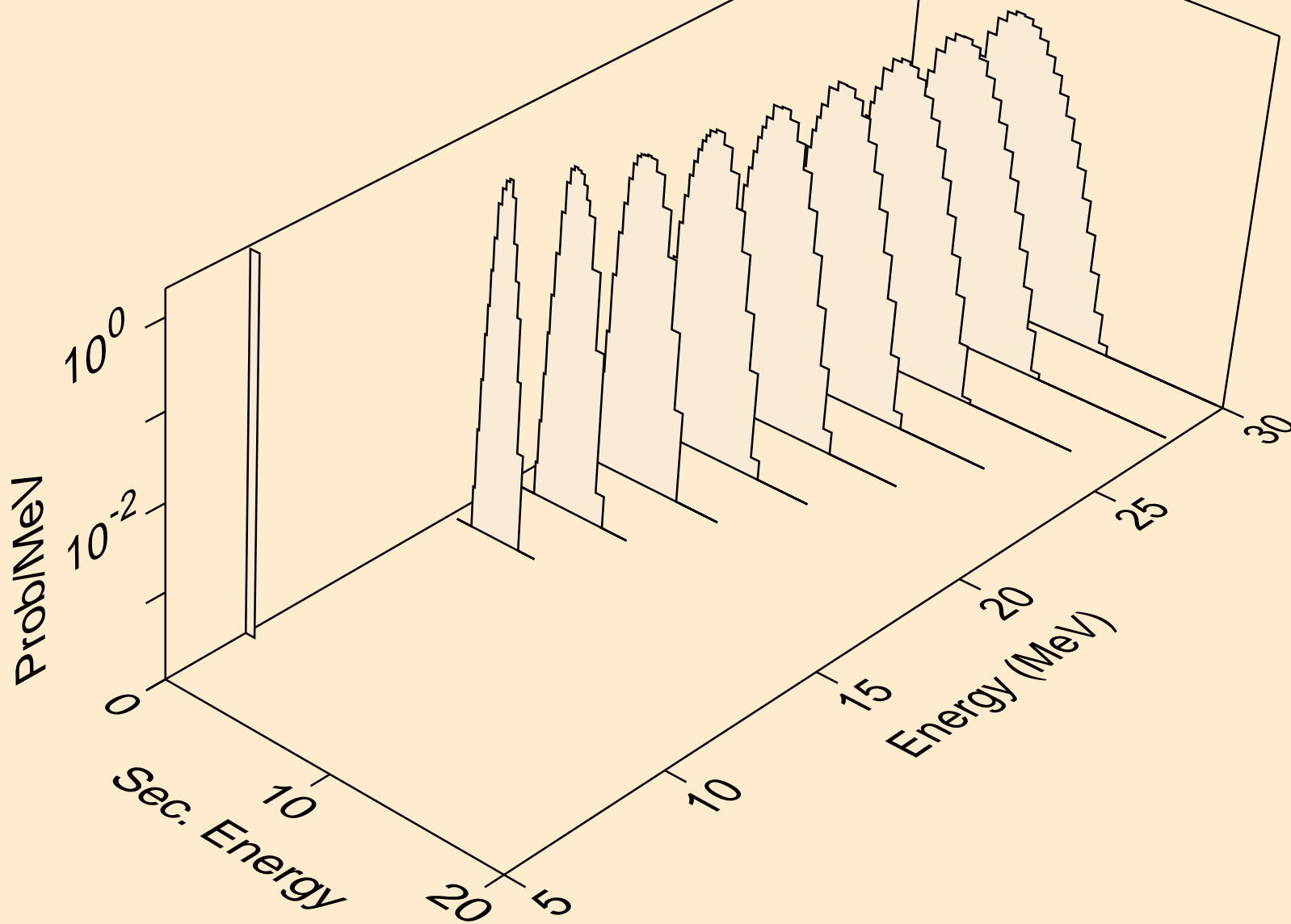

HF171 NEUTRON ACER TENDL-2019 LIBRARY; T=293.16K  
protons from (n,pt)

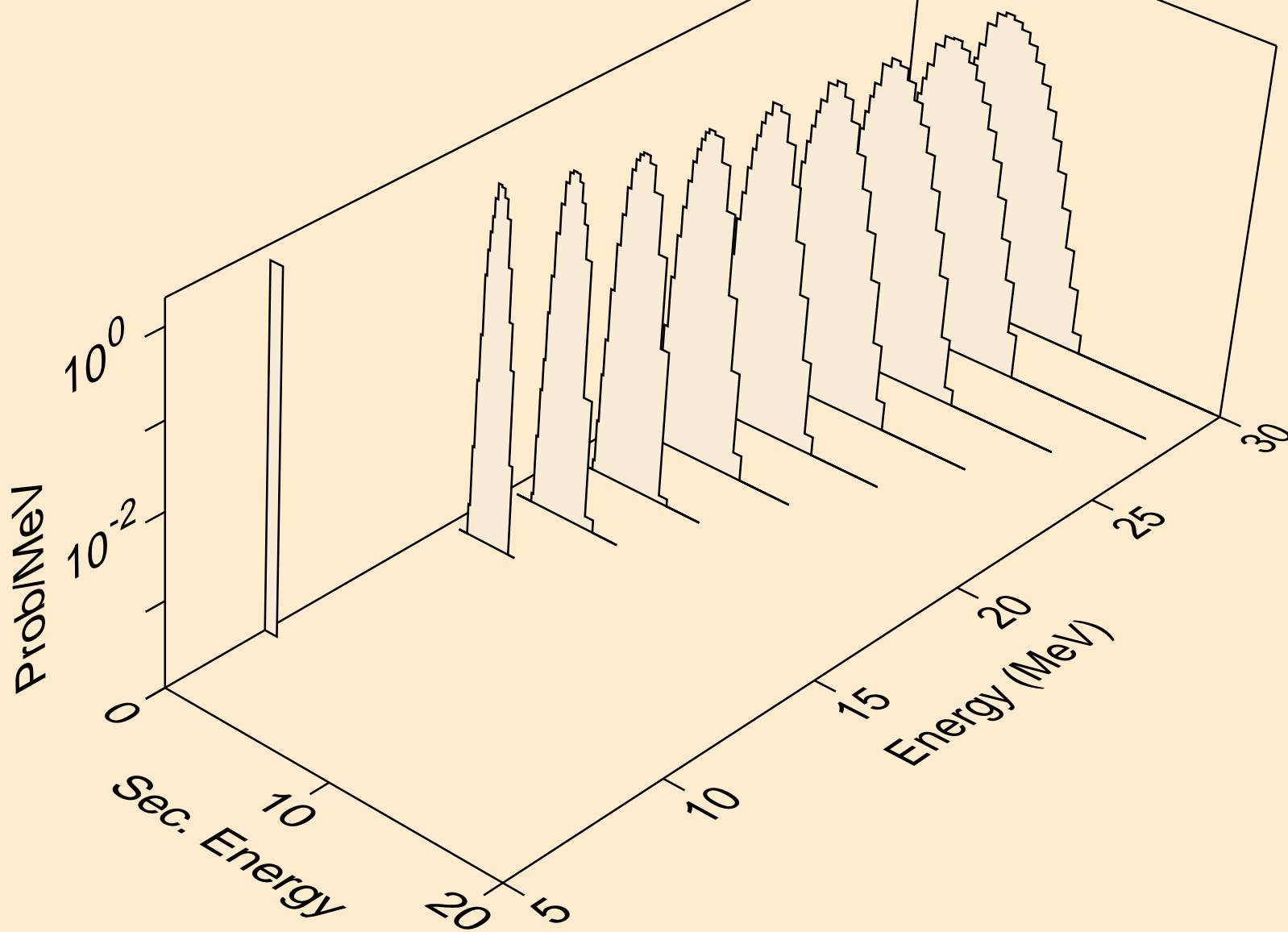

HF171 NEUTRON ACER TENDL-2019 LIBRARY; T=293.16K  
deuterons from (n,x)

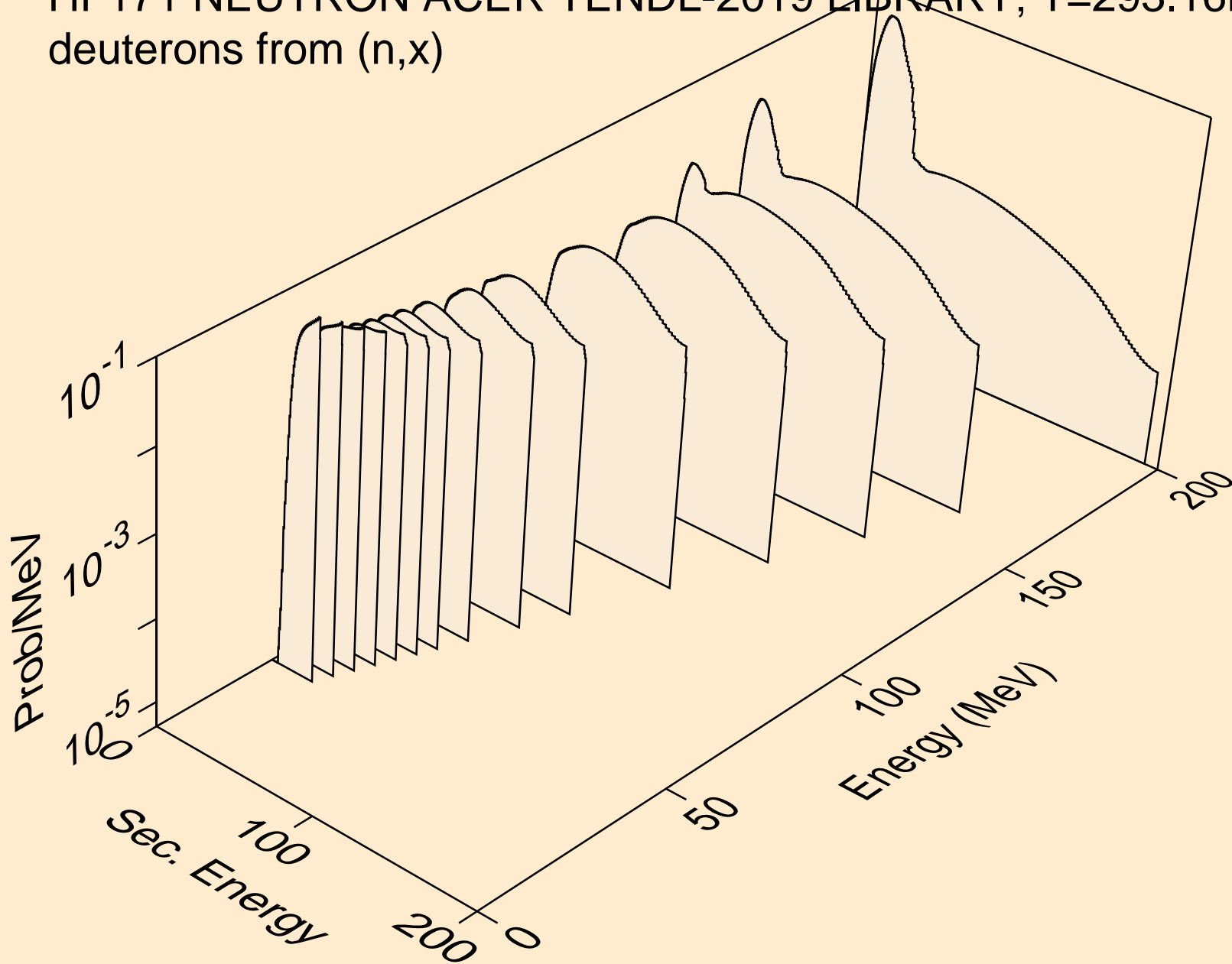

HF171 NEUTRON ACER TENDL-2019 LIBRARY; T=293.16K  
deuterons from (n,2nd)

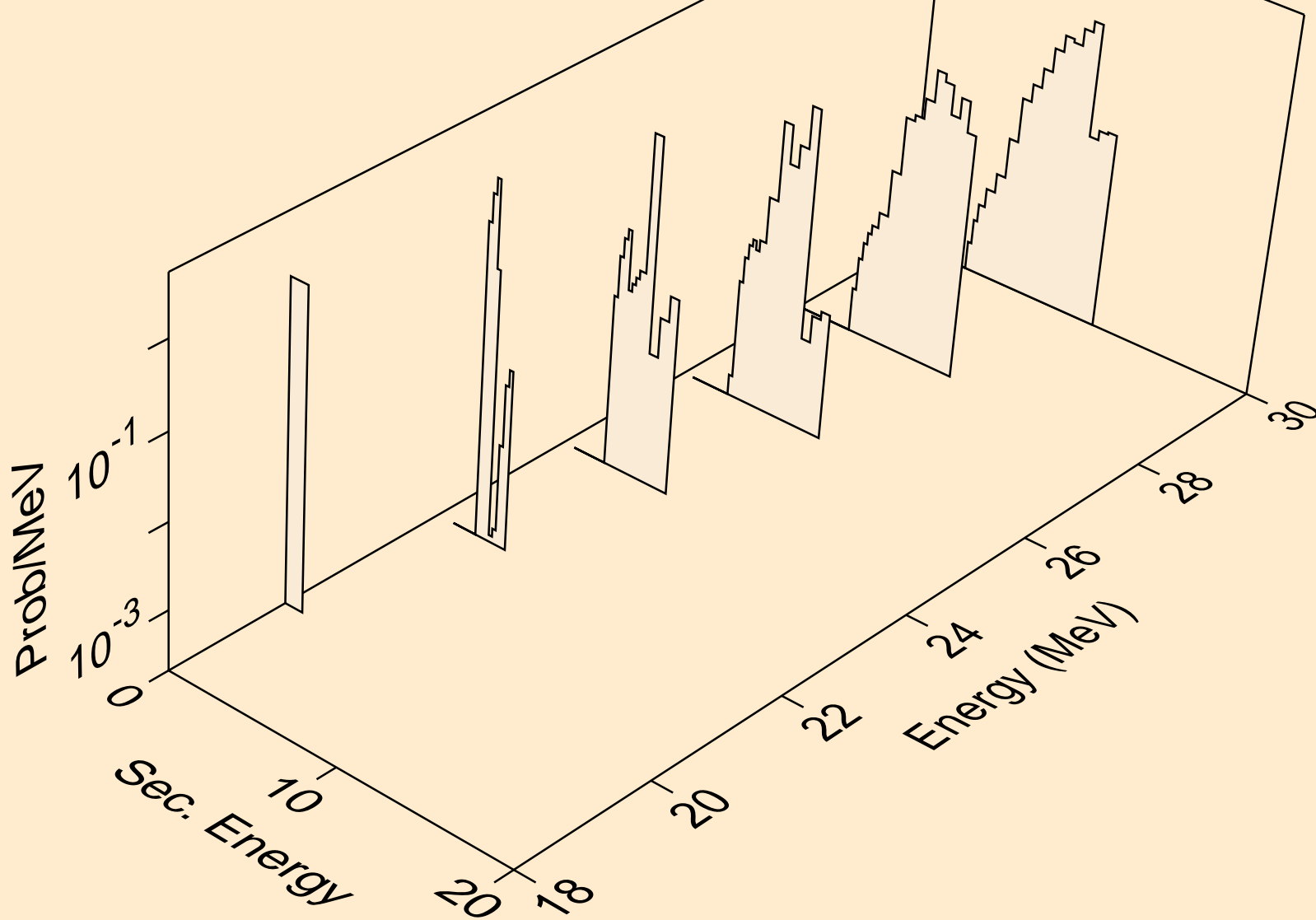

HF171 NEUTRON ACER TENDL-2019 LIBRARY; T=293.16K  
deuterons from (n,n\*)d

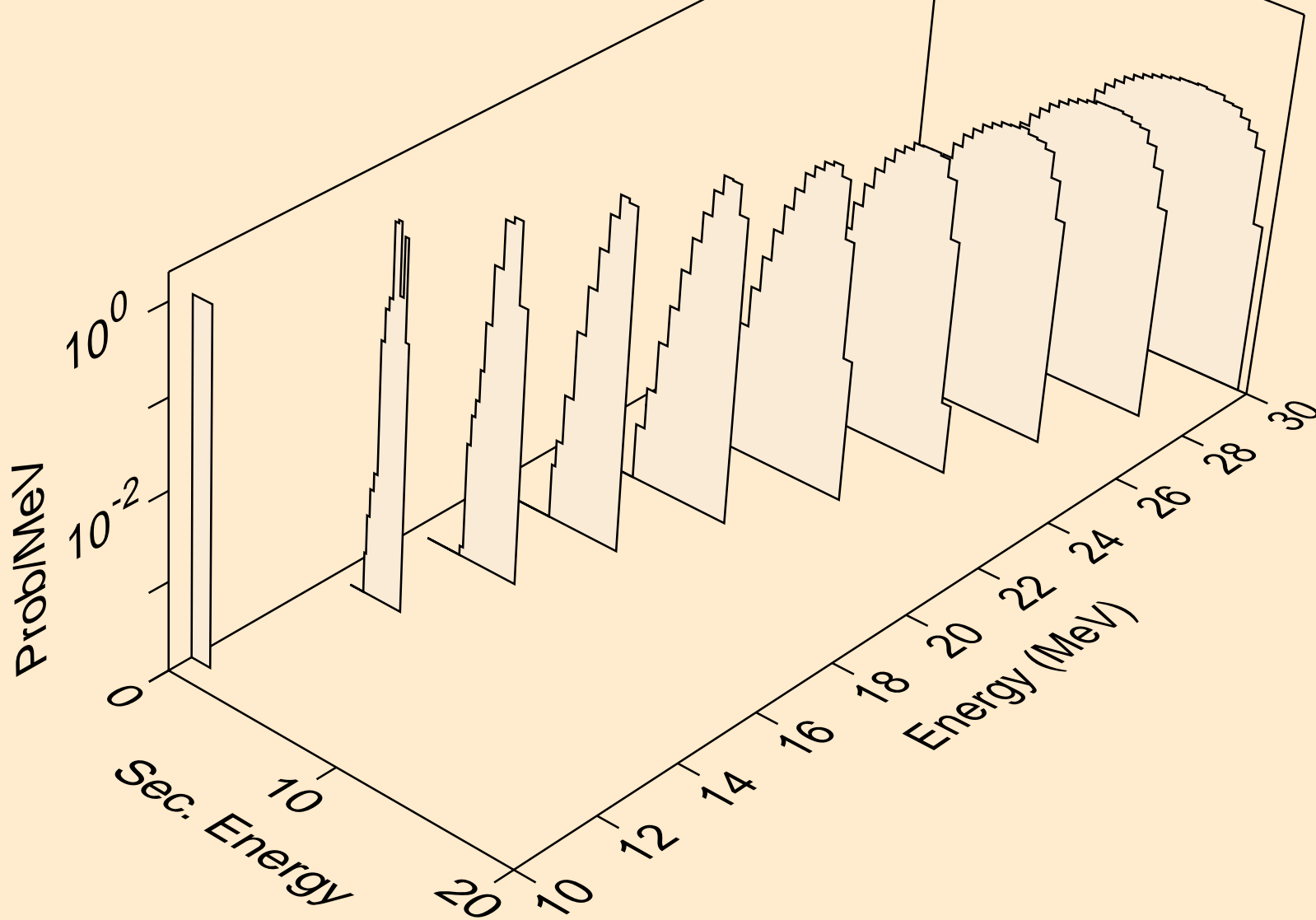



HF171 NEUTRON ACER TENDL-2019 LIBRARY; T=293.16K  
deuterons from (n,d)

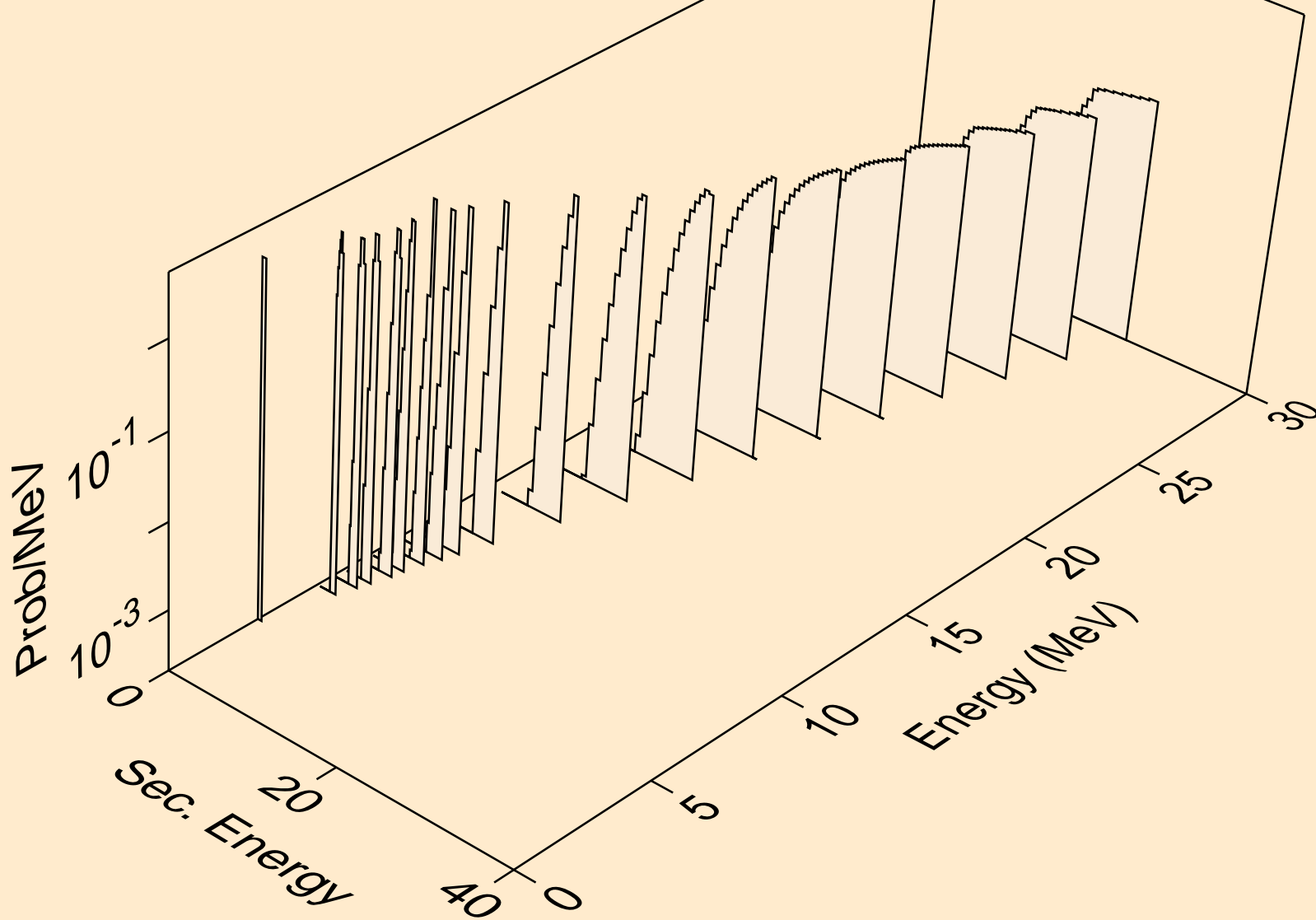

HF171 NEUTRON ACER TENDL-2019 LIBRARY; T=293.16K  
deuterons from (n,pd)

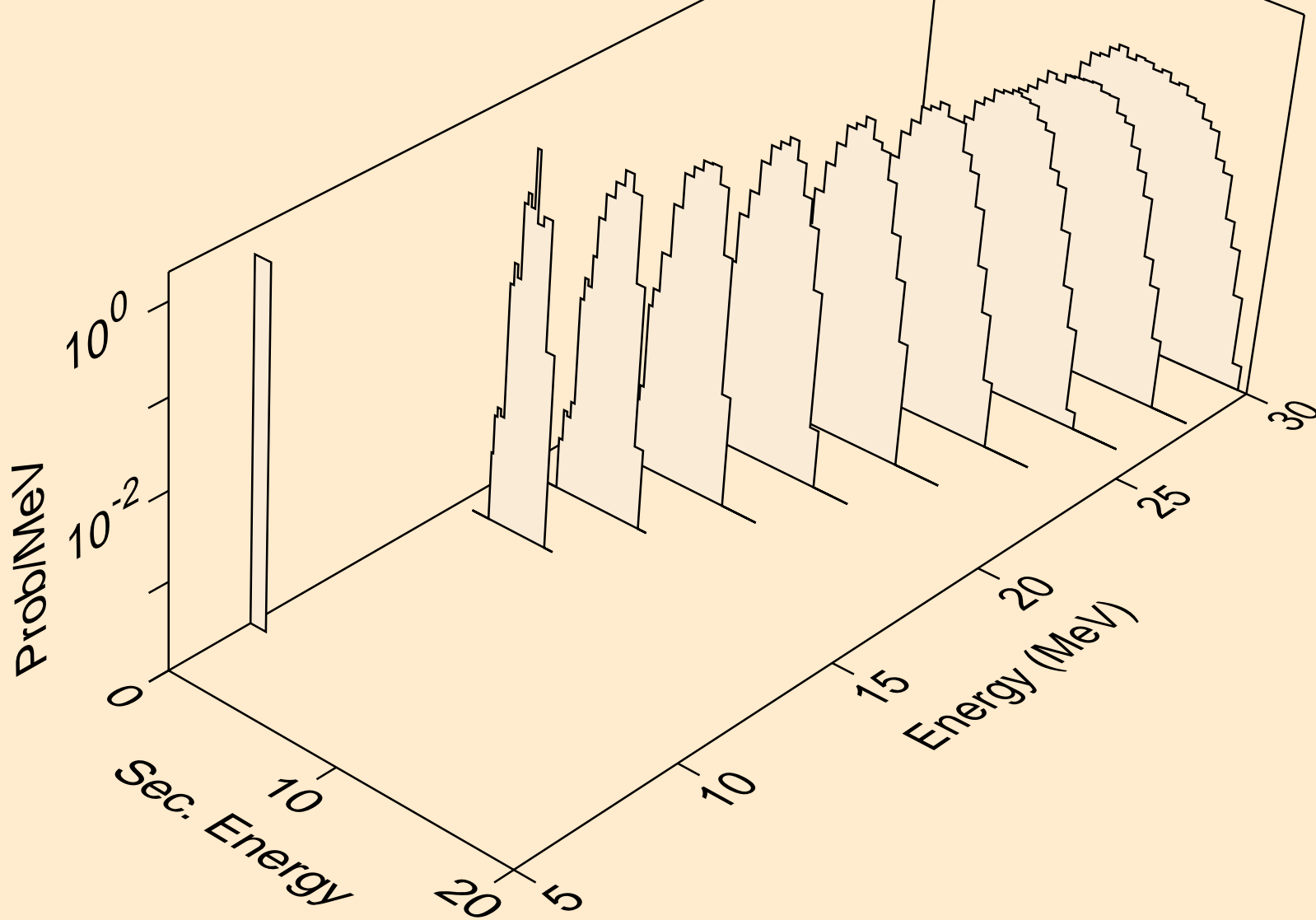

HF171 NEUTRON ACER TENDL-2019 LIBRARY; T=293.16K  
deuterons from (n,da)

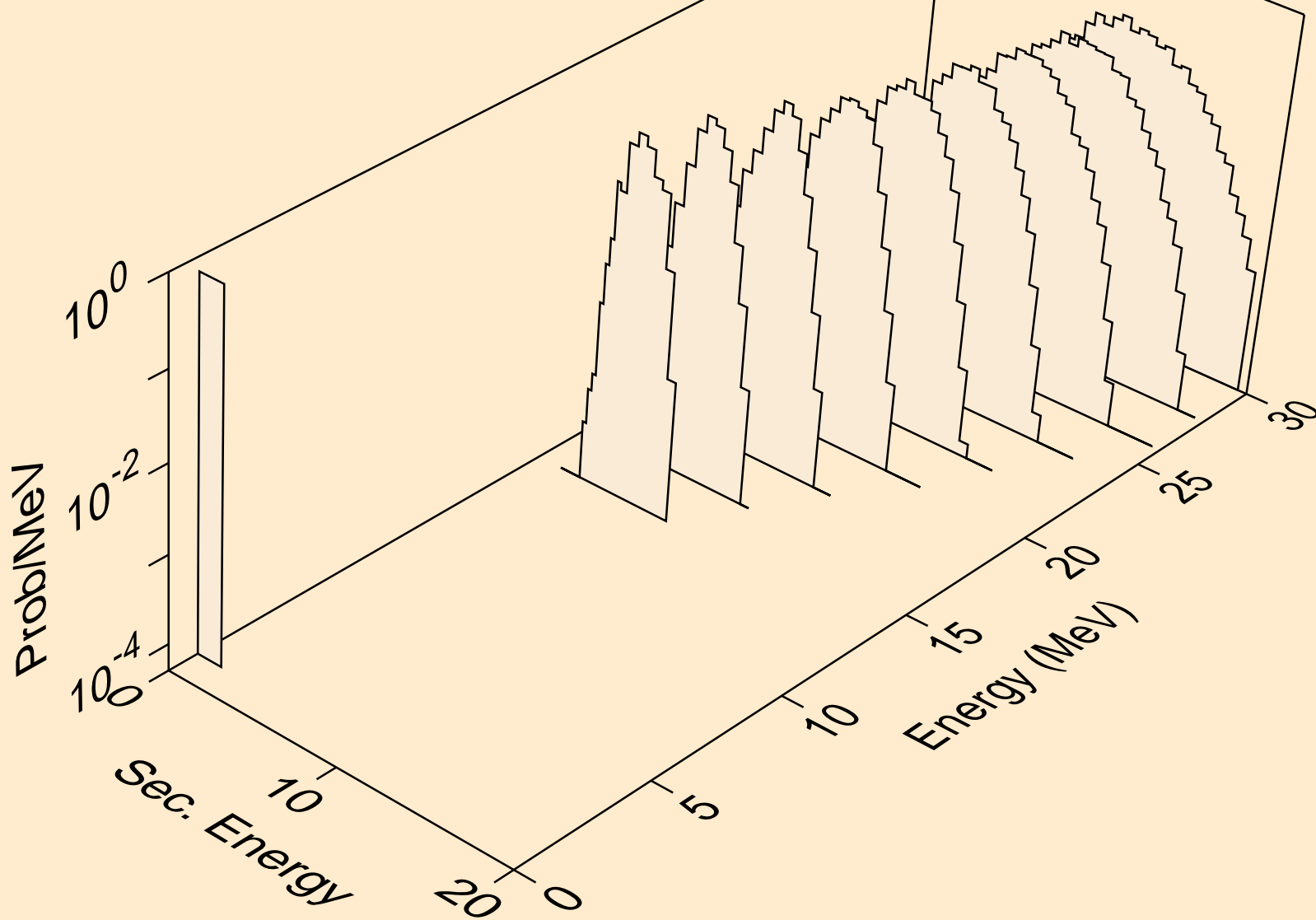

HF171 NEUTRON ACER TENDL-2019 LIBRARY; T=293.16K  
tritons from (n,x)

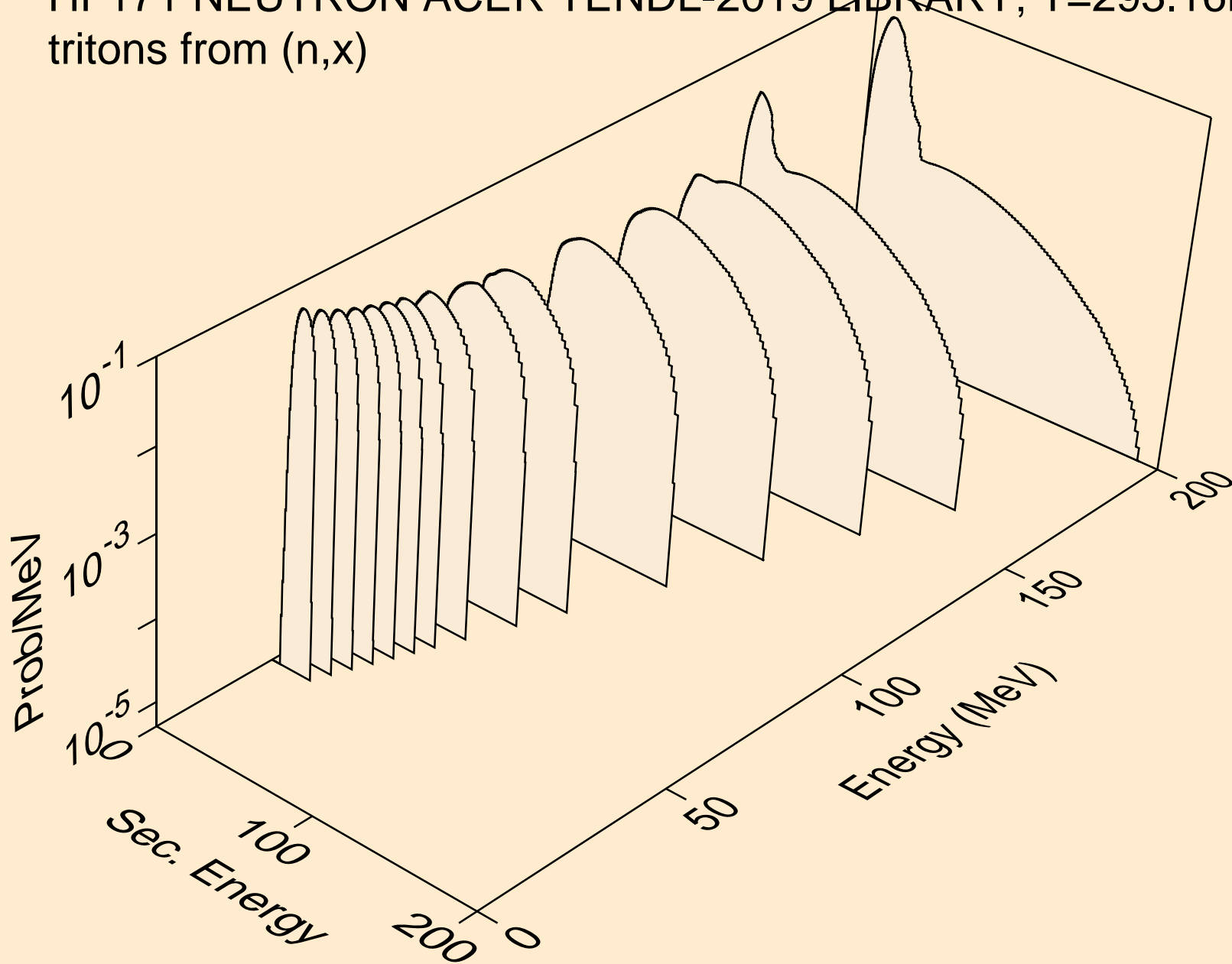

HF171 NEUTRON ACER TENDL-2019 LIBRARY; T=293.16K  
tritons from (n,n\*)t

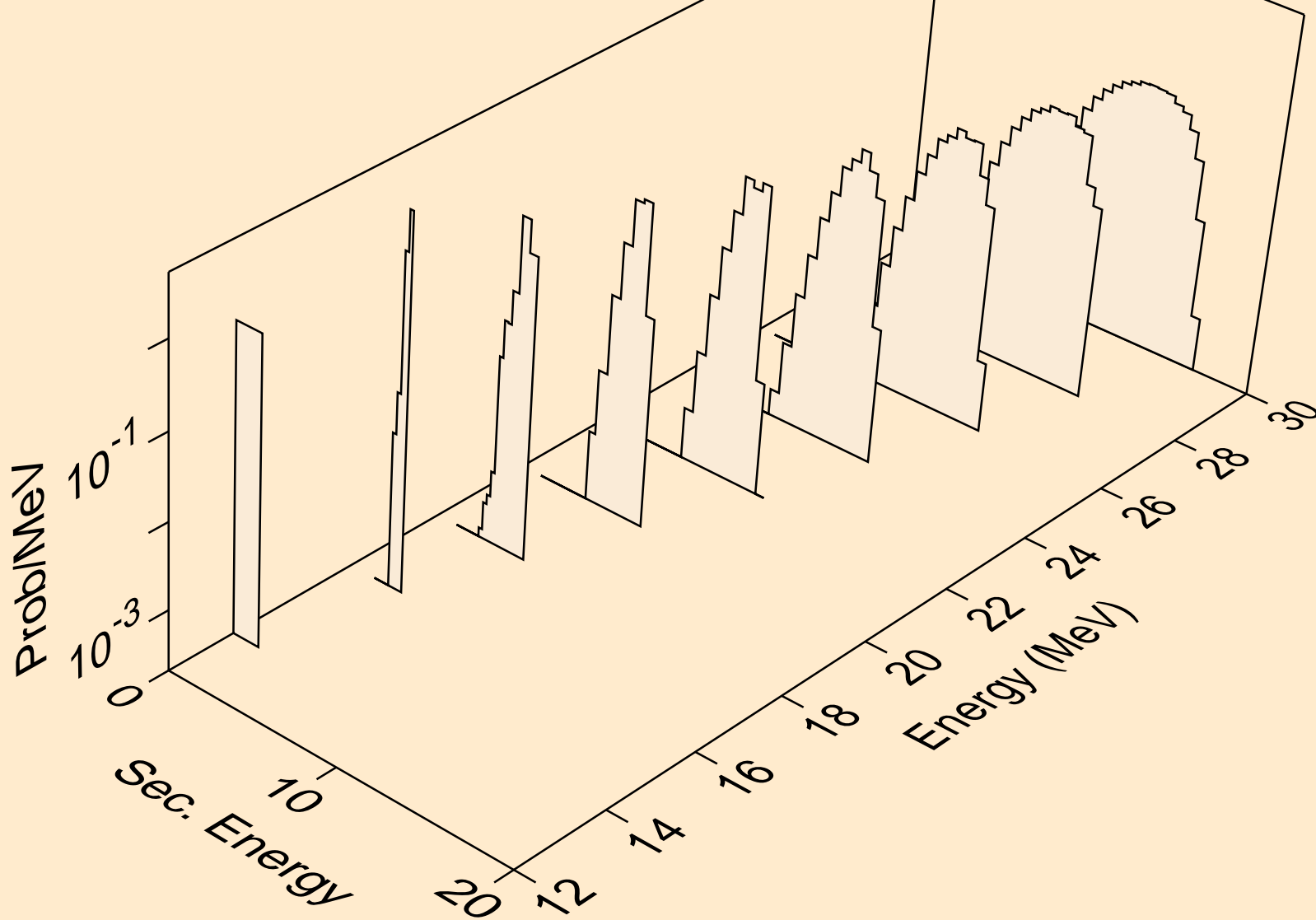

HF171 NEUTRON ACER TENDL-2019 LIBRARY; T=293.16K  
tritons from (n,t)

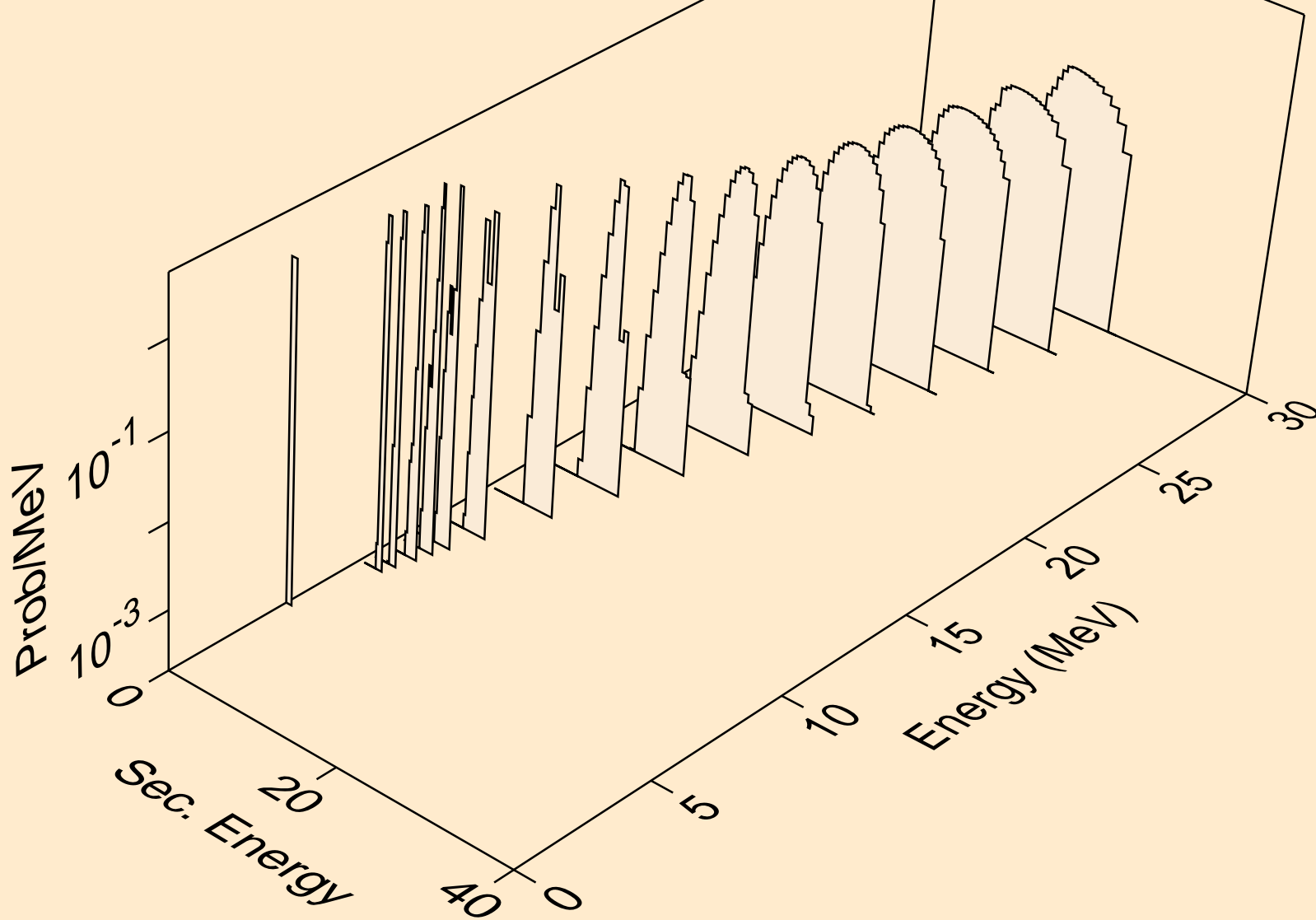

HF171 NEUTRON ACER TENDL-2019 LIBRARY; T=293.16K  
tritons from (n,pt)

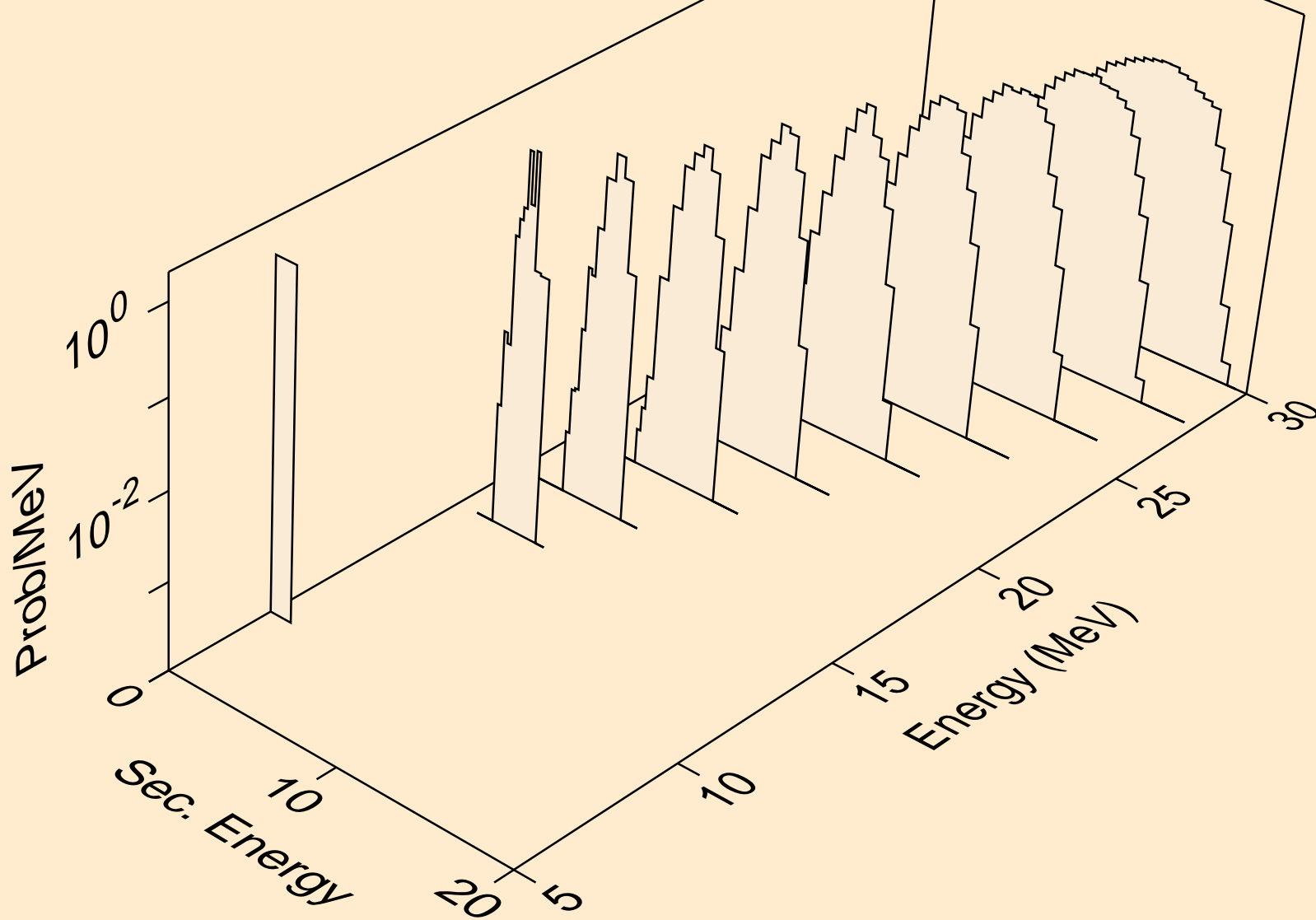

HF171 NEUTRON ACER TENDL-2019 LIBRARY; T=293.16K  
he3s from (n,x)

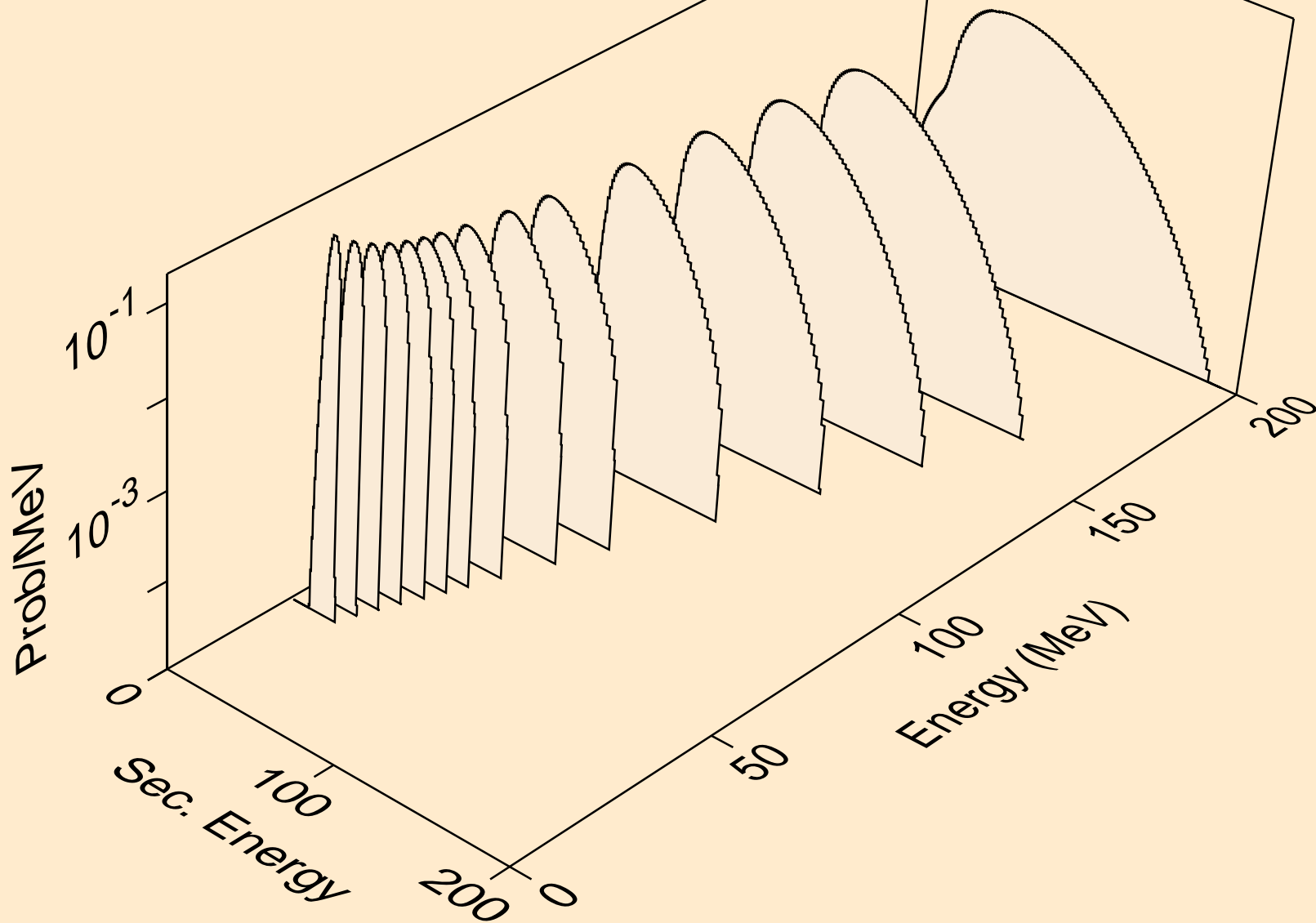



HF171 NEUTRON ACER TENDL-2019 LIBRARY; T=293.16K  
he3s from (n,n\*)he3

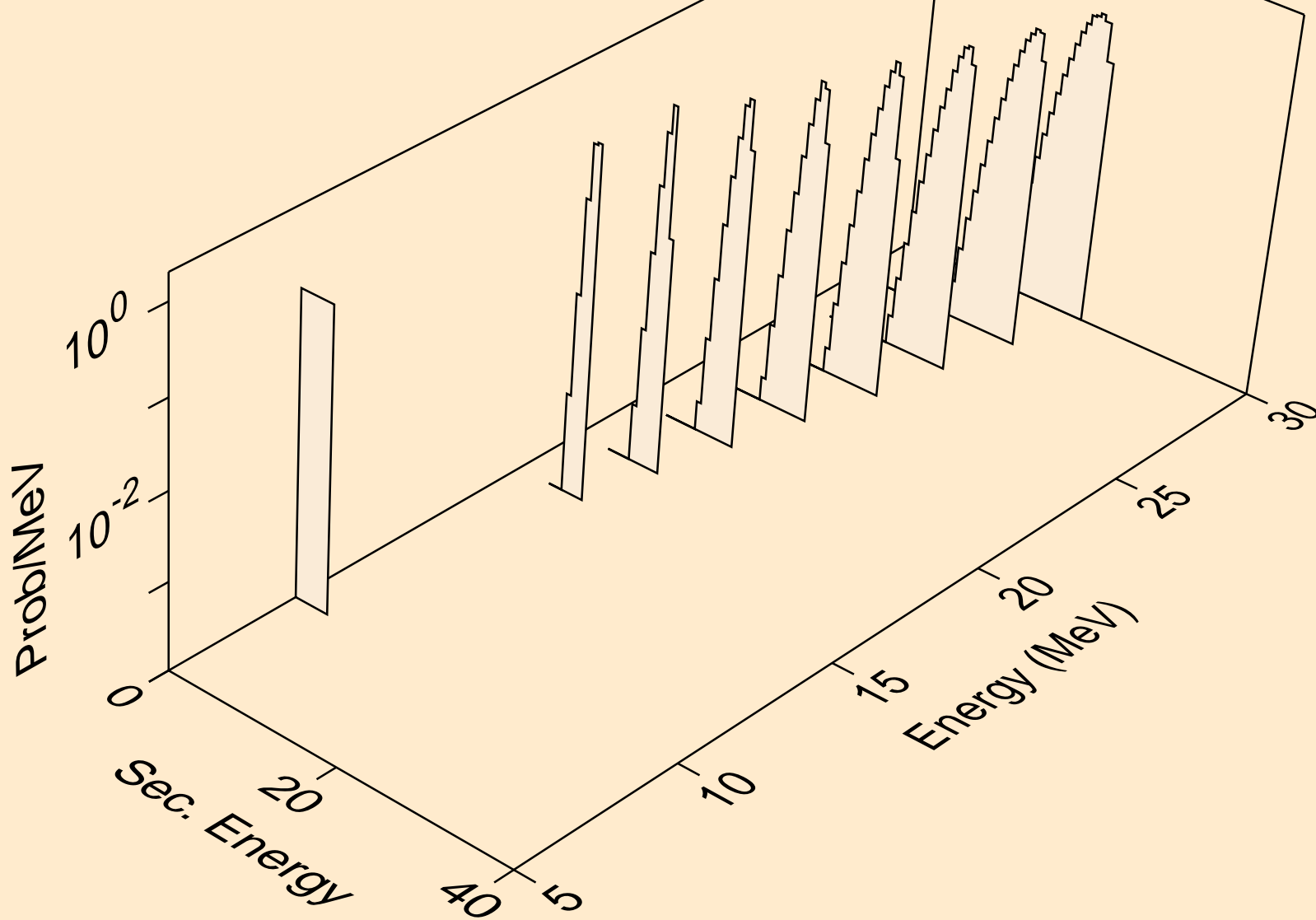

HF171 NEUTRON ACER TENDL-2019 LIBRARY; T=293.16K  
he3s from (n,he3)

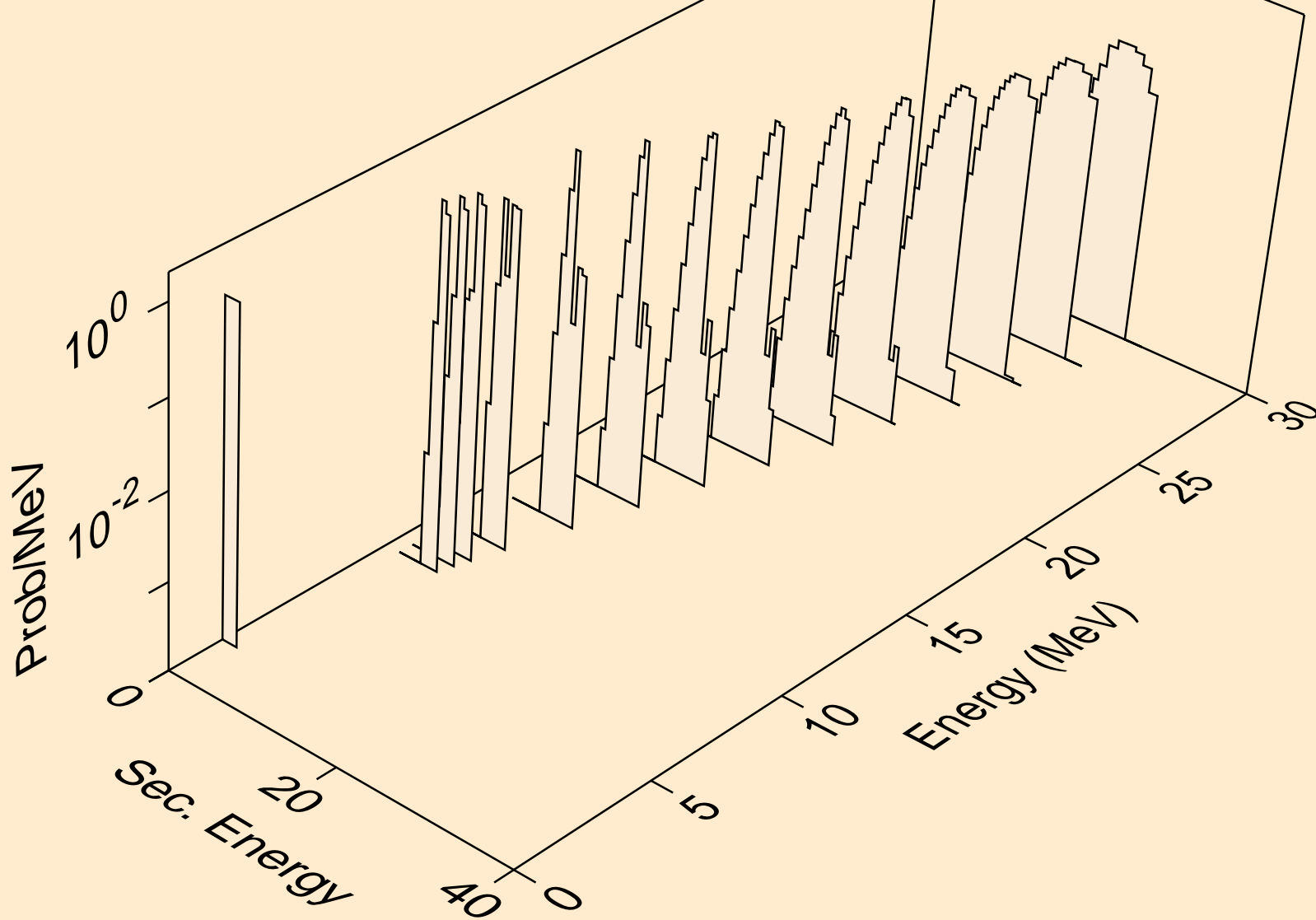

HF171 NEUTRON ACER TENDL-2019 LIBRARY; T=293.16K  
alphas from (n,x)

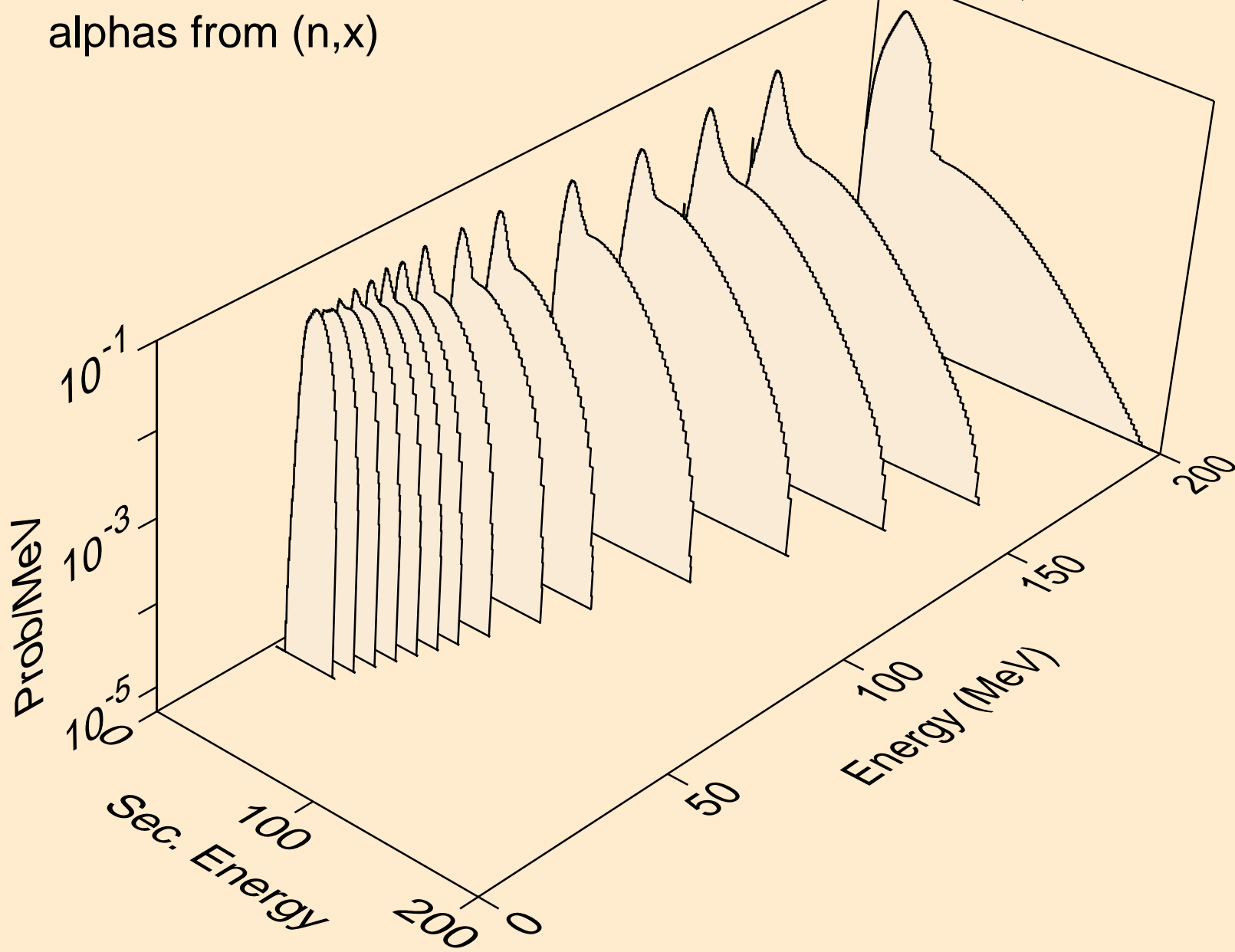

HF171 NEUTRON ACER TENDL-2019 LIBRARY; T=293.16K  
alphas from (n,n\*)a

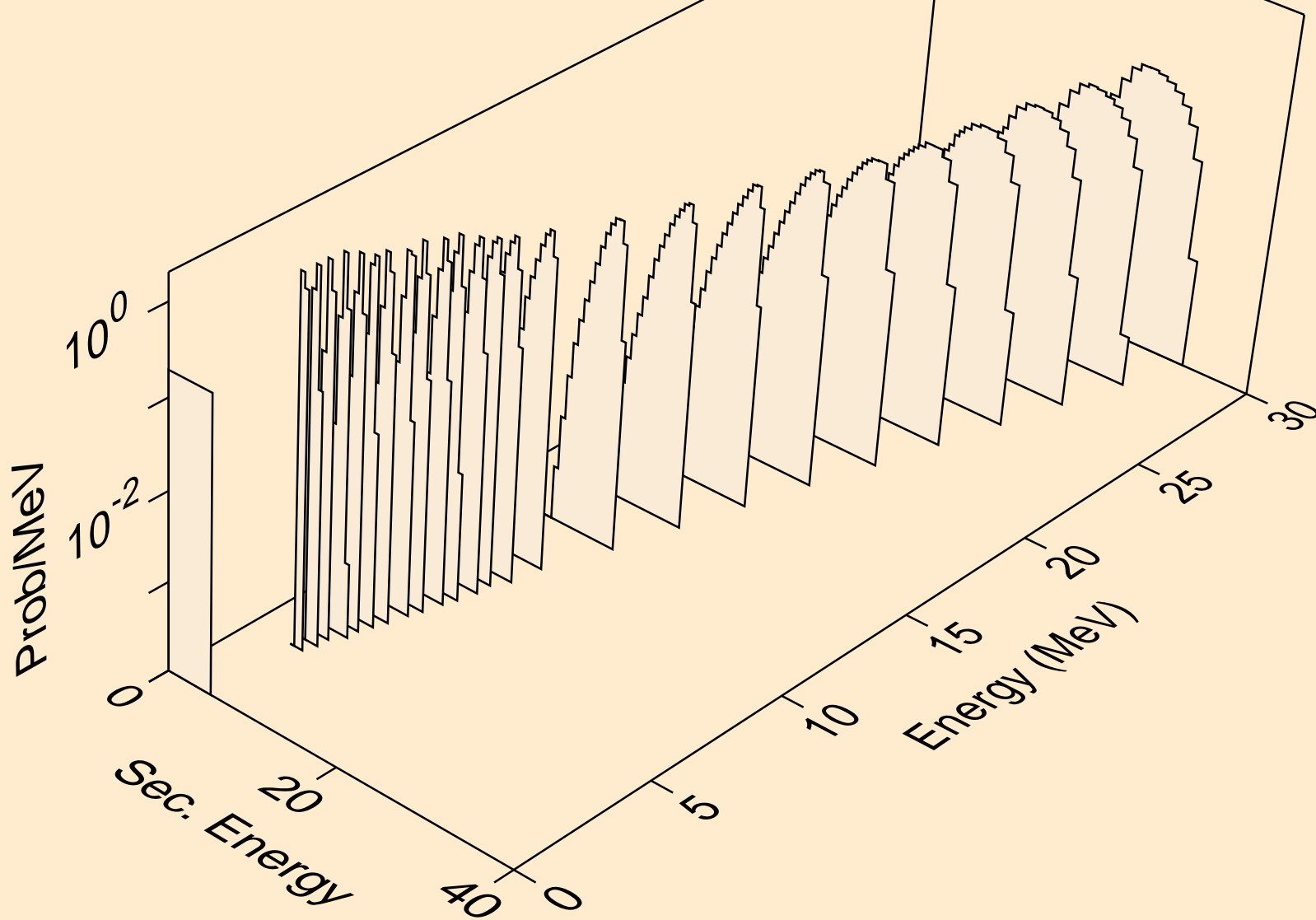

HF171 NEUTRON ACER TENDL-2019 LIBRARY; T=293.16K  
alphas from (n,2n)a

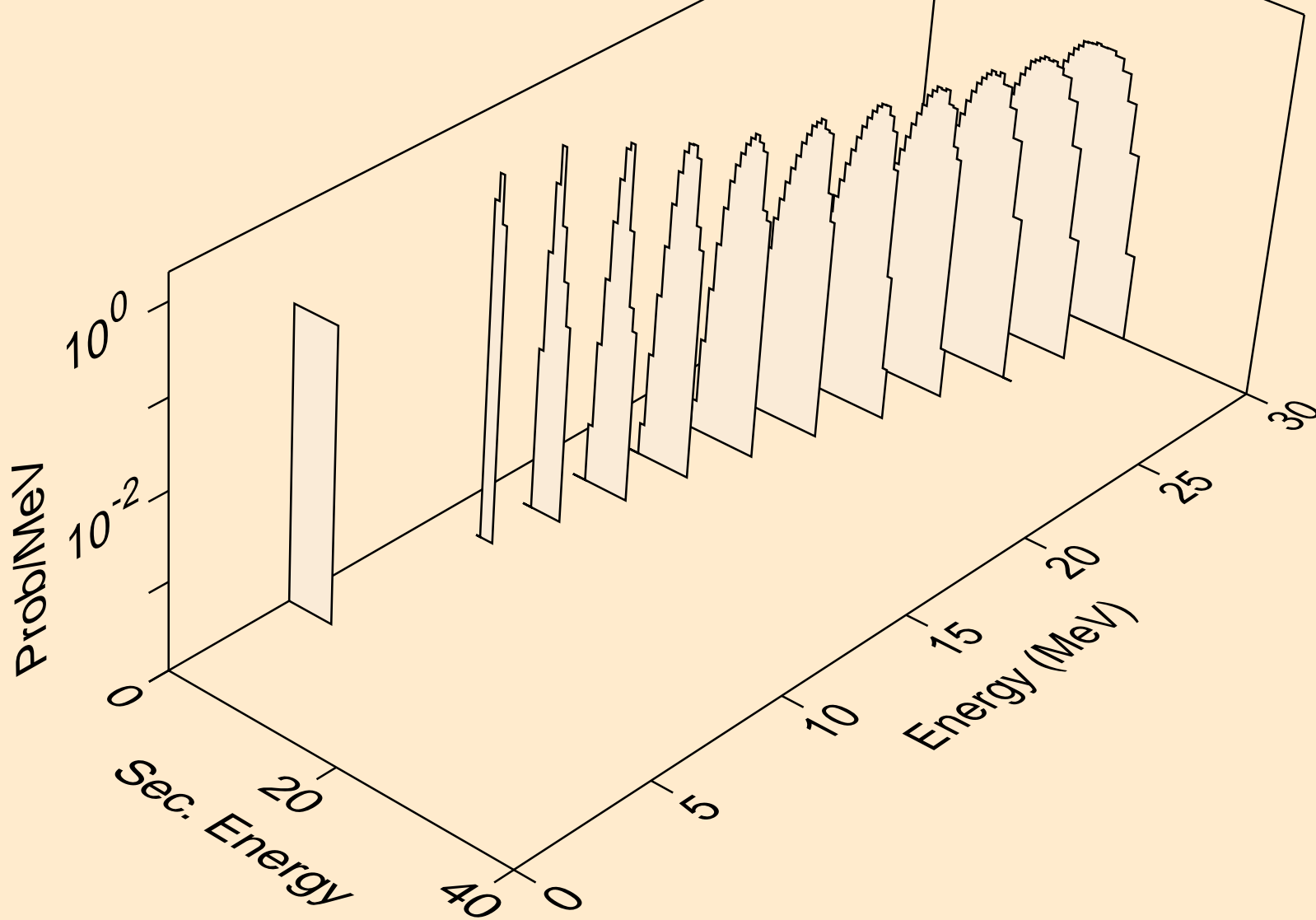

HF171 NEUTRON ACER TENDL-2019 LIBRARY; T=293.16K  
alphas from (n,3n)a

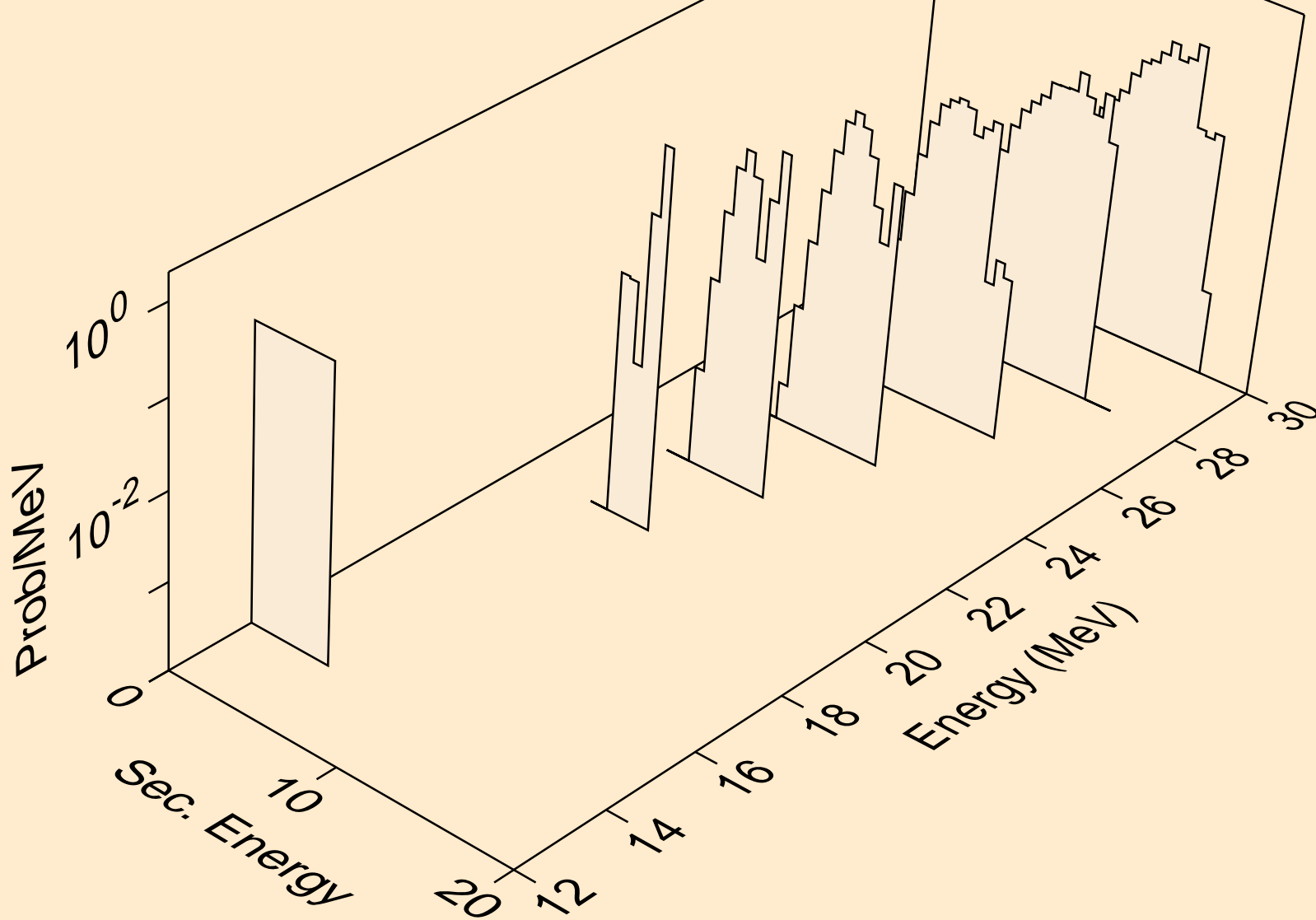

HF171 NEUTRON ACER TENDL-2019 LIBRARY; T=293.16K  
alphas from (n,n\*)2a

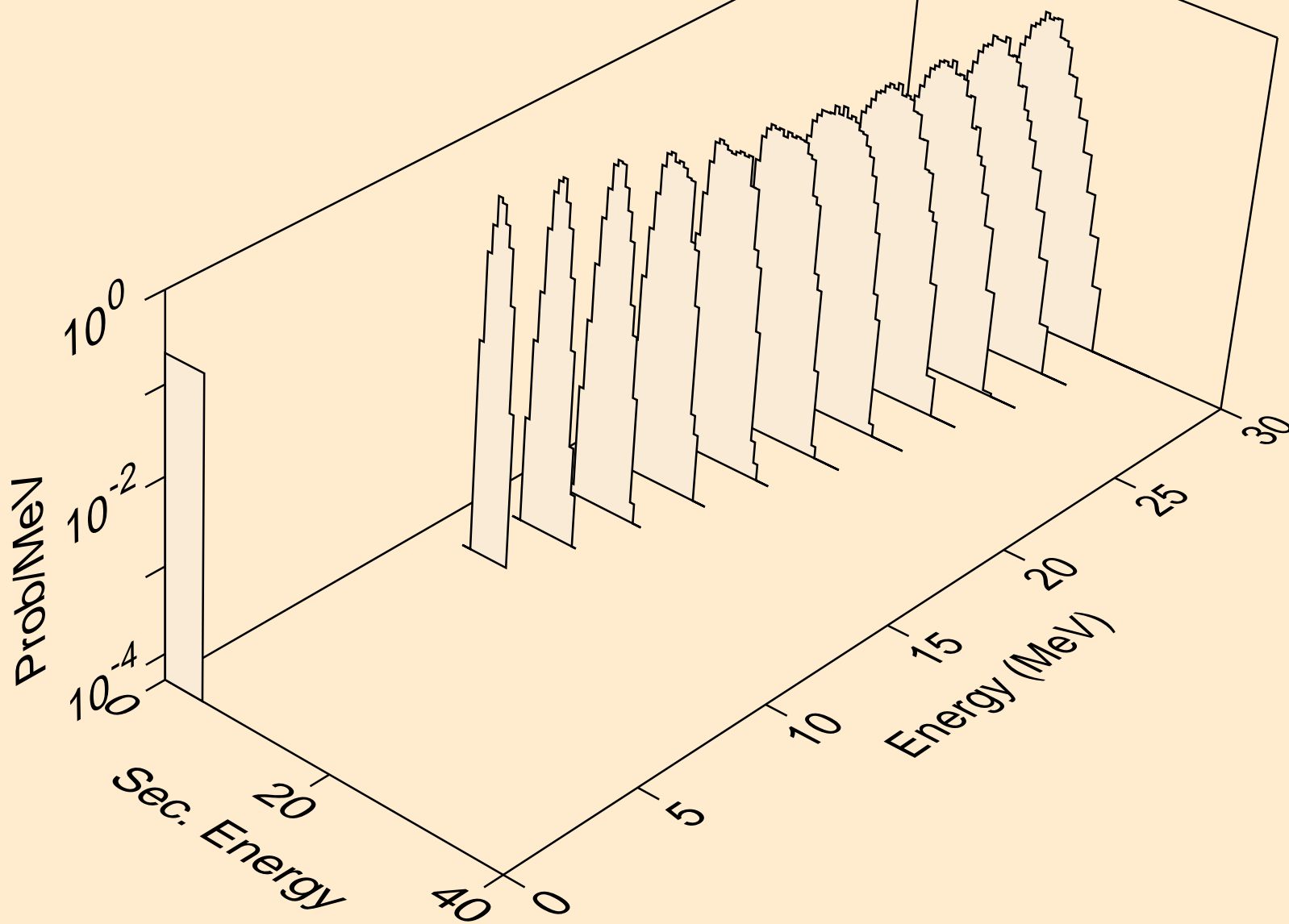

HF171 NEUTRON ACER TENDL-2019 LIBRARY; T=293.16K  
alphas from (n,2n)2a

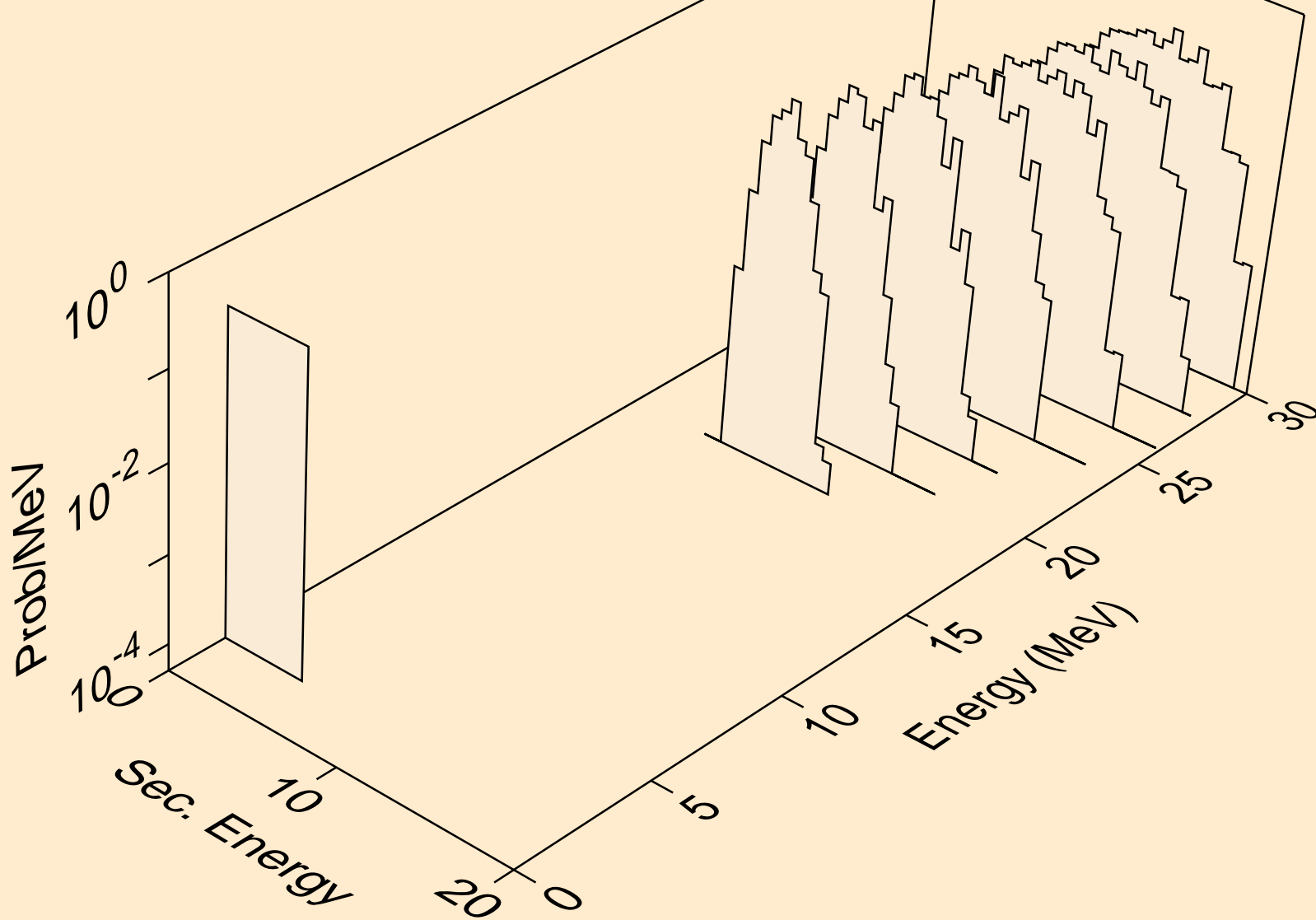



HF171 NEUTRON ACER TENDL-2019 LIBRARY; T=293.16K  
alphas from (n,npa)

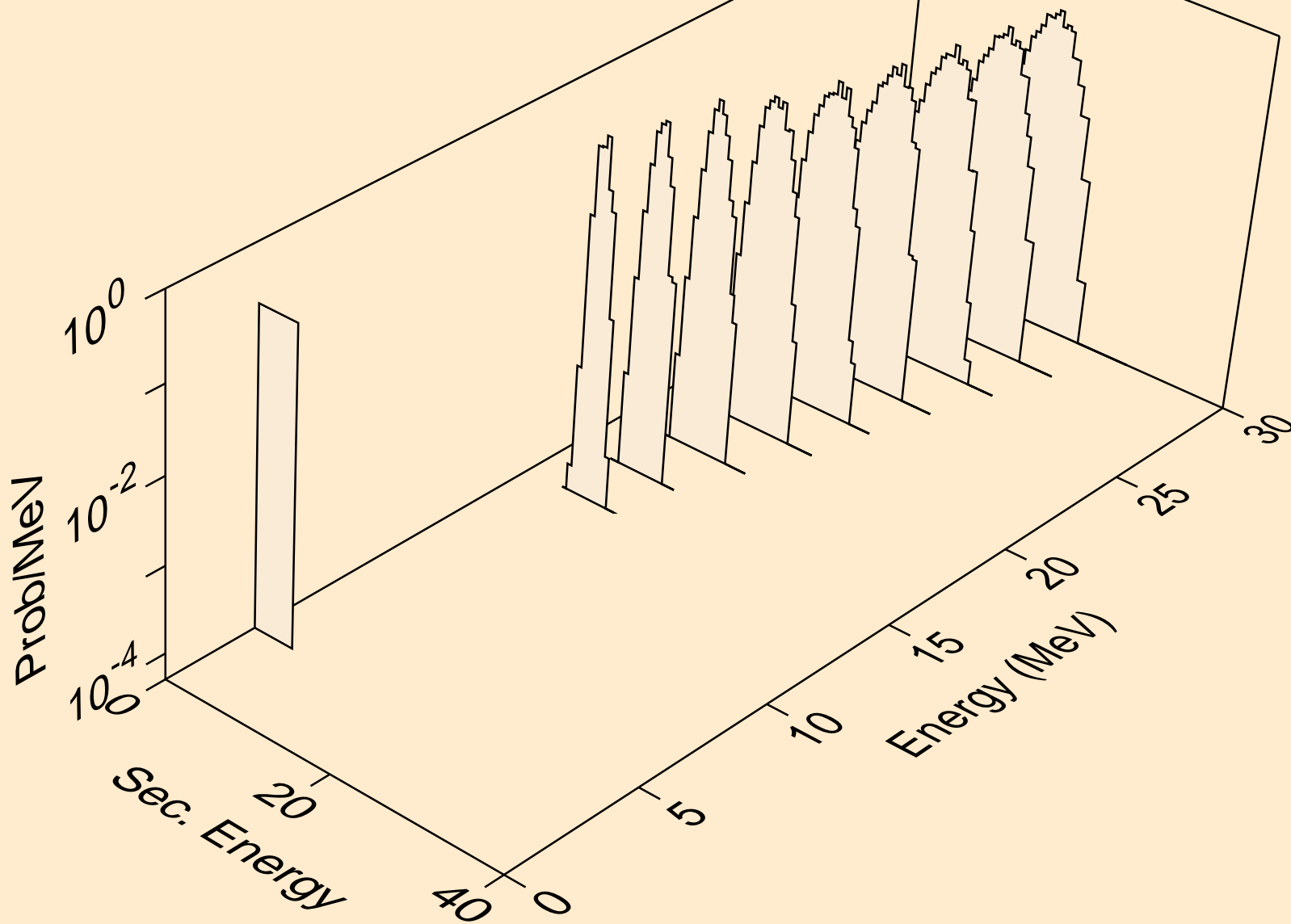

HF171 NEUTRON ACER TENDL-2019 LIBRARY; T=293.16K  
alphas from (n,a)

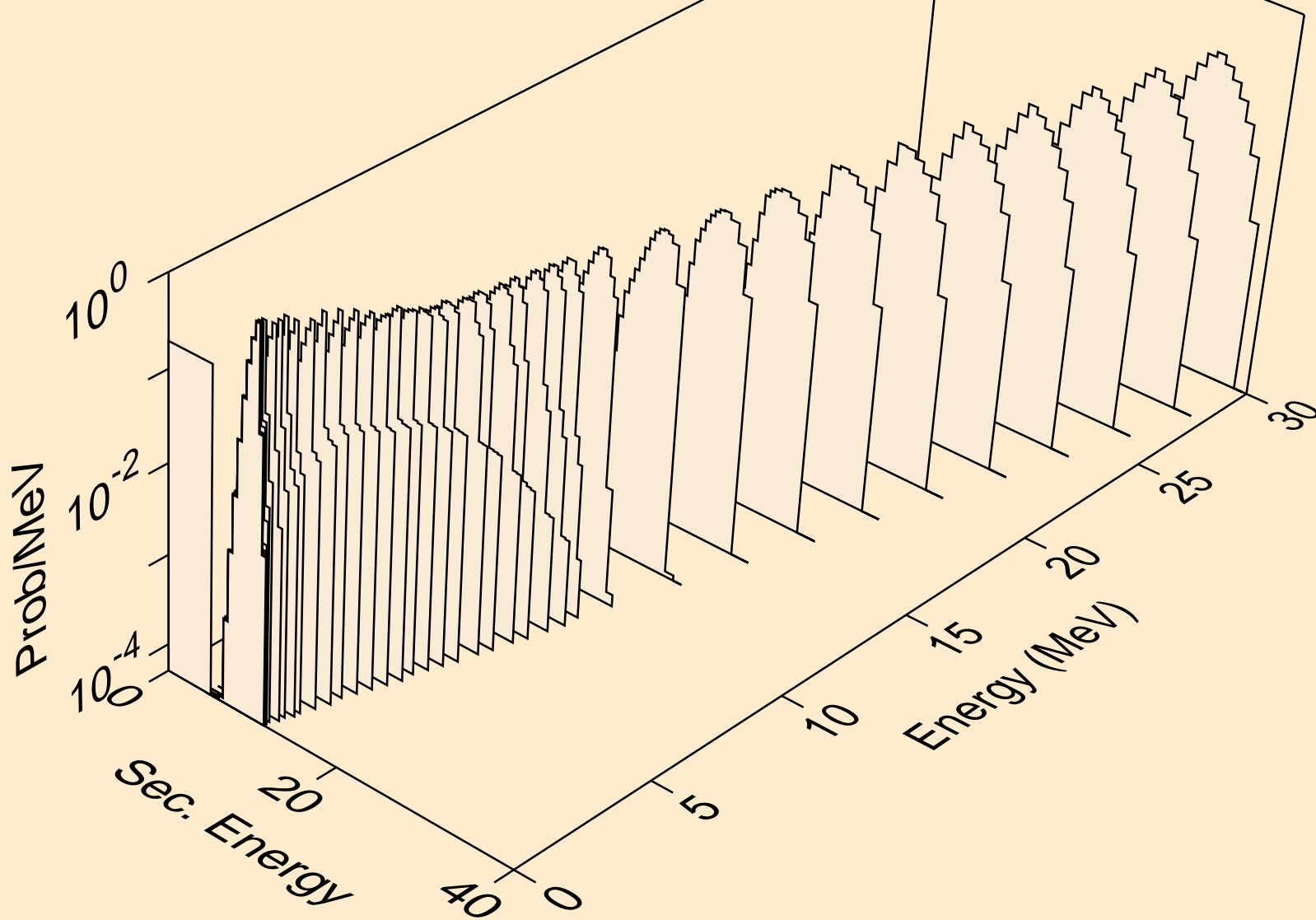

HF171 NEUTRON ACER TENDL-2019 LIBRARY; T=293.16K  
alphas from (n,2a)

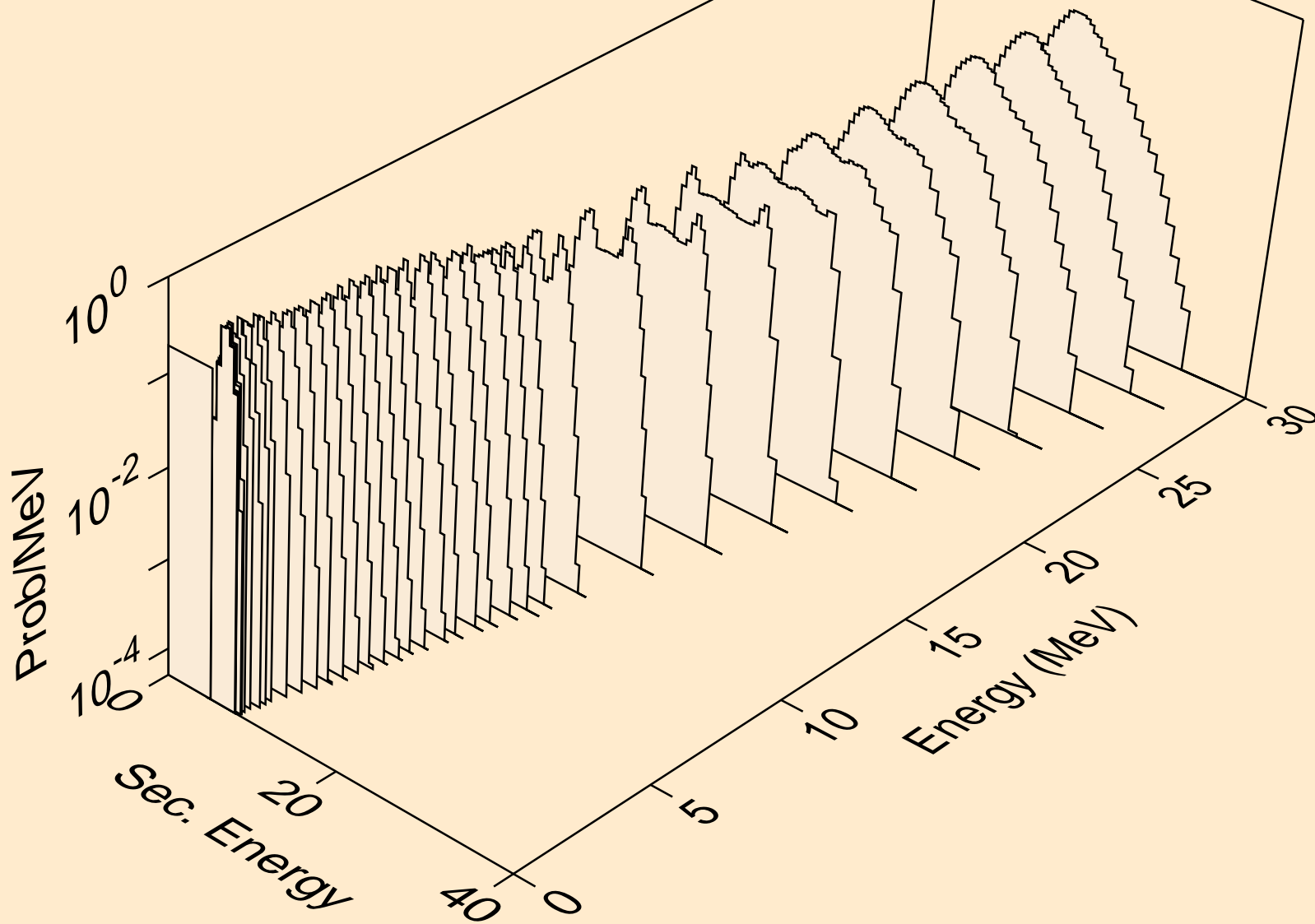

HF171 NEUTRON ACER TENDL-2019 LIBRARY; T=293.16K  
alphas from (n,pa)

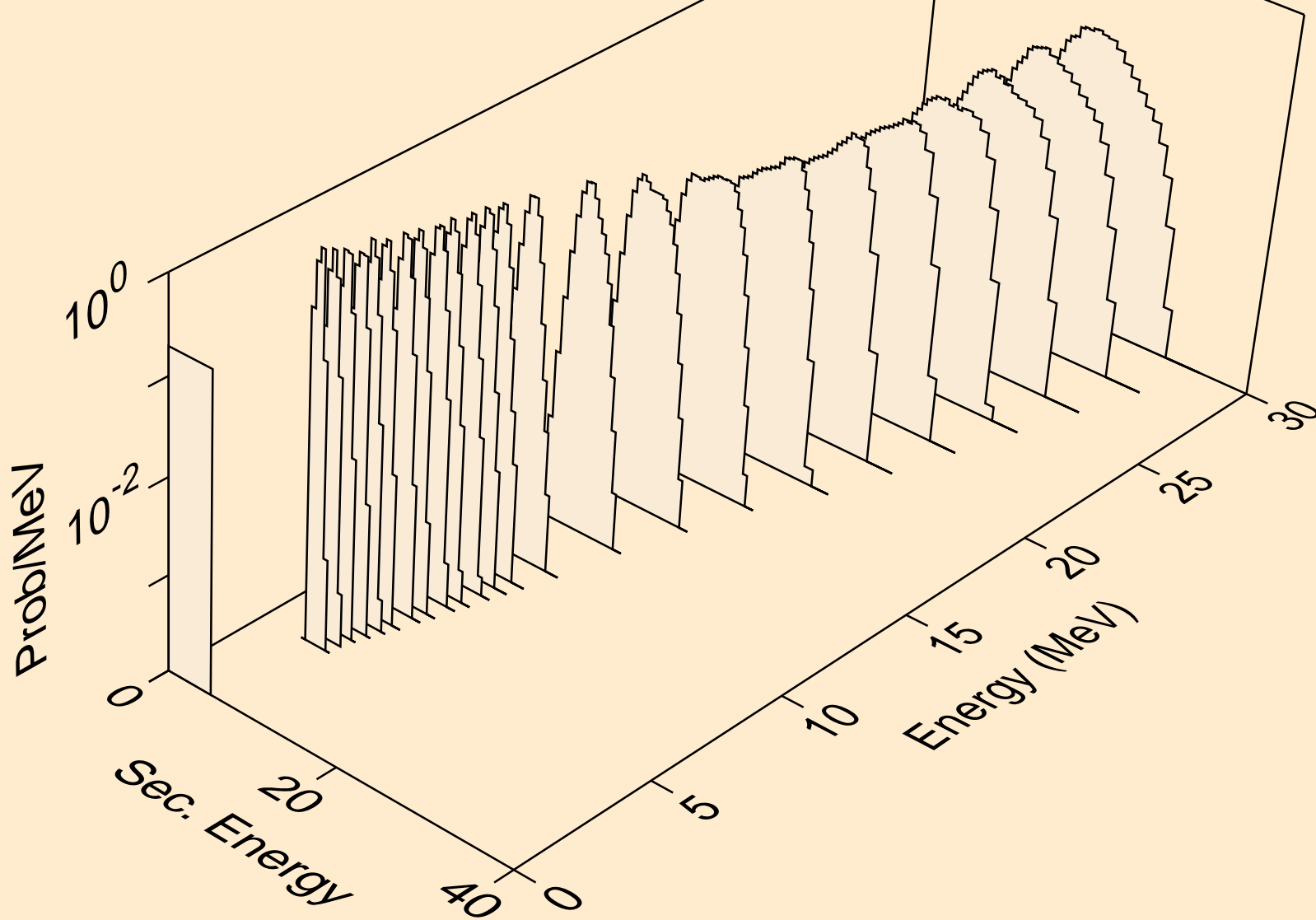

HF171 NEUTRON ACER TENDL-2019 LIBRARY; T=293.16K  
alphas from (n,da)

