

HF177N NEUTRON ACER TENDL-2019 LIBRARY; T=293.16K

Principal cross sections

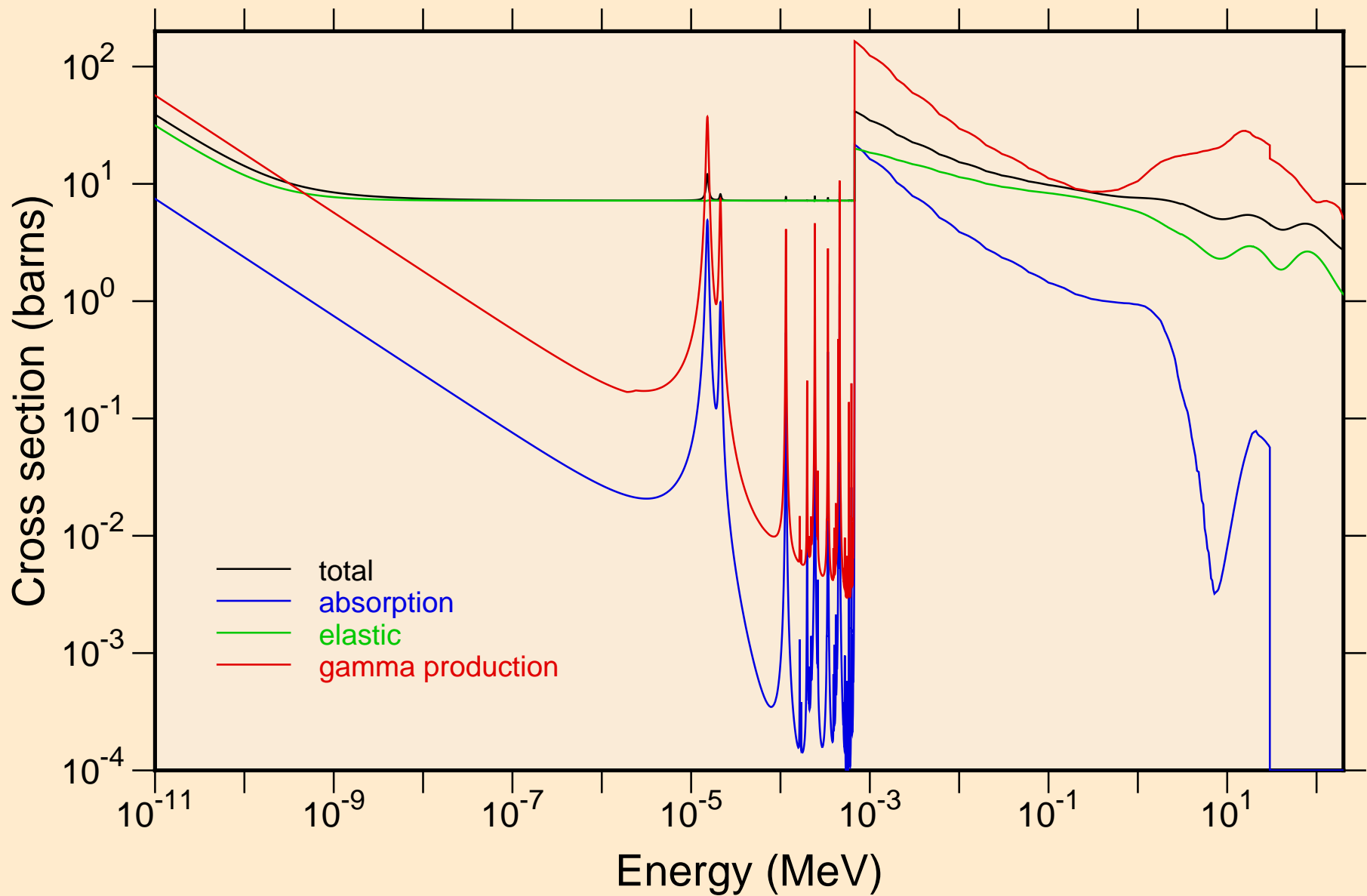

HF177N NEUTRON ACER TENDL-2019 LIBRARY; T=293.16K
resonance total cross section

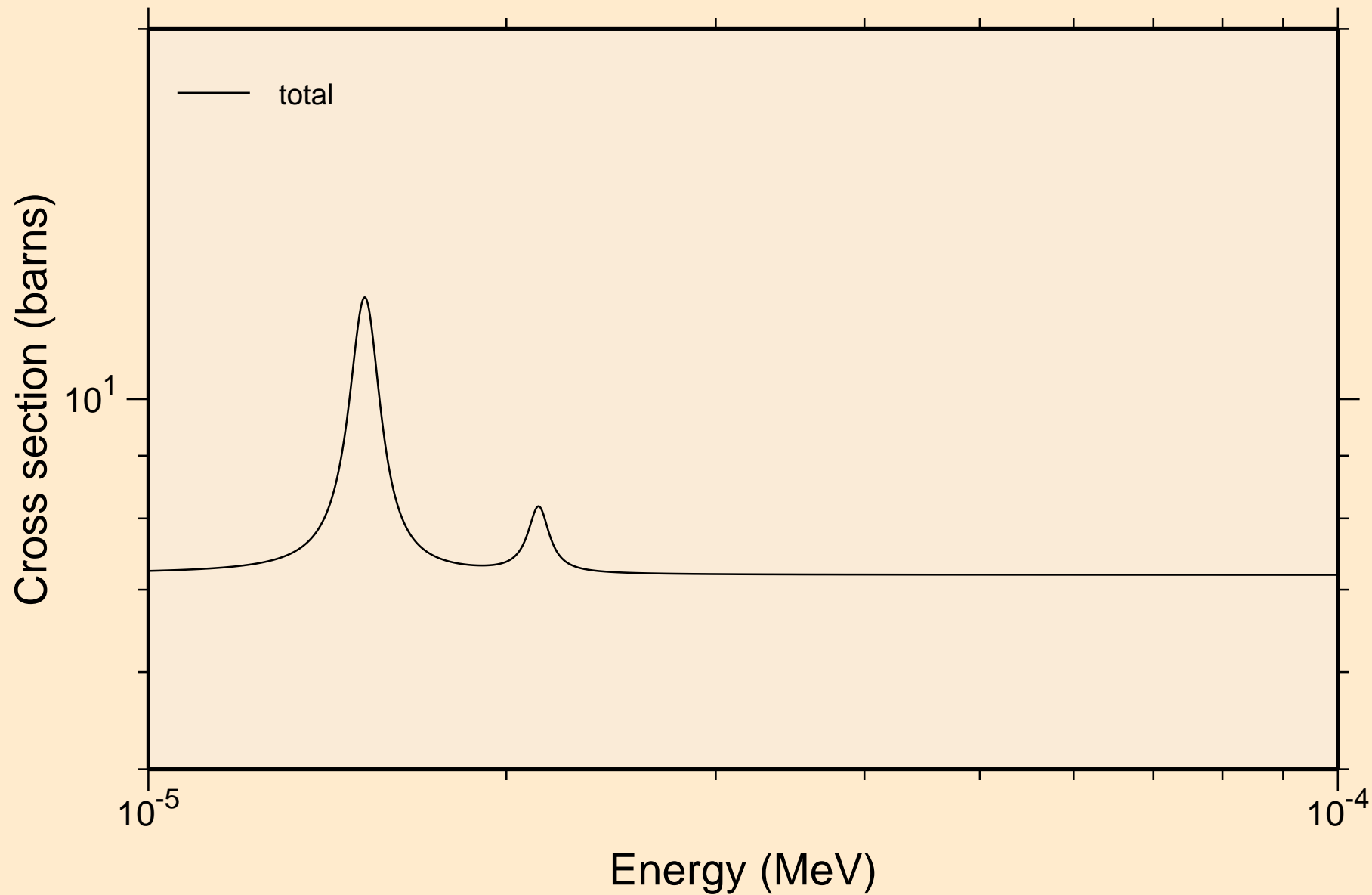

HF177N NEUTRON ACER TENDL-2019 LIBRARY; T=293.16K
resonance total cross section

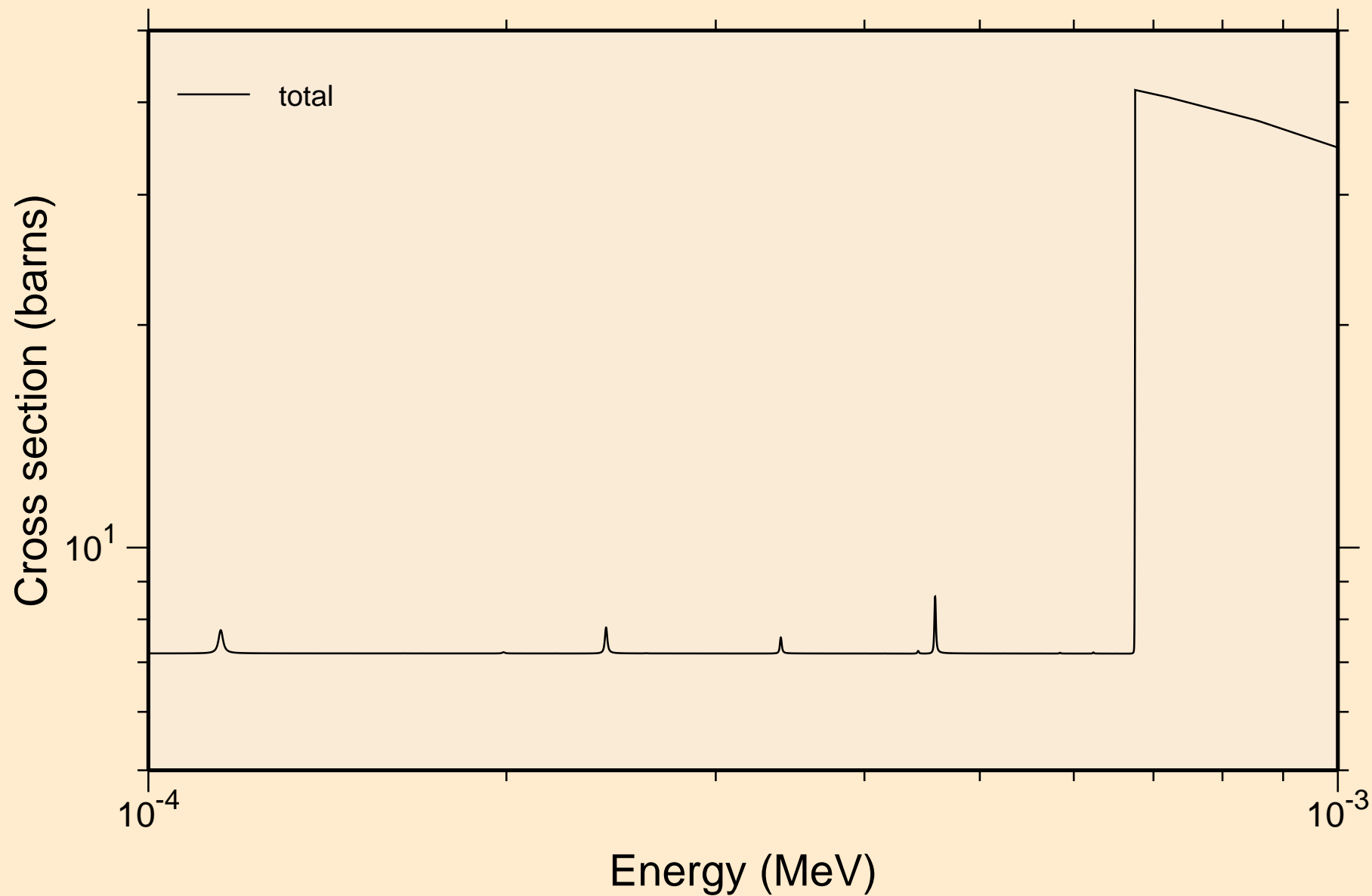

HF177N NEUTRON ACER TENDL-2019 LIBRARY; T=293.16K
resonance total cross section

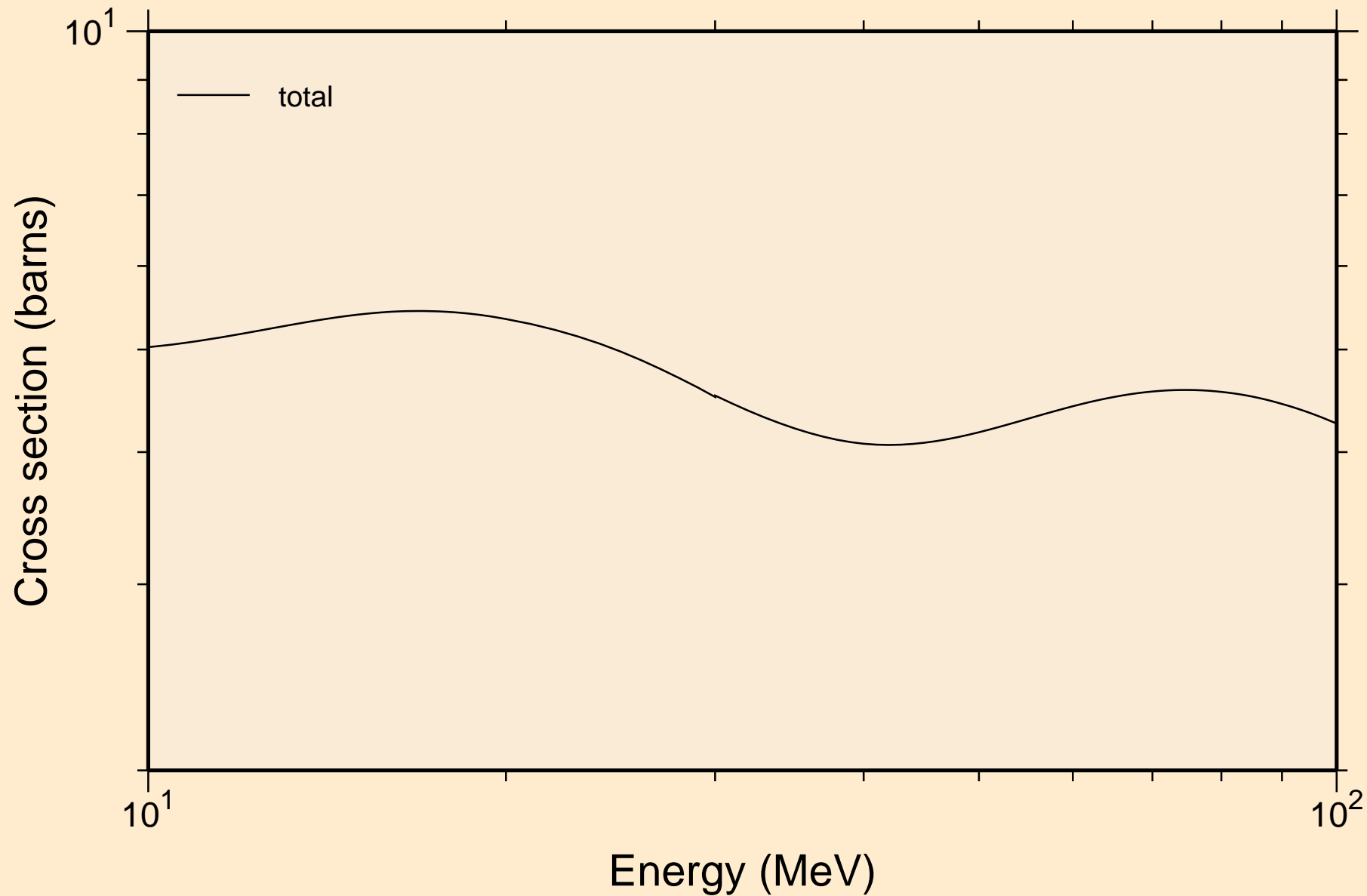

HF177N NEUTRON ACER TENDL-2019 LIBRARY; T=293.16K
resonance absorption cross sections

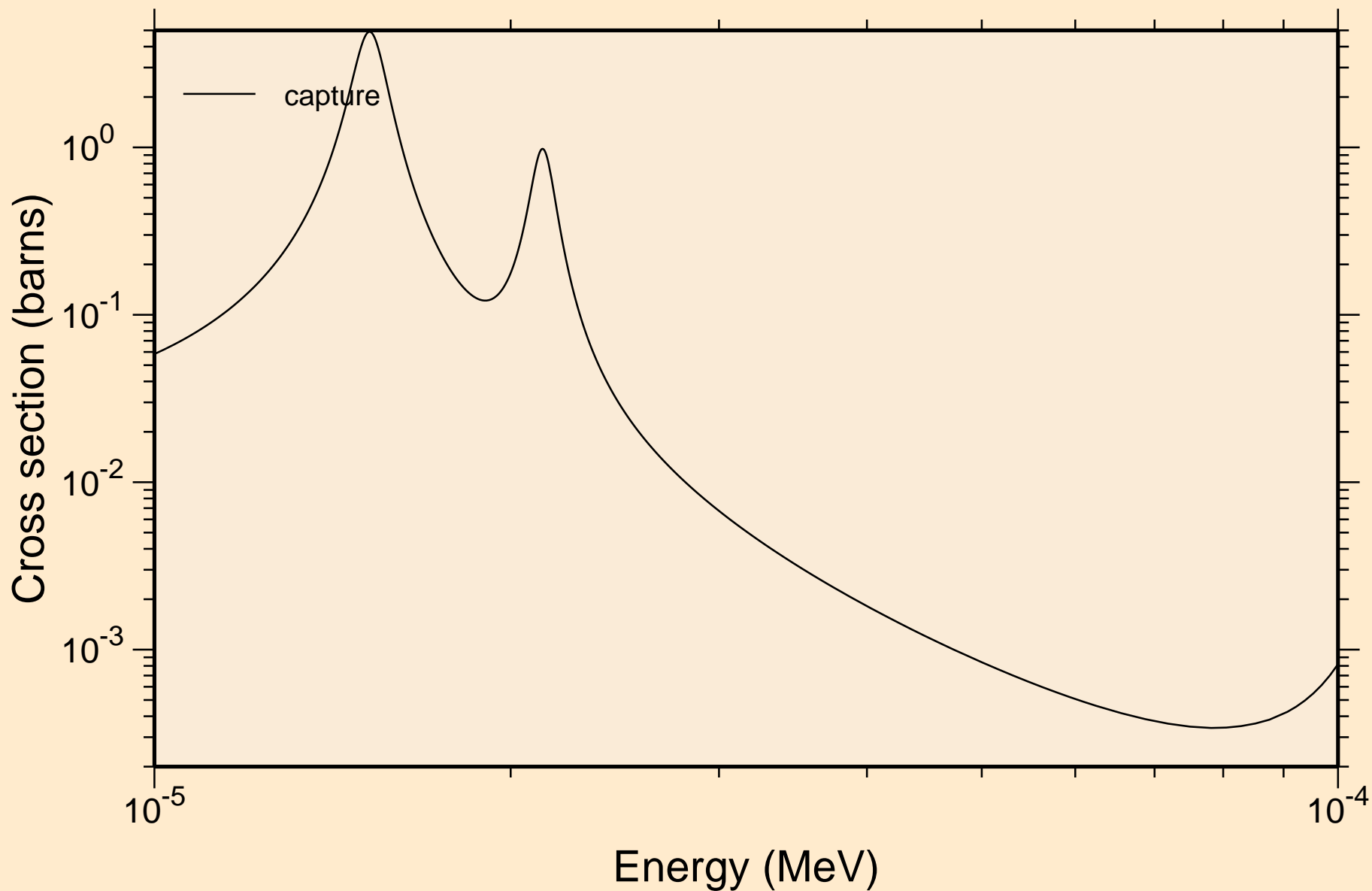

HF177N NEUTRON ACER TENDL-2019 LIBRARY; T=293.16K
resonance absorption cross sections

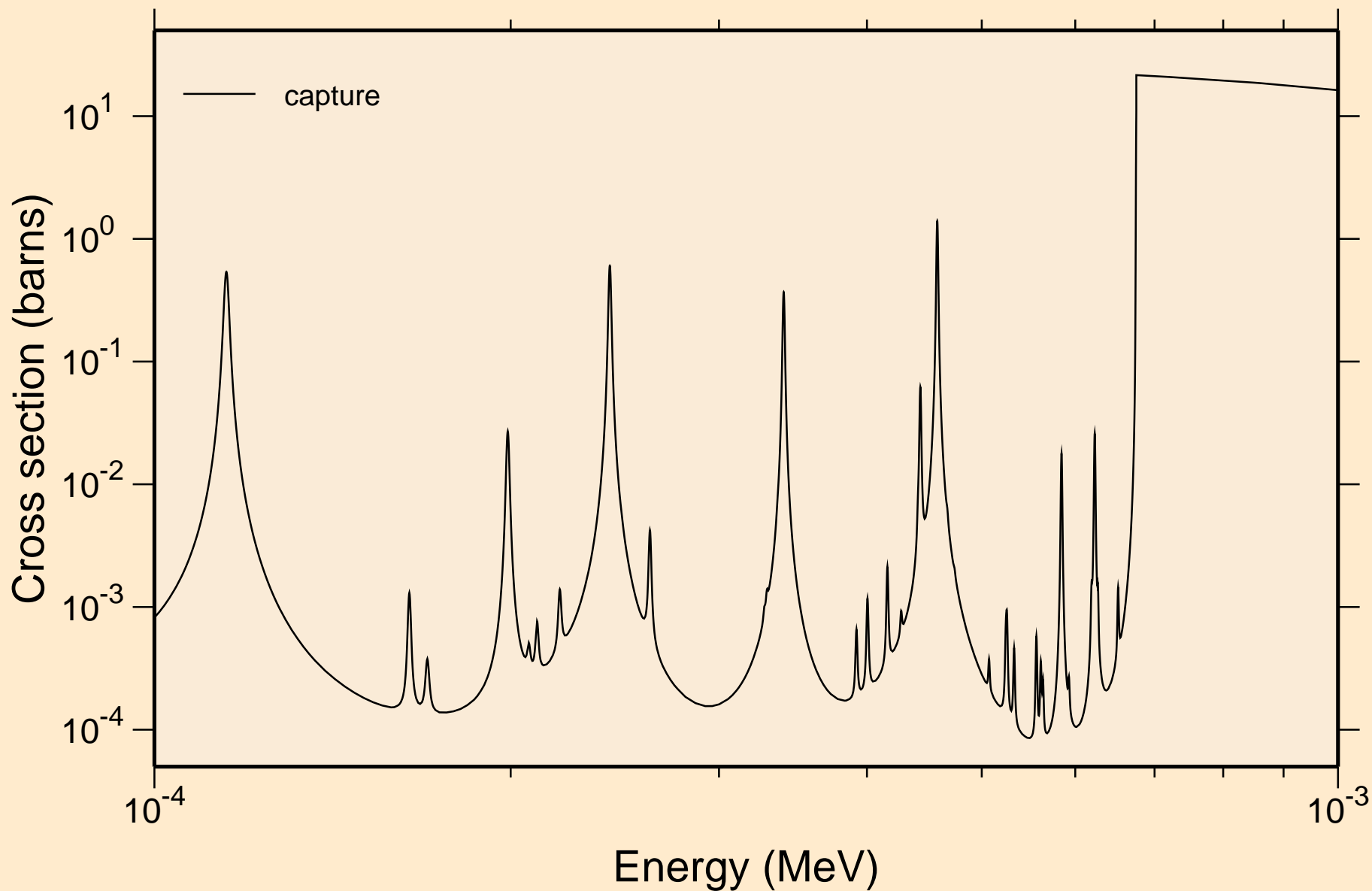

HF177N NEUTRON ACER TENDL-2019 LIBRARY; T=293.16K
resonance absorption cross sections

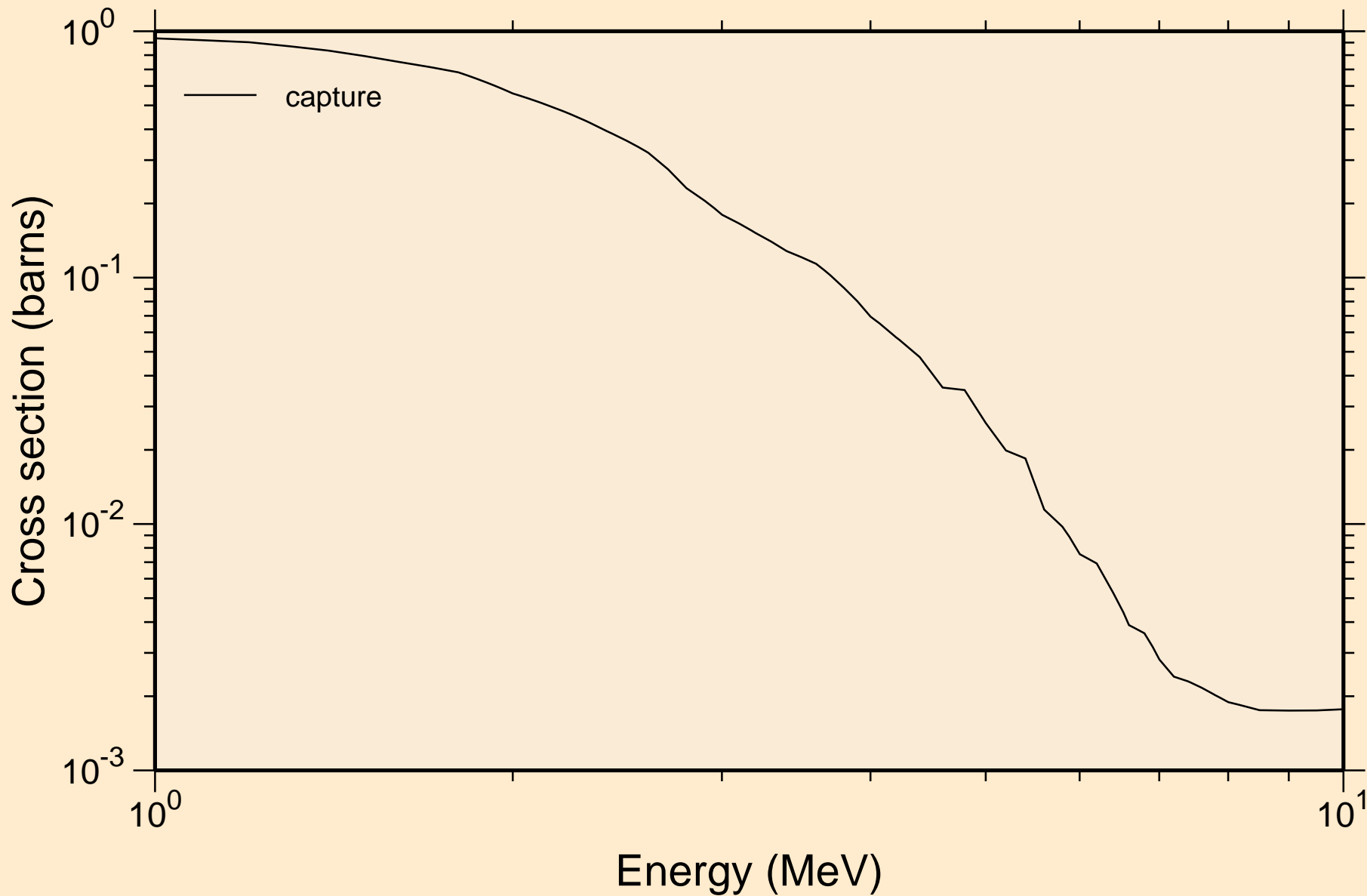

HF177N NEUTRON ACER TENDL-2019 LIBRARY; T=293.16K
Heating

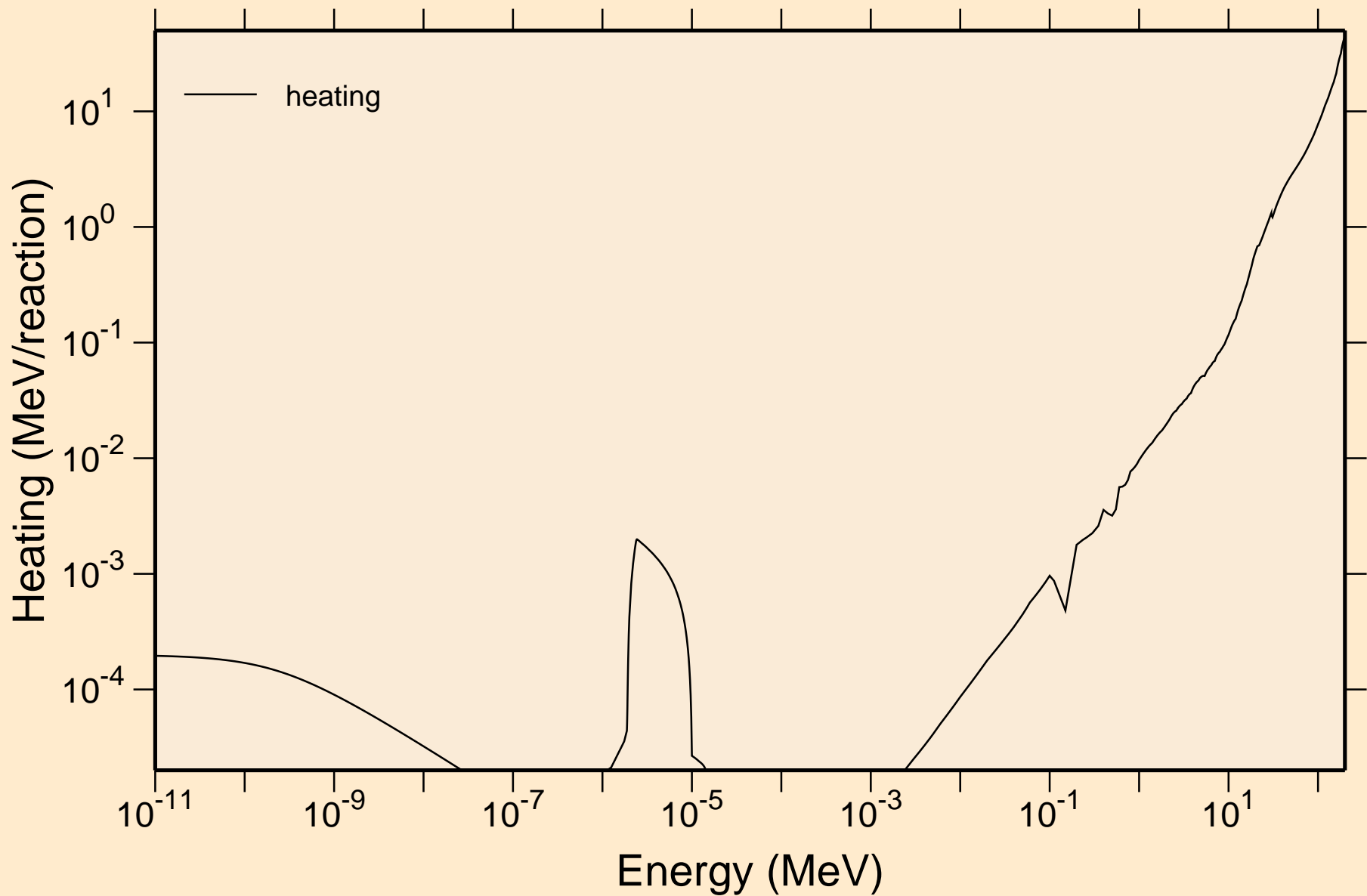

HF177N NEUTRON ACER TENDL-2019 LIBRARY; T=293.16K Damage

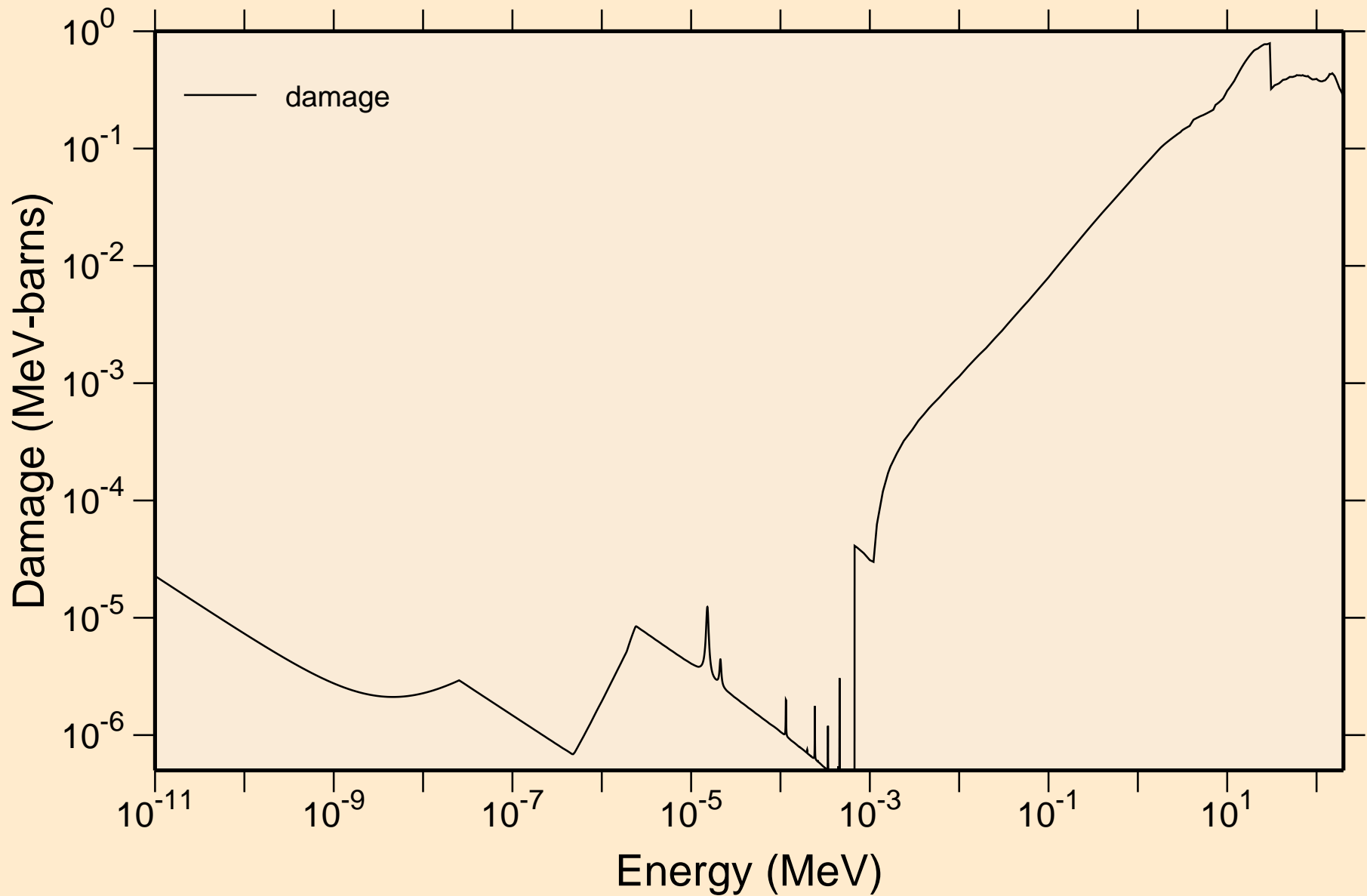

HF177N NEUTRON ACER TENDL-2019 LIBRARY; T=293.16K

Non-threshold reactions

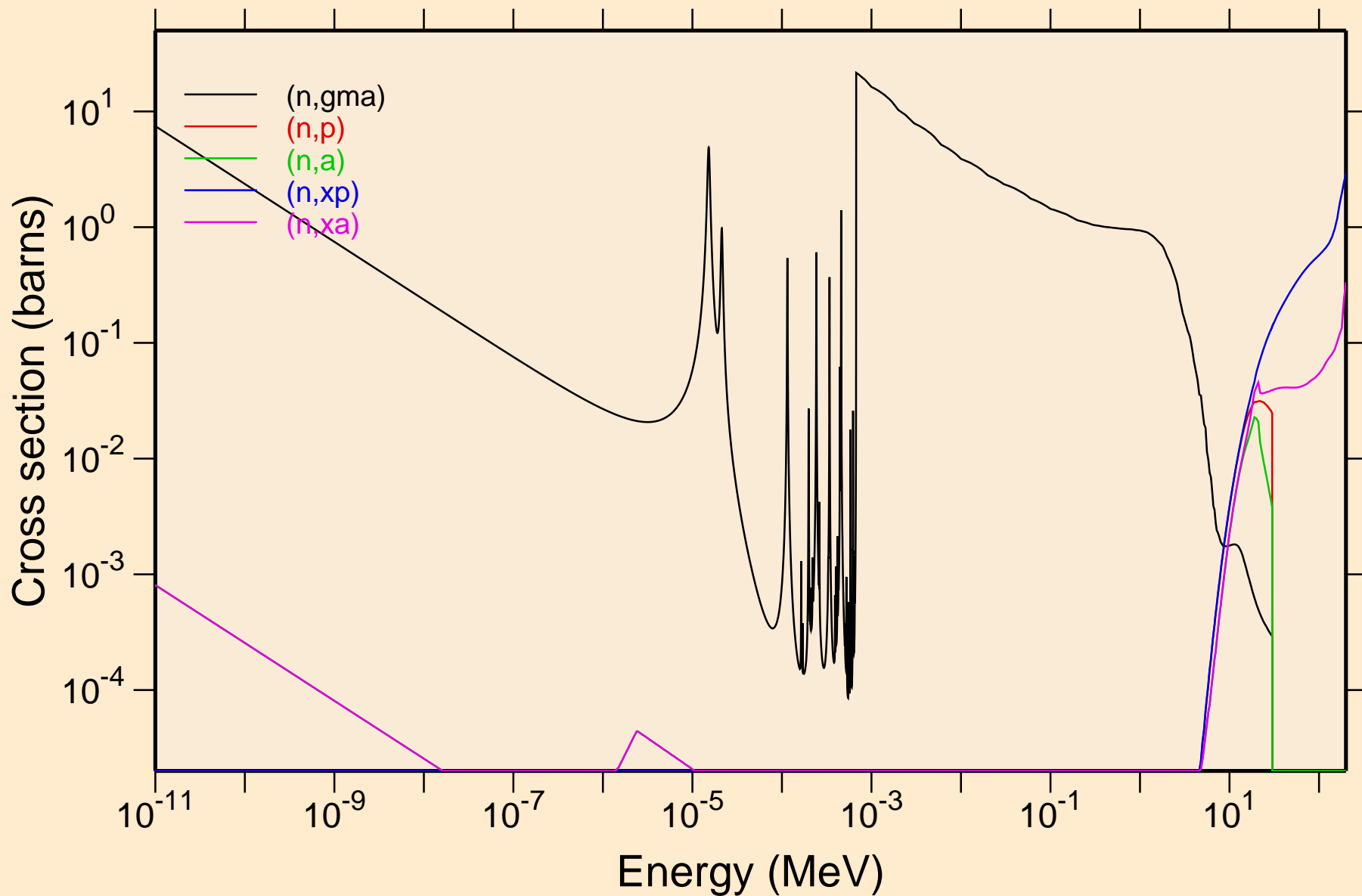

HF177N NEUTRON ACER TENDL-2019 LIBRARY; T=293.16K

Principal cross sections

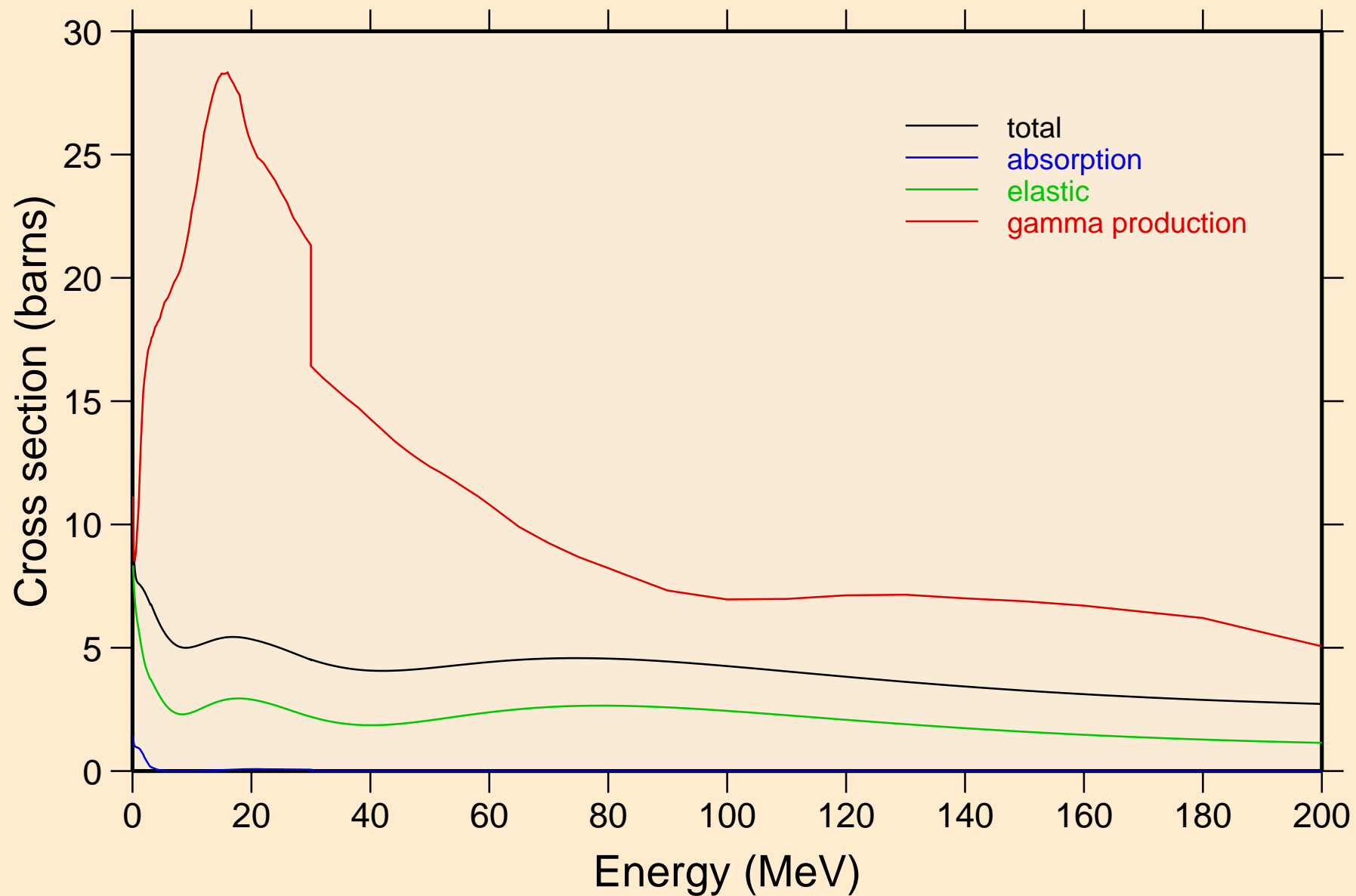

HF177N NEUTRON ACER TENDL-2019 LIBRARY; T=293.16K
Heating

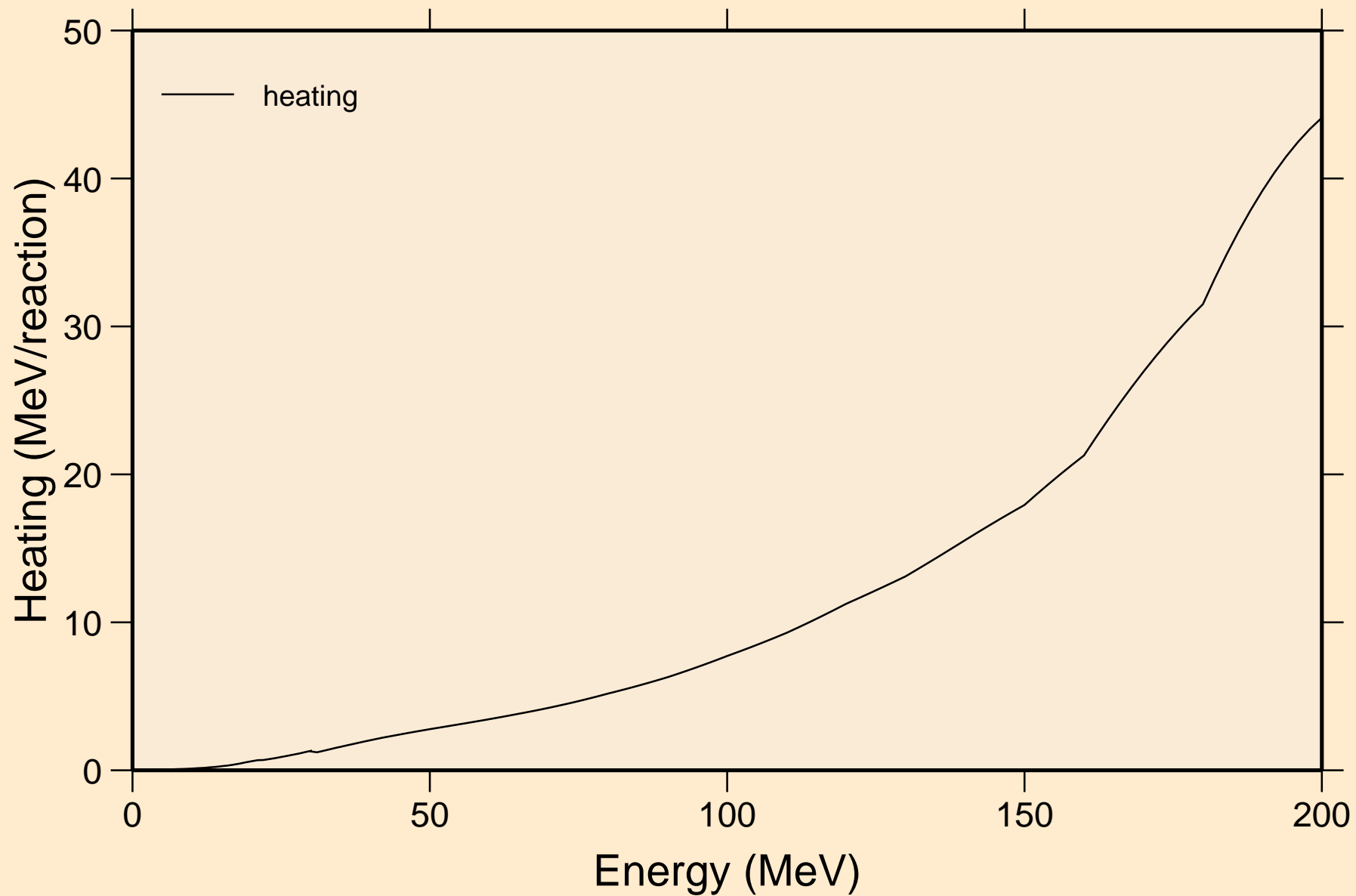

HF177N NEUTRON ACER TENDL-2019 LIBRARY; T=293.16K
Damage

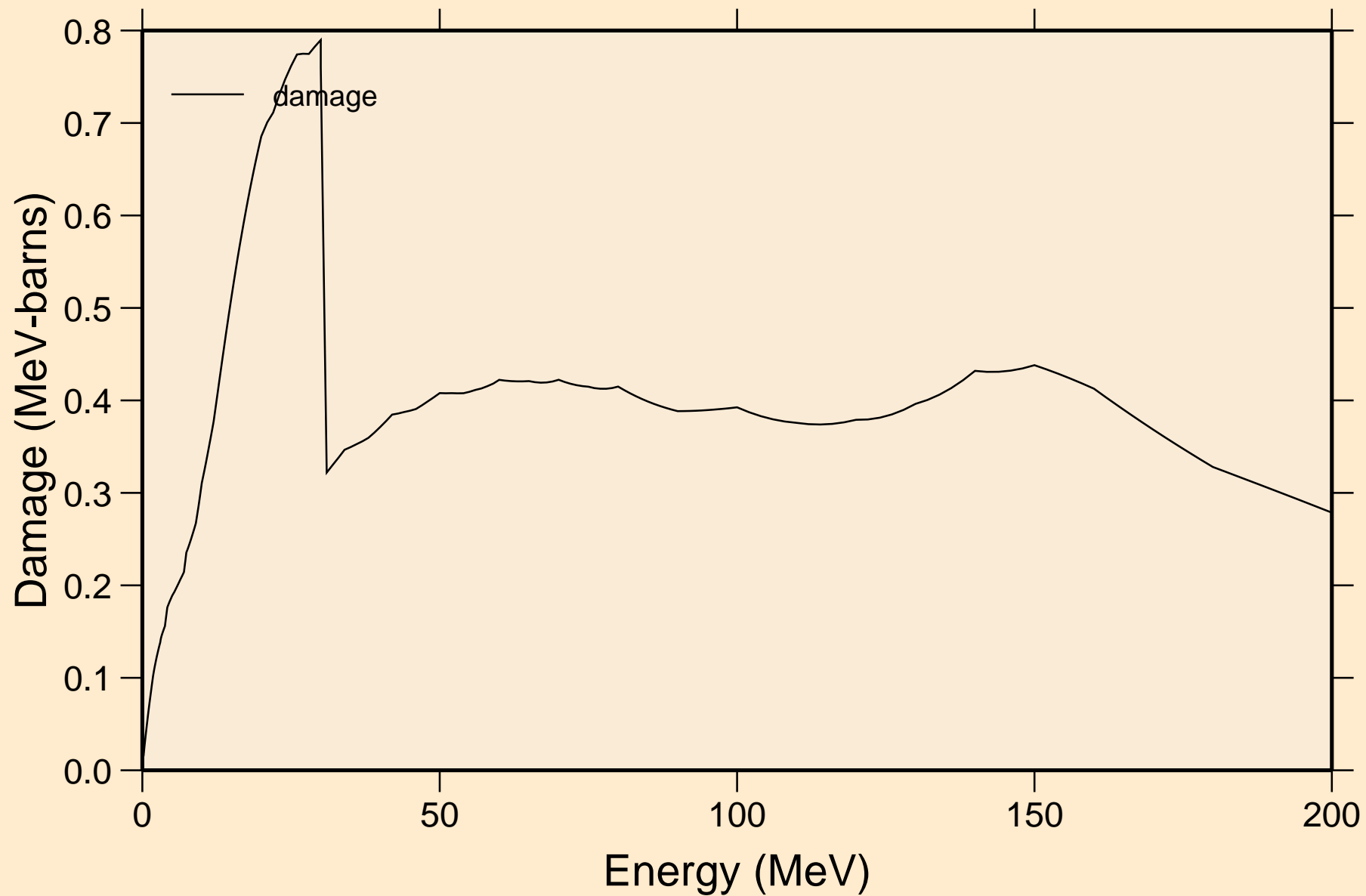

HF177N NEUTRON ACER TENDL-2019 LIBRARY; T=293.16K
Non-threshold reactions

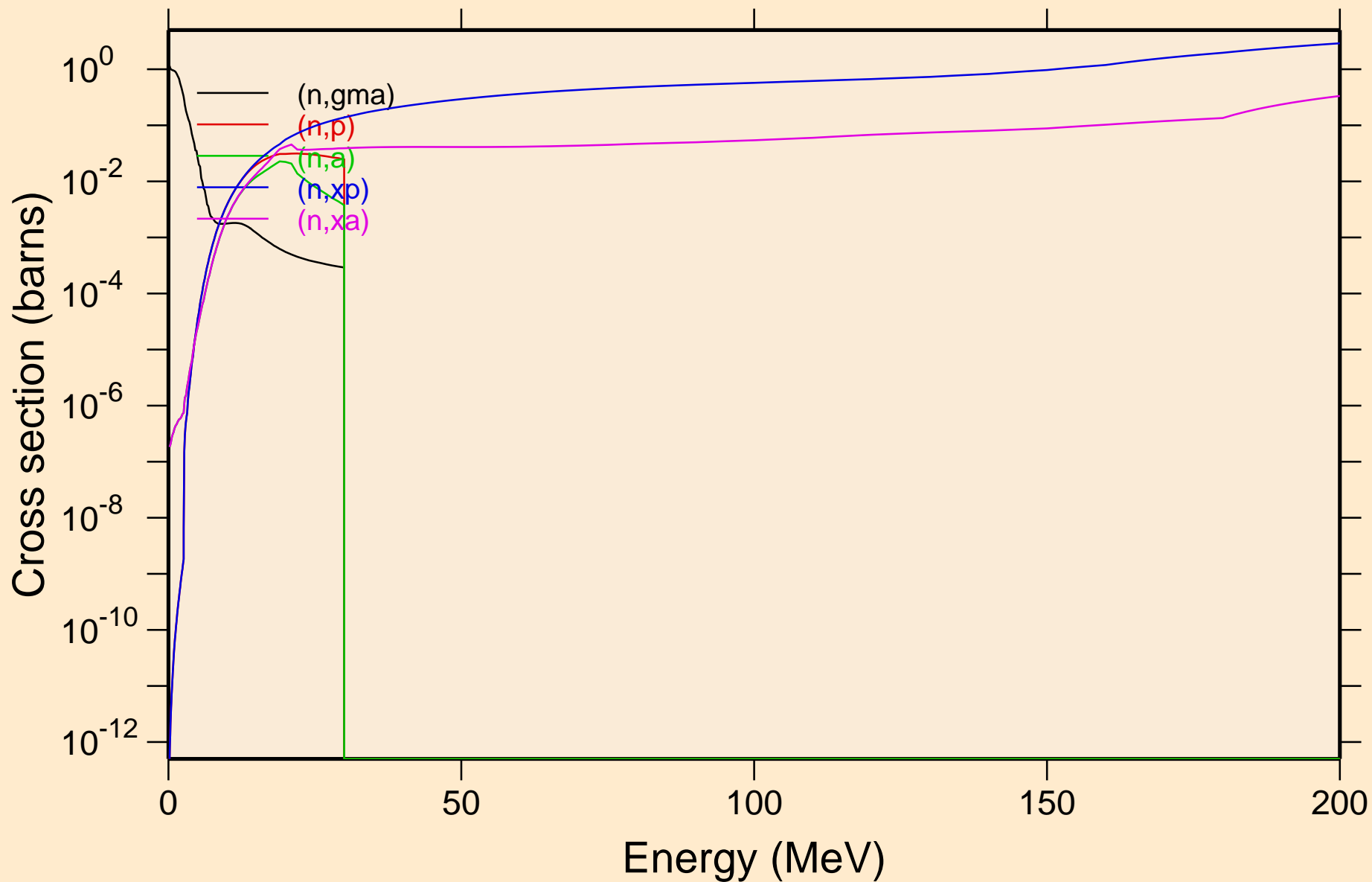

HF177N NEUTRON ACER TENDL-2019 LIBRARY; T=293.16K
Inelastic levels

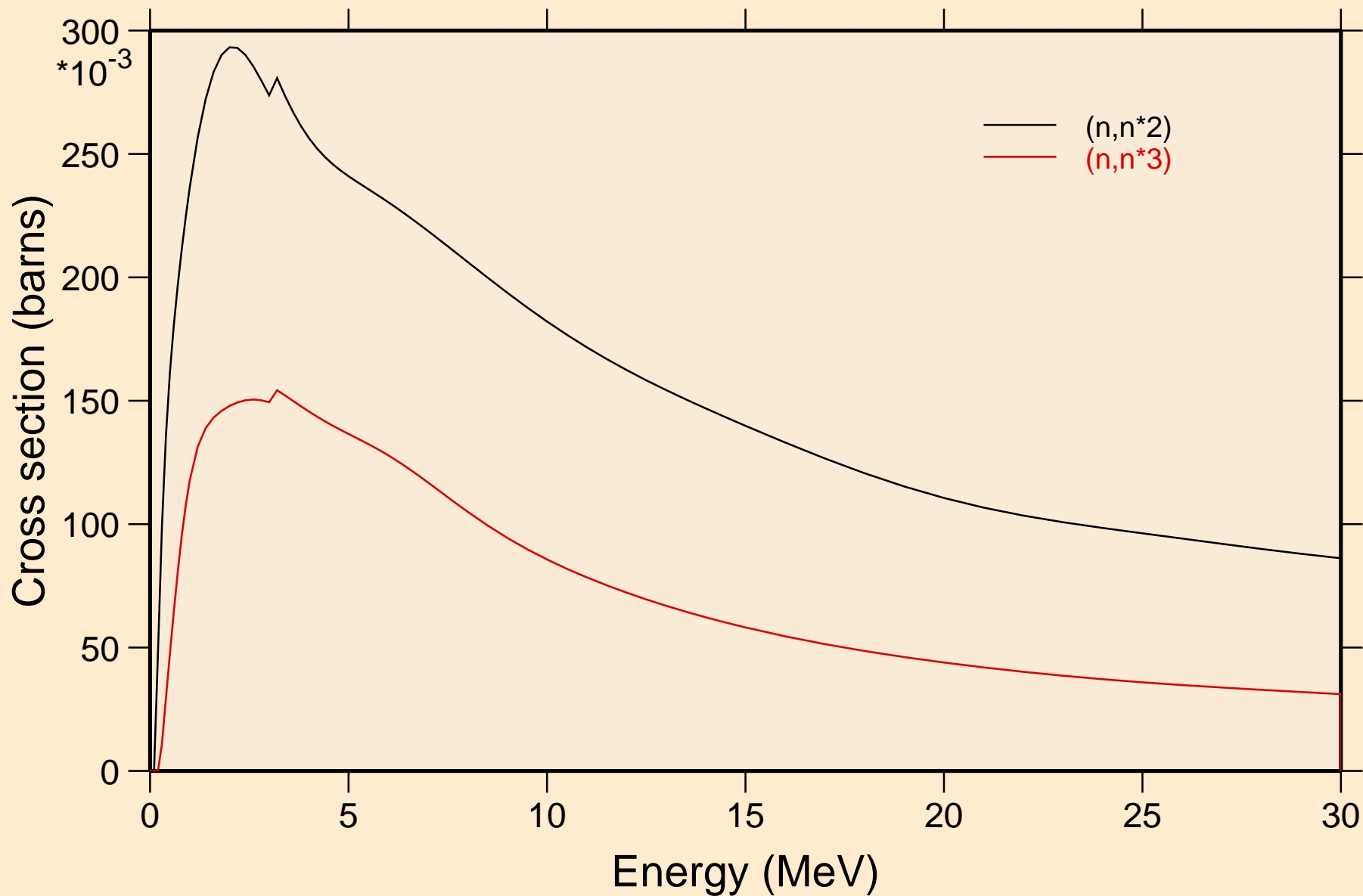

HF177N NEUTRON ACER TENDL-2019 LIBRARY; T=293.16K
Inelastic levels

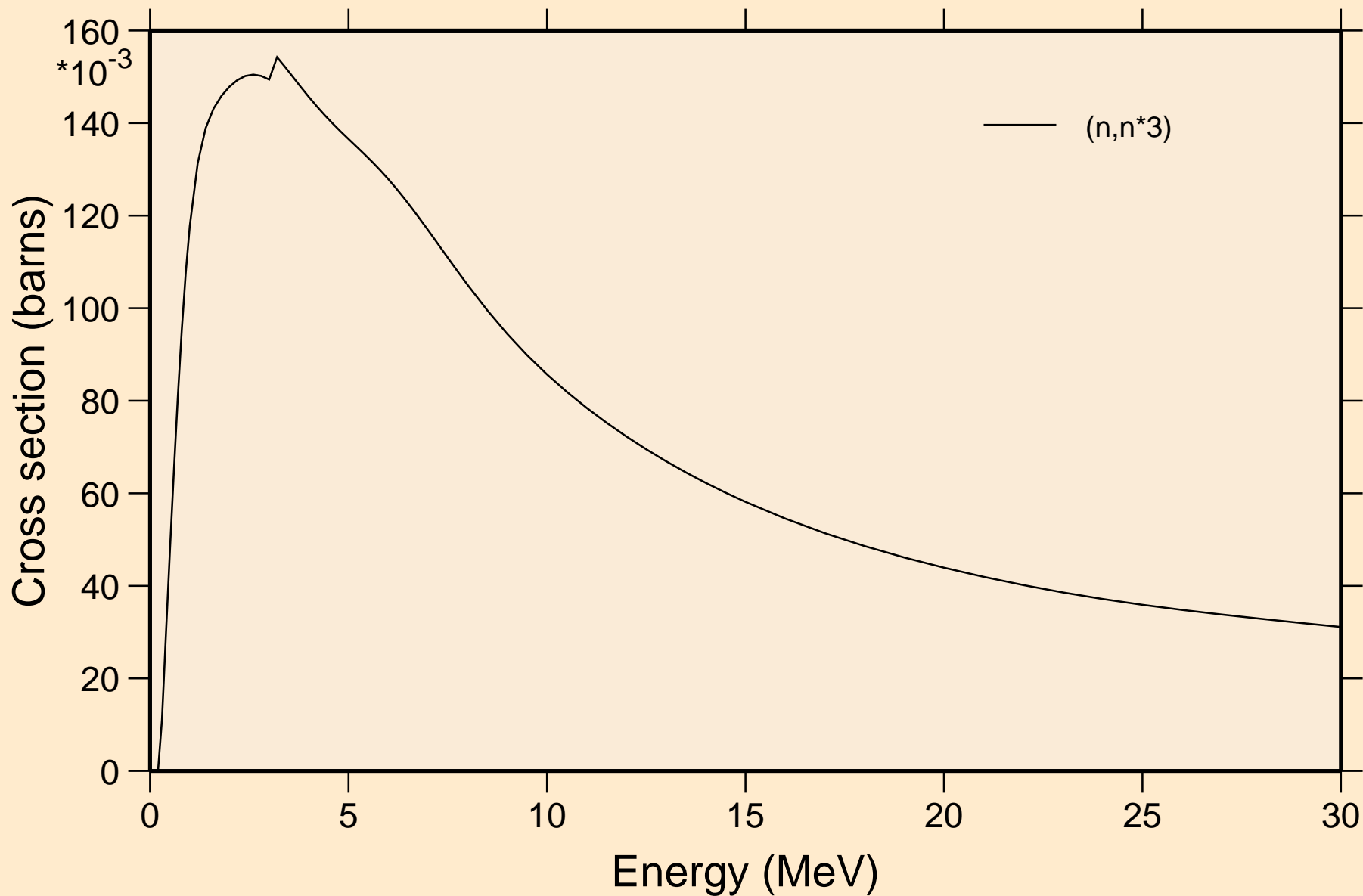

HF177N NEUTRON ACER TENDL-2019 LIBRARY; T=293.16K

Threshold reactions

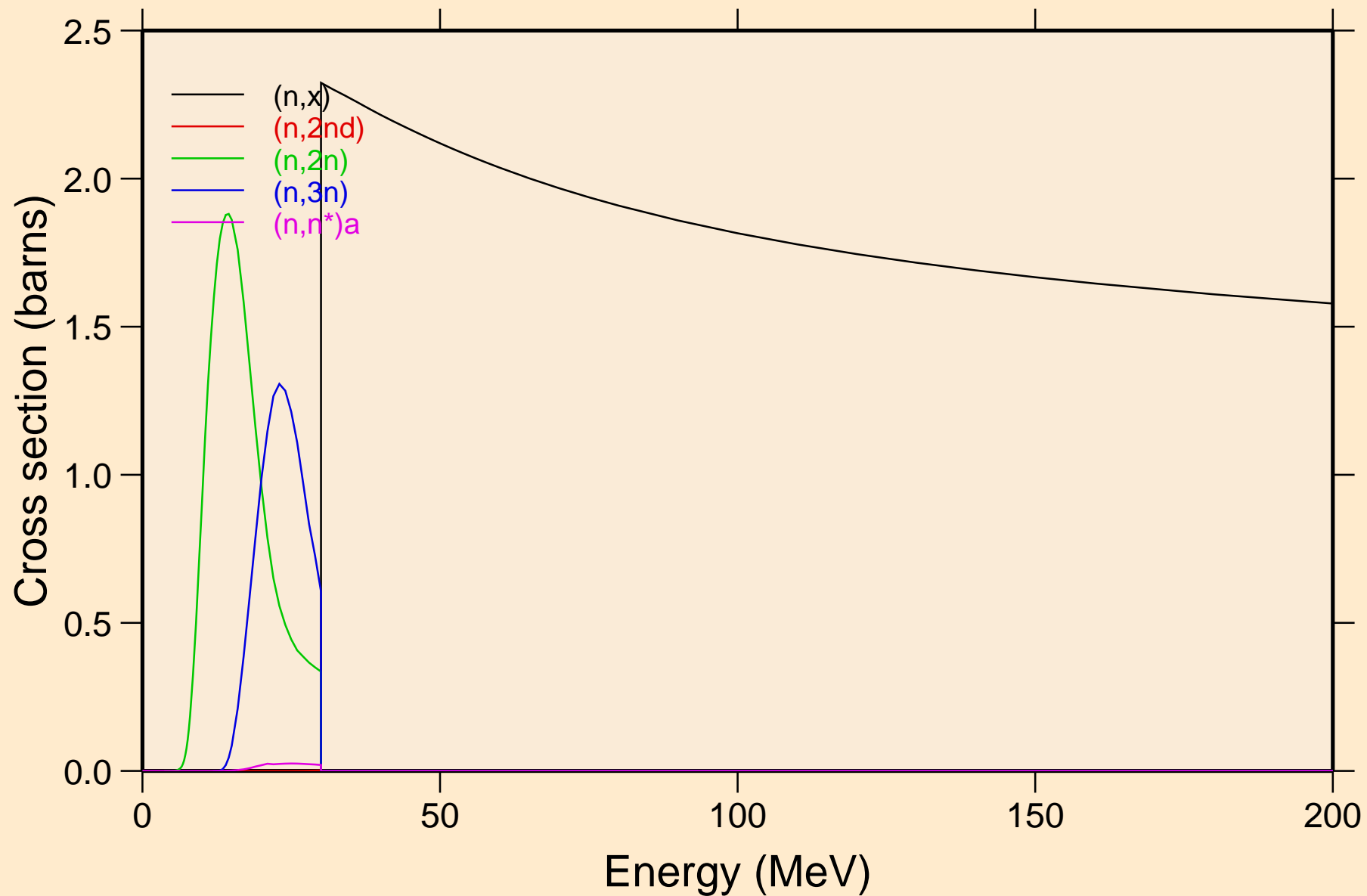

HF177N NEUTRON ACER TENDL-2019 LIBRARY; T=293.16K

Threshold reactions

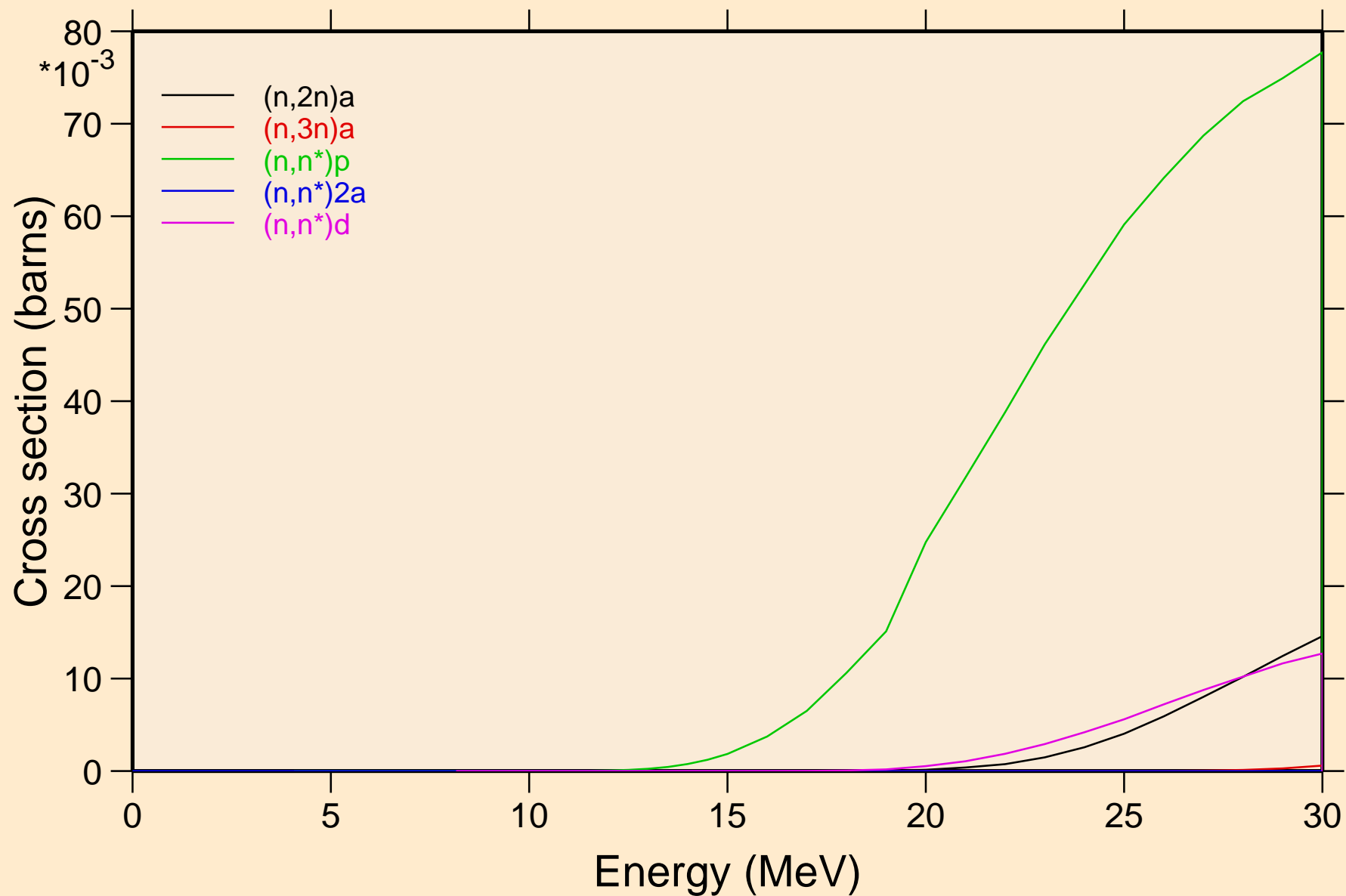

HF177N NEUTRON ACER TENDL-2019 LIBRARY; T=293.16K
Threshold reactions

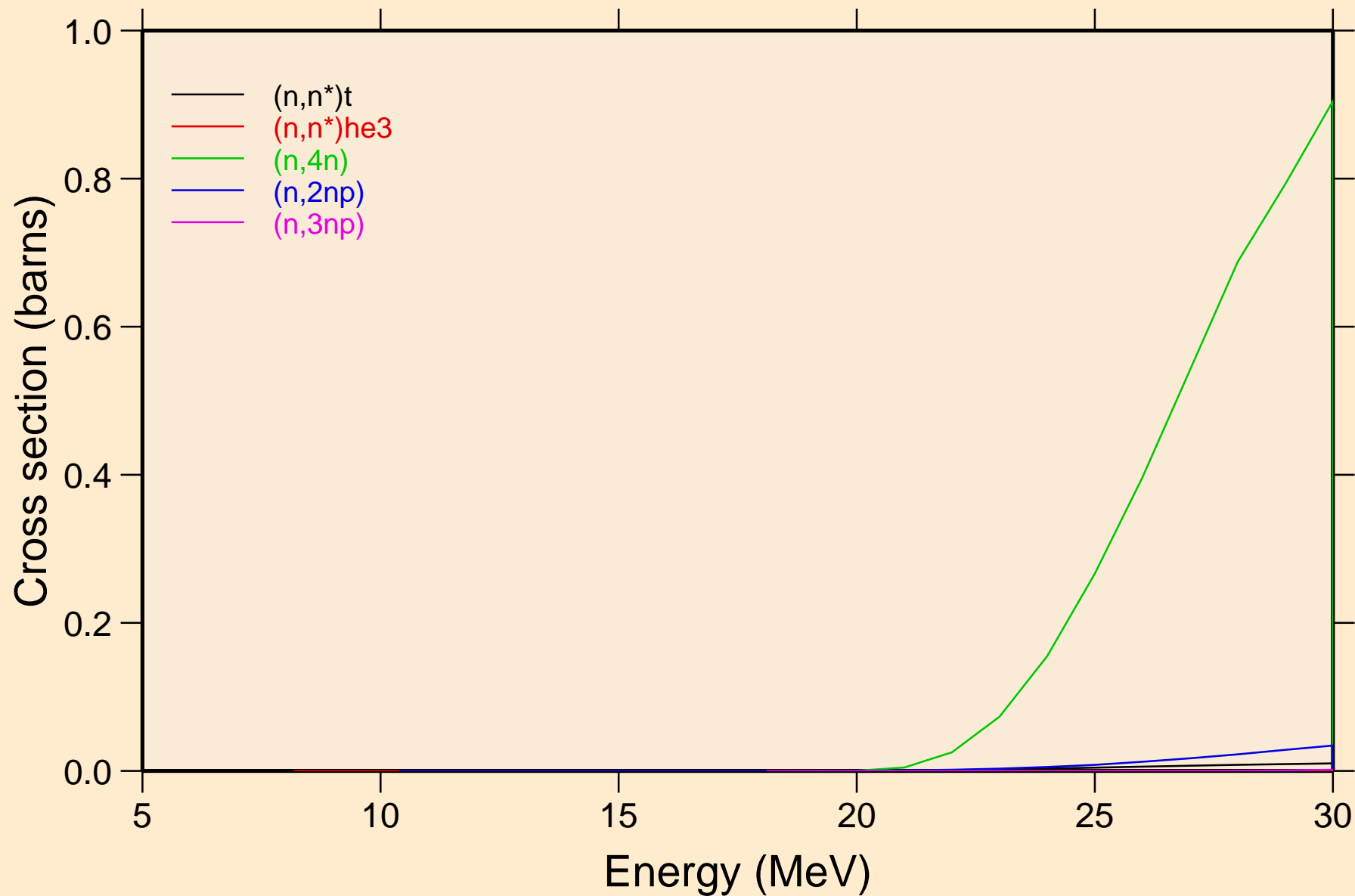

HF177N NEUTRON ACER TENDL-2019 LIBRARY; T=293.16K
Threshold reactions

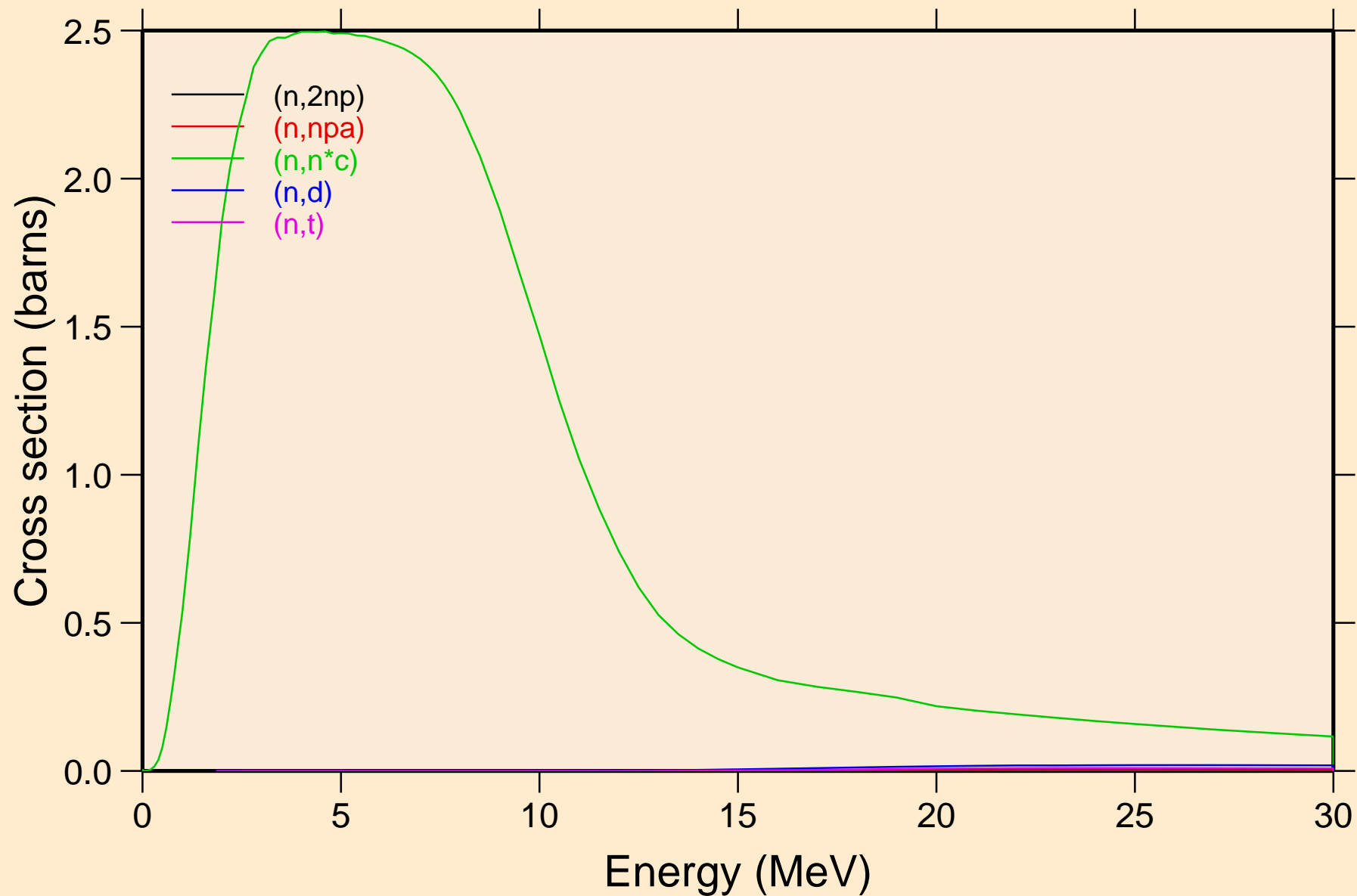

HF177N NEUTRON ACER TENDL-2019 LIBRARY; T=293.16K

Threshold reactions

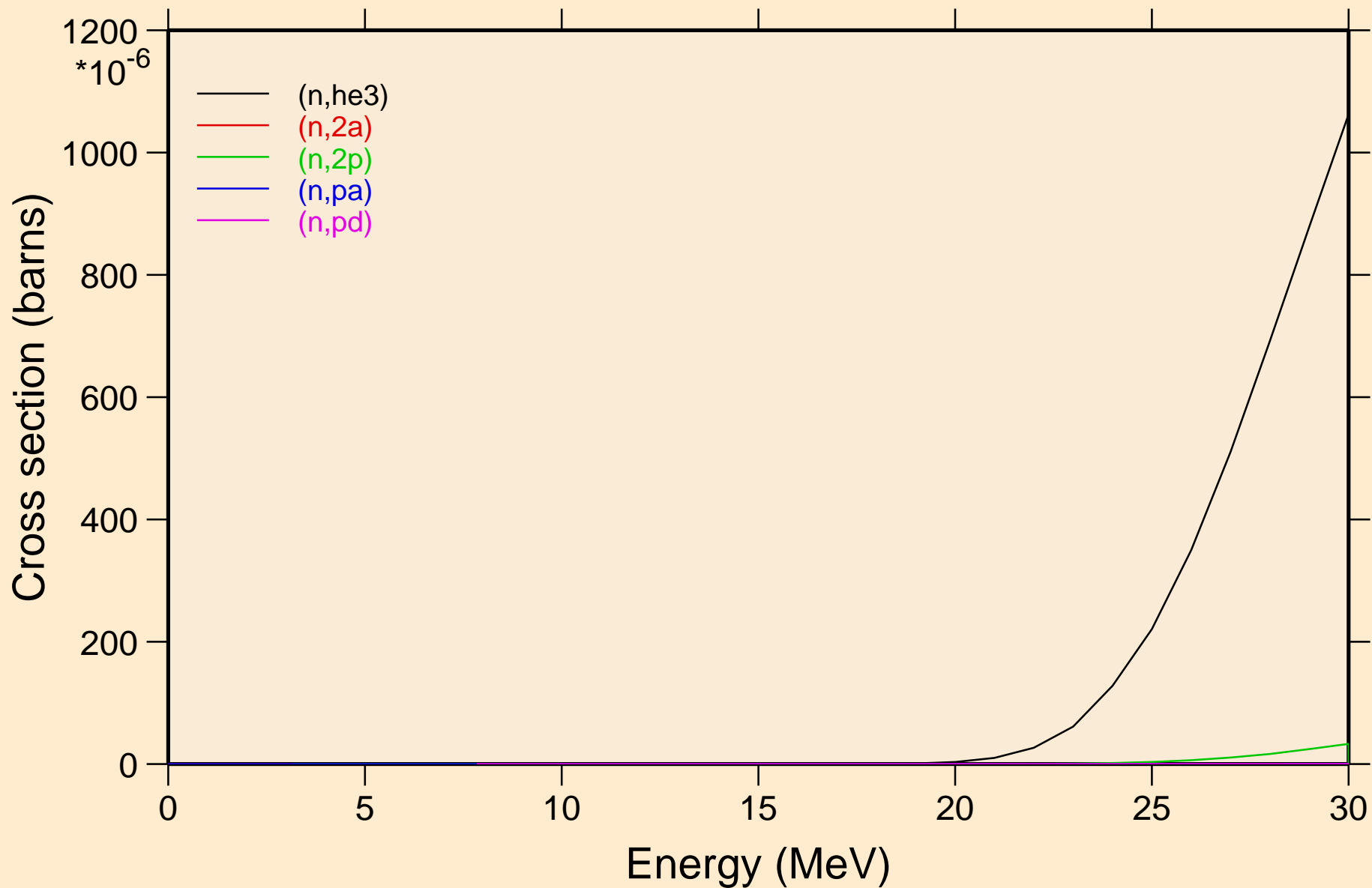

HF177N NEUTRON ACER TENDL-2019 LIBRARY; T=293.16K

Threshold reactions

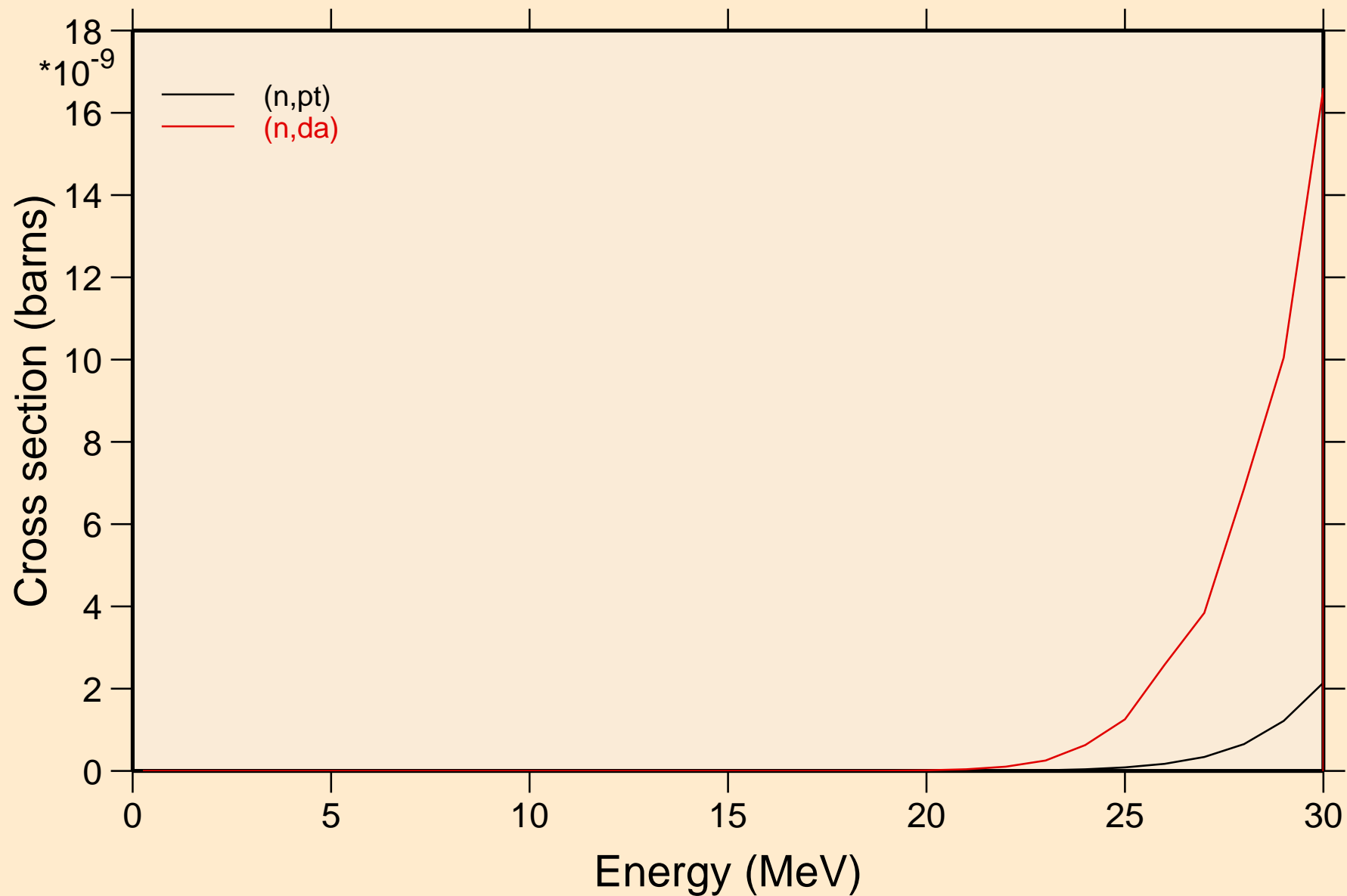

HF177N NEUTRON ACER TENDL-2019 LIBRARY; T=293.16K
Threshold reactions

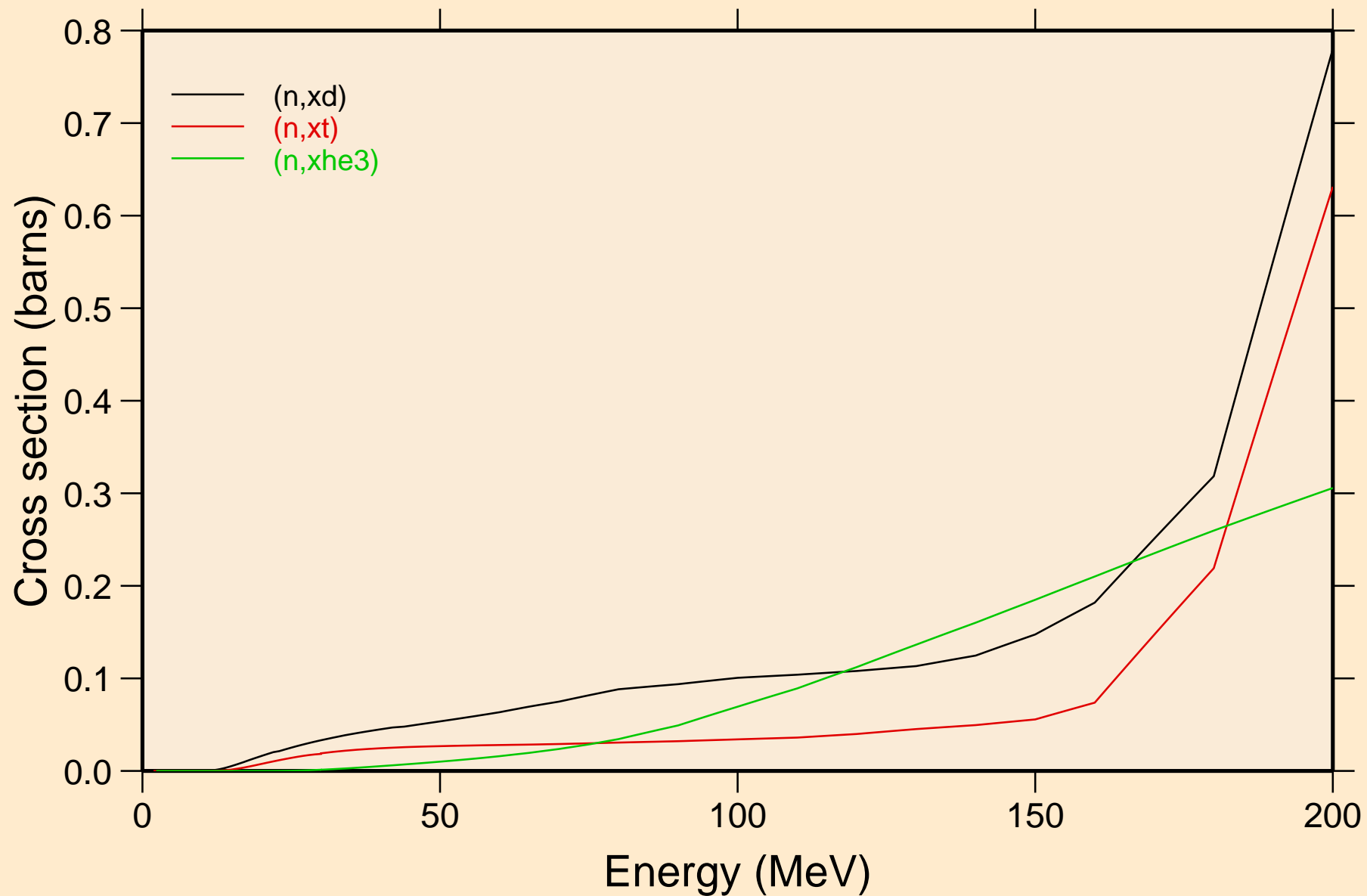

HF177N NEUTRON ACER TENDL-2019 LIBRARY; T=293.16K
angular distribution for elastic

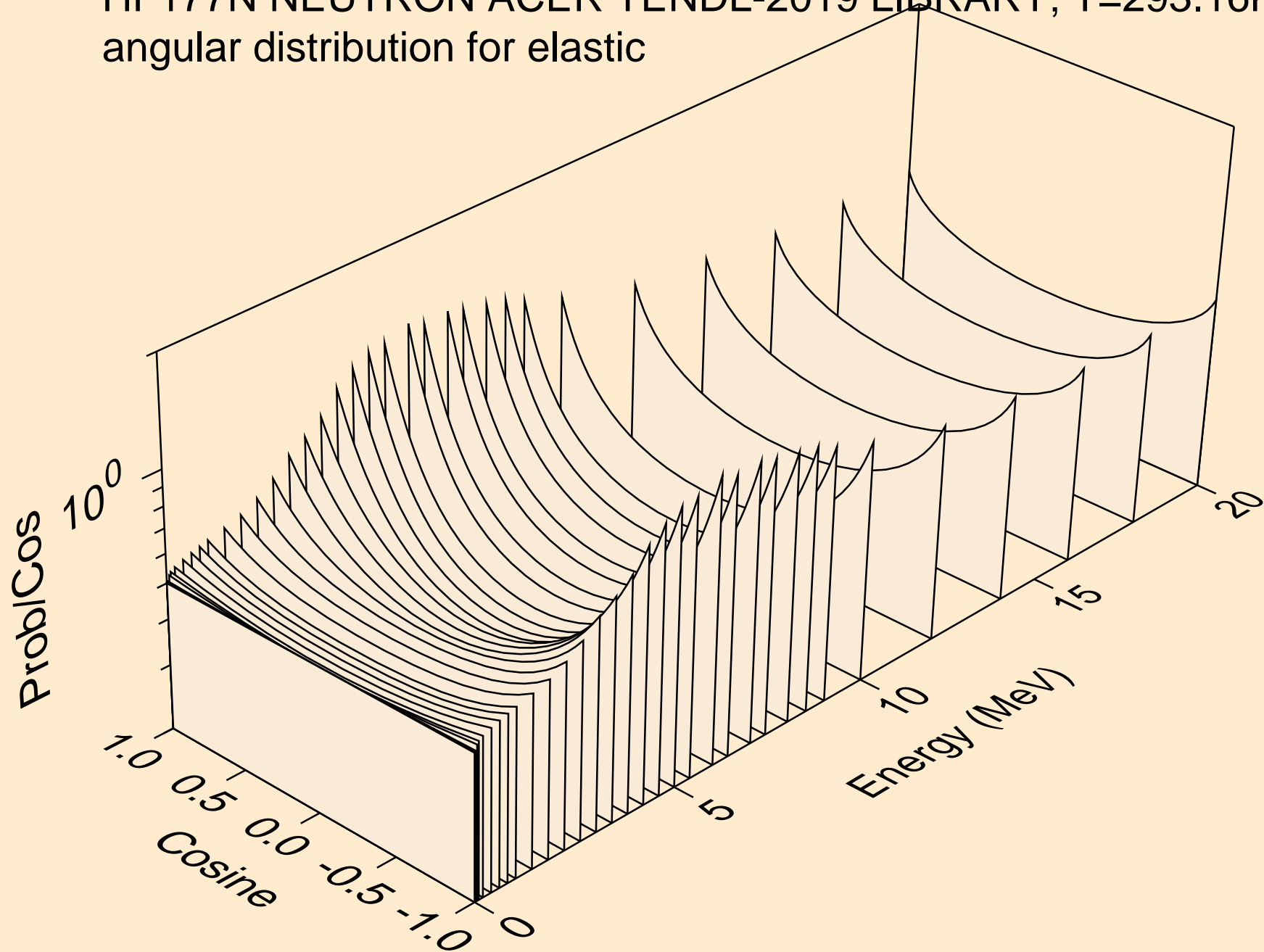

HF177N NEUTRON ACER TENDL-2019 LIBRARY; T=293.16K
angular distribution for elastic

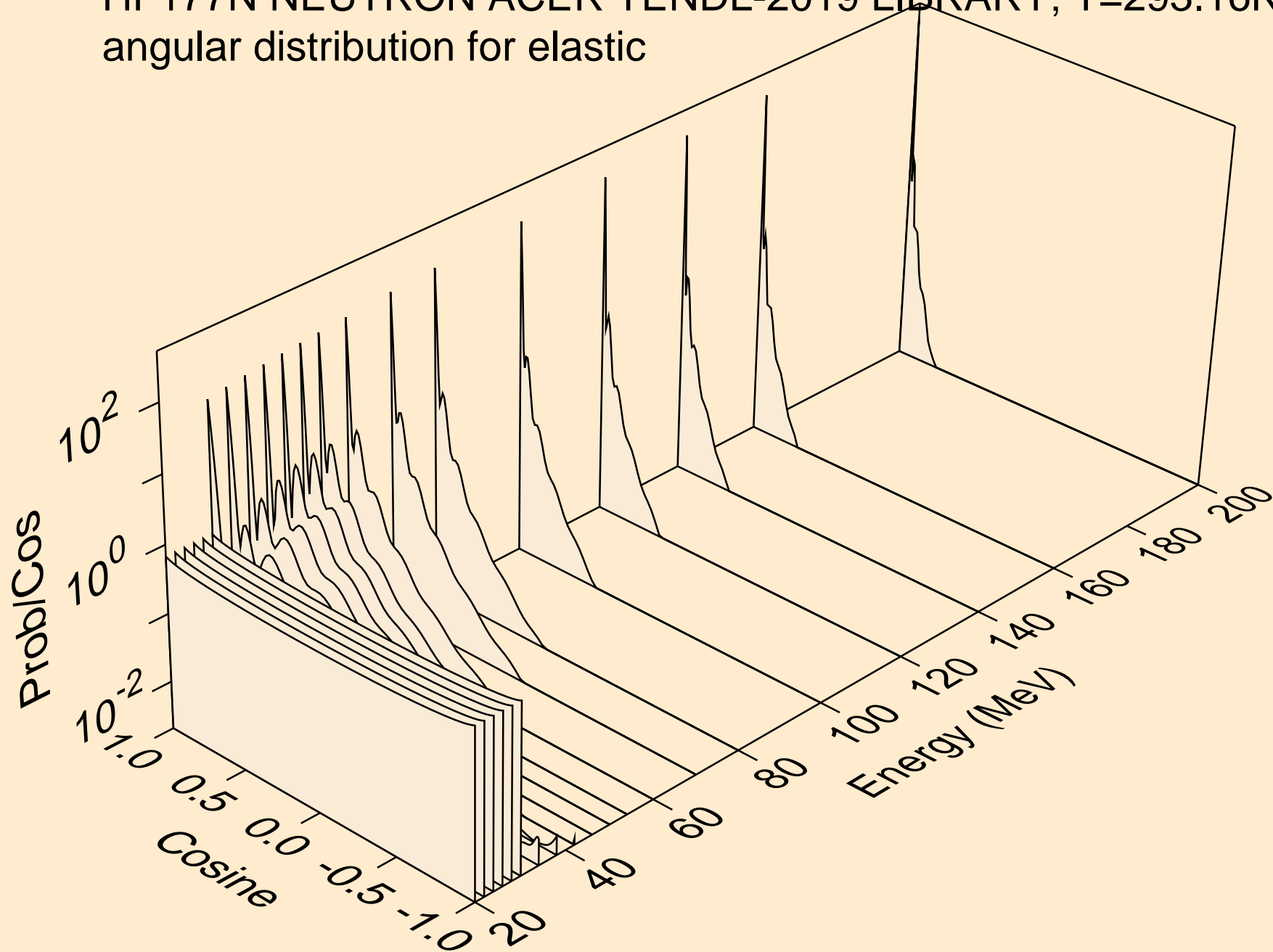

HF177N NEUTRON ACER TENDL-2019 LIBRARY; T=293.16K
angular distribution for (n,n*2)

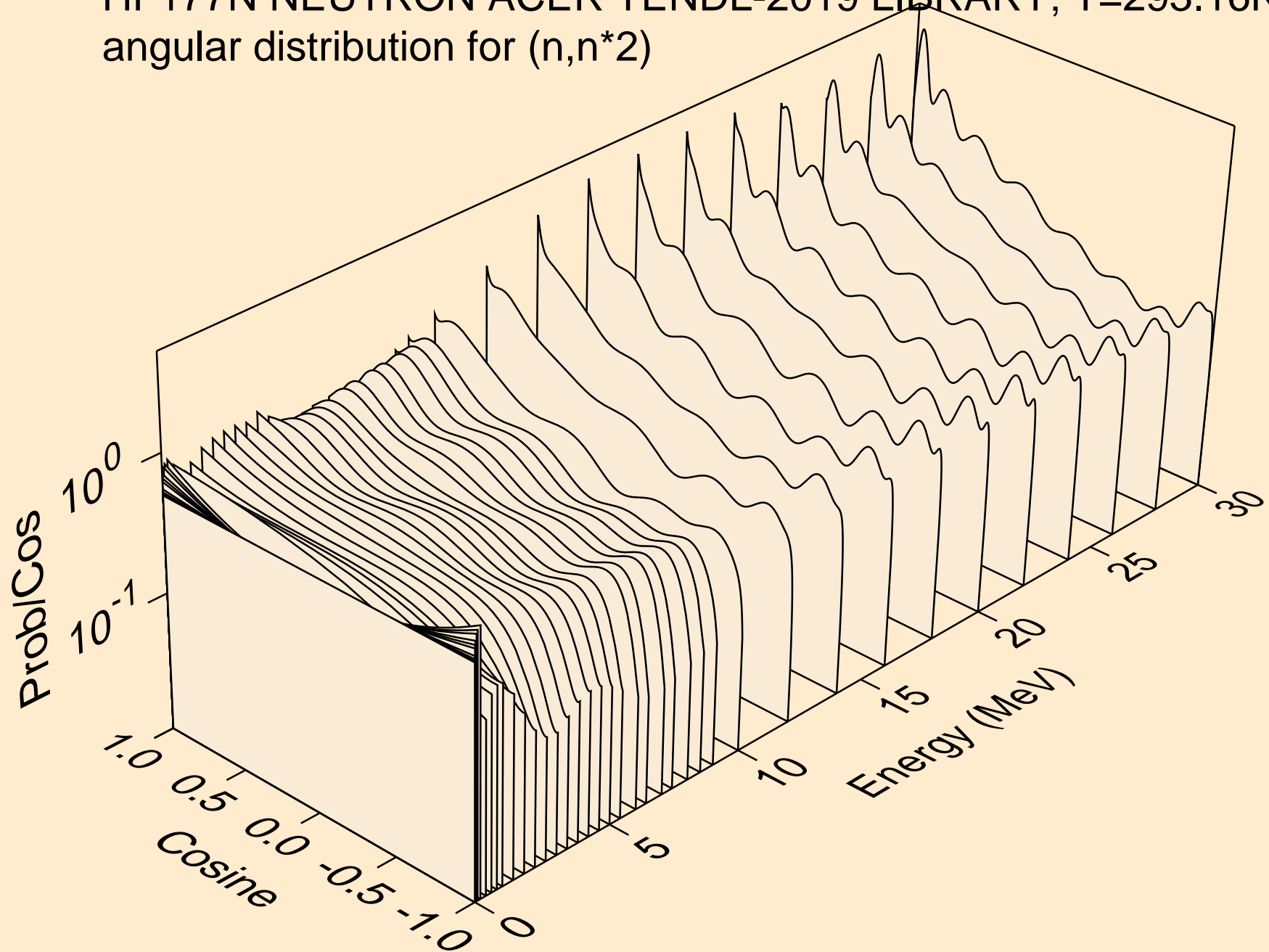

HF177N NEUTRON ACER TENDL-2019 LIBRARY; T=293.16K
angular distribution for (n,n*3)

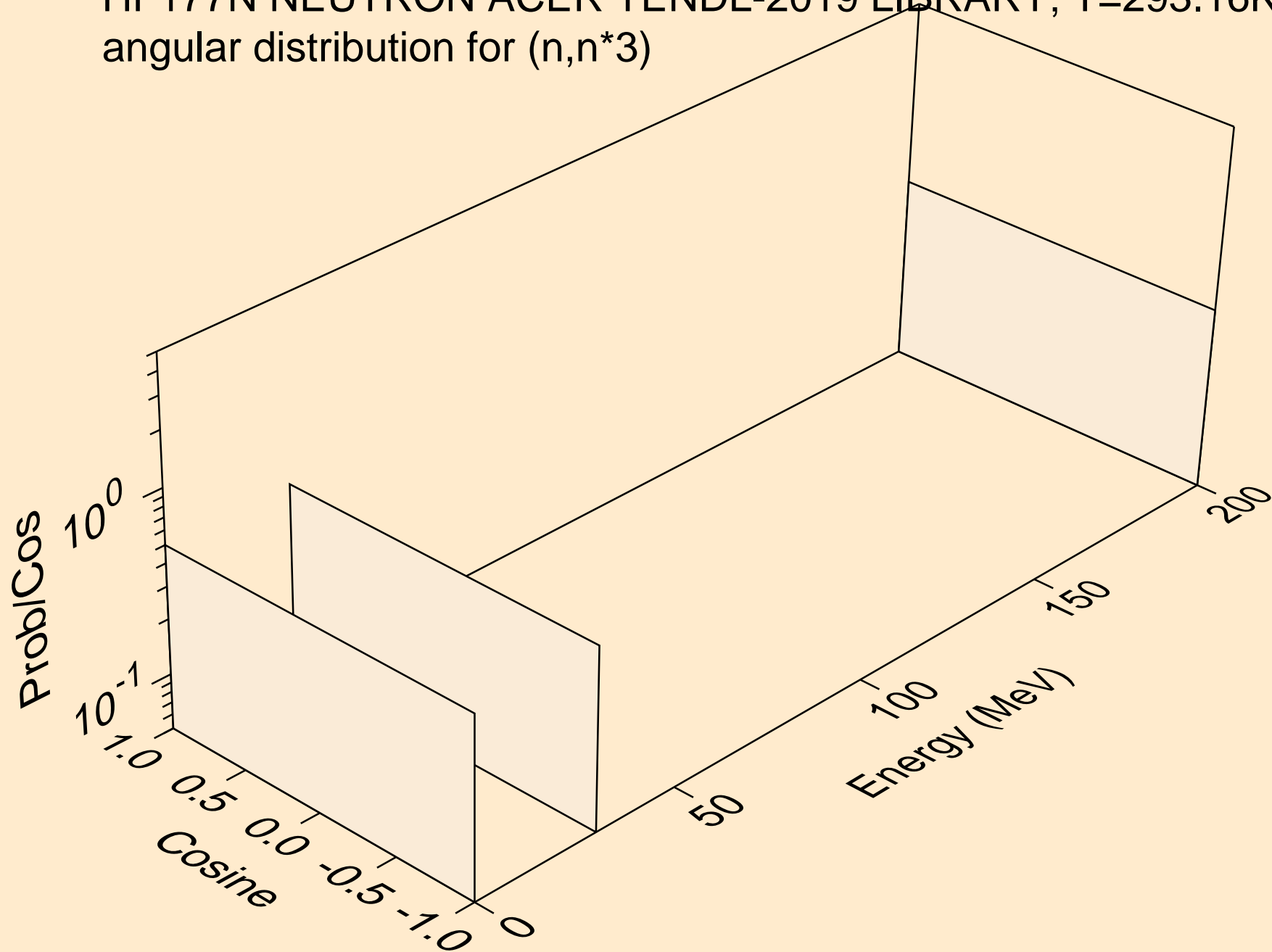

HF177N NEUTRON ACER TENDL-2019 LIBRARY; T=293.16K
Neutron emission for (n,x)

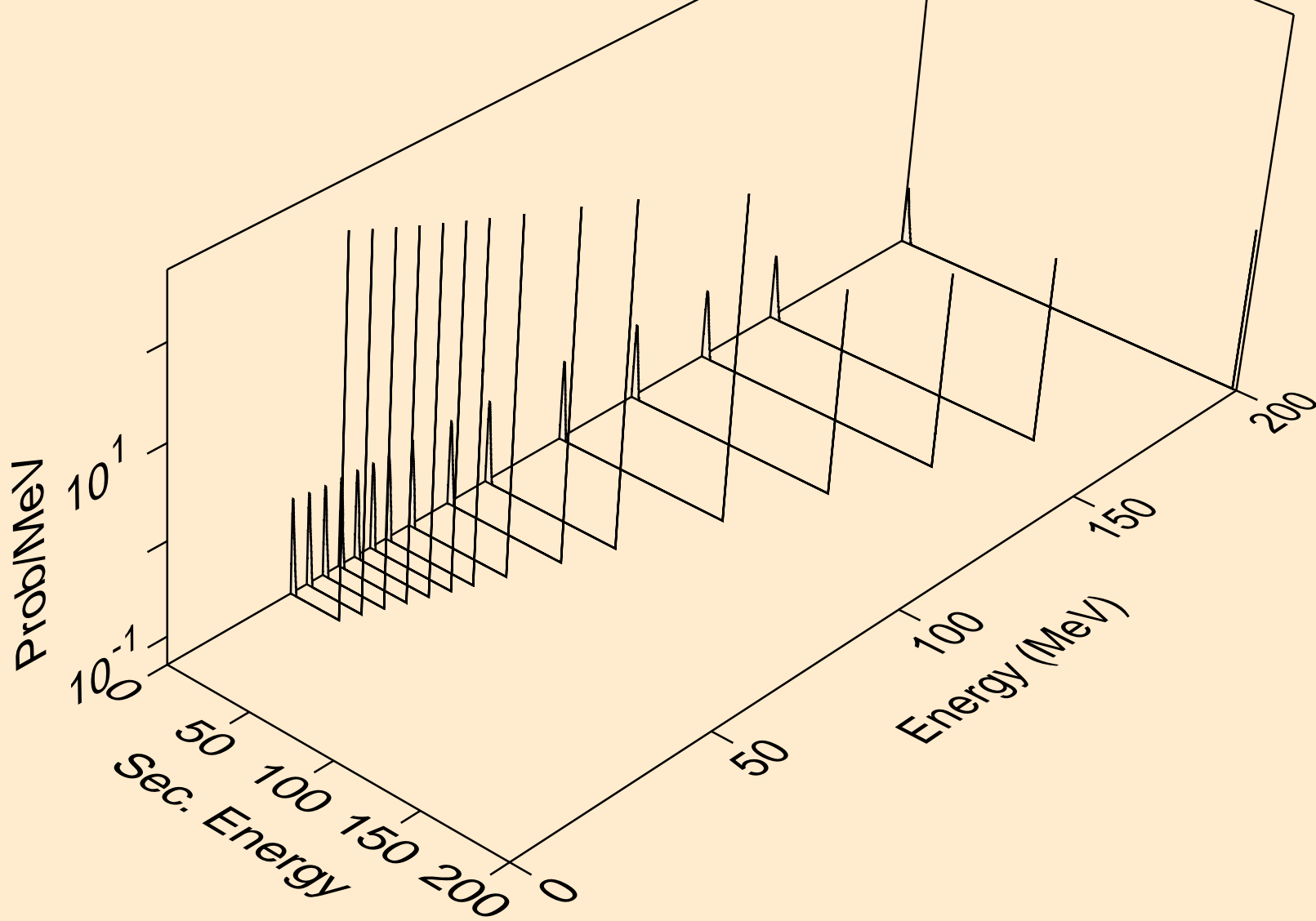

HF177N NEUTRON ACER TENDL-2019 LIBRARY; T=293.16K
Neutron emission for (n,2nd)

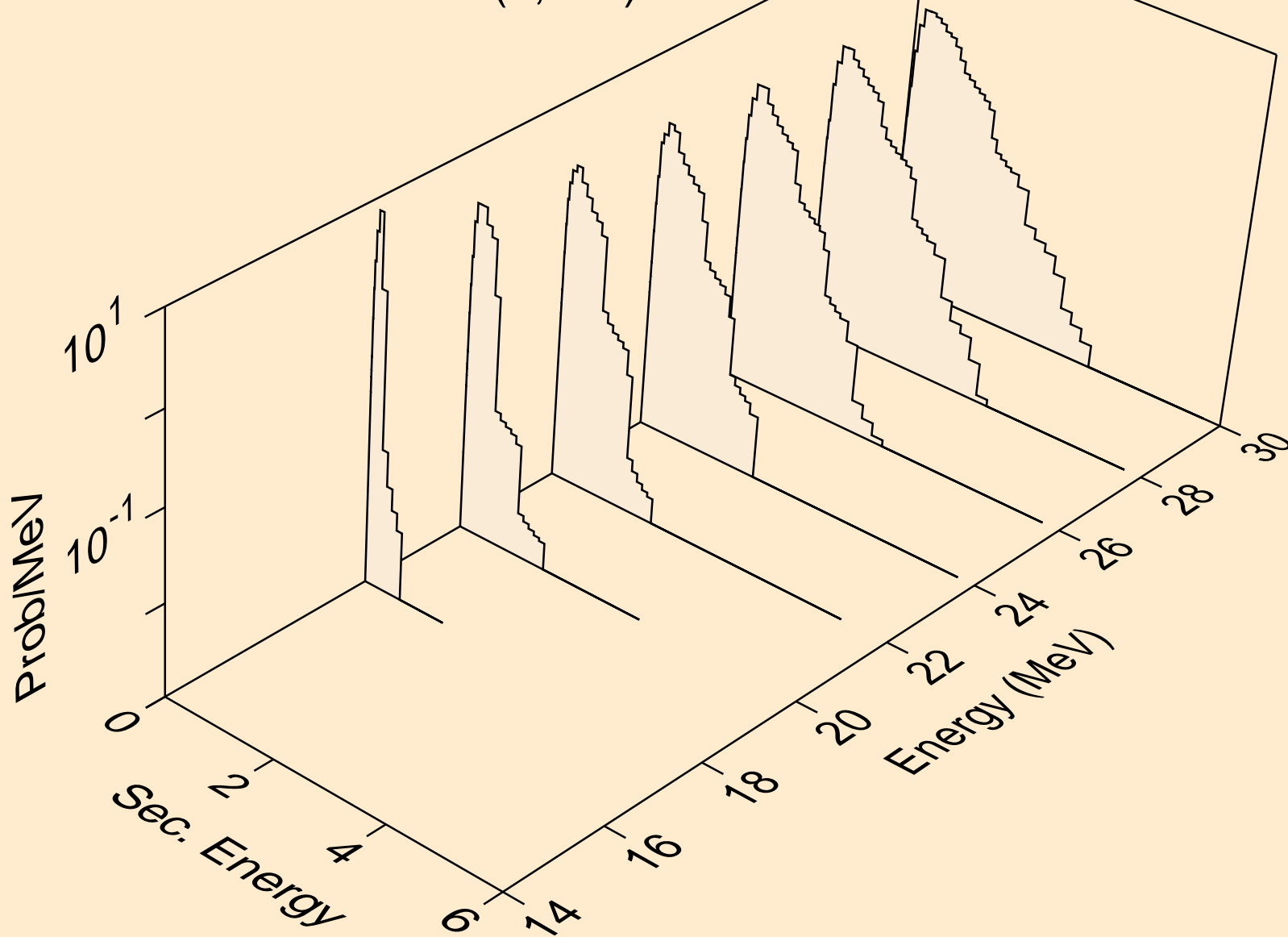

HF177N NEUTRON ACER TENDL-2019 LIBRARY; T=293.16K
Neutron emission for (n,2n)

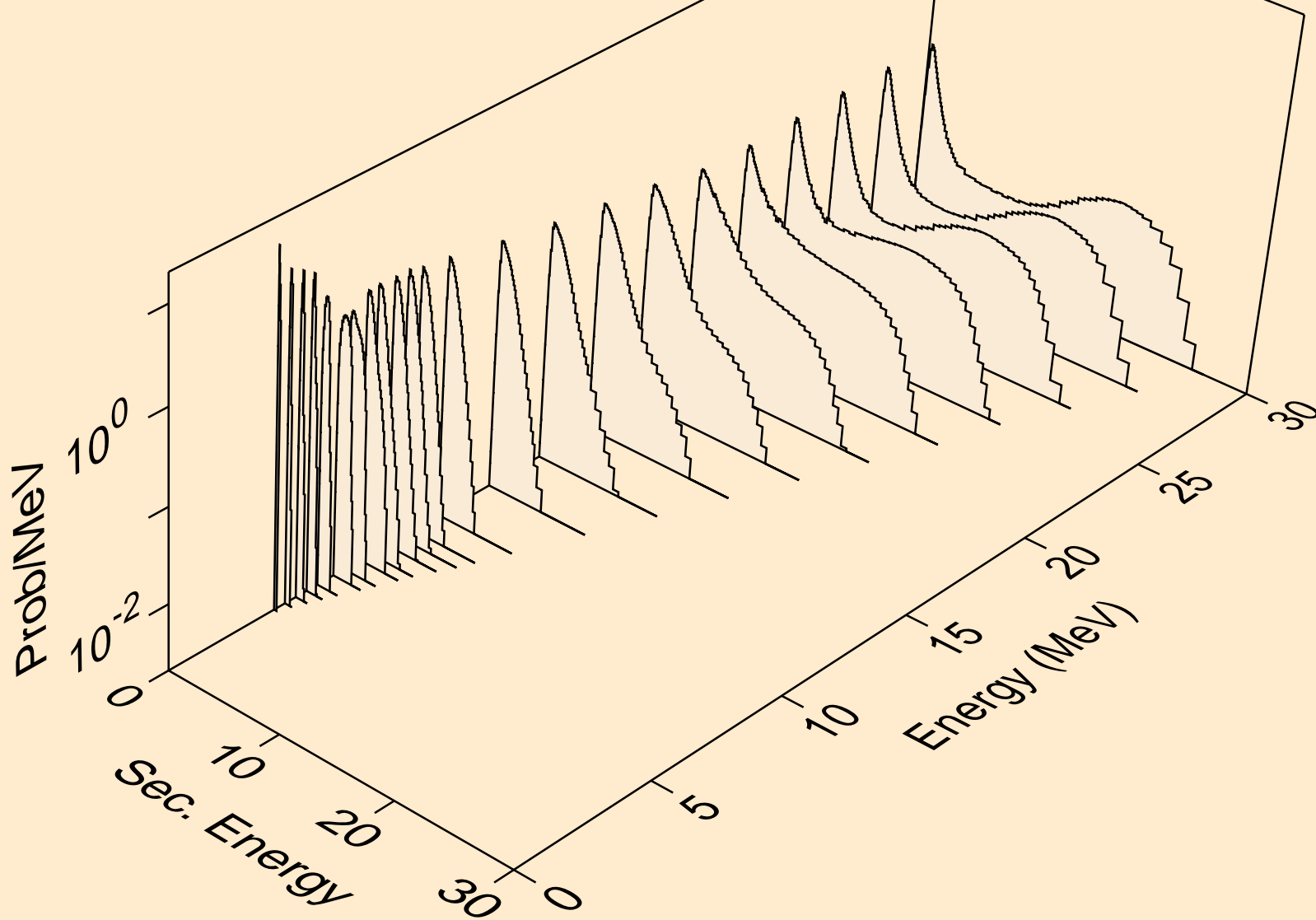

HF177N NEUTRON ACER TENDL-2019 LIBRARY; T=293.16K
Neutron emission for (n,3n)

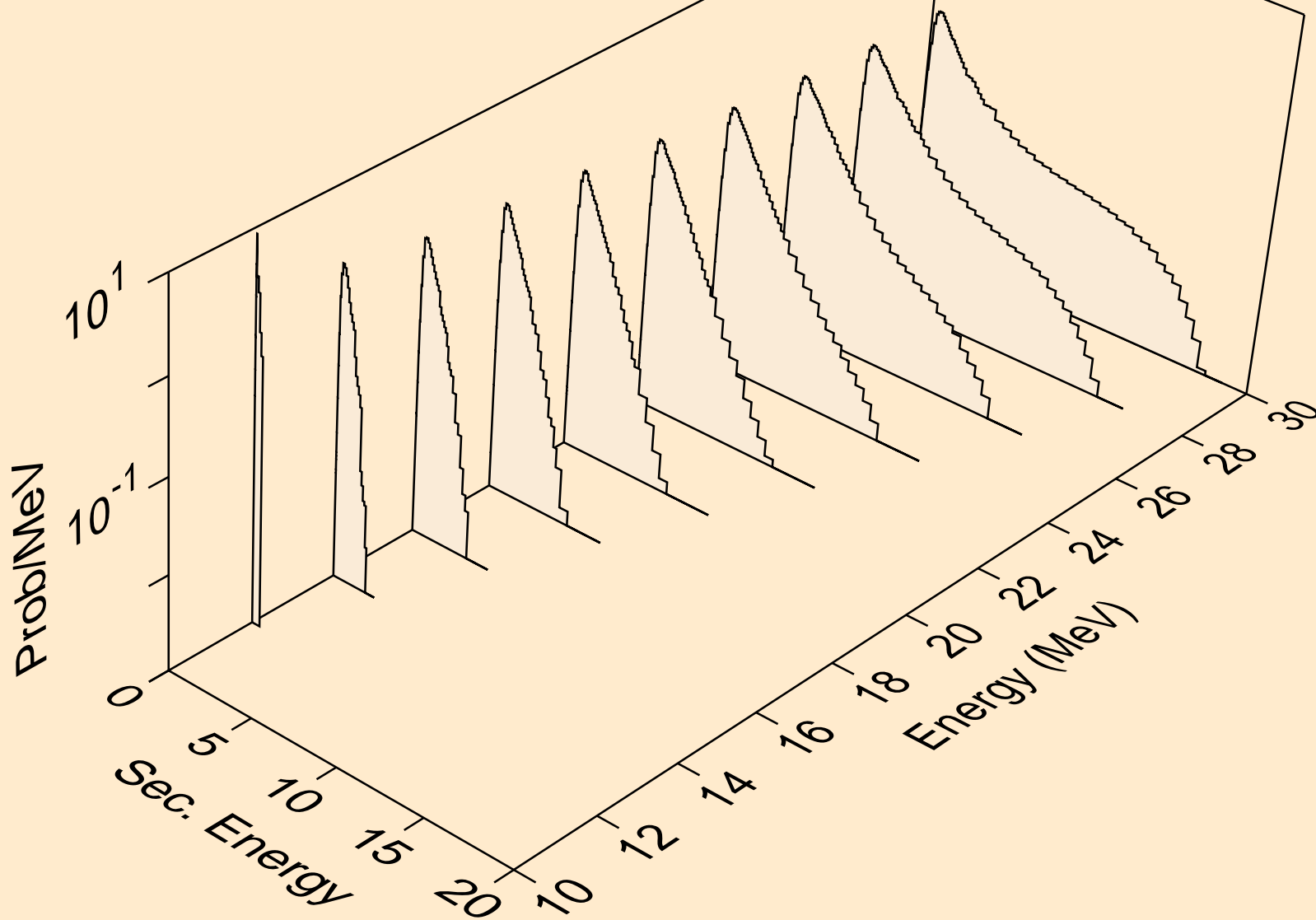

HF177N NEUTRON ACER TENDL-2019 LIBRARY; T=293.16K
Neutron emission for (n,n*)a

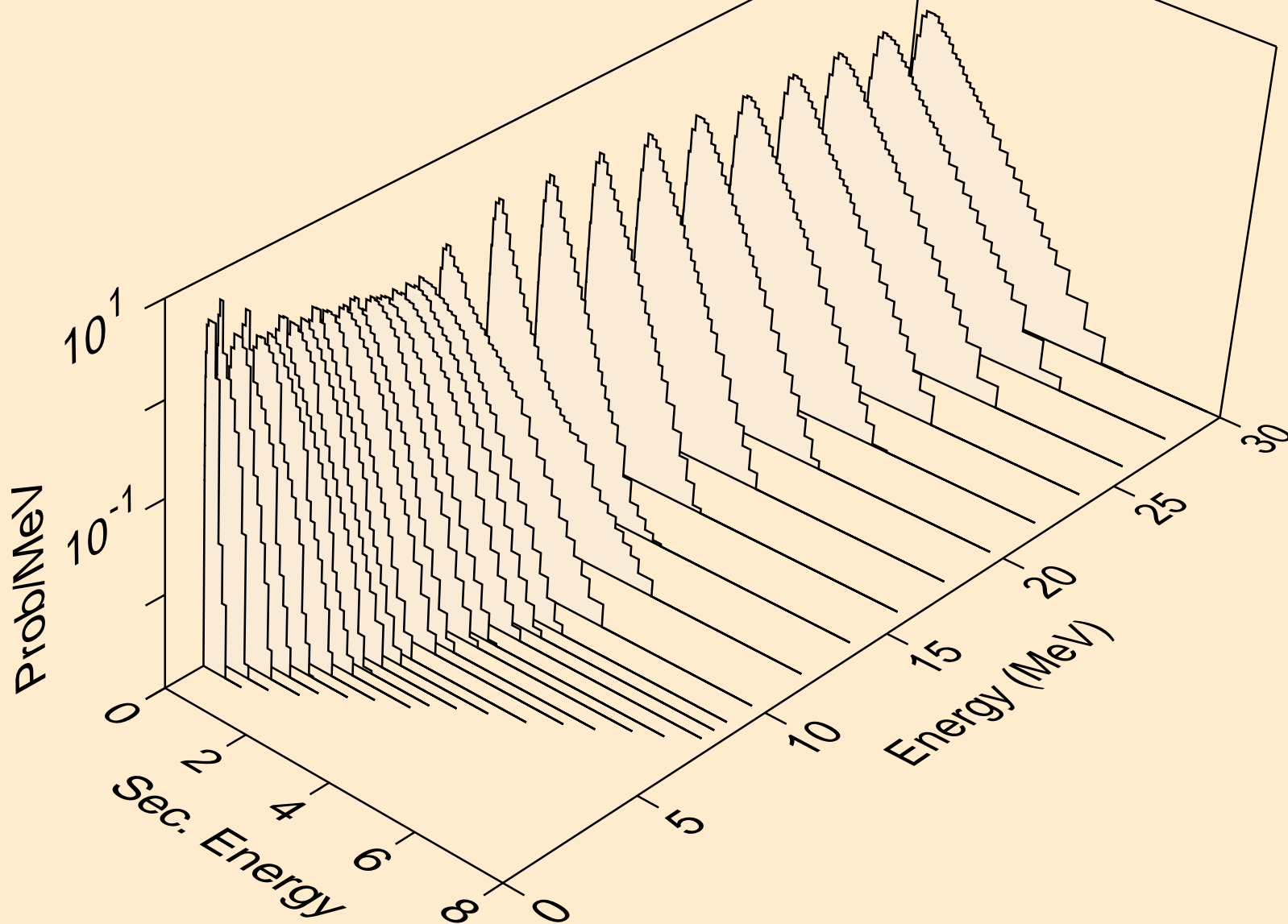

HF177N NEUTRON ACER TENDL-2019 LIBRARY; T=293.16K
Neutron emission for (n,2n)a

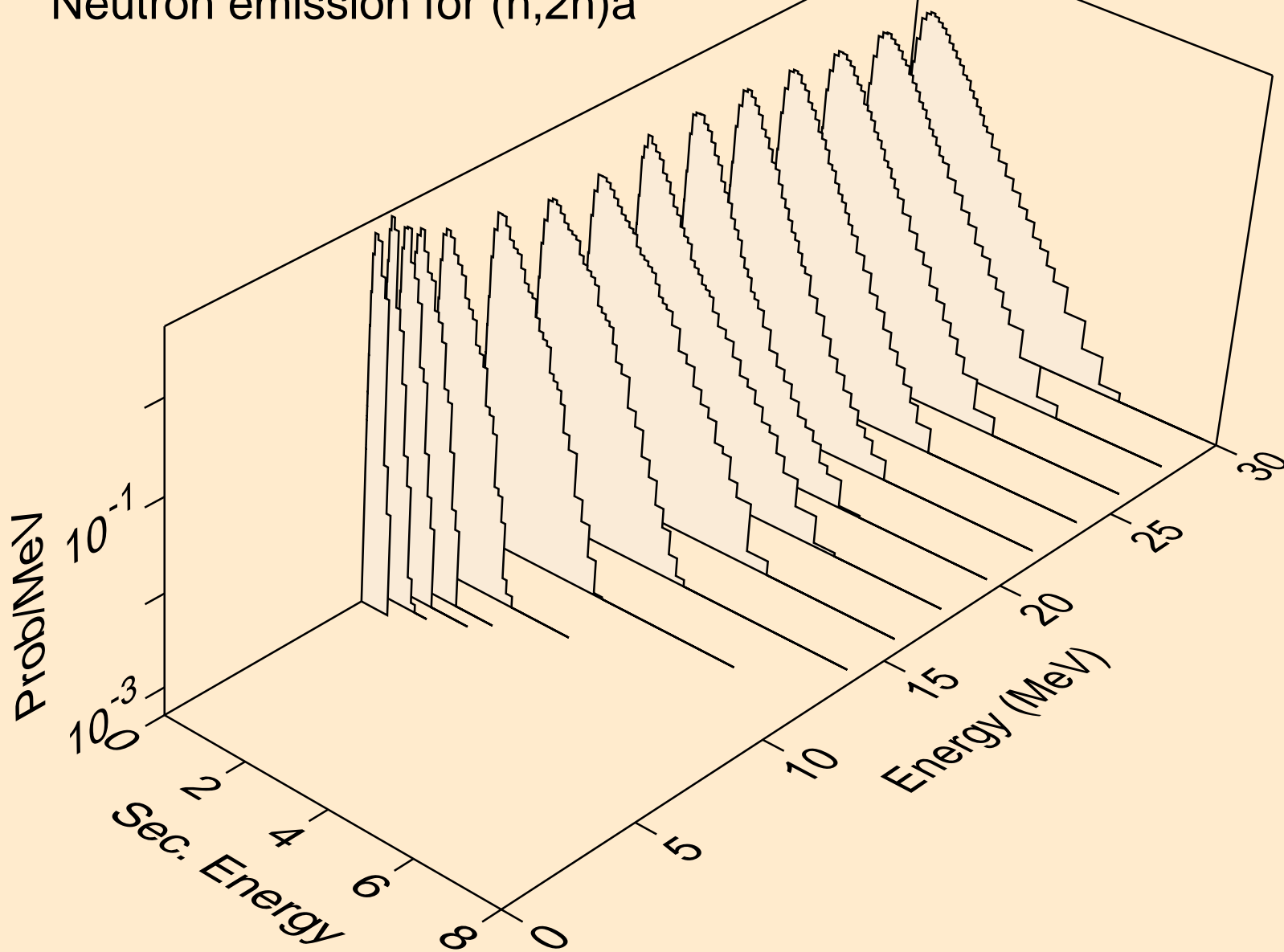

HF177N NEUTRON ACER TENDL-2019 LIBRARY; T=293.16K
Neutron emission for (n,3n)a

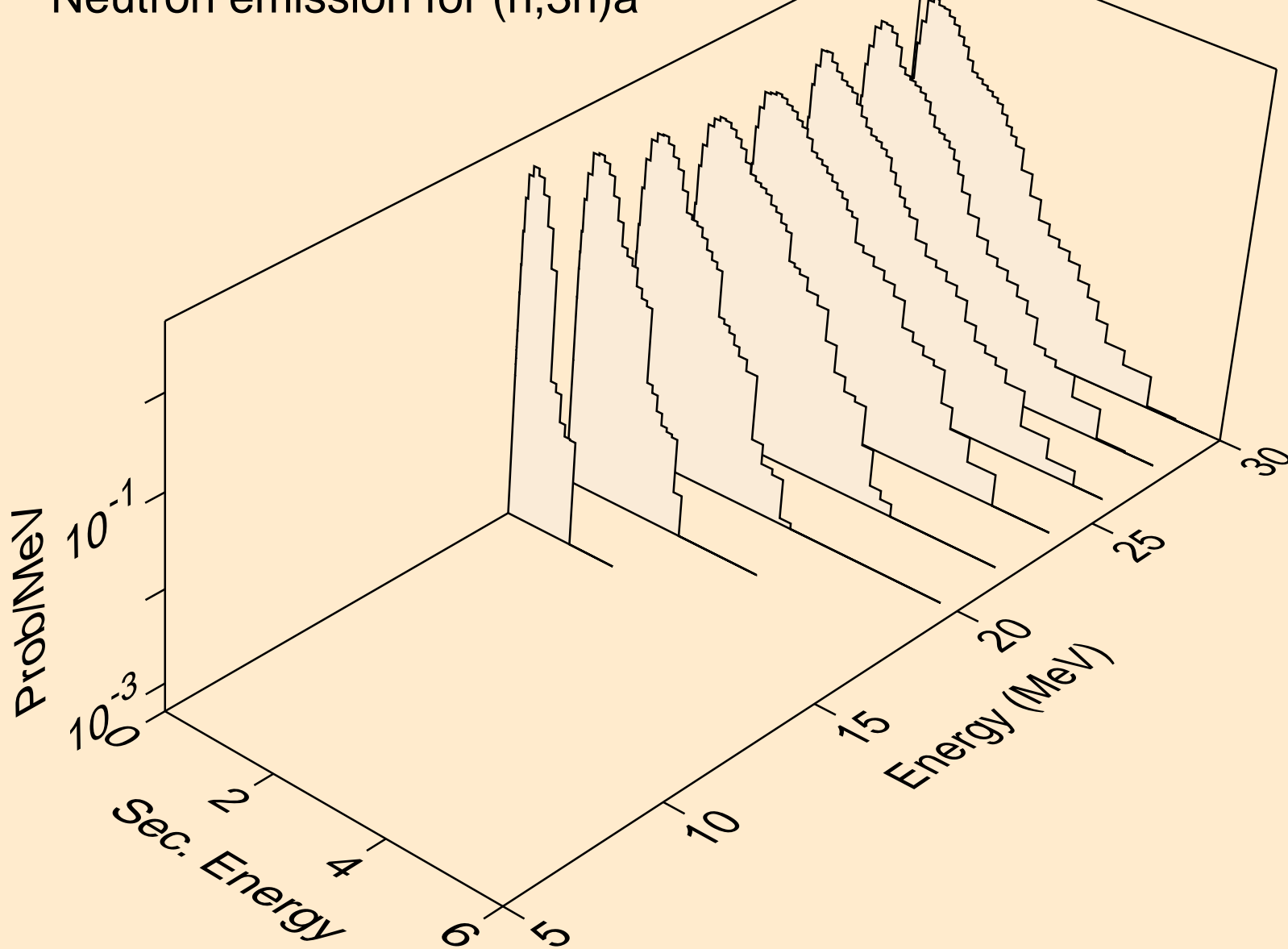

HF177N NEUTRON ACER TENDL-2019 LIBRARY; T=293.16K
Neutron emission for (n,n*)p

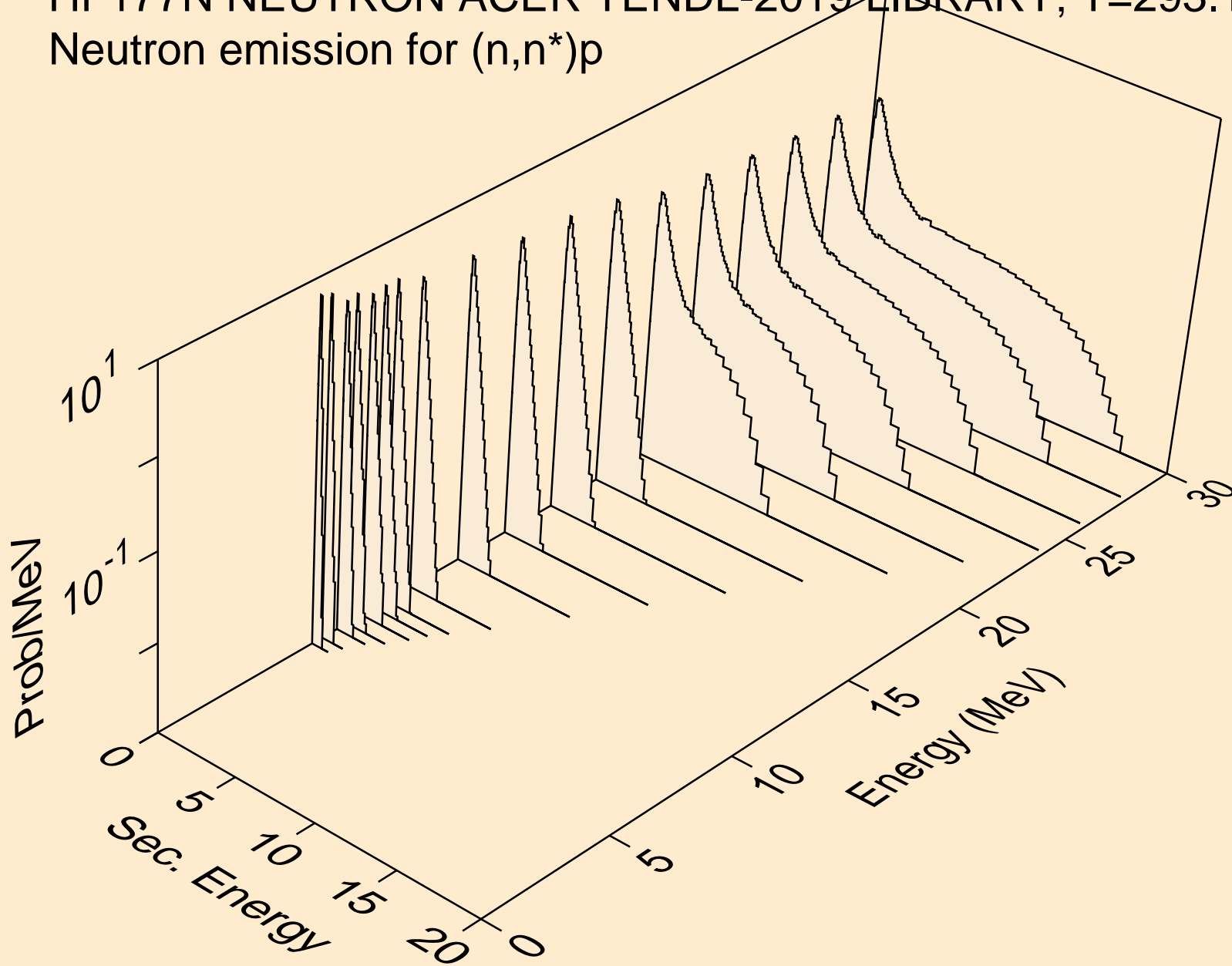

HF177N NEUTRON ACER TENDL-2019 LIBRARY; T=293.16K
Neutron emission for (n,n*)2a

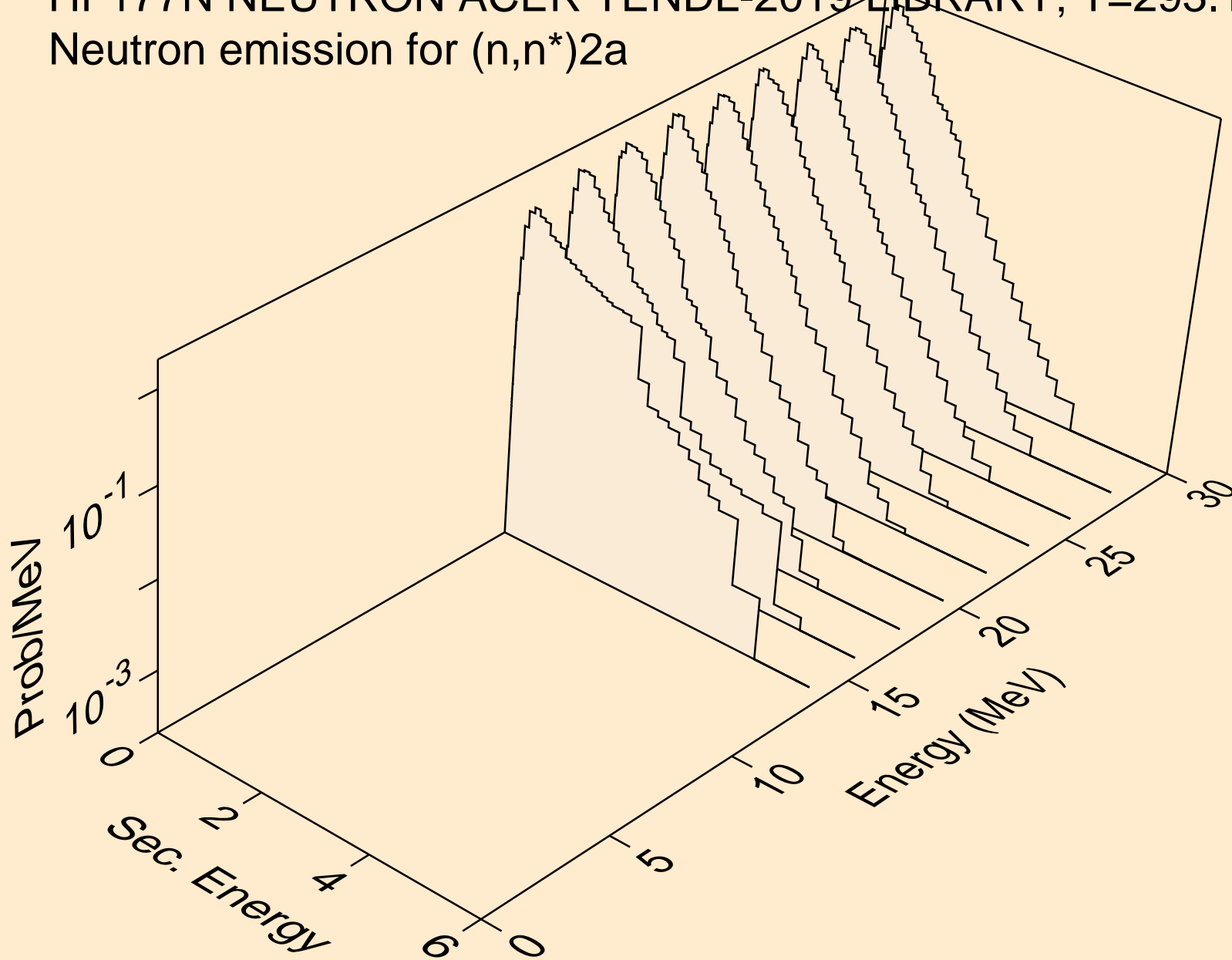

HF177N NEUTRON ACER TENDL-2019 LIBRARY; T=293.16K
Neutron emission for (n,n*)d

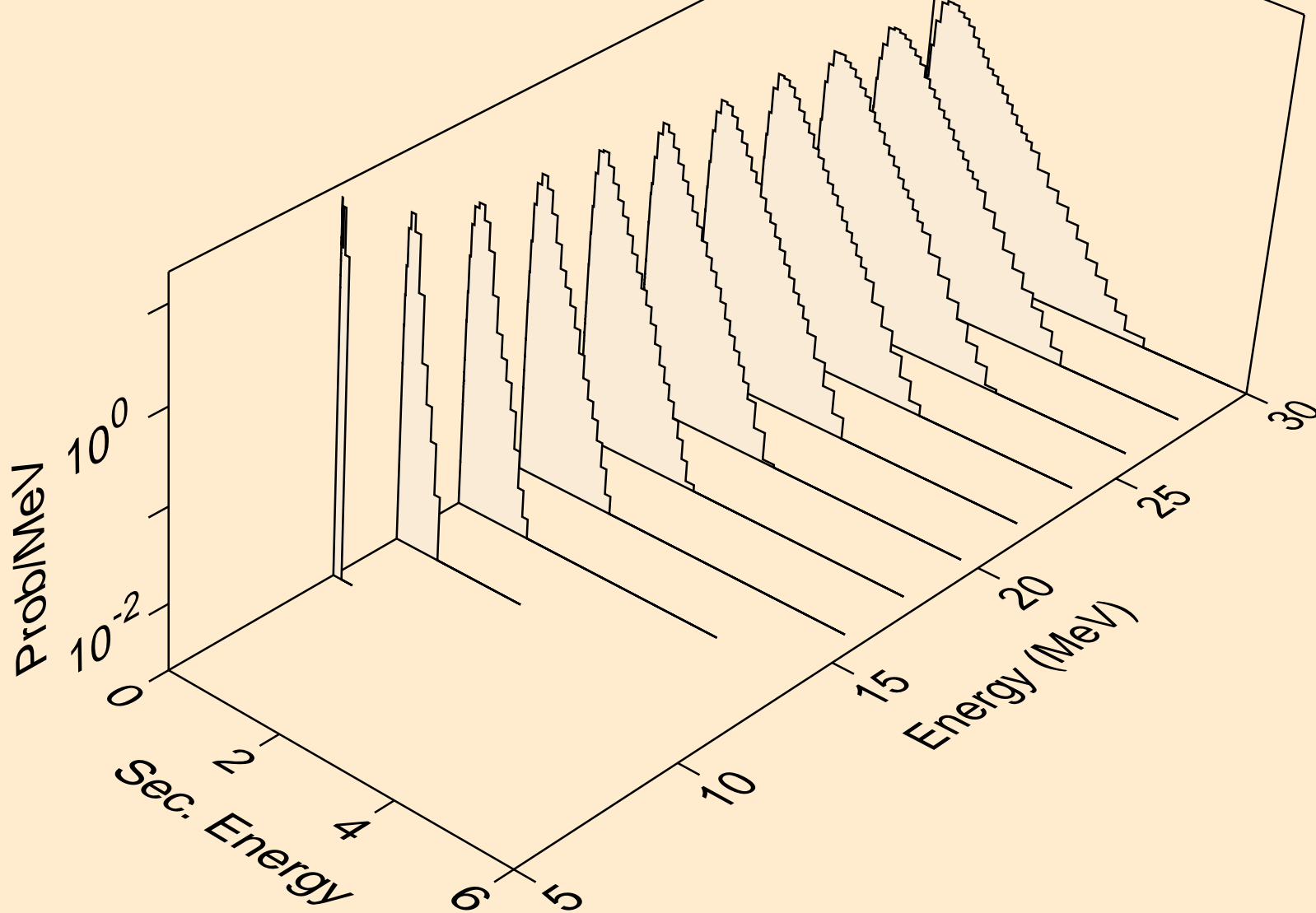

HF177N NEUTRON ACER TENDL-2019 LIBRARY; T=293.16K
Neutron emission for (n,n*)t

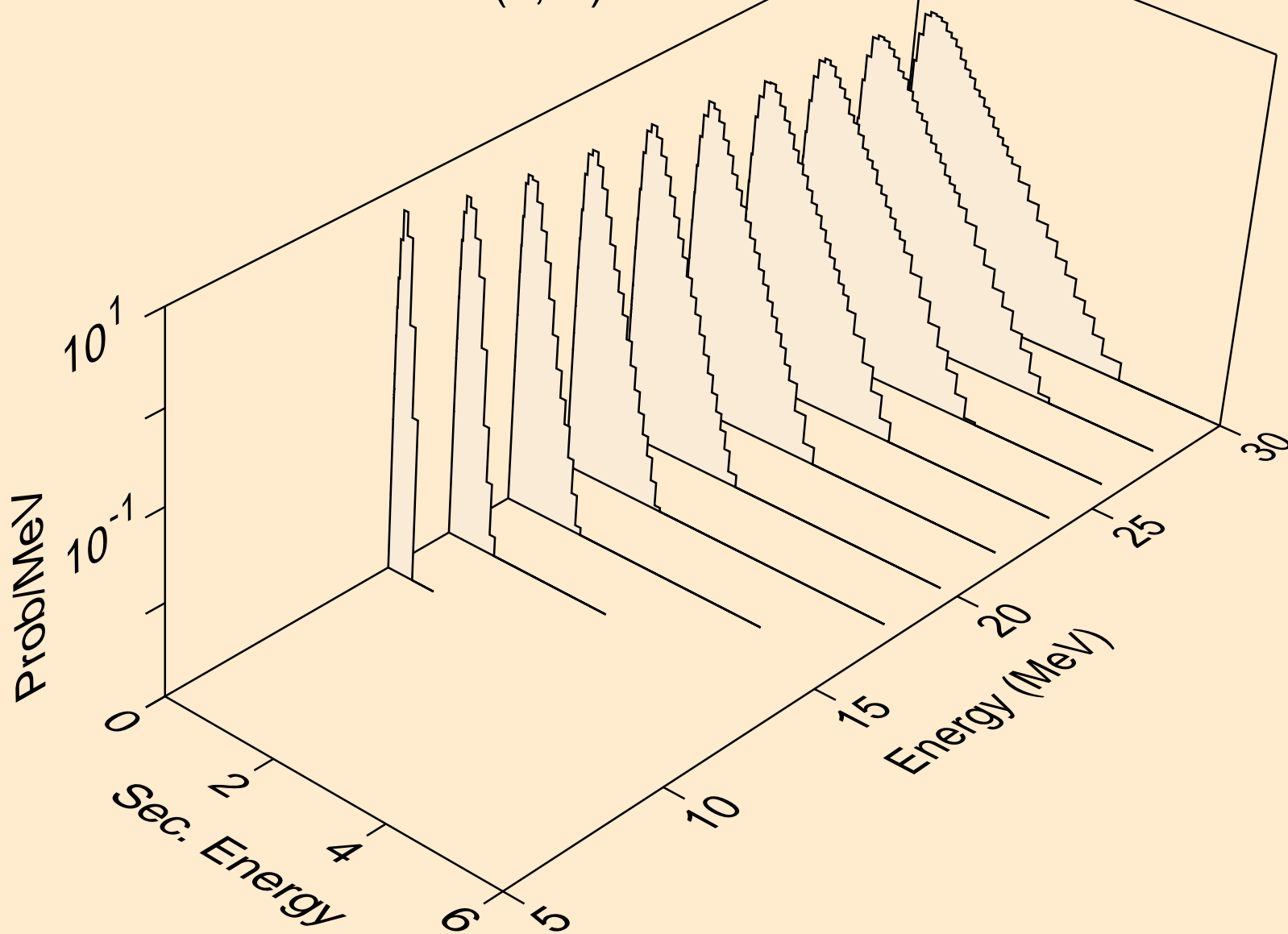

HF177N NEUTRON ACER TENDL-2019 LIBRARY; T=293.16K
Neutron emission for (n,n*)he3

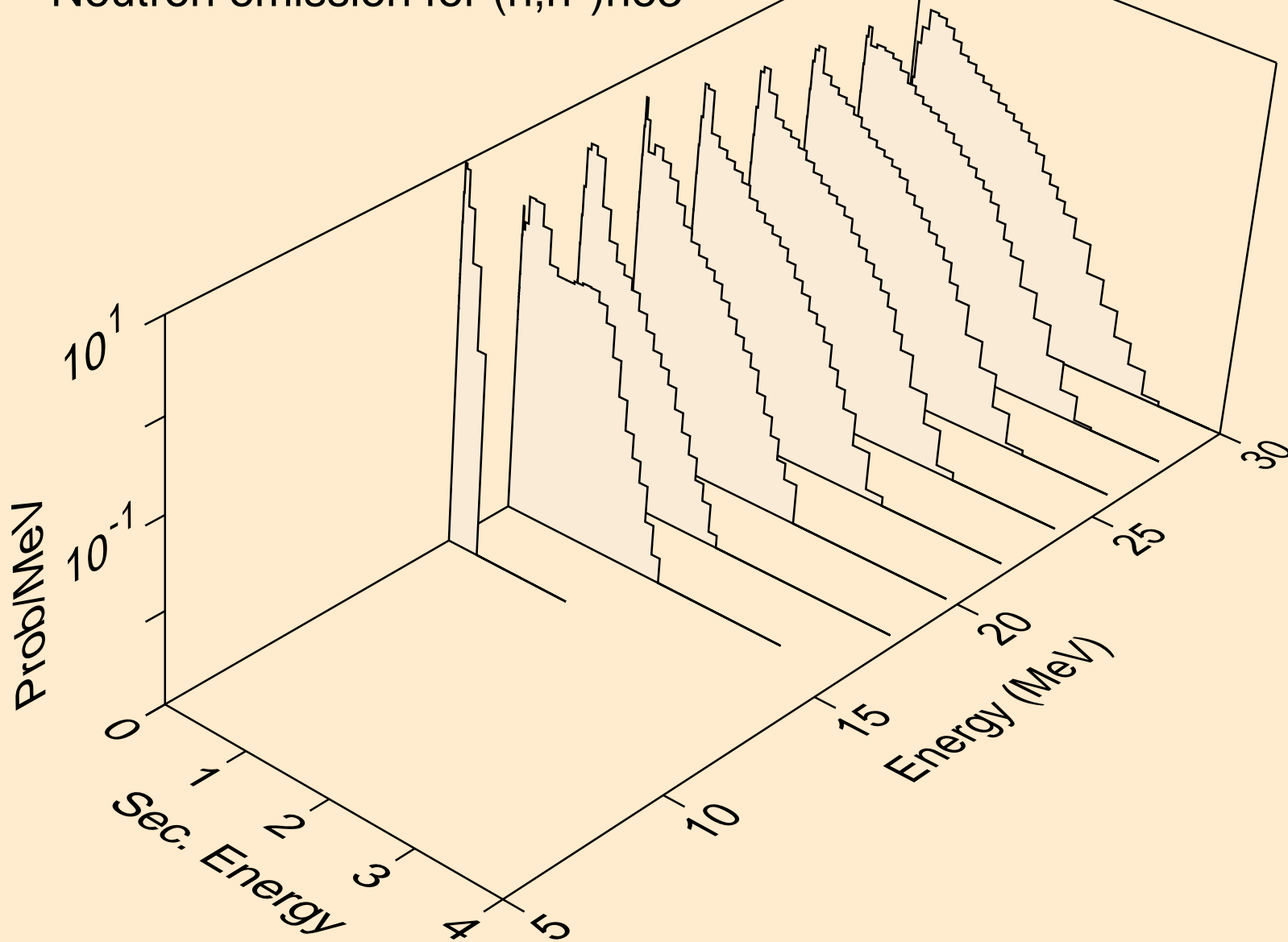

HF177N NEUTRON ACER TENDL-2019 LIBRARY; T=293.16K
Neutron emission for (n,4n)

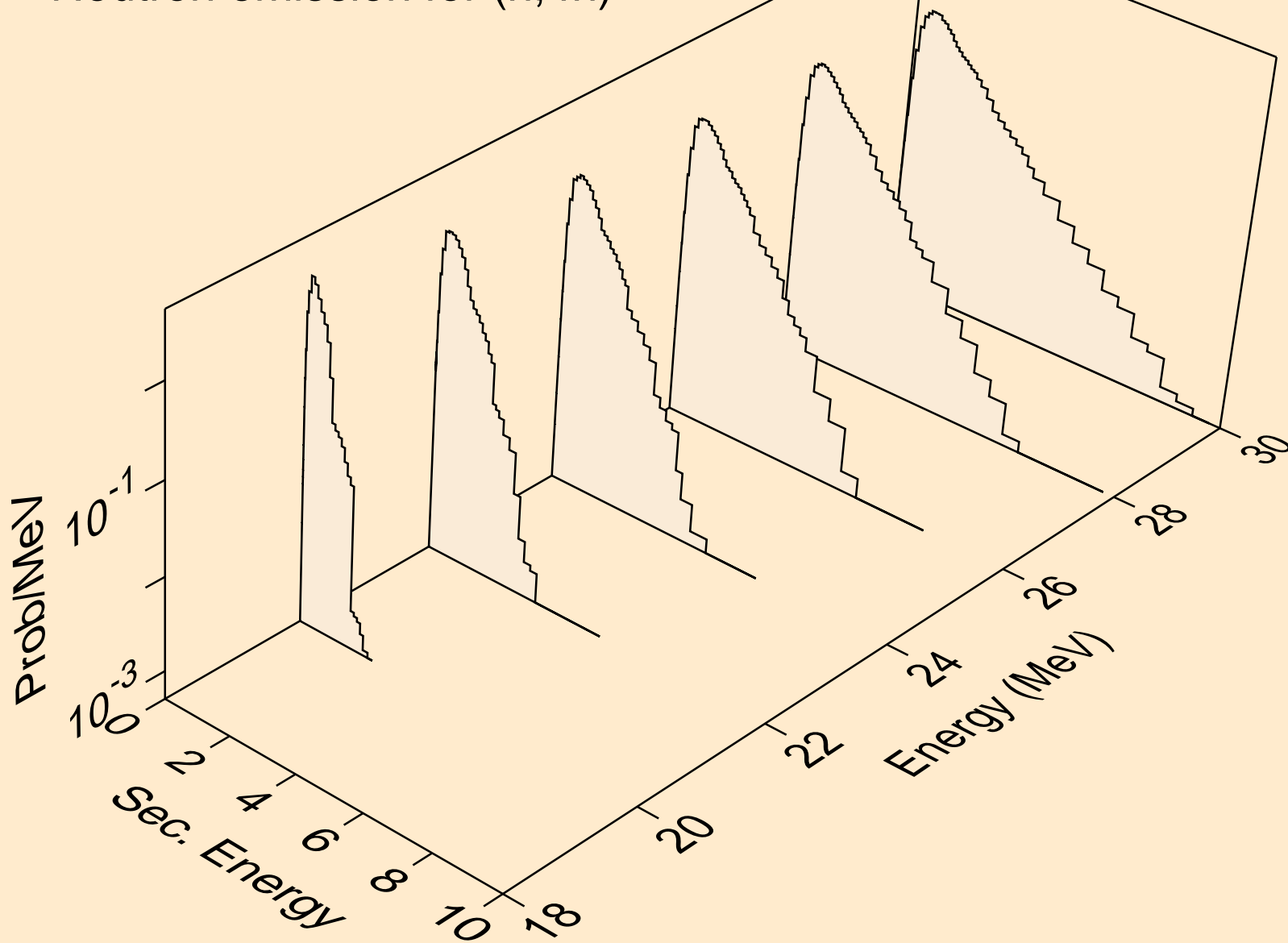

HF177N NEUTRON ACER TENDL-2019 LIBRARY; T=293.16K
Neutron emission for (n,2np)

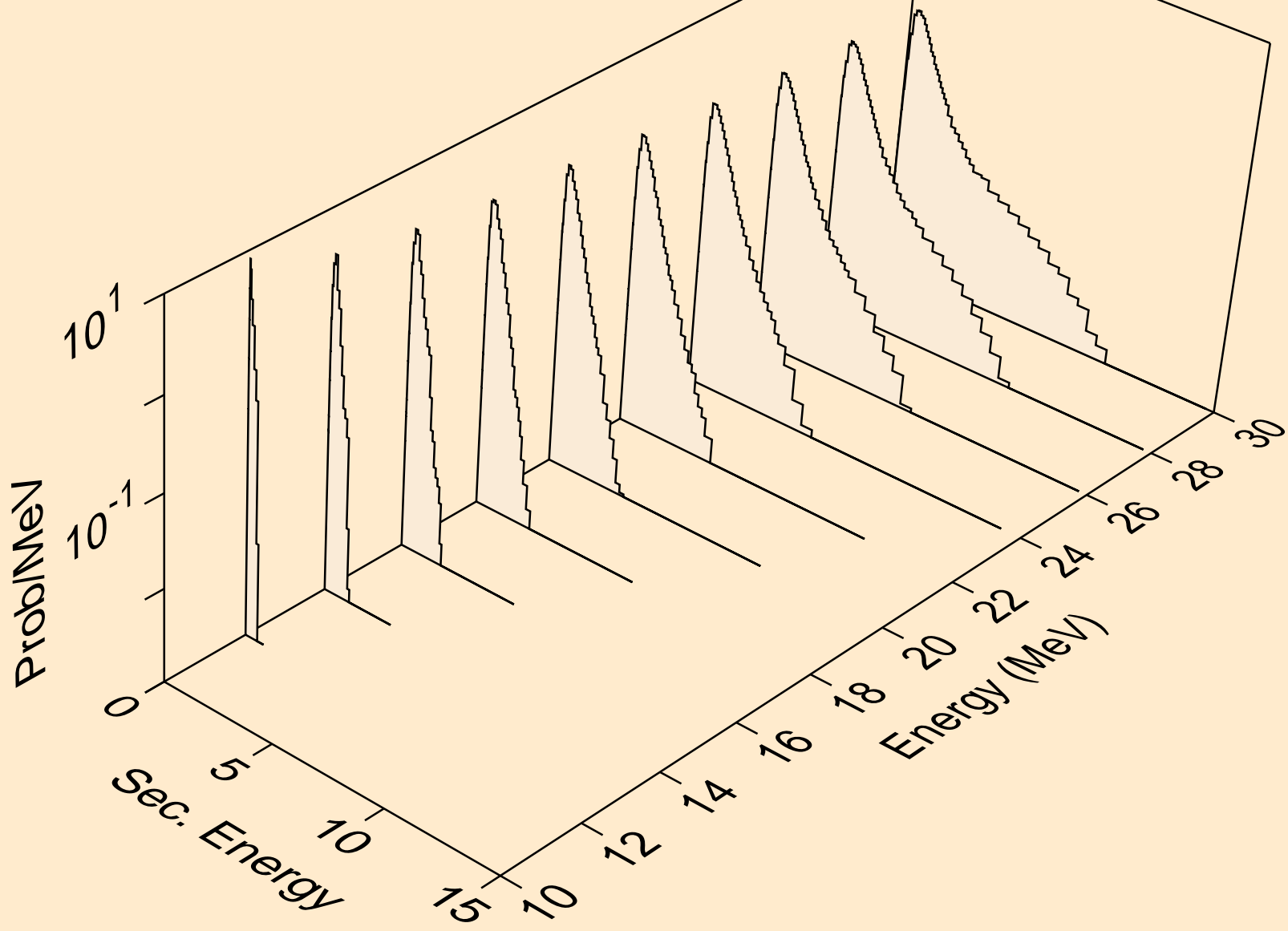

HF177N NEUTRON ACER TENDL-2019 LIBRARY; T=293.16K
Neutron emission for (n,3np)

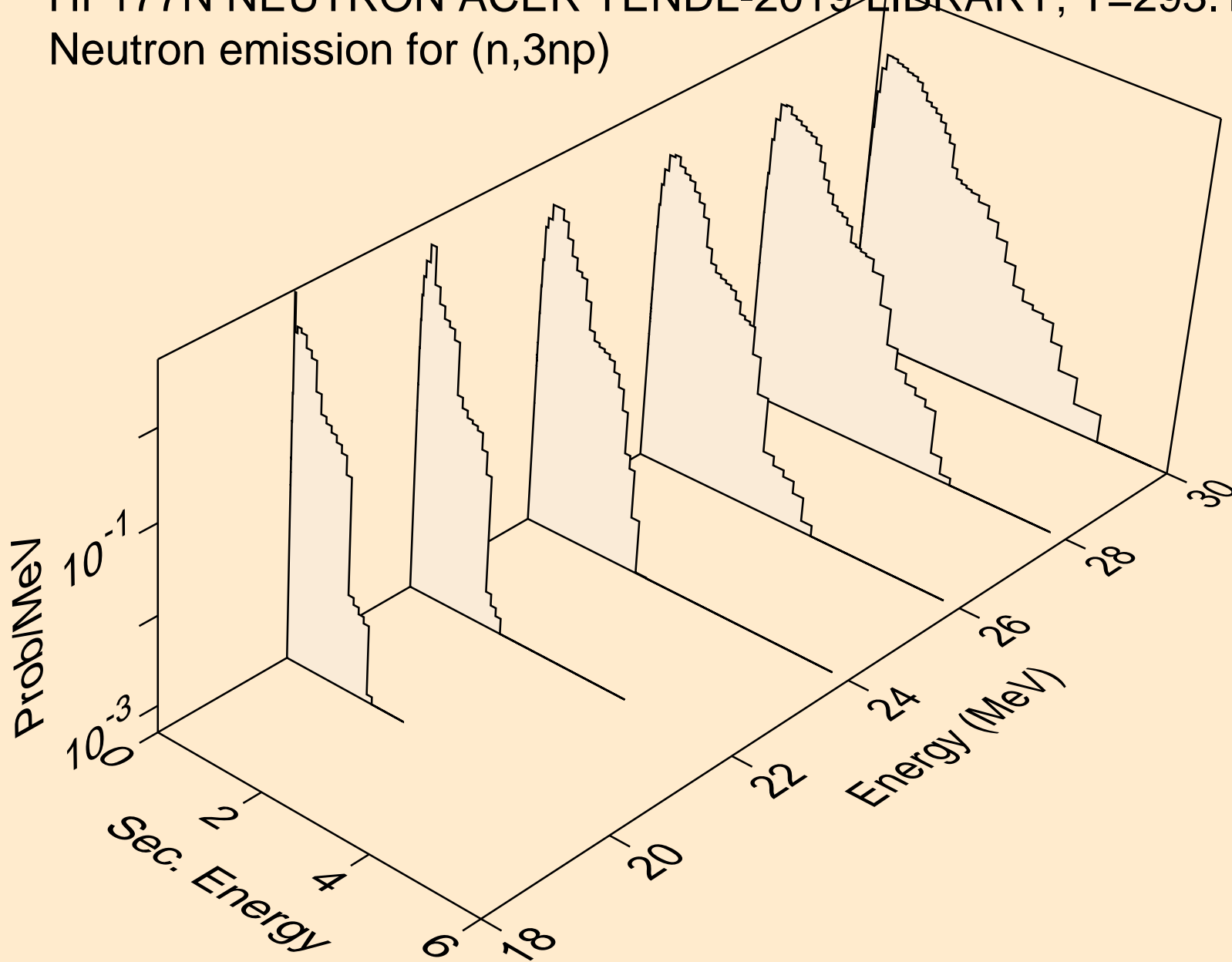

HF177N NEUTRON ACER TENDL-2019 LIBRARY; T=293.16K
Neutron emission for (n,2np)

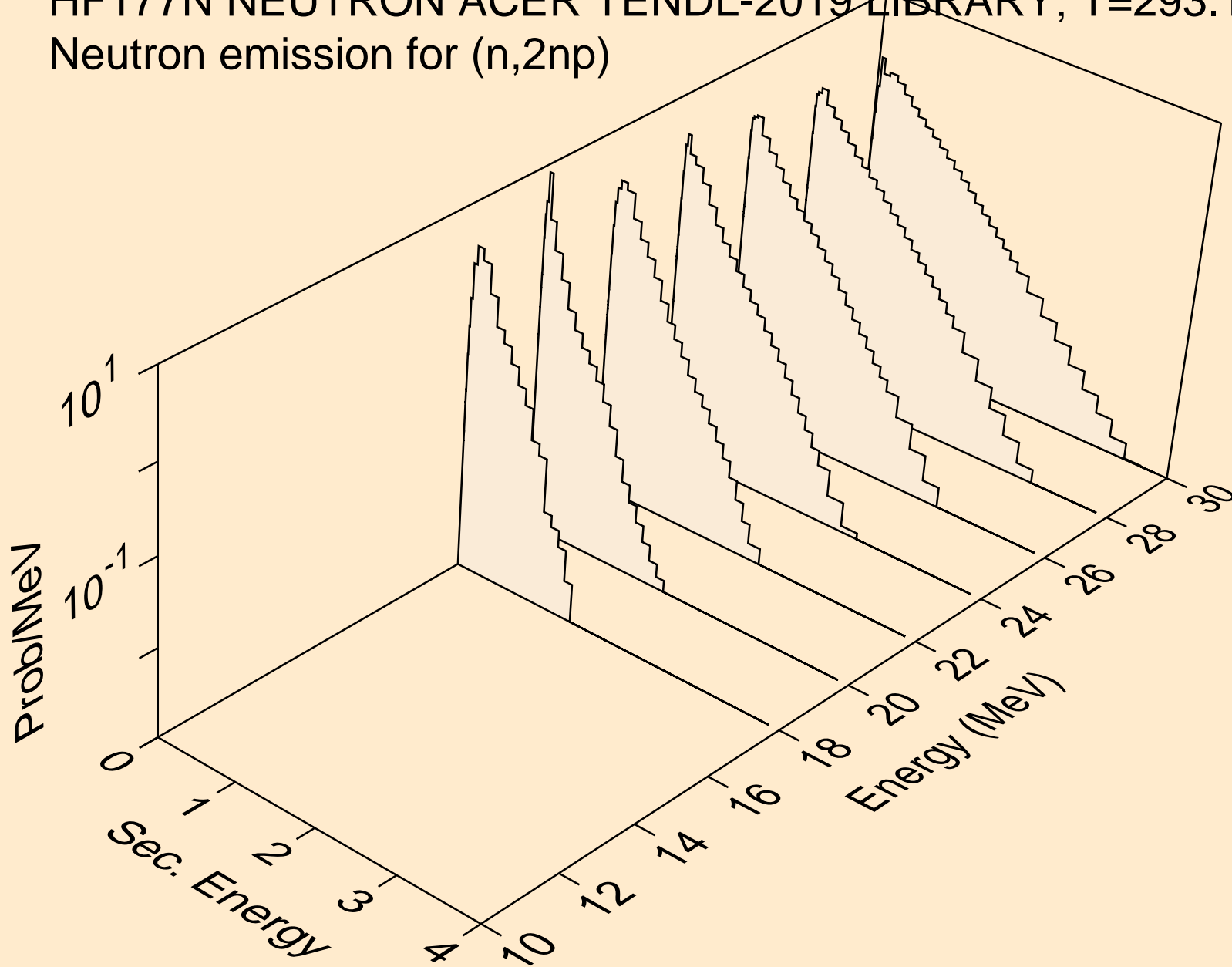

HF177N NEUTRON ACER TENDL-2019 LIBRARY; T=293.16K
Neutron emission for (n,npa)

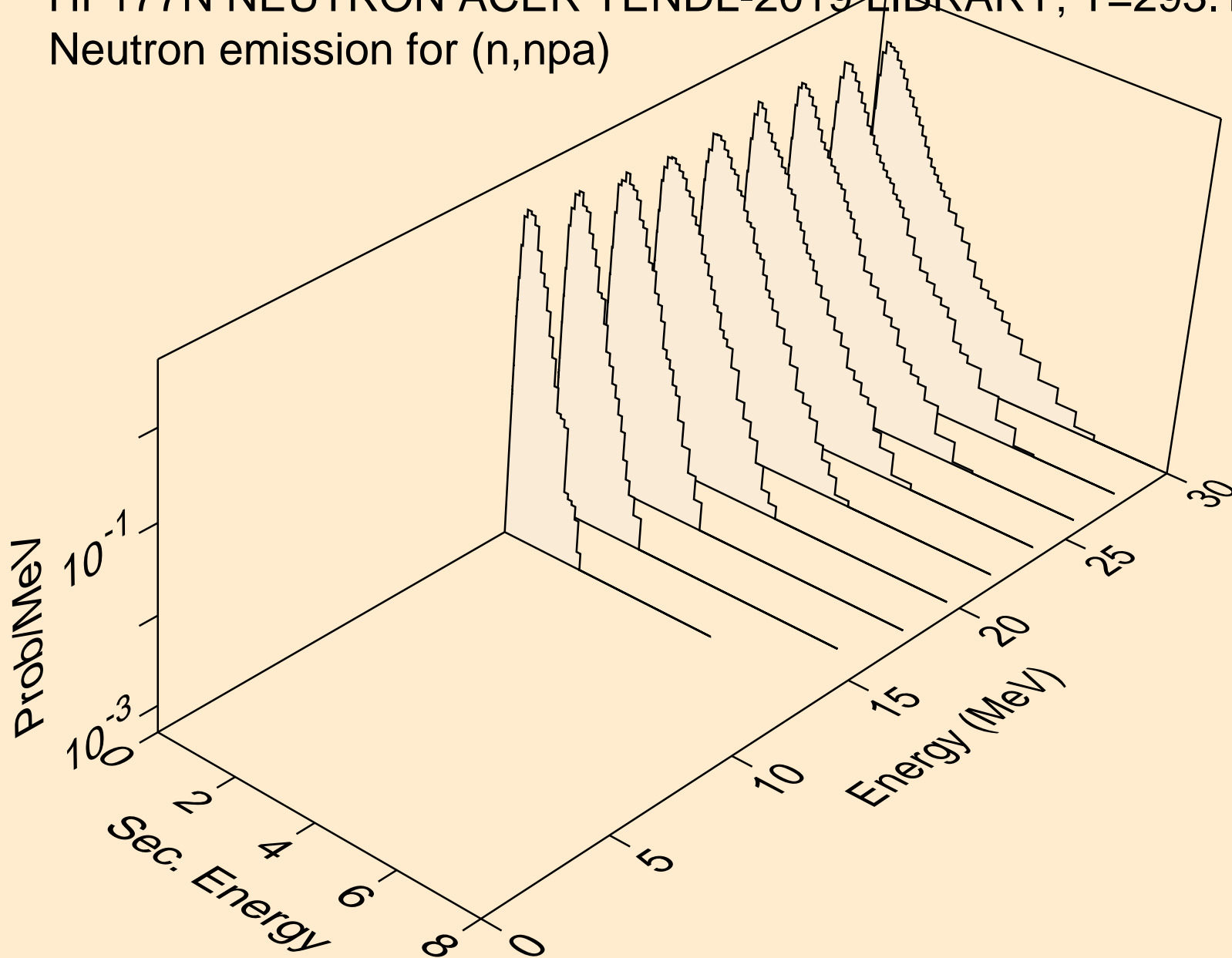

HF177N NEUTRON ACER TENDL-2019 LIBRARY; T=293.16K
Neutron emission for (n,n*c)

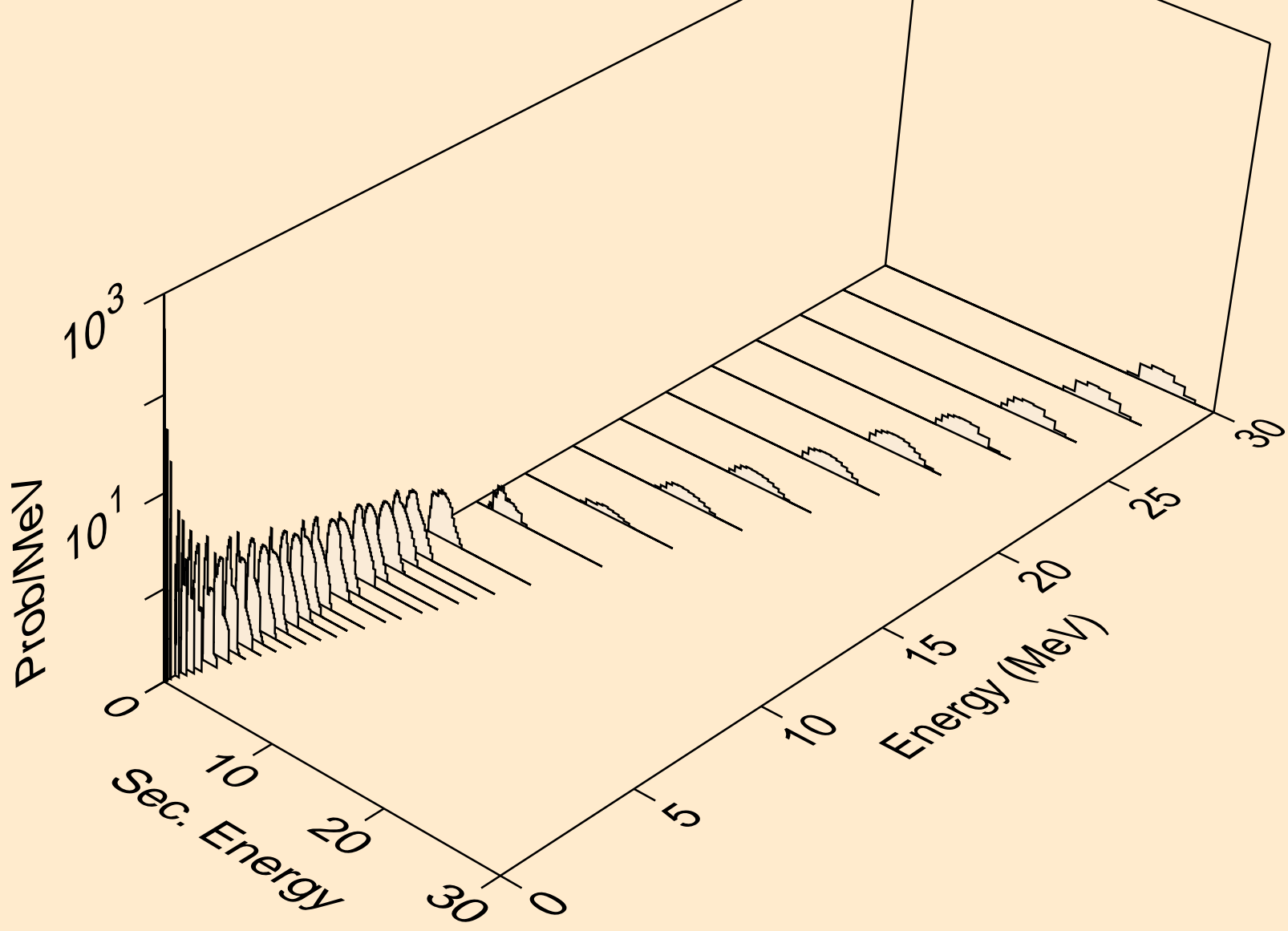

HF177N NEUTRON ACER TENDL-2019 LIBRARY; T=293.16K
Photon emission for (n,x)

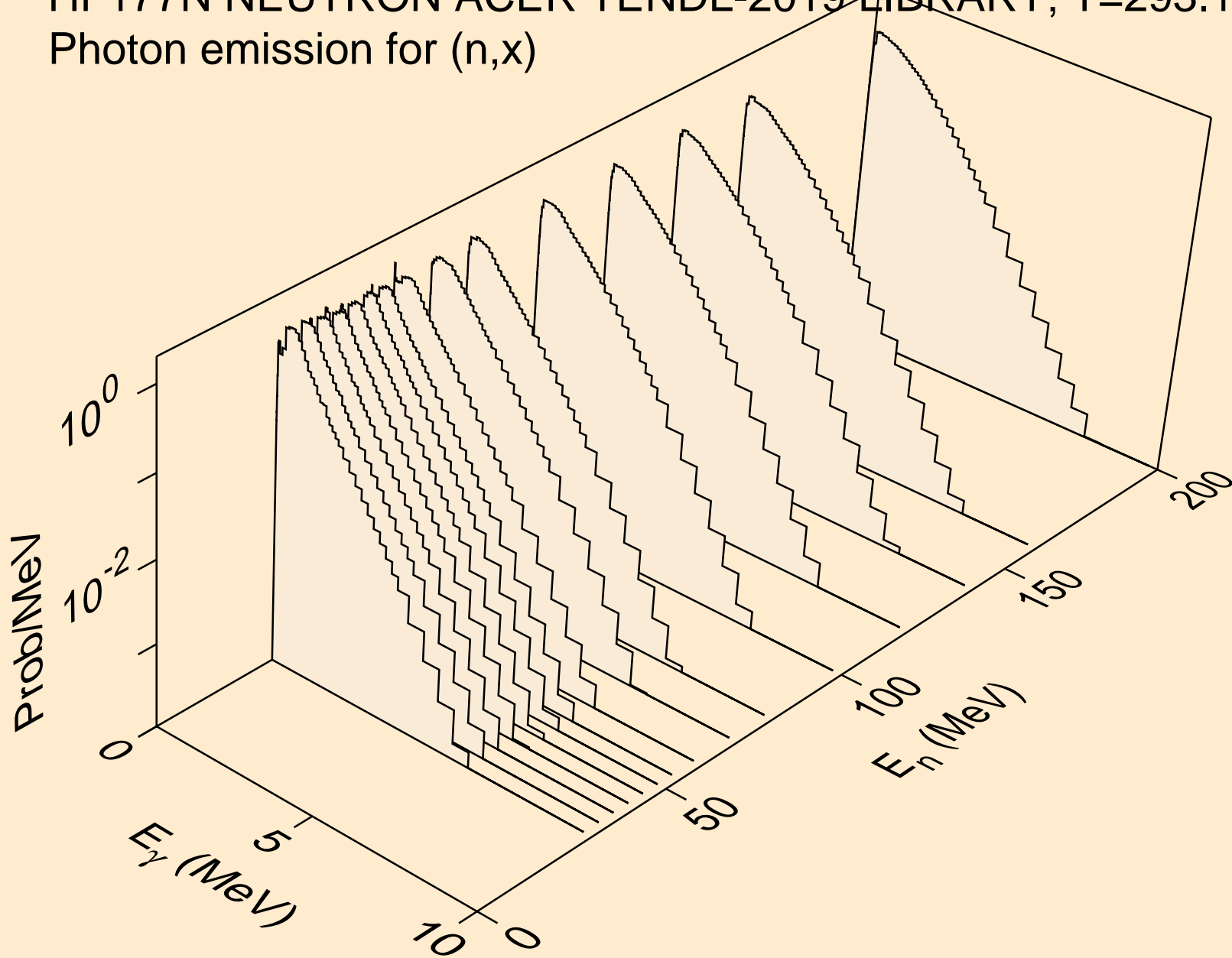

HF177N NEUTRON ACER TENDL-2019 LIBRARY; T=293.16K
Photon emission for (n,2nd)

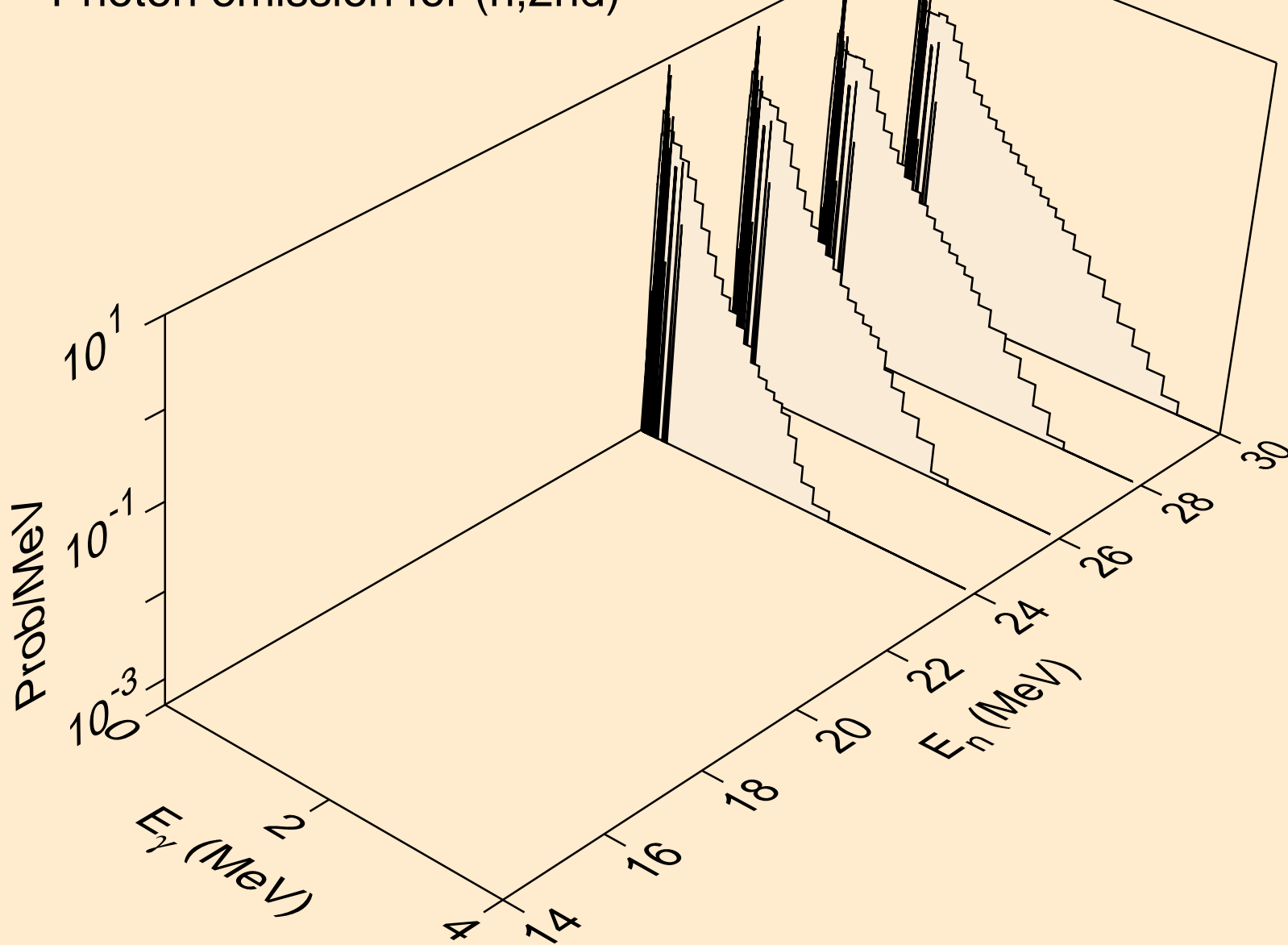

HF177N NEUTRON ACER TENDL-2019 LIBRARY; T=293.16K
Photon emission for (n,2n)

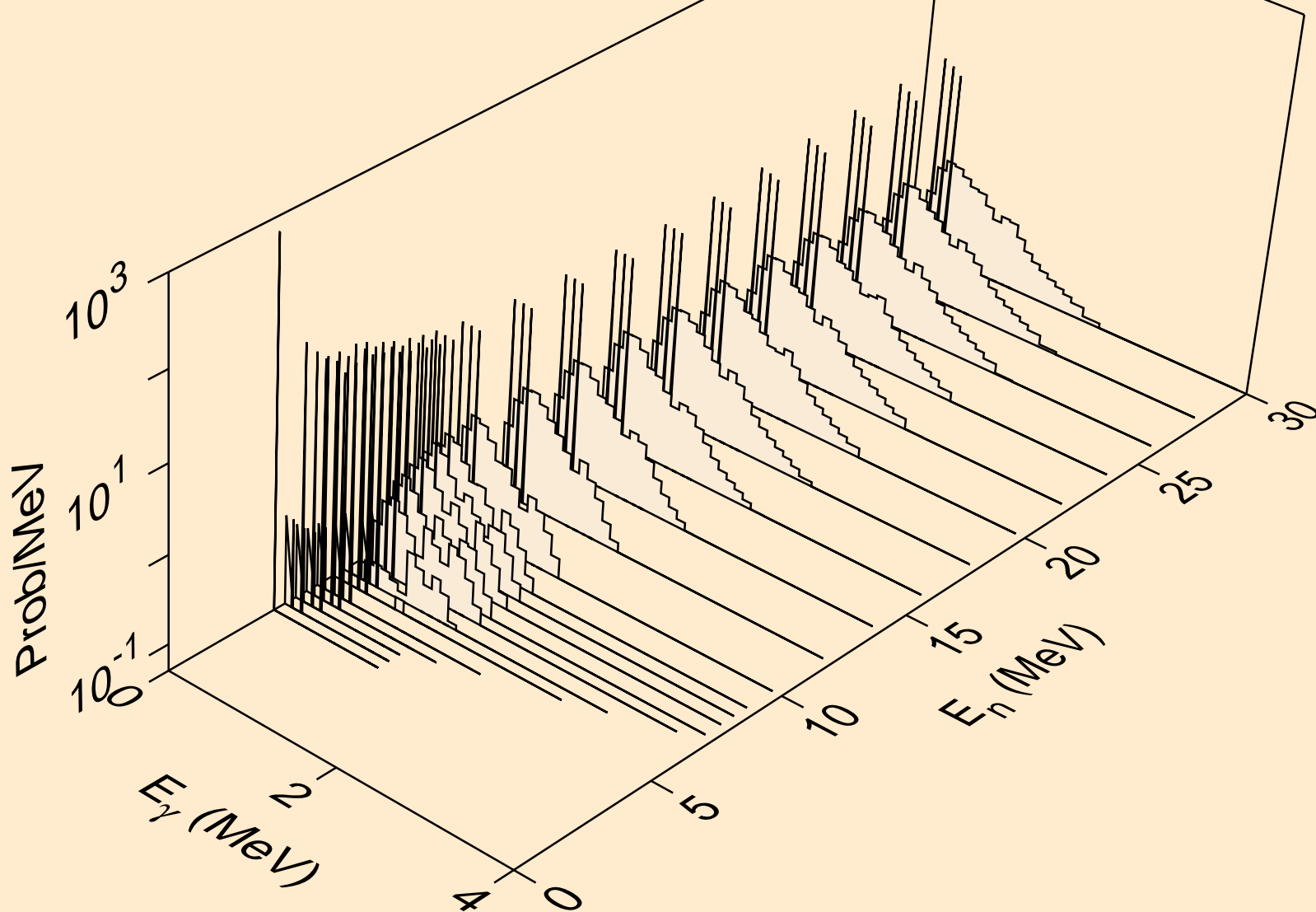

HF177N NEUTRON ACER TENDL-2019 LIBRARY; T=293.16K
Photon emission for (n,3n)

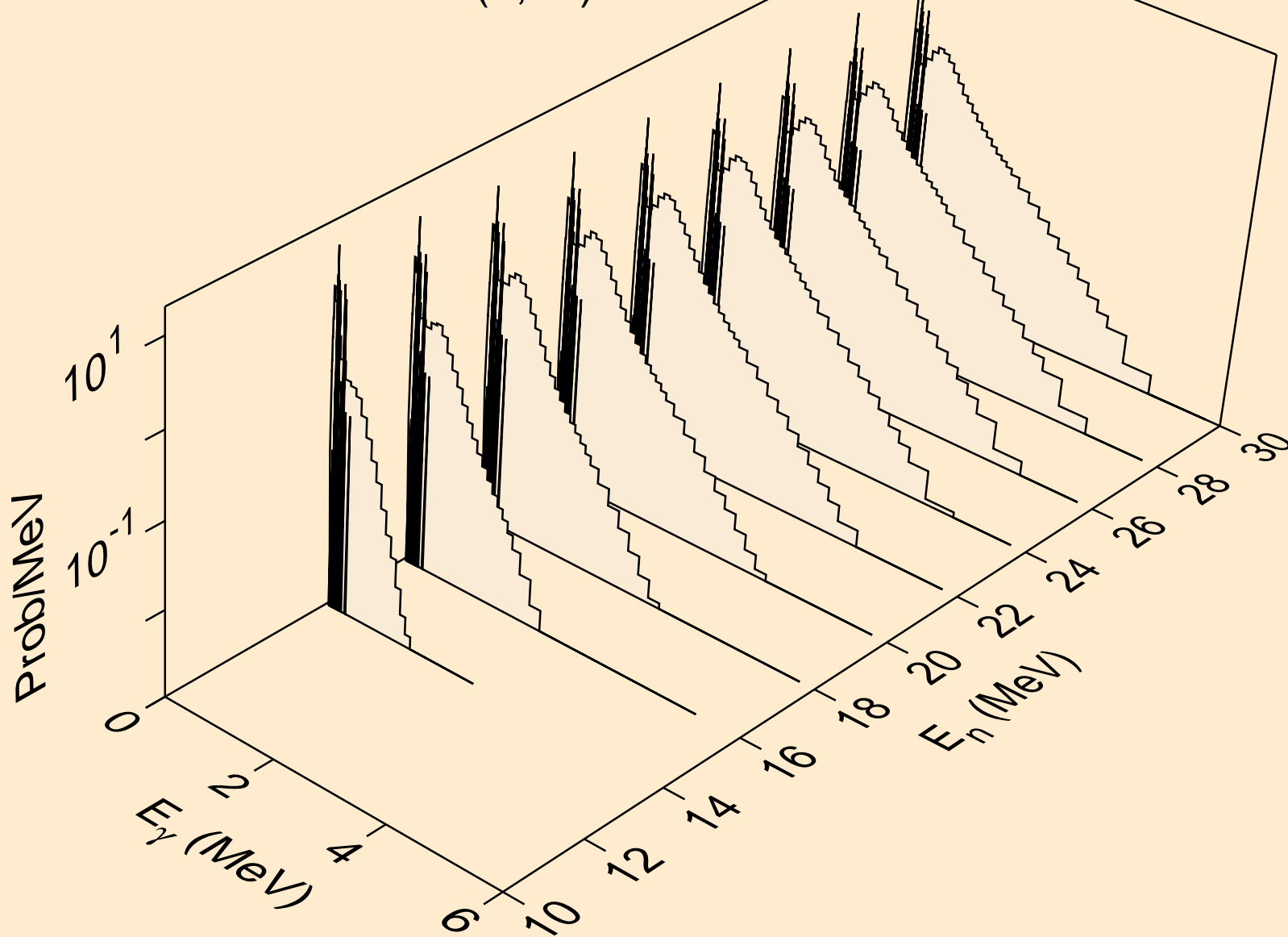

HF177N NEUTRON ACER TENDL-2019 LIBRARY; T=293.16K
Photon emission for (n,n*)a

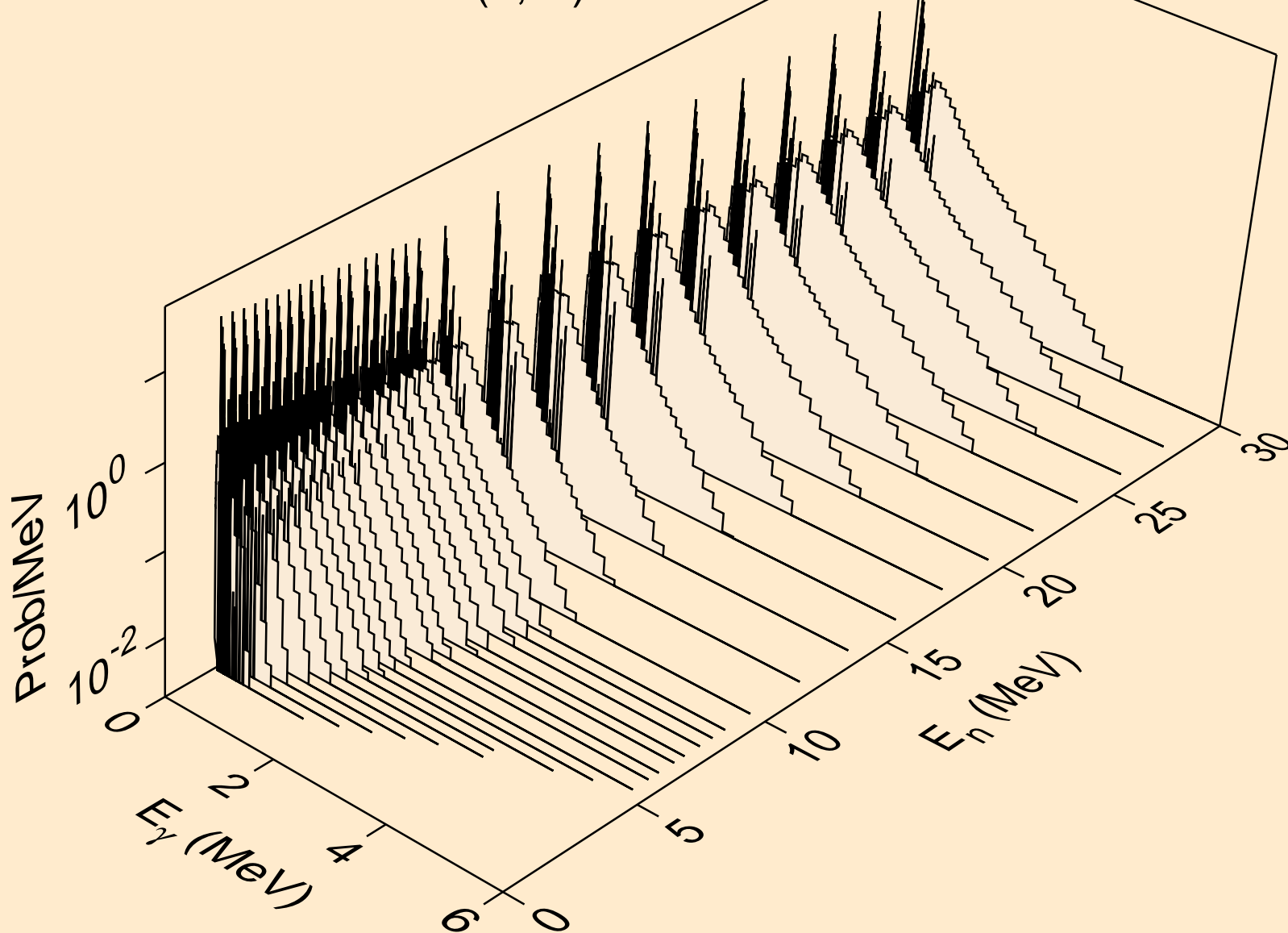

HF177N NEUTRON ACER TENDL-2019 LIBRARY; T=293.16K
Photon emission for (n,2n)a

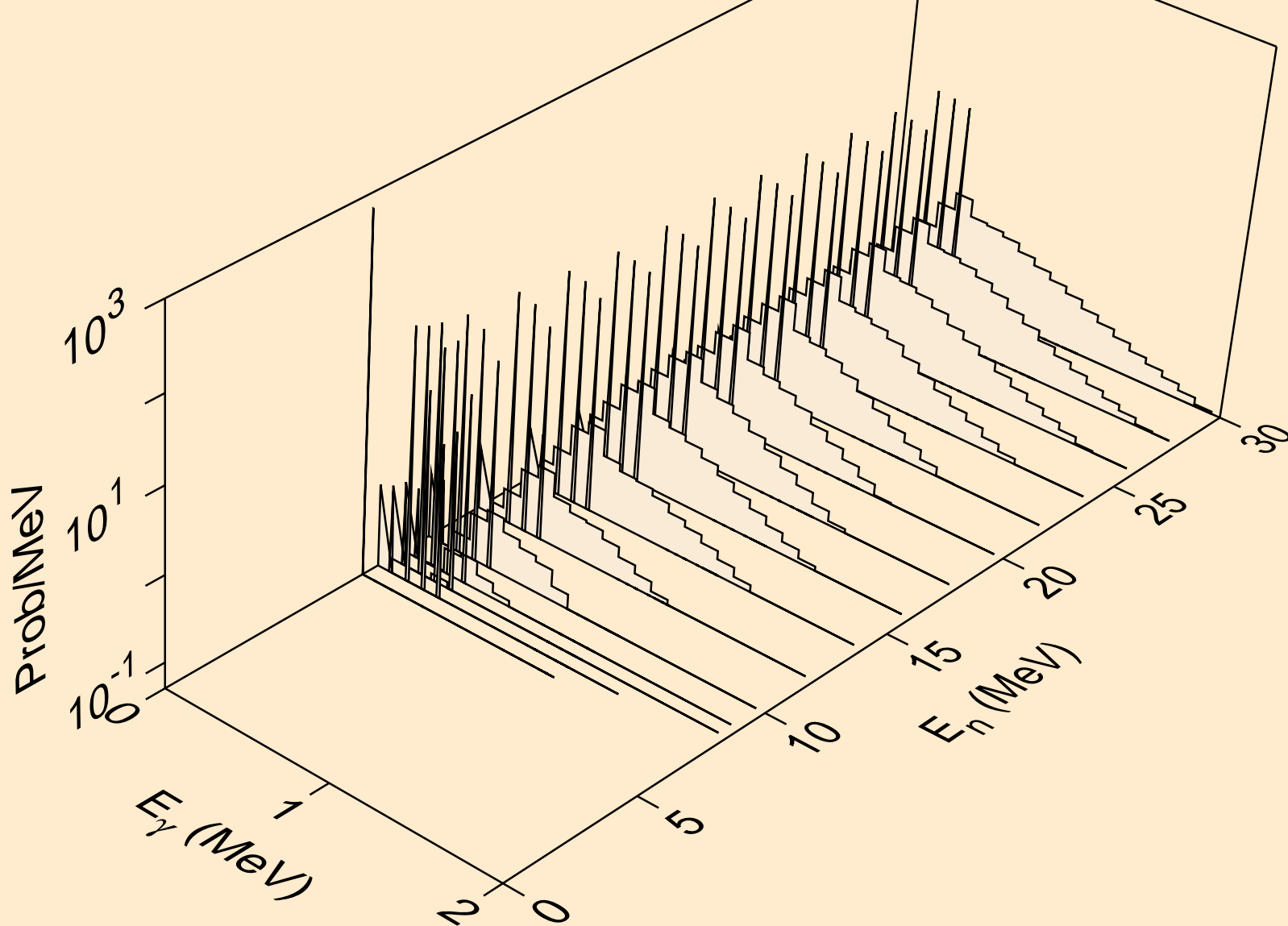

HF177N NEUTRON ACER TENDL-2019 LIBRARY; T=293.16K
Photon emission for (n,3n)a

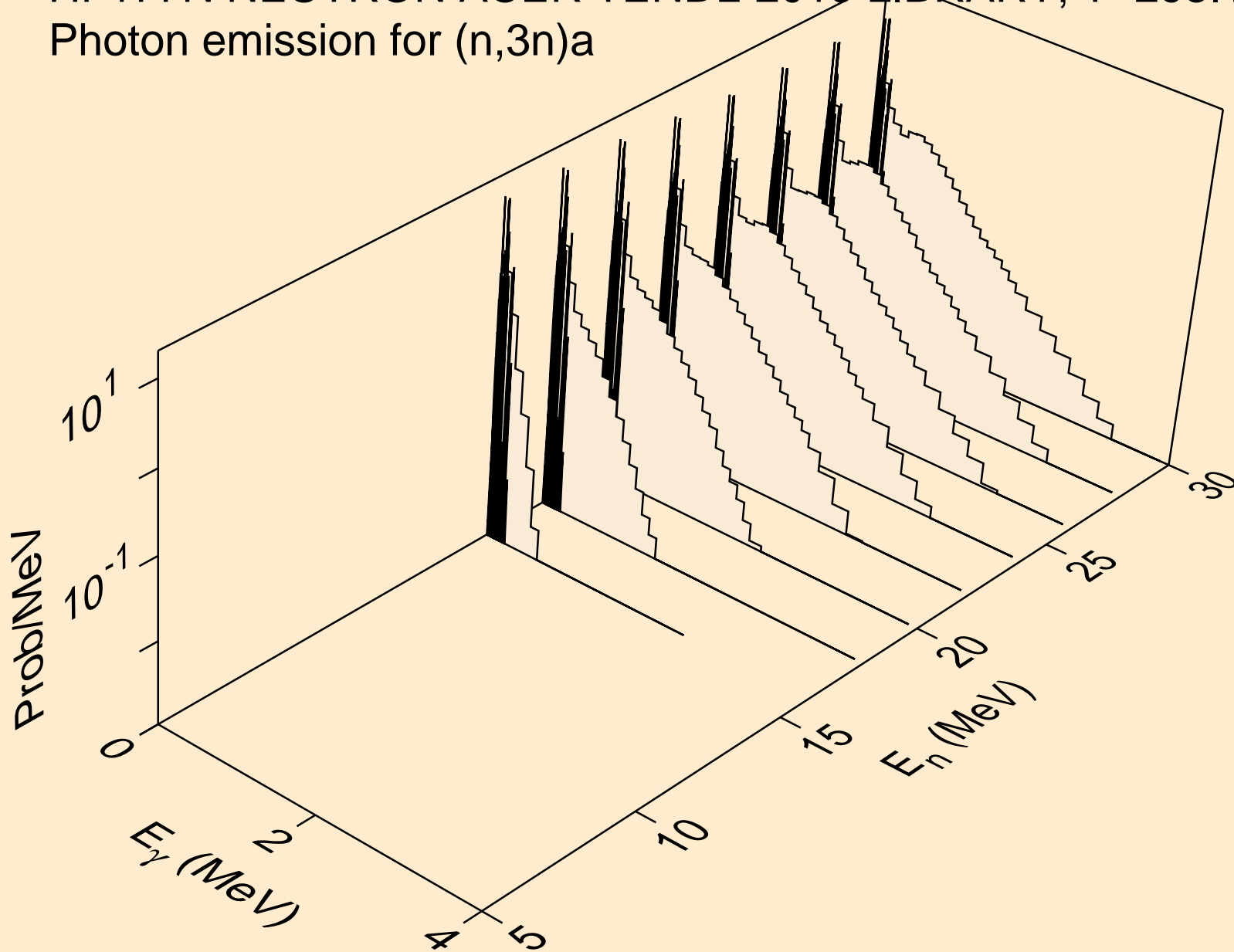

HF177N NEUTRON ACER TENDL-2019 LIBRARY; T=293.16K
Photon emission for (n,n*)p

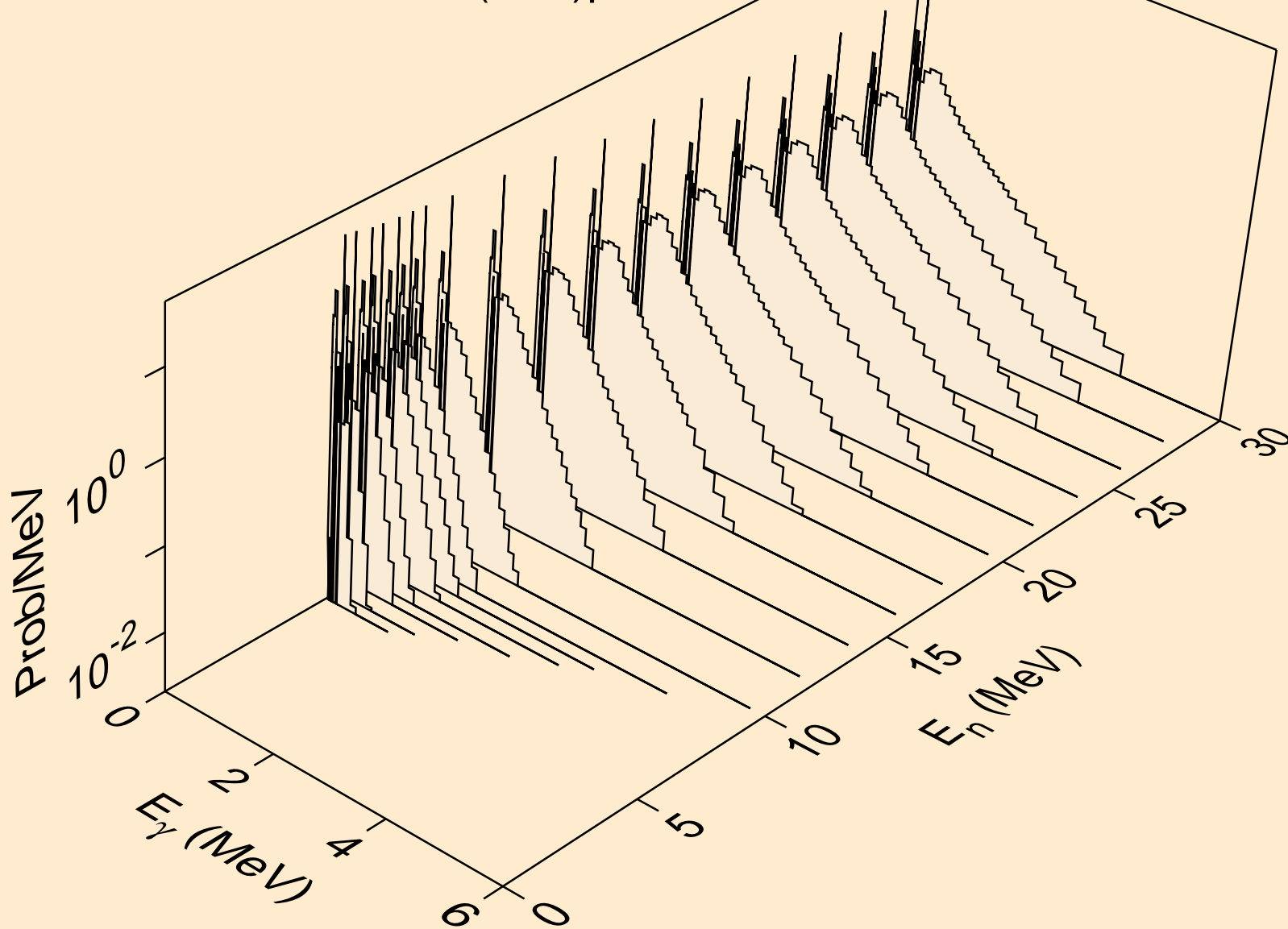

HF177N NEUTRON ACER TENDL-2019 LIBRARY; T=293.16K
Photon emission for (n,n*)2a

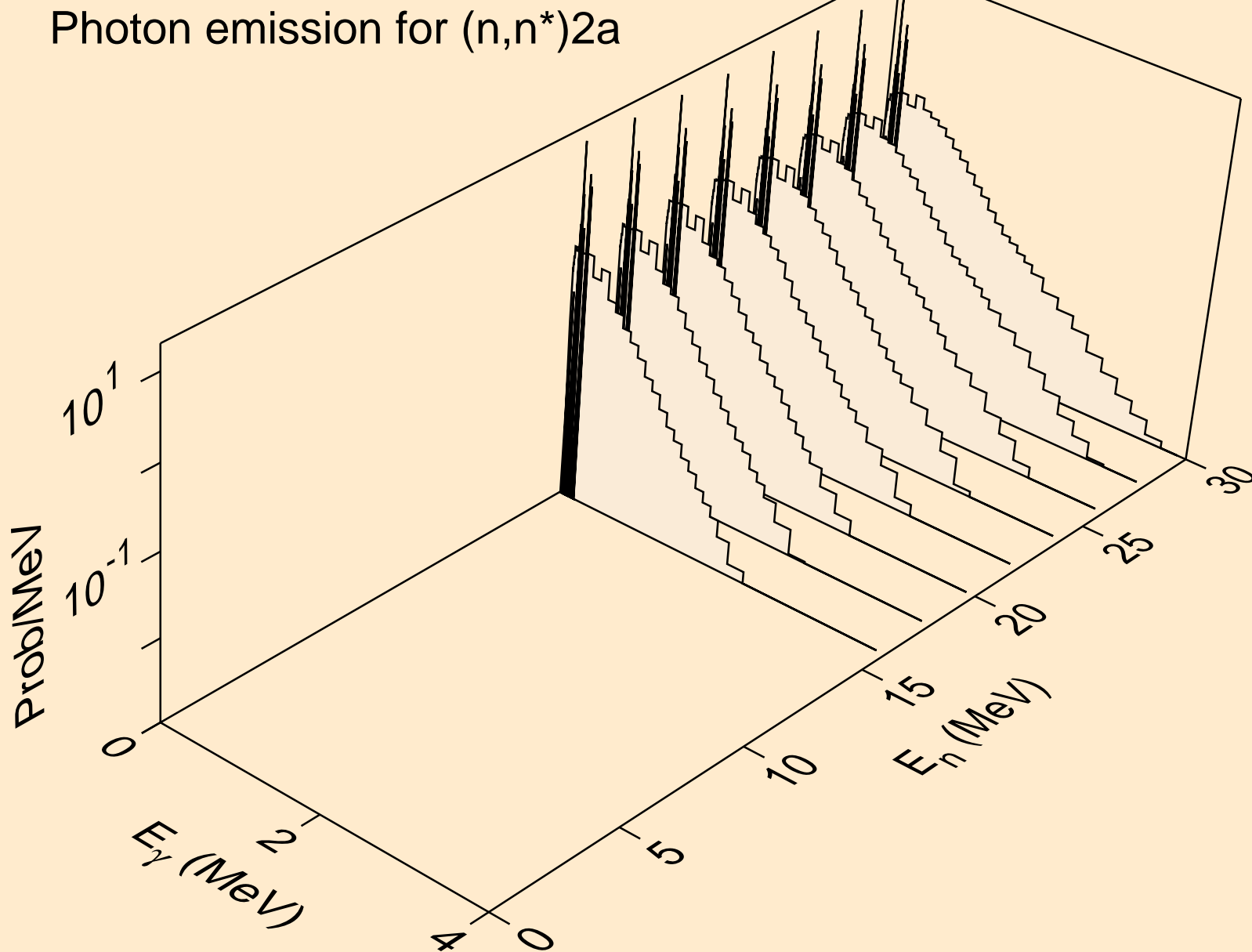

HF177N NEUTRON ACER TENDL-2019 LIBRARY; T=293.16K
Photon emission for (n,n*)d

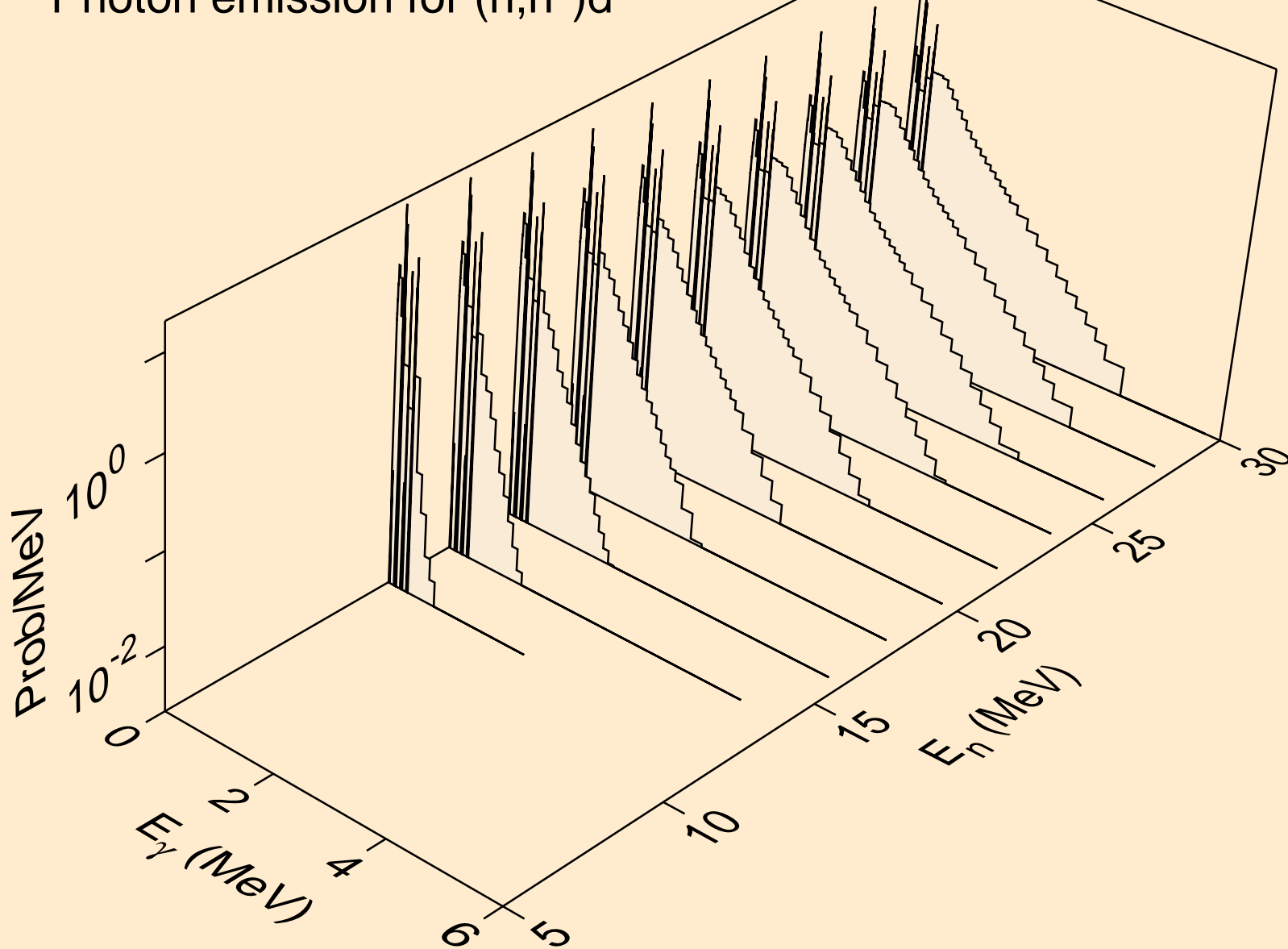

HF177N NEUTRON ACER TENDL-2019 LIBRARY; T=293.16K
Photon emission for (n,n*)t

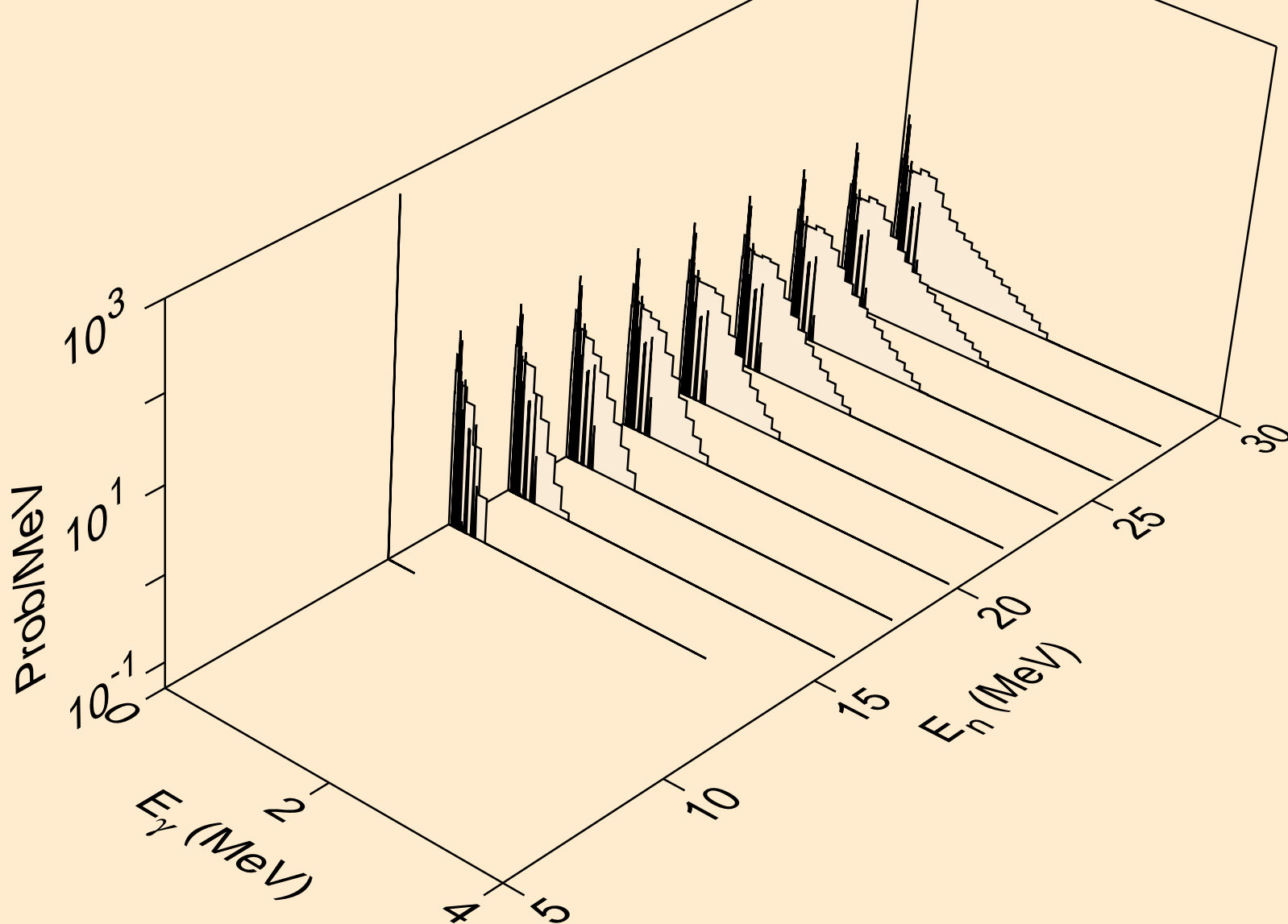

HF177N NEUTRON ACER TENDL-2019 LIBRARY; T=293.16K
Photon emission for (n,n*)he3

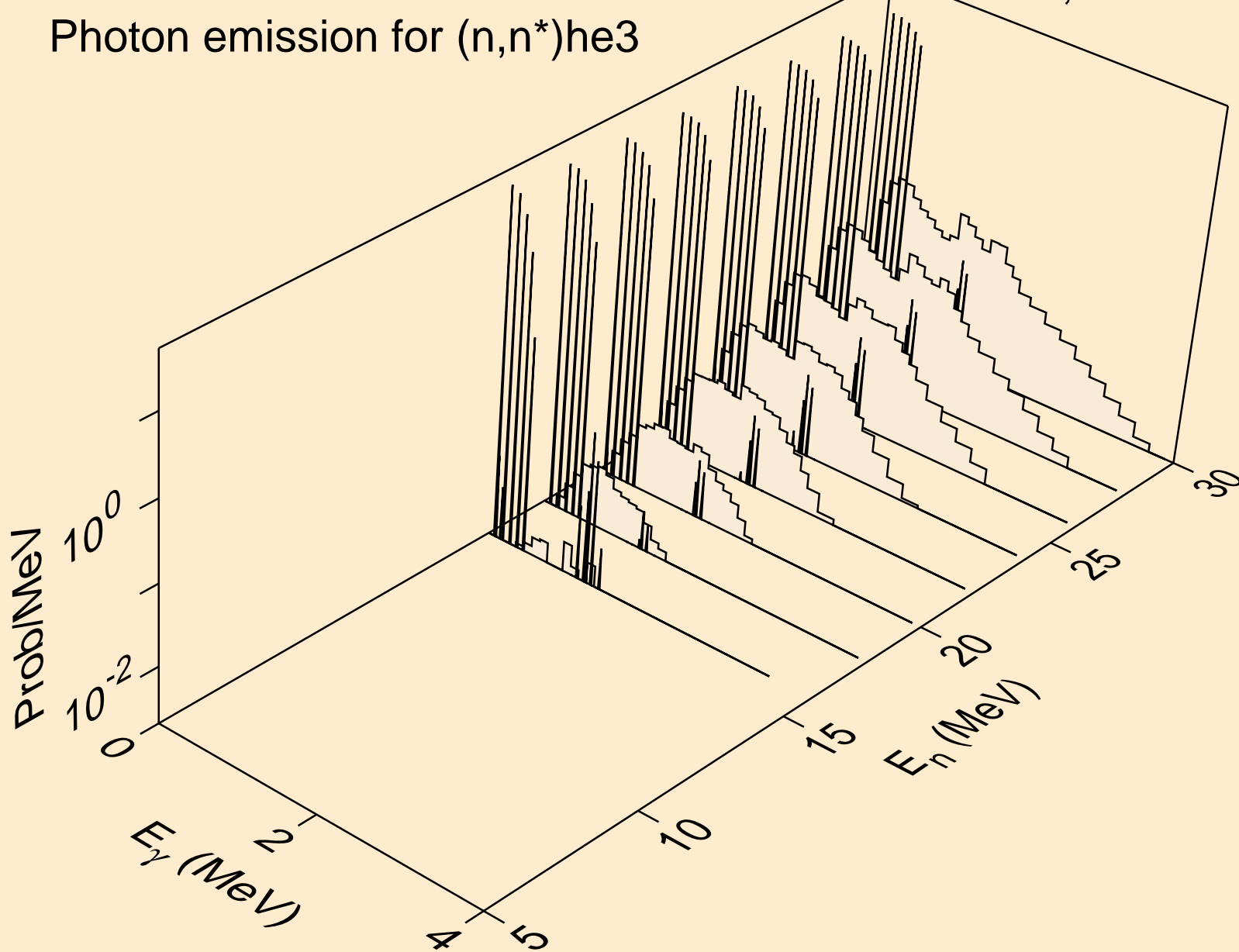

HF177N NEUTRON ACER TENDL-2019 LIBRARY; T=293.16K
Photon emission for (n,4n)

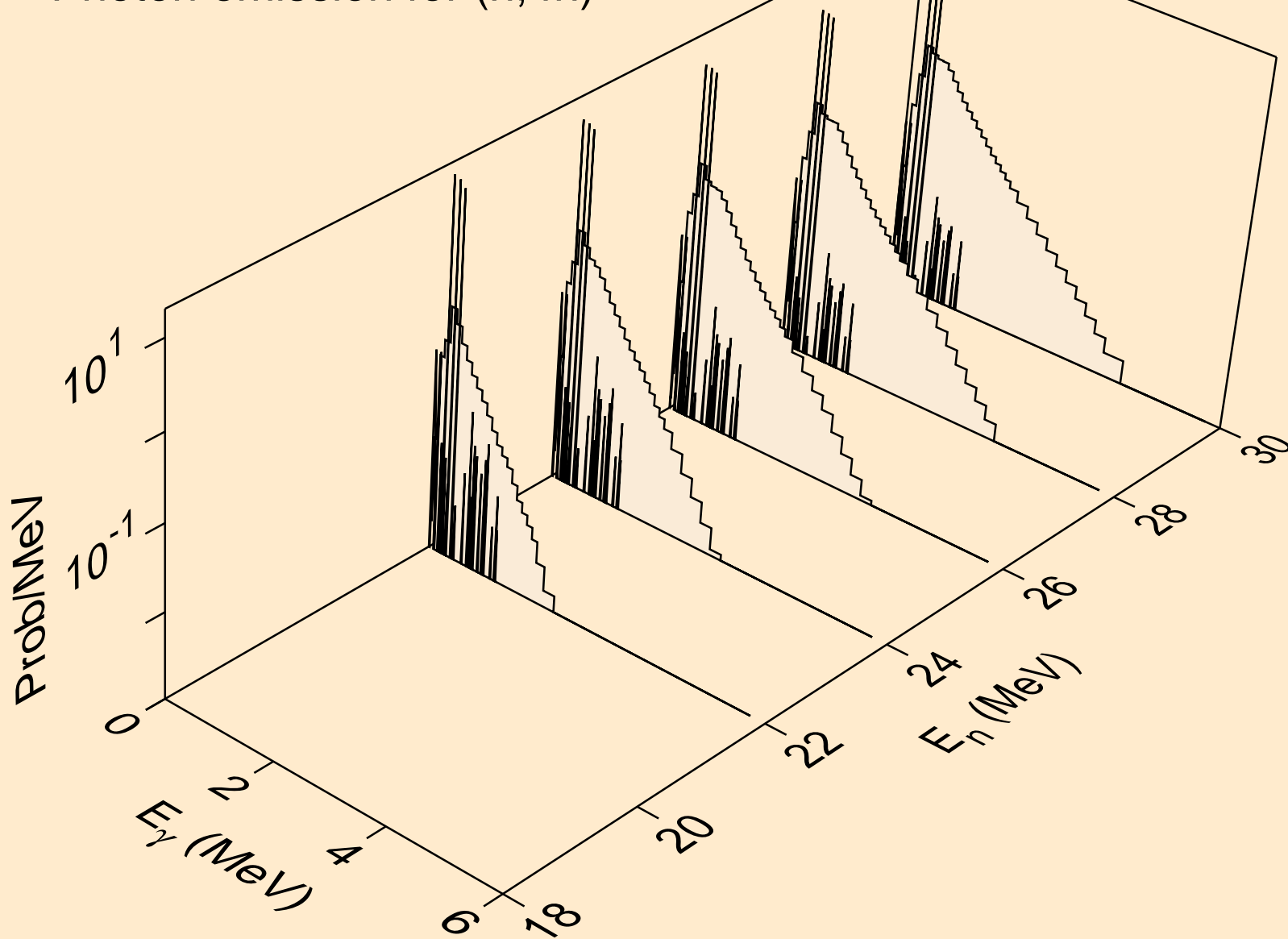

HF177N NEUTRON ACER TENDL-2019 LIBRARY; T=293.16K
Photon emission for (n,2np)

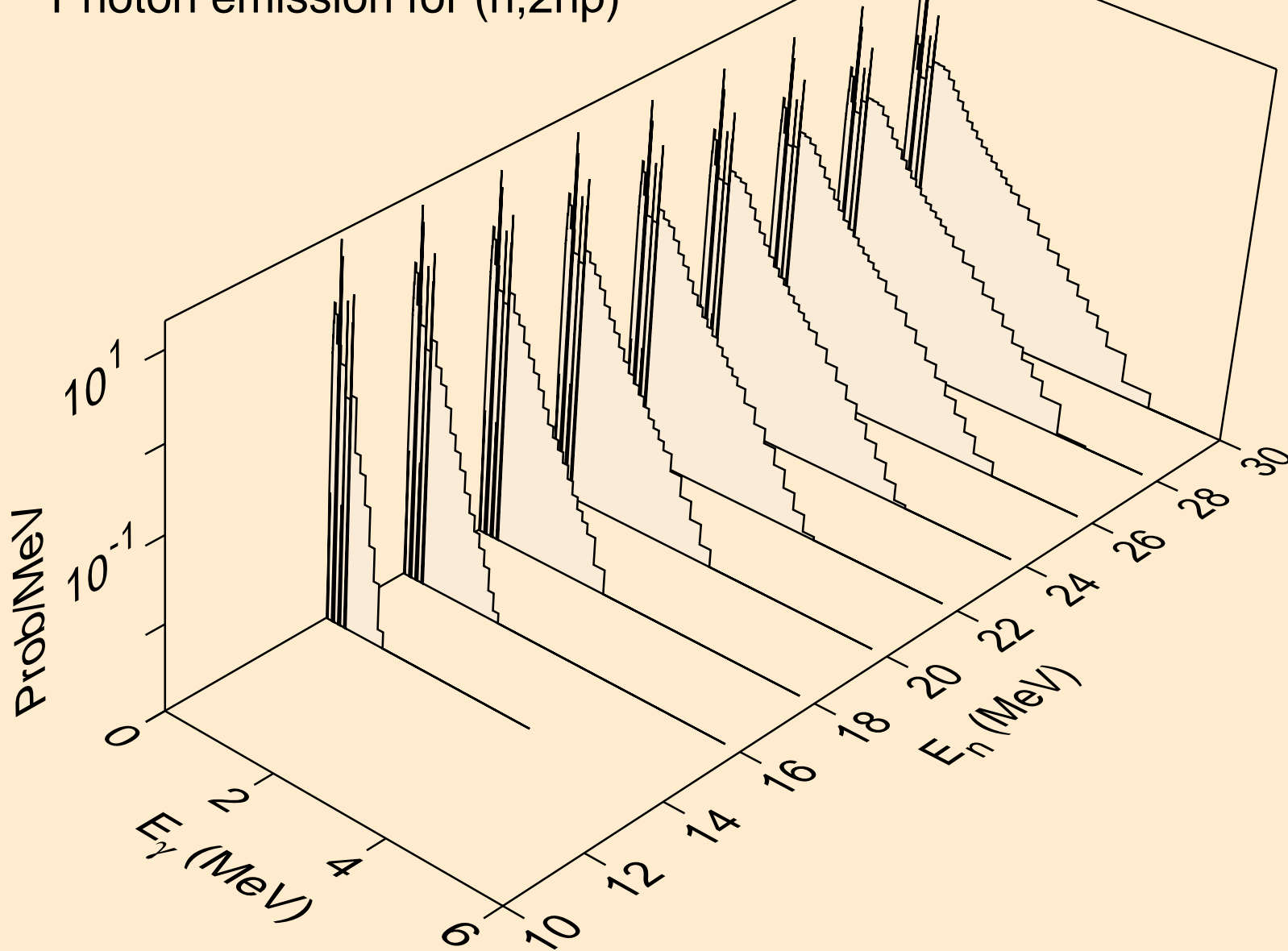

HF177N NEUTRON ACER TENDL-2019 LIBRARY; T=293.16K
Photon emission for (n,3np)

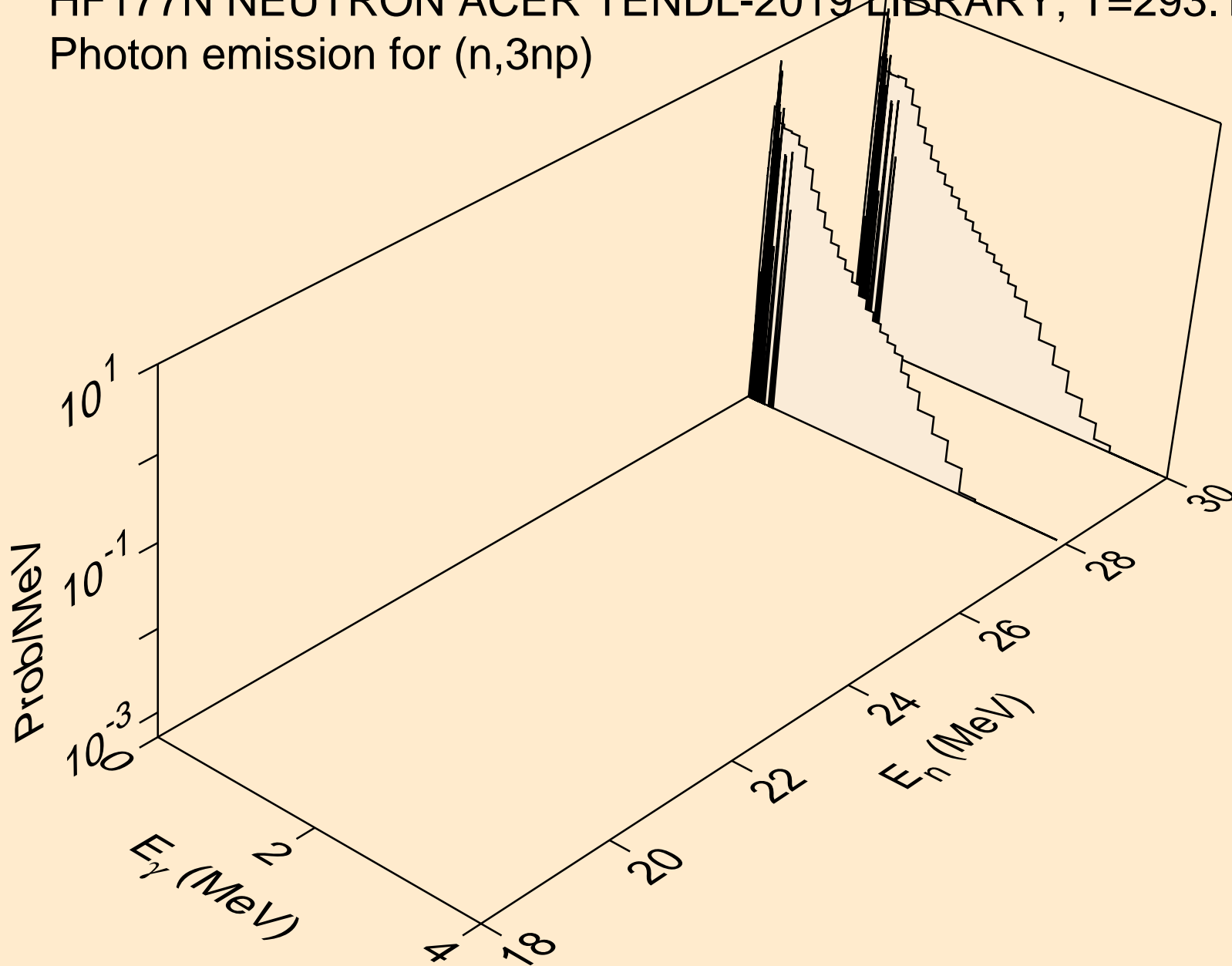

HF177N NEUTRON ACER TENDL-2019 LIBRARY; T=293.16K
Photon emission for (n,2np)

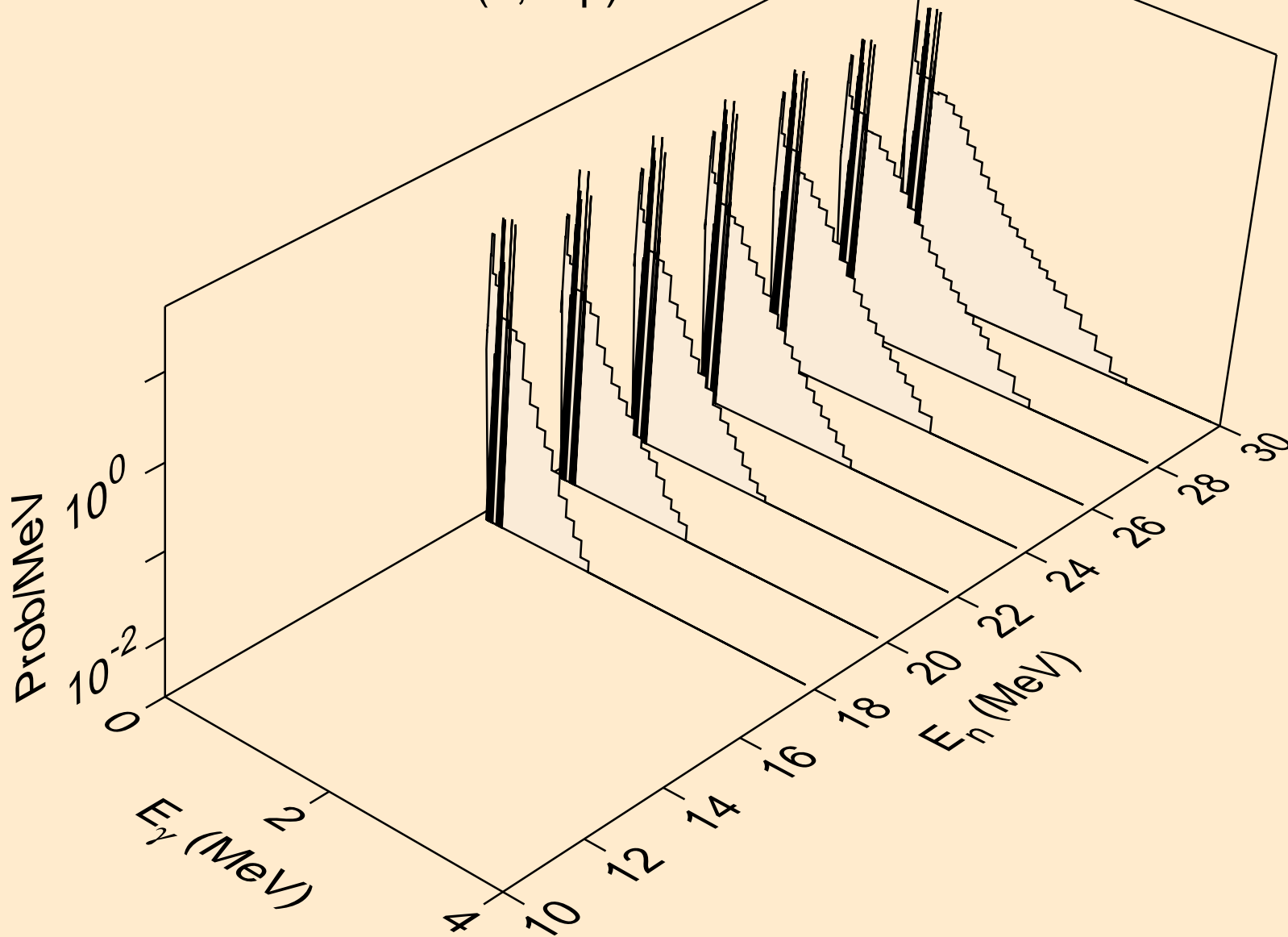

HF177N NEUTRON ACER TENDL-2019 LIBRARY; T=293.16K
Photon emission for (n,npa)

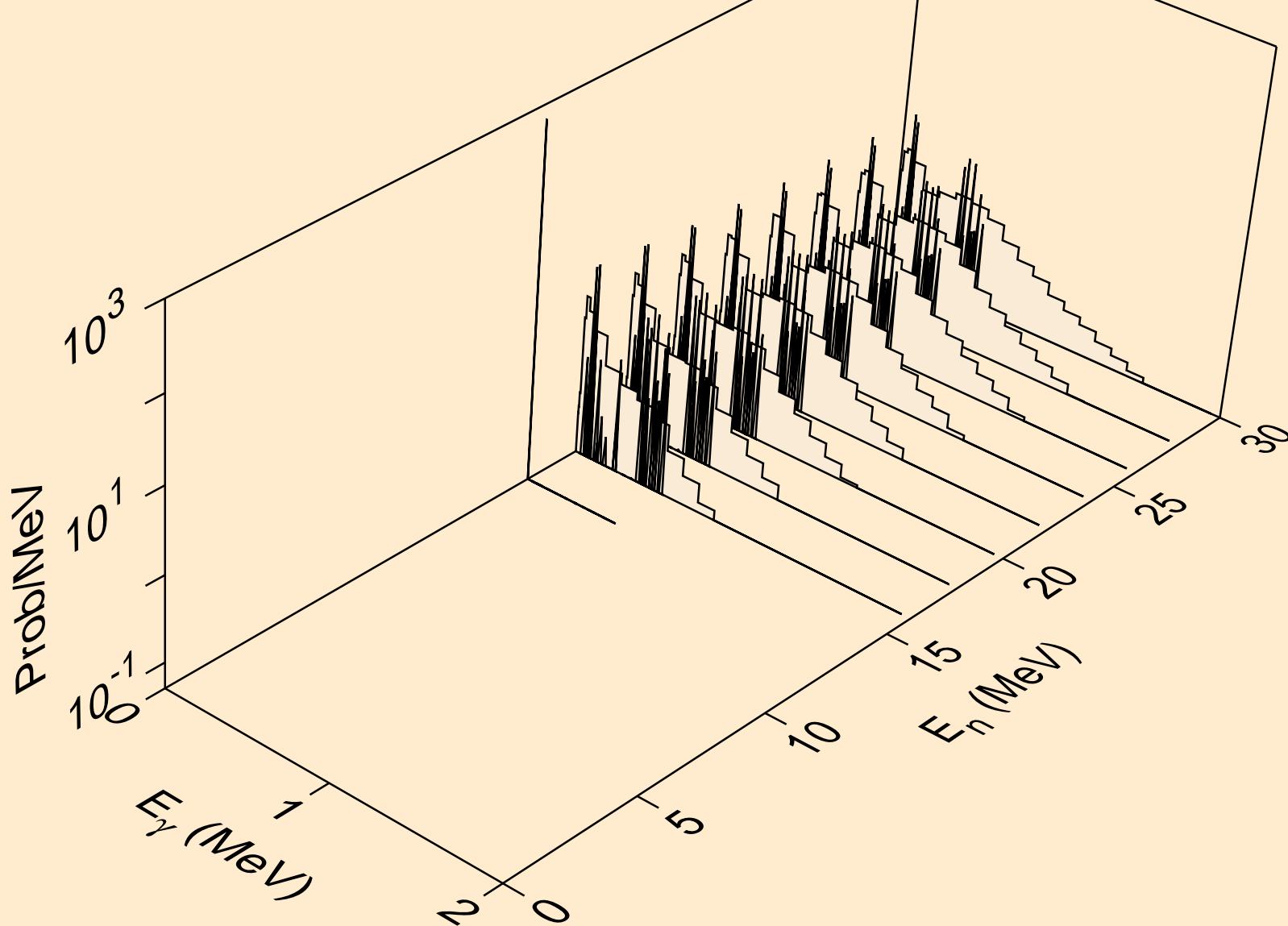

HF177N NEUTRON ACER TENDL-2019 LIBRARY; T=293.16K
Photon emission for (n,n*2)

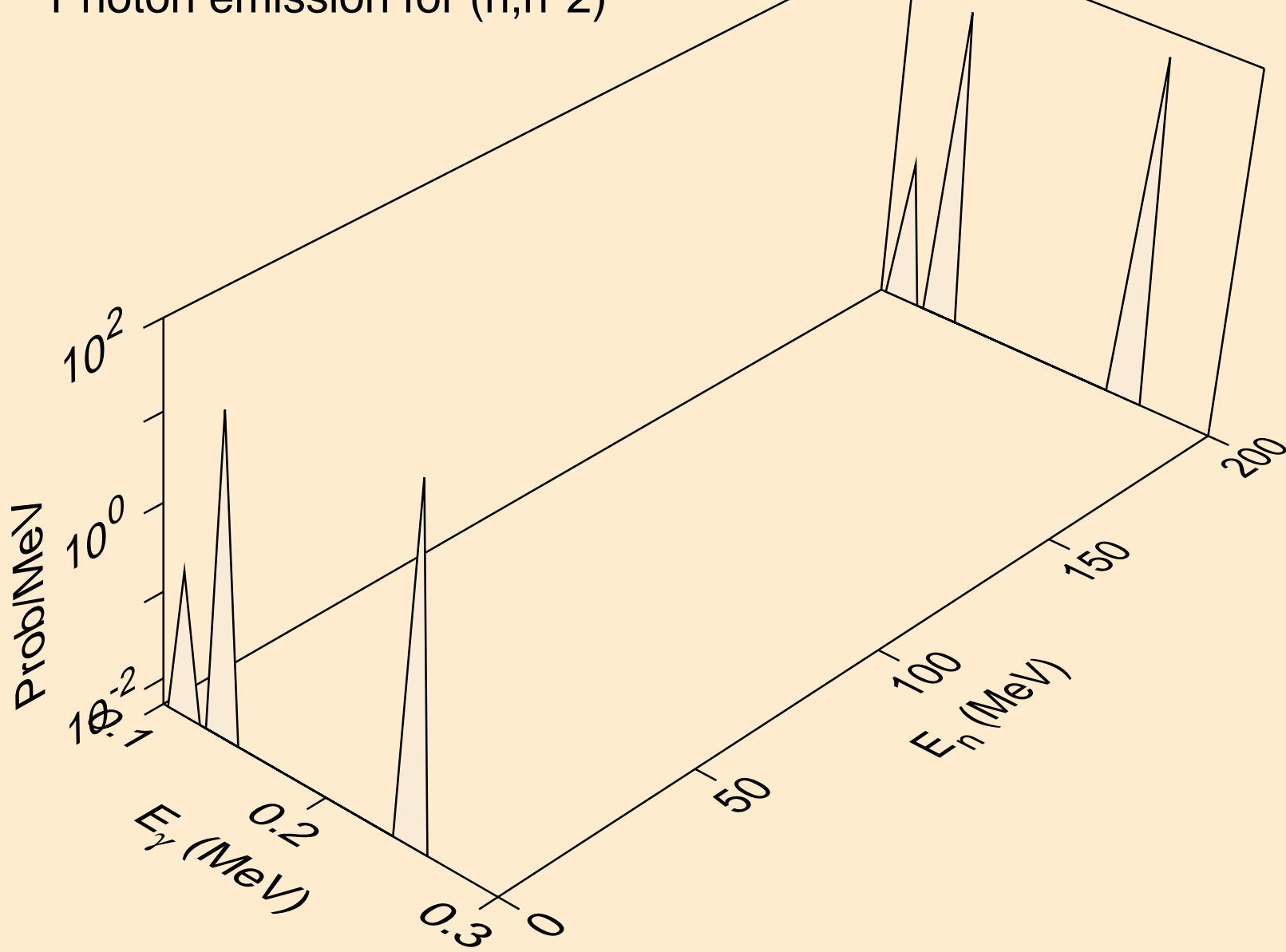

HF177N NEUTRON ACER TENDL-2019 LIBRARY; T=293.16K
Photon emission for (n,n*3)

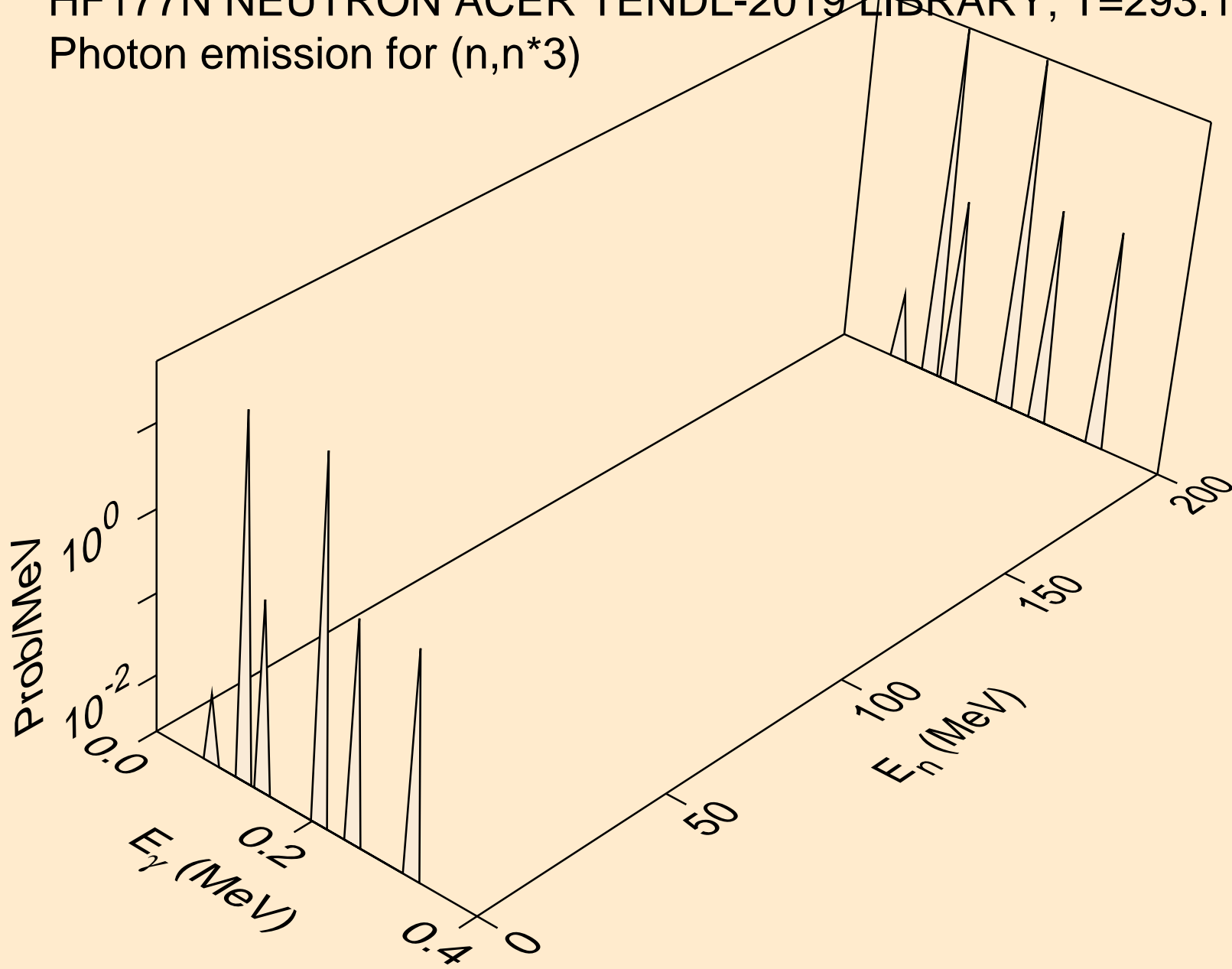

HF177N NEUTRON ACER TENDL-2019 LIBRARY; T=293.16K
Photon emission for (n,n*c)

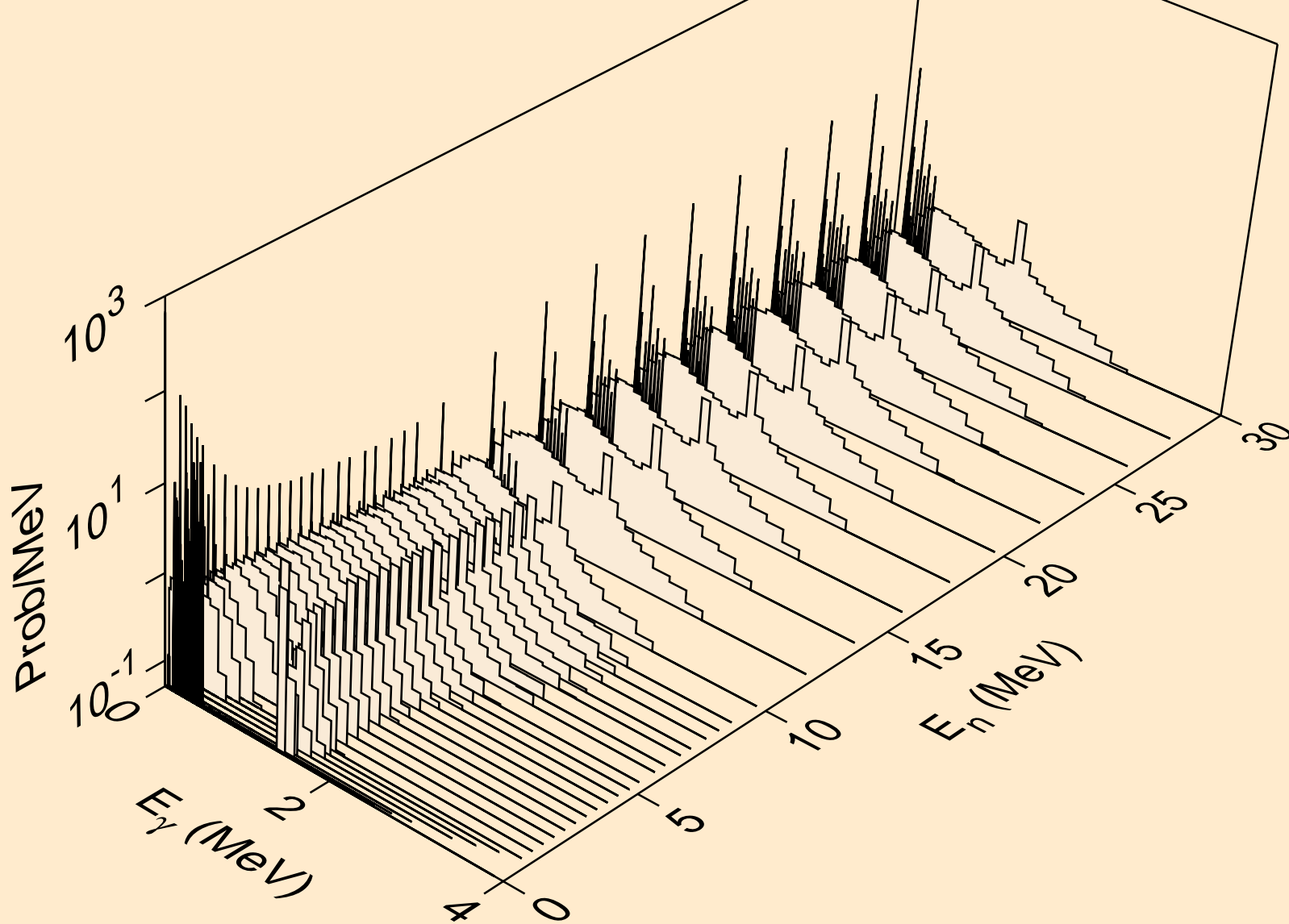

HF177N NEUTRON ACER TENDL-2019 LIBRARY; T=293.16K
Photon emission for (n,gma)

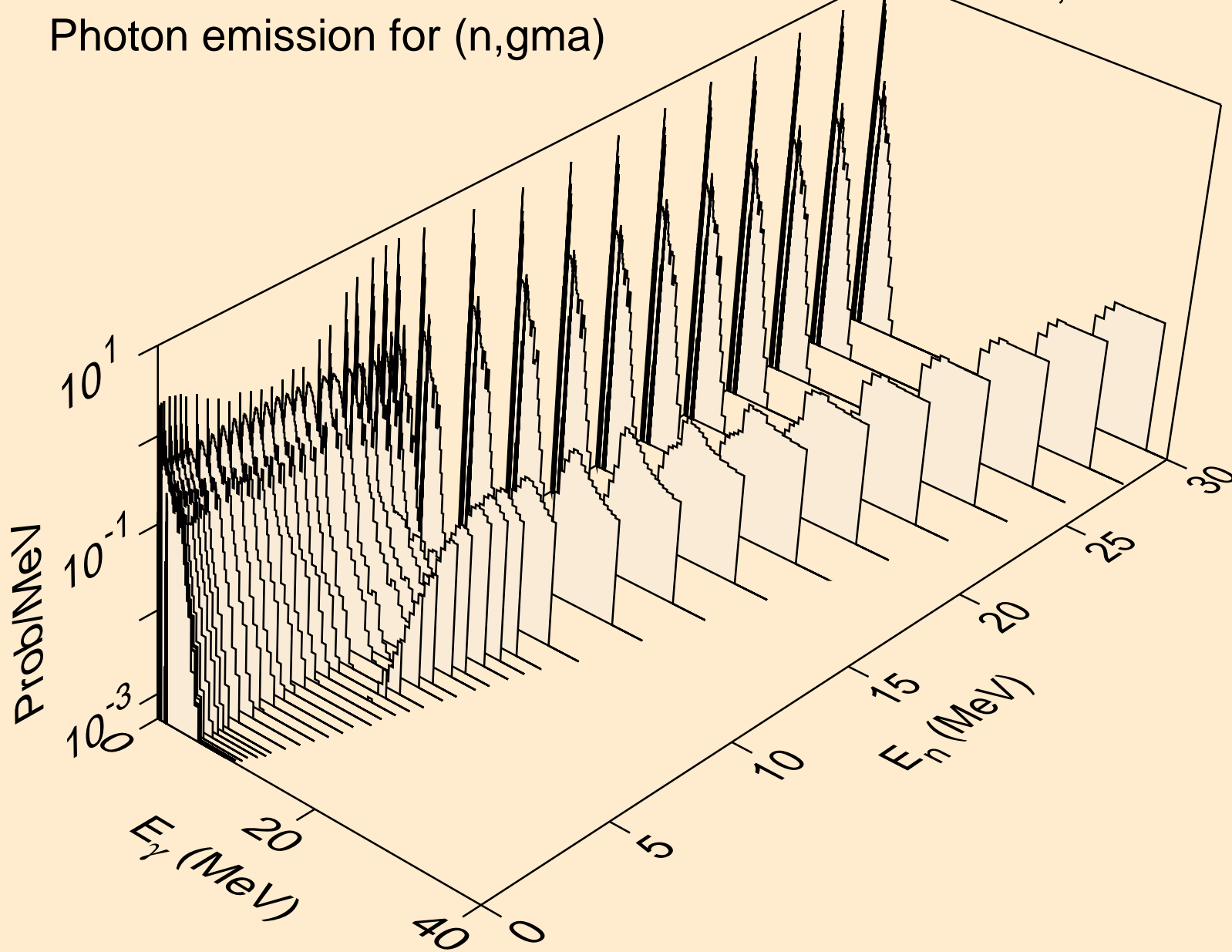

HF177N NEUTRON ACER TENDL-2019 LIBRARY; T=293.16K
Photon emission for (n,p)

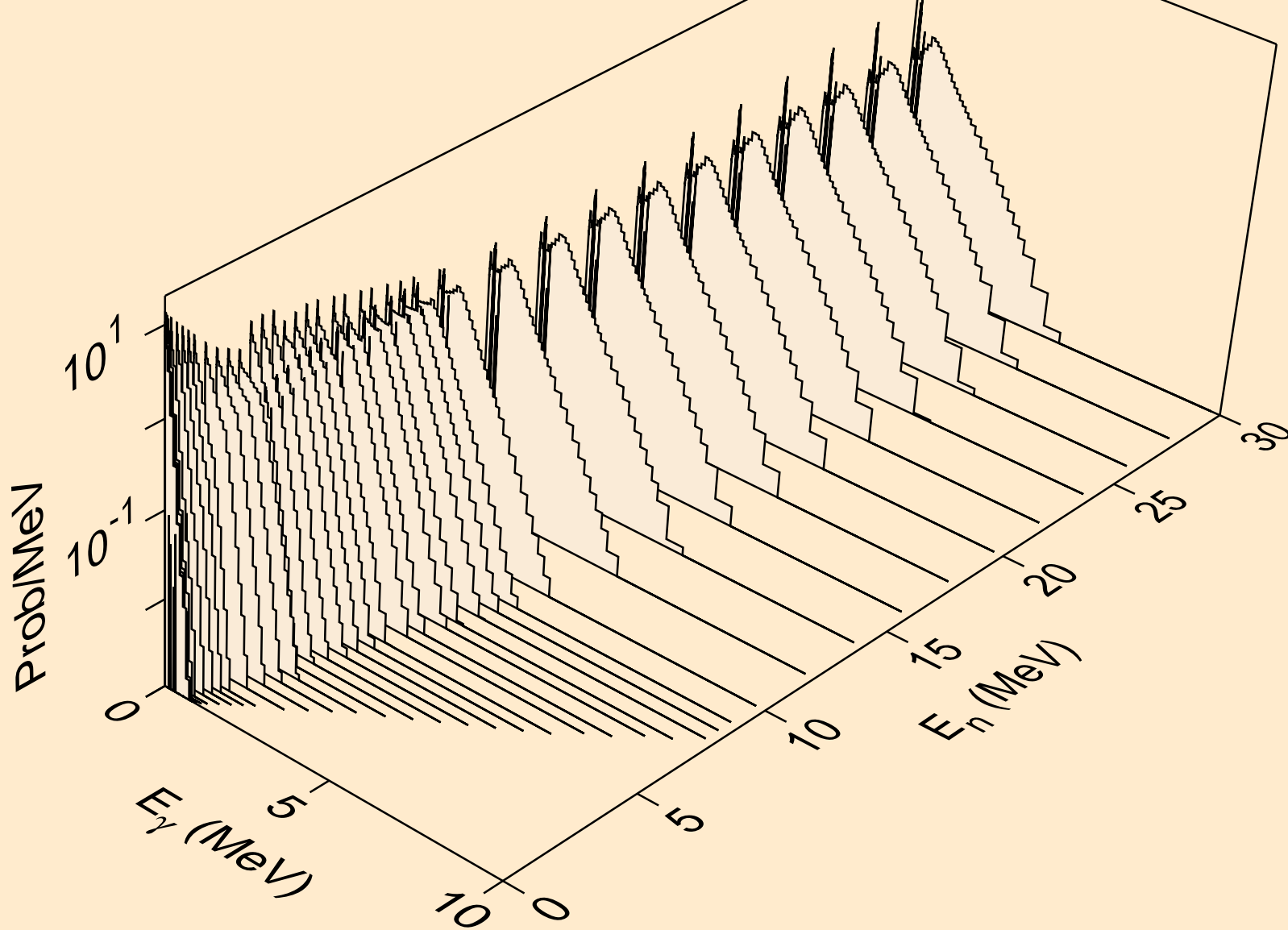

HF177N NEUTRON ACER TENDL-2019 LIBRARY; T=293.16K
Photon emission for (n,d)

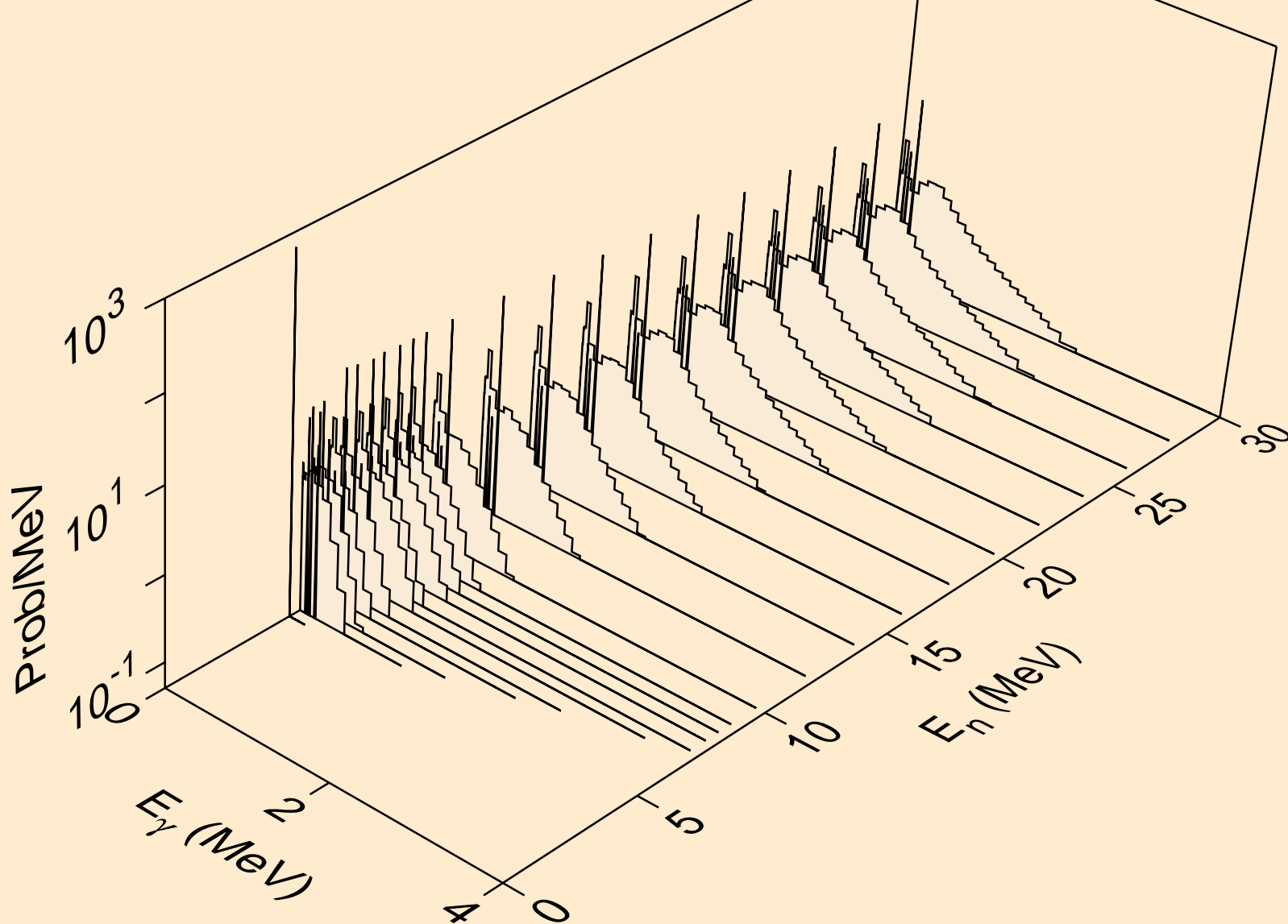

HF177N NEUTRON ACER TENDL-2019 LIBRARY; T=293.16K
Photon emission for (n,t)

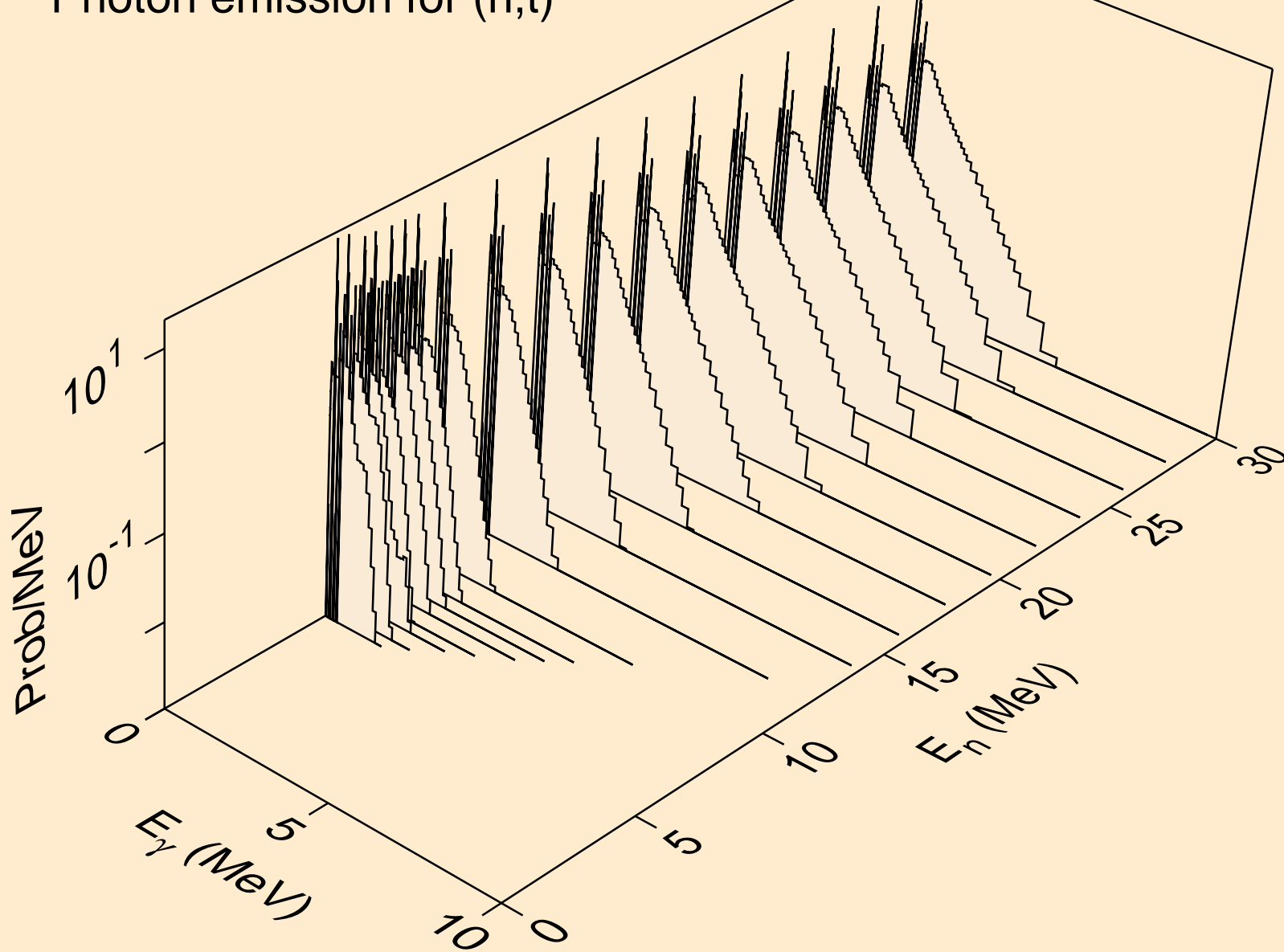

HF177N NEUTRON ACER TENDL-2019 LIBRARY; T=293.16K
Photon emission for (n,he3)

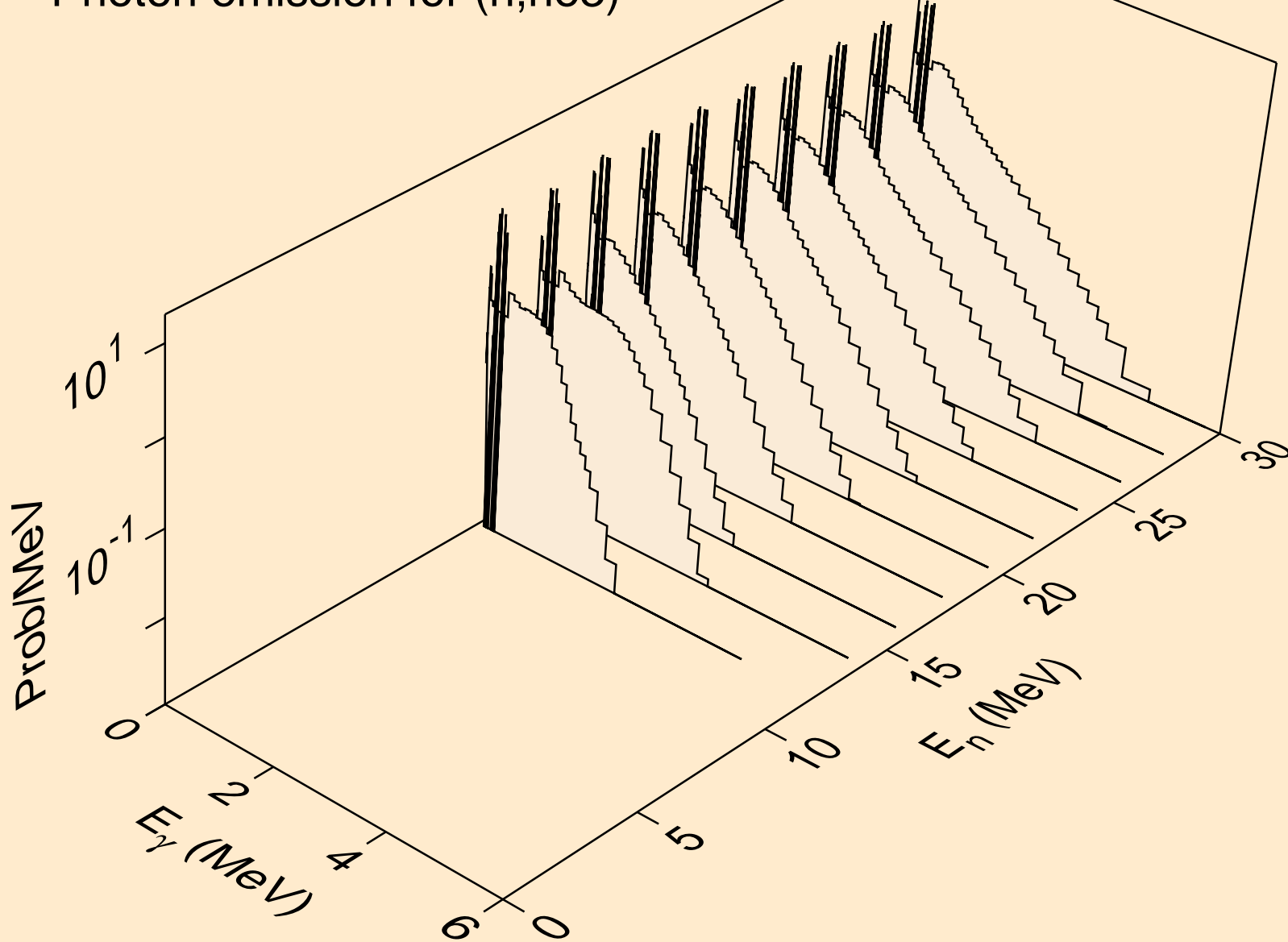

HF177N NEUTRON ACER TENDL-2019 LIBRARY; T=293.16K
Photon emission for (n,a)

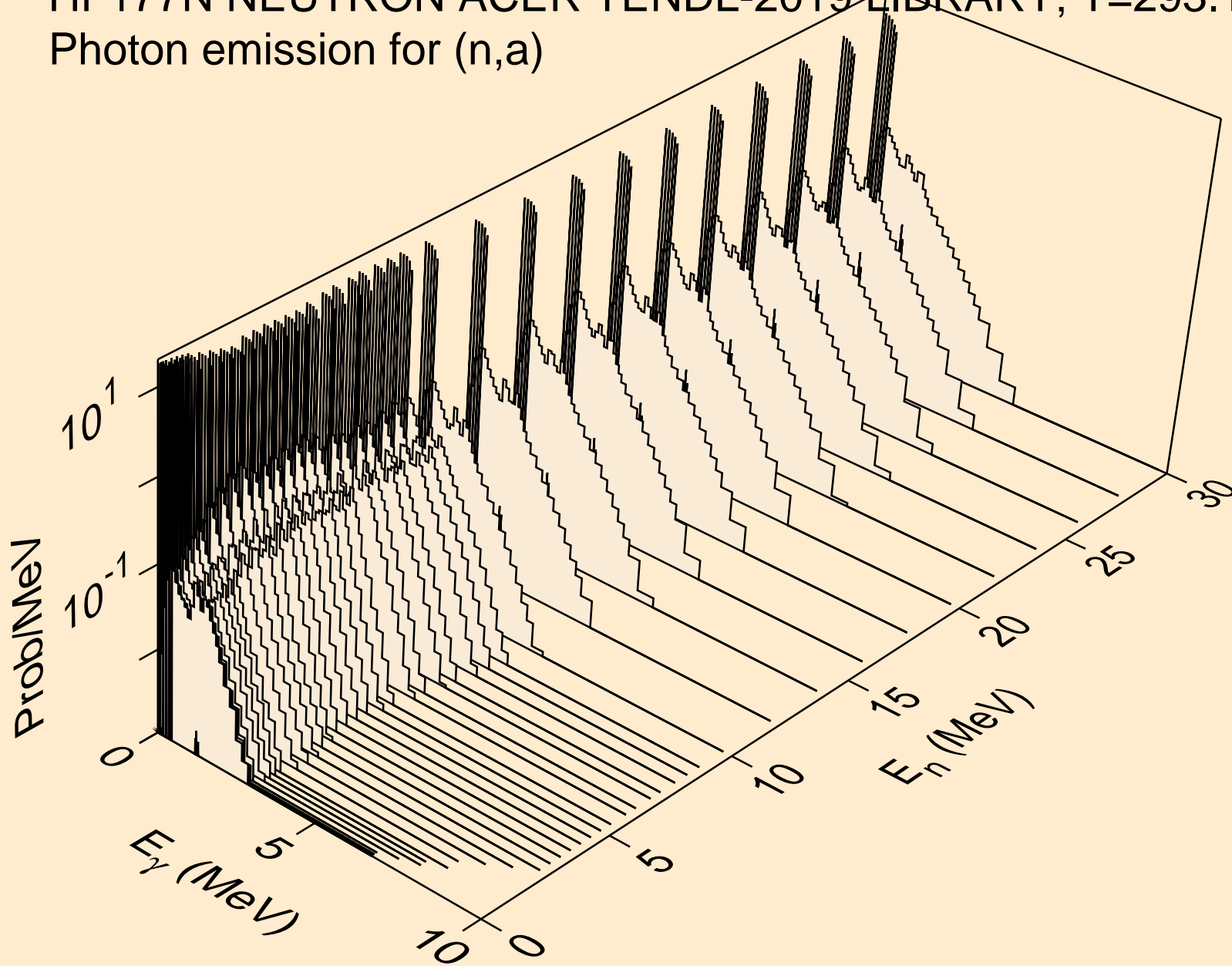

HF177N NEUTRON ACER TENDL-2019 LIBRARY; T=293.16K
Photon emission for (n,2a)

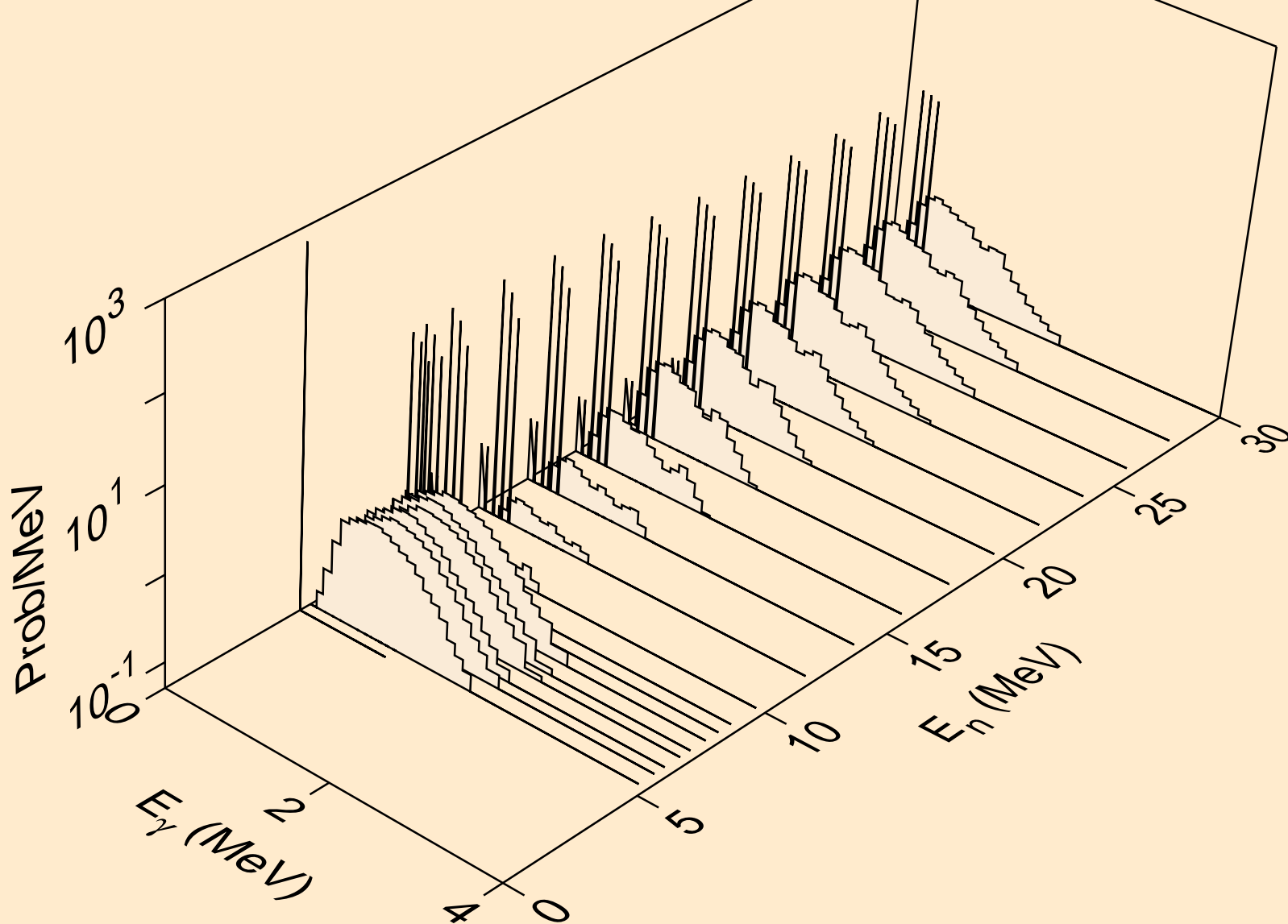

HF177N NEUTRON ACER TENDL-2019 LIBRARY; T=293.16K
Photon emission for (n,2p)

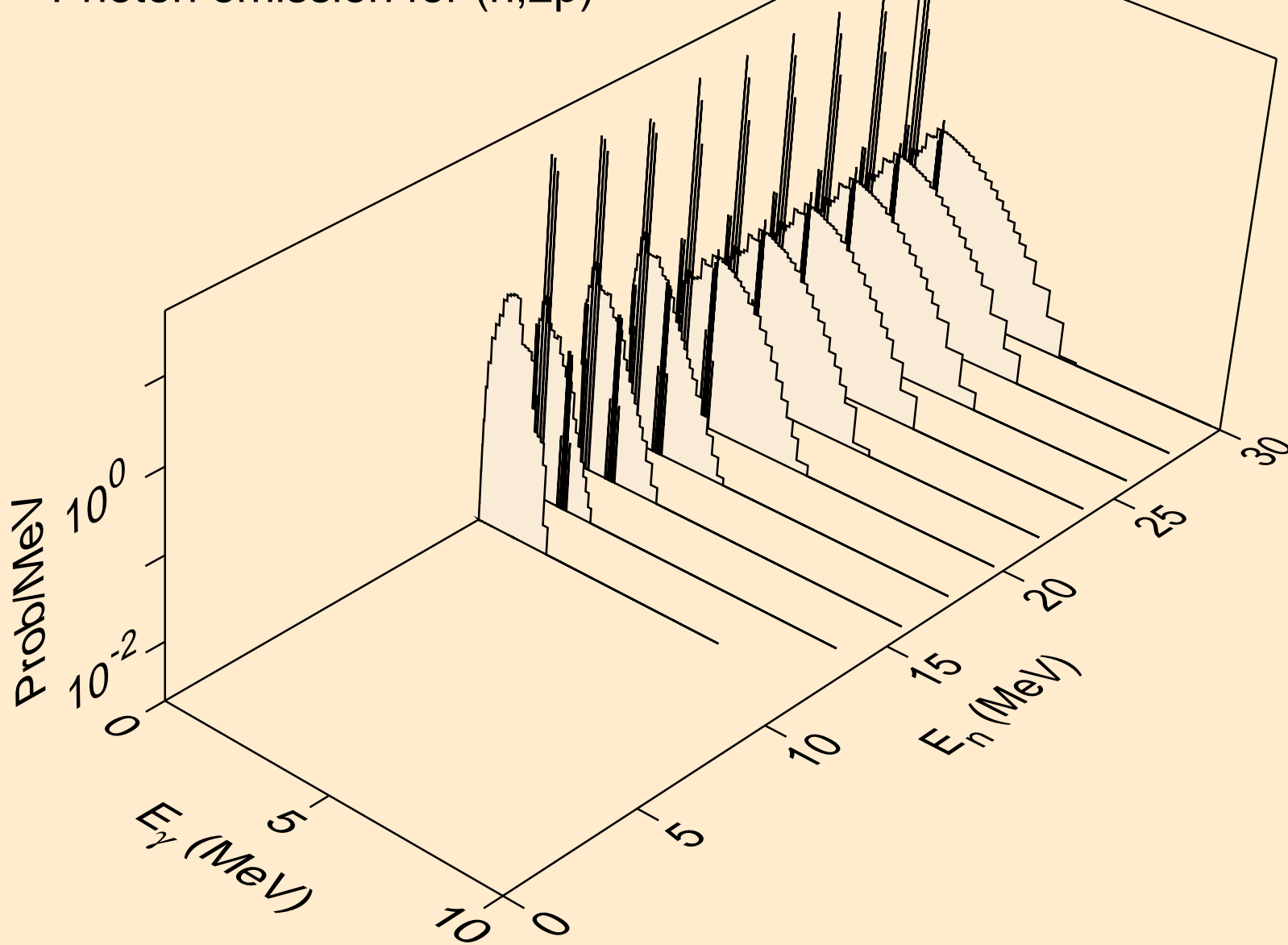

HF177N NEUTRON ACER TENDL-2019 LIBRARY; T=293.16K
Photon emission for (n,p α)

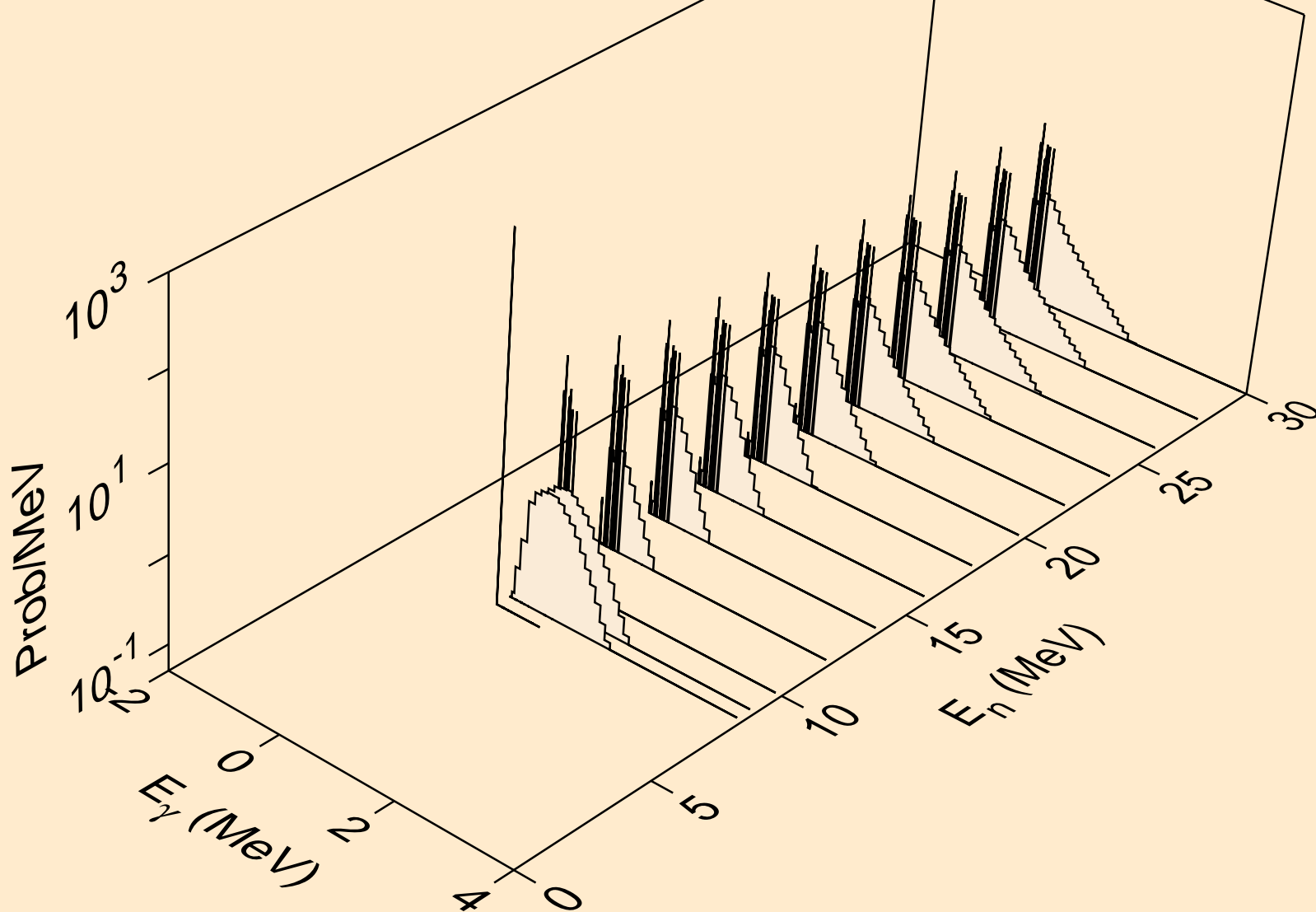

HF177N NEUTRON ACER TENDL-2019 LIBRARY; T=293.16K
Photon emission for (n,pd)

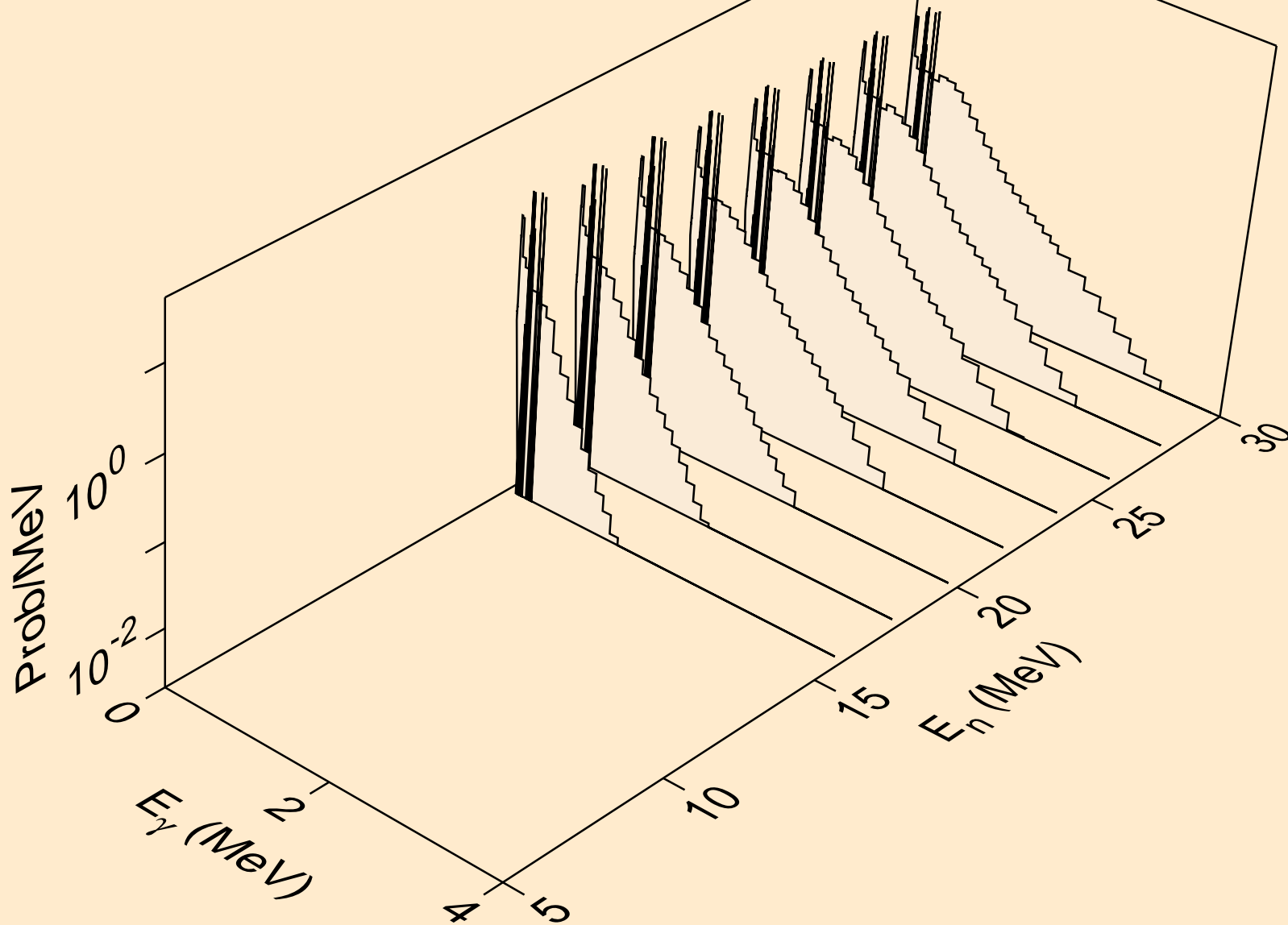

HF177N NEUTRON ACER TENDL-2019 LIBRARY; T=293.16K
Photon emission for (n,pt)

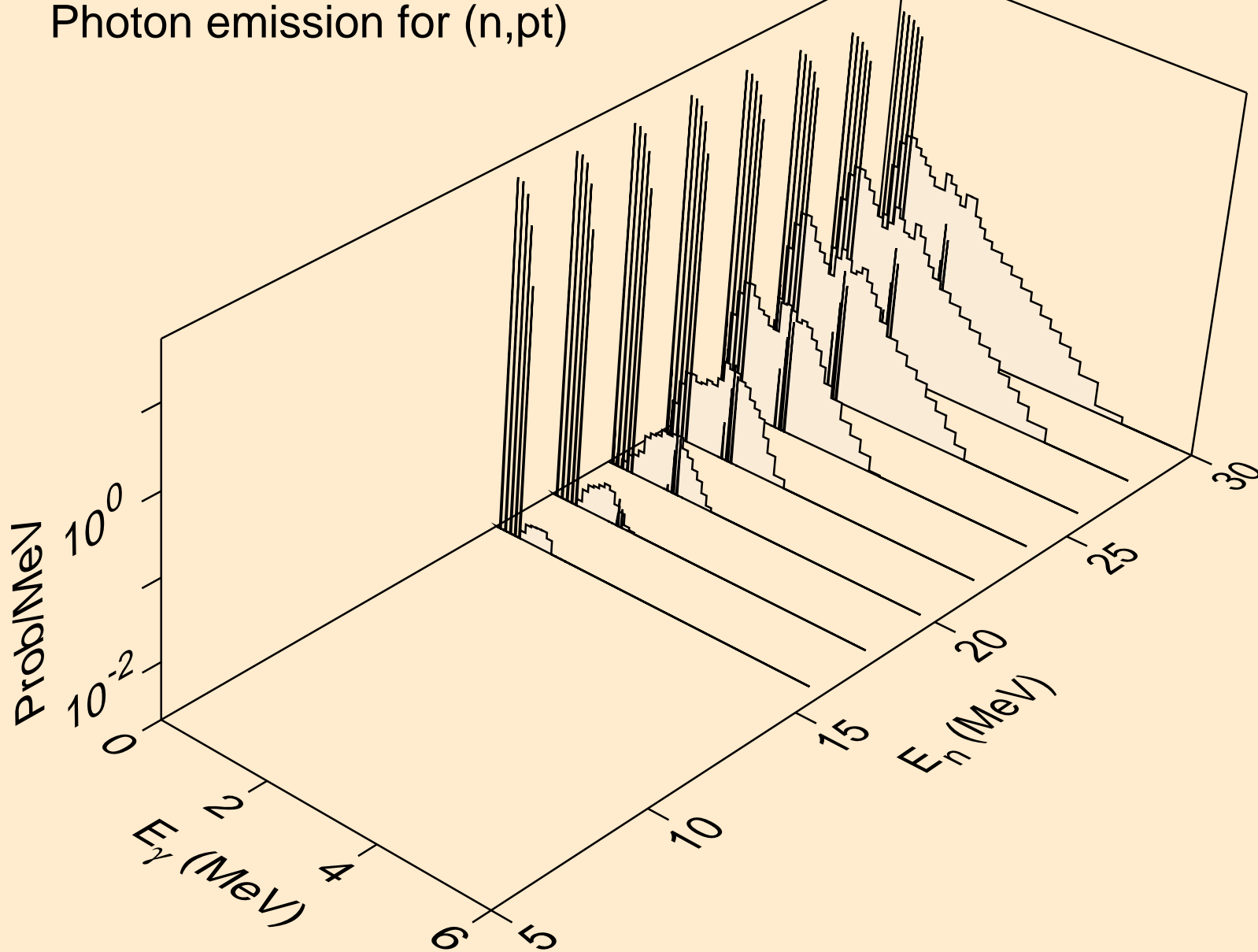

HF177N NEUTRON ACER TENDL-2019 LIBRARY; T=293.16K
Photon emission for (n,da)

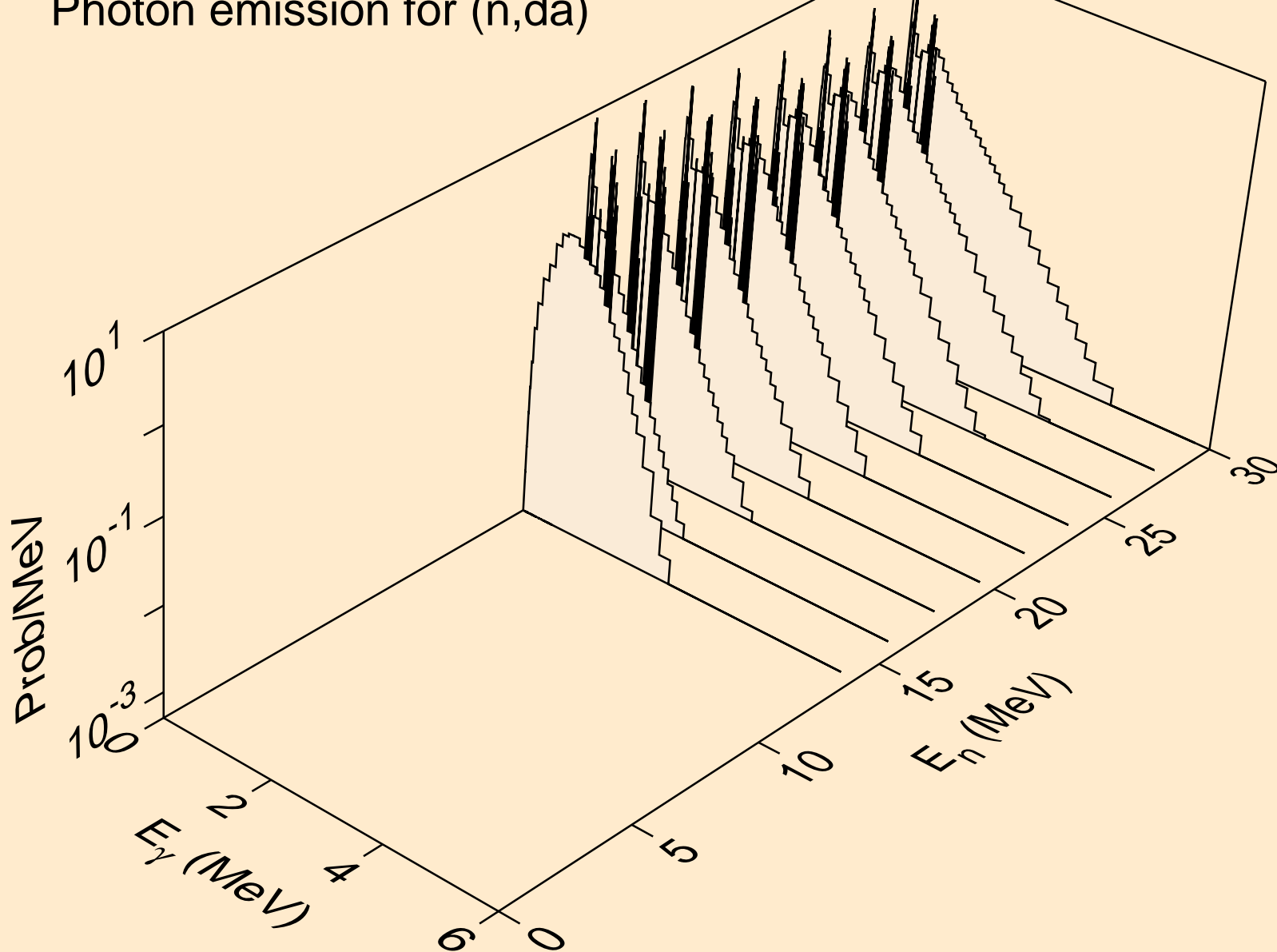

HF177N NEUTRON ACER TENDL-2019 LIBRARY; T=293.16K
thermal capture photon spectrum

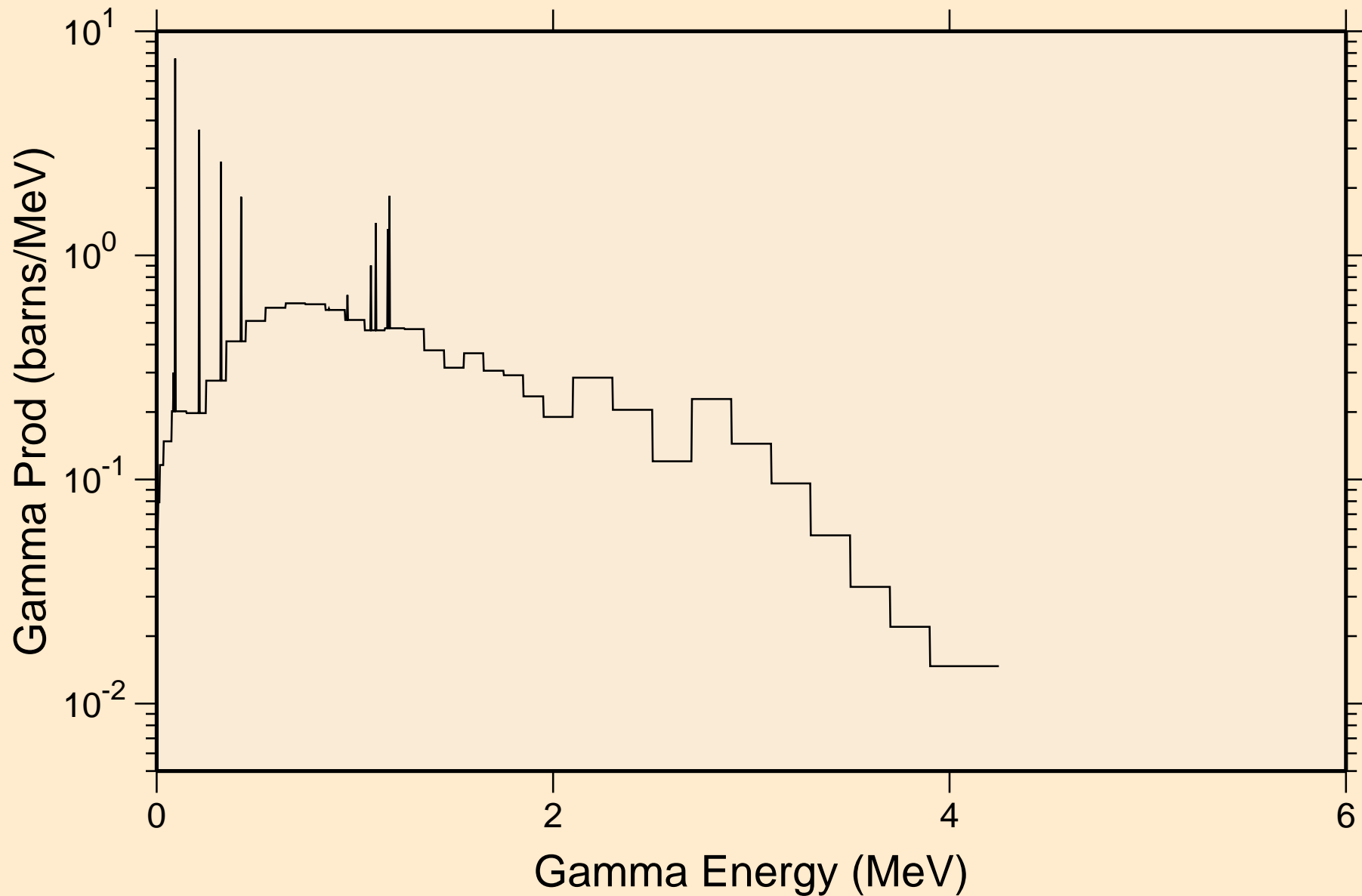

HF177N NEUTRON ACER TENDL-2019 LIBRARY; T=293.16K
14 MeV photon spectrum

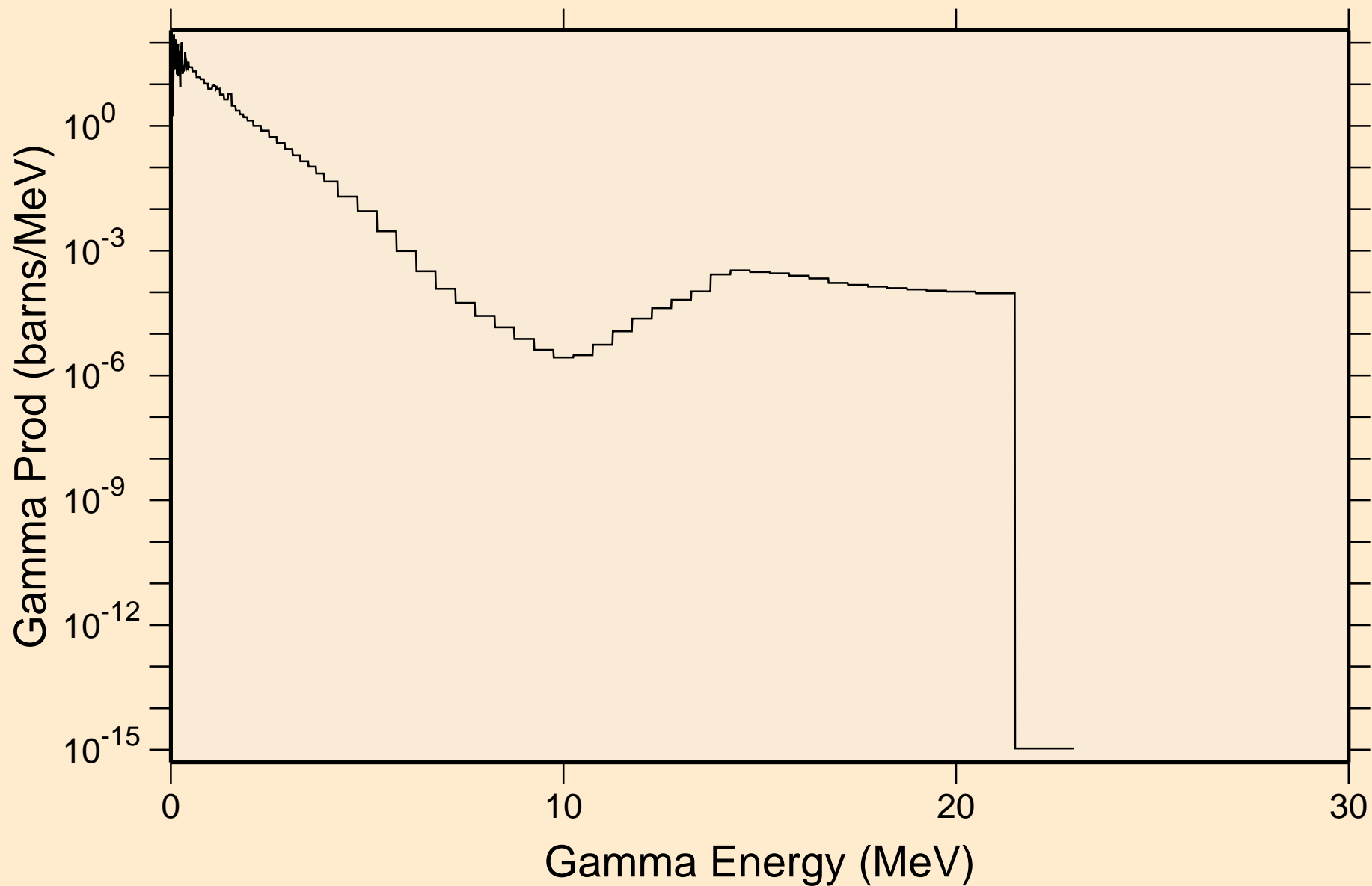

HF177N NEUTRON ACER TENDL-2019 LIBRARY; T=293.16K

Particle heating contributions

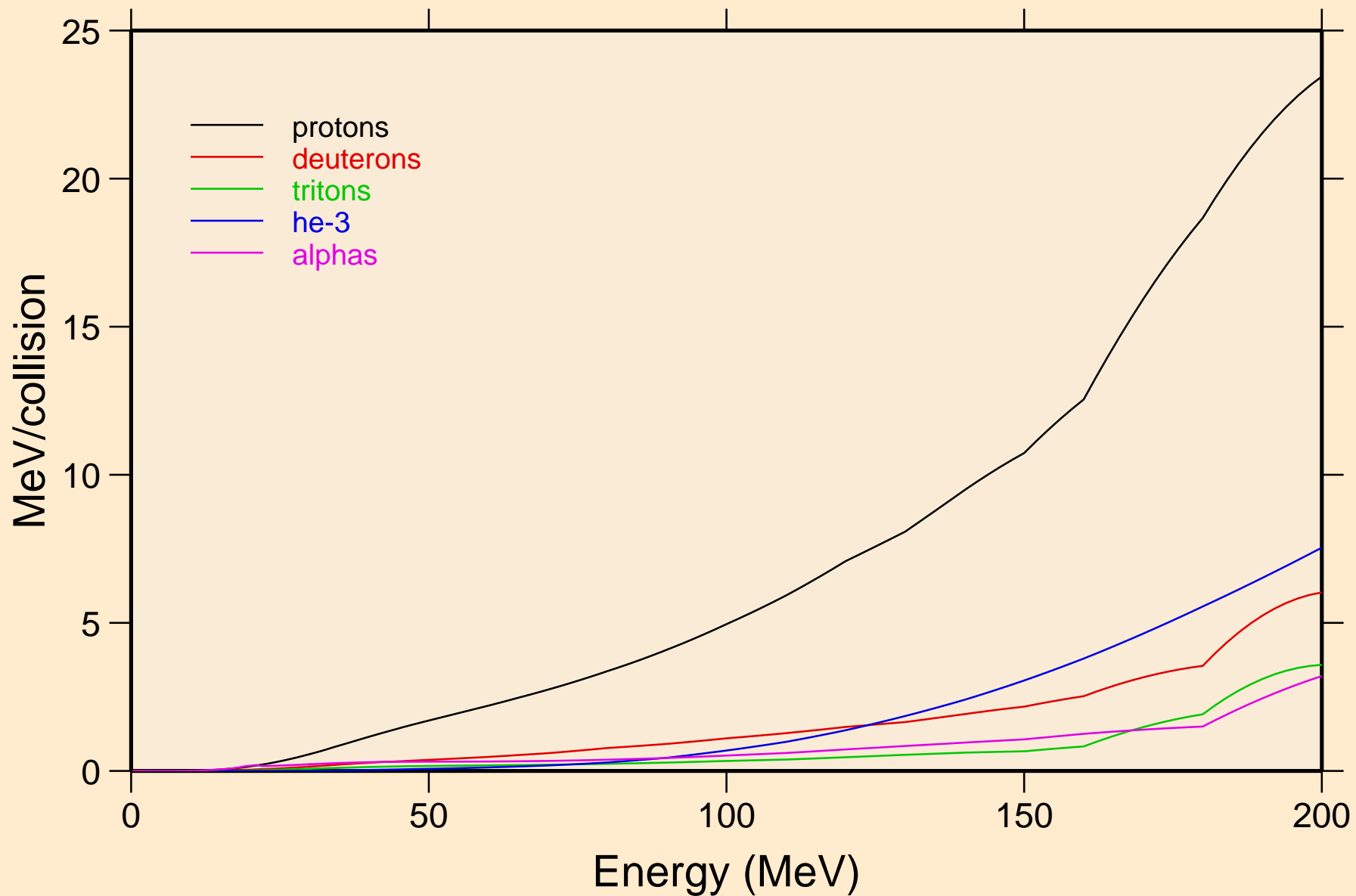

HF177N NEUTRON ACER TENDL-2019 LIBRARY; T=293.16K
Recoil Heating

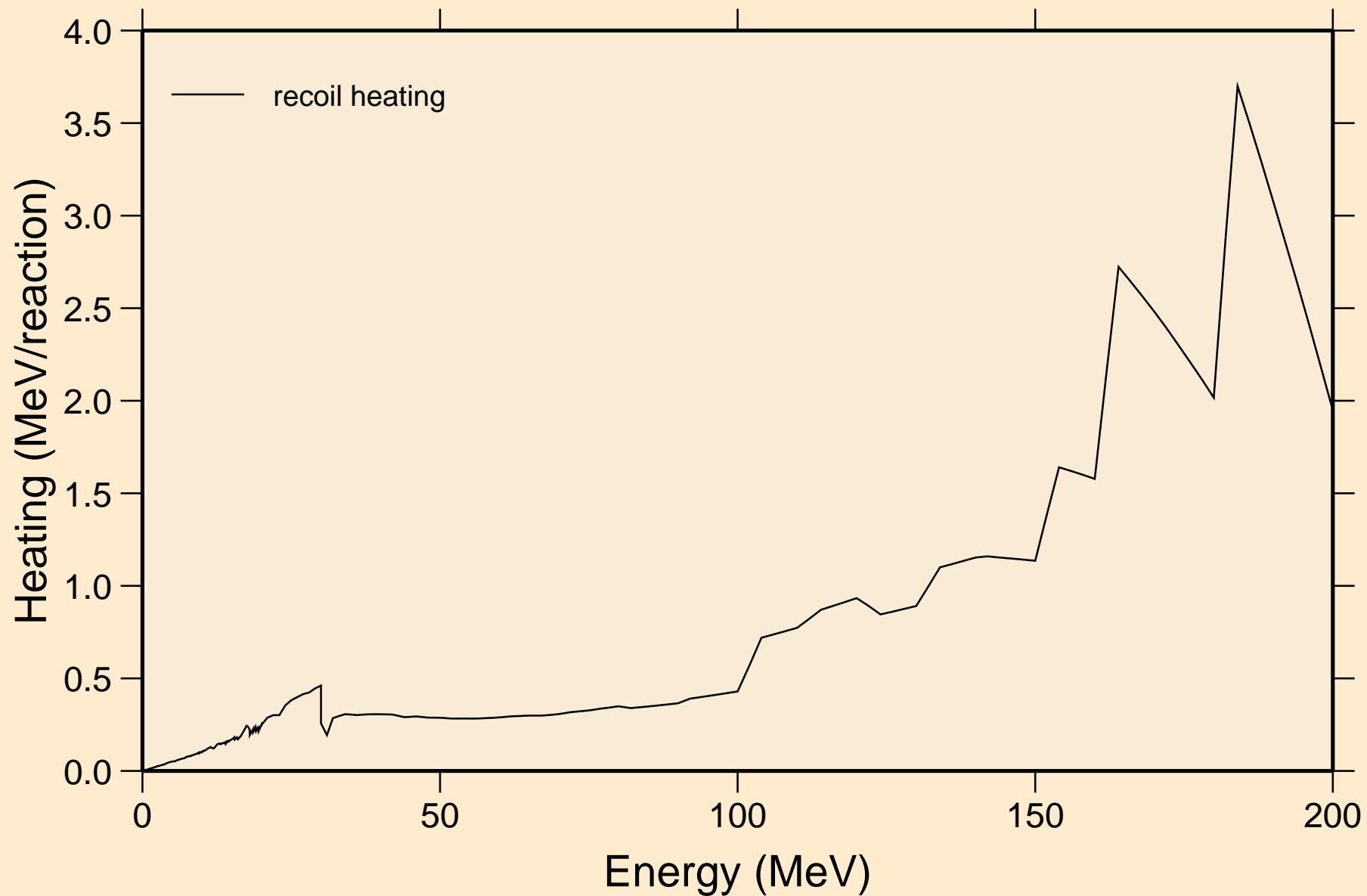

HF177N NEUTRON ACER TENDL-2019 LIBRARY; T=293.16K

Particle production cross sections

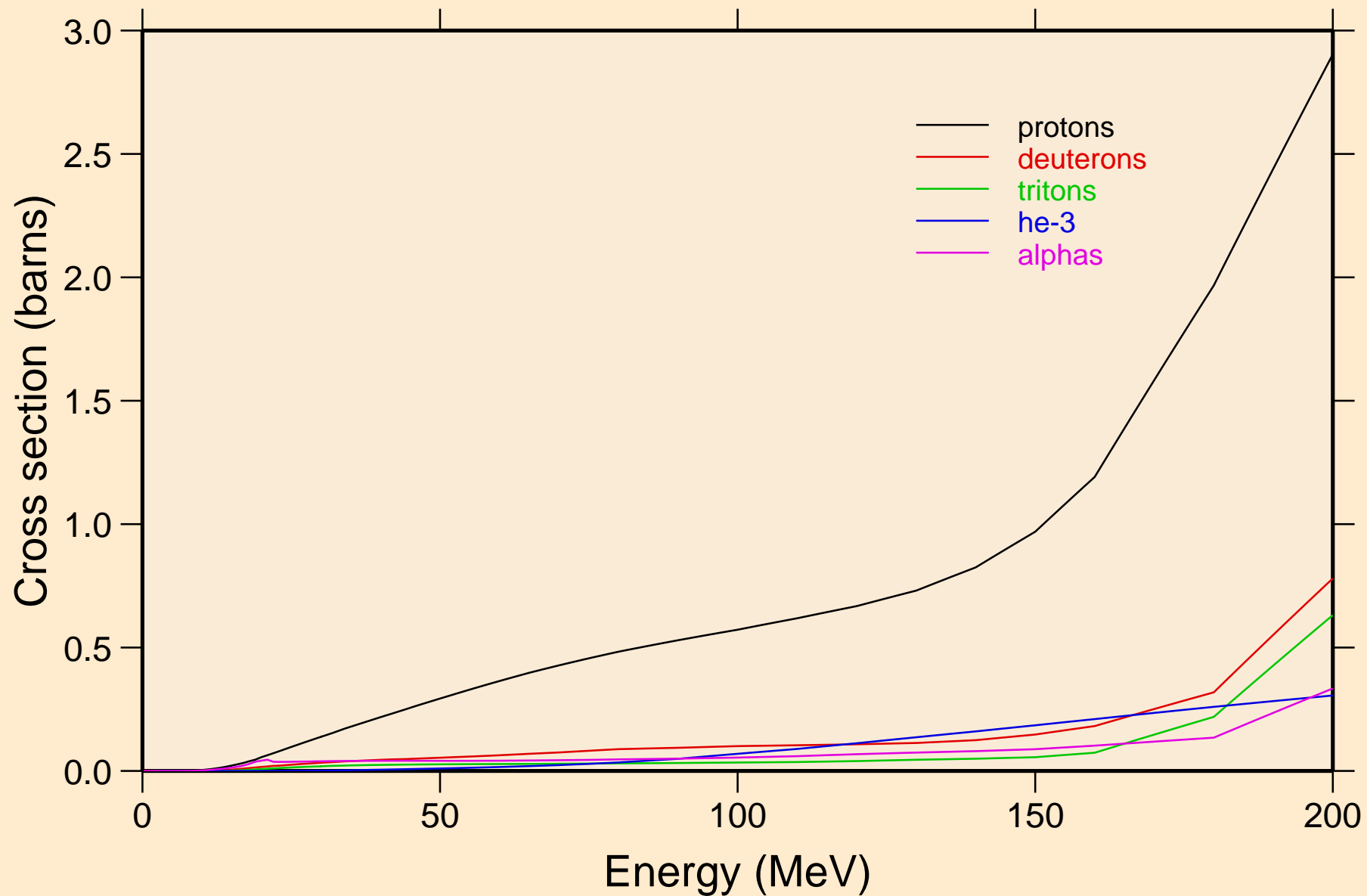

HF177N NEUTRON ACER TENDL-2019 LIBRARY; T=293.16K
protons from (n,x)

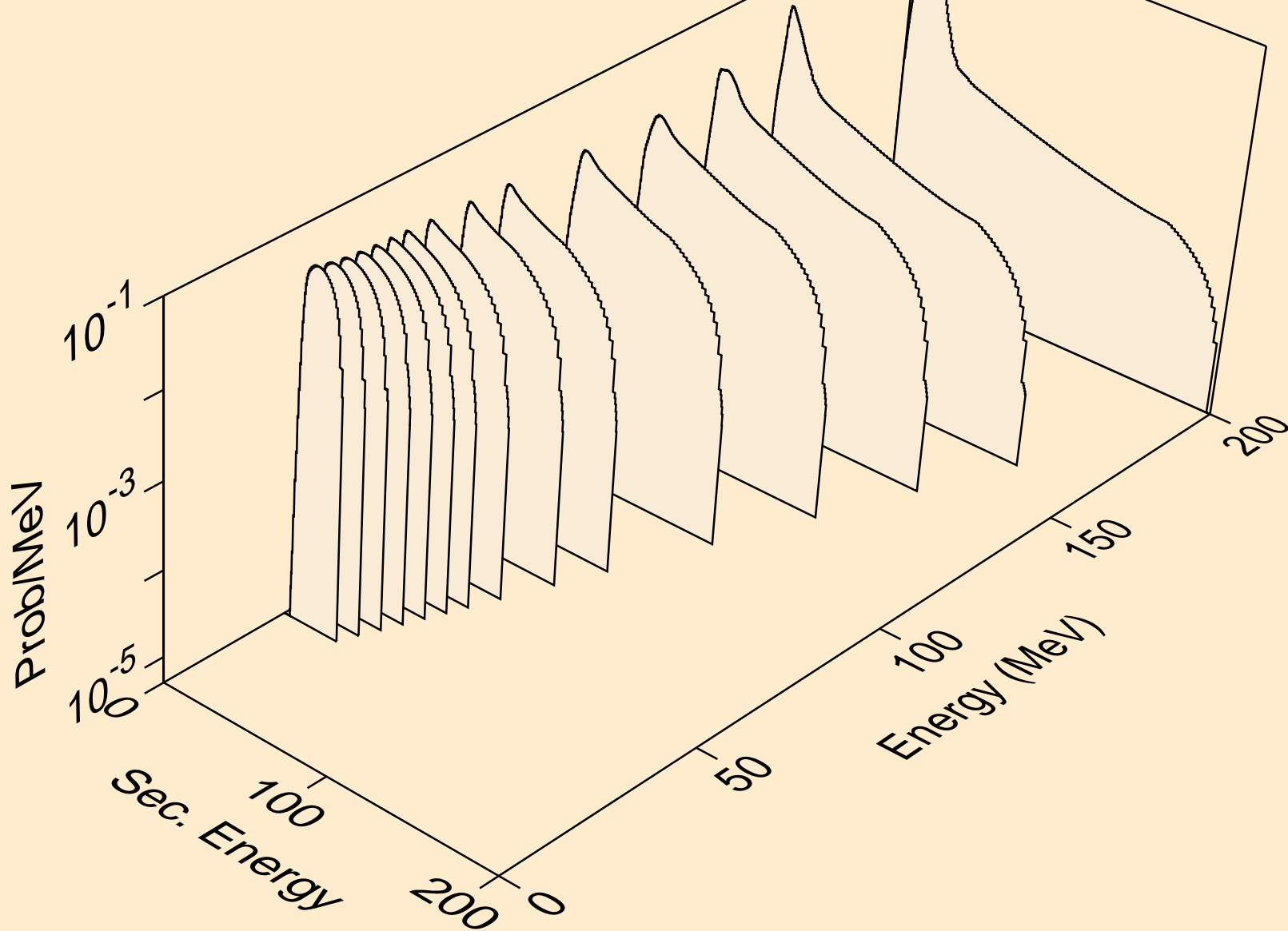

HF177N NEUTRON ACER TENDL-2019 LIBRARY; T=293.16K
protons from (n,n*)p

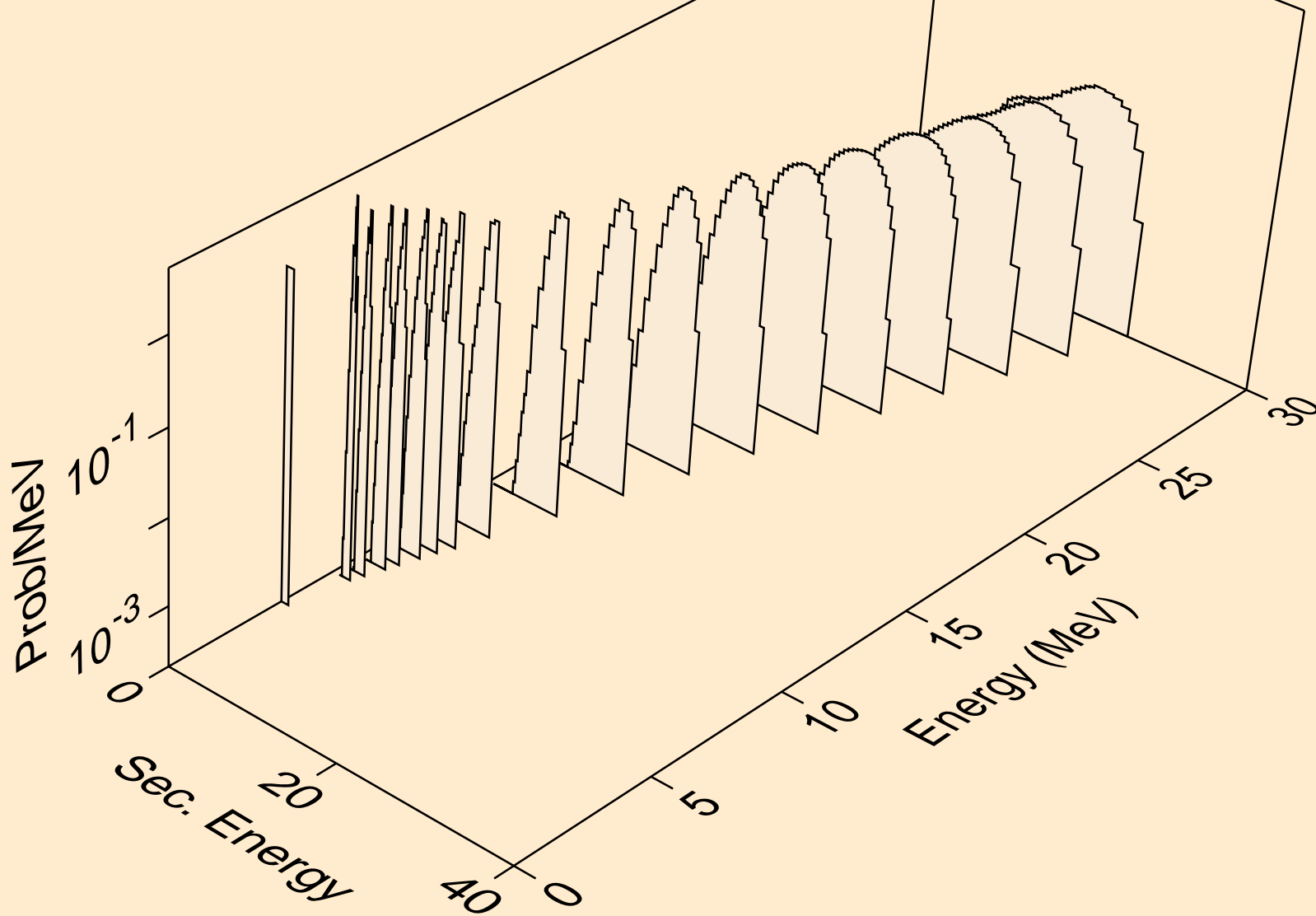

HF177N NEUTRON ACER TENDL-2019 LIBRARY; T=293.16K
protons from (n,2np)

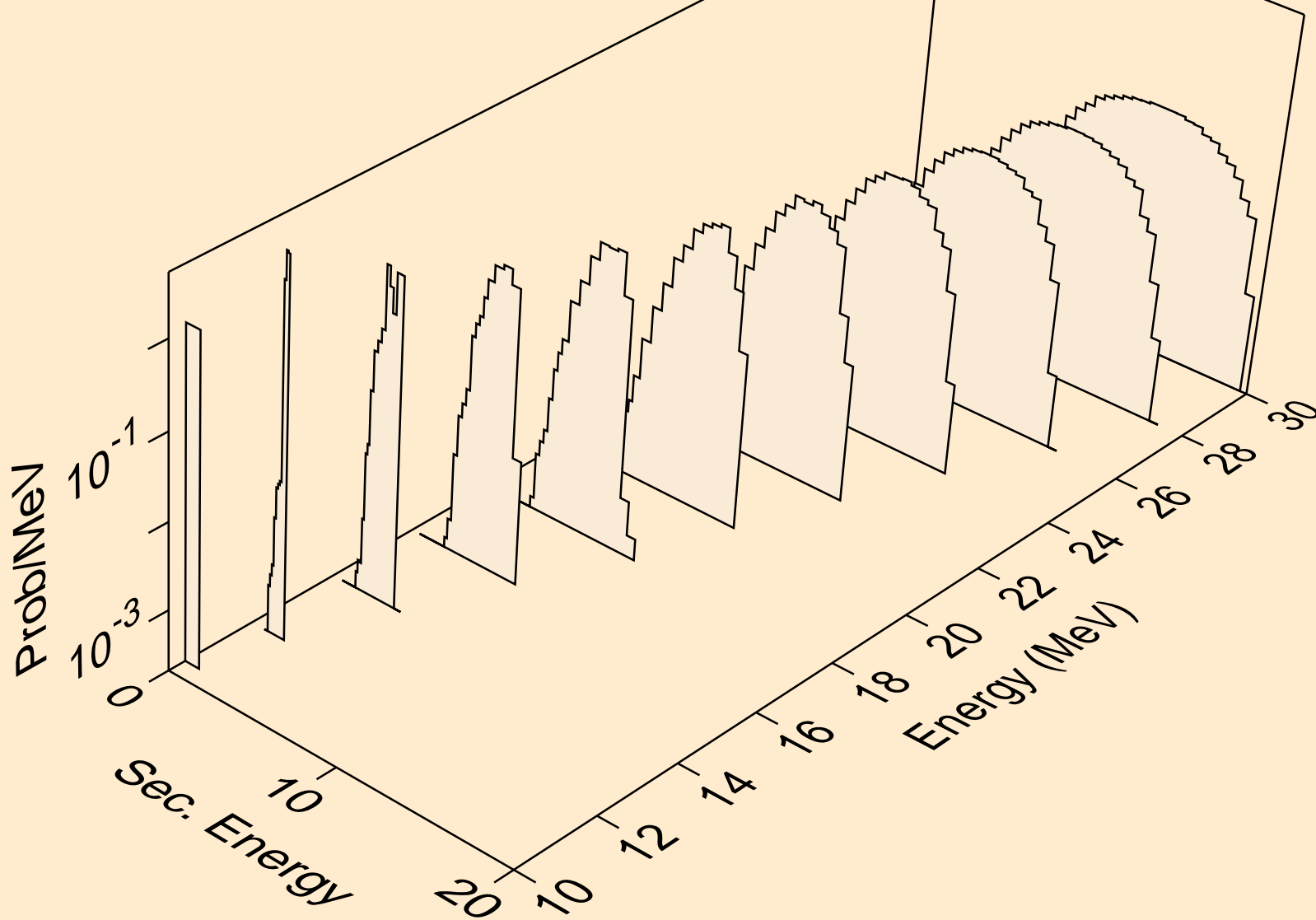

HF177N NEUTRON ACER TENDL-2019 LIBRARY; T=293.16K
protons from (n,3np)

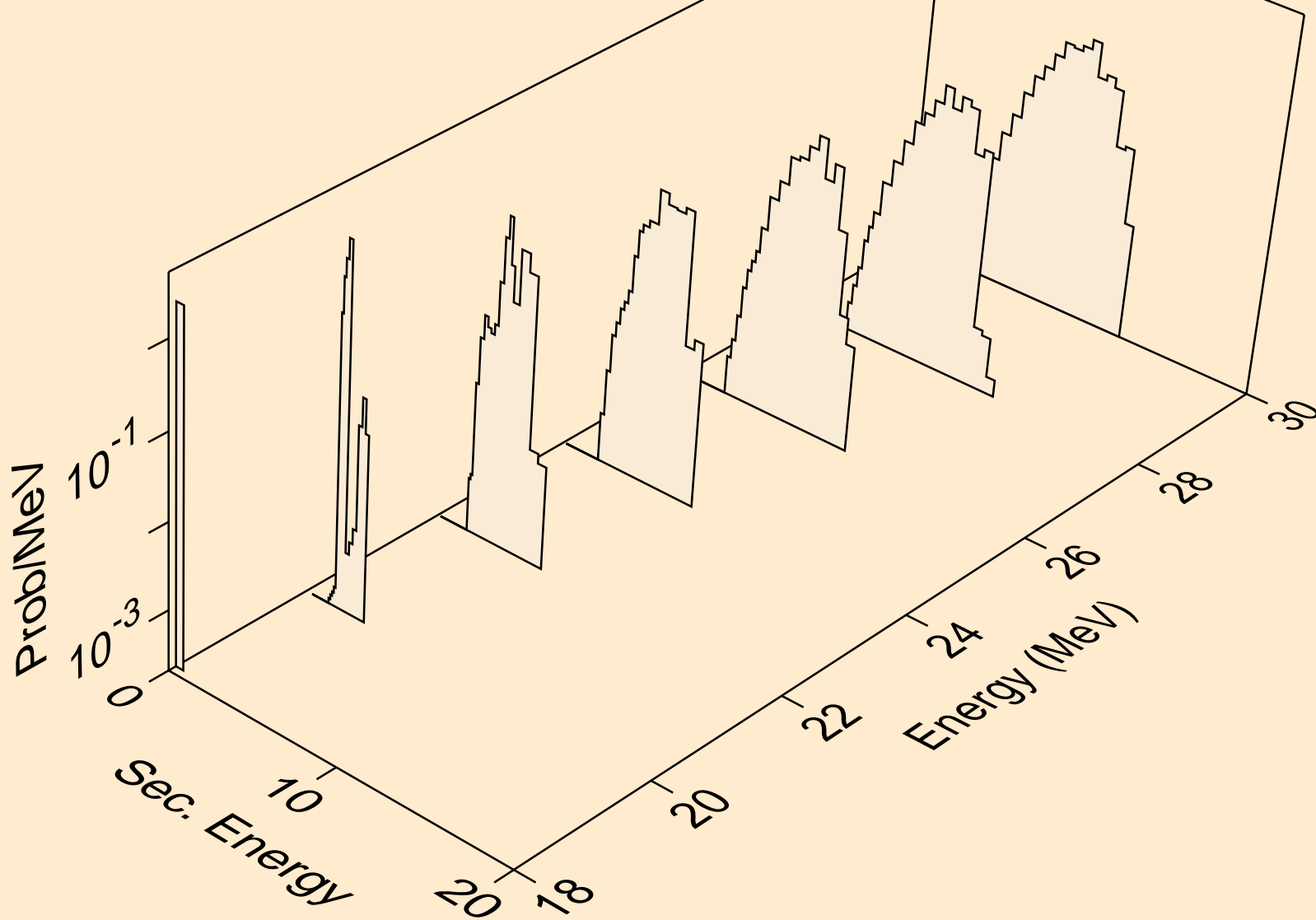

HF177N NEUTRON ACER TENDL-2019 LIBRARY; T=293.16K
protons from (n,2np)

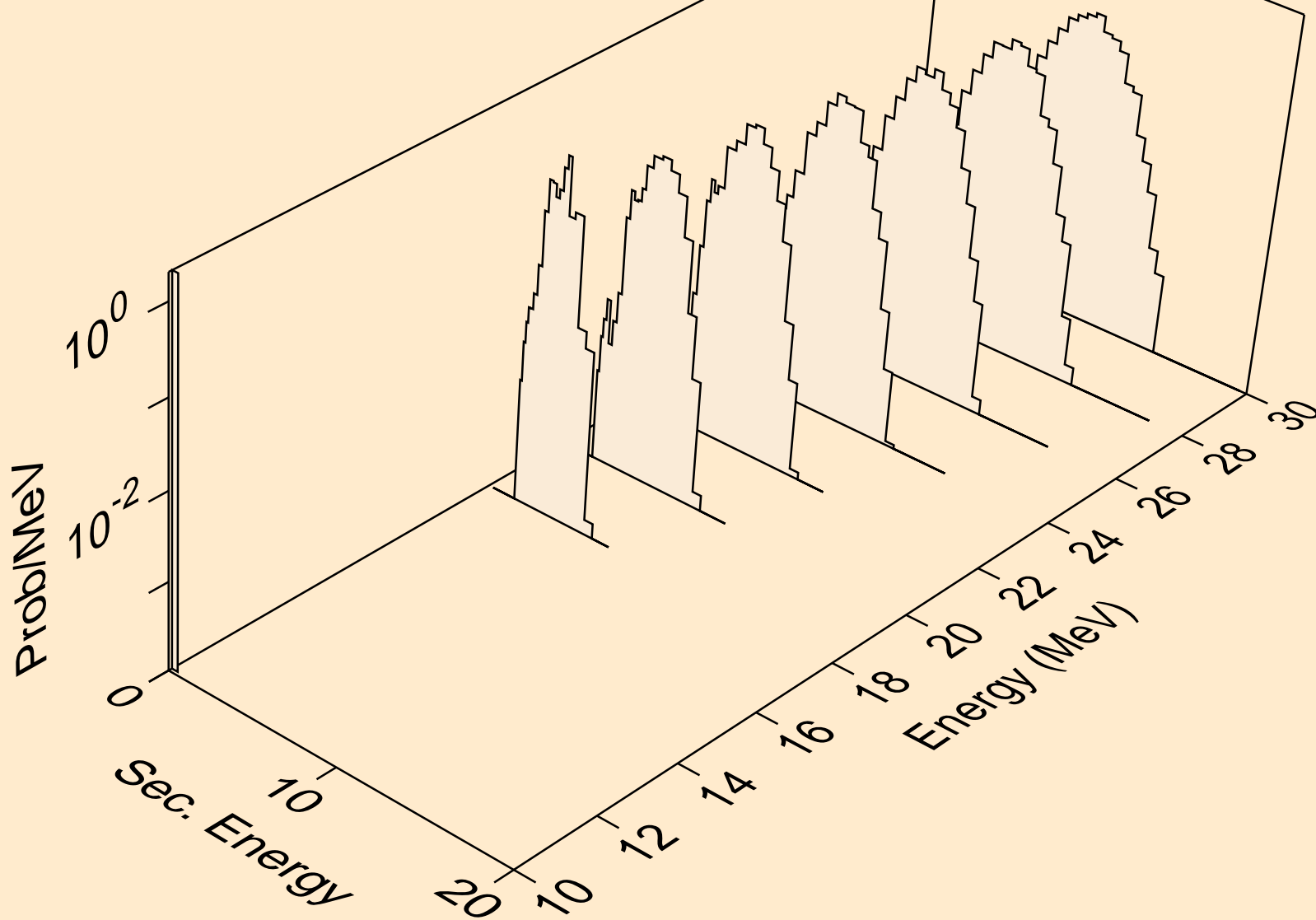

HF177N NEUTRON ACER TENDL-2019 LIBRARY; T=293.16K
protons from (n,npa)

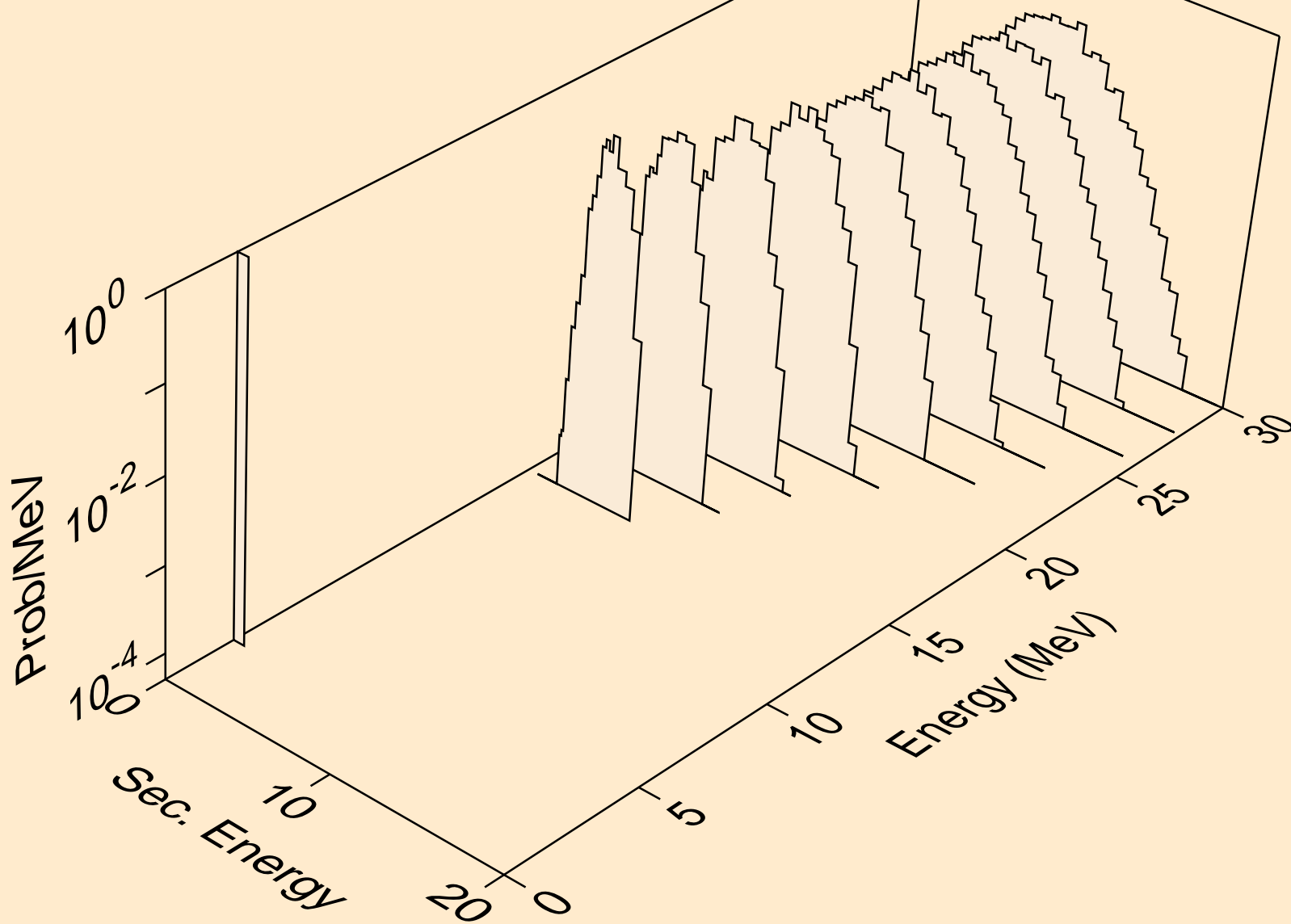

HF177N NEUTRON ACER TENDL-2019 LIBRARY; T=293.16K
protons from (n,p)

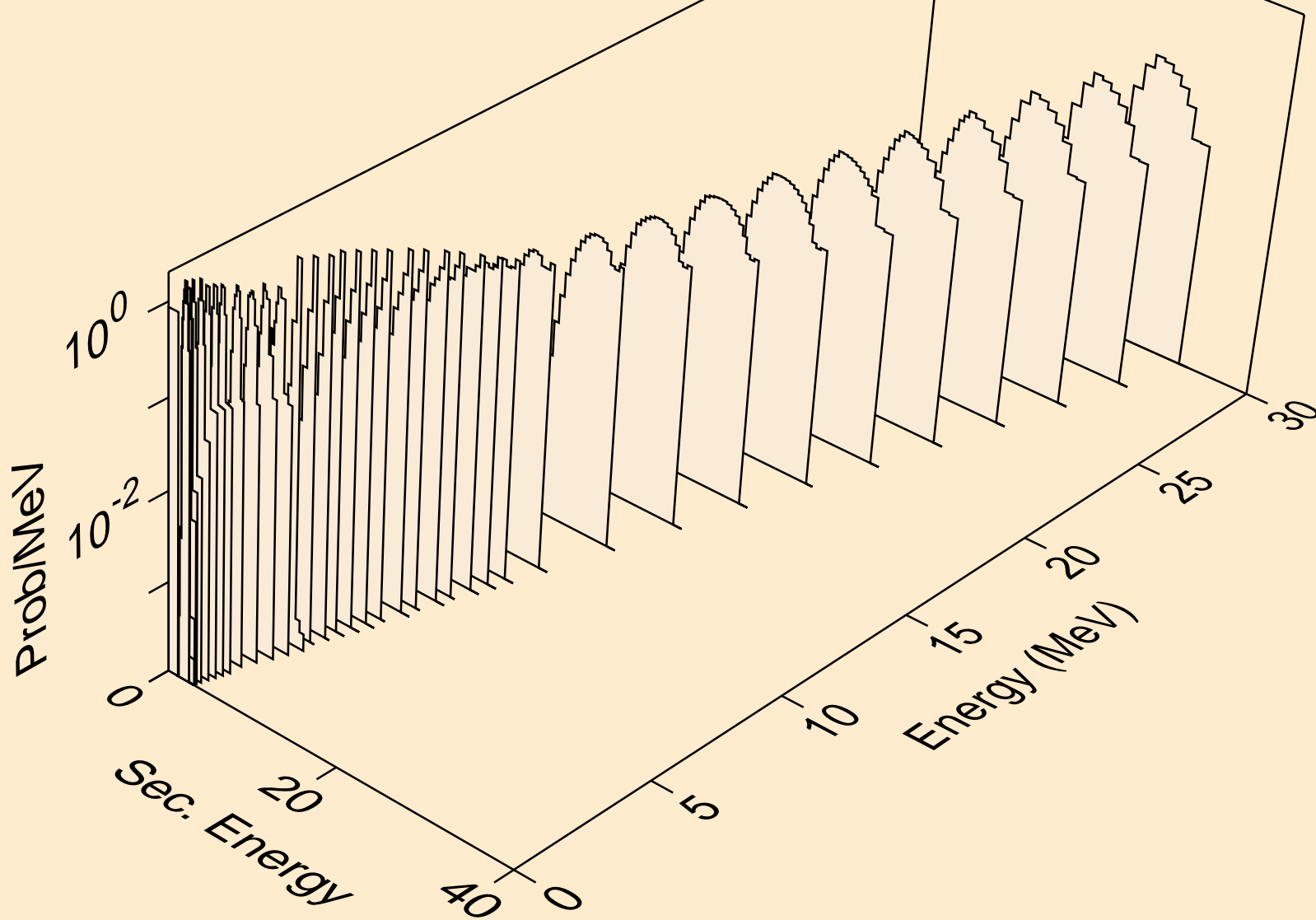

HF177N NEUTRON ACER TENDL-2019 LIBRARY; T=293.16K
protons from (n,2p)

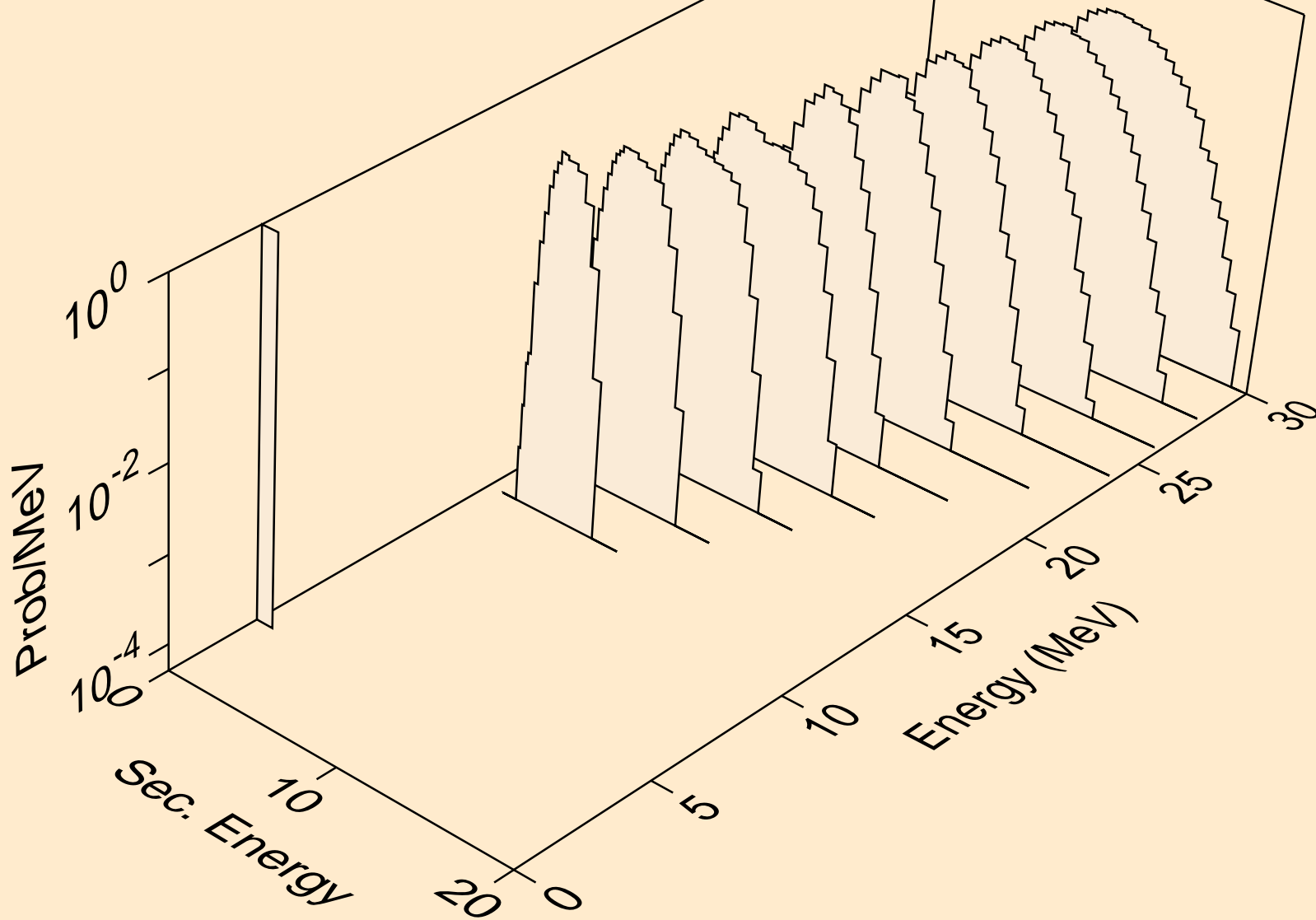

HF177N NEUTRON ACER TENDL-2019 LIBRARY; T=293.16K
protons from (n,p)

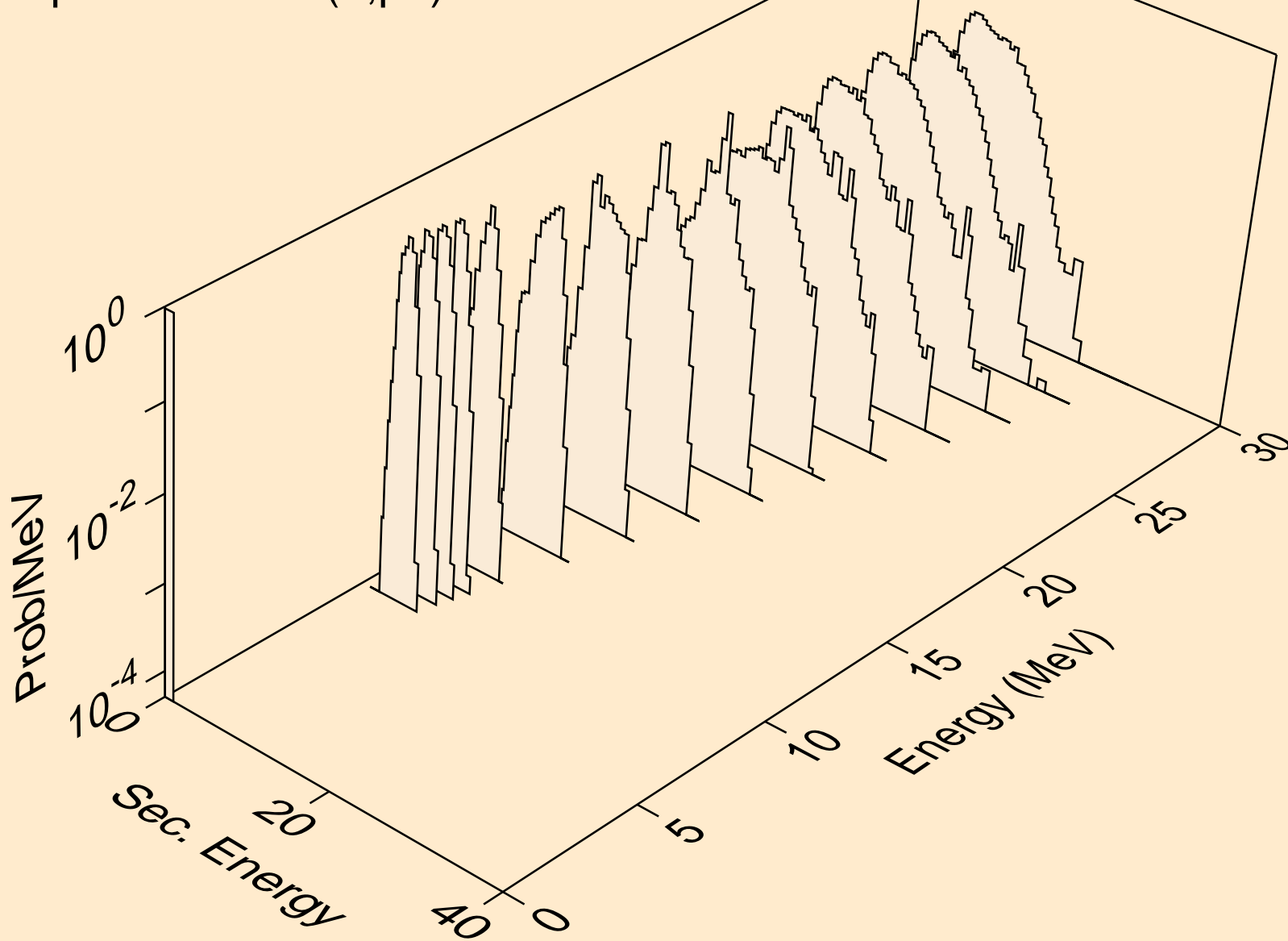

HF177N NEUTRON ACER TENDL-2019 LIBRARY; T=293.16K
protons from (n,pd)

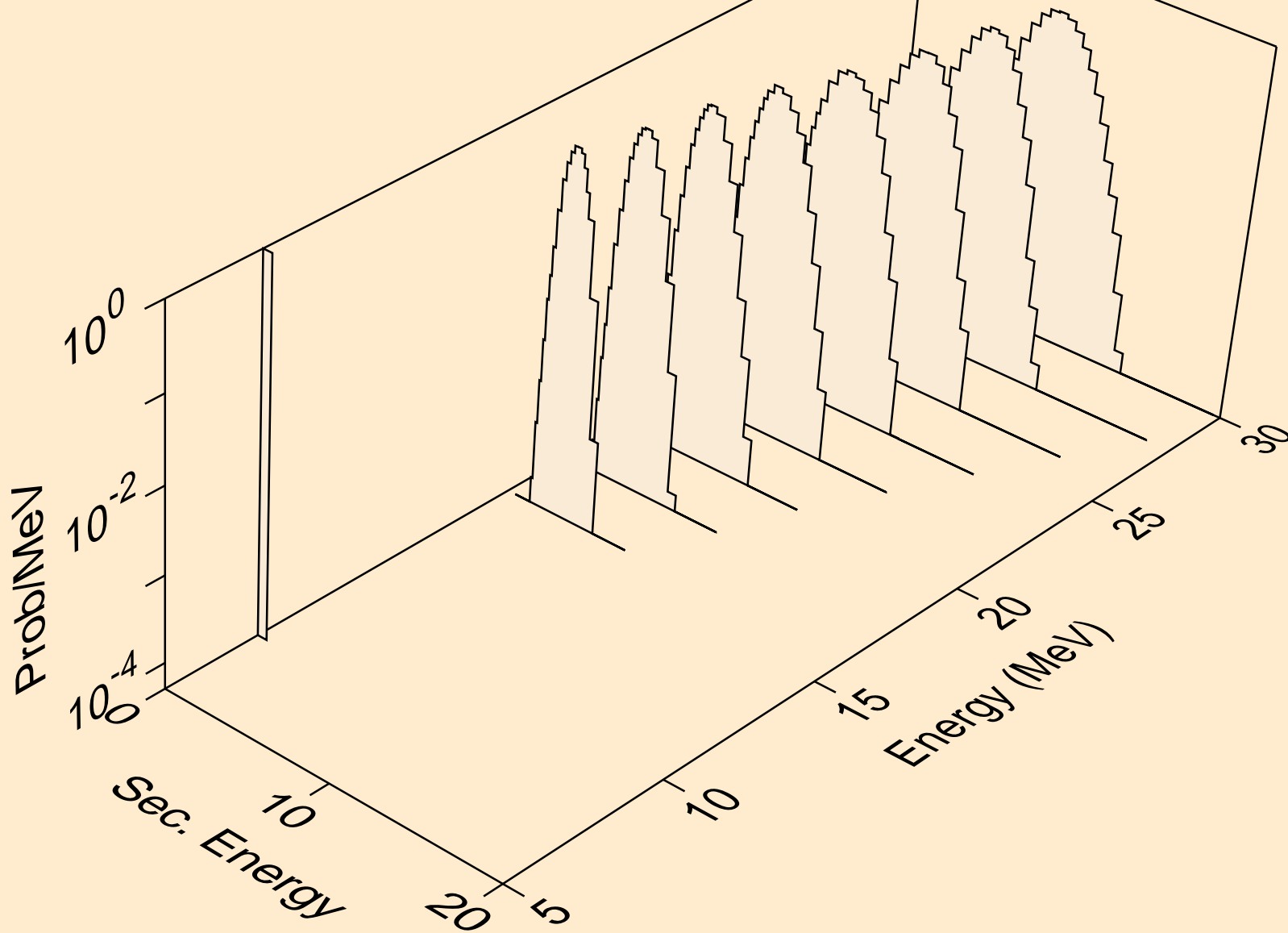

HF177N NEUTRON ACER TENDL-2019 LIBRARY; T=293.16K
protons from (n,pt)

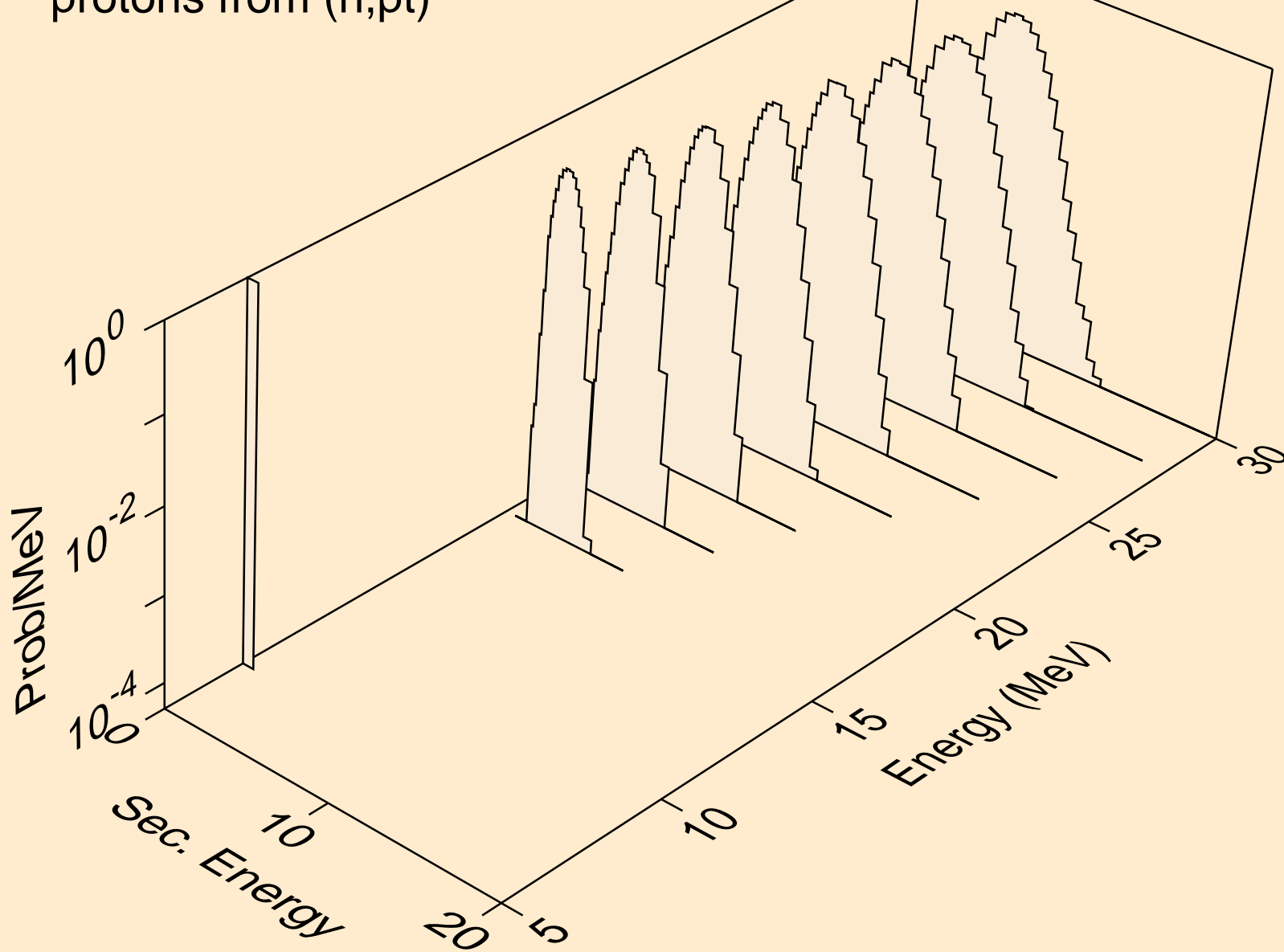

HF177N NEUTRON ACER TENDL-2019 LIBRARY; T=293.16K
deuterons from (n,x)

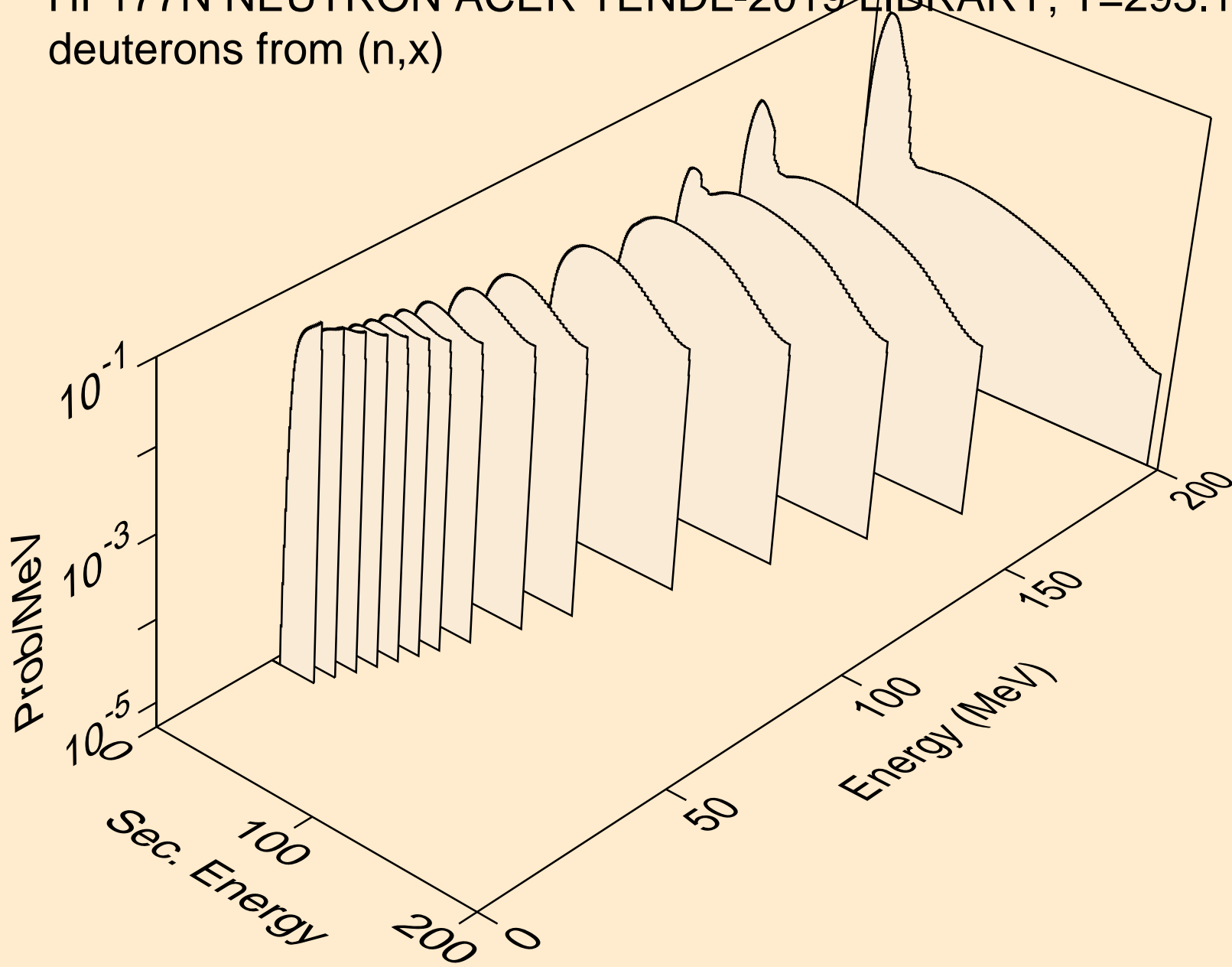

HF177N NEUTRON ACER TENDL-2019 LIBRARY; T=293.16K
deuterons from (n,2nd)

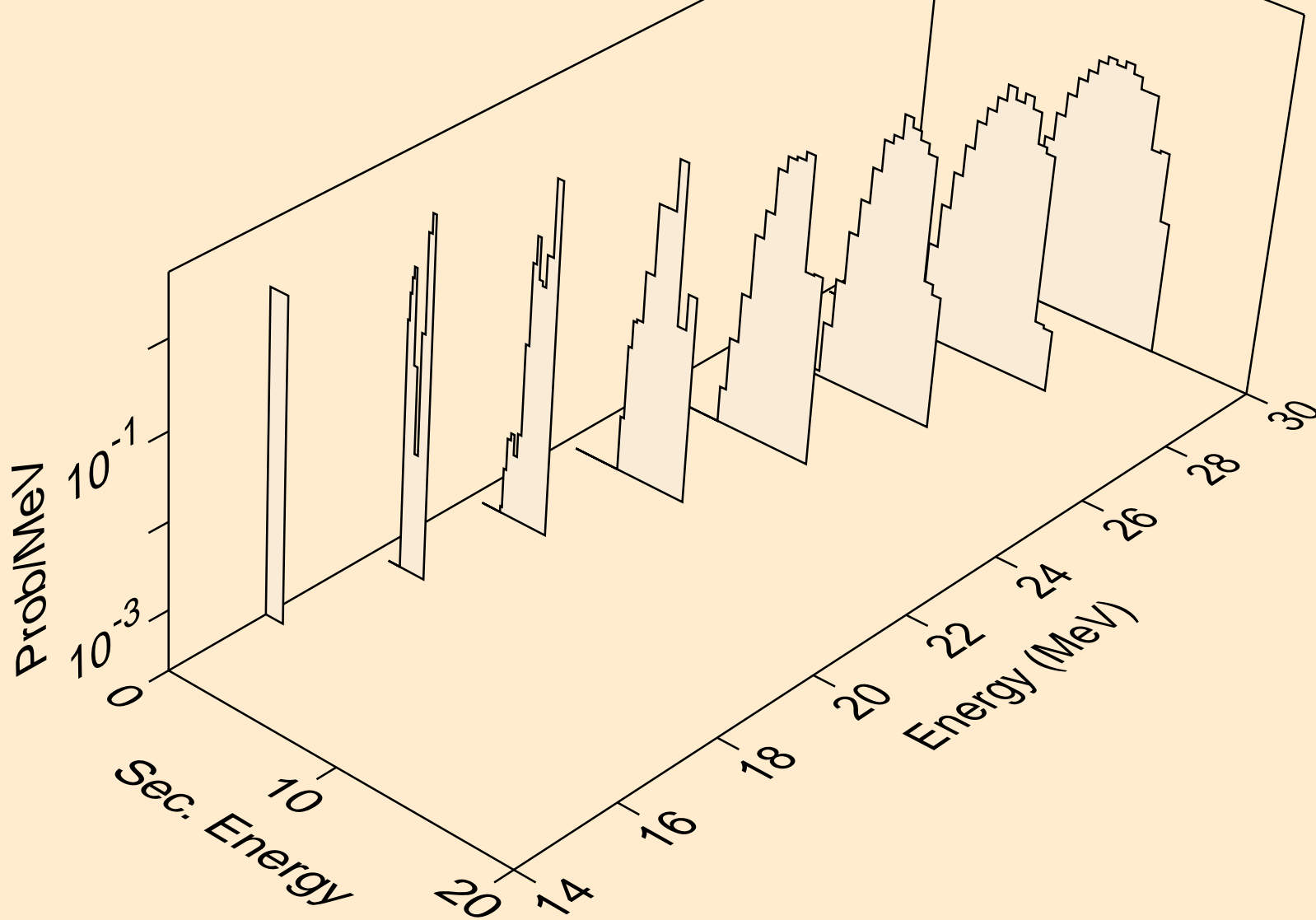

HF177N NEUTRON ACER TENDL-2019 LIBRARY; T=293.16K
deuterons from (n,n*)d

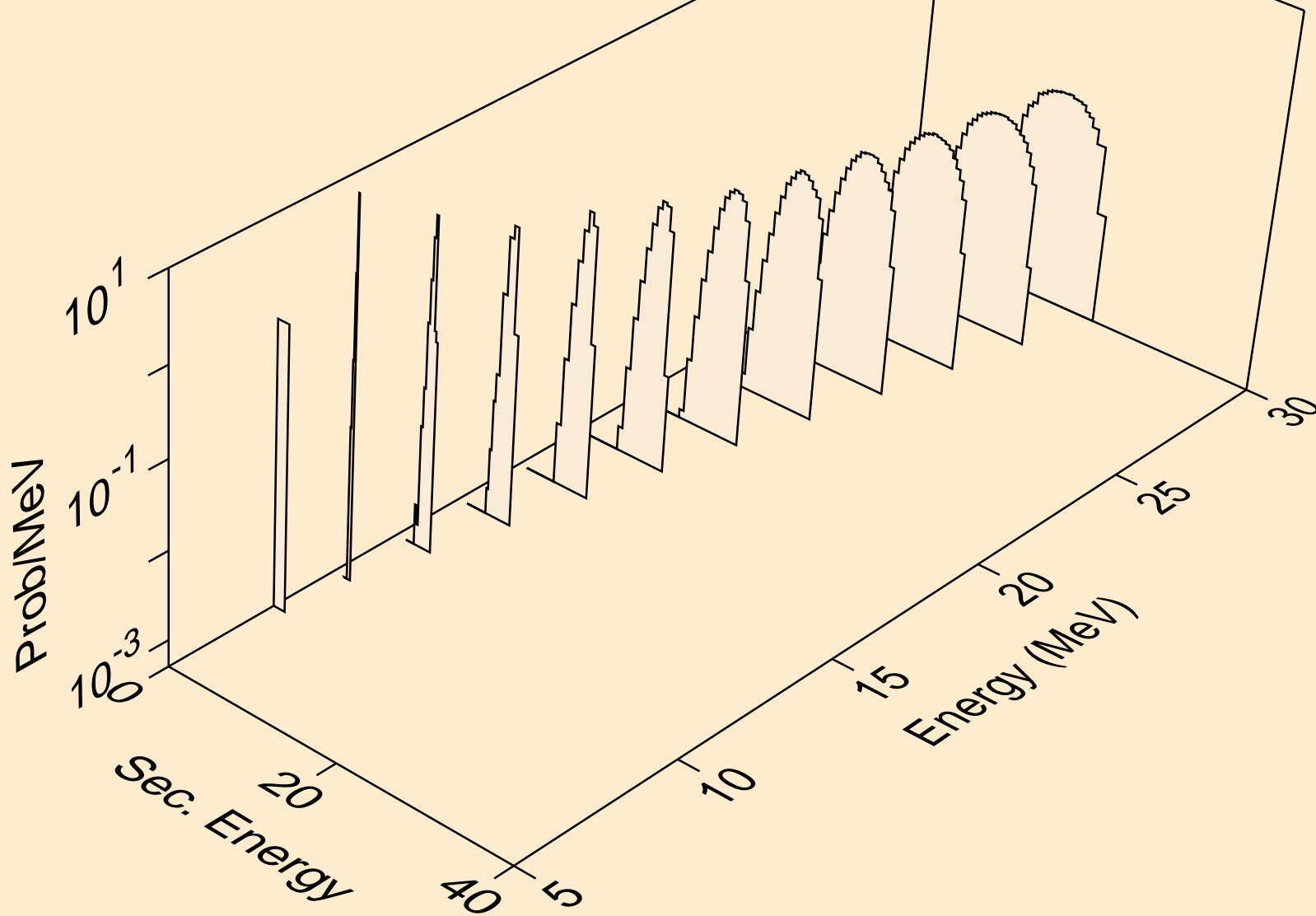

HF177N NEUTRON ACER TENDL-2019 LIBRARY; T=293.16K
deuterons from (n,d)

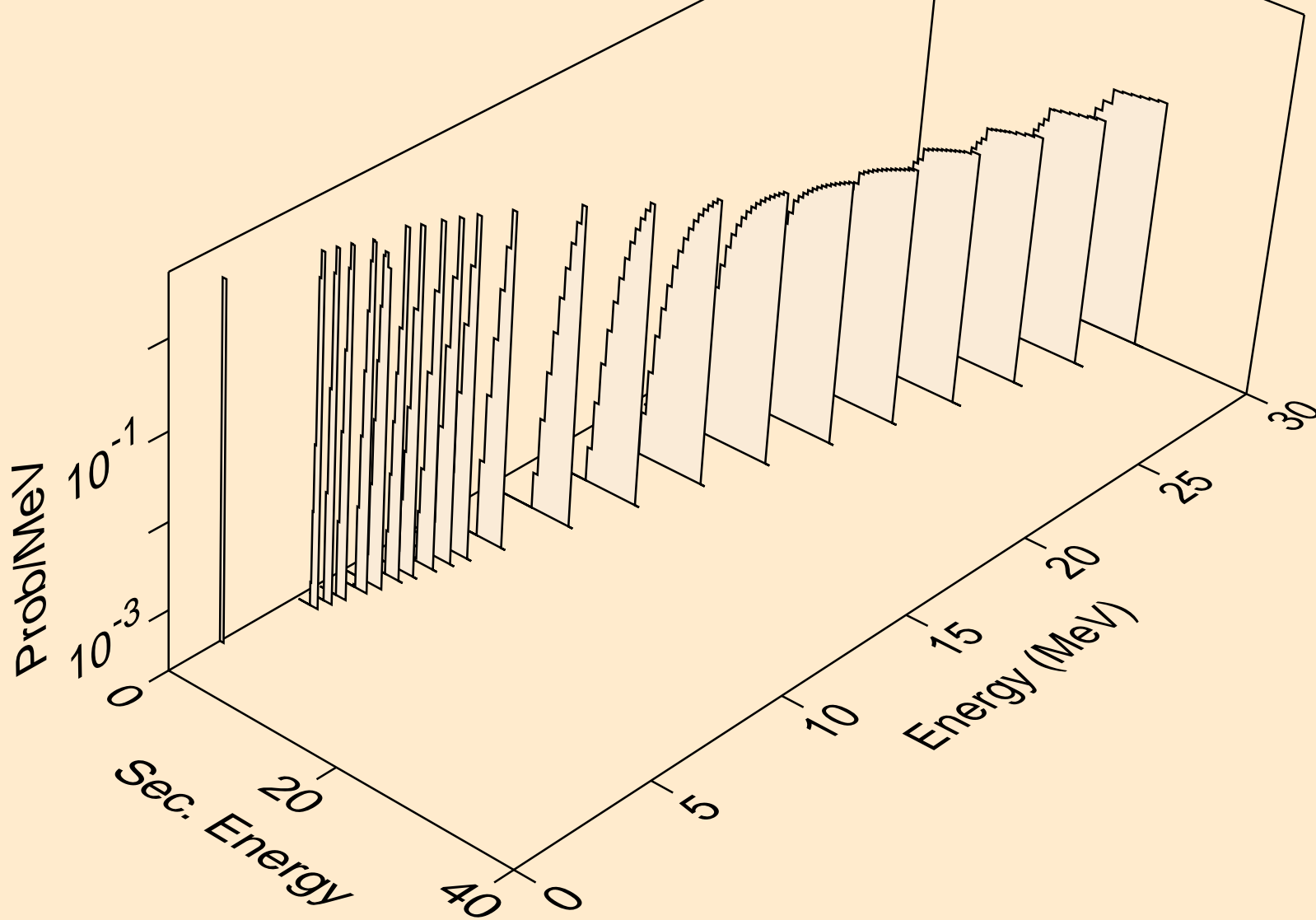

HF177N NEUTRON ACER TENDL-2019 LIBRARY; T=293.16K
deuterons from (n,pd)

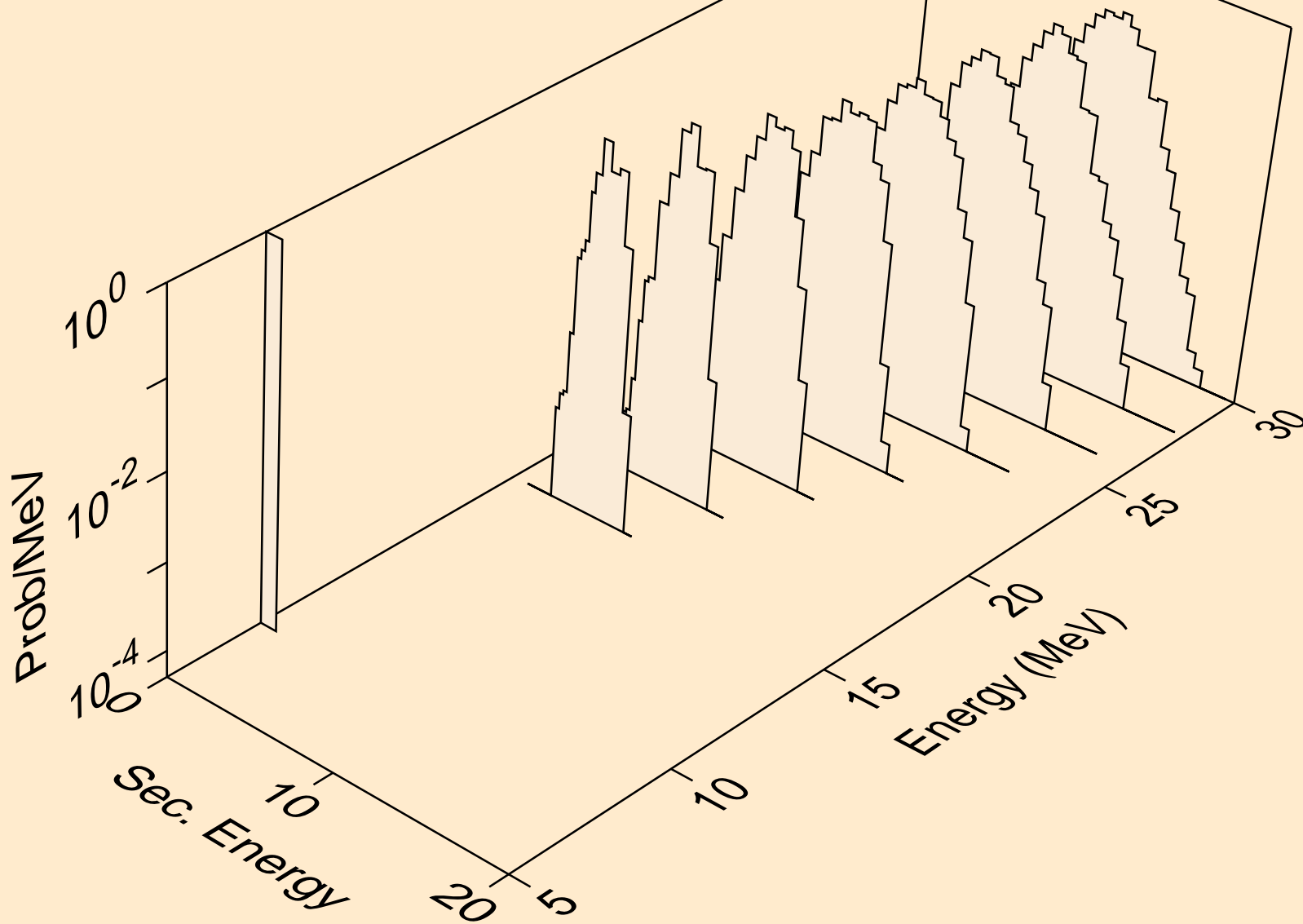

HF177N NEUTRON ACER TENDL-2019 LIBRARY; T=293.16K
deuterons from (n,da)

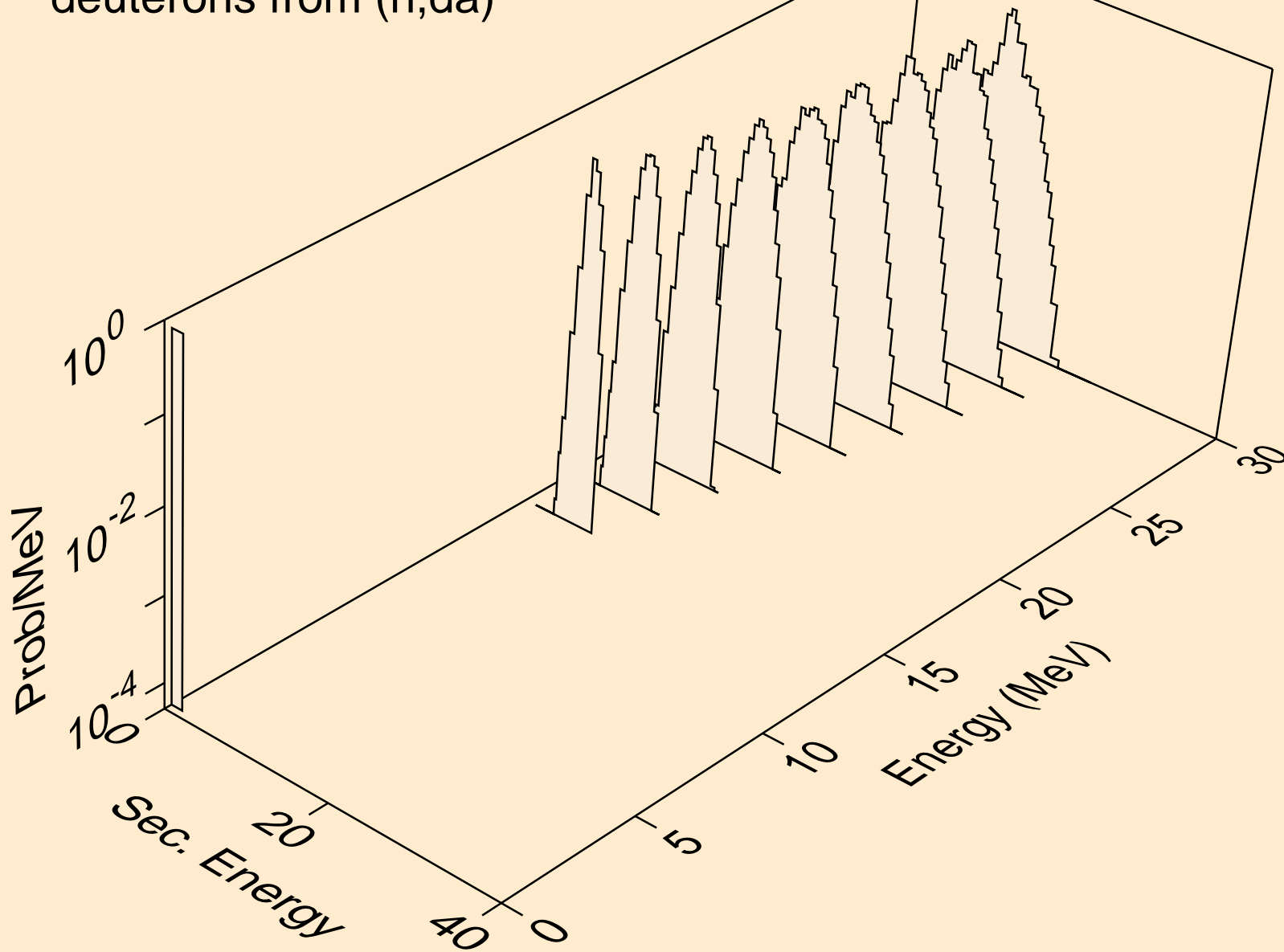

HF177N NEUTRON ACER TENDL-2019 LIBRARY; T=293.16K
tritons from (n,x)

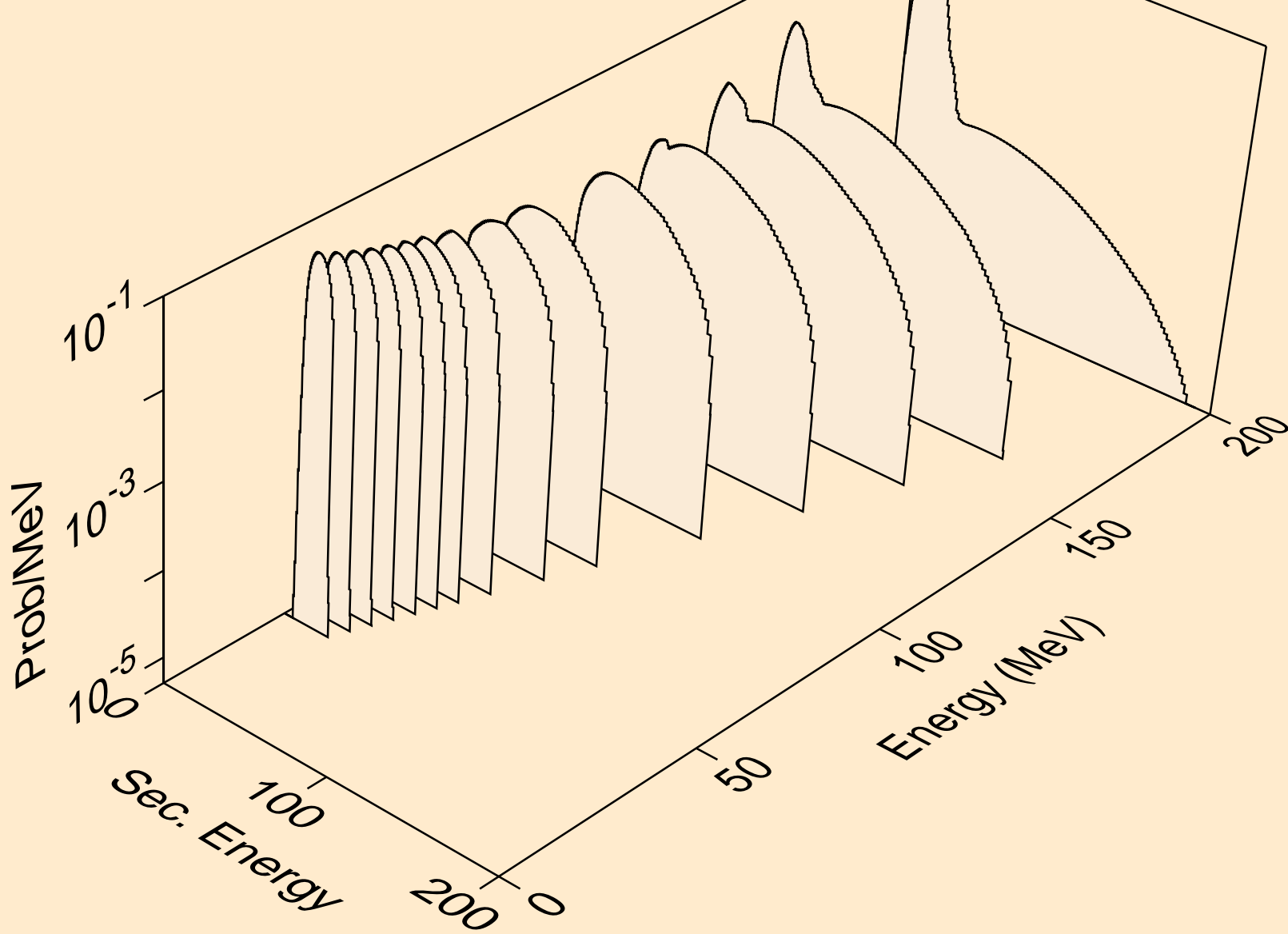

HF177N NEUTRON ACER TENDL-2019 LIBRARY; T=293.16K
tritons from (n,n*)t

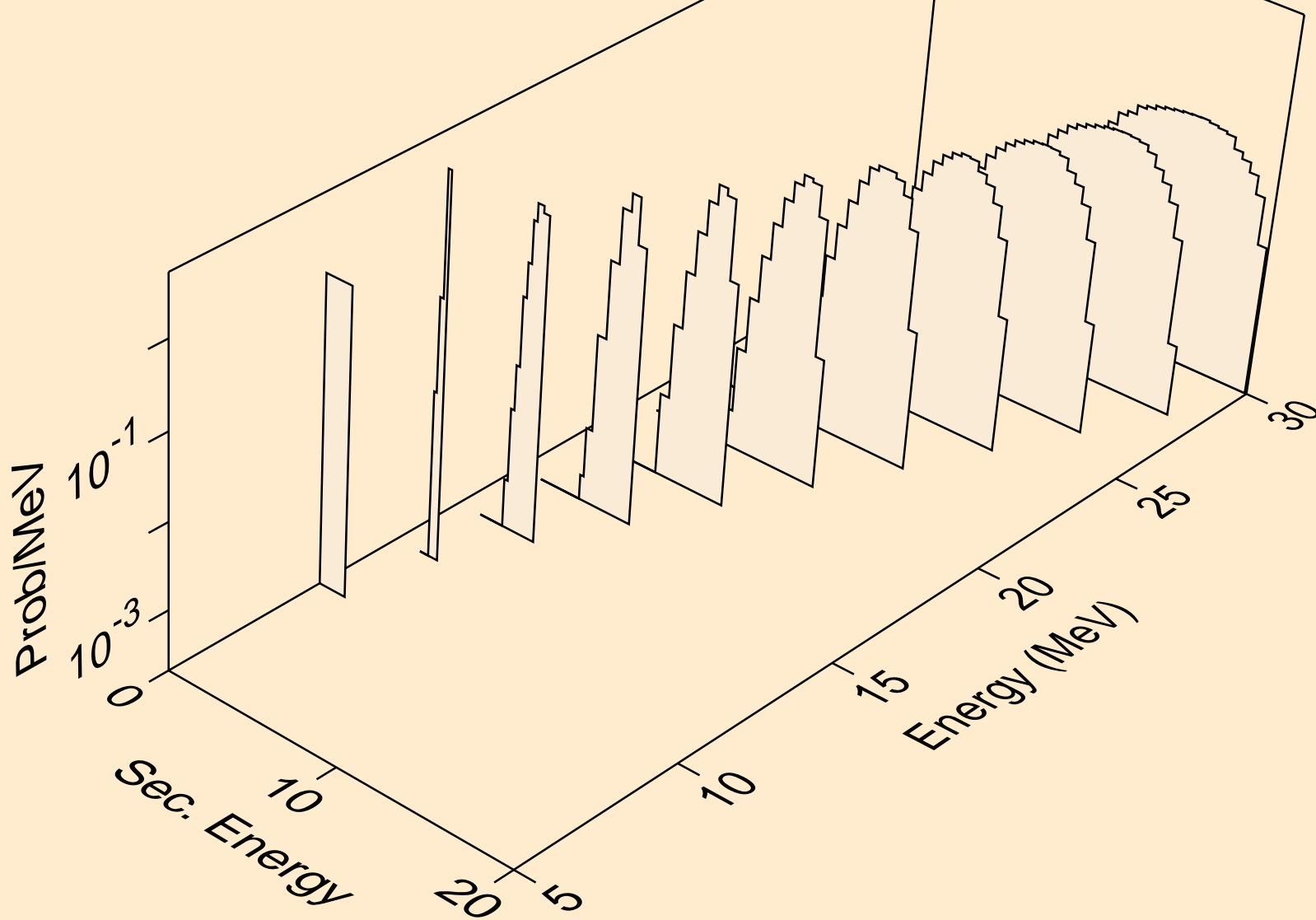

HF177N NEUTRON ACER TENDL-2019 LIBRARY; T=293.16K
tritons from (n,t)

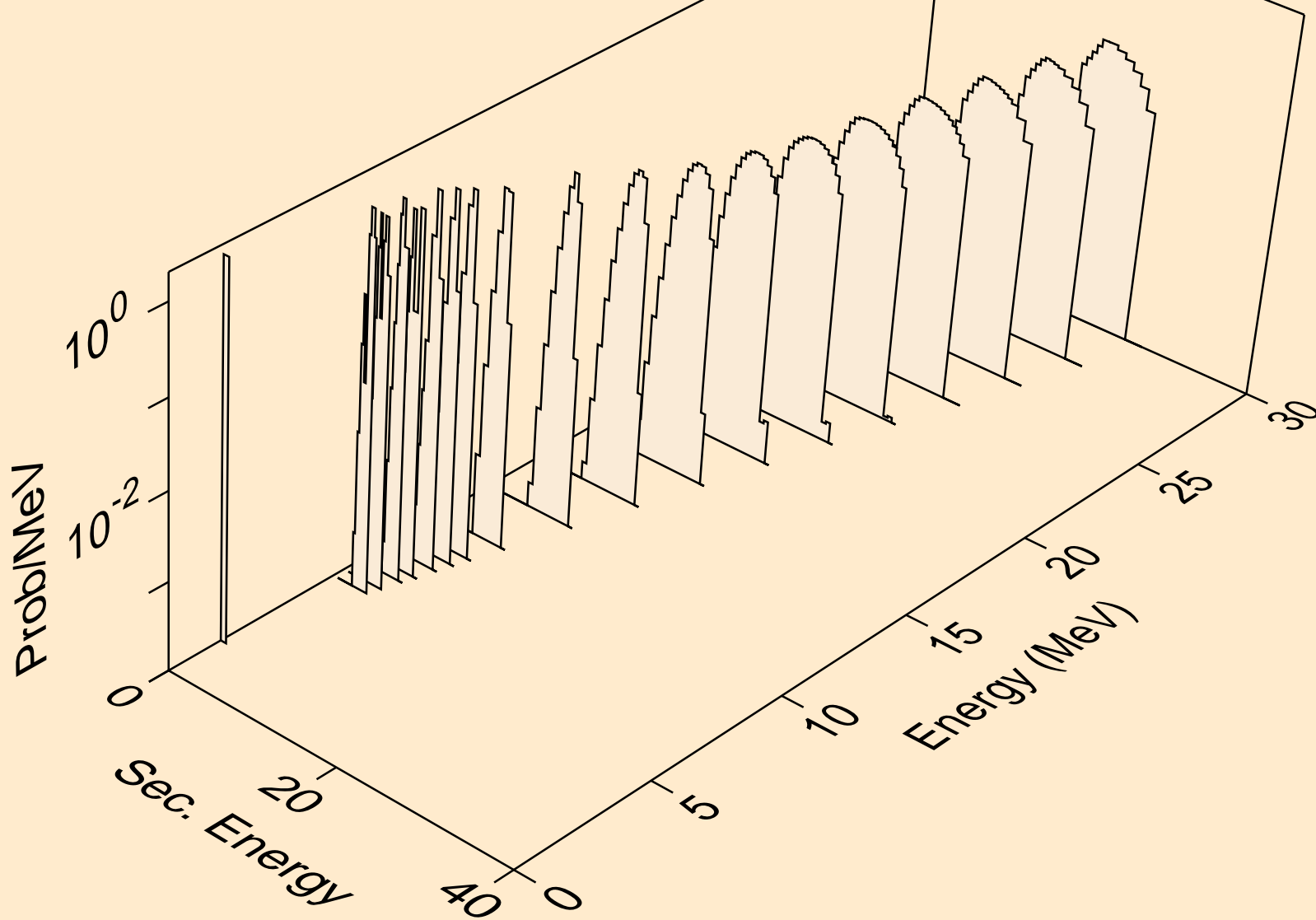

HF177N NEUTRON ACER TENDL-2019 LIBRARY; T=293.16K
tritons from (n,pt)

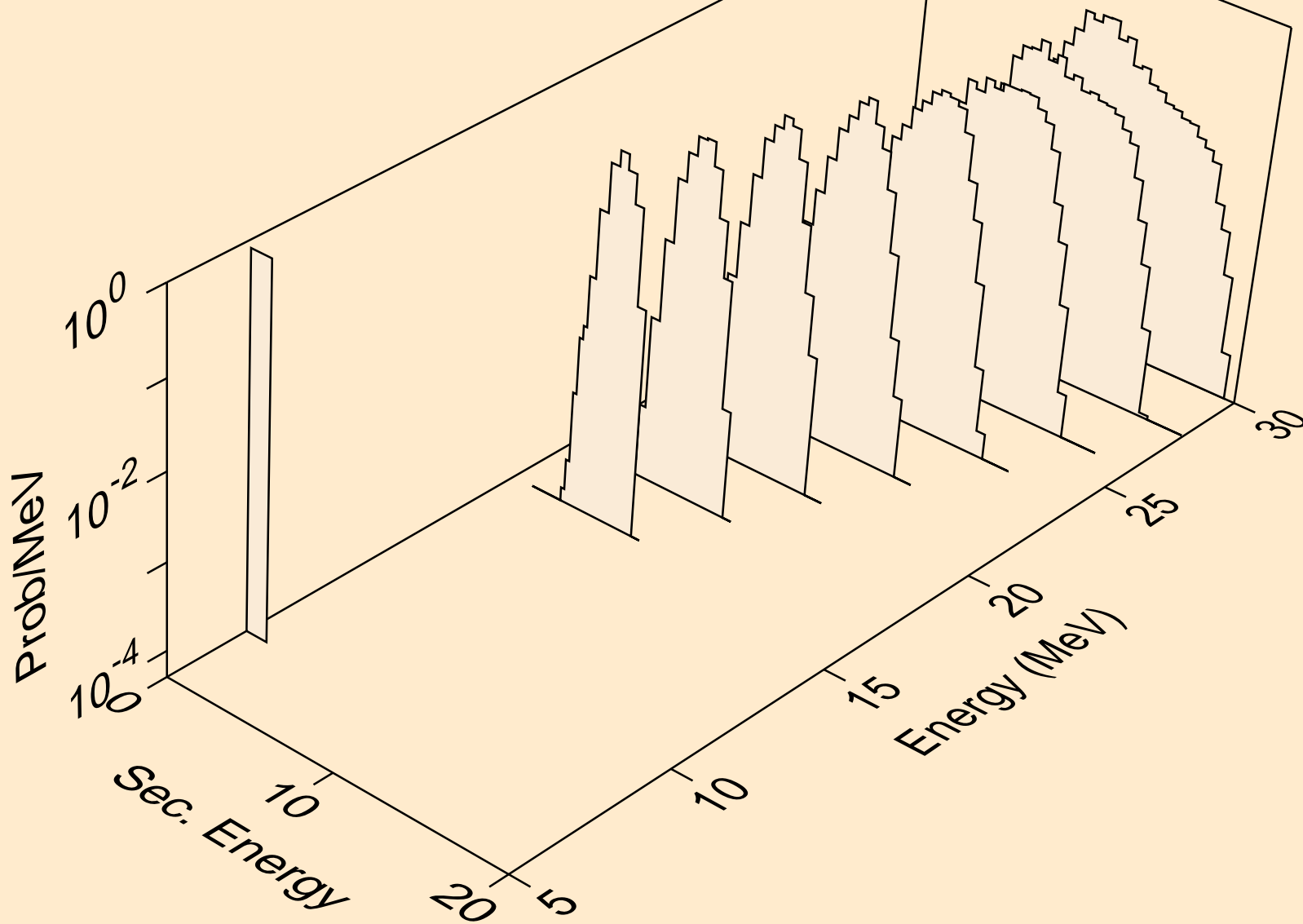

HF177N NEUTRON ACER TENDL-2019 LIBRARY; T=293.16K
he3s from (n,x)

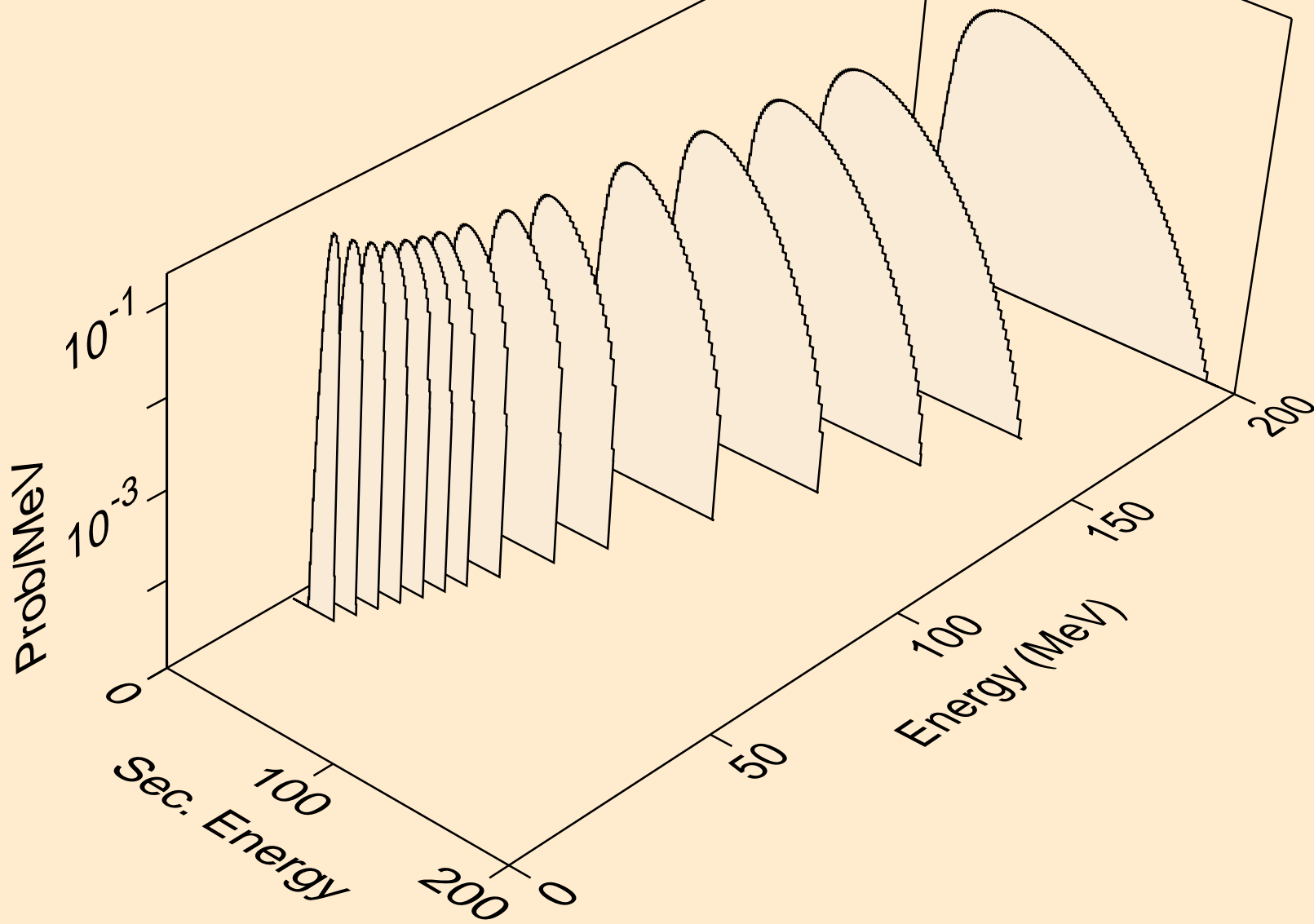

HF177N NEUTRON ACER TENDL-2019 LIBRARY; T=293.16K
he3s from (n,n*)he3

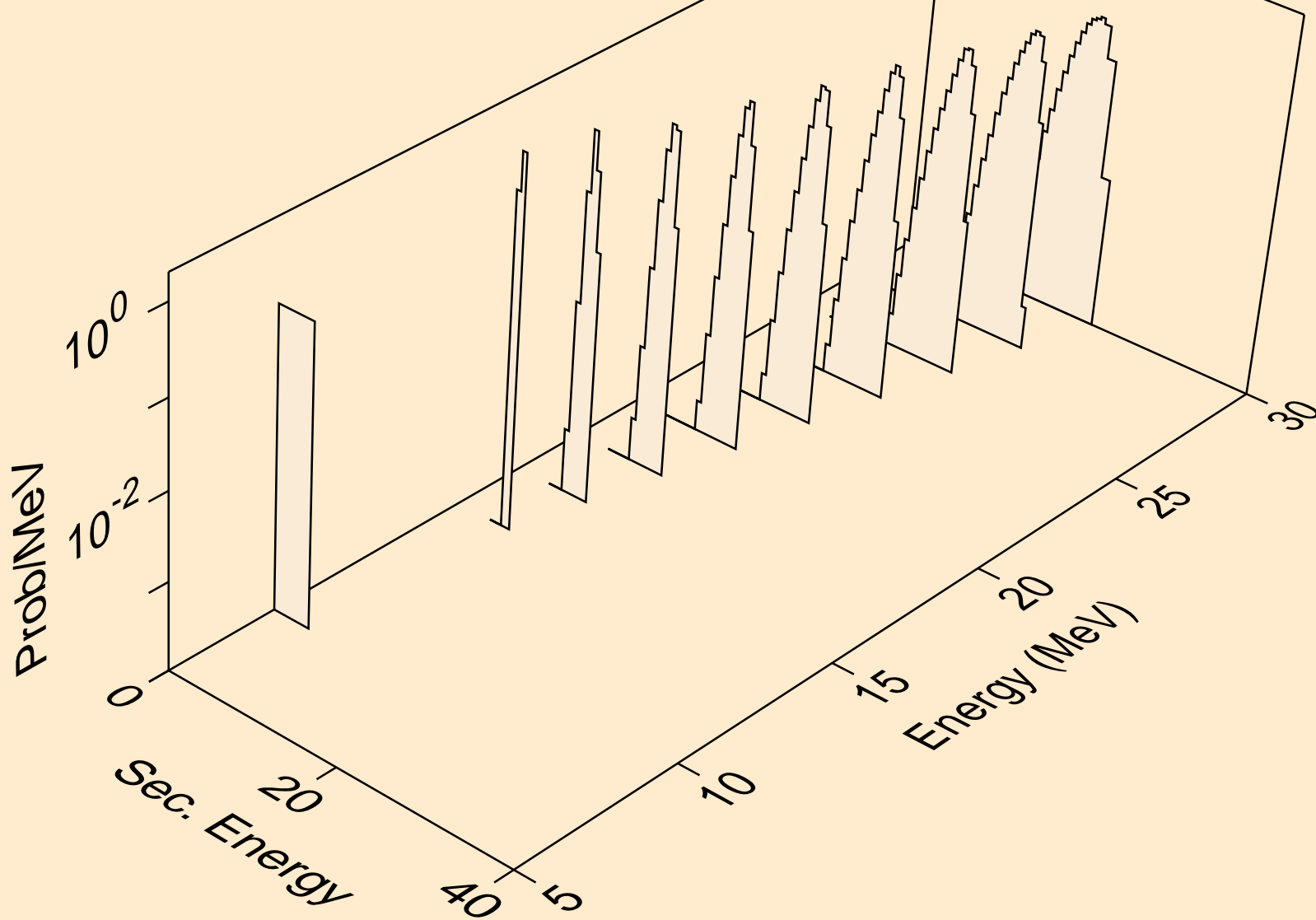

HF177N NEUTRON ACER TENDL-2019 LIBRARY; T=293.16K
he3s from (n,he3)

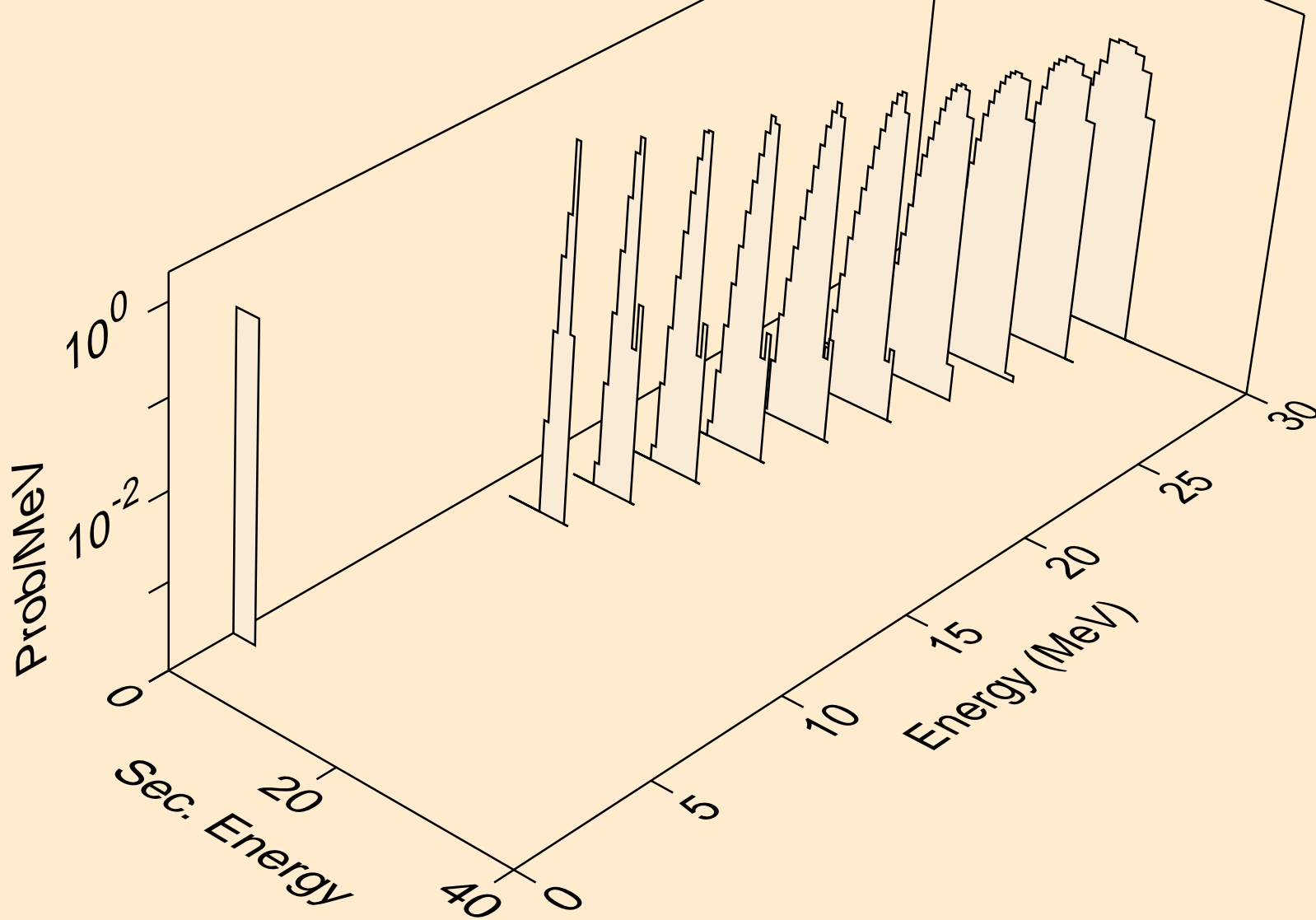

HF177N NEUTRON ACER TENDL-2019 LIBRARY; T=293.16K
alphas from (n,x)

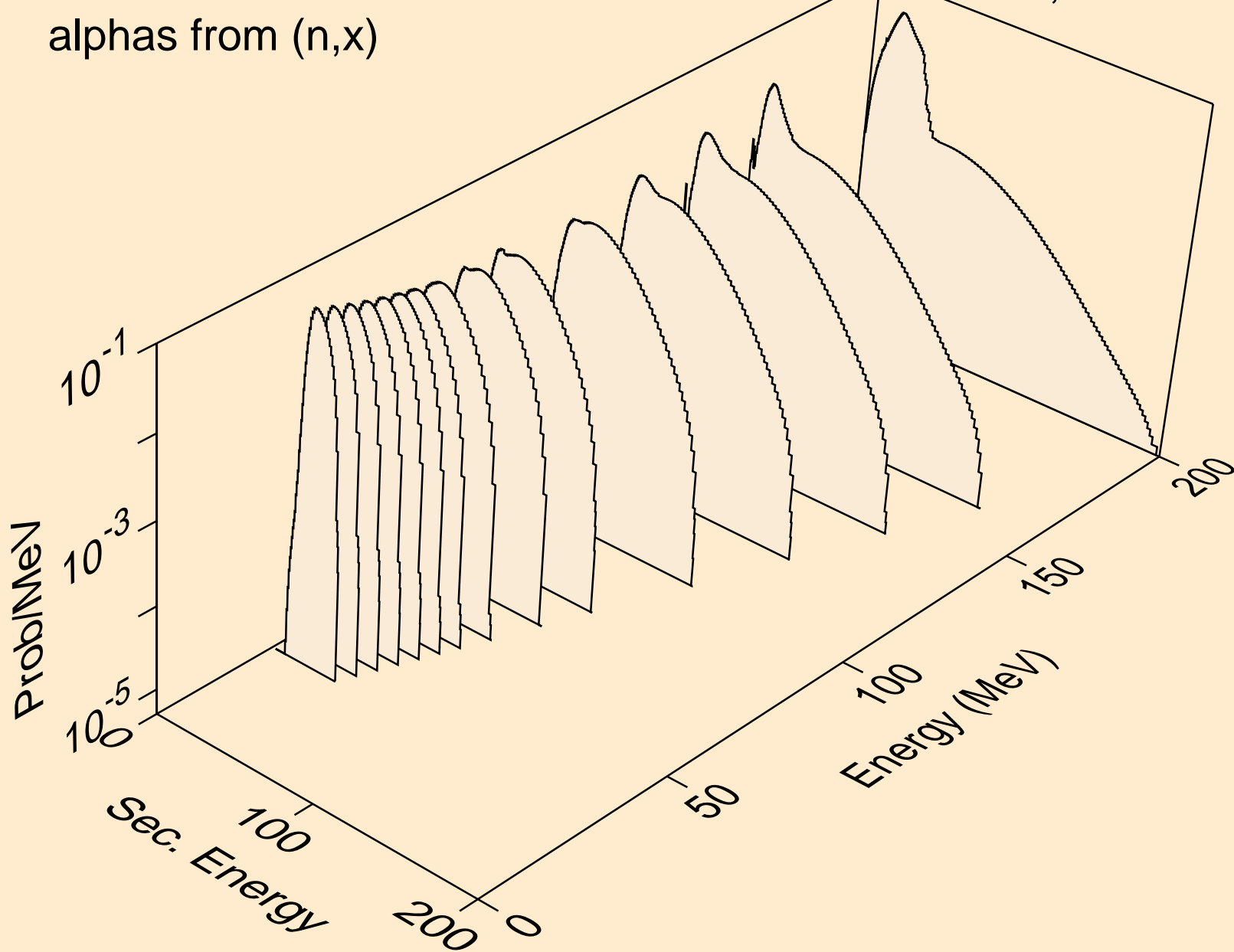

HF177N NEUTRON ACER TENDL-2019 LIBRARY; T=293.16K
alphas from (n,n*)a

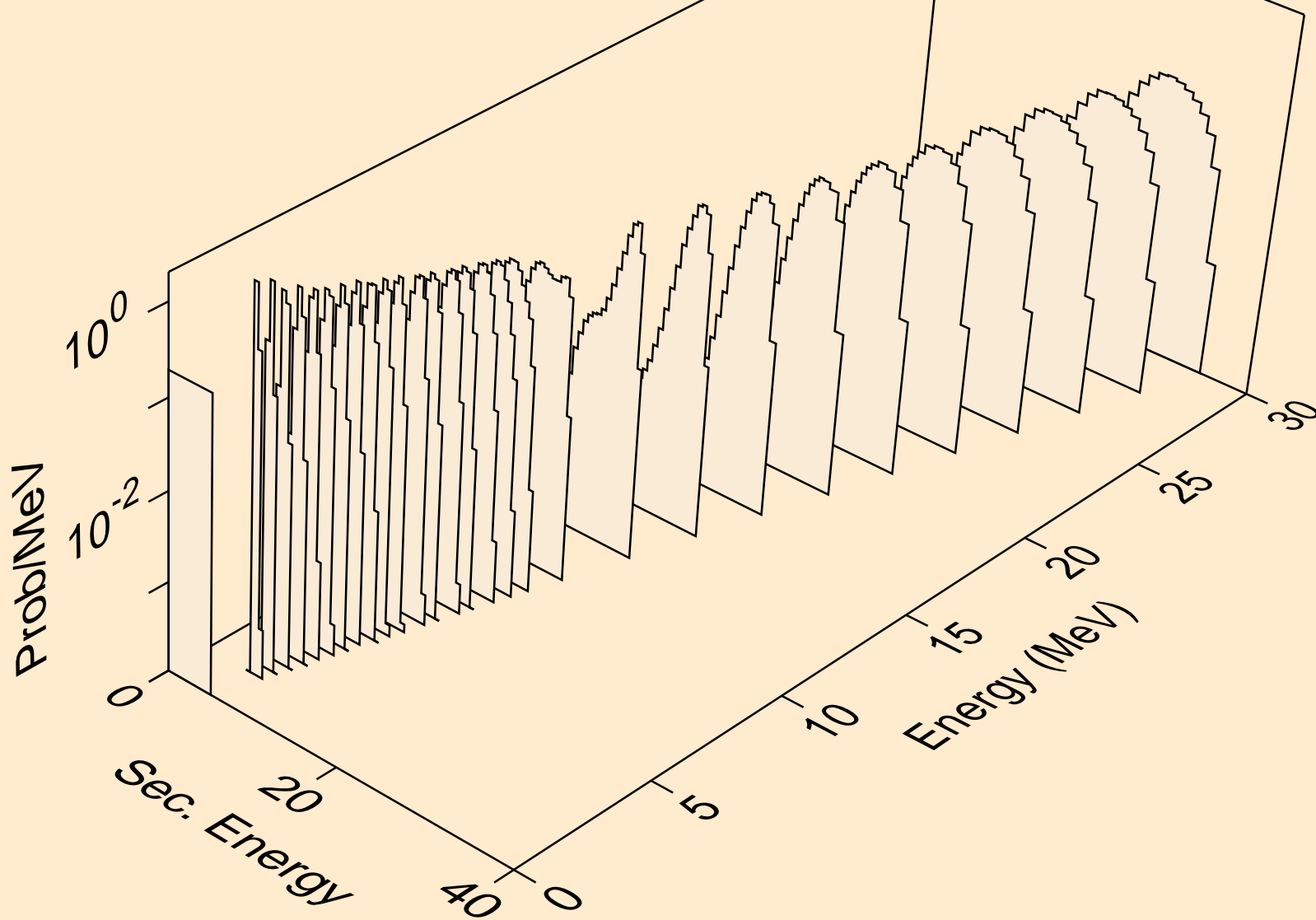

HF177N NEUTRON ACER TENDL-2019 LIBRARY; T=293.16K
alphas from (n,2n)a

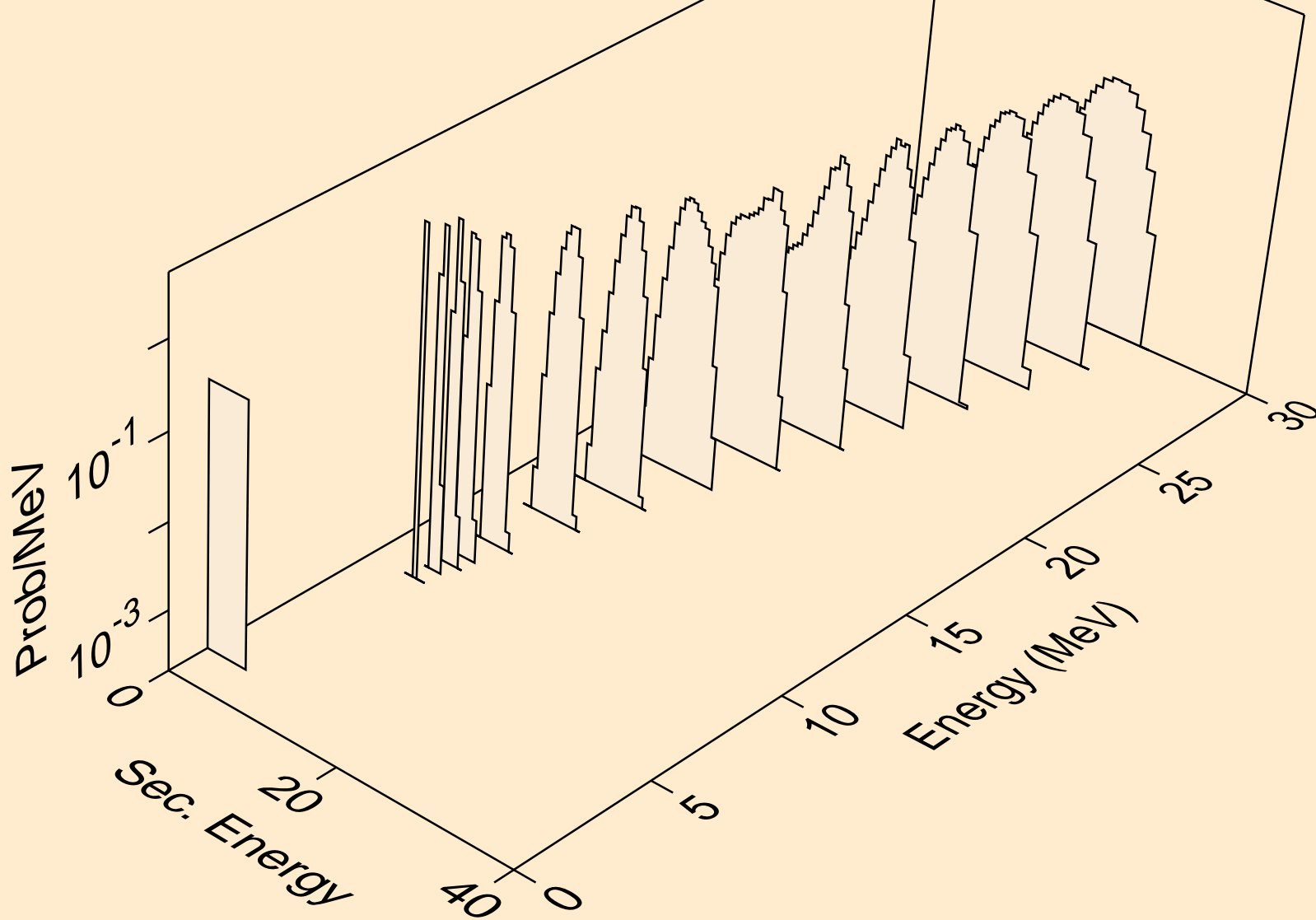

HF177N NEUTRON ACER TENDL-2019 LIBRARY; T=293.16K
alphas from (n,3n)a

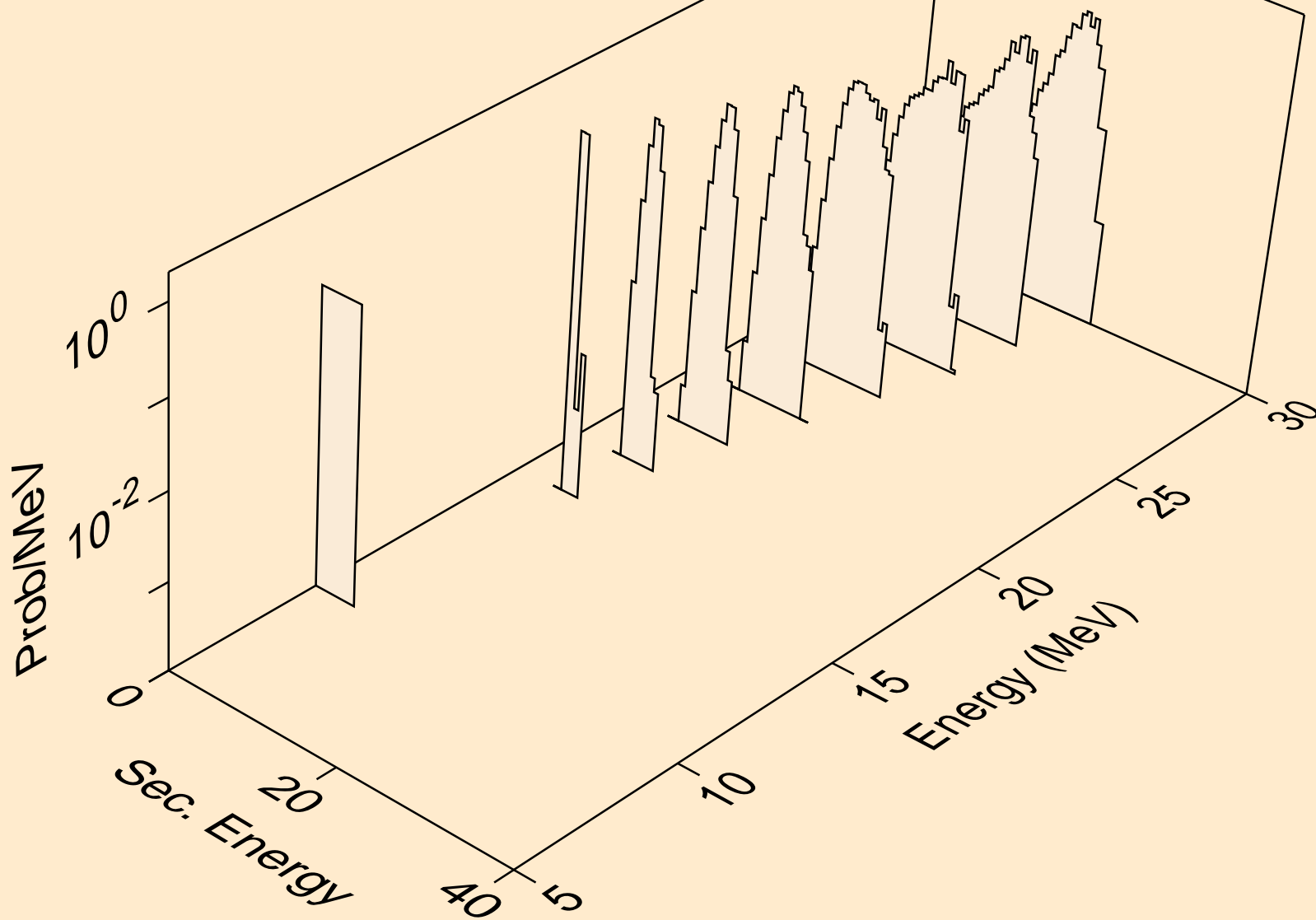

HF177N NEUTRON ACER TENDL-2019 LIBRARY; T=293.16K
alphas from (n,n*)2a

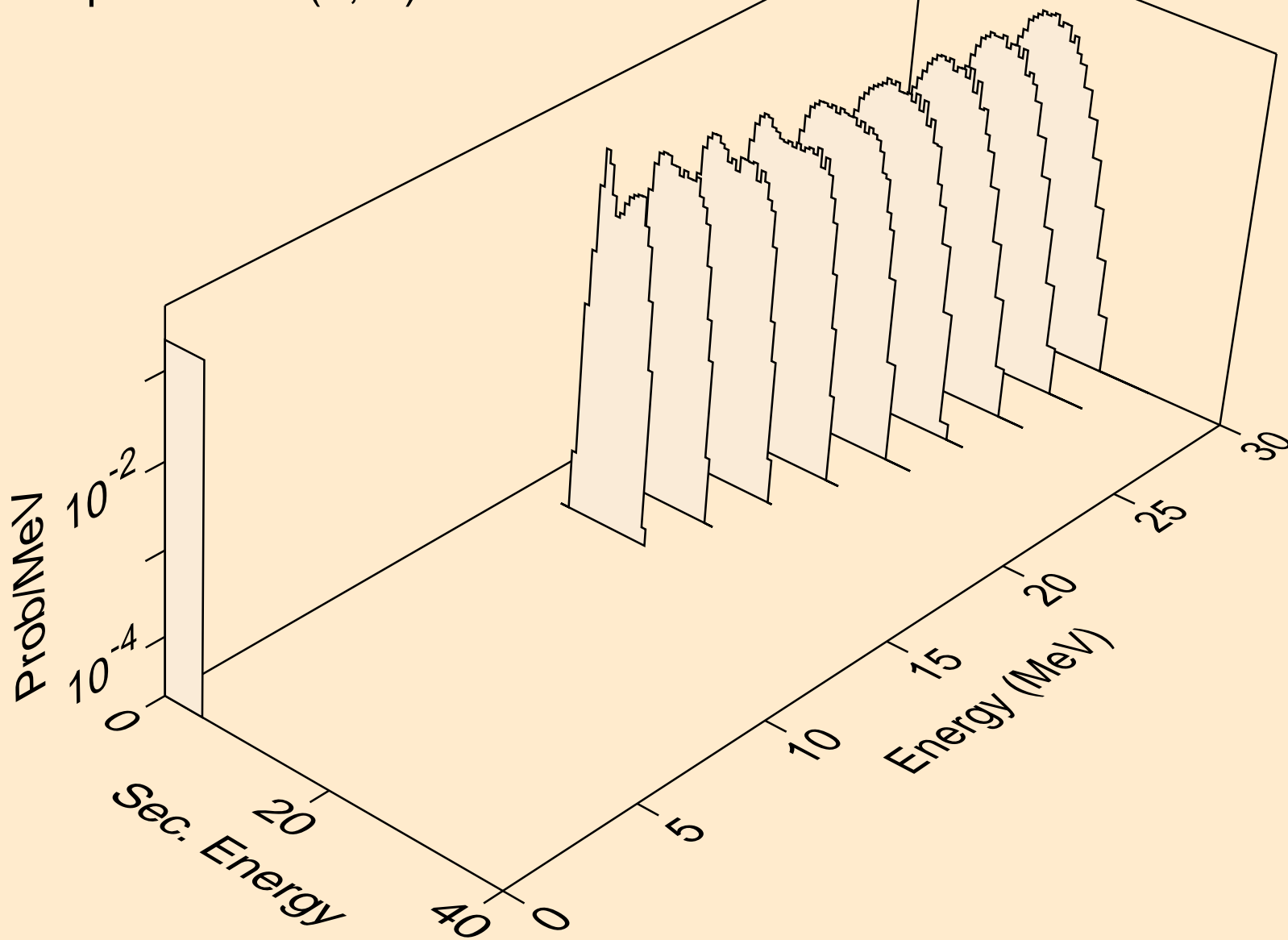

HF177N NEUTRON ACER TENDL-2019 LIBRARY; T=293.16K
alphas from (n,npa)

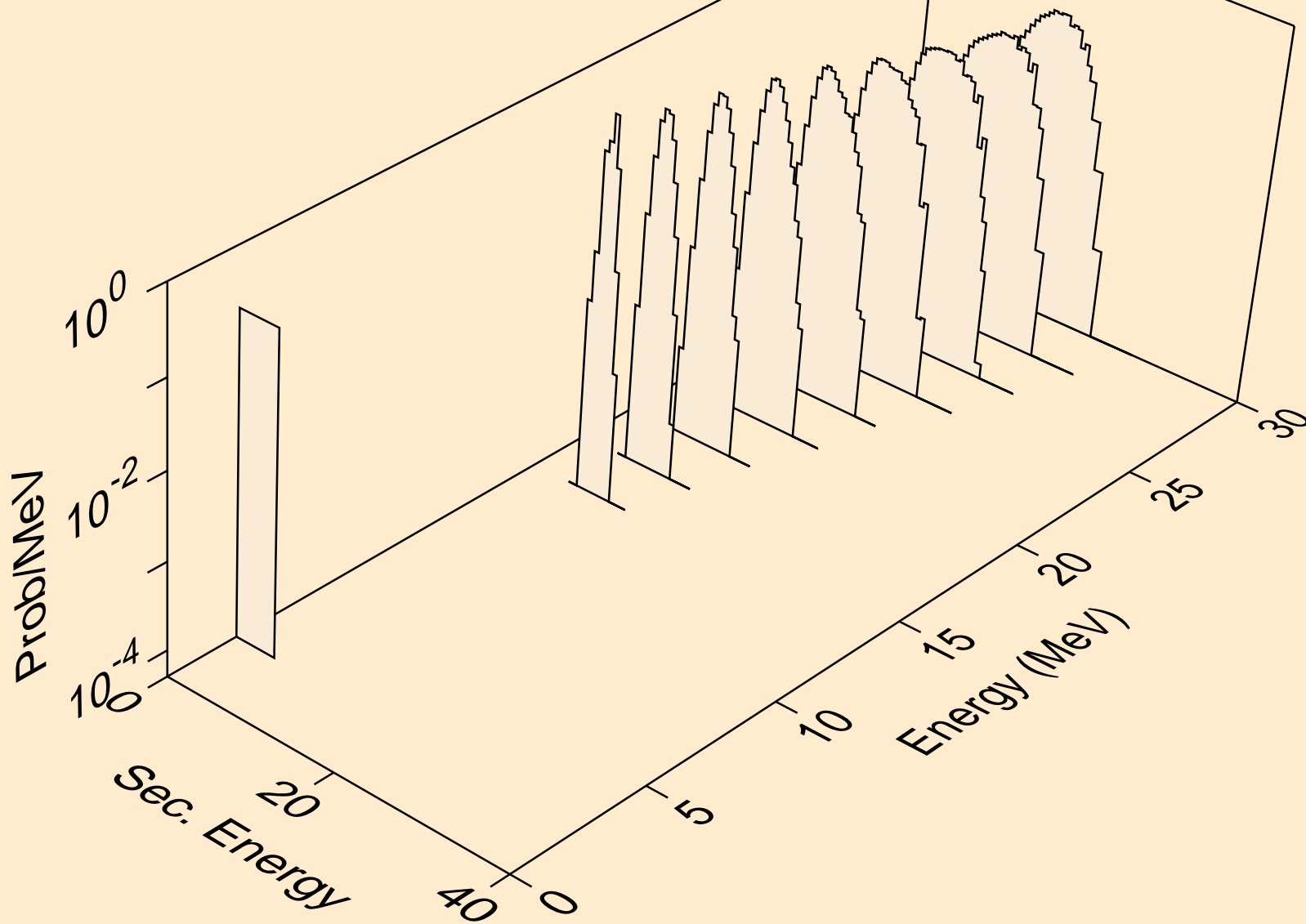

HF177N NEUTRON ACER TENDL-2019 LIBRARY; T=293.16K
alphas from (n,a)

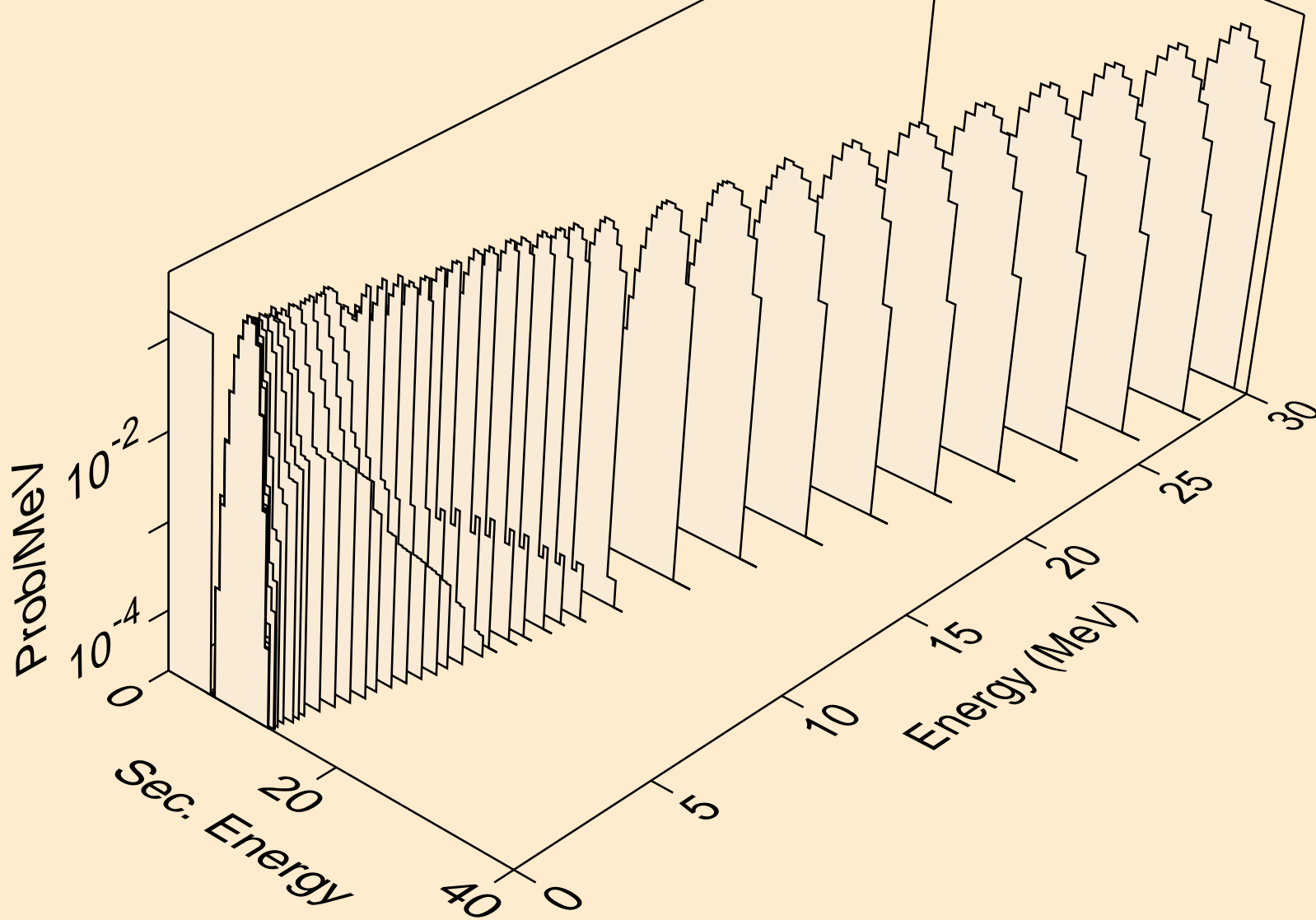

HF177N NEUTRON ACER TENDL-2019 LIBRARY; T=293.16K
alphas from (n,2a)

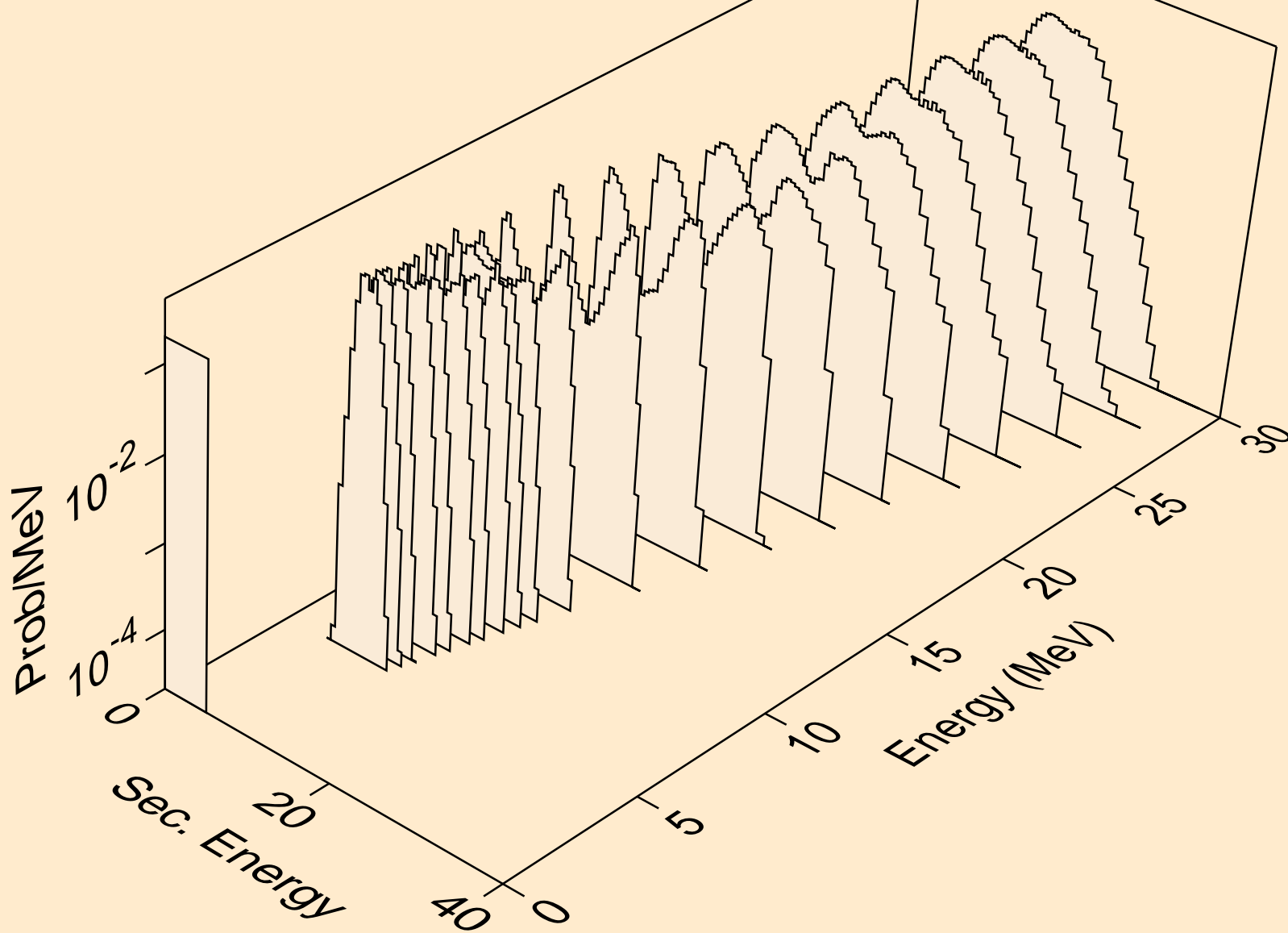

HF177N NEUTRON ACER TENDL-2019 LIBRARY; T=293.16K
alphas from (n,pa)

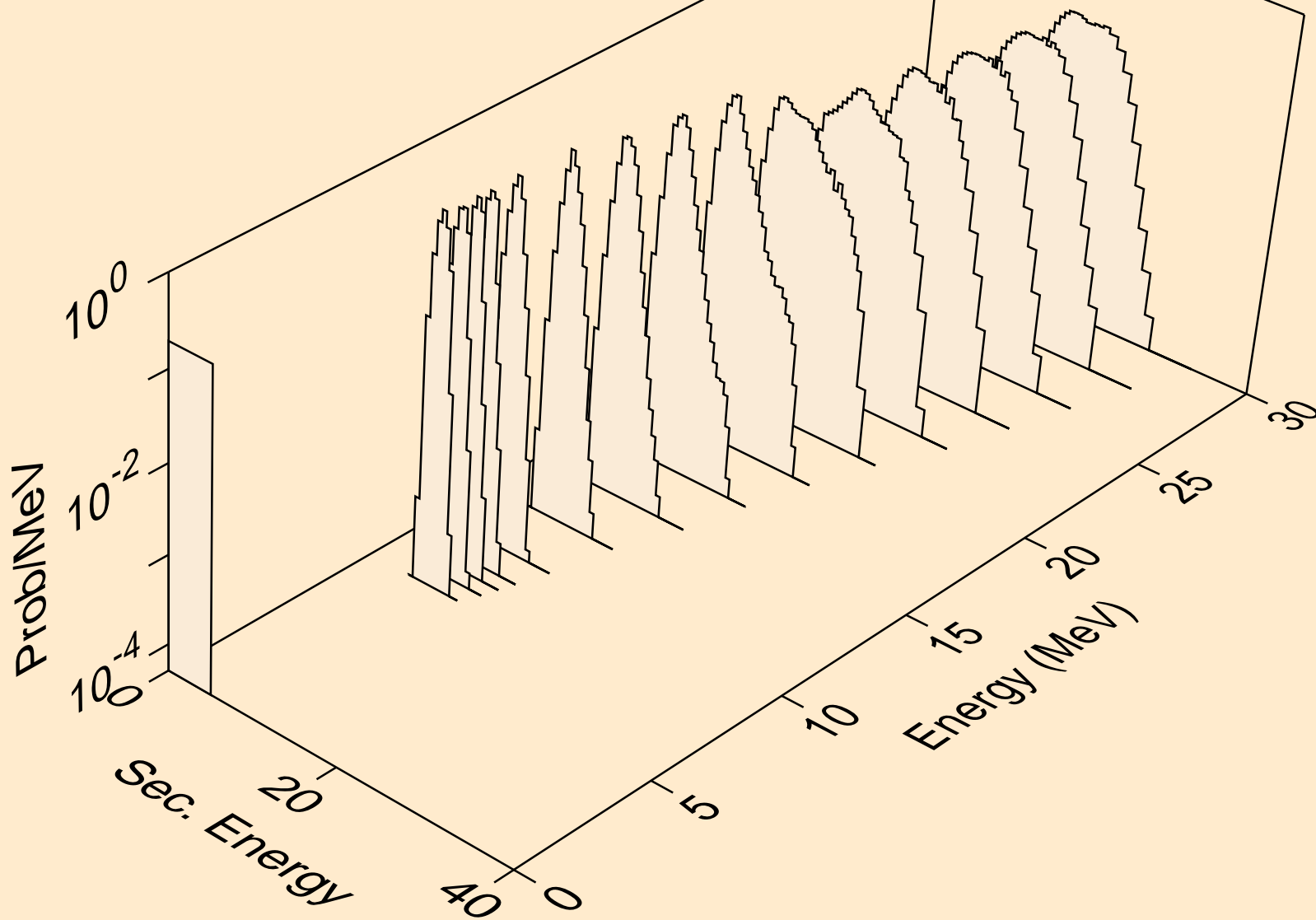

HF177N NEUTRON ACER TENDL-2019 LIBRARY; T=293.16K
alphas from (n,da)

