

# HF183 NEUTRON ACER TENDL-2019 LIBRARY; T=293.16K

## Principal cross sections

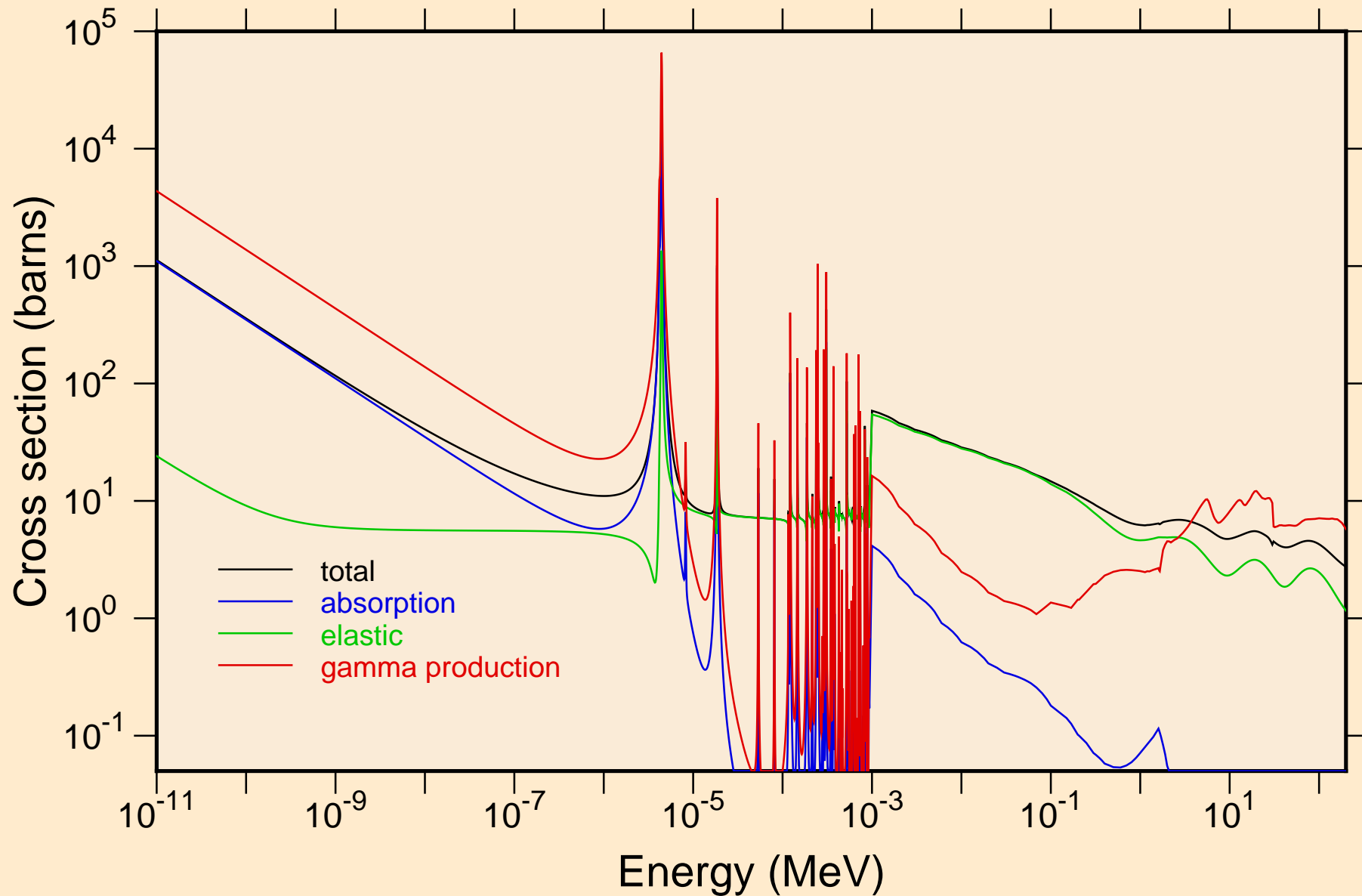

HF183 NEUTRON ACER TENDL-2019 LIBRARY; T=293.16K  
resonance total cross section

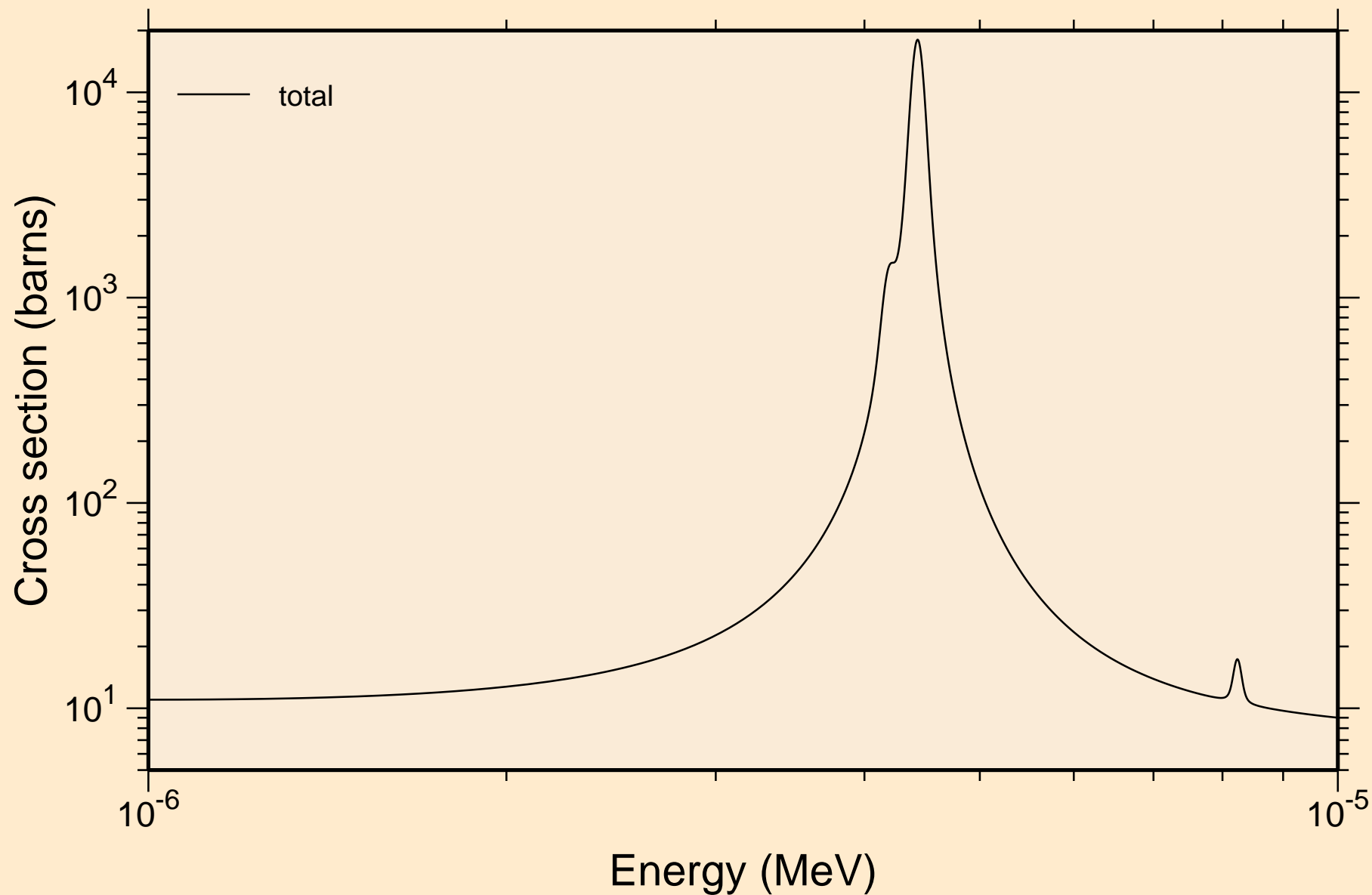

HF183 NEUTRON ACER TENDL-2019 LIBRARY; T=293.16K  
resonance total cross section

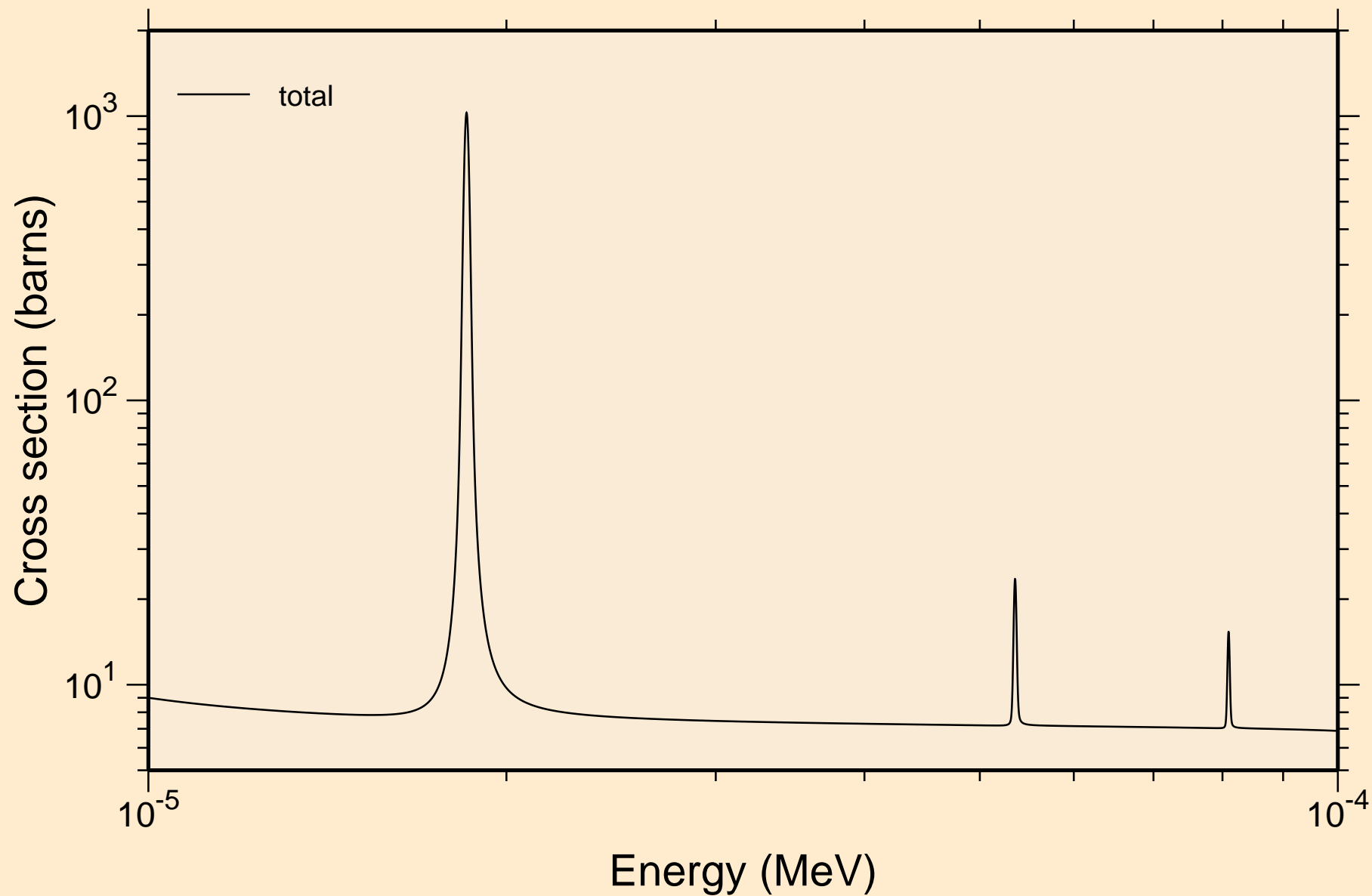

HF183 NEUTRON ACER TENDL-2019 LIBRARY; T=293.16K  
resonance total cross section

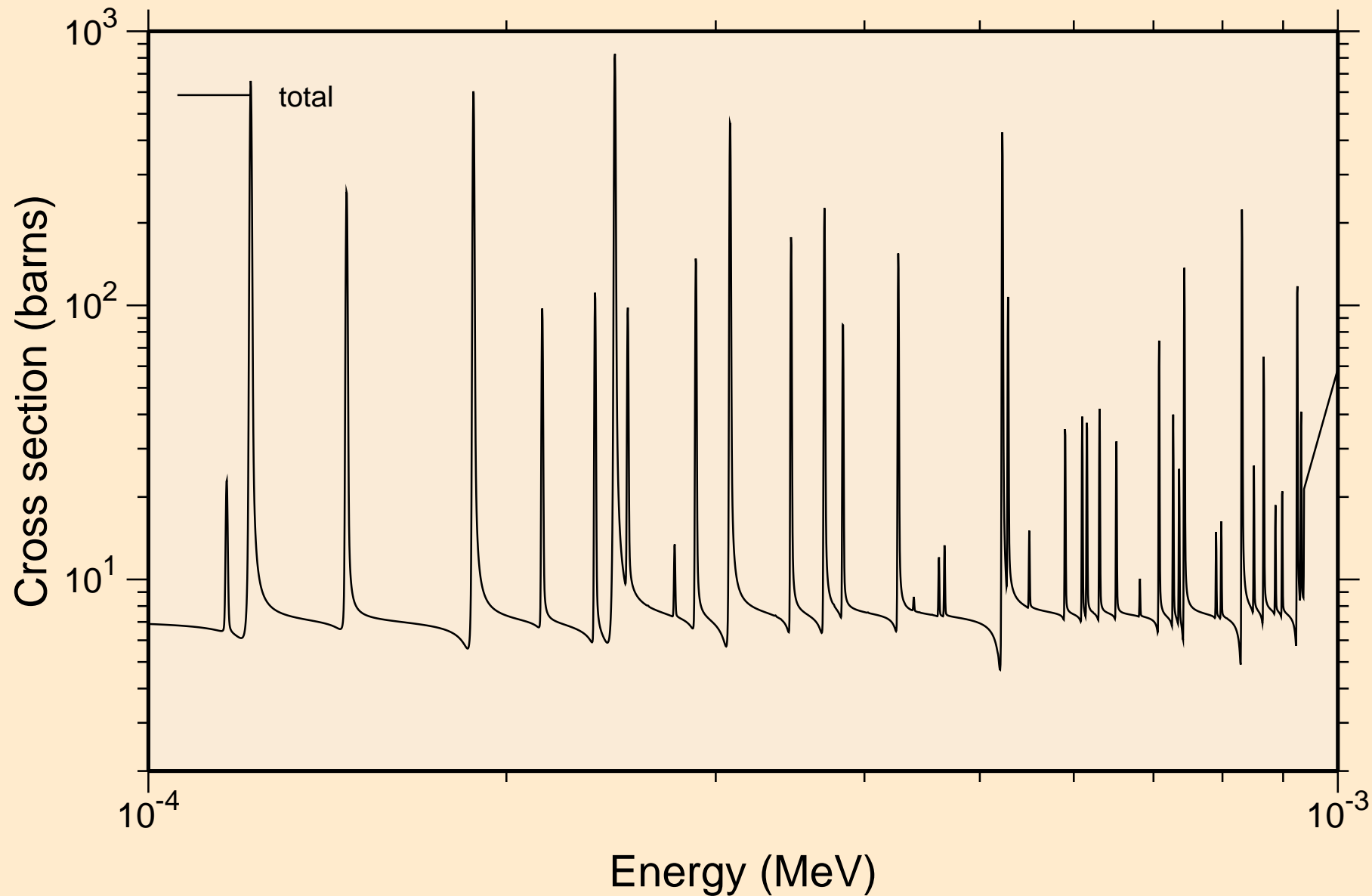

HF183 NEUTRON ACER TENDL-2019 LIBRARY; T=293.16K  
resonance total cross section

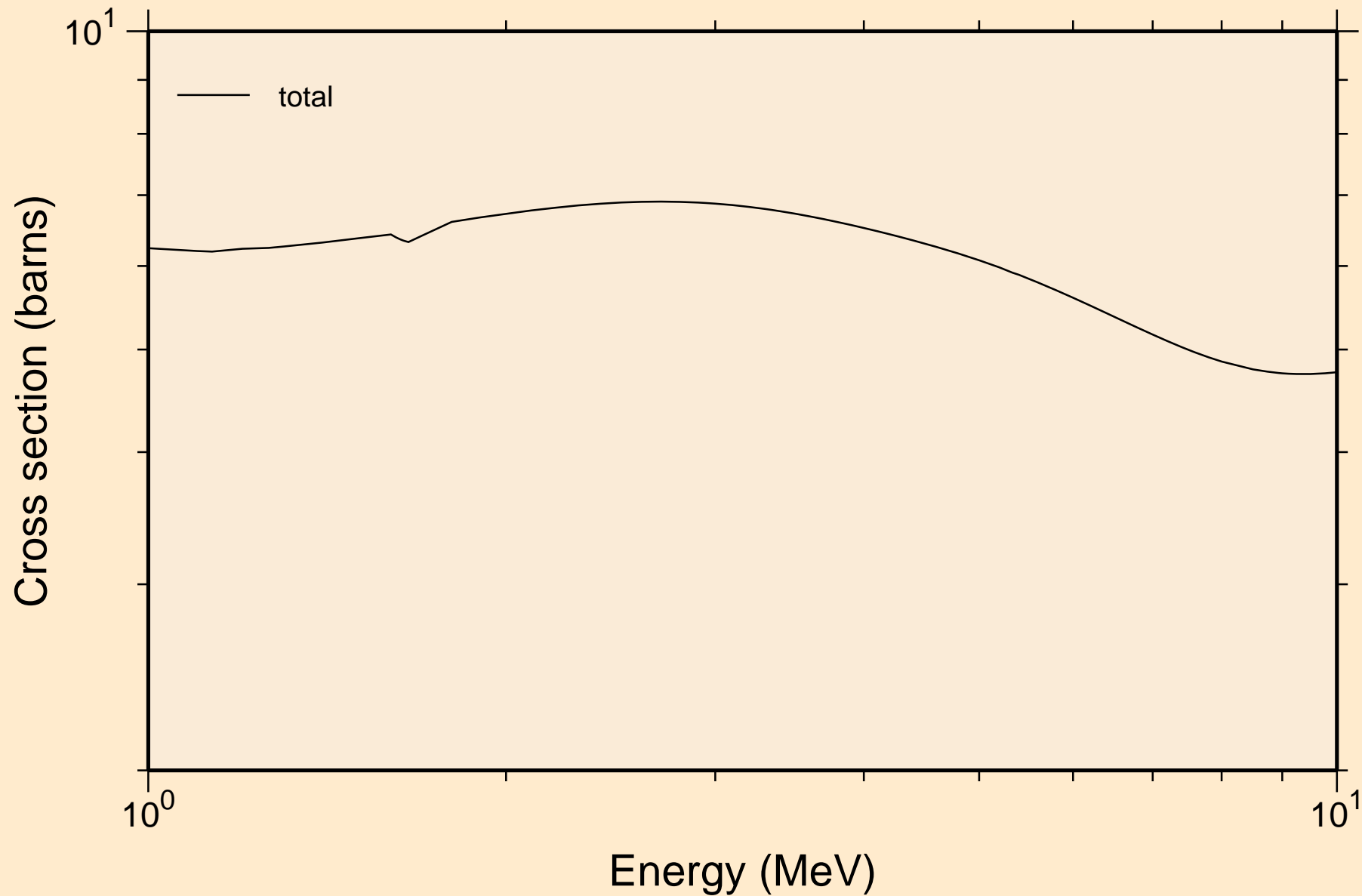

HF183 NEUTRON ACER TENDL-2019 LIBRARY; T=293.16K  
resonance absorption cross sections

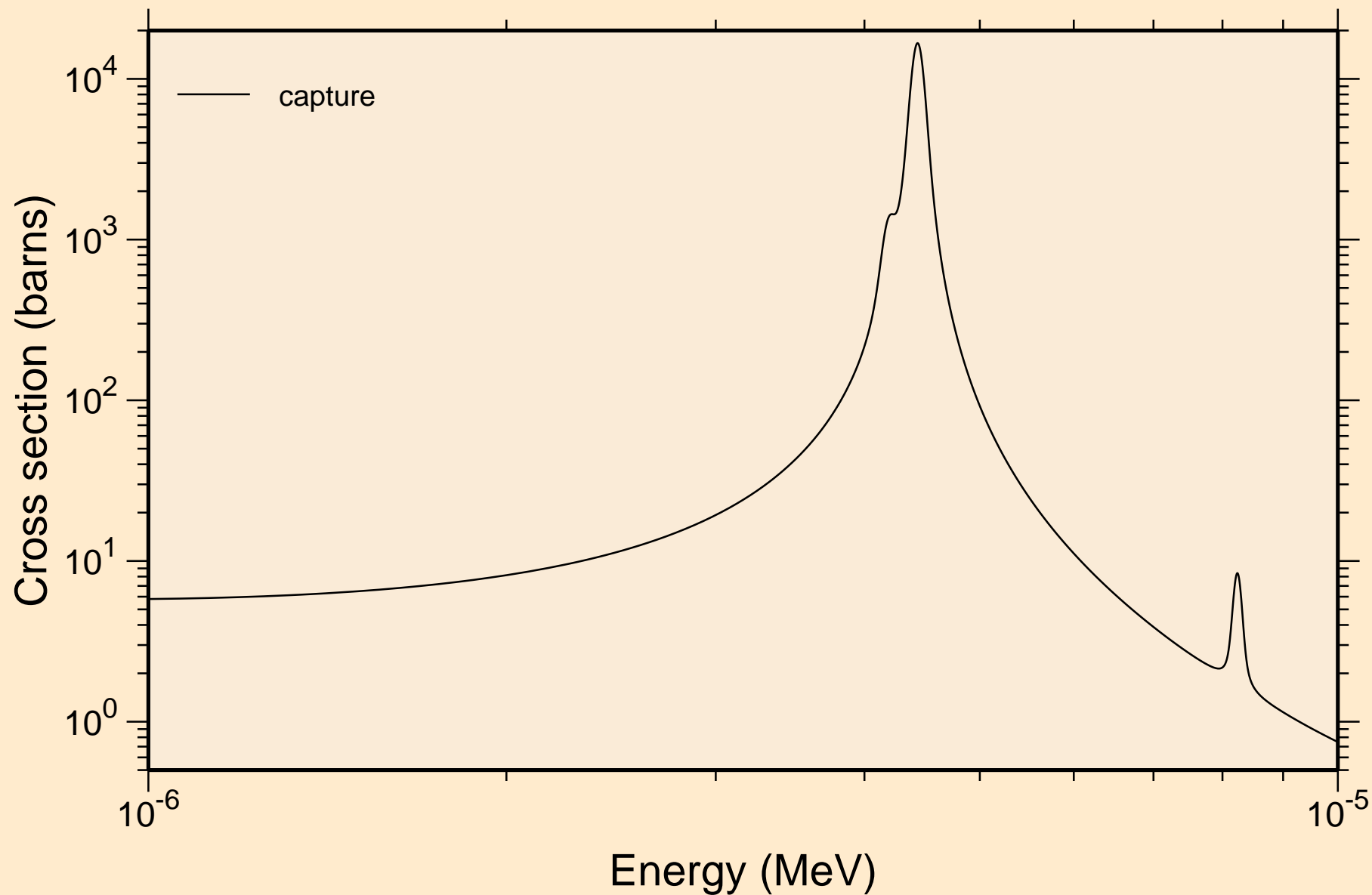

HF183 NEUTRON ACER TENDL-2019 LIBRARY; T=293.16K  
resonance absorption cross sections

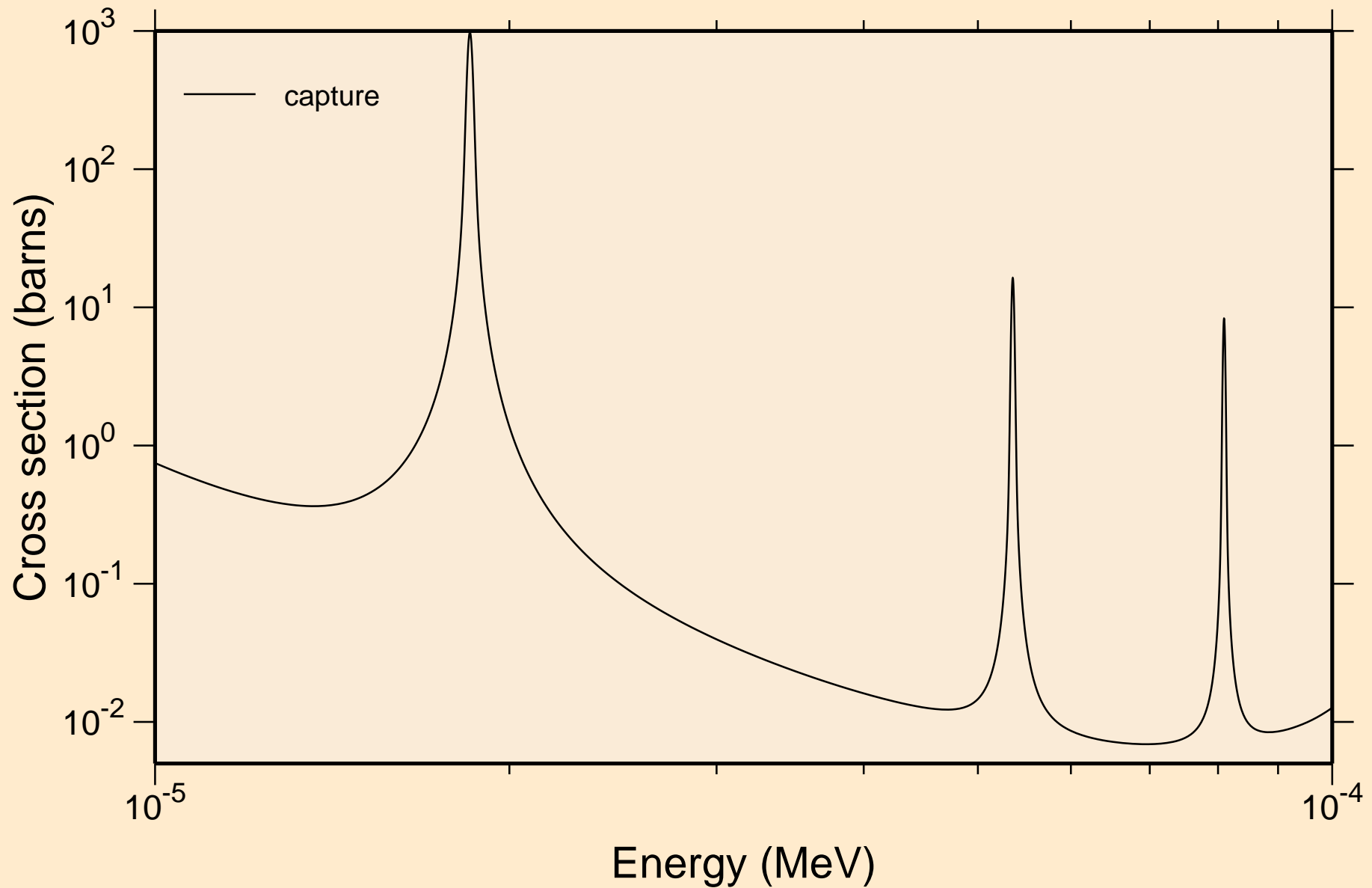

HF183 NEUTRON ACER TENDL-2019 LIBRARY; T=293.16K  
resonance absorption cross sections

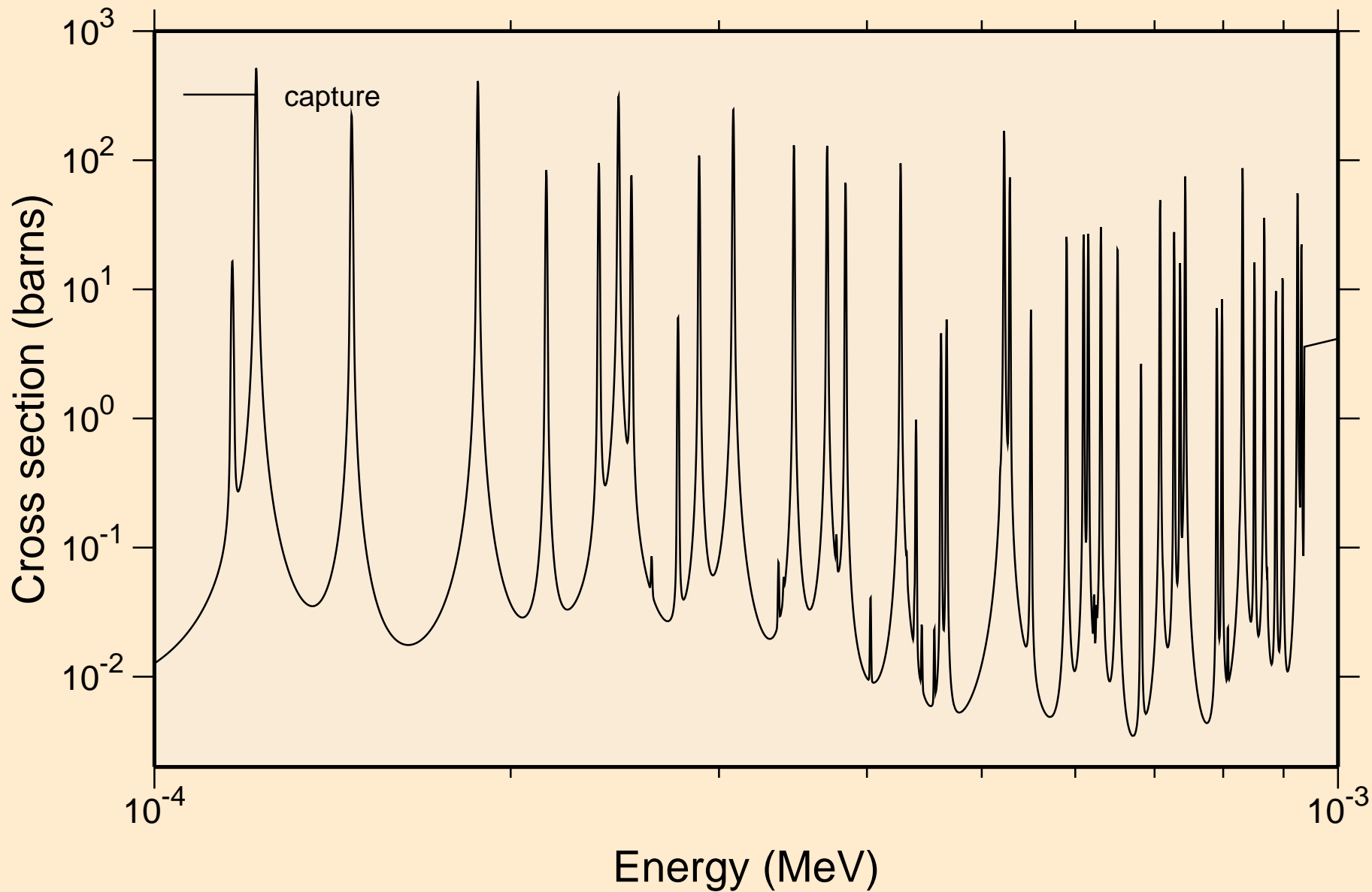



HF183 NEUTRON ACER TENDL-2019 LIBRARY; T=293.16K  
resonance absorption cross sections

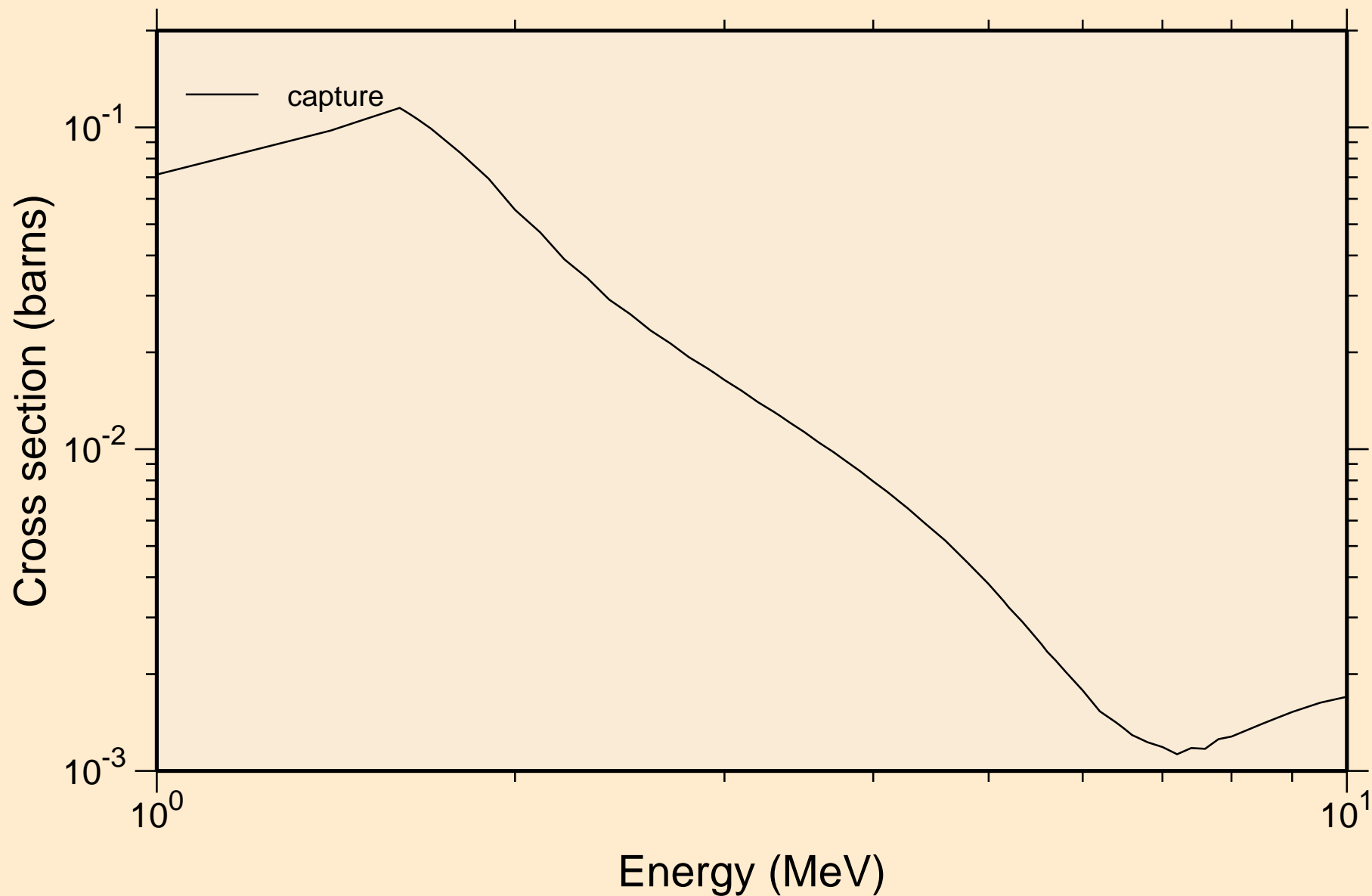

HF183 NEUTRON ACER TENDL-2019 LIBRARY; T=293.16K  
Heating

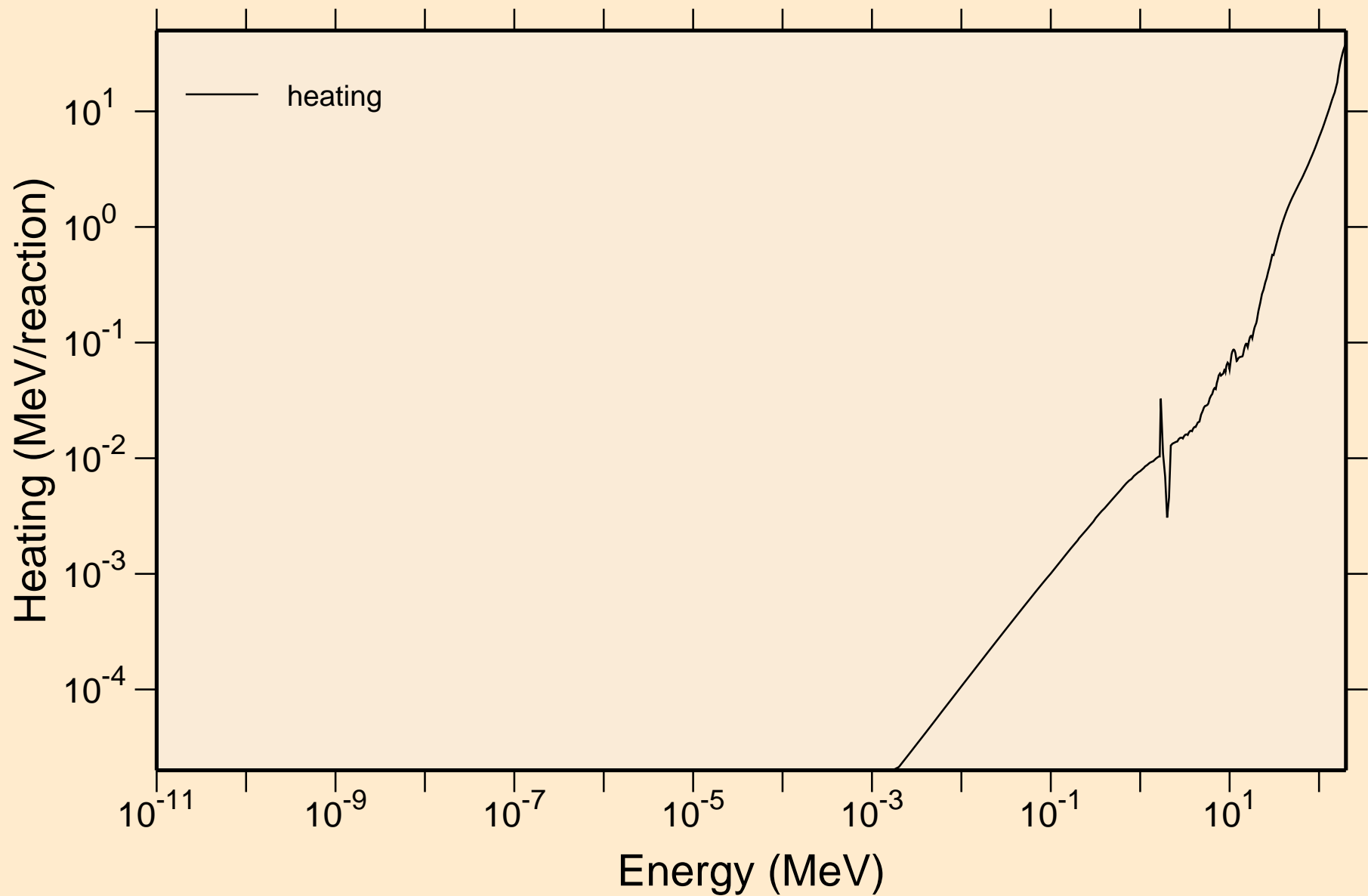

# HF183 NEUTRON ACER TENDL-2019 LIBRARY; T=293.16K

## Damage

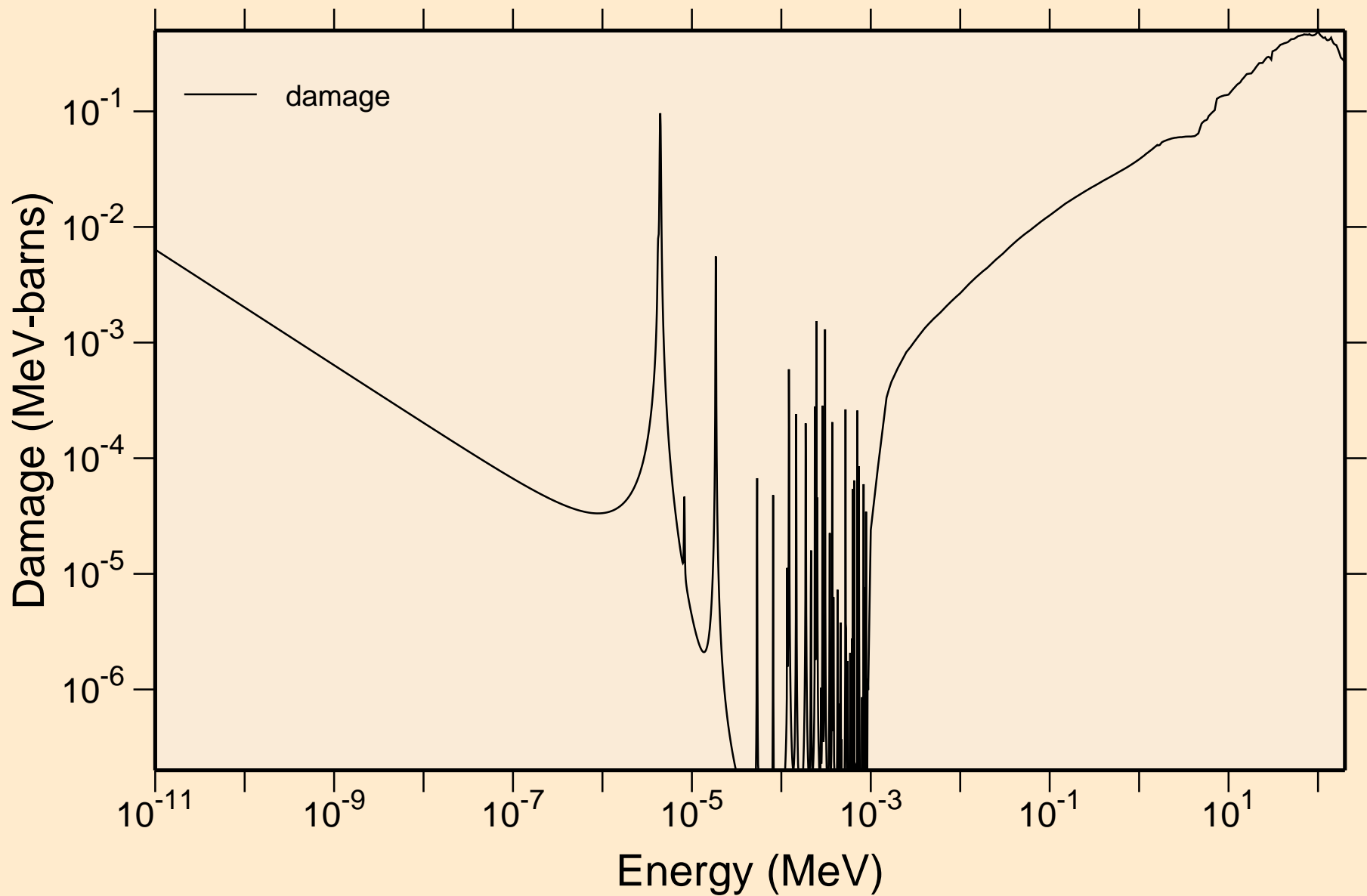

# HF183 NEUTRON ACER TENDL-2019 LIBRARY; T=293.16K

## Non-threshold reactions

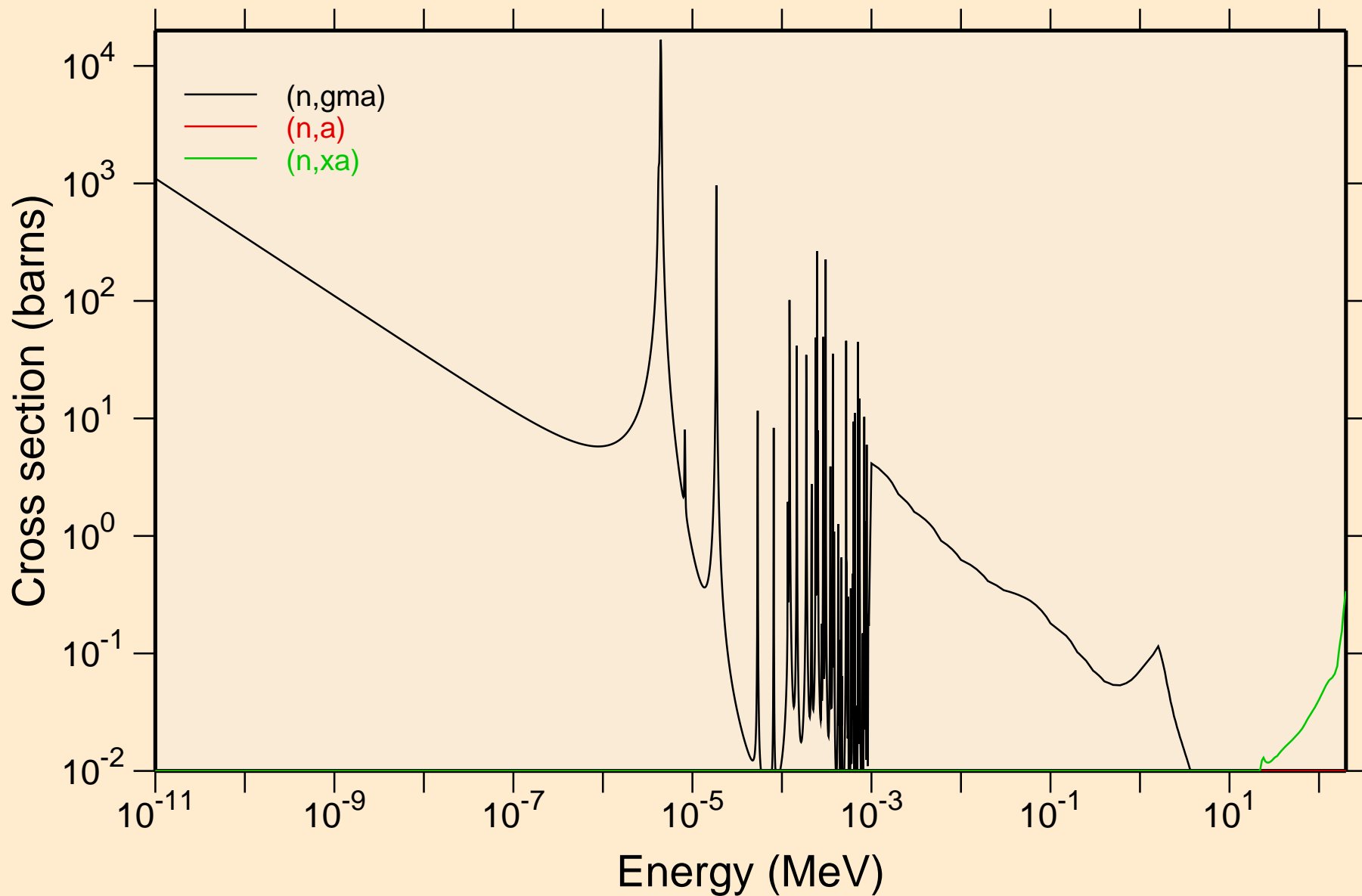

# HF183 NEUTRON ACER TENDL-2019 LIBRARY; T=293.16K

## Principal cross sections

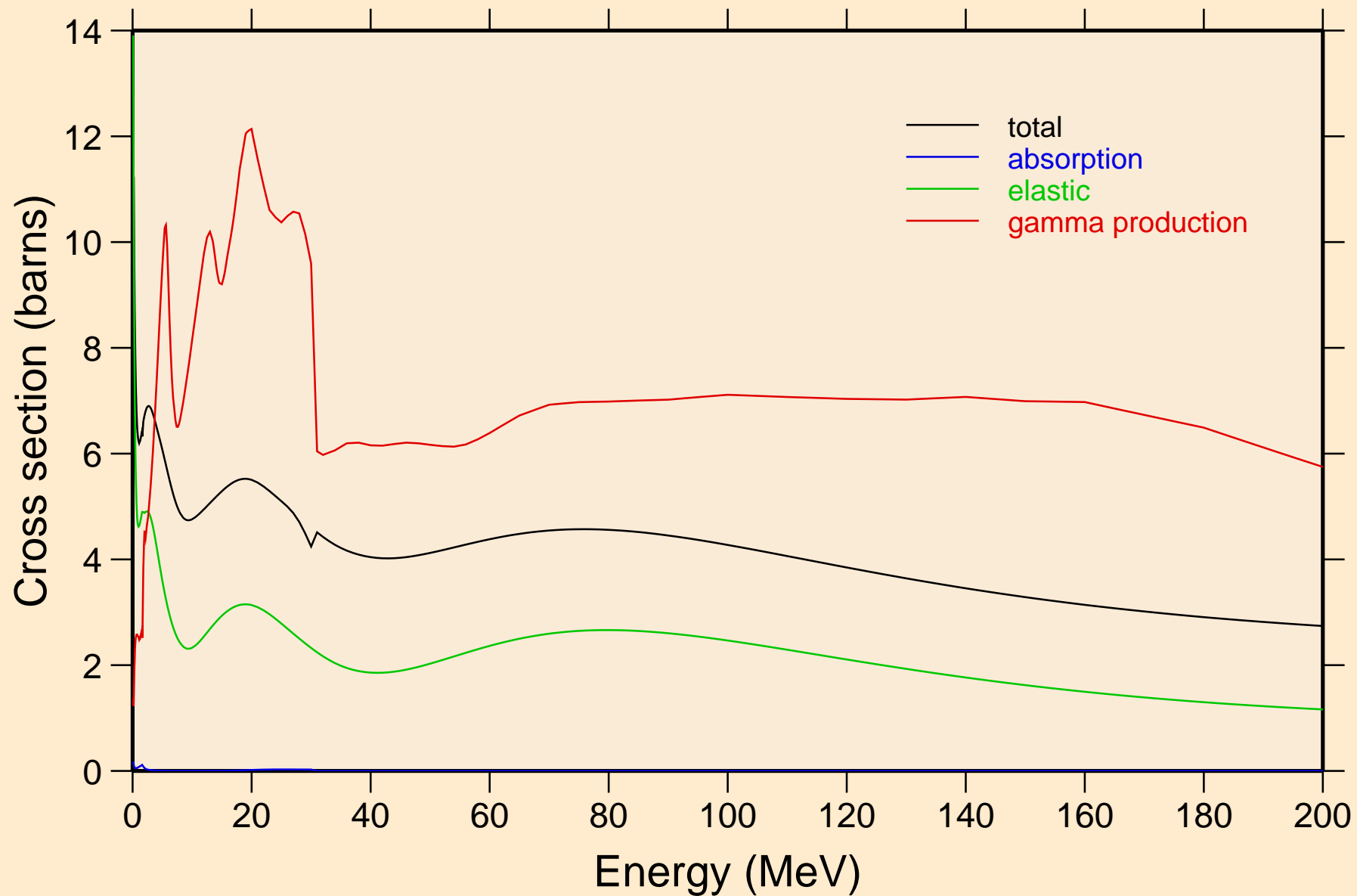

HF183 NEUTRON ACER TENDL-2019 LIBRARY; T=293.16K  
Heating

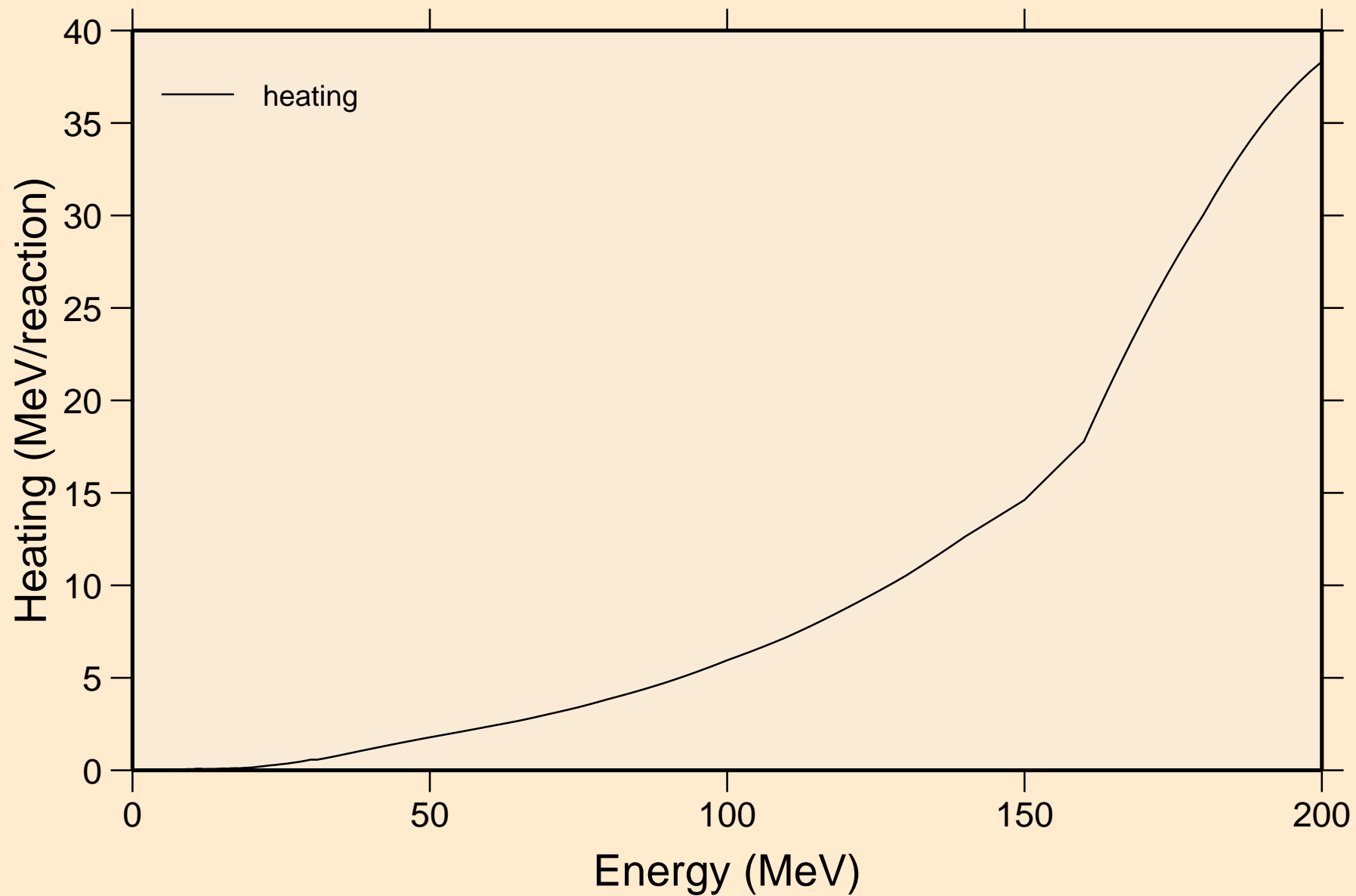

# HF183 NEUTRON ACER TENDL-2019 LIBRARY; T=293.16K

## Damage

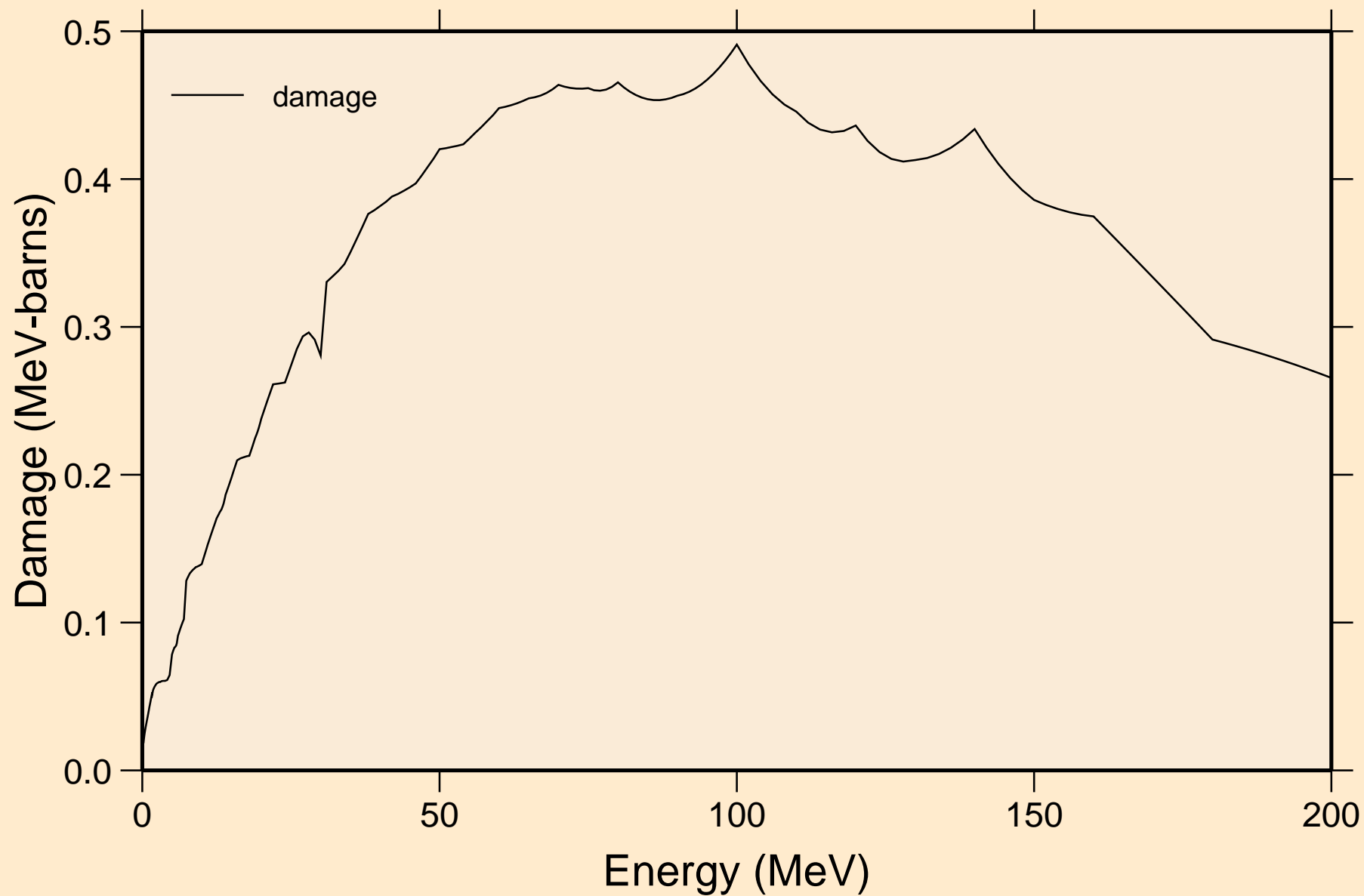

HF183 NEUTRON ACER TENDL-2019 LIBRARY; T=293.16K  
Non-threshold reactions

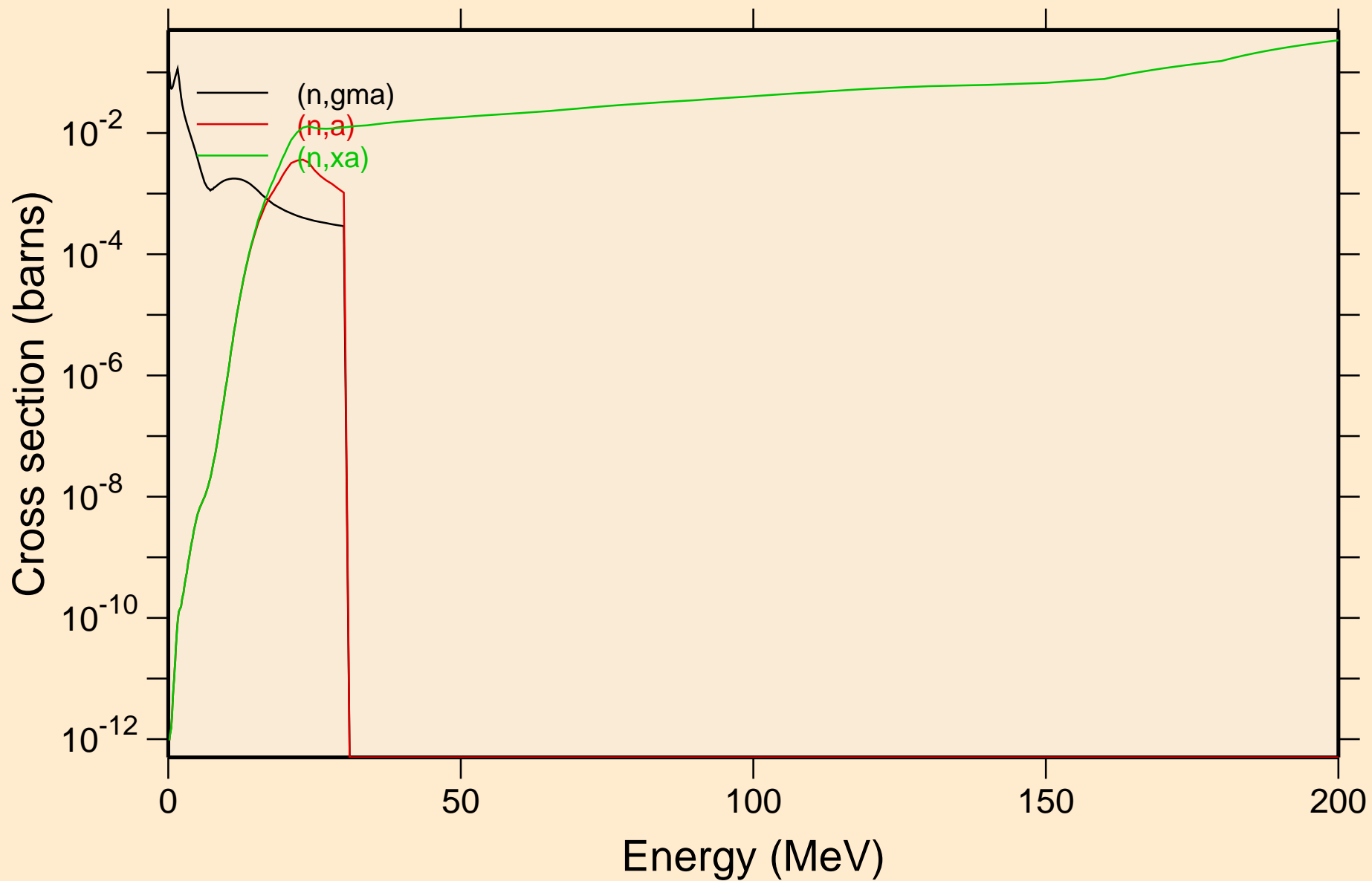



HF183 NEUTRON ACER TENDL-2019 LIBRARY; T=293.16K  
Inelastic levels

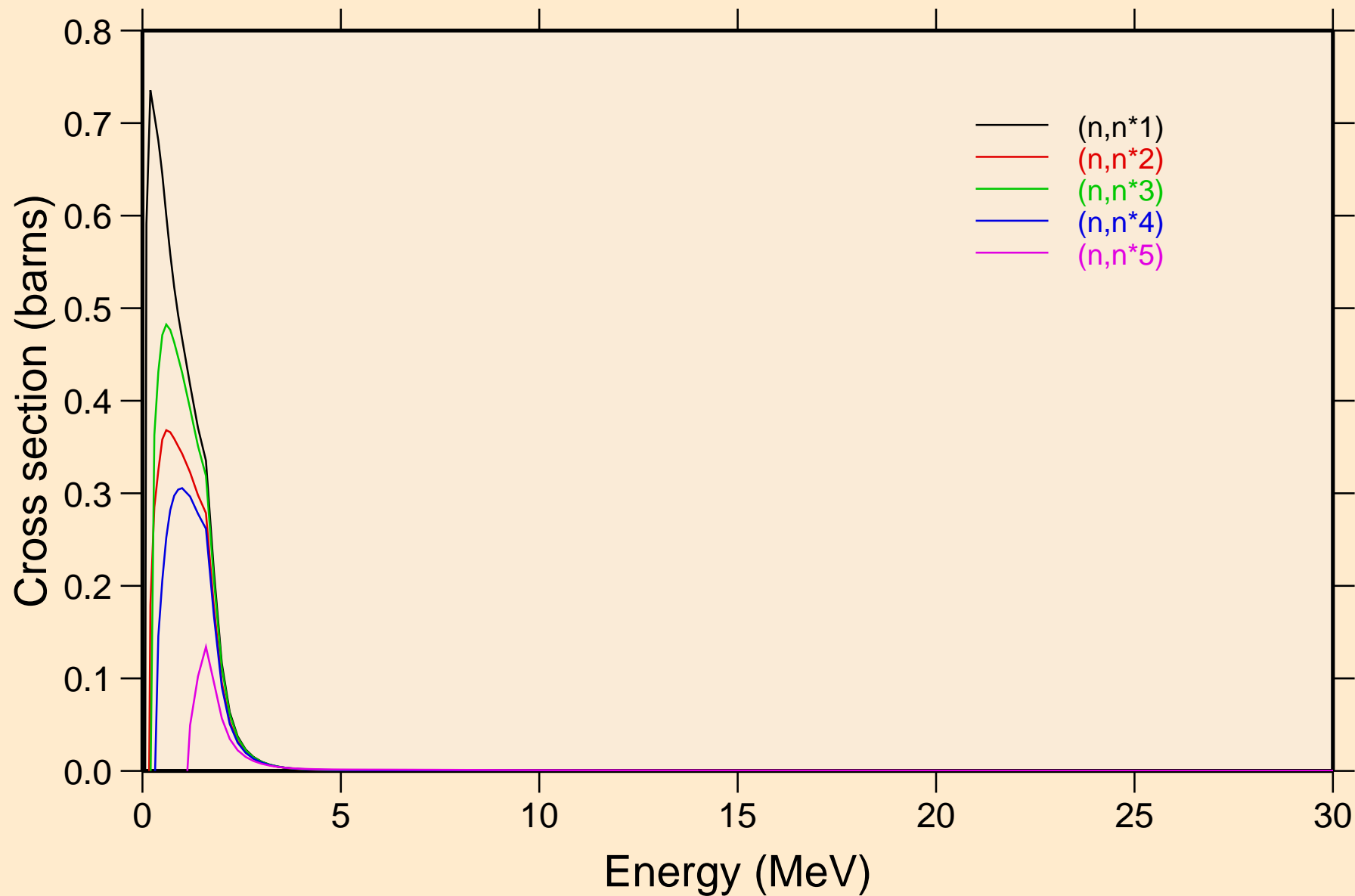

# HF183 NEUTRON ACER TENDL-2019 LIBRARY; T=293.16K

## Inelastic levels

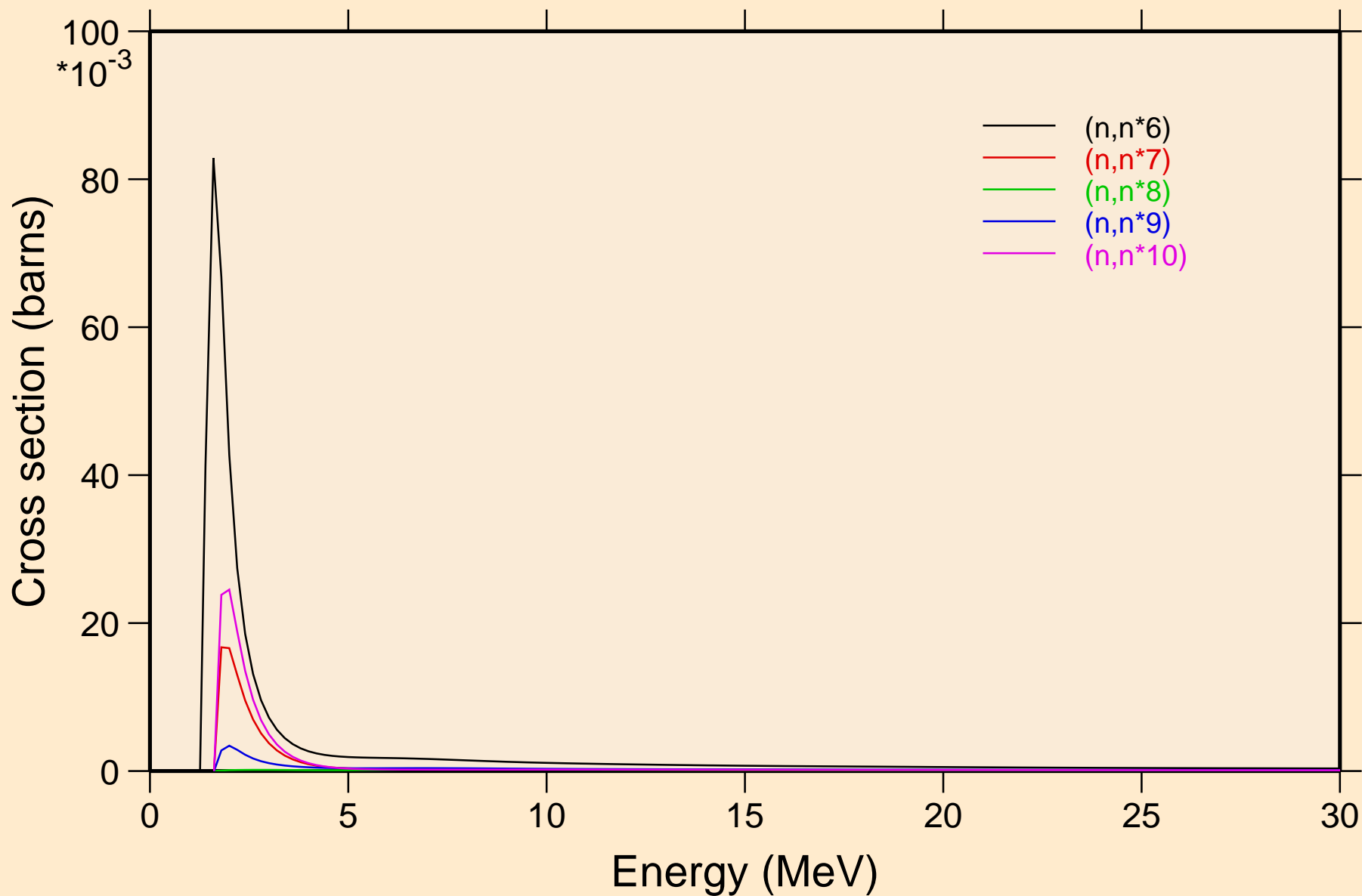

HF183 NEUTRON ACER TENDL-2019 LIBRARY; T=293.16K  
Inelastic levels

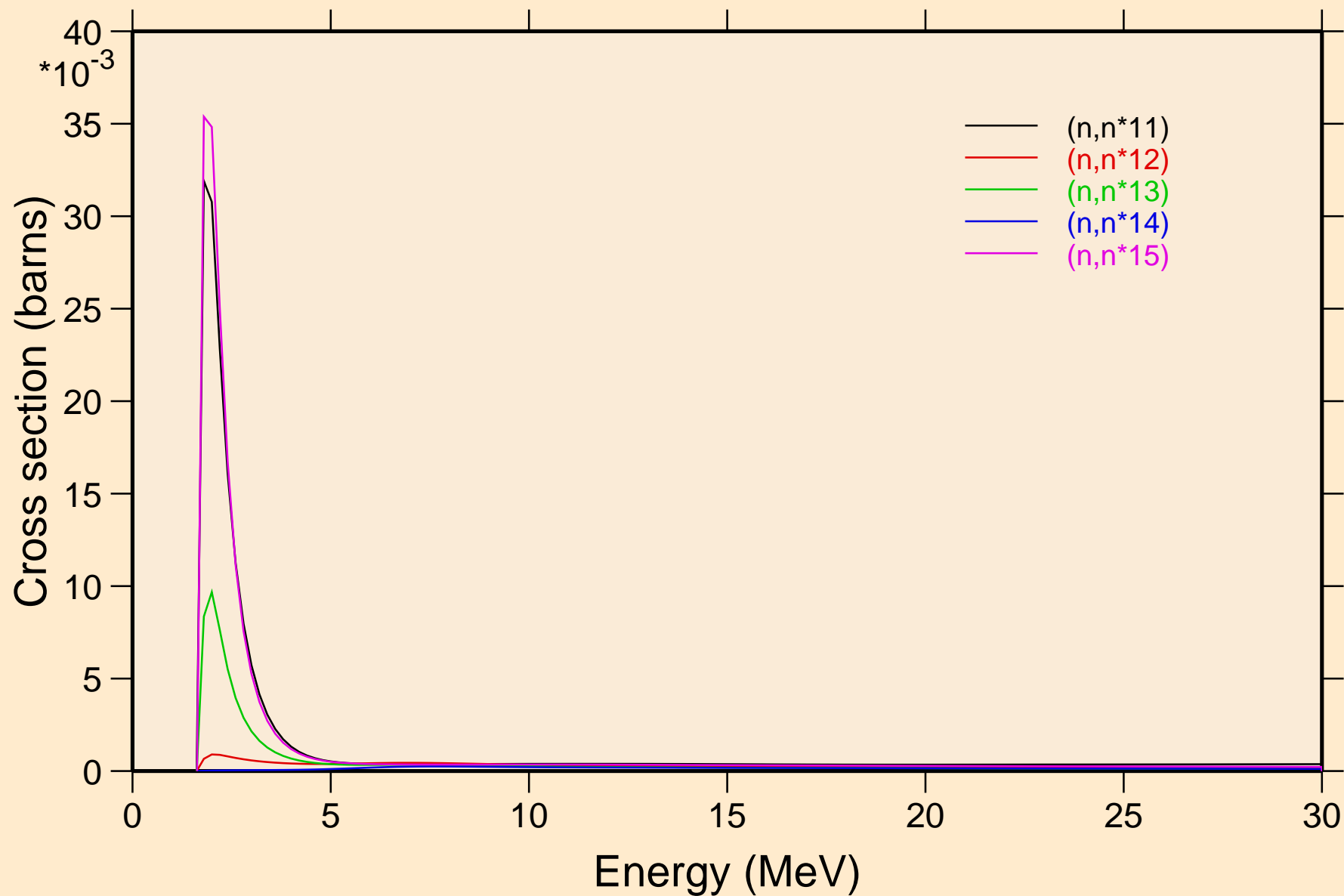

HF183 NEUTRON ACER TENDL-2019 LIBRARY; T=293.16K  
Inelastic levels

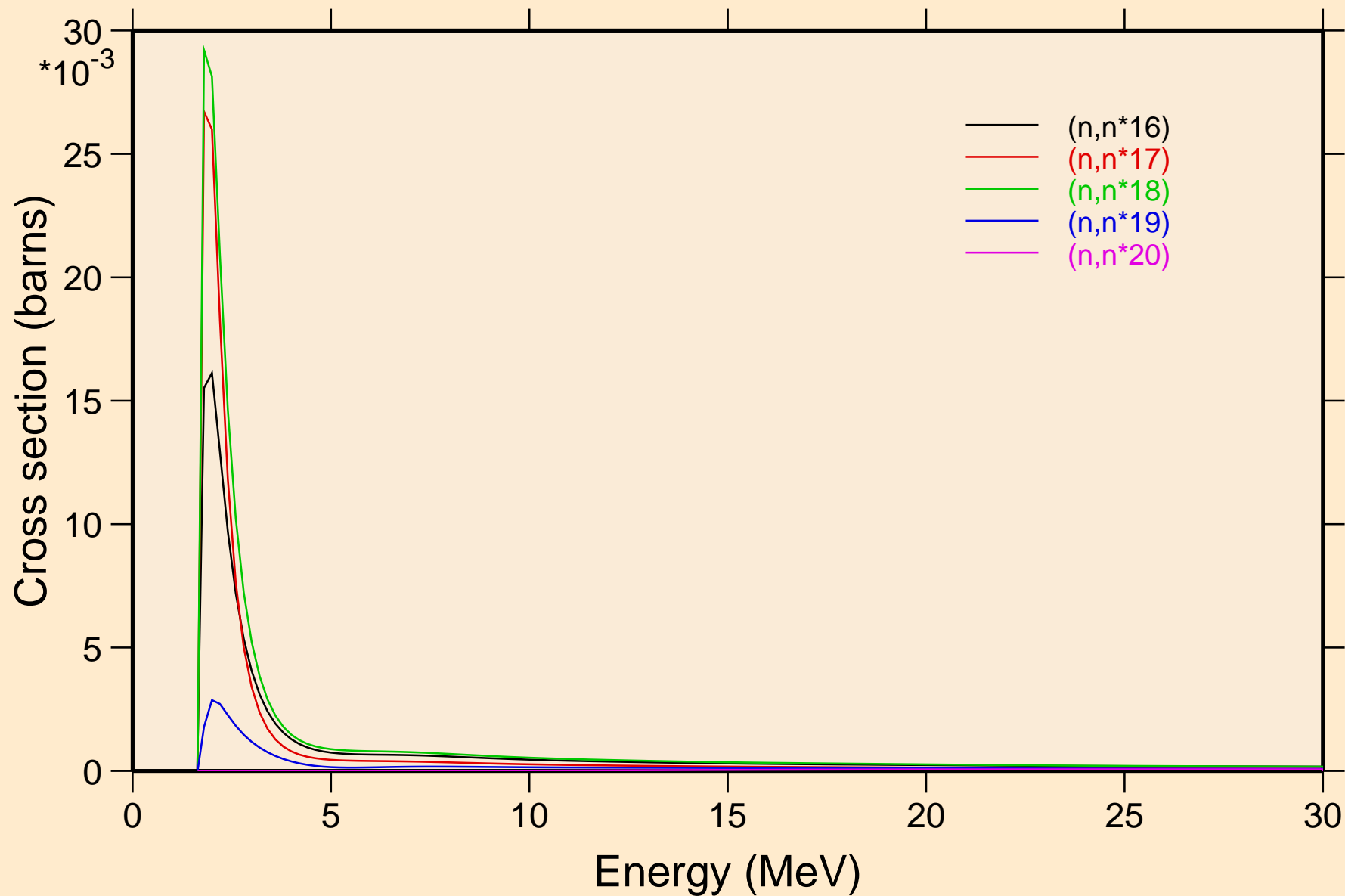

HF183 NEUTRON ACER TENDL-2019 LIBRARY; T=293.16K  
Inelastic levels

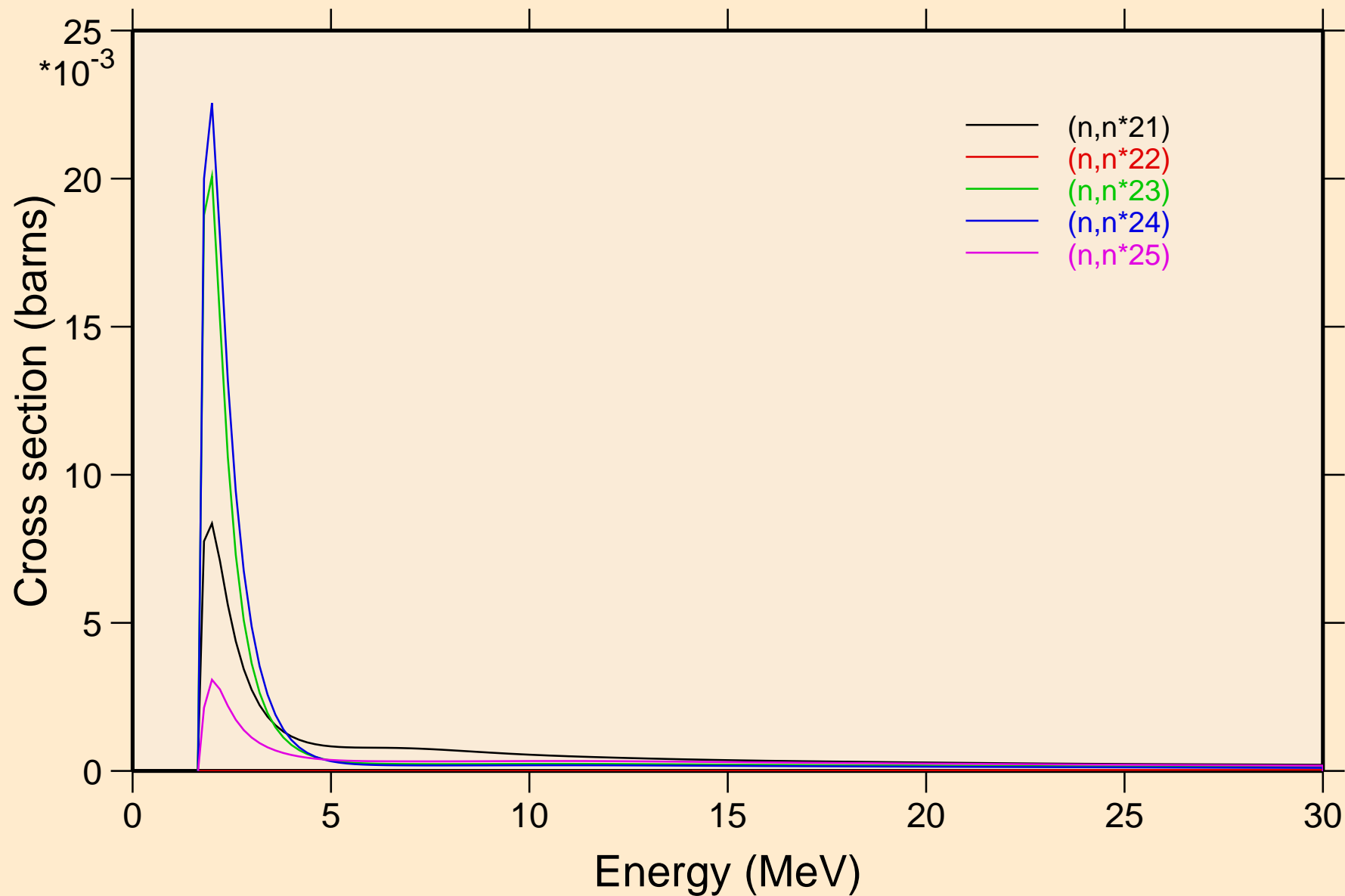

HF183 NEUTRON ACER TENDL-2019 LIBRARY; T=293.16K  
Inelastic levels

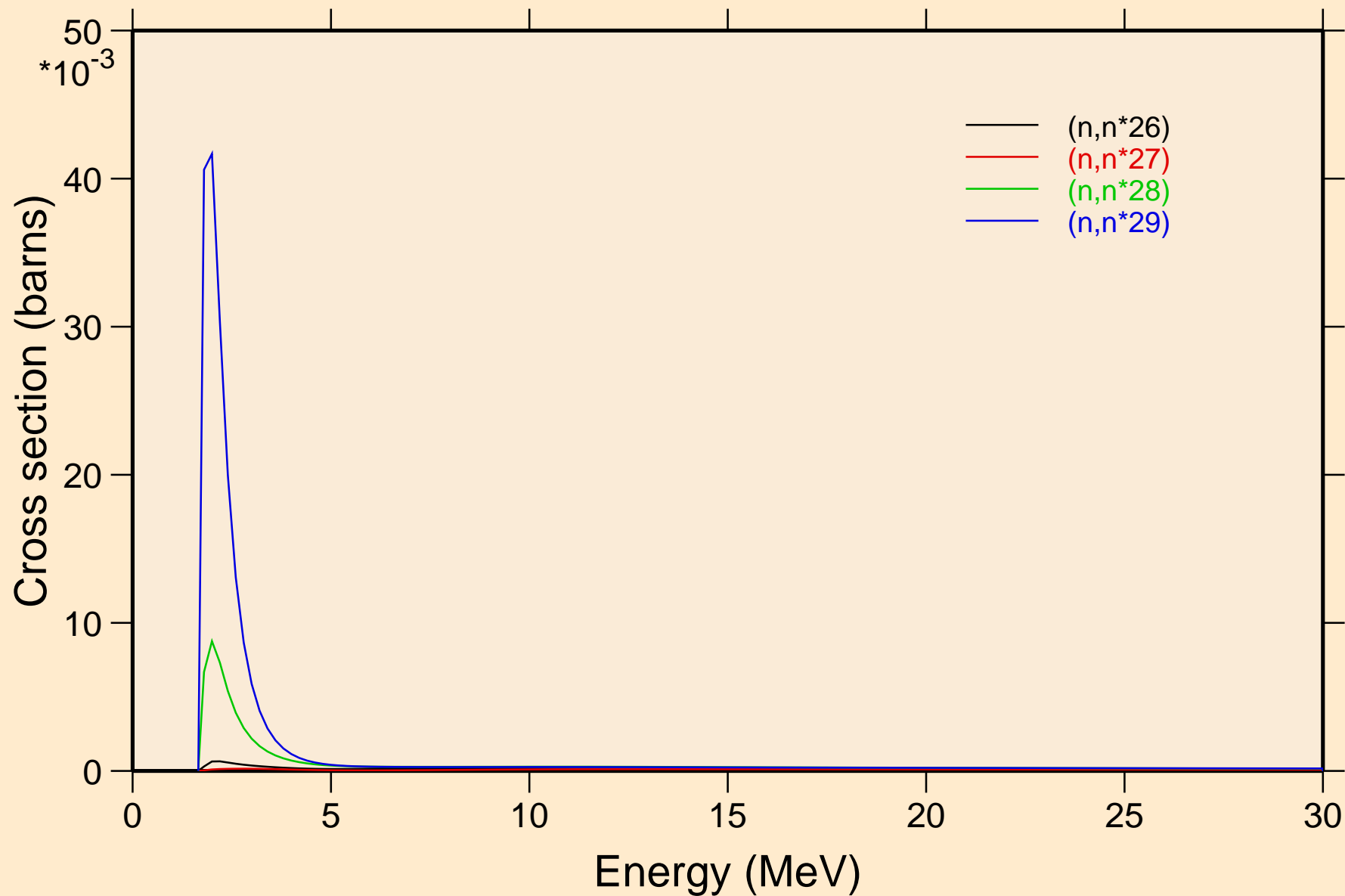

# HF183 NEUTRON ACER TENDL-2019 LIBRARY; T=293.16K

## Threshold reactions

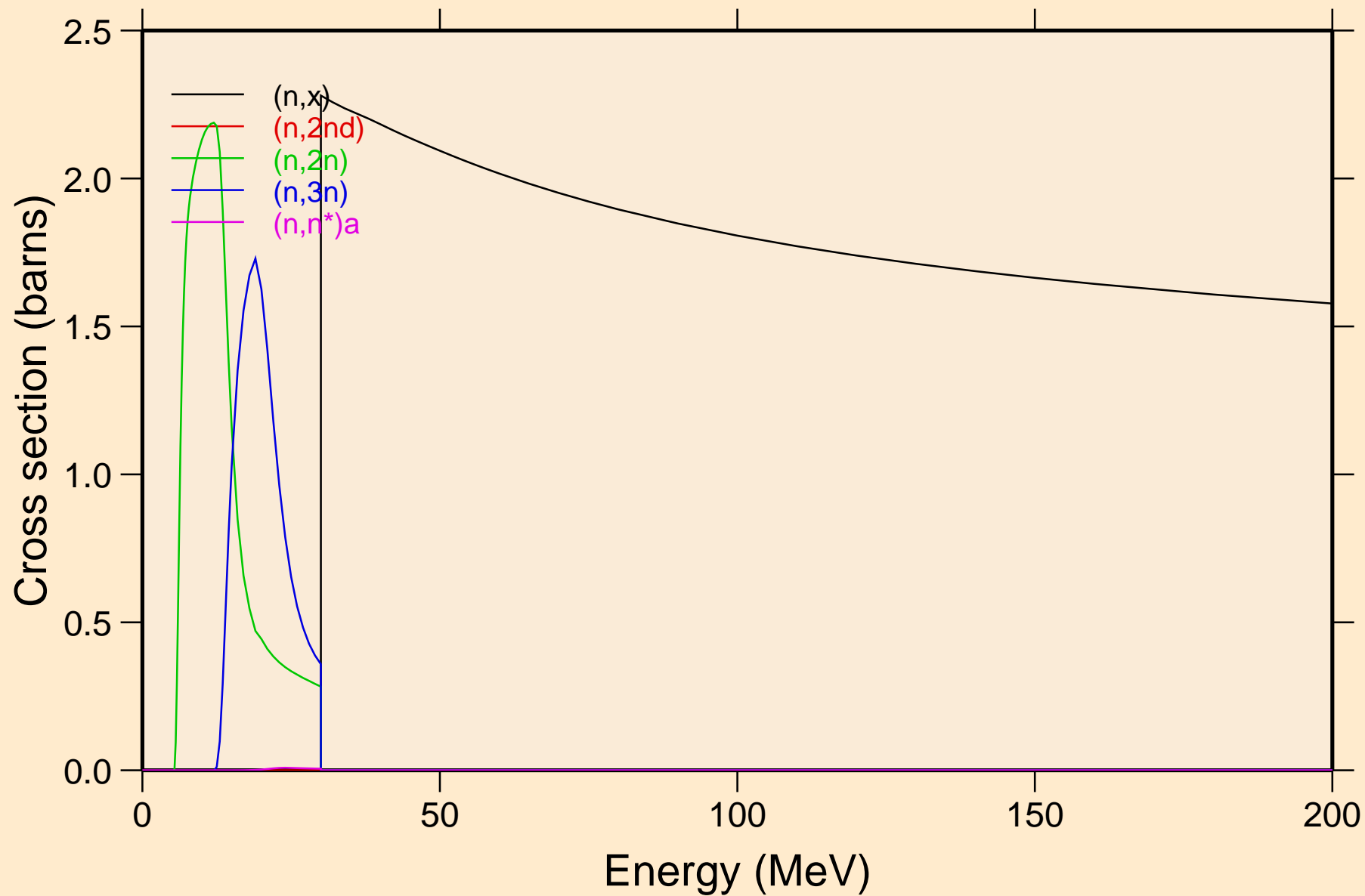

# HF183 NEUTRON ACER TENDL-2019 LIBRARY; T=293.16K

## Threshold reactions

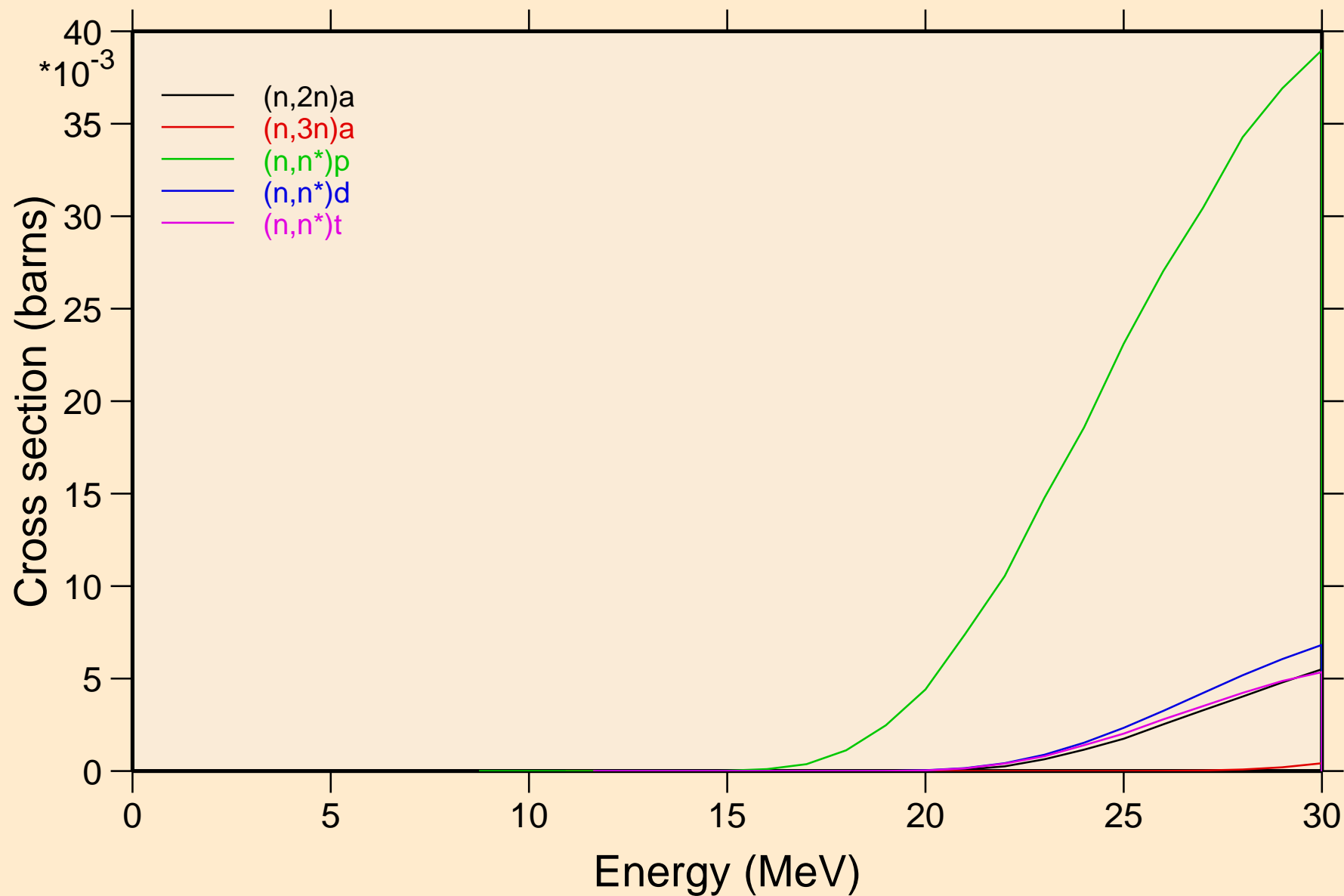



HF183 NEUTRON ACER TENDL-2019 LIBRARY; T=293.16K  
Threshold reactions

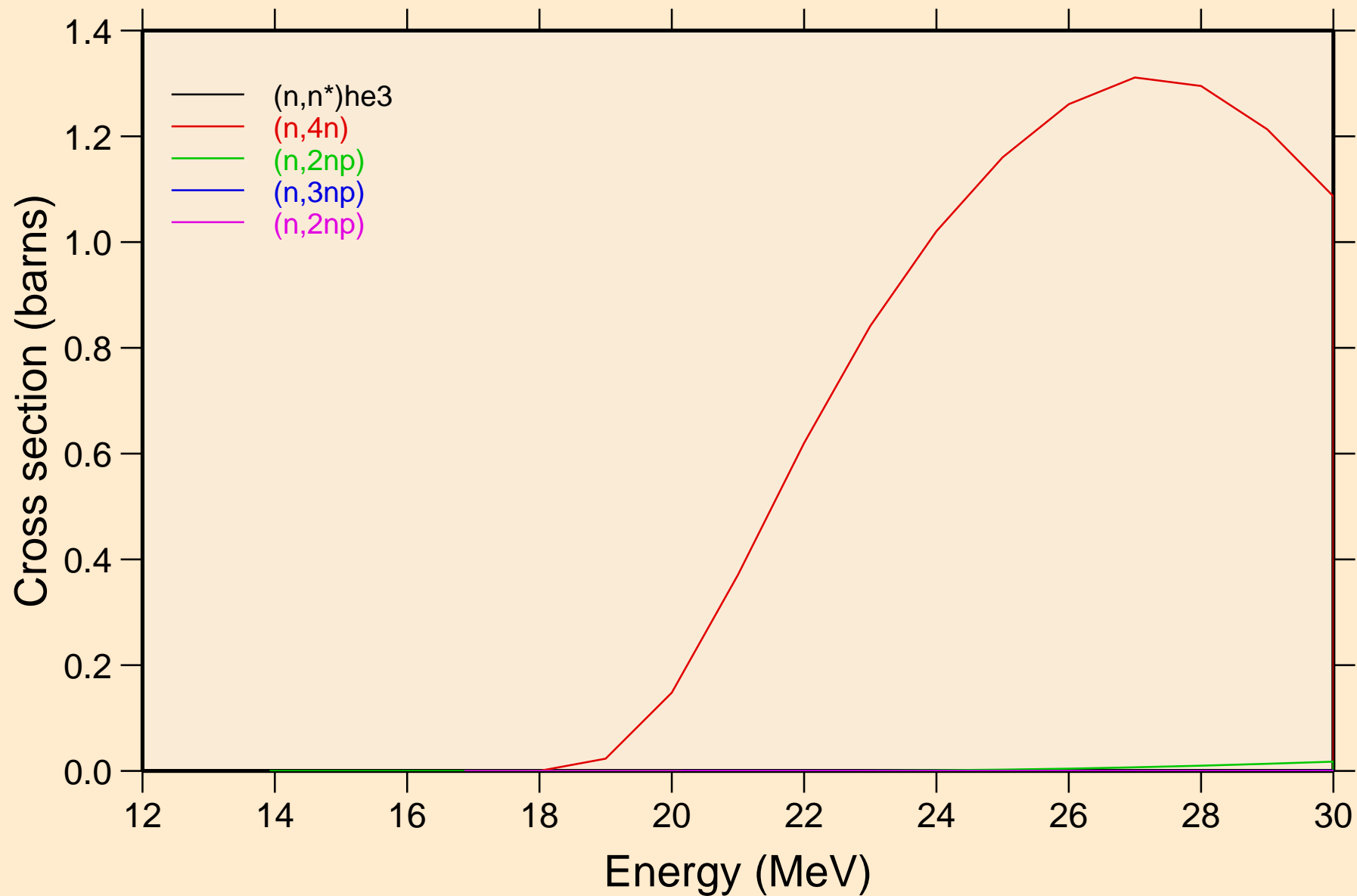

HF183 NEUTRON ACER TENDL-2019 LIBRARY; T=293.16K  
Threshold reactions

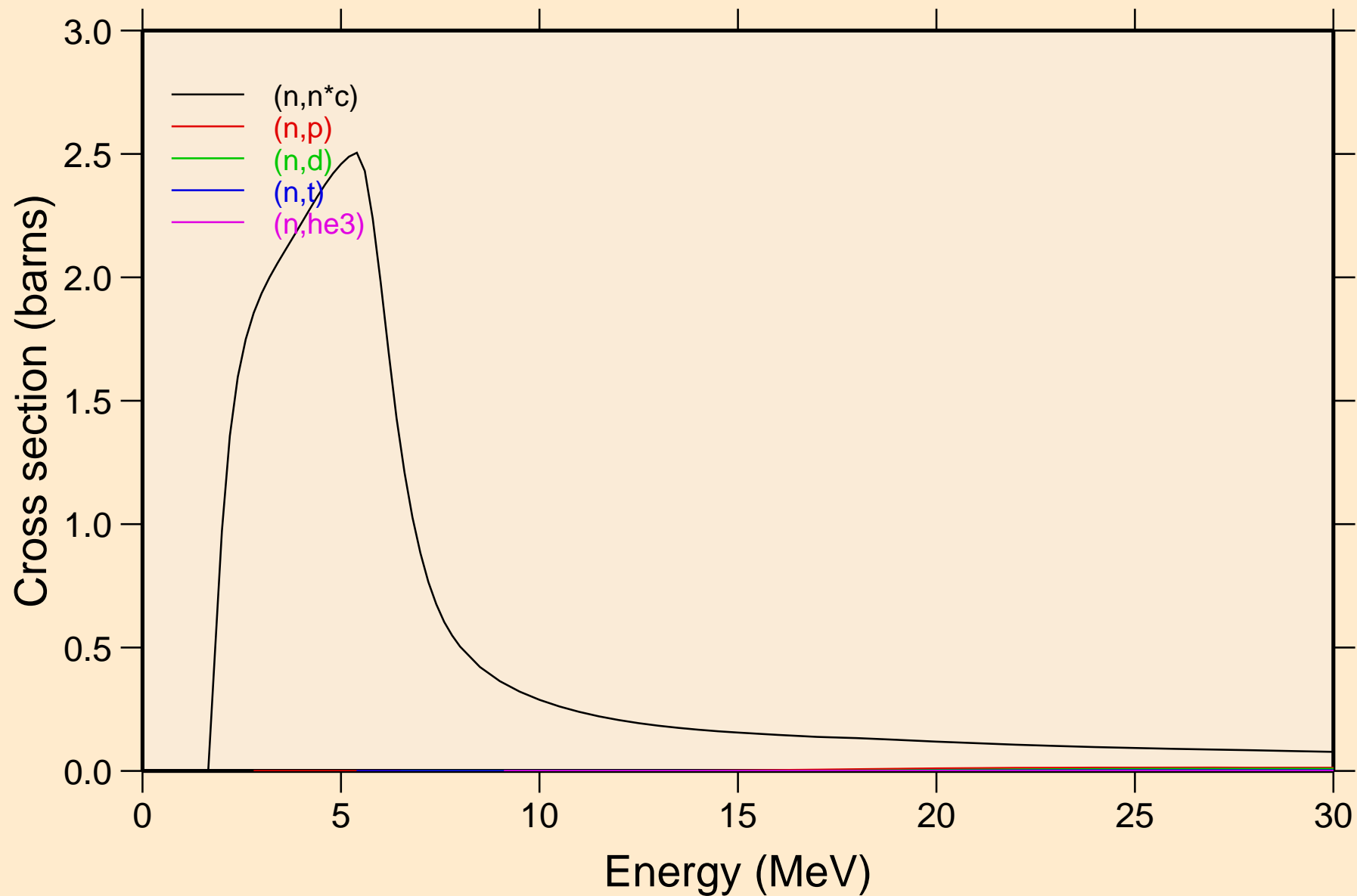

HF183 NEUTRON ACER TENDL-2019 LIBRARY; T=293.16K  
Threshold reactions

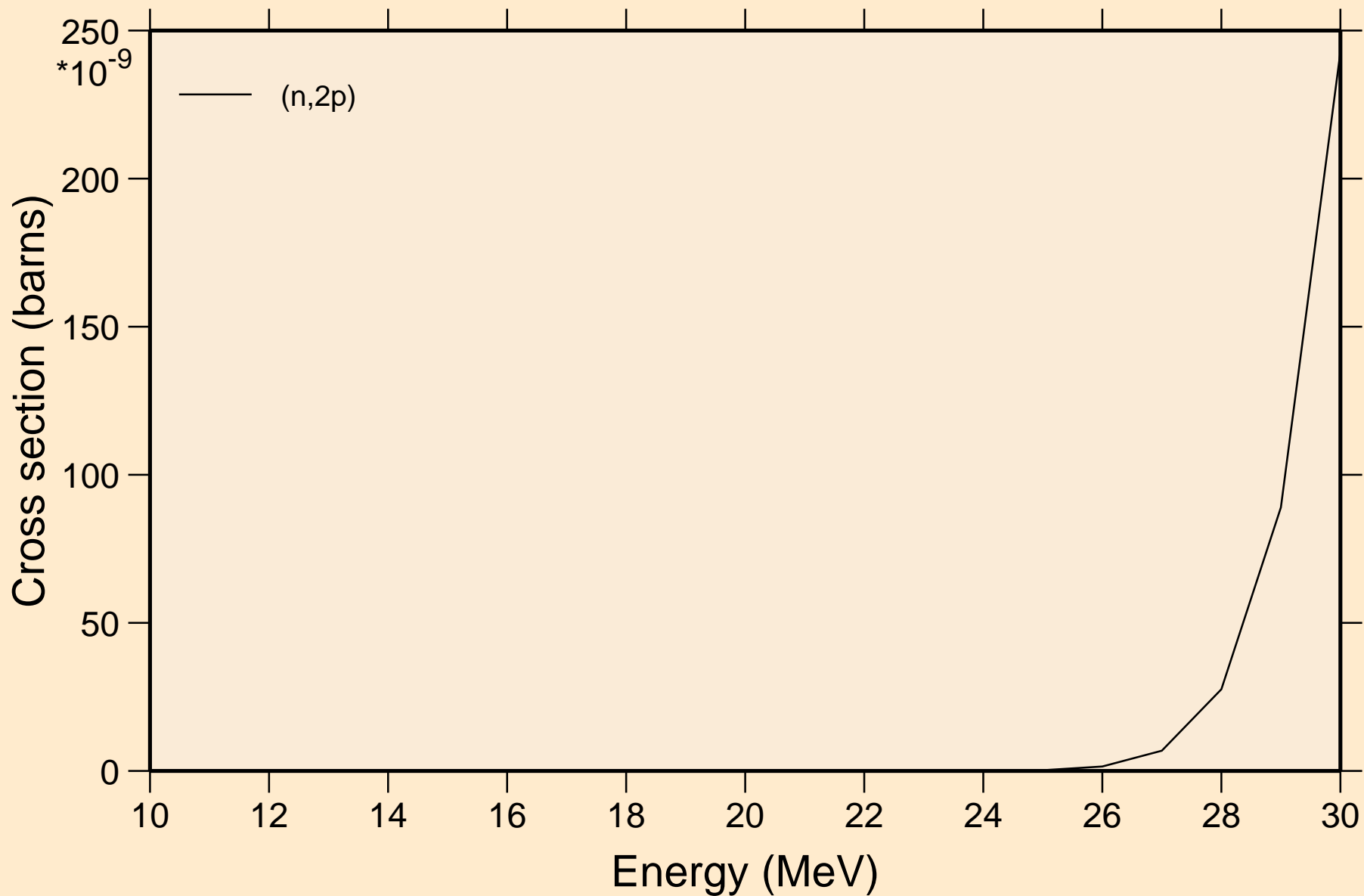

# HF183 NEUTRON ACER TENDL-2019 LIBRARY; T=293.16K

## Threshold reactions

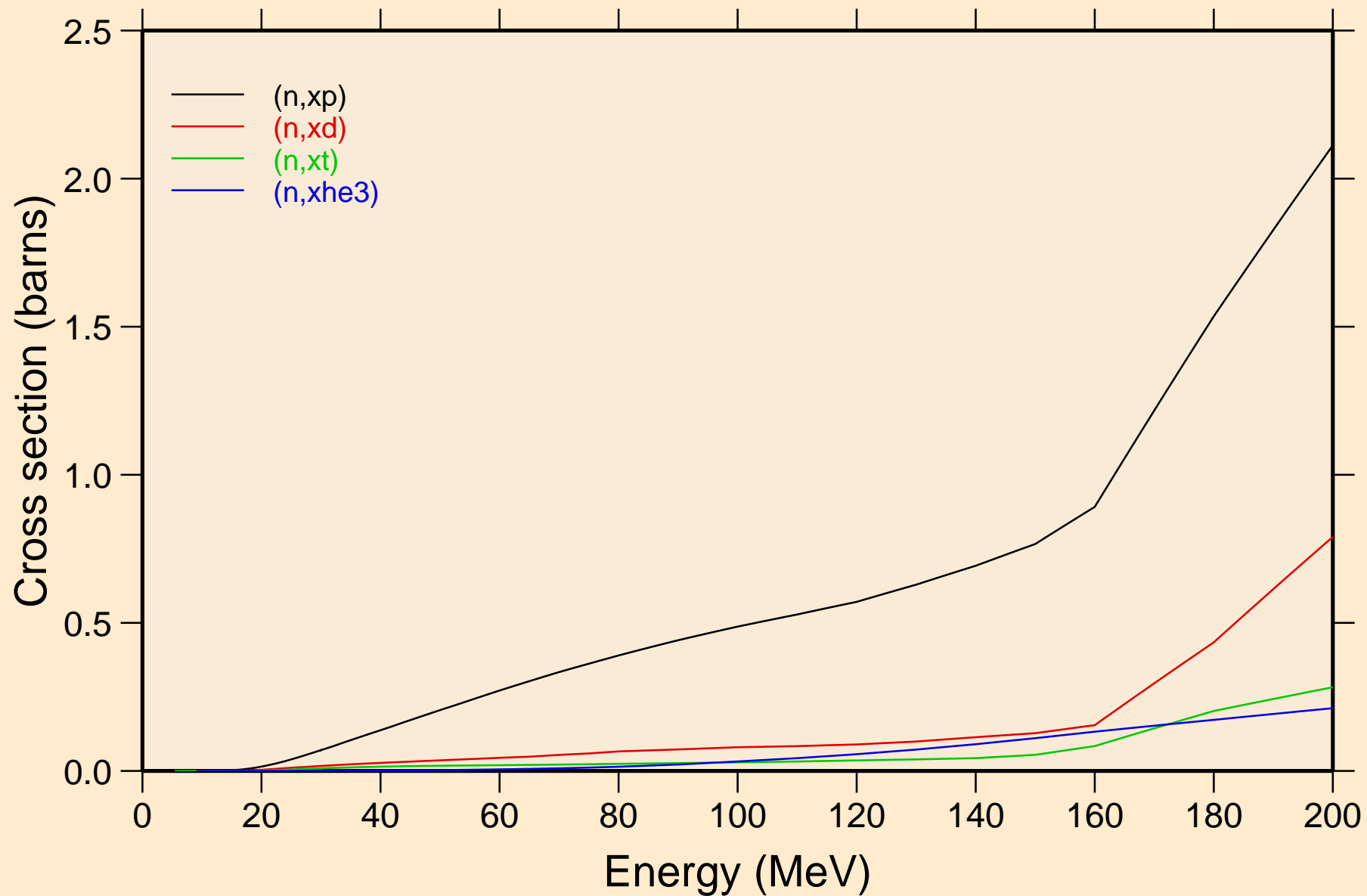

HF183 NEUTRON ACER TENDL-2019 LIBRARY; T=293.16K  
angular distribution for elastic

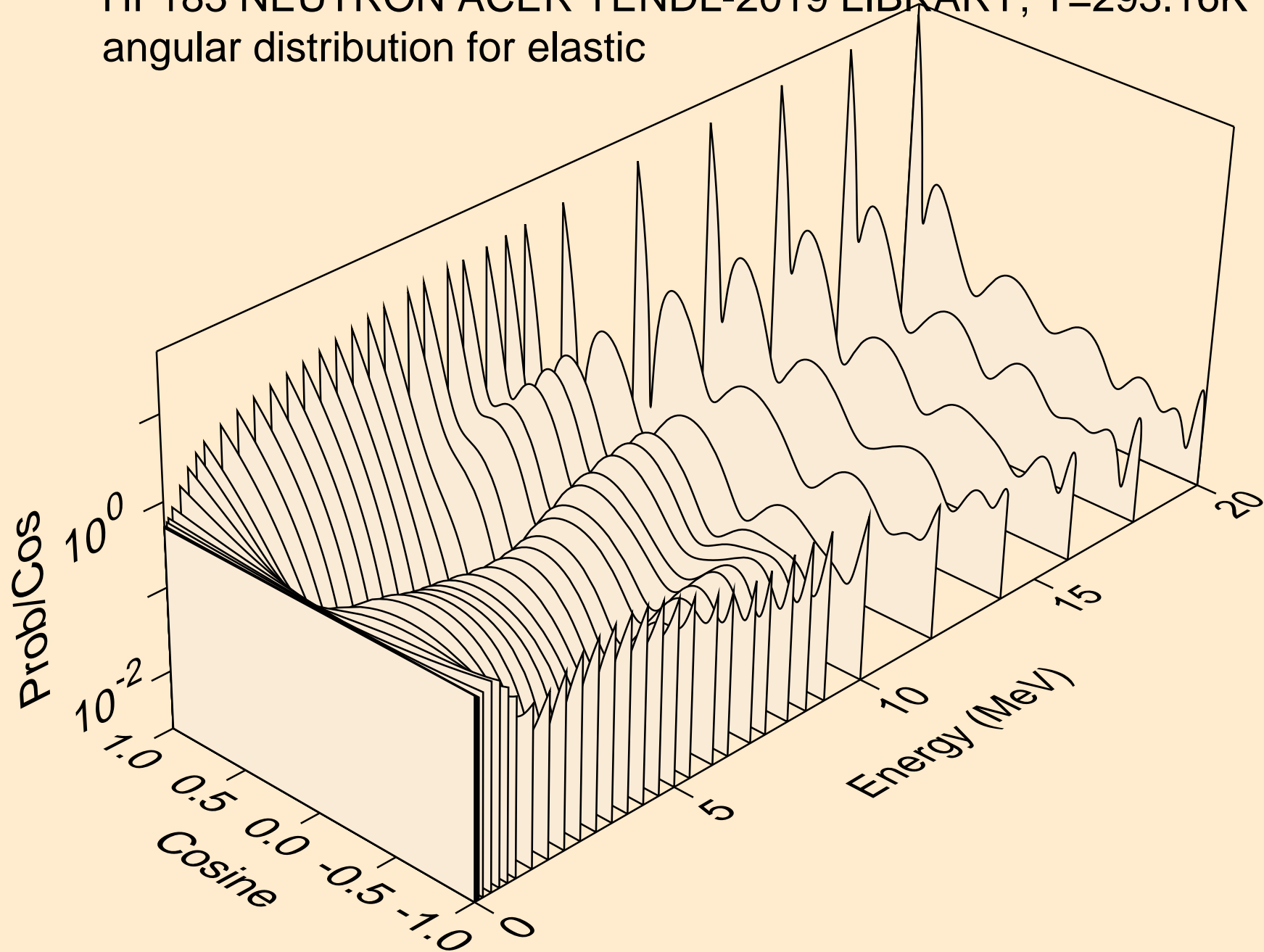

HF183 NEUTRON ACER TENDL-2019 LIBRARY; T=293.16K  
angular distribution for elastic

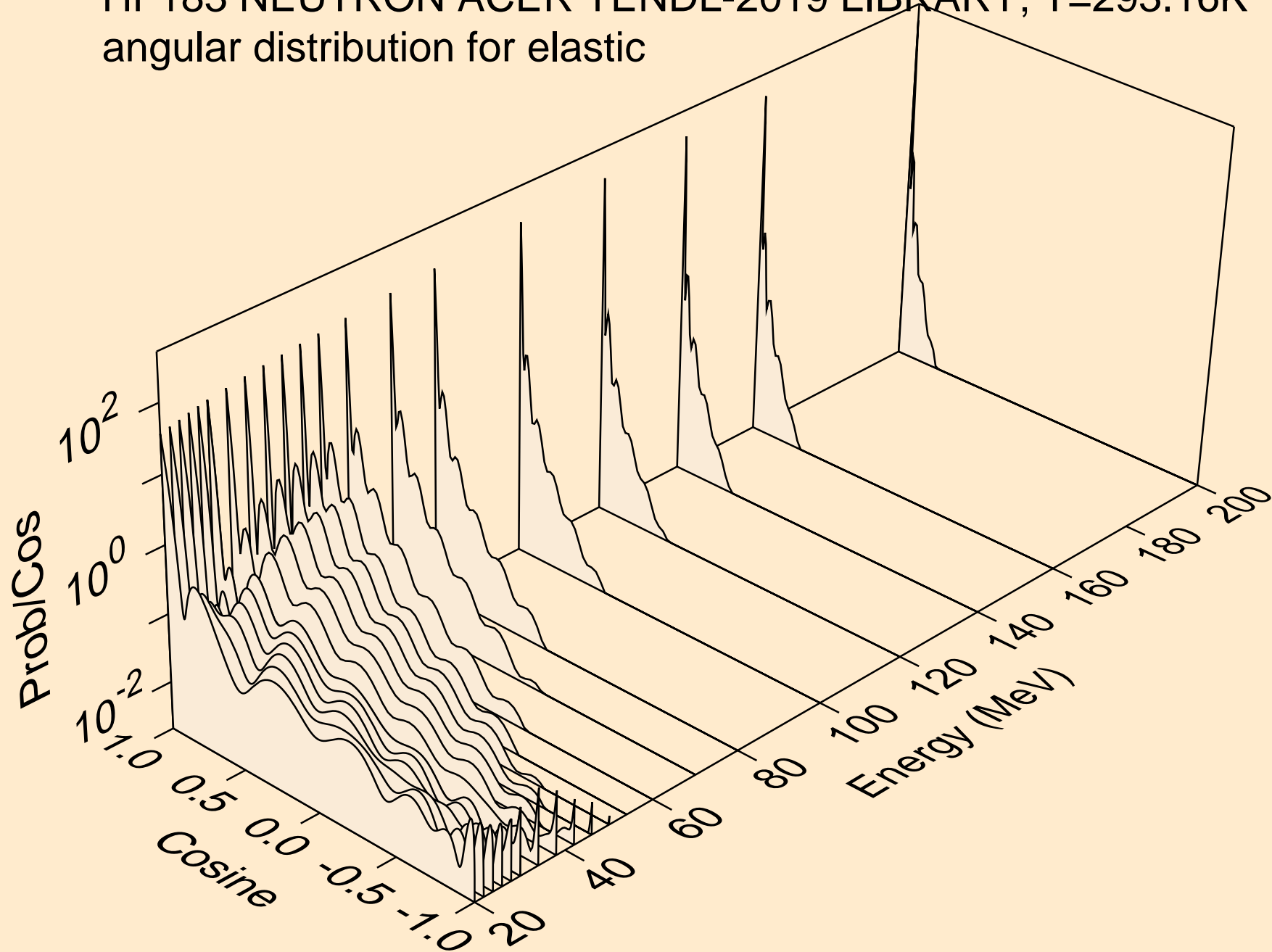

HF183 NEUTRON ACER TENDL-2019 LIBRARY; T=293.16K  
angular distribution for (n,n\*1)

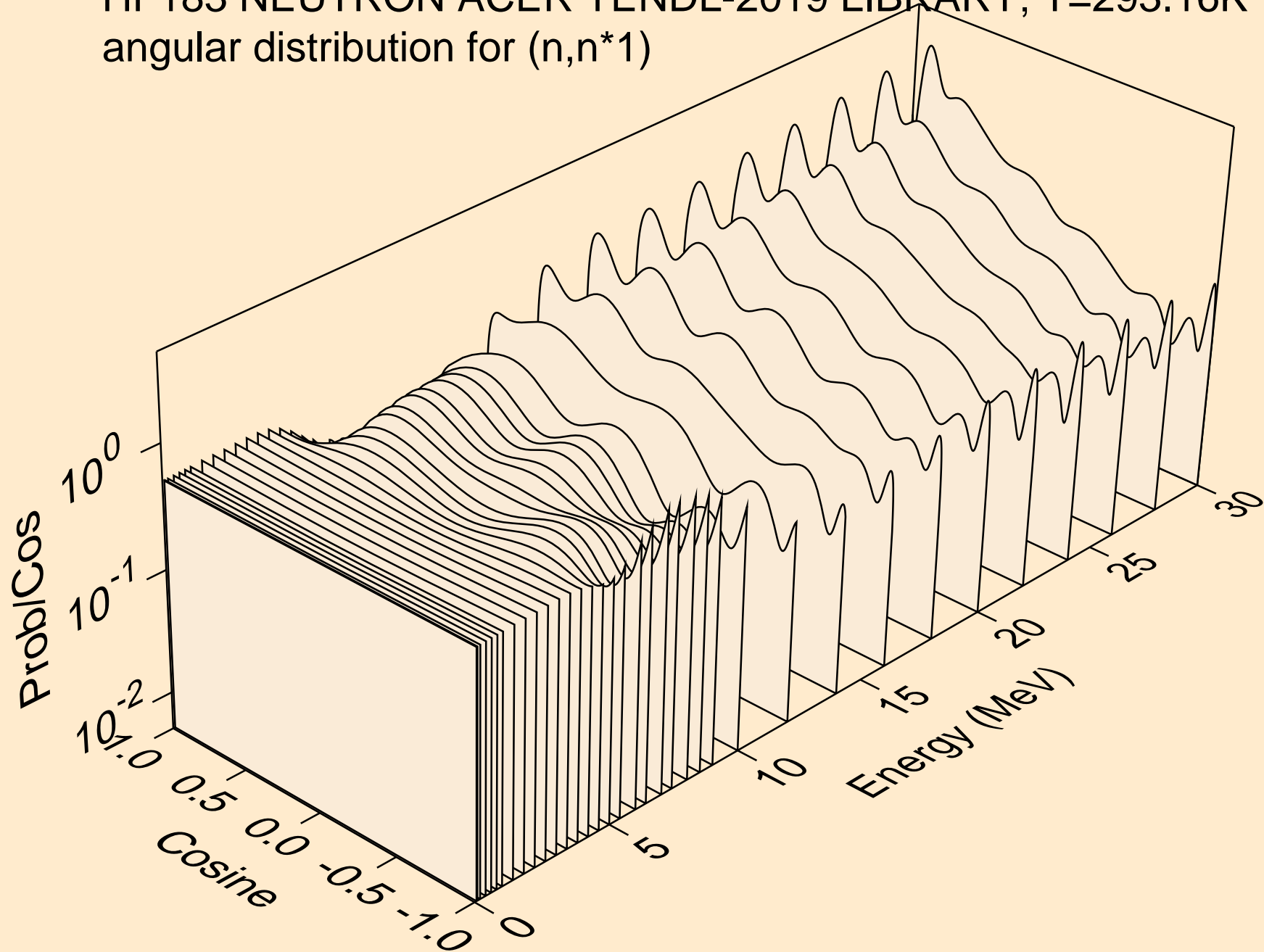

HF183 NEUTRON ACER TENDL-2019 LIBRARY; T=293.16K  
angular distribution for (n,n\*2)

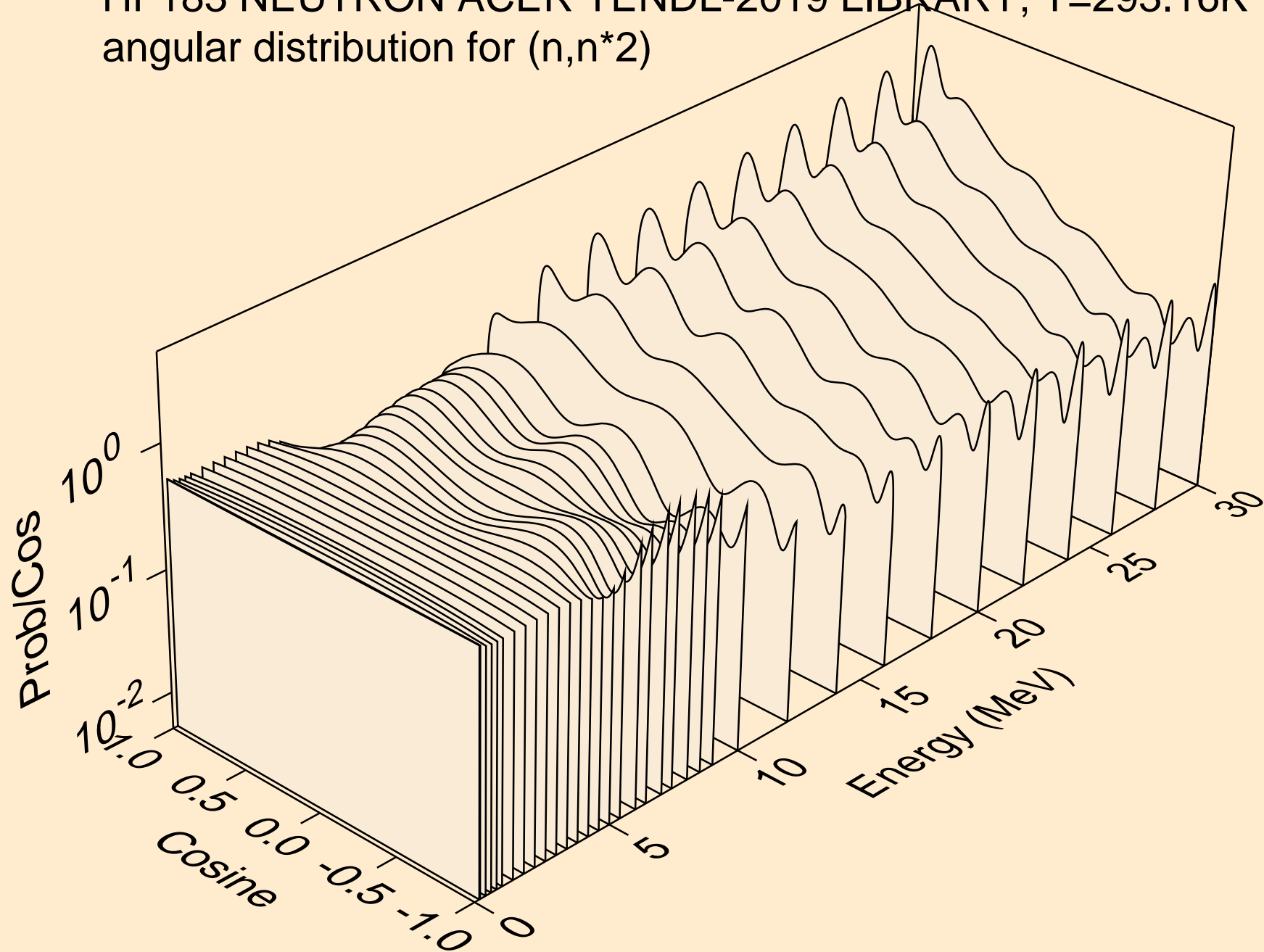



HF183 NEUTRON ACER TENDL-2019 LIBRARY; T=293.16K  
angular distribution for (n,n\*3)

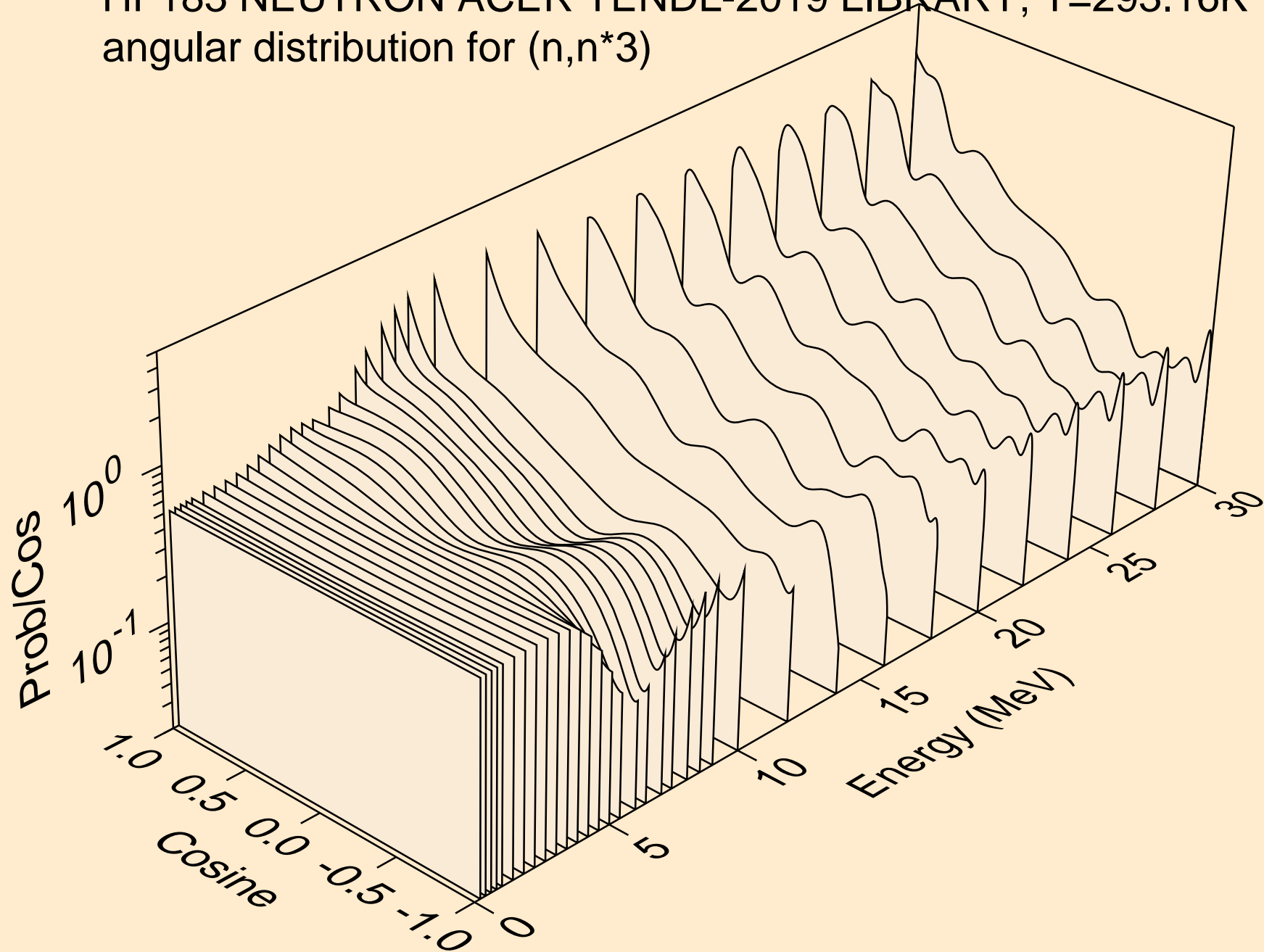

HF183 NEUTRON ACER TENDL-2019 LIBRARY; T=293.16K  
angular distribution for (n,n\*4)

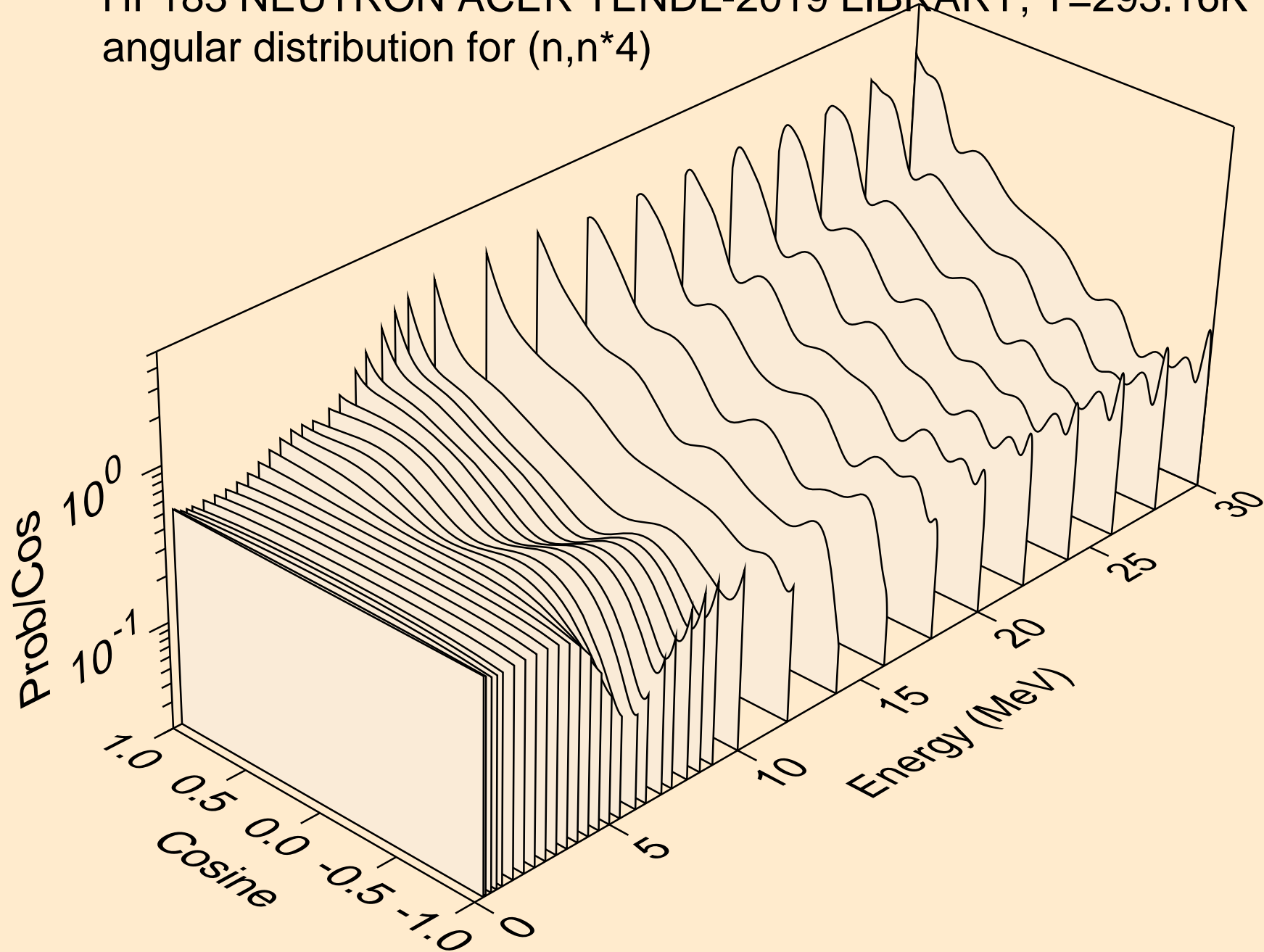

HF183 NEUTRON ACER TENDL-2019 LIBRARY; T=293.16K  
angular distribution for (n,n\*5)

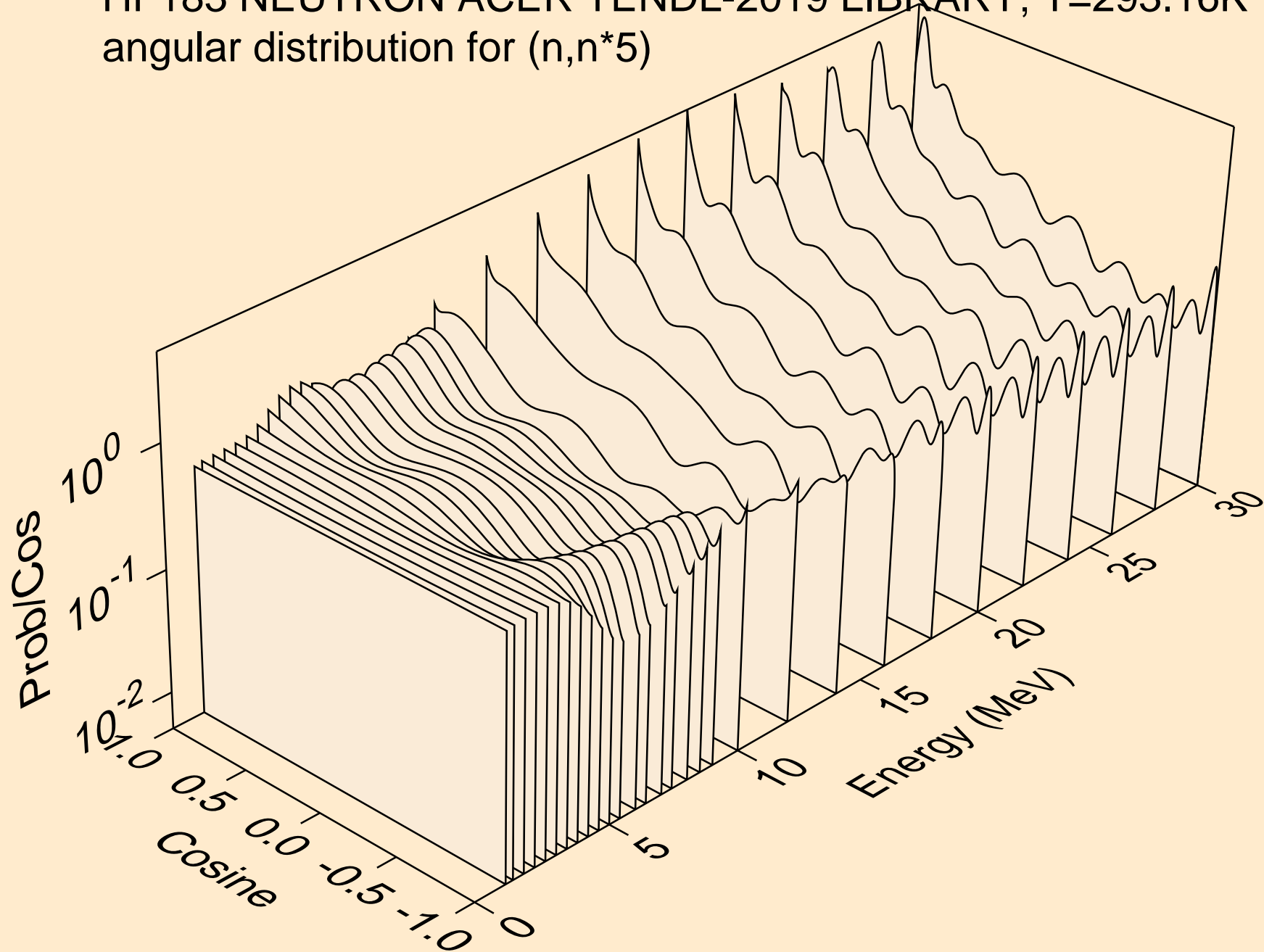

HF183 NEUTRON ACER TENDL-2019 LIBRARY; T=293.16K  
angular distribution for (n,n\*6)

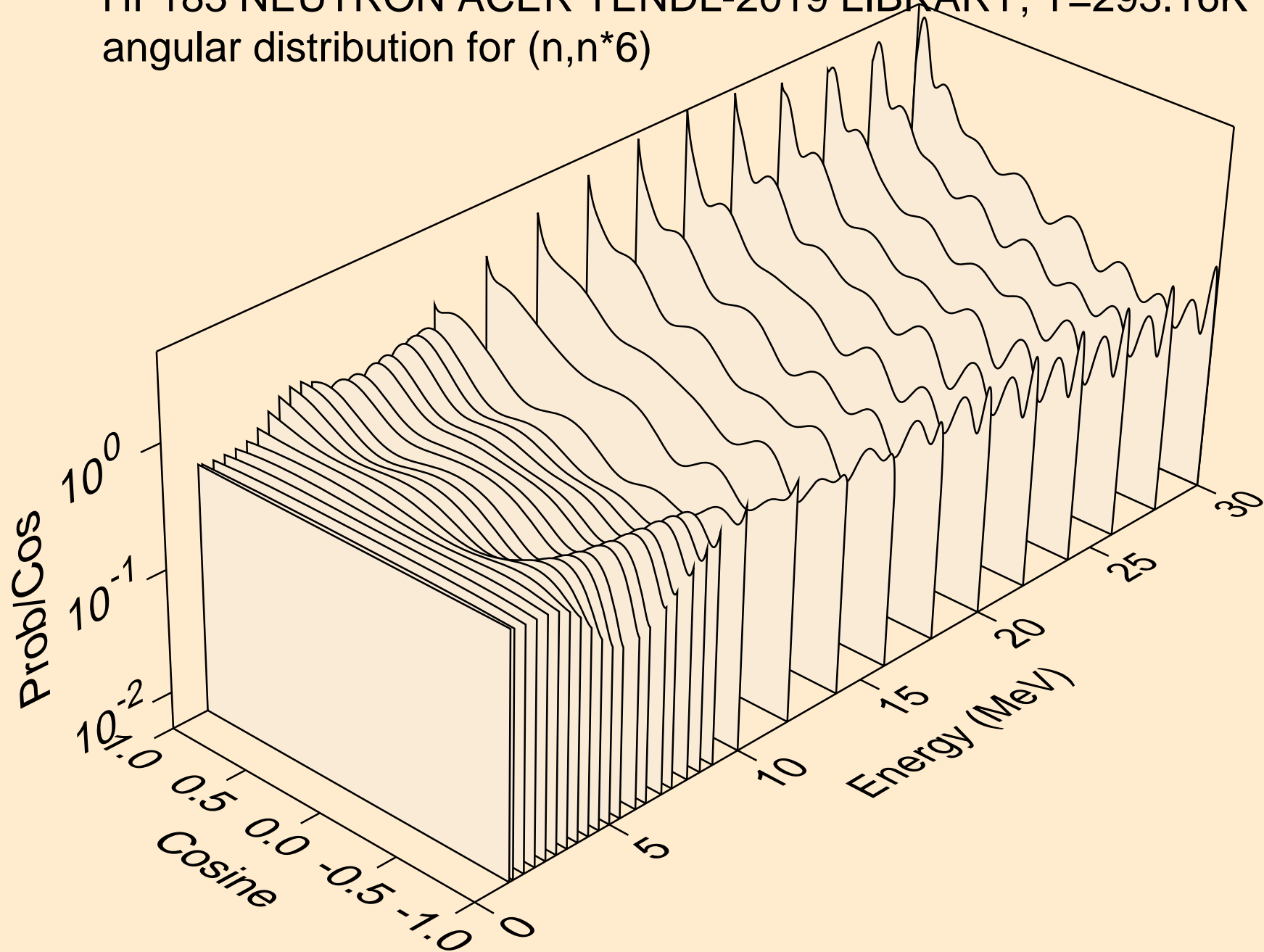

HF183 NEUTRON ACER TENDL-2019 LIBRARY; T=293.16K  
angular distribution for (n,n\*7)

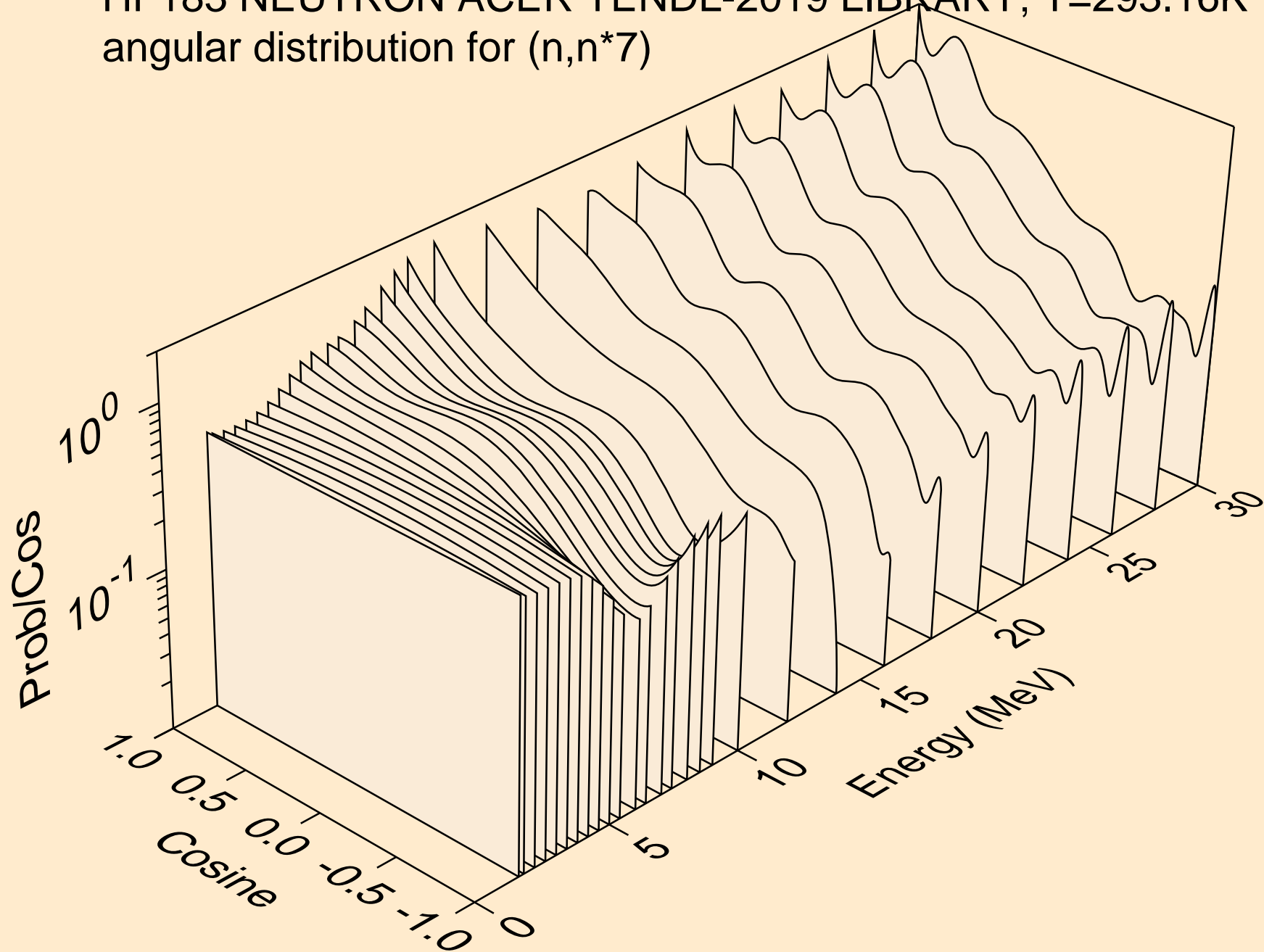

HF183 NEUTRON ACER TENDL-2019 LIBRARY; T=293.16K  
angular distribution for (n,n\*8)

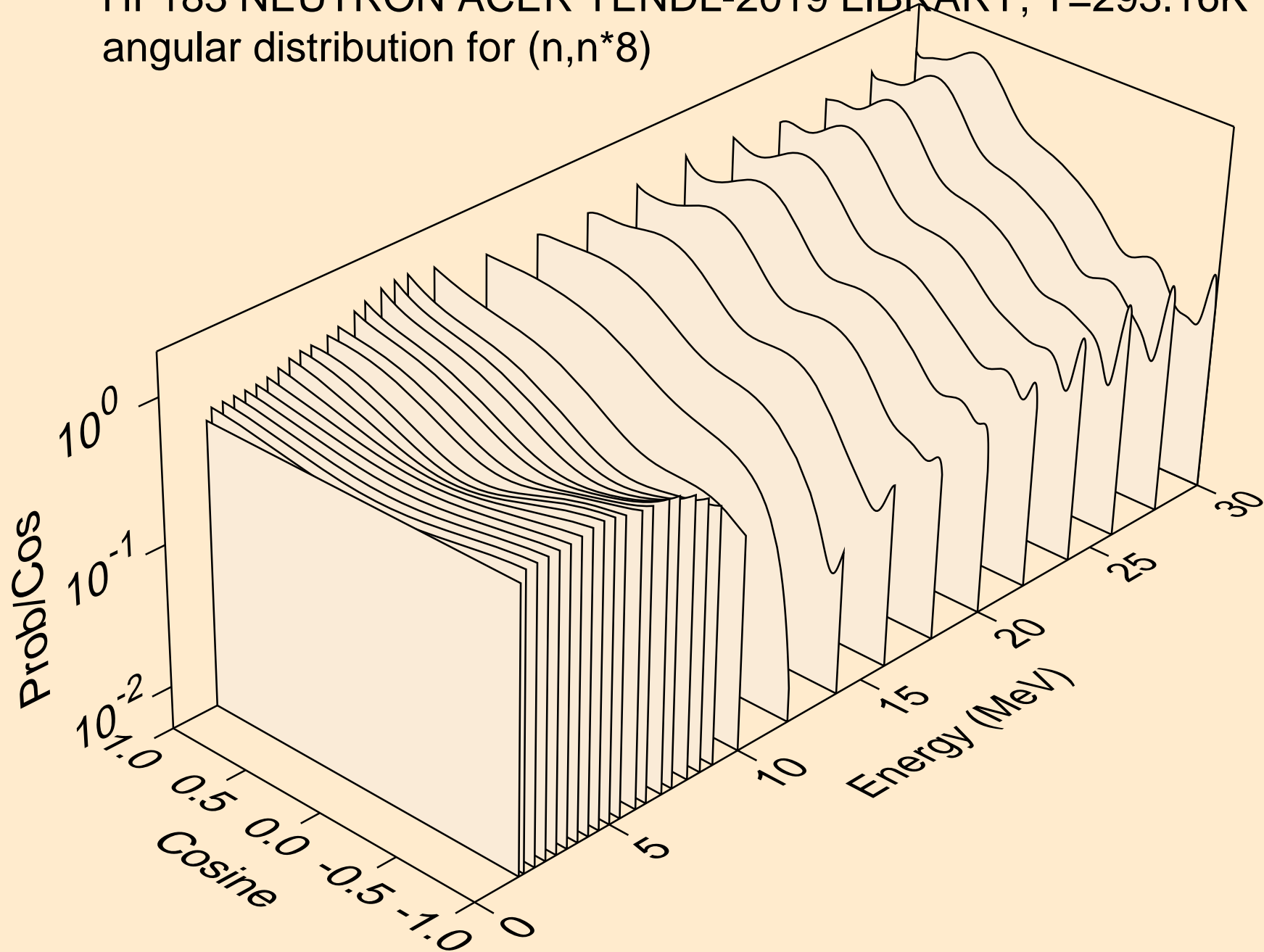

HF183 NEUTRON ACER TENDL-2019 LIBRARY; T=293.16K  
angular distribution for (n,n\*9)

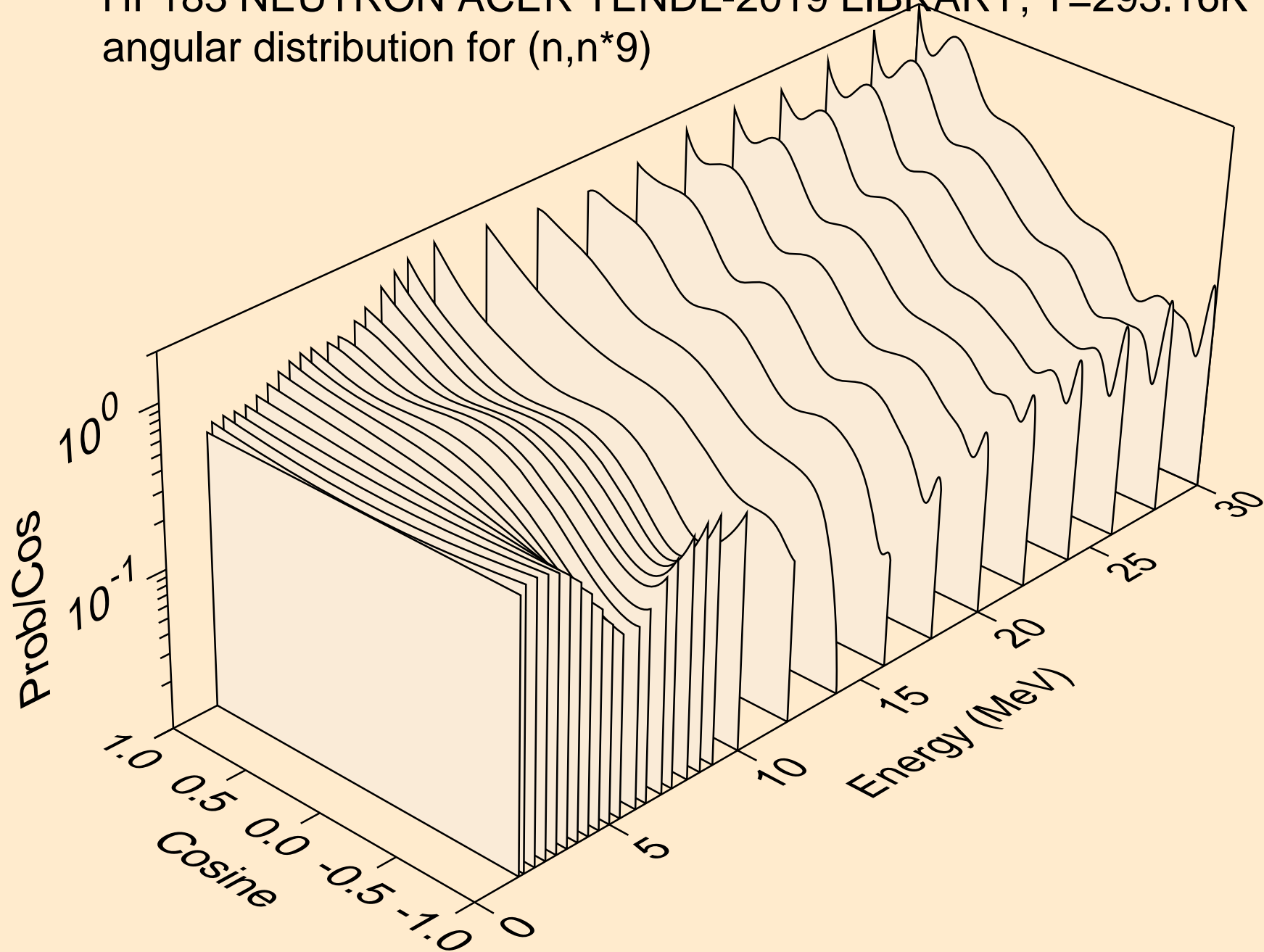

HF183 NEUTRON ACER TENDL-2019 LIBRARY; T=293.16K  
angular distribution for (n,n\*10)

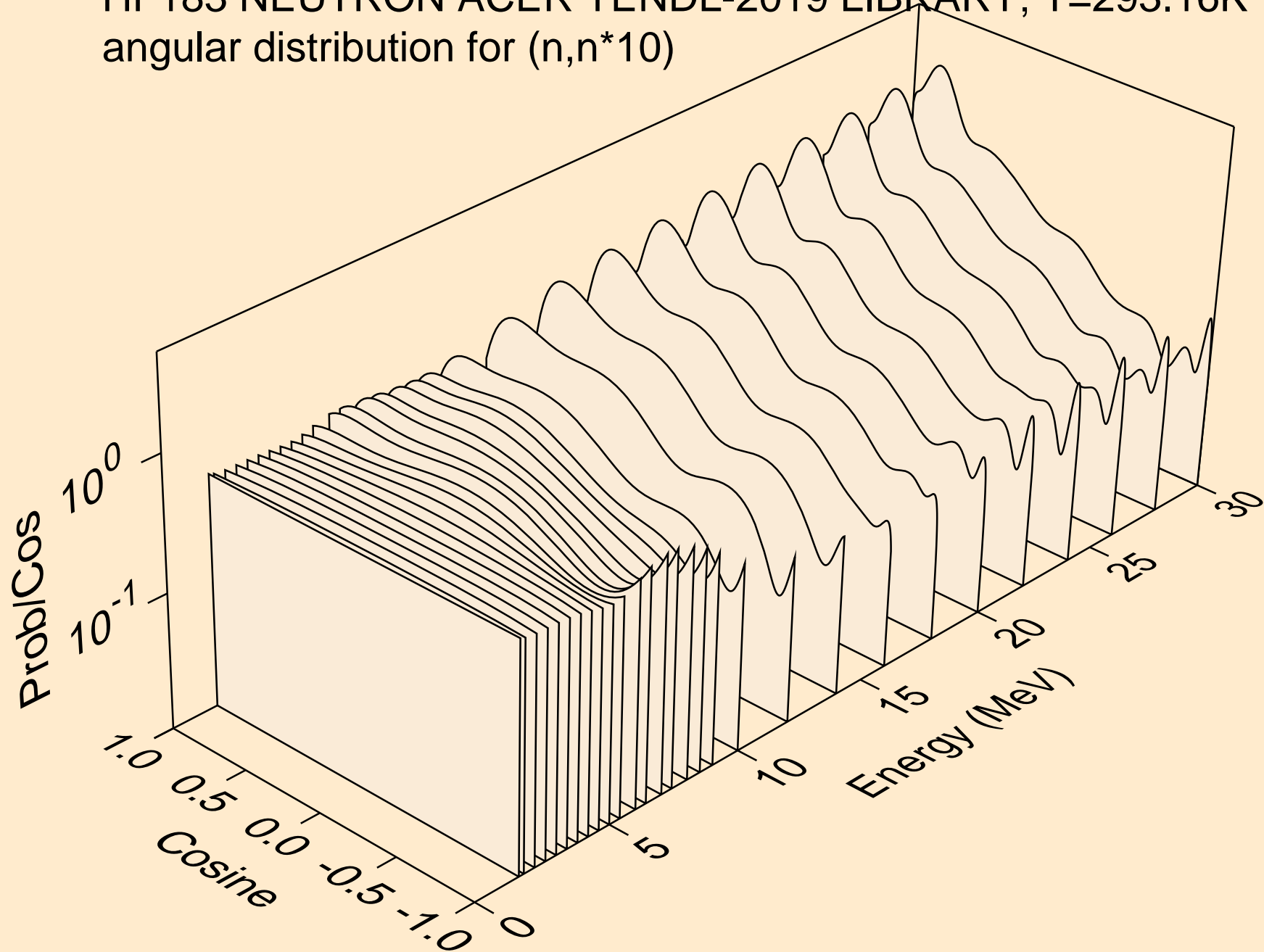



HF183 NEUTRON ACER TENDL-2019 LIBRARY; T=293.16K  
angular distribution for (n,n\*11)

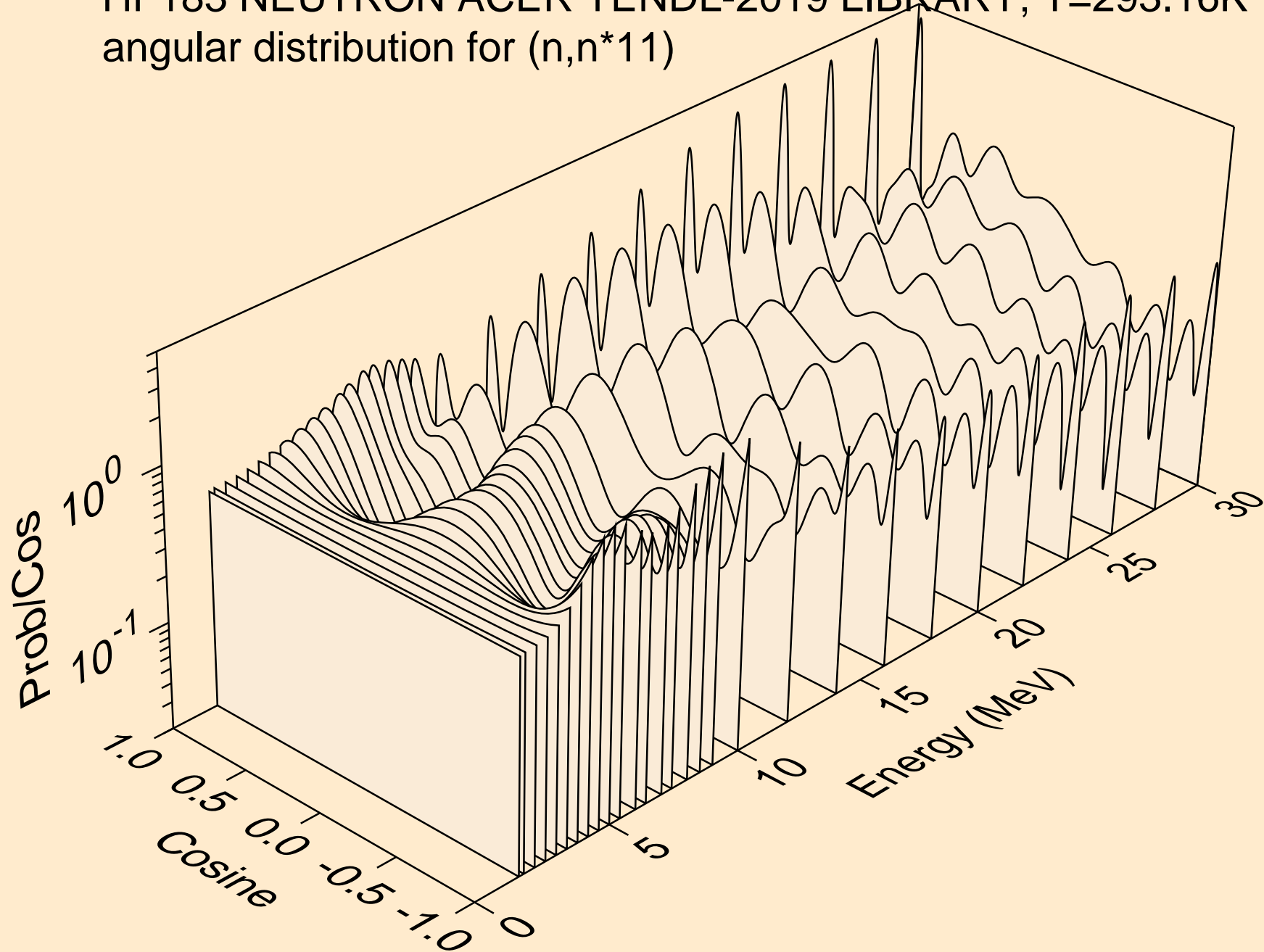

HF183 NEUTRON ACER TENDL-2019 LIBRARY; T=293.16K  
angular distribution for (n,n\*12)

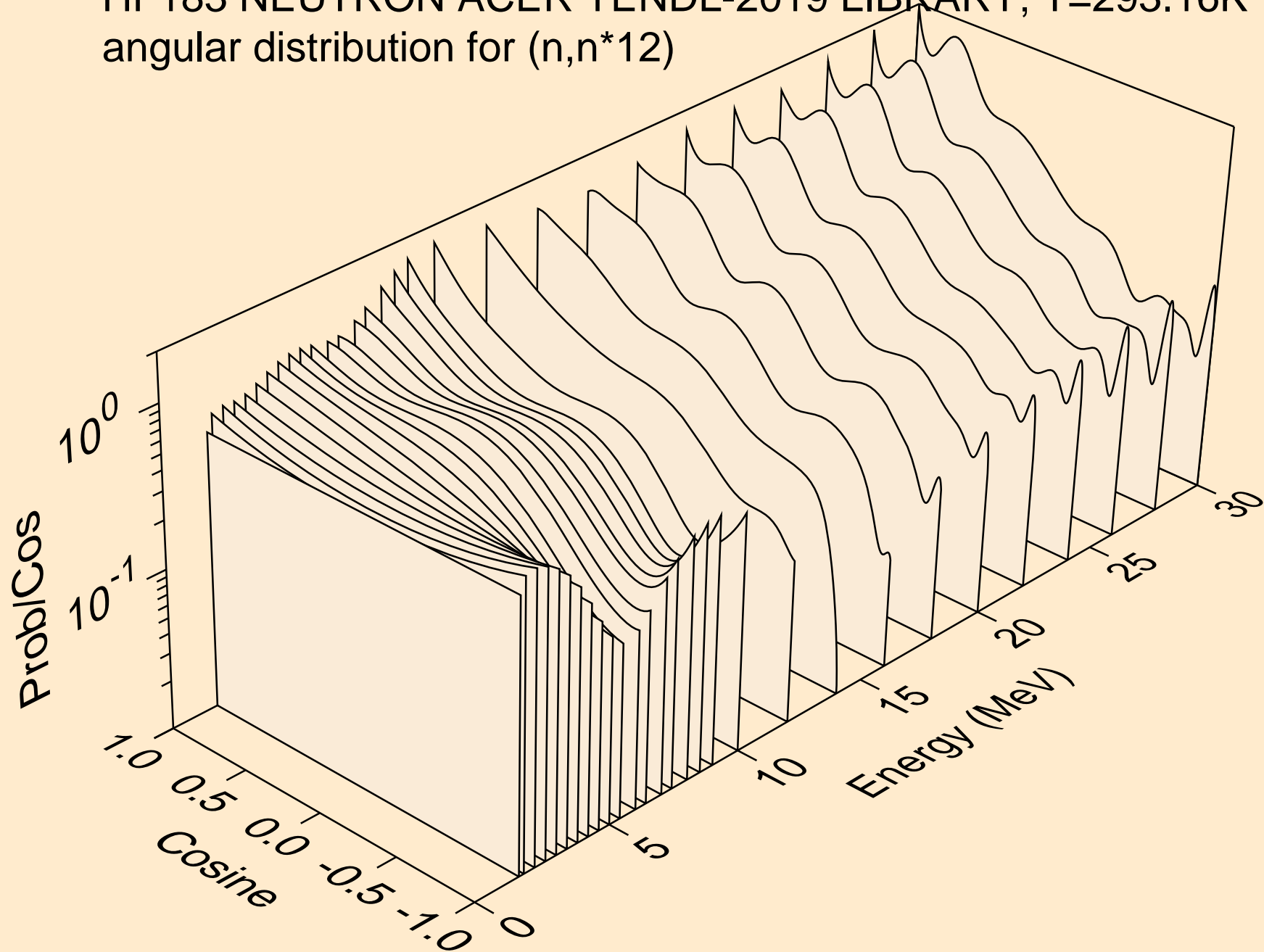

HF183 NEUTRON ACER TENDL-2019 LIBRARY; T=293.16K  
angular distribution for (n,n\*13)

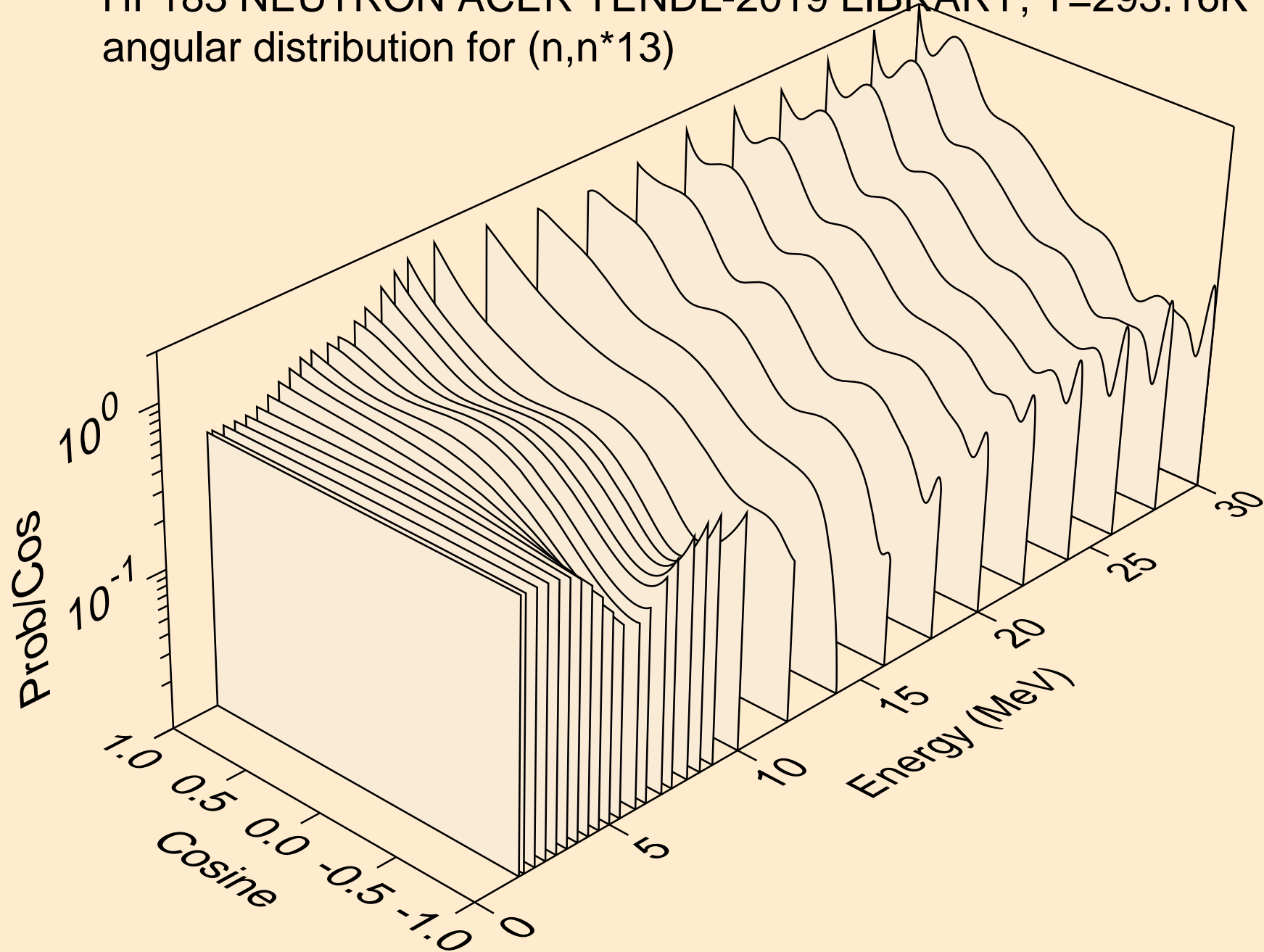

HF183 NEUTRON ACER TENDL-2019 LIBRARY; T=293.16K  
angular distribution for (n,n\*14)

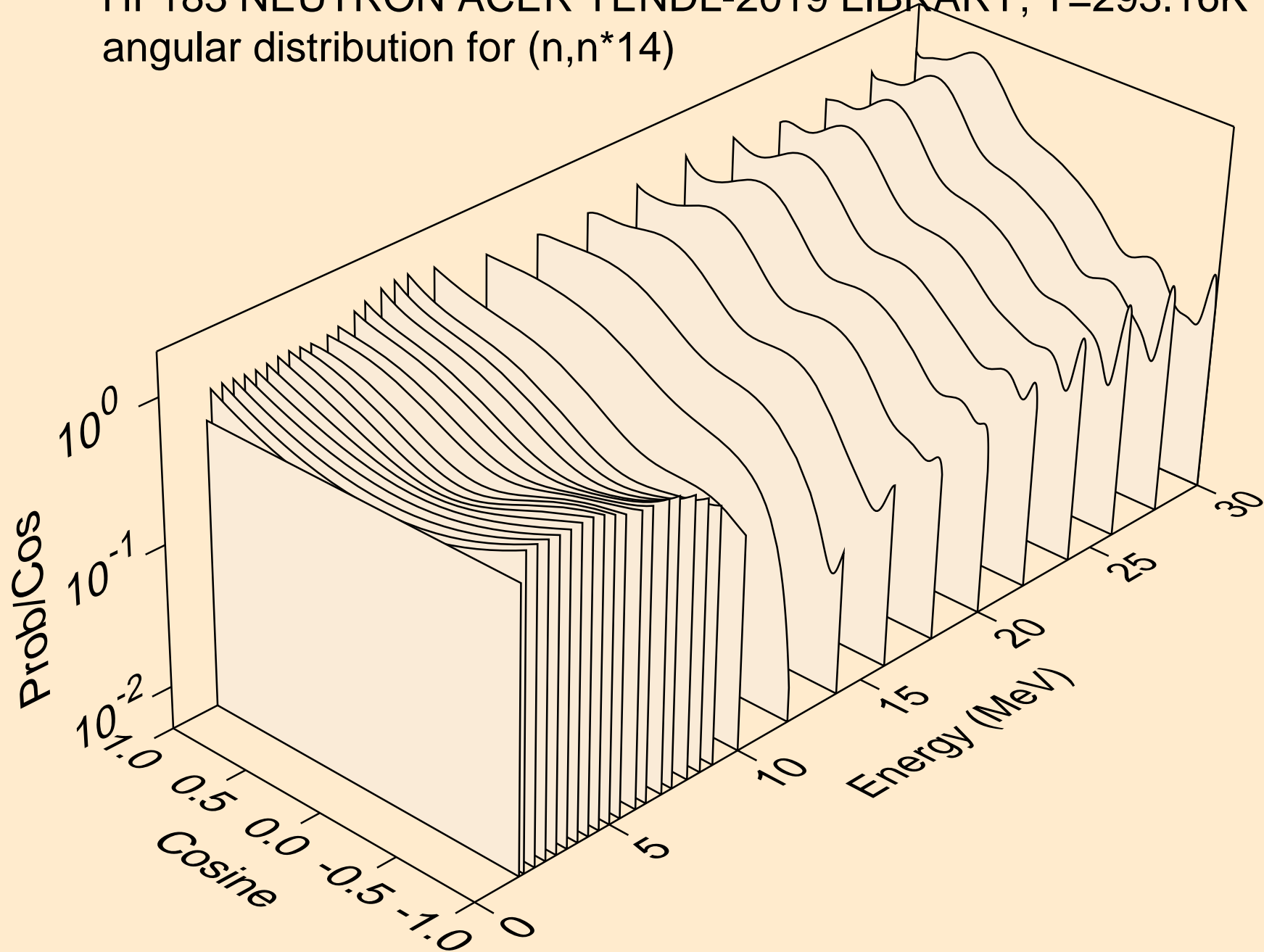

HF183 NEUTRON ACER TENDL-2019 LIBRARY; T=293.16K  
angular distribution for (n,n\*15)

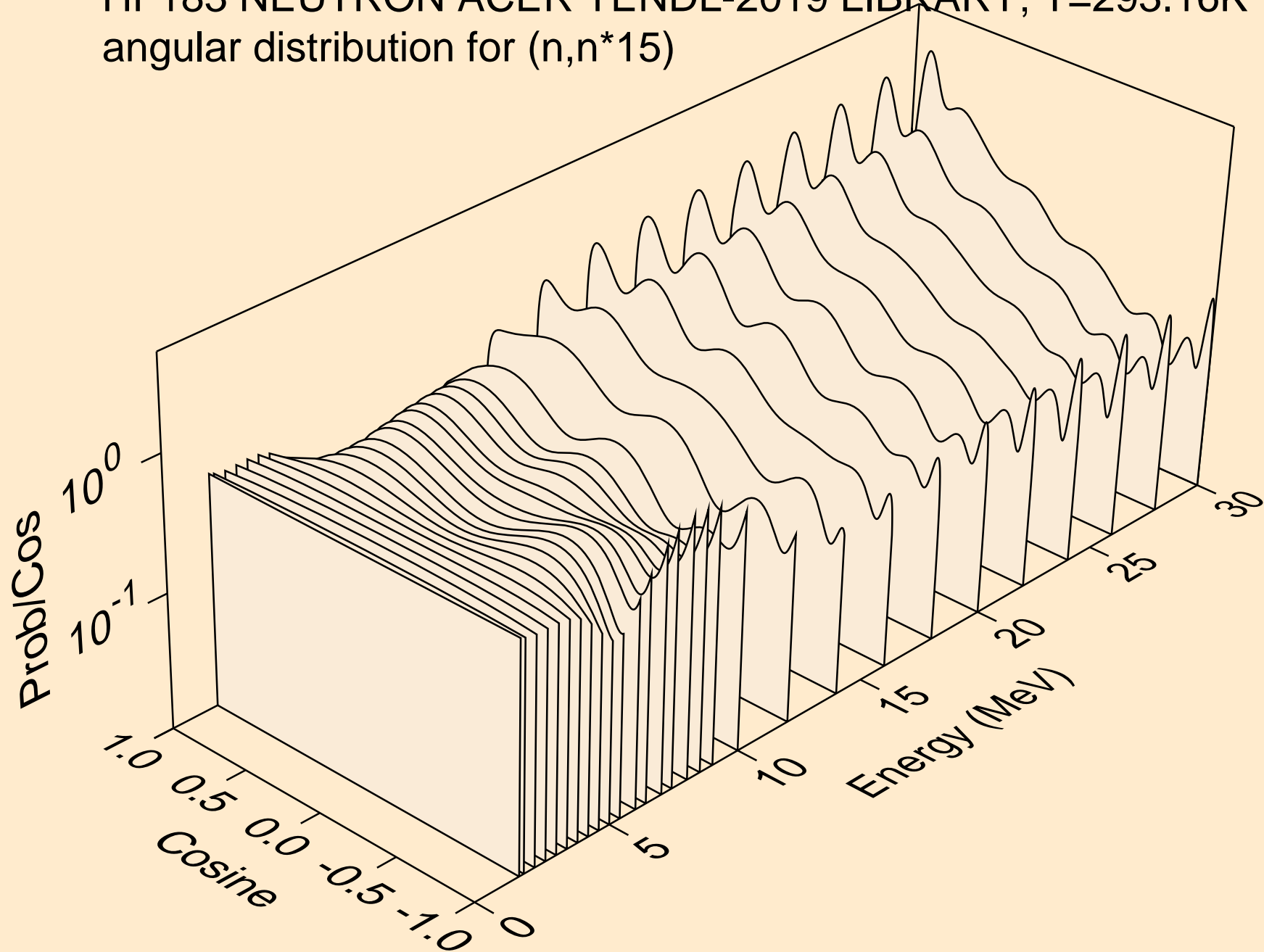

HF183 NEUTRON ACER TENDL-2019 LIBRARY; T=293.16K  
angular distribution for (n,n\*16)

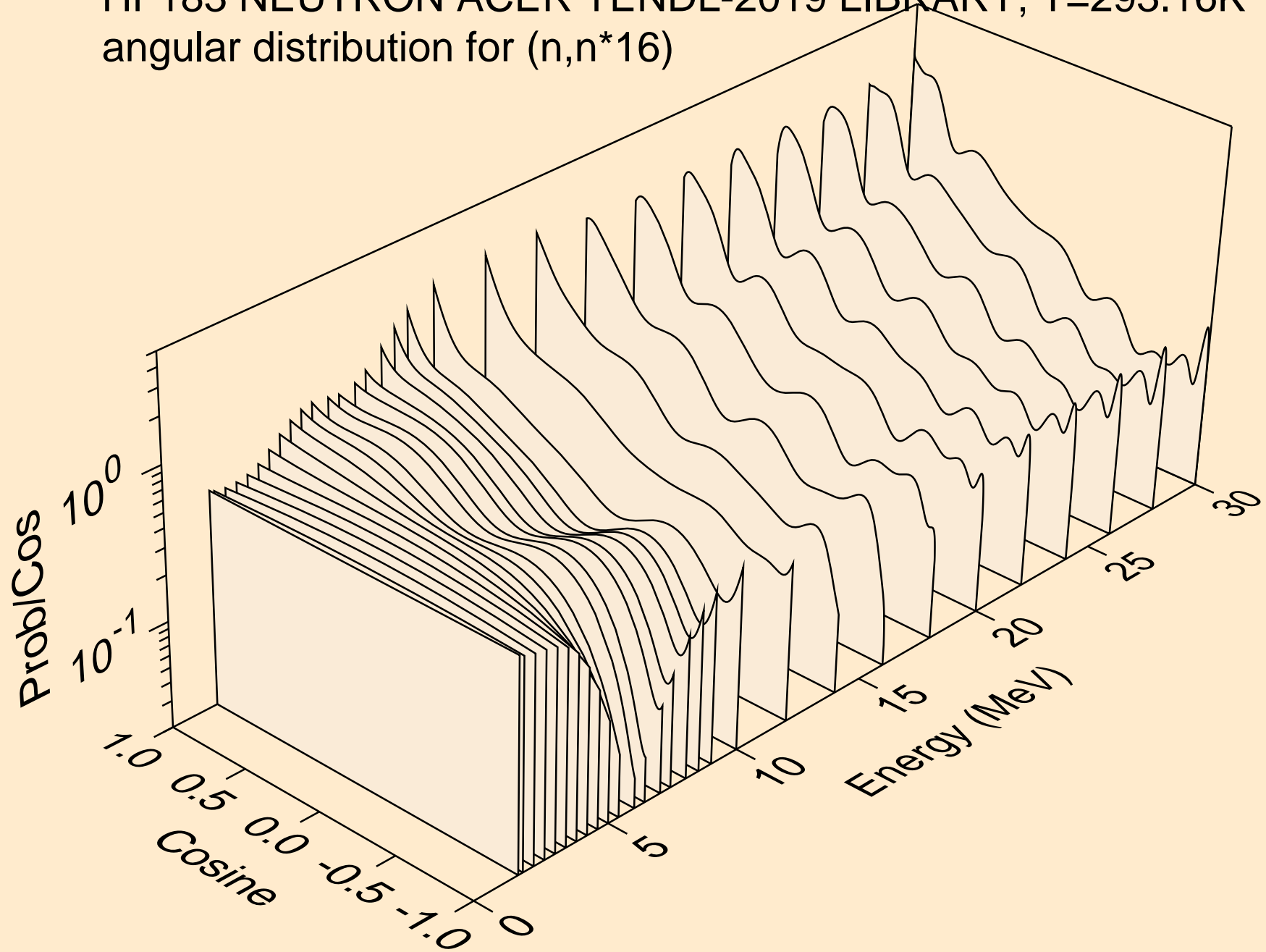

HF183 NEUTRON ACER TENDL-2019 LIBRARY; T=293.16K  
angular distribution for (n,n\*17)

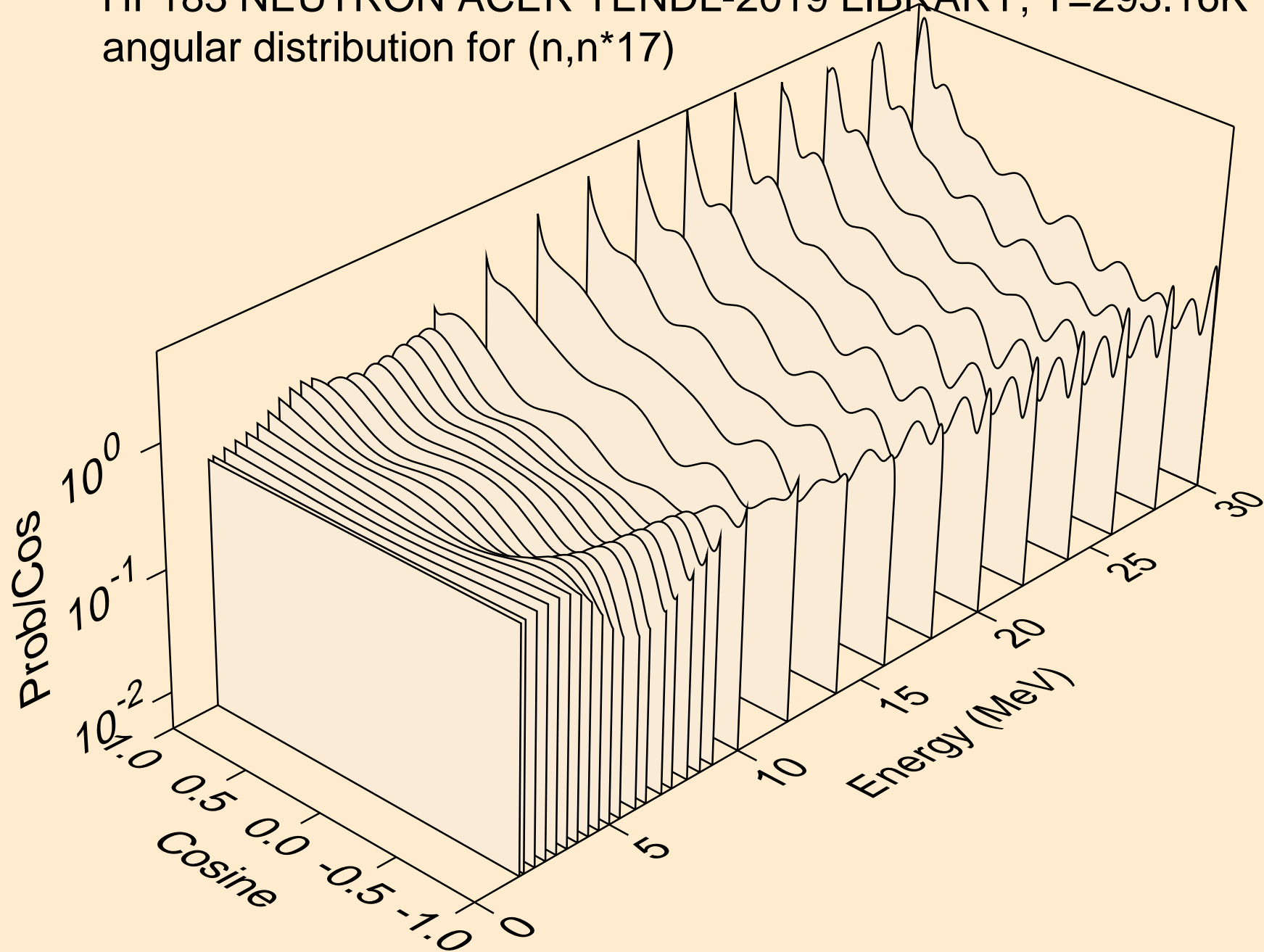

HF183 NEUTRON ACER TENDL-2019 LIBRARY; T=293.16K  
angular distribution for (n,n\*18)

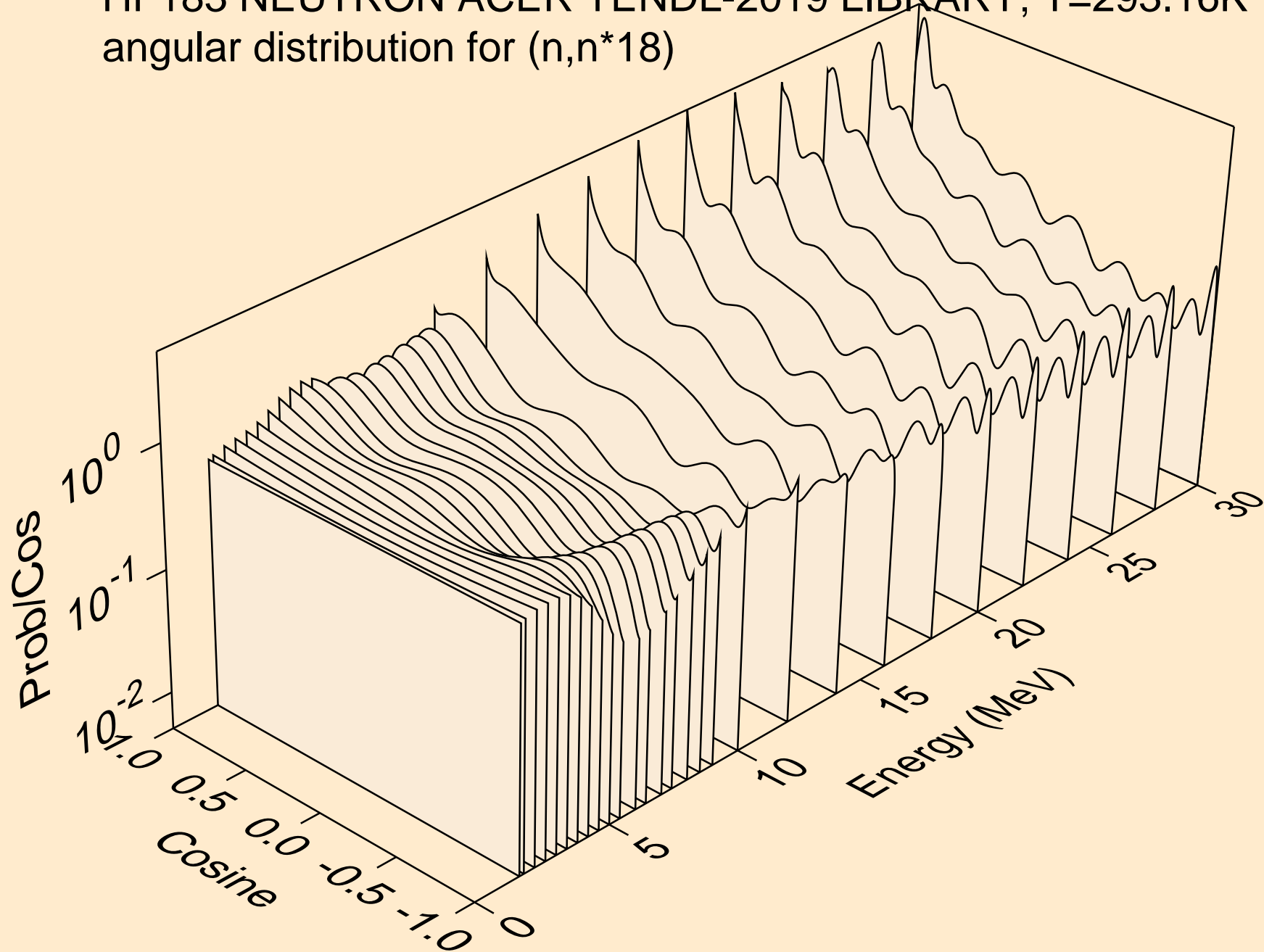



HF183 NEUTRON ACER TENDL-2019 LIBRARY; T=293.16K  
angular distribution for (n,n\*19)

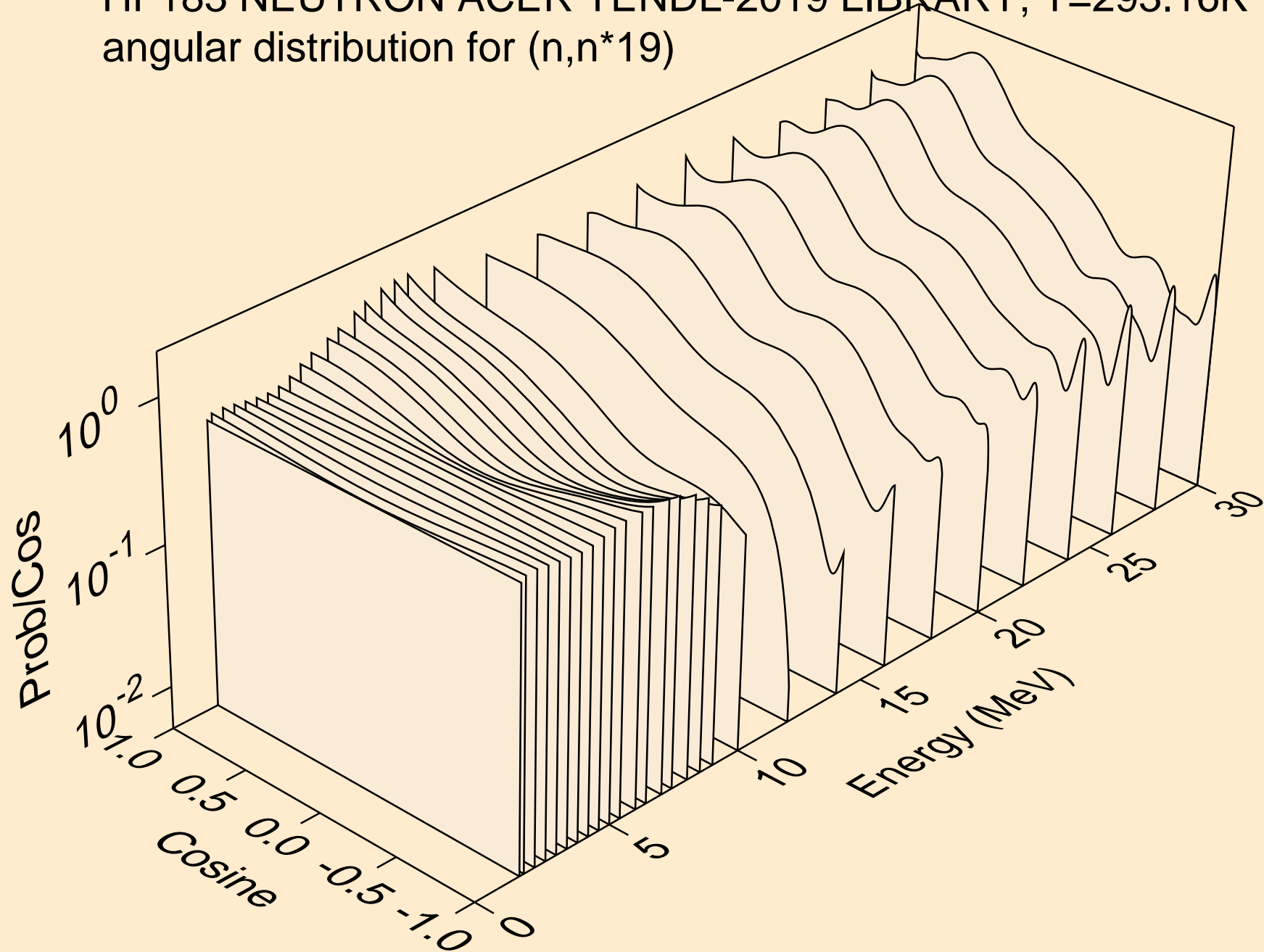

HF183 NEUTRON ACER TENDL-2019 LIBRARY; T=293.16K  
angular distribution for (n,n\*20)

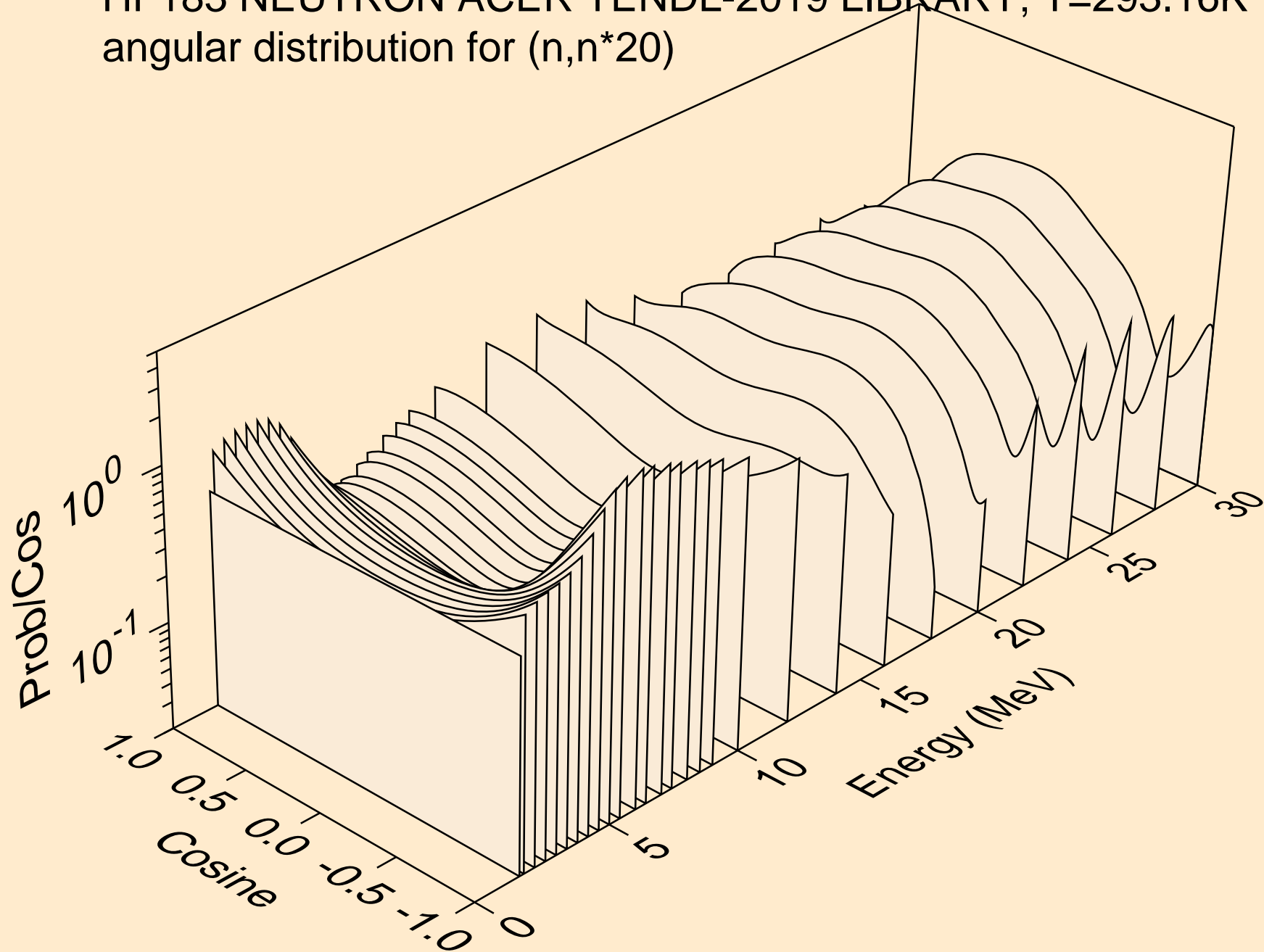

HF183 NEUTRON ACER TENDL-2019 LIBRARY; T=293.16K  
angular distribution for (n,n\*21)

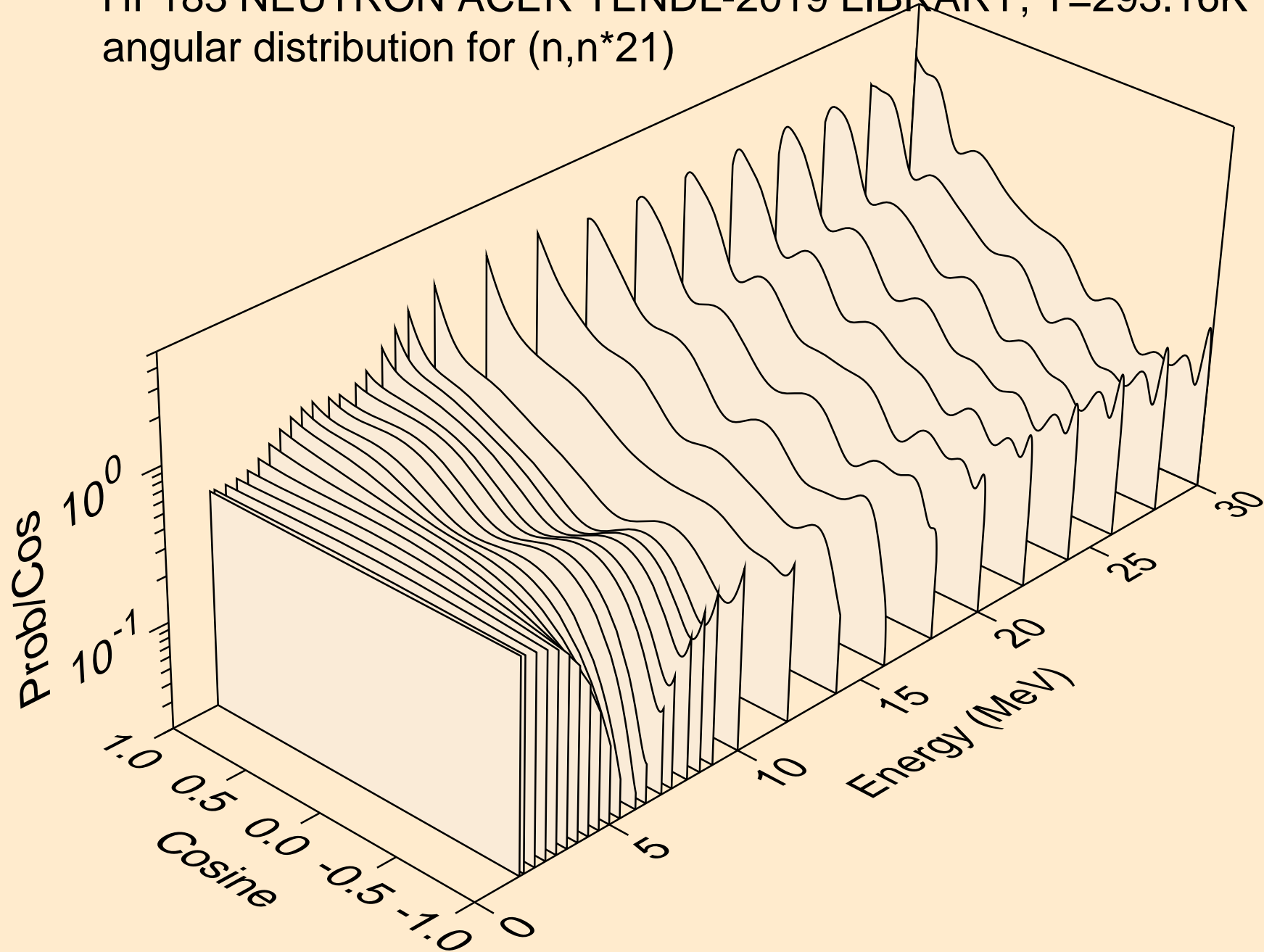

HF183 NEUTRON ACER TENDL-2019 LIBRARY; T=293.16K  
angular distribution for (n,n\*22)

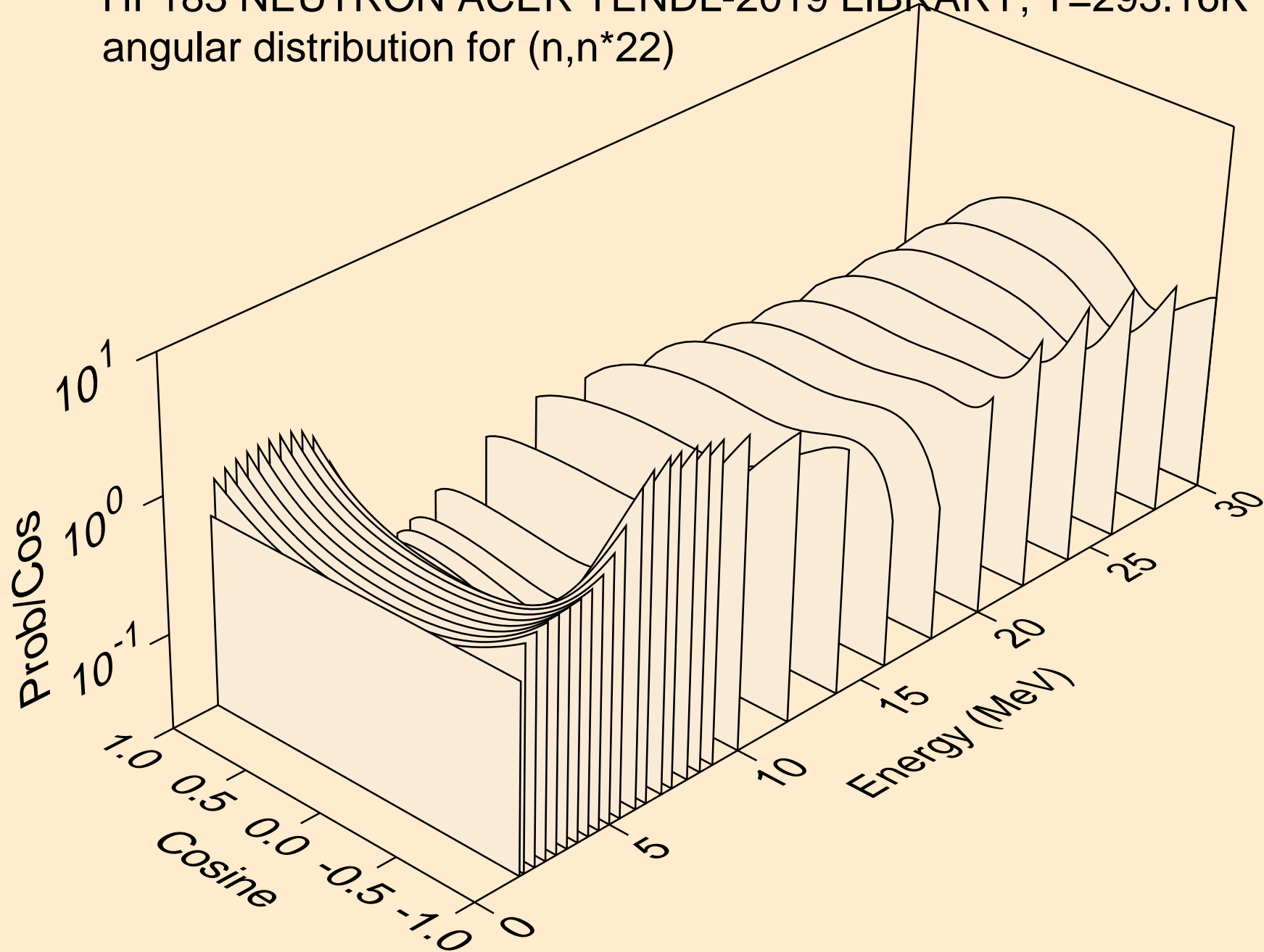

HF183 NEUTRON ACER TENDL-2019 LIBRARY; T=293.16K  
angular distribution for (n,n\*23)

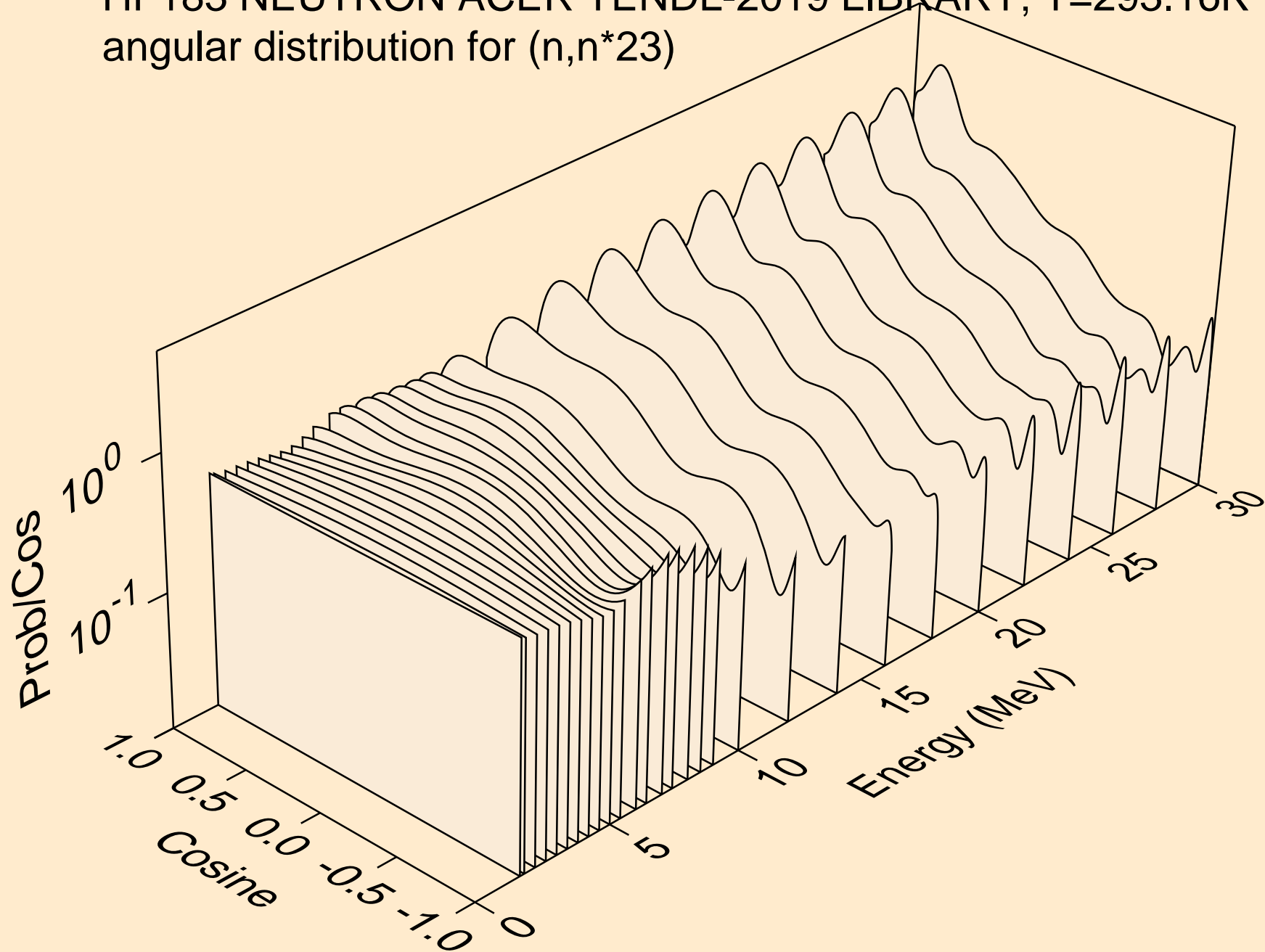

HF183 NEUTRON ACER TENDL-2019 LIBRARY; T=293.16K  
angular distribution for (n,n\*24)

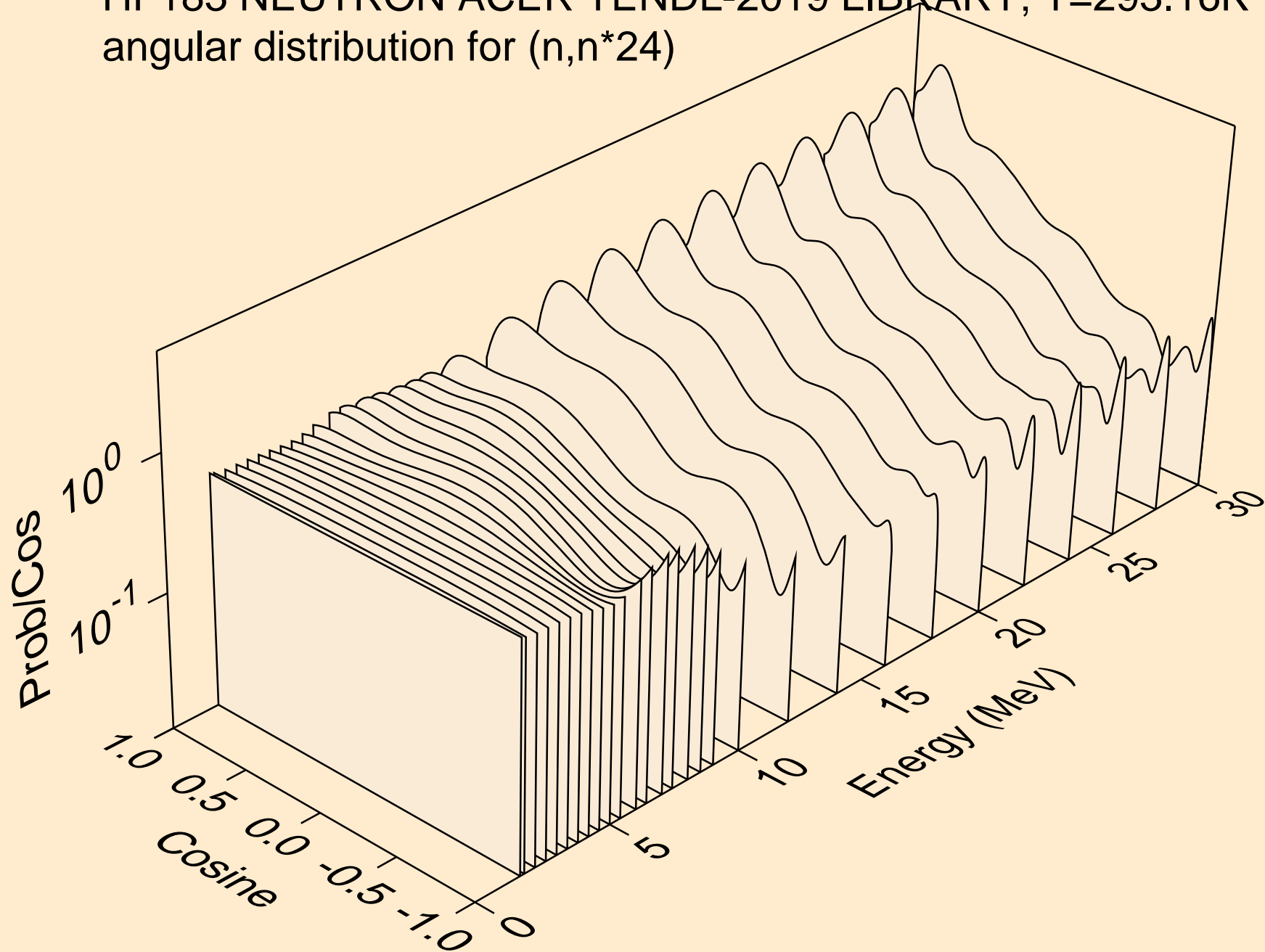

HF183 NEUTRON ACER TENDL-2019 LIBRARY; T=293.16K  
angular distribution for (n,n\*25)

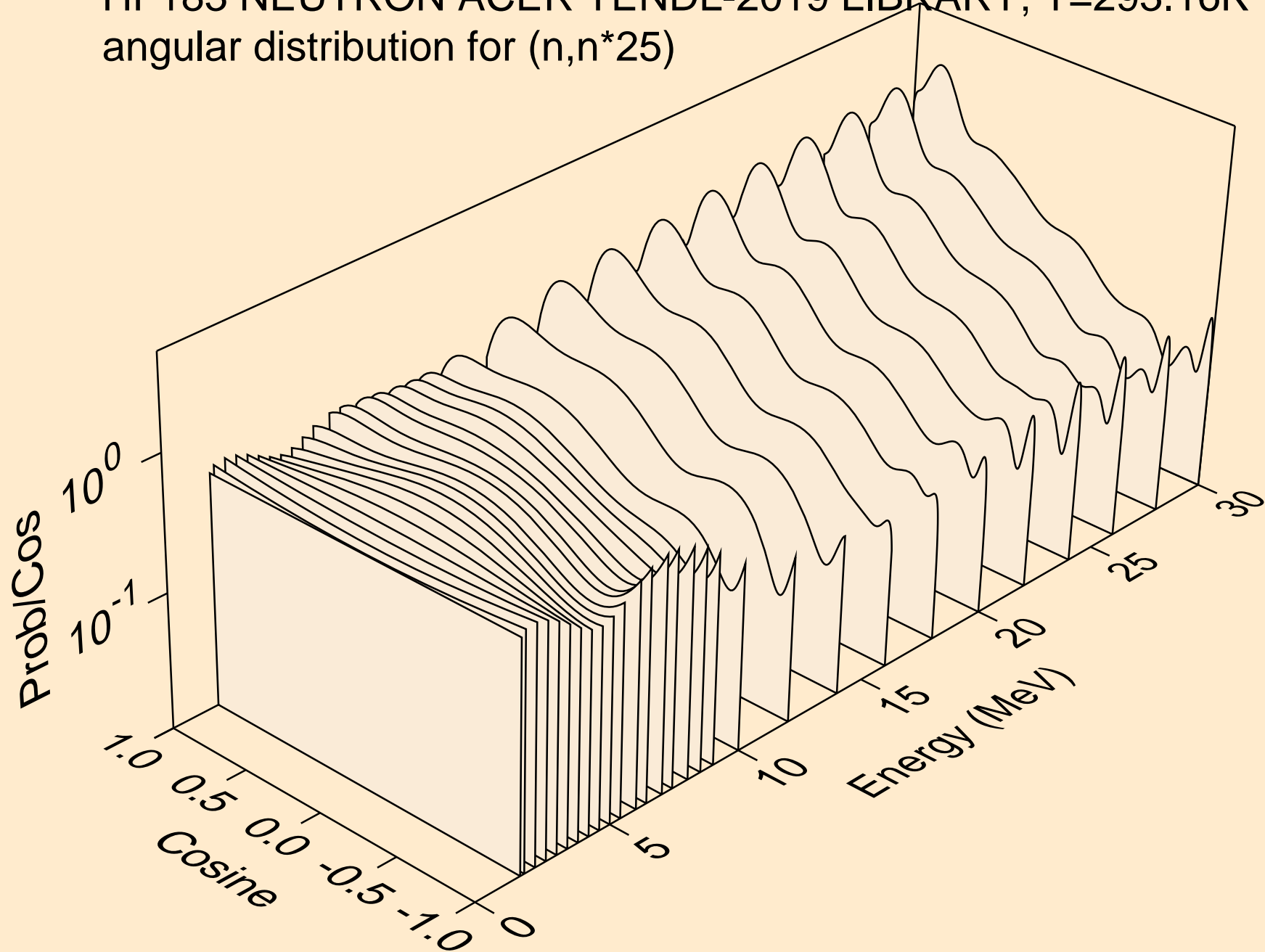

HF183 NEUTRON ACER TENDL-2019 LIBRARY; T=293.16K  
angular distribution for (n,n\*26)

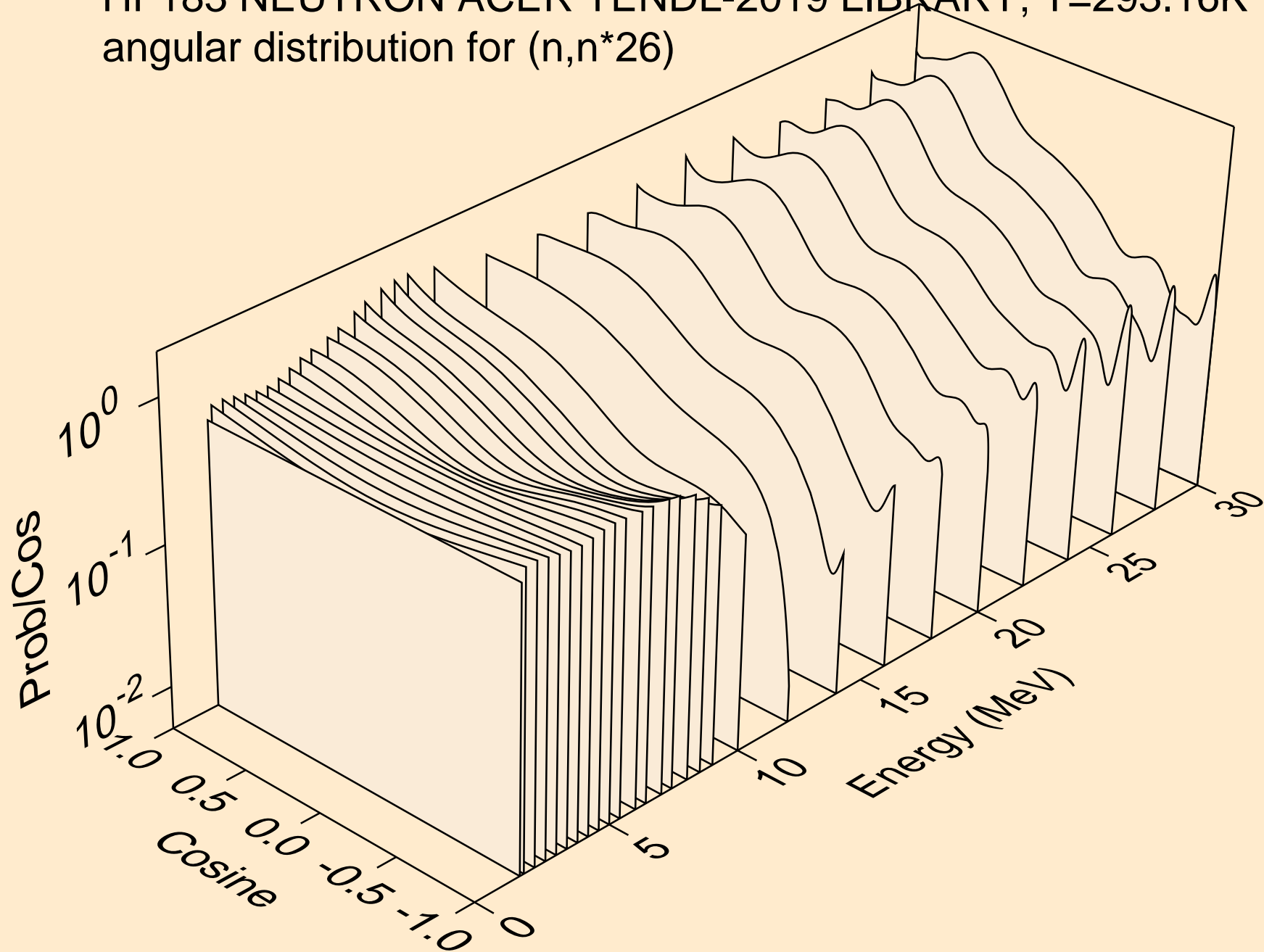



HF183 NEUTRON ACER TENDL-2019 LIBRARY; T=293.16K  
angular distribution for (n,n\*27)

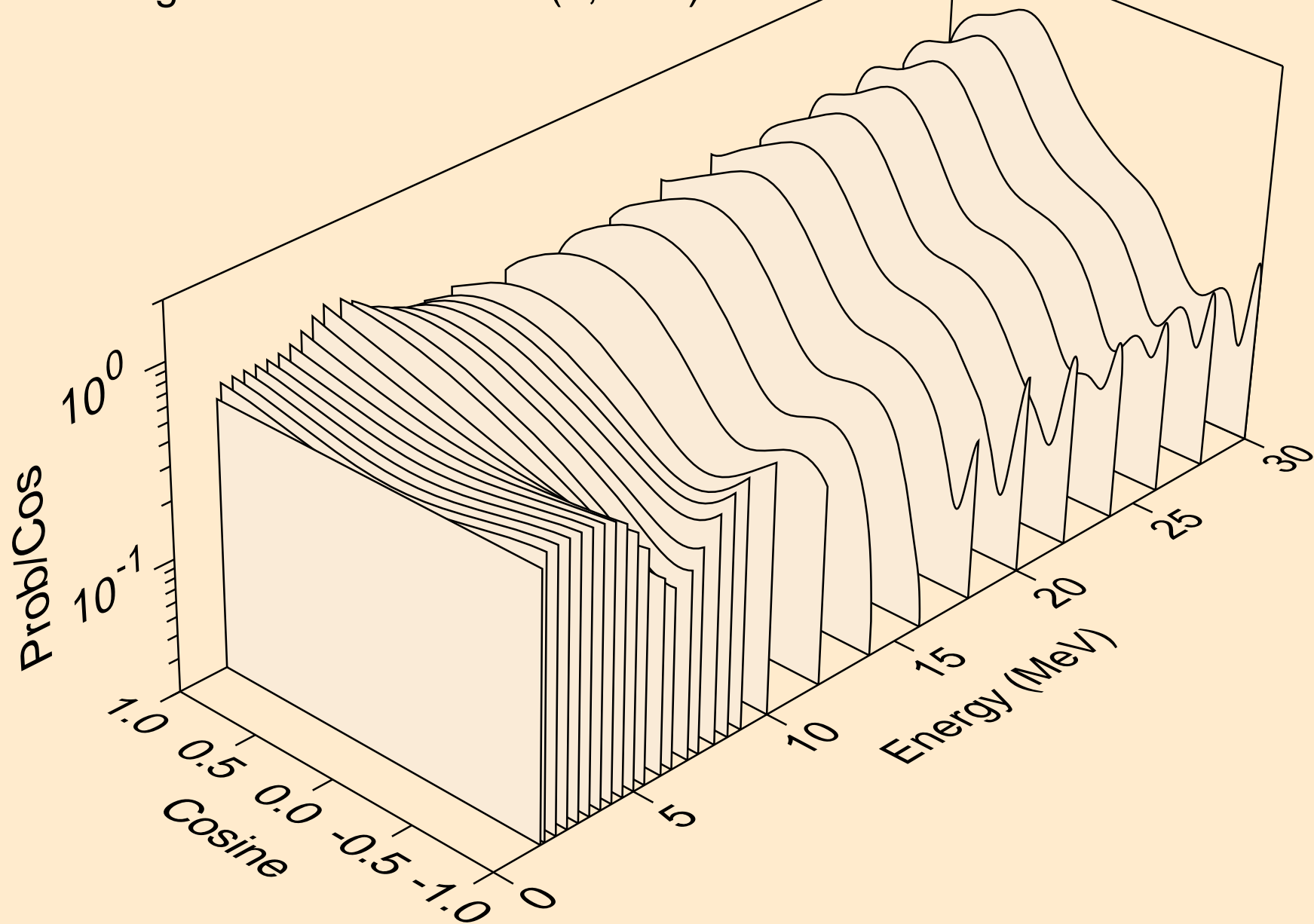

HF183 NEUTRON ACER TENDL-2019 LIBRARY; T=293.16K  
angular distribution for (n,n\*28)

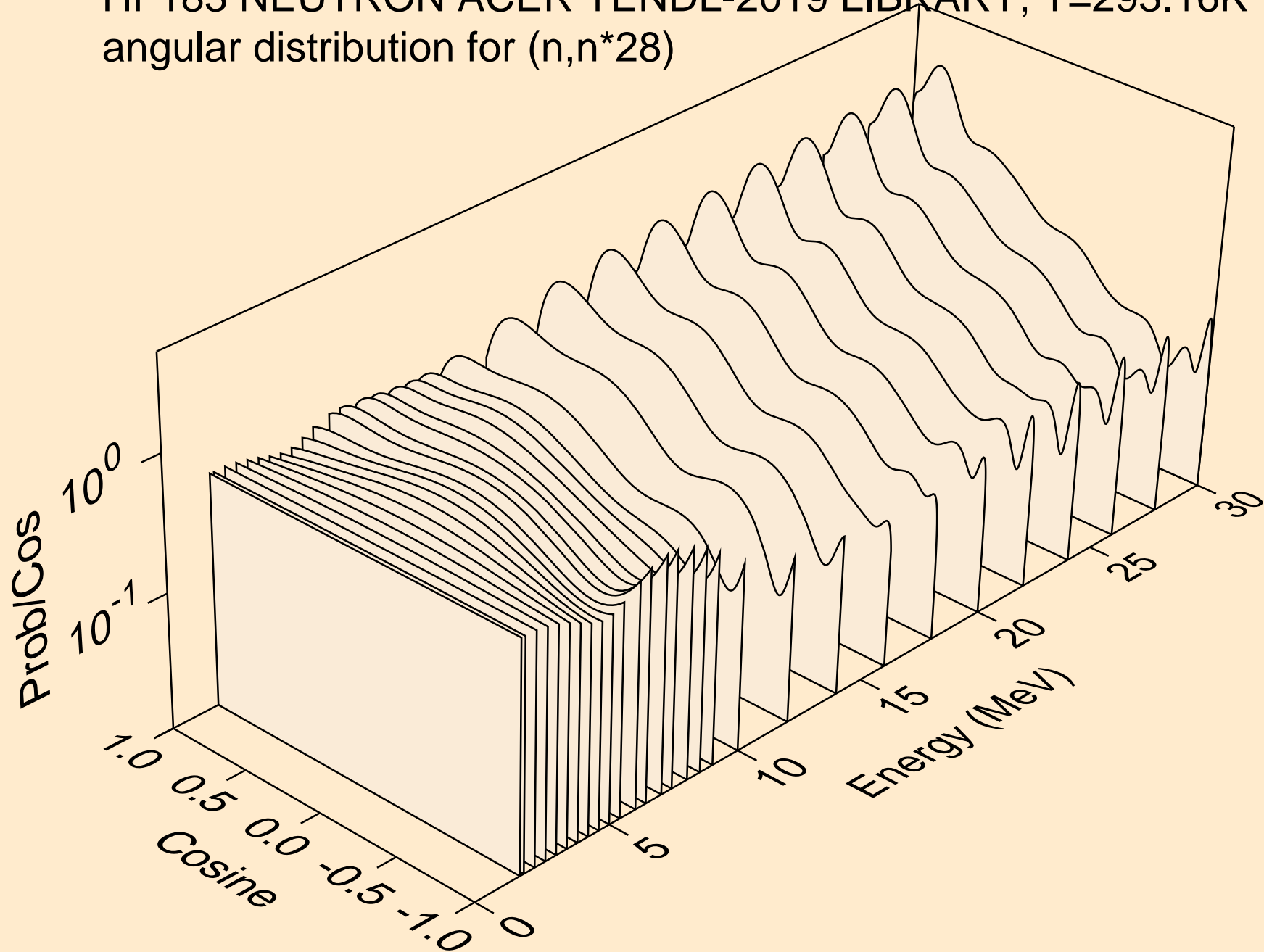

HF183 NEUTRON ACER TENDL-2019 LIBRARY; T=293.16K  
angular distribution for (n,n\*29)

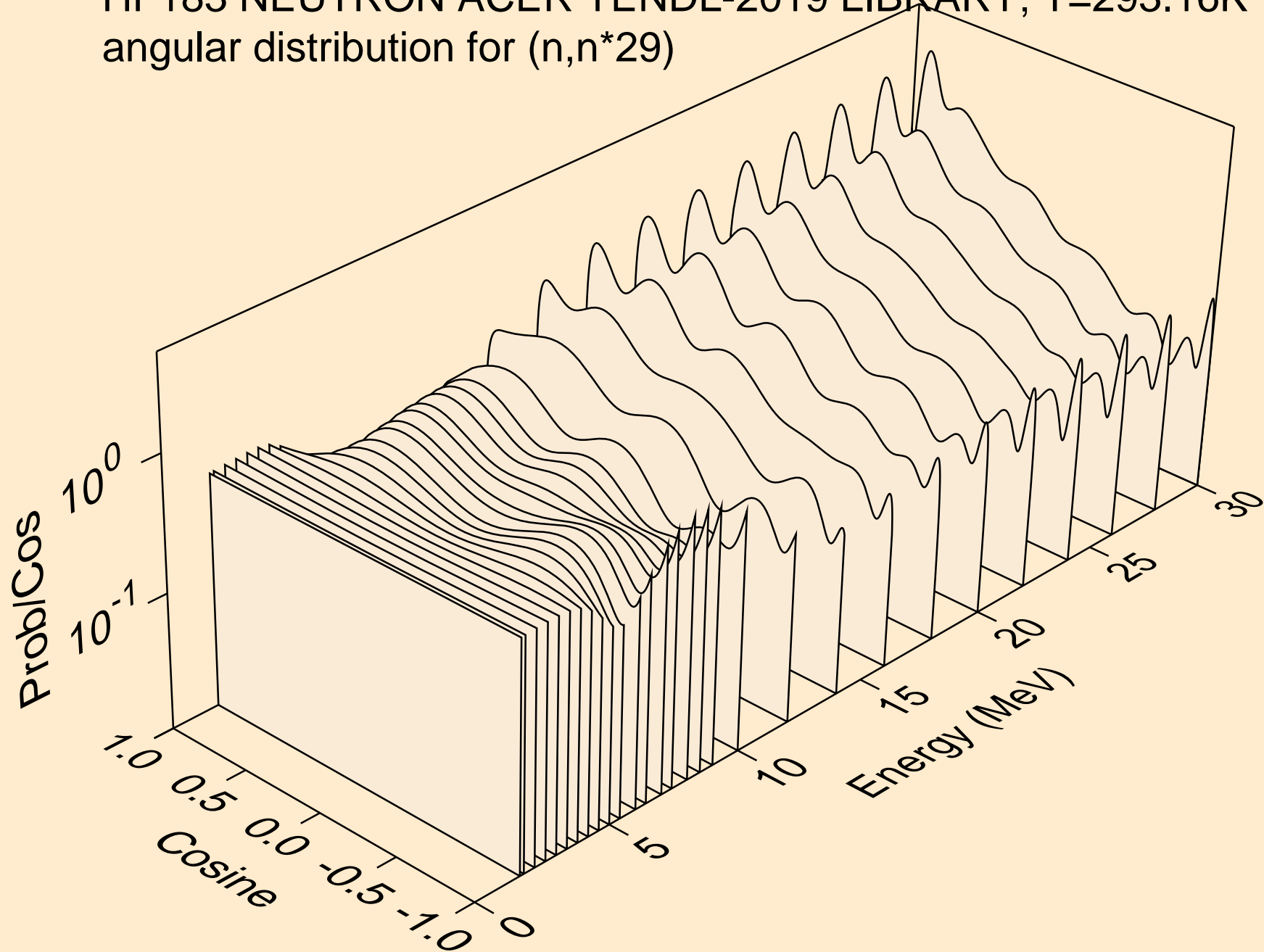

HF183 NEUTRON ACER TENDL-2019 LIBRARY; T=293.16K  
Neutron emission for (n,x)

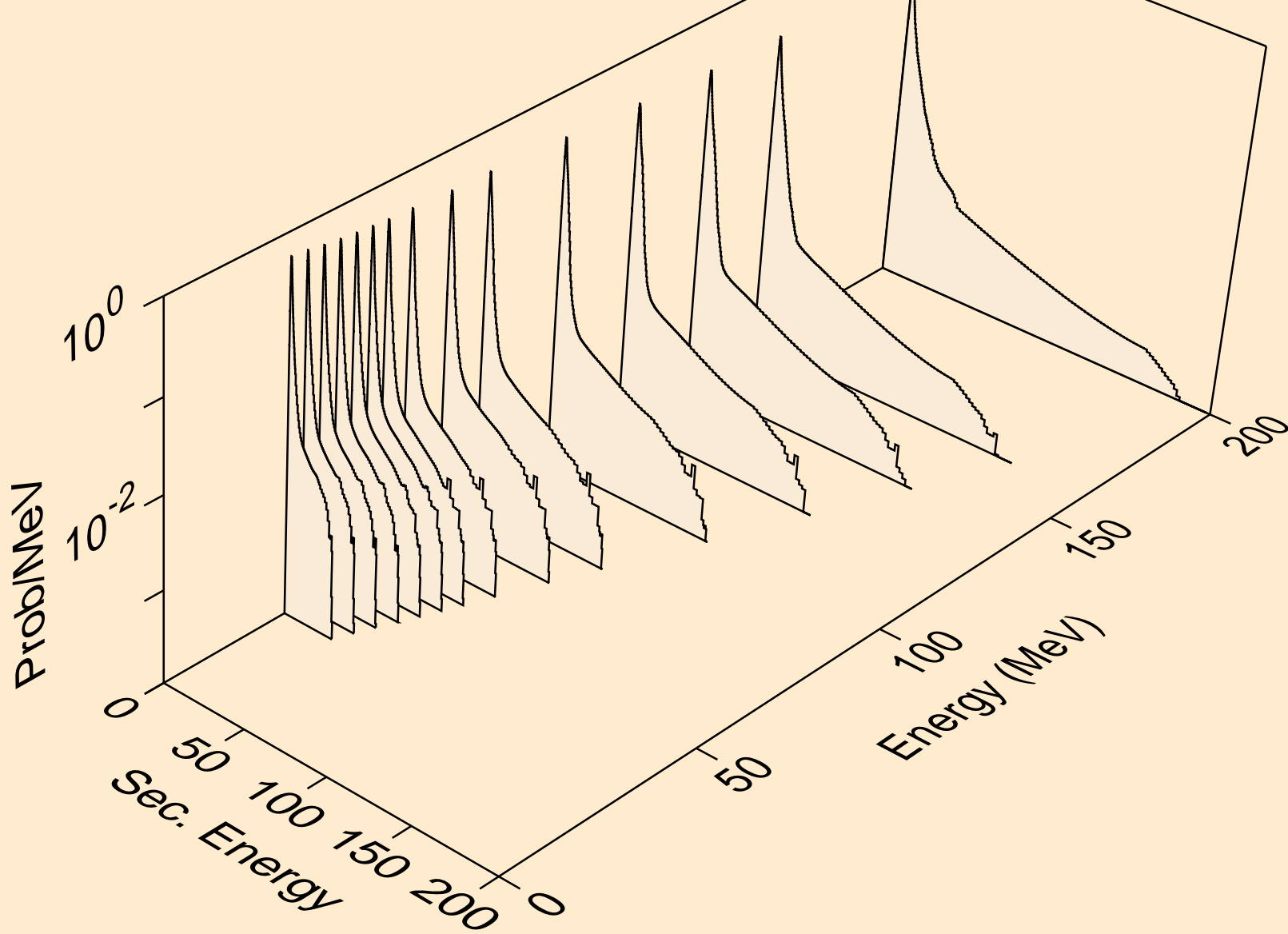

HF183 NEUTRON ACER TENDL-2019 LIBRARY; T=293.16K  
Neutron emission for (n,2nd)

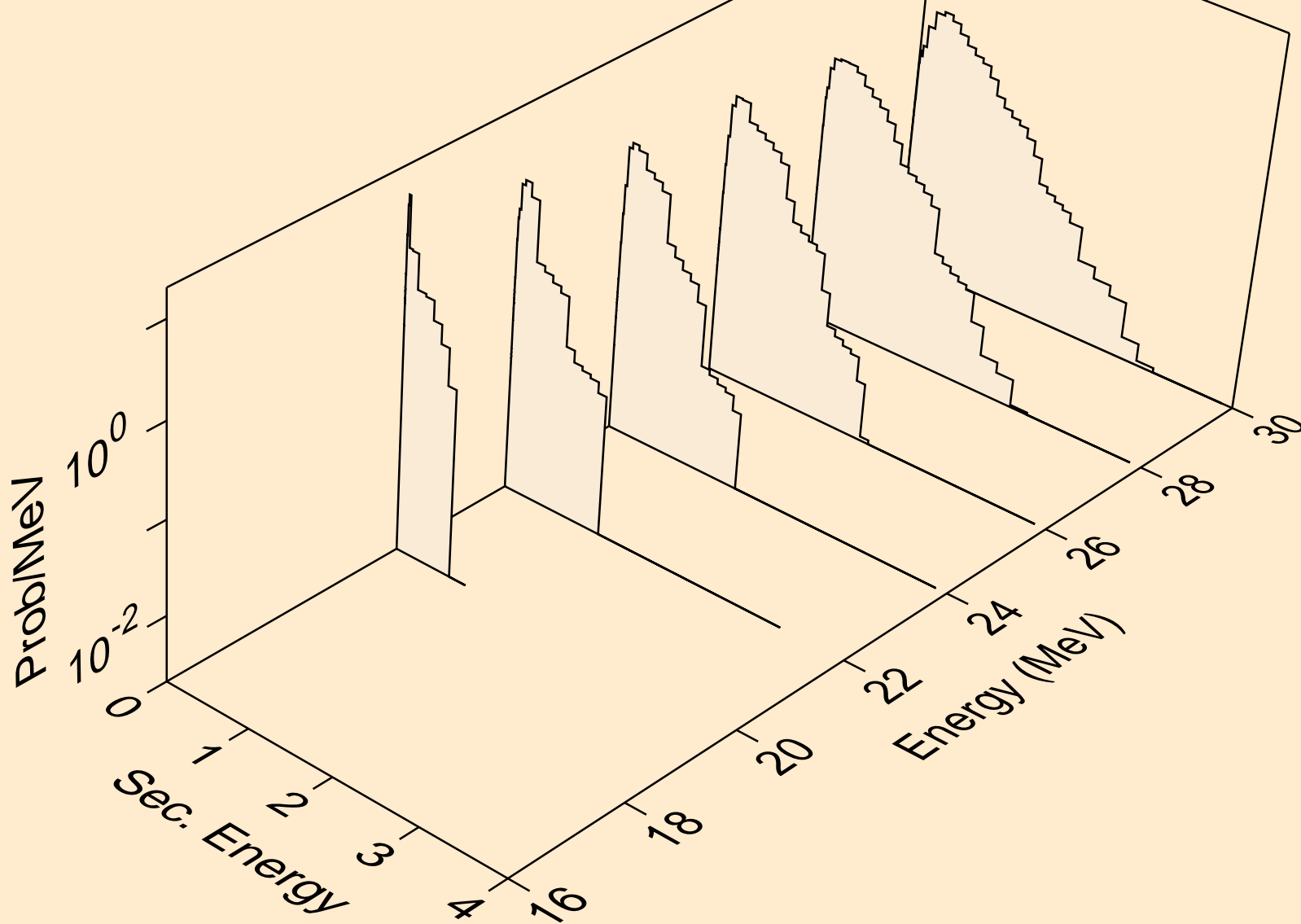

HF183 NEUTRON ACER TENDL-2019 LIBRARY; T=293.16K  
Neutron emission for (n,2n)

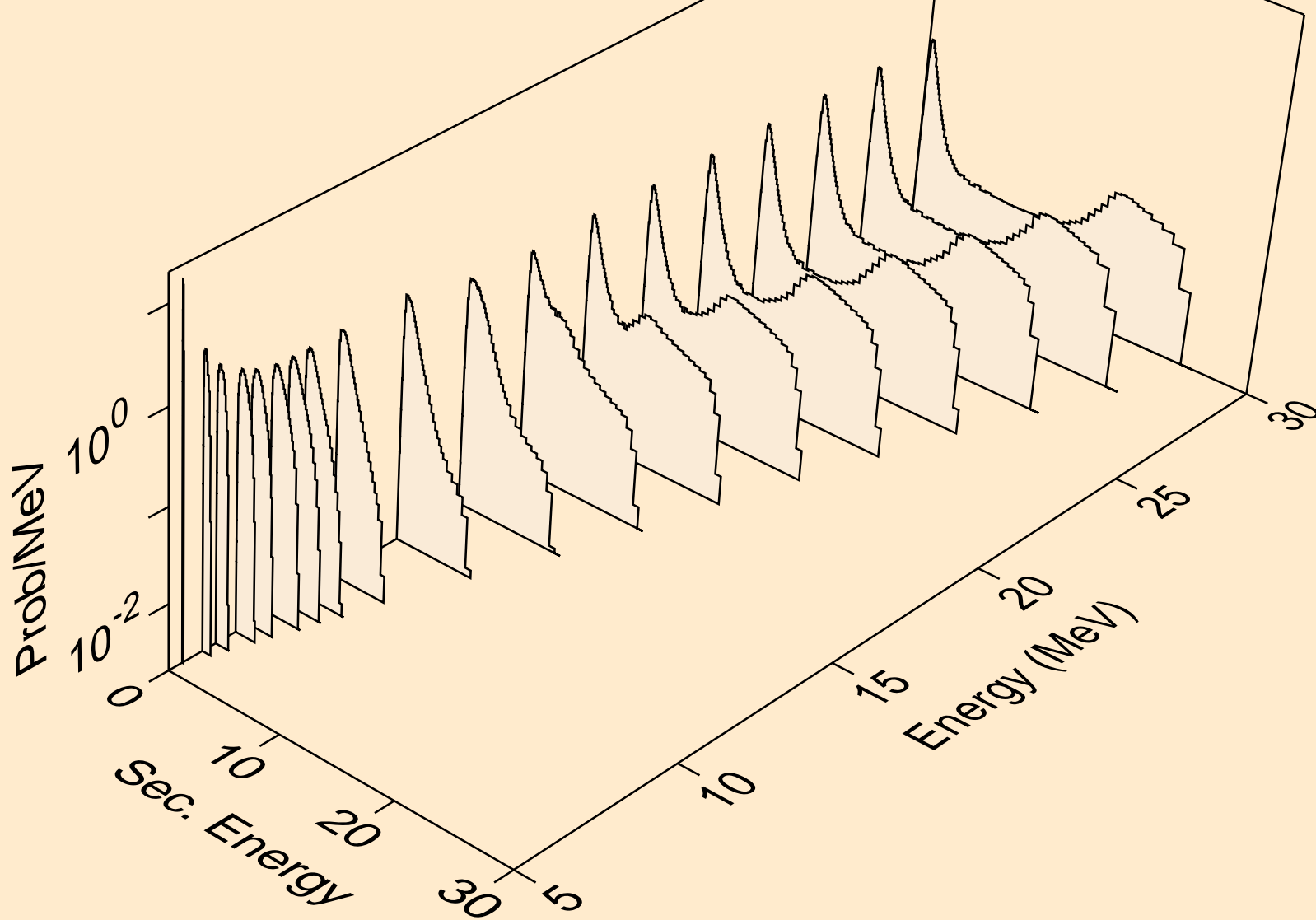

HF183 NEUTRON ACER TENDL-2019 LIBRARY; T=293.16K  
Neutron emission for (n,3n)

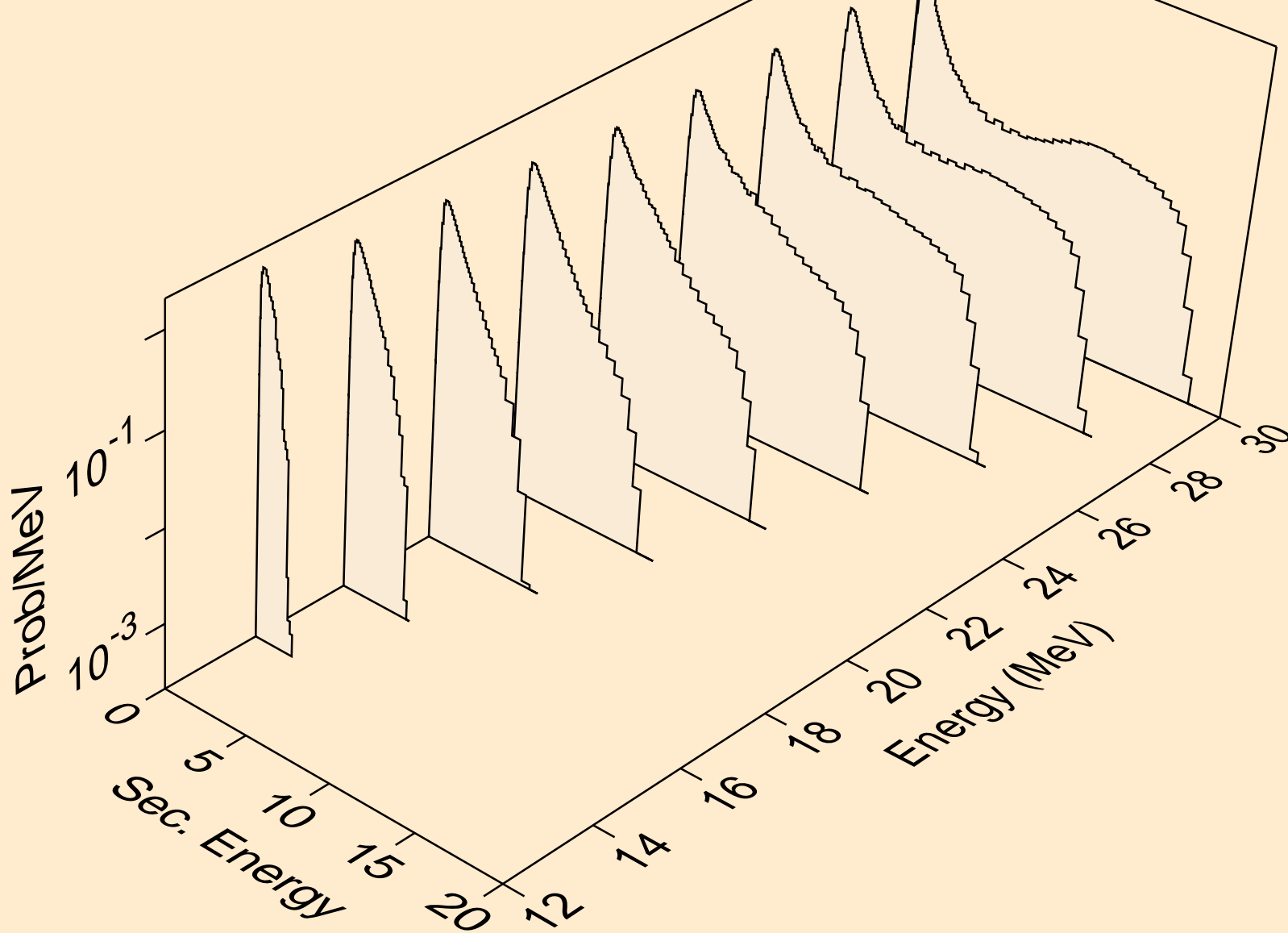

HF183 NEUTRON ACER TENDL-2019 LIBRARY; T=293.16K  
Neutron emission for (n,n\*)a

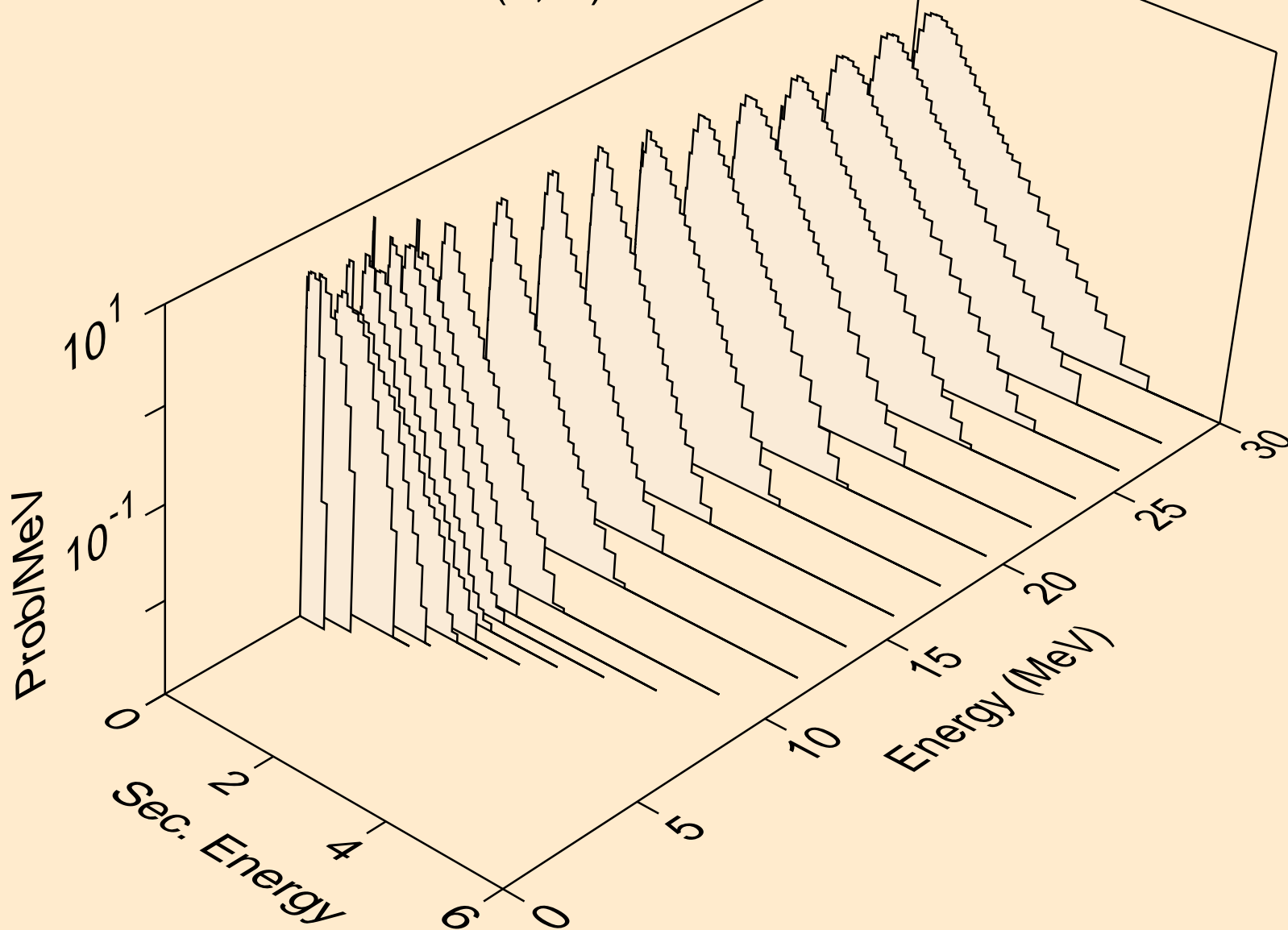



HF183 NEUTRON ACER TENDL-2019 LIBRARY; T=293.16K  
Neutron emission for (n,2n)<sub>a</sub>

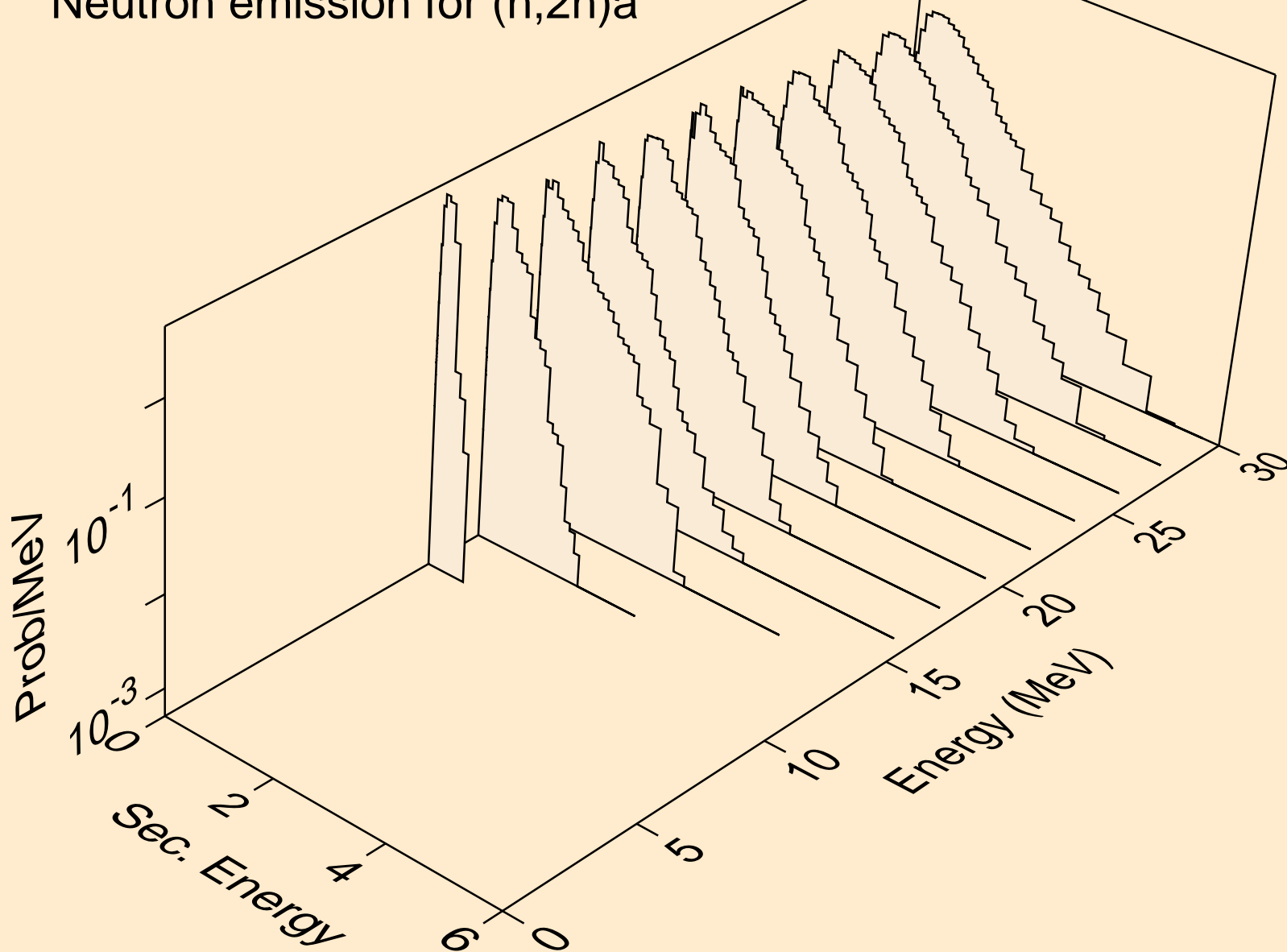

HF183 NEUTRON ACER TENDL-2019 LIBRARY; T=293.16K  
Neutron emission for (n,3n)a

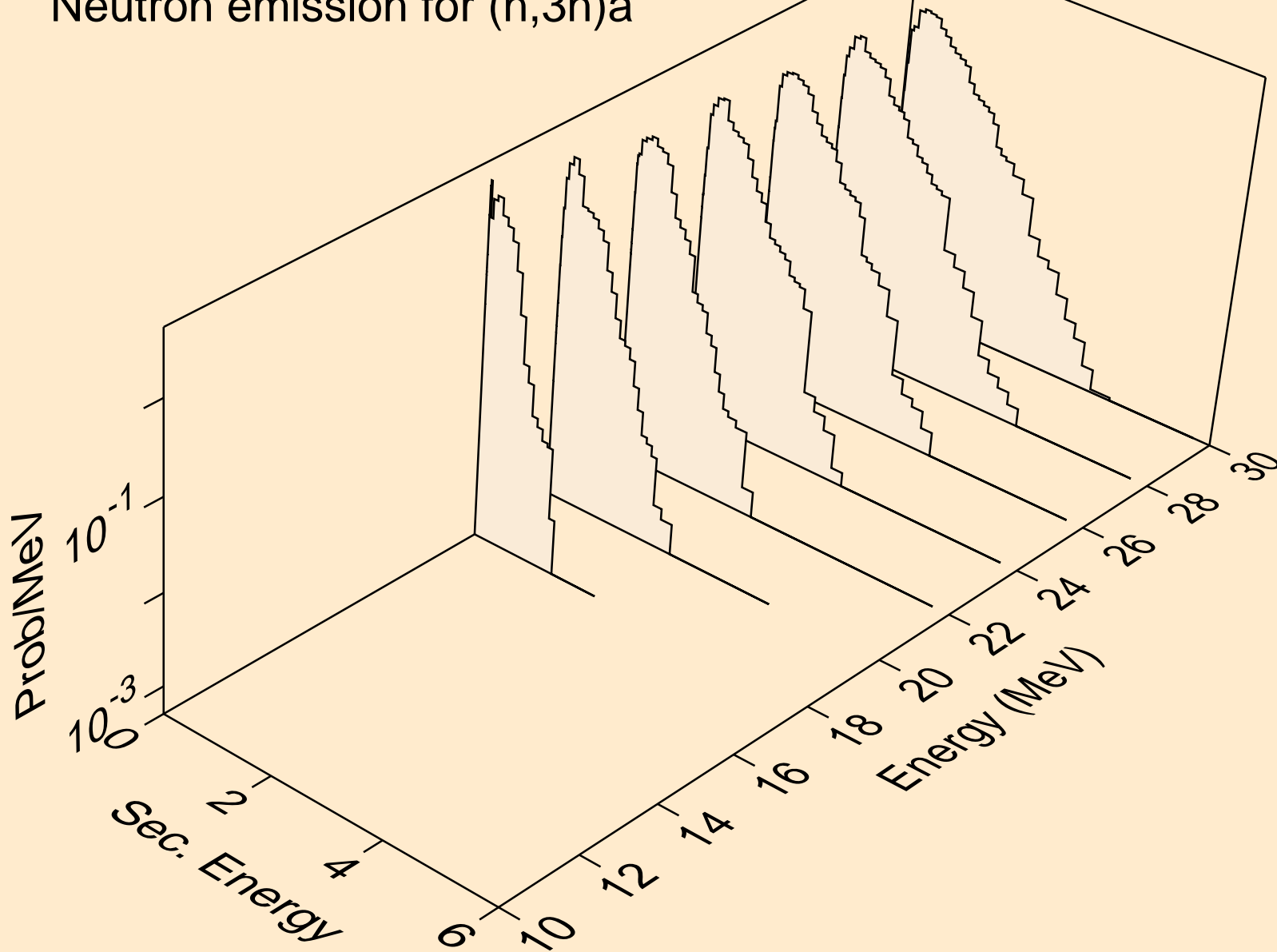

HF183 NEUTRON ACER TENDL-2019 LIBRARY; T=293.16K  
Neutron emission for (n,n\*)p

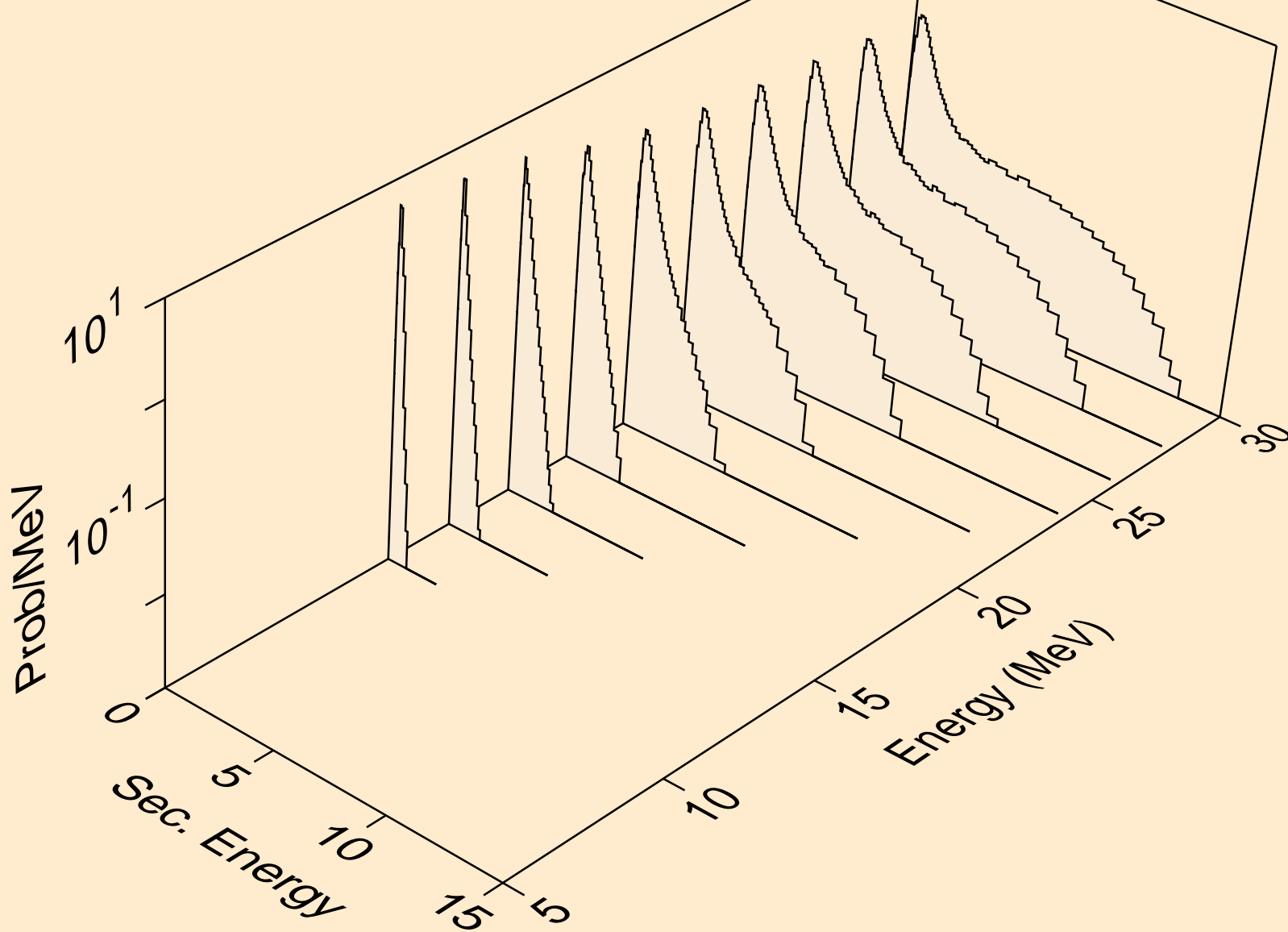

HF183 NEUTRON ACER TENDL-2019 LIBRARY; T=293.16K  
Neutron emission for (n,n\*)d

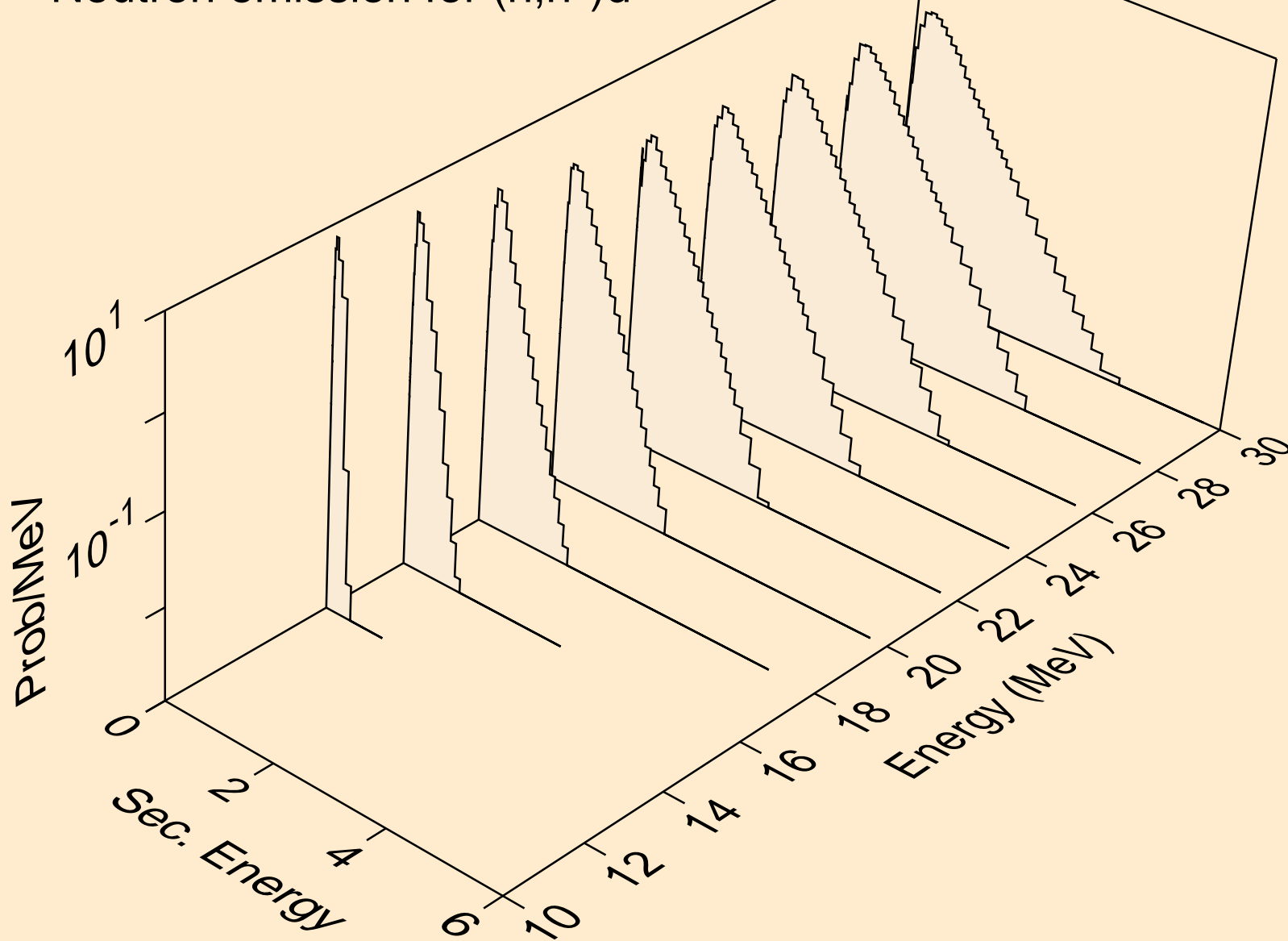

HF183 NEUTRON ACER TENDL-2019 LIBRARY; T=293.16K  
Neutron emission for (n,n\*)t

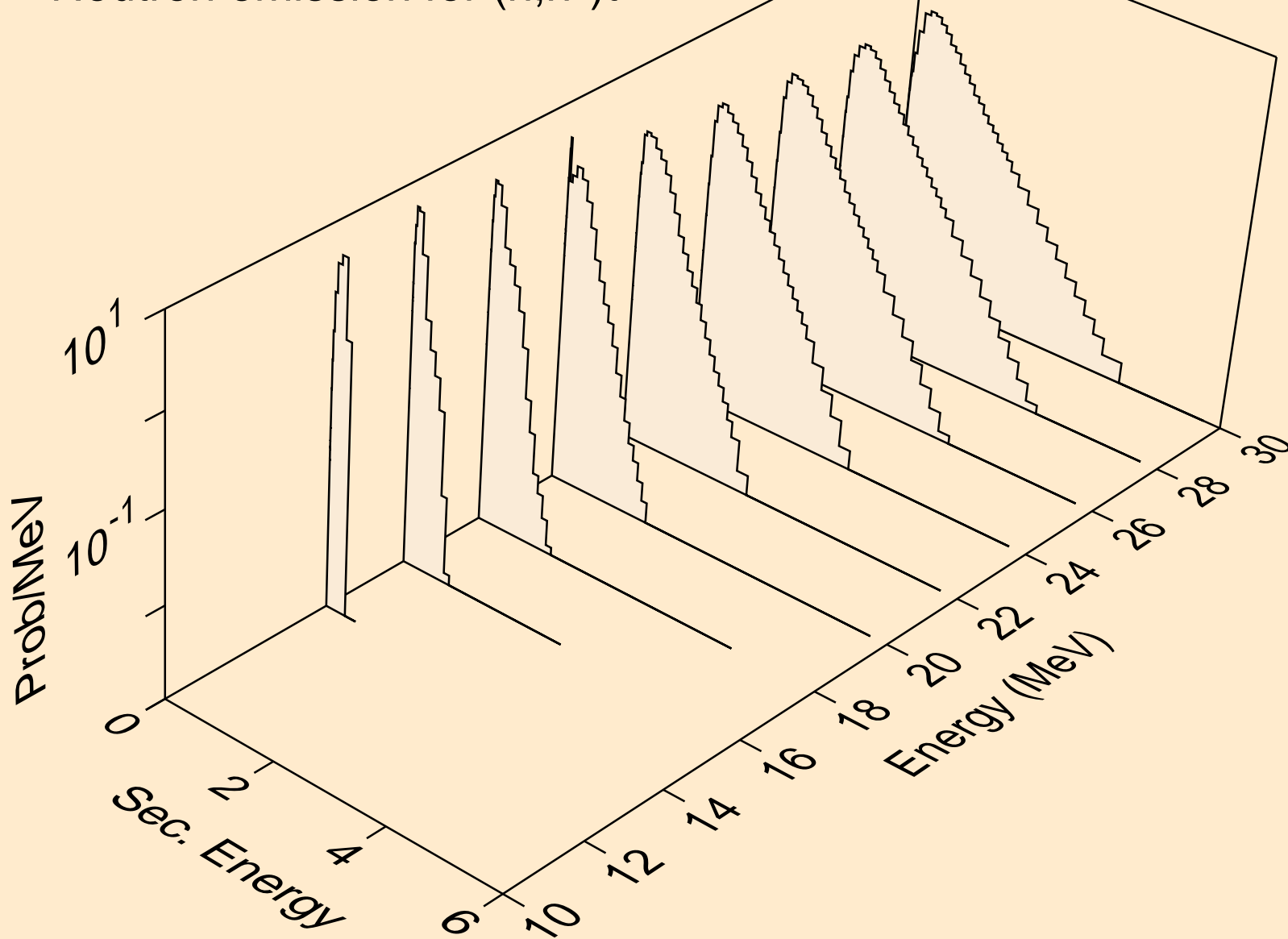

HF183 NEUTRON ACER TENDL-2019 LIBRARY; T=293.16K  
Neutron emission for (n,n\*)he3

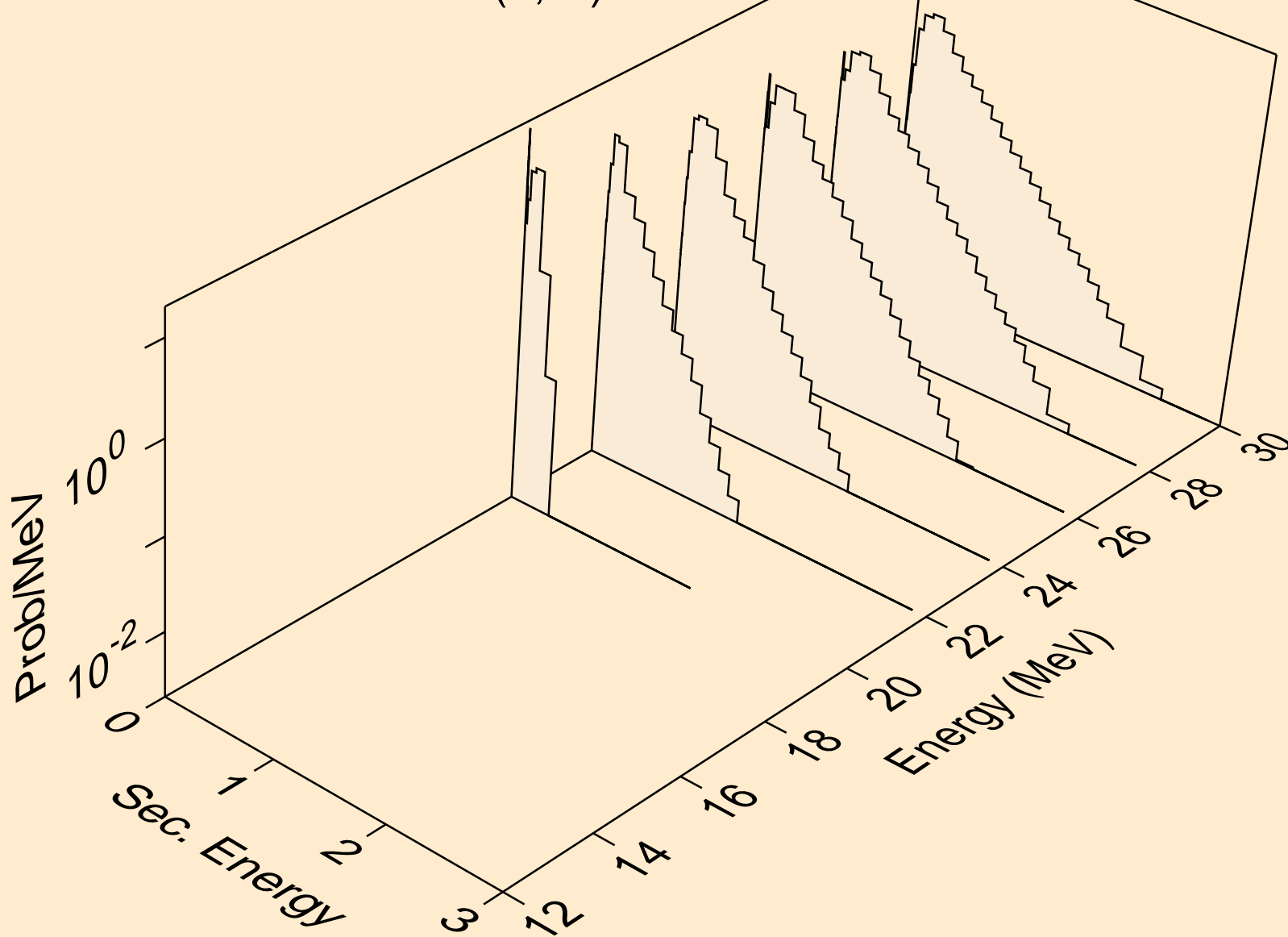

HF183 NEUTRON ACER TENDL-2019 LIBRARY; T=293.16K  
Neutron emission for (n,4n)

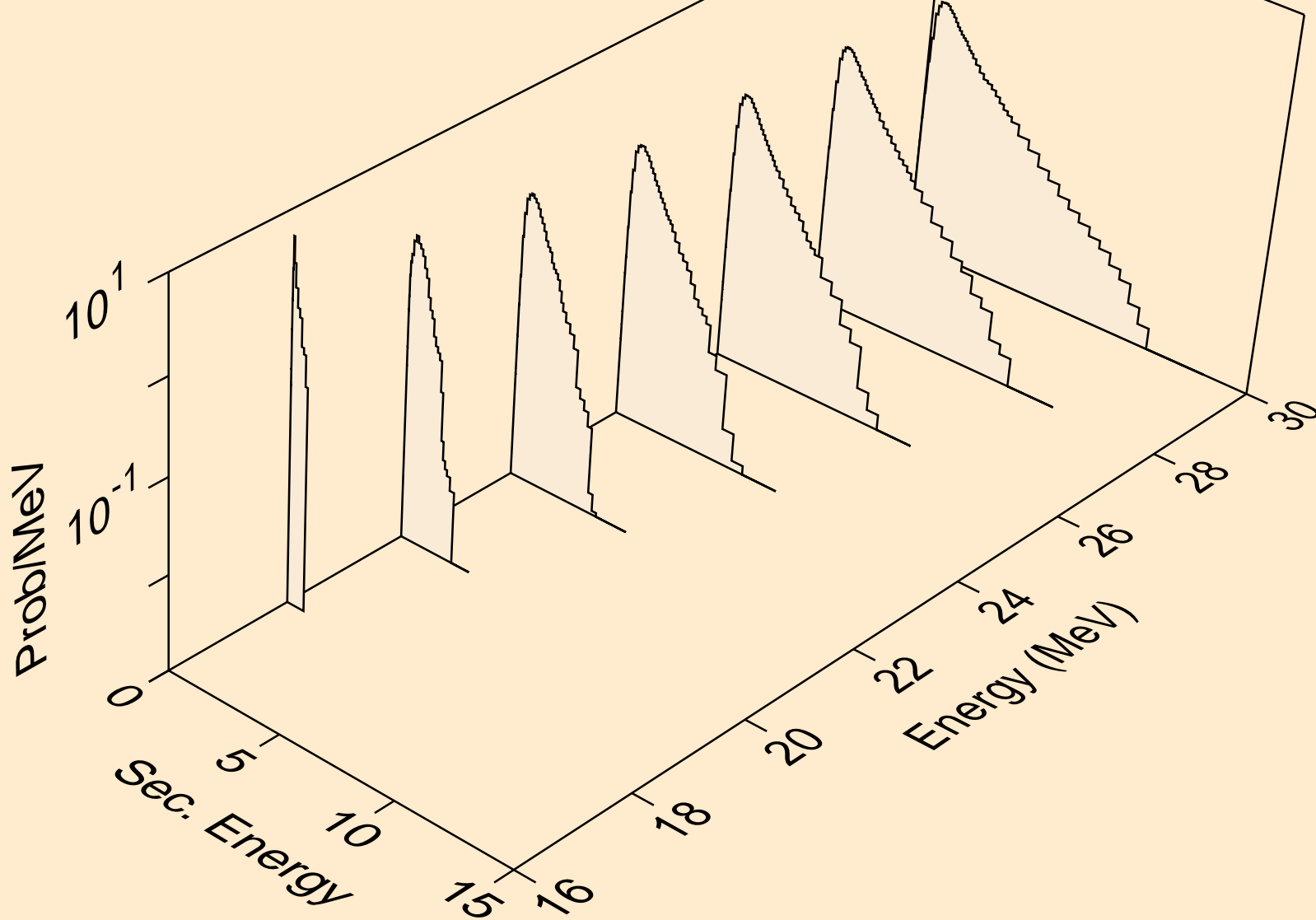

HF183 NEUTRON ACER TENDL-2019 LIBRARY; T=293.16K  
Neutron emission for (n,2np)

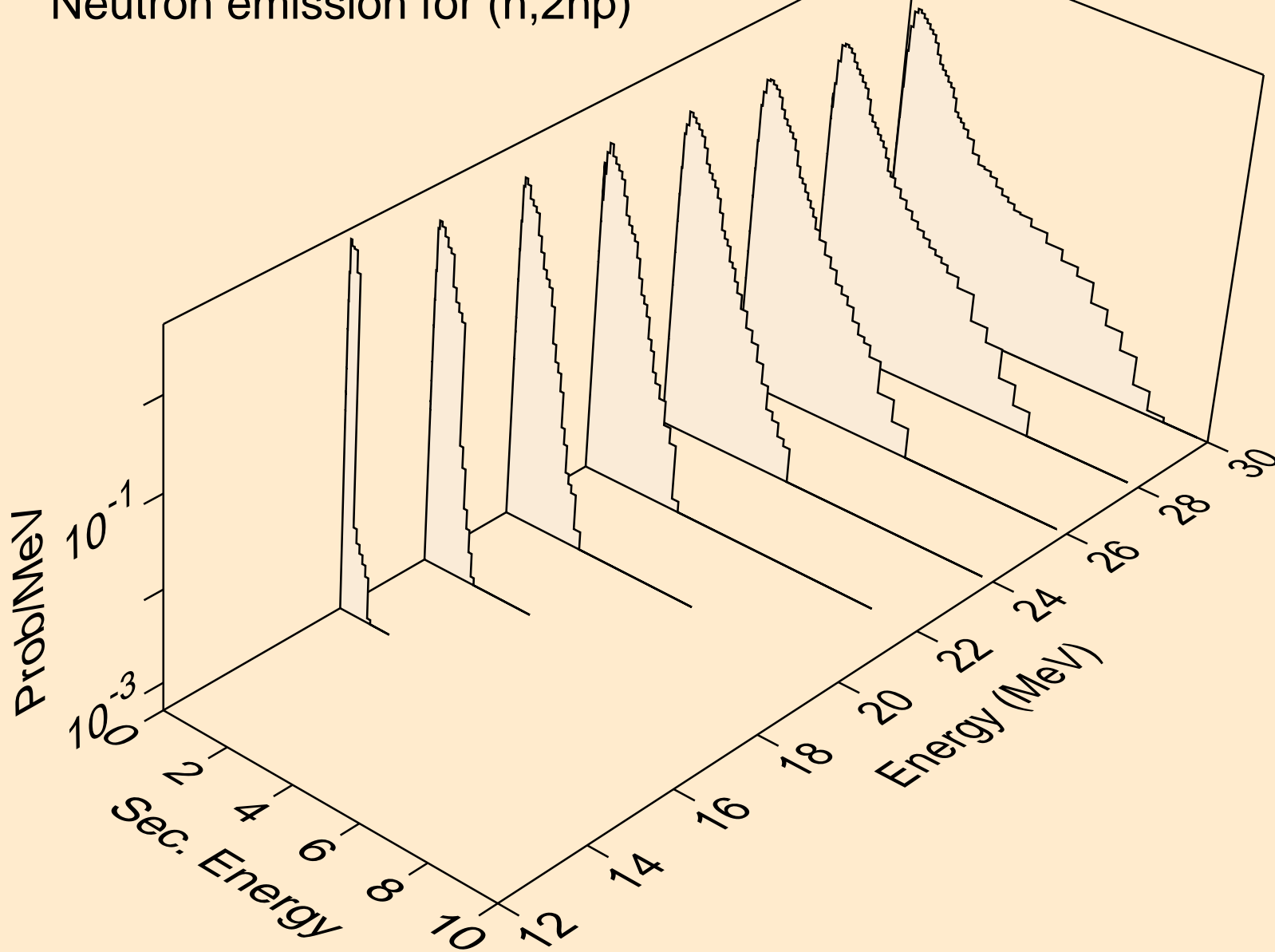



HF183 NEUTRON ACER TENDL-2019 LIBRARY; T=293.16K  
Neutron emission for (n,3np)

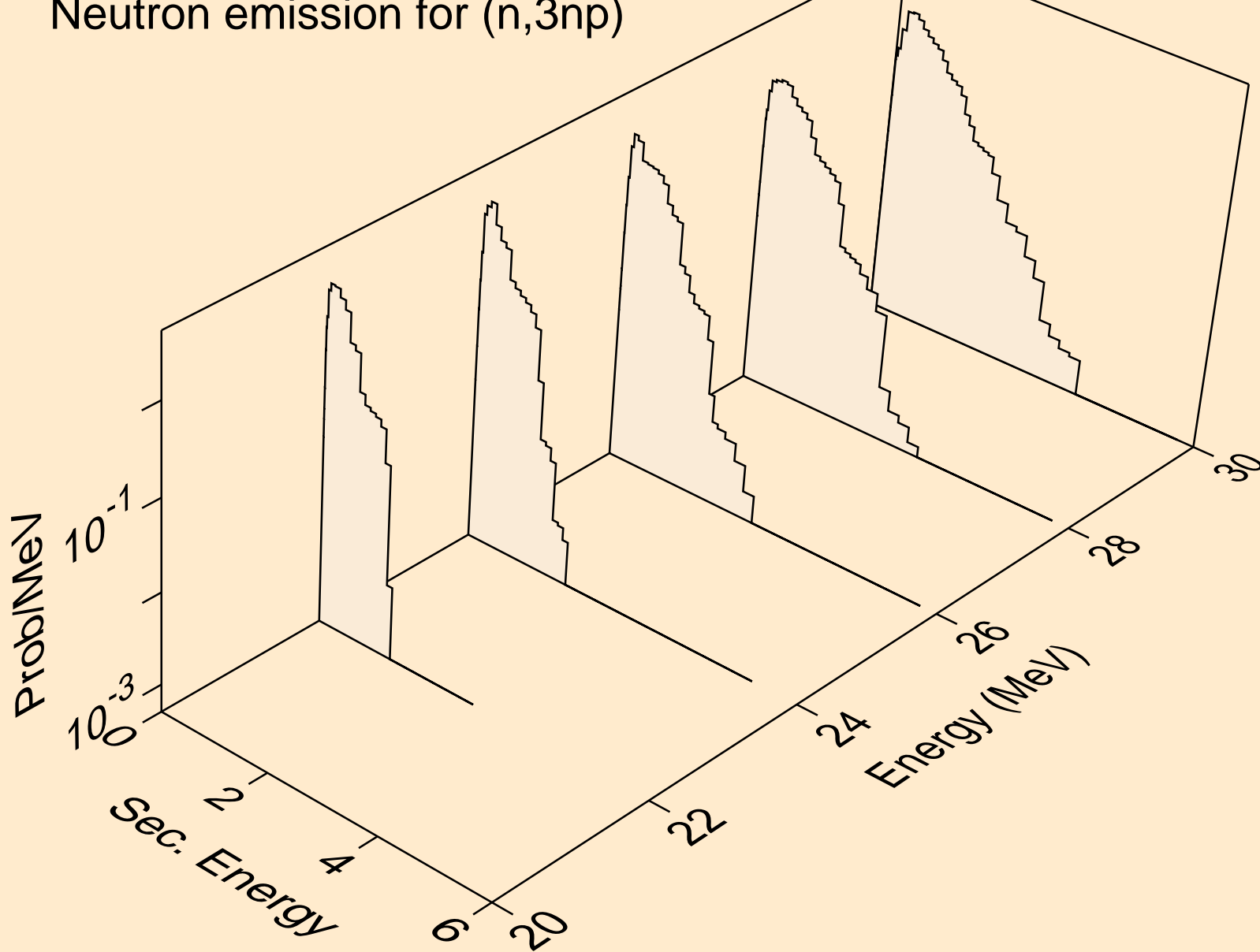

HF183 NEUTRON ACER TENDL-2019 LIBRARY; T=293.16K  
Neutron emission for (n,2np)

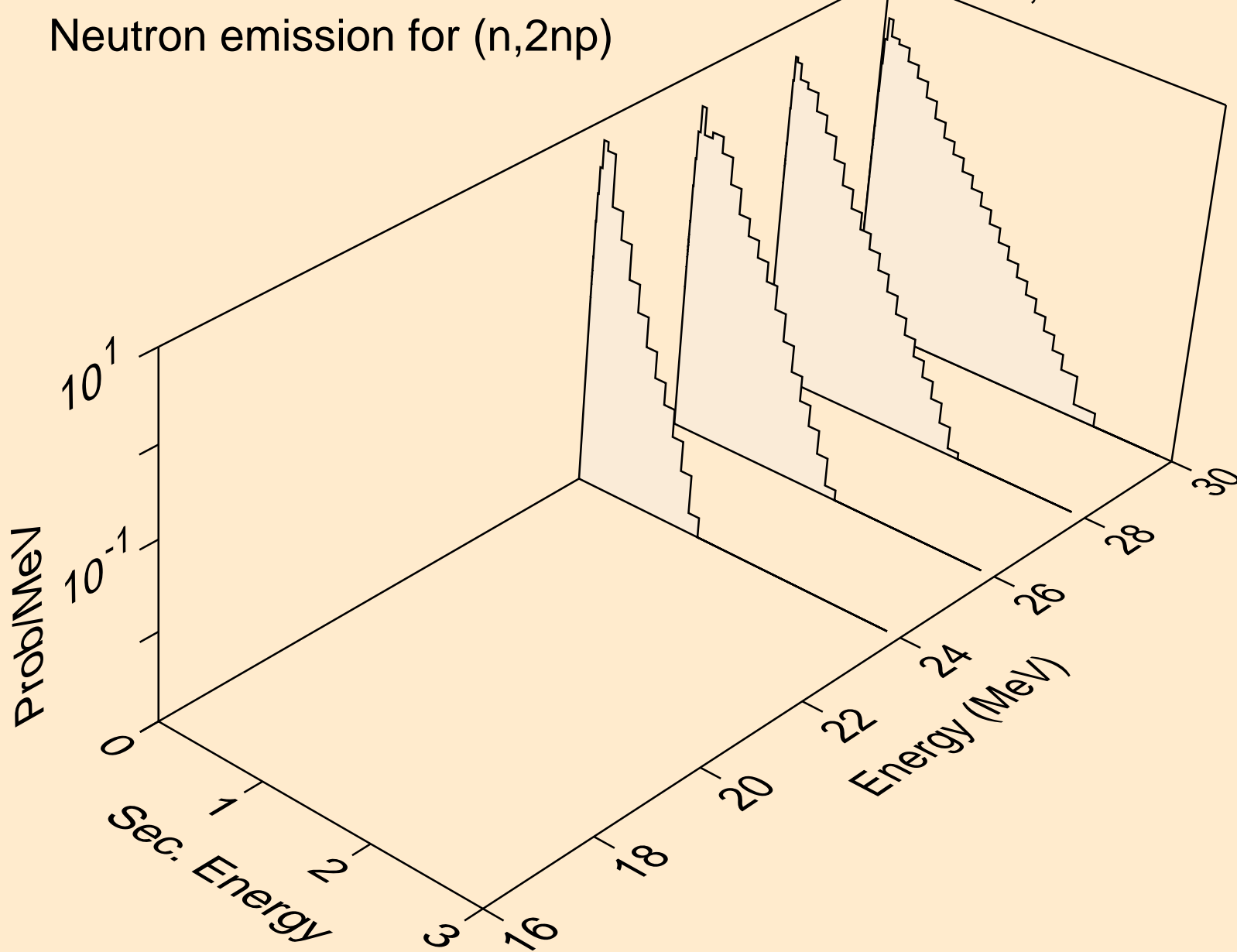

HF183 NEUTRON ACER TENDL-2019 LIBRARY; T=293.16K  
Neutron emission for (n,n\*c)

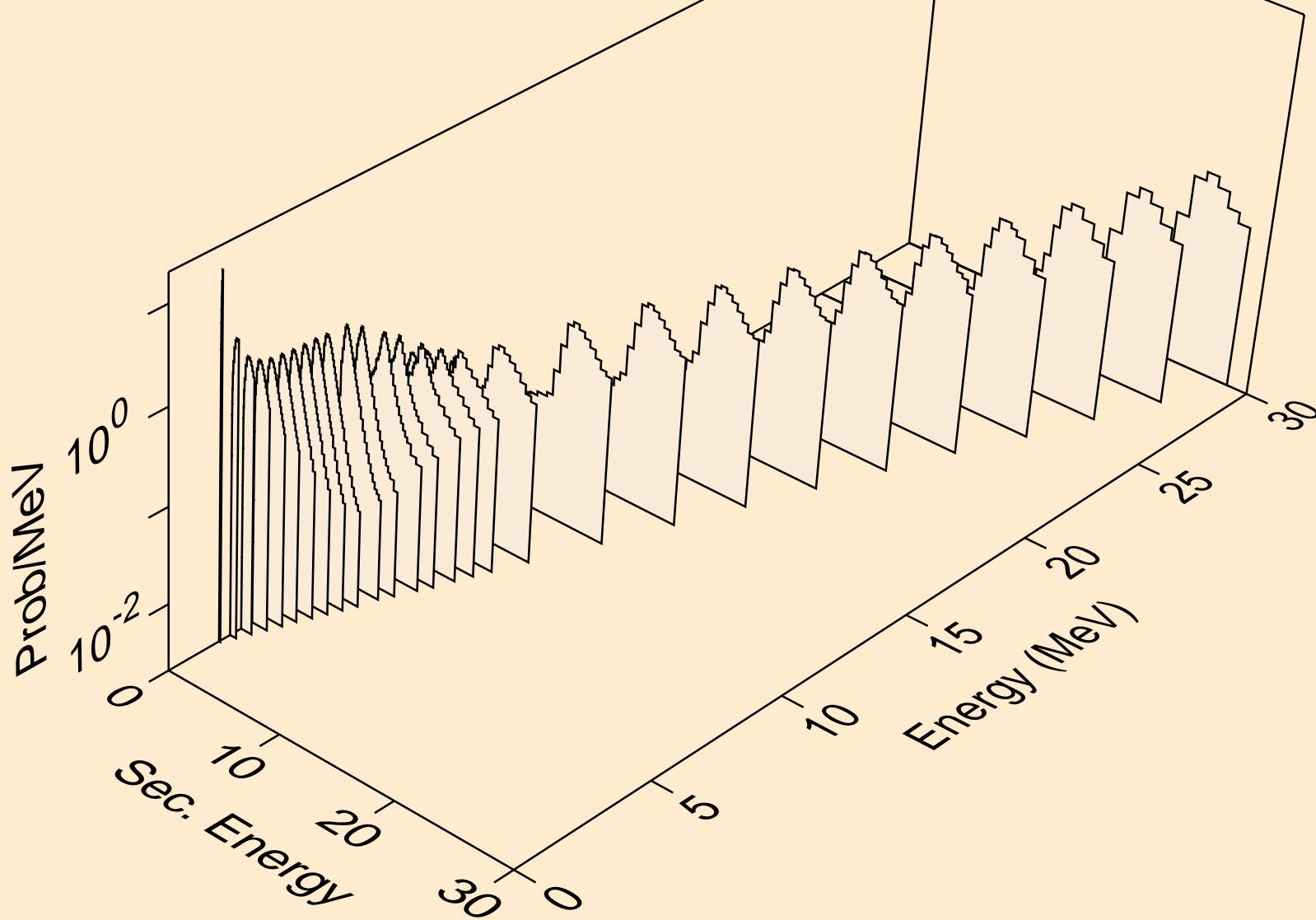

HF183 NEUTRON ACER TENDL-2019 LIBRARY; T=293.16K  
Photon emission for (n,x)

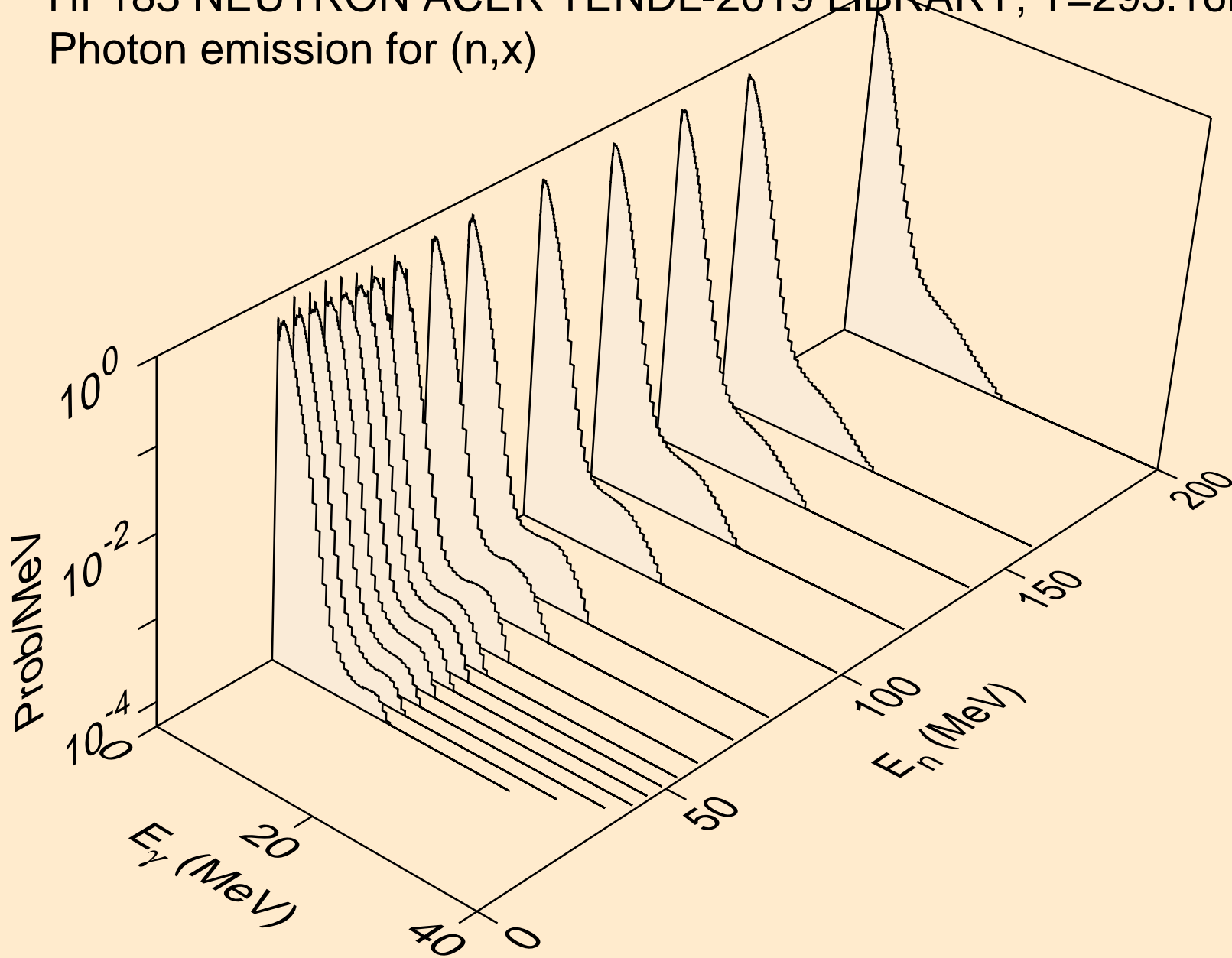

HF183 NEUTRON ACER TENDL-2019 LIBRARY; T=293.16K  
Photon emission for (n,2nd)

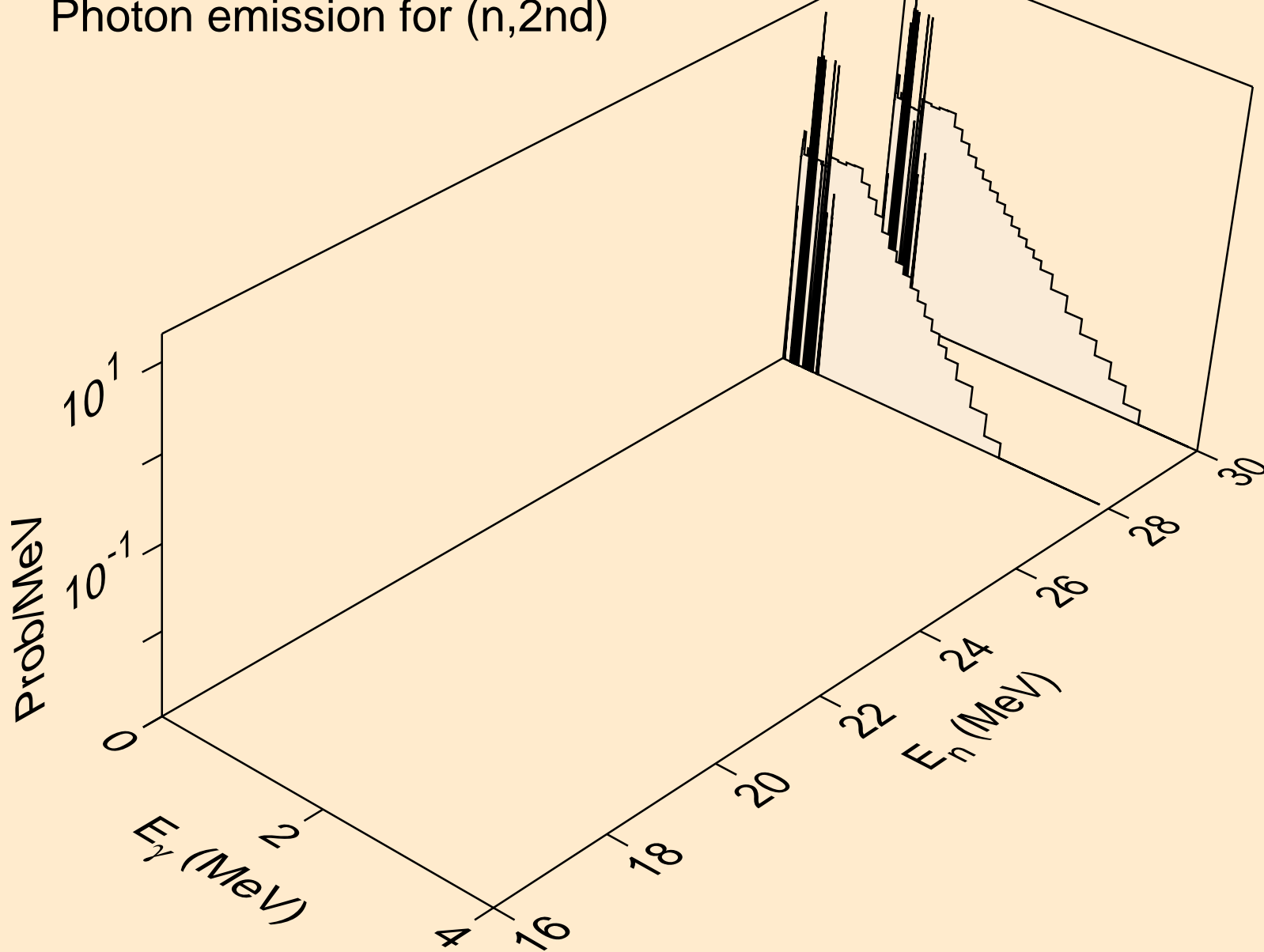

HF183 NEUTRON ACER TENDL-2019 LIBRARY; T=293.16K  
Photon emission for (n,2n)

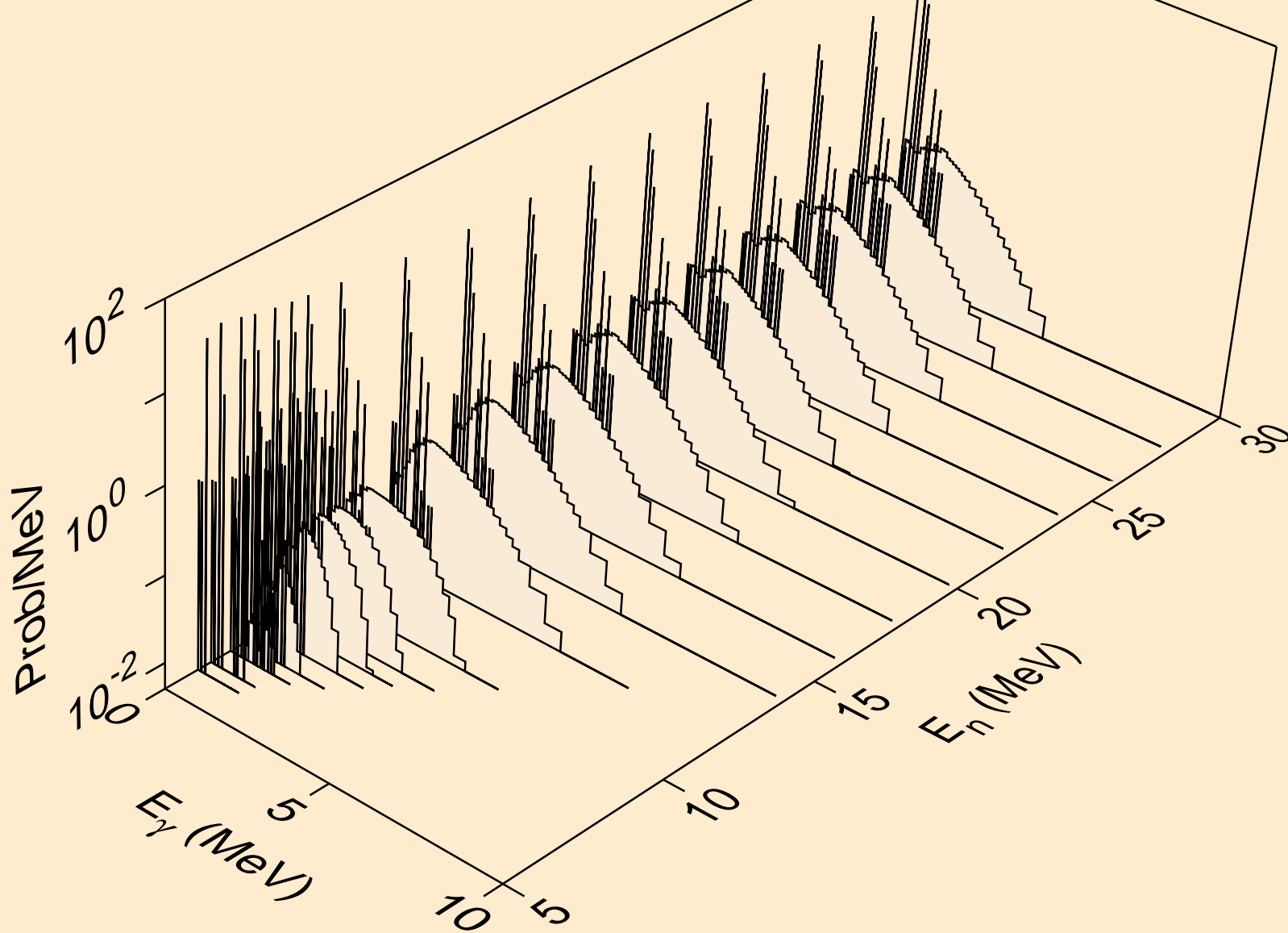

HF183 NEUTRON ACER TENDL-2019 LIBRARY; T=293.16K  
Photon emission for (n,3n)

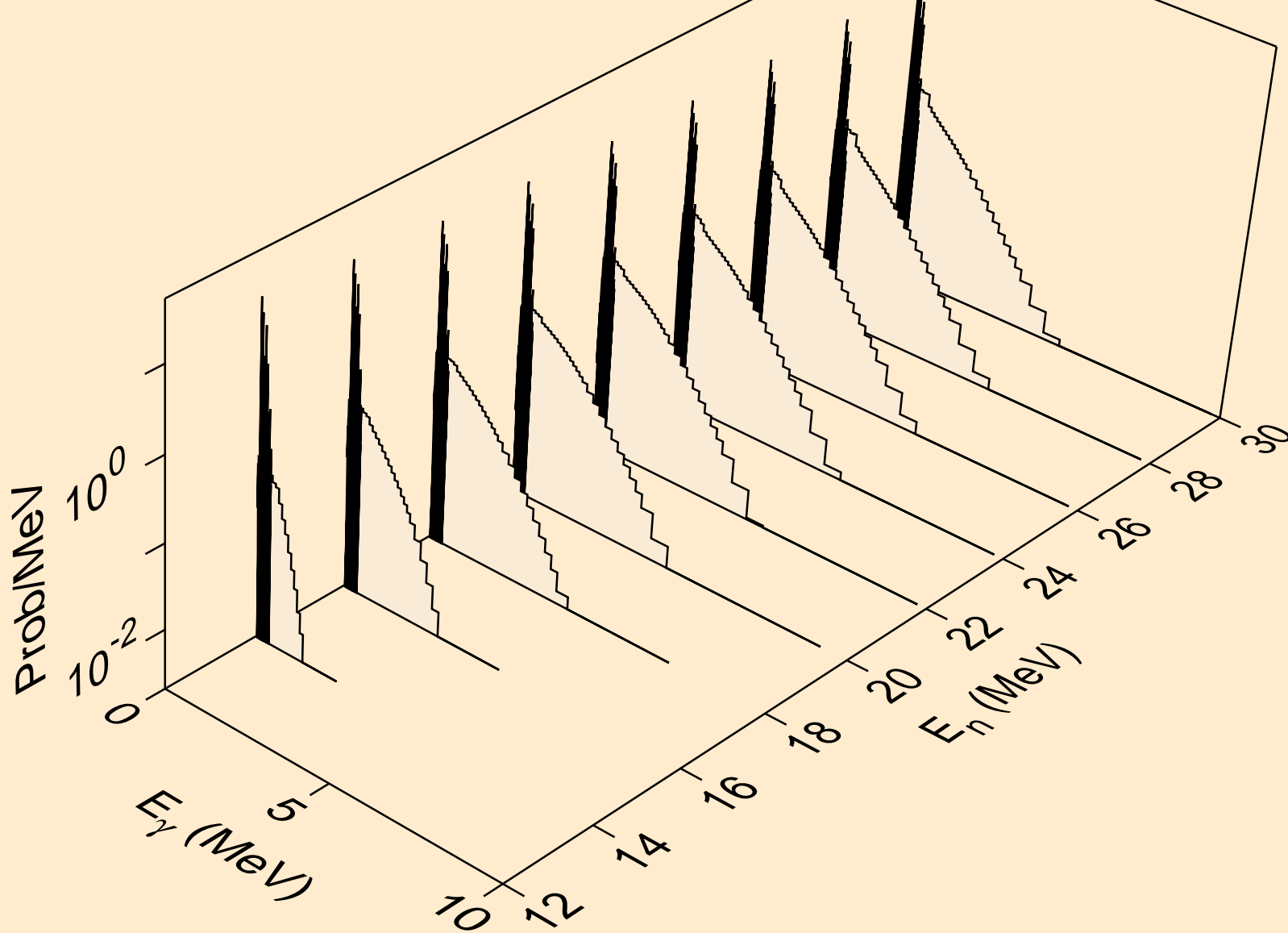

HF183 NEUTRON ACER TENDL-2019 LIBRARY; T=293.16K  
Photon emission for (n,n\*)a

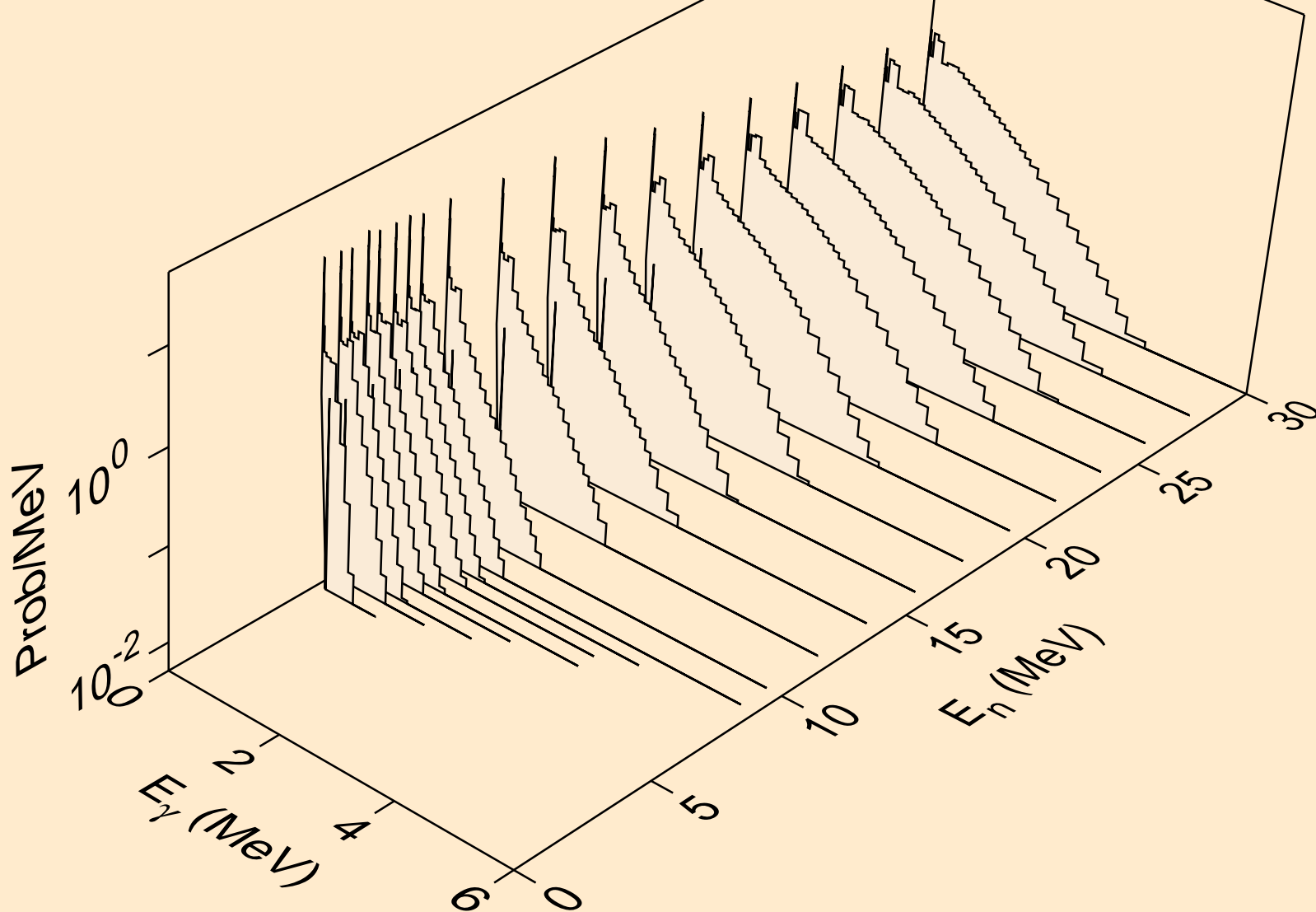



HF183 NEUTRON ACER TENDL-2019 LIBRARY; T=293.16K  
Photon emission for (n,2n)a

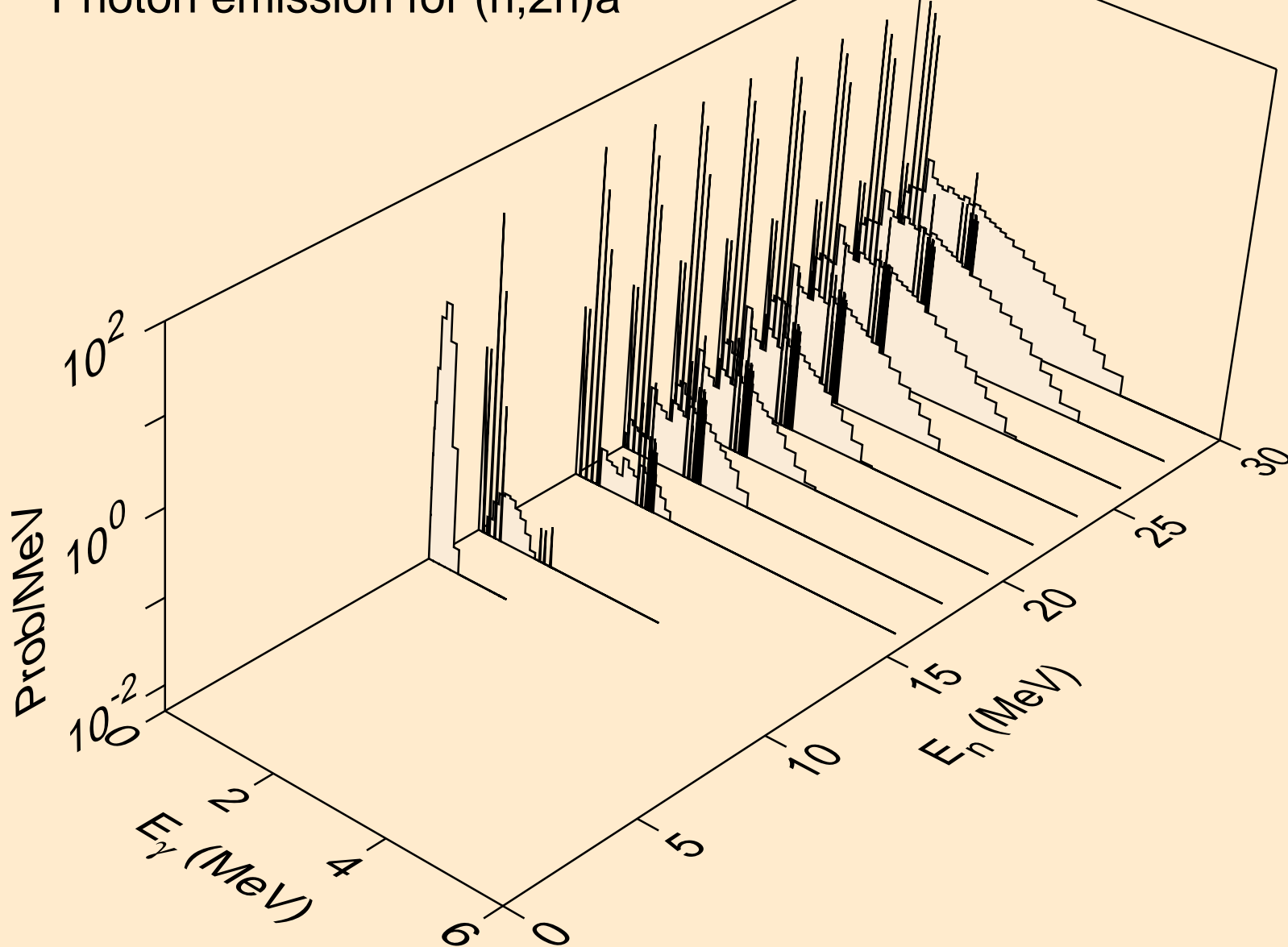

HF183 NEUTRON ACER TENDL-2019 LIBRARY; T=293.16K  
Photon emission for (n,3n)a

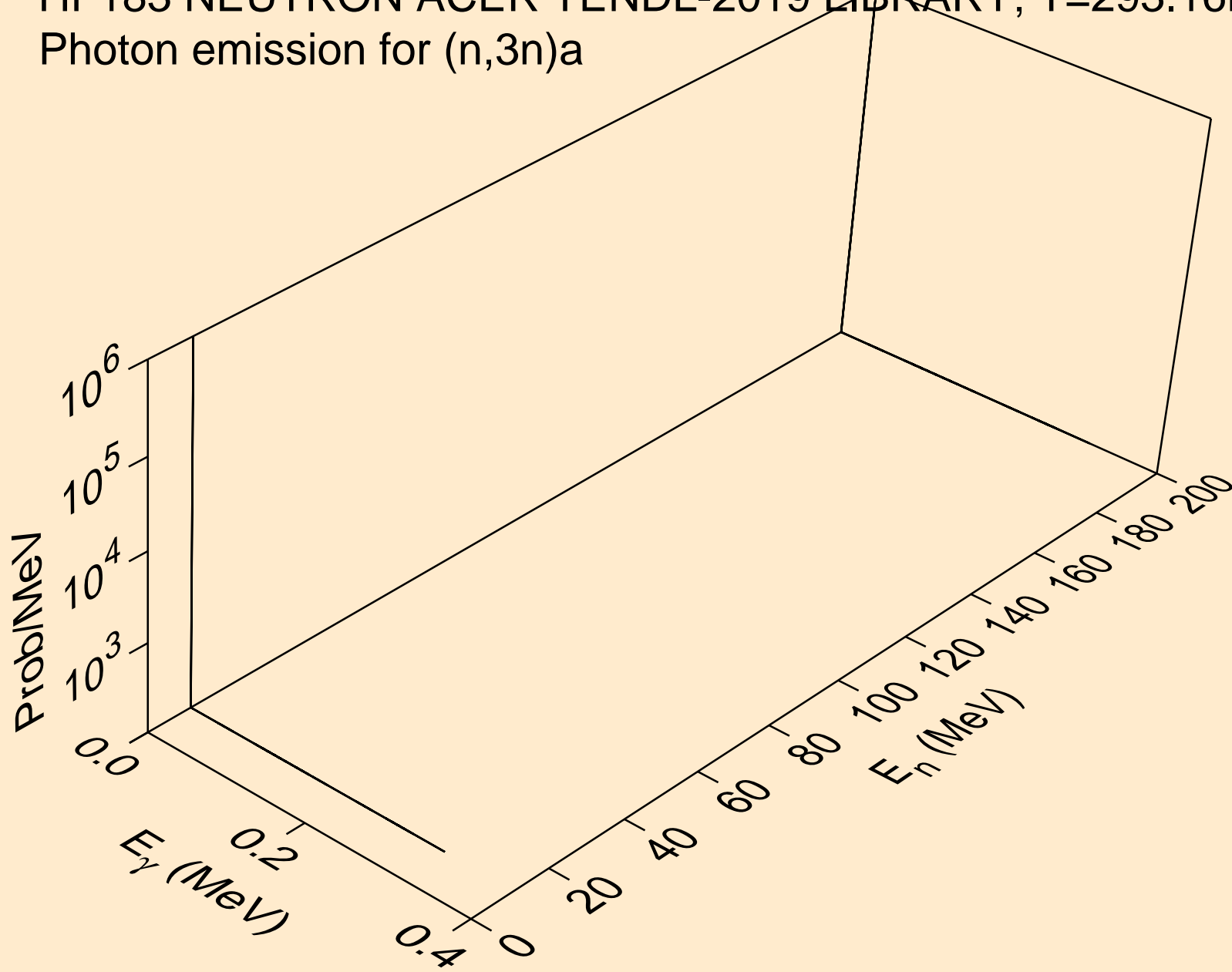

HF183 NEUTRON ACER TENDL-2019 LIBRARY; T=293.16K  
Photon emission for (n,n\*)p

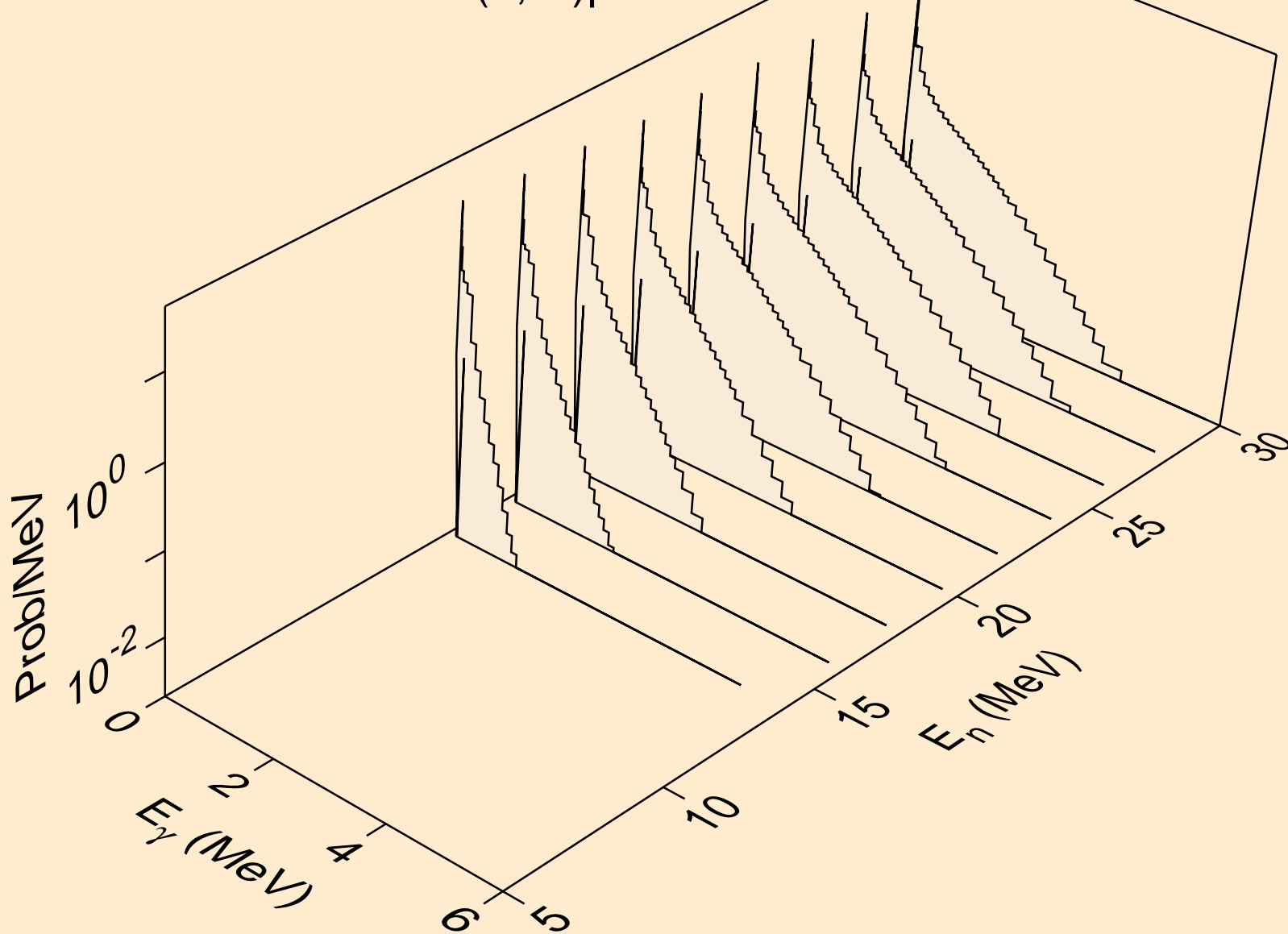

HF183 NEUTRON ACER TENDL-2019 LIBRARY; T=293.16K  
Photon emission for (n,n\*)d

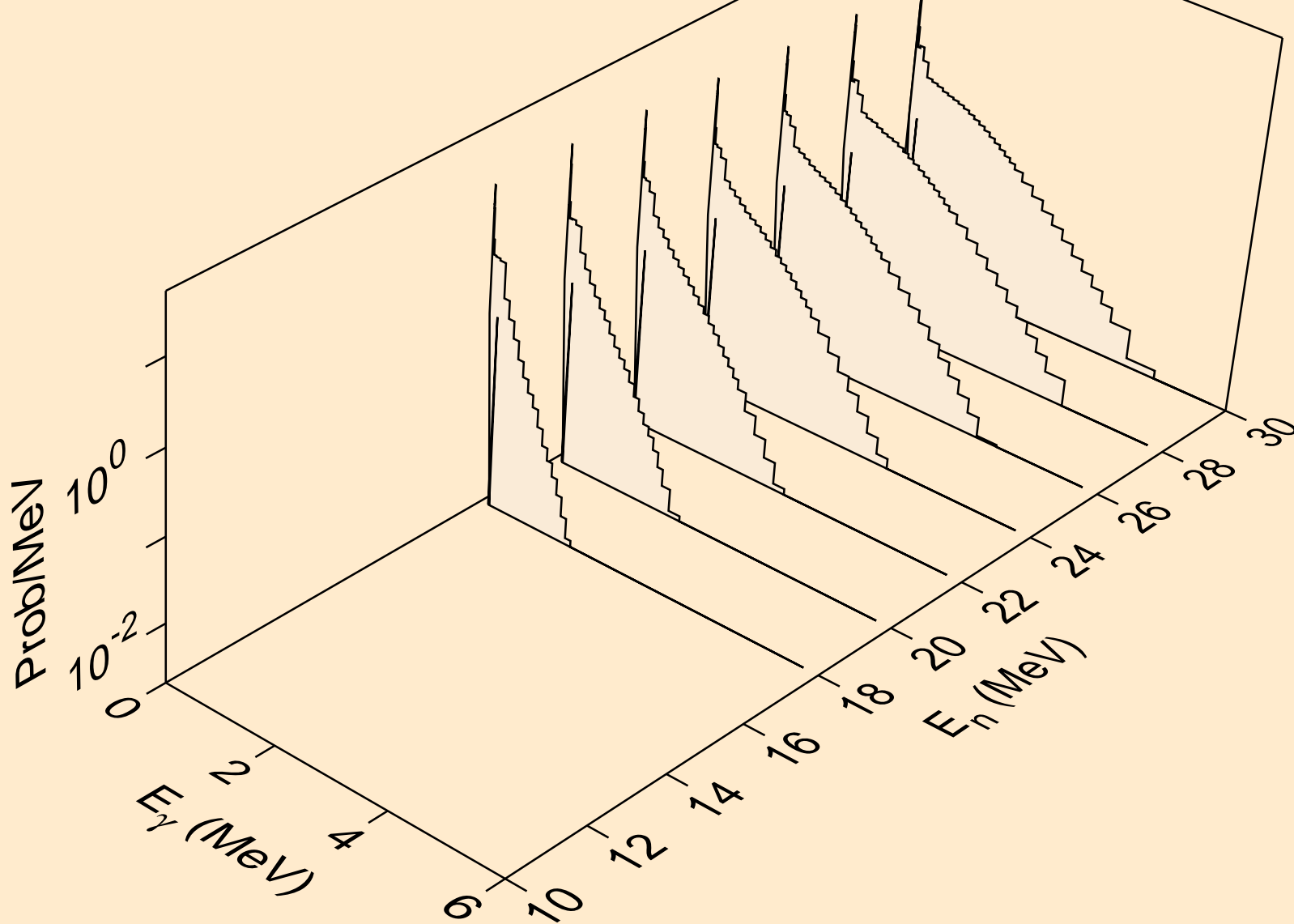

HF183 NEUTRON ACER TENDL-2019 LIBRARY; T=293.16K  
Photon emission for (n,n\*)t

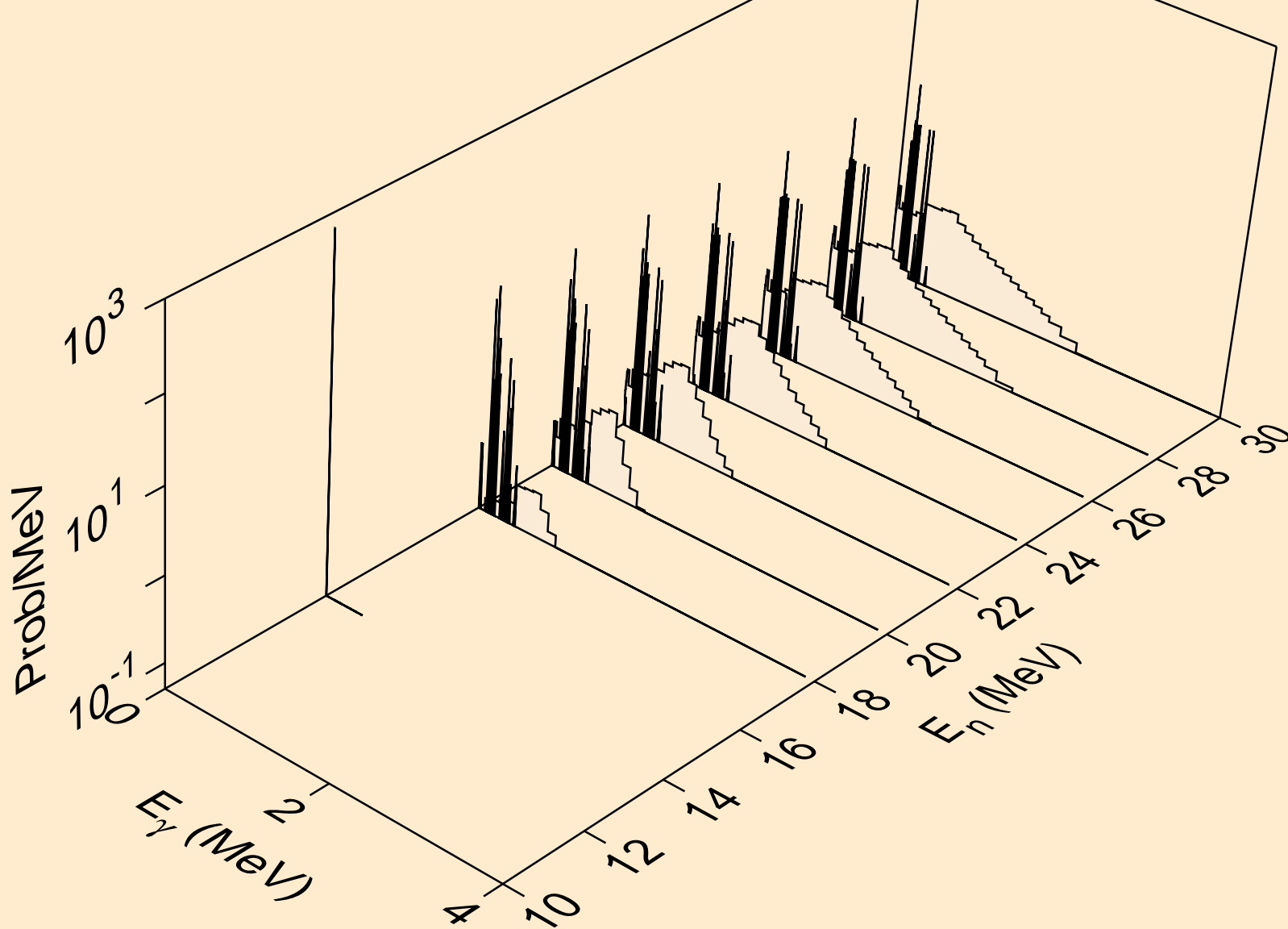

HF183 NEUTRON ACER TENDL-2019 LIBRARY; T=293.16K  
Photon emission for (n,n\*)he3

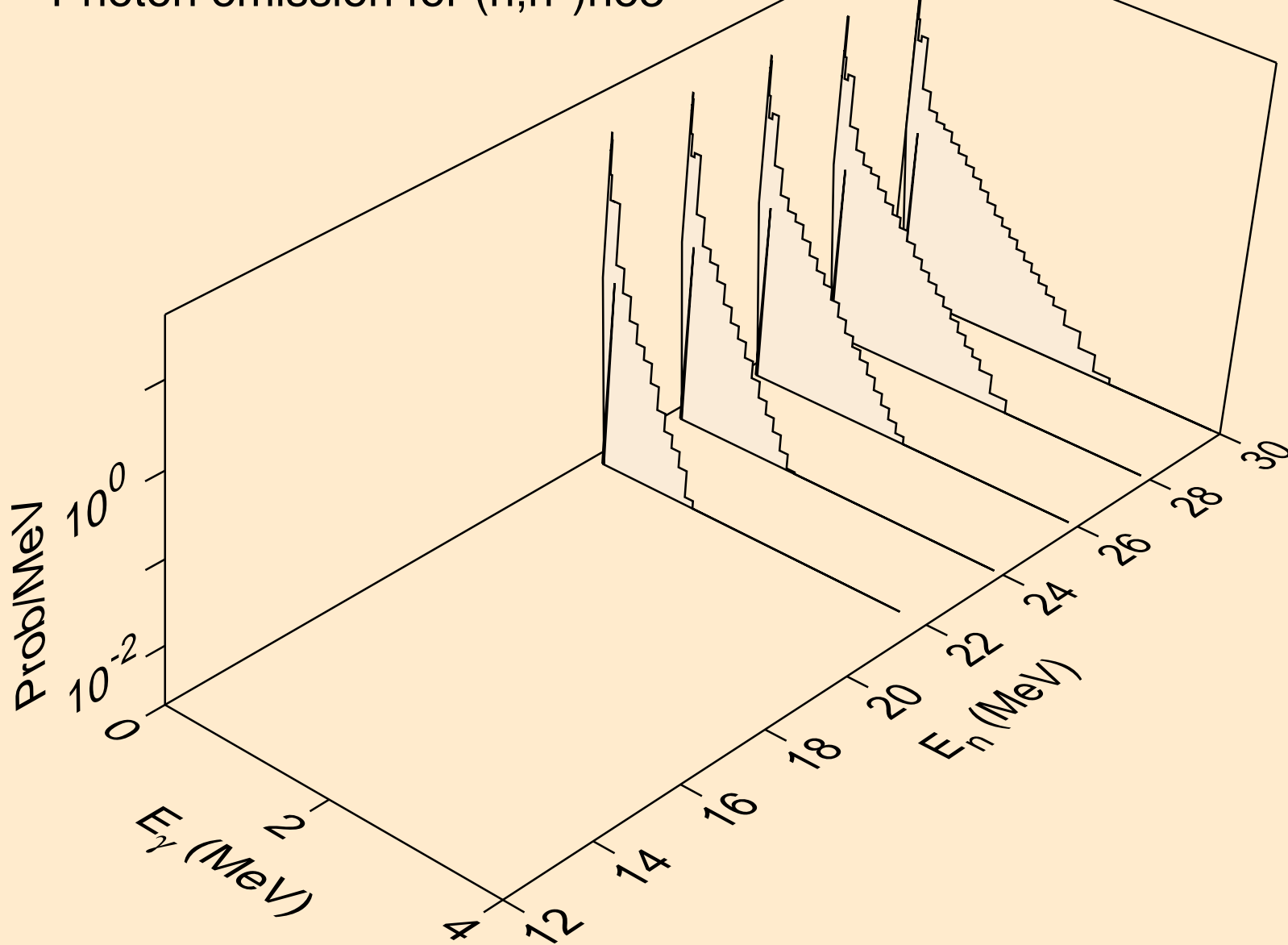

HF183 NEUTRON ACER TENDL-2019 LIBRARY; T=293.16K  
Photon emission for (n,4n)

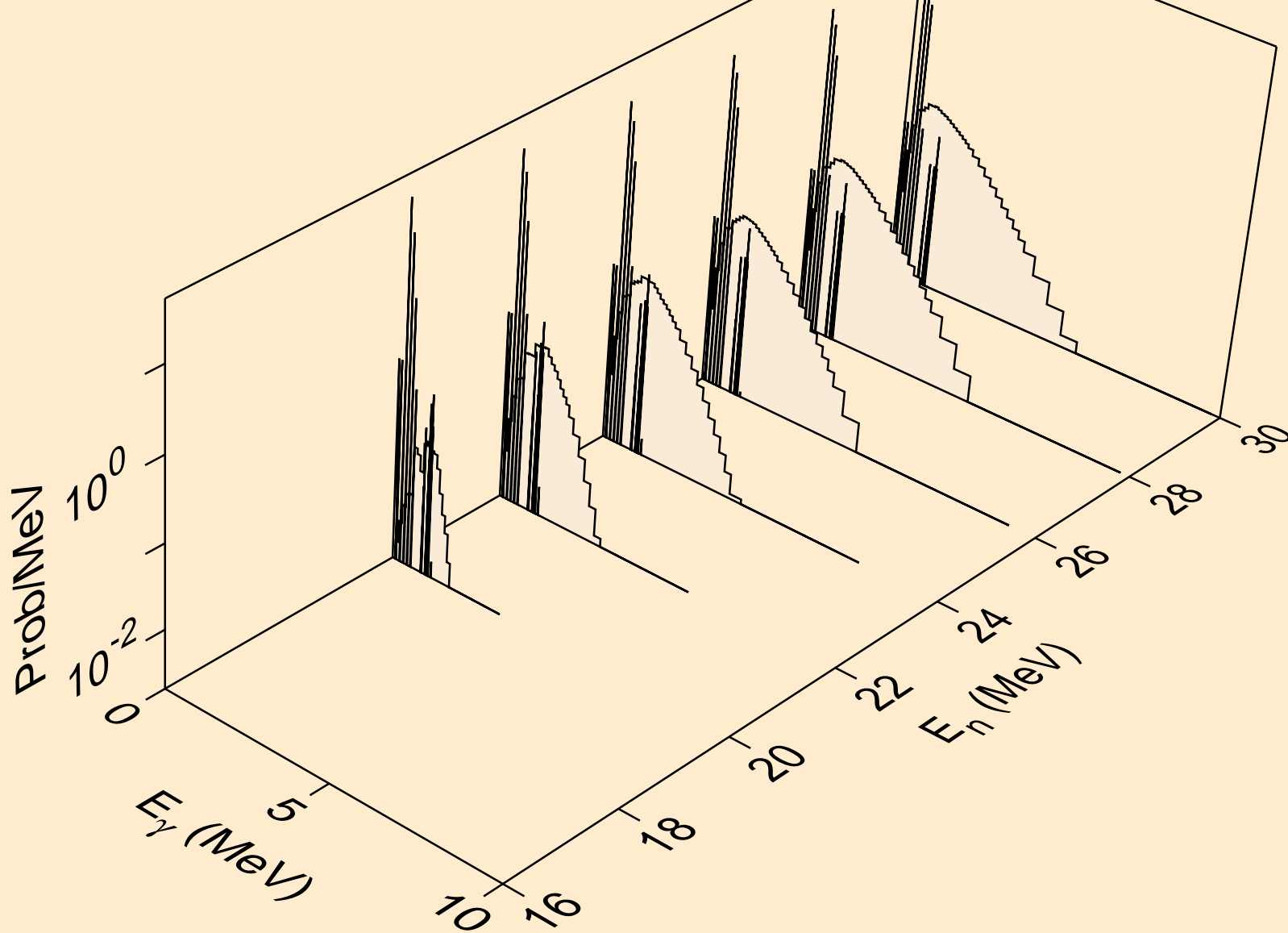

HF183 NEUTRON ACER TENDL-2019 LIBRARY; T=293.16K  
Photon emission for (n,2np)

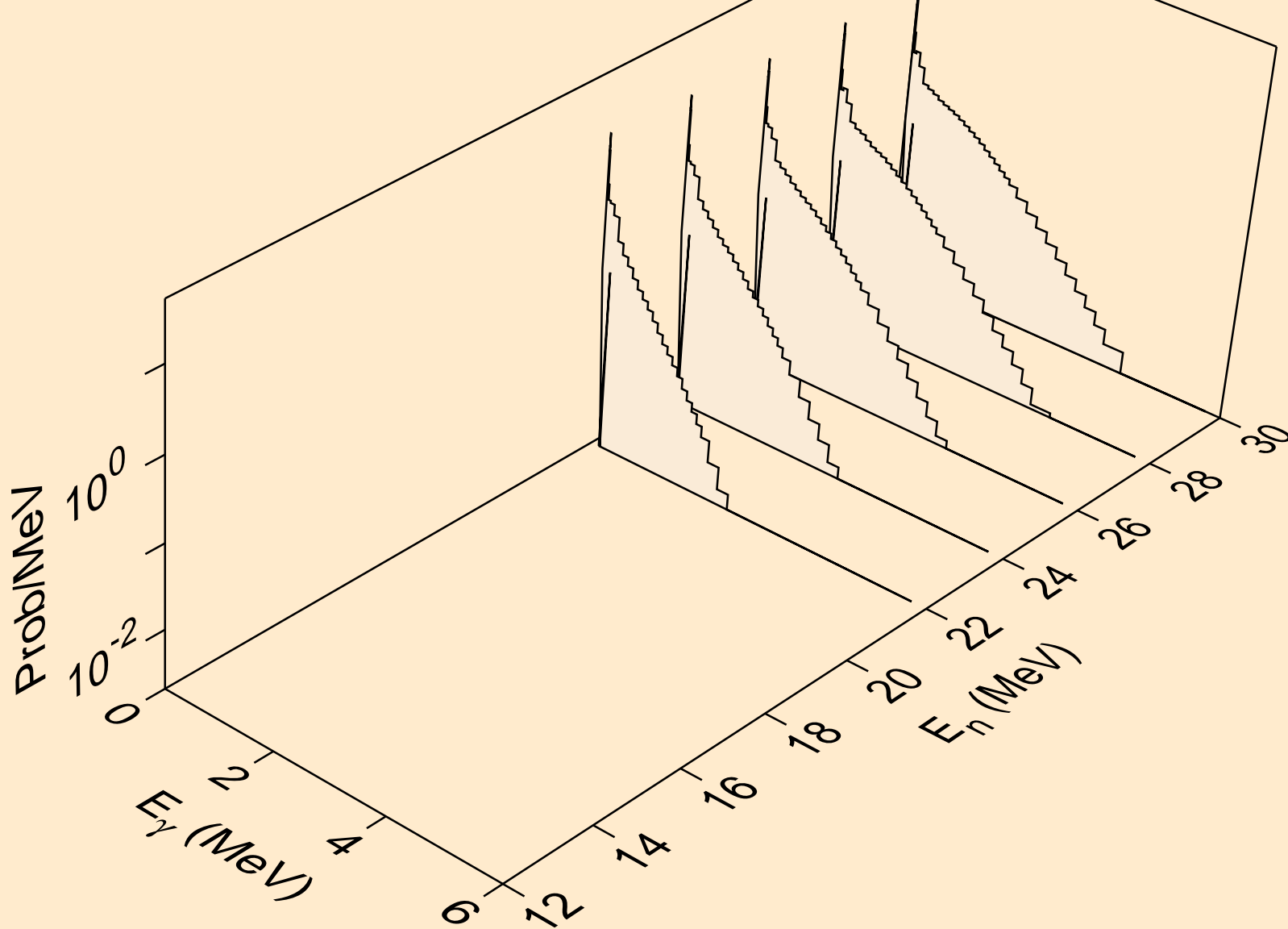



HF183 NEUTRON ACER TENDL-2019 LIBRARY; T=293.16K  
Photon emission for (n,3np)

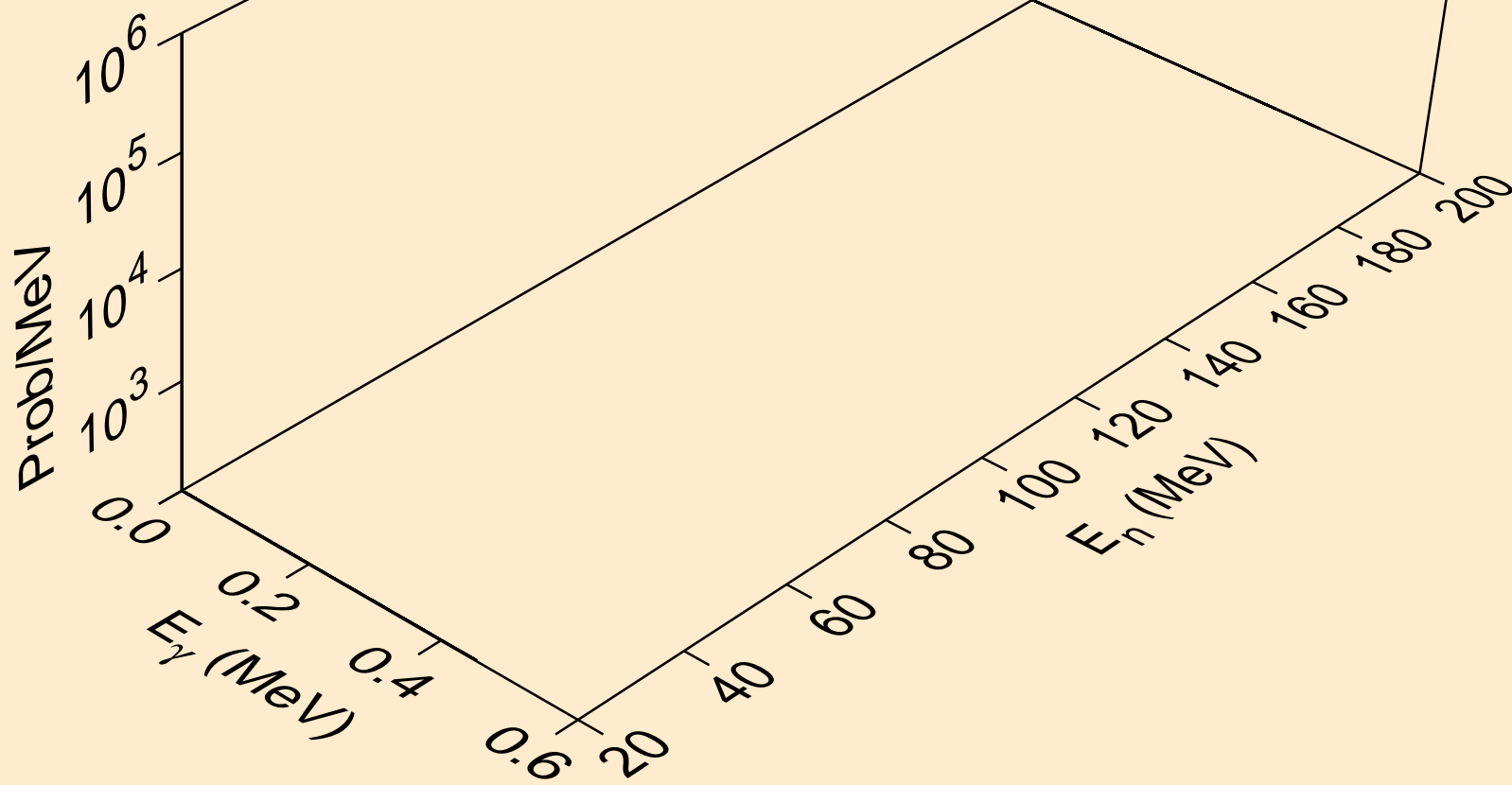

HF183 NEUTRON ACER TENDL-2019 LIBRARY; T=293.16K  
Photon emission for (n,2np)

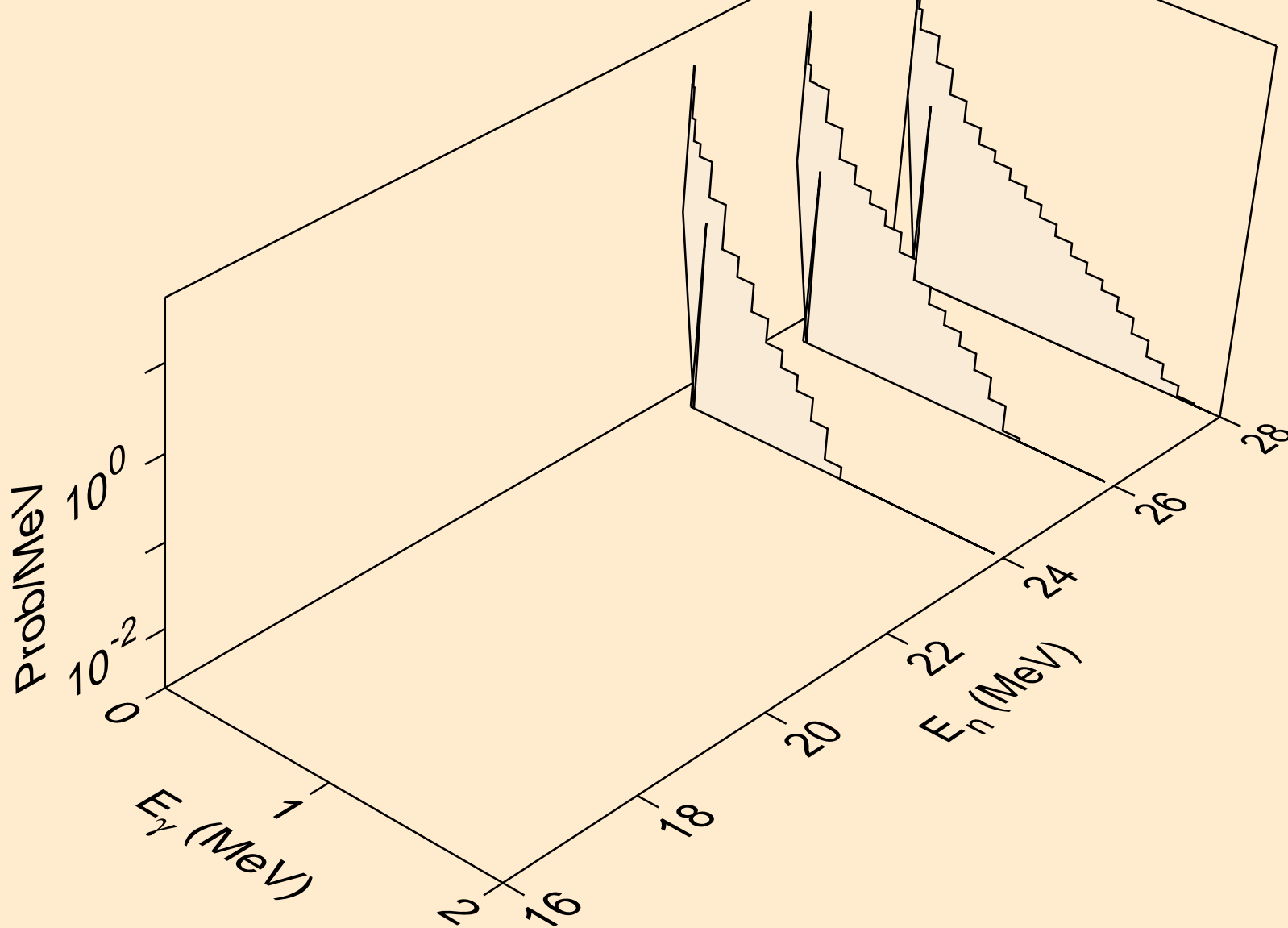

HF183 NEUTRON ACER TENDL-2019 LIBRARY; T=293.16K  
Photon emission for (n,n\*c)

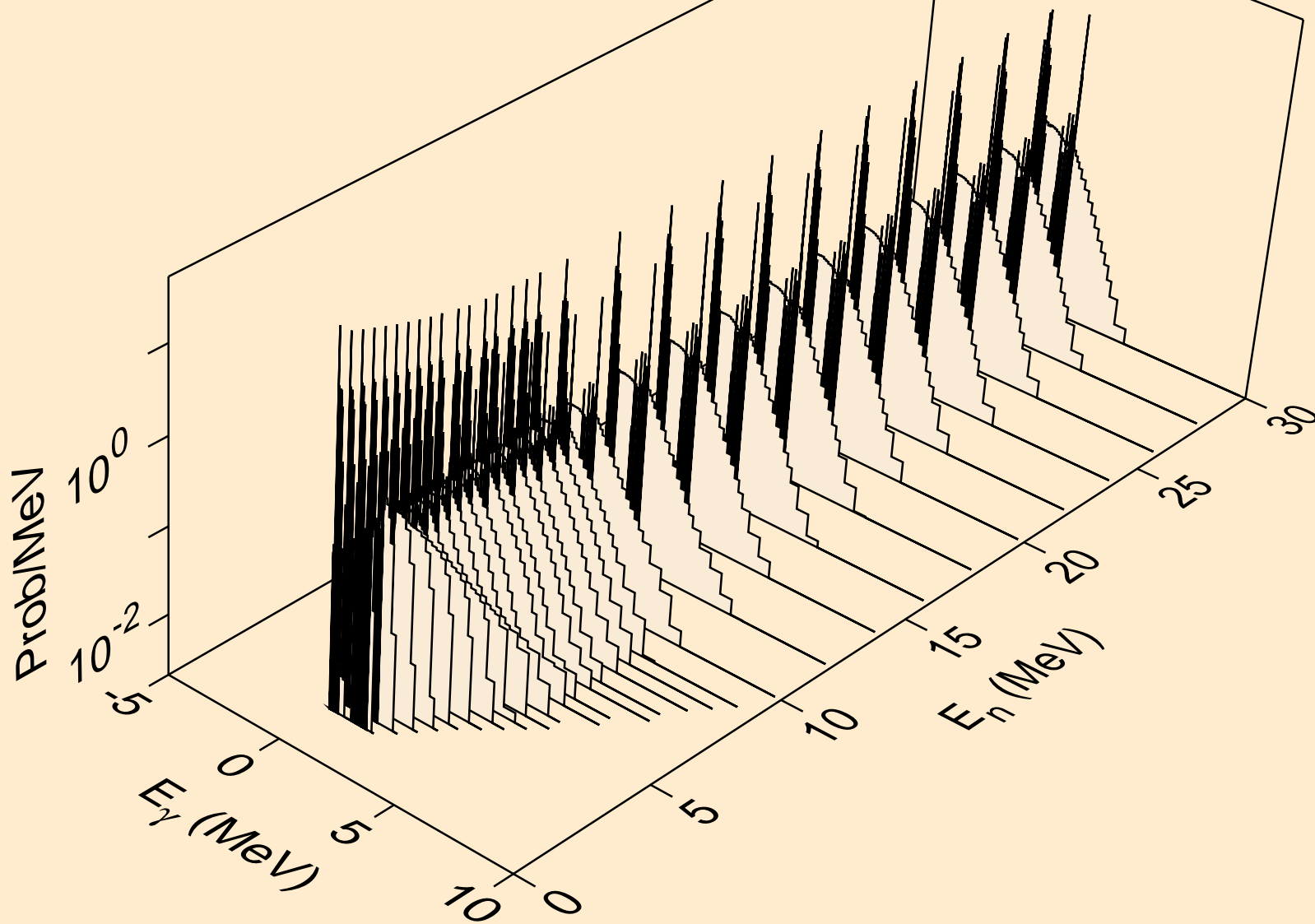

HF183 NEUTRON ACER TENDL-2019 LIBRARY; T=293.16K  
Photon emission for (n,gma)

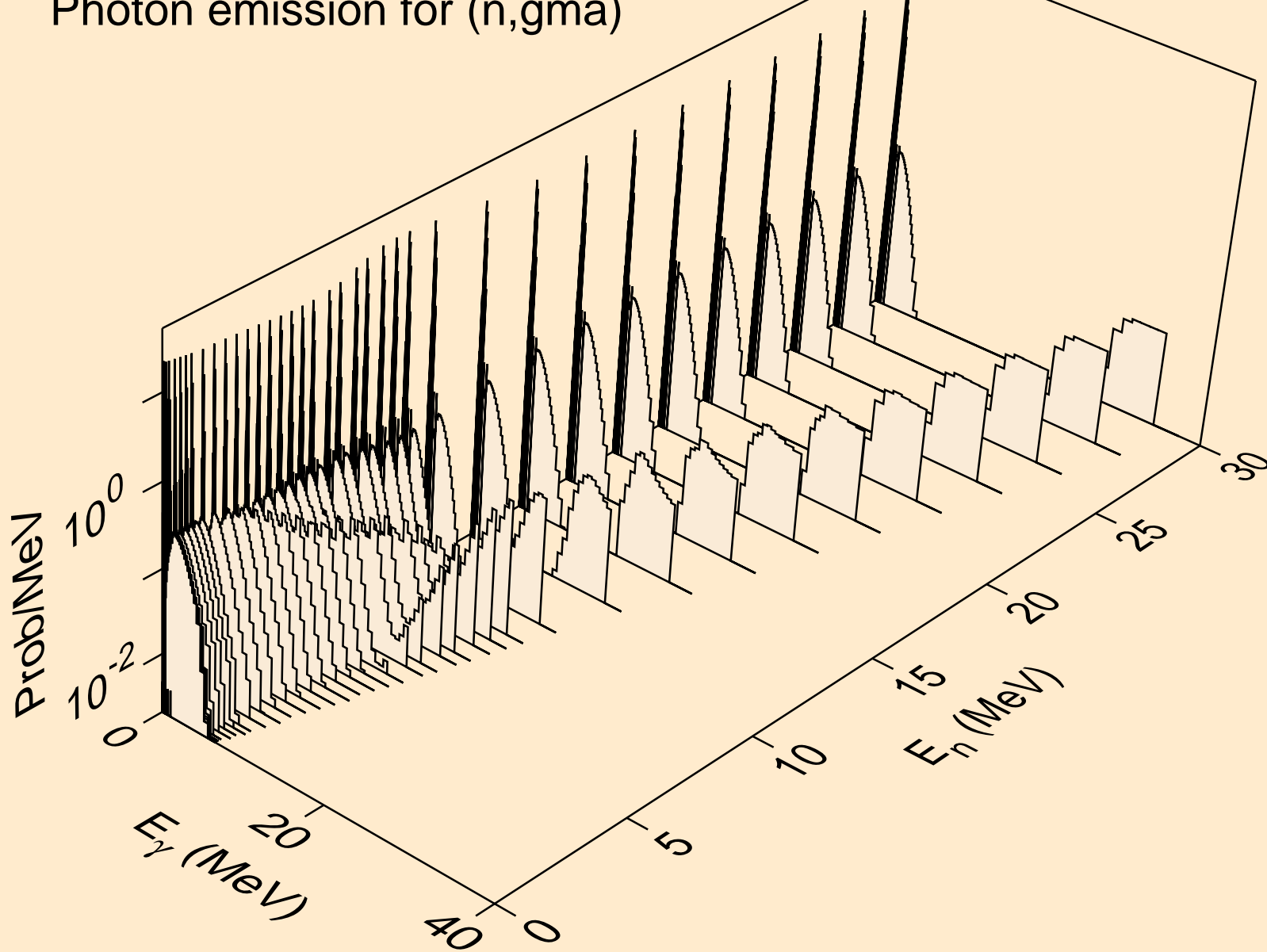

HF183 NEUTRON ACER TENDL-2019 LIBRARY; T=293.16K  
Photon emission for (n,p)

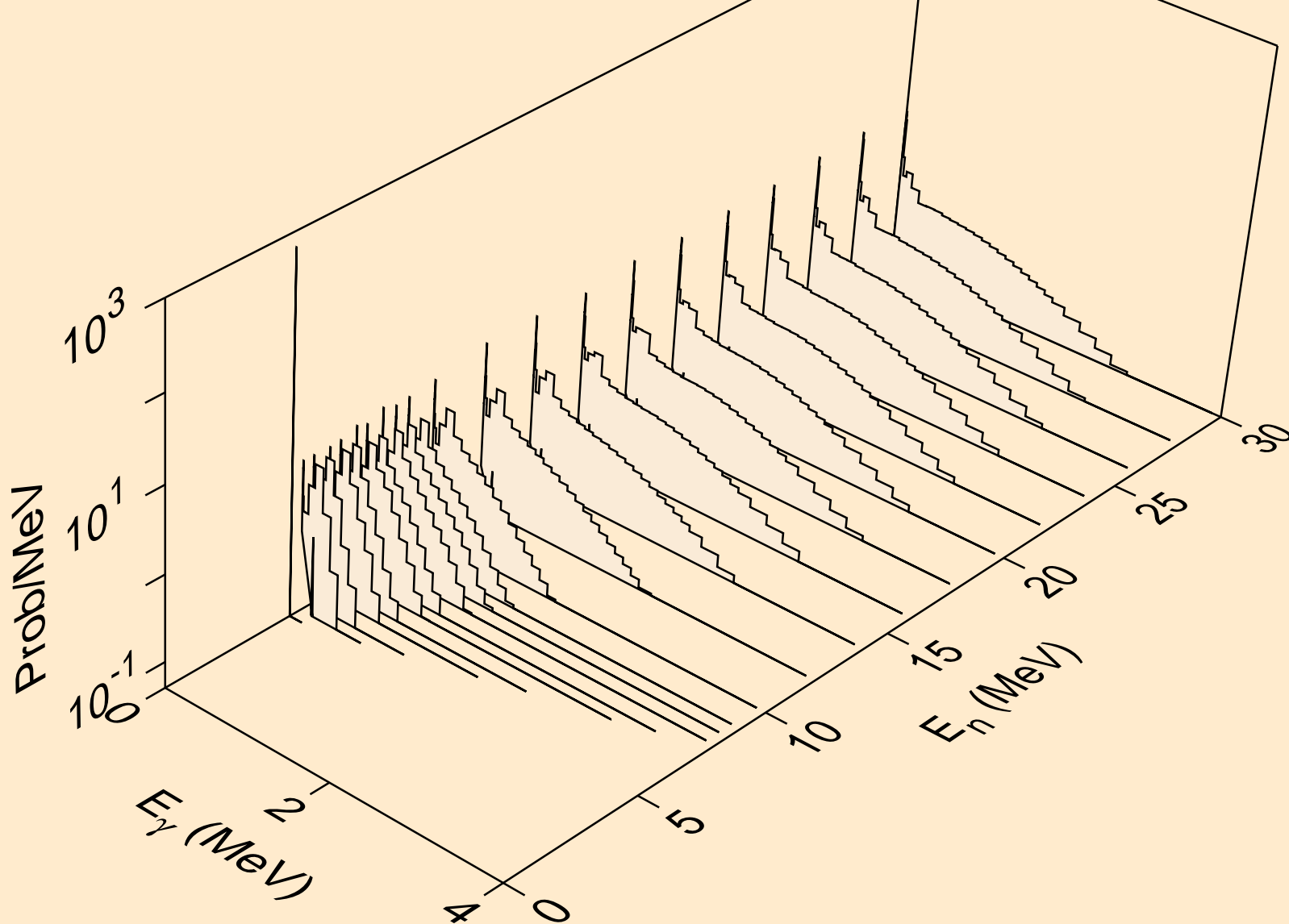

HF183 NEUTRON ACER TENDL-2019 LIBRARY; T=293.16K  
Photon emission for (n,d)

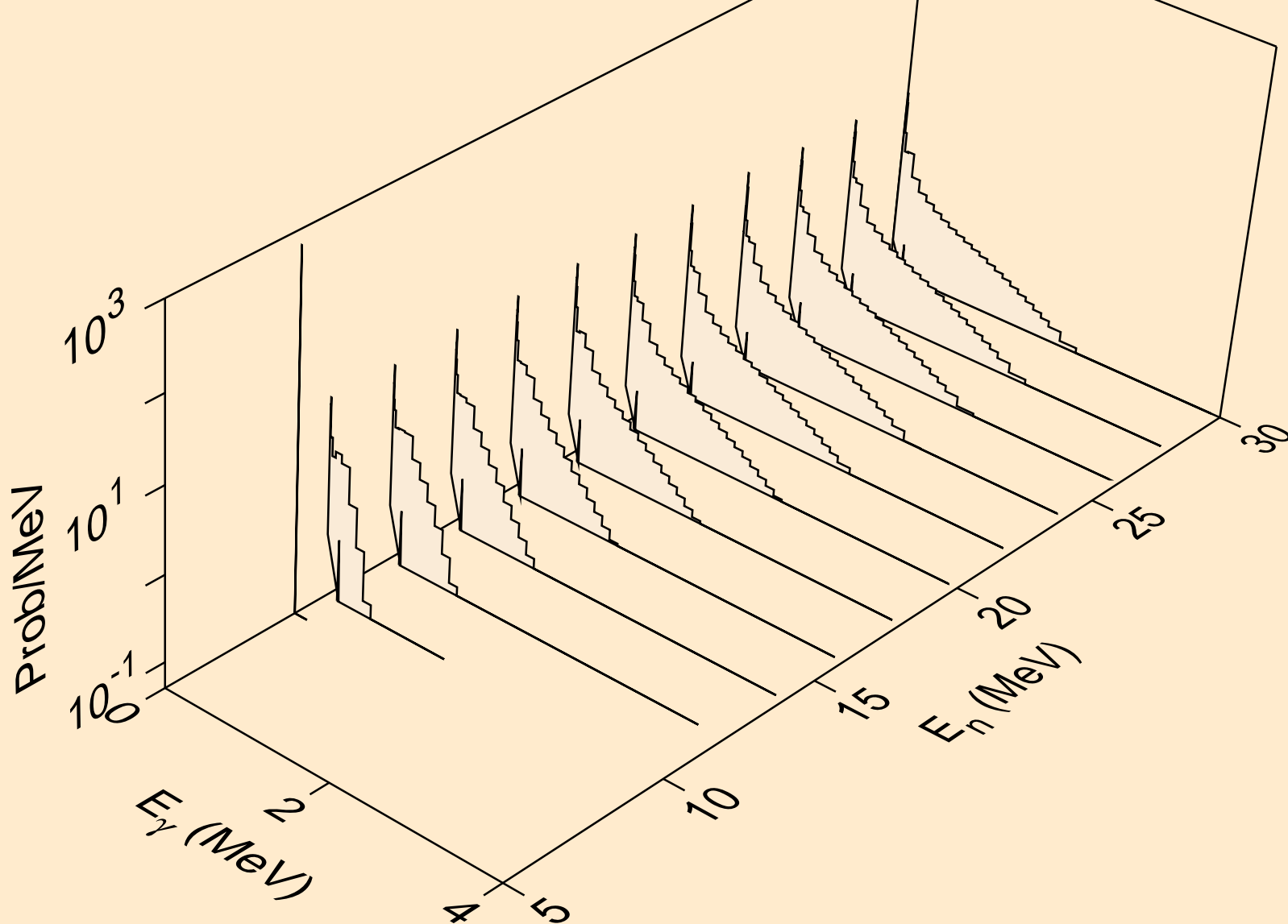

HF183 NEUTRON ACER TENDL-2019 LIBRARY; T=293.16K  
Photon emission for (n,t)

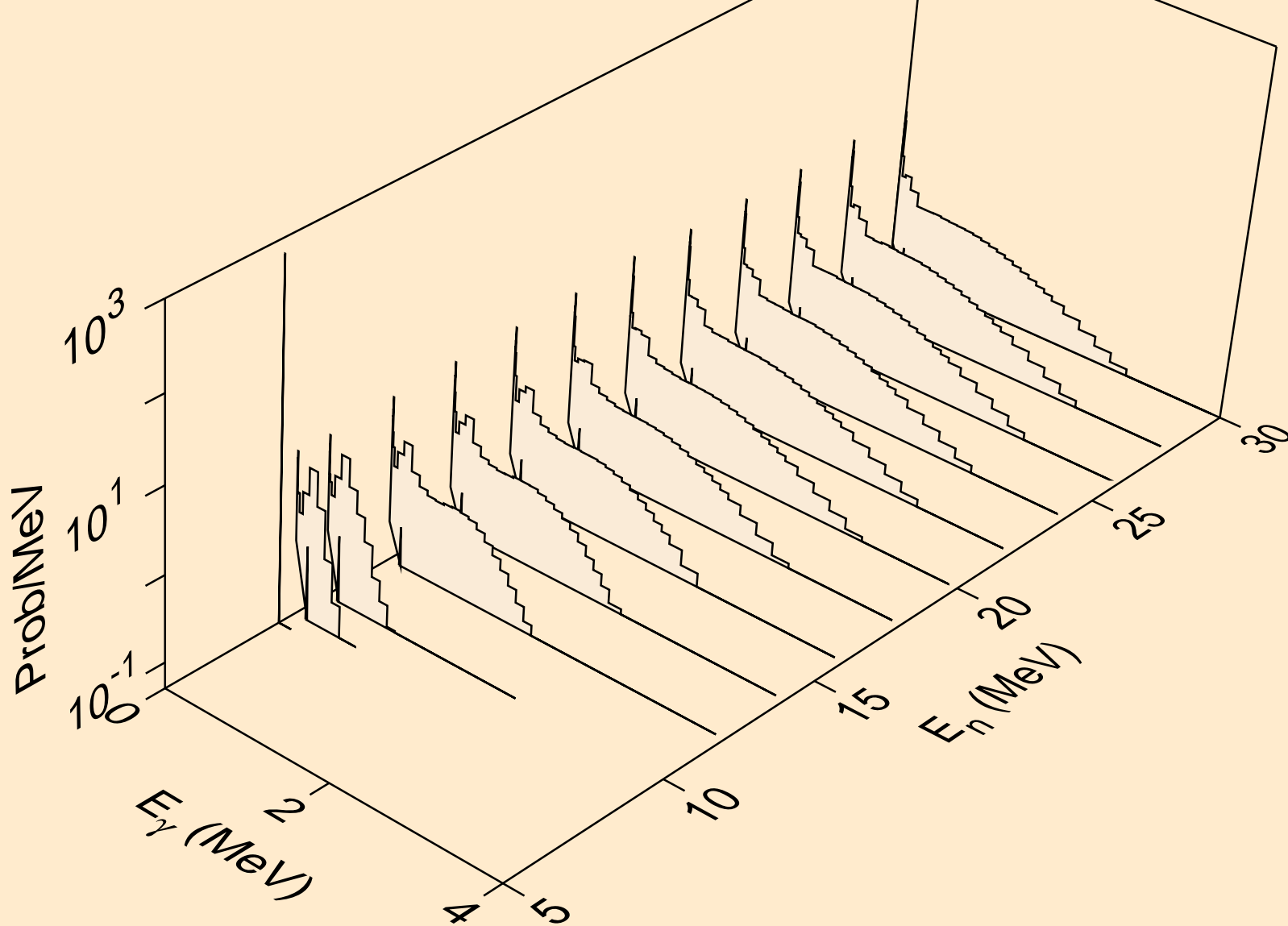

HF183 NEUTRON ACER TENDL-2019 LIBRARY; T=293.16K  
Photon emission for (n,he3)

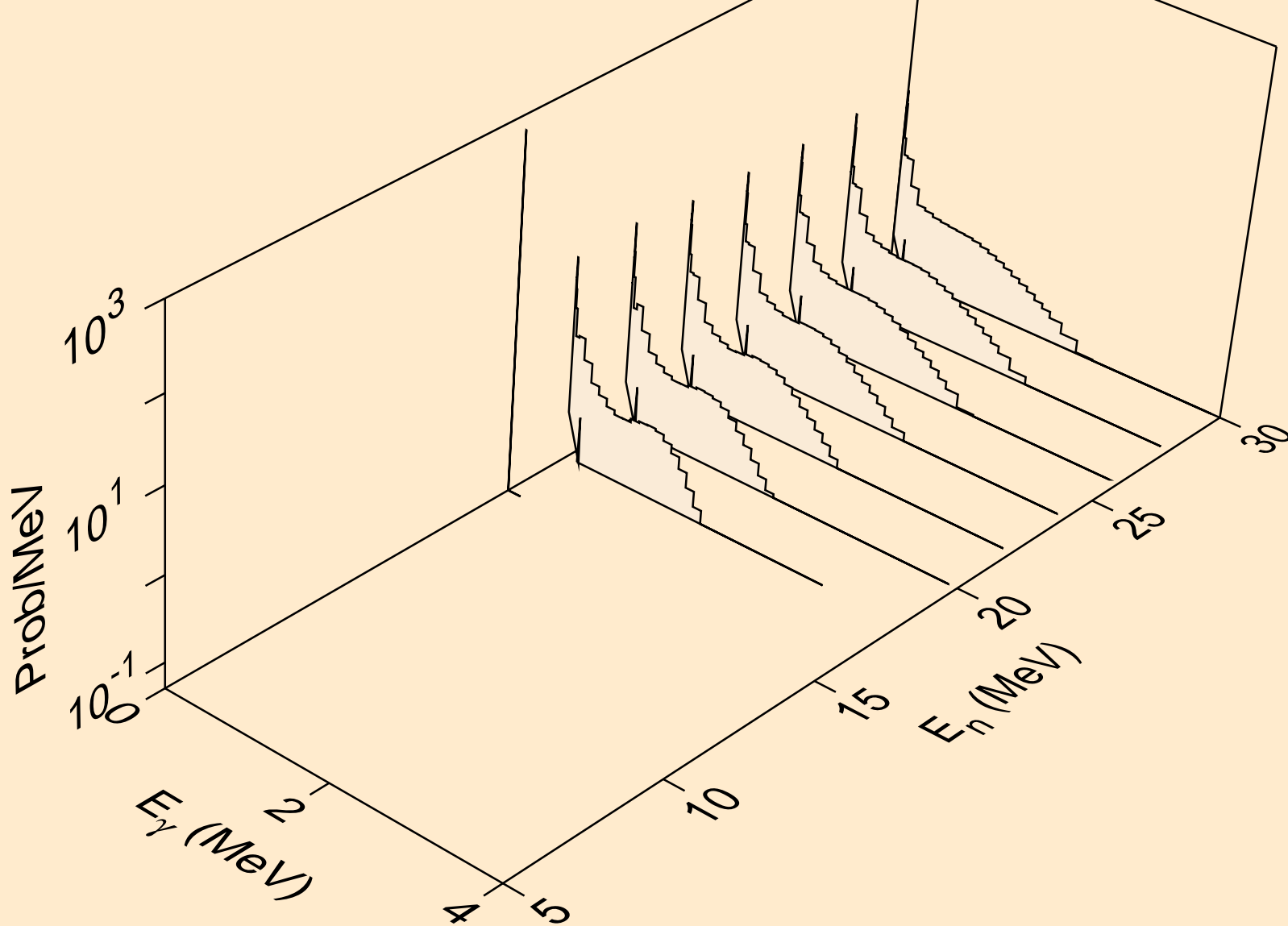



HF183 NEUTRON ACER TENDL-2019 LIBRARY; T=293.16K  
Photon emission for (n,a)

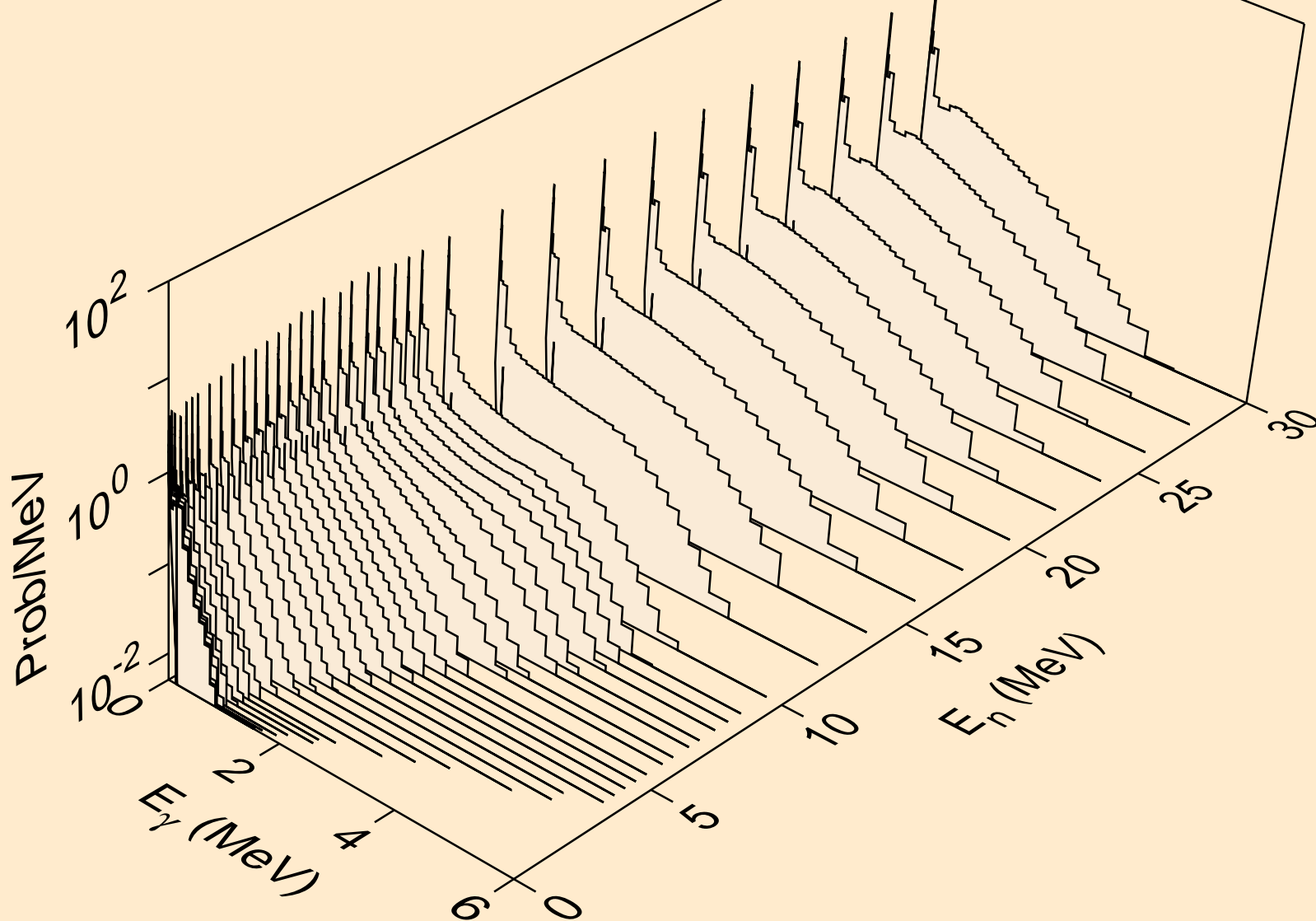

HF183 NEUTRON ACER TENDL-2019 LIBRARY; T=293.16K  
Photon emission for (n,2p)

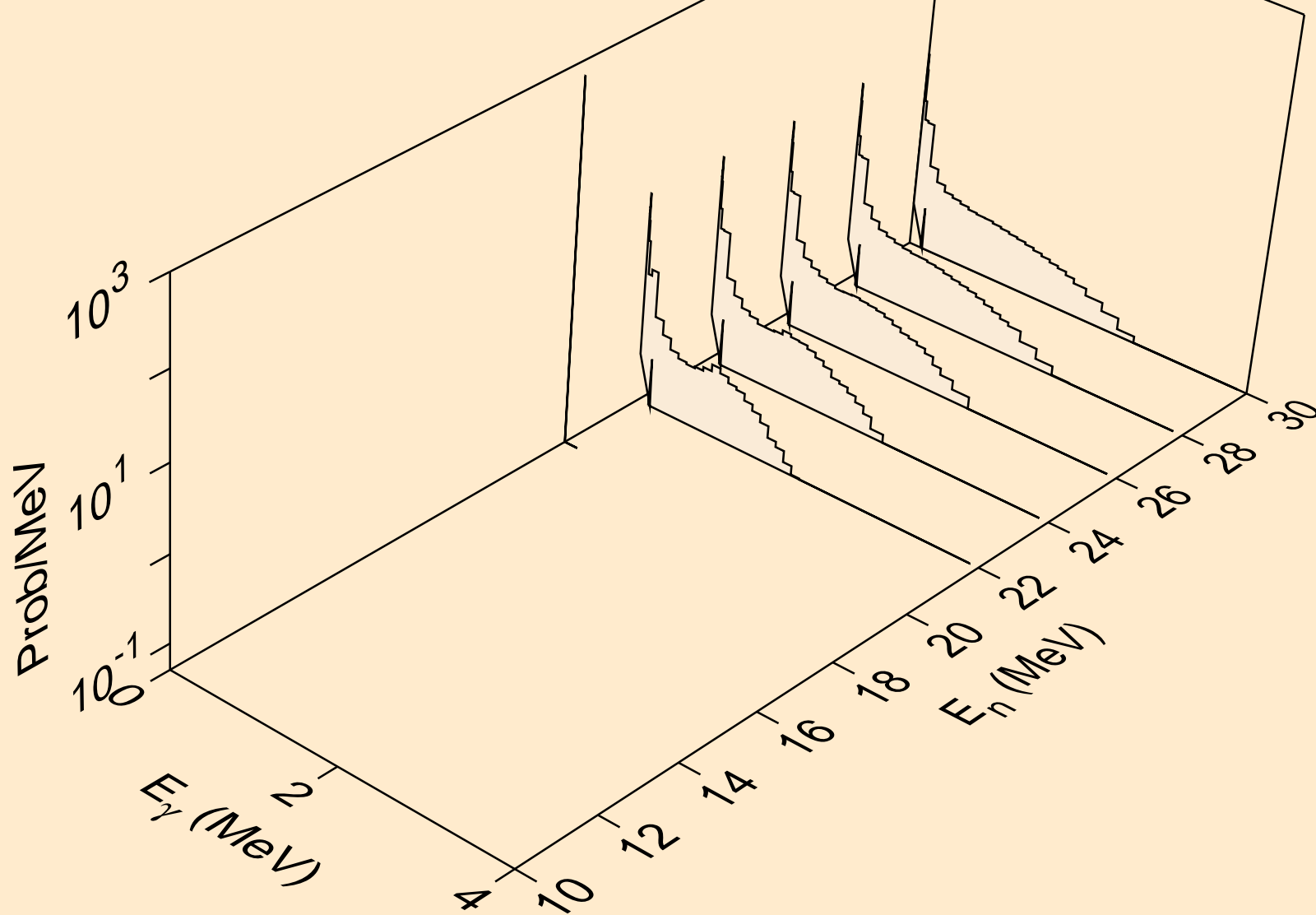

HF183 NEUTRON ACER TENDL-2019 LIBRARY; T=293.16K  
thermal capture photon spectrum

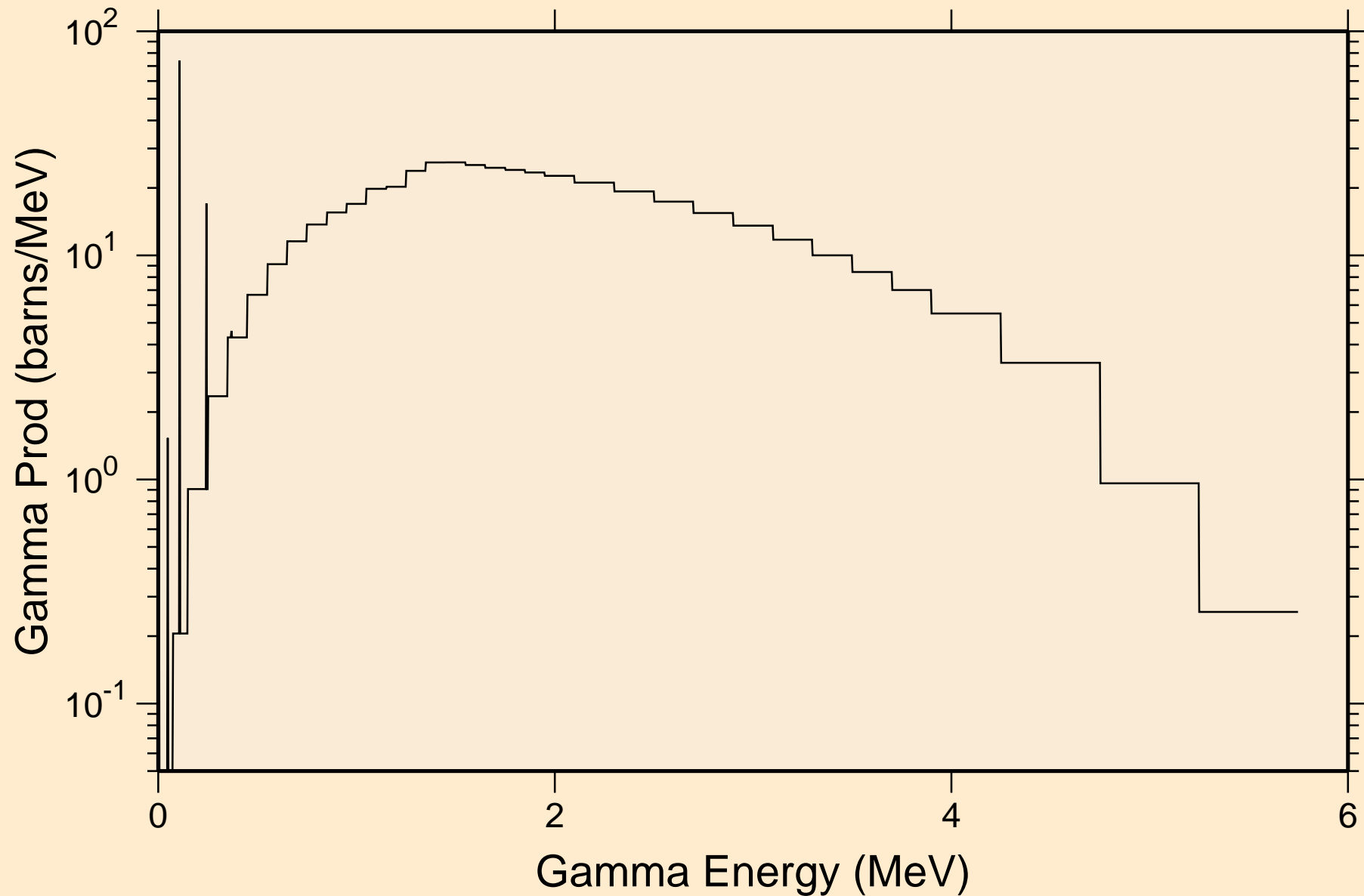

HF183 NEUTRON ACER TENDL-2019 LIBRARY; T=293.16K  
14 MeV photon spectrum

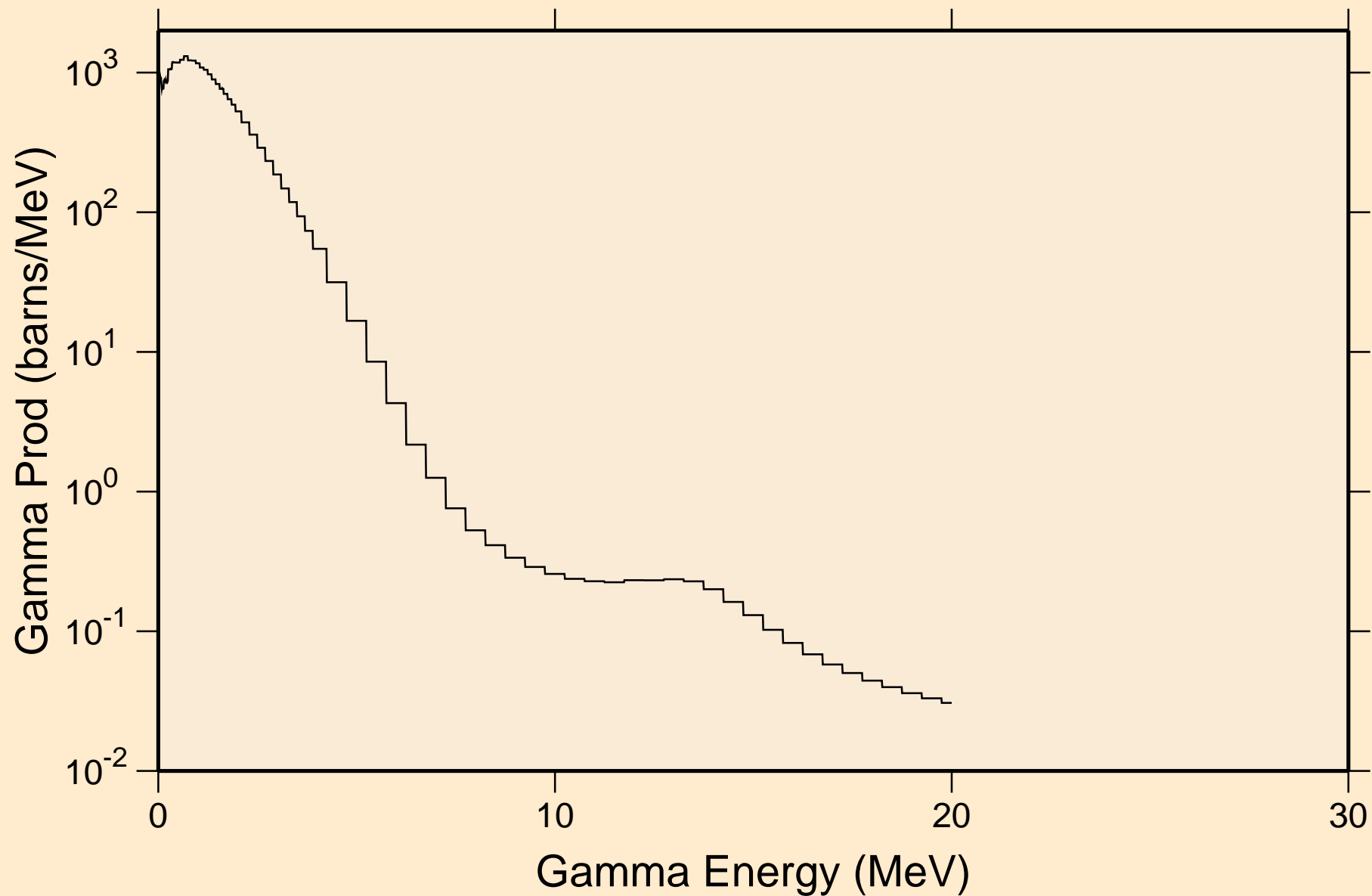

# HF183 NEUTRON ACER TENDL-2019 LIBRARY; T=293.16K

## Particle heating contributions

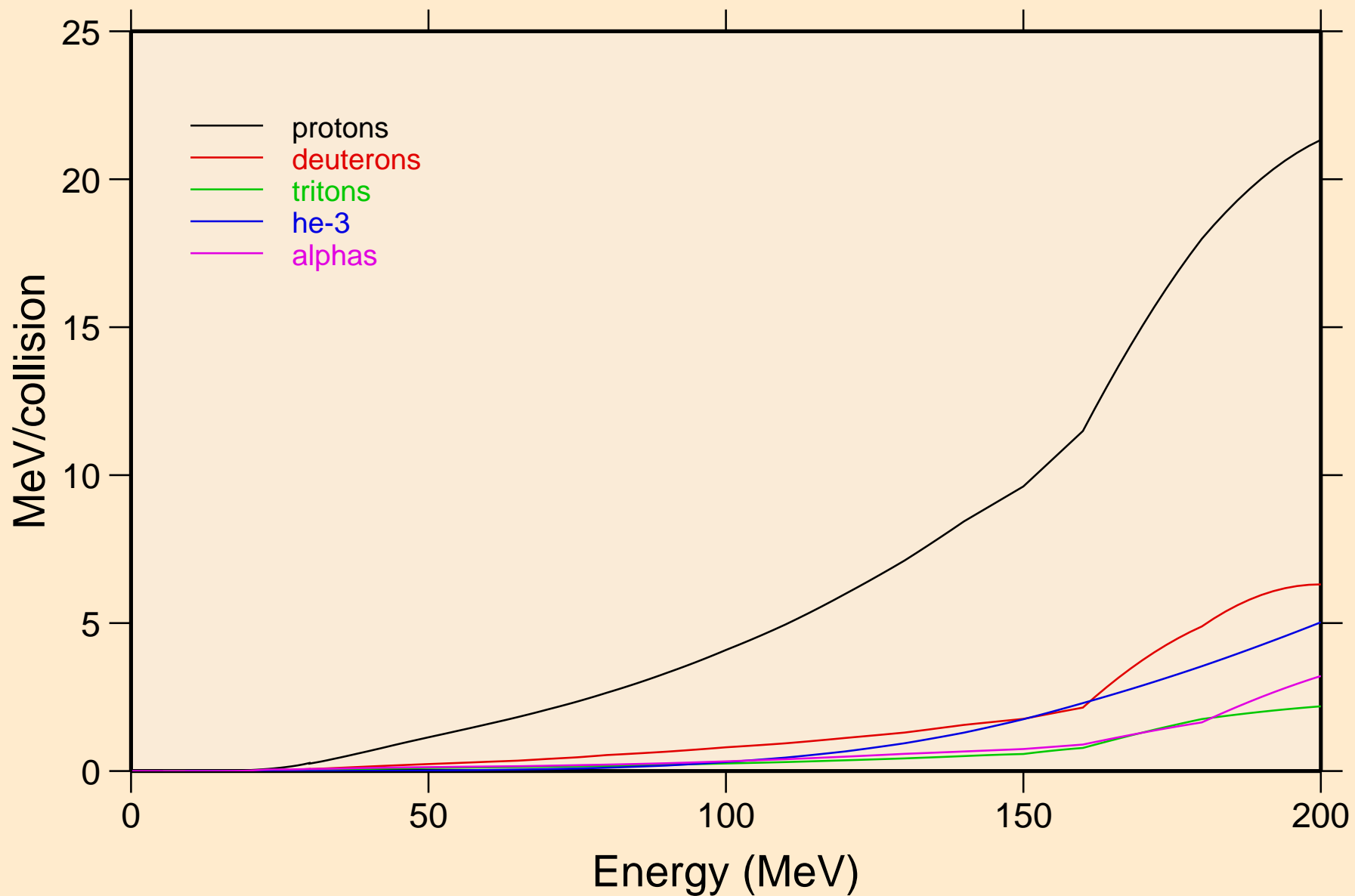

HF183 NEUTRON ACER TENDL-2019 LIBRARY; T=293.16K  
Recoil Heating

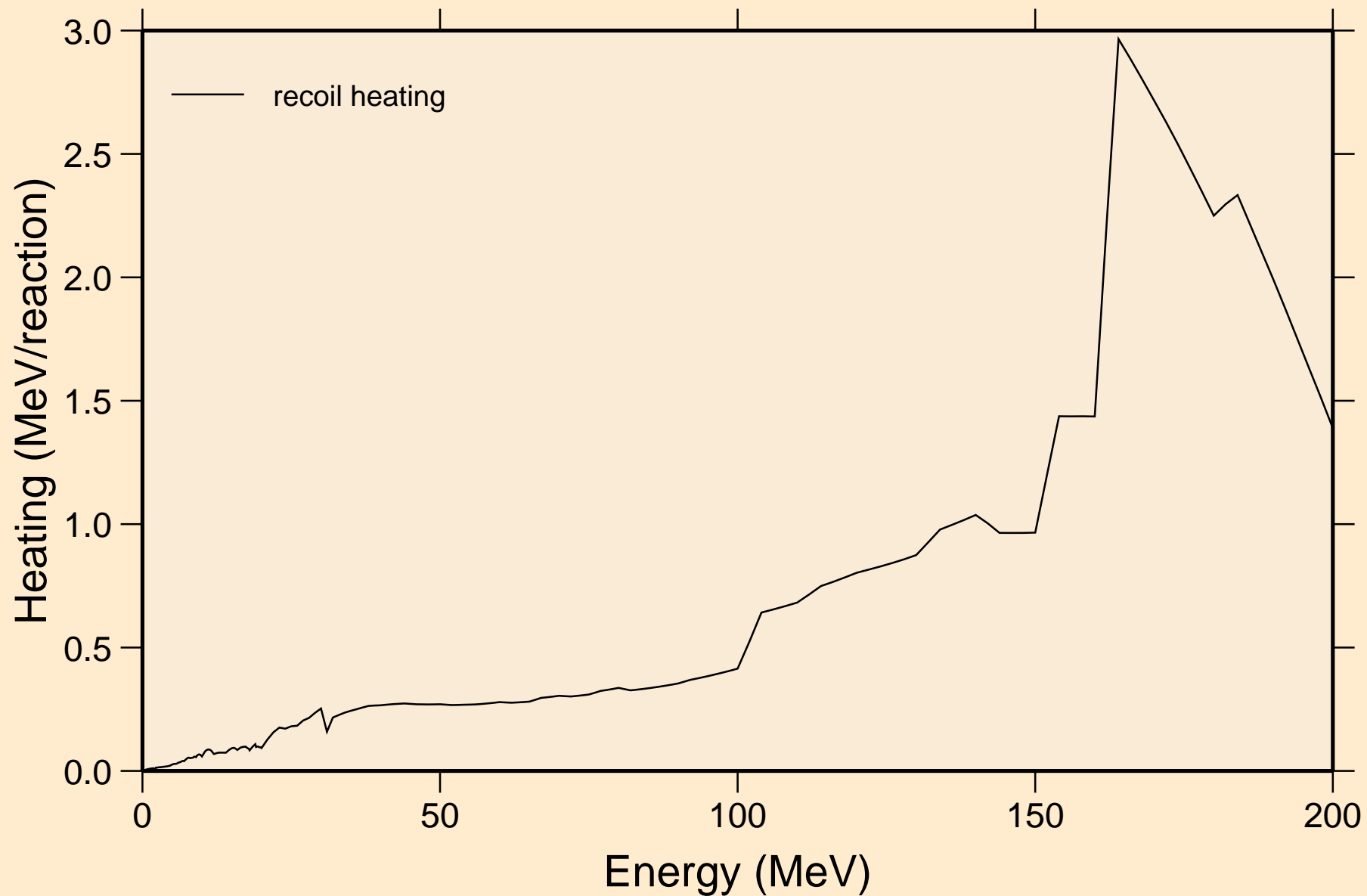

HF183 NEUTRON ACER TENDL-2019 LIBRARY; T=293.16K  
Particle production cross sections

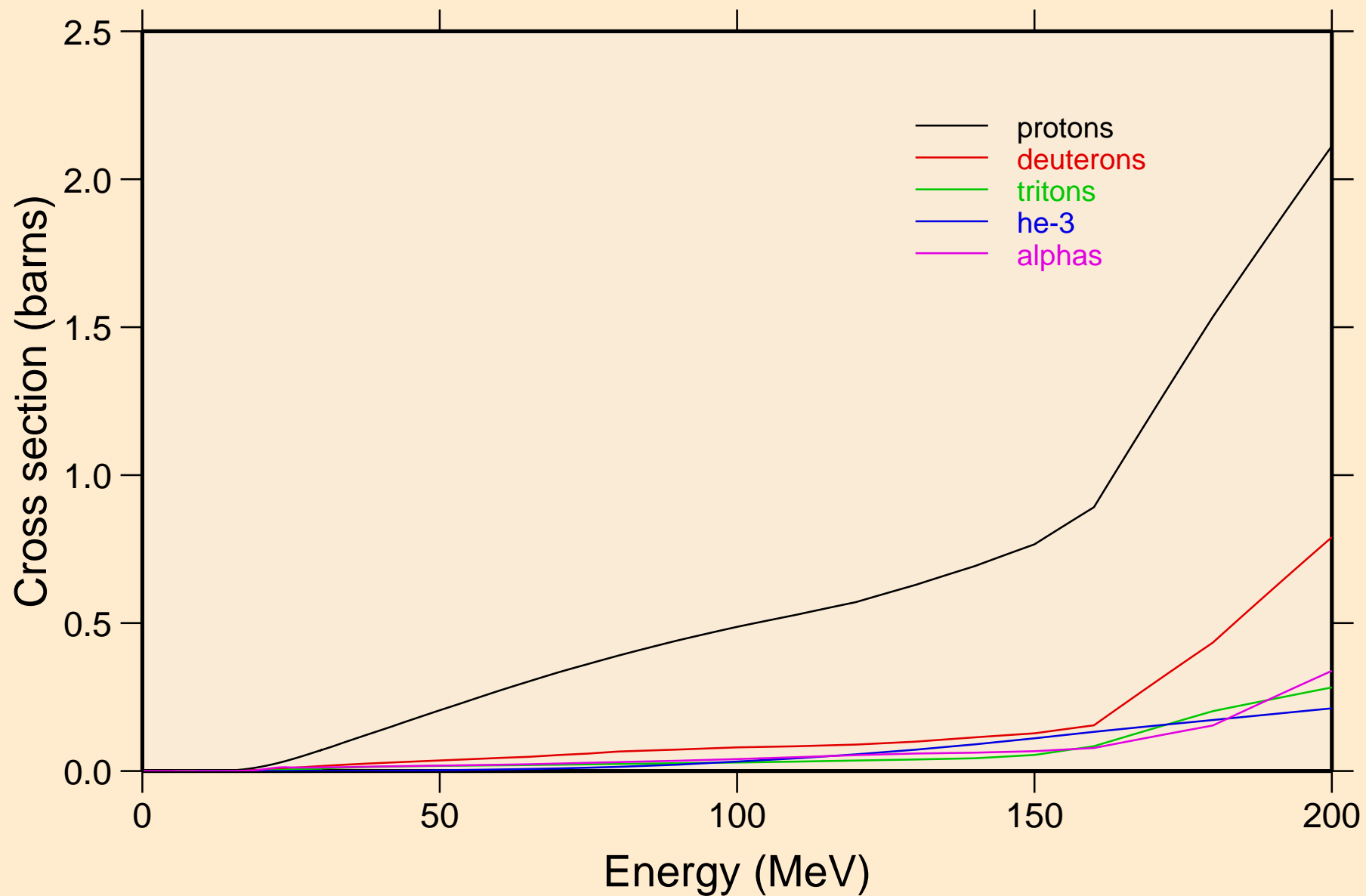

HF183 NEUTRON ACER TENDL-2019 LIBRARY; T=293.16K  
protons from (n,x)

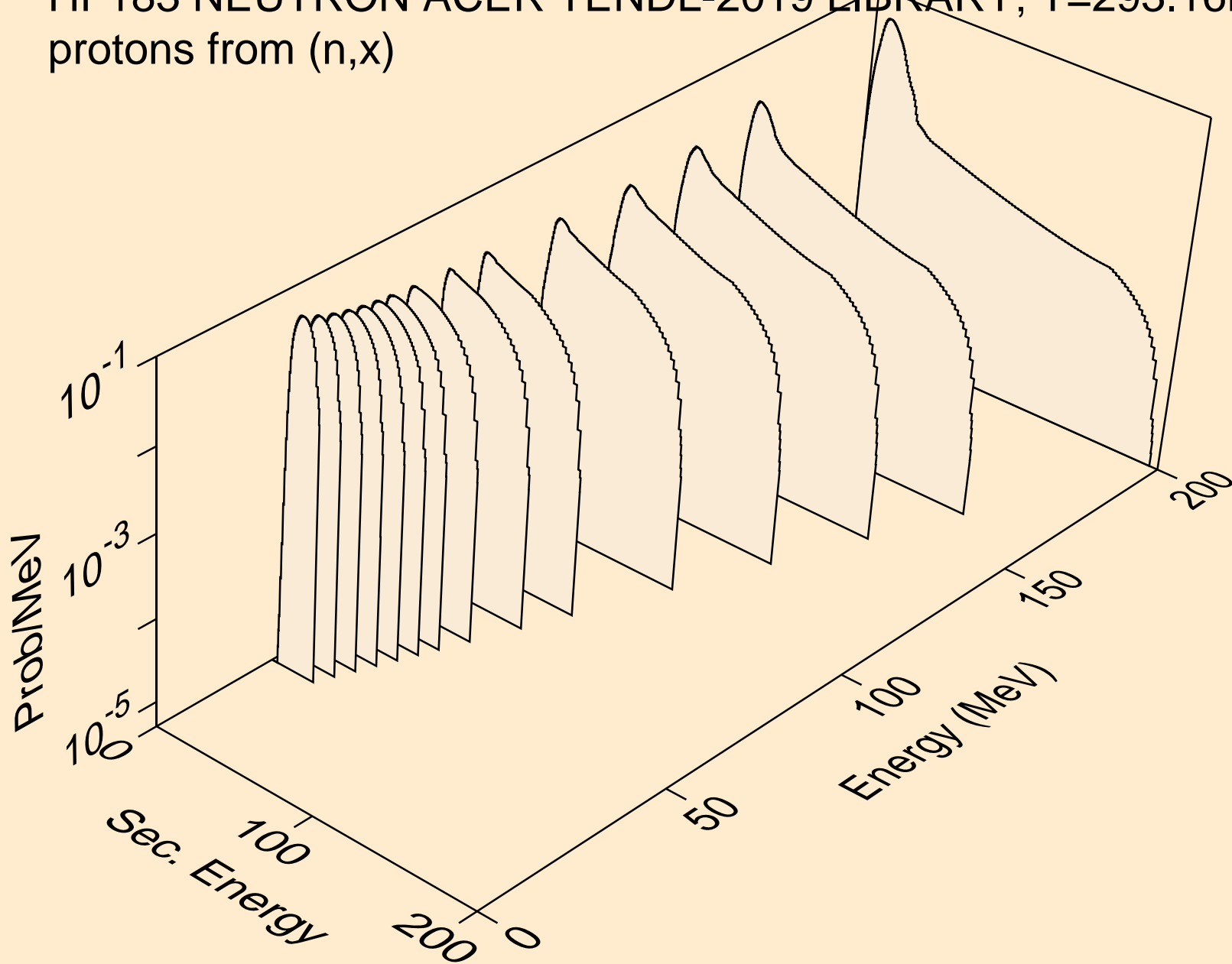



HF183 NEUTRON ACER TENDL-2019 LIBRARY; T=293.16K  
protons from (n,n\*)p

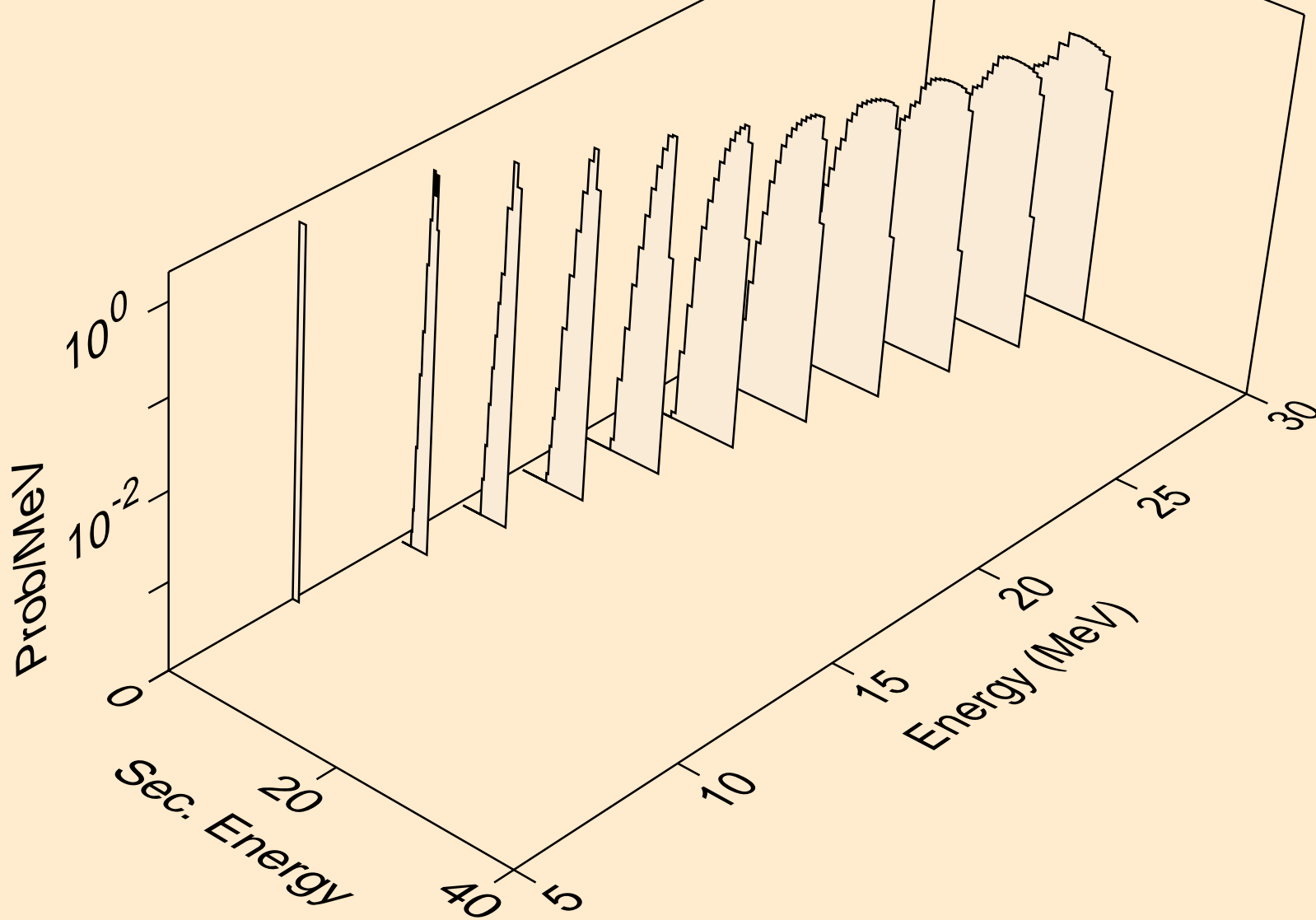

HF183 NEUTRON ACER TENDL-2019 LIBRARY; T=293.16K  
protons from (n,2np)

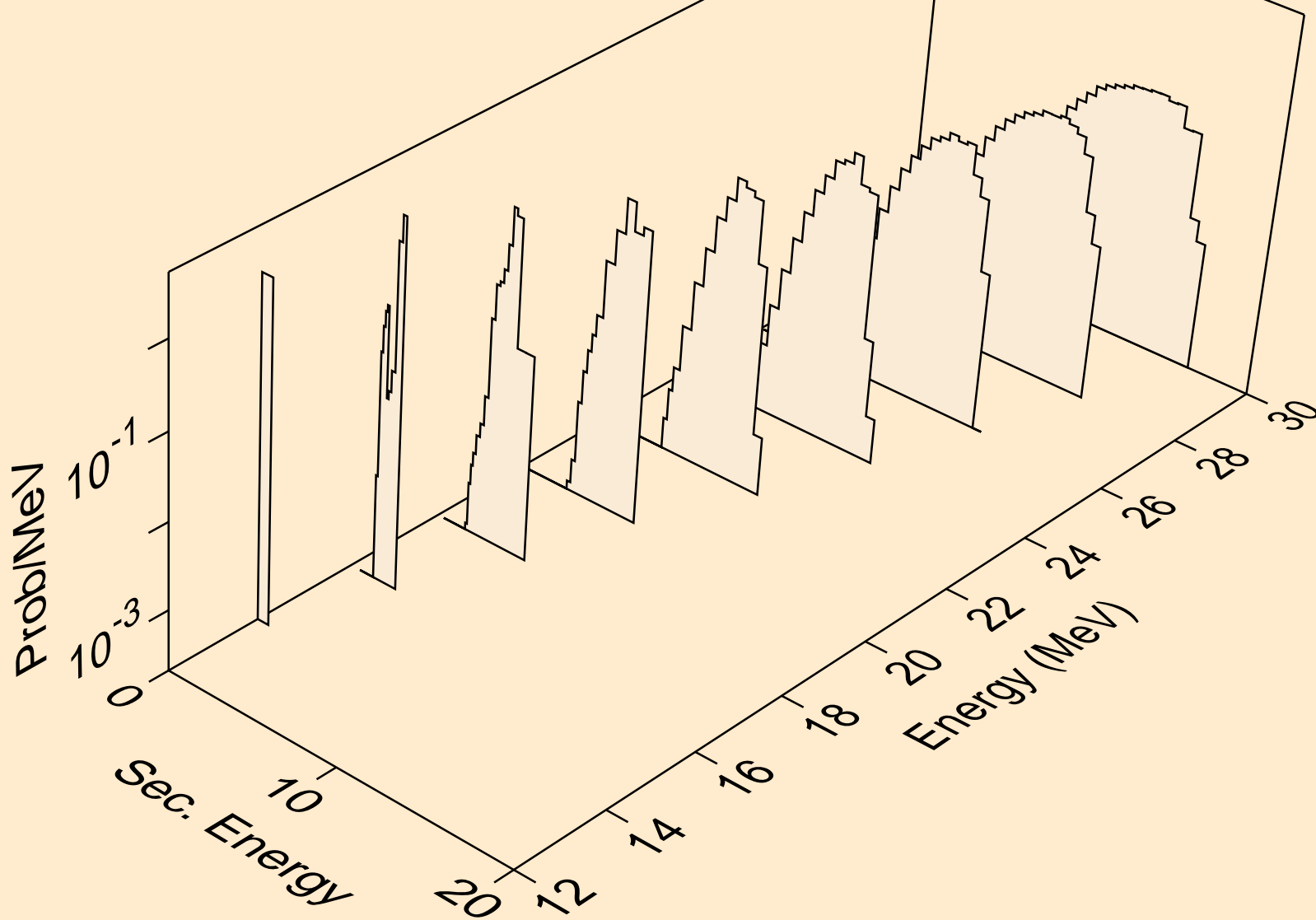

HF183 NEUTRON ACER TENDL-2019 LIBRARY; T=293.16K  
protons from (n,3np)

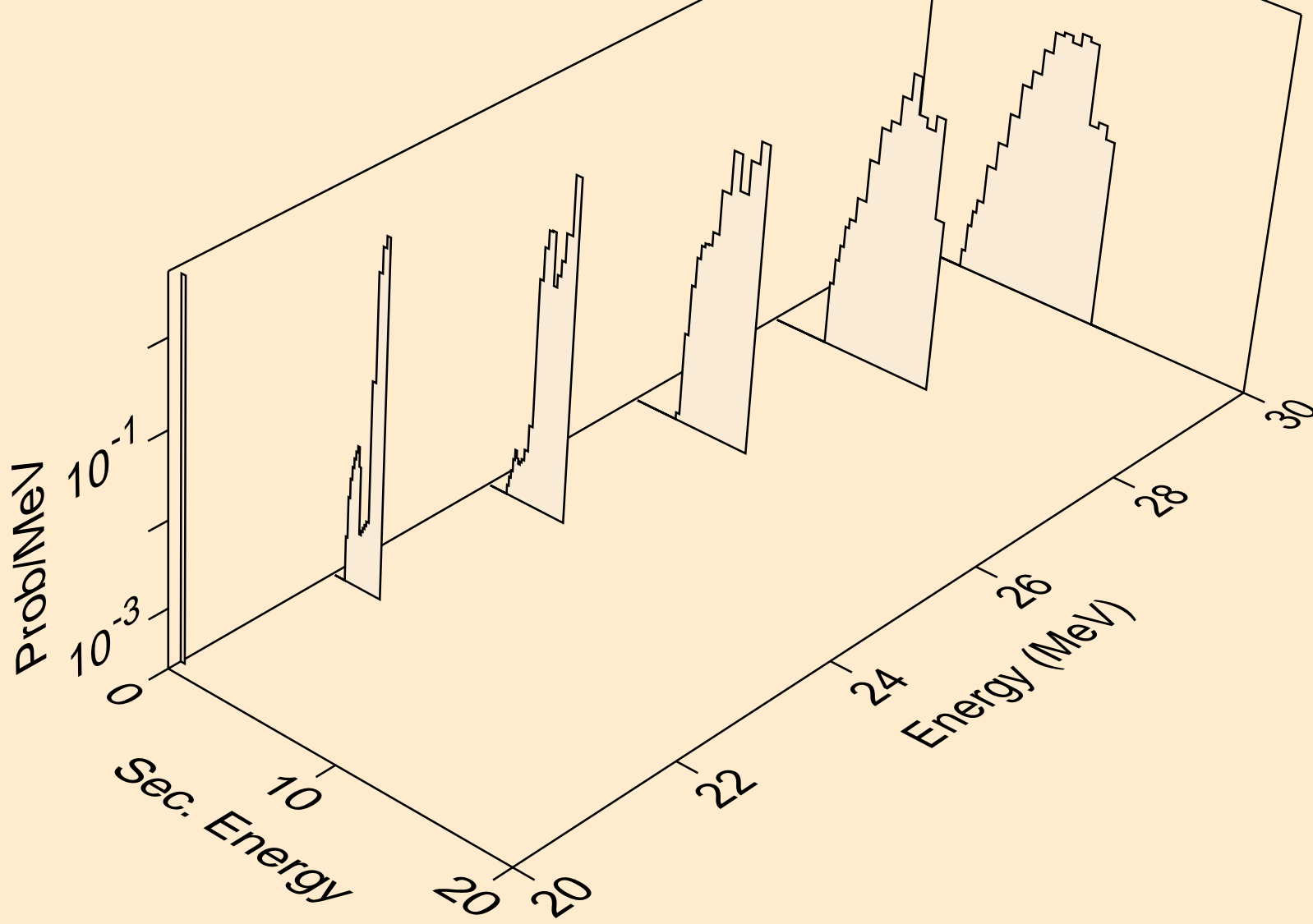

HF183 NEUTRON ACER TENDL-2019 LIBRARY; T=293.16K  
protons from (n,2np)

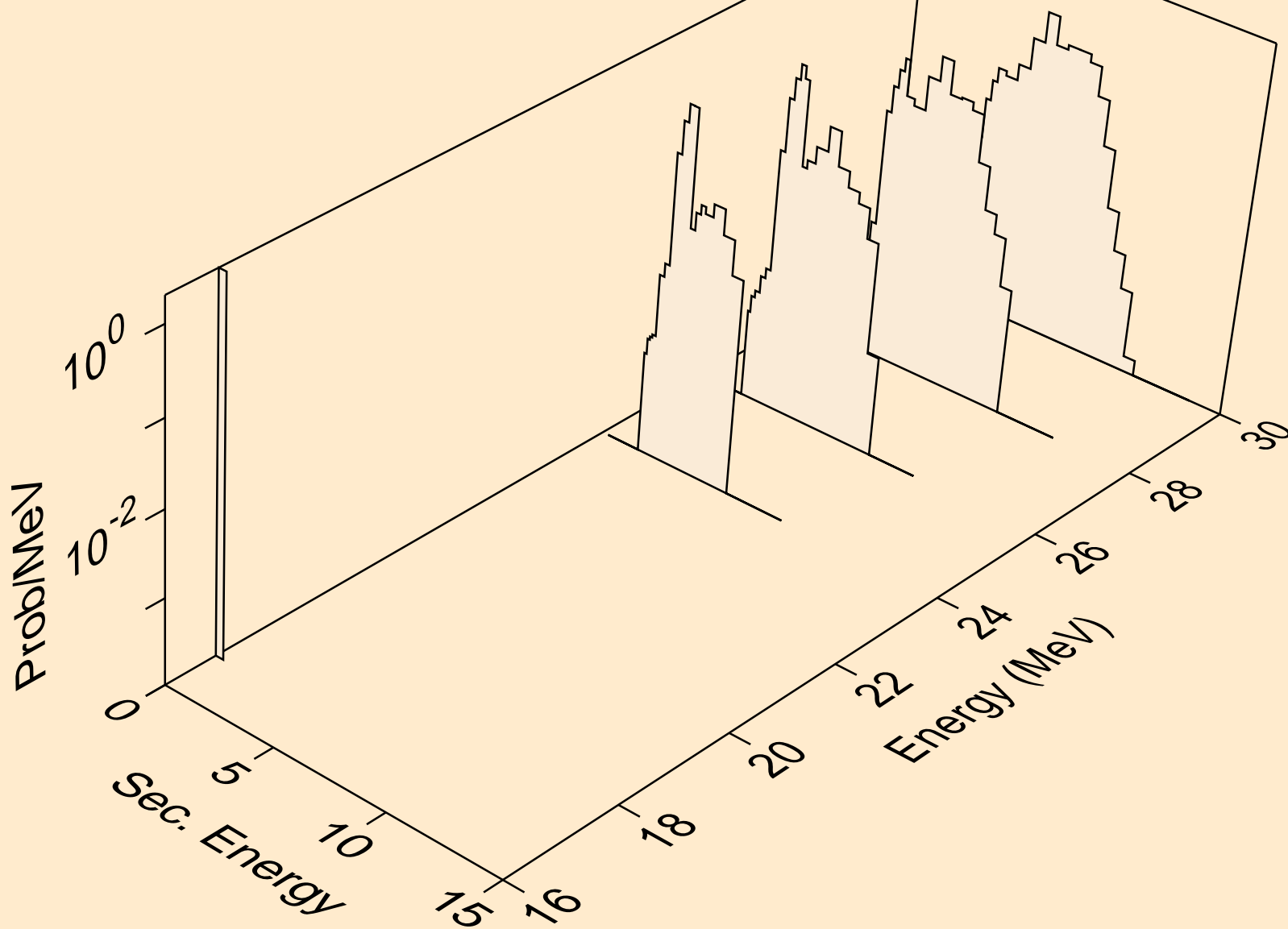

HF183 NEUTRON ACER TENDL-2019 LIBRARY; T=293.16K  
protons from (n,p)

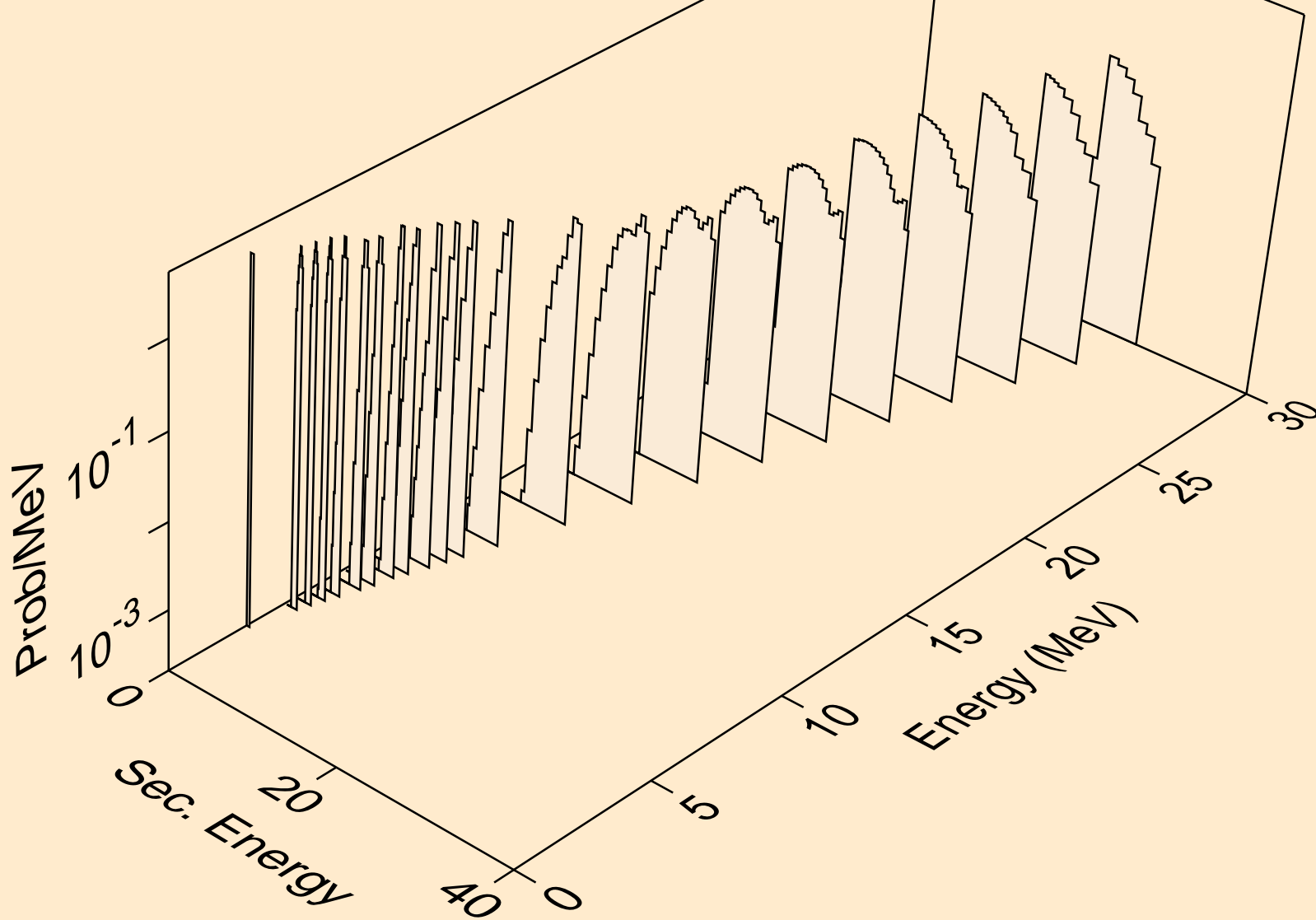

HF183 NEUTRON ACER TENDL-2019 LIBRARY; T=293.16K  
protons from (n,2p)

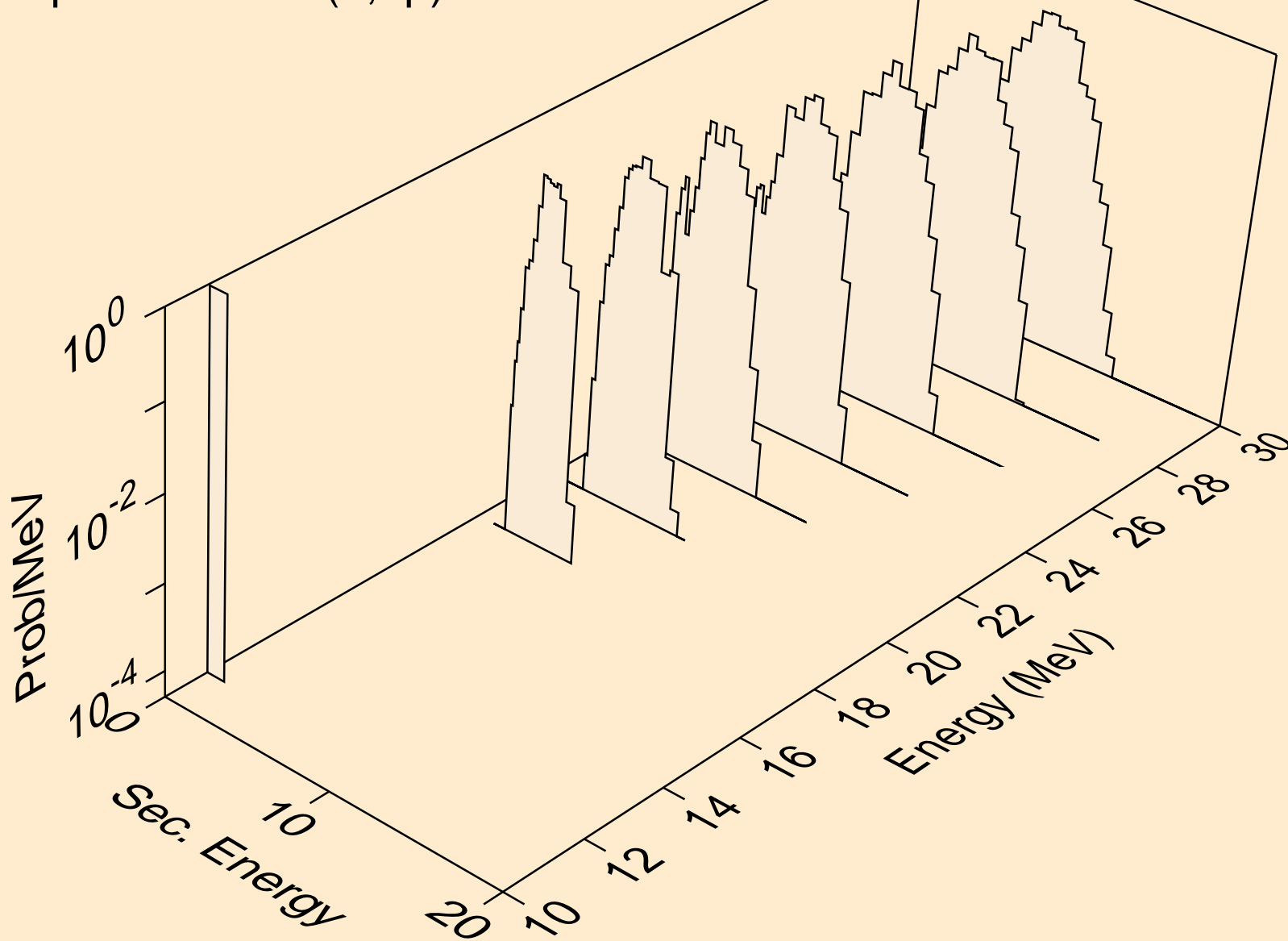

HF183 NEUTRON ACER TENDL-2019 LIBRARY; T=293.16K  
deuterons from (n,x)

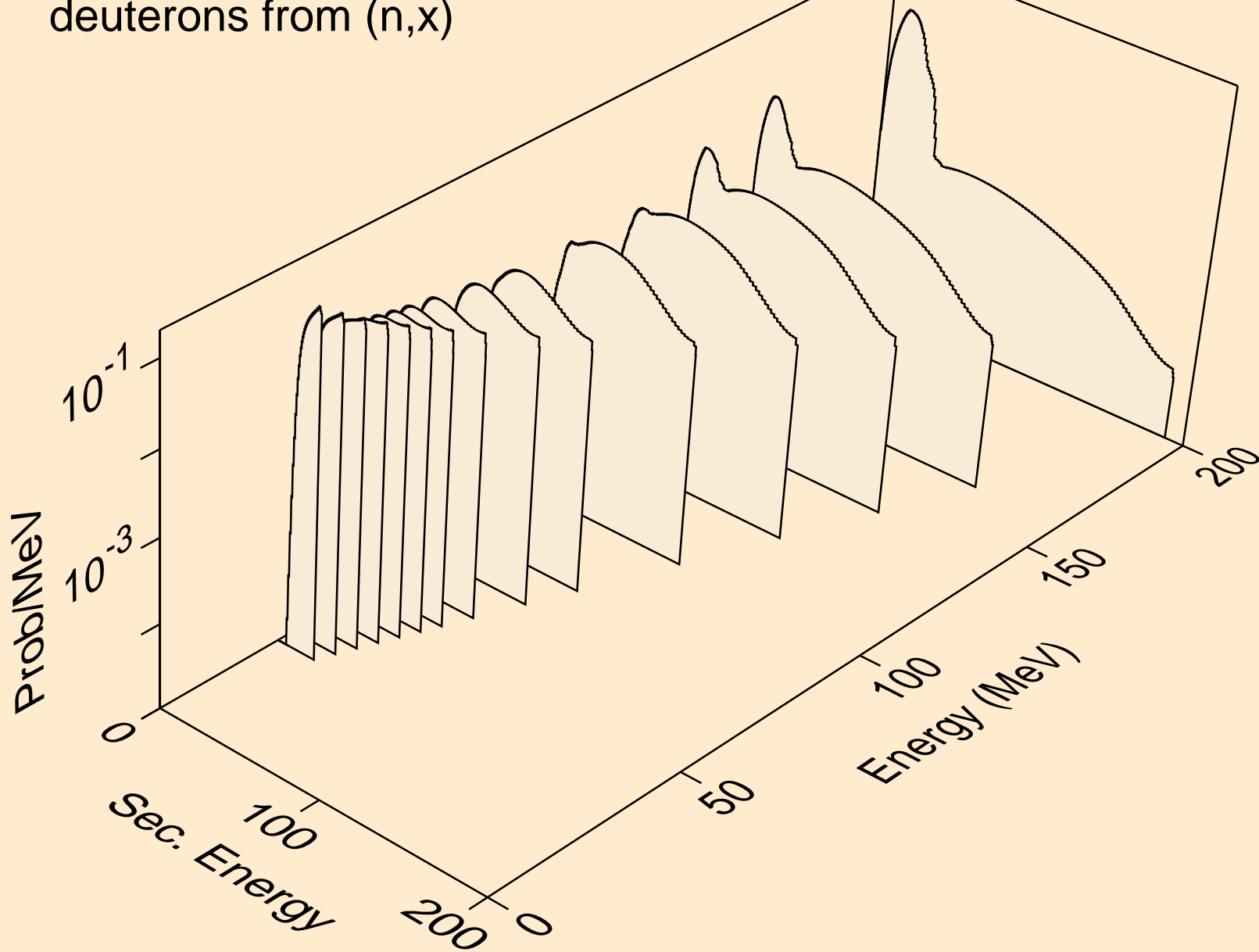

HF183 NEUTRON ACER TENDL-2019 LIBRARY; T=293.16K  
deuterons from (n,2nd)

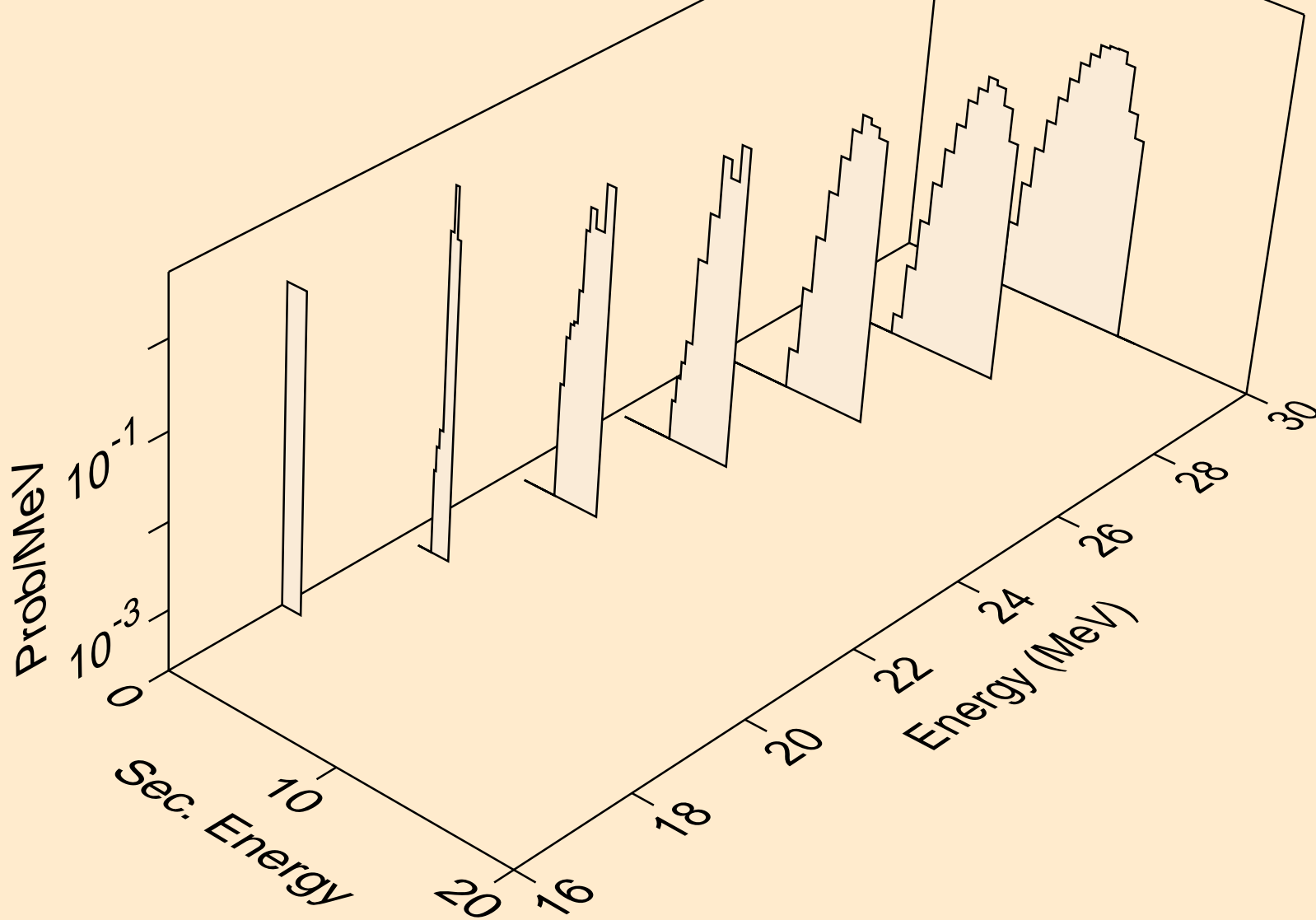



HF183 NEUTRON ACER TENDL-2019 LIBRARY; T=293.16K  
deuterons from (n,n\*)d

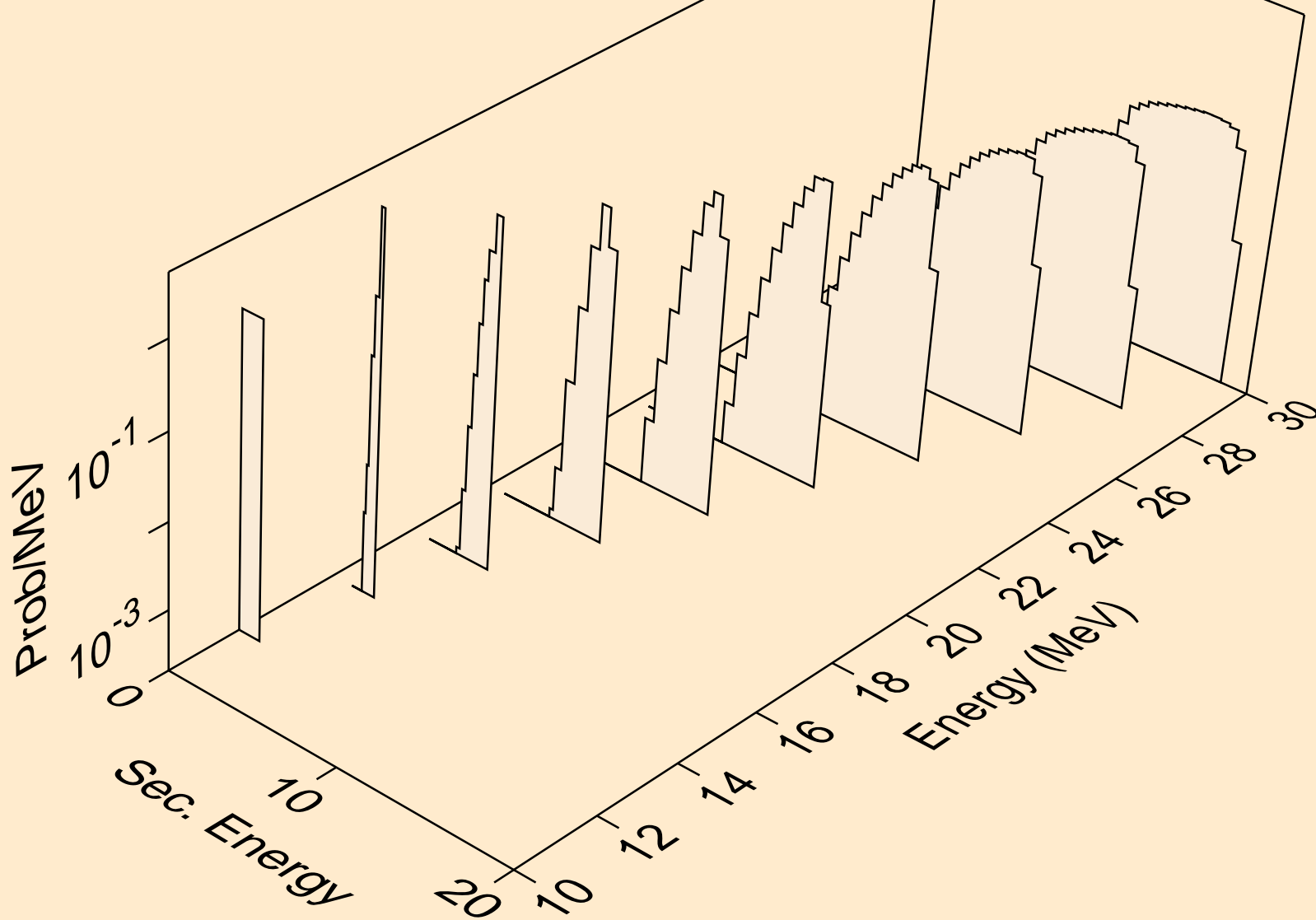

HF183 NEUTRON ACER TENDL-2019 LIBRARY; T=293.16K  
deuterons from (n,d)

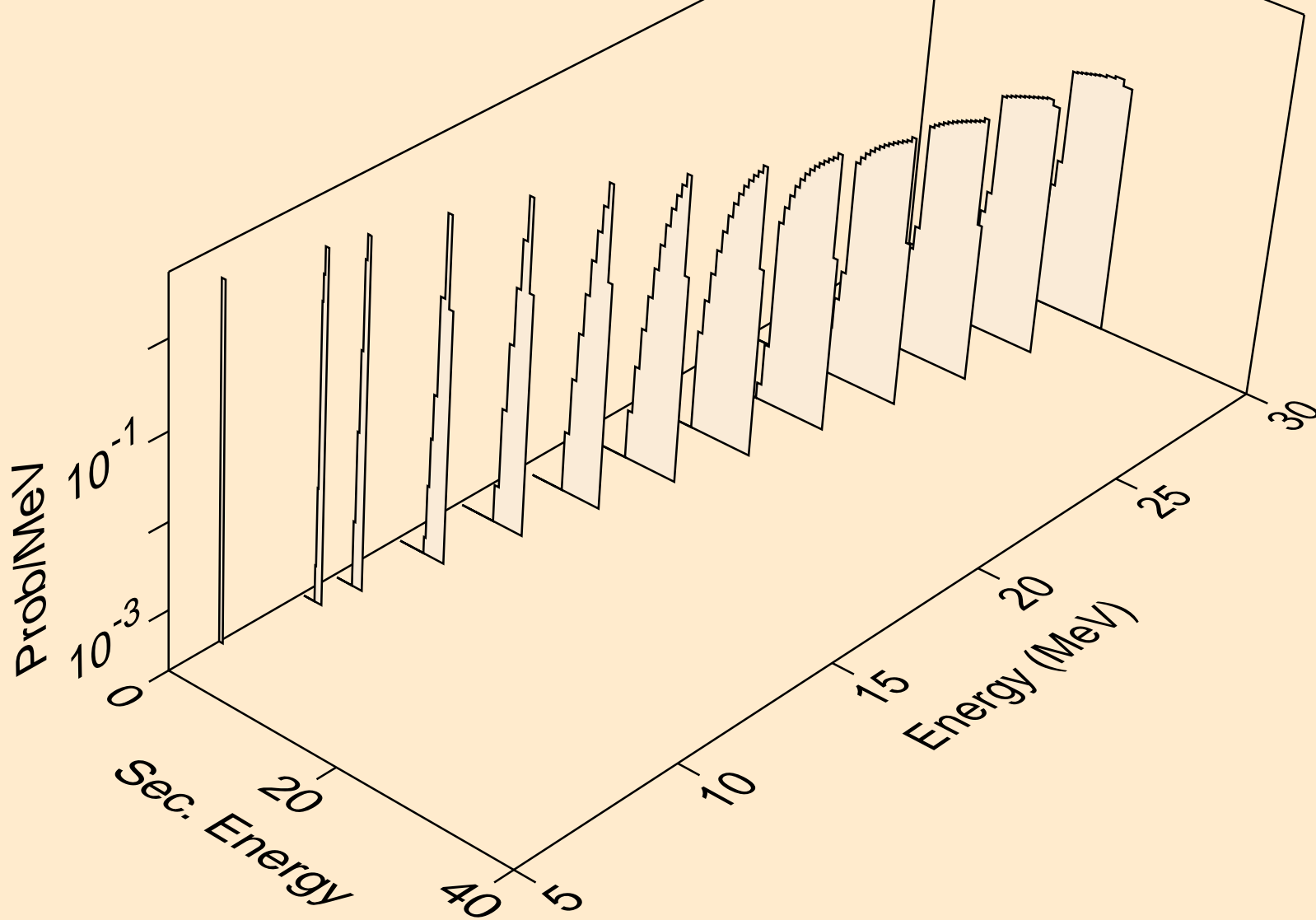

HF183 NEUTRON ACER TENDL-2019 LIBRARY; T=293.16K  
tritons from (n,x)

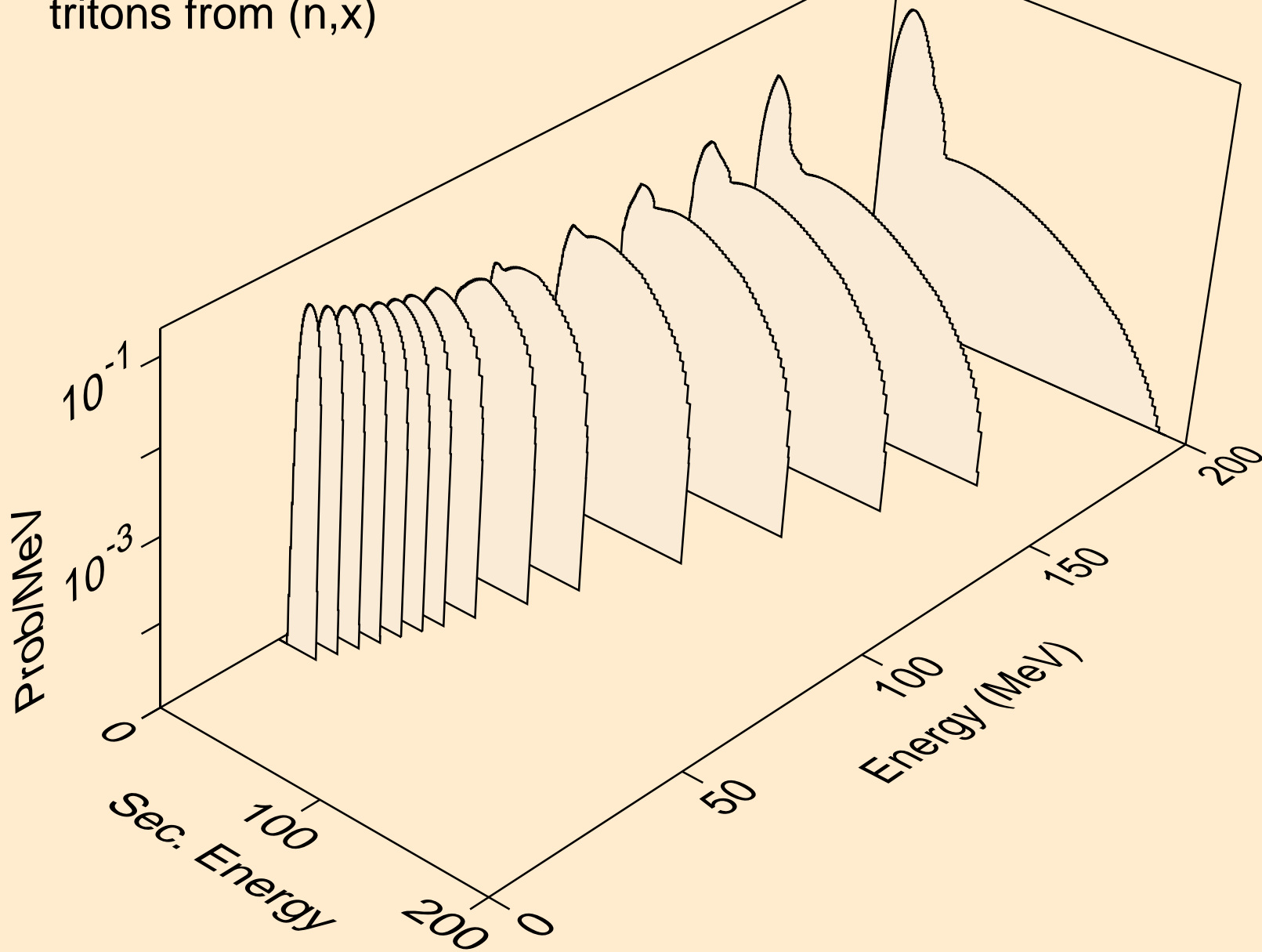

HF183 NEUTRON ACER TENDL-2019 LIBRARY; T=293.16K  
tritons from (n,n\*)t

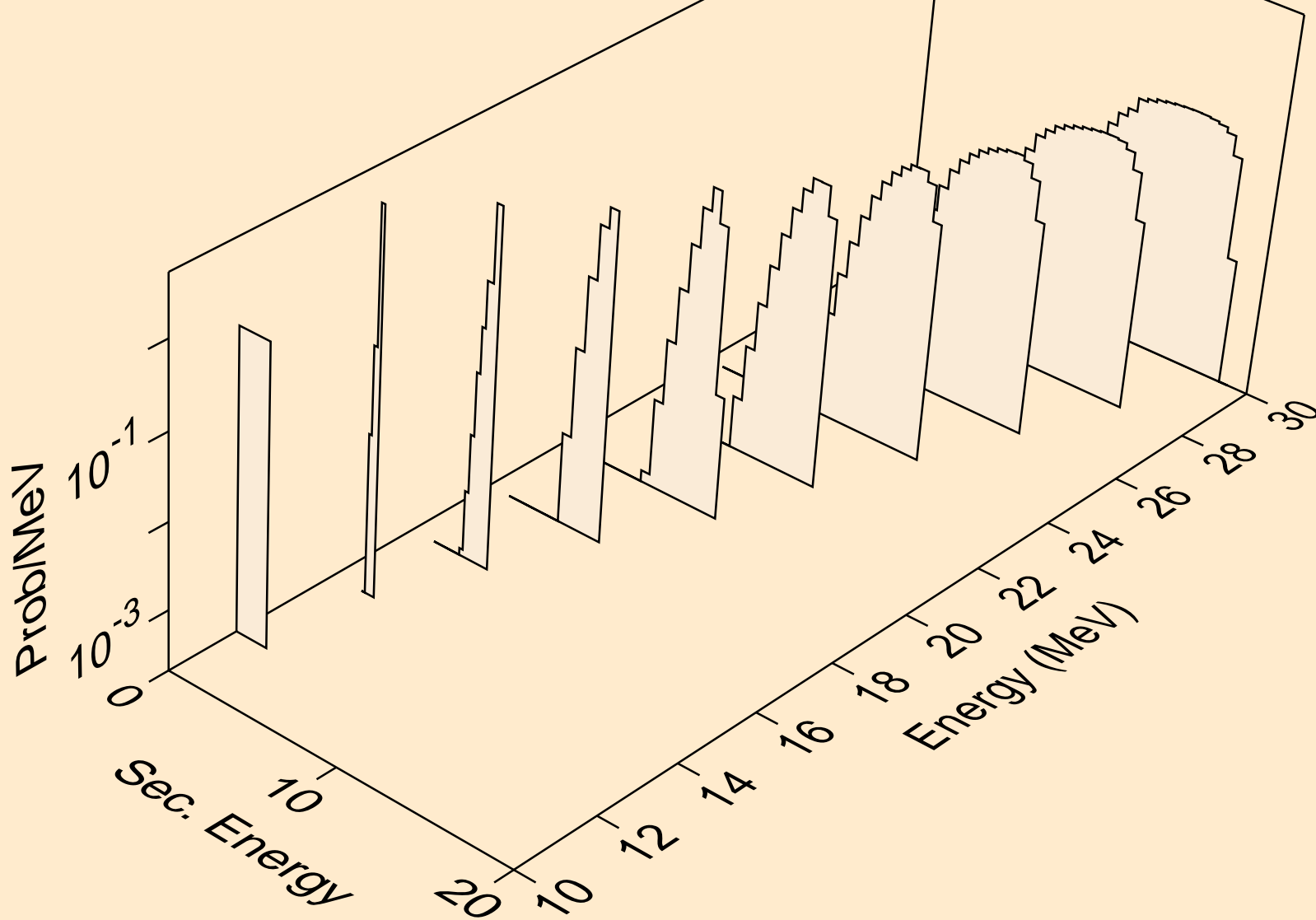

HF183 NEUTRON ACER TENDL-2019 LIBRARY; T=293.16K  
tritons from (n,t)

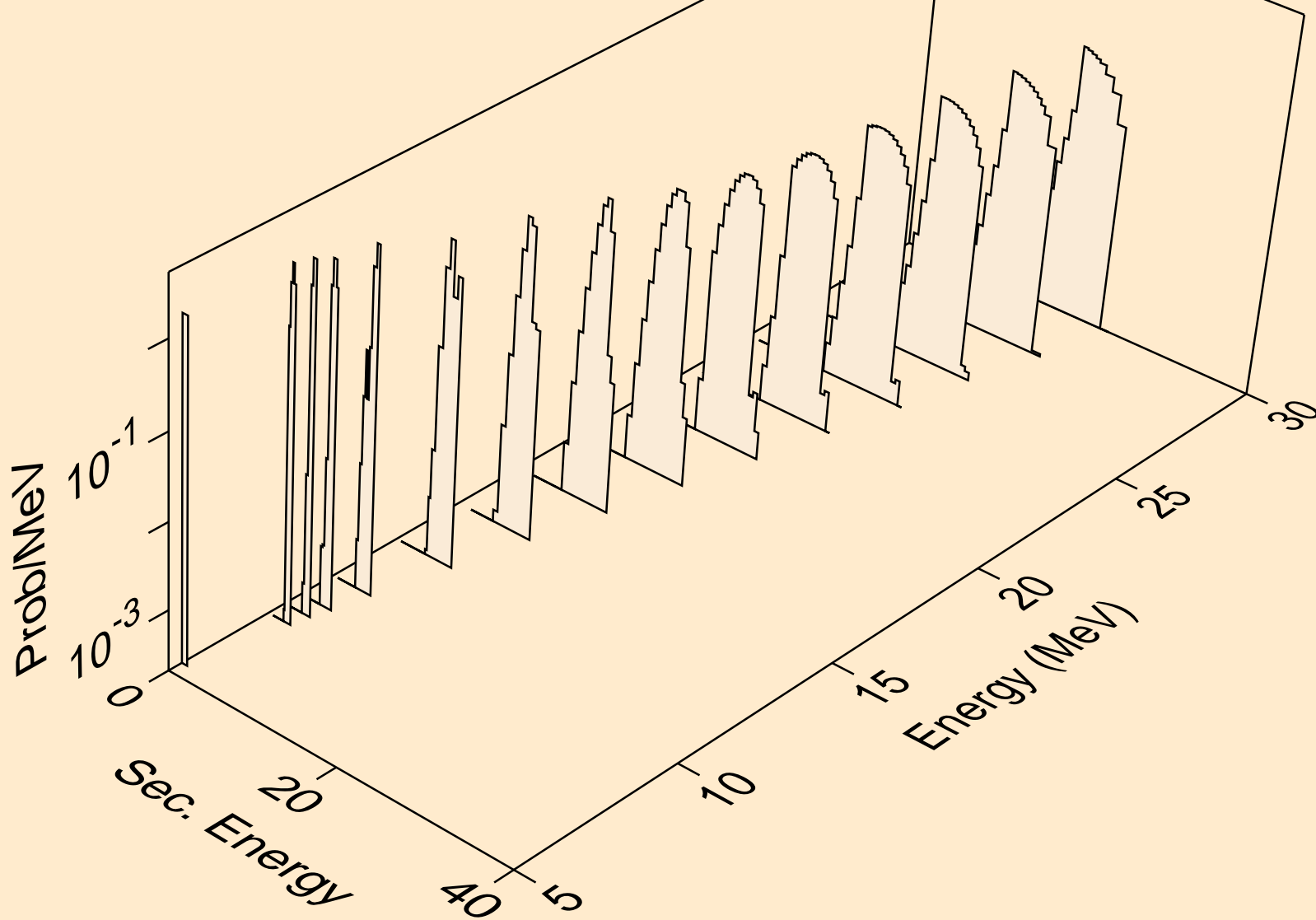

HF183 NEUTRON ACER TENDL-2019 LIBRARY; T=293.16K  
he3s from (n,x)

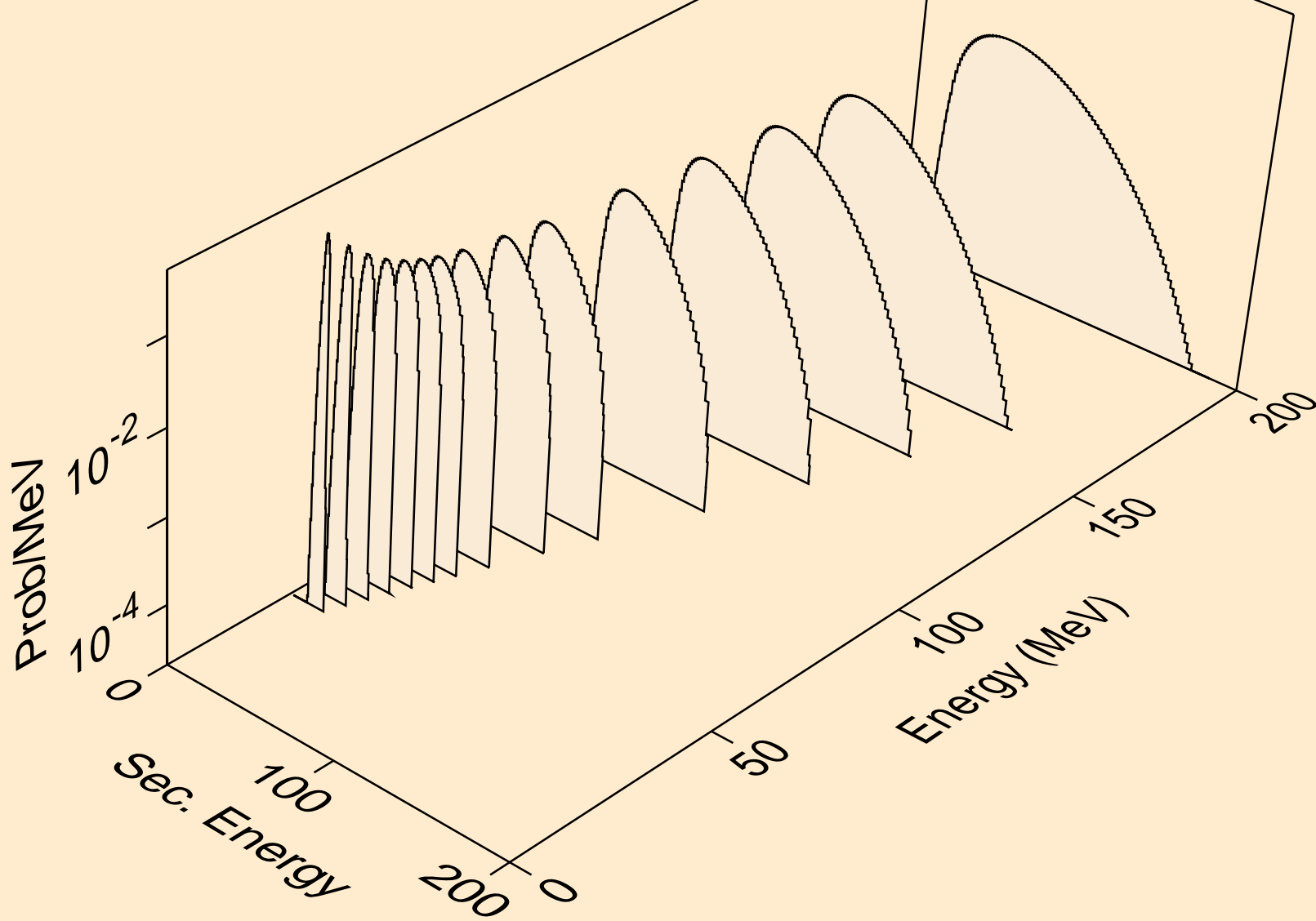

HF183 NEUTRON ACER TENDL-2019 LIBRARY; T=293.16K  
he3s from (n,n\*)he3

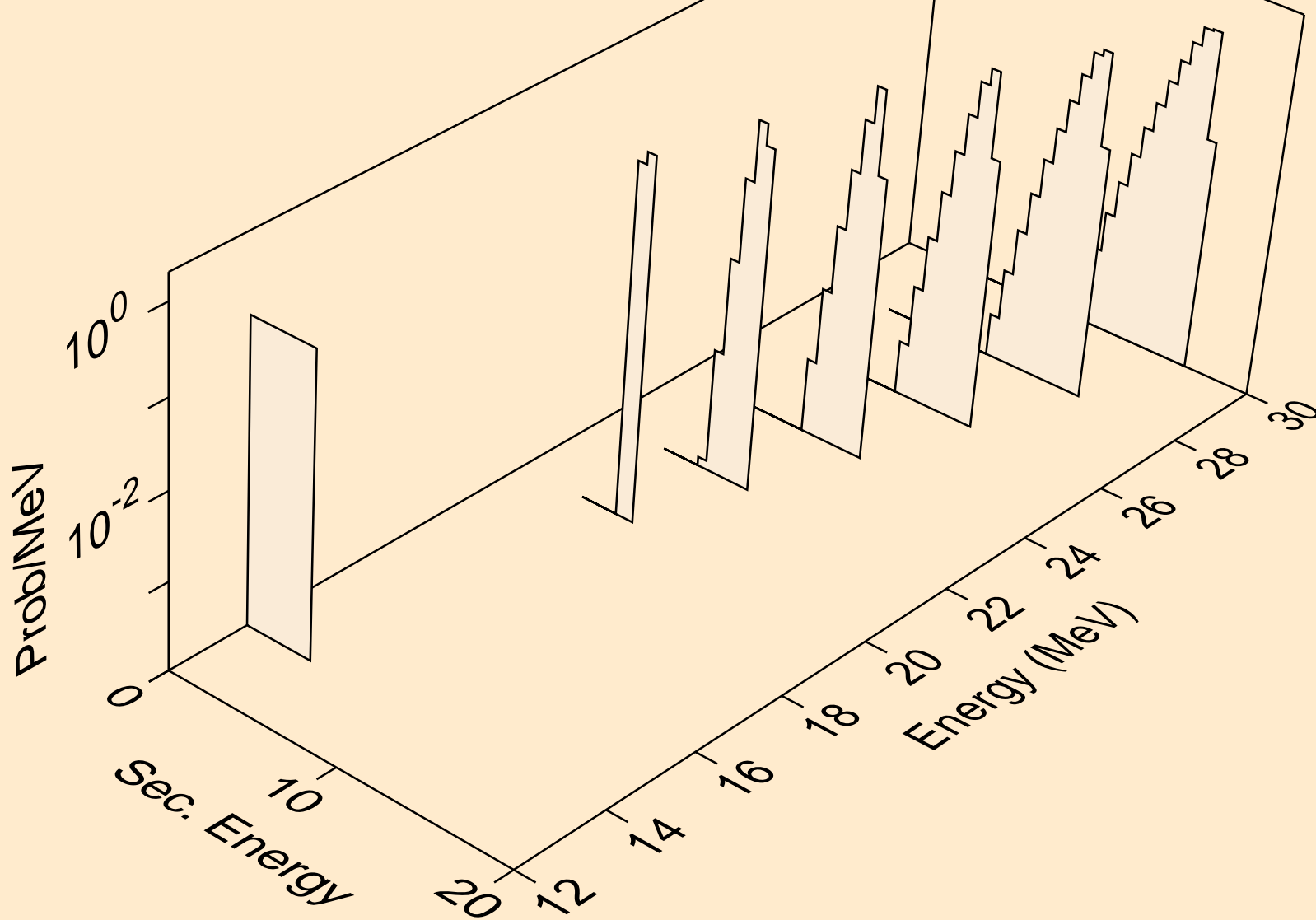

HF183 NEUTRON ACER TENDL-2019 LIBRARY; T=293.16K  
he3s from (n,he3)

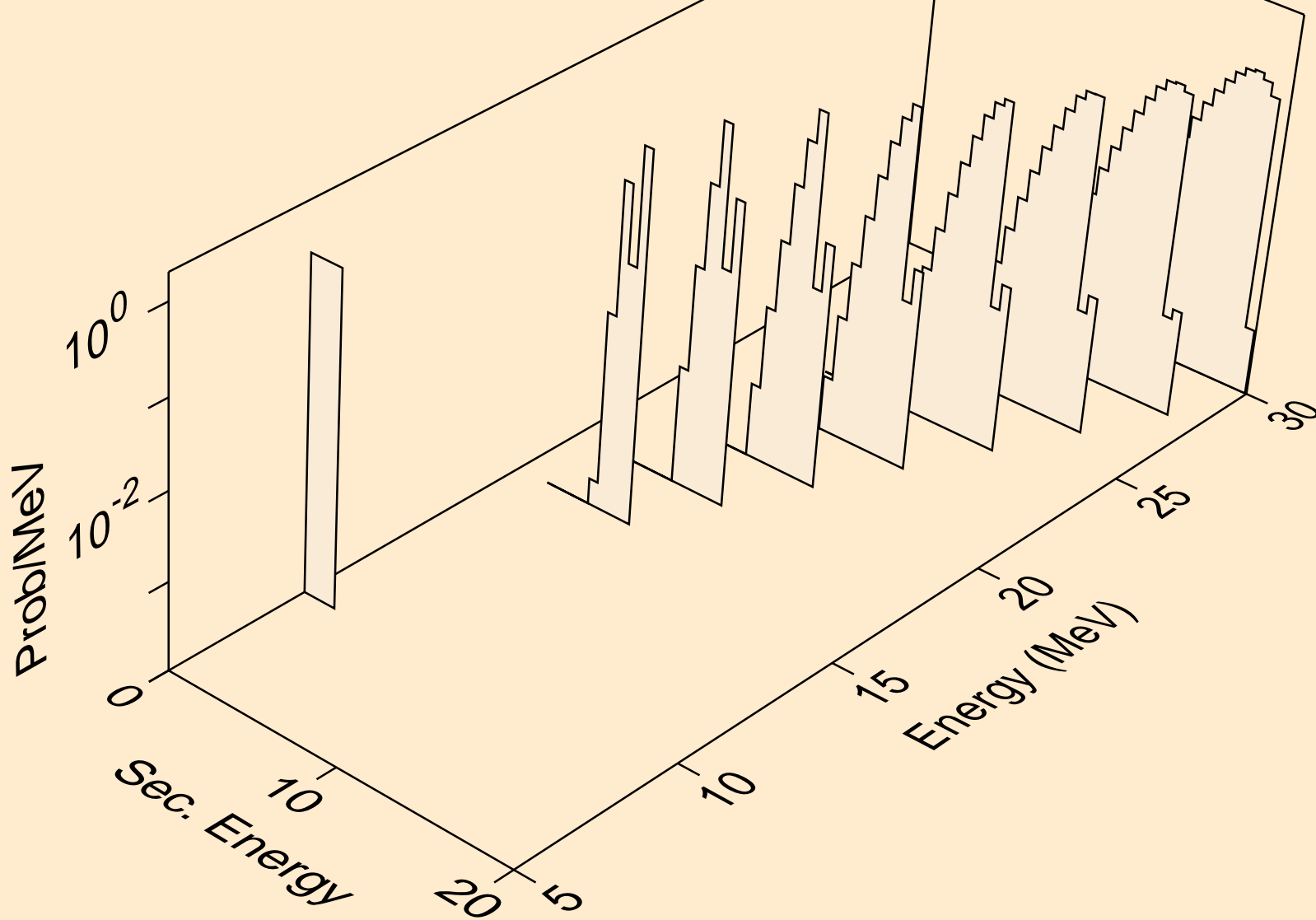



HF183 NEUTRON ACER TENDL-2019 LIBRARY; T=293.16K  
alphas from (n,x)

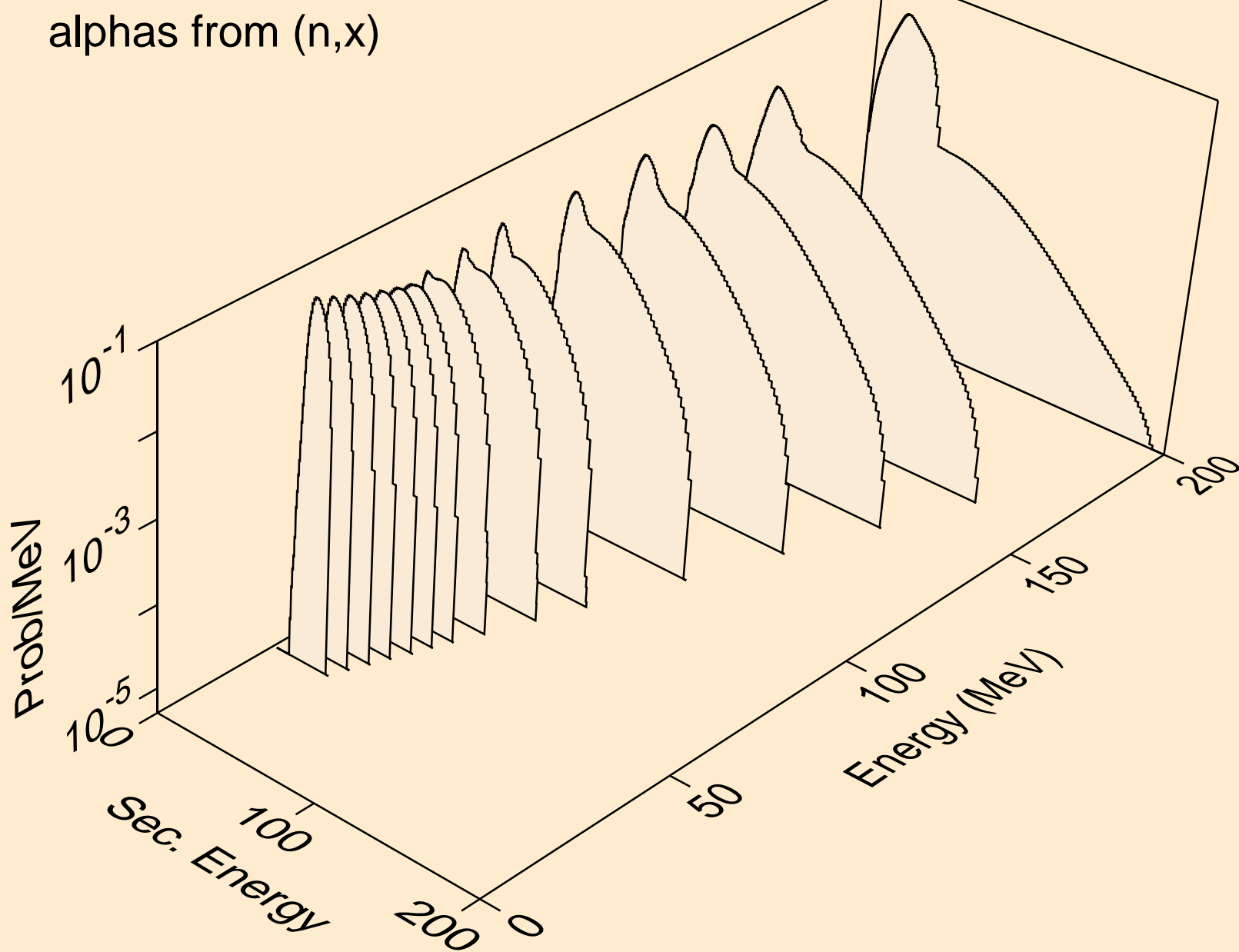

HF183 NEUTRON ACER TENDL-2019 LIBRARY; T=293.16K  
alphas from (n,n\*)a

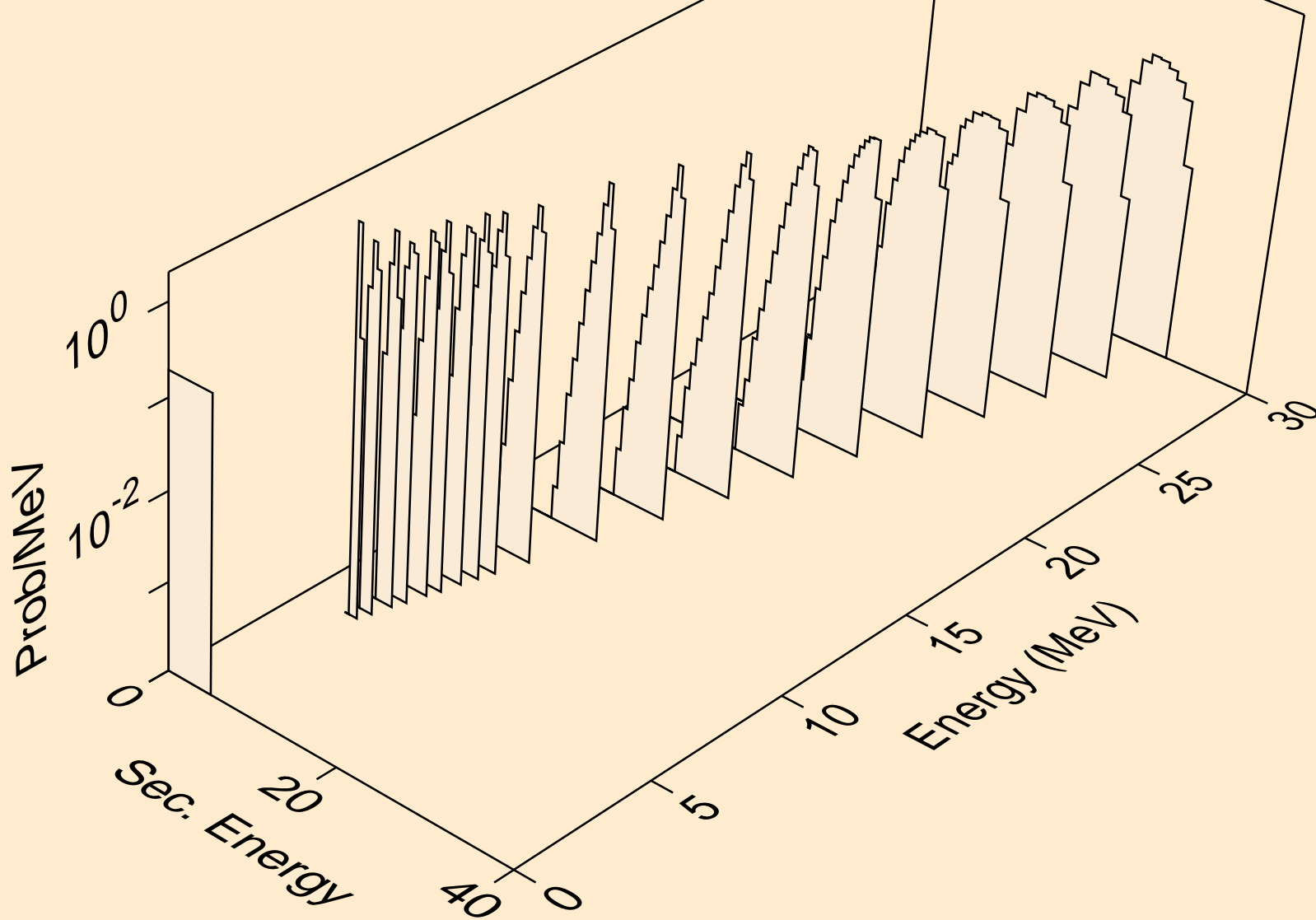

HF183 NEUTRON ACER TENDL-2019 LIBRARY; T=293.16K  
alphas from (n,2n)a

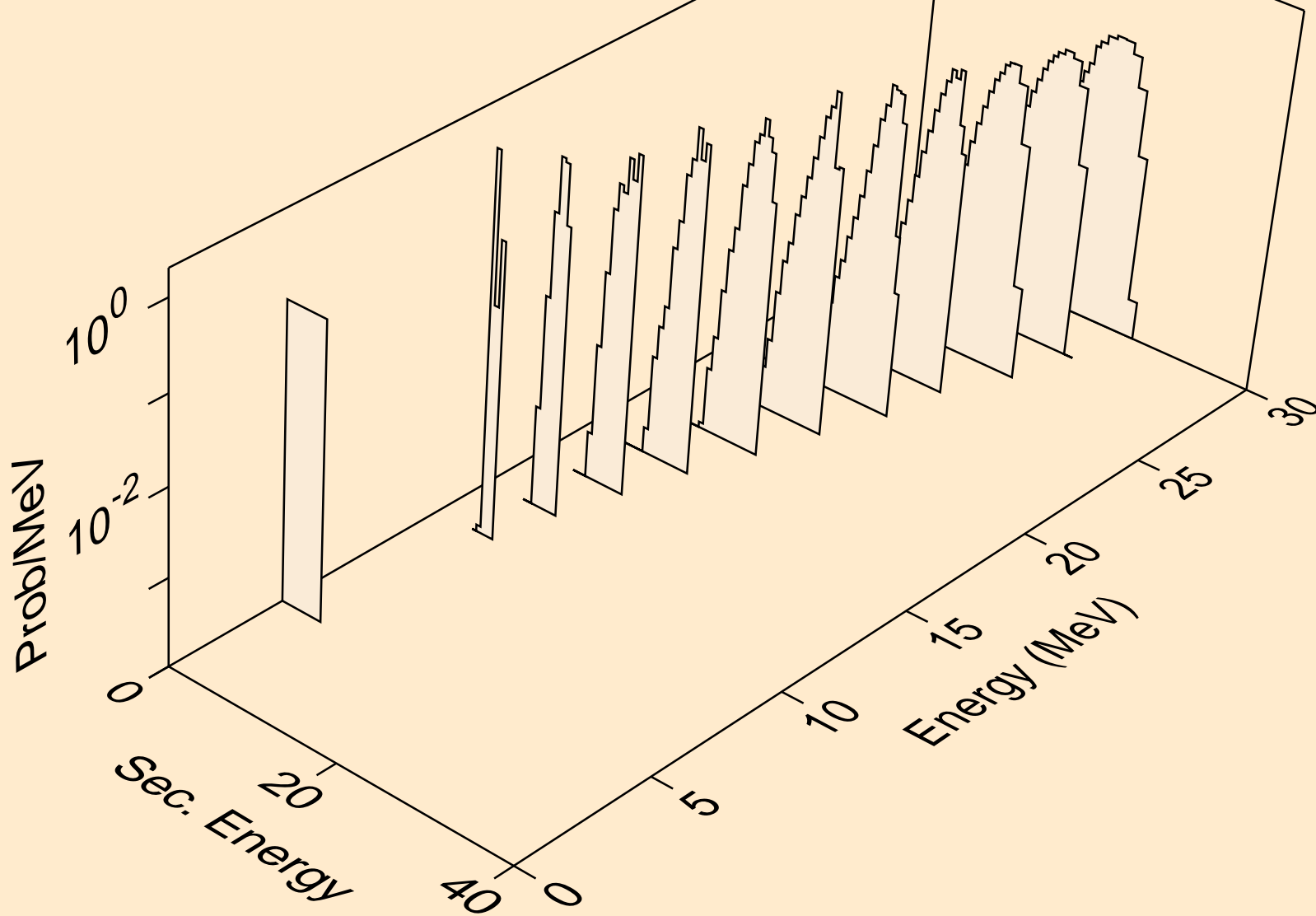

HF183 NEUTRON ACER TENDL-2019 LIBRARY; T=293.16K  
alphas from (n,3n)a

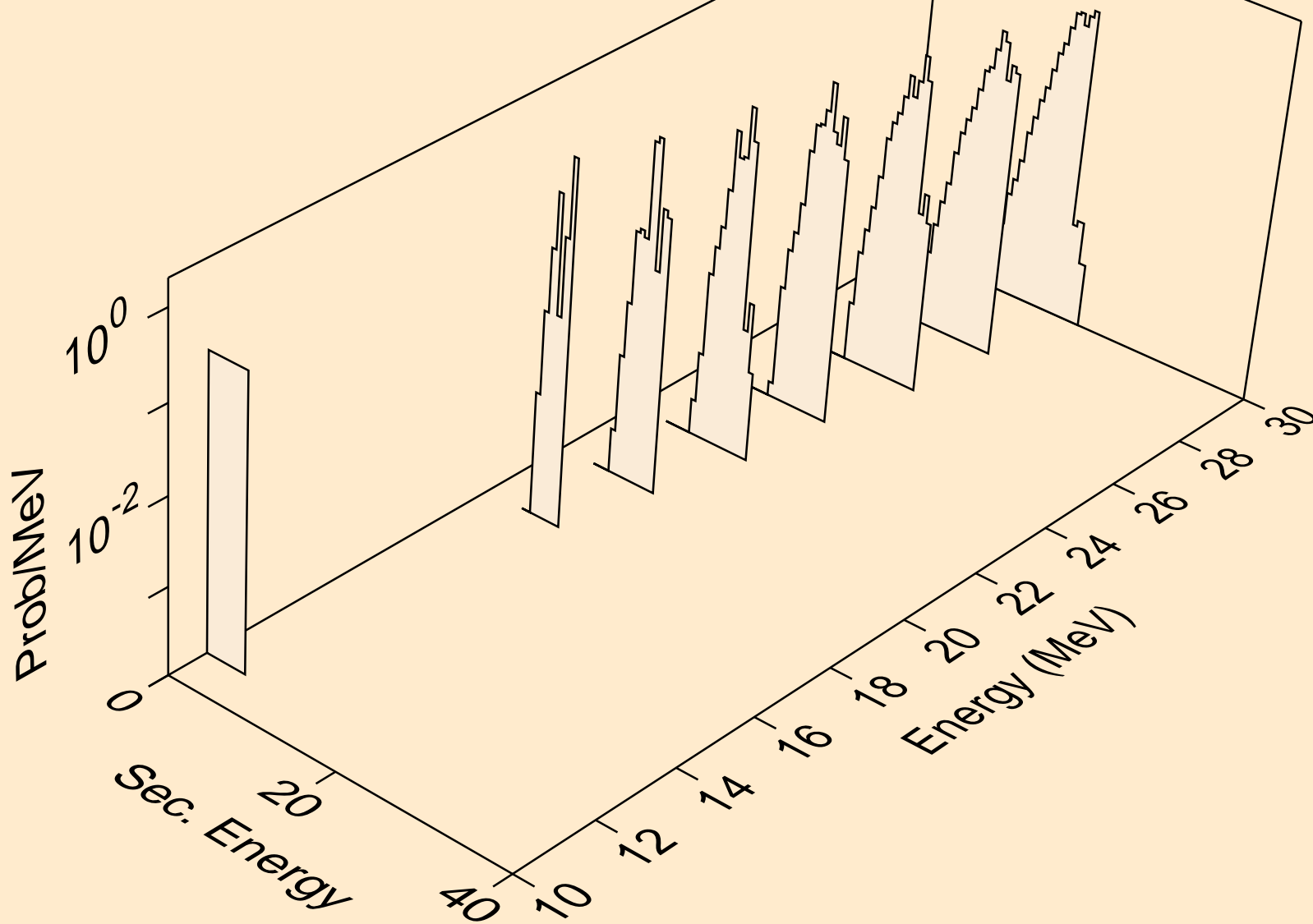

HF183 NEUTRON ACER TENDL-2019 LIBRARY; T=293.16K  
alphas from (n,a)

