

HG185M NEUTRON ACER TENDL-2019 LIBRARY; T=293.16K

Principal cross sections

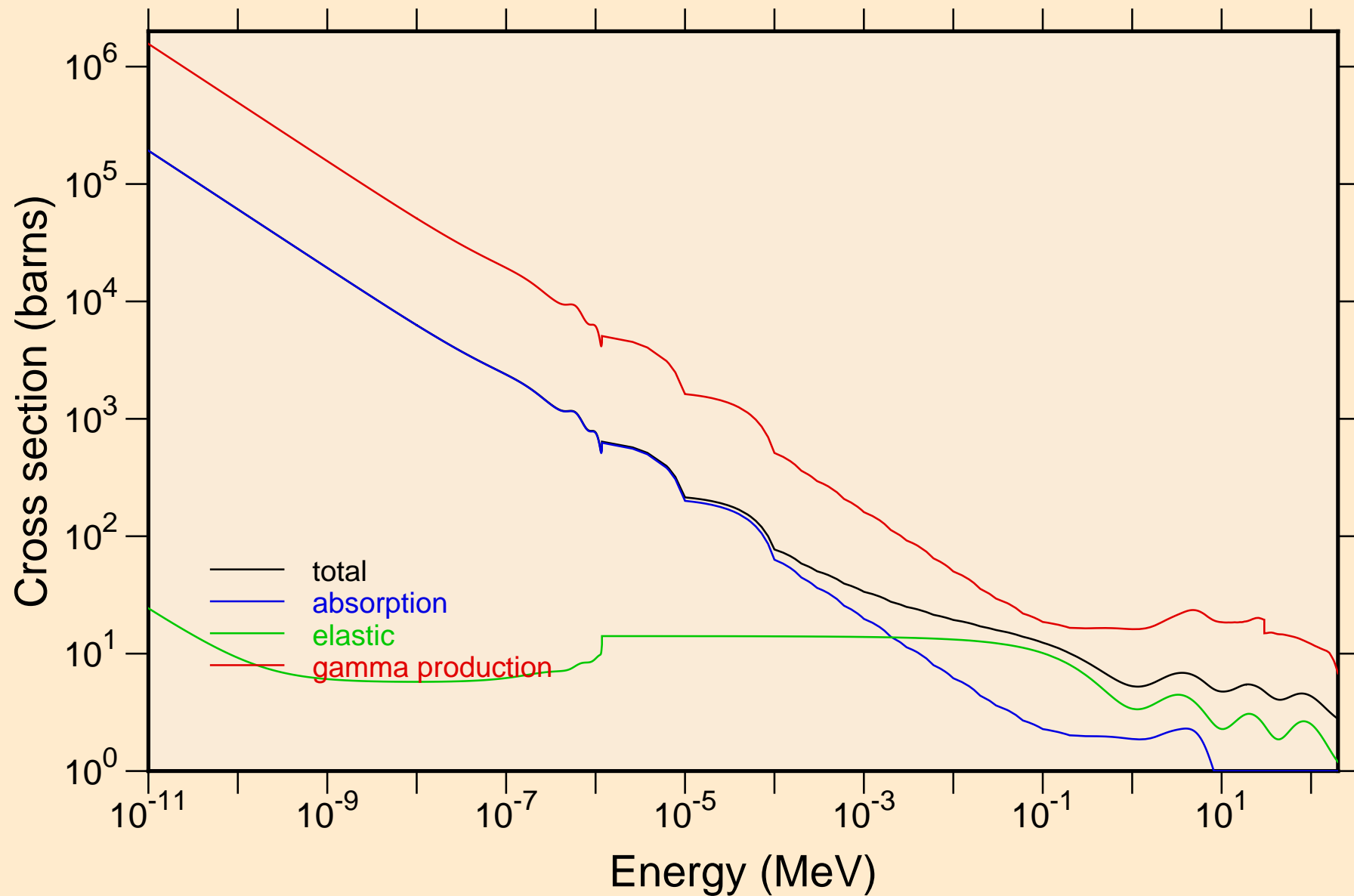

HG185M NEUTRON ACER TENDL-2019 LIBRARY; T=293.16K
Heating

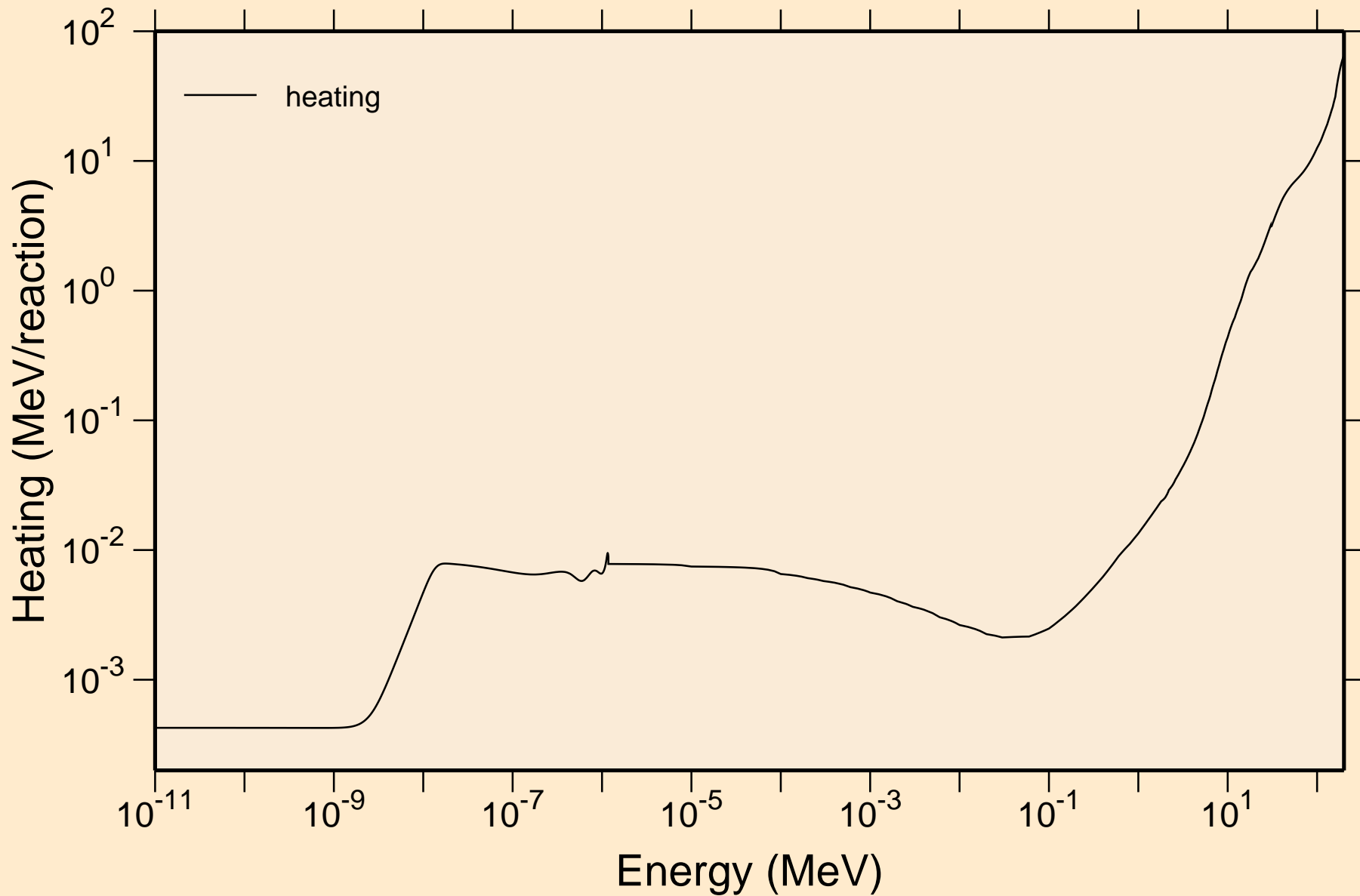

HG185M NEUTRON ACER TENDL-2019 LIBRARY; T=293.16K
Damage

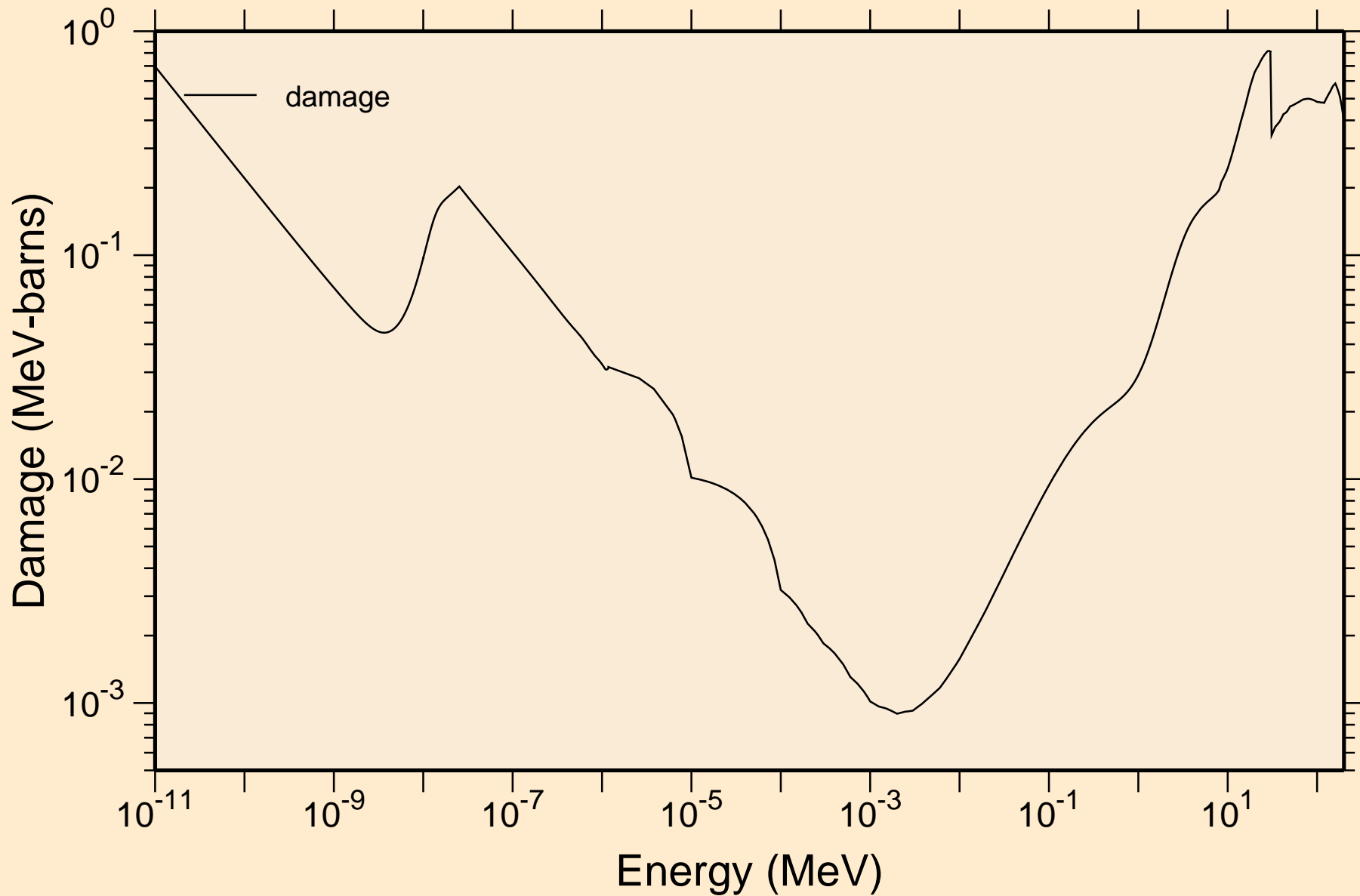

HG185M NEUTRON ACER TENDL-2019 LIBRARY; T=293.16K

Non-threshold reactions

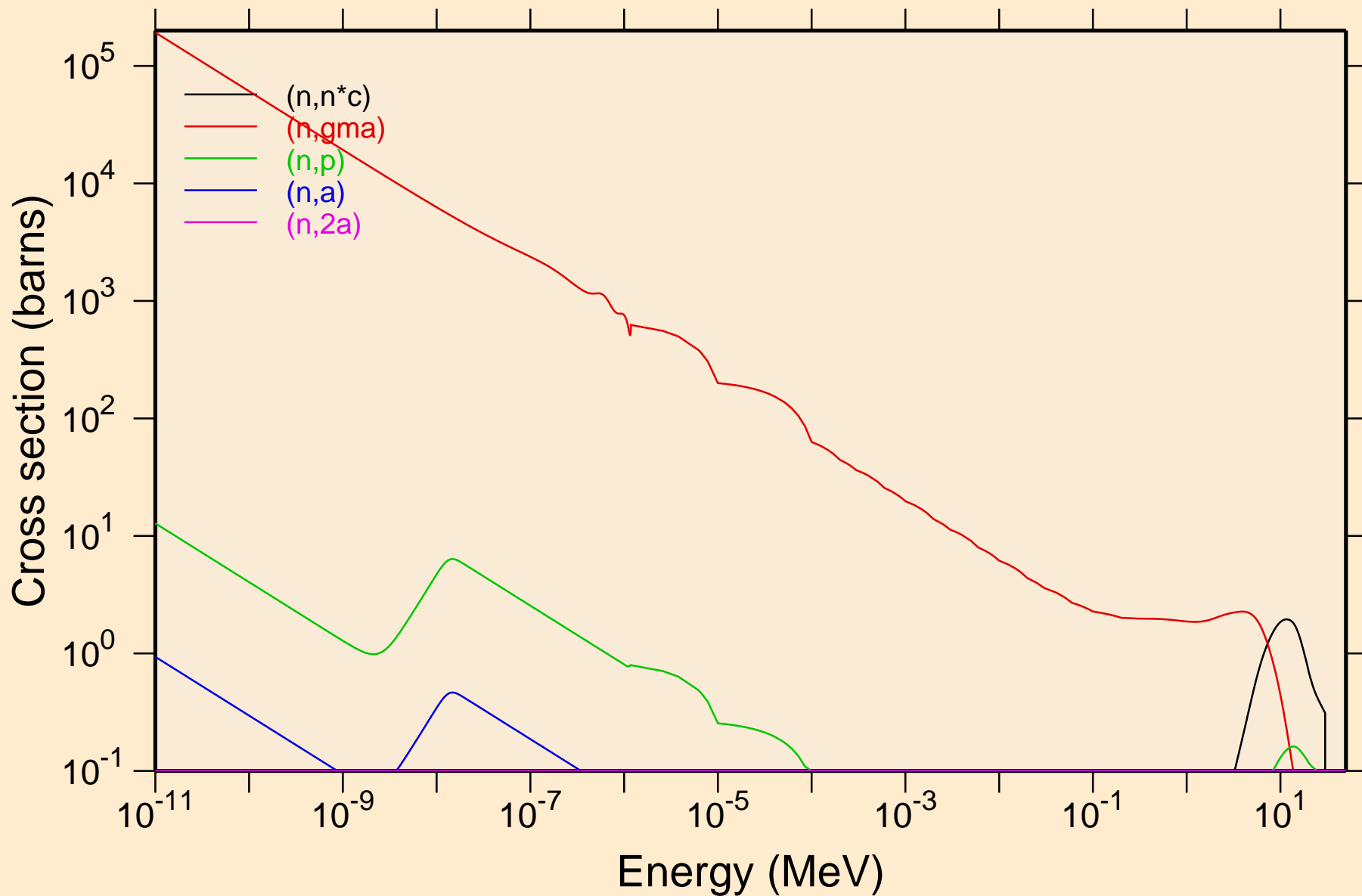

HG185M NEUTRON ACER TENDL-2019 LIBRARY; T=293.16K
Non-threshold reactions

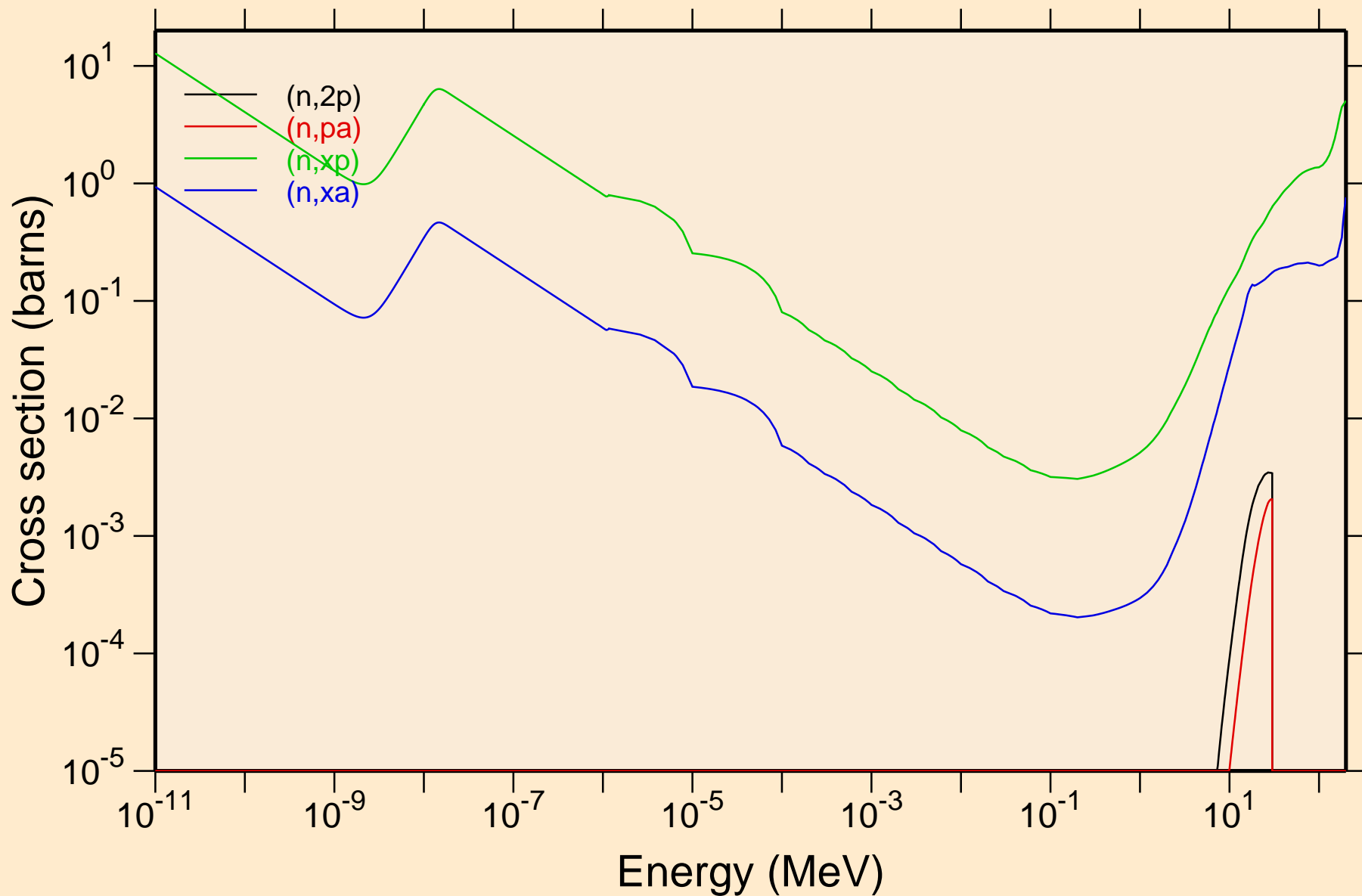

HG185M NEUTRON ACER TENDL-2019 LIBRARY; T=293.16K

Principal cross sections

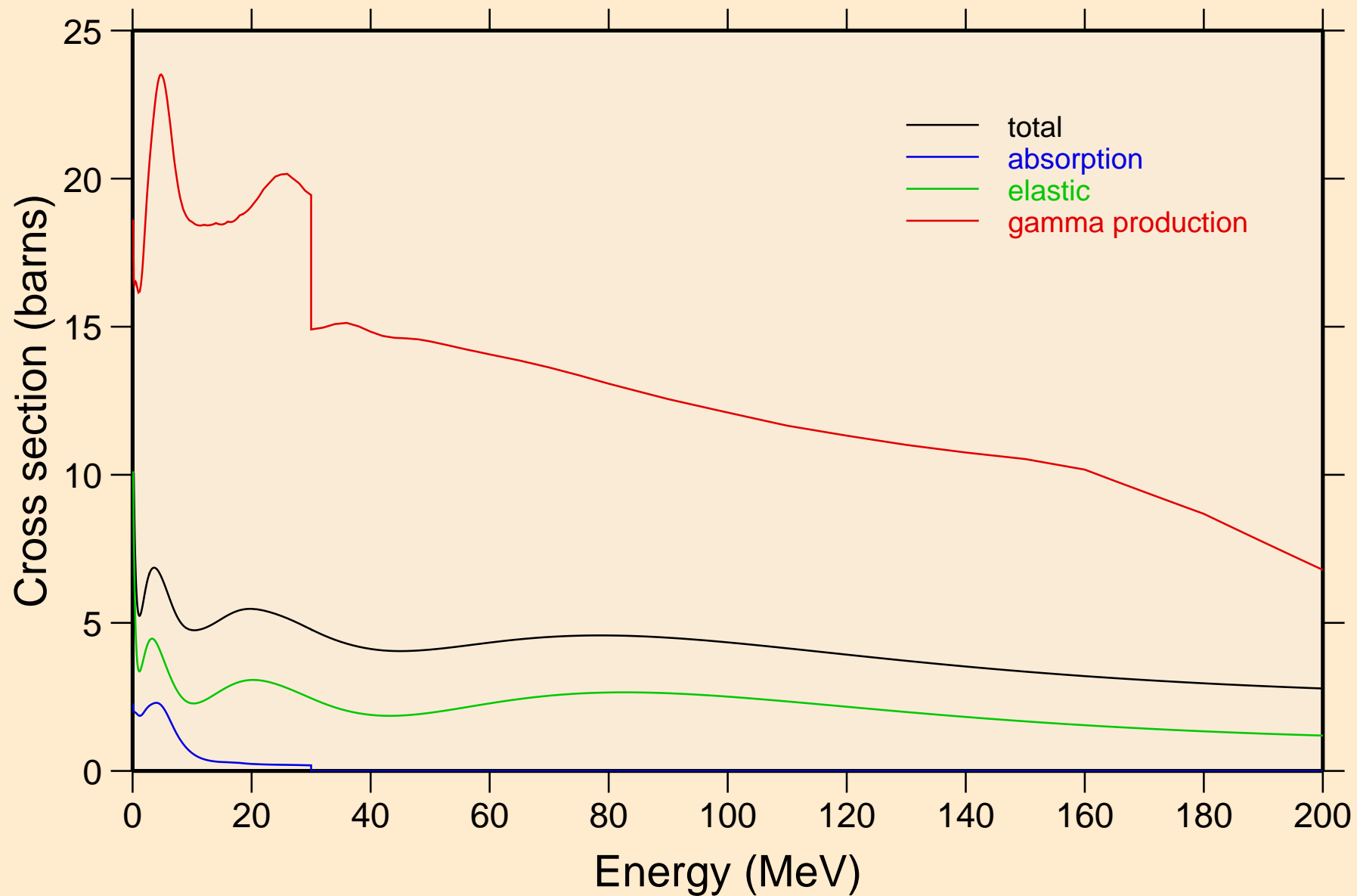

HG185M NEUTRON ACER TENDL-2019 LIBRARY; T=293.16K
Heating

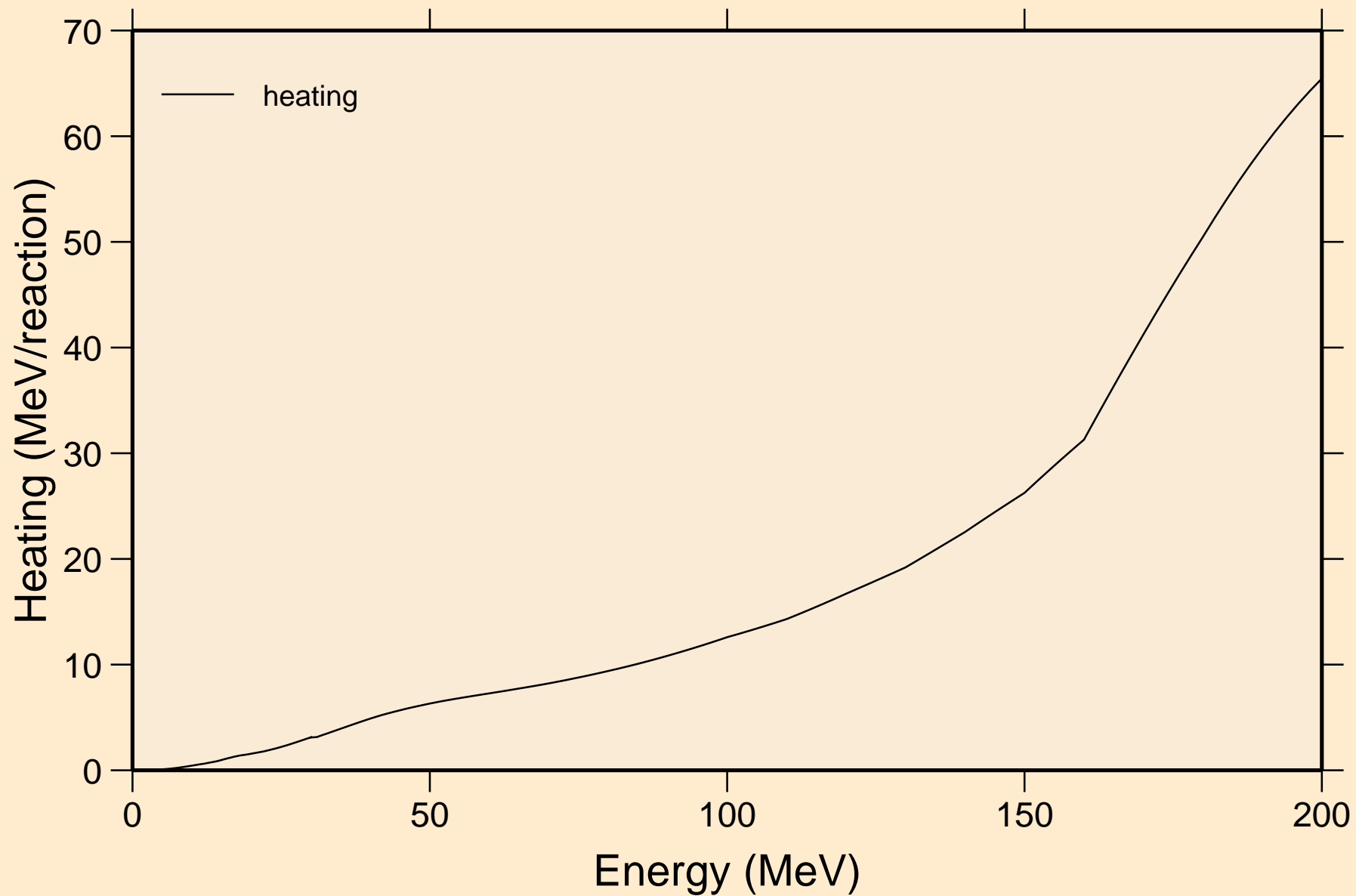

HG185M NEUTRON ACER TENDL-2019 LIBRARY; T=293.16K Damage

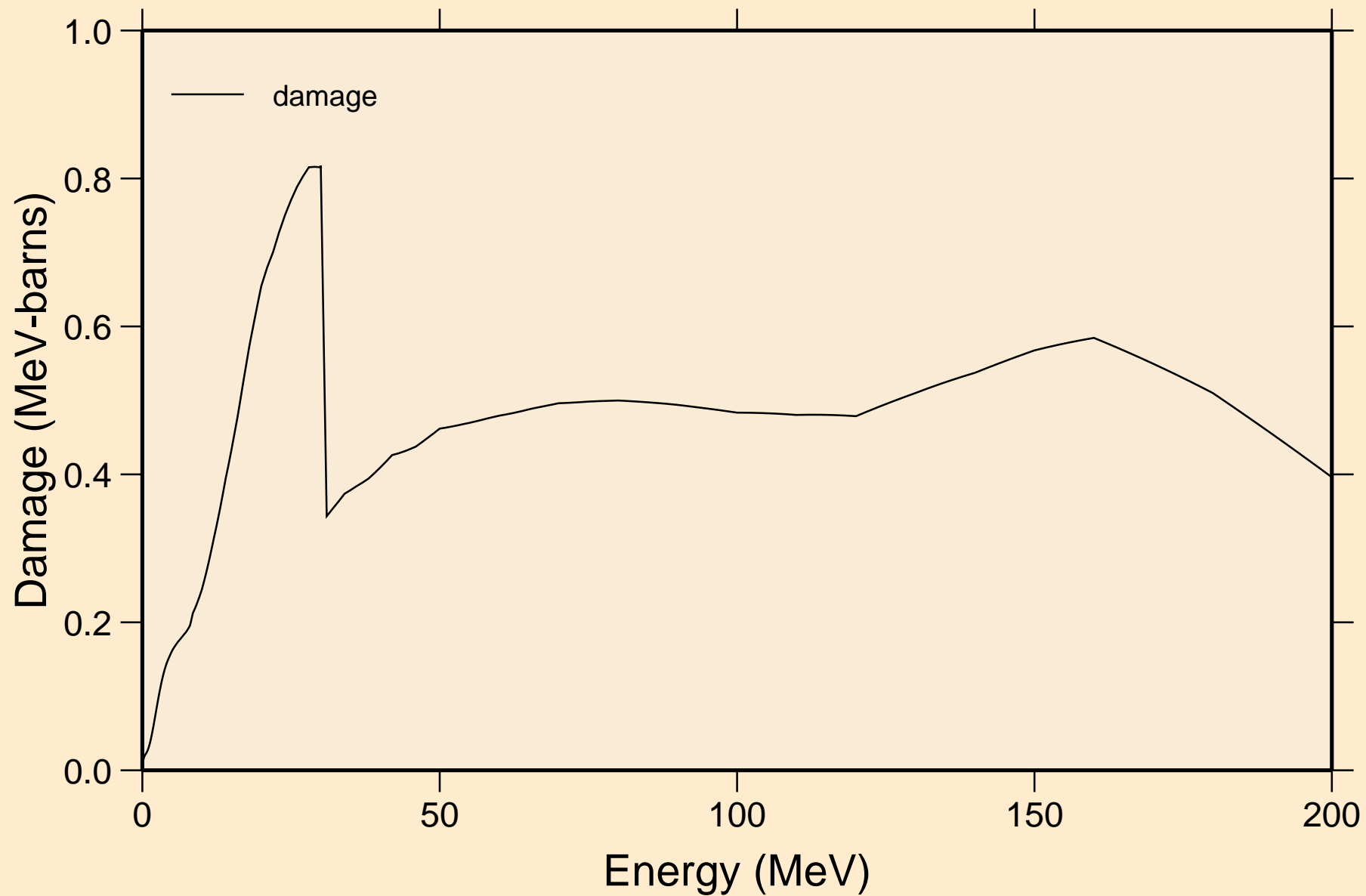

HG185M NEUTRON ACER TENDL-2019 LIBRARY; T=293.16K

Non-threshold reactions

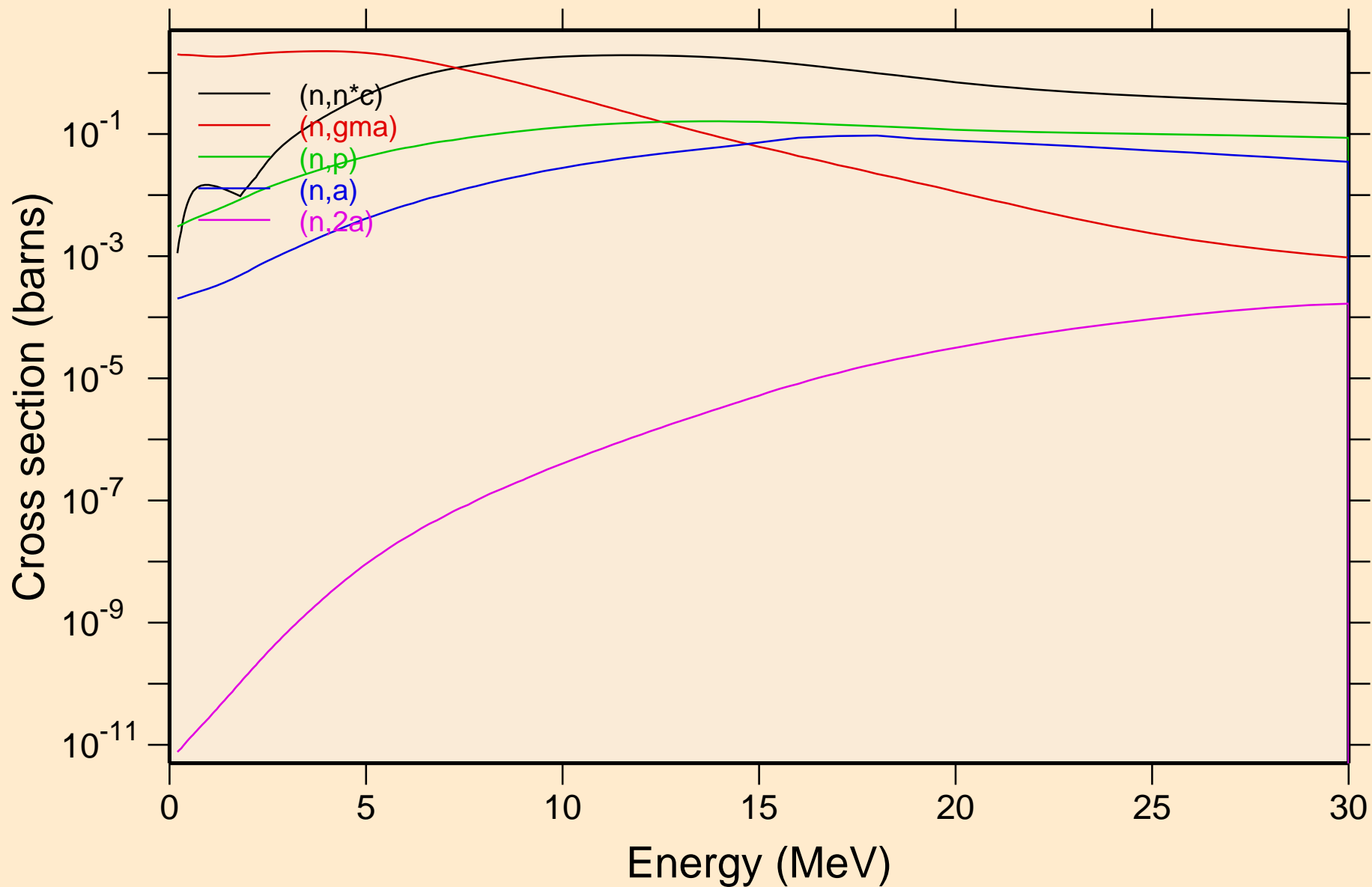

HG185M NEUTRON ACER TENDL-2019 LIBRARY; T=293.16K
Non-threshold reactions

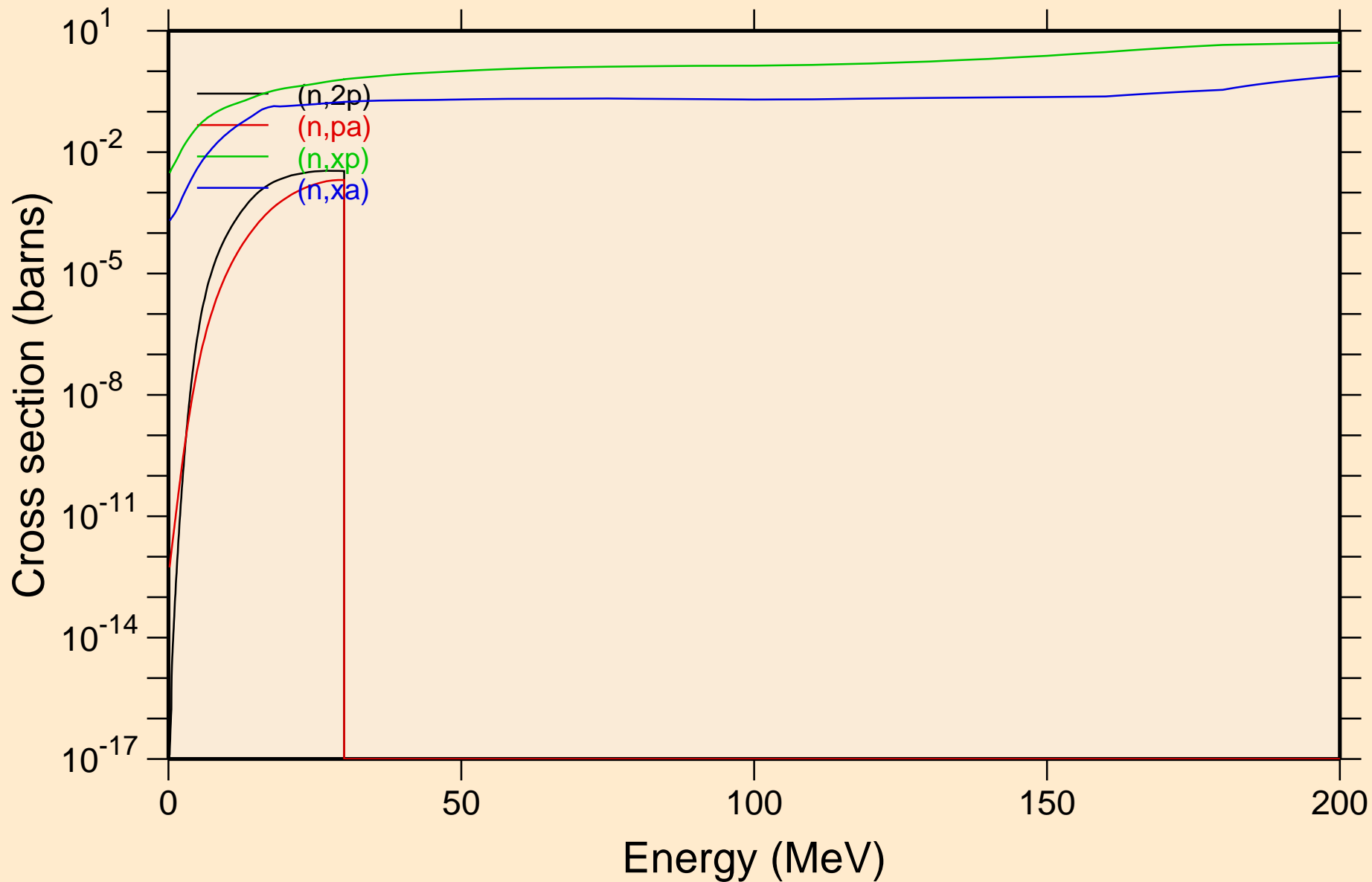

HG185M NEUTRON ACER TENDL-2019 LIBRARY; T=293.16K
Inelastic levels

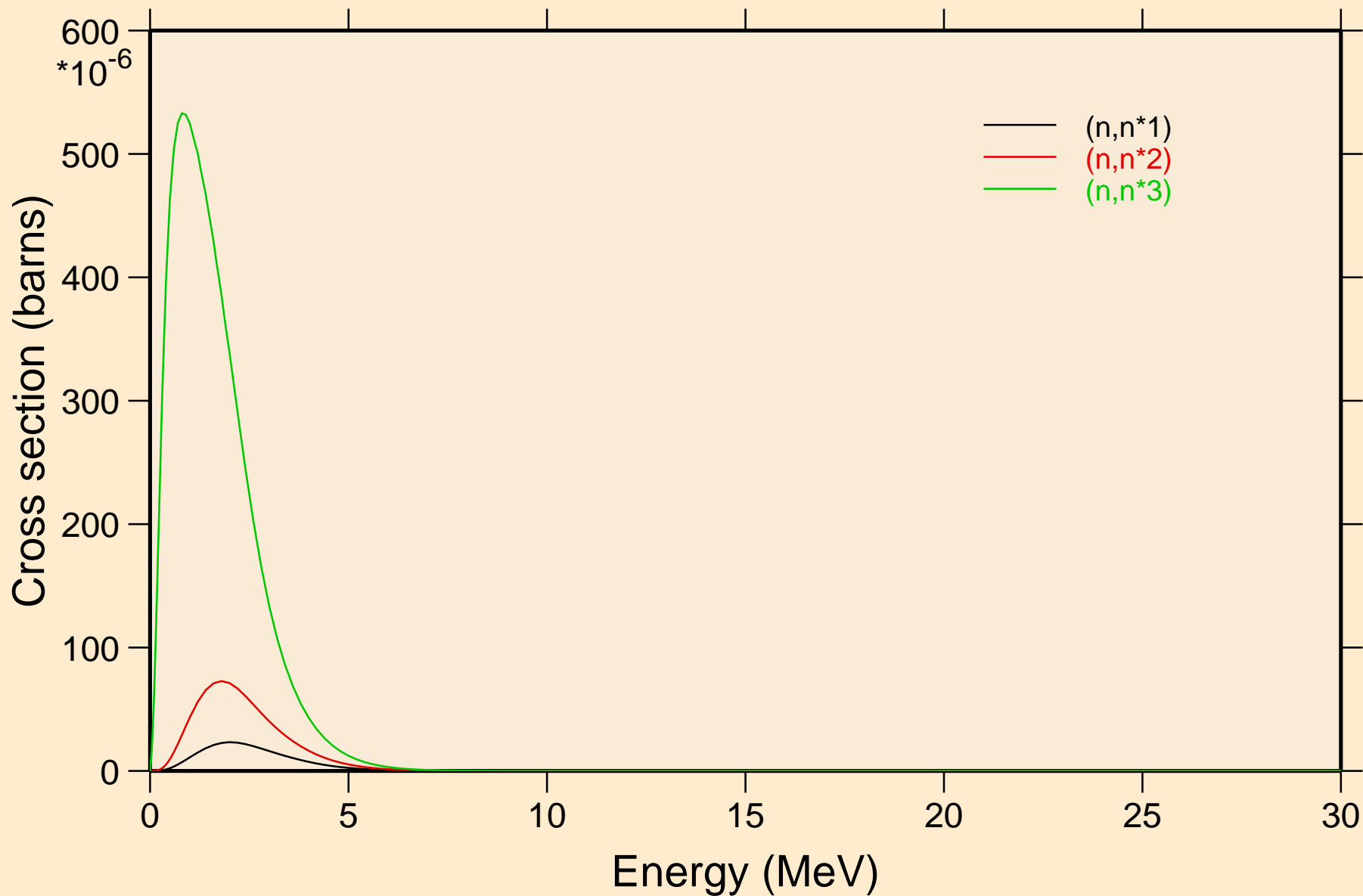

HG185M NEUTRON ACER TENDL-2019 LIBRARY; T=293.16K
Threshold reactions

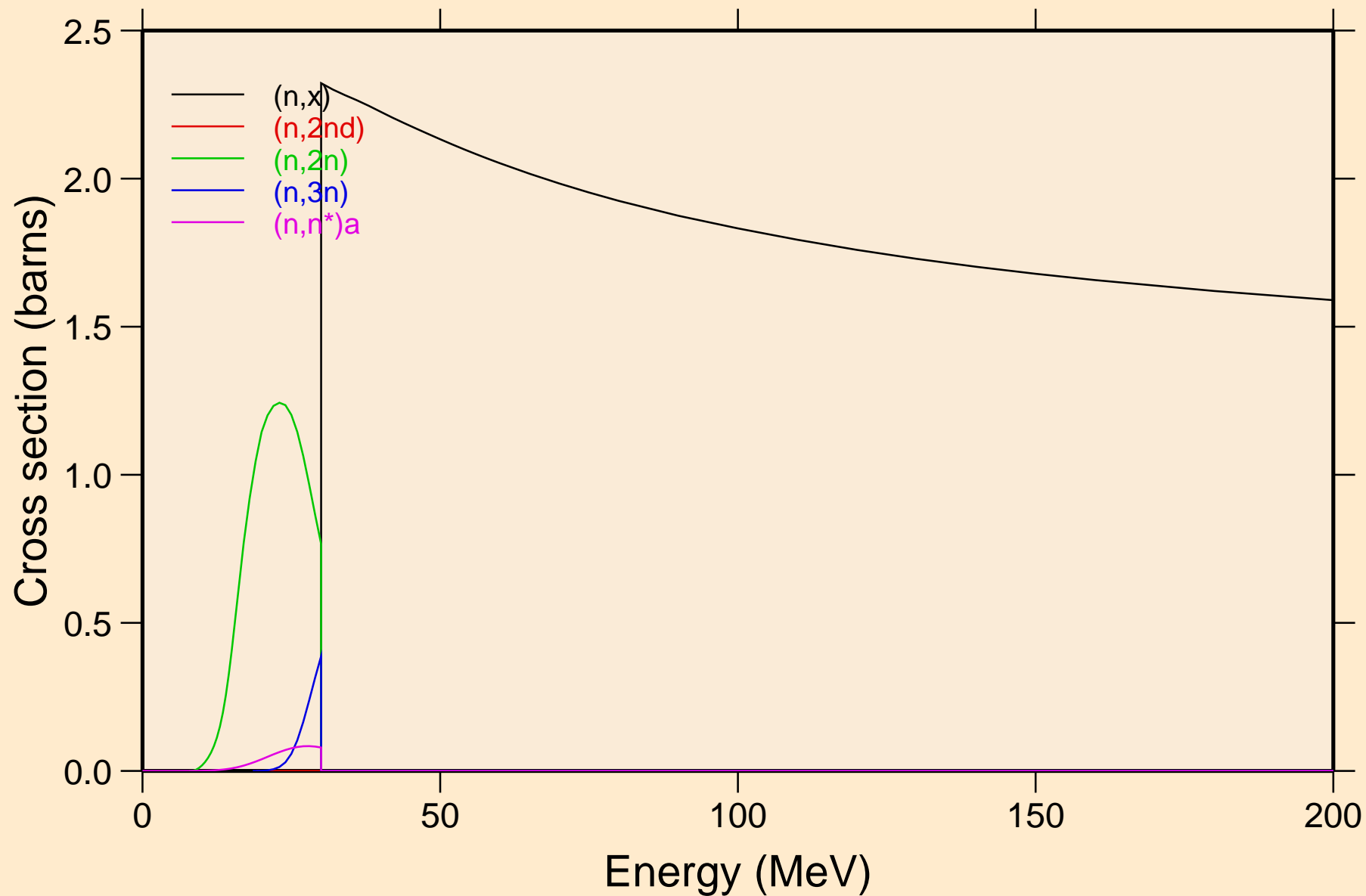

HG185M NEUTRON ACER TENDL-2019 LIBRARY; T=293.16K
Threshold reactions

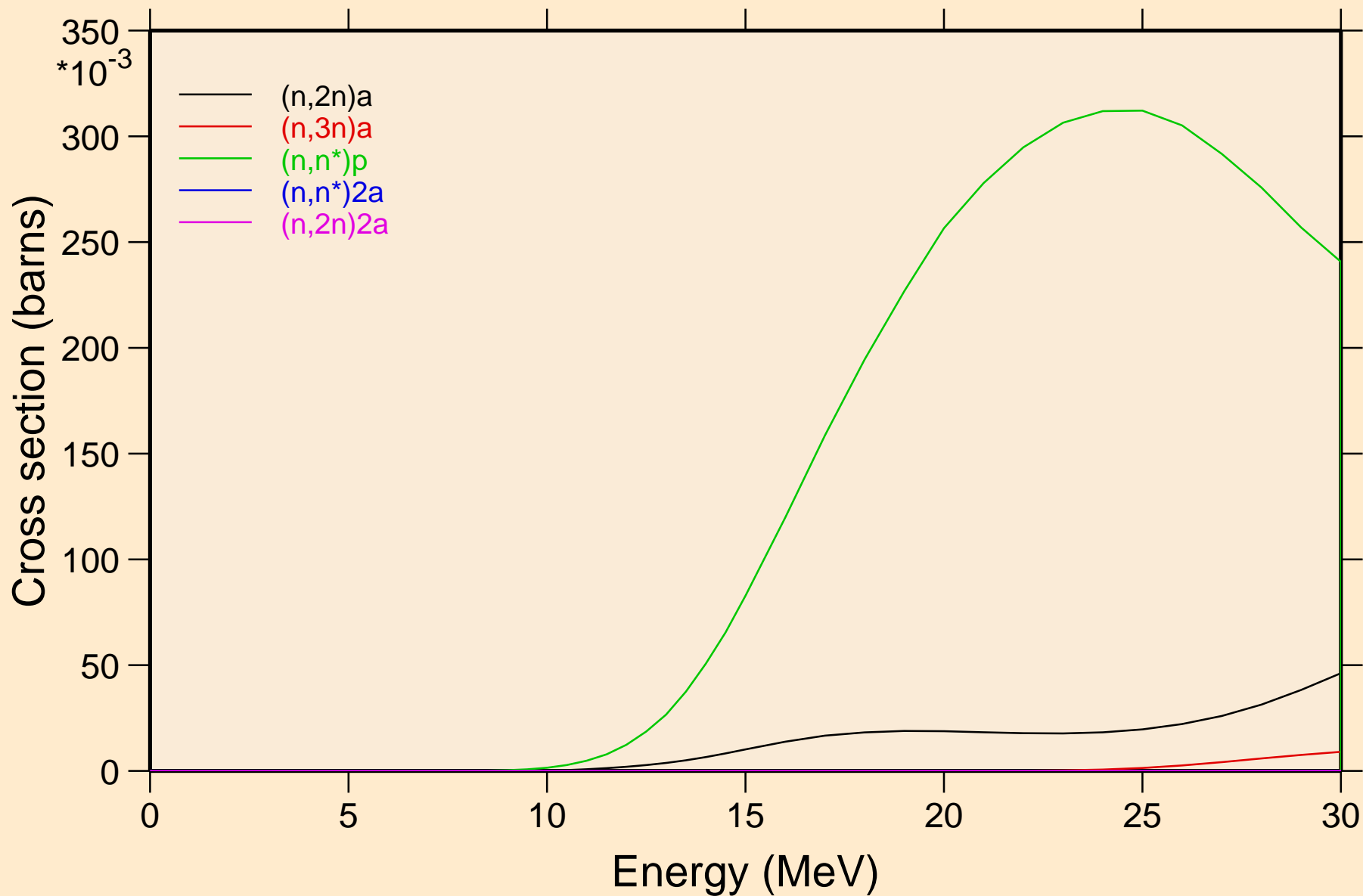

HG185M NEUTRON ACER TENDL-2019 LIBRARY; T=293.16K

Threshold reactions

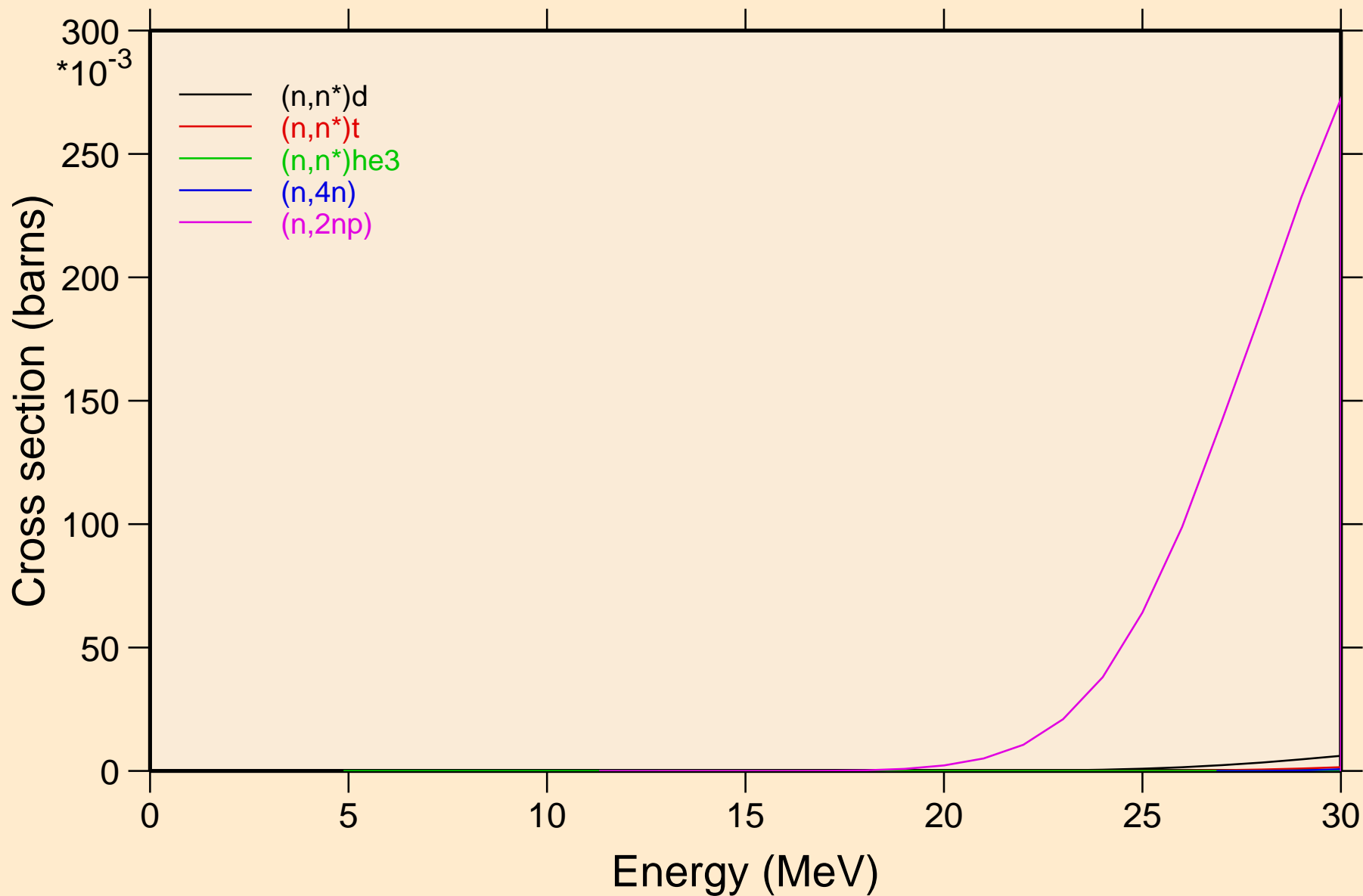

HG185M NEUTRON ACER TENDL-2019 LIBRARY; T=293.16K

Threshold reactions

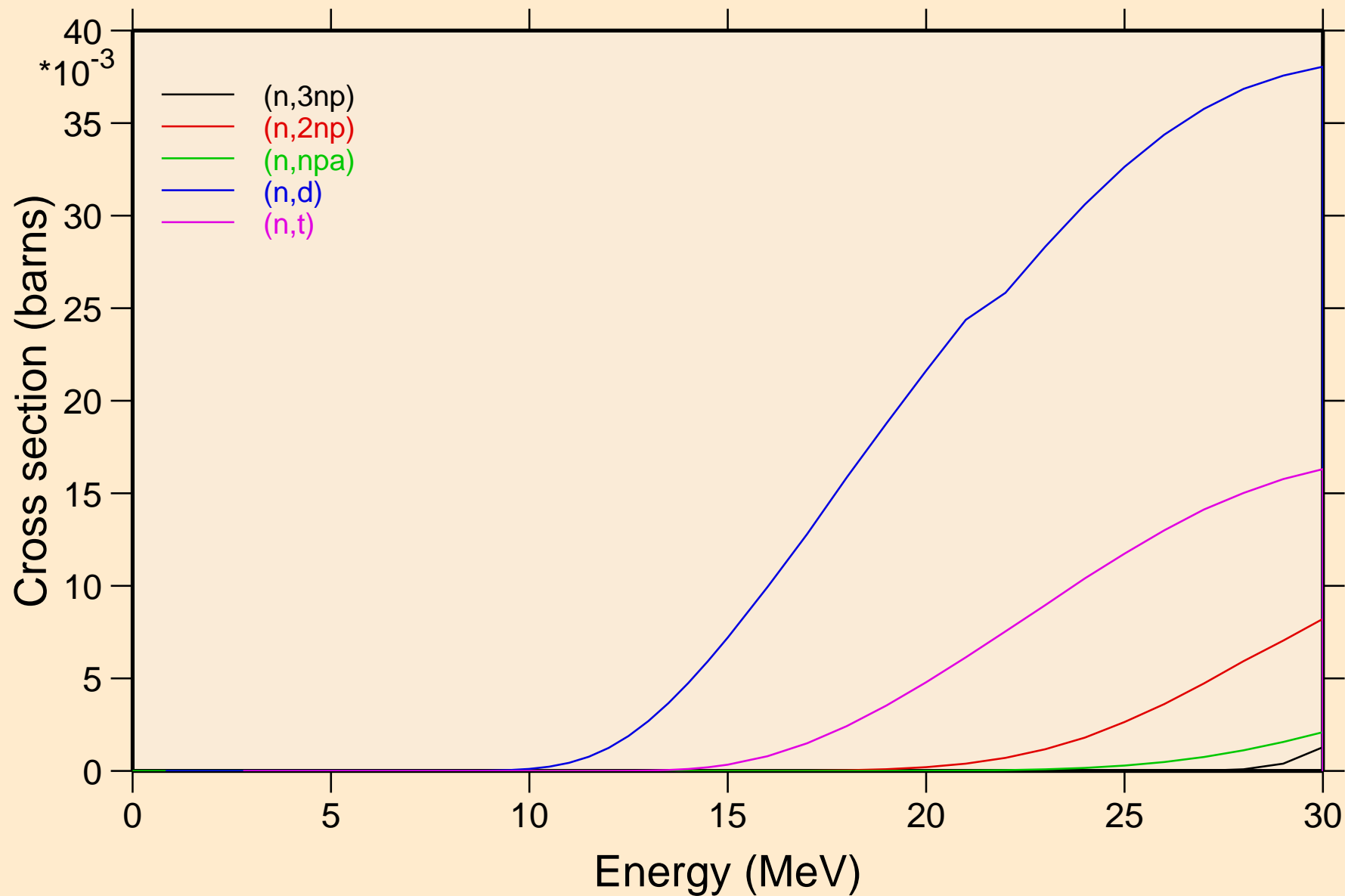

HG185M NEUTRON ACER TENDL-2019 LIBRARY; T=293.16K

Threshold reactions

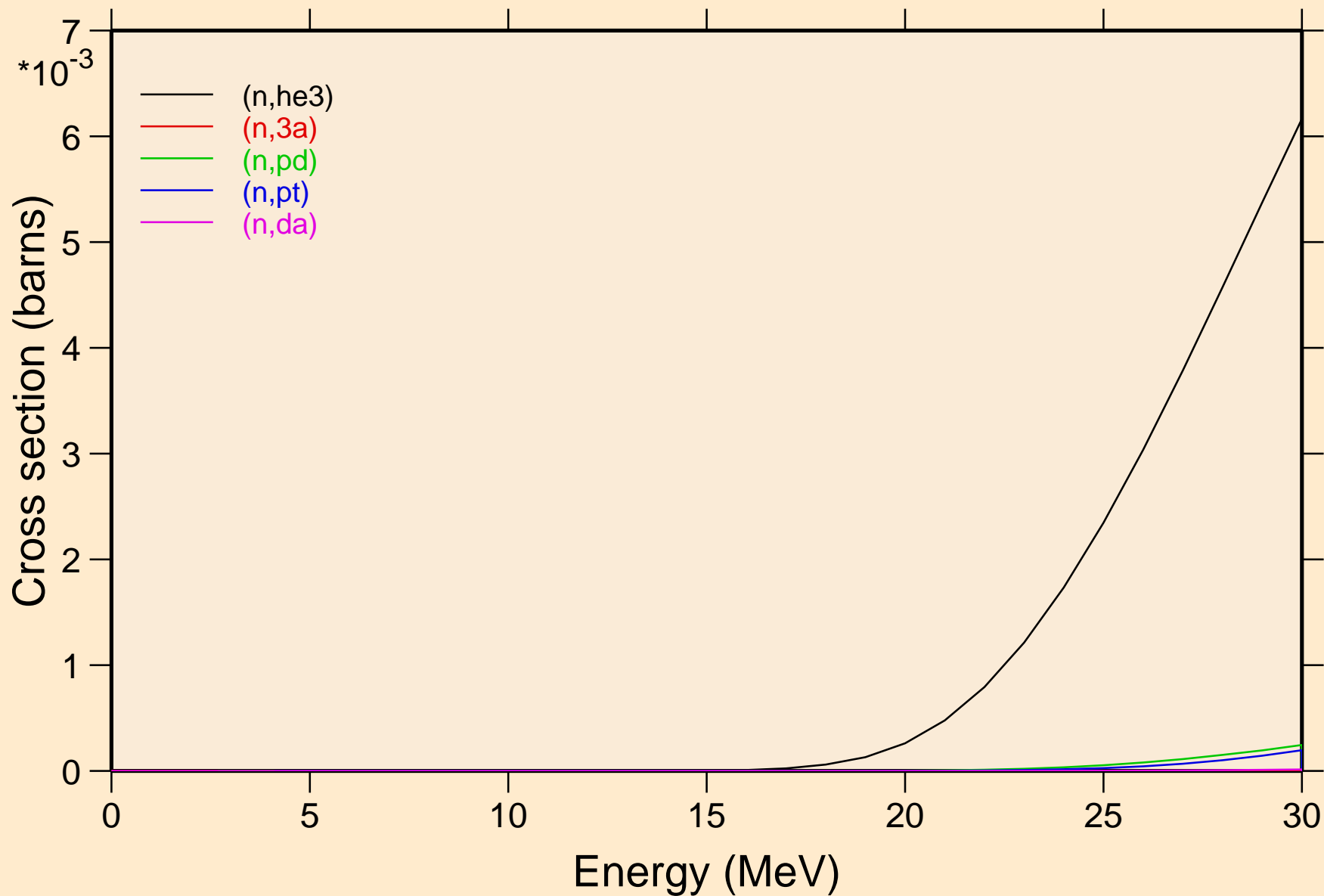

HG185M NEUTRON ACER TENDL-2019 LIBRARY; T=293.16K
Threshold reactions

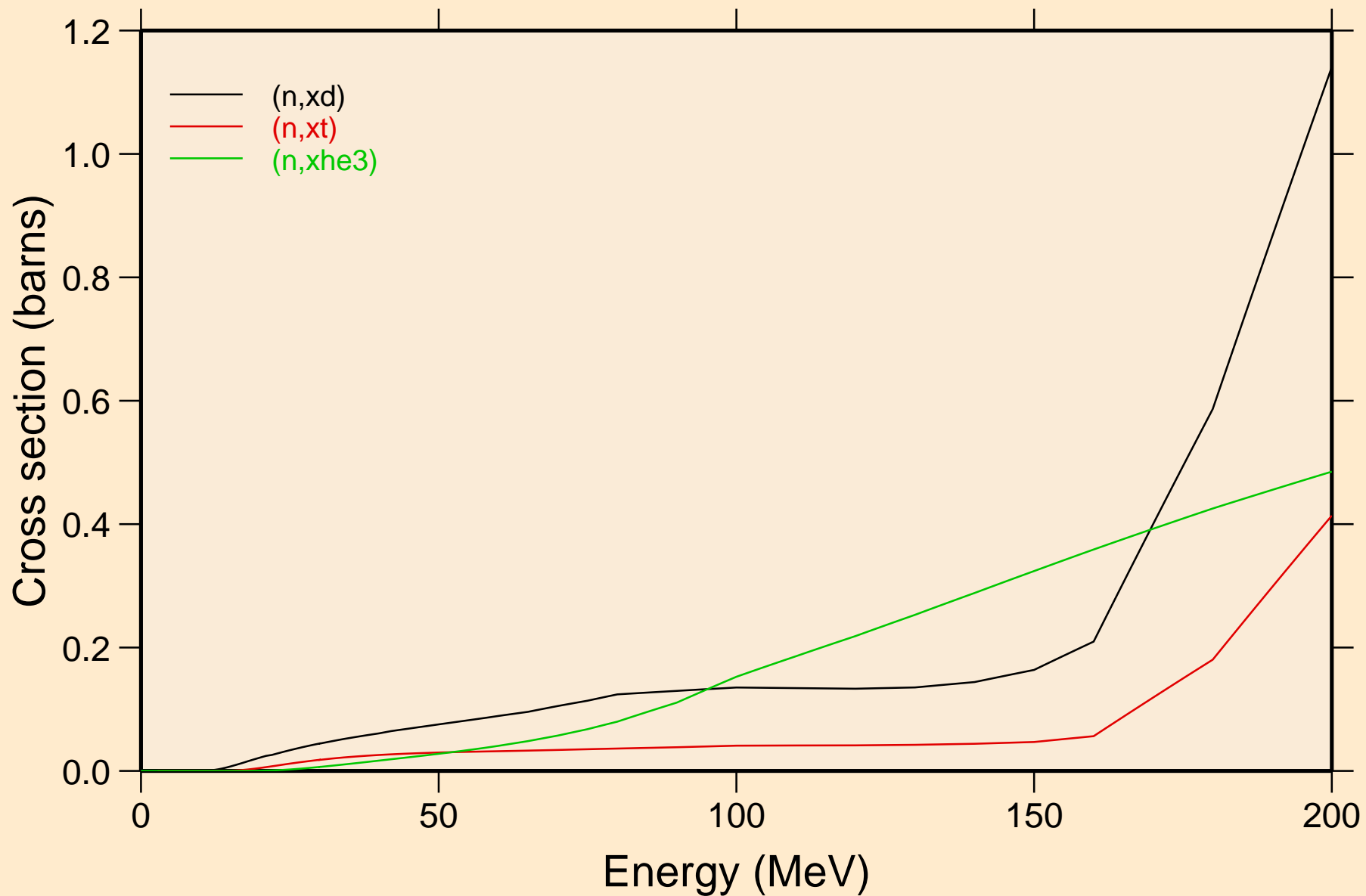

HG185M NEUTRON ACER TENDL-2019 LIBRARY; T=293.16K
angular distribution for elastic

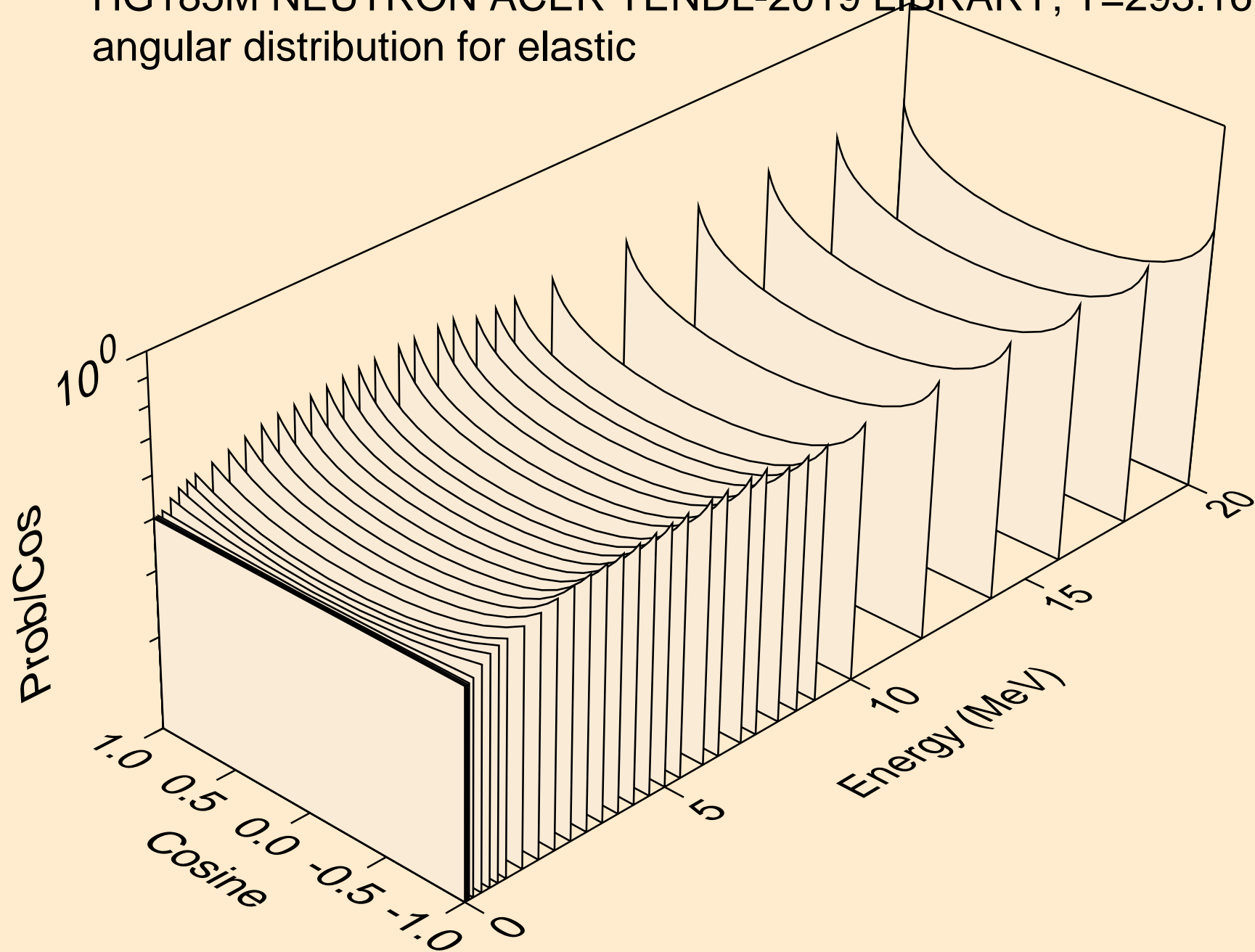

HG185M NEUTRON ACER TENDL-2019 LIBRARY; T=293.16K
angular distribution for elastic

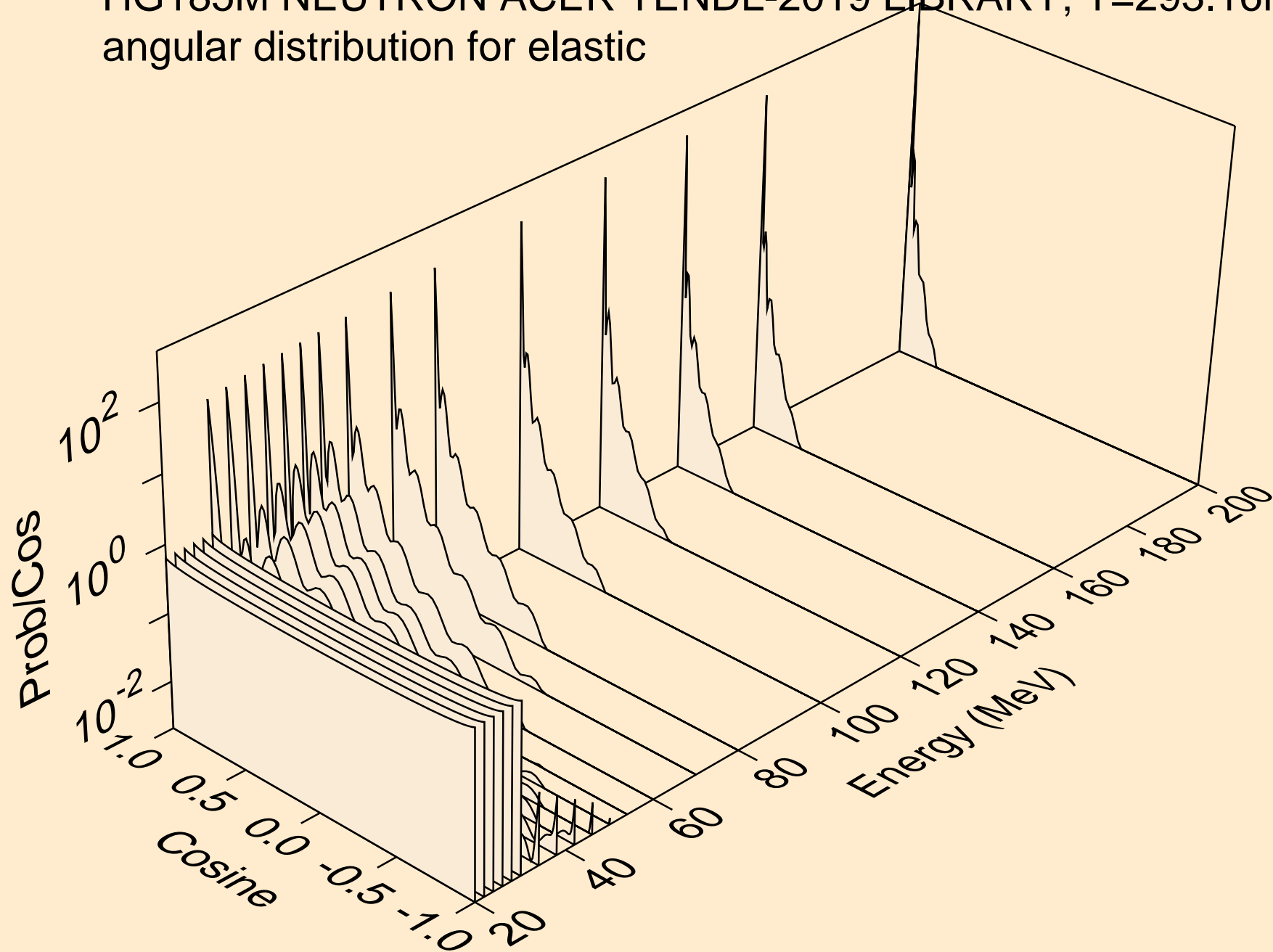

HG185M NEUTRON ACER TENDL-2019 LIBRARY; T=293.16K
angular distribution for (n,n*1)

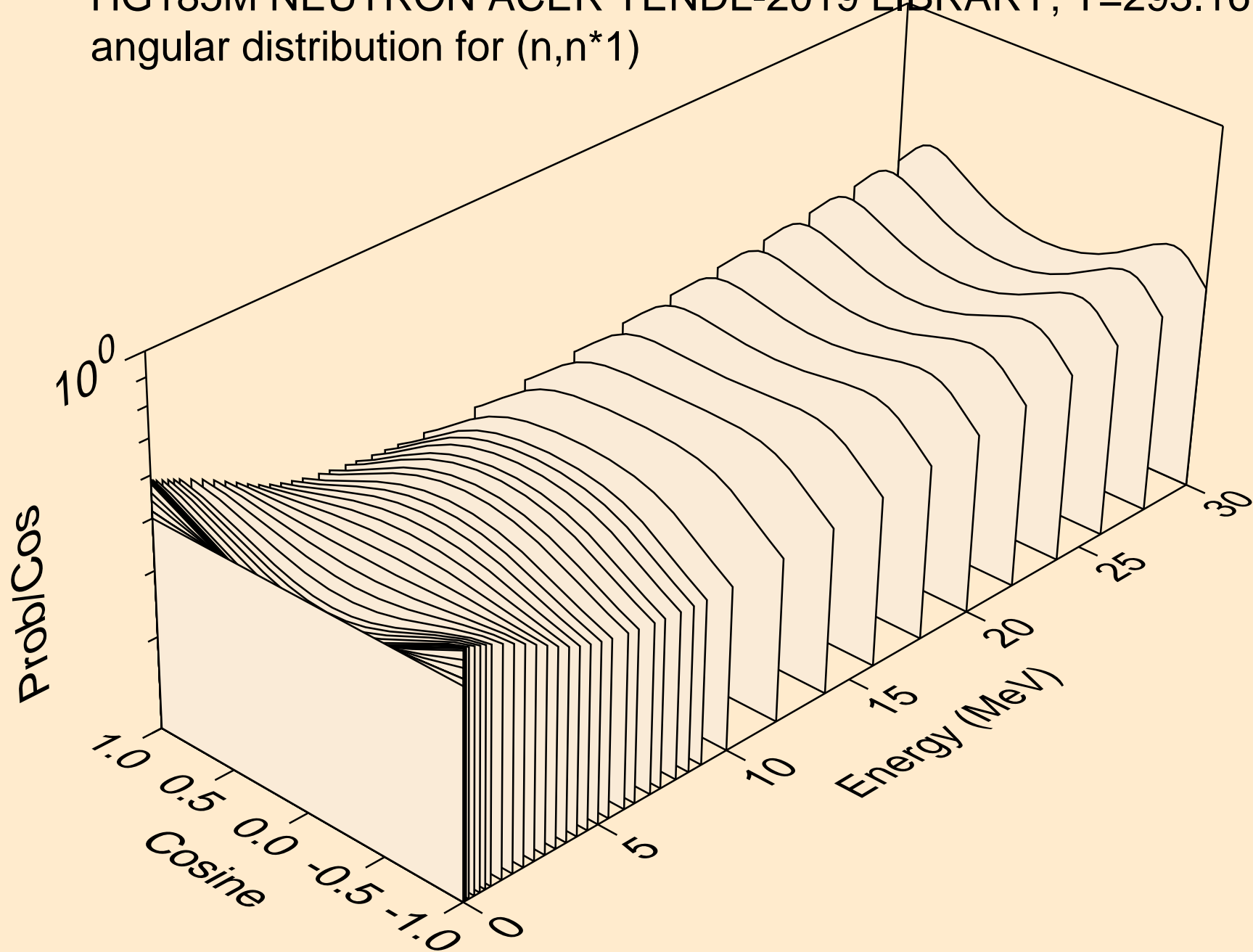

HG185M NEUTRON ACER TENDL-2019 LIBRARY; T=293.16K
angular distribution for (n,n*2)

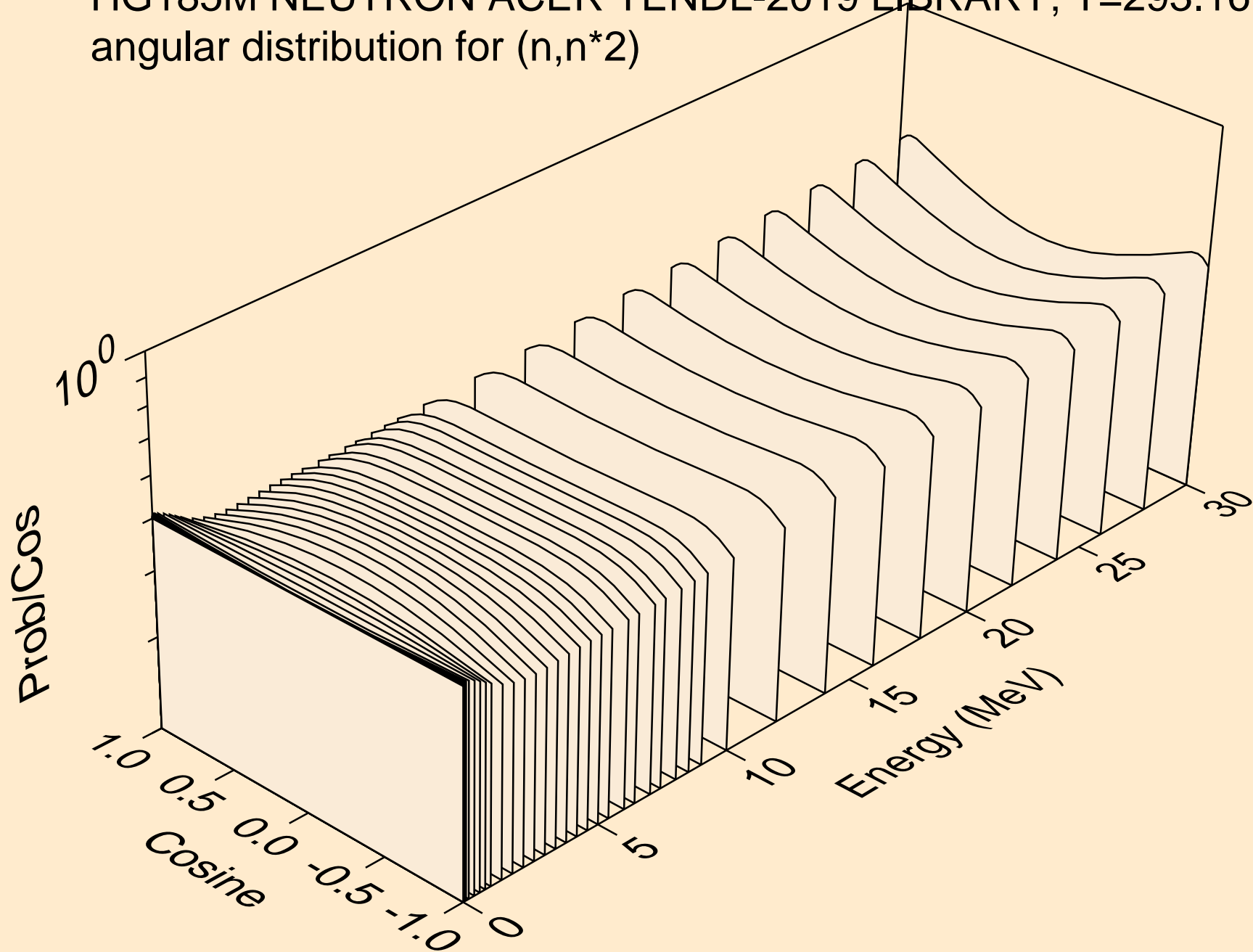

HG185M NEUTRON ACER TENDL-2019 LIBRARY; T=293.16K
angular distribution for (n,n*3)

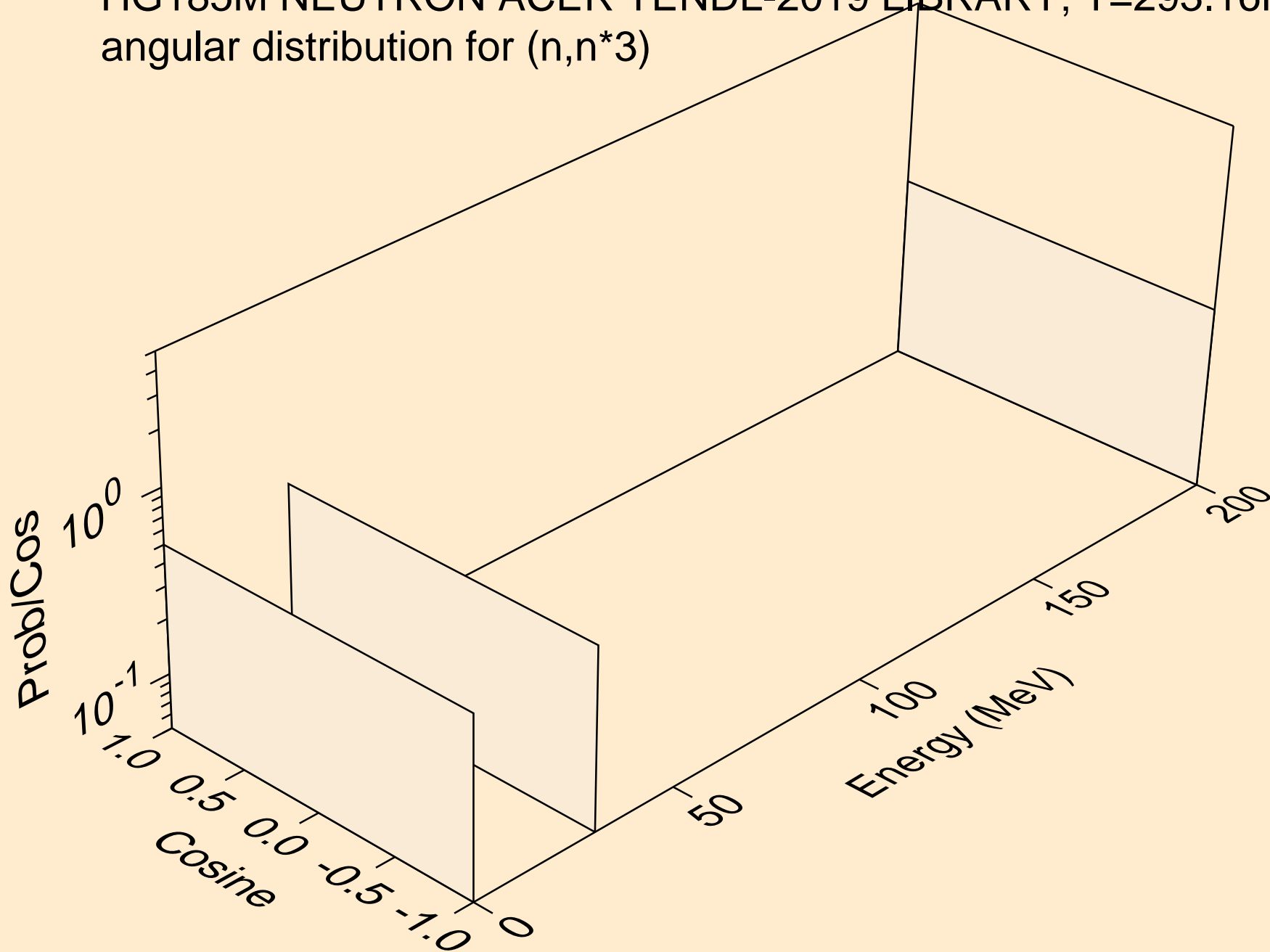

HG185M NEUTRON ACER TENDL-2019 LIBRARY; T=293.16K
Neutron emission for (n,x)

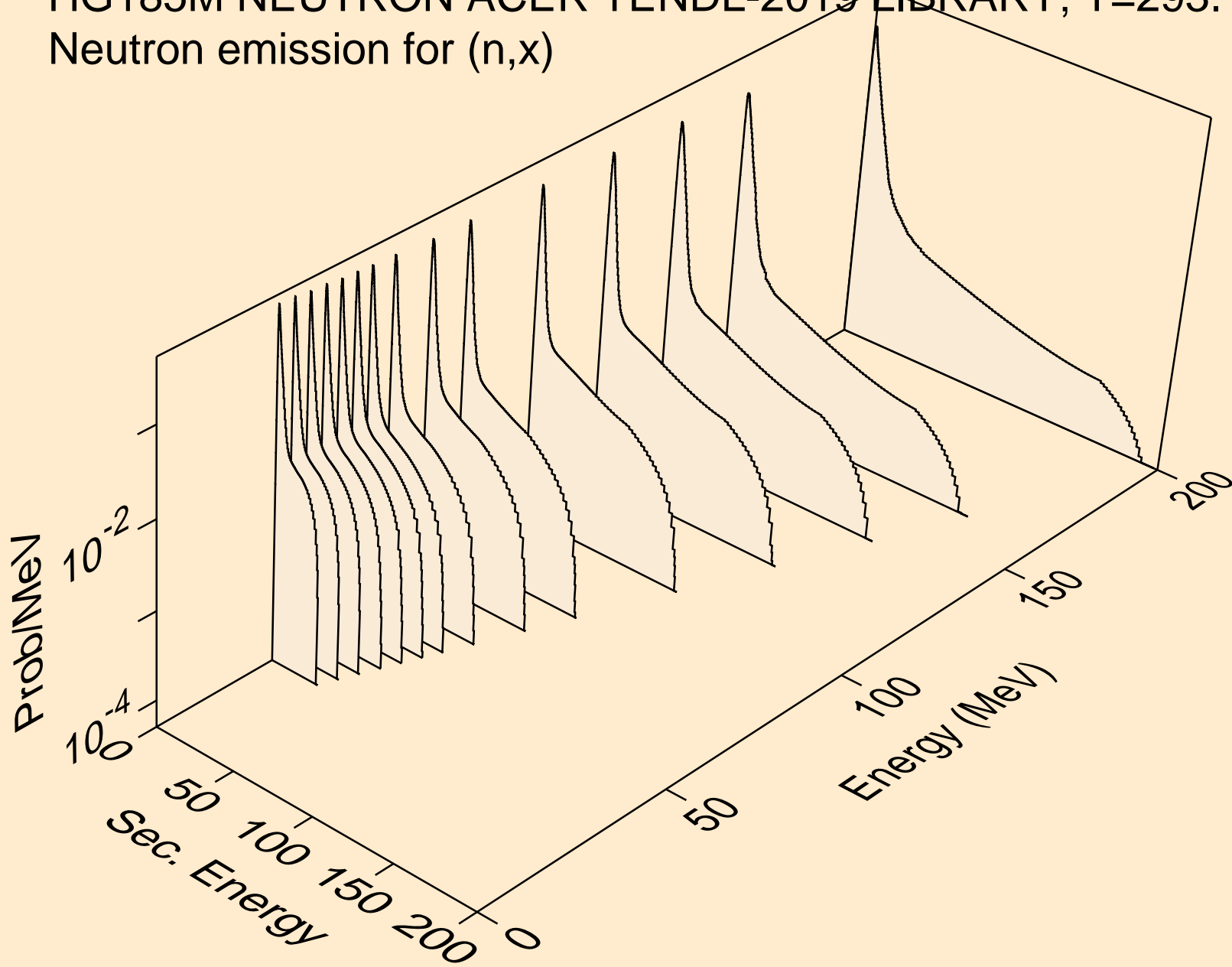

HG185M NEUTRON ACER TENDL-2019 LIBRARY; T=293.16K
Neutron emission for (n,2nd)

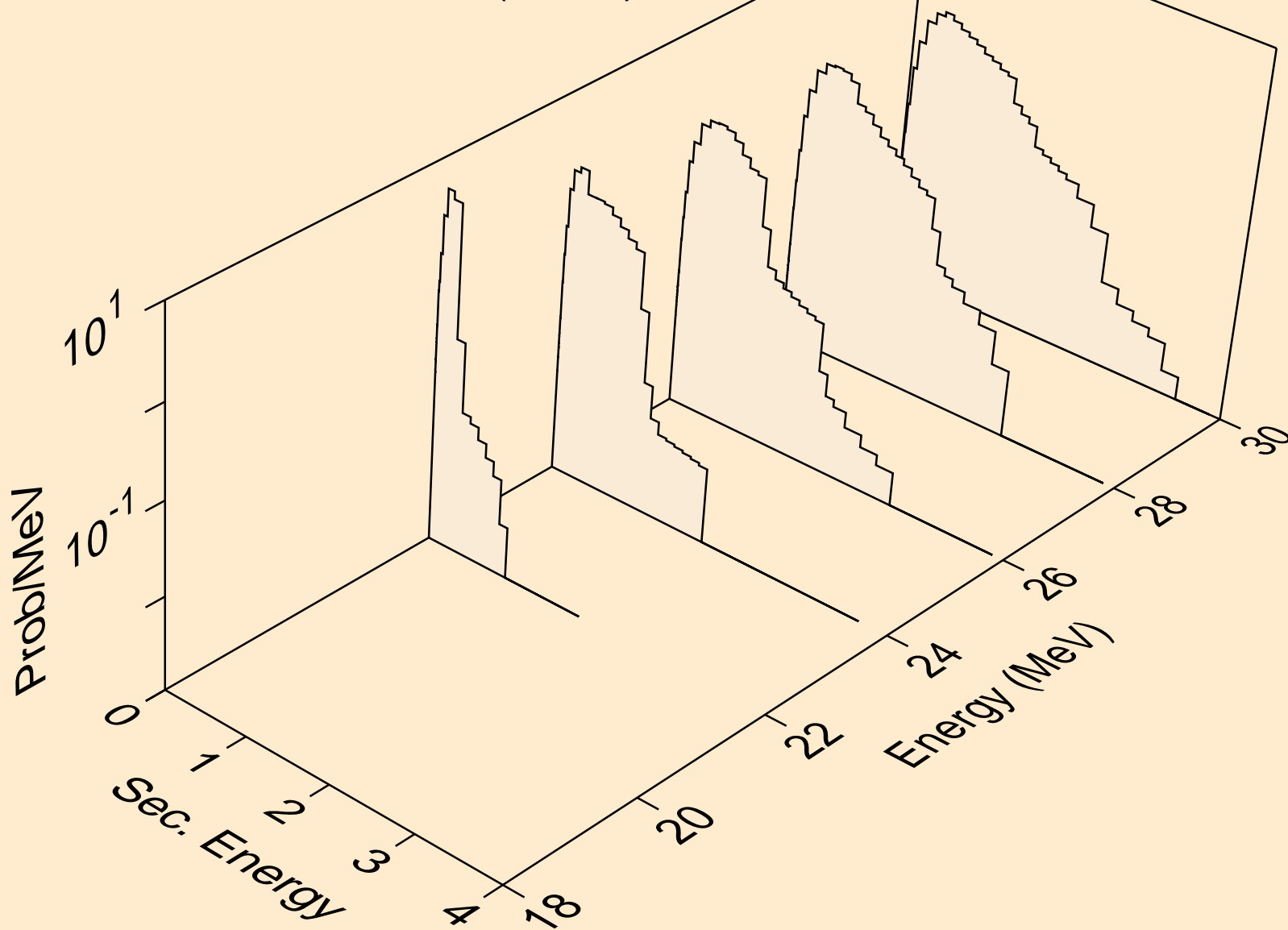

HG185M NEUTRON ACER TENDL-2019 LIBRARY; T=293.16K
Neutron emission for (n,2n)

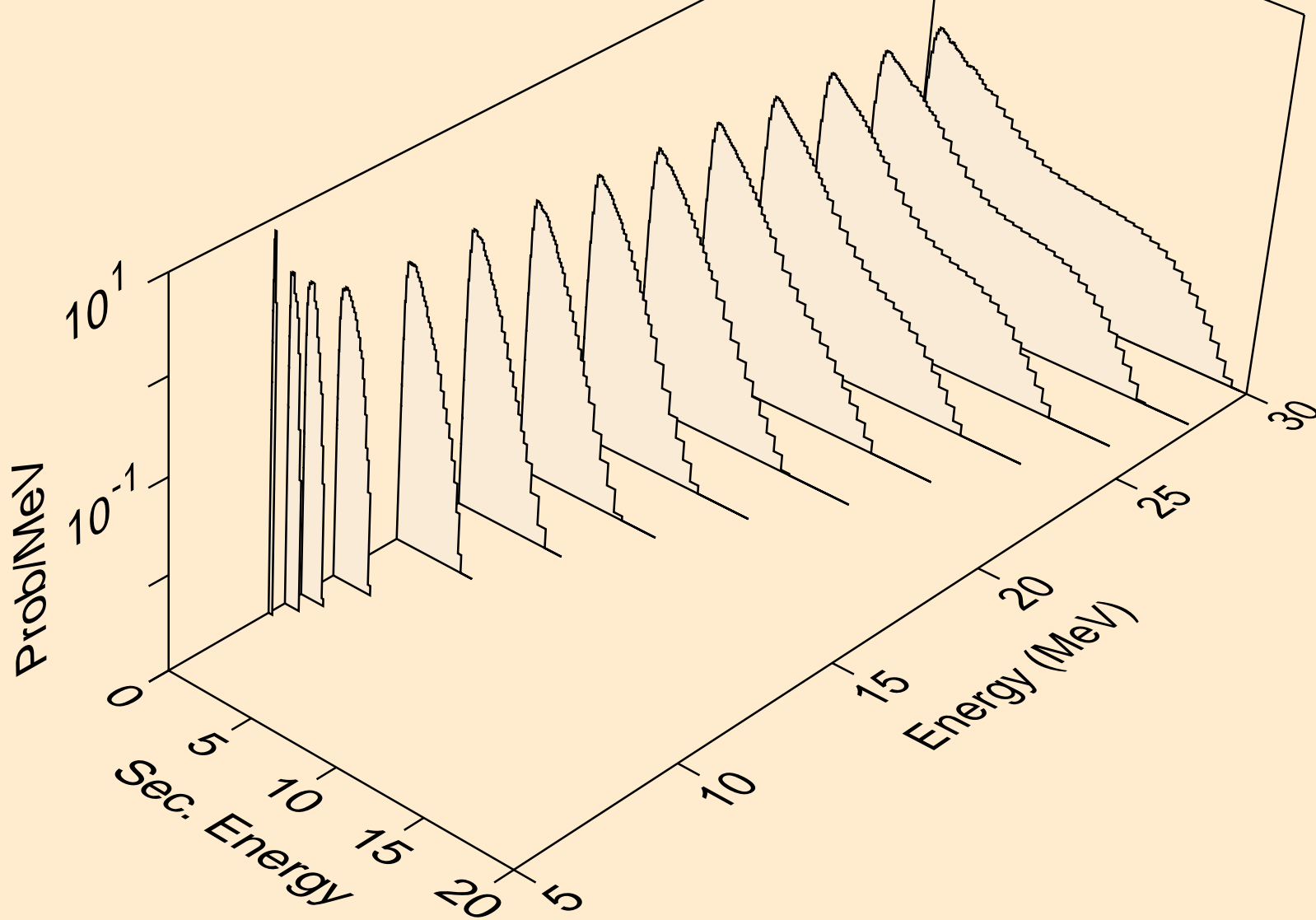

HG185M NEUTRON ACER TENDL-2019 LIBRARY; T=293.16K
Neutron emission for (n,3n)

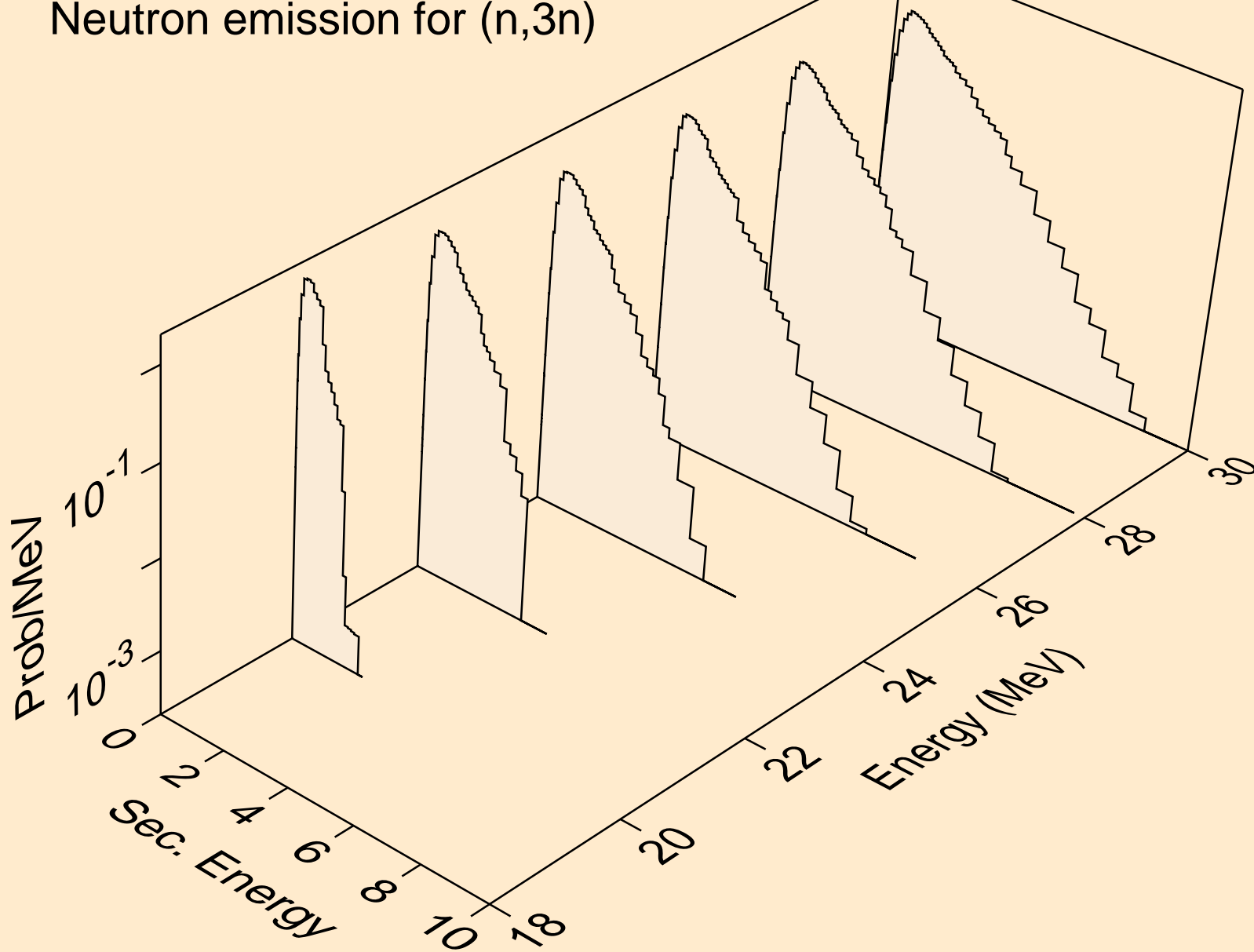

HG185M NEUTRON ACER TENDL-2019 LIBRARY; T=293.16K
Neutron emission for (n,n*)a

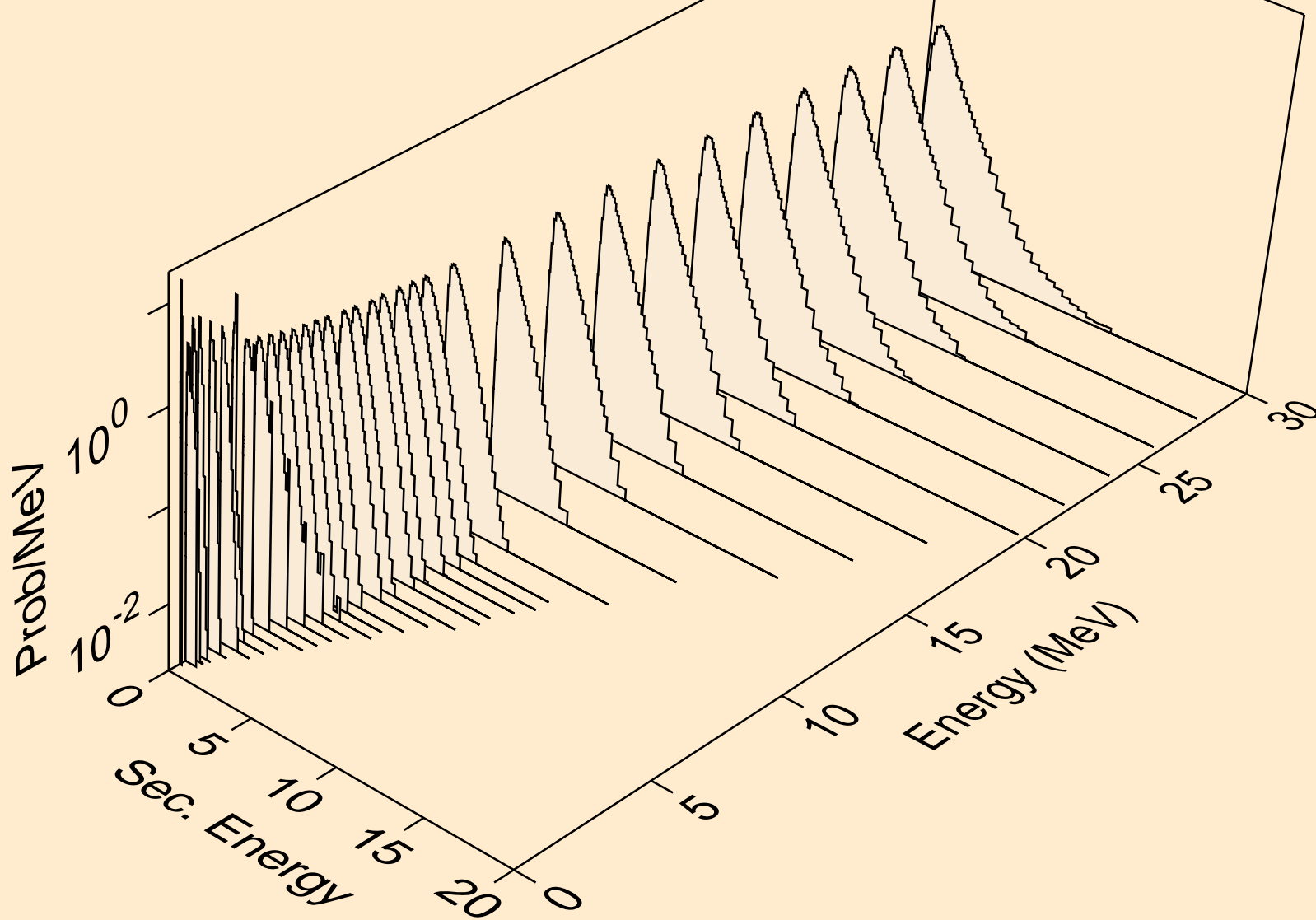

HG185M NEUTRON ACER TENDL-2019 LIBRARY; T=293.16K
Neutron emission for (n,2n)a

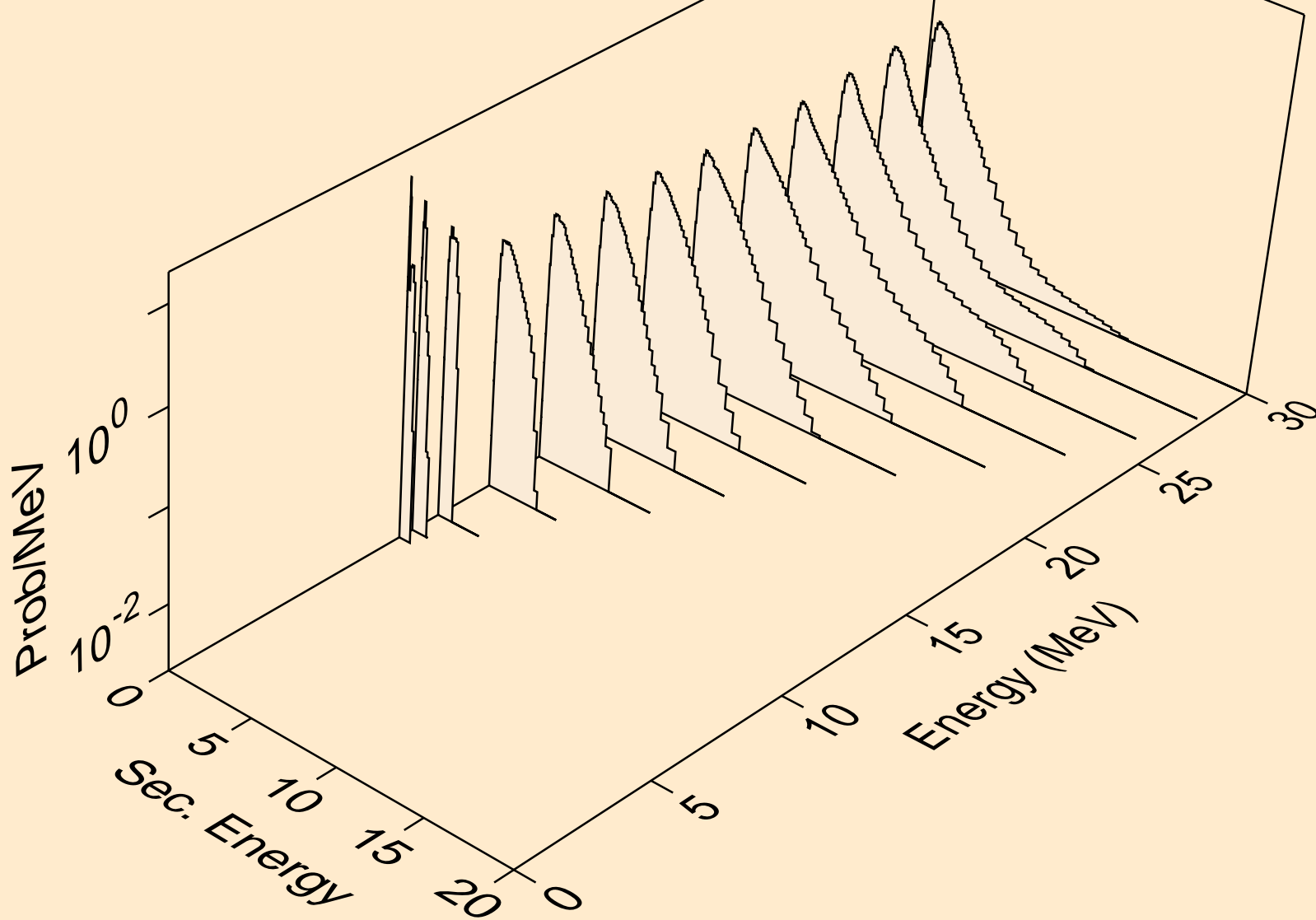

HG185M NEUTRON ACER TENDL-2019 LIBRARY; T=293.16K
Neutron emission for (n,3n)a

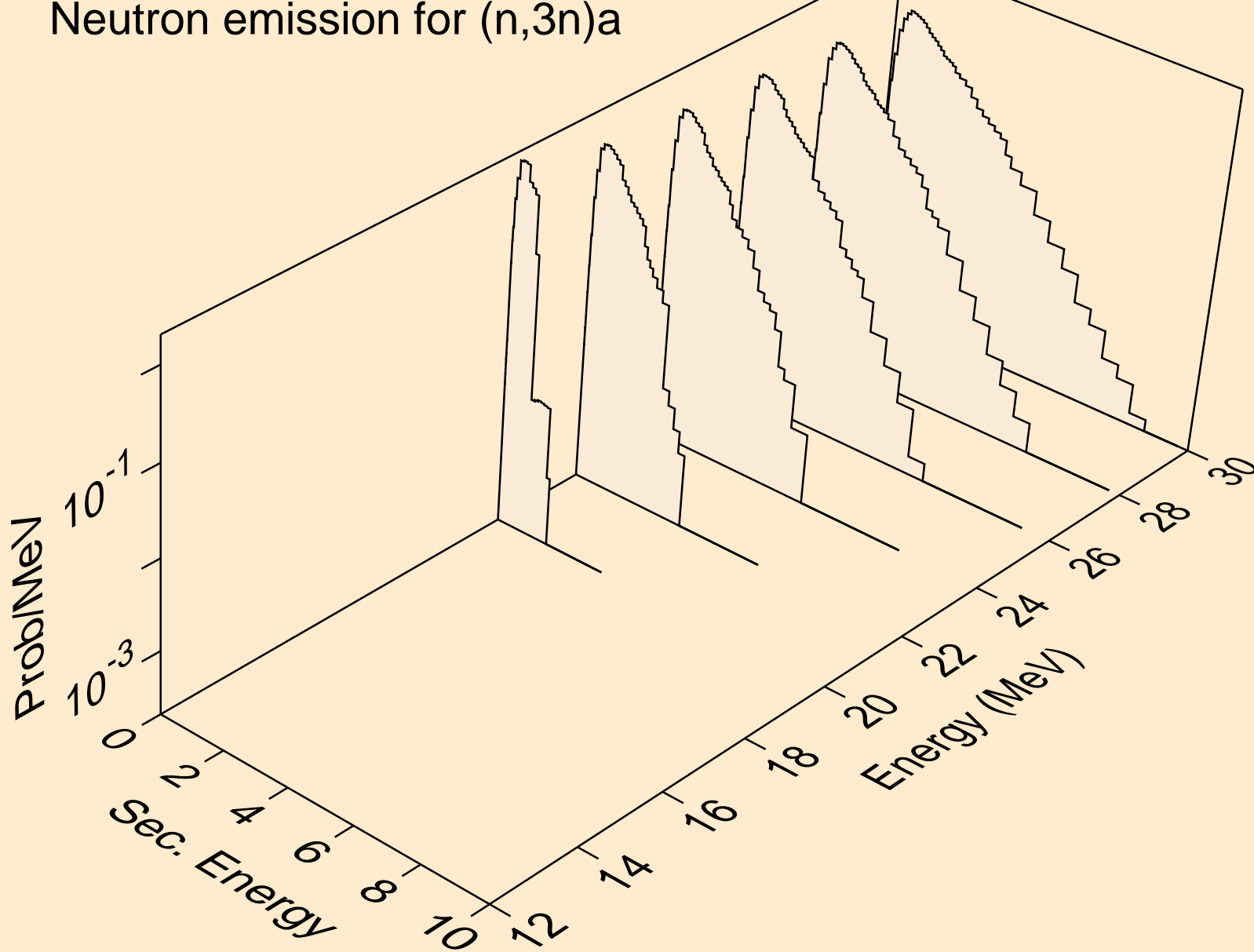

HG185M NEUTRON ACER TENDL-2019 LIBRARY; T=293.16K
Neutron emission for (n,n*)p

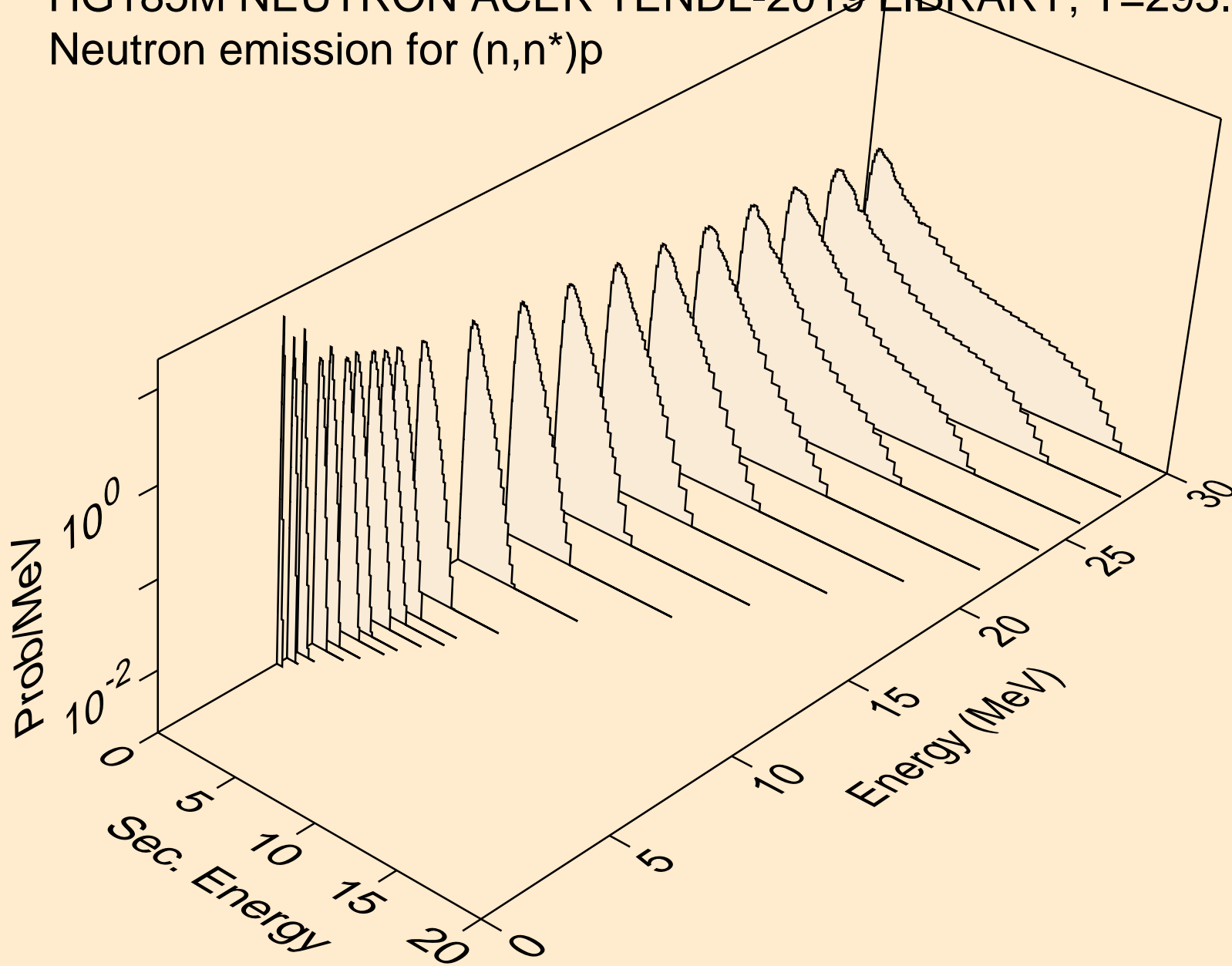

HG185M NEUTRON ACER TENDL-2019 LIBRARY; T=293.16K
Neutron emission for (n,n*)2a

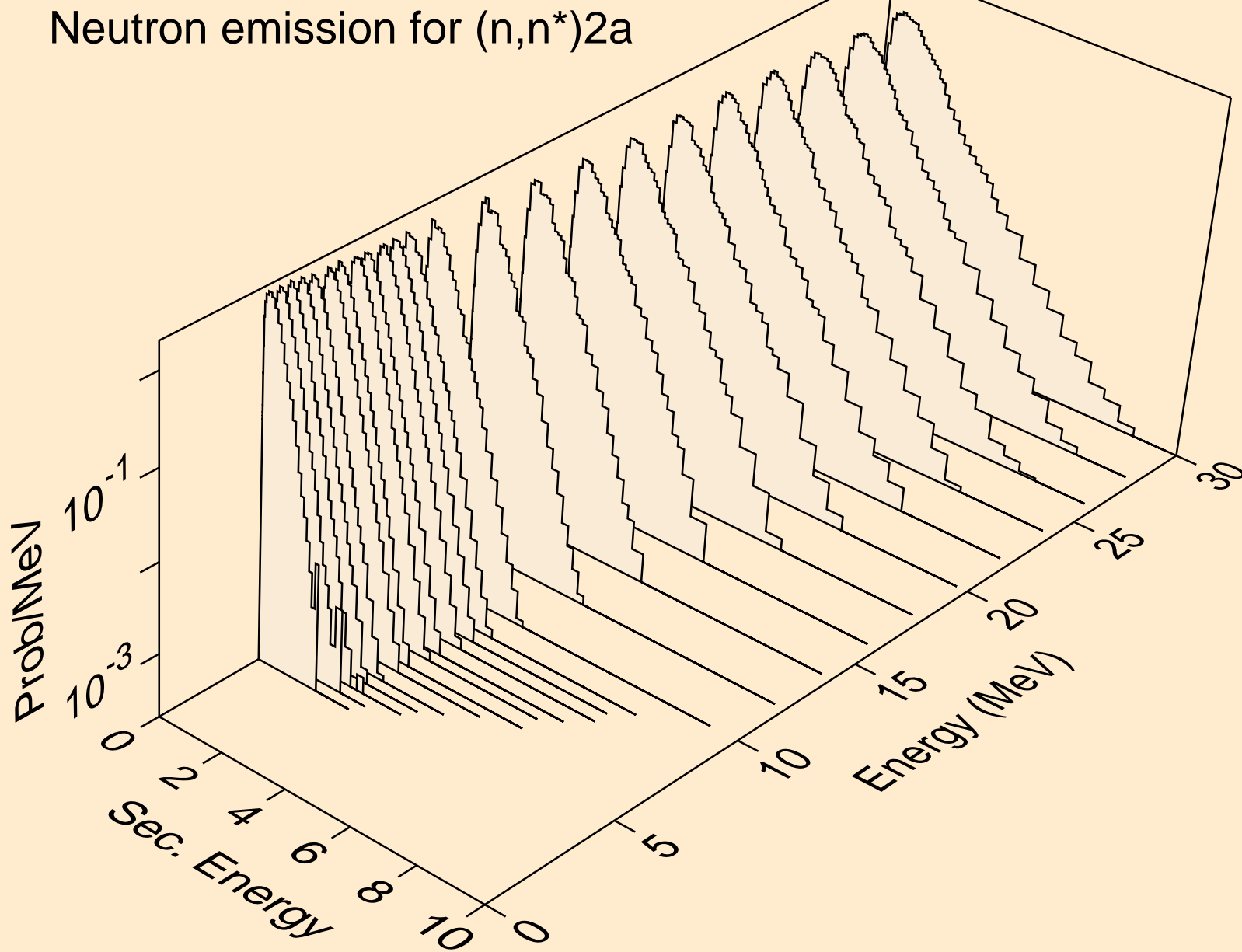

HG185M NEUTRON ACER TENDL-2019 LIBRARY; T=293.16K
Neutron emission for (n,2n)2a

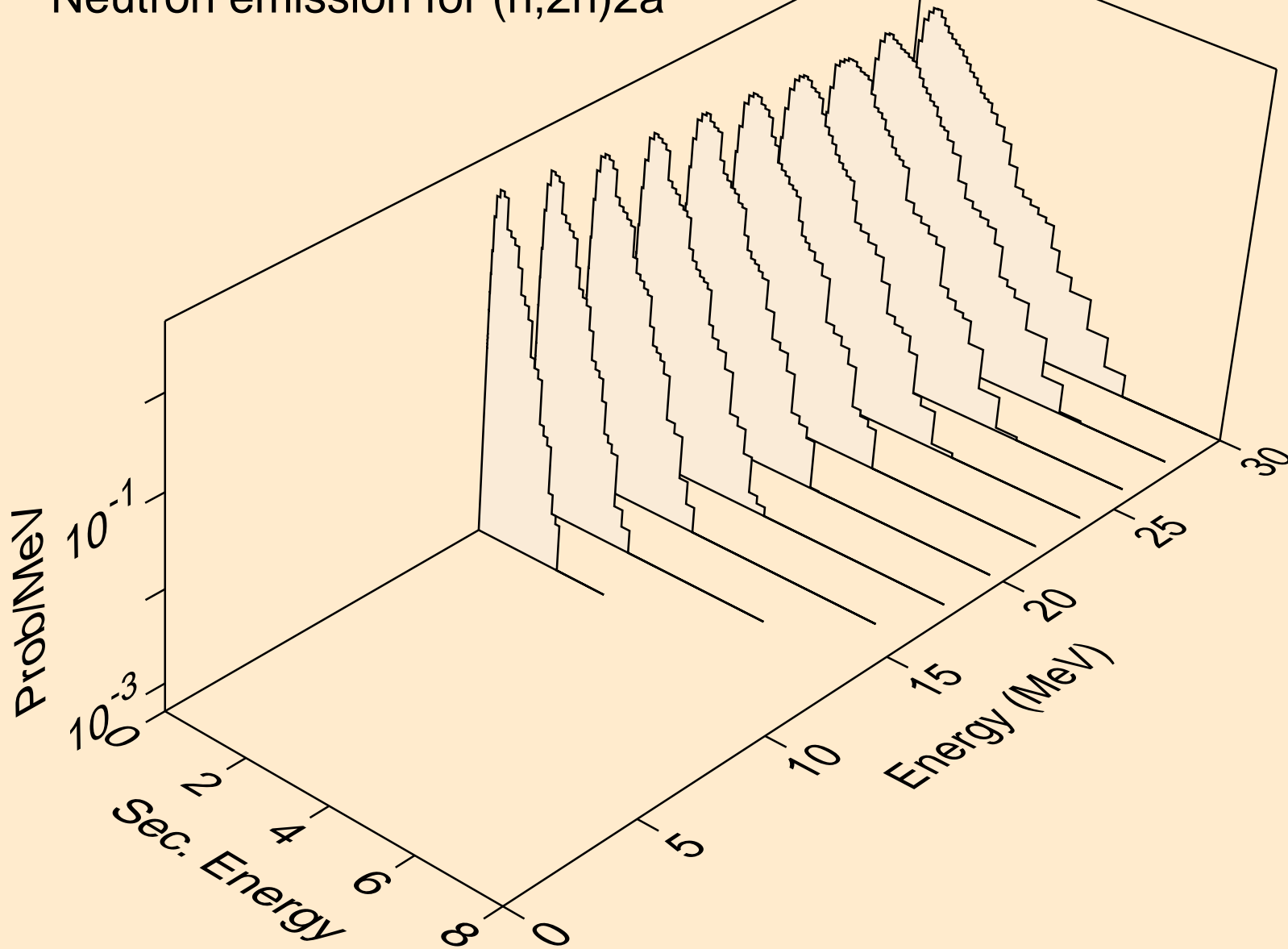

HG185M NEUTRON ACER TENDL-2019 LIBRARY; T=293.16K
Neutron emission for (n,n*)d

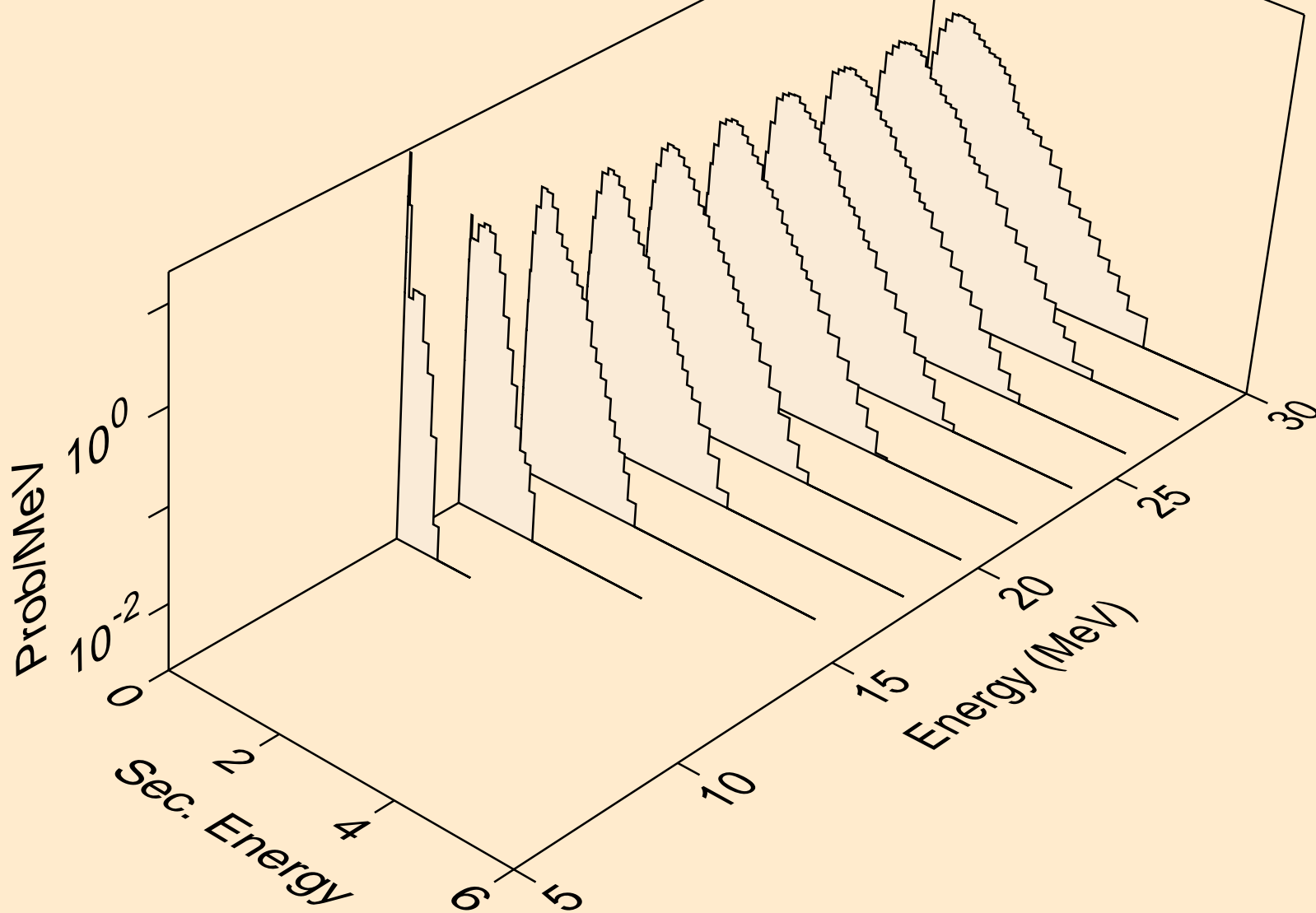

HG185M NEUTRON ACER TENDL-2019 LIBRARY; T=293.16K
Neutron emission for (n,n*)t

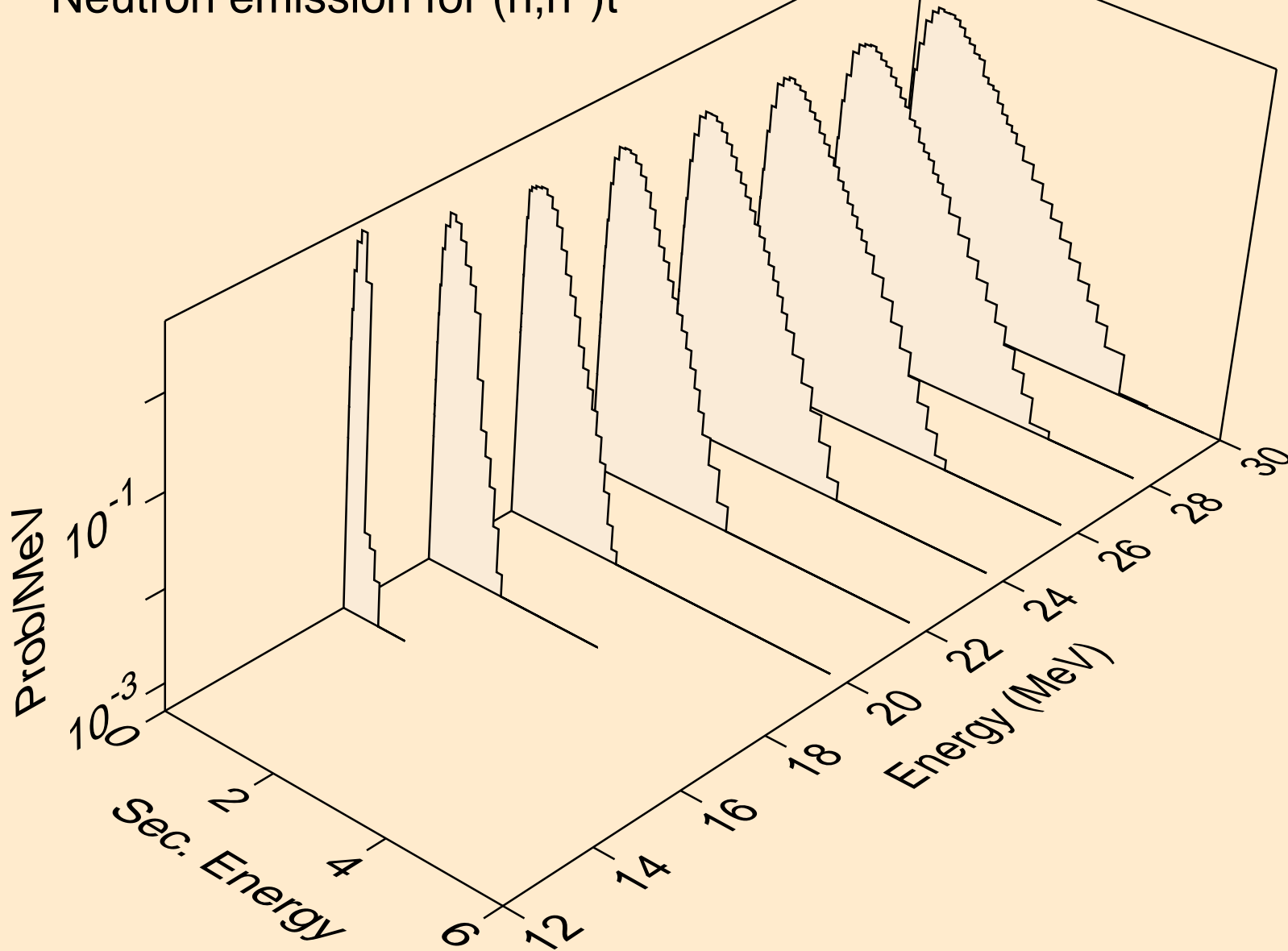

HG185M NEUTRON ACER TENDL-2019 LIBRARY; T=293.16K
Neutron emission for (n,n*)he3

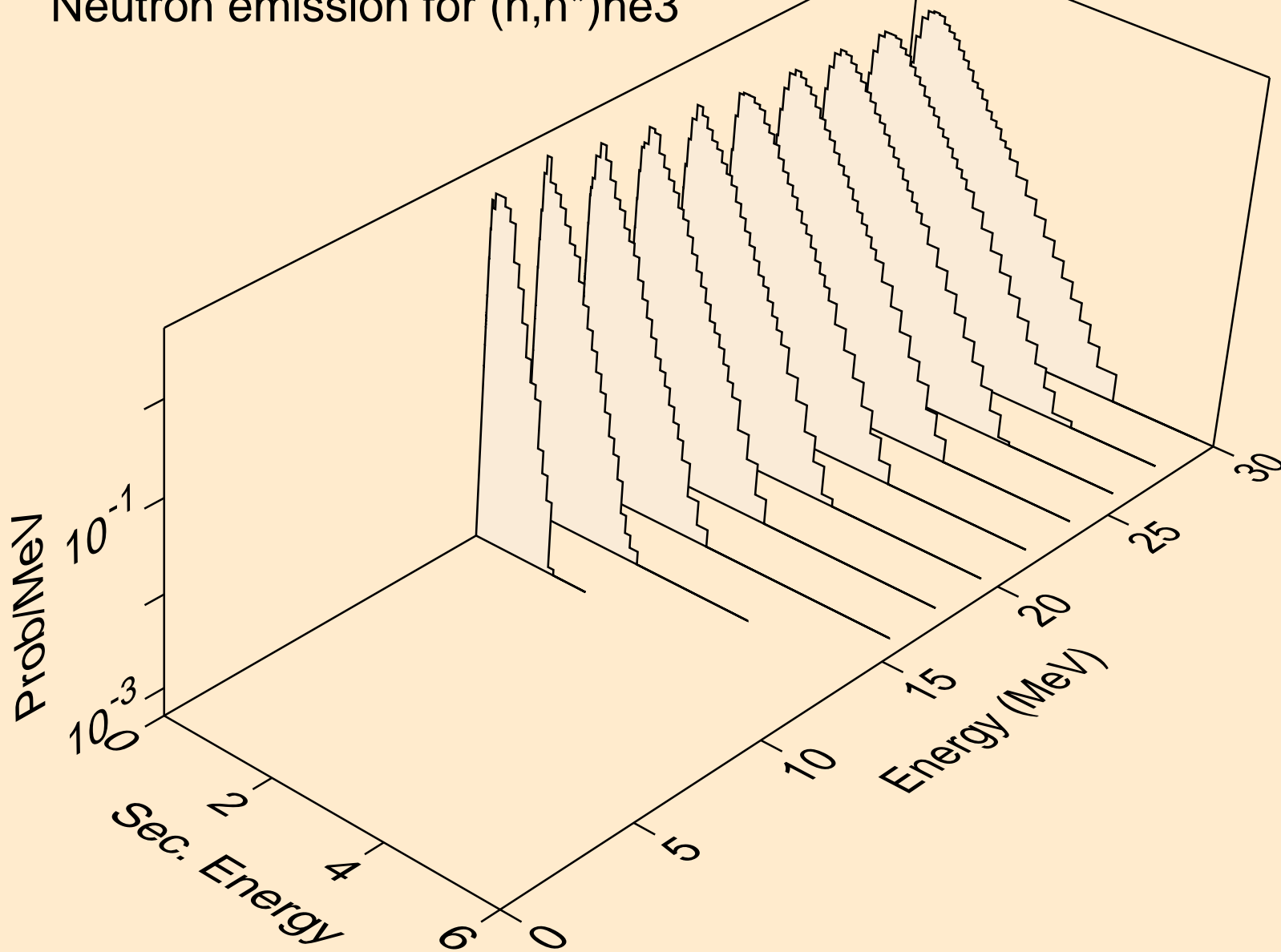

HG185M NEUTRON ACER TENDL-2019 LIBRARY; T=293.16K
Neutron emission for (n,4n)

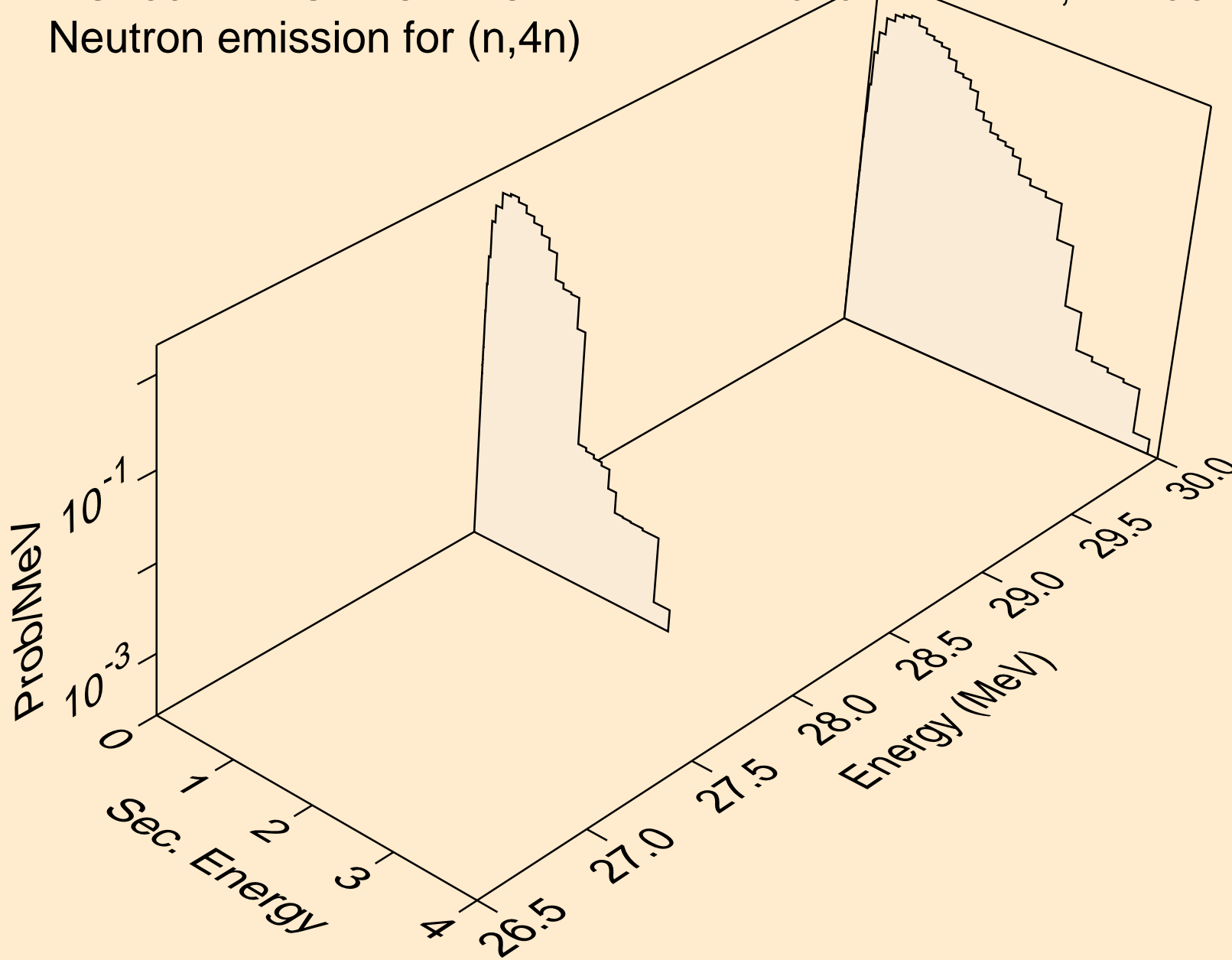

HG185M NEUTRON ACER TENDL-2019 LIBRARY; T=293.16K
Neutron emission for (n,2np)

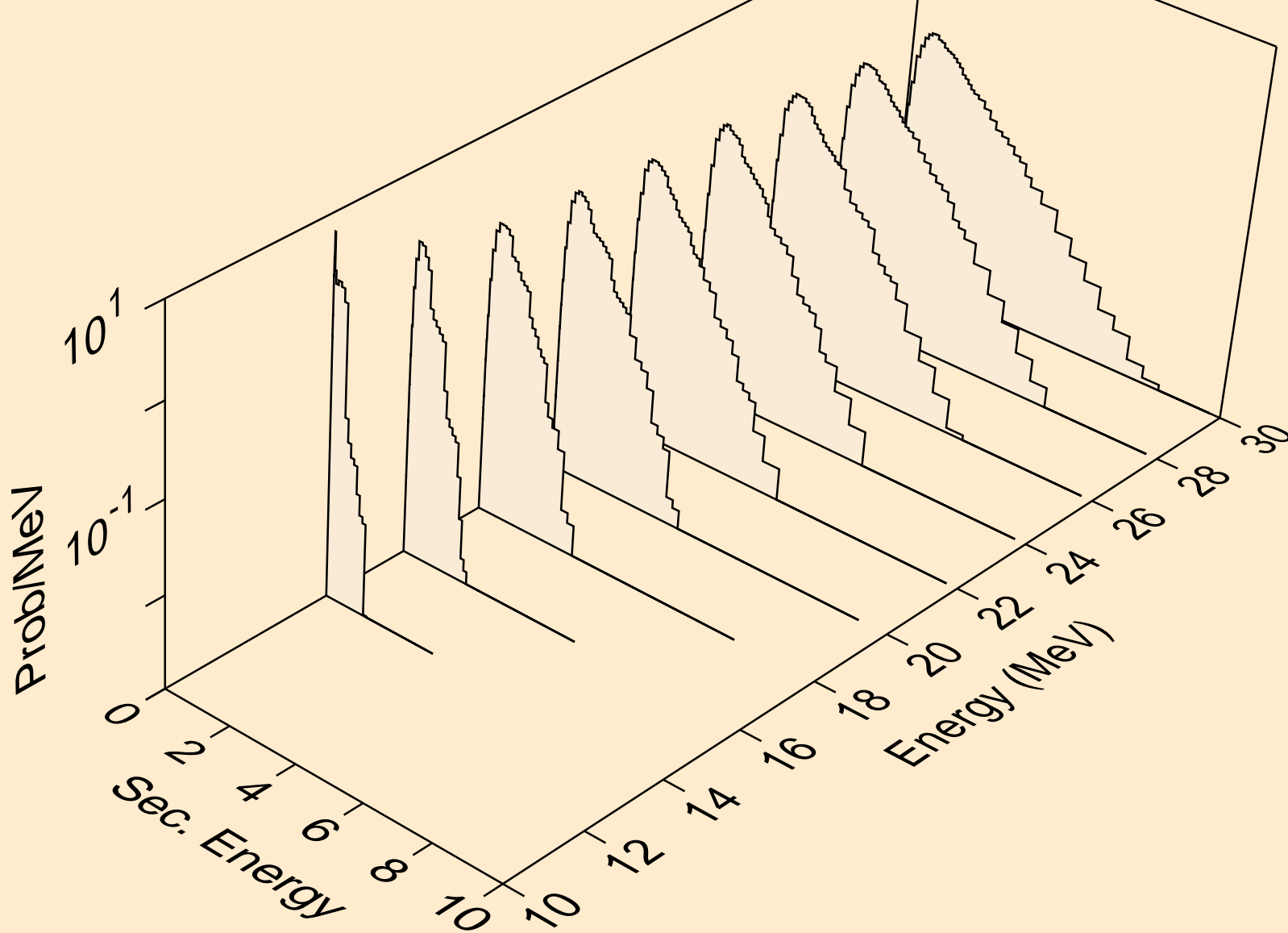

HG185M NEUTRON ACER TENDL-2019 LIBRARY; T=293.16K
Neutron emission for (n,3np)

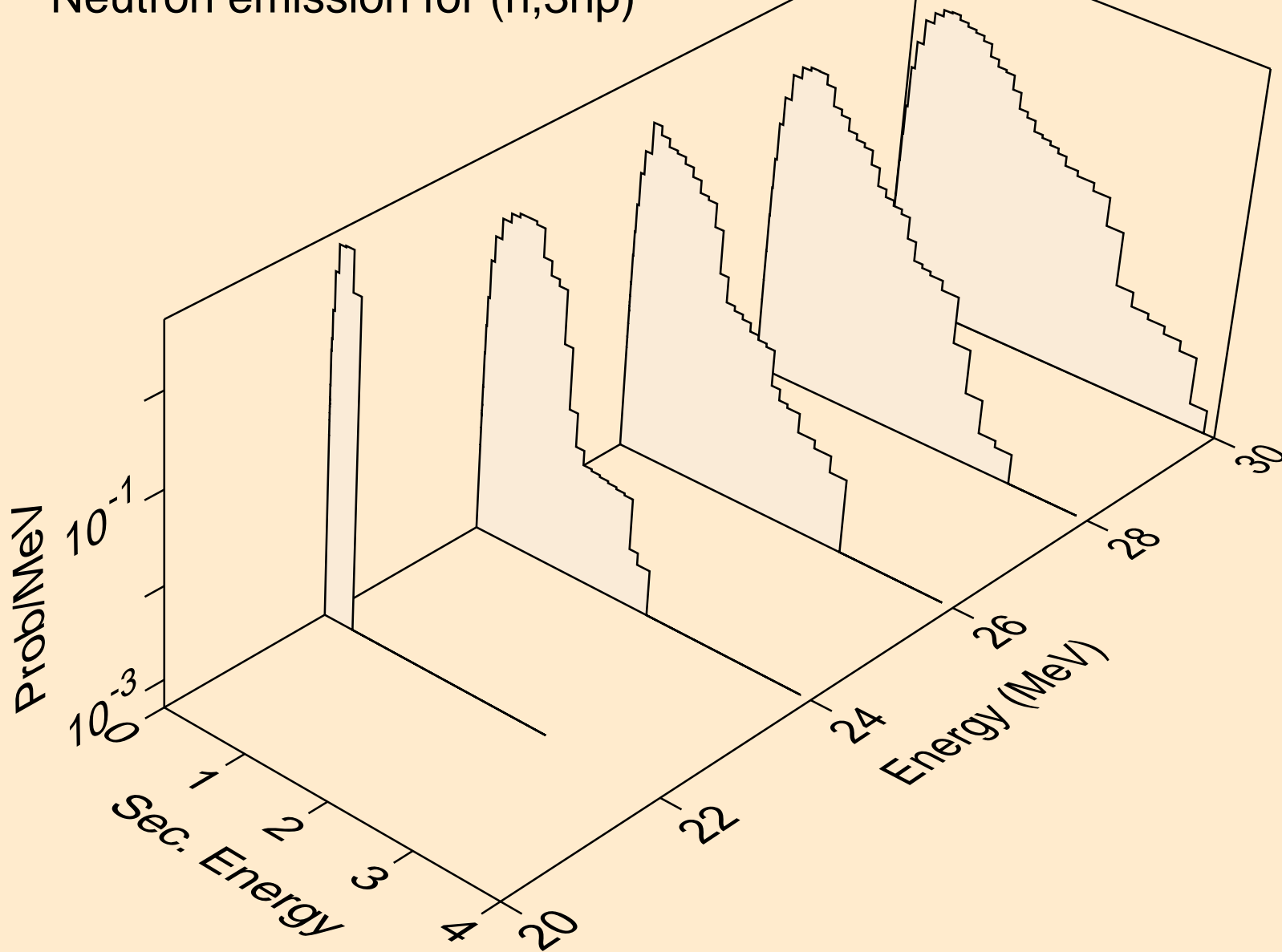

HG185M NEUTRON ACER TENDL-2019 LIBRARY; T=293.16K
Neutron emission for (n,2np)

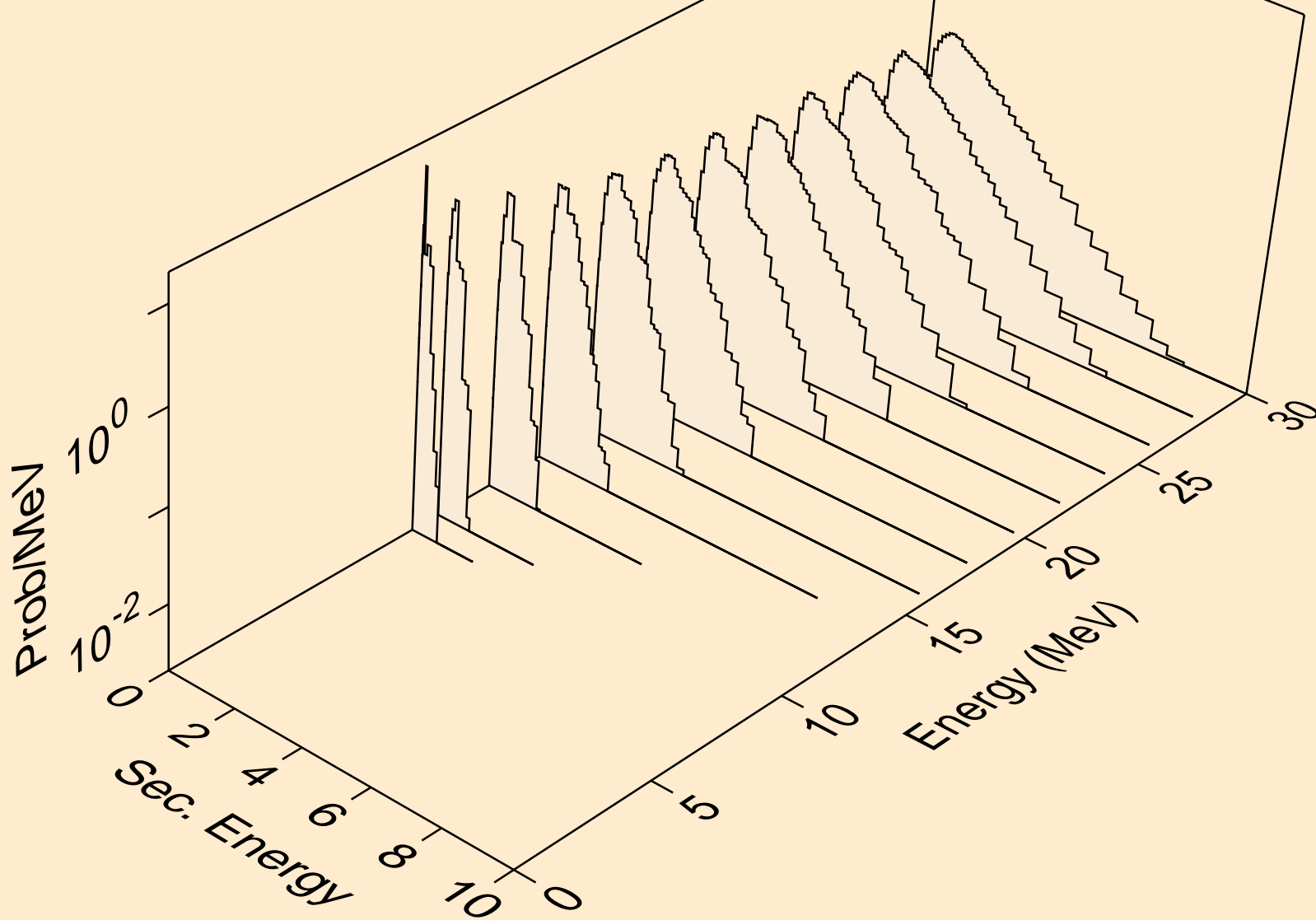

HG185M NEUTRON ACER TENDL-2019 LIBRARY; T=293.16K
Neutron emission for (n,npa)

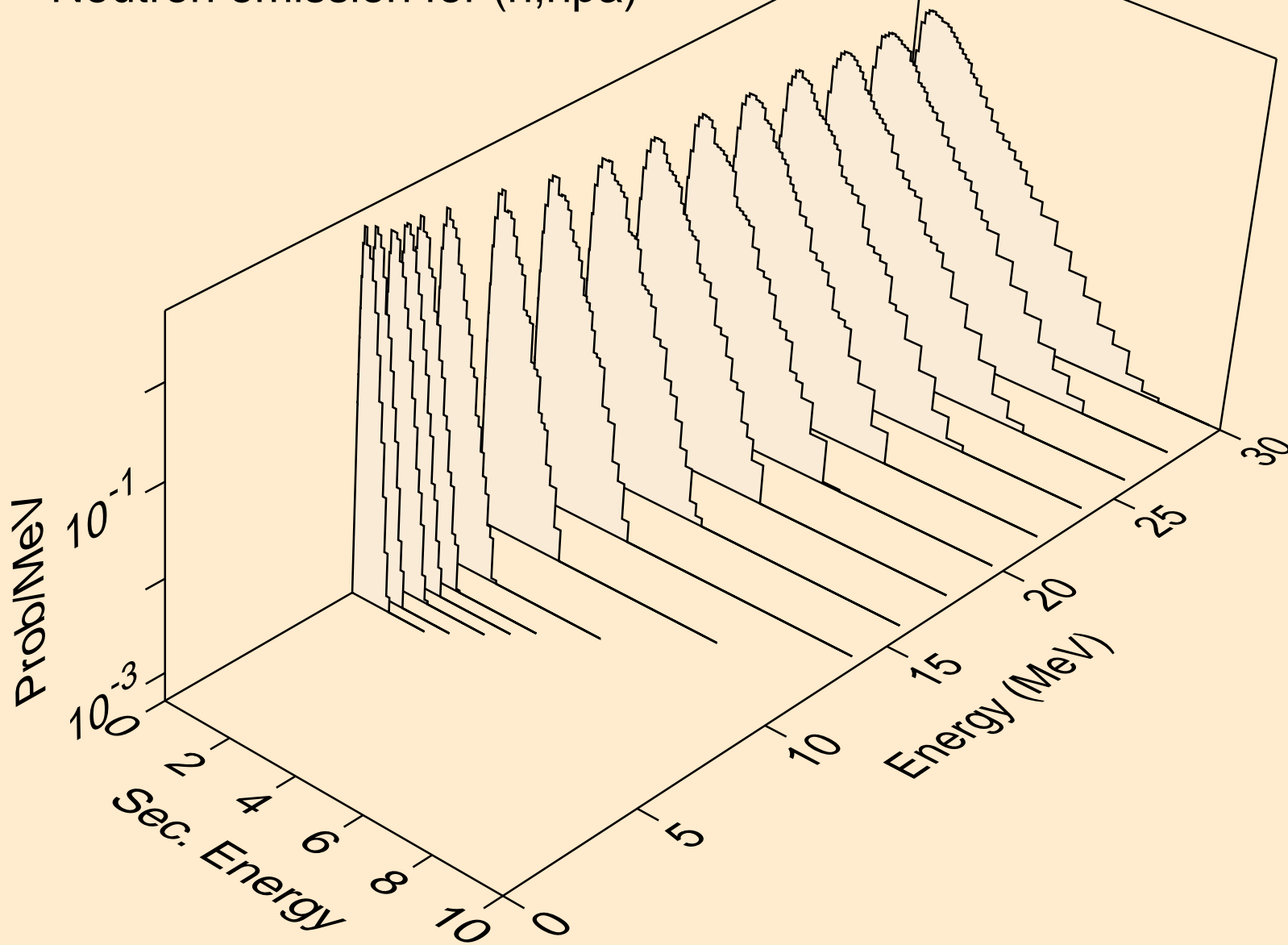

HG185M NEUTRON ACER TENDL-2019 LIBRARY; T=293.16K
Neutron emission for (n,n*c)

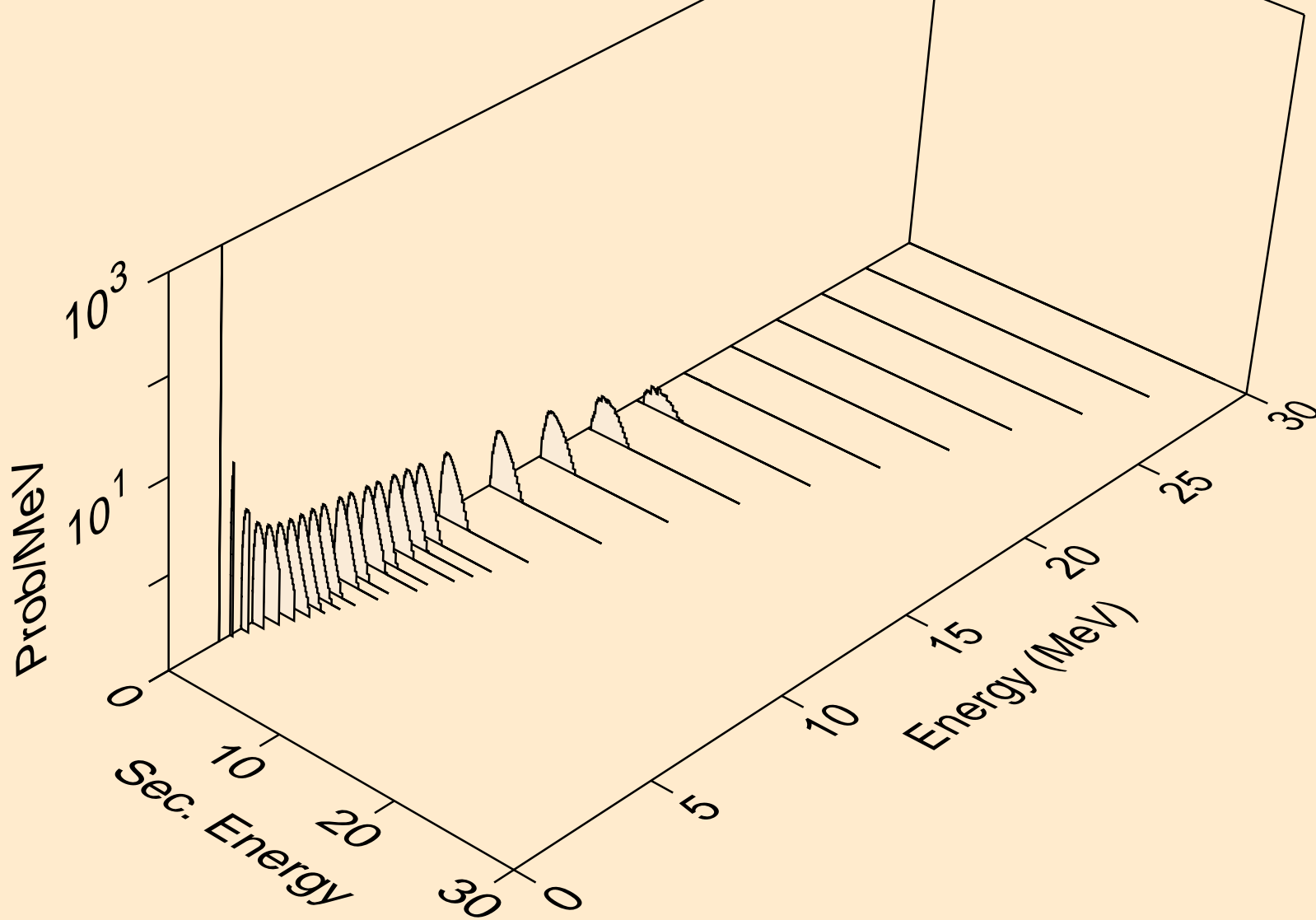

HG185M NEUTRON ACER TENDL-2019 LIBRARY; T=293.16K
Photon emission for (n,x)

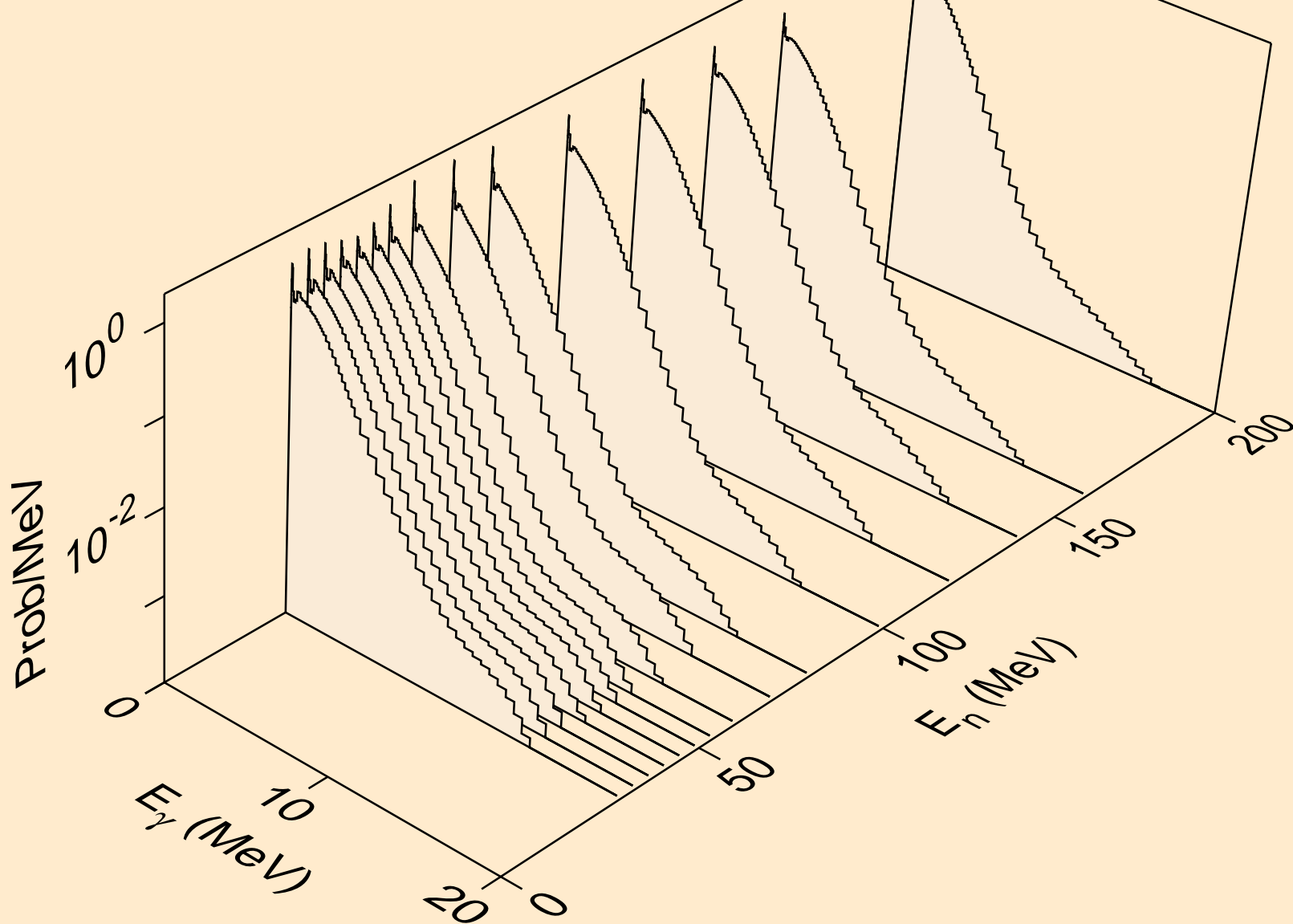

HG185M NEUTRON ACER TENDL-2019 LIBRARY; T=293.16K
Photon emission for (n,2nd)

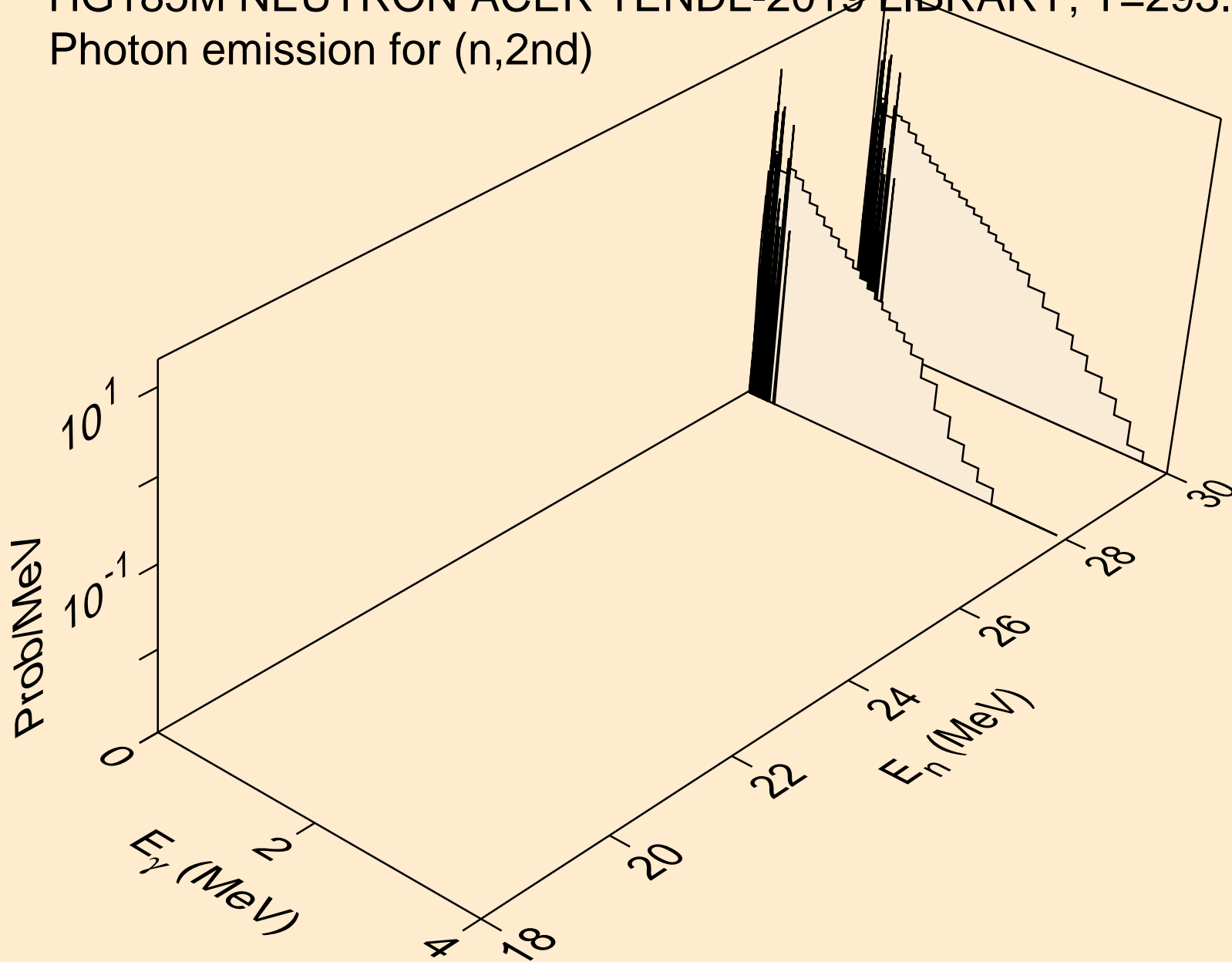

HG185M NEUTRON ACER TENDL-2019 LIBRARY; T=293.16K
Photon emission for (n,2n)

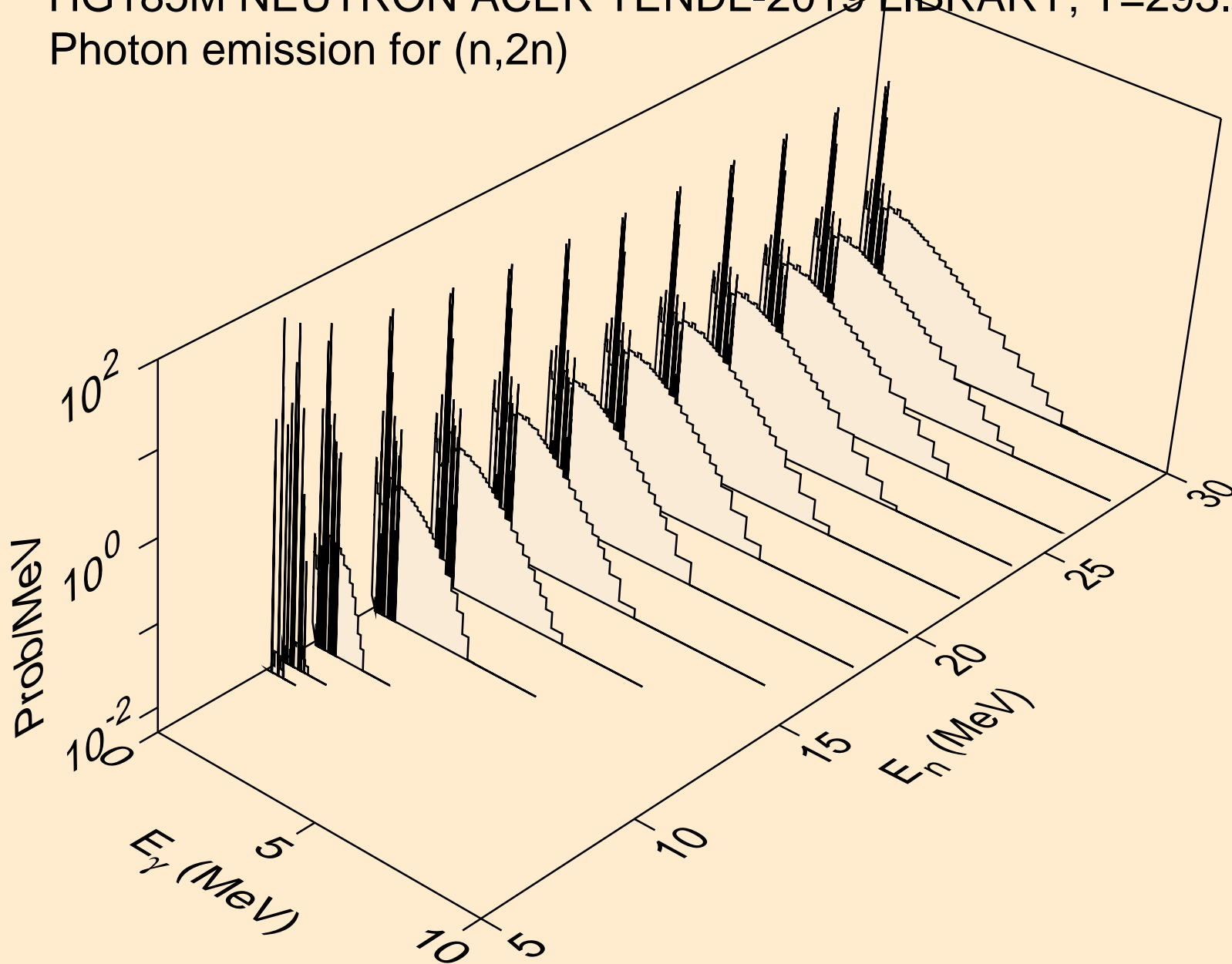

HG185M NEUTRON ACER TENDL-2019 LIBRARY; T=293.16K
Photon emission for (n,3n)

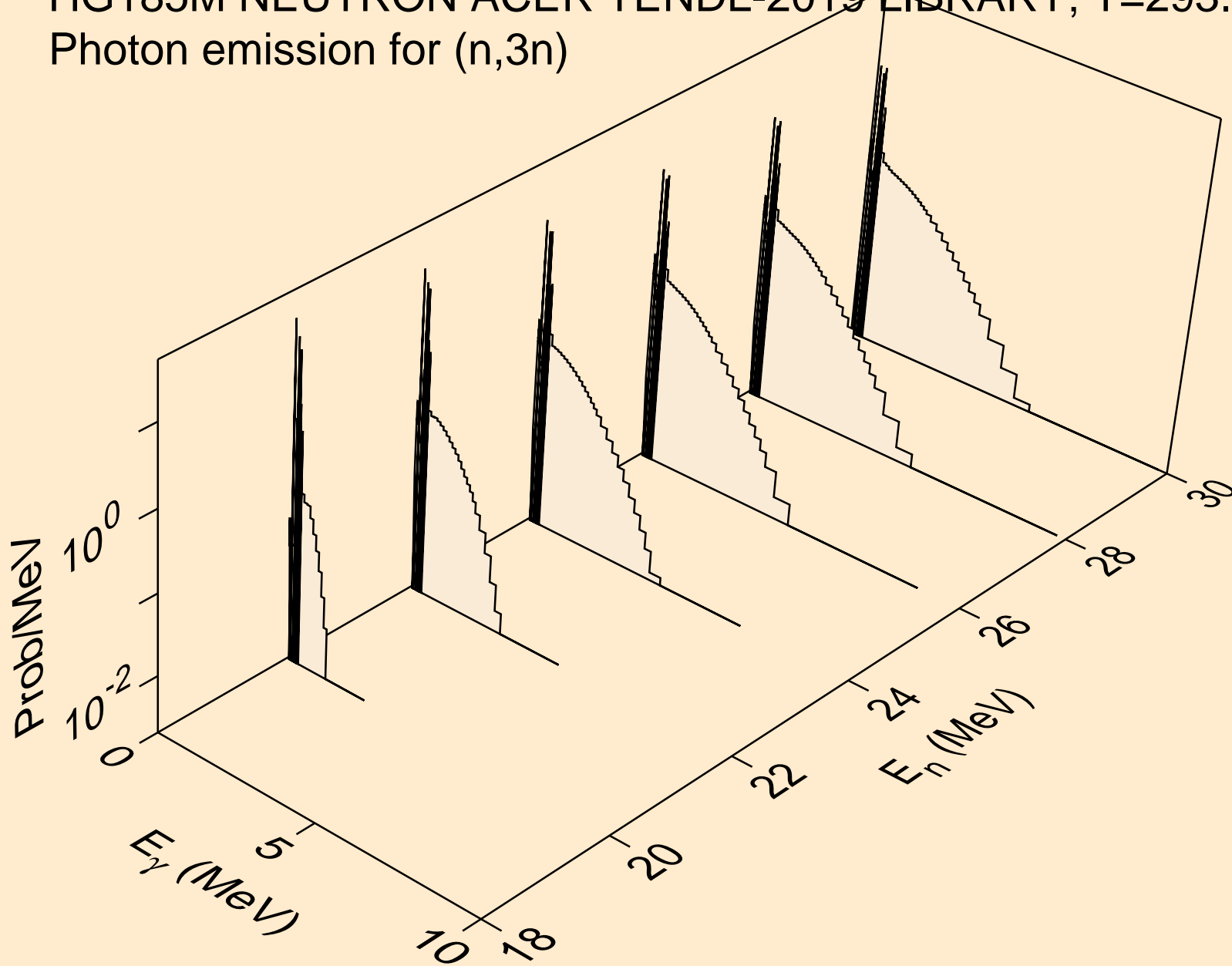

HG185M NEUTRON ACER TENDL-2019 LIBRARY; T=293.16K
Photon emission for (n,n*)a

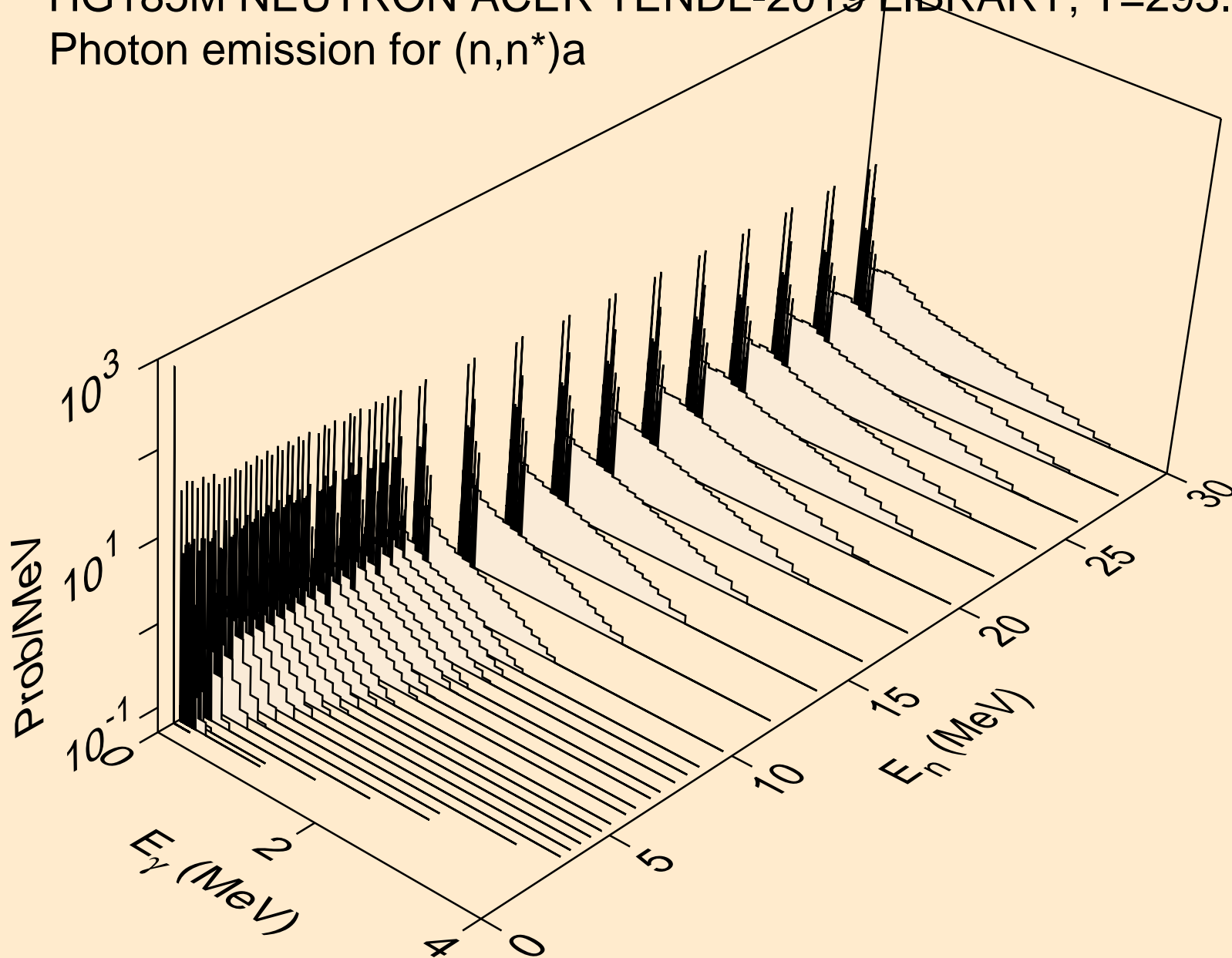

HG185M NEUTRON ACER TENDL-2019 LIBRARY; T=293.16K
Photon emission for (n,2n)a

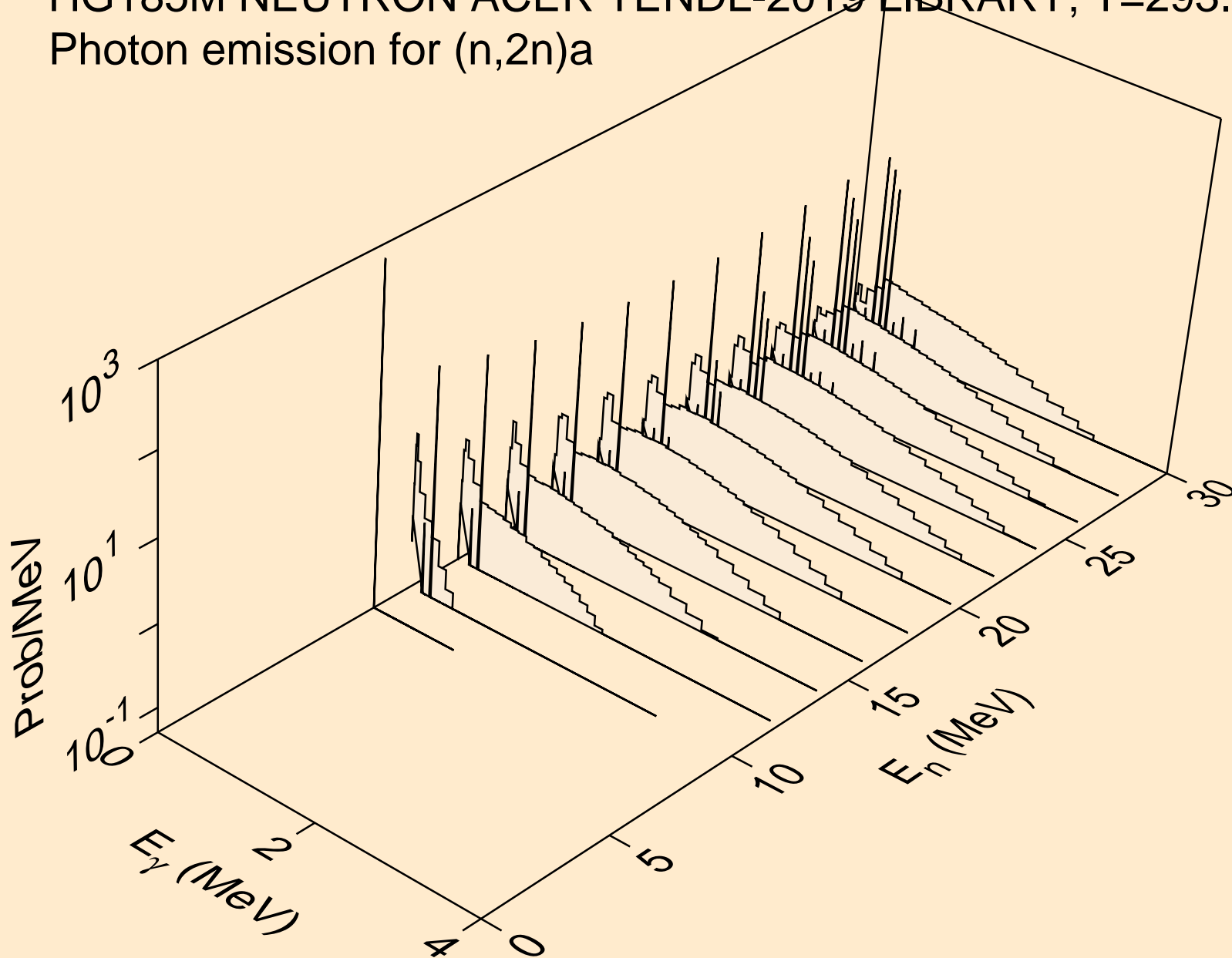

HG185M NEUTRON ACER TENDL-2019 LIBRARY; T=293.16K
Photon emission for (n,3n)a

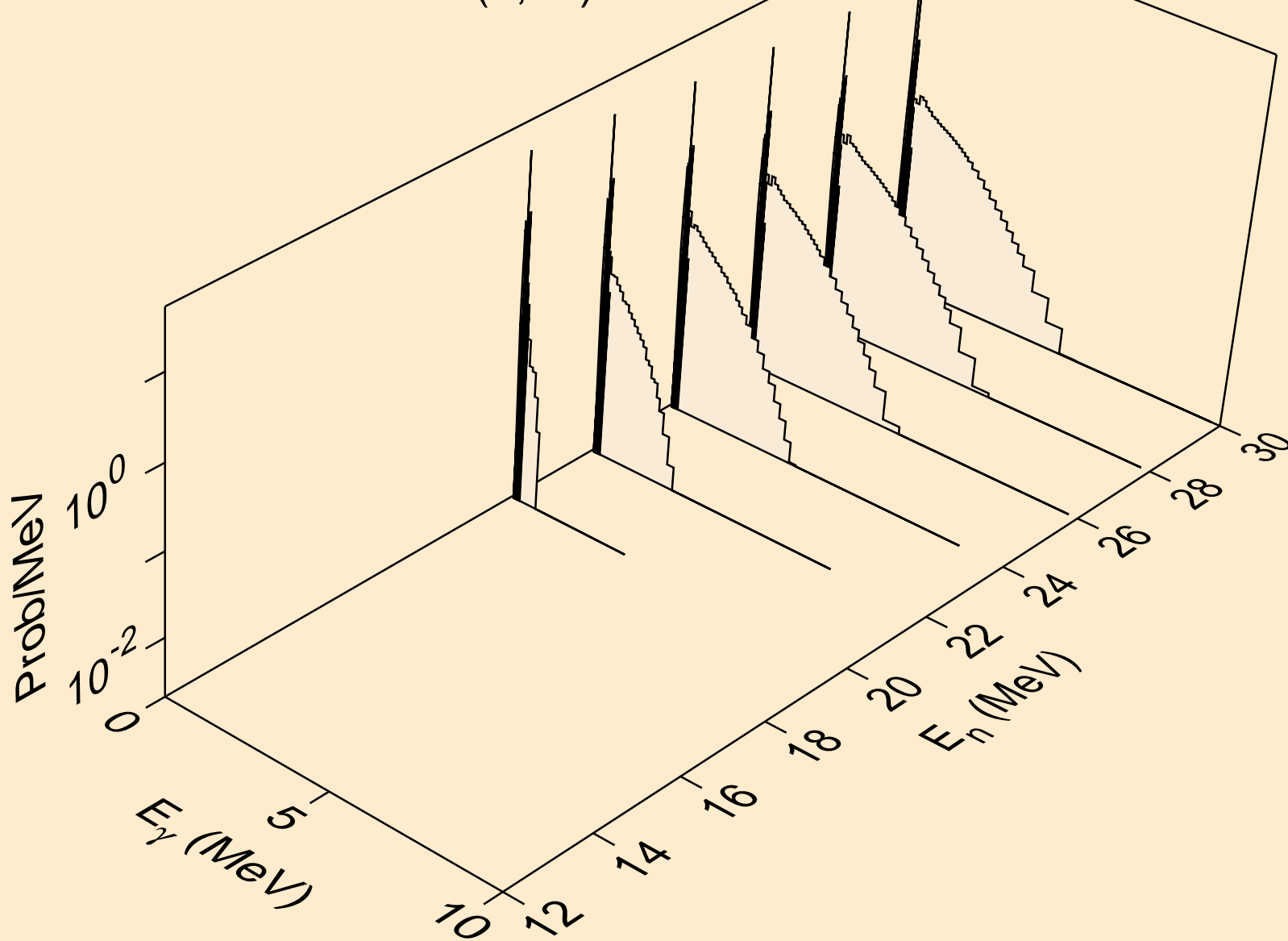

HG185M NEUTRON ACER TENDL-2019 LIBRARY; T=293.16K
Photon emission for (n,n*)p

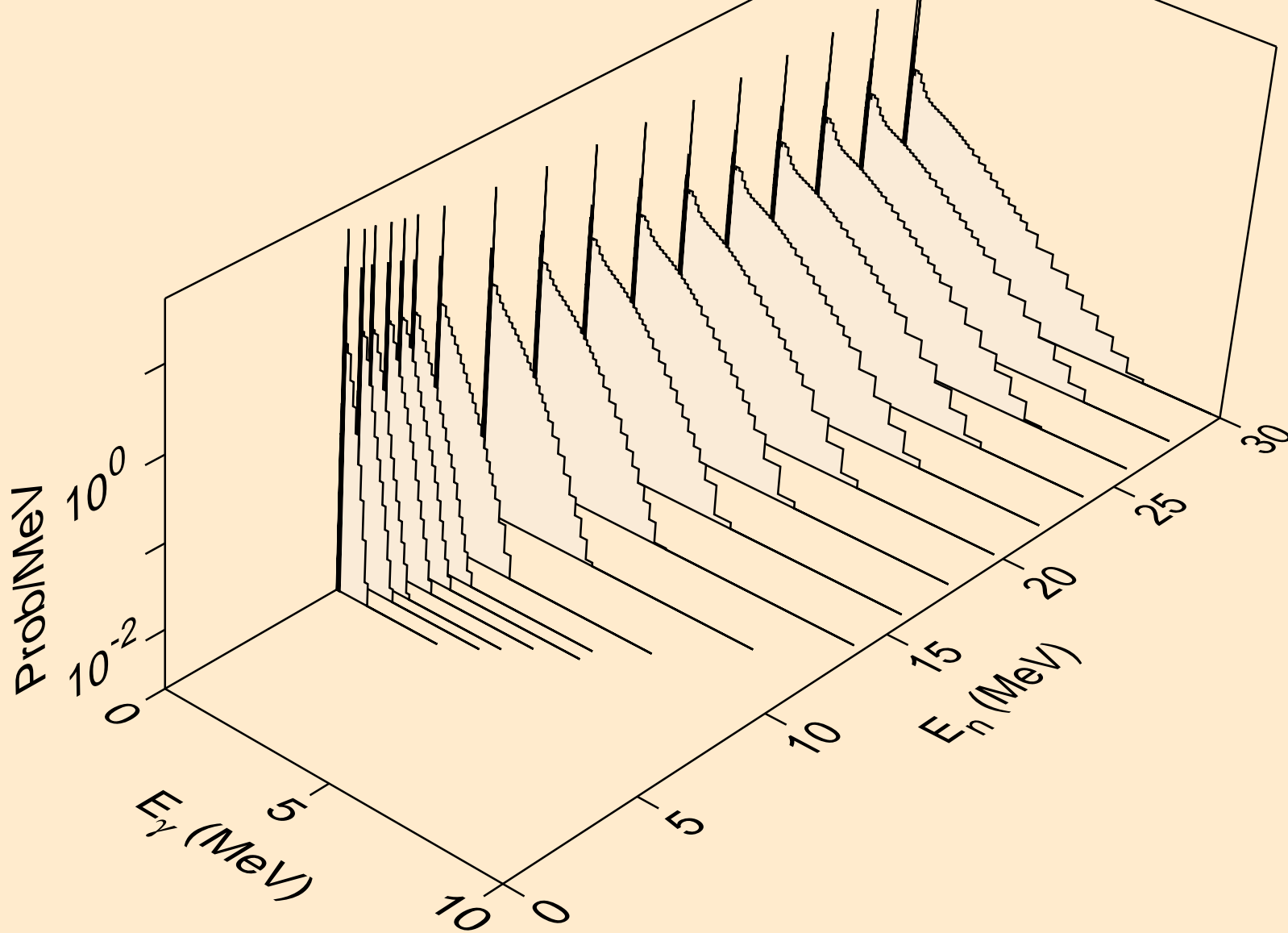

HG185M NEUTRON ACER TENDL-2019 LIBRARY; T=293.16K
Photon emission for (n,n*)2a

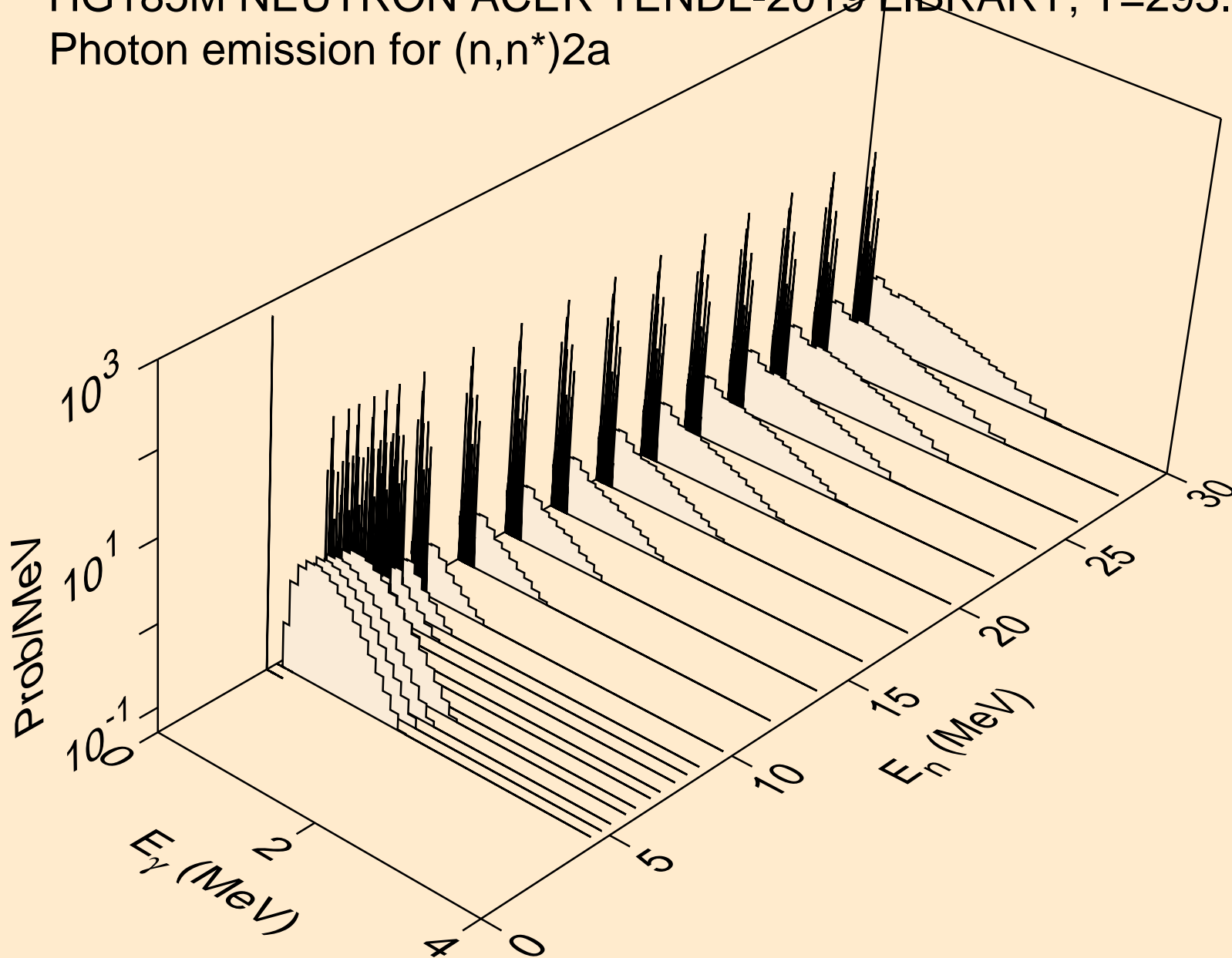

HG185M NEUTRON ACER TENDL-2019 LIBRARY; T=293.16K
Photon emission for (n,2n)2a

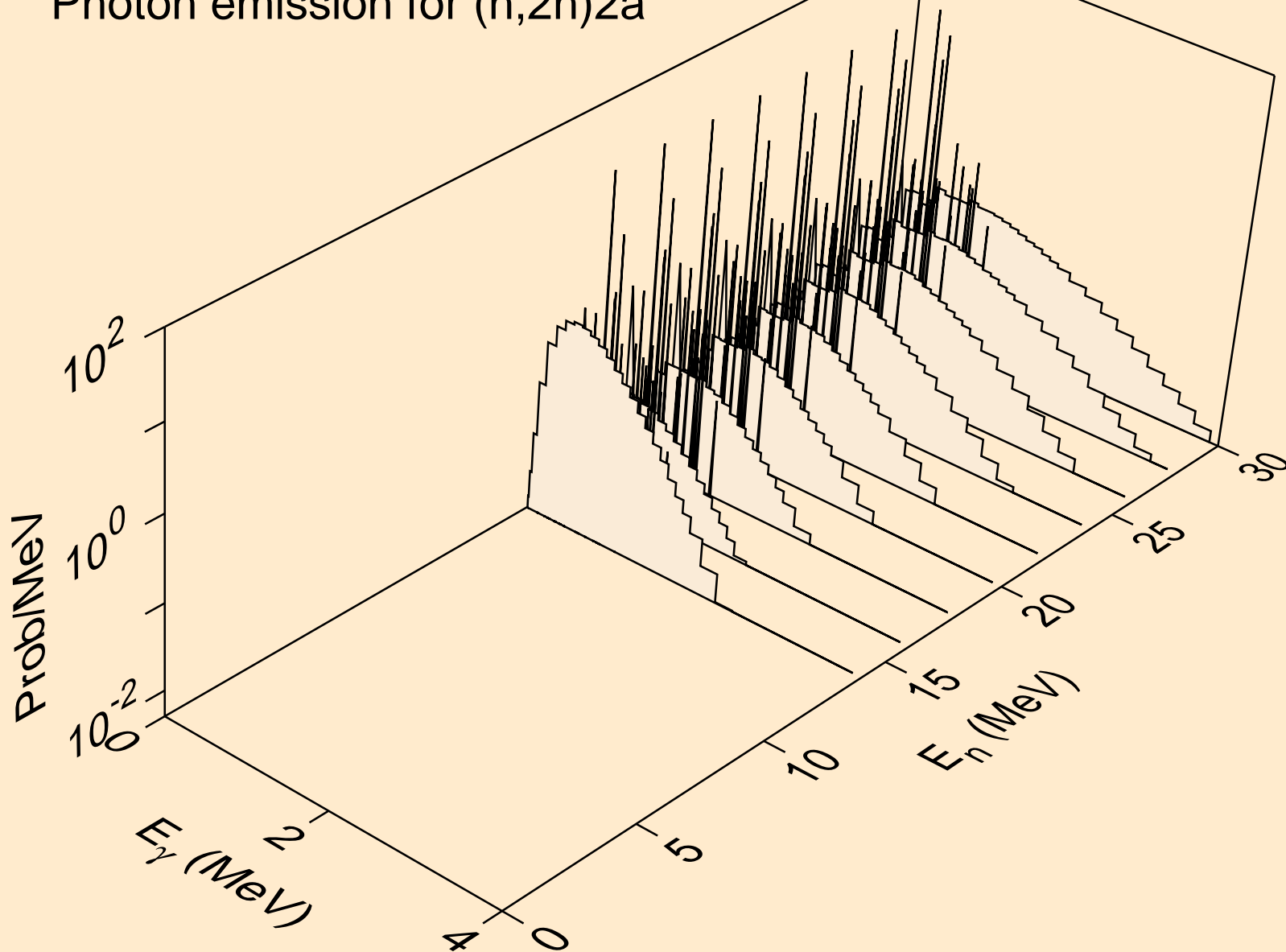

HG185M NEUTRON ACER TENDL-2019 LIBRARY; T=293.16K
Photon emission for (n,n*)d

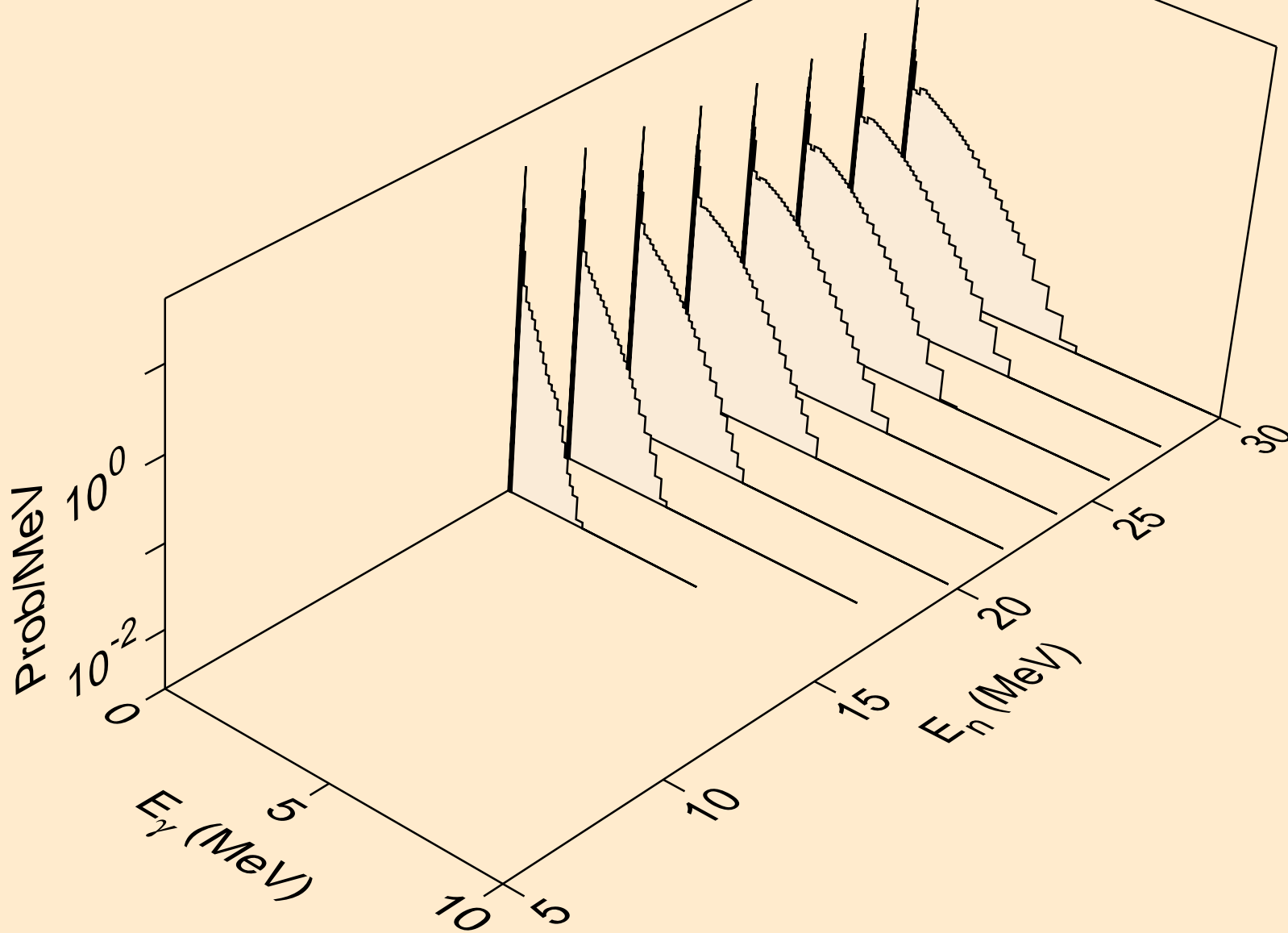

HG185M NEUTRON ACER TENDL-2019 LIBRARY; T=293.16K
Photon emission for (n,n*)t

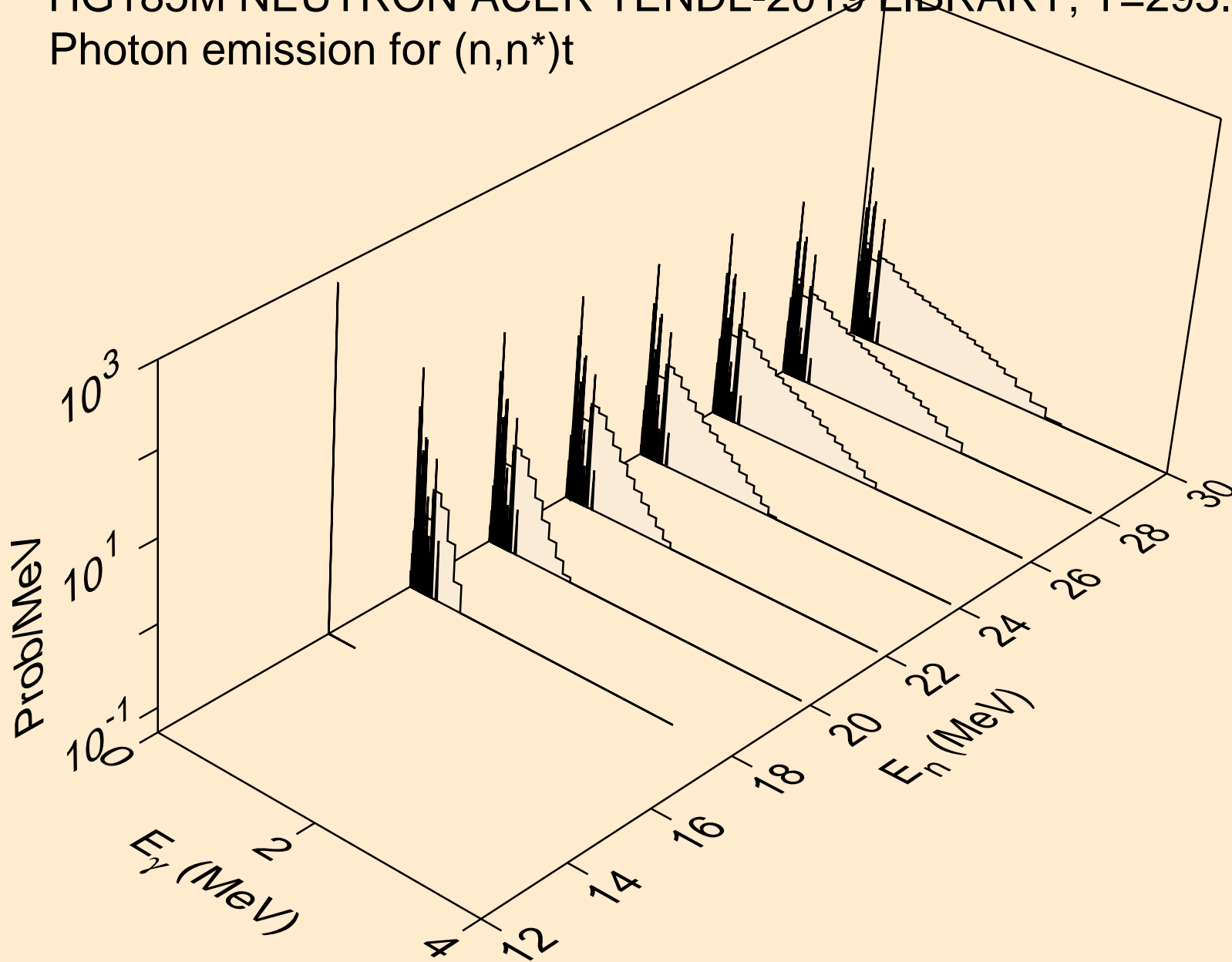

HG185M NEUTRON ACER TENDL-2019 LIBRARY; T=293.16K
Photon emission for (n,n*)he3

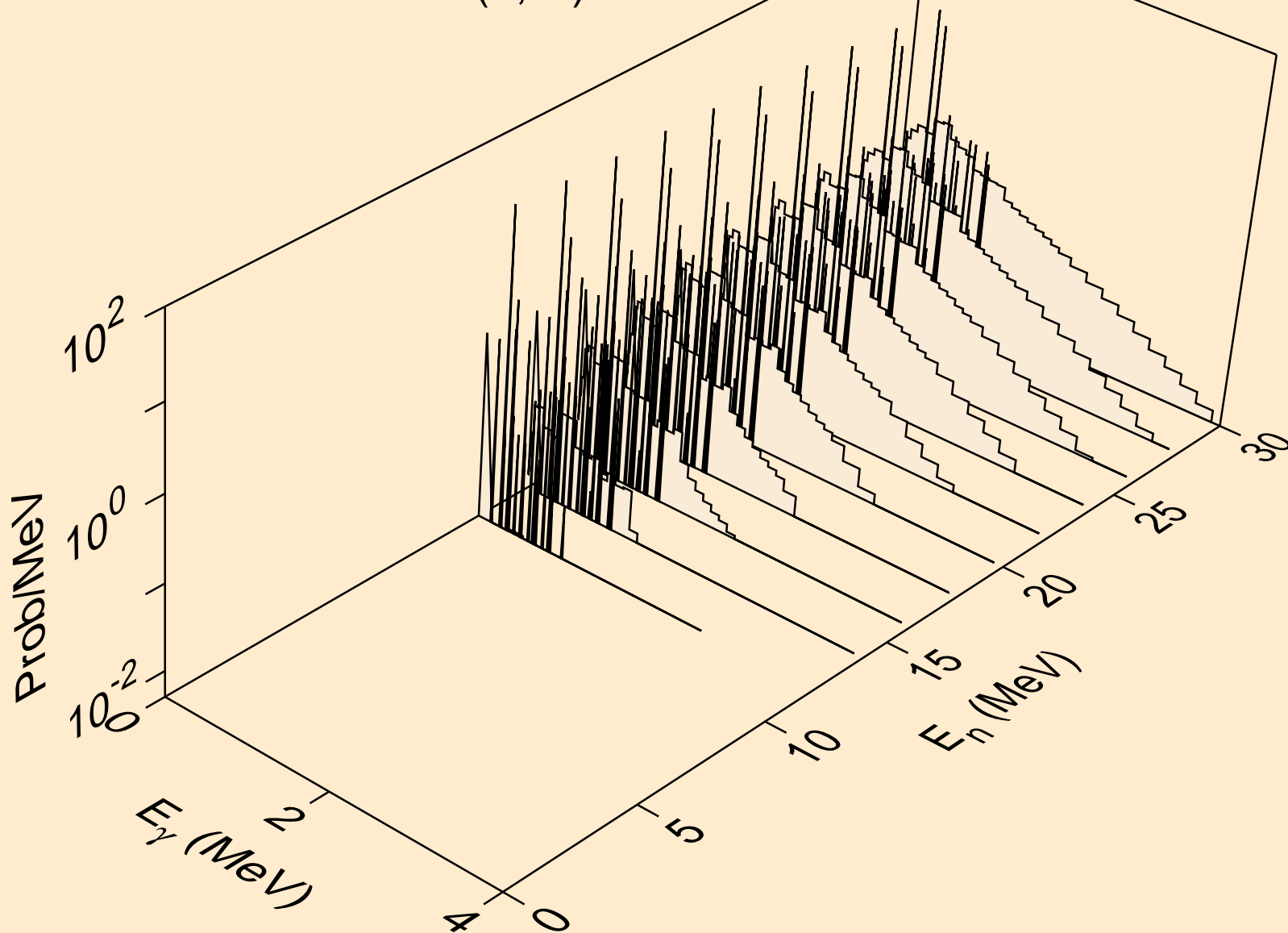

HG185M NEUTRON ACER TENDL-2019 LIBRARY; T=293.16K
Photon emission for (n,4n)

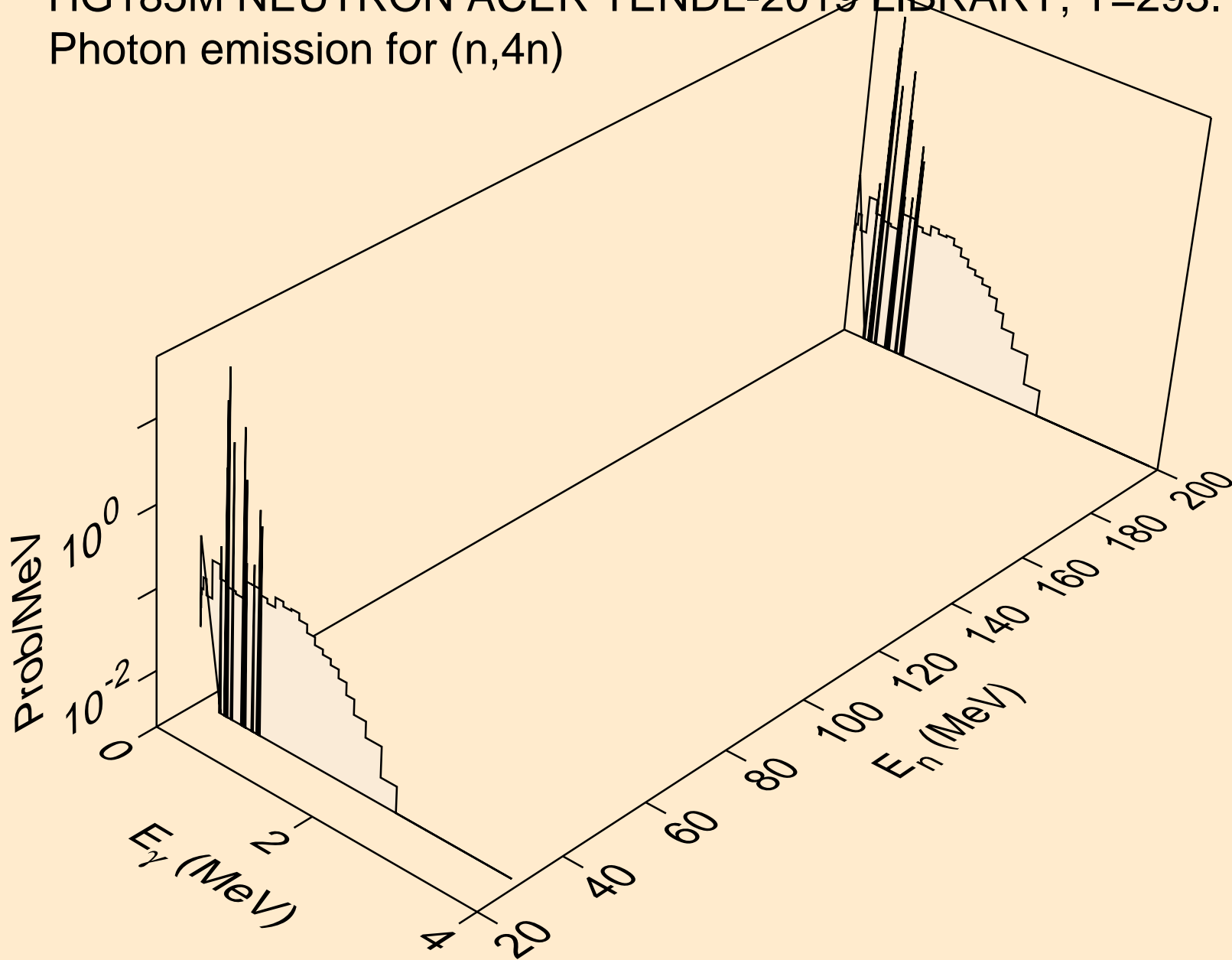

HG185M NEUTRON ACER TENDL-2019 LIBRARY; T=293.16K
Photon emission for (n,2np)

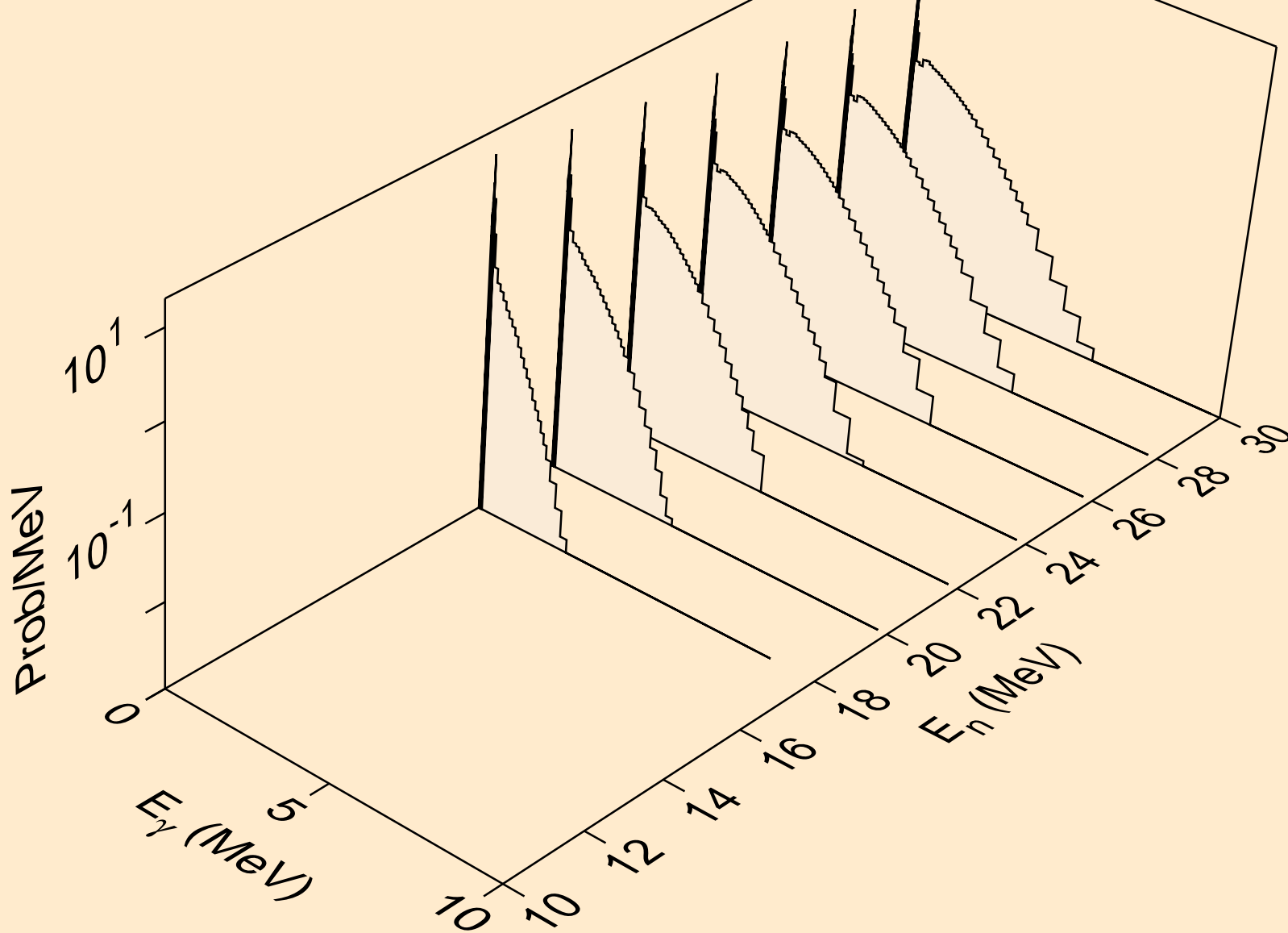

HG185M NEUTRON ACER TENDL-2019 LIBRARY; T=293.16K
Photon emission for (n,3np)

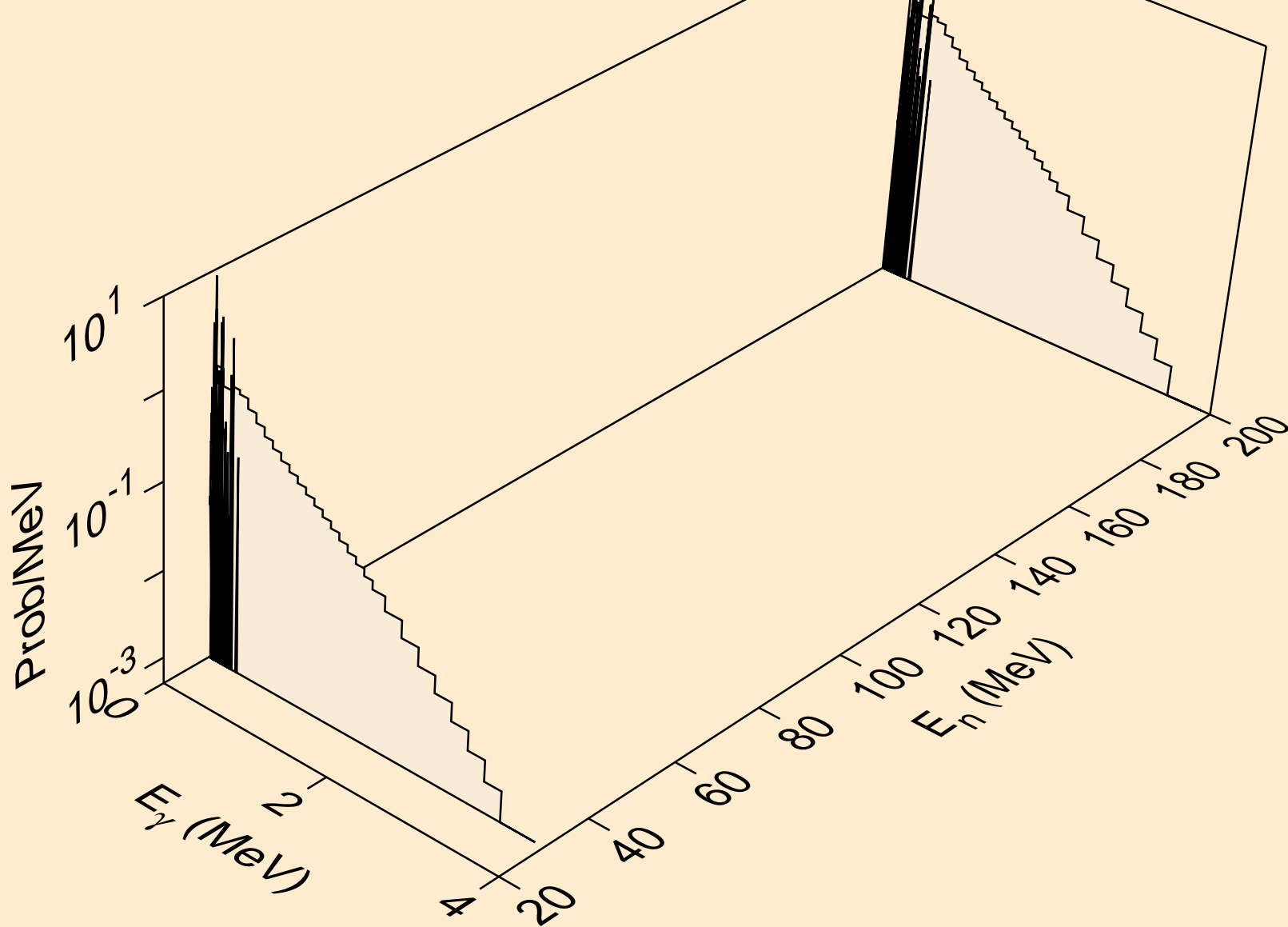

HG185M NEUTRON ACER TENDL-2019 LIBRARY; T=293.16K
Photon emission for (n,2np)

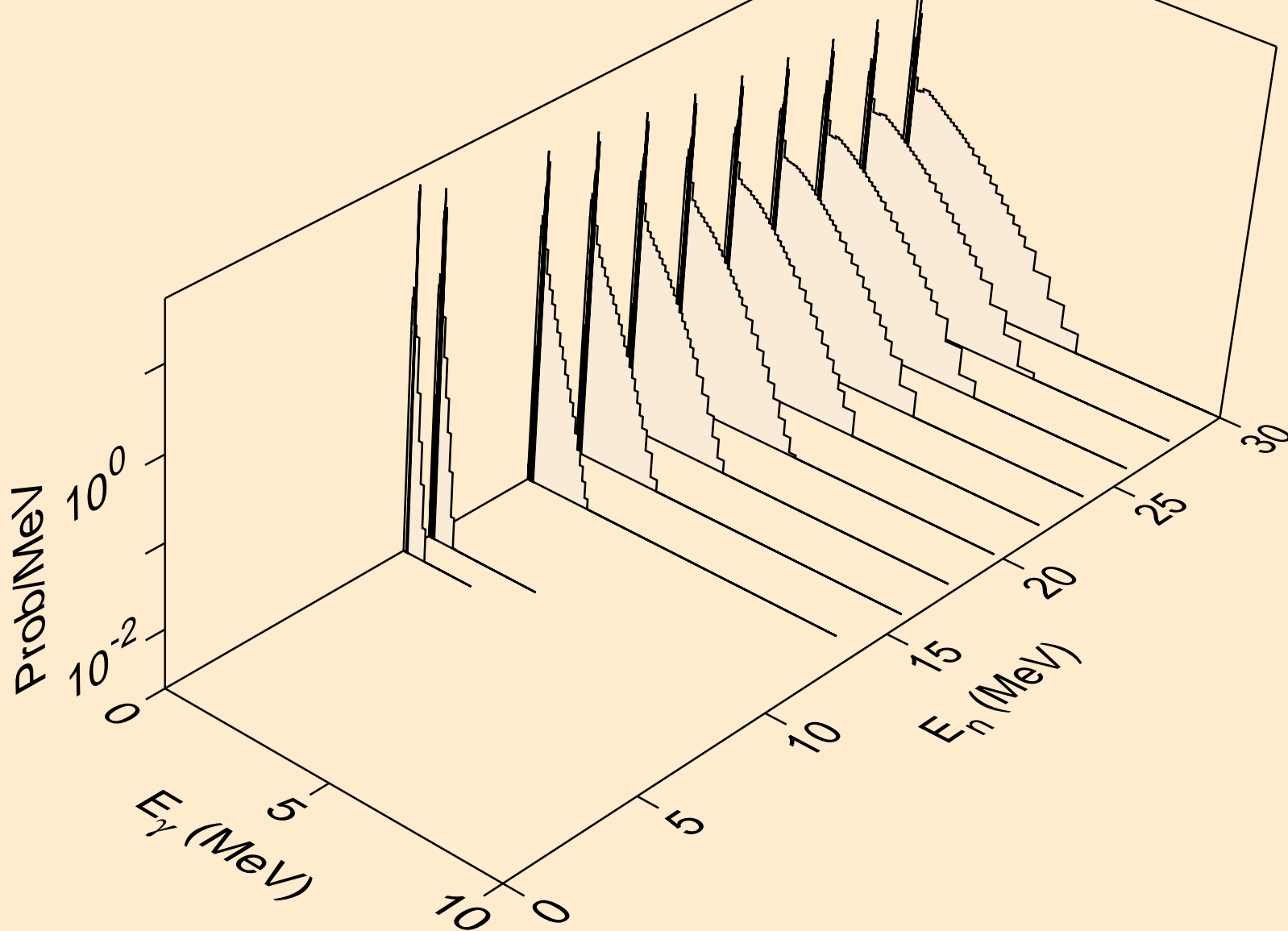

HG185M NEUTRON ACER TENDL-2019 LIBRARY; T=293.16K
Photon emission for (n,npa)

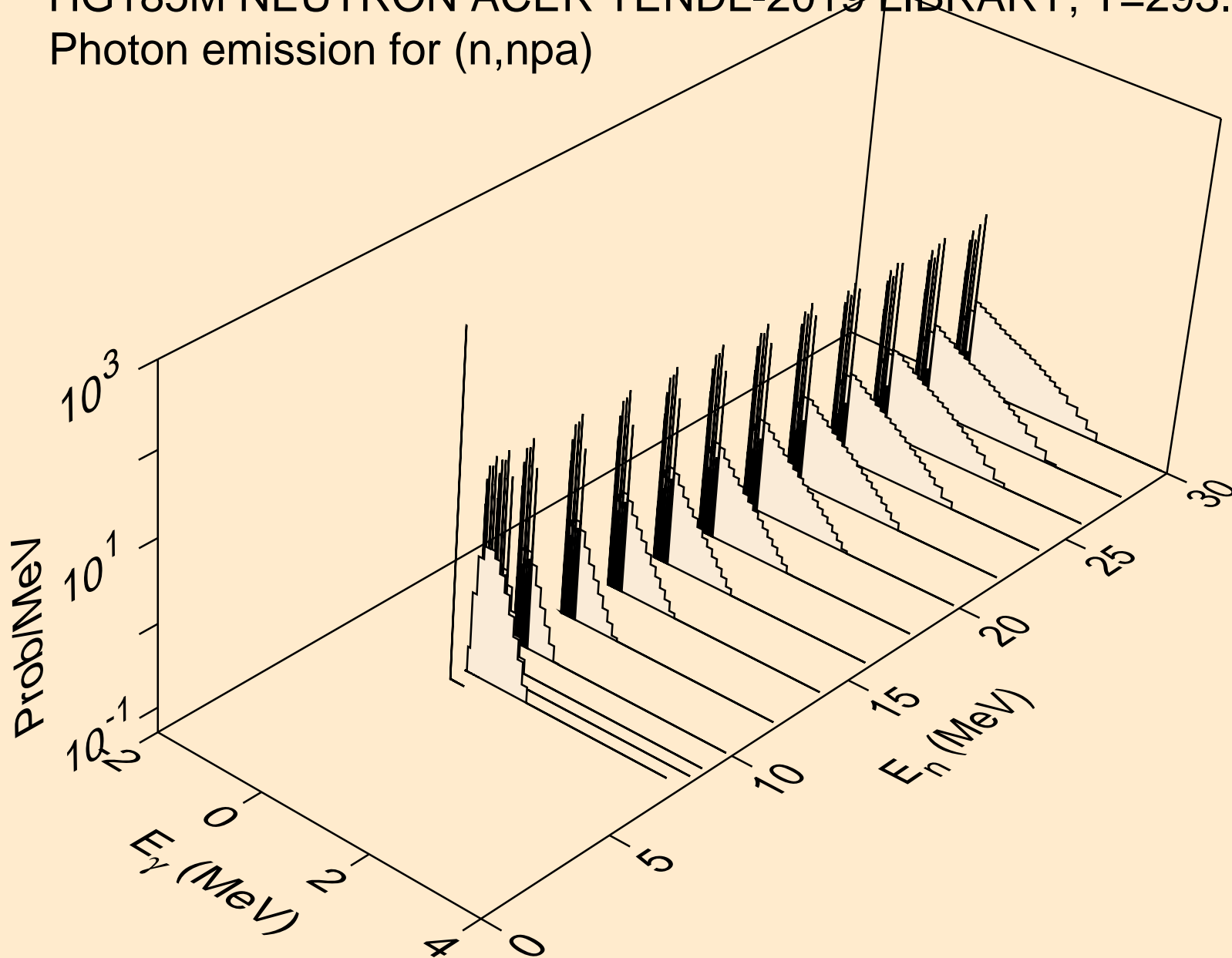

HG185M NEUTRON ACER TENDL-2019 LIBRARY; T=293.16K
Photon emission for (n,n*1)

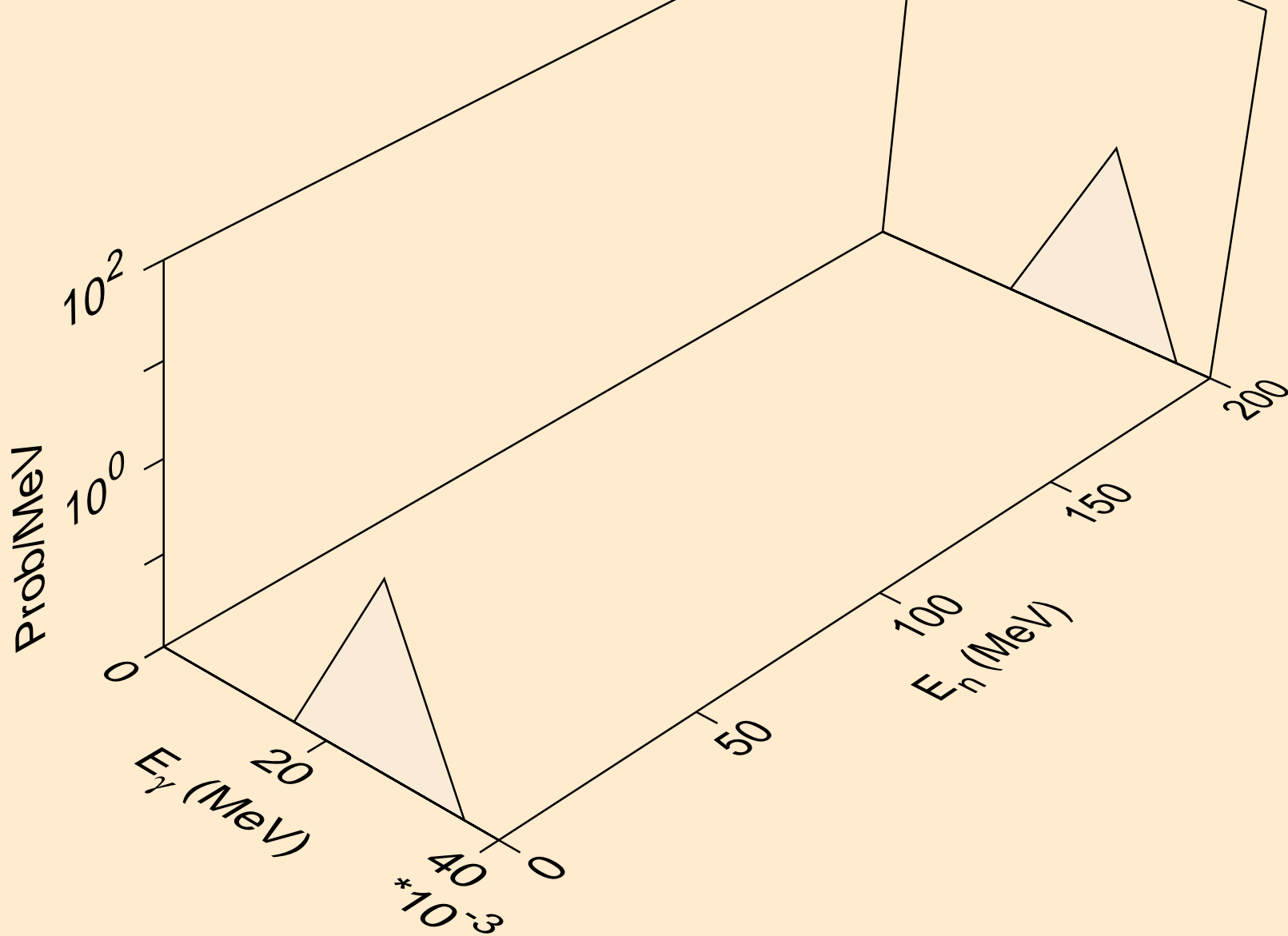

HG185M NEUTRON ACER TENDL-2019 LIBRARY; T=293.16K
Photon emission for (n,n*2)

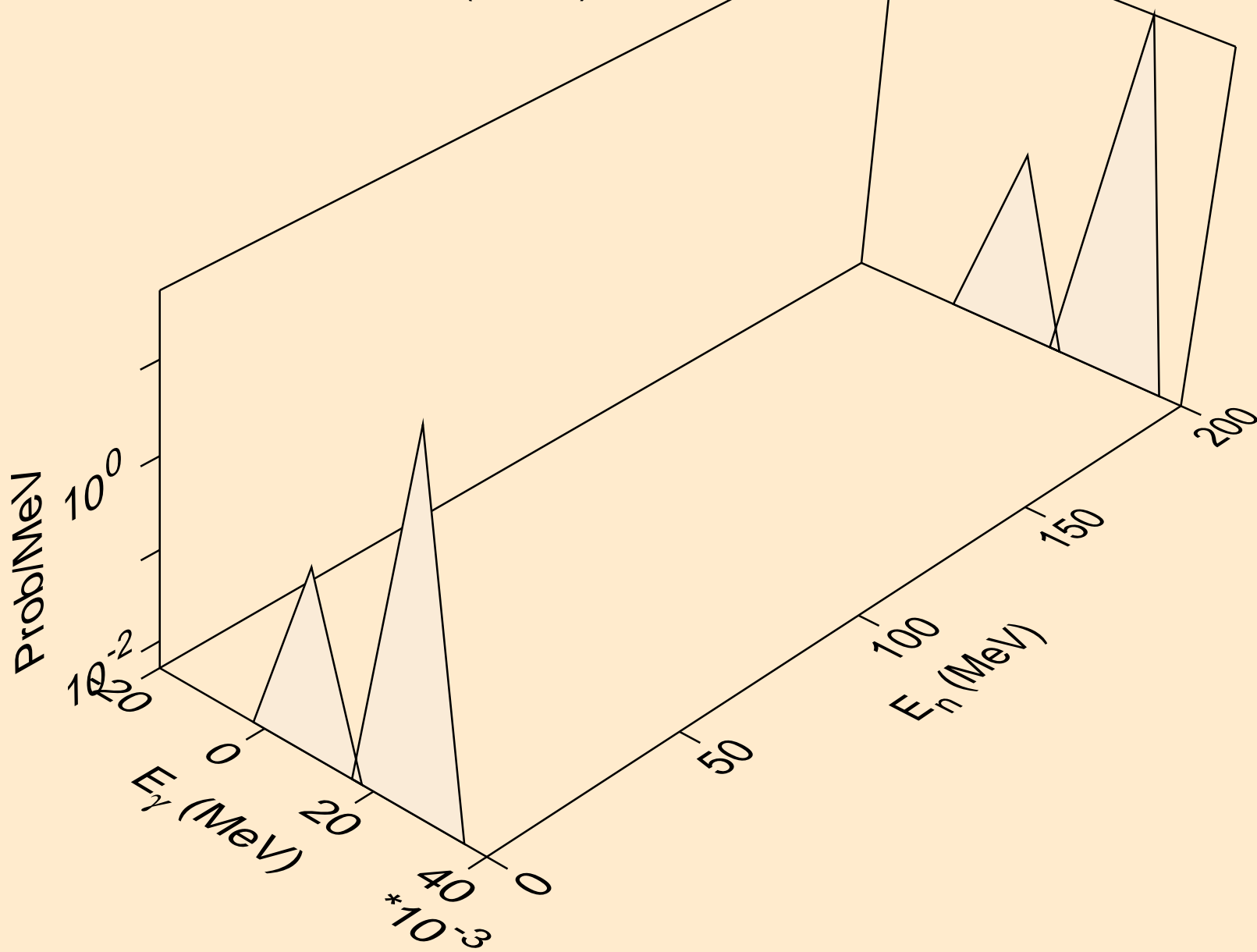

HG185M NEUTRON ACER TENDL-2019 LIBRARY; T=293.16K
Photon emission for (n,n*3)

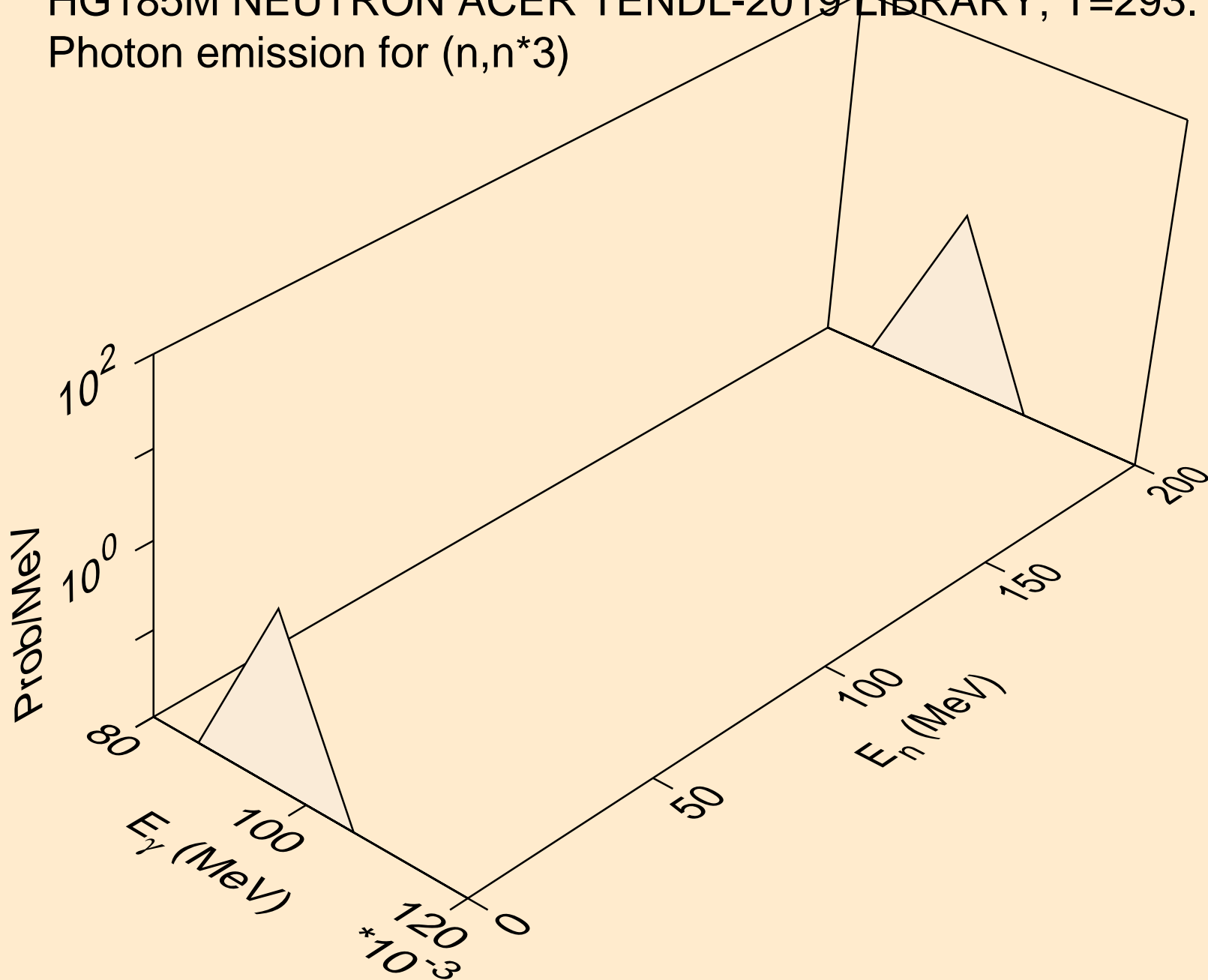

HG185M NEUTRON ACER TENDL-2019 LIBRARY; T=293.16K
Photon emission for (n,n*c)

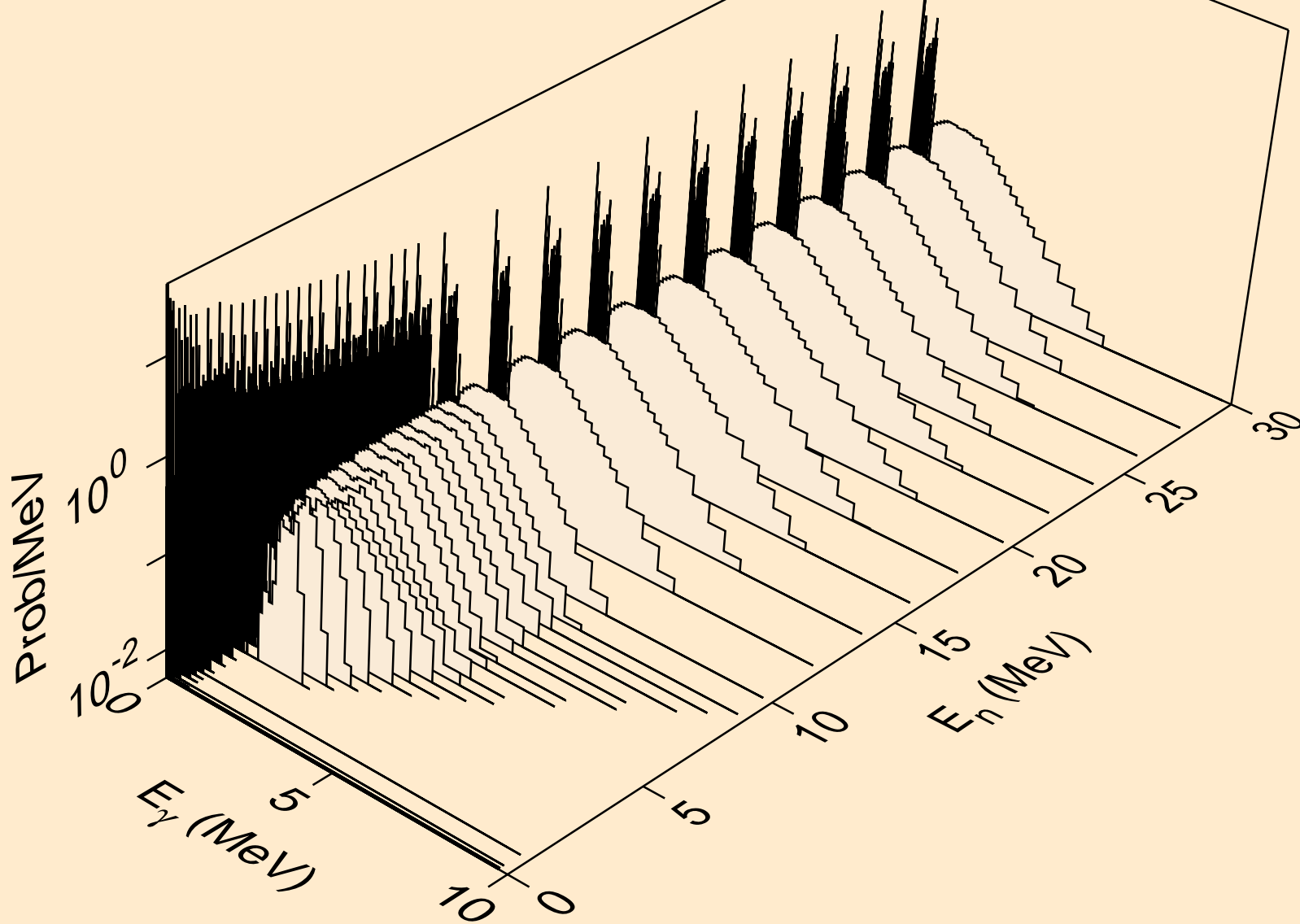

HG185M NEUTRON ACER TENDL-2019 LIBRARY; T=293.16K
Photon emission for (n,gma)

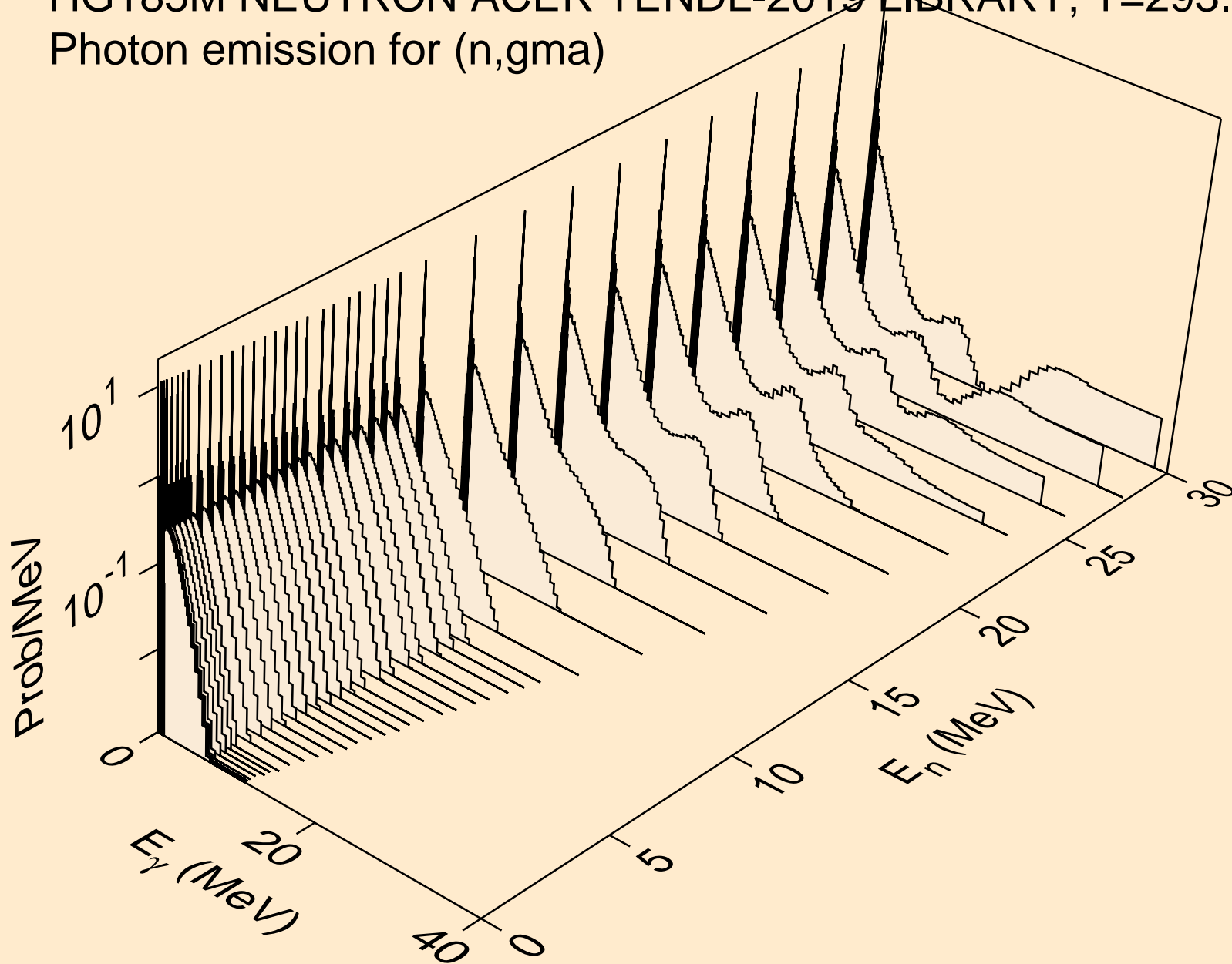

HG185M NEUTRON ACER TENDL-2019 LIBRARY; T=293.16K
Photon emission for (n,p)

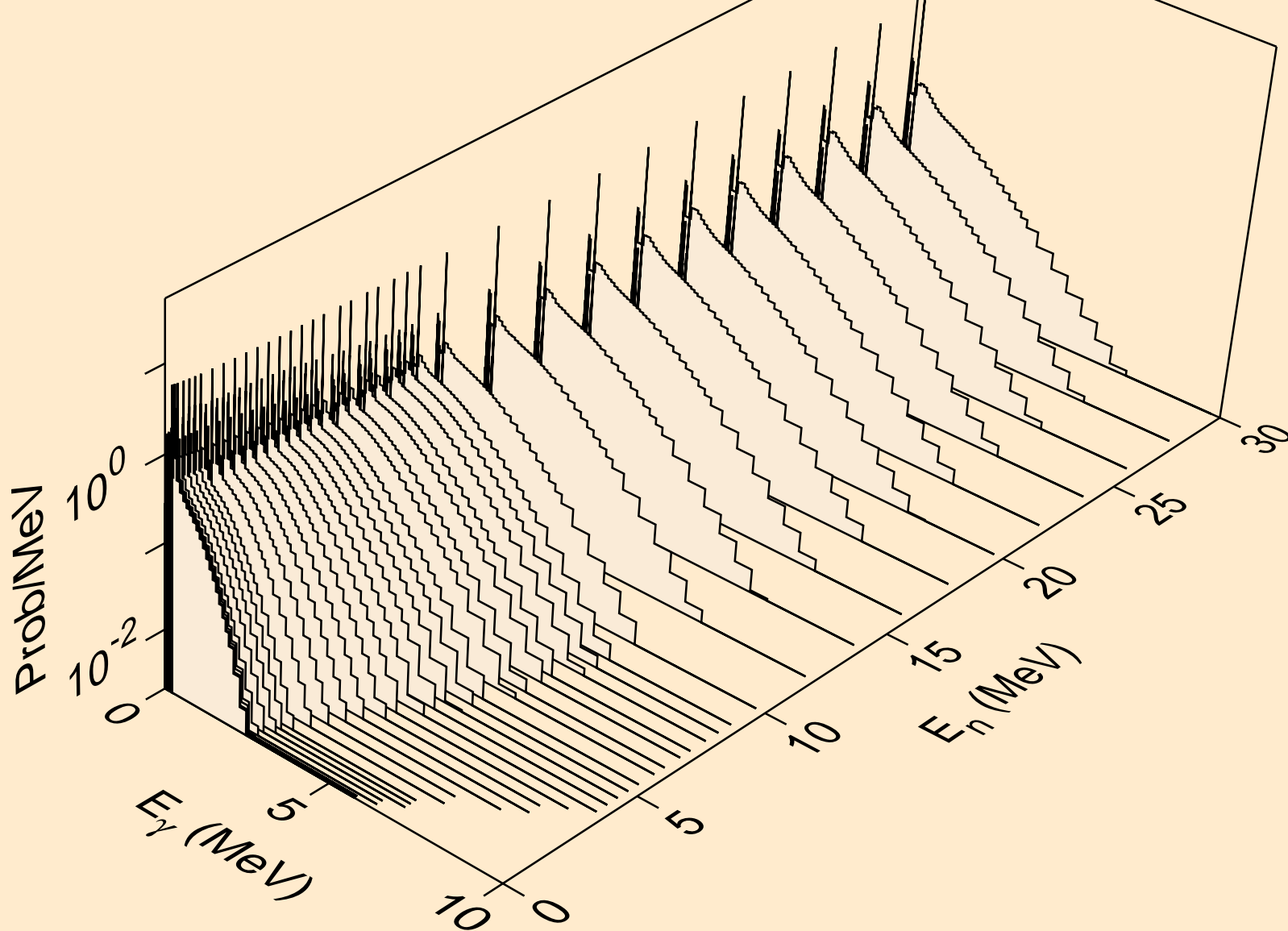

HG185M NEUTRON ACER TENDL-2019 LIBRARY; T=293.16K
Photon emission for (n,d)

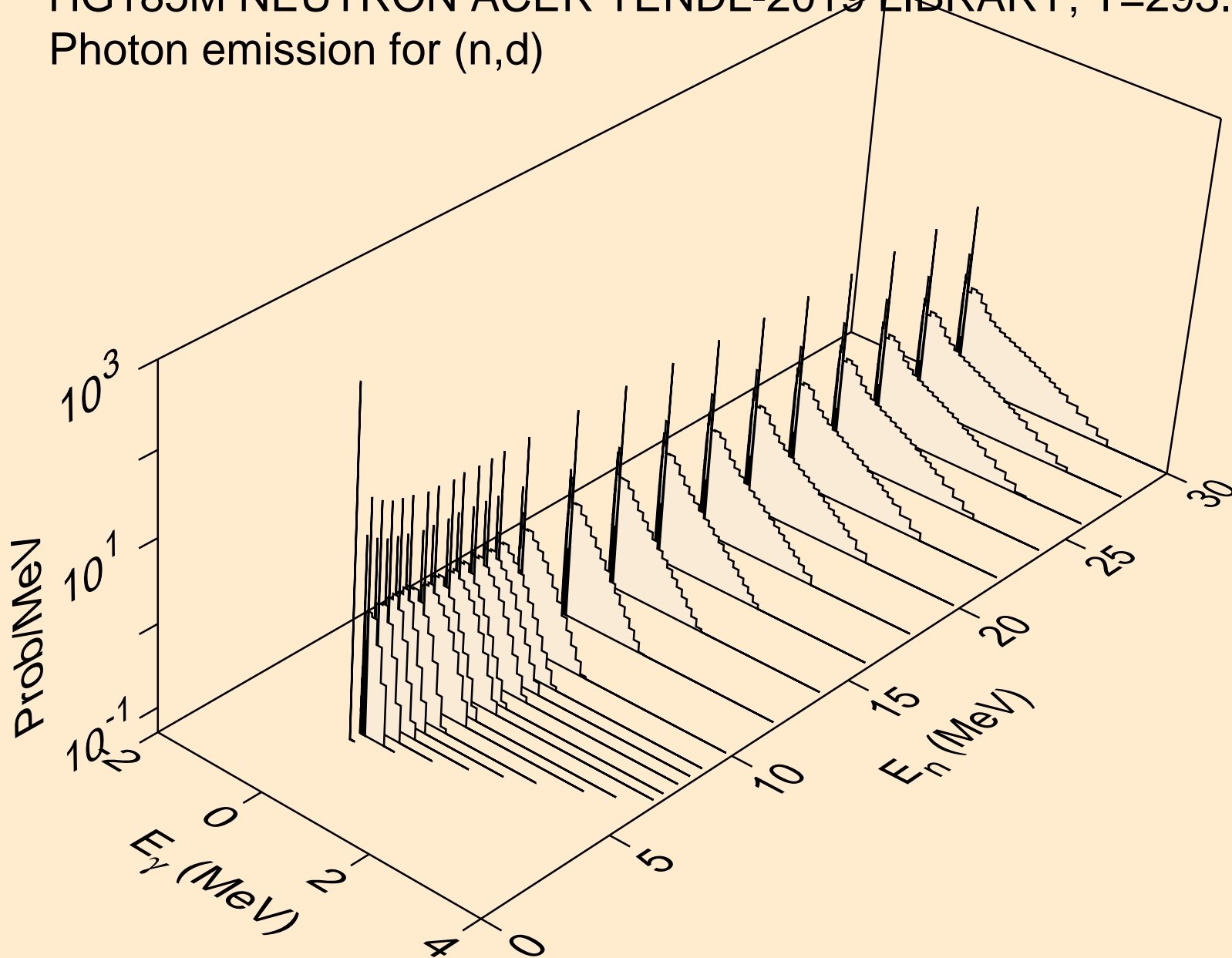

HG185M NEUTRON ACER TENDL-2019 LIBRARY; T=293.16K
Photon emission for (n,t)

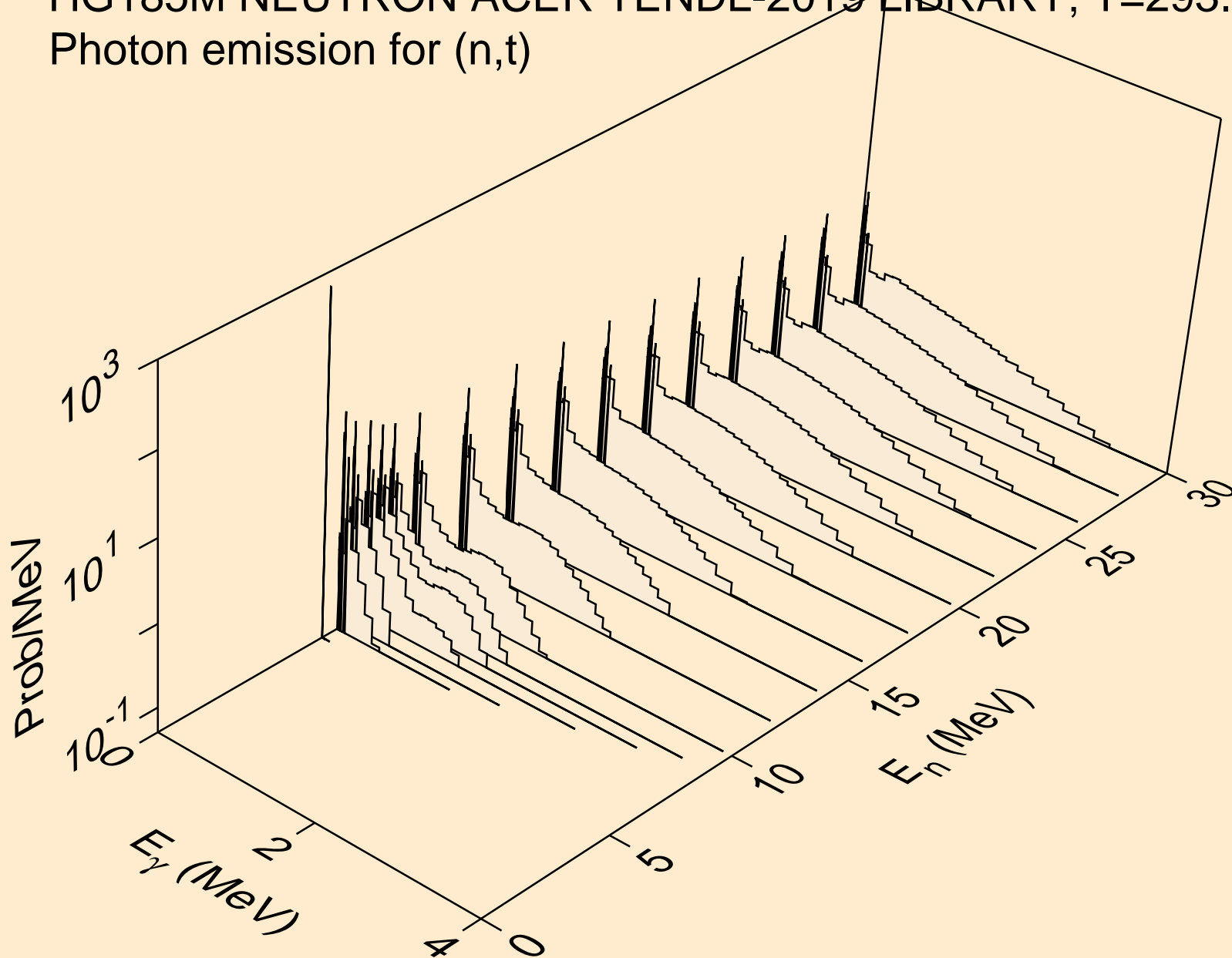

HG185M NEUTRON ACER TENDL-2019 LIBRARY; T=293.16K
Photon emission for (n,he3)

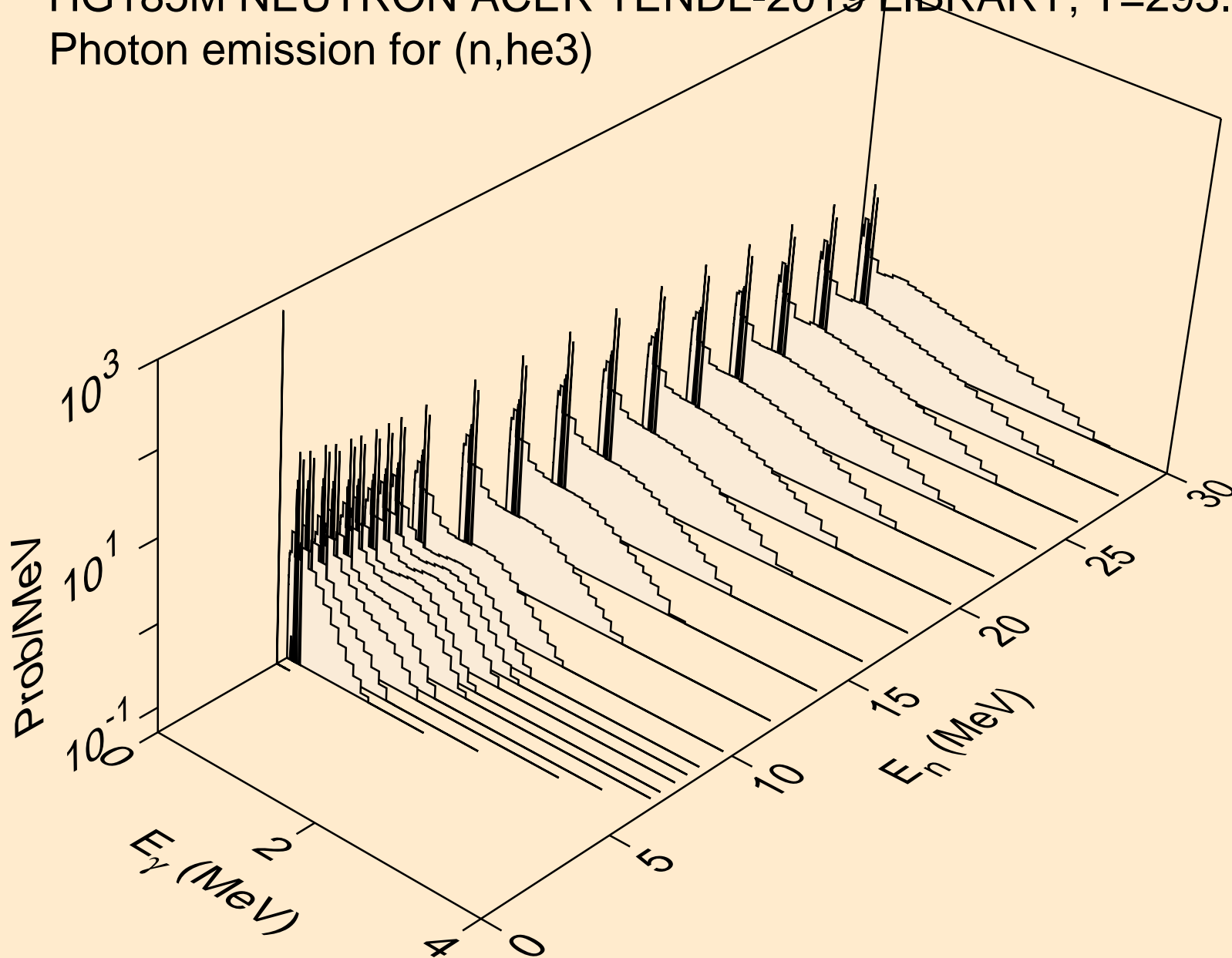

HG185M NEUTRON ACER TENDL-2019 LIBRARY; T=293.16K
Photon emission for (n,a)

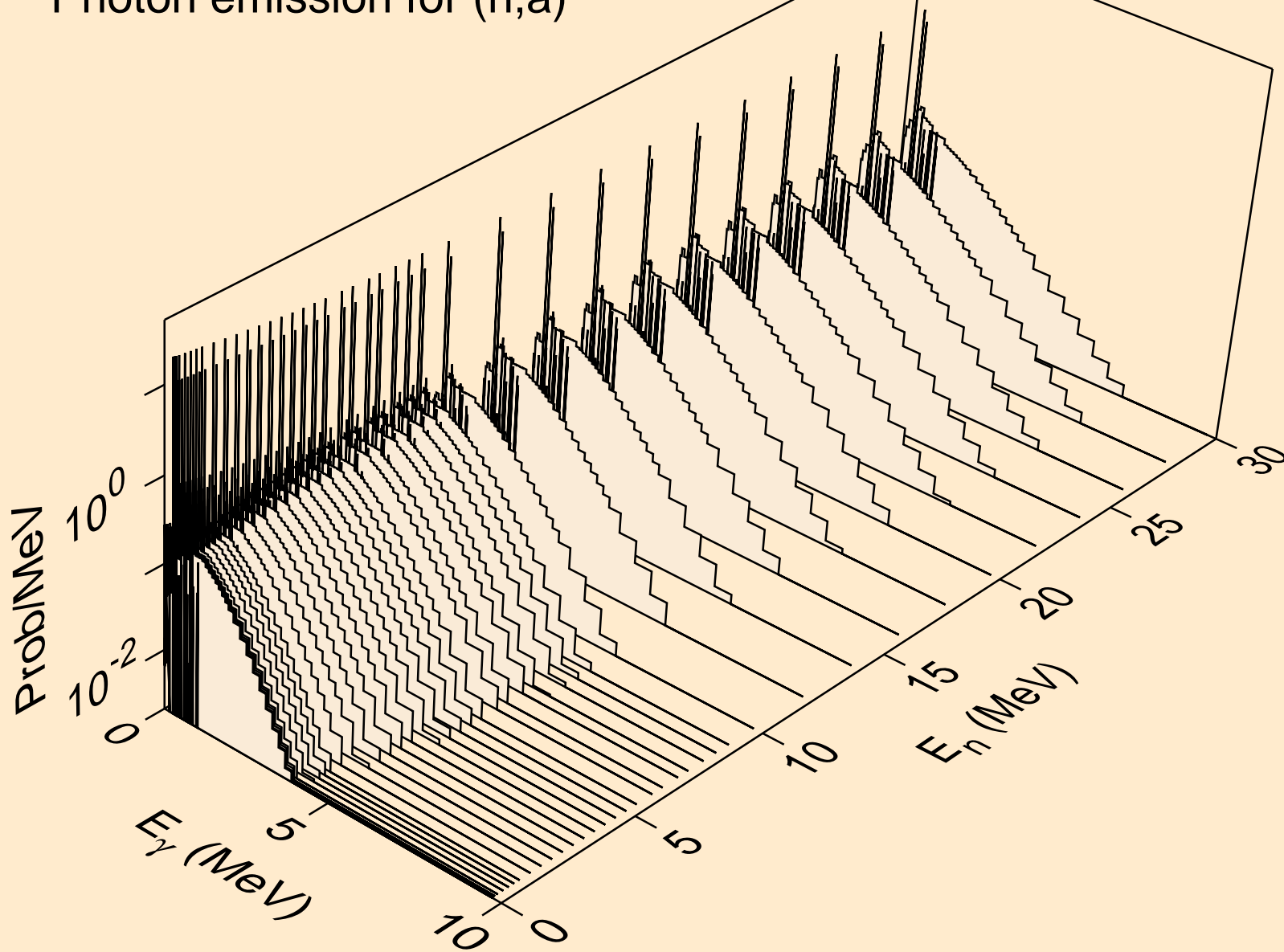

HG185M NEUTRON ACER TENDL-2019 LIBRARY; T=293.16K
Photon emission for (n,2a)

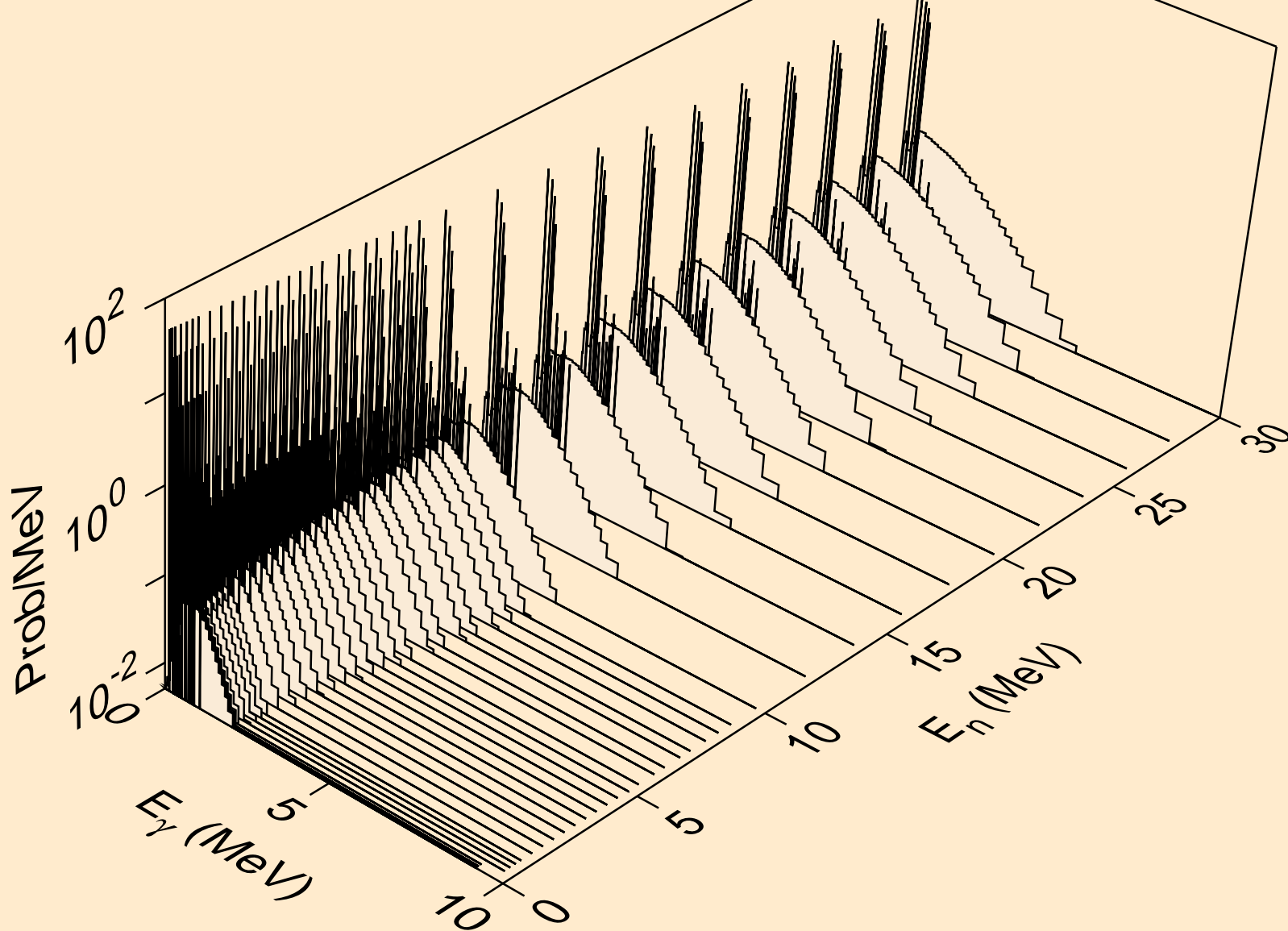

HG185M NEUTRON ACER TENDL-2019 LIBRARY; T=293.16K
Photon emission for (n,3a)

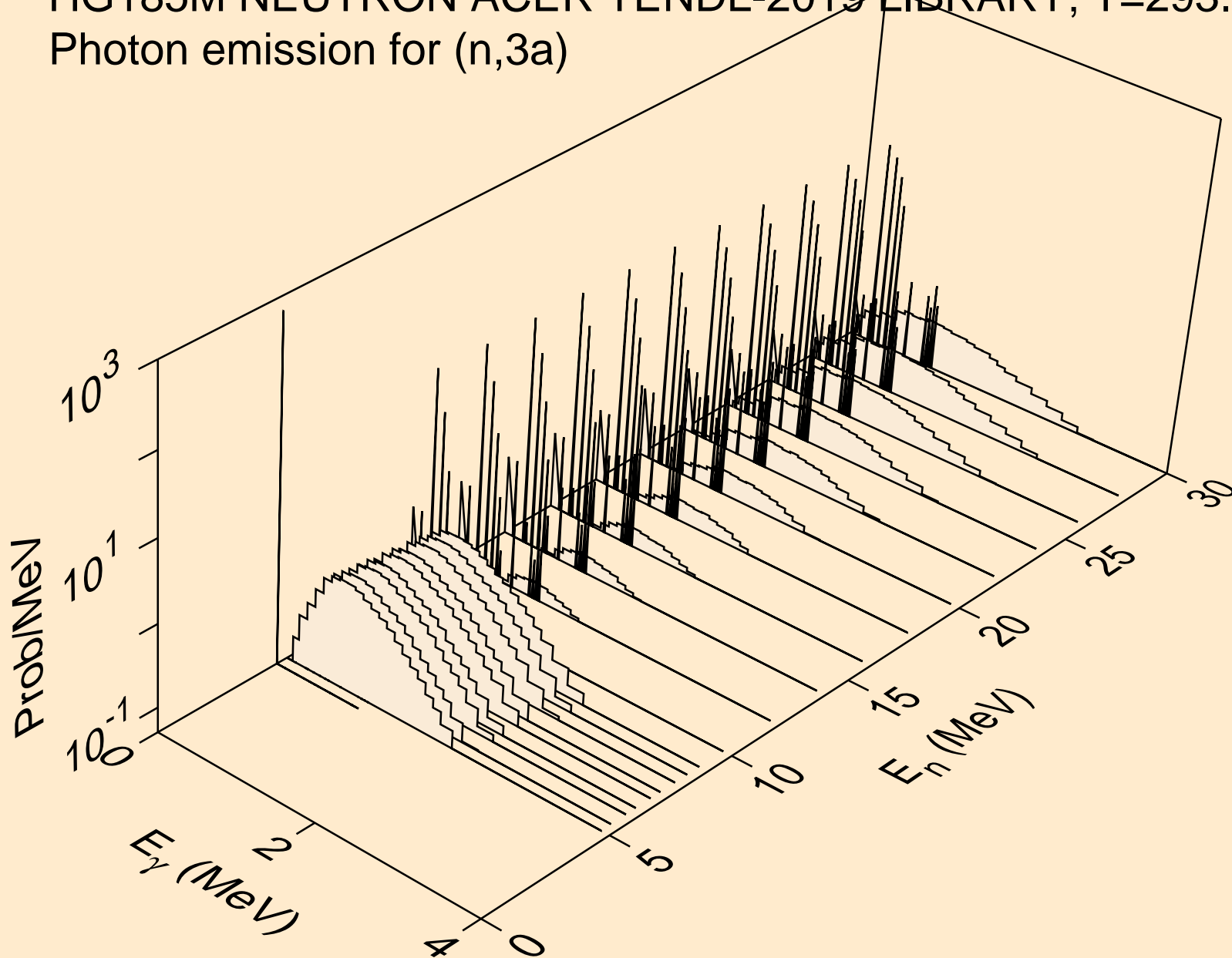

HG185M NEUTRON ACER TENDL-2019 LIBRARY; T=293.16K
Photon emission for (n,2p)

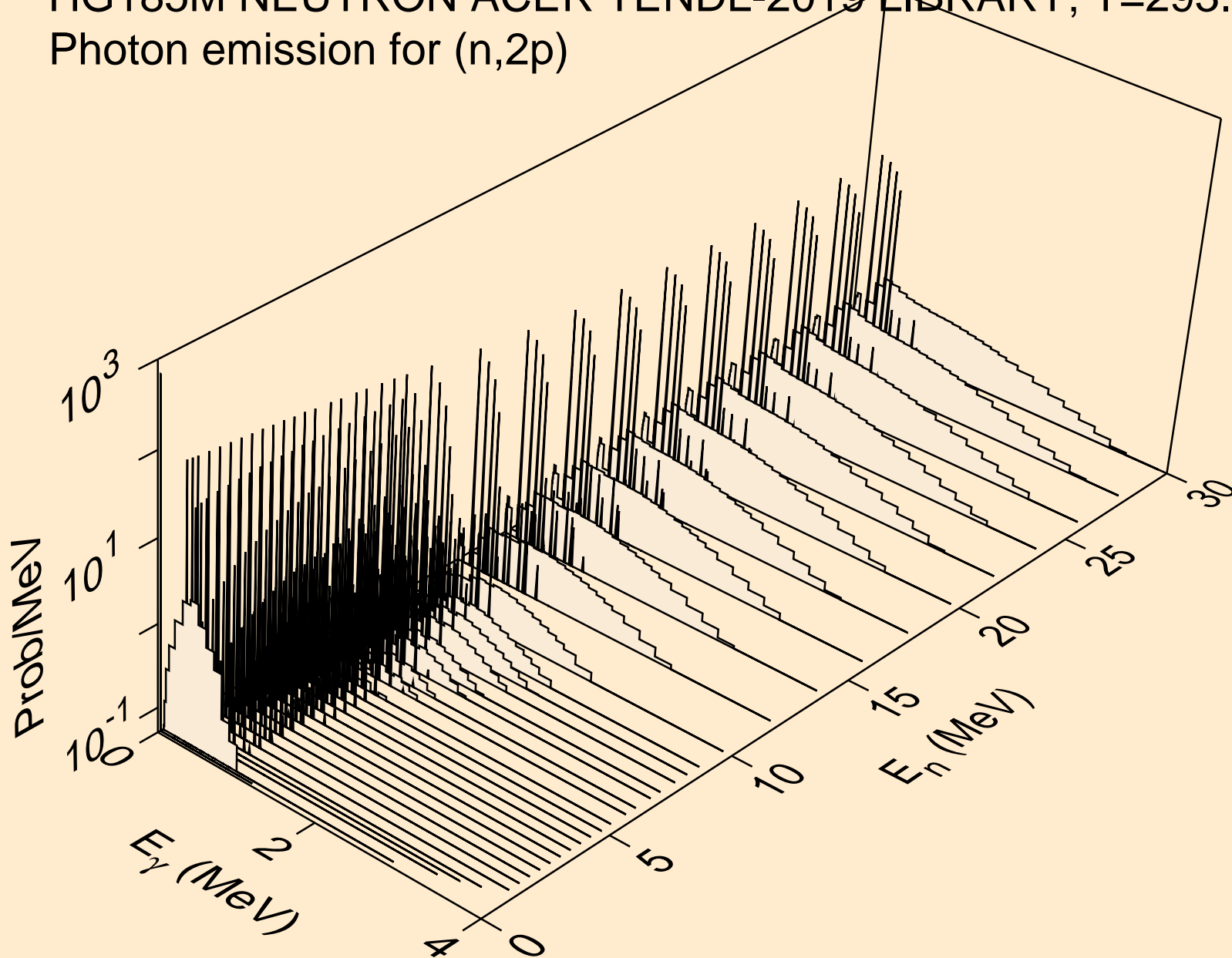

HG185M NEUTRON ACER TENDL-2019 LIBRARY; T=293.16K
Photon emission for (n,p α)

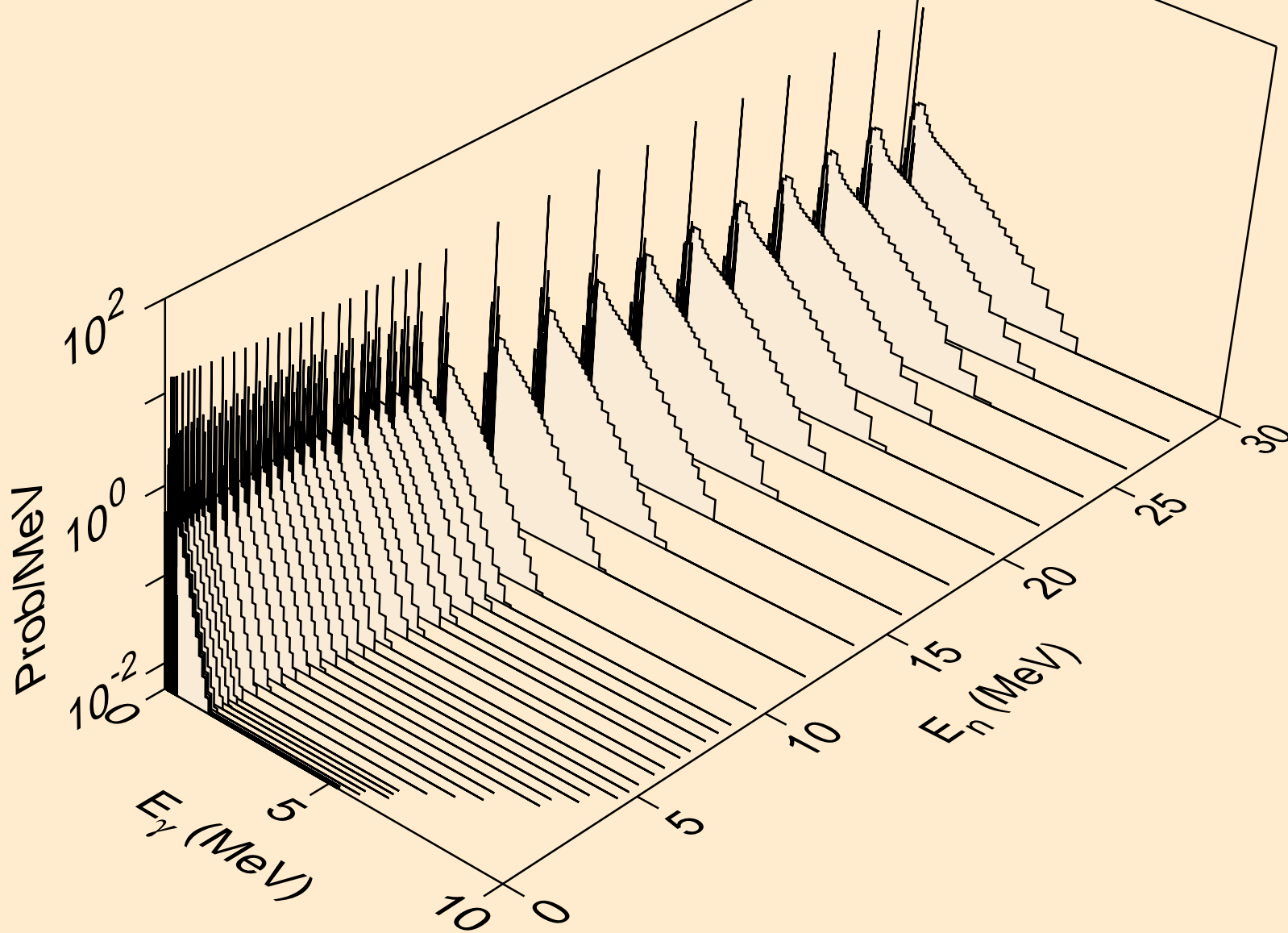

HG185M NEUTRON ACER TENDL-2019 LIBRARY; T=293.16K
Photon emission for (n,pd)

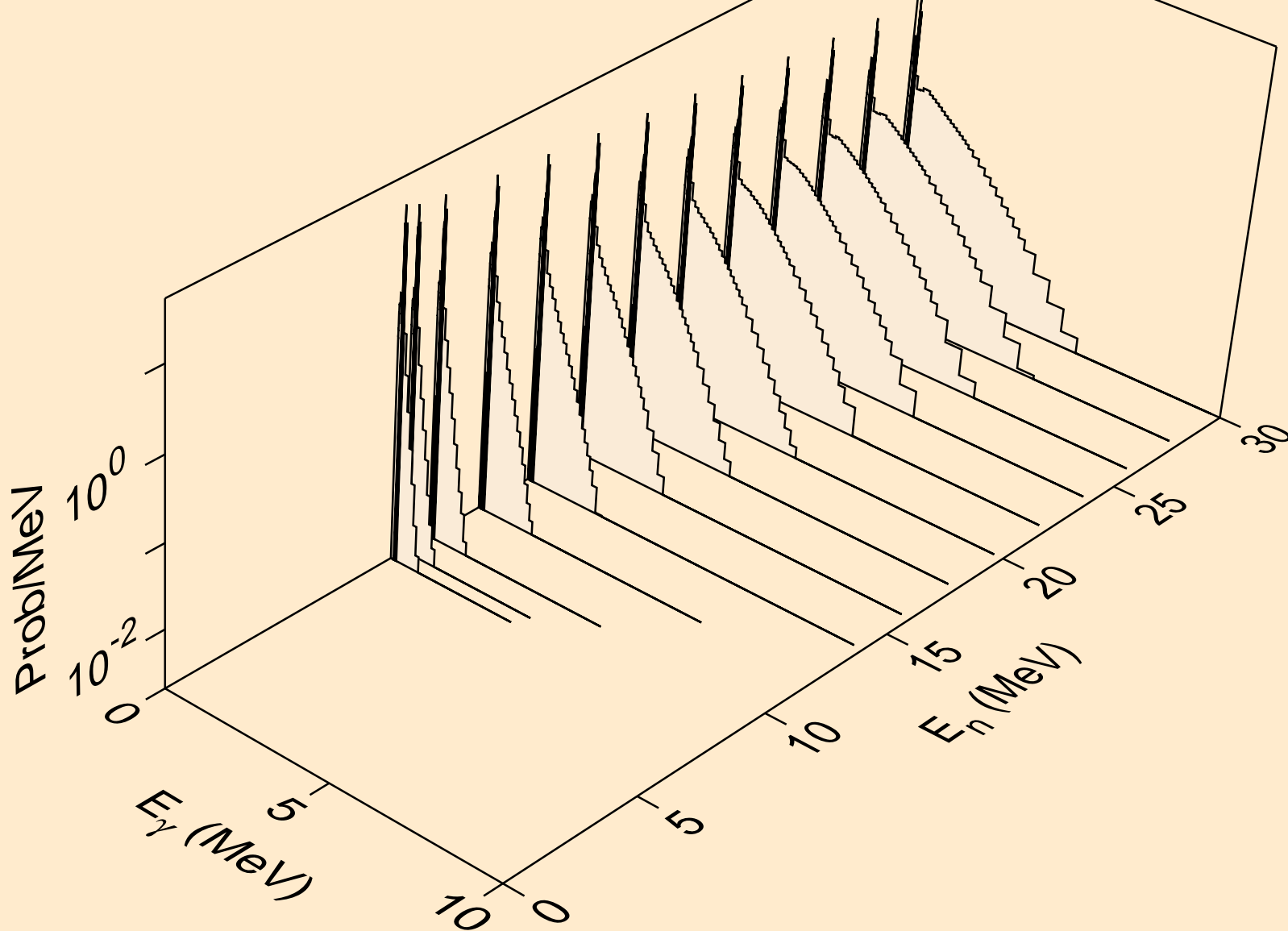

HG185M NEUTRON ACER TENDL-2019 LIBRARY; T=293.16K
Photon emission for (n,pt)

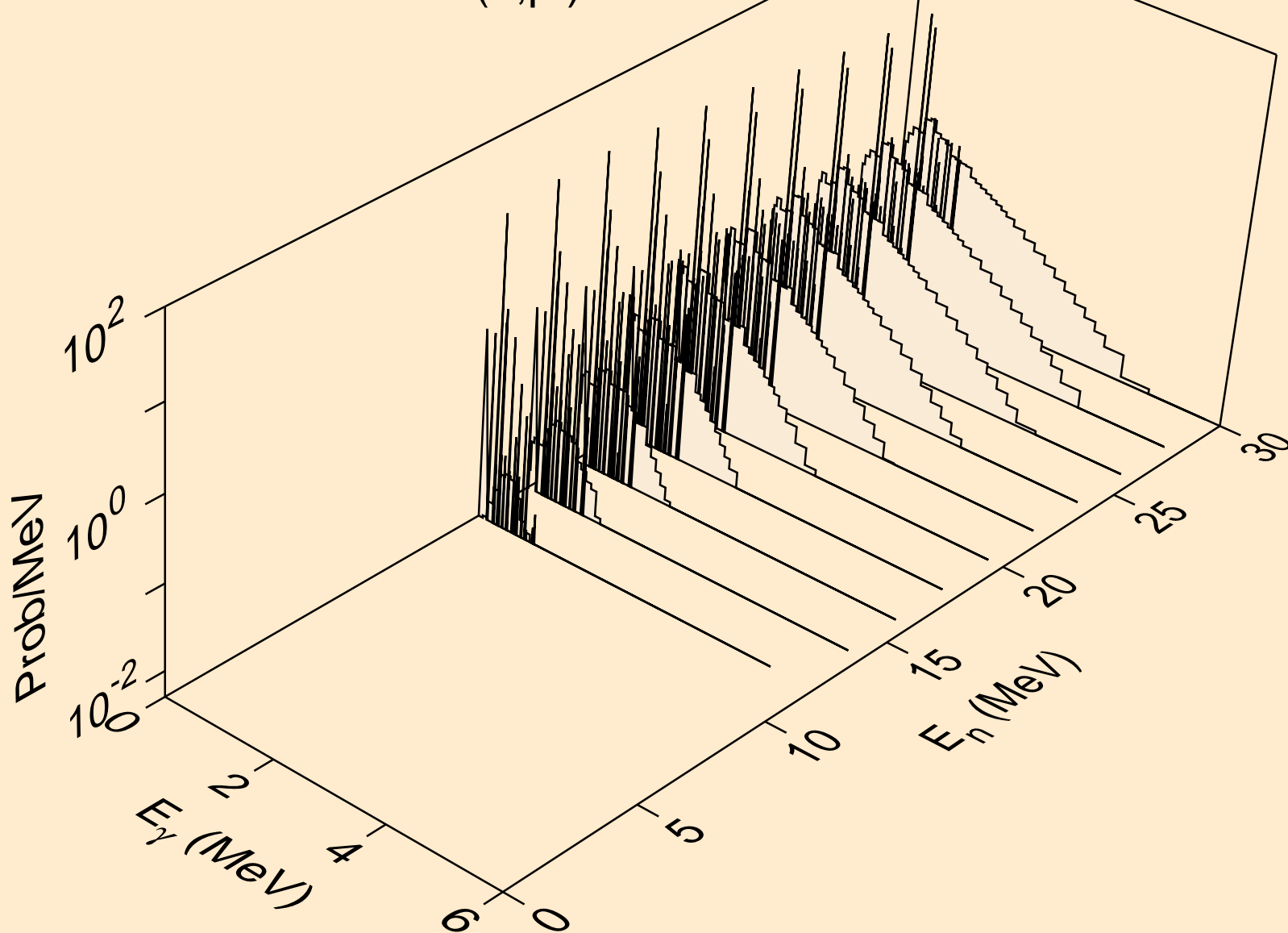

HG185M NEUTRON ACER TENDL-2019 LIBRARY; T=293.16K
Photon emission for (n,da)

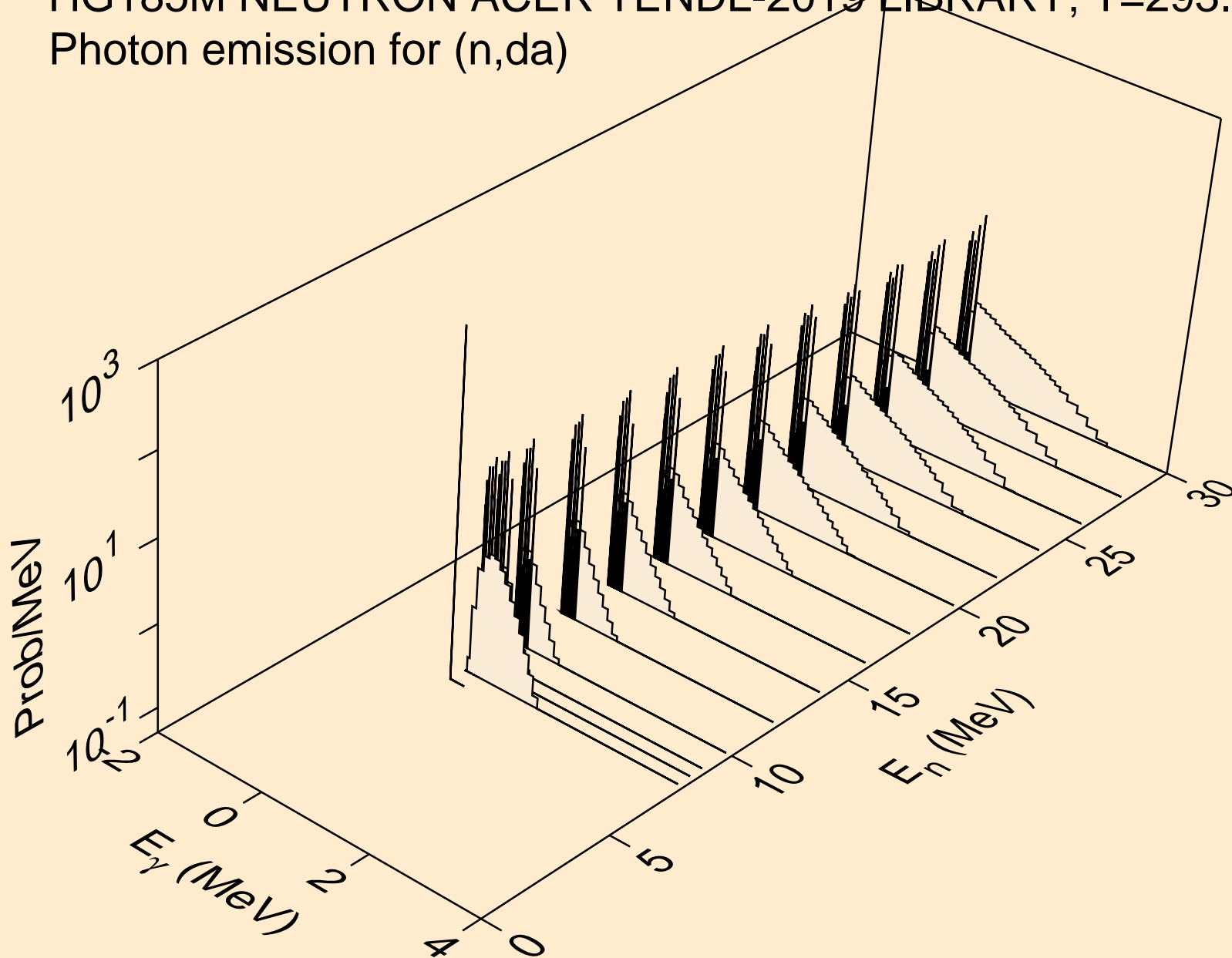

HG185M NEUTRON ACER TENDL-2019 LIBRARY; T=293.16K
thermal capture photon spectrum

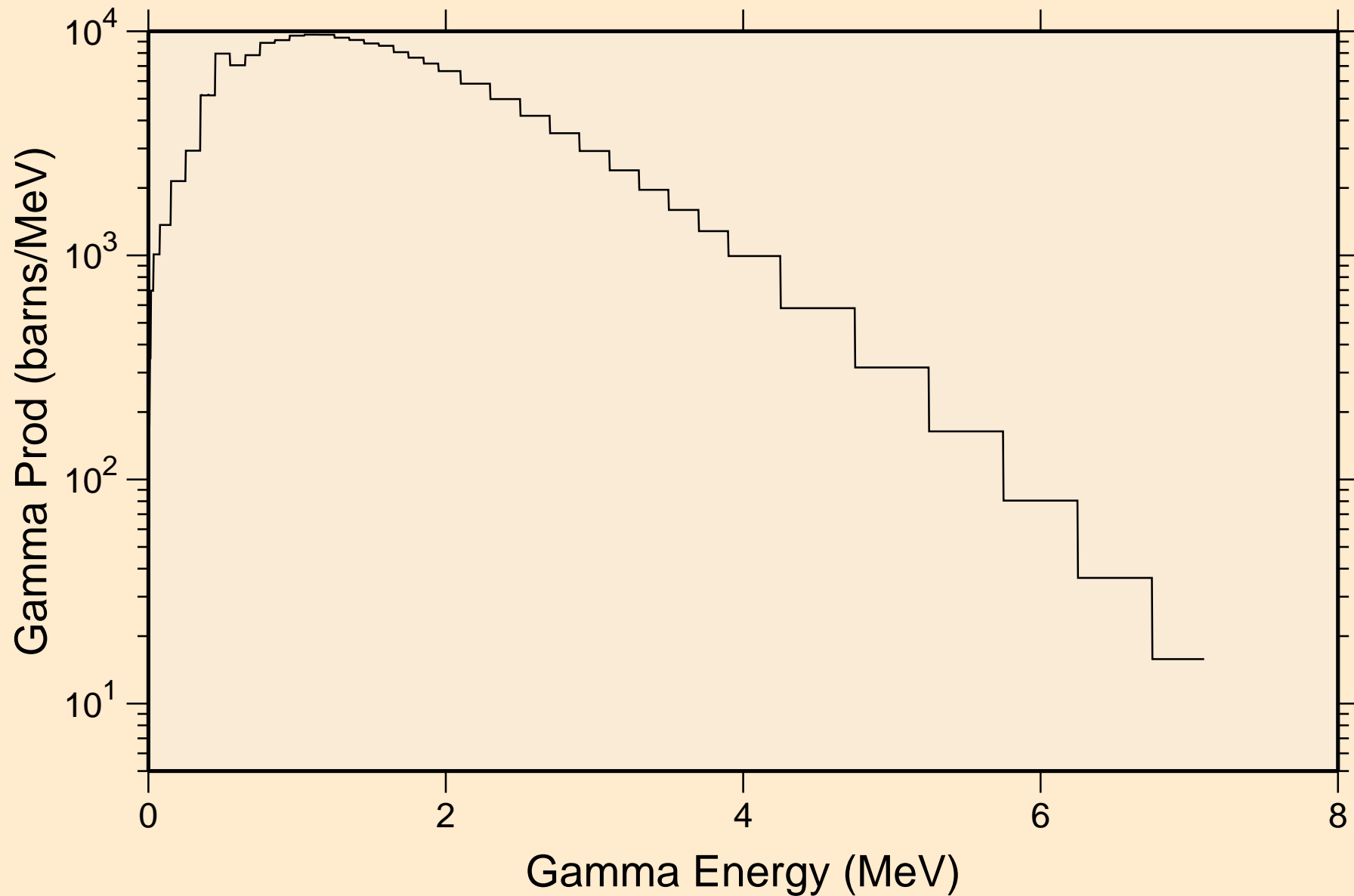

HG185M NEUTRON ACER TENDL-2019 LIBRARY; T=293.16K
14 MeV photon spectrum

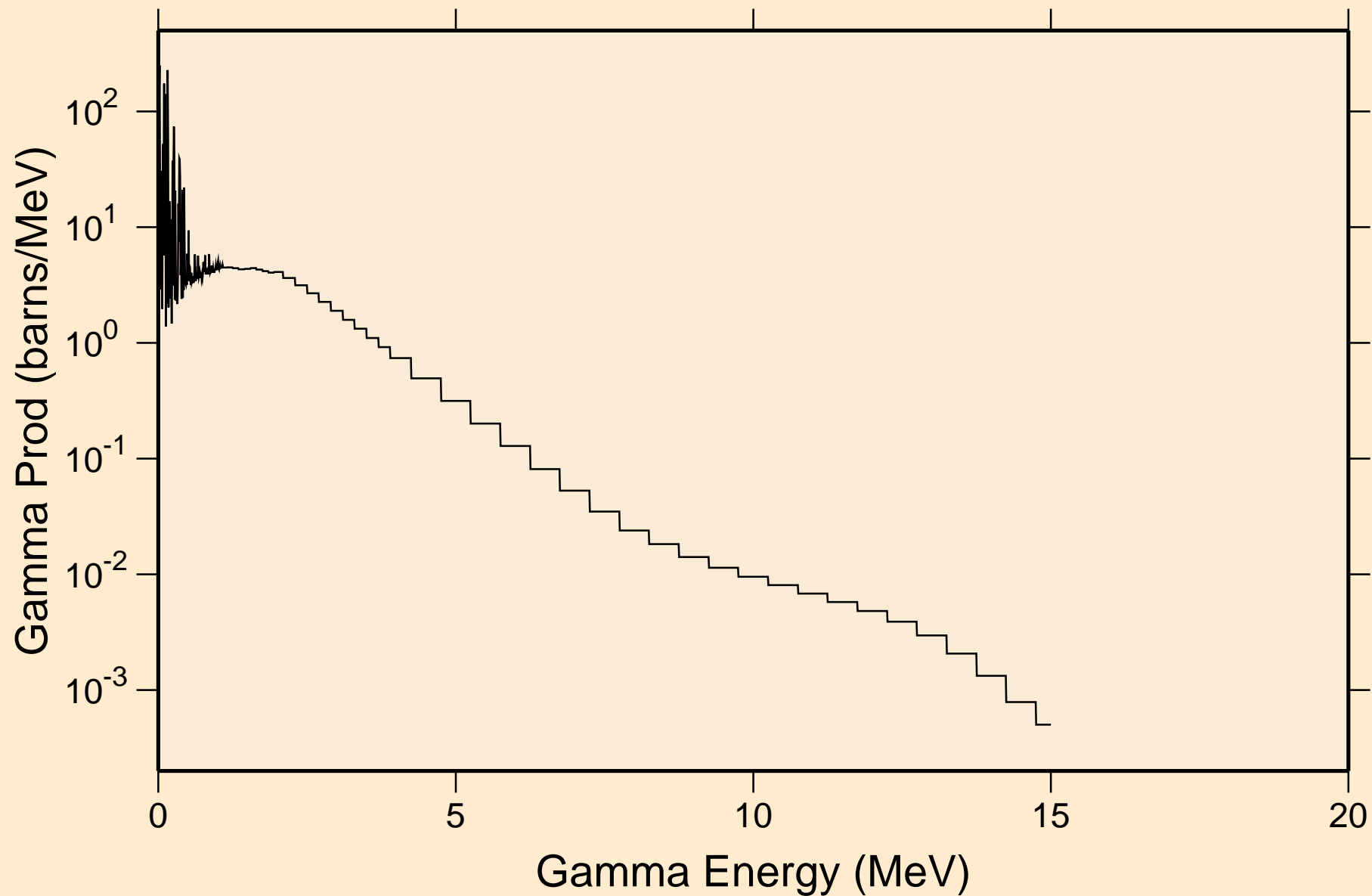

HG185M NEUTRON ACER TENDL-2019 LIBRARY; T=293.16K

Particle heating contributions

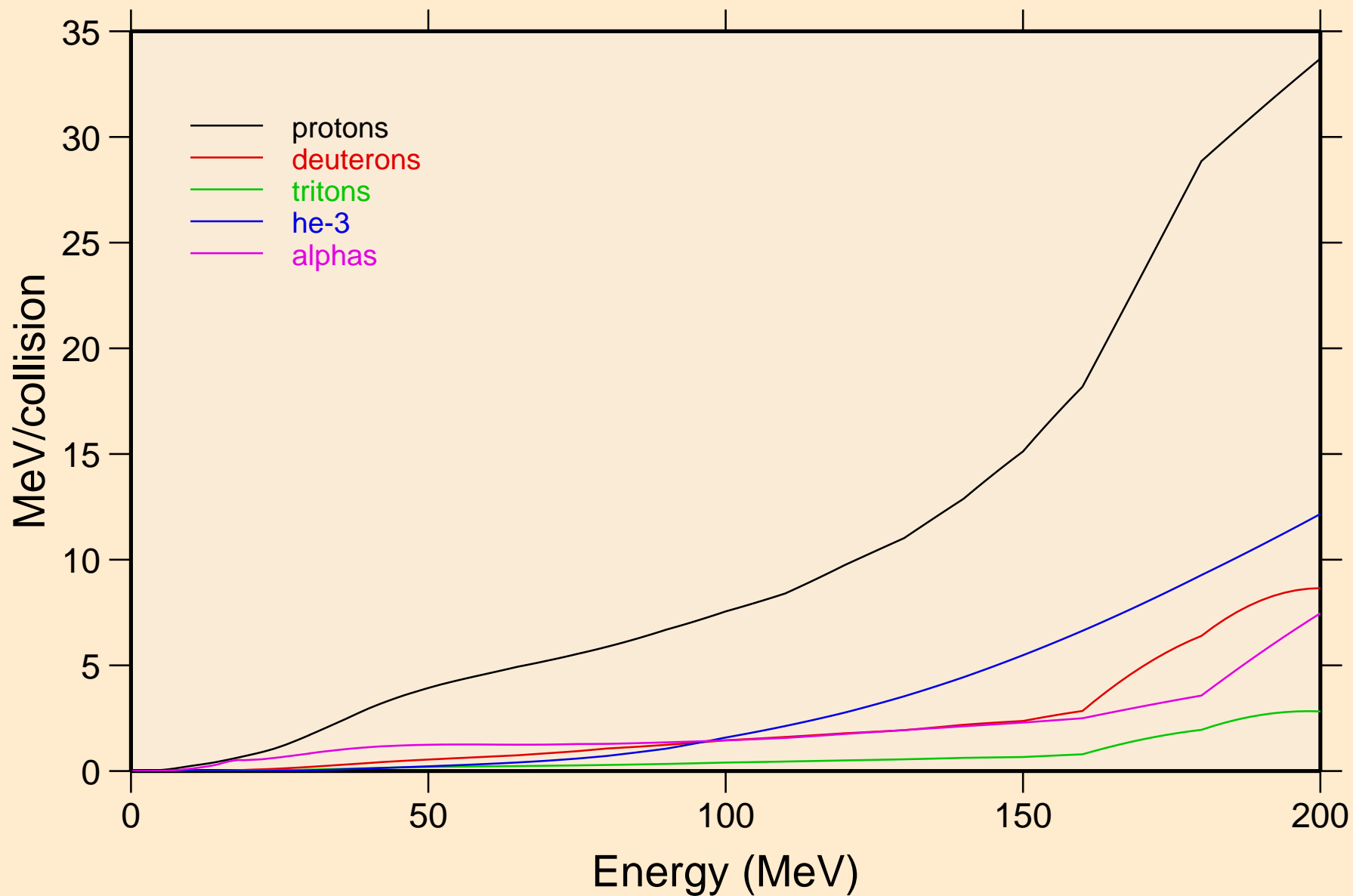

HG185M NEUTRON ACER TENDL-2019 LIBRARY; T=293.16K
Recoil Heating

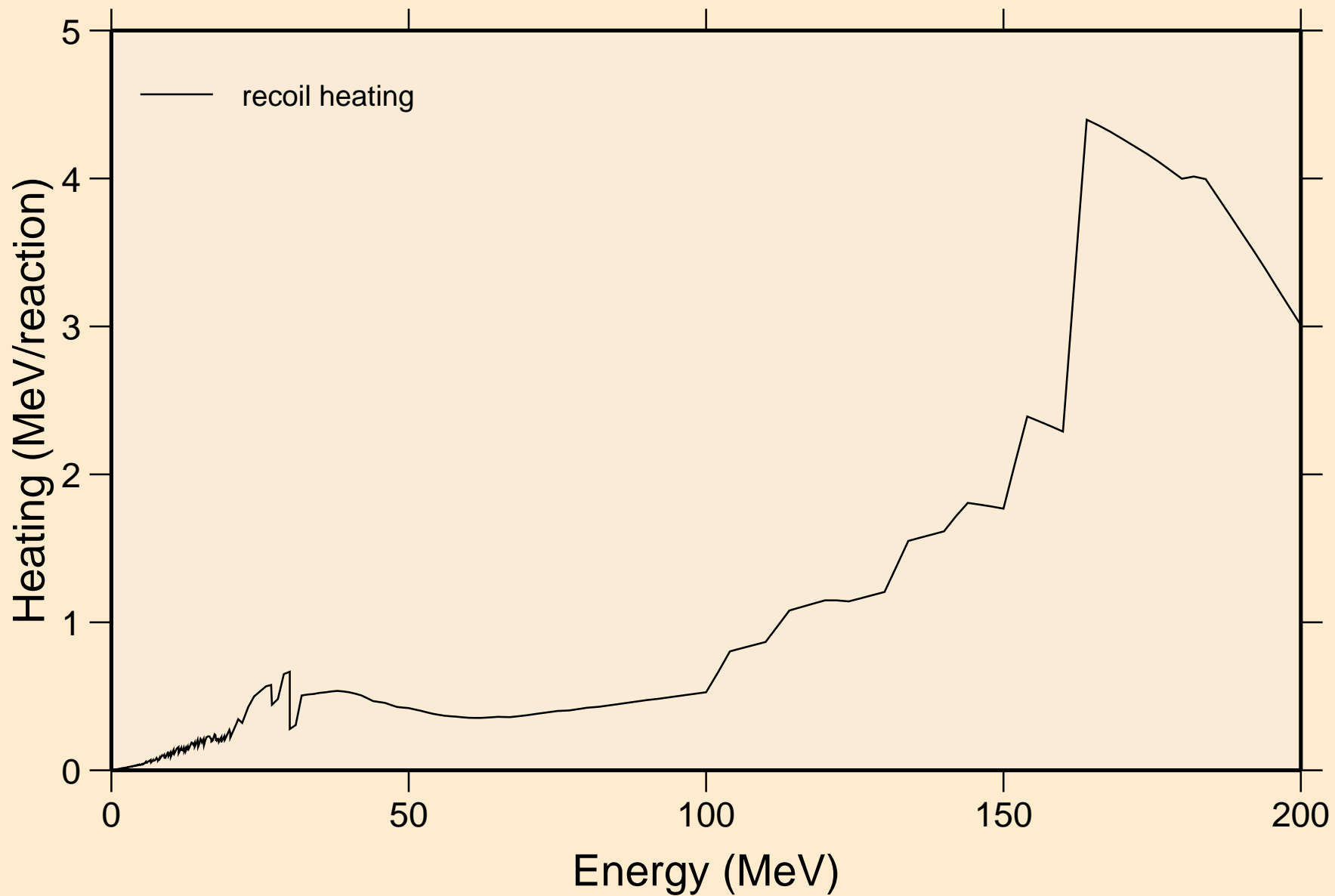

HG185M NEUTRON ACER TENDL-2019 LIBRARY; T=293.16K

Particle production cross sections

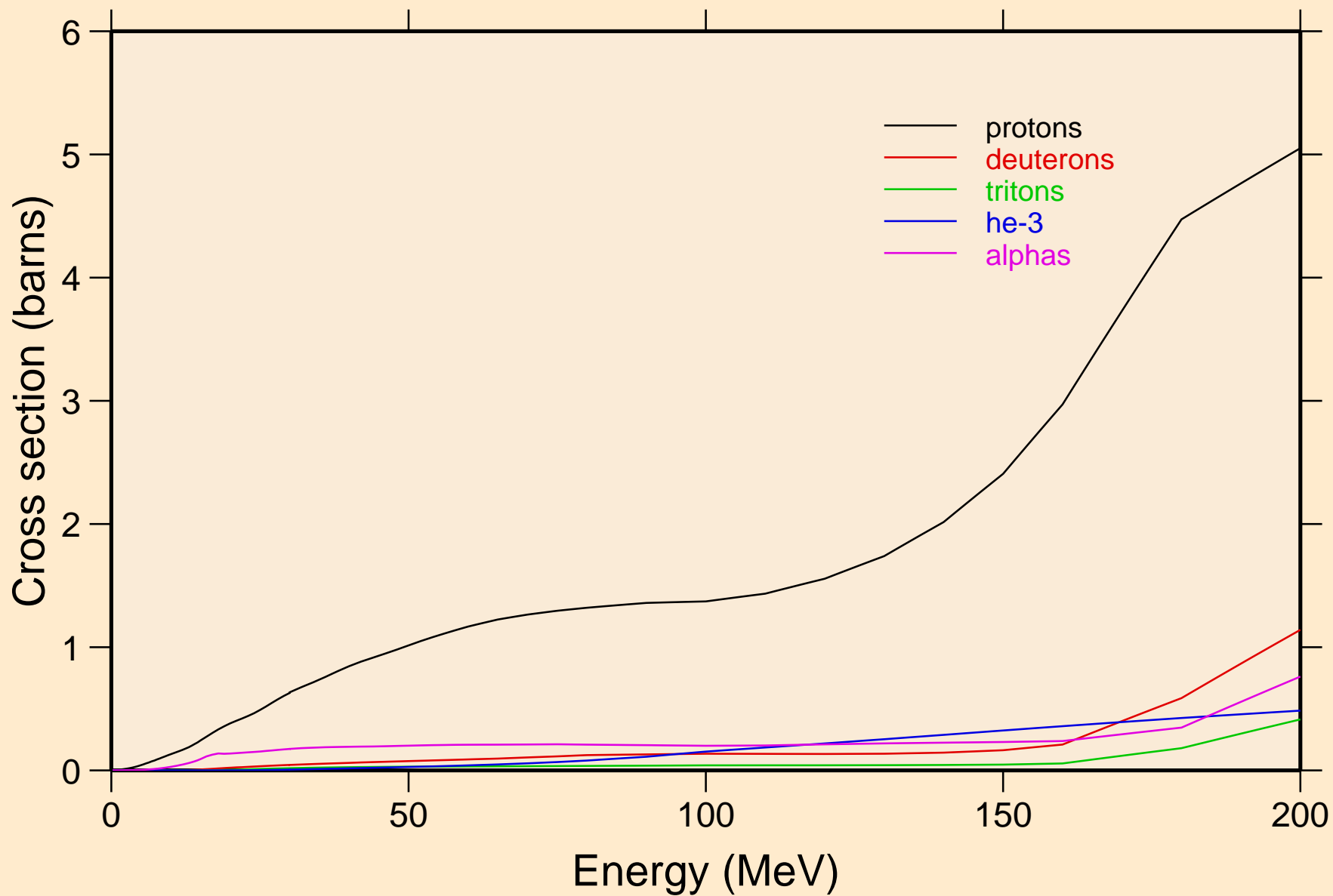

HG185M NEUTRON ACER TENDL-2019 LIBRARY; T=293.16K
protons from (n,x)

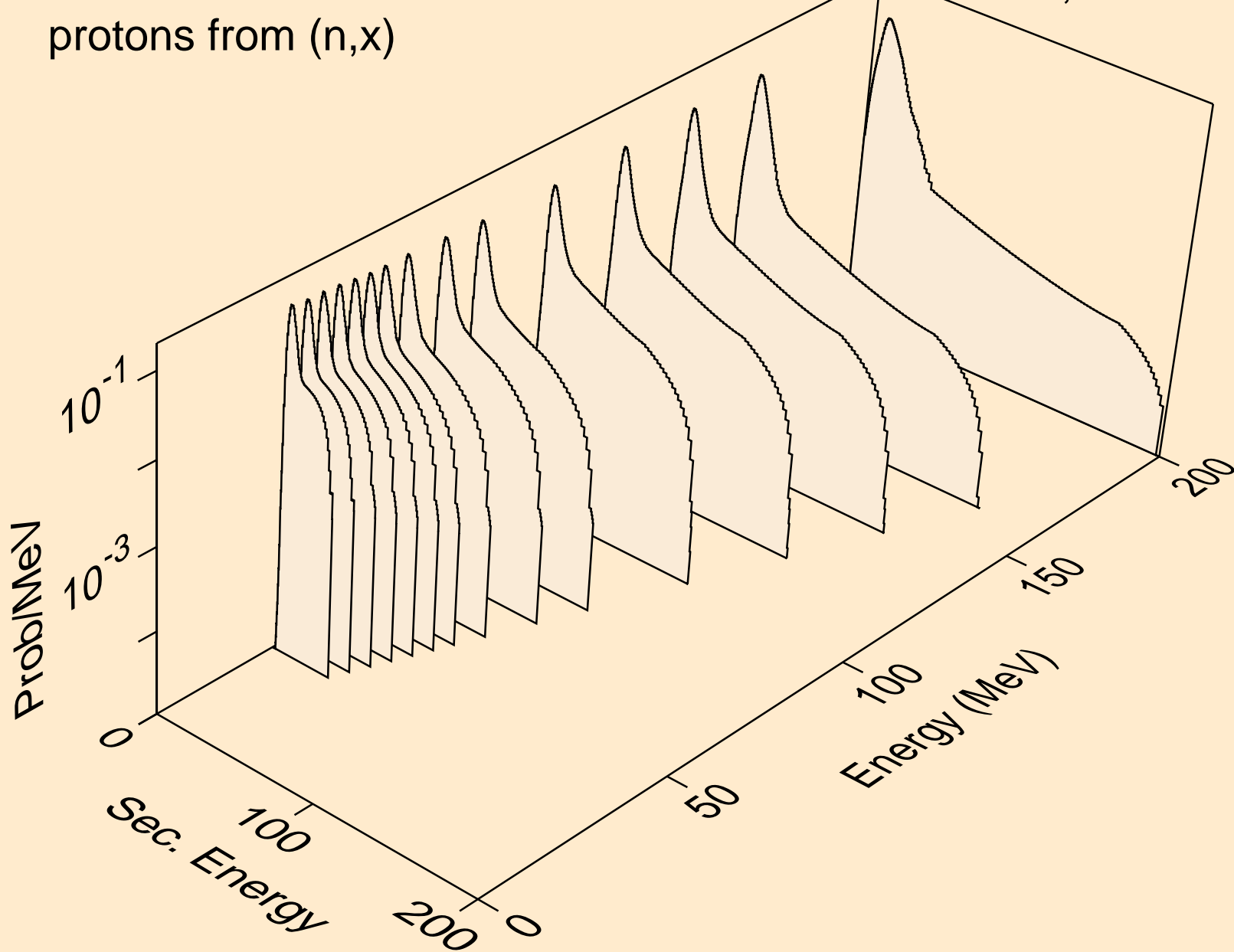

HG185M NEUTRON ACER TENDL-2019 LIBRARY; T=293.16K
protons from (n,n*)p

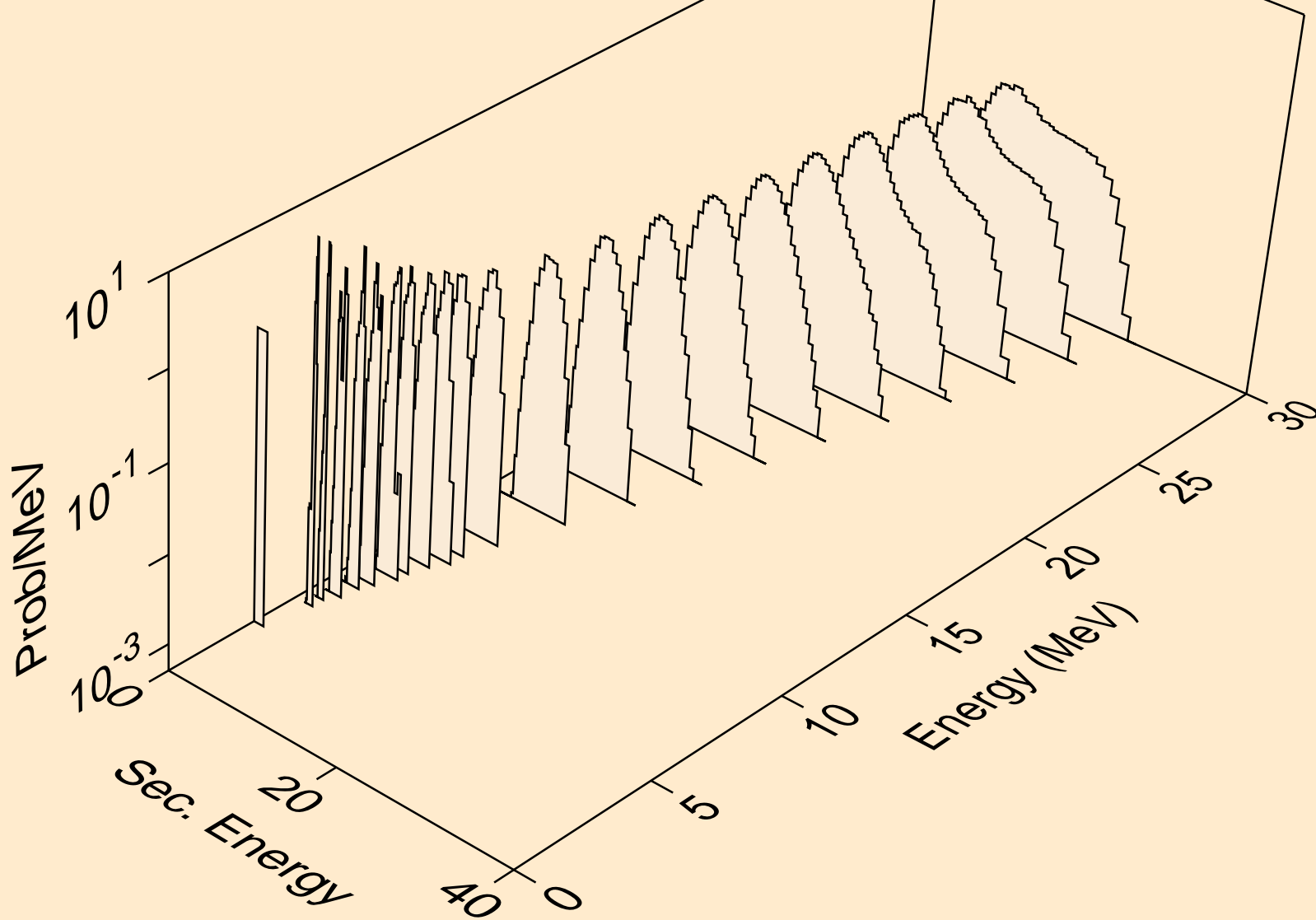

HG185M NEUTRON ACER TENDL-2019 LIBRARY; T=293.16K
protons from (n,2np)

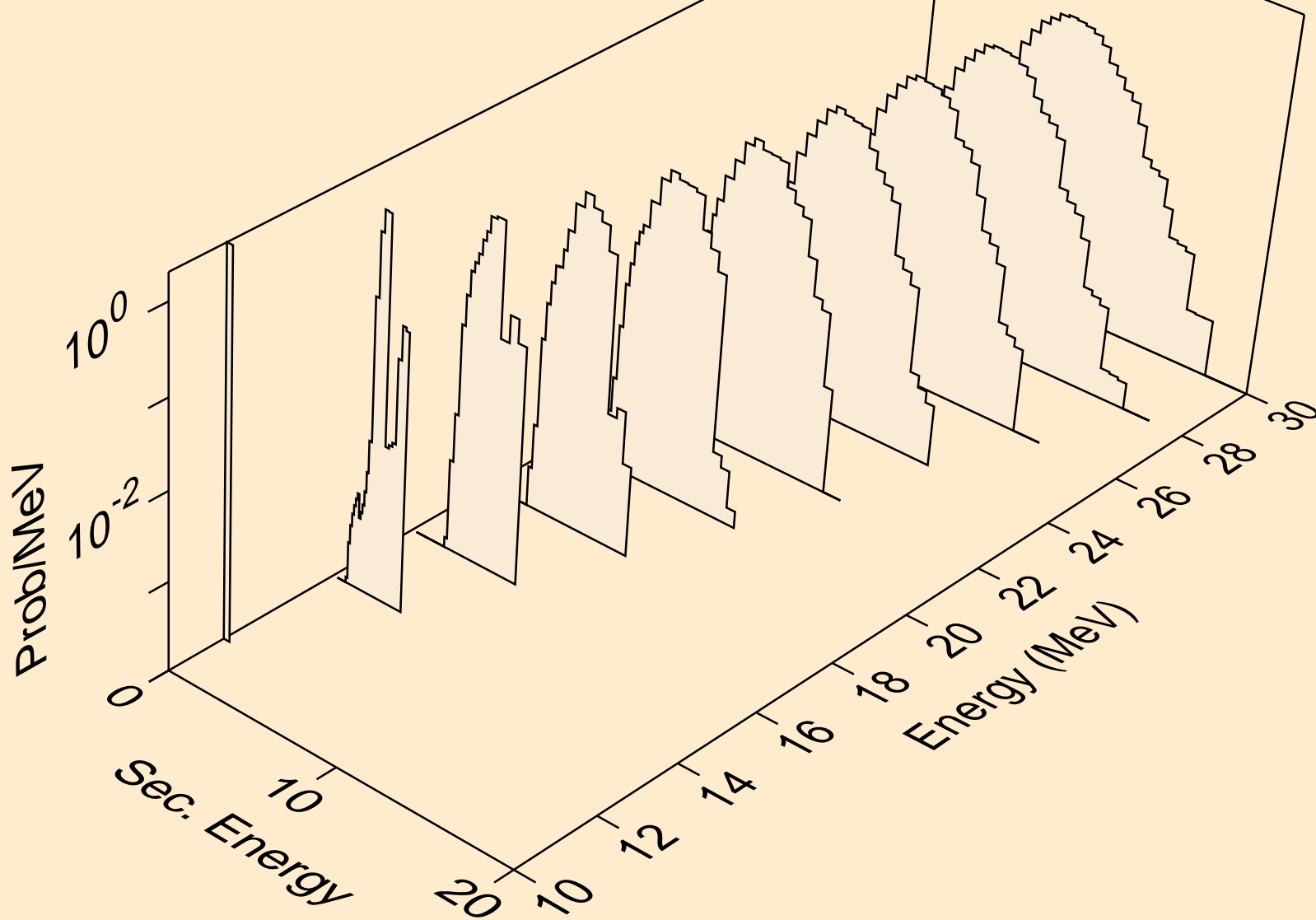

HG185M NEUTRON ACER TENDL-2019 LIBRARY; T=293.16K
protons from (n,3np)

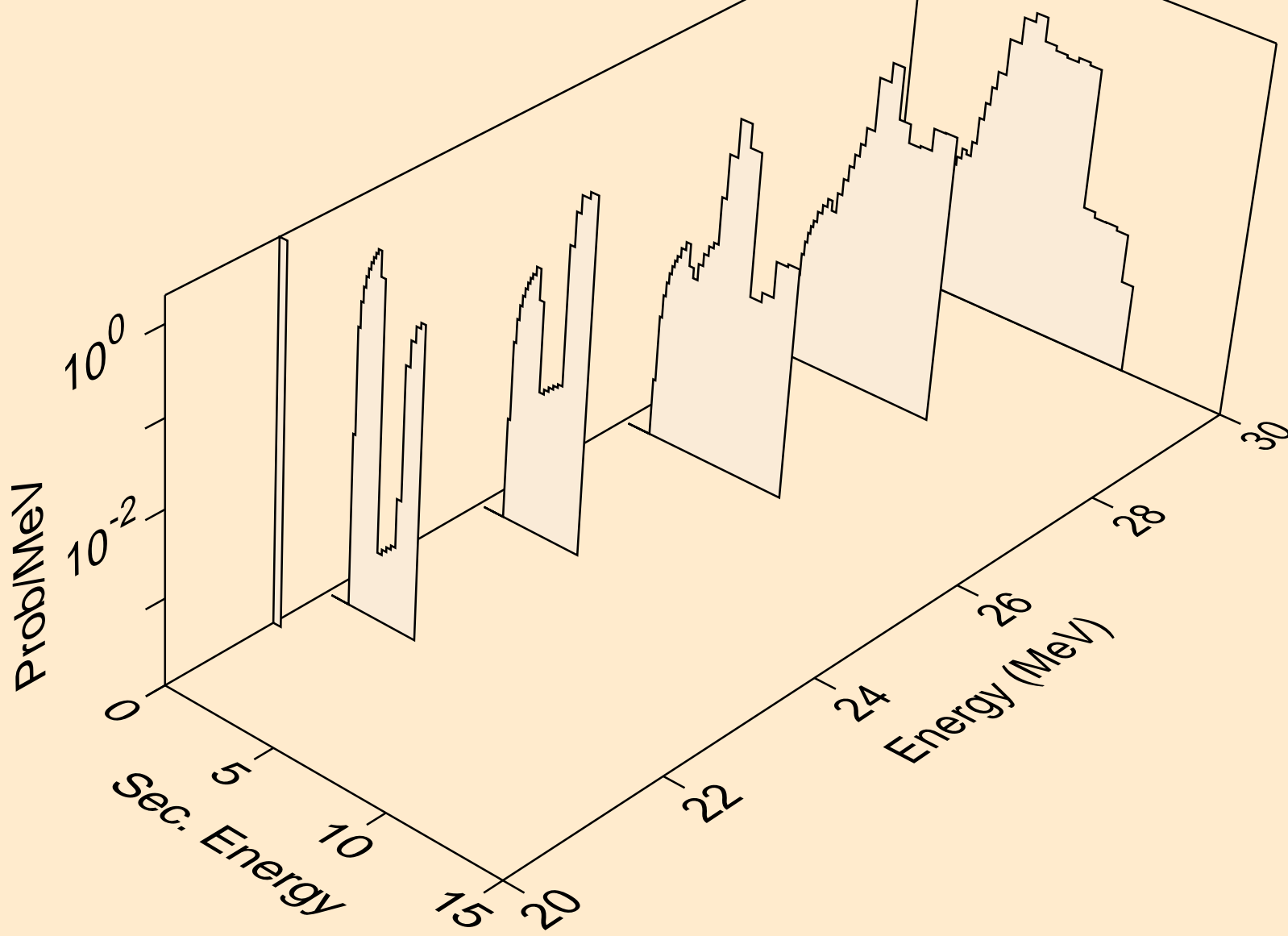

HG185M NEUTRON ACER TENDL-2019 LIBRARY; T=293.16K
protons from (n,2np)

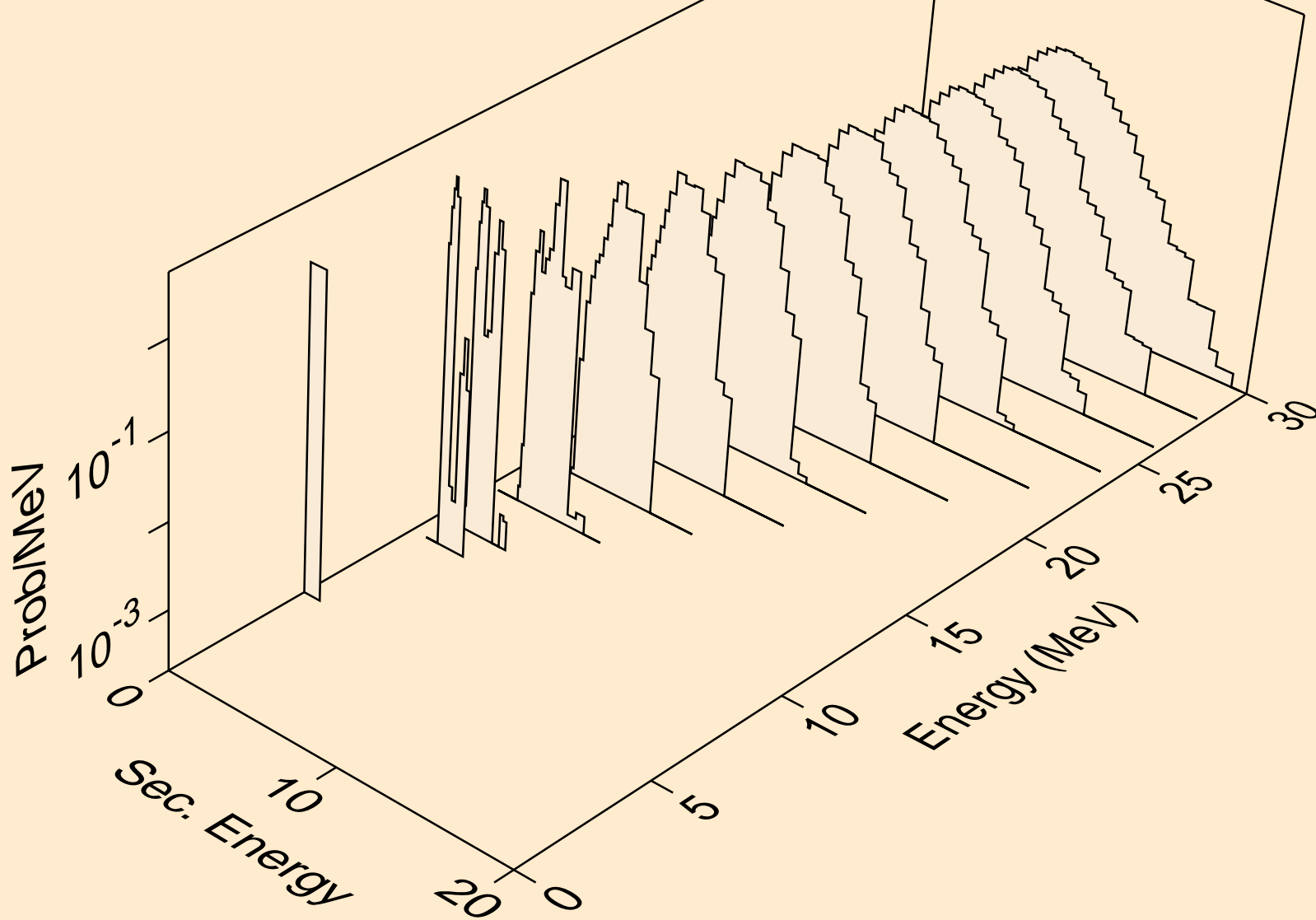

HG185M NEUTRON ACER TENDL-2019 LIBRARY; T=293.16K
protons from (n,npa)

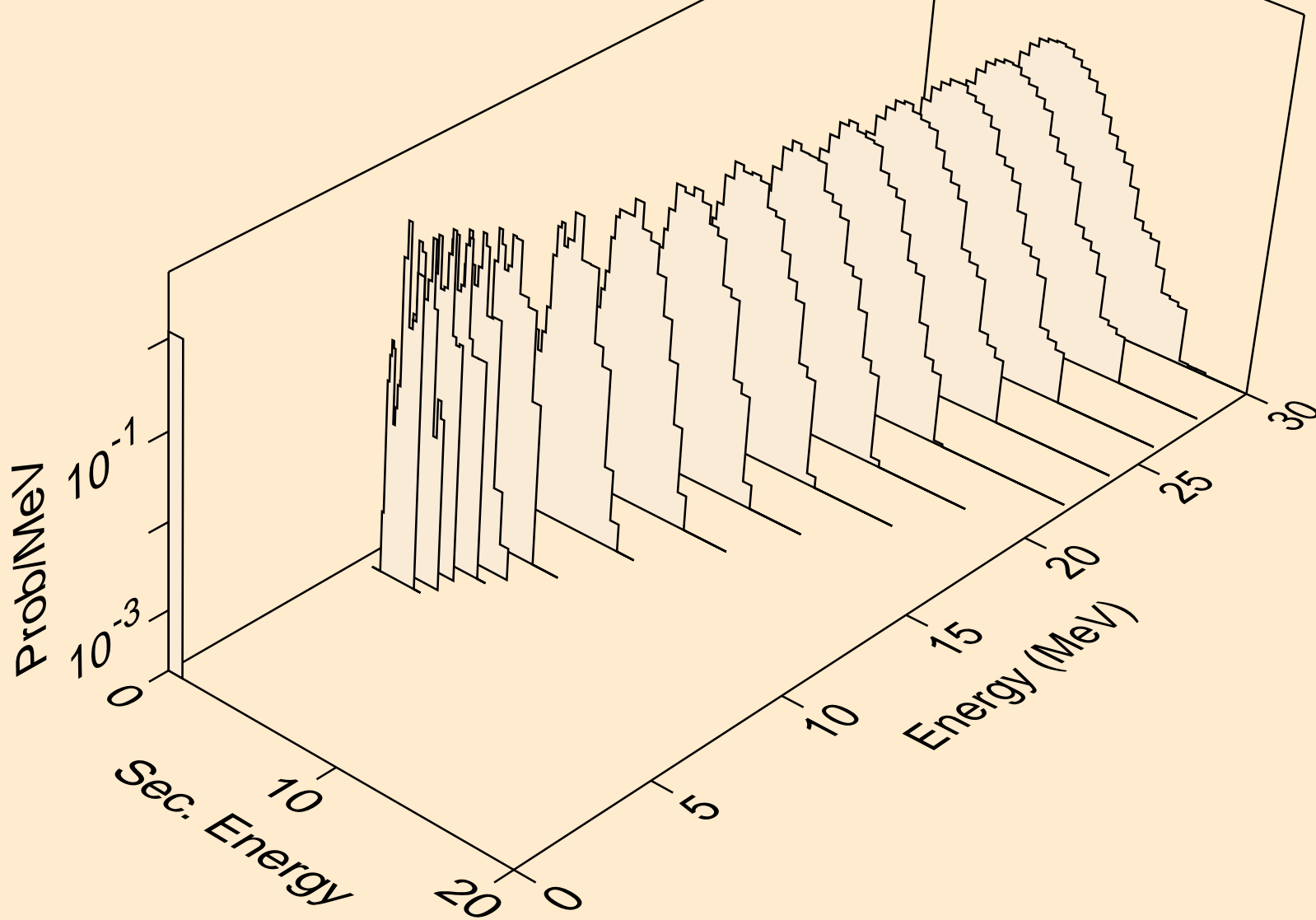

HG185M NEUTRON ACER TENDL-2019 LIBRARY; T=293.16K
protons from (n,p)

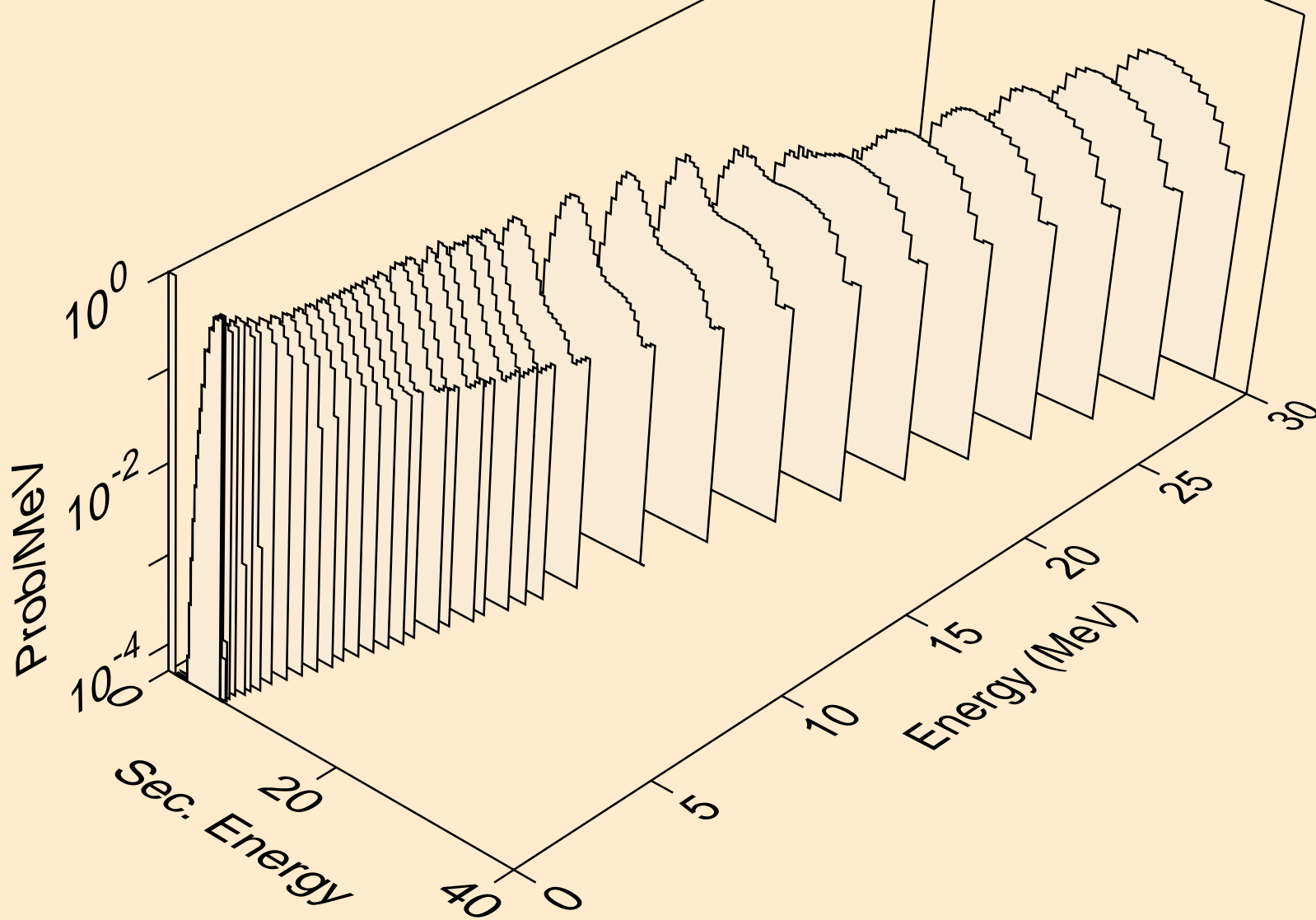

HG185M NEUTRON ACER TENDL-2019 LIBRARY; T=293.16K
protons from (n,2p)

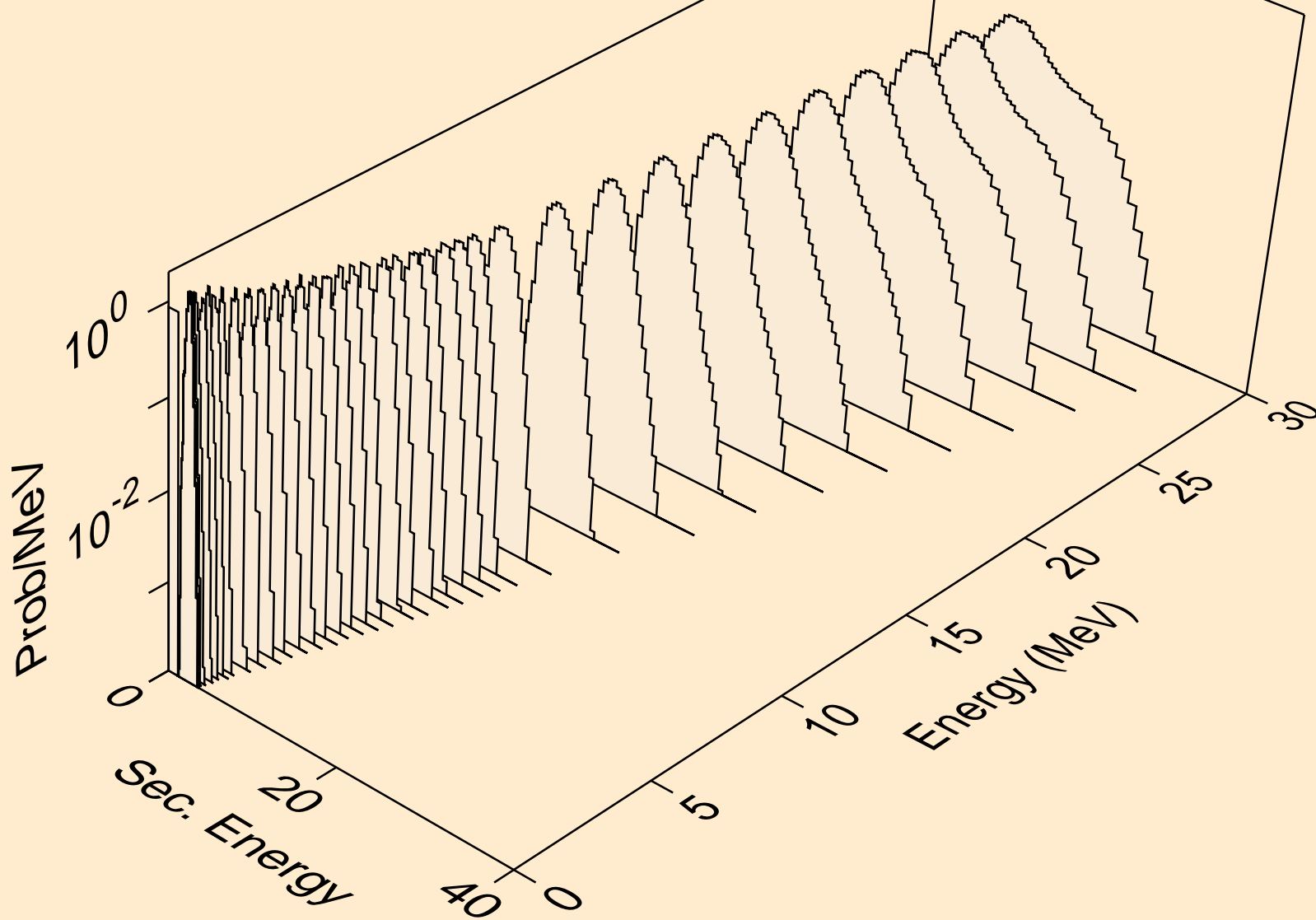

HG185M NEUTRON ACER TENDL-2019 LIBRARY; T=293.16K
protons from (n,p)

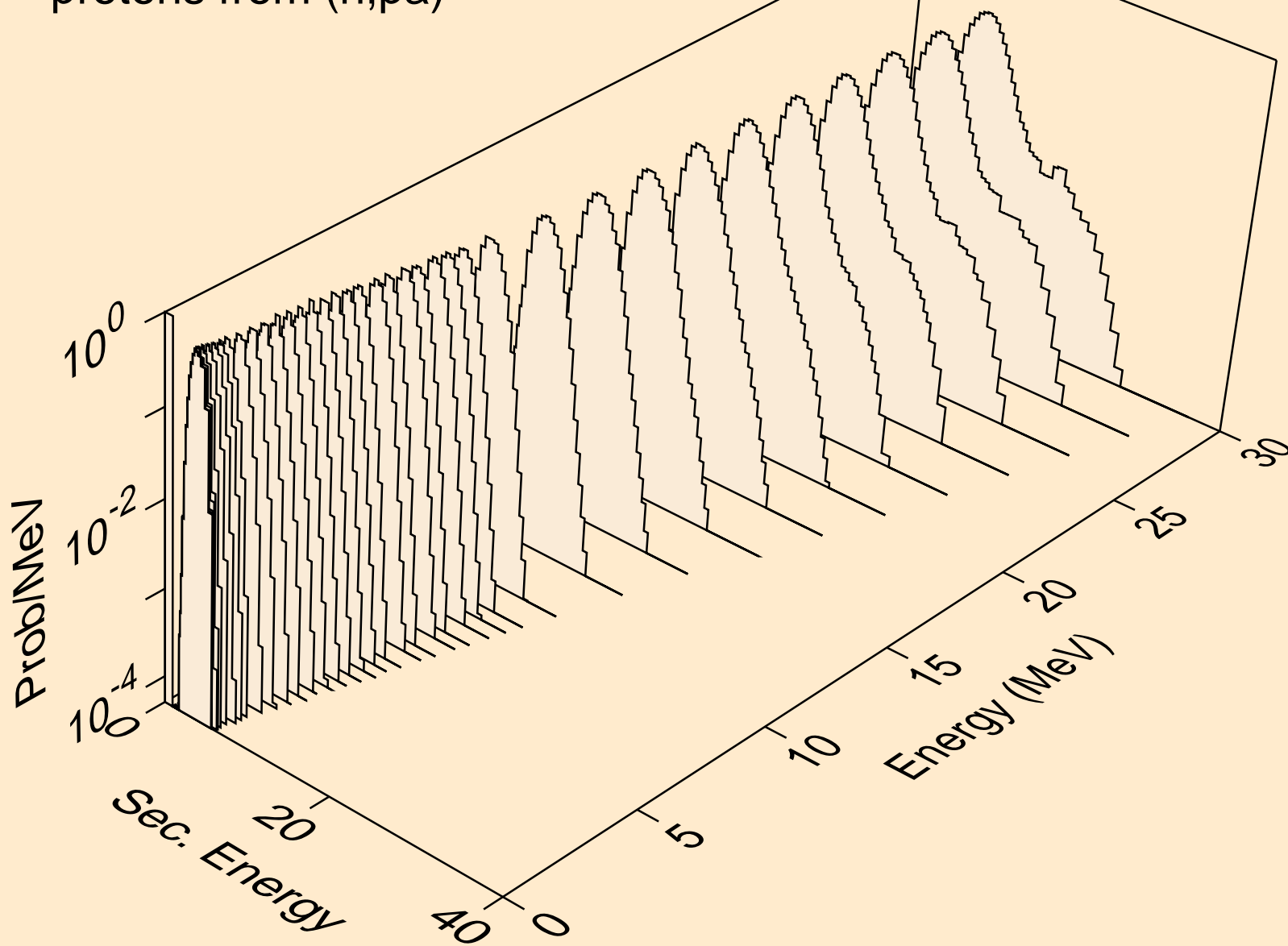

HG185M NEUTRON ACER TENDL-2019 LIBRARY; T=293.16K
protons from (n,pd)

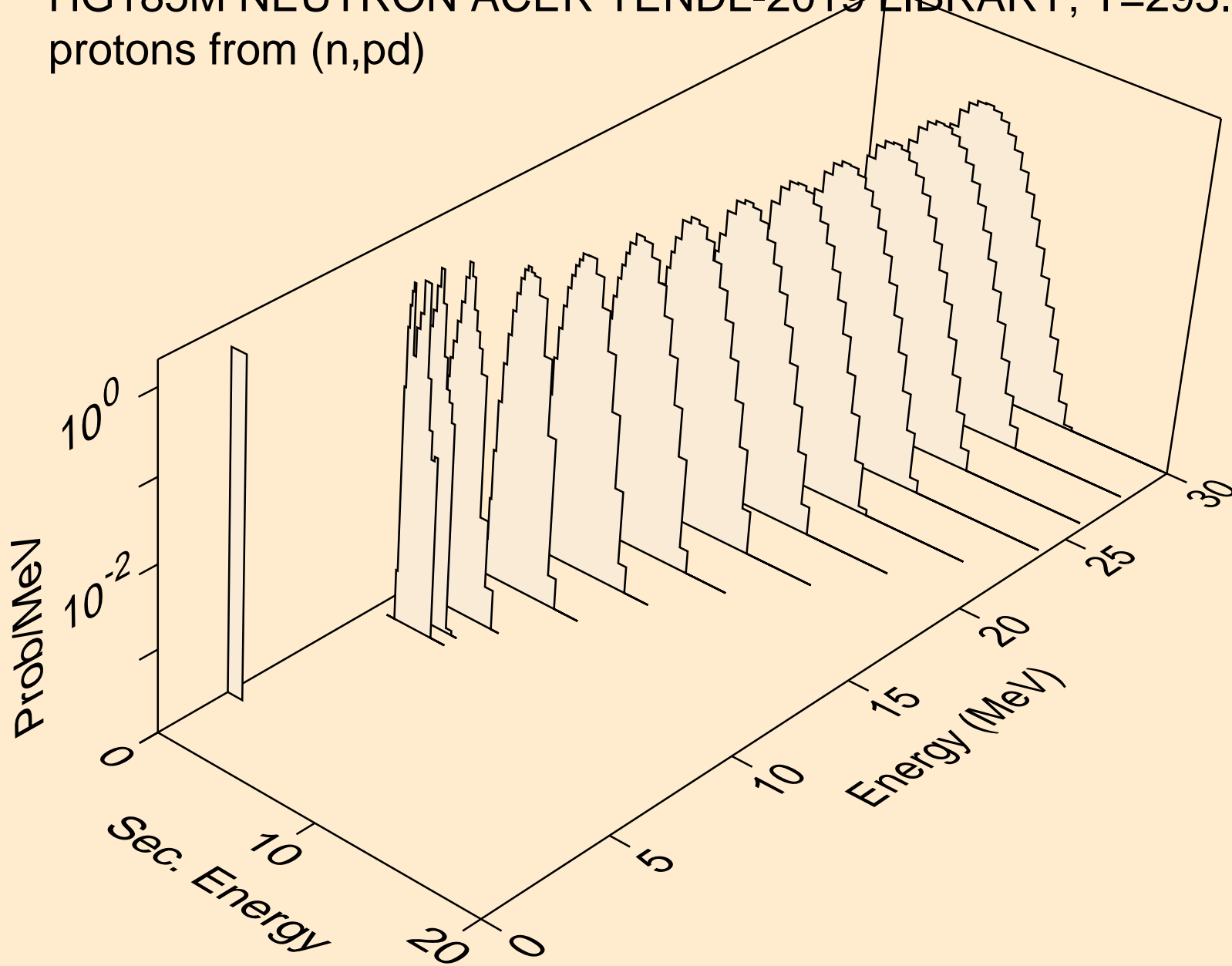

HG185M NEUTRON ACER TENDL-2019 LIBRARY; T=293.16K
protons from (n,pt)

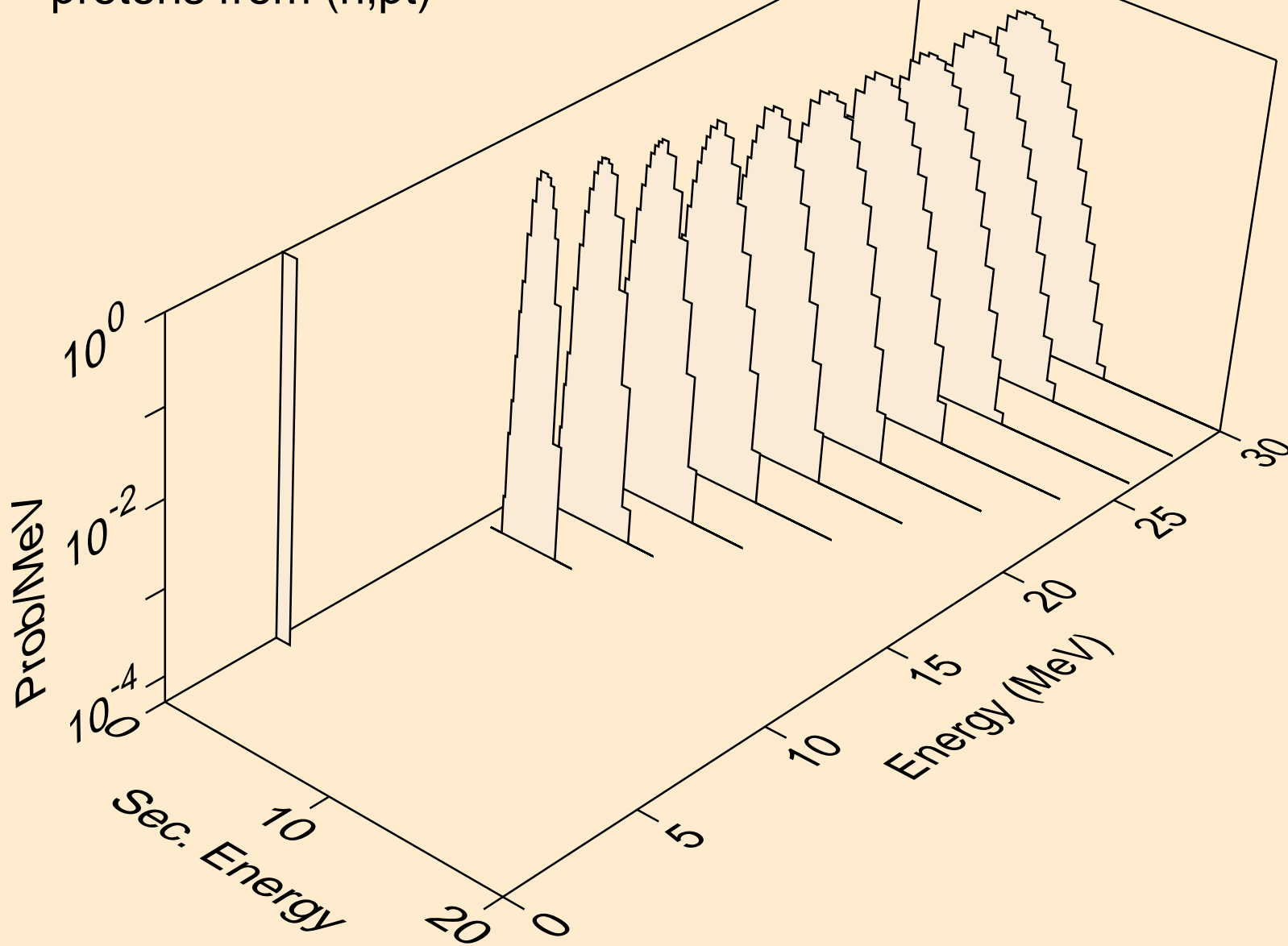

HG185M NEUTRON ACER TENDL-2019 LIBRARY; T=293.16K
deuterons from (n,x)

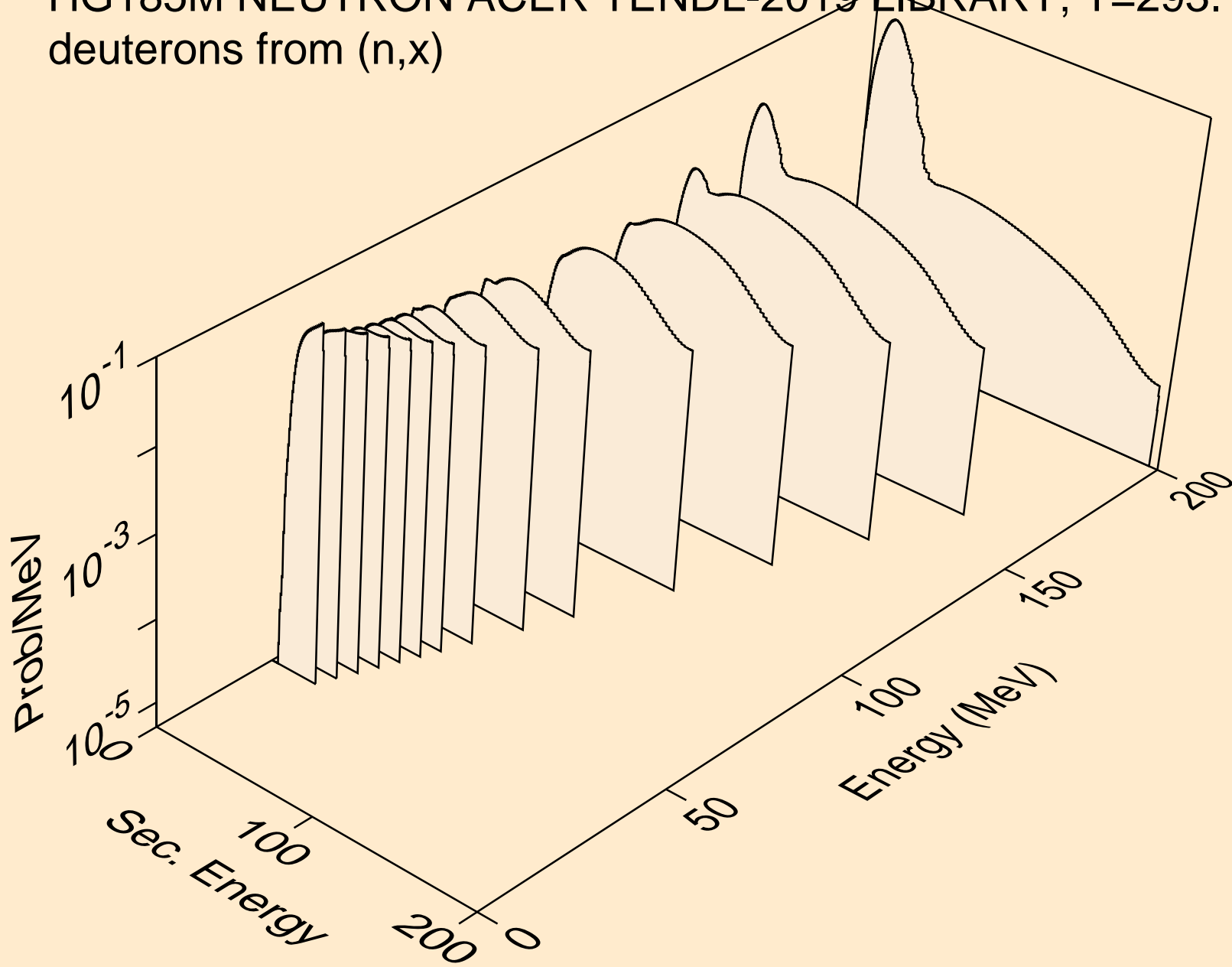

HG185M NEUTRON ACER TENDL-2019 LIBRARY; T=293.16K
deuterons from (n,2nd)

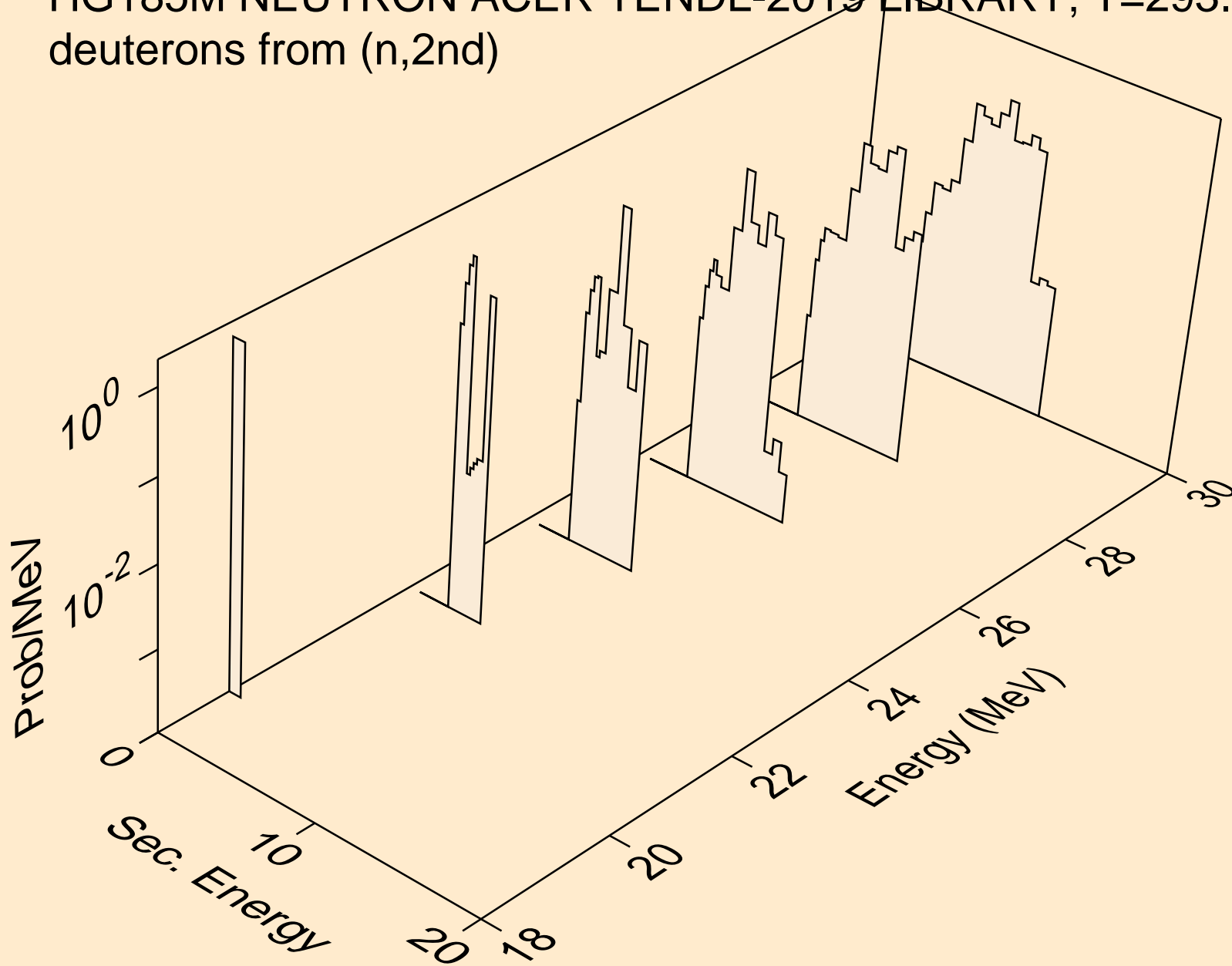

HG185M NEUTRON ACER TENDL-2019 LIBRARY; T=293.16K
deuterons from (n,n*)d

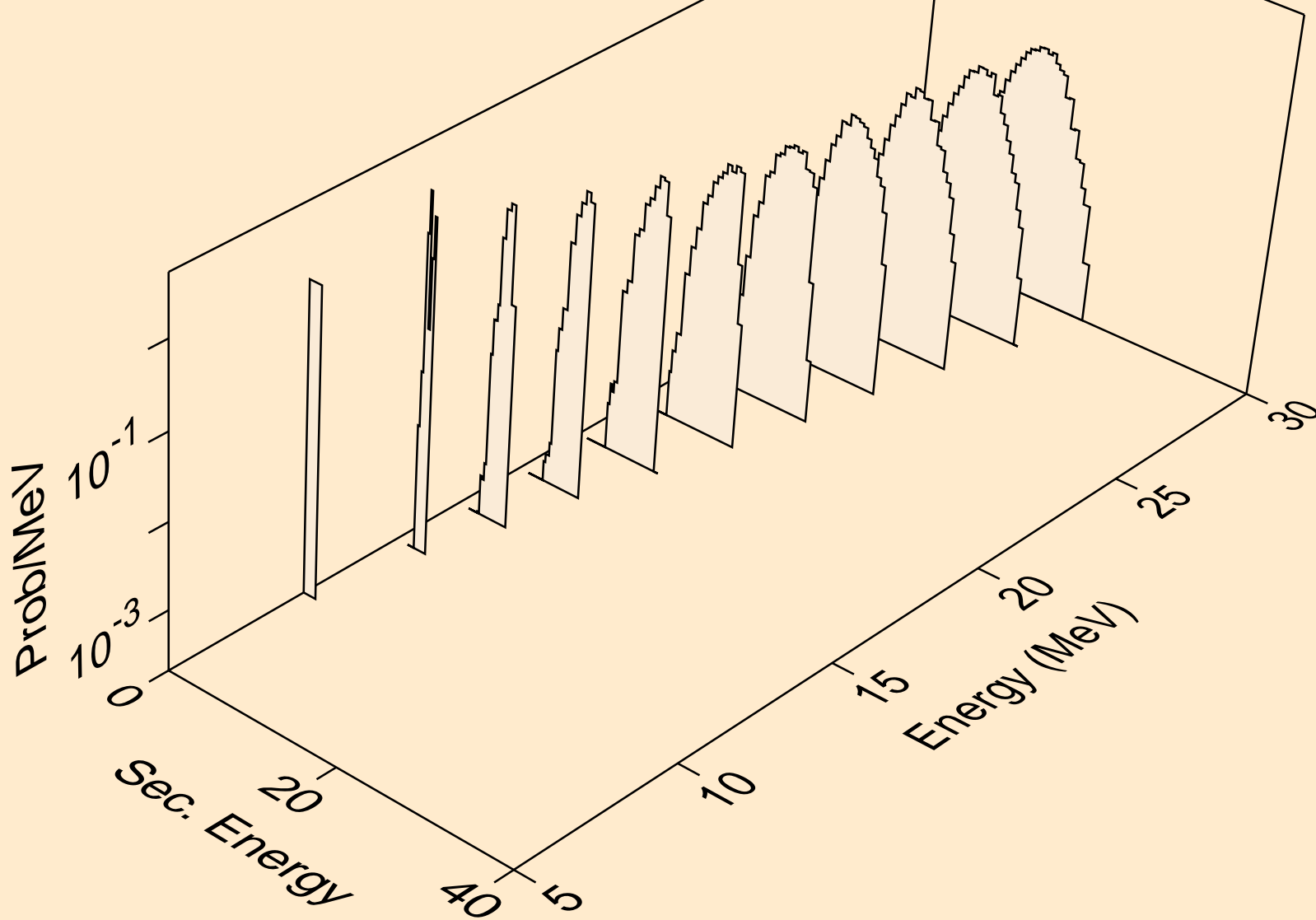

HG185M NEUTRON ACER TENDL-2019 LIBRARY; T=293.16K
deuterons from (n,d)

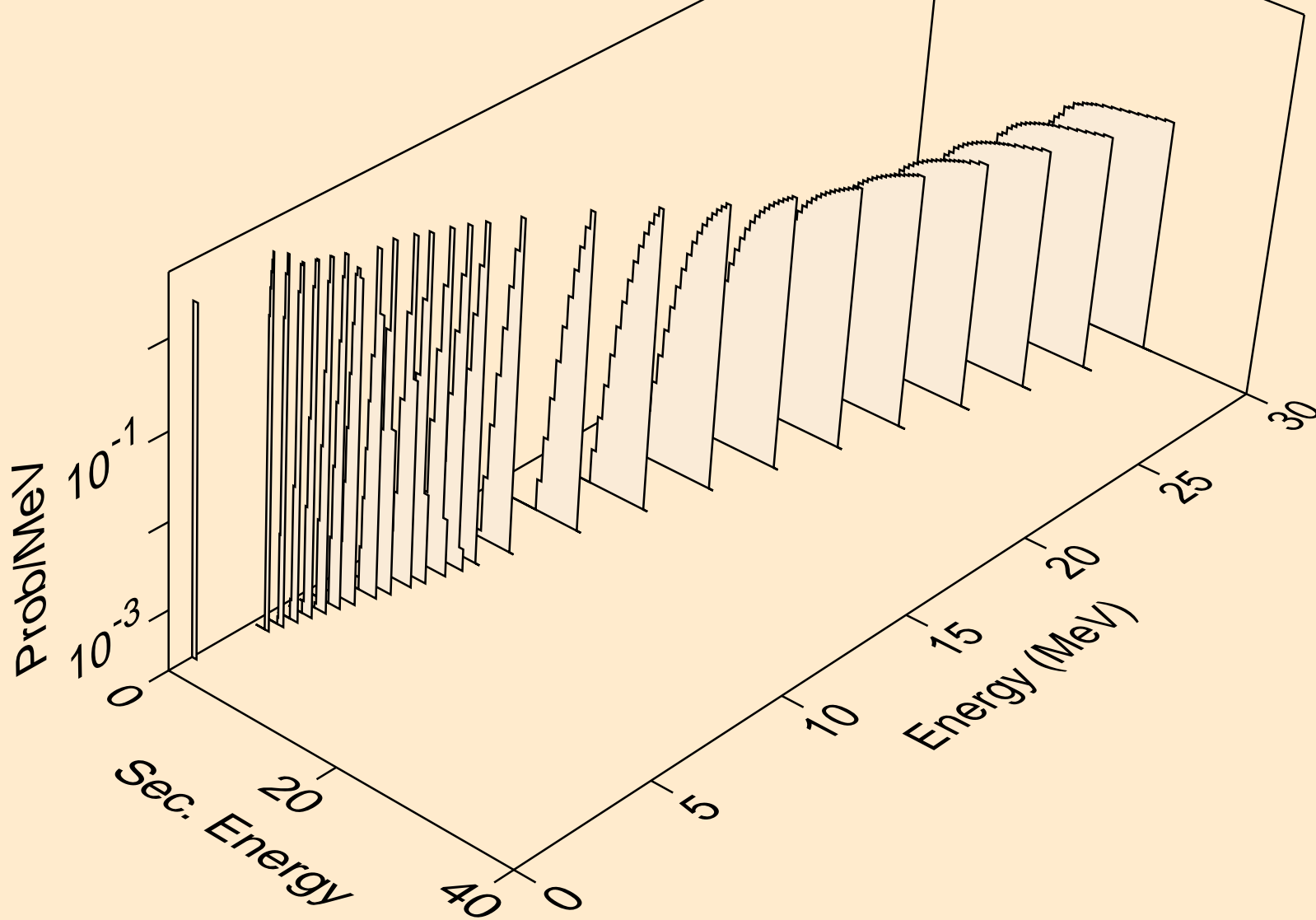

HG185M NEUTRON ACER TENDL-2019 LIBRARY; T=293.16K
deuterons from (n,pd)

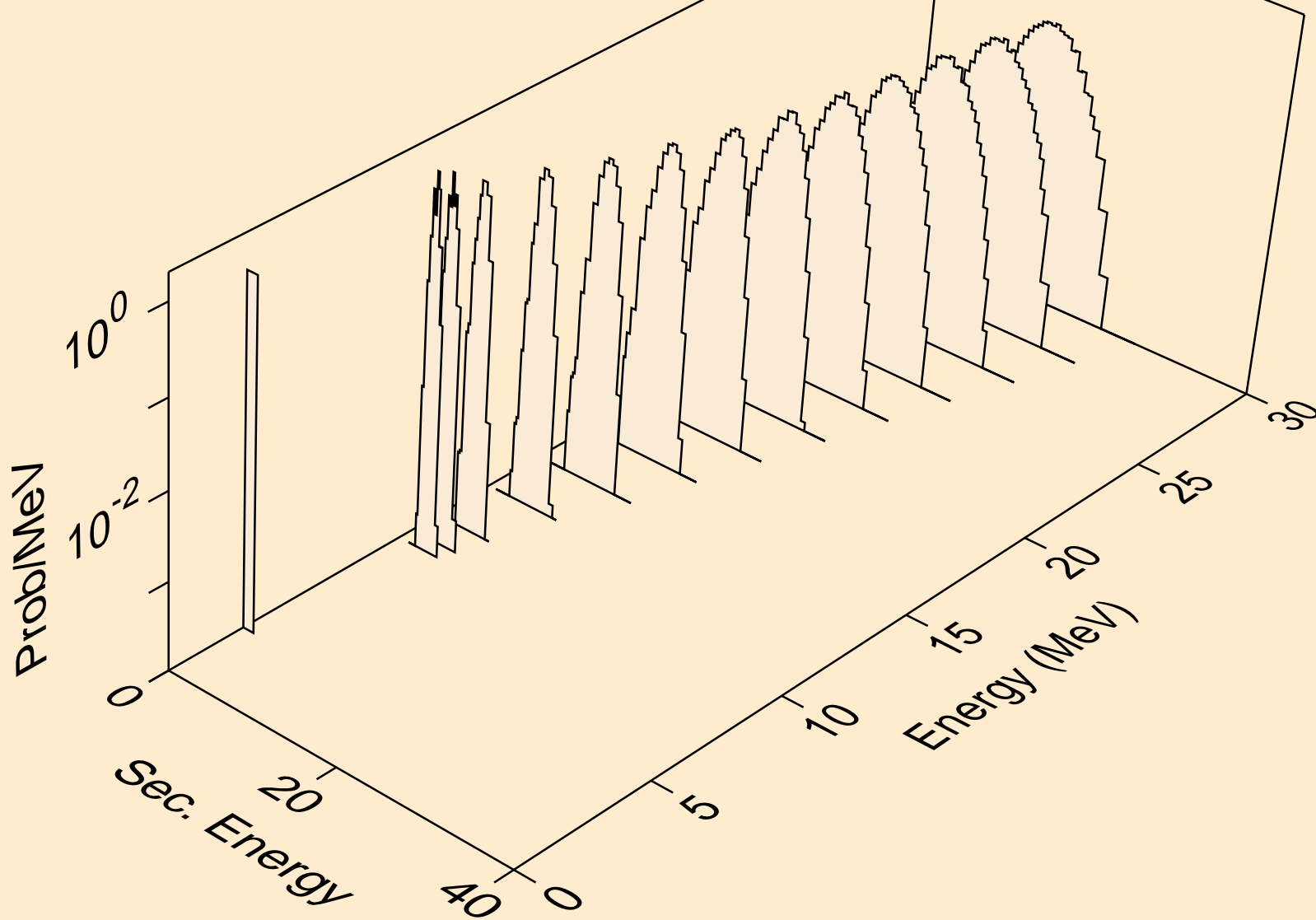

HG185M NEUTRON ACER TENDL-2019 LIBRARY; T=293.16K
deuterons from (n,da)

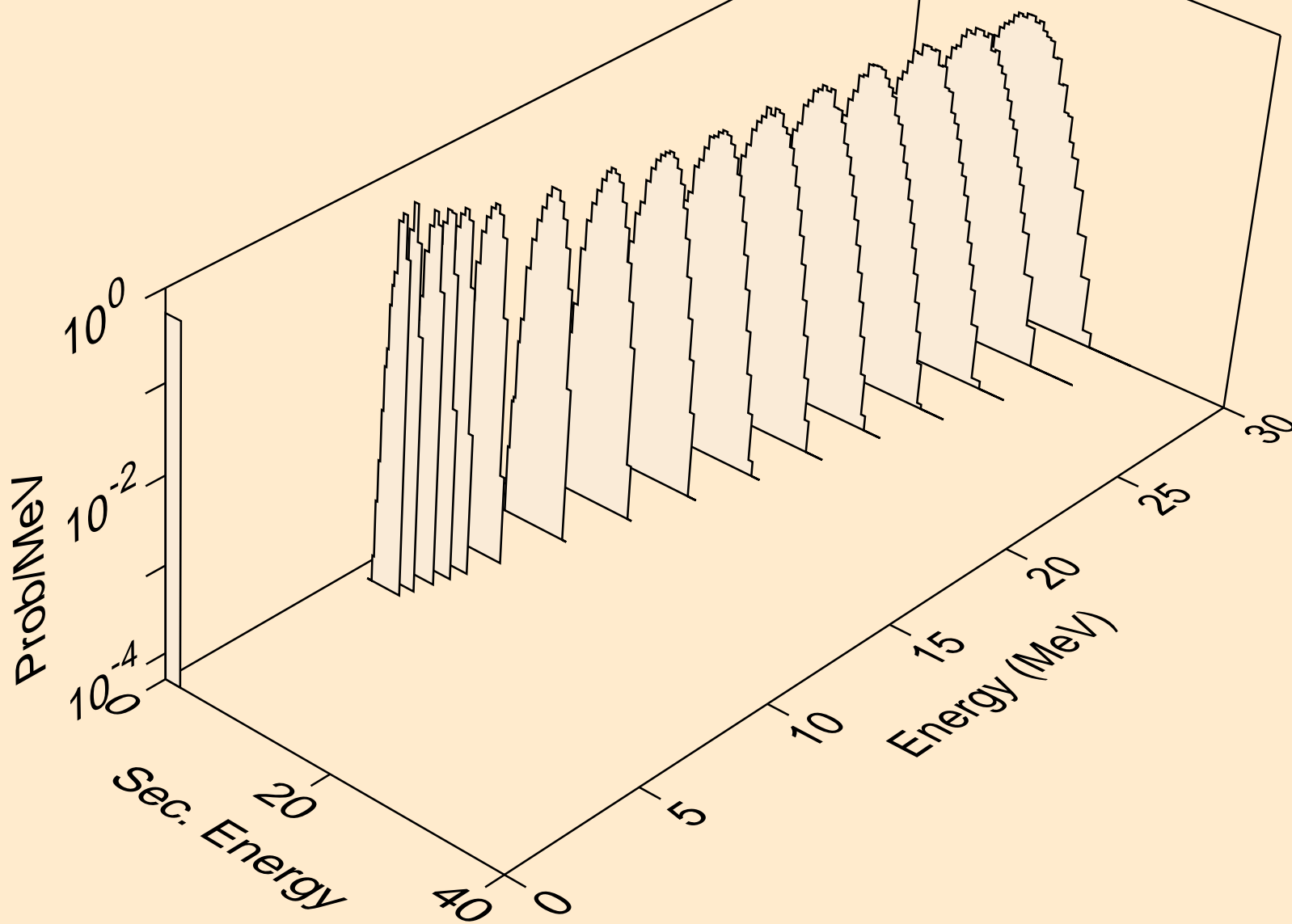

HG185M NEUTRON ACER TENDL-2019 LIBRARY; T=293.16K
tritons from (n,x)

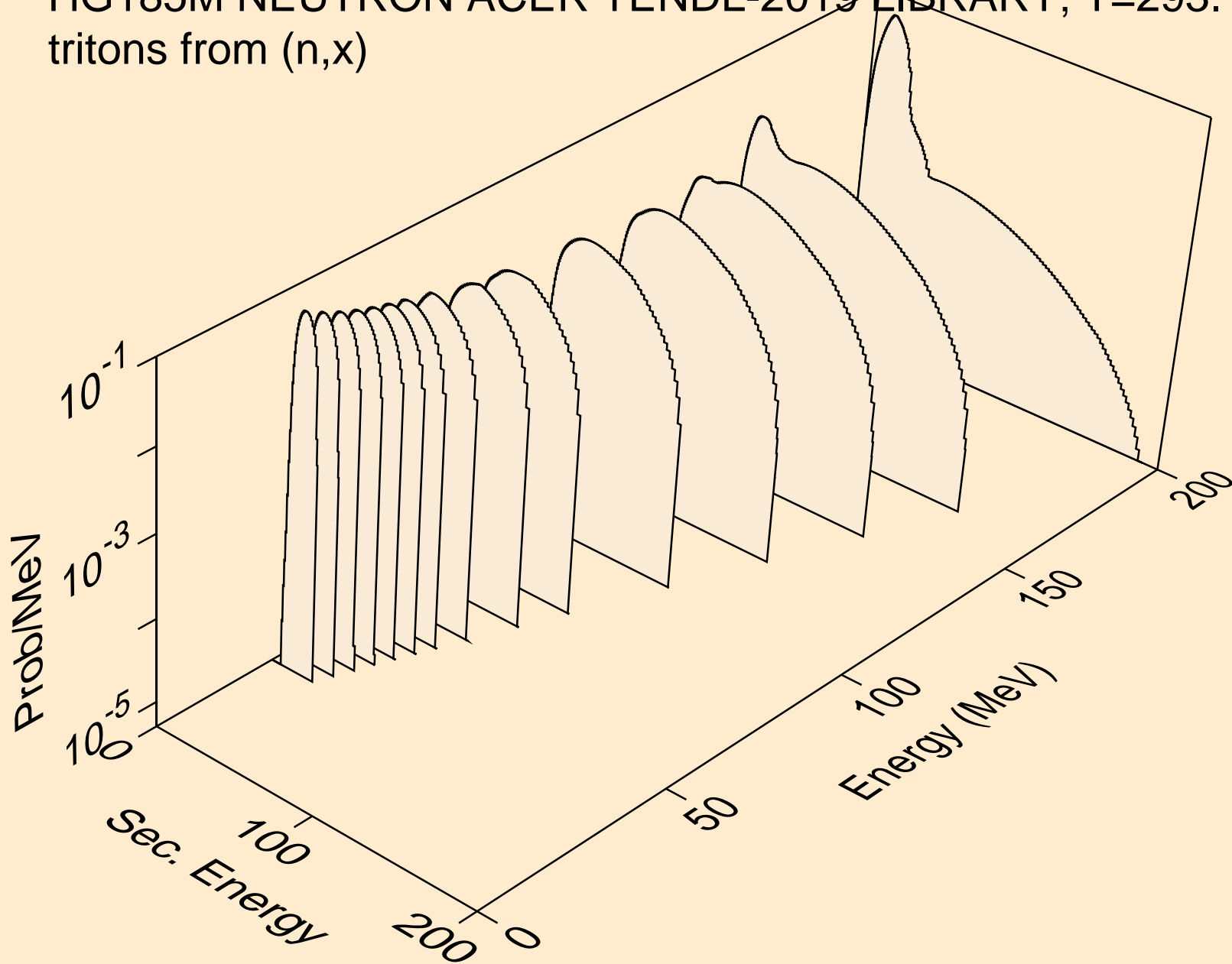

HG185M NEUTRON ACER TENDL-2019 LIBRARY; T=293.16K
tritons from (n,n*)t

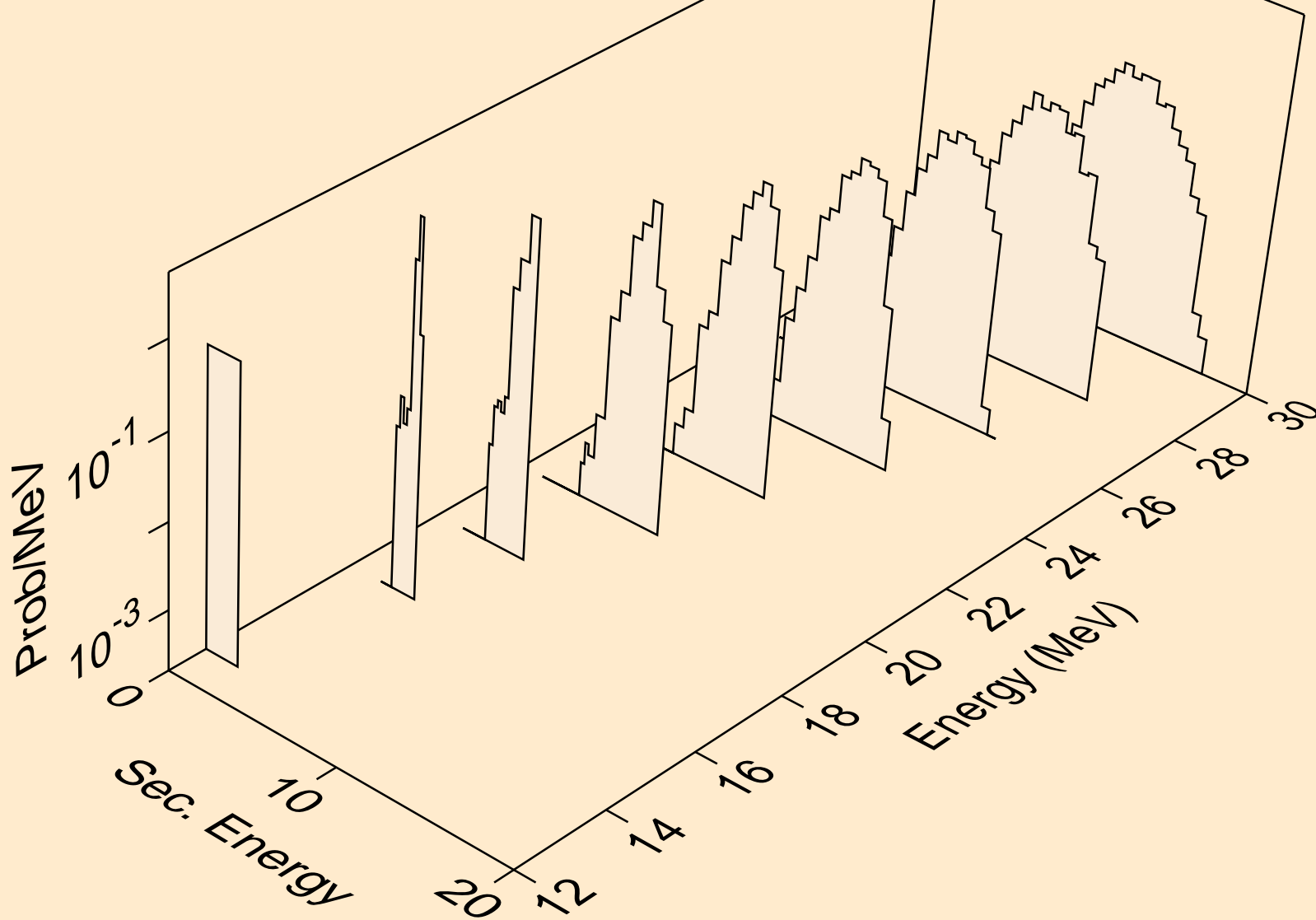

HG185M NEUTRON ACER TENDL-2019 LIBRARY; T=293.16K
tritons from (n,t)

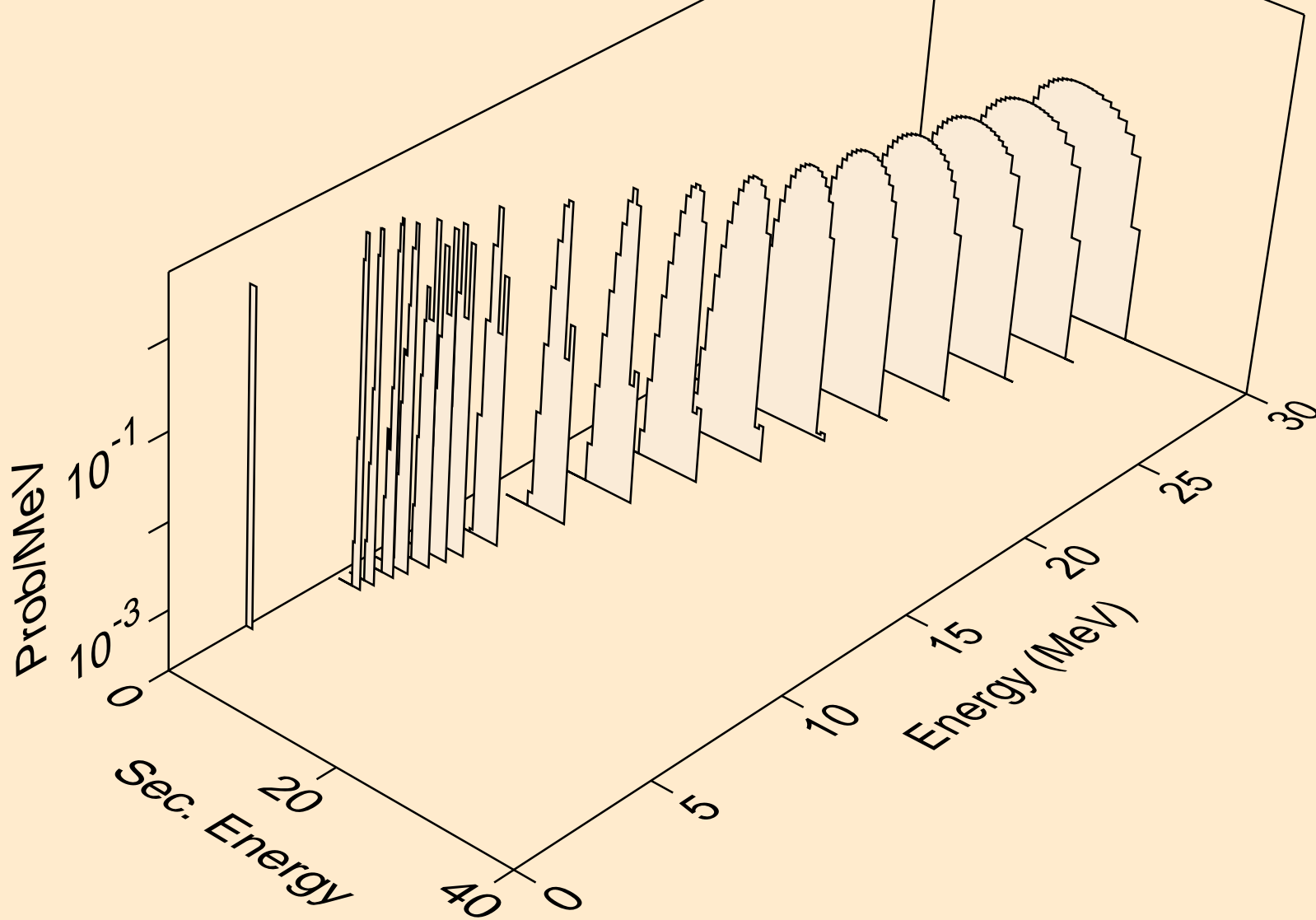

HG185M NEUTRON ACER TENDL-2019 LIBRARY; T=293.16K
tritons from (n,pt)

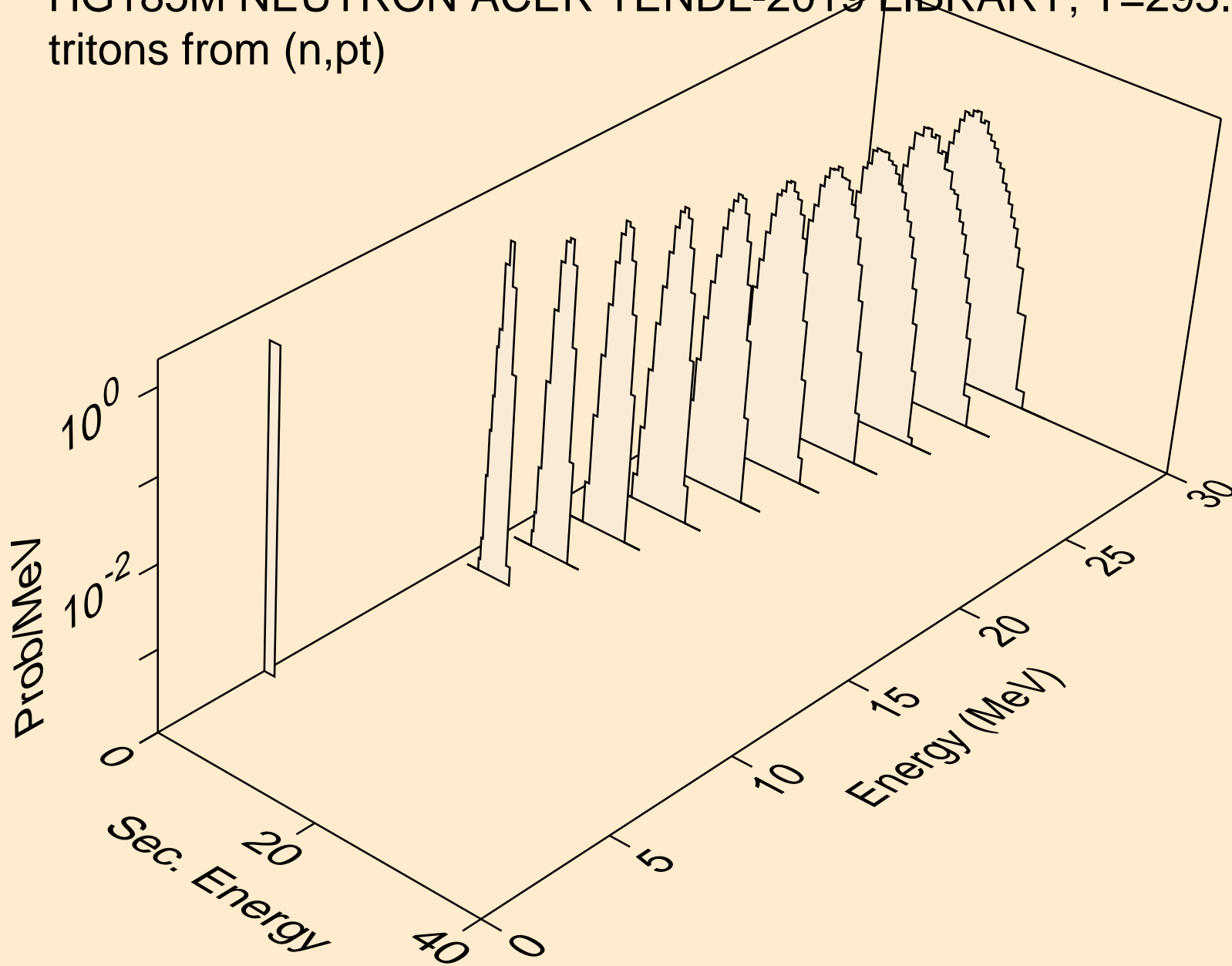

HG185M NEUTRON ACER TENDL-2019 LIBRARY; T=293.16K
he3s from (n,x)

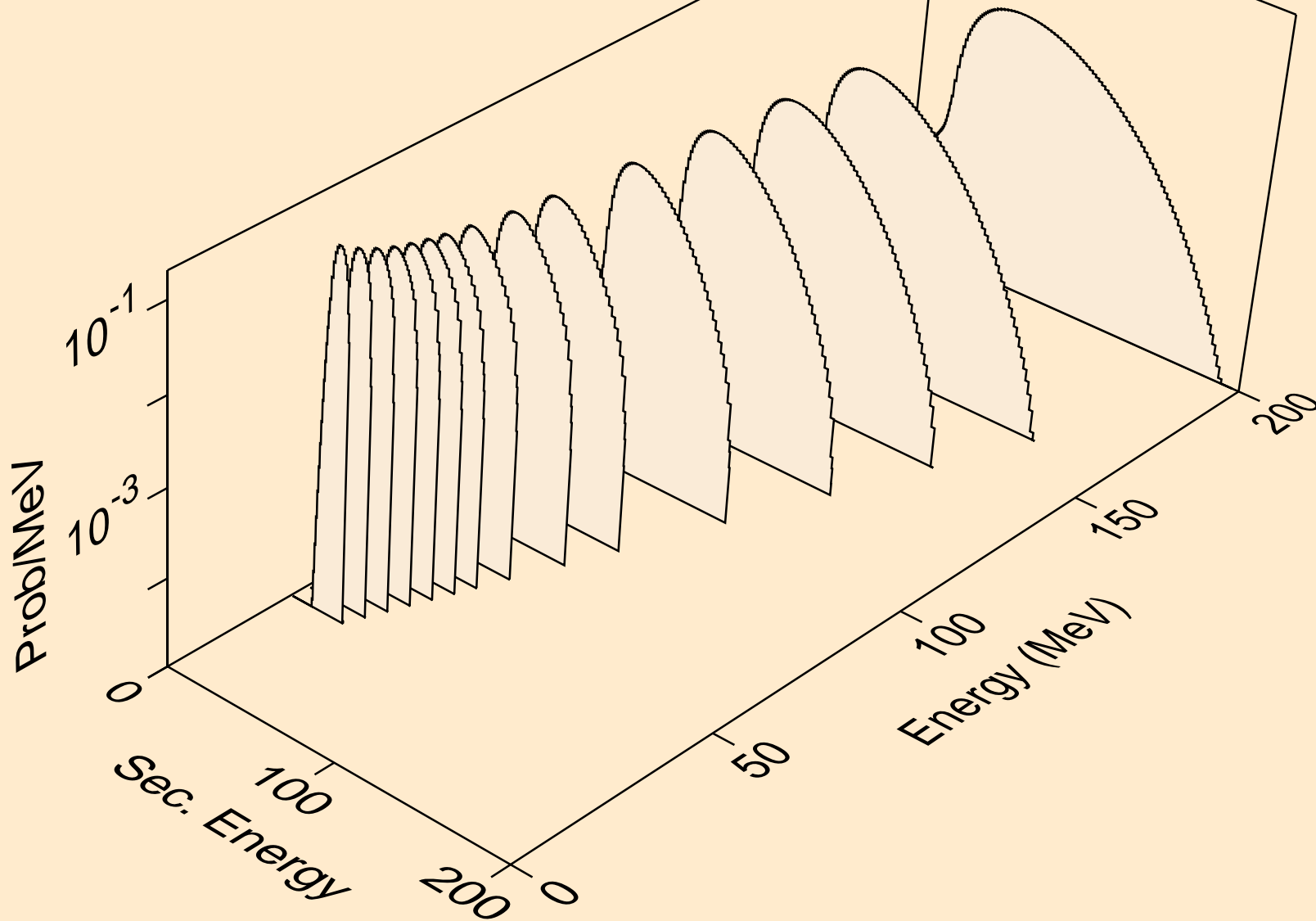

HG185M NEUTRON ACER TENDL-2019 LIBRARY; T=293.16K
he3s from (n,n*)he3

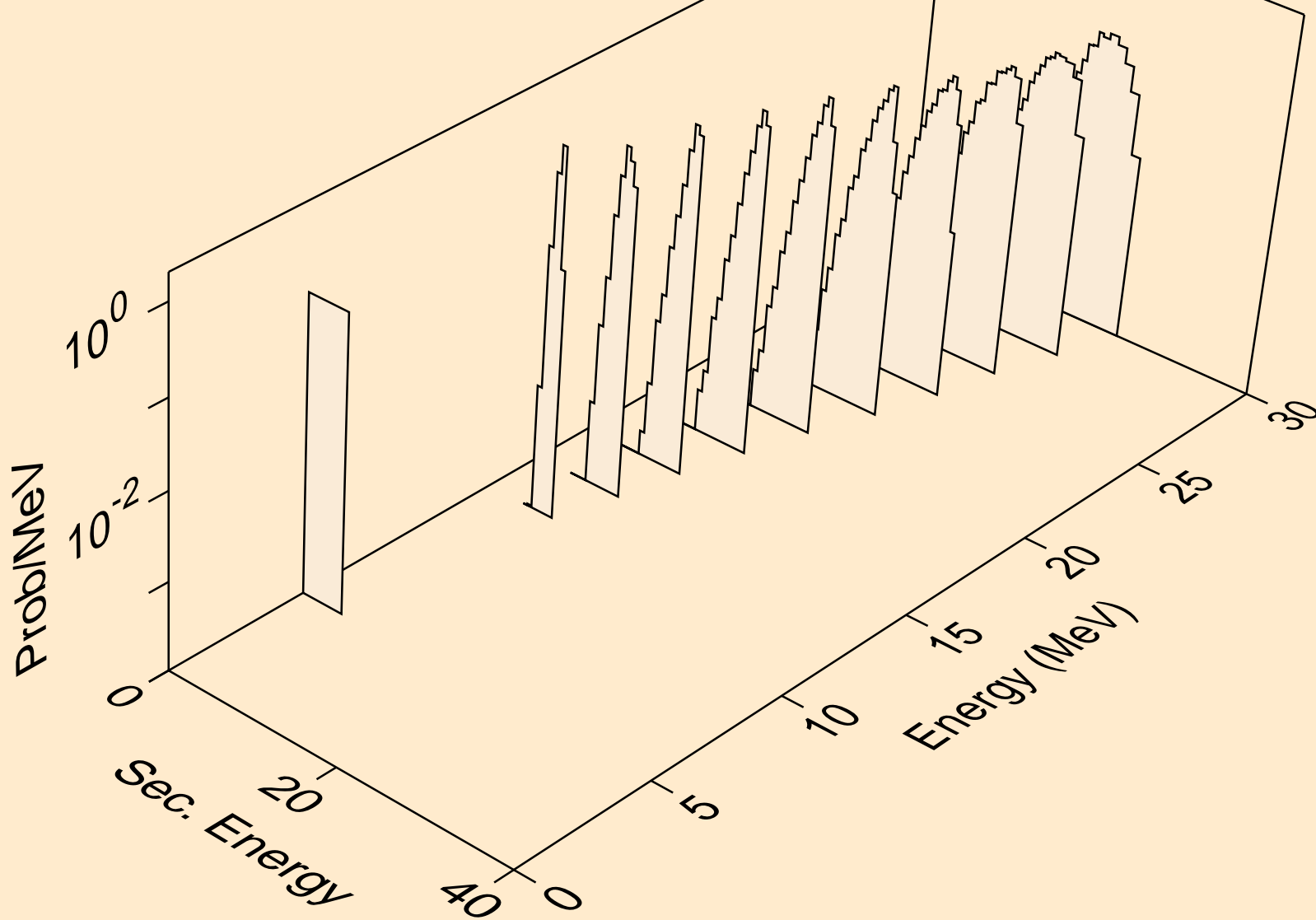

HG185M NEUTRON ACER TENDL-2019 LIBRARY; T=293.16K
he3s from (n,he3)

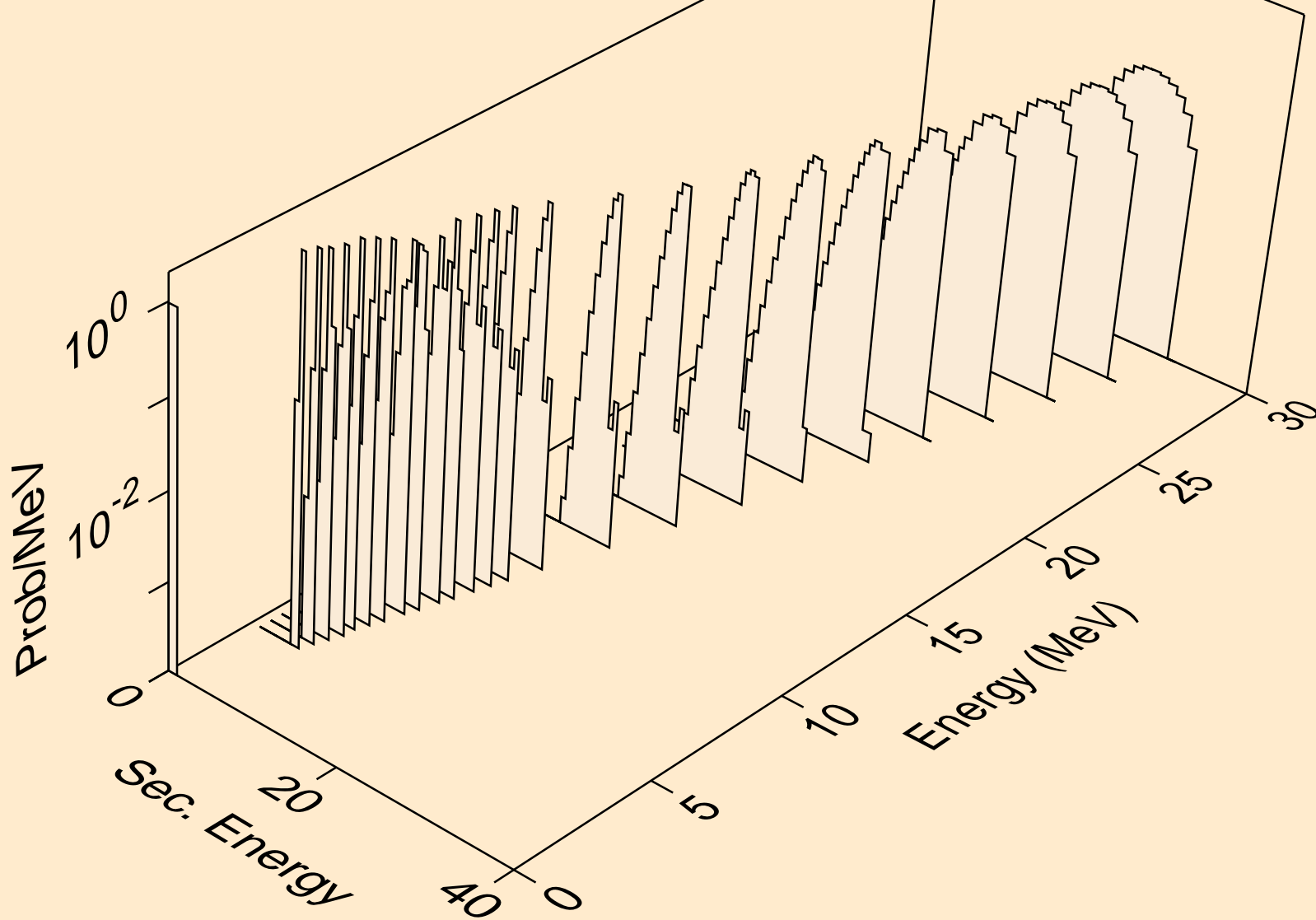

HG185M NEUTRON ACER TENDL-2019 LIBRARY; T=293.16K
alphas from (n,x)

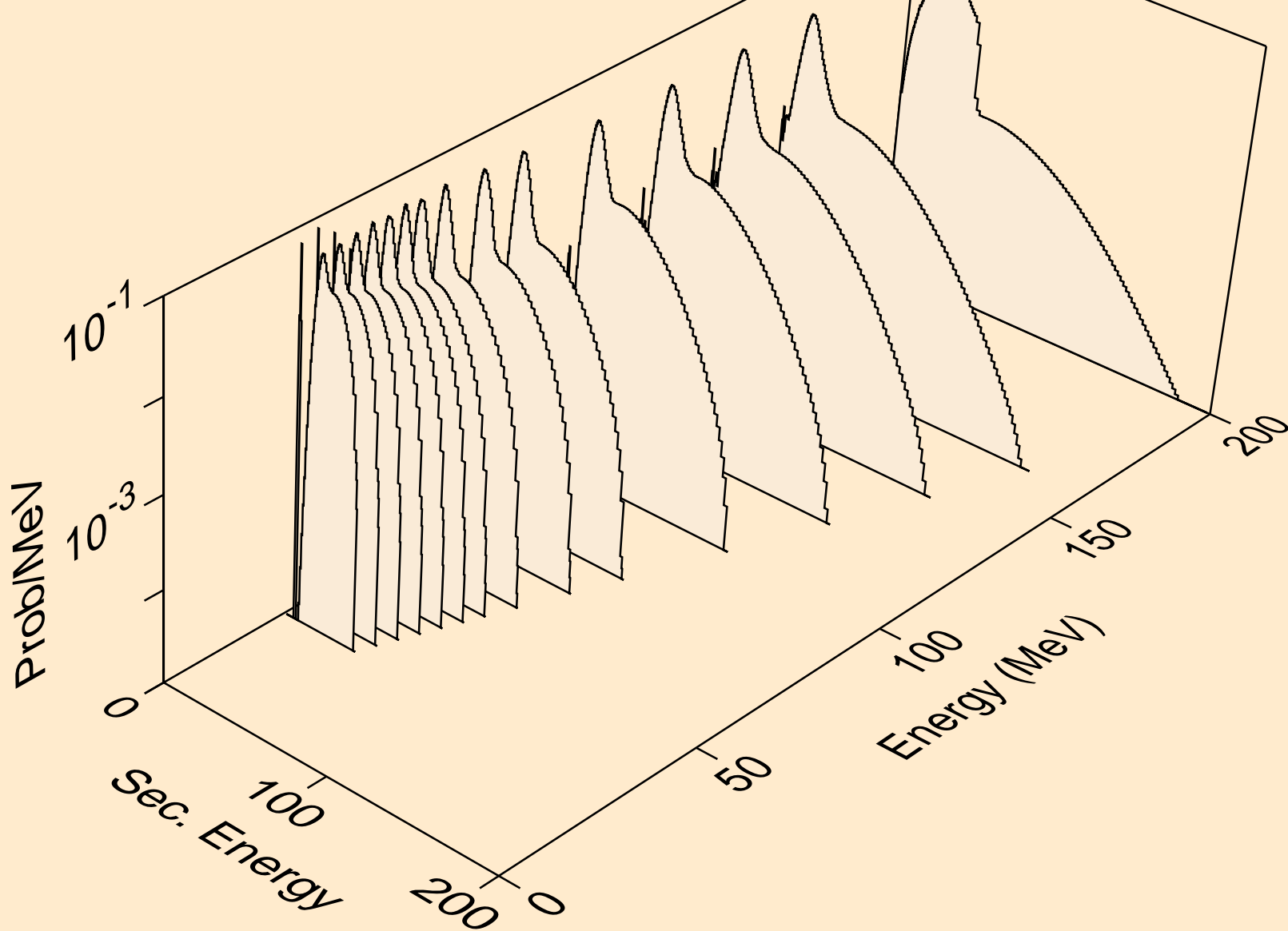

HG185M NEUTRON ACER TENDL-2019 LIBRARY; T=293.16K
alphas from (n,n*)a

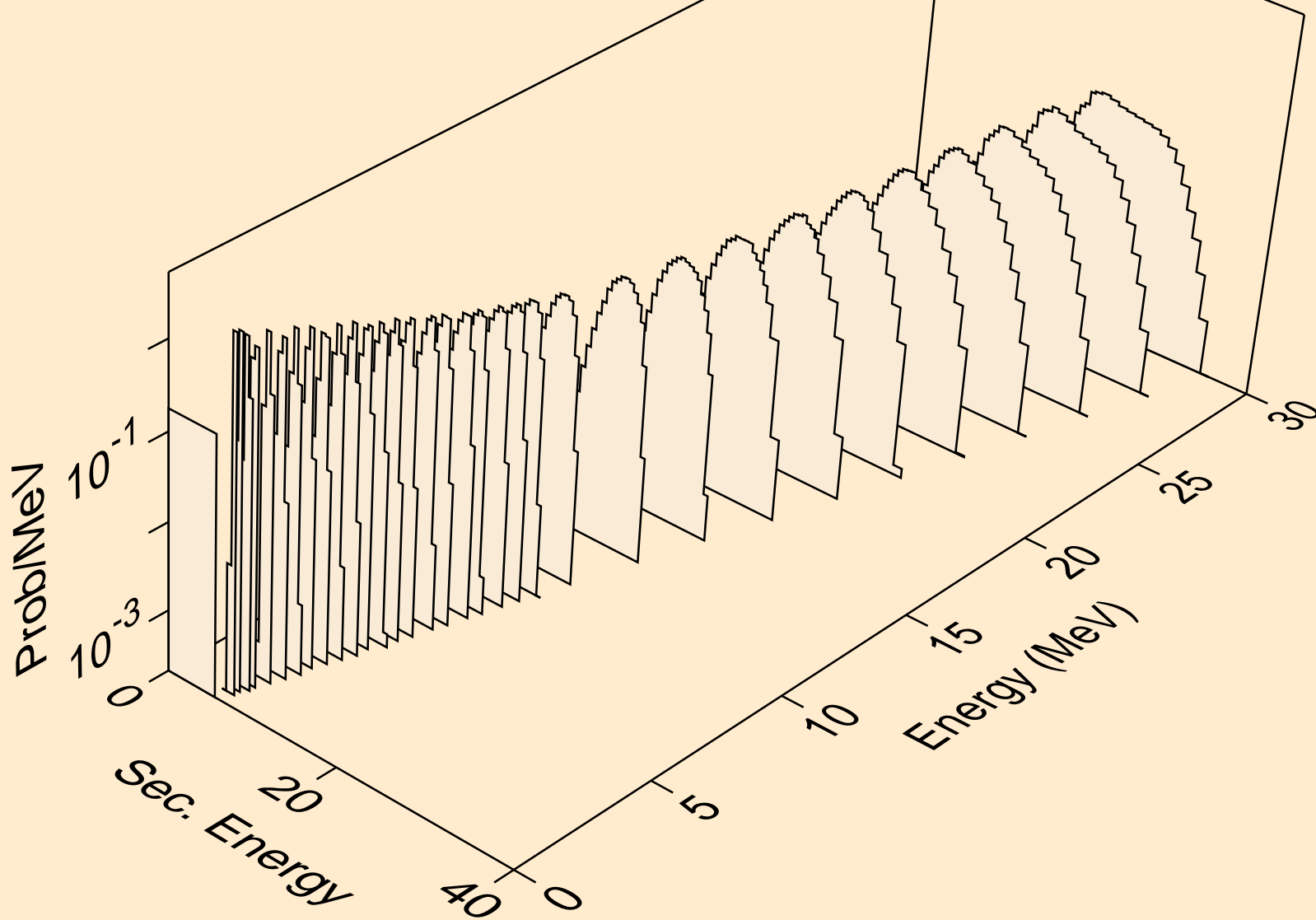

HG185M NEUTRON ACER TENDL-2019 LIBRARY; T=293.16K
alphas from (n,2n)a

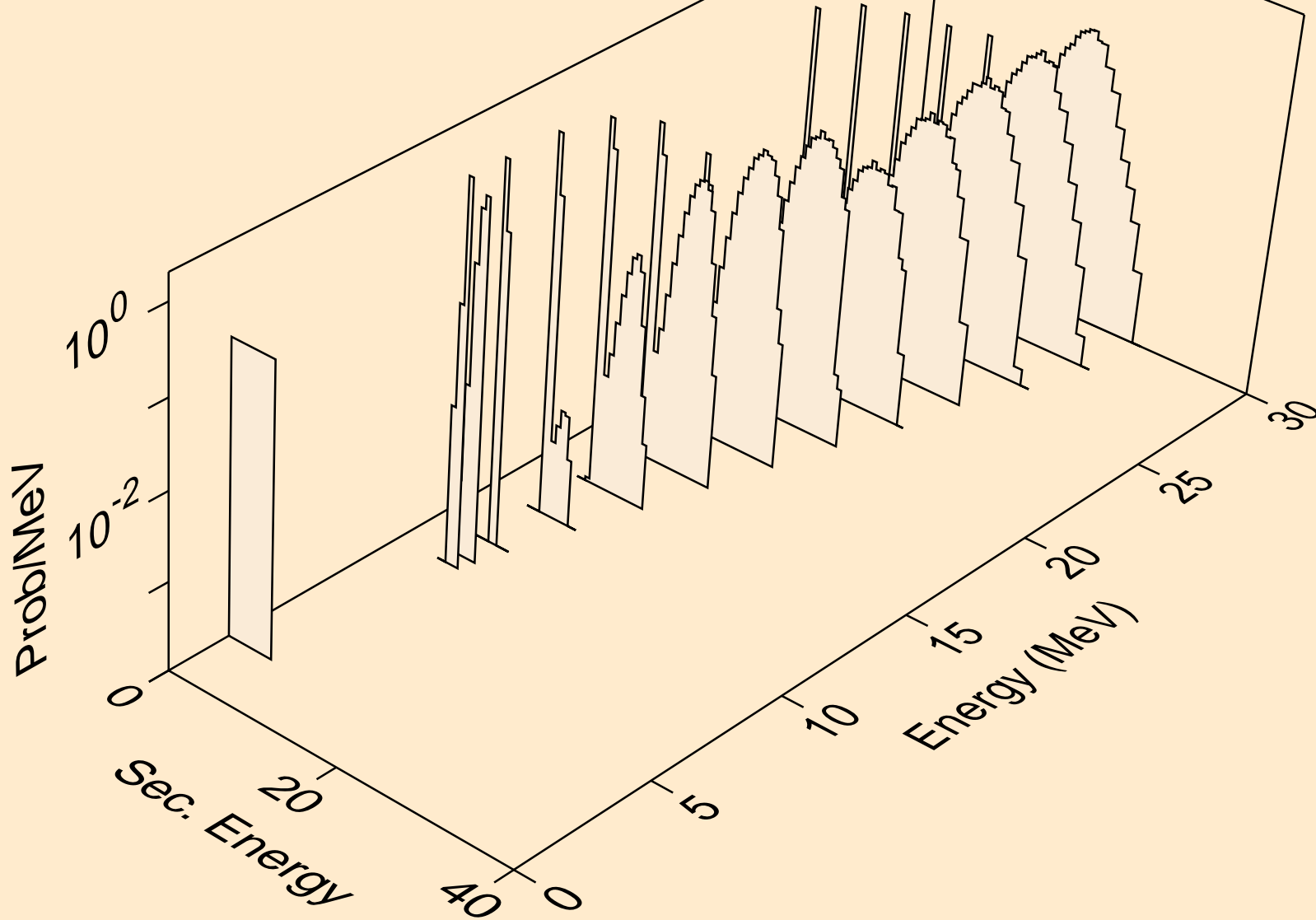

HG185M NEUTRON ACER TENDL-2019 LIBRARY; T=293.16K
alphas from (n,3n)a

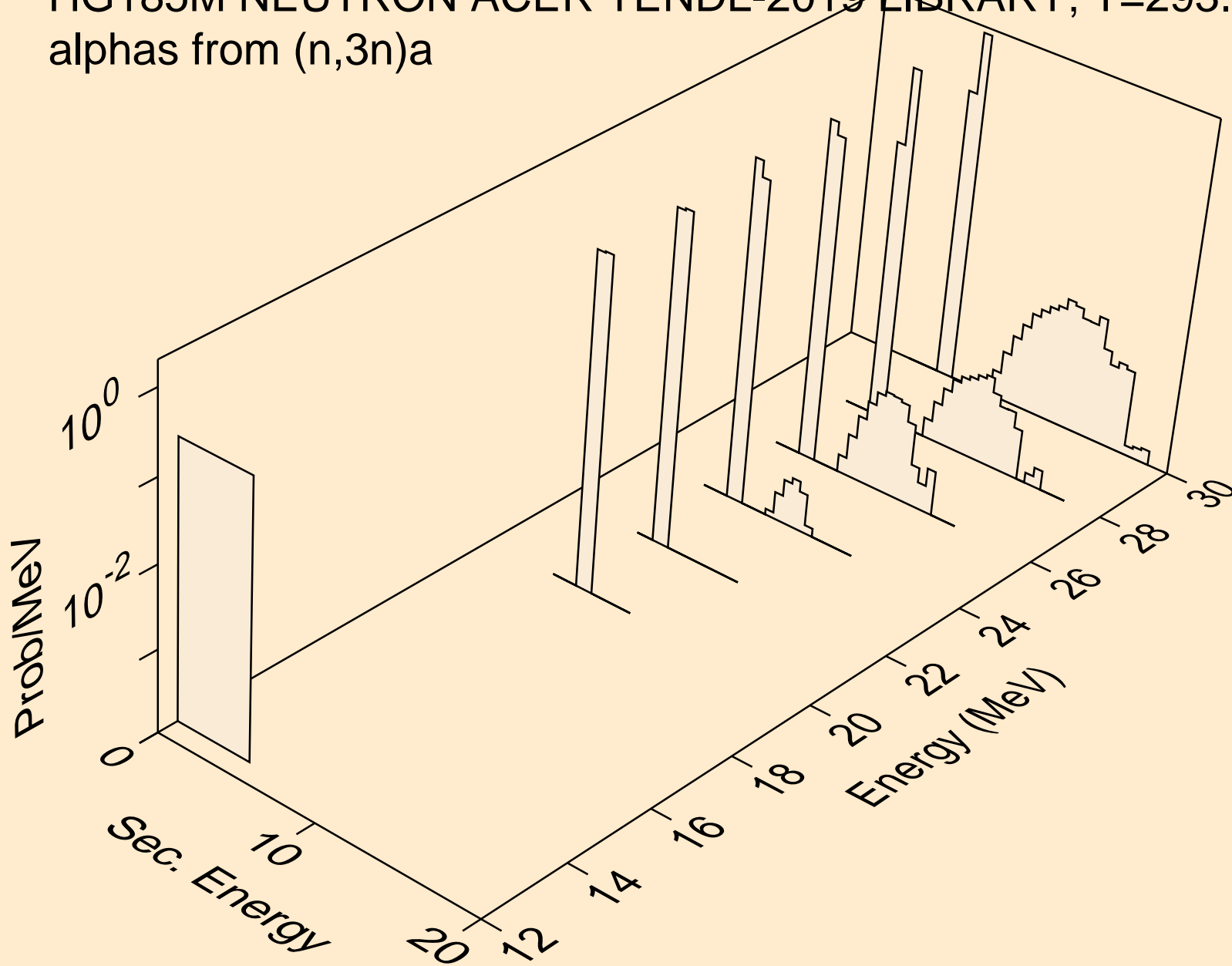

HG185M NEUTRON ACER TENDL-2019 LIBRARY; T=293.16K
alphas from (n,n*)2a

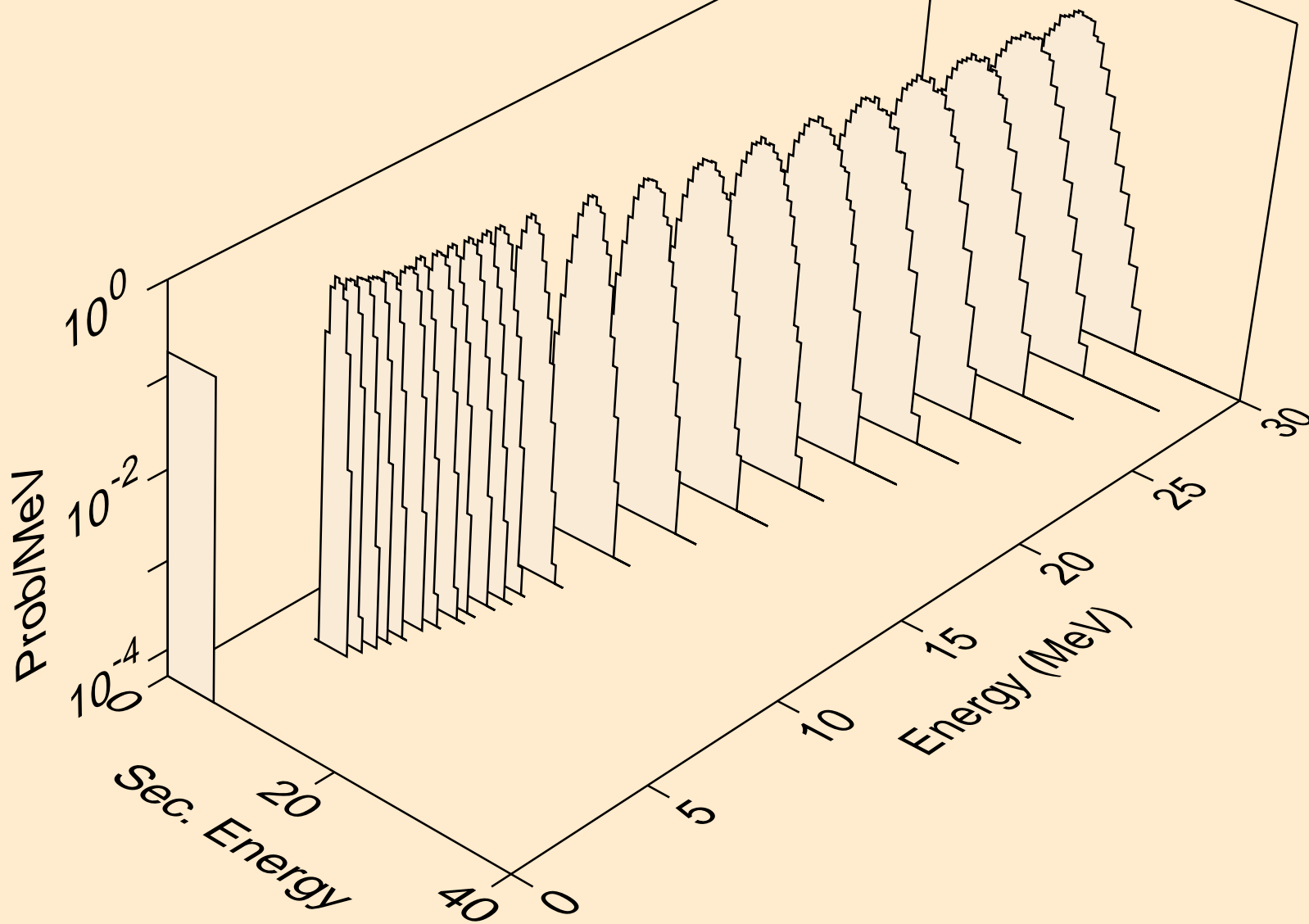

HG185M NEUTRON ACER TENDL-2019 LIBRARY; T=293.16K
alphas from (n,2n)2a

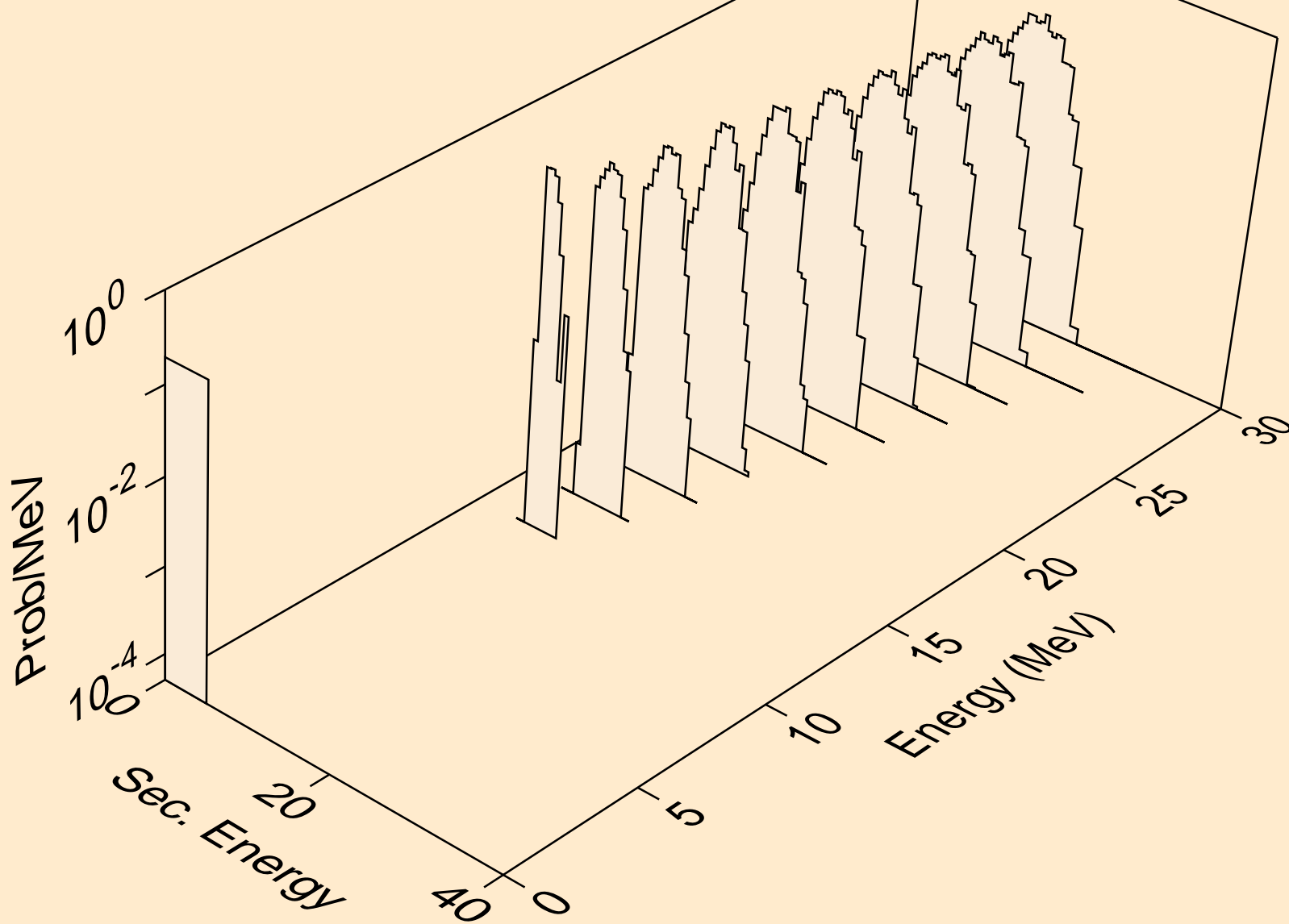

HG185M NEUTRON ACER TENDL-2019 LIBRARY; T=293.16K
alphas from (n,npa)

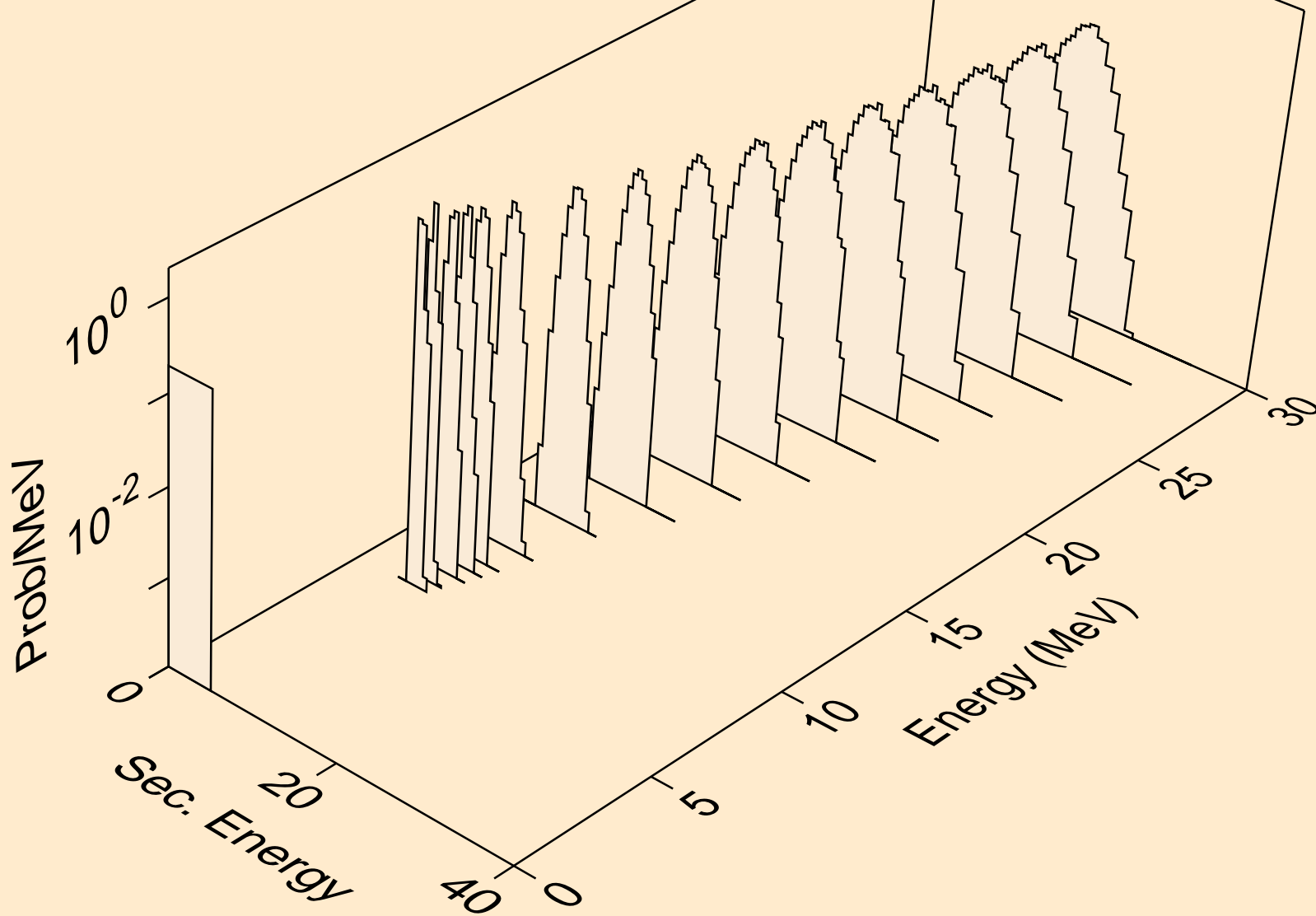

HG185M NEUTRON ACER TENDL-2019 LIBRARY; T=293.16K
alphas from (n,a)

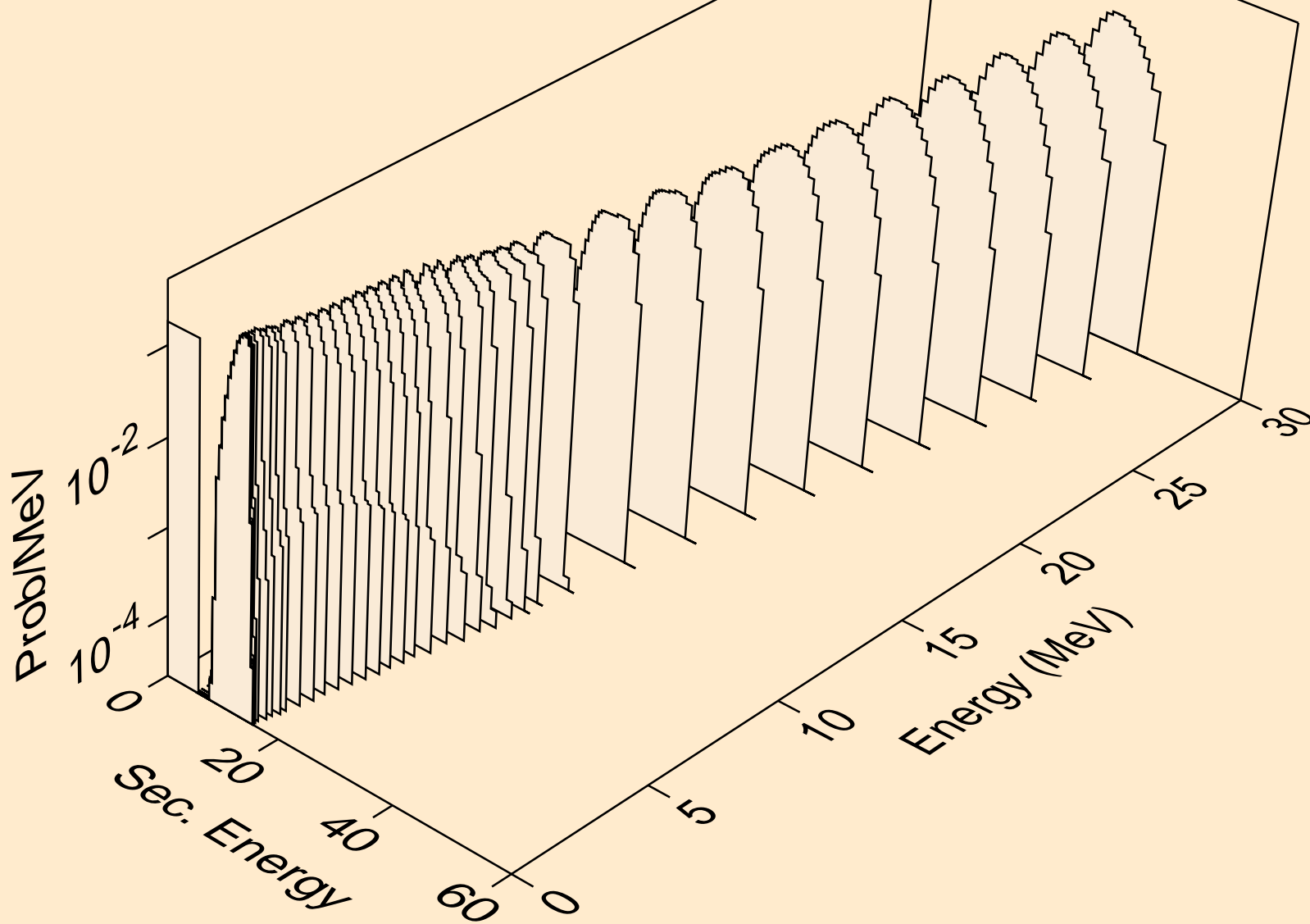

HG185M NEUTRON ACER TENDL-2019 LIBRARY; T=293.16K
alphas from (n,2a)

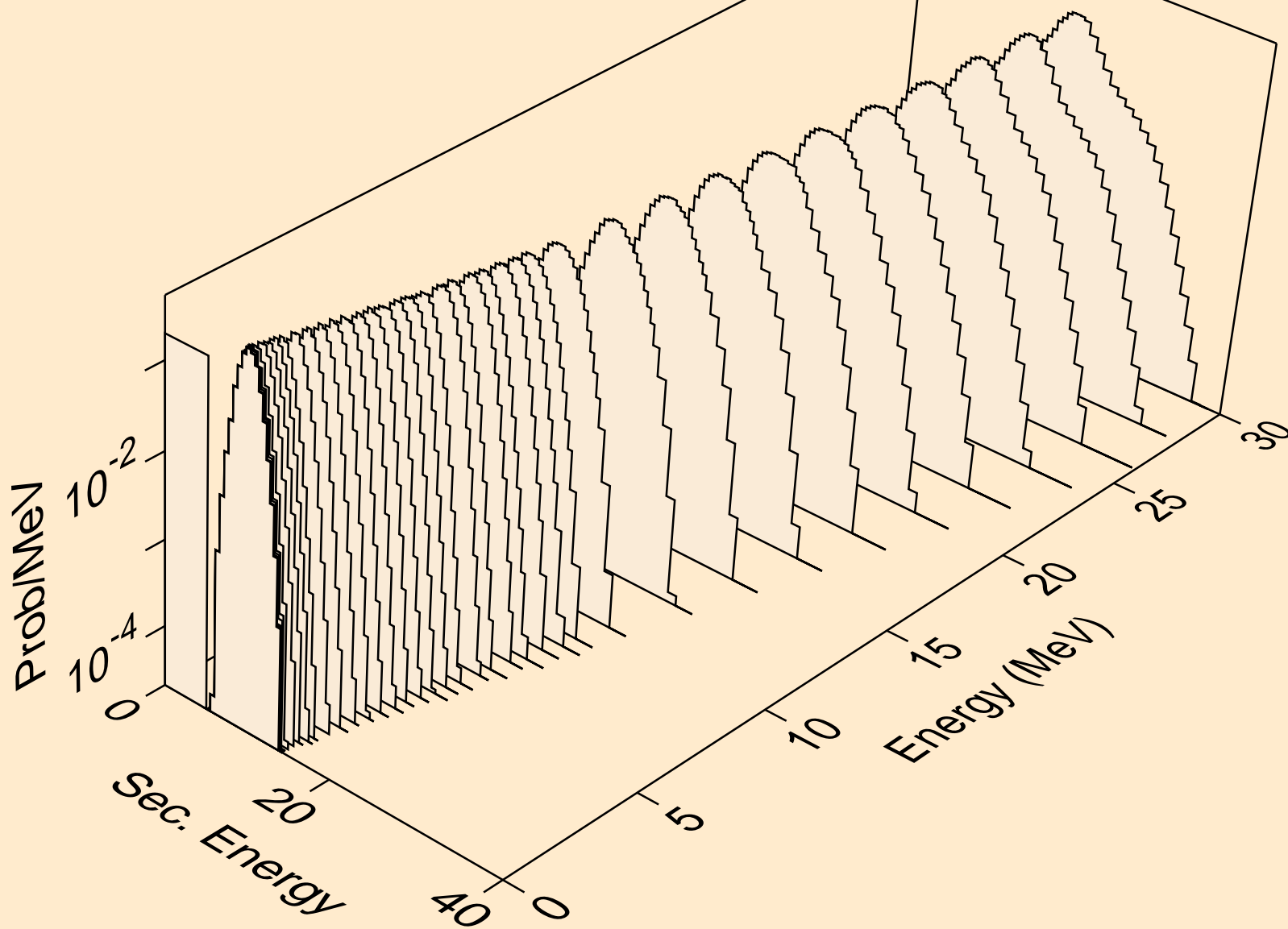

HG185M NEUTRON ACER TENDL-2019 LIBRARY; T=293.16K
alphas from (n,3a)

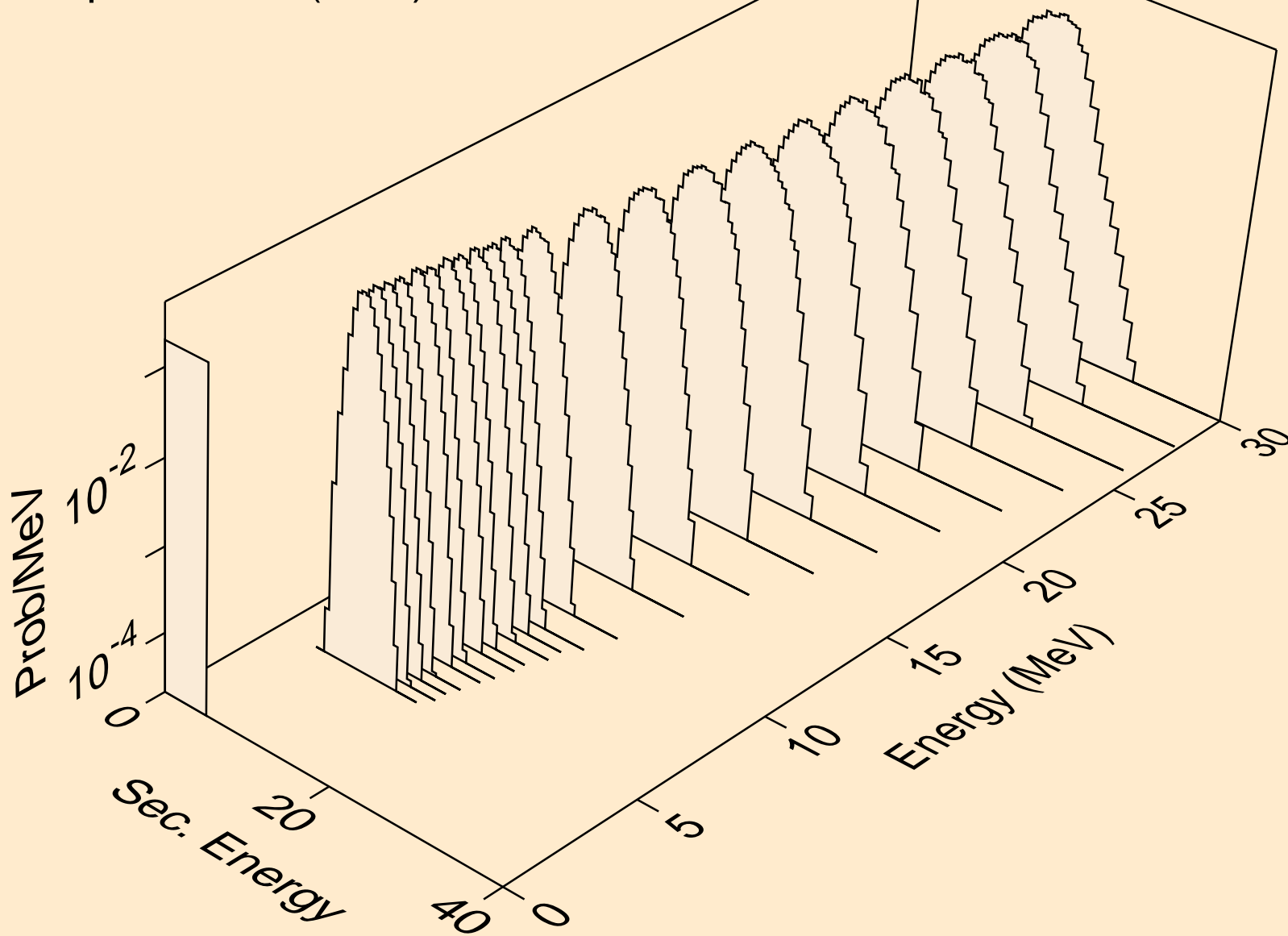

HG185M NEUTRON ACER TENDL-2019 LIBRARY; T=293.16K
alphas from (n,pa)

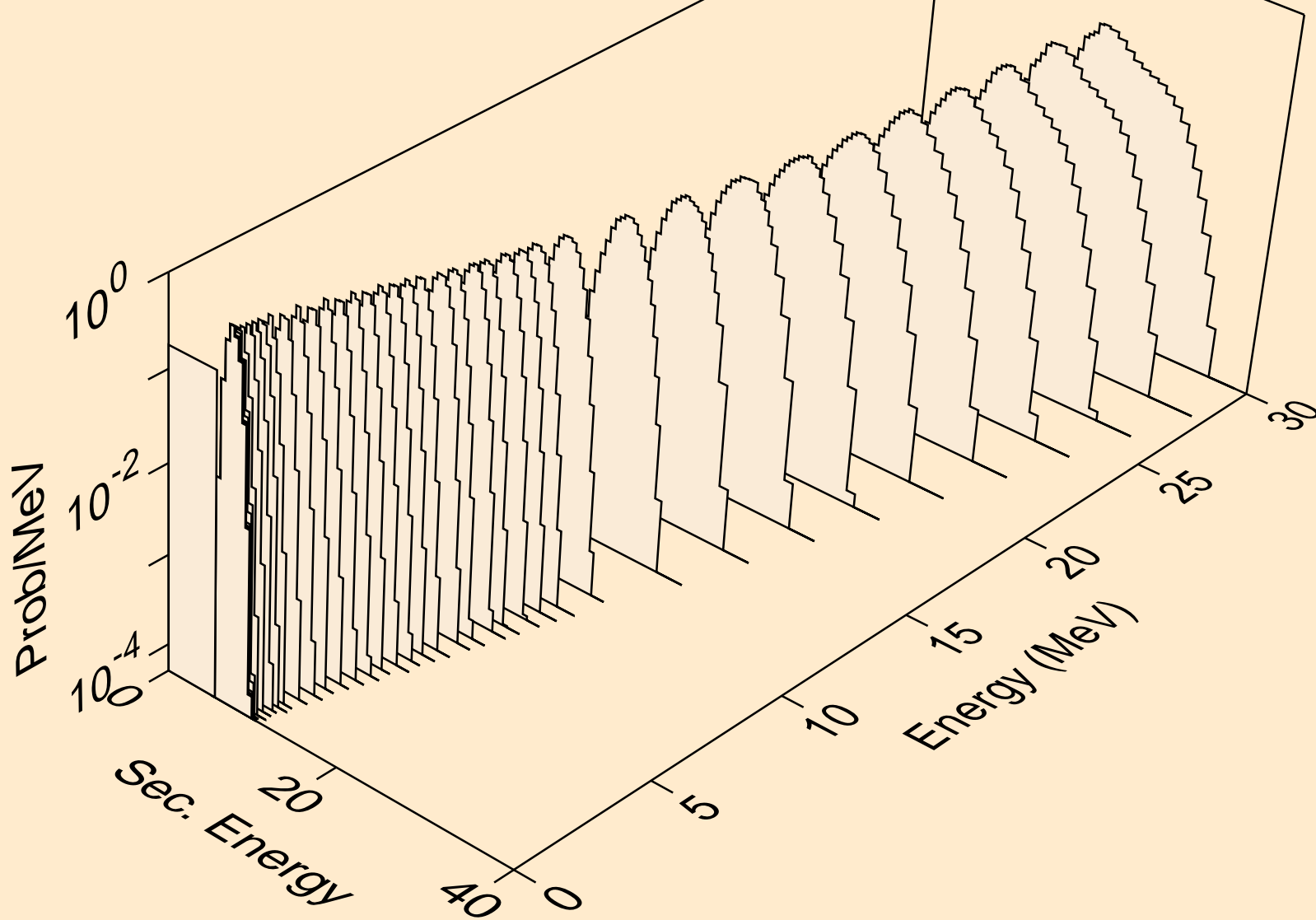

HG185M NEUTRON ACER TENDL-2019 LIBRARY; T=293.16K
alphas from (n,da)

