

HG195 NEUTRON ACER TENDL-2019 LIBRARY; T=293.16K

Principal cross sections

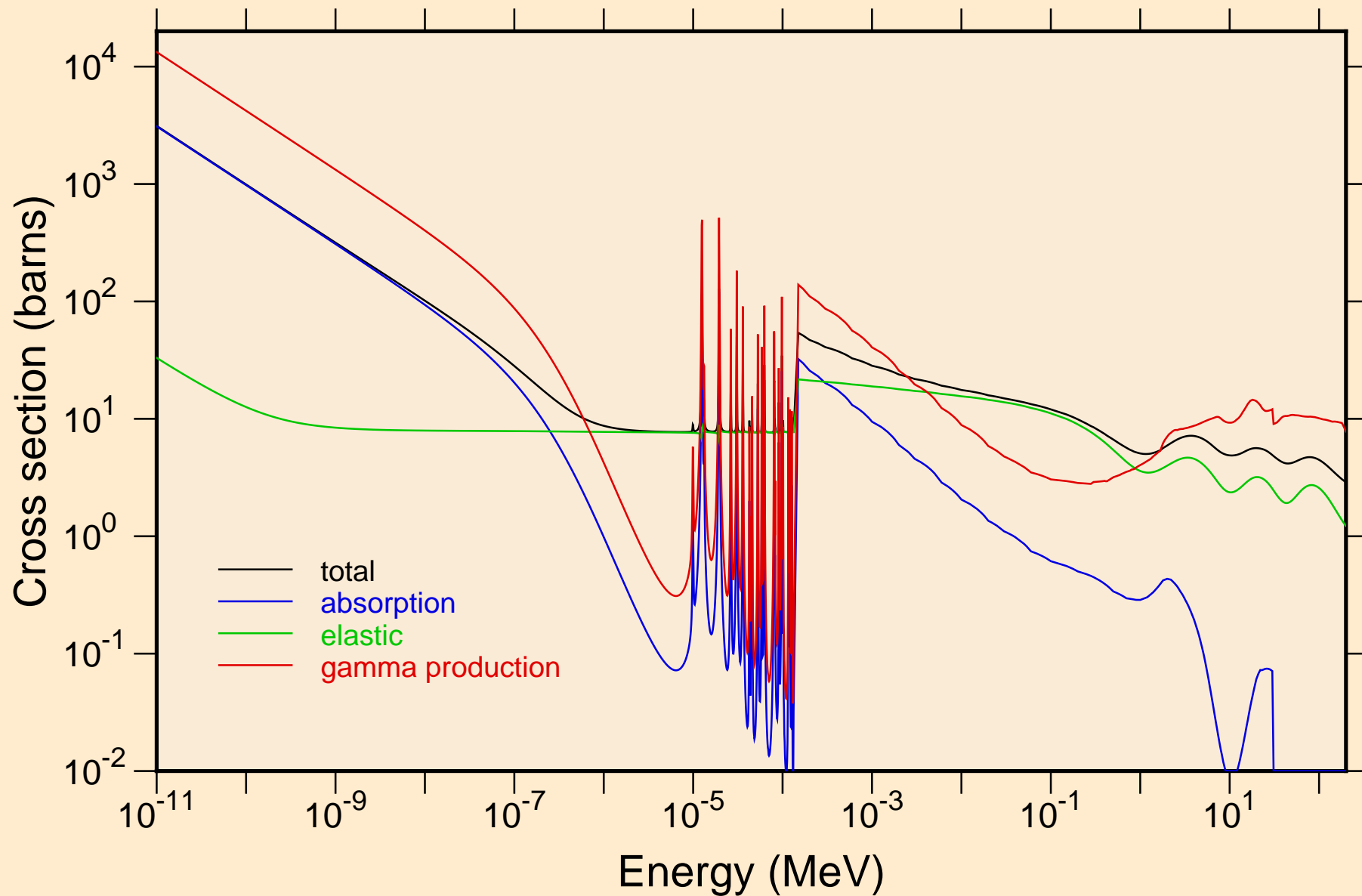

HG195 NEUTRON ACER TENDL-2019 LIBRARY; T=293.16K
resonance total cross section

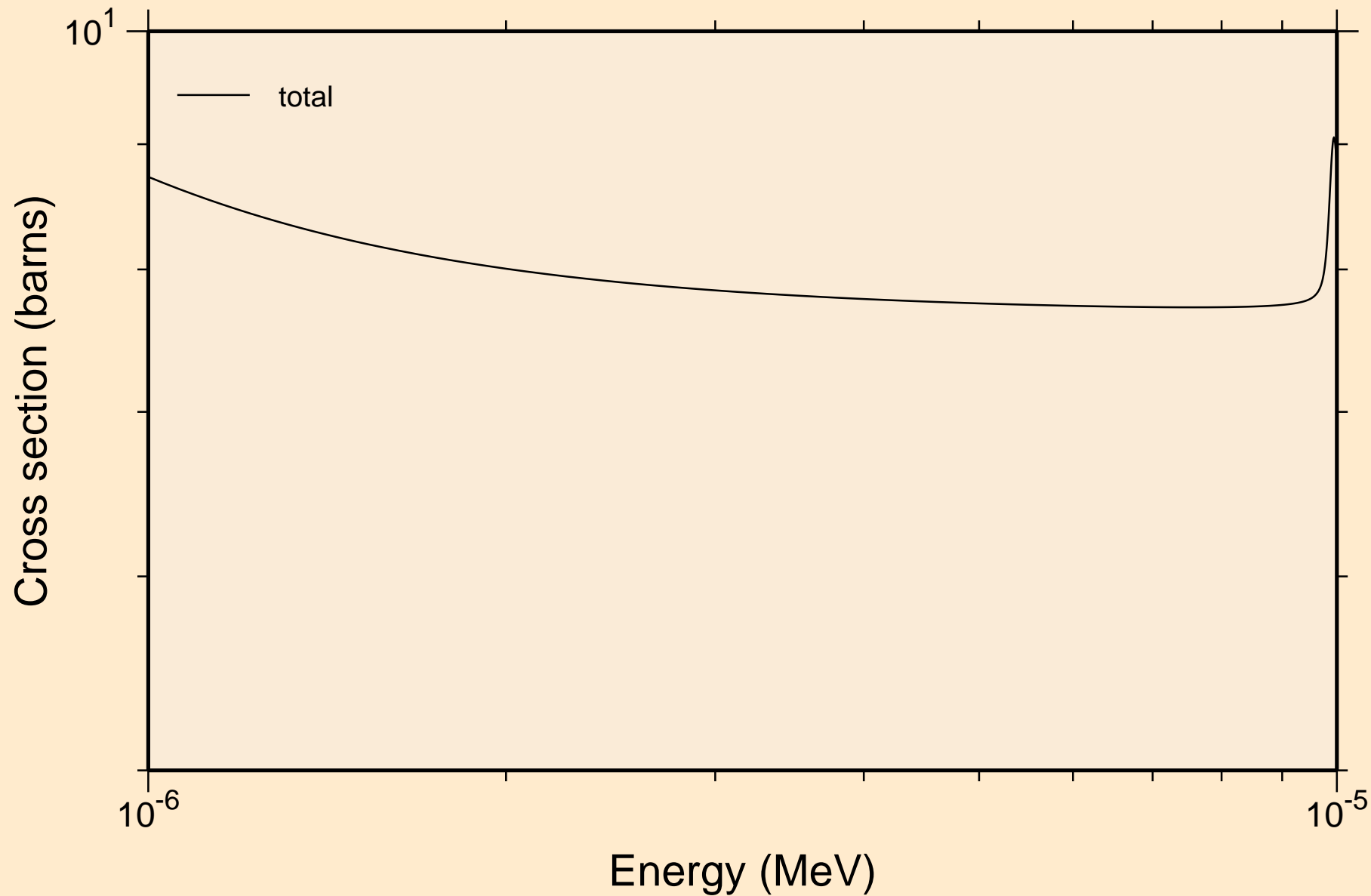

HG195 NEUTRON ACER TENDL-2019 LIBRARY; T=293.16K
resonance total cross section

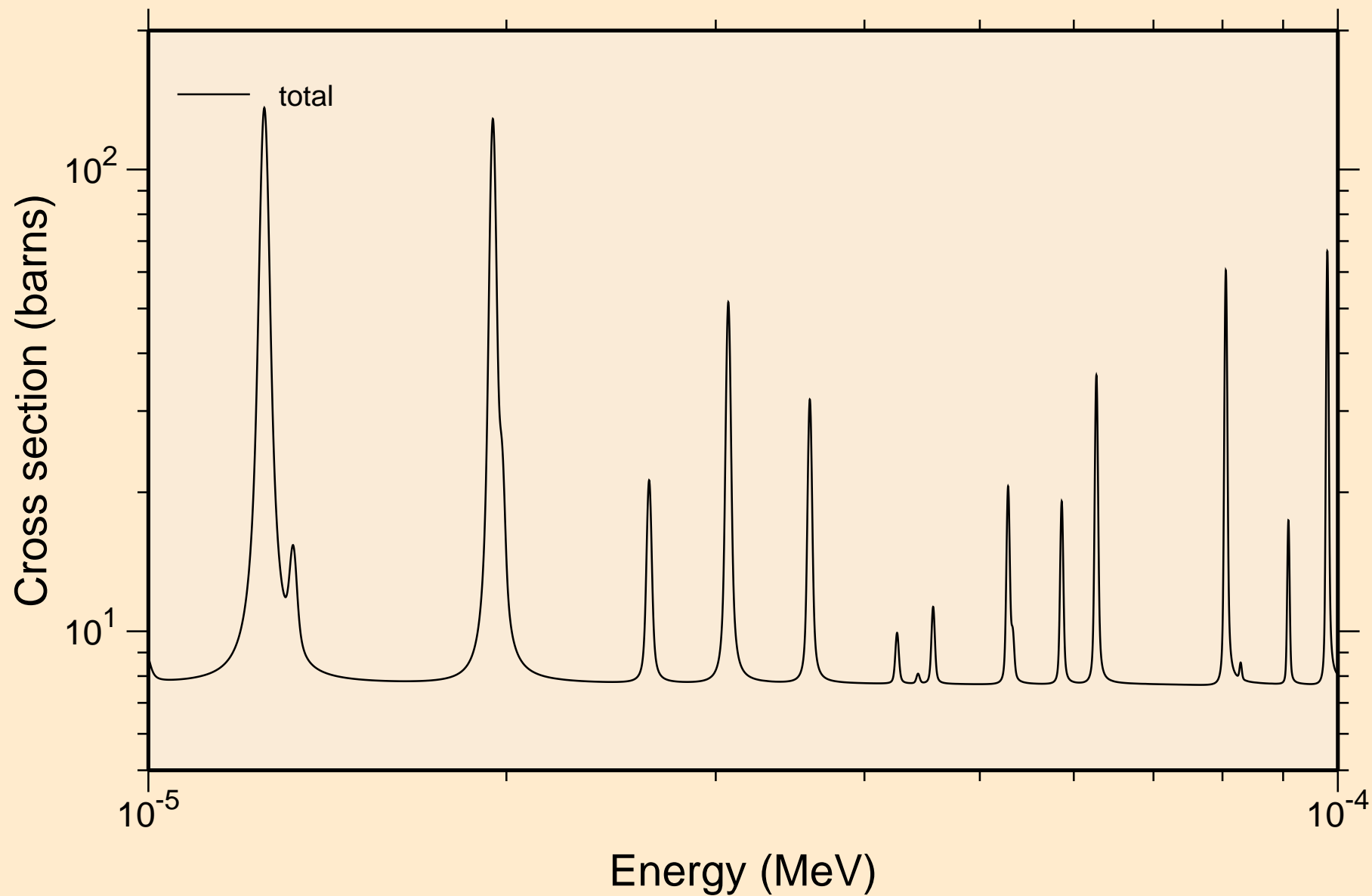

HG195 NEUTRON ACER TENDL-2019 LIBRARY; T=293.16K
resonance total cross section

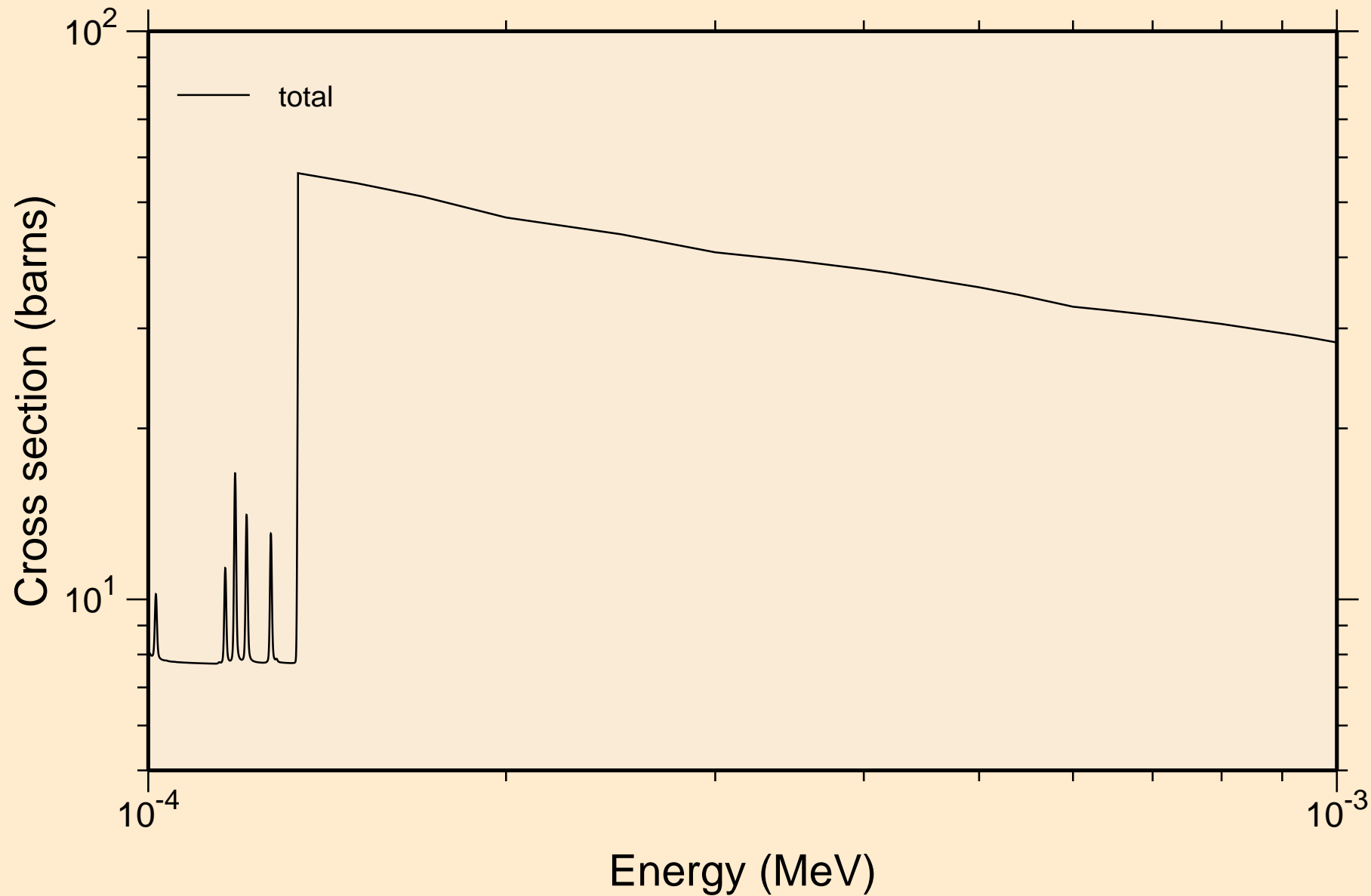

HG195 NEUTRON ACER TENDL-2019 LIBRARY; T=293.16K
resonance total cross section

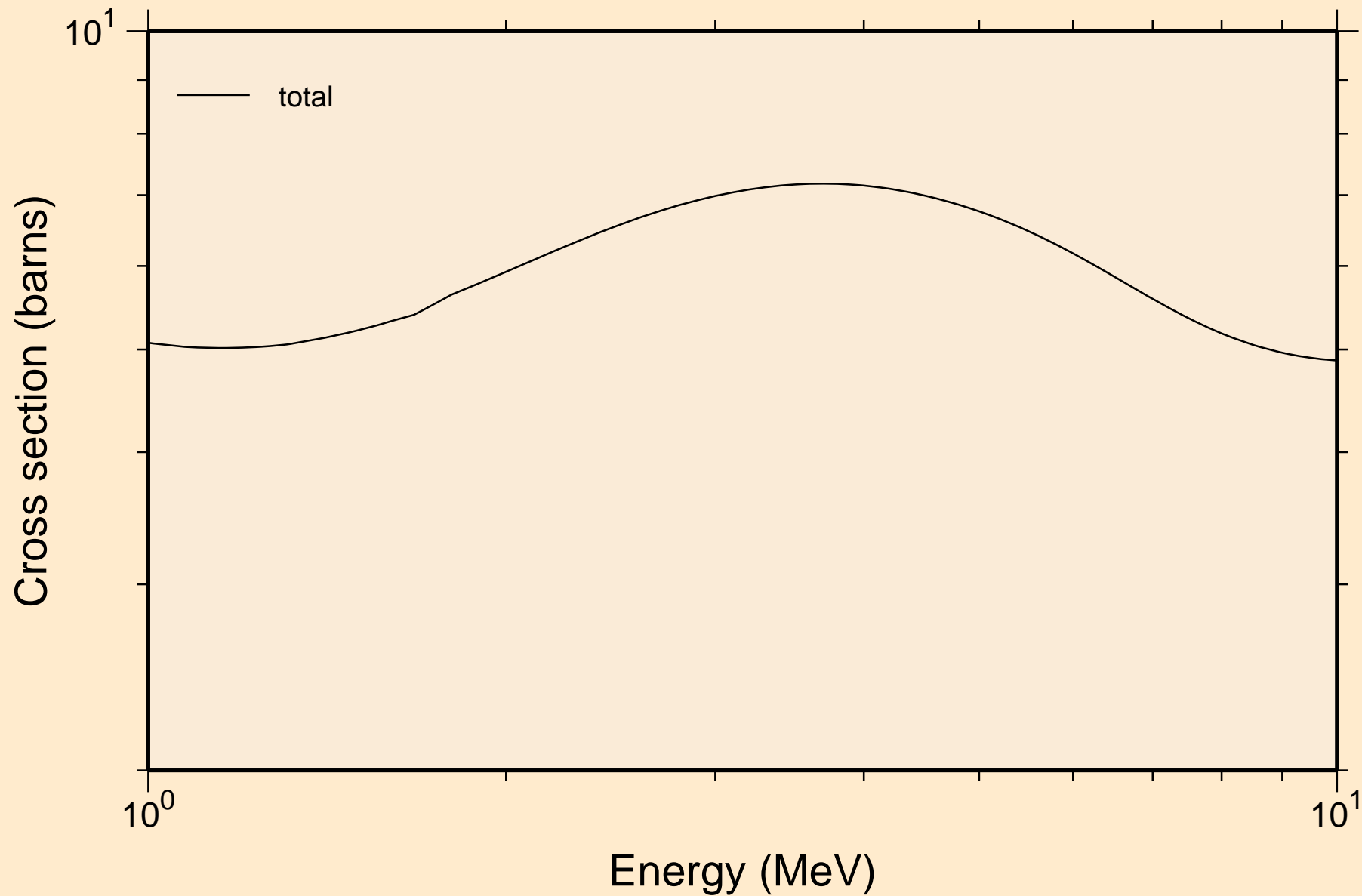

HG195 NEUTRON ACER TENDL-2019 LIBRARY; T=293.16K
resonance absorption cross sections

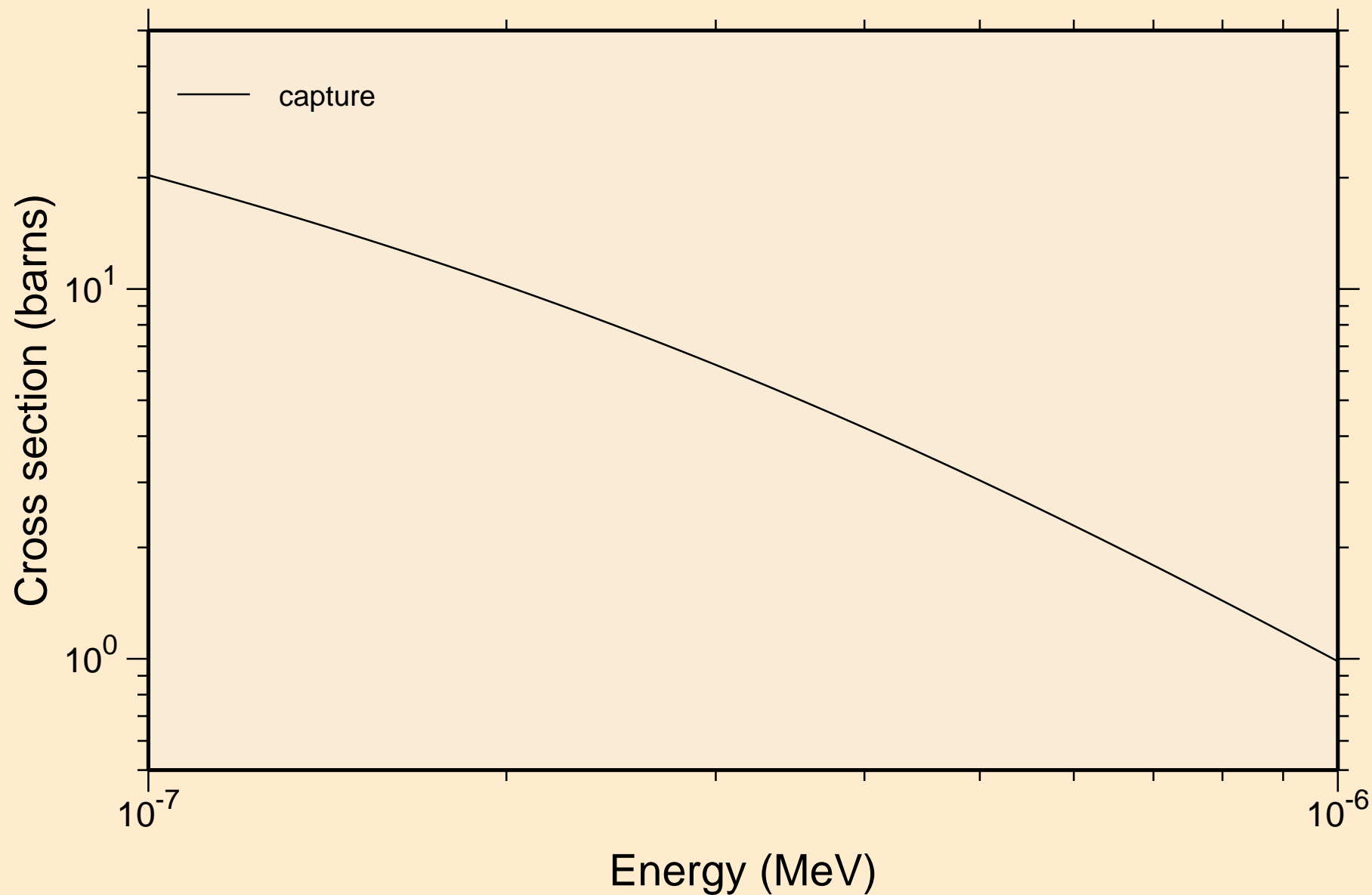

HG195 NEUTRON ACER TENDL-2019 LIBRARY; T=293.16K
resonance absorption cross sections

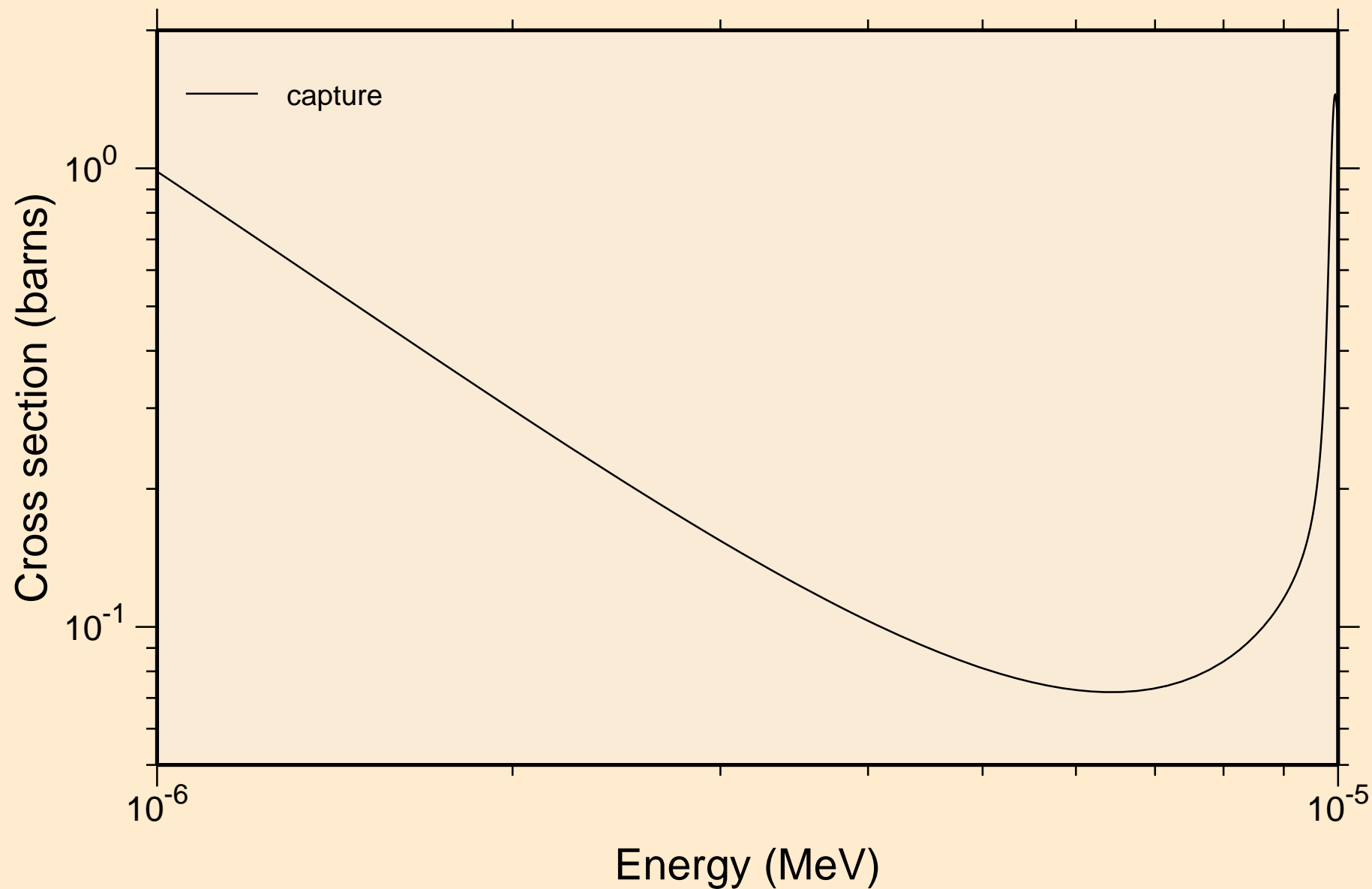

HG195 NEUTRON ACER TENDL-2019 LIBRARY; T=293.16K
resonance absorption cross sections

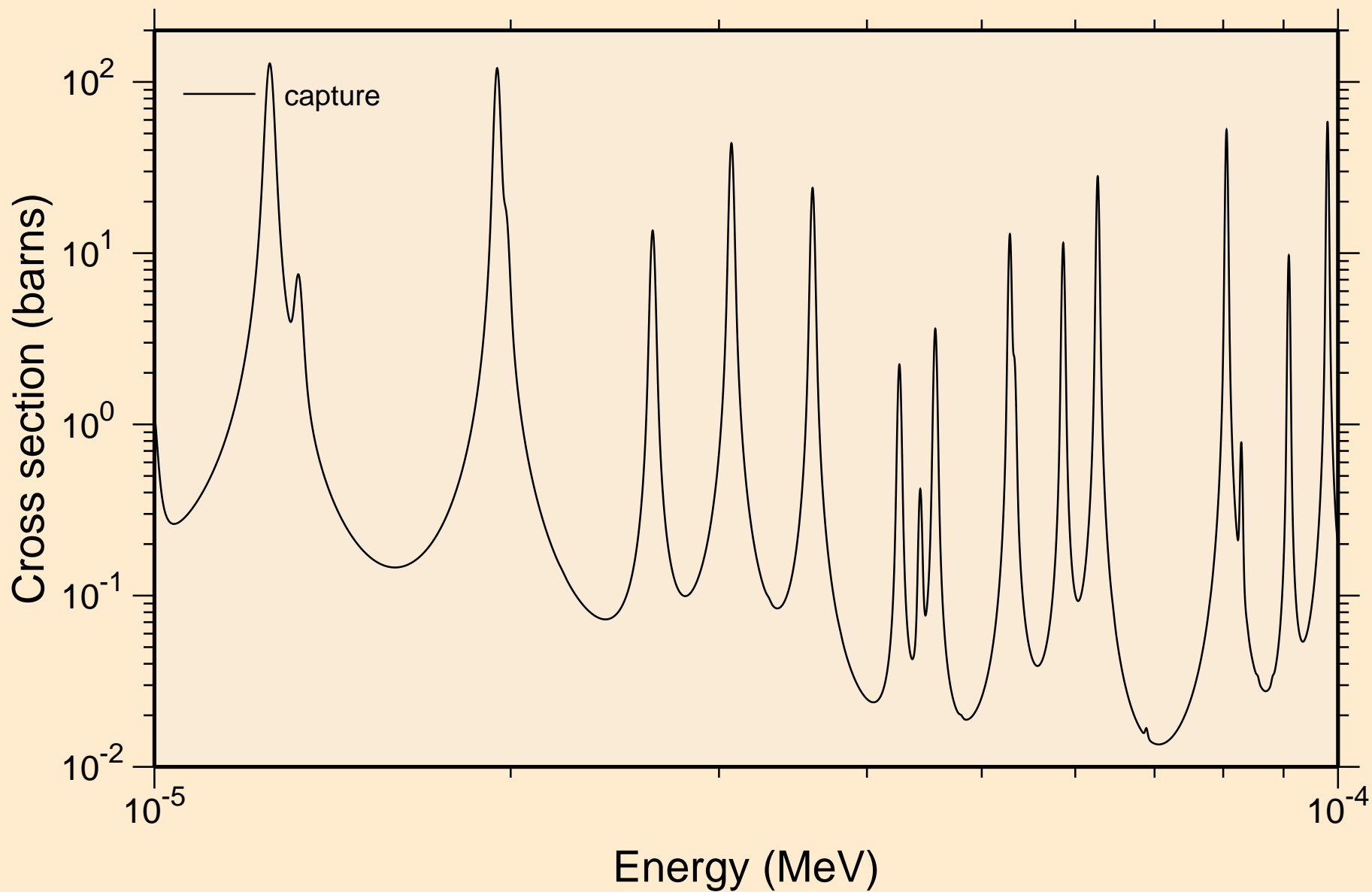

HG195 NEUTRON ACER TENDL-2019 LIBRARY; T=293.16K
resonance absorption cross sections

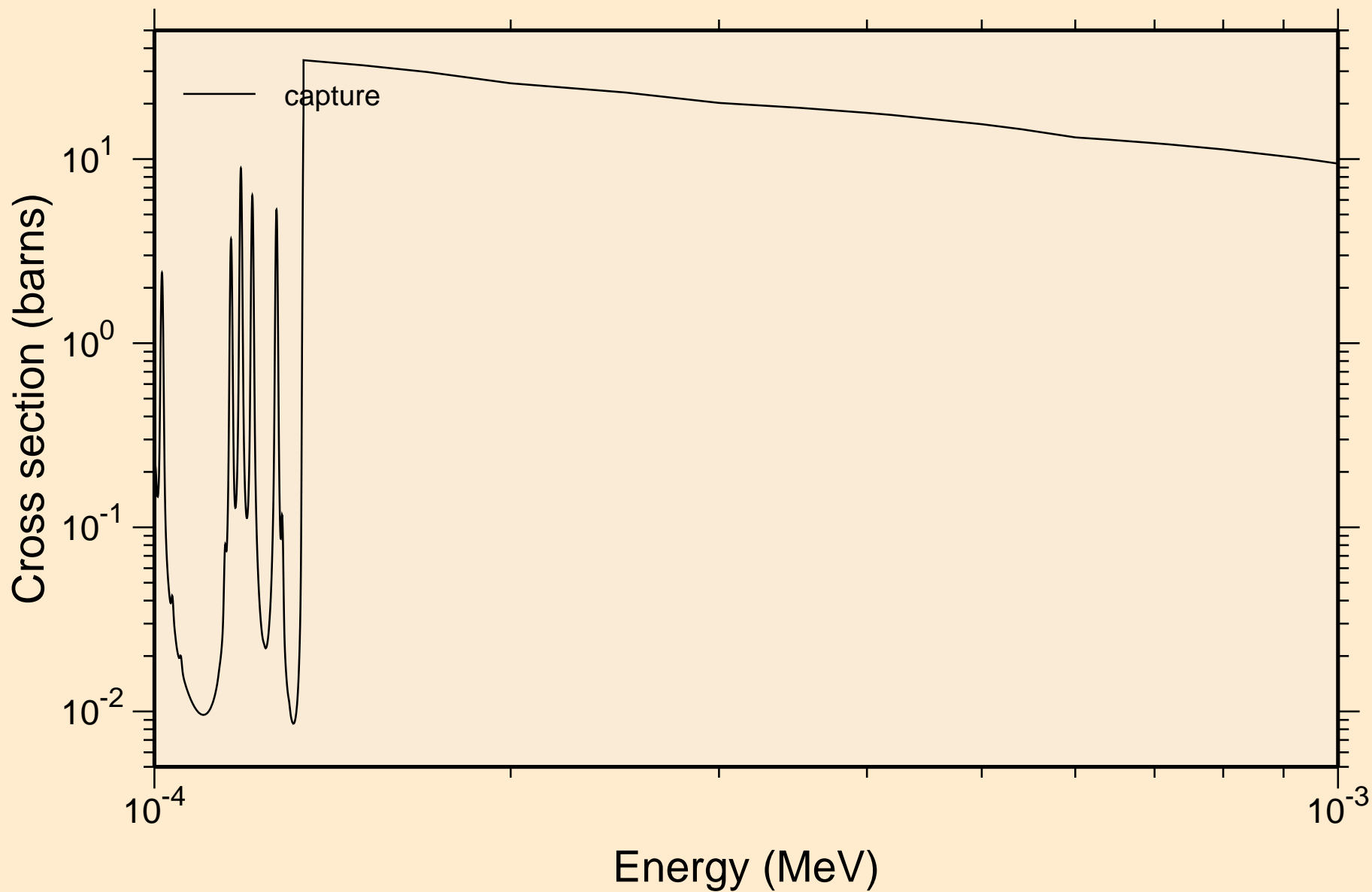

HG195 NEUTRON ACER TENDL-2019 LIBRARY; T=293.16K
resonance absorption cross sections

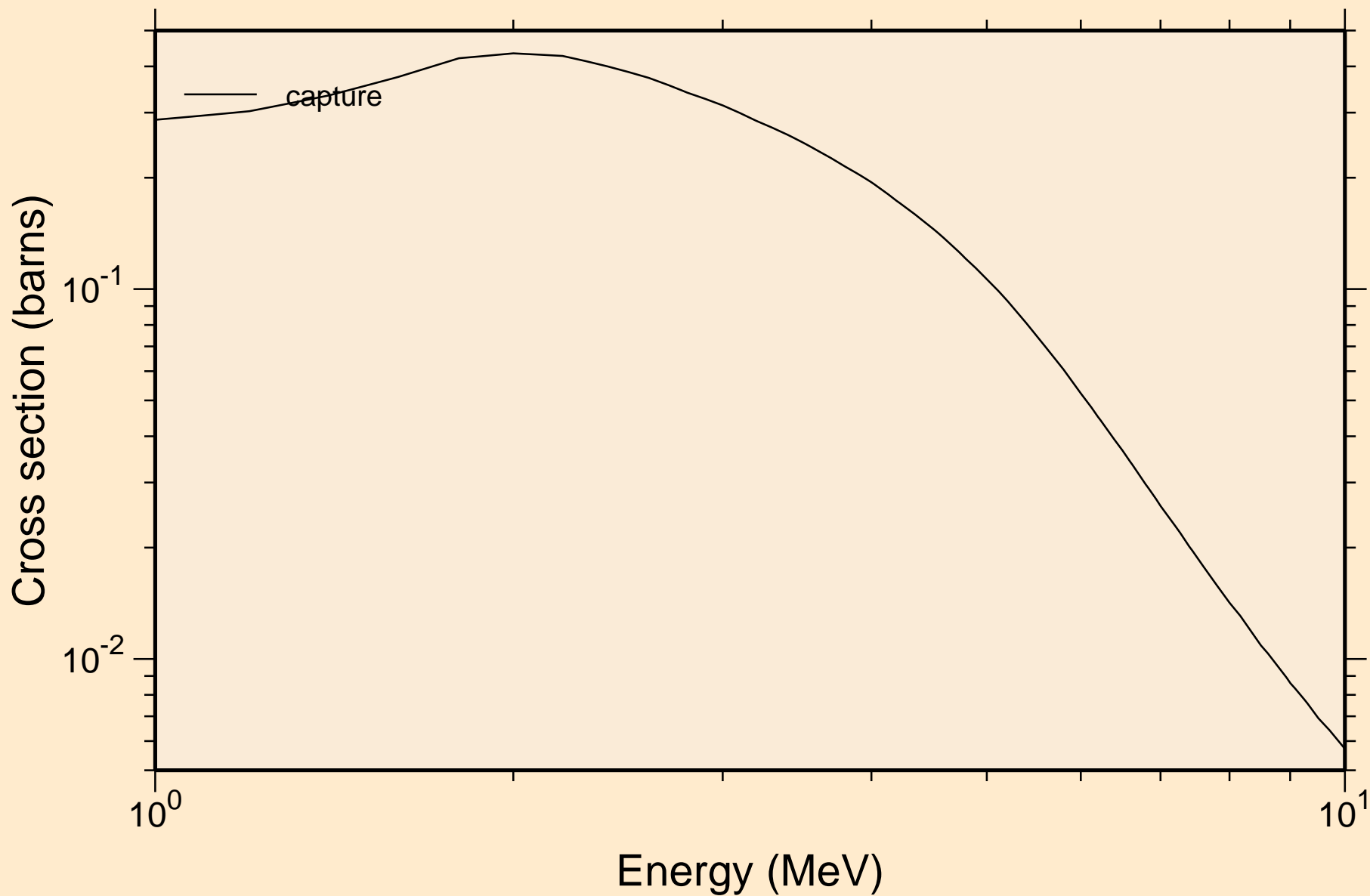

HG195 NEUTRON ACER TENDL-2019 LIBRARY; T=293.16K
Heating

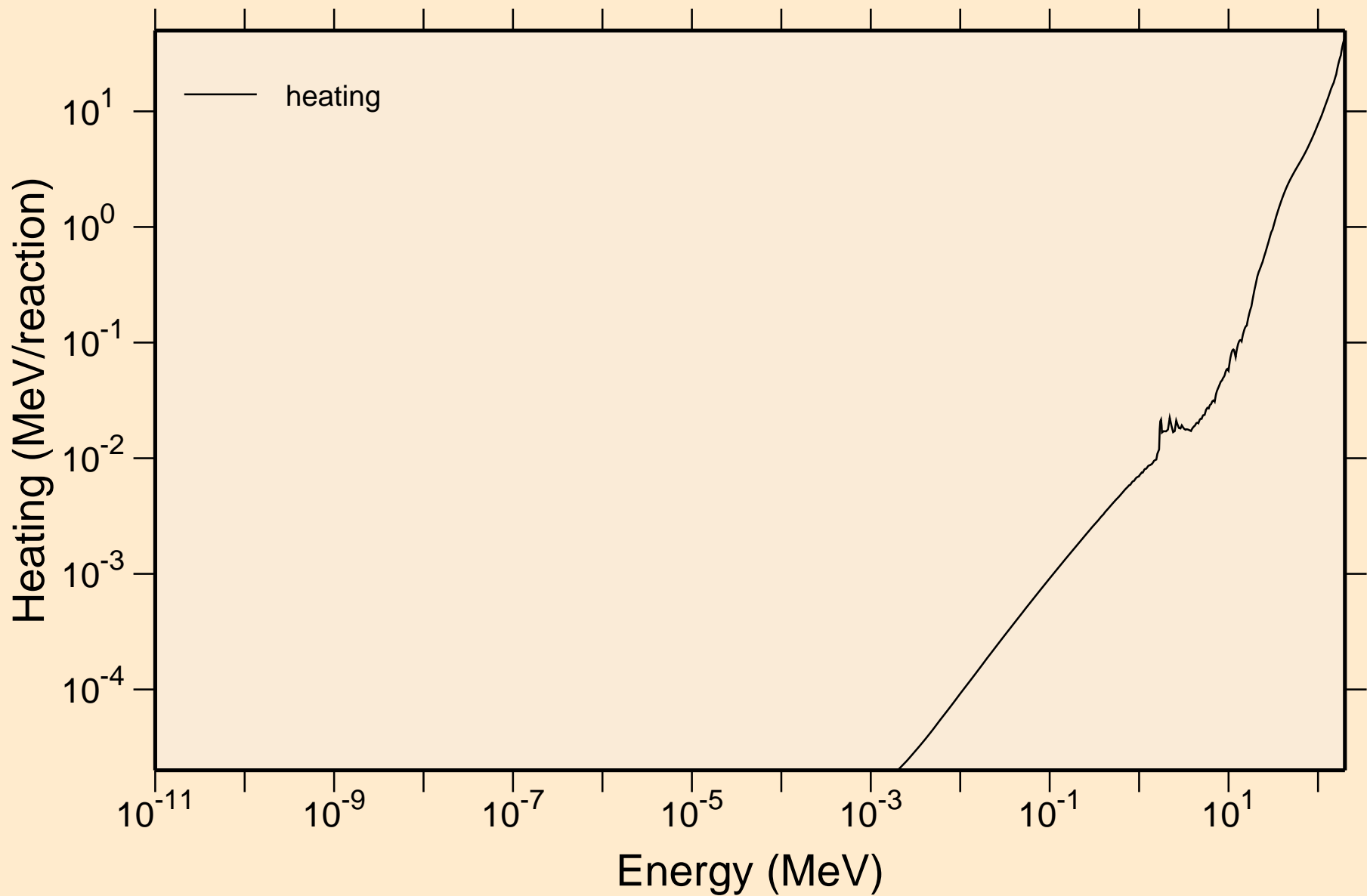

HG195 NEUTRON ACER TENDL-2019 LIBRARY; T=293.16K Damage

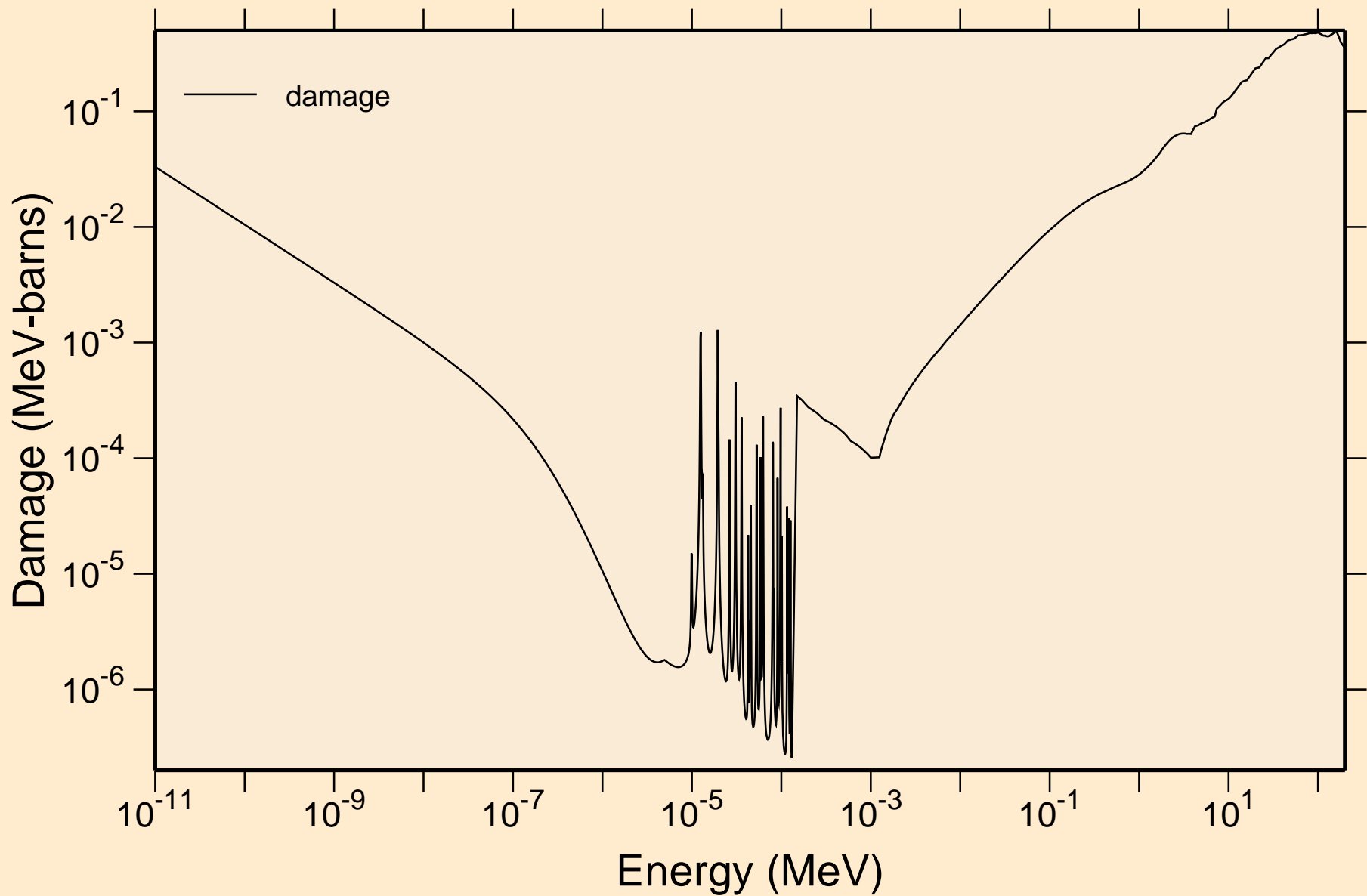

HG195 NEUTRON ACER TENDL-2019 LIBRARY; T=293.16K
Non-threshold reactions

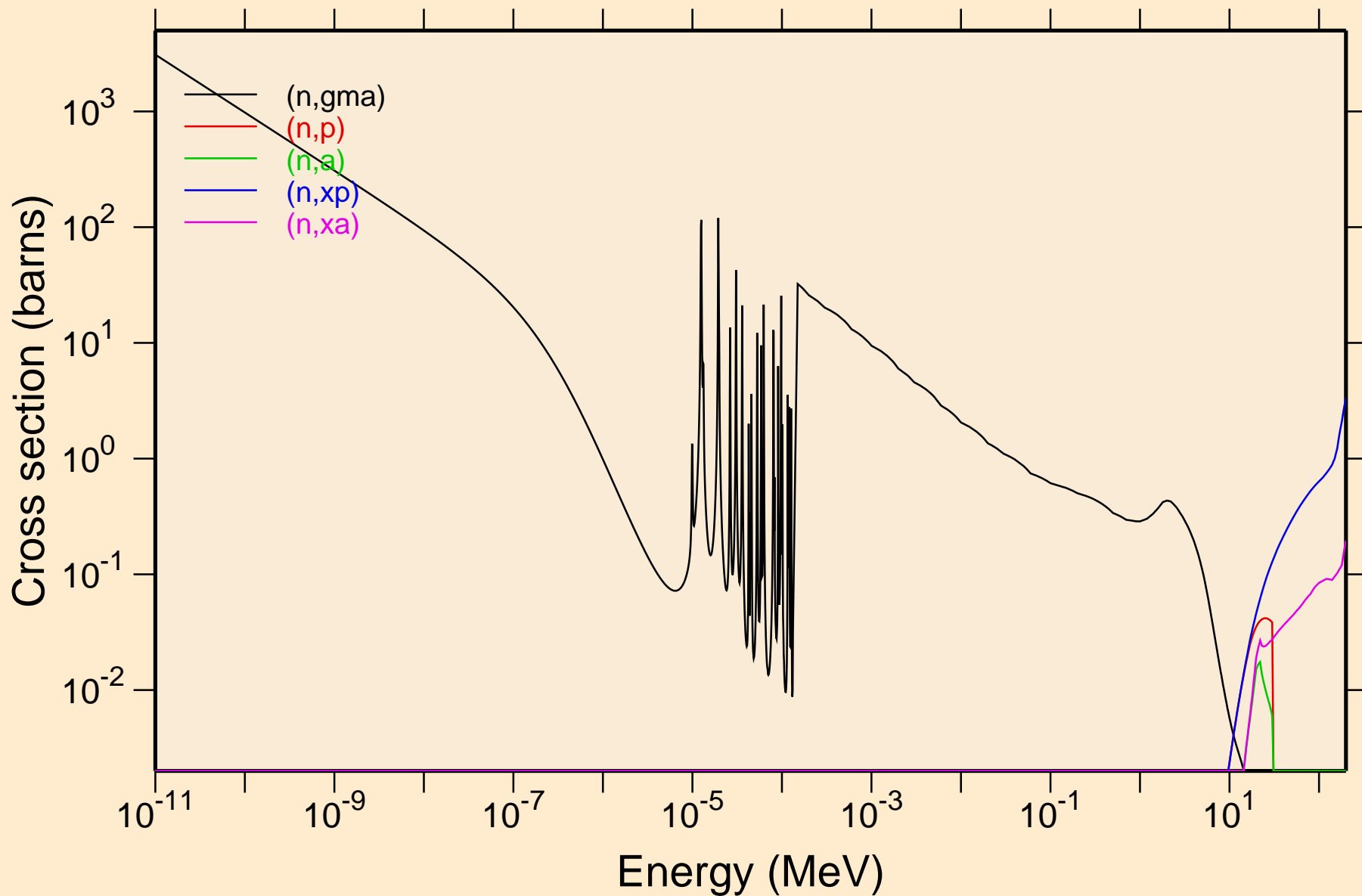

HG195 NEUTRON ACER TENDL-2019 LIBRARY; T=293.16K

Principal cross sections

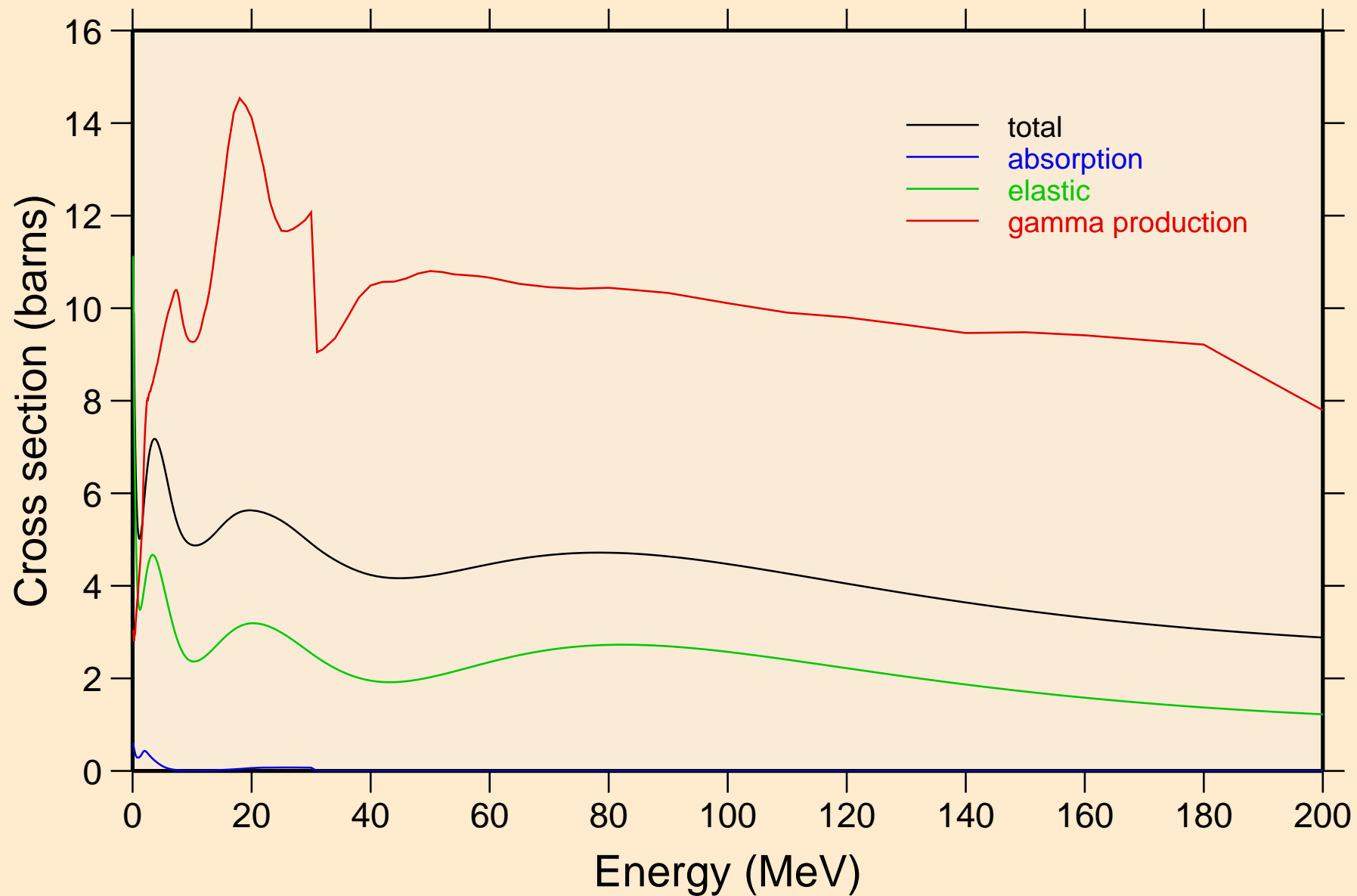

HG195 NEUTRON ACER TENDL-2019 LIBRARY; T=293.16K

Heating

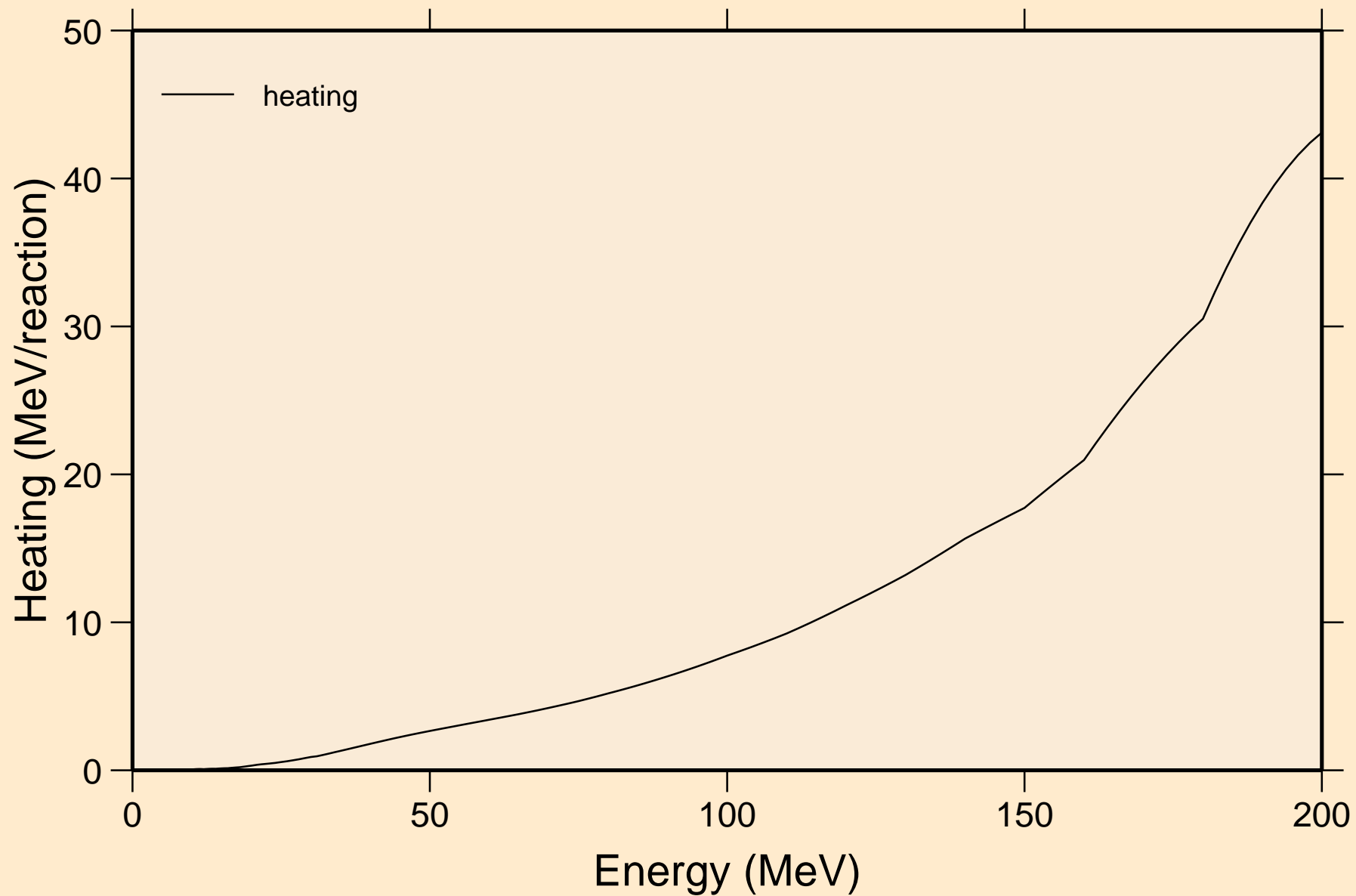

HG195 NEUTRON ACER TENDL-2019 LIBRARY; T=293.16K Damage

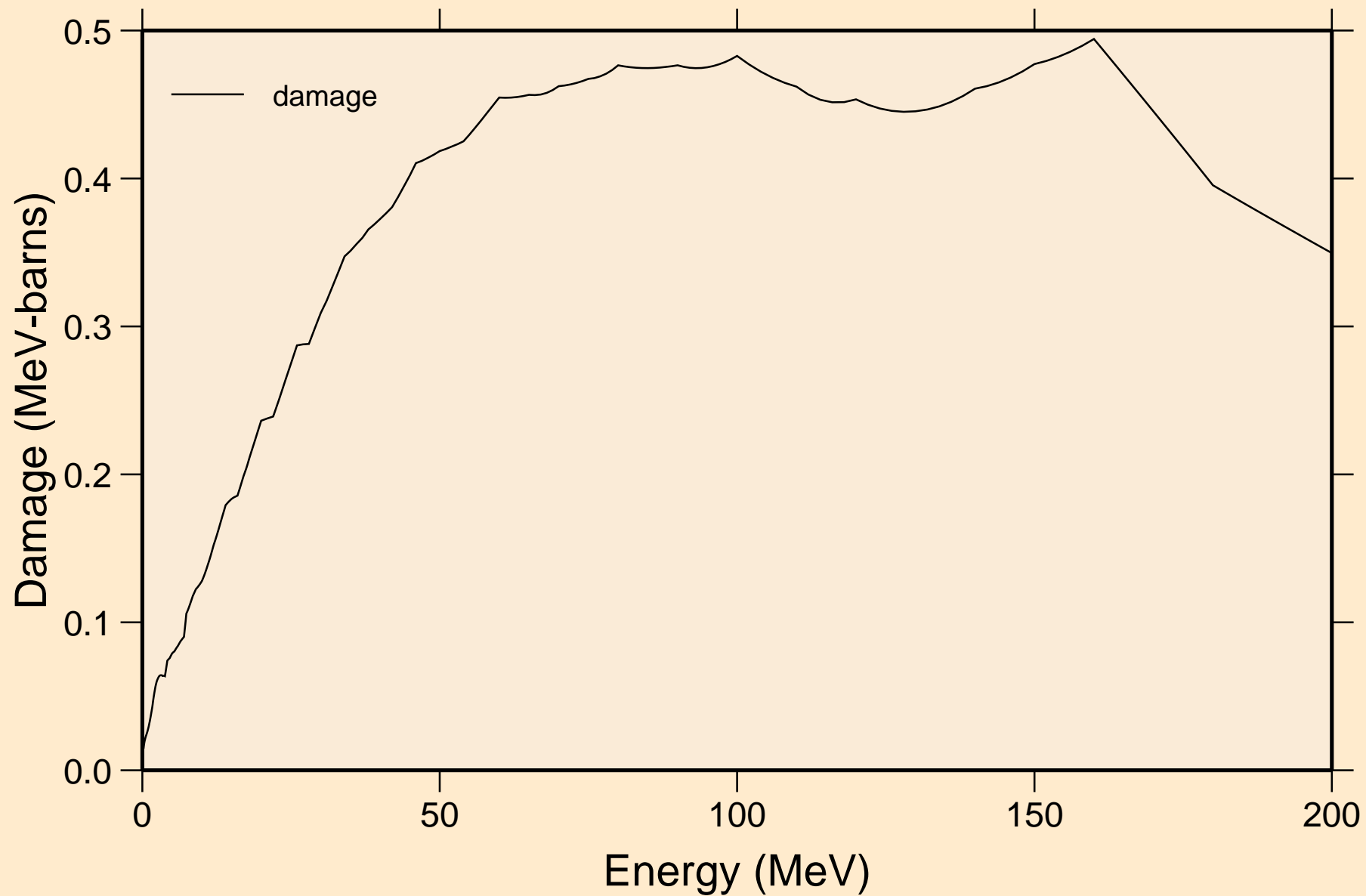

HG195 NEUTRON ACER TENDL-2019 LIBRARY; T=293.16K

Non-threshold reactions

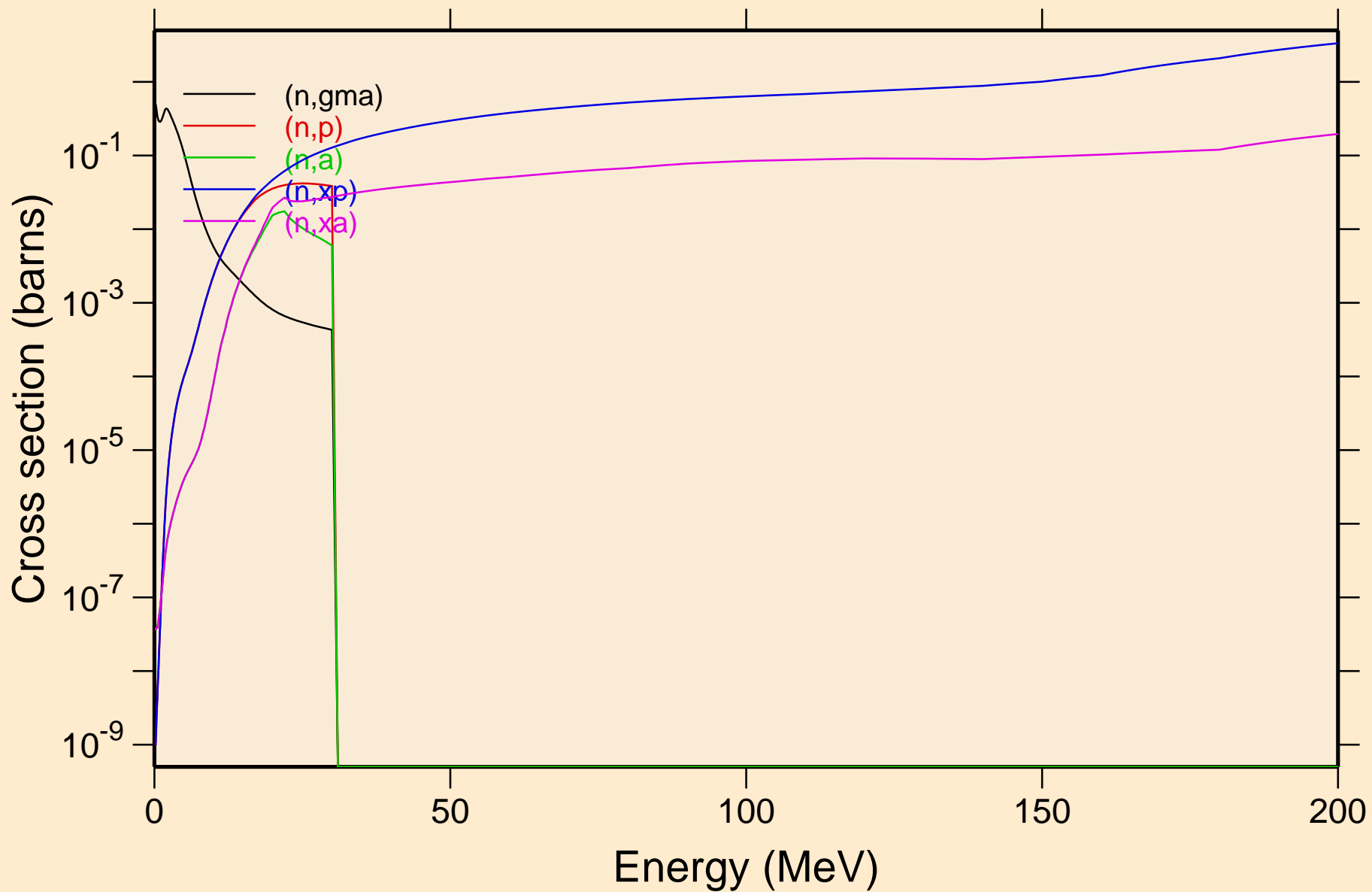

HG195 NEUTRON ACER TENDL-2019 LIBRARY; T=293.16K
Inelastic levels

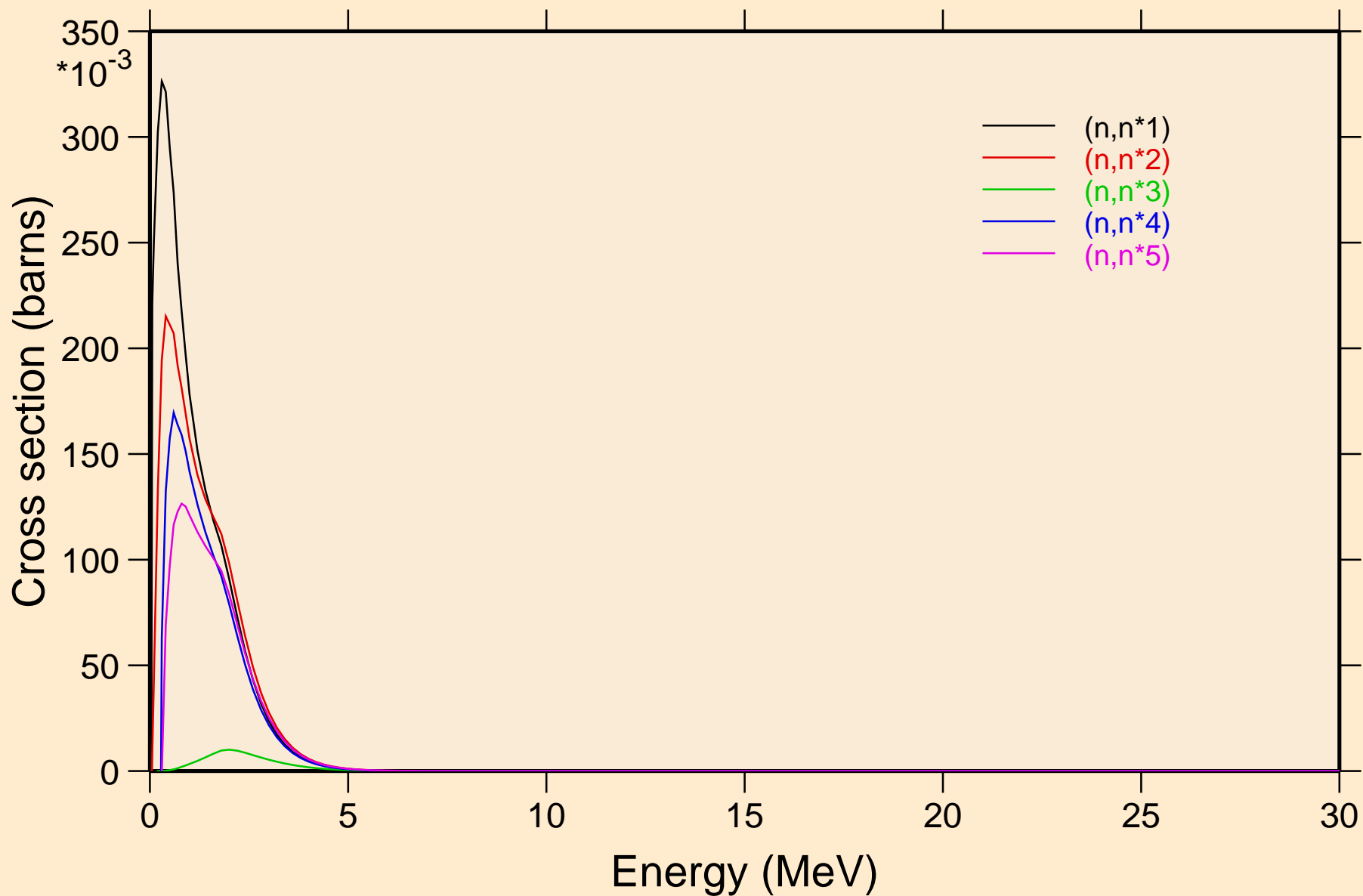

HG195 NEUTRON ACER TENDL-2019 LIBRARY; T=293.16K
Inelastic levels

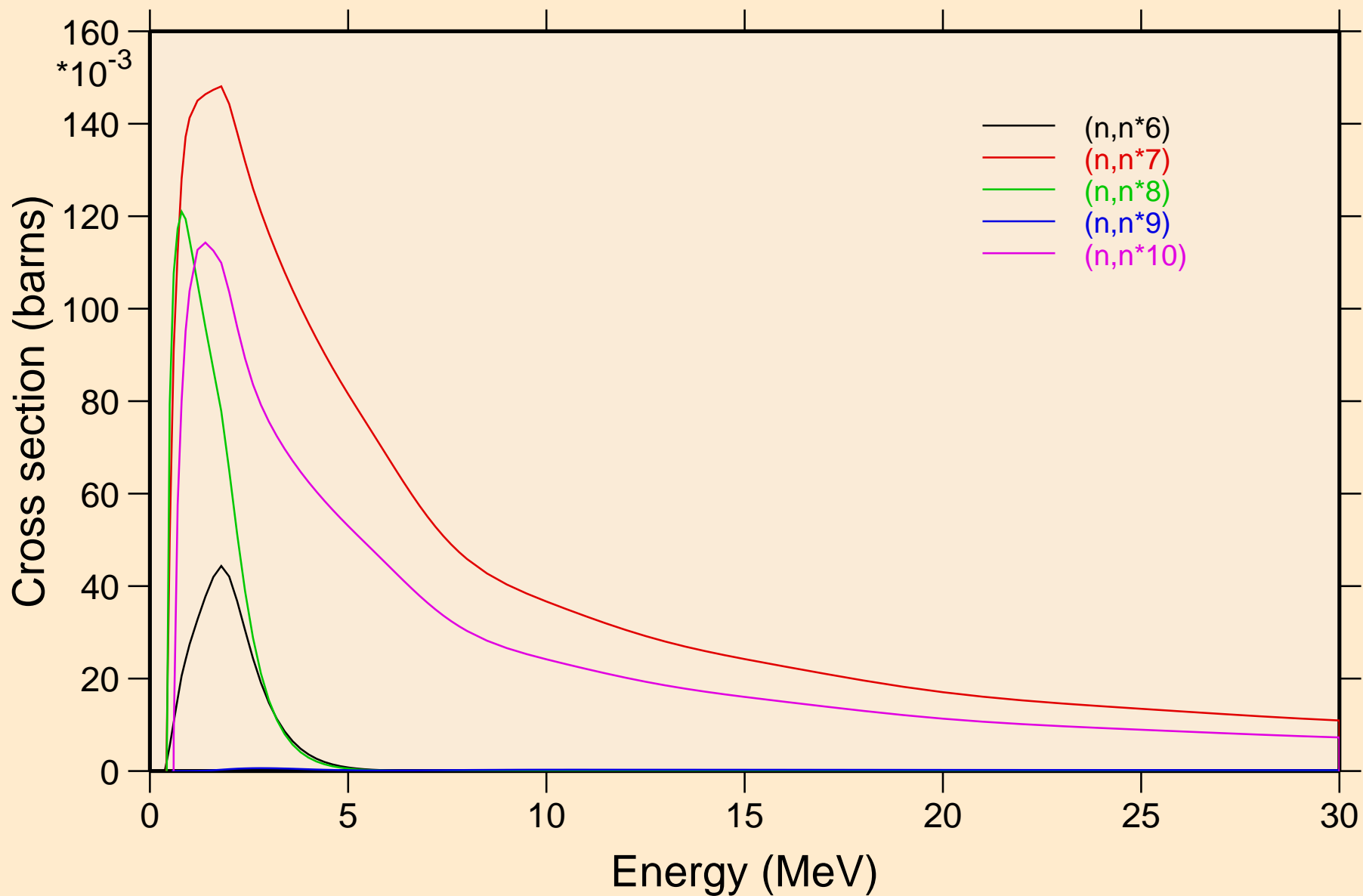

HG195 NEUTRON ACER TENDL-2019 LIBRARY; T=293.16K

Inelastic levels

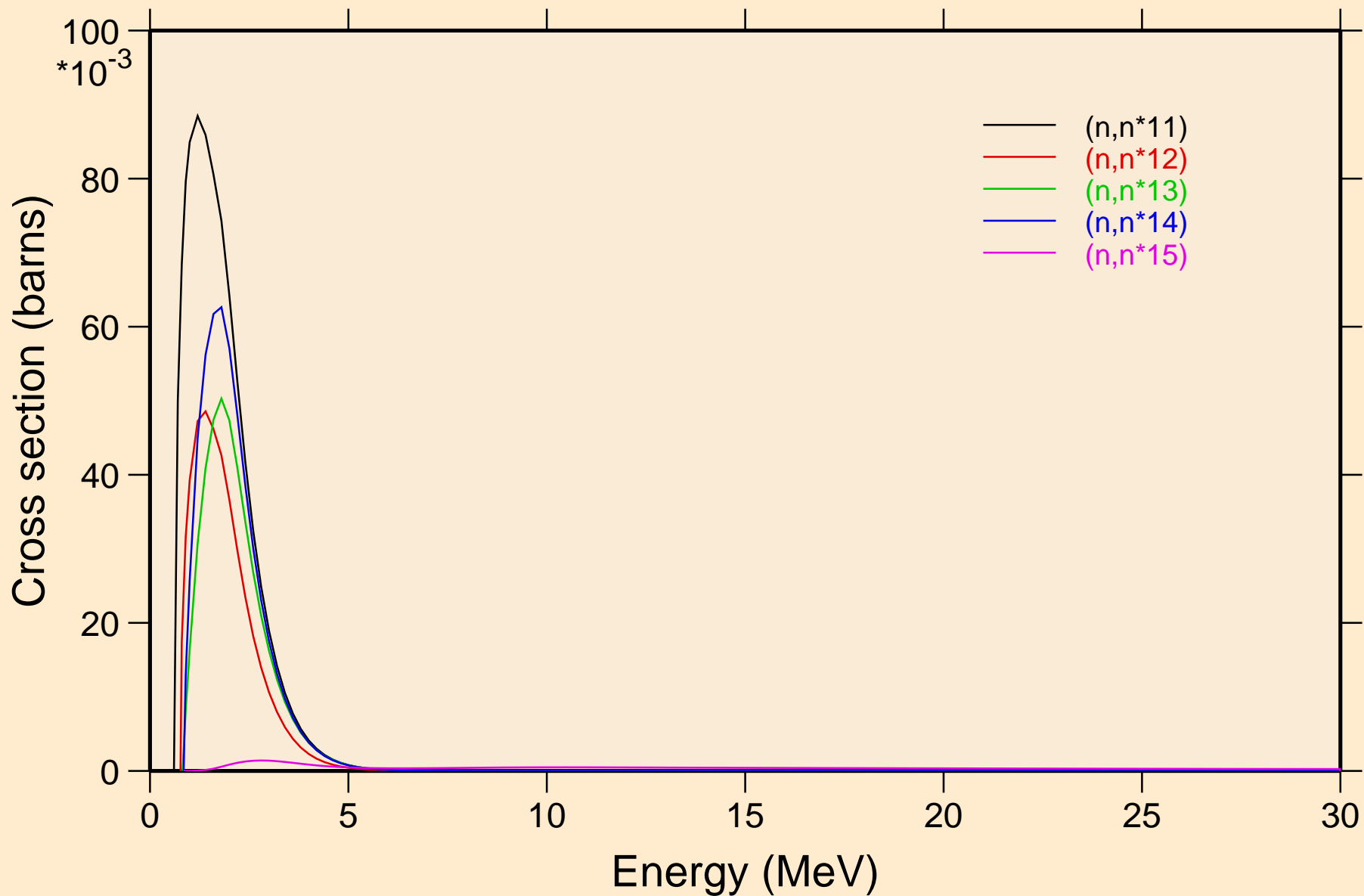

HG195 NEUTRON ACER TENDL-2019 LIBRARY; T=293.16K

Inelastic levels

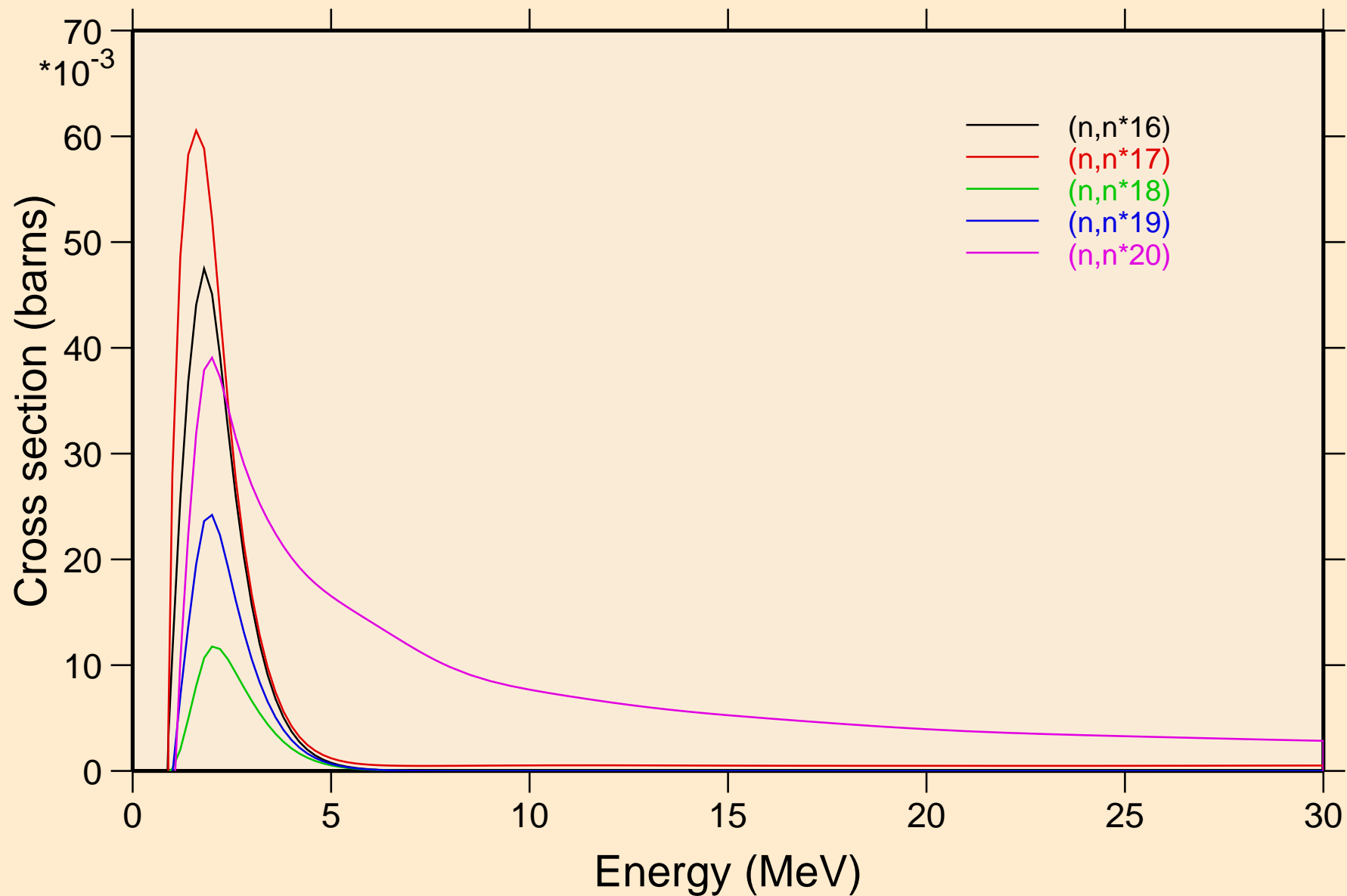

HG195 NEUTRON ACER TENDL-2019 LIBRARY; T=293.16K

Inelastic levels

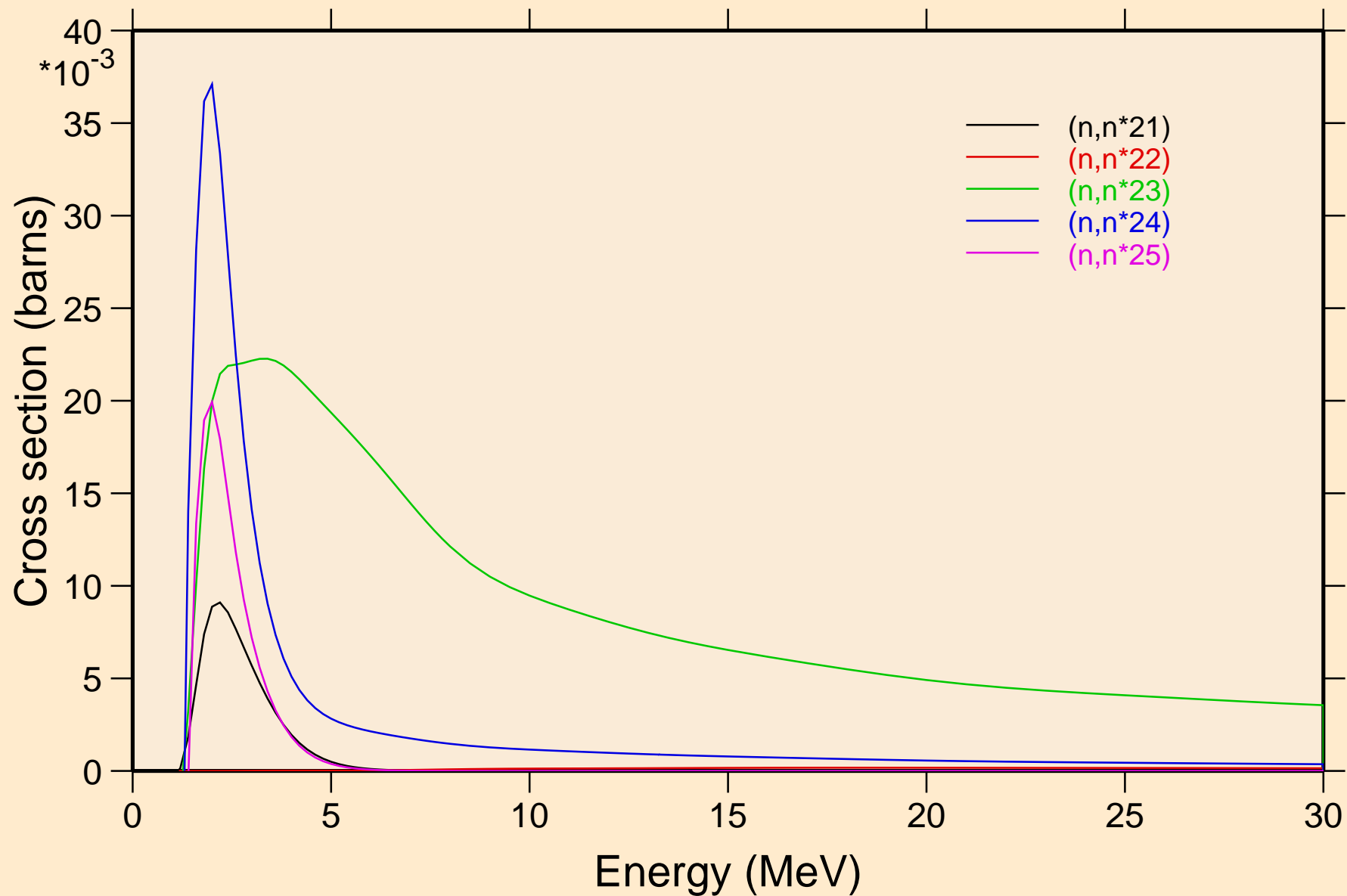

HG195 NEUTRON ACER TENDL-2019 LIBRARY; T=293.16K

Inelastic levels

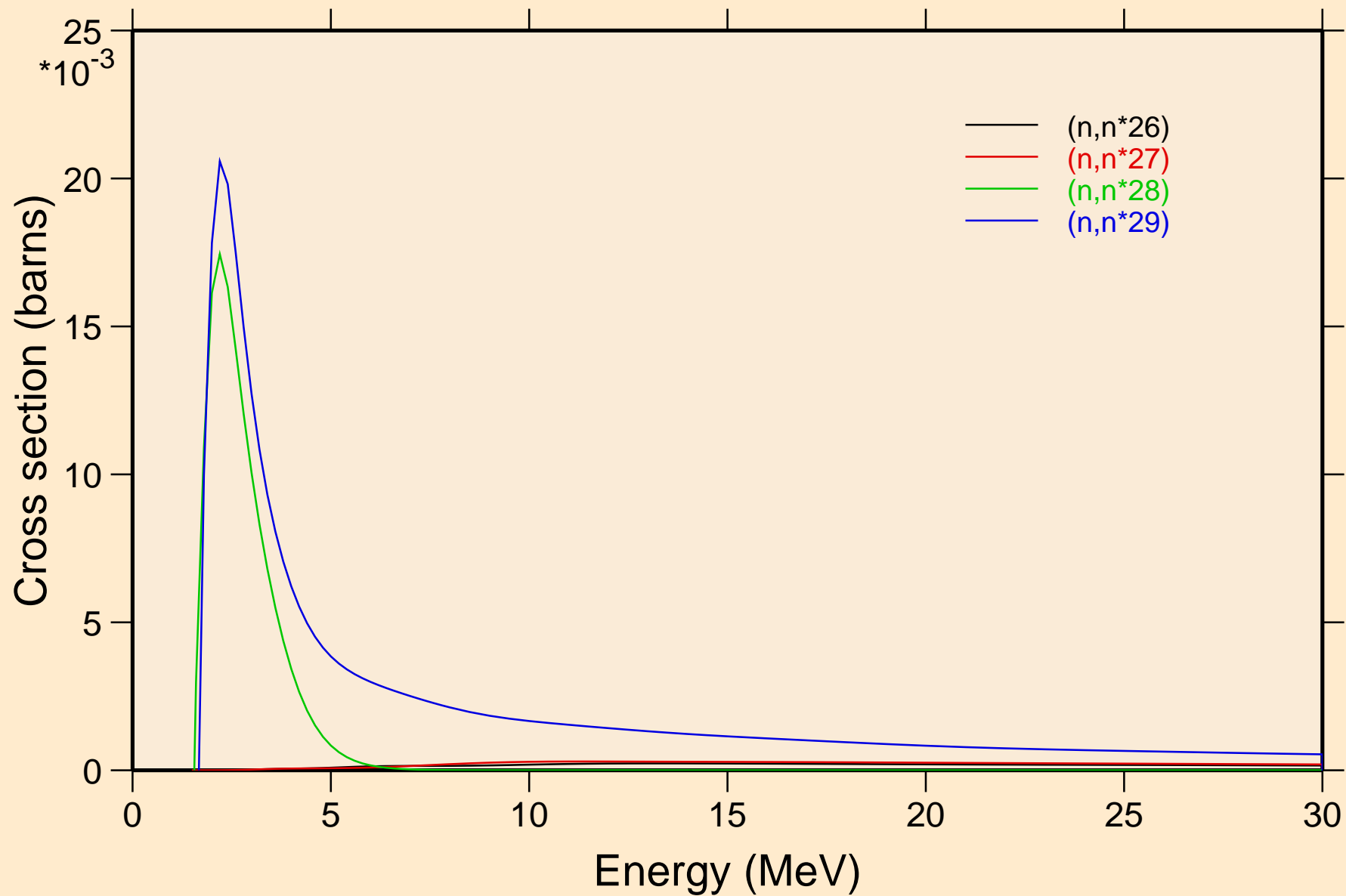

HG195 NEUTRON ACER TENDL-2019 LIBRARY; T=293.16K

Threshold reactions

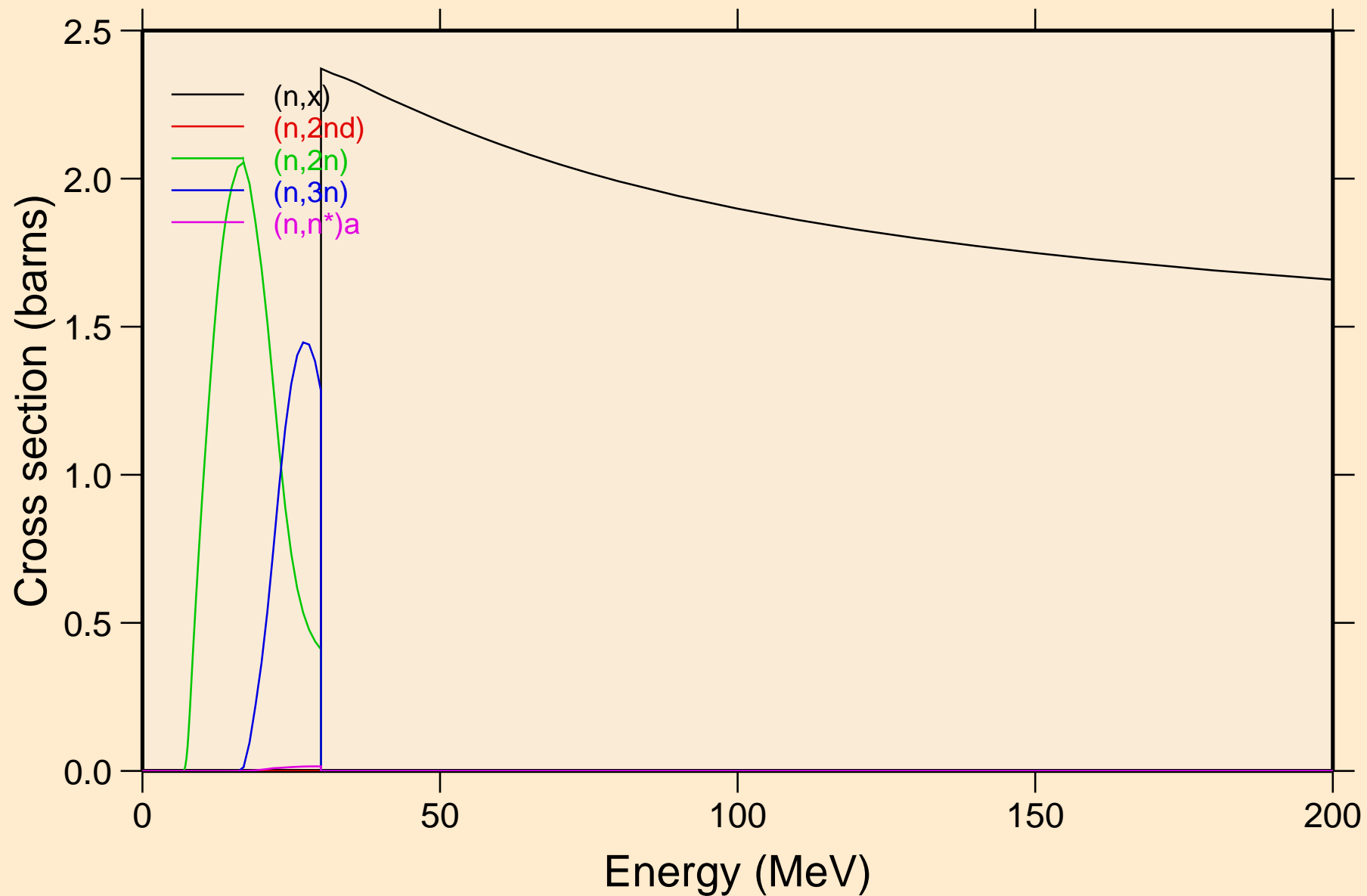

HG195 NEUTRON ACER TENDL-2019 LIBRARY; T=293.16K

Threshold reactions

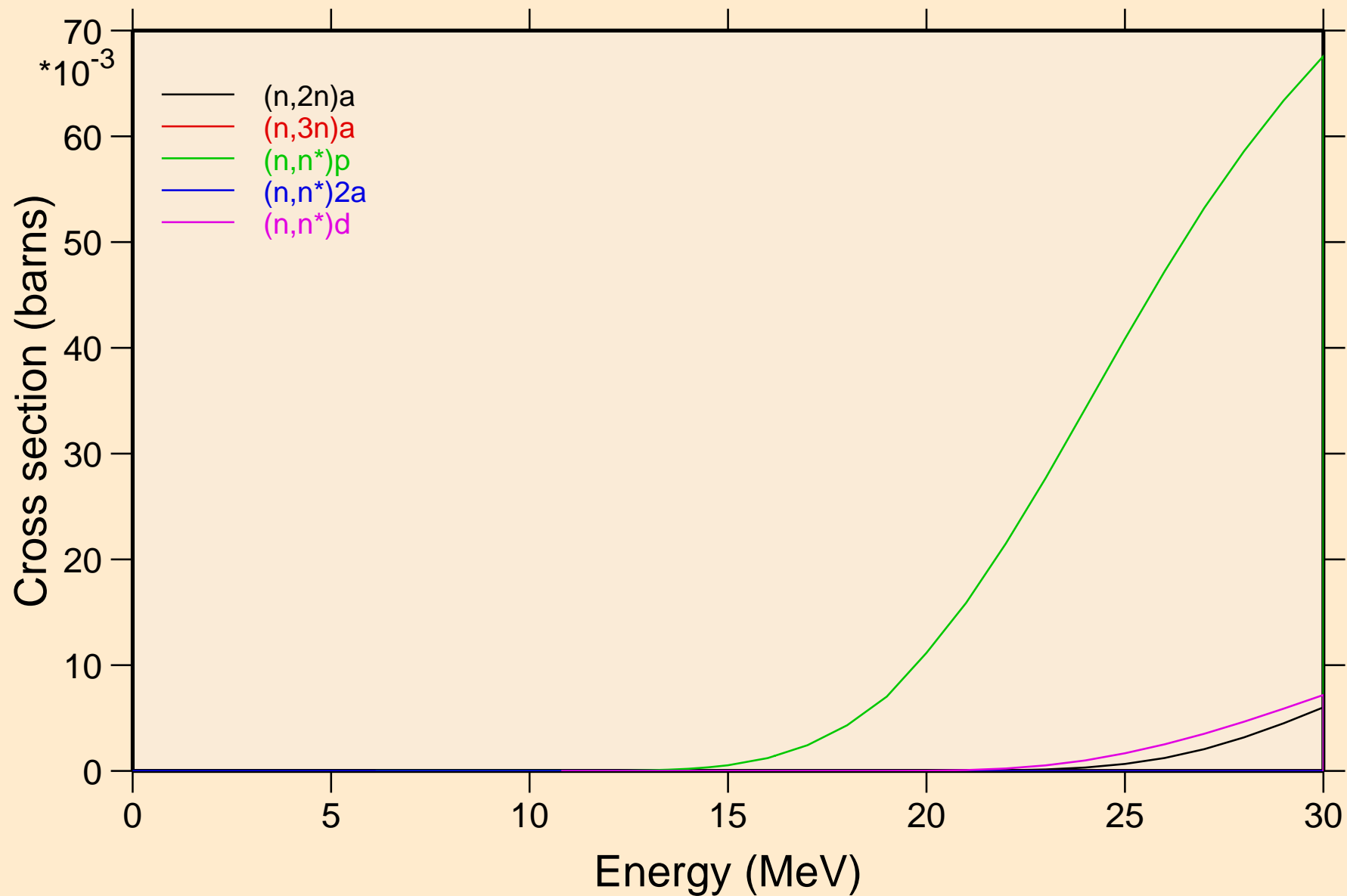

HG195 NEUTRON ACER TENDL-2019 LIBRARY; T=293.16K

Threshold reactions

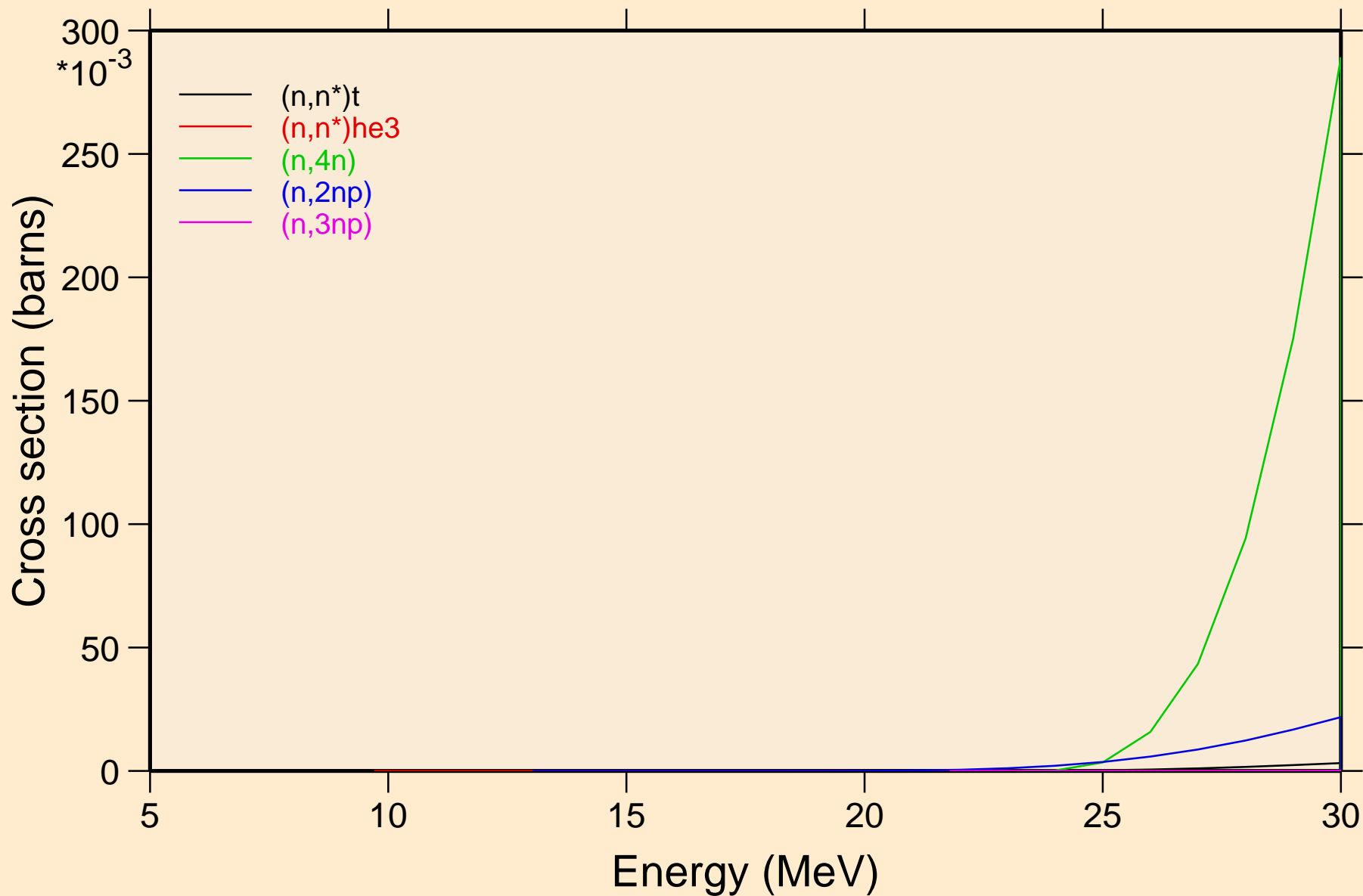

HG195 NEUTRON ACER TENDL-2019 LIBRARY; T=293.16K

Threshold reactions

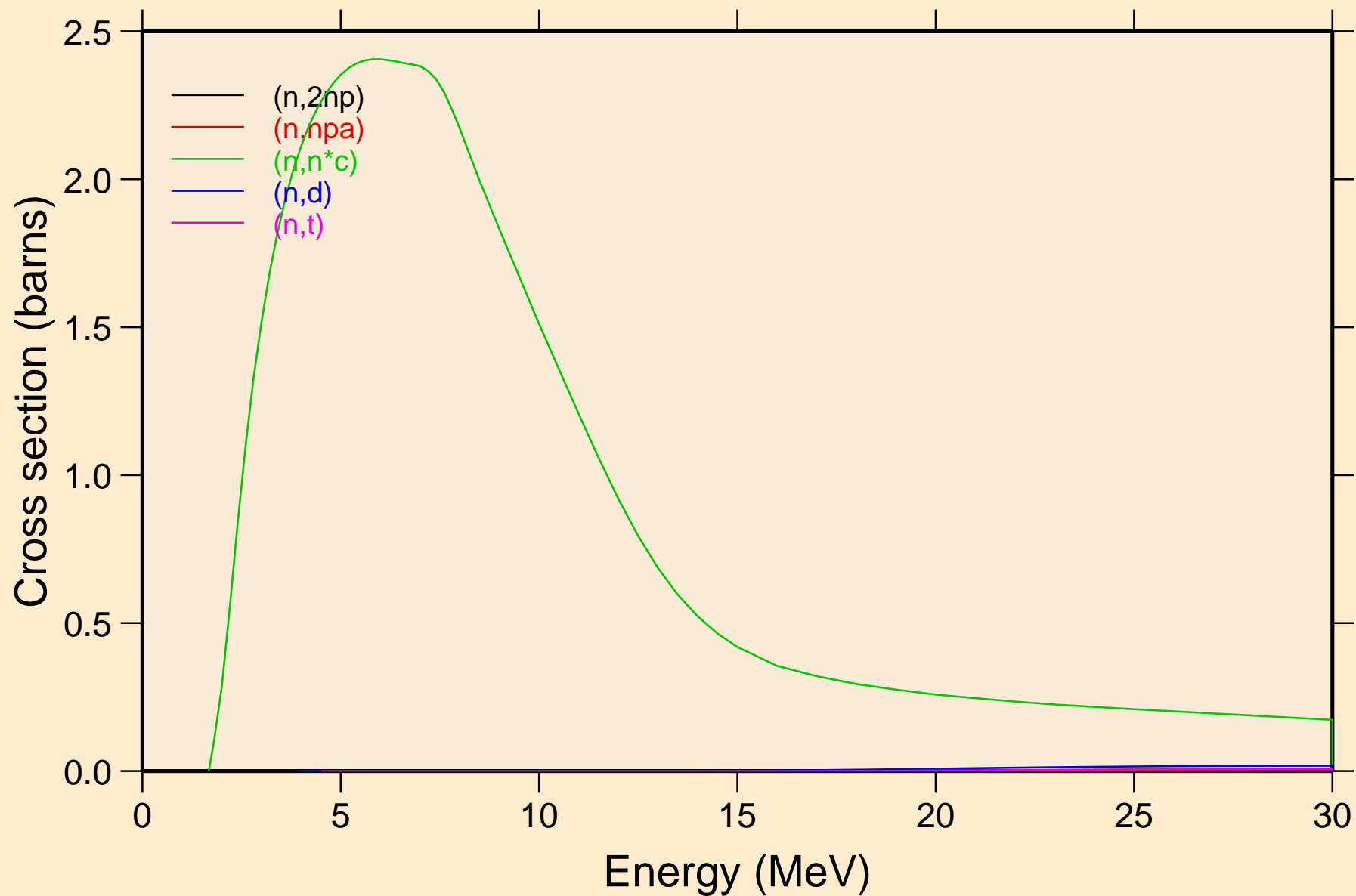

HG195 NEUTRON ACER TENDL-2019 LIBRARY; T=293.16K

Threshold reactions

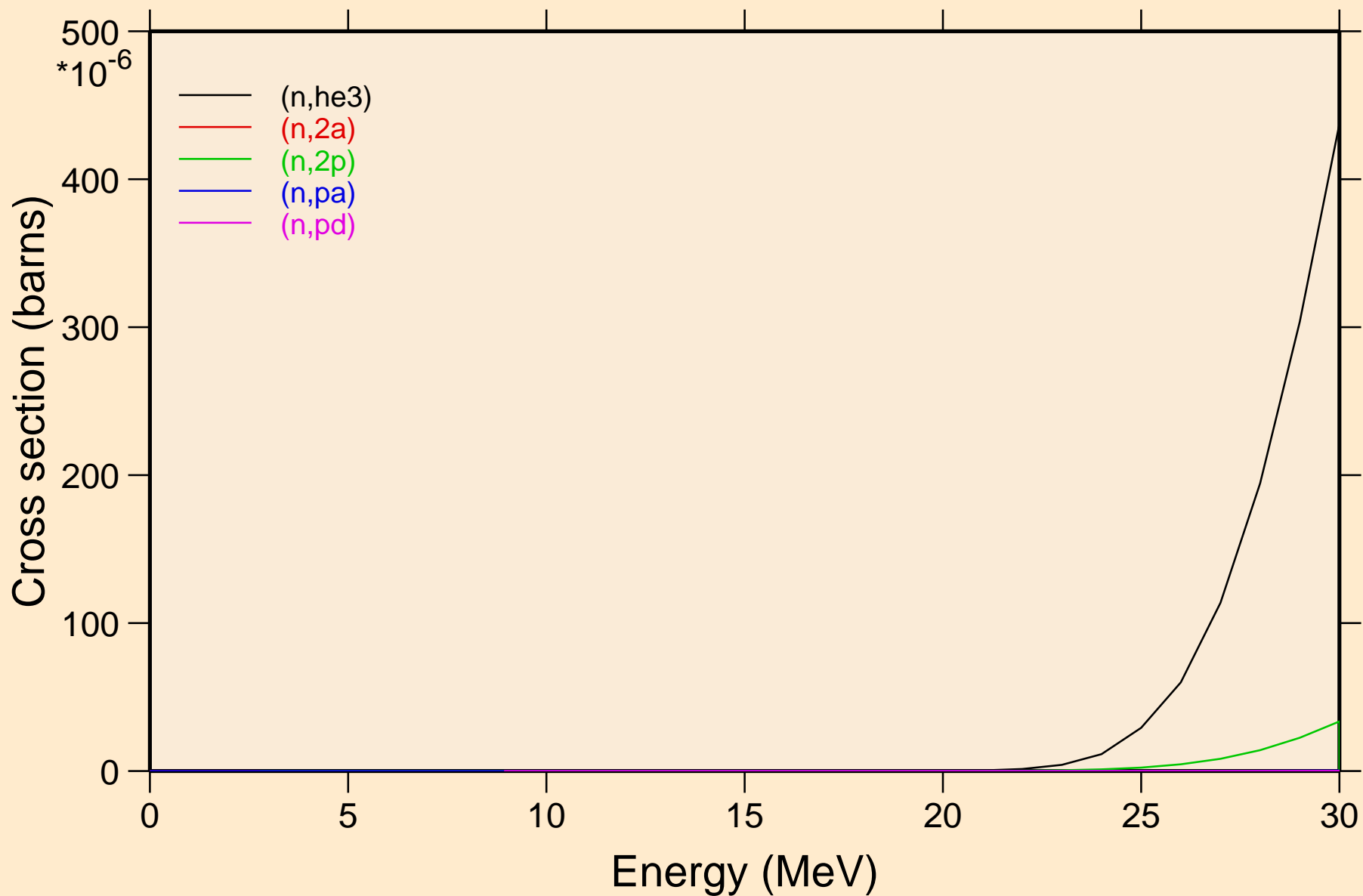

HG195 NEUTRON ACER TENDL-2019 LIBRARY; T=293.16K

Threshold reactions

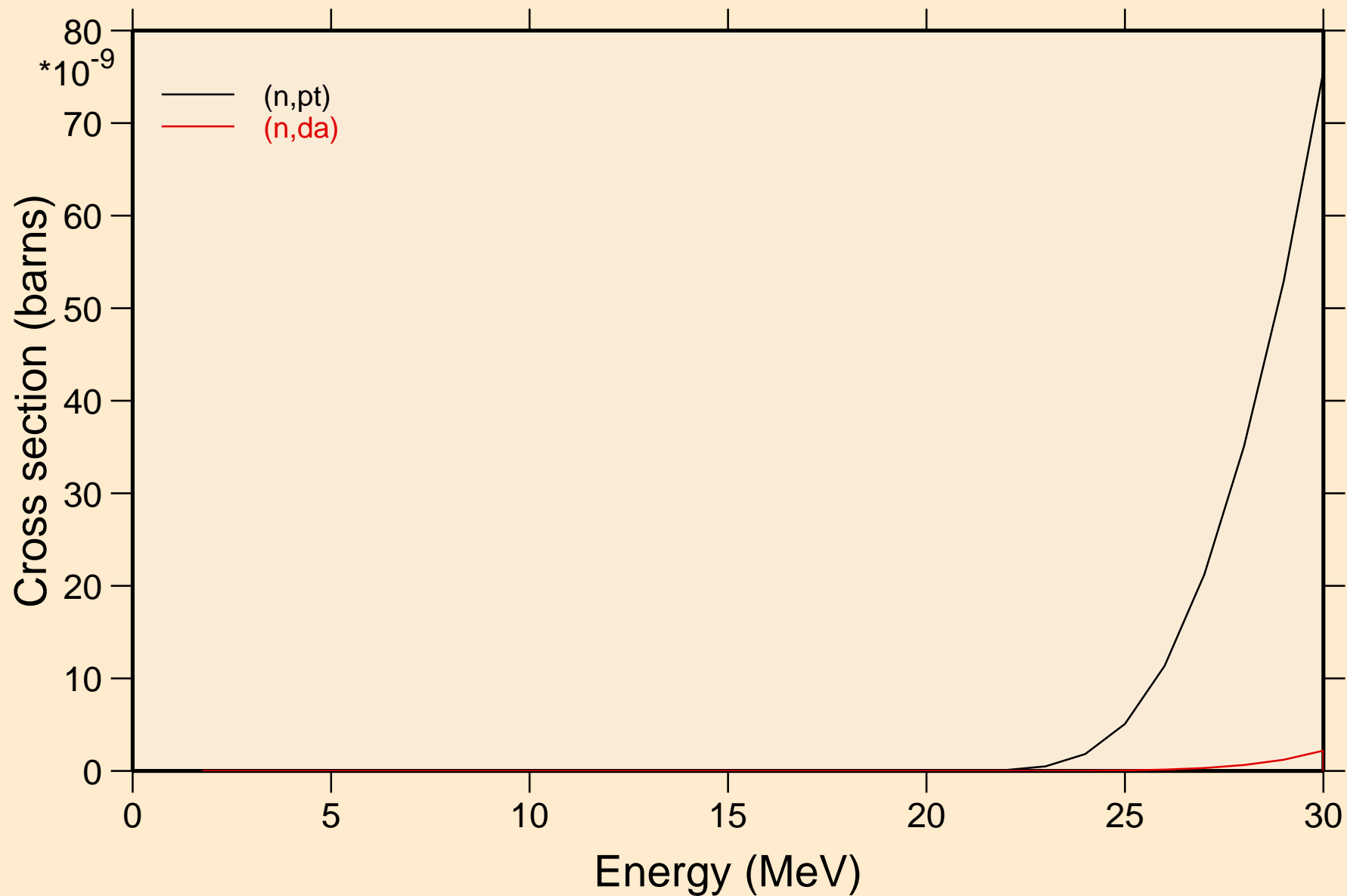

HG195 NEUTRON ACER TENDL-2019 LIBRARY; T=293.16K

Threshold reactions

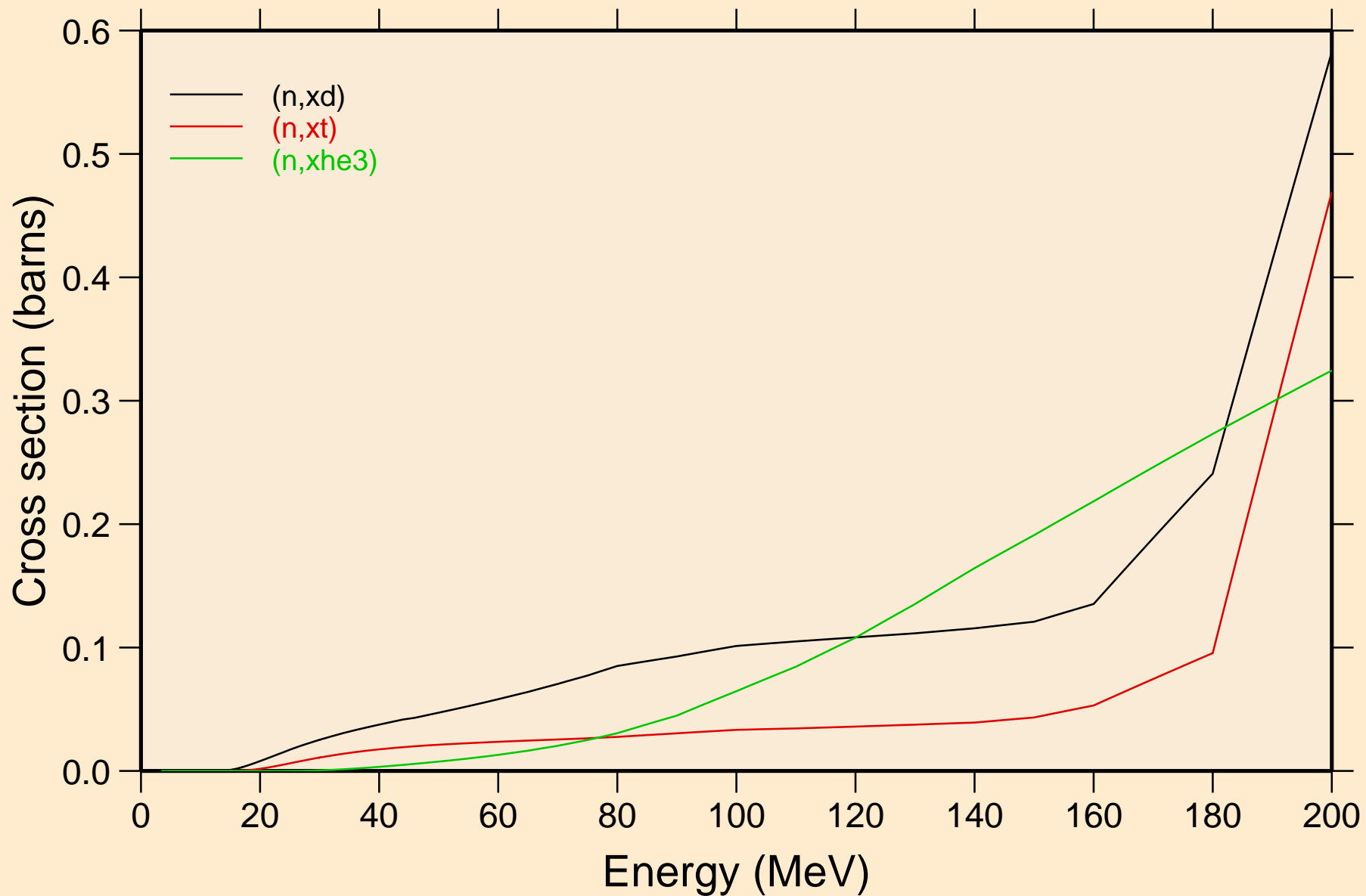

HG195 NEUTRON ACER TENDL-2019 LIBRARY; T=293.16K
angular distribution for elastic

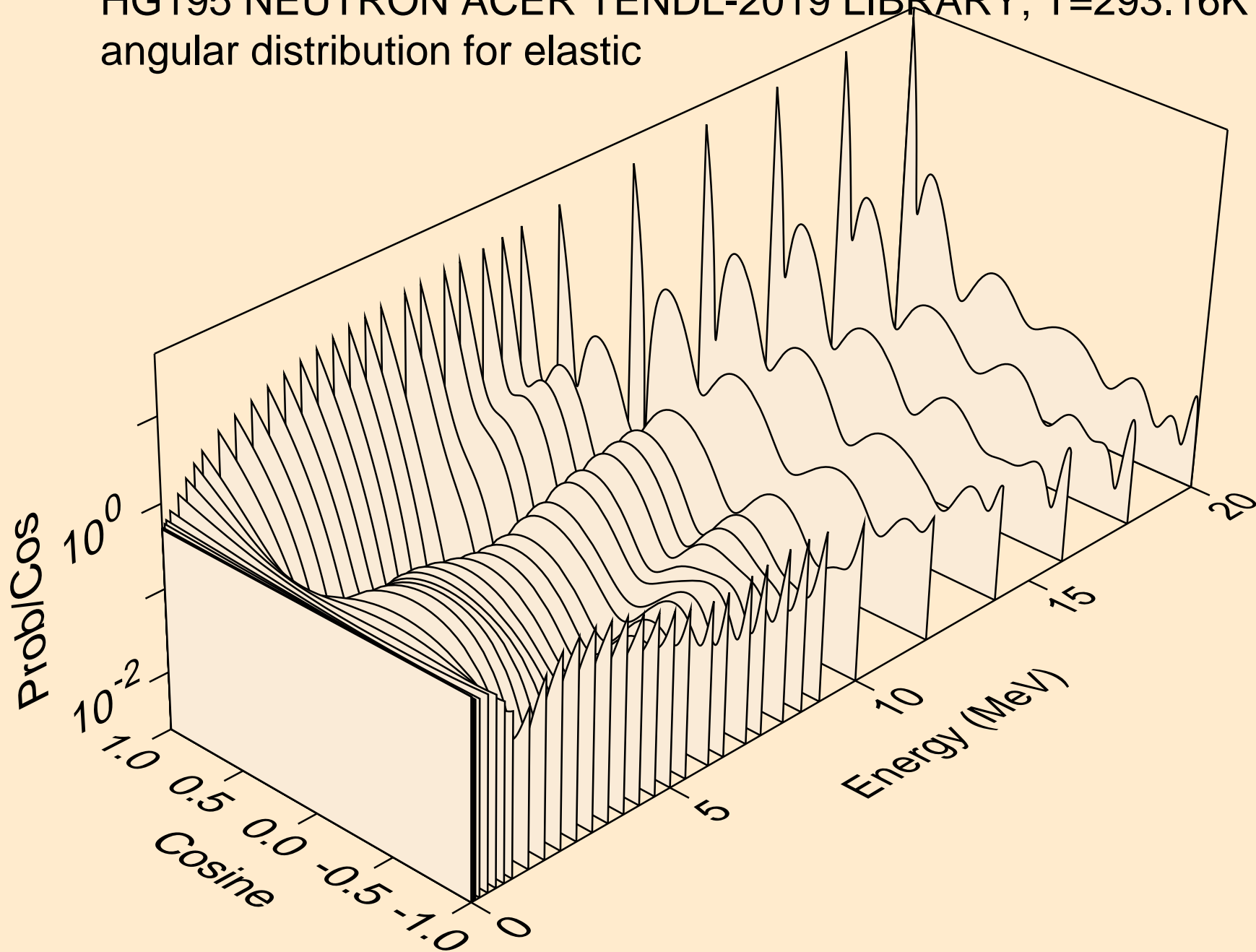

HG195 NEUTRON ACER TENDL-2019 LIBRARY; T=293.16K
angular distribution for elastic

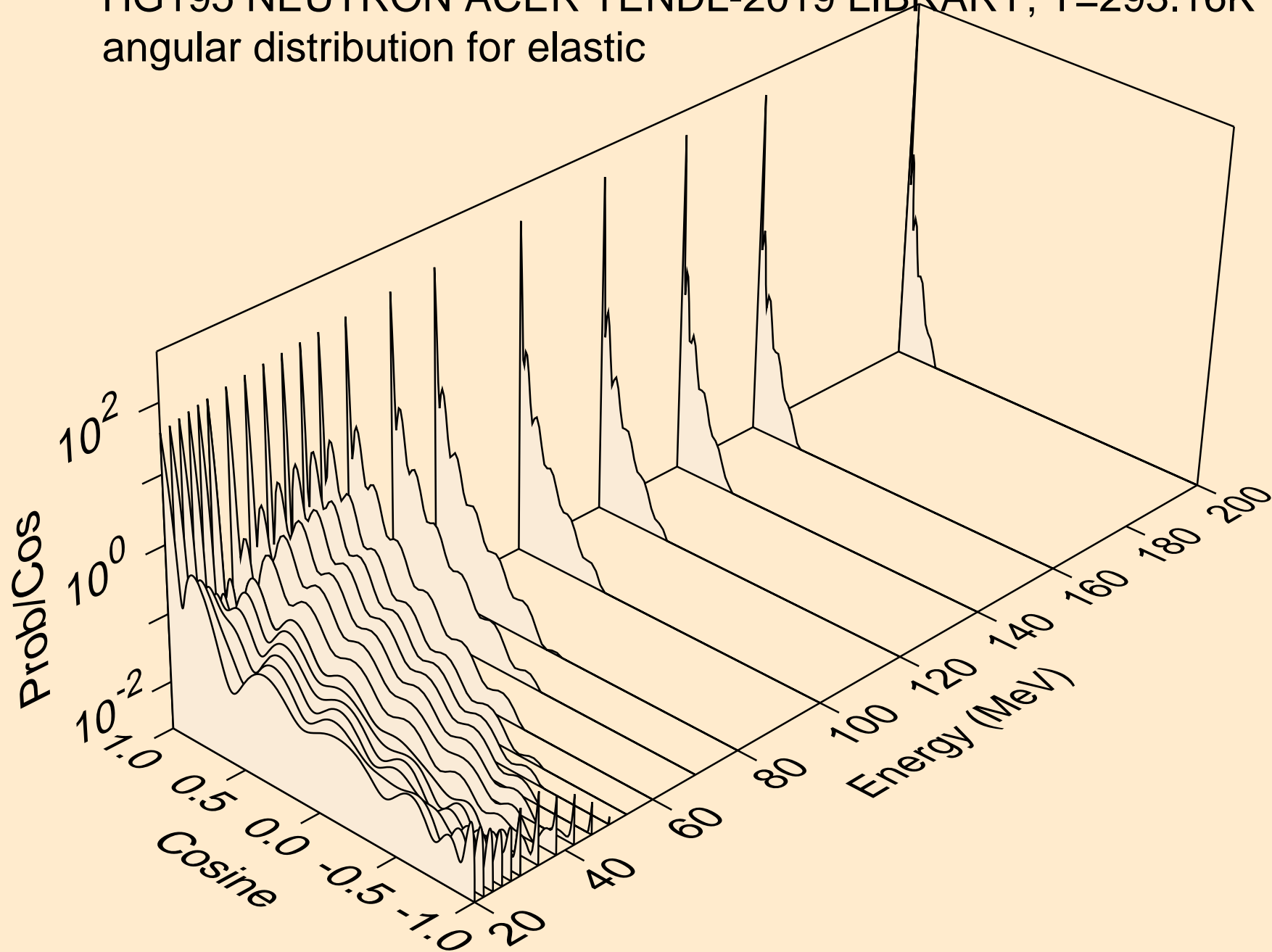

HG195 NEUTRON ACER TENDL-2019 LIBRARY; T=293.16K
angular distribution for (n,n*1)

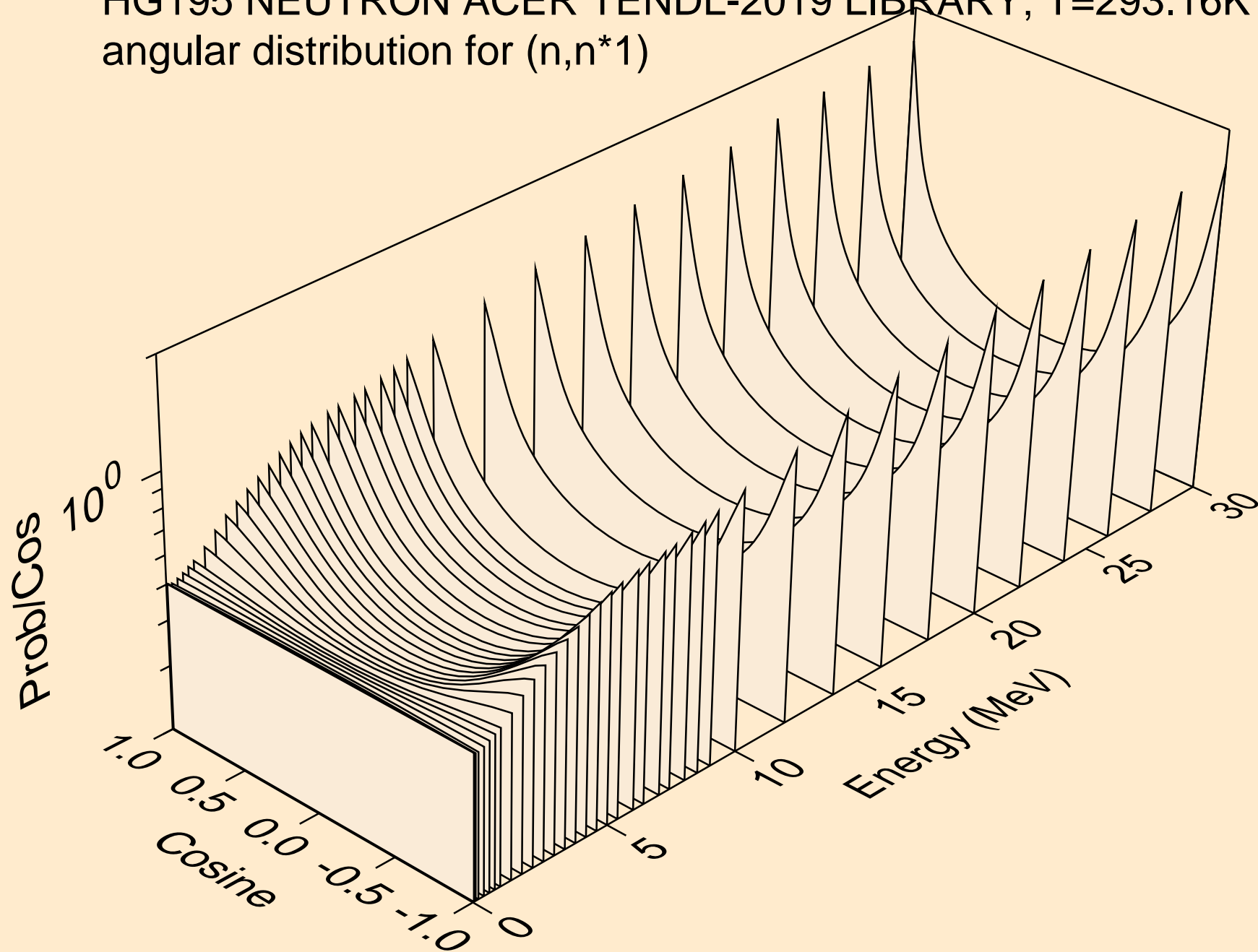

HG195 NEUTRON ACER TENDL-2019 LIBRARY; T=293.16K
angular distribution for (n,n*2)

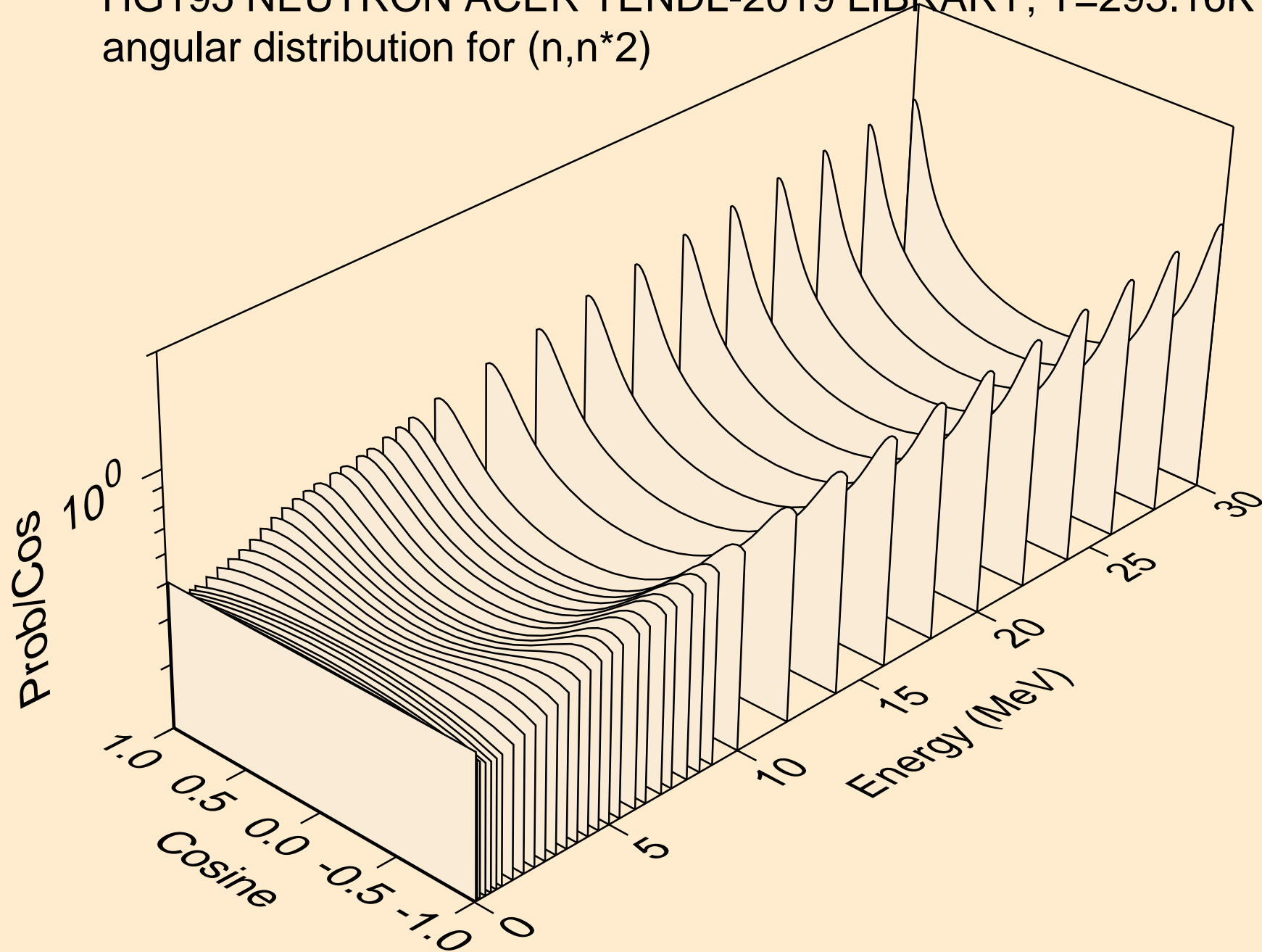

HG195 NEUTRON ACER TENDL-2019 LIBRARY; T=293.16K
angular distribution for (n,n*3)

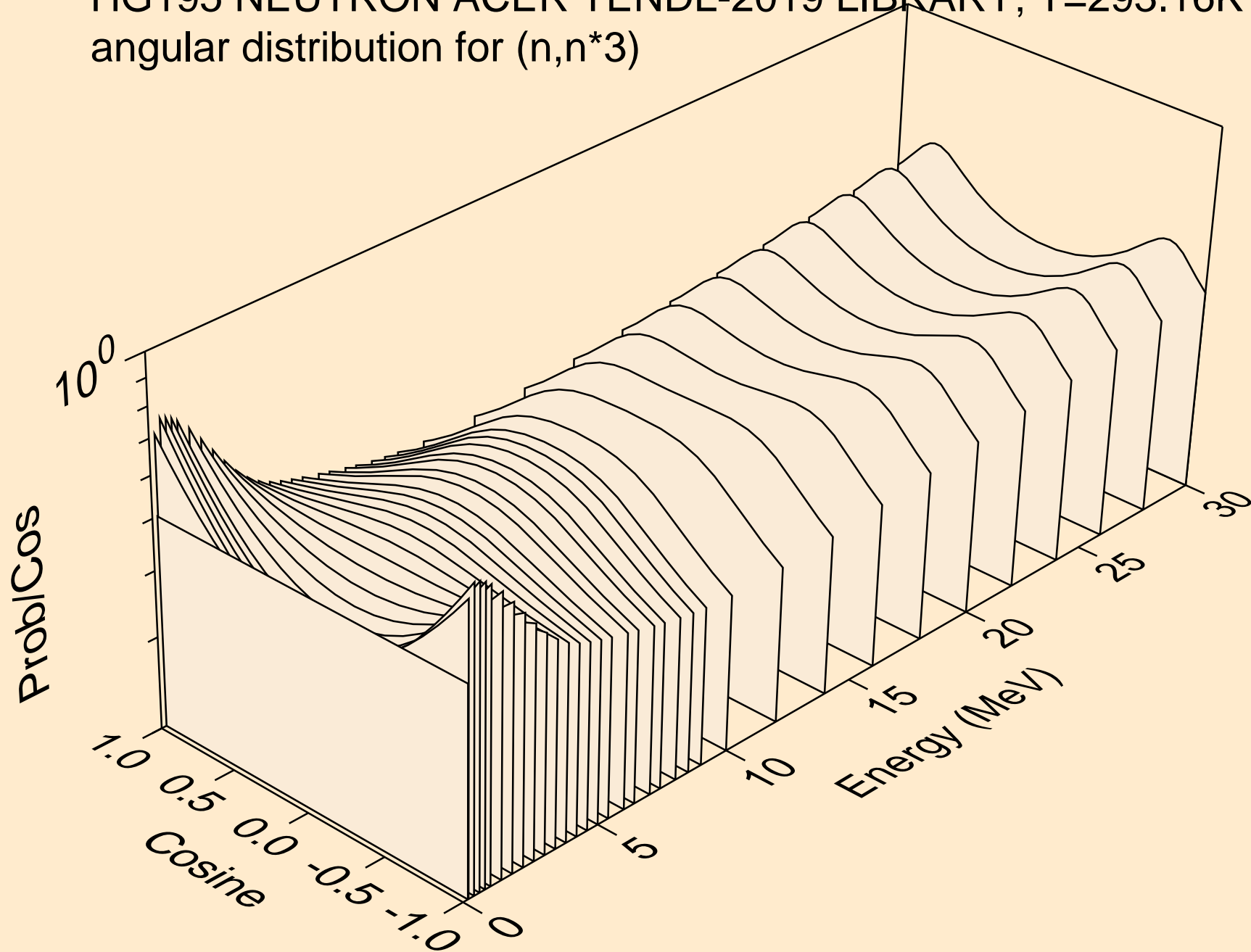

HG195 NEUTRON ACER TENDL-2019 LIBRARY; T=293.16K
angular distribution for (n,n*4)

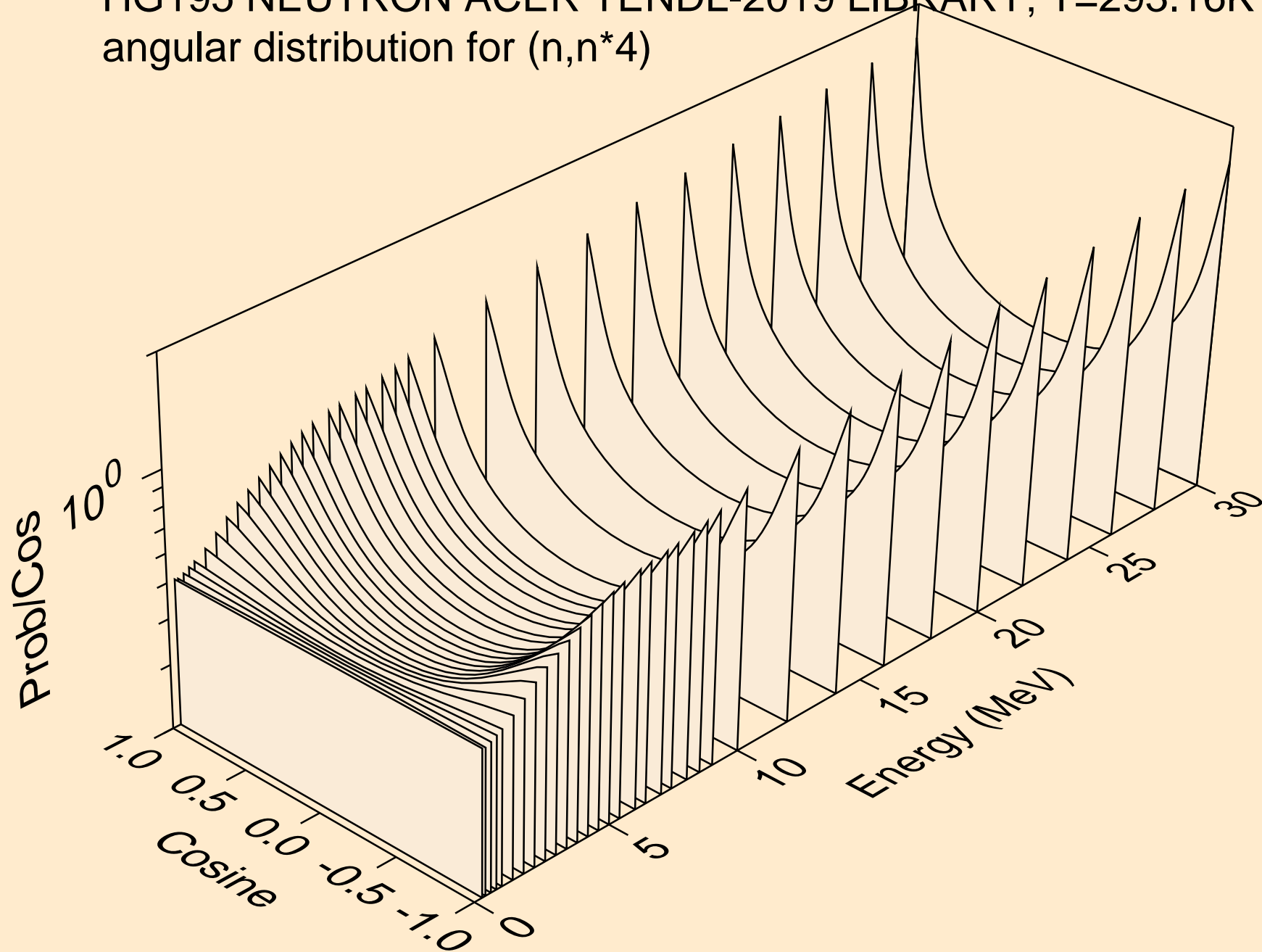

HG195 NEUTRON ACER TENDL-2019 LIBRARY; T=293.16K
angular distribution for (n,n*5)

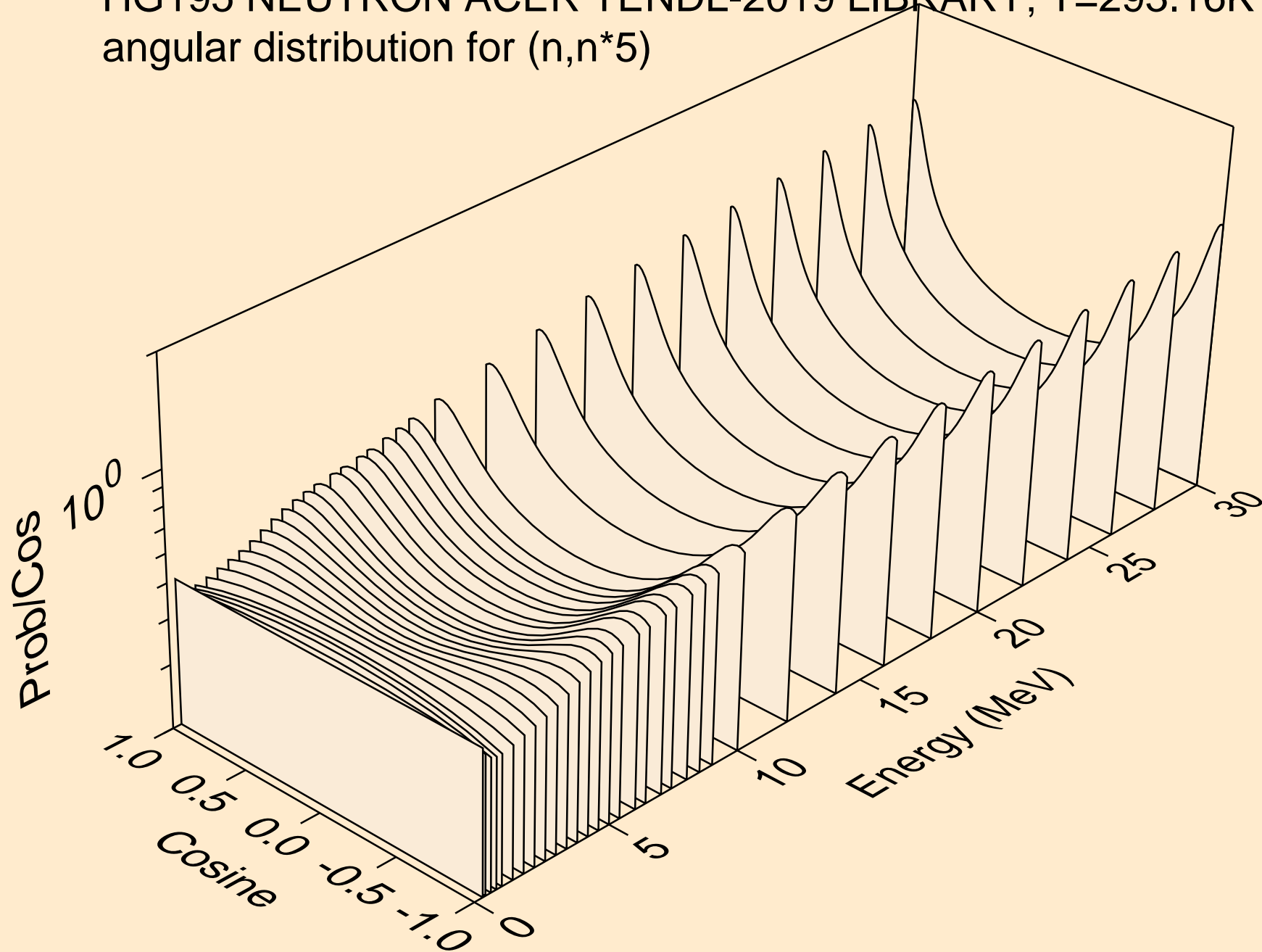

HG195 NEUTRON ACER TENDL-2019 LIBRARY; T=293.16K
angular distribution for (n,n*6)

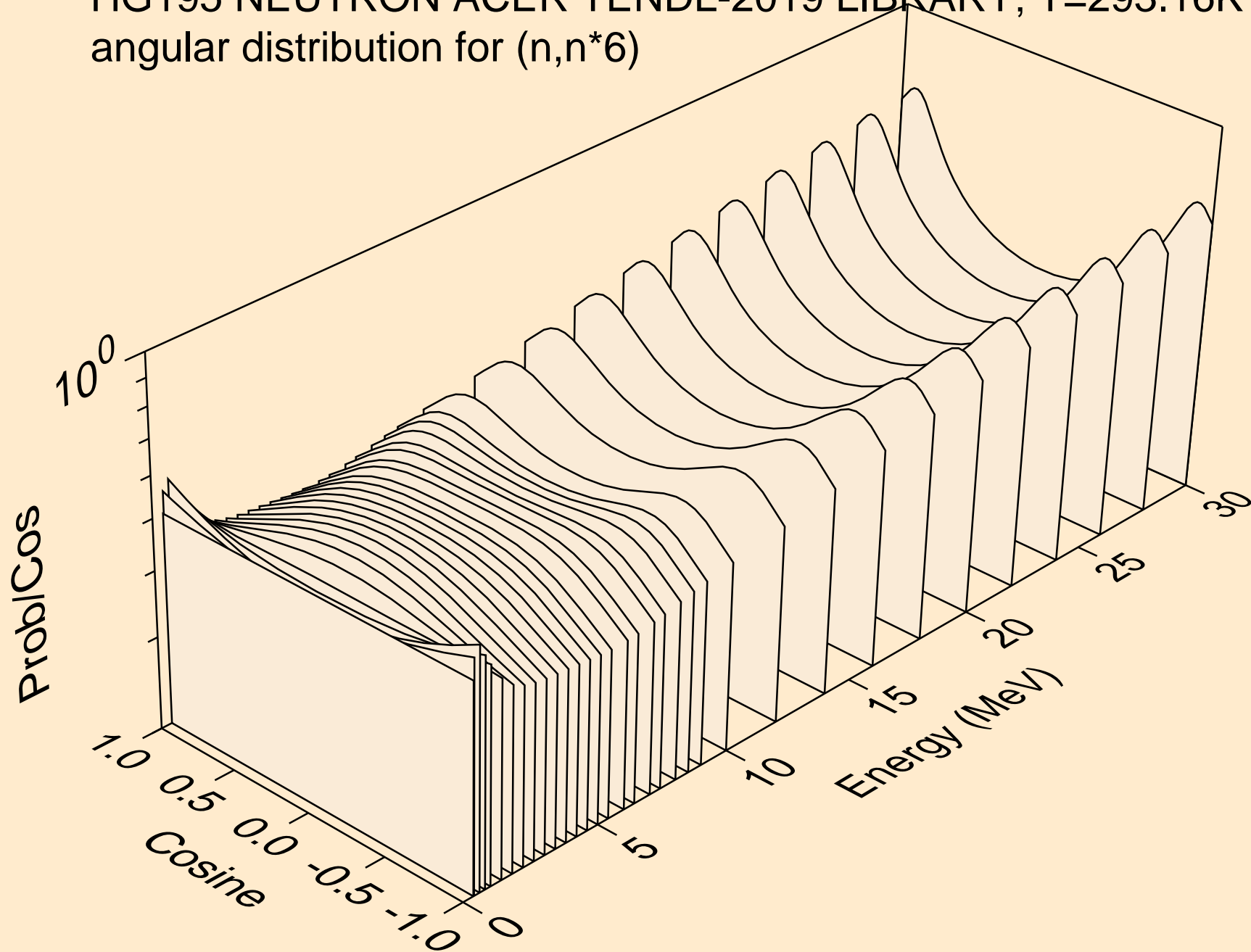

HG195 NEUTRON ACER TENDL-2019 LIBRARY; T=293.16K
angular distribution for (n,n*7)

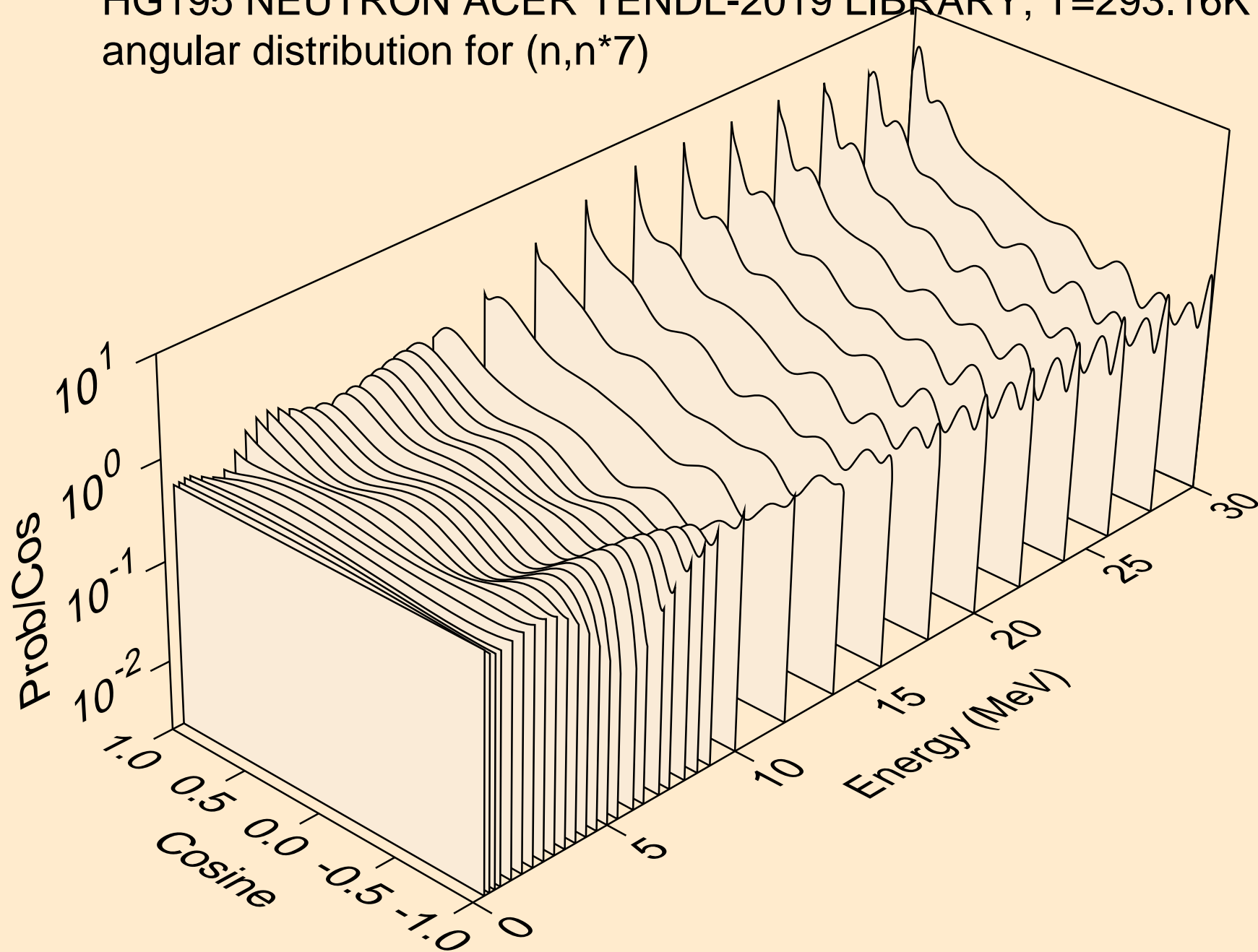

HG195 NEUTRON ACER TENDL-2019 LIBRARY; T=293.16K
angular distribution for (n,n*8)

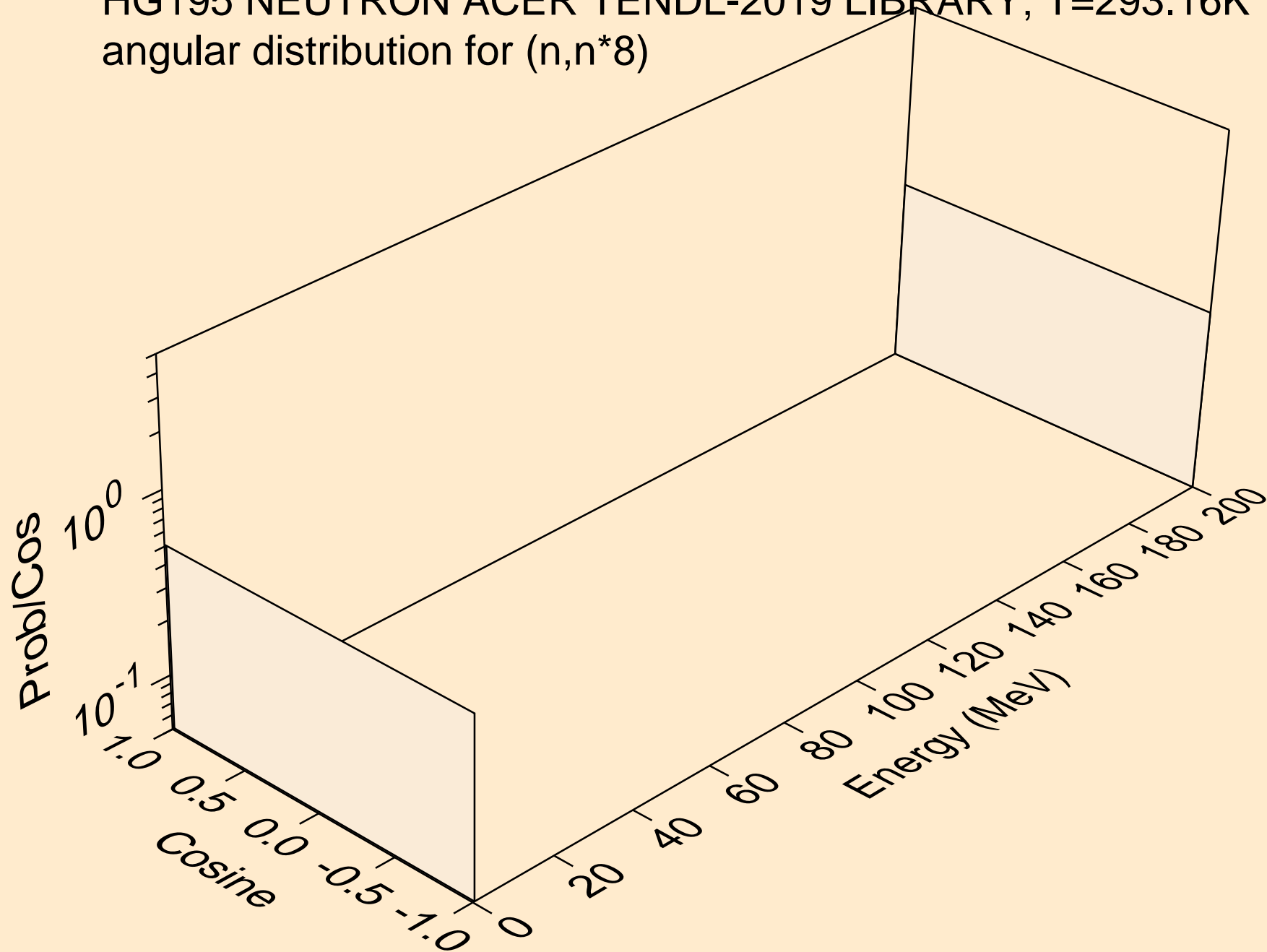

HG195 NEUTRON ACER TENDL-2019 LIBRARY; T=293.16K
angular distribution for (n,n*9)

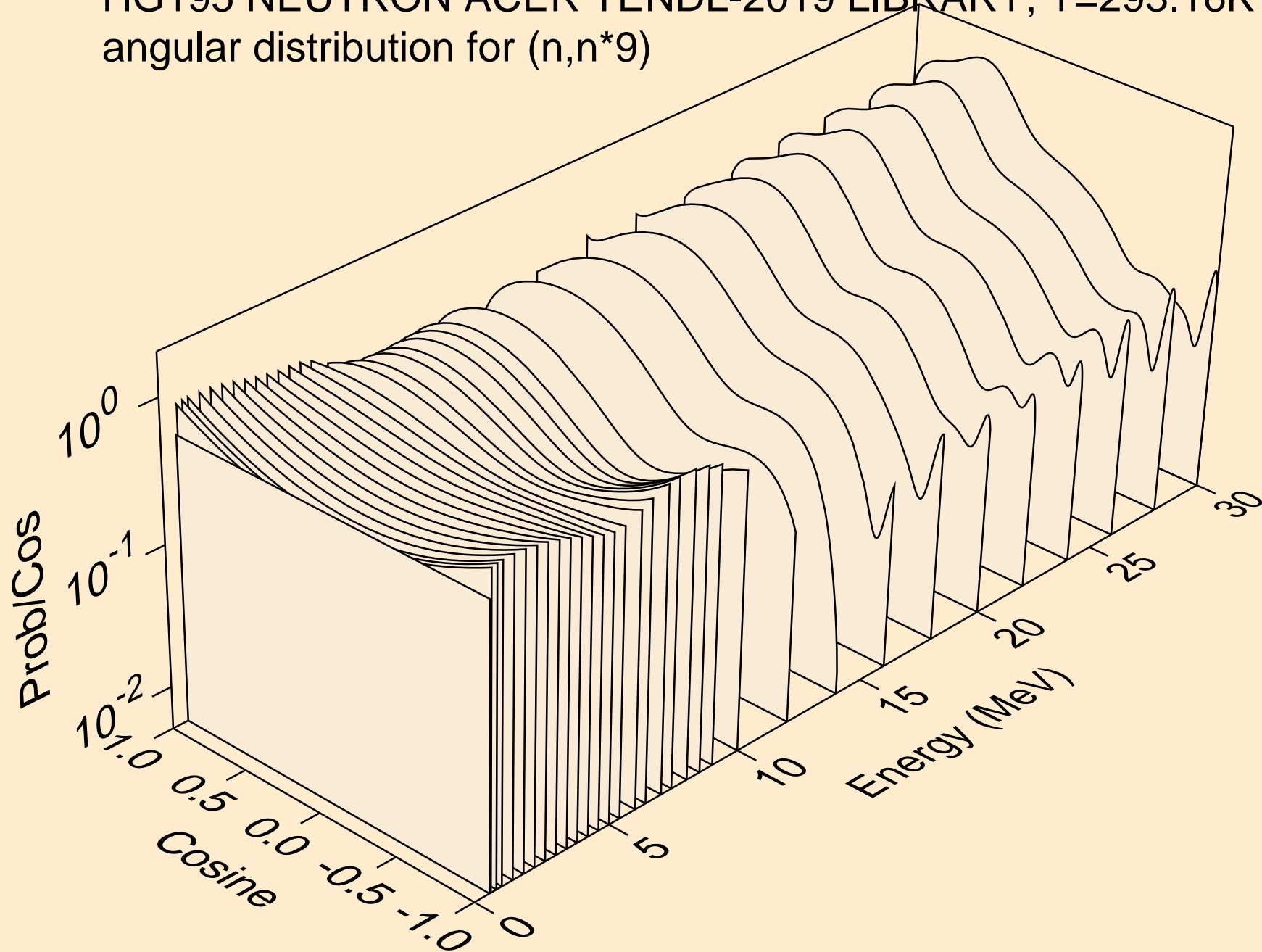

HG195 NEUTRON ACER TENDL-2019 LIBRARY; T=293.16K
angular distribution for (n,n*10)

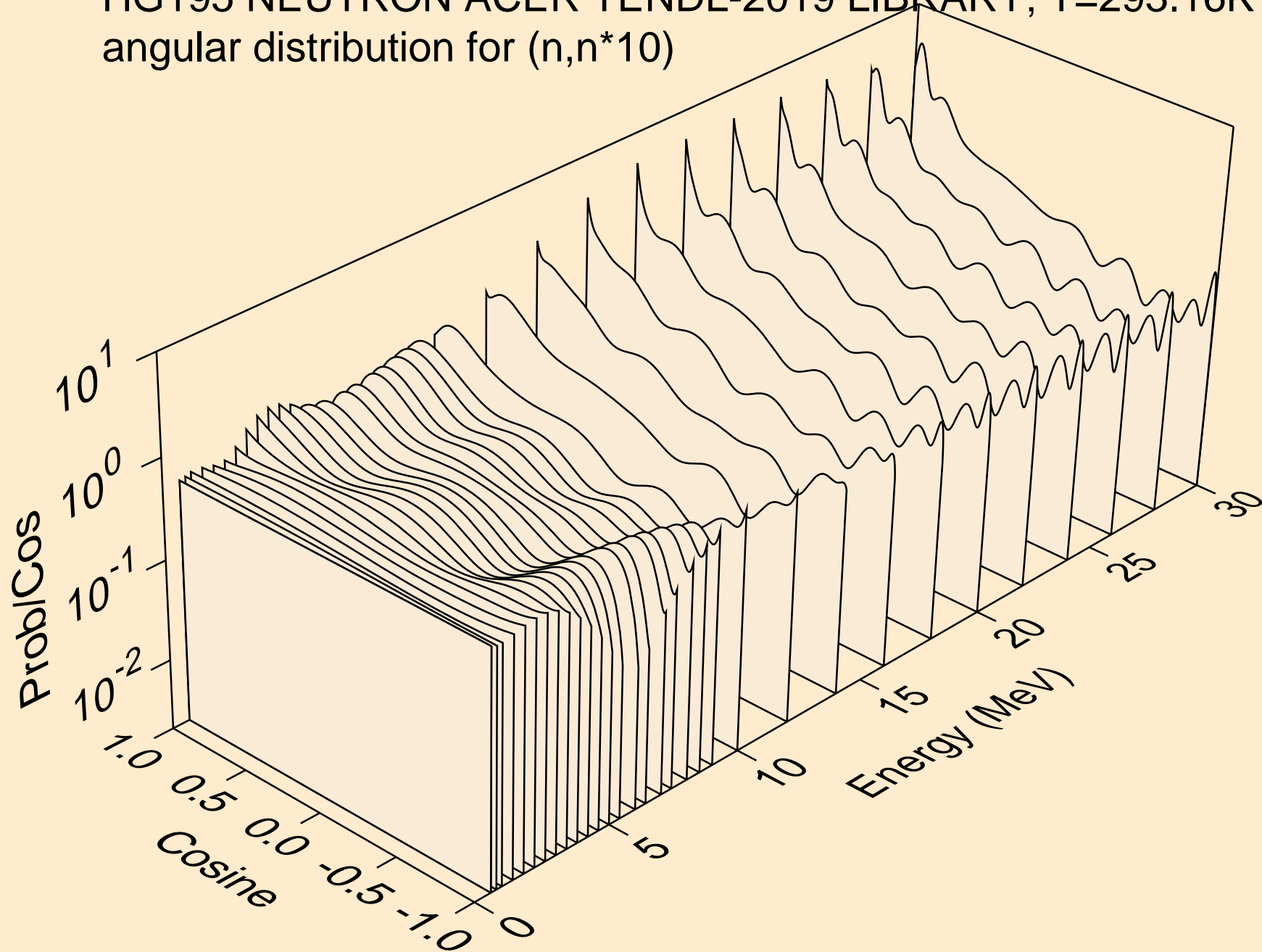

HG195 NEUTRON ACER TENDL-2019 LIBRARY; T=293.16K
angular distribution for (n,n*11)

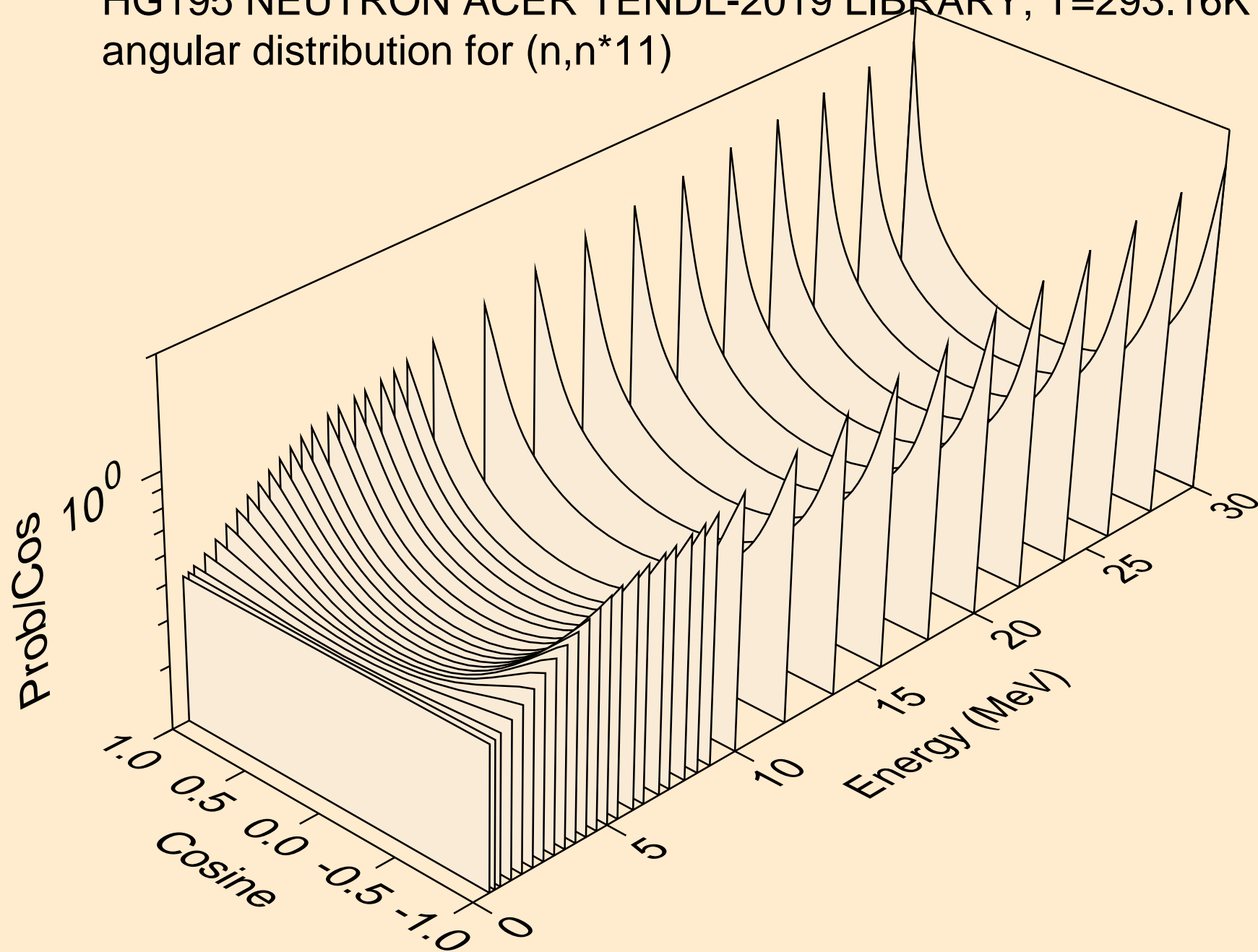

HG195 NEUTRON ACER TENDL-2019 LIBRARY; T=293.16K
angular distribution for (n,n*12)

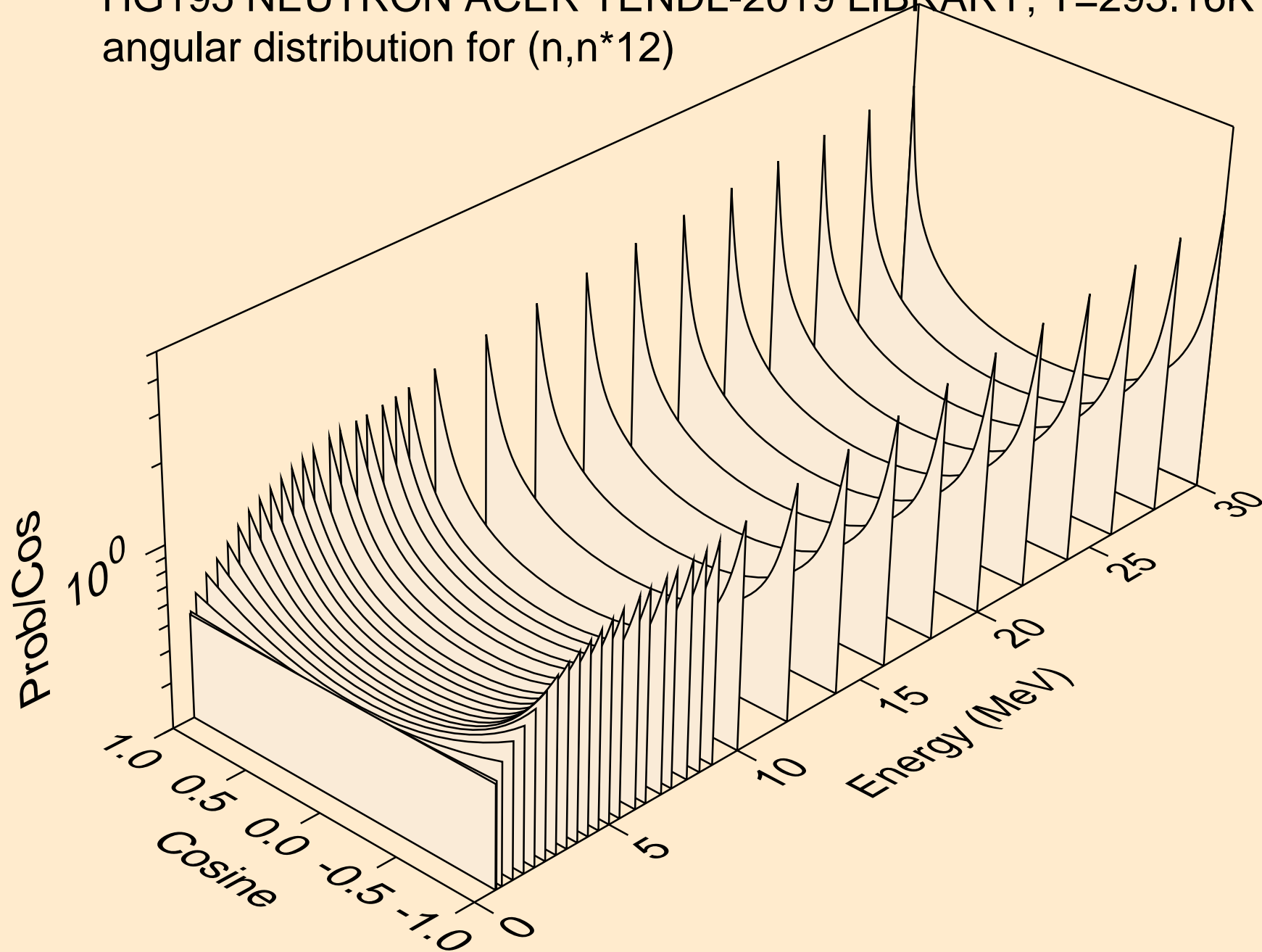

HG195 NEUTRON ACER TENDL-2019 LIBRARY; T=293.16K
angular distribution for (n,n*13)

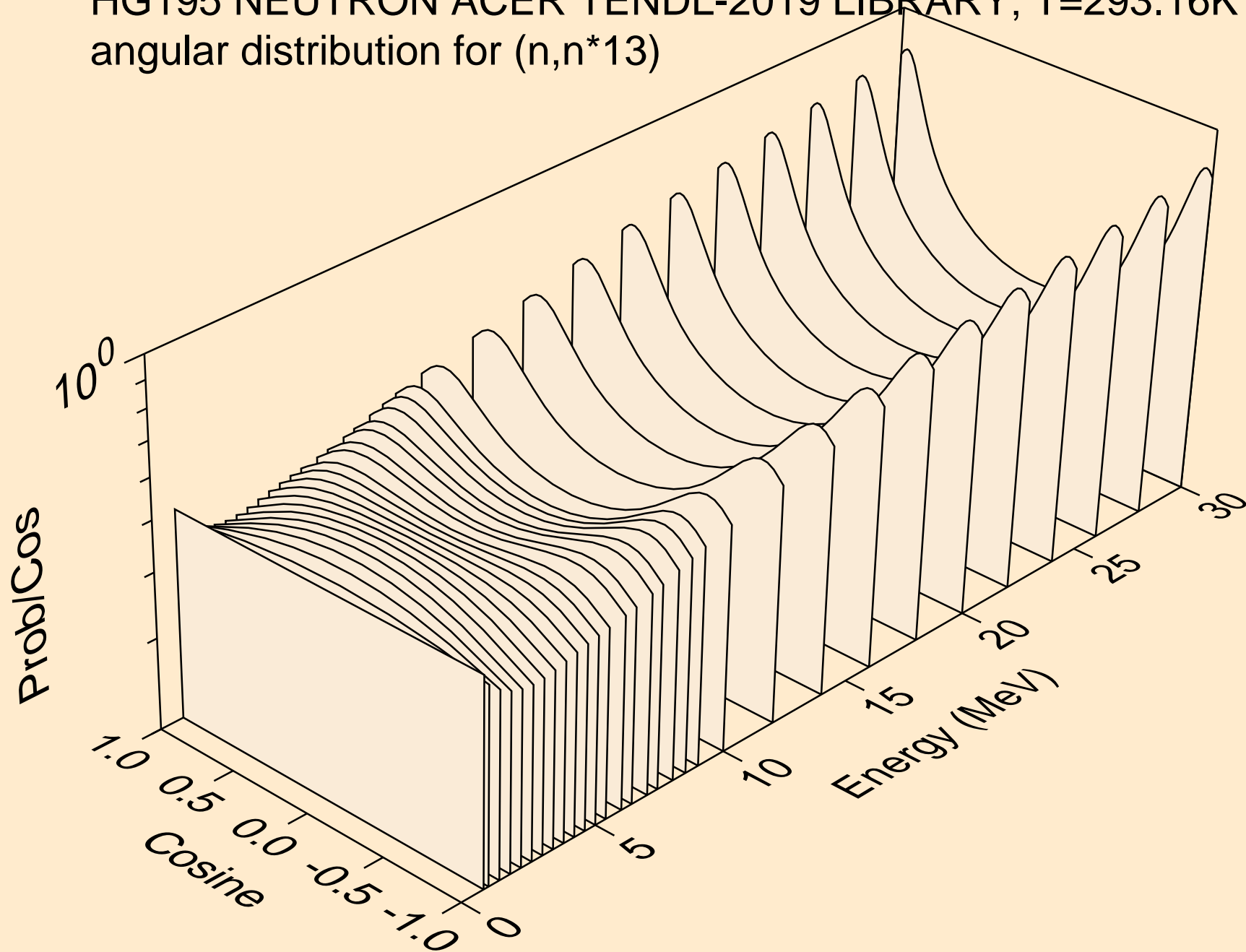

HG195 NEUTRON ACER TENDL-2019 LIBRARY; T=293.16K
angular distribution for (n,n*14)

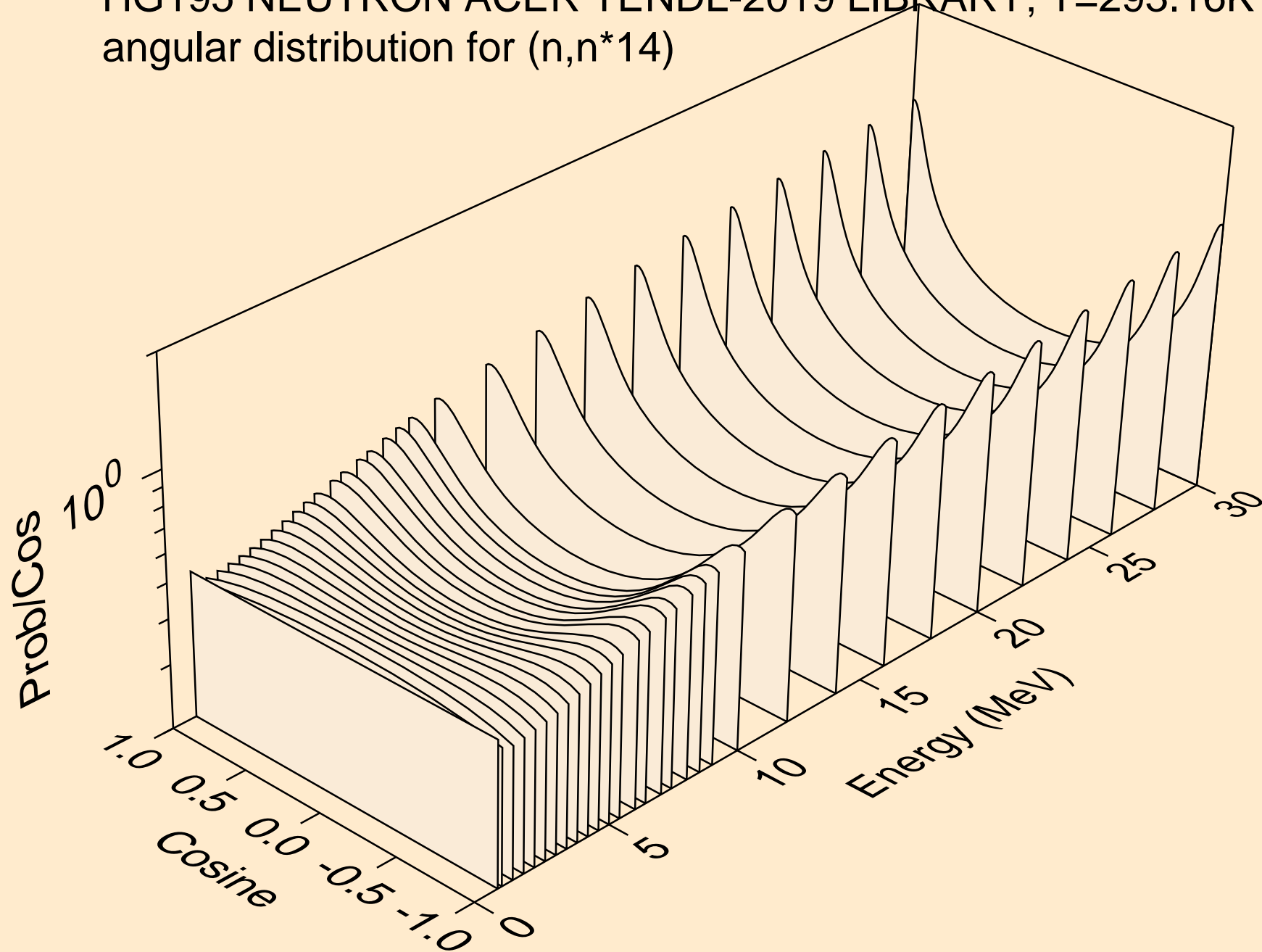

HG195 NEUTRON ACER TENDL-2019 LIBRARY; T=293.16K
angular distribution for (n,n*15)

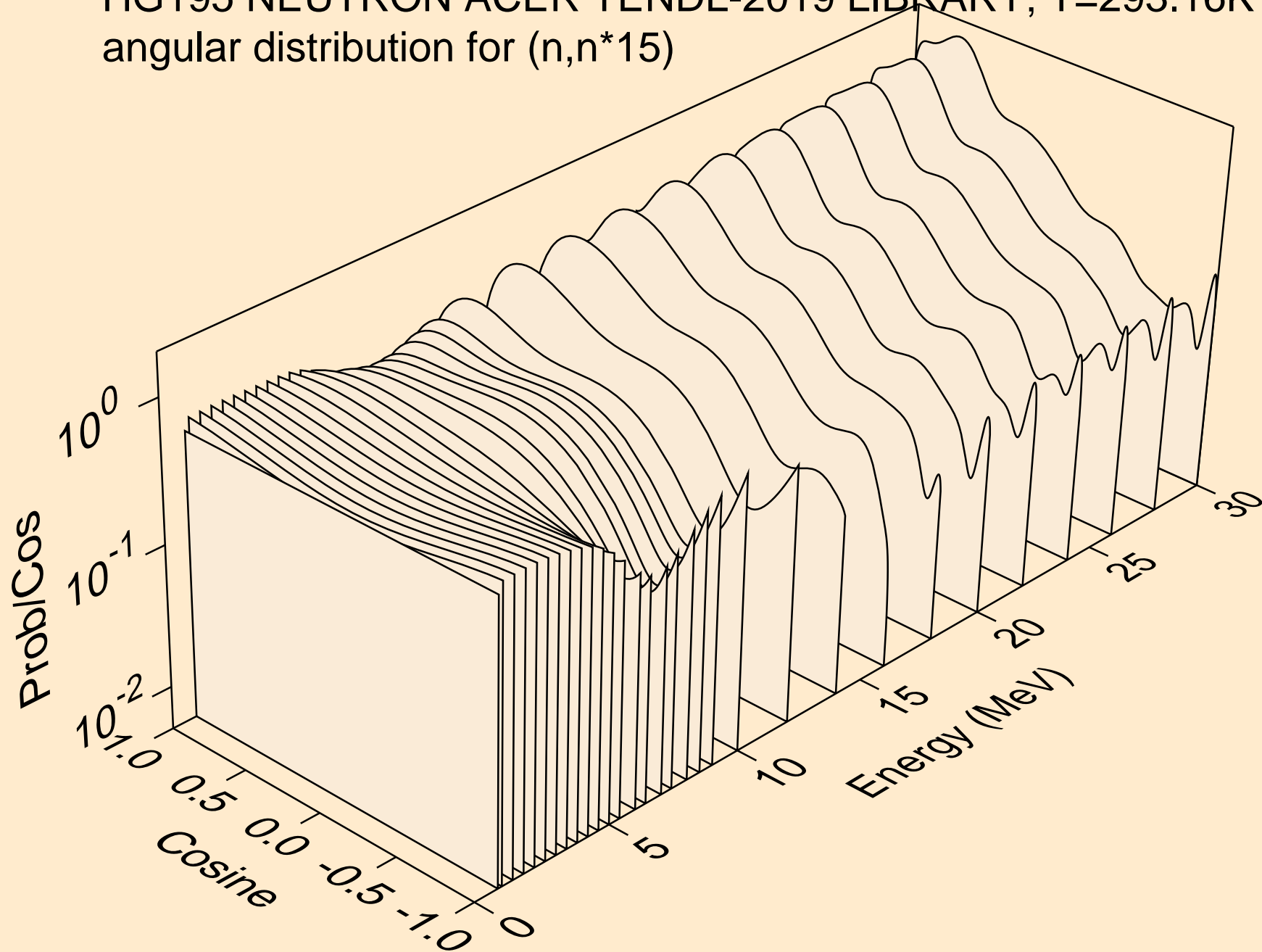

HG195 NEUTRON ACER TENDL-2019 LIBRARY; T=293.16K
angular distribution for (n,n*16)

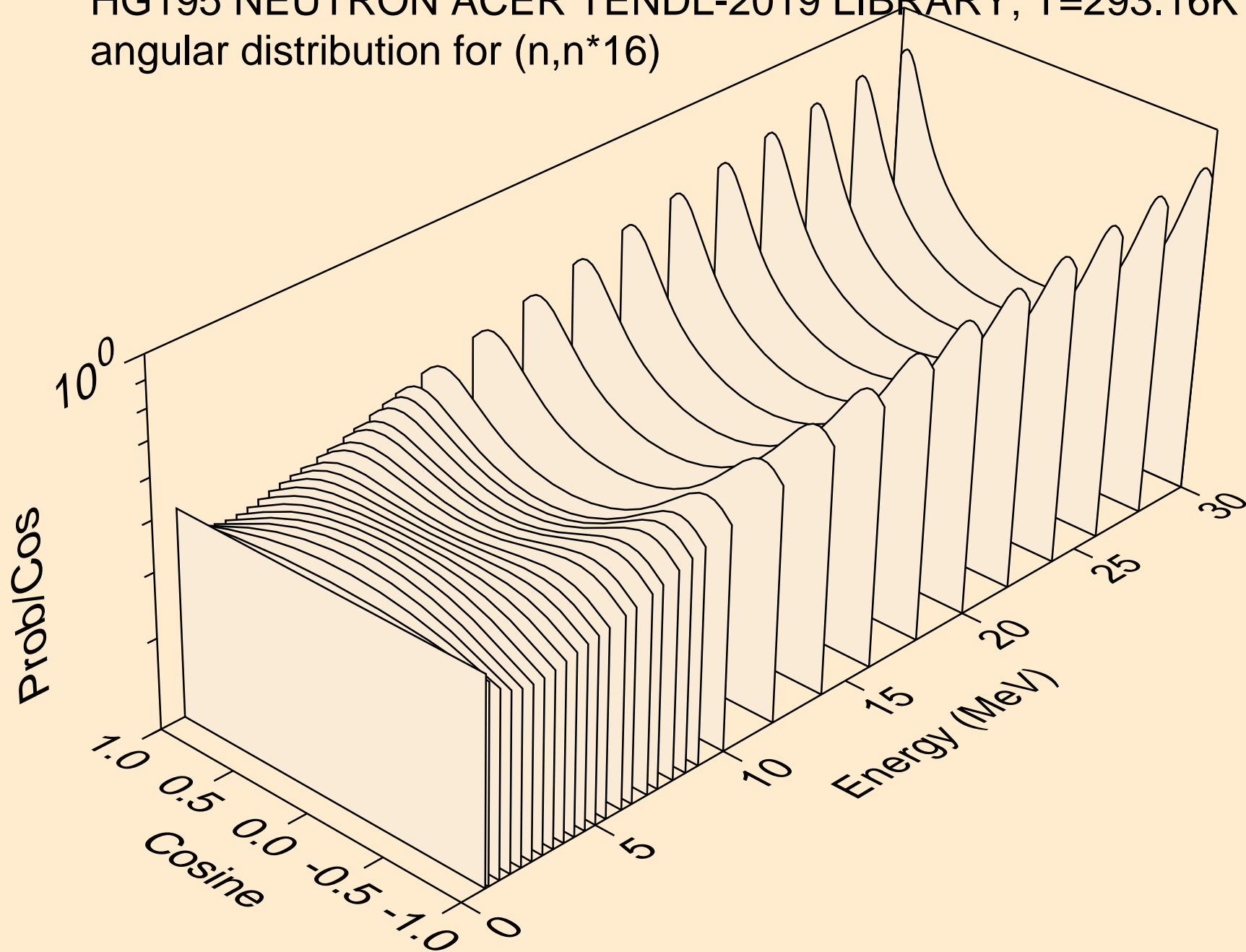

HG195 NEUTRON ACER TENDL-2019 LIBRARY; T=293.16K
angular distribution for (n,n*17)

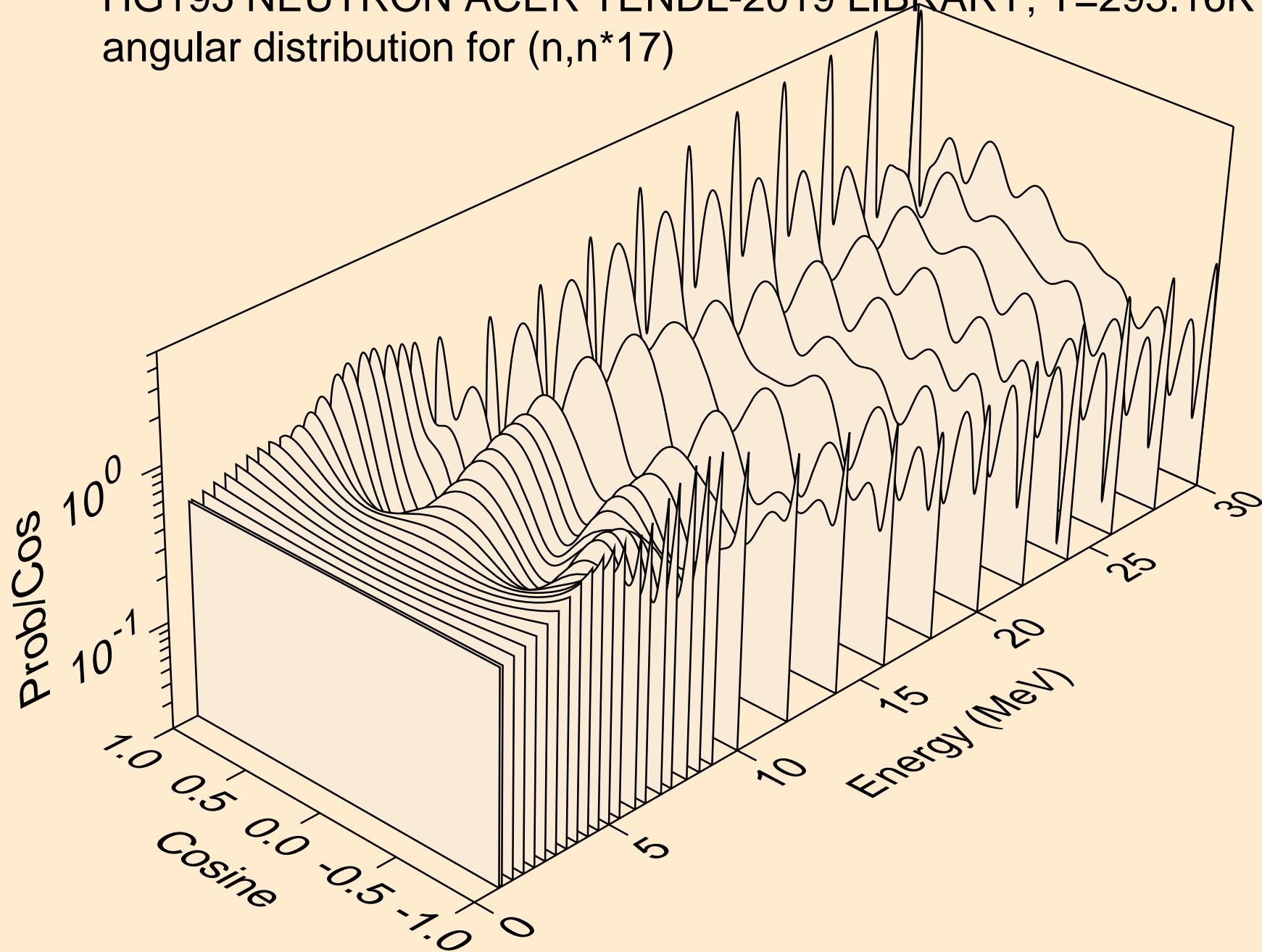

HG195 NEUTRON ACER TENDL-2019 LIBRARY; T=293.16K
angular distribution for (n,n*18)

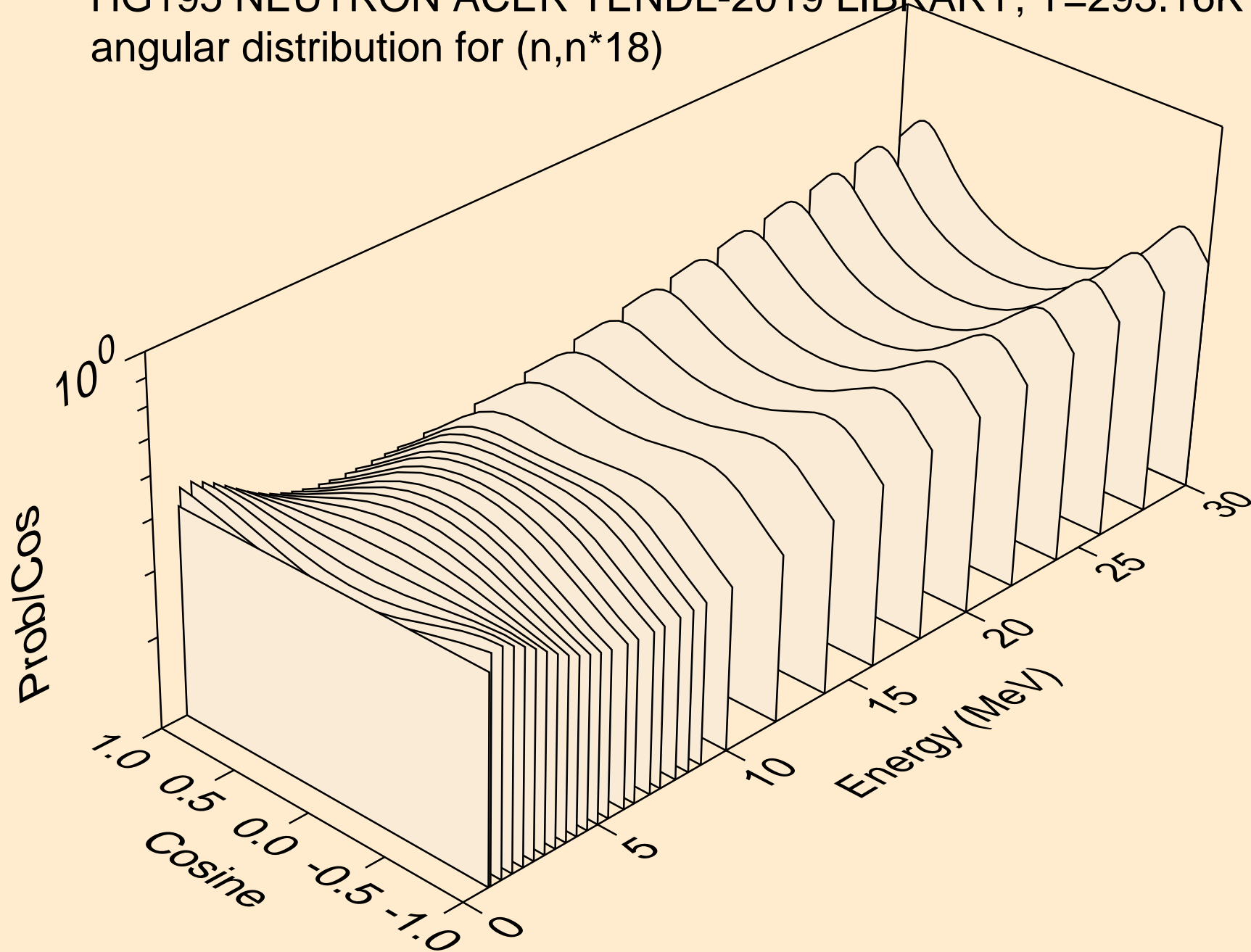

HG195 NEUTRON ACER TENDL-2019 LIBRARY; T=293.16K
angular distribution for (n,n*19)

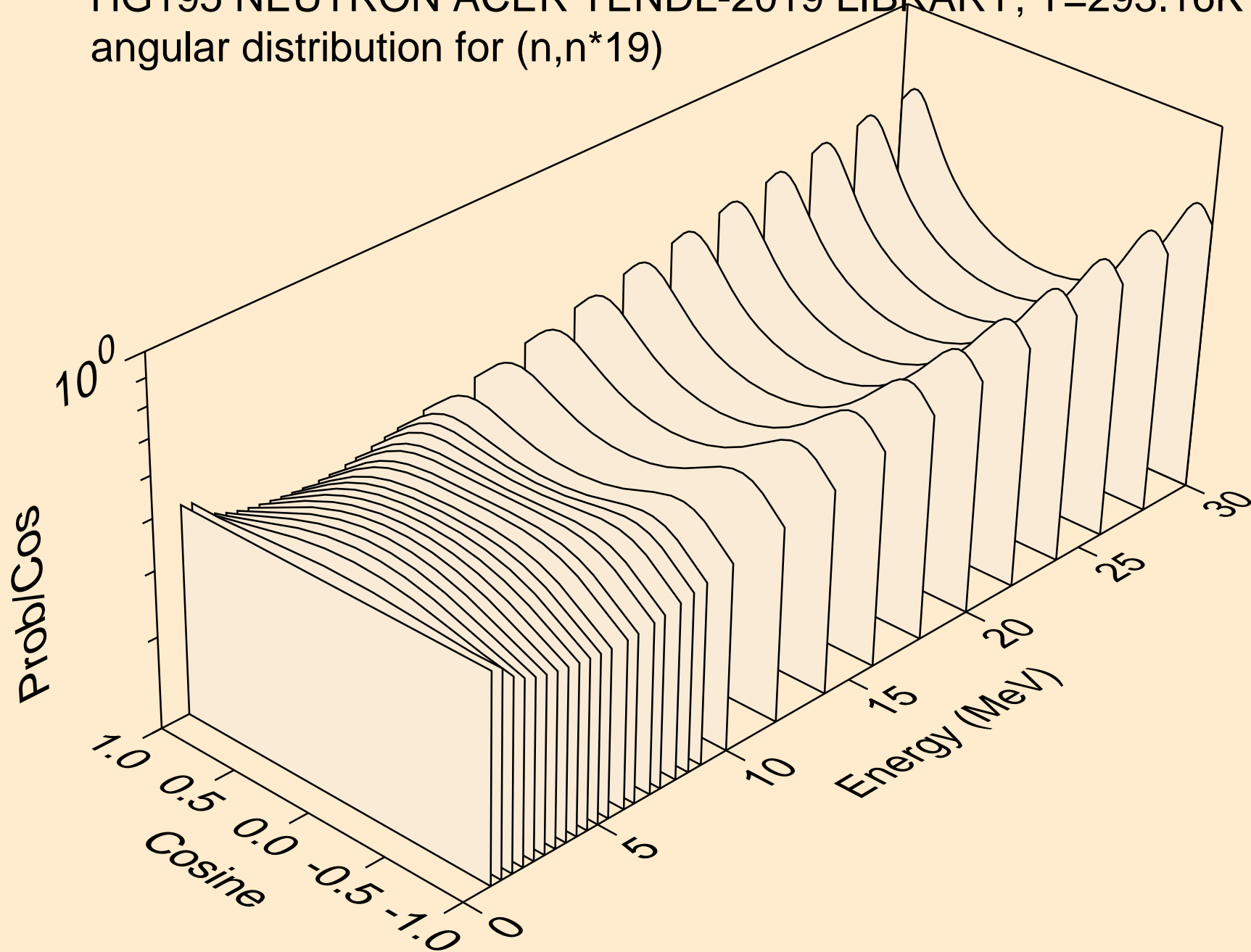

HG195 NEUTRON ACER TENDL-2019 LIBRARY; T=293.16K
angular distribution for (n,n*20)

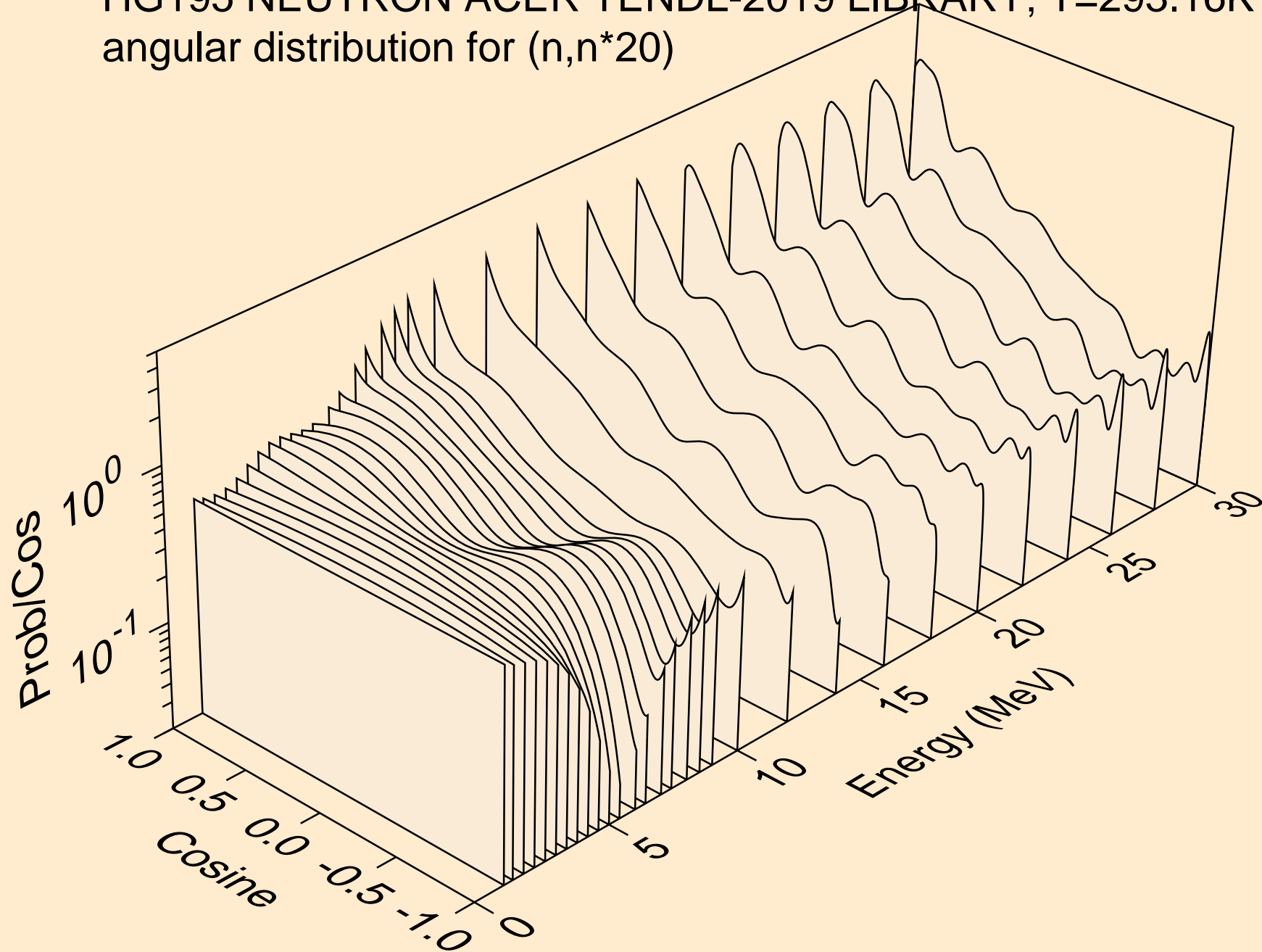

HG195 NEUTRON ACER TENDL-2019 LIBRARY; T=293.16K
angular distribution for (n,n*21)

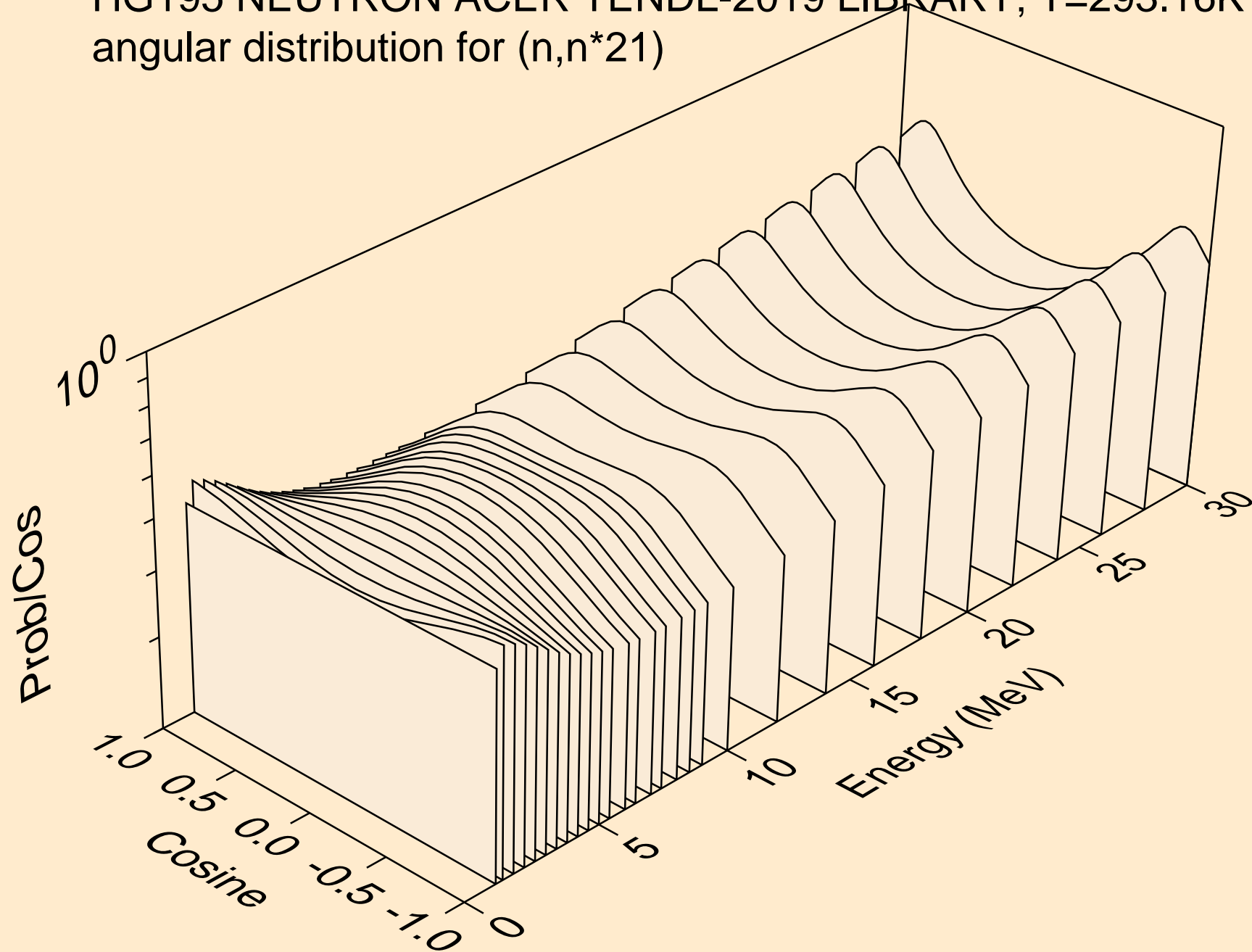

HG195 NEUTRON ACER TENDL-2019 LIBRARY; T=293.16K
angular distribution for (n,n*22)

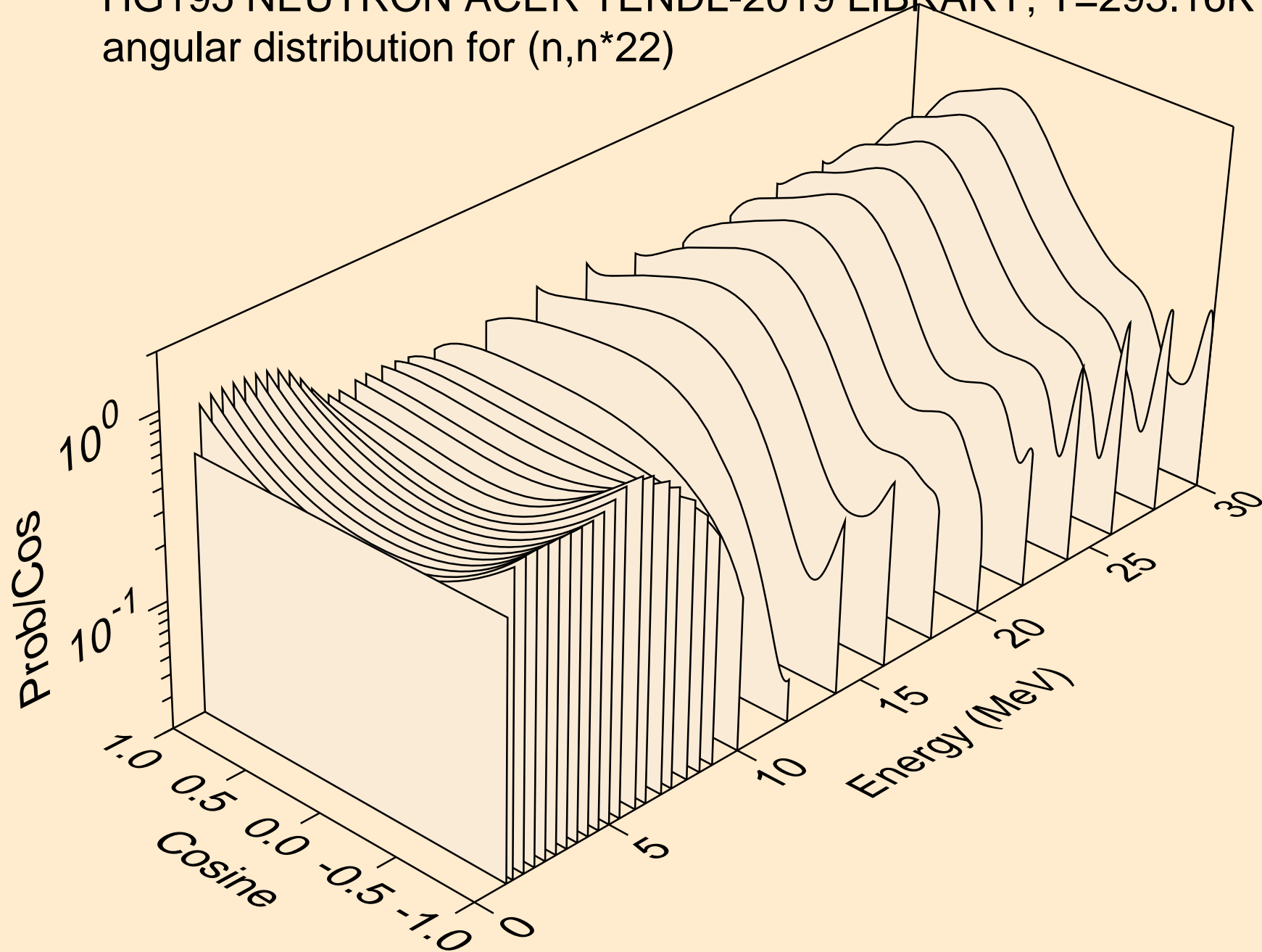

HG195 NEUTRON ACER TENDL-2019 LIBRARY; T=293.16K
angular distribution for (n,n*23)

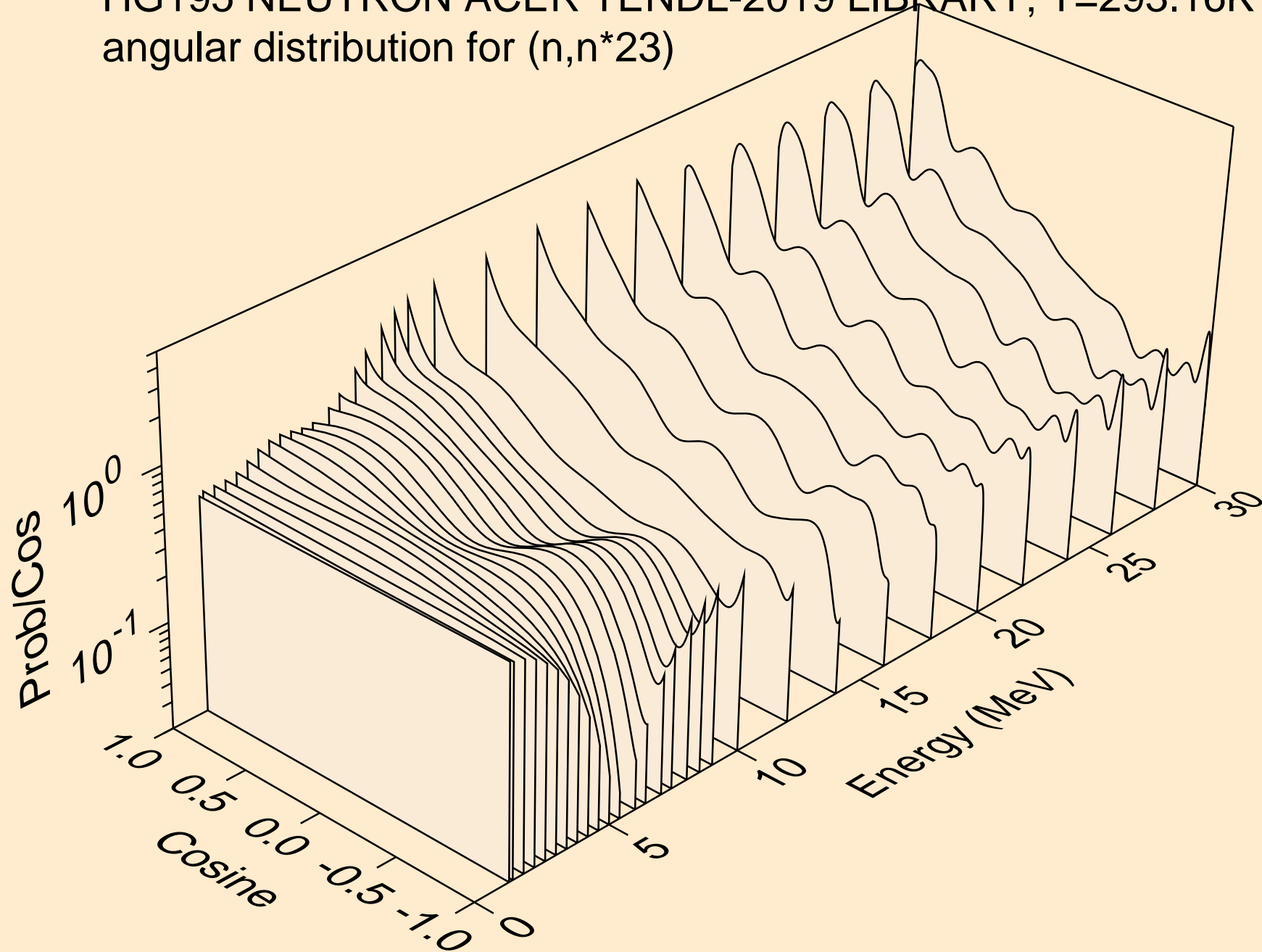

HG195 NEUTRON ACER TENDL-2019 LIBRARY; T=293.16K
angular distribution for (n,n*24)

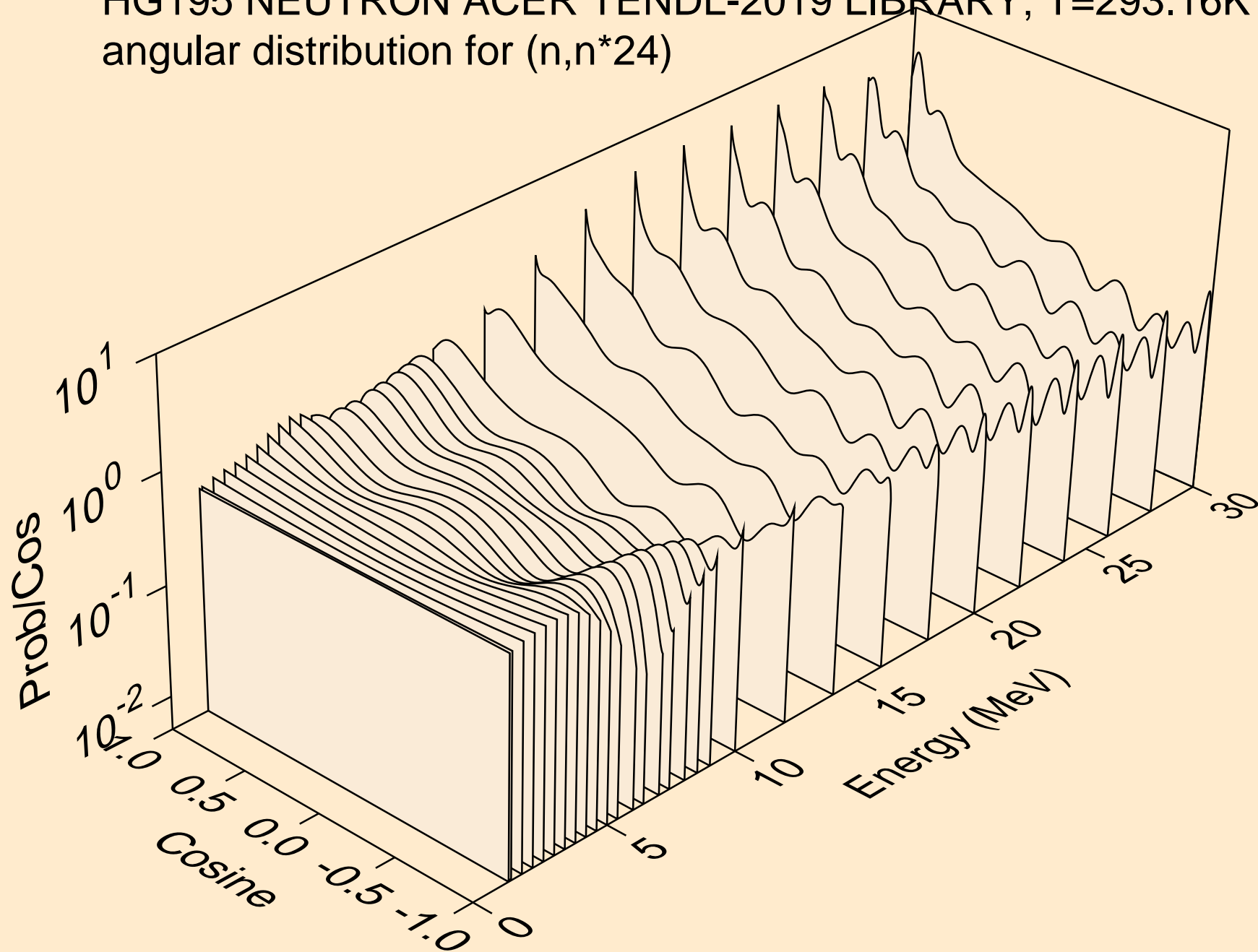

HG195 NEUTRON ACER TENDL-2019 LIBRARY; T=293.16K
angular distribution for (n,n*25)

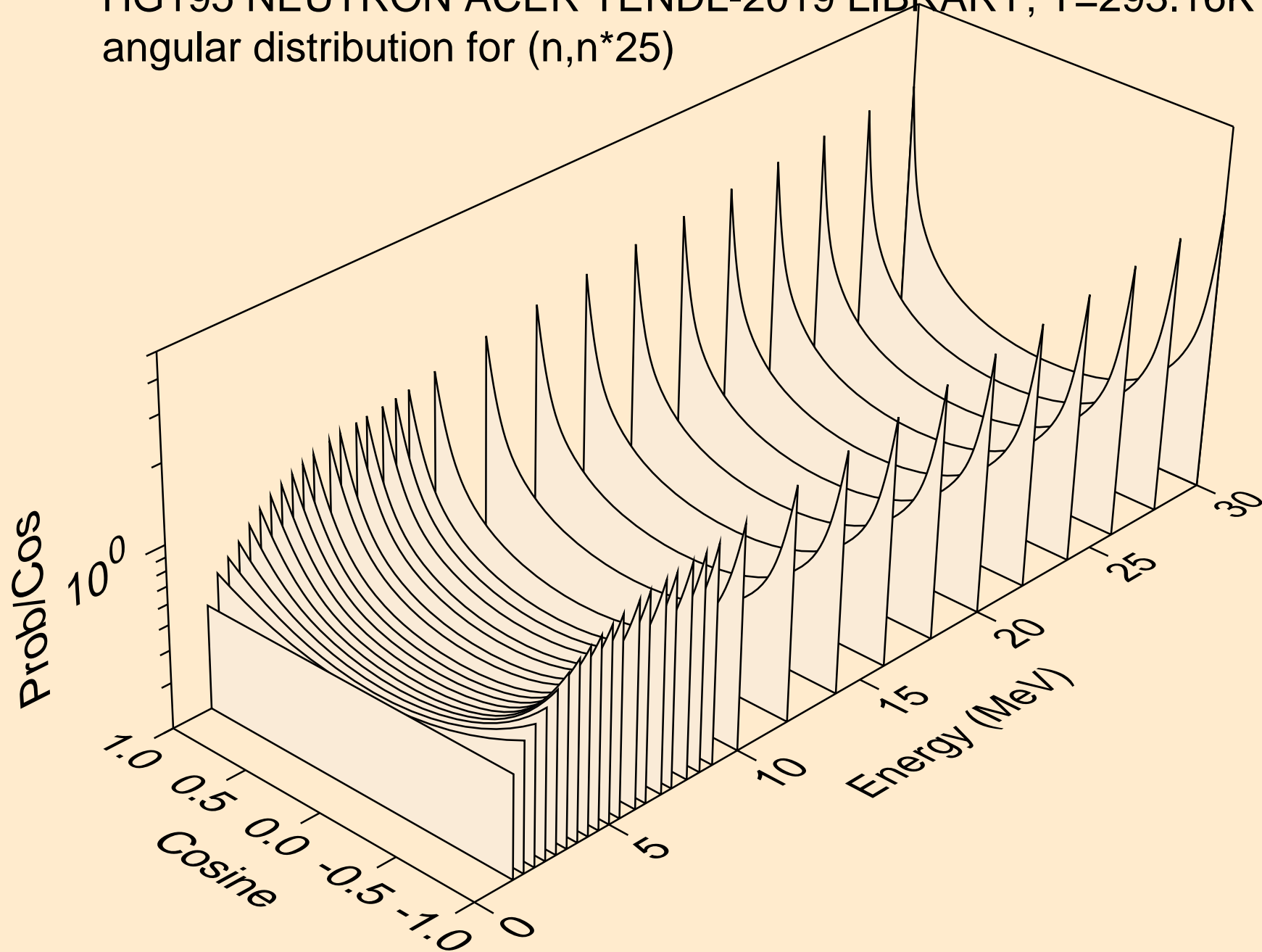

HG195 NEUTRON ACER TENDL-2019 LIBRARY; T=293.16K
angular distribution for (n,n*26)

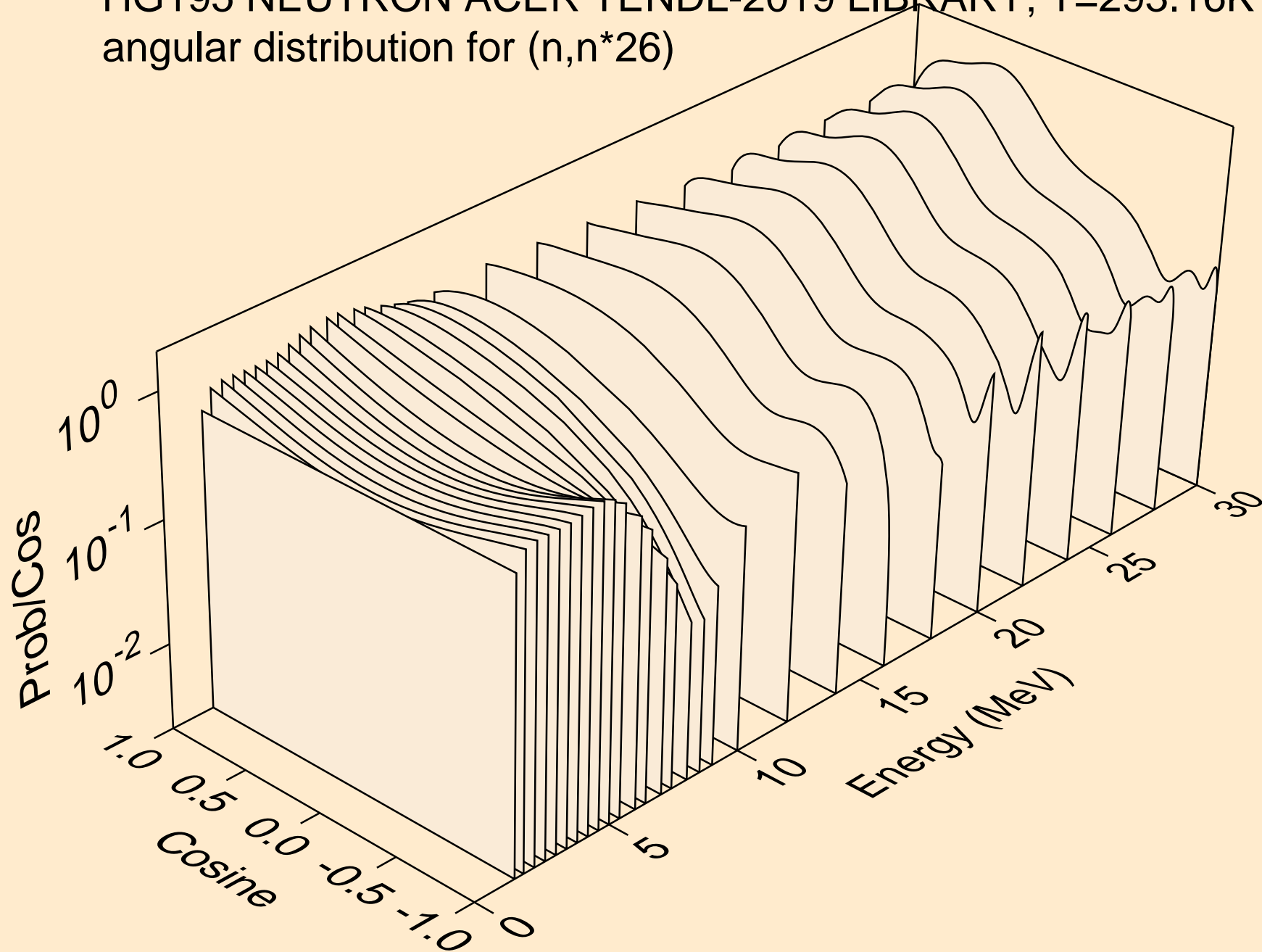

HG195 NEUTRON ACER TENDL-2019 LIBRARY; T=293.16K
angular distribution for (n,n*27)

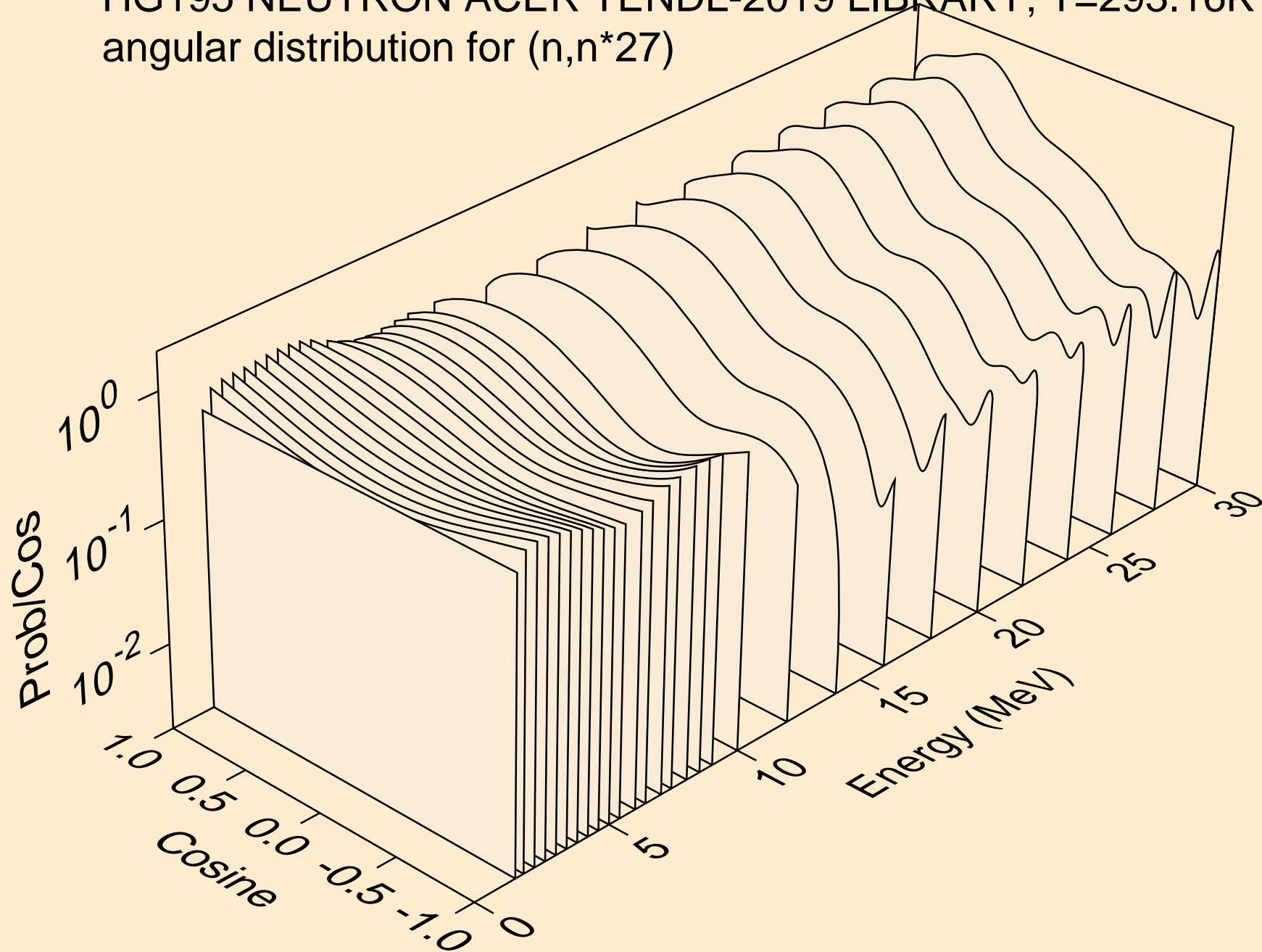

HG195 NEUTRON ACER TENDL-2019 LIBRARY; T=293.16K
angular distribution for (n,n*28)

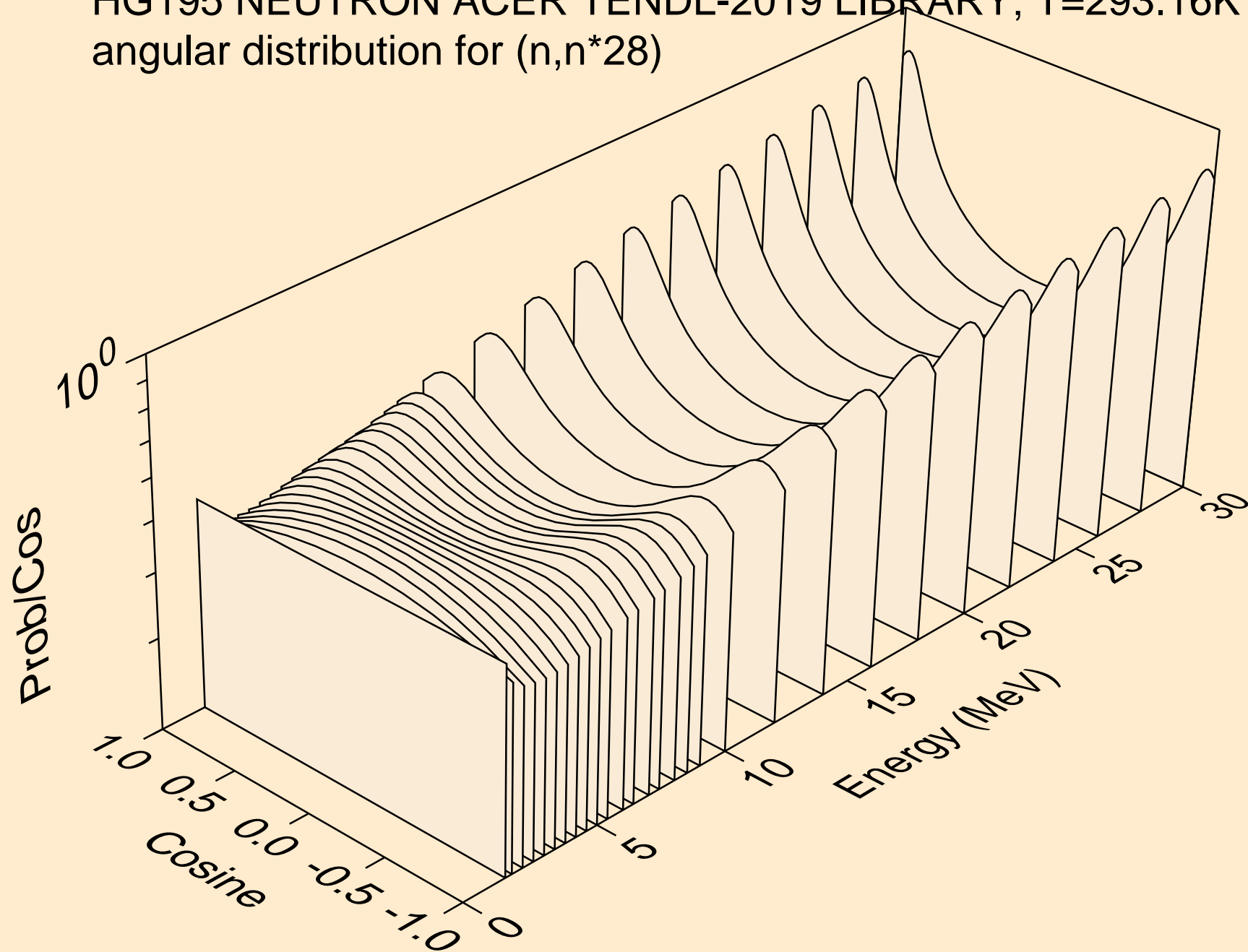

HG195 NEUTRON ACER TENDL-2019 LIBRARY; T=293.16K
angular distribution for (n,n*29)

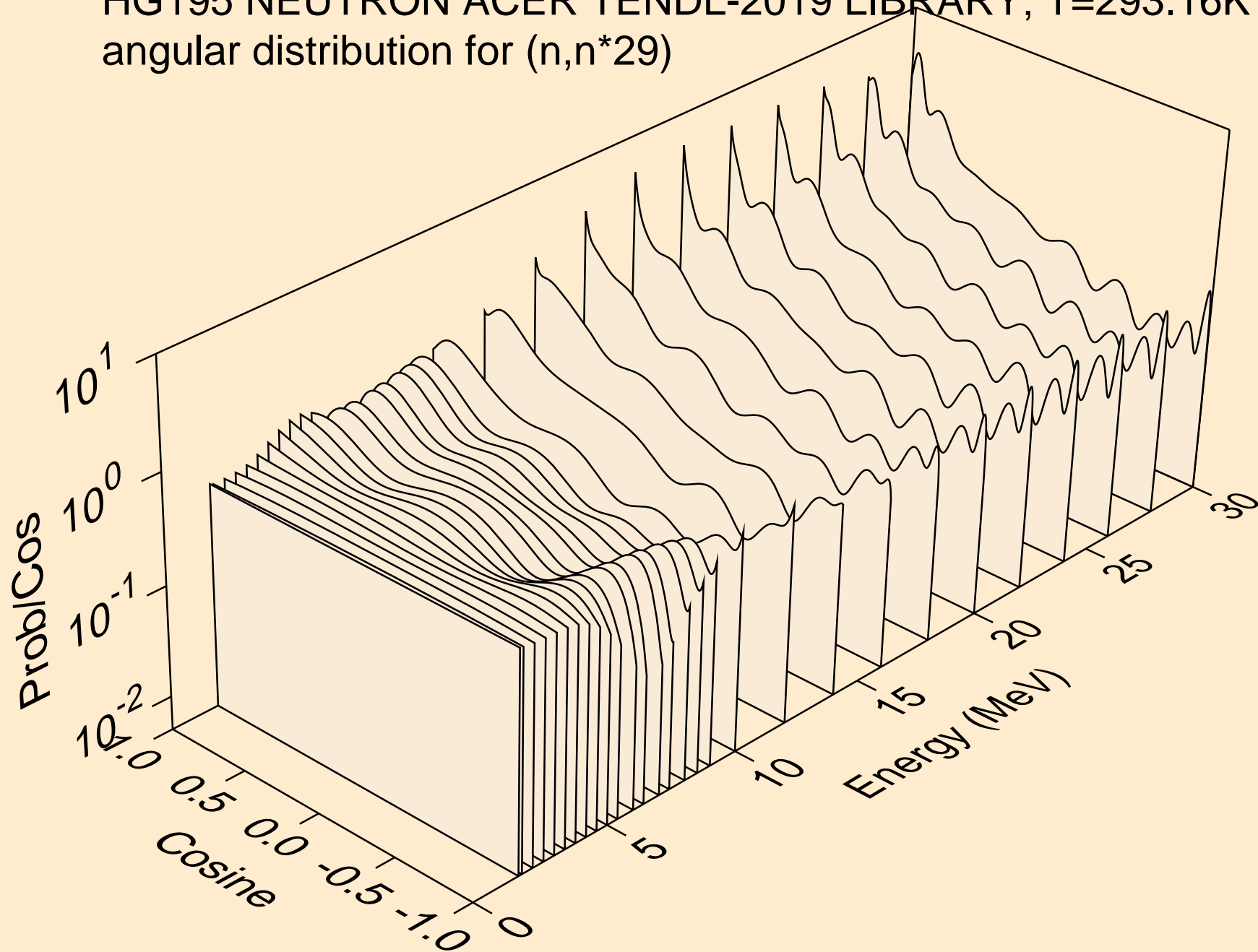

HG195 NEUTRON ACER TENDL-2019 LIBRARY; T=293.16K
Neutron emission for (n,x)

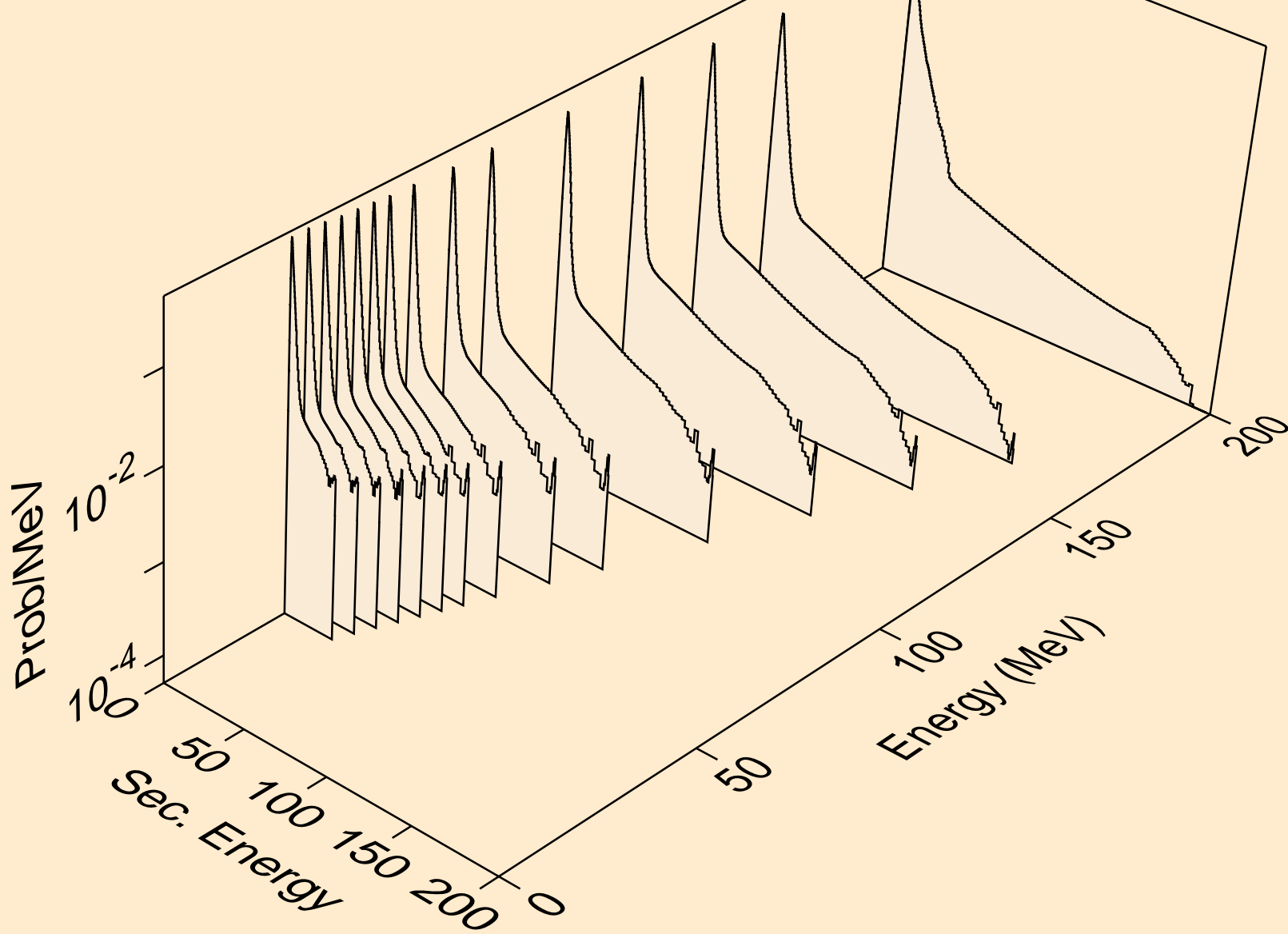

HG195 NEUTRON ACER TENDL-2019 LIBRARY; T=293.16K
Neutron emission for (n,2nd)

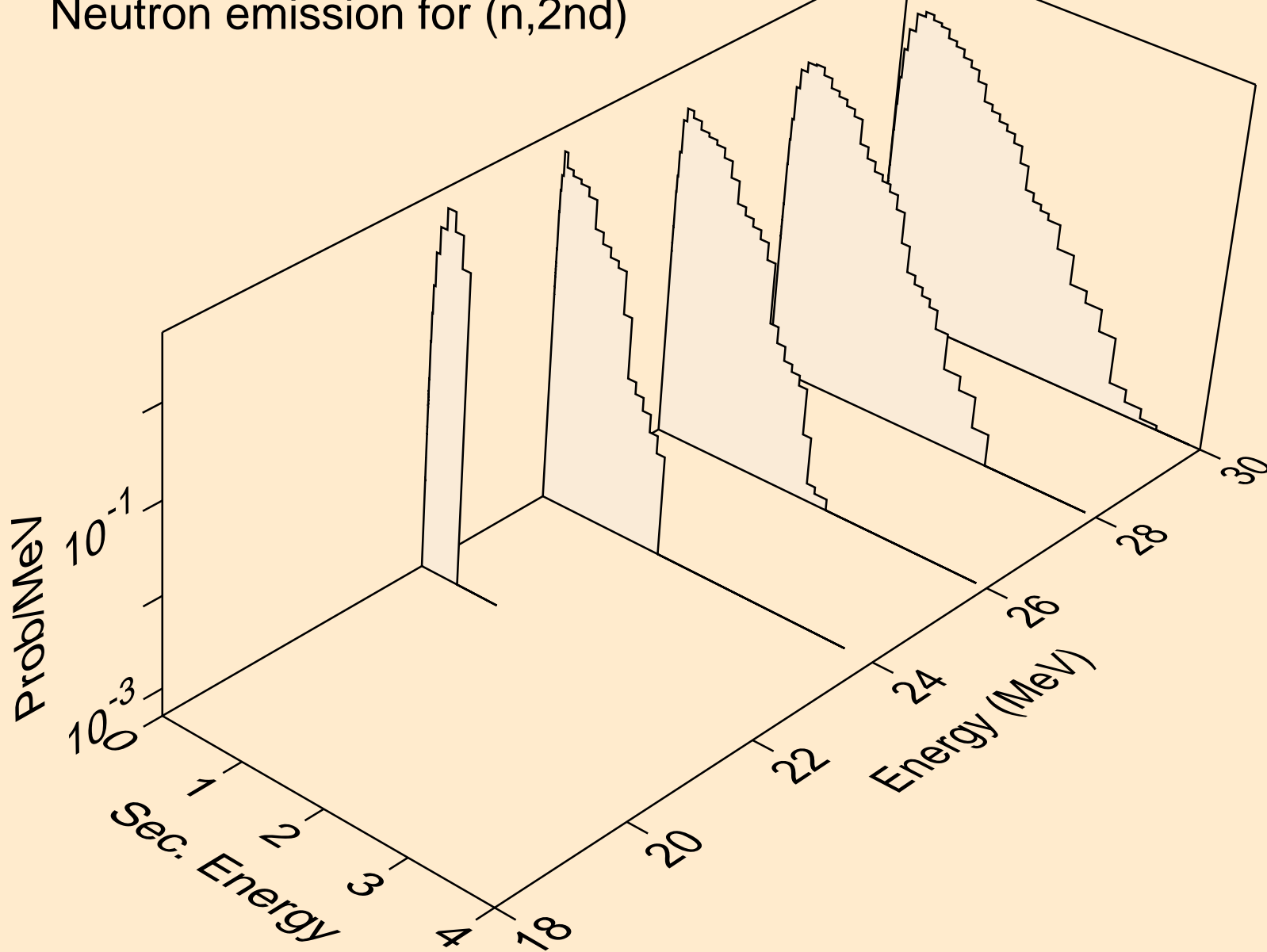

HG195 NEUTRON ACER TENDL-2019 LIBRARY; T=293.16K
Neutron emission for (n,2n)

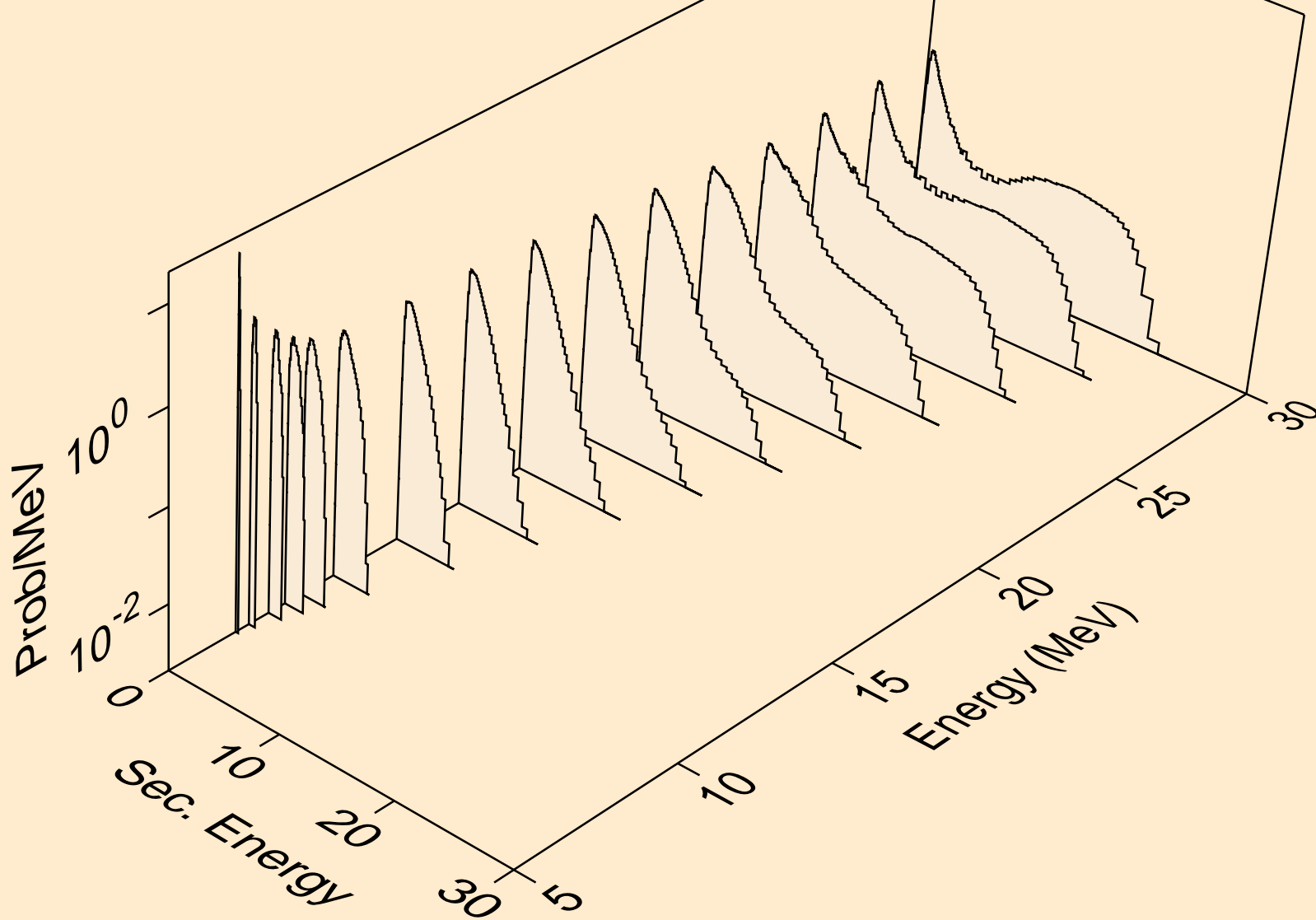

HG195 NEUTRON ACER TENDL-2019 LIBRARY; T=293.16K
Neutron emission for (n,3n)

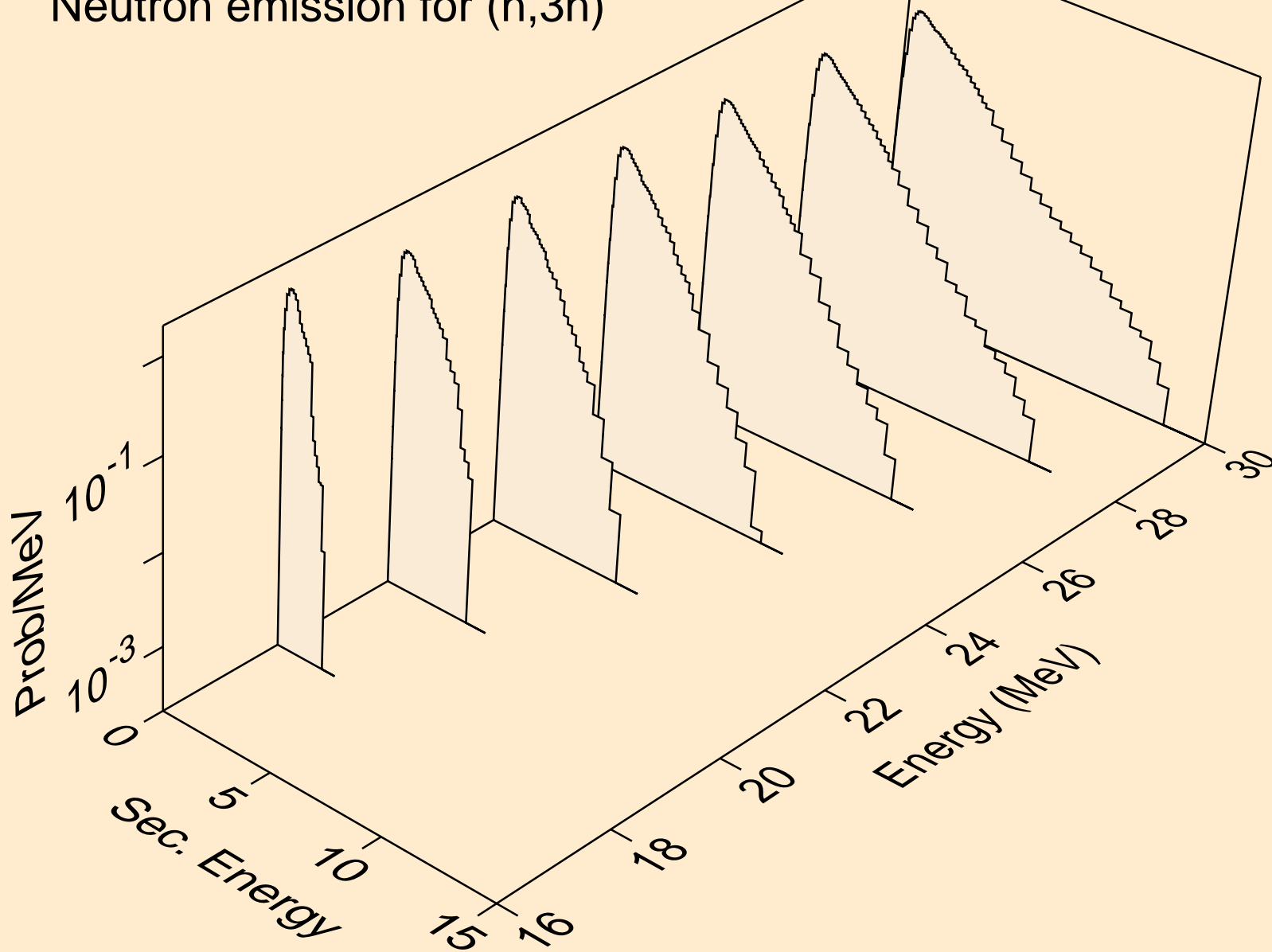

HG195 NEUTRON ACER TENDL-2019 LIBRARY; T=293.16K
Neutron emission for (n,n*)a

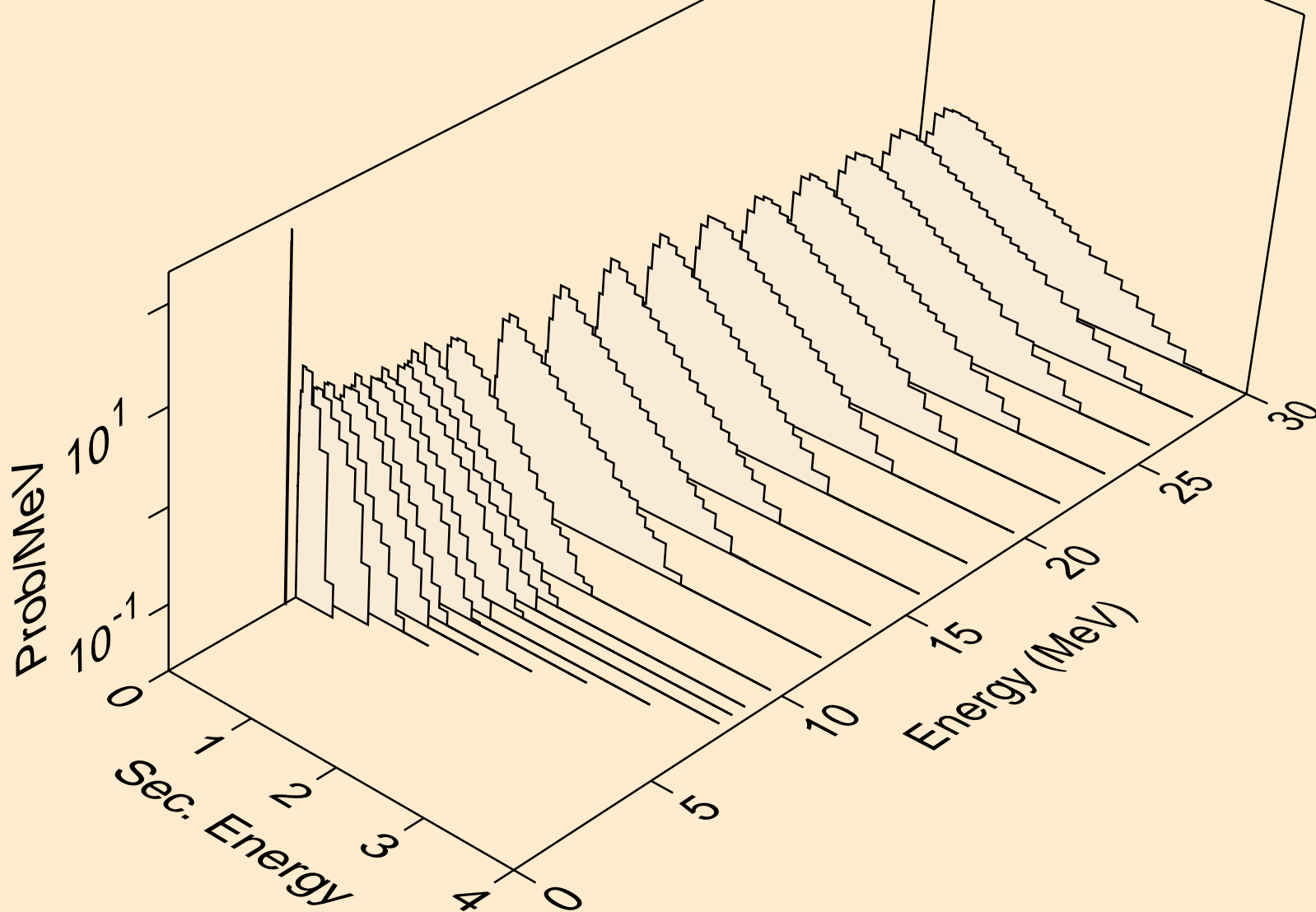

HG195 NEUTRON ACER TENDL-2019 LIBRARY; T=293.16K
Neutron emission for (n,2n)a

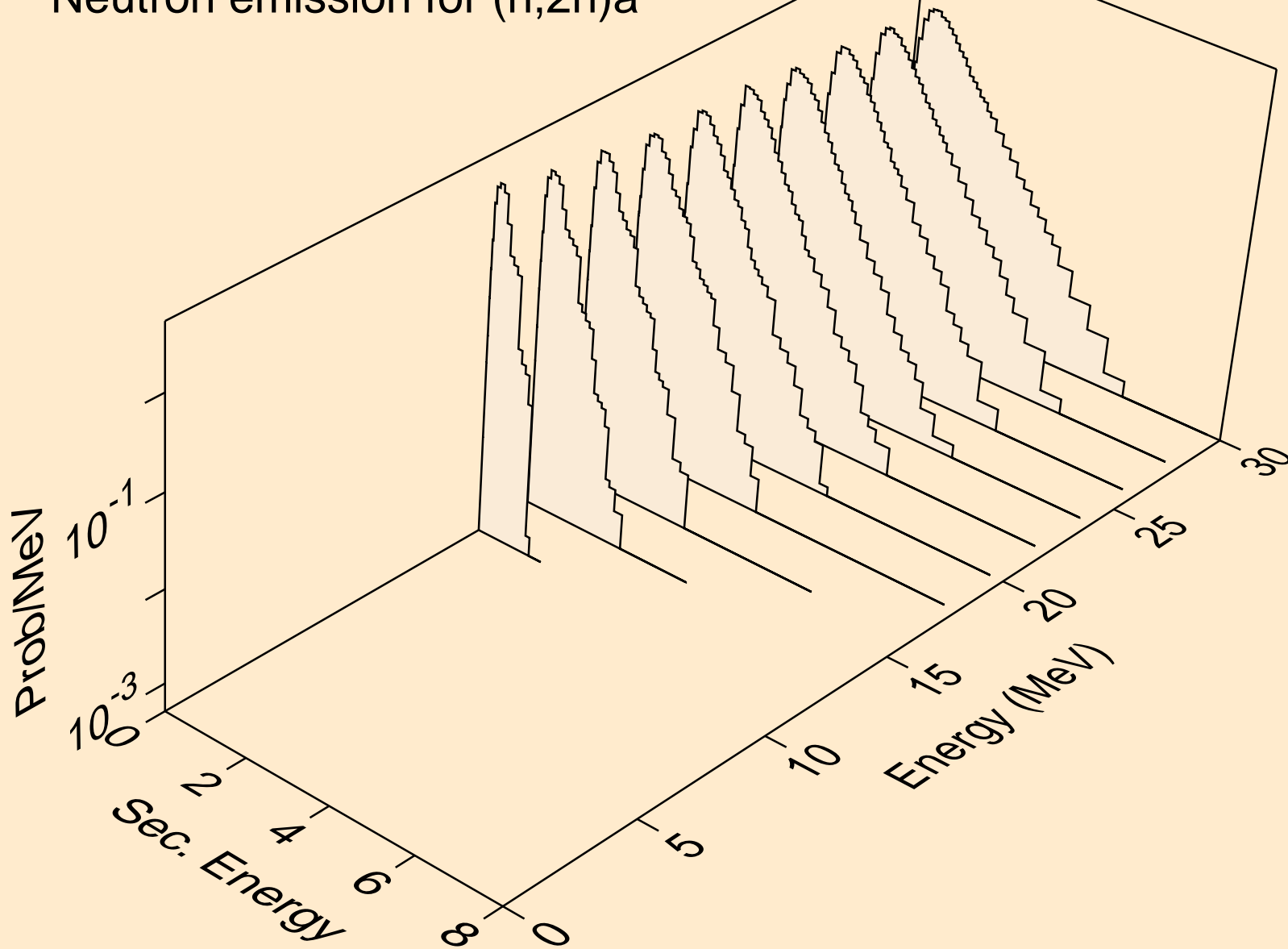

HG195 NEUTRON ACER TENDL-2019 LIBRARY; T=293.16K
Neutron emission for (n,3n)a

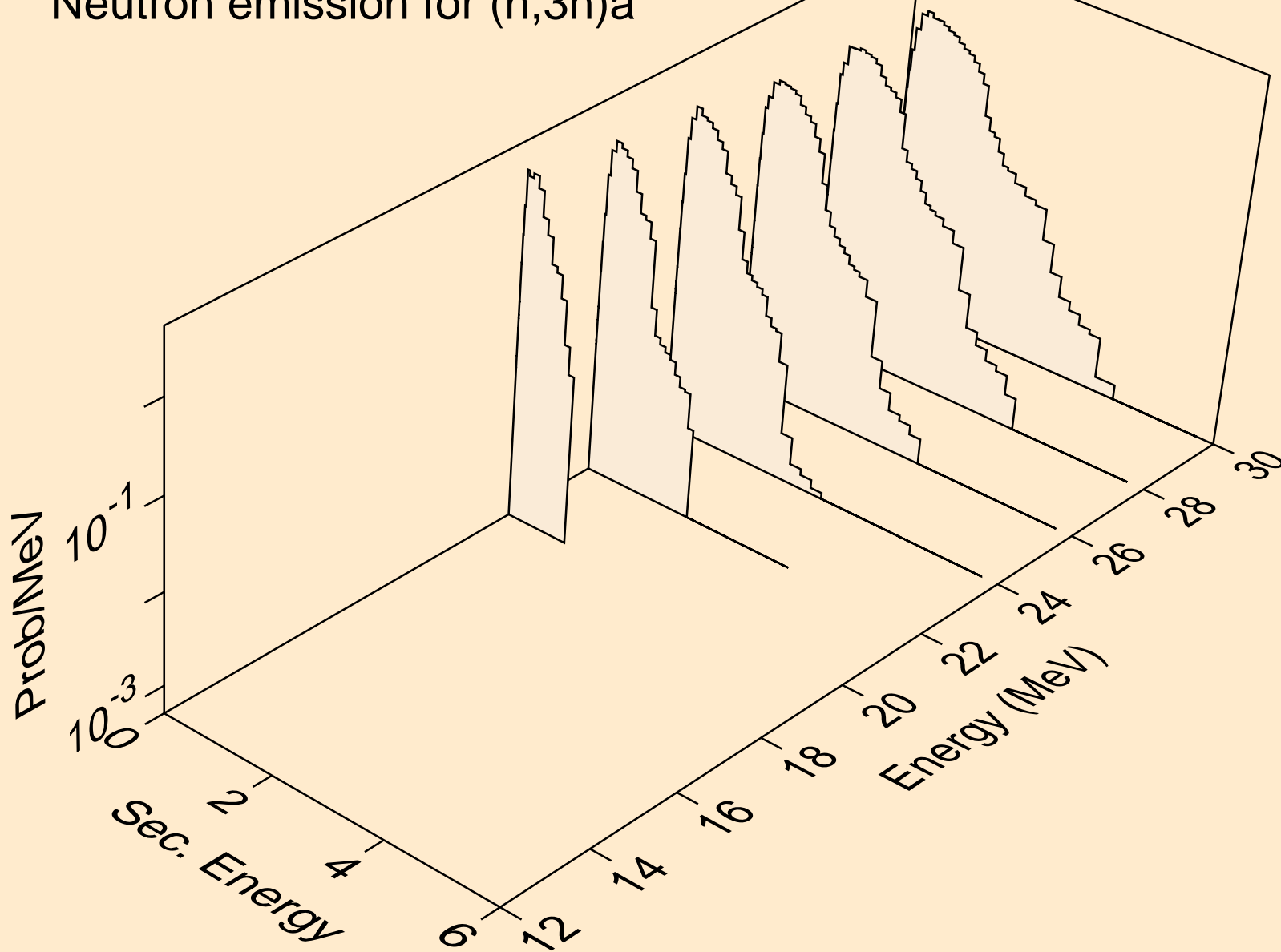

HG195 NEUTRON ACER TENDL-2019 LIBRARY; T=293.16K
Neutron emission for (n,n*)p

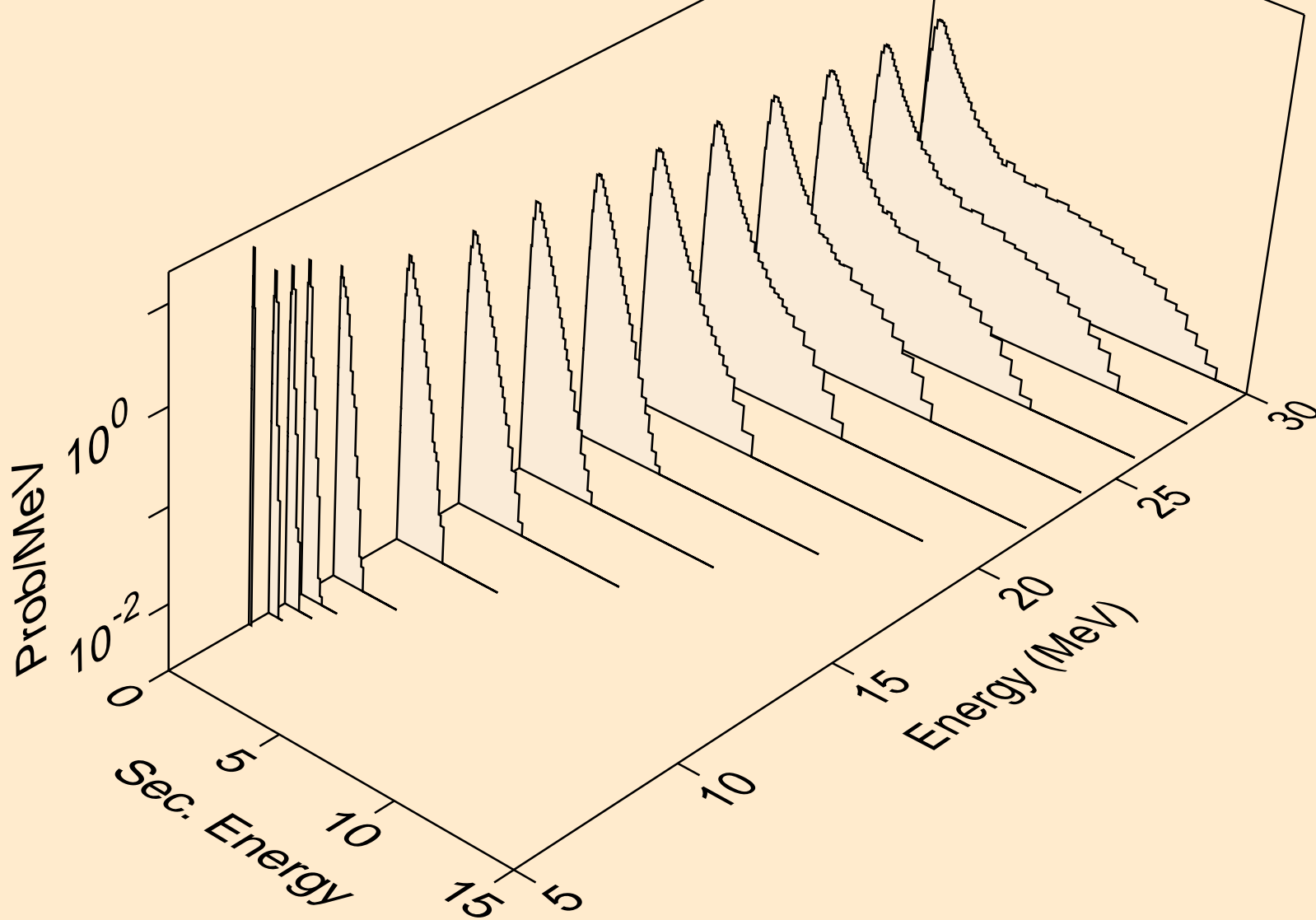

HG195 NEUTRON ACER TENDL-2019 LIBRARY; T=293.16K
Neutron emission for (n,n*)2a

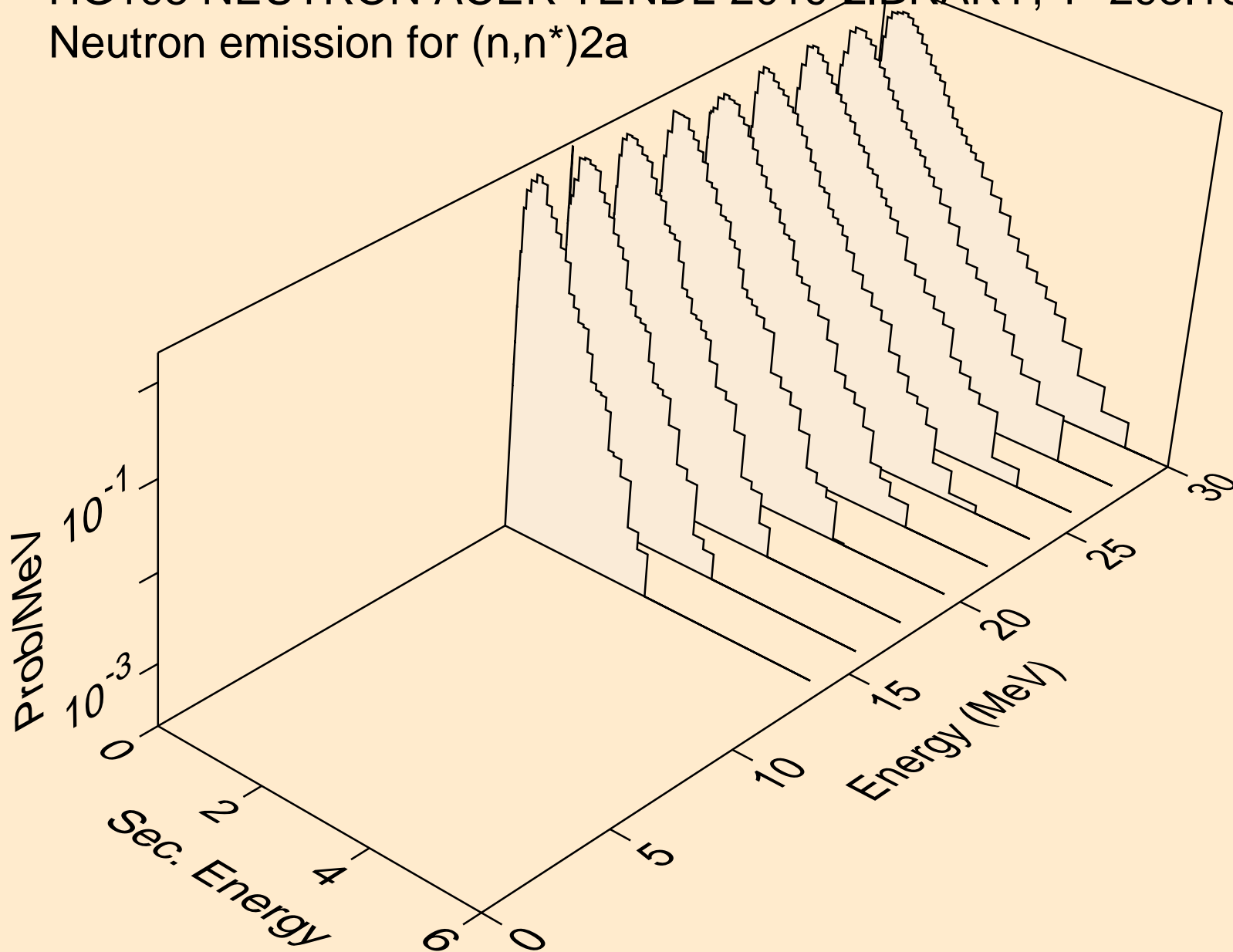

HG195 NEUTRON ACER TENDL-2019 LIBRARY; T=293.16K
Neutron emission for (n,n*)d

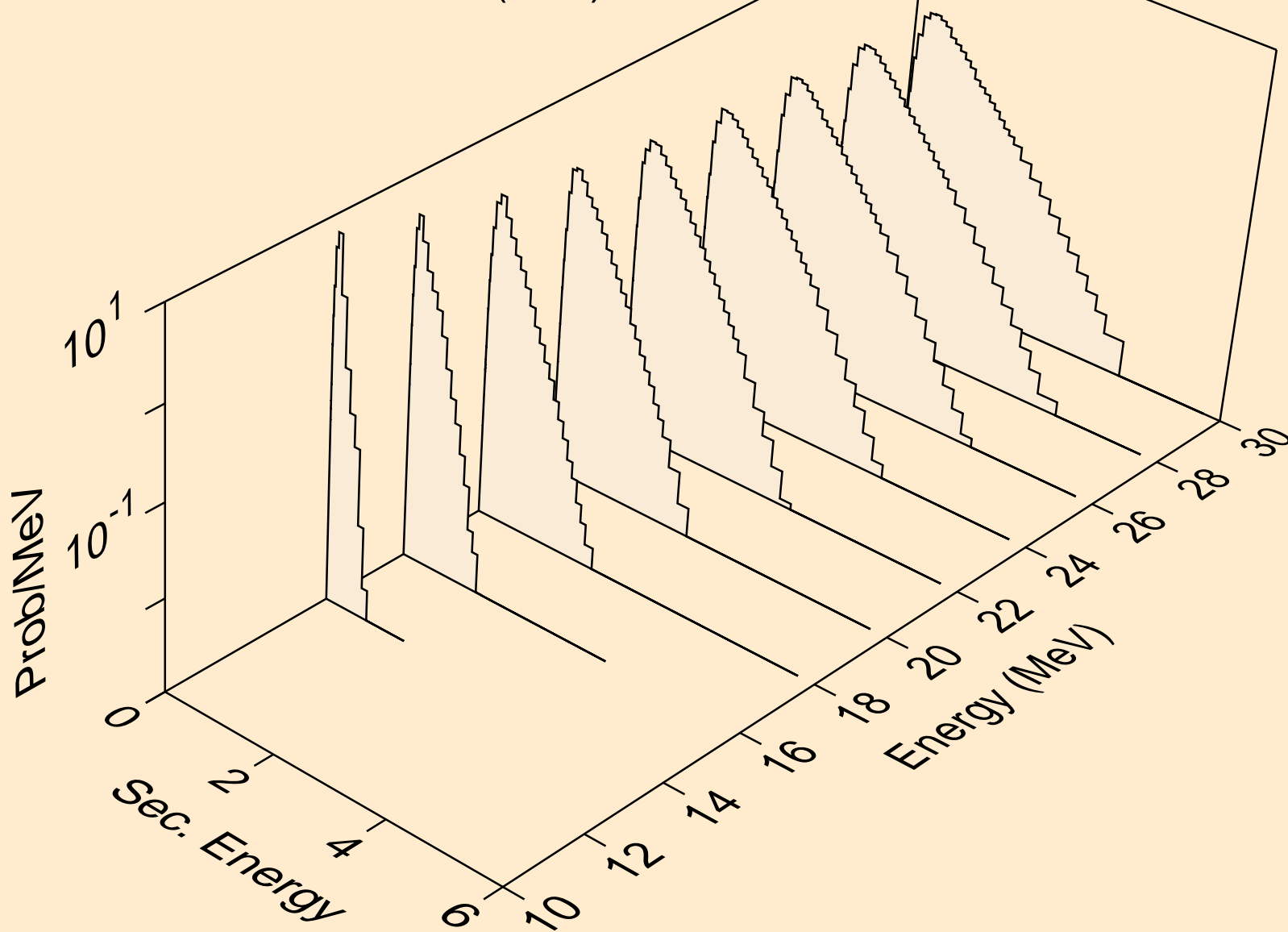

HG195 NEUTRON ACER TENDL-2019 LIBRARY; T=293.16K
Neutron emission for (n,n*)t

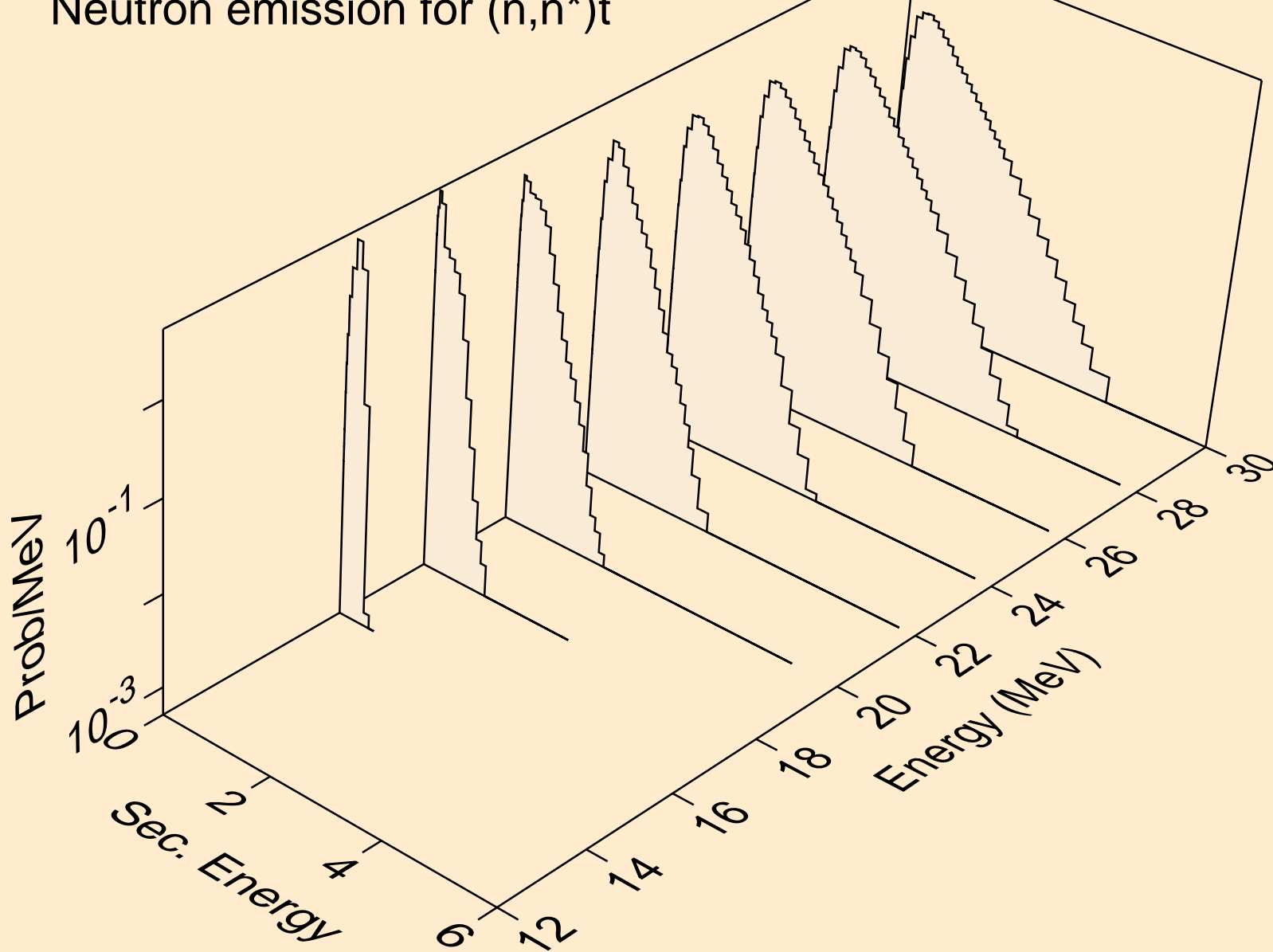

HG195 NEUTRON ACER TENDL-2019 LIBRARY; T=293.16K
Neutron emission for (n,n*)he3

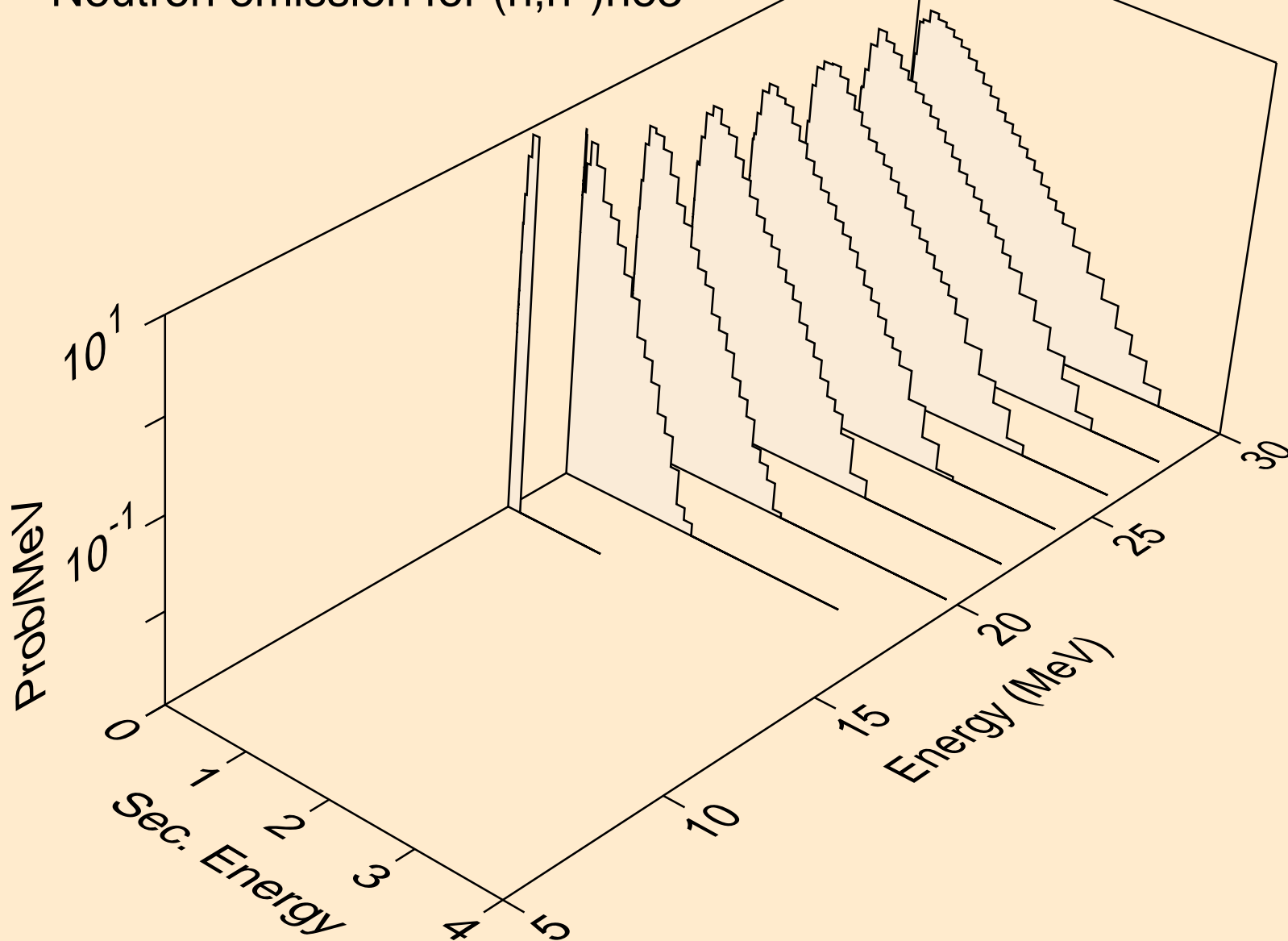

HG195 NEUTRON ACER TENDL-2019 LIBRARY; T=293.16K
Neutron emission for (n,4n)

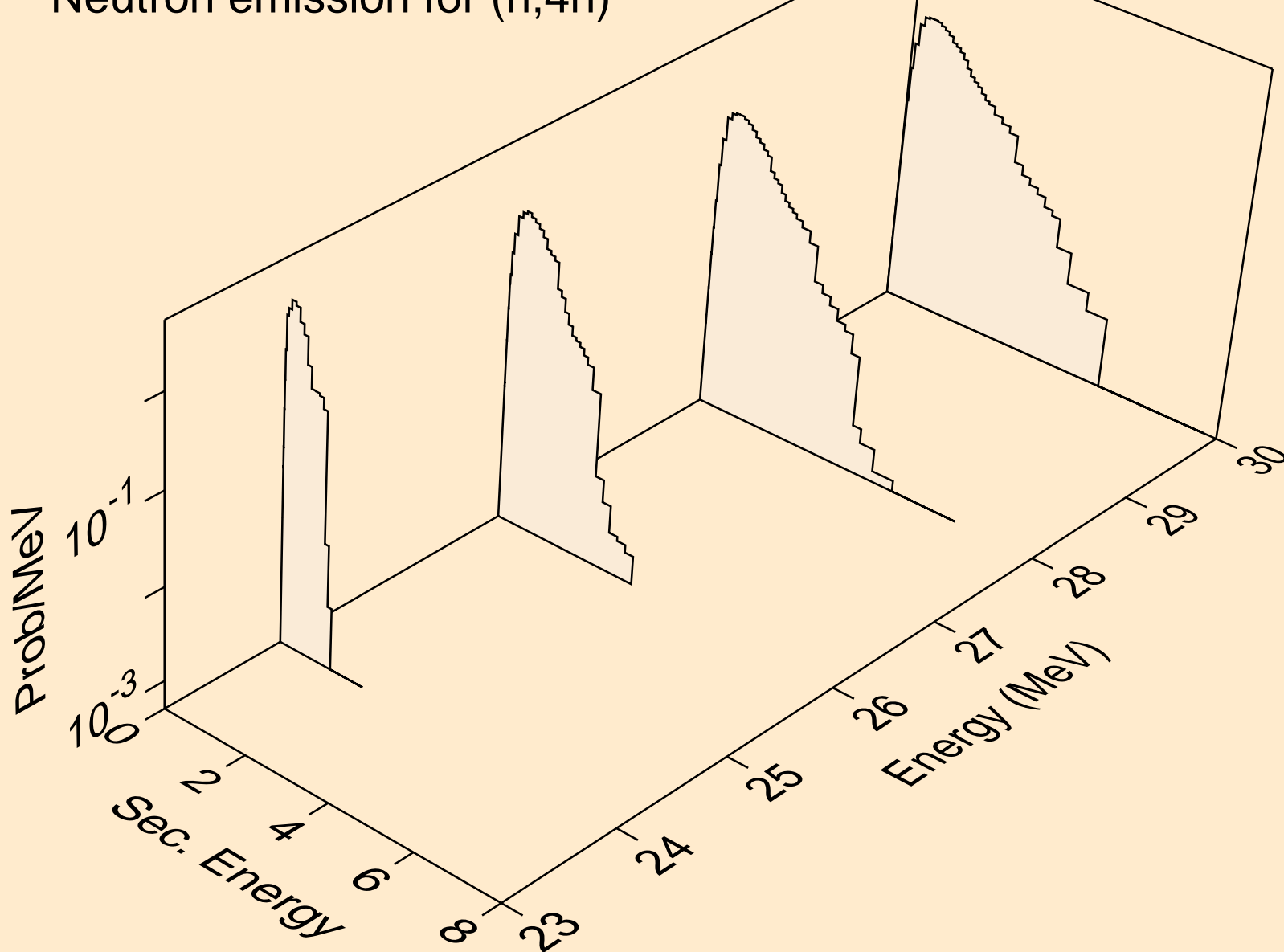

HG195 NEUTRON ACER TENDL-2019 LIBRARY; T=293.16K
Neutron emission for (n,2np)

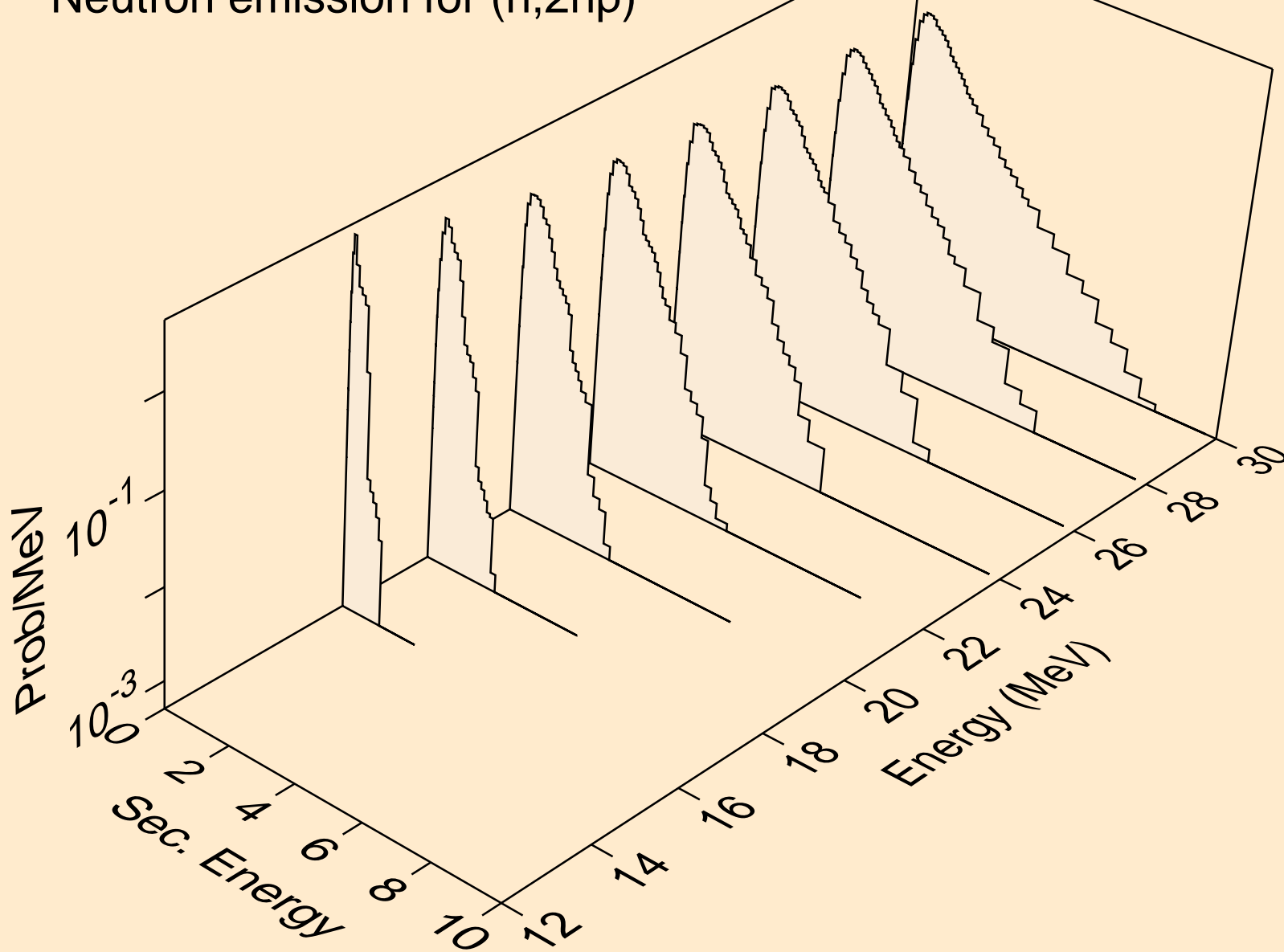

HG195 NEUTRON ACER TENDL-2019 LIBRARY; T=293.16K
Neutron emission for (n,3np)

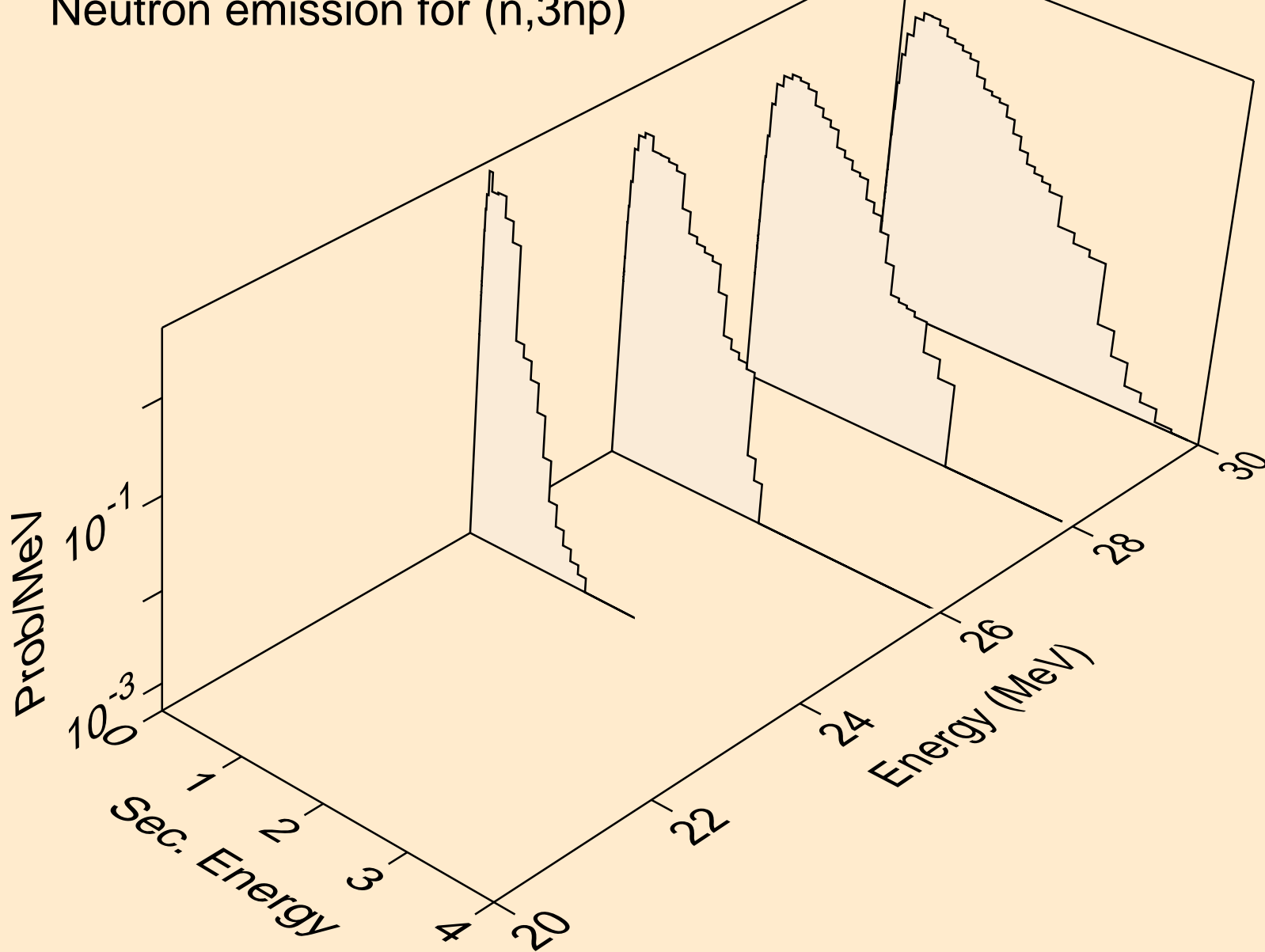

HG195 NEUTRON ACER TENDL-2019 LIBRARY; T=293.16K
Neutron emission for (n,2np)

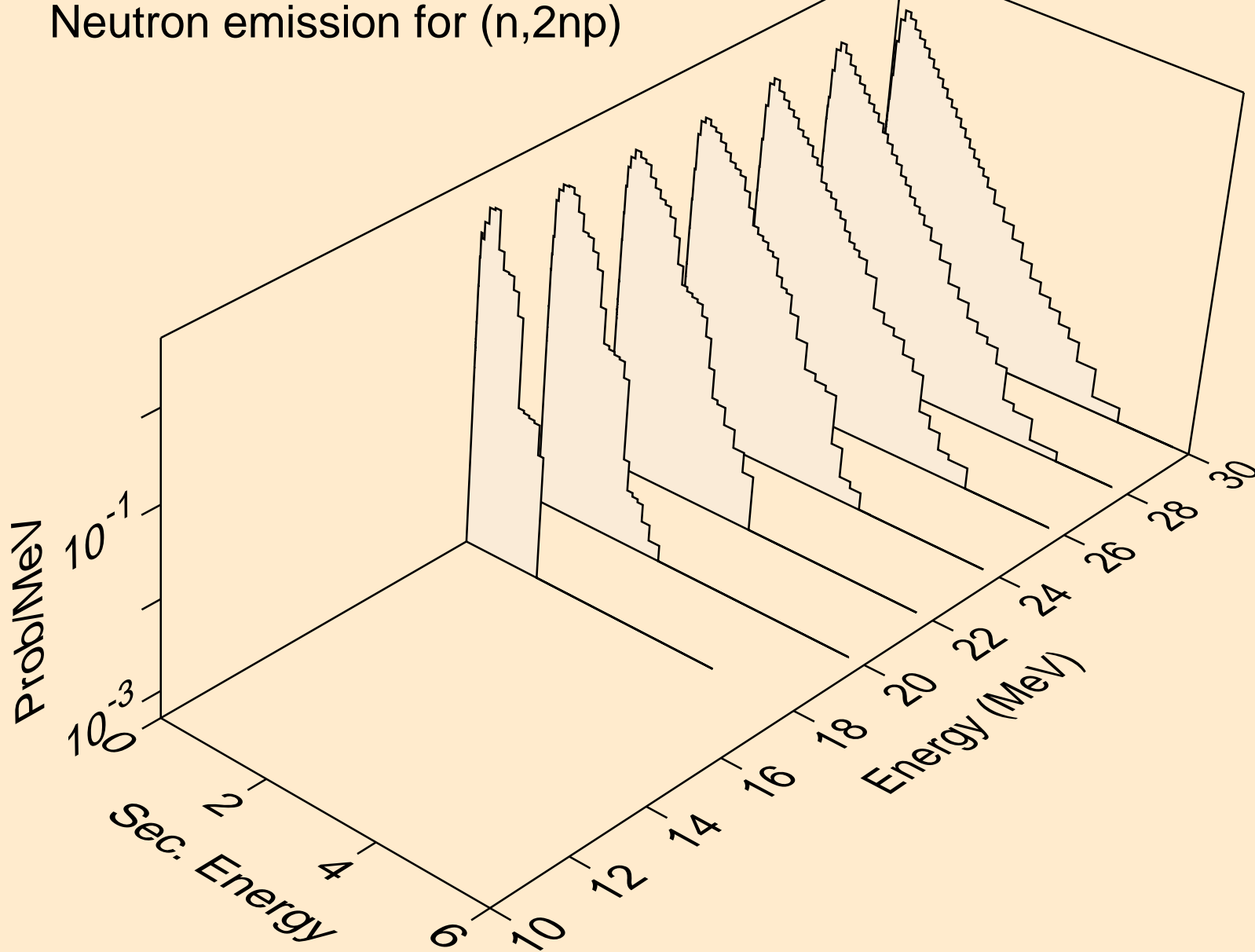

HG195 NEUTRON ACER TENDL-2019 LIBRARY; T=293.16K
Neutron emission for (n,npa)

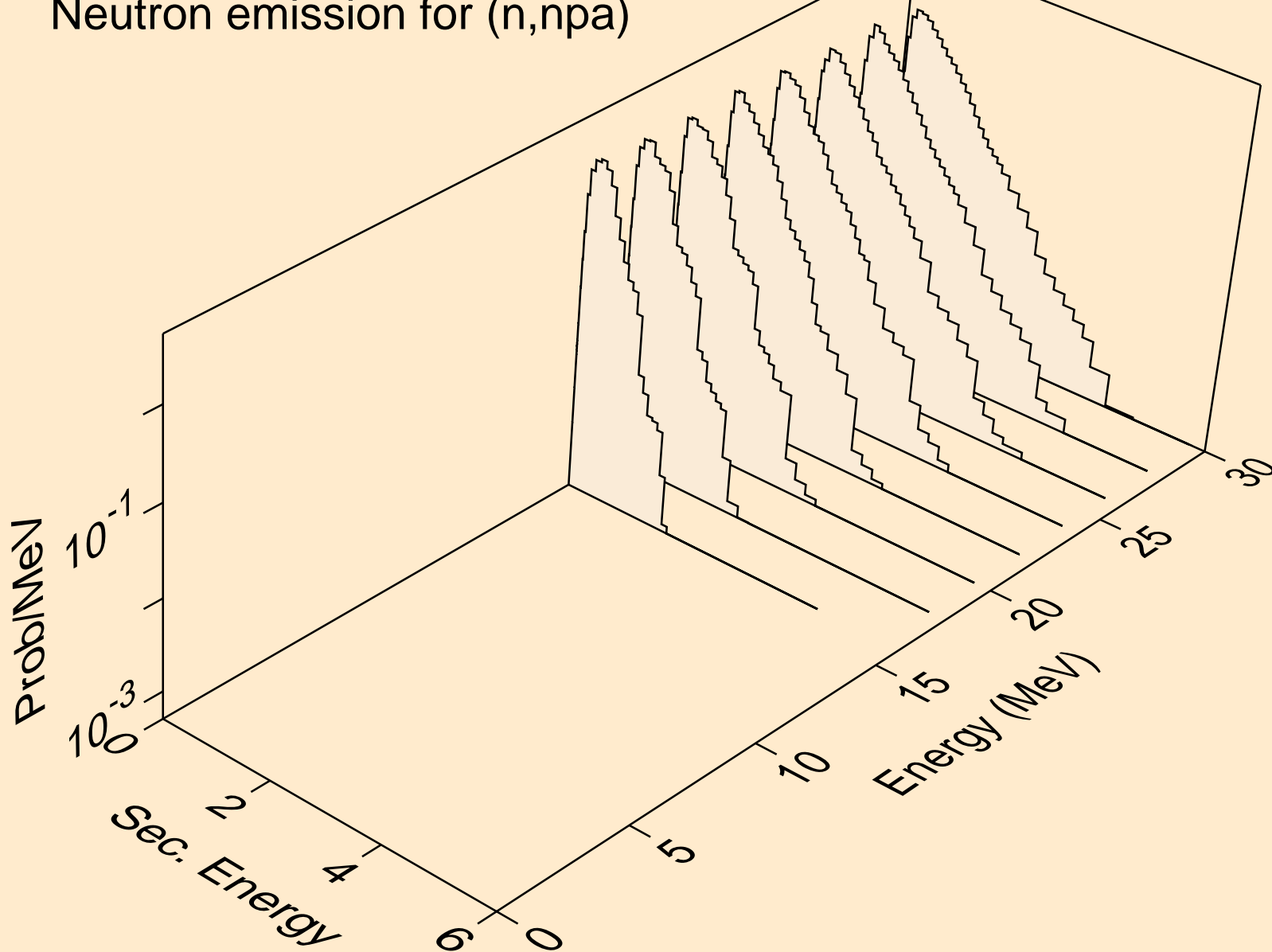

HG195 NEUTRON ACER TENDL-2019 LIBRARY; T=293.16K
Neutron emission for (n,n*c)

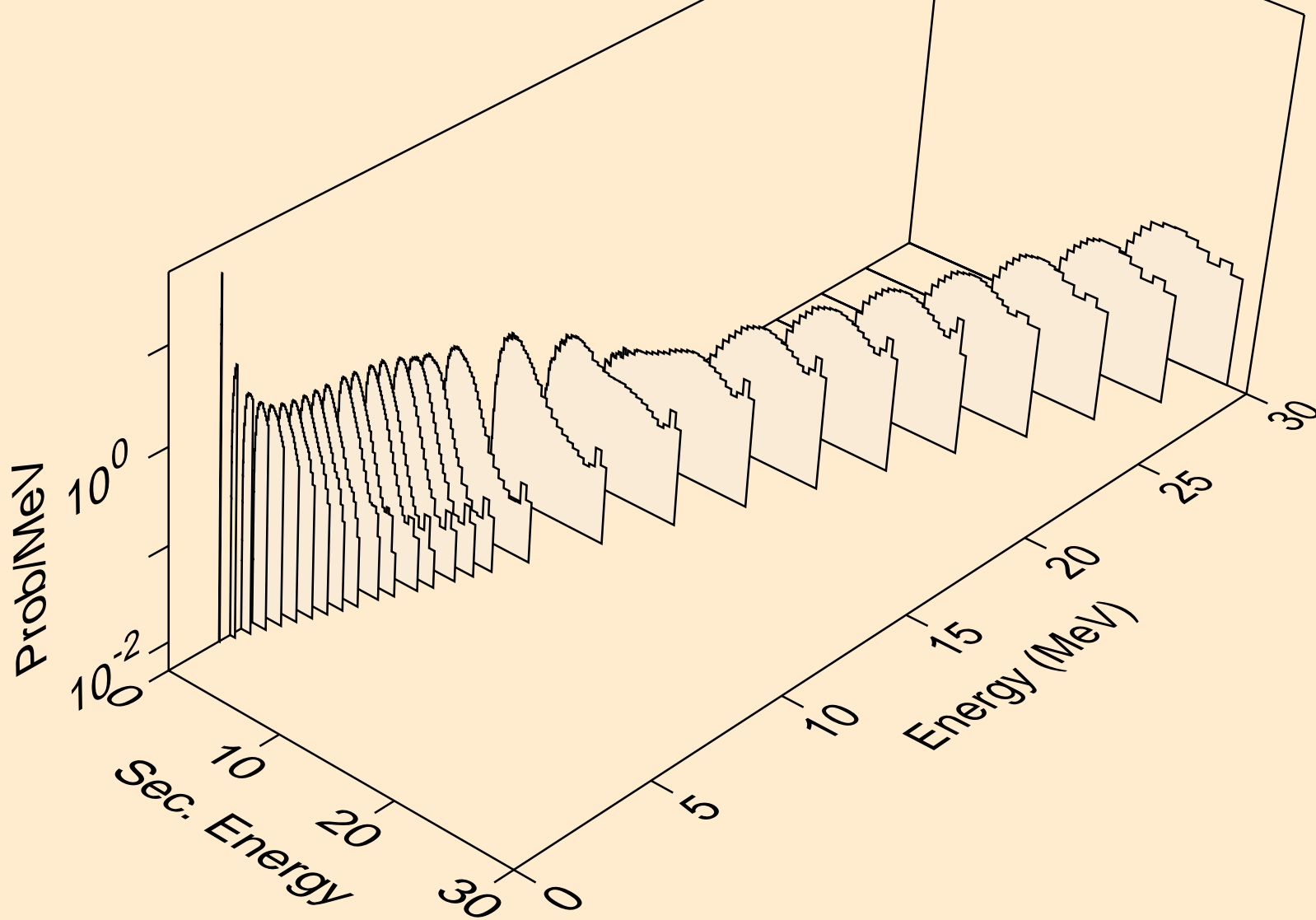

HG195 NEUTRON ACER TENDL-2019 LIBRARY; T=293.16K
Photon emission for (n,x)

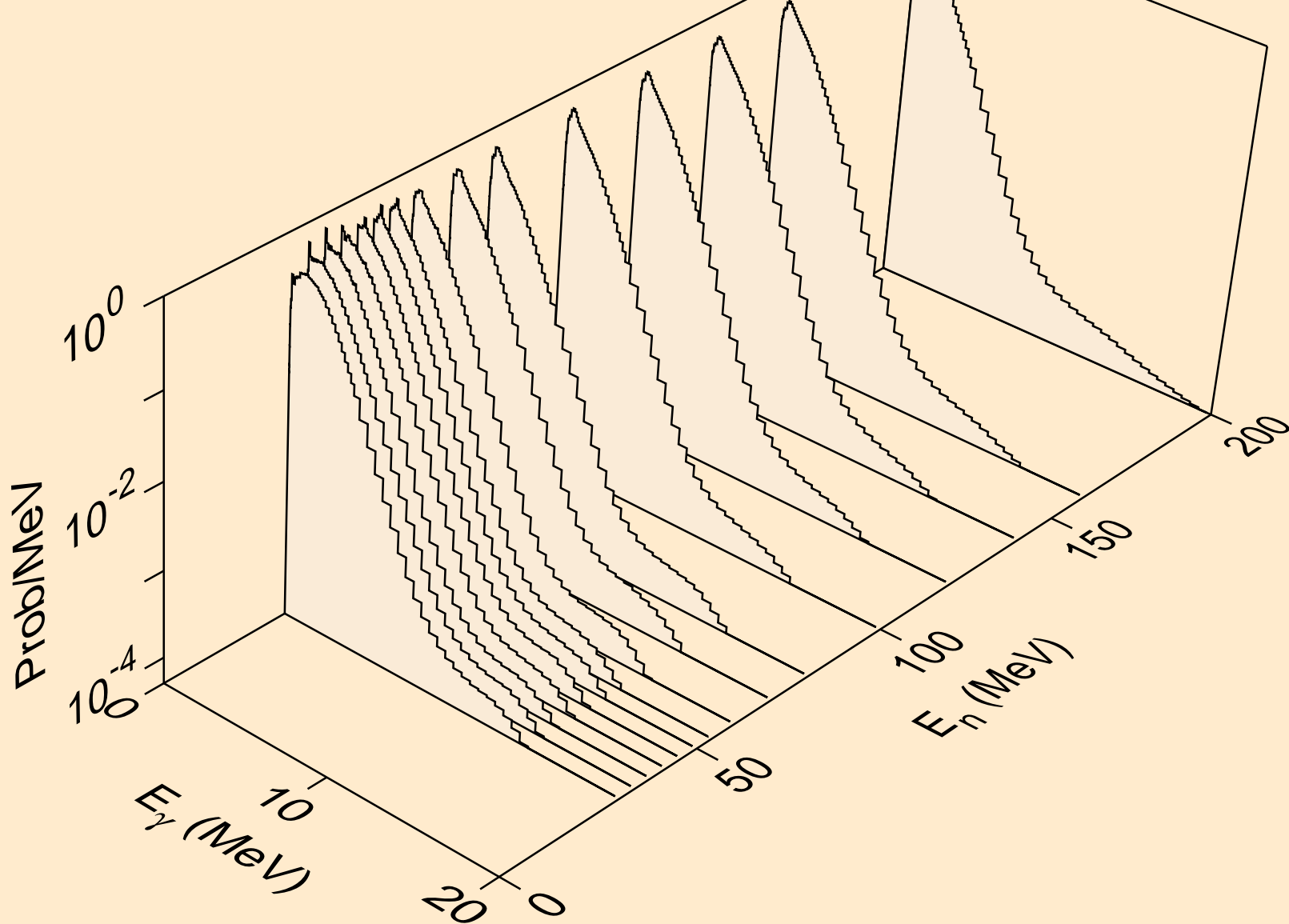

HG195 NEUTRON ACER TENDL-2019 LIBRARY; T=293.16K
Photon emission for (n,2nd)

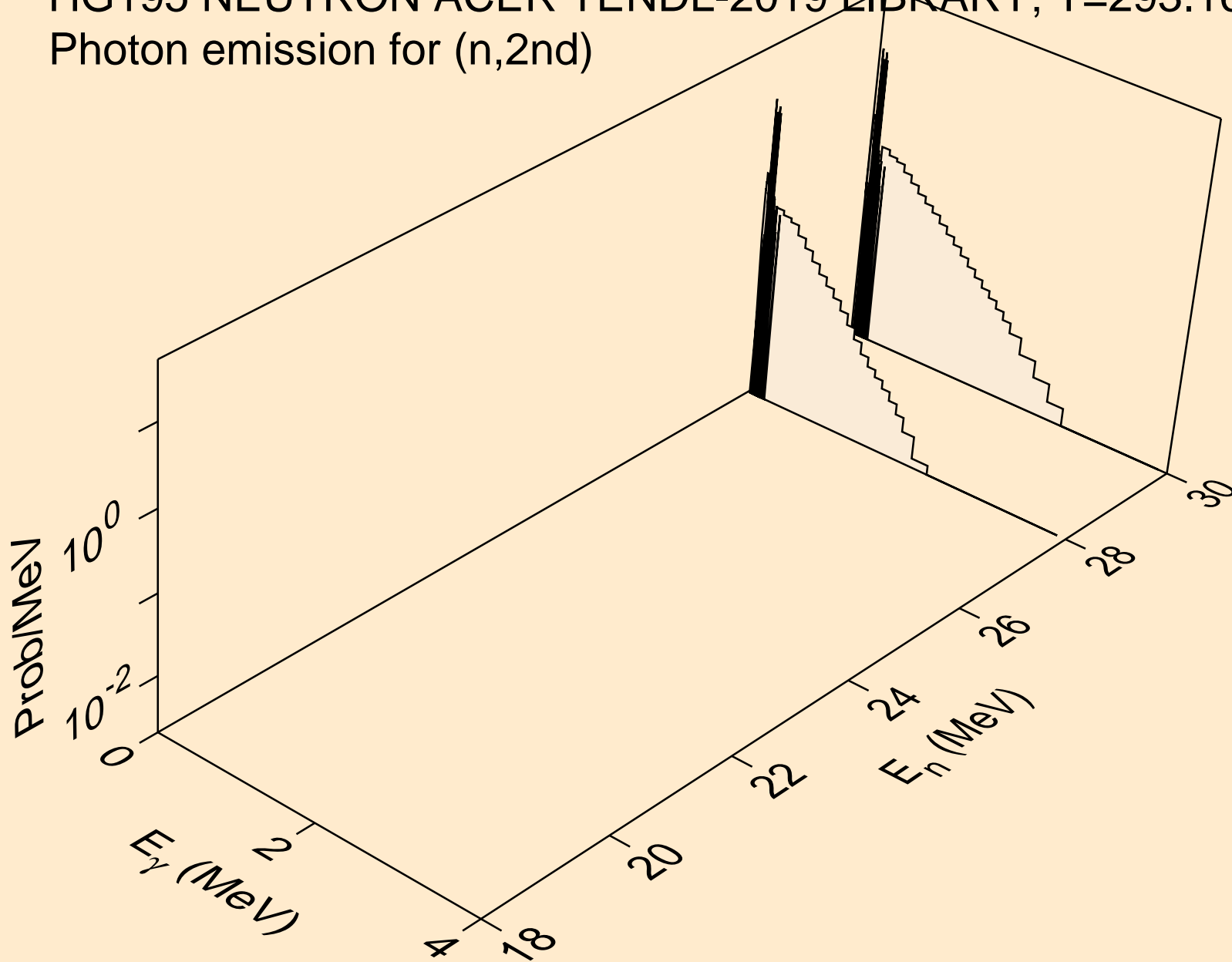

HG195 NEUTRON ACER TENDL-2019 LIBRARY; T=293.16K
Photon emission for (n,2n)

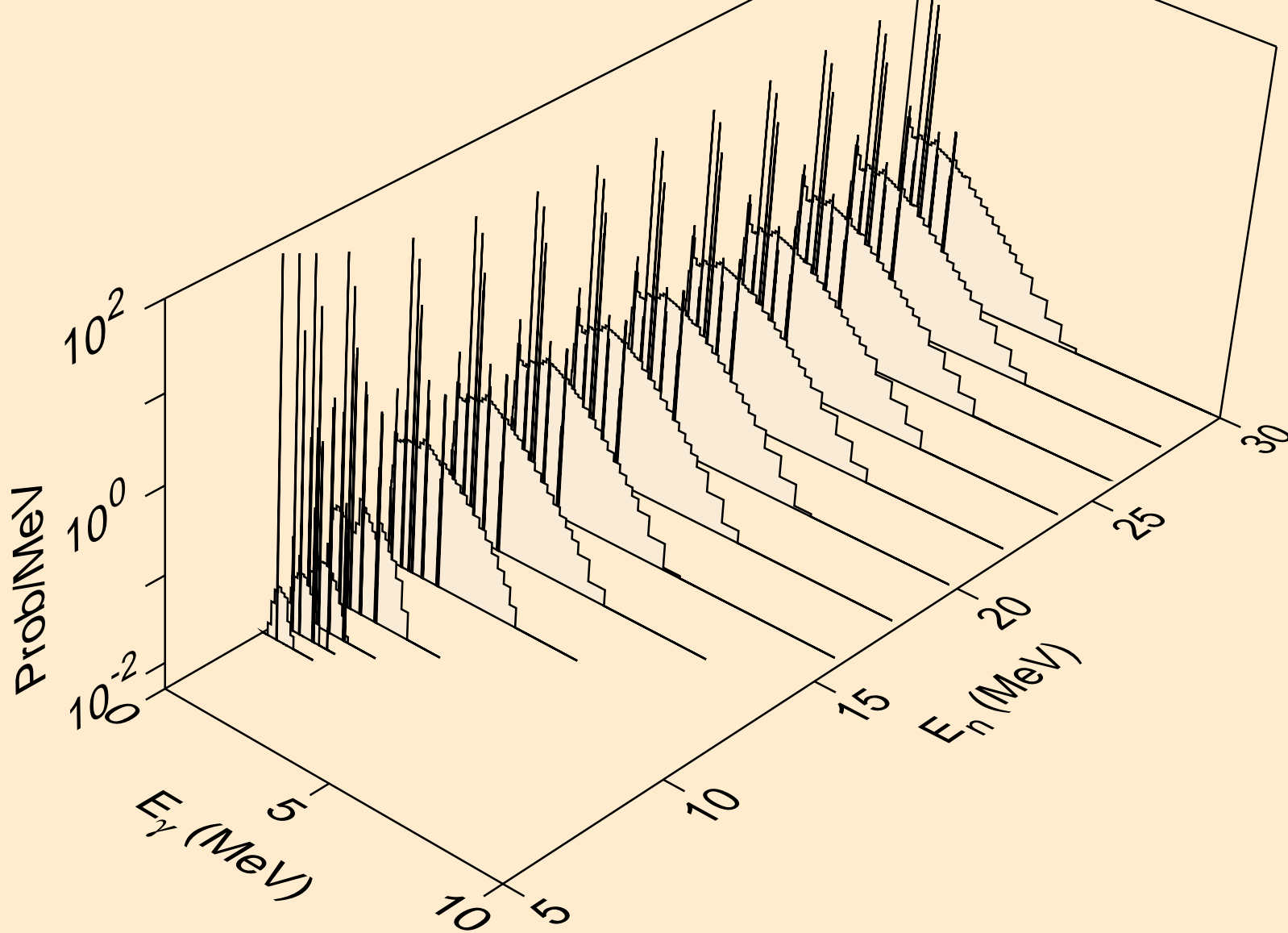

HG195 NEUTRON ACER TENDL-2019 LIBRARY; T=293.16K
Photon emission for (n,3n)

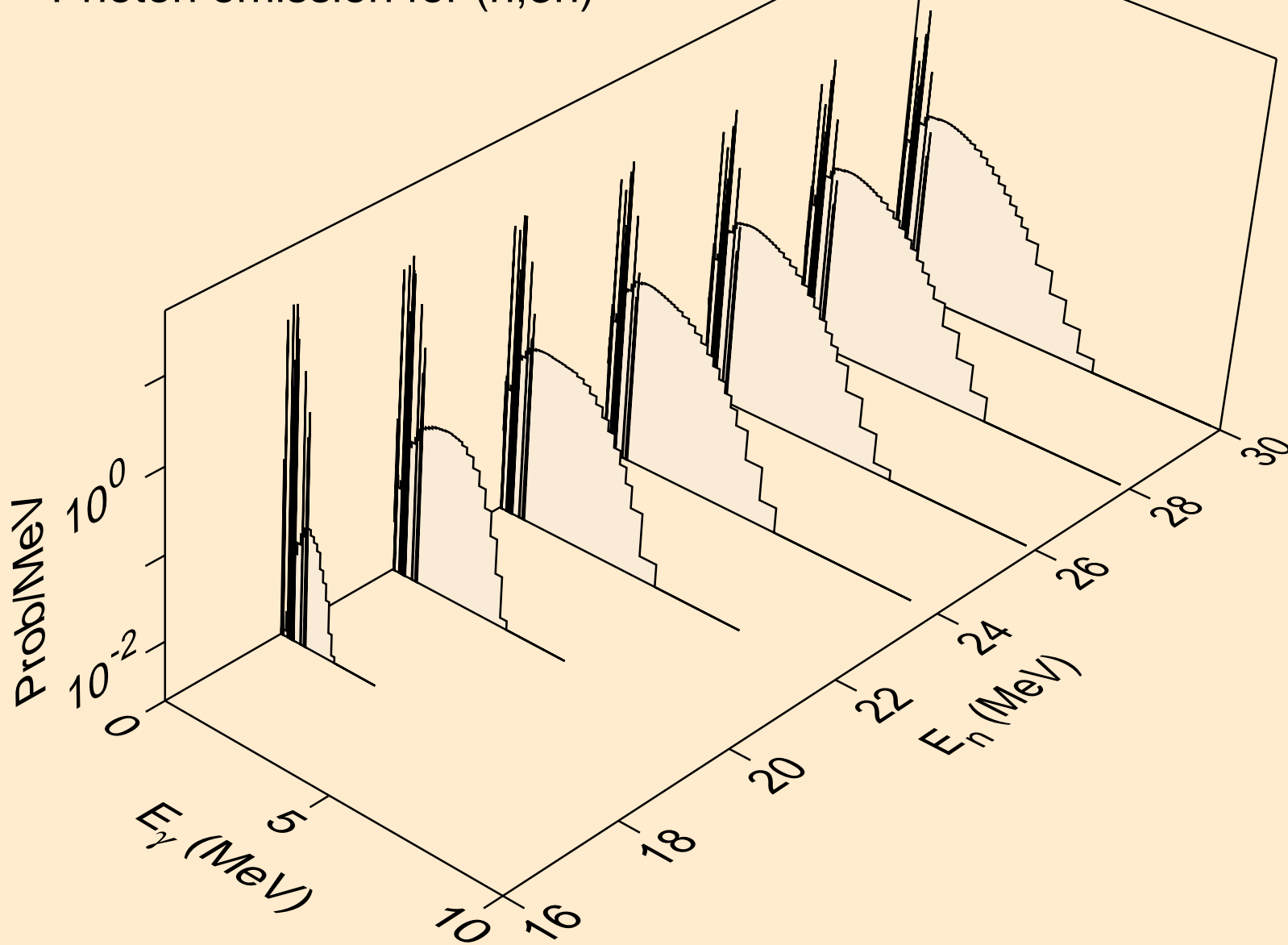

HG195 NEUTRON ACER TENDL-2019 LIBRARY; T=293.16K
Photon emission for (n,n*)a

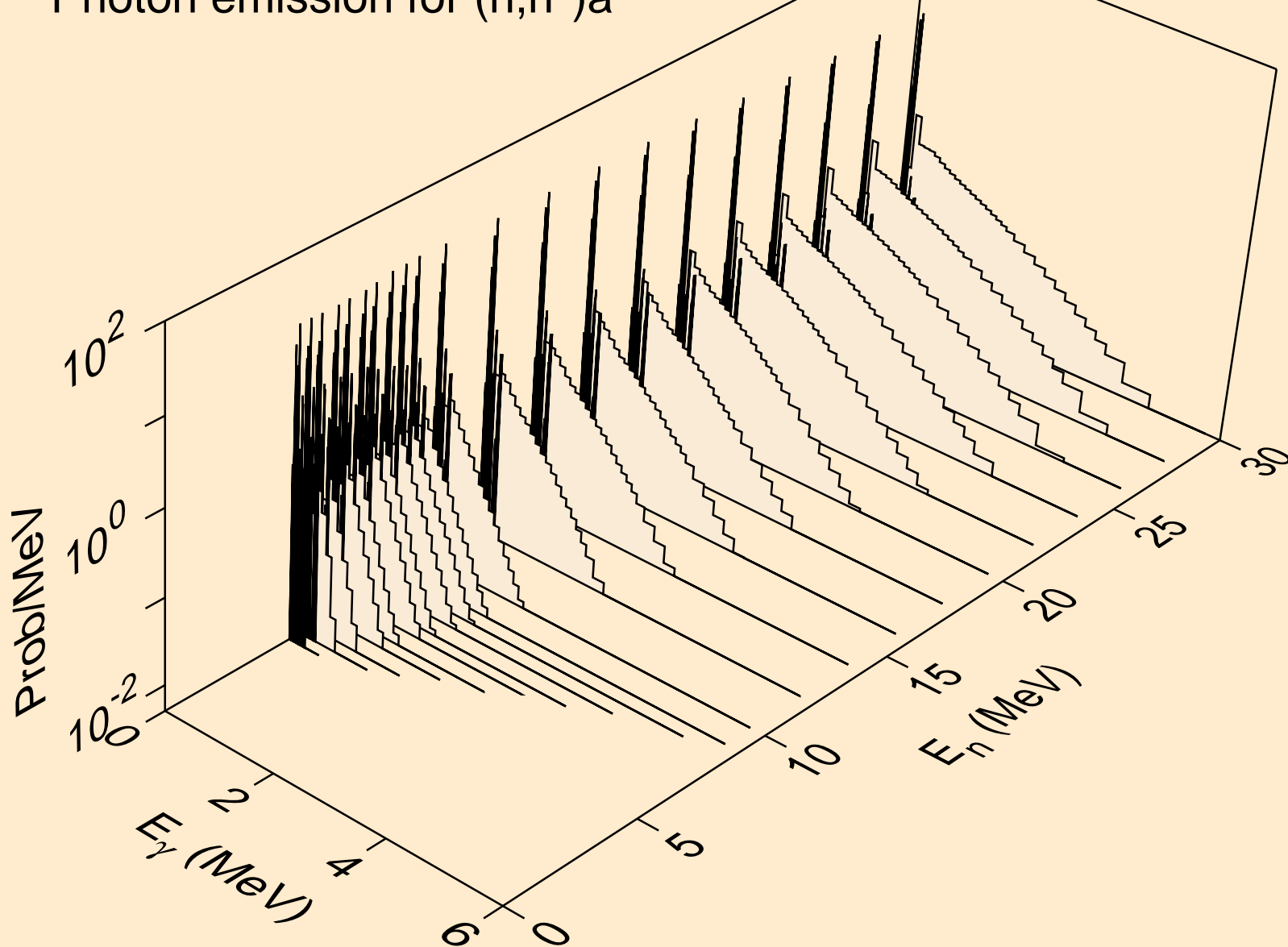

HG195 NEUTRON ACER TENDL-2019 LIBRARY; T=293.16K
Photon emission for (n,2n)a

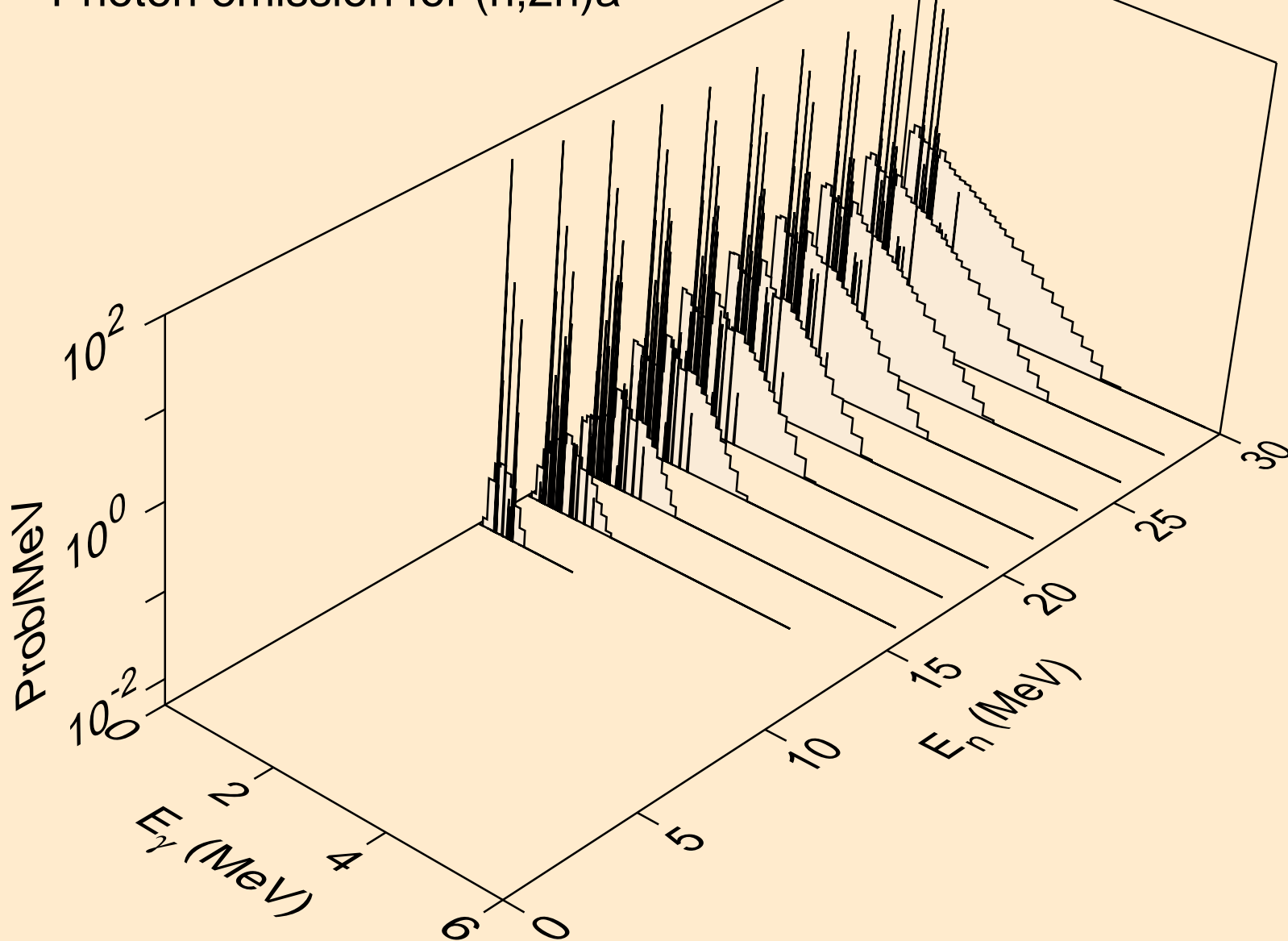

HG195 NEUTRON ACER TENDL-2019 LIBRARY; T=293.16K
Photon emission for (n,3n)a

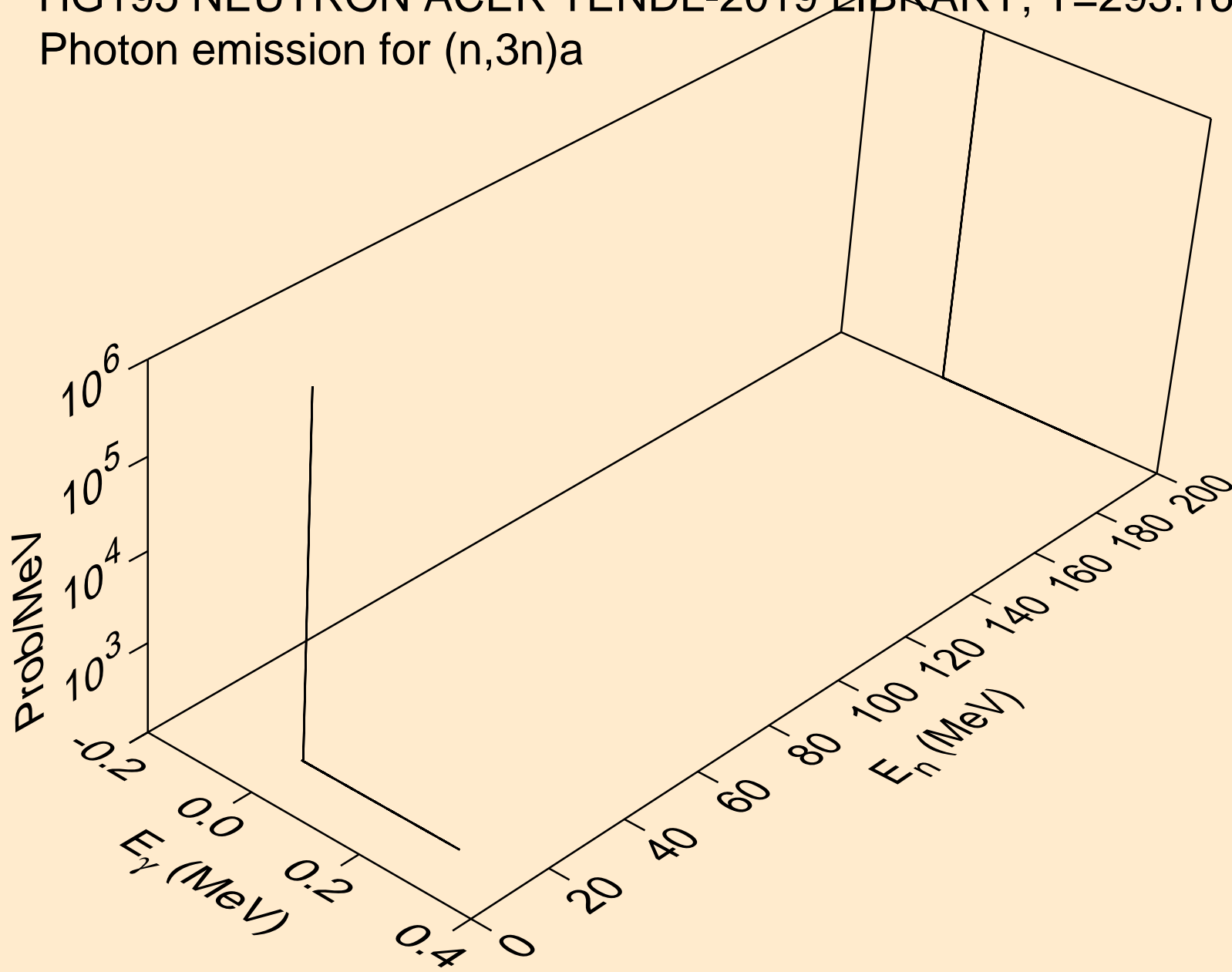

HG195 NEUTRON ACER TENDL-2019 LIBRARY; T=293.16K
Photon emission for (n,n*)p

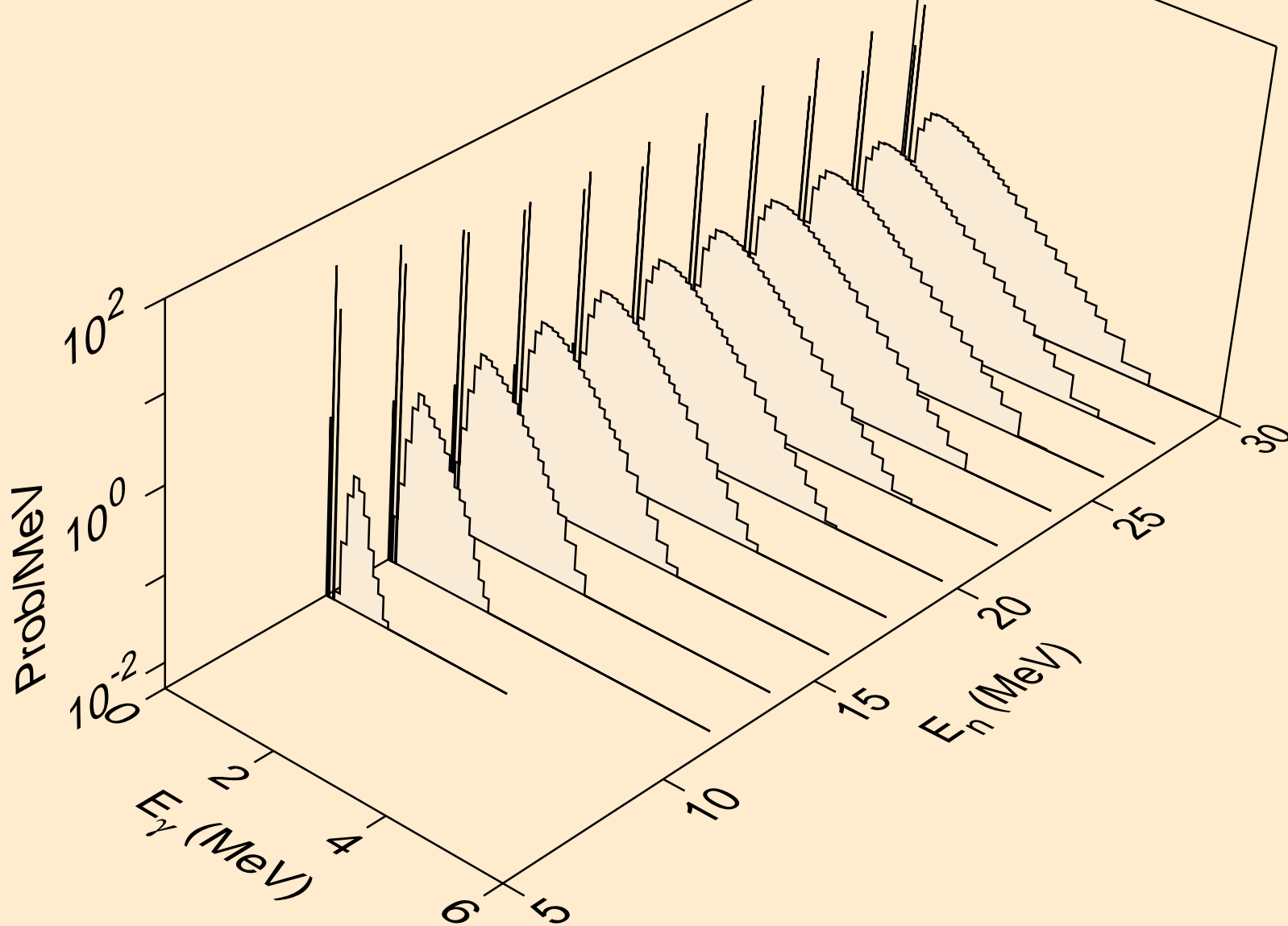

HG195 NEUTRON ACER TENDL-2019 LIBRARY; T=293.16K
Photon emission for (n,n*)2a

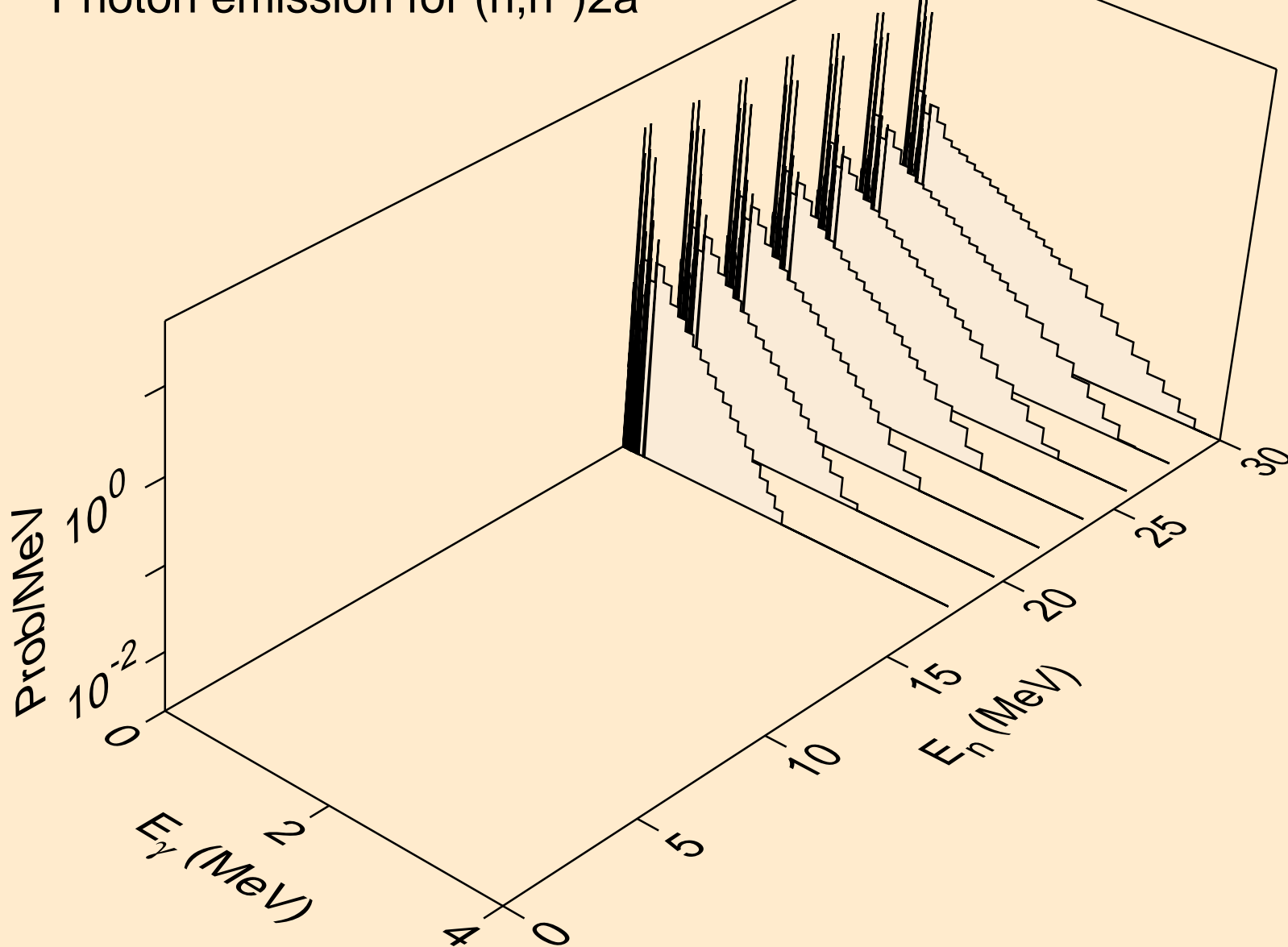

HG195 NEUTRON ACER TENDL-2019 LIBRARY; T=293.16K
Photon emission for (n,n*)d

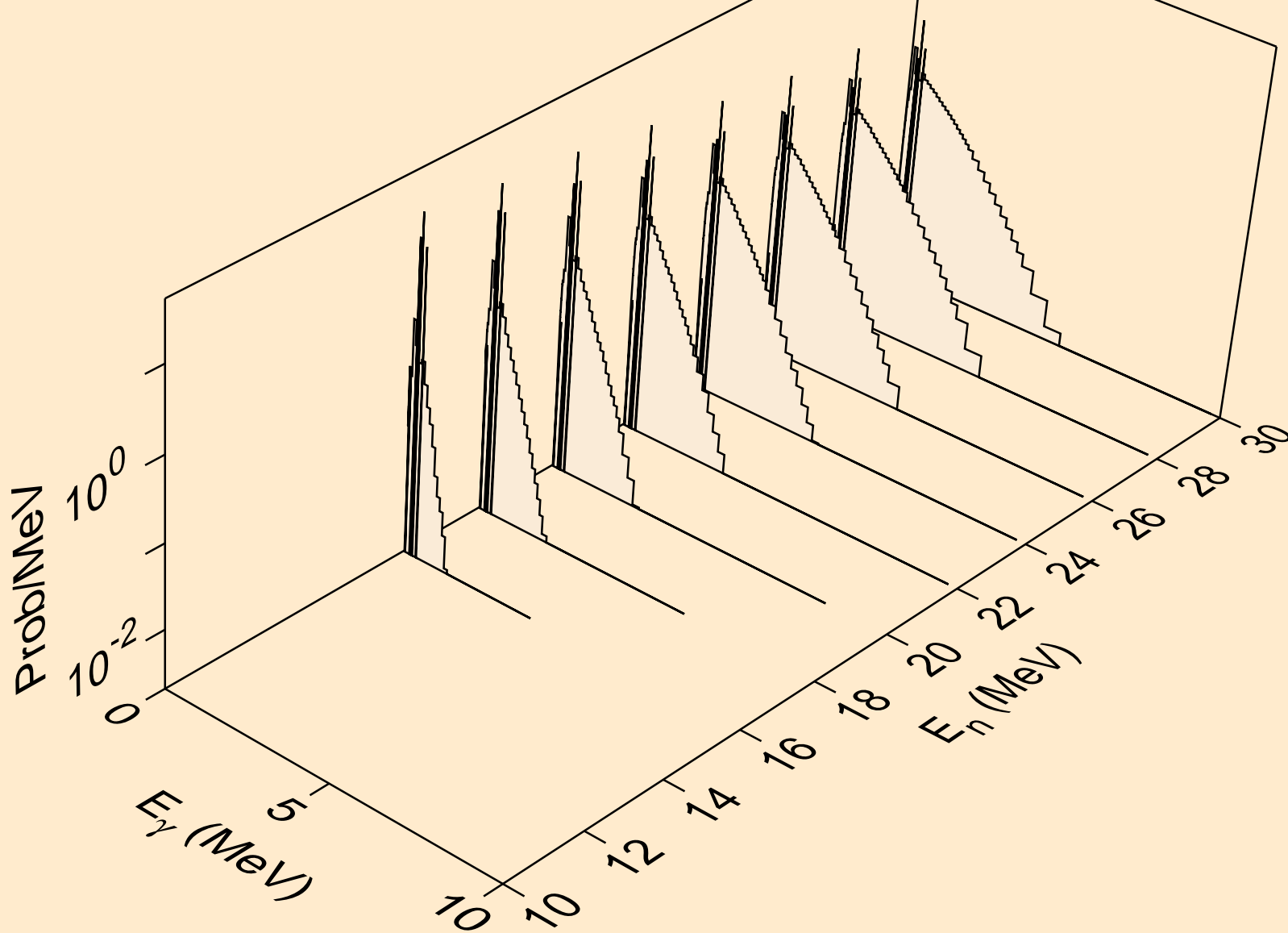

HG195 NEUTRON ACER TENDL-2019 LIBRARY; T=293.16K
Photon emission for (n,n*)t

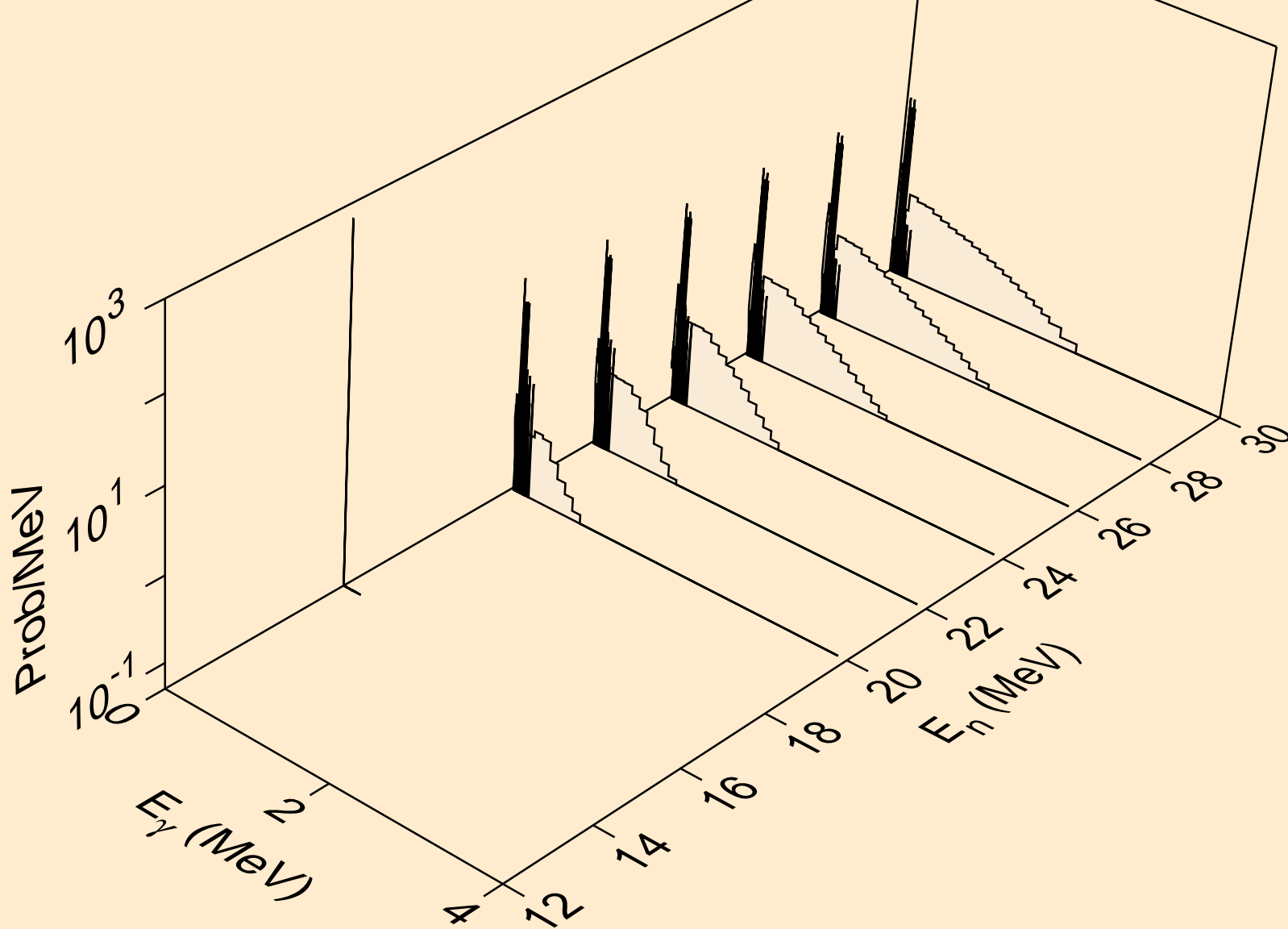

HG195 NEUTRON ACER TENDL-2019 LIBRARY; T=293.16K
Photon emission for (n,n*)he3

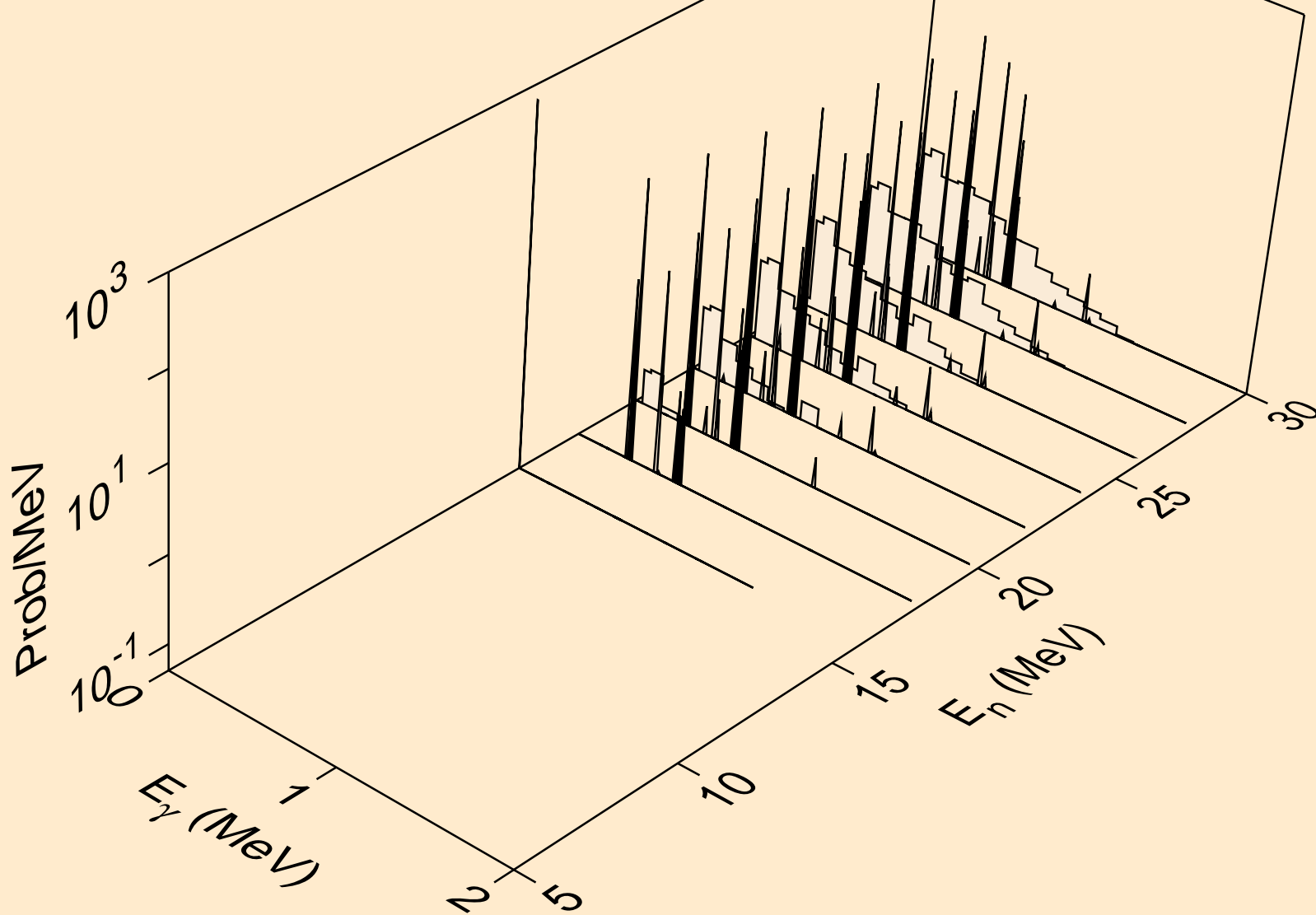

HG195 NEUTRON ACER TENDL-2019 LIBRARY; T=293.16K
Photon emission for (n,4n)

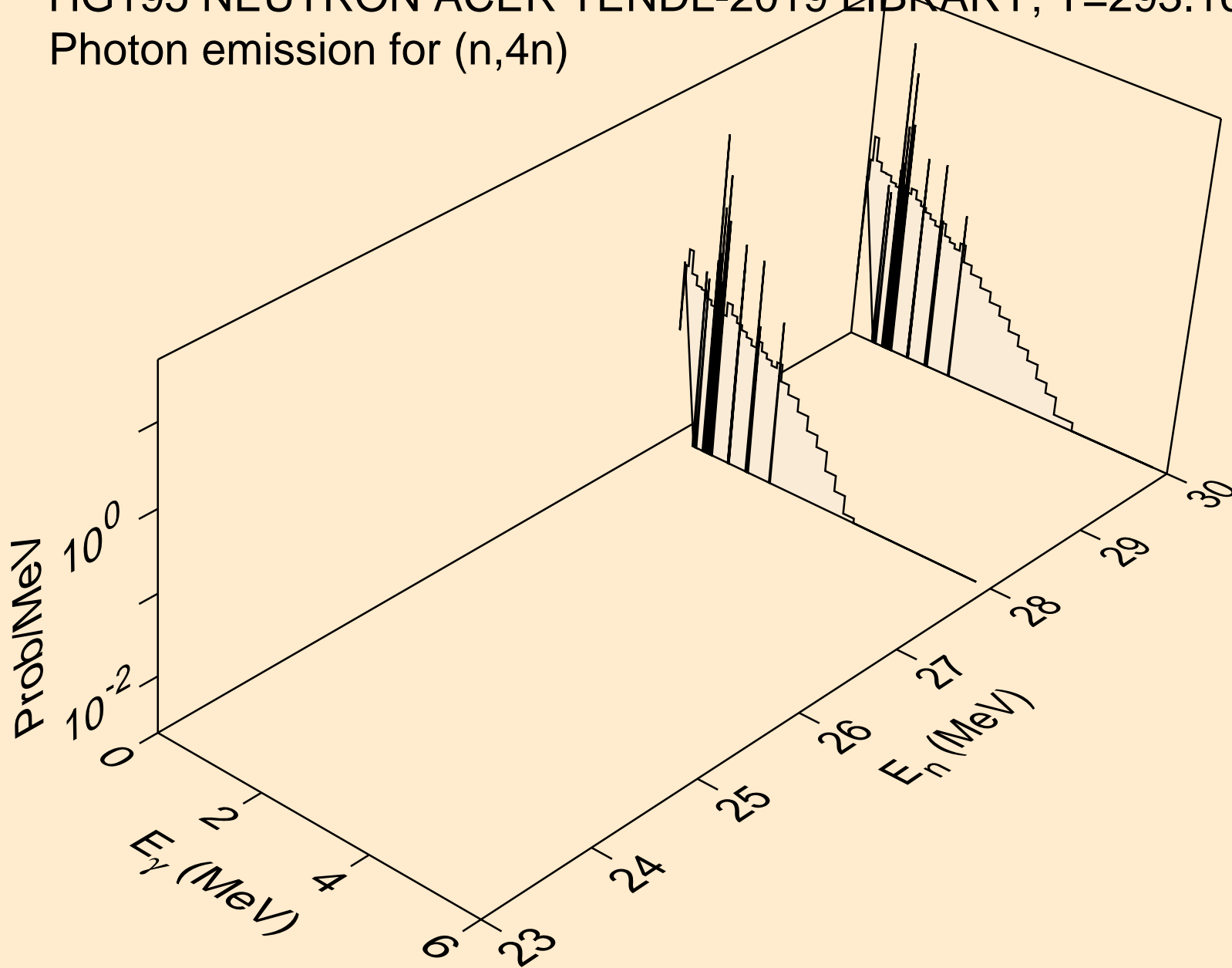

HG195 NEUTRON ACER TENDL-2019 LIBRARY; T=293.16K
Photon emission for (n,2np)

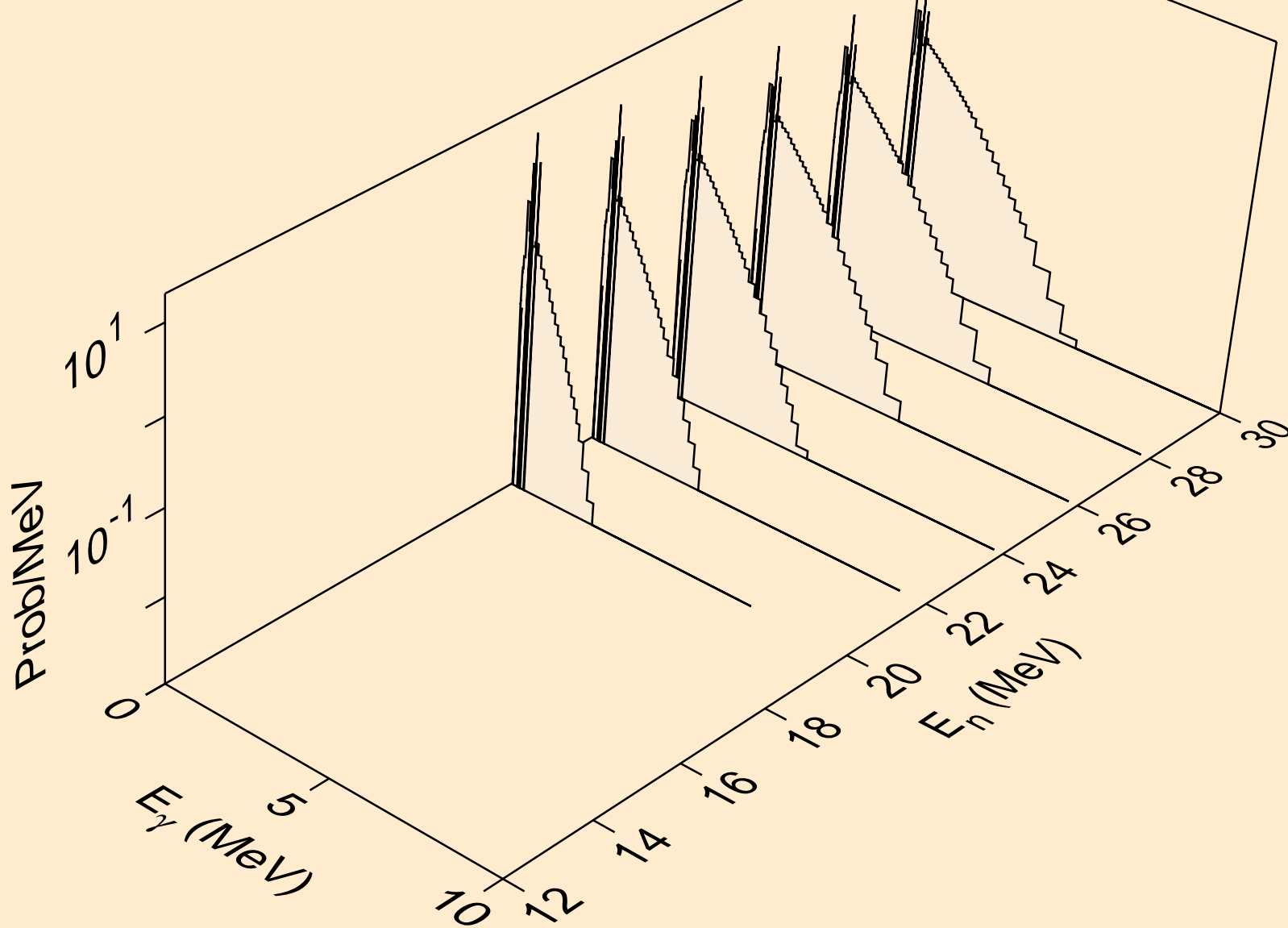

HG195 NEUTRON ACER TENDL-2019 LIBRARY; T=293.16K
Photon emission for (n,3np)

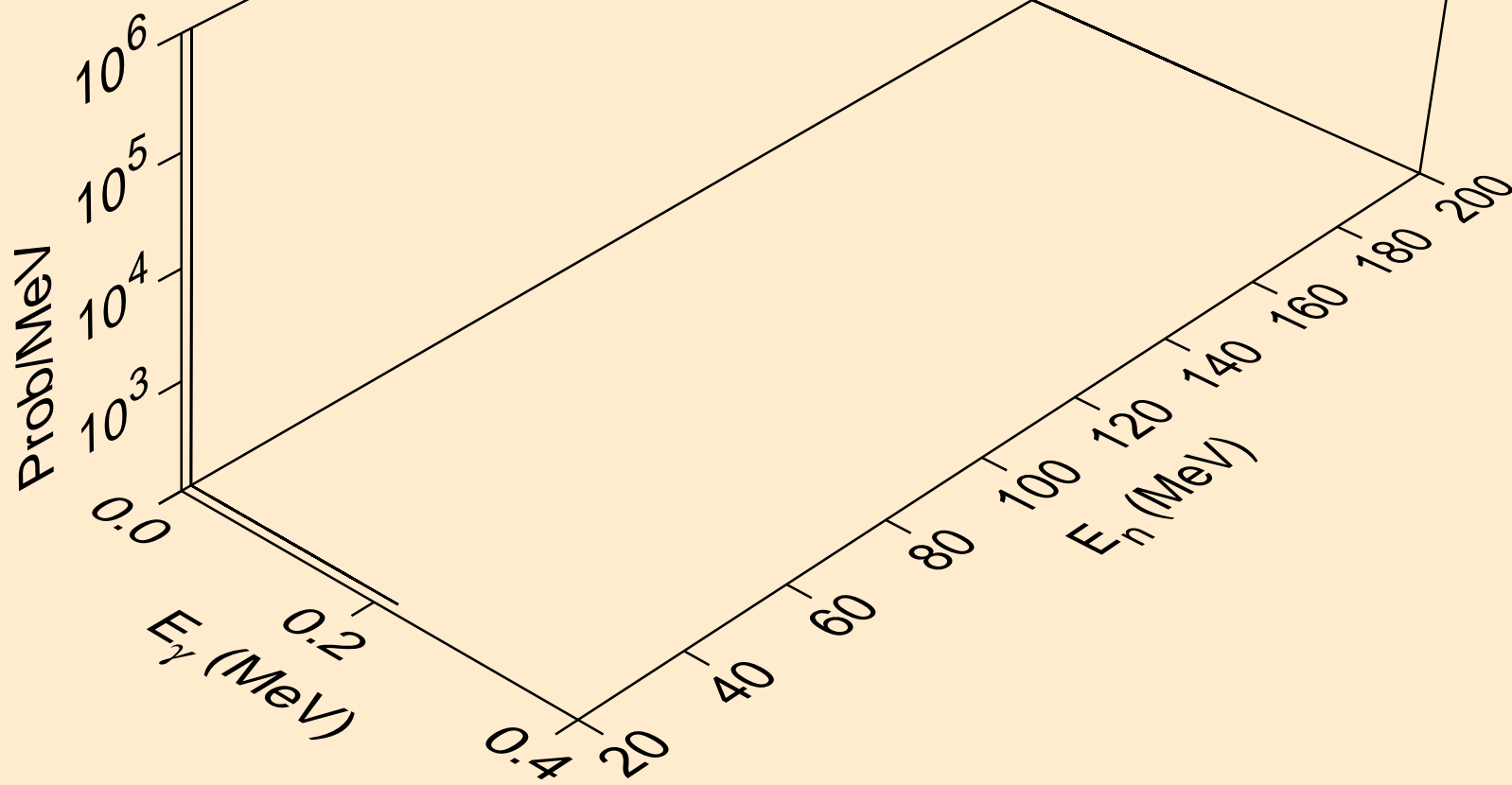

HG195 NEUTRON ACER TENDL-2019 LIBRARY; T=293.16K
Photon emission for (n,2np)

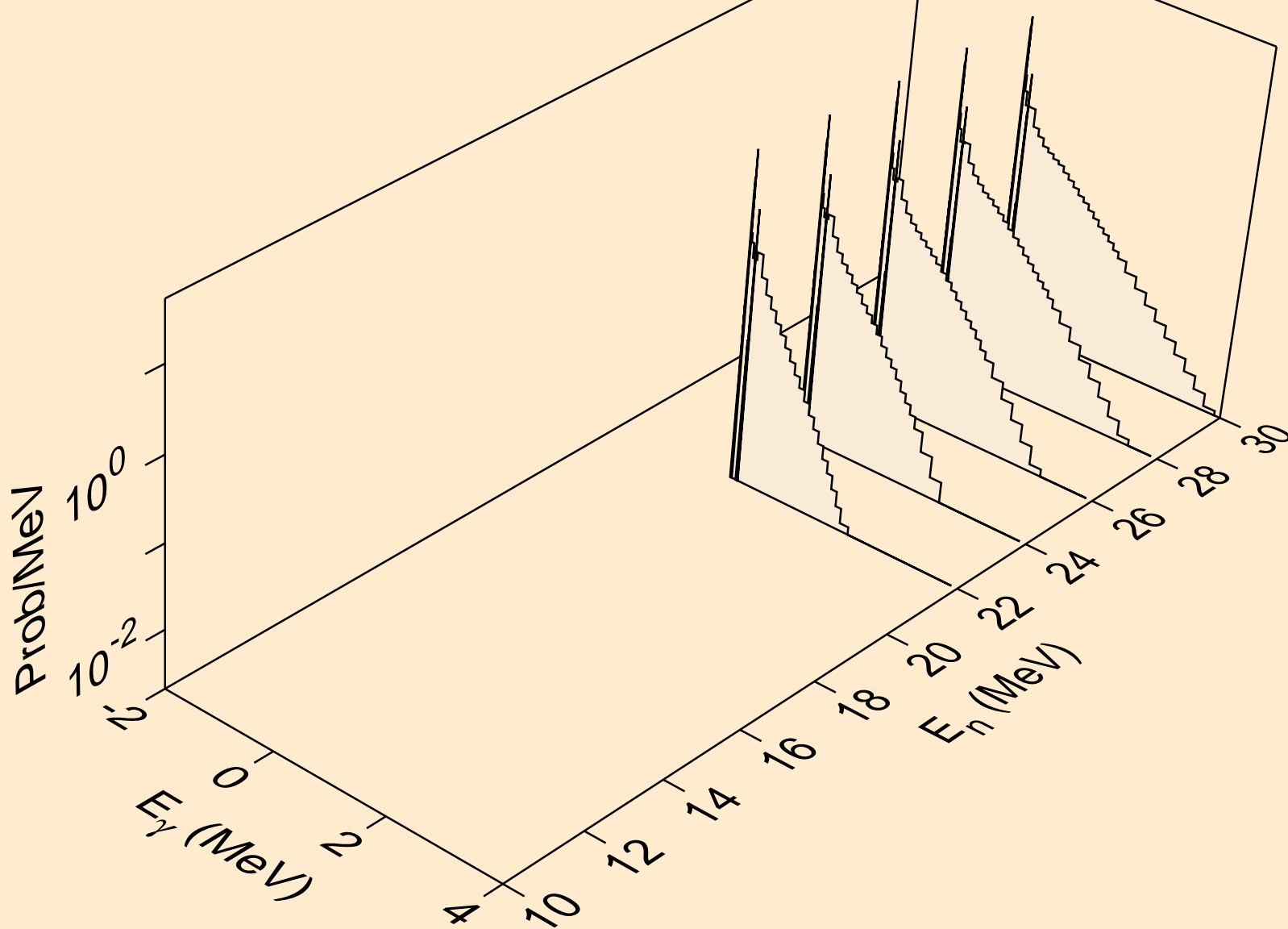

HG195 NEUTRON ACER TENDL-2019 LIBRARY; T=293.16K
Photon emission for (n,npa)

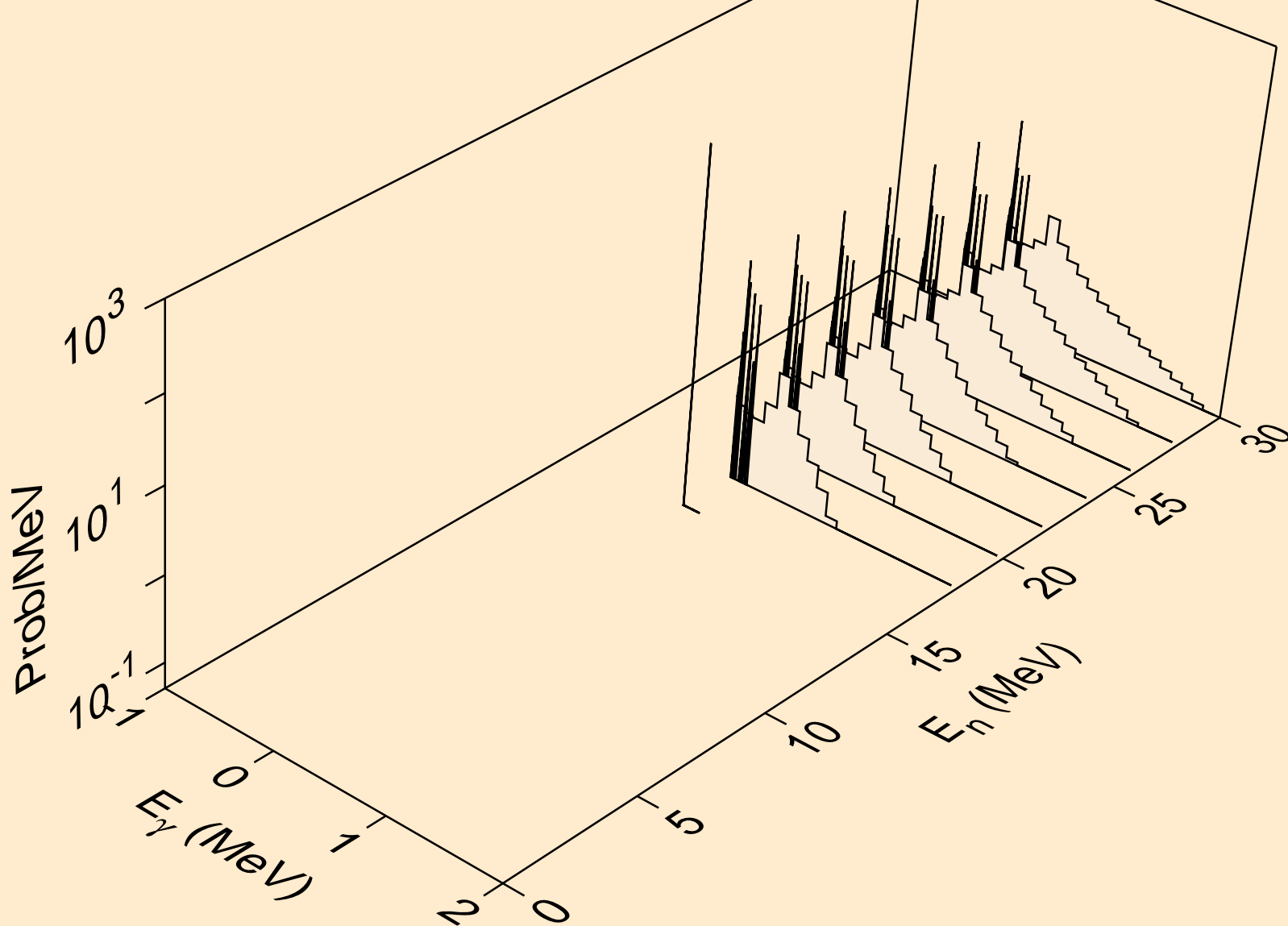

HG195 NEUTRON ACER TENDL-2019 LIBRARY; T=293.16K
Photon emission for (n,n*c)

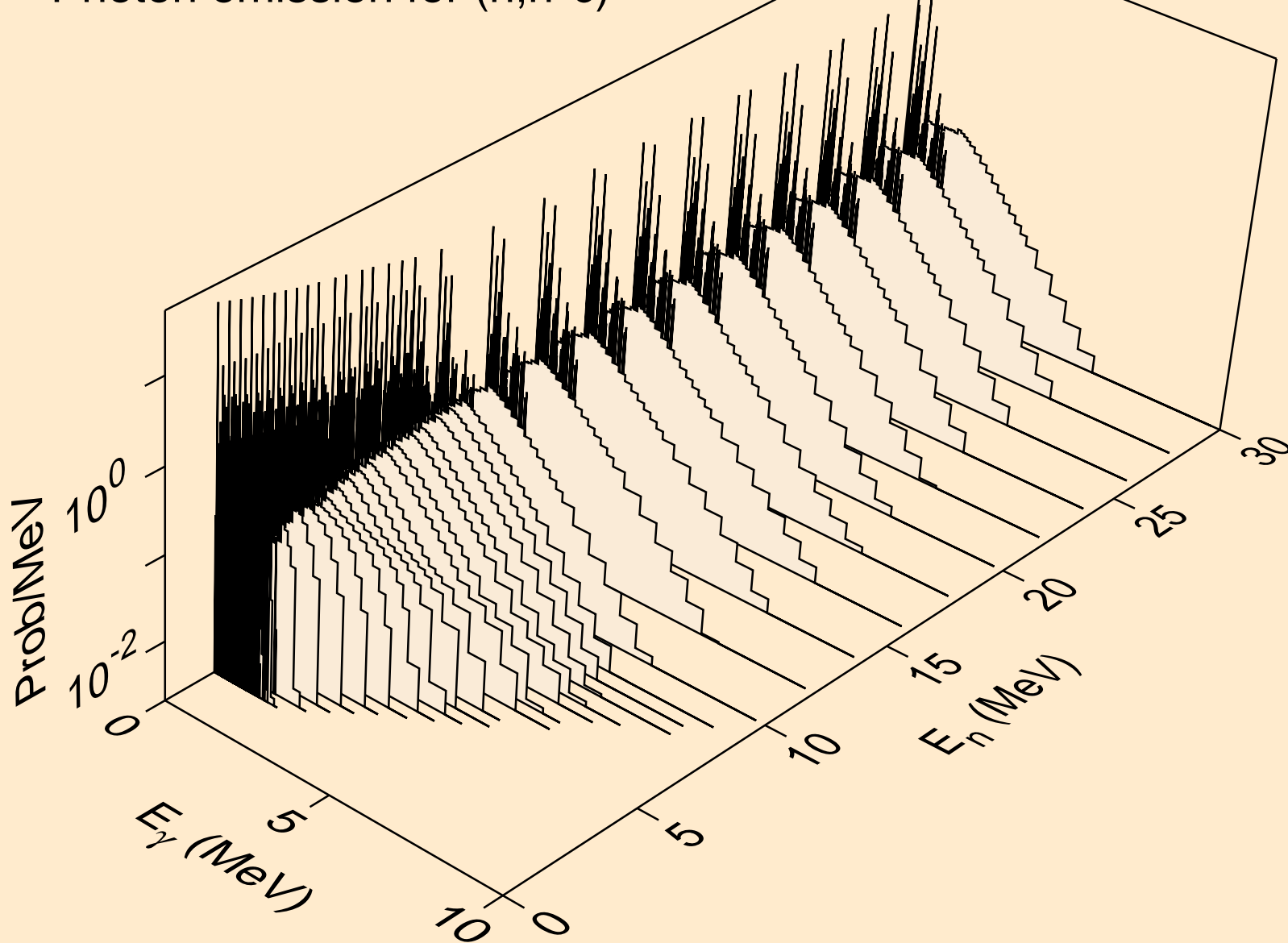

HG195 NEUTRON ACER TENDL-2019 LIBRARY; T=293.16K
Photon emission for (n,gma)

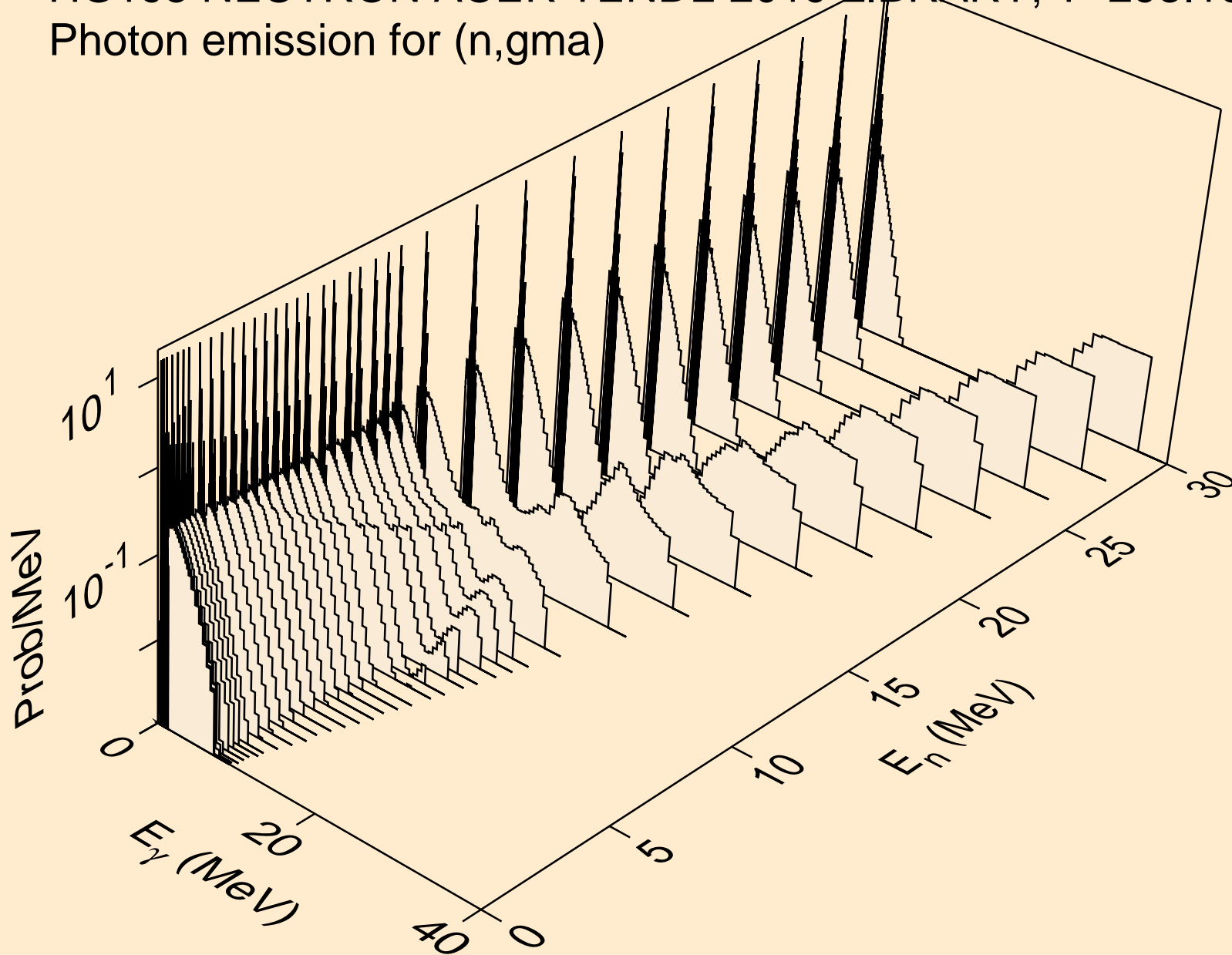

HG195 NEUTRON ACER TENDL-2019 LIBRARY; T=293.16K
Photon emission for (n,p)

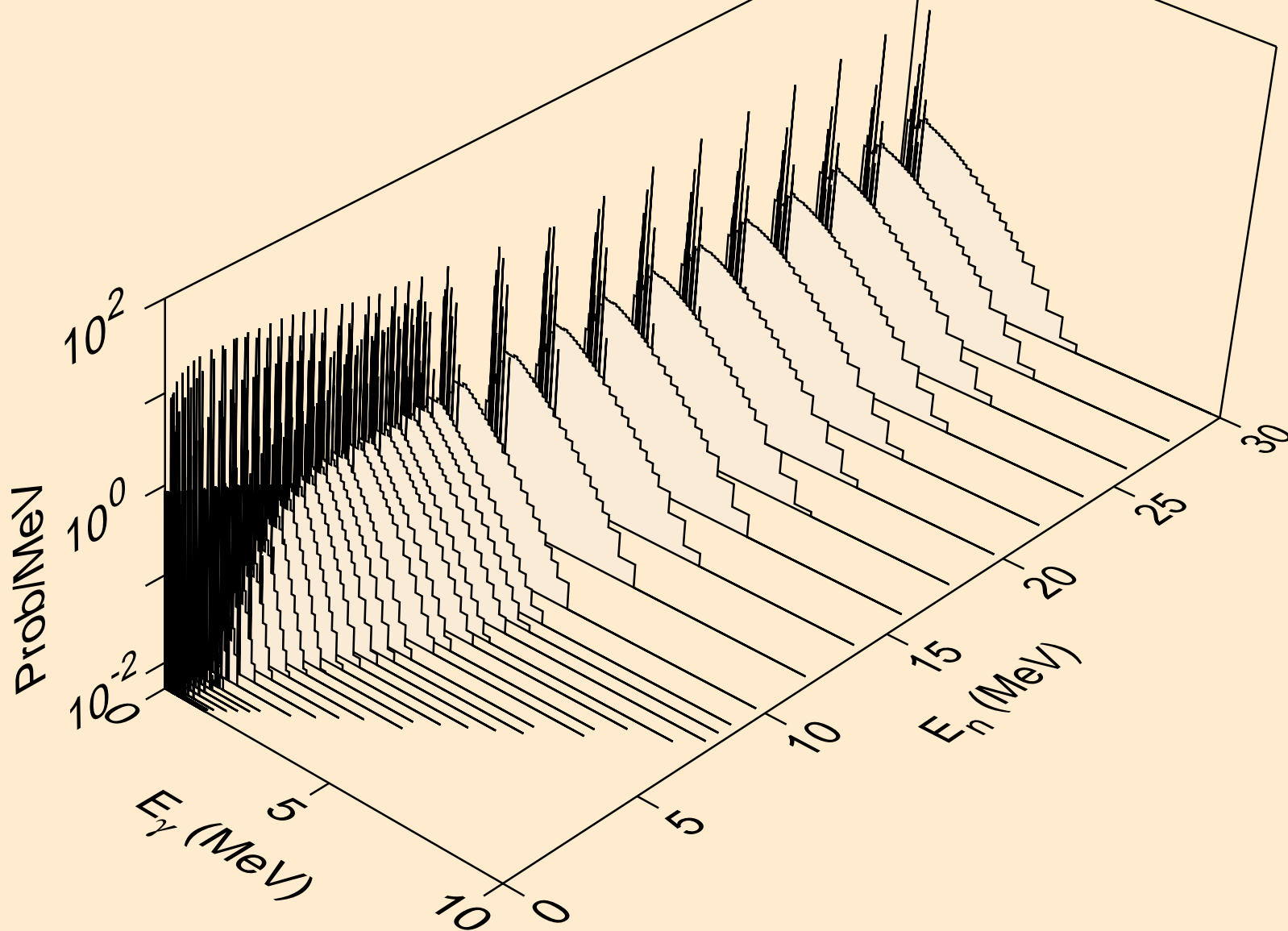

HG195 NEUTRON ACER TENDL-2019 LIBRARY; T=293.16K
Photon emission for (n,d)

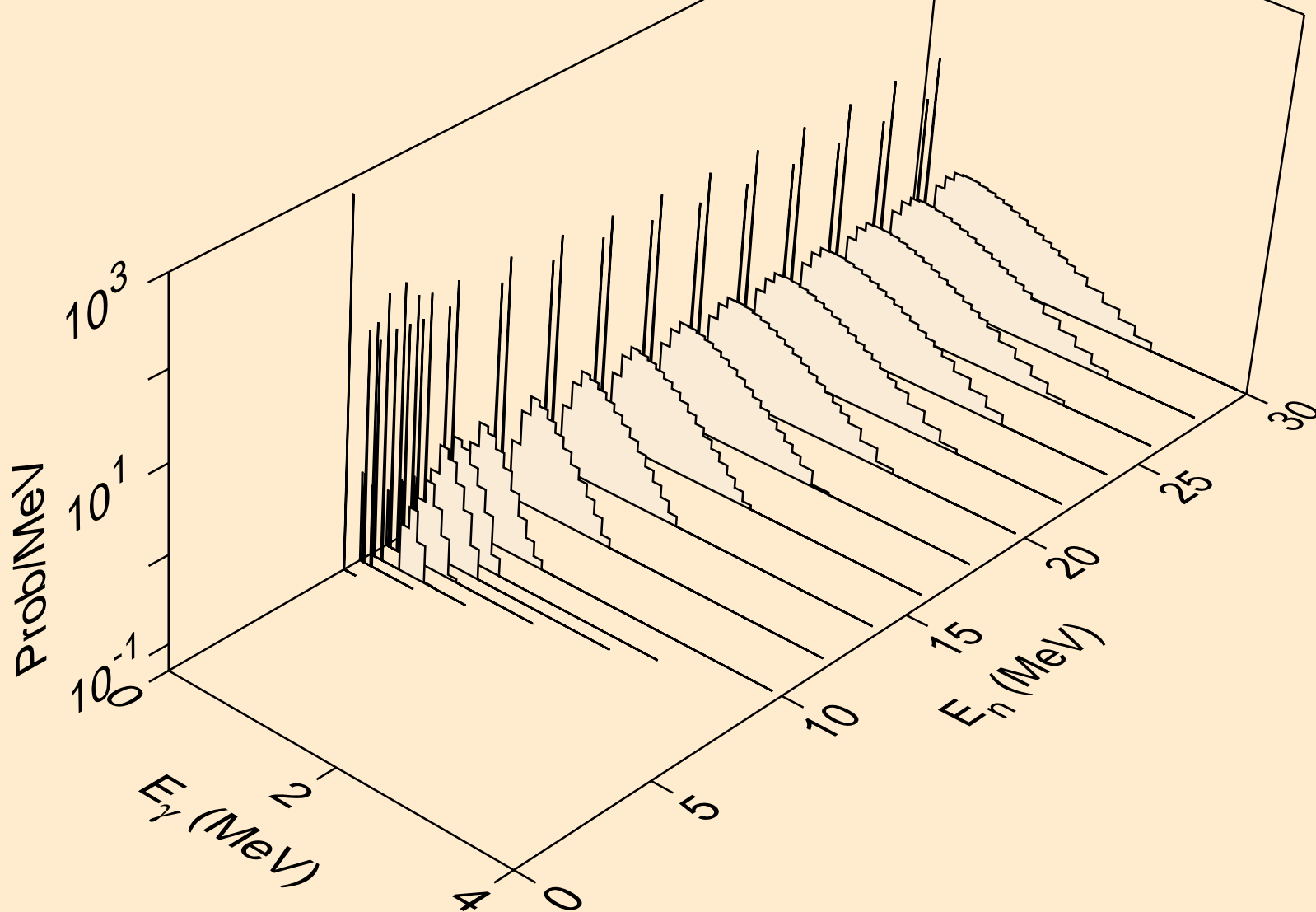

HG195 NEUTRON ACER TENDL-2019 LIBRARY; T=293.16K
Photon emission for (n,t)

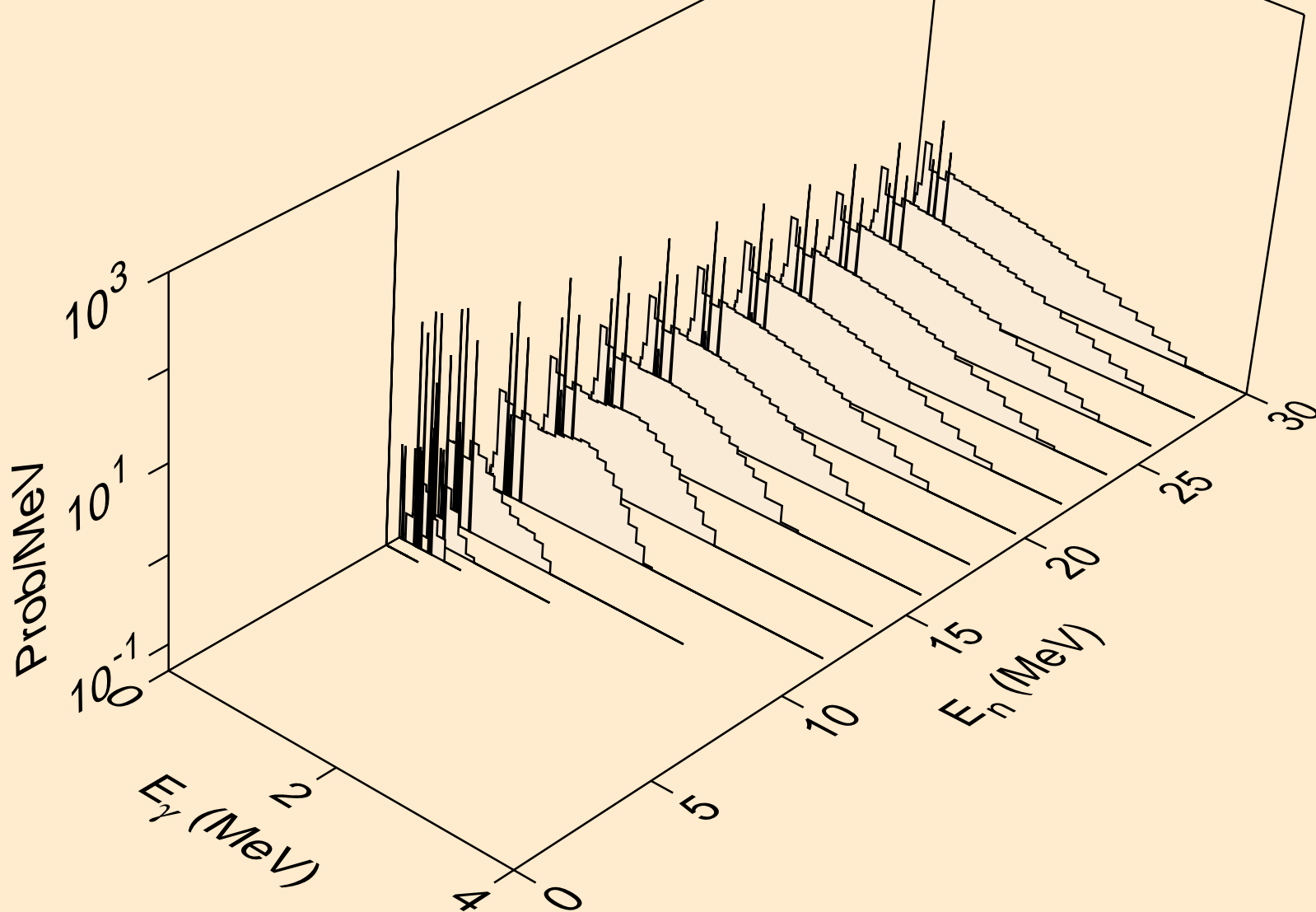

HG195 NEUTRON ACER TENDL-2019 LIBRARY; T=293.16K
Photon emission for (n,he3)

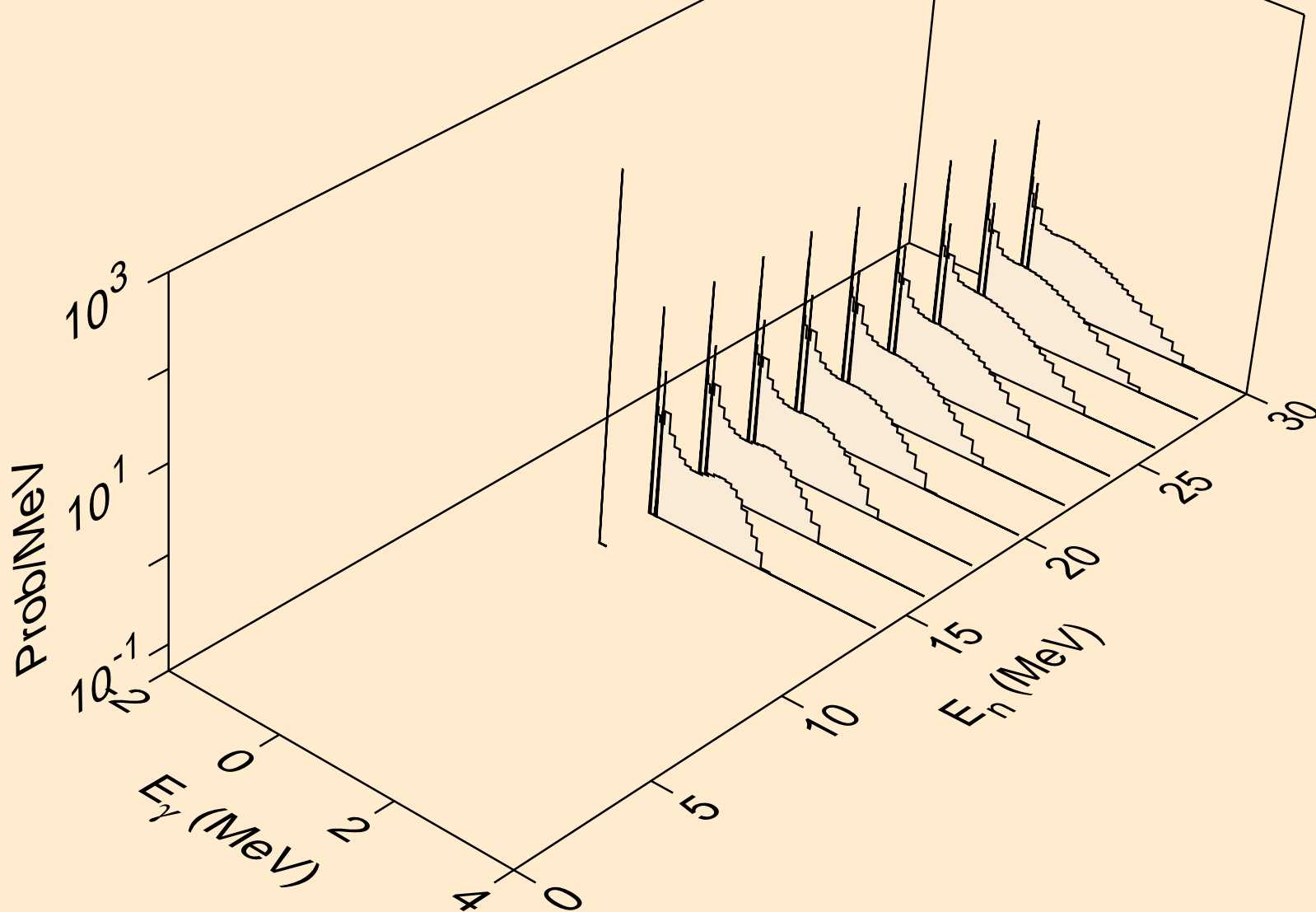

HG195 NEUTRON ACER TENDL-2019 LIBRARY; T=293.16K
Photon emission for (n,a)

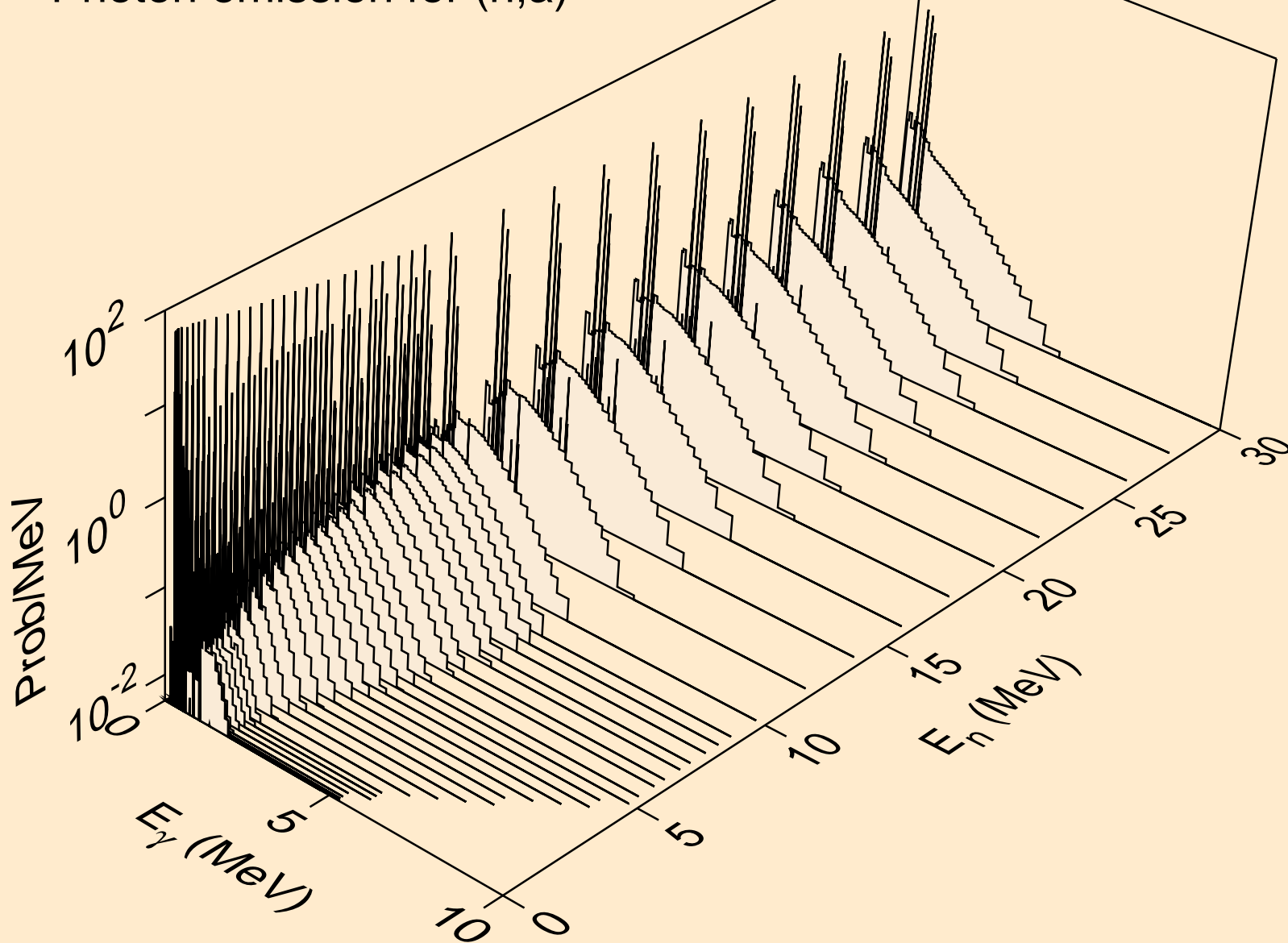

HG195 NEUTRON ACER TENDL-2019 LIBRARY; T=293.16K
Photon emission for (n,2a)

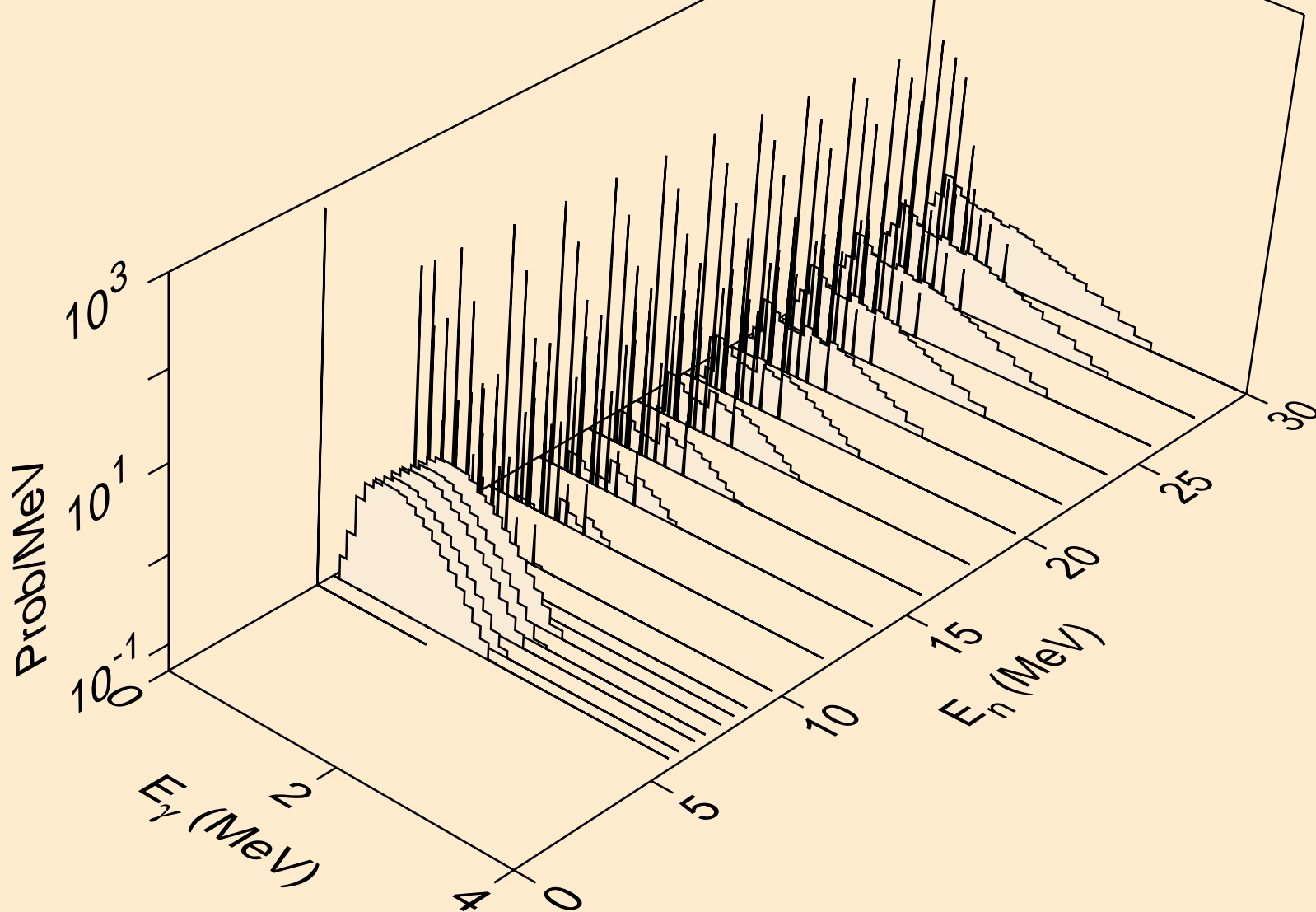

HG195 NEUTRON ACER TENDL-2019 LIBRARY; T=293.16K
Photon emission for (n,2p)

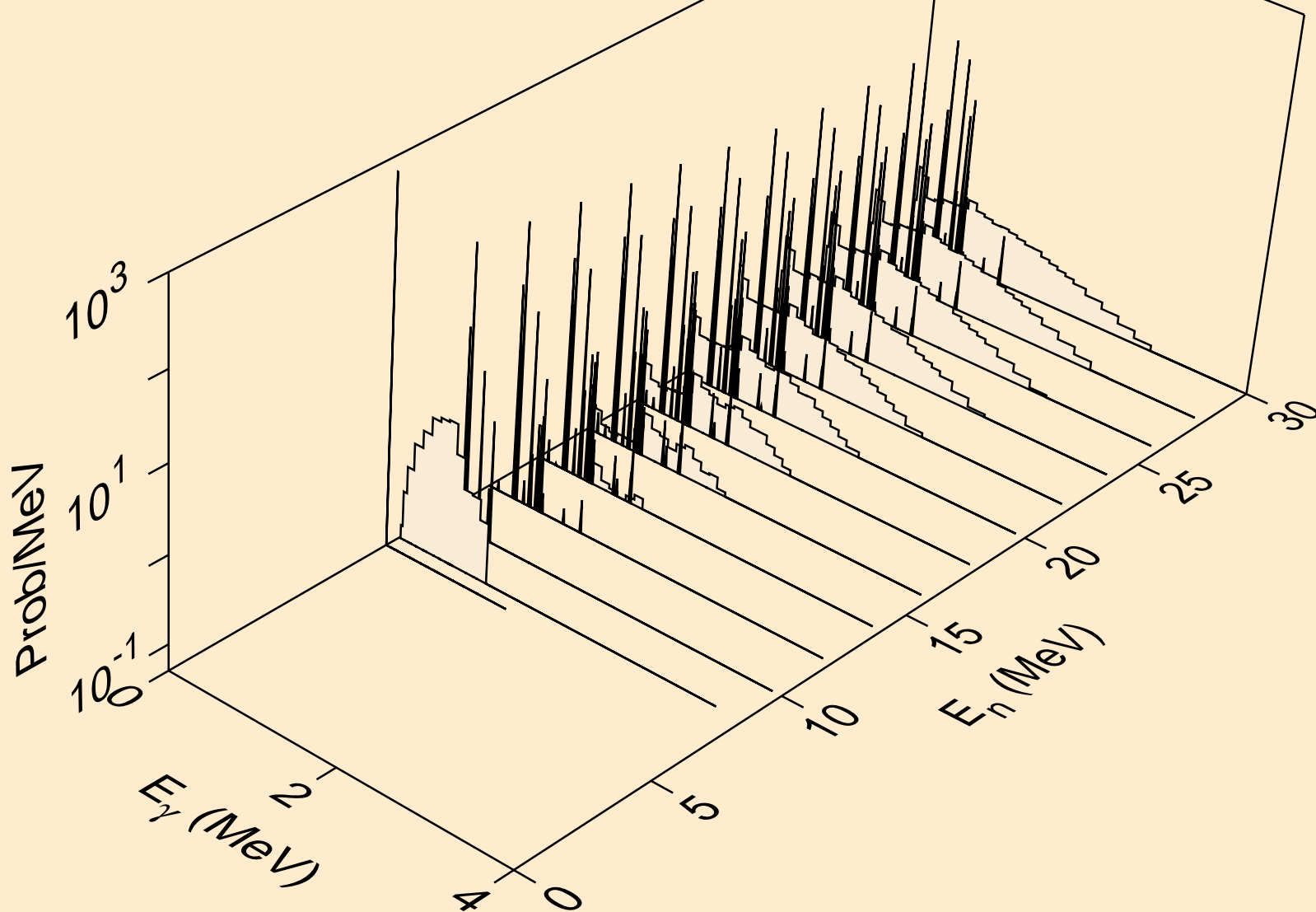

HG195 NEUTRON ACER TENDL-2019 LIBRARY; T=293.16K
Photon emission for (n,p α)

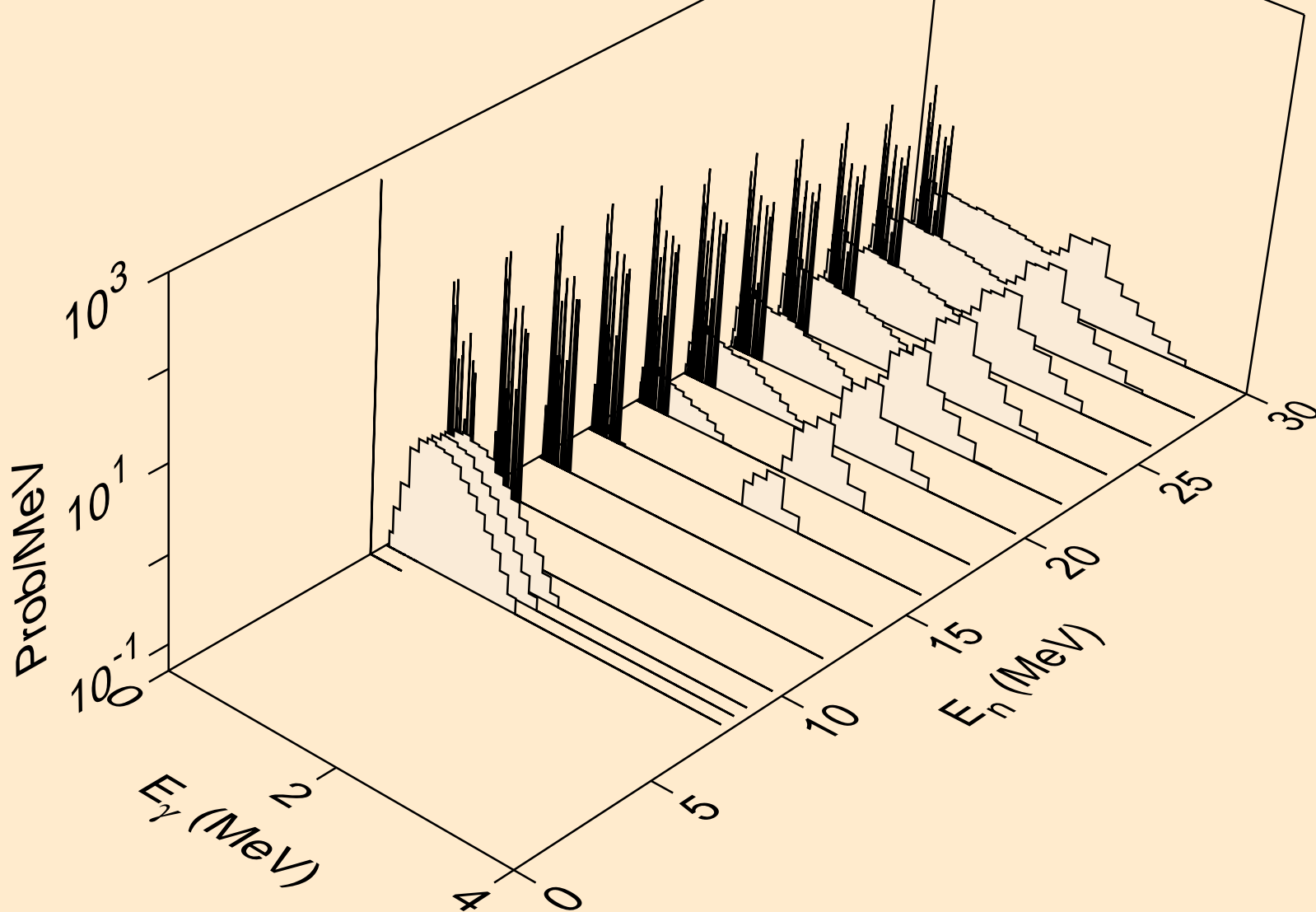

HG195 NEUTRON ACER TENDL-2019 LIBRARY; T=293.16K
Photon emission for (n,pd)

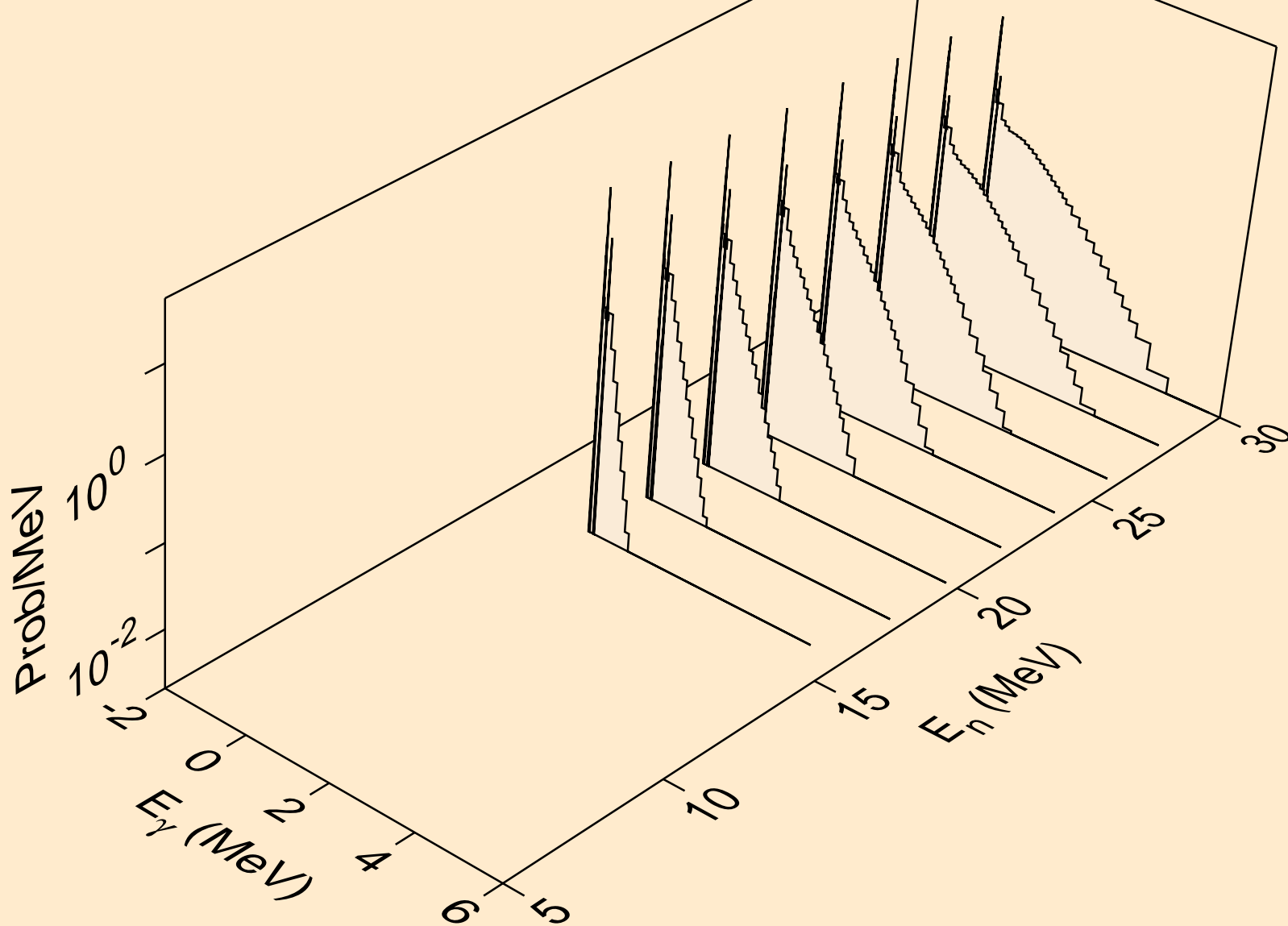

HG195 NEUTRON ACER TENDL-2019 LIBRARY; T=293.16K
Photon emission for (n,pt)

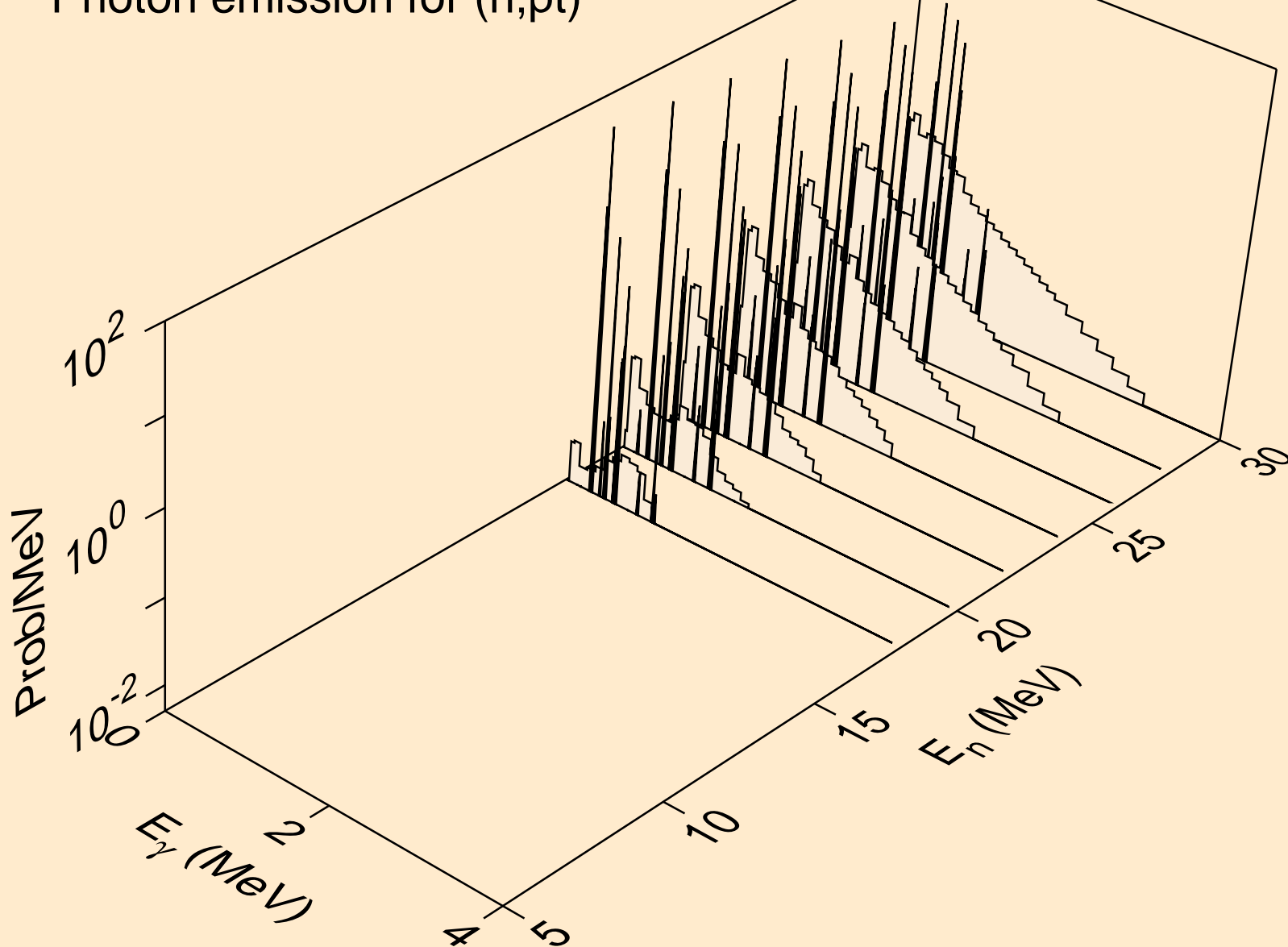

HG195 NEUTRON ACER TENDL-2019 LIBRARY; T=293.16K
Photon emission for (n,da)

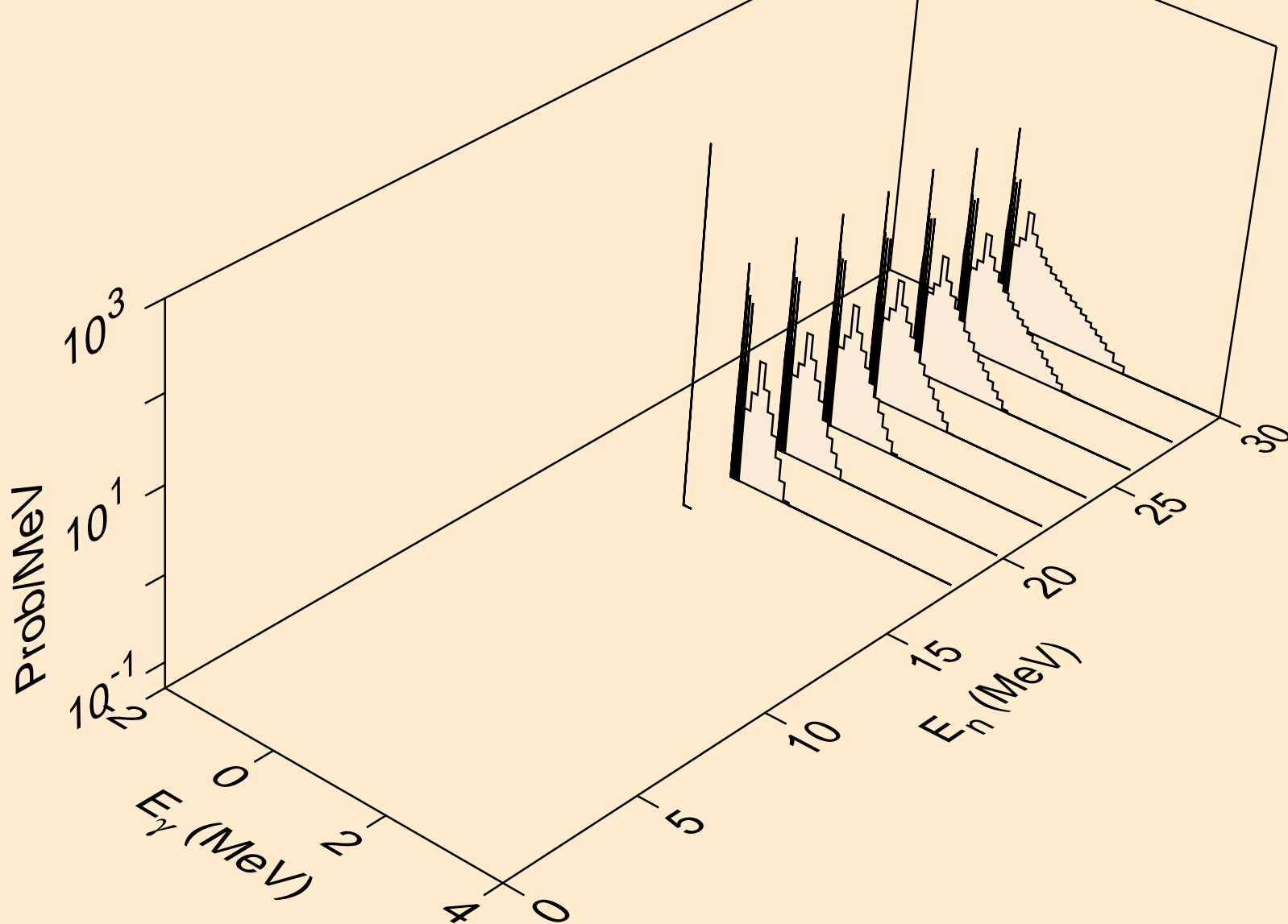

HG195 NEUTRON ACER TENDL-2019 LIBRARY; T=293.16K
thermal capture photon spectrum

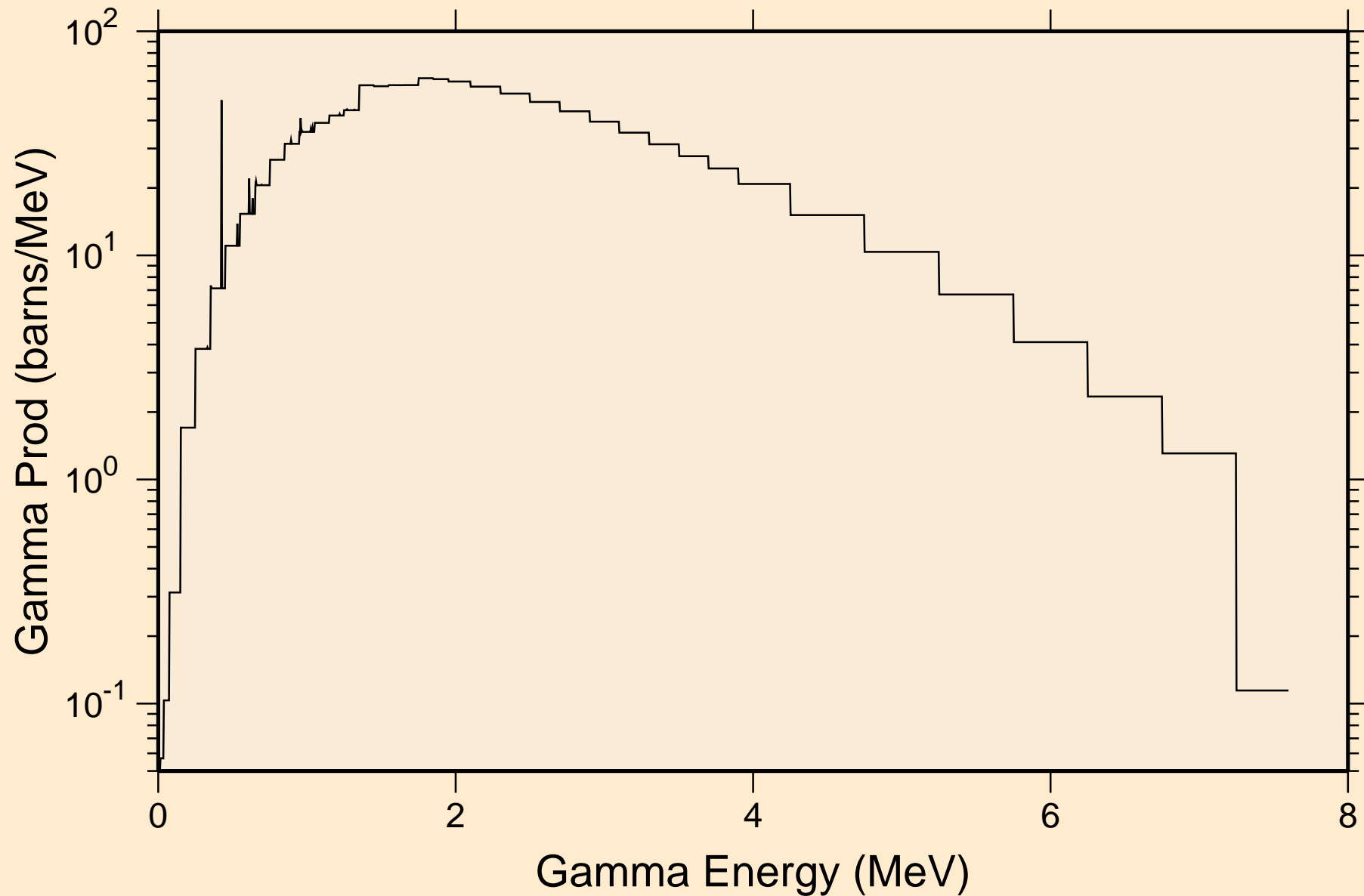

HG195 NEUTRON ACER TENDL-2019 LIBRARY; T=293.16K
14 MeV photon spectrum

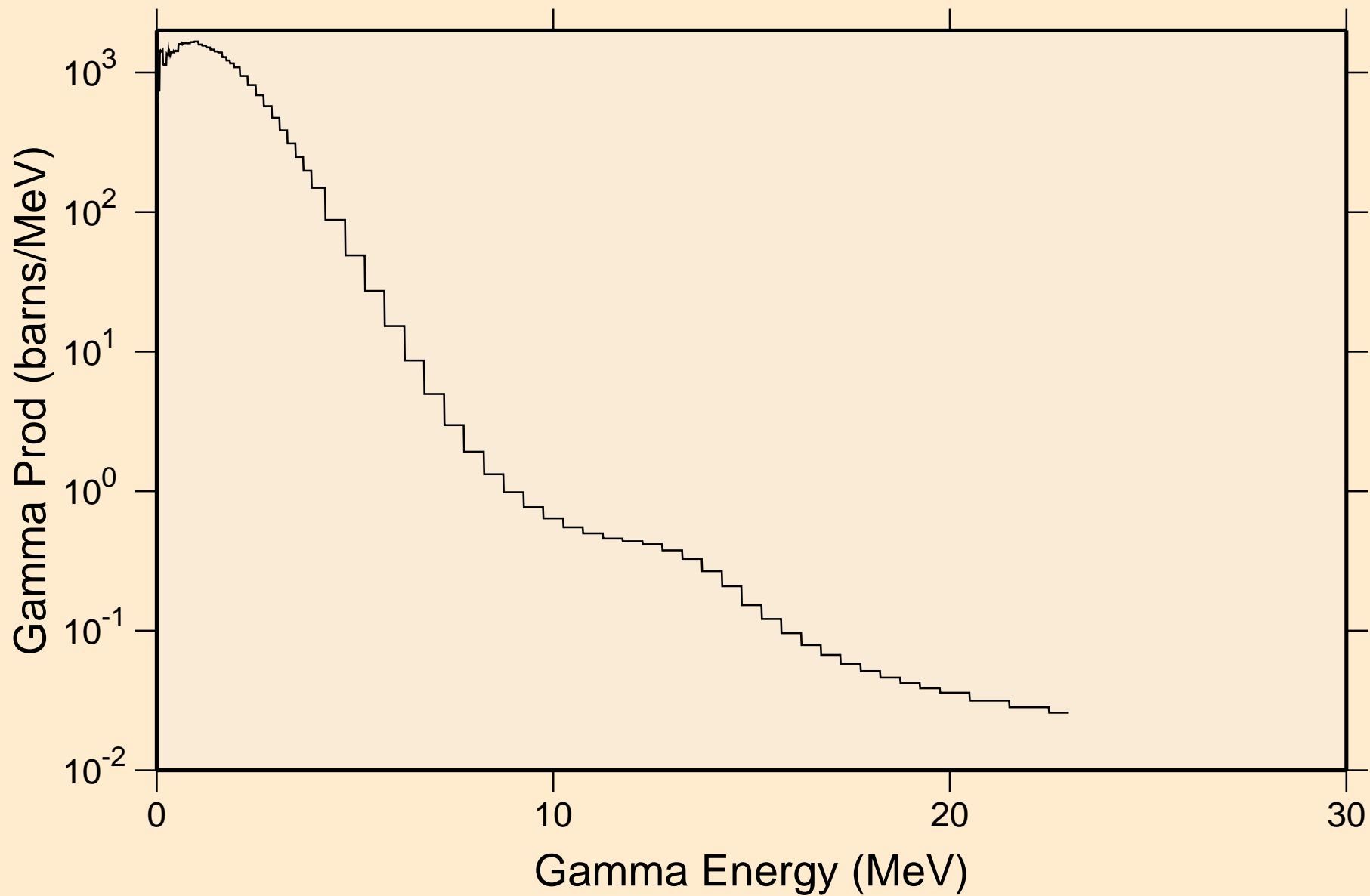

HG195 NEUTRON ACER TENDL-2019 LIBRARY; T=293.16K

Particle heating contributions

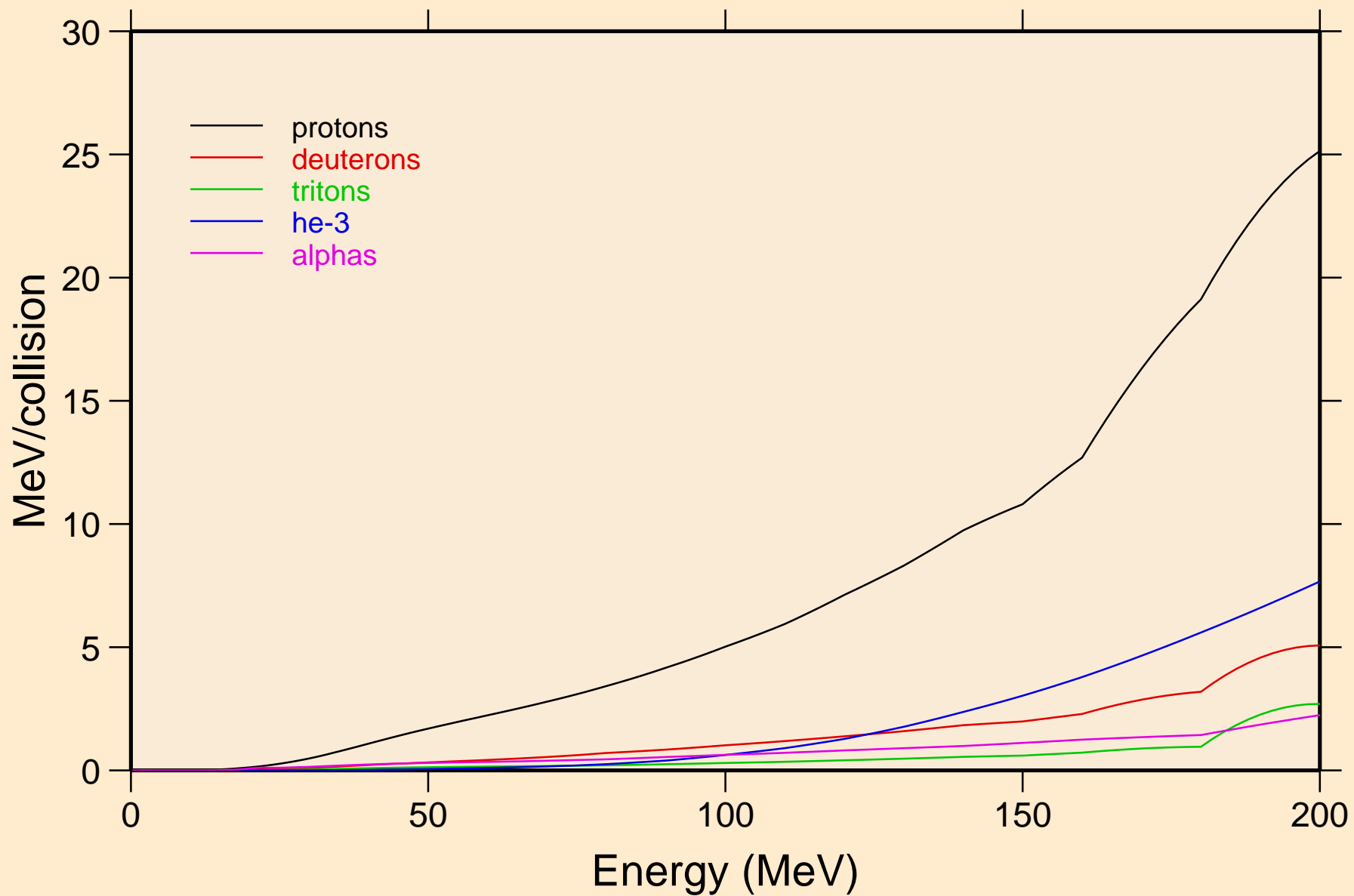

HG195 NEUTRON ACER TENDL-2019 LIBRARY; T=293.16K
Recoil Heating

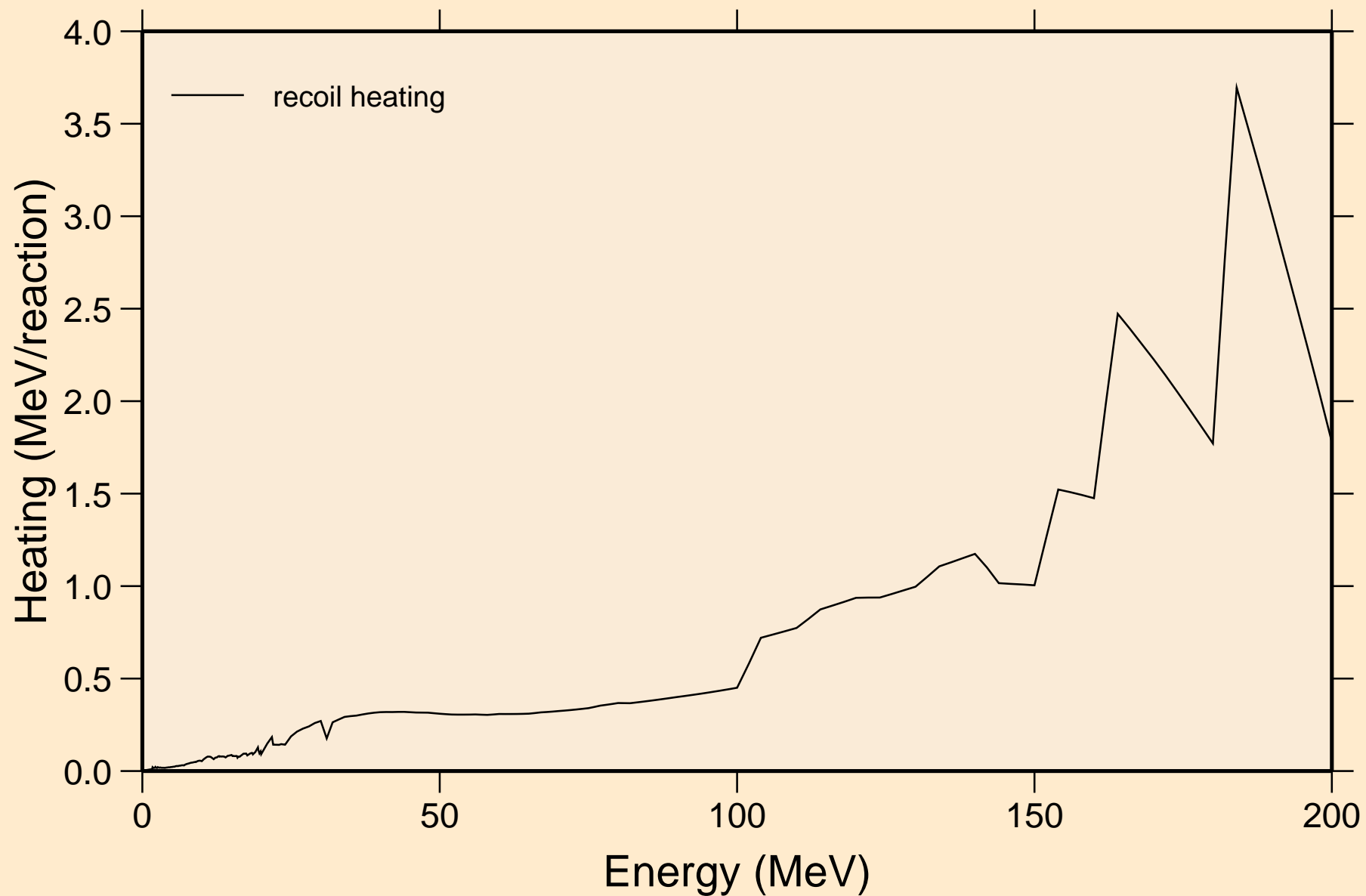

HG195 NEUTRON ACER TENDL-2019 LIBRARY; T=293.16K

Particle production cross sections

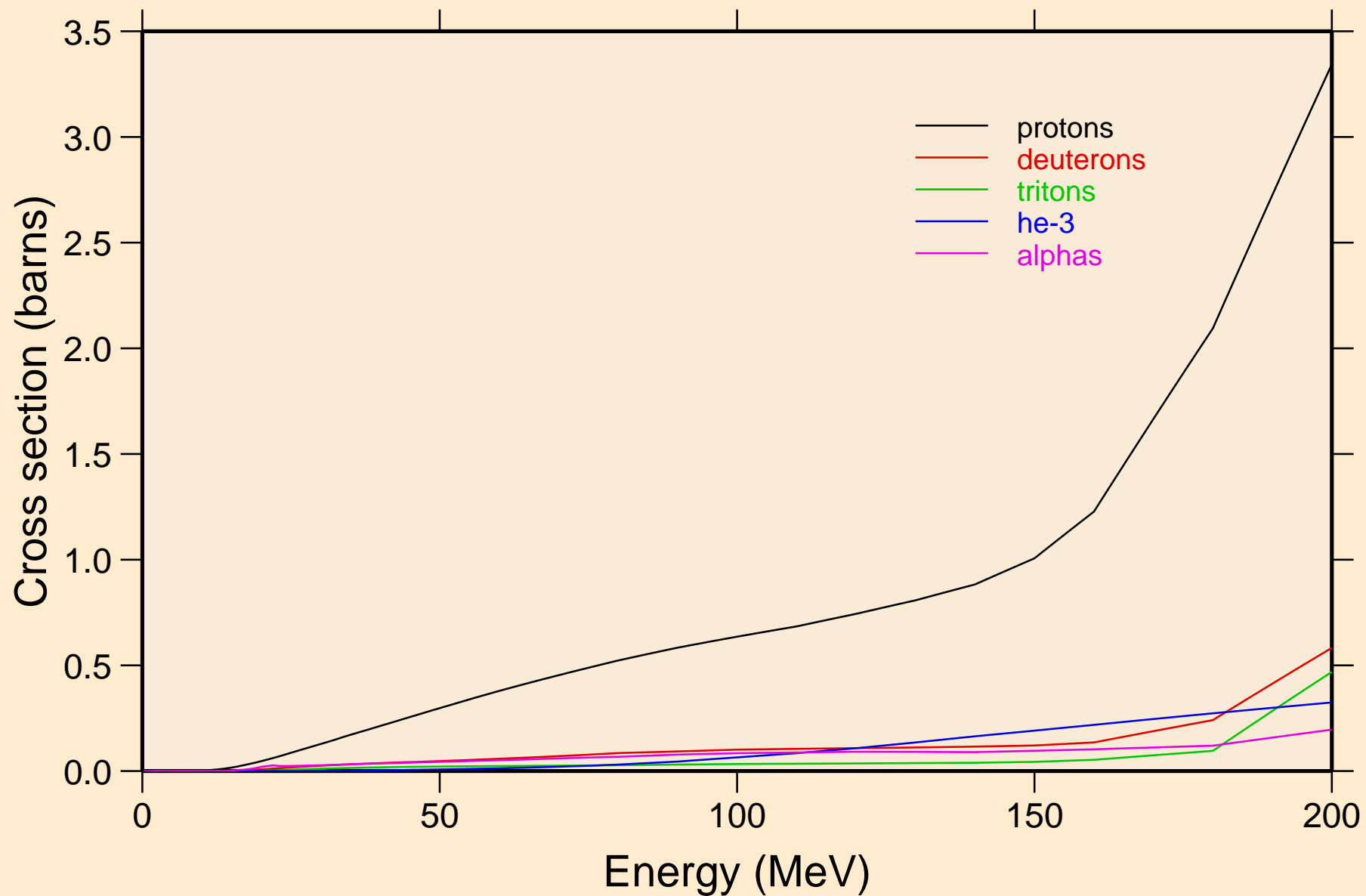

HG195 NEUTRON ACER TENDL-2019 LIBRARY; T=293.16K
protons from (n,x)

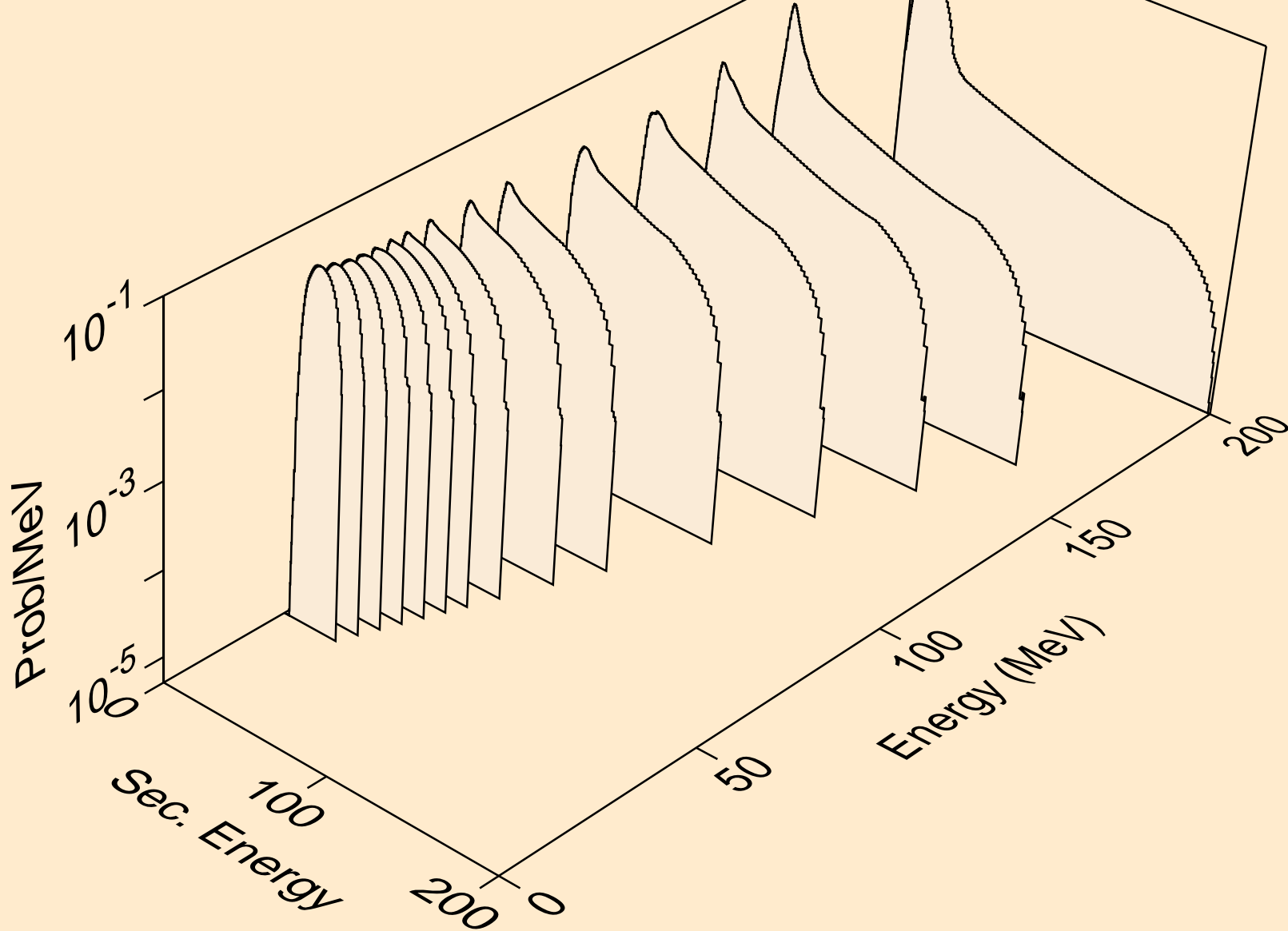

HG195 NEUTRON ACER TENDL-2019 LIBRARY; T=293.16K
protons from (n,n*)p

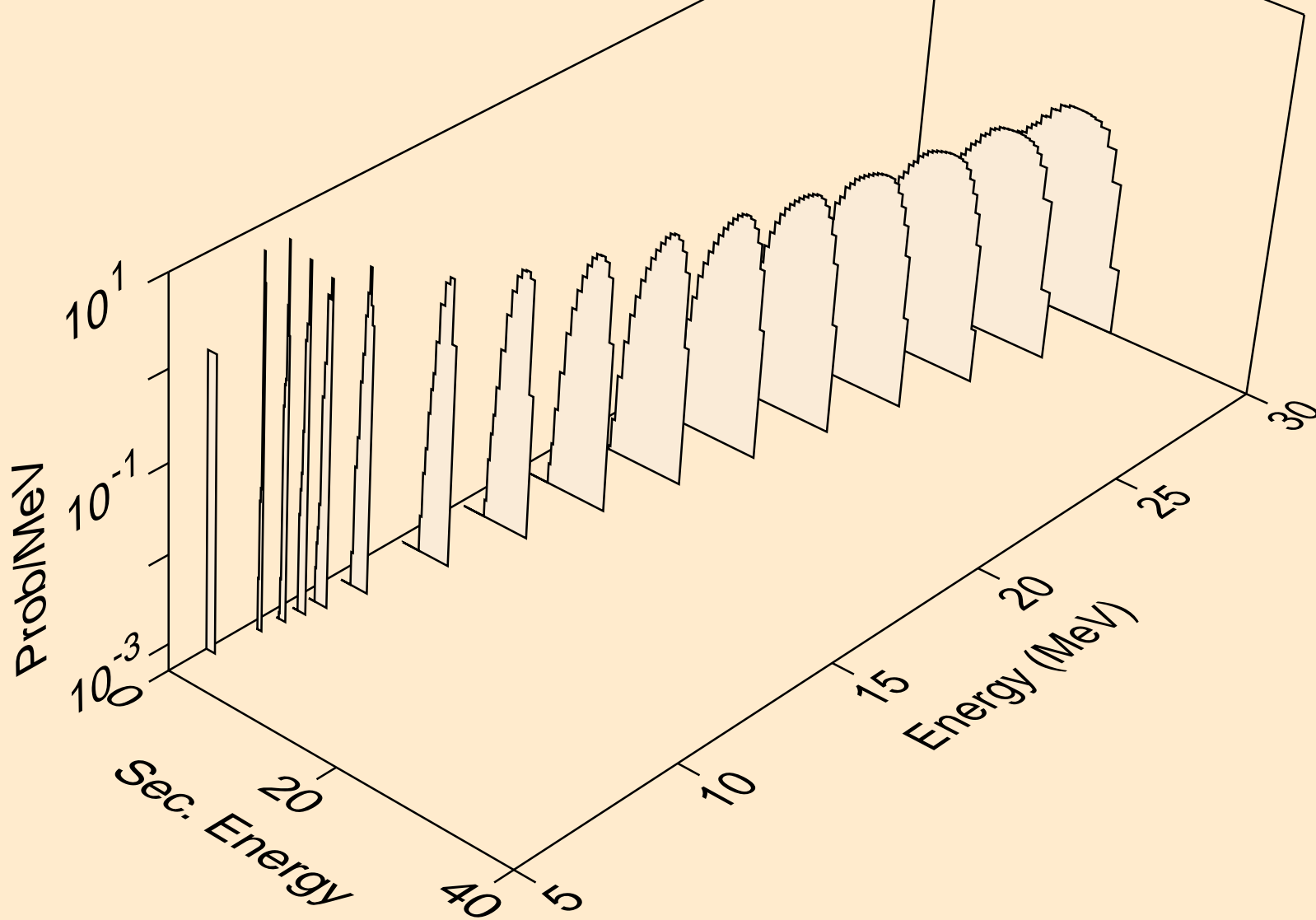

HG195 NEUTRON ACER TENDL-2019 LIBRARY; T=293.16K
protons from (n,2np)

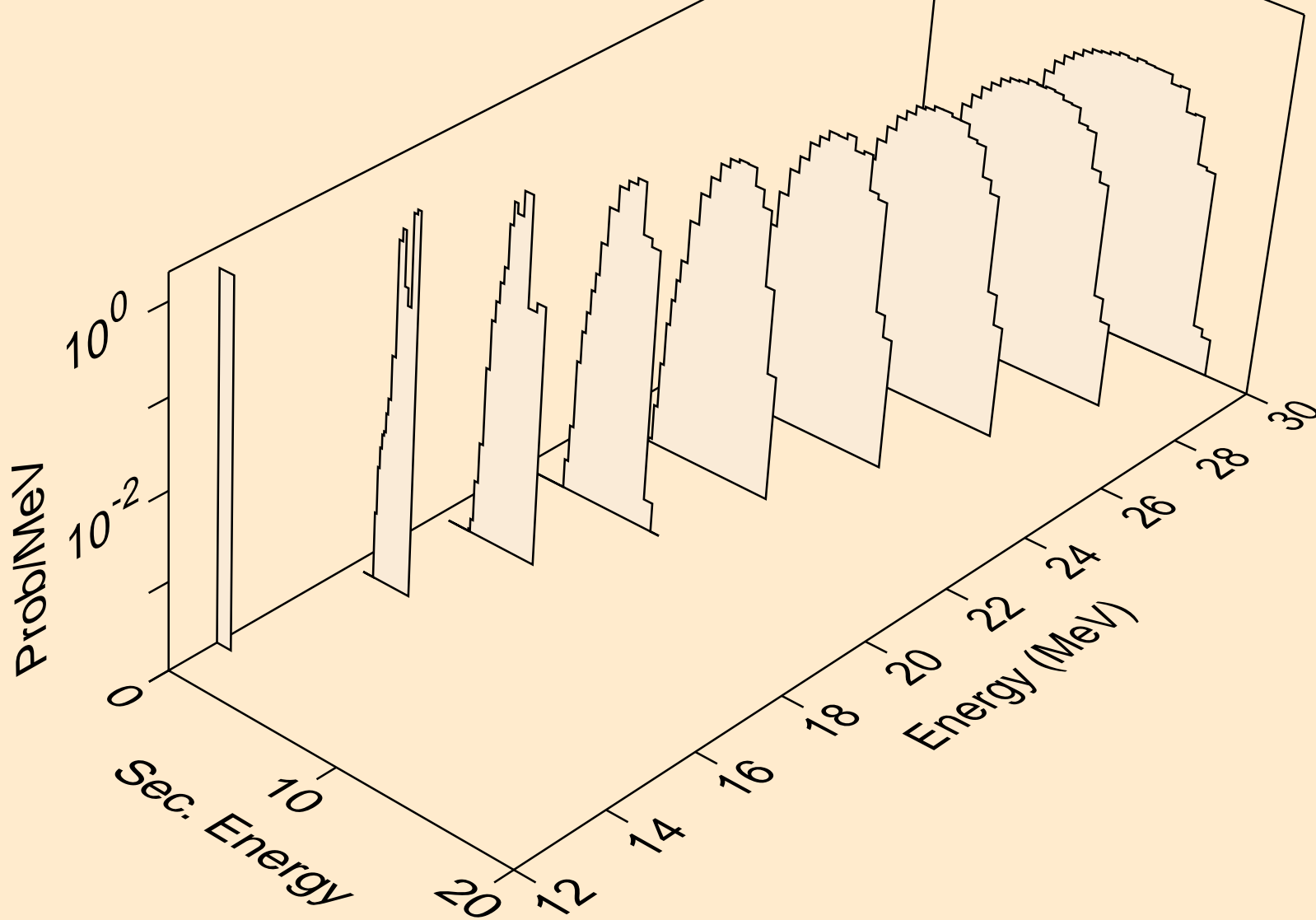

HG195 NEUTRON ACER TENDL-2019 LIBRARY; T=293.16K
protons from (n,3np)

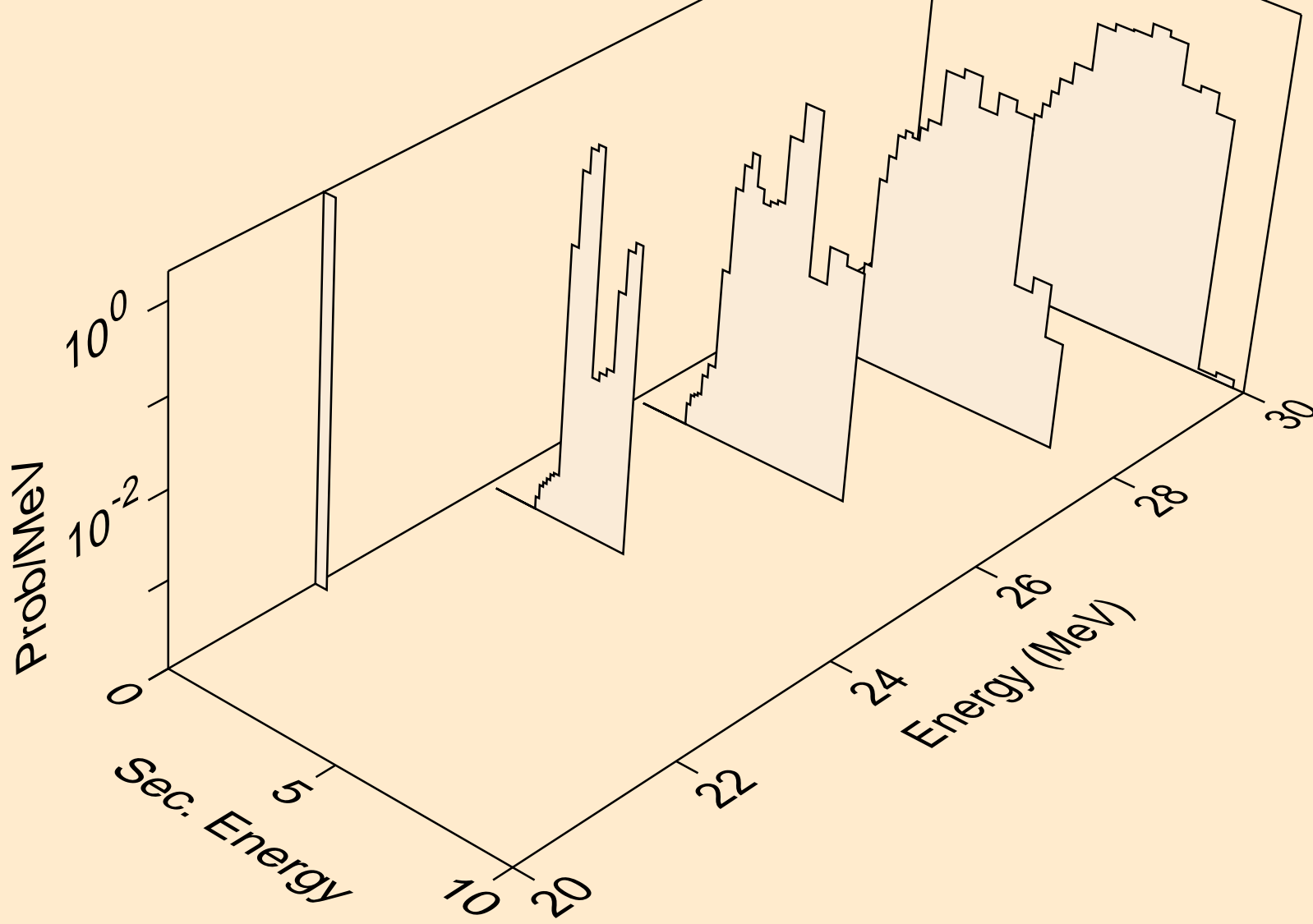

HG195 NEUTRON ACER TENDL-2019 LIBRARY; T=293.16K
protons from (n,2np)

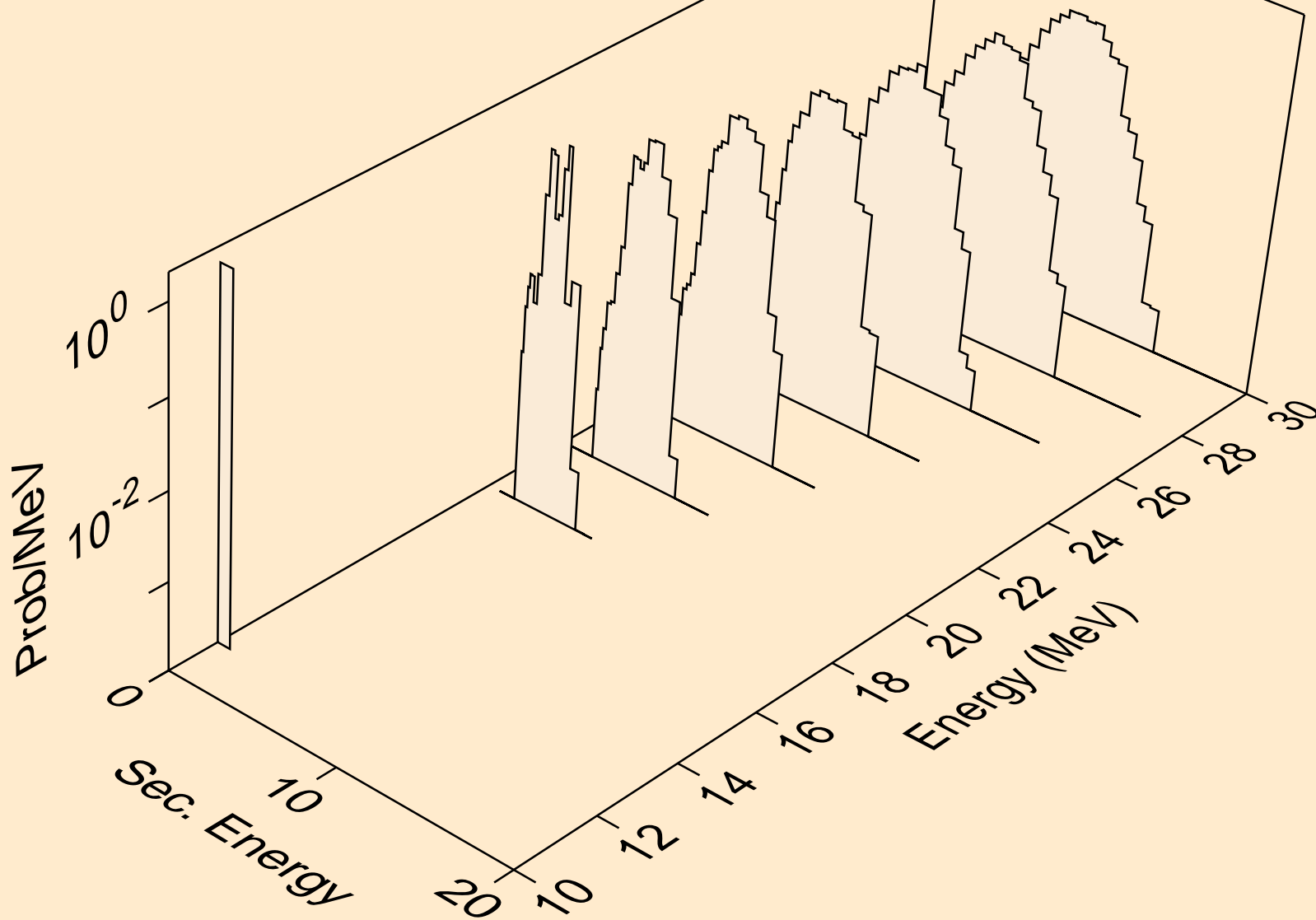

HG195 NEUTRON ACER TENDL-2019 LIBRARY; T=293.16K
protons from (n,npa)

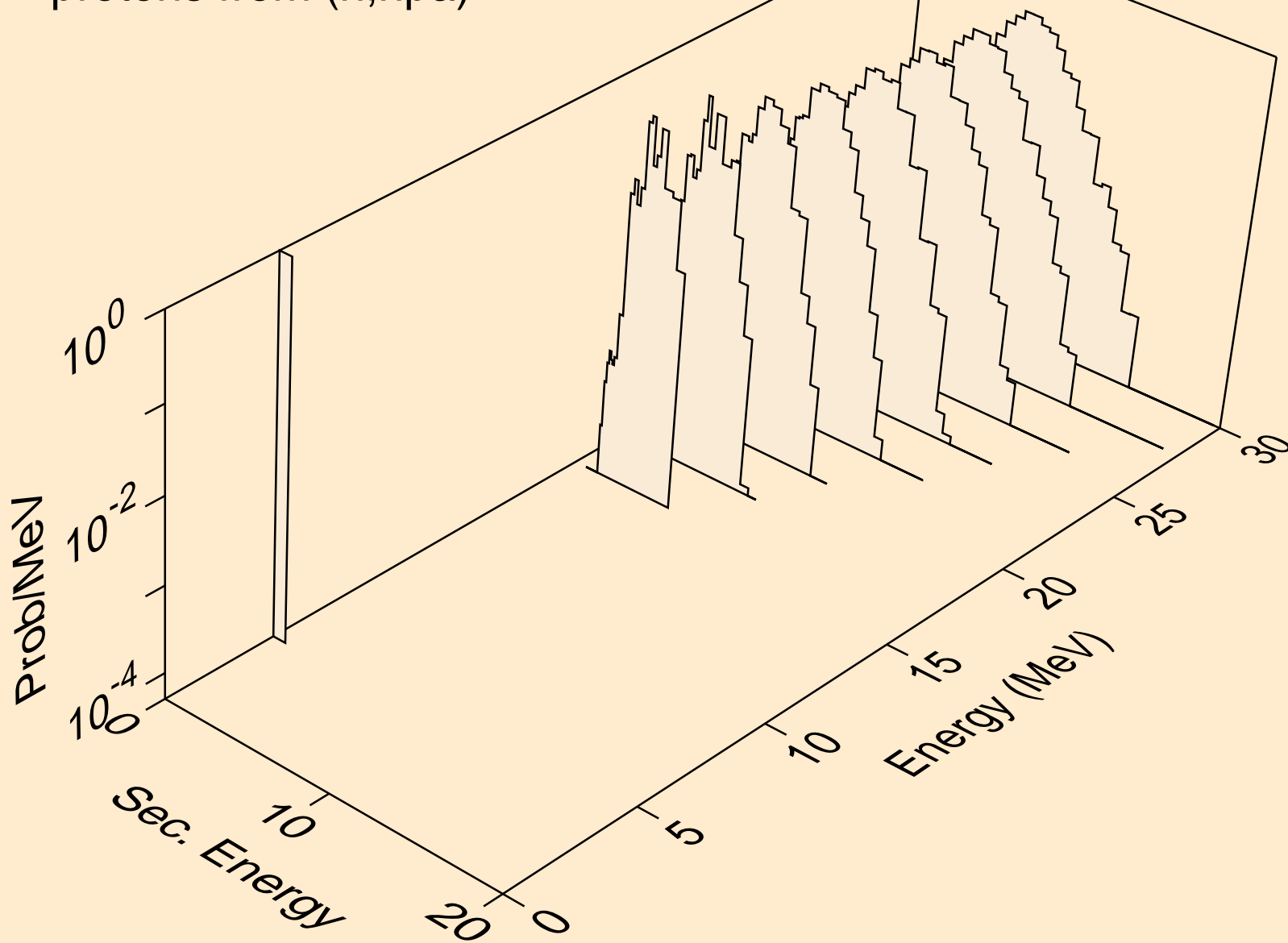

HG195 NEUTRON ACER TENDL-2019 LIBRARY; T=293.16K
protons from (n,p)

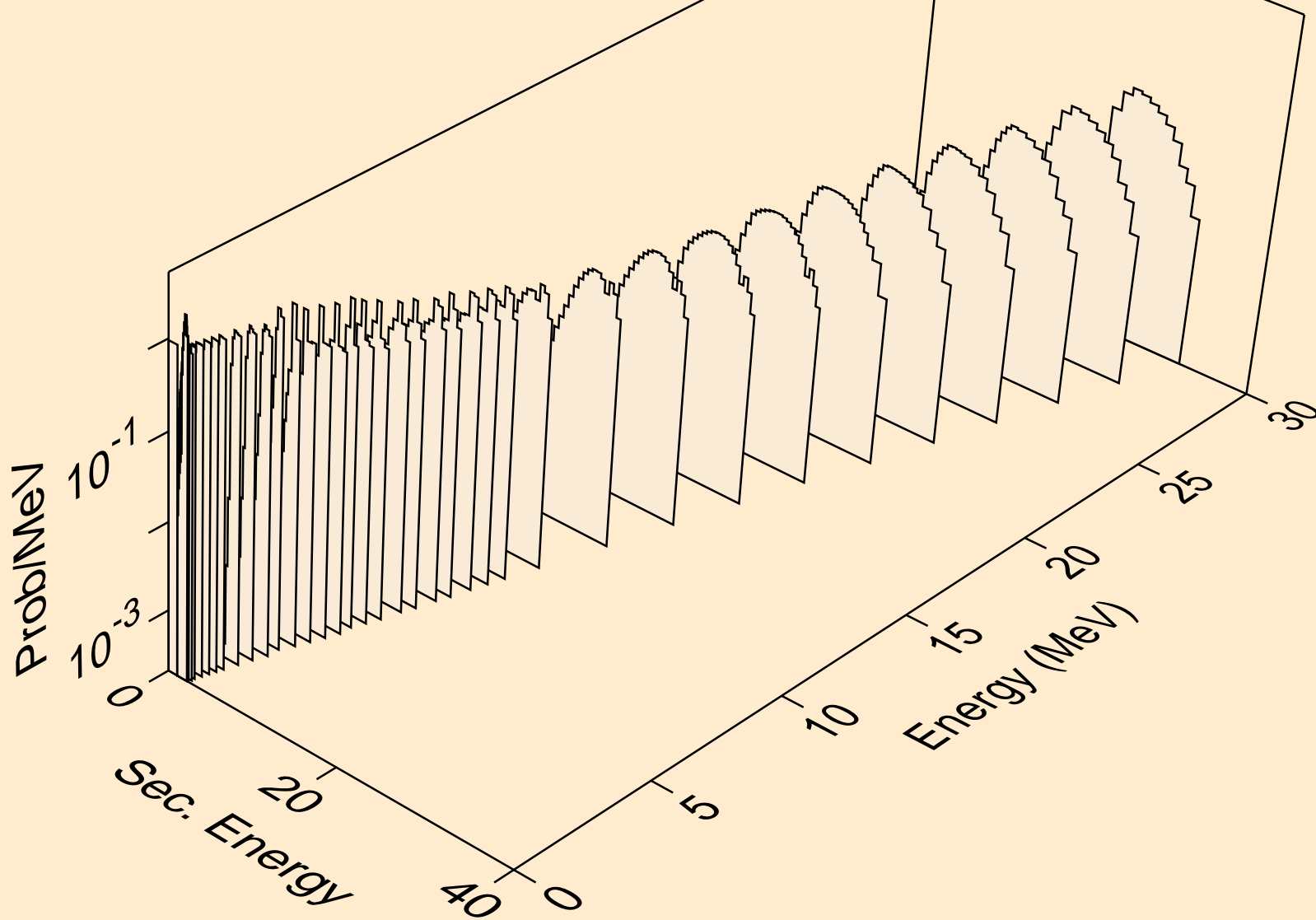

HG195 NEUTRON ACER TENDL-2019 LIBRARY; T=293.16K
protons from (n,2p)

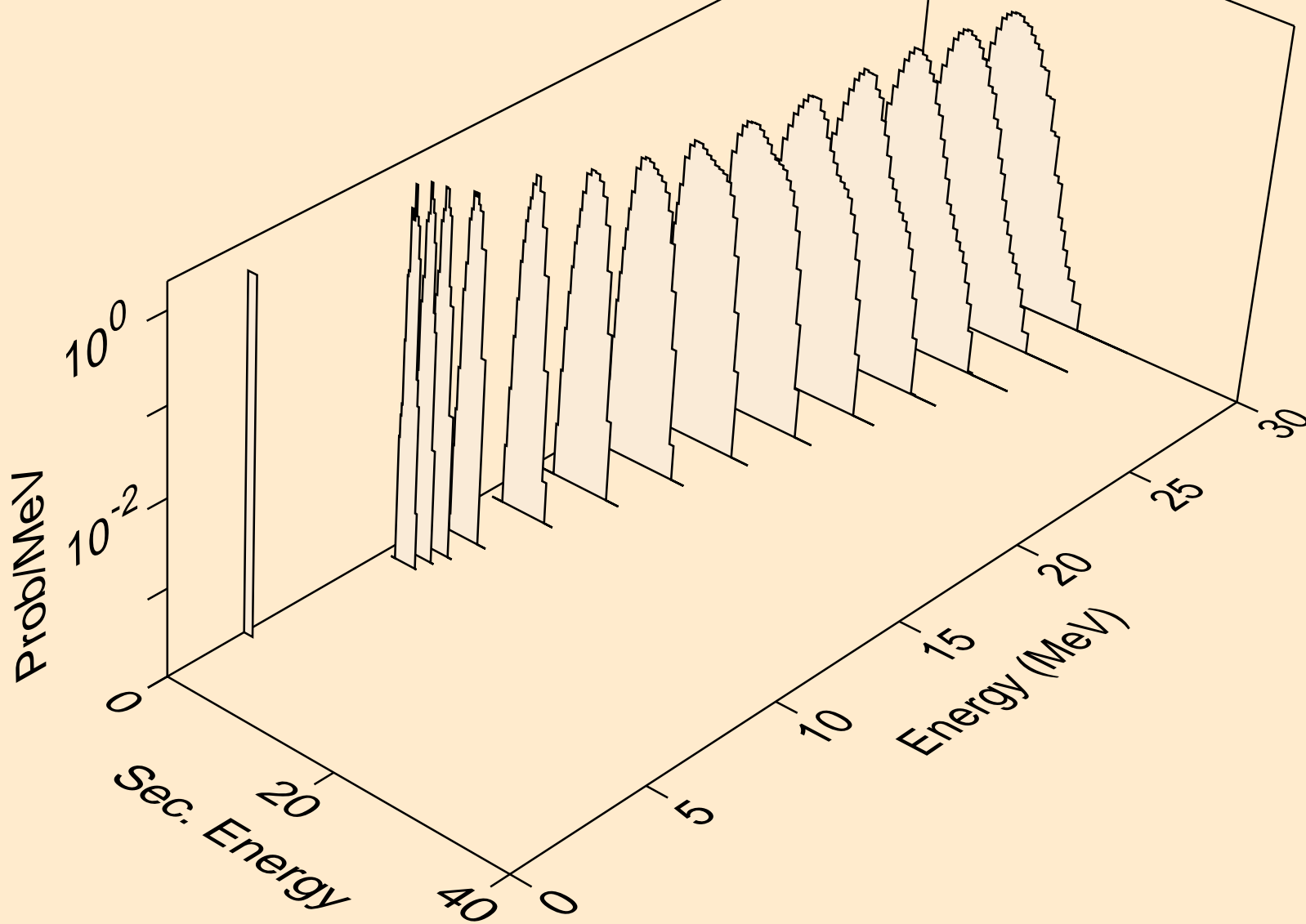

HG195 NEUTRON ACER TENDL-2019 LIBRARY; T=293.16K
protons from (n,p)

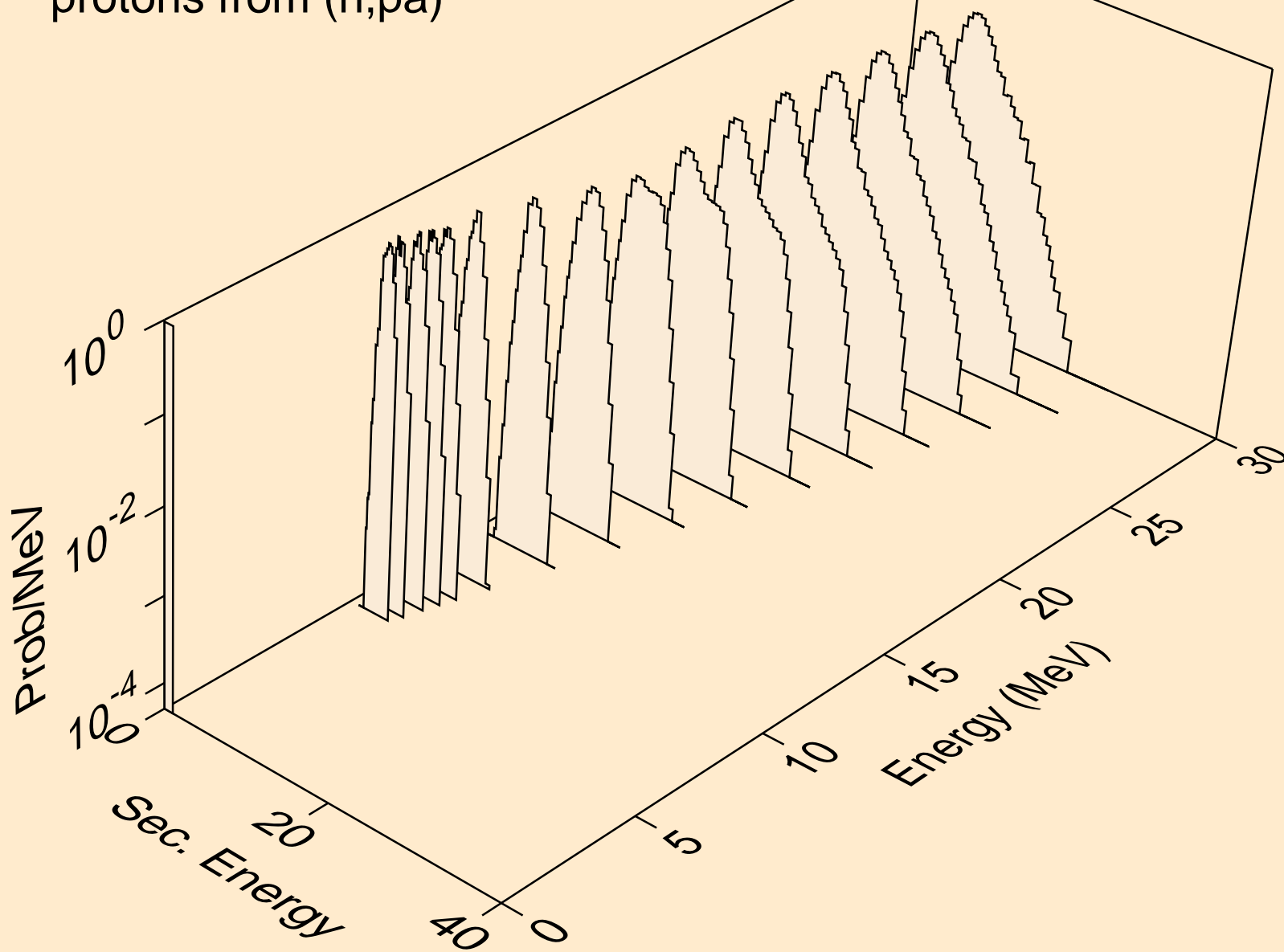

HG195 NEUTRON ACER TENDL-2019 LIBRARY; T=293.16K
protons from (n,pd)

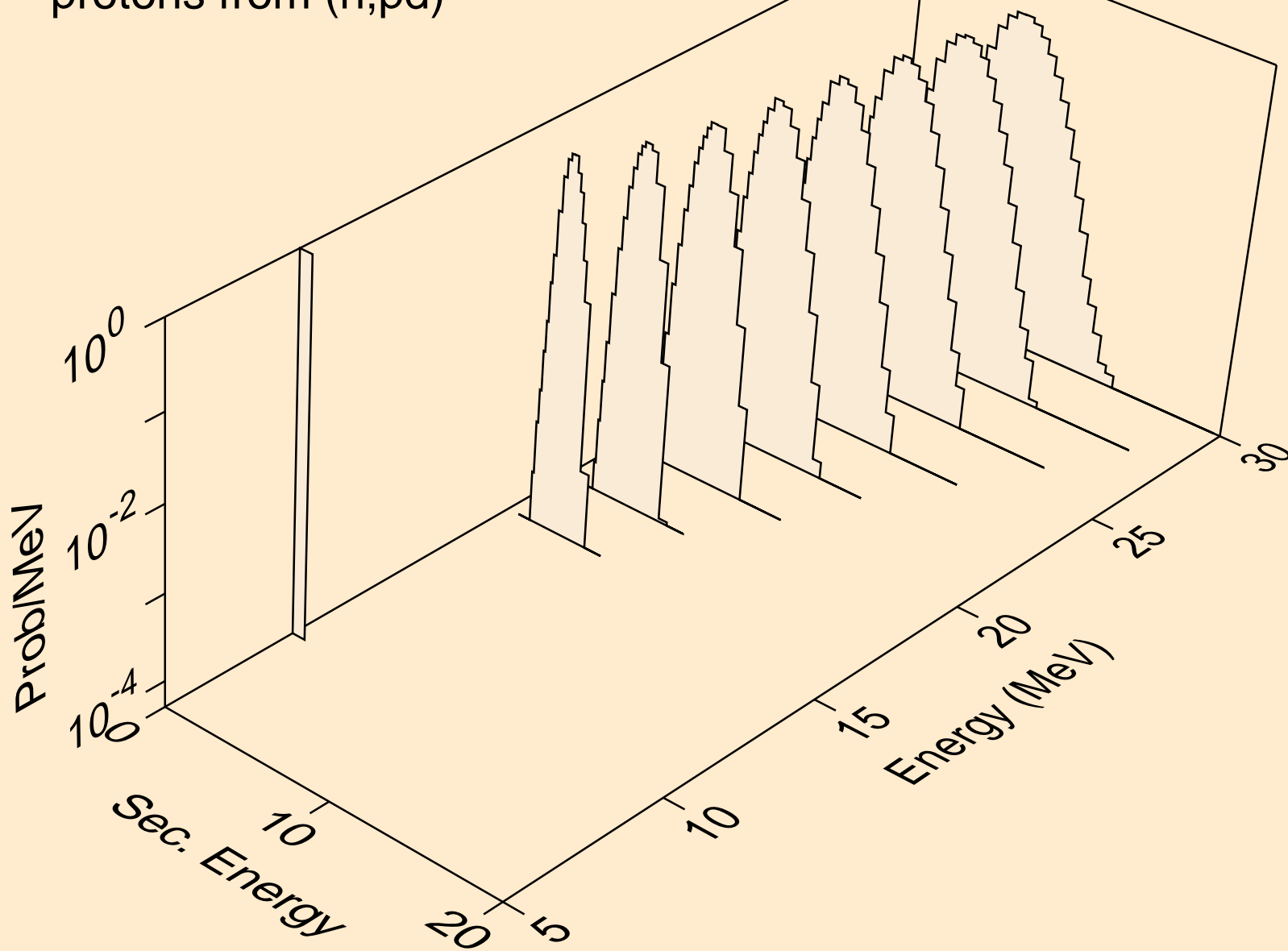

HG195 NEUTRON ACER TENDL-2019 LIBRARY; T=293.16K
protons from (n,pt)

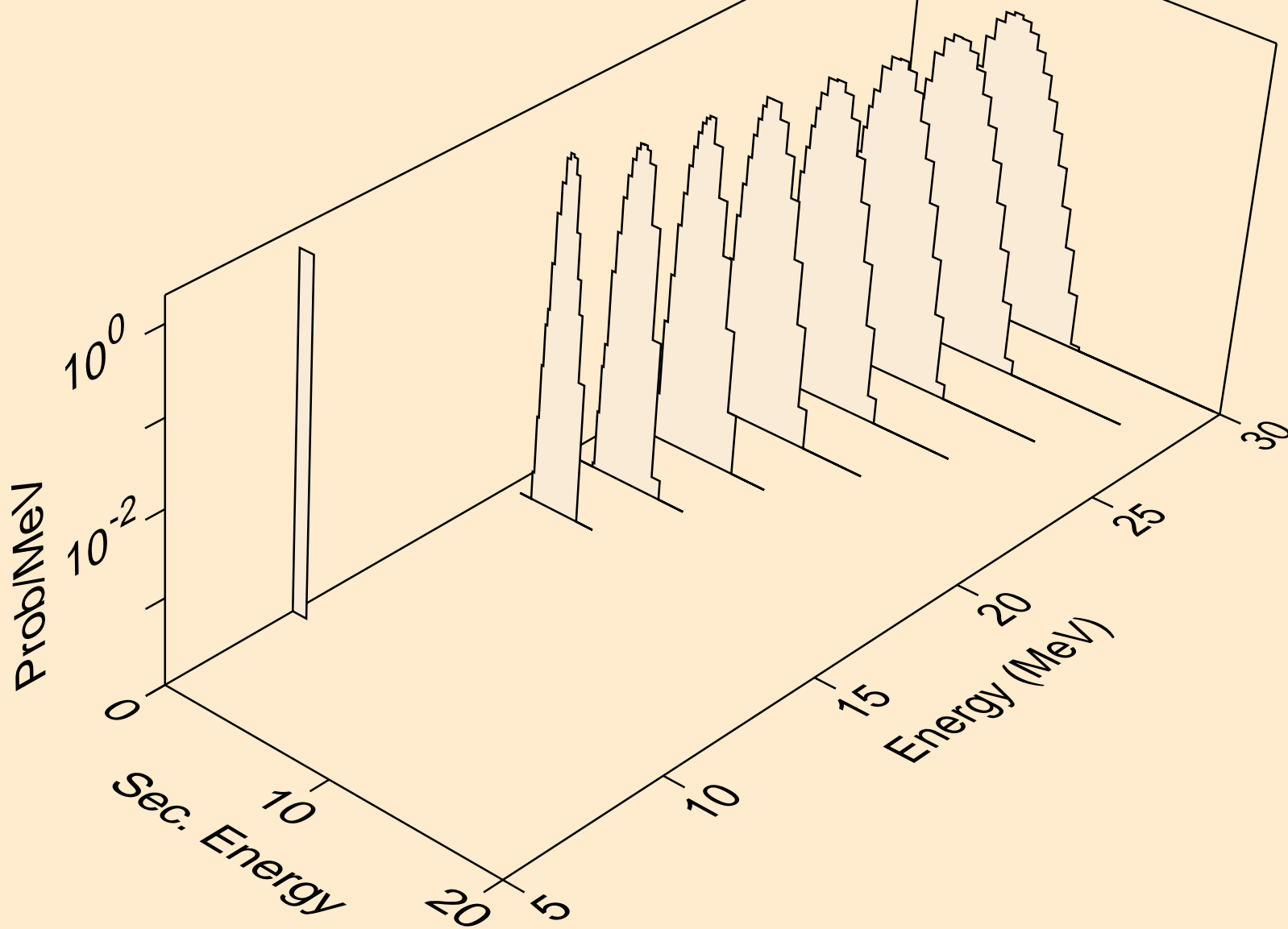

HG195 NEUTRON ACER TENDL-2019 LIBRARY; T=293.16K
deuterons from (n,x)

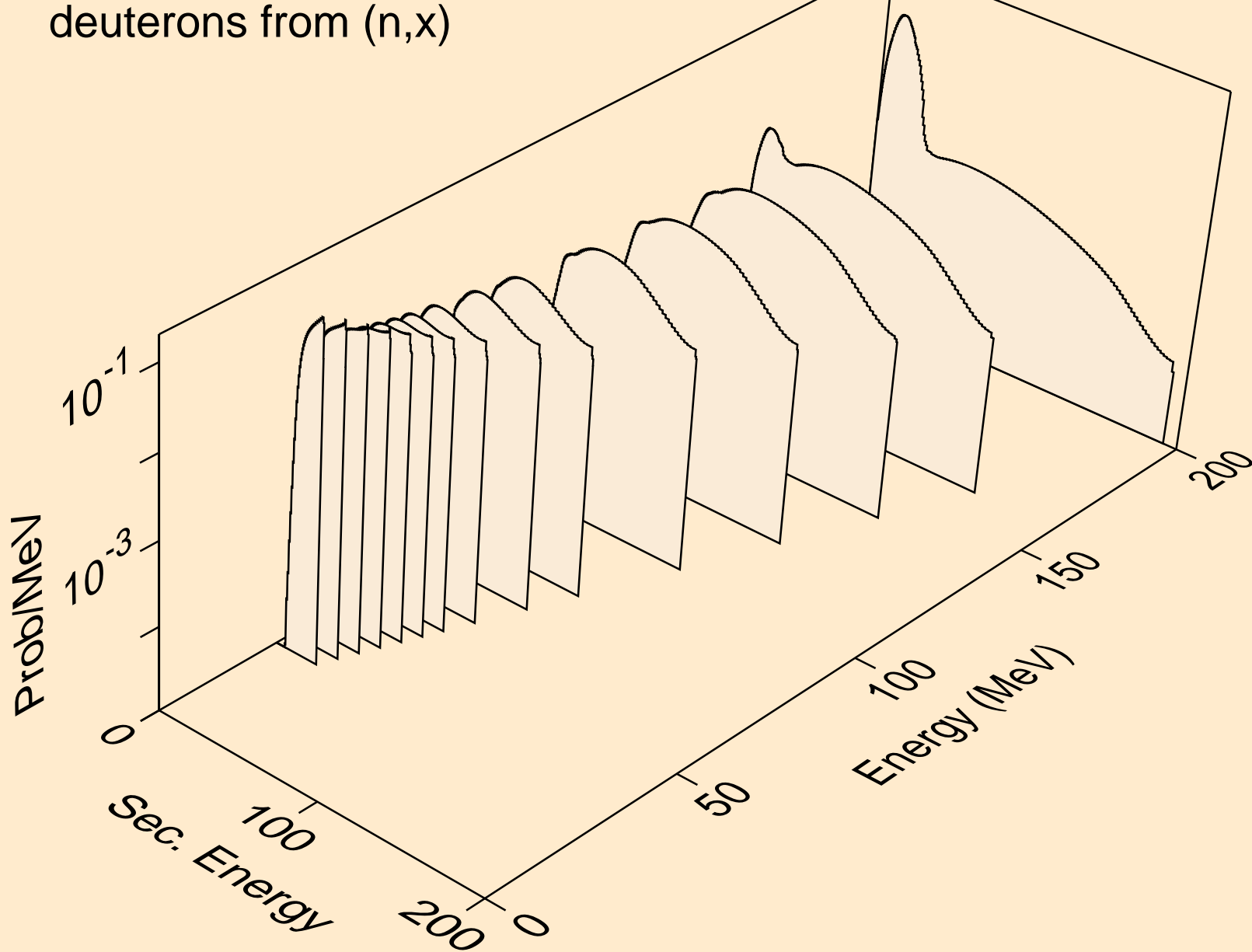

HG195 NEUTRON ACER TENDL-2019 LIBRARY; T=293.16K
deuterons from (n,2nd)

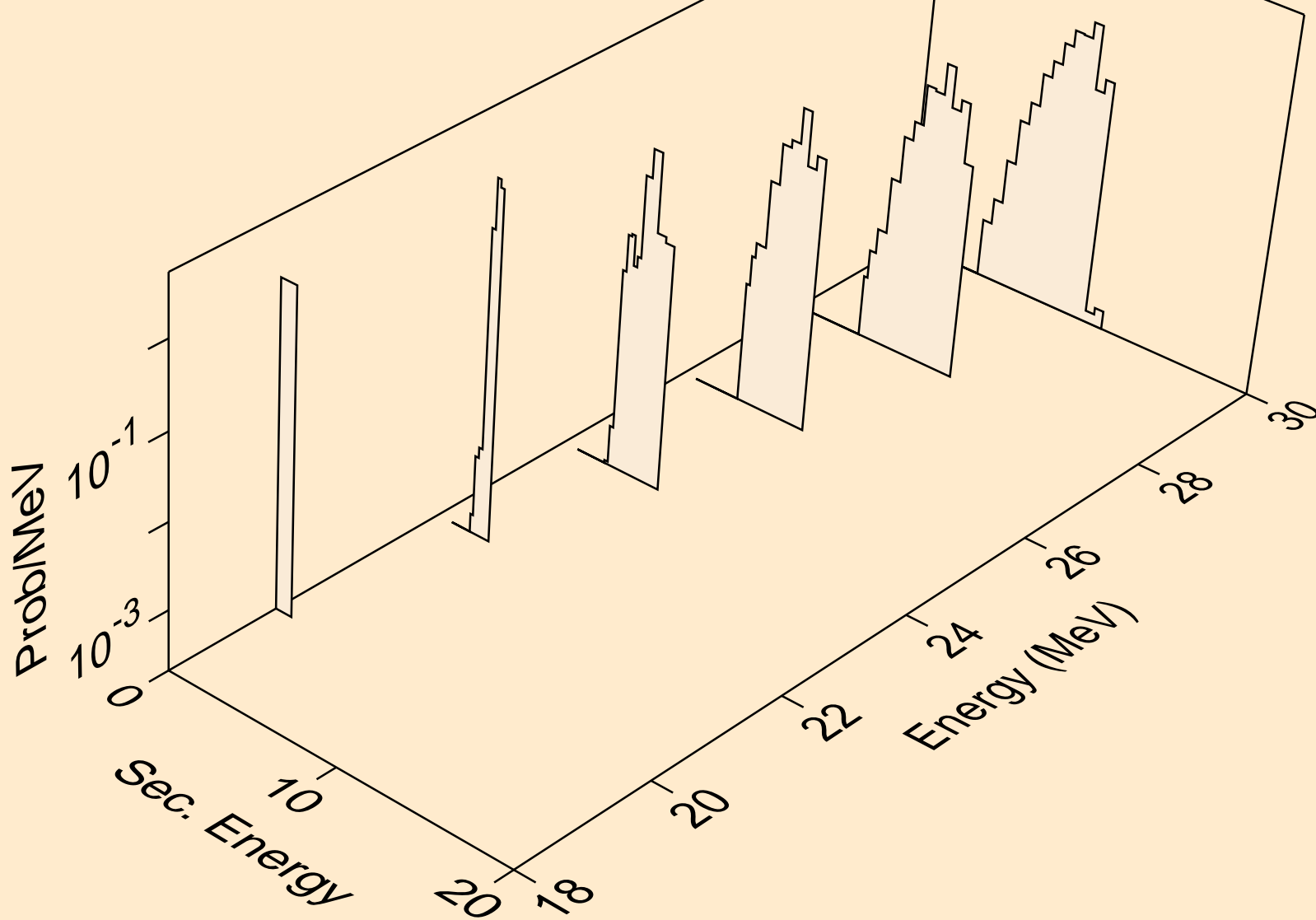

HG195 NEUTRON ACER TENDL-2019 LIBRARY; T=293.16K
deuterons from (n,n*)d

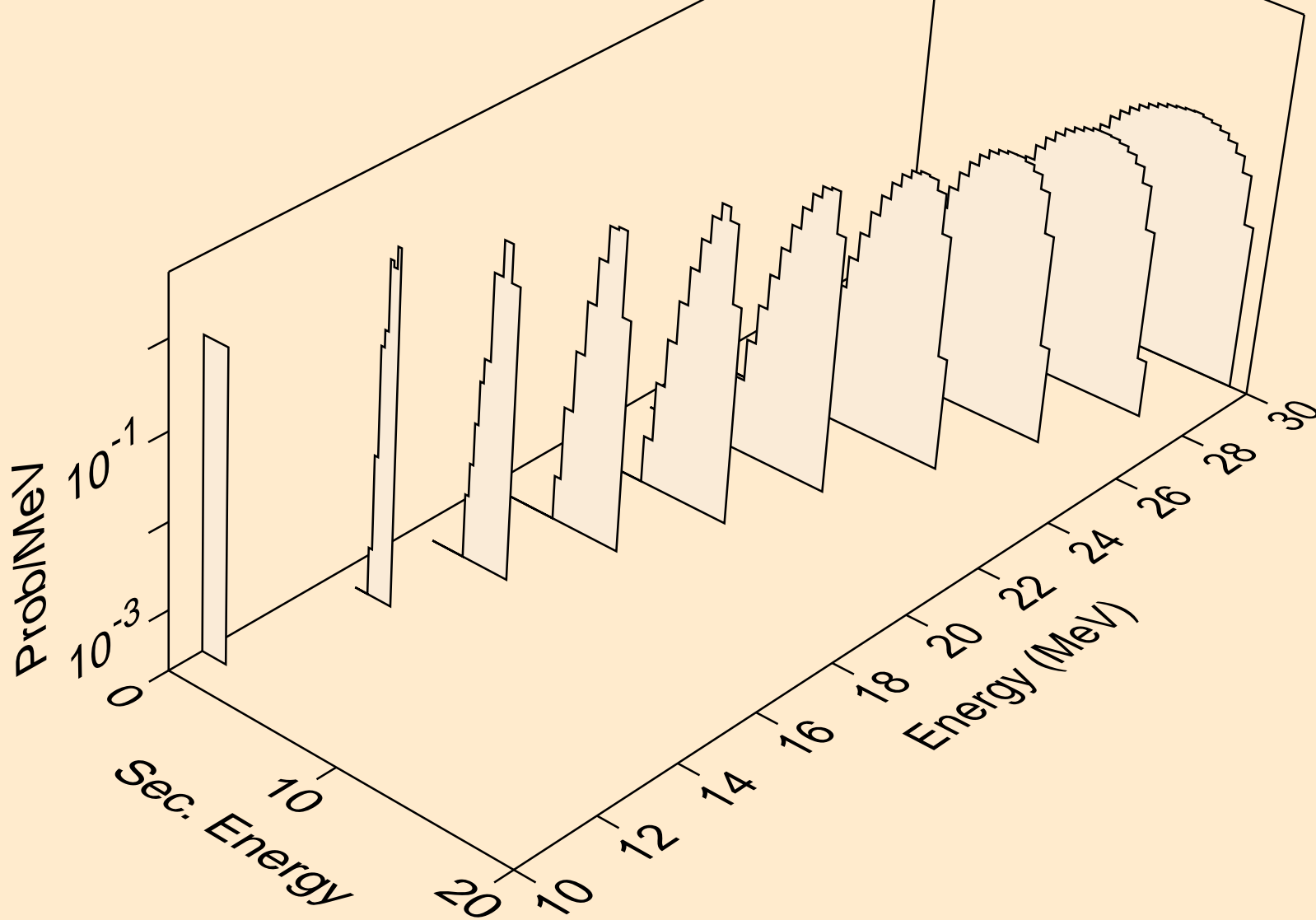

HG195 NEUTRON ACER TENDL-2019 LIBRARY; T=293.16K
deuterons from (n,d)

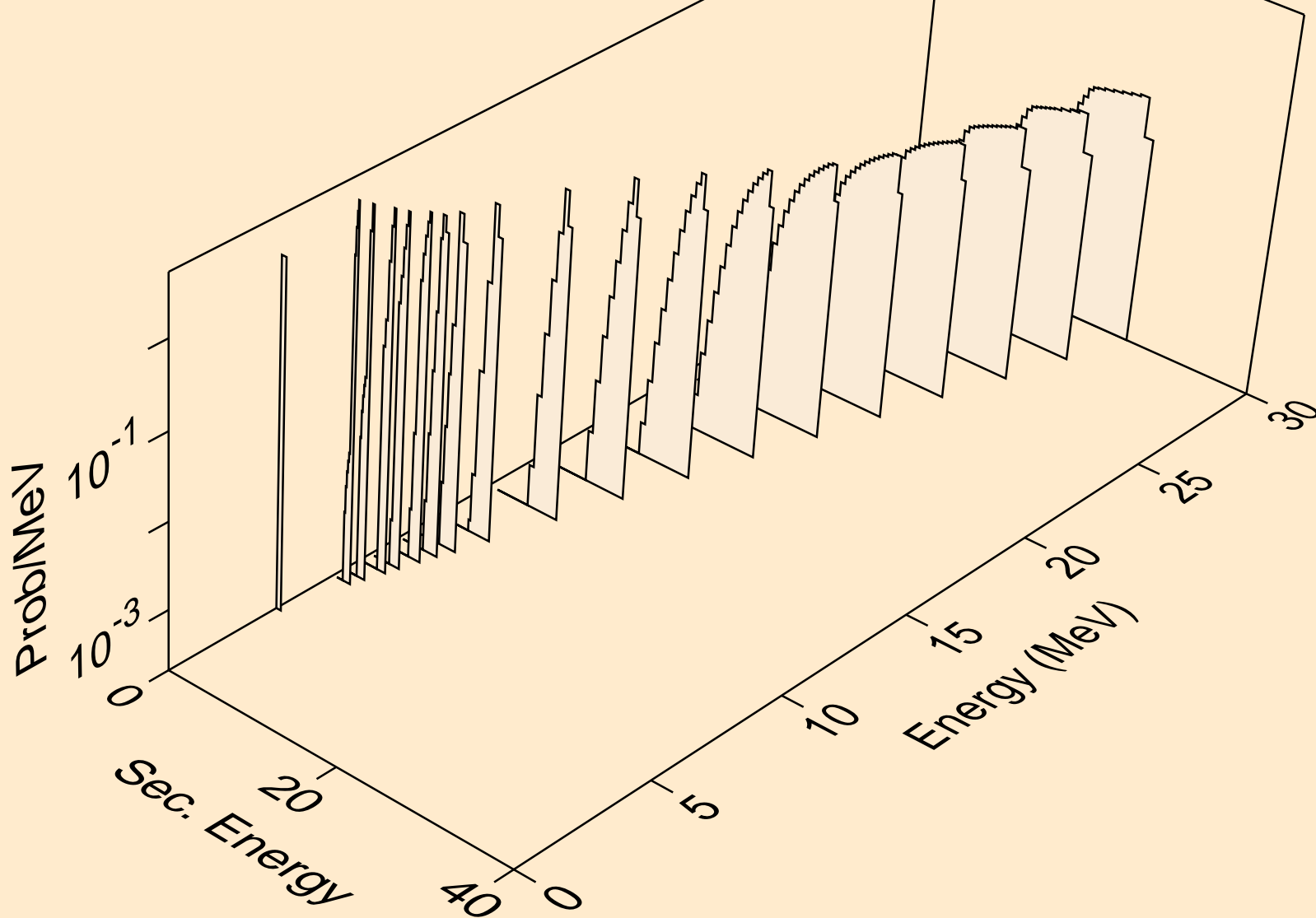

HG195 NEUTRON ACER TENDL-2019 LIBRARY; T=293.16K
deuterons from (n,pd)

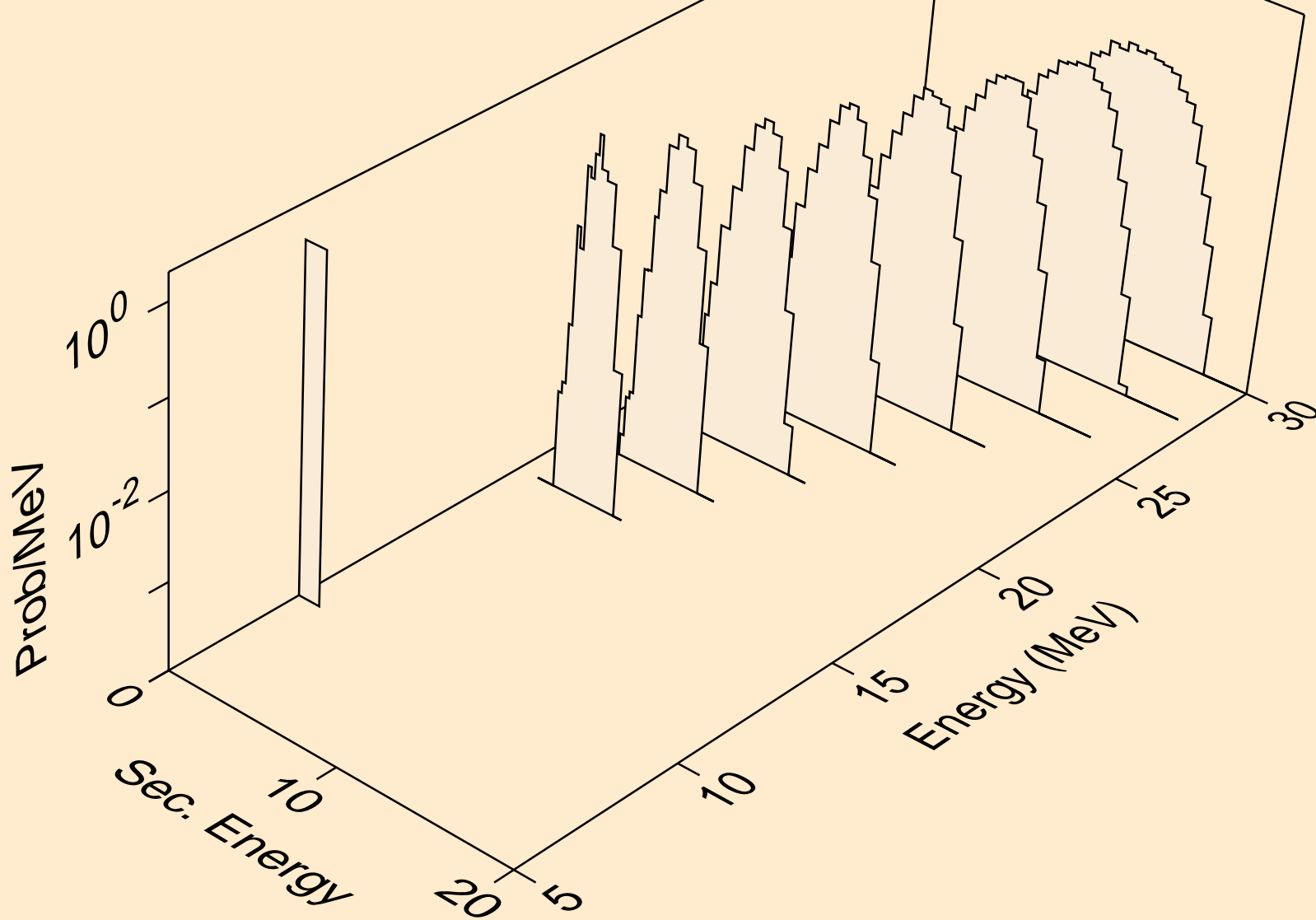

HG195 NEUTRON ACER TENDL-2019 LIBRARY; T=293.16K
deuterons from (n,da)

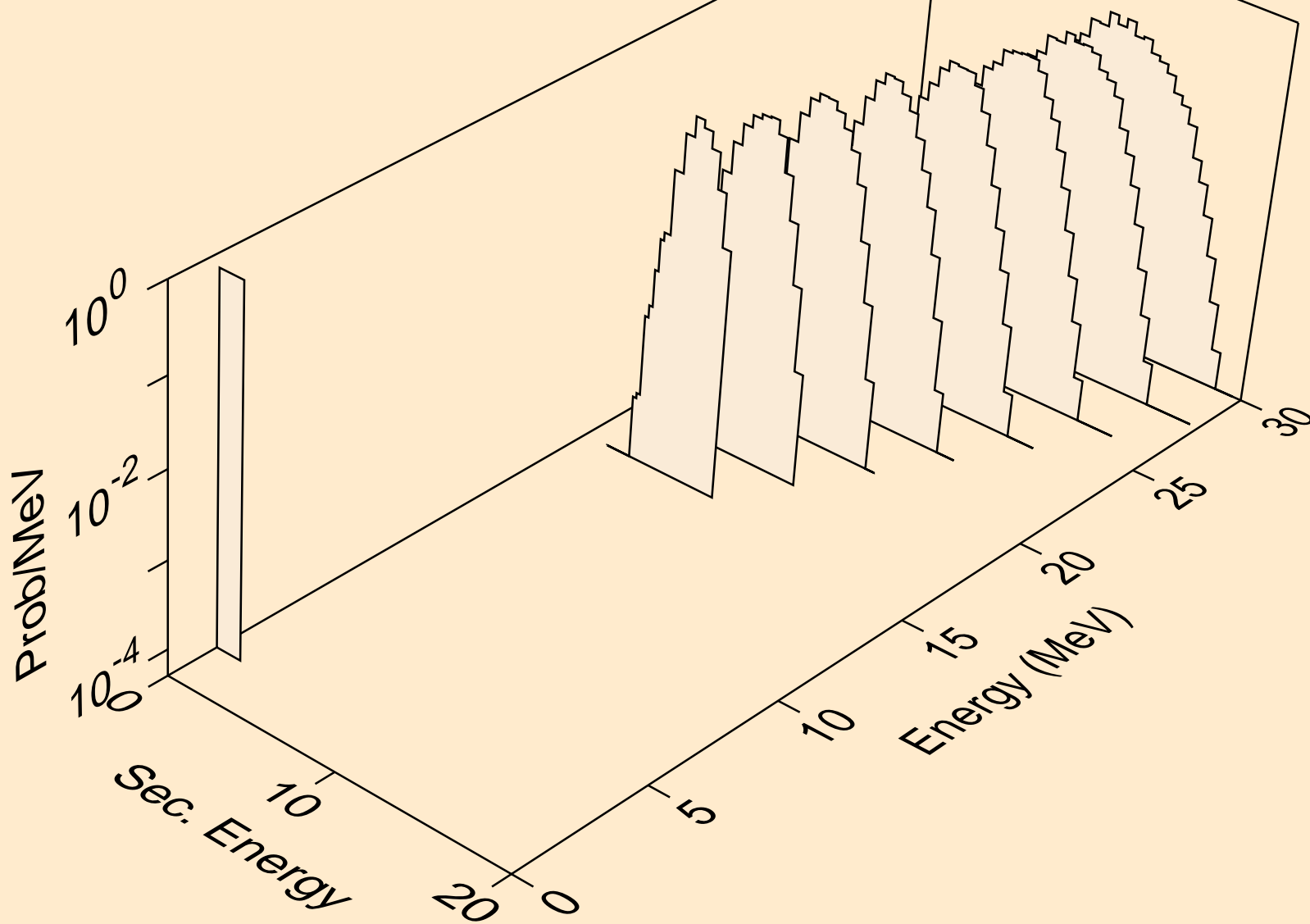

HG195 NEUTRON ACER TENDL-2019 LIBRARY; T=293.16K
tritons from (n,x)

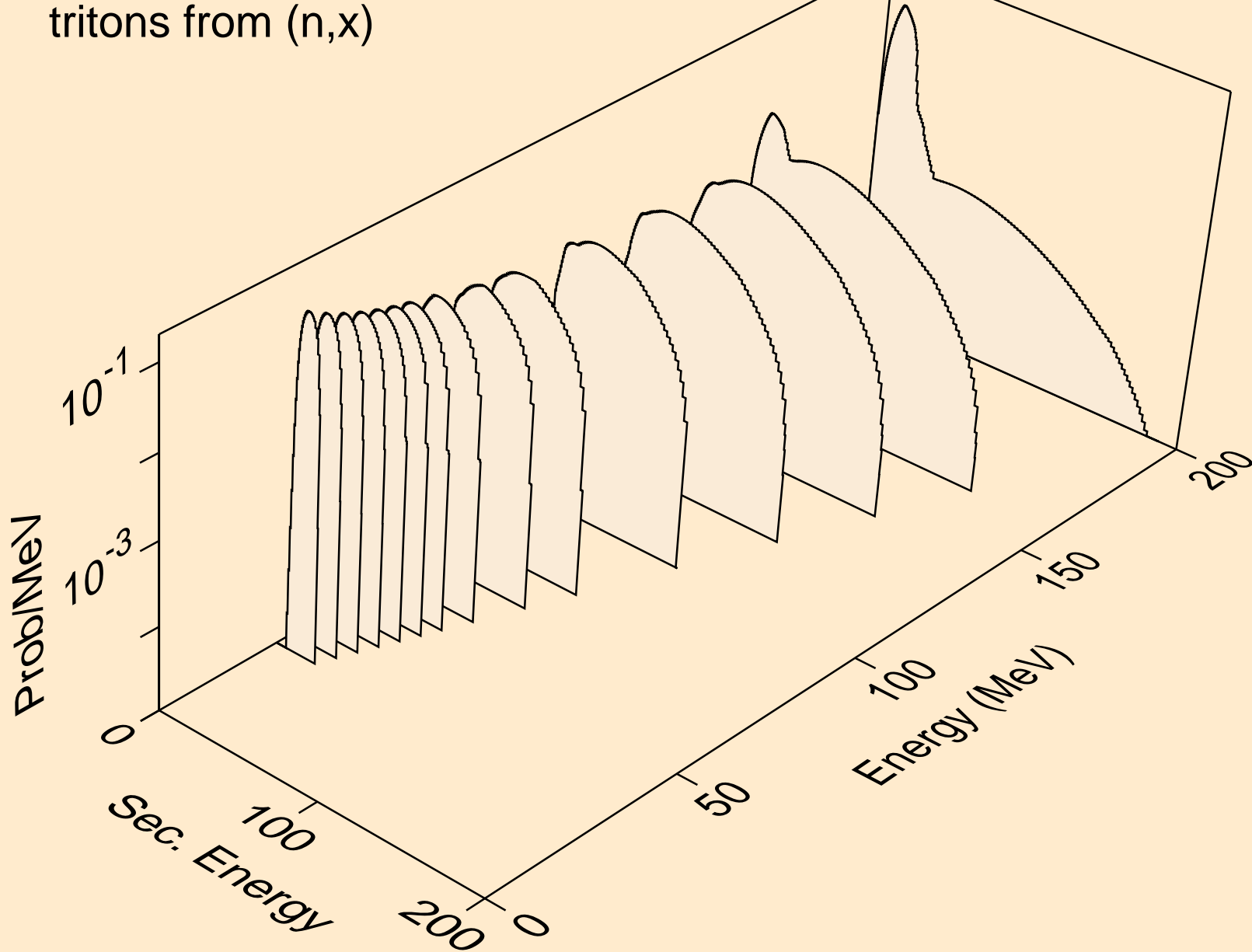

HG195 NEUTRON ACER TENDL-2019 LIBRARY; T=293.16K
tritons from (n,n*)t

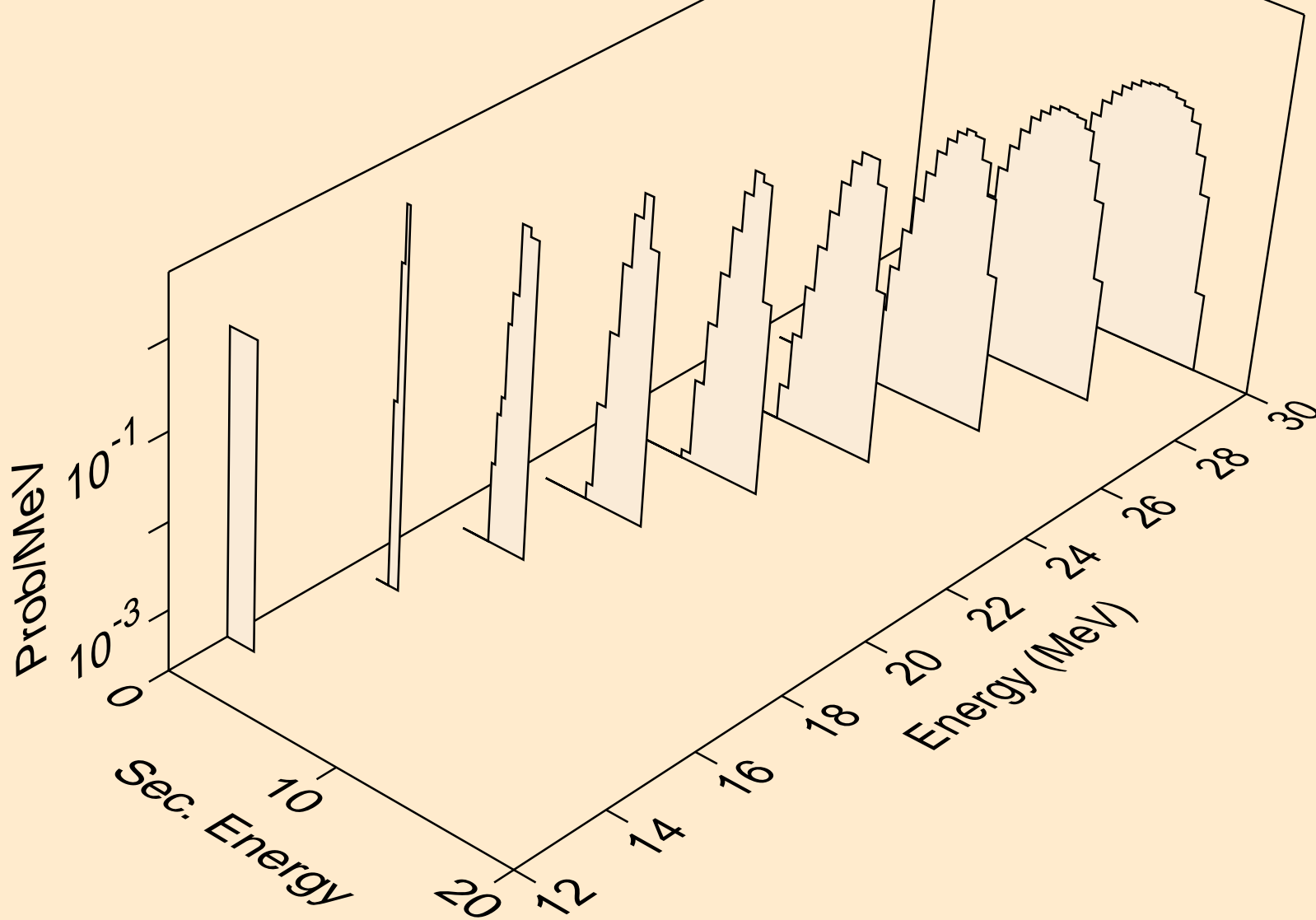

HG195 NEUTRON ACER TENDL-2019 LIBRARY; T=293.16K
tritons from (n,t)

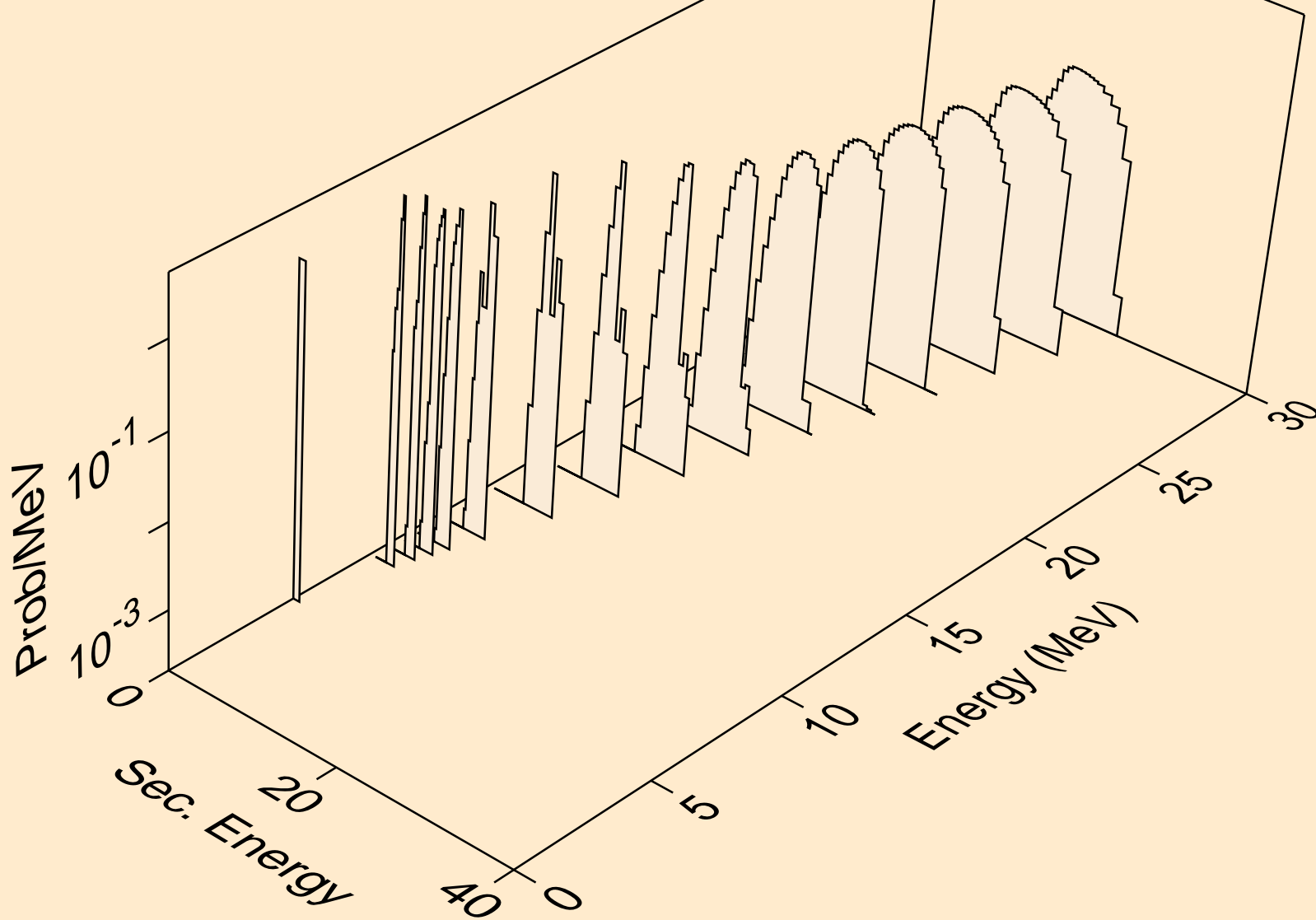

HG195 NEUTRON ACER TENDL-2019 LIBRARY; T=293.16K
tritons from (n,pt)

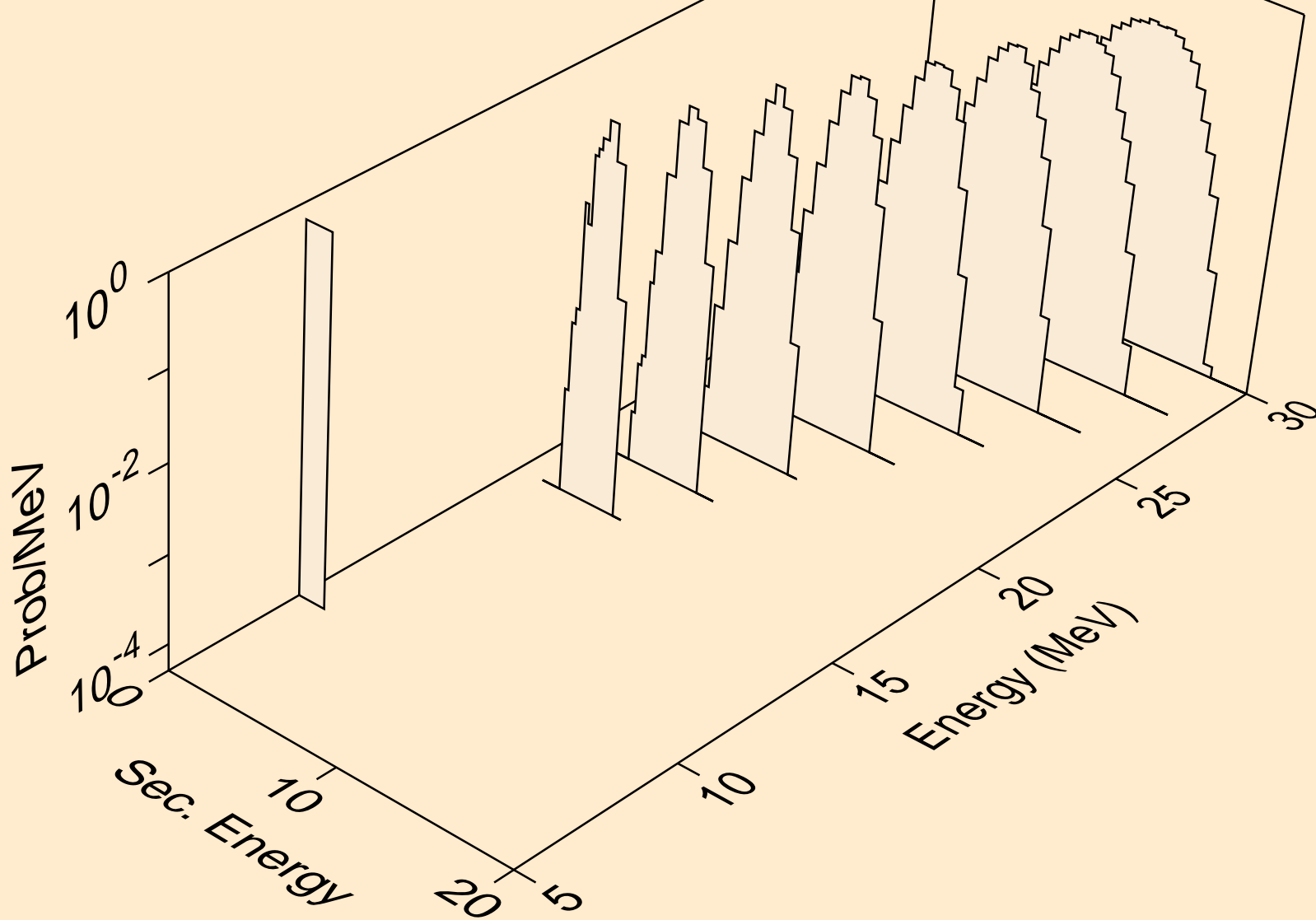

HG195 NEUTRON ACER TENDL-2019 LIBRARY; T=293.16K
he3s from (n,x)

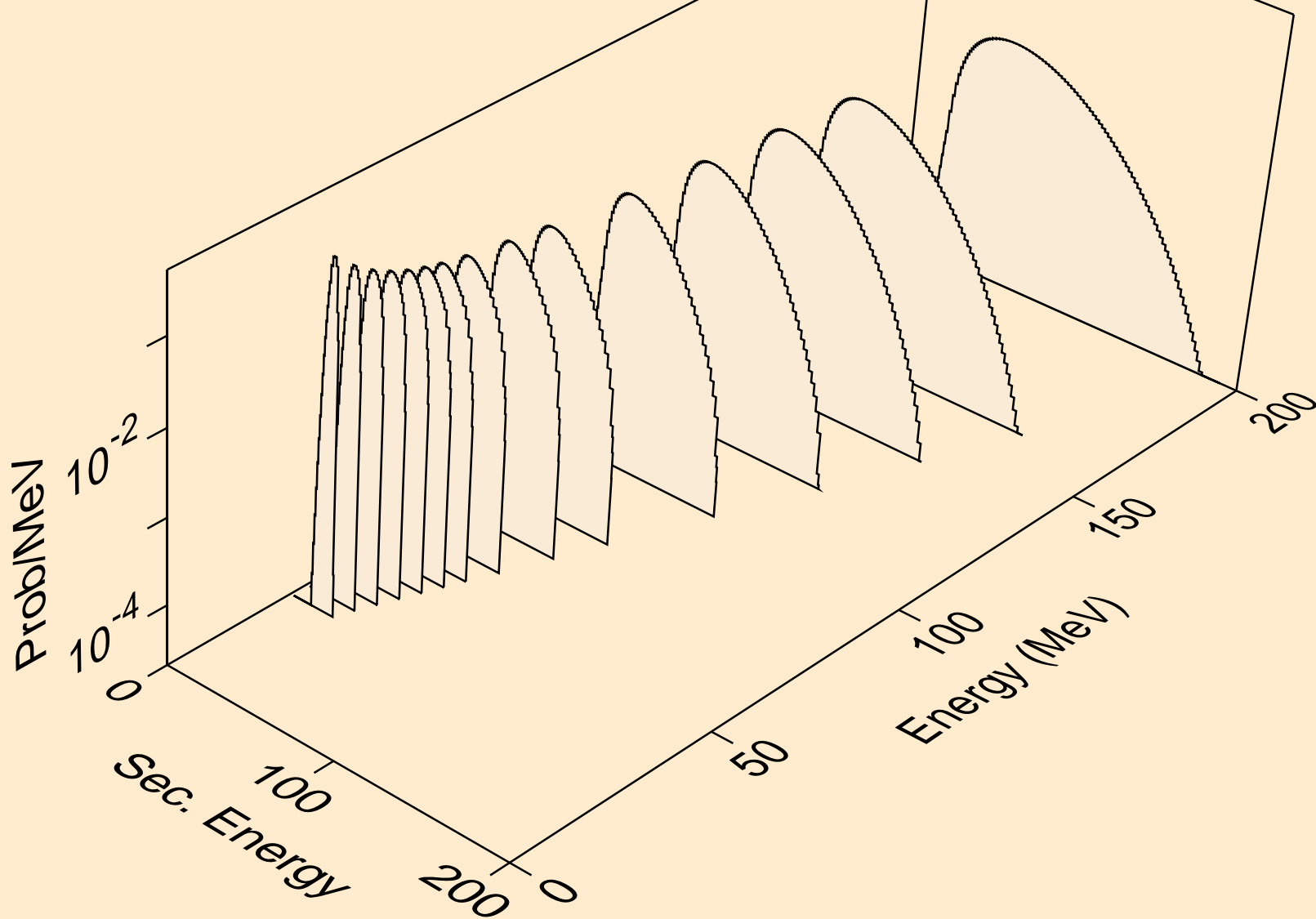

HG195 NEUTRON ACER TENDL-2019 LIBRARY; T=293.16K
he3s from (n,n*)he3

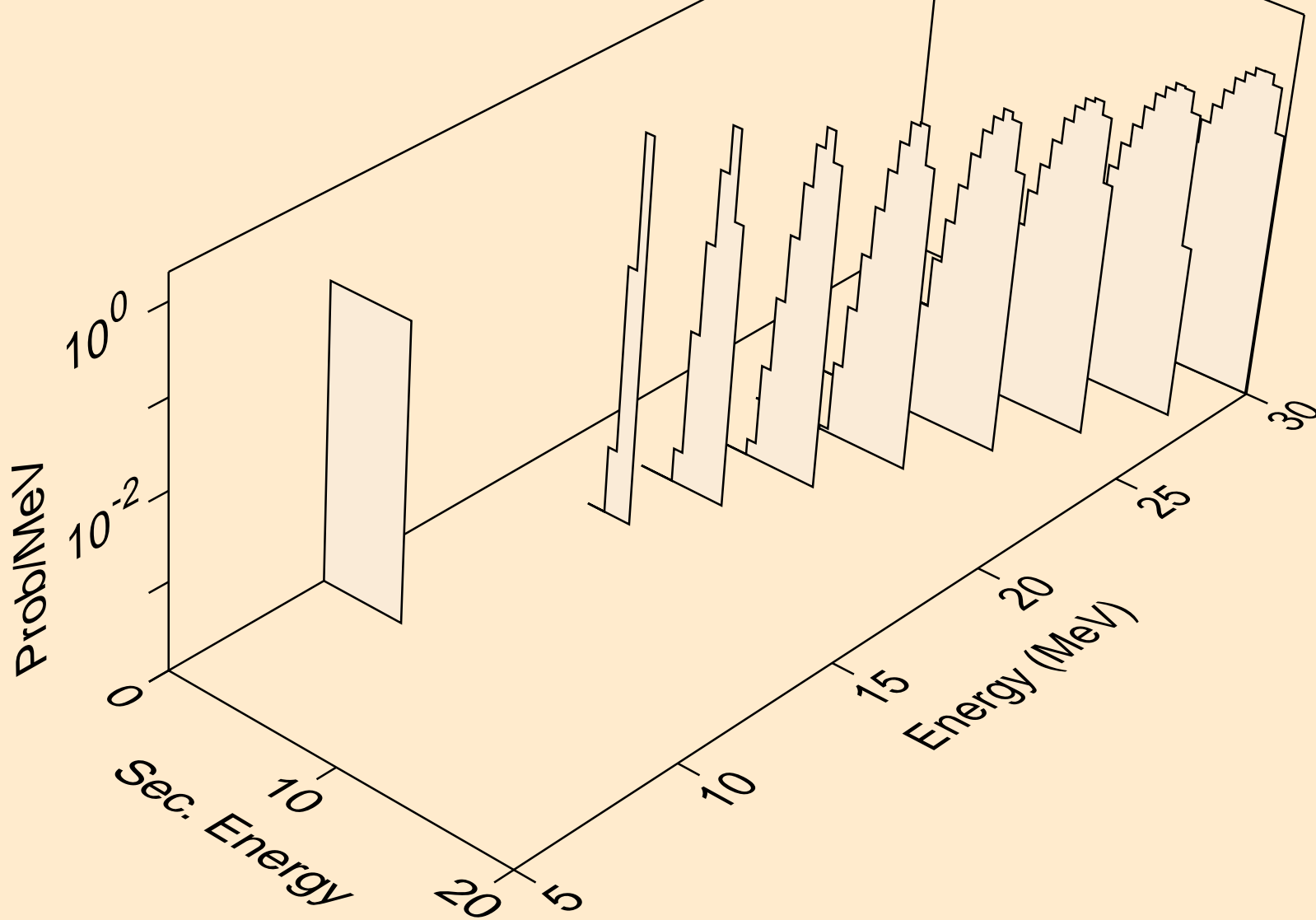

HG195 NEUTRON ACER TENDL-2019 LIBRARY; T=293.16K
he3s from (n,he3)

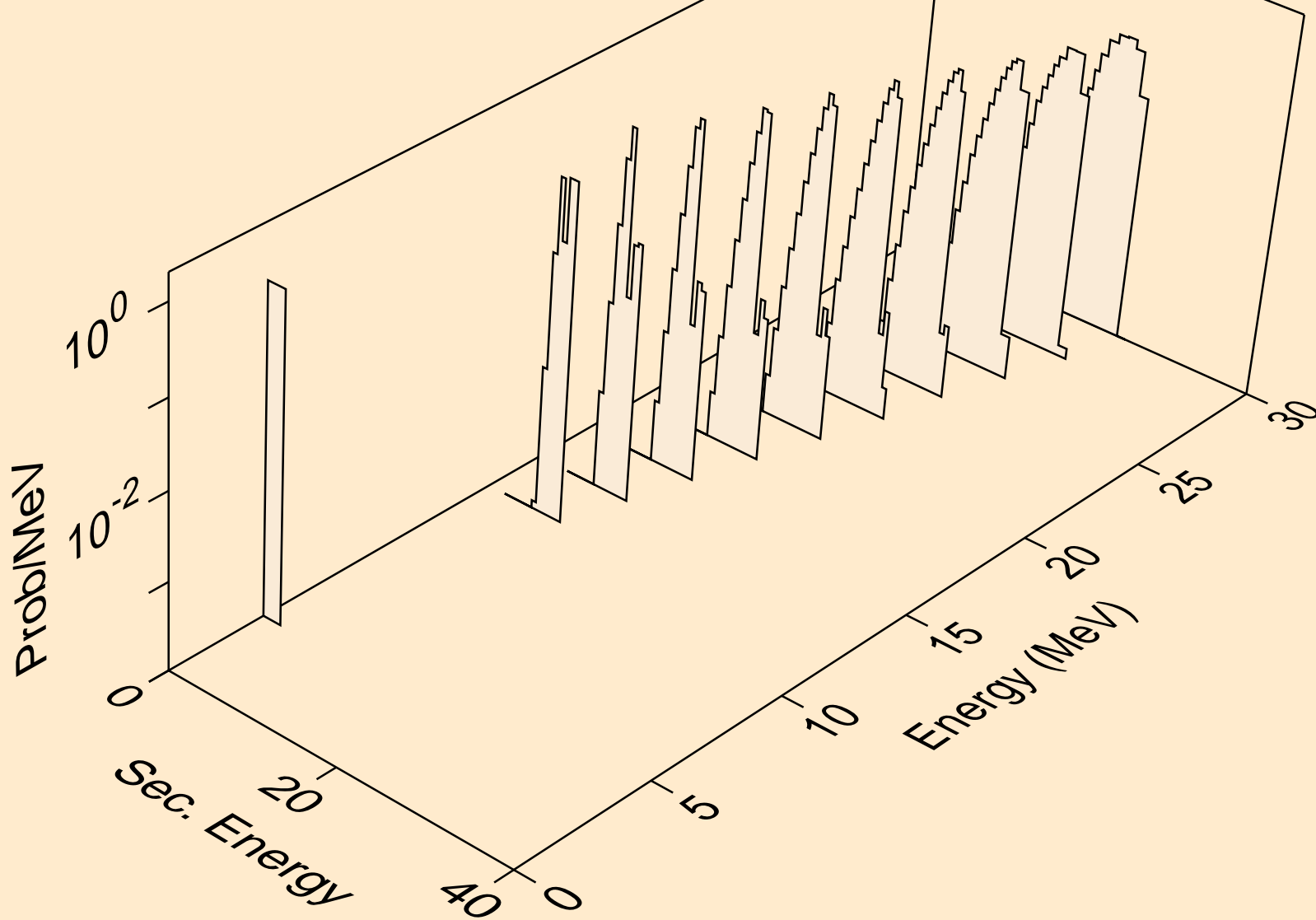

HG195 NEUTRON ACER TENDL-2019 LIBRARY; T=293.16K
alphas from (n,x)

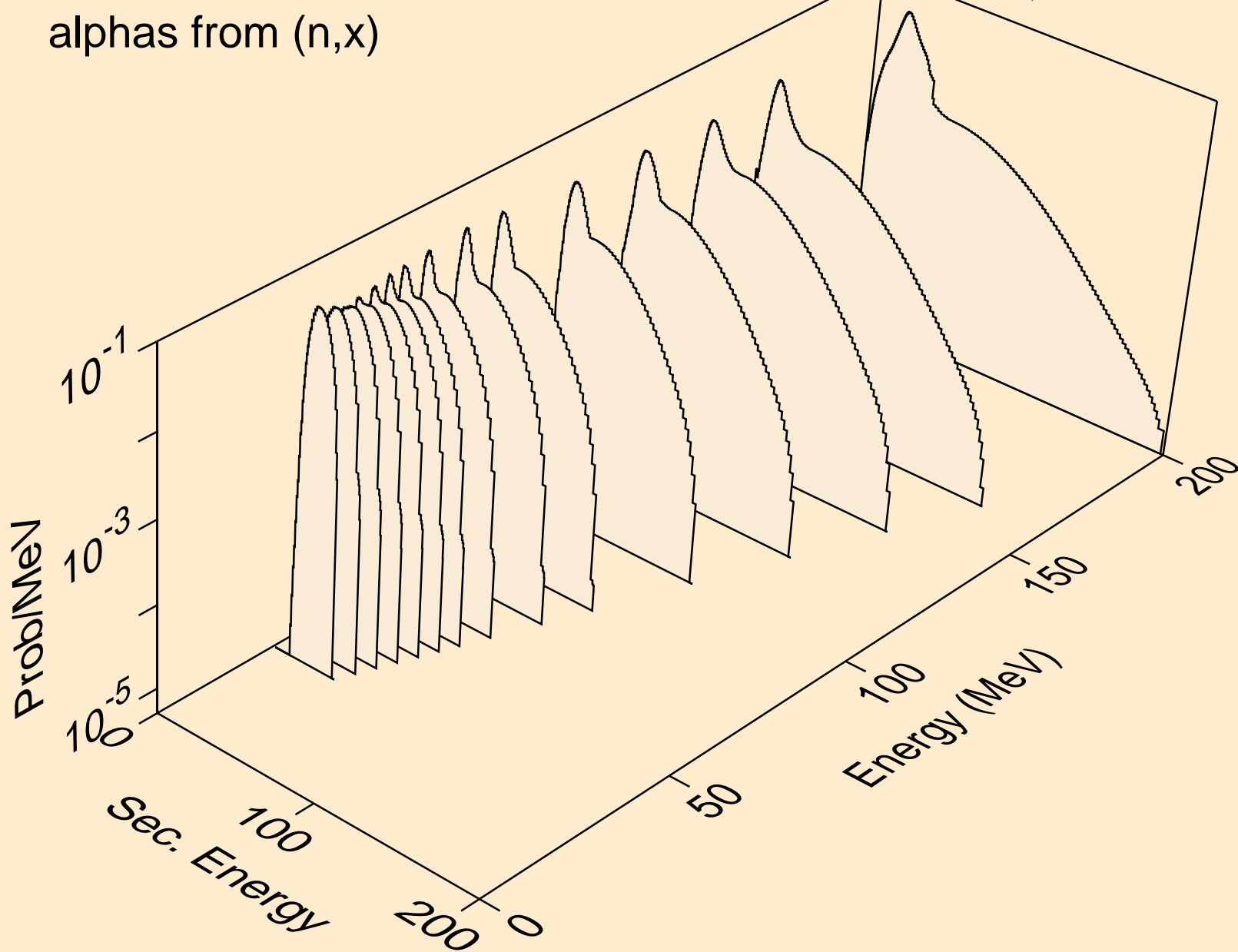

HG195 NEUTRON ACER TENDL-2019 LIBRARY; T=293.16K
alphas from (n,n*)a

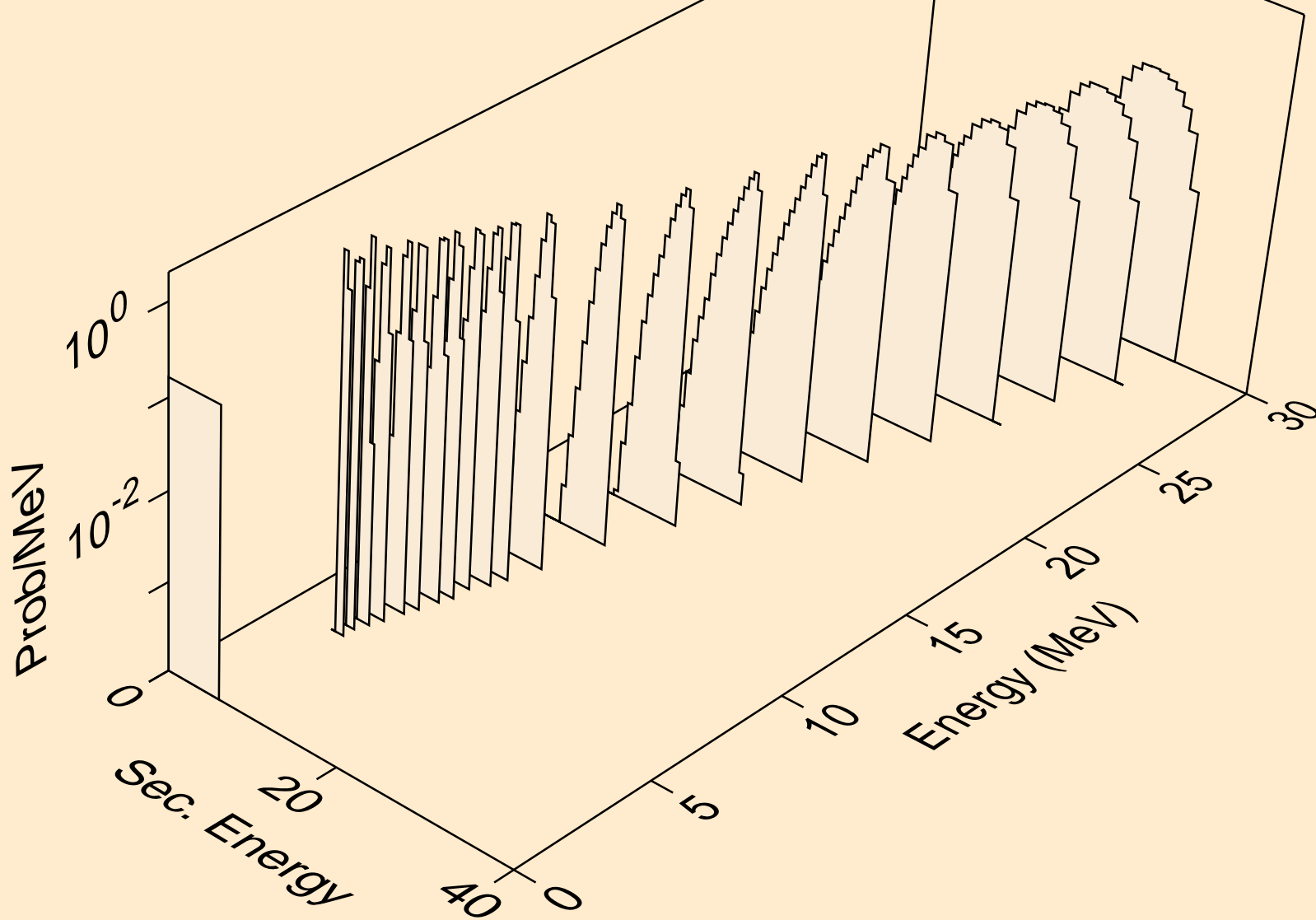

HG195 NEUTRON ACER TENDL-2019 LIBRARY; T=293.16K
alphas from (n,2n)a

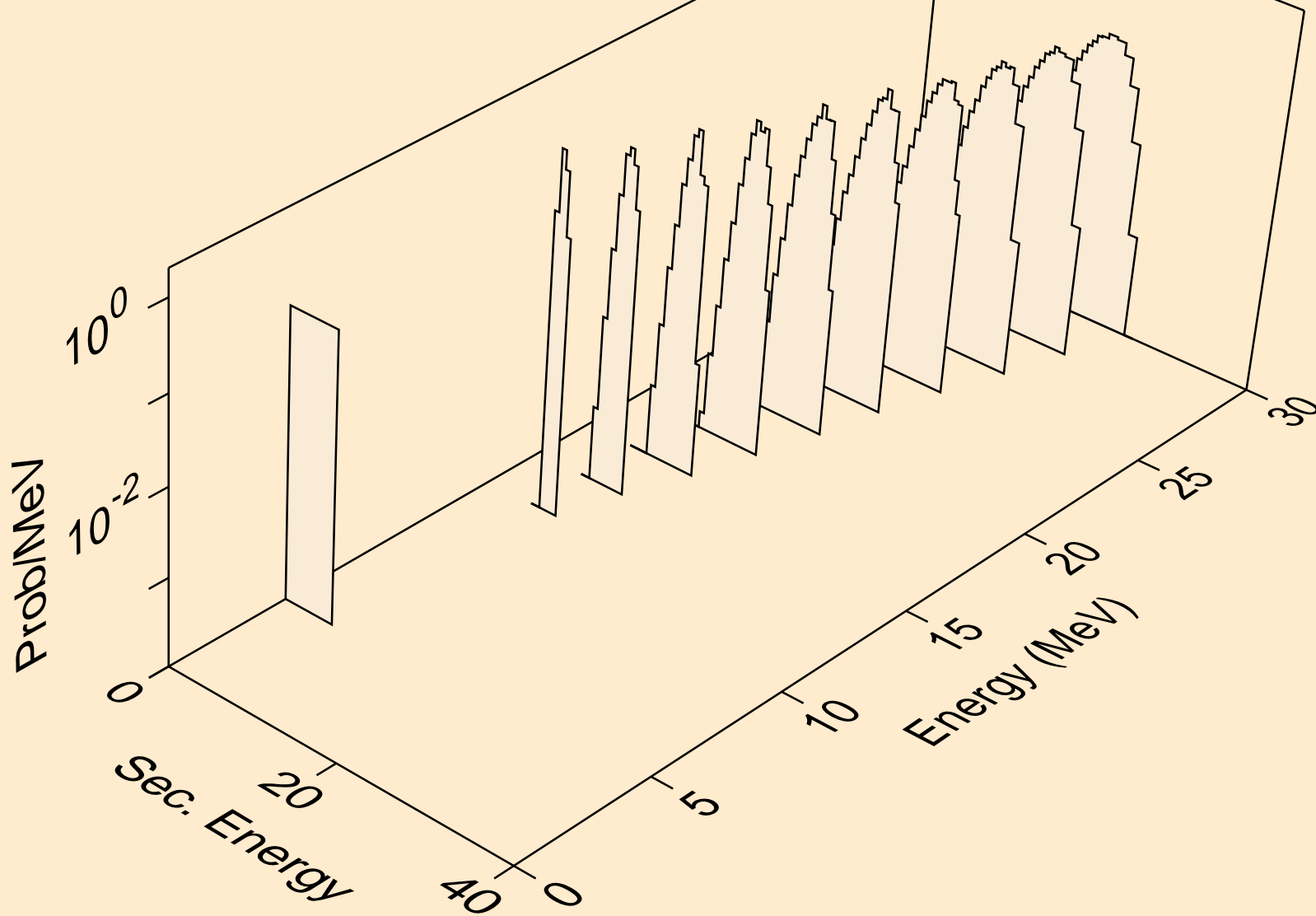

HG195 NEUTRON ACER TENDL-2019 LIBRARY; T=293.16K
alphas from (n,3n)a

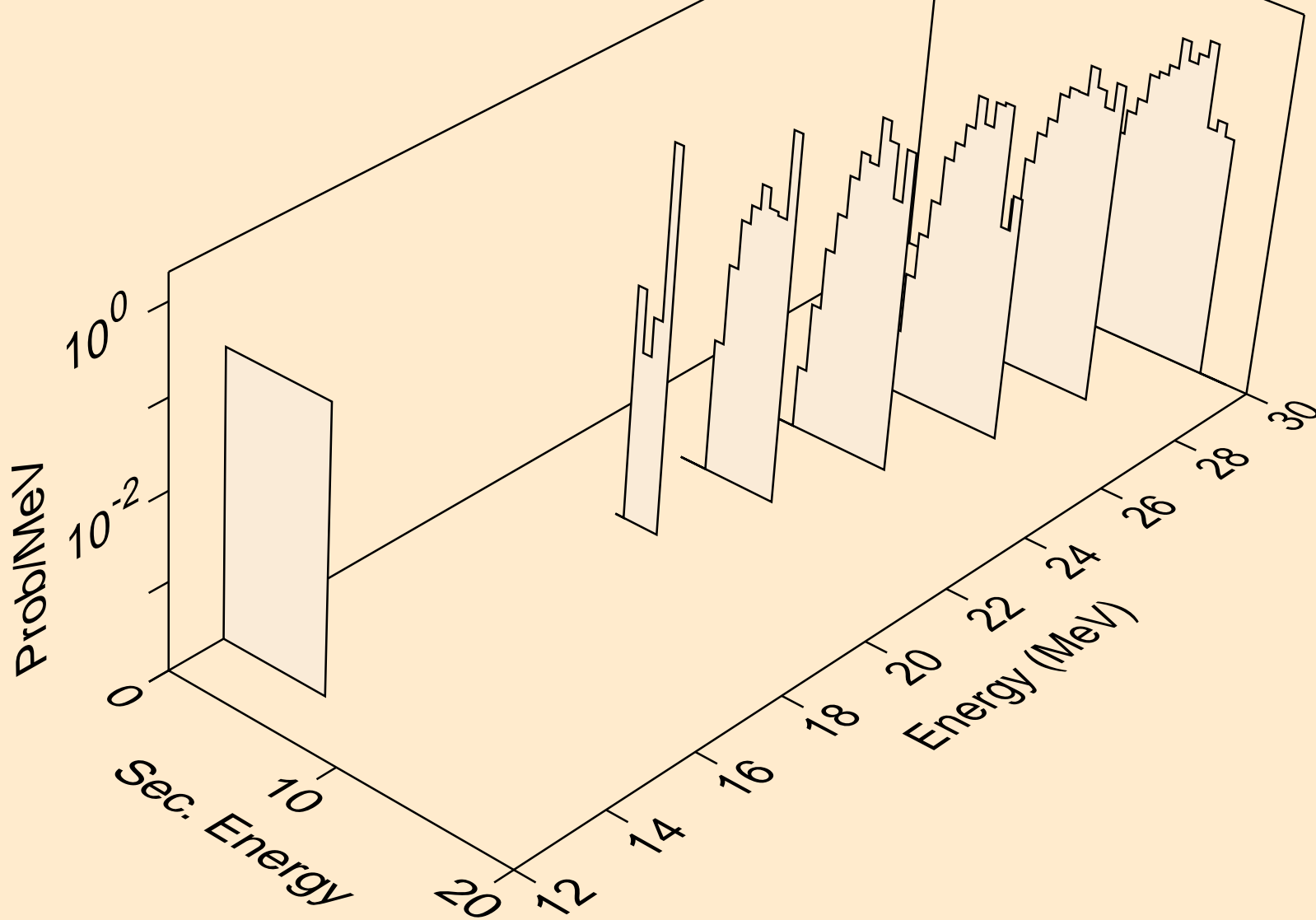

HG195 NEUTRON ACER TENDL-2019 LIBRARY; T=293.16K
alphas from (n,n*)2a

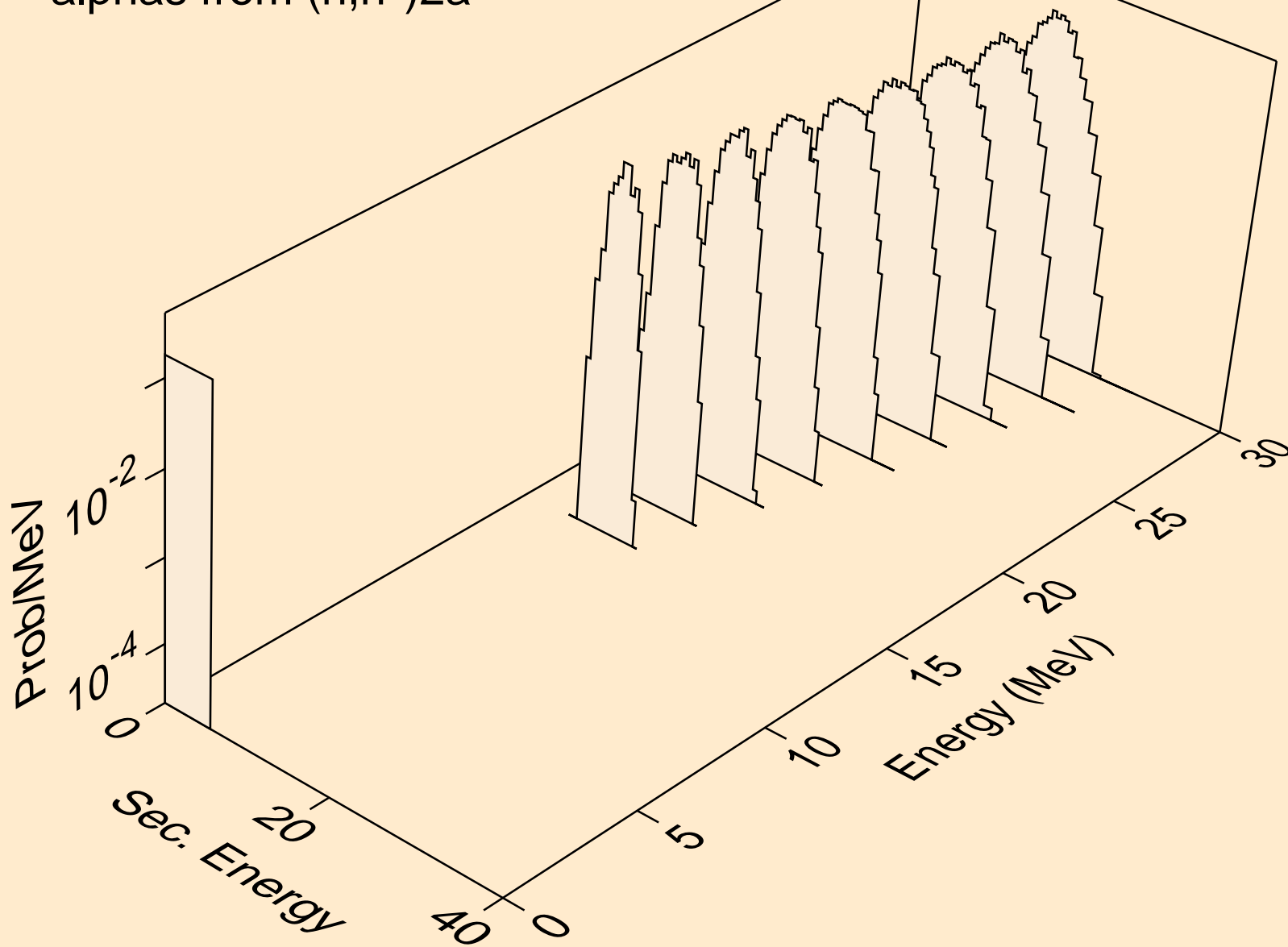

HG195 NEUTRON ACER TENDL-2019 LIBRARY; T=293.16K
alphas from (n,npa)

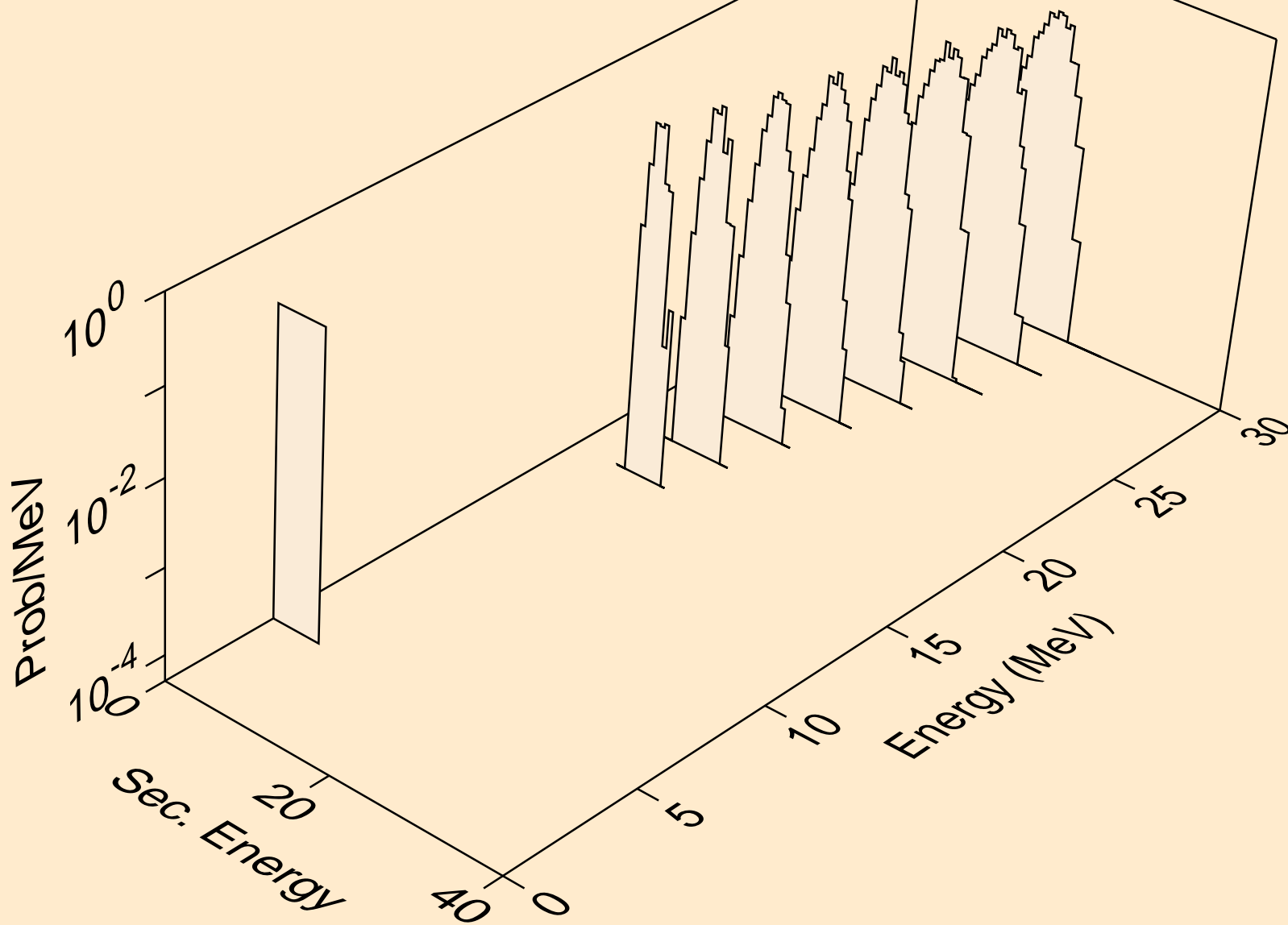

HG195 NEUTRON ACER TENDL-2019 LIBRARY; T=293.16K
alphas from (n,a)

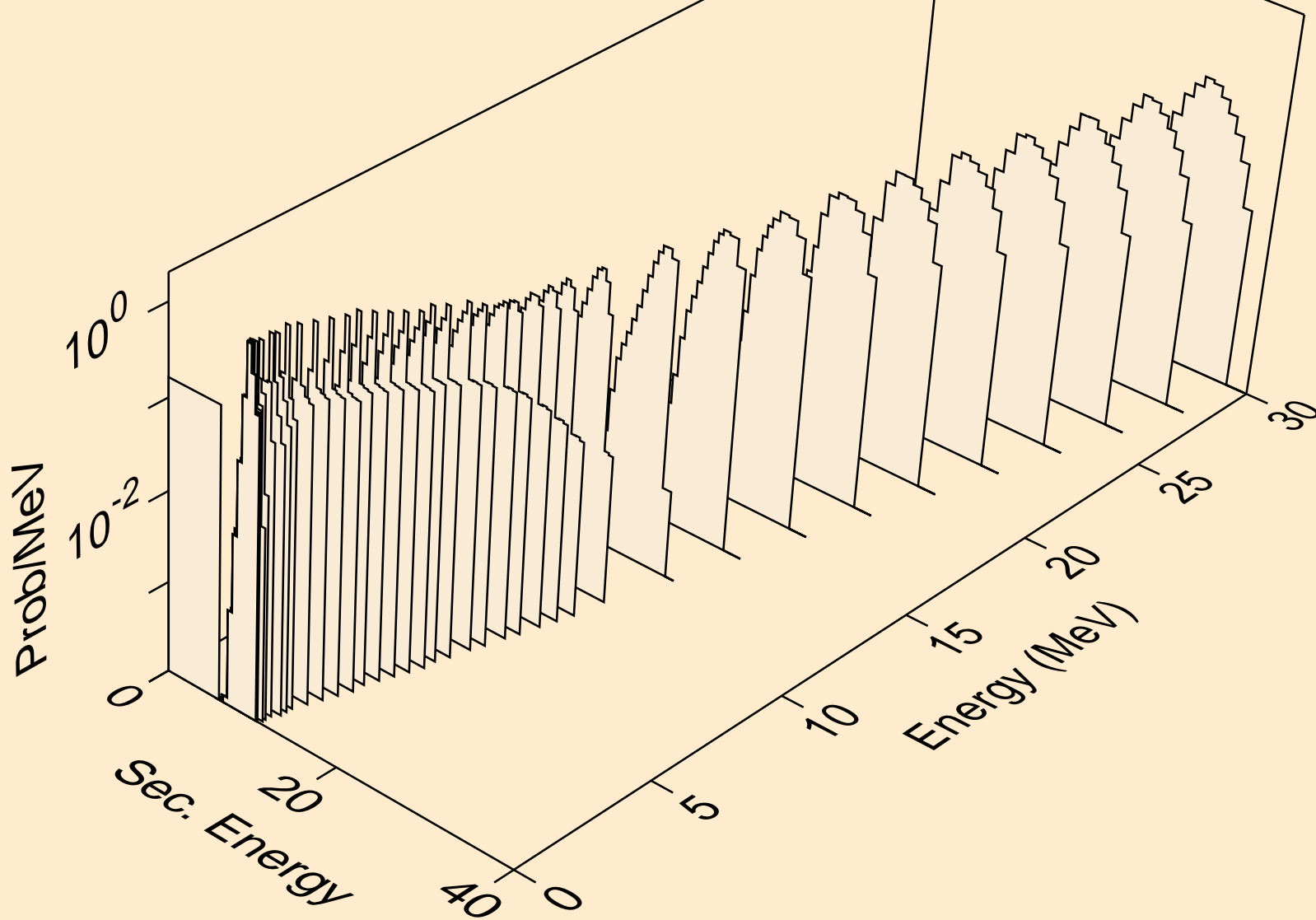

HG195 NEUTRON ACER TENDL-2019 LIBRARY; T=293.16K
alphas from (n,2a)

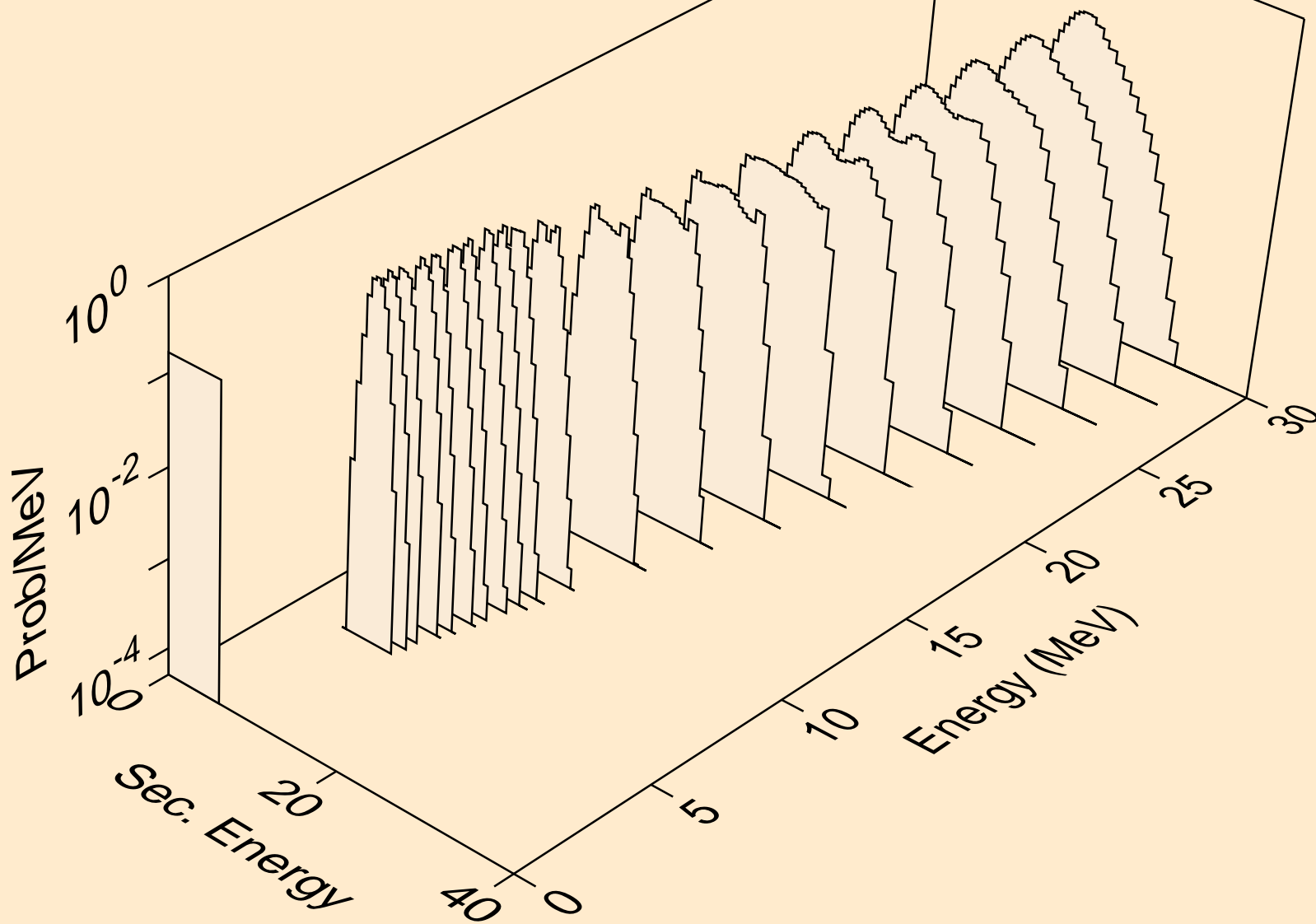

HG195 NEUTRON ACER TENDL-2019 LIBRARY; T=293.16K
alphas from (n,pa)

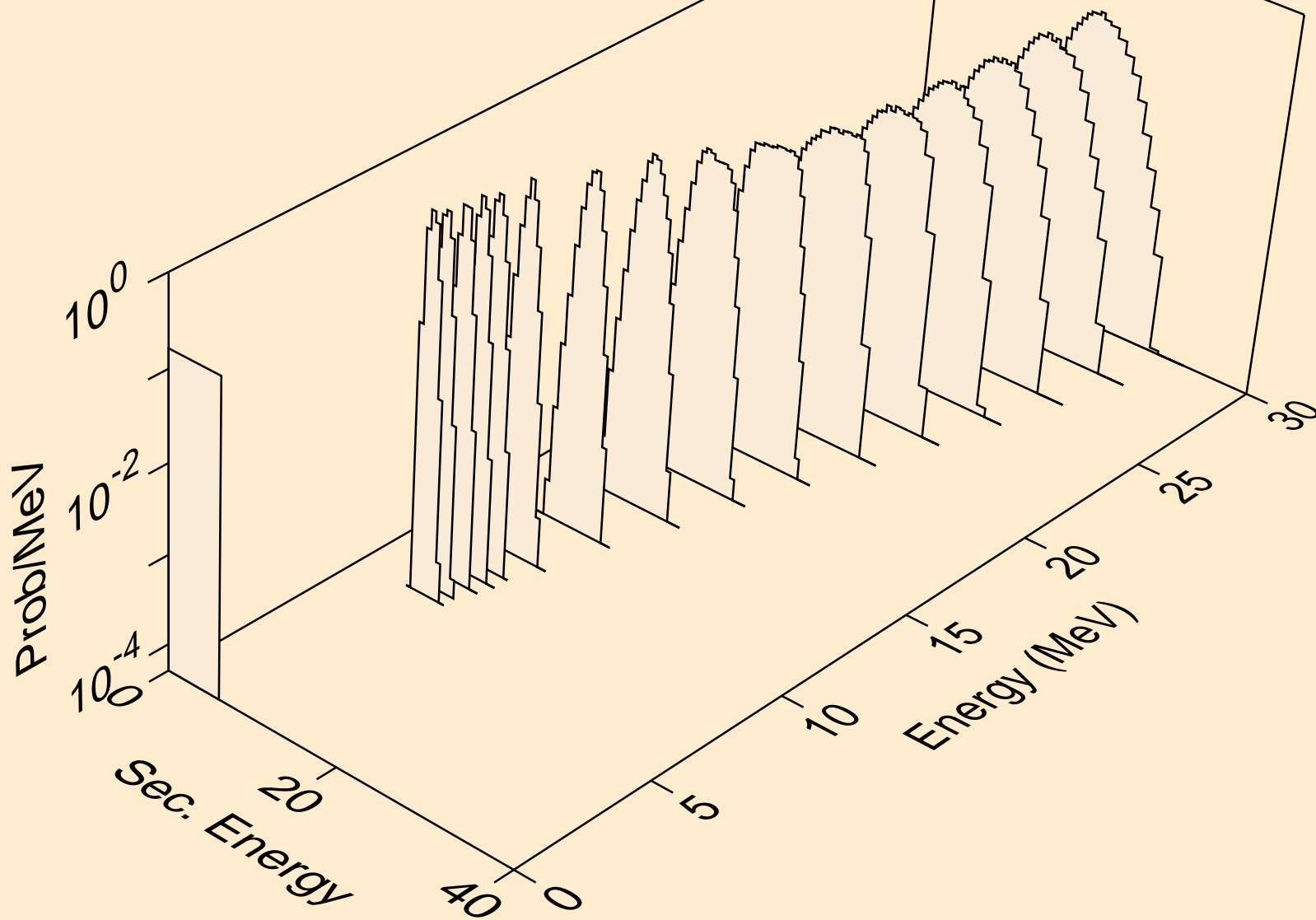

HG195 NEUTRON ACER TENDL-2019 LIBRARY; T=293.16K
alphas from (n,da)

