

# HG198 NEUTRON ACER TENDL-2019 LIBRARY; T=293.16K

## Principal cross sections

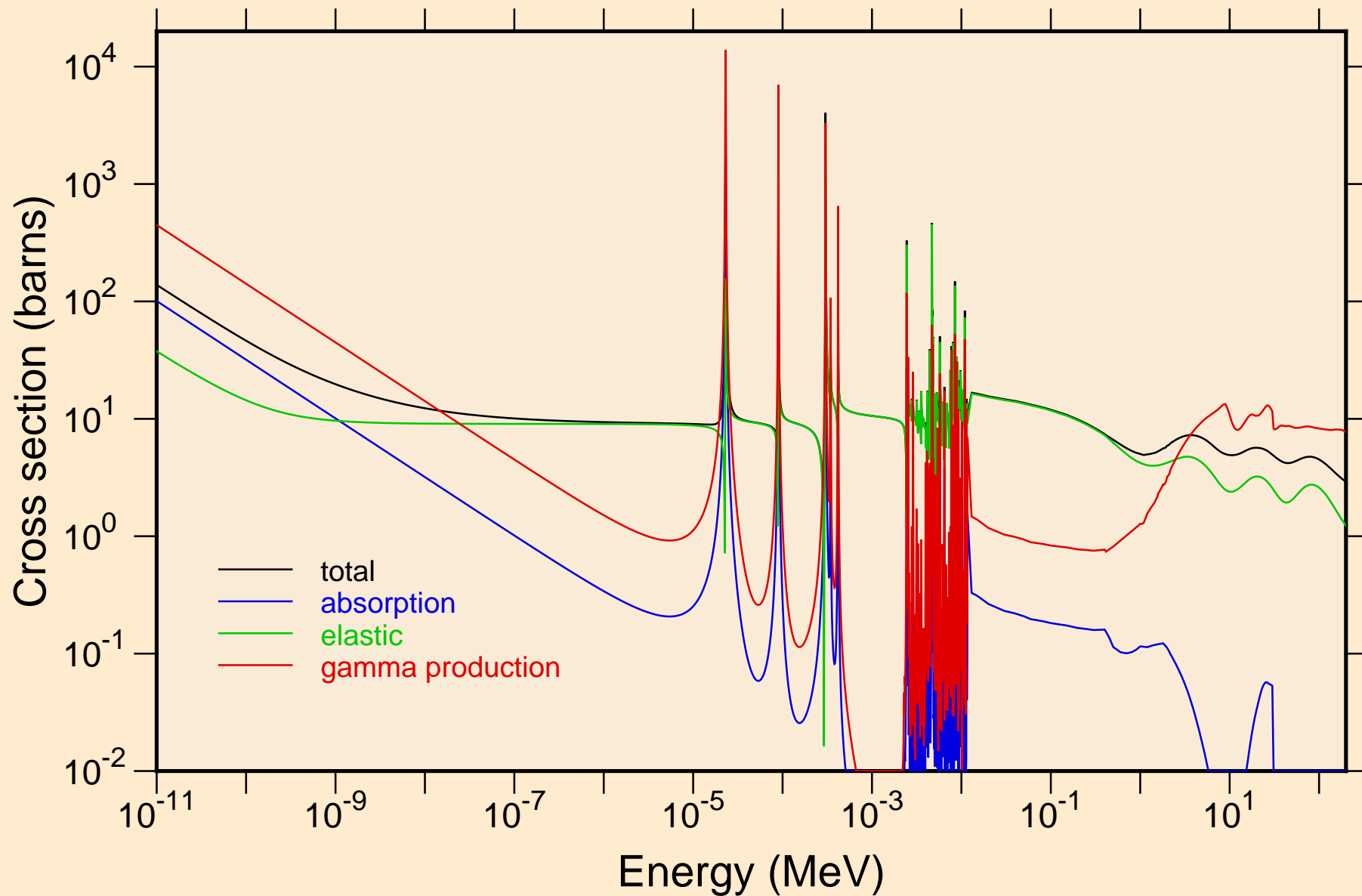

HG198 NEUTRON ACER TENDL-2019 LIBRARY; T=293.16K  
resonance total cross section

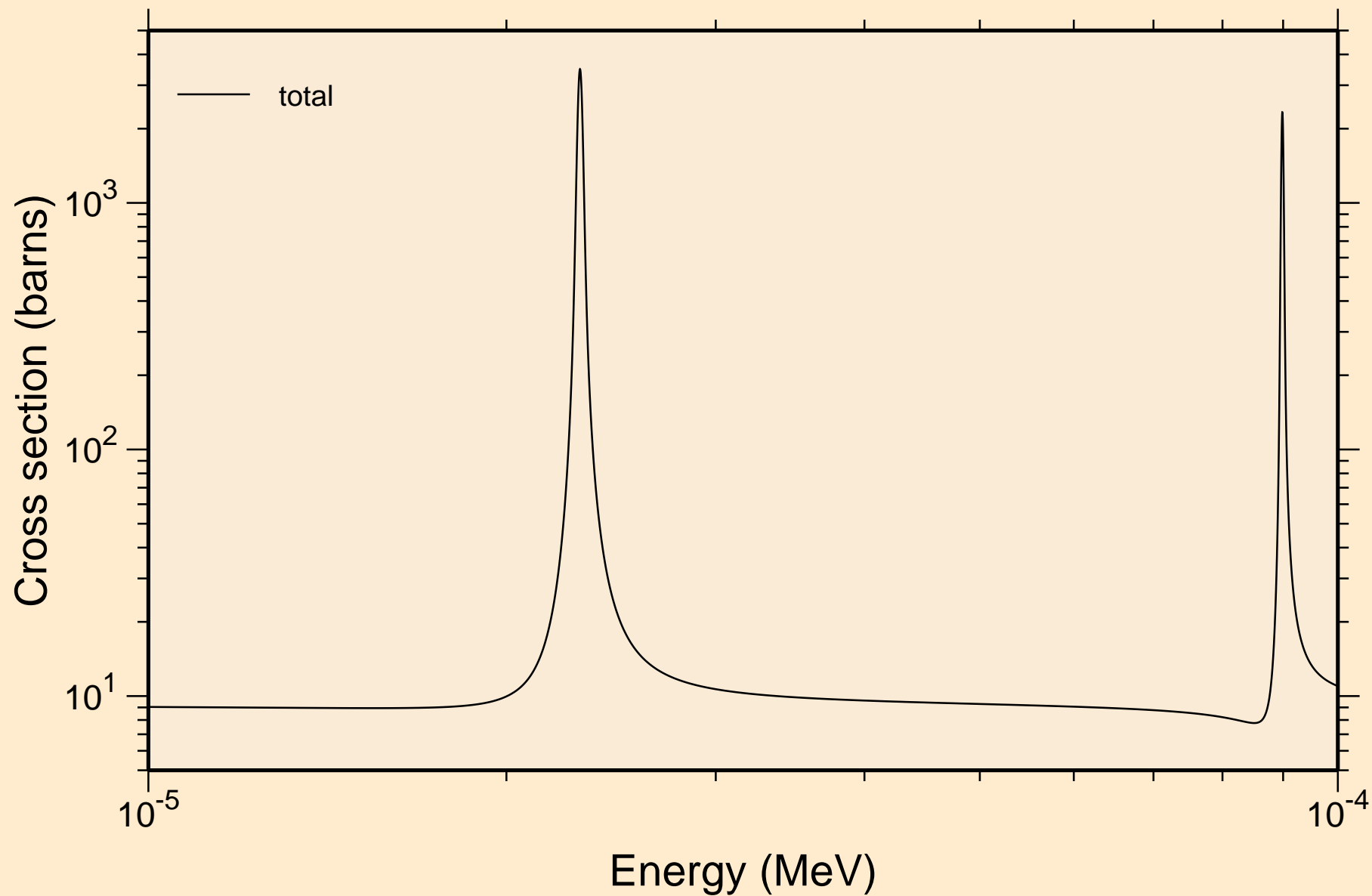

HG198 NEUTRON ACER TENDL-2019 LIBRARY; T=293.16K  
resonance total cross section

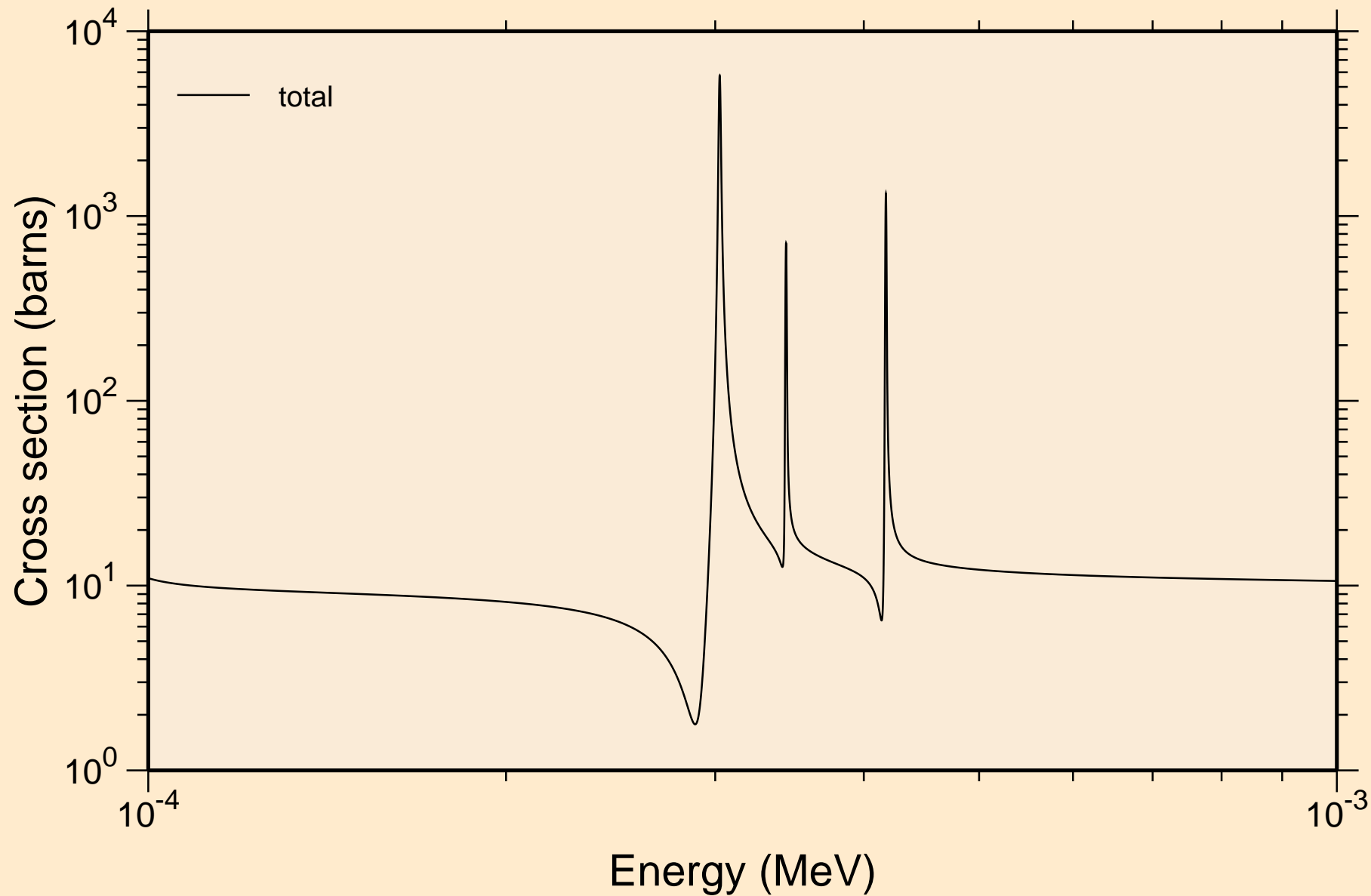

HG198 NEUTRON ACER TENDL-2019 LIBRARY; T=293.16K  
resonance total cross section

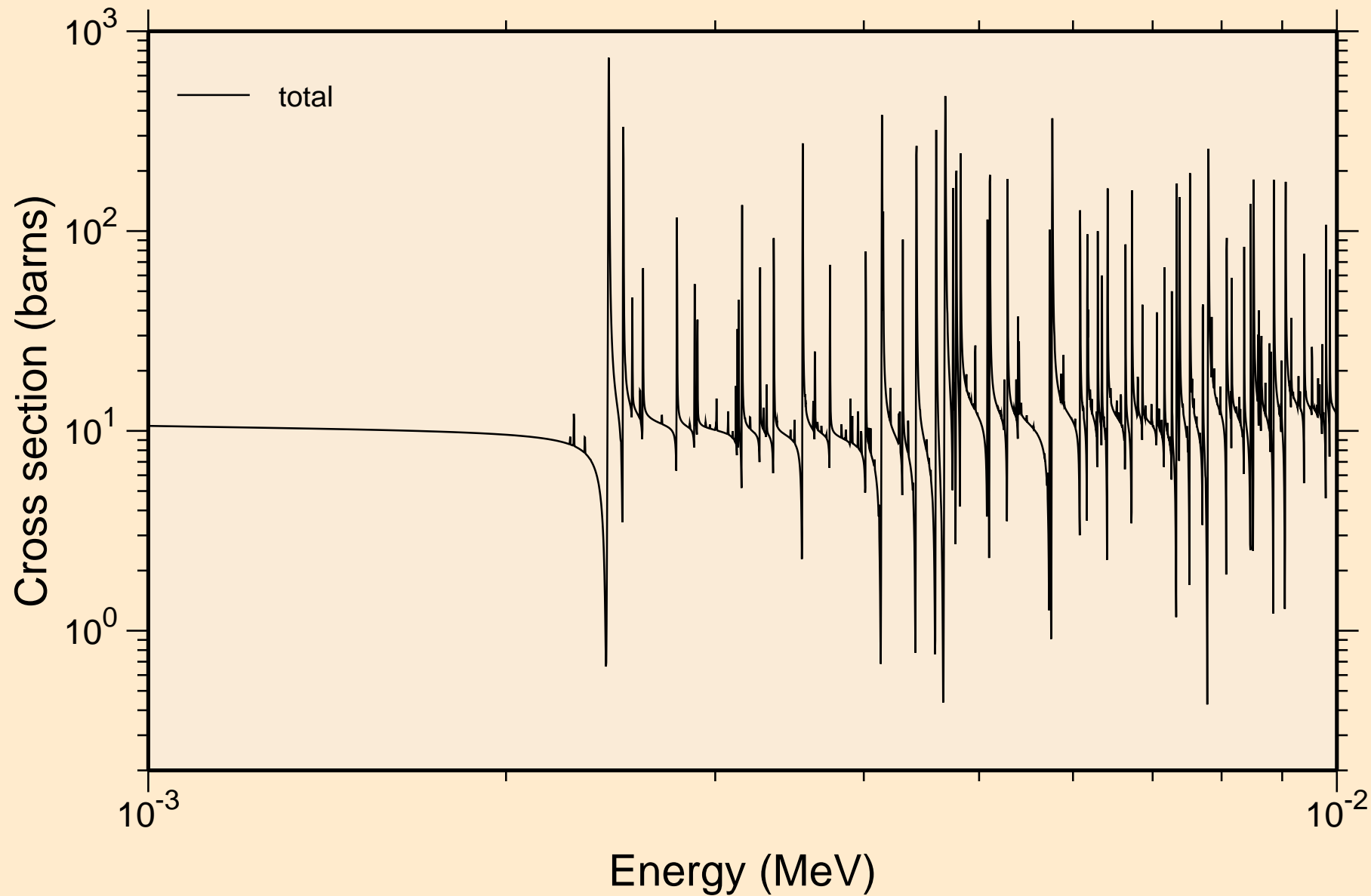

HG198 NEUTRON ACER TENDL-2019 LIBRARY; T=293.16K  
resonance total cross section

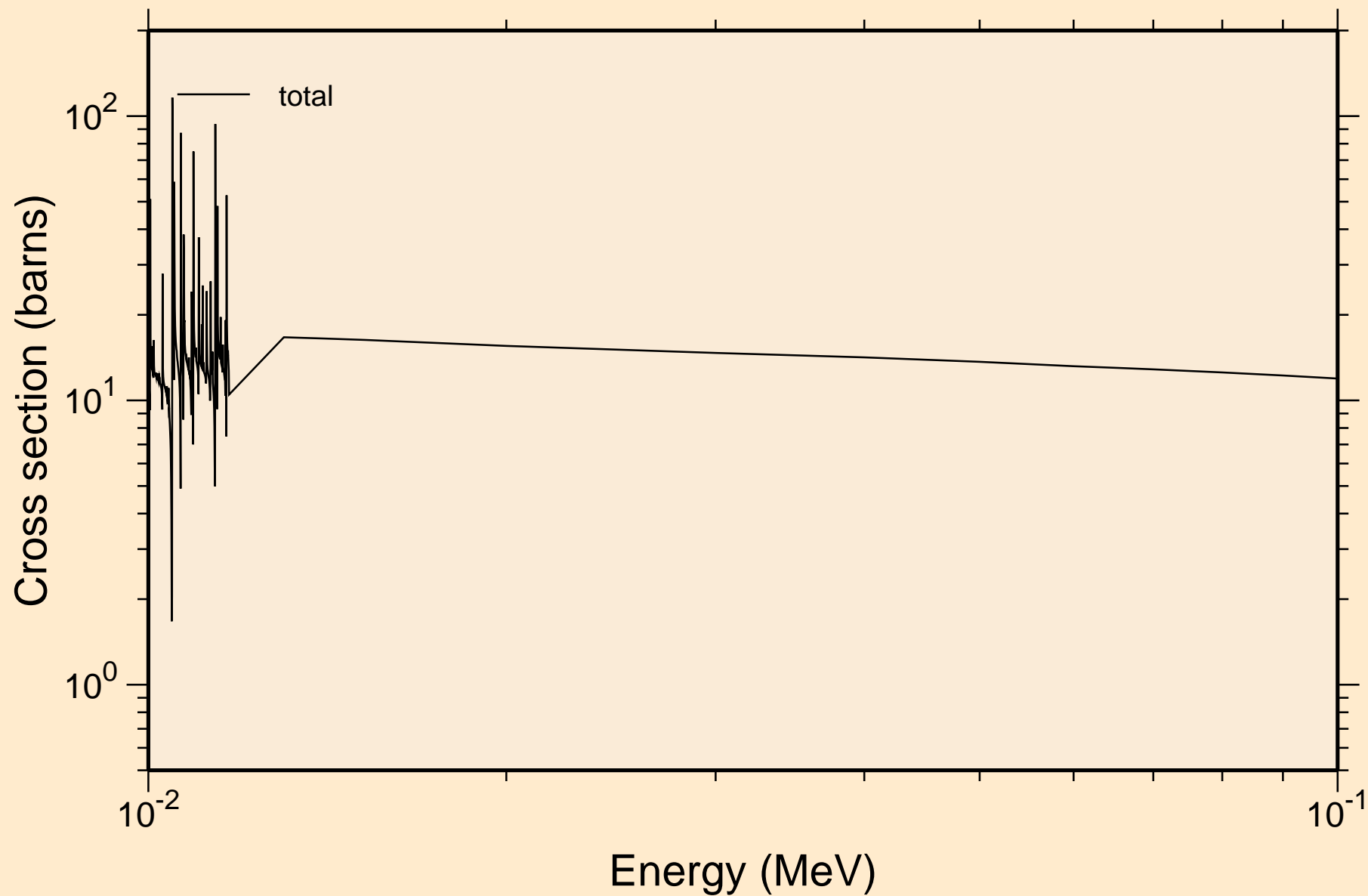

HG198 NEUTRON ACER TENDL-2019 LIBRARY; T=293.16K  
resonance total cross section

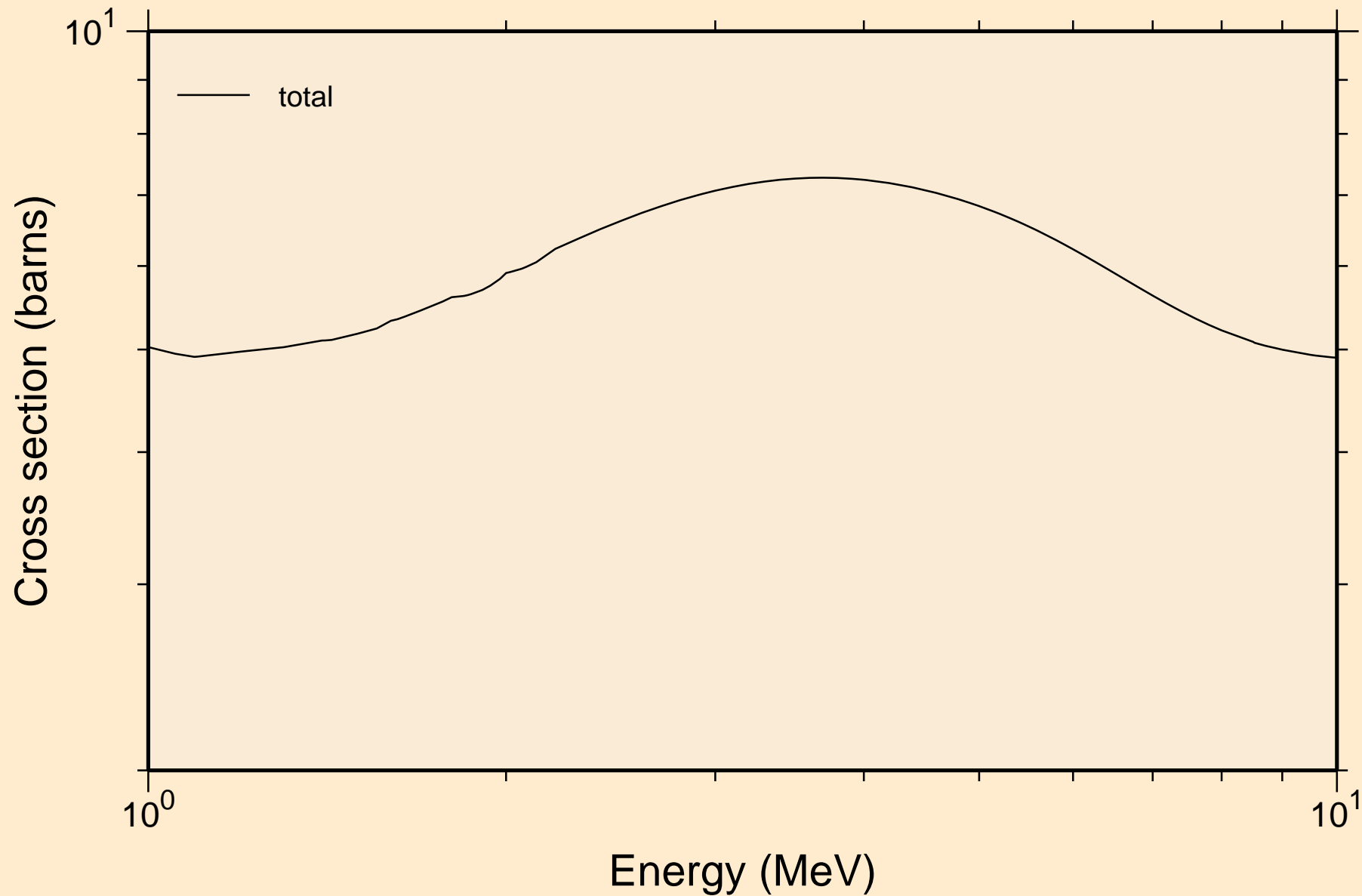

HG198 NEUTRON ACER TENDL-2019 LIBRARY; T=293.16K  
resonance absorption cross sections

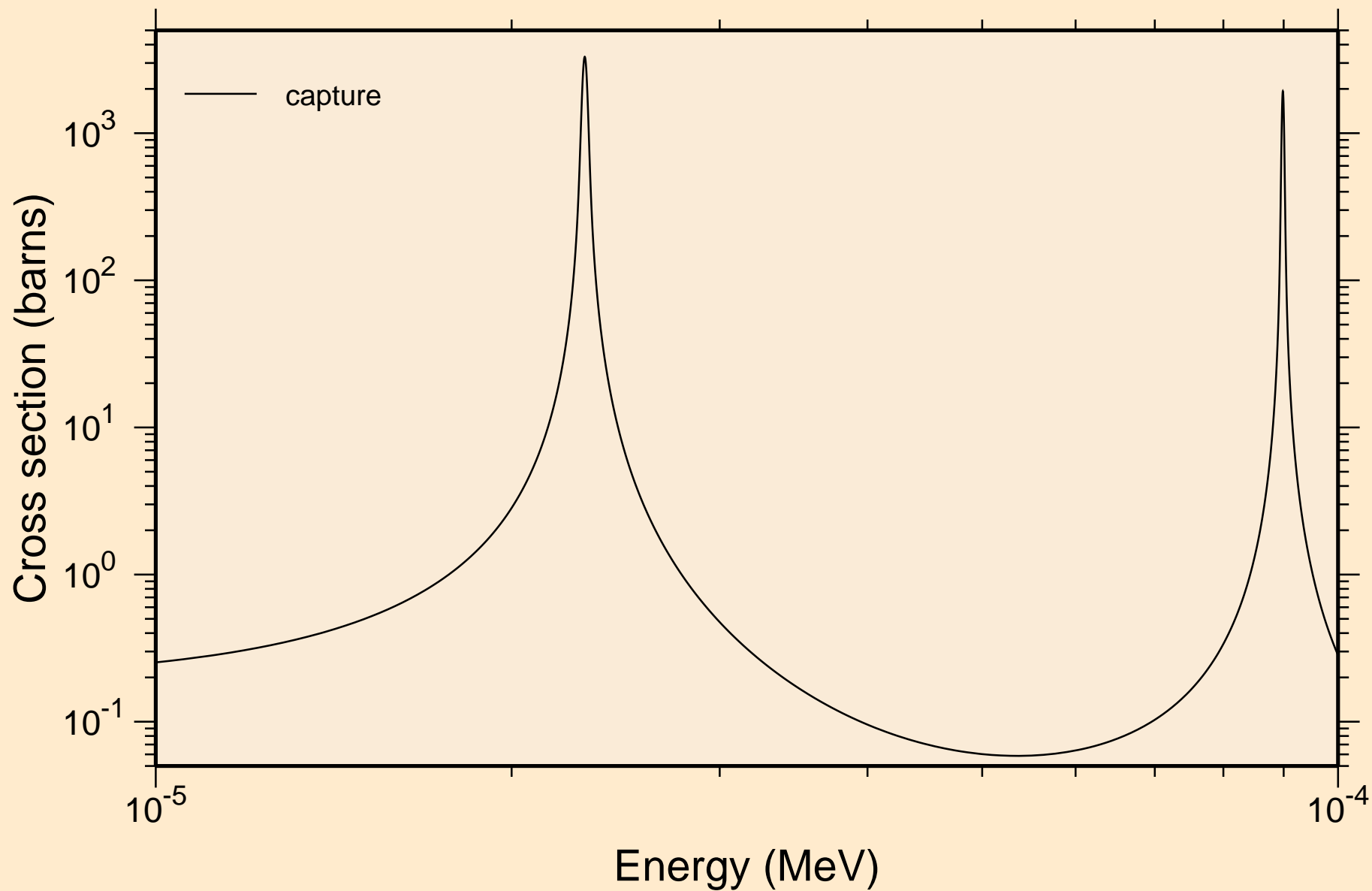

HG198 NEUTRON ACER TENDL-2019 LIBRARY; T=293.16K  
resonance absorption cross sections

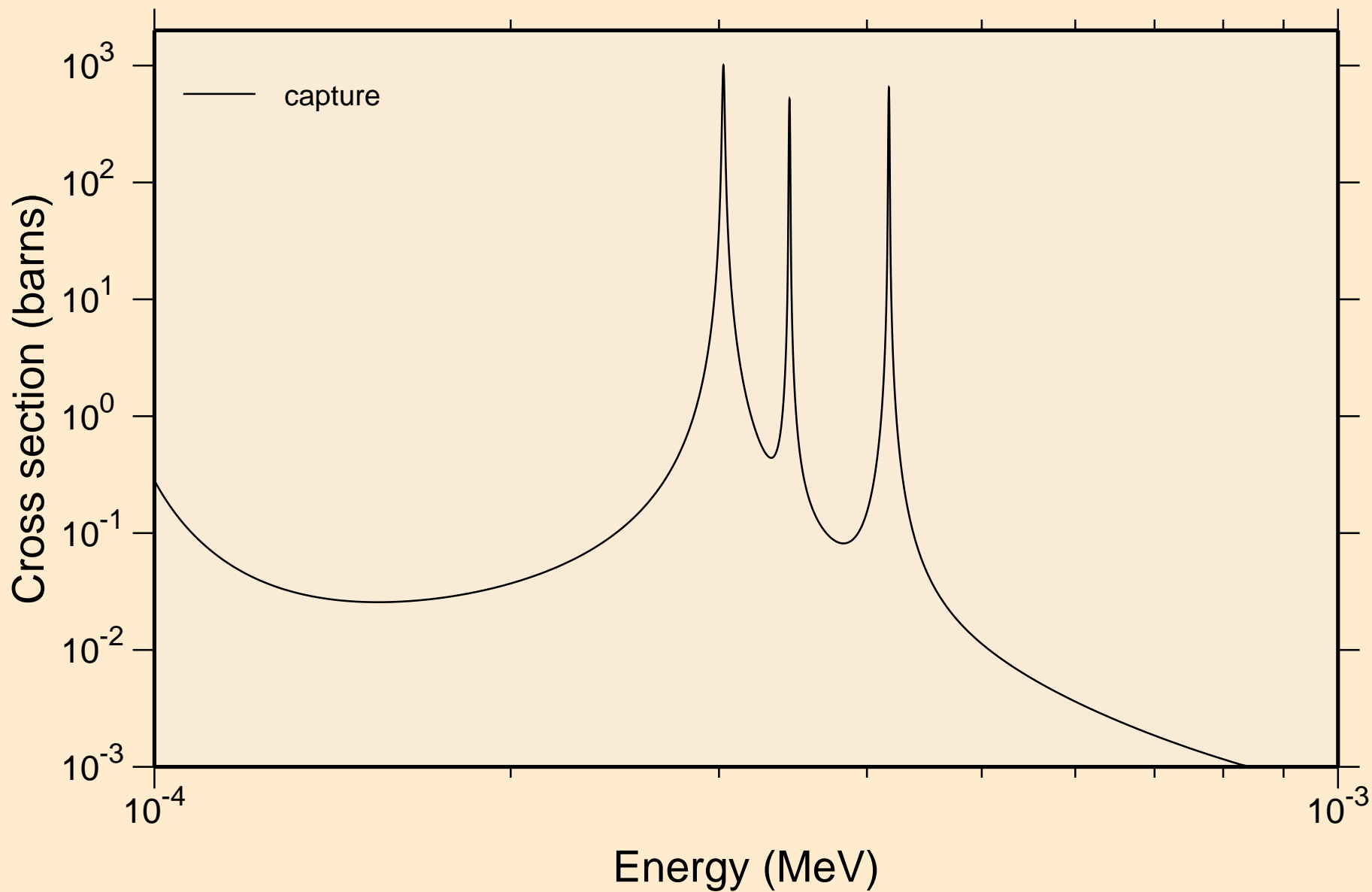



HG198 NEUTRON ACER TENDL-2019 LIBRARY; T=293.16K  
resonance absorption cross sections

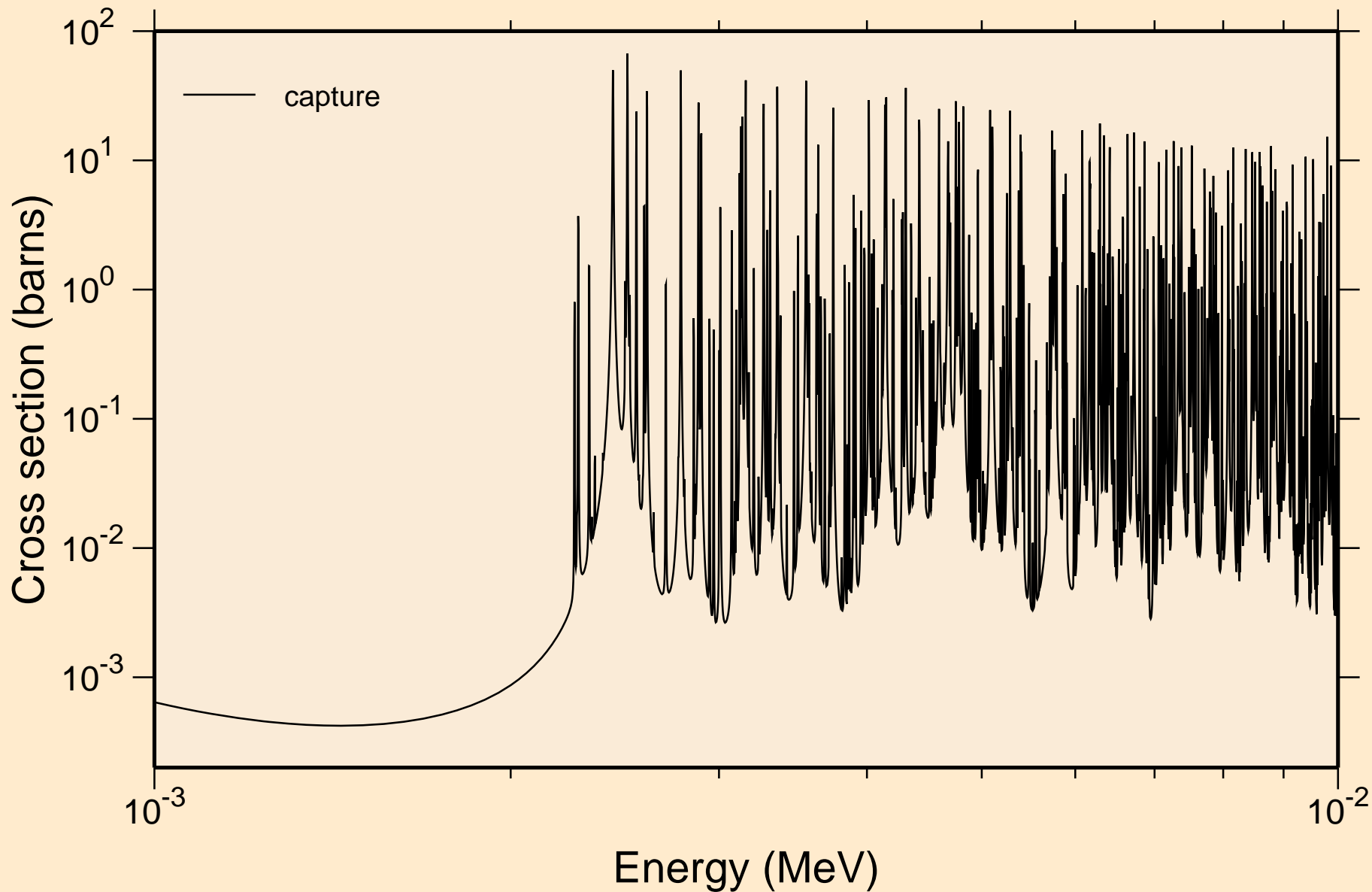

HG198 NEUTRON ACER TENDL-2019 LIBRARY; T=293.16K  
resonance absorption cross sections

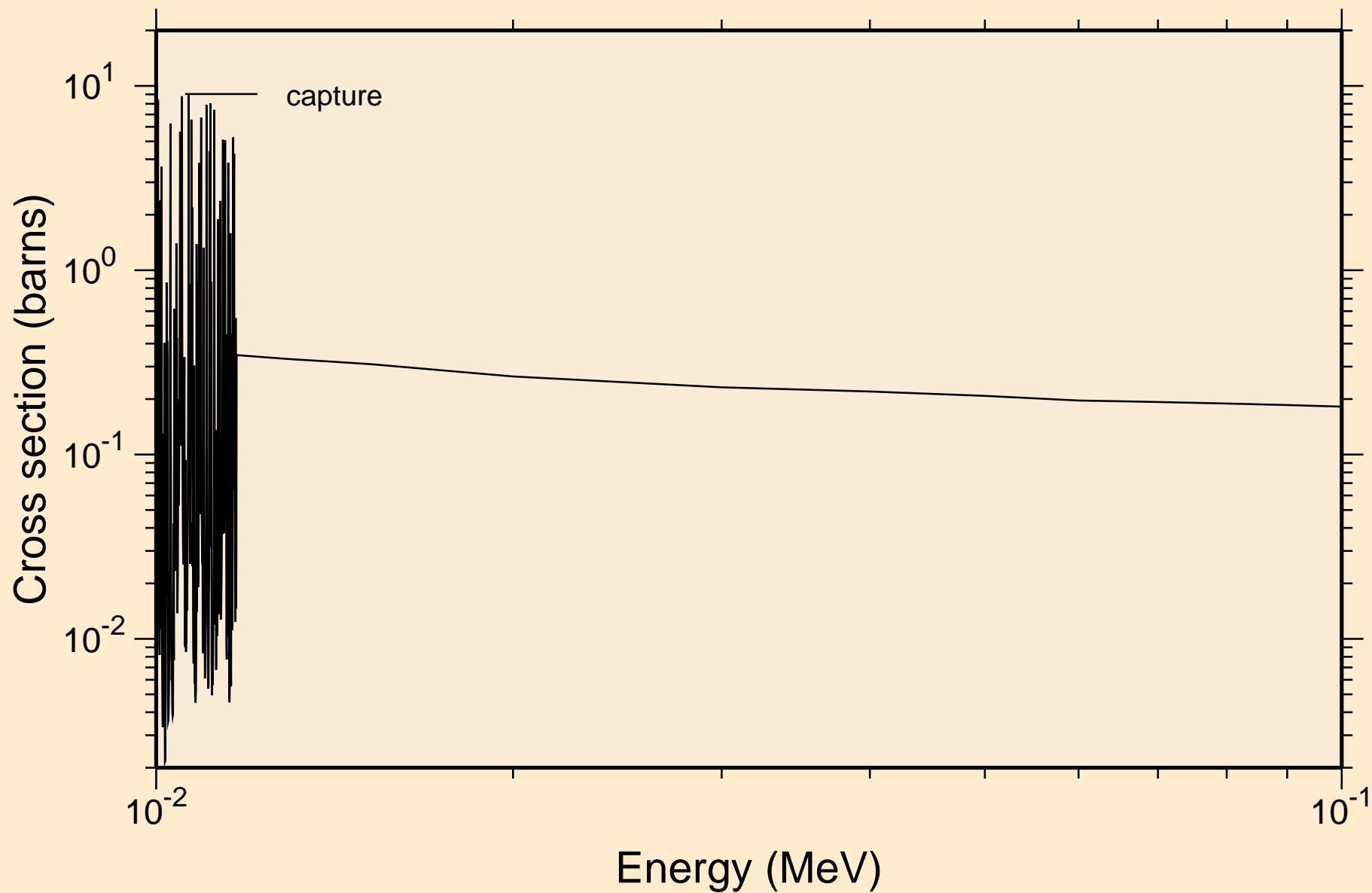

HG198 NEUTRON ACER TENDL-2019 LIBRARY; T=293.16K  
resonance absorption cross sections

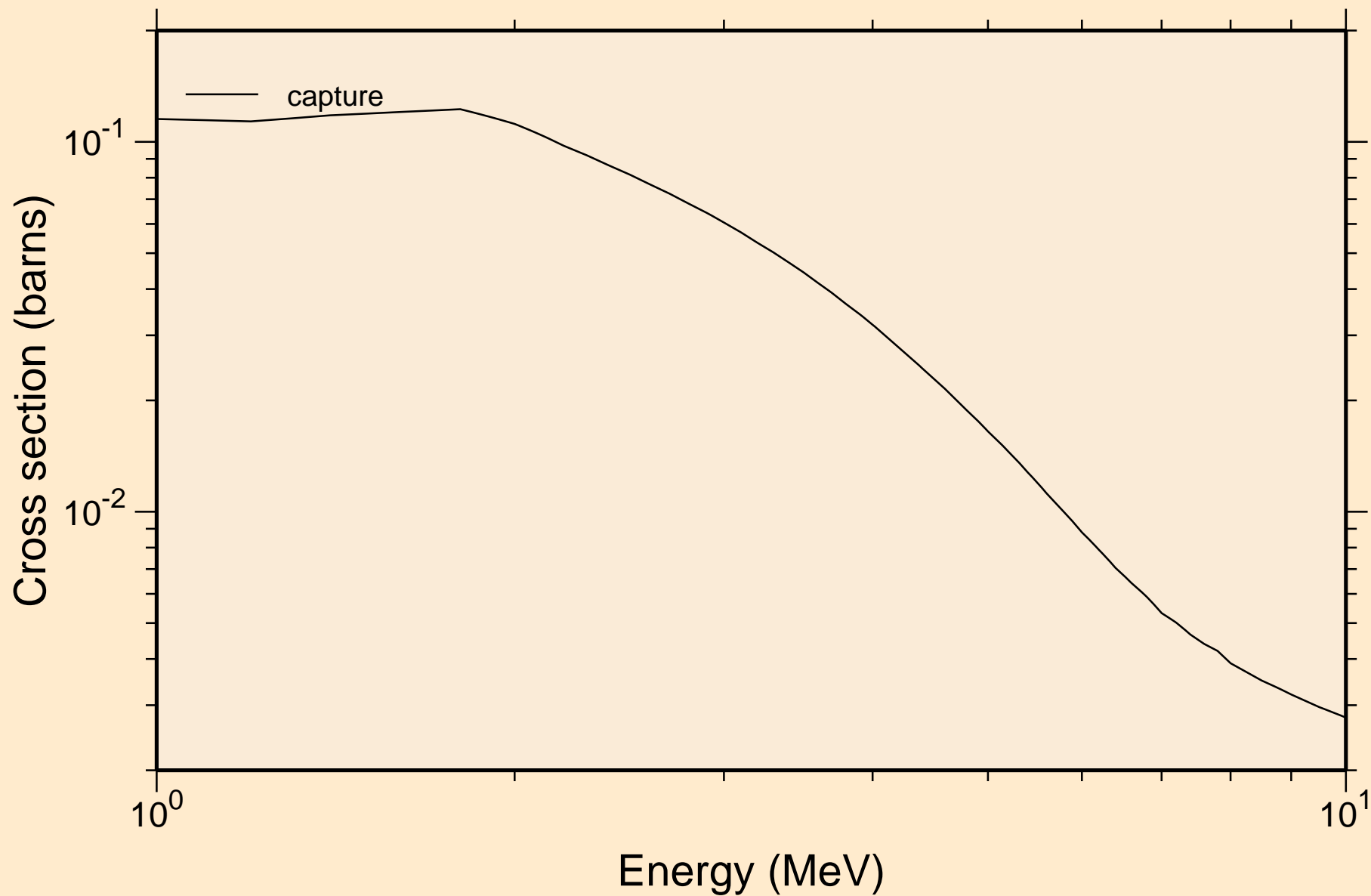

HG198 NEUTRON ACER TENDL-2019 LIBRARY; T=293.16K  
Heating

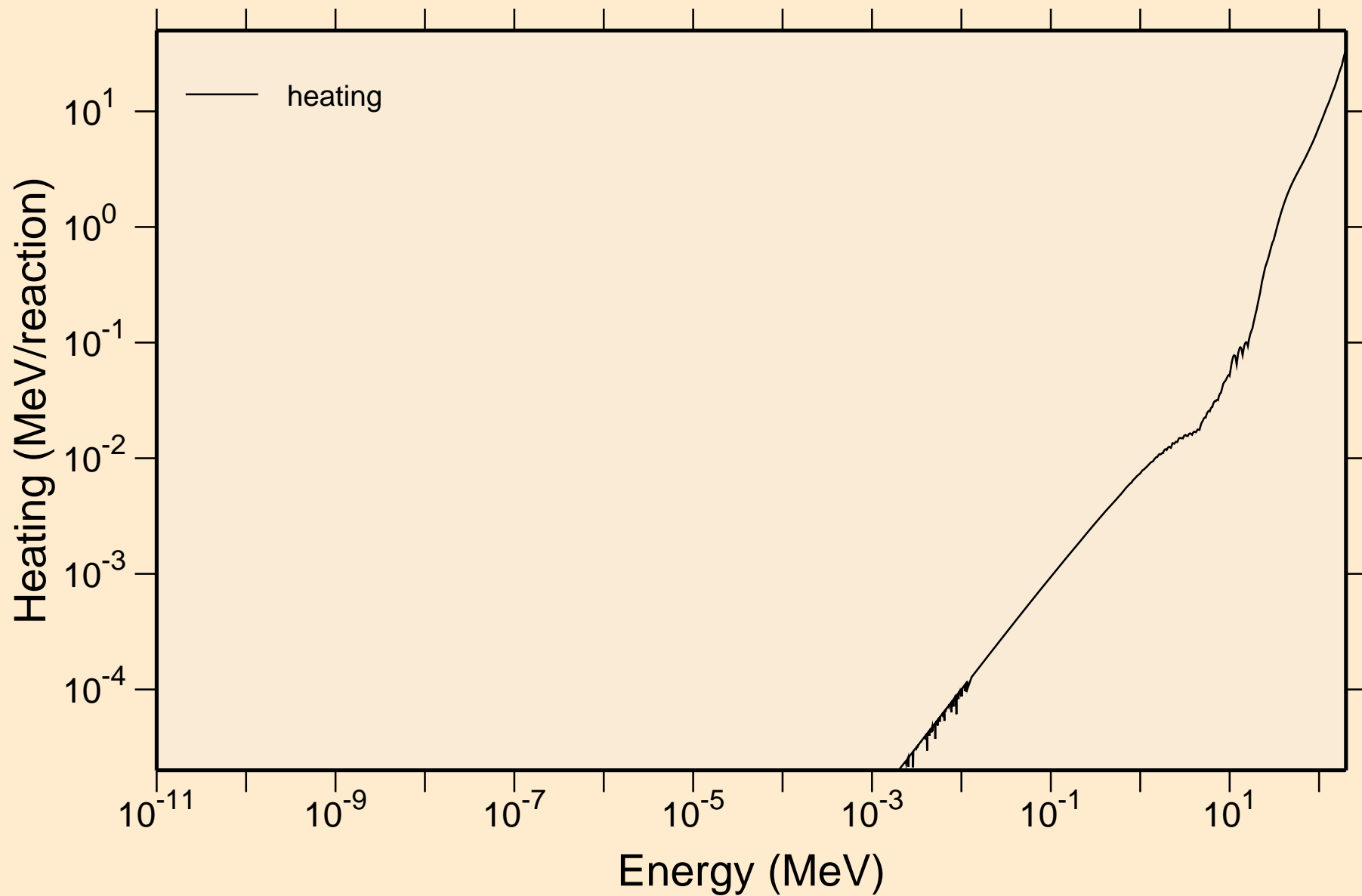

# HG198 NEUTRON ACER TENDL-2019 LIBRARY; T=293.16K Damage

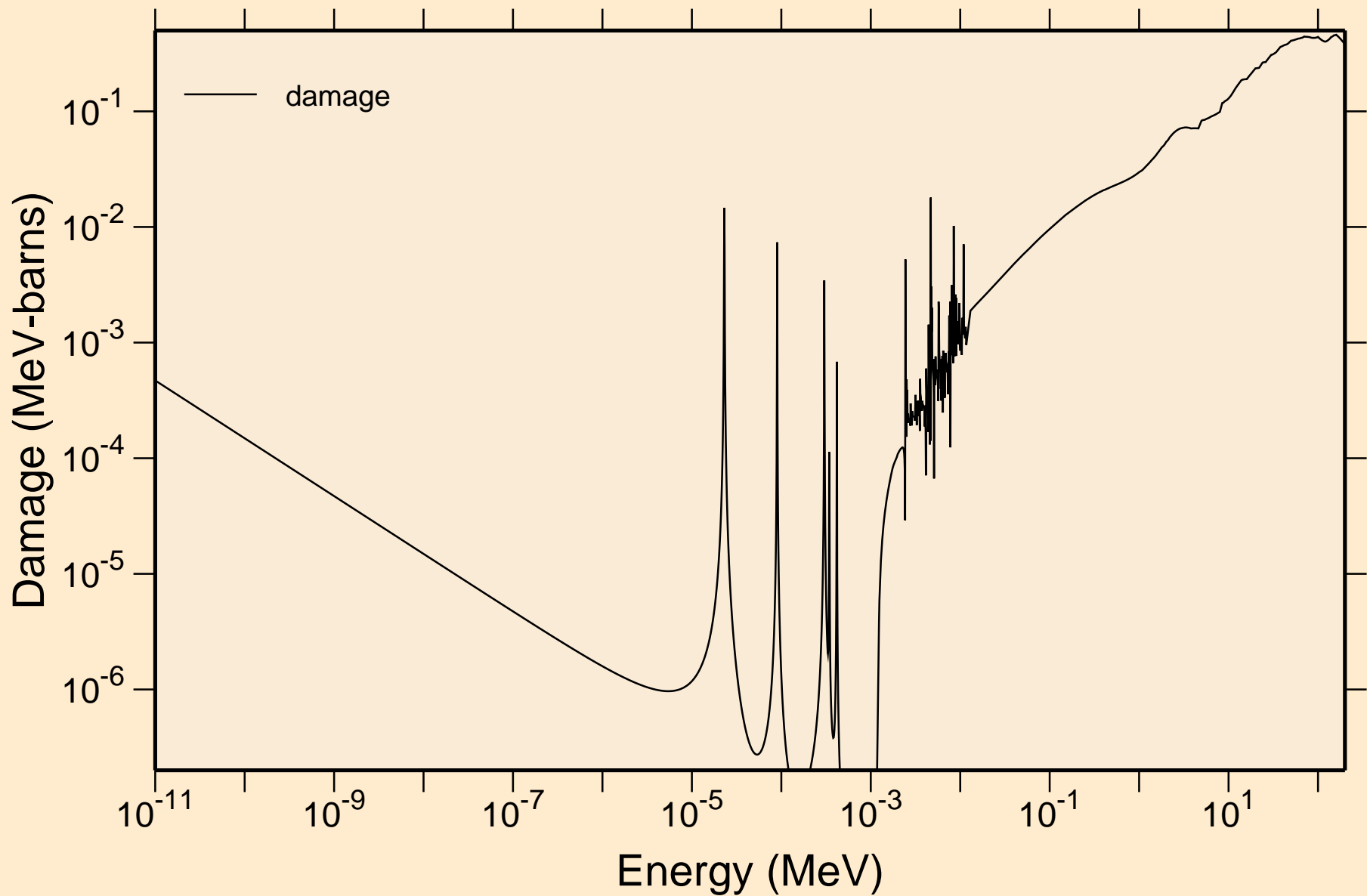

# HG198 NEUTRON ACER TENDL-2019 LIBRARY; T=293.16K

## Non-threshold reactions

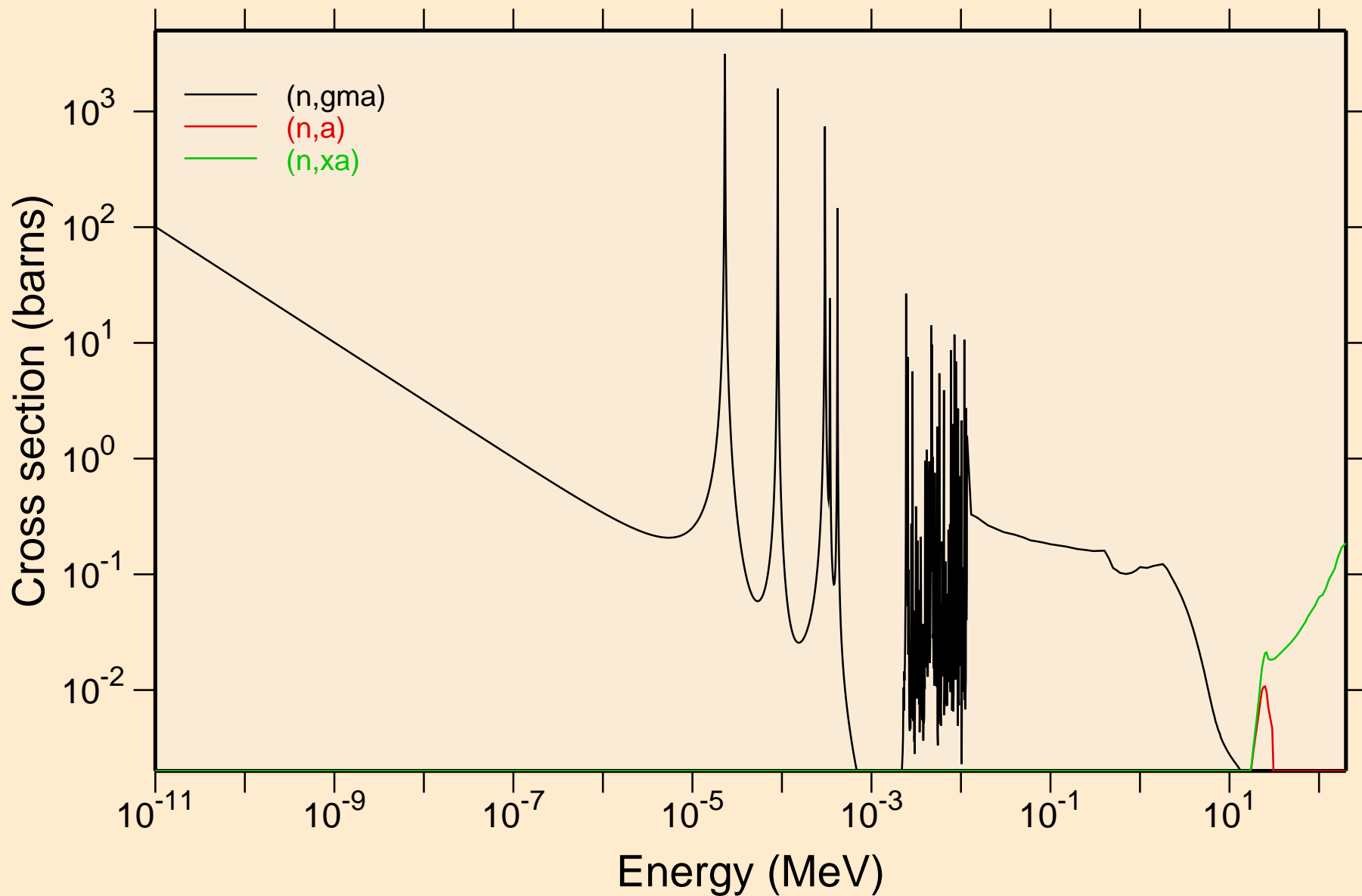

# HG198 NEUTRON ACER TENDL-2019 LIBRARY; T=293.16K

## Principal cross sections

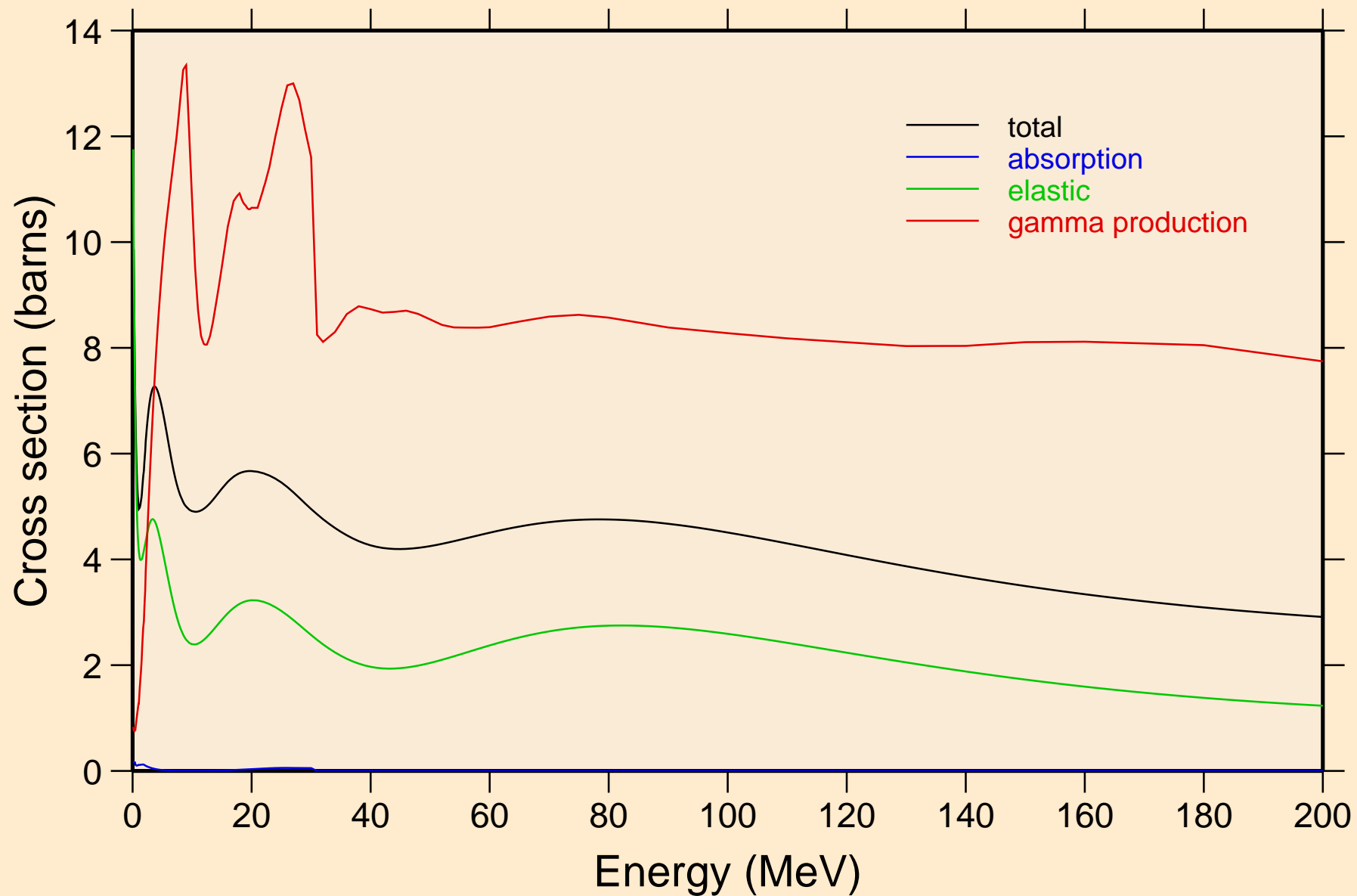

# HG198 NEUTRON ACER TENDL-2019 LIBRARY; T=293.16K Heating

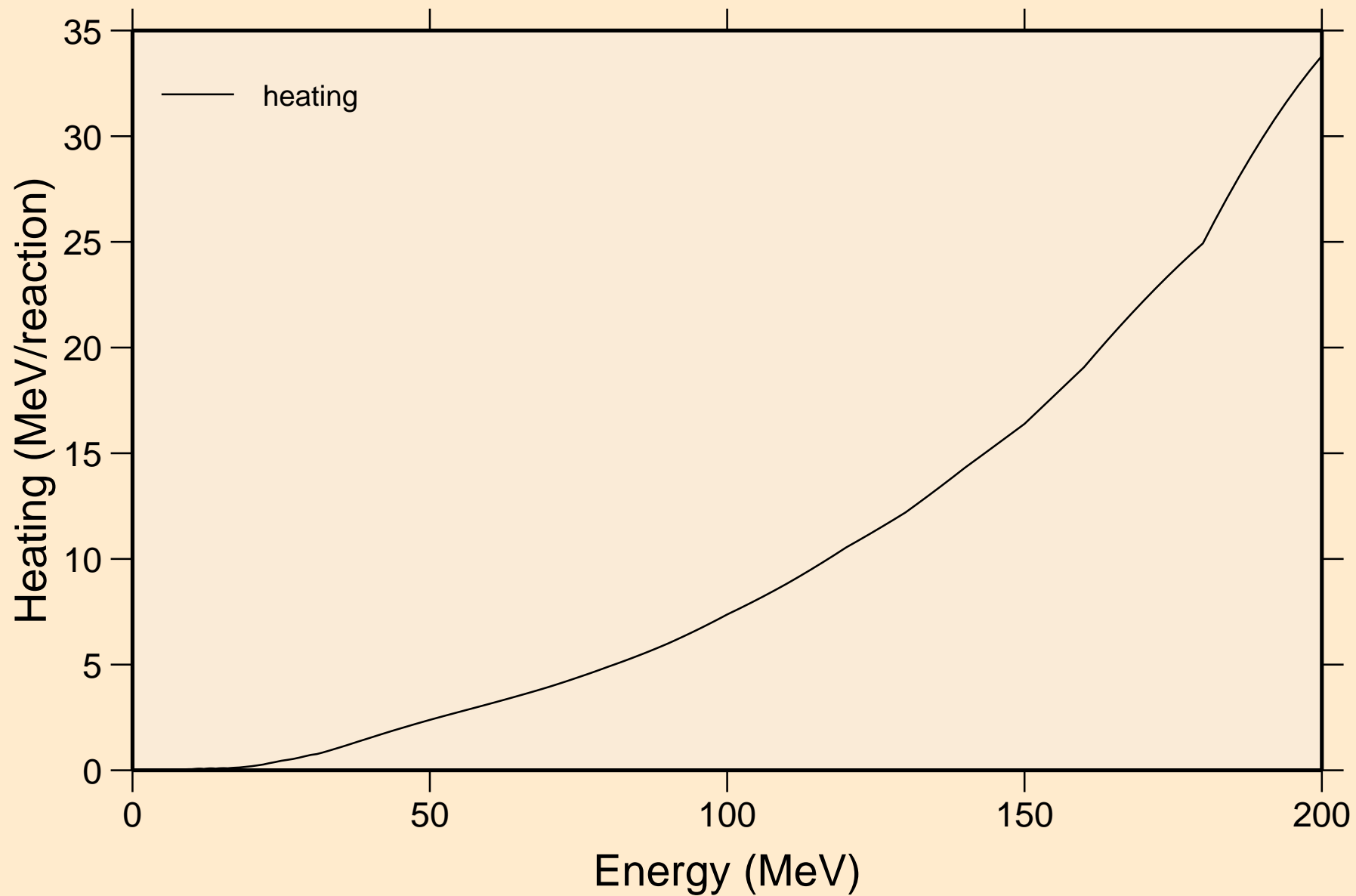



# HG198 NEUTRON ACER TENDL-2019 LIBRARY; T=293.16K Damage

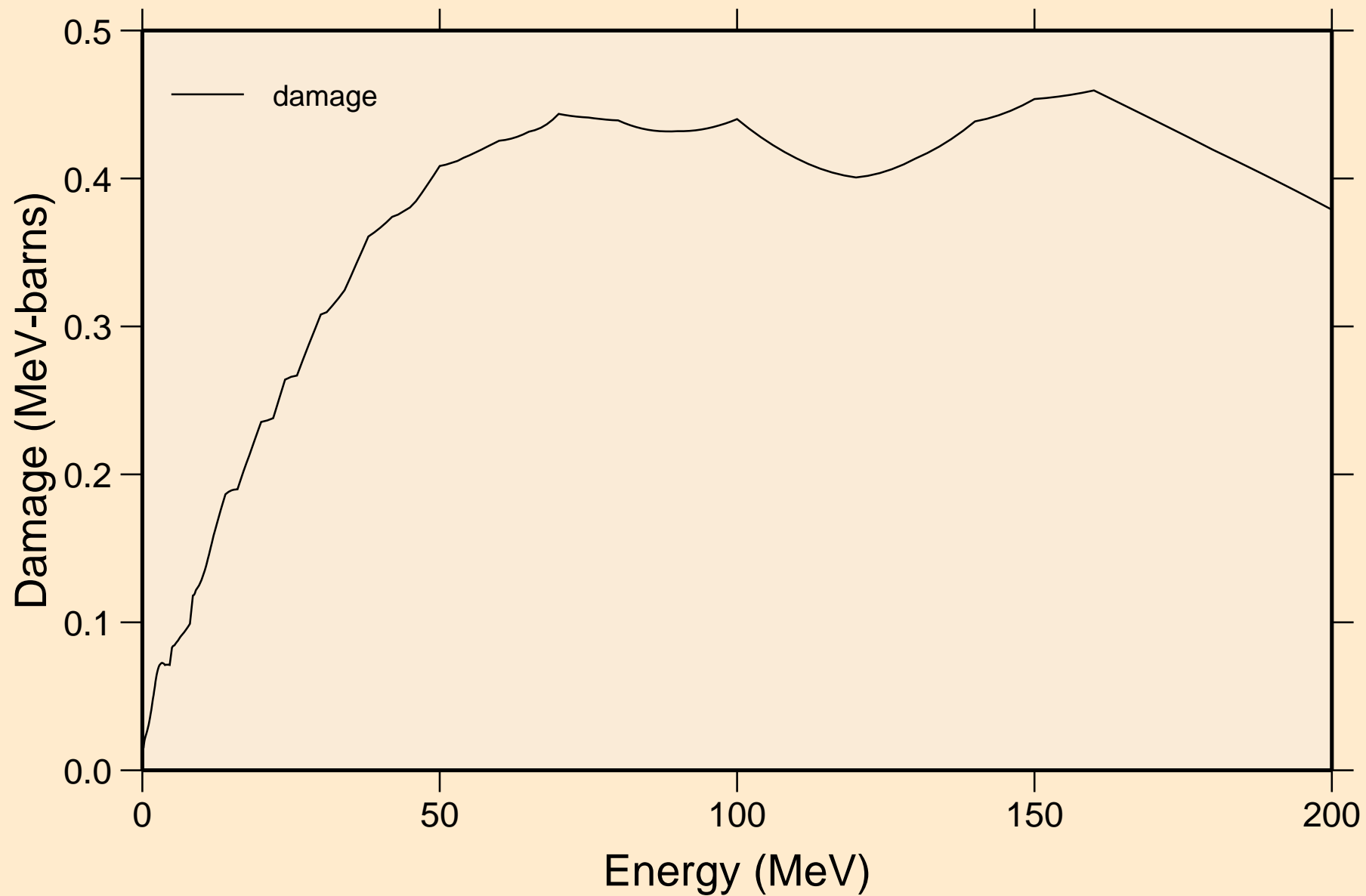

HG198 NEUTRON ACER TENDL-2019 LIBRARY; T=293.16K  
Non-threshold reactions

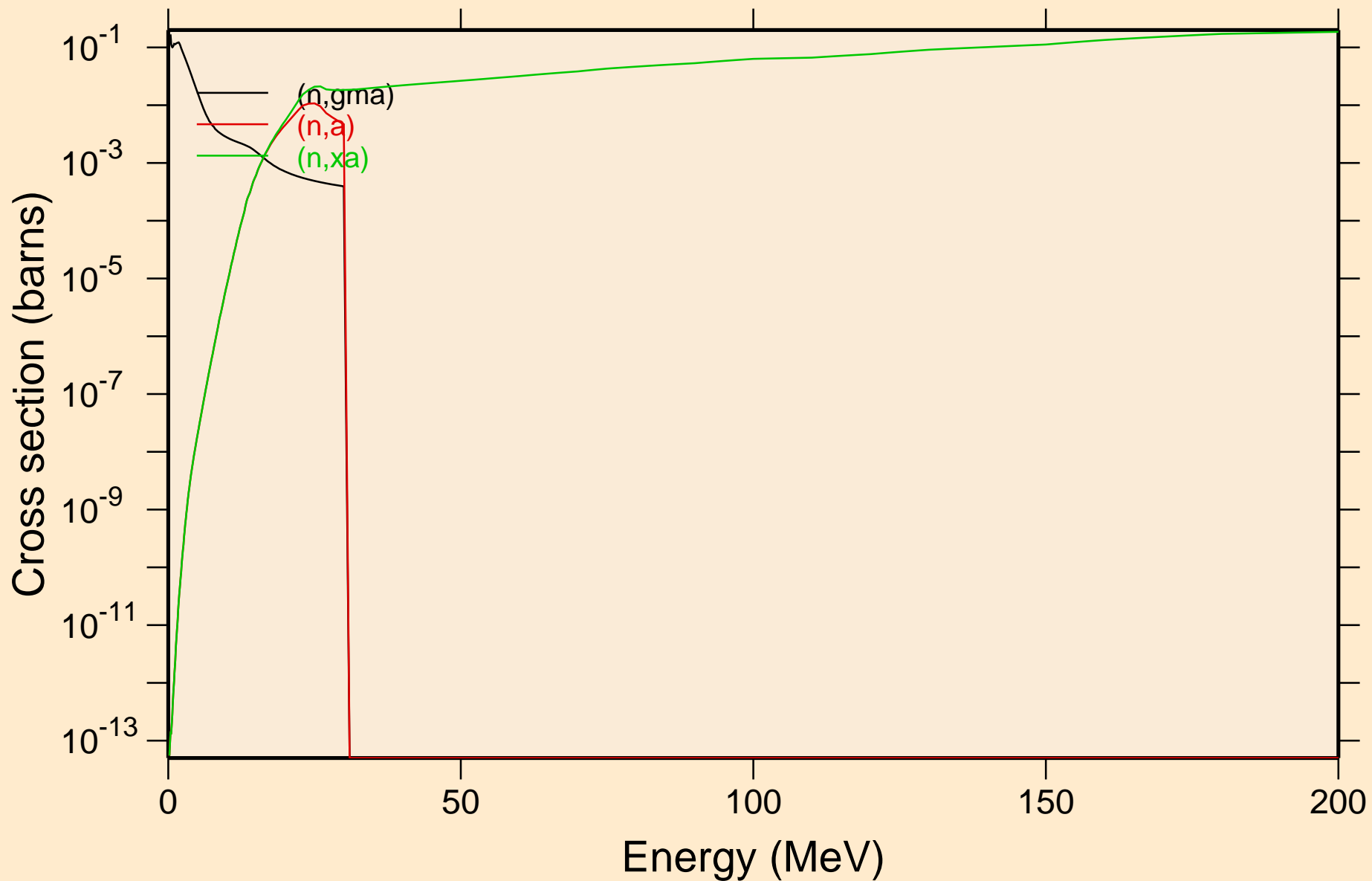

HG198 NEUTRON ACER TENDL-2019 LIBRARY; T=293.16K  
Inelastic levels

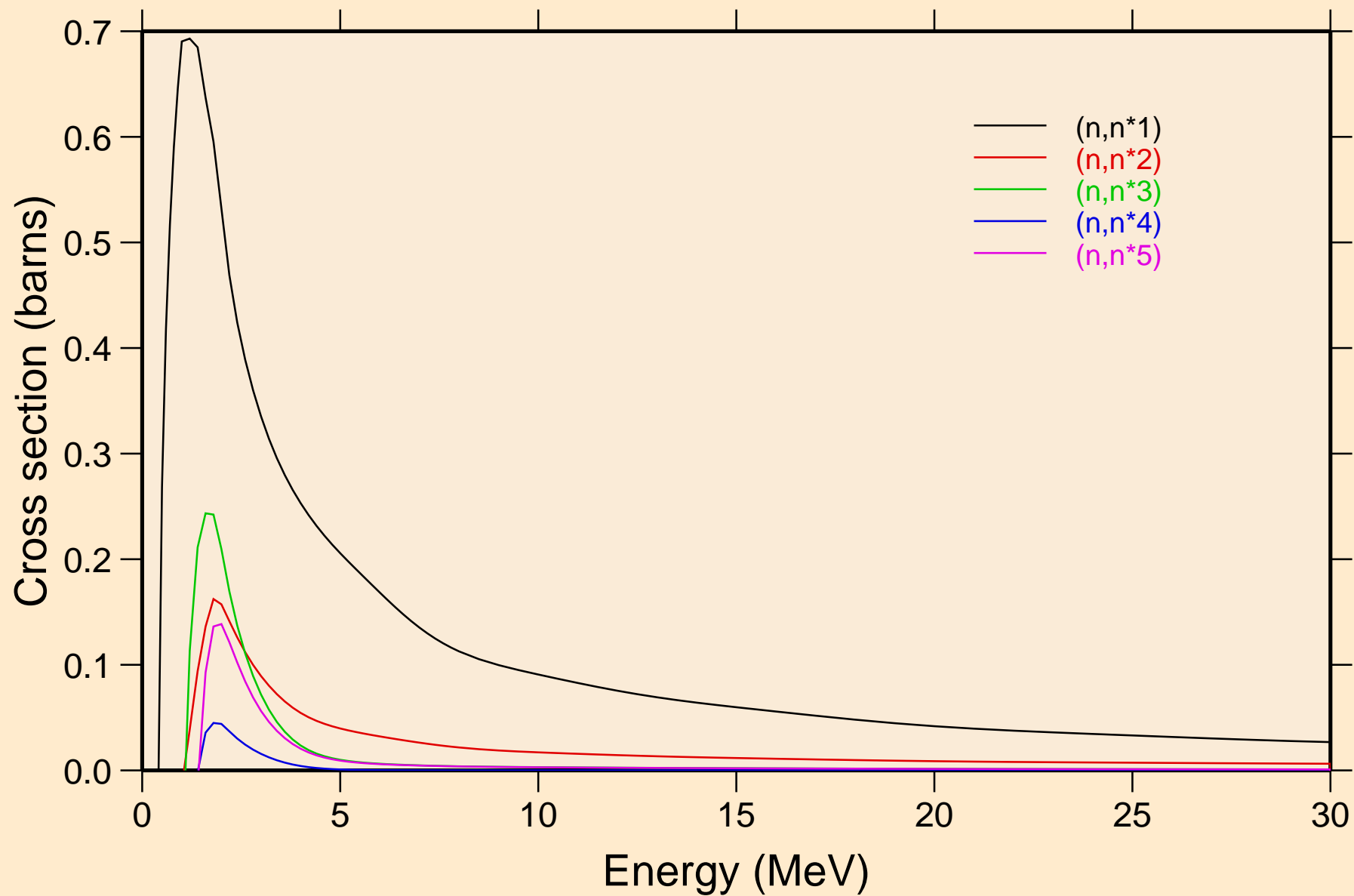

HG198 NEUTRON ACER TENDL-2019 LIBRARY; T=293.16K  
Inelastic levels

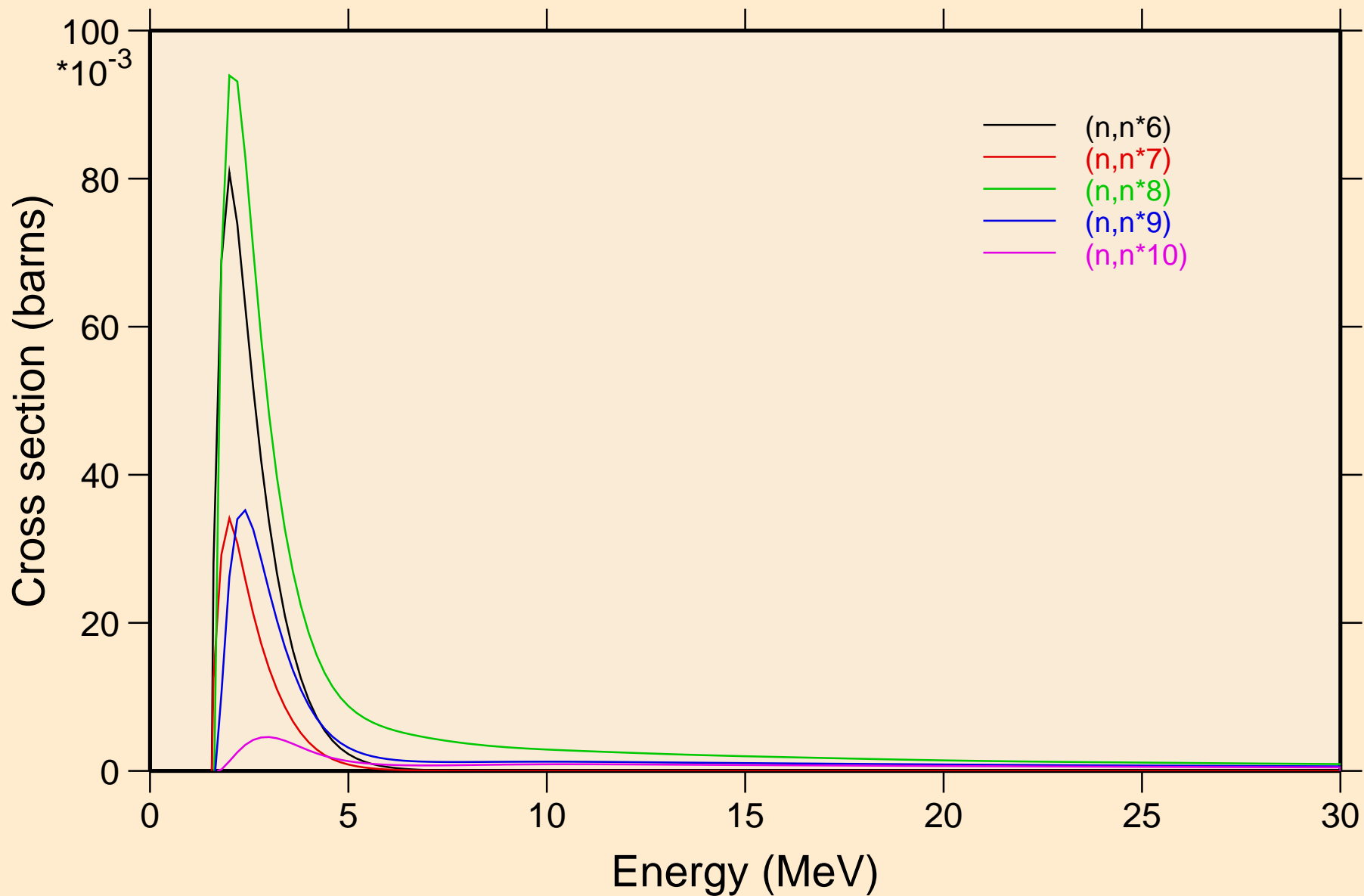

# HG198 NEUTRON ACER TENDL-2019 LIBRARY; T=293.16K

## Inelastic levels

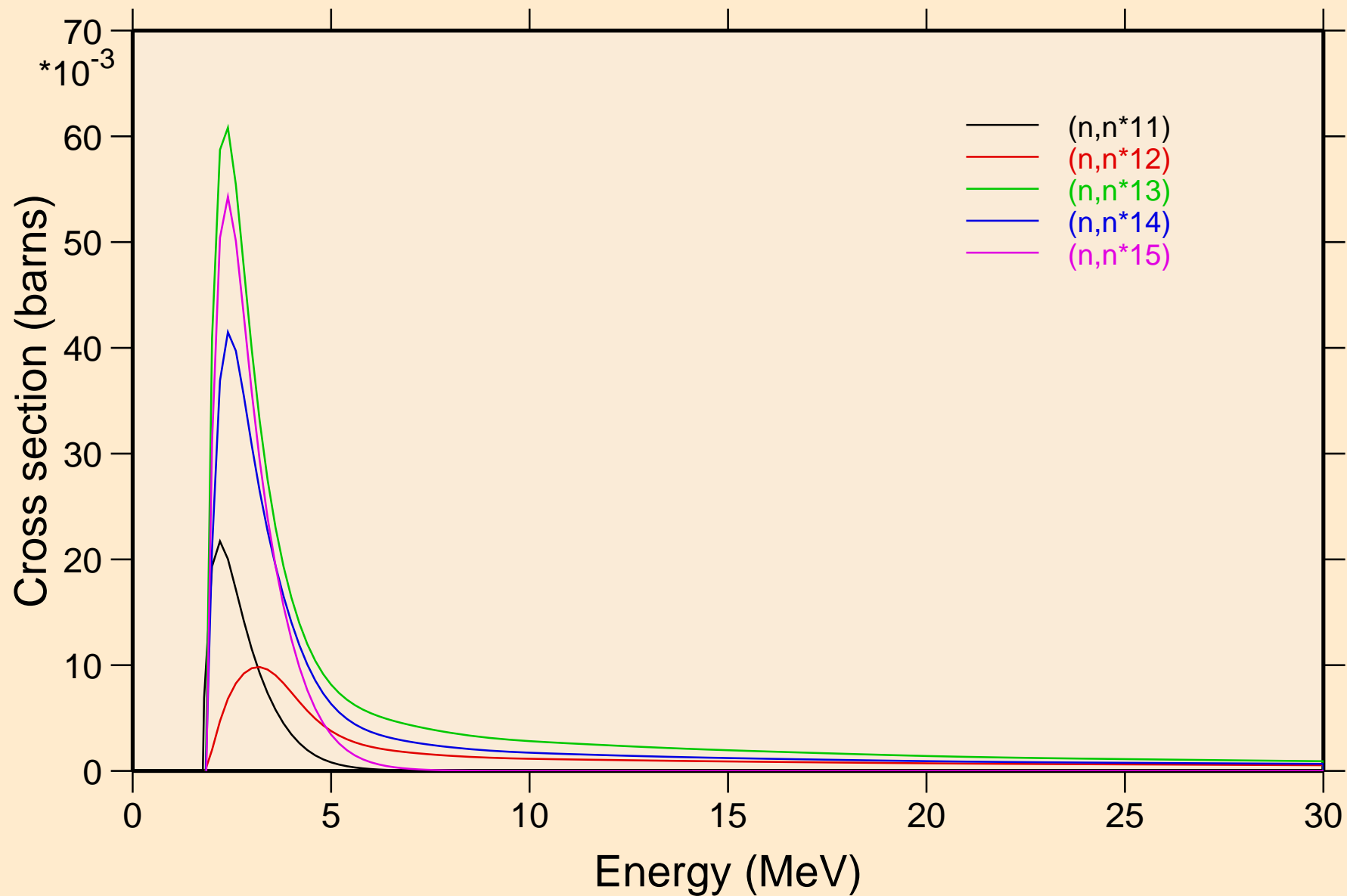

# HG198 NEUTRON ACER TENDL-2019 LIBRARY; T=293.16K

## Inelastic levels

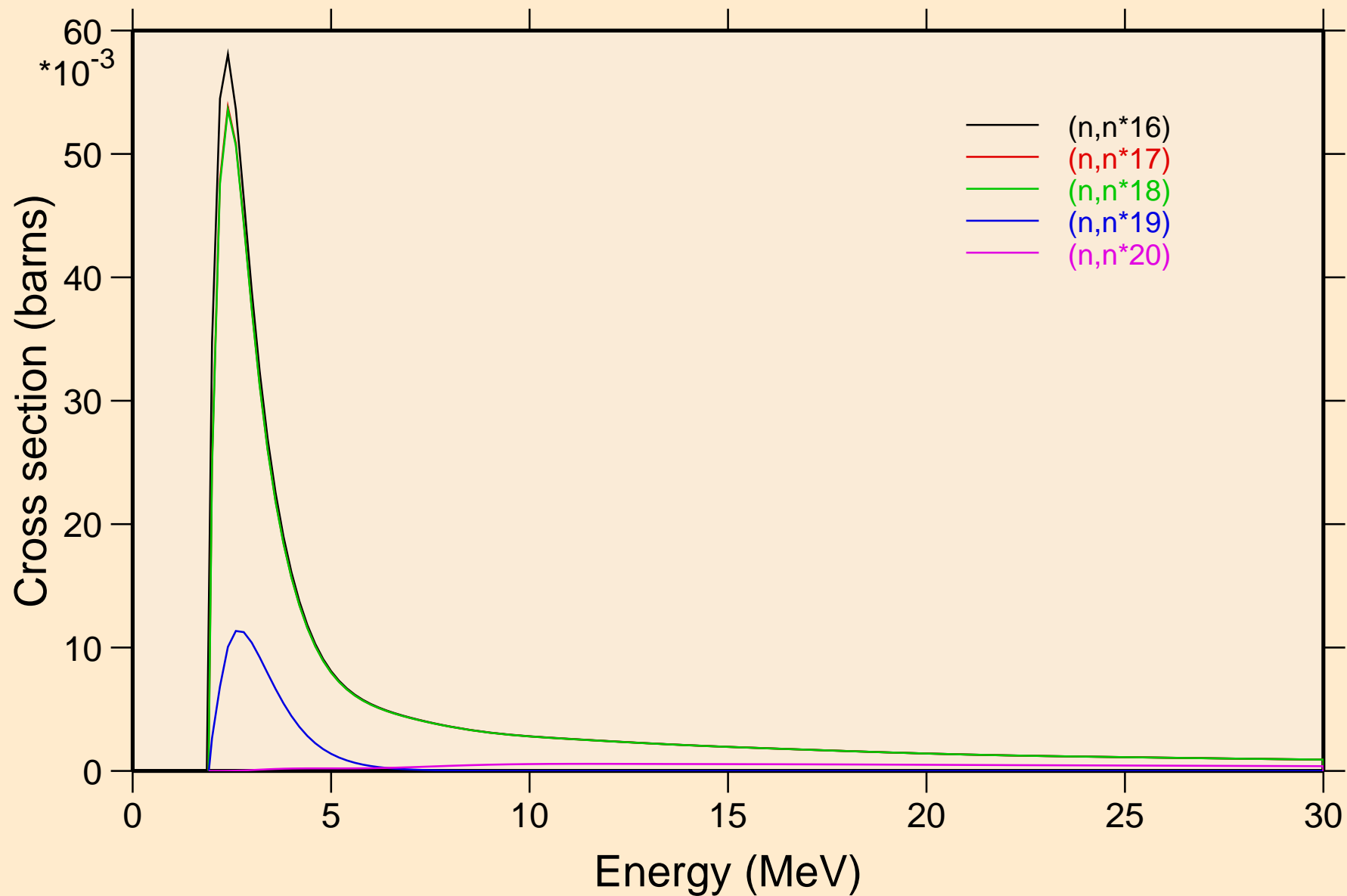

HG198 NEUTRON ACER TENDL-2019 LIBRARY; T=293.16K  
Inelastic levels

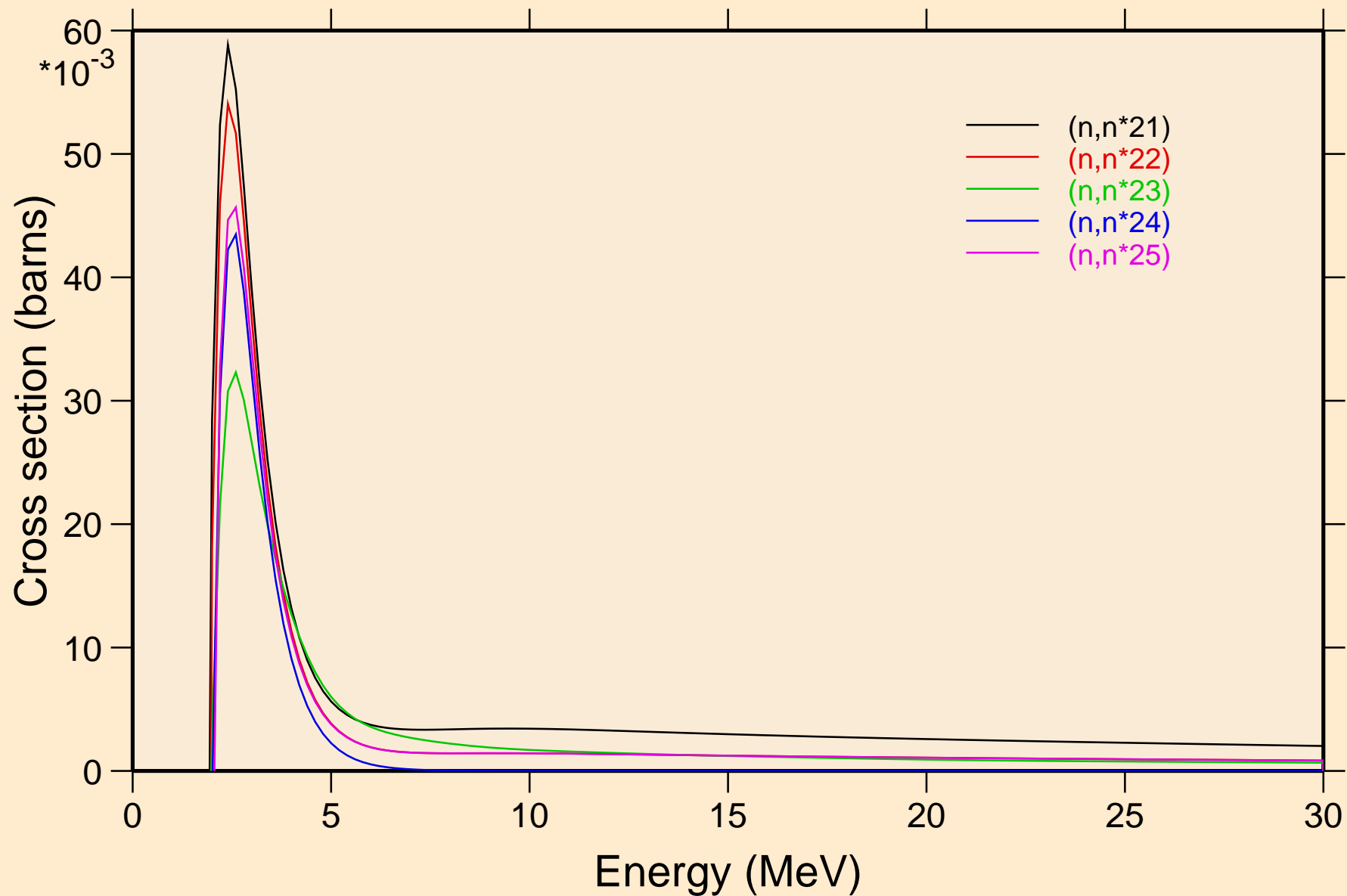

HG198 NEUTRON ACER TENDL-2019 LIBRARY; T=293.16K  
Inelastic levels

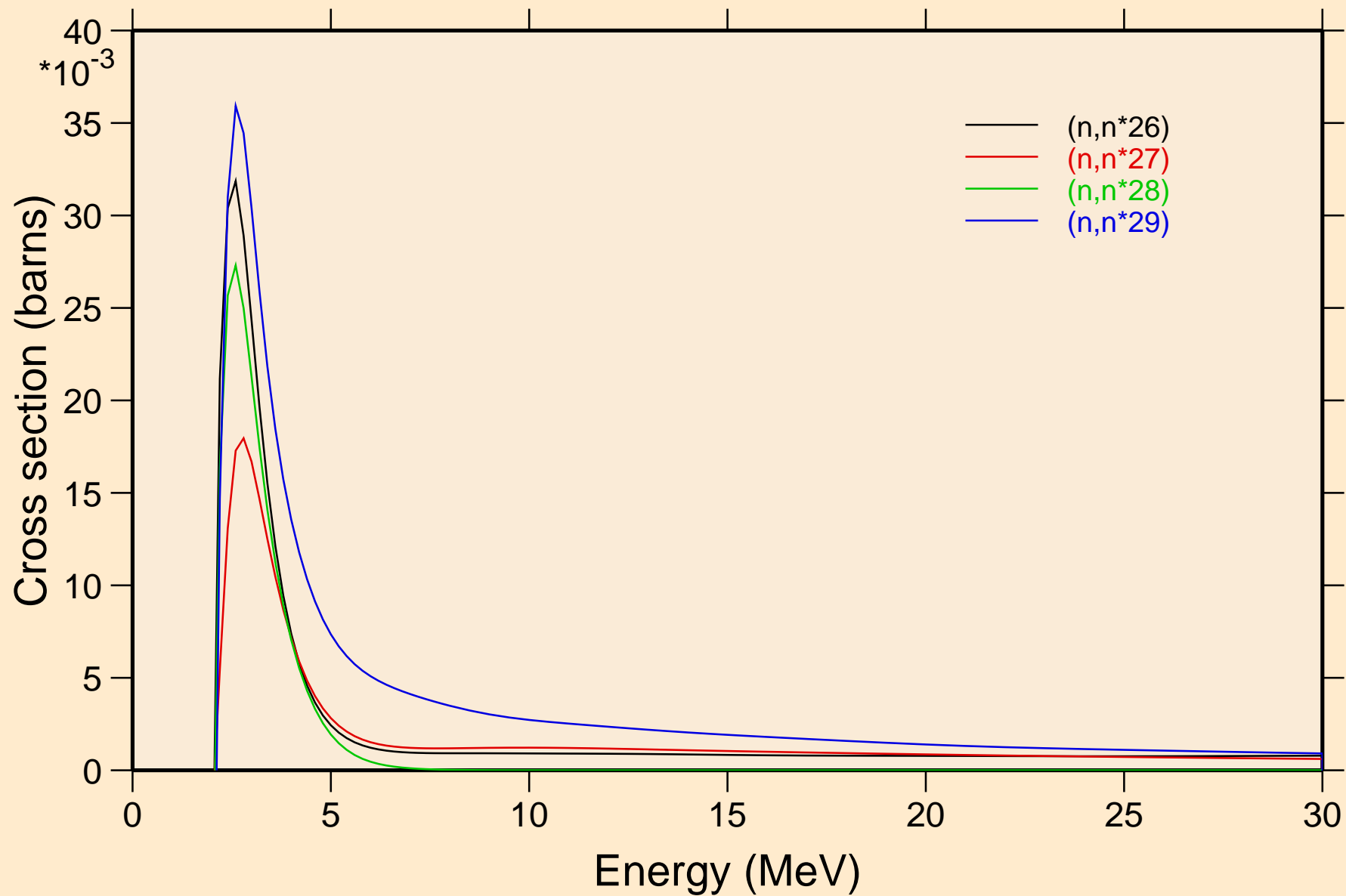



# HG198 NEUTRON ACER TENDL-2019 LIBRARY; T=293.16K

## Threshold reactions

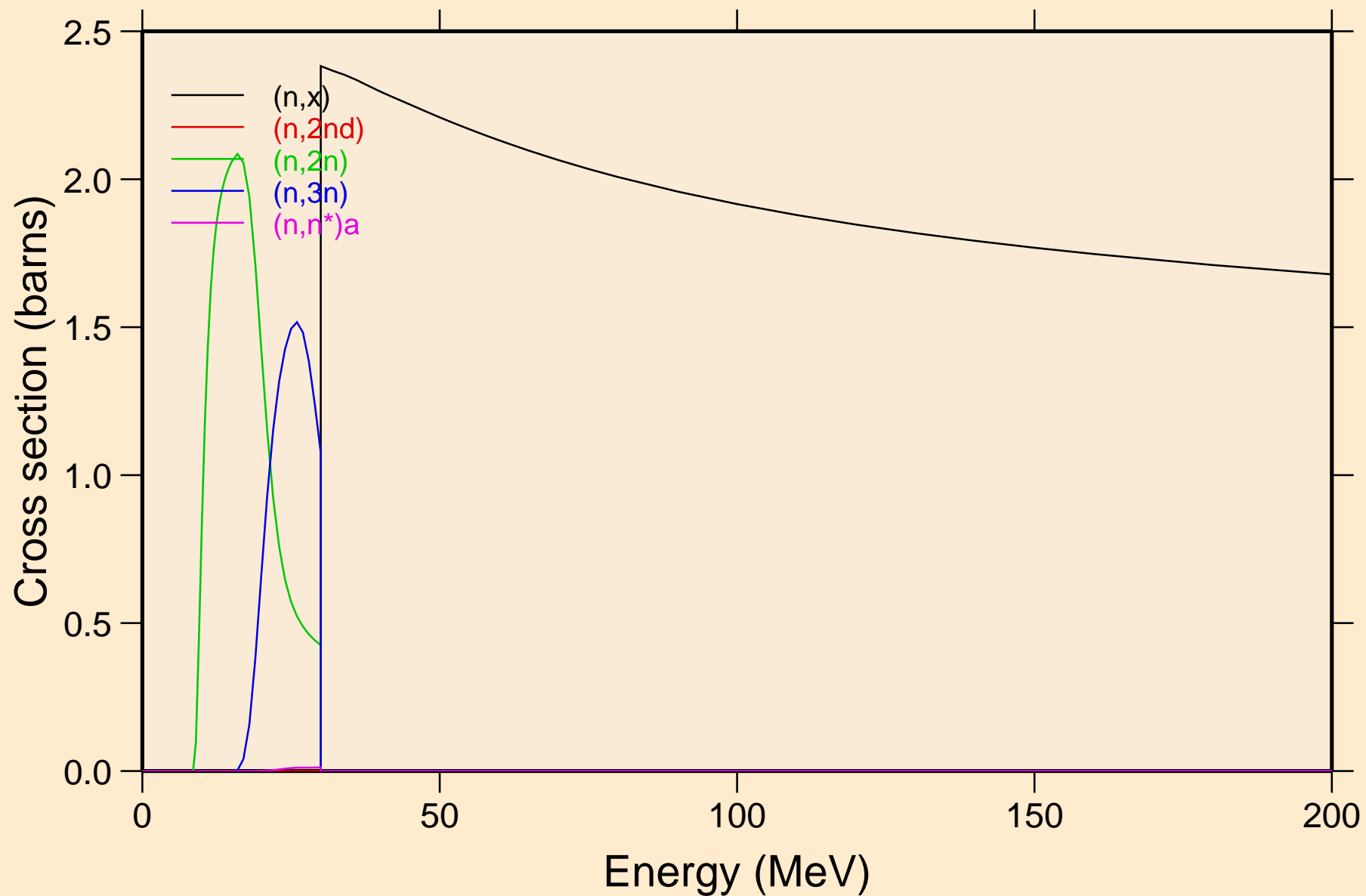

# HG198 NEUTRON ACER TENDL-2019 LIBRARY; T=293.16K

## Threshold reactions

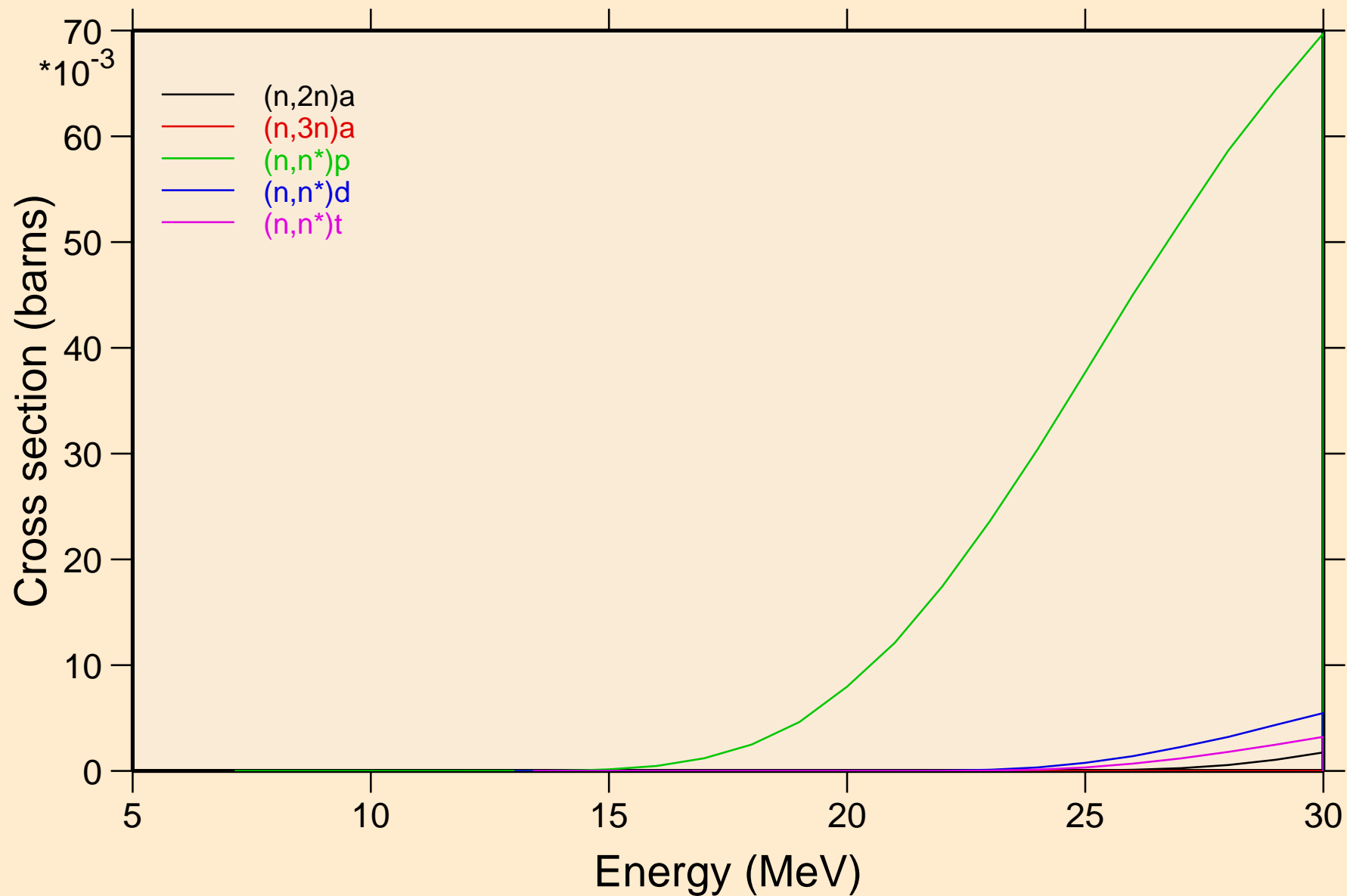

# HG198 NEUTRON ACER TENDL-2019 LIBRARY; T=293.16K

## Threshold reactions

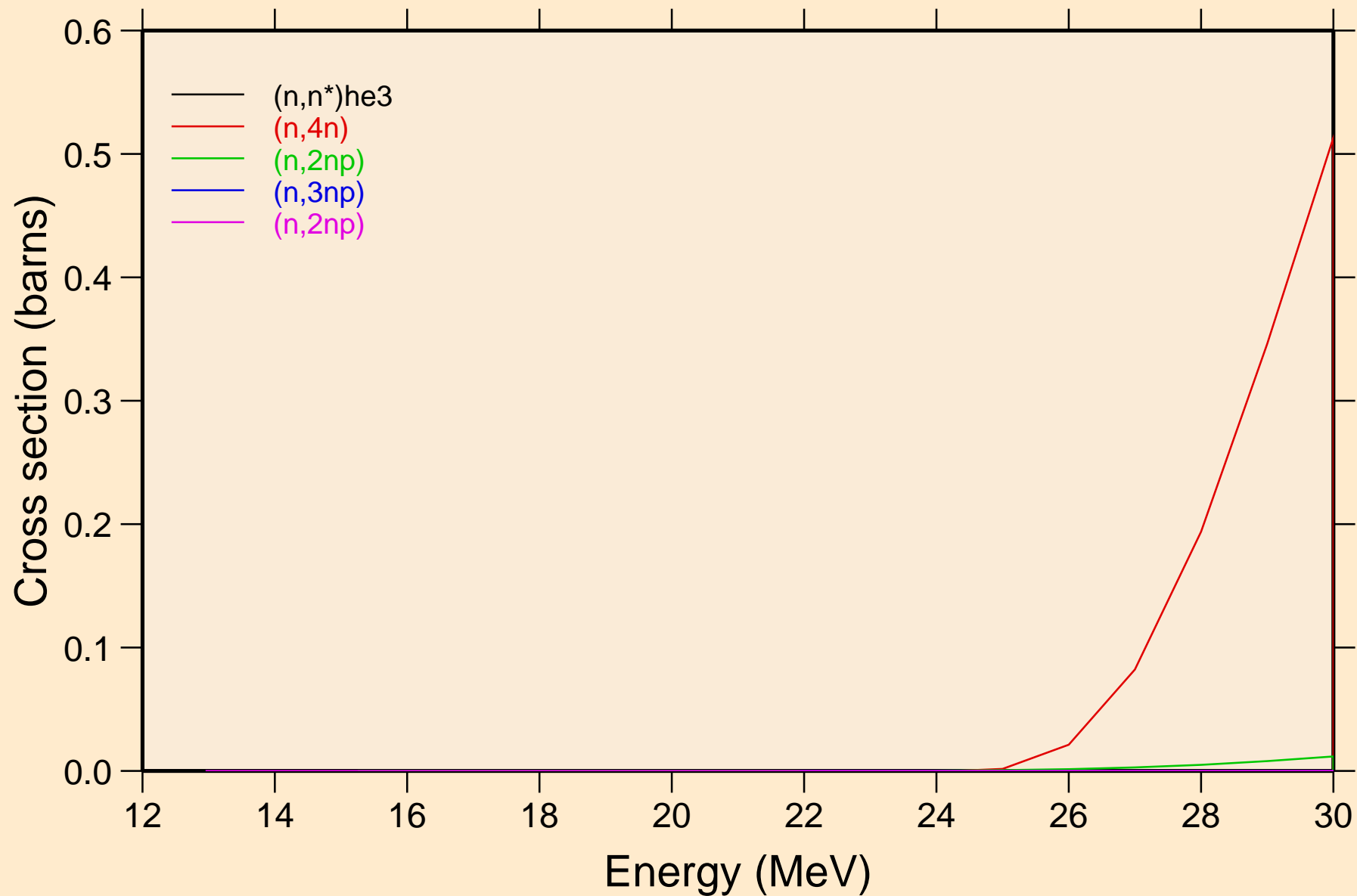

HG198 NEUTRON ACER TENDL-2019 LIBRARY; T=293.16K  
Threshold reactions

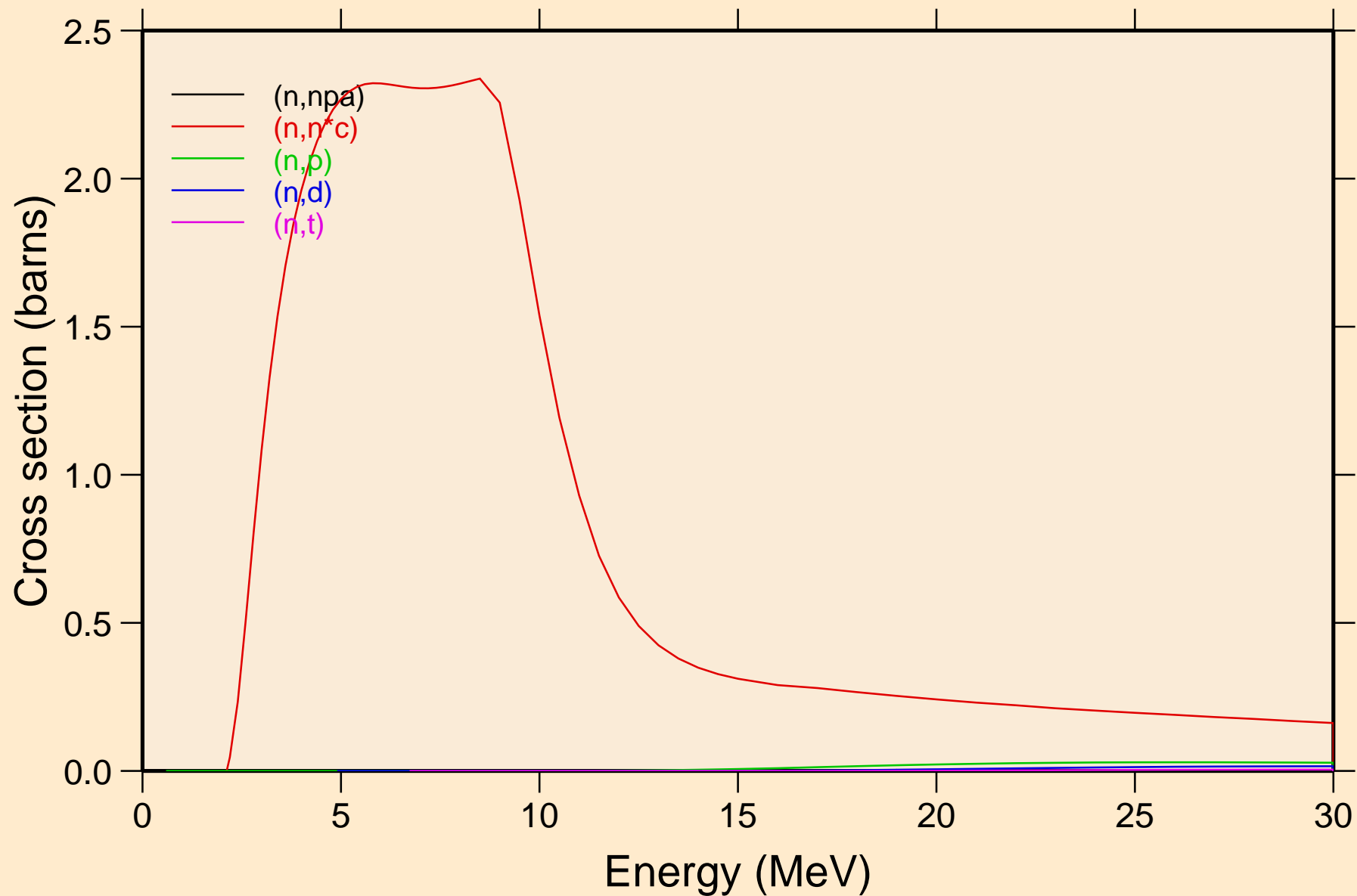

# HG198 NEUTRON ACER TENDL-2019 LIBRARY; T=293.16K

## Threshold reactions

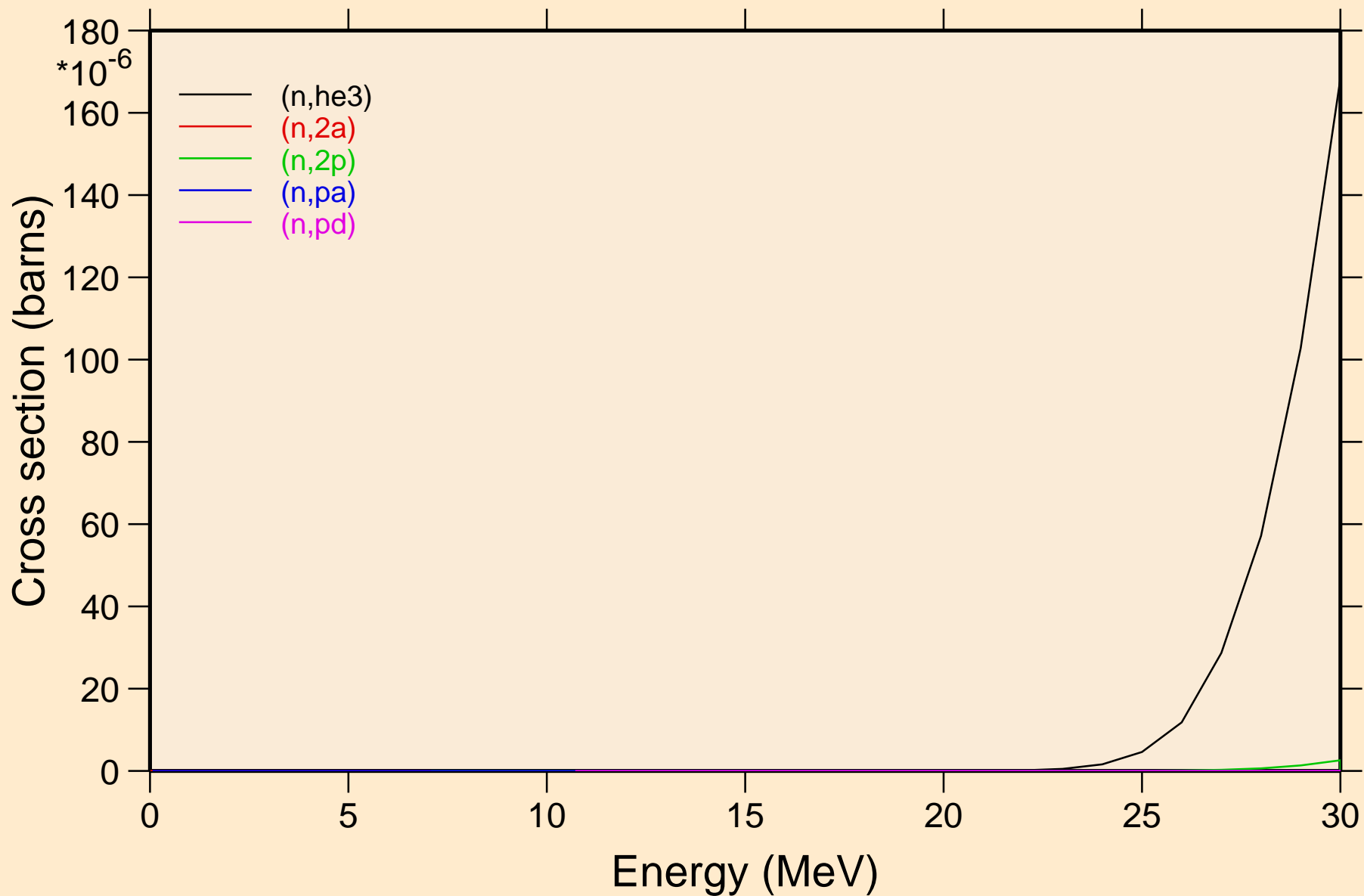

HG198 NEUTRON ACER TENDL-2019 LIBRARY; T=293.16K  
Threshold reactions

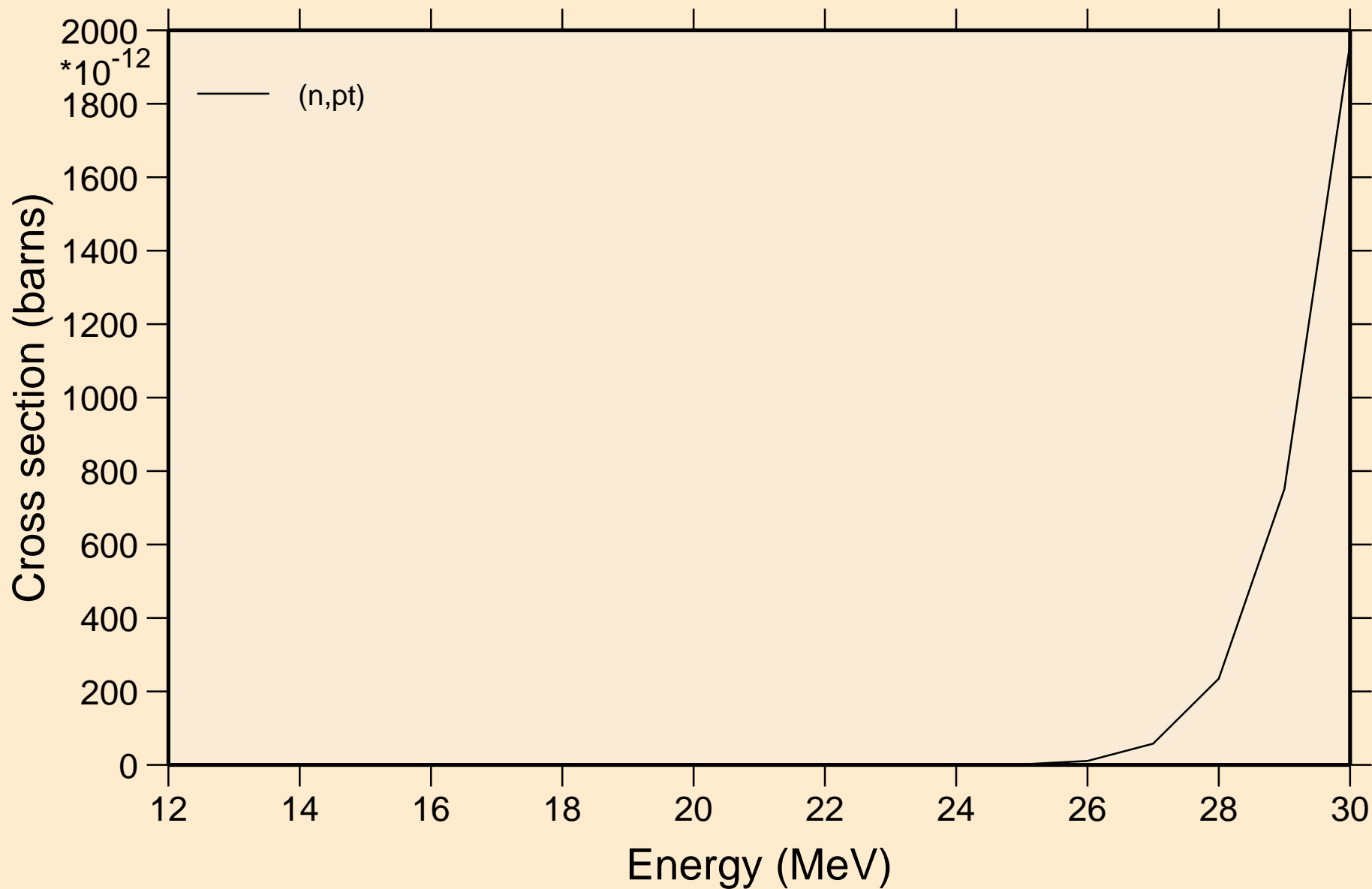

HG198 NEUTRON ACER TENDL-2019 LIBRARY; T=293.16K  
Threshold reactions

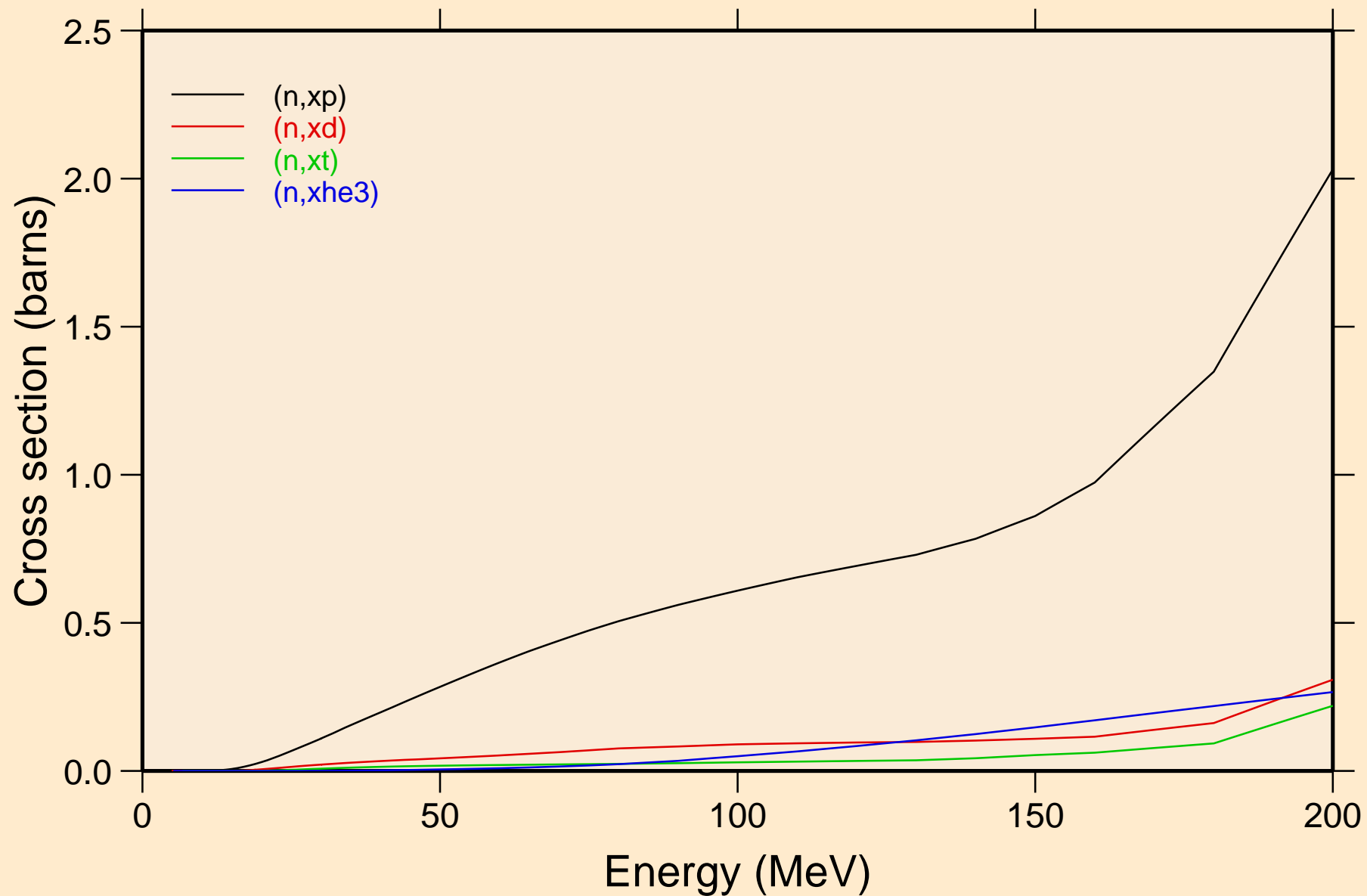

HG198 NEUTRON ACER TENDL-2019 LIBRARY; T=293.16K  
angular distribution for elastic

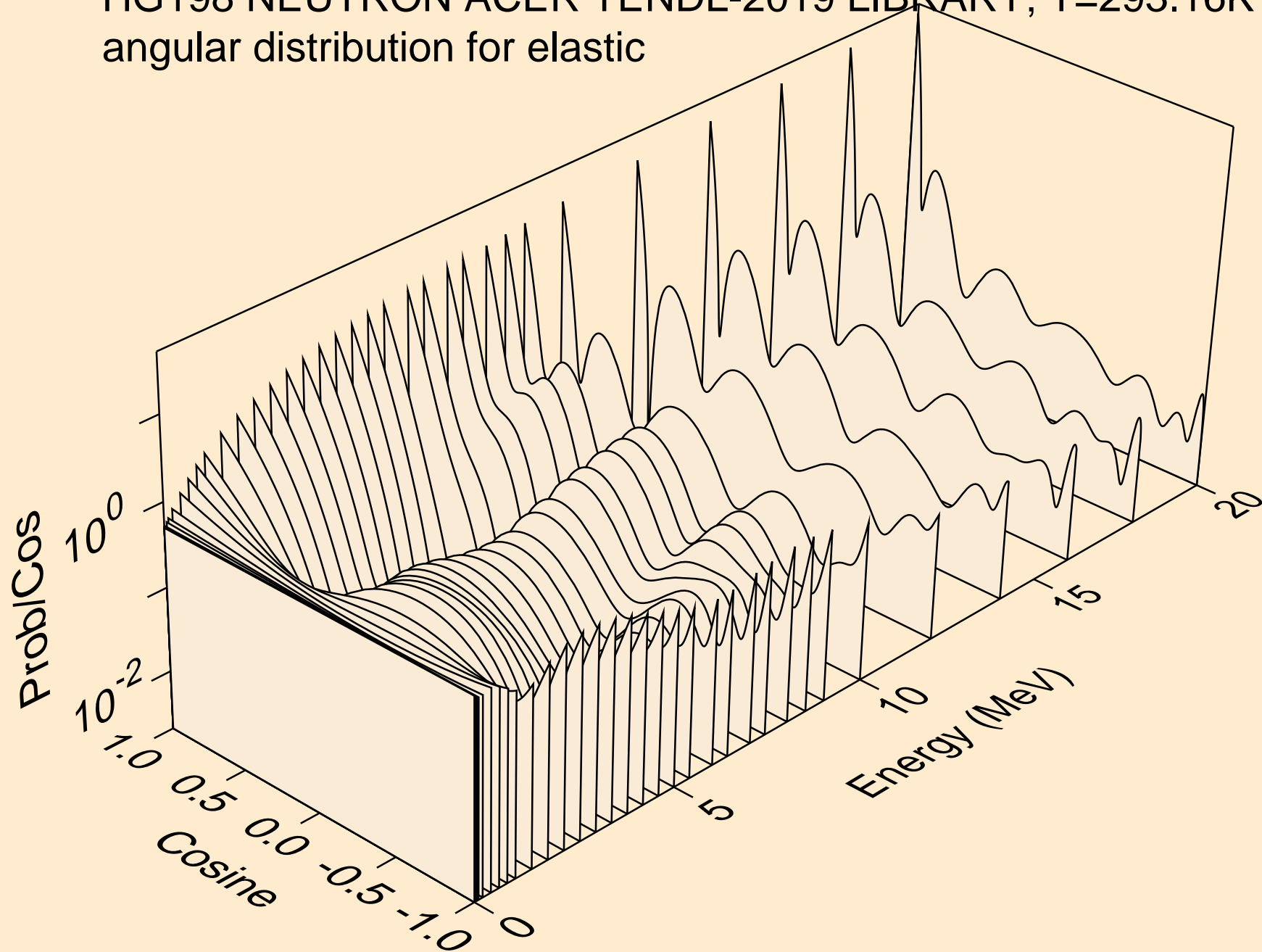



HG198 NEUTRON ACER TENDL-2019 LIBRARY; T=293.16K  
angular distribution for elastic

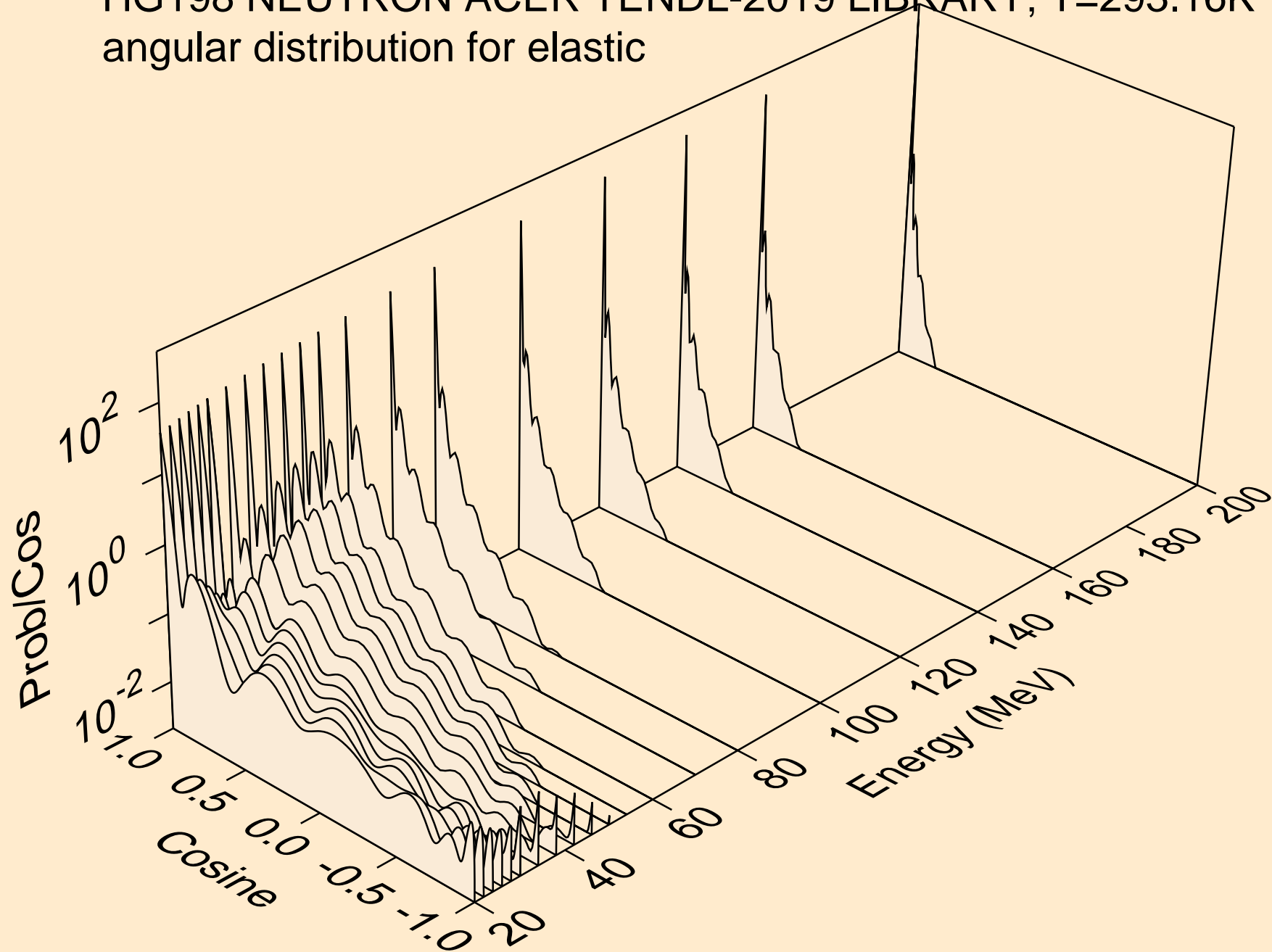

HG198 NEUTRON ACER TENDL-2019 LIBRARY; T=293.16K  
angular distribution for (n,n\*1)

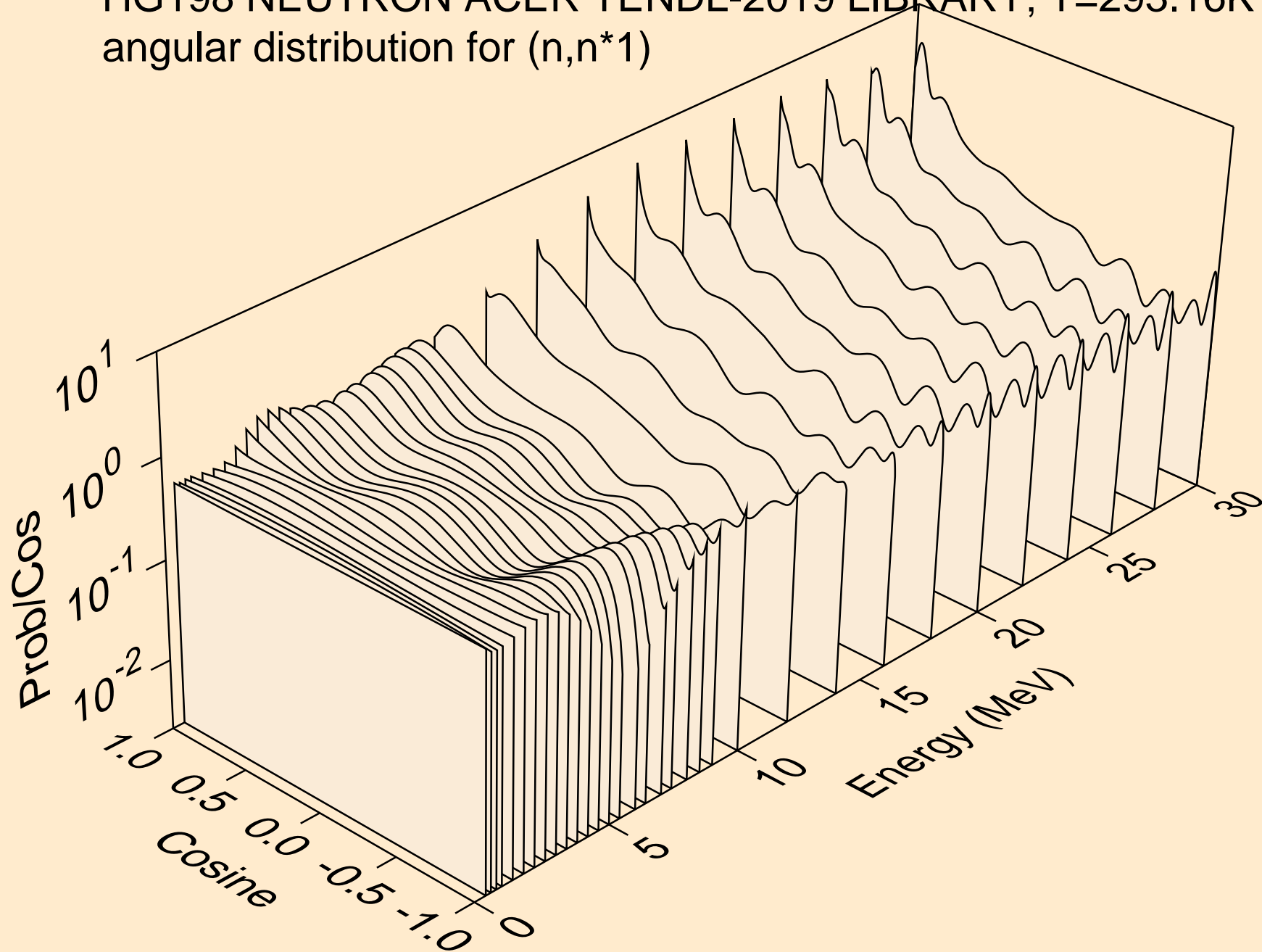

HG198 NEUTRON ACER TENDL-2019 LIBRARY; T=293.16K  
angular distribution for (n,n\*2)

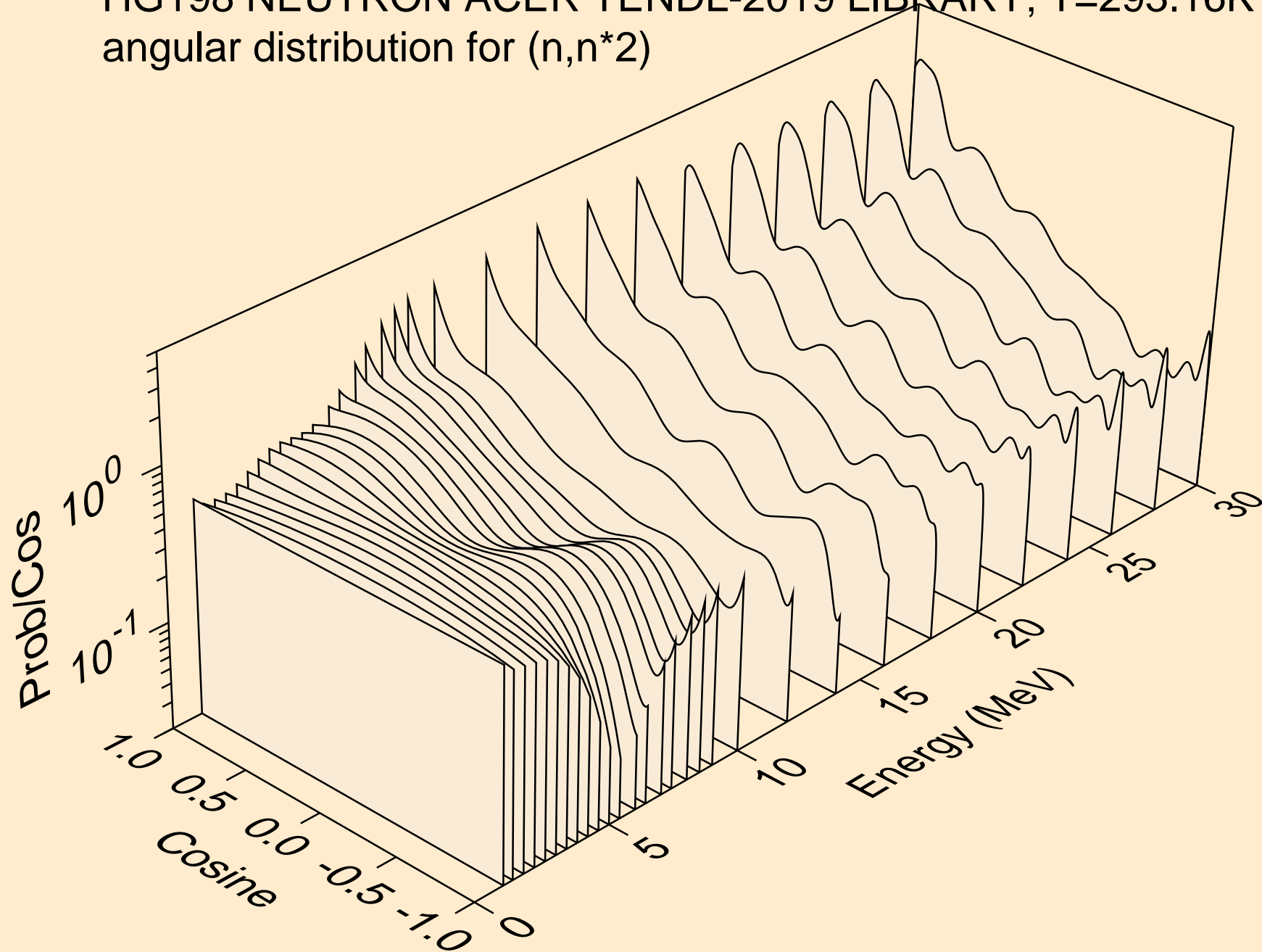

HG198 NEUTRON ACER TENDL-2019 LIBRARY; T=293.16K  
angular distribution for (n,n\*3)

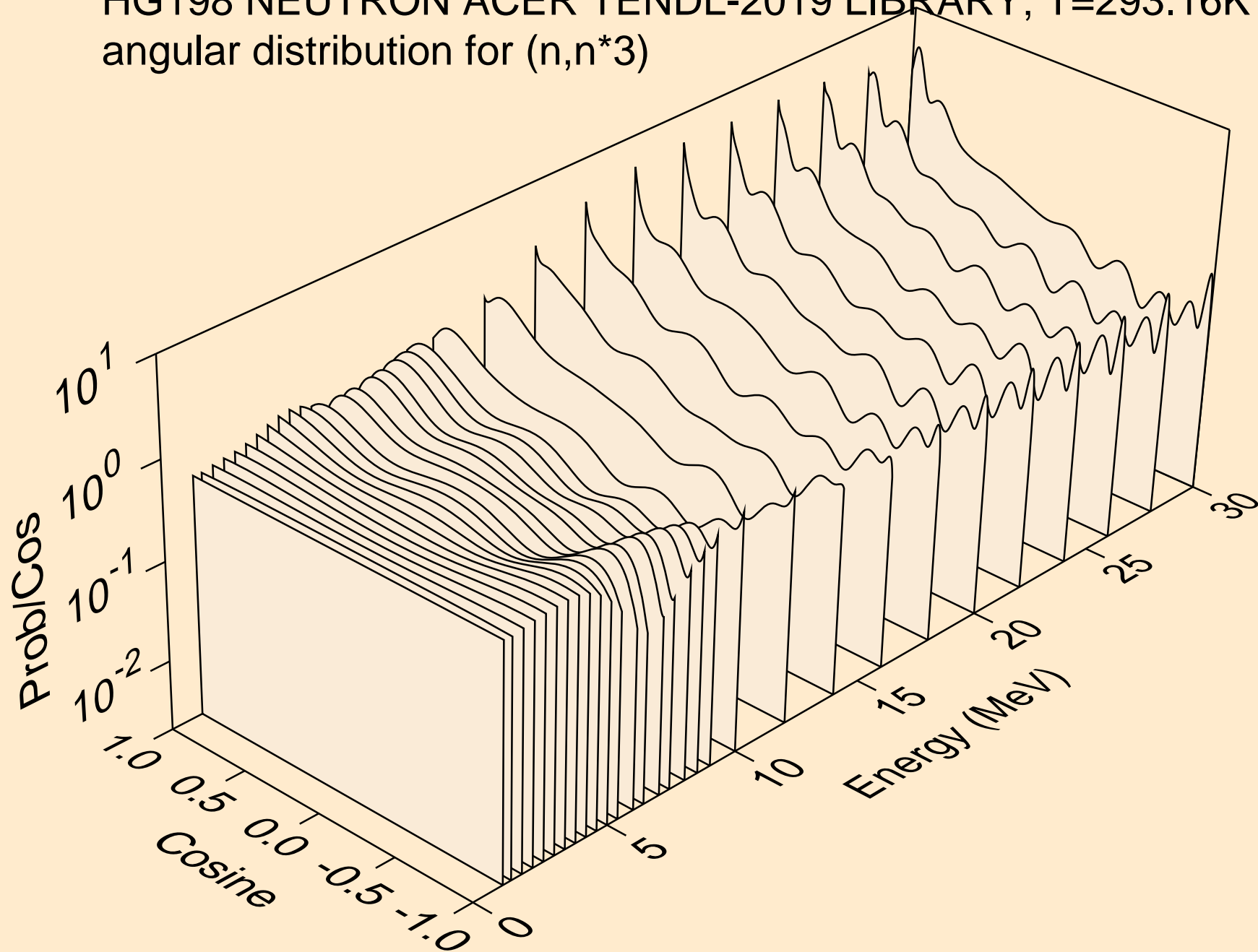

HG198 NEUTRON ACER TENDL-2019 LIBRARY; T=293.16K  
angular distribution for (n,n\*4)

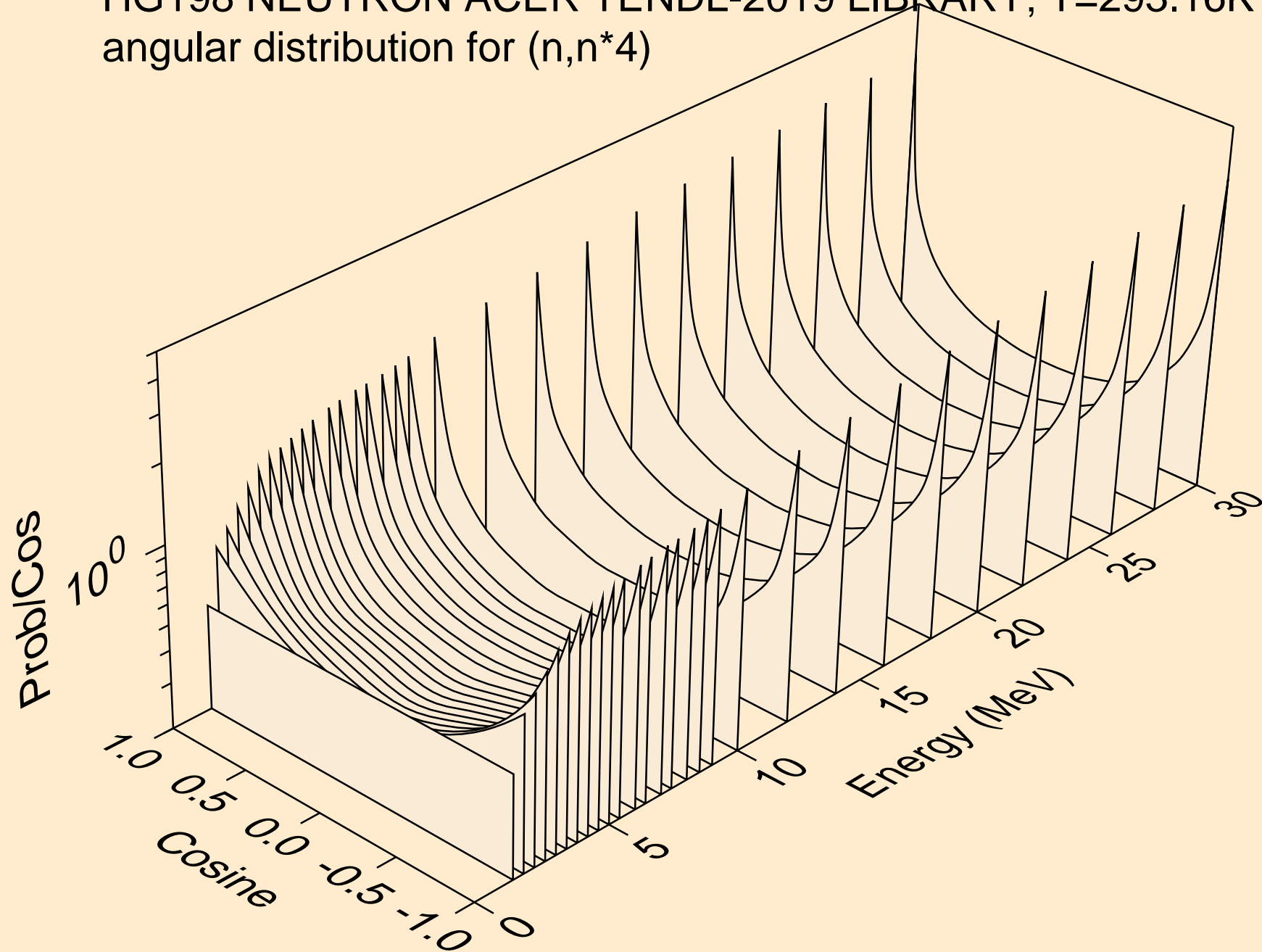

HG198 NEUTRON ACER TENDL-2019 LIBRARY; T=293.16K  
angular distribution for (n,n\*5)

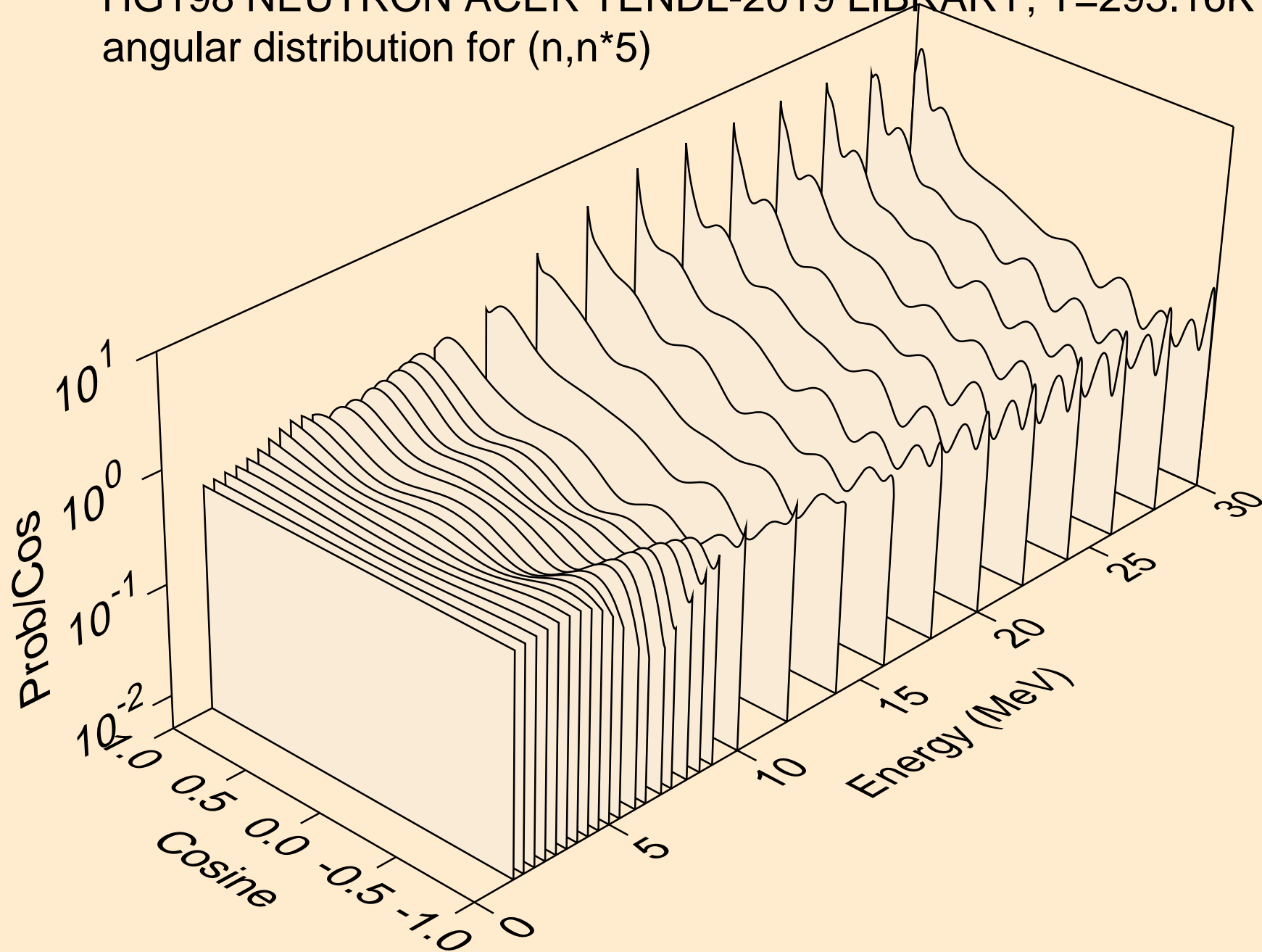

HG198 NEUTRON ACER TENDL-2019 LIBRARY; T=293.16K  
angular distribution for (n,n\*6)

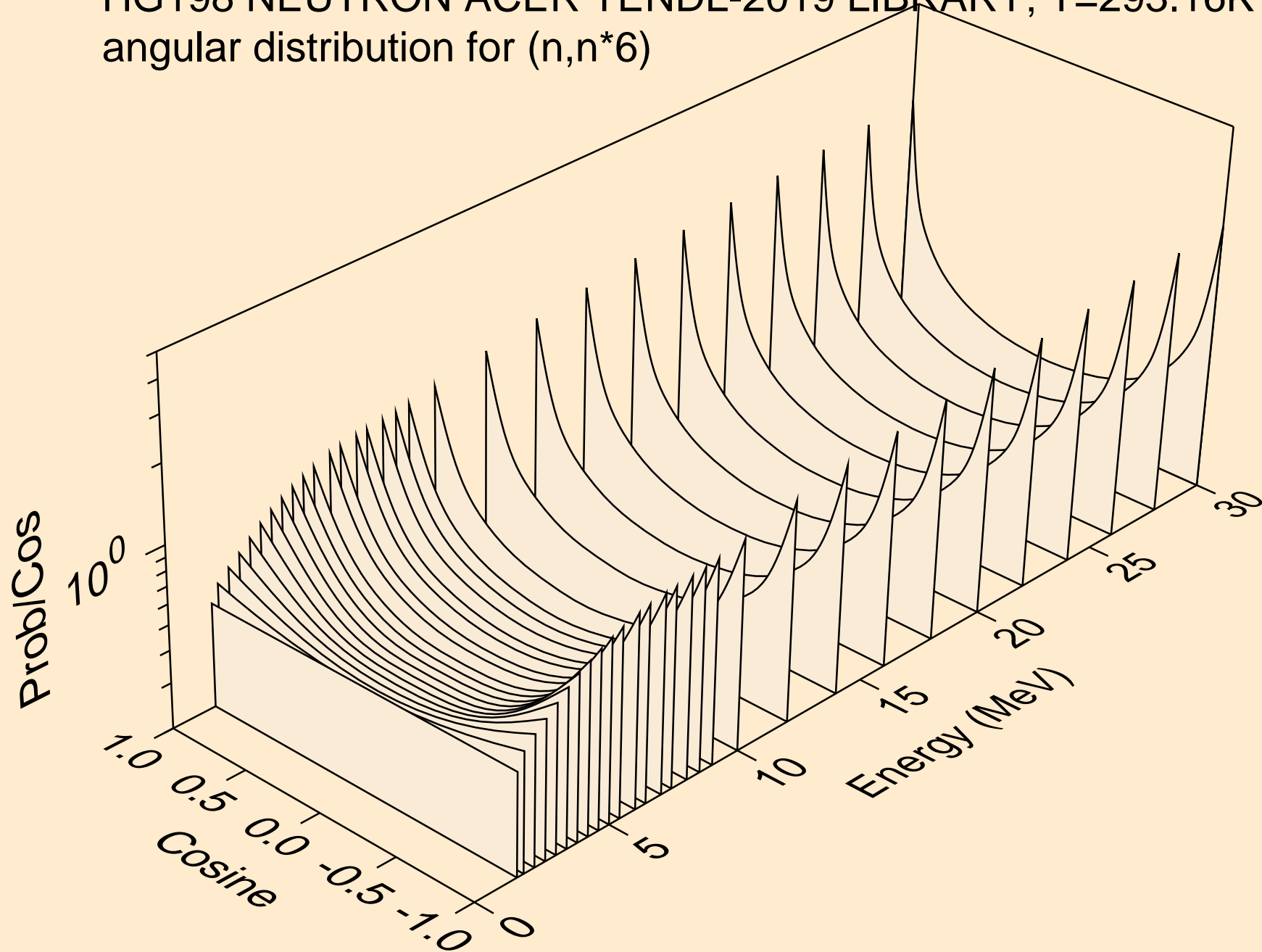

HG198 NEUTRON ACER TENDL-2019 LIBRARY; T=293.16K  
angular distribution for (n,n\*7)

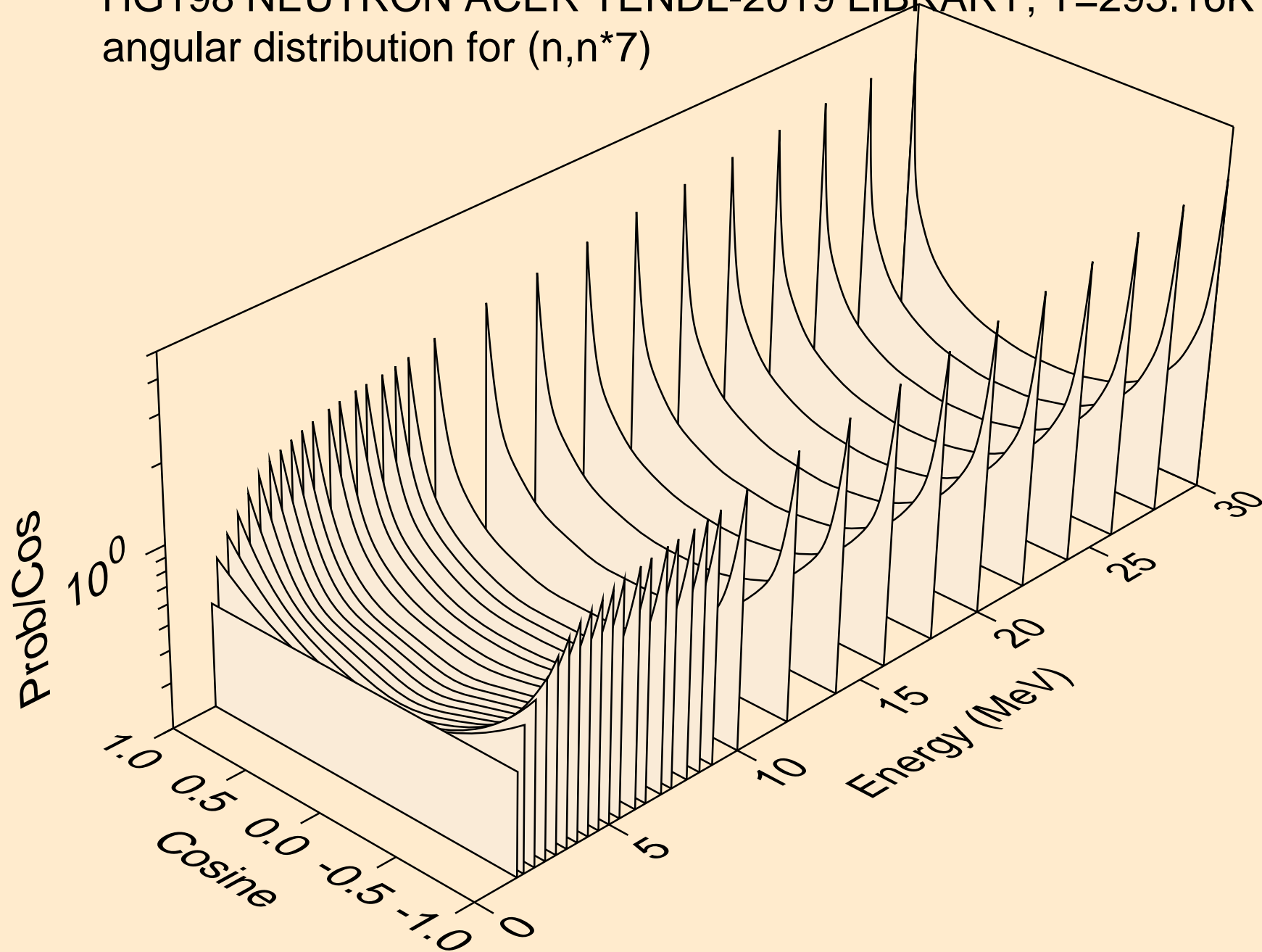



HG198 NEUTRON ACER TENDL-2019 LIBRARY; T=293.16K  
angular distribution for (n,n\*8)

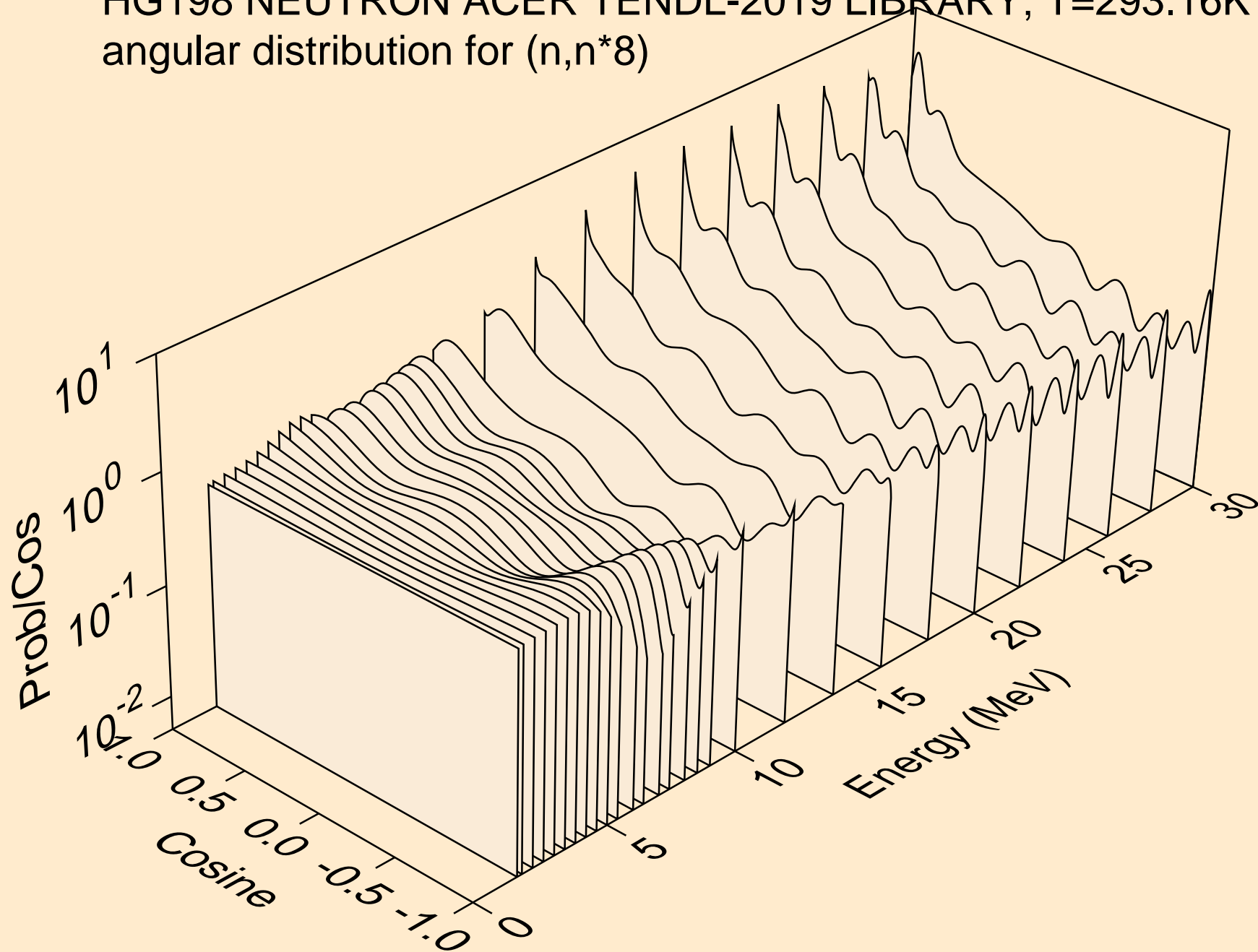

HG198 NEUTRON ACER TENDL-2019 LIBRARY; T=293.16K  
angular distribution for (n,n\*9)

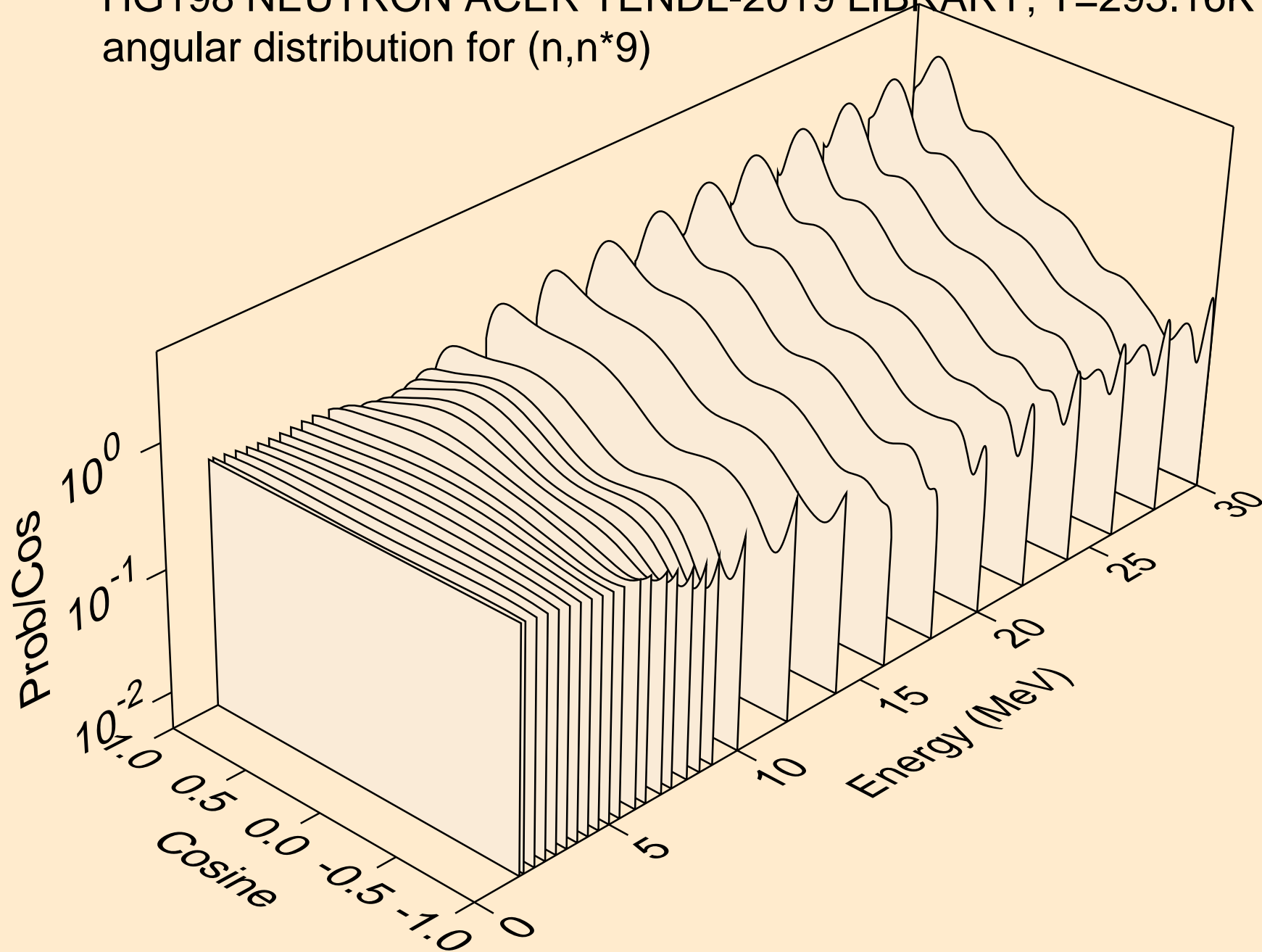

HG198 NEUTRON ACER TENDL-2019 LIBRARY; T=293.16K  
angular distribution for (n,n\*10)

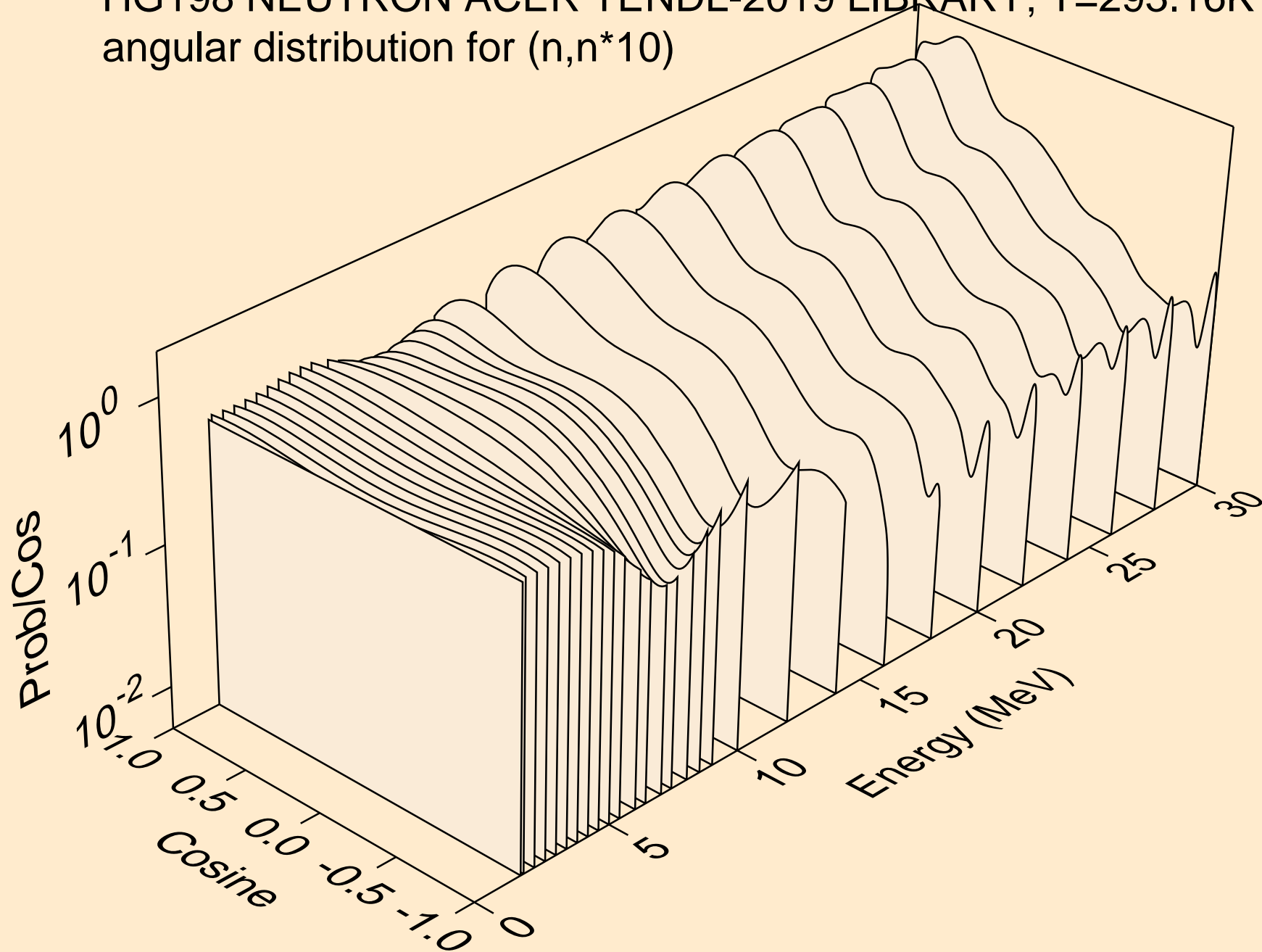

HG198 NEUTRON ACER TENDL-2019 LIBRARY; T=293.16K  
angular distribution for (n,n\*11)

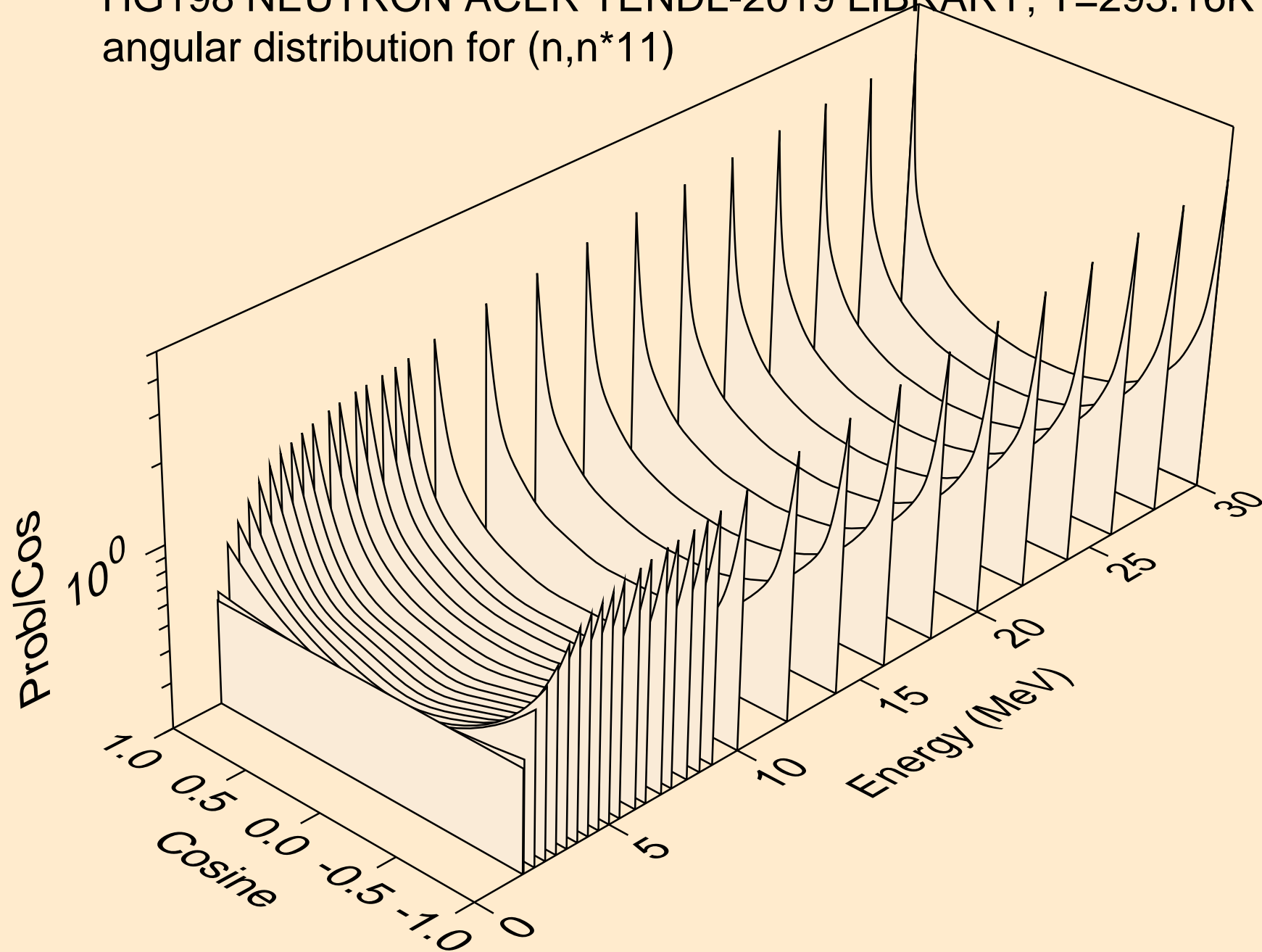

HG198 NEUTRON ACER TENDL-2019 LIBRARY; T=293.16K  
angular distribution for (n,n\*12)

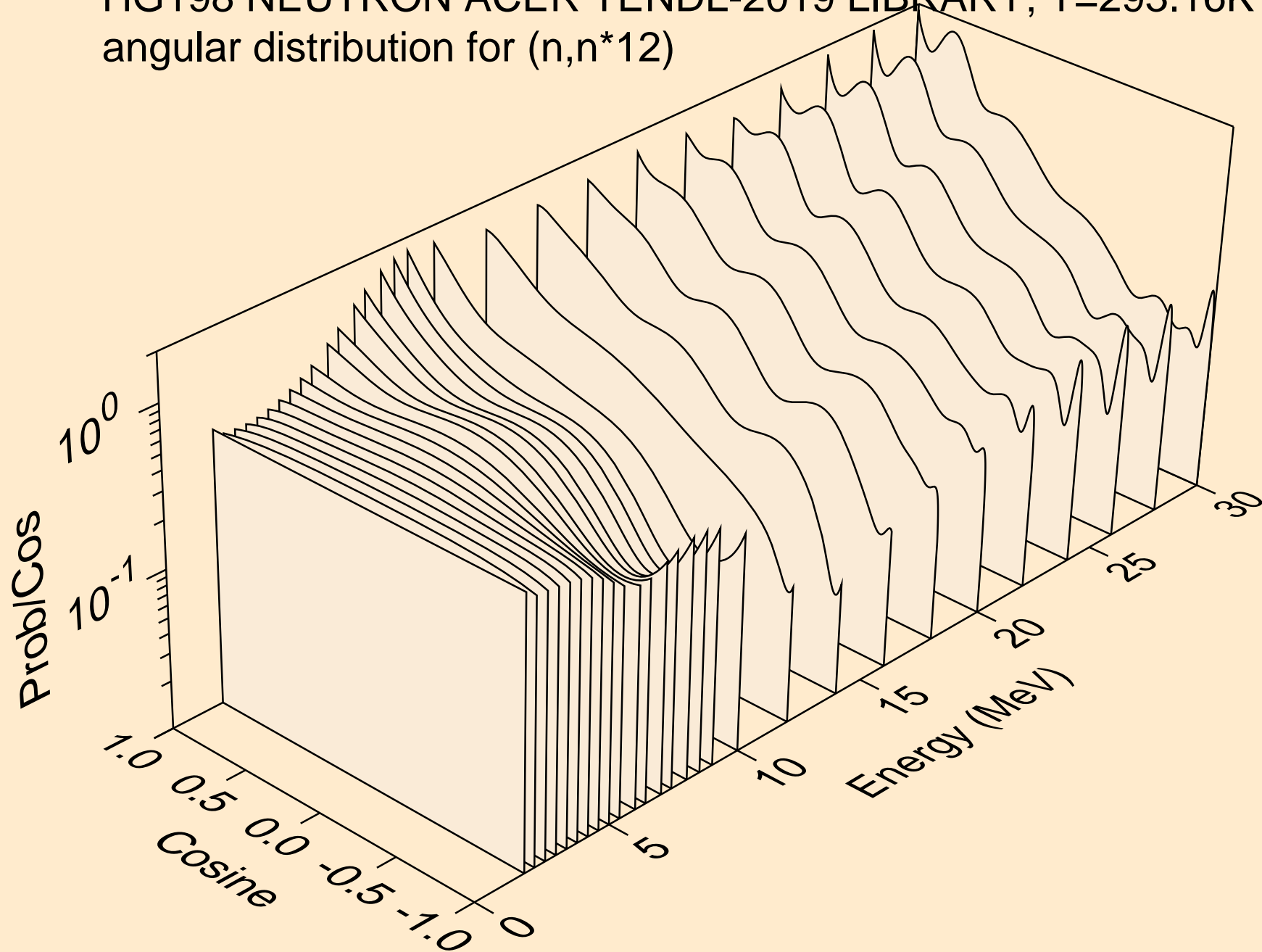

HG198 NEUTRON ACER TENDL-2019 LIBRARY; T=293.16K  
angular distribution for (n,n\*13)

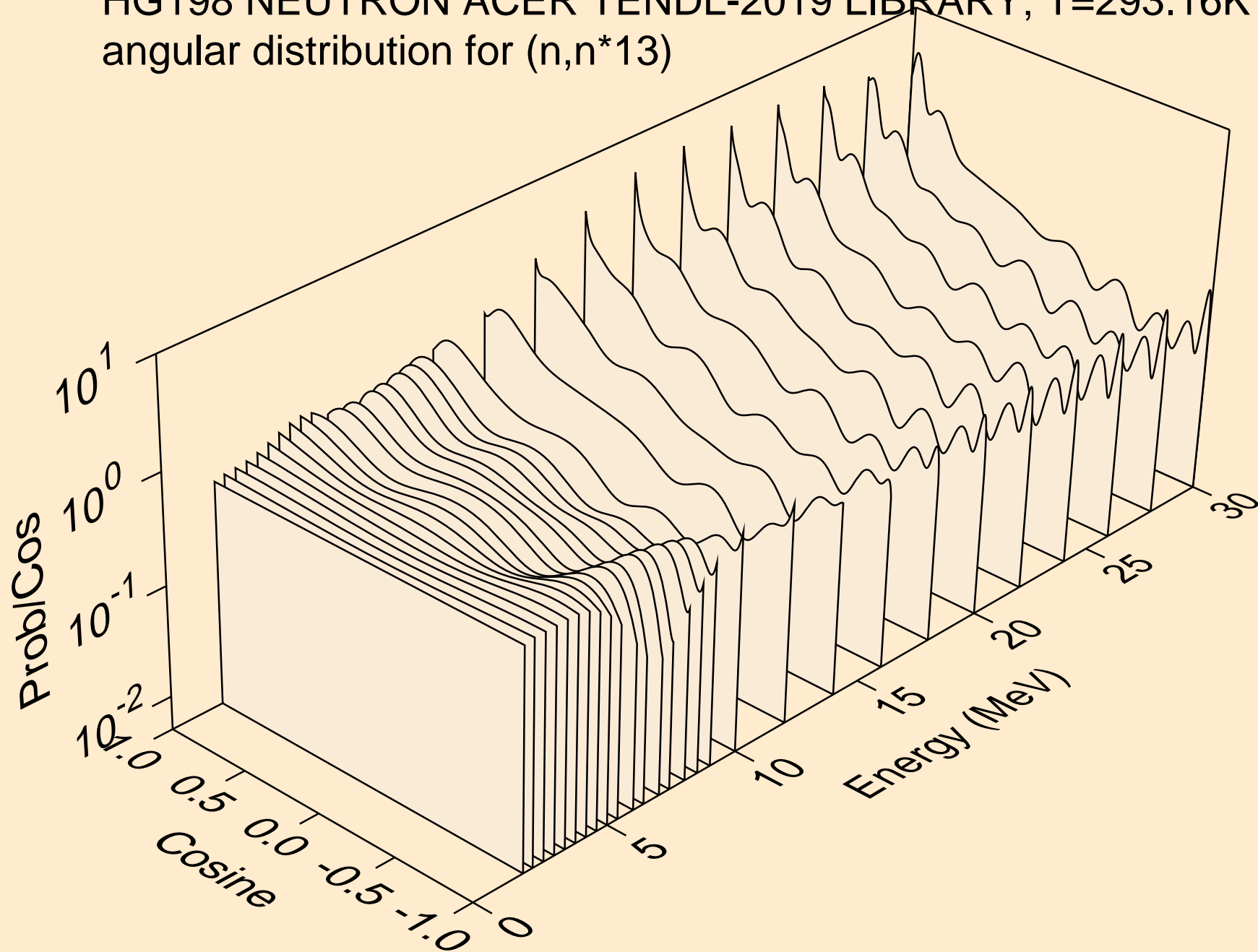

HG198 NEUTRON ACER TENDL-2019 LIBRARY; T=293.16K  
angular distribution for (n,n\*14)

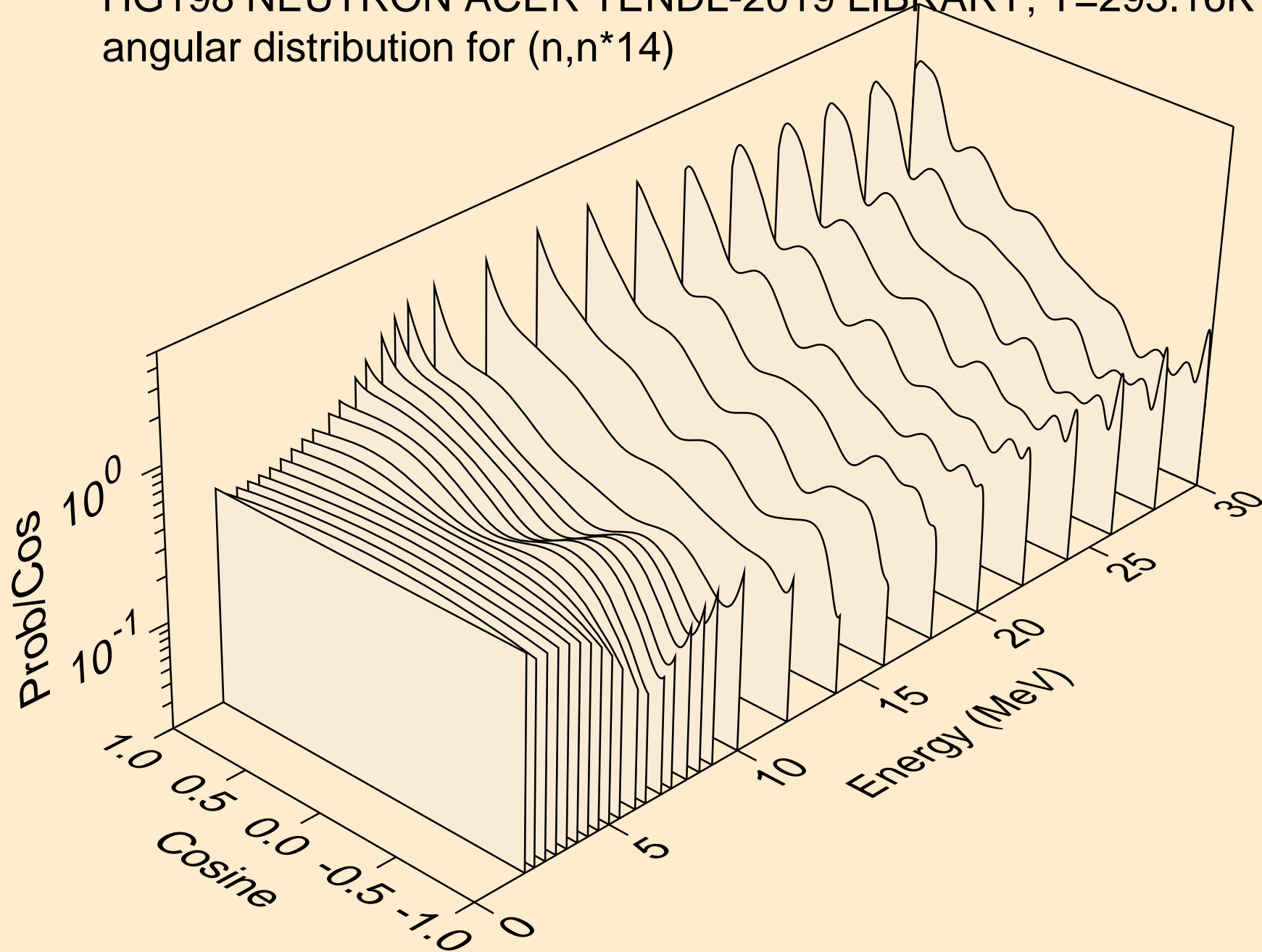

HG198 NEUTRON ACER TENDL-2019 LIBRARY; T=293.16K  
angular distribution for (n,n\*15)

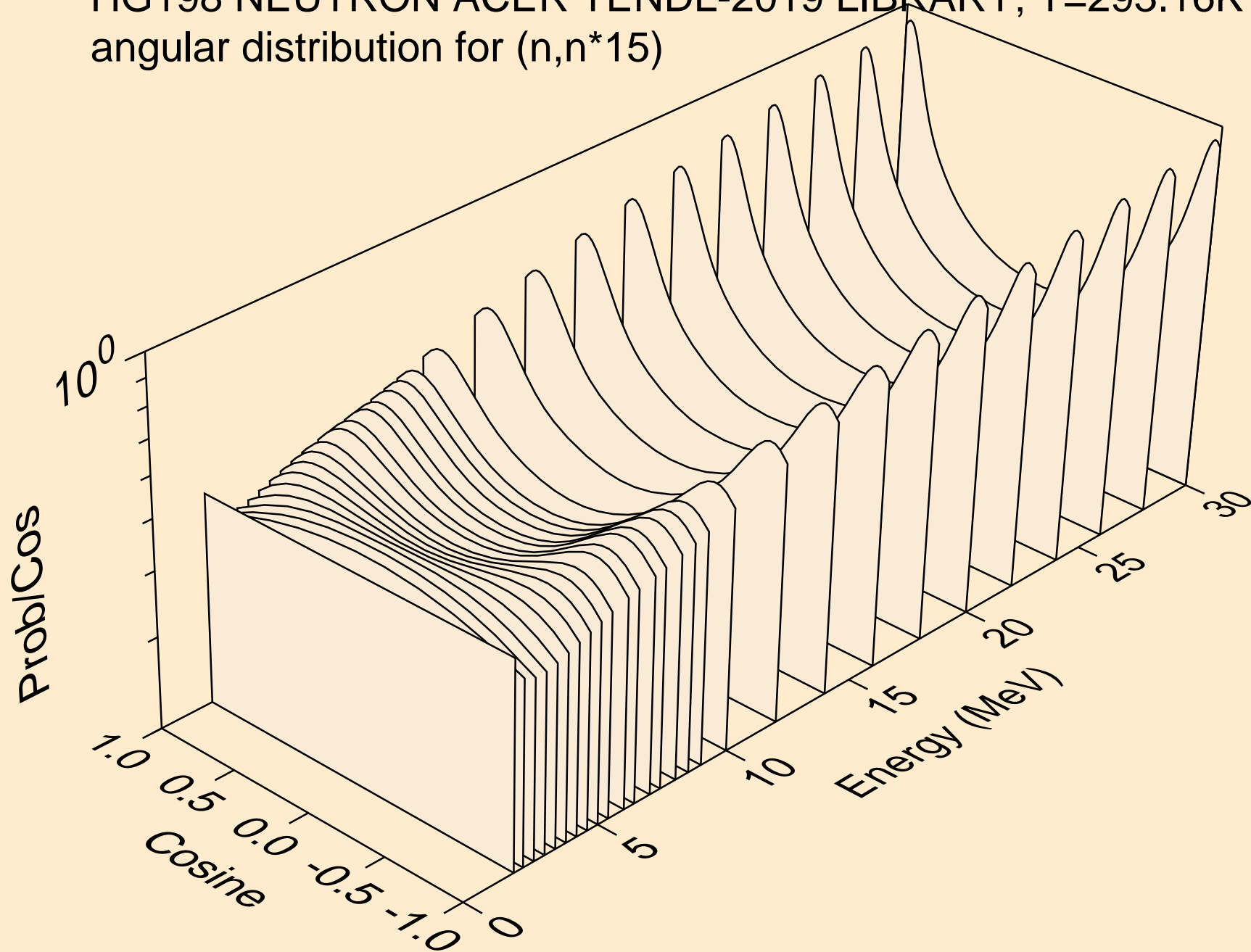



HG198 NEUTRON ACER TENDL-2019 LIBRARY; T=293.16K  
angular distribution for (n,n\*16)

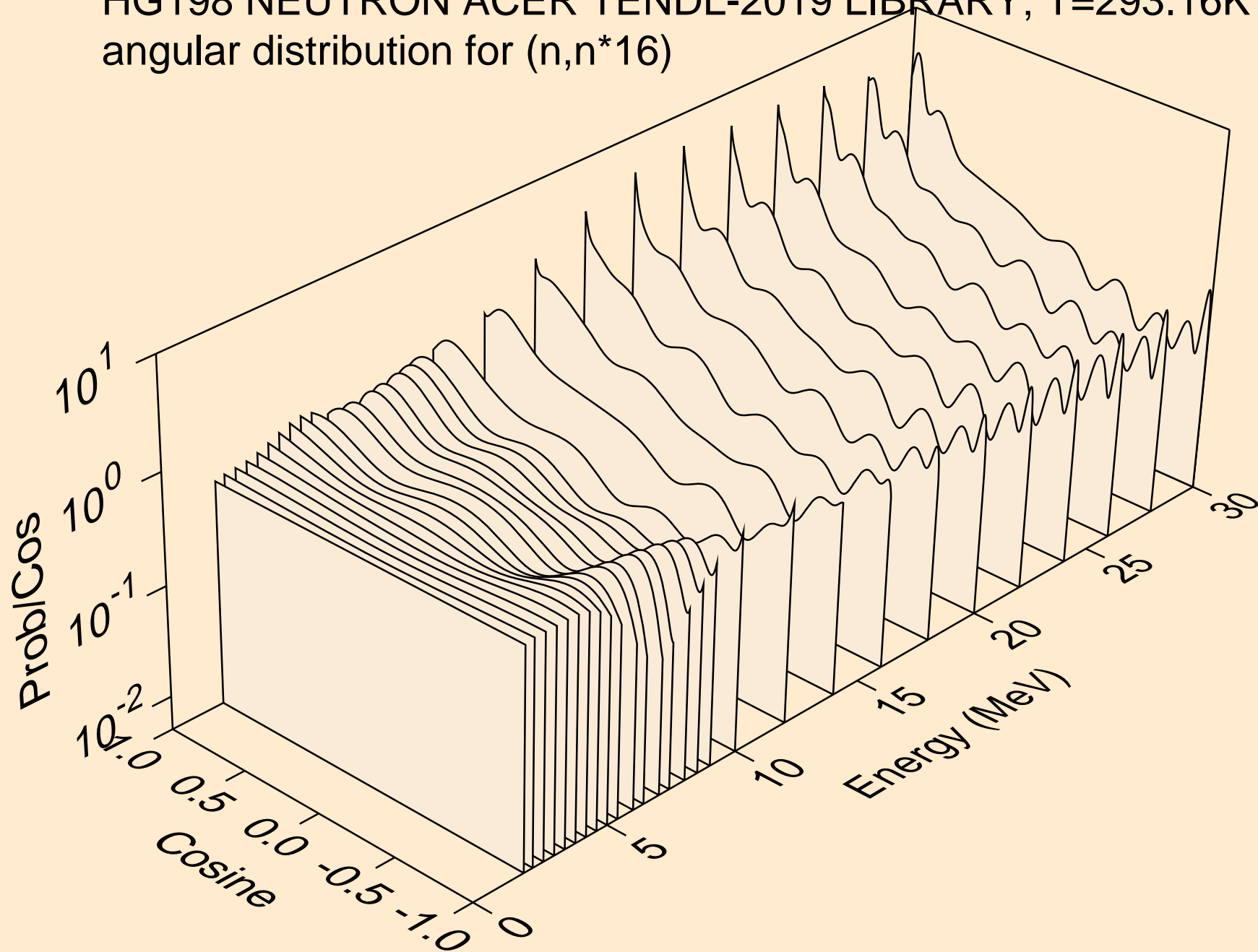

HG198 NEUTRON ACER TENDL-2019 LIBRARY; T=293.16K  
angular distribution for (n,n\*17)

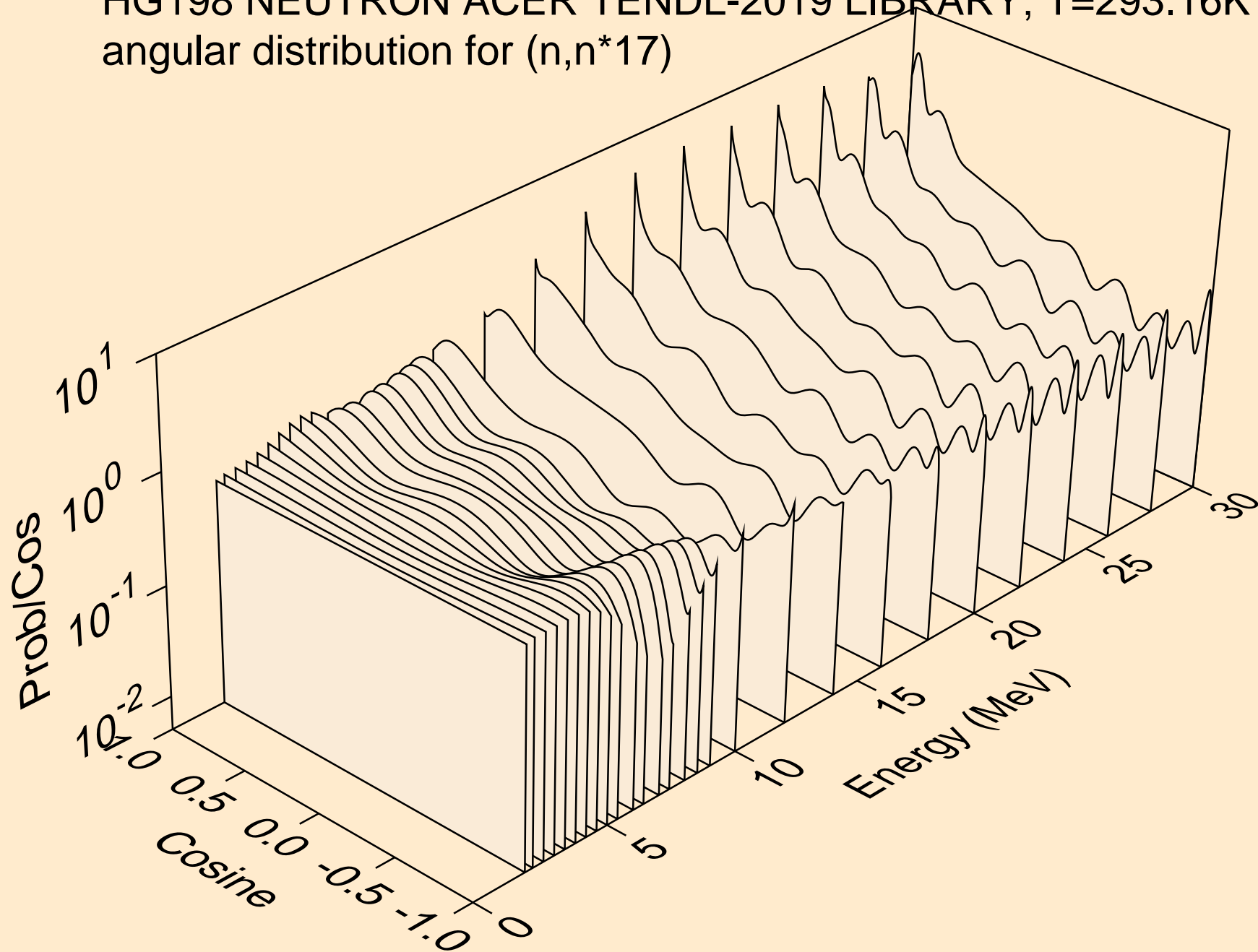

HG198 NEUTRON ACER TENDL-2019 LIBRARY; T=293.16K  
angular distribution for (n,n\*18)

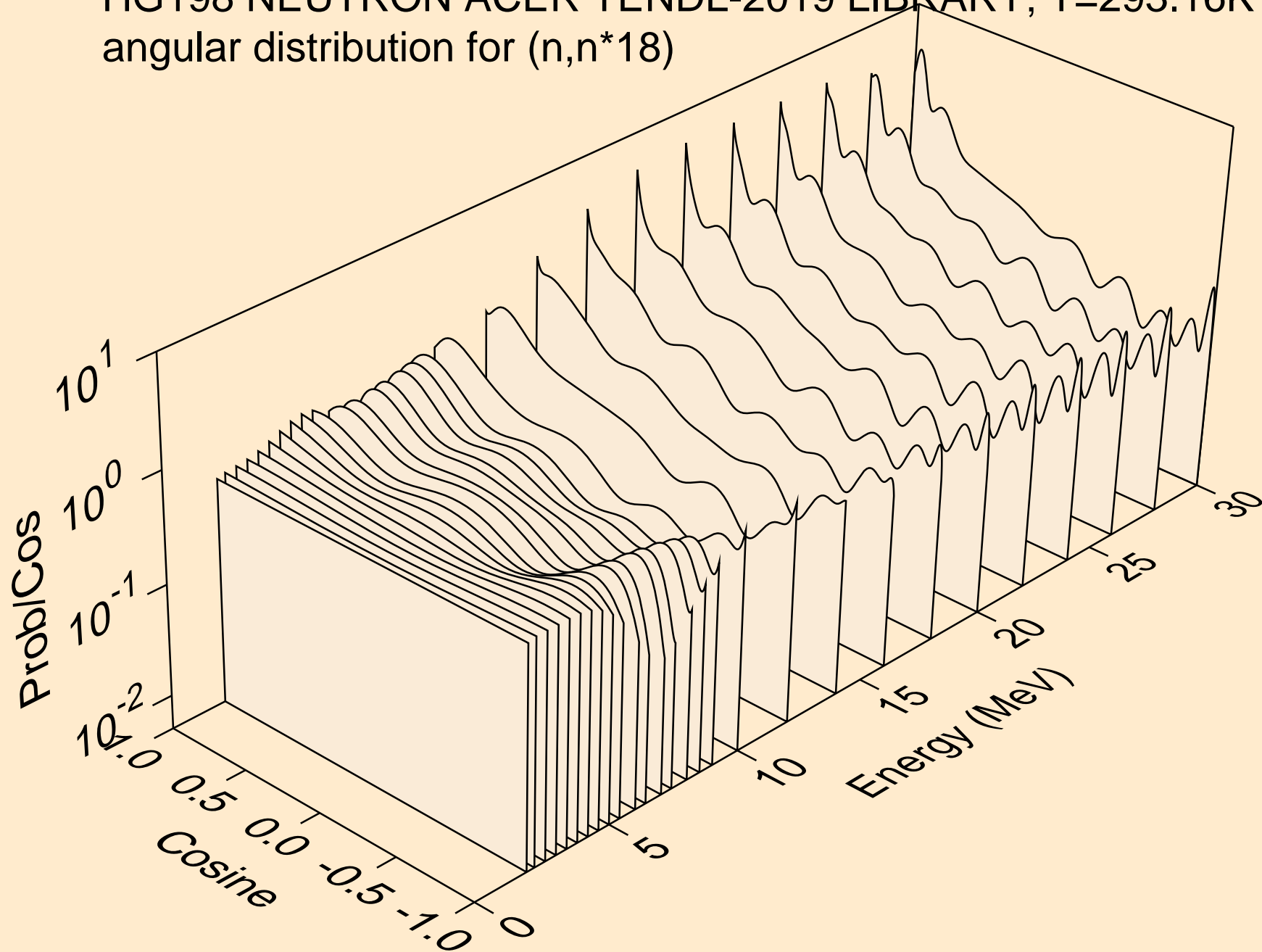

HG198 NEUTRON ACER TENDL-2019 LIBRARY; T=293.16K  
angular distribution for (n,n\*19)

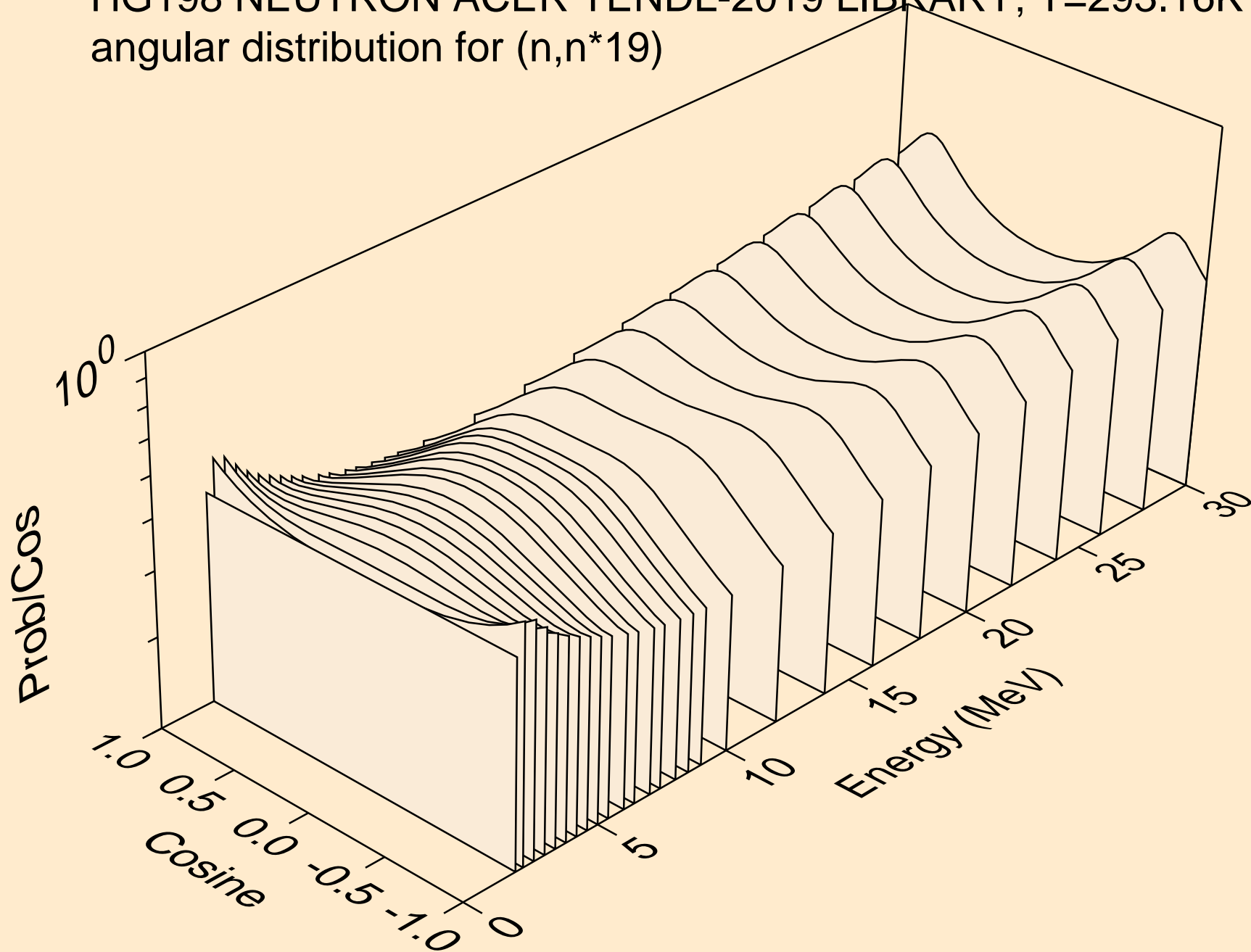

HG198 NEUTRON ACER TENDL-2019 LIBRARY; T=293.16K  
angular distribution for (n,n\*20)

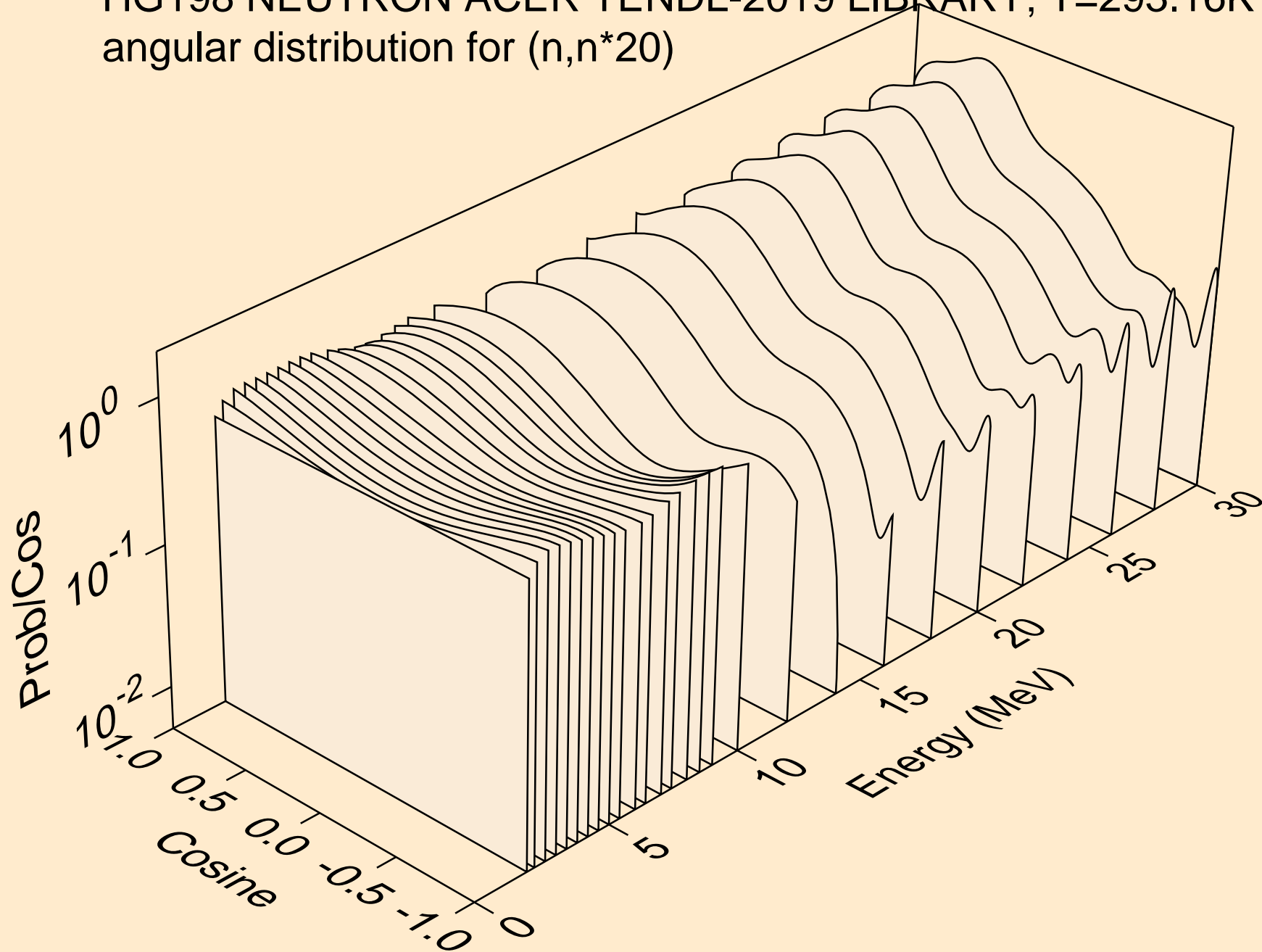

HG198 NEUTRON ACER TENDL-2019 LIBRARY; T=293.16K  
angular distribution for (n,n\*21)

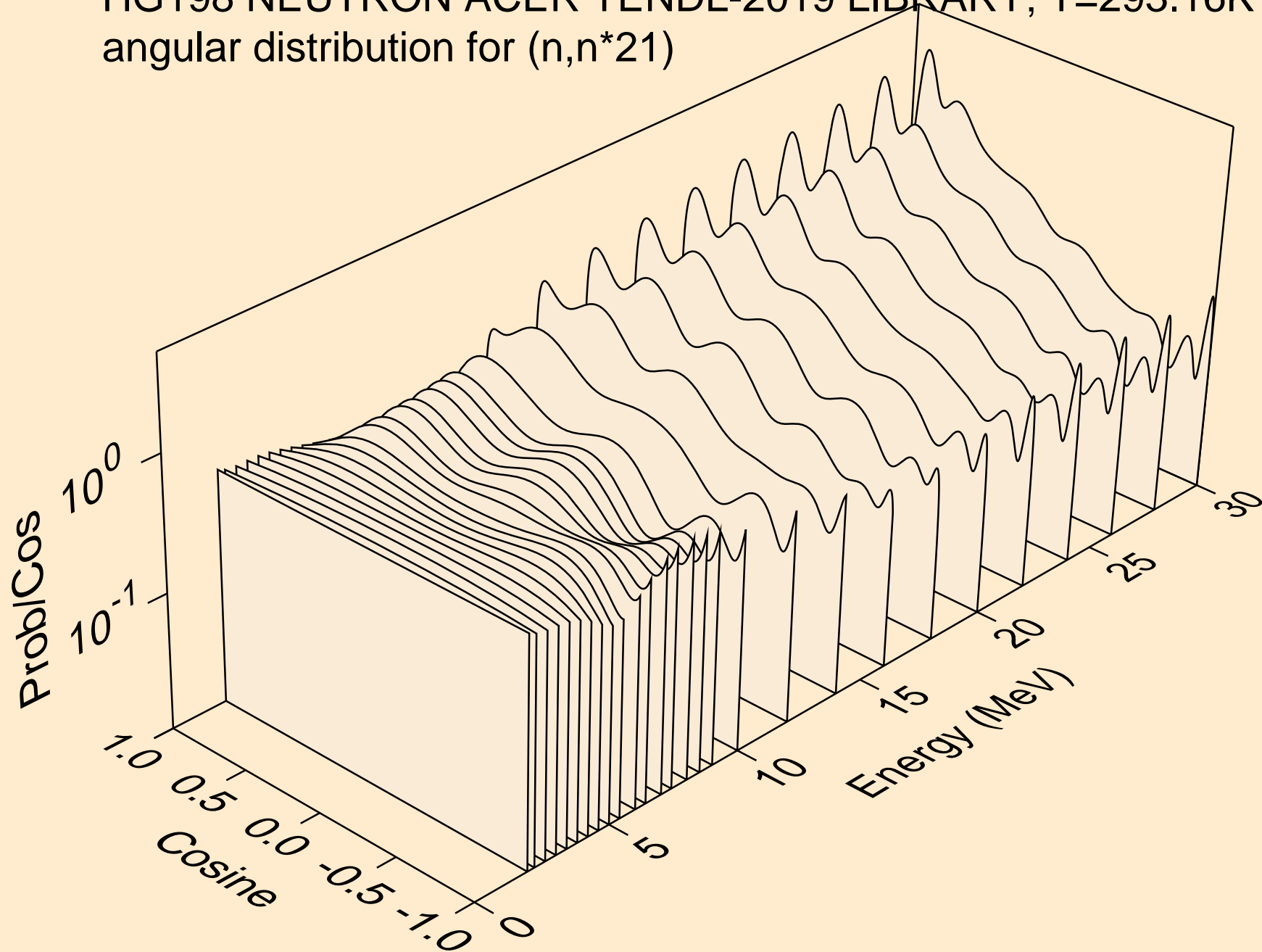

HG198 NEUTRON ACER TENDL-2019 LIBRARY; T=293.16K  
angular distribution for (n,n\*22)

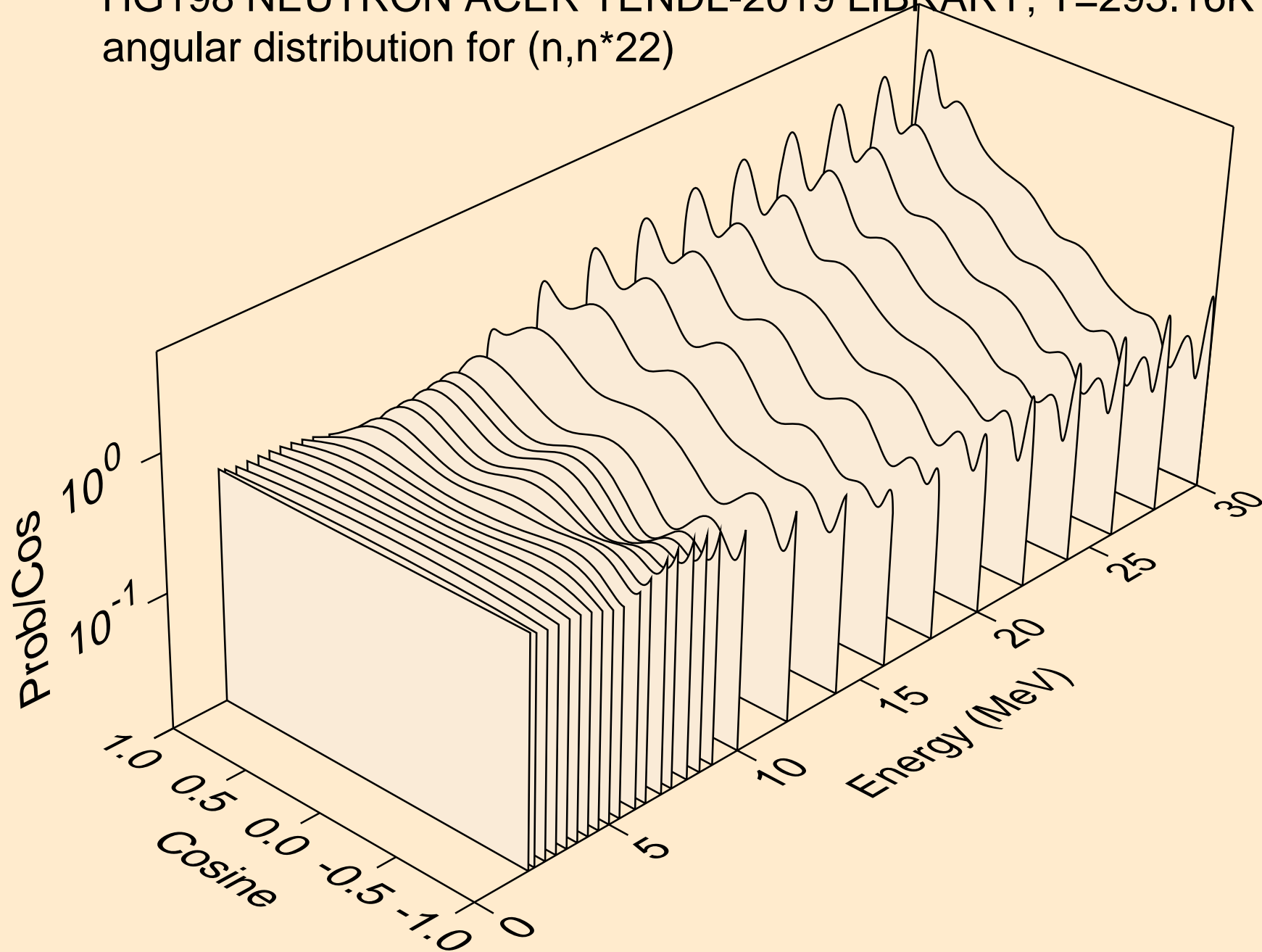

HG198 NEUTRON ACER TENDL-2019 LIBRARY; T=293.16K  
angular distribution for (n,n\*23)

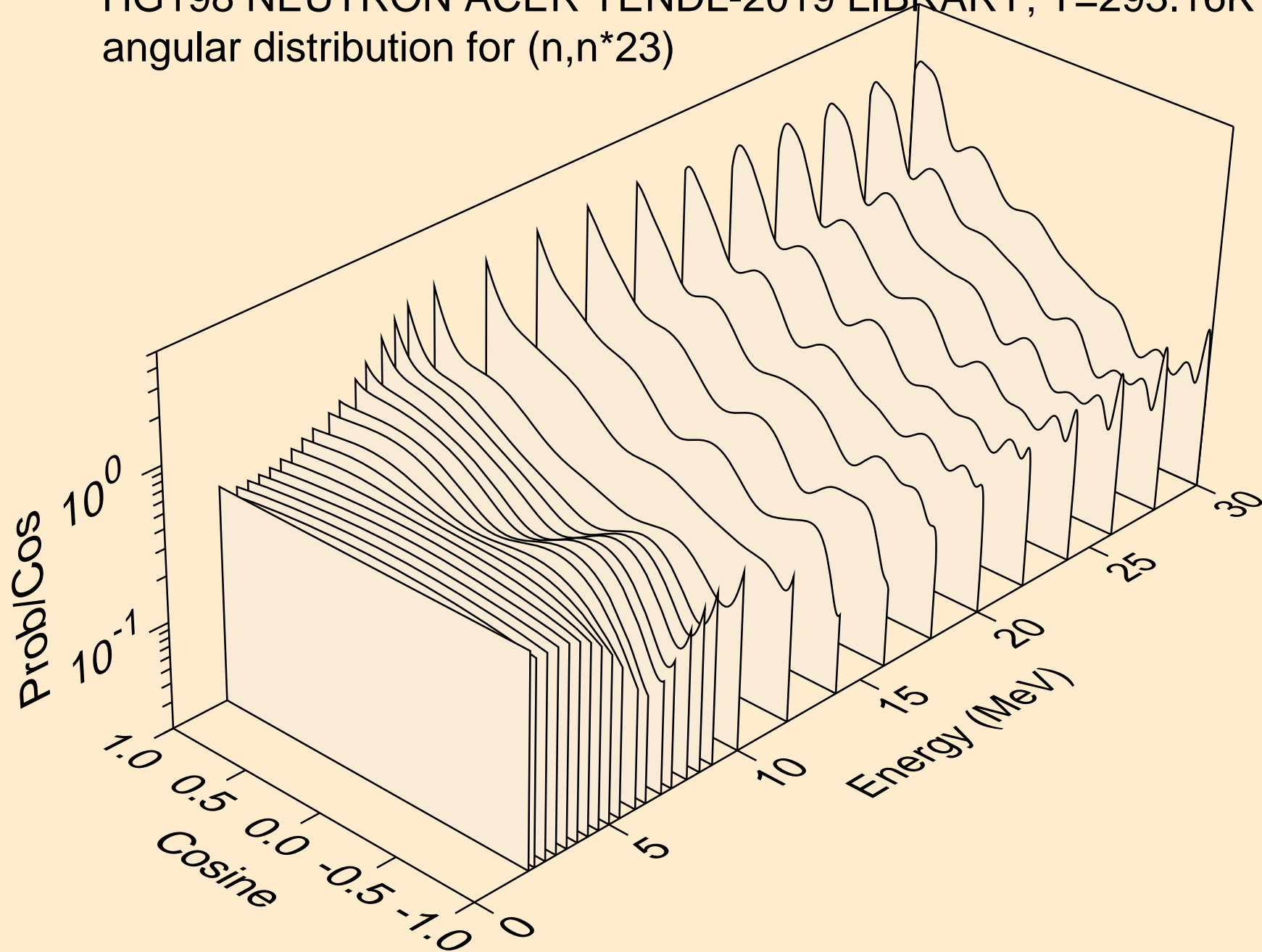



HG198 NEUTRON ACER TENDL-2019 LIBRARY; T=293.16K  
angular distribution for (n,n\*24)

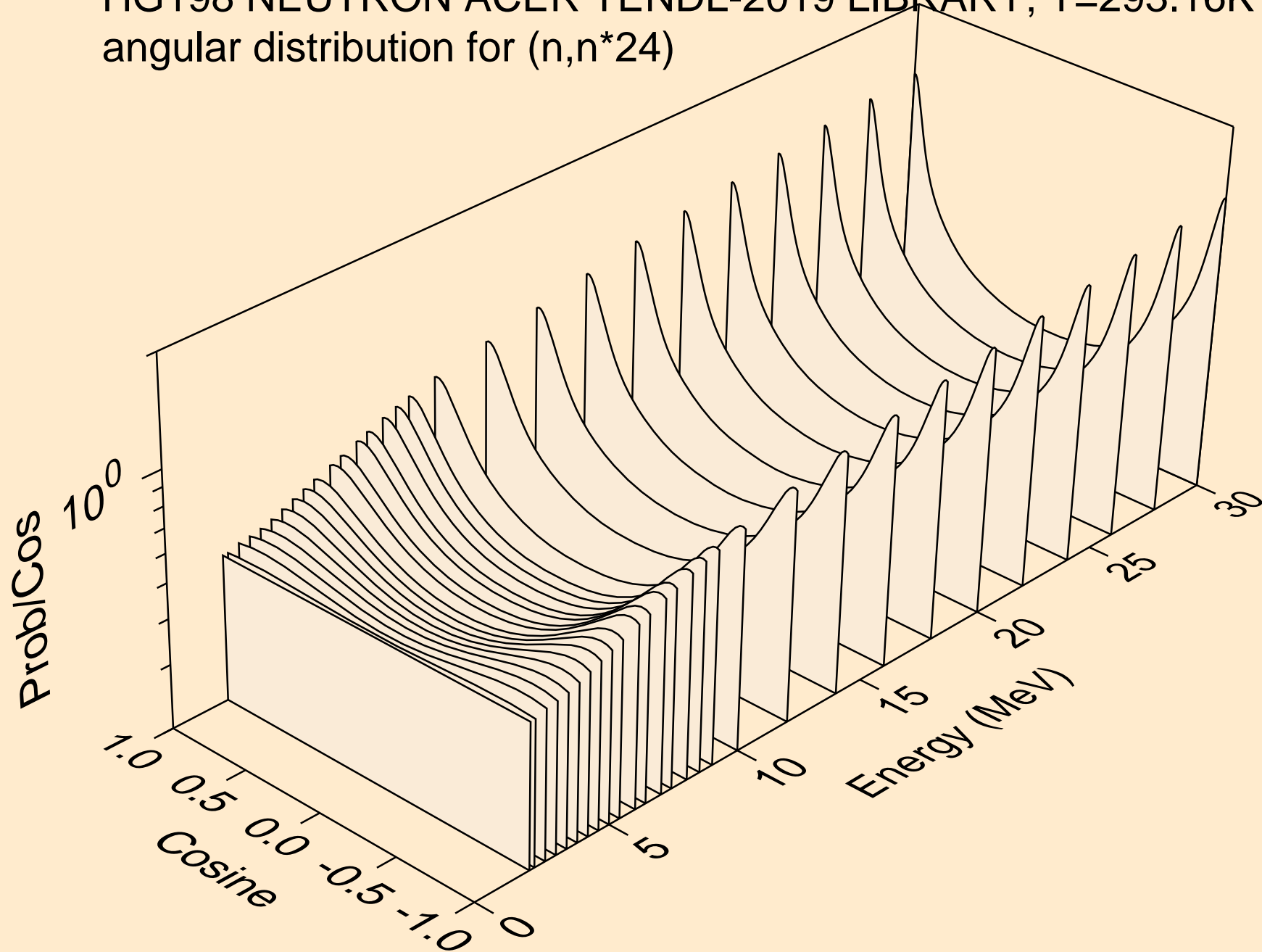

HG198 NEUTRON ACER TENDL-2019 LIBRARY; T=293.16K  
angular distribution for (n,n\*25)

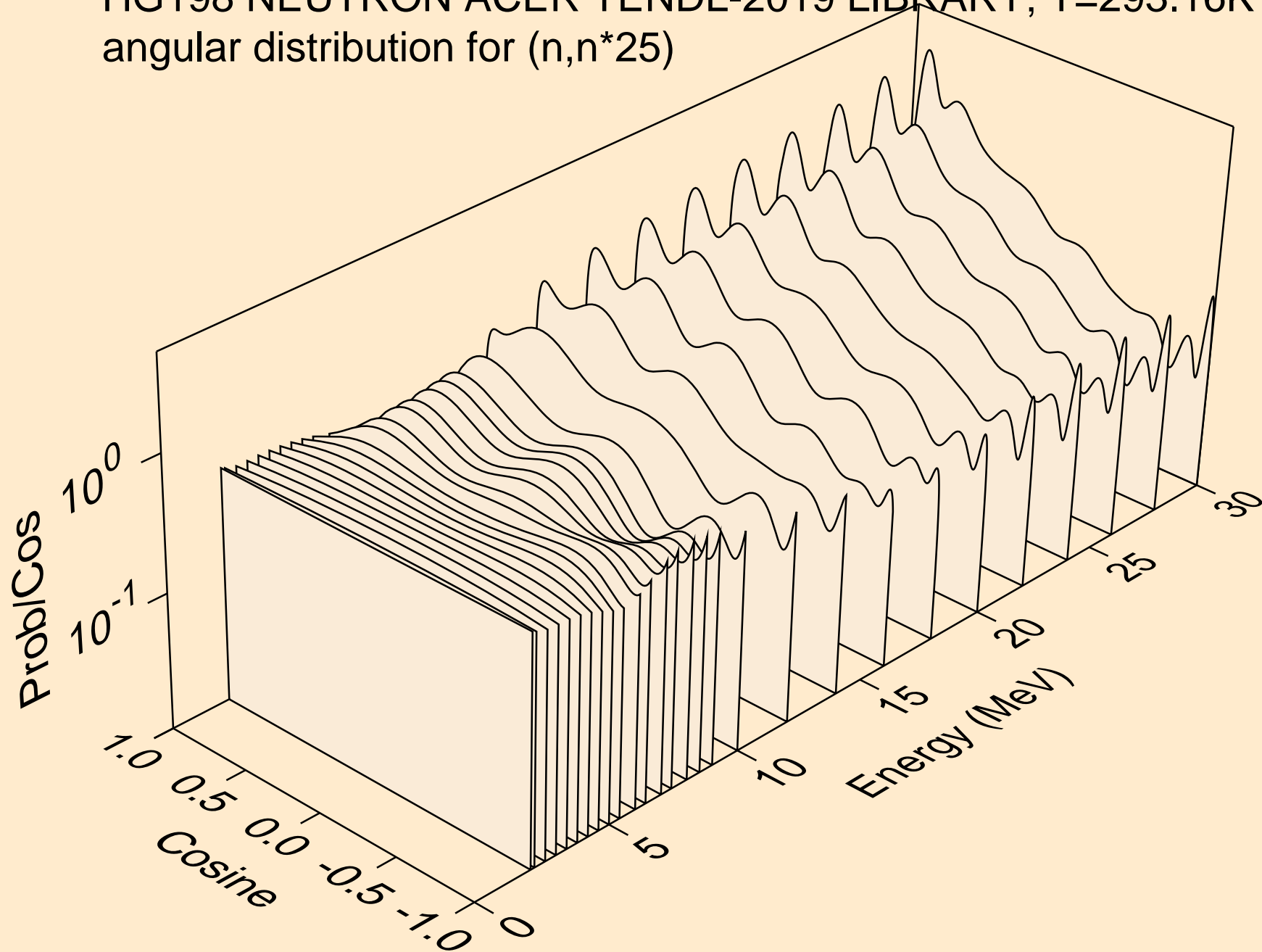

HG198 NEUTRON ACER TENDL-2019 LIBRARY; T=293.16K  
angular distribution for (n,n\*26)

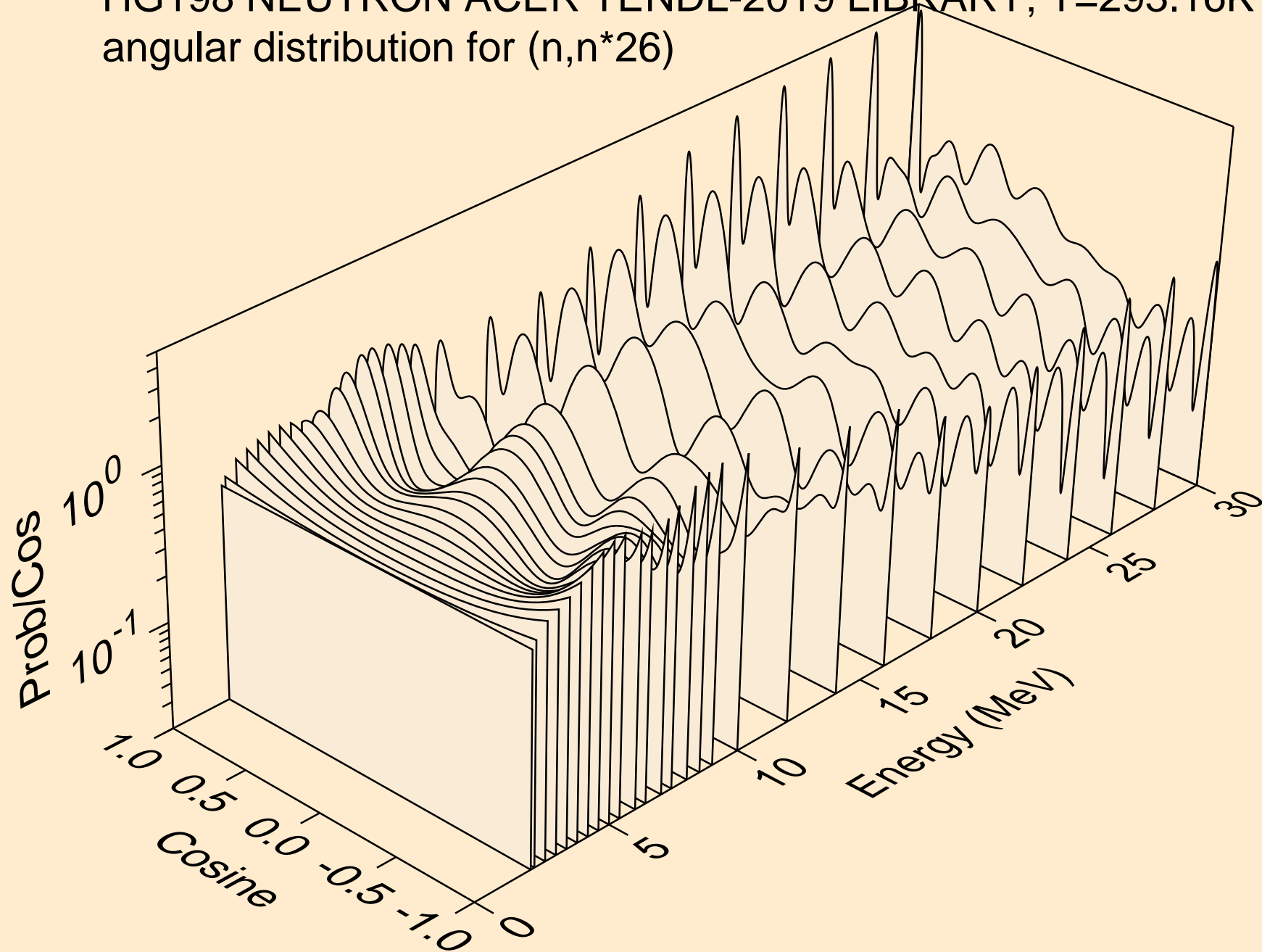

HG198 NEUTRON ACER TENDL-2019 LIBRARY; T=293.16K  
angular distribution for (n,n\*27)

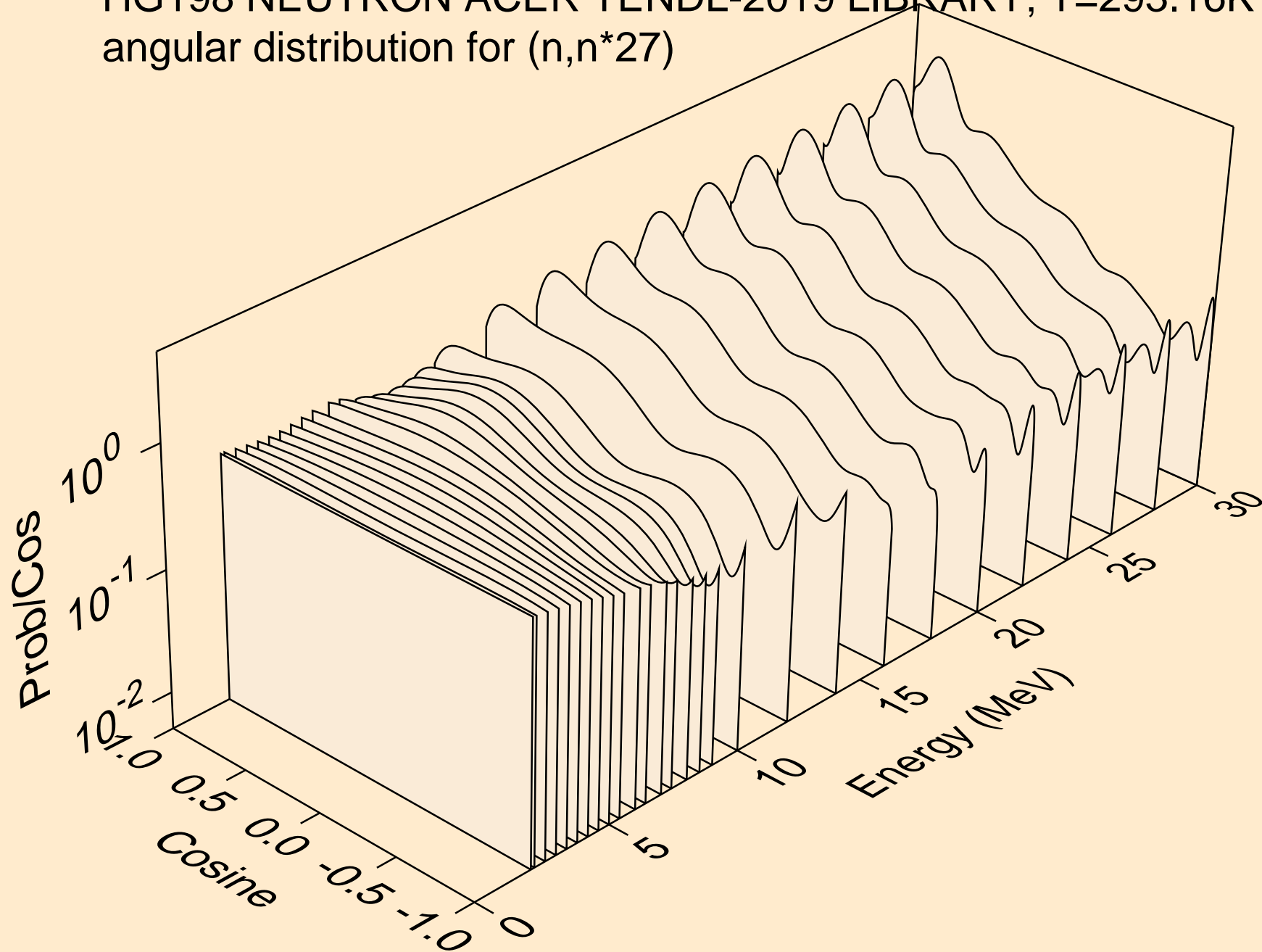

HG198 NEUTRON ACER TENDL-2019 LIBRARY; T=293.16K  
angular distribution for (n,n\*28)

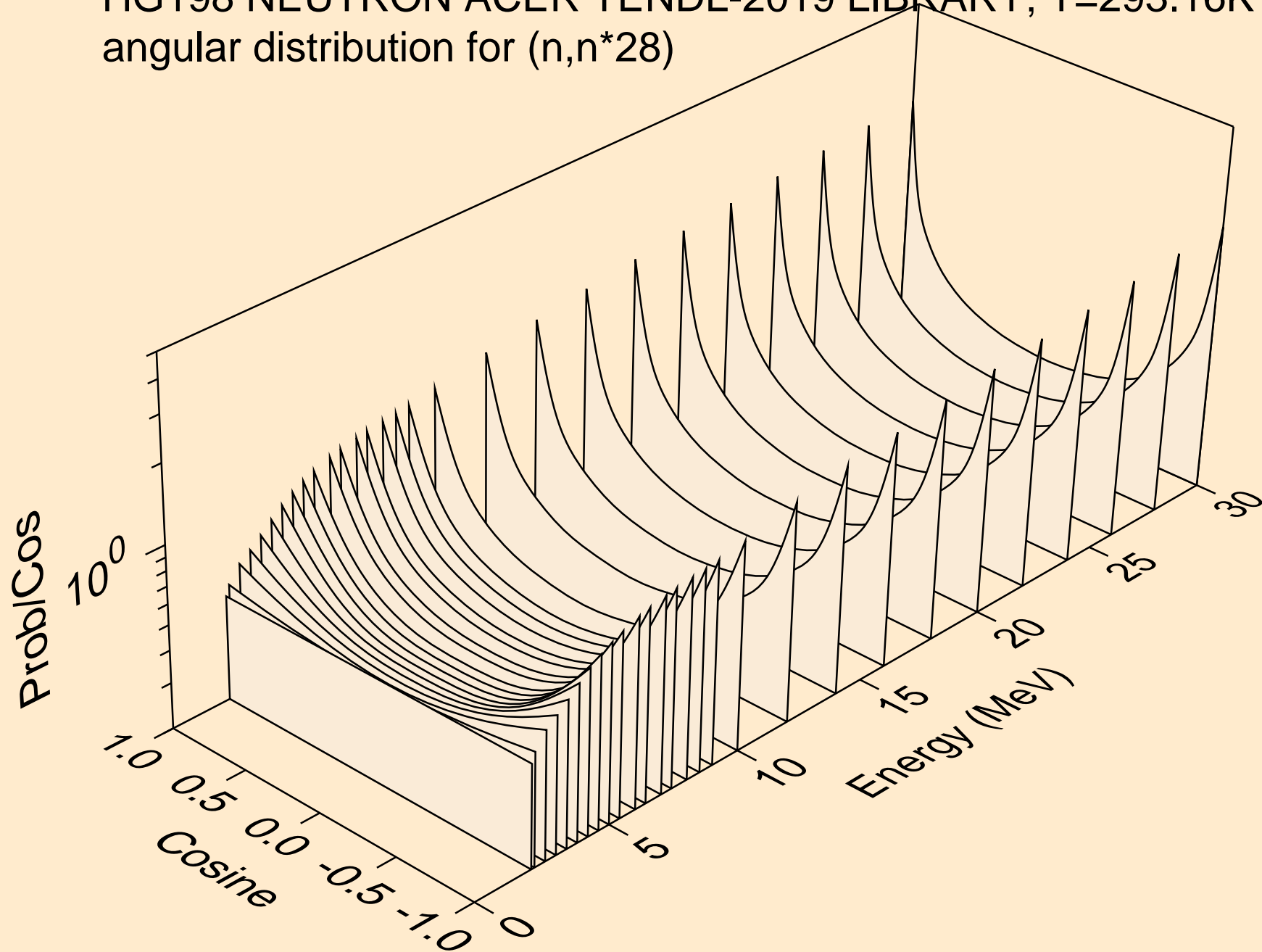

HG198 NEUTRON ACER TENDL-2019 LIBRARY; T=293.16K  
angular distribution for (n,n\*29)

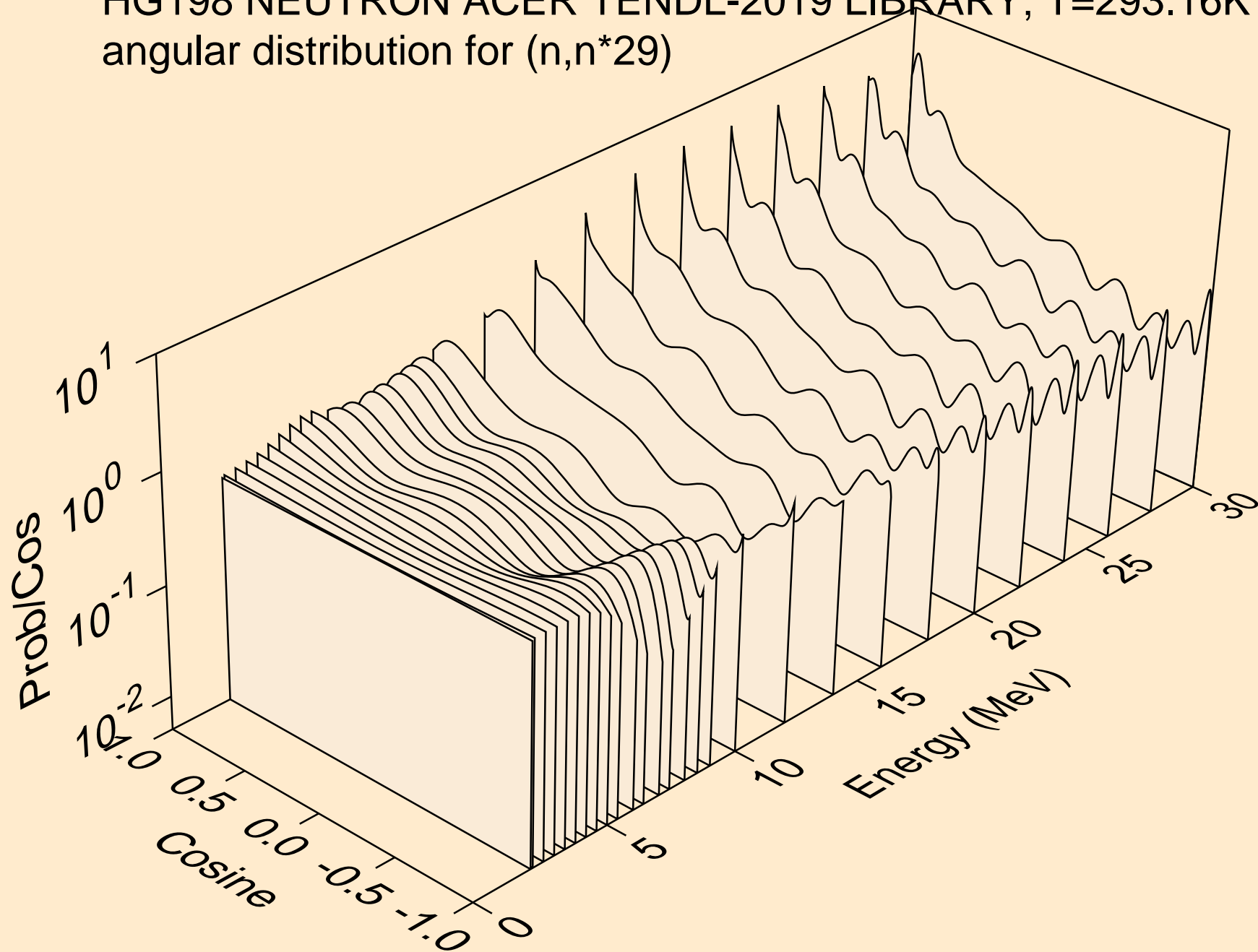

HG198 NEUTRON ACER TENDL-2019 LIBRARY; T=293.16K  
Neutron emission for (n,x)

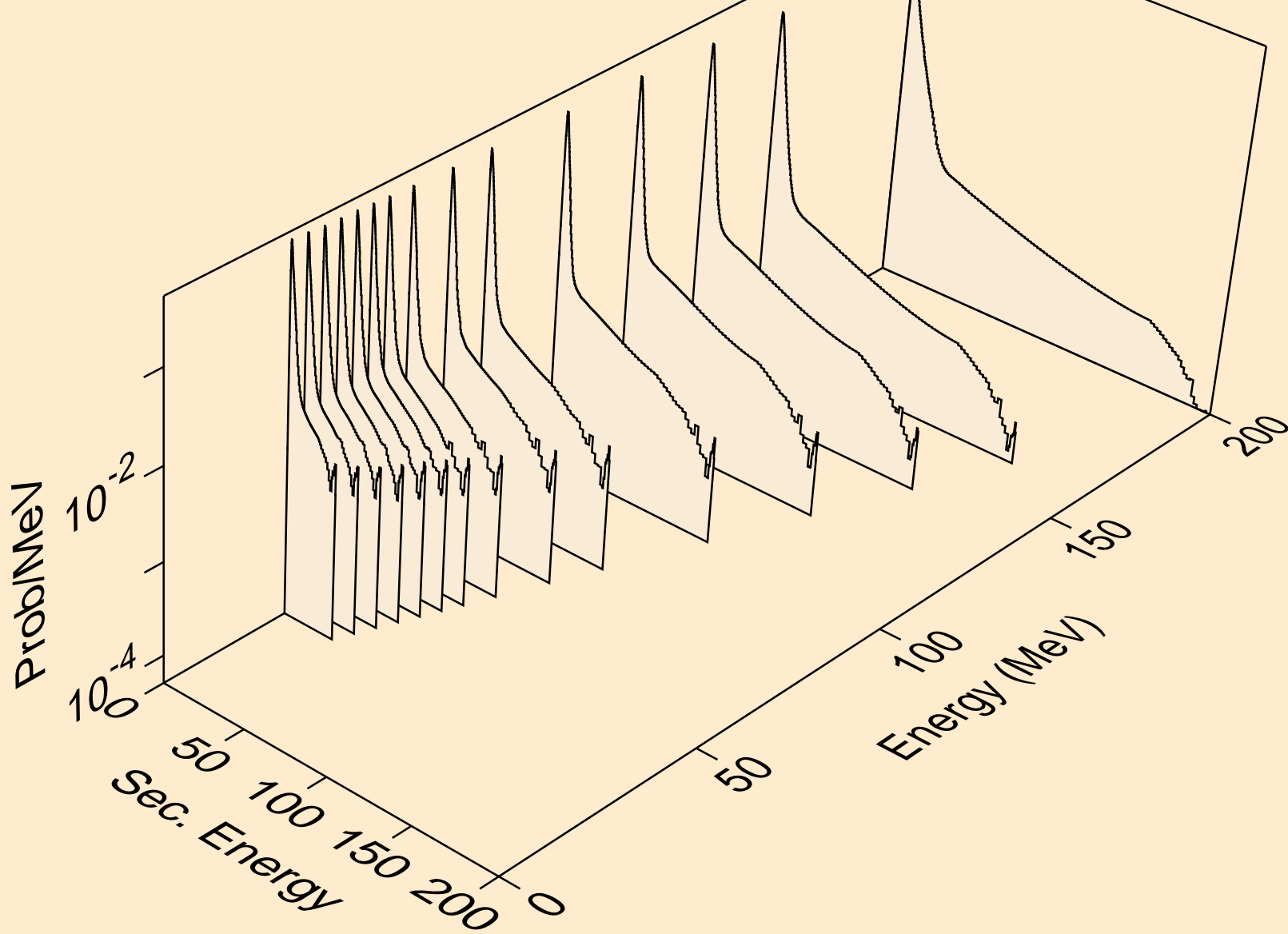

HG198 NEUTRON ACER TENDL-2019 LIBRARY; T=293.16K  
Neutron emission for (n,2nd)

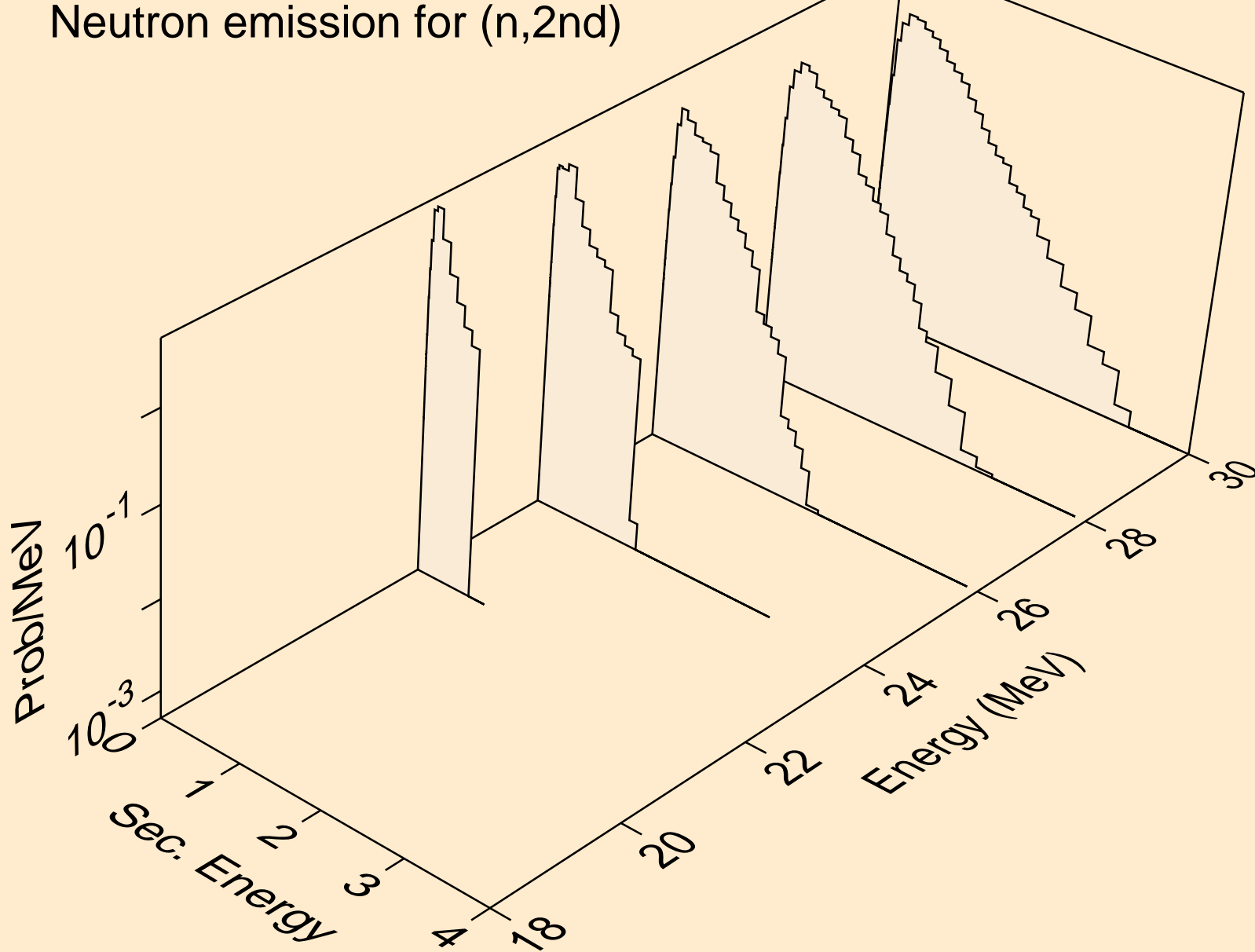



HG198 NEUTRON ACER TENDL-2019 LIBRARY; T=293.16K  
Neutron emission for (n,2n)

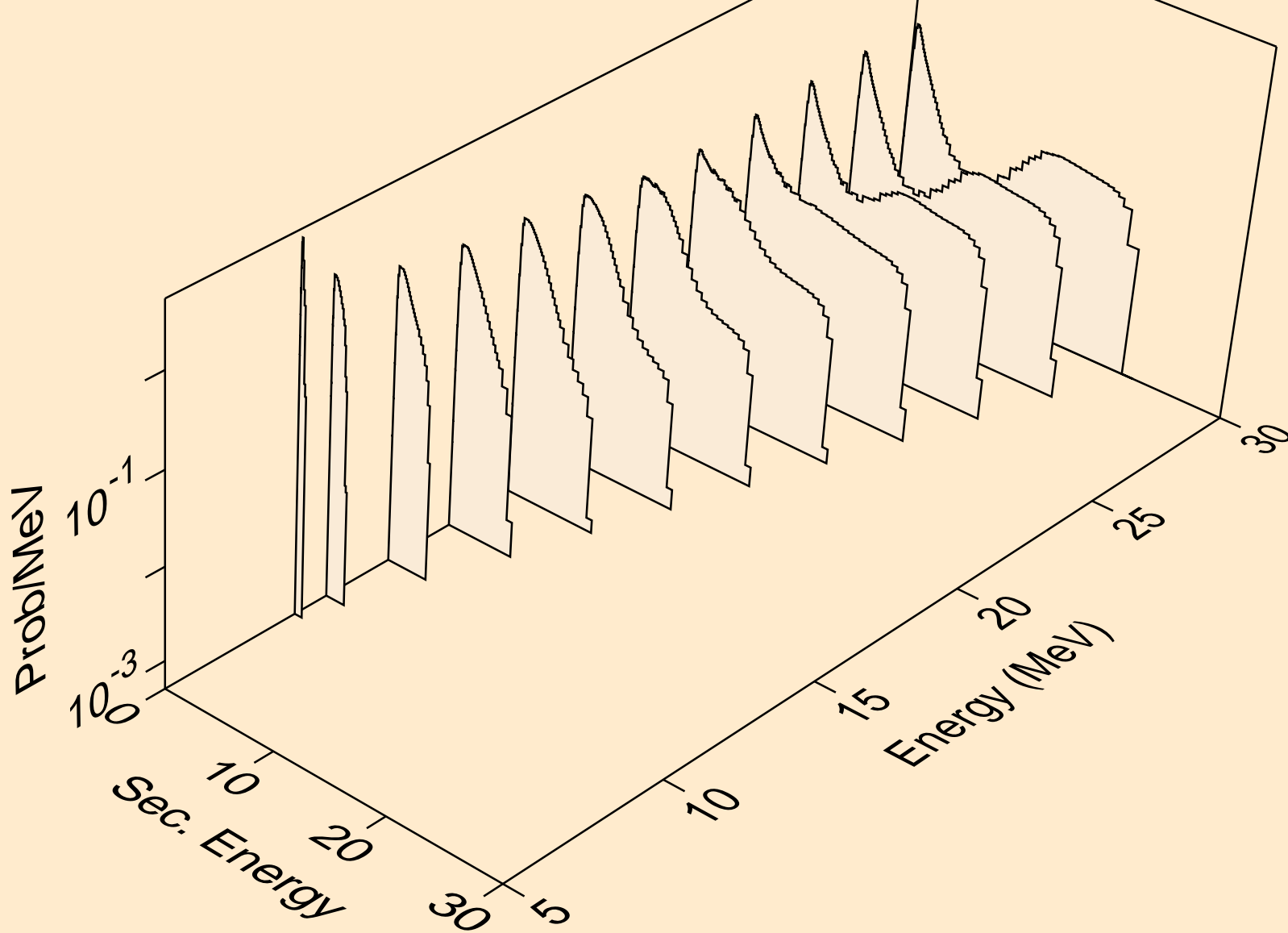

HG198 NEUTRON ACER TENDL-2019 LIBRARY; T=293.16K  
Neutron emission for (n,3n)

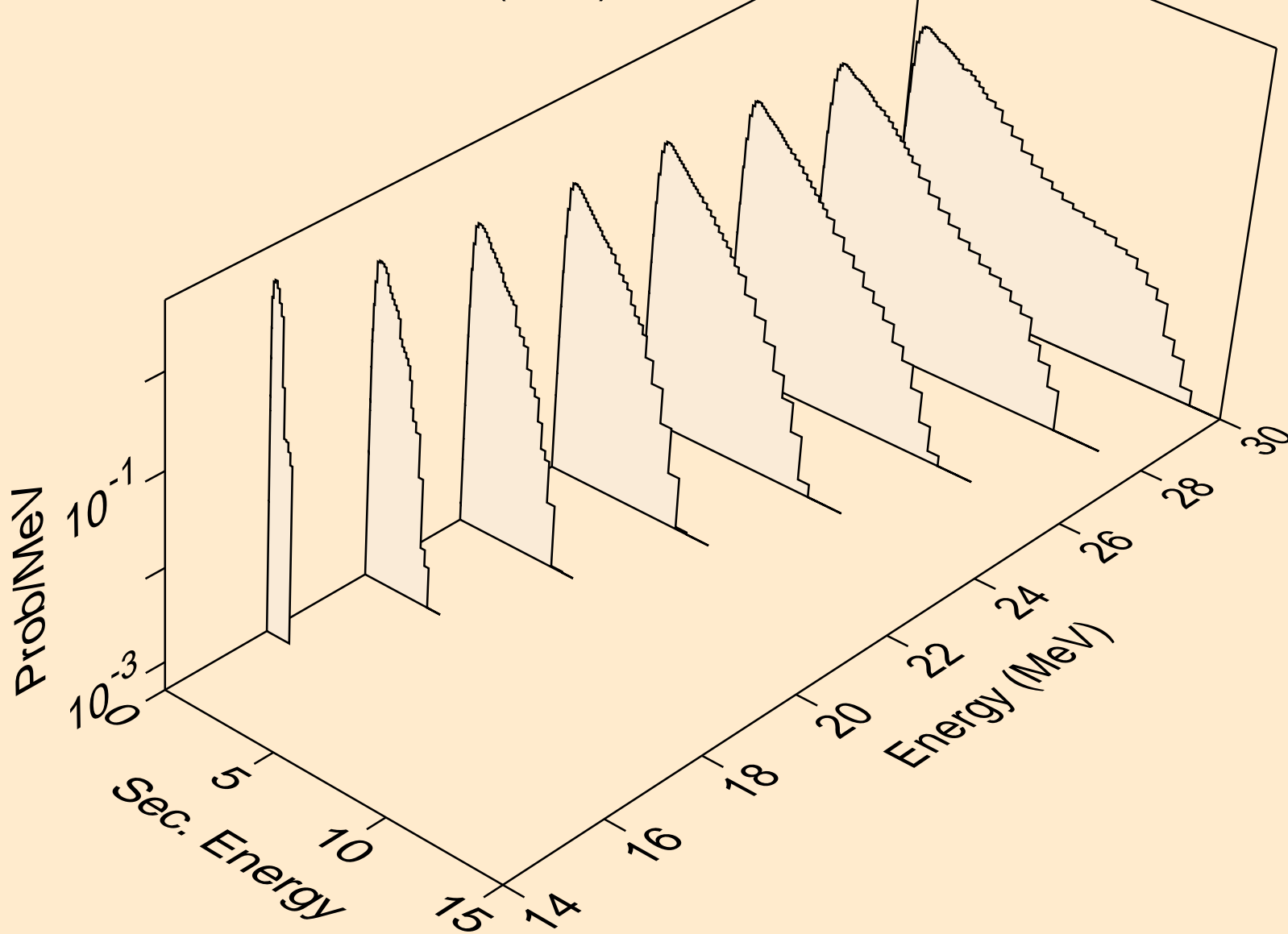

HG198 NEUTRON ACER TENDL-2019 LIBRARY; T=293.16K  
Neutron emission for (n,n\*)a

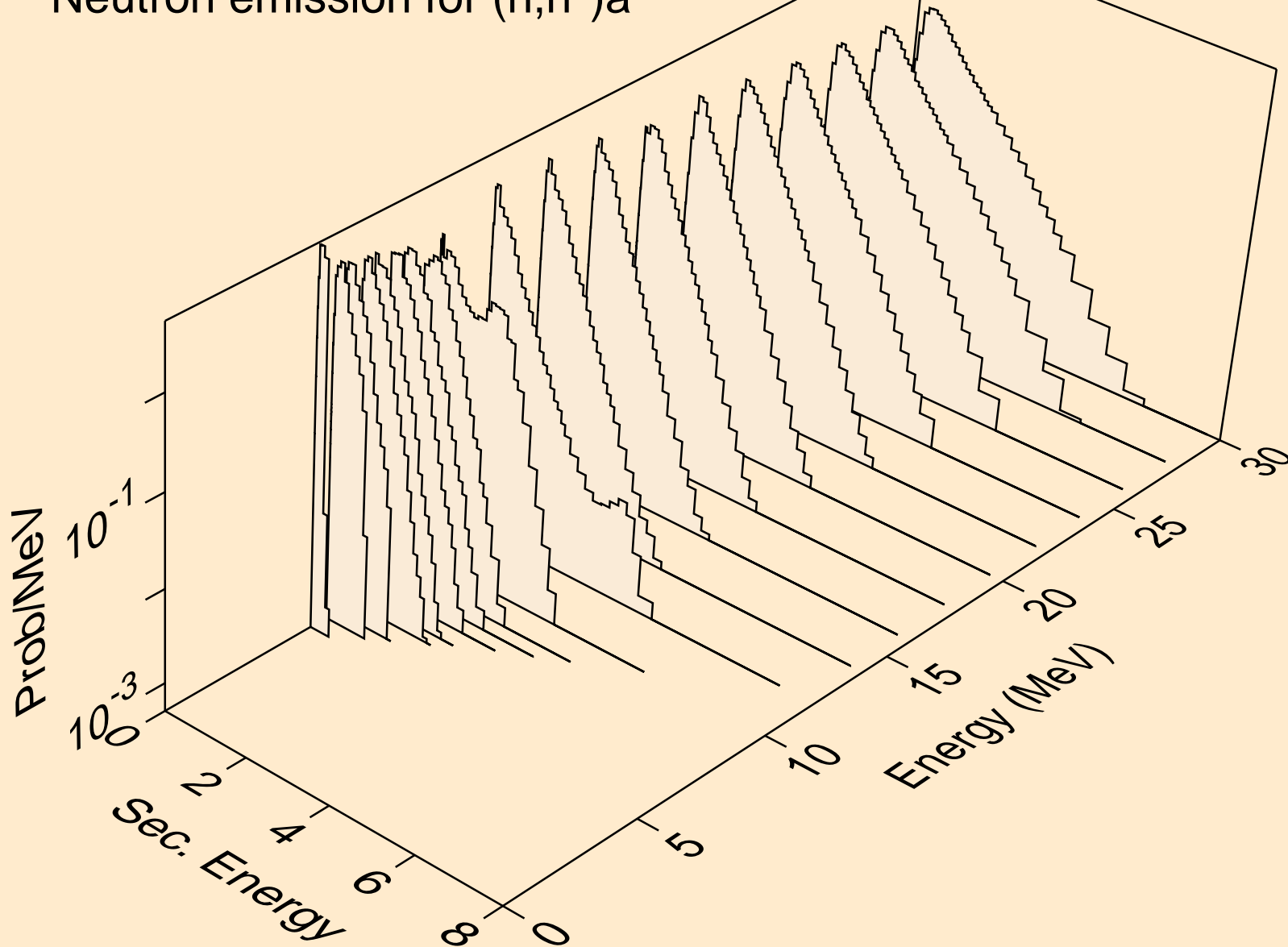

HG198 NEUTRON ACER TENDL-2019 LIBRARY; T=293.16K  
Neutron emission for (n,2n)a

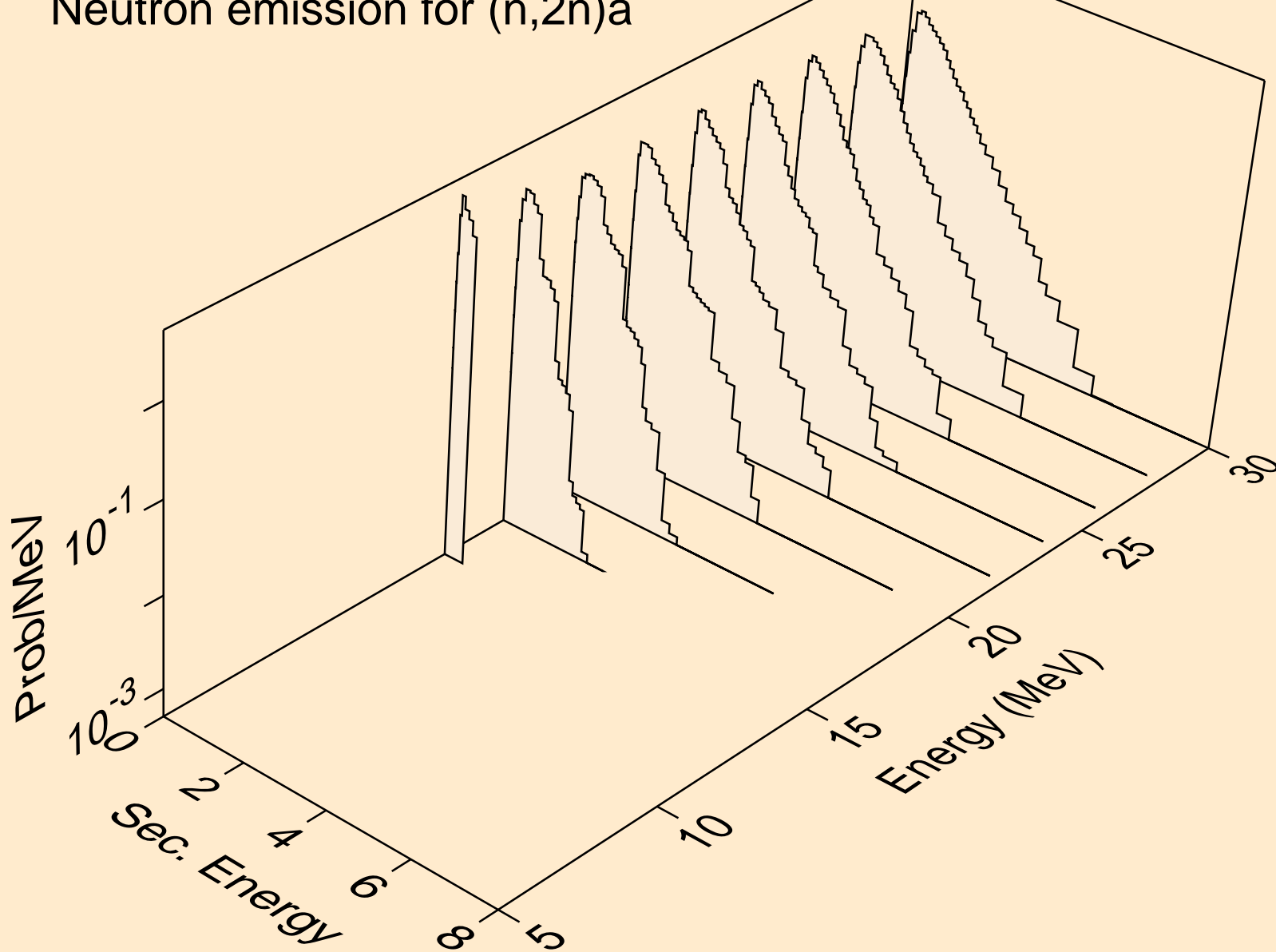

HG198 NEUTRON ACER TENDL-2019 LIBRARY; T=293.16K  
Neutron emission for (n,3n)a

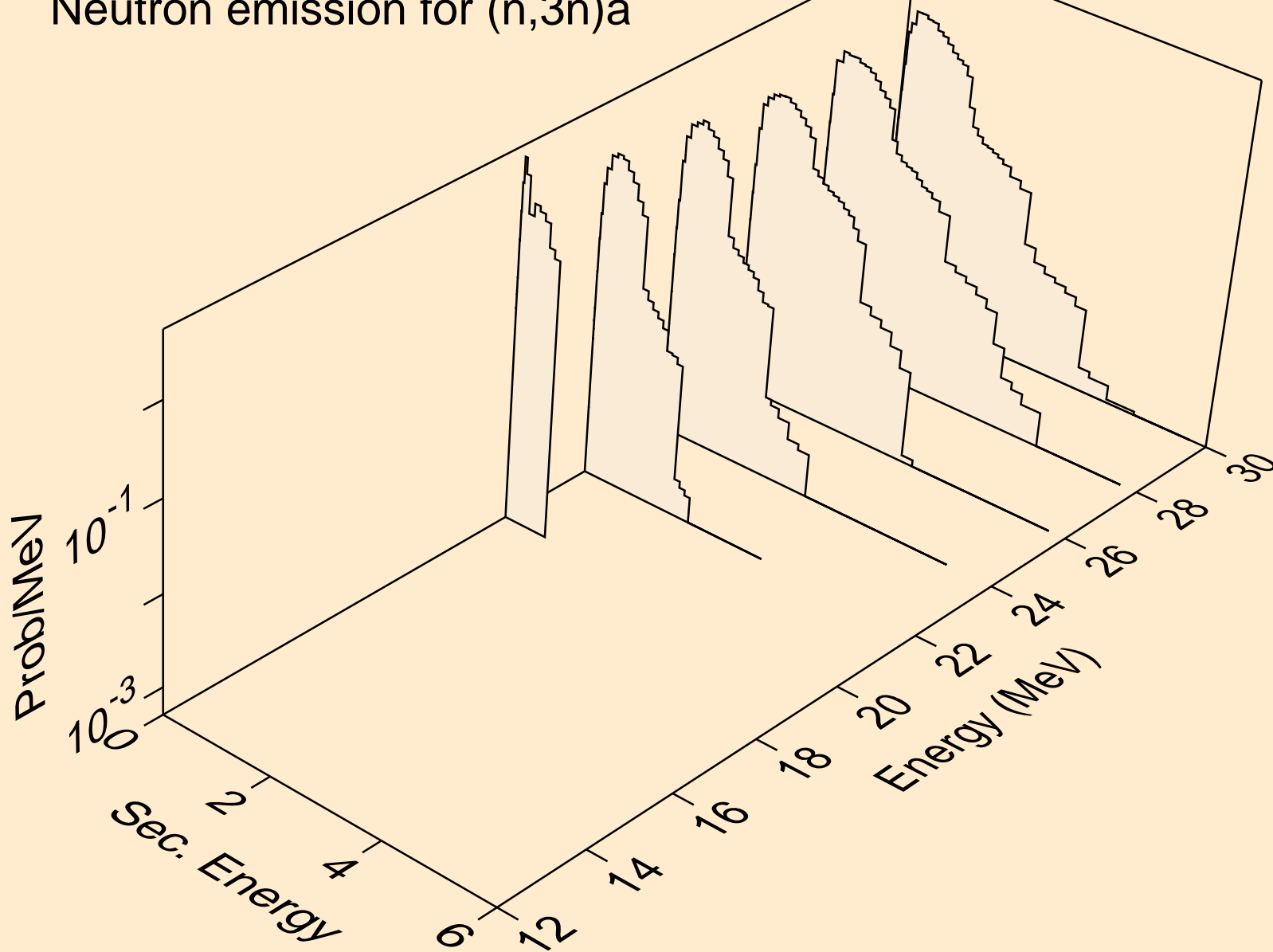

HG198 NEUTRON ACER TENDL-2019 LIBRARY; T=293.16K  
Neutron emission for (n,n\*)p

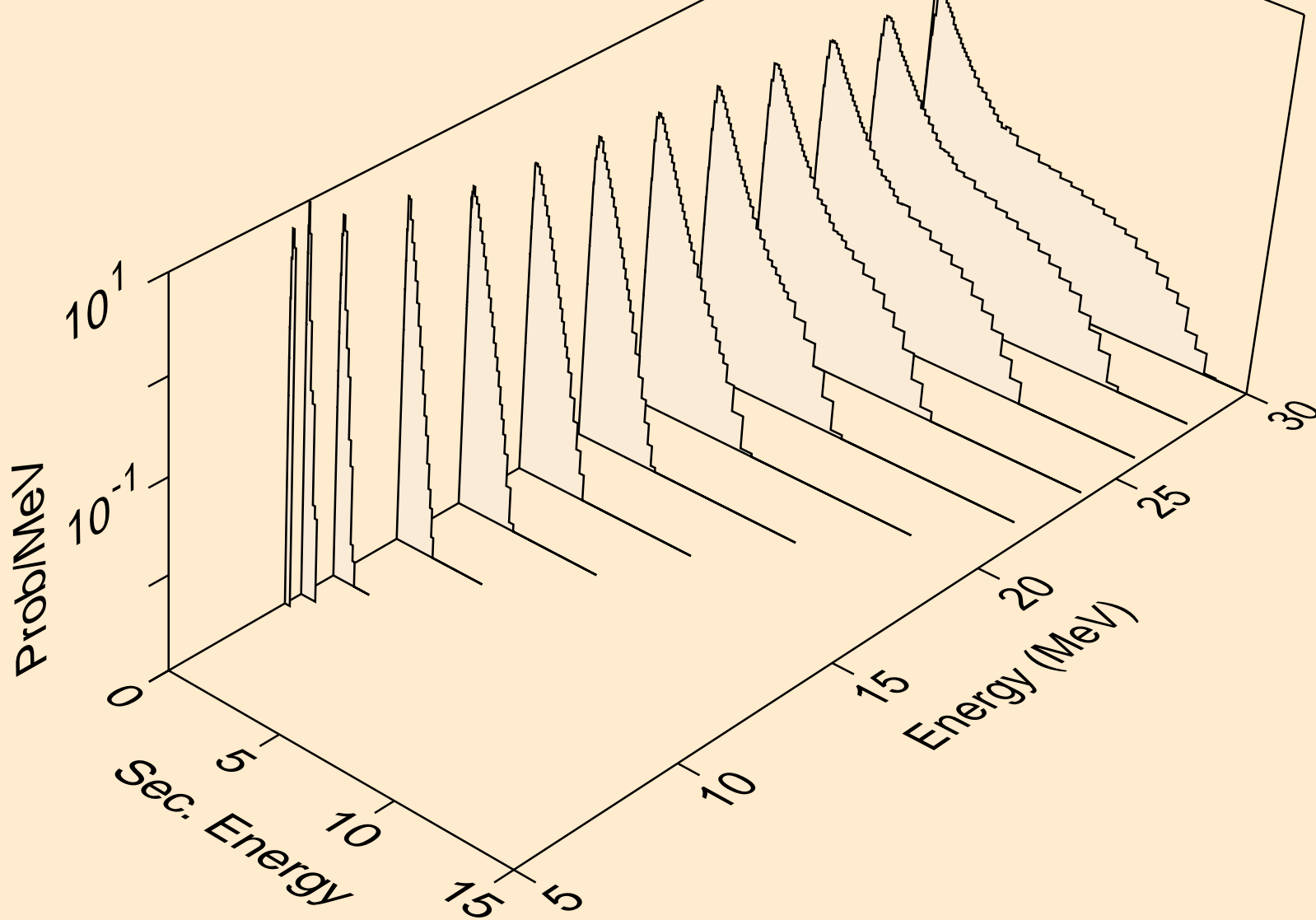

HG198 NEUTRON ACER TENDL-2019 LIBRARY; T=293.16K  
Neutron emission for (n,n\*)d

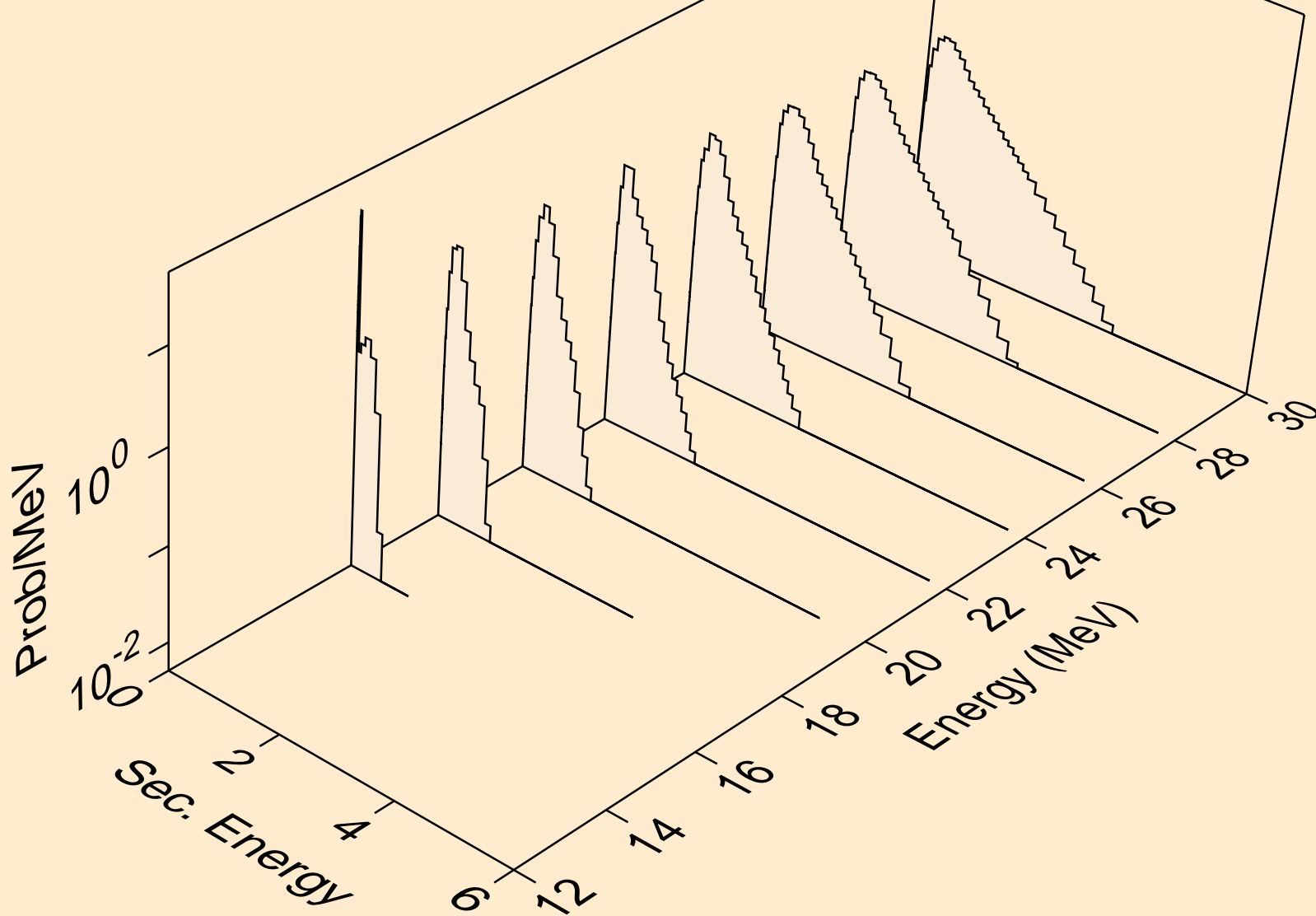

HG198 NEUTRON ACER TENDL-2019 LIBRARY; T=293.16K  
Neutron emission for (n,n\*)t

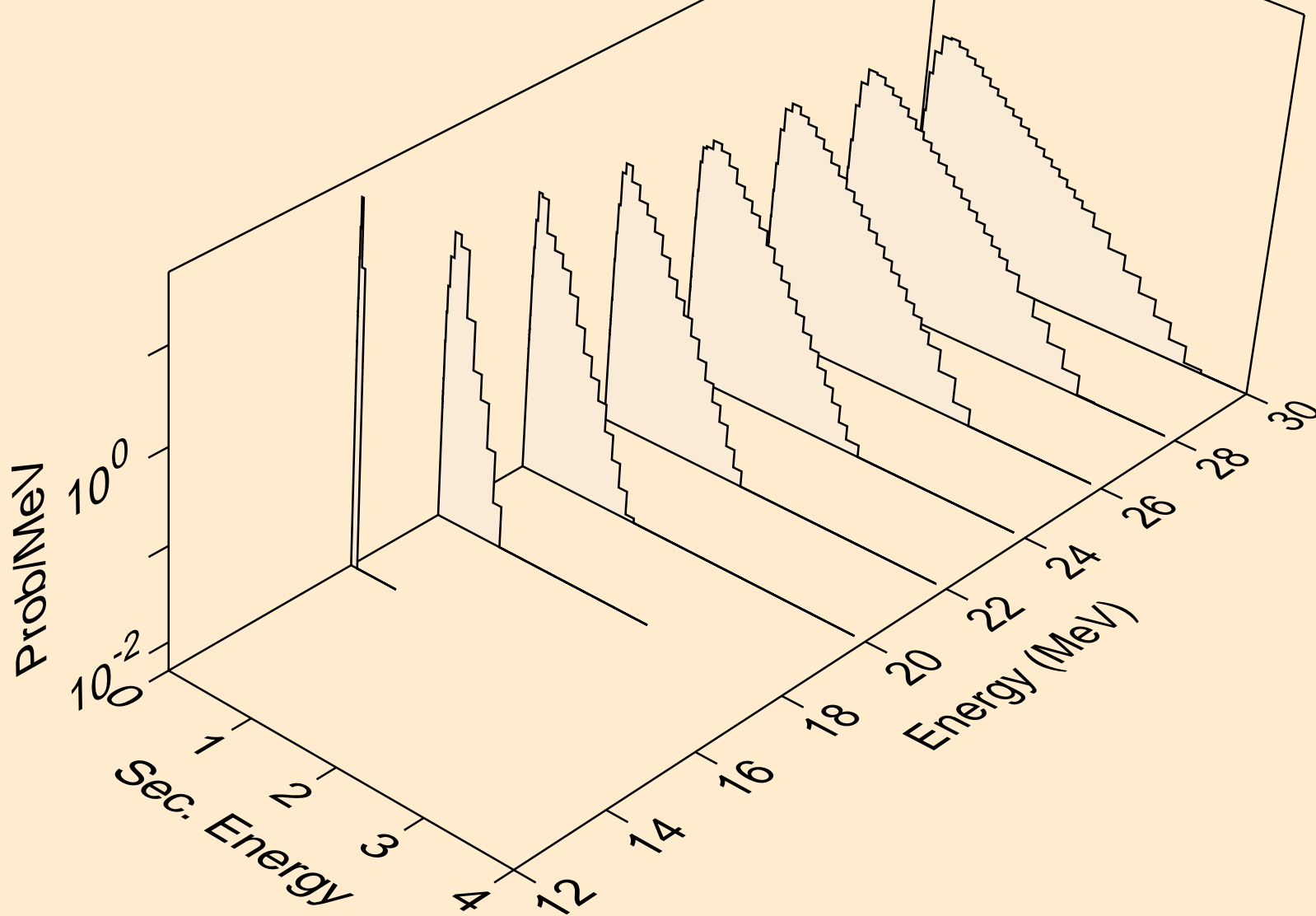



HG198 NEUTRON ACER TENDL-2019 LIBRARY; T=293.16K  
Neutron emission for (n,n\*)he3

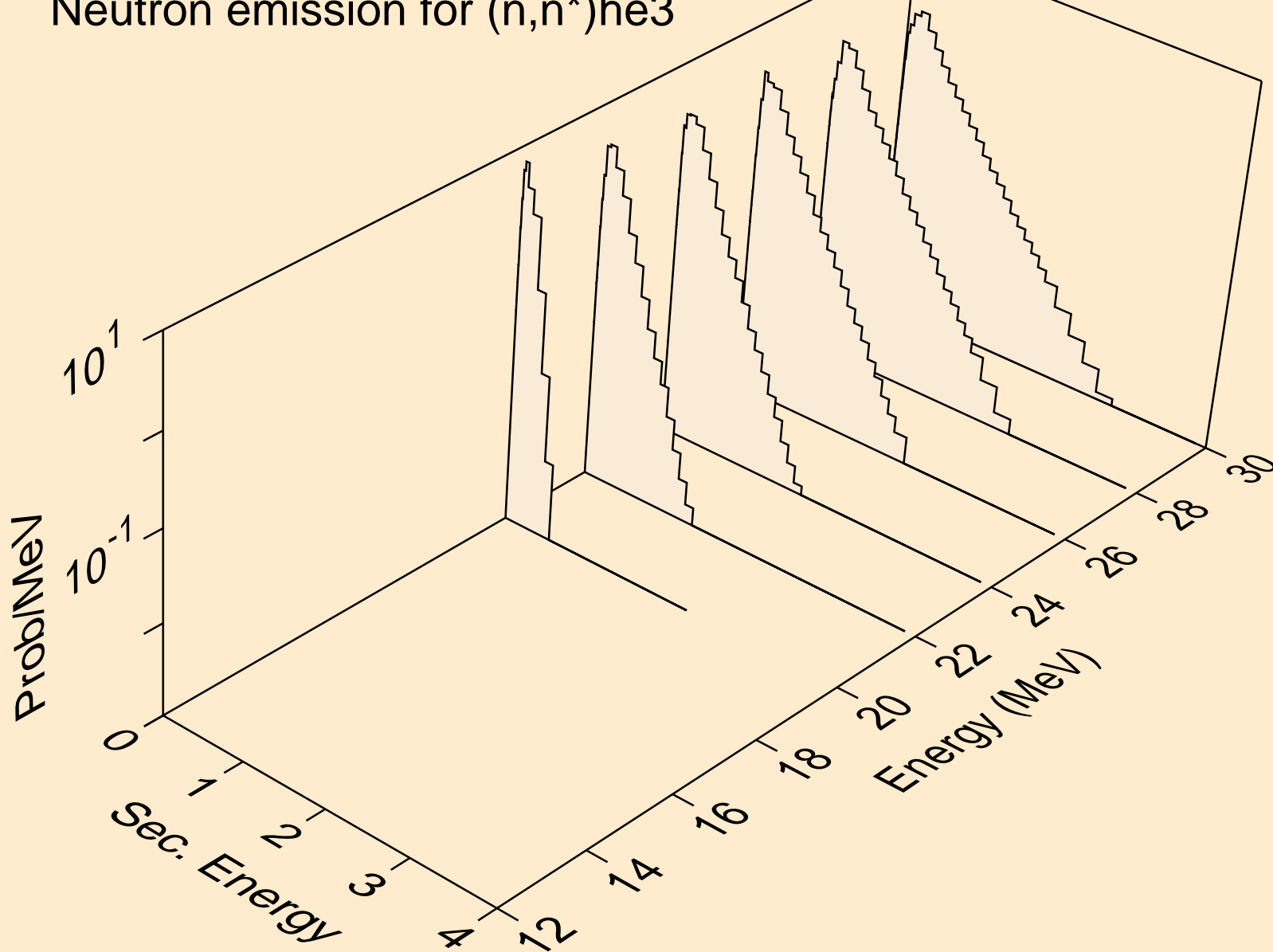

HG198 NEUTRON ACER TENDL-2019 LIBRARY; T=293.16K  
Neutron emission for (n,4n)

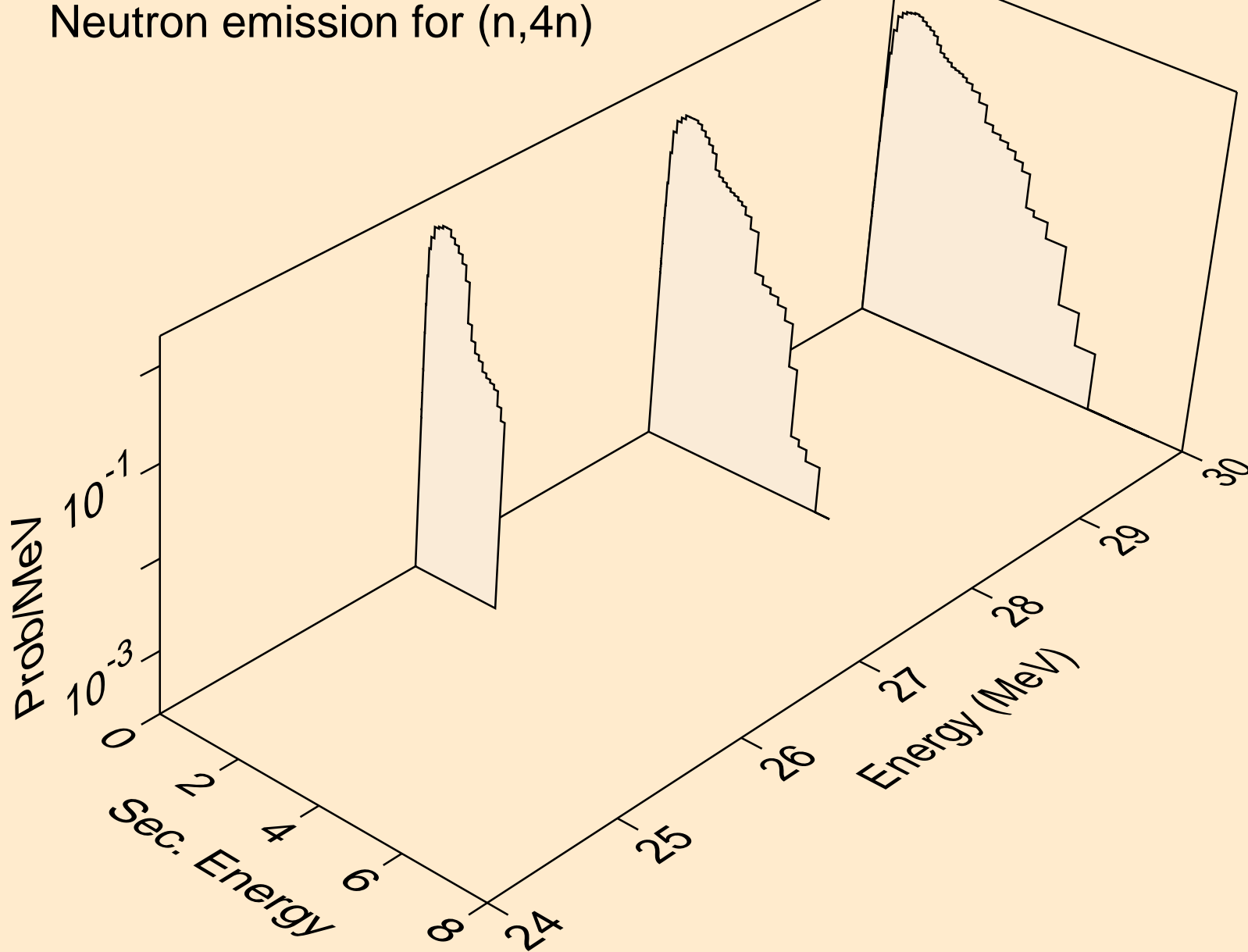

HG198 NEUTRON ACER TENDL-2019 LIBRARY; T=293.16K  
Neutron emission for (n,2np)

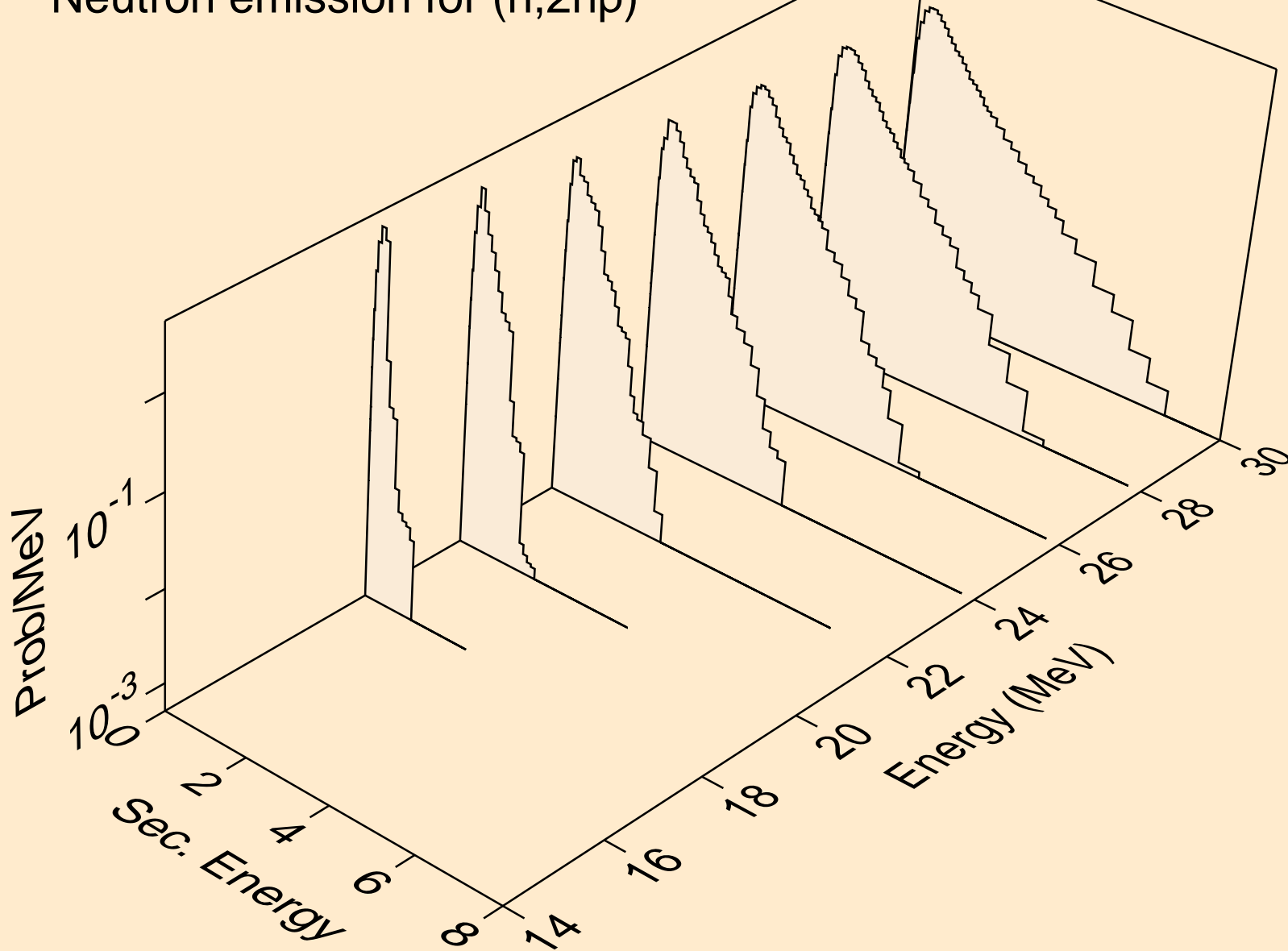

HG198 NEUTRON ACER TENDL-2019 LIBRARY; T=293.16K  
Neutron emission for (n,3np)

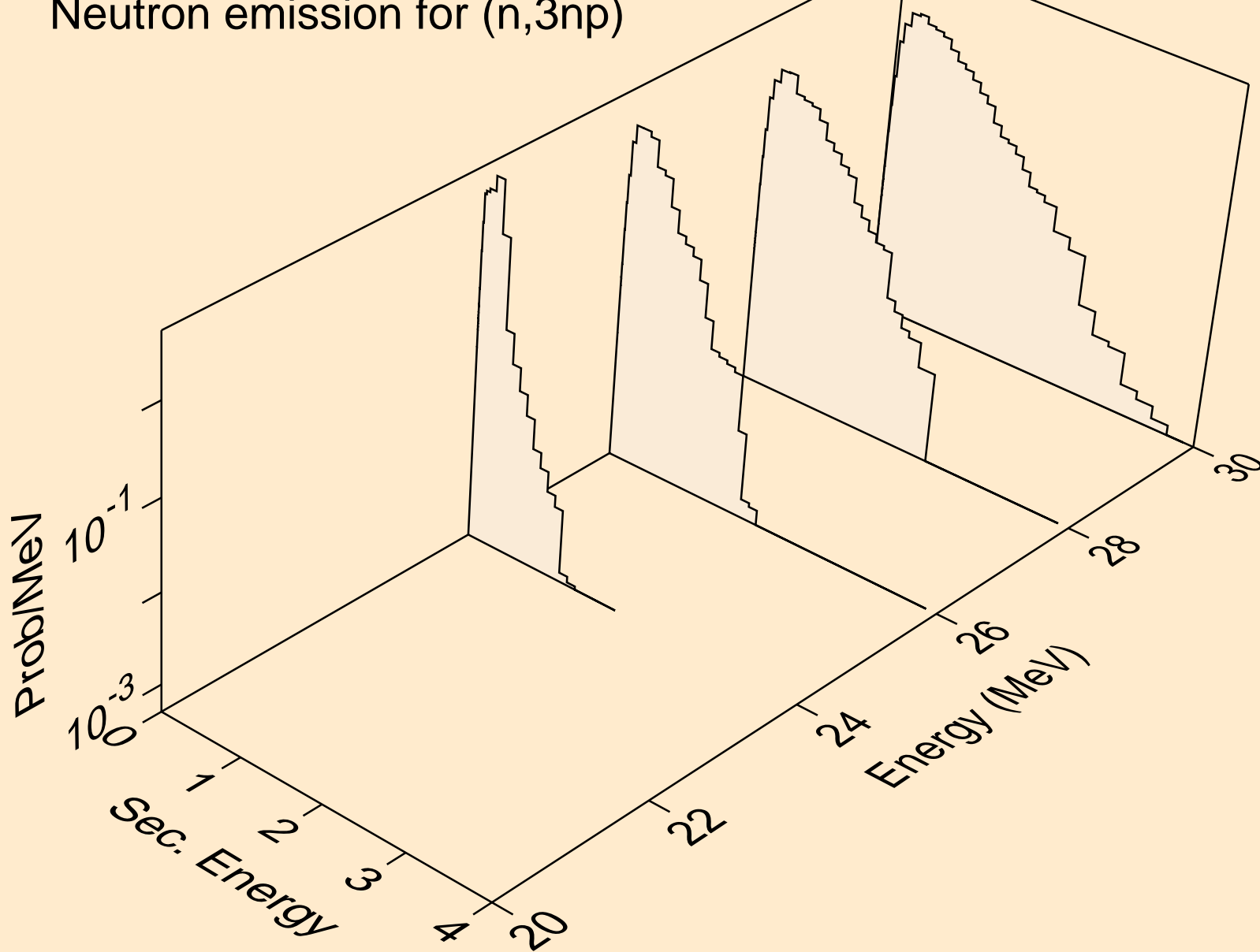

HG198 NEUTRON ACER TENDL-2019 LIBRARY; T=293.16K  
Neutron emission for (n,2np)

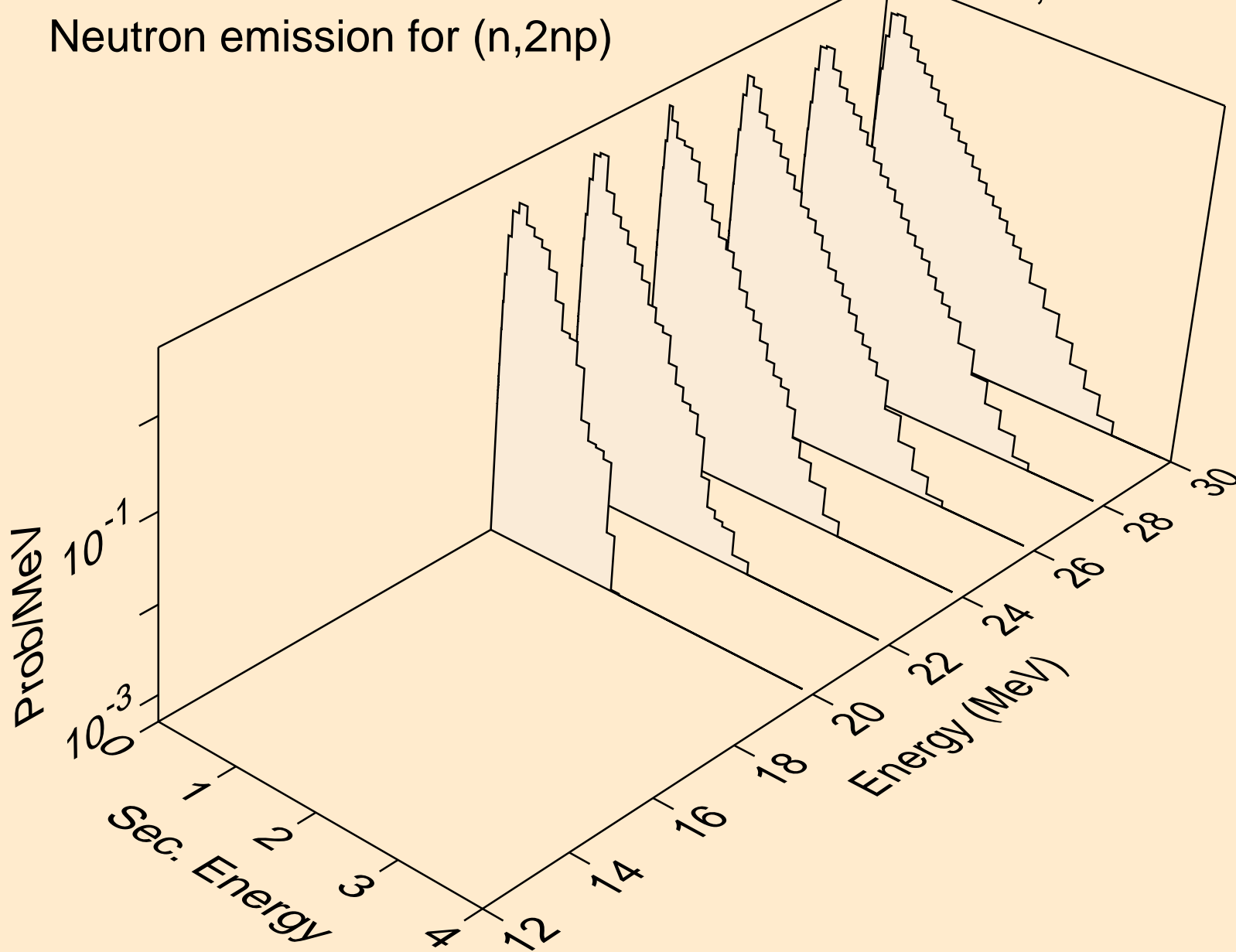

HG198 NEUTRON ACER TENDL-2019 LIBRARY; T=293.16K  
Neutron emission for (n,npa)

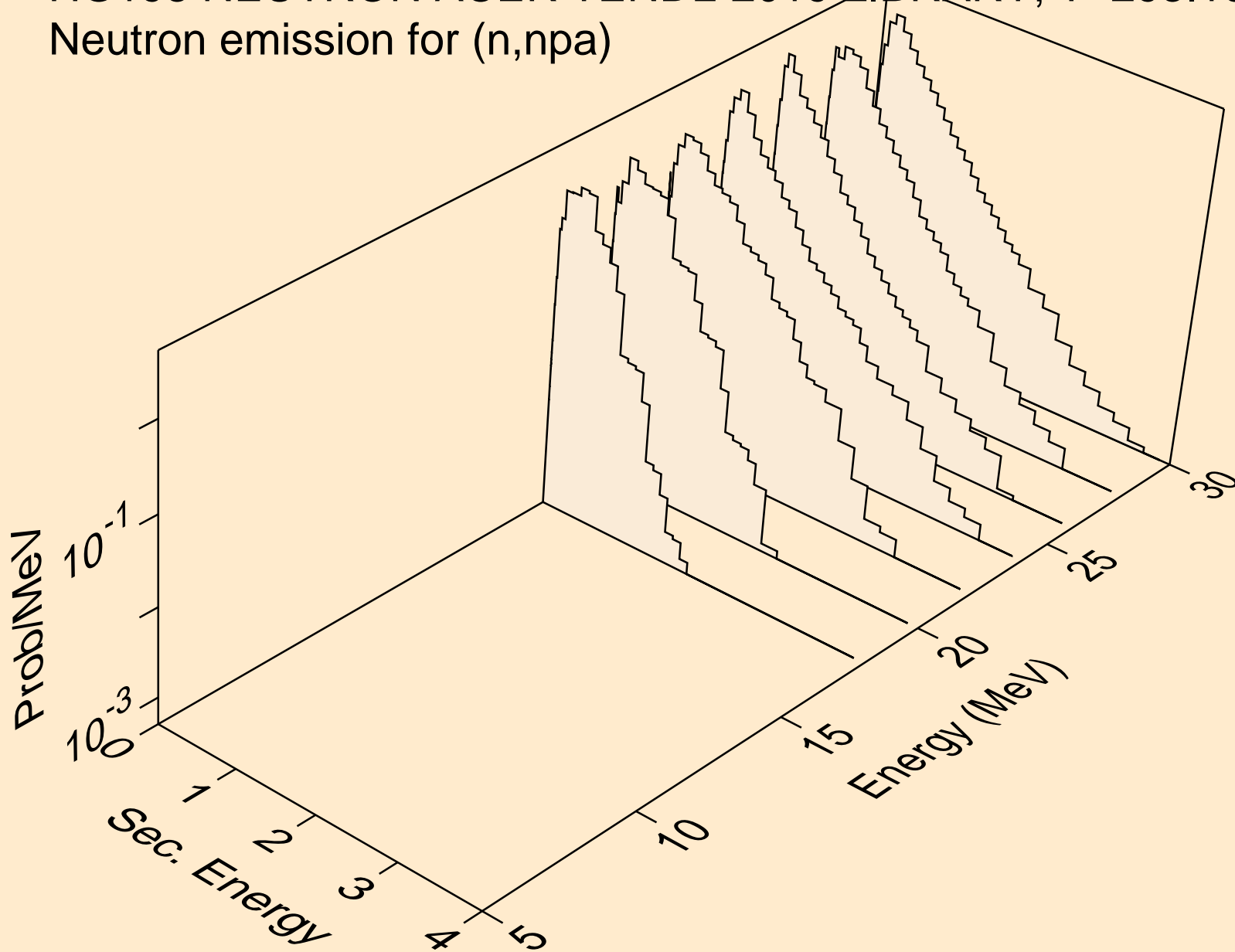

HG198 NEUTRON ACER TENDL-2019 LIBRARY; T=293.16K  
Neutron emission for (n,n\*c)

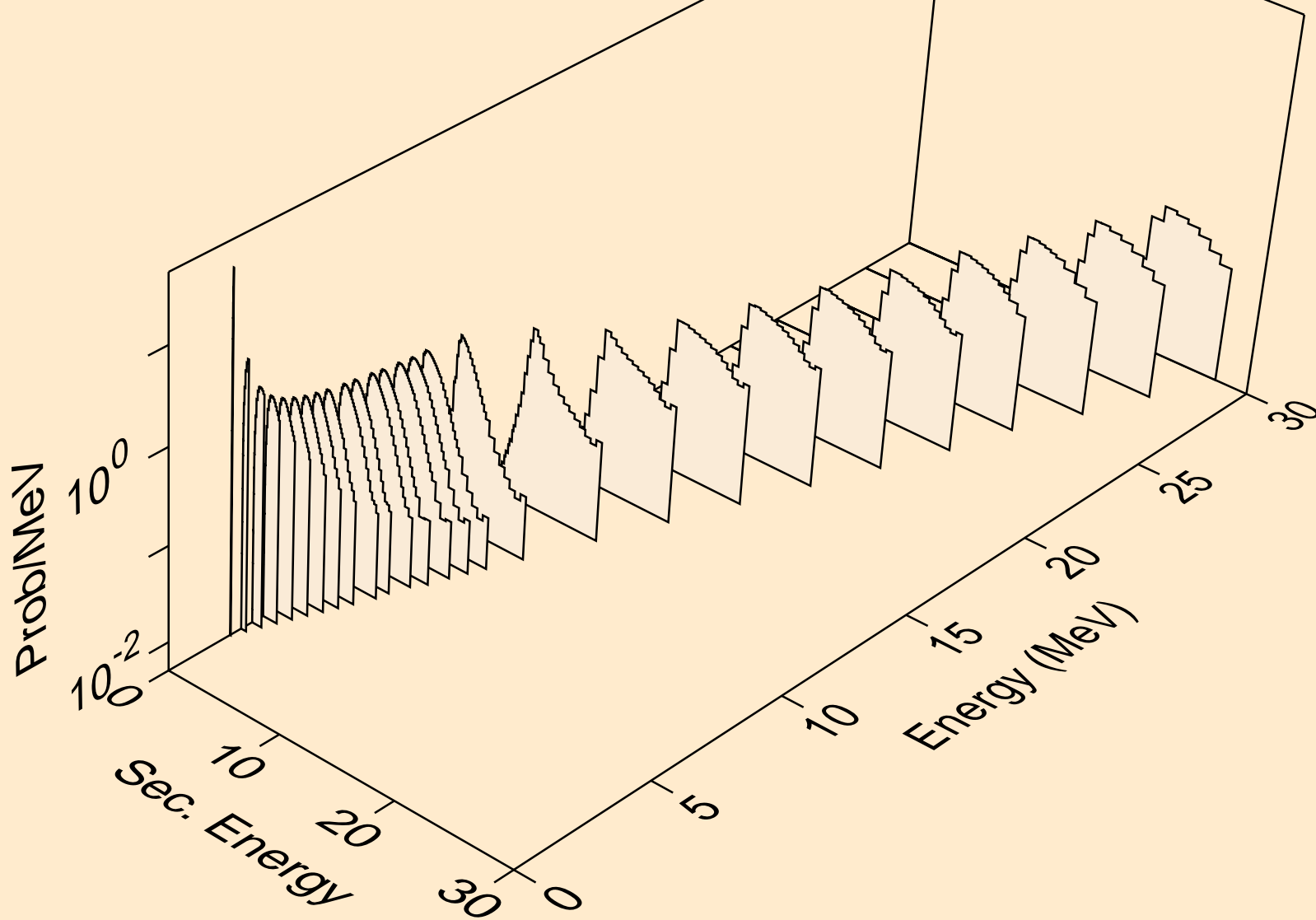

HG198 NEUTRON ACER TENDL-2019 LIBRARY; T=293.16K  
Photon emission for (n,x)

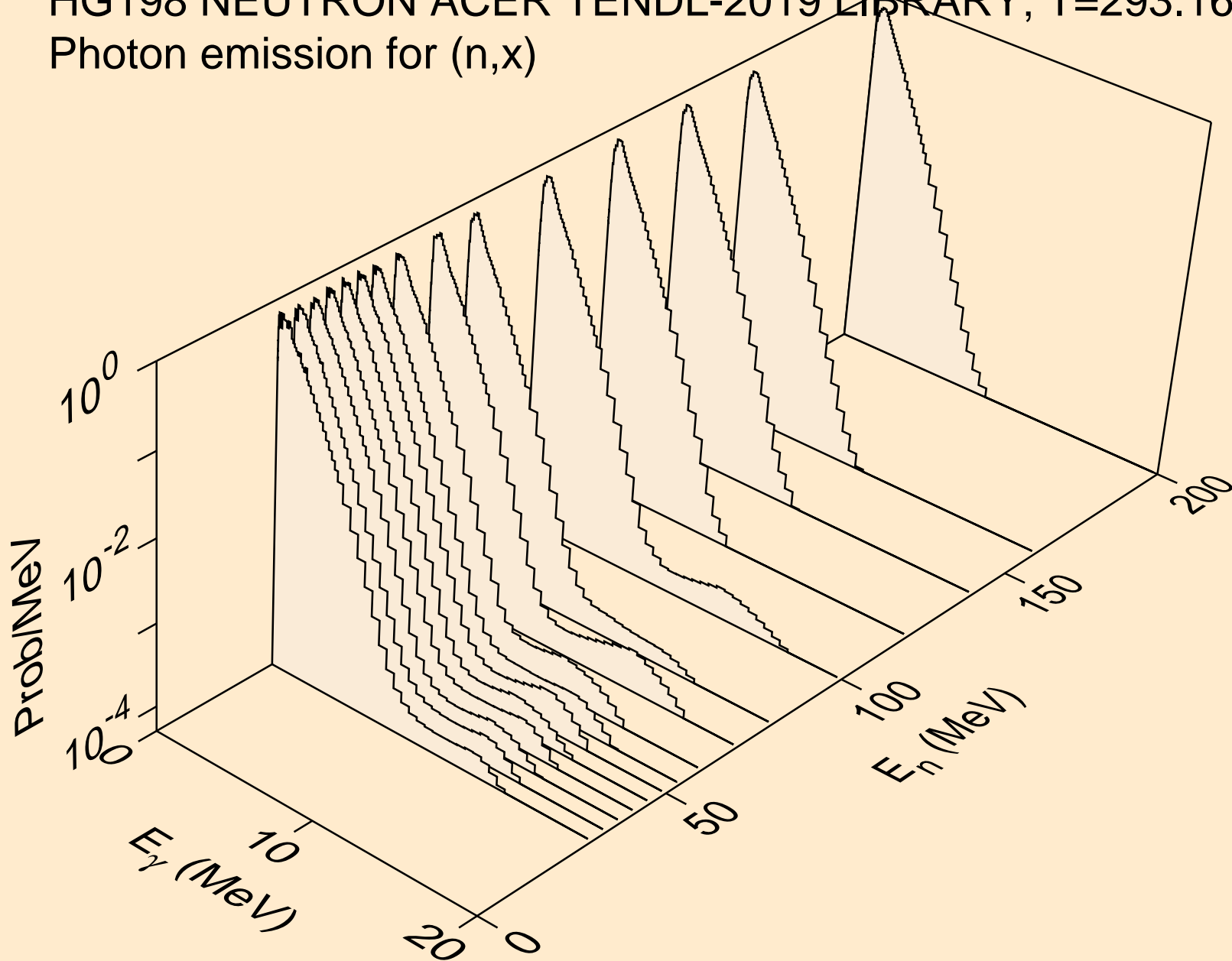



HG198 NEUTRON ACER TENDL-2019 LIBRARY; T=293.16K  
Photon emission for (n,2nd)

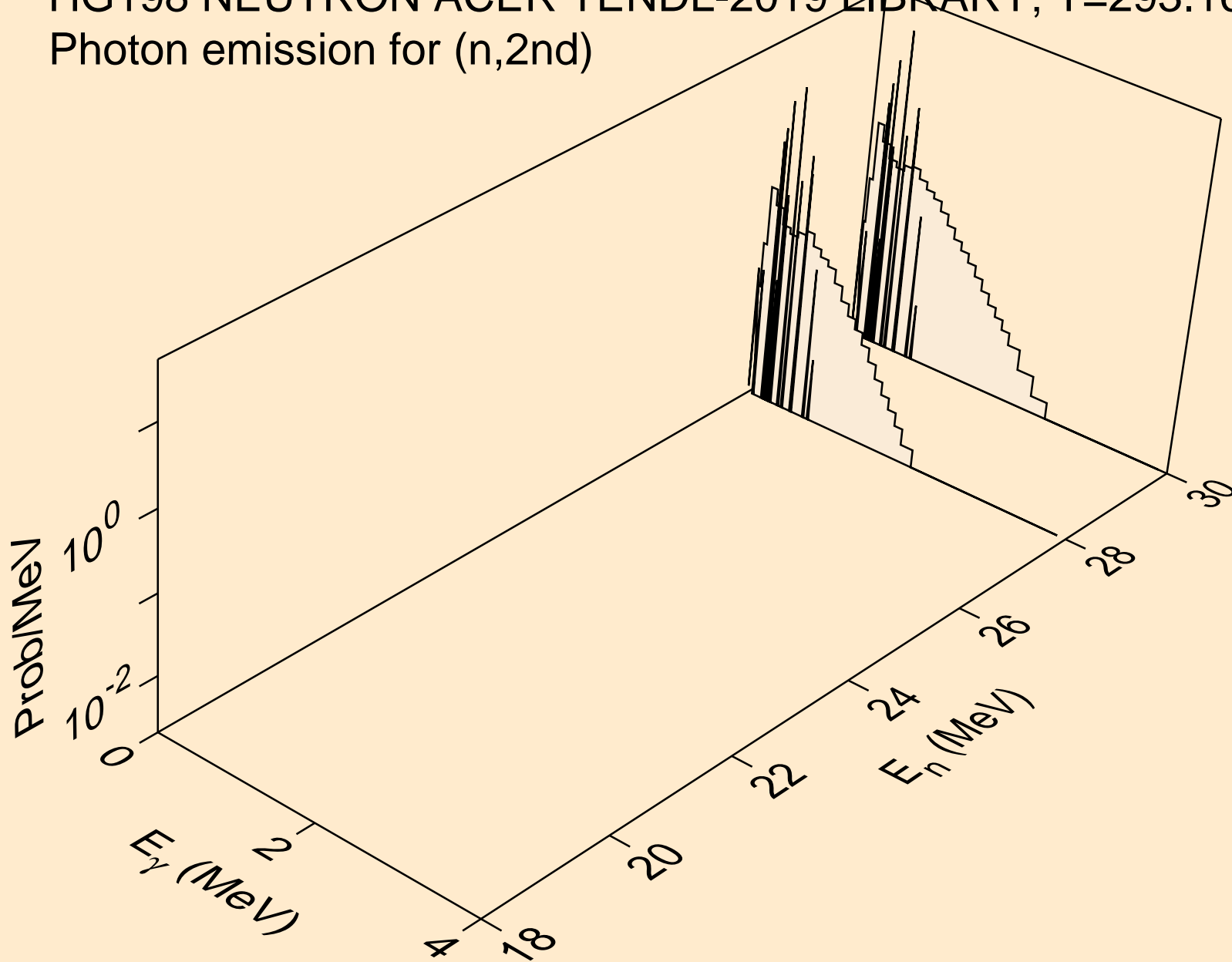

HG198 NEUTRON ACER TENDL-2019 LIBRARY; T=293.16K  
Photon emission for (n,2n)

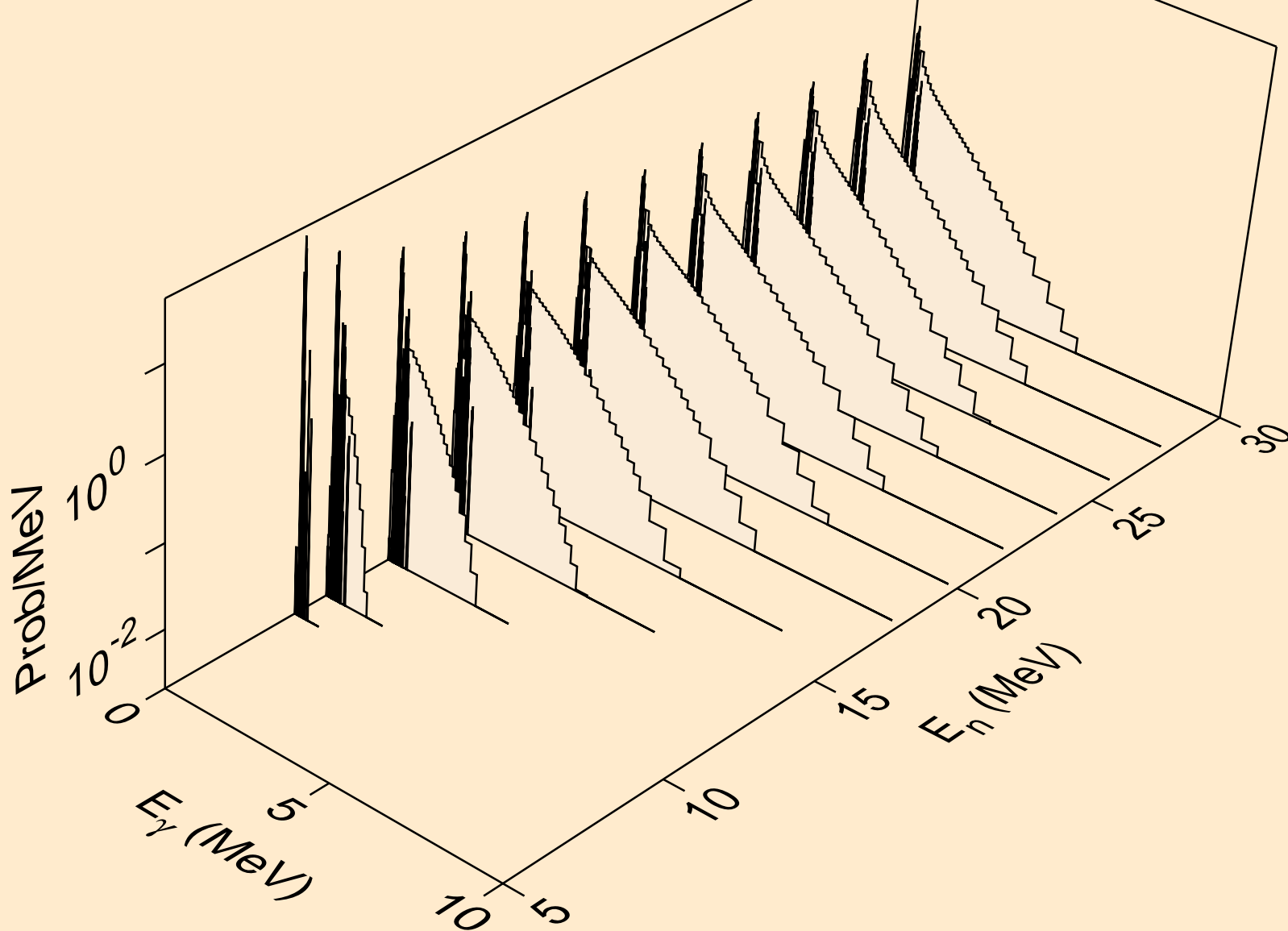

HG198 NEUTRON ACER TENDL-2019 LIBRARY; T=293.16K  
Photon emission for (n,3n)

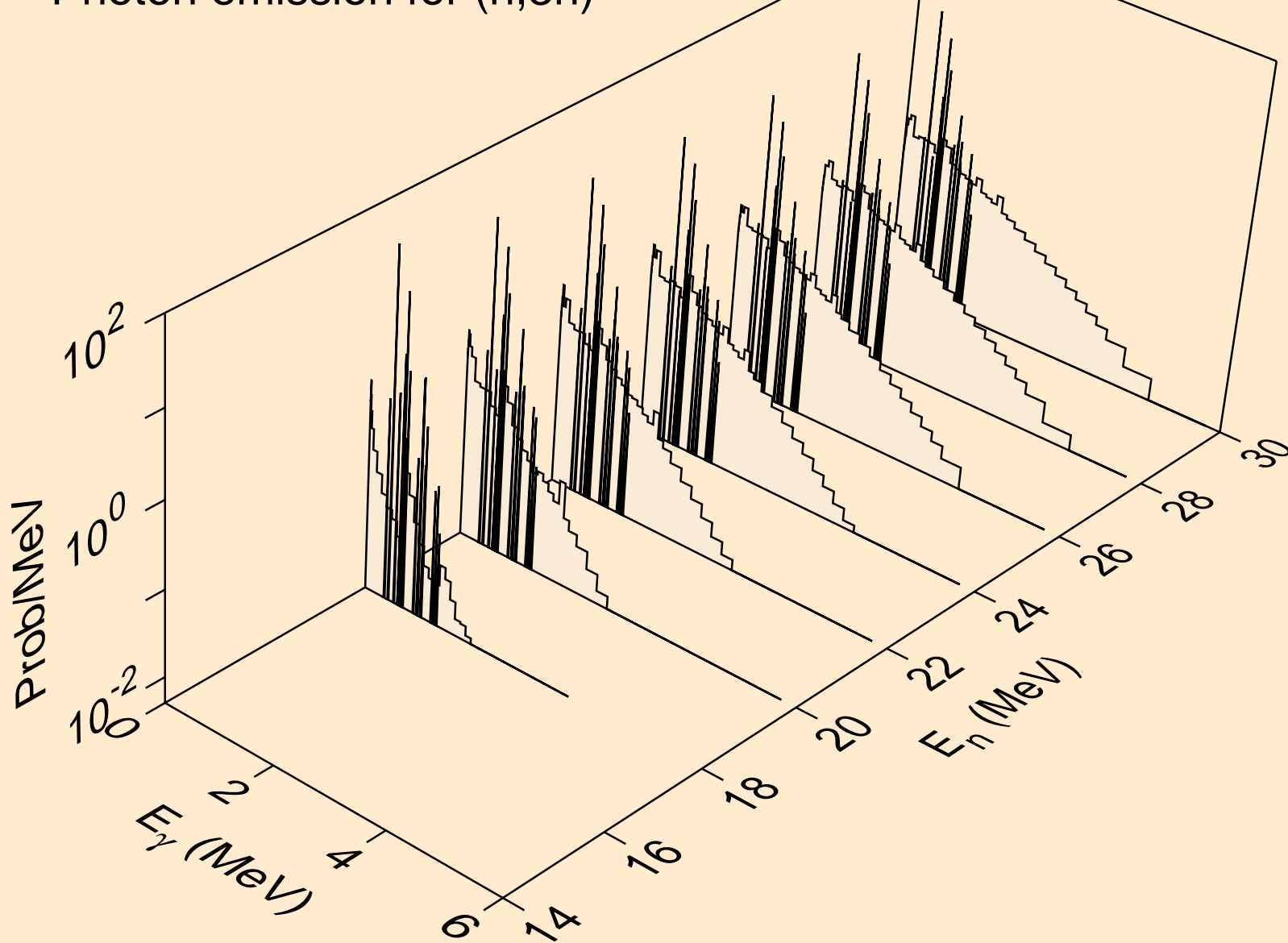

HG198 NEUTRON ACER TENDL-2019 LIBRARY; T=293.16K  
Photon emission for (n,n\*)a

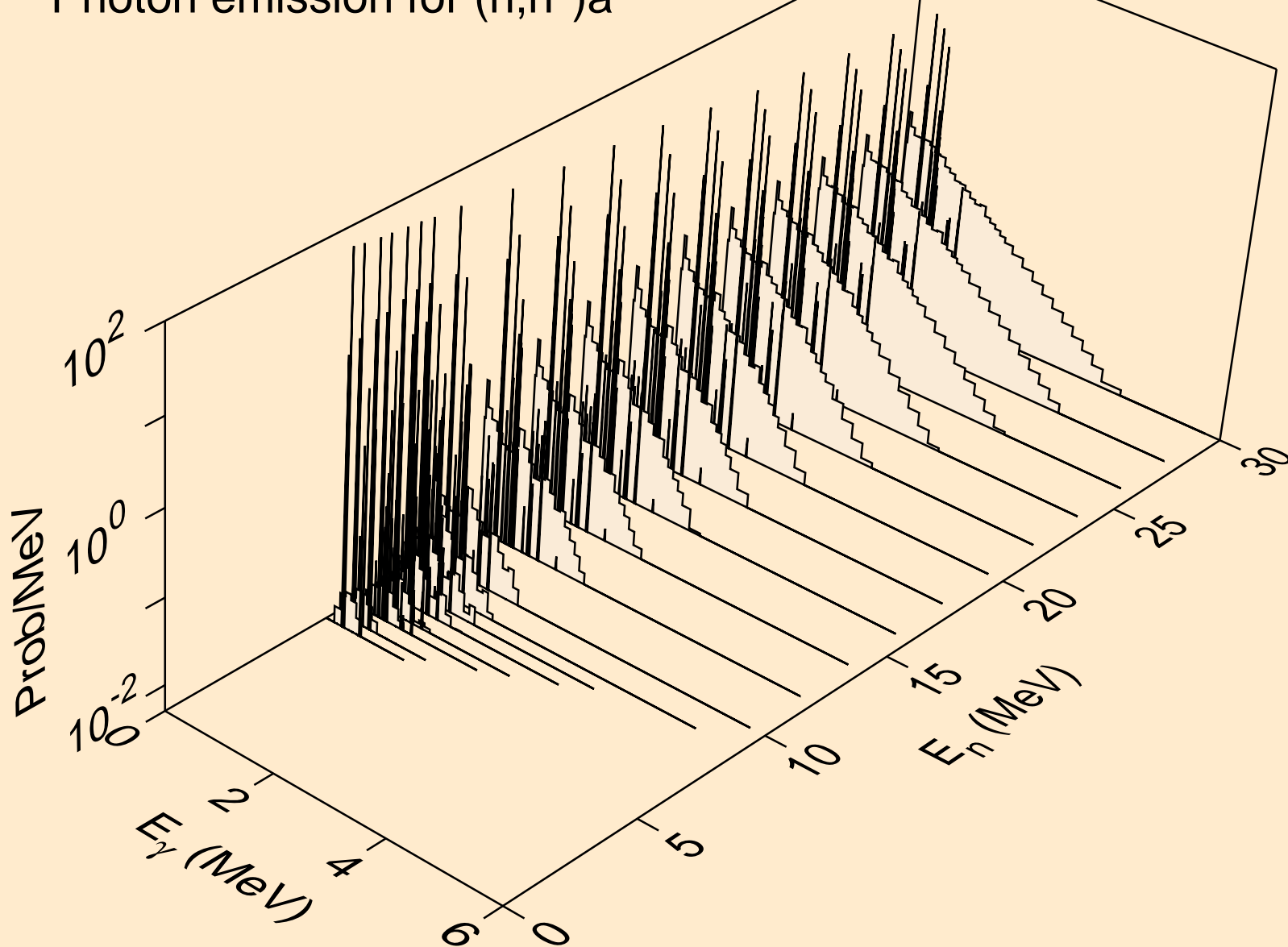

HG198 NEUTRON ACER TENDL-2019 LIBRARY; T=293.16K  
Photon emission for (n,2n)a

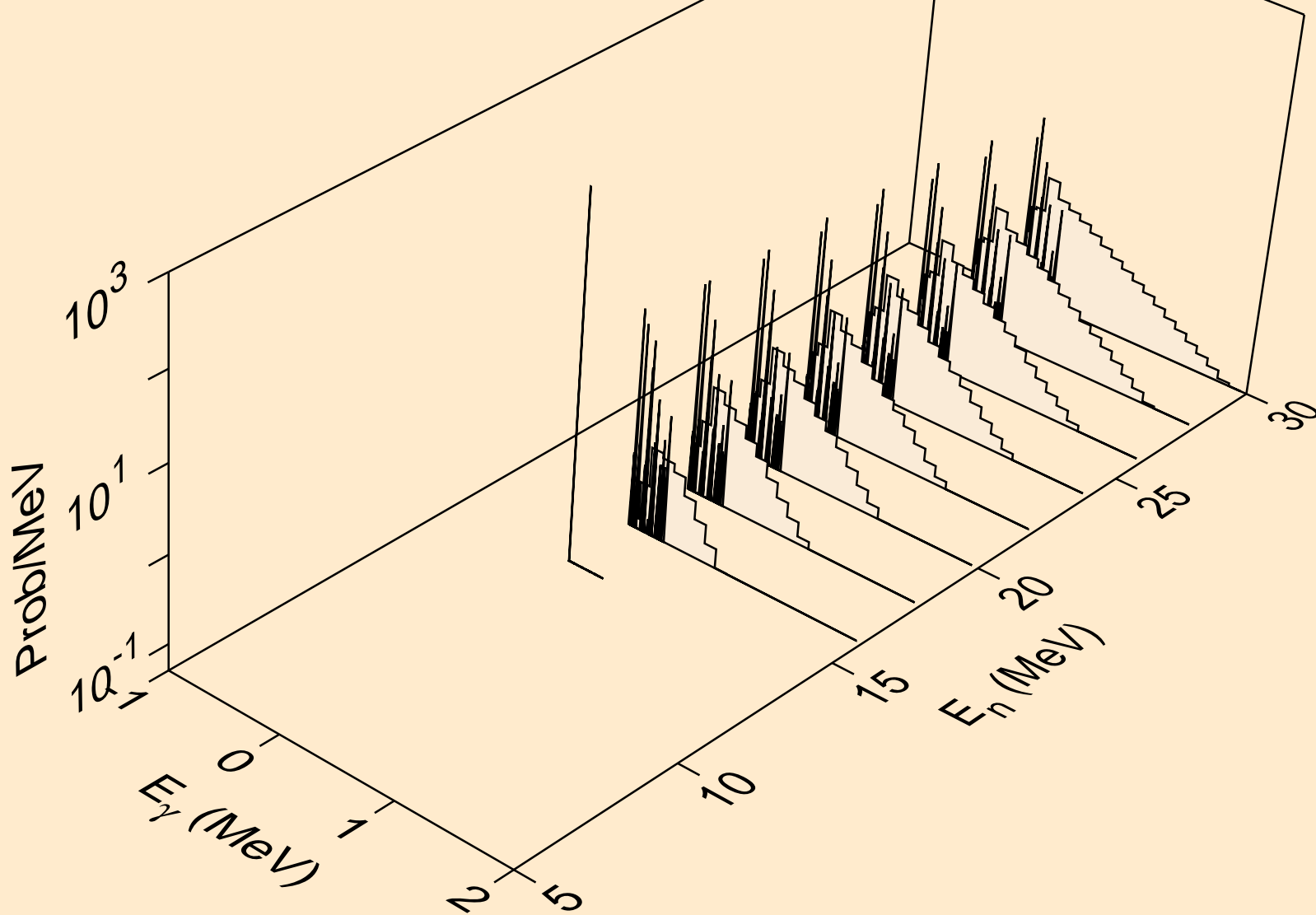

HG198 NEUTRON ACER TENDL-2019 LIBRARY; T=293.16K  
Photon emission for (n,3n)a

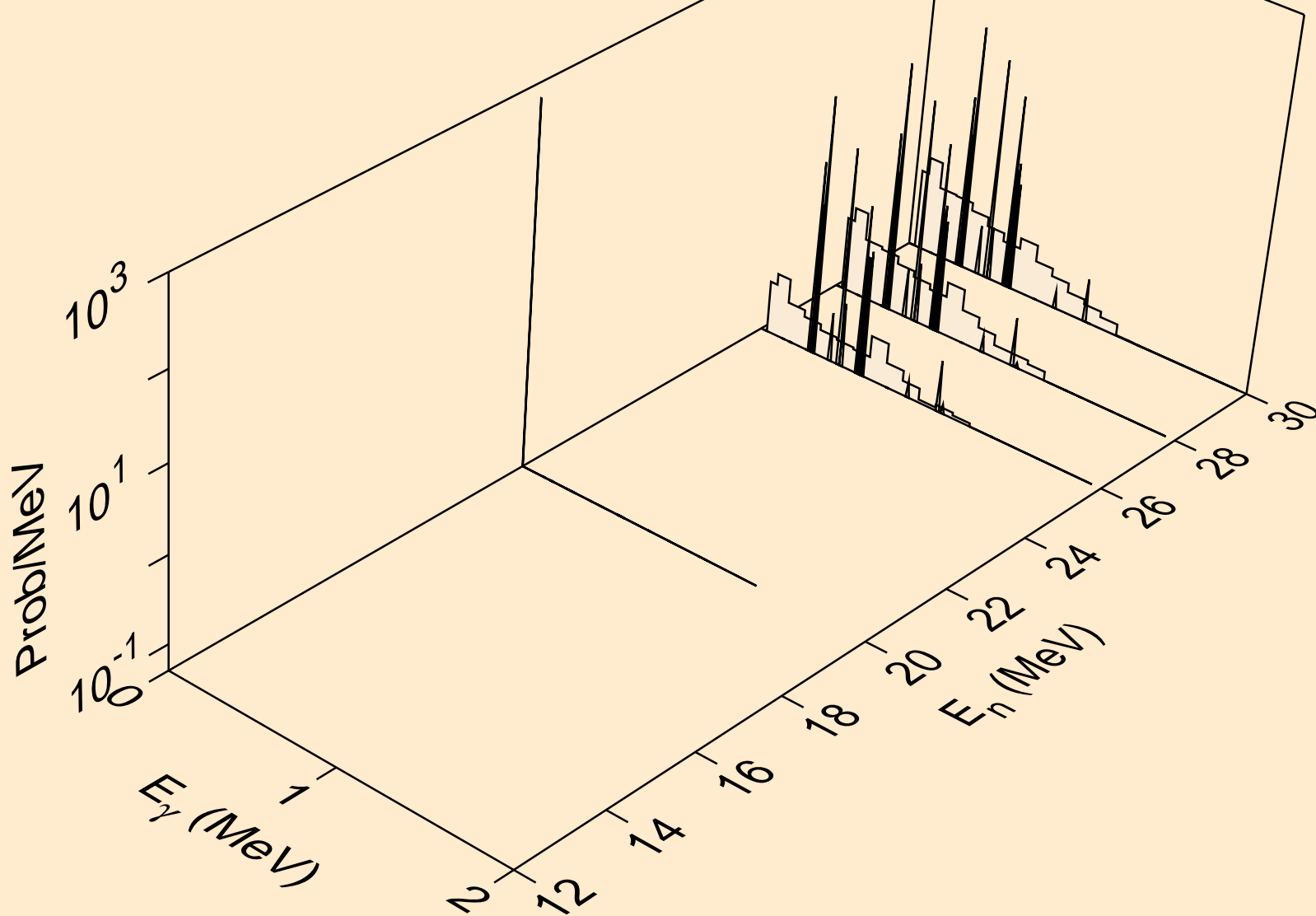

HG198 NEUTRON ACER TENDL-2019 LIBRARY; T=293.16K  
Photon emission for (n,n\*)p

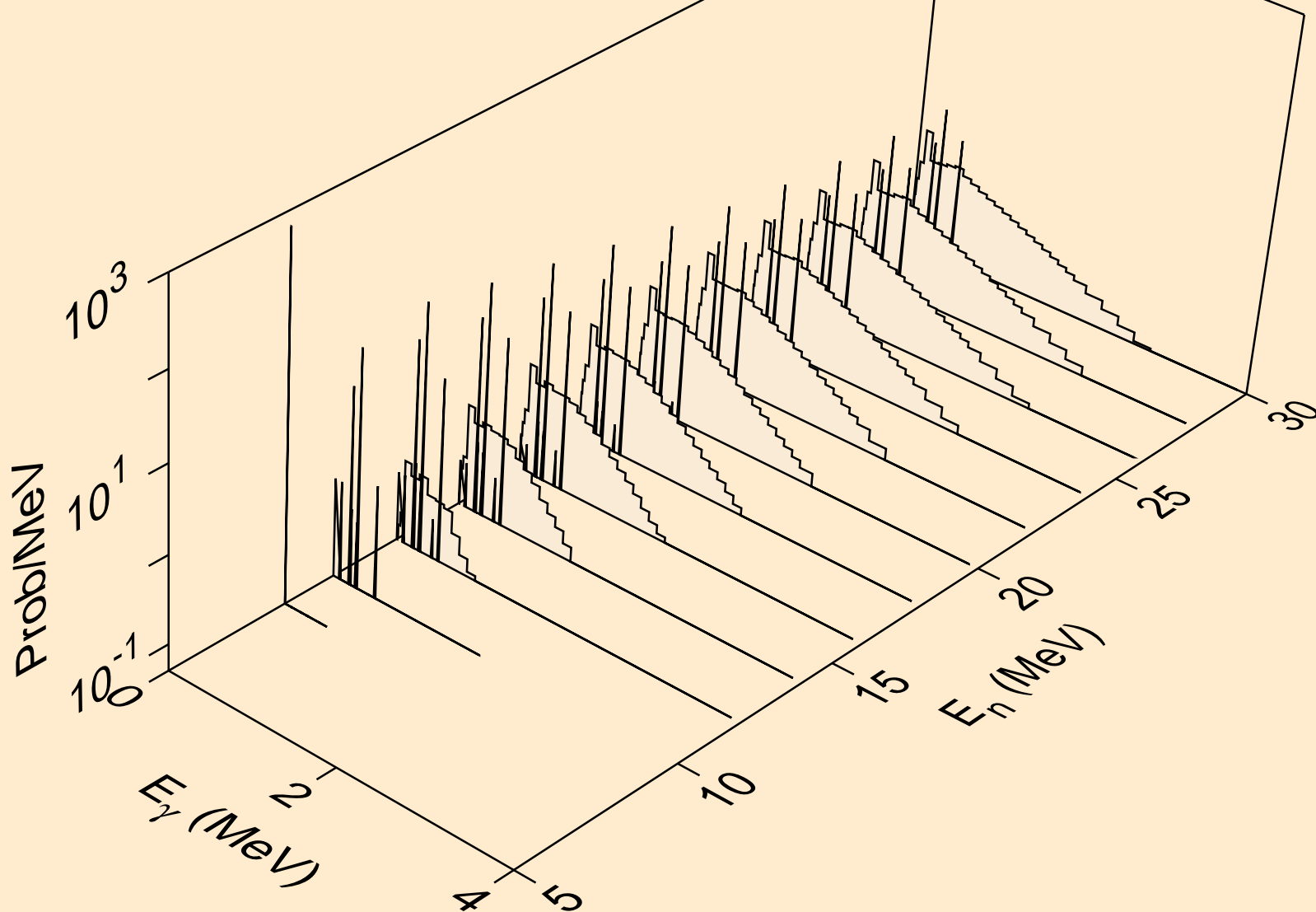

HG198 NEUTRON ACER TENDL-2019 LIBRARY; T=293.16K  
Photon emission for (n,n\*)d

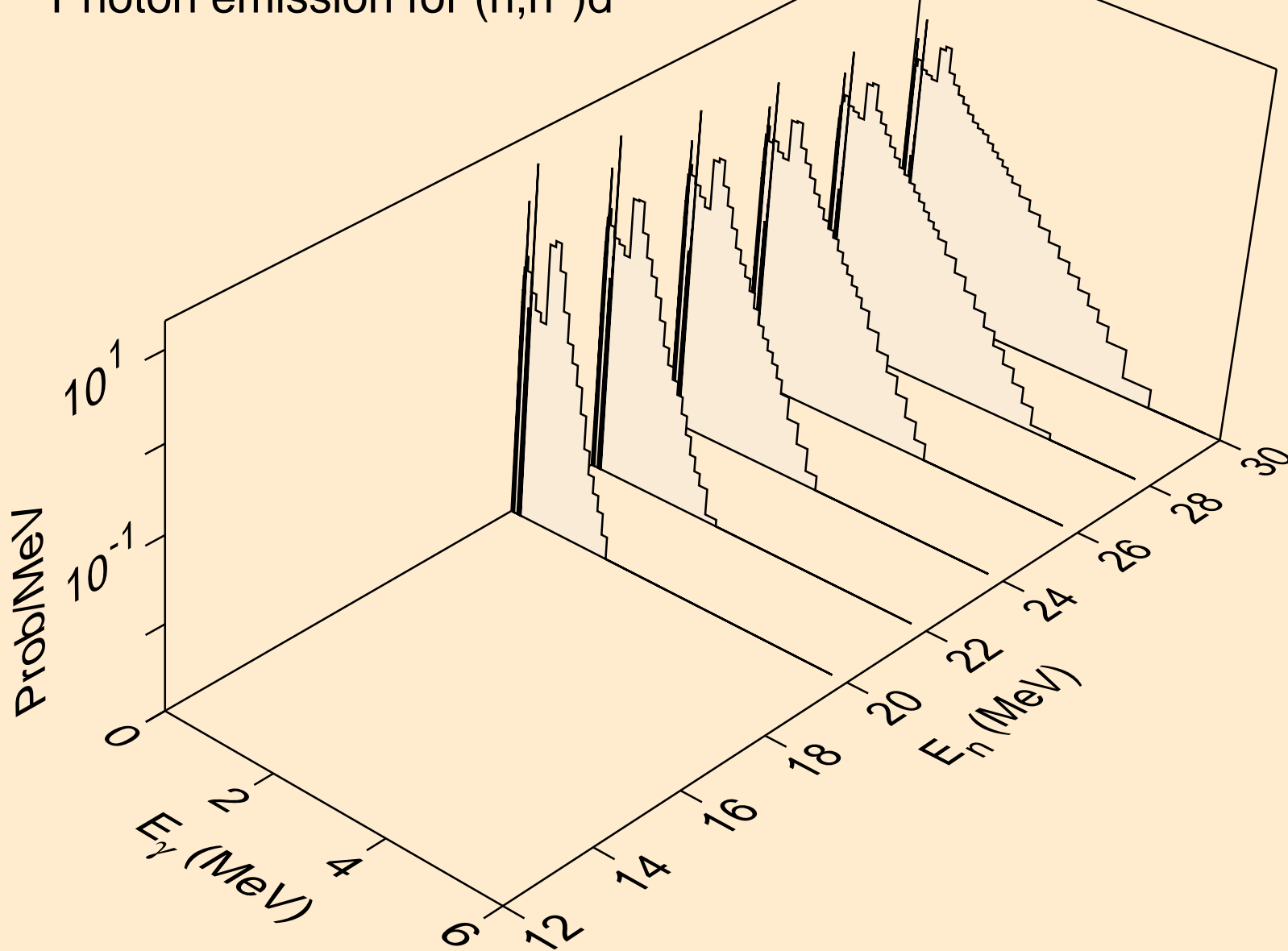



HG198 NEUTRON ACER TENDL-2019 LIBRARY; T=293.16K  
Photon emission for (n,n\*)t

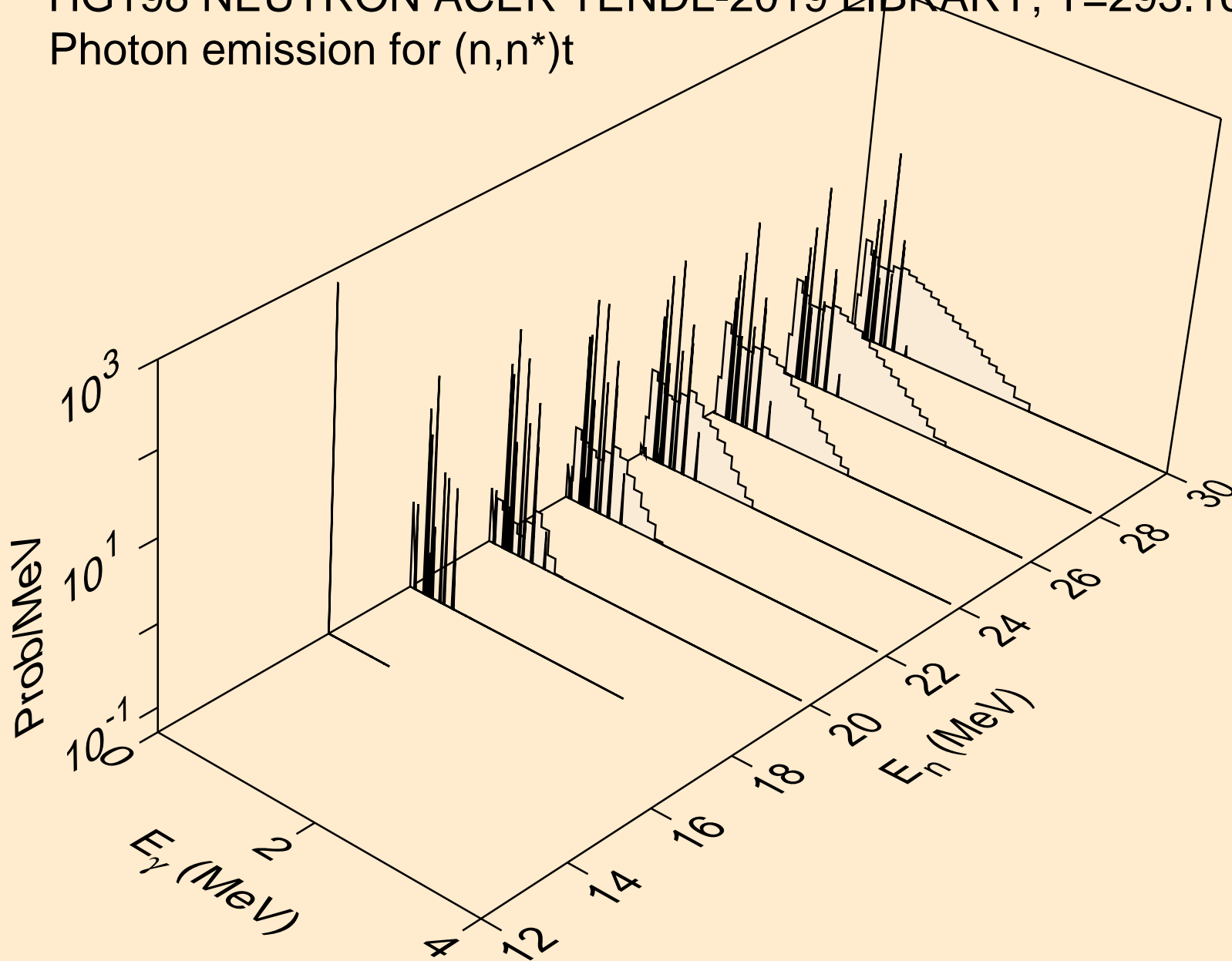

HG198 NEUTRON ACER TENDL-2019 LIBRARY; T=293.16K  
Photon emission for (n,n\*)he3

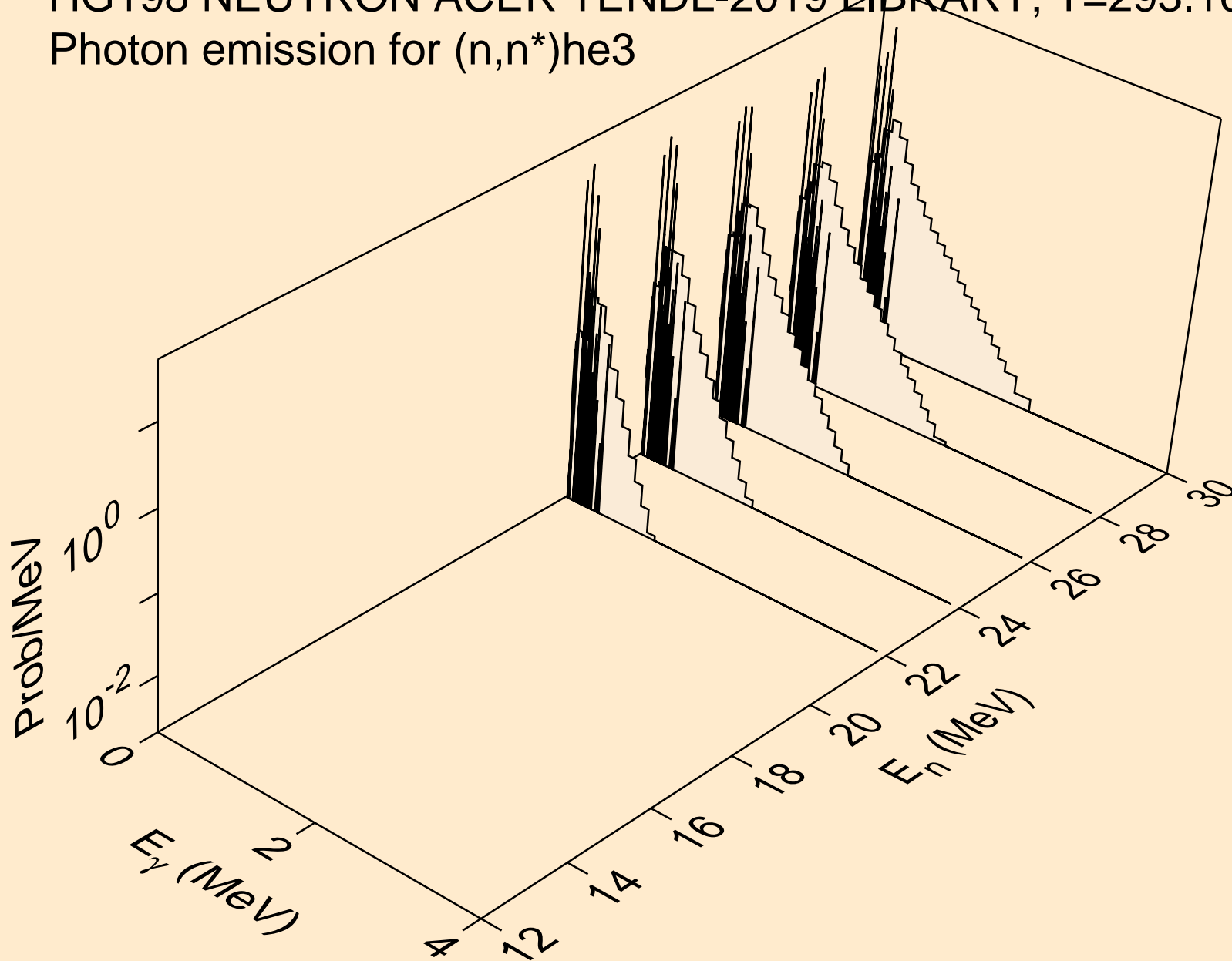

HG198 NEUTRON ACER TENDL-2019 LIBRARY; T=293.16K  
Photon emission for (n,4n)

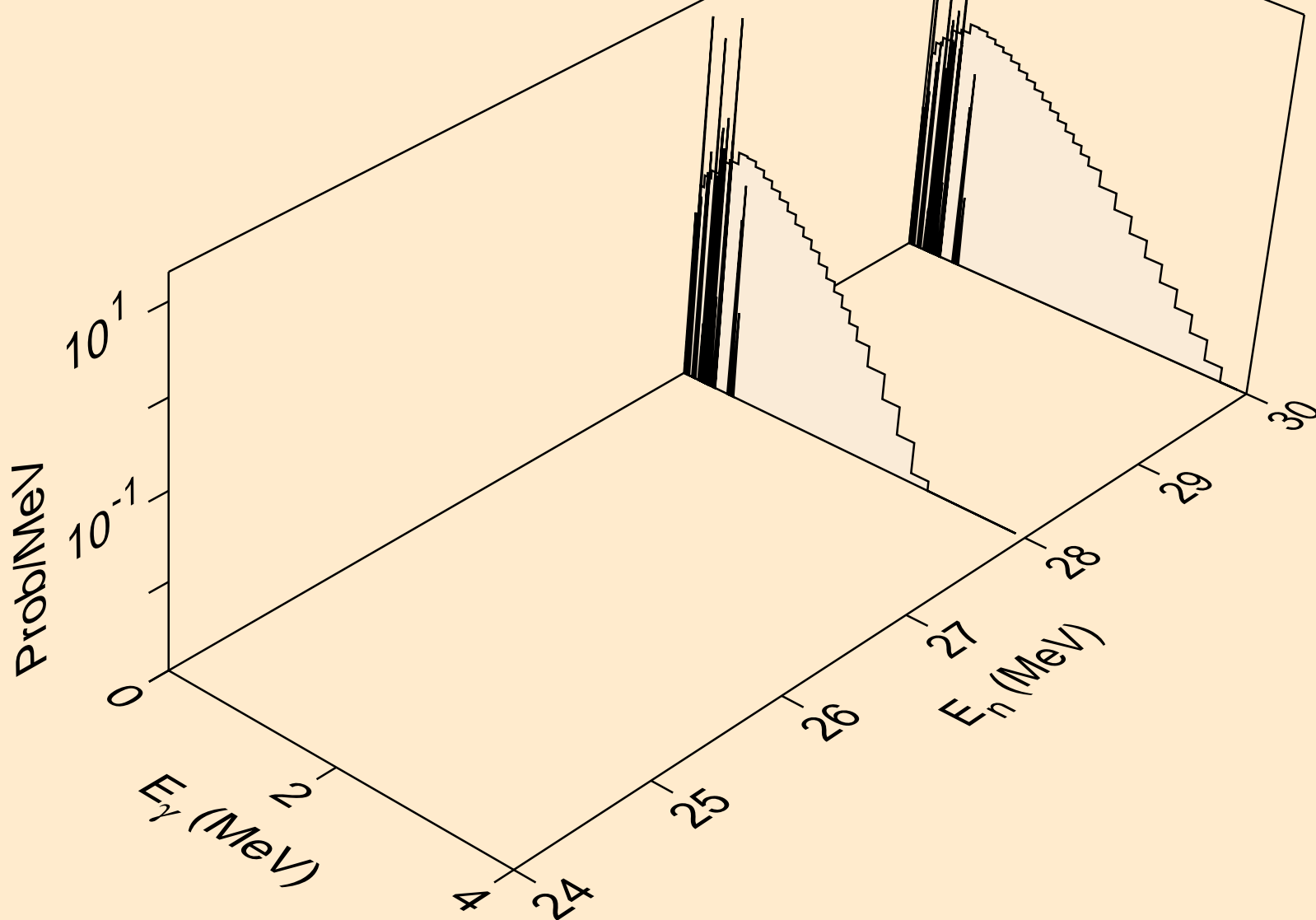

HG198 NEUTRON ACER TENDL-2019 LIBRARY; T=293.16K  
Photon emission for (n,2np)

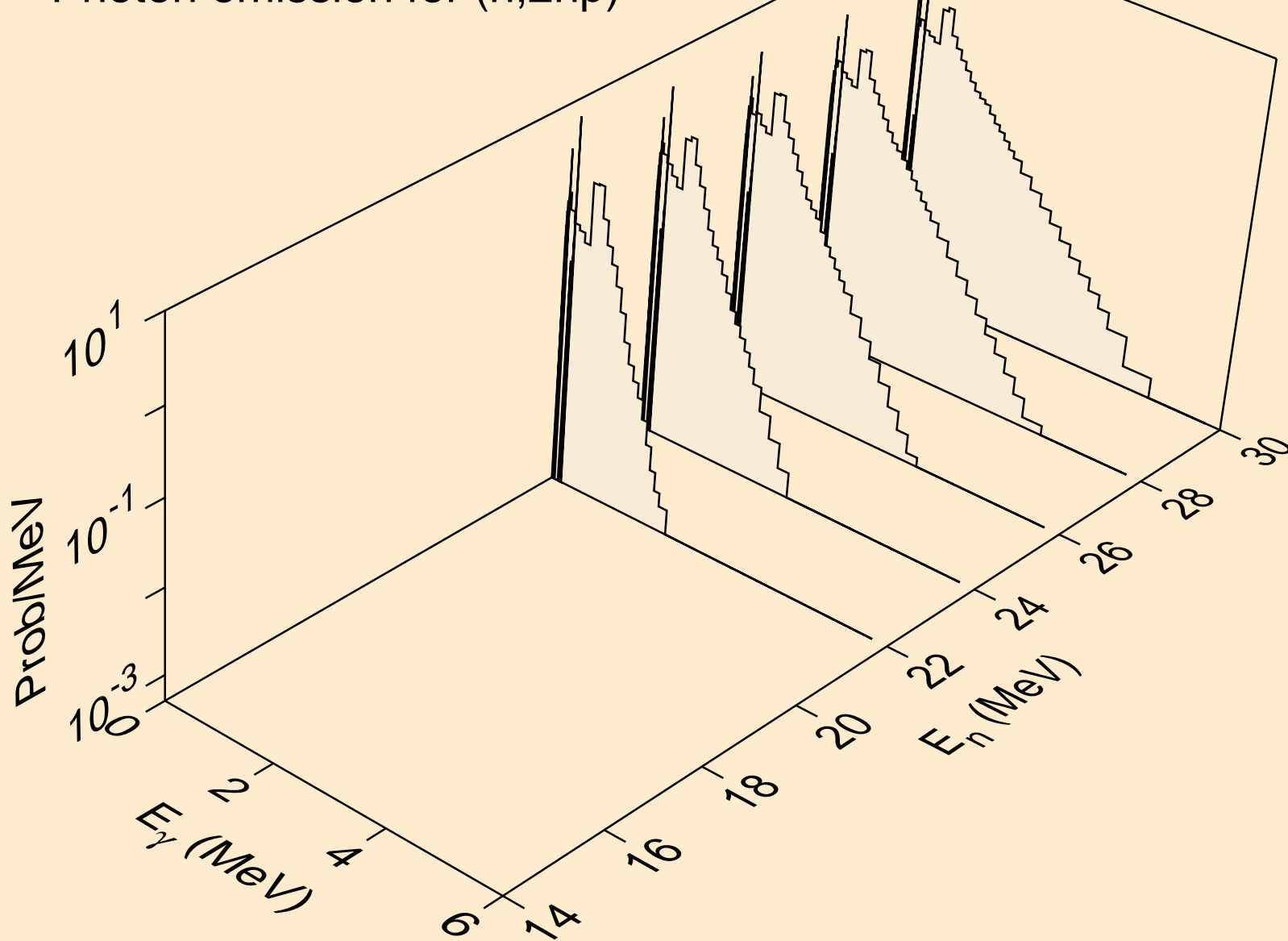

HG198 NEUTRON ACER TENDL-2019 LIBRARY; T=293.16K  
Photon emission for (n,3np)

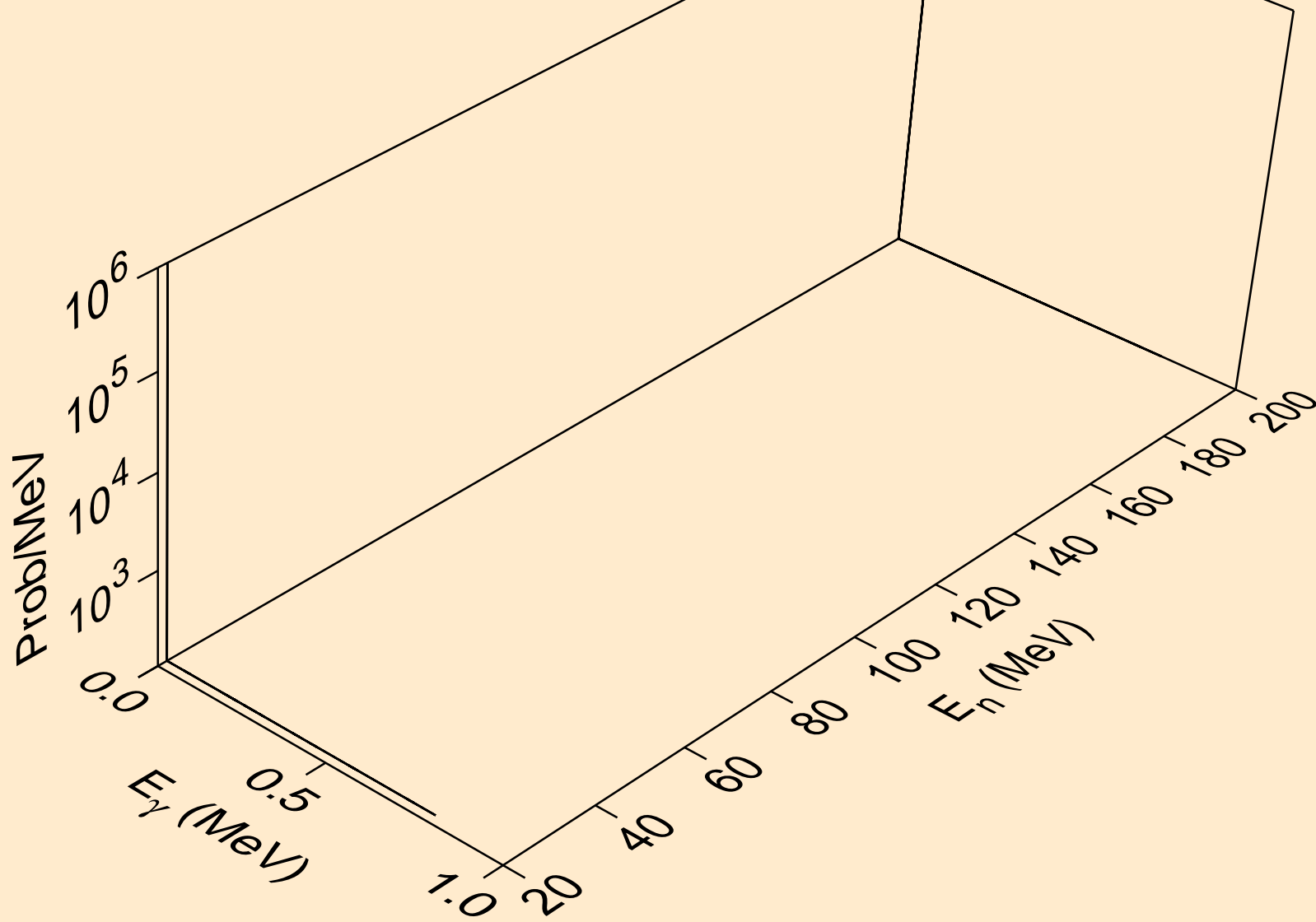

HG198 NEUTRON ACER TENDL-2019 LIBRARY; T=293.16K  
Photon emission for (n,2np)

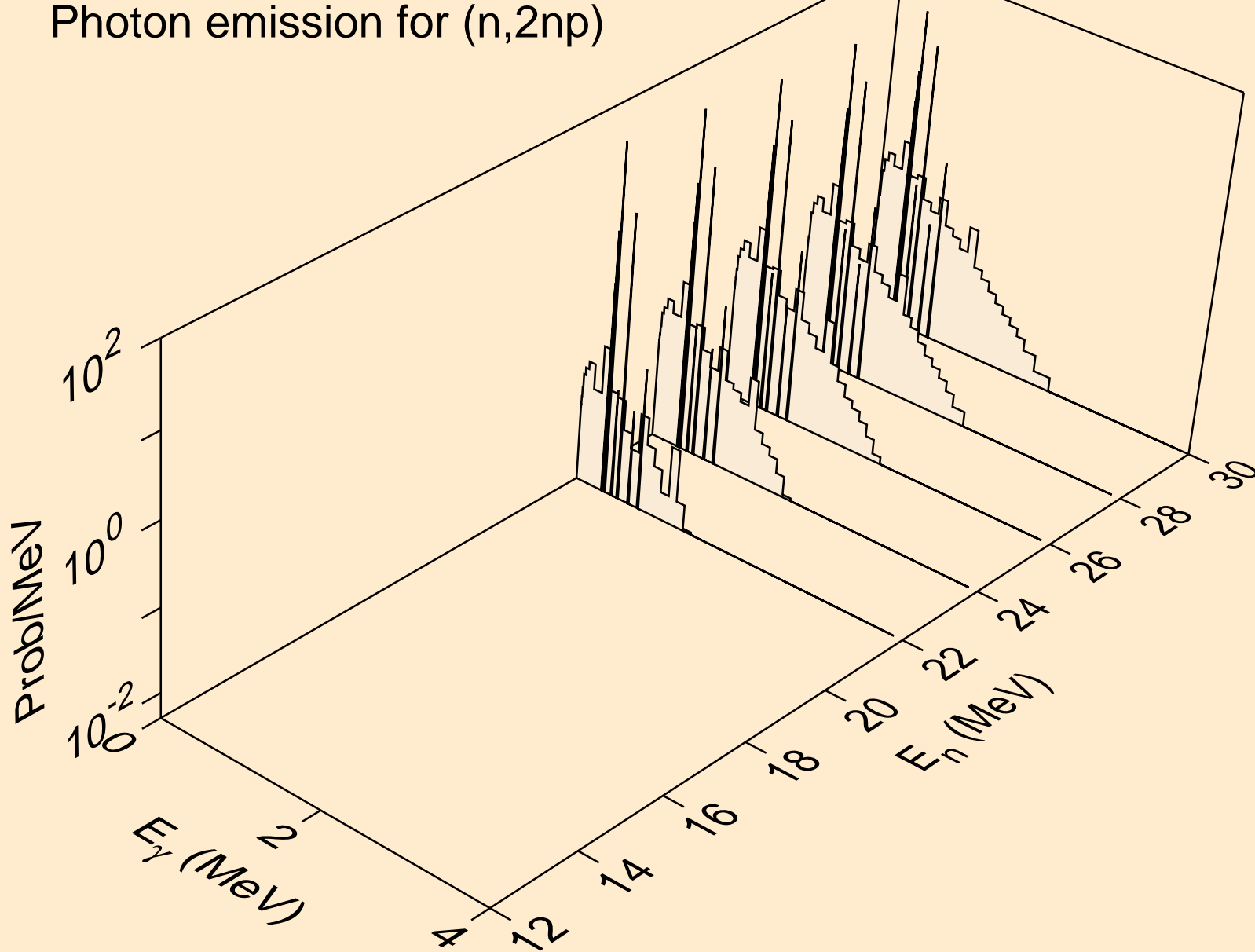

HG198 NEUTRON ACER TENDL-2019 LIBRARY; T=293.16K  
Photon emission for (n,npa)

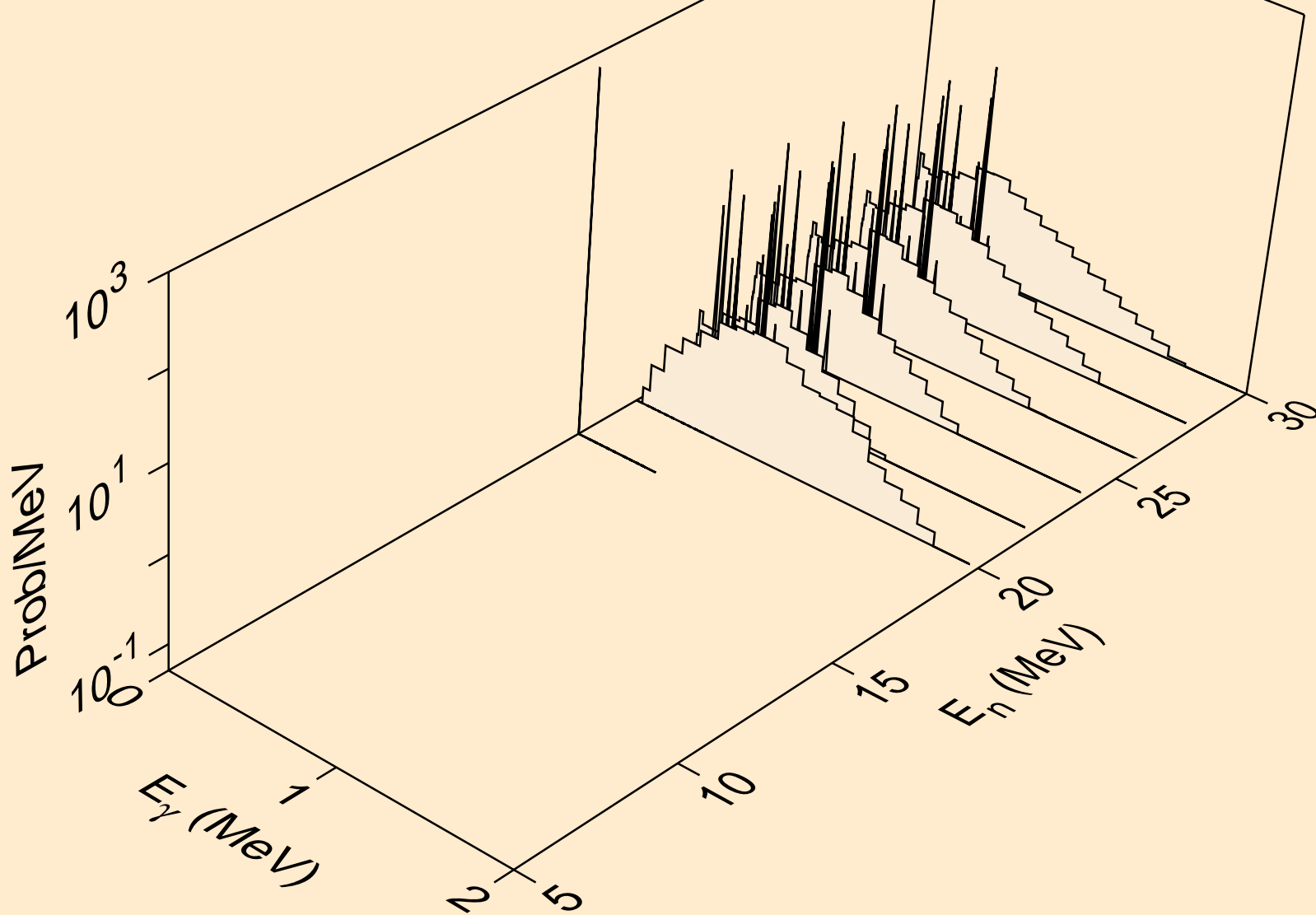

HG198 NEUTRON ACER TENDL-2019 LIBRARY; T=293.16K  
Photon emission for (n,n\*c)

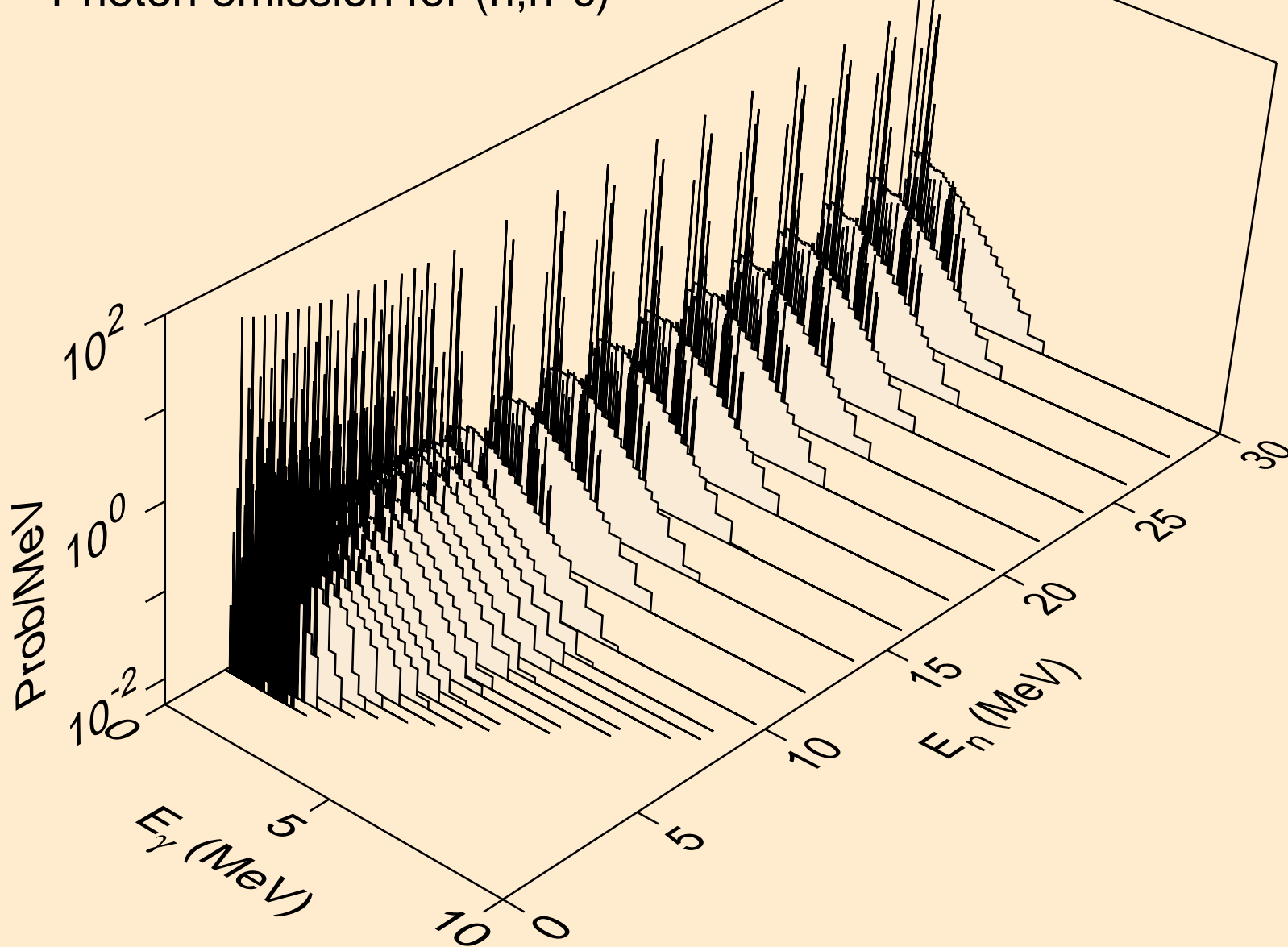



HG198 NEUTRON ACER TENDL-2019 LIBRARY; T=293.16K  
Photon emission for (n,gma)

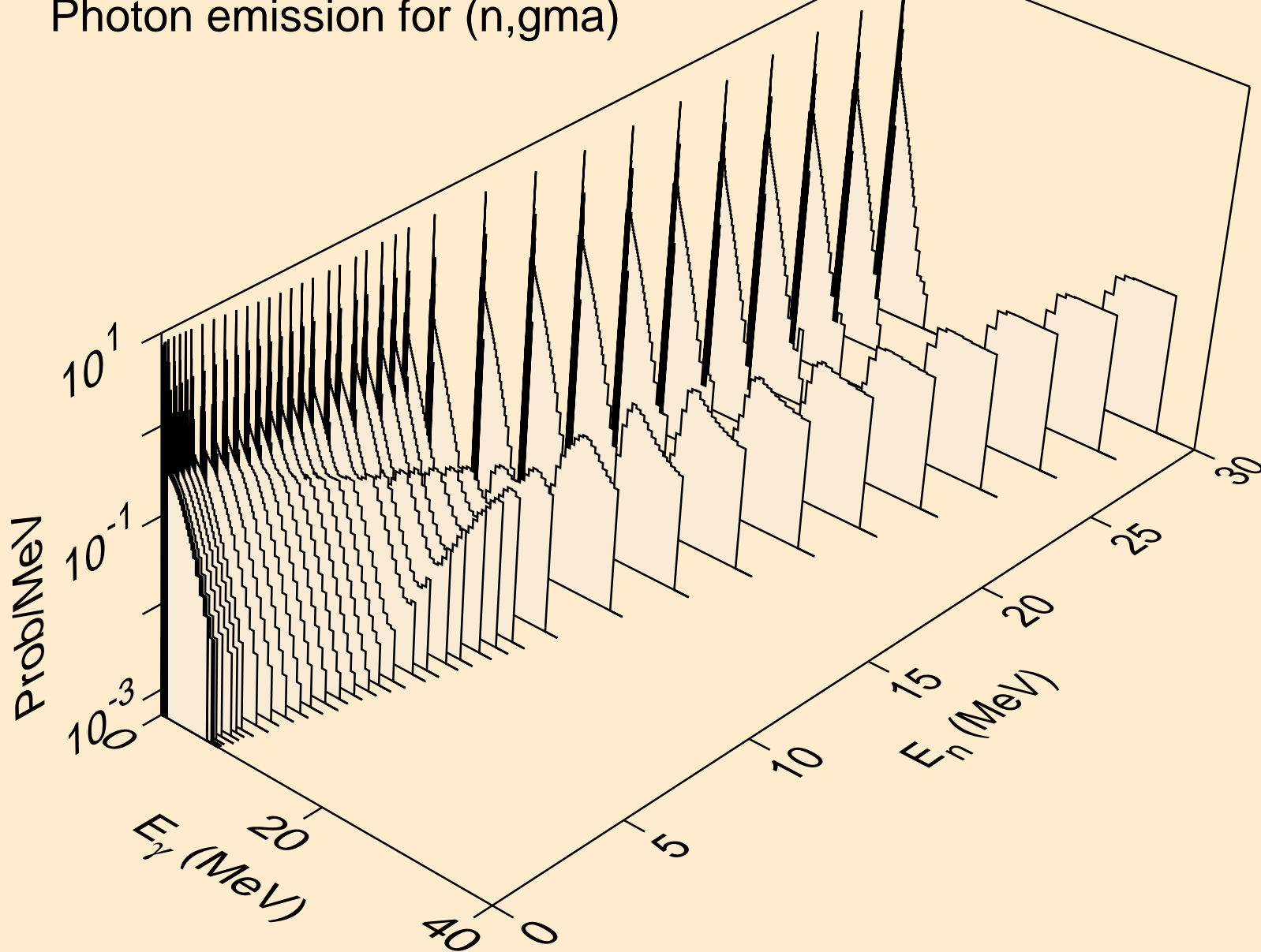

HG198 NEUTRON ACER TENDL-2019 LIBRARY; T=293.16K  
Photon emission for (n,p)

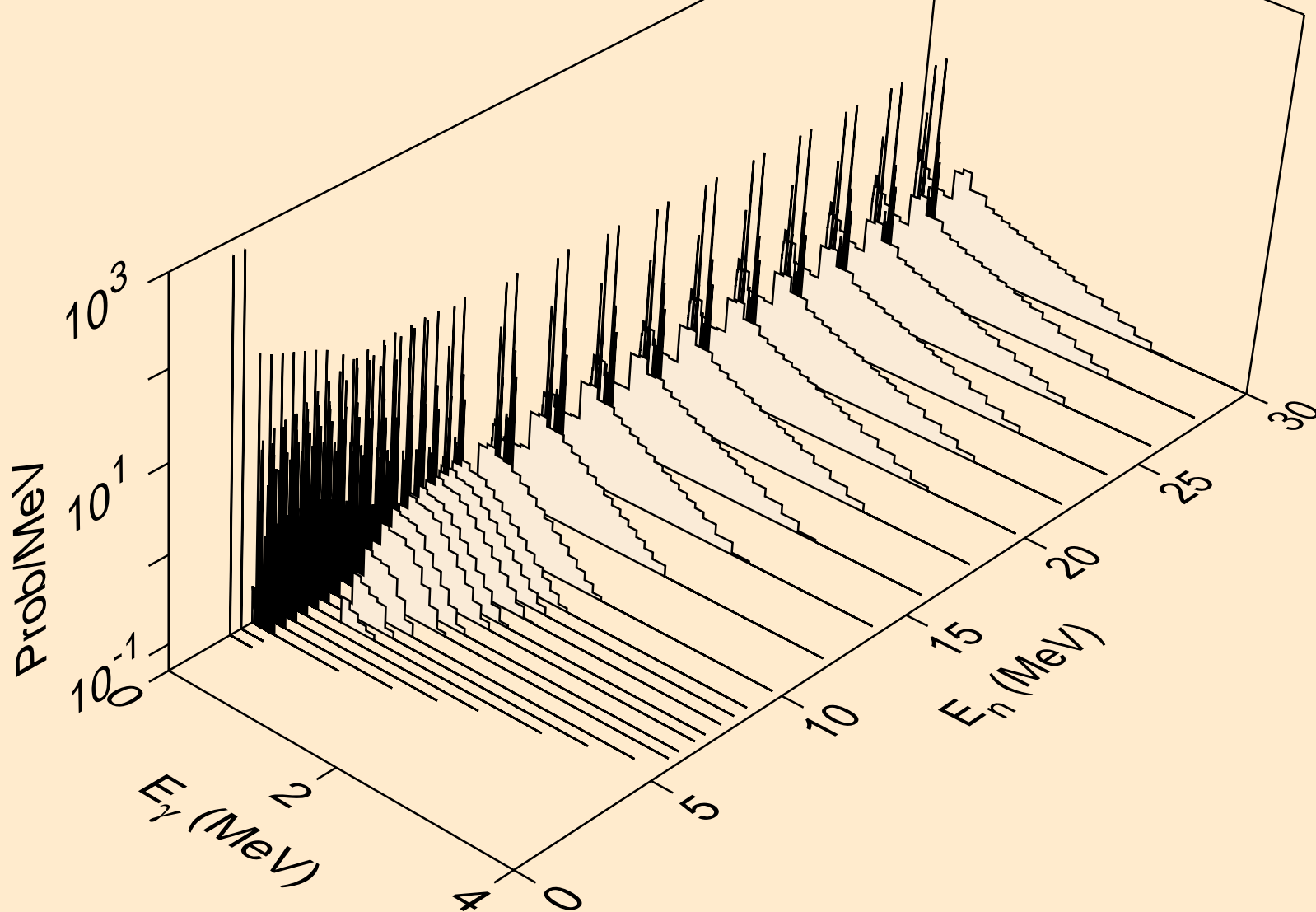

HG198 NEUTRON ACER TENDL-2019 LIBRARY; T=293.16K  
Photon emission for (n,d)

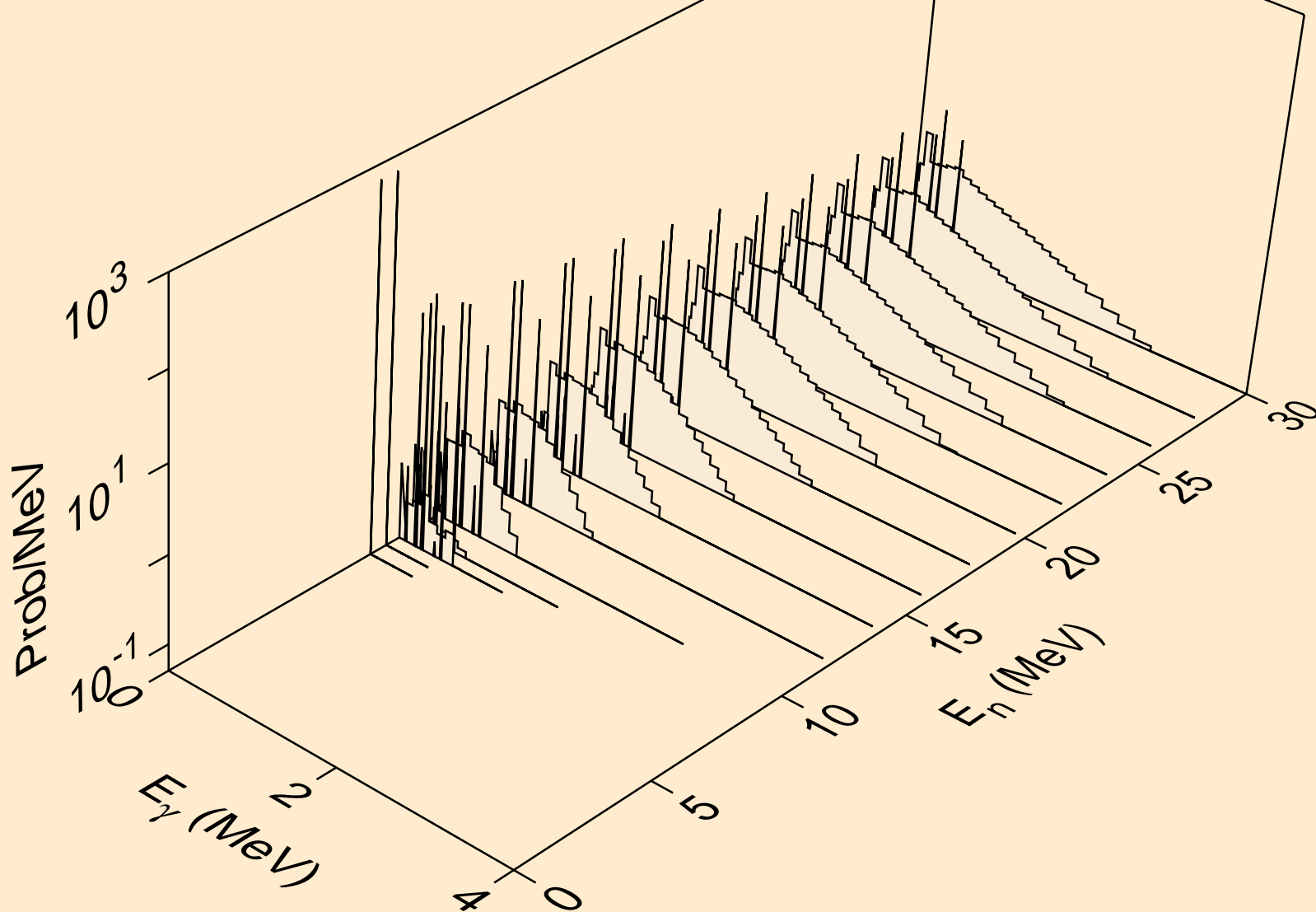

HG198 NEUTRON ACER TENDL-2019 LIBRARY; T=293.16K  
Photon emission for (n,t)

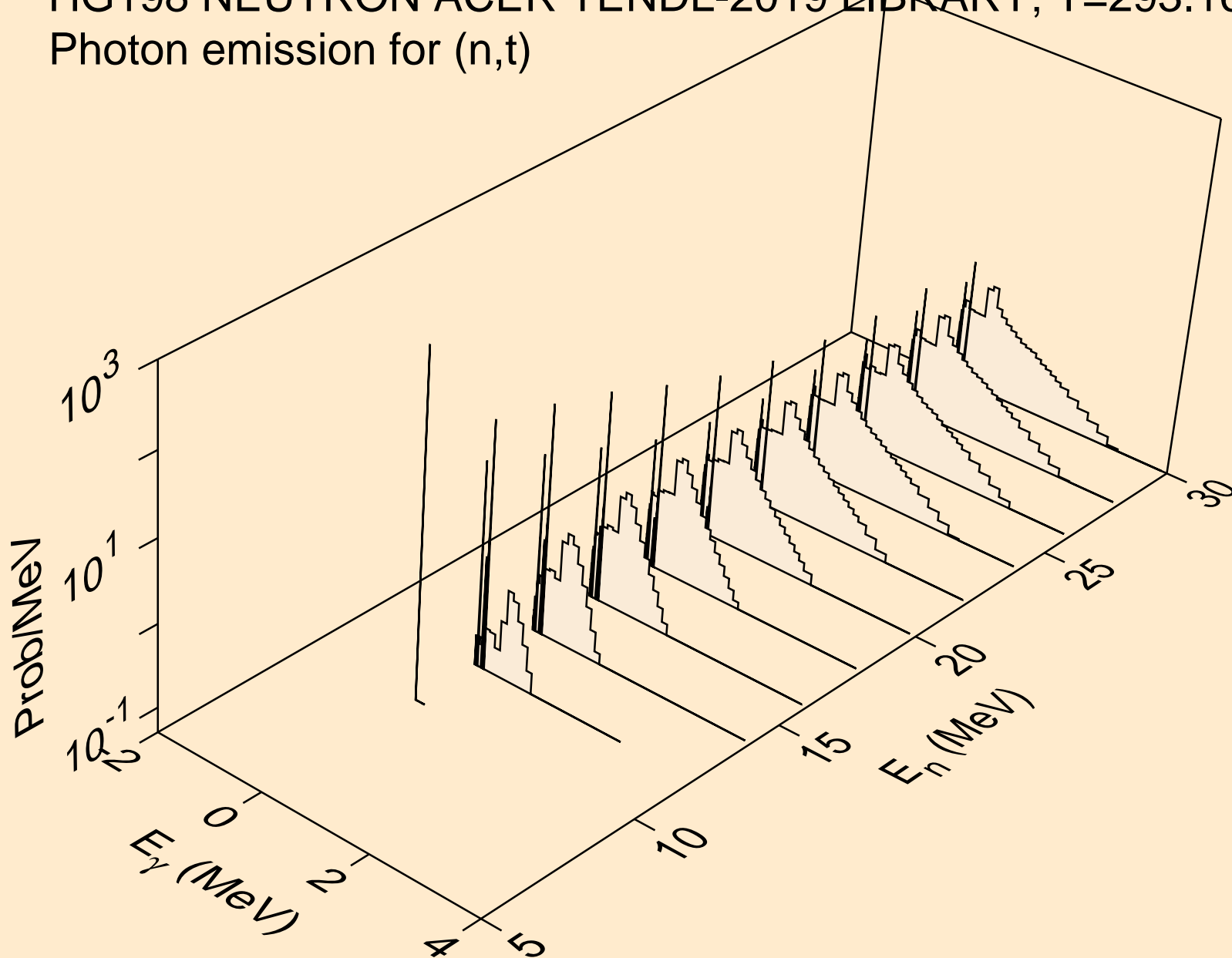

HG198 NEUTRON ACER TENDL-2019 LIBRARY; T=293.16K  
Photon emission for (n,he3)

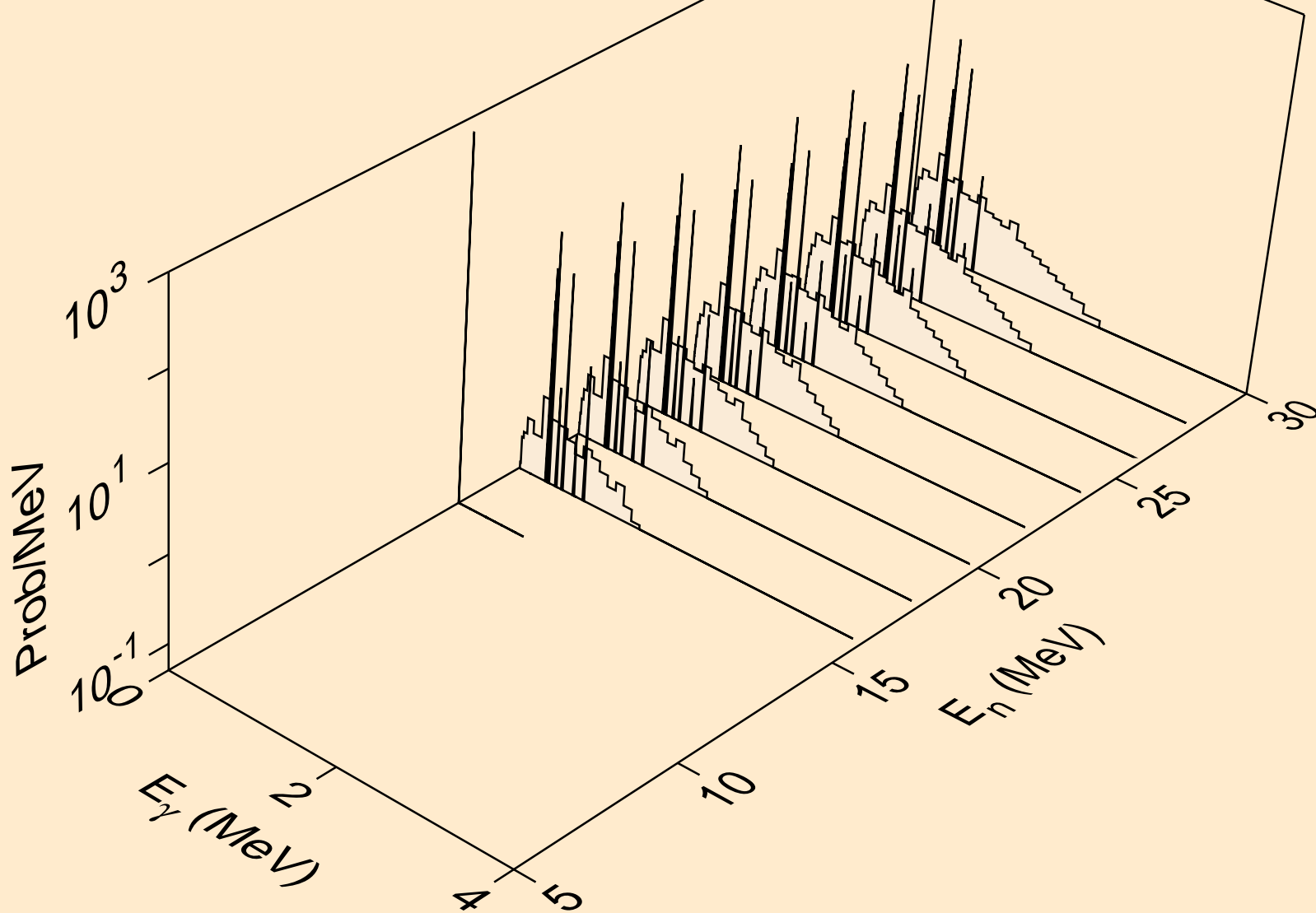

HG198 NEUTRON ACER TENDL-2019 LIBRARY; T=293.16K  
Photon emission for (n,a)

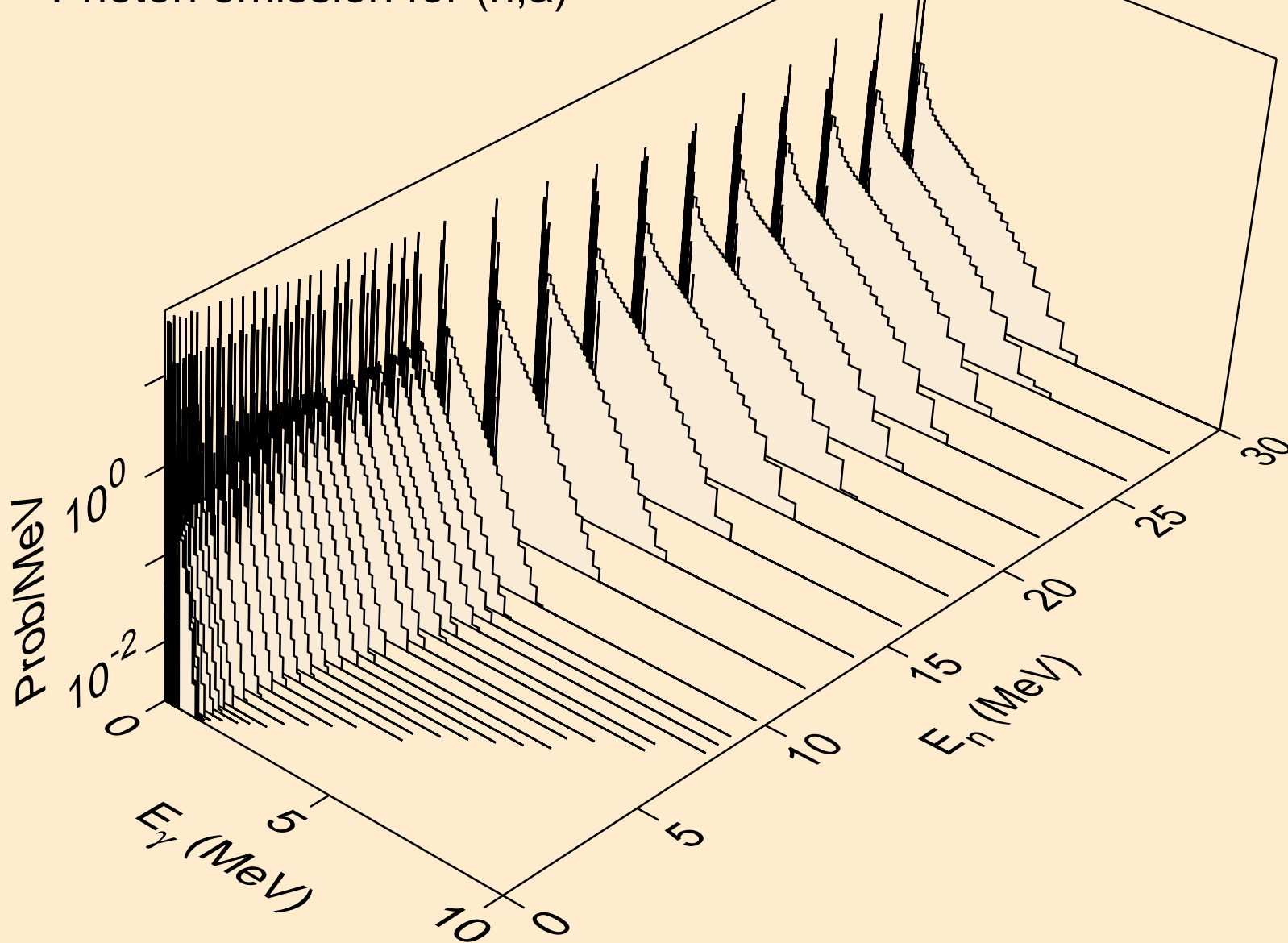

HG198 NEUTRON ACER TENDL-2019 LIBRARY; T=293.16K  
Photon emission for (n,2a)

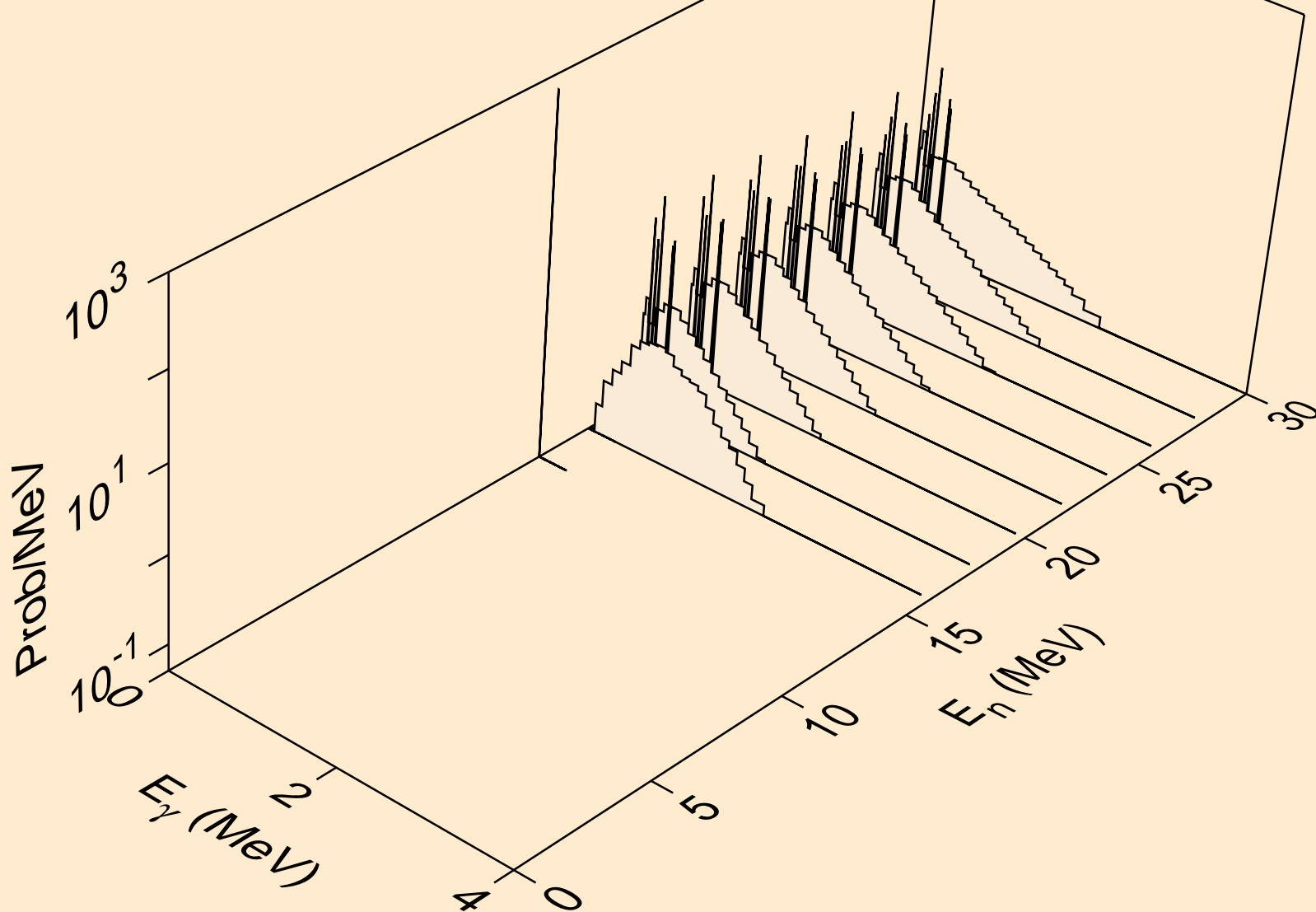

HG198 NEUTRON ACER TENDL-2019 LIBRARY; T=293.16K  
Photon emission for (n,2p)

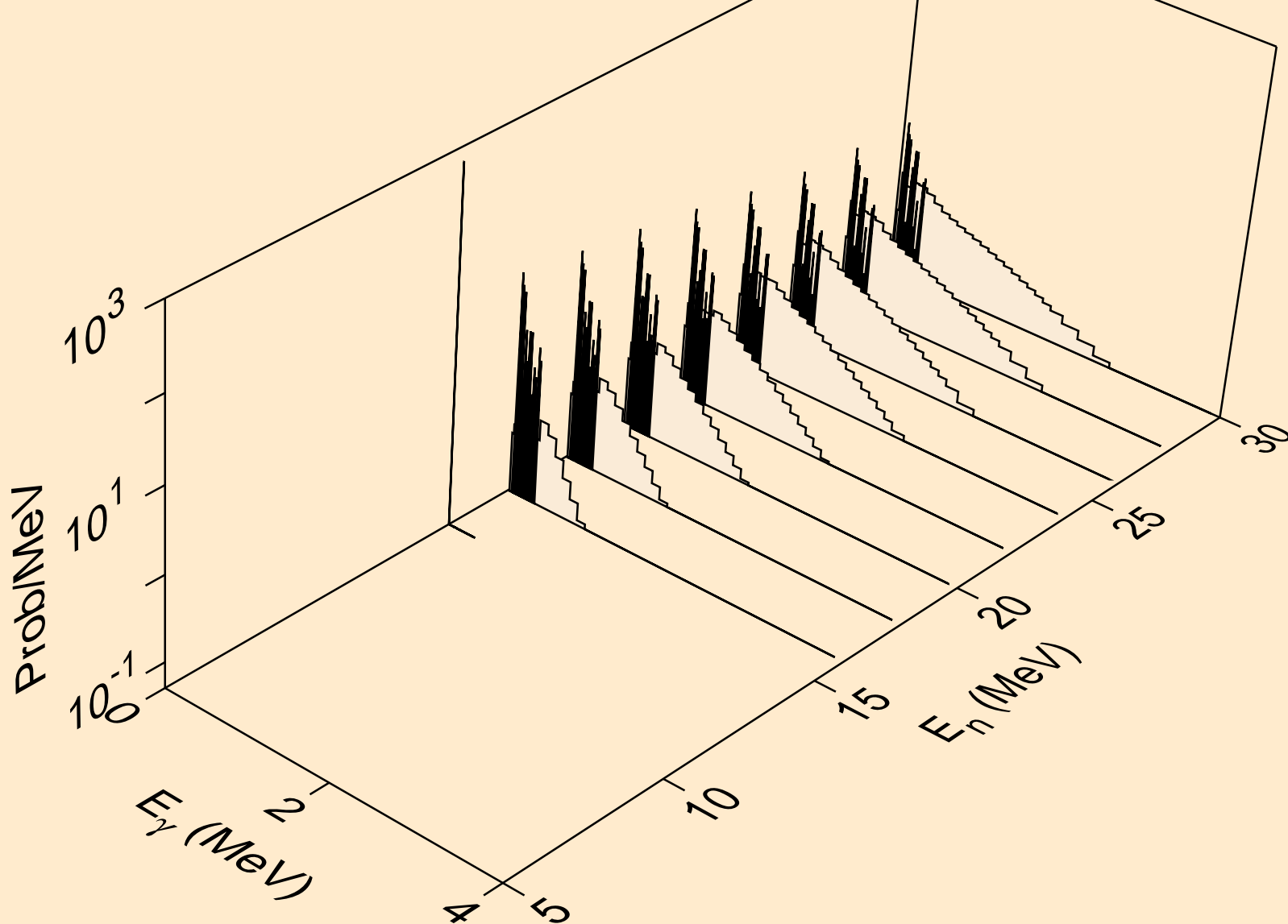



HG198 NEUTRON ACER TENDL-2019 LIBRARY; T=293.16K  
Photon emission for (n,p)

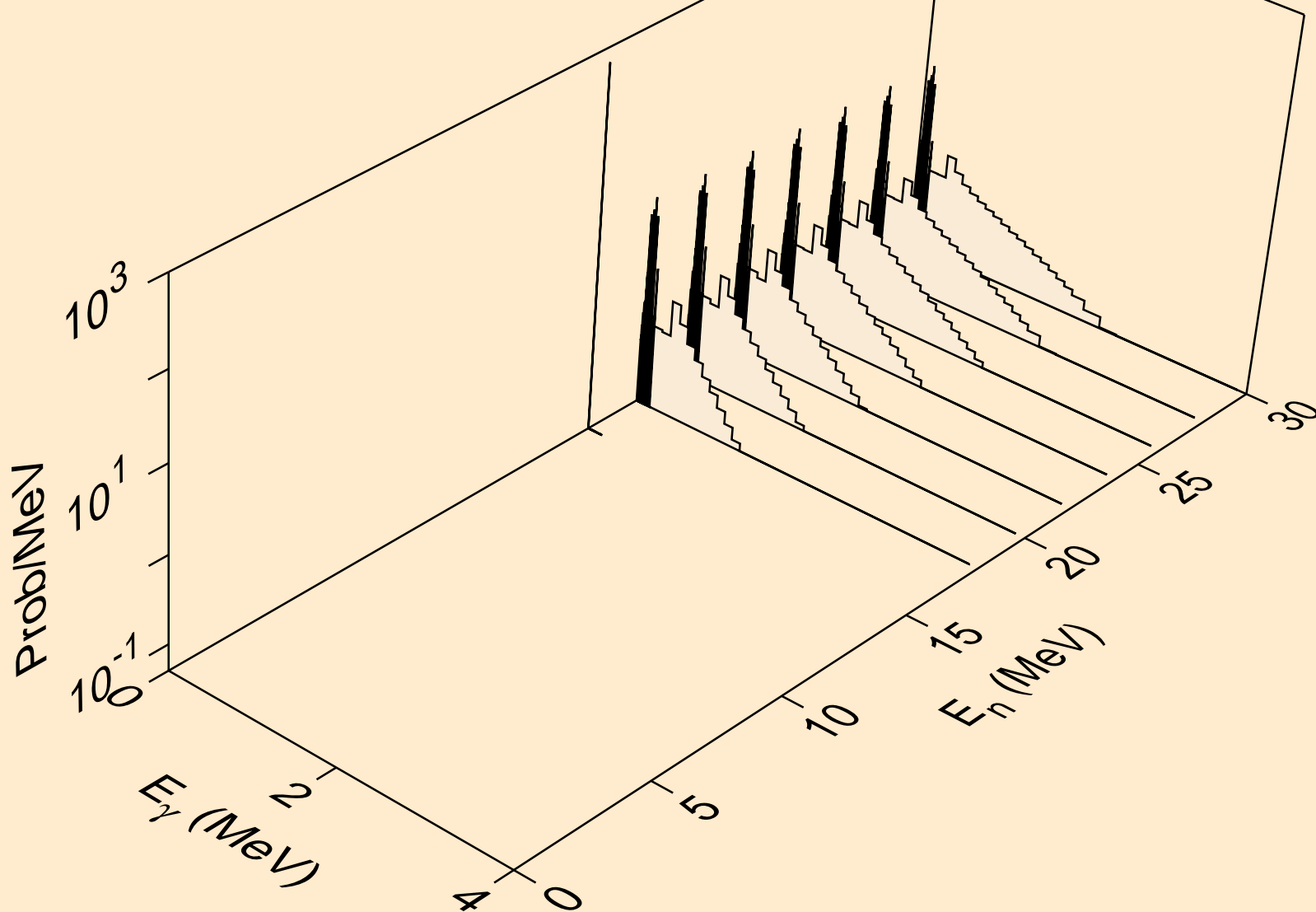

HG198 NEUTRON ACER TENDL-2019 LIBRARY; T=293.16K  
Photon emission for (n,pd)

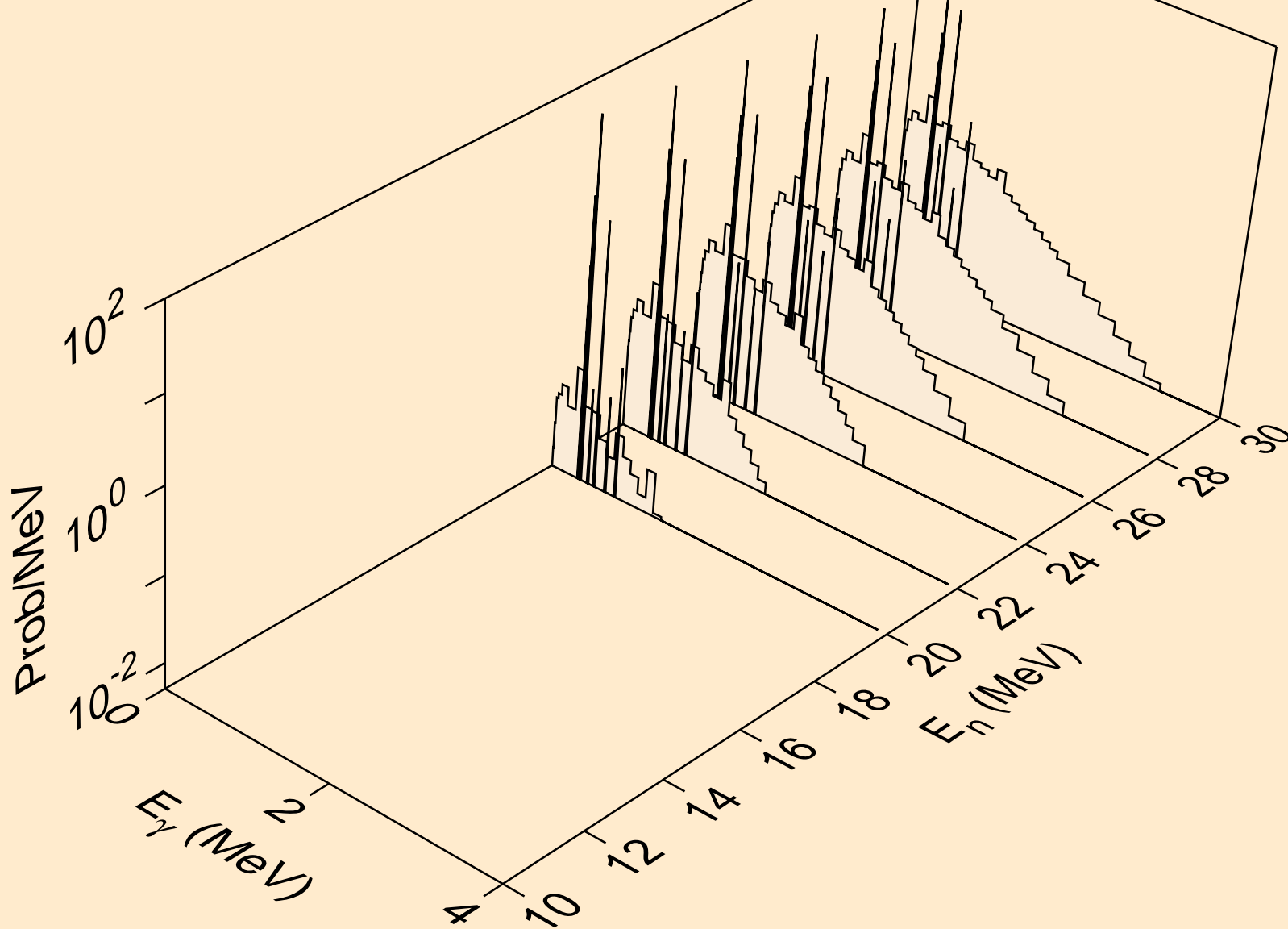

HG198 NEUTRON ACER TENDL-2019 LIBRARY; T=293.16K  
Photon emission for (n,pt)

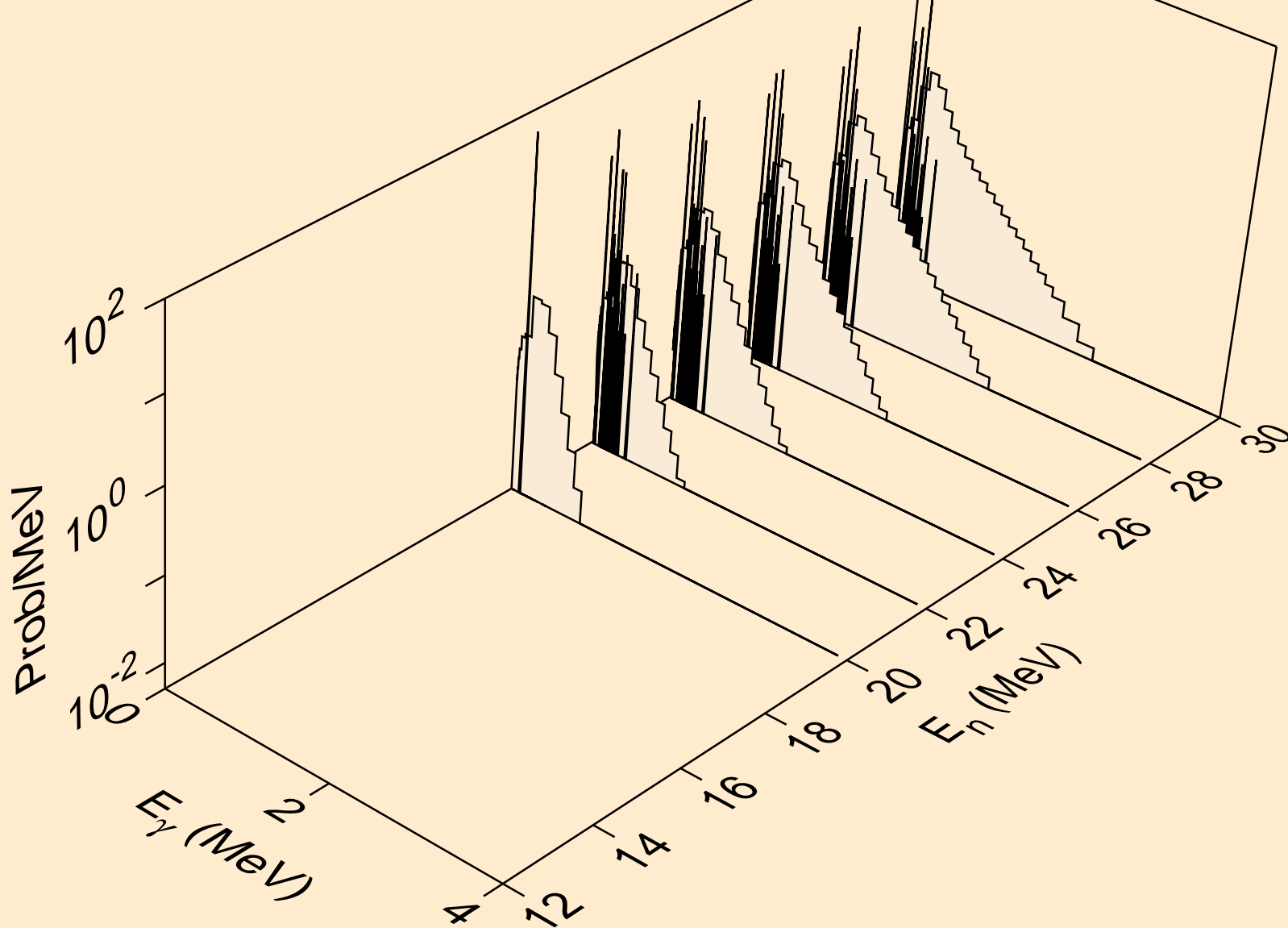

HG198 NEUTRON ACER TENDL-2019 LIBRARY; T=293.16K  
thermal capture photon spectrum

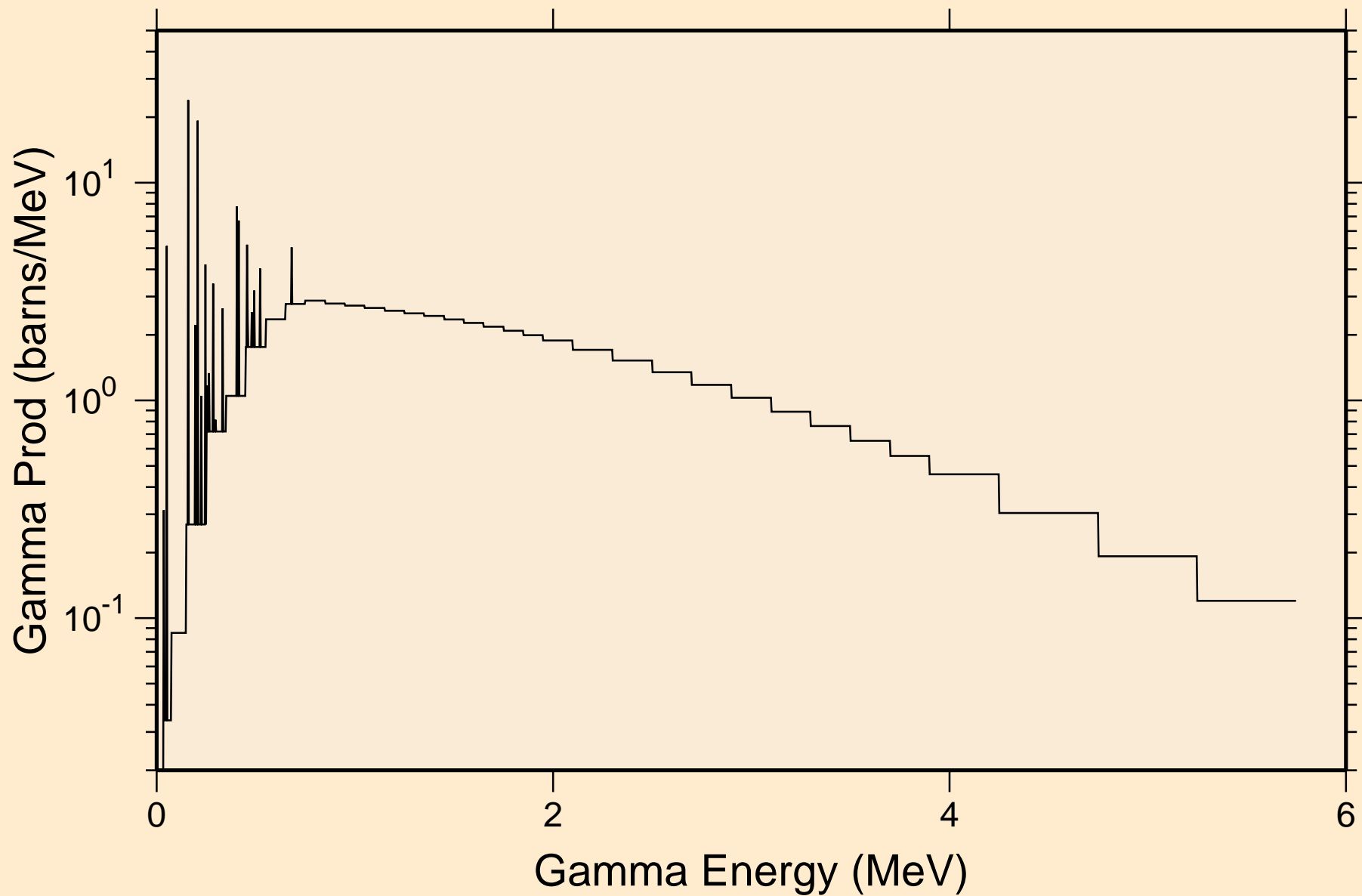

HG198 NEUTRON ACER TENDL-2019 LIBRARY; T=293.16K  
14 MeV photon spectrum

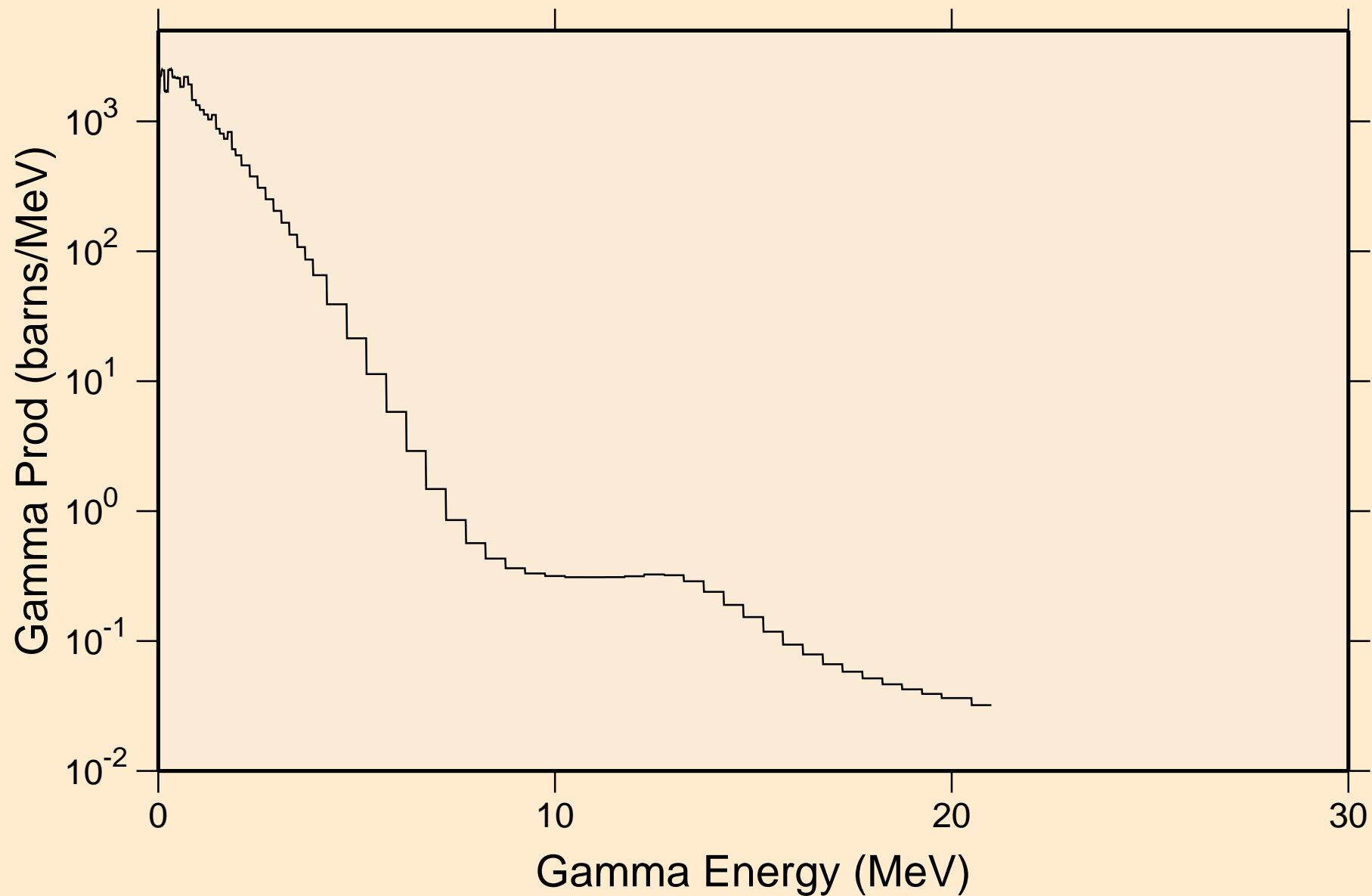

# HG198 NEUTRON ACER TENDL-2019 LIBRARY; T=293.16K

## Particle heating contributions

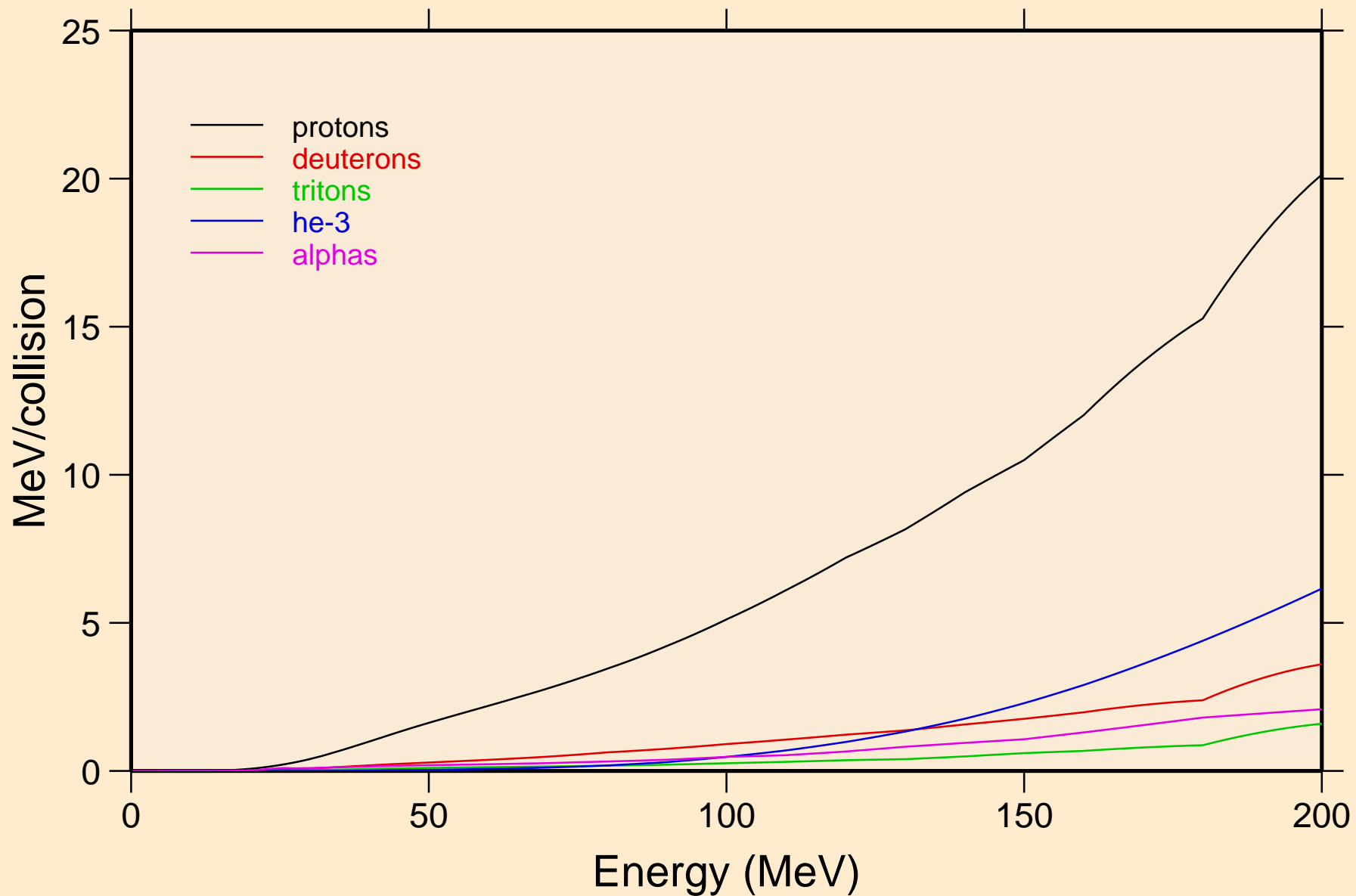

HG198 NEUTRON ACER TENDL-2019 LIBRARY; T=293.16K  
Recoil Heating

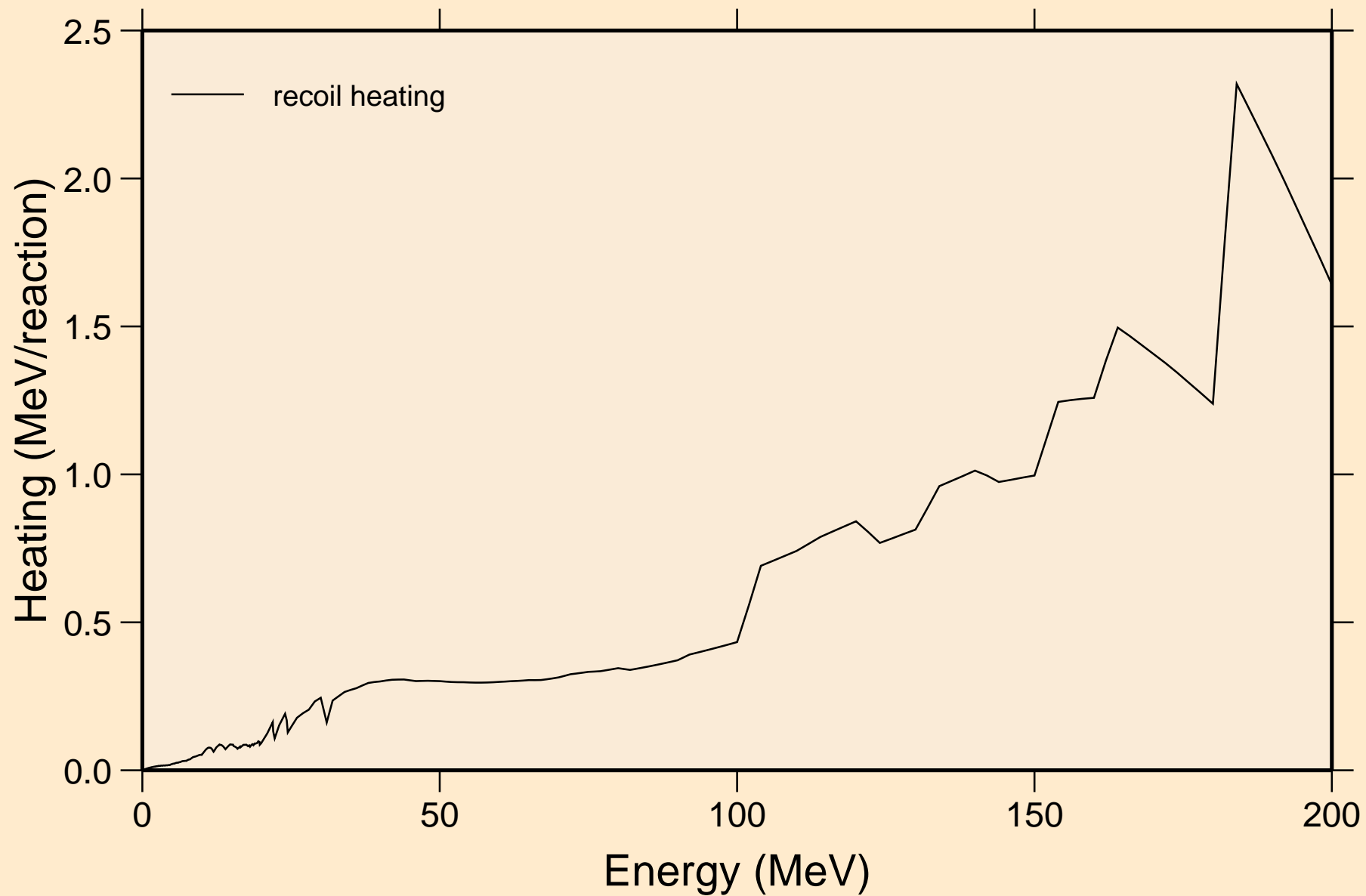

HG198 NEUTRON ACER TENDL-2019 LIBRARY; T=293.16K  
Particle production cross sections

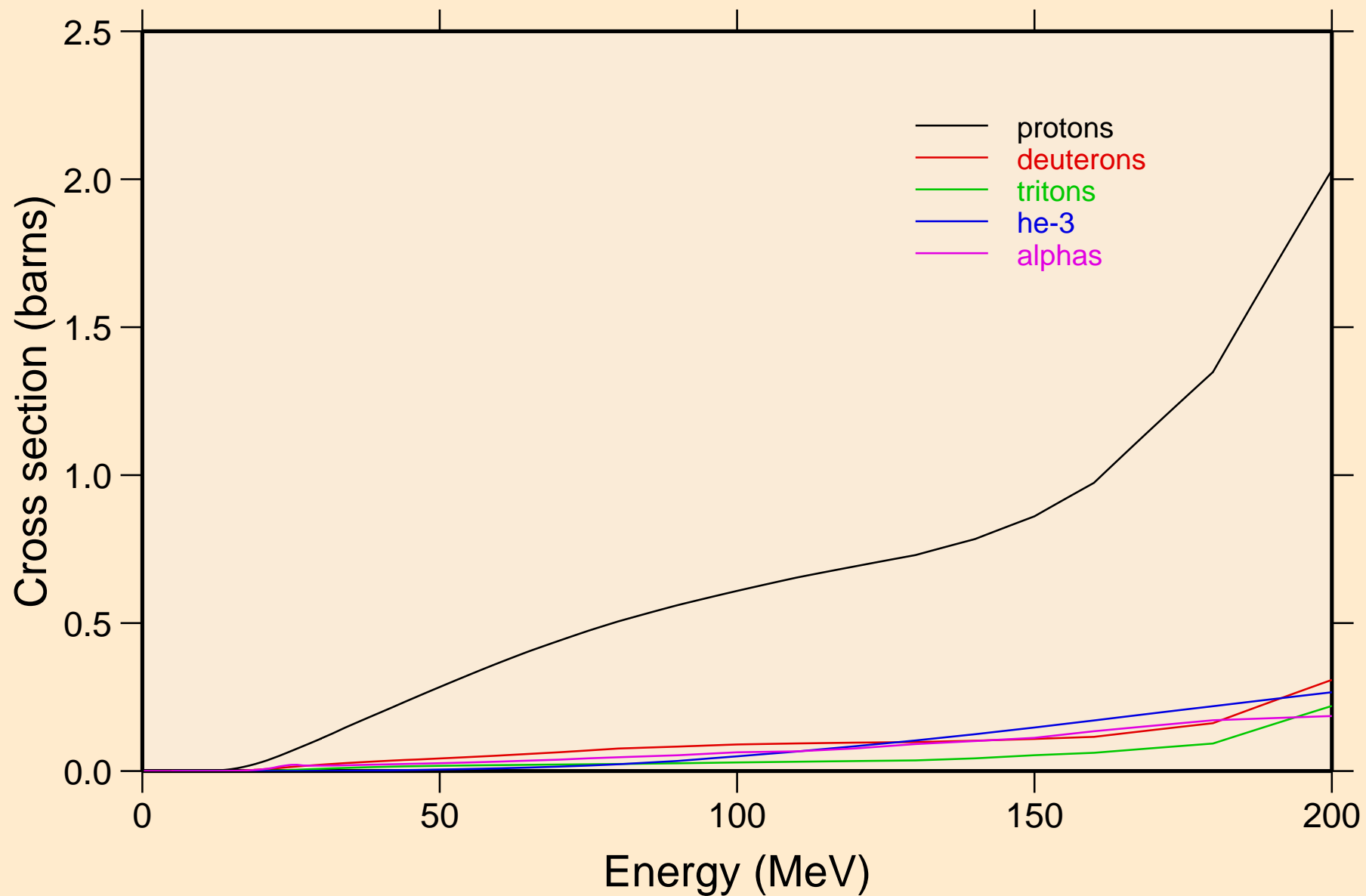



HG198 NEUTRON ACER TENDL-2019 LIBRARY; T=293.16K  
protons from (n,x)

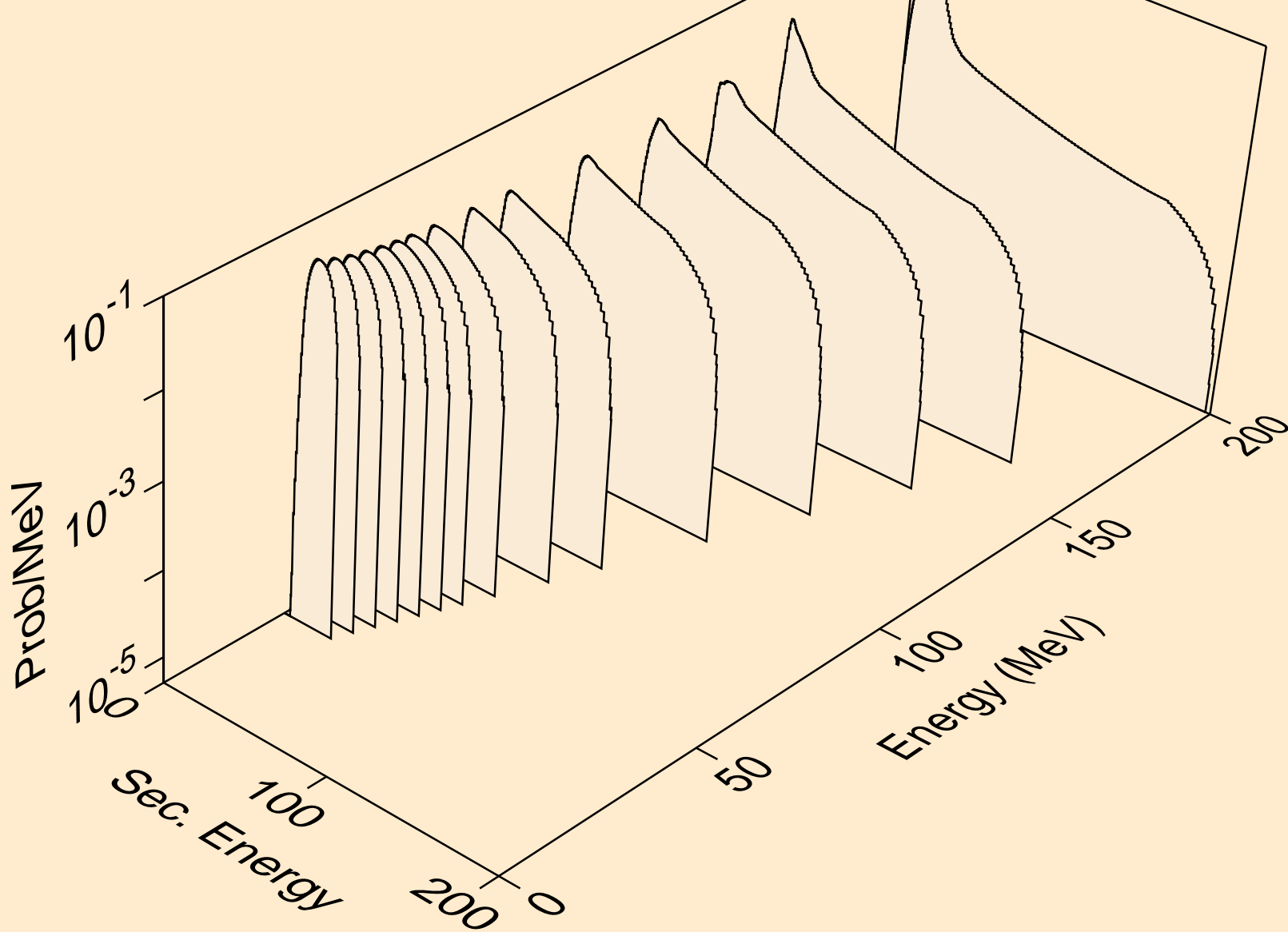

HG198 NEUTRON ACER TENDL-2019 LIBRARY; T=293.16K  
protons from (n,n\*)p

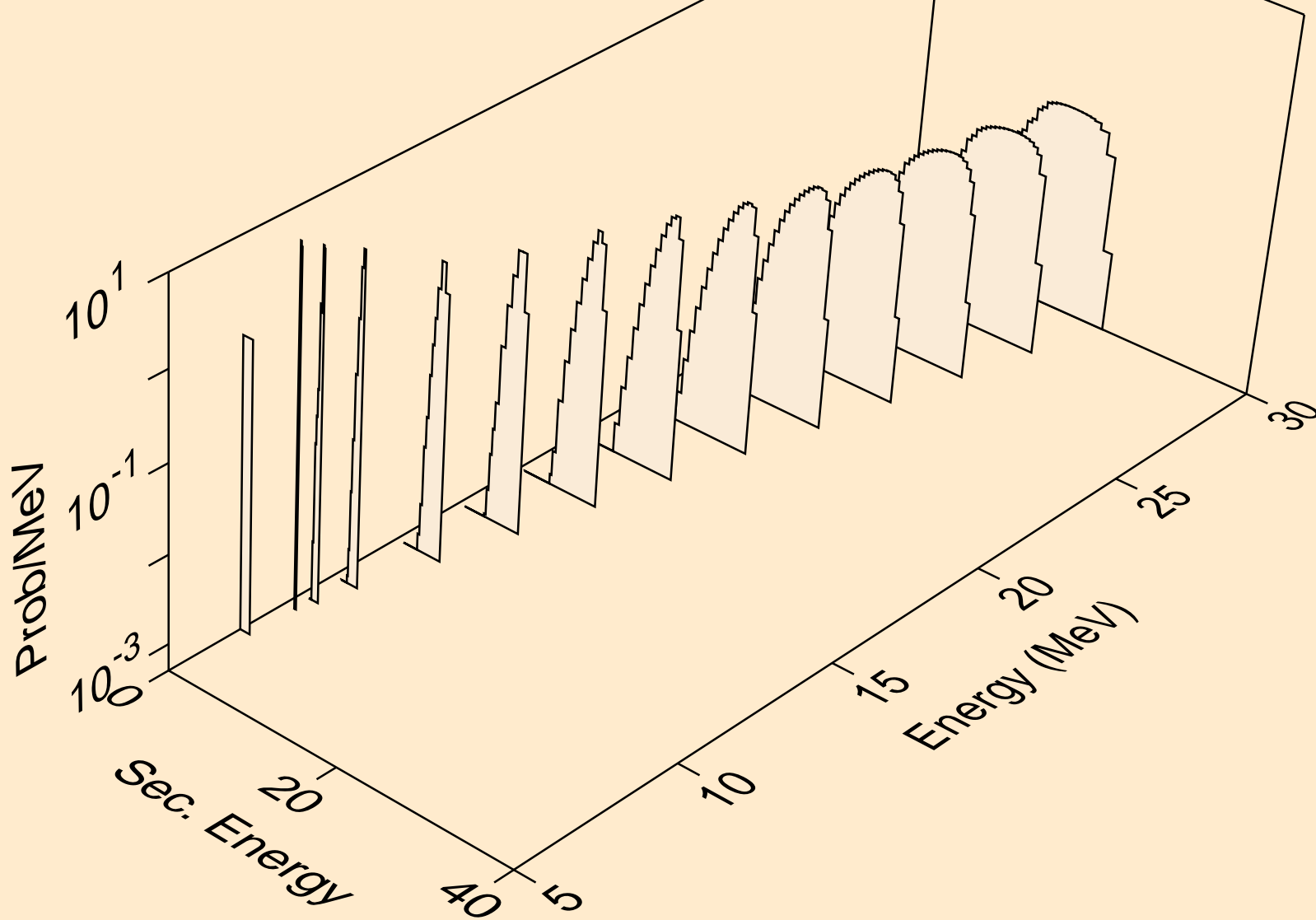

HG198 NEUTRON ACER TENDL-2019 LIBRARY; T=293.16K  
protons from (n,2np)

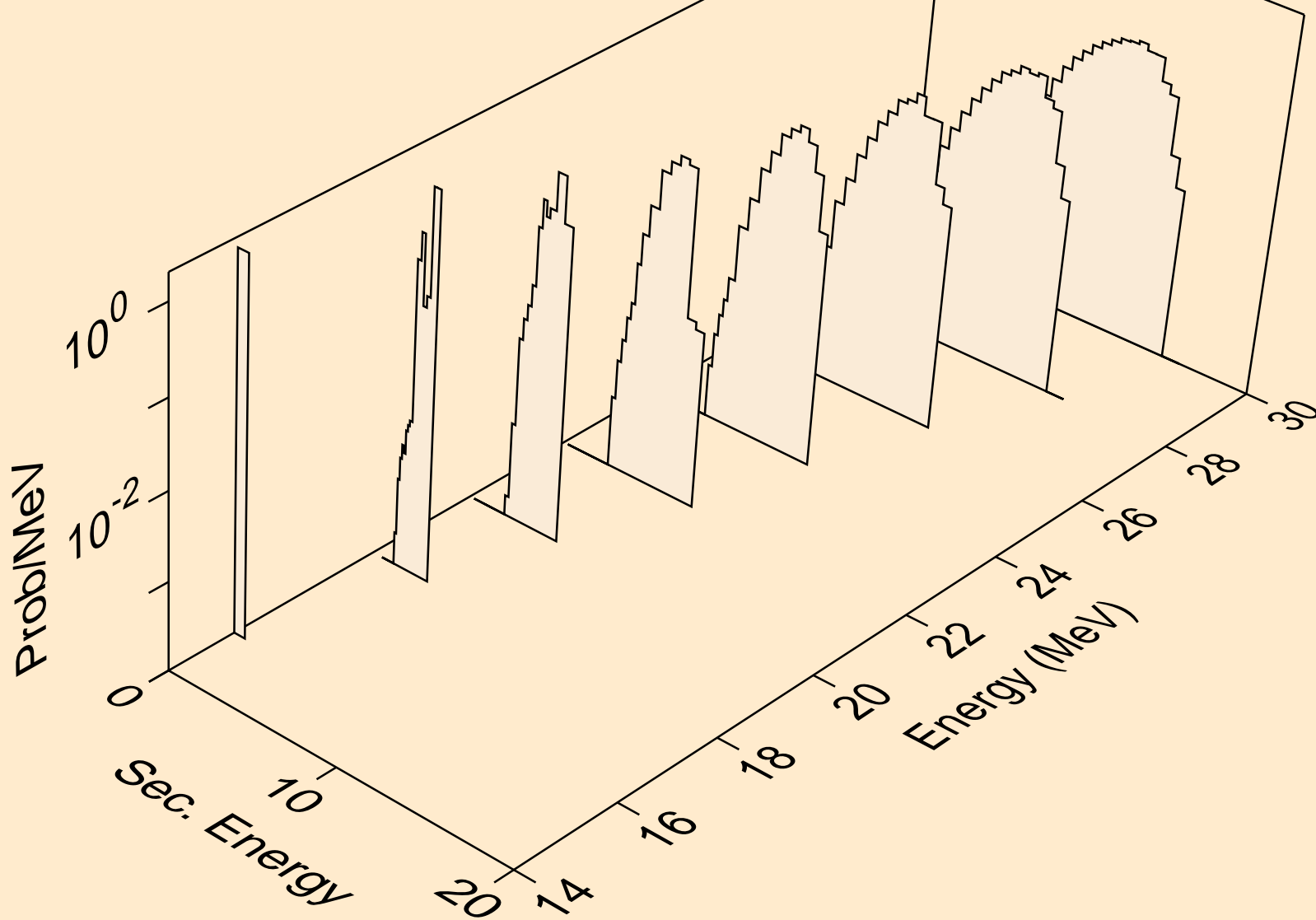

HG198 NEUTRON ACER TENDL-2019 LIBRARY; T=293.16K  
protons from (n,3np)

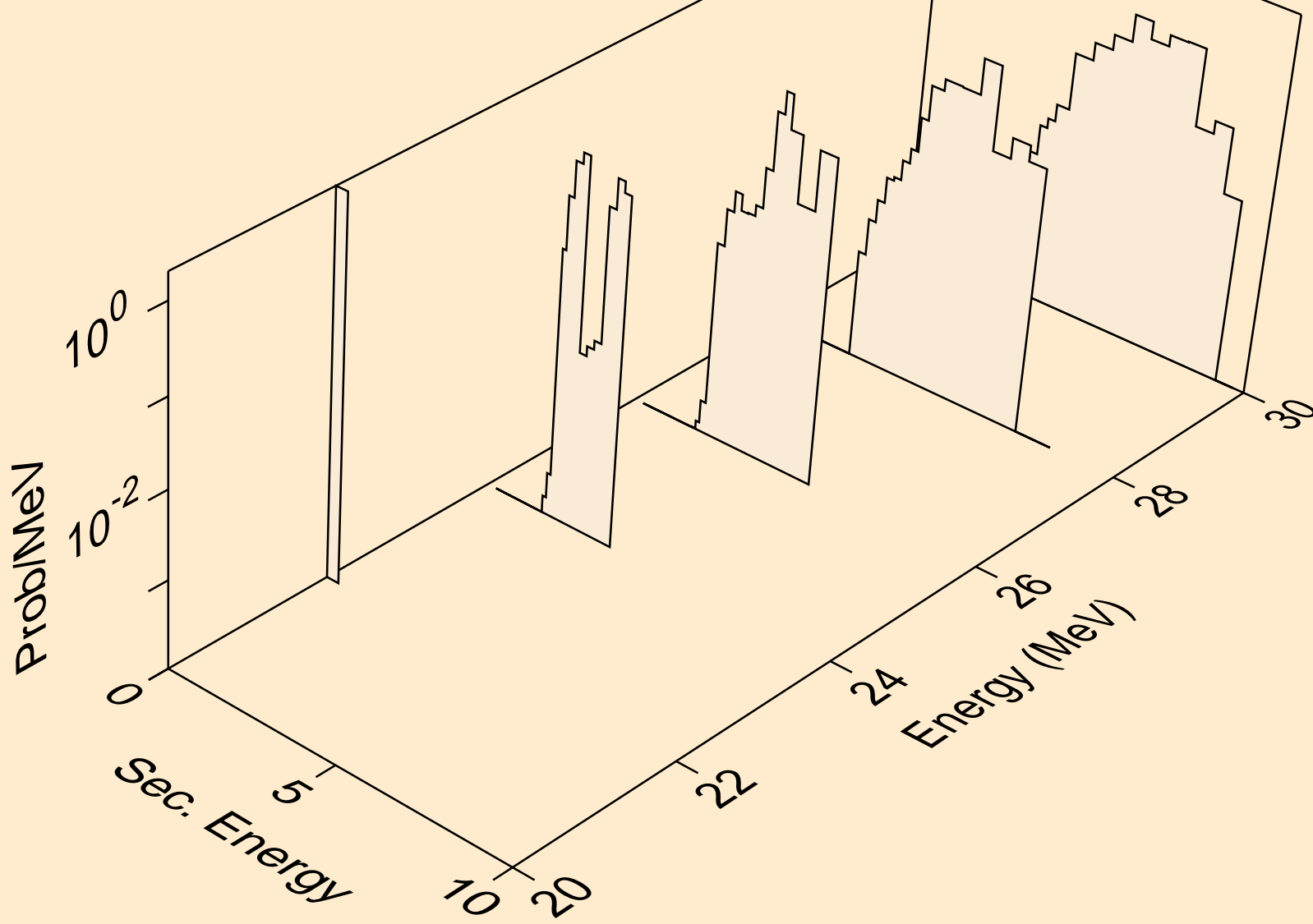

HG198 NEUTRON ACER TENDL-2019 LIBRARY; T=293.16K  
protons from (n,2np)

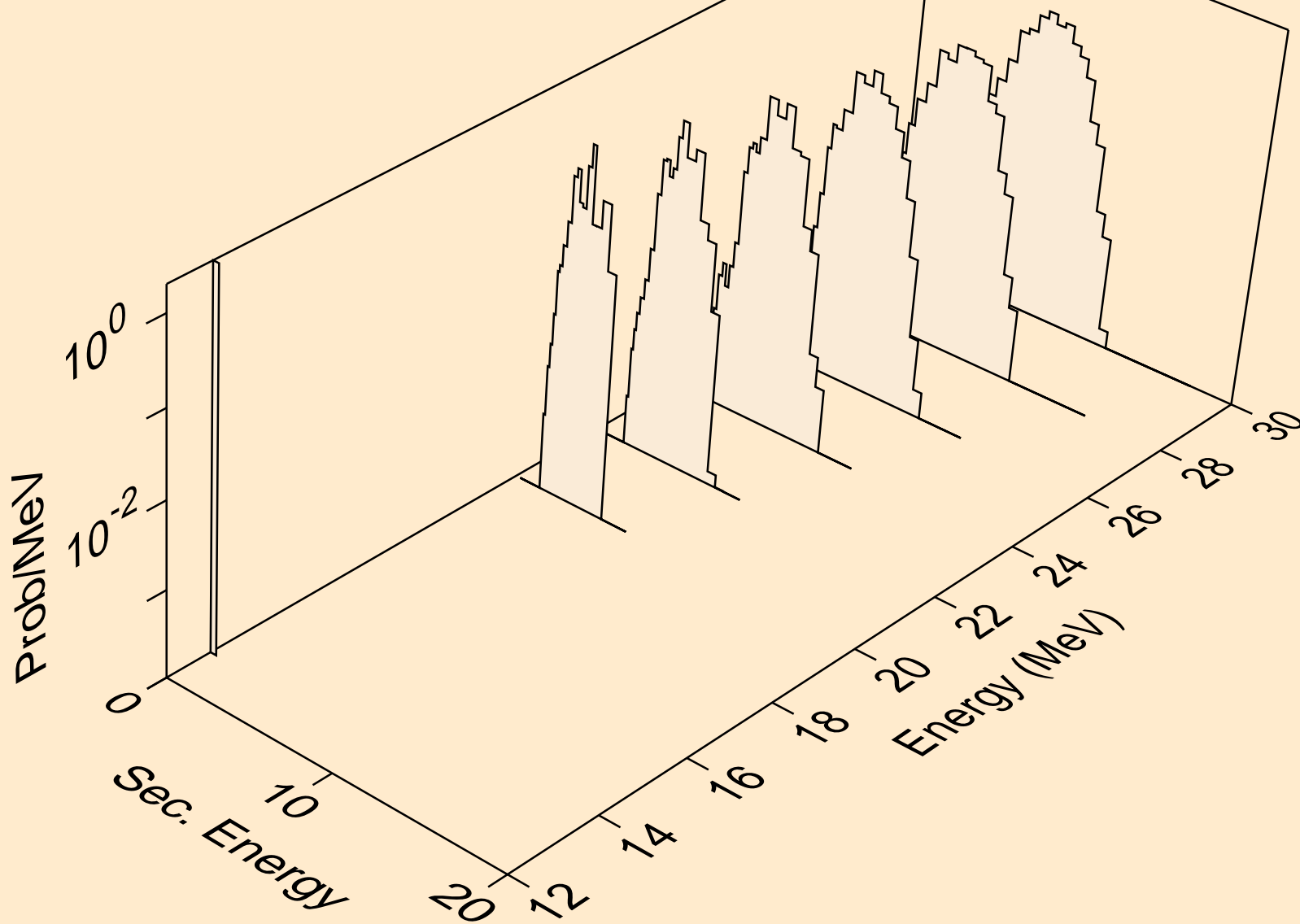

HG198 NEUTRON ACER TENDL-2019 LIBRARY; T=293.16K  
protons from (n,npa)

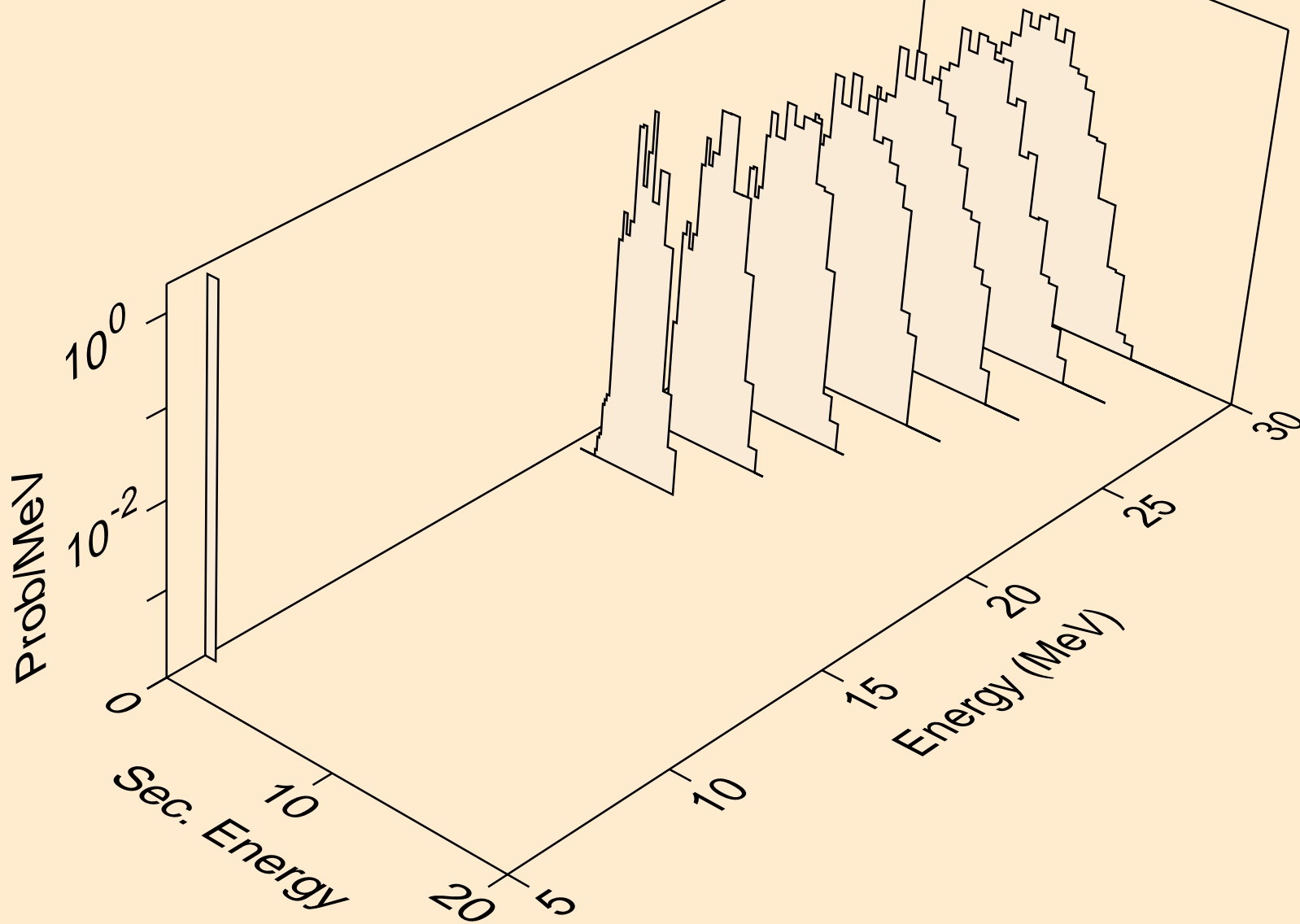

HG198 NEUTRON ACER TENDL-2019 LIBRARY; T=293.16K  
protons from (n,p)

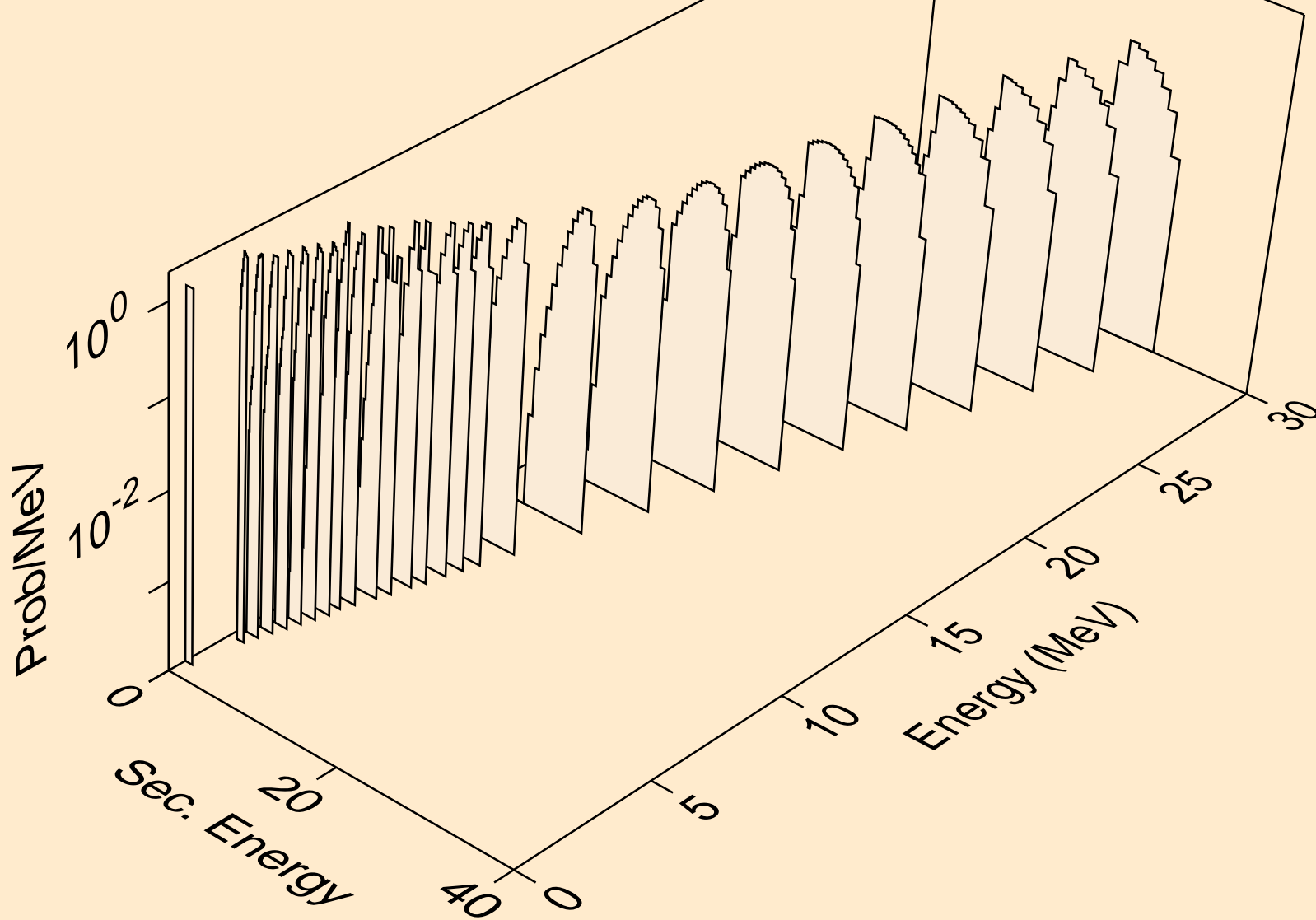

HG198 NEUTRON ACER TENDL-2019 LIBRARY; T=293.16K  
protons from (n,2p)

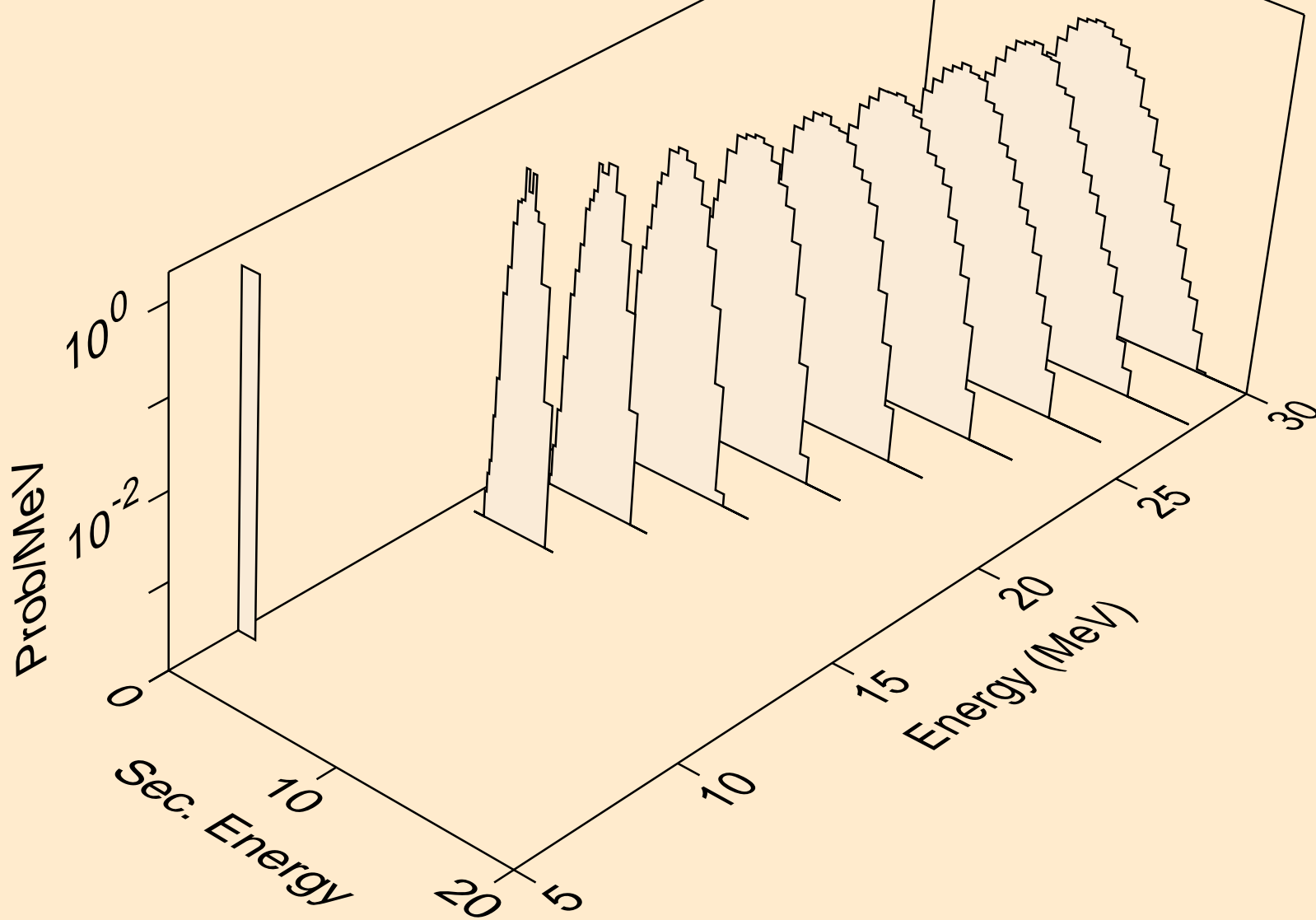



HG198 NEUTRON ACER TENDL-2019 LIBRARY; T=293.16K  
protons from (n,p)

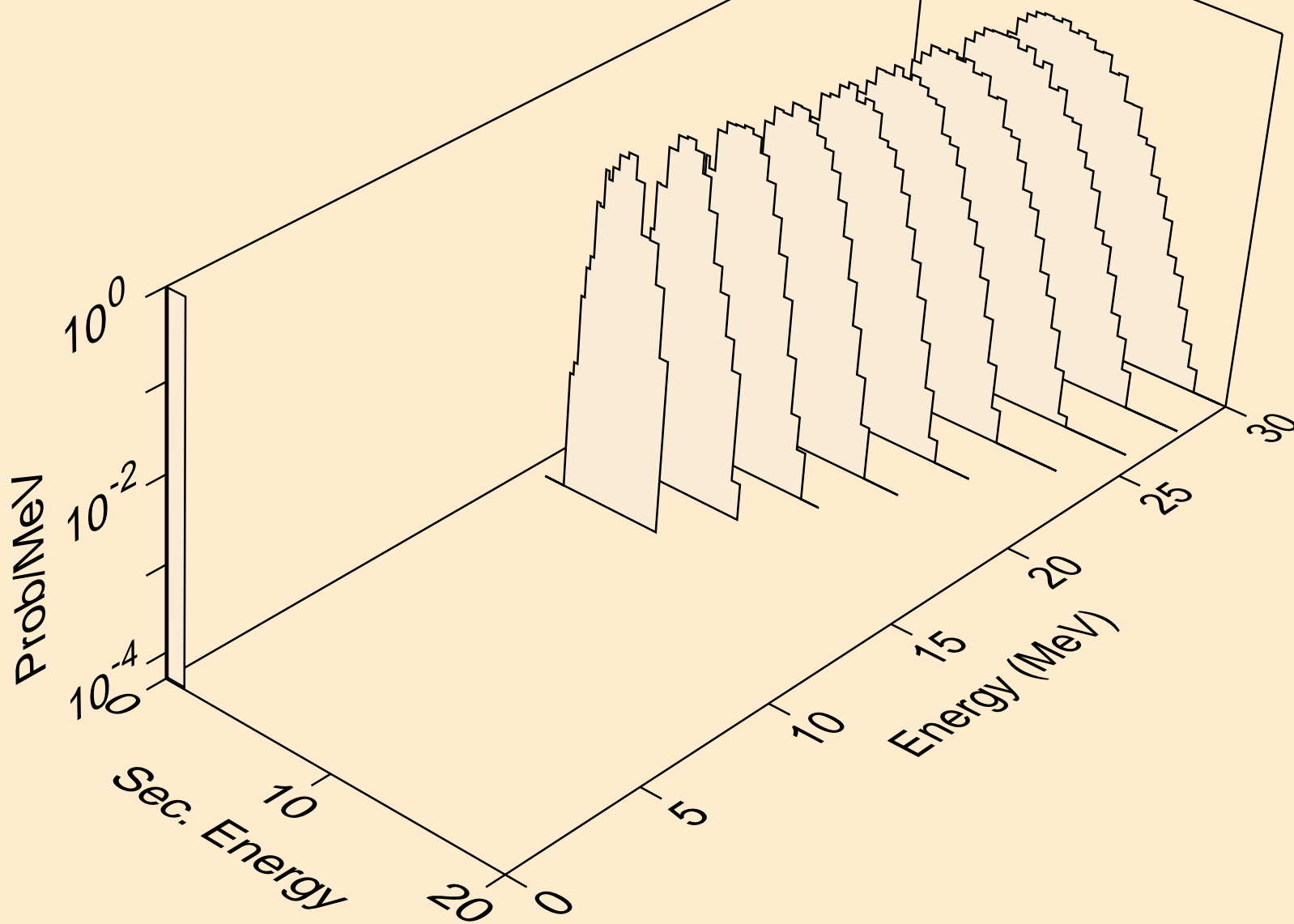

HG198 NEUTRON ACER TENDL-2019 LIBRARY; T=293.16K  
protons from (n,pd)

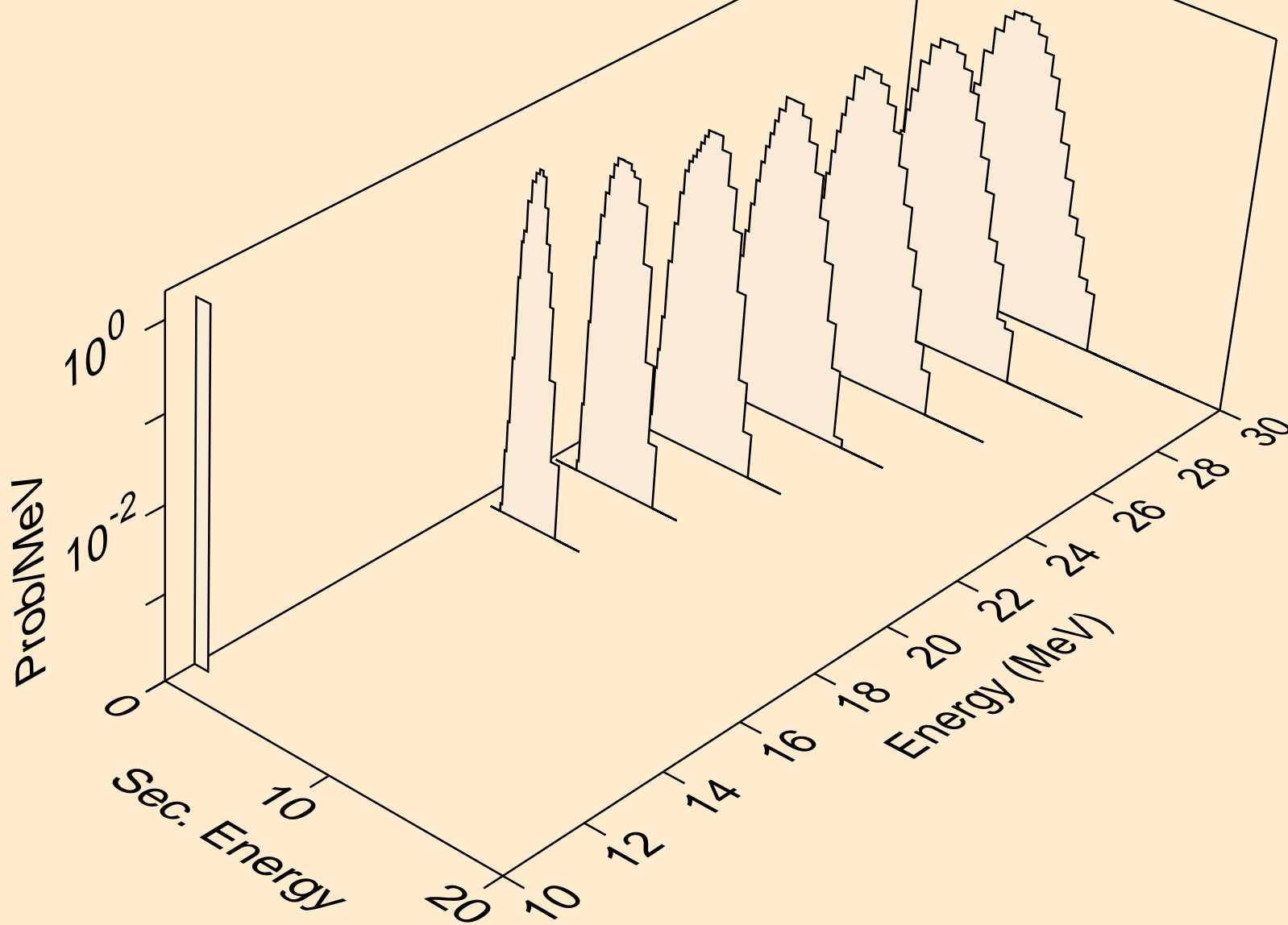

HG198 NEUTRON ACER TENDL-2019 LIBRARY; T=293.16K  
protons from (n,pt)

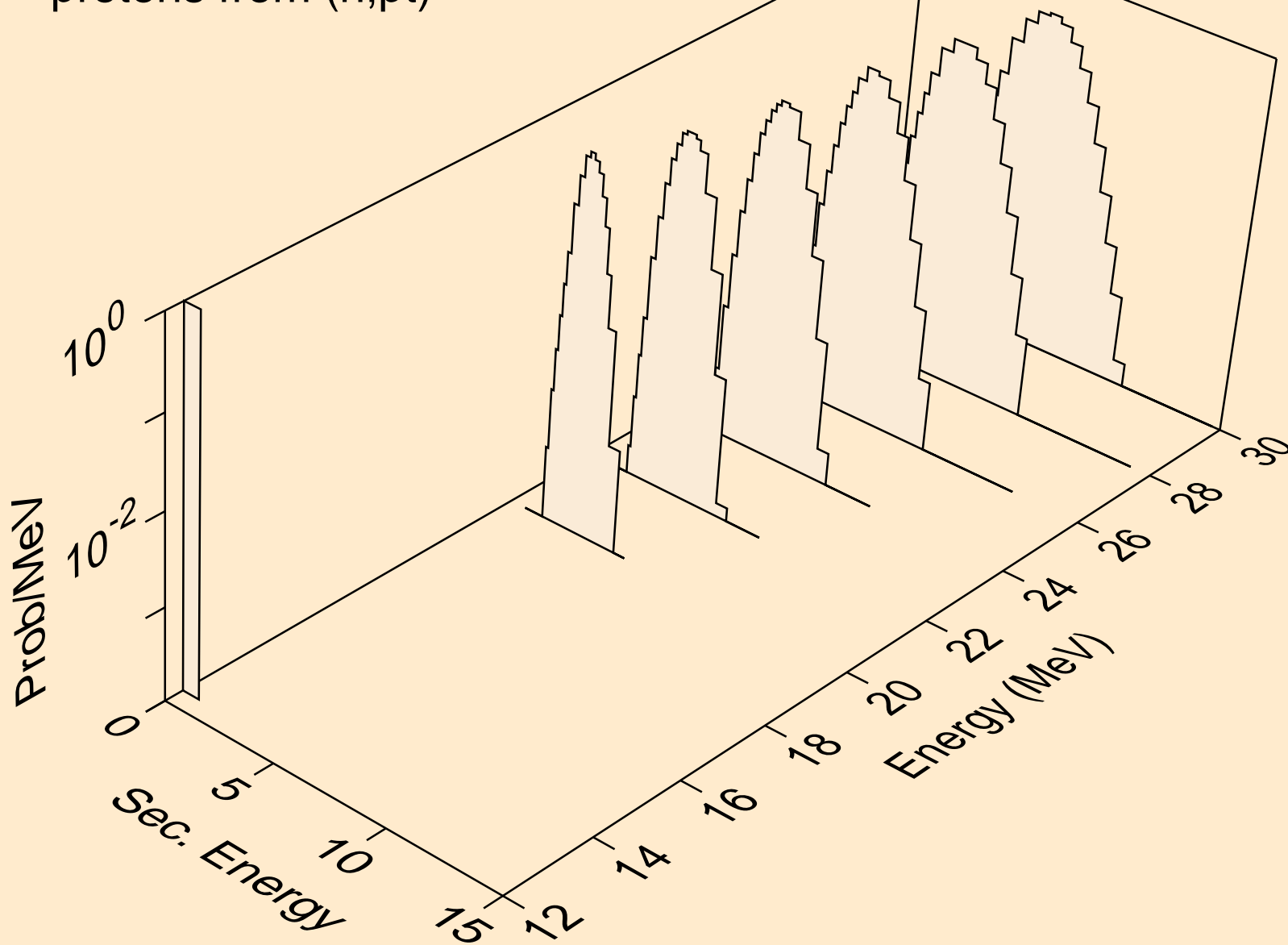

HG198 NEUTRON ACER TENDL-2019 LIBRARY; T=293.16K  
deuterons from (n,x)

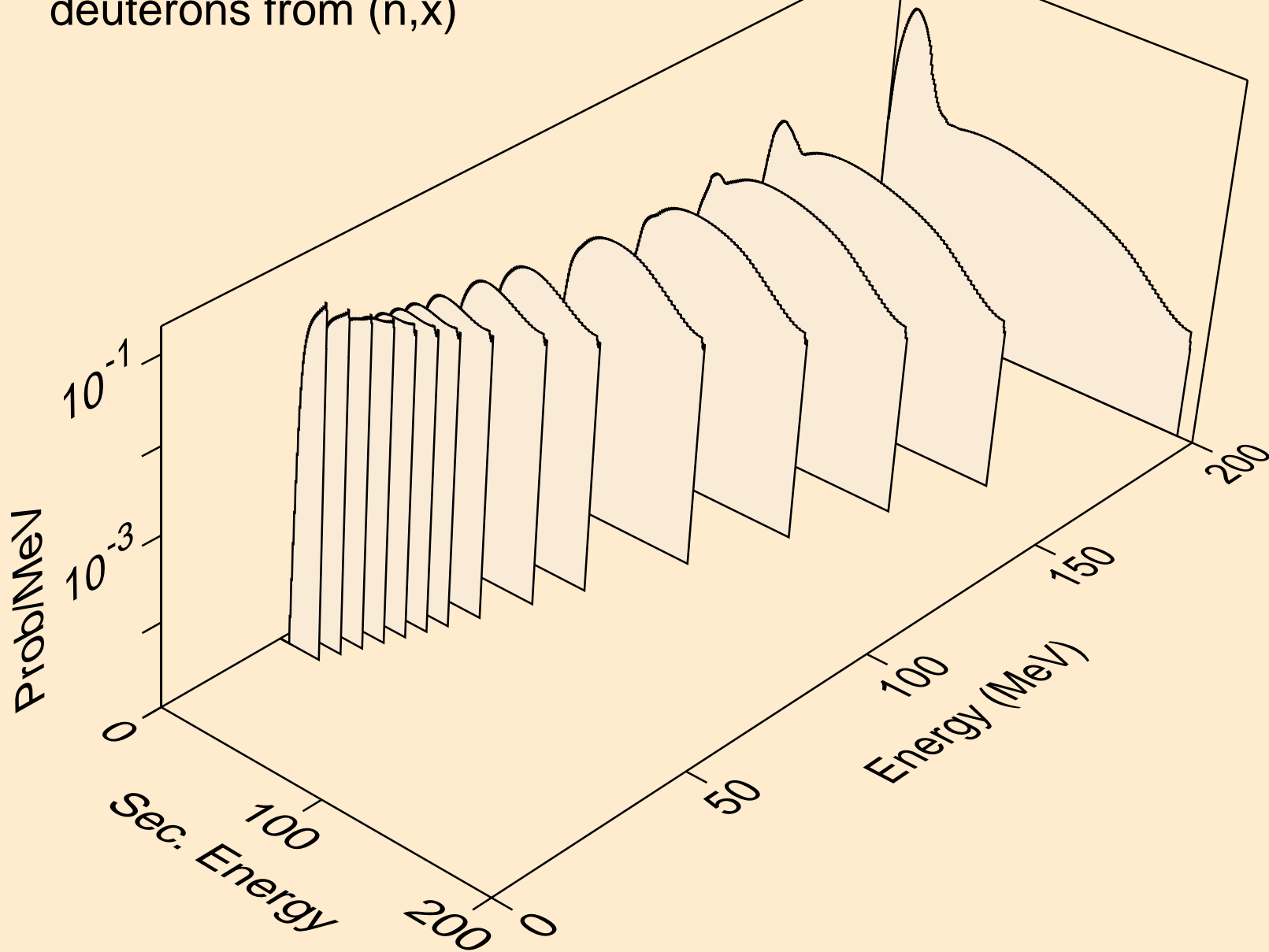

HG198 NEUTRON ACER TENDL-2019 LIBRARY; T=293.16K  
deuterons from (n,2nd)

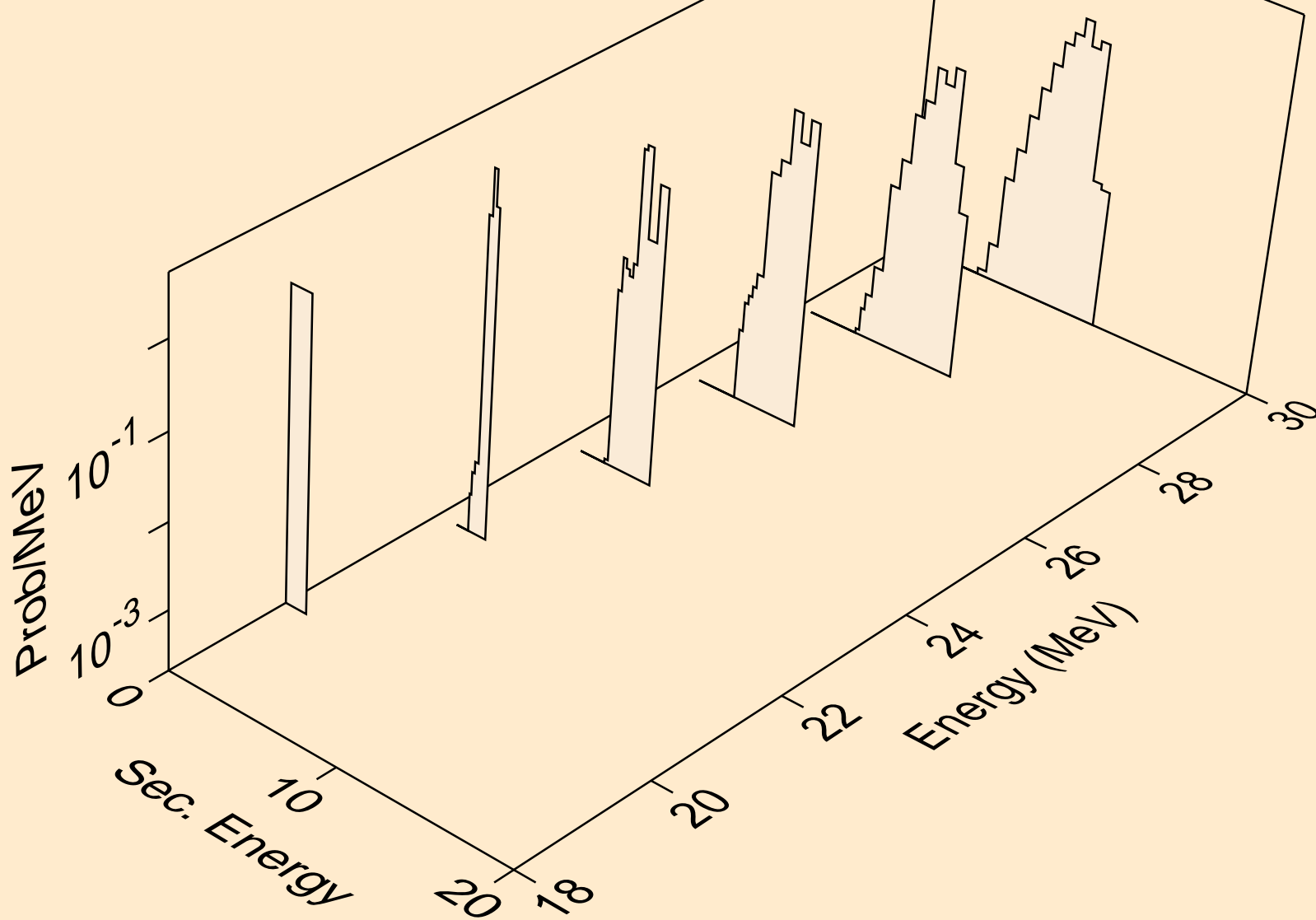

HG198 NEUTRON ACER TENDL-2019 LIBRARY; T=293.16K  
deuterons from (n,n\*)d

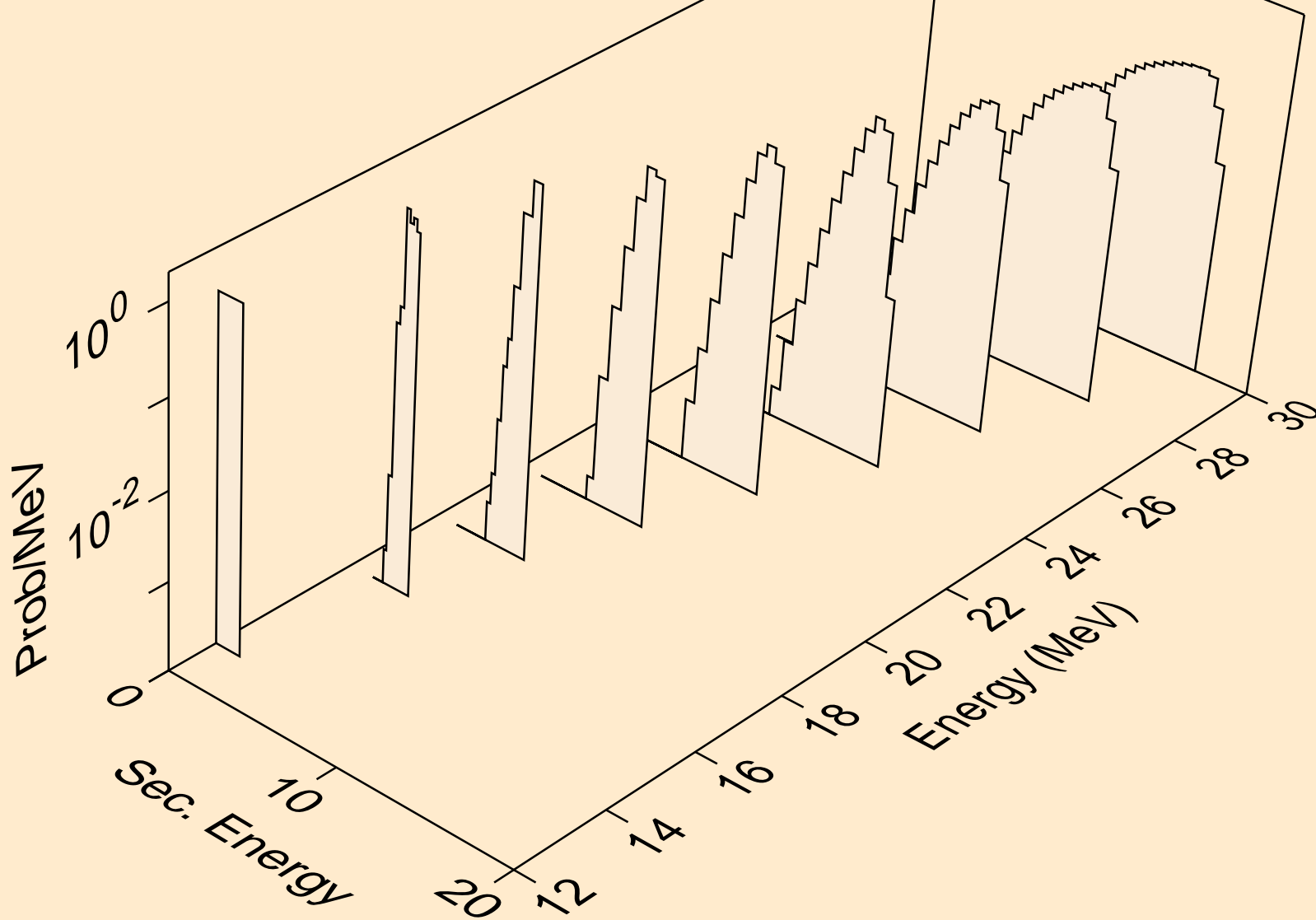

HG198 NEUTRON ACER TENDL-2019 LIBRARY; T=293.16K  
deuterons from (n,d)

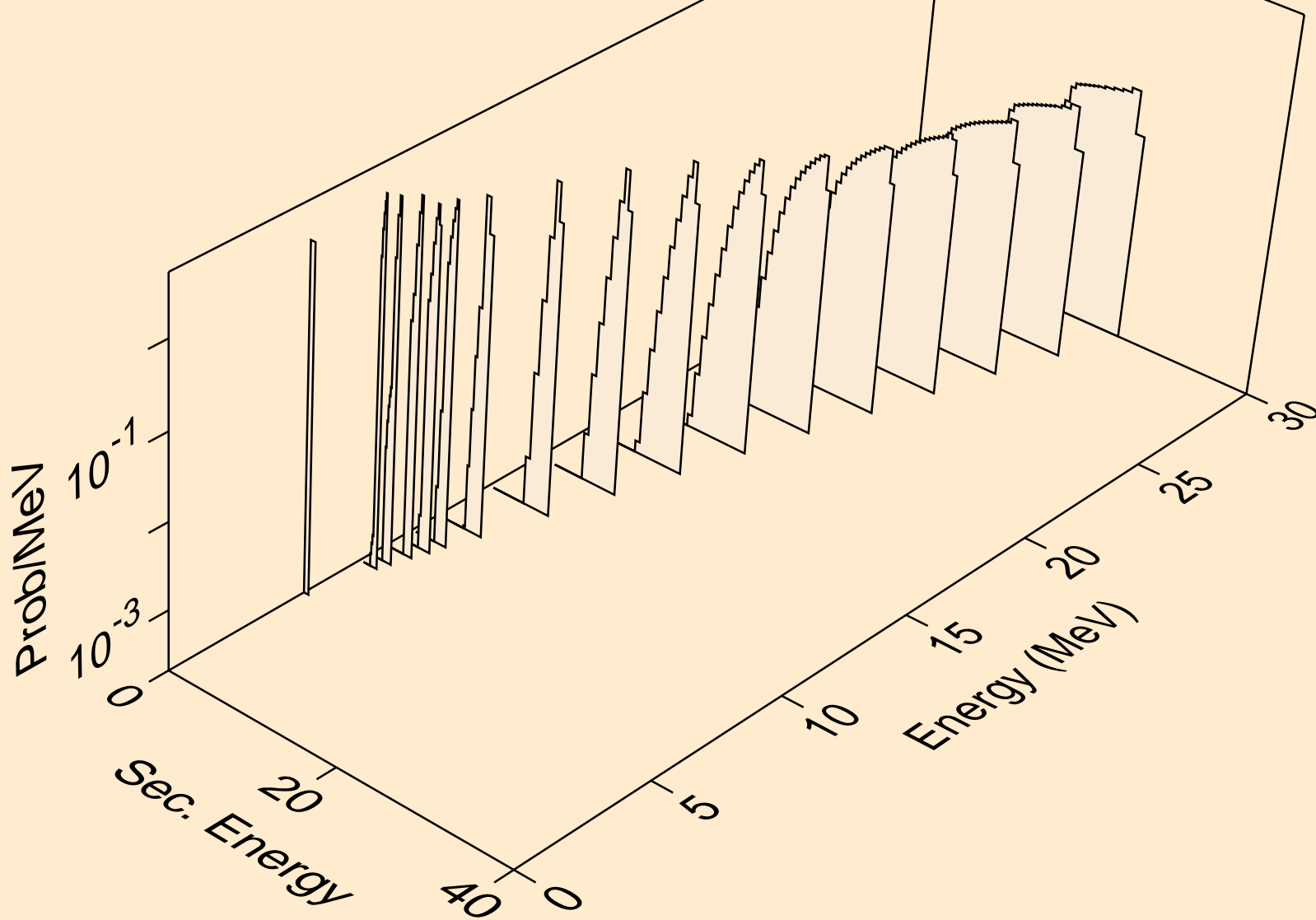

HG198 NEUTRON ACER TENDL-2019 LIBRARY; T=293.16K  
deuterons from (n,pd)

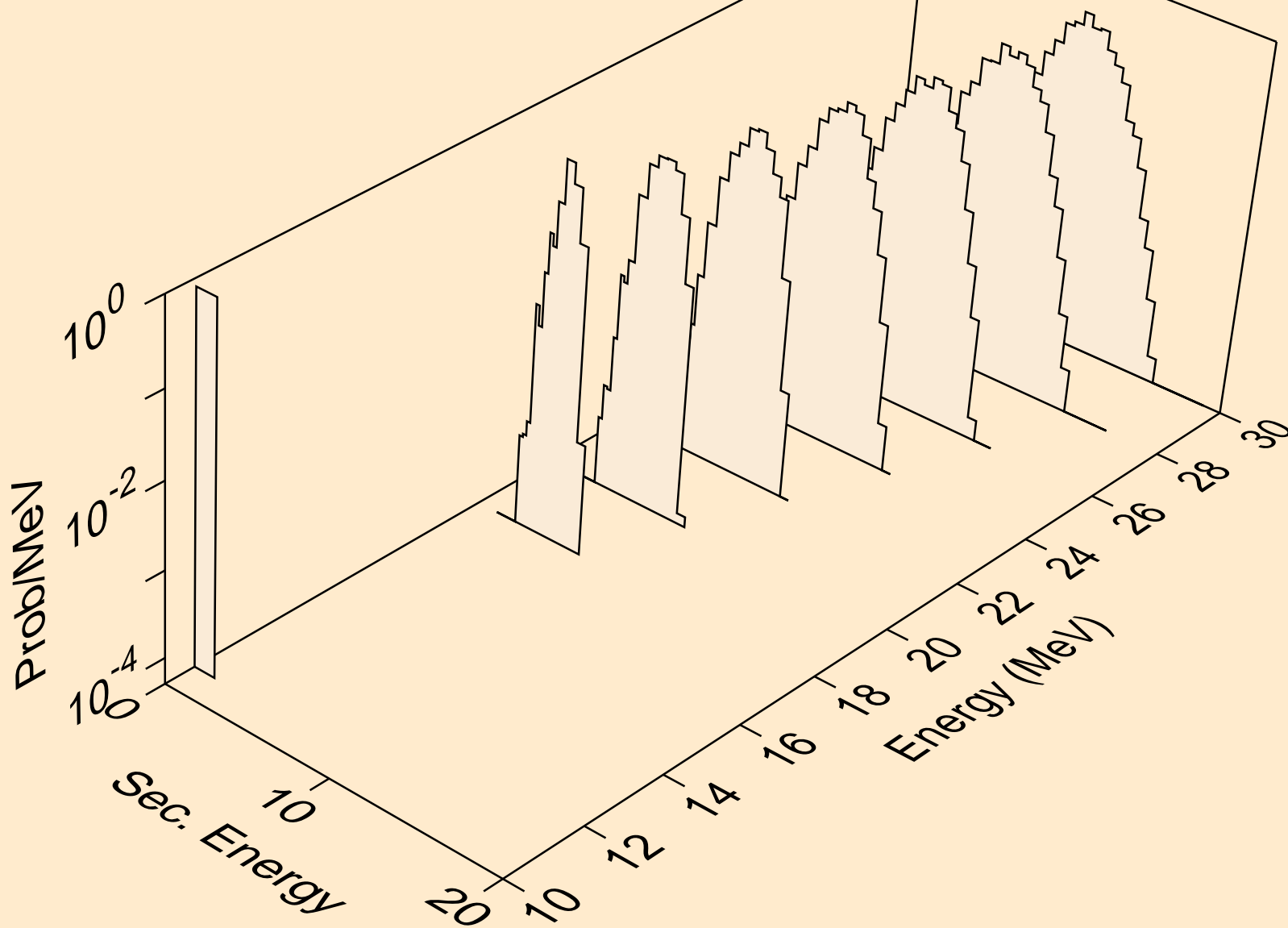



HG198 NEUTRON ACER TENDL-2019 LIBRARY; T=293.16K  
tritons from (n,x)

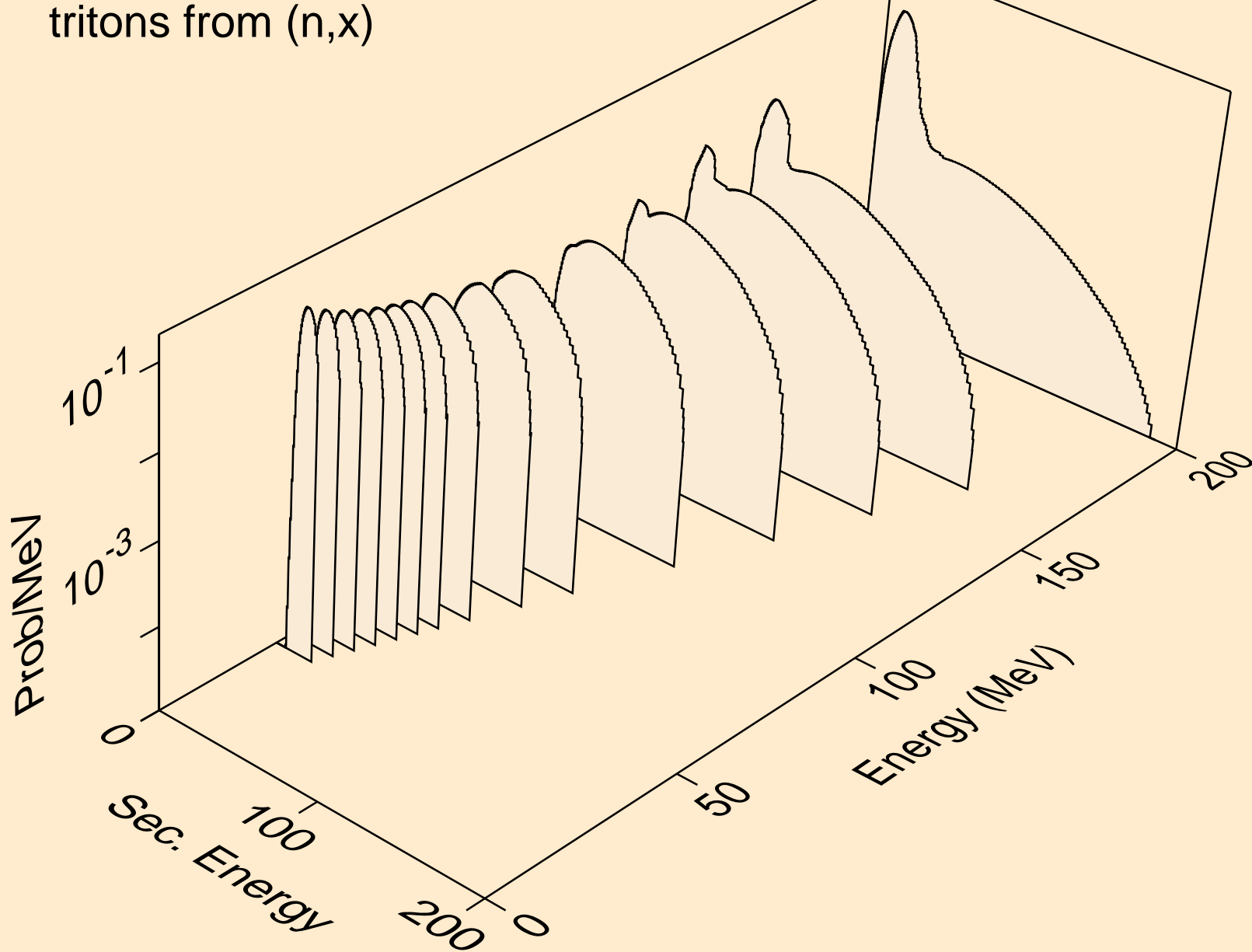

HG198 NEUTRON ACER TENDL-2019 LIBRARY; T=293.16K  
tritons from (n,n\*)t

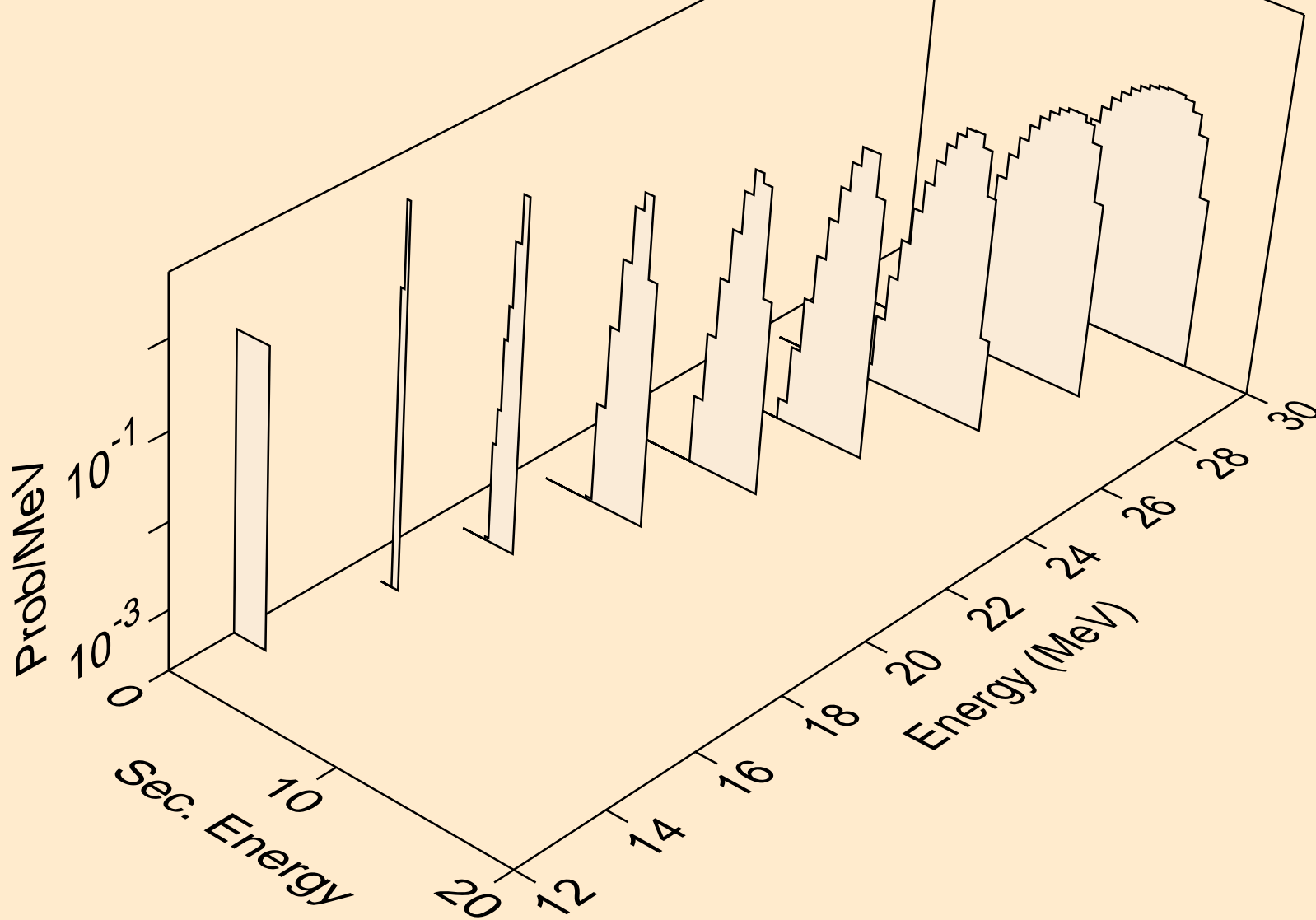

HG198 NEUTRON ACER TENDL-2019 LIBRARY; T=293.16K  
tritons from (n,t)

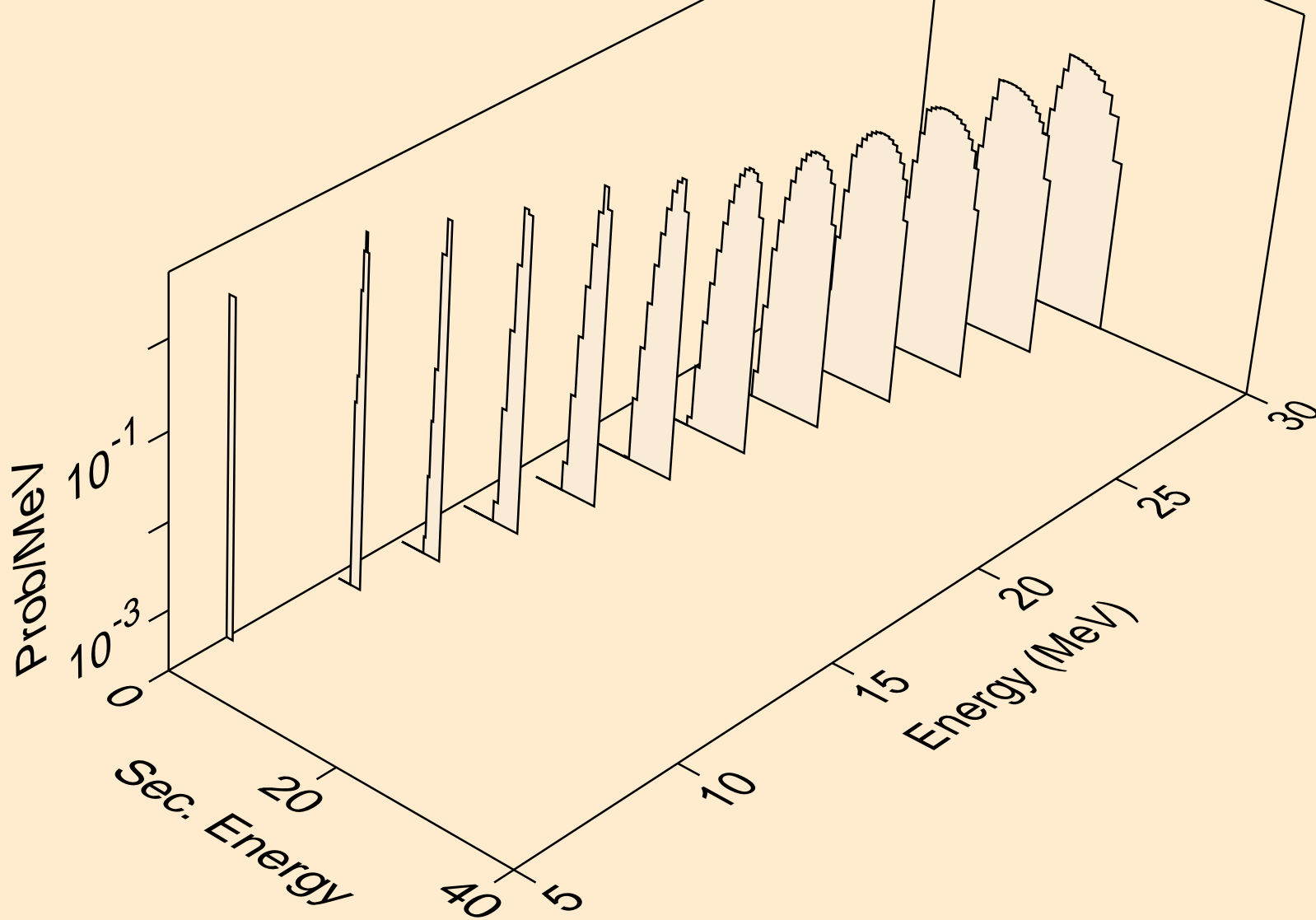

HG198 NEUTRON ACER TENDL-2019 LIBRARY; T=293.16K  
tritons from (n,pt)

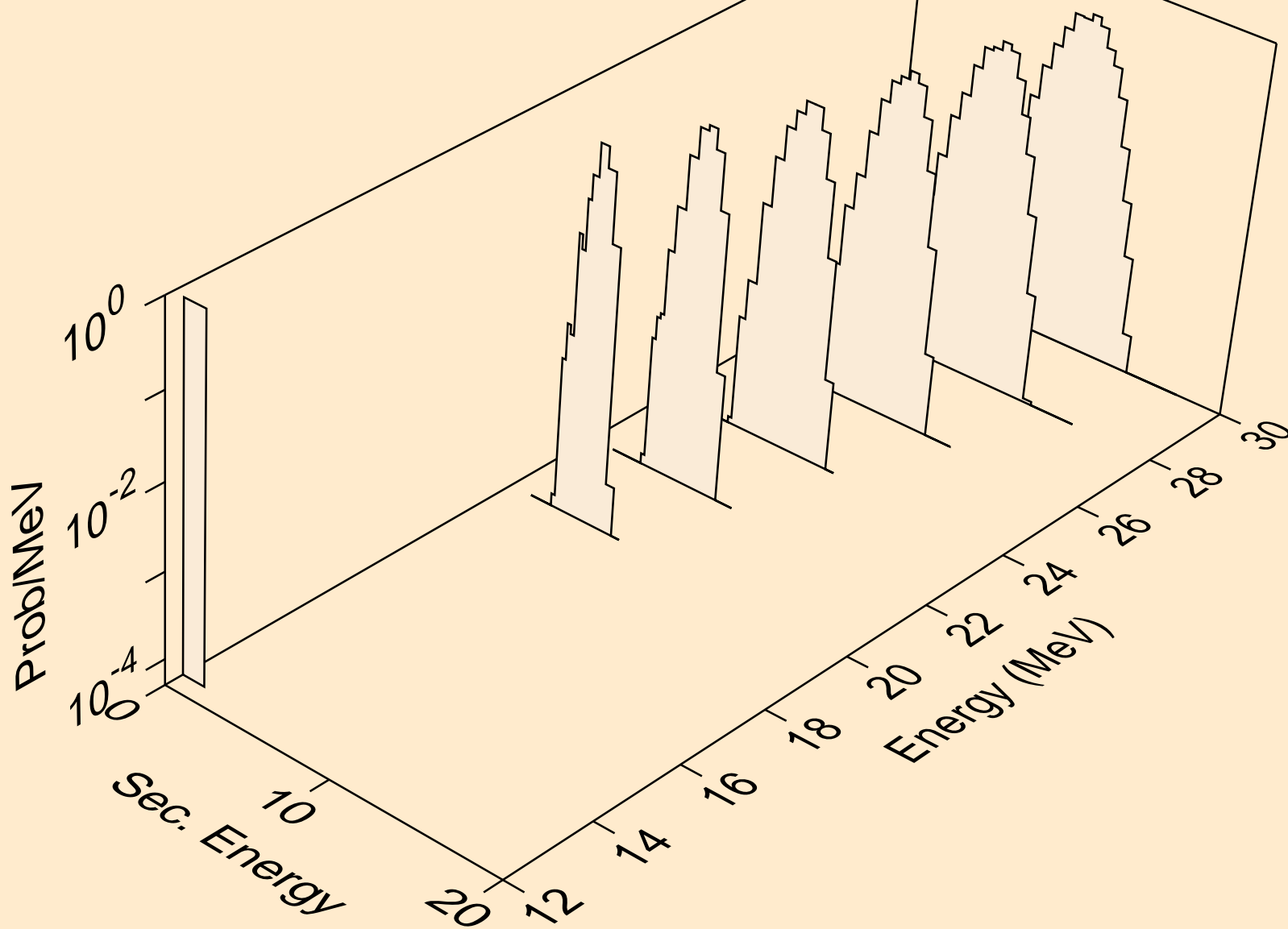

HG198 NEUTRON ACER TENDL-2019 LIBRARY; T=293.16K  
he3s from (n,x)

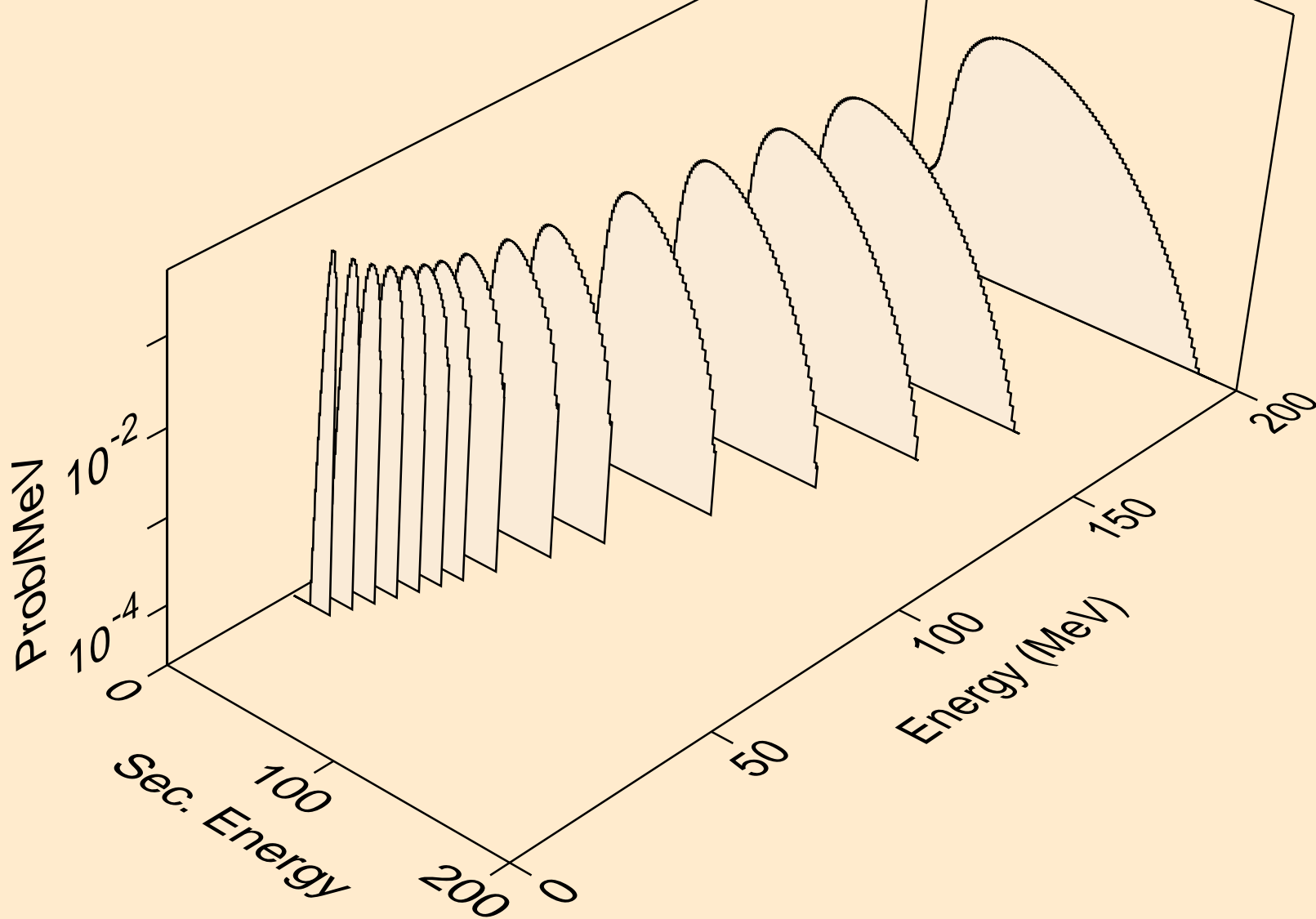

HG198 NEUTRON ACER TENDL-2019 LIBRARY; T=293.16K  
he3s from (n,n\*)he3

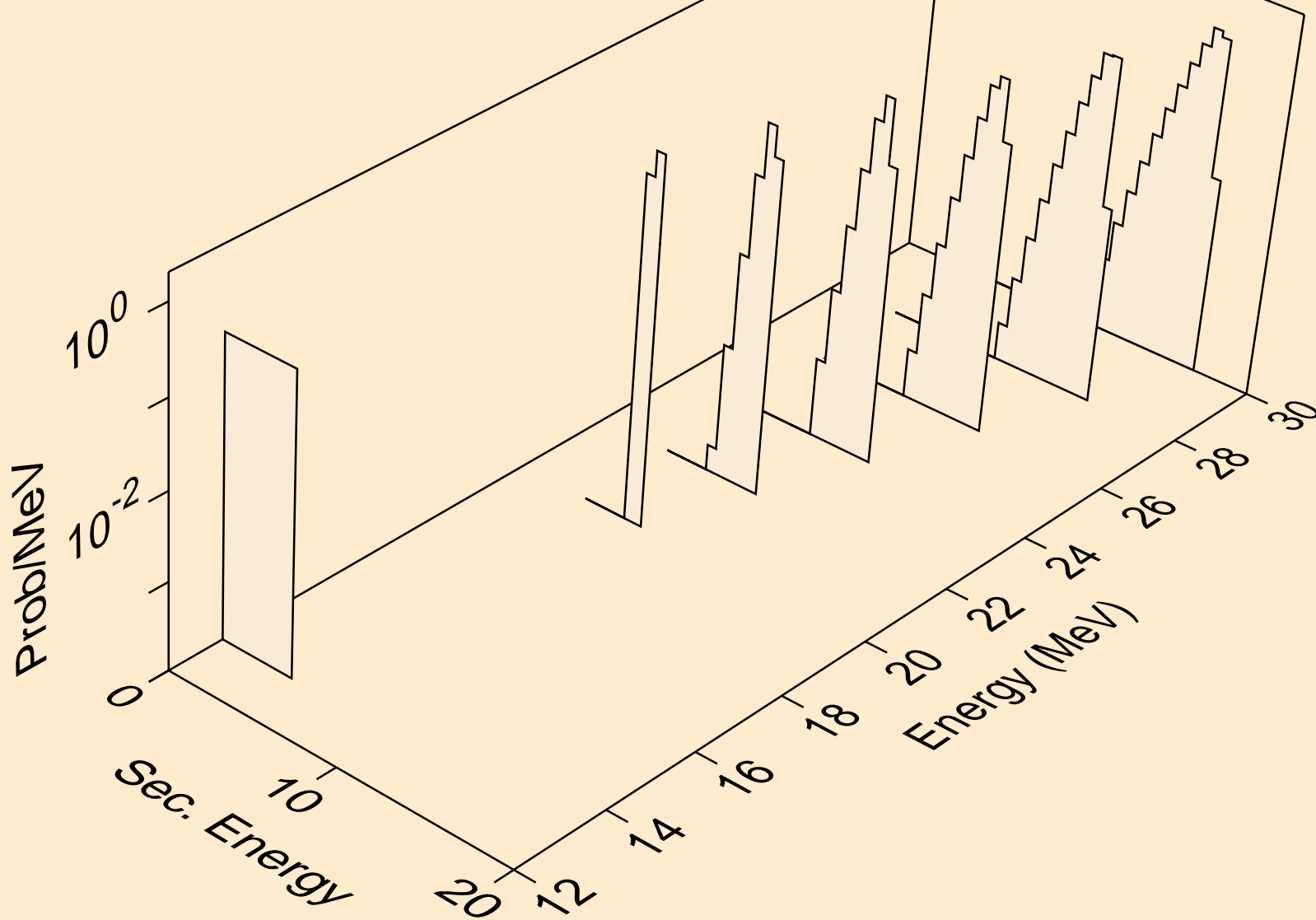

HG198 NEUTRON ACER TENDL-2019 LIBRARY; T=293.16K  
he3s from (n,he3)

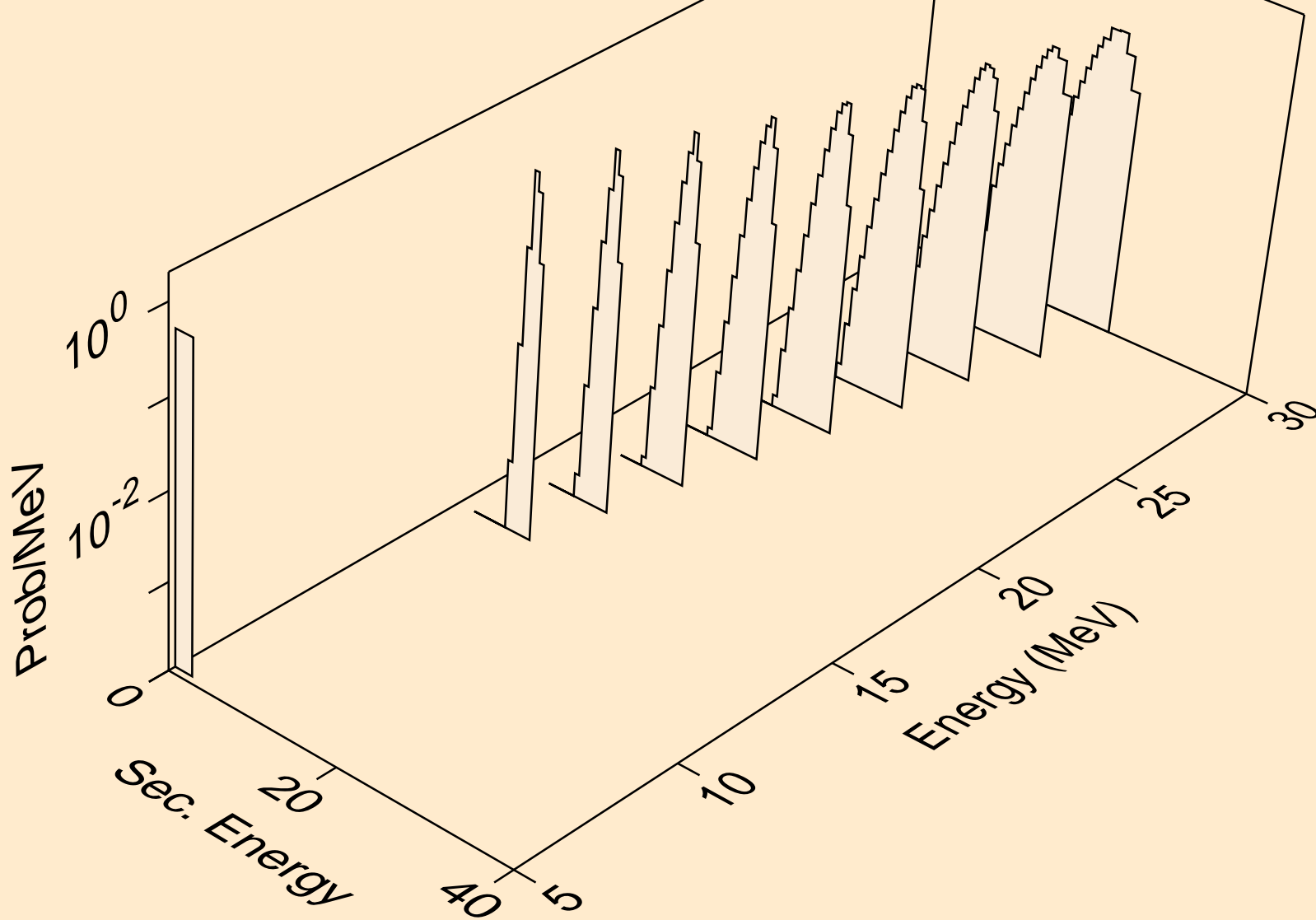

HG198 NEUTRON ACER TENDL-2019 LIBRARY; T=293.16K  
alphas from (n,x)

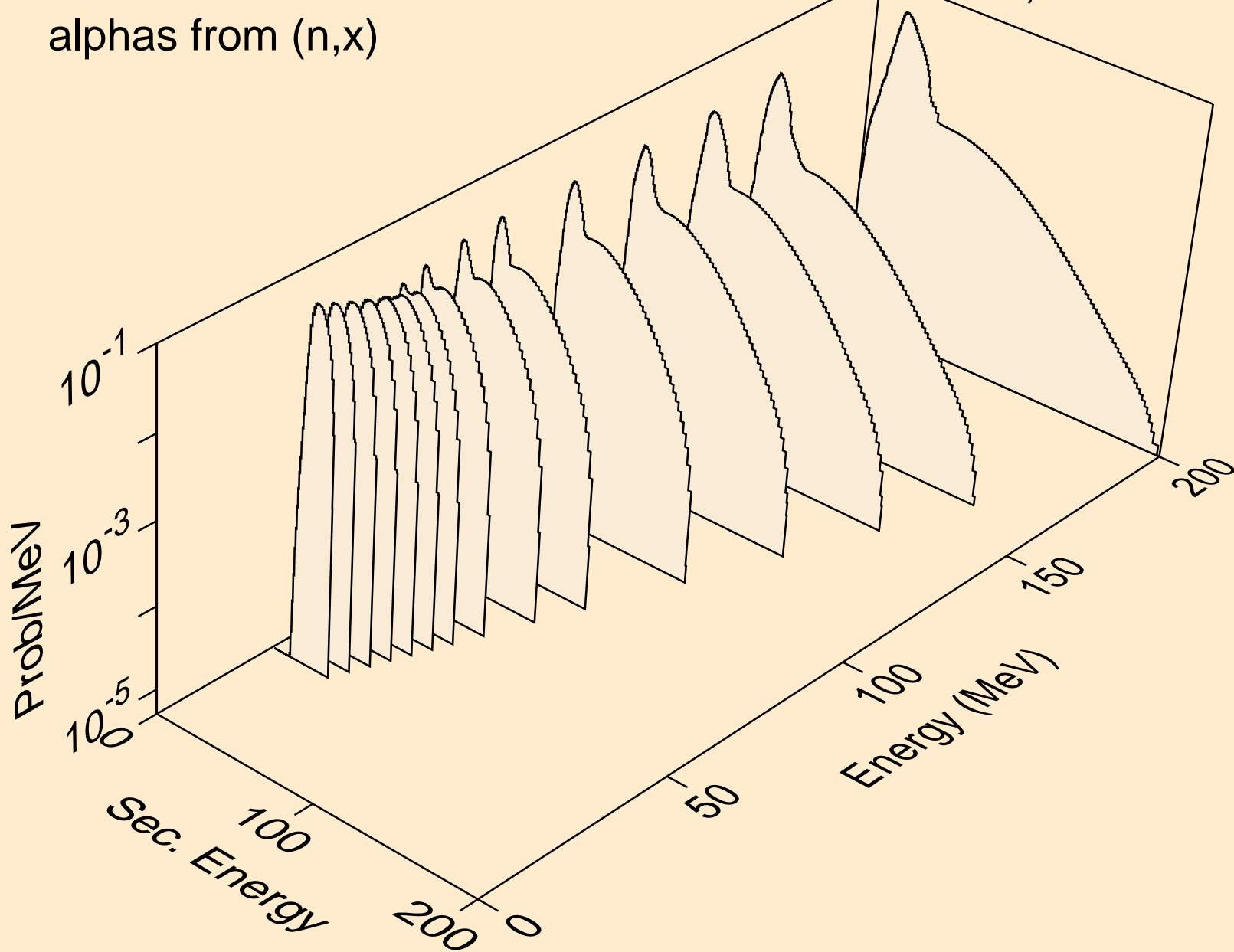



HG198 NEUTRON ACER TENDL-2019 LIBRARY; T=293.16K  
alphas from (n,n\*)a

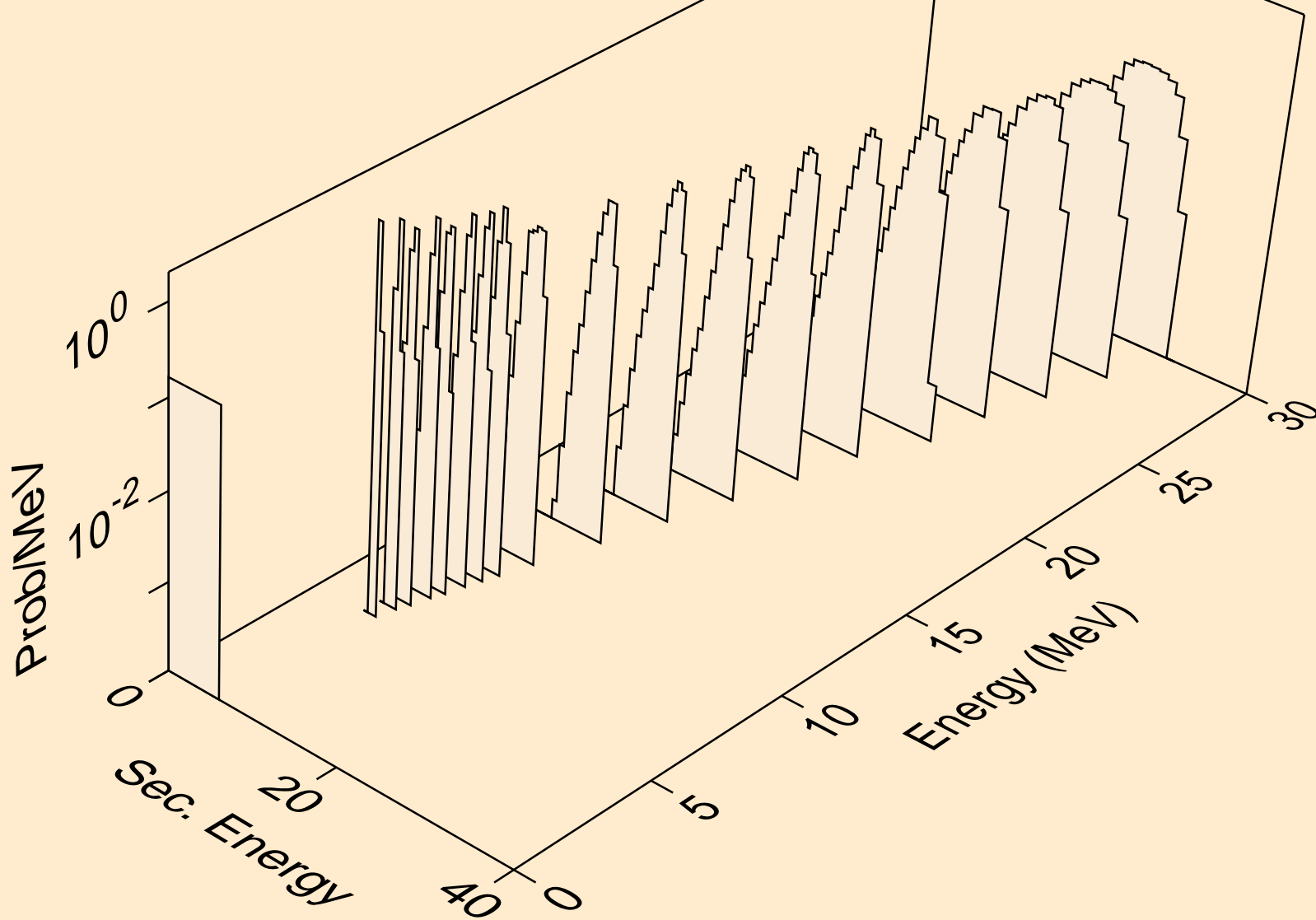

HG198 NEUTRON ACER TENDL-2019 LIBRARY; T=293.16K  
alphas from (n,2n)a

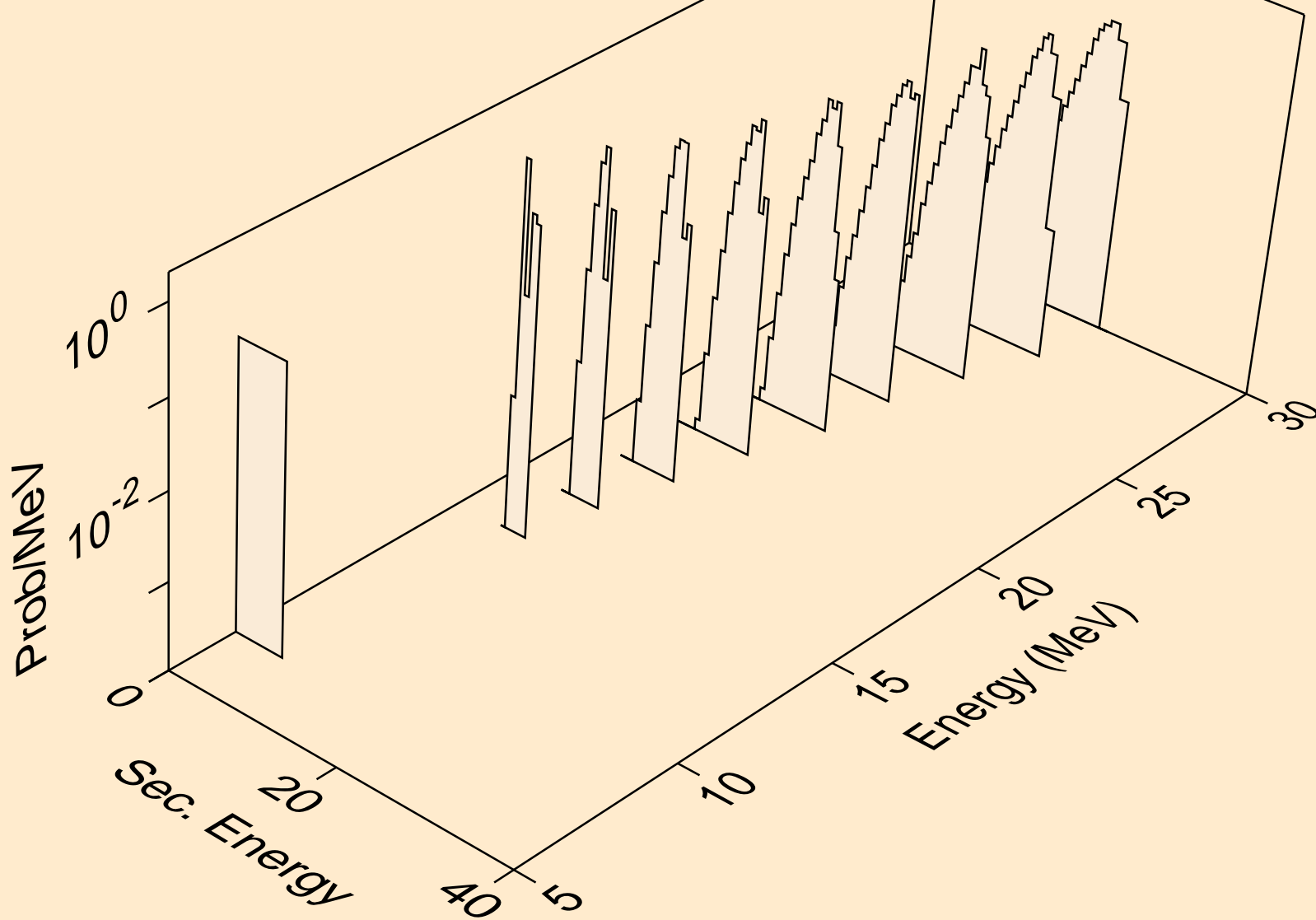

HG198 NEUTRON ACER TENDL-2019 LIBRARY; T=293.16K  
alphas from (n,3n)a

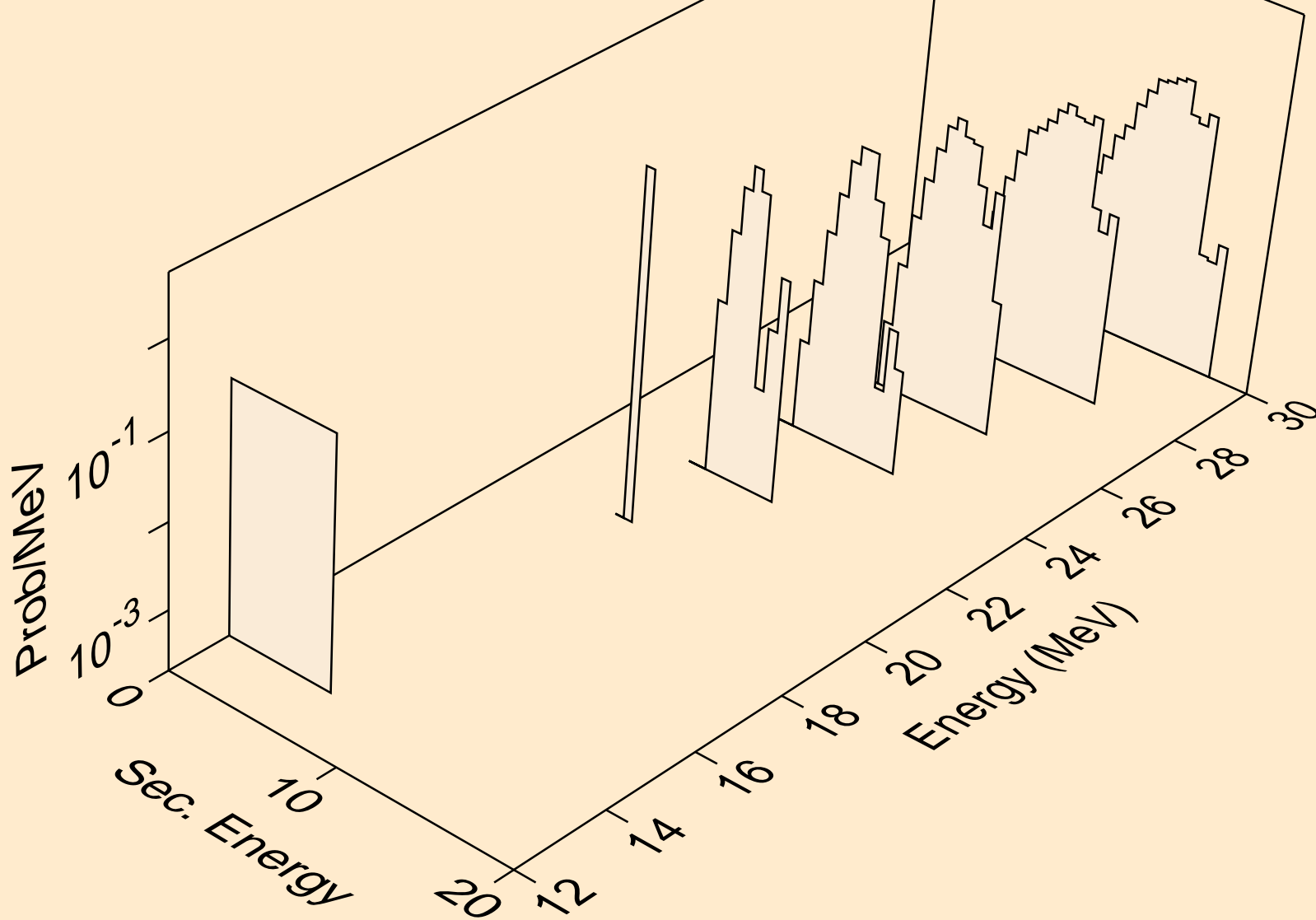

HG198 NEUTRON ACER TENDL-2019 LIBRARY; T=293.16K  
alphas from (n,npa)

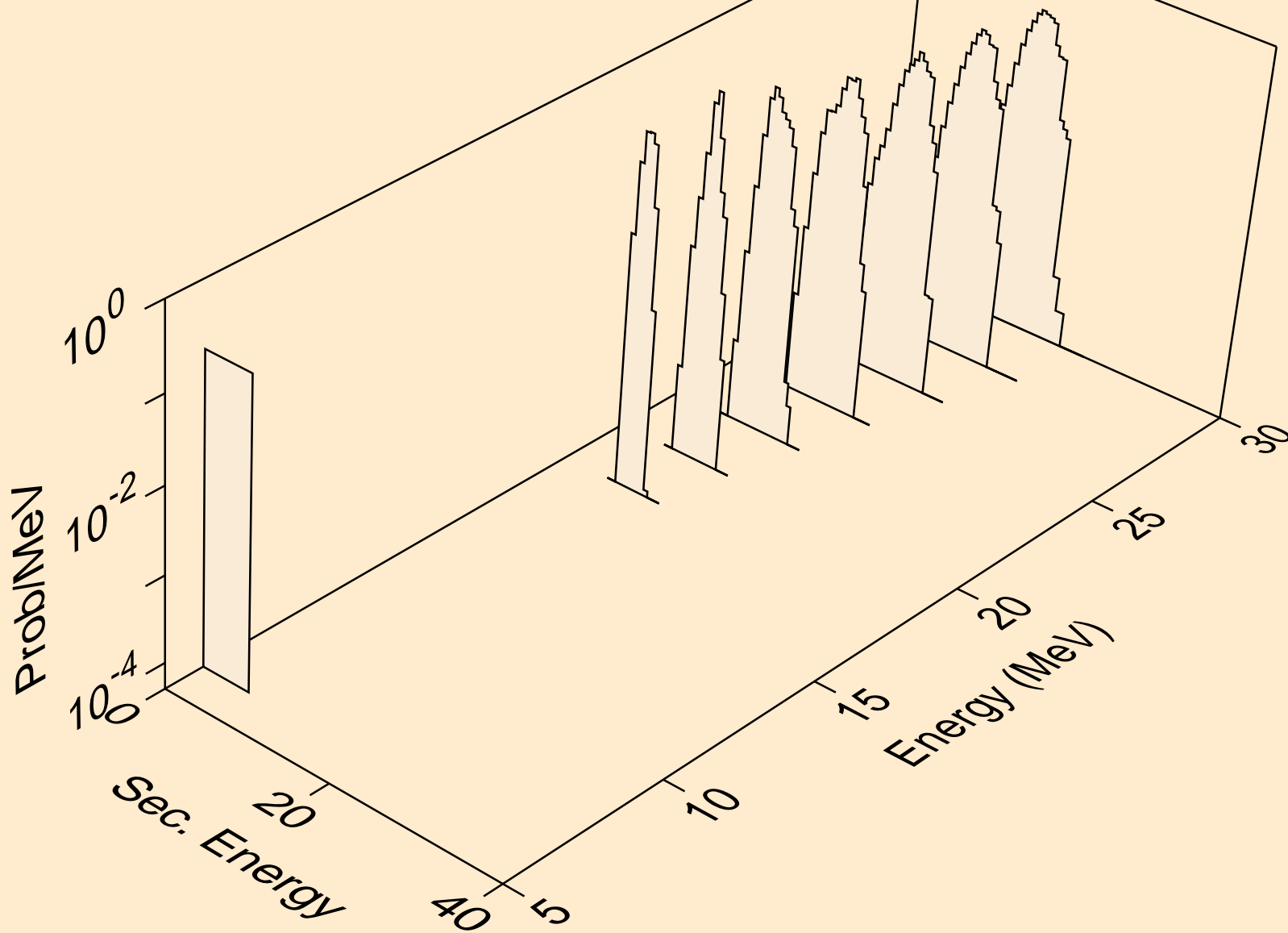

HG198 NEUTRON ACER TENDL-2019 LIBRARY; T=293.16K  
alphas from (n,a)

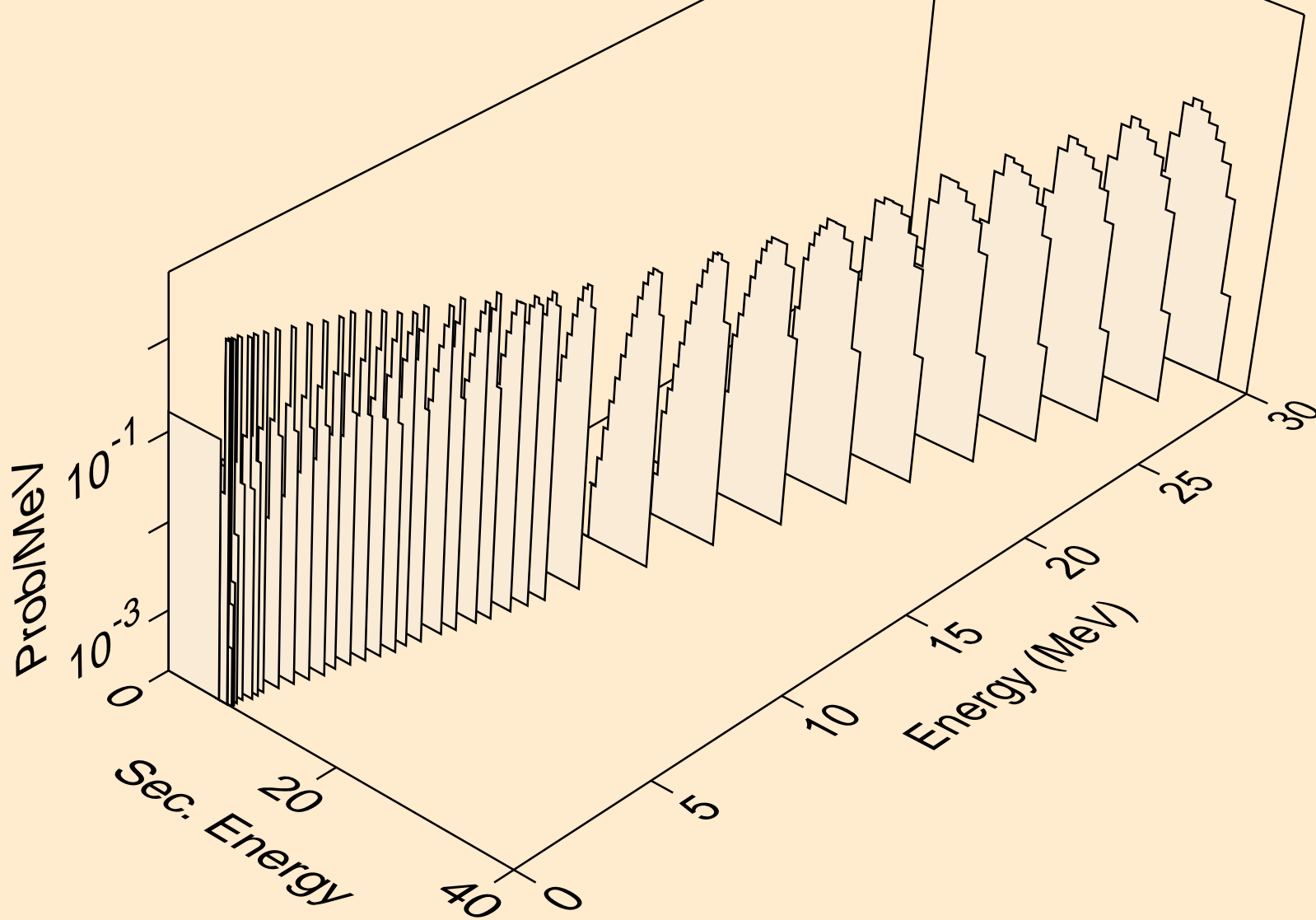

HG198 NEUTRON ACER TENDL-2019 LIBRARY; T=293.16K  
alphas from (n,2a)

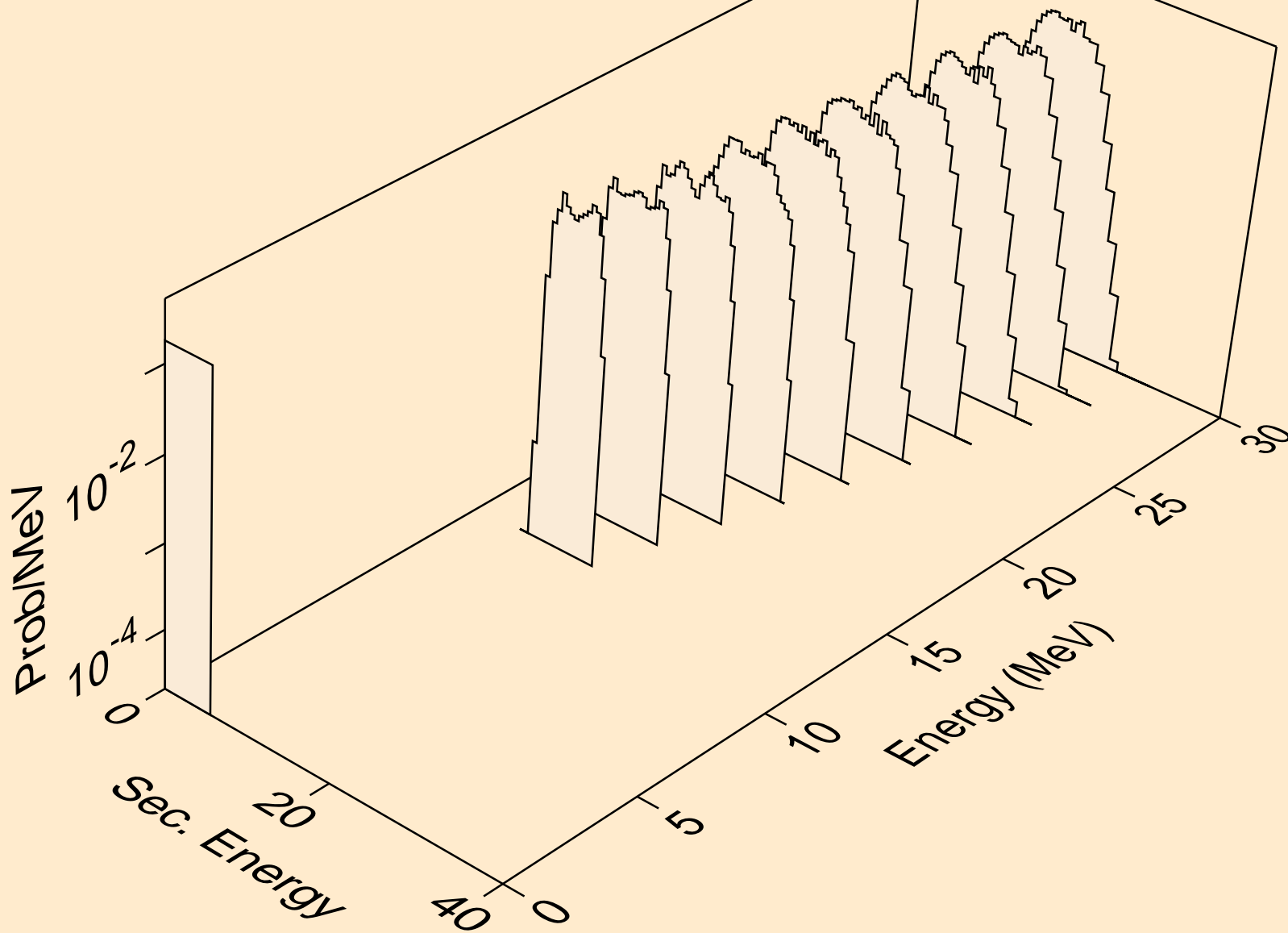

HG198 NEUTRON ACER TENDL-2019 LIBRARY; T=293.16K  
alphas from (n,pa)

