

I115 NEUTRON ACER TENDL-2019 LIBRARY; T=293.16K  
Principal cross sections

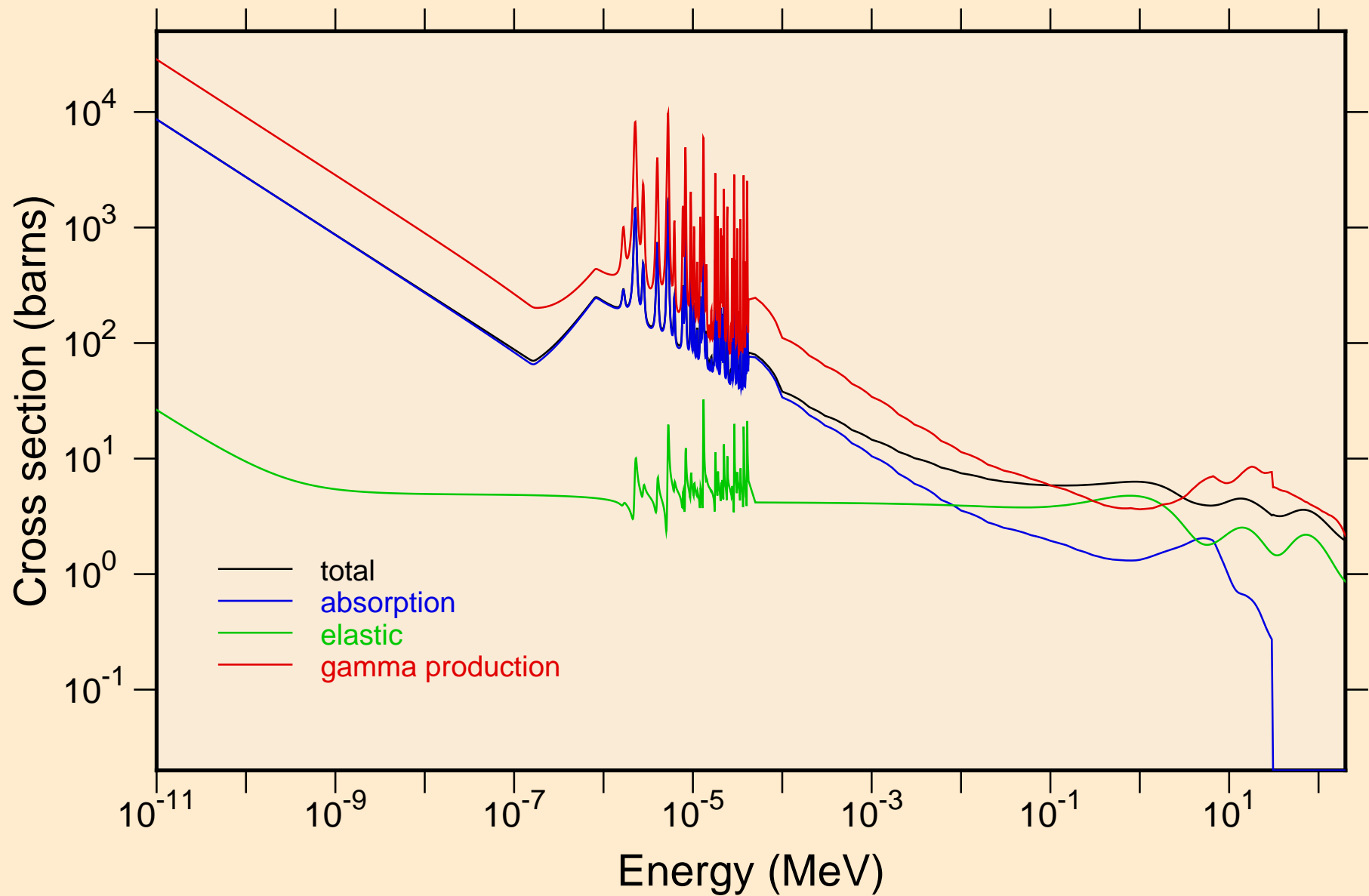

I115 NEUTRON ACER TENDL-2019 LIBRARY; T=293.16K  
resonance total cross section

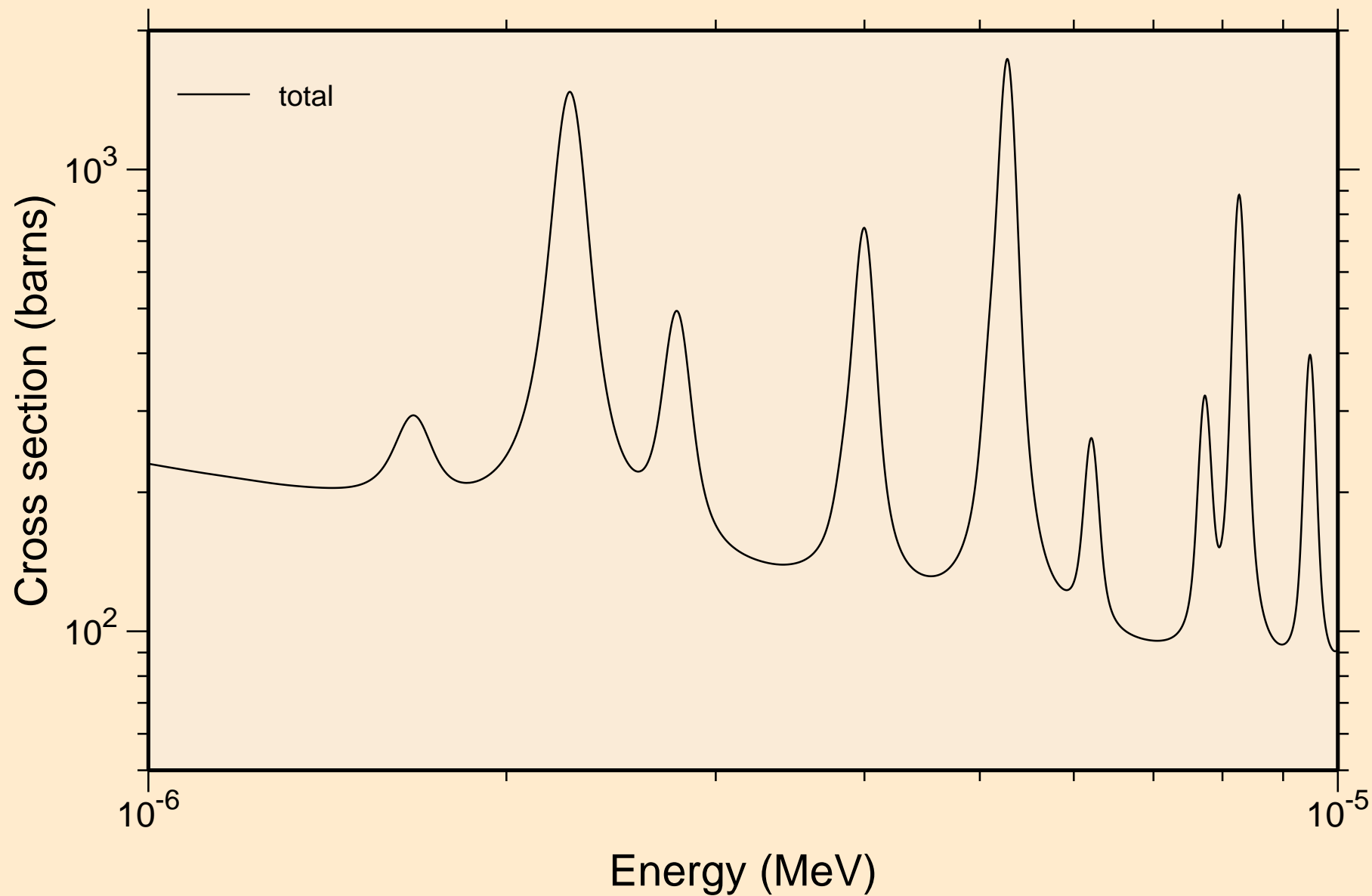

I115 NEUTRON ACER TENDL-2019 LIBRARY; T=293.16K  
resonance total cross section

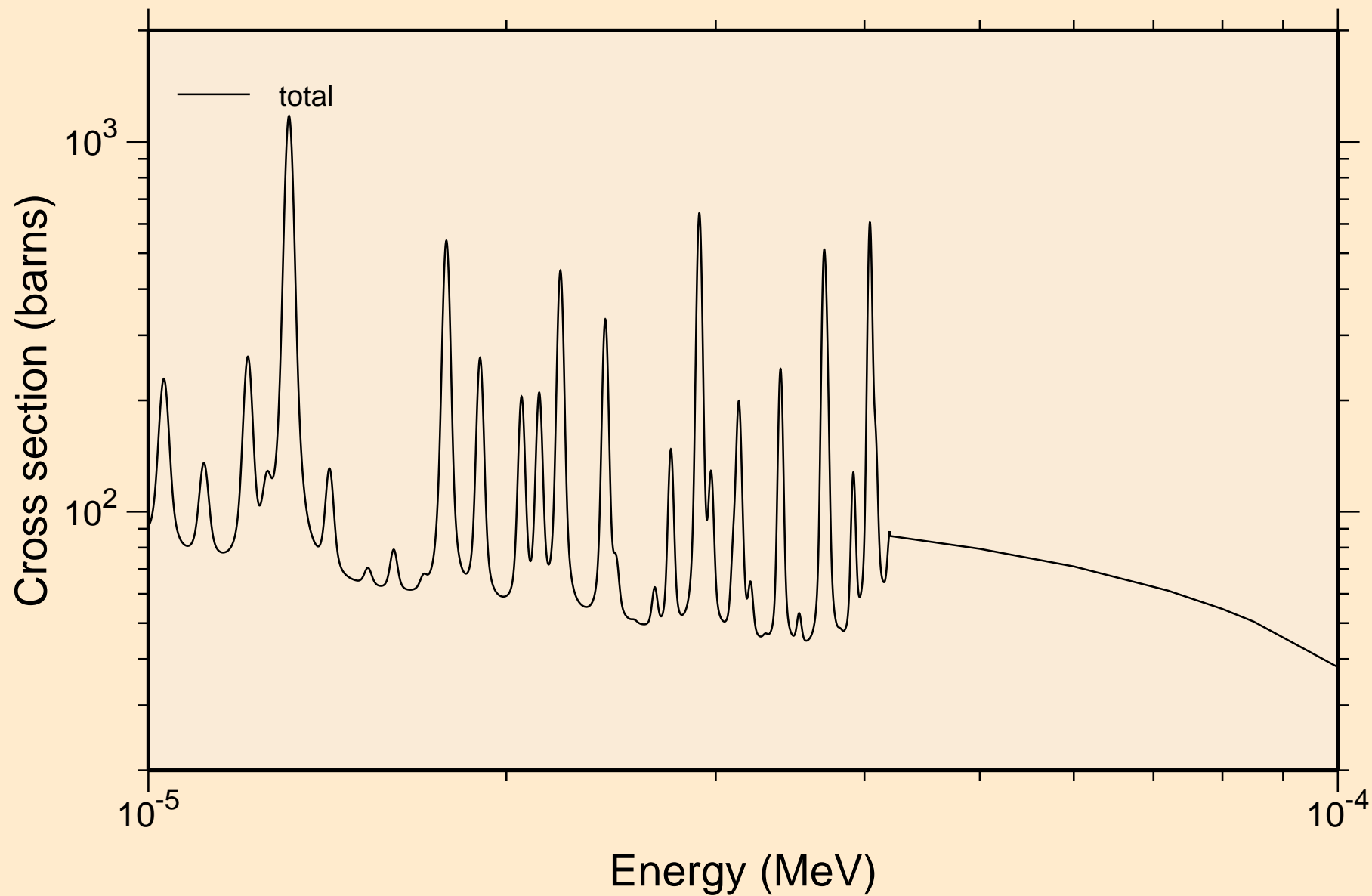

I115 NEUTRON ACER TENDL-2019 LIBRARY; T=293.16K  
resonance total cross section

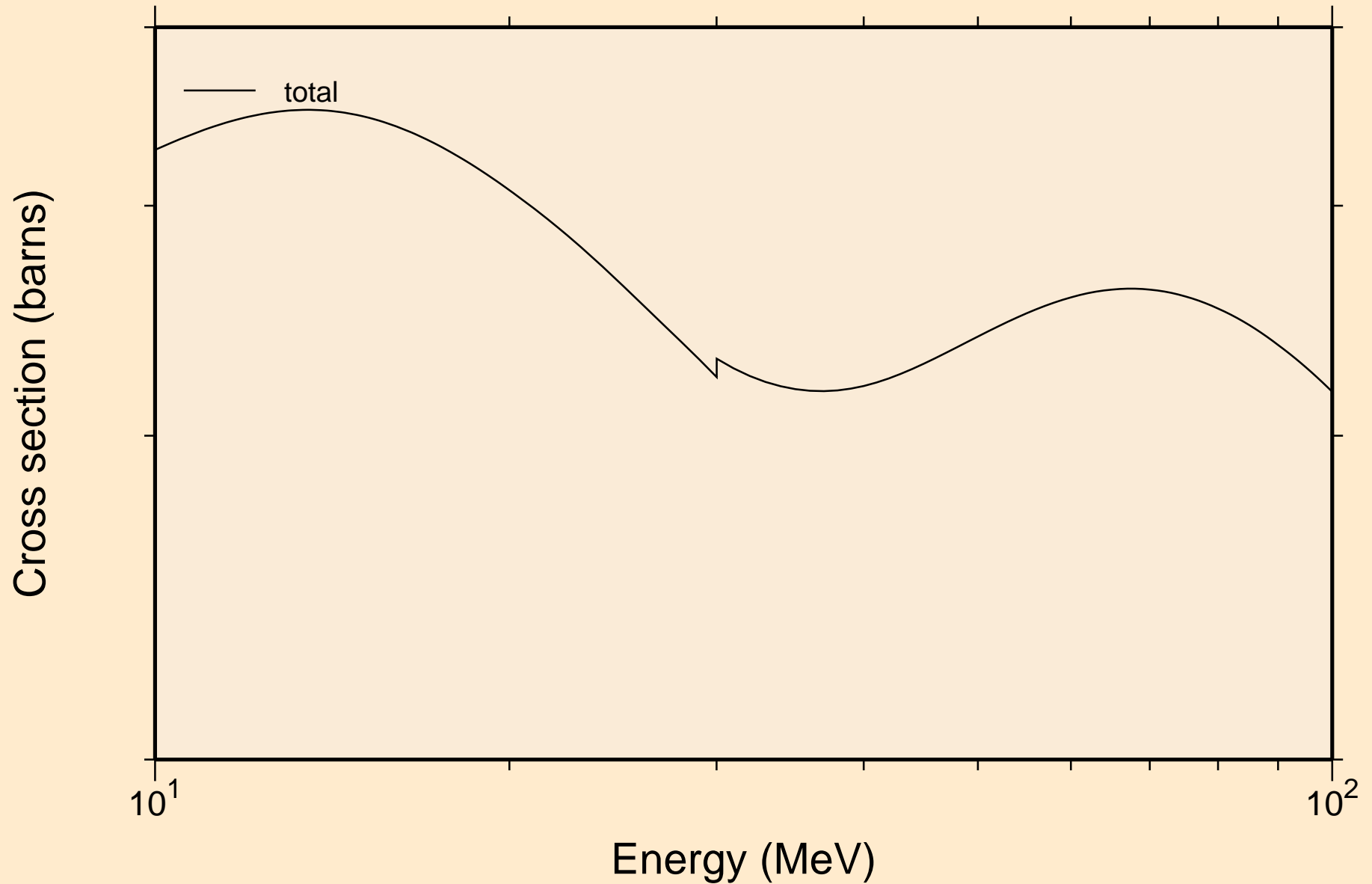

I115 NEUTRON ACER TENDL-2019 LIBRARY; T=293.16K  
resonance absorption cross sections

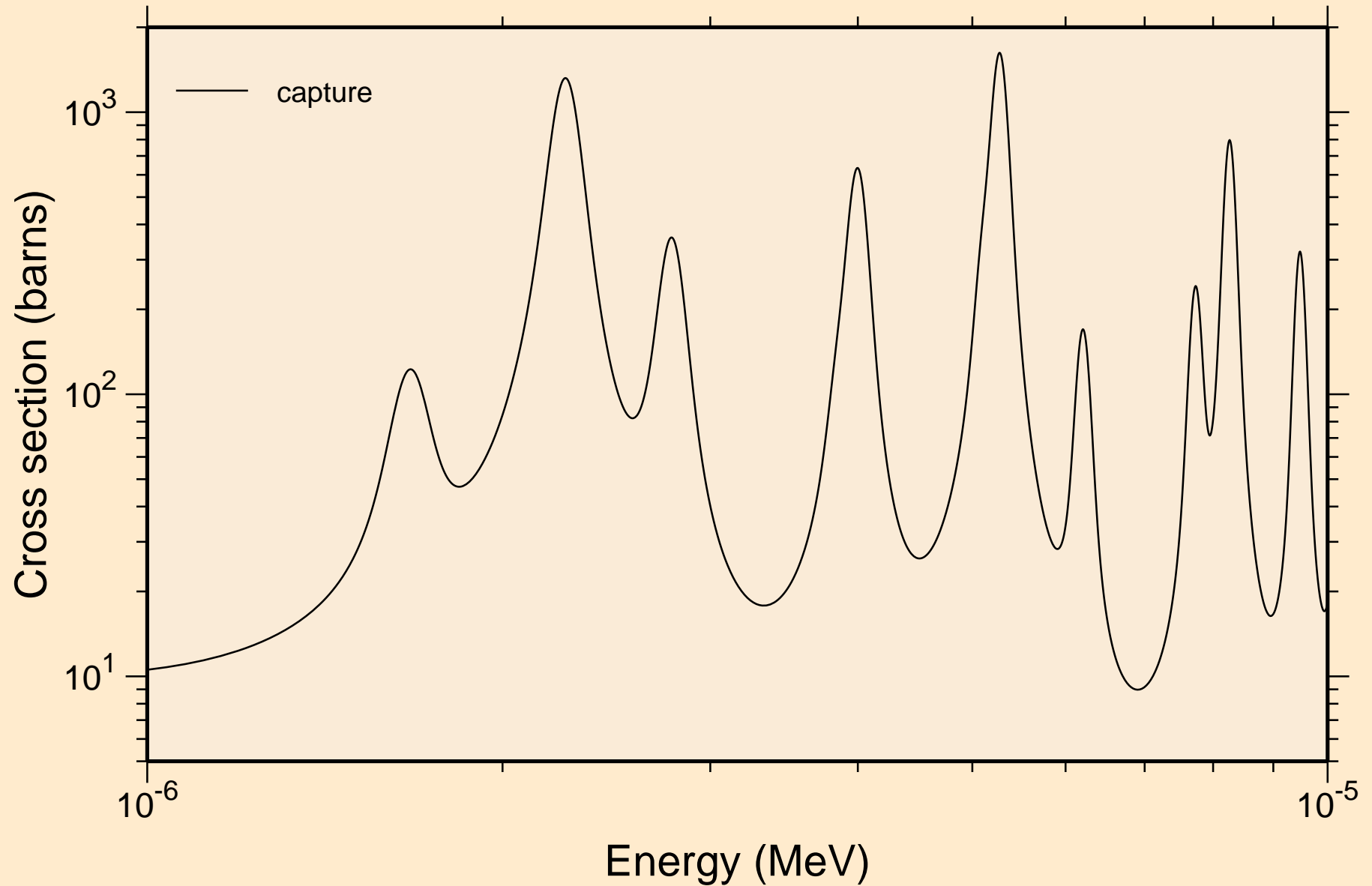

I115 NEUTRON ACER TENDL-2019 LIBRARY; T=293.16K  
resonance absorption cross sections

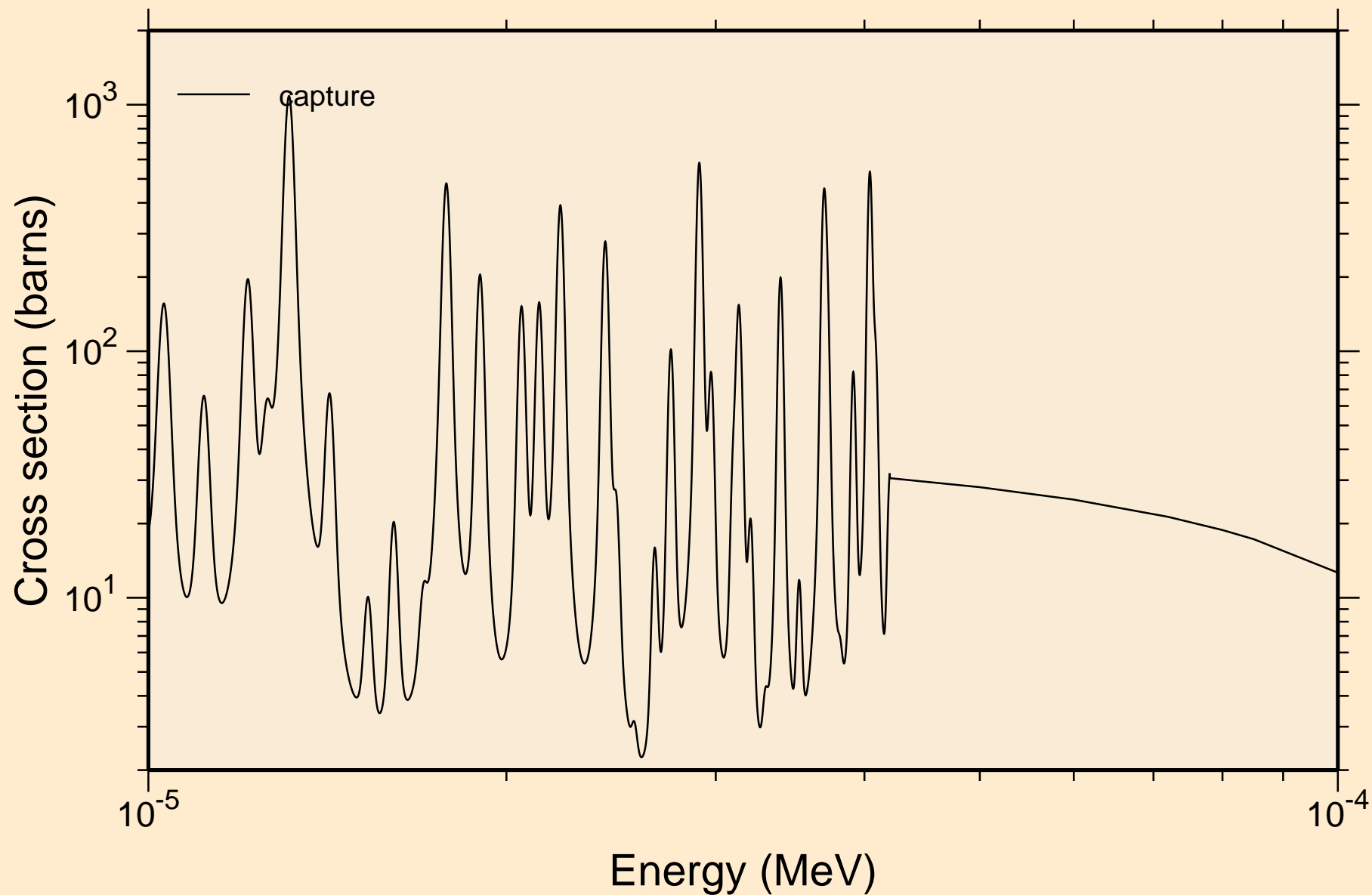

I115 NEUTRON ACER TENDL-2019 LIBRARY; T=293.16K  
resonance absorption cross sections

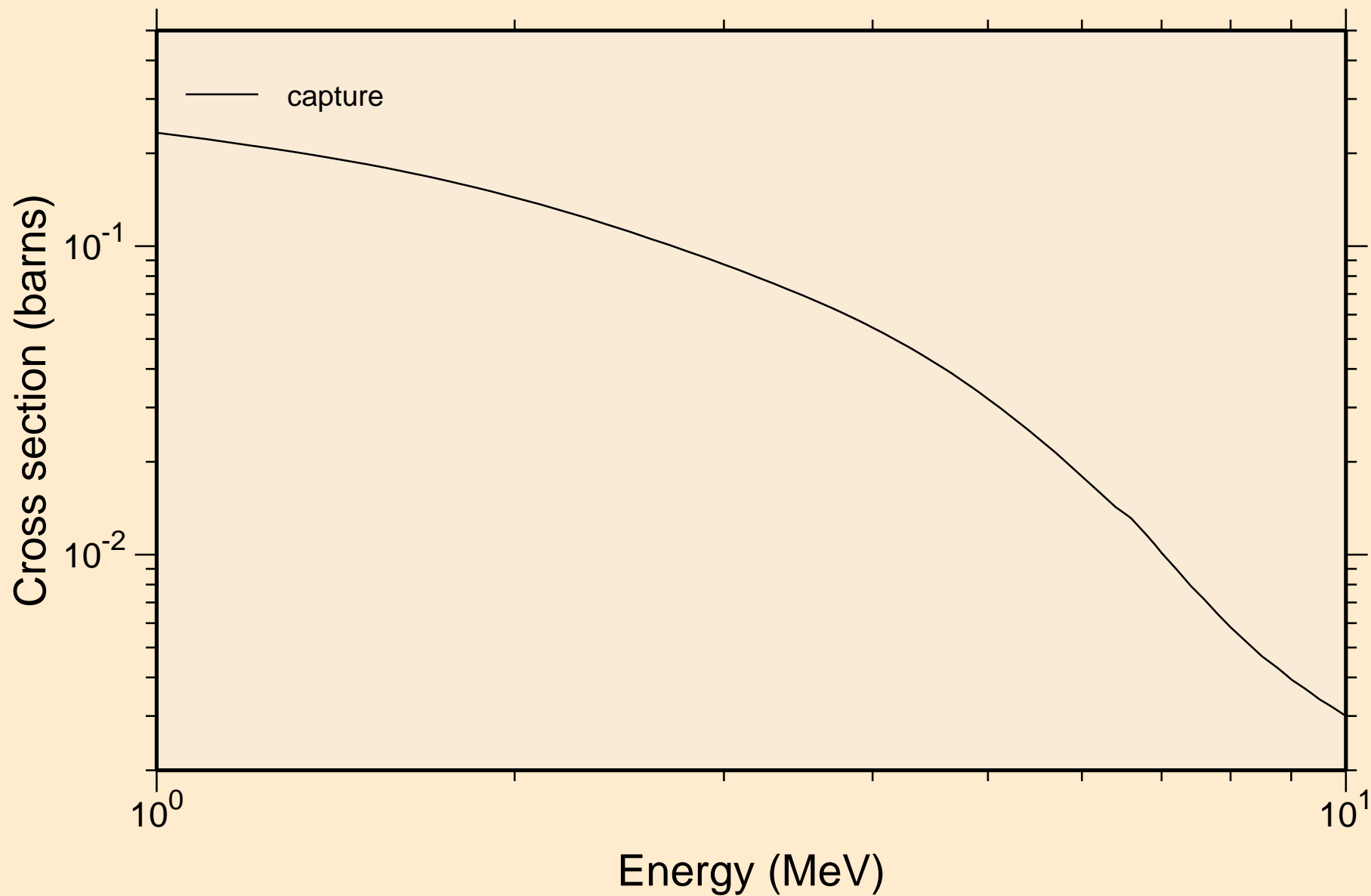

I115 NEUTRON ACER TENDL-2019 LIBRARY; T=293.16K  
Heating

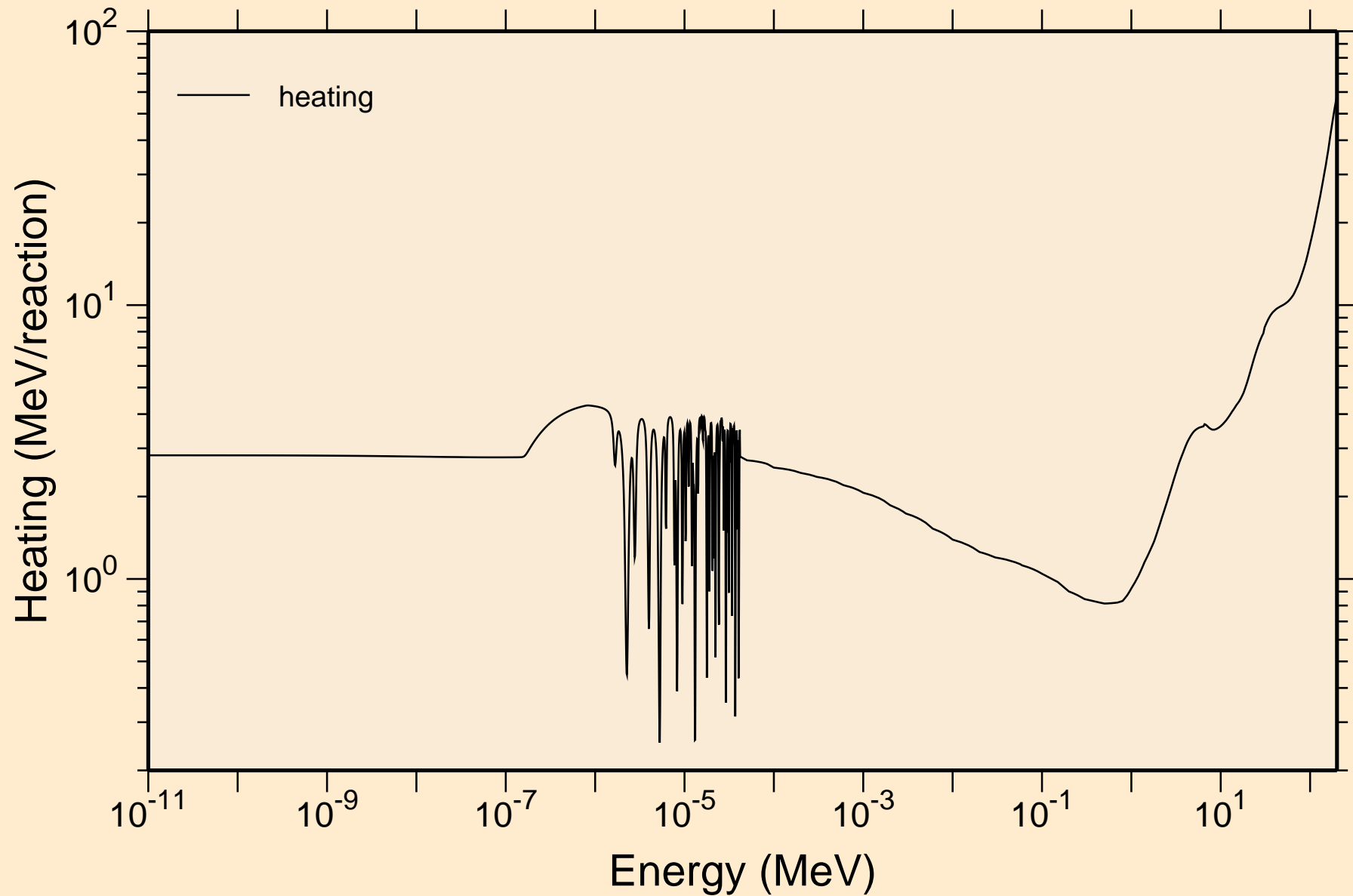



I115 NEUTRON ACER TENDL-2019 LIBRARY; T=293.16K  
Damage

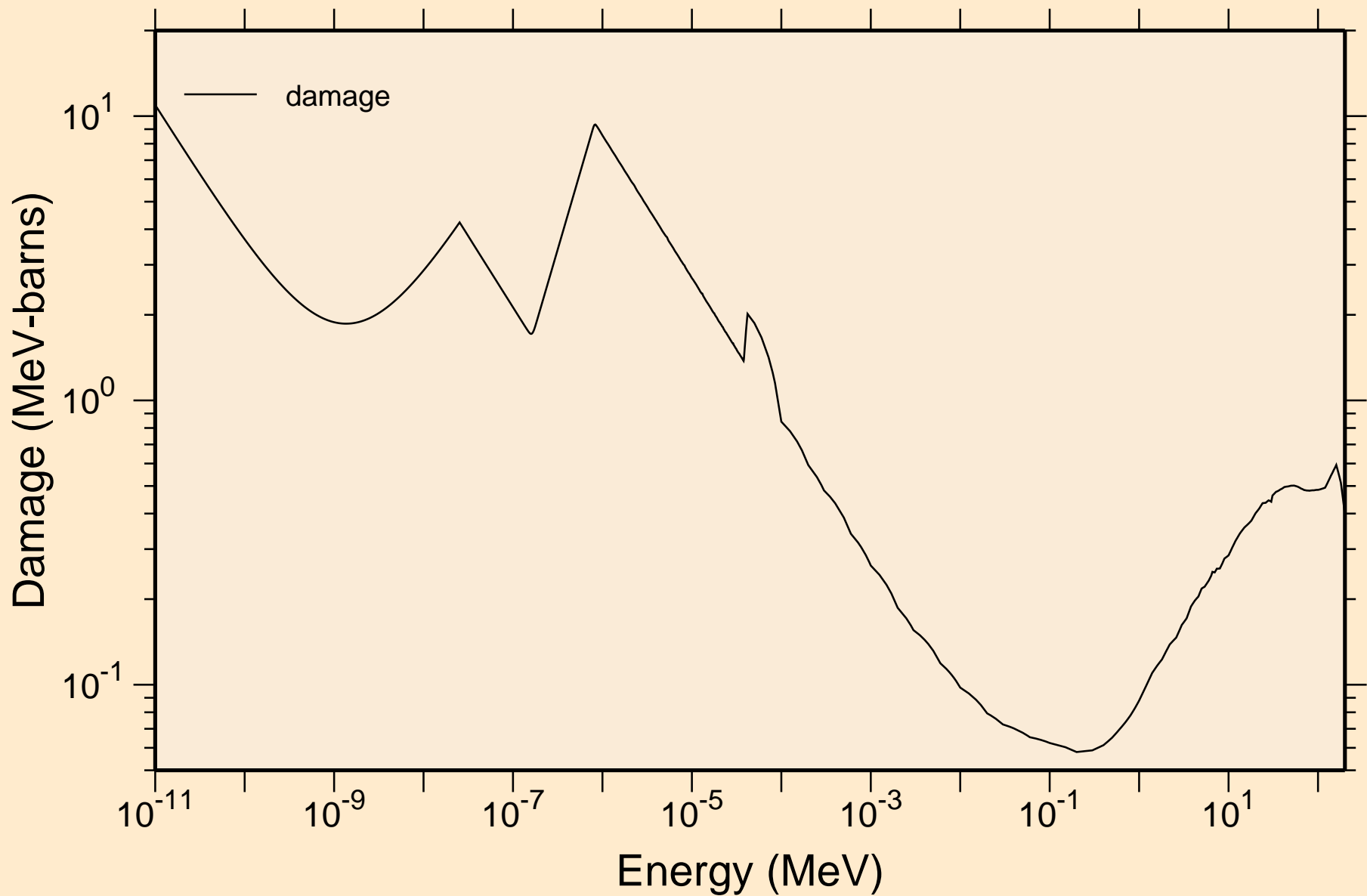

I115 NEUTRON ACER TENDL-2019 LIBRARY; T=293.16K  
Non-threshold reactions

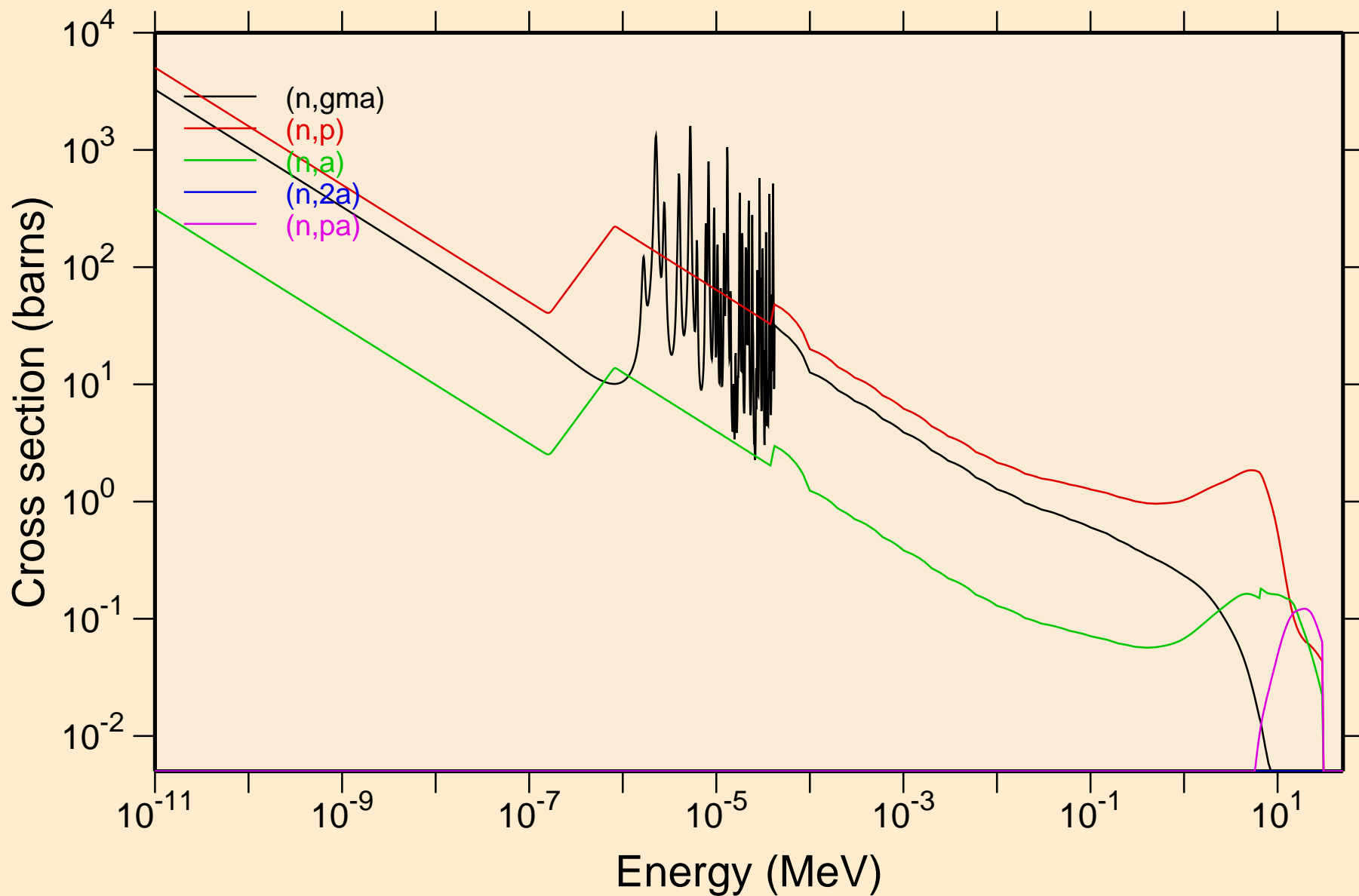

I115 NEUTRON ACER TENDL-2019 LIBRARY; T=293.16K  
Non-threshold reactions

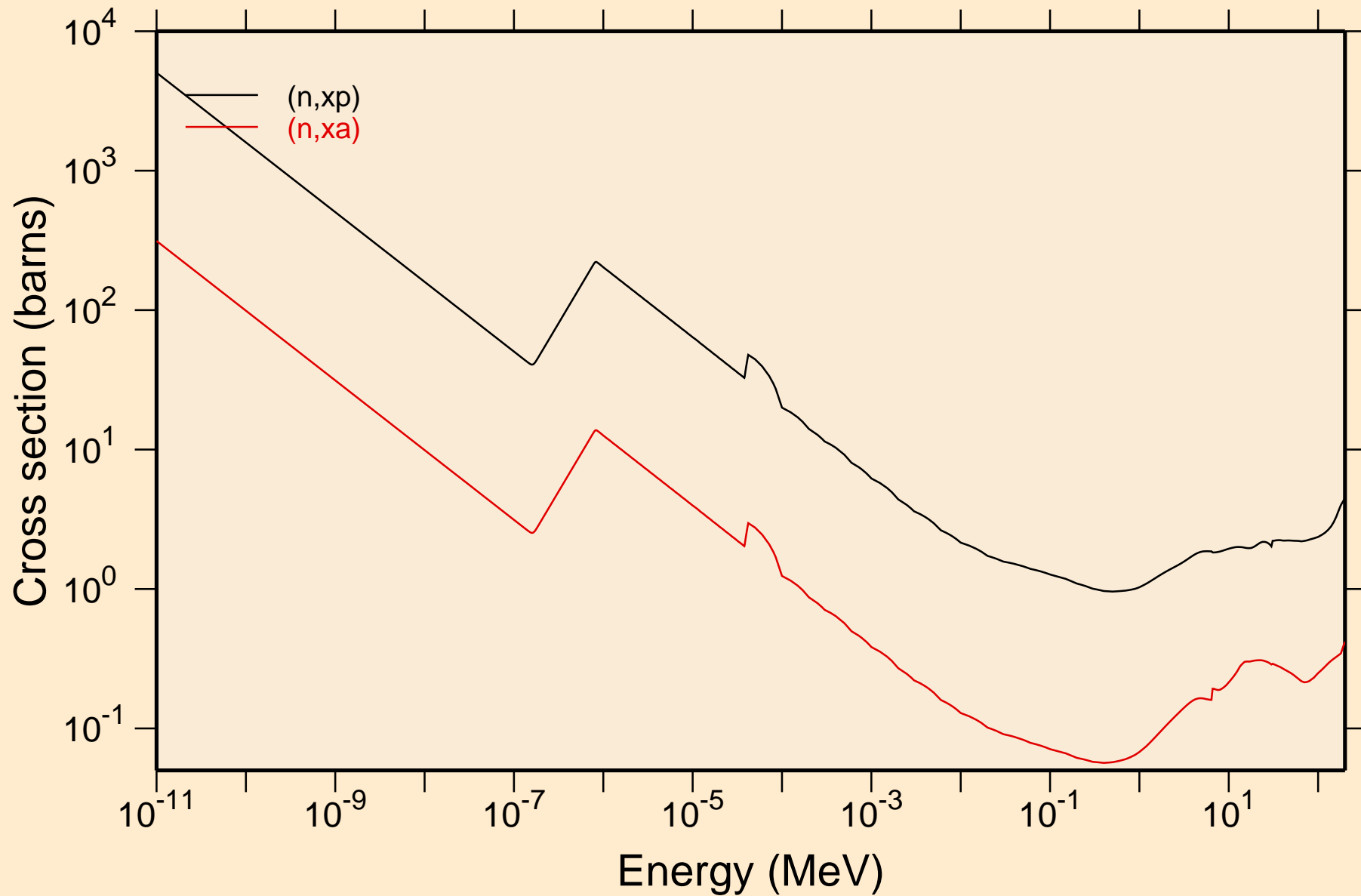

I115 NEUTRON ACER TENDL-2019 LIBRARY; T=293.16K  
Principal cross sections

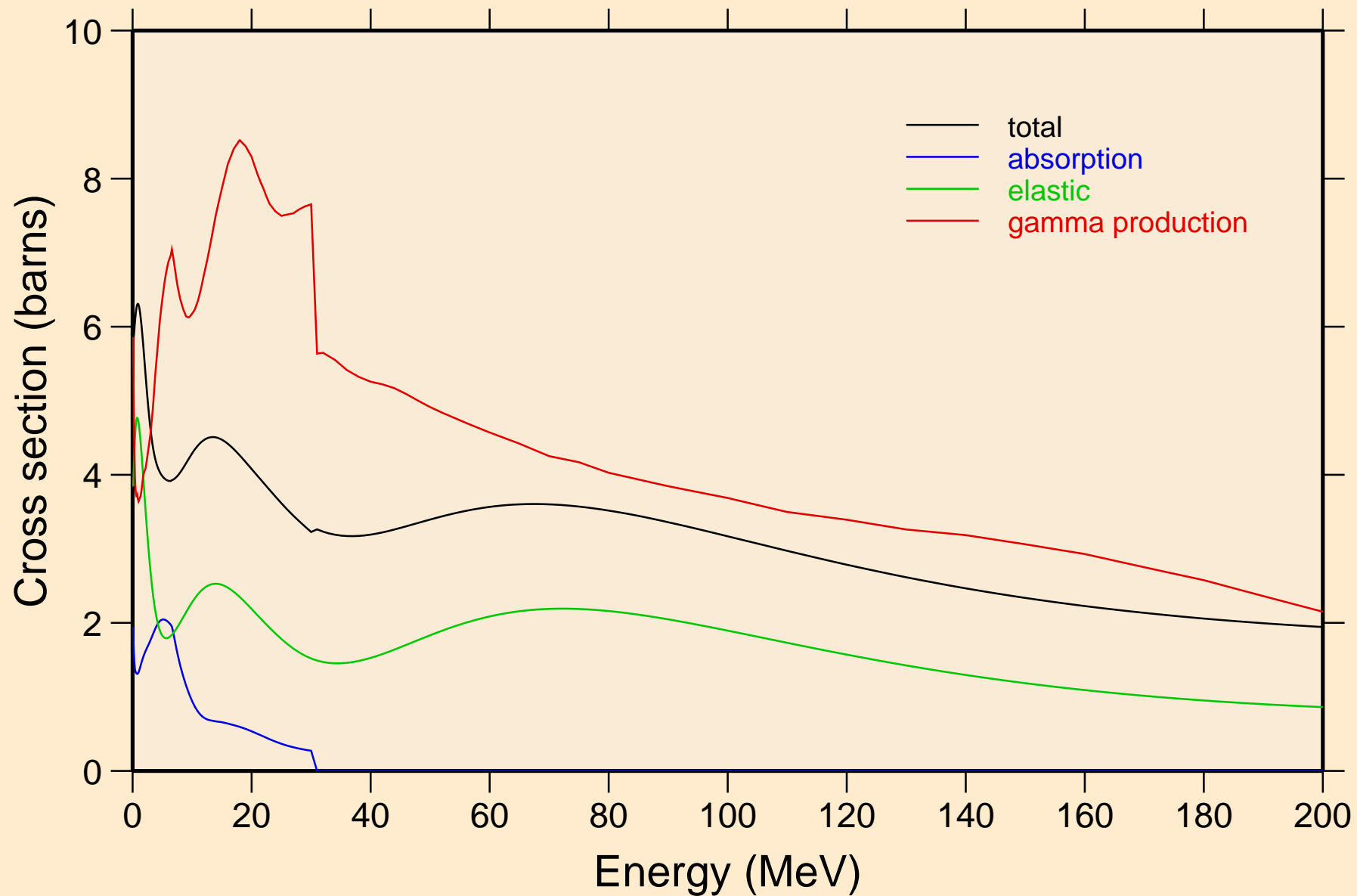

I115 NEUTRON ACER TENDL-2019 LIBRARY; T=293.16K  
Heating

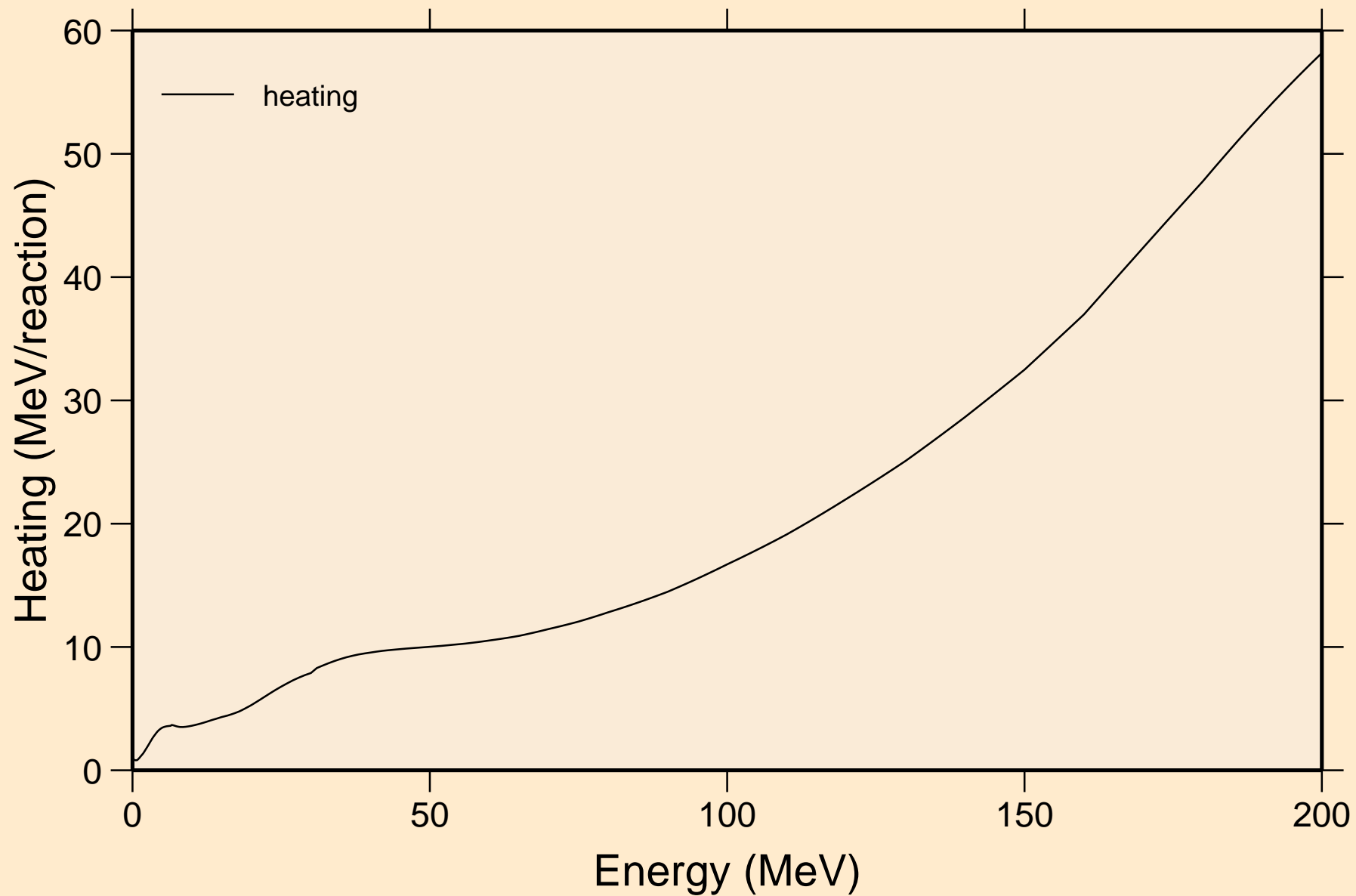

I115 NEUTRON ACER TENDL-2019 LIBRARY; T=293.16K  
Damage

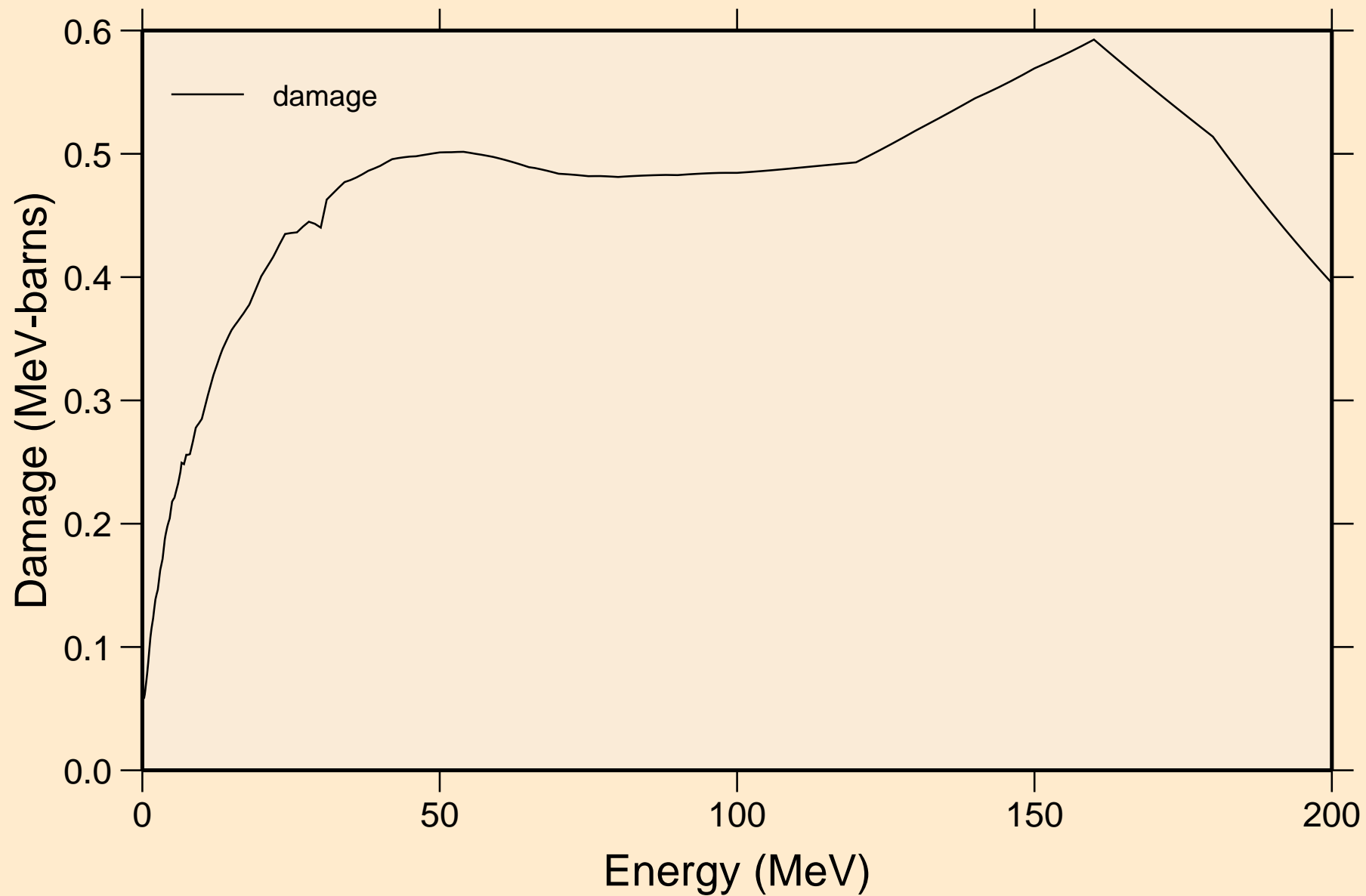

I115 NEUTRON ACER TENDL-2019 LIBRARY; T=293.16K  
Non-threshold reactions

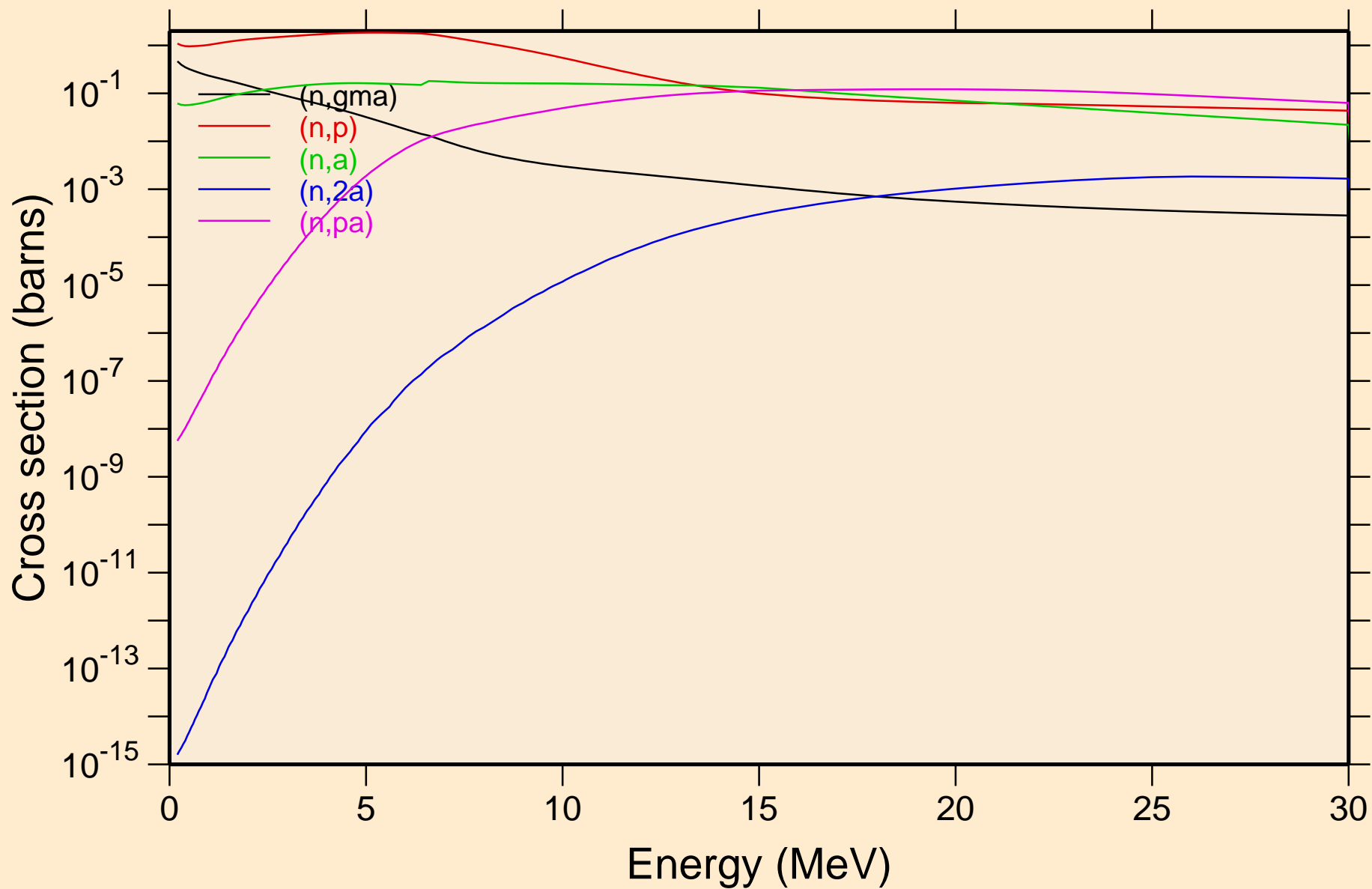

I115 NEUTRON ACER TENDL-2019 LIBRARY; T=293.16K  
Non-threshold reactions

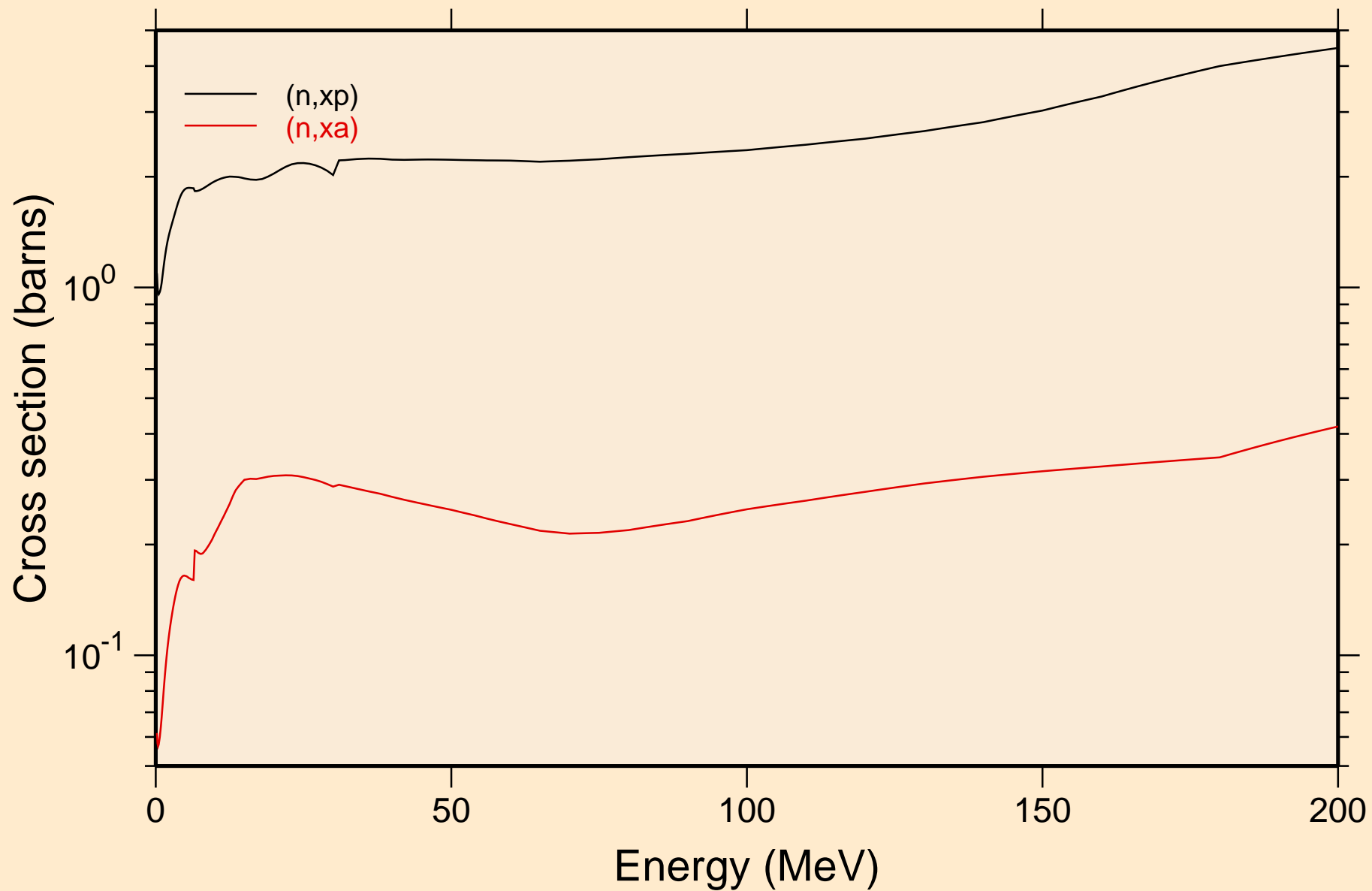



I115 NEUTRON ACER TENDL-2019 LIBRARY; T=293.16K  
Inelastic levels

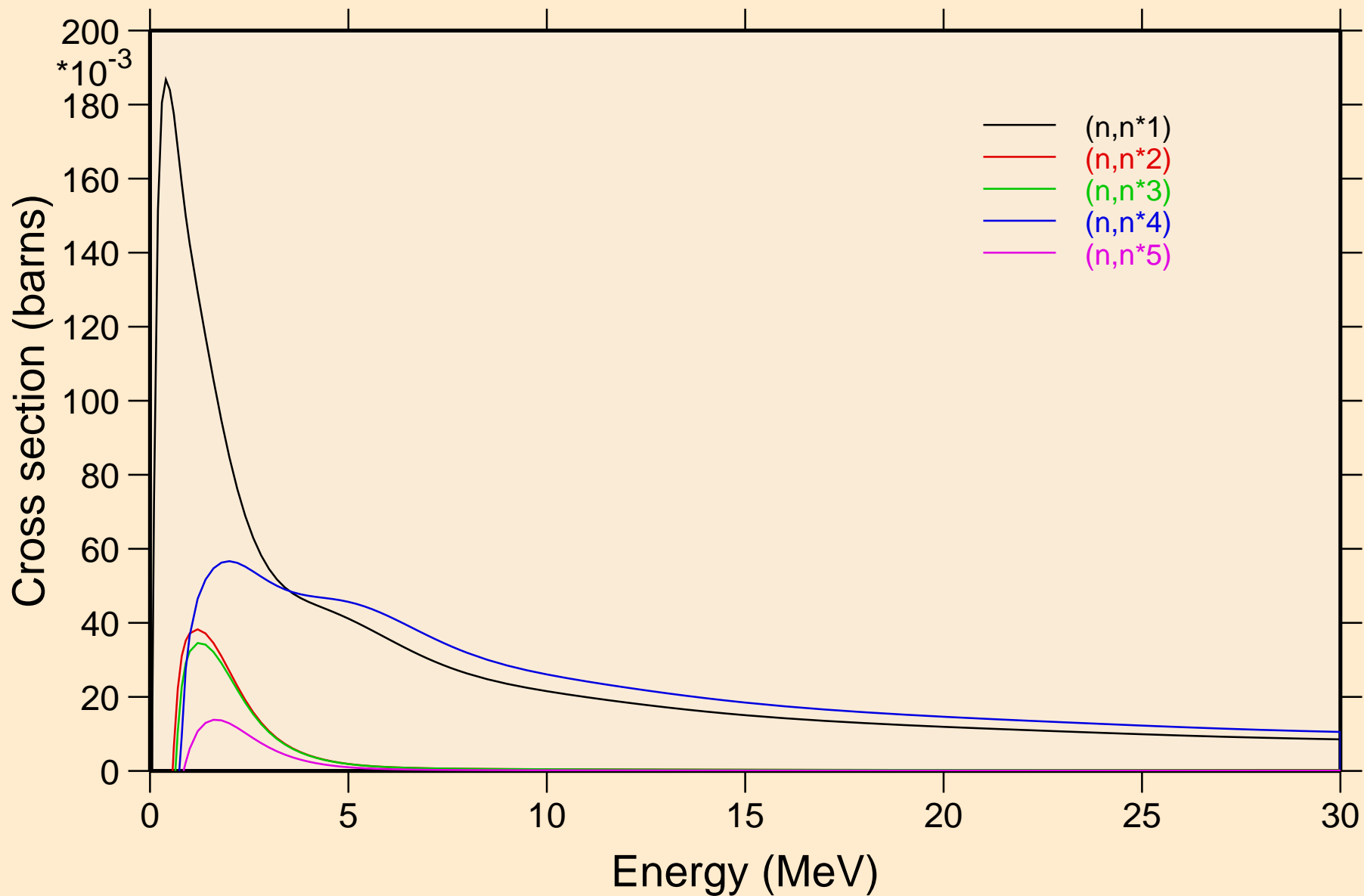

I115 NEUTRON ACER TENDL-2019 LIBRARY; T=293.16K  
Inelastic levels

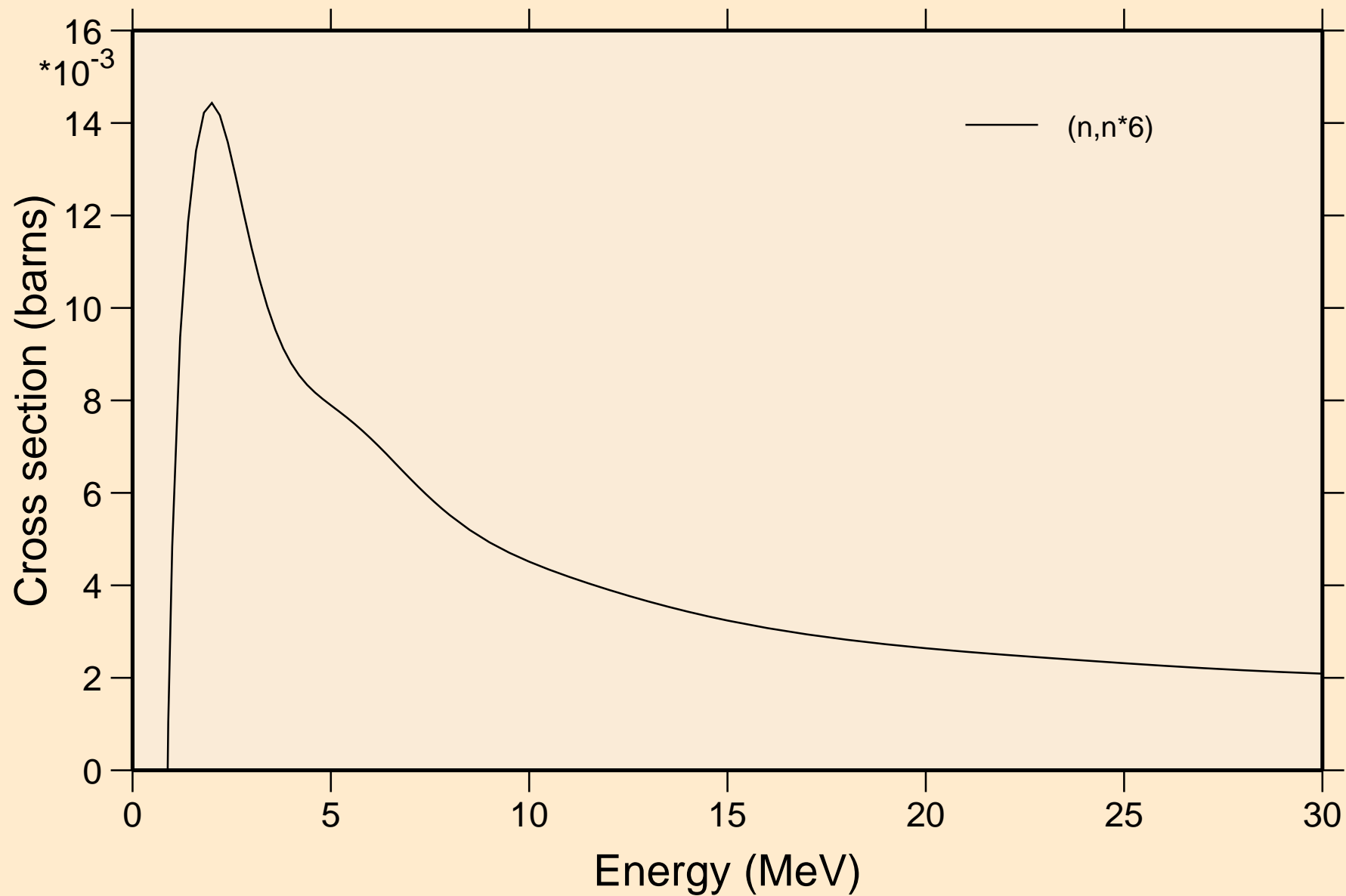

# I115 NEUTRON ACER TENDL-2019 LIBRARY; T=293.16K

## Threshold reactions

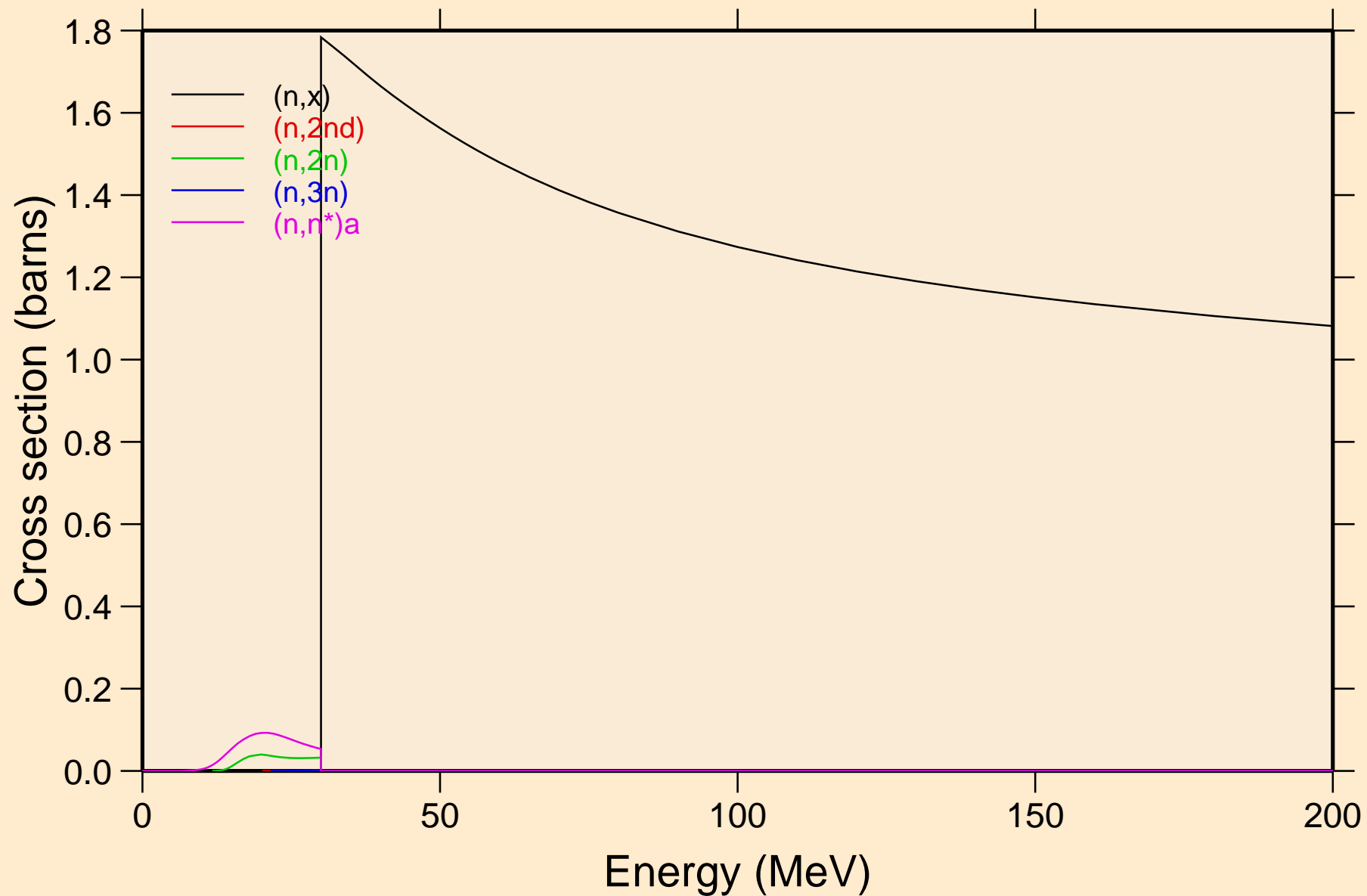

I115 NEUTRON ACER TENDL-2019 LIBRARY; T=293.16K  
Threshold reactions

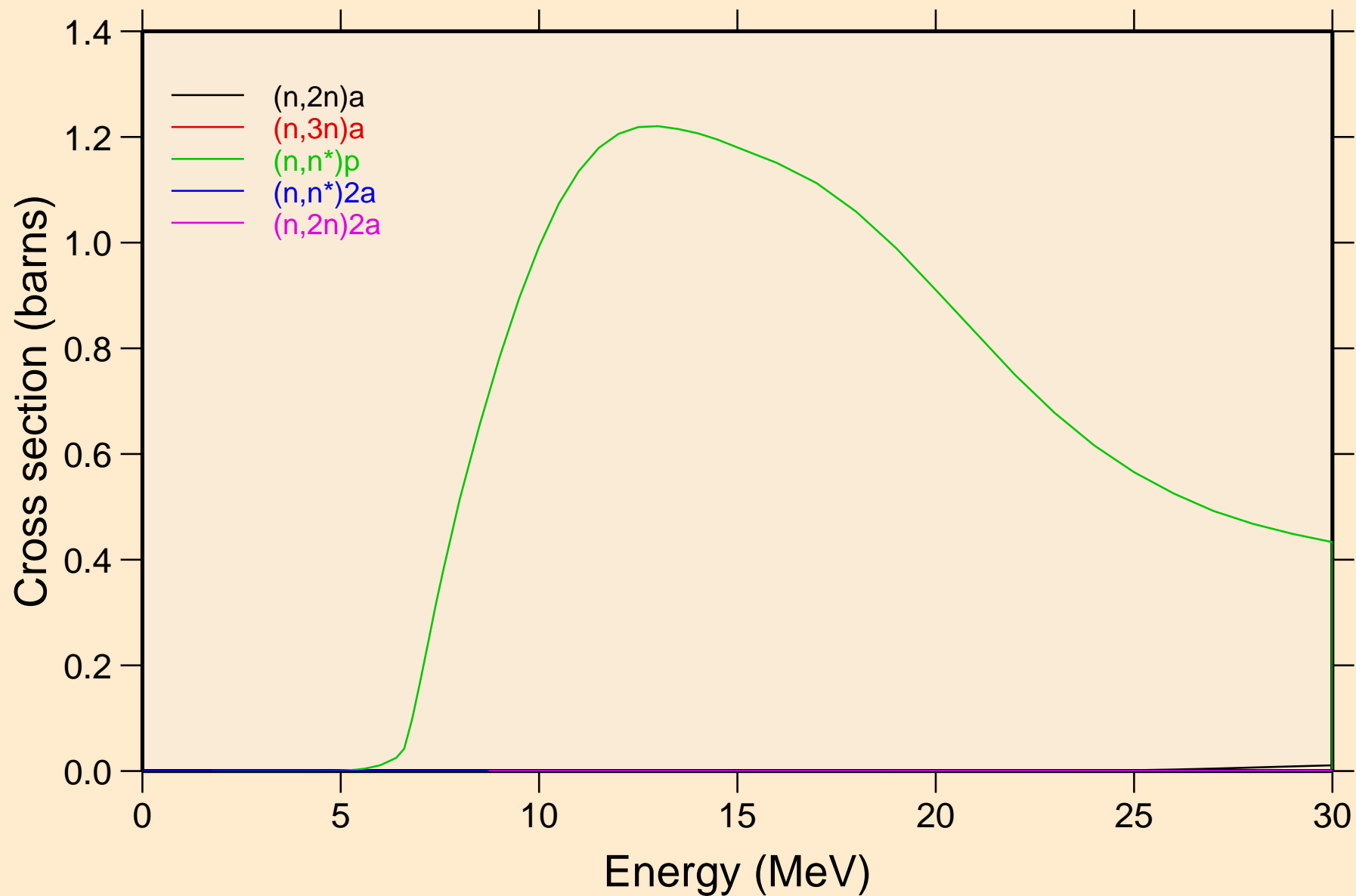

I115 NEUTRON ACER TENDL-2019 LIBRARY; T=293.16K  
Threshold reactions

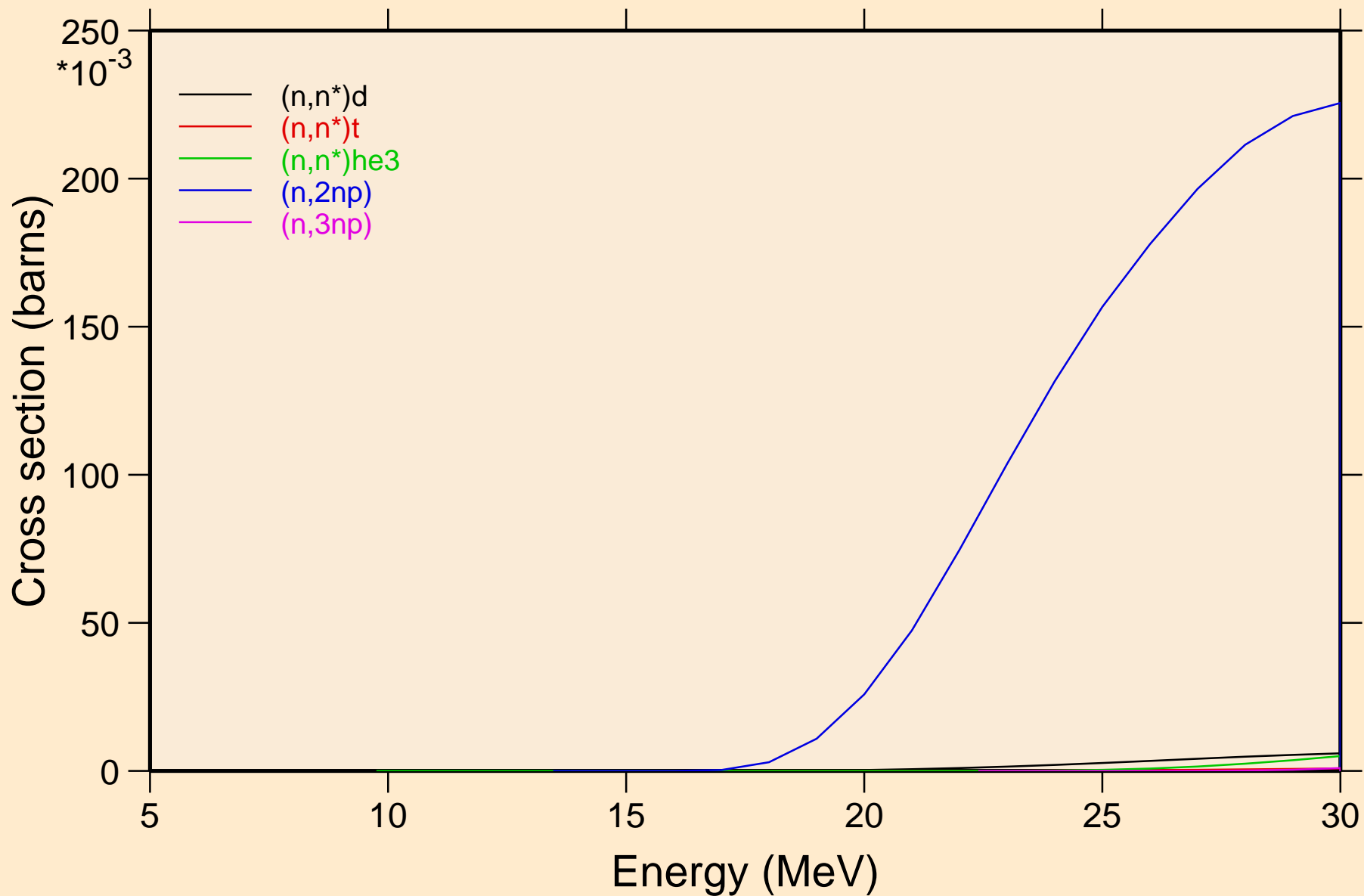

I115 NEUTRON ACER TENDL-2019 LIBRARY; T=293.16K  
Threshold reactions

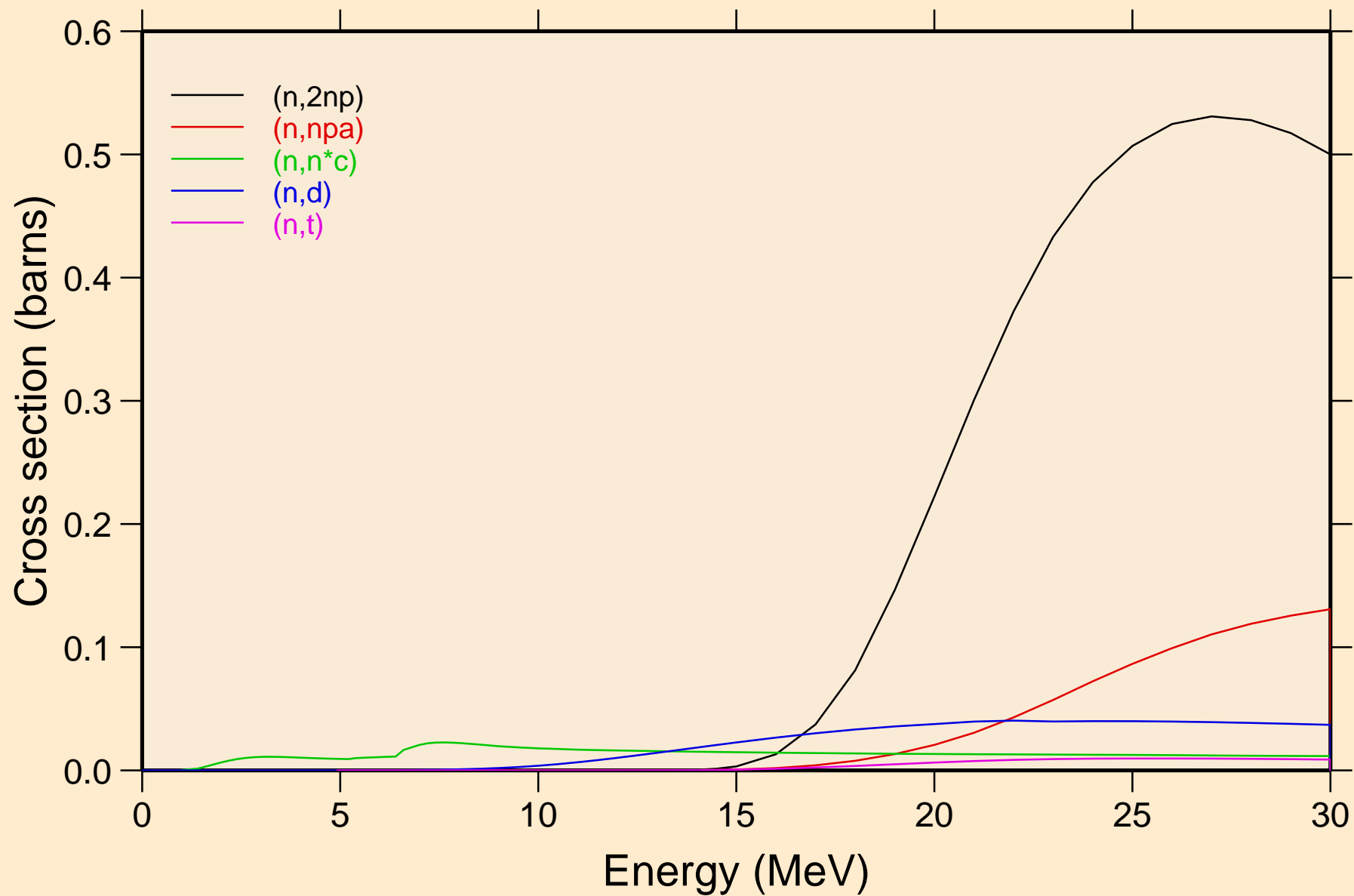

I115 NEUTRON ACER TENDL-2019 LIBRARY; T=293.16K  
Threshold reactions

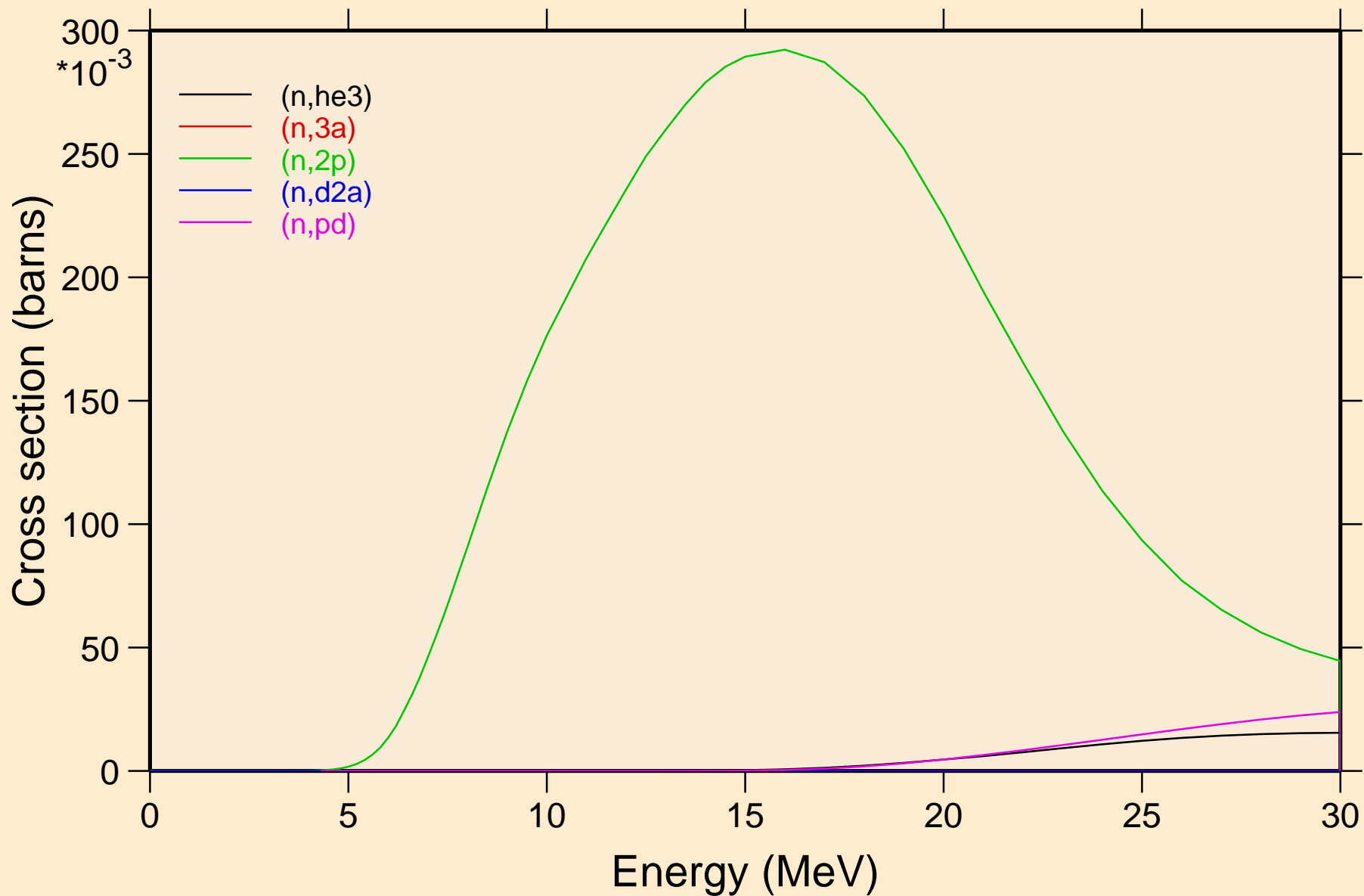

I115 NEUTRON ACER TENDL-2019 LIBRARY; T=293.16K  
Threshold reactions

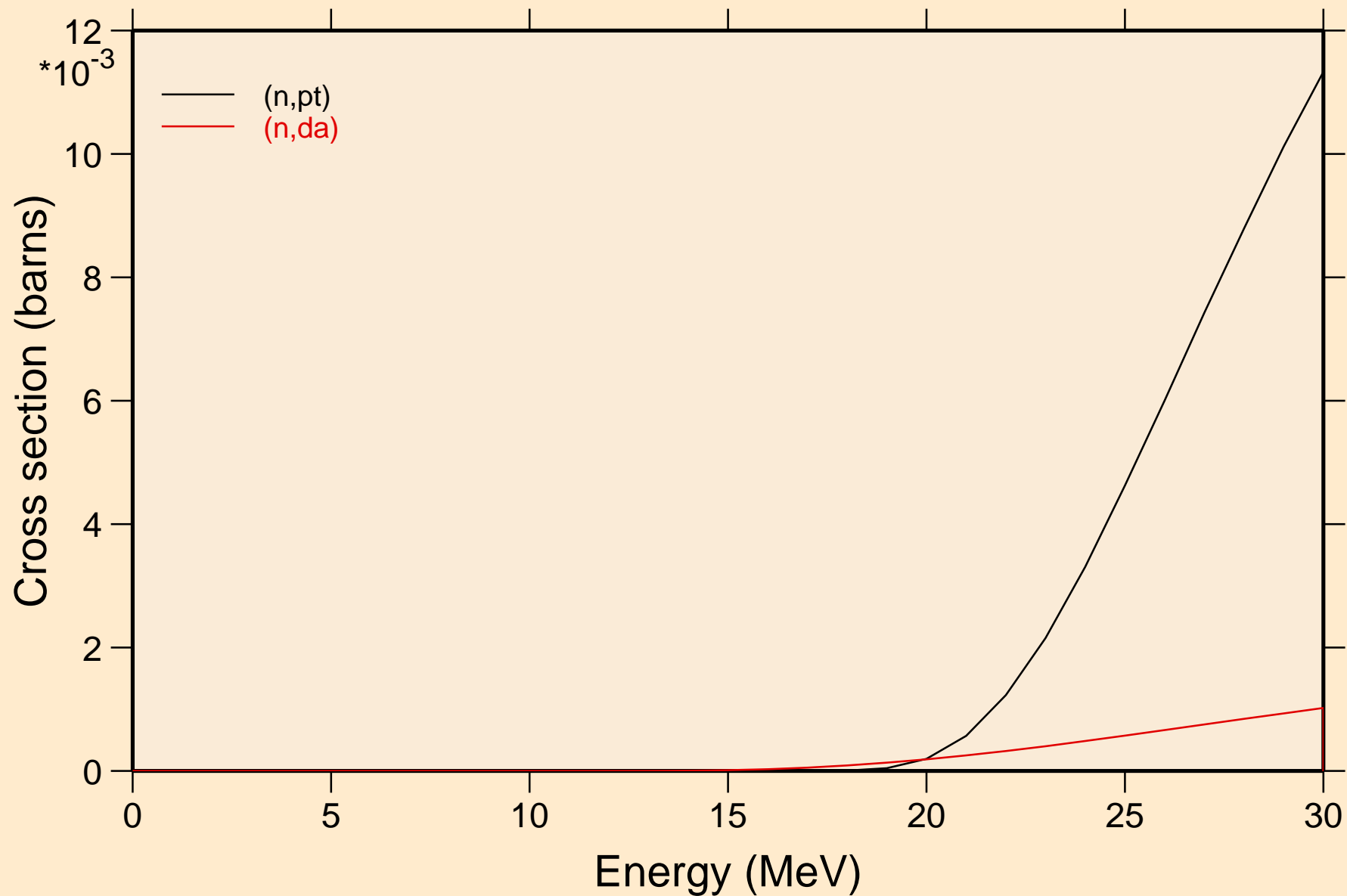



I115 NEUTRON ACER TENDL-2019 LIBRARY; T=293.16K  
Threshold reactions

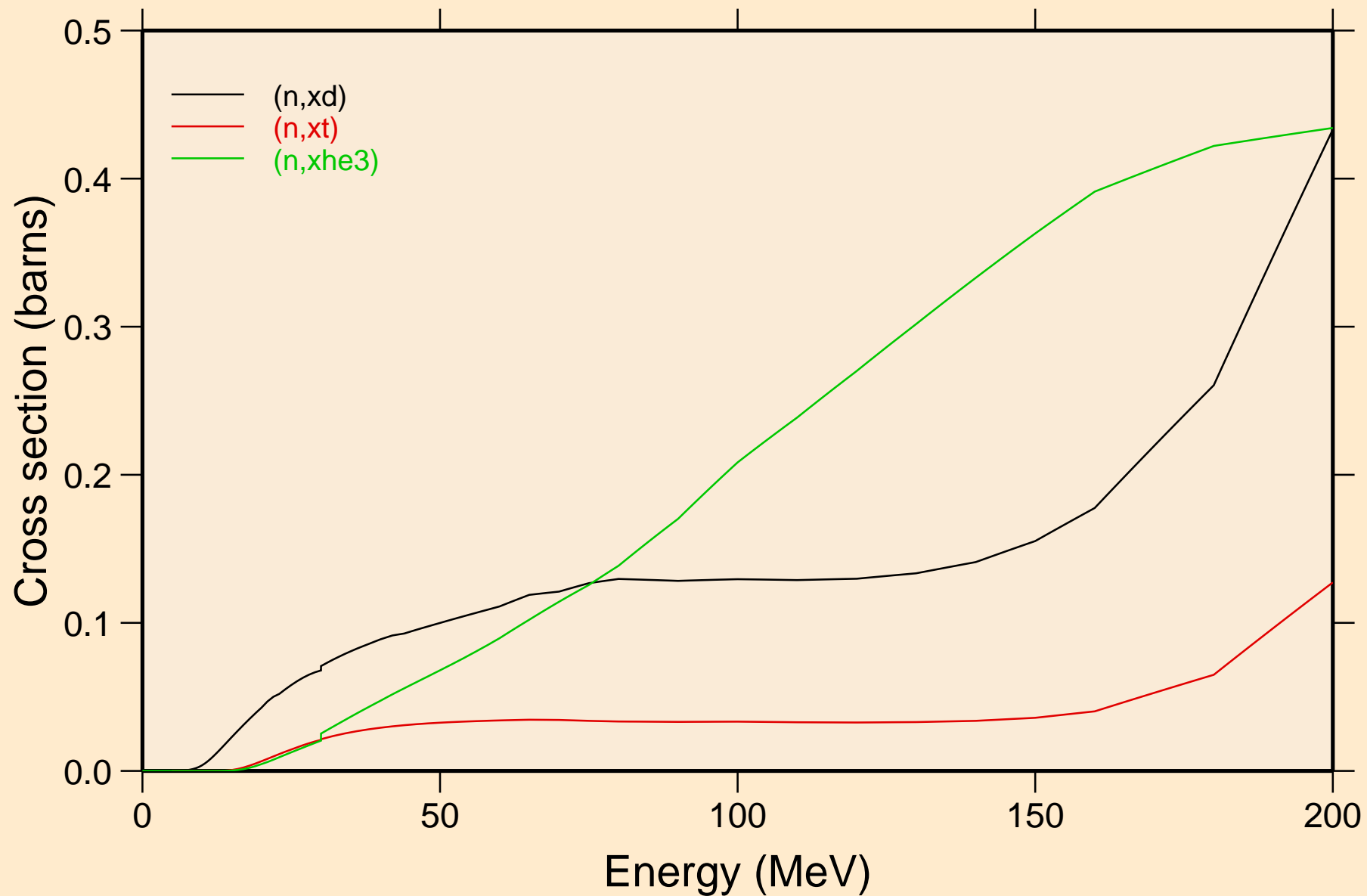

I115 NEUTRON ACER TENDL-2019 LIBRARY; T=293.16K  
angular distribution for elastic

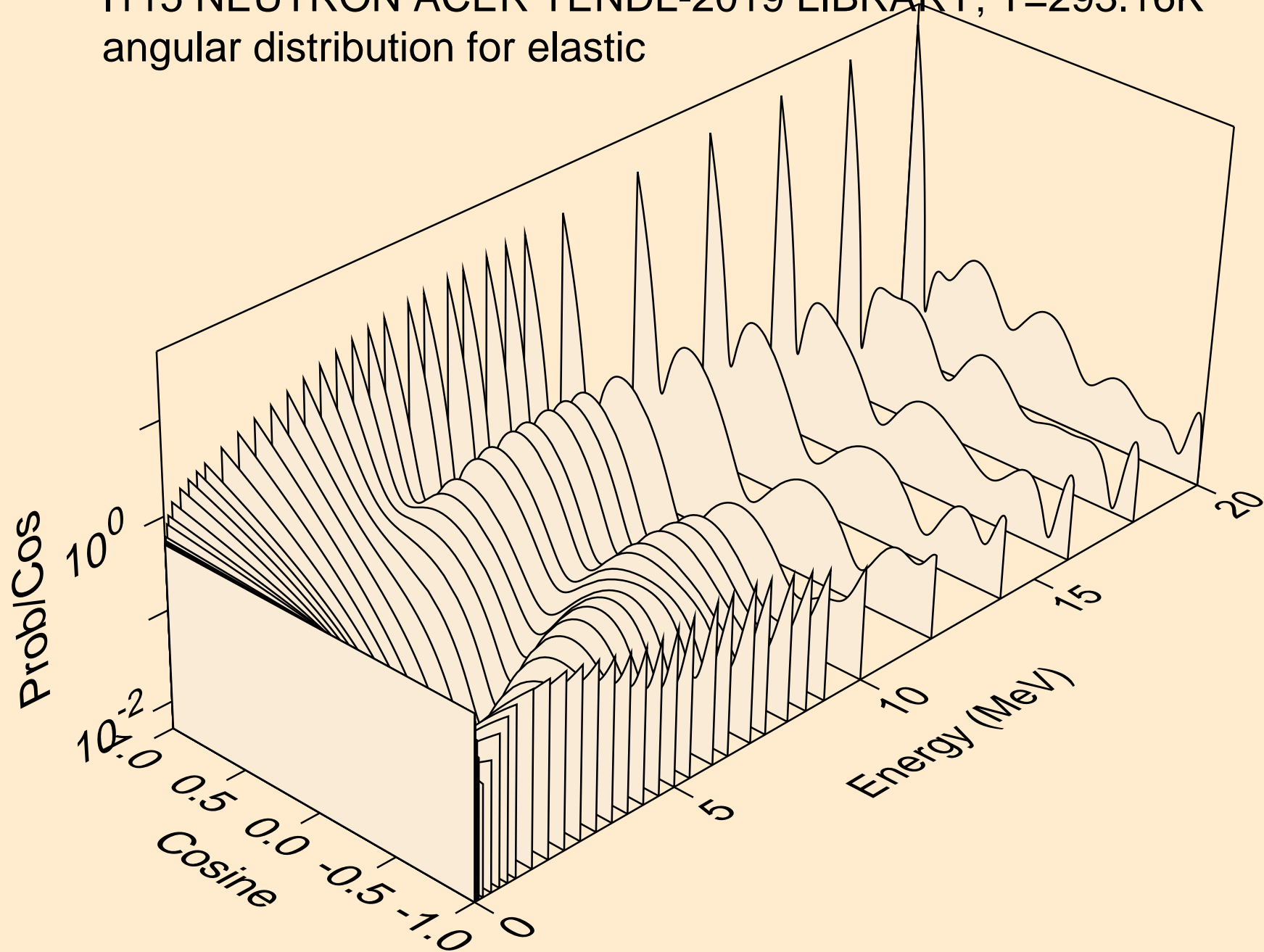

I115 NEUTRON ACER TENDL-2019 LIBRARY; T=293.16K  
angular distribution for elastic

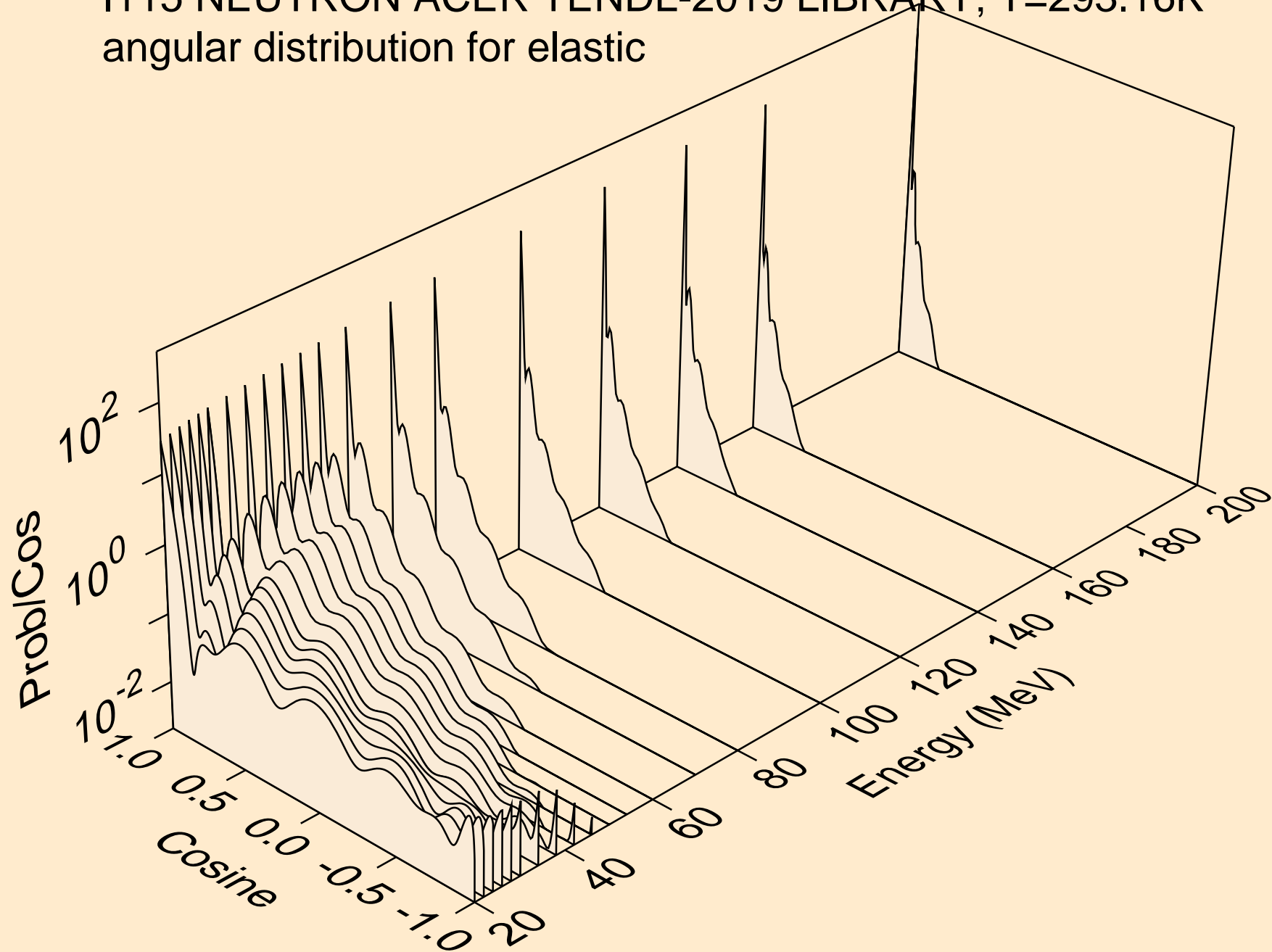

I115 NEUTRON ACER TENDL-2019 LIBRARY; T=293.16K  
angular distribution for (n,n\*1)

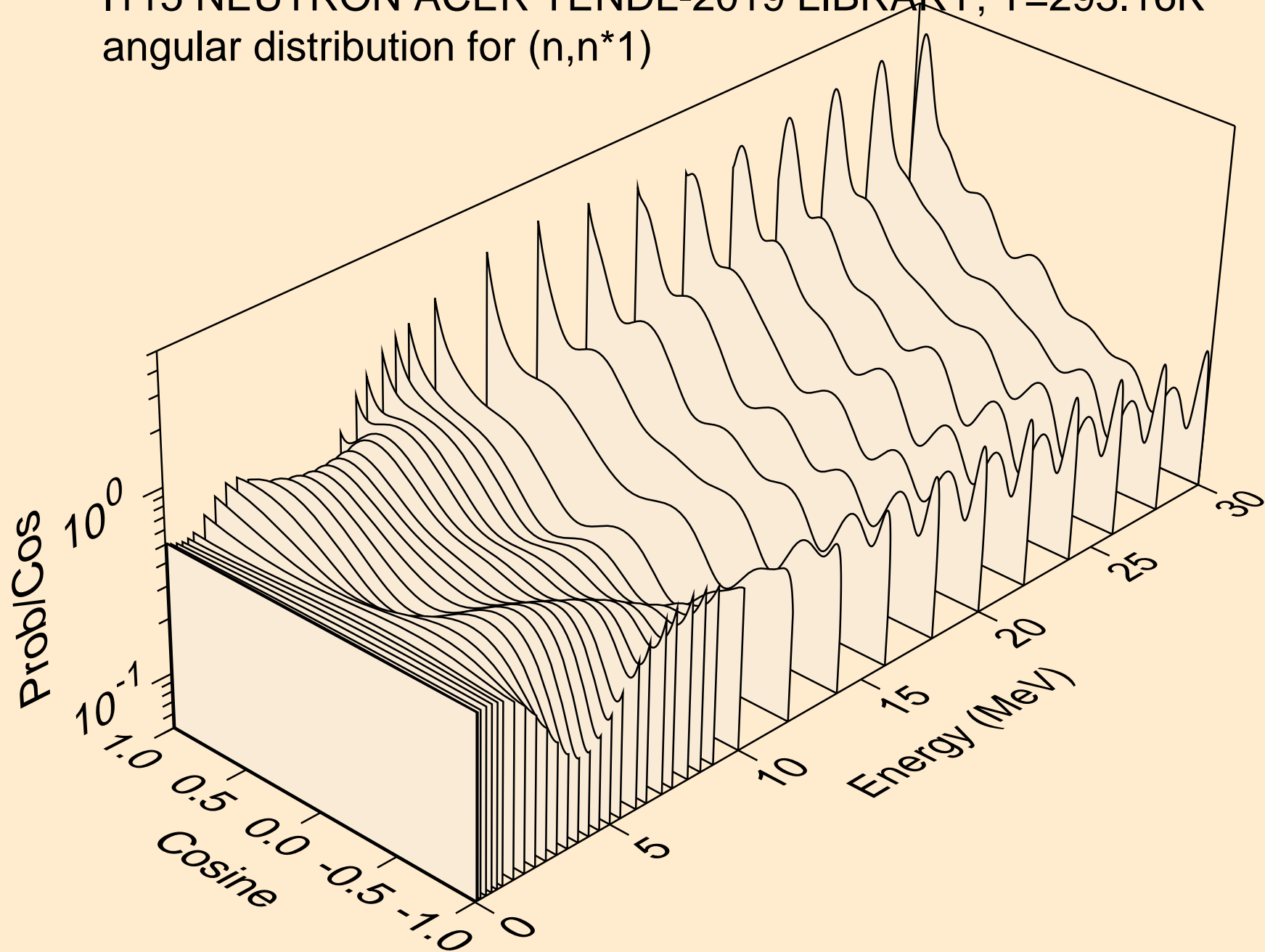

I115 NEUTRON ACER TENDL-2019 LIBRARY; T=293.16K  
angular distribution for (n,n\*2)

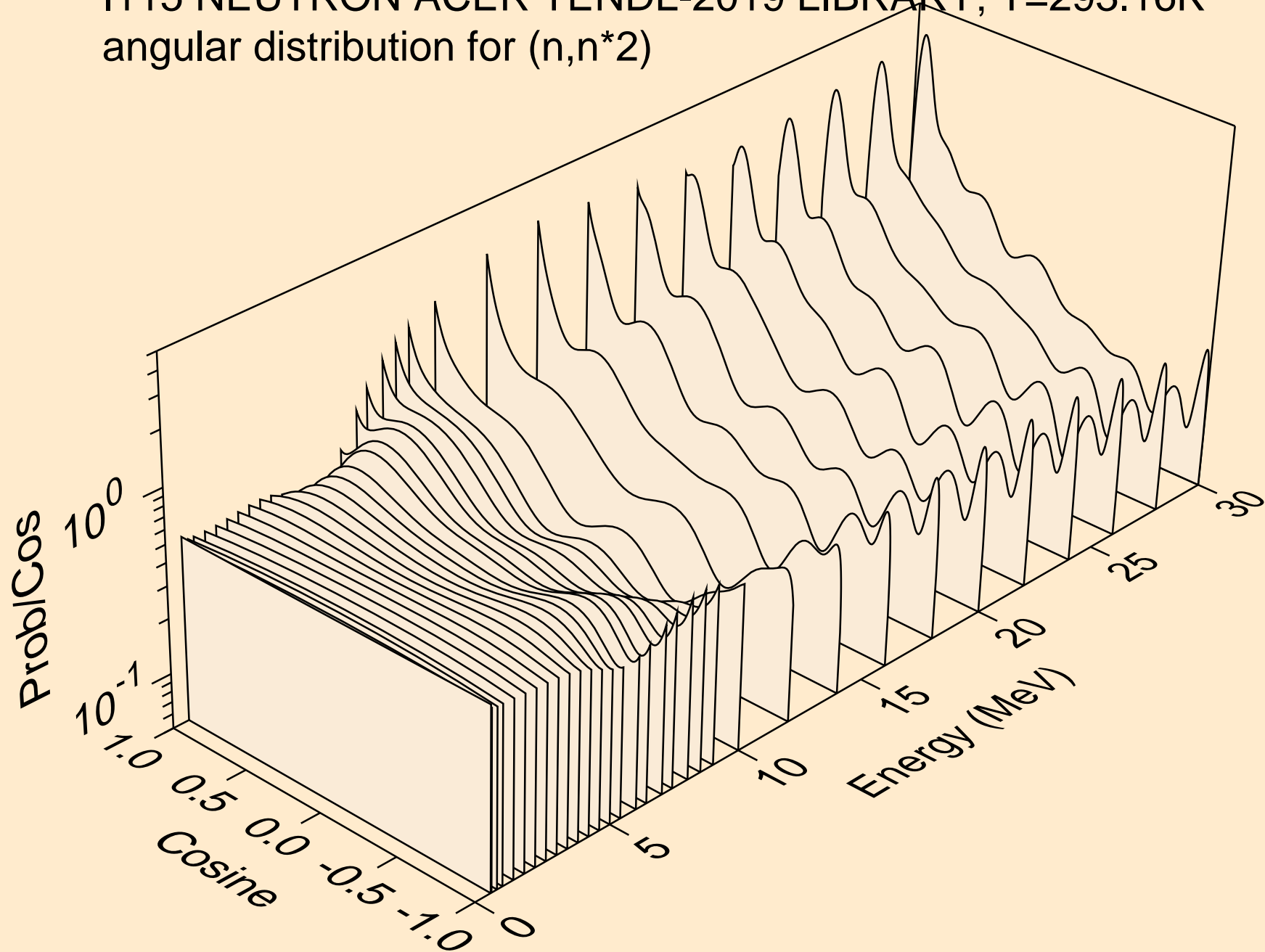

I115 NEUTRON ACER TENDL-2019 LIBRARY; T=293.16K  
angular distribution for (n,n\*3)

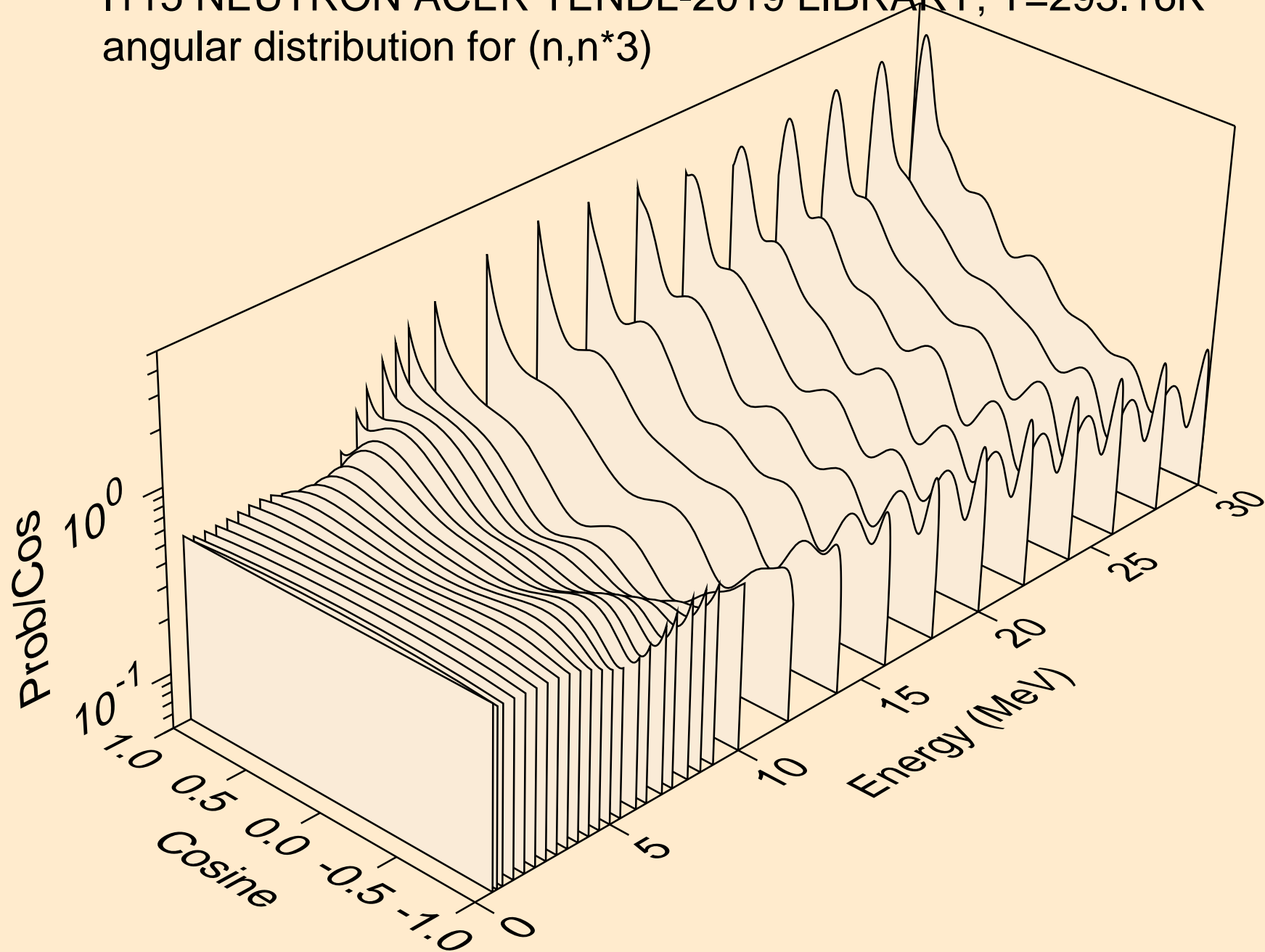

I115 NEUTRON ACER TENDL-2019 LIBRARY; T=293.16K  
angular distribution for (n,n\*4)

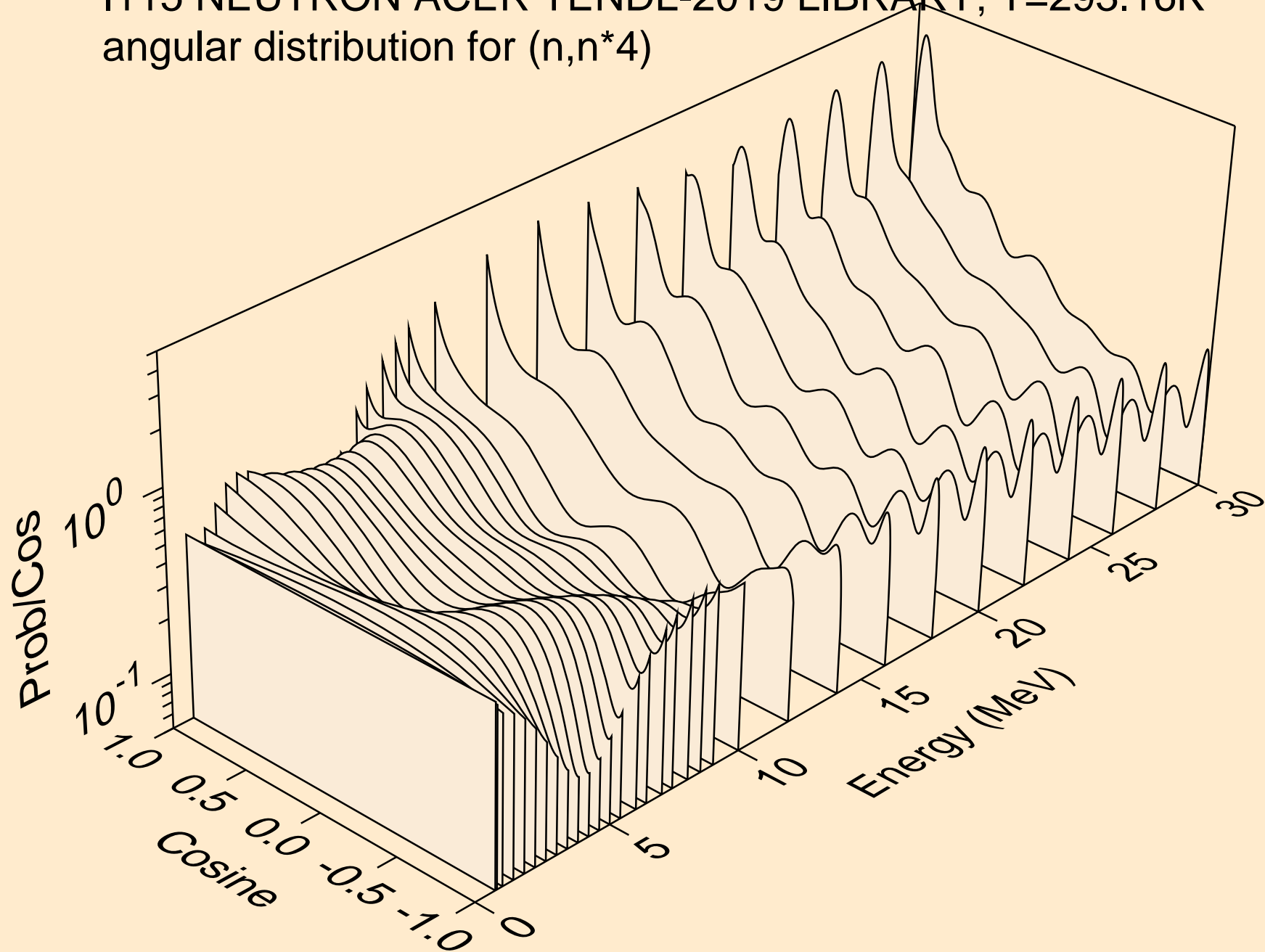

I115 NEUTRON ACER TENDL-2019 LIBRARY; T=293.16K  
angular distribution for (n,n\*5)

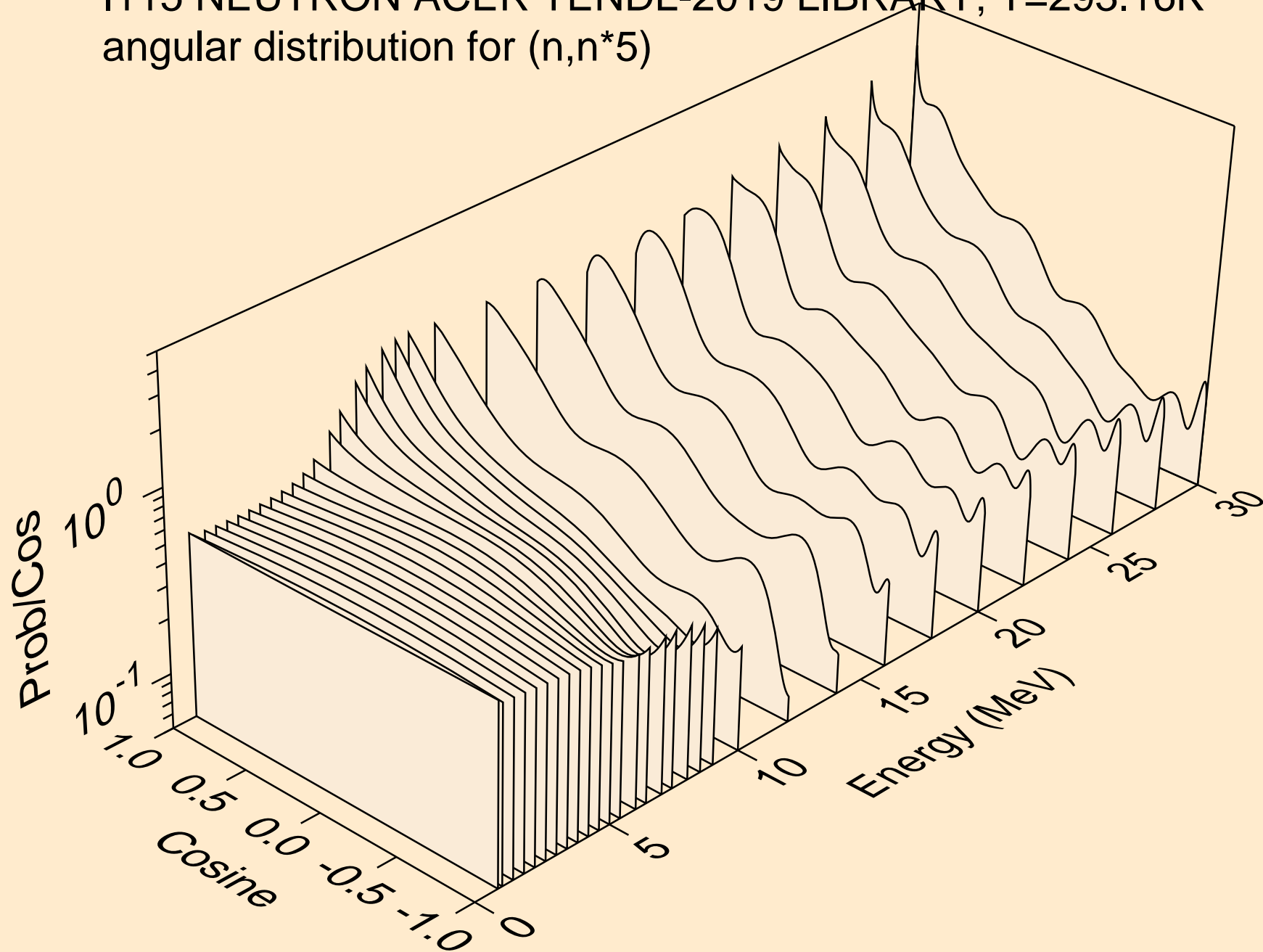



I115 NEUTRON ACER TENDL-2019 LIBRARY; T=293.16K  
angular distribution for (n,n\*6)

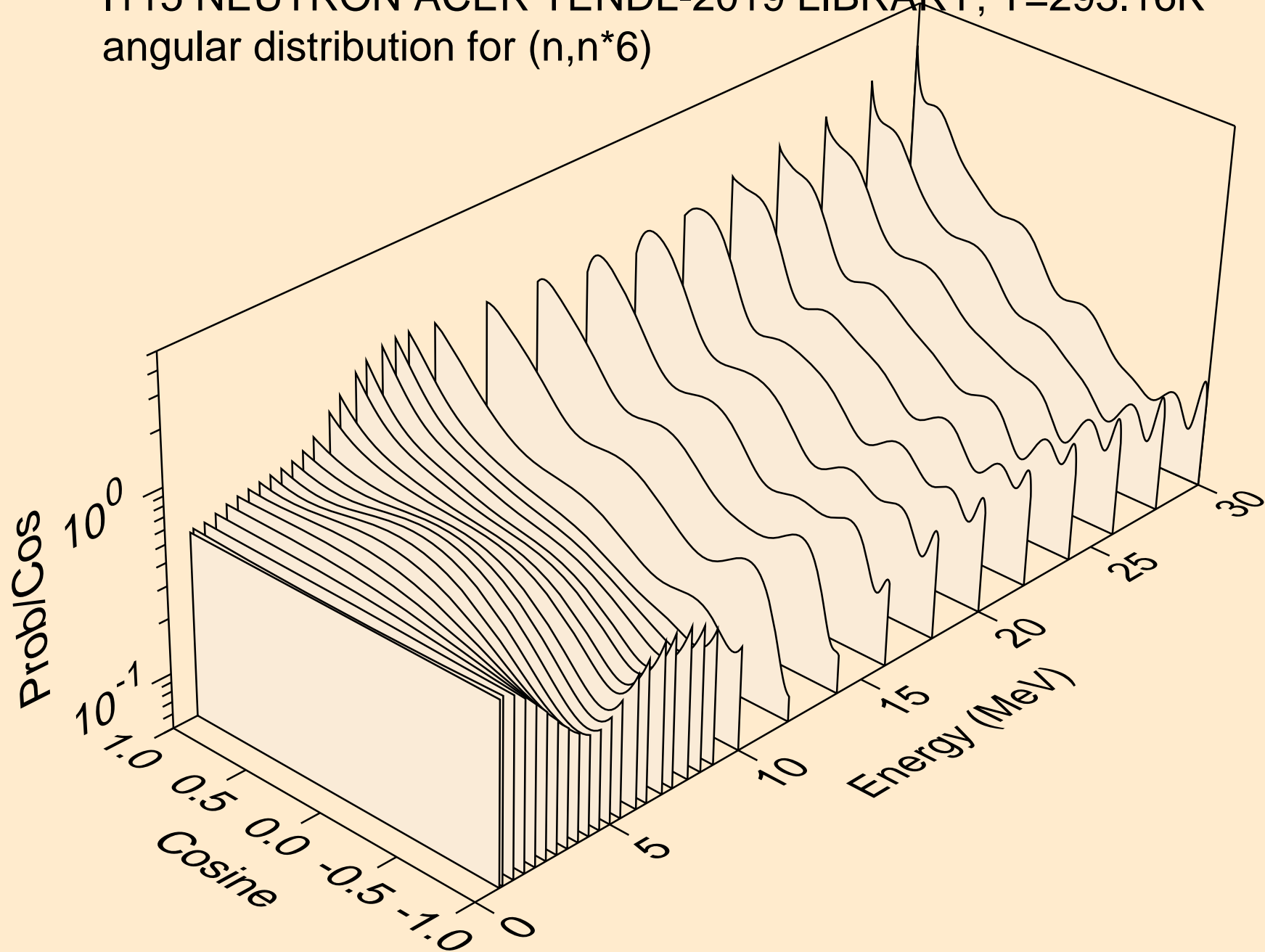

I115 NEUTRON ACER TENDL-2019 LIBRARY; T=293.16K  
Neutron emission for (n,x)

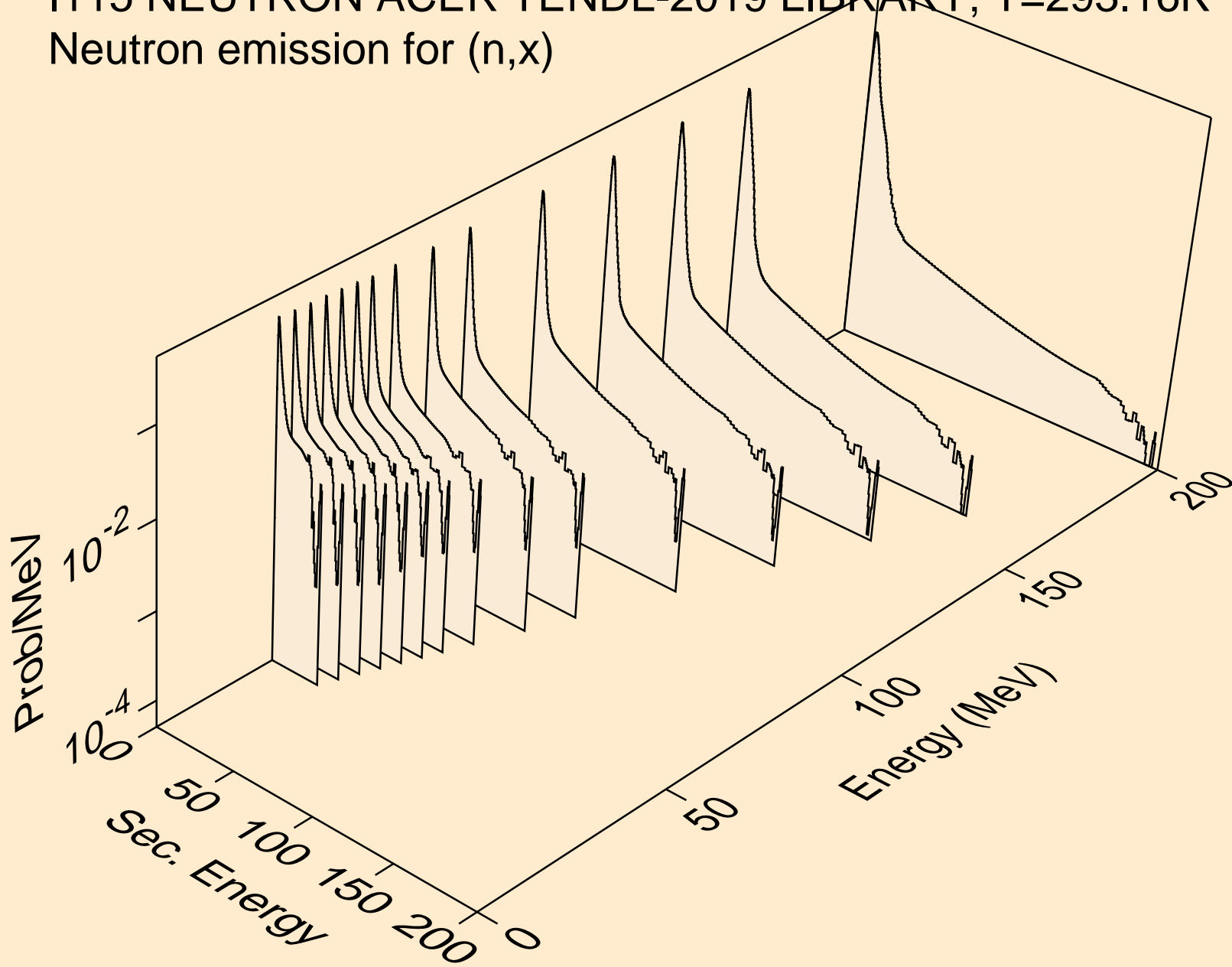

I115 NEUTRON ACER TENDL-2019 LIBRARY; T=293.16K  
Neutron emission for (n,2nd)

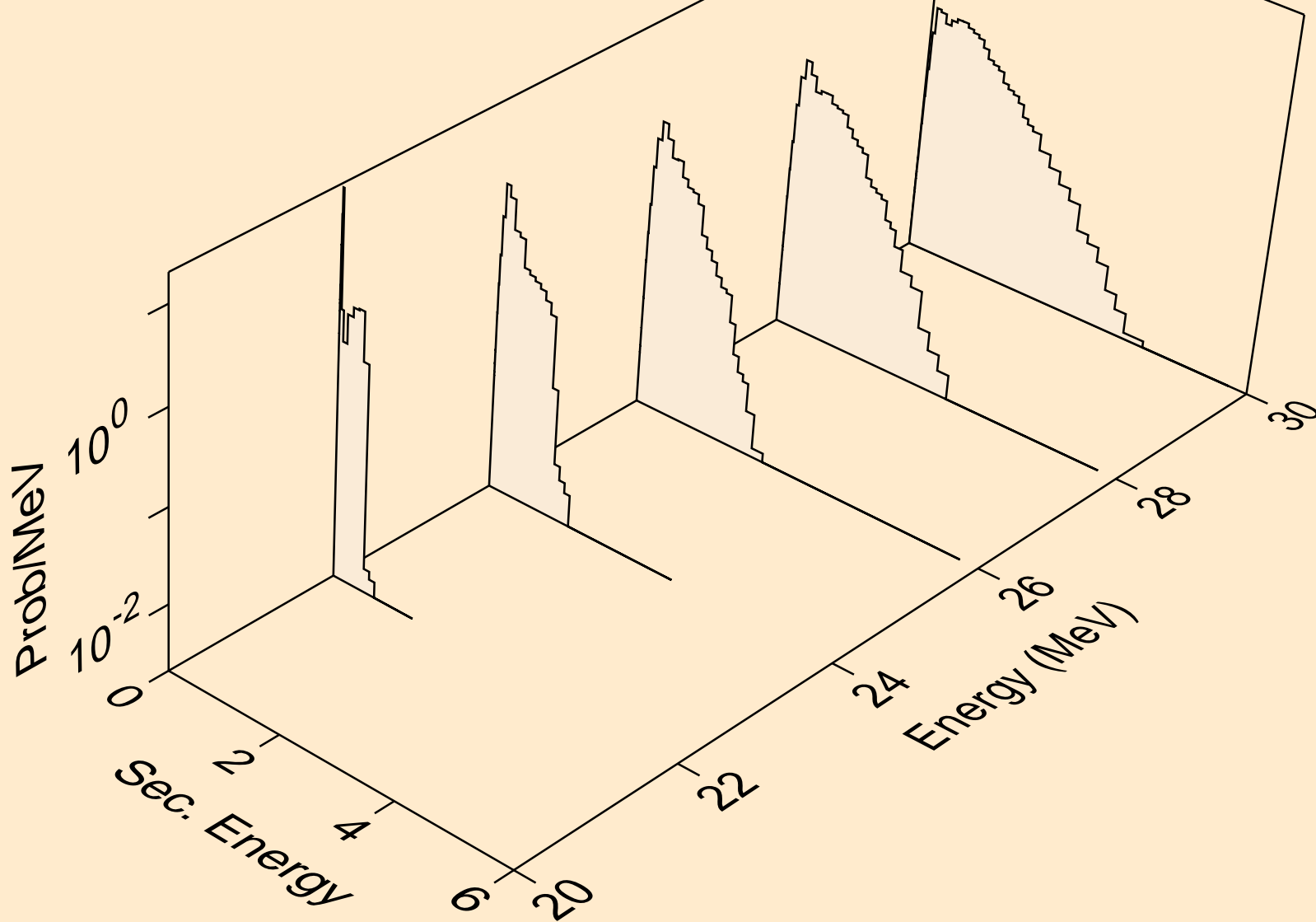

I115 NEUTRON ACER TENDL-2019 LIBRARY; T=293.16K  
Neutron emission for (n,2n)

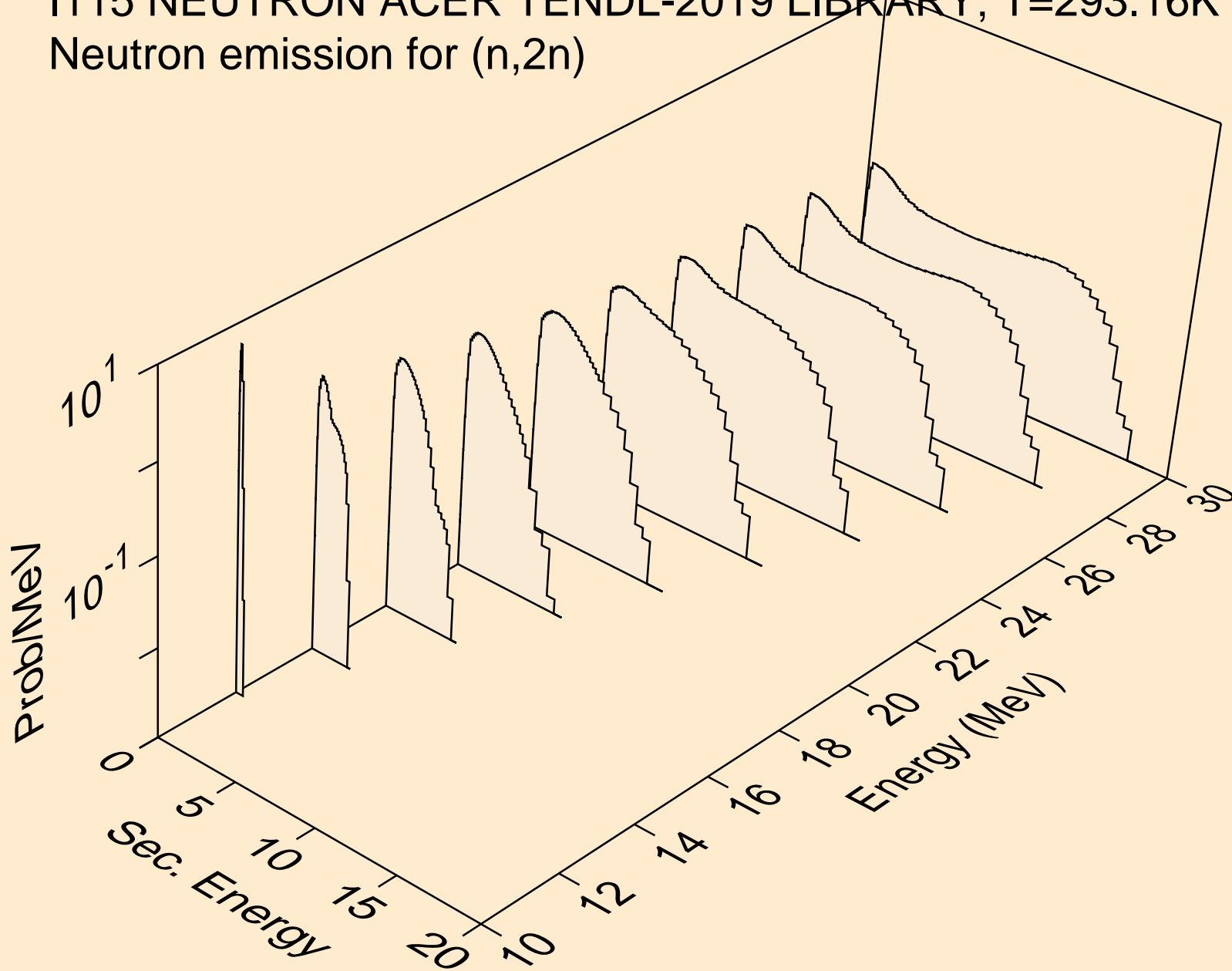

I115 NEUTRON ACER TENDL-2019 LIBRARY; T=293.16K  
Neutron emission for (n,3n)

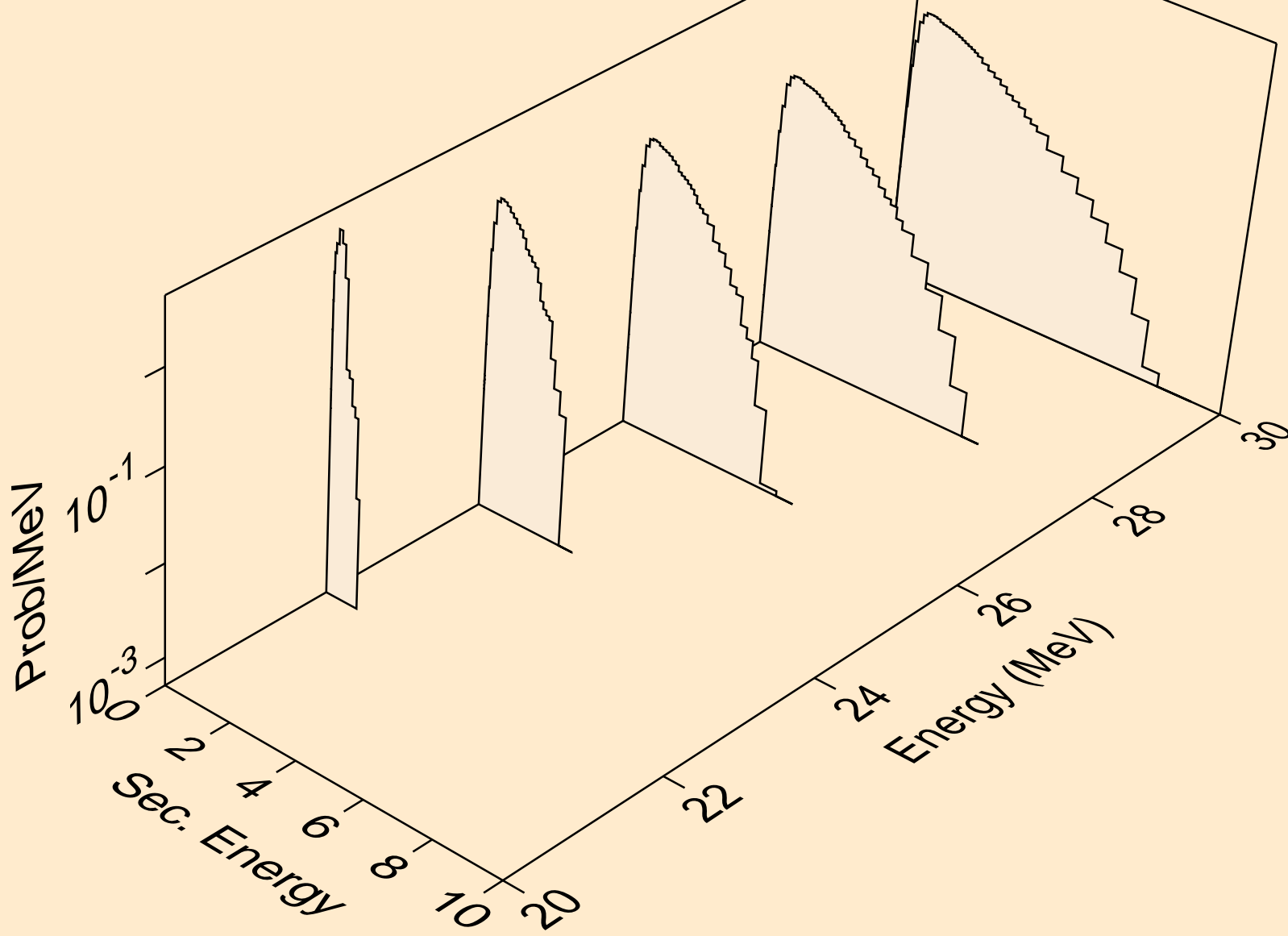

I115 NEUTRON ACER TENDL-2019 LIBRARY; T=293.16K  
Neutron emission for (n,n\*)a

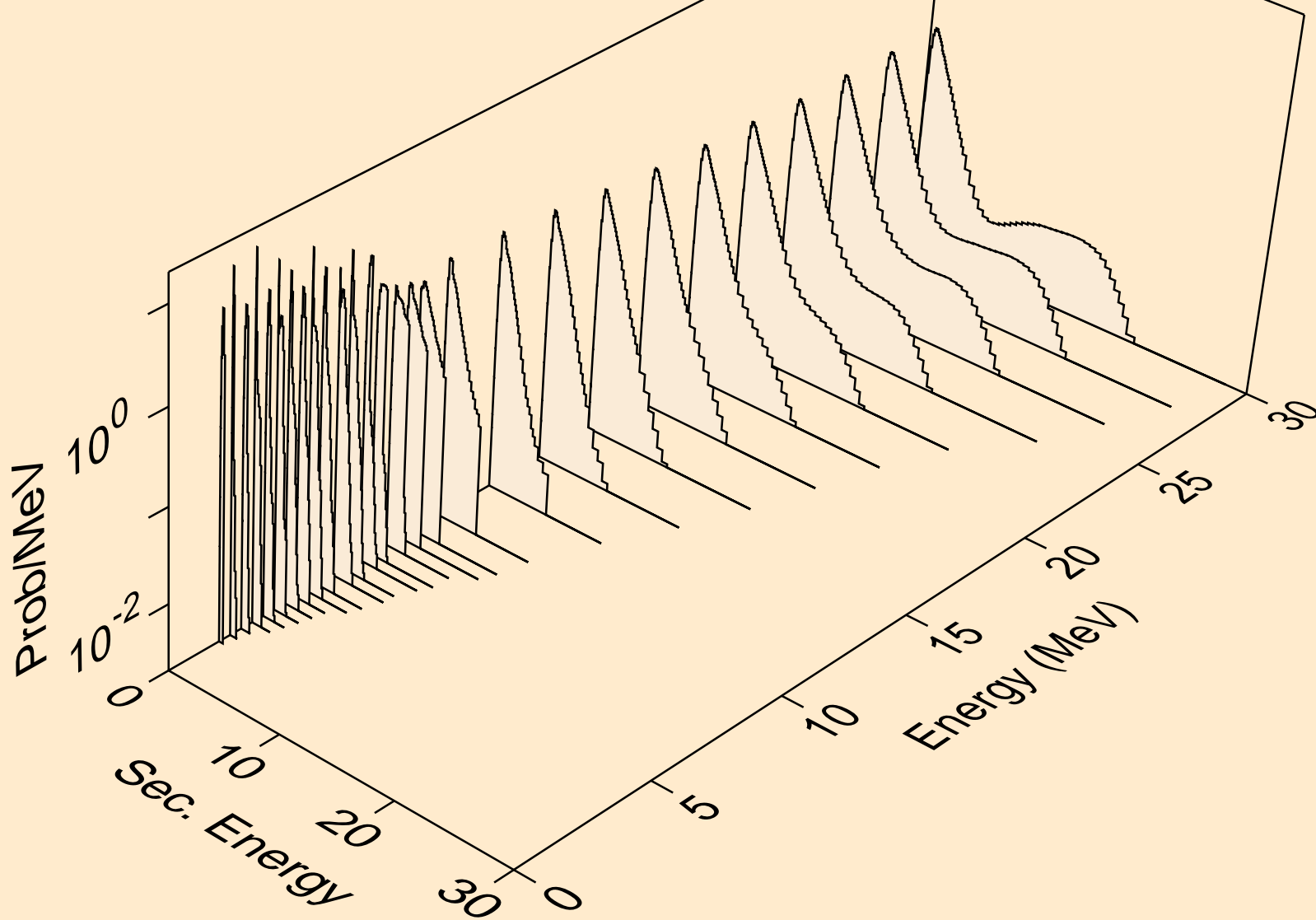

I115 NEUTRON ACER TENDL-2019 LIBRARY; T=293.16K  
Neutron emission for (n,2n)<sub>a</sub>

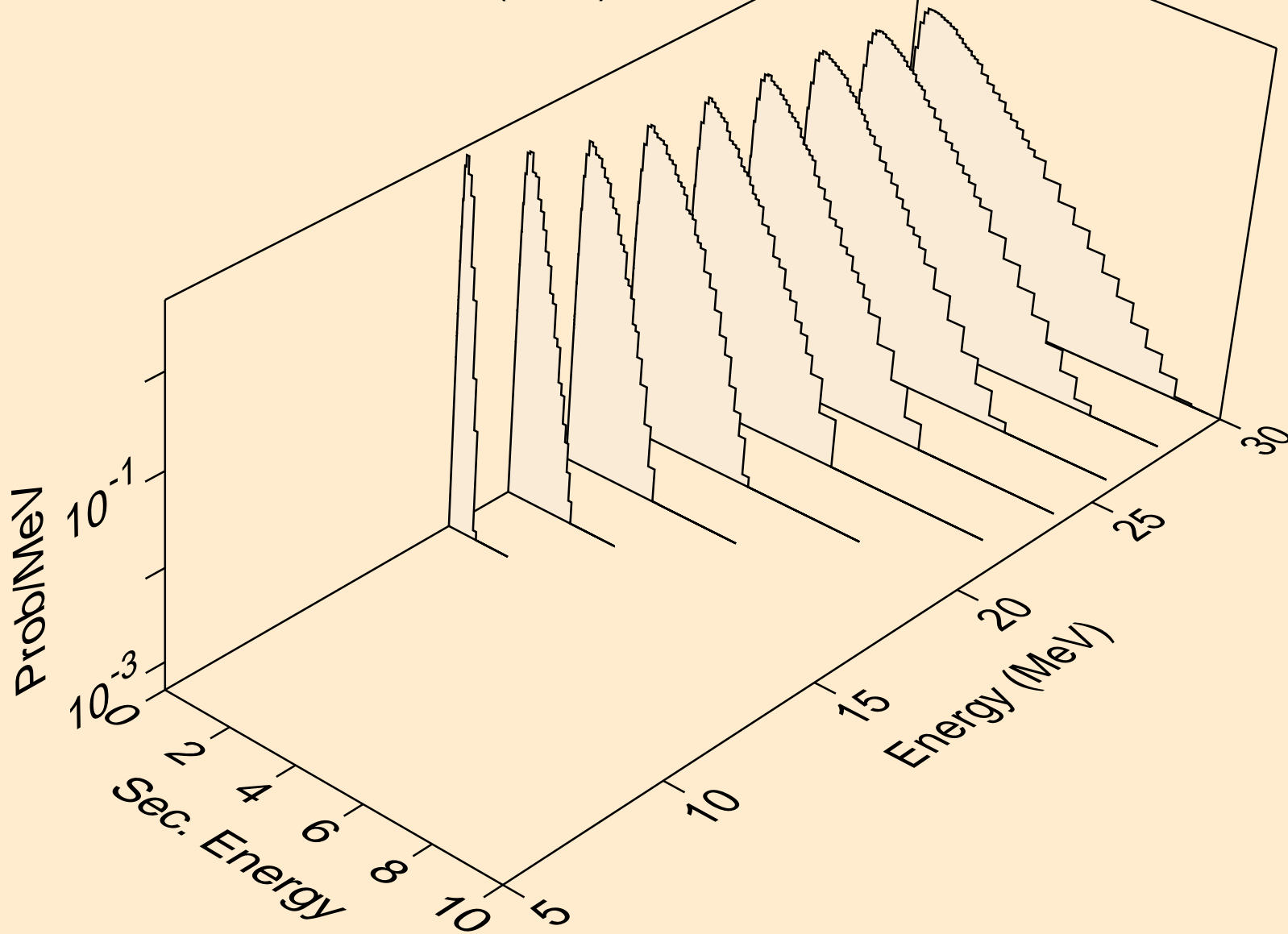

I115 NEUTRON ACER TENDL-2019 LIBRARY; T=293.16K  
Neutron emission for (n,3n)a

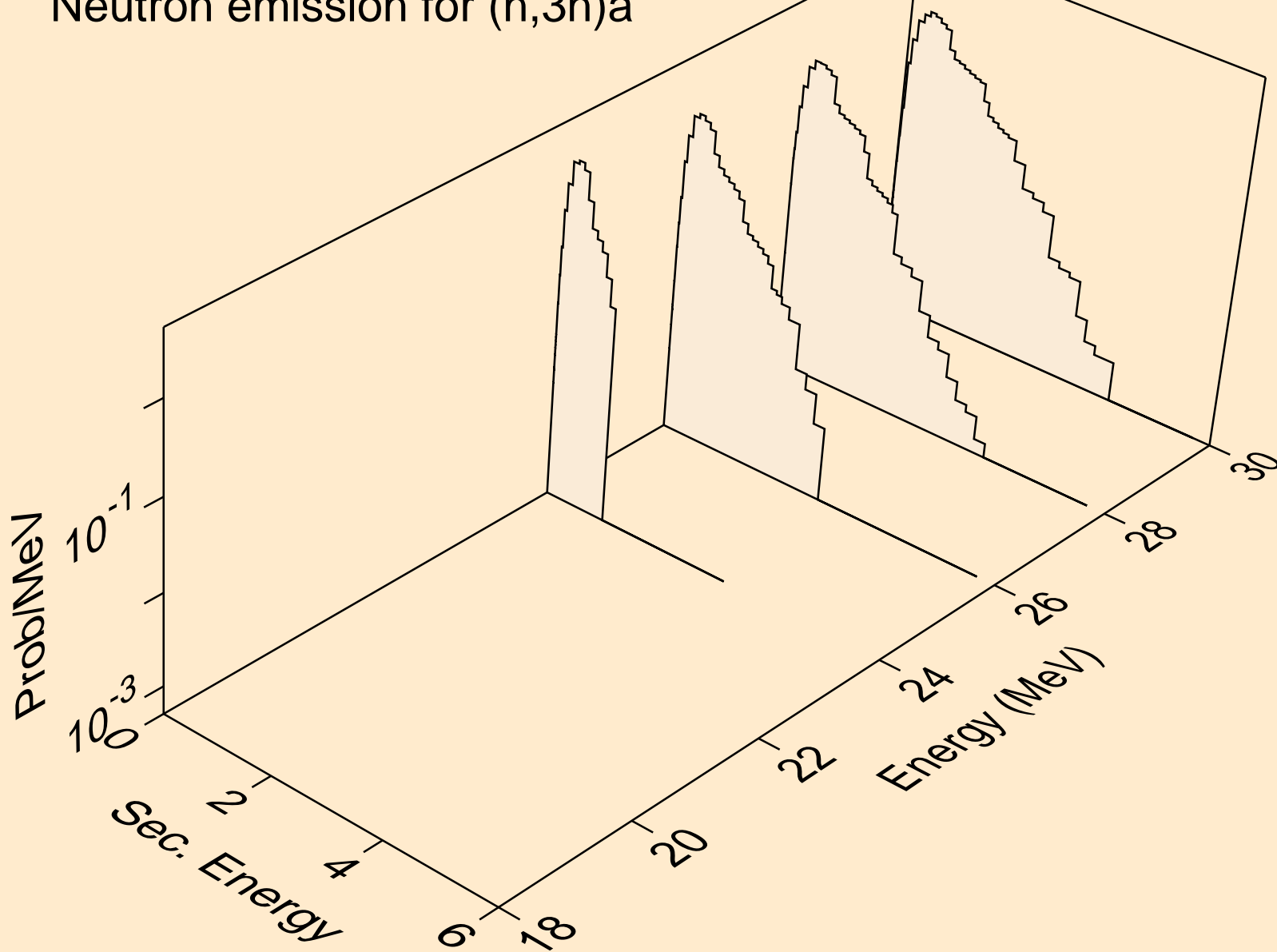



I115 NEUTRON ACER TENDL-2019 LIBRARY; T=293.16K  
Neutron emission for (n,n\*)p

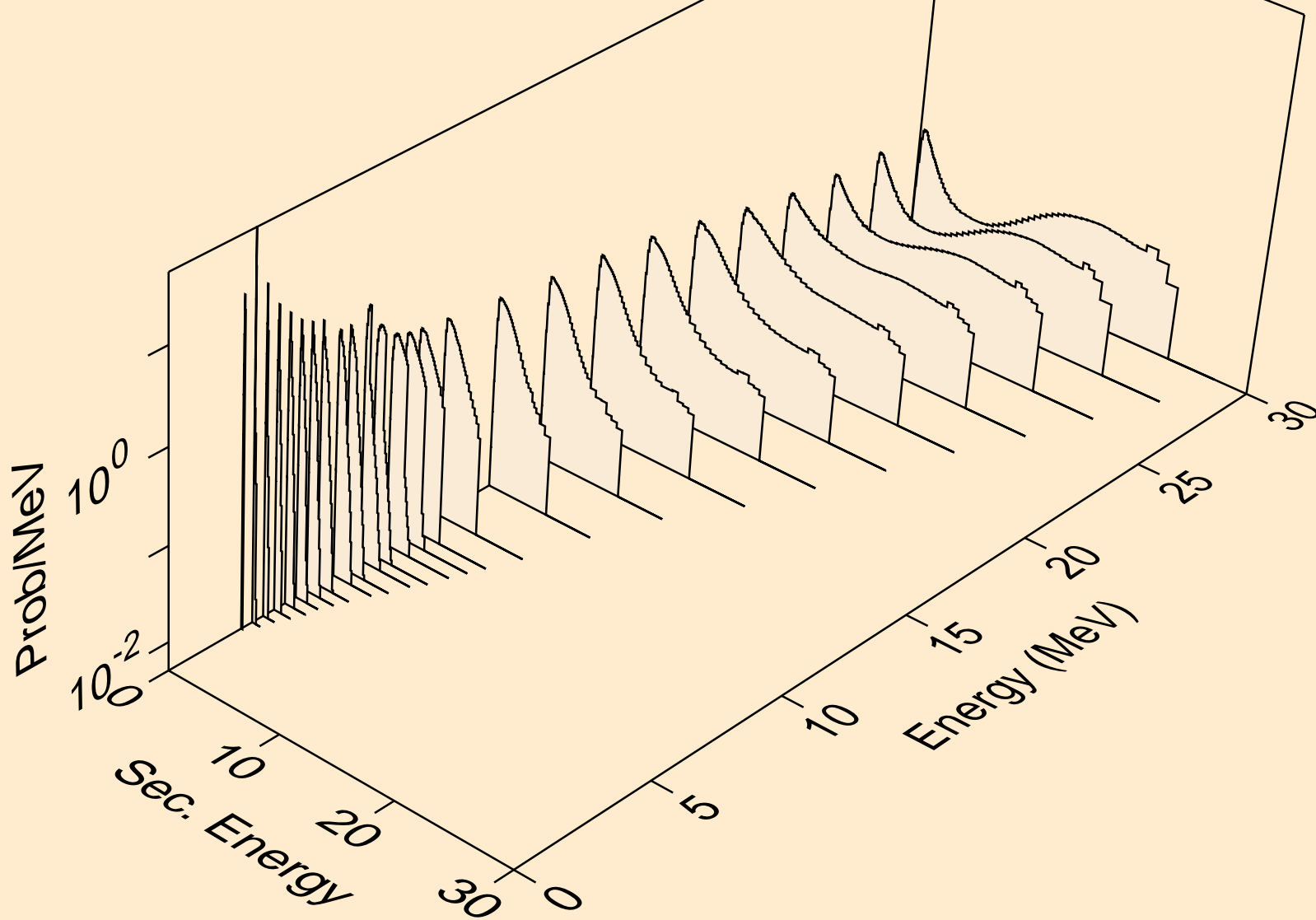

I115 NEUTRON ACER TENDL-2019 LIBRARY; T=293.16K  
Neutron emission for (n,n\*)2a

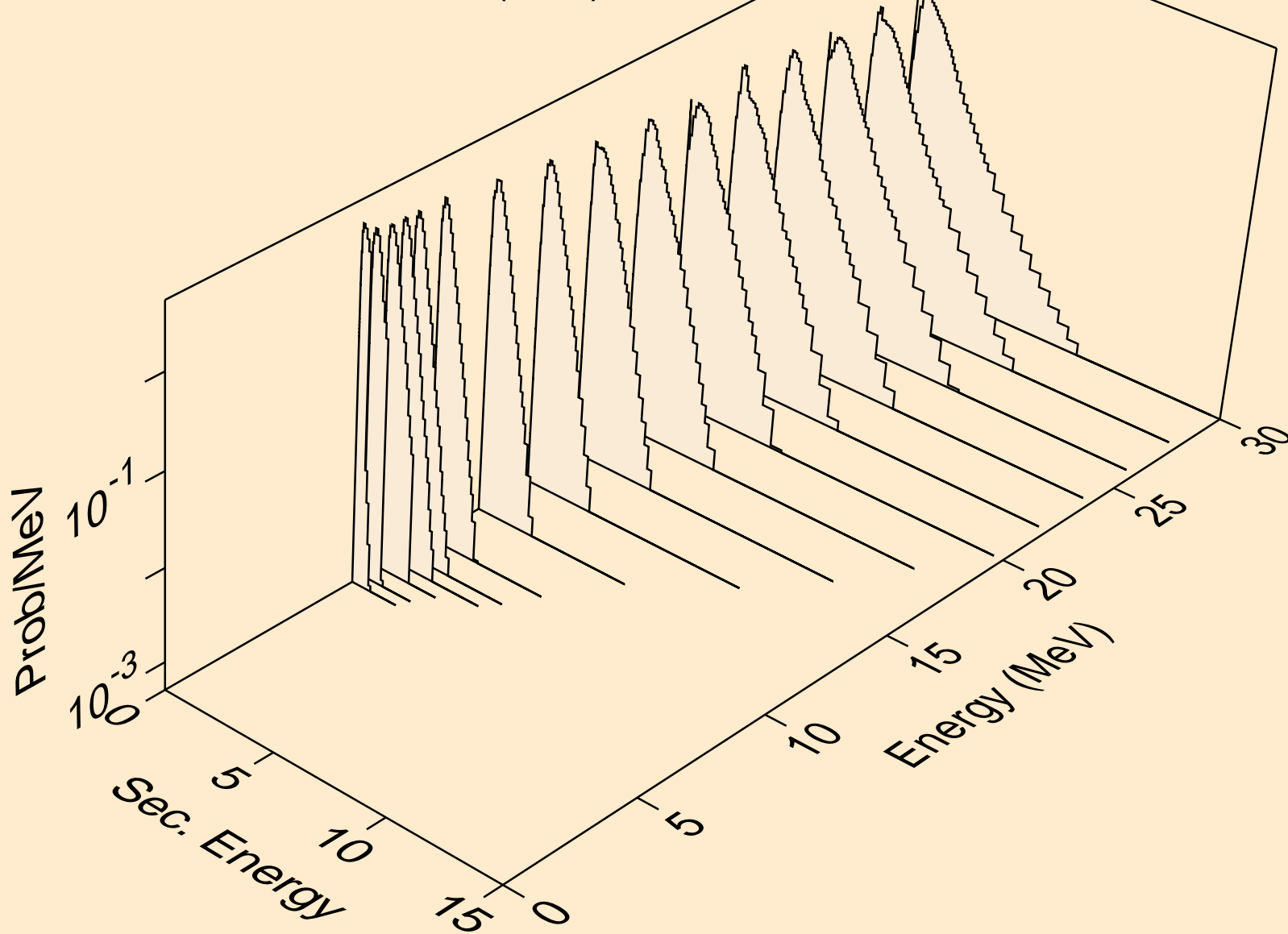

I115 NEUTRON ACER TENDL-2019 LIBRARY; T=293.16K  
Neutron emission for (n,2n)2a

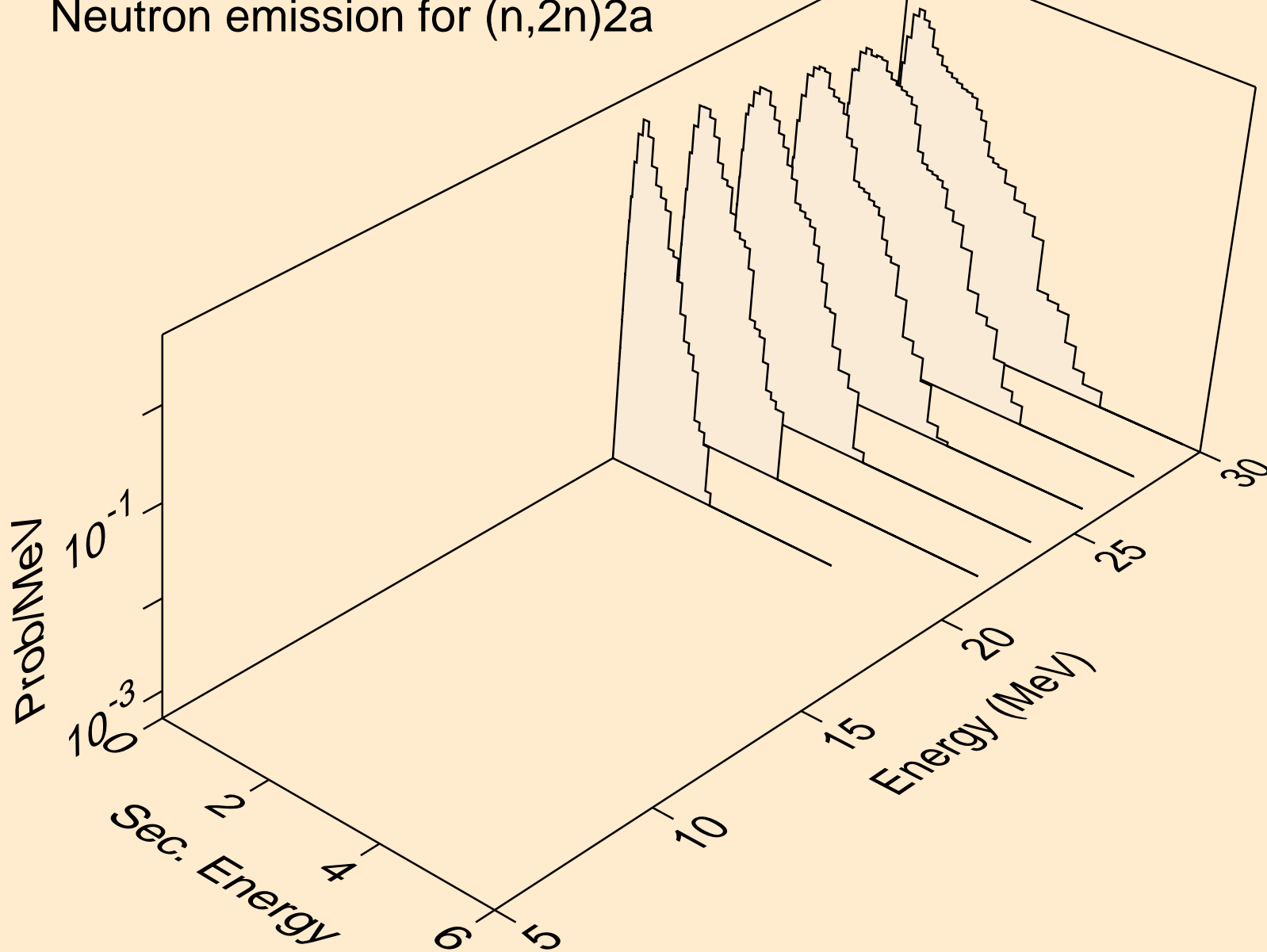

I115 NEUTRON ACER TENDL-2019 LIBRARY; T=293.16K  
Neutron emission for (n,n\*)d

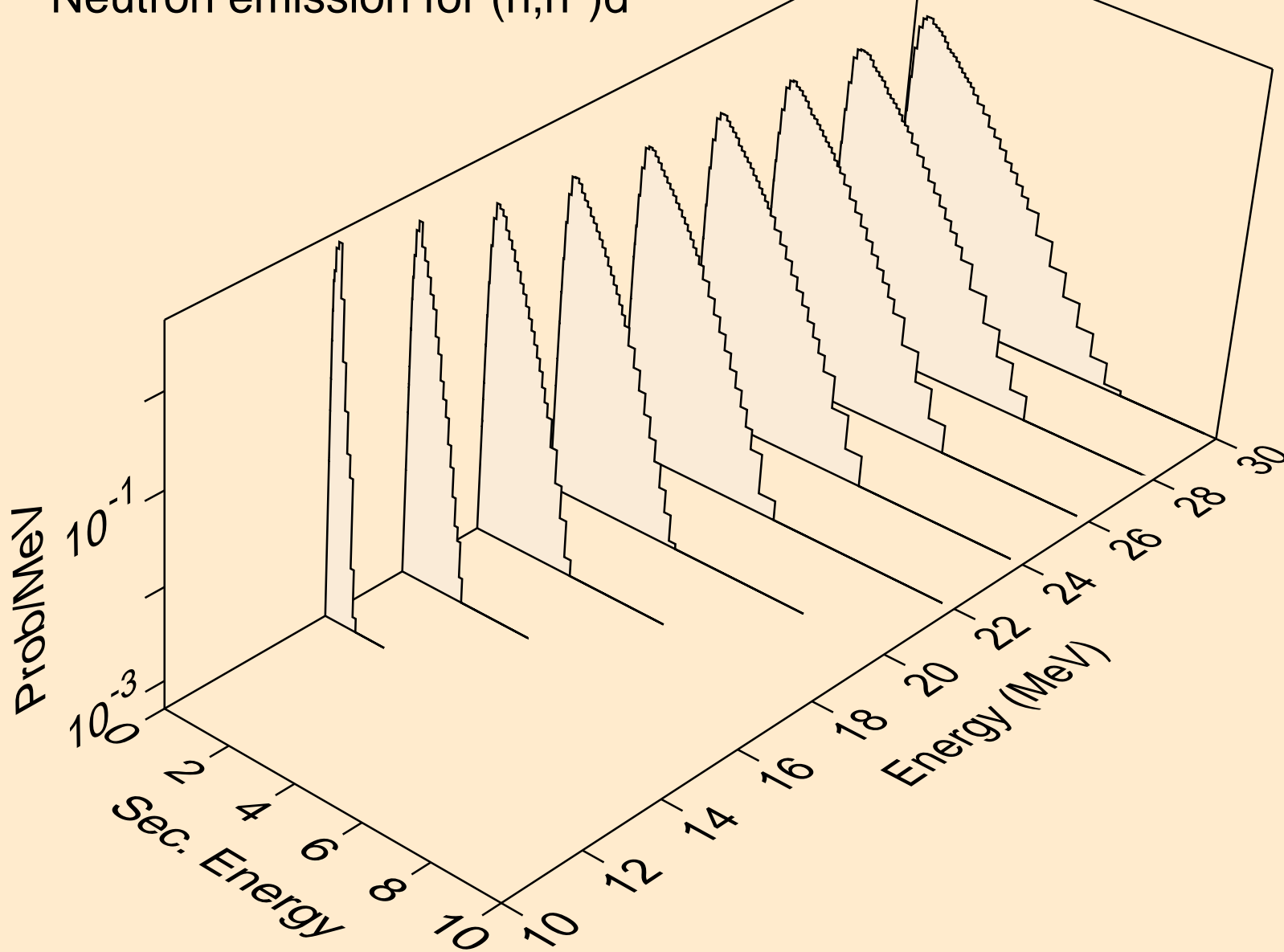

I115 NEUTRON ACER TENDL-2019 LIBRARY; T=293.16K  
Neutron emission for (n,n\*)t

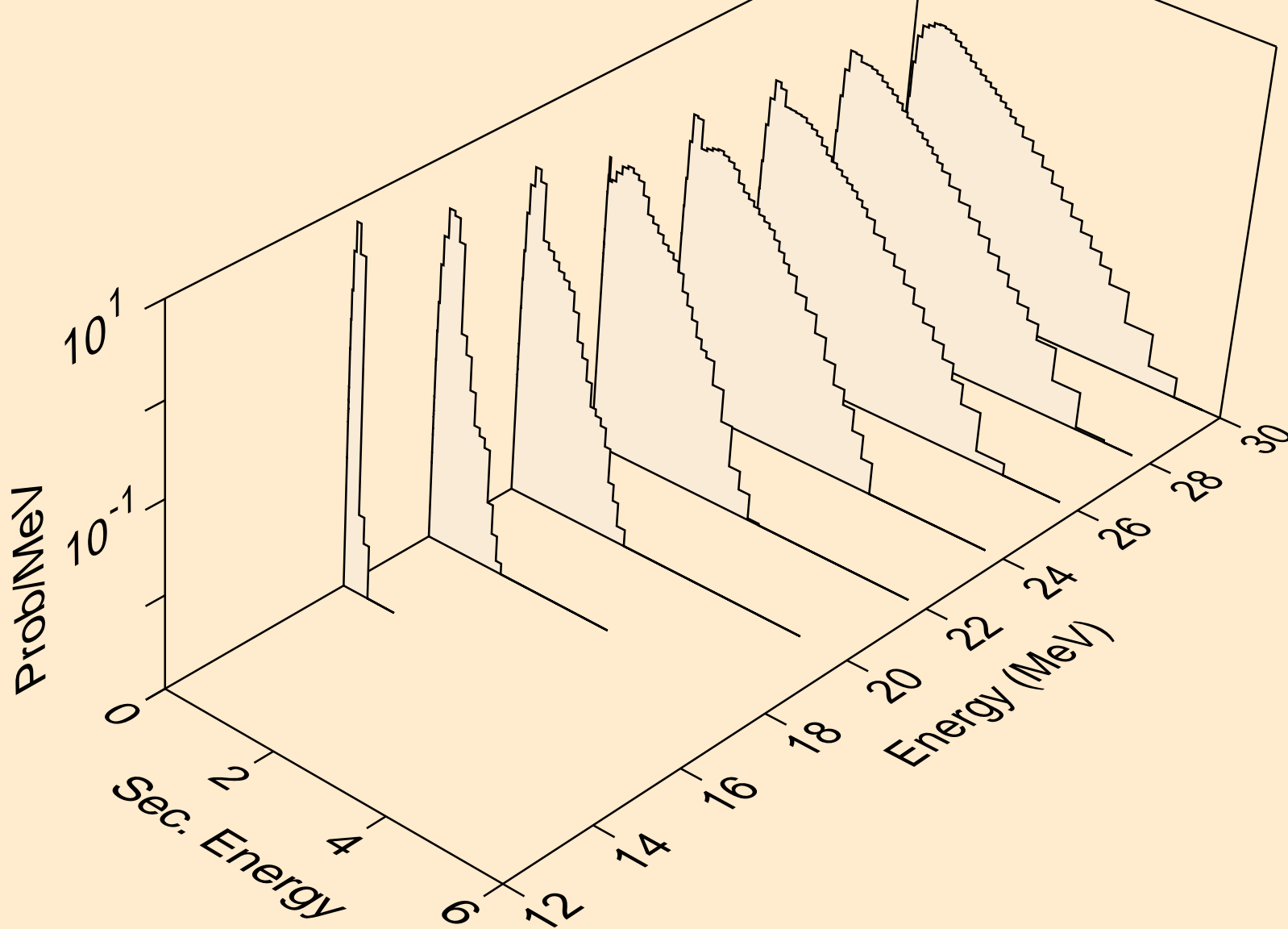

I115 NEUTRON ACER TENDL-2019 LIBRARY; T=293.16K  
Neutron emission for (n,n\*)he3

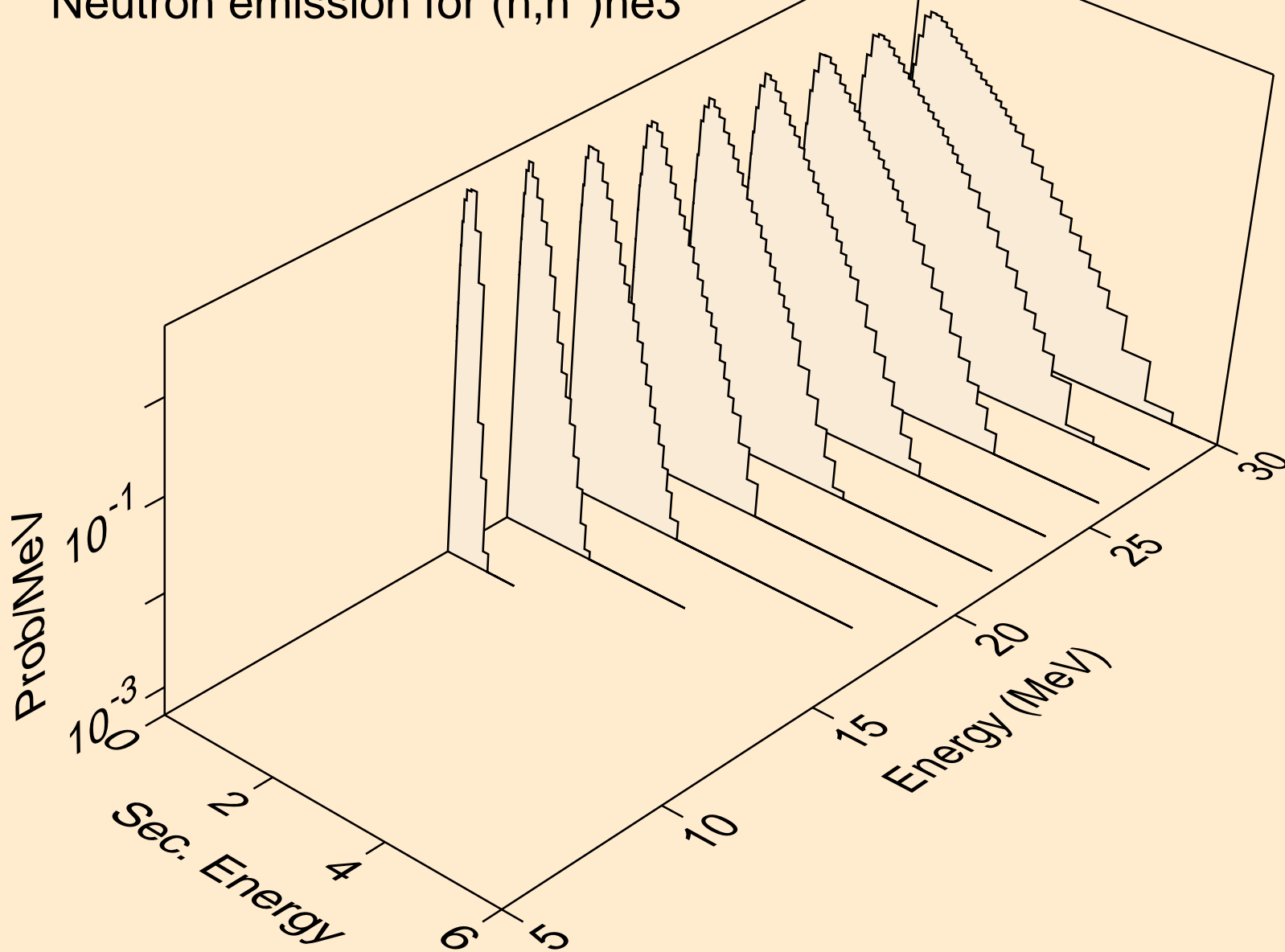

I115 NEUTRON ACER TENDL-2019 LIBRARY; T=293.16K  
Neutron emission for (n,2np)

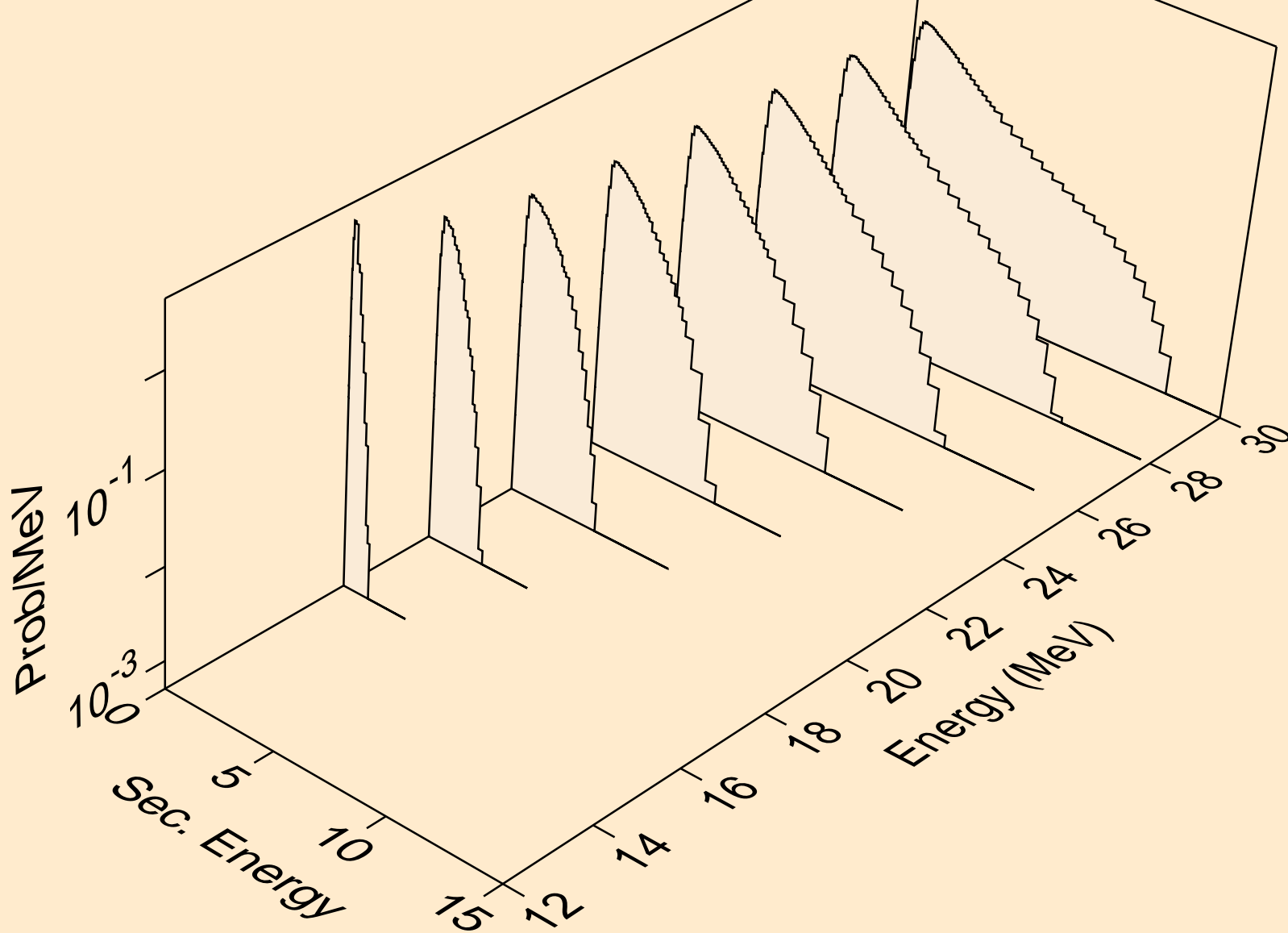

I115 NEUTRON ACER TENDL-2019 LIBRARY; T=293.16K  
Neutron emission for (n,3np)

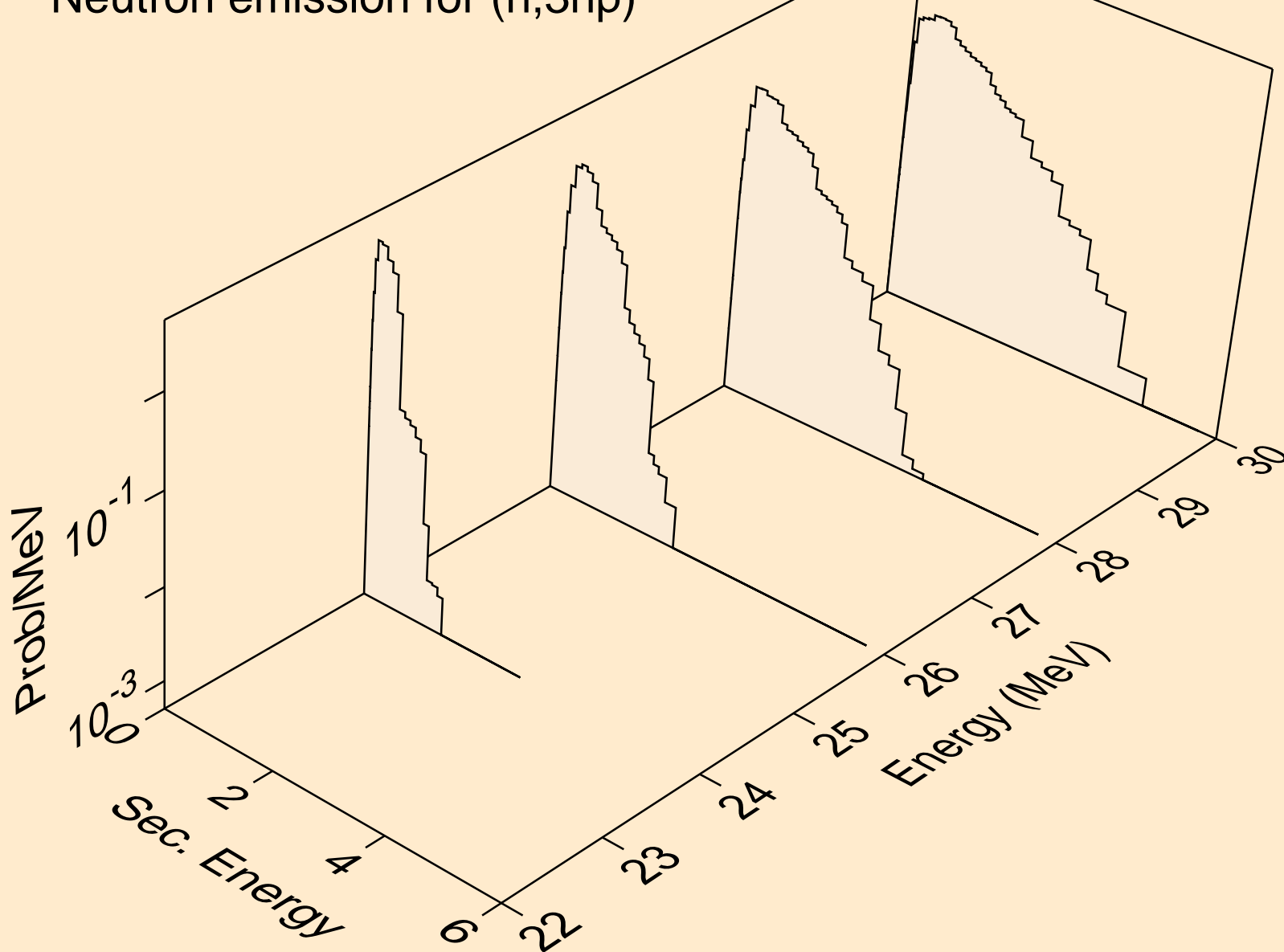



I115 NEUTRON ACER TENDL-2019 LIBRARY; T=293.16K  
Neutron emission for (n,2np)

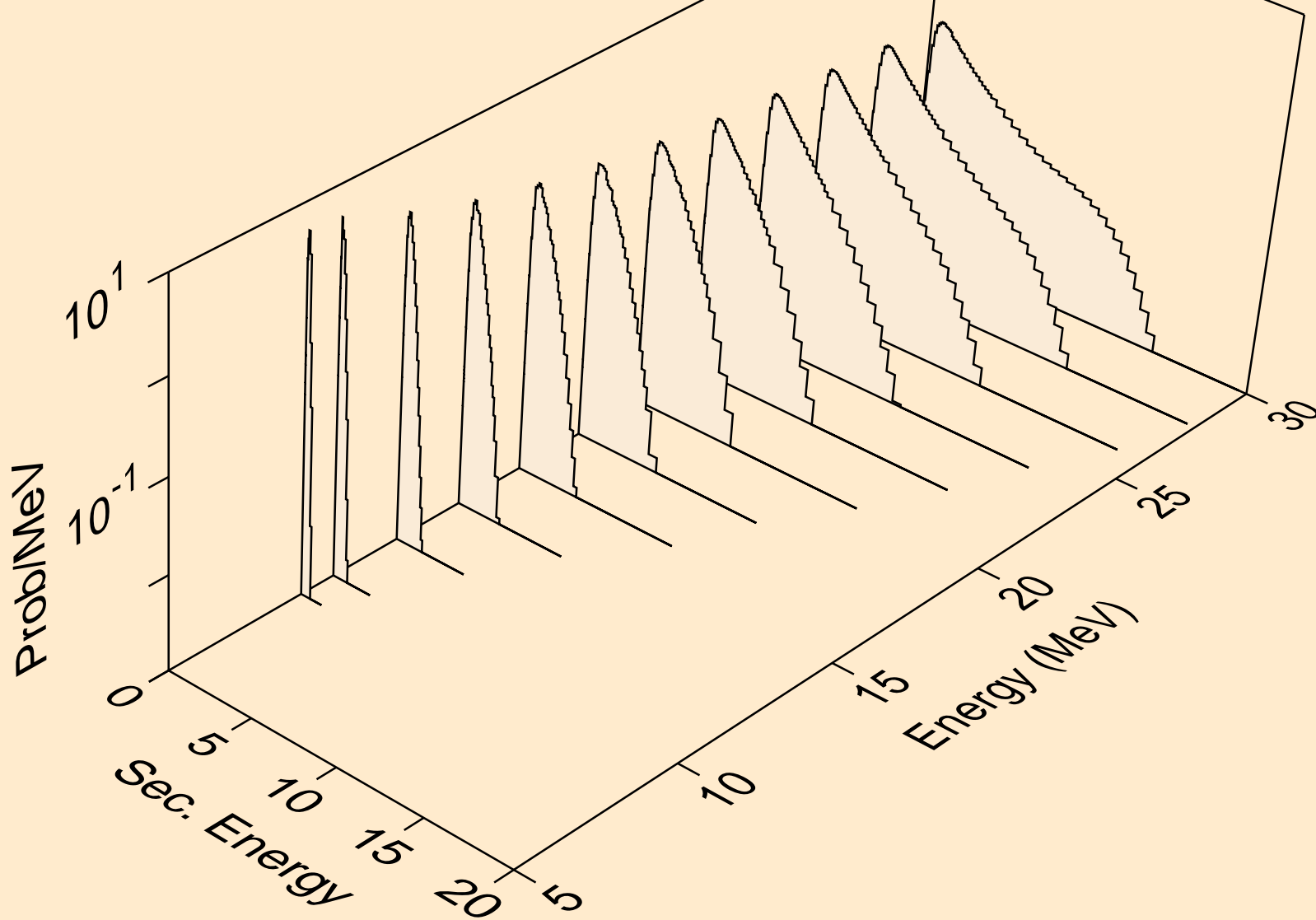

I115 NEUTRON ACER TENDL-2019 LIBRARY; T=293.16K  
Neutron emission for (n,npa)

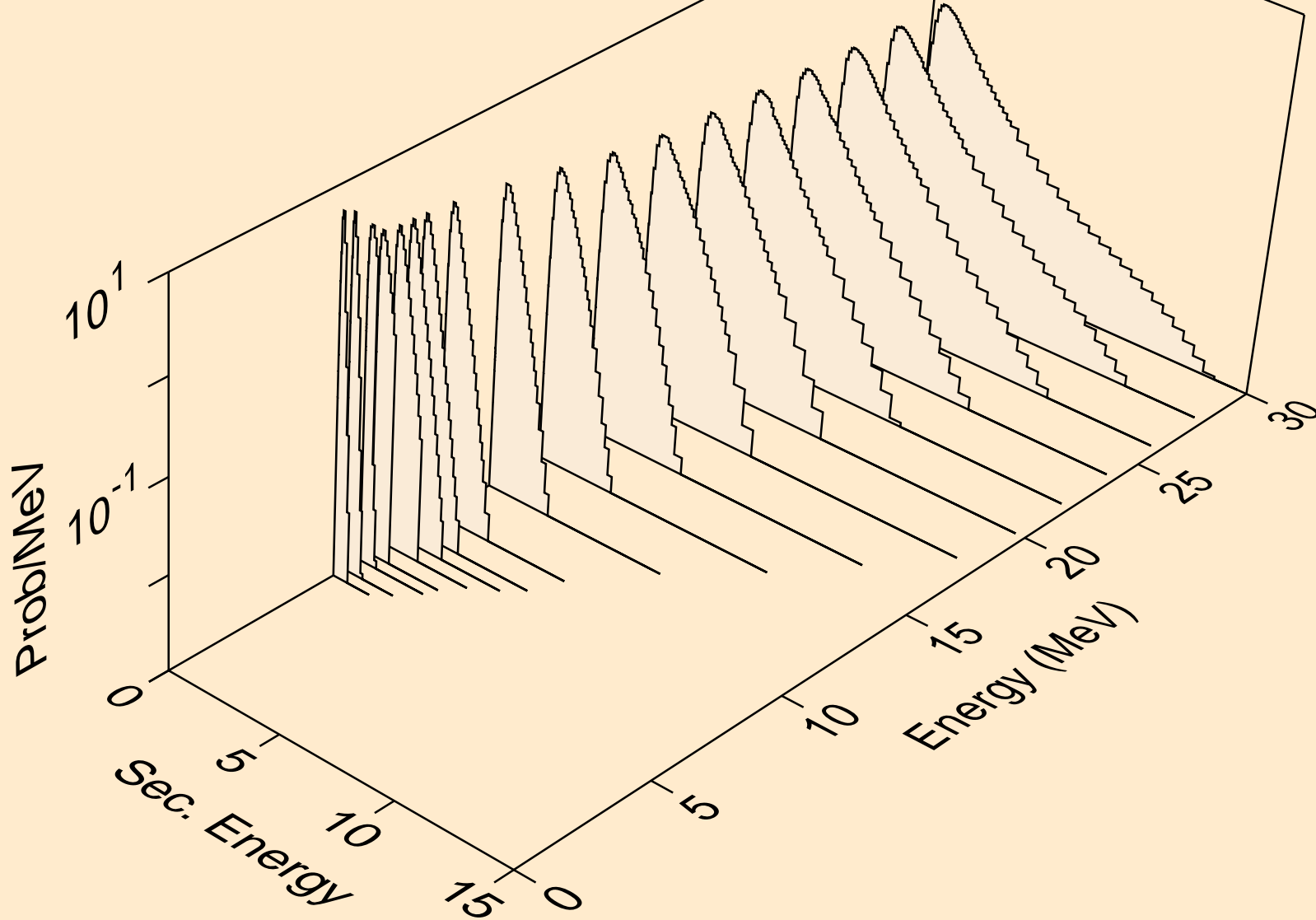

I115 NEUTRON ACER TENDL-2019 LIBRARY; T=293.16K  
Neutron emission for (n,n\*c)

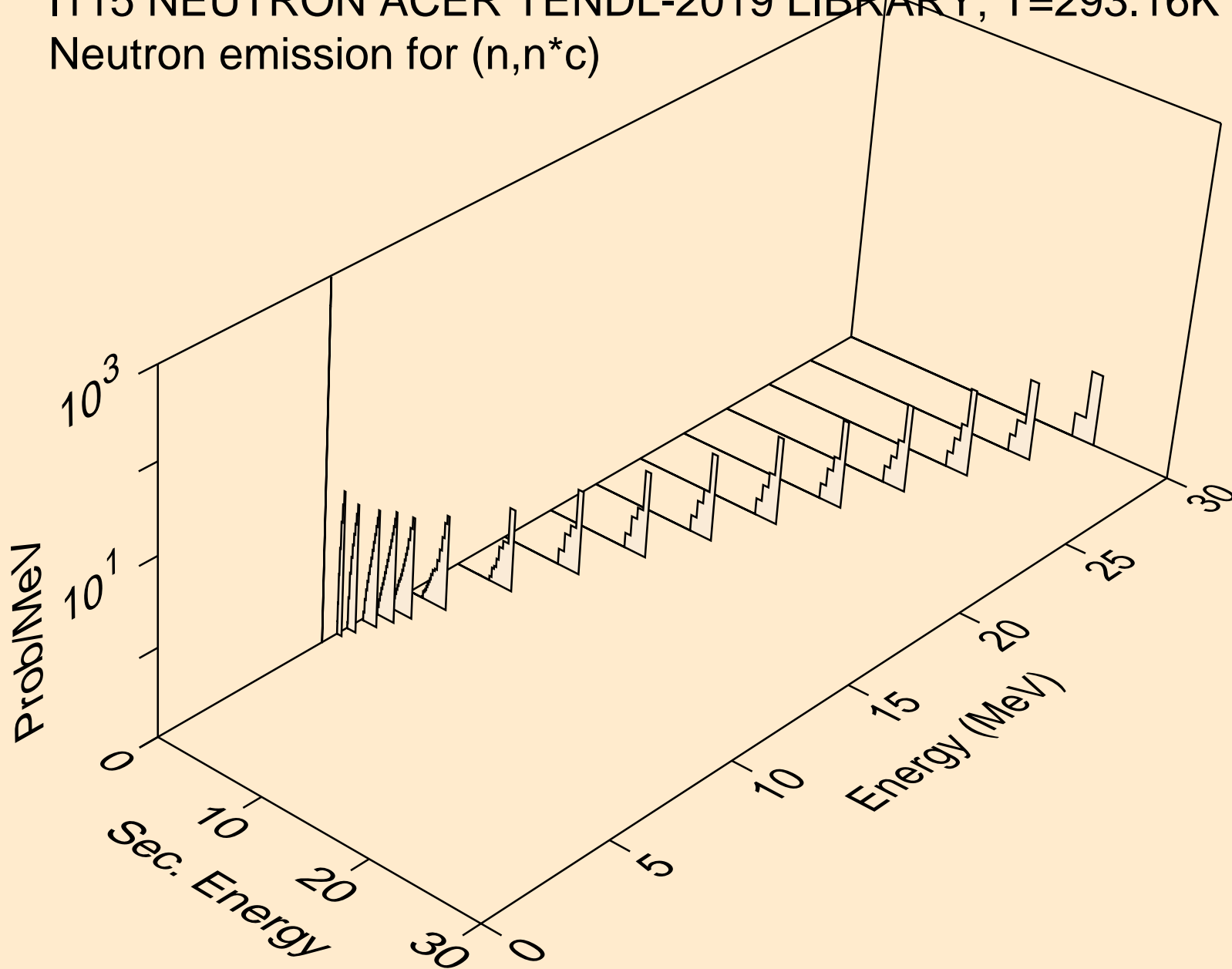

I115 NEUTRON ACER TENDL-2019 LIBRARY; T=293.16K  
Photon emission for (n,x)

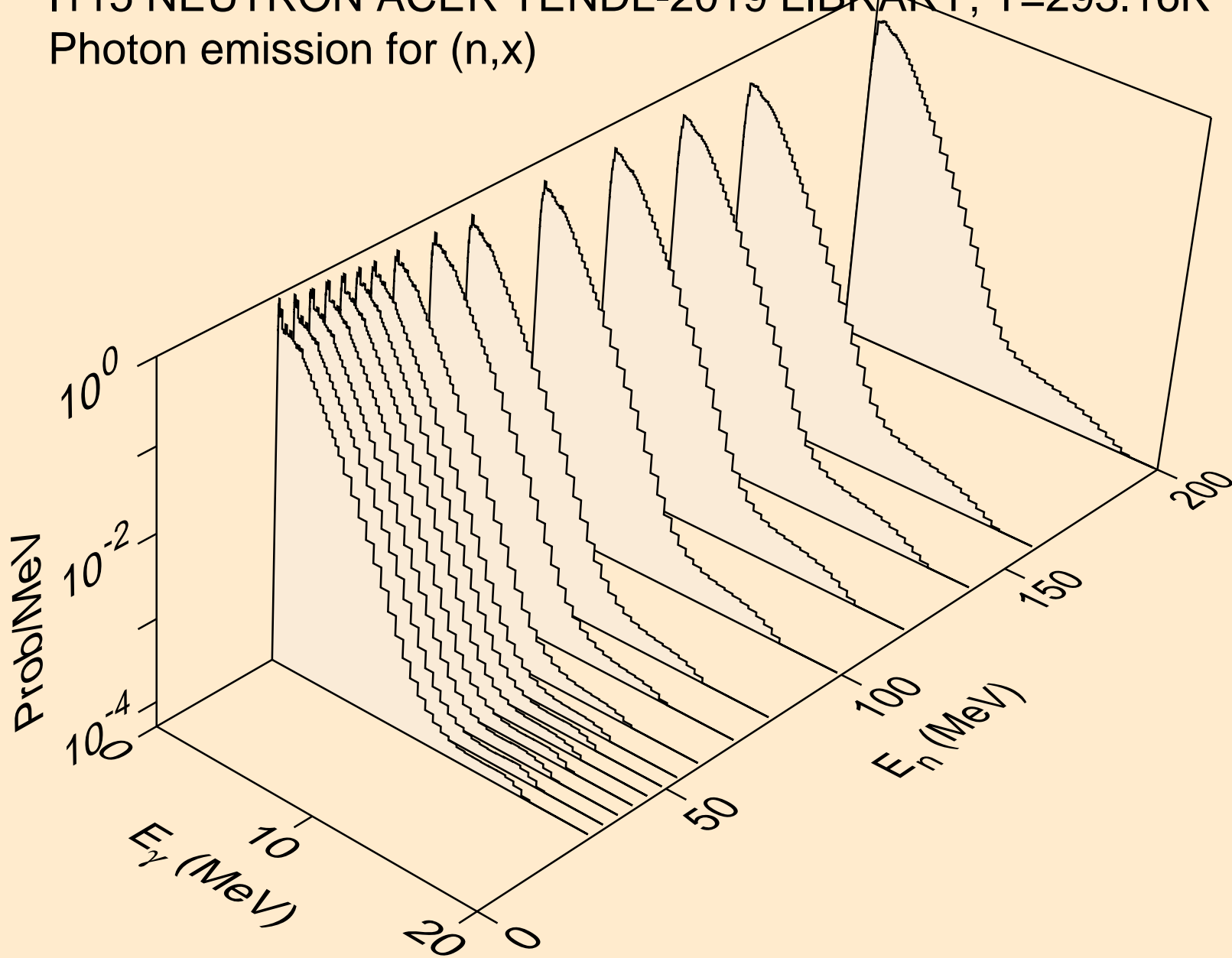

I115 NEUTRON ACER TENDL-2019 LIBRARY; T=293.16K  
Photon emission for (n,2nd)

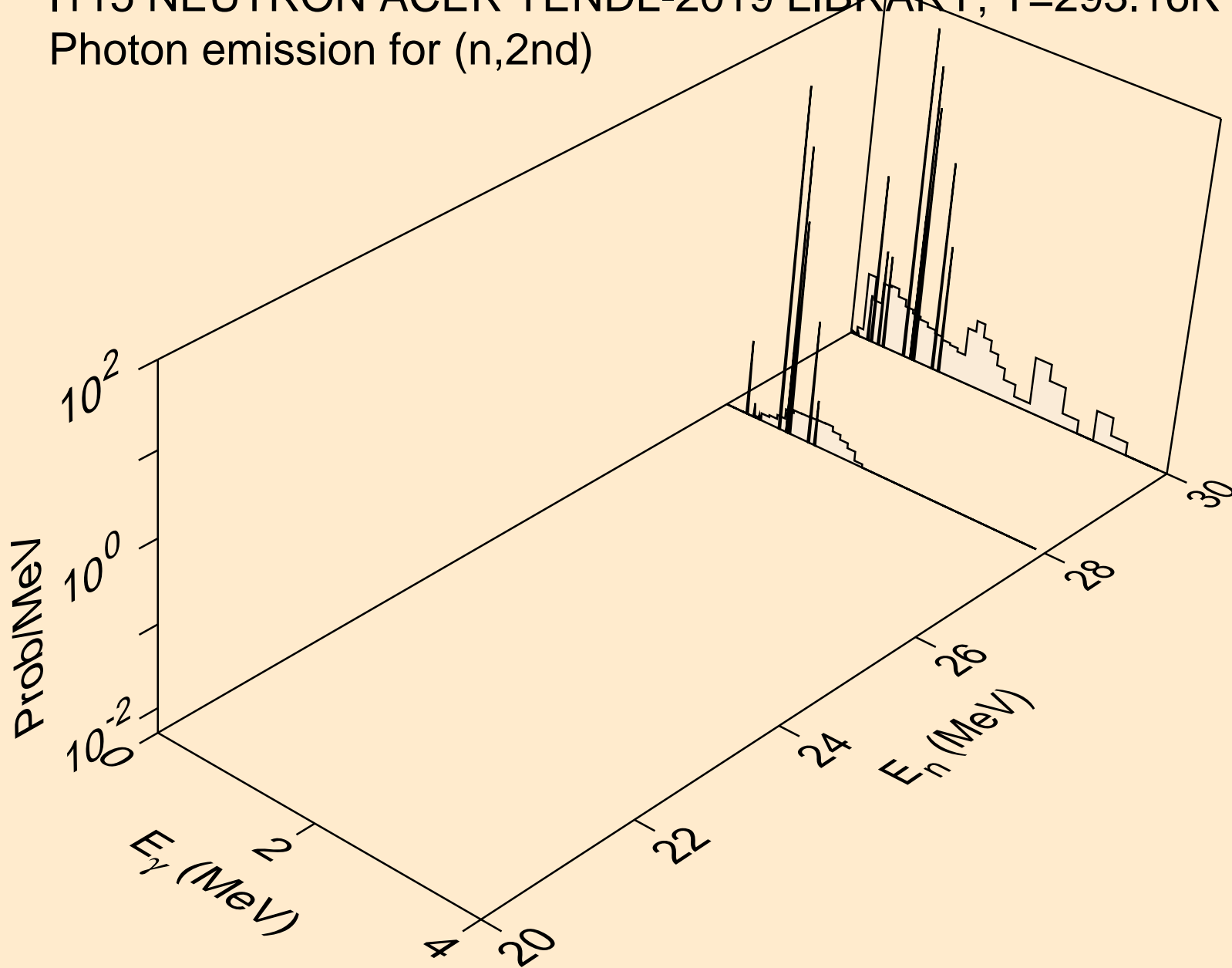

I115 NEUTRON ACER TENDL-2019 LIBRARY; T=293.16K  
Photon emission for (n,2n)

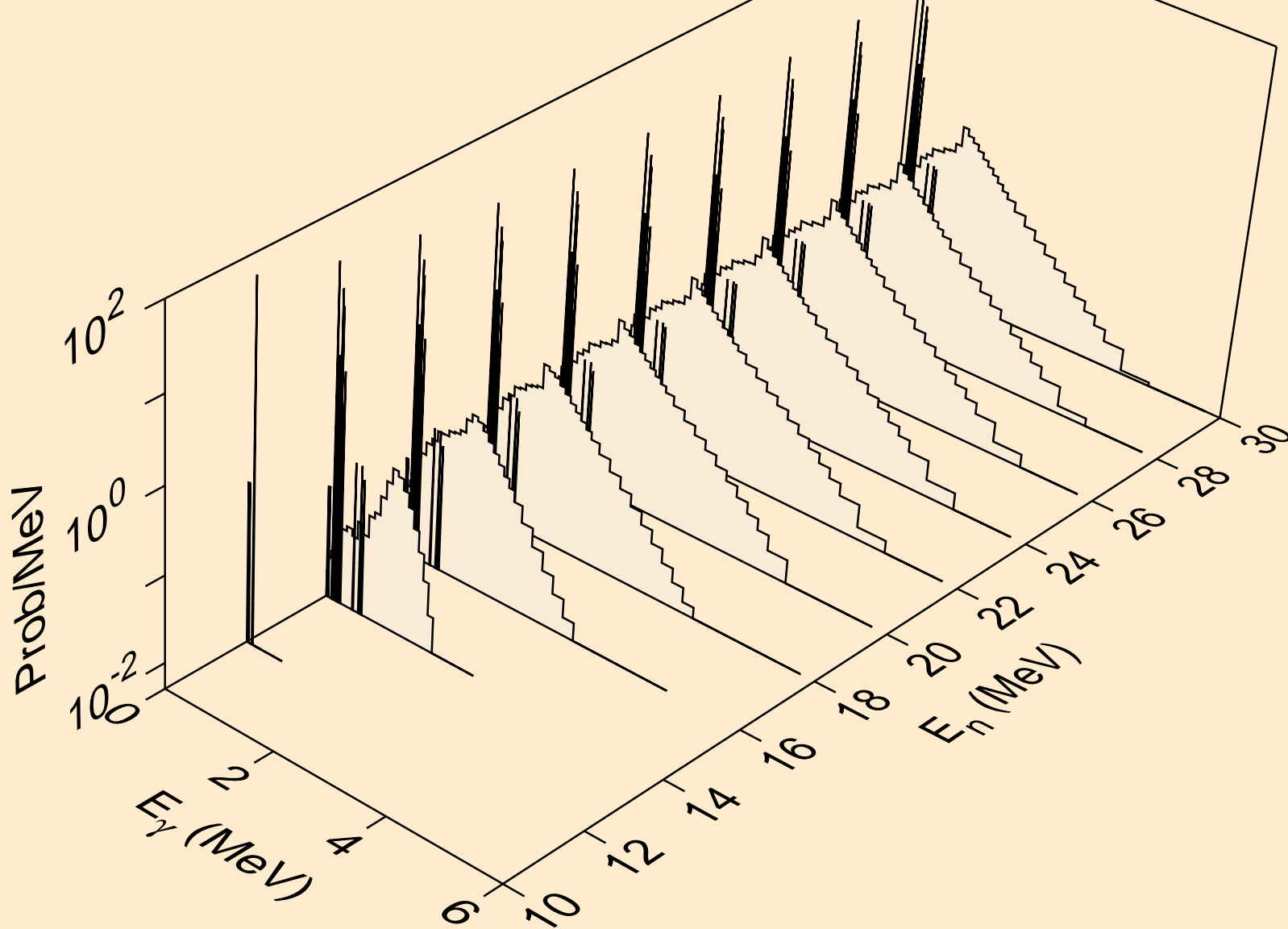

I115 NEUTRON ACER TENDL-2019 LIBRARY; T=293.16K  
Photon emission for (n,3n)

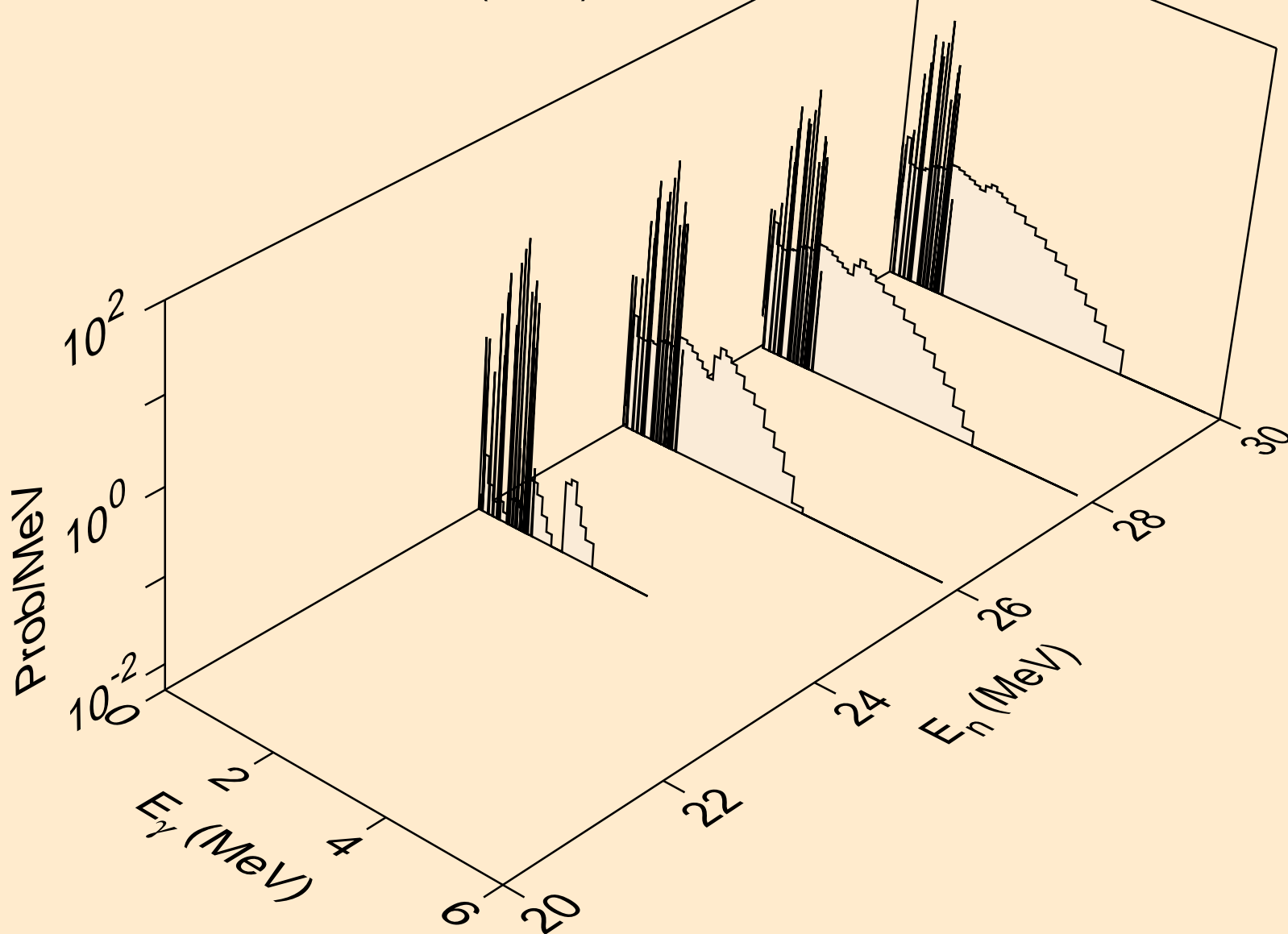

I115 NEUTRON ACER TENDL-2019 LIBRARY; T=293.16K  
Photon emission for (n,n\*)a

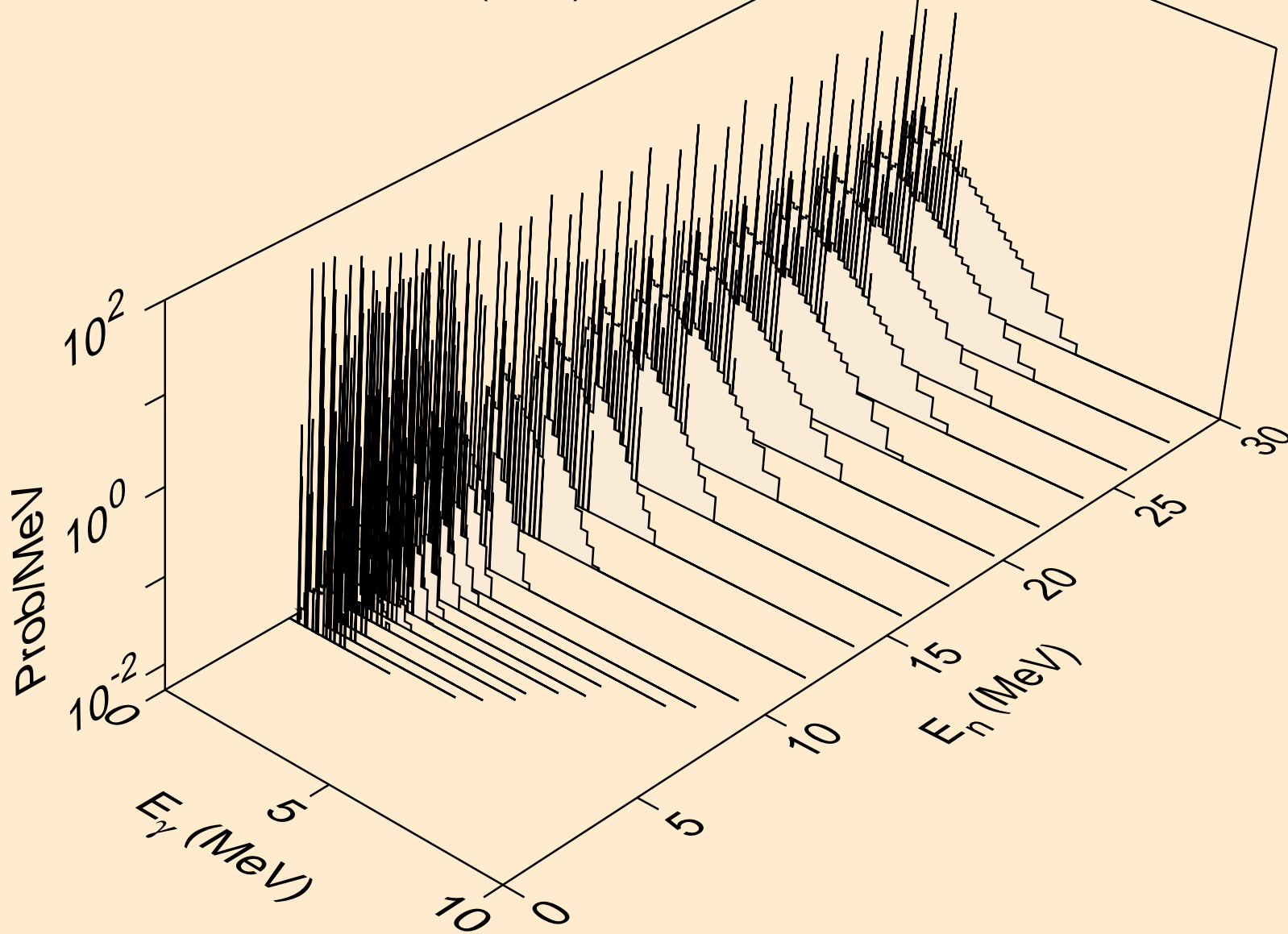



I115 NEUTRON ACER TENDL-2019 LIBRARY; T=293.16K  
Photon emission for (n,2n)a

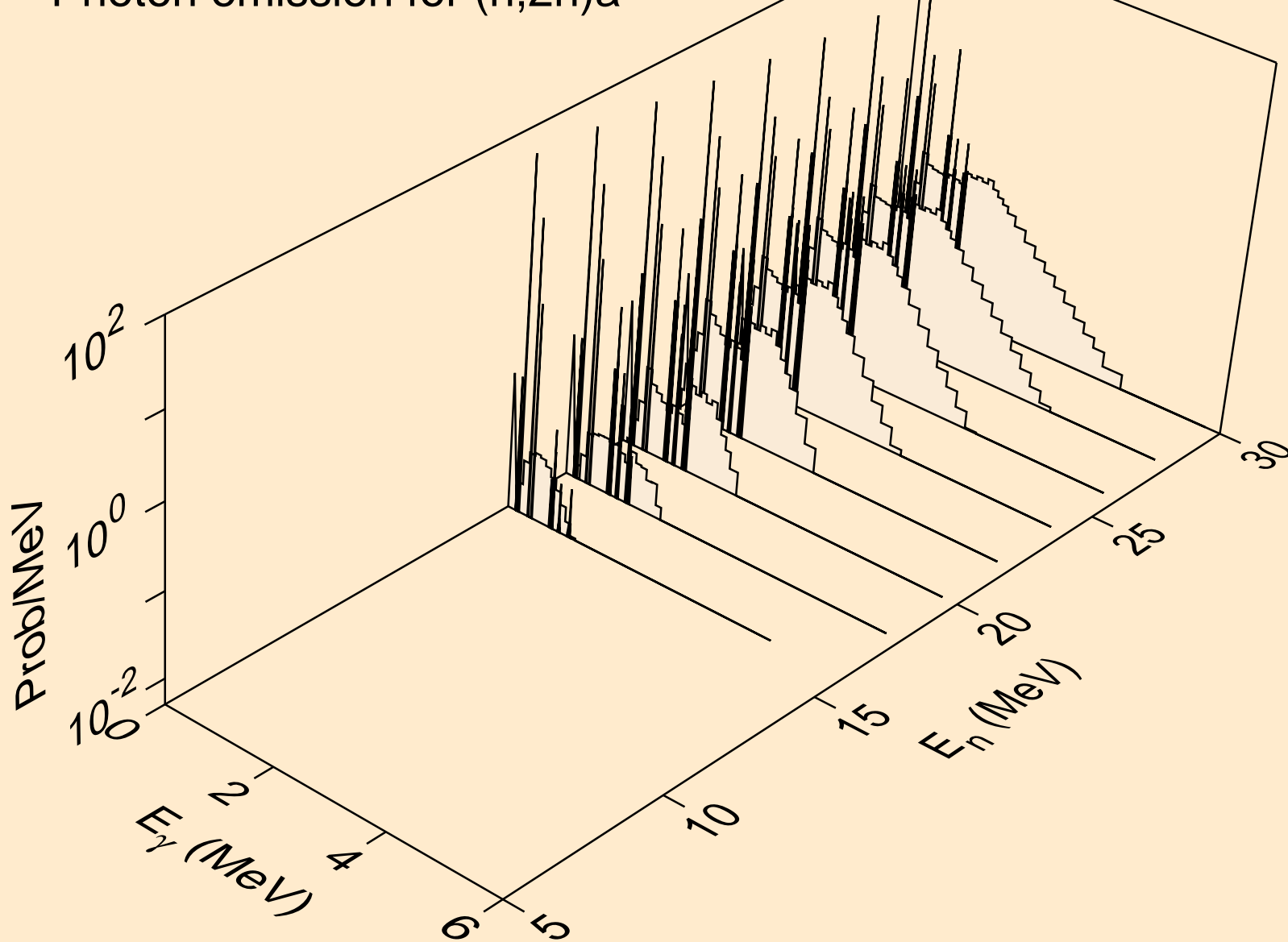

I115 NEUTRON ACER TENDL-2019 LIBRARY; T=293.16K  
Photon emission for (n,3n)a

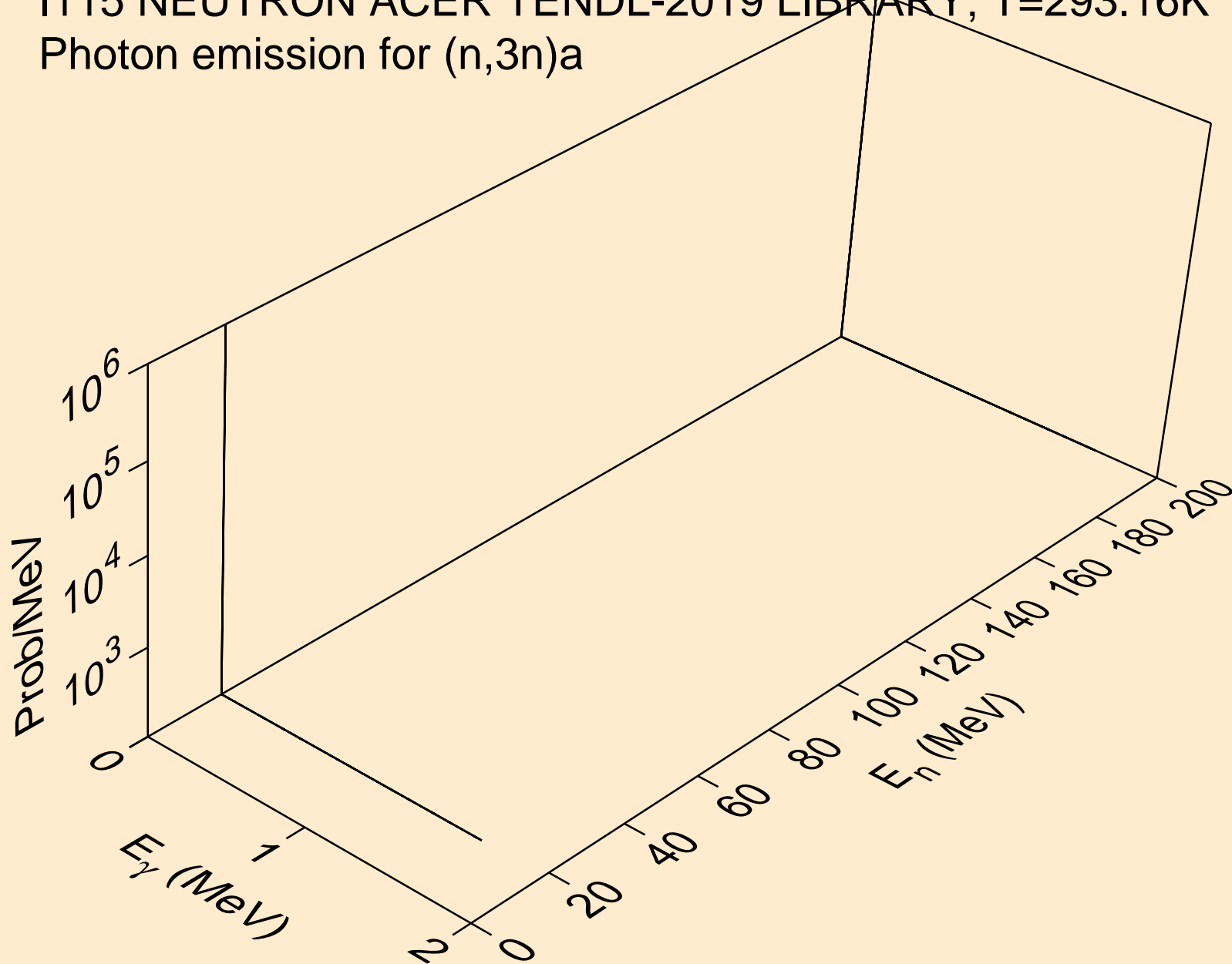

I115 NEUTRON ACER TENDL-2019 LIBRARY; T=293.16K  
Photon emission for (n,n\*)p

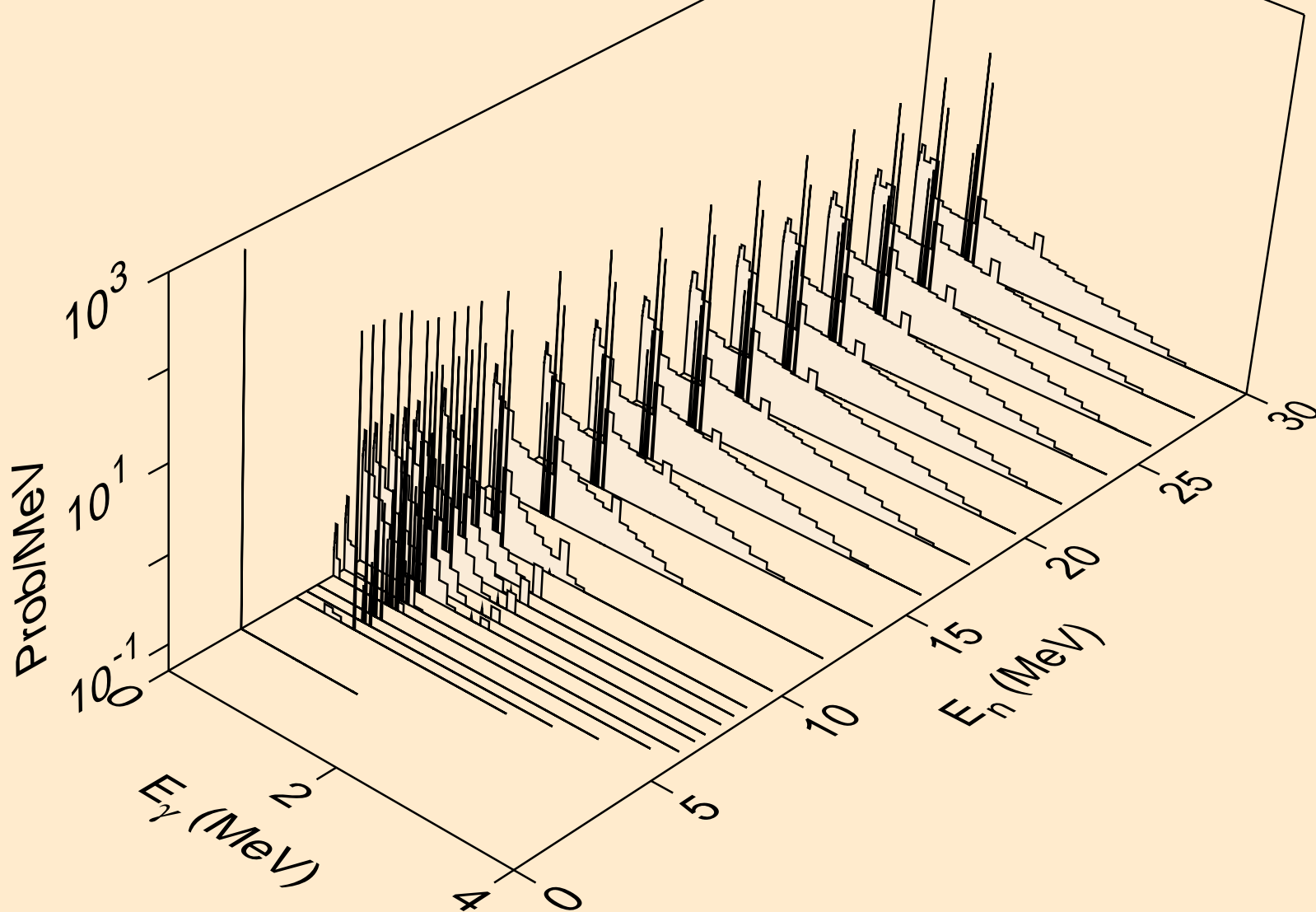

I115 NEUTRON ACER TENDL-2019 LIBRARY; T=293.16K  
Photon emission for (n,n\*)2a

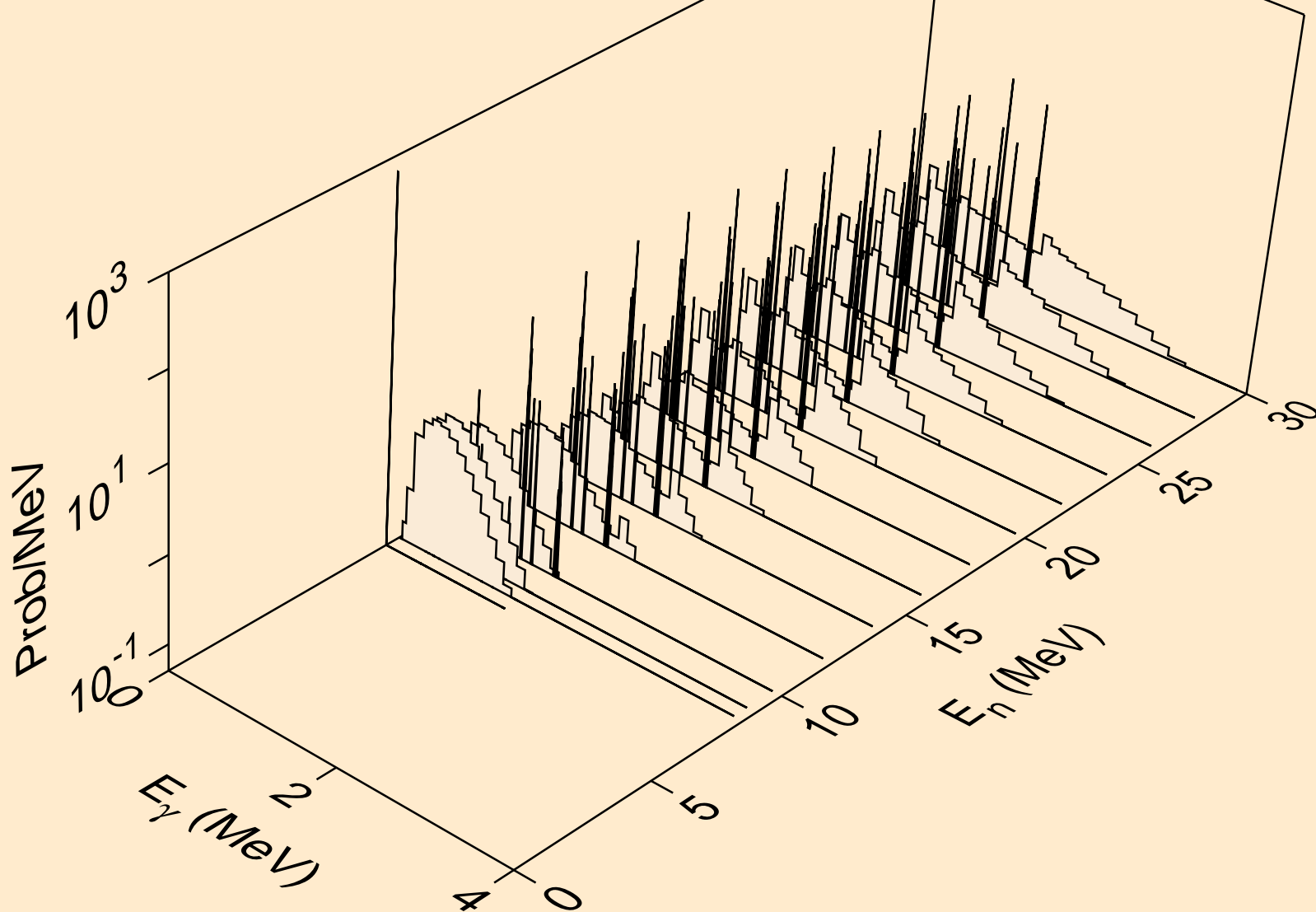

I115 NEUTRON ACER TENDL-2019 LIBRARY; T=293.16K  
Photon emission for (n,2n)2a

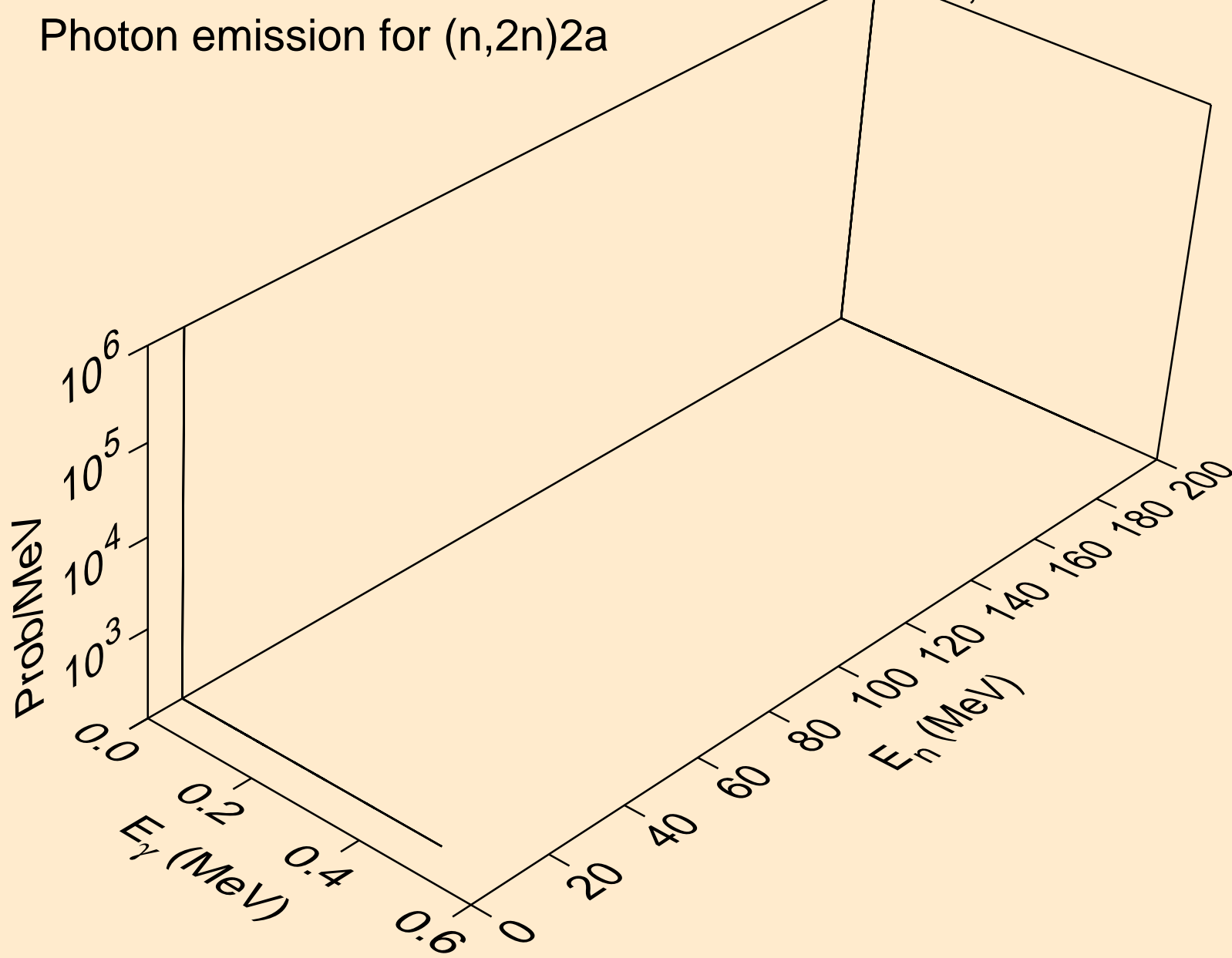

I115 NEUTRON ACER TENDL-2019 LIBRARY; T=293.16K  
Photon emission for (n,n\*)d

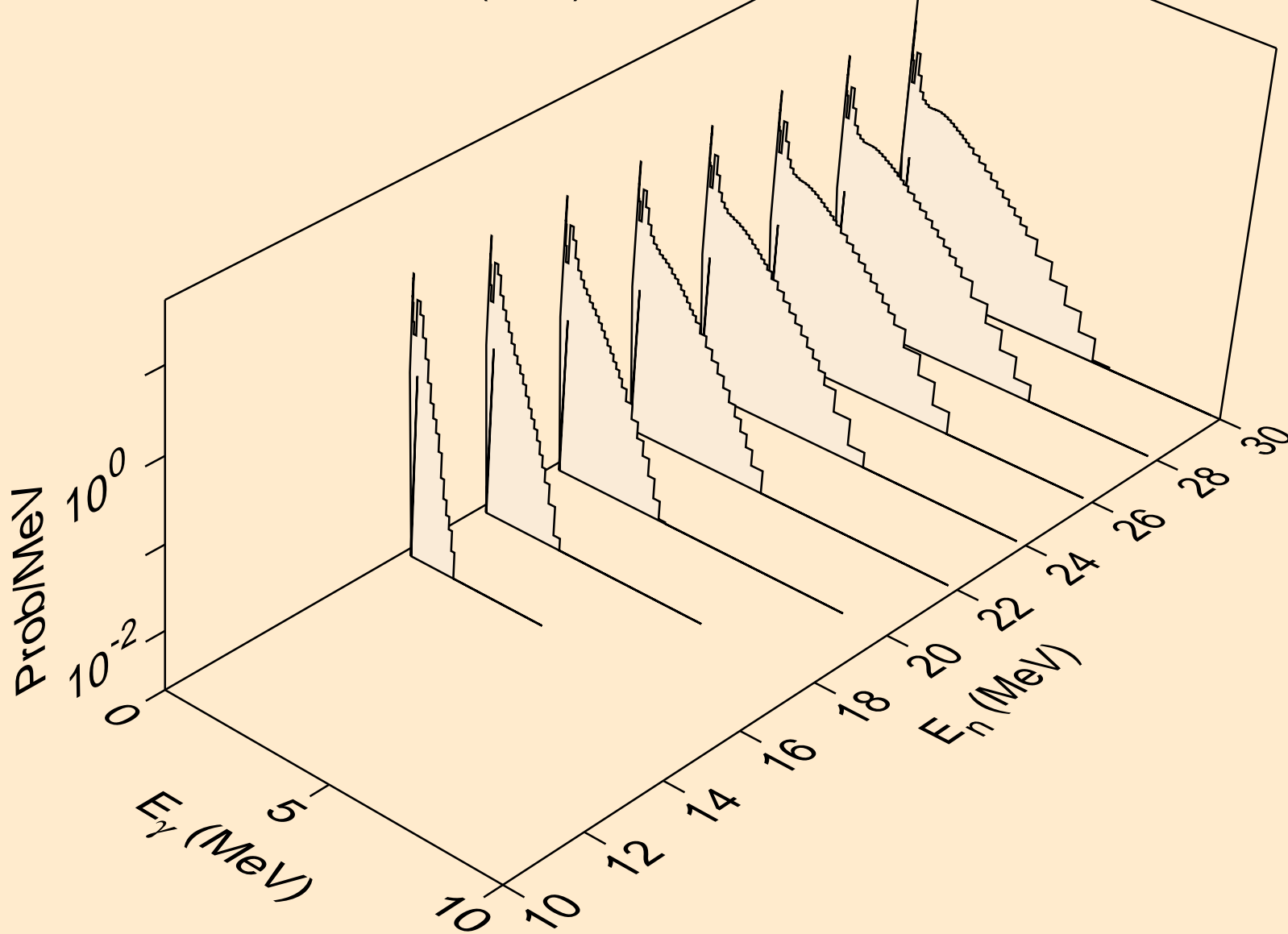

I115 NEUTRON ACER TENDL-2019 LIBRARY; T=293.16K  
Photon emission for (n,n\*)t

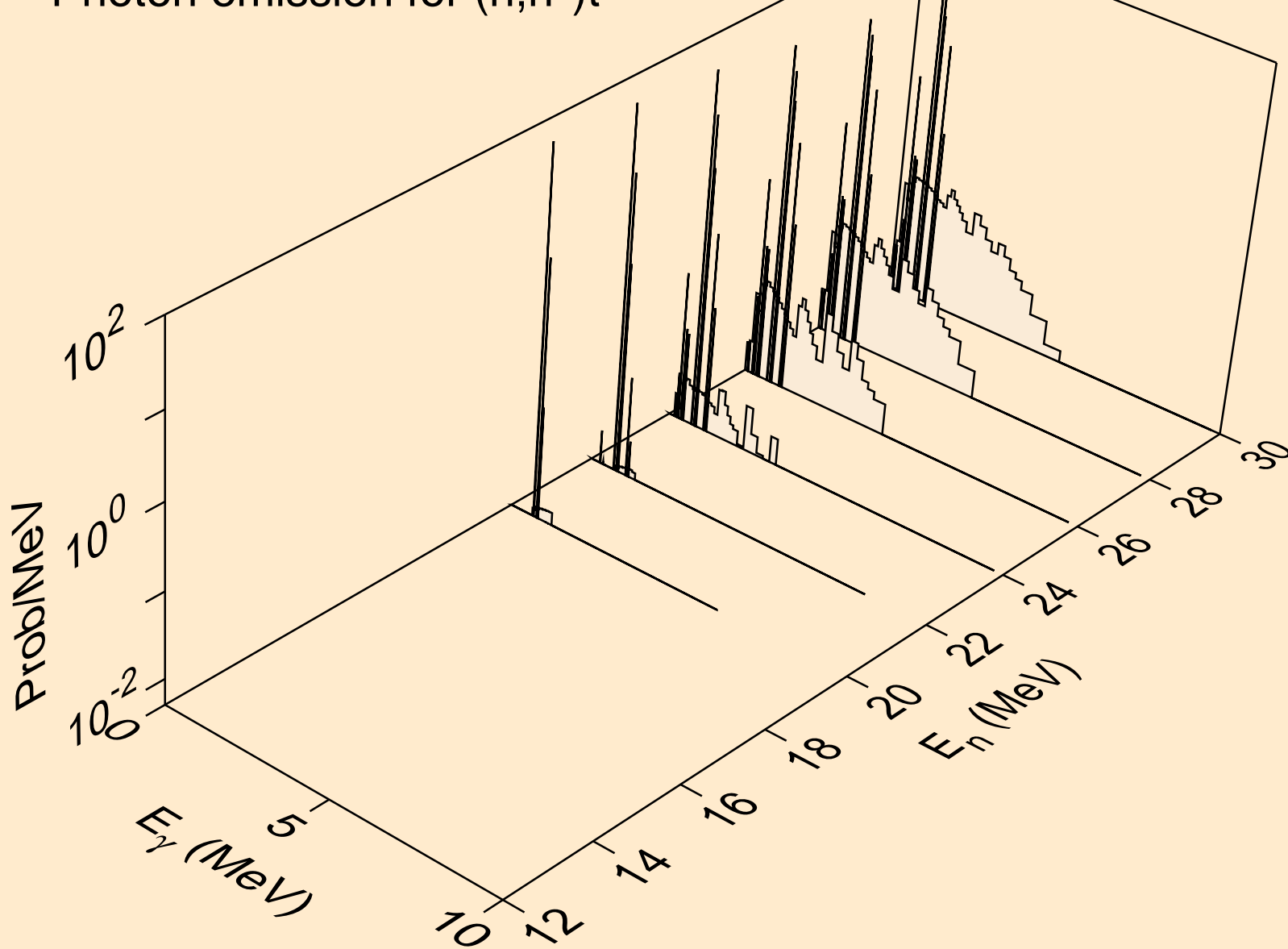

I115 NEUTRON ACER TENDL-2019 LIBRARY; T=293.16K  
Photon emission for (n,n\*)he3

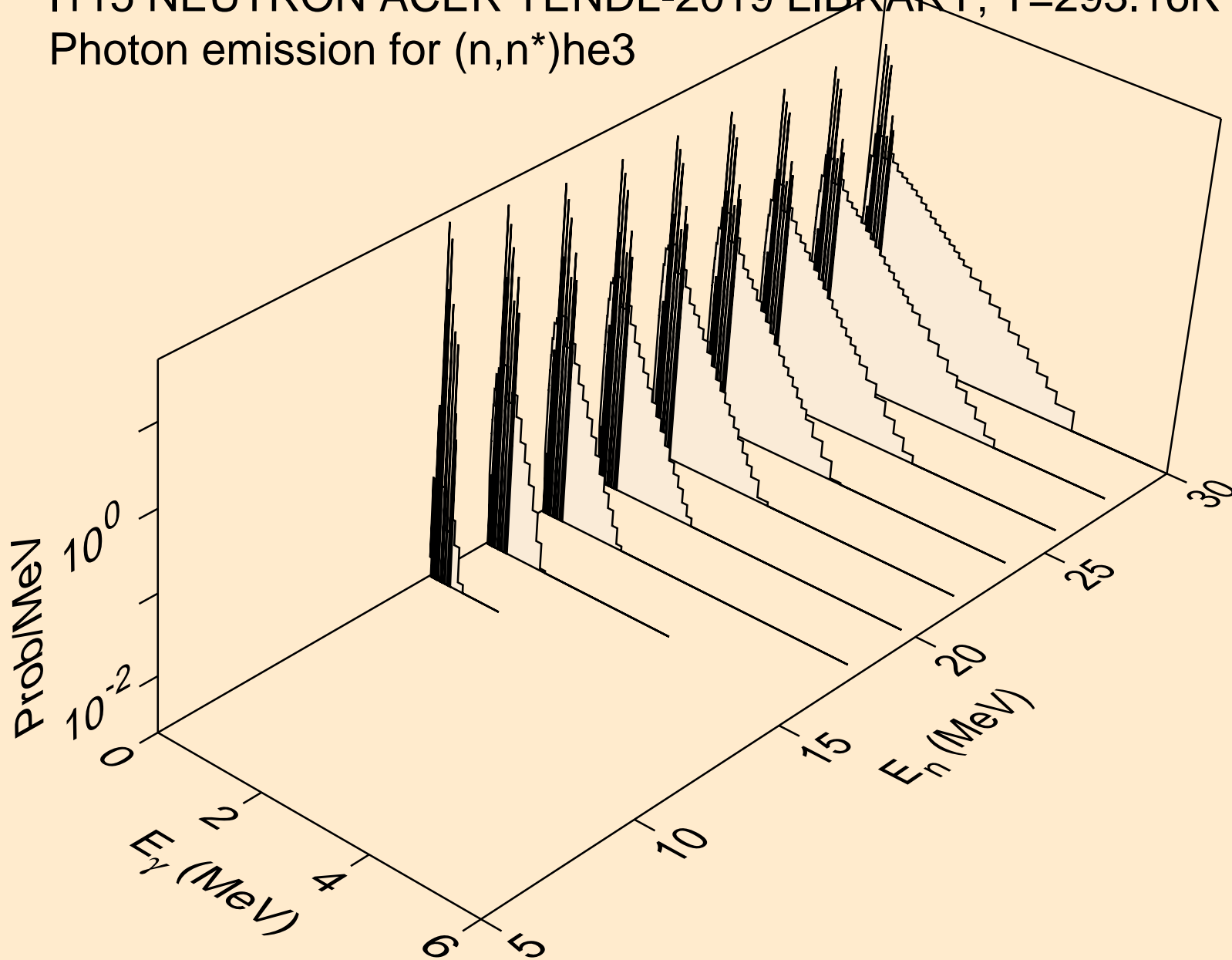



I115 NEUTRON ACER TENDL-2019 LIBRARY; T=293.16K  
Photon emission for (n,2np)

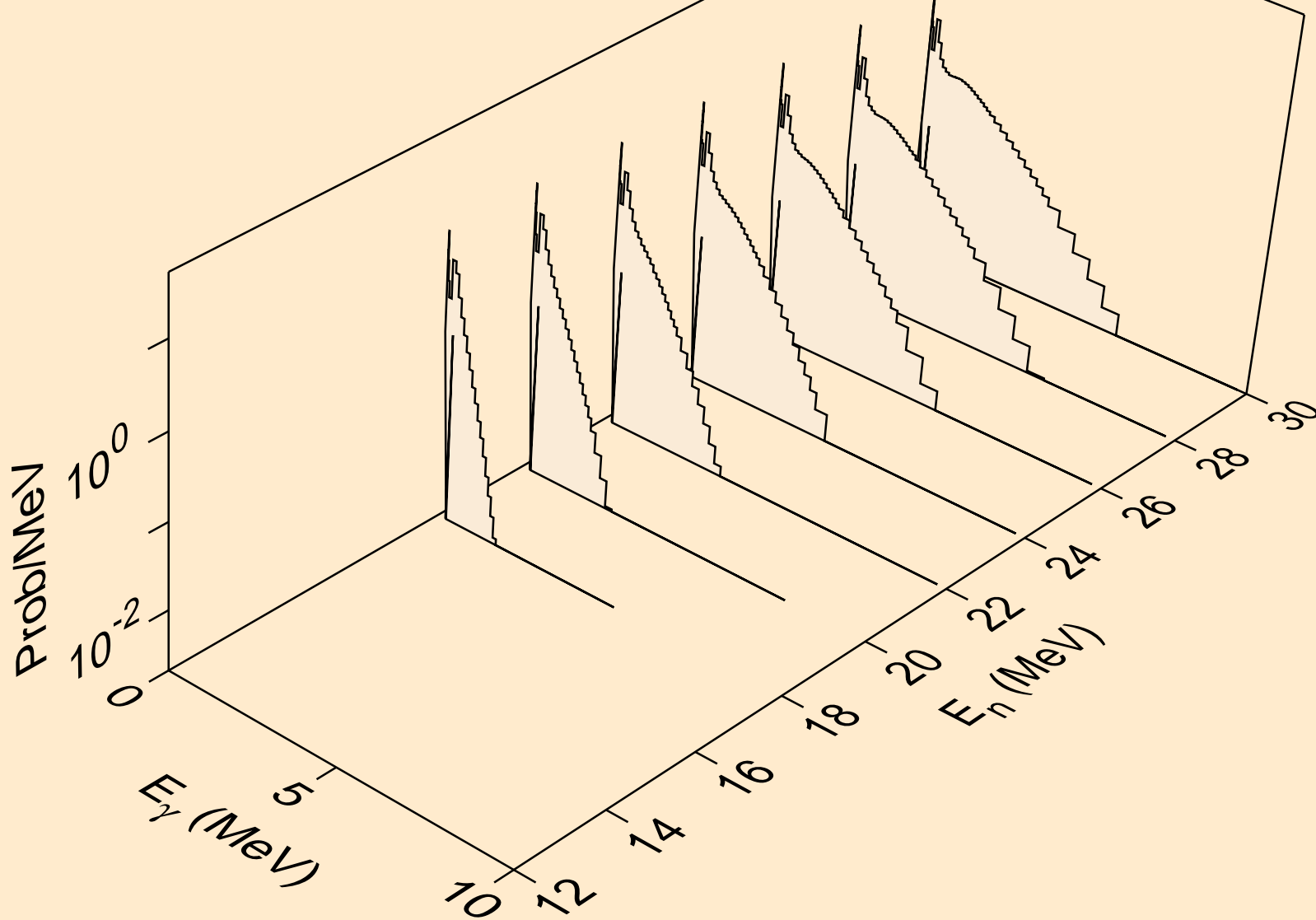

I115 NEUTRON ACER TENDL-2019 LIBRARY; T=293.16K  
Photon emission for (n,3np)

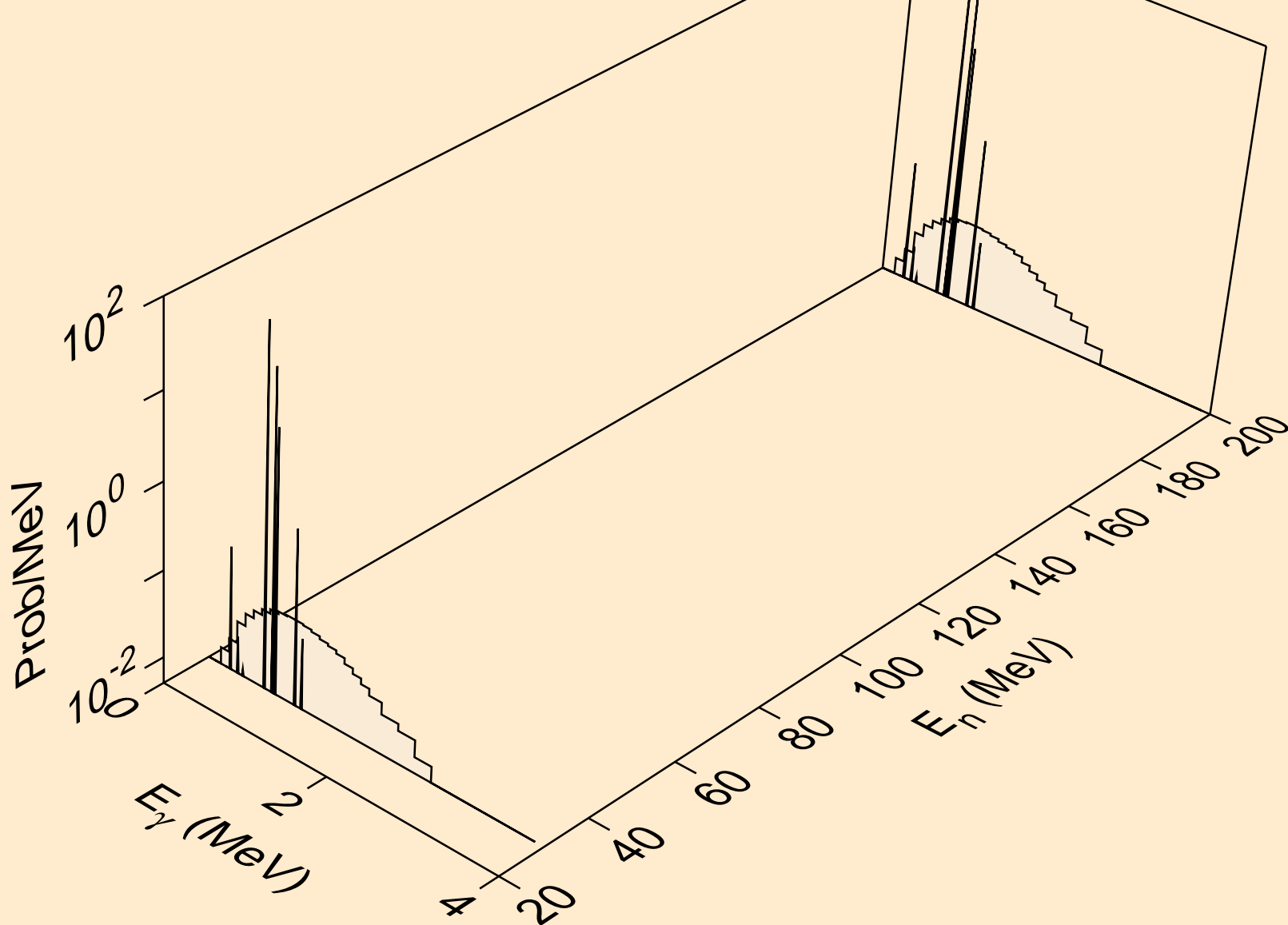

I115 NEUTRON ACER TENDL-2019 LIBRARY; T=293.16K  
Photon emission for (n,2np)

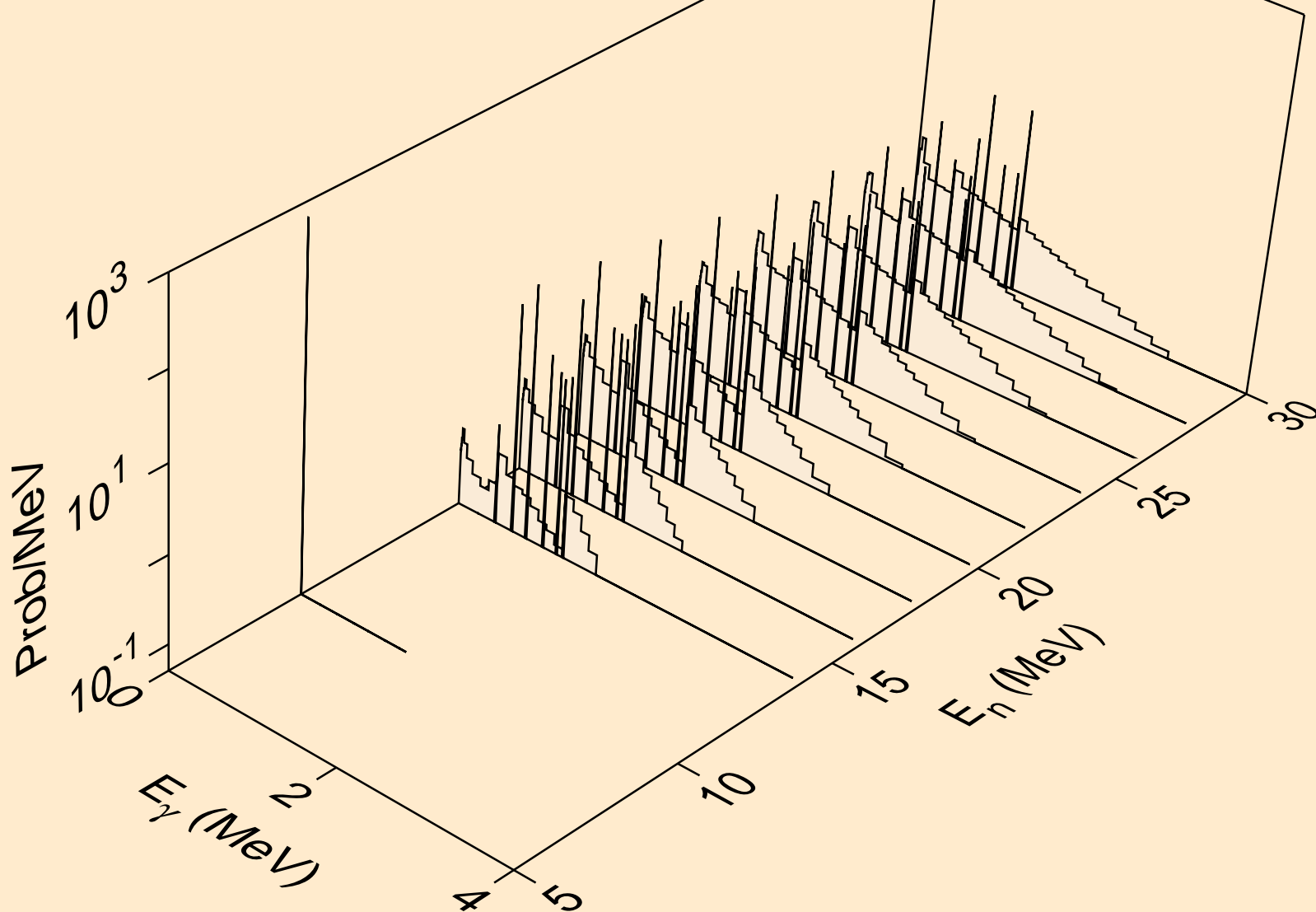

I115 NEUTRON ACER TENDL-2019 LIBRARY; T=293.16K  
Photon emission for (n,npa)

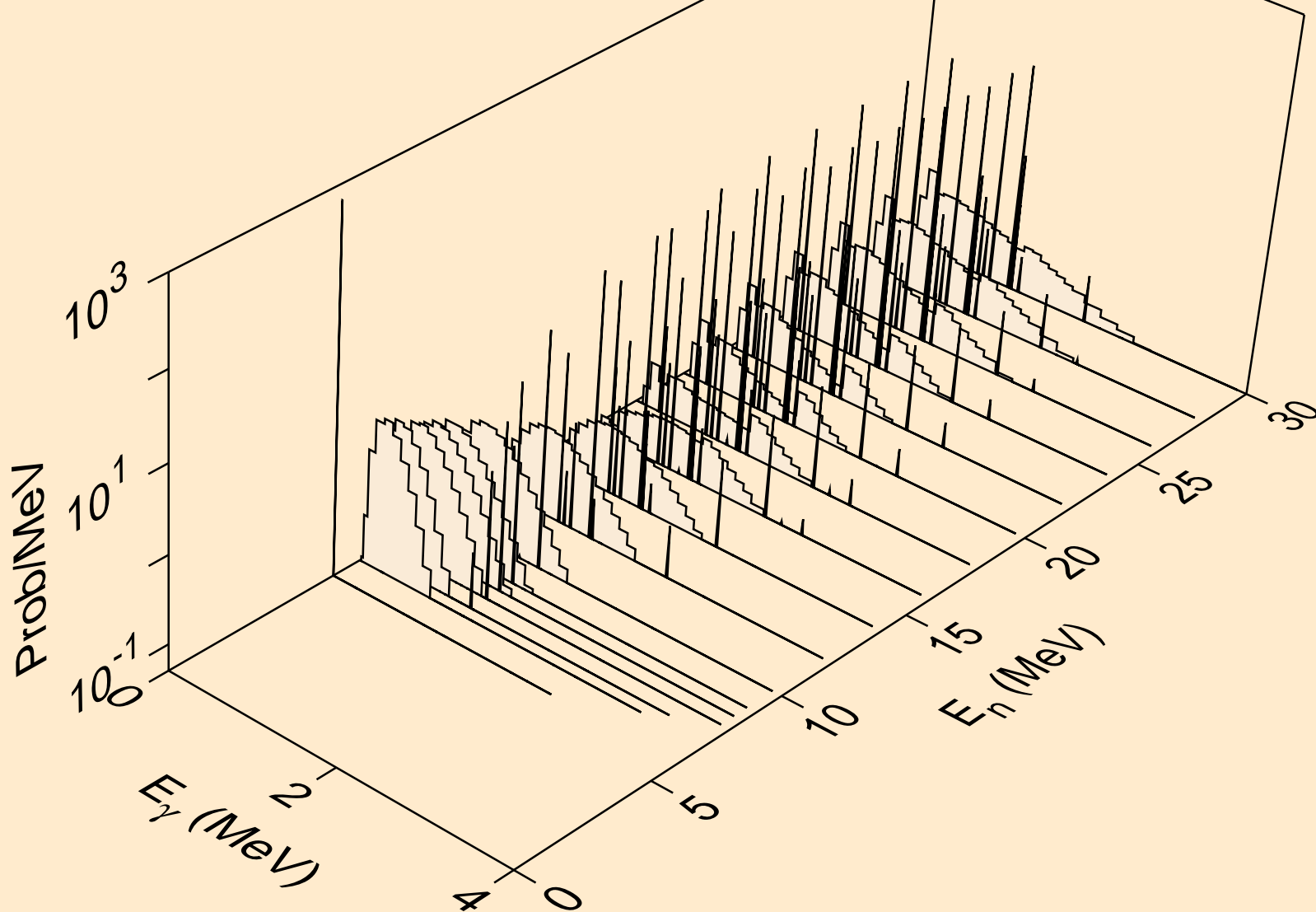

I115 NEUTRON ACER TENDL-2019 LIBRARY; T=293.16K  
Photon emission for (n,n\*c)

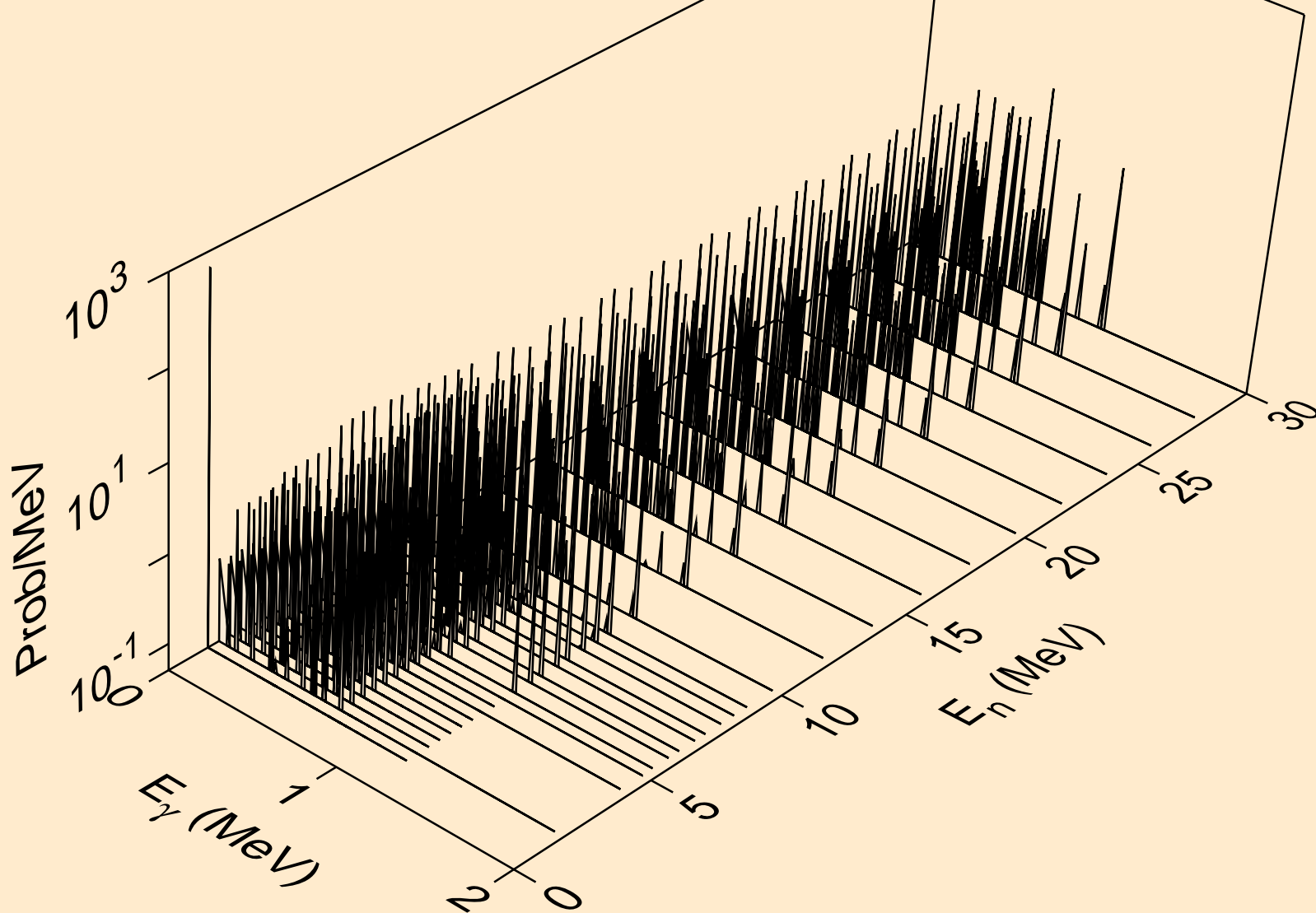

I115 NEUTRON ACER TENDL-2019 LIBRARY; T=293.16K  
Photon emission for (n,gma)

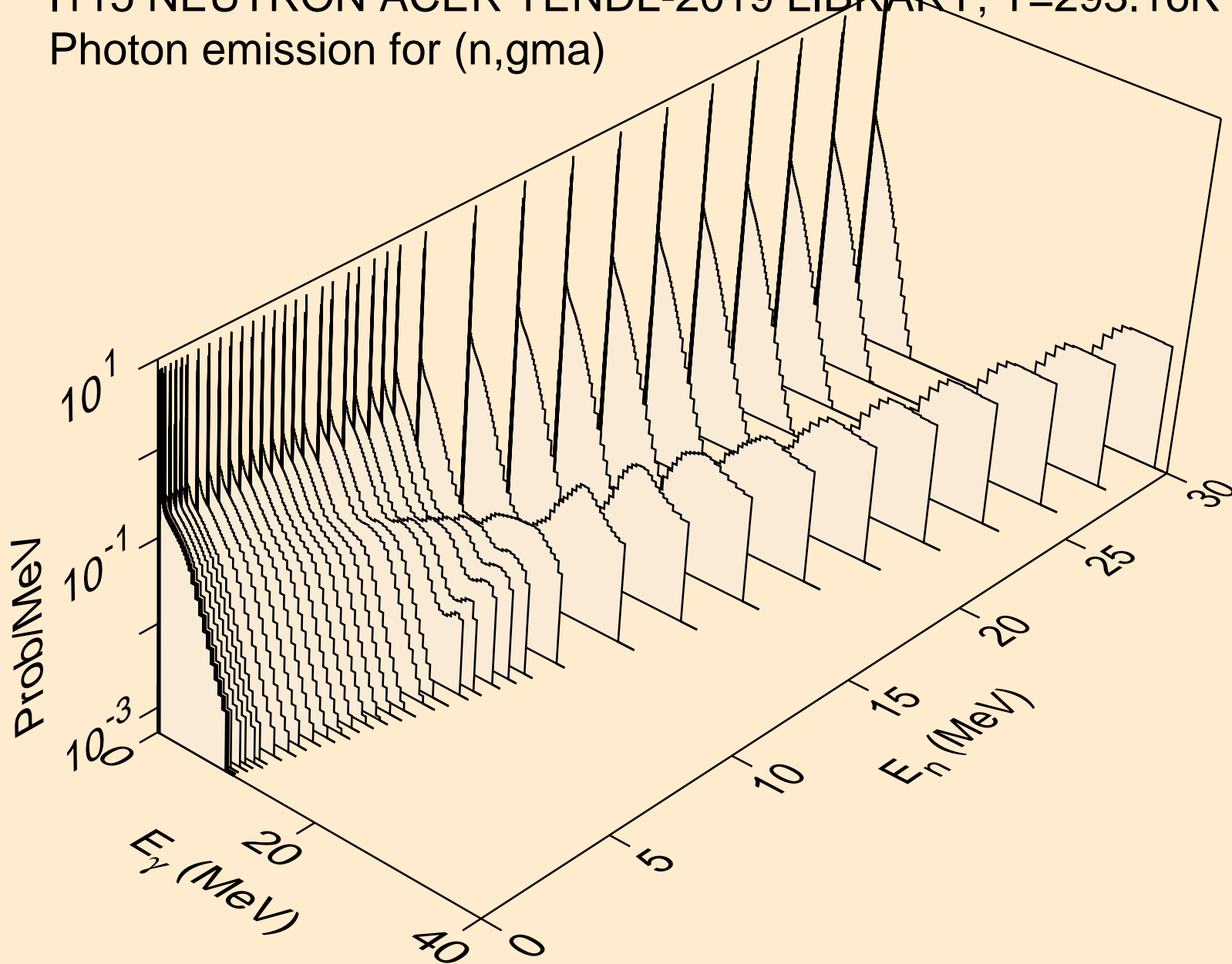

I115 NEUTRON ACER TENDL-2019 LIBRARY; T=293.16K  
Photon emission for (n,p)

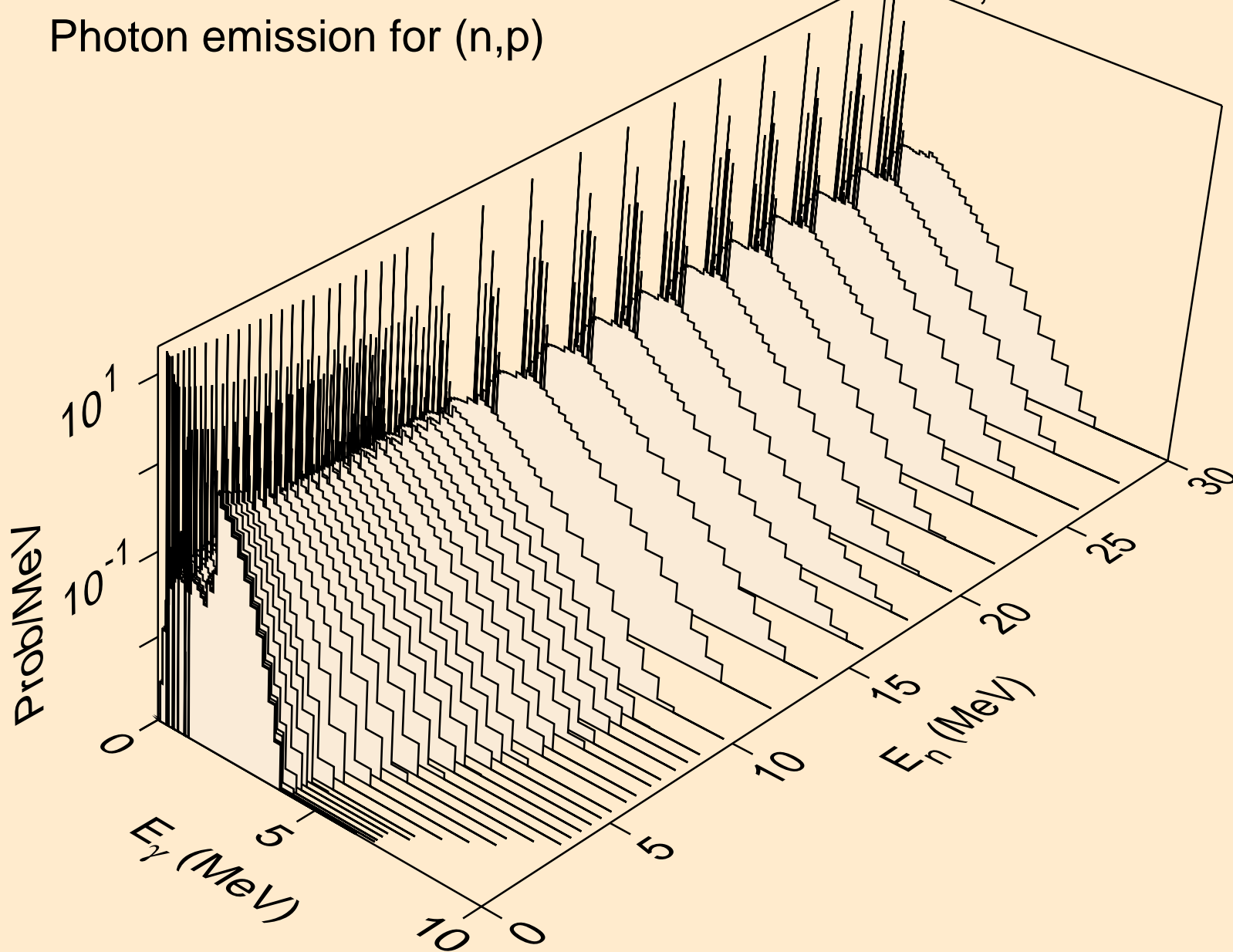

I115 NEUTRON ACER TENDL-2019 LIBRARY; T=293.16K  
Photon emission for (n,d)

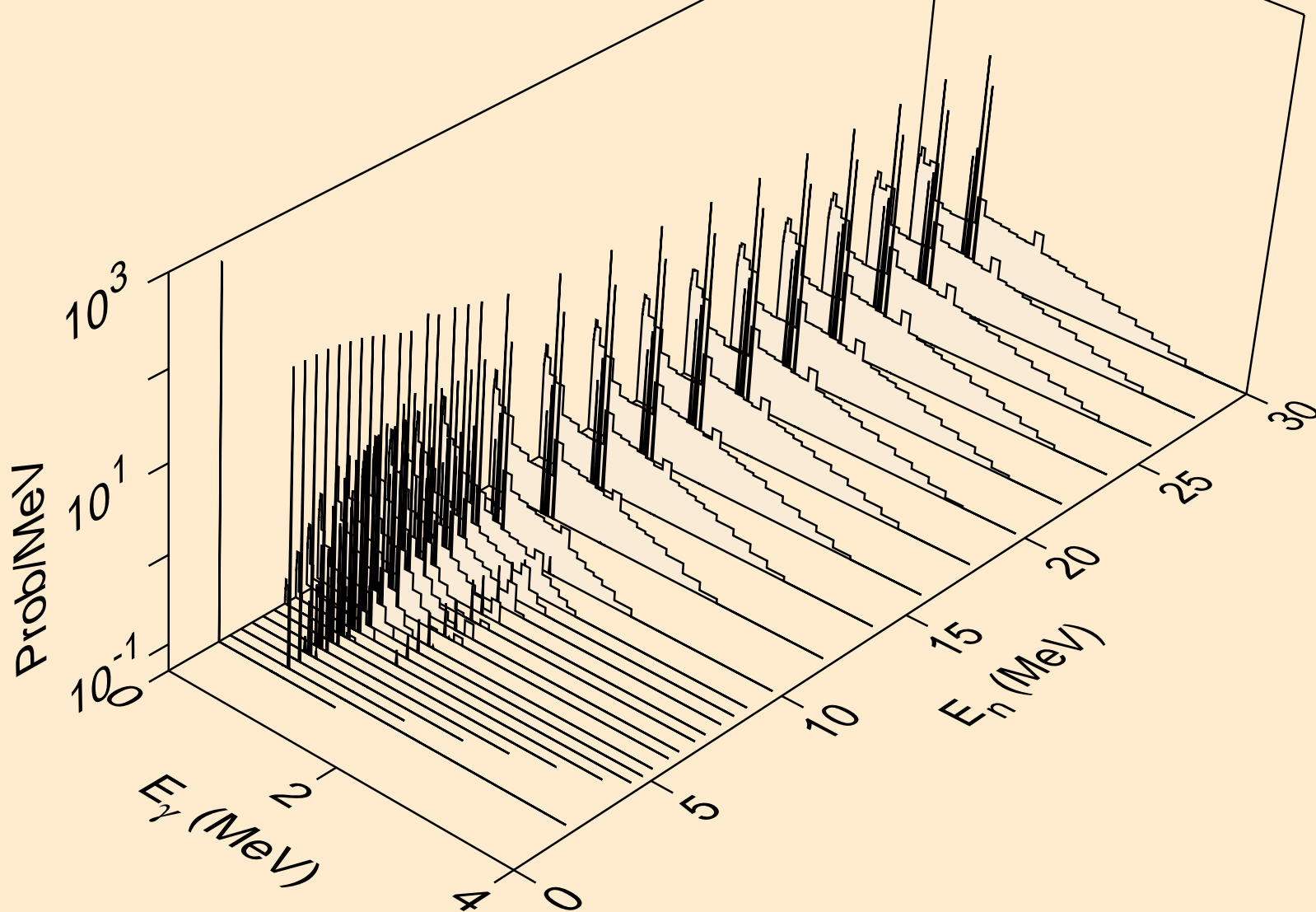



I115 NEUTRON ACER TENDL-2019 LIBRARY; T=293.16K  
Photon emission for (n,t)

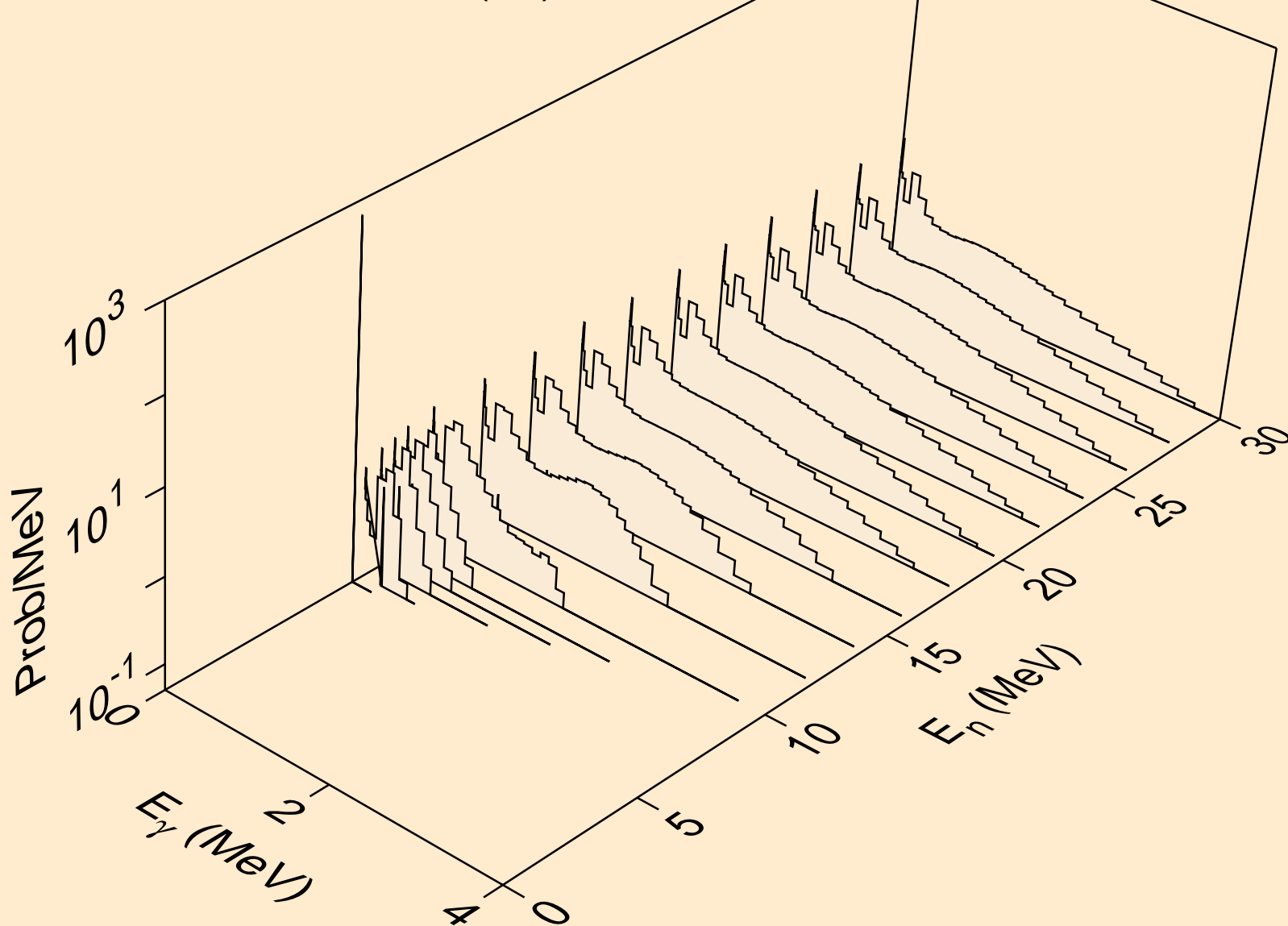

I115 NEUTRON ACER TENDL-2019 LIBRARY; T=293.16K  
Photon emission for (n,he3)

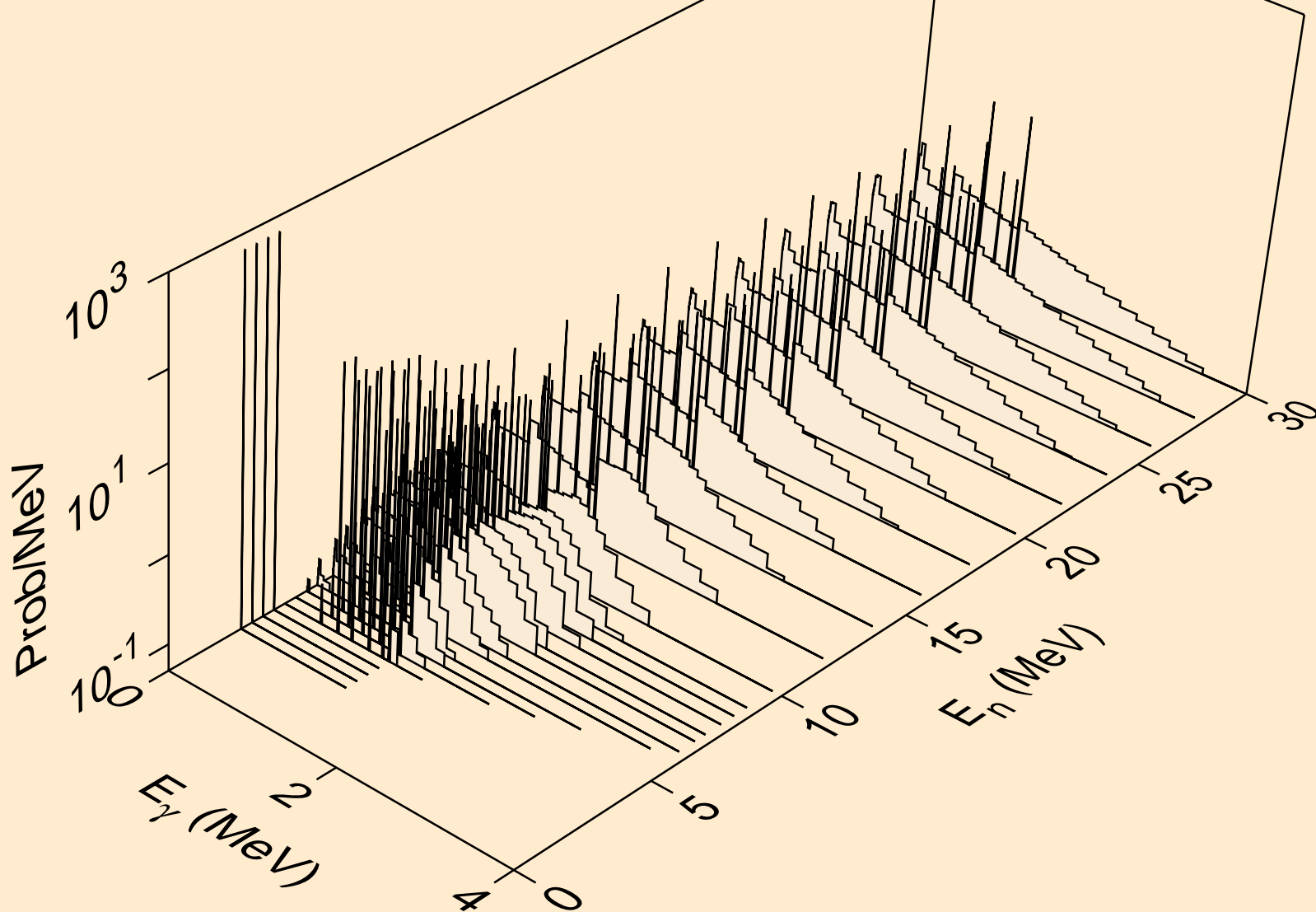

I115 NEUTRON ACER TENDL-2019 LIBRARY; T=293.16K  
Photon emission for (n,a)

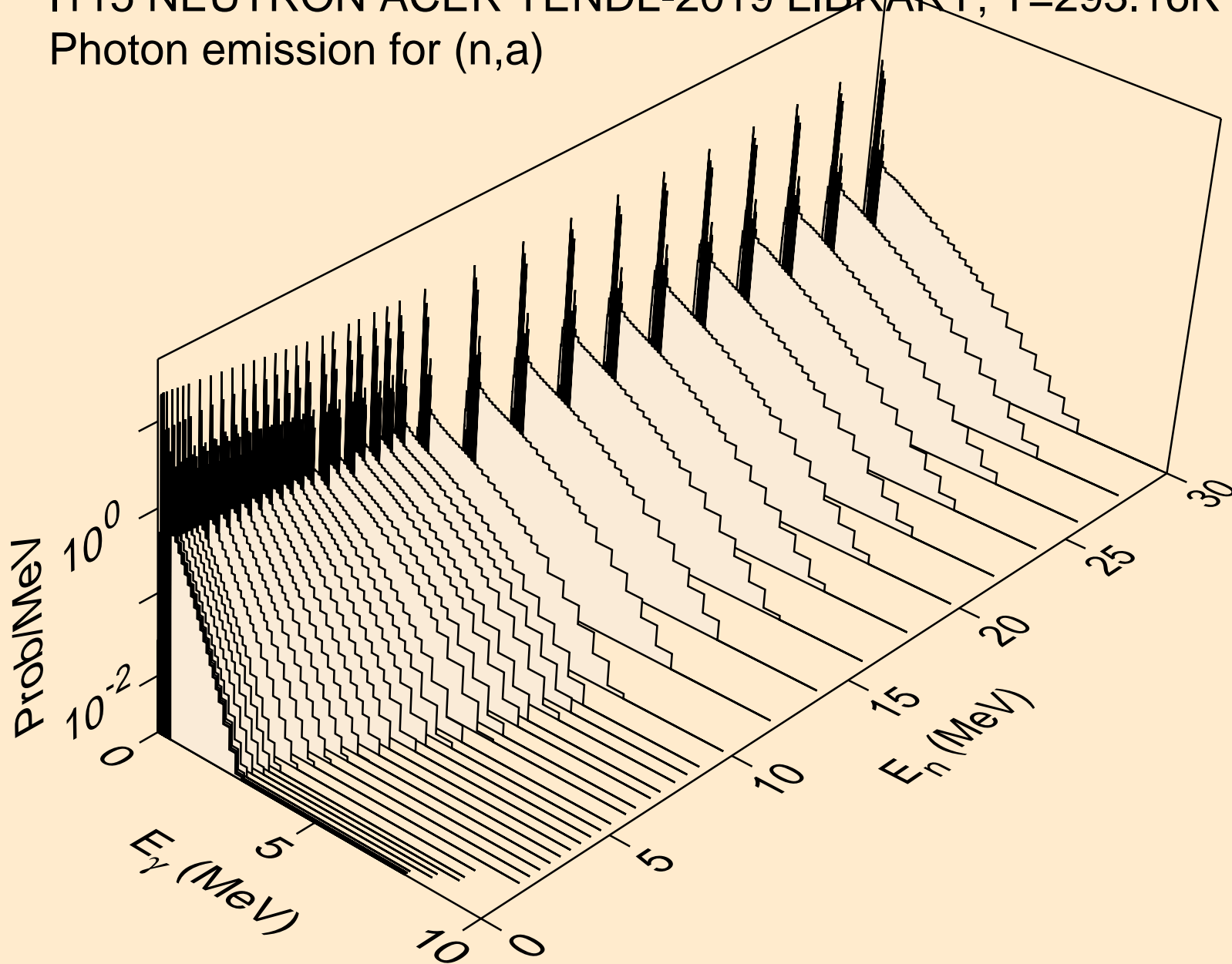

I115 NEUTRON ACER TENDL-2019 LIBRARY; T=293.16K  
Photon emission for (n,2a)

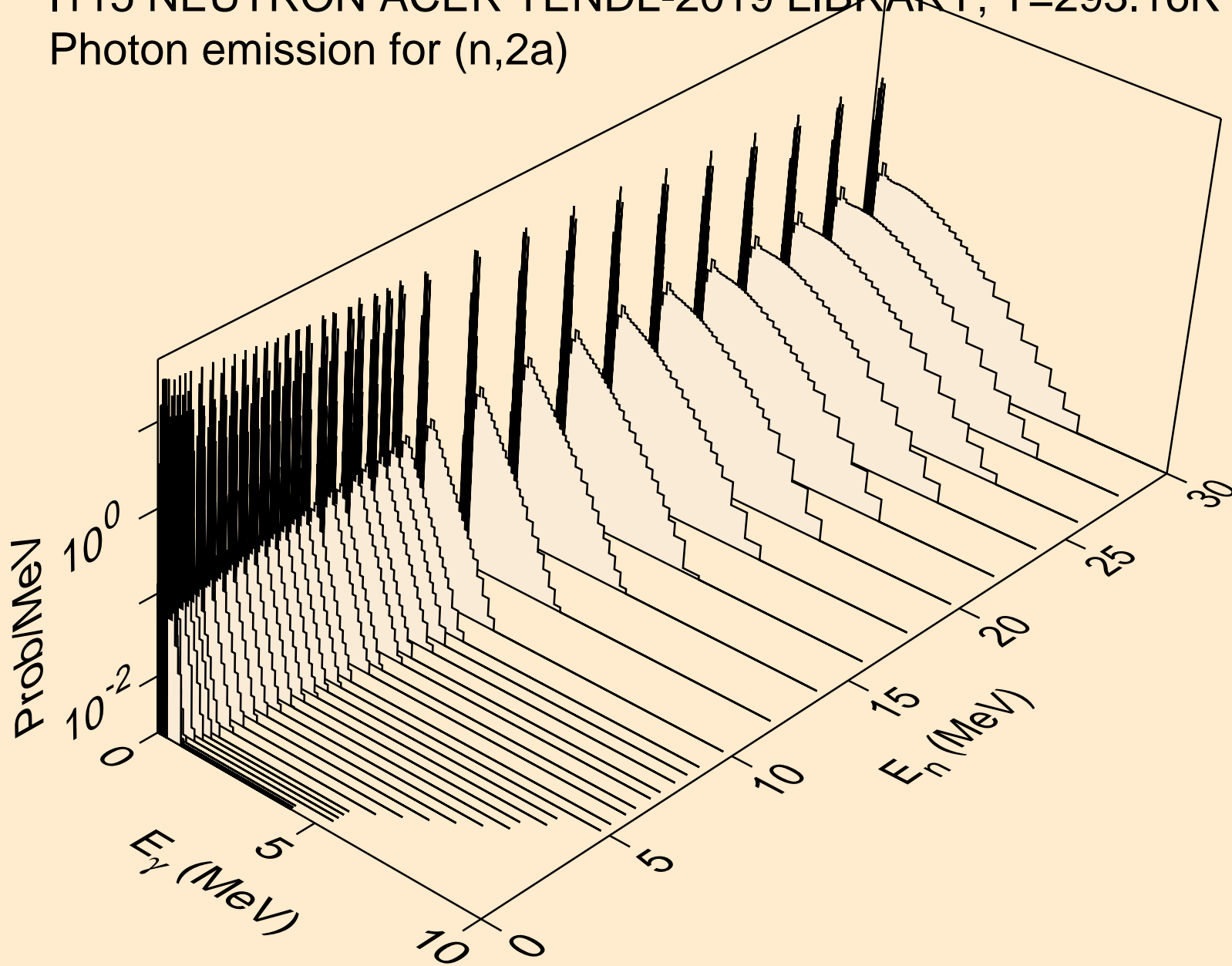

I115 NEUTRON ACER TENDL-2019 LIBRARY; T=293.16K  
Photon emission for (n,3a)

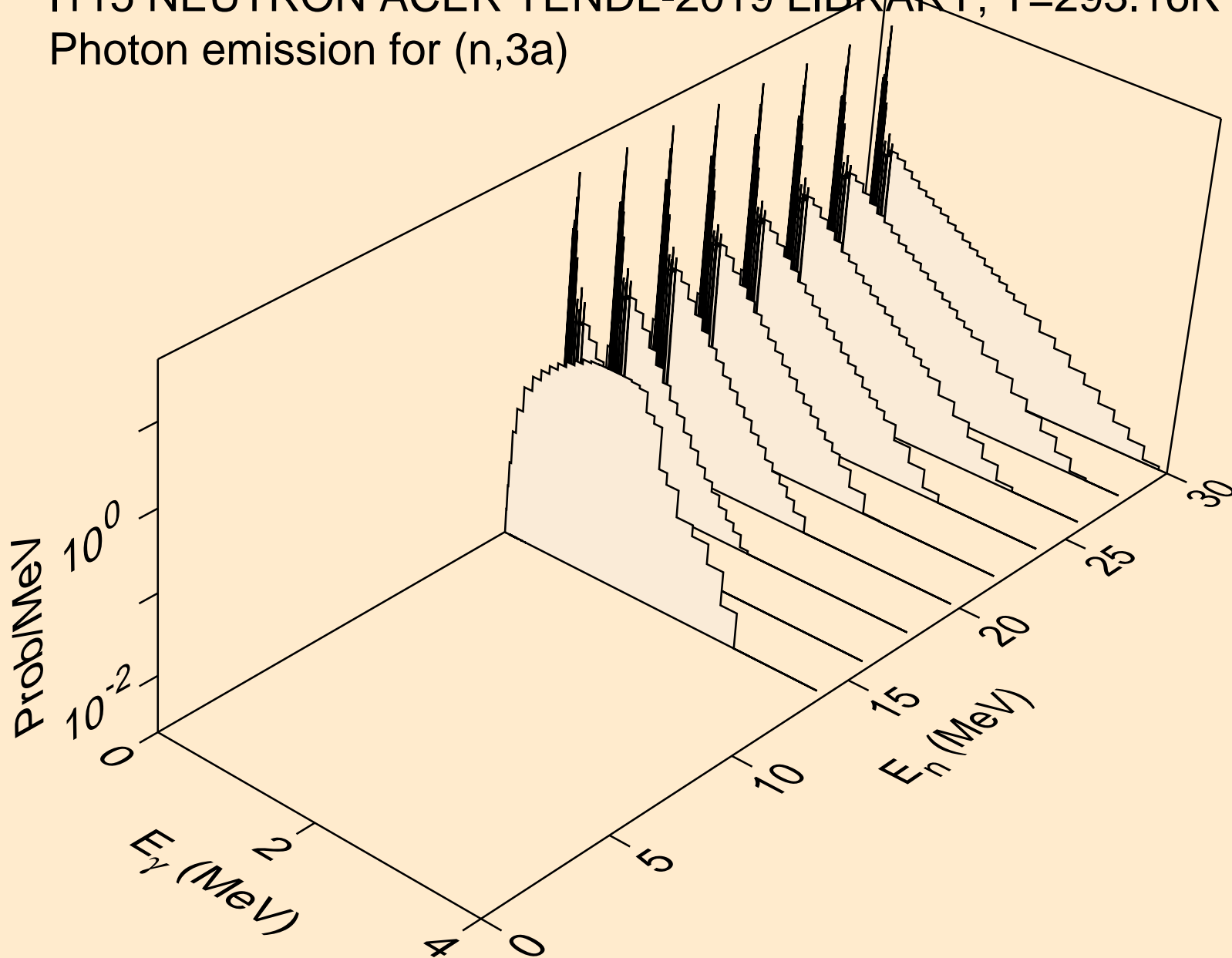

I115 NEUTRON ACER TENDL-2019 LIBRARY; T=293.16K  
Photon emission for (n,2p)

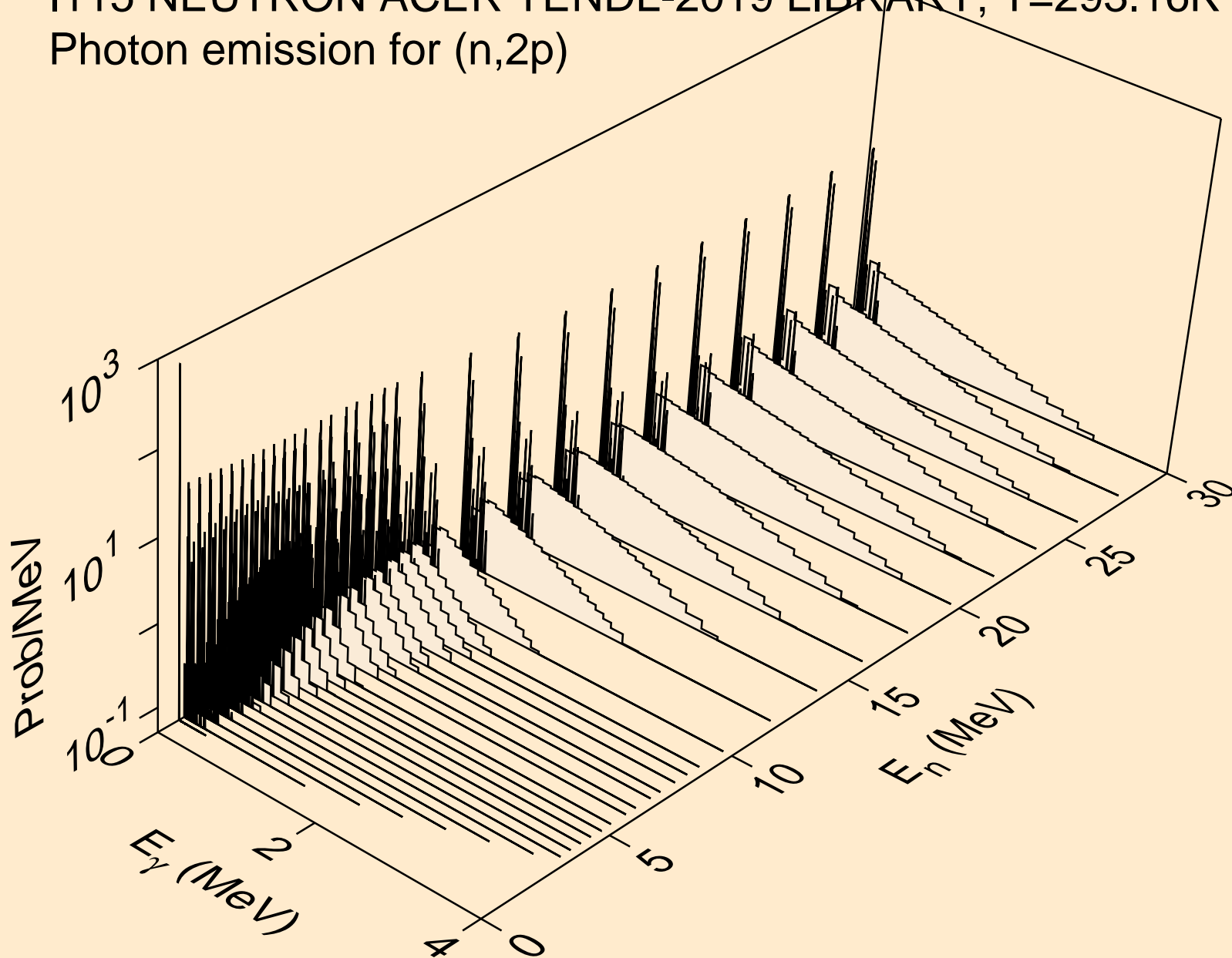

I115 NEUTRON ACER TENDL-2019 LIBRARY; T=293.16K  
Photon emission for (n,p $\alpha$ )

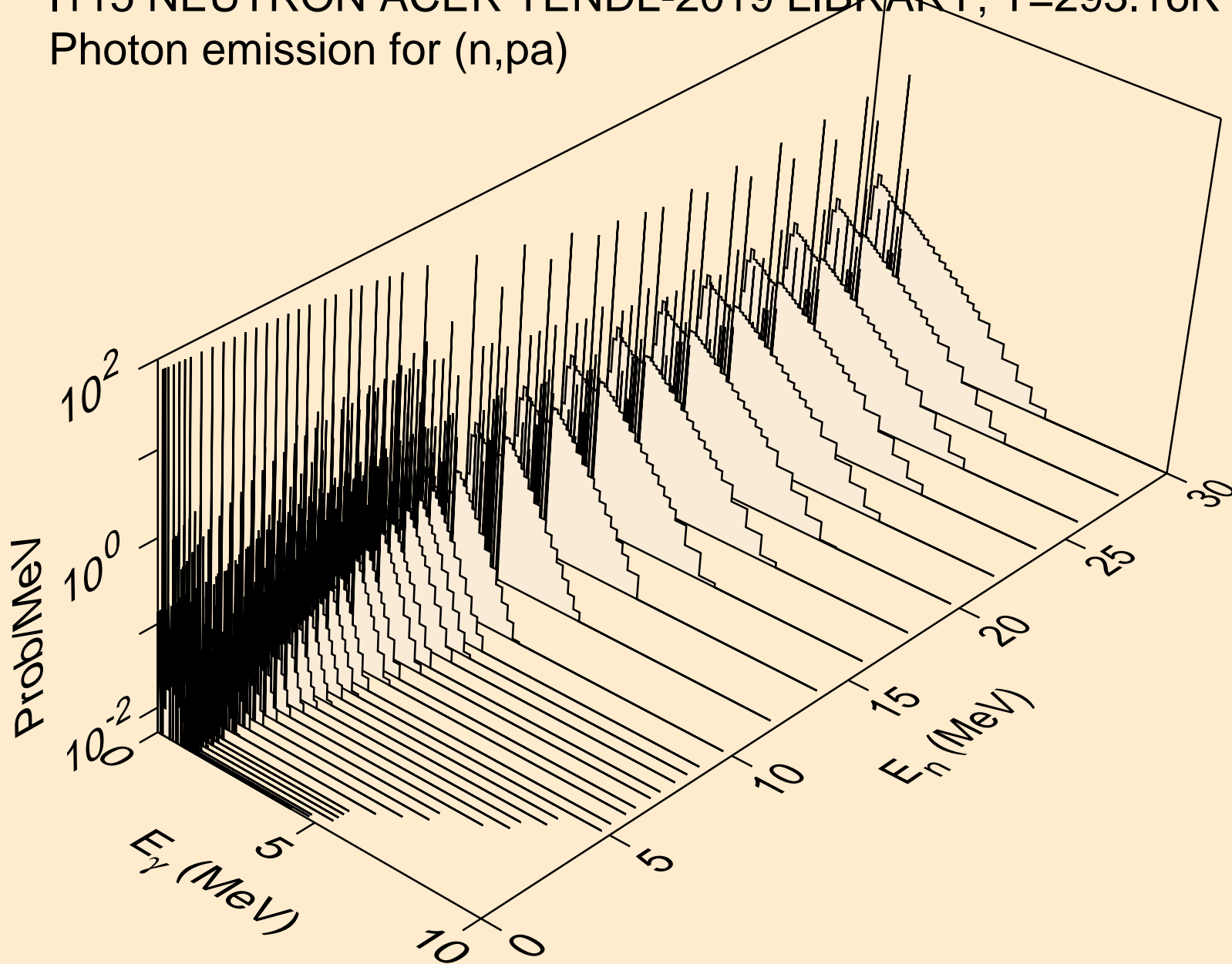

I115 NEUTRON ACER TENDL-2019 LIBRARY; T=293.16K  
Photon emission for (n,d2a)

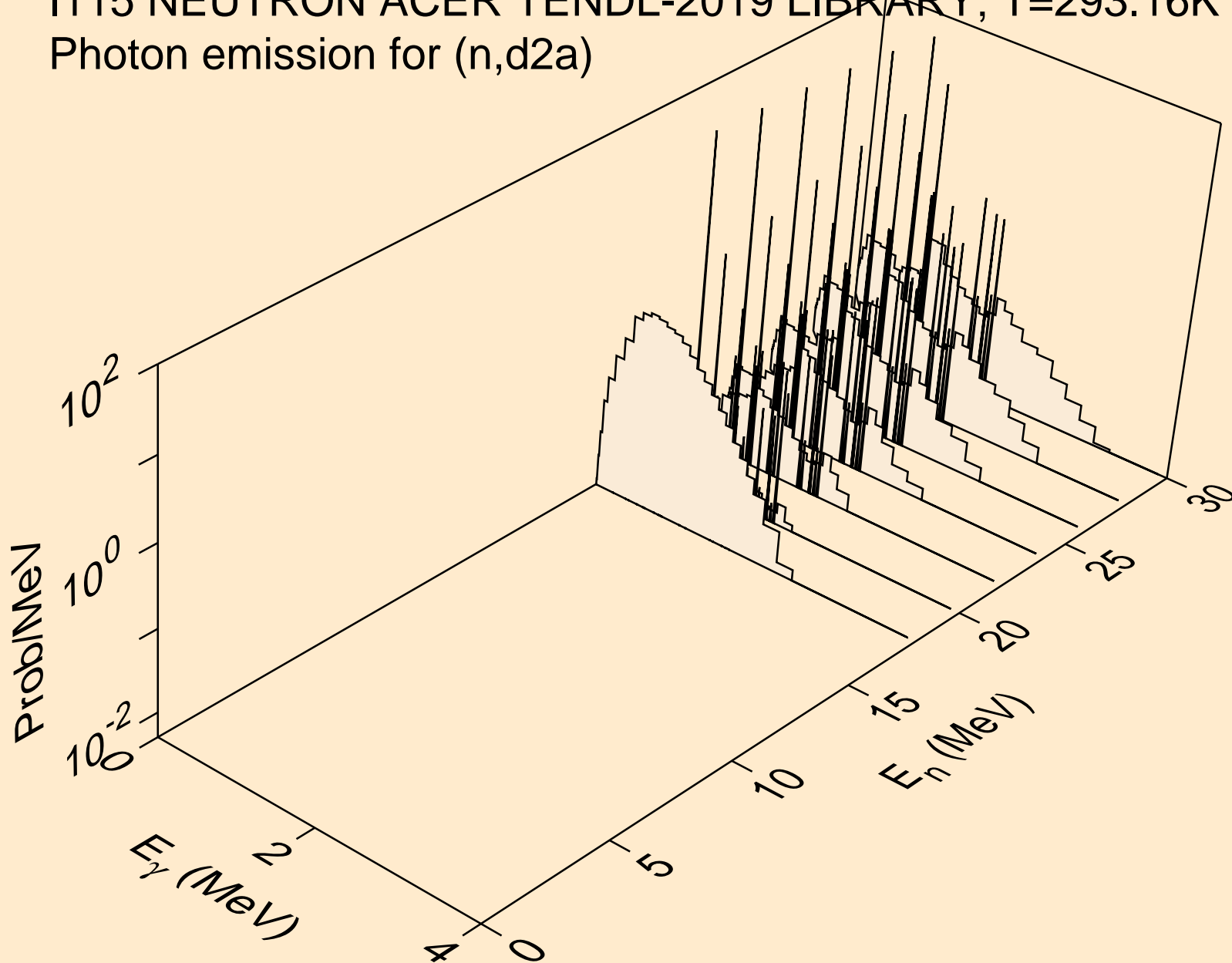



I115 NEUTRON ACER TENDL-2019 LIBRARY; T=293.16K  
Photon emission for (n,pd)

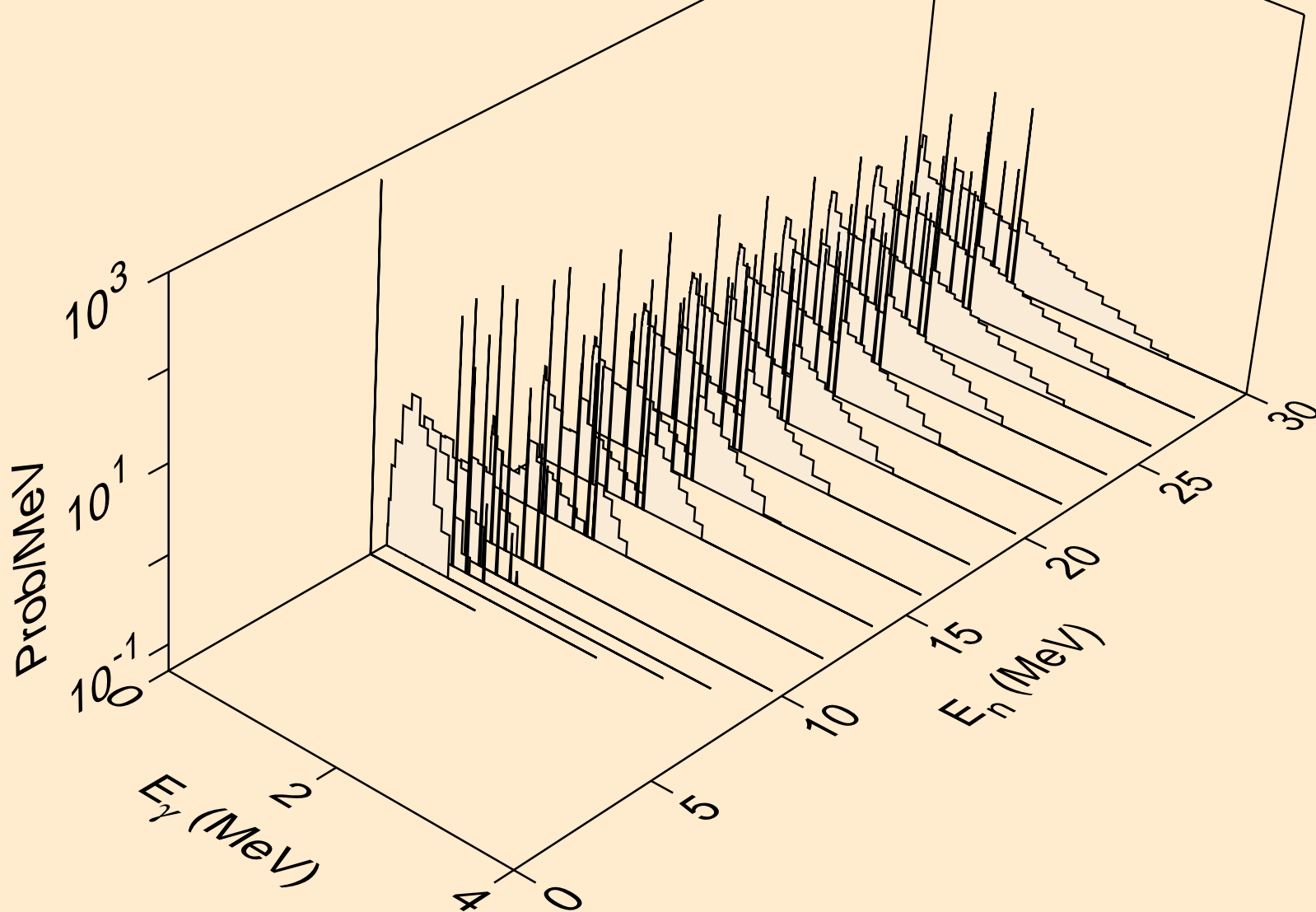

I115 NEUTRON ACER TENDL-2019 LIBRARY; T=293.16K  
Photon emission for (n,pt)

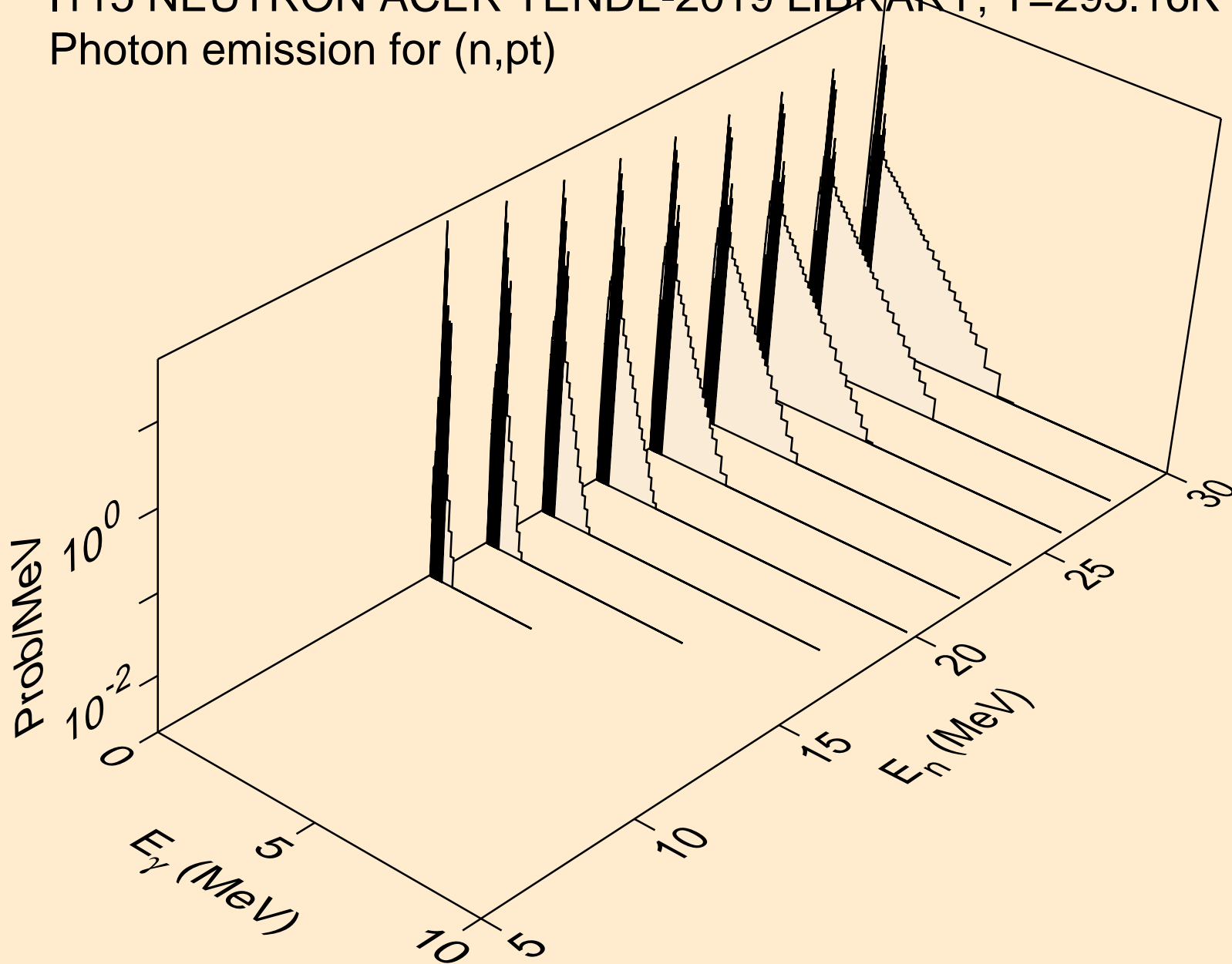

I115 NEUTRON ACER TENDL-2019 LIBRARY; T=293.16K  
Photon emission for (n,da)

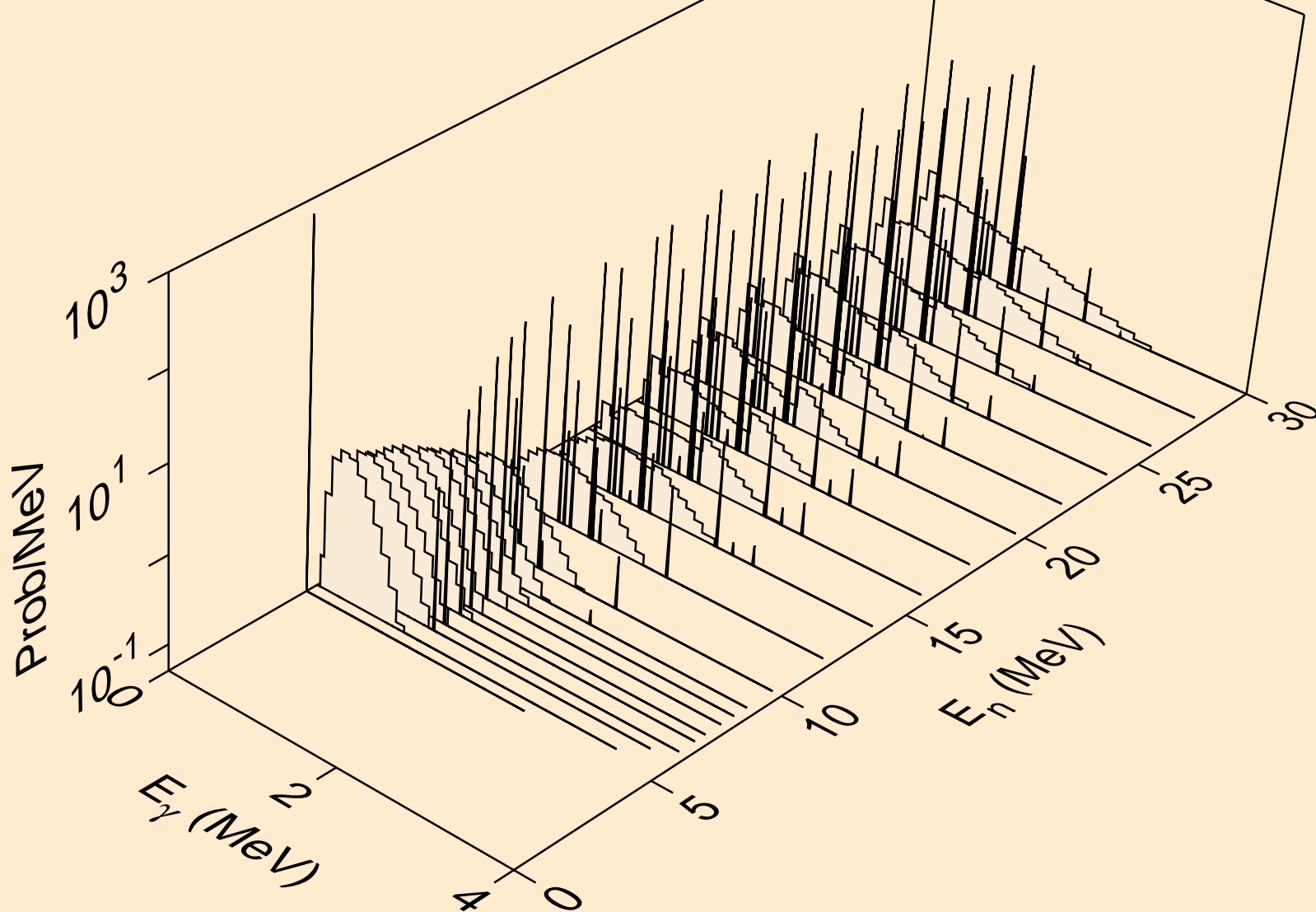

I115 NEUTRON ACER TENDL-2019 LIBRARY; T=293.16K  
thermal capture photon spectrum

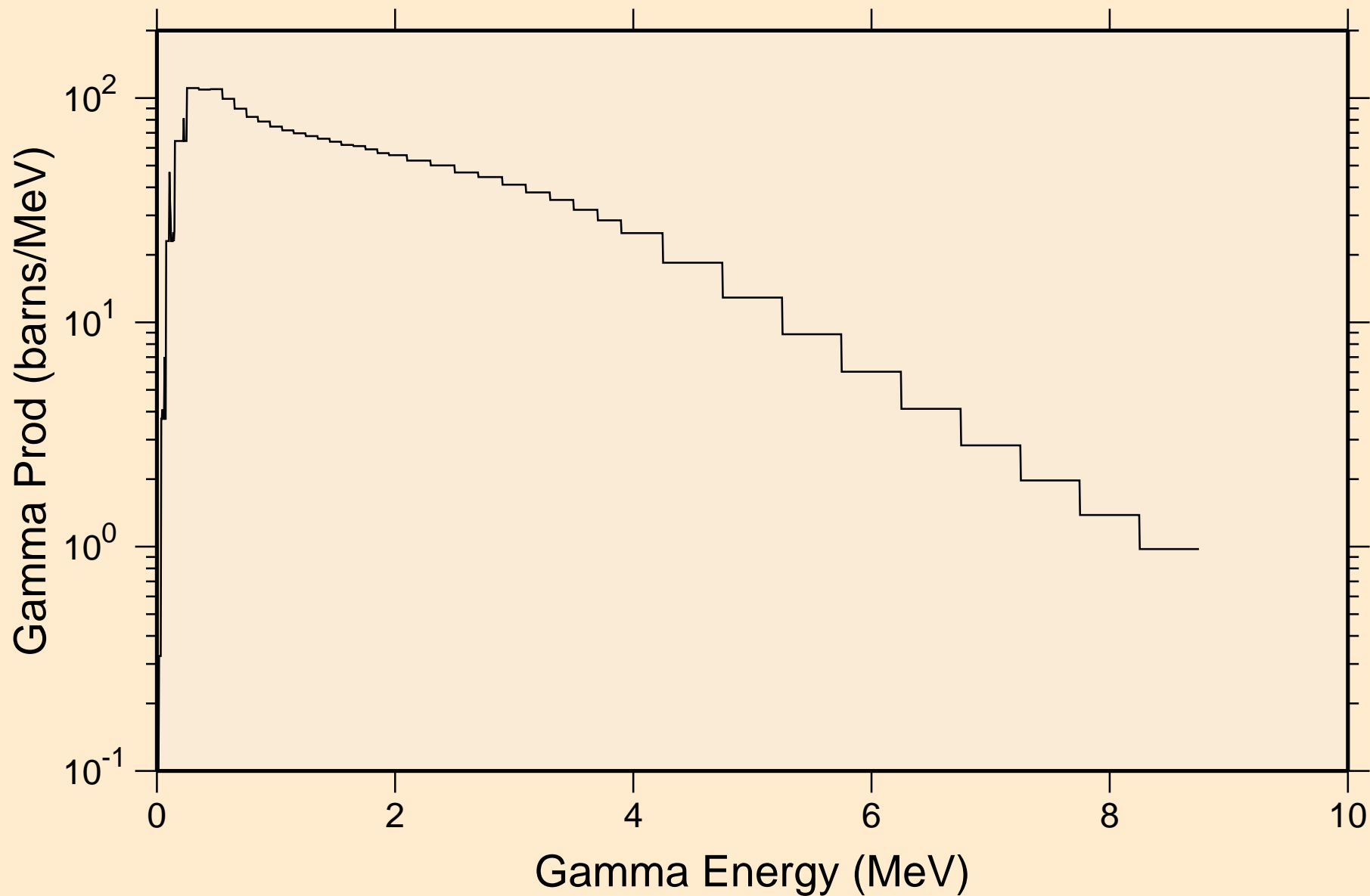

I115 NEUTRON ACER TENDL-2019 LIBRARY; T=293.16K  
14 MeV photon spectrum

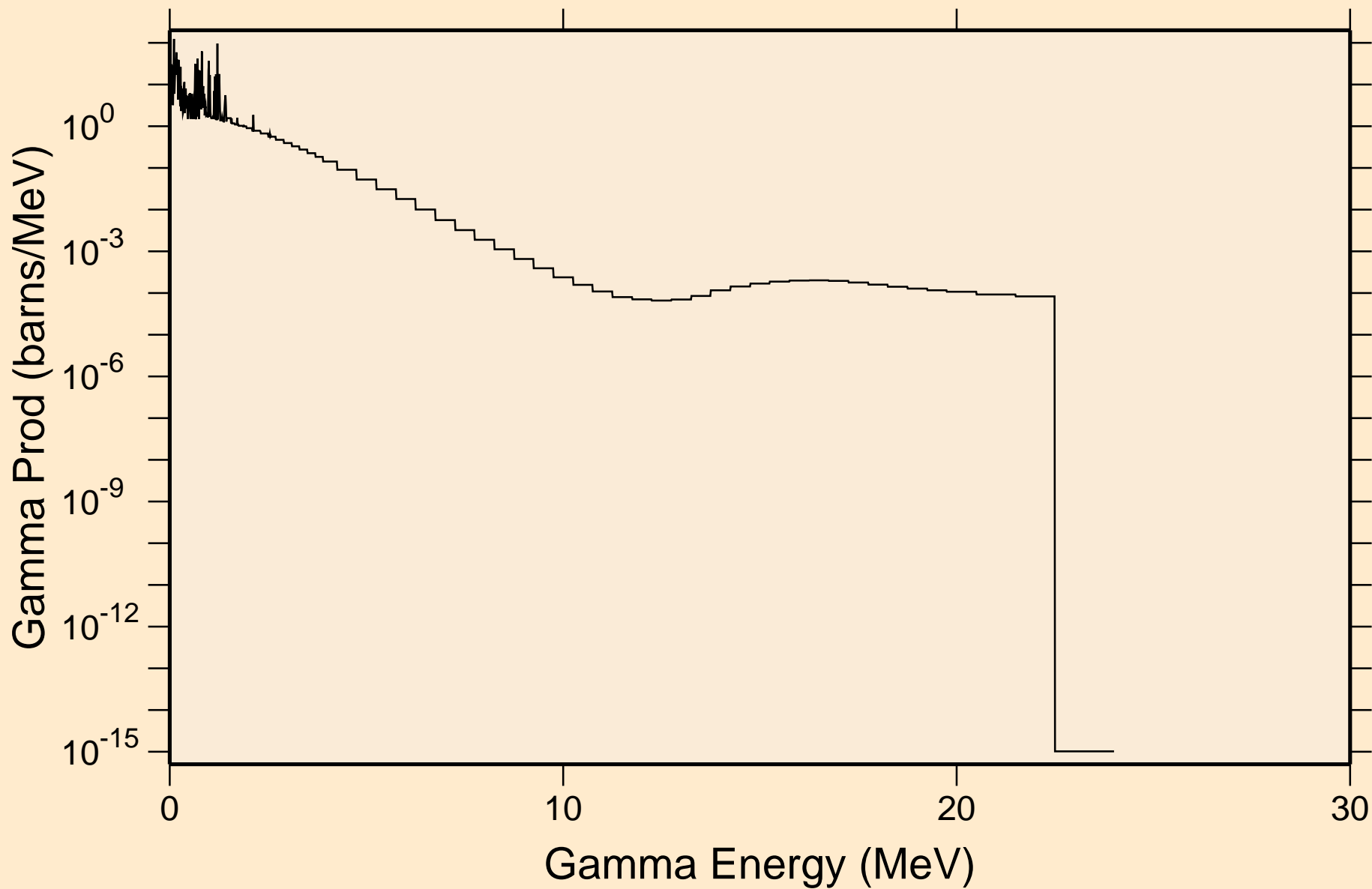

# I115 NEUTRON ACER TENDL-2019 LIBRARY; T=293.16K

## Particle heating contributions

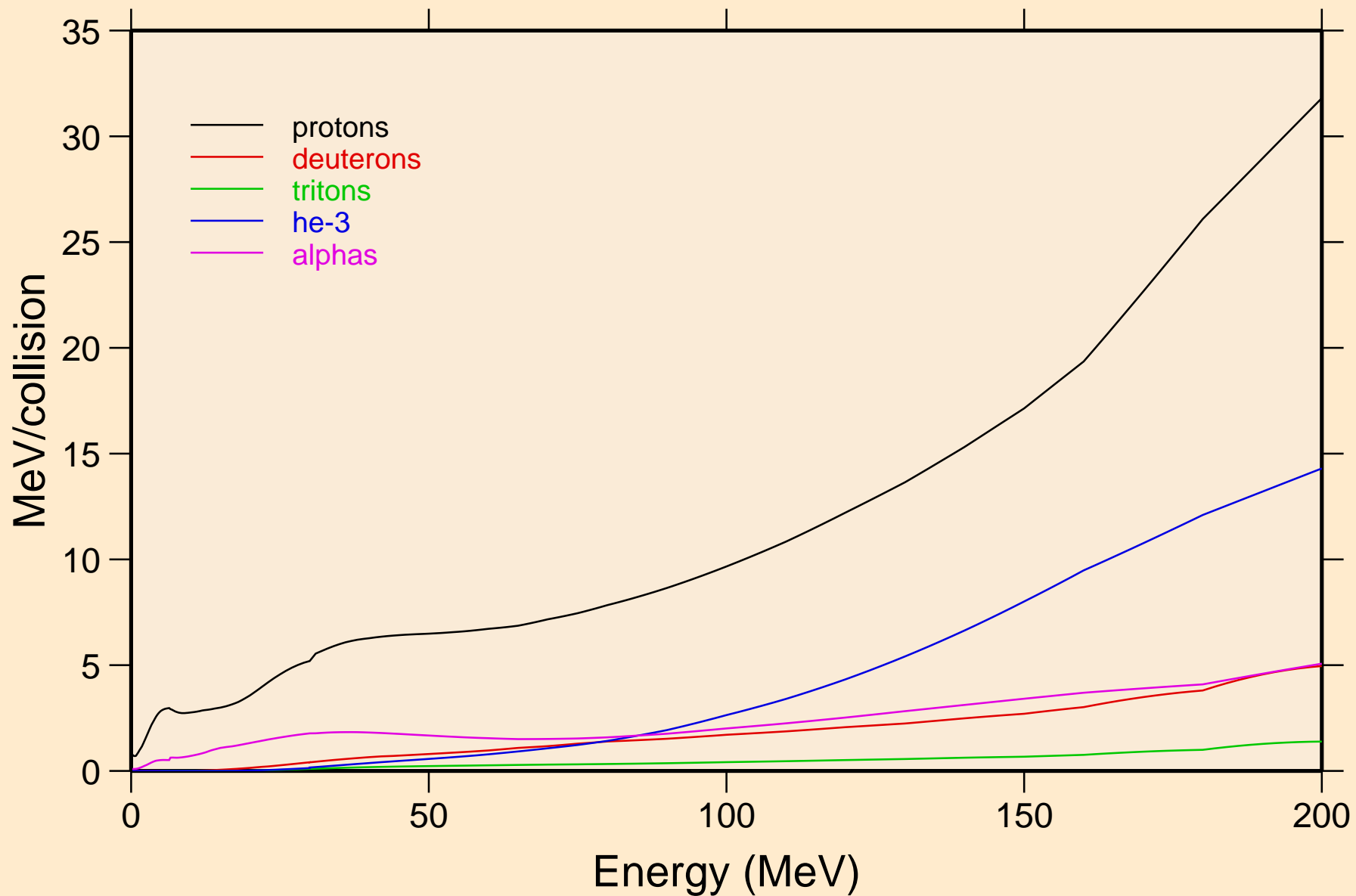

I115 NEUTRON ACER TENDL-2019 LIBRARY; T=293.16K  
Recoil Heating

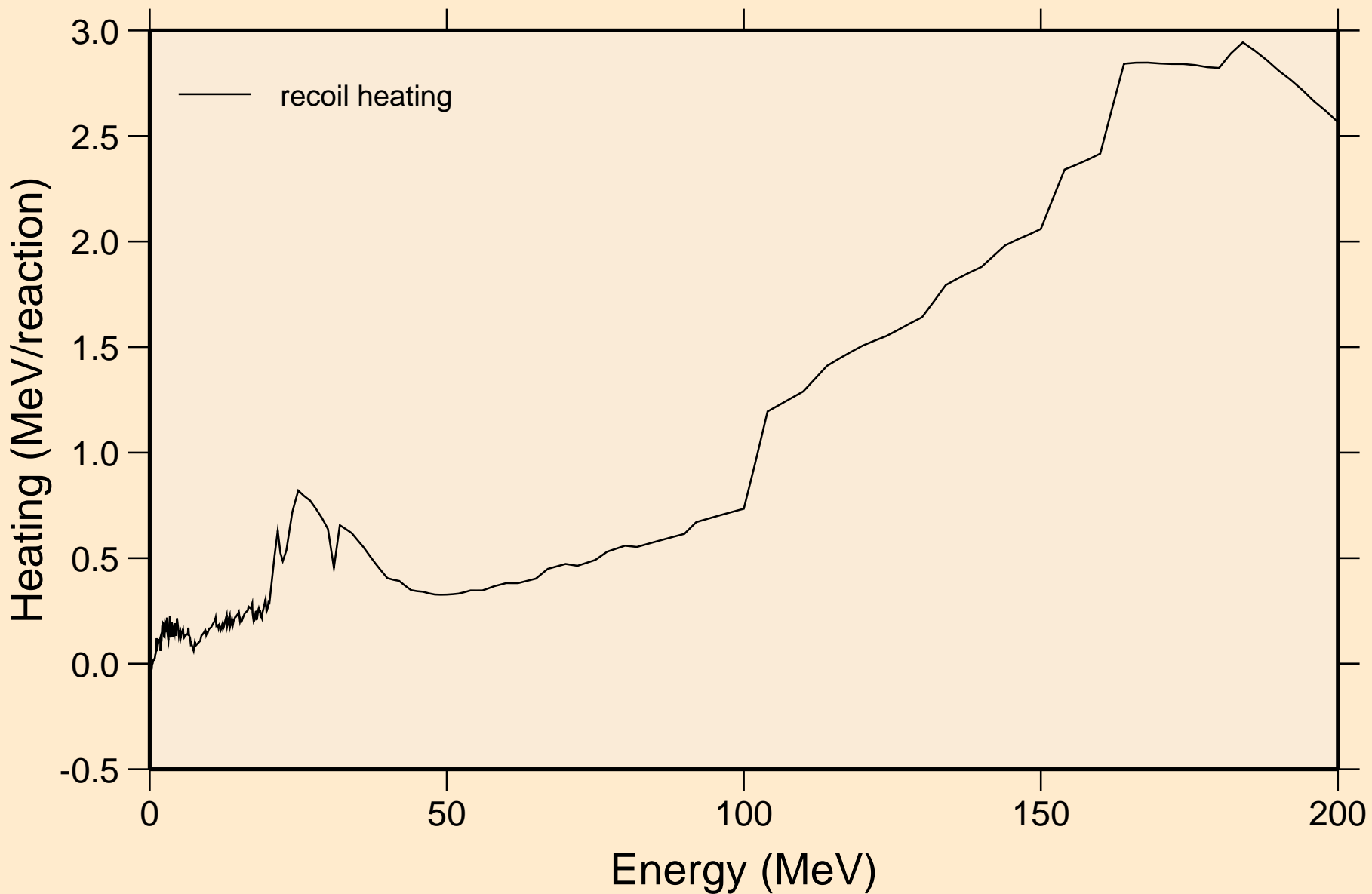

I115 NEUTRON ACER TENDL-2019 LIBRARY; T=293.16K  
Particle production cross sections

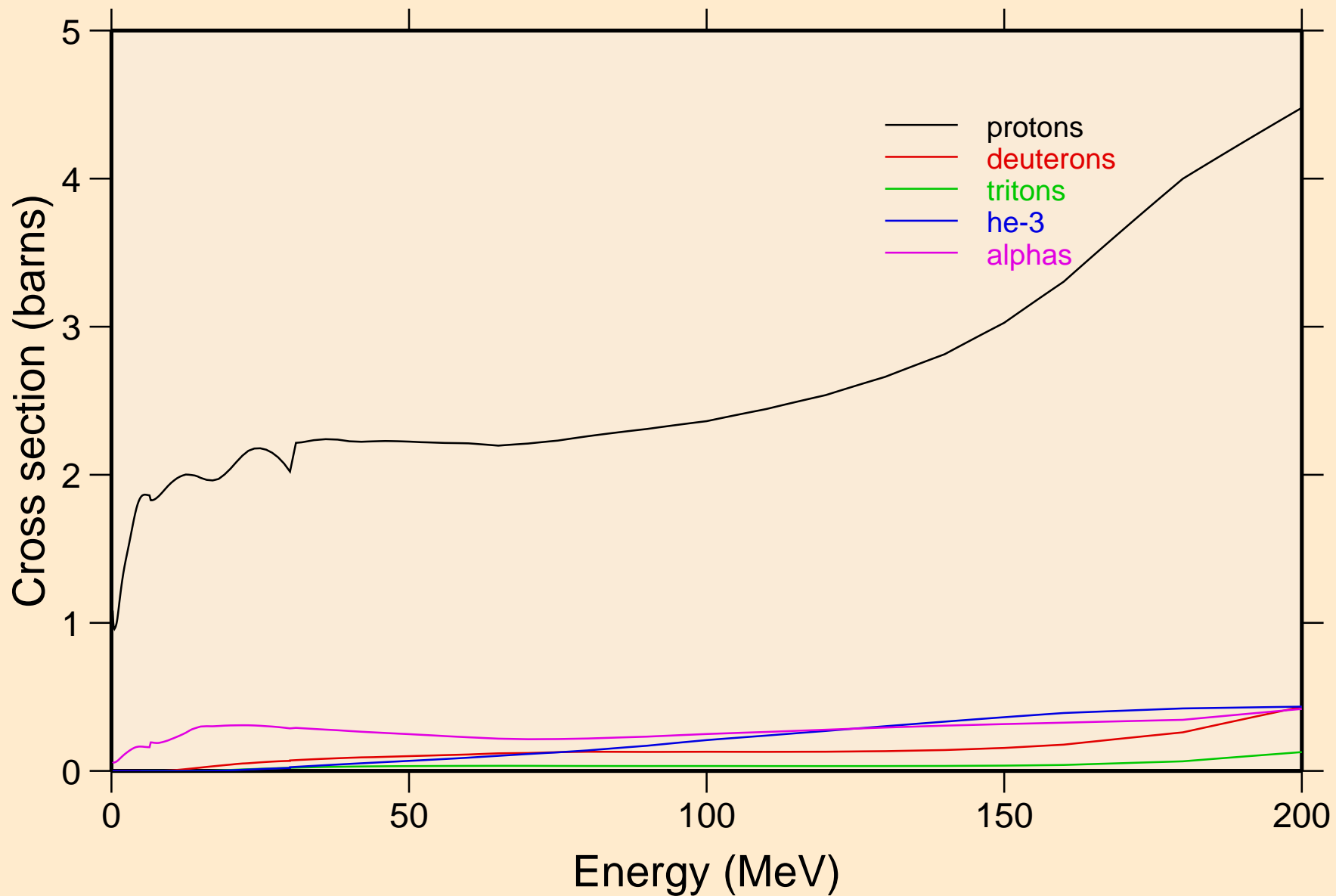



I115 NEUTRON ACER TENDL-2019 LIBRARY; T=293.16K  
protons from (n,x)

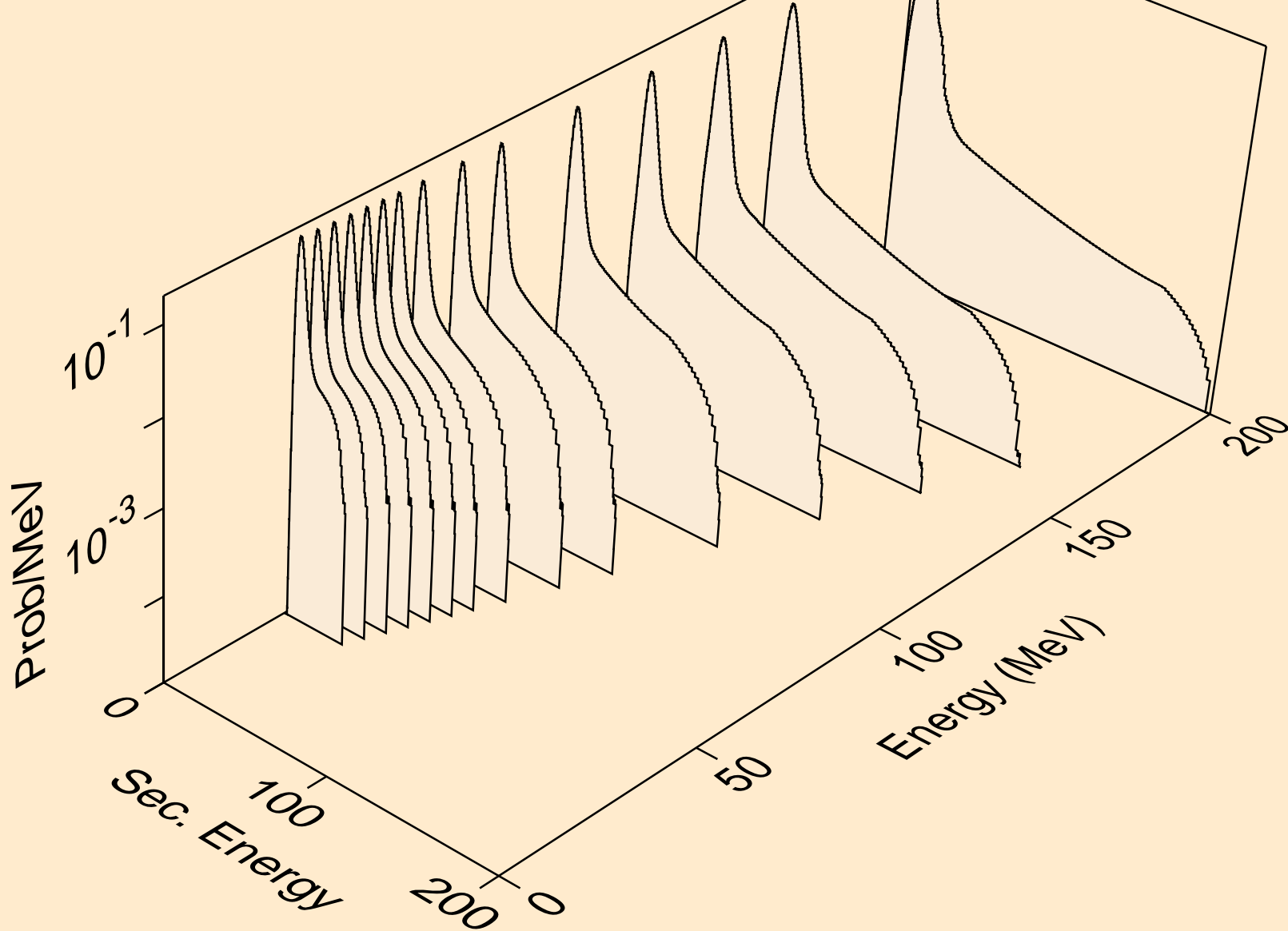

I115 NEUTRON ACER TENDL-2019 LIBRARY; T=293.16K  
protons from (n,n\*)p

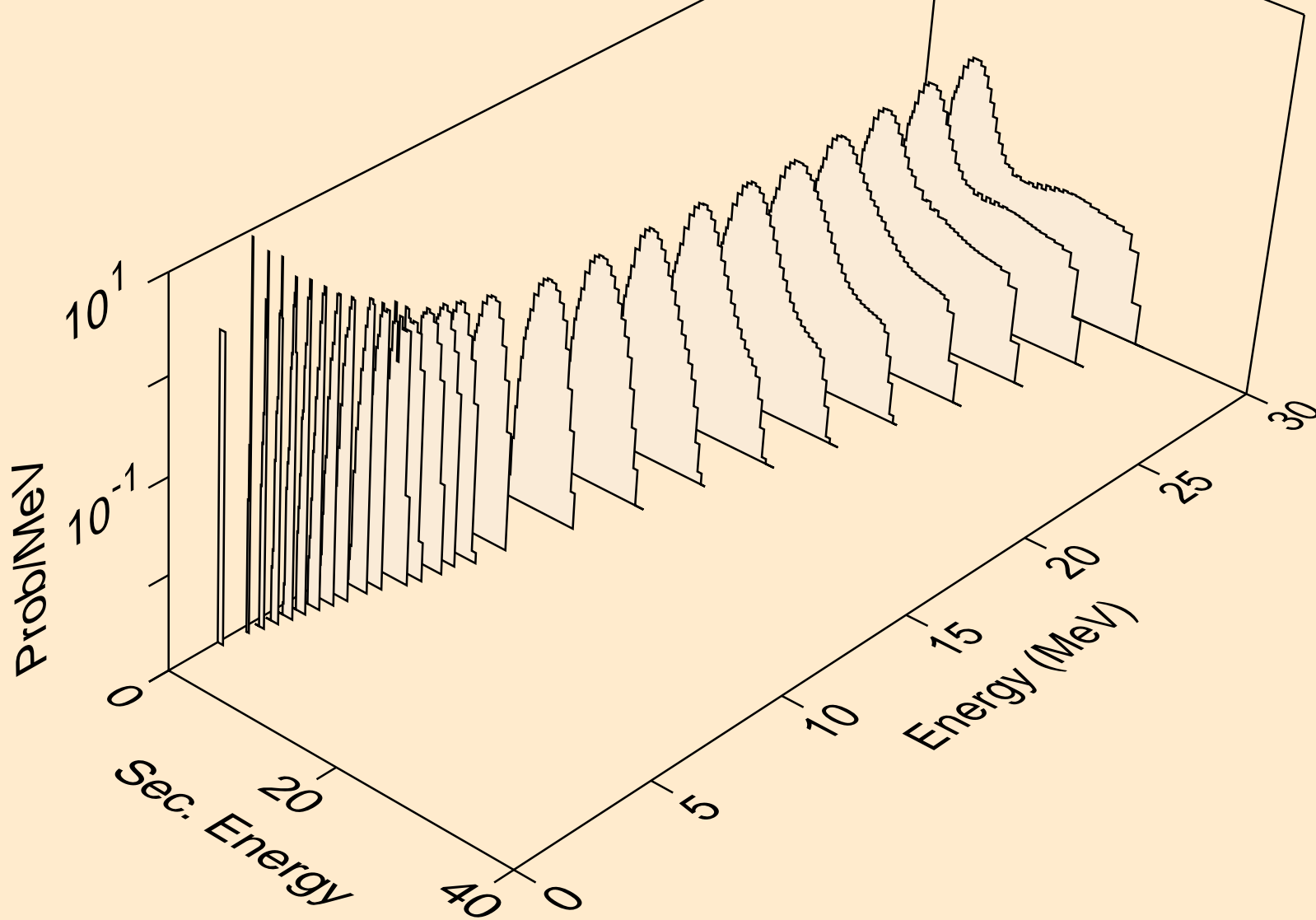

I115 NEUTRON ACER TENDL-2019 LIBRARY; T=293.16K  
protons from (n,2np)

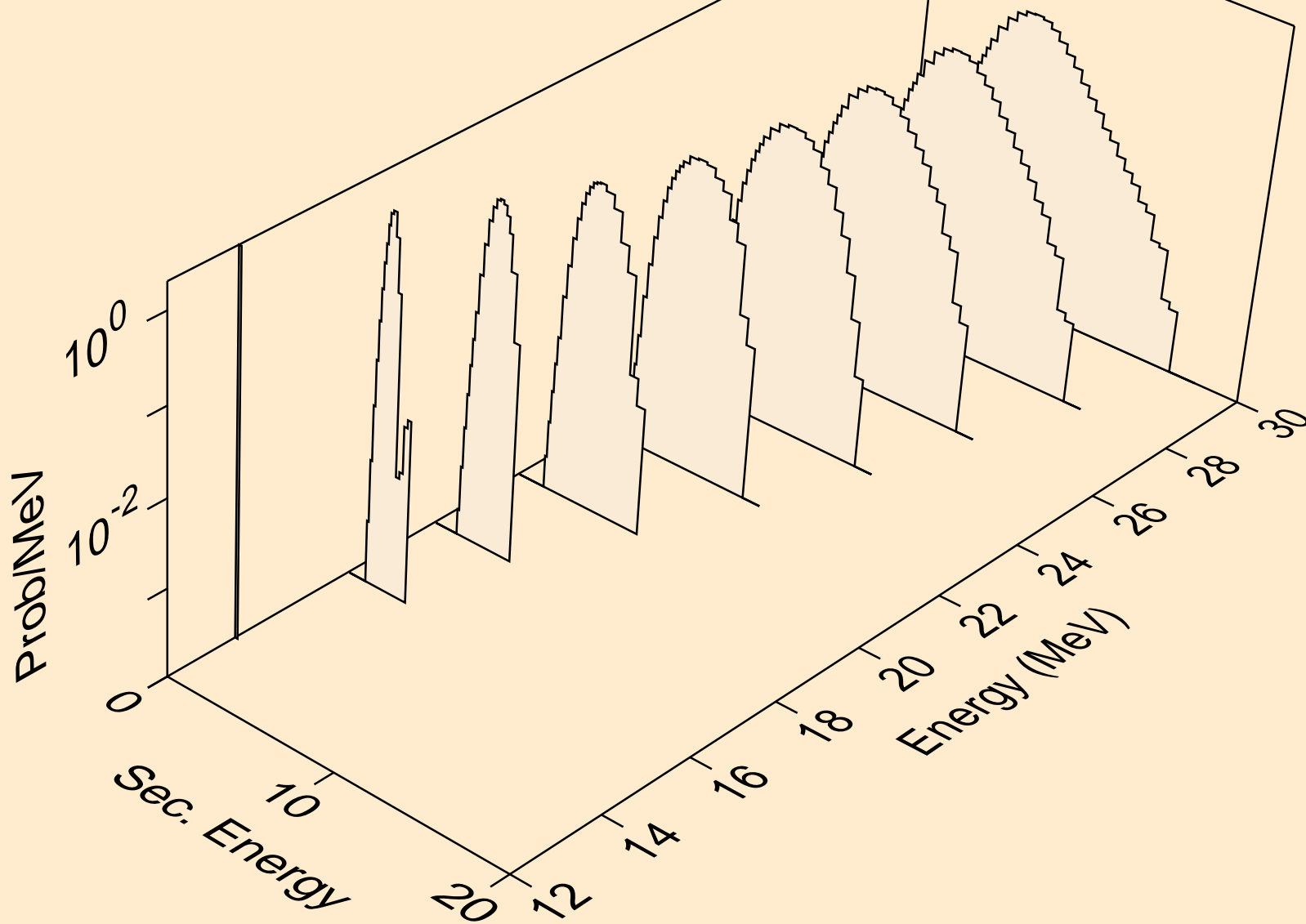

I115 NEUTRON ACER TENDL-2019 LIBRARY; T=293.16K  
protons from (n,3np)

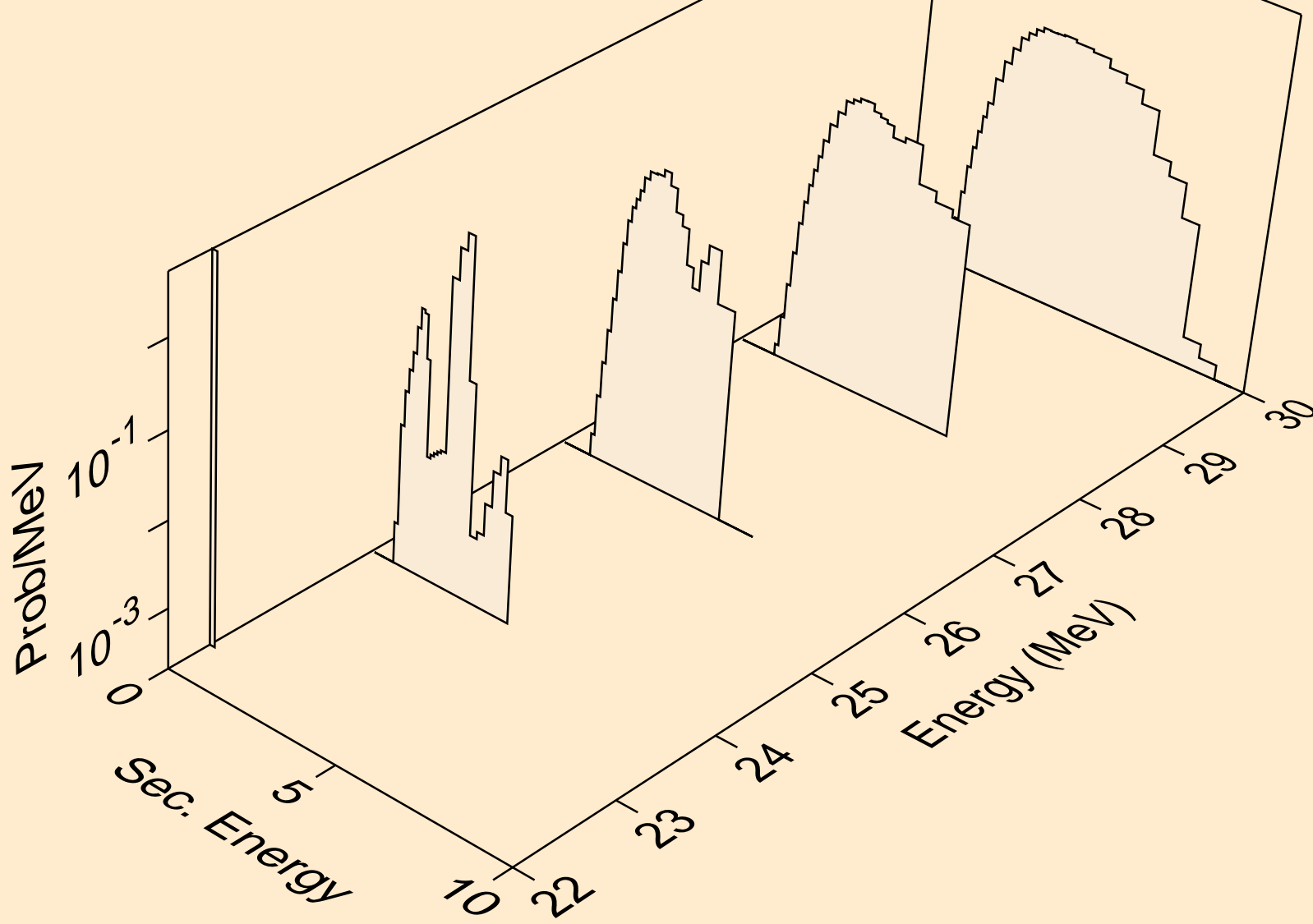

I115 NEUTRON ACER TENDL-2019 LIBRARY; T=293.16K  
protons from (n,2np)

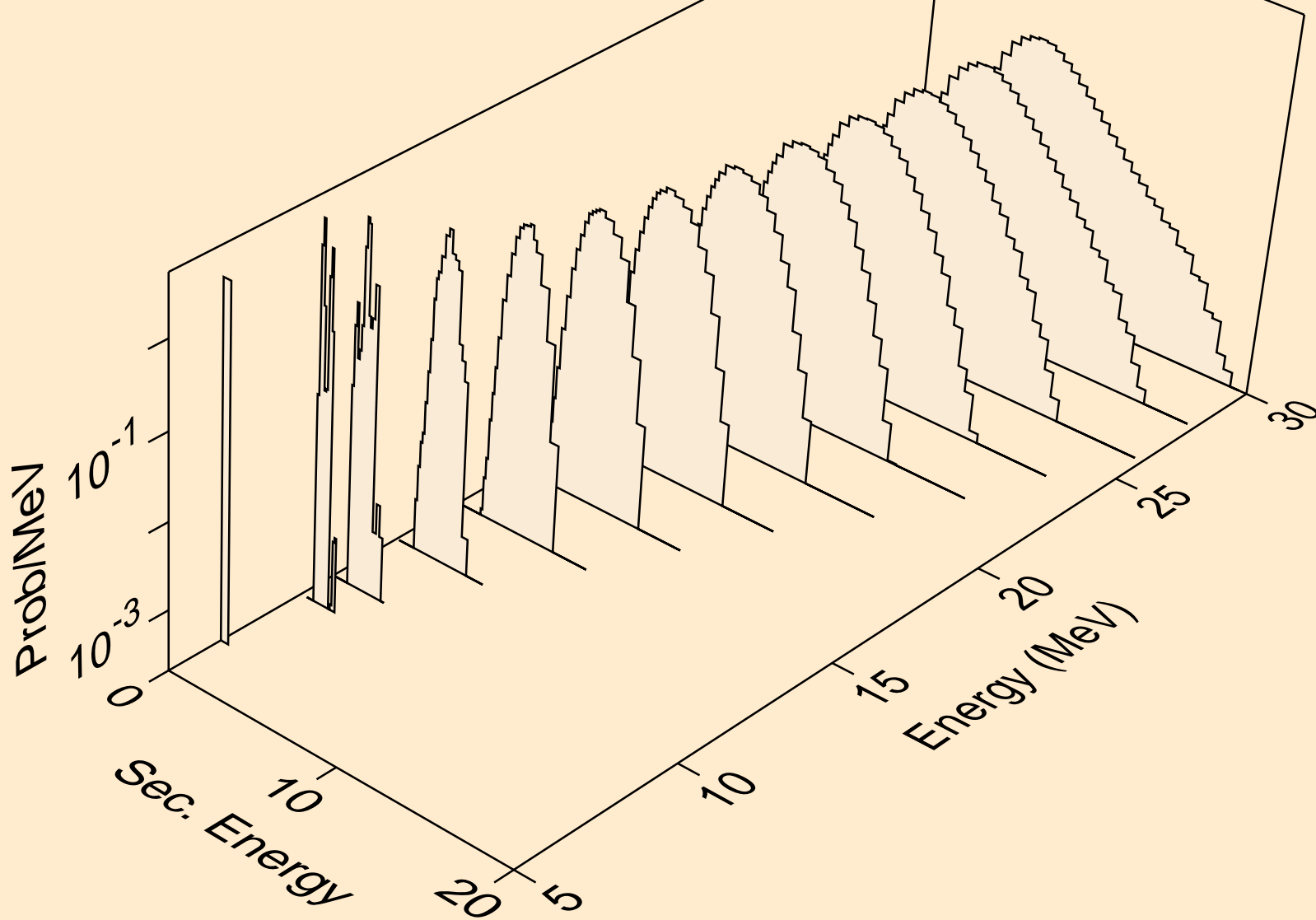

I115 NEUTRON ACER TENDL-2019 LIBRARY; T=293.16K  
protons from (n,npa)

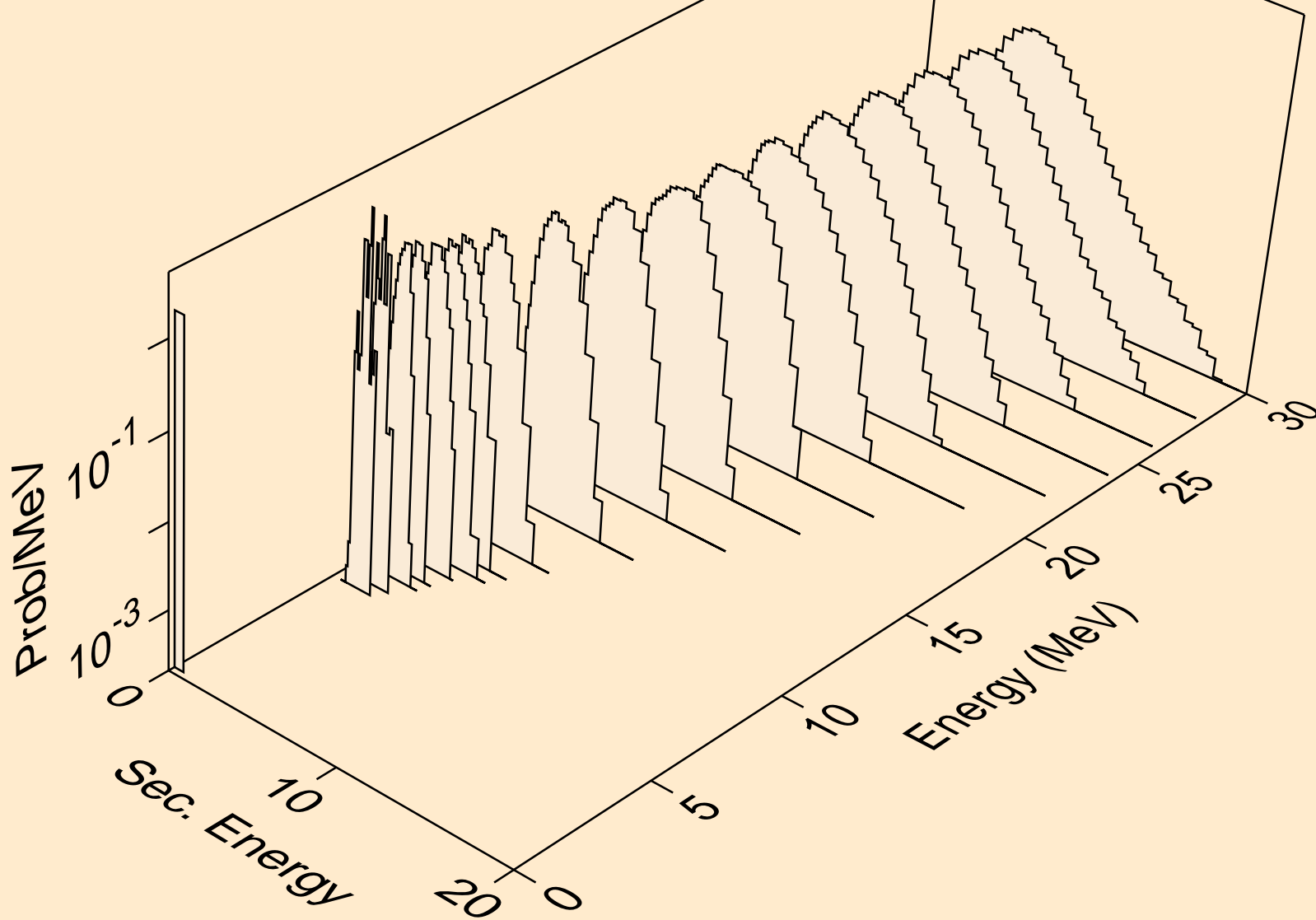

I115 NEUTRON ACER TENDL-2019 LIBRARY; T=293.16K  
protons from (n,p)

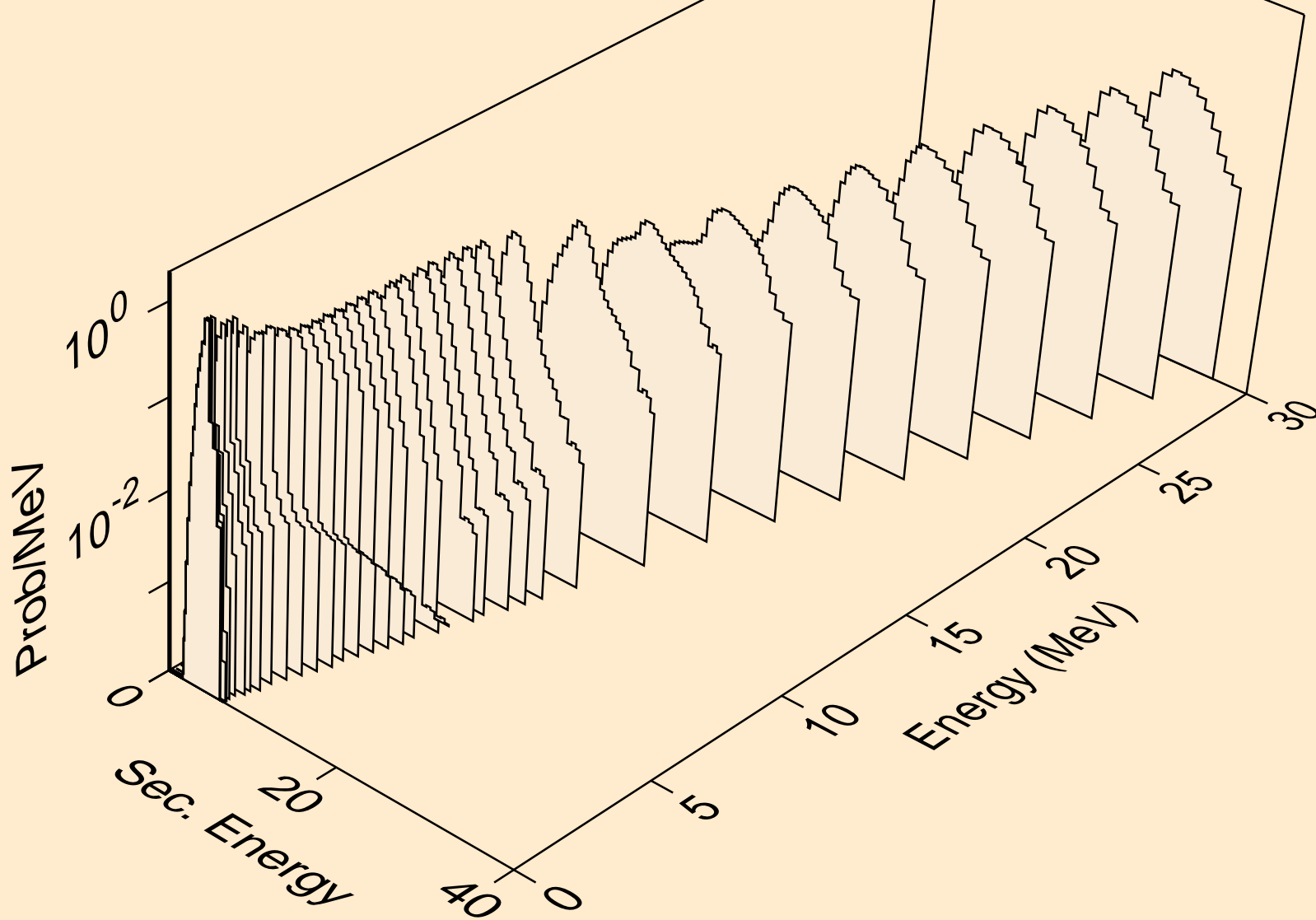

I115 NEUTRON ACER TENDL-2019 LIBRARY; T=293.16K  
protons from (n,2p)

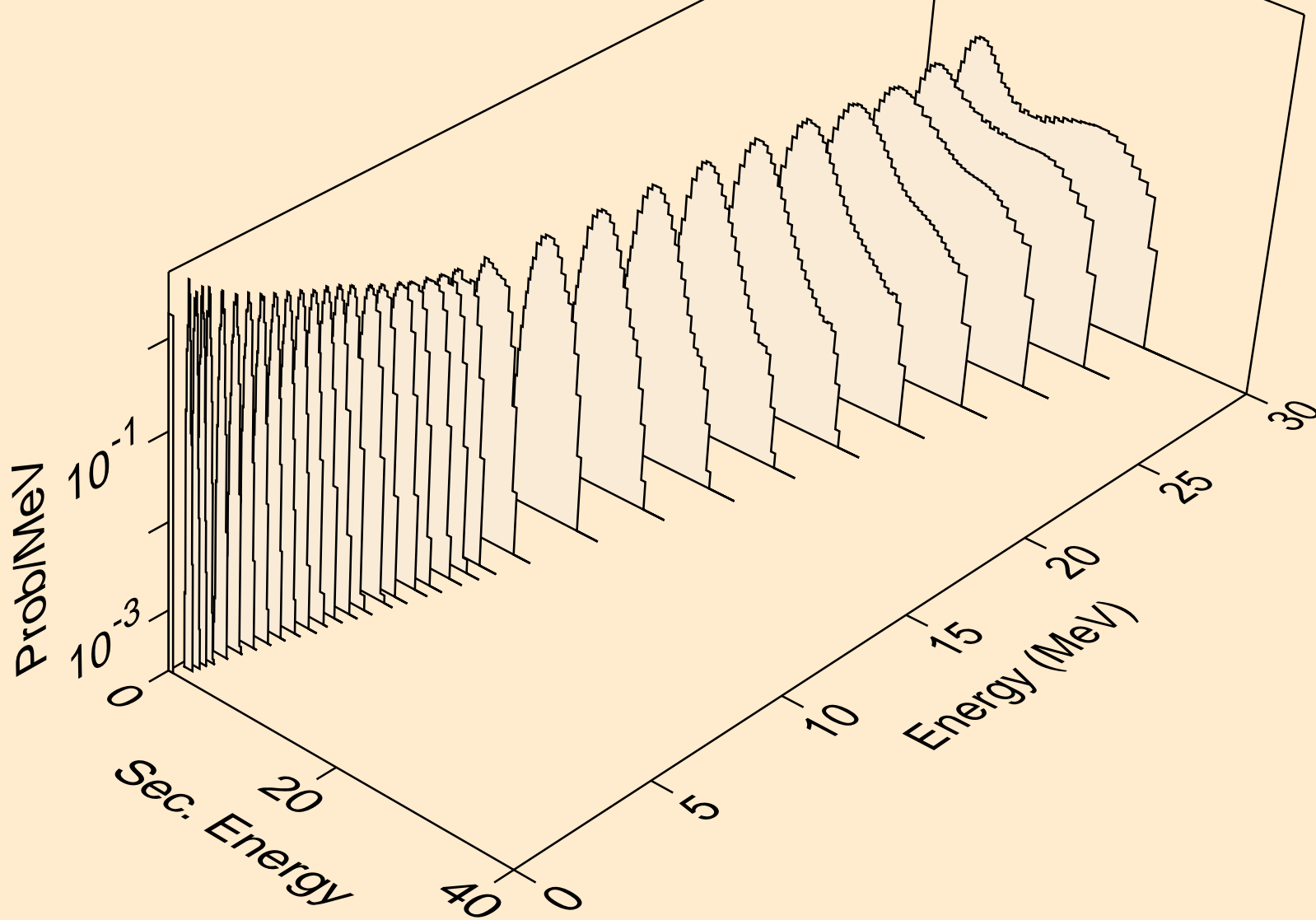



I115 NEUTRON ACER TENDL-2019 LIBRARY; T=293.16K  
protons from (n,p)

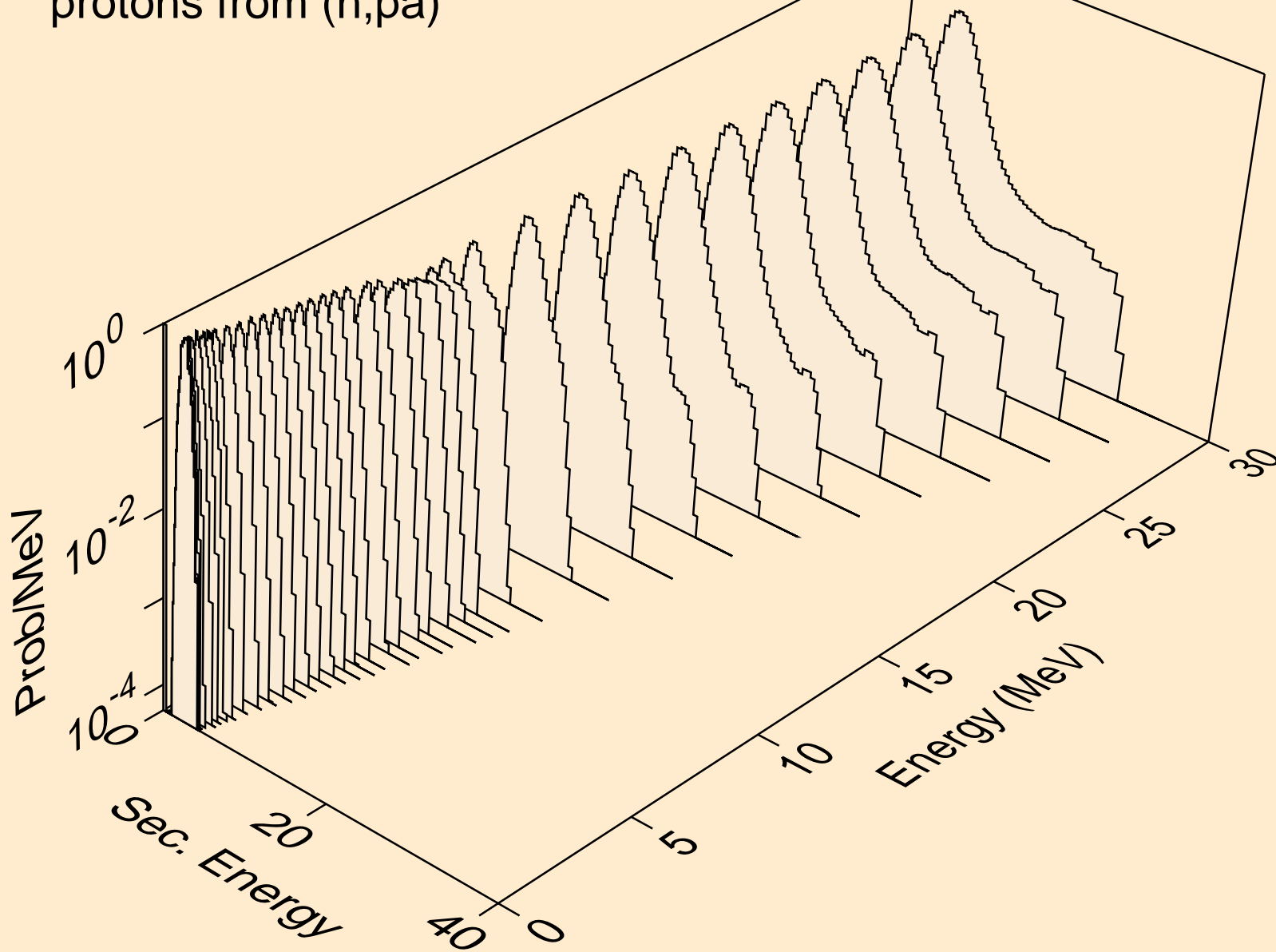

I115 NEUTRON ACER TENDL-2019 LIBRARY; T=293.16K  
protons from (n,pd)

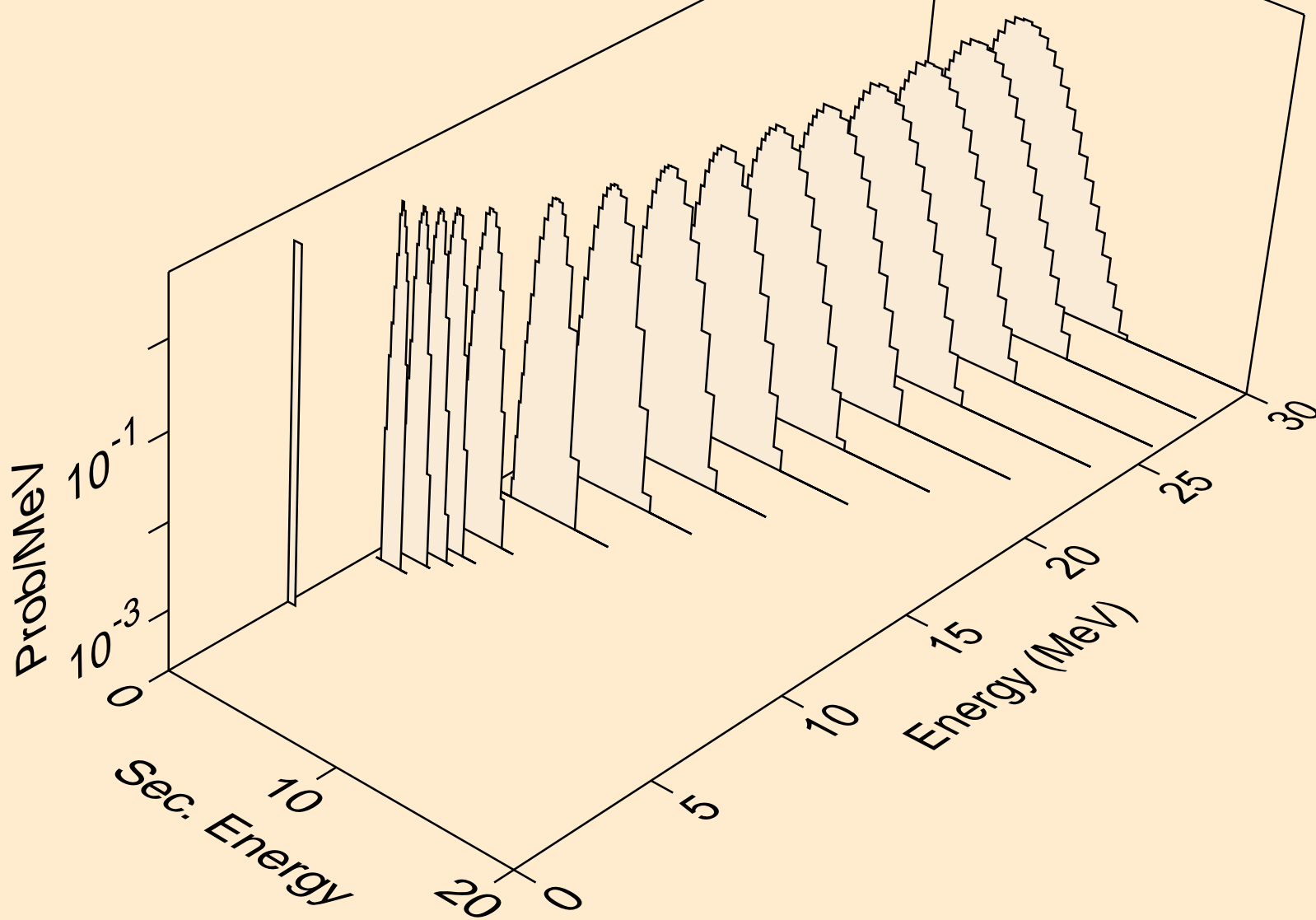

I115 NEUTRON ACER TENDL-2019 LIBRARY; T=293.16K  
protons from (n,pt)

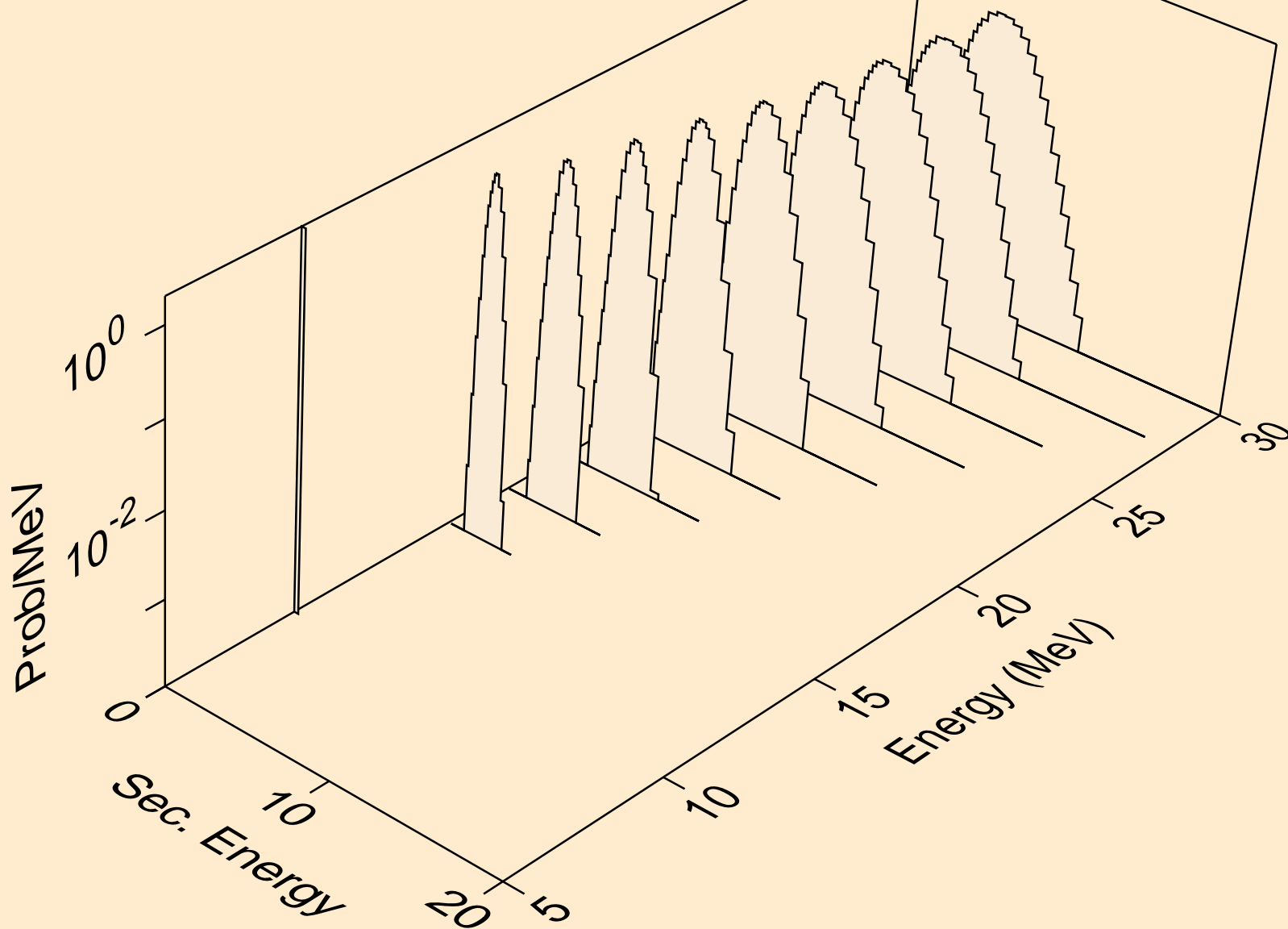

I115 NEUTRON ACER TENDL-2019 LIBRARY; T=293.16K  
deuterons from (n,x)

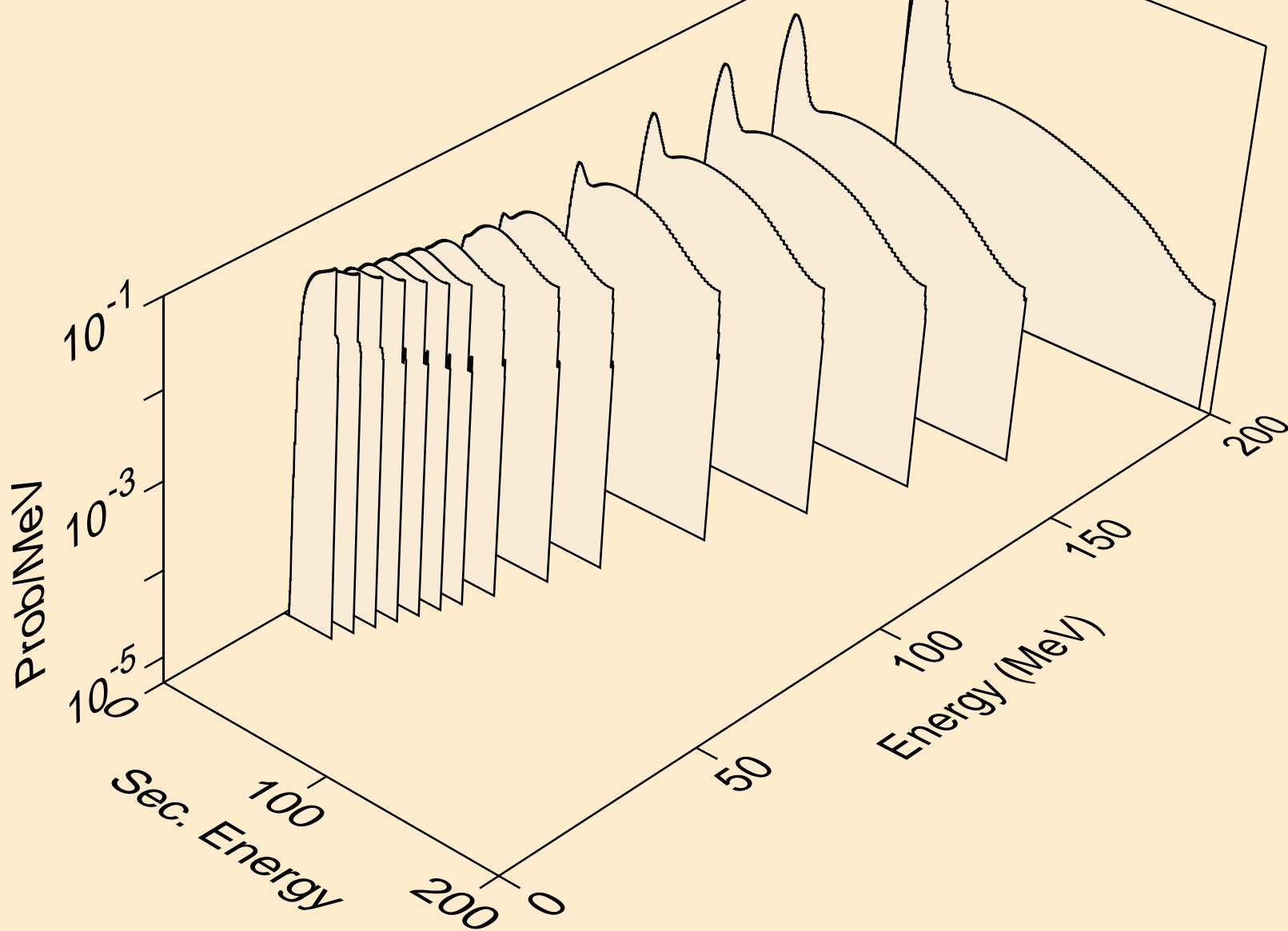

I115 NEUTRON ACER TENDL-2019 LIBRARY; T=293.16K  
deuterons from (n,2nd)

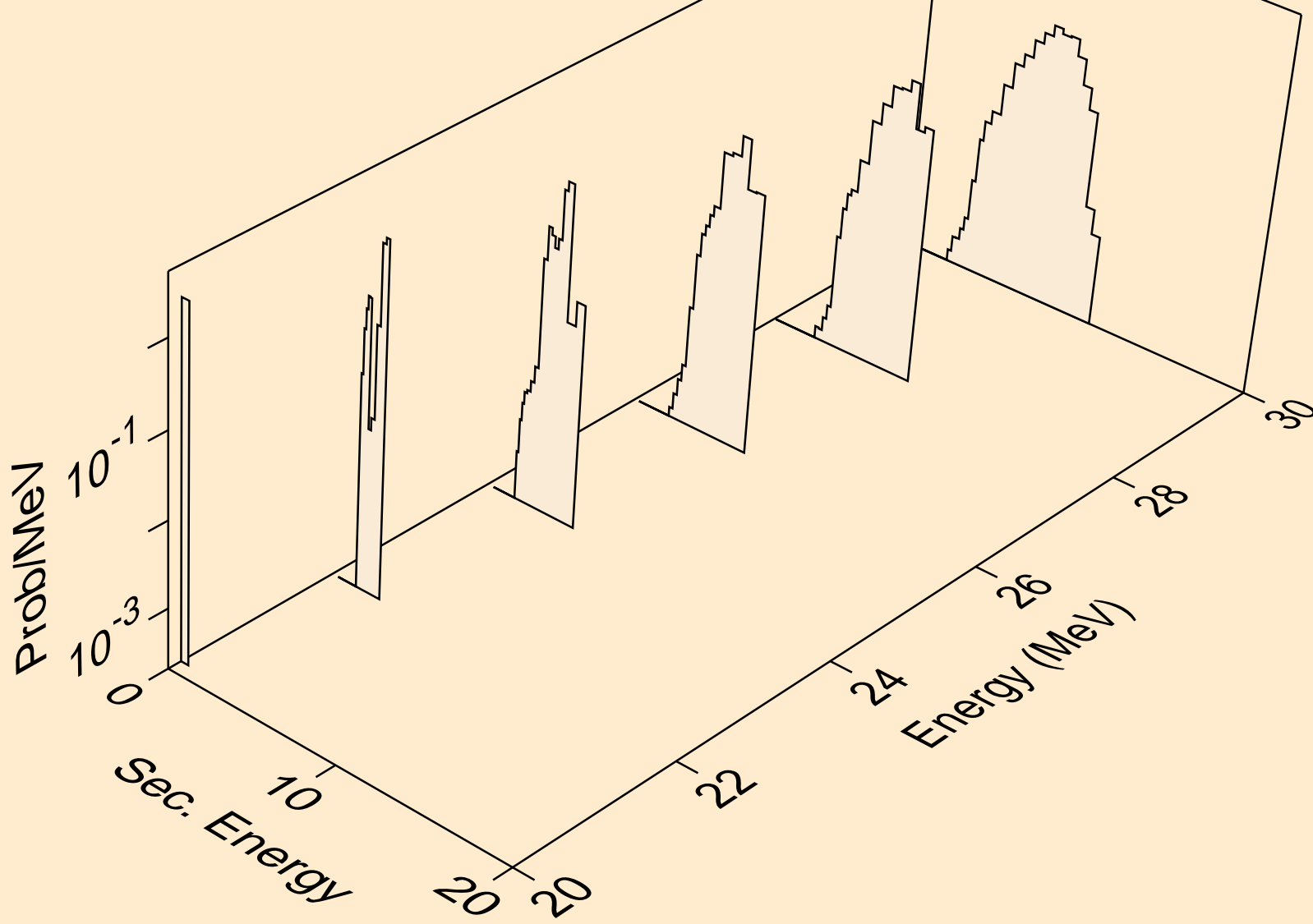

I115 NEUTRON ACER TENDL-2019 LIBRARY; T=293.16K  
deuterons from (n,n\*)d

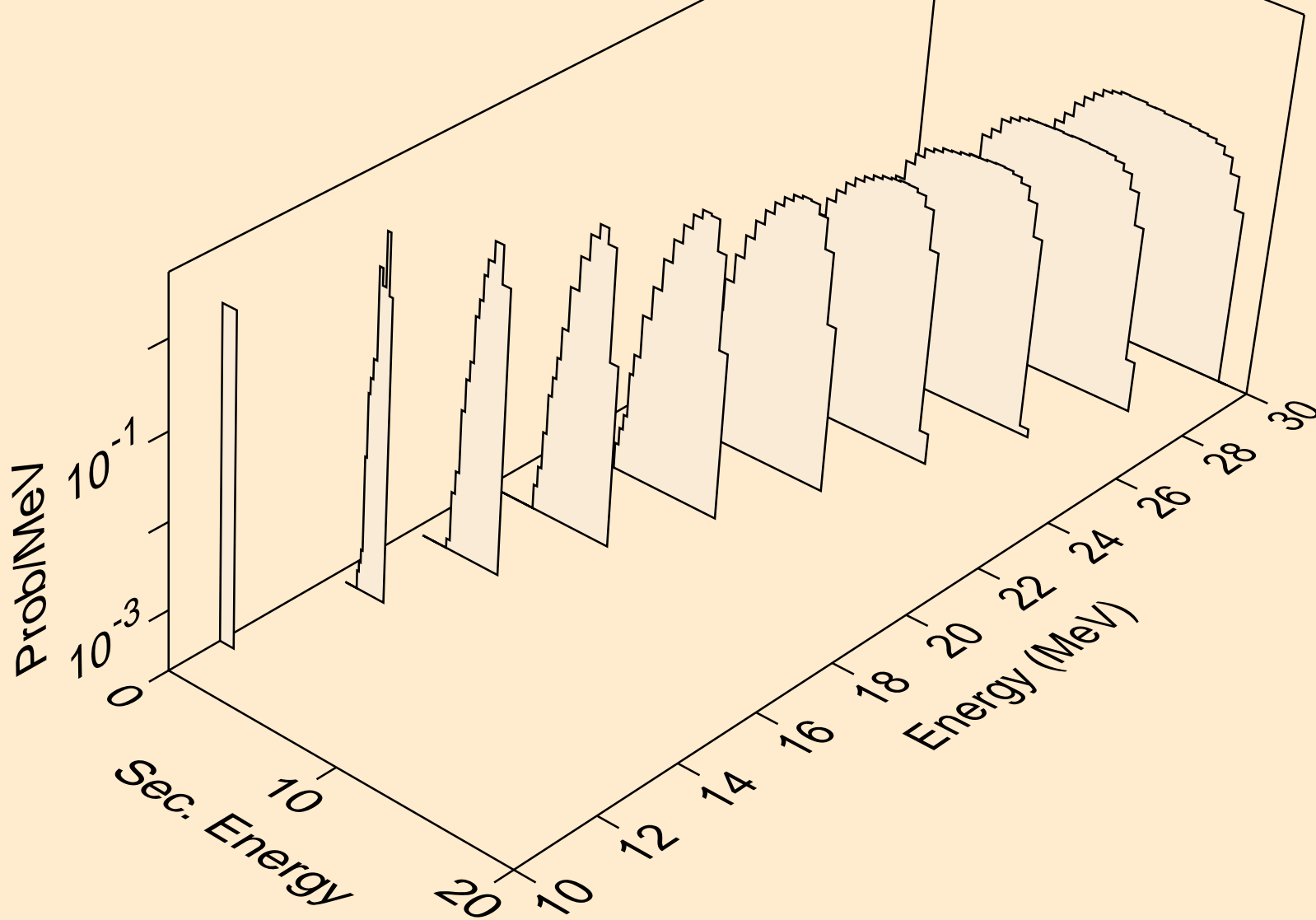

I115 NEUTRON ACER TENDL-2019 LIBRARY; T=293.16K  
deuterons from (n,d)

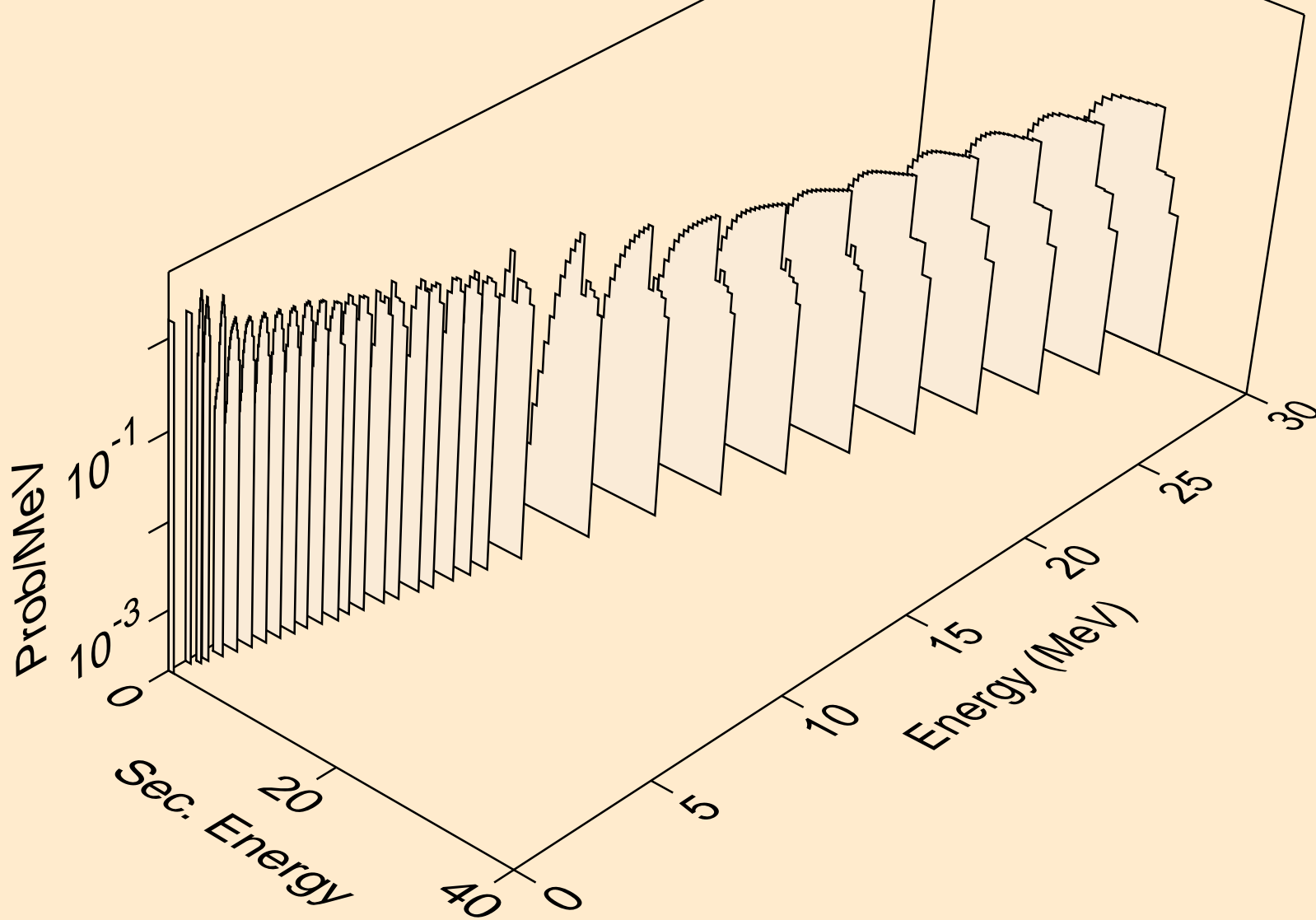

I115 NEUTRON ACER TENDL-2019 LIBRARY; T=293.16K  
deuterons from (n,d2a)

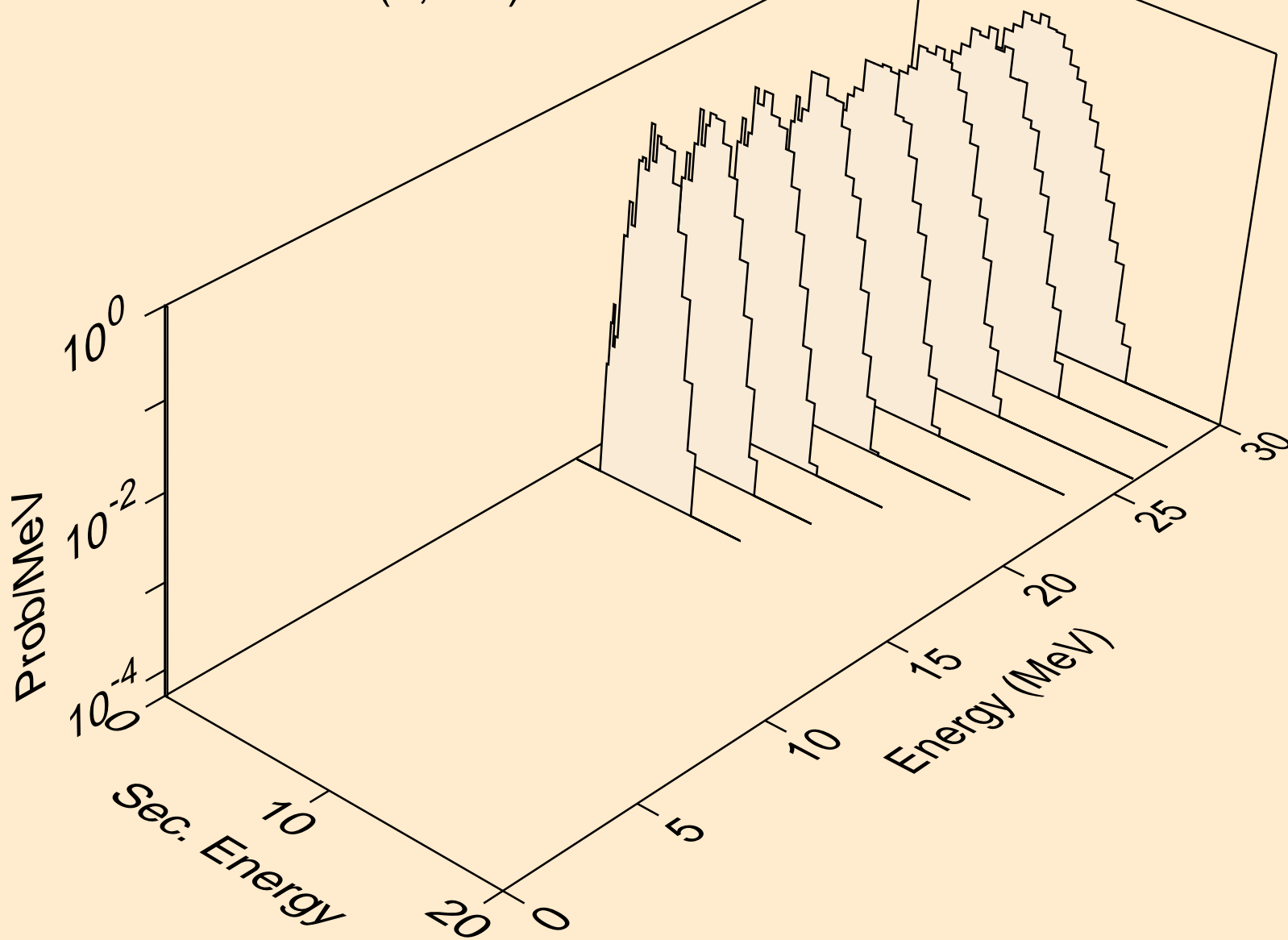



I115 NEUTRON ACER TENDL-2019 LIBRARY; T=293.16K  
deuterons from (n,pd)

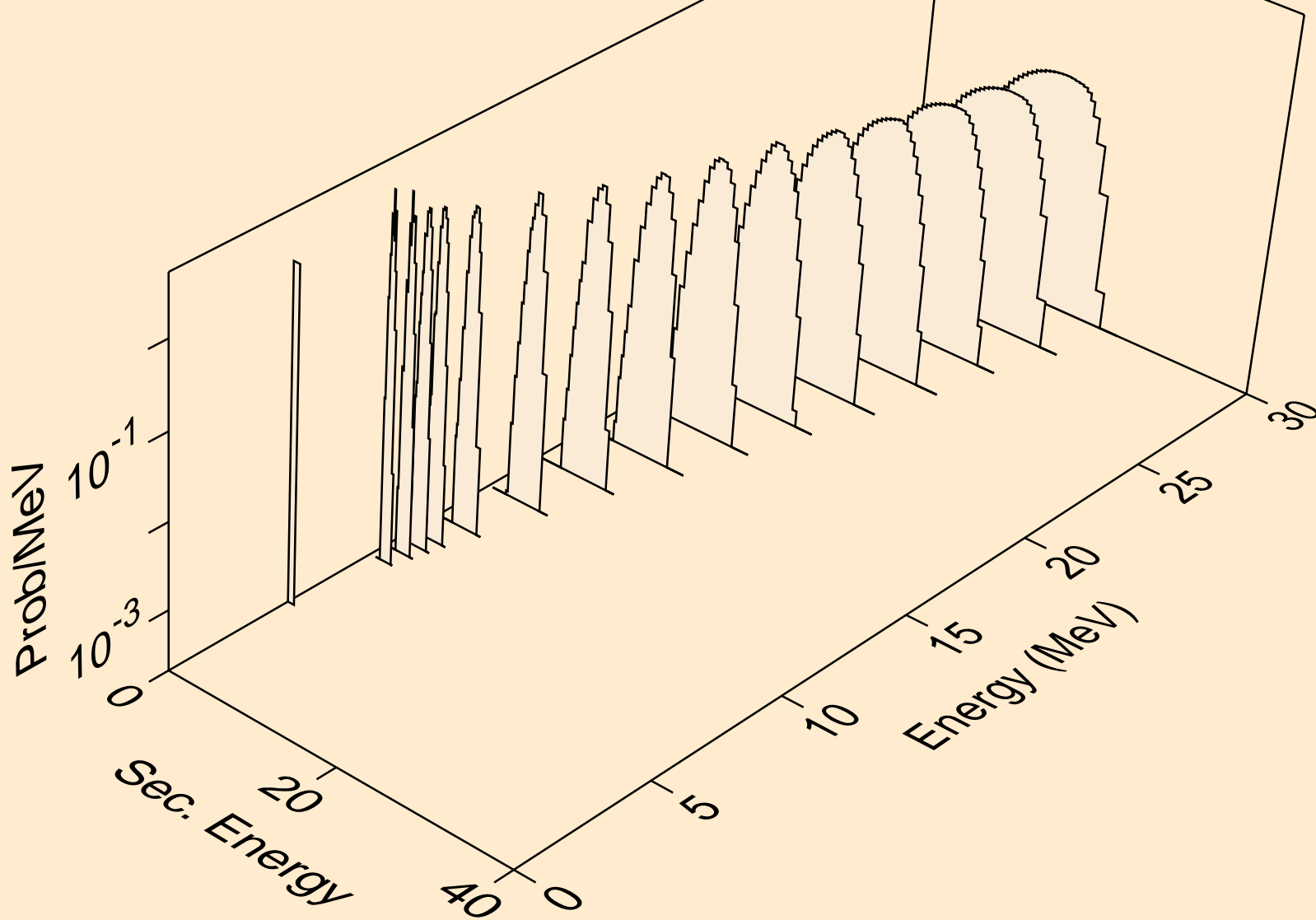

I115 NEUTRON ACER TENDL-2019 LIBRARY; T=293.16K  
deuterons from (n,da)

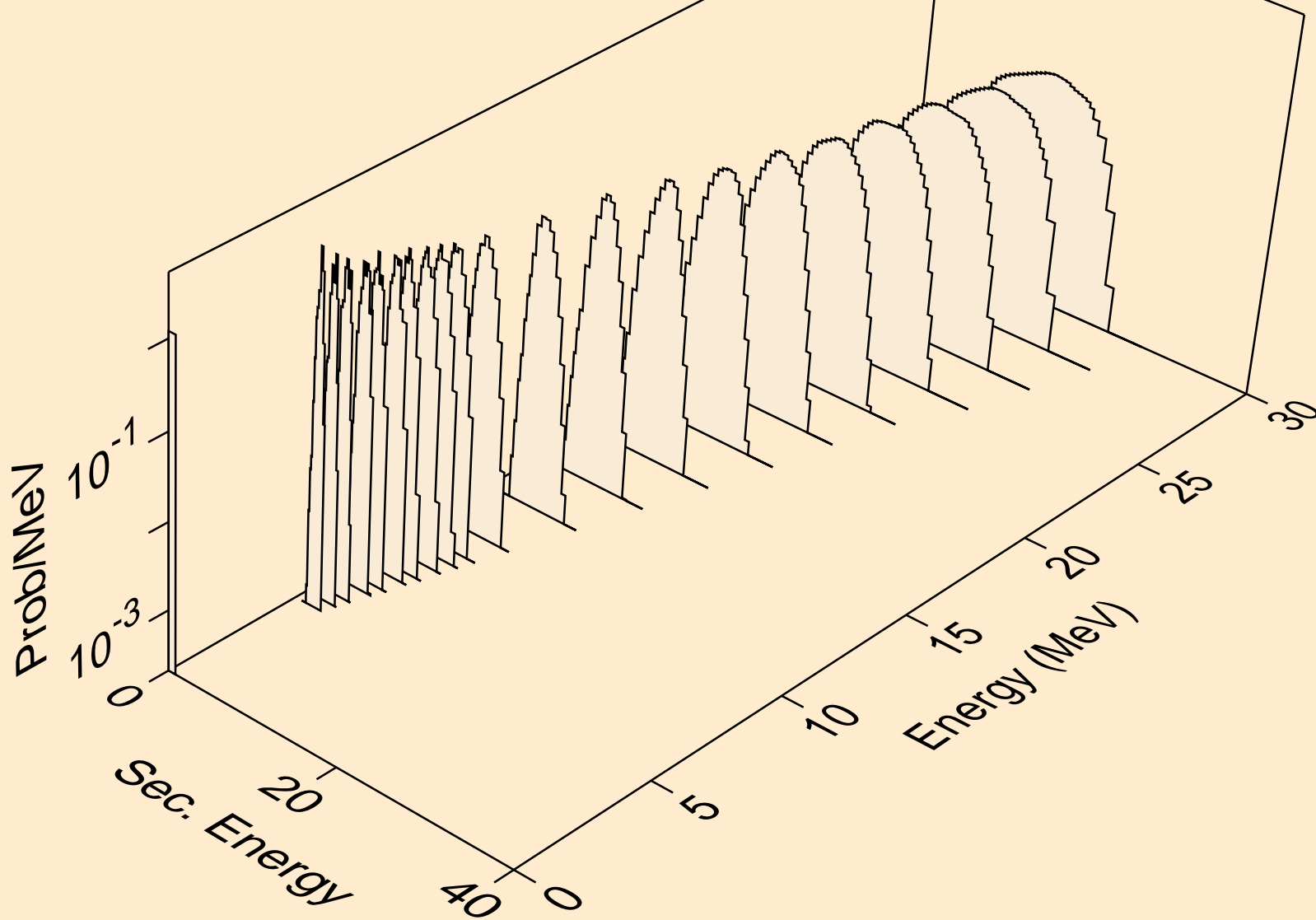

I115 NEUTRON ACER TENDL-2019 LIBRARY; T=293.16K  
tritons from (n,x)

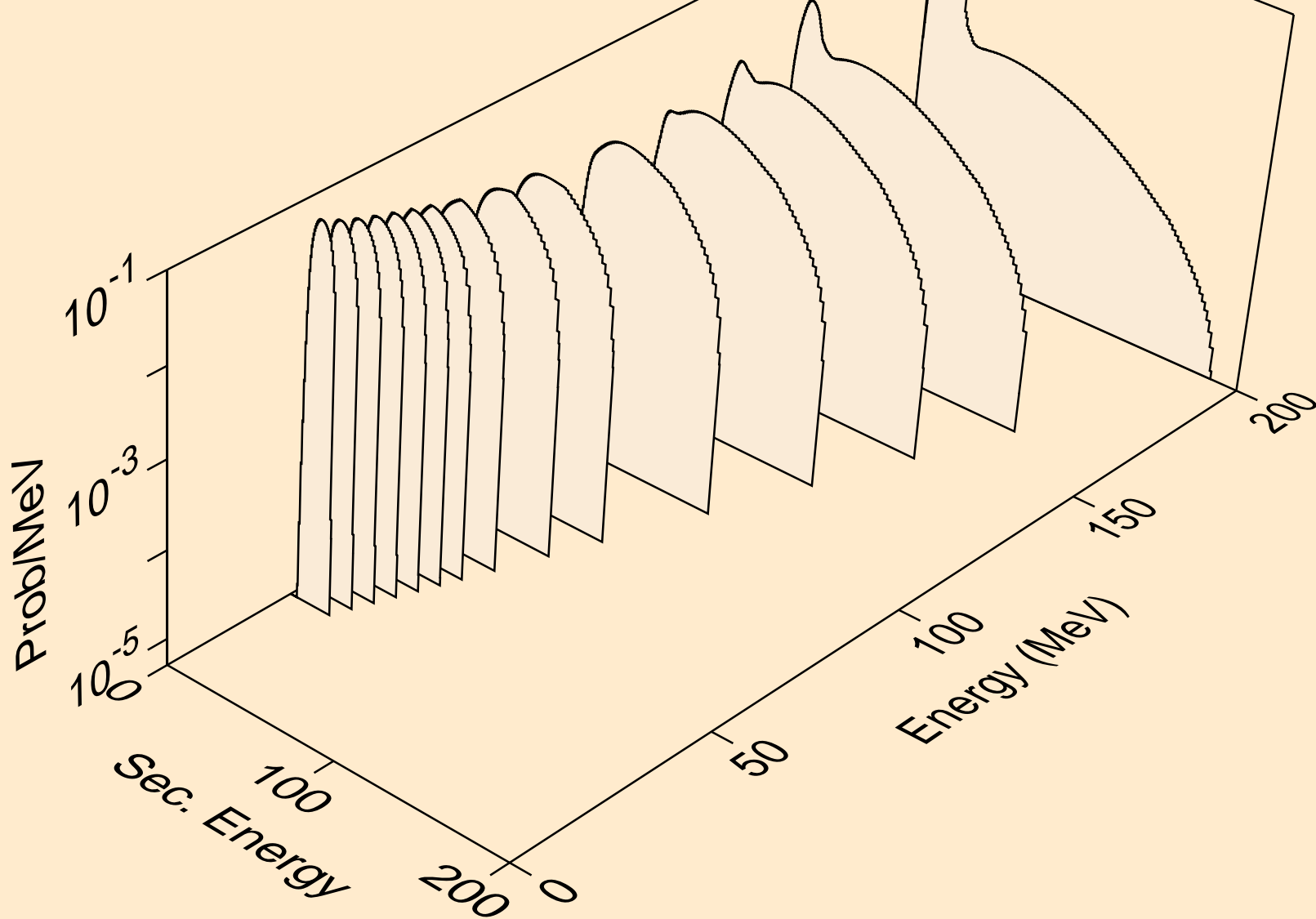

I115 NEUTRON ACER TENDL-2019 LIBRARY; T=293.16K  
tritons from (n,n\*)t

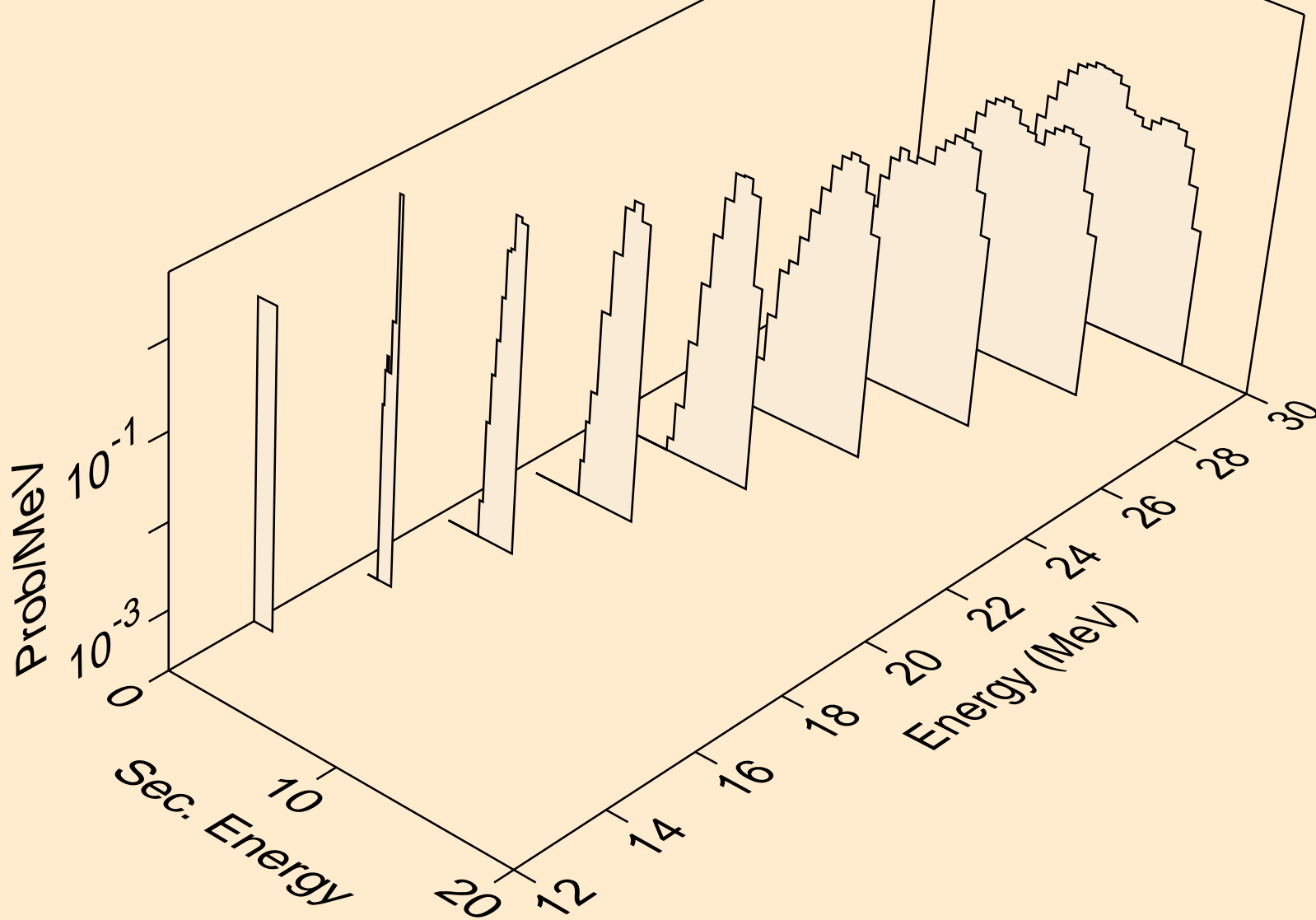

I115 NEUTRON ACER TENDL-2019 LIBRARY; T=293.16K  
tritons from (n,t)

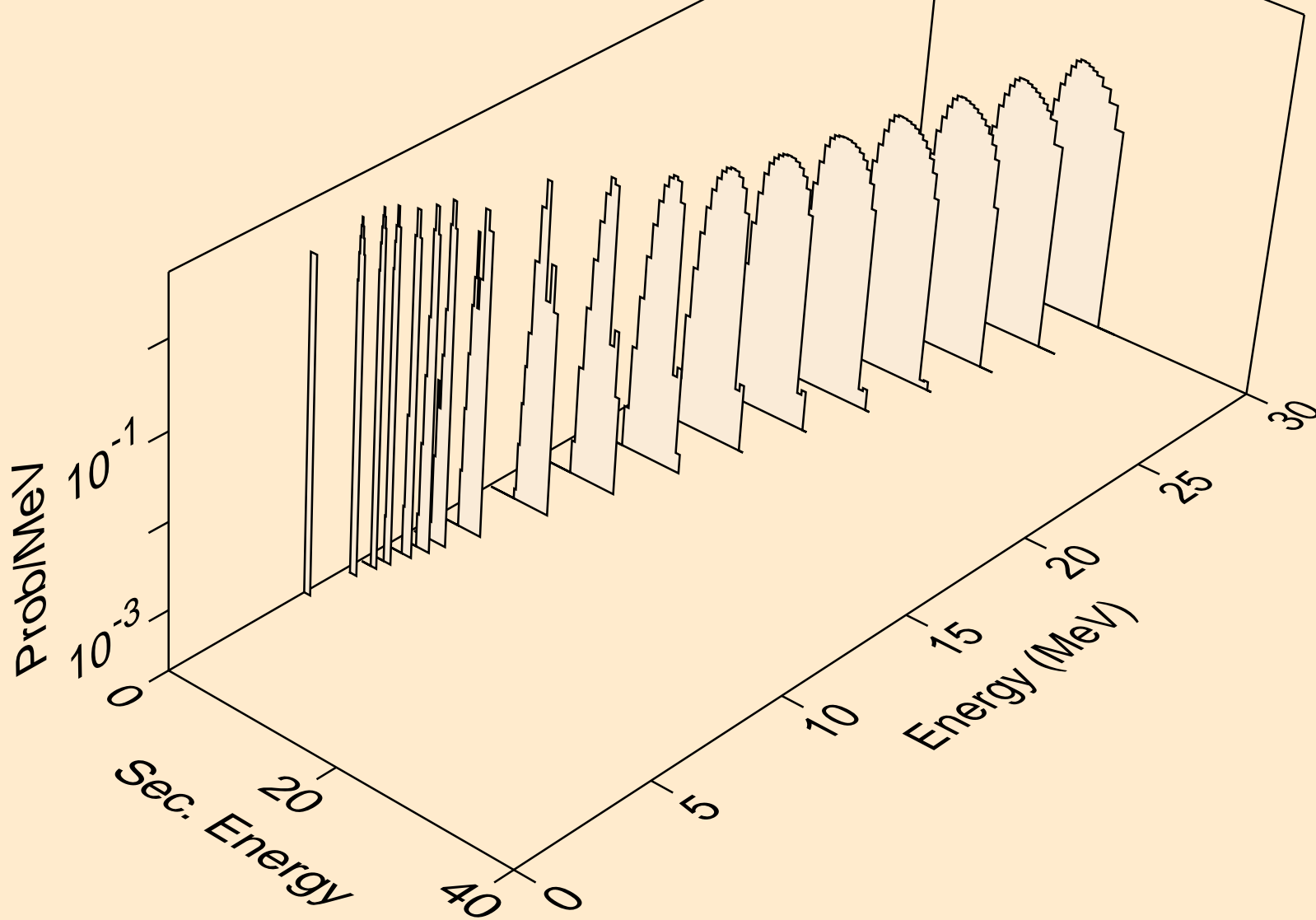

I115 NEUTRON ACER TENDL-2019 LIBRARY; T=293.16K  
tritons from (n,pt)

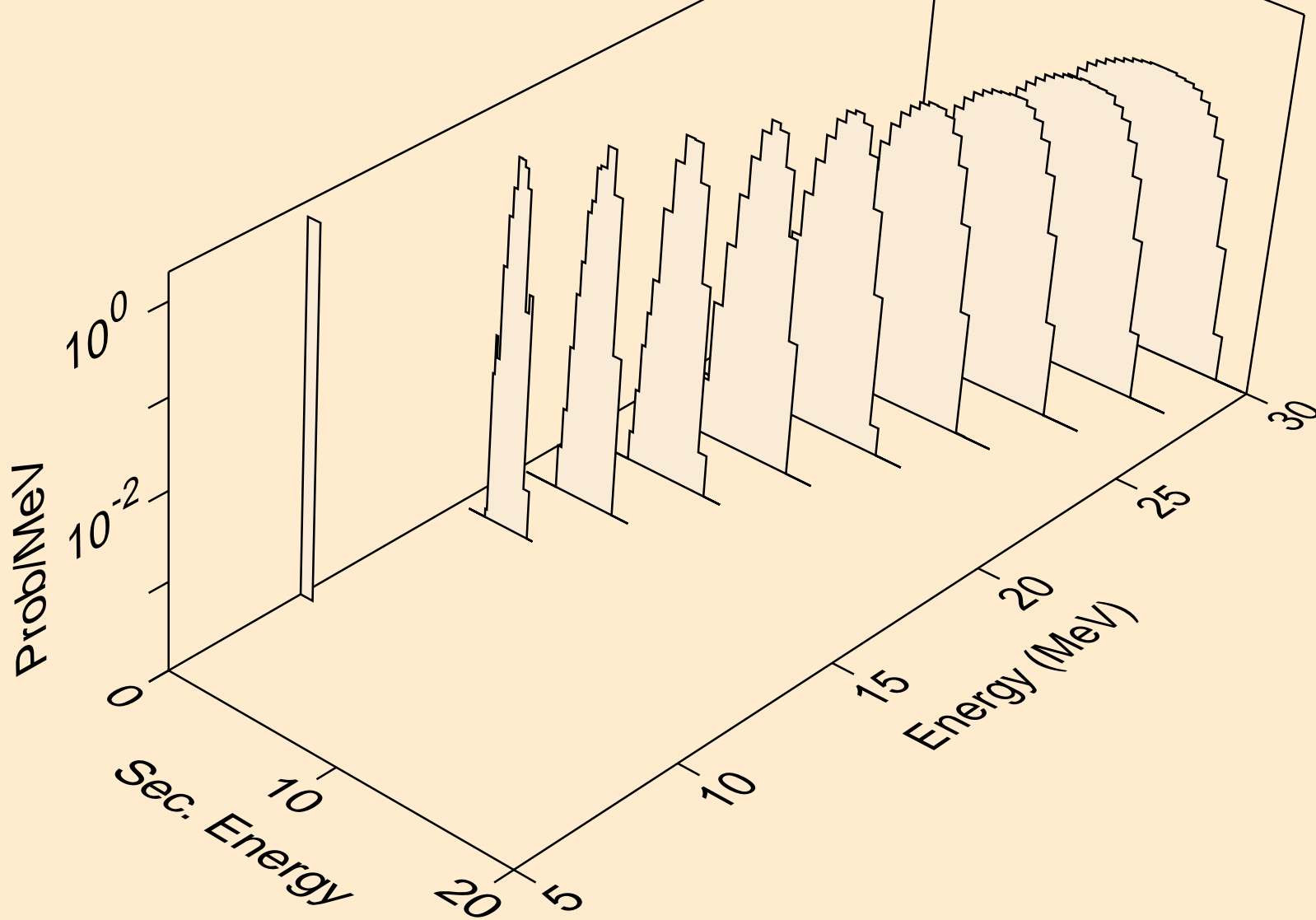

I115 NEUTRON ACER TENDL-2019 LIBRARY; T=293.16K  
he3s from (n,x)

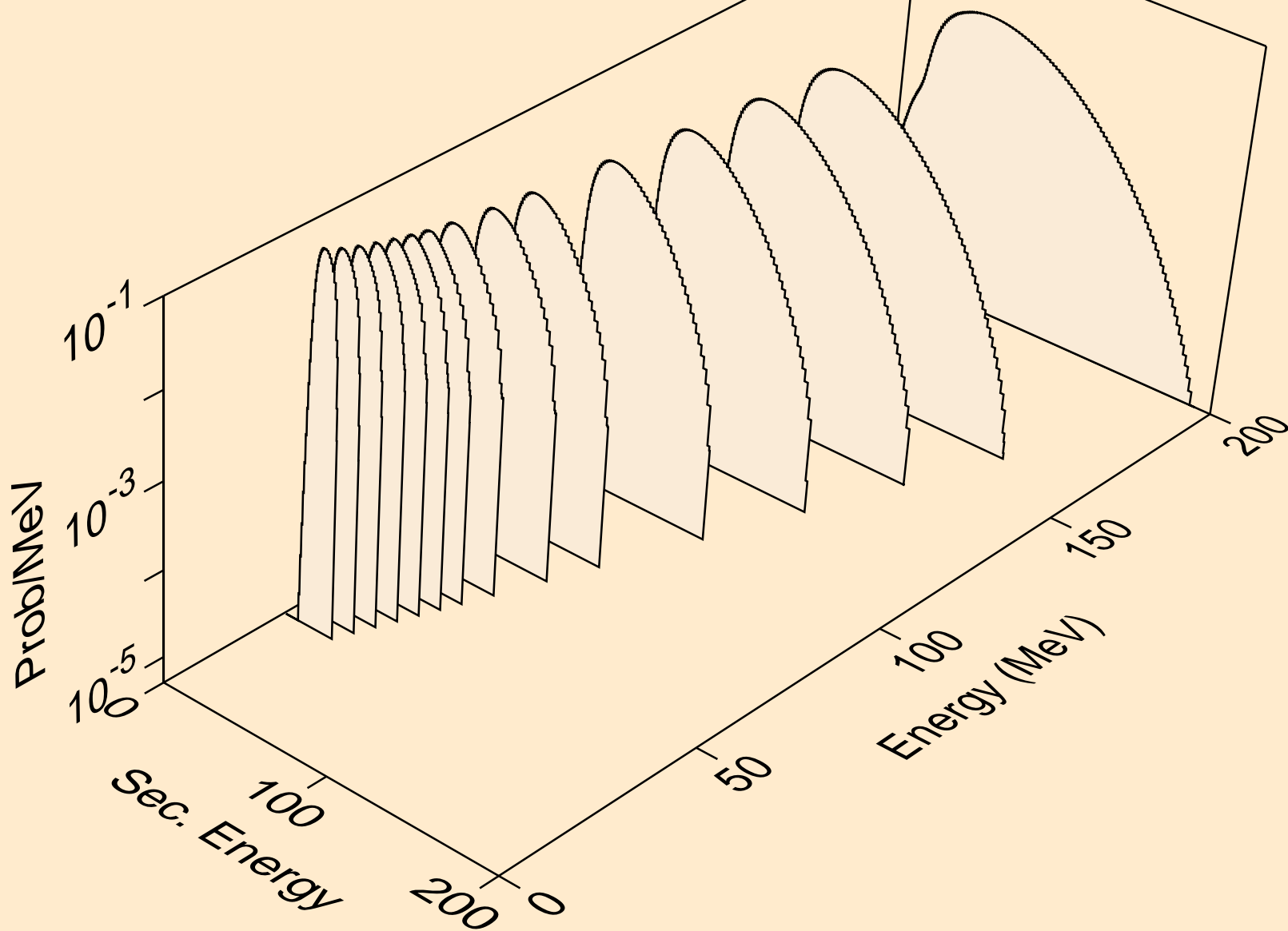

I115 NEUTRON ACER TENDL-2019 LIBRARY; T=293.16K  
he3s from (n,n\*)he3

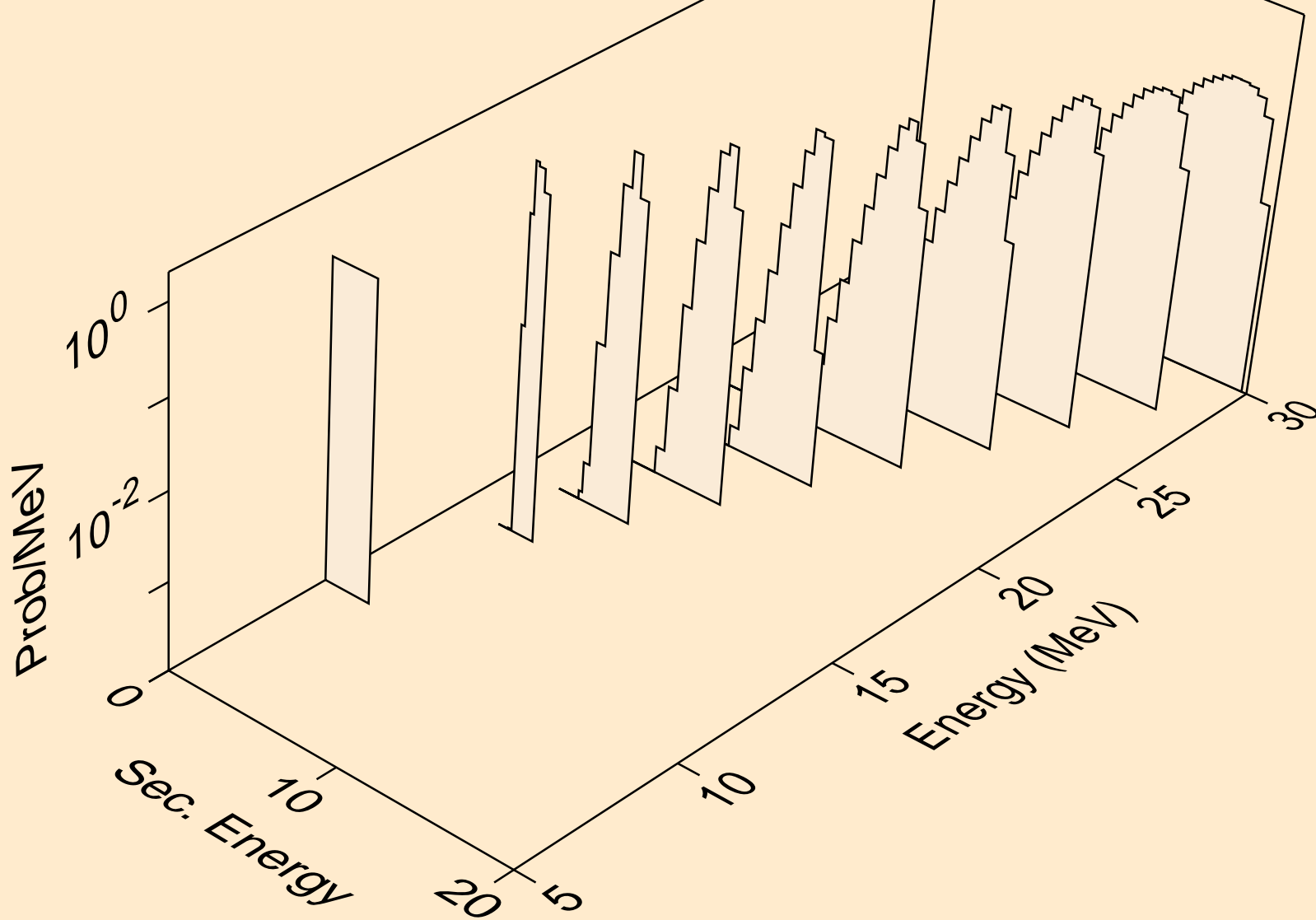



I115 NEUTRON ACER TENDL-2019 LIBRARY; T=293.16K  
he3s from (n,he3)

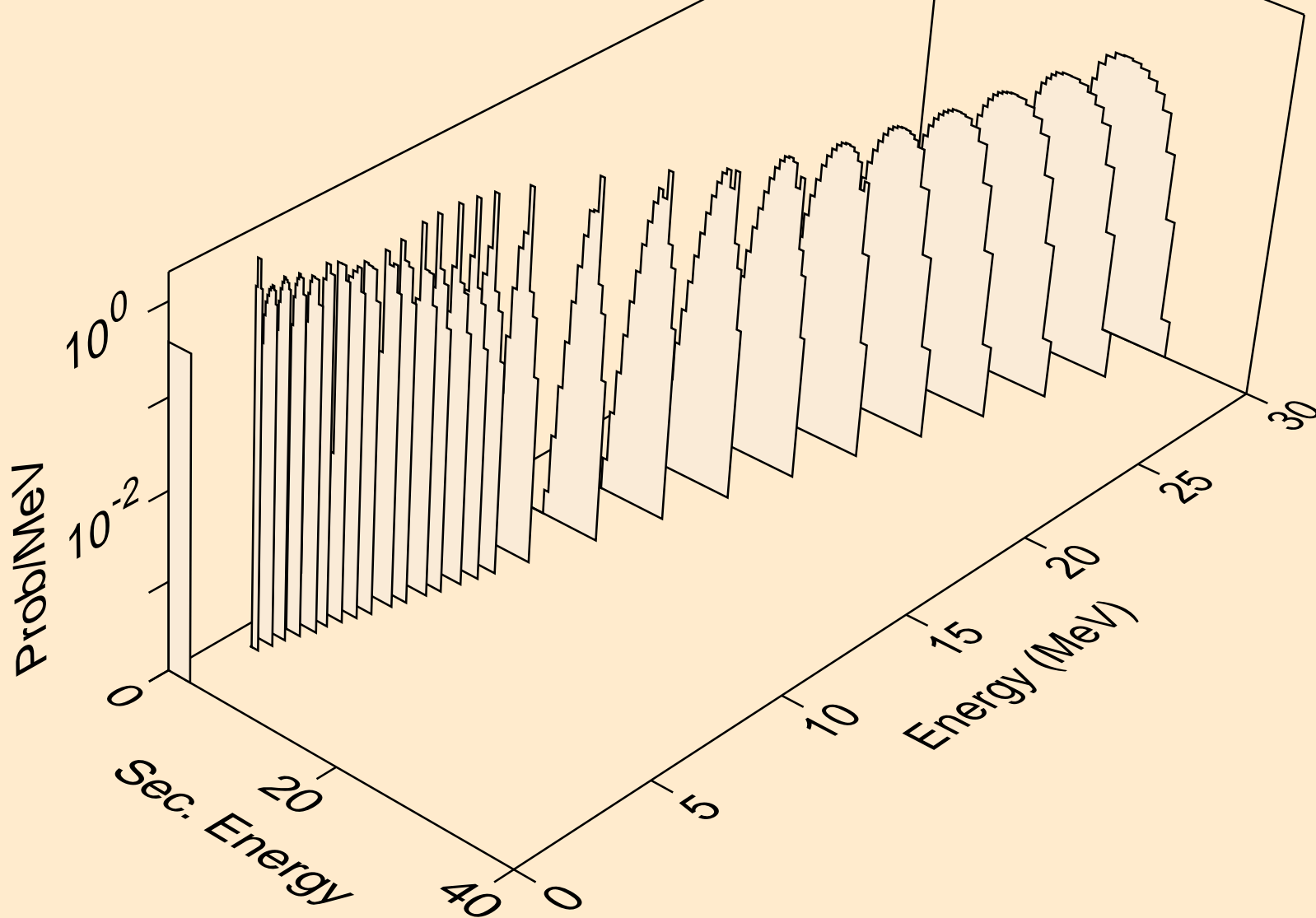

I115 NEUTRON ACER TENDL-2019 LIBRARY; T=293.16K  
alphas from (n,x)

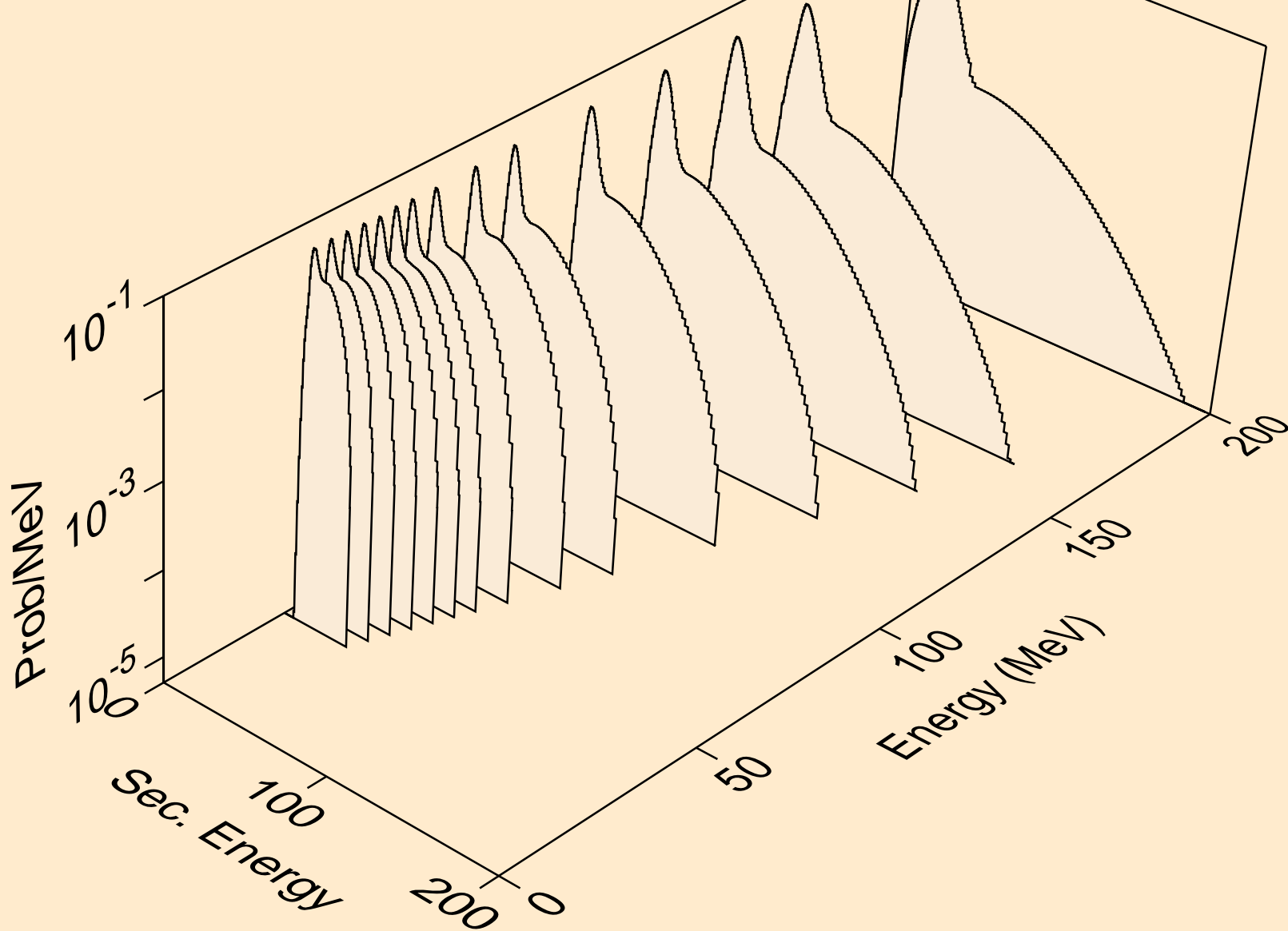

I115 NEUTRON ACER TENDL-2019 LIBRARY; T=293.16K  
alphas from (n,n\*)a

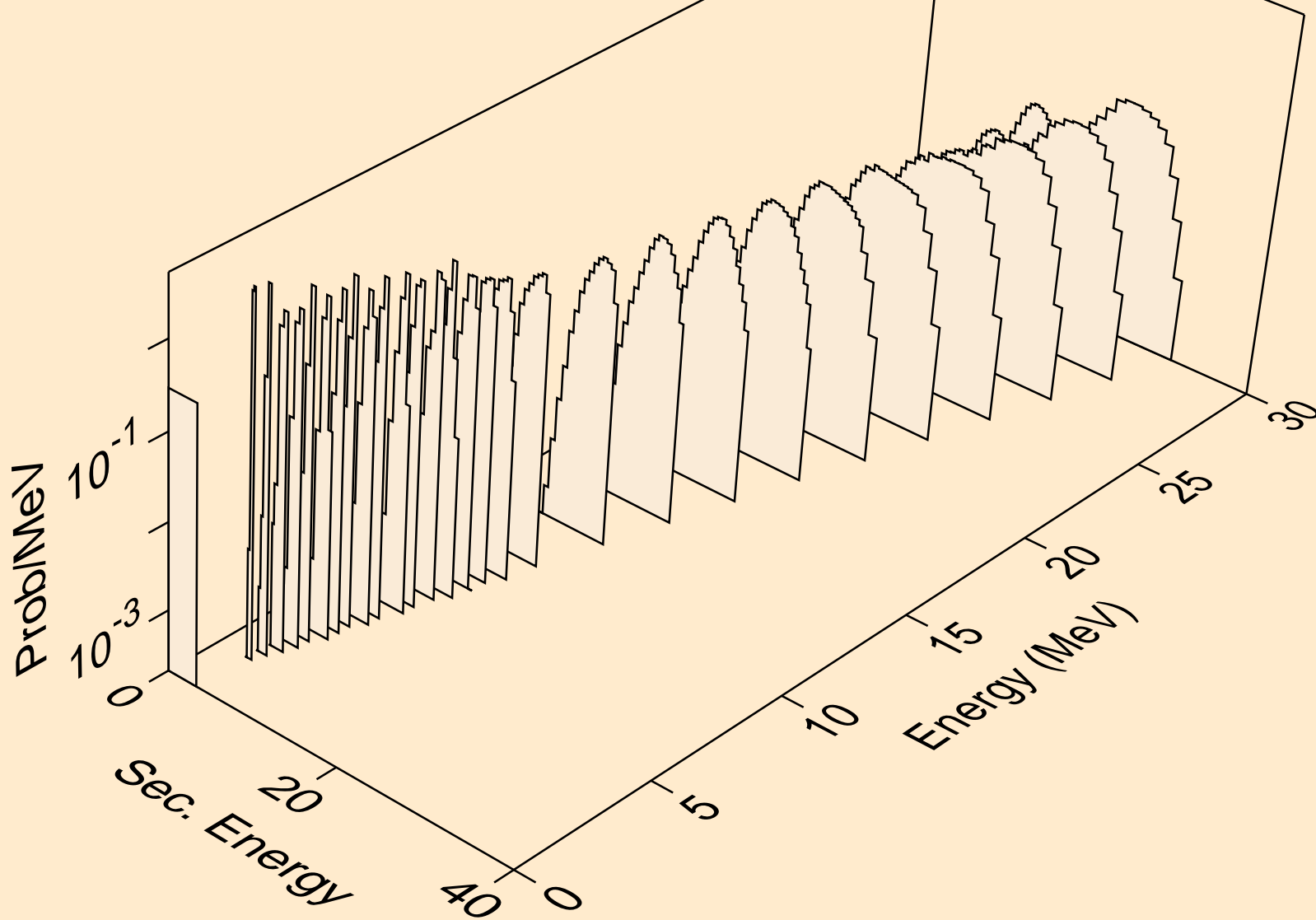

I115 NEUTRON ACER TENDL-2019 LIBRARY; T=293.16K  
alphas from (n,2n)a

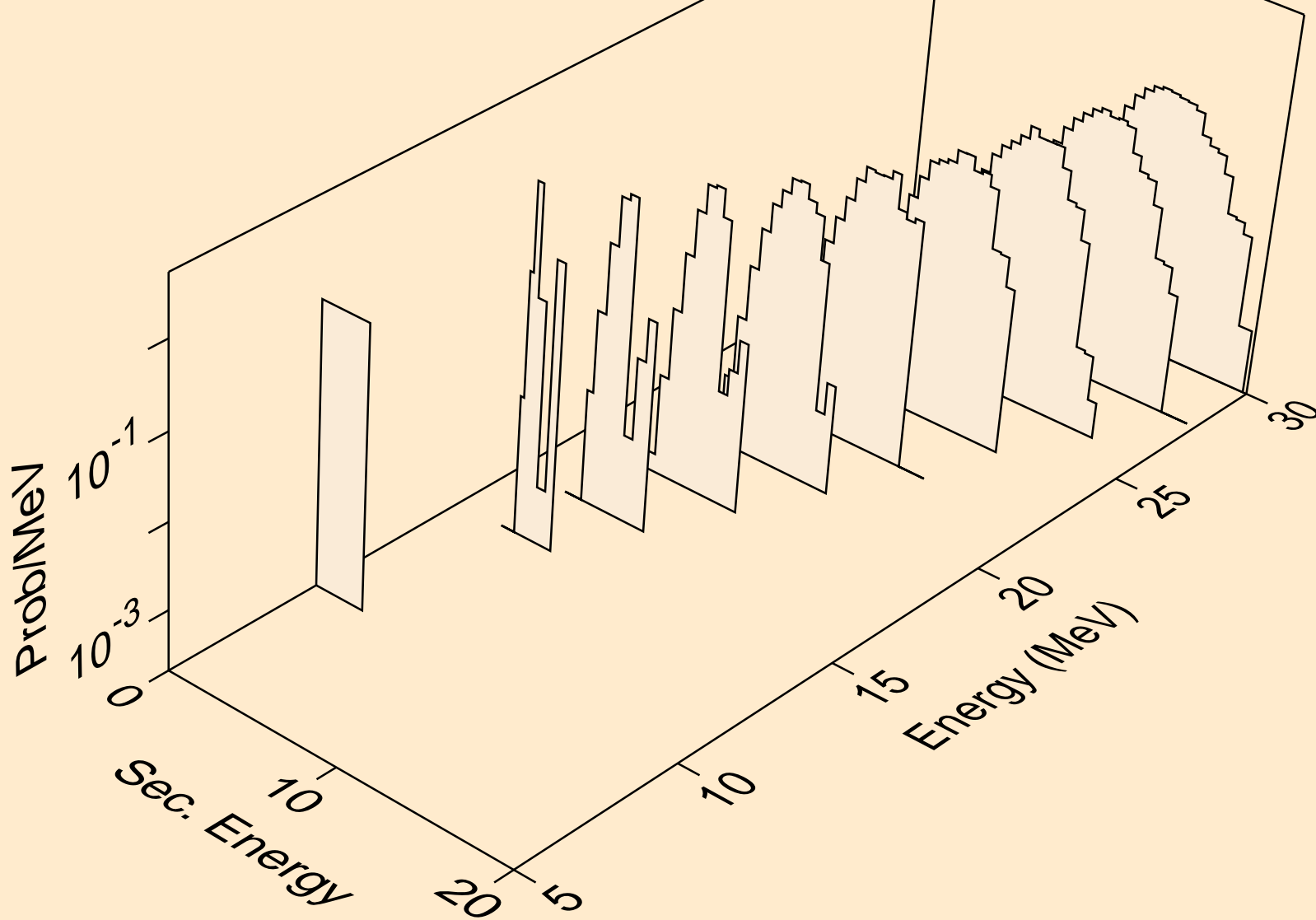

I115 NEUTRON ACER TENDL-2019 LIBRARY; T=293.16K  
alphas from (n,3n)a

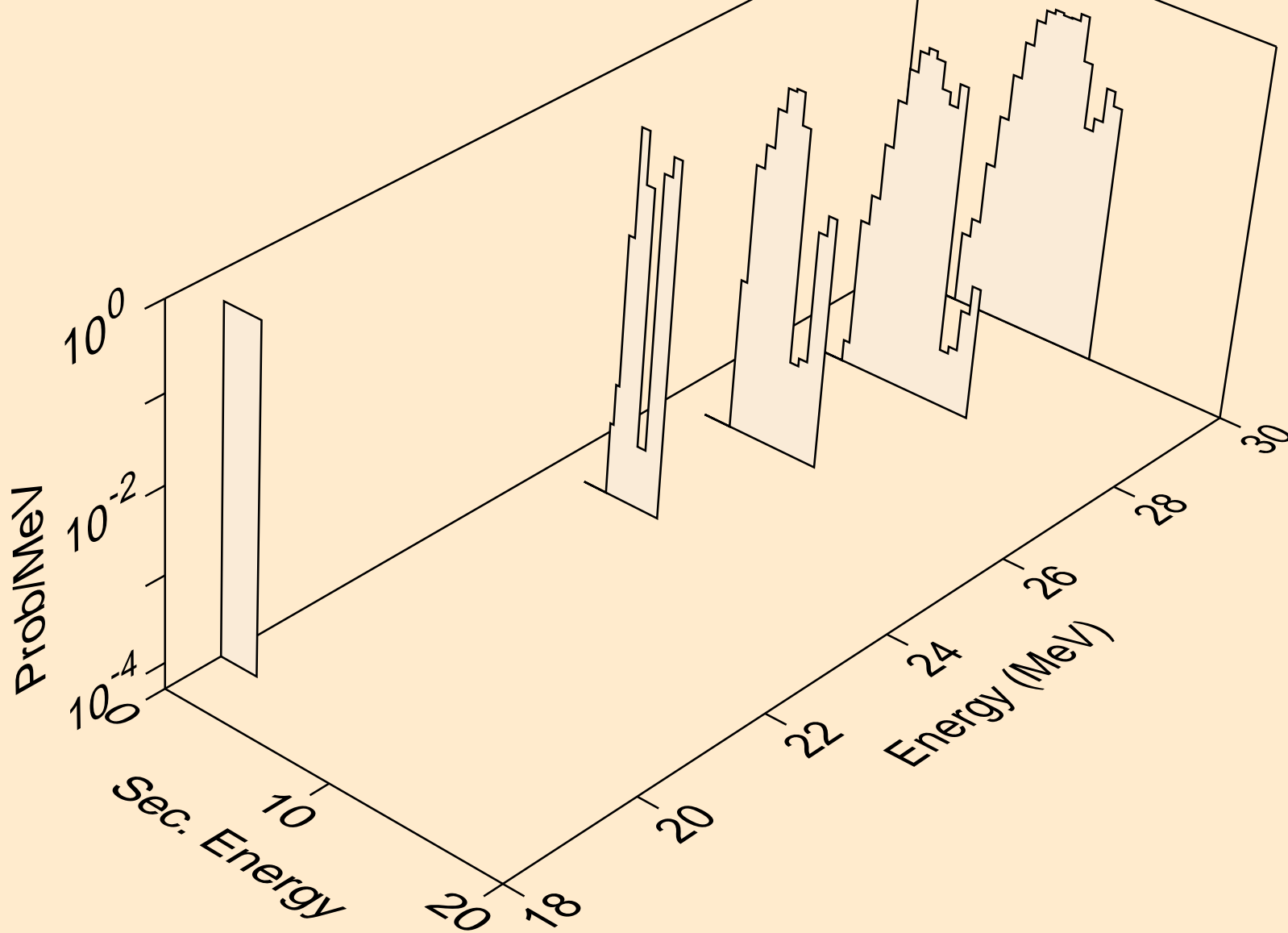

I115 NEUTRON ACER TENDL-2019 LIBRARY; T=293.16K  
alphas from (n,n\*)2a

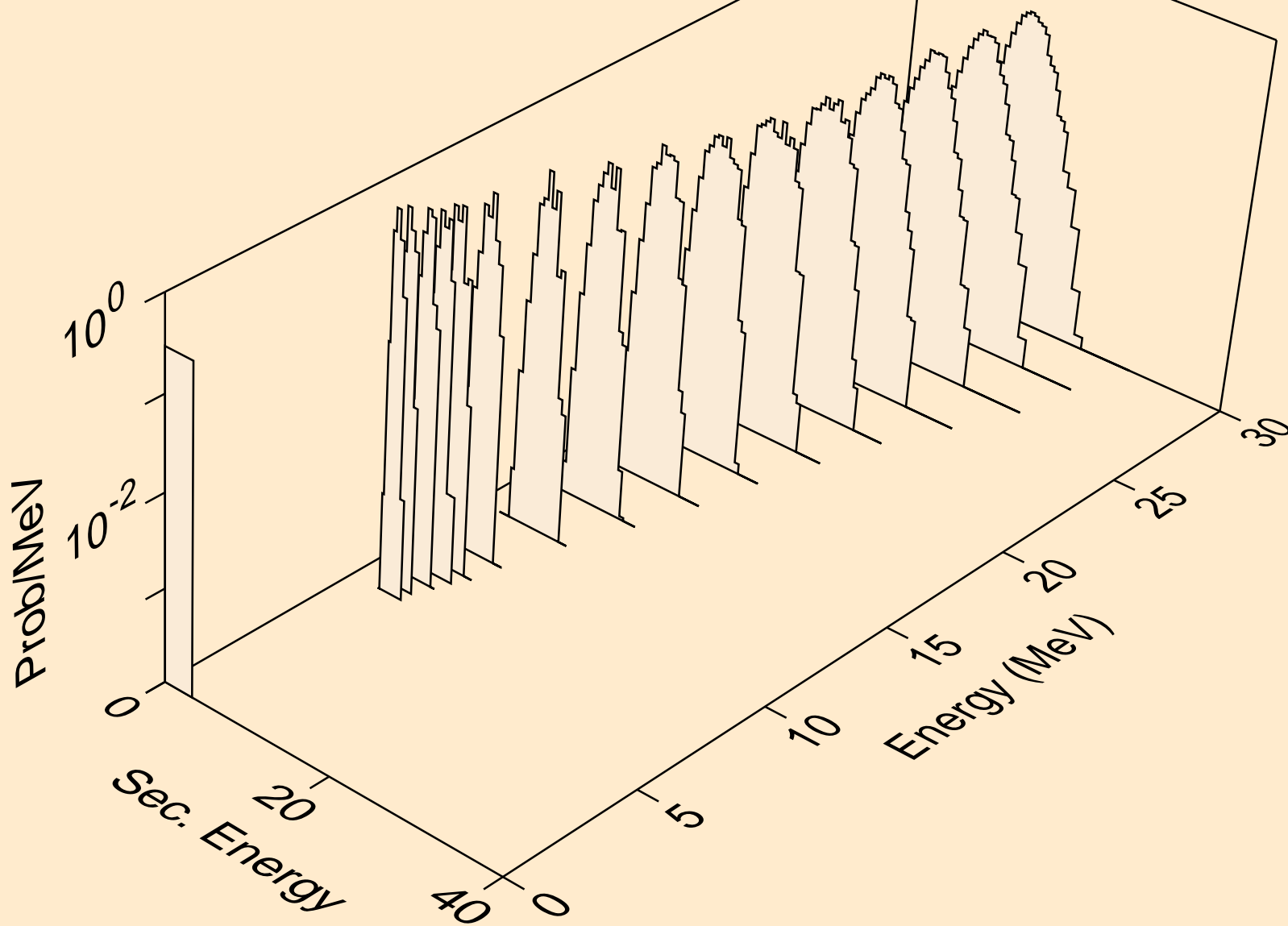

I115 NEUTRON ACER TENDL-2019 LIBRARY; T=293.16K  
alphas from (n,2n)2a

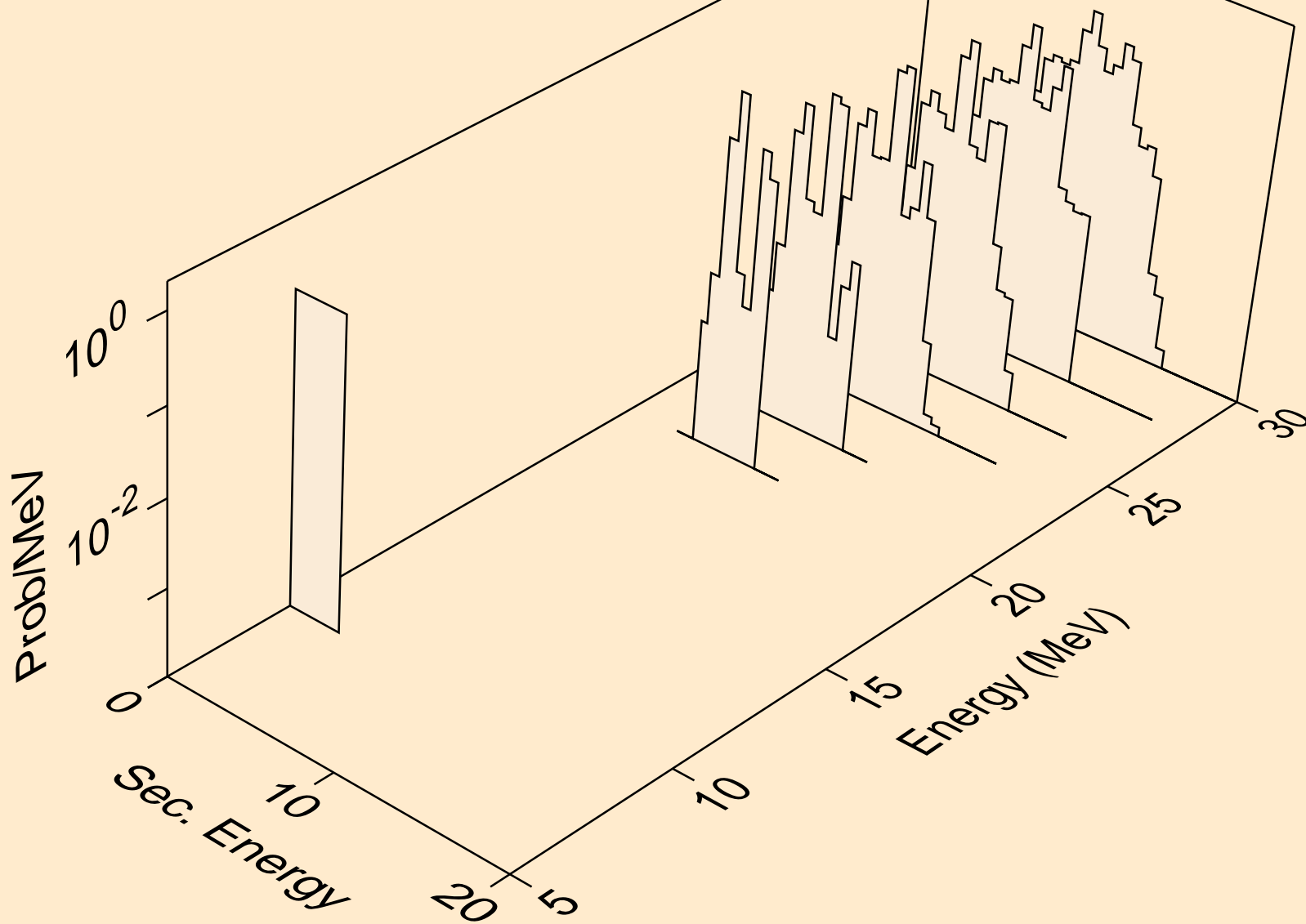

I115 NEUTRON ACER TENDL-2019 LIBRARY; T=293.16K  
alphas from (n,npa)

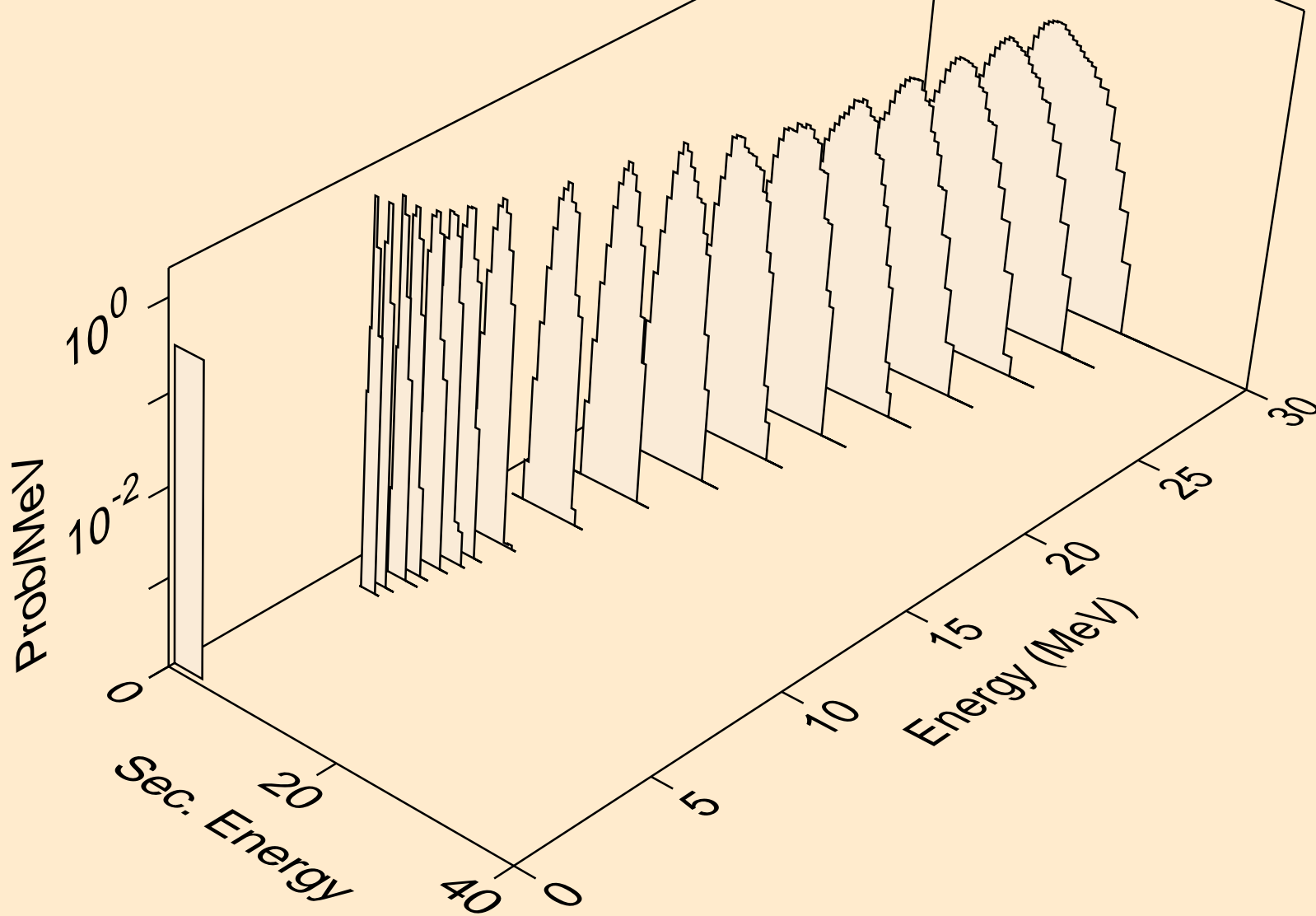



I115 NEUTRON ACER TENDL-2019 LIBRARY; T=293.16K  
alphas from (n,a)

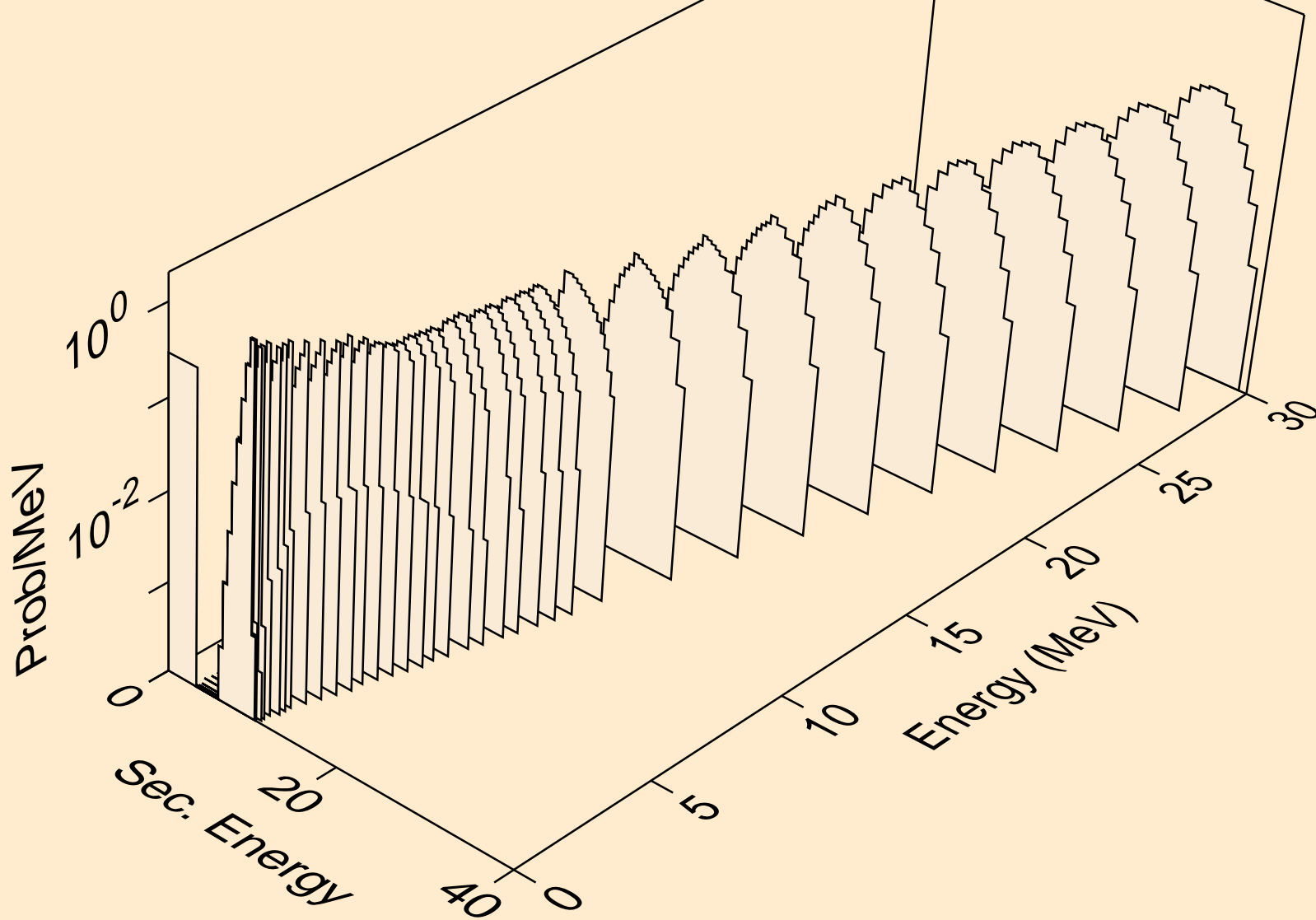

I115 NEUTRON ACER TENDL-2019 LIBRARY; T=293.16K  
alphas from (n,2a)

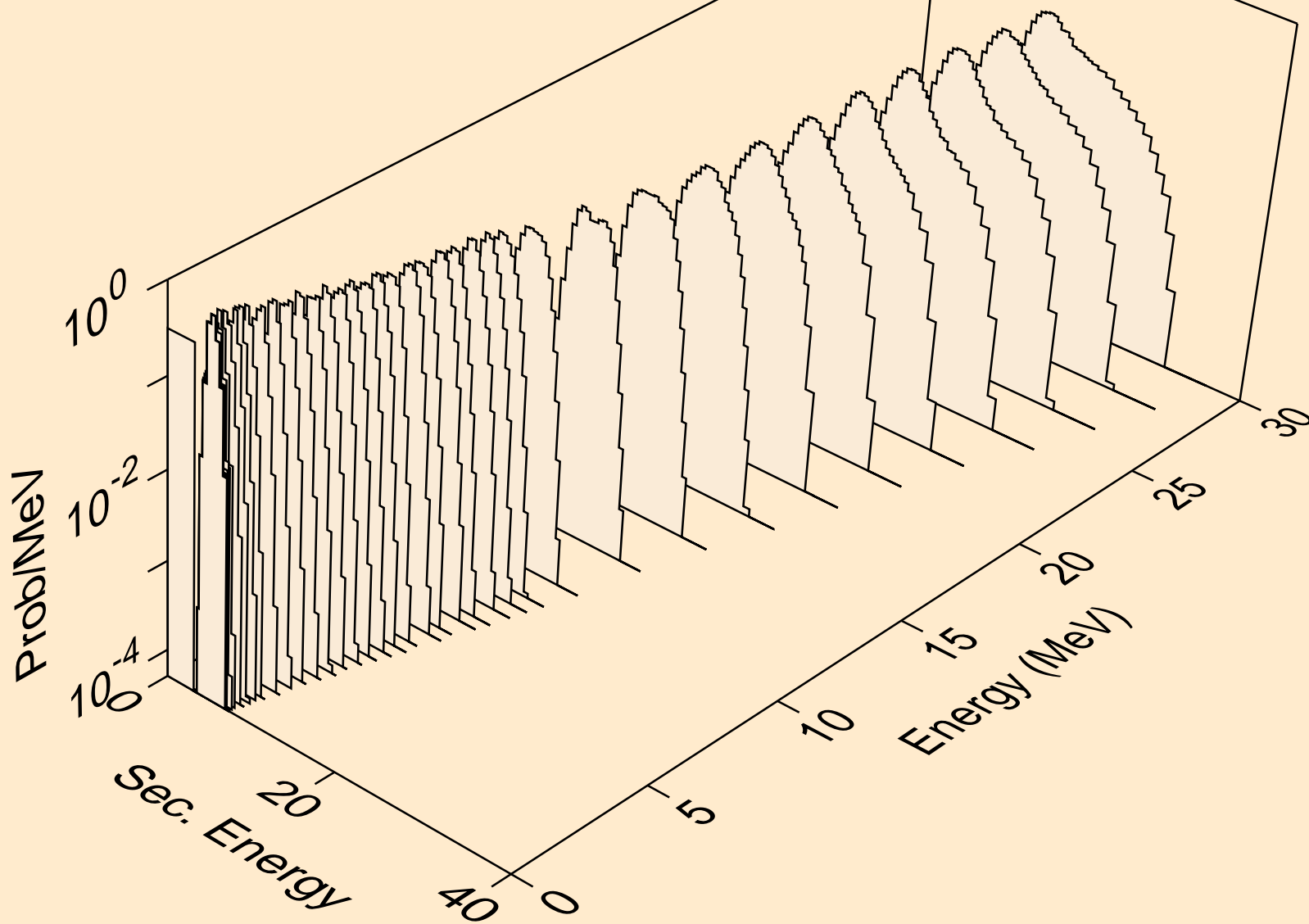

I115 NEUTRON ACER TENDL-2019 LIBRARY; T=293.16K  
alphas from (n,3a)

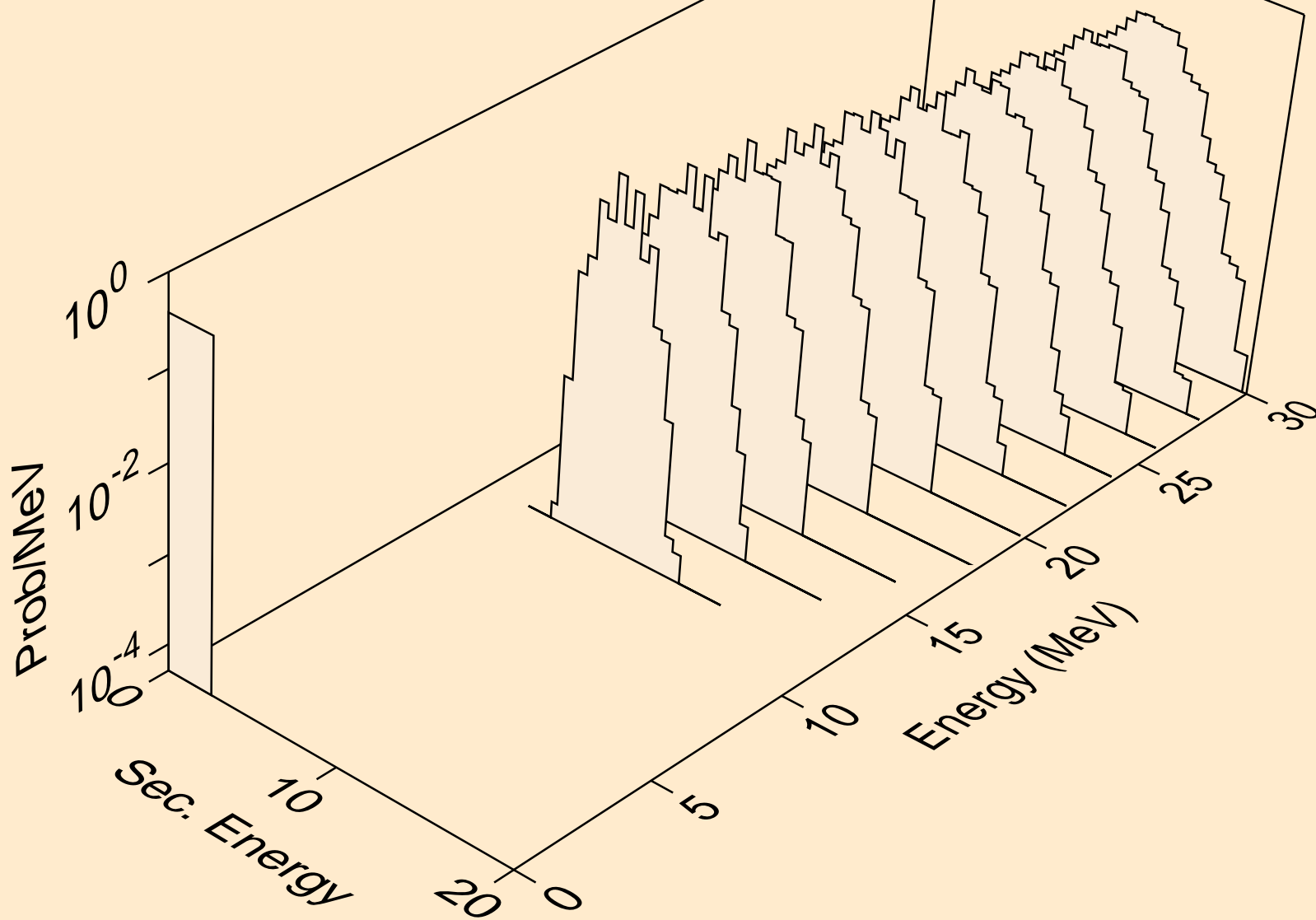

I115 NEUTRON ACER TENDL-2019 LIBRARY; T=293.16K  
alphas from (n,pa)

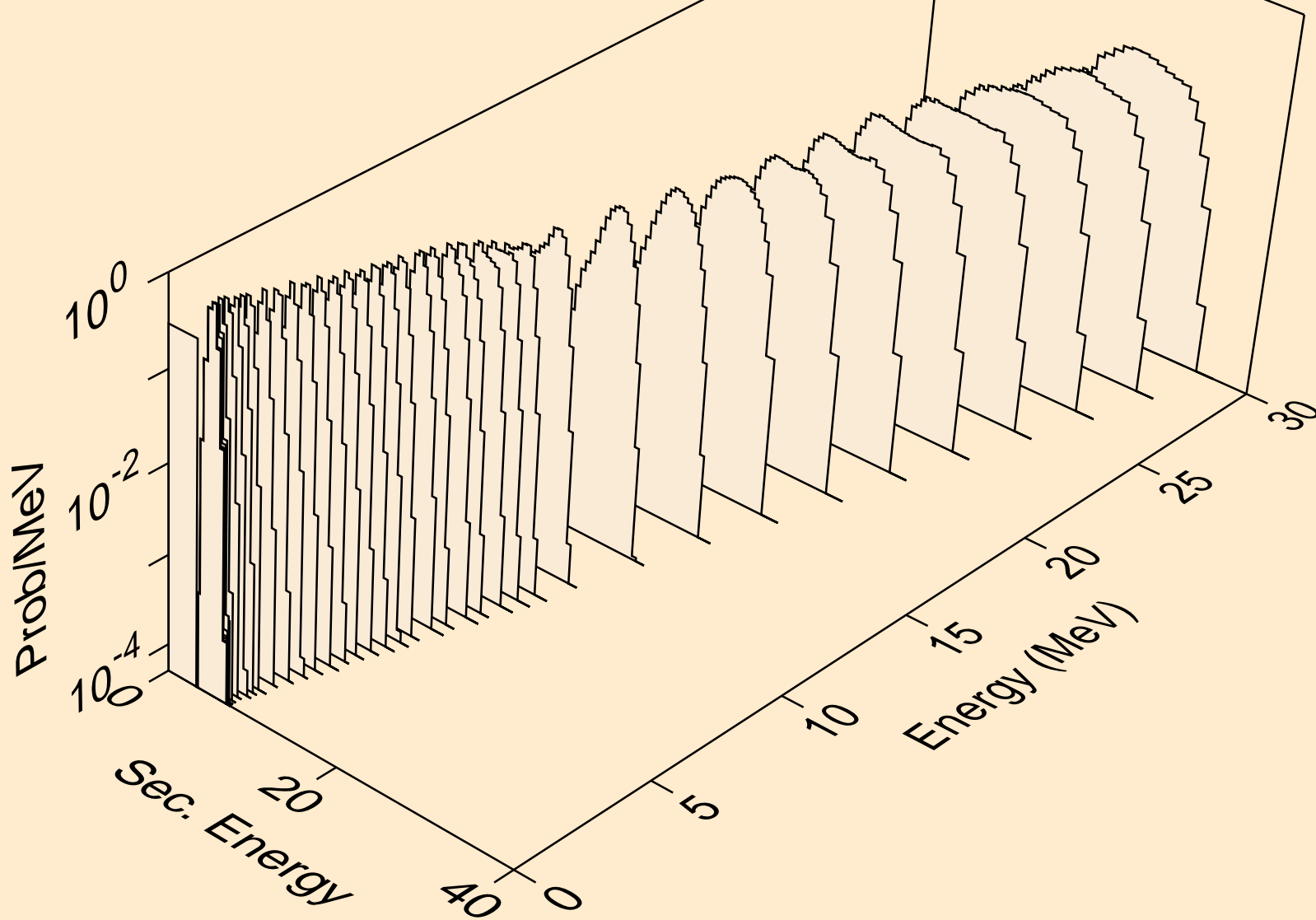

I115 NEUTRON ACER TENDL-2019 LIBRARY; T=293.16K  
alphas from (n,d2a)

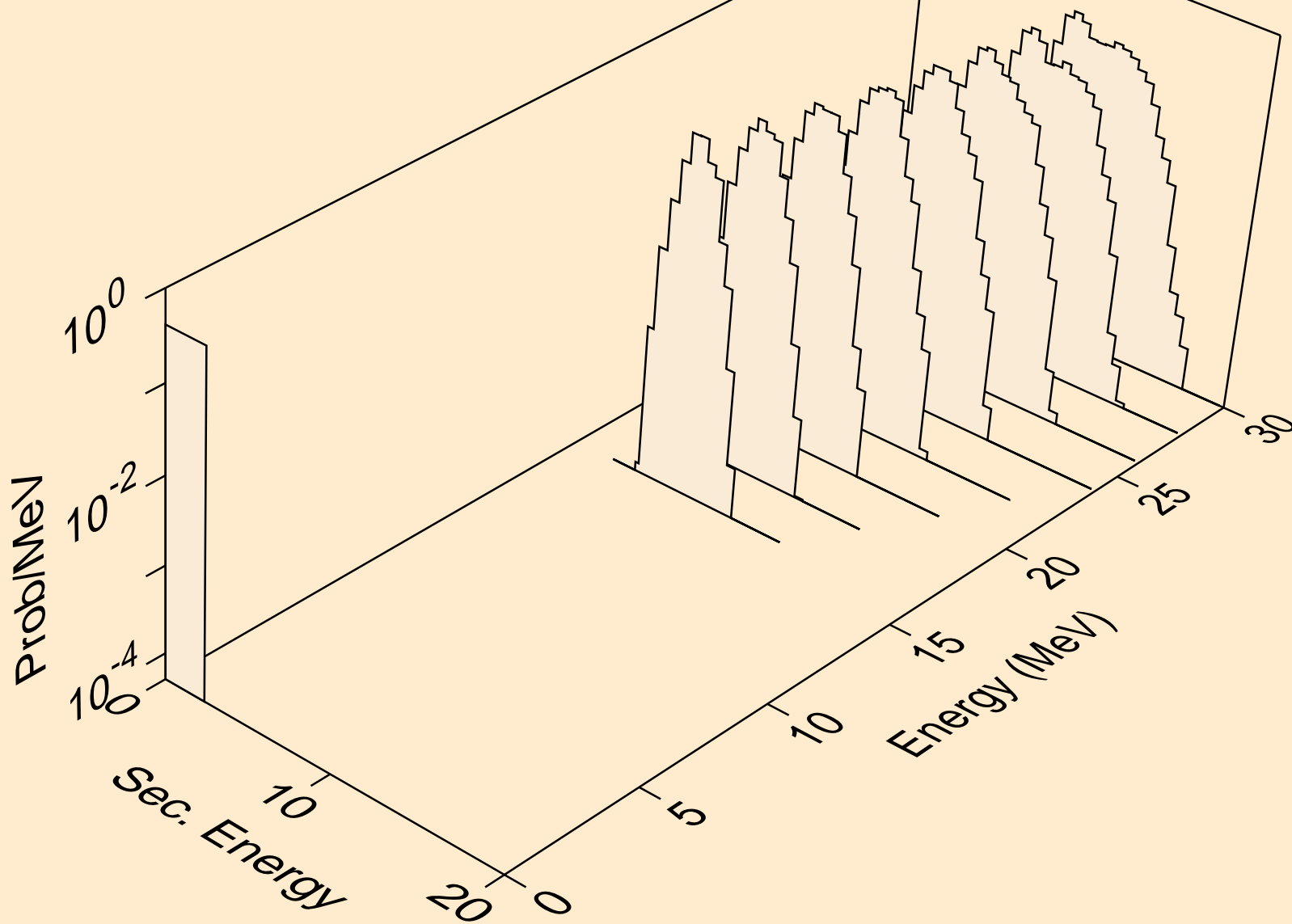

I115 NEUTRON ACER TENDL-2019 LIBRARY; T=293.16K  
alphas from (n,da)

