

I123 NEUTRON ACER TENDL-2019 LIBRARY; T=293.16K

Principal cross sections

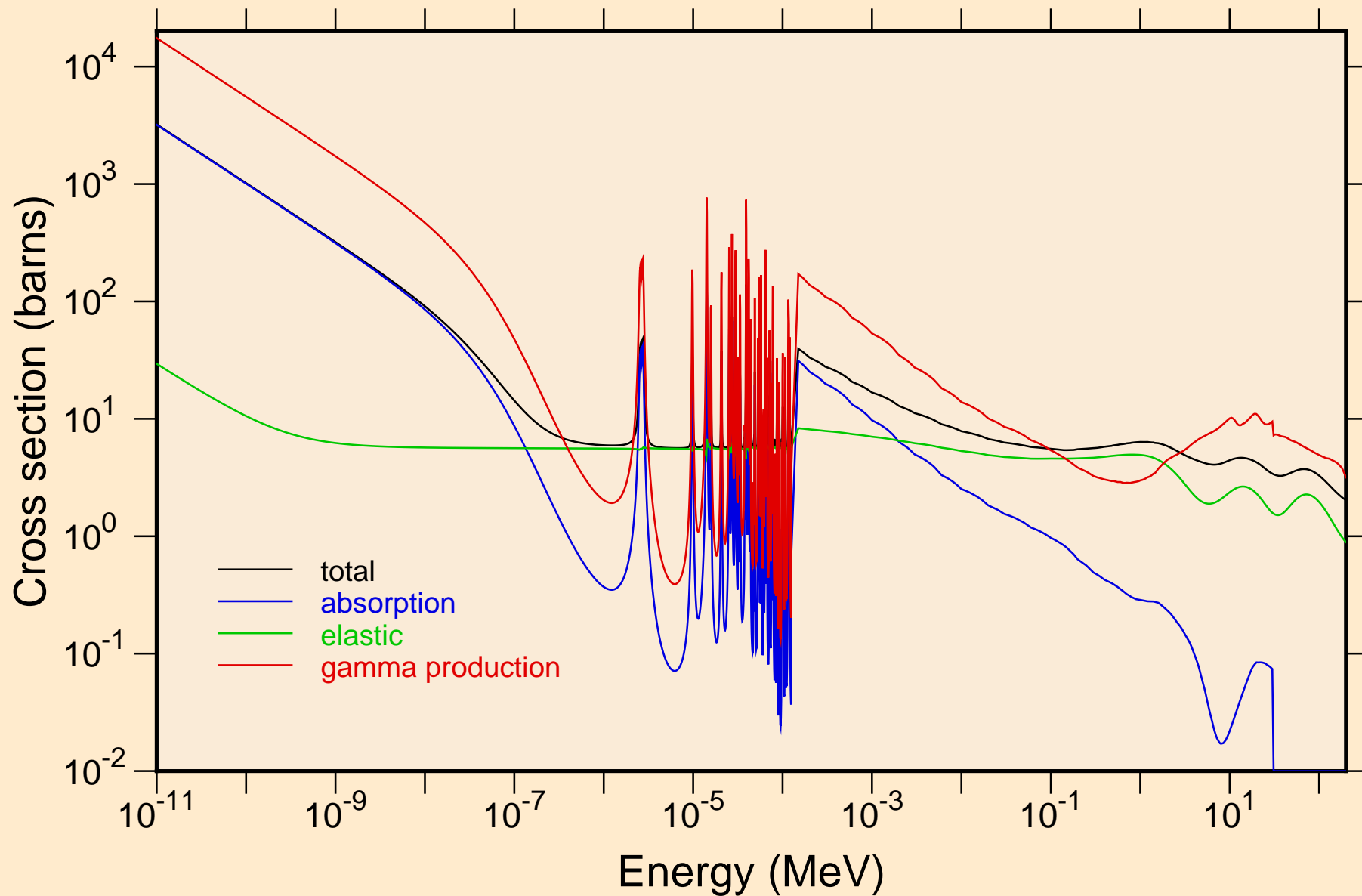

I123 NEUTRON ACER TENDL-2019 LIBRARY; T=293.16K
resonance total cross section

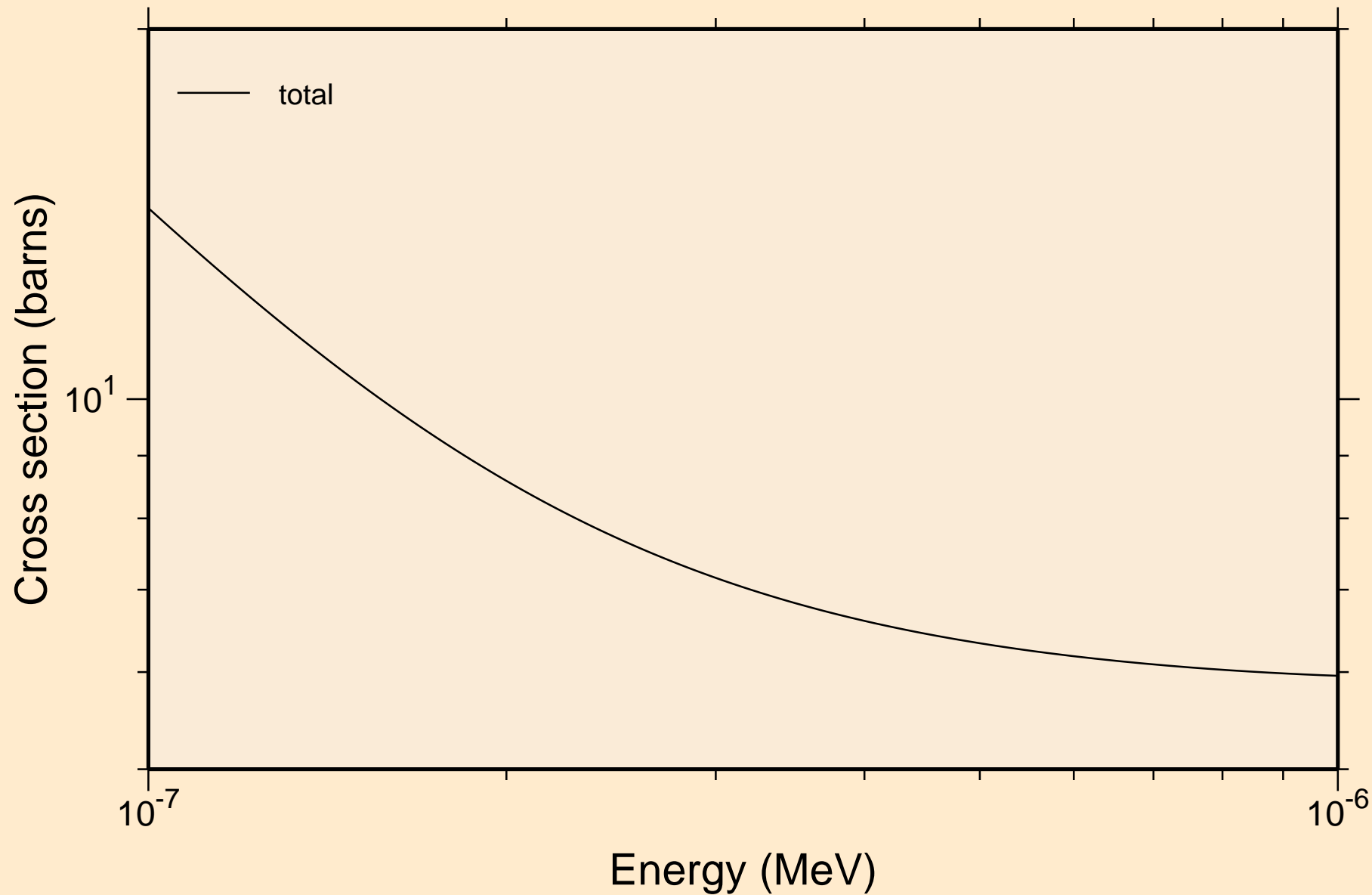

I123 NEUTRON ACER TENDL-2019 LIBRARY; T=293.16K
resonance total cross section

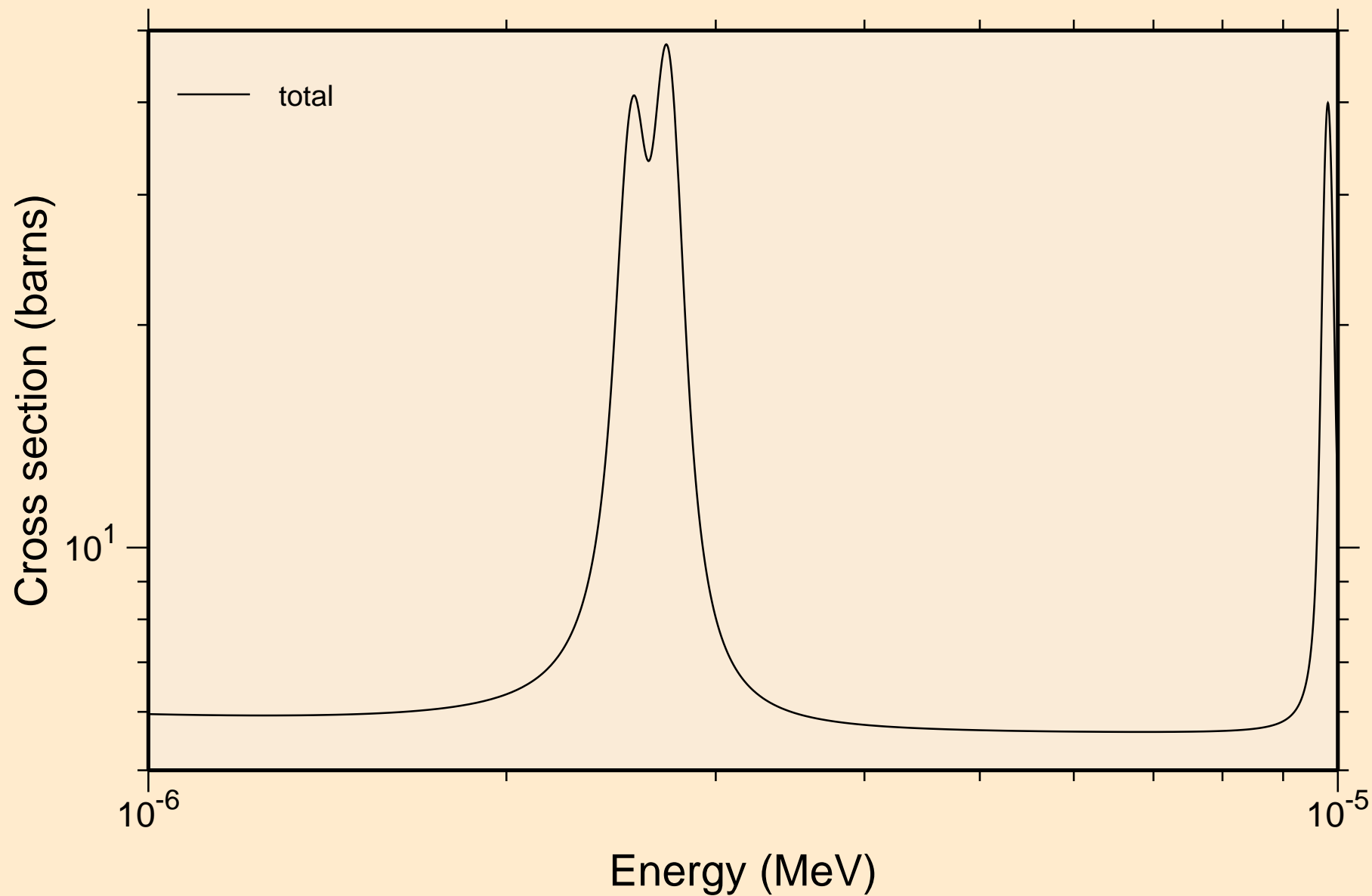

I123 NEUTRON ACER TENDL-2019 LIBRARY; T=293.16K
resonance total cross section

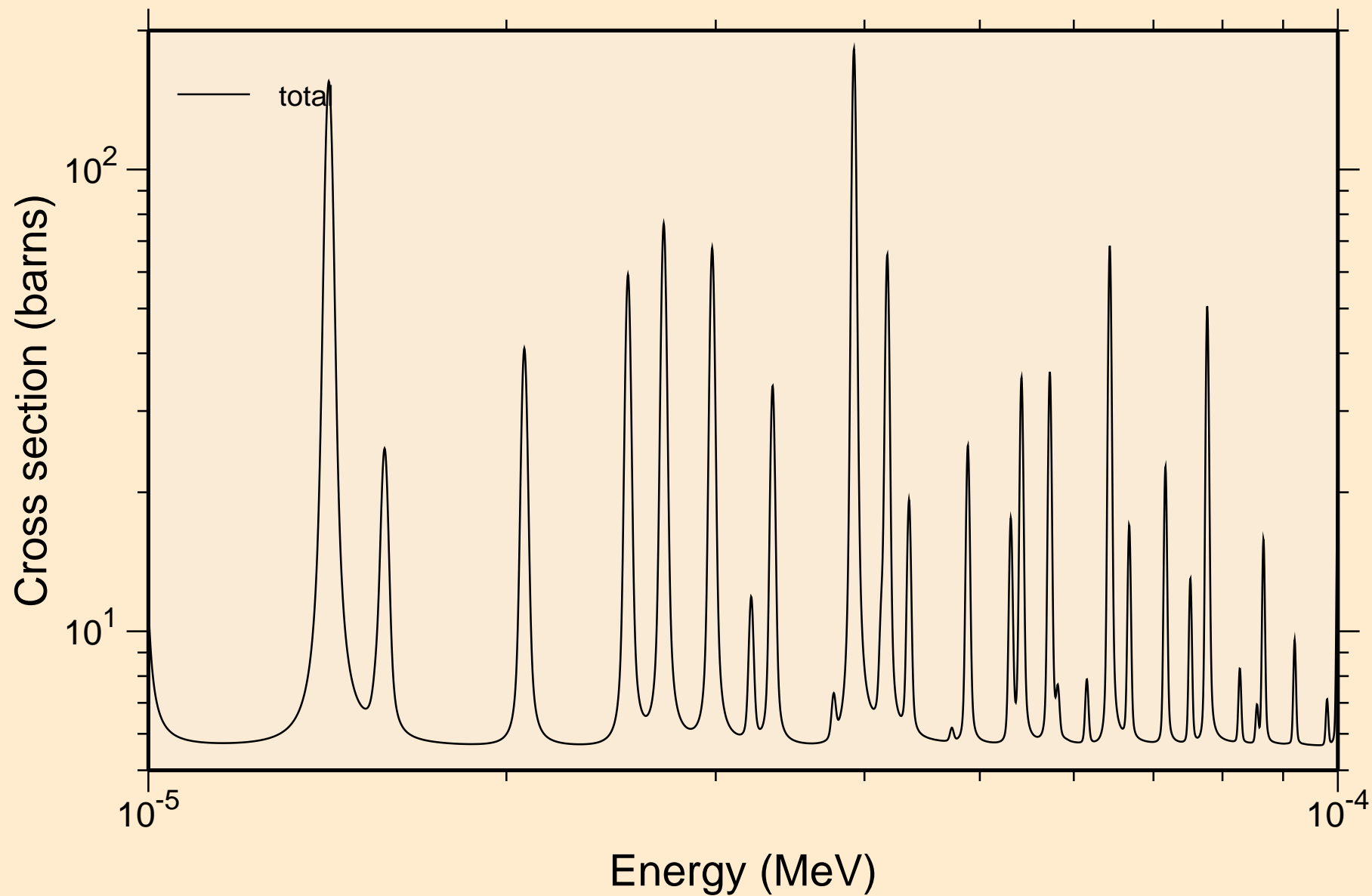

I123 NEUTRON ACER TENDL-2019 LIBRARY; T=293.16K
resonance total cross section

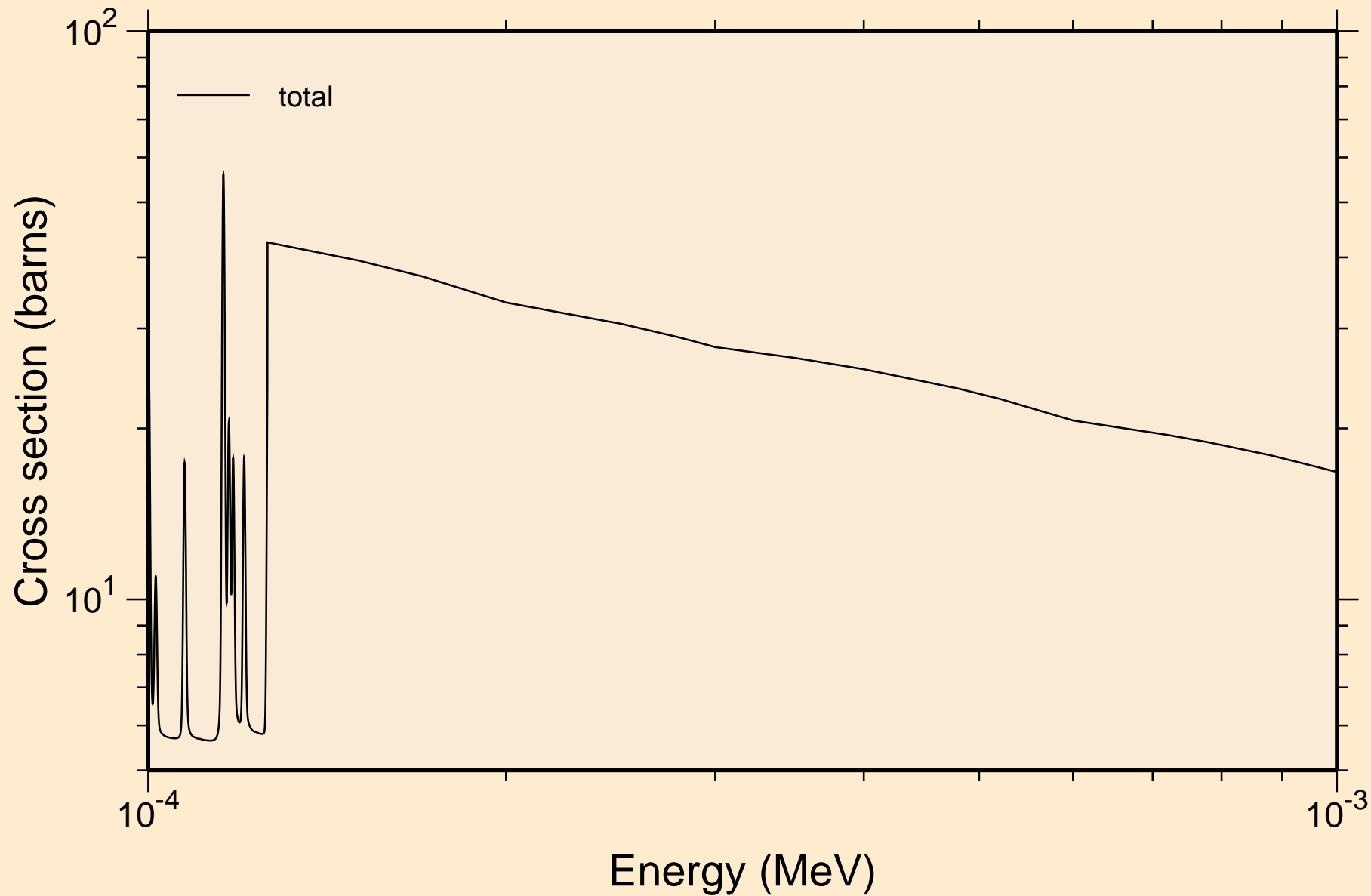

I123 NEUTRON ACER TENDL-2019 LIBRARY; T=293.16K
resonance total cross section

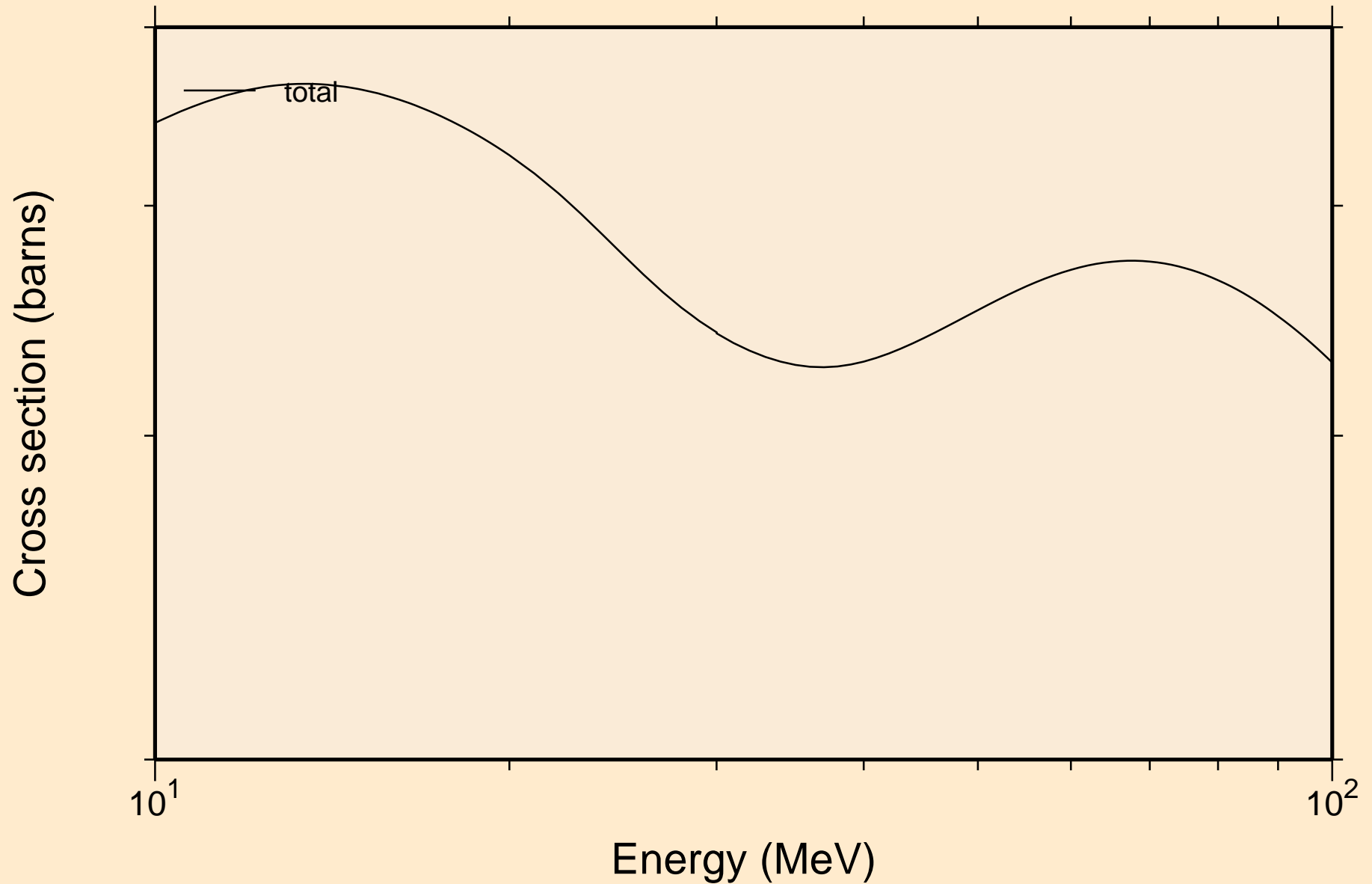

I123 NEUTRON ACER TENDL-2019 LIBRARY; T=293.16K
resonance absorption cross sections

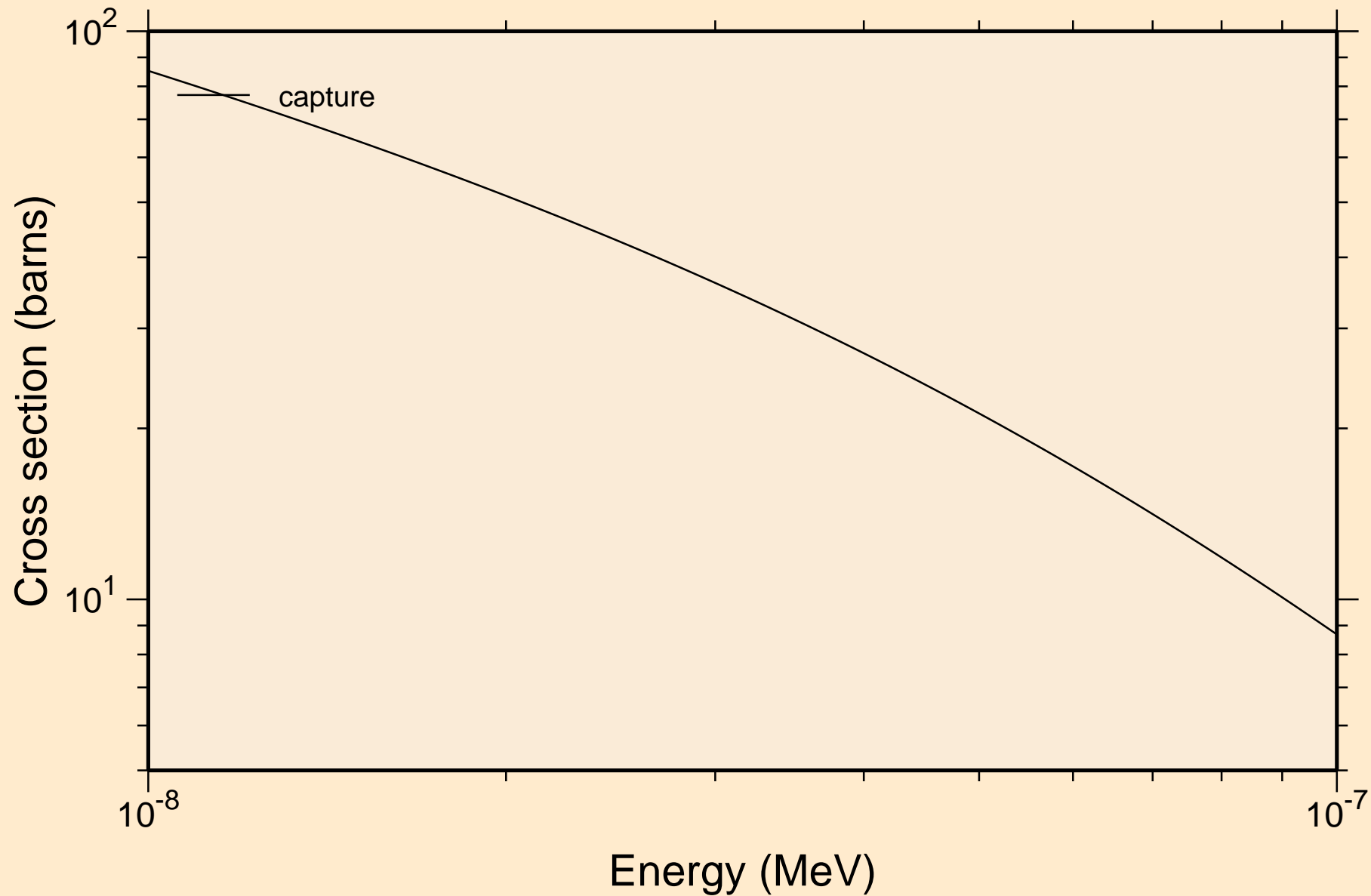

I123 NEUTRON ACER TENDL-2019 LIBRARY; T=293.16K
resonance absorption cross sections

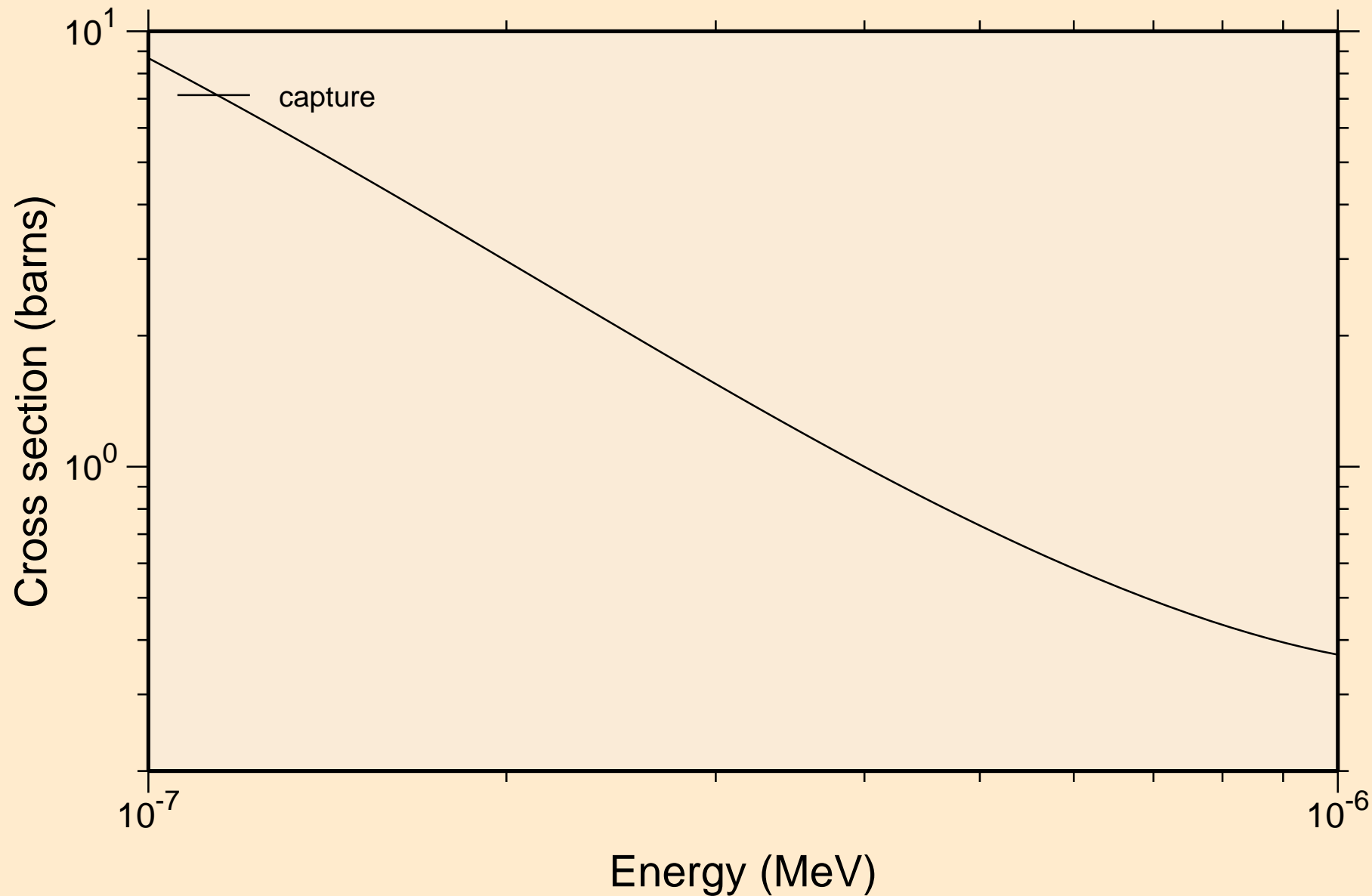

I123 NEUTRON ACER TENDL-2019 LIBRARY; T=293.16K
resonance absorption cross sections

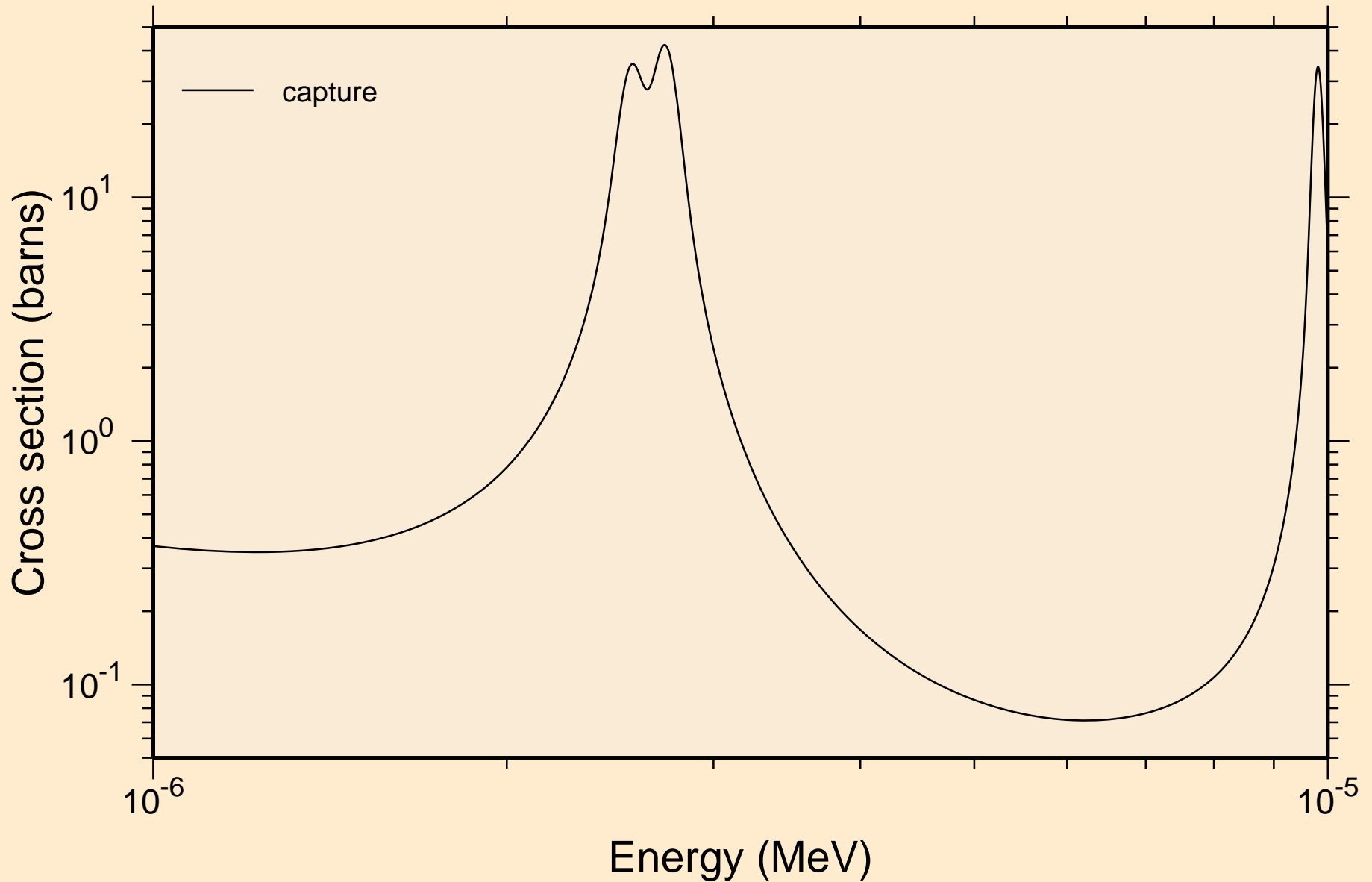

I123 NEUTRON ACER TENDL-2019 LIBRARY; T=293.16K
resonance absorption cross sections

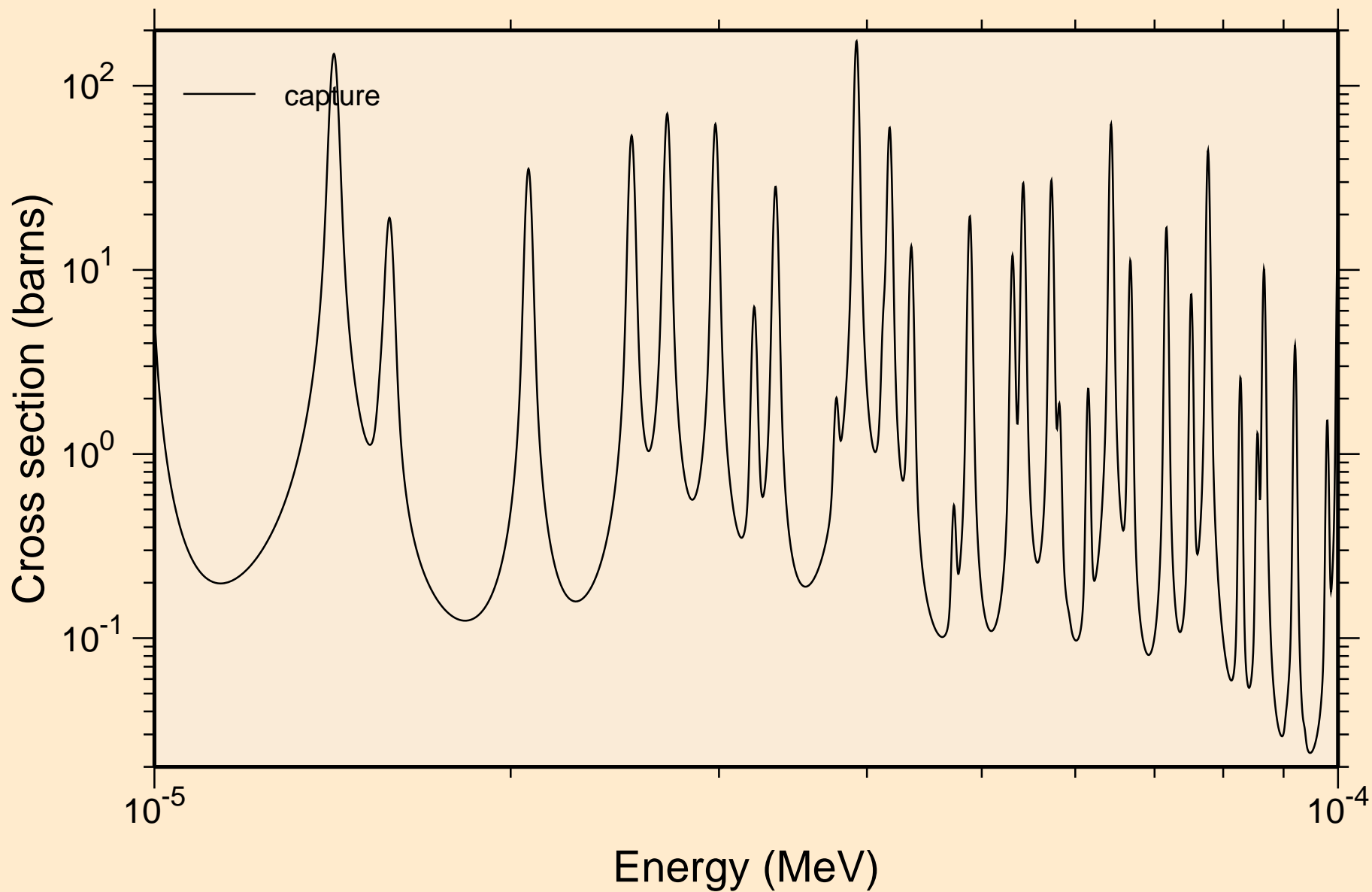

I123 NEUTRON ACER TENDL-2019 LIBRARY; T=293.16K
resonance absorption cross sections

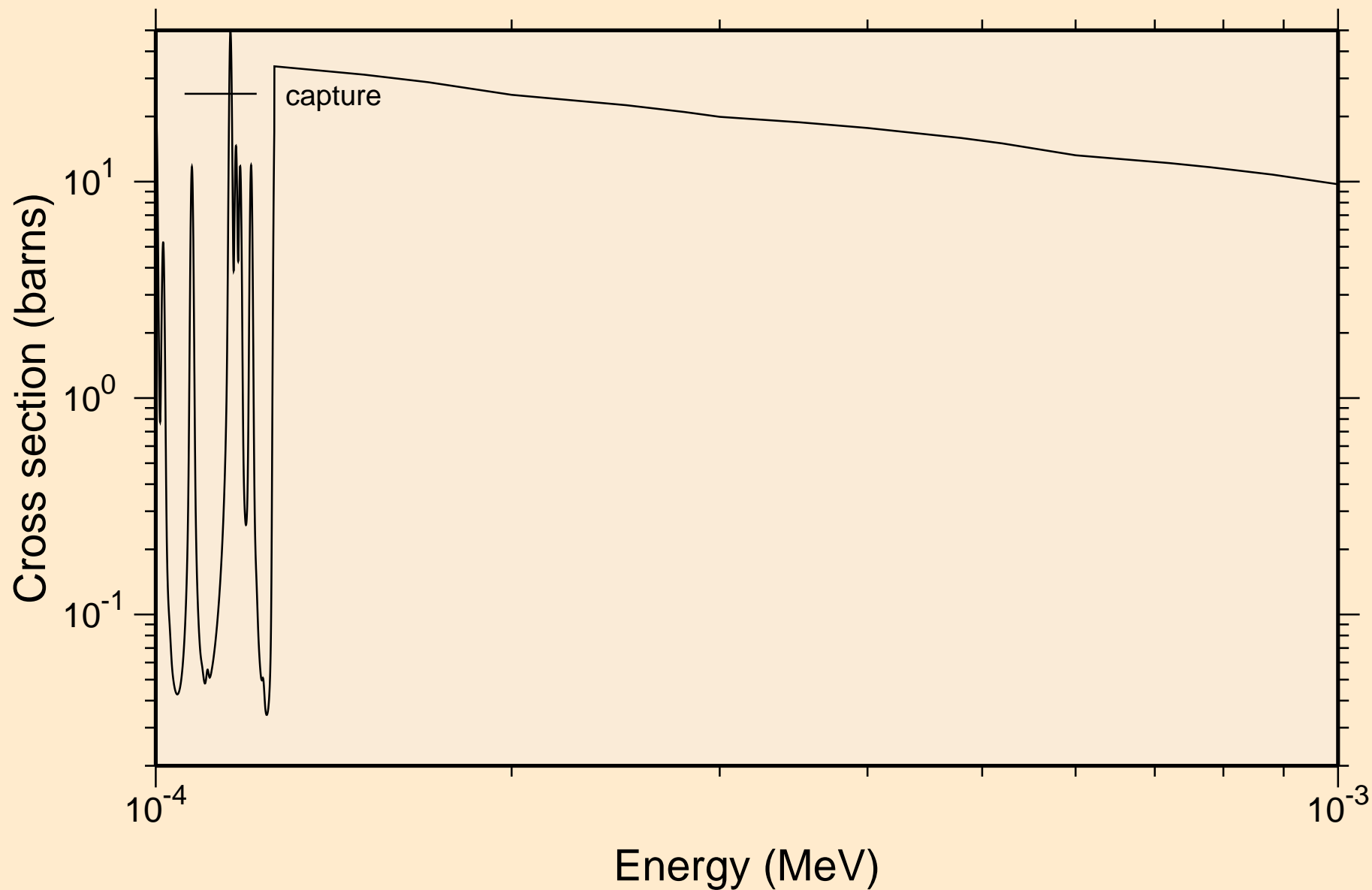

I123 NEUTRON ACER TENDL-2019 LIBRARY; T=293.16K
resonance absorption cross sections

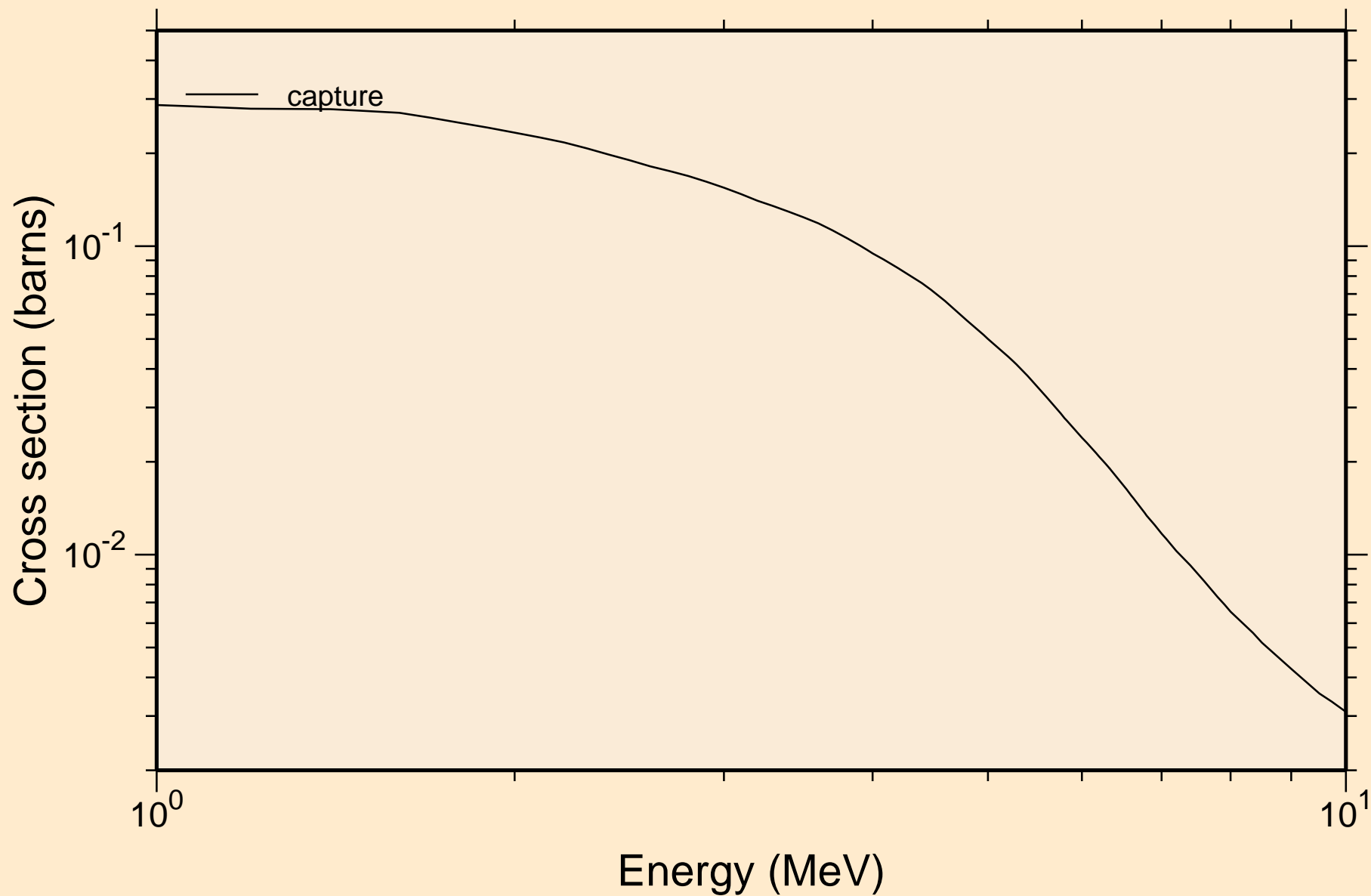

I123 NEUTRON ACER TENDL-2019 LIBRARY; T=293.16K
Heating

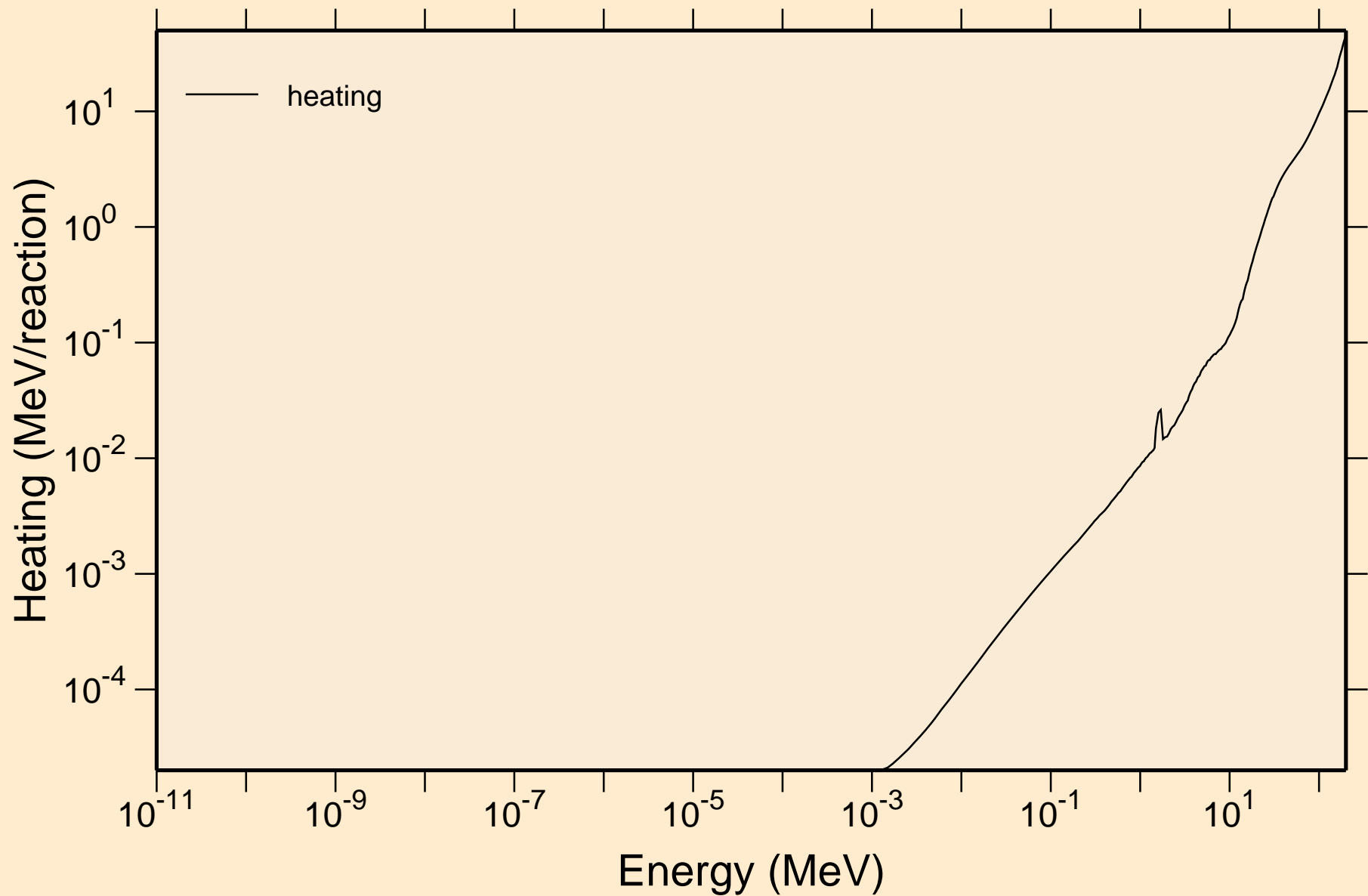

I123 NEUTRON ACER TENDL-2019 LIBRARY; T=293.16K
Damage

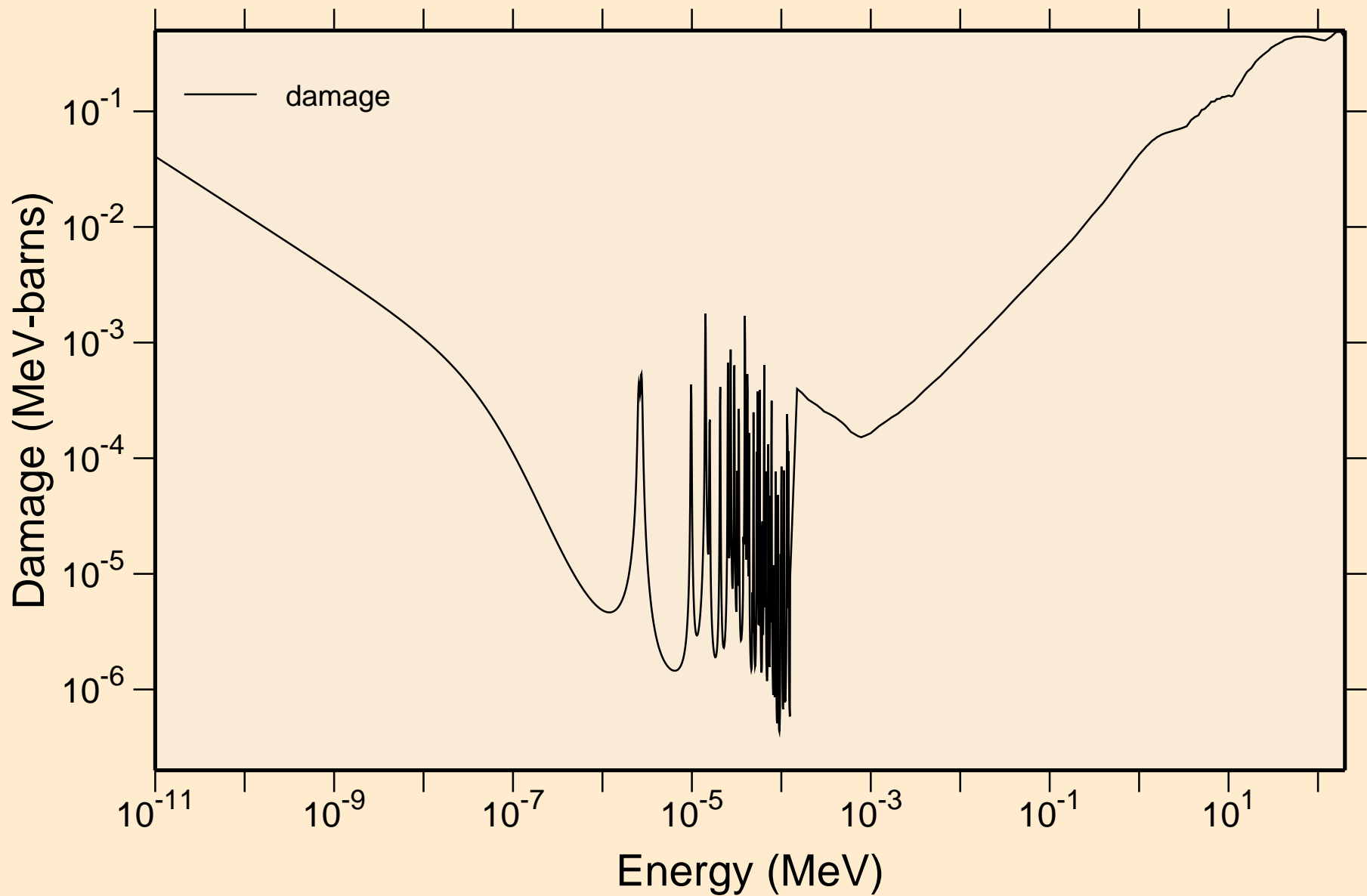

I123 NEUTRON ACER TENDL-2019 LIBRARY; T=293.16K

Non-threshold reactions

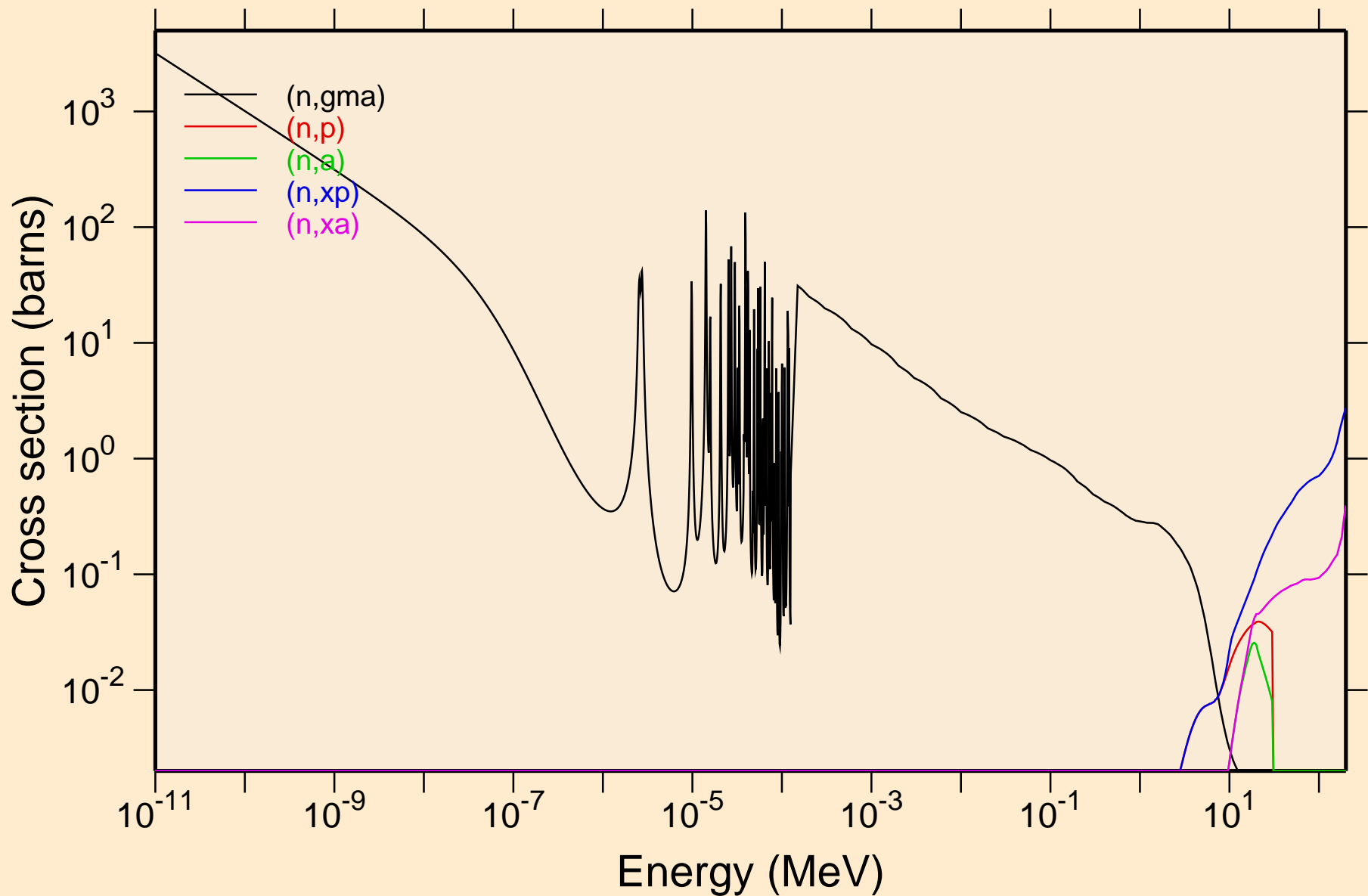

I123 NEUTRON ACER TENDL-2019 LIBRARY; T=293.16K
Principal cross sections

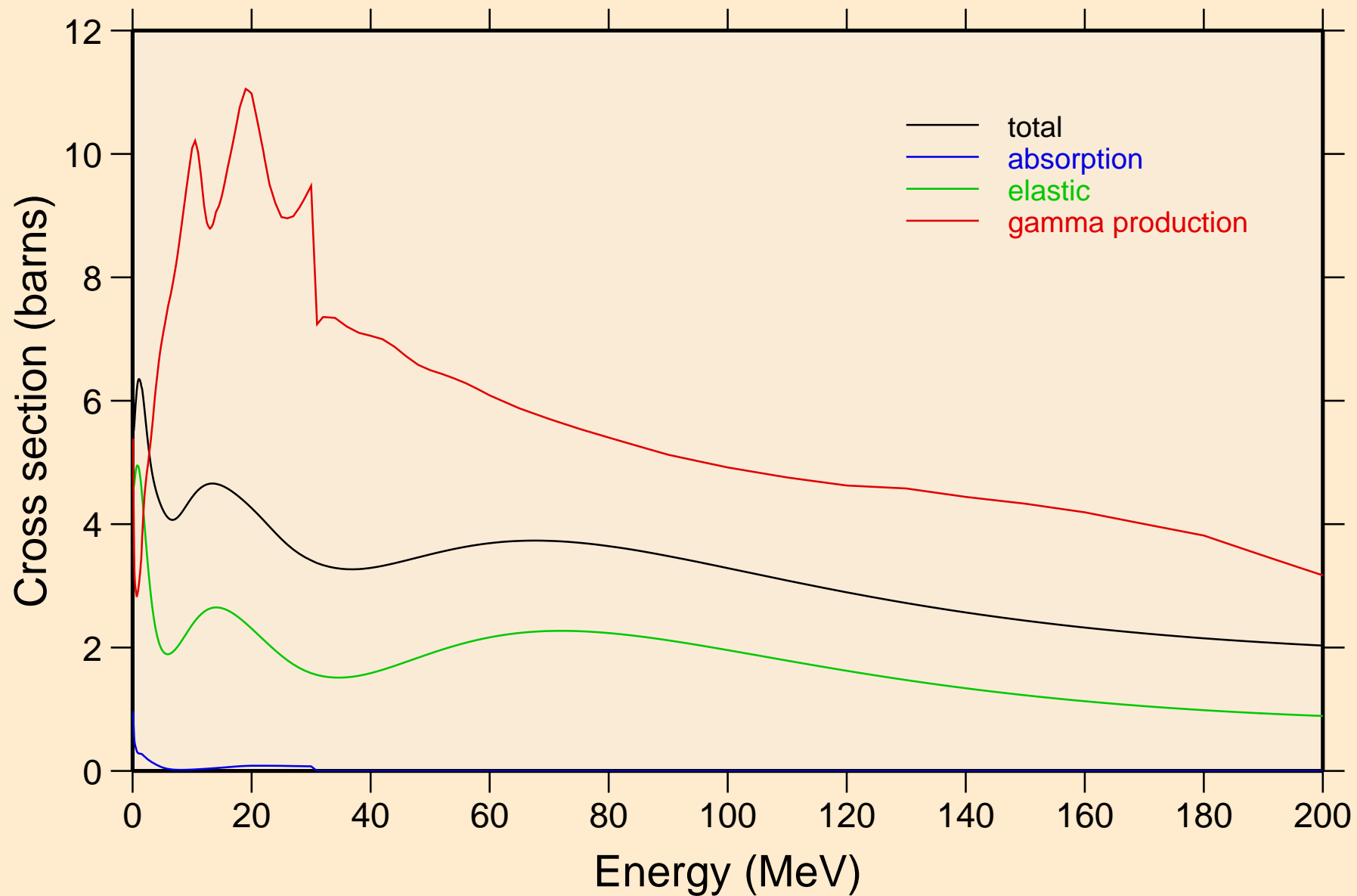

I123 NEUTRON ACER TENDL-2019 LIBRARY; T=293.16K
Heating

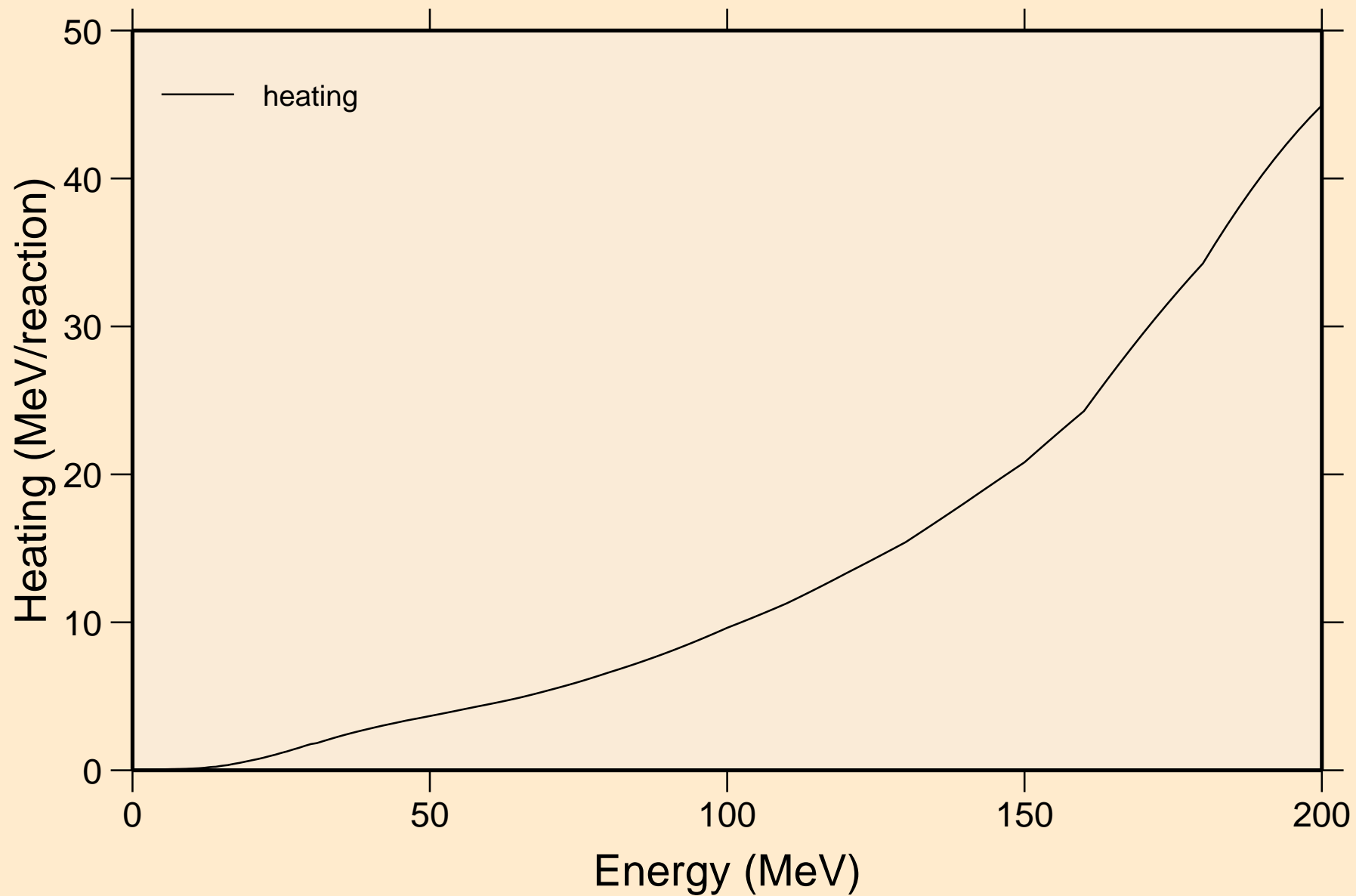

I123 NEUTRON ACER TENDL-2019 LIBRARY; T=293.16K
Damage

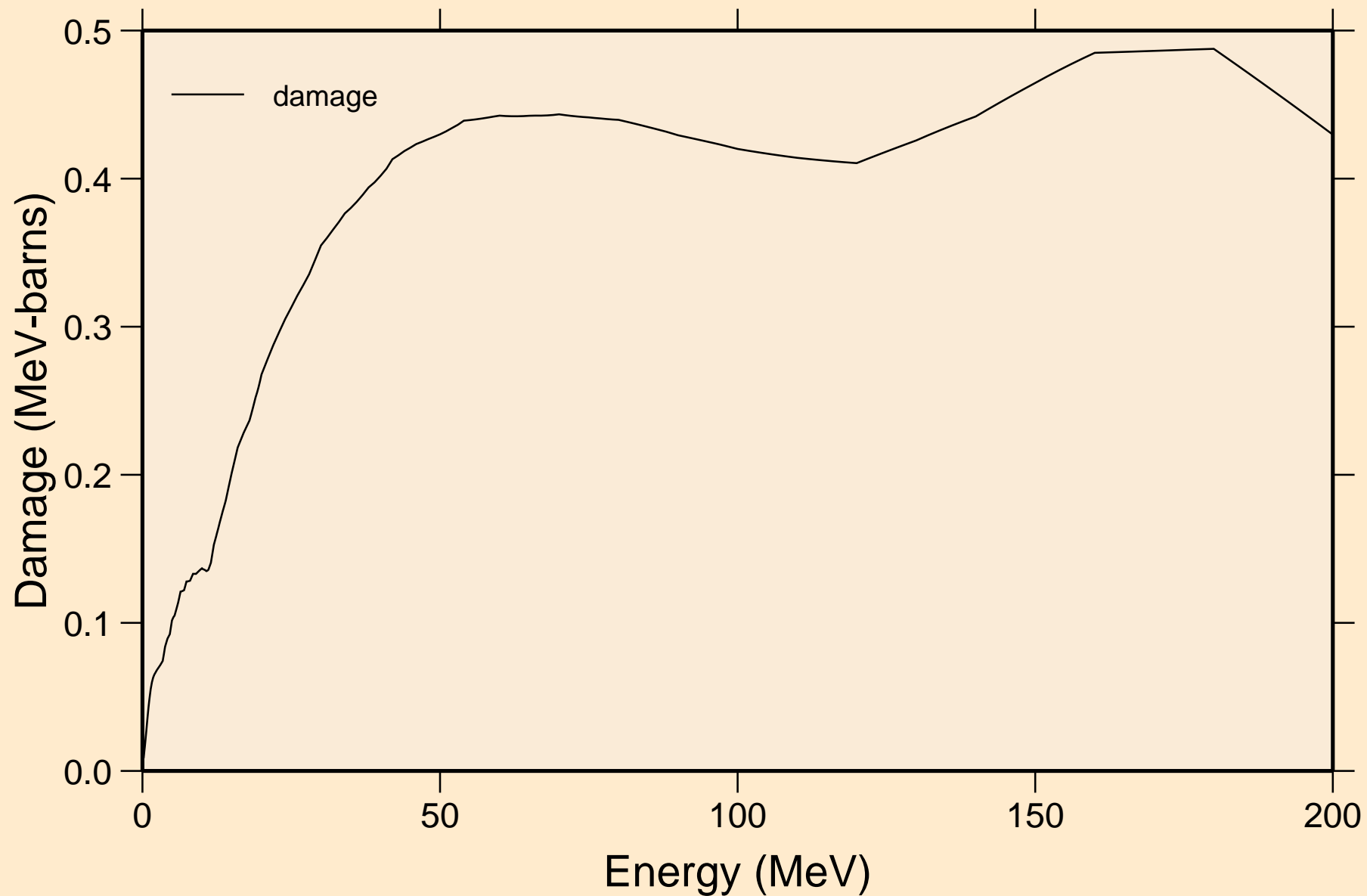

I123 NEUTRON ACER TENDL-2019 LIBRARY; T=293.16K
Non-threshold reactions

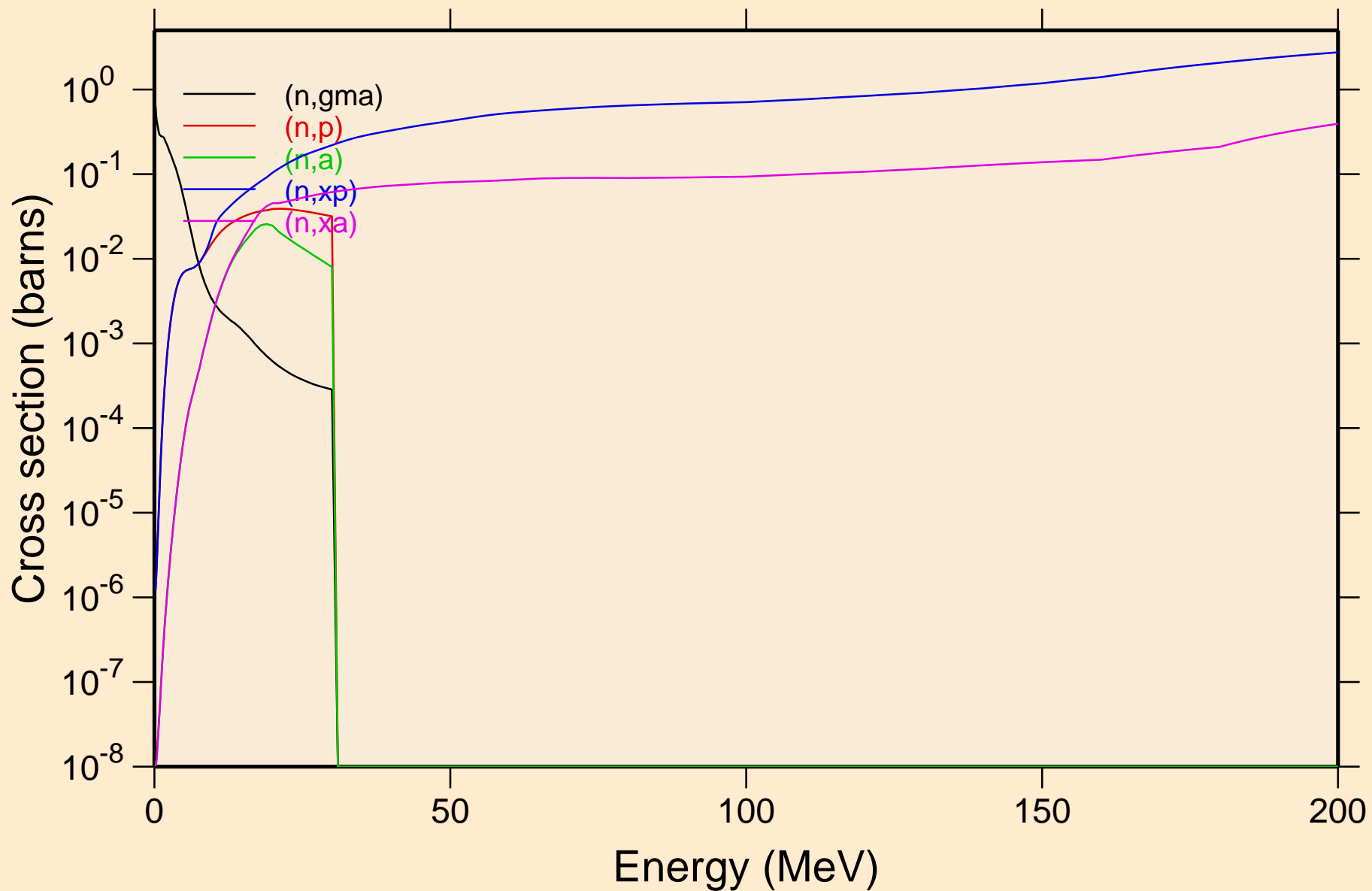

I123 NEUTRON ACER TENDL-2019 LIBRARY; T=293.16K
Inelastic levels

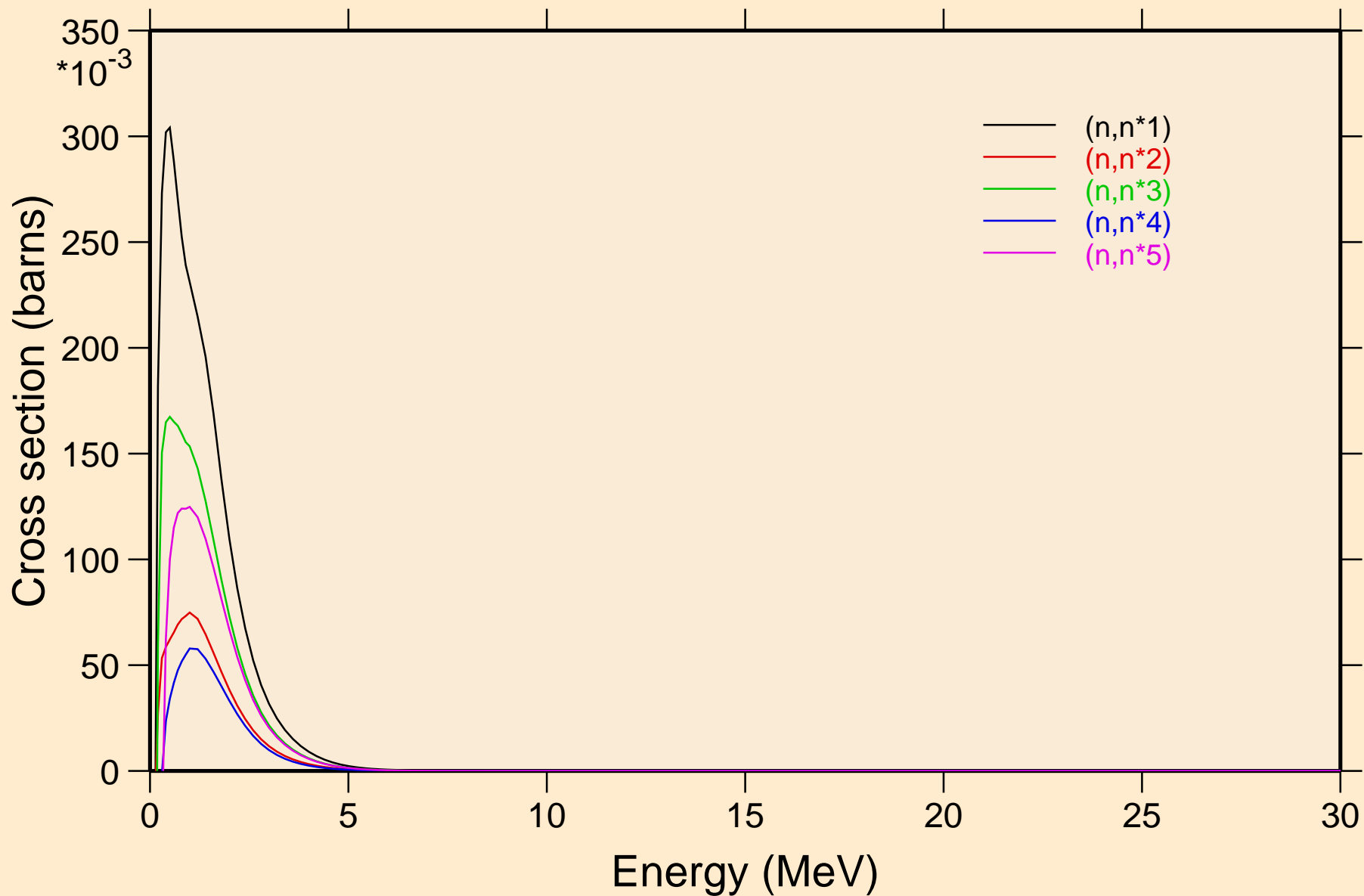

I123 NEUTRON ACER TENDL-2019 LIBRARY; T=293.16K
Inelastic levels

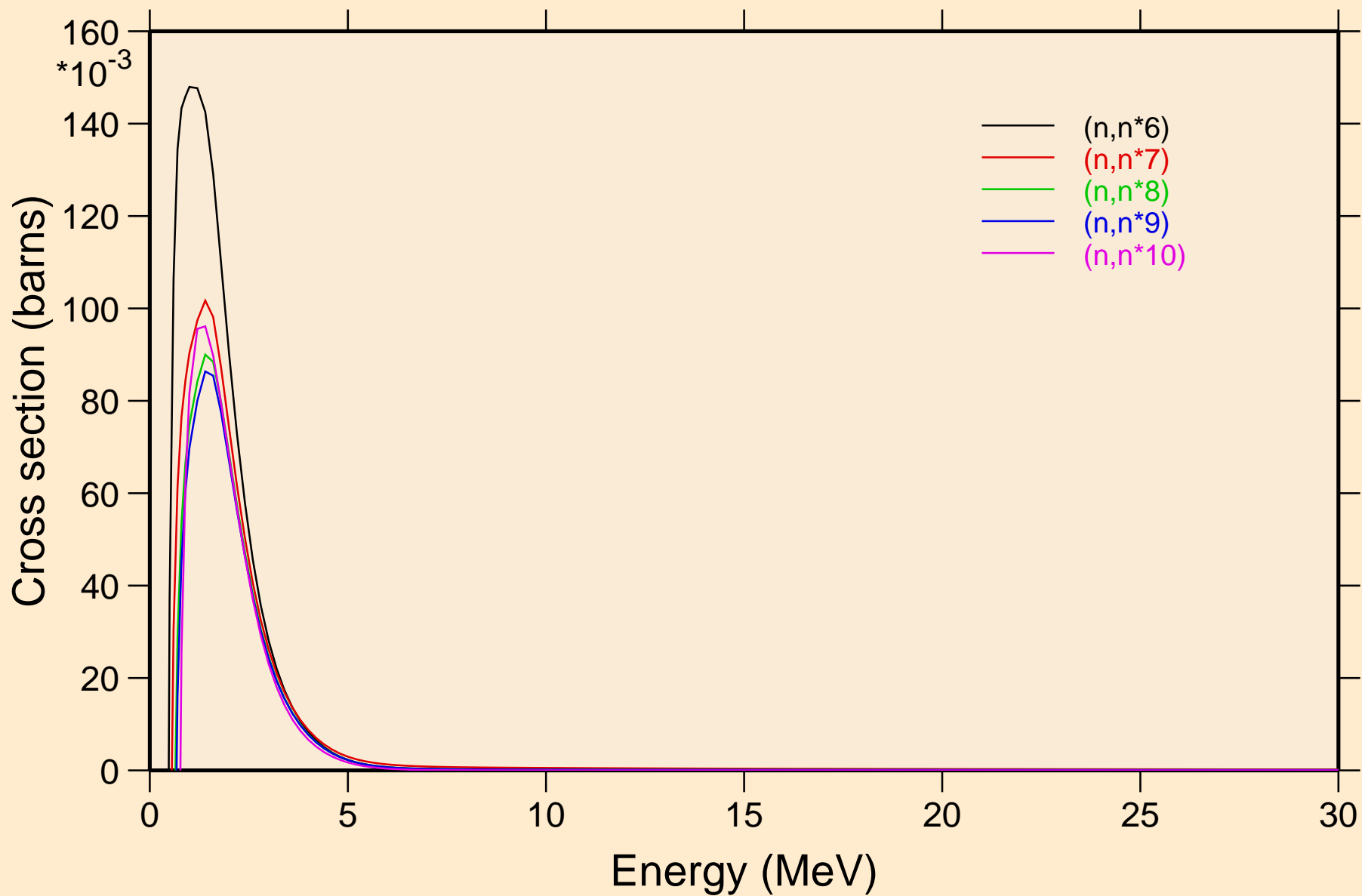

I123 NEUTRON ACER TENDL-2019 LIBRARY; T=293.16K
Inelastic levels

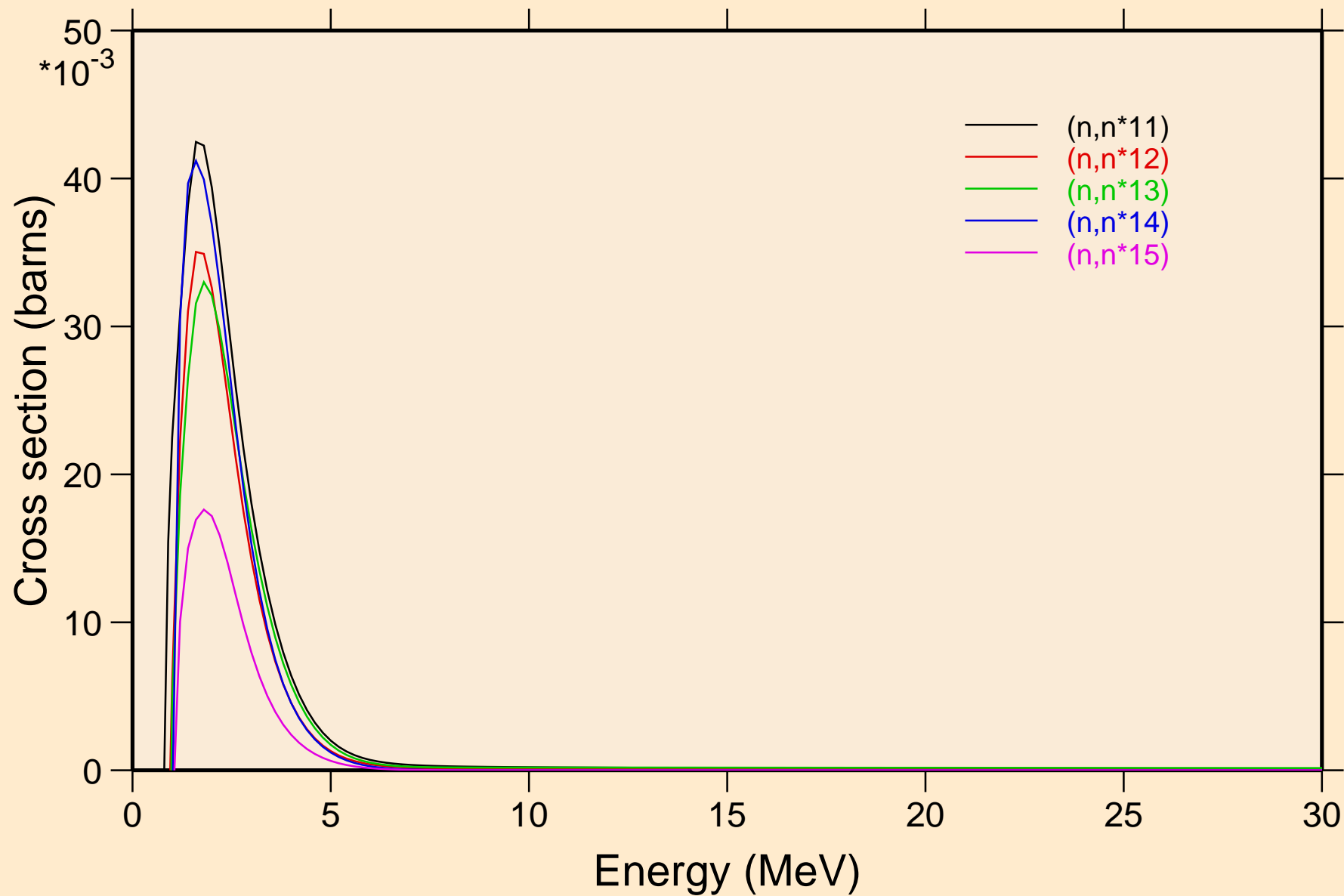

I123 NEUTRON ACER TENDL-2019 LIBRARY; T=293.16K
Inelastic levels

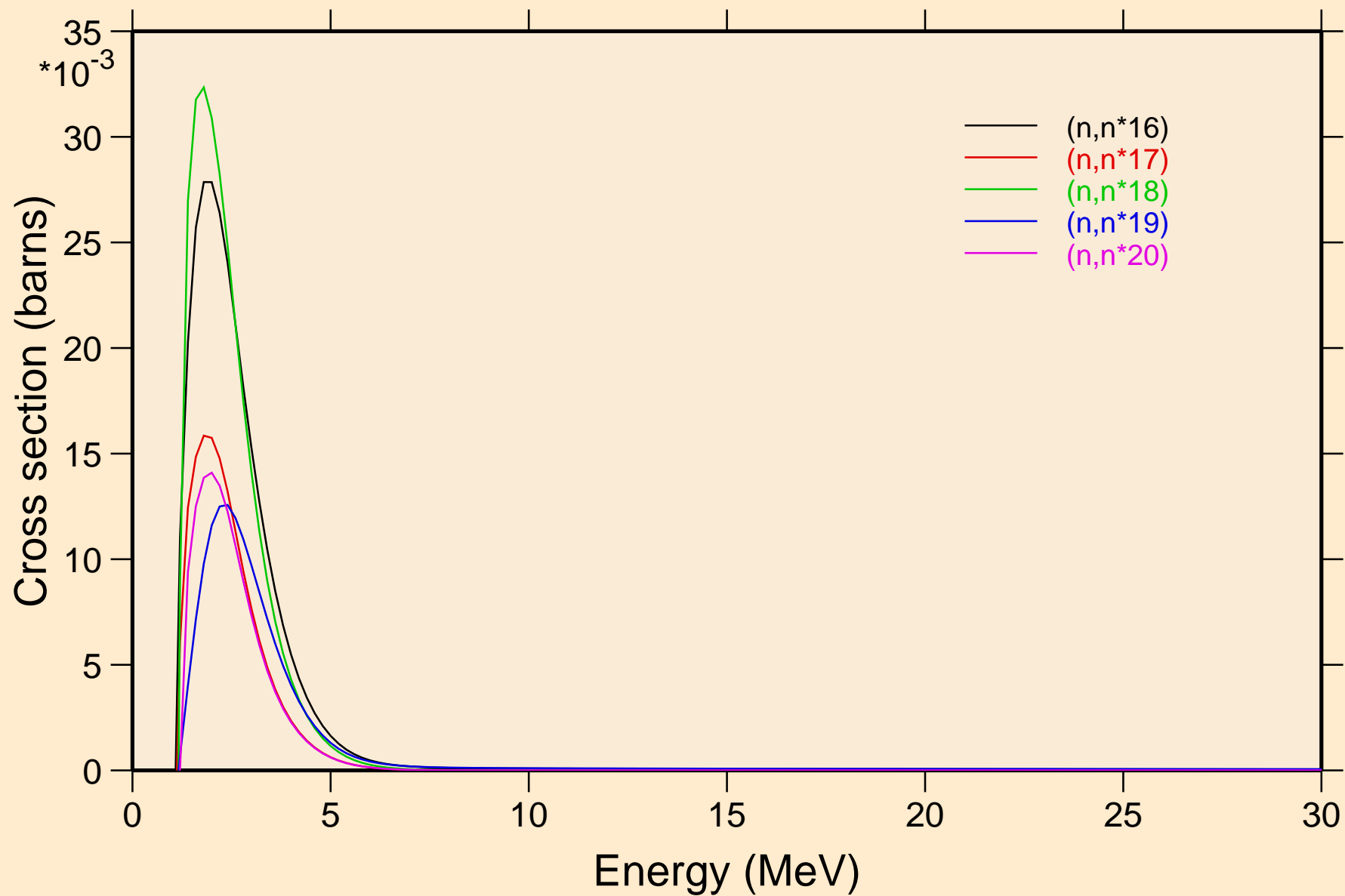

I123 NEUTRON ACER TENDL-2019 LIBRARY; T=293.16K
Inelastic levels

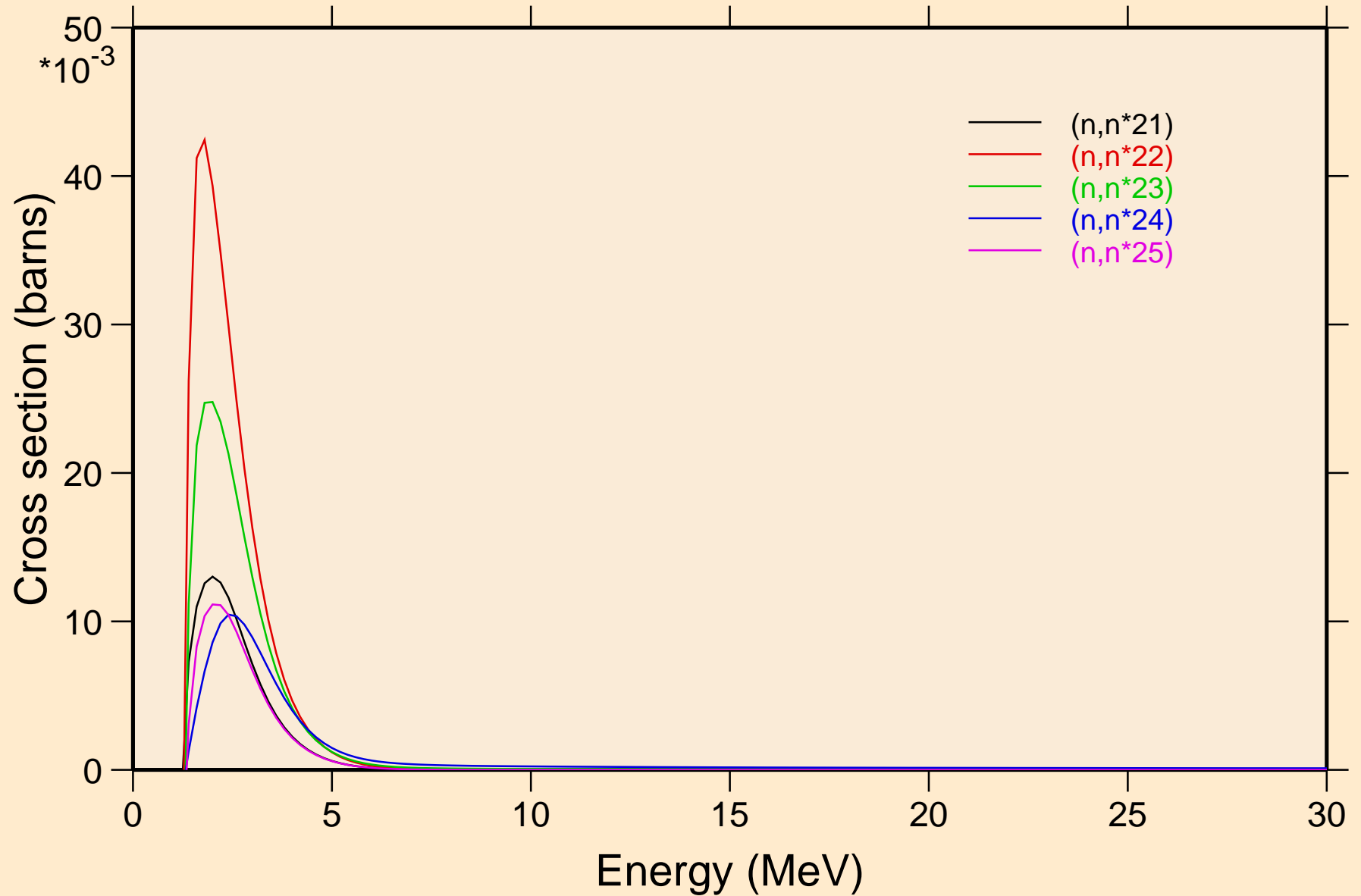

I123 NEUTRON ACER TENDL-2019 LIBRARY; T=293.16K
Inelastic levels

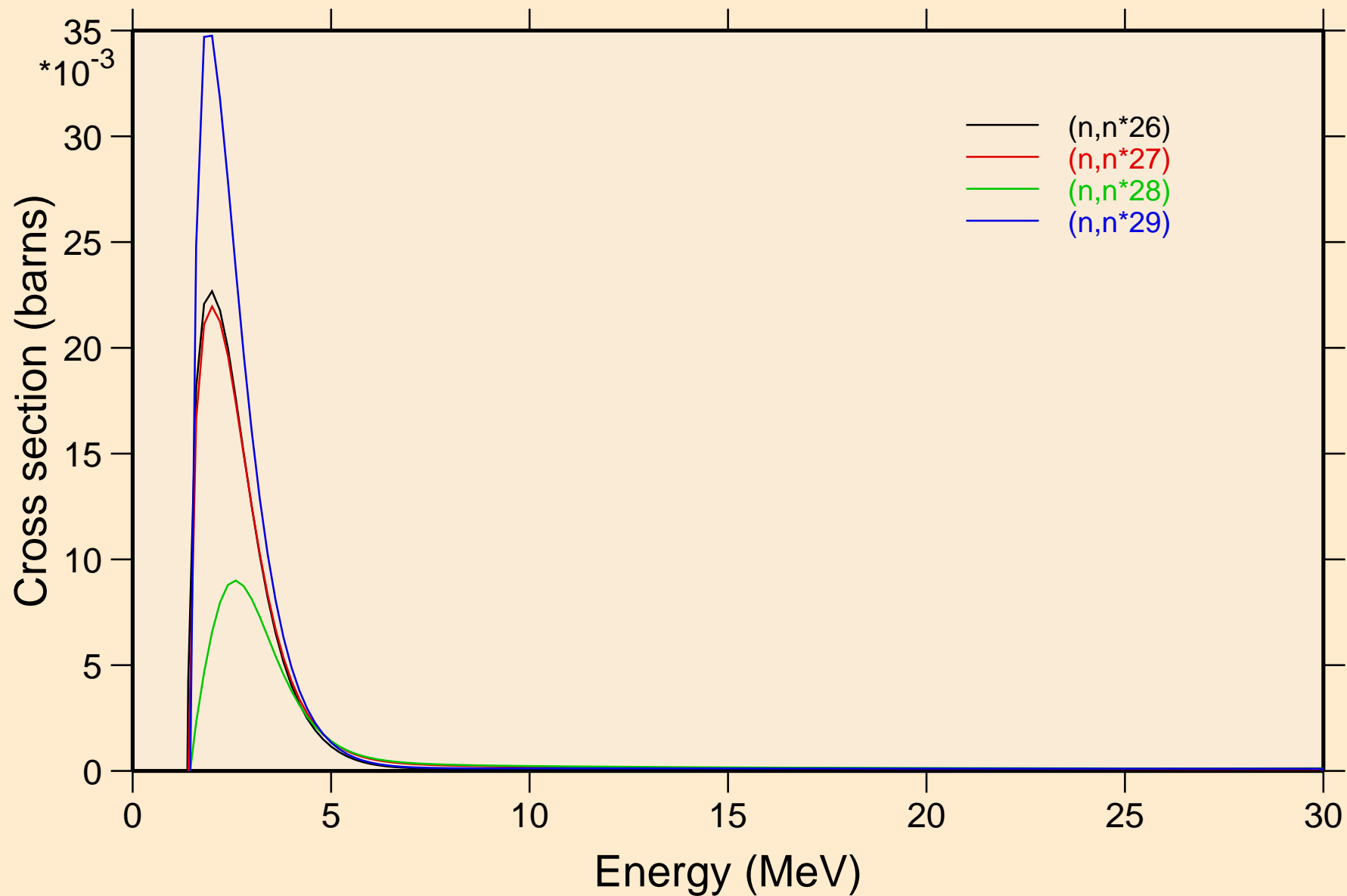

I123 NEUTRON ACER TENDL-2019 LIBRARY; T=293.16K
Threshold reactions

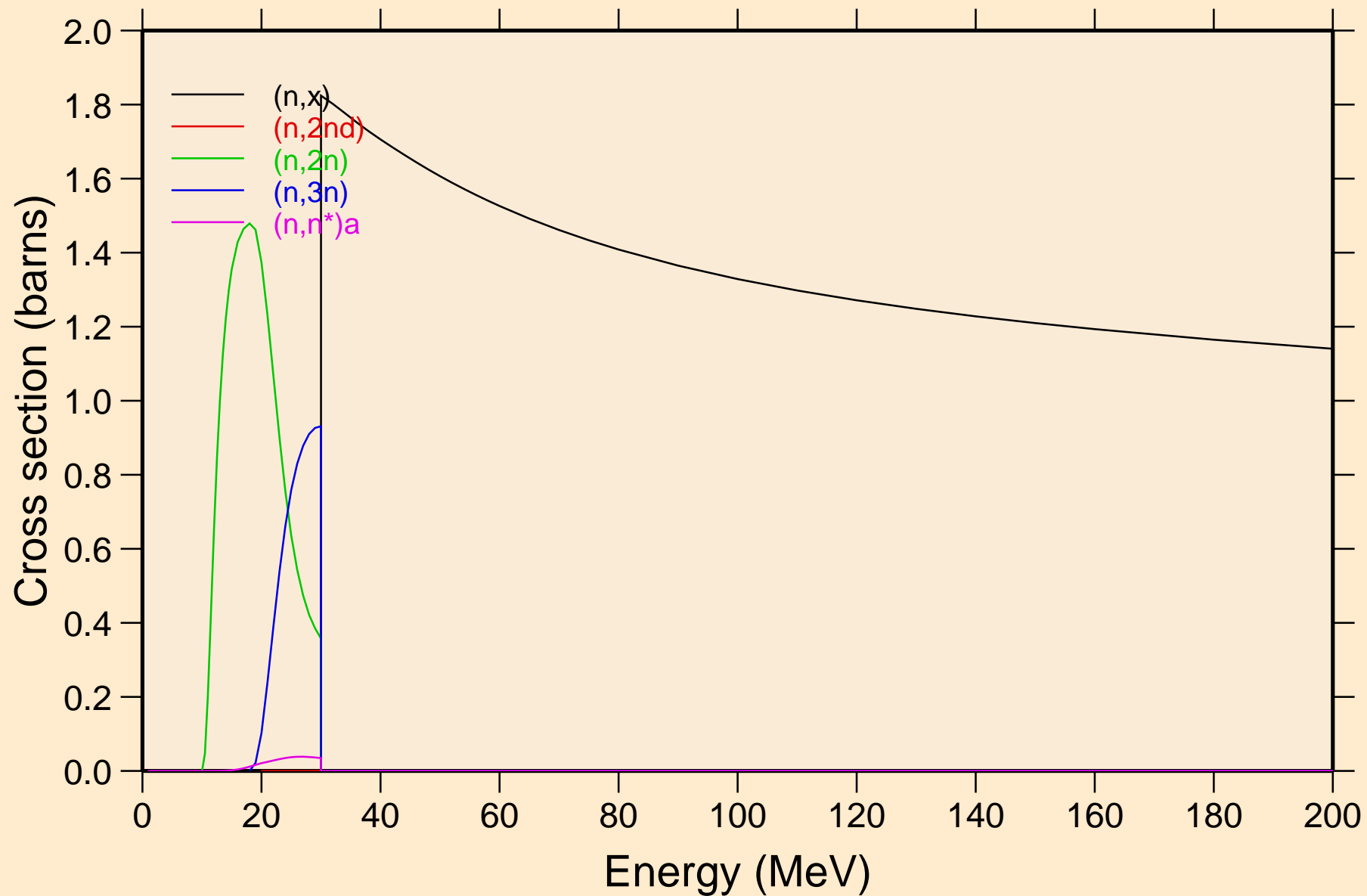

I123 NEUTRON ACER TENDL-2019 LIBRARY; T=293.16K
Threshold reactions

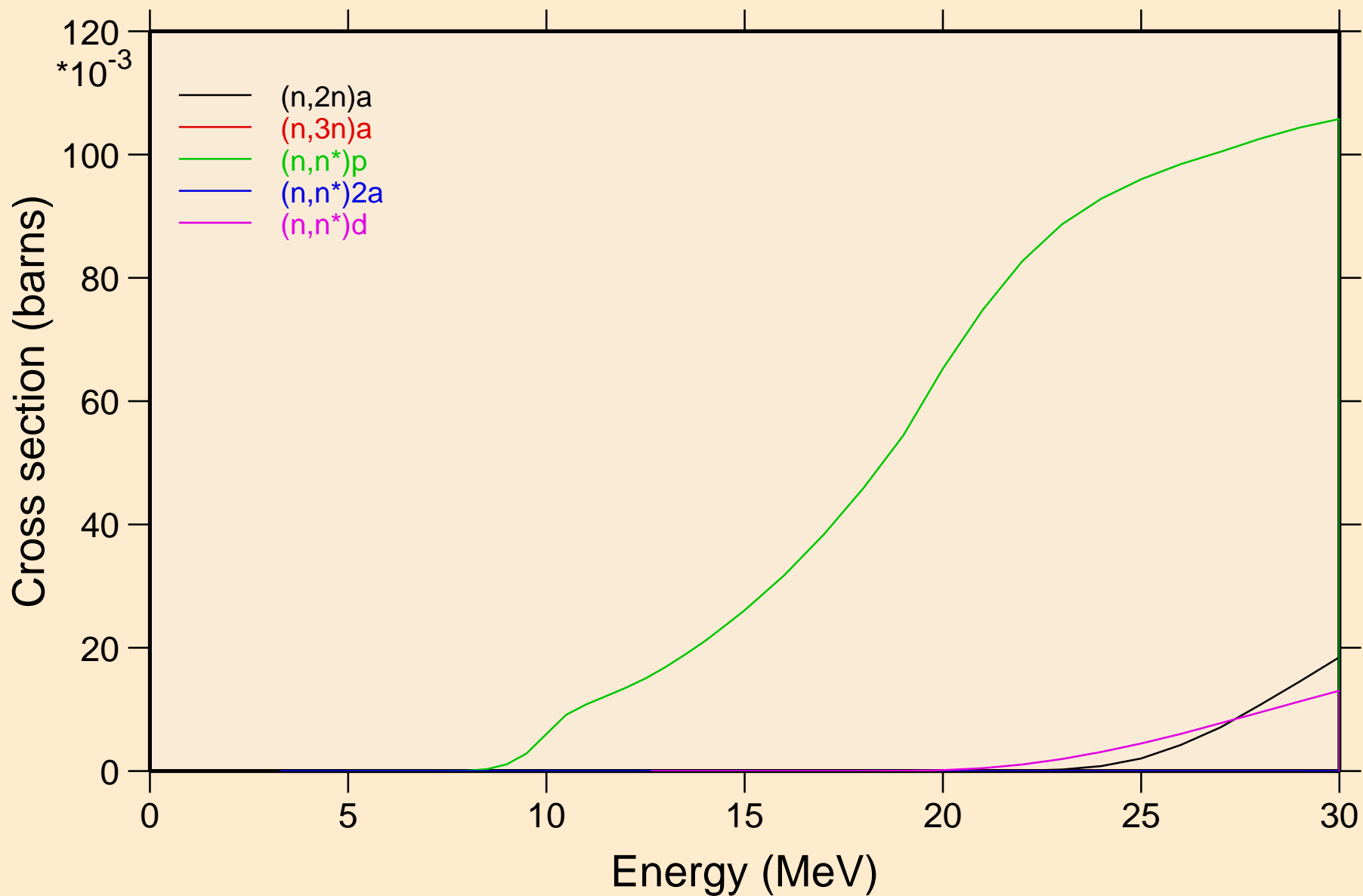

I123 NEUTRON ACER TENDL-2019 LIBRARY; T=293.16K

Threshold reactions

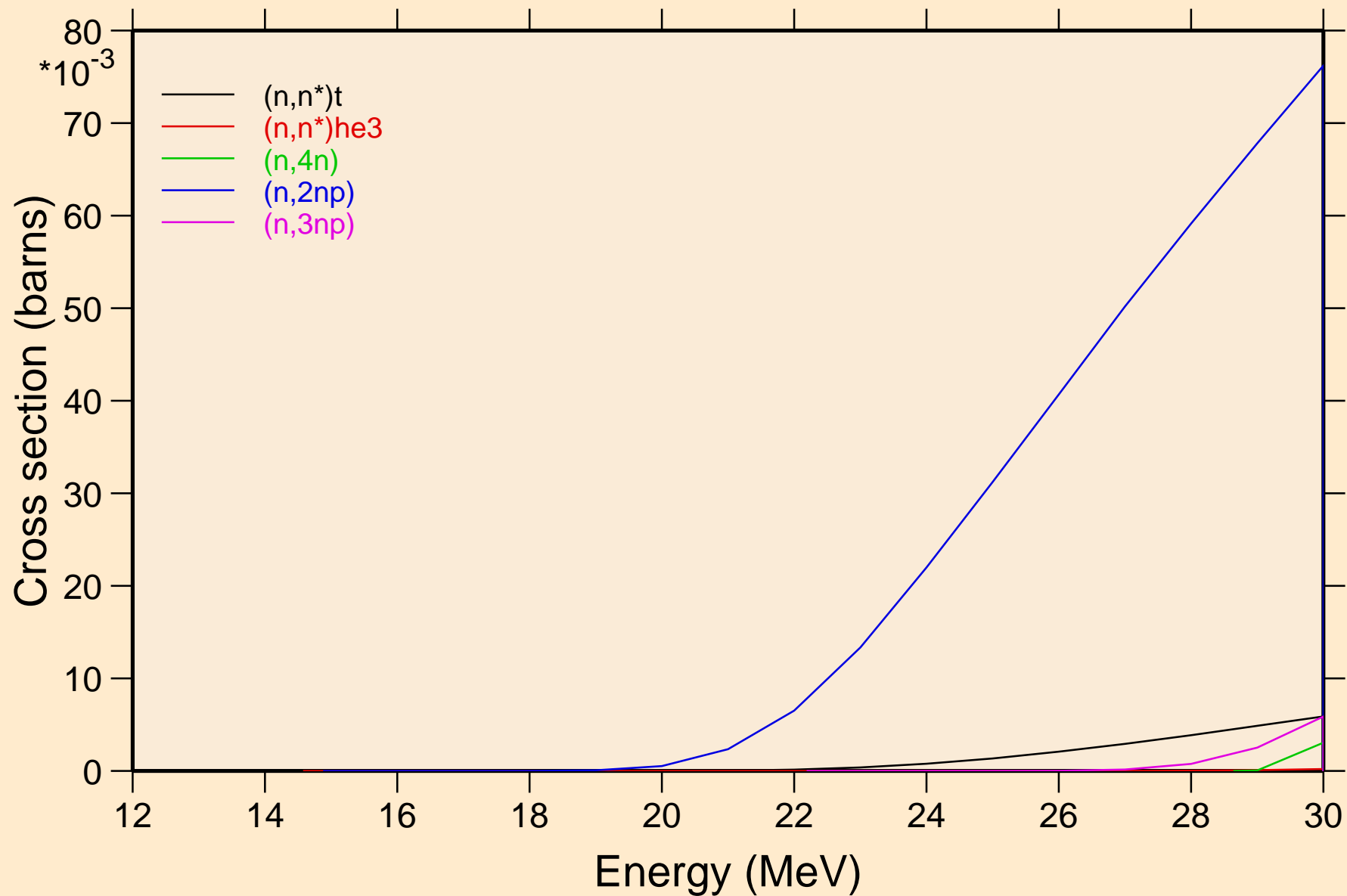

I123 NEUTRON ACER TENDL-2019 LIBRARY; T=293.16K
Threshold reactions

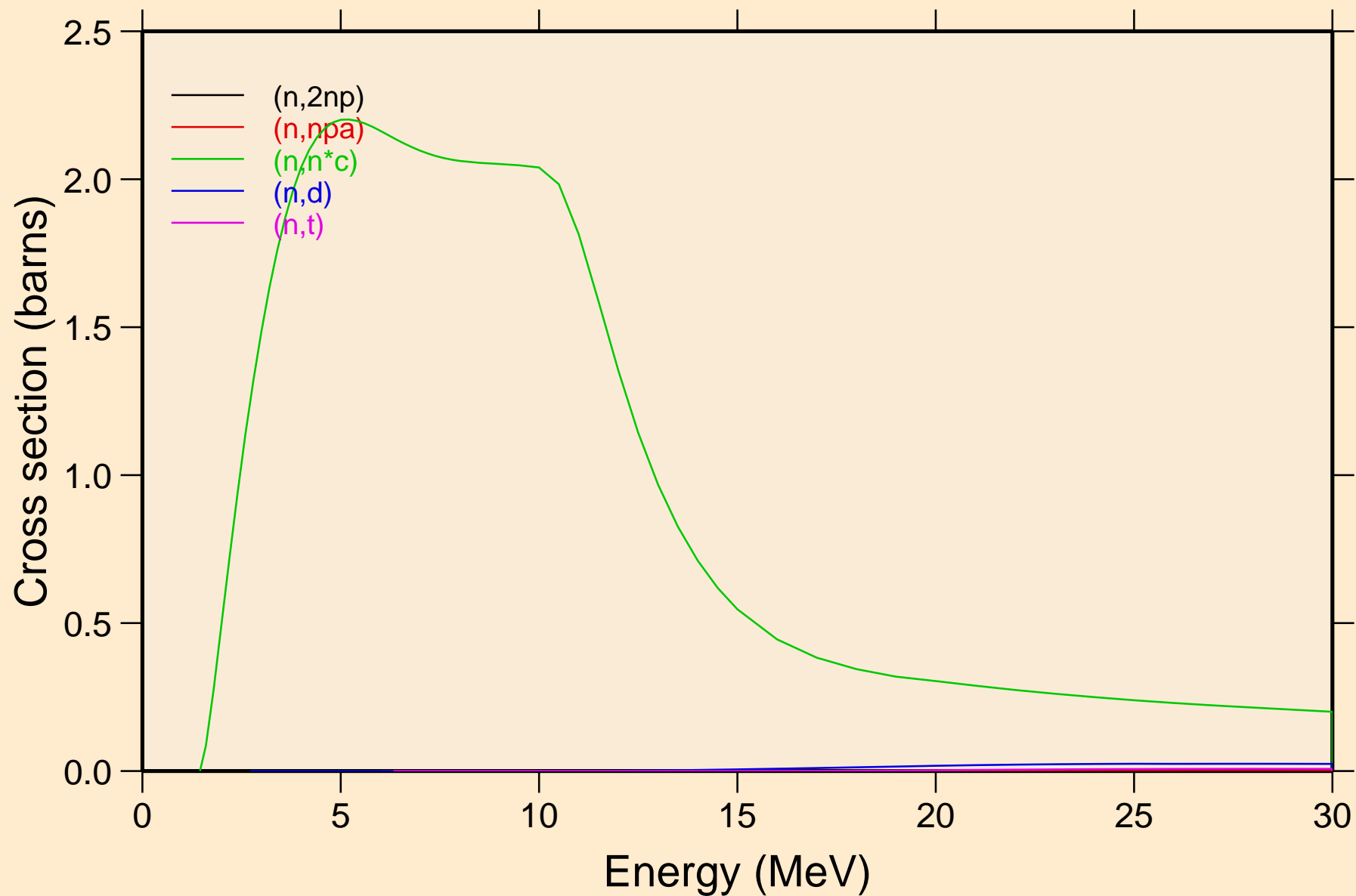

I123 NEUTRON ACER TENDL-2019 LIBRARY; T=293.16K
Threshold reactions

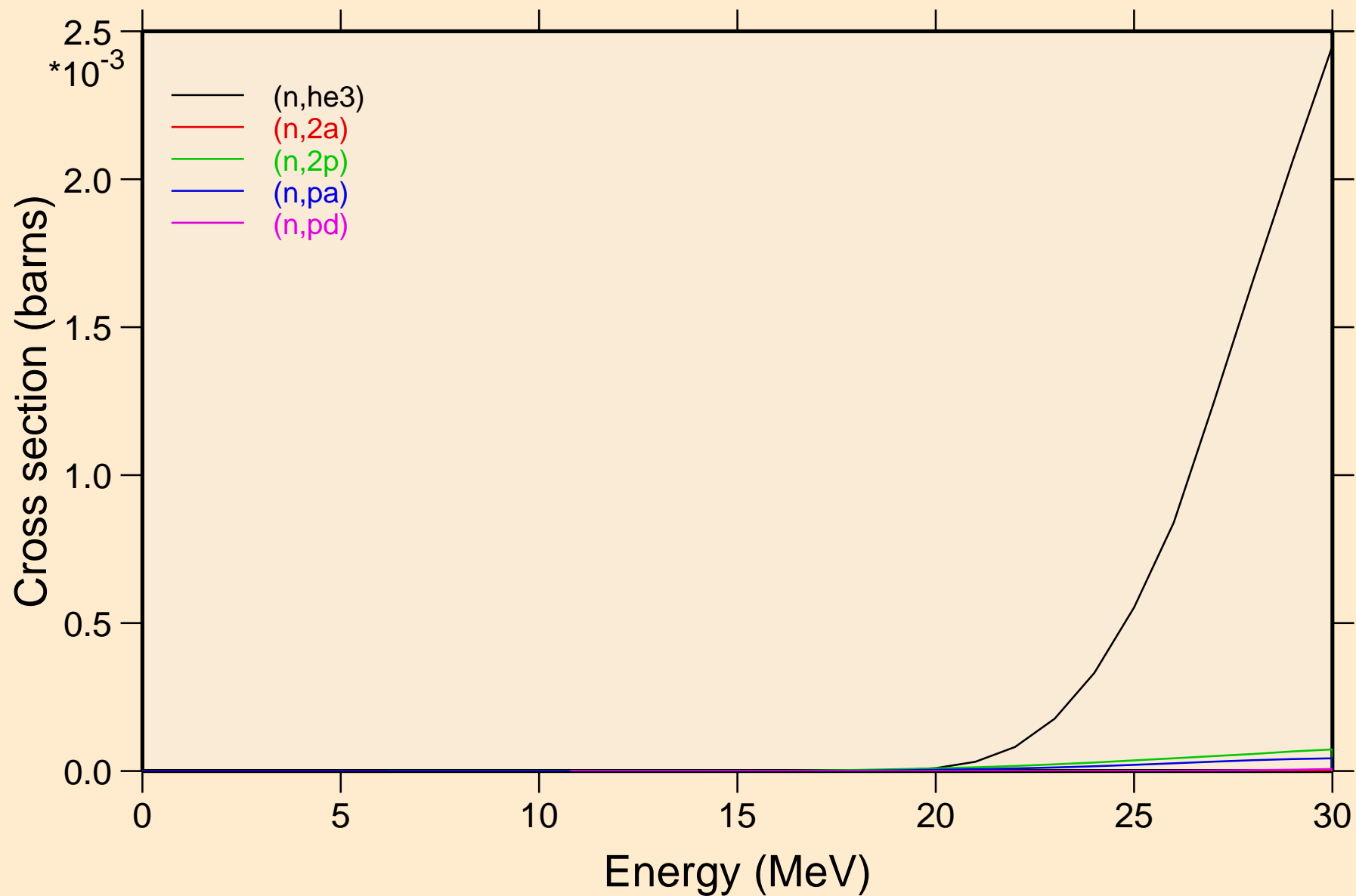

I123 NEUTRON ACER TENDL-2019 LIBRARY; T=293.16K
Threshold reactions

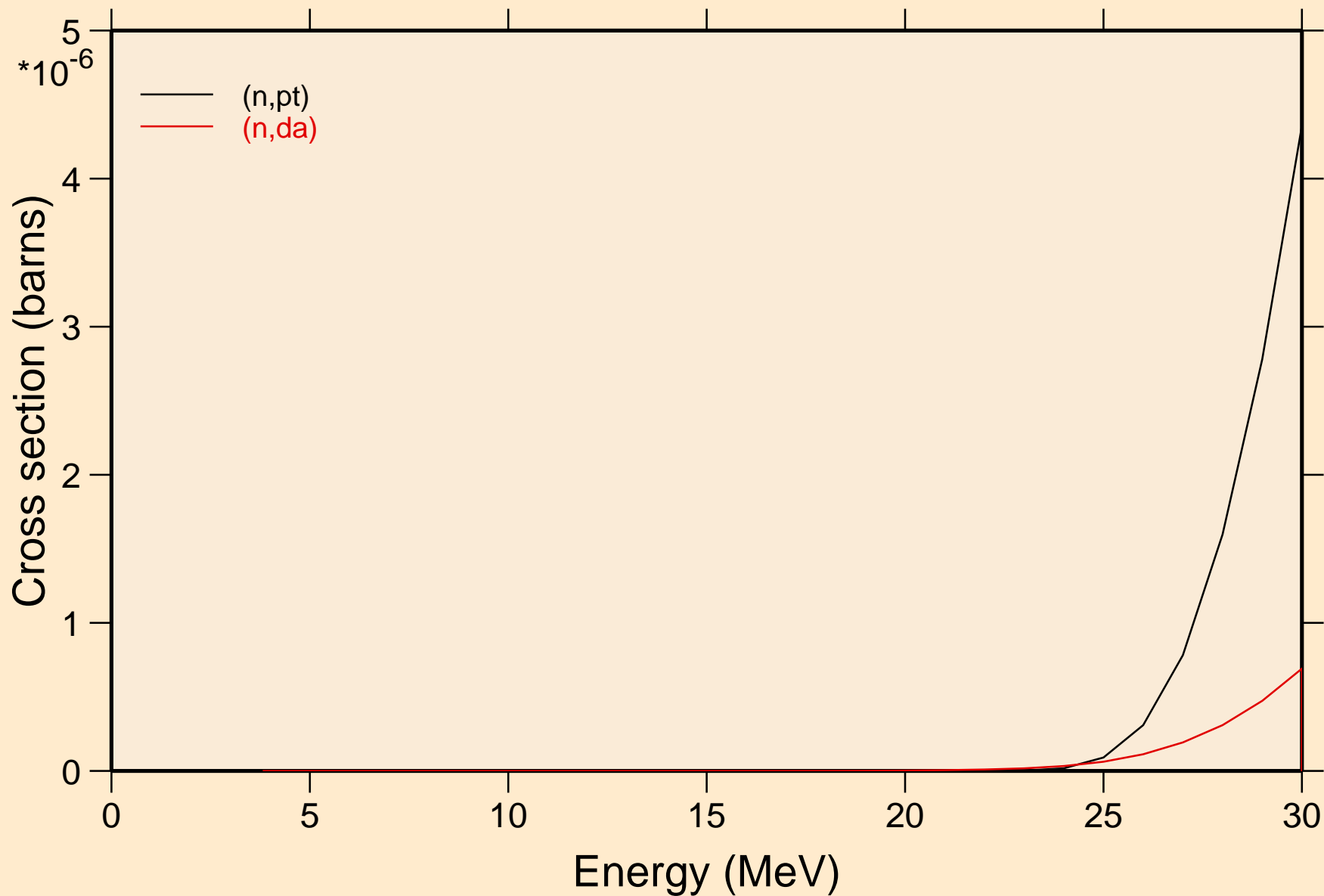

I123 NEUTRON ACER TENDL-2019 LIBRARY; T=293.16K

Threshold reactions

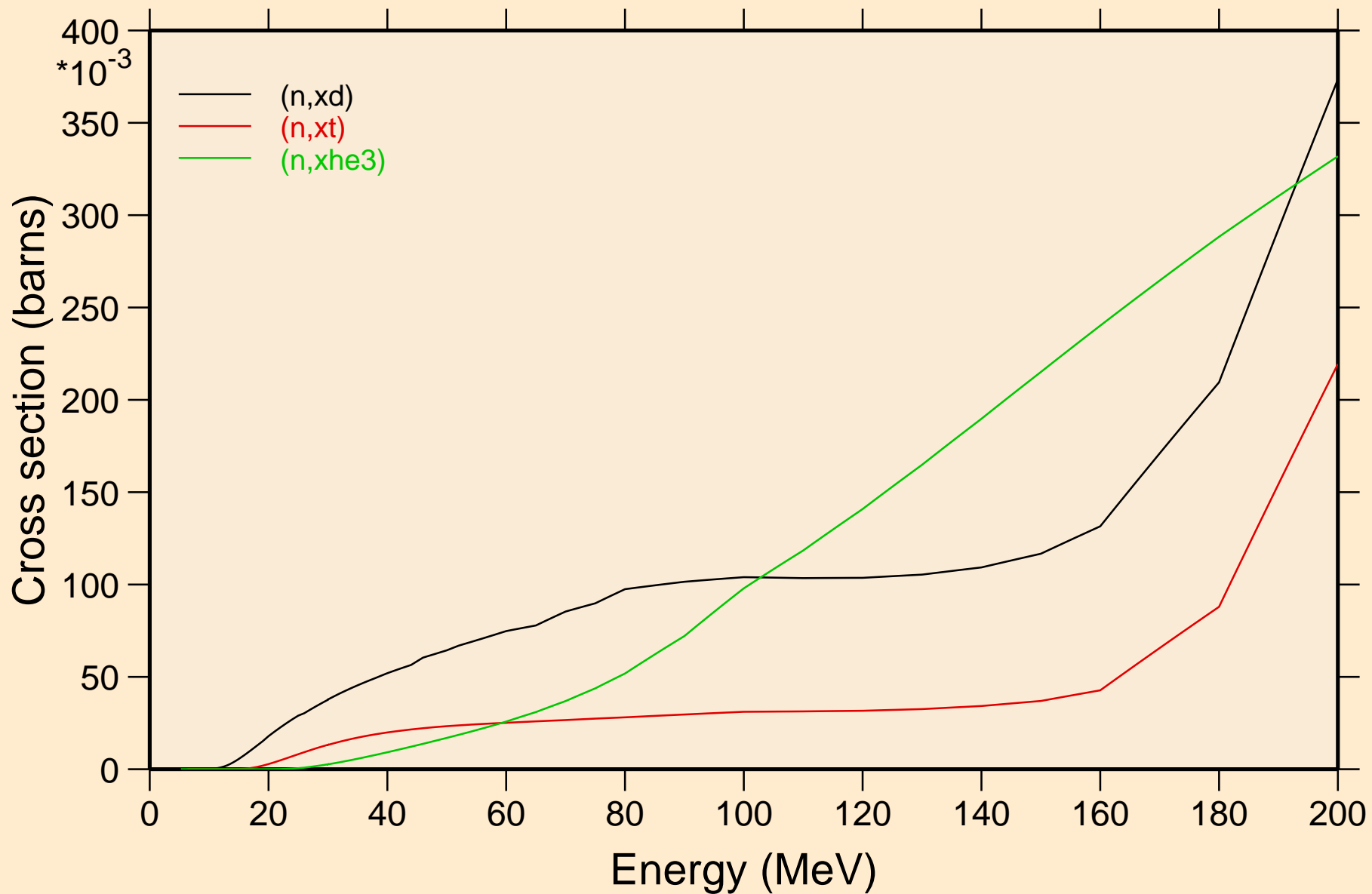

I123 NEUTRON ACER TENDL-2019 LIBRARY; T=293.16K
angular distribution for elastic

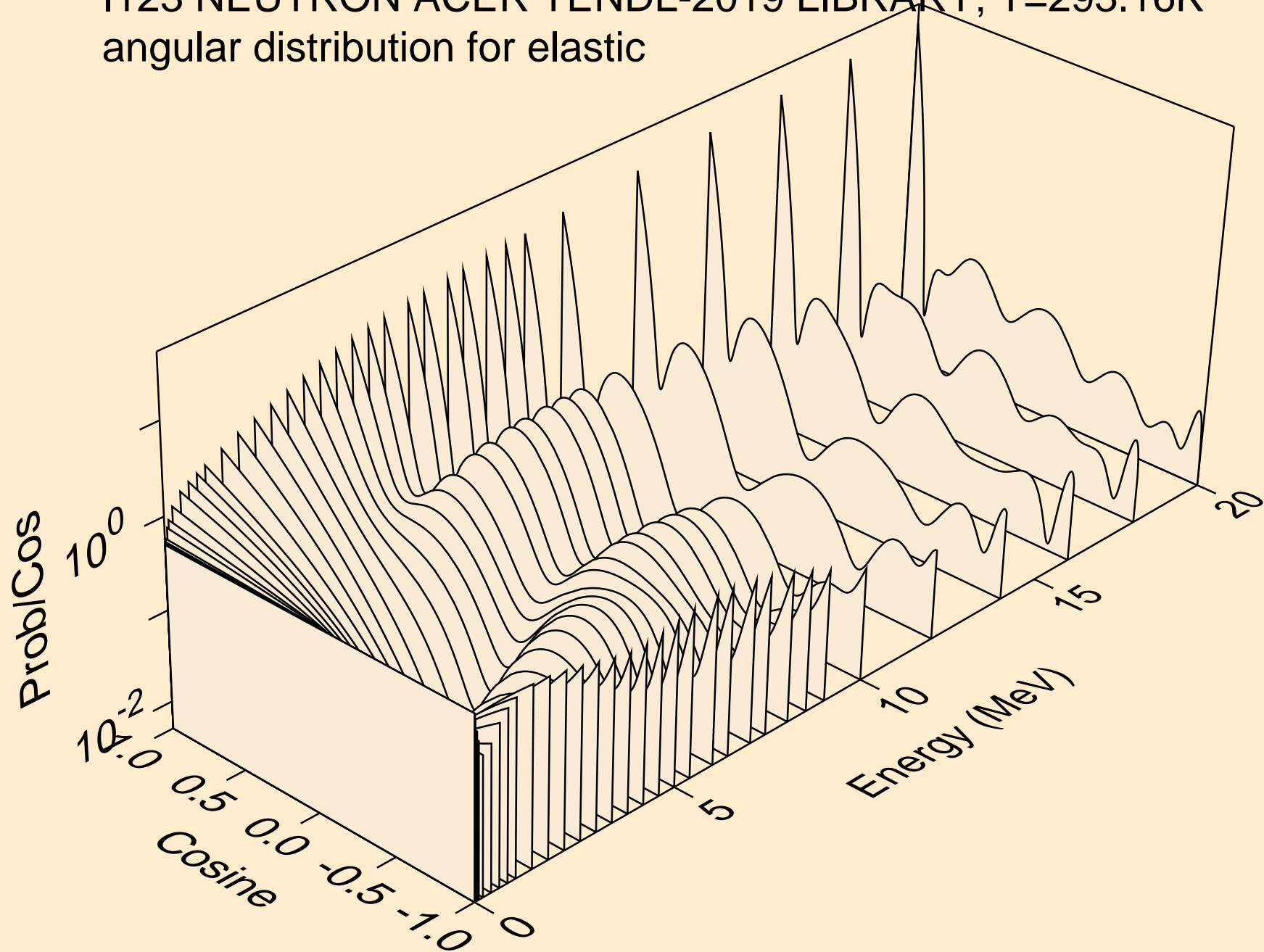

I123 NEUTRON ACER TENDL-2019 LIBRARY; T=293.16K
angular distribution for elastic

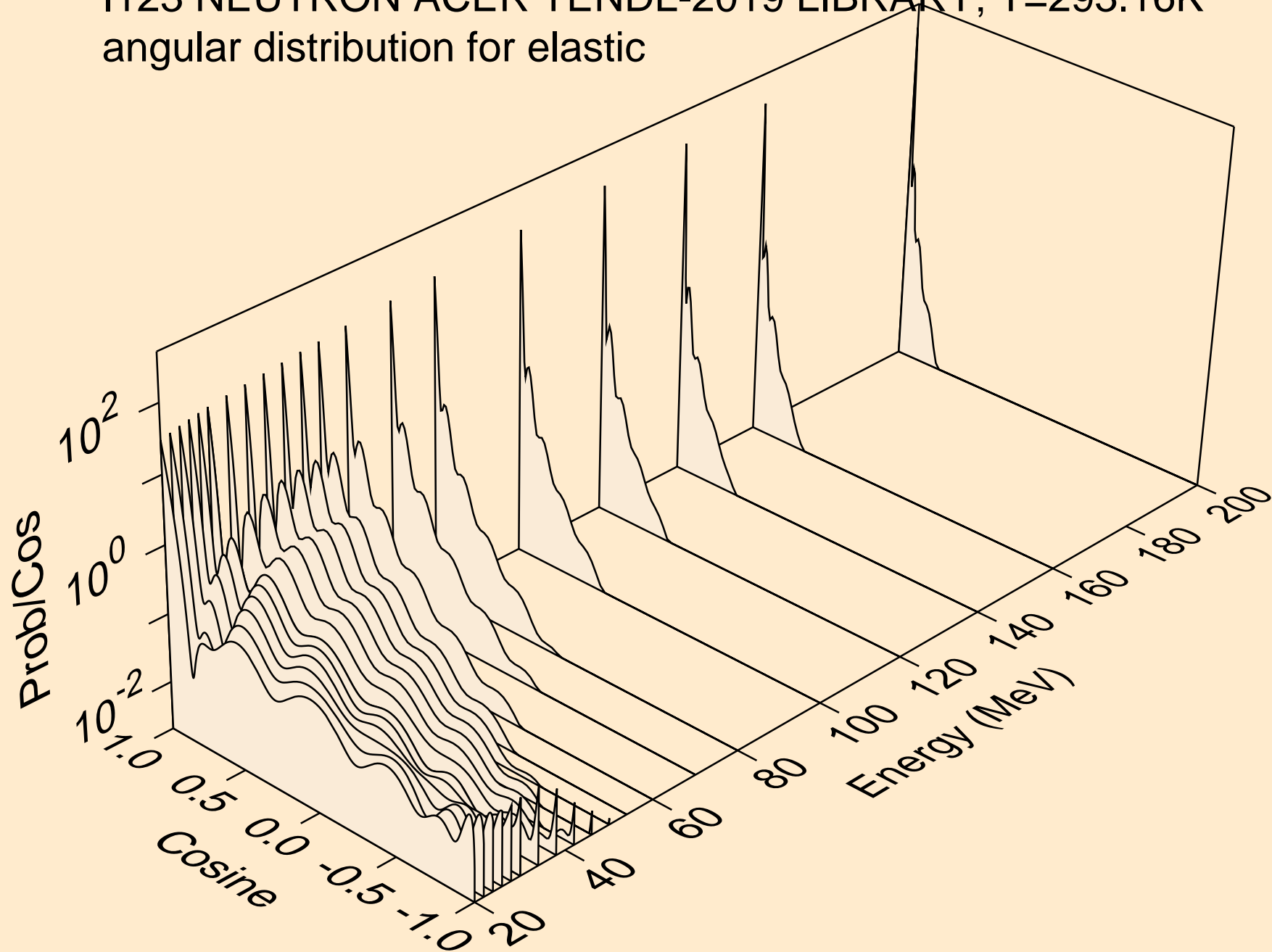

I123 NEUTRON ACER TENDL-2019 LIBRARY; T=293.16K
angular distribution for (n,n*1)

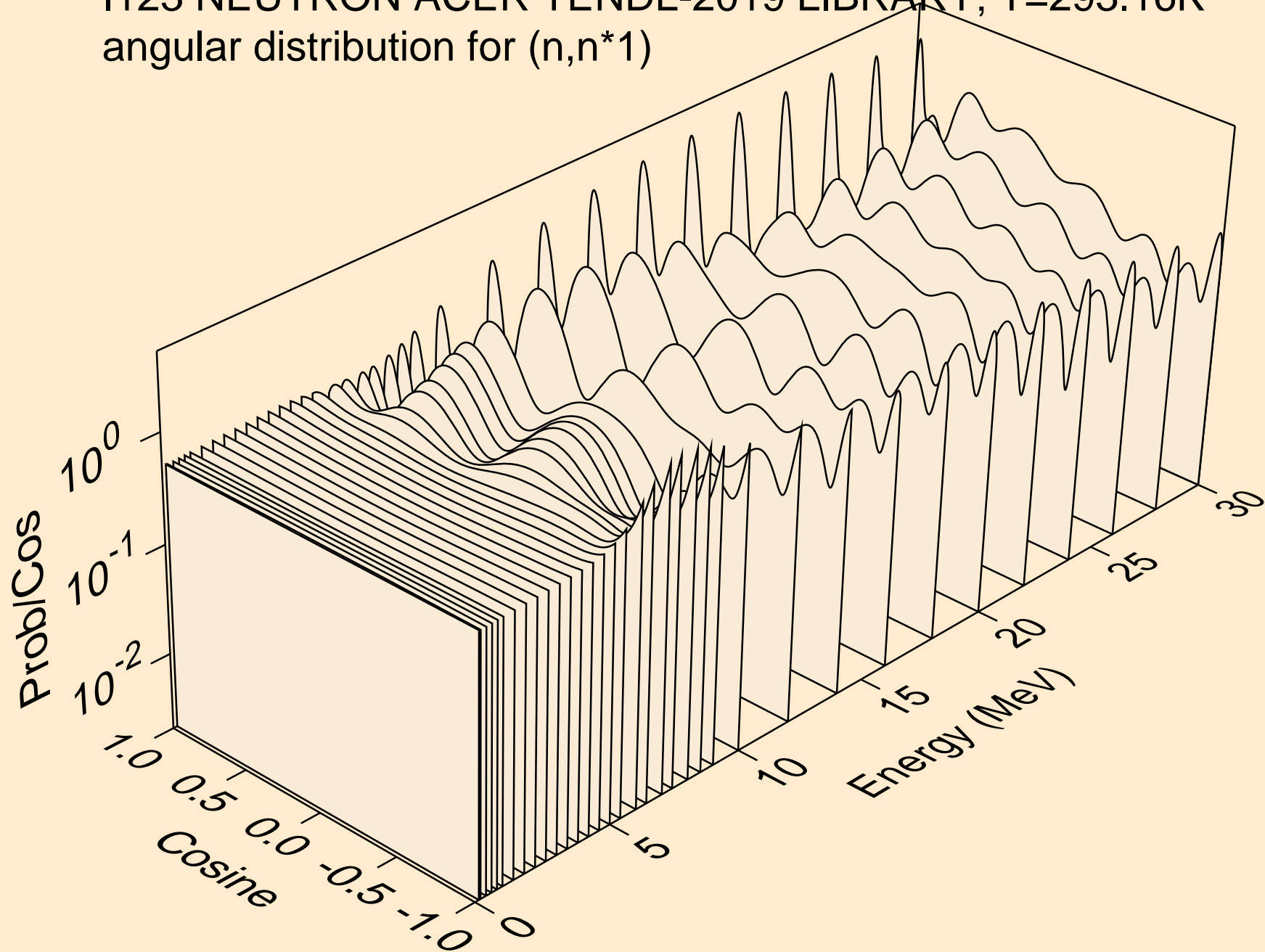

I123 NEUTRON ACER TENDL-2019 LIBRARY; T=293.16K
angular distribution for (n,n*2)

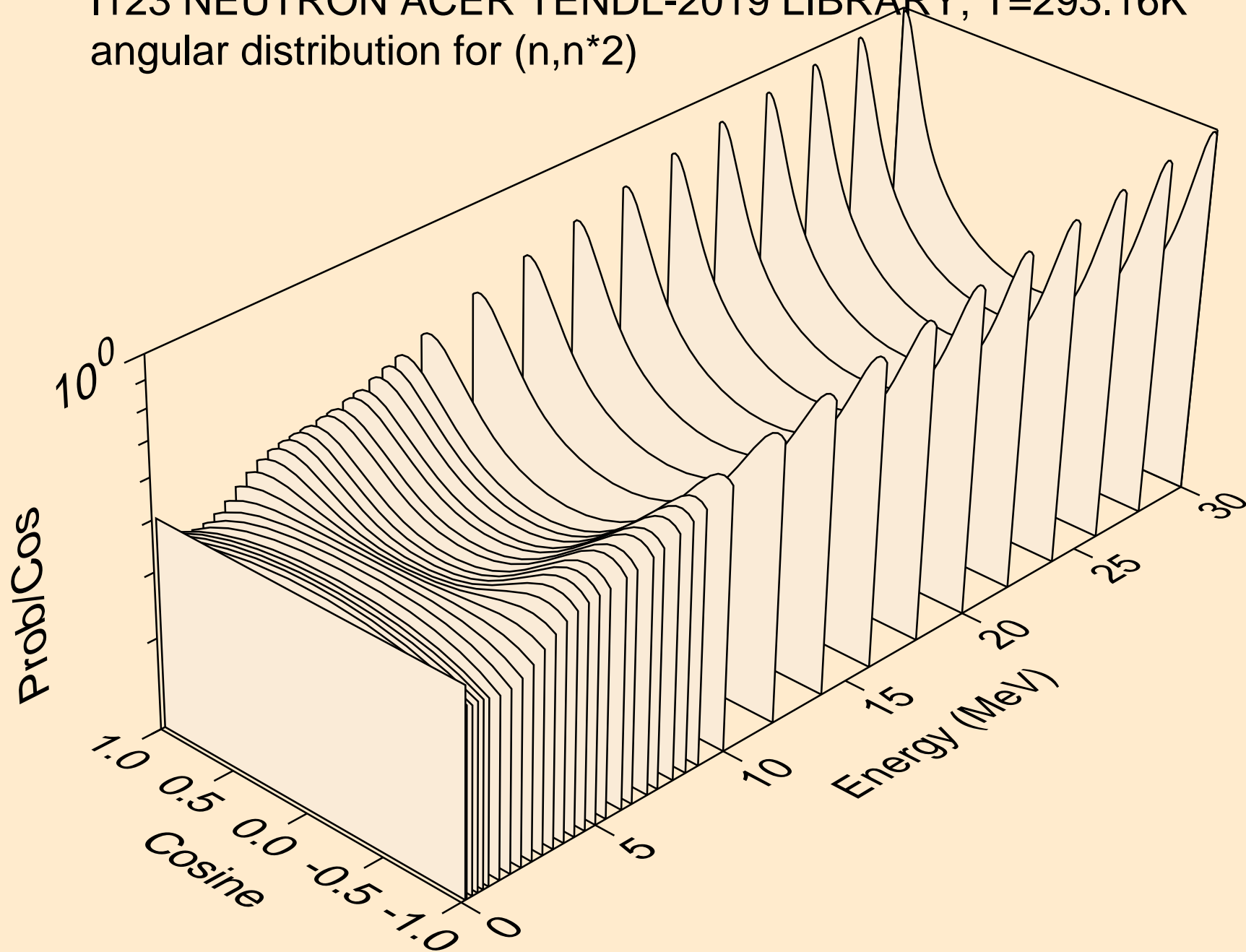

I123 NEUTRON ACER TENDL-2019 LIBRARY; T=293.16K
angular distribution for (n,n*3)

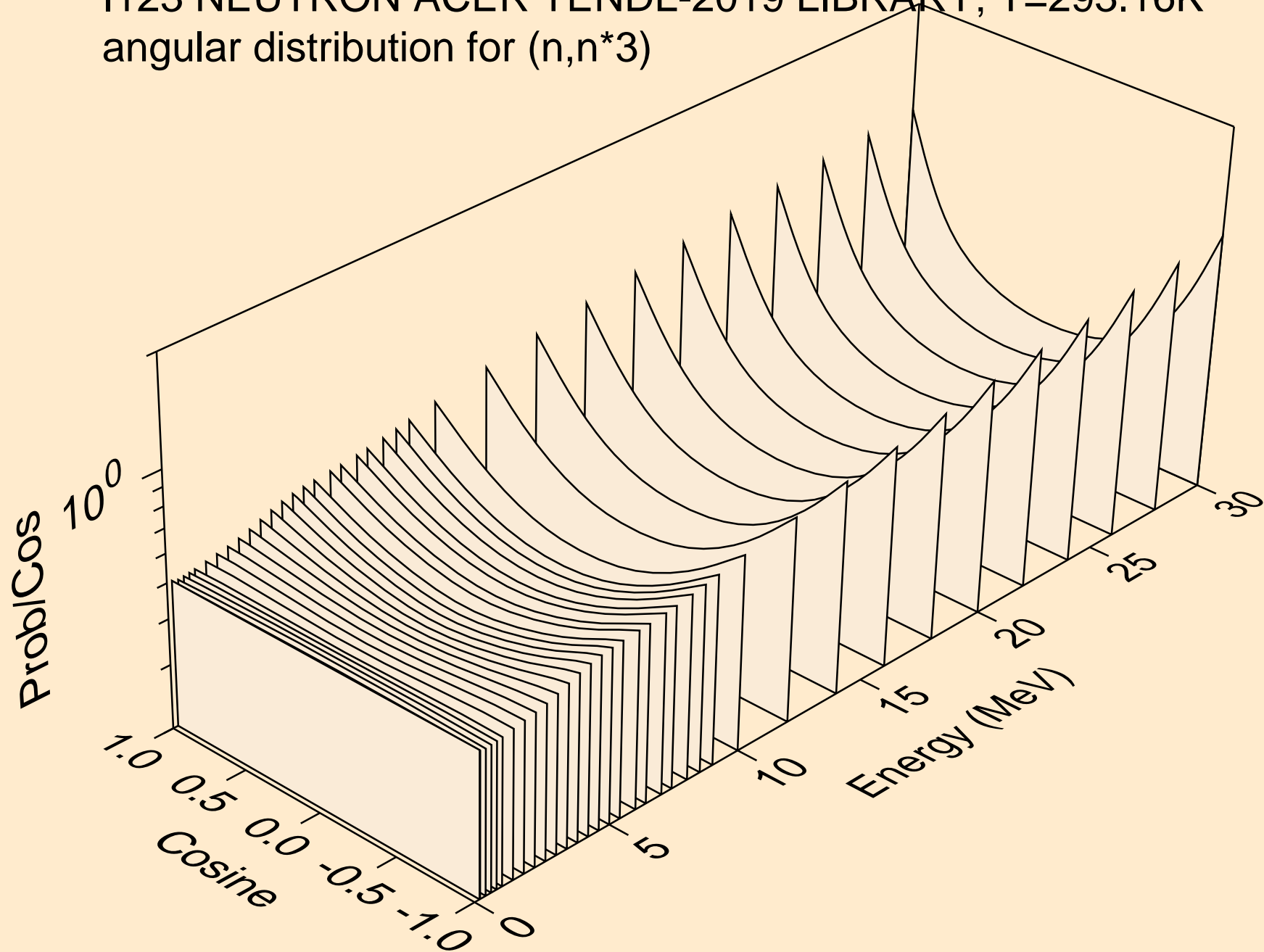

I123 NEUTRON ACER TENDL-2019 LIBRARY; T=293.16K
angular distribution for (n,n*4)

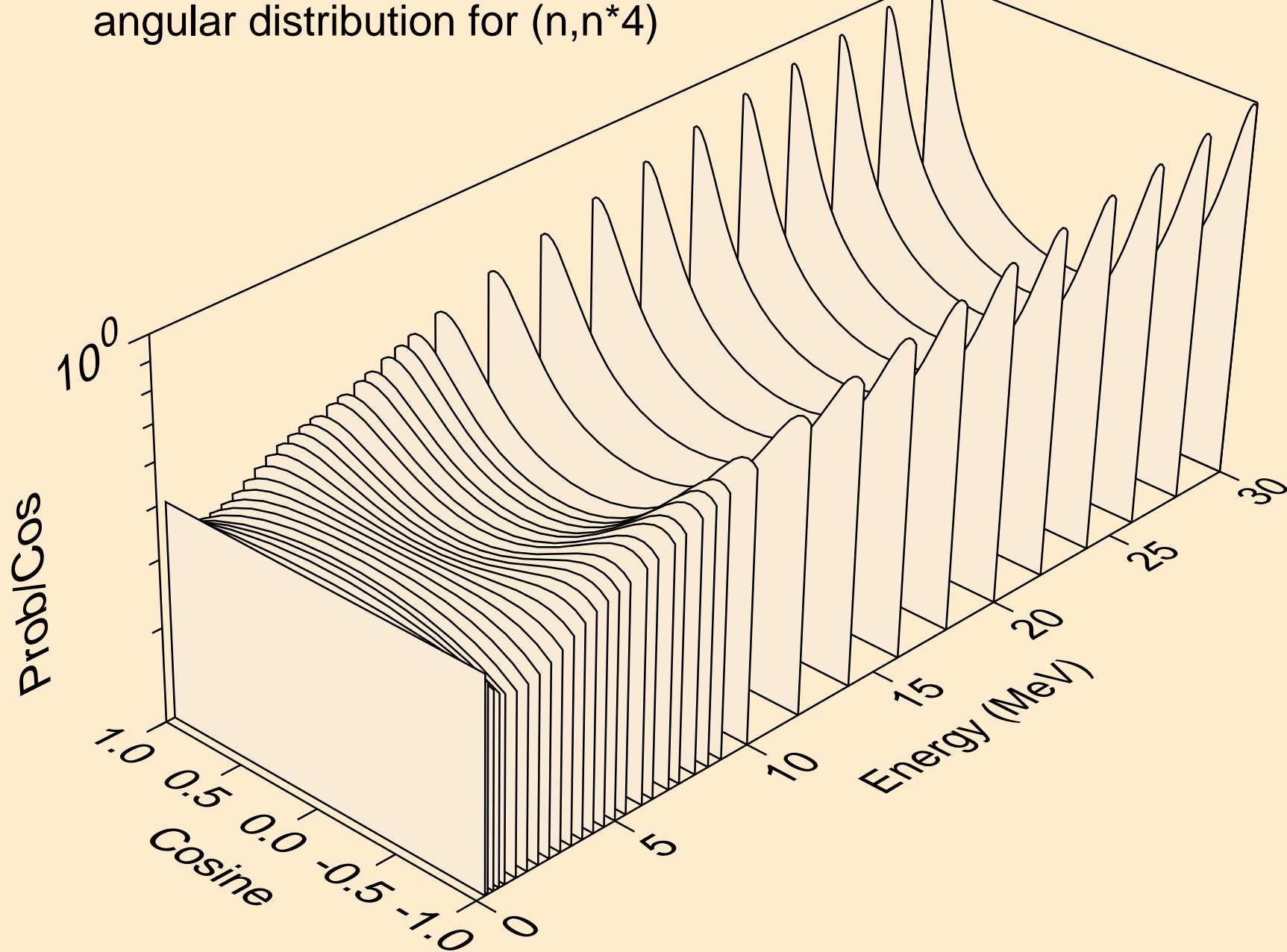

I123 NEUTRON ACER TENDL-2019 LIBRARY; T=293.16K
angular distribution for (n,n*5)

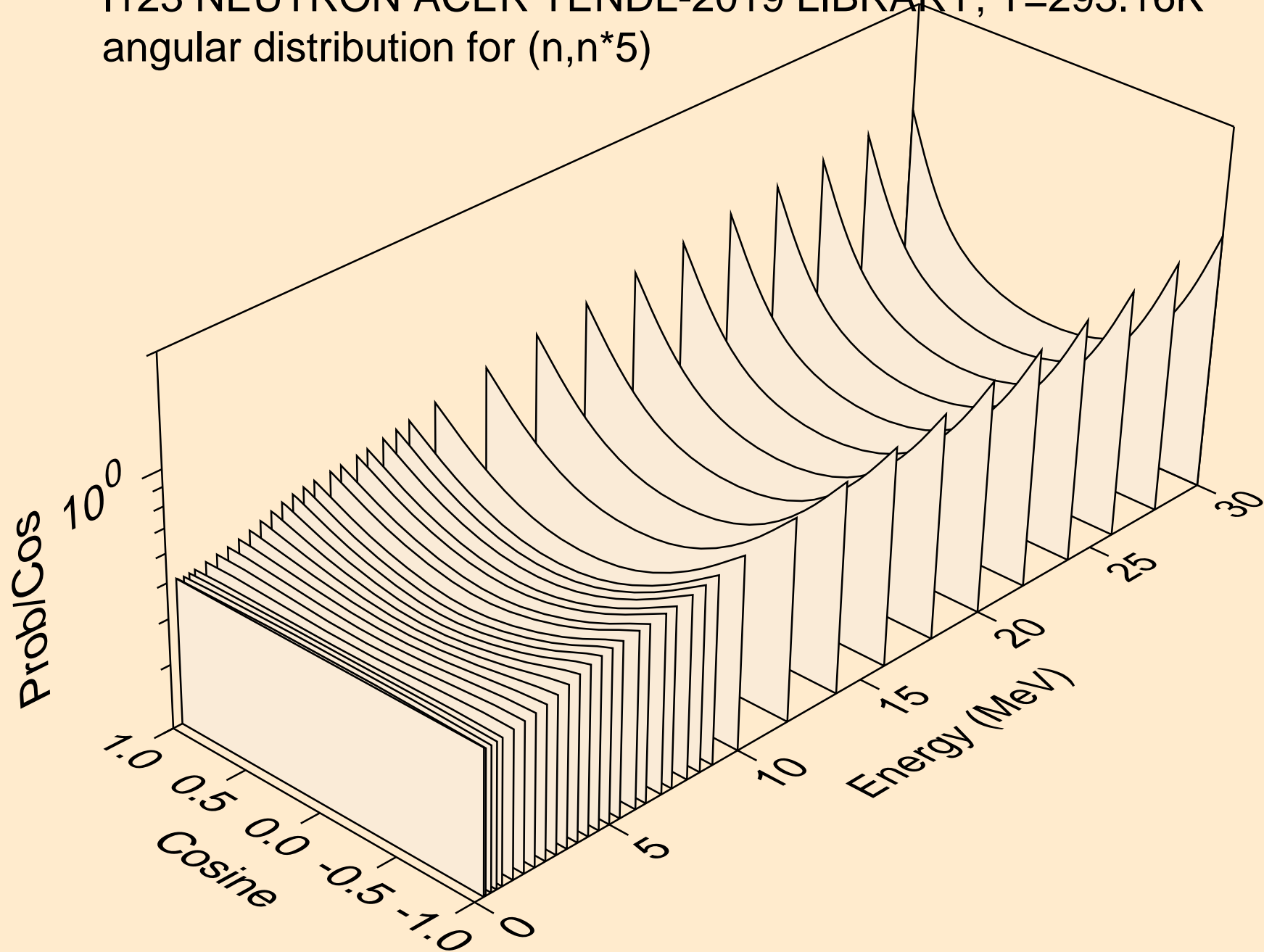

I123 NEUTRON ACER TENDL-2019 LIBRARY; T=293.16K
angular distribution for (n,n*6)

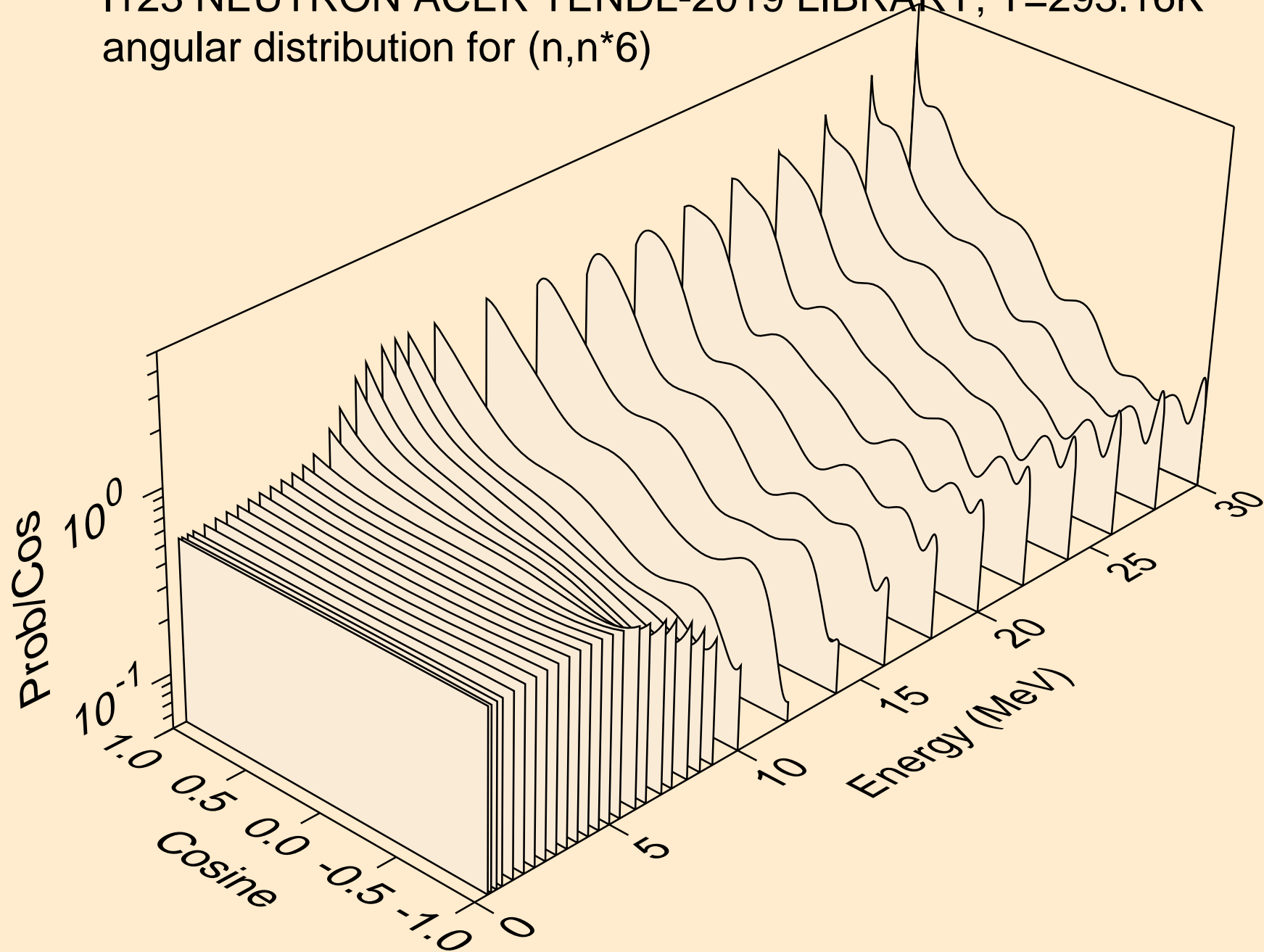

I123 NEUTRON ACER TENDL-2019 LIBRARY; T=293.16K
angular distribution for (n,n*7)

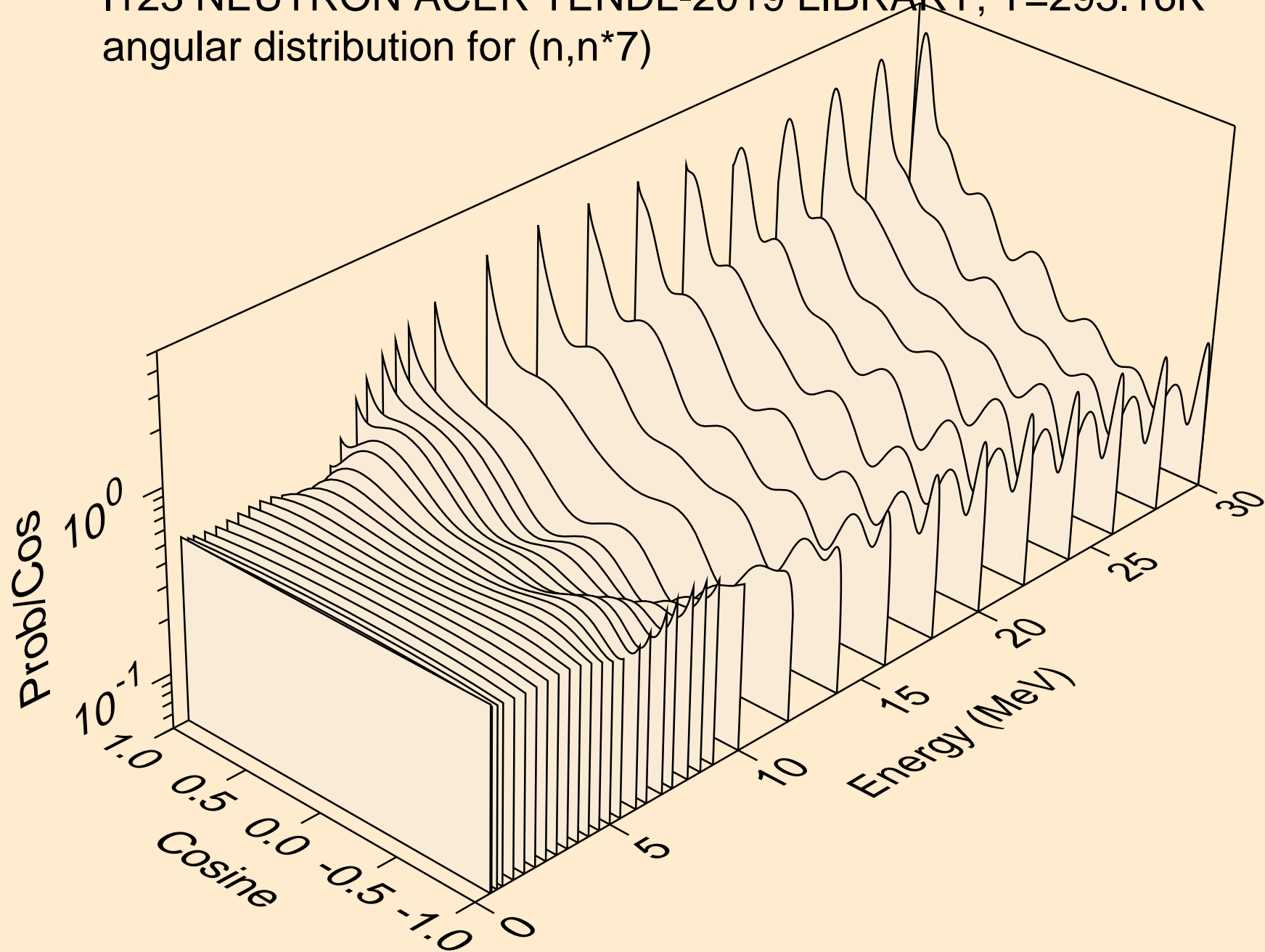

I123 NEUTRON ACER TENDL-2019 LIBRARY; T=293.16K
angular distribution for (n,n*8)

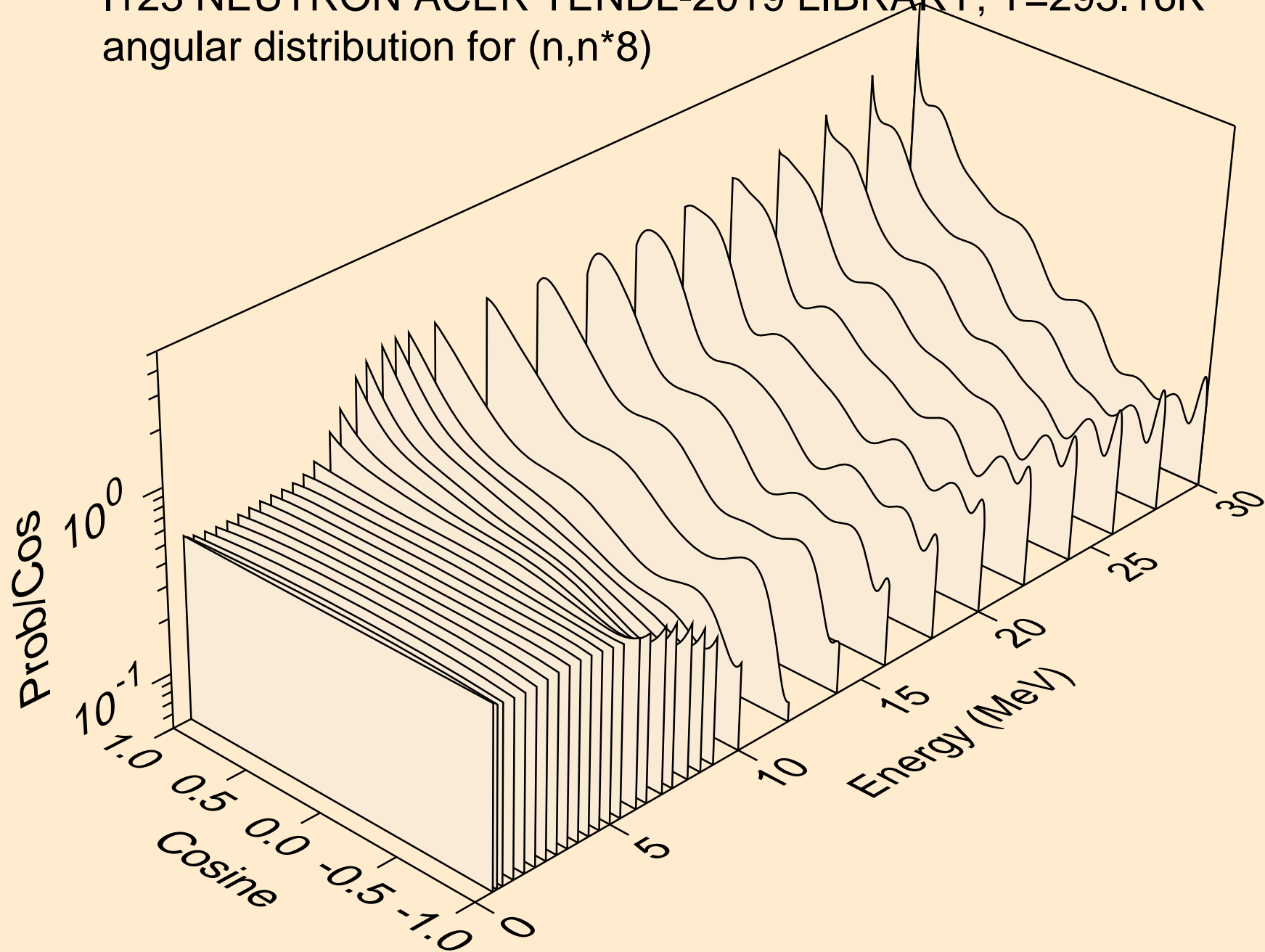

I123 NEUTRON ACER TENDL-2019 LIBRARY; T=293.16K
angular distribution for (n,n*9)

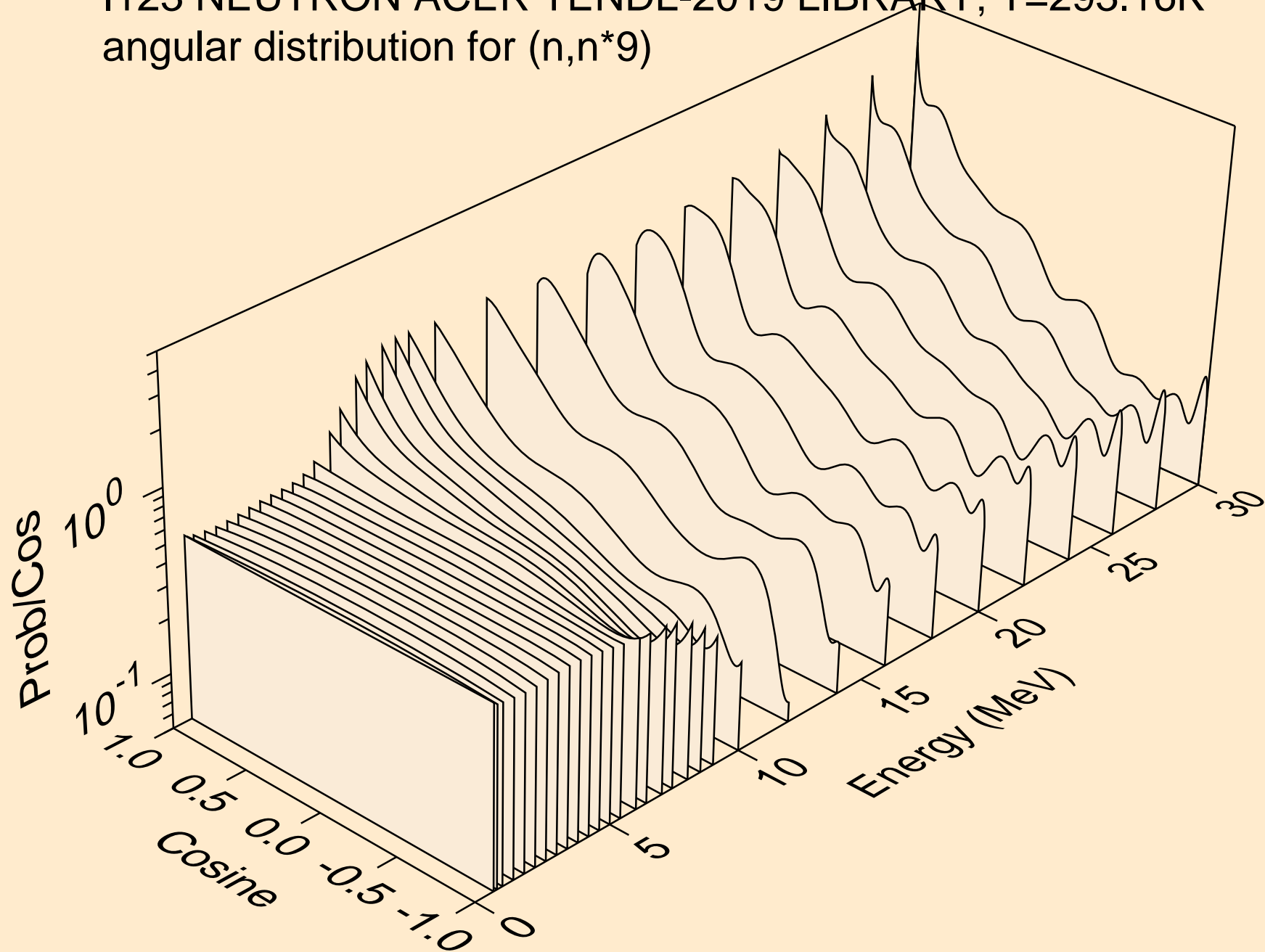

I123 NEUTRON ACER TENDL-2019 LIBRARY; T=293.16K
angular distribution for (n,n*10)

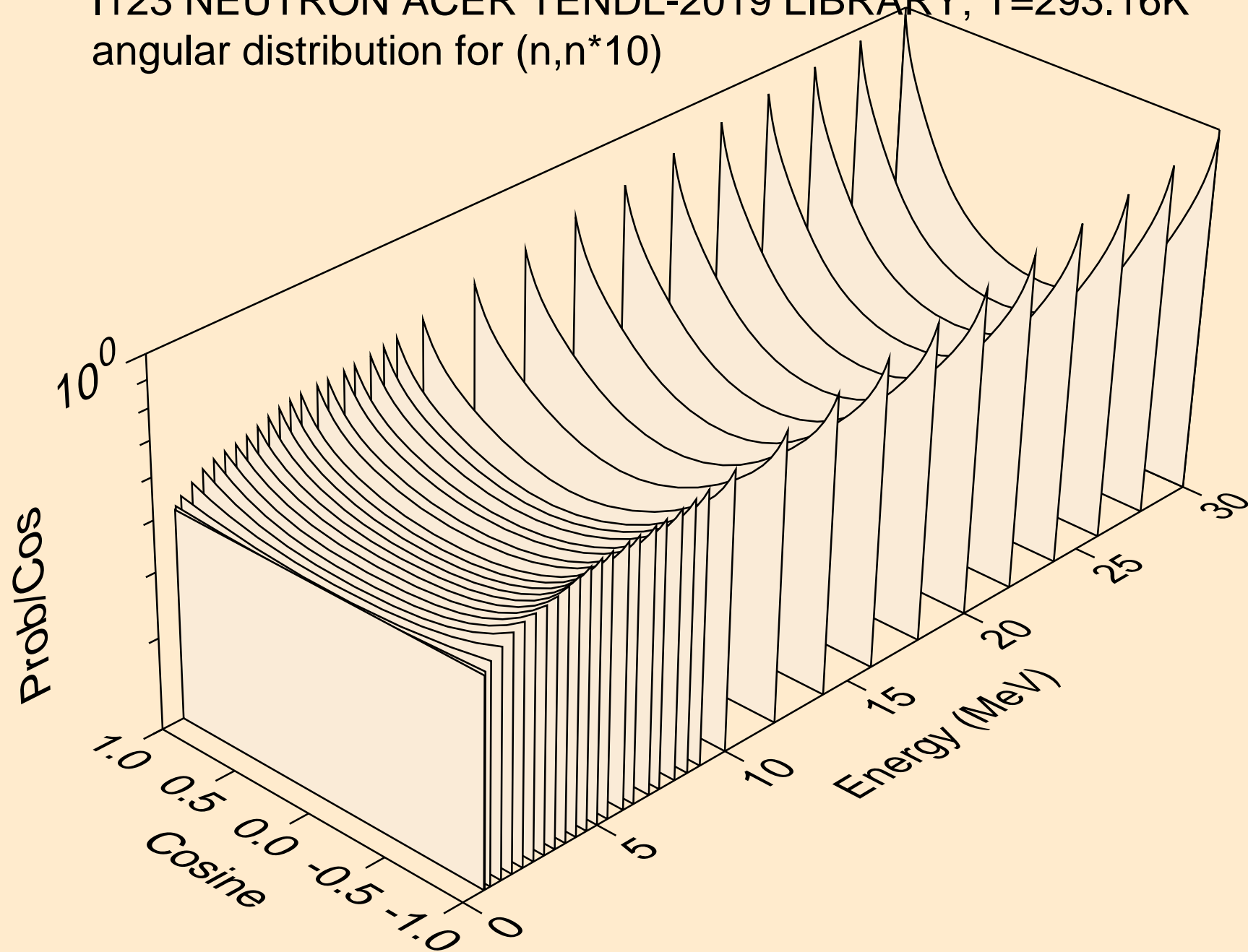

I123 NEUTRON ACER TENDL-2019 LIBRARY; T=293.16K
angular distribution for (n,n*11)

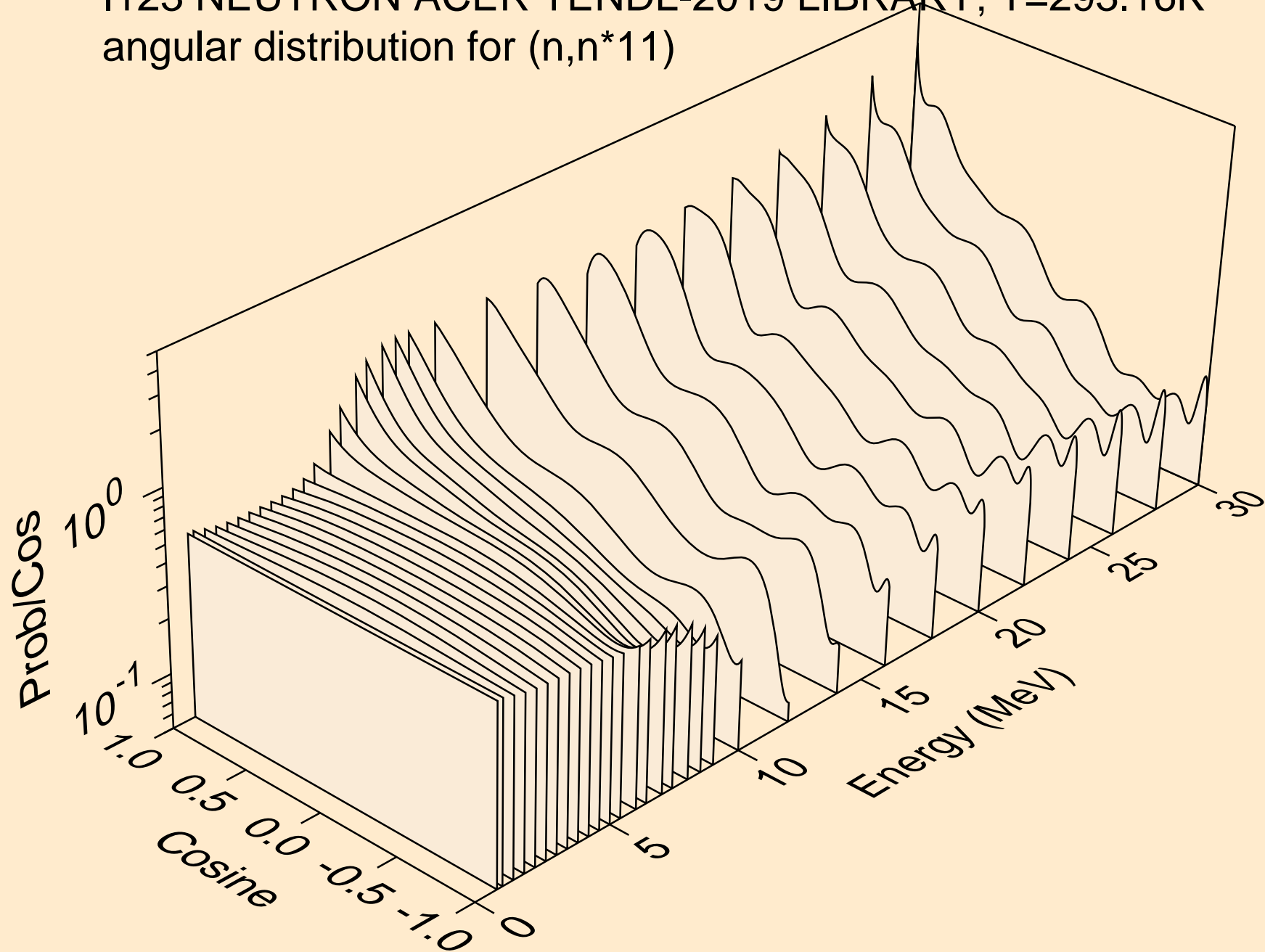

I123 NEUTRON ACER TENDL-2019 LIBRARY; T=293.16K
angular distribution for (n,n*12)

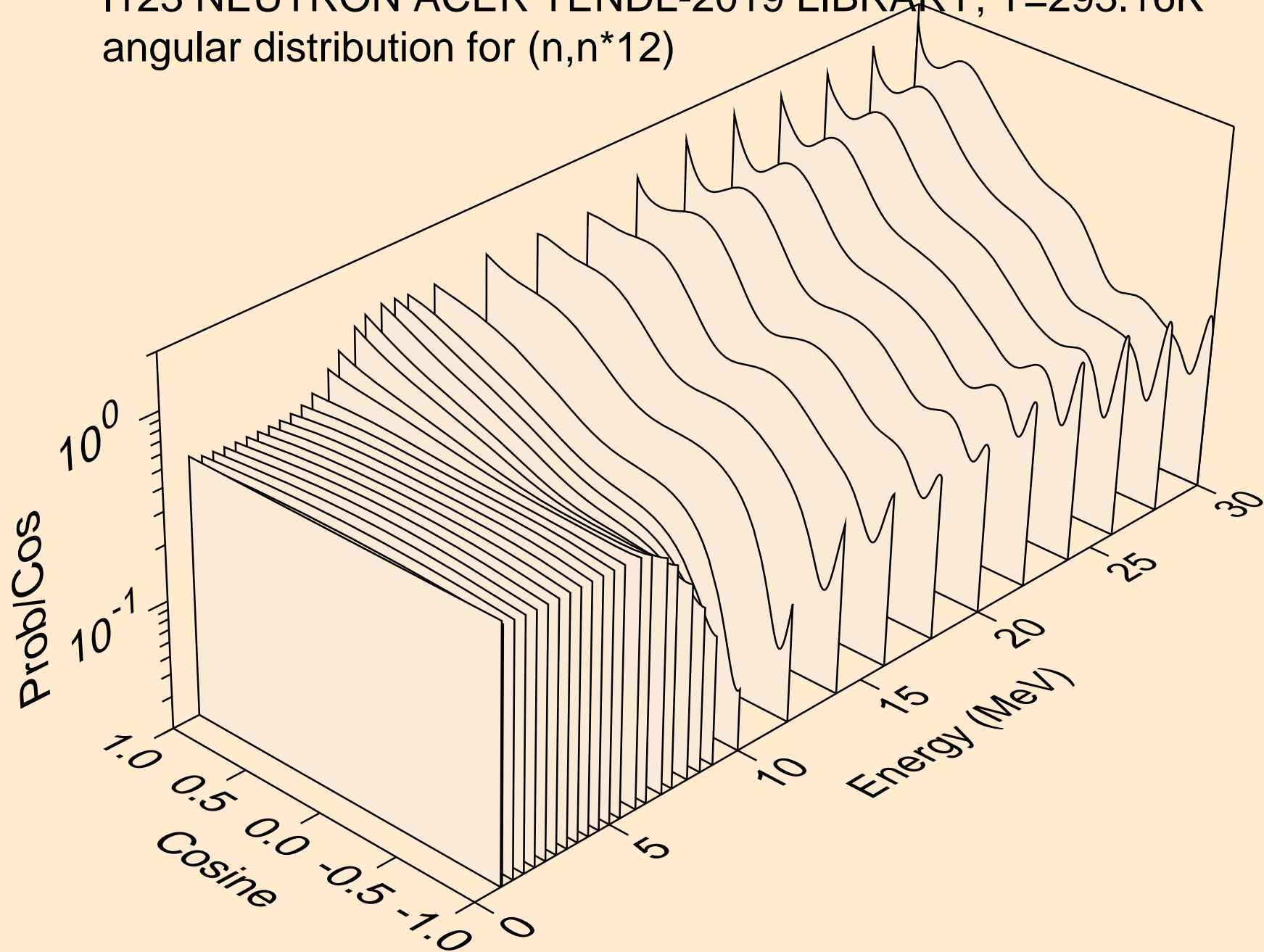

I123 NEUTRON ACER TENDL-2019 LIBRARY; T=293.16K
angular distribution for (n,n*13)

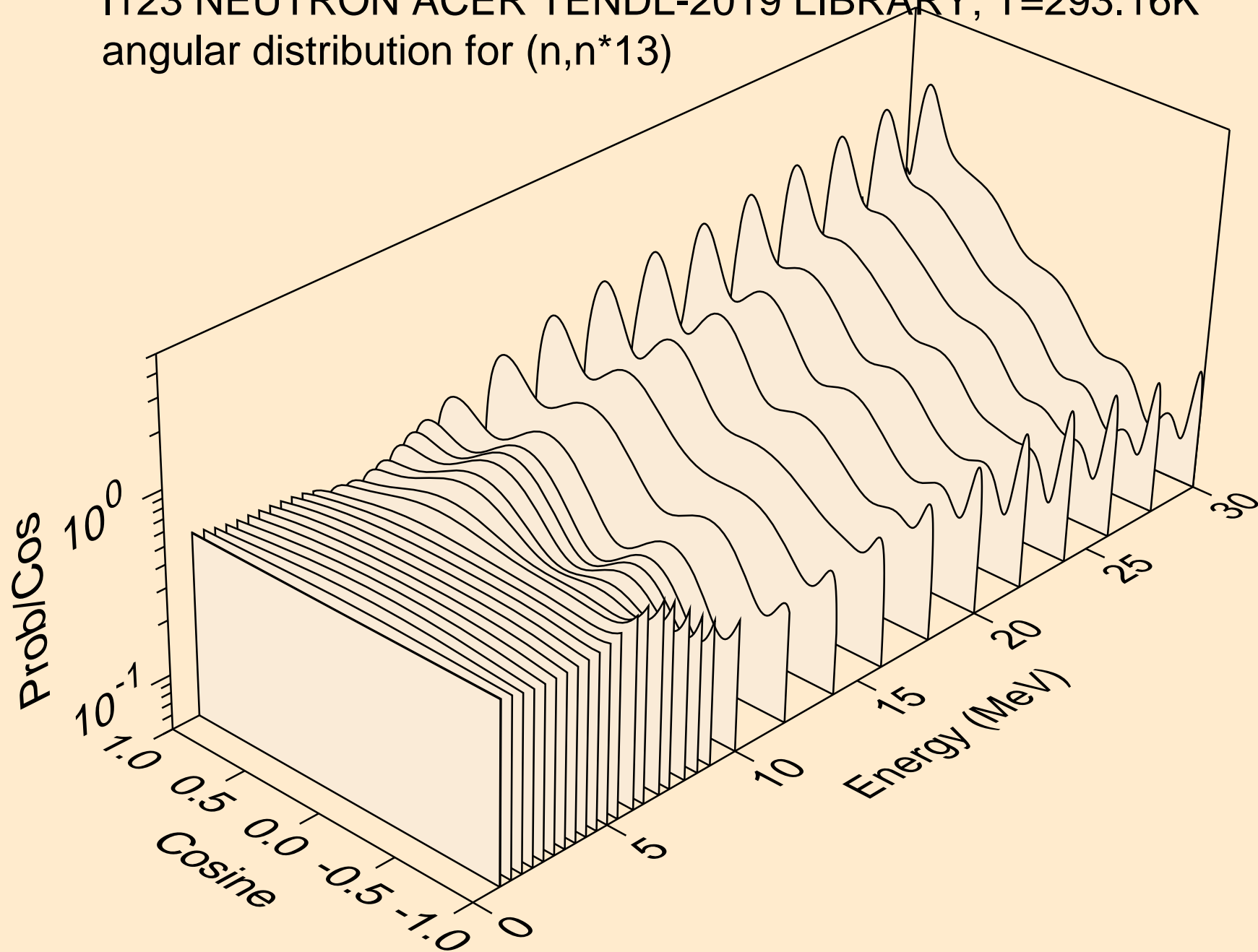

I123 NEUTRON ACER TENDL-2019 LIBRARY; T=293.16K
angular distribution for (n,n*14)

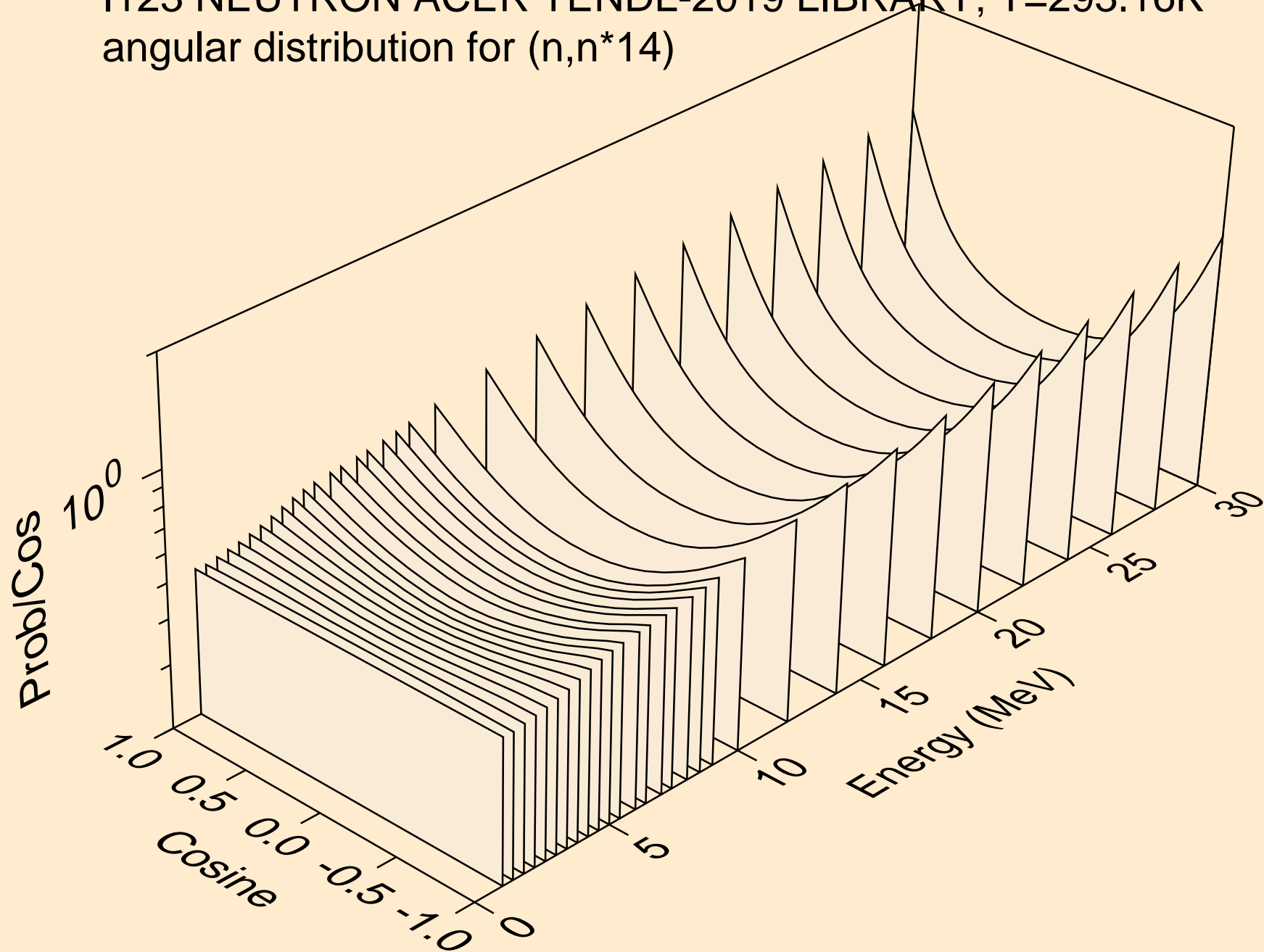

I123 NEUTRON ACER TENDL-2019 LIBRARY; T=293.16K
angular distribution for (n,n*15)

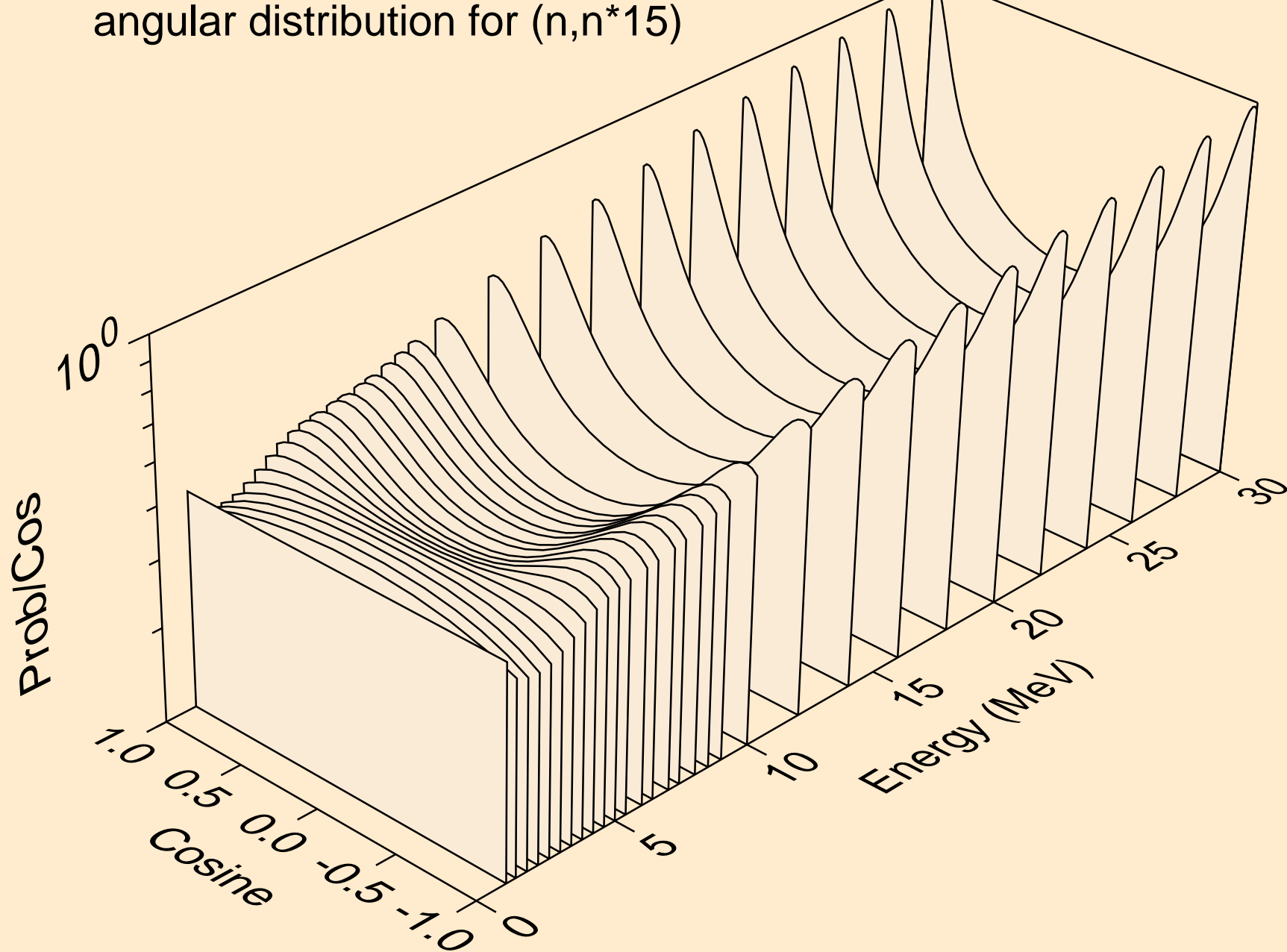

I123 NEUTRON ACER TENDL-2019 LIBRARY; T=293.16K
angular distribution for (n,n*16)

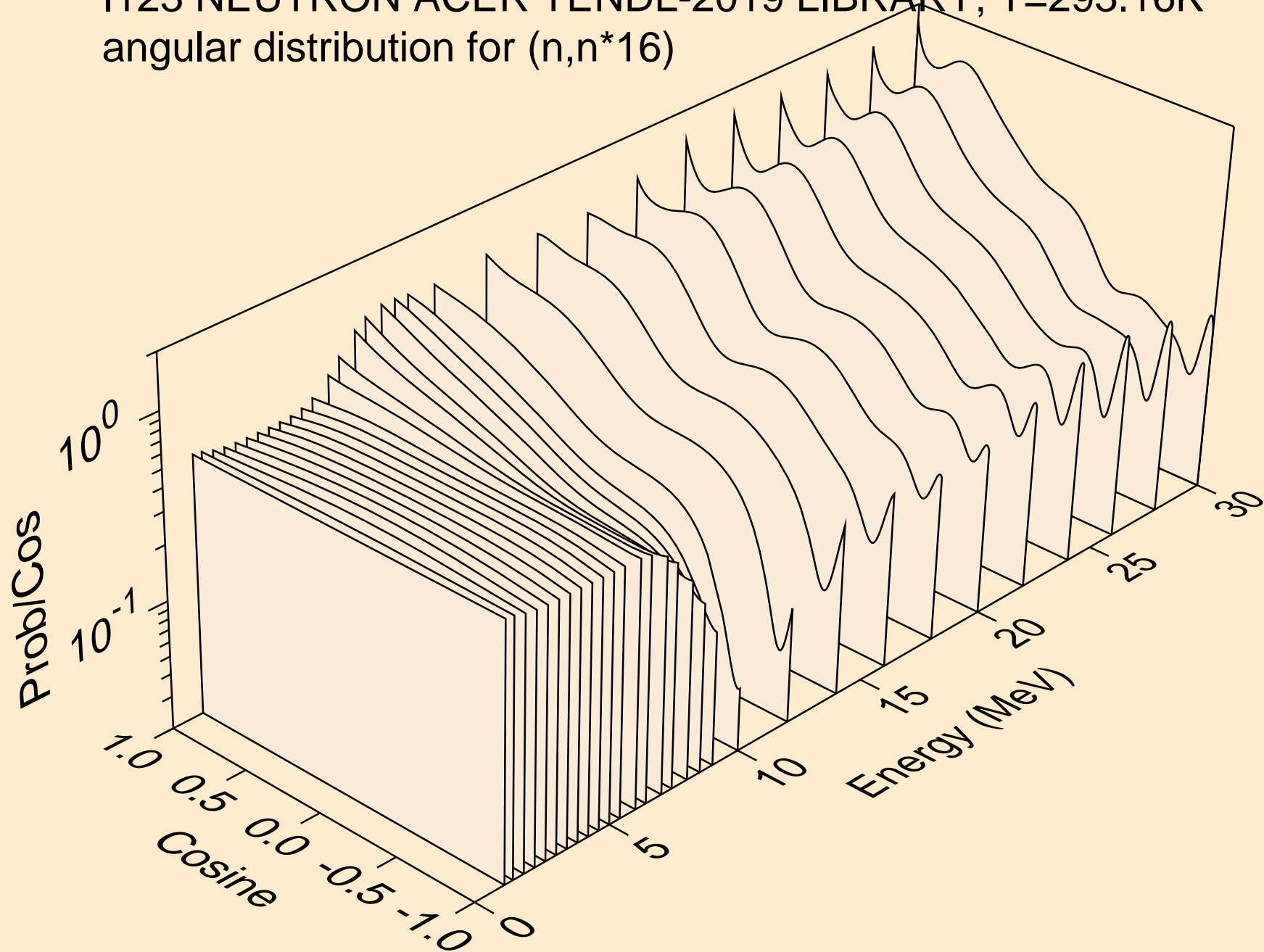

I123 NEUTRON ACER TENDL-2019 LIBRARY; T=293.16K
angular distribution for (n,n*17)

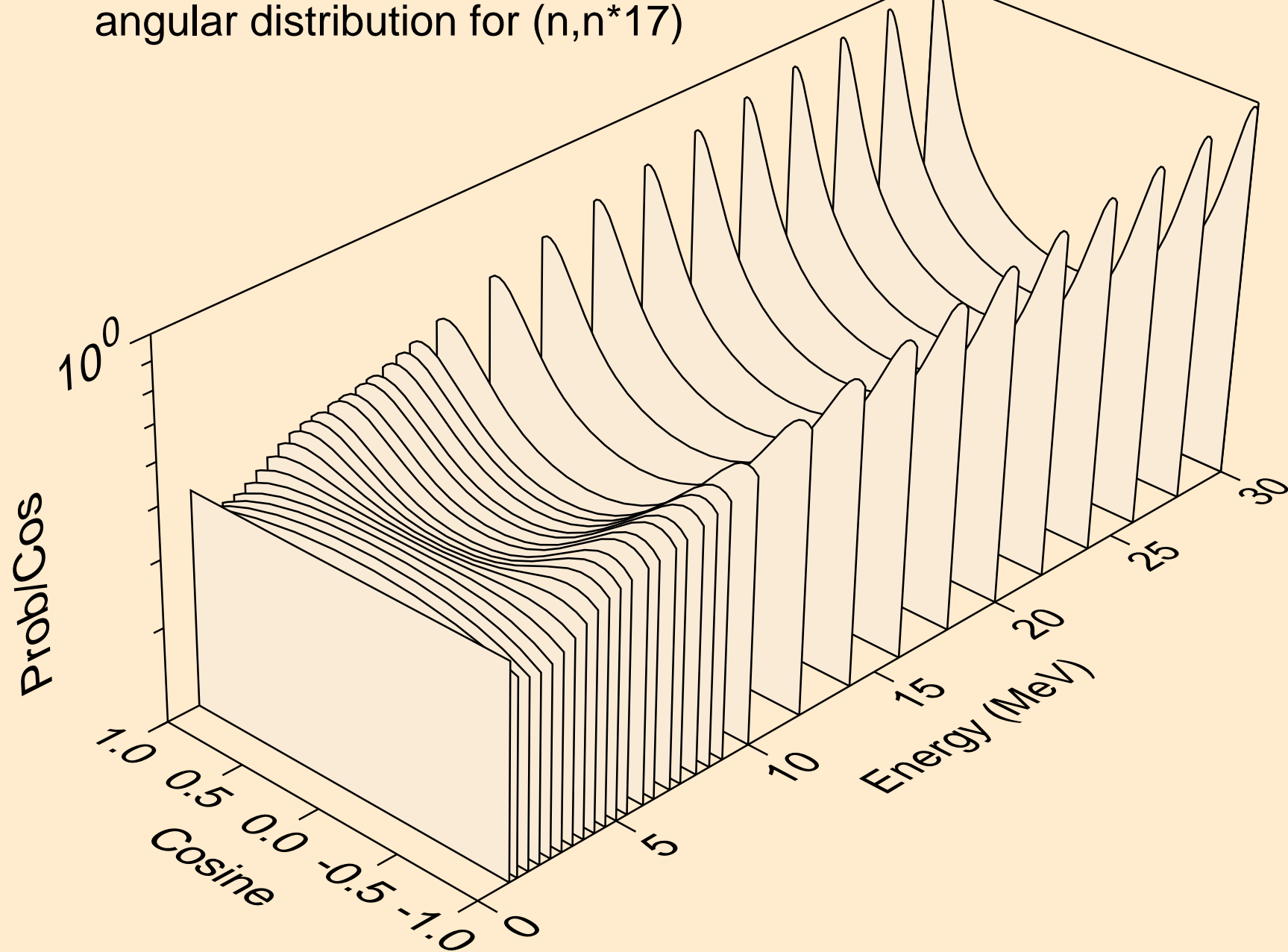

I123 NEUTRON ACER TENDL-2019 LIBRARY; T=293.16K
angular distribution for (n,n*18)

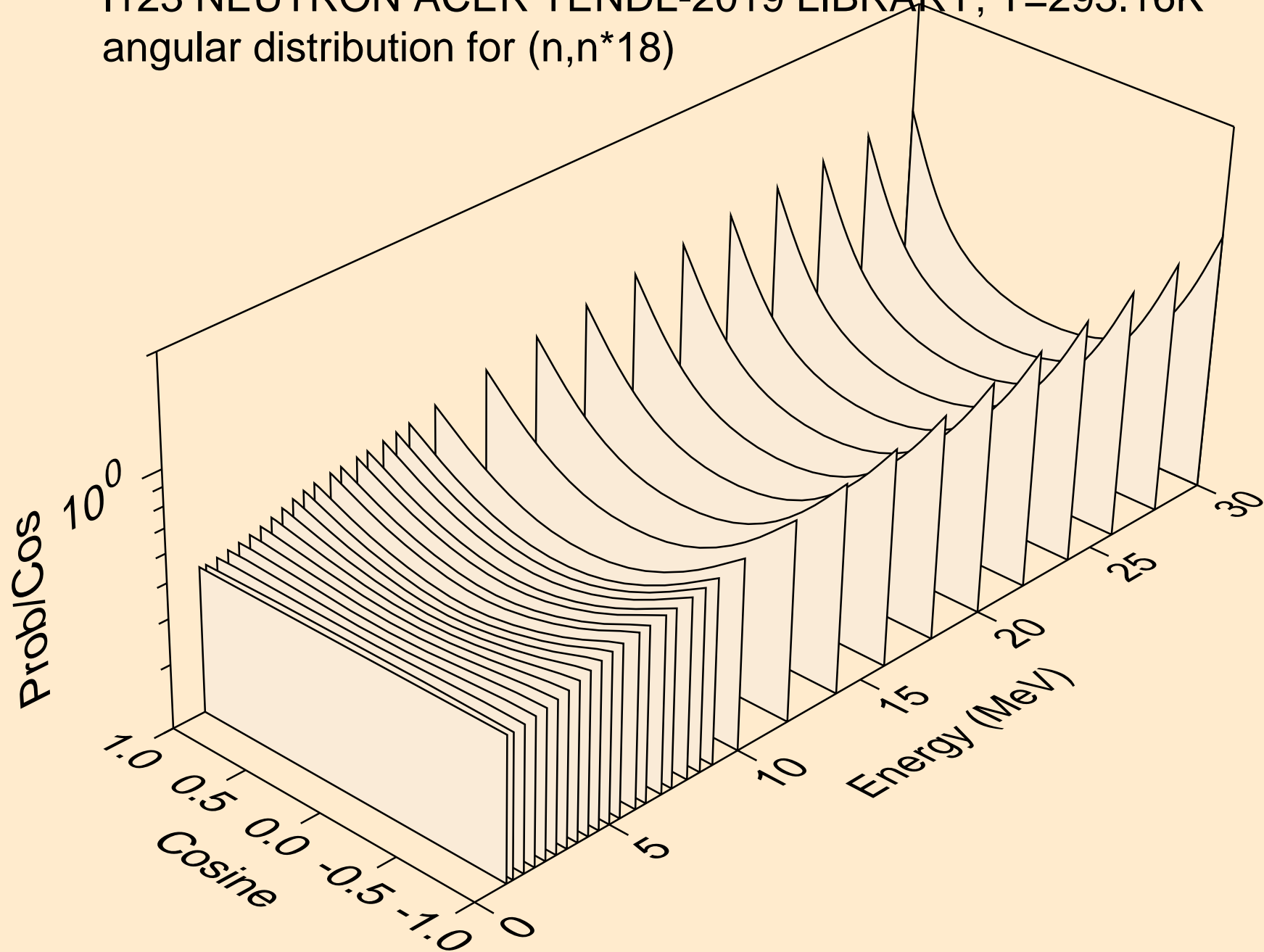

I123 NEUTRON ACER TENDL-2019 LIBRARY; T=293.16K
angular distribution for (n,n*19)

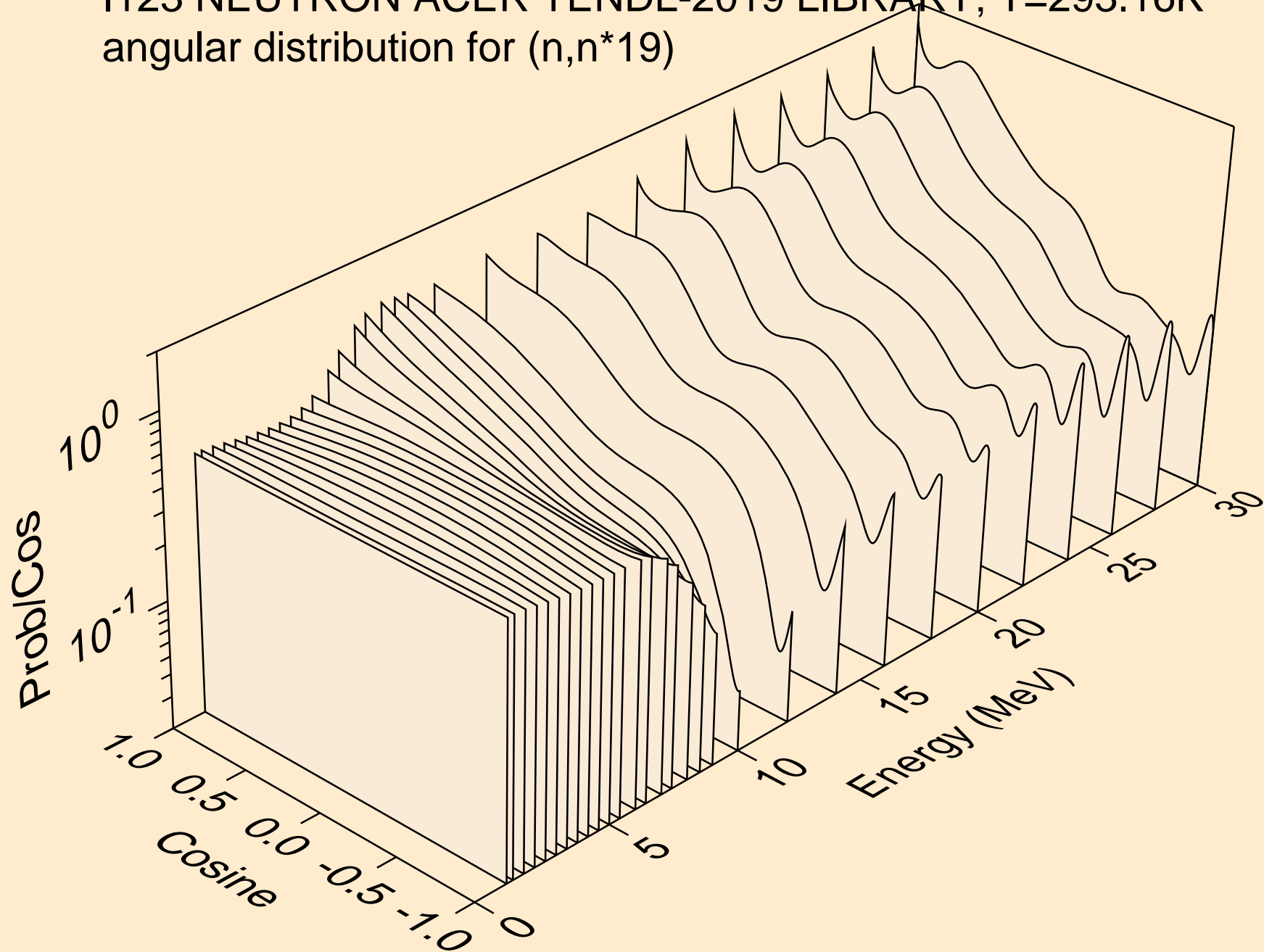

I123 NEUTRON ACER TENDL-2019 LIBRARY; T=293.16K
angular distribution for (n,n*20)

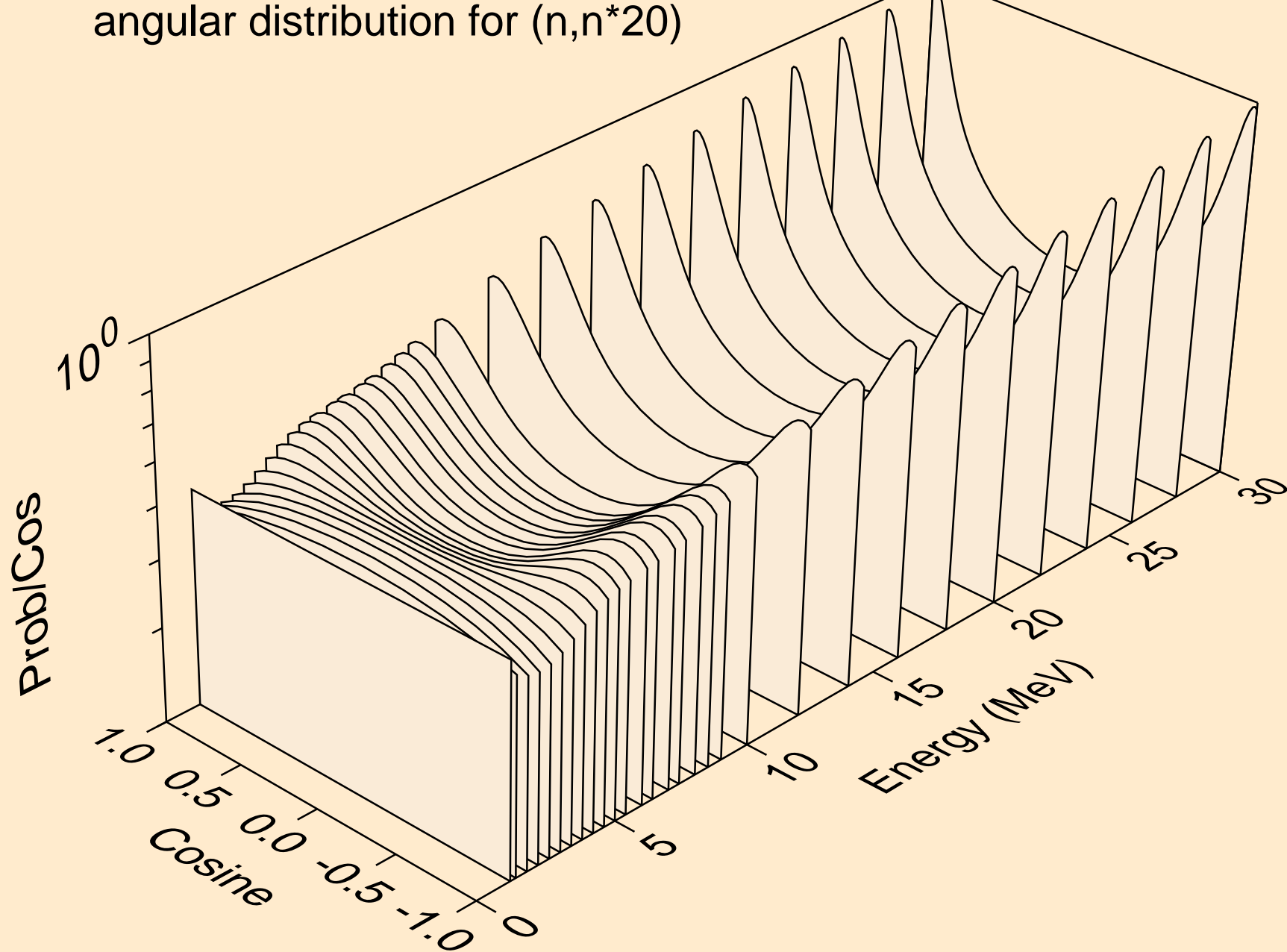

I123 NEUTRON ACER TENDL-2019 LIBRARY; T=293.16K
angular distribution for (n,n*21)

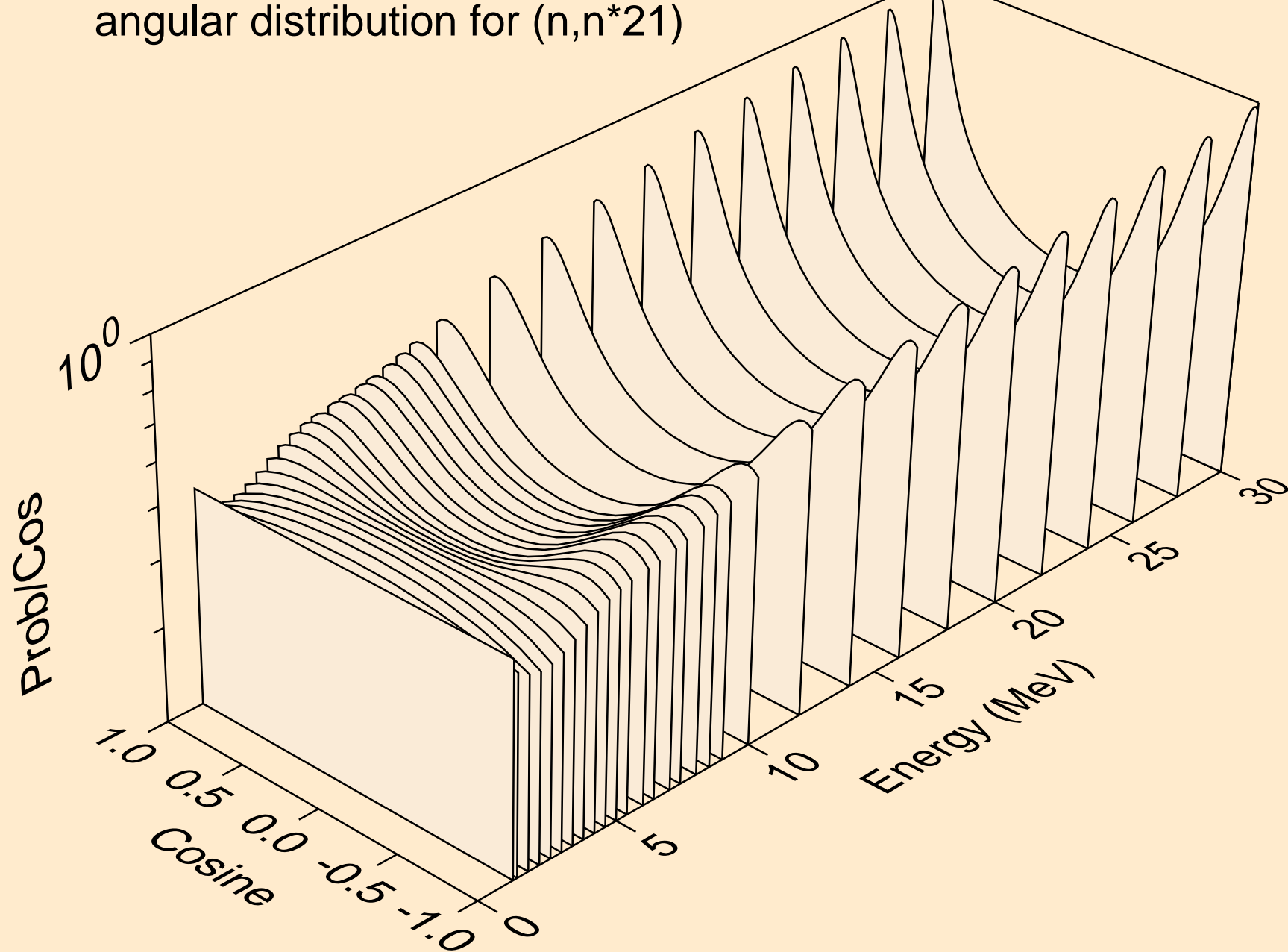

I123 NEUTRON ACER TENDL-2019 LIBRARY; T=293.16K
angular distribution for (n,n*22)

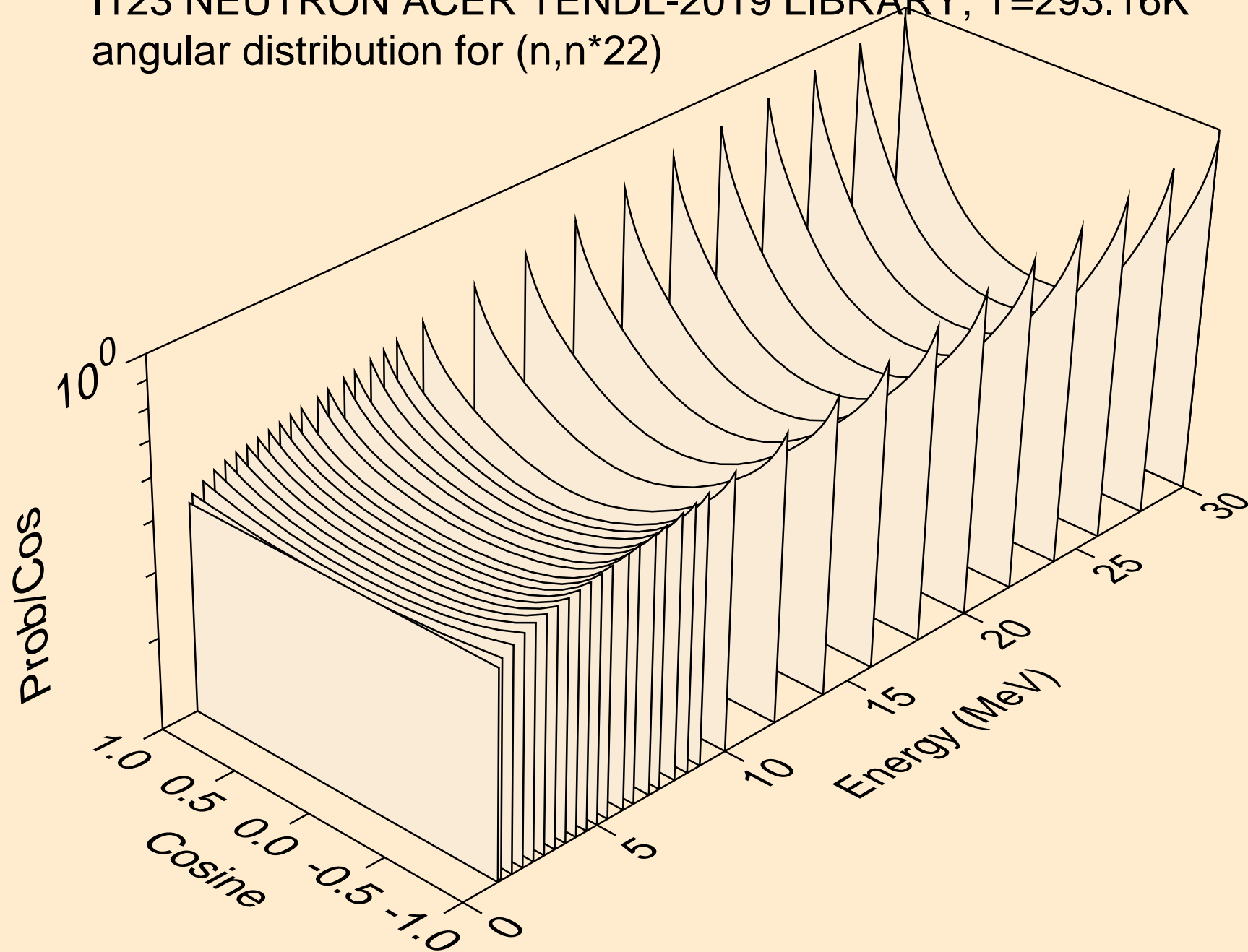

I123 NEUTRON ACER TENDL-2019 LIBRARY; T=293.16K
angular distribution for (n,n*23)

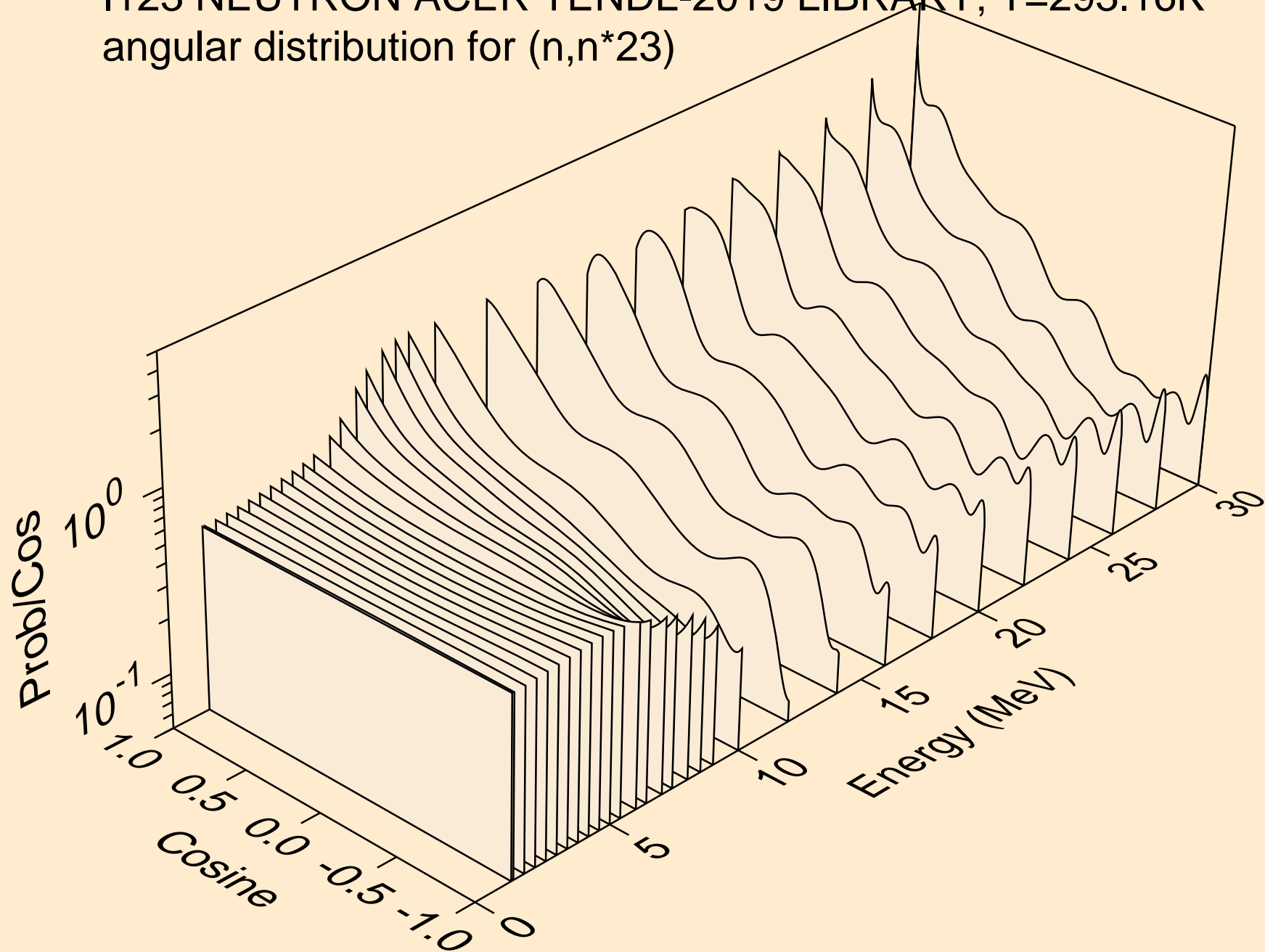

I123 NEUTRON ACER TENDL-2019 LIBRARY; T=293.16K
angular distribution for (n,n*24)

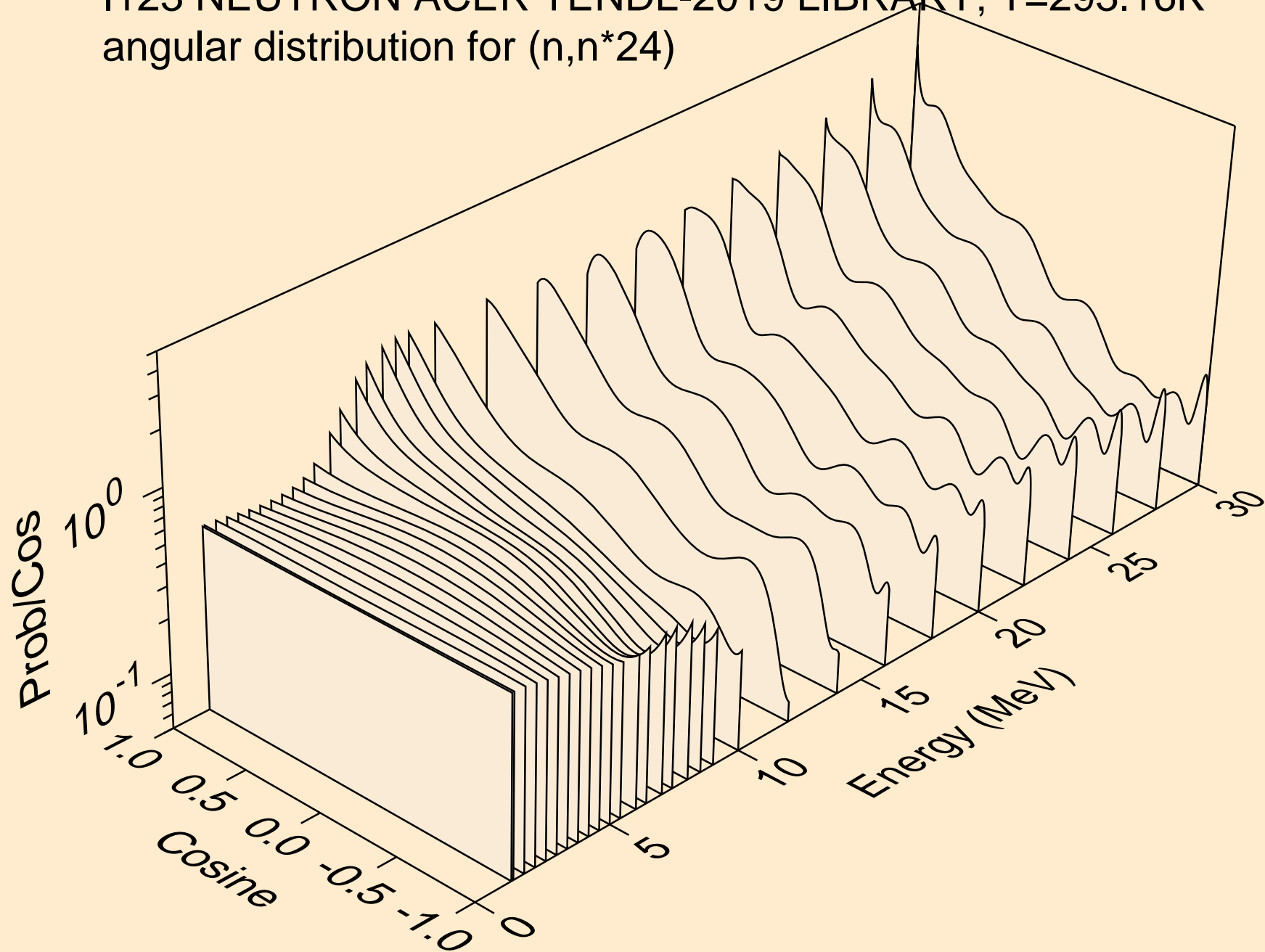

I123 NEUTRON ACER TENDL-2019 LIBRARY; T=293.16K
angular distribution for (n,n*25)

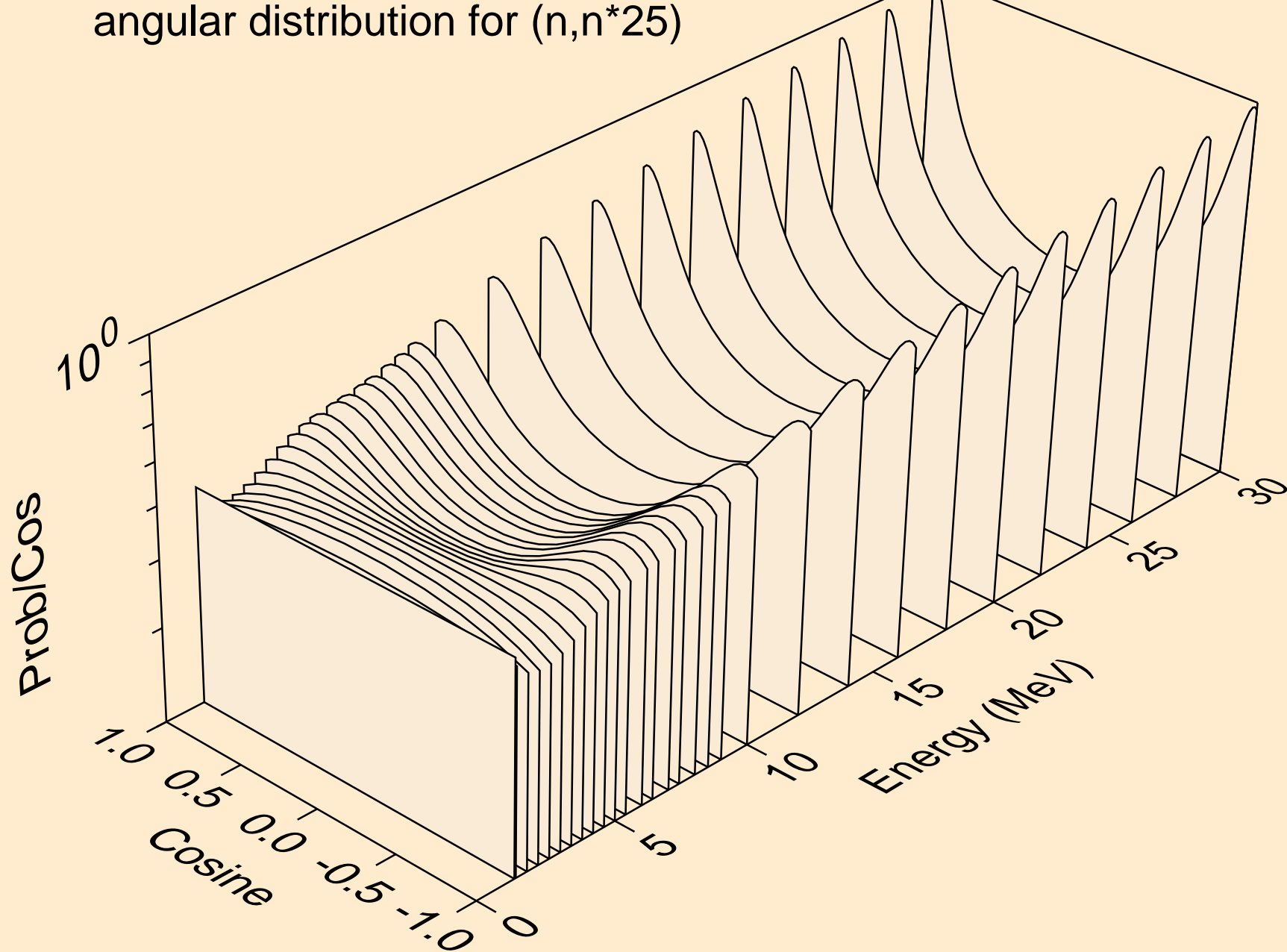

I123 NEUTRON ACER TENDL-2019 LIBRARY; T=293.16K
angular distribution for (n,n*26)

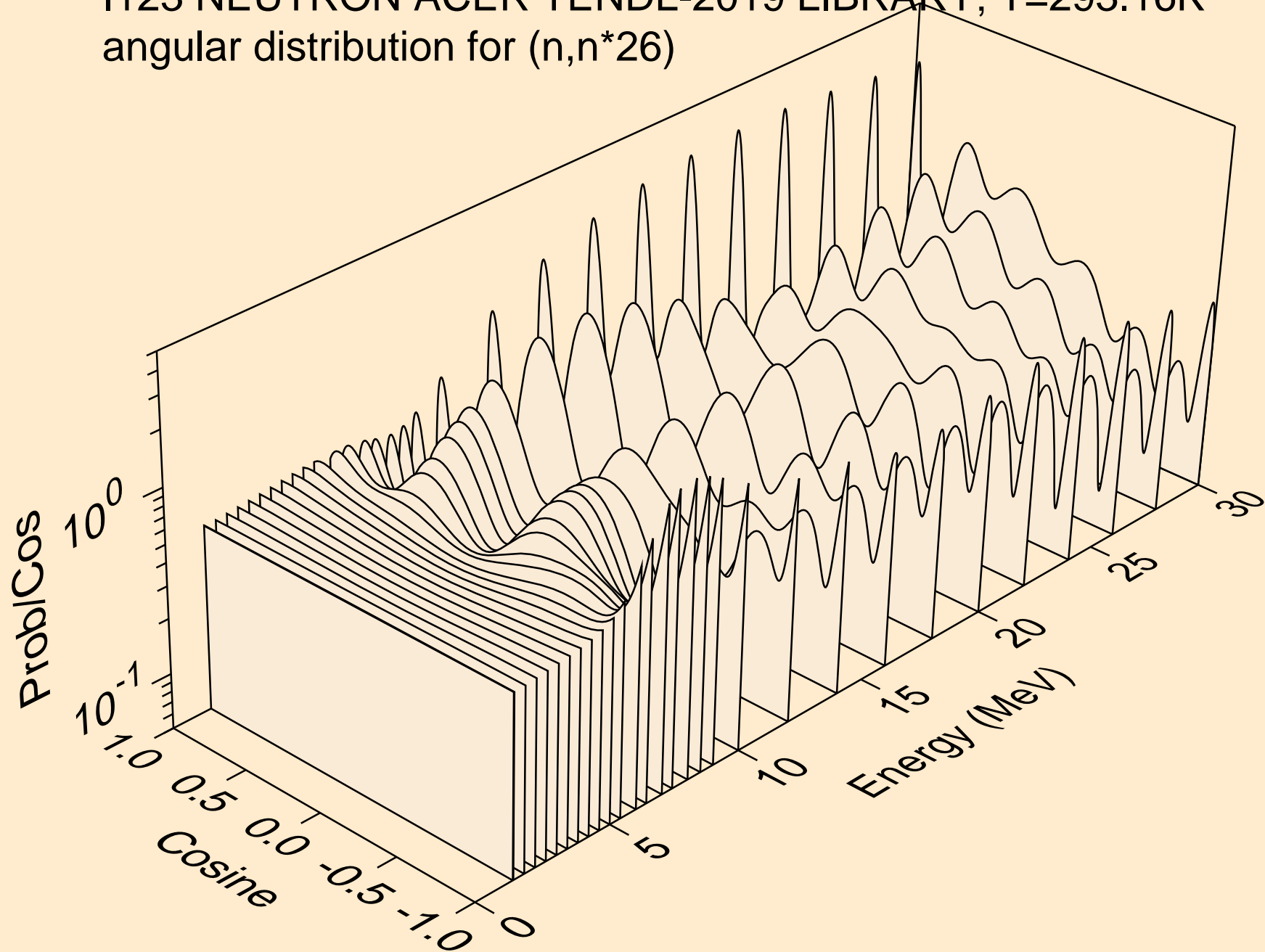

I123 NEUTRON ACER TENDL-2019 LIBRARY; T=293.16K
angular distribution for (n,n*27)

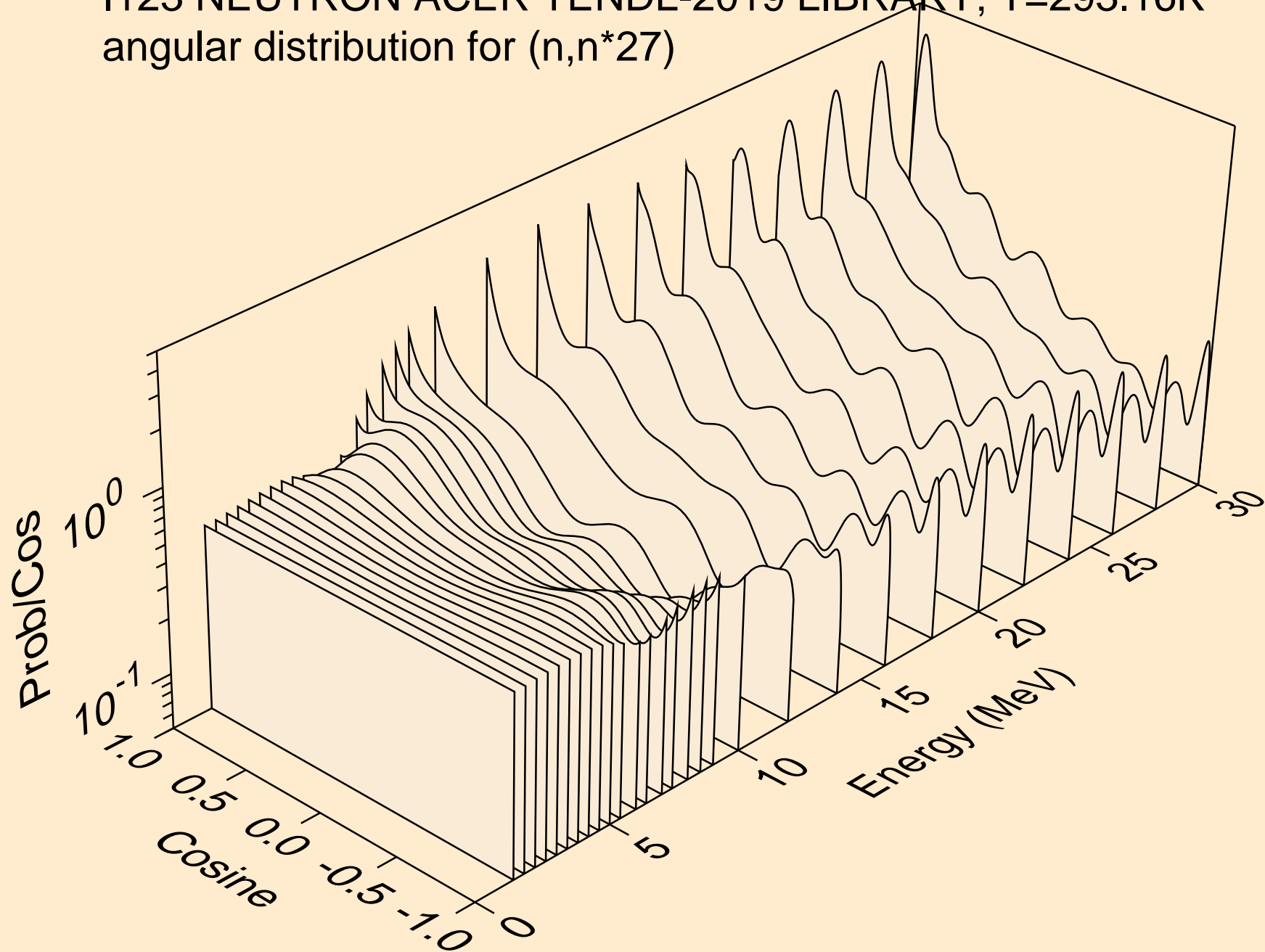

I123 NEUTRON ACER TENDL-2019 LIBRARY; T=293.16K
angular distribution for (n,n*28)

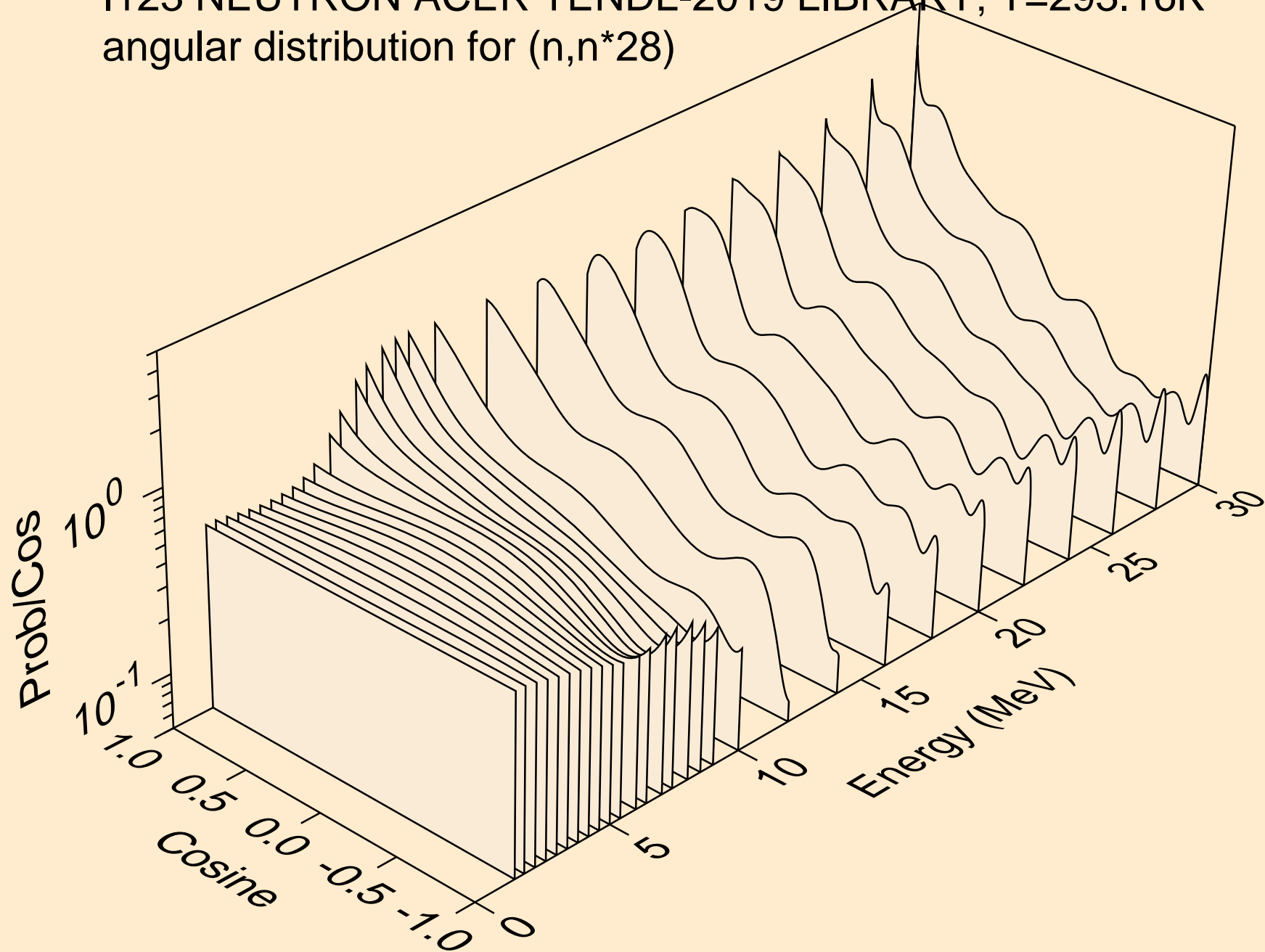

I123 NEUTRON ACER TENDL-2019 LIBRARY; T=293.16K
angular distribution for (n,n*29)

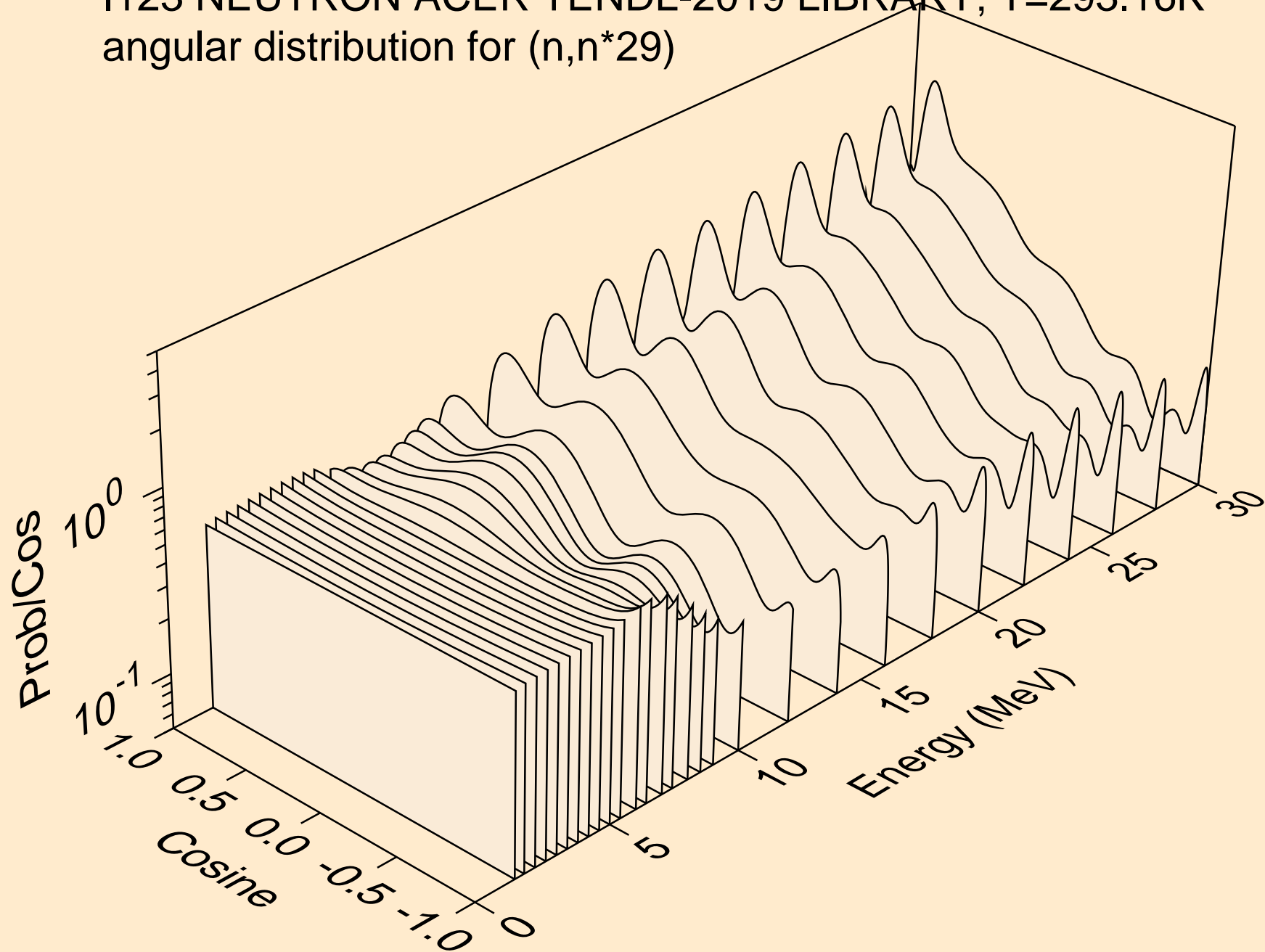

I123 NEUTRON ACER TENDL-2019 LIBRARY; T=293.16K
Neutron emission for (n,x)

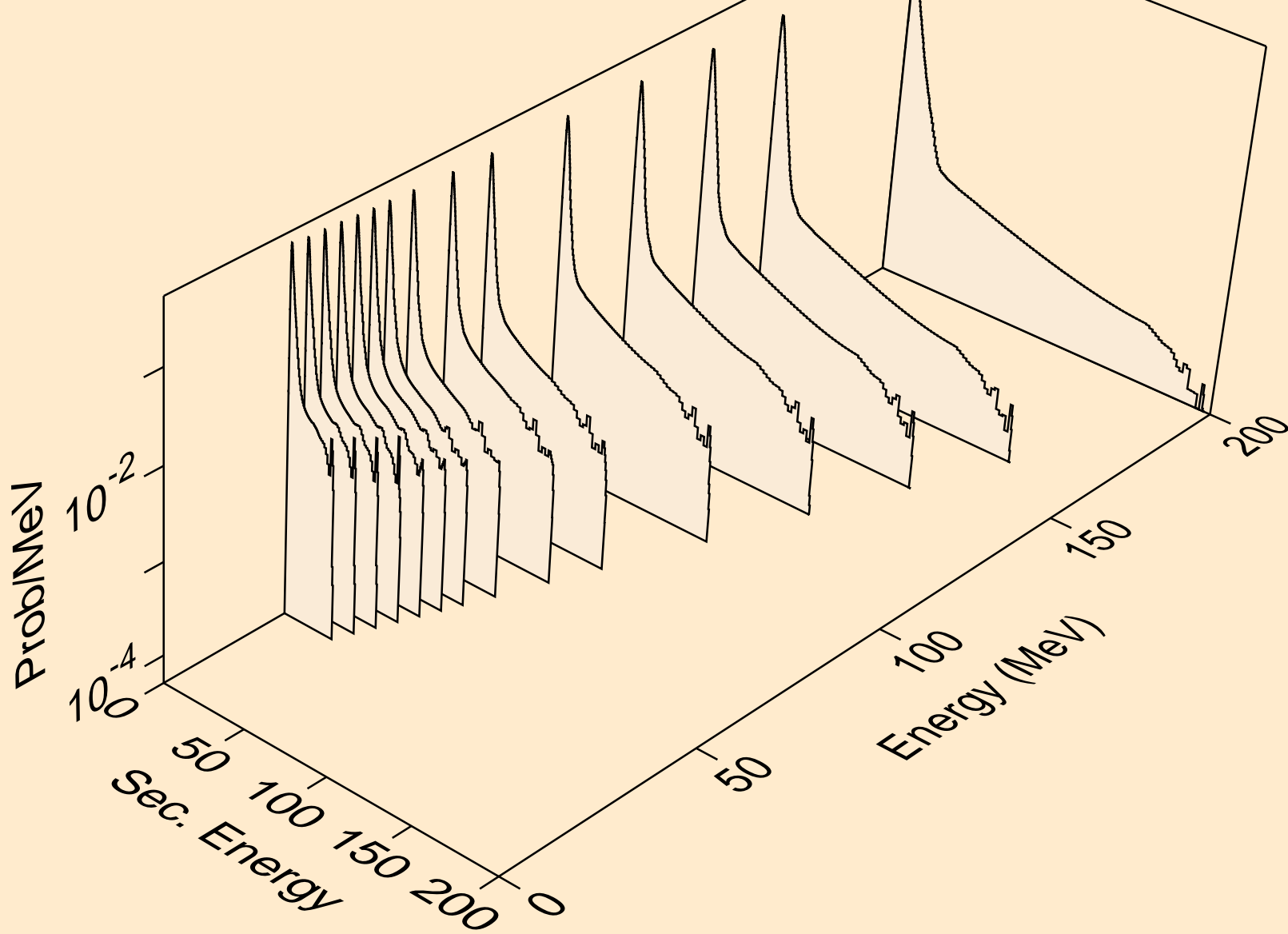

I123 NEUTRON ACER TENDL-2019 LIBRARY; T=293.16K
Neutron emission for (n,2nd)

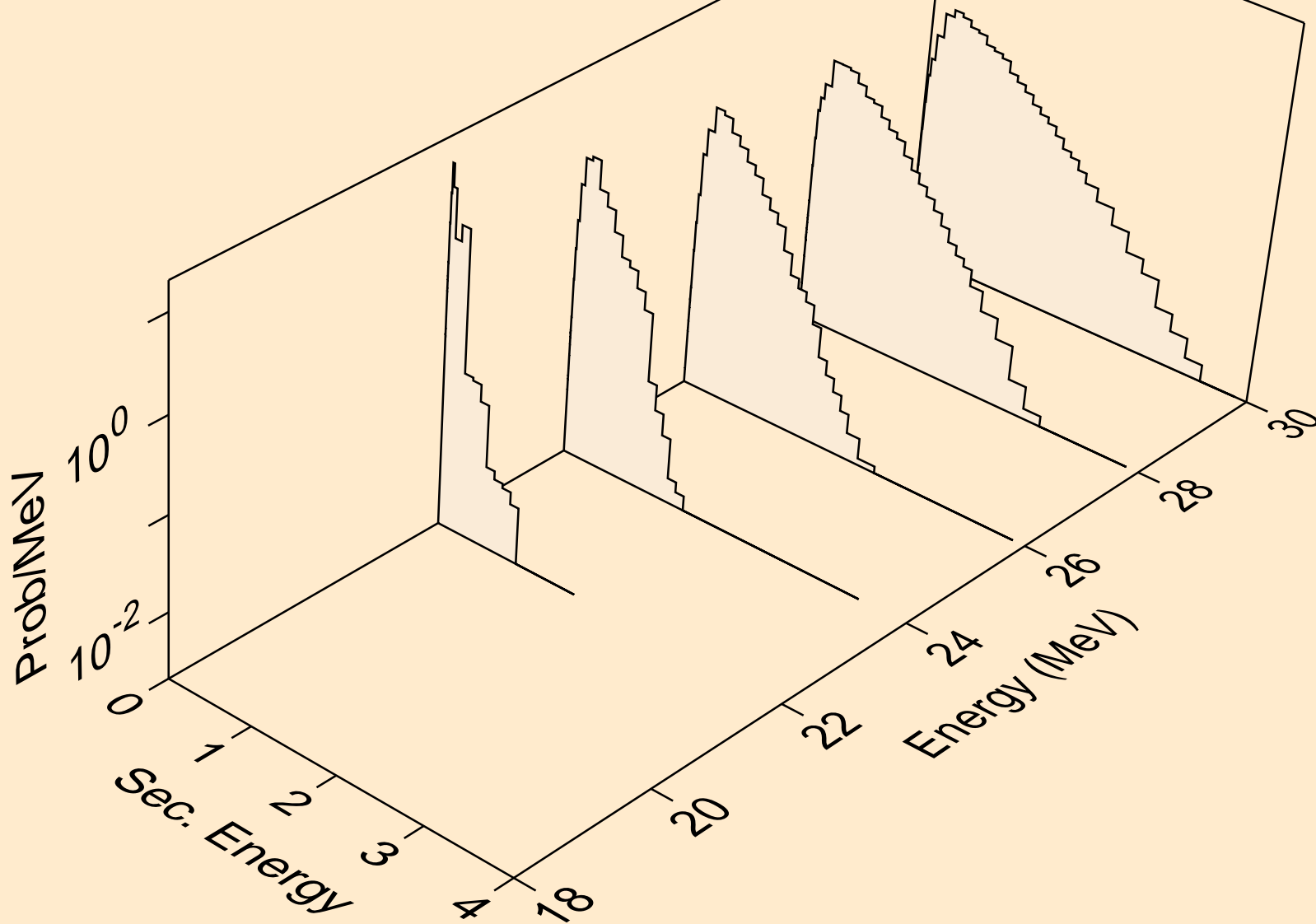

I123 NEUTRON ACER TENDL-2019 LIBRARY; T=293.16K
Neutron emission for (n,2n)

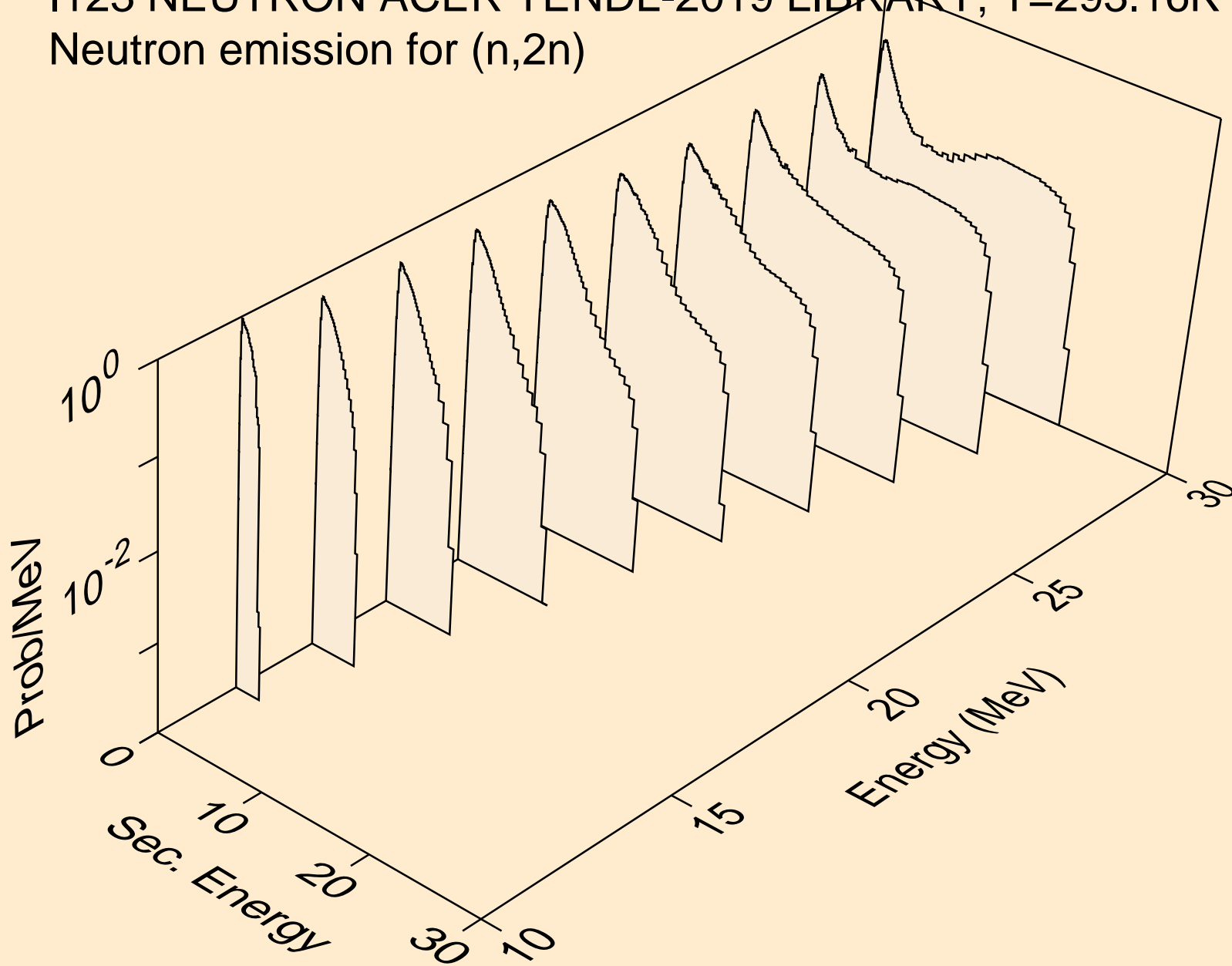

I123 NEUTRON ACER TENDL-2019 LIBRARY; T=293.16K
Neutron emission for (n,3n)

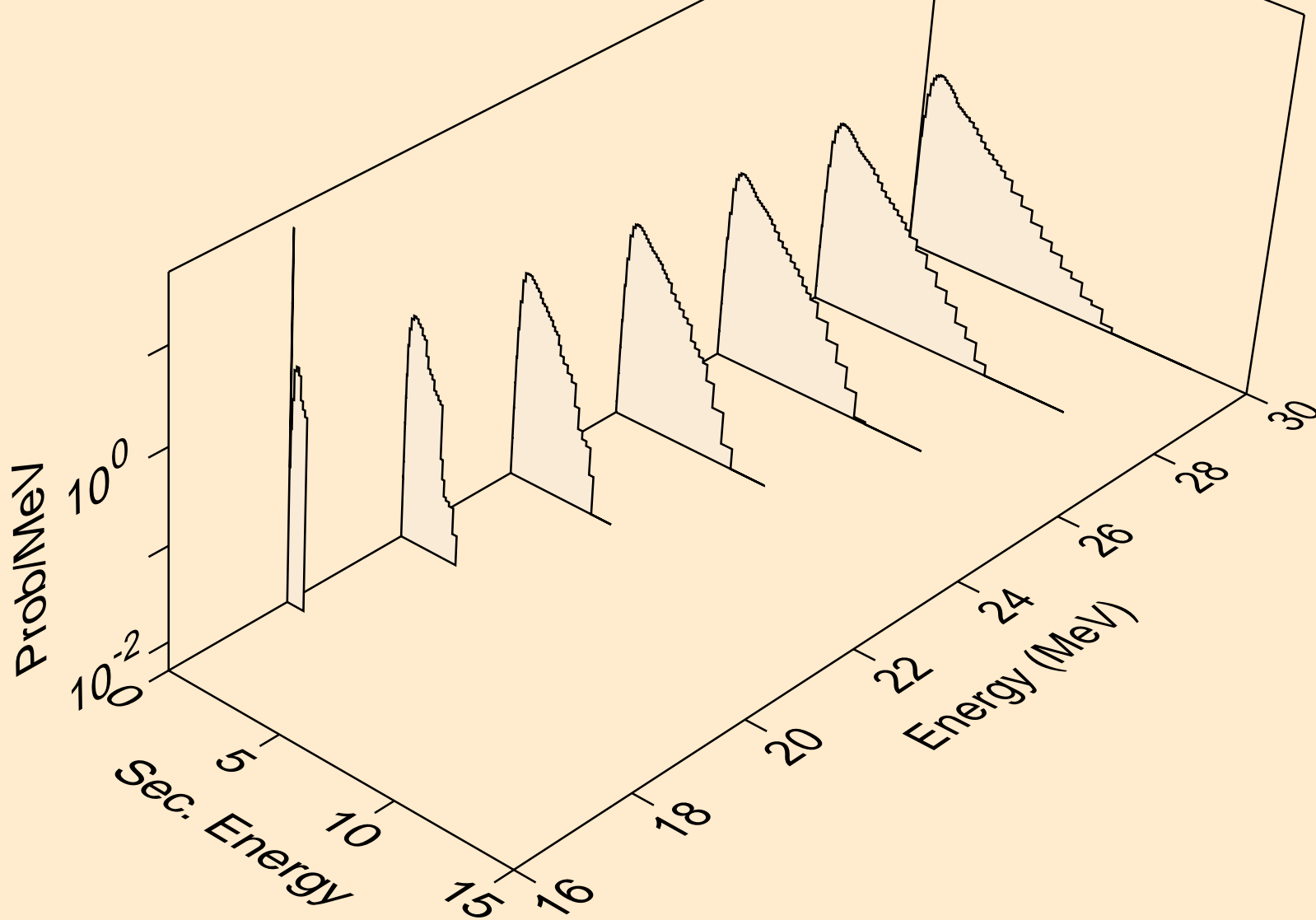

I123 NEUTRON ACER TENDL-2019 LIBRARY; T=293.16K
Neutron emission for (n,n*)a

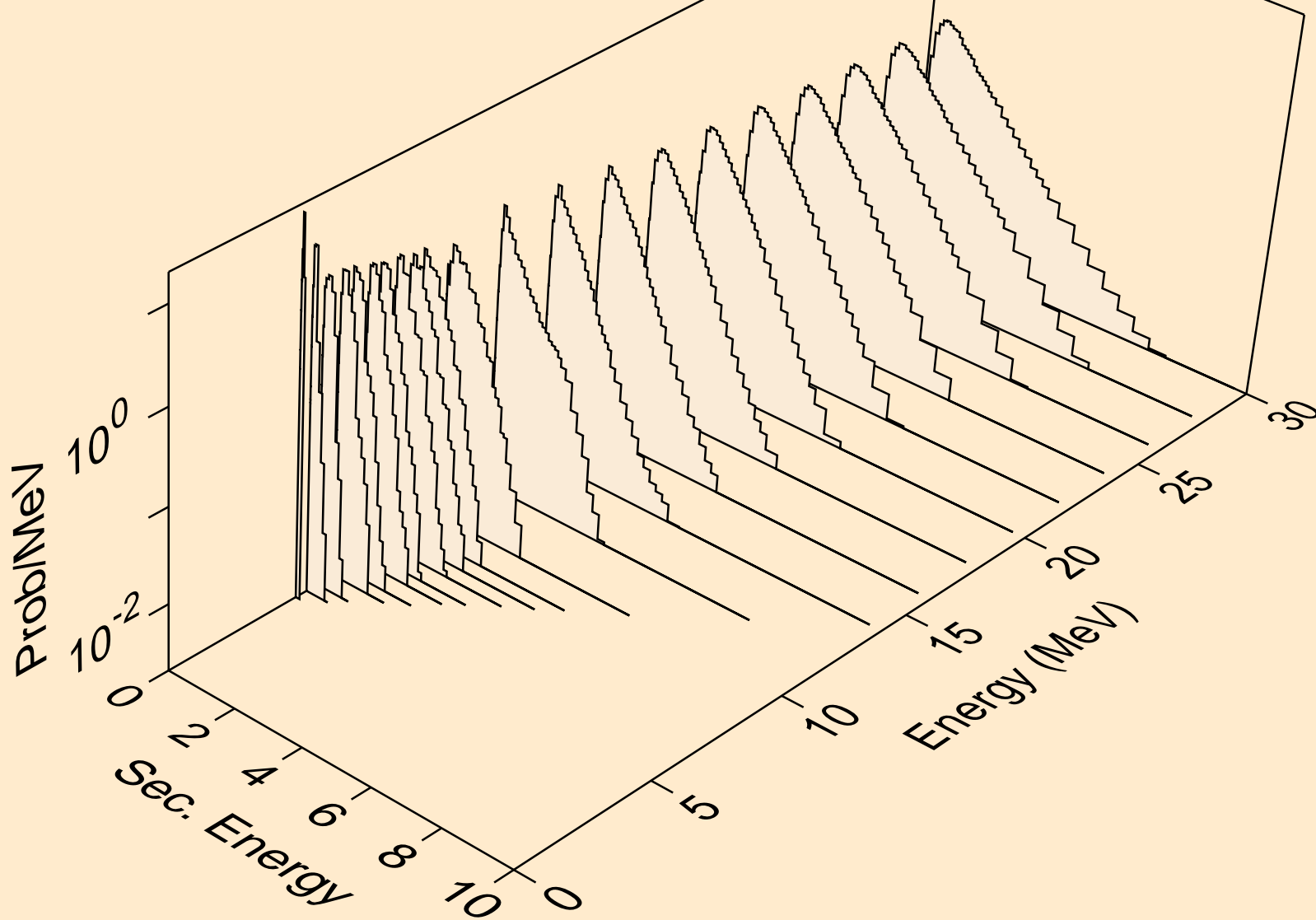

I123 NEUTRON ACER TENDL-2019 LIBRARY; T=293.16K
Neutron emission for (n,2n)a

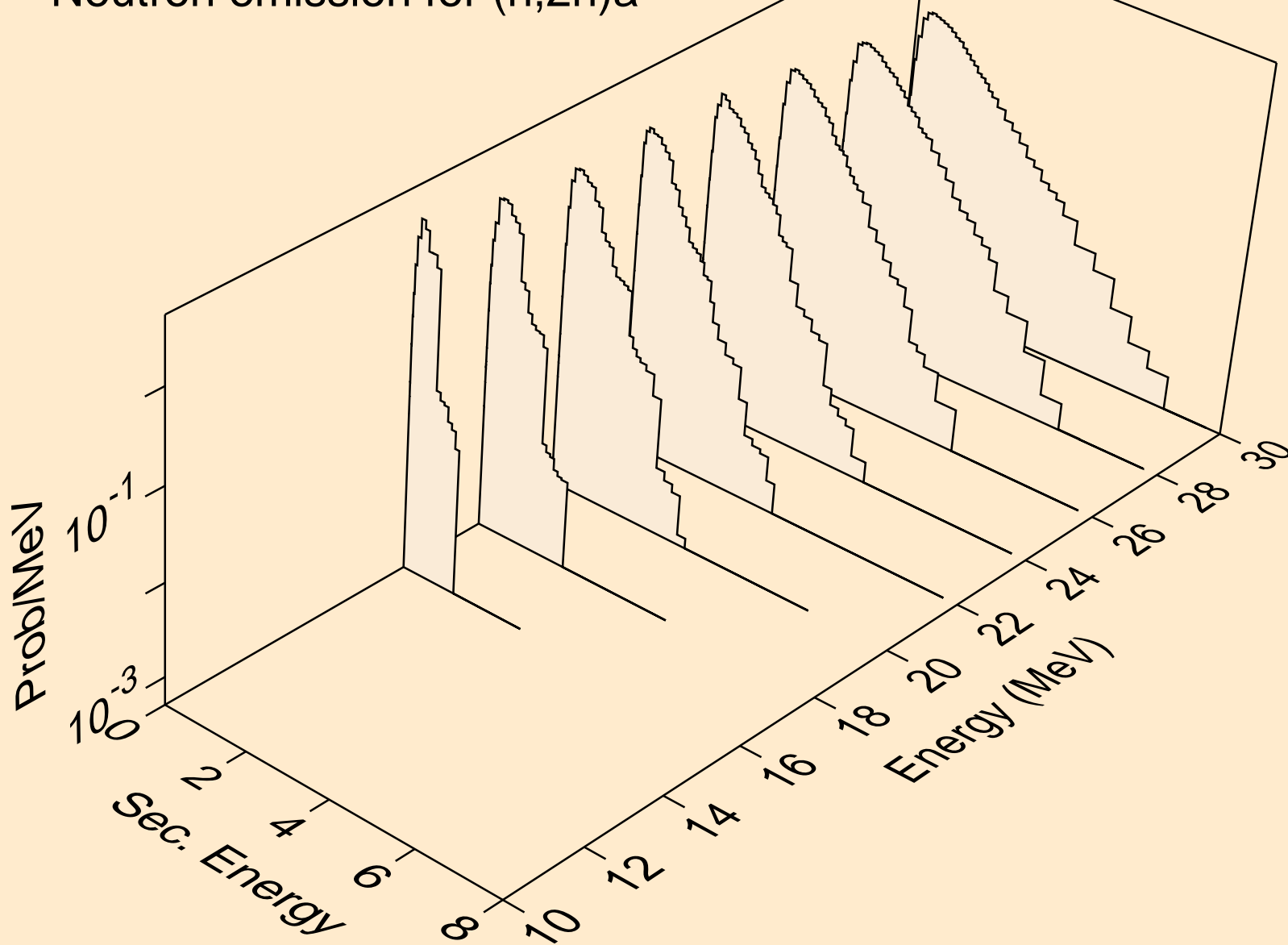

I123 NEUTRON ACER TENDL-2019 LIBRARY; T=293.16K
Neutron emission for (n,3n)a

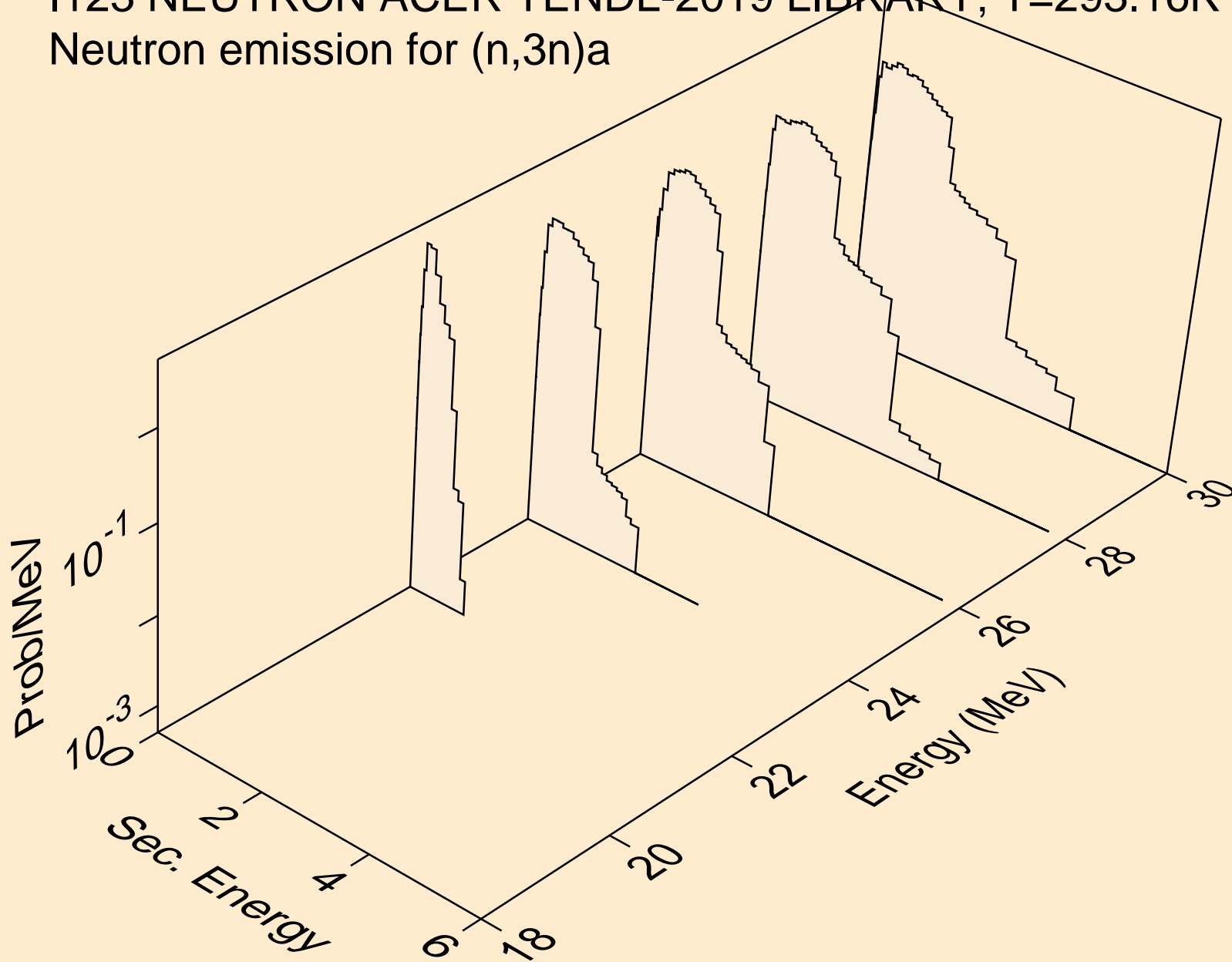

I123 NEUTRON ACER TENDL-2019 LIBRARY; T=293.16K
Neutron emission for (n,n*)p

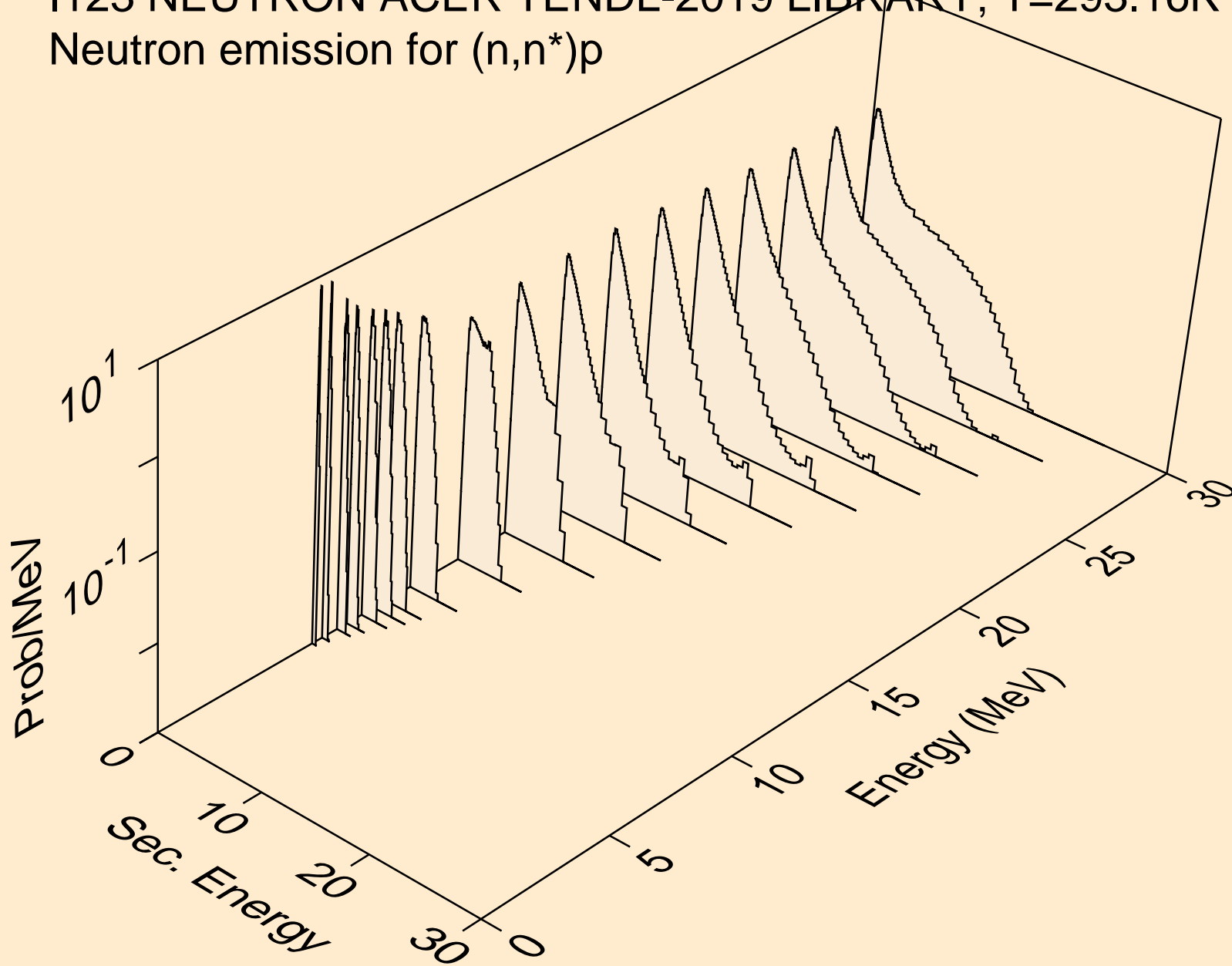

I123 NEUTRON ACER TENDL-2019 LIBRARY; T=293.16K
Neutron emission for (n,n*)2a

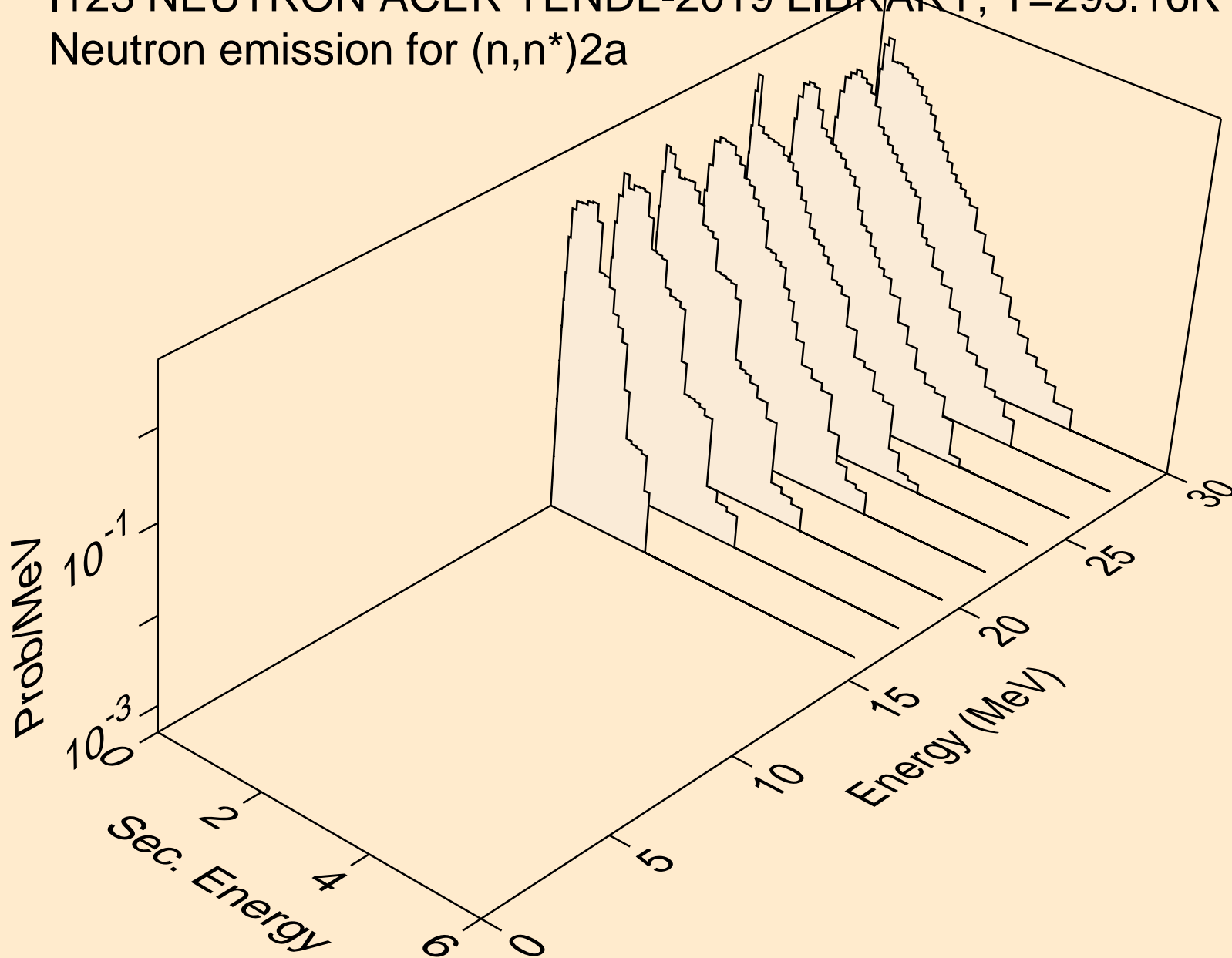

I123 NEUTRON ACER TENDL-2019 LIBRARY; T=293.16K
Neutron emission for (n,n*)d

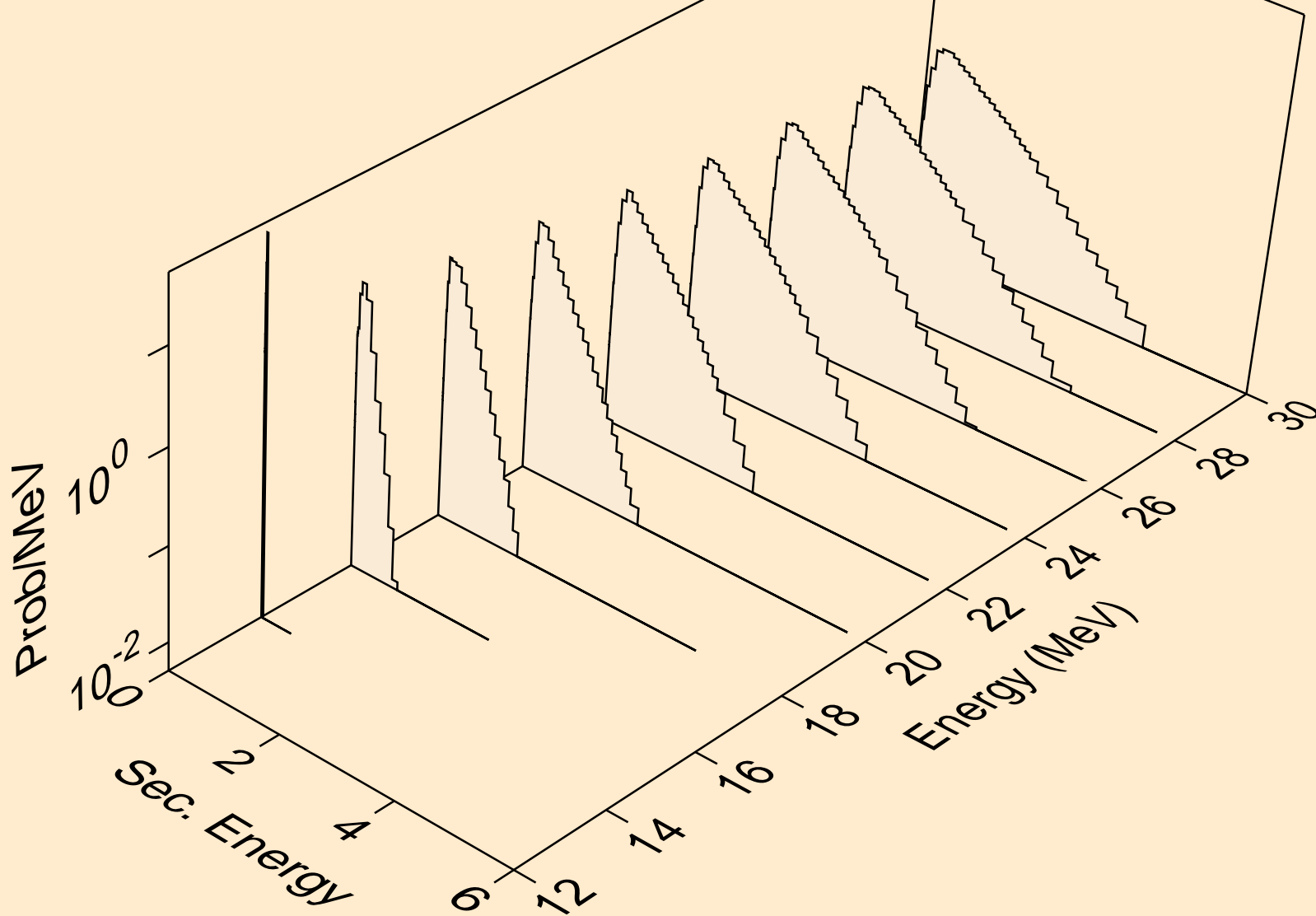

I123 NEUTRON ACER TENDL-2019 LIBRARY; T=293.16K
Neutron emission for (n,n*)t

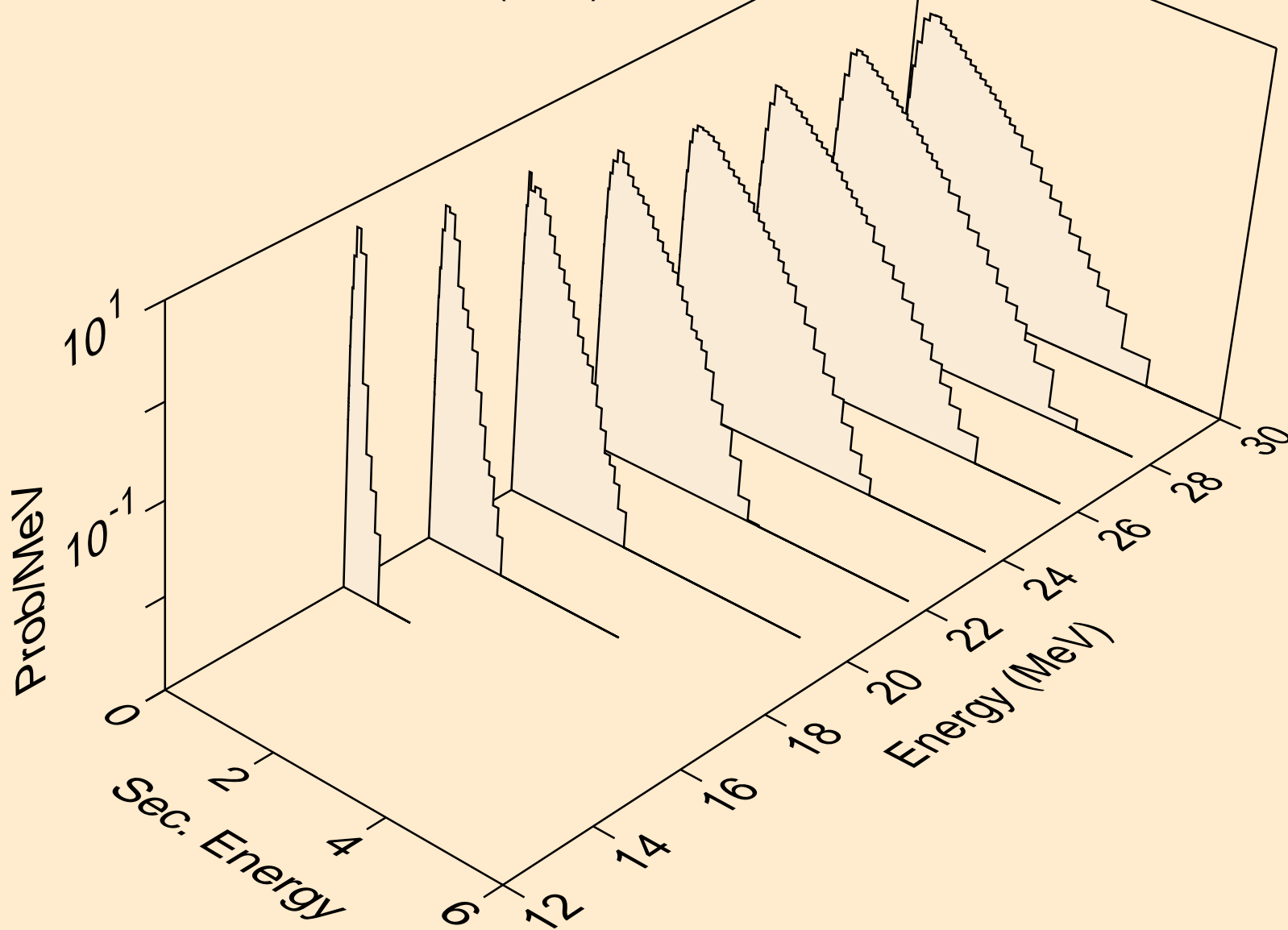

I123 NEUTRON ACER TENDL-2019 LIBRARY; T=293.16K
Neutron emission for (n,n*)he3

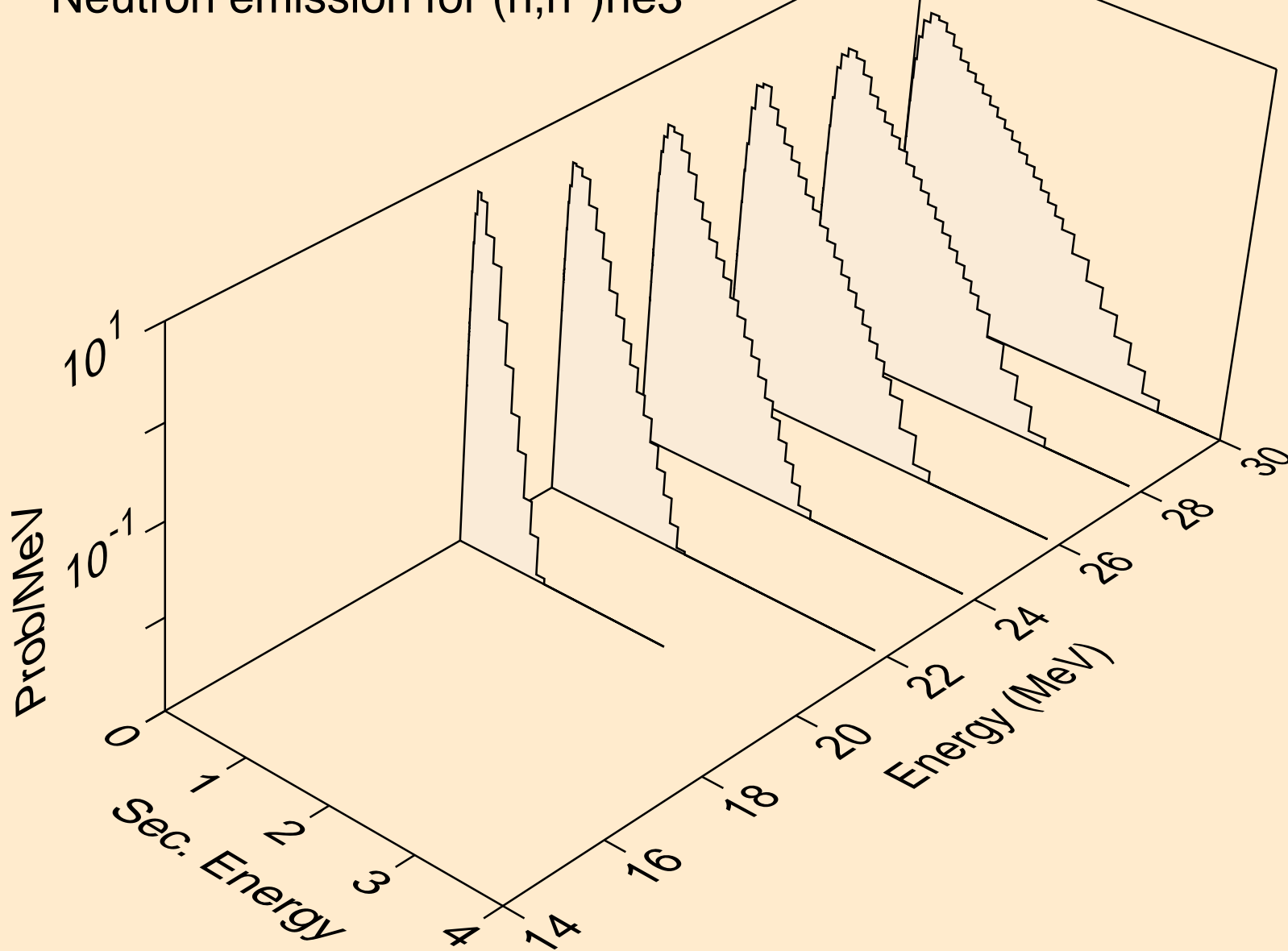

I123 NEUTRON ACER TENDL-2019 LIBRARY; T=293.16K
Neutron emission for (n,4n)

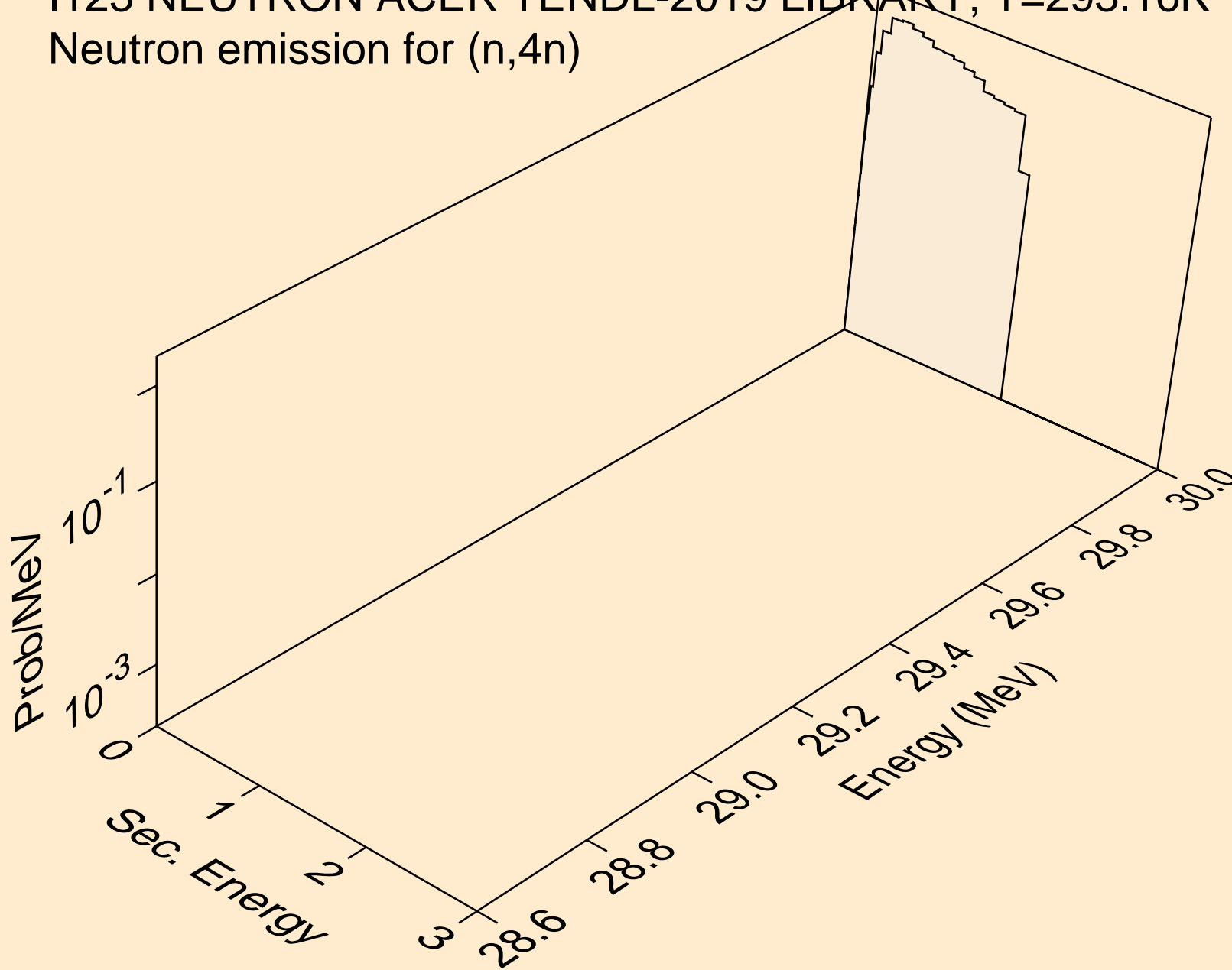

I123 NEUTRON ACER TENDL-2019 LIBRARY; T=293.16K
Neutron emission for (n,2np)

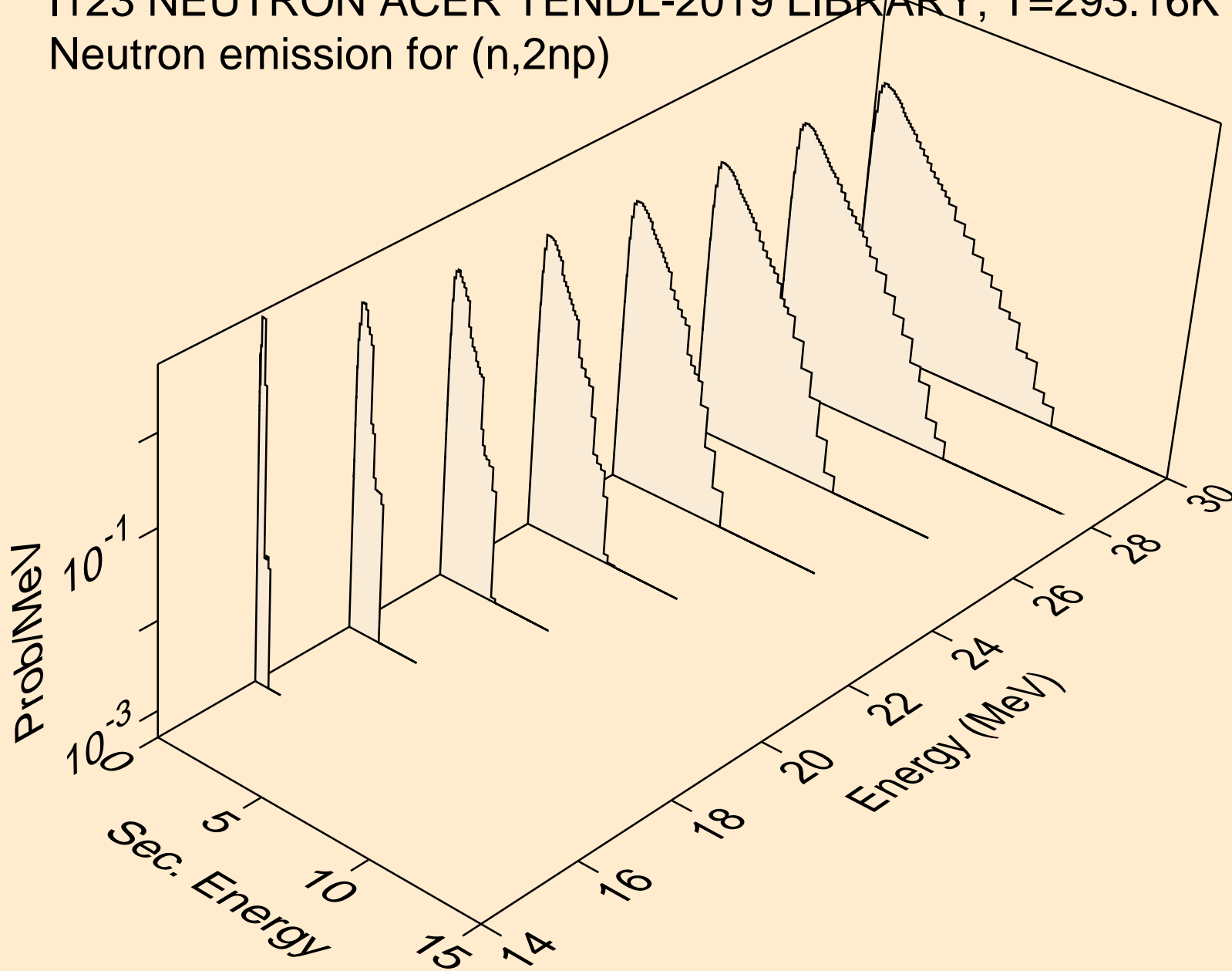

I123 NEUTRON ACER TENDL-2019 LIBRARY; T=293.16K
Neutron emission for (n,3np)

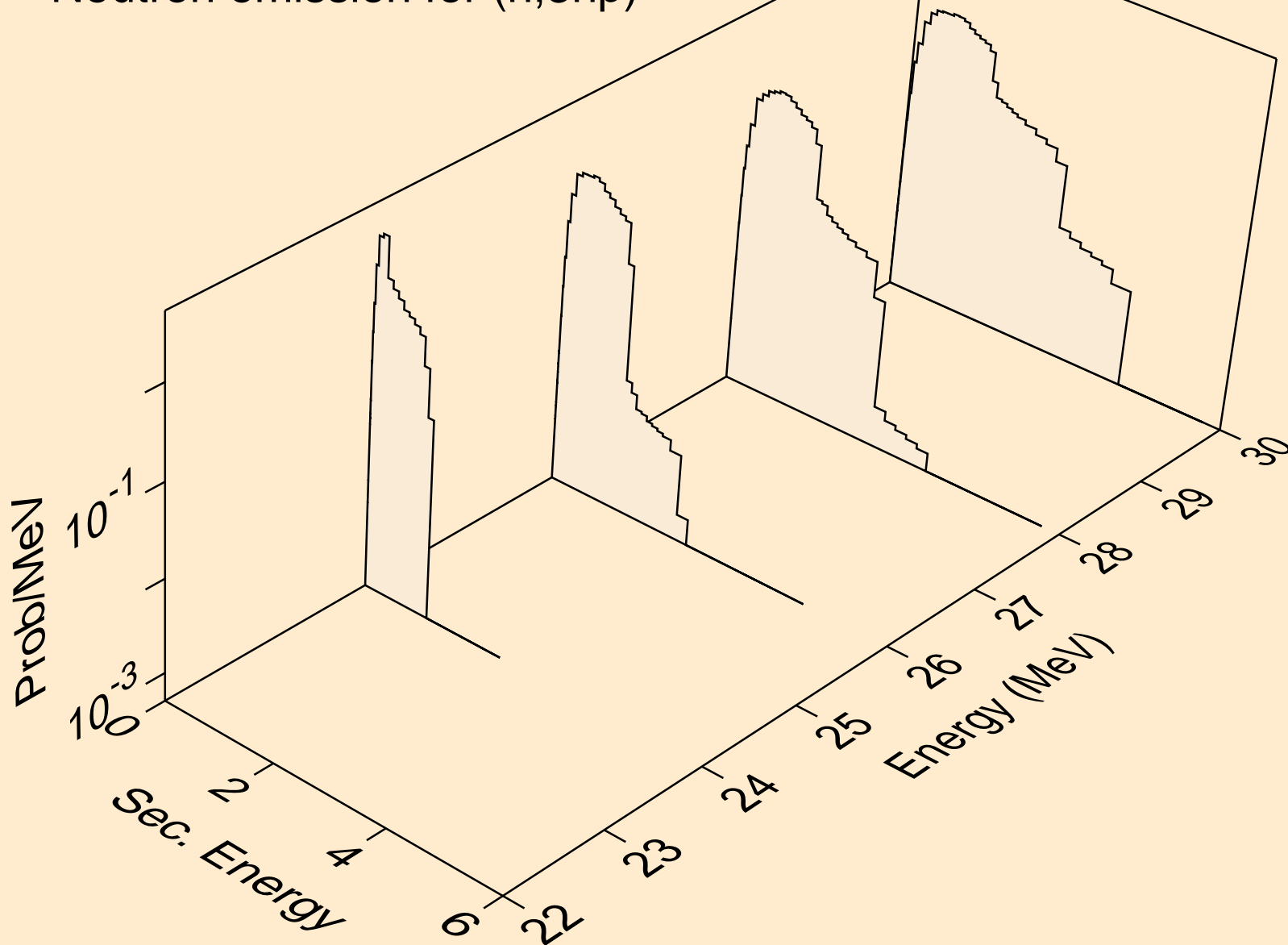

I123 NEUTRON ACER TENDL-2019 LIBRARY; T=293.16K
Neutron emission for (n,2np)

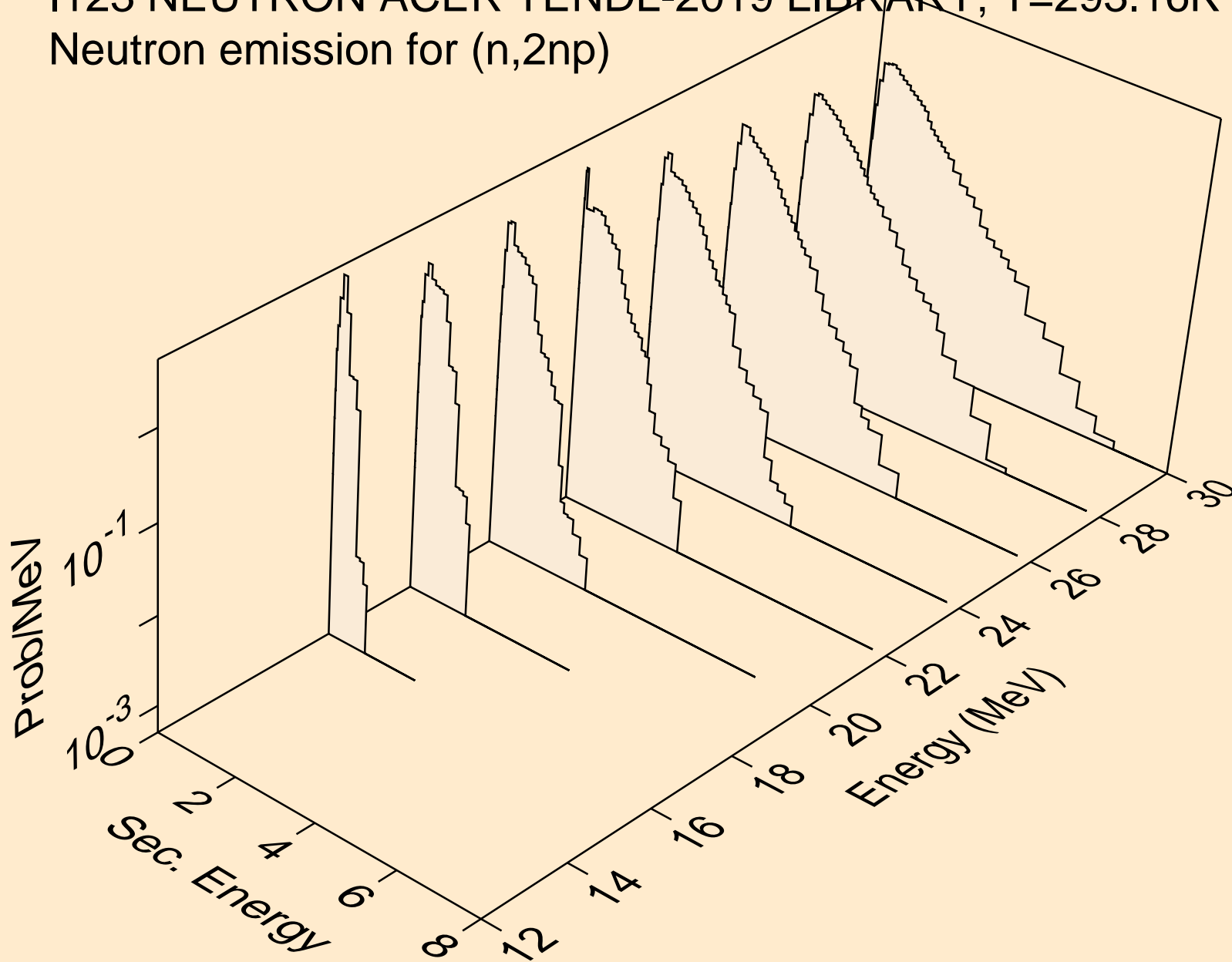

I123 NEUTRON ACER TENDL-2019 LIBRARY; T=293.16K
Neutron emission for (n,npa)

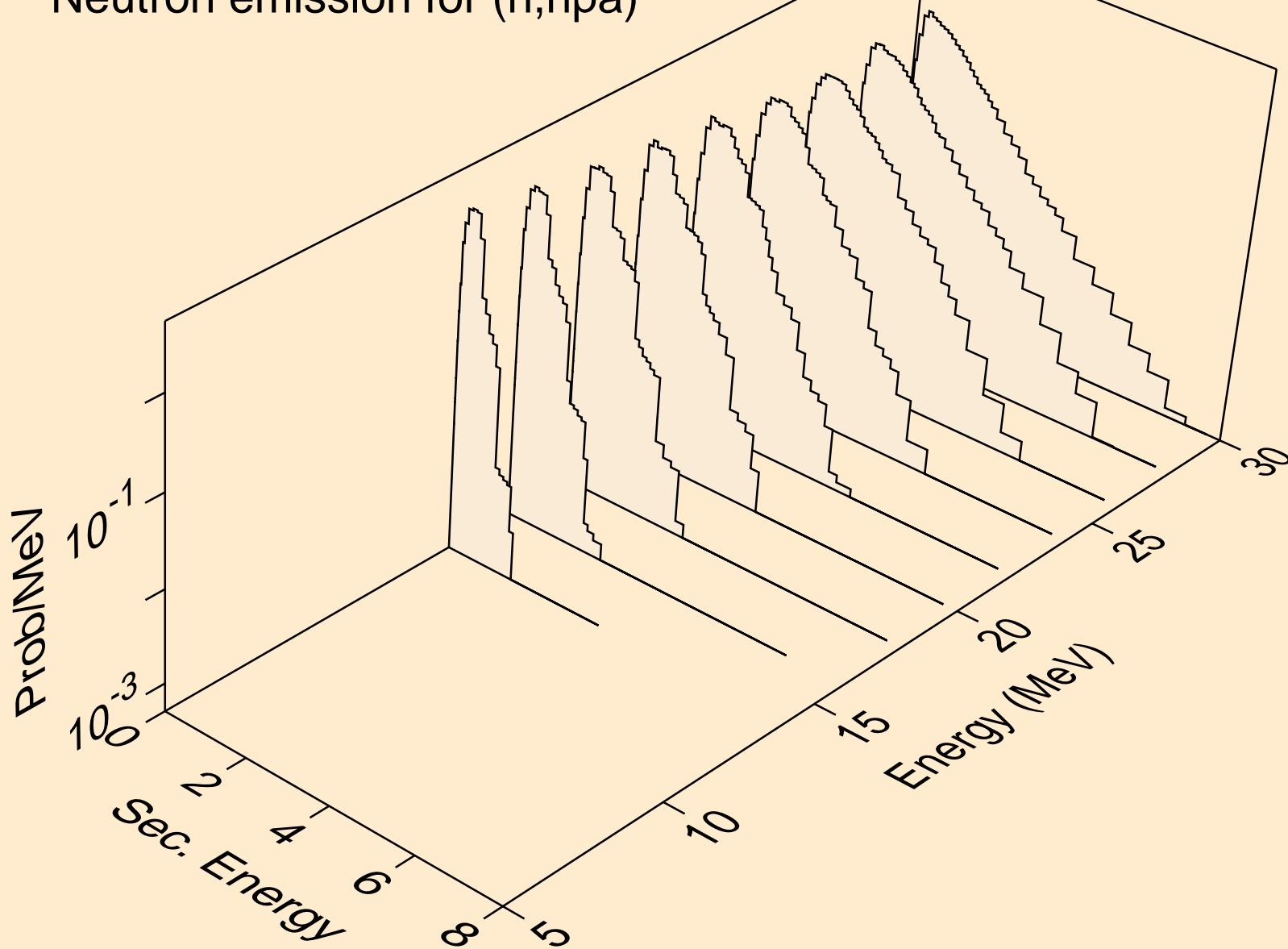

I123 NEUTRON ACER TENDL-2019 LIBRARY; T=293.16K
Neutron emission for (n,n*c)

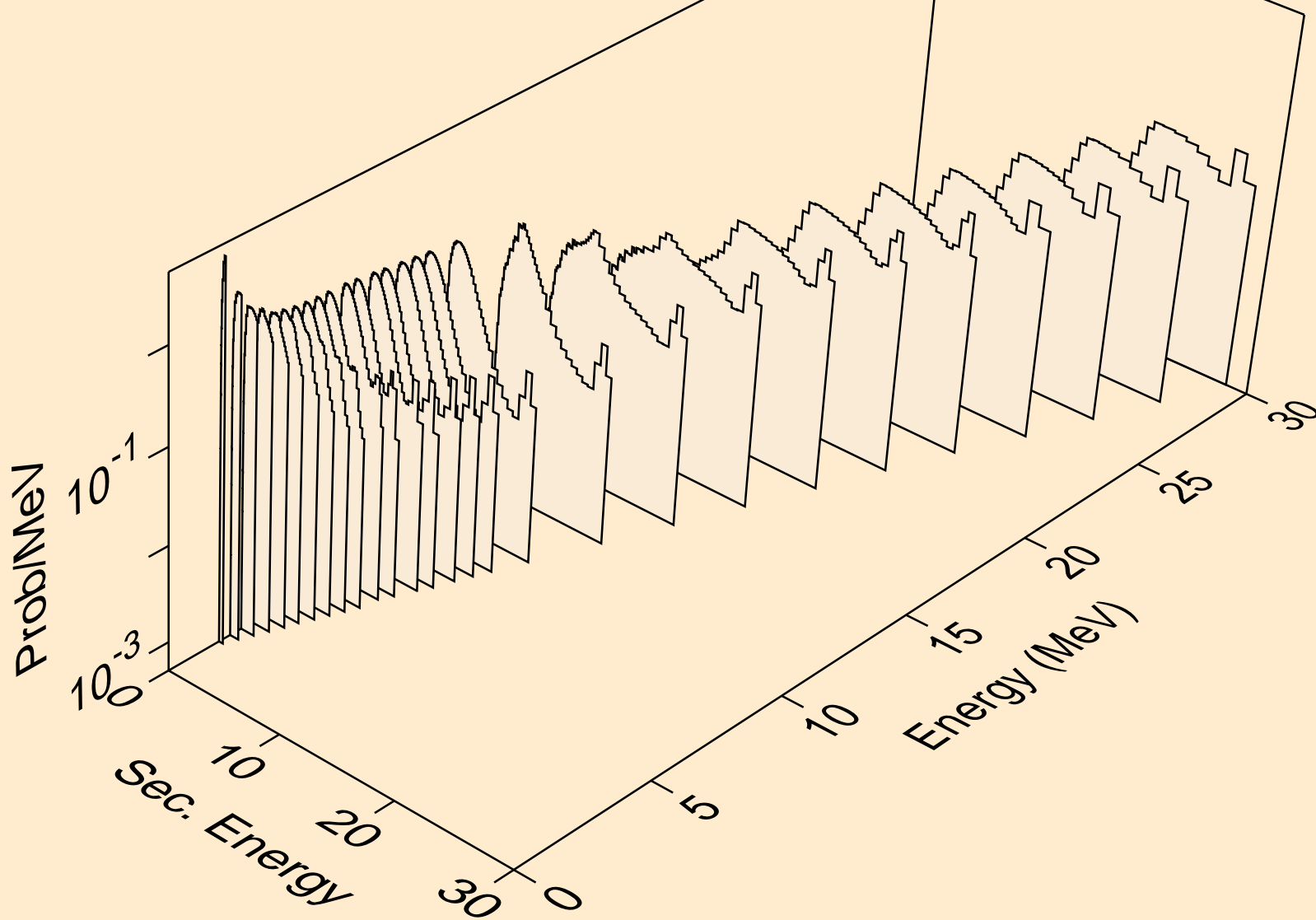

I123 NEUTRON ACER TENDL-2019 LIBRARY; T=293.16K
Photon emission for (n,x)

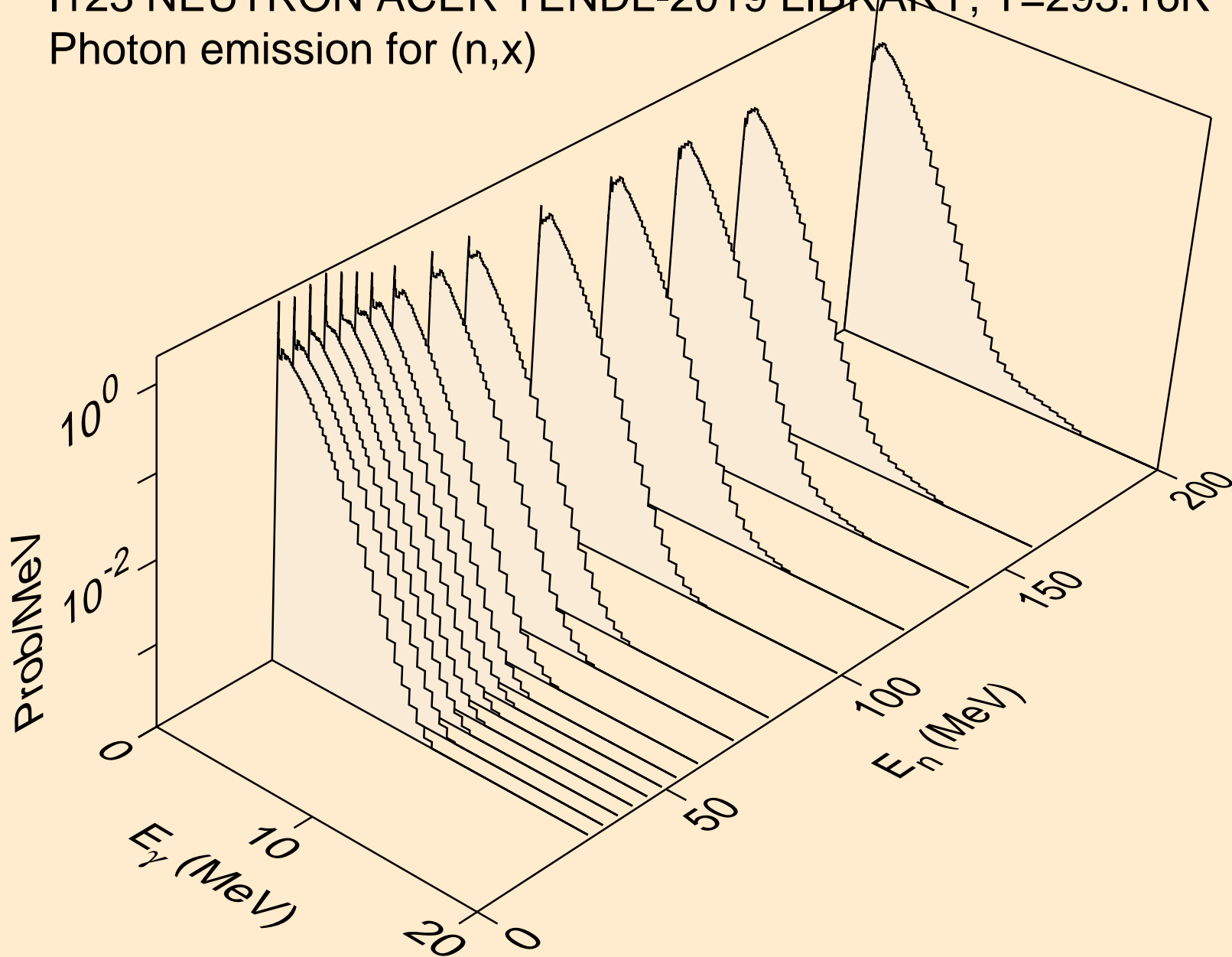

I123 NEUTRON ACER TENDL-2019 LIBRARY; T=293.16K
Photon emission for (n,2nd)

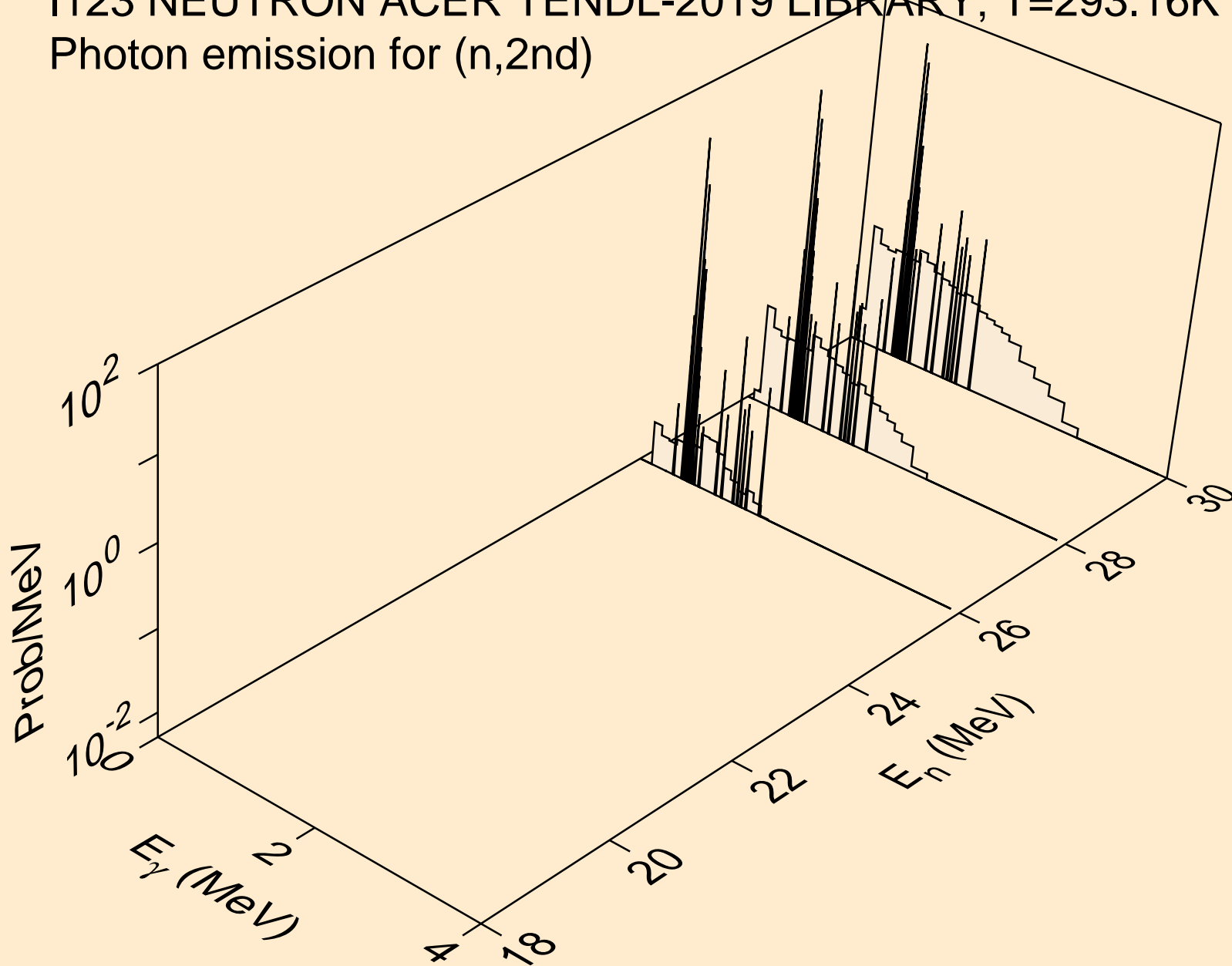

I123 NEUTRON ACER TENDL-2019 LIBRARY; T=293.16K
Photon emission for (n,2n)

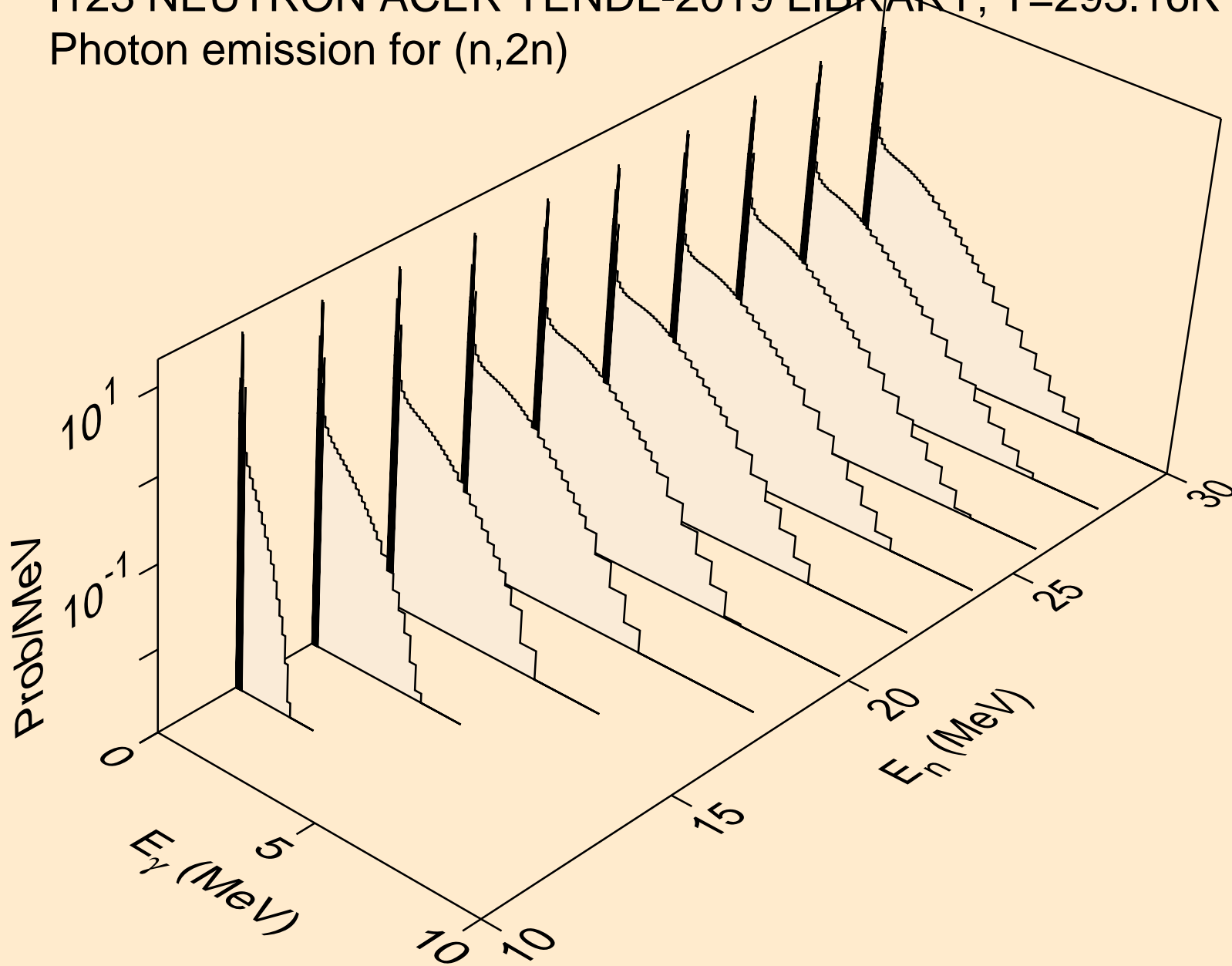

I123 NEUTRON ACER TENDL-2019 LIBRARY; T=293.16K
Photon emission for (n,3n)

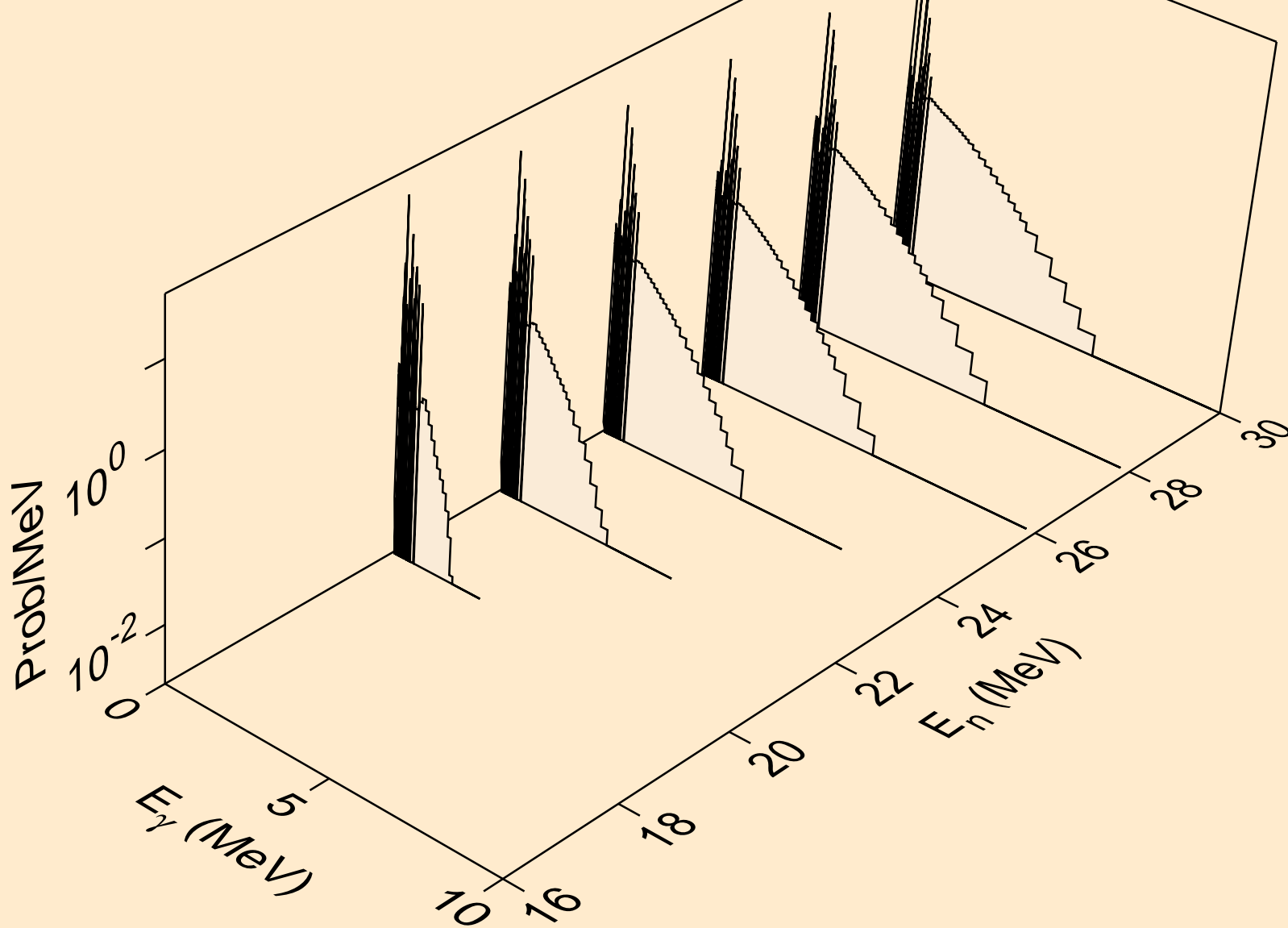

I123 NEUTRON ACER TENDL-2019 LIBRARY; T=293.16K
Photon emission for (n,n*)a

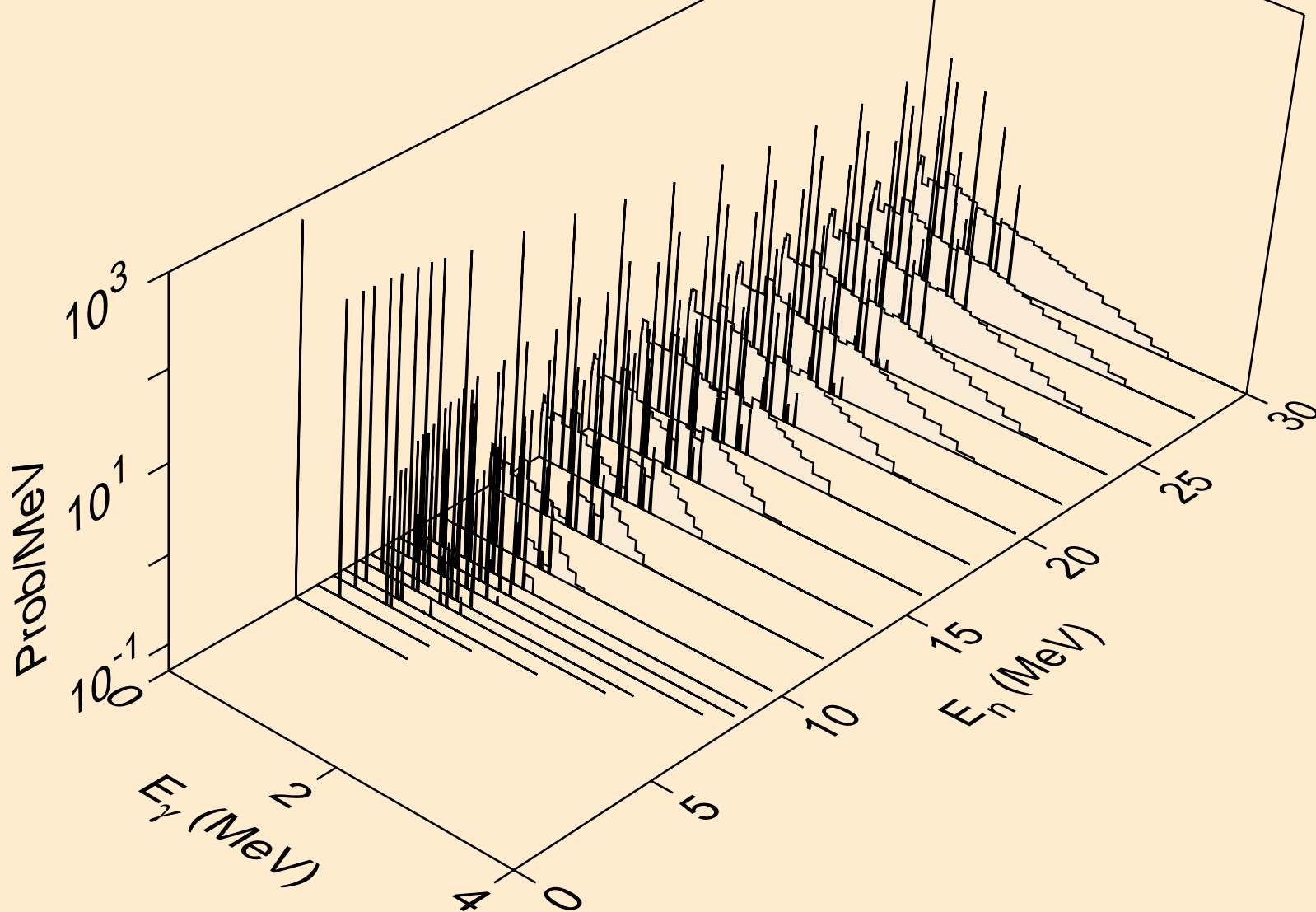

I123 NEUTRON ACER TENDL-2019 LIBRARY; T=293.16K
Photon emission for (n,2n)a

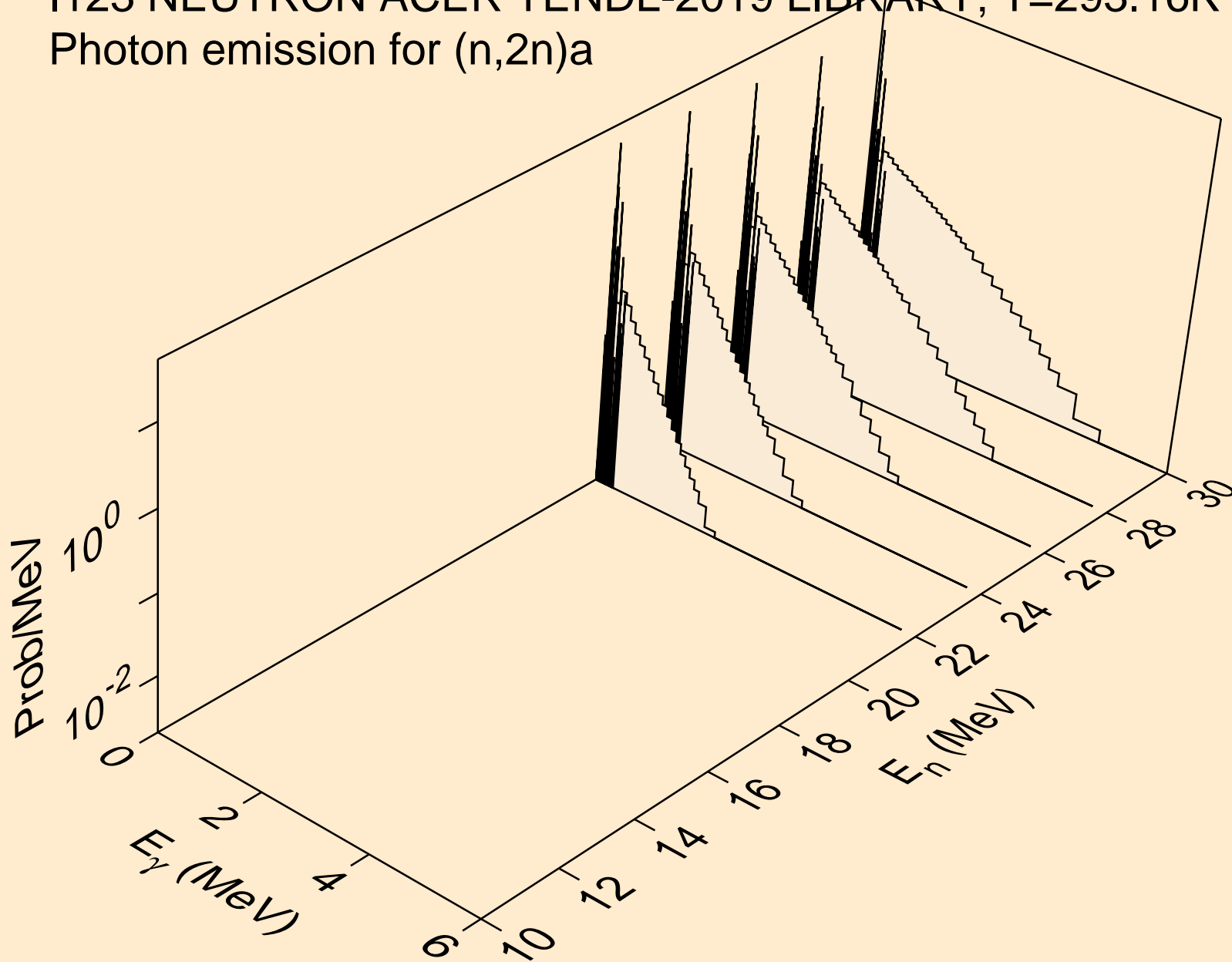

I123 NEUTRON ACER TENDL-2019 LIBRARY; T=293.16K
Photon emission for (n,3n)a

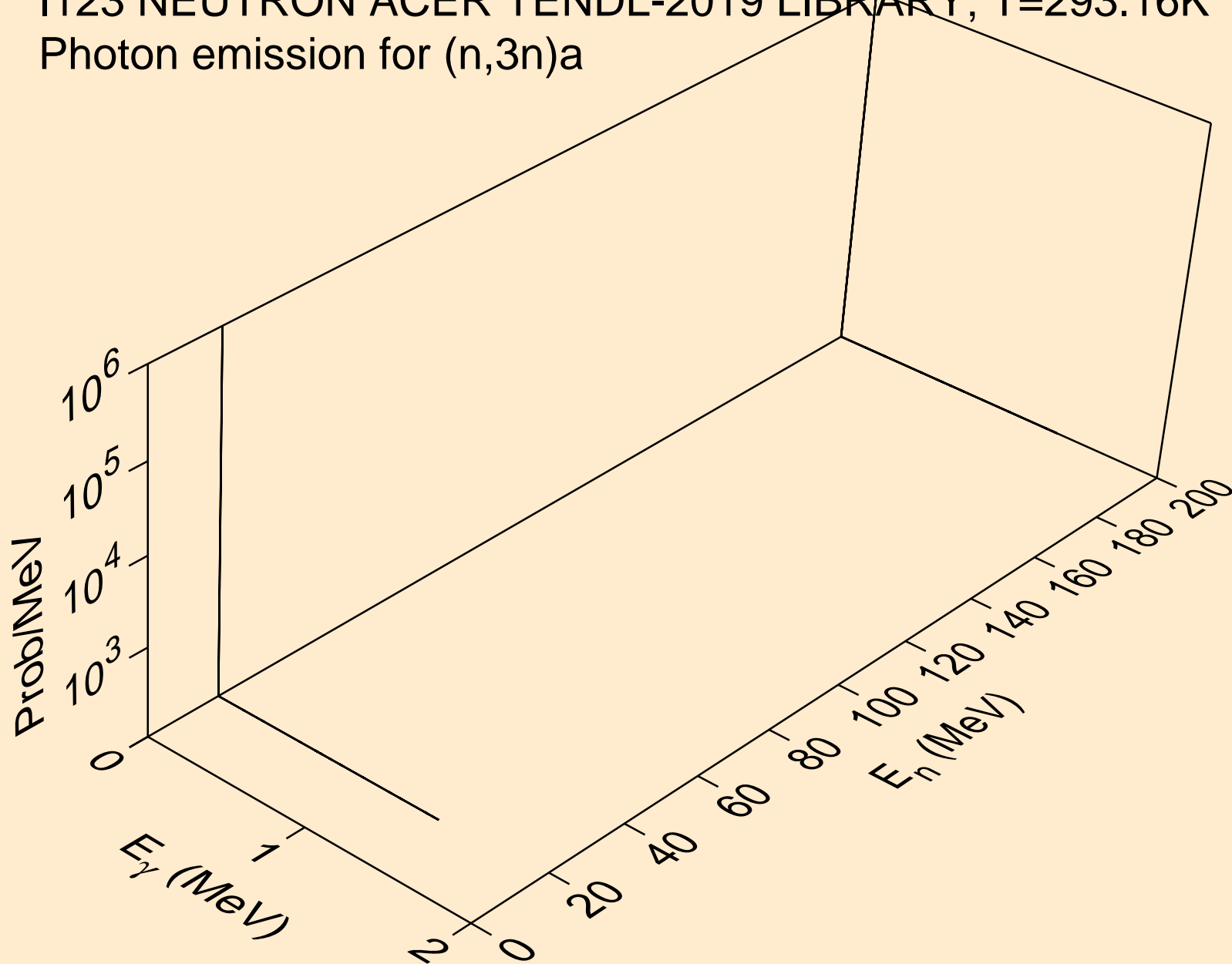

I123 NEUTRON ACER TENDL-2019 LIBRARY; T=293.16K
Photon emission for (n,n*)p

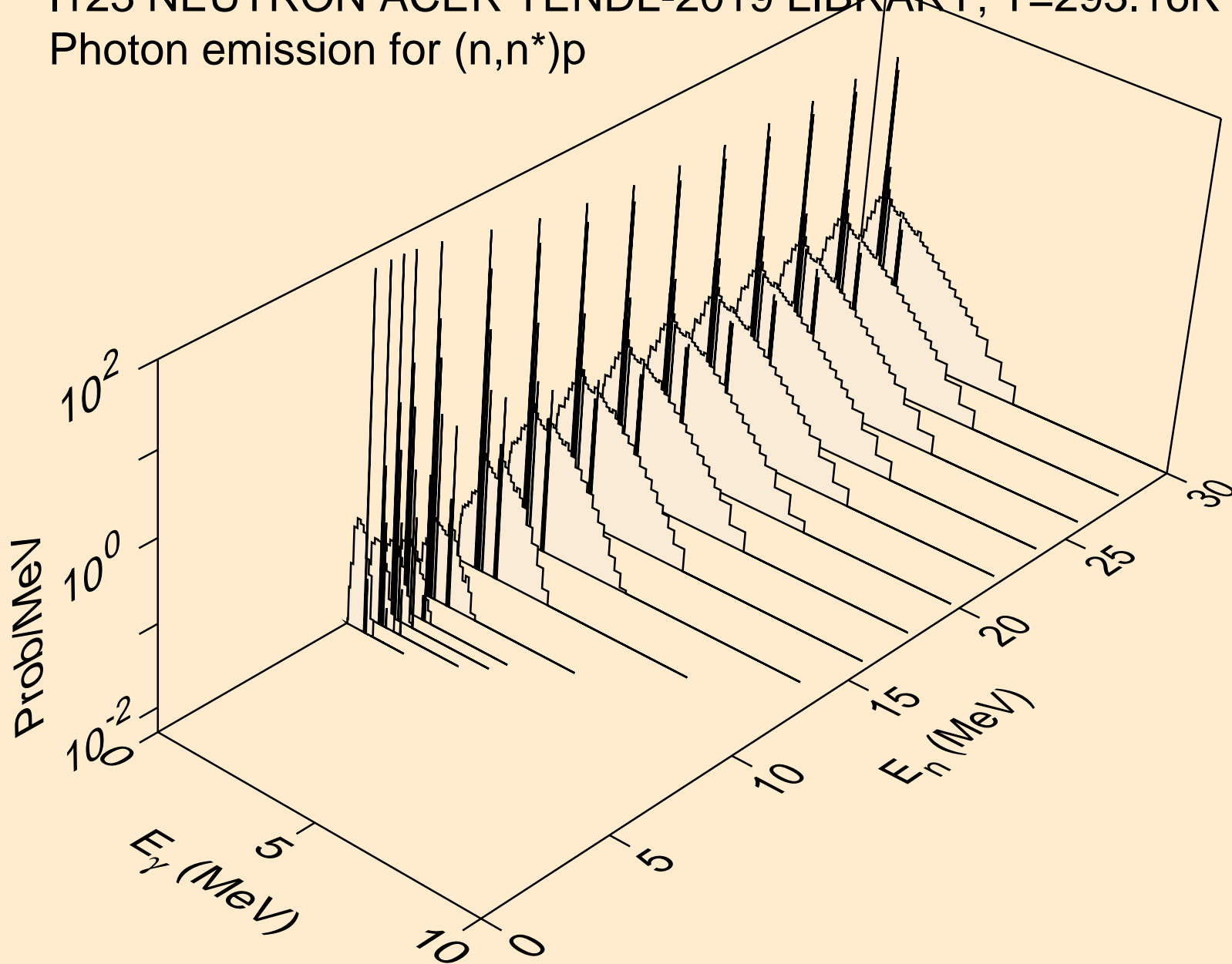

I123 NEUTRON ACER TENDL-2019 LIBRARY; T=293.16K
Photon emission for (n,n*)2a

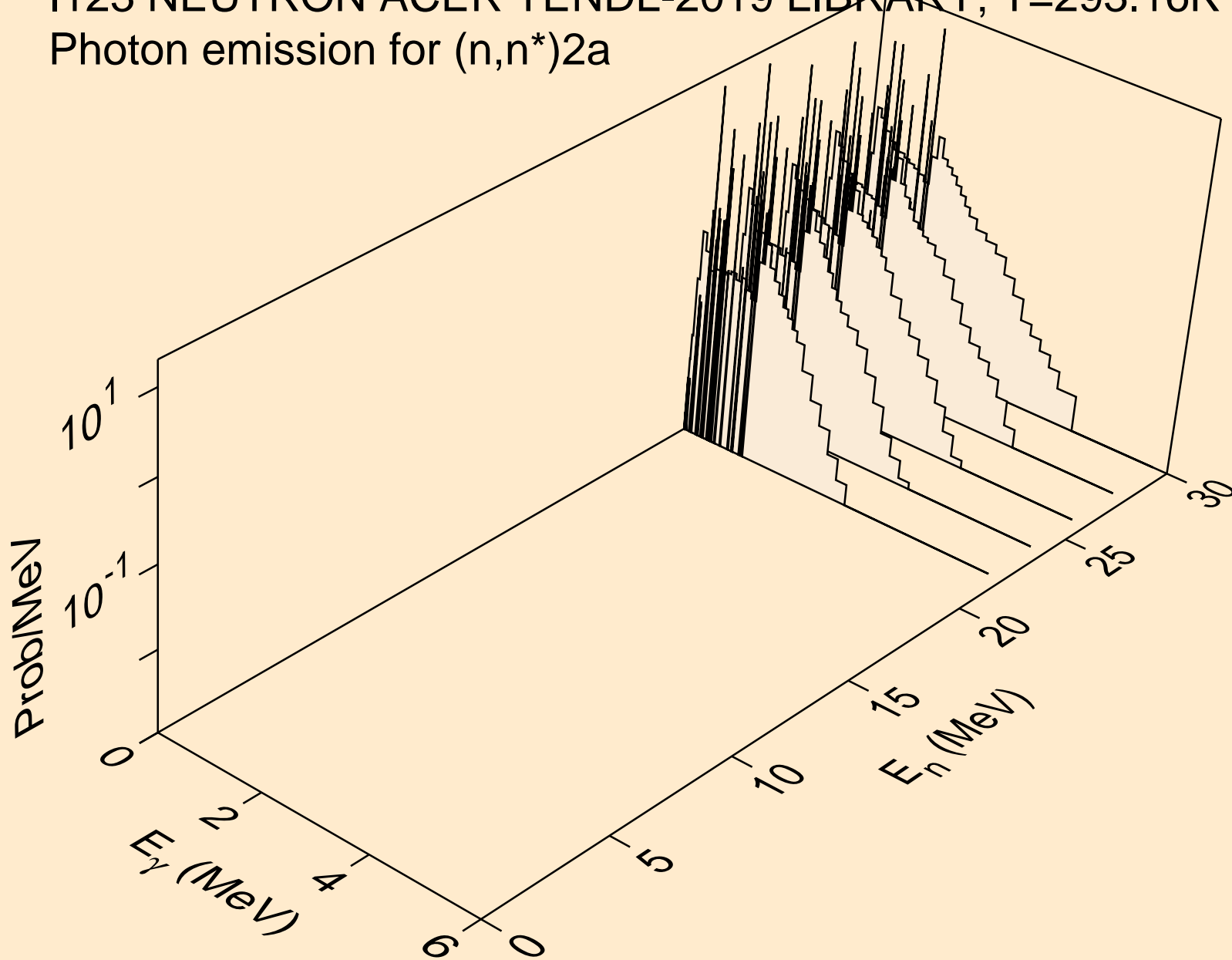

I123 NEUTRON ACER TENDL-2019 LIBRARY; T=293.16K
Photon emission for (n,n*)d

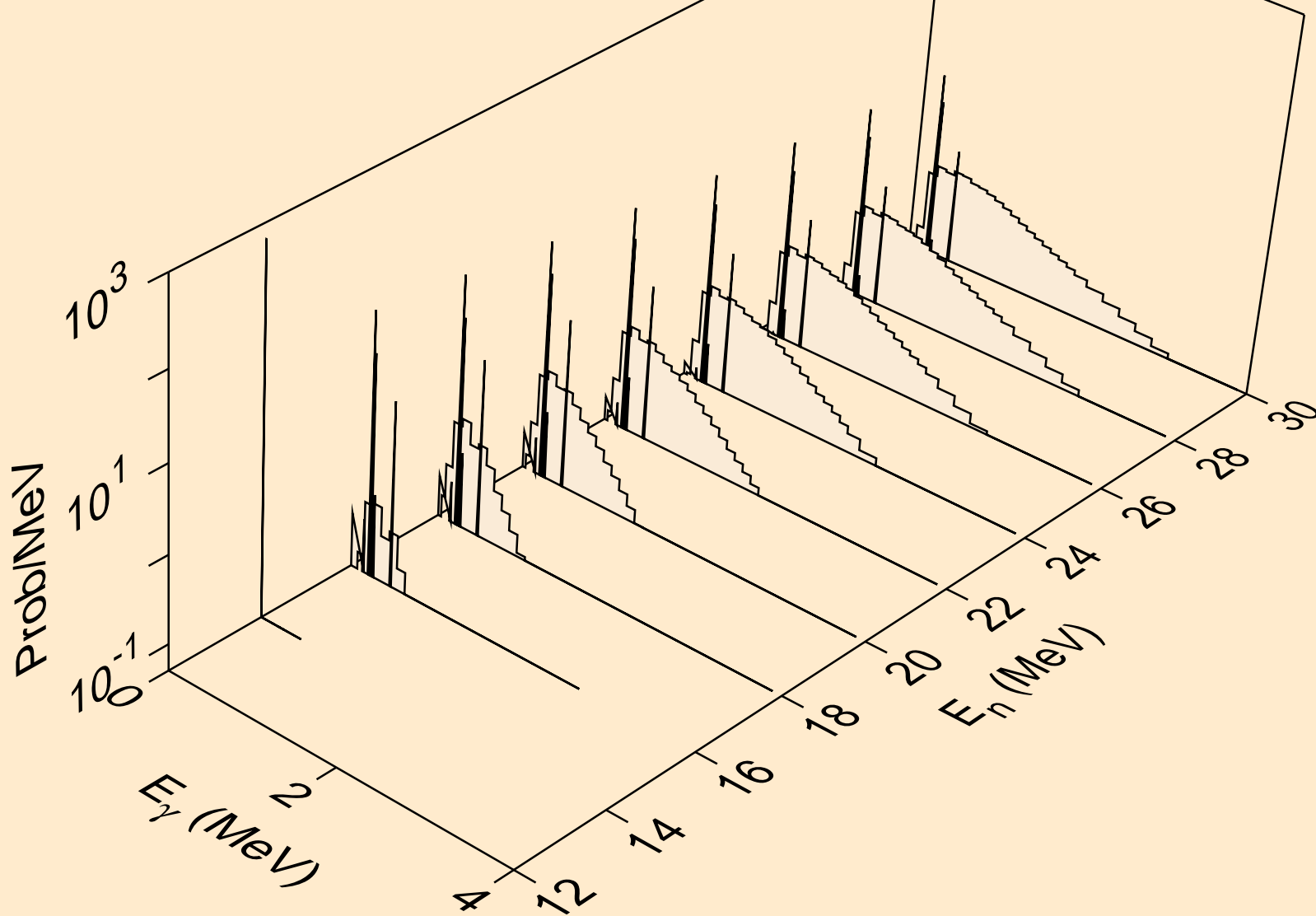

I123 NEUTRON ACER TENDL-2019 LIBRARY; T=293.16K
Photon emission for (n,n*)t

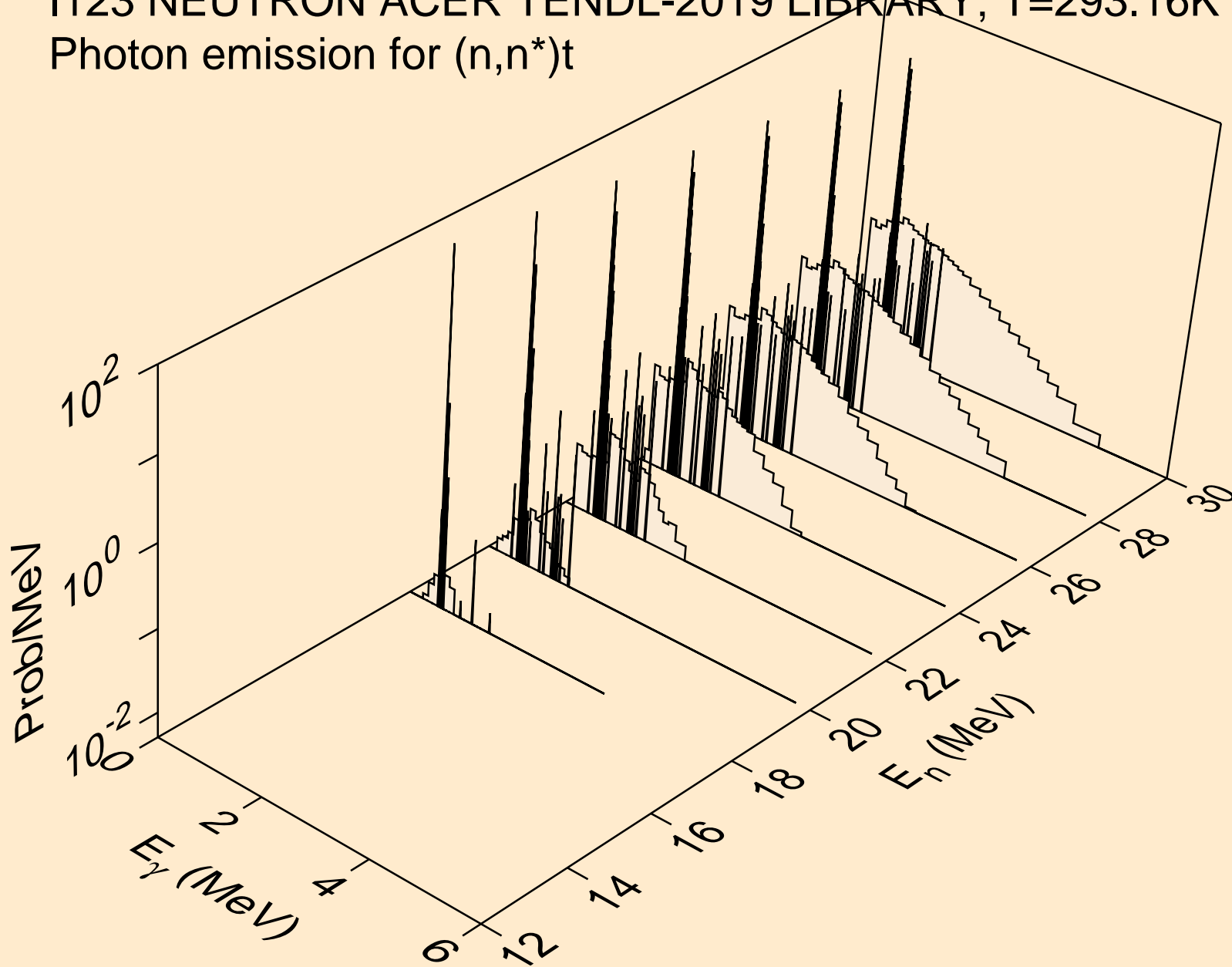

I123 NEUTRON ACER TENDL-2019 LIBRARY; T=293.16K
Photon emission for (n,n*)he3

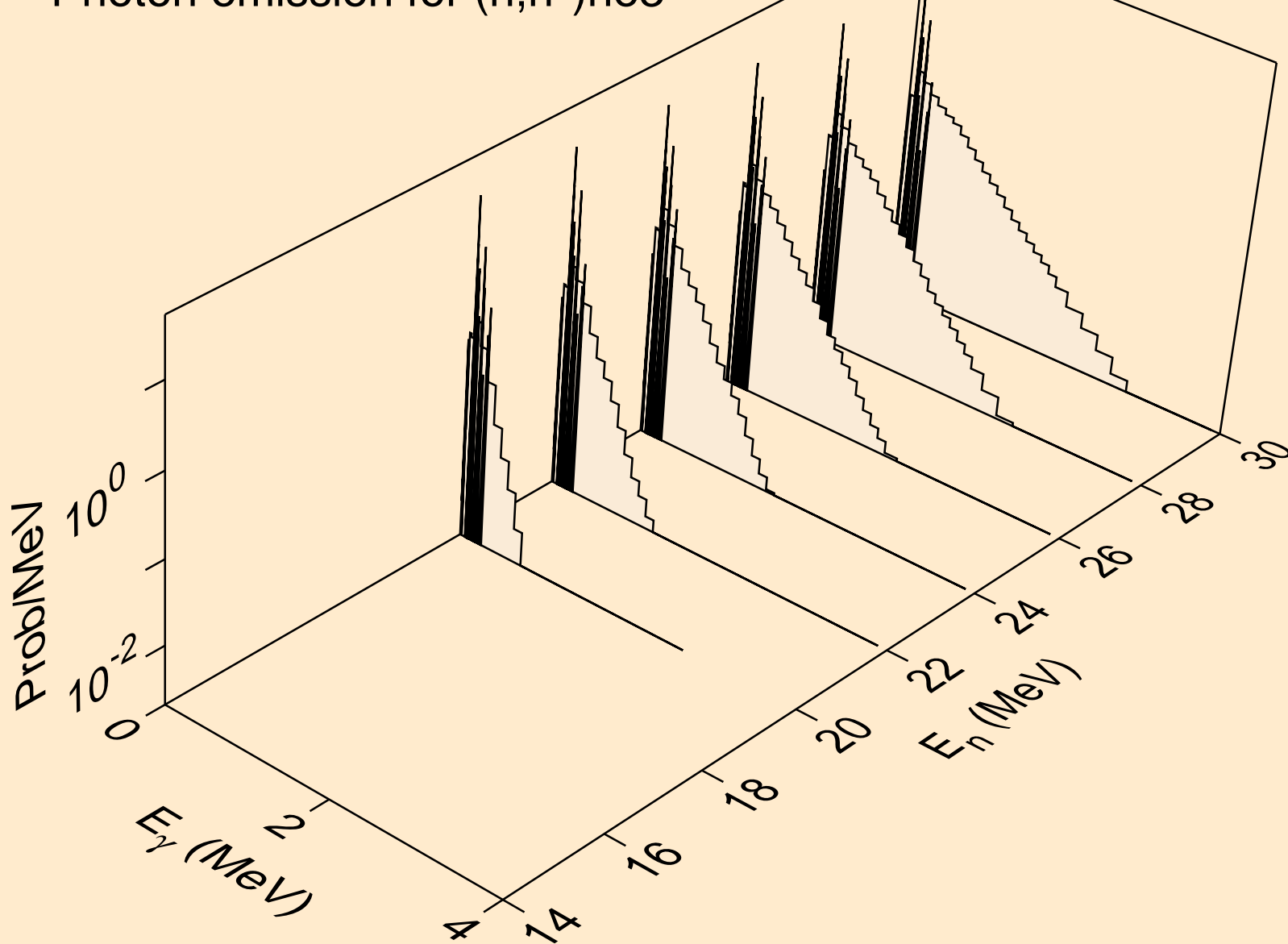

I123 NEUTRON ACER TENDL-2019 LIBRARY; T=293.16K
Photon emission for (n,4n)

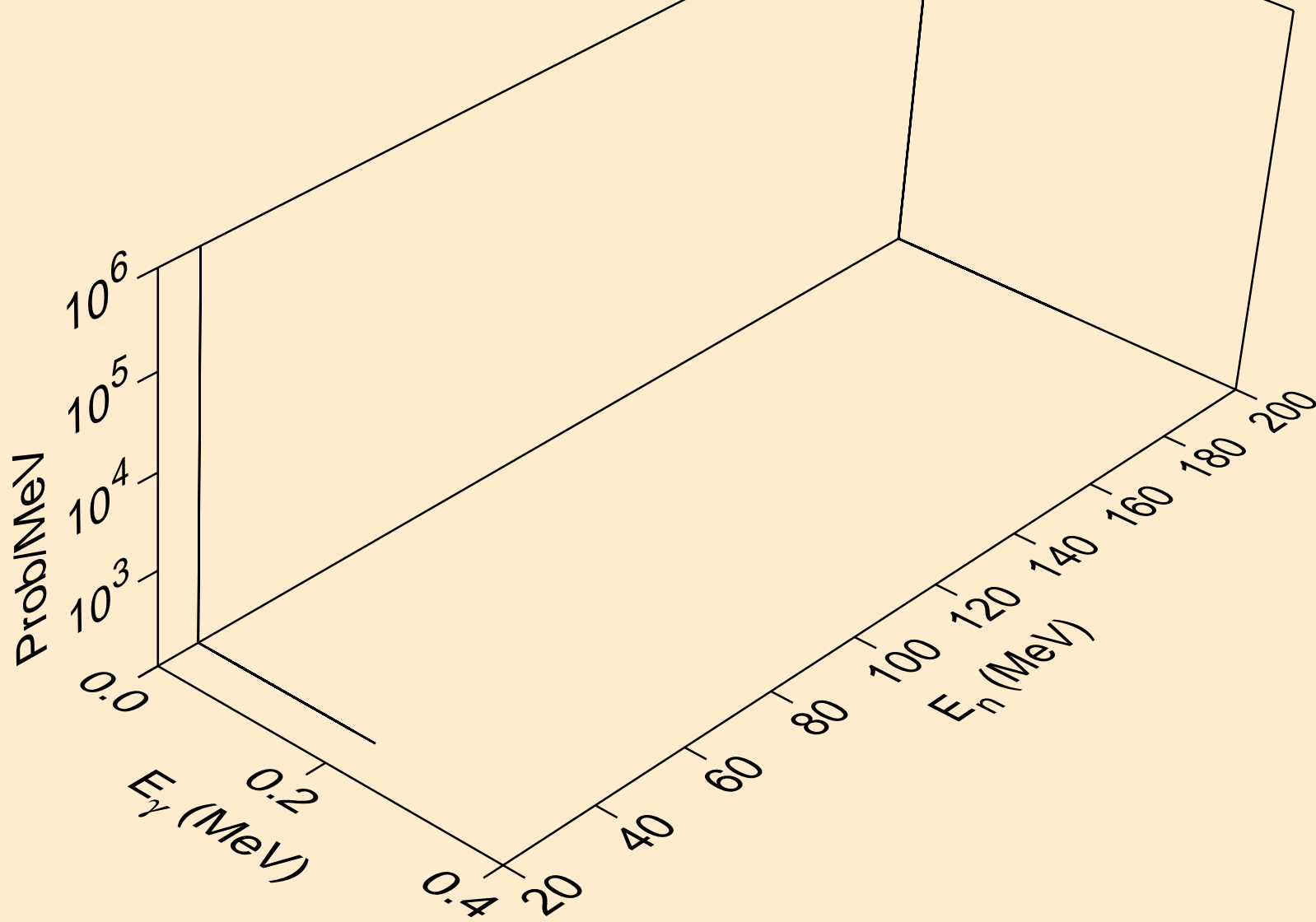

I123 NEUTRON ACER TENDL-2019 LIBRARY; T=293.16K
Photon emission for (n,2np)

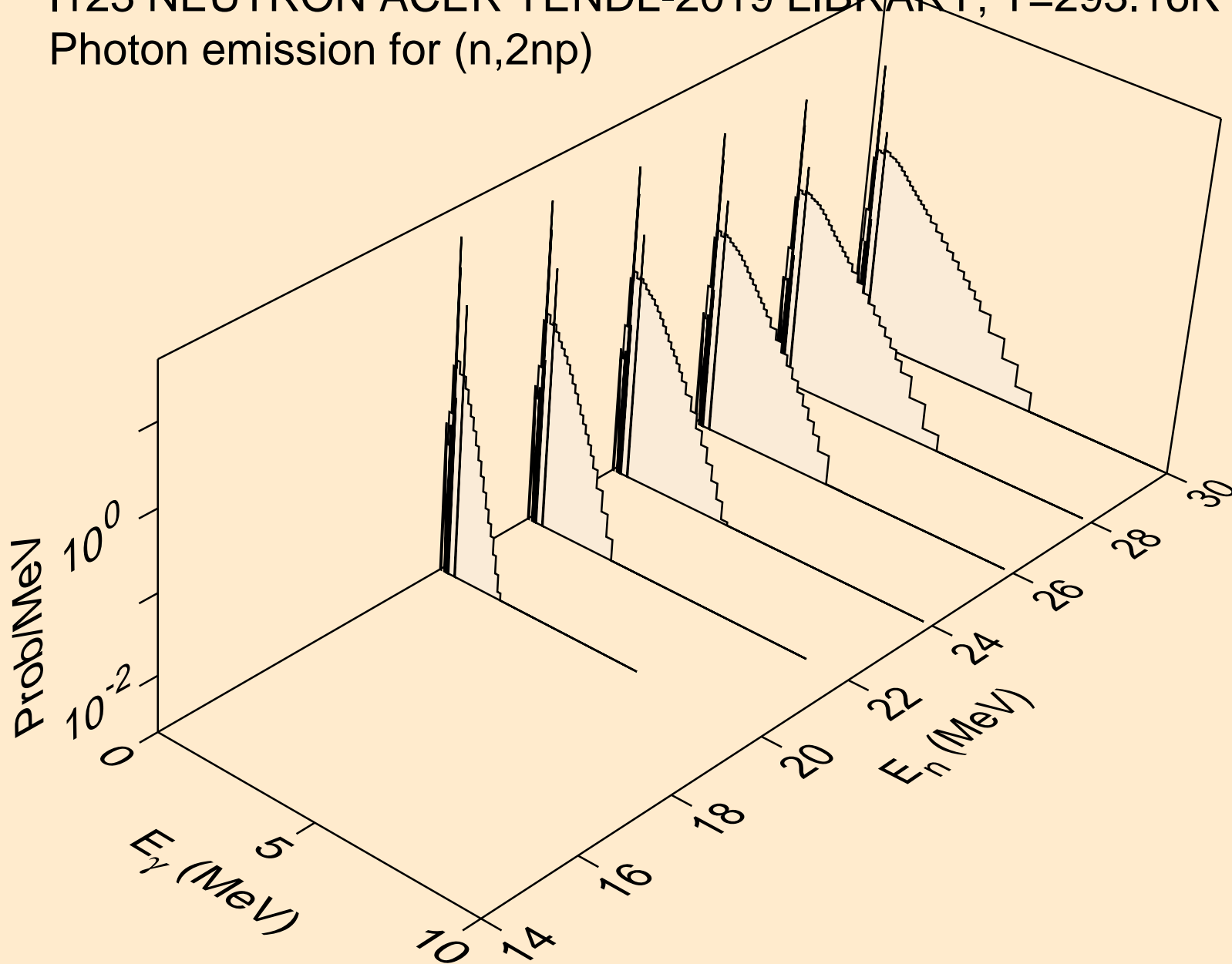

I123 NEUTRON ACER TENDL-2019 LIBRARY; T=293.16K
Photon emission for (n,3np)

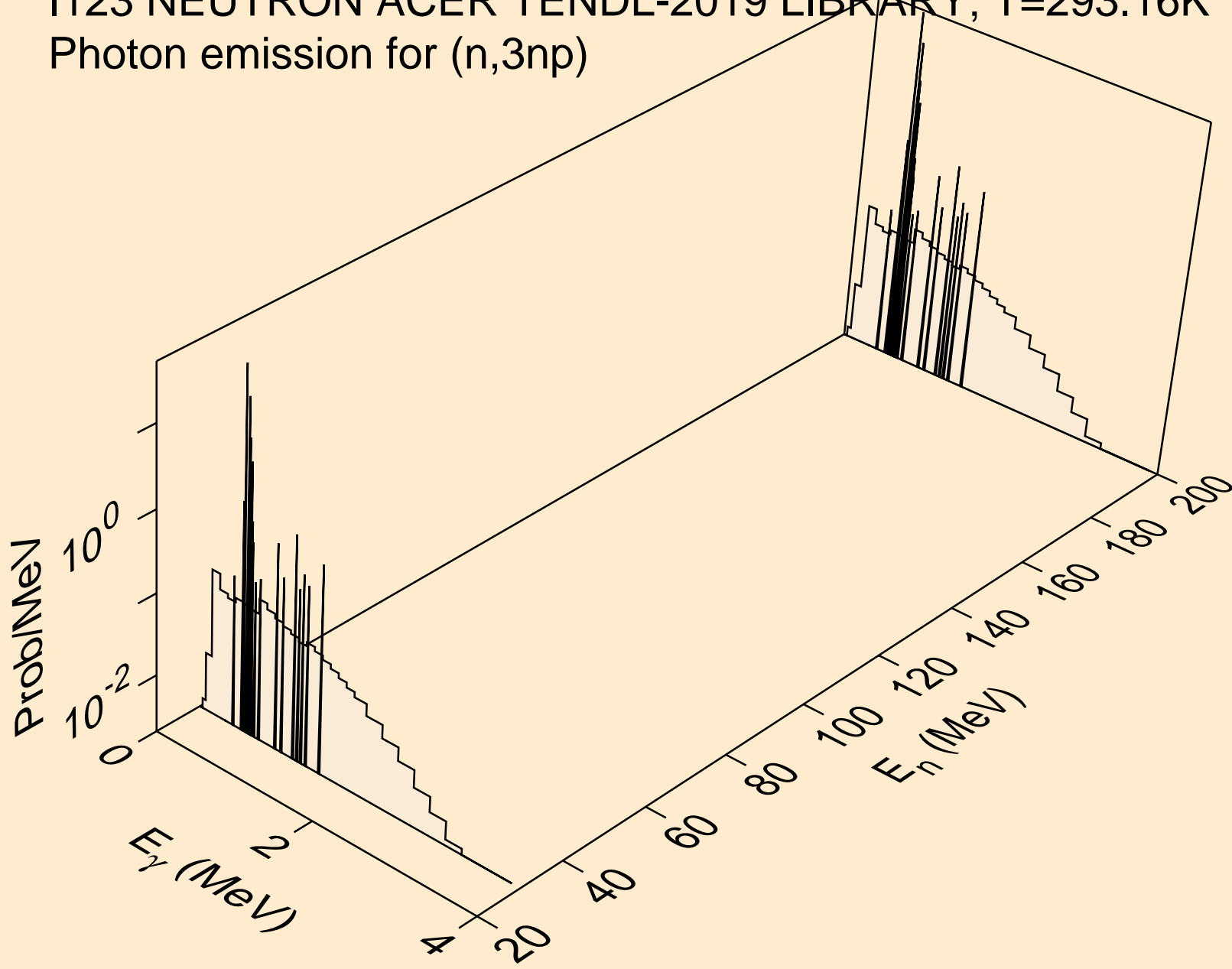

I123 NEUTRON ACER TENDL-2019 LIBRARY; T=293.16K
Photon emission for (n,2np)

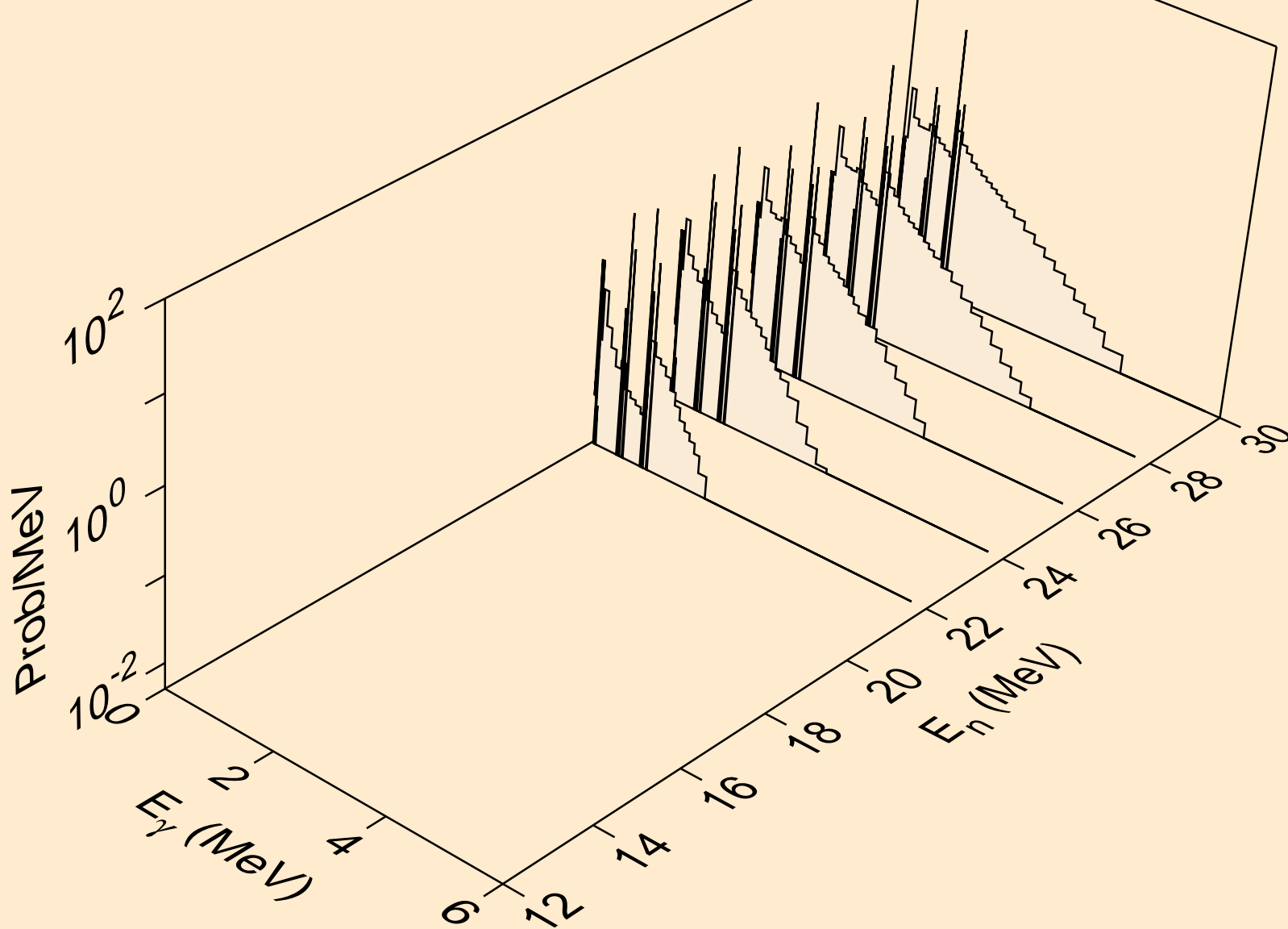

I123 NEUTRON ACER TENDL-2019 LIBRARY; T=293.16K
Photon emission for (n,npa)

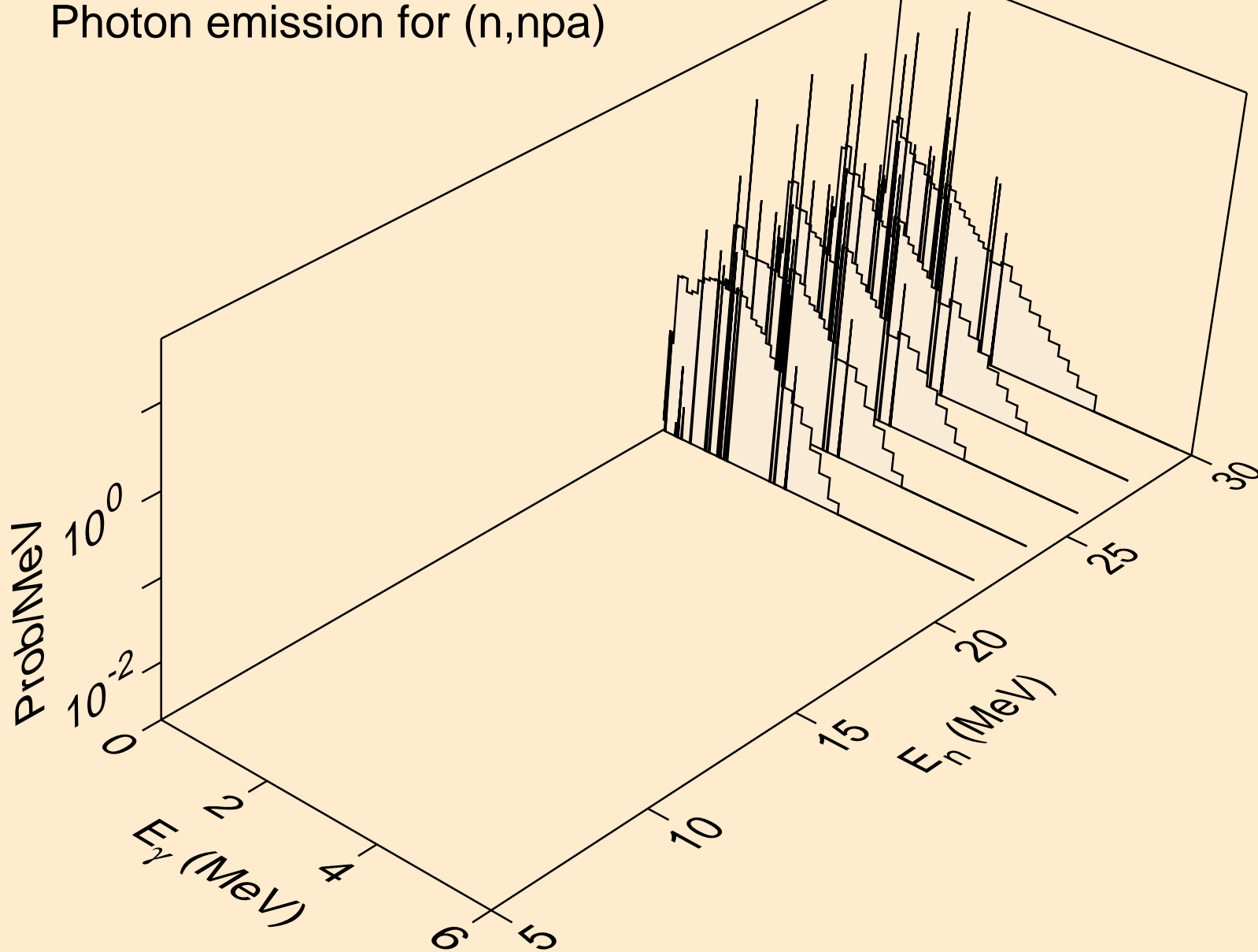

I123 NEUTRON ACER TENDL-2019 LIBRARY; T=293.16K
Photon emission for (n,n*c)

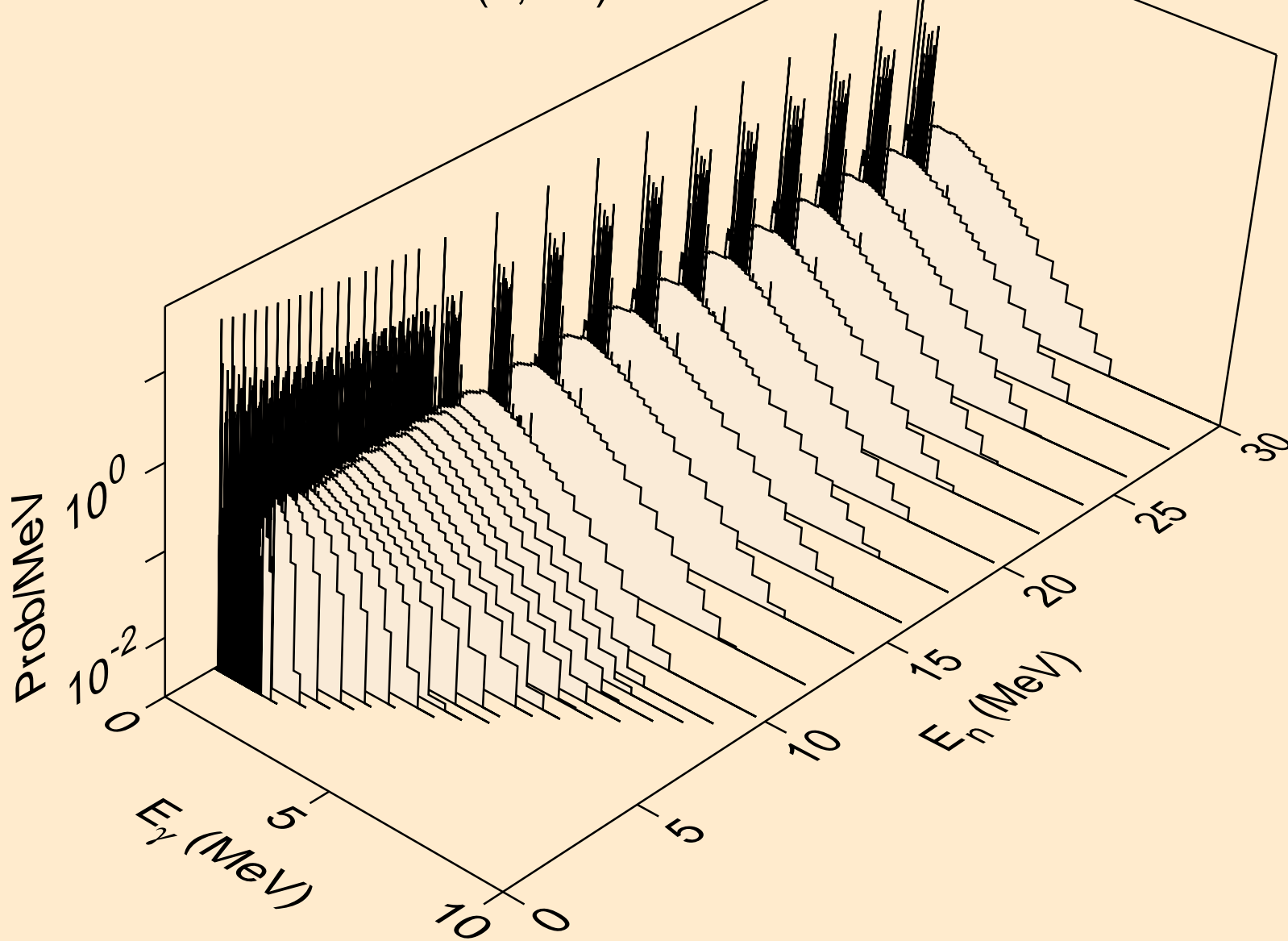

I123 NEUTRON ACER TENDL-2019 LIBRARY; T=293.16K
Photon emission for (n,gma)

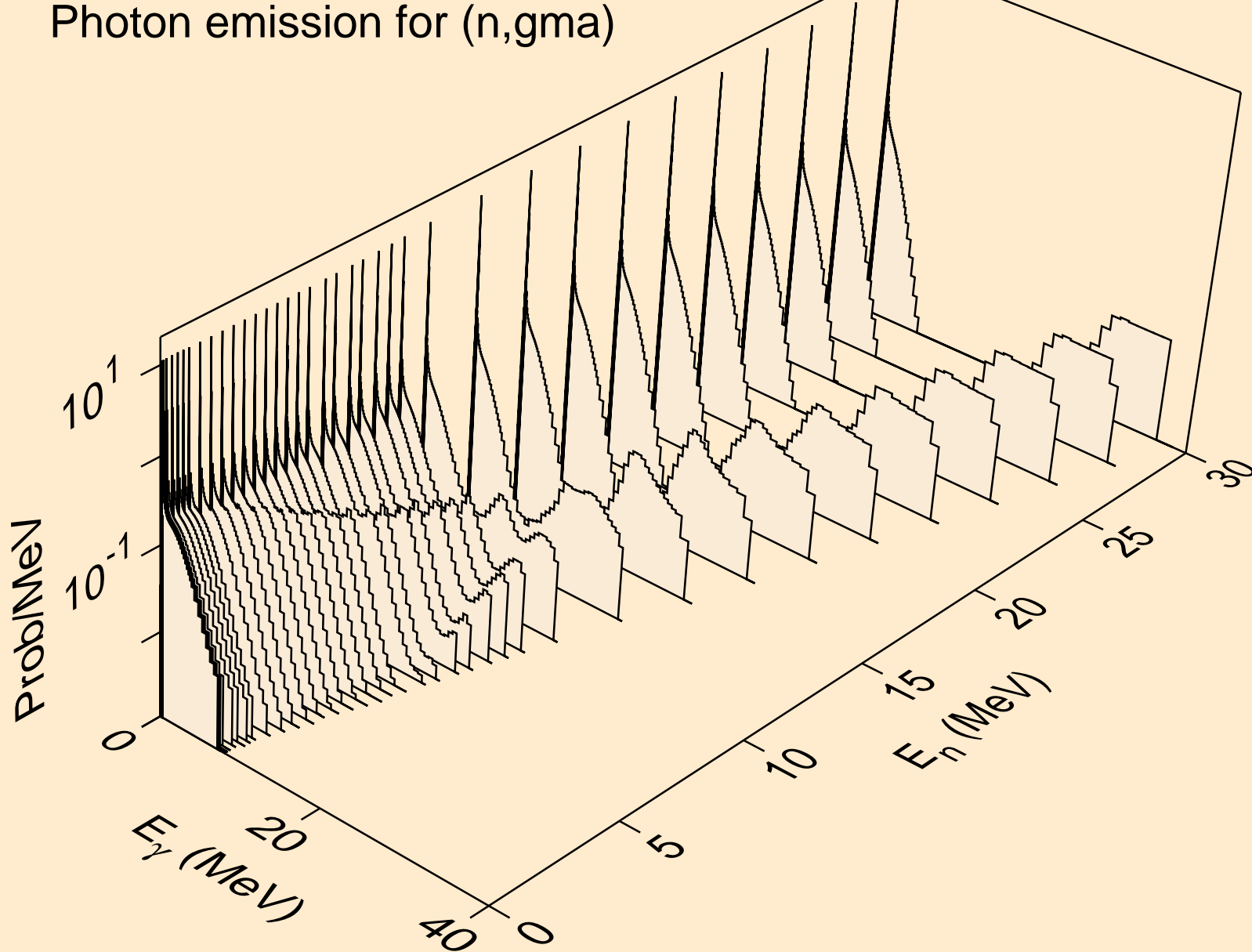

I123 NEUTRON ACER TENDL-2019 LIBRARY; T=293.16K
Photon emission for (n,p)

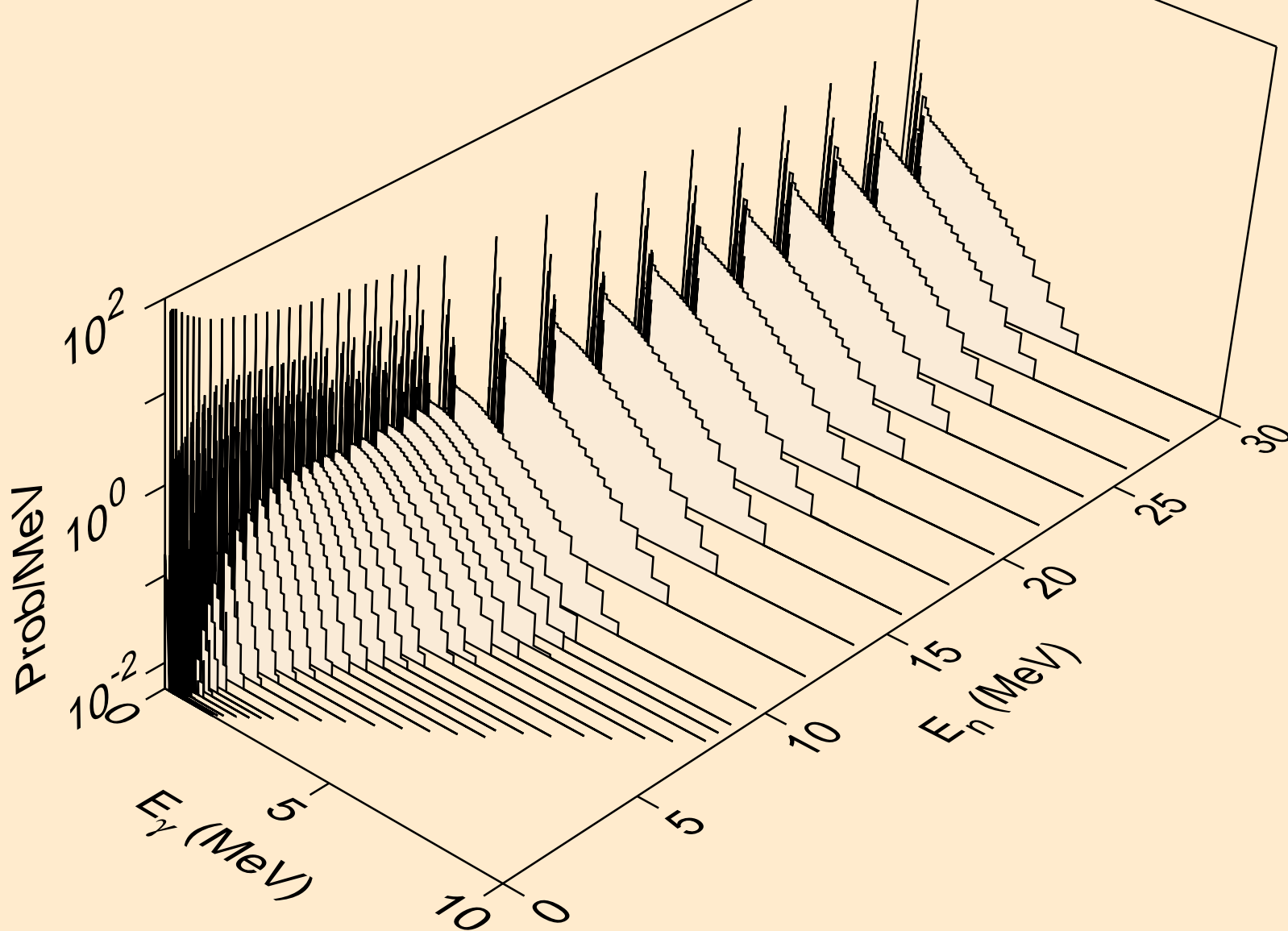

I123 NEUTRON ACER TENDL-2019 LIBRARY; T=293.16K
Photon emission for (n,d)

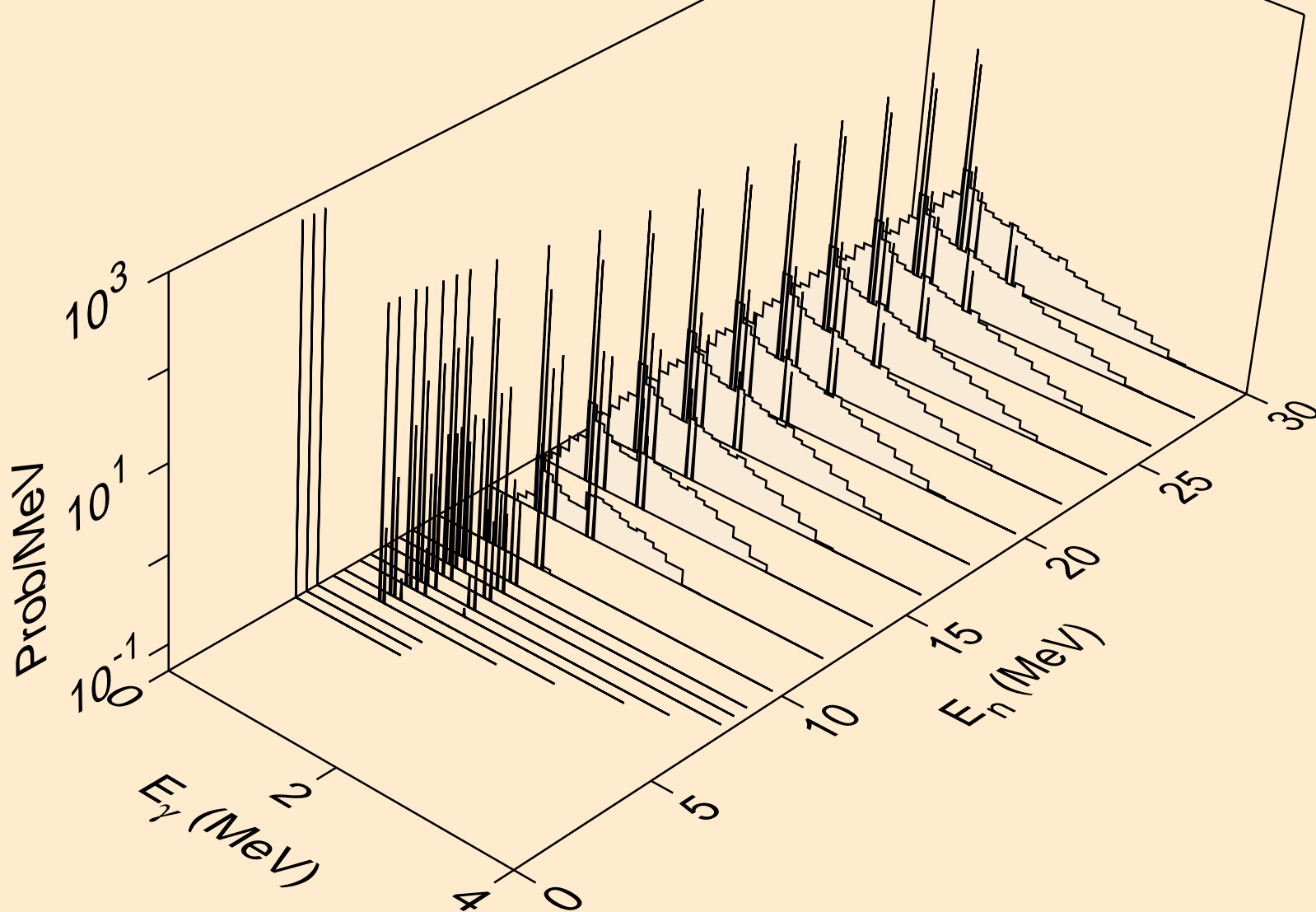

I123 NEUTRON ACER TENDL-2019 LIBRARY; T=293.16K
Photon emission for (n,t)

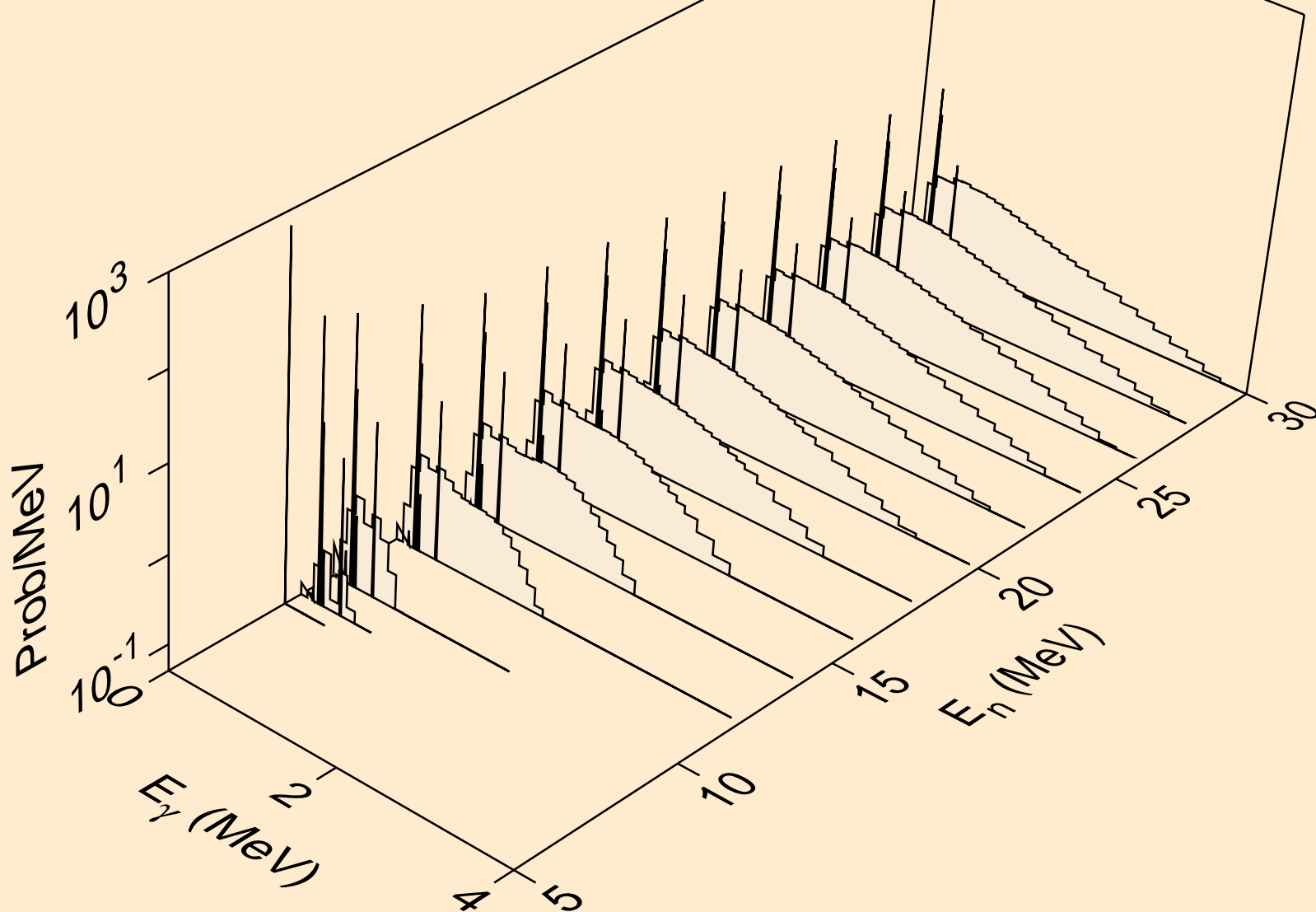

I123 NEUTRON ACER TENDL-2019 LIBRARY; T=293.16K
Photon emission for (n,he3)

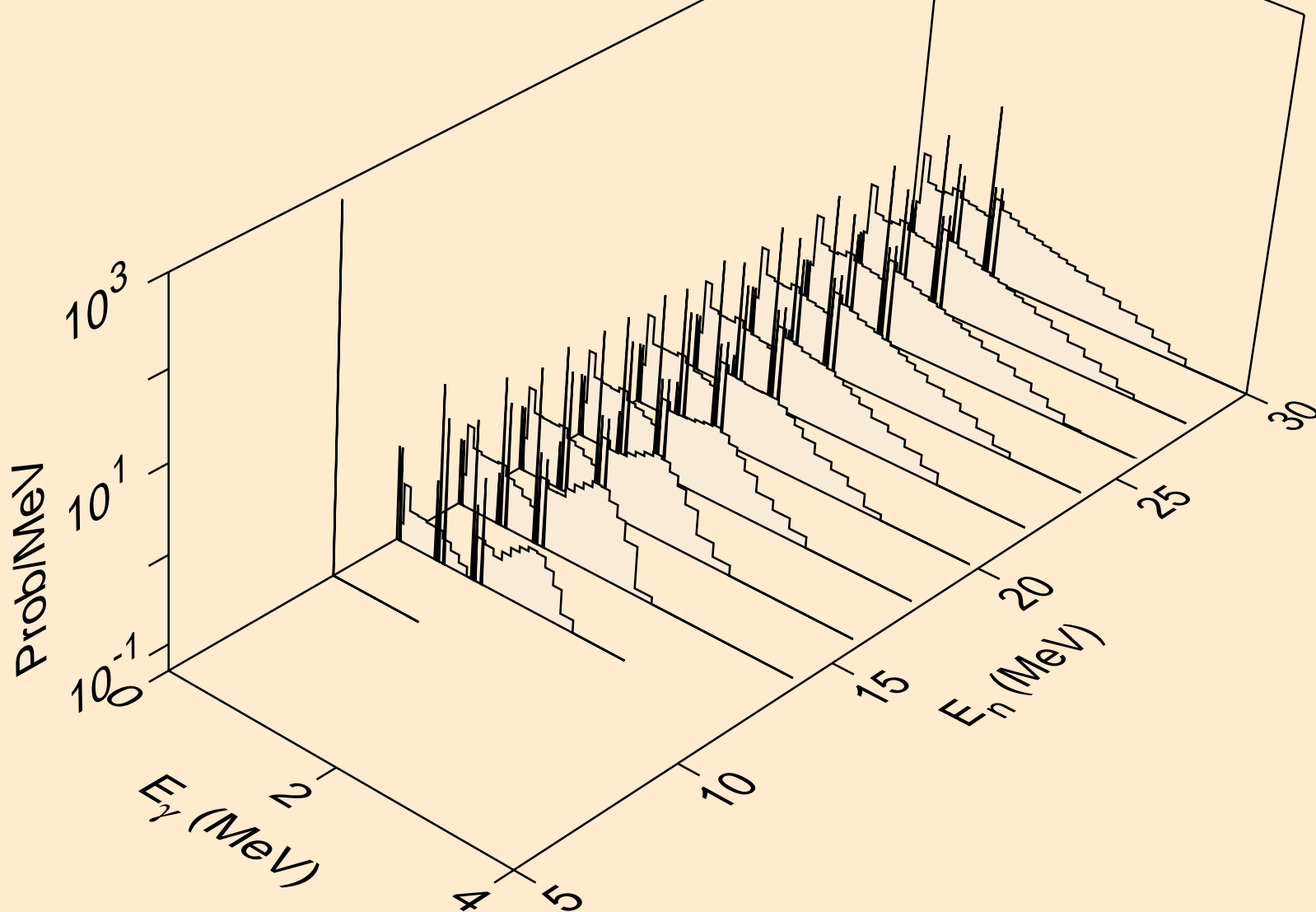

I123 NEUTRON ACER TENDL-2019 LIBRARY; T=293.16K
Photon emission for (n,a)

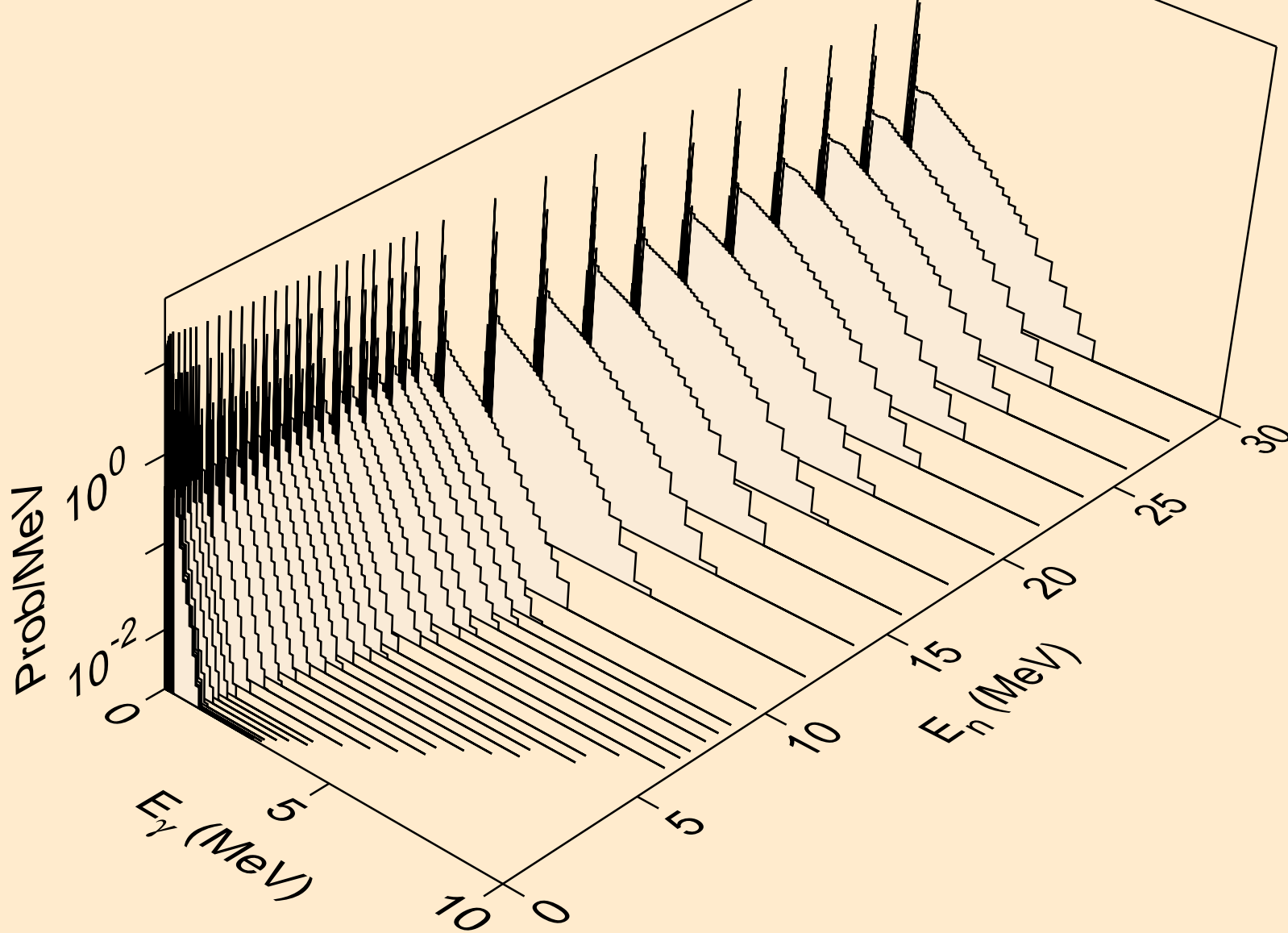

I123 NEUTRON ACER TENDL-2019 LIBRARY; T=293.16K
Photon emission for (n,2a)

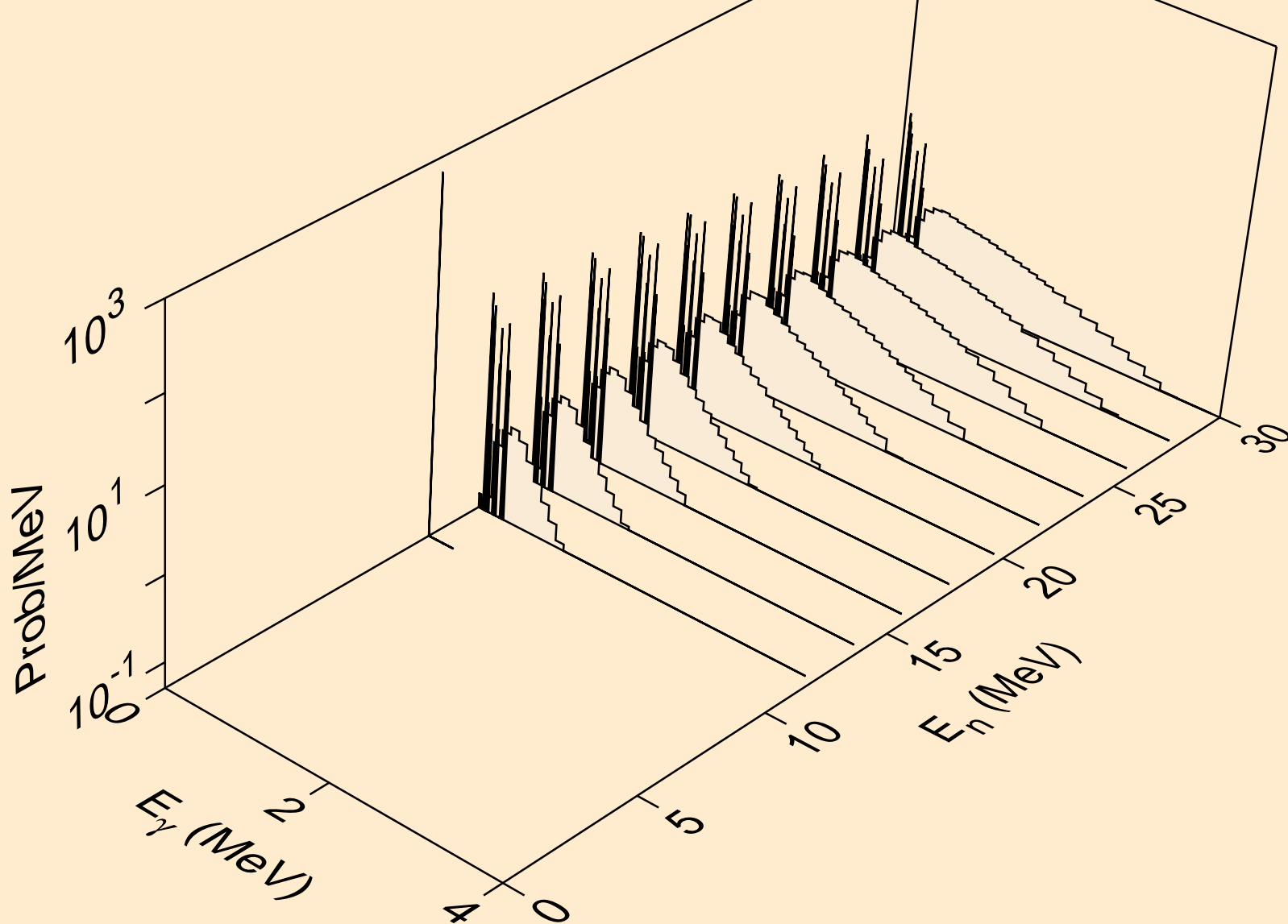

I123 NEUTRON ACER TENDL-2019 LIBRARY; T=293.16K
Photon emission for (n,2p)

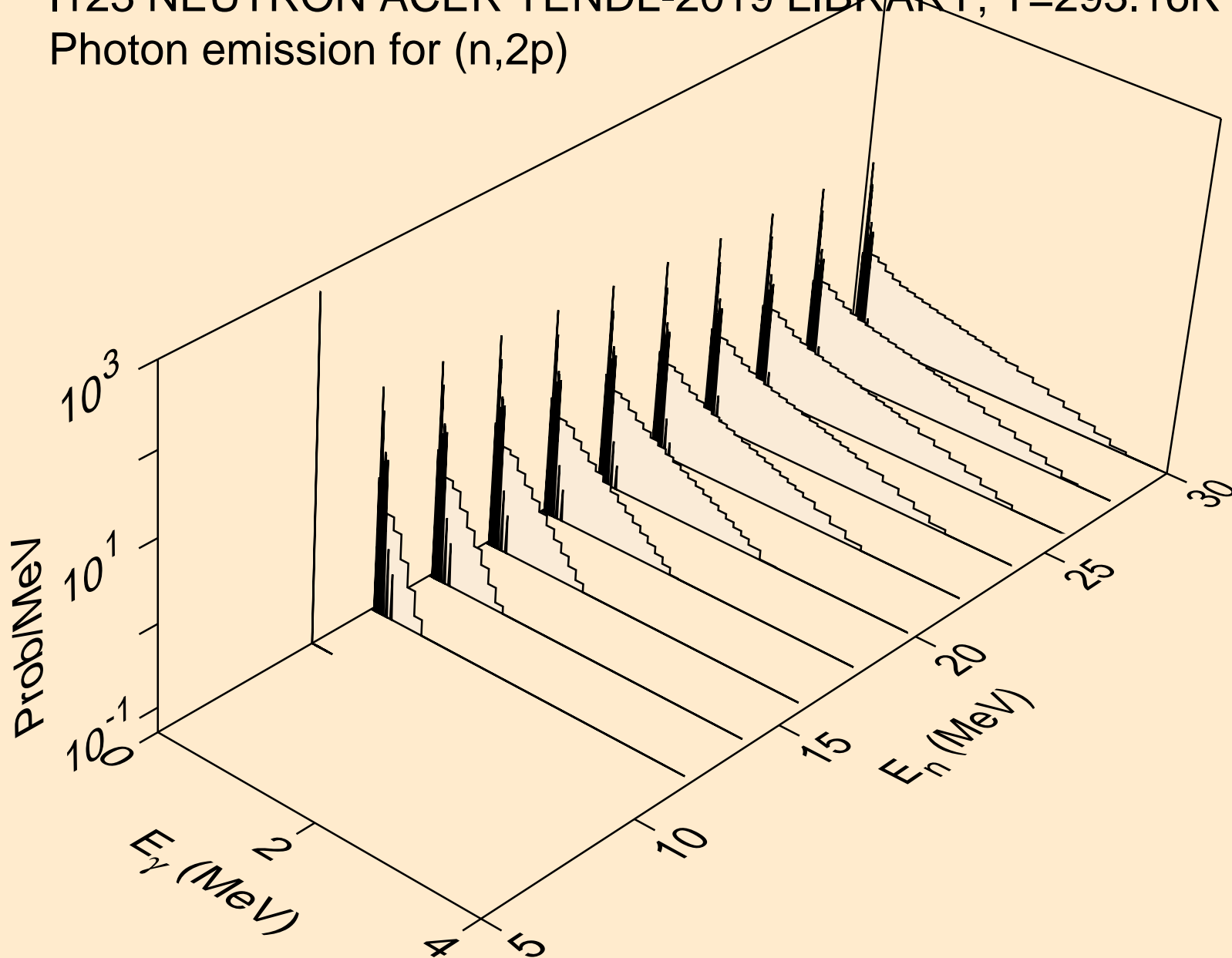

I123 NEUTRON ACER TENDL-2019 LIBRARY; T=293.16K
Photon emission for (n,p α)

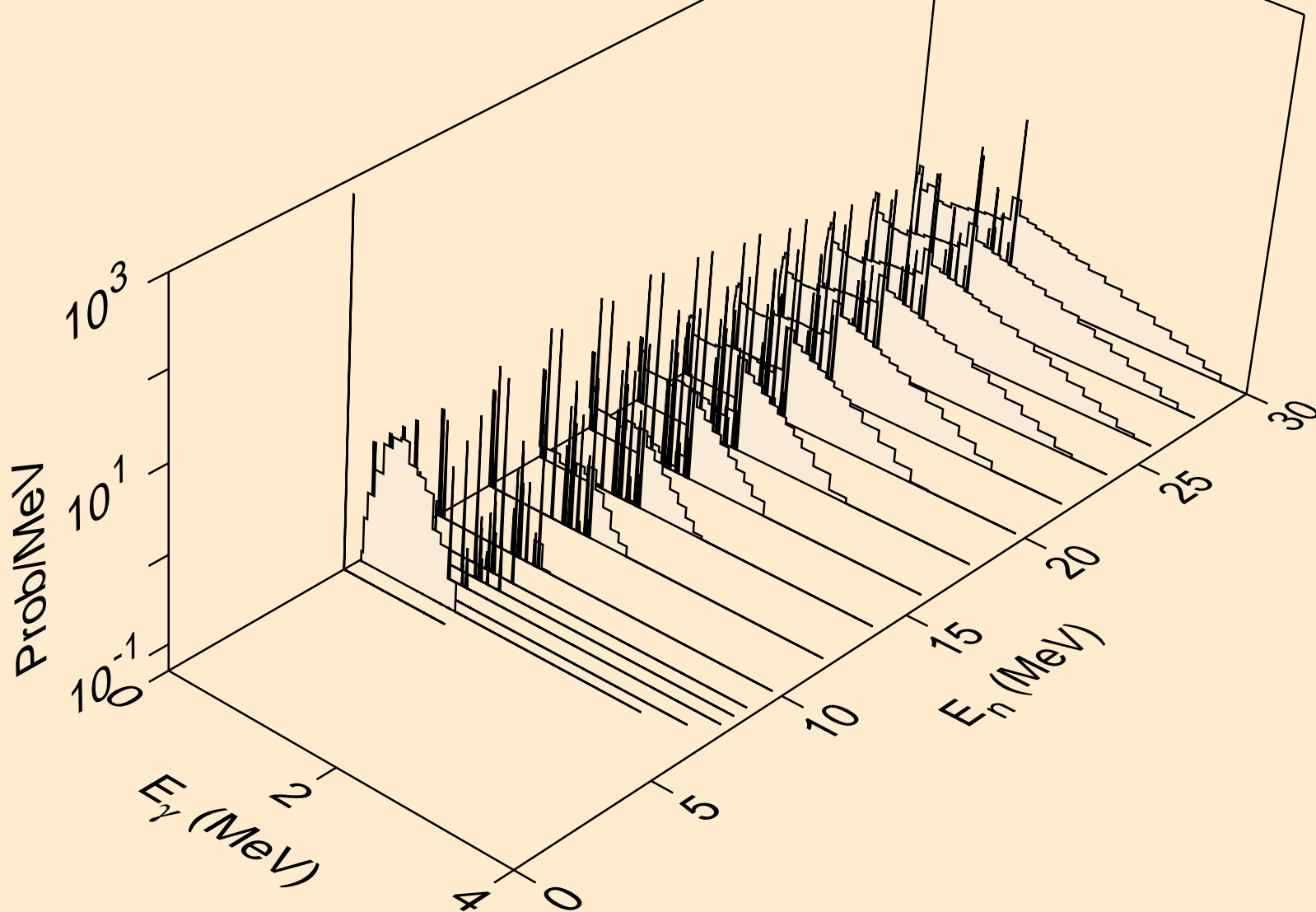

I123 NEUTRON ACER TENDL-2019 LIBRARY; T=293.16K
Photon emission for (n,pd)

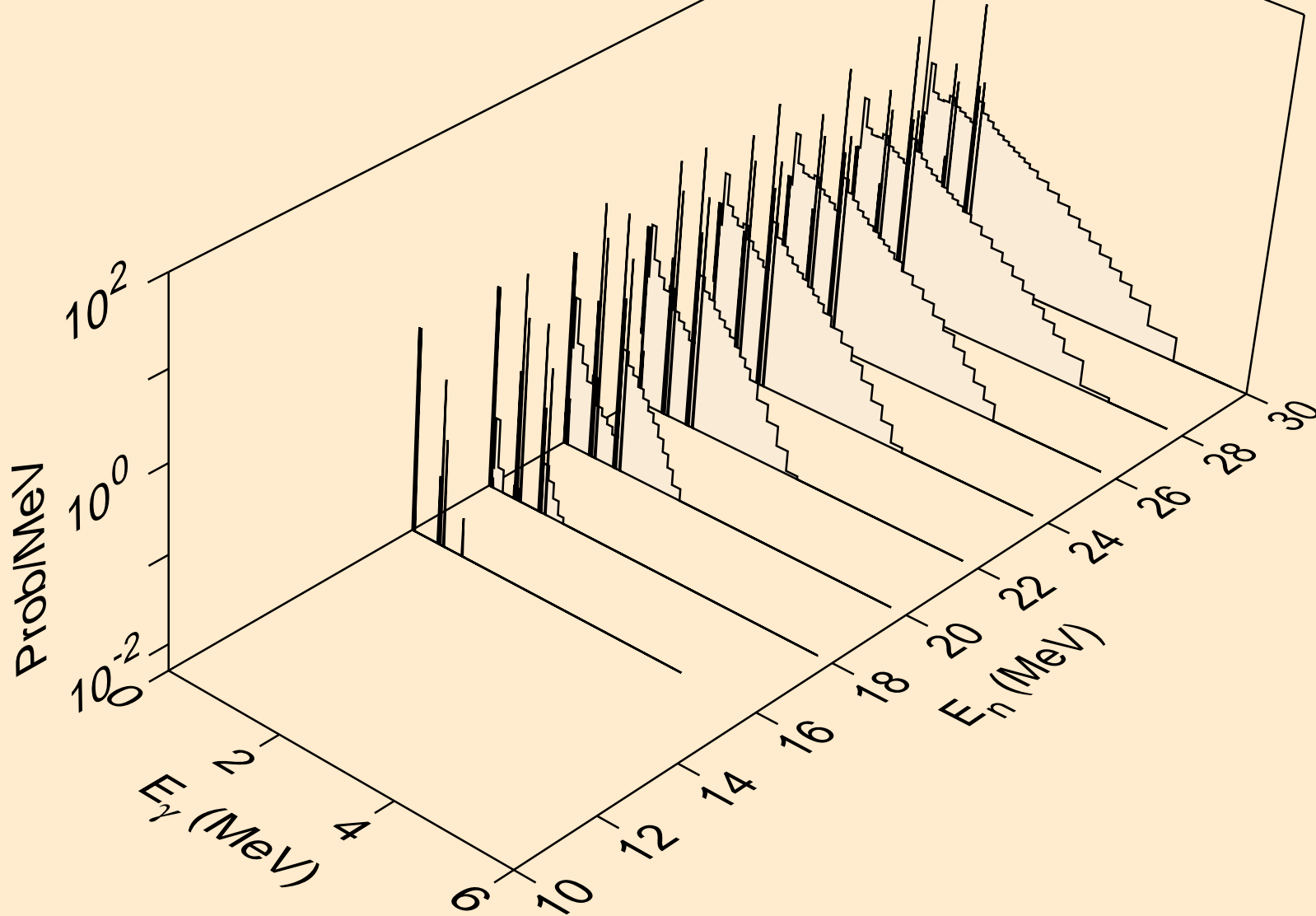

I123 NEUTRON ACER TENDL-2019 LIBRARY; T=293.16K
Photon emission for (n,pt)

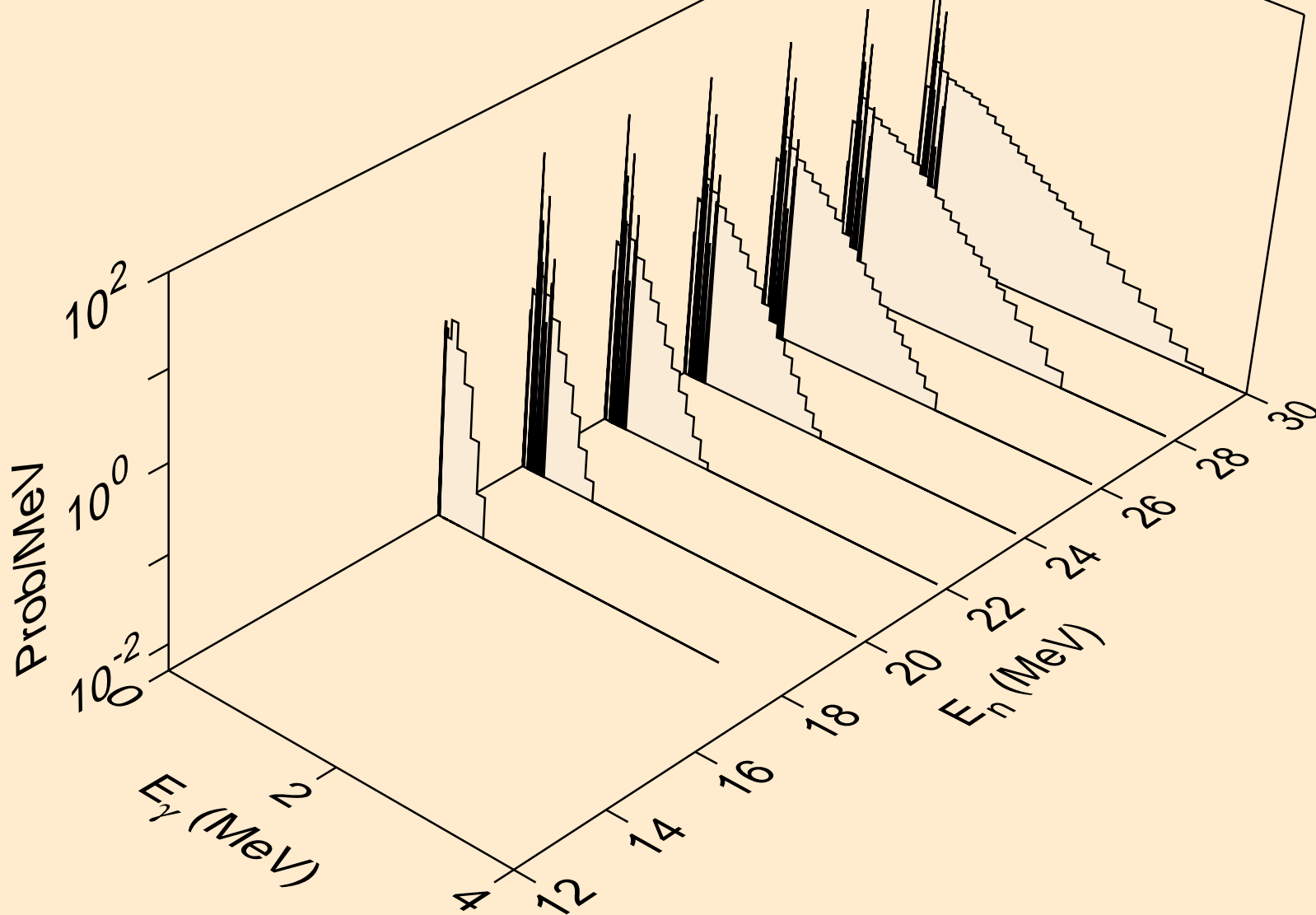

I123 NEUTRON ACER TENDL-2019 LIBRARY; T=293.16K
Photon emission for (n,da)

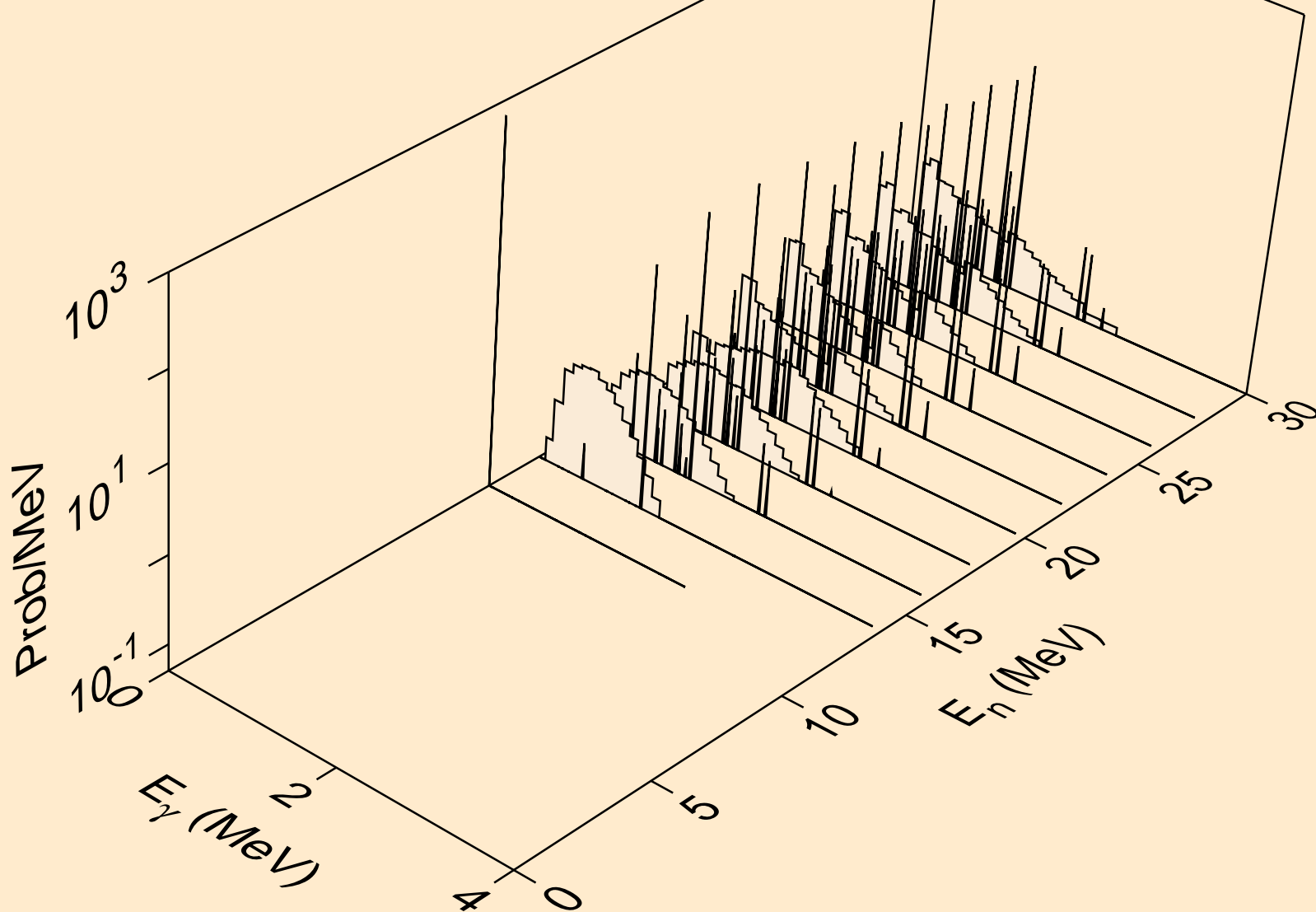

I123 NEUTRON ACER TENDL-2019 LIBRARY; T=293.16K
thermal capture photon spectrum

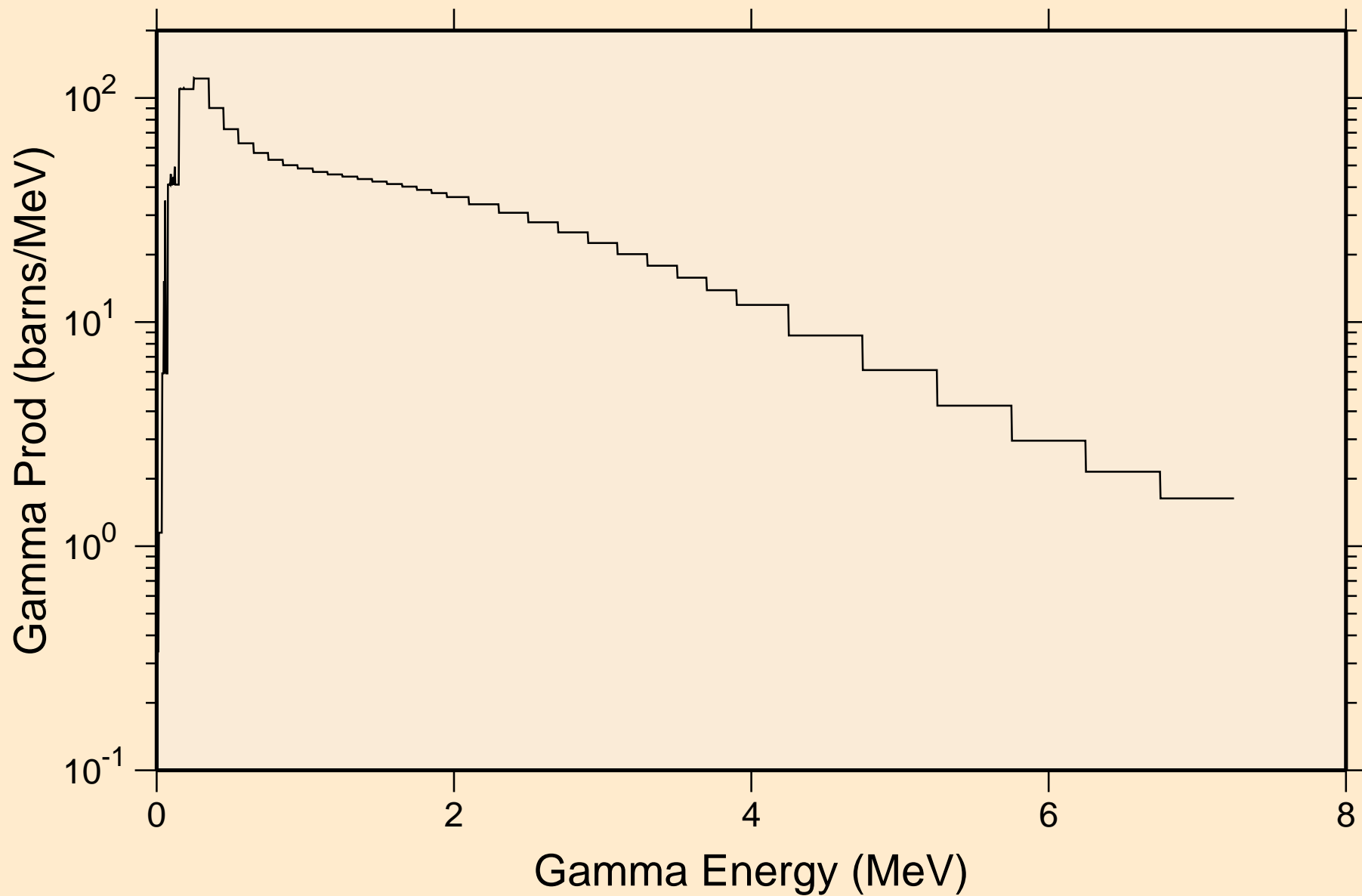

I123 NEUTRON ACER TENDL-2019 LIBRARY; T=293.16K
14 MeV photon spectrum

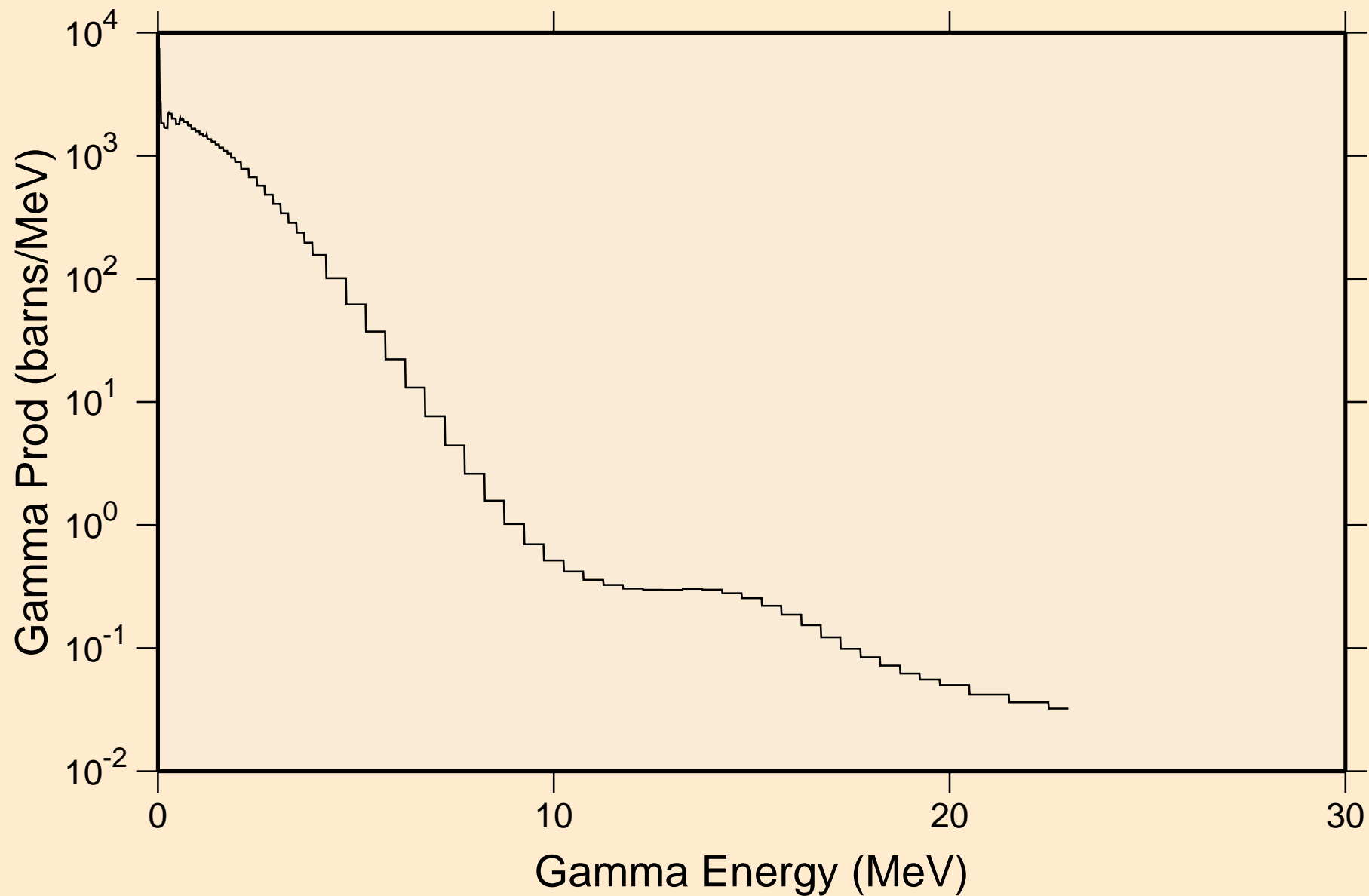

I123 NEUTRON ACER TENDL-2019 LIBRARY; T=293.16K

Particle heating contributions

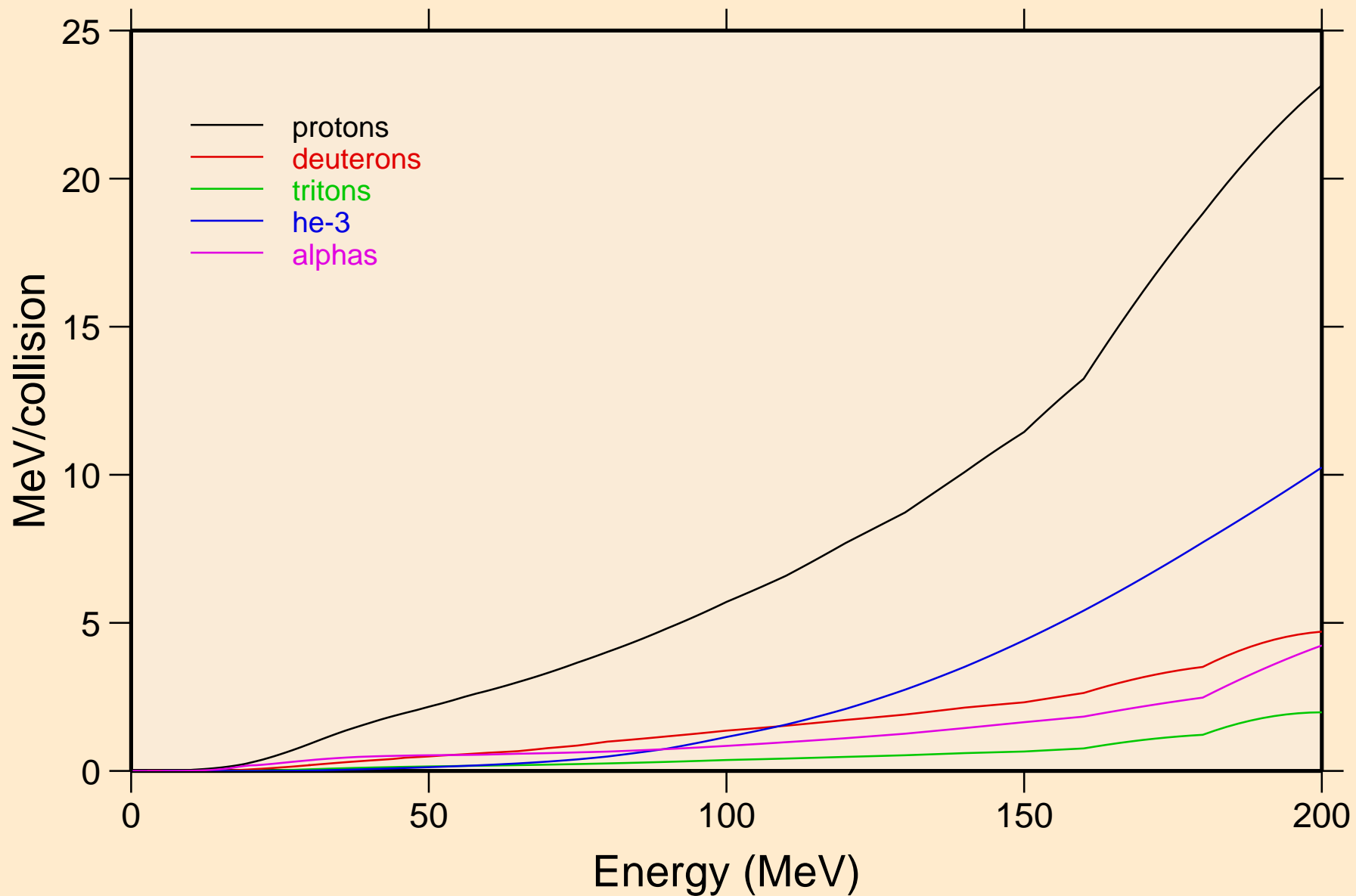

I123 NEUTRON ACER TENDL-2019 LIBRARY; T=293.16K
Recoil Heating

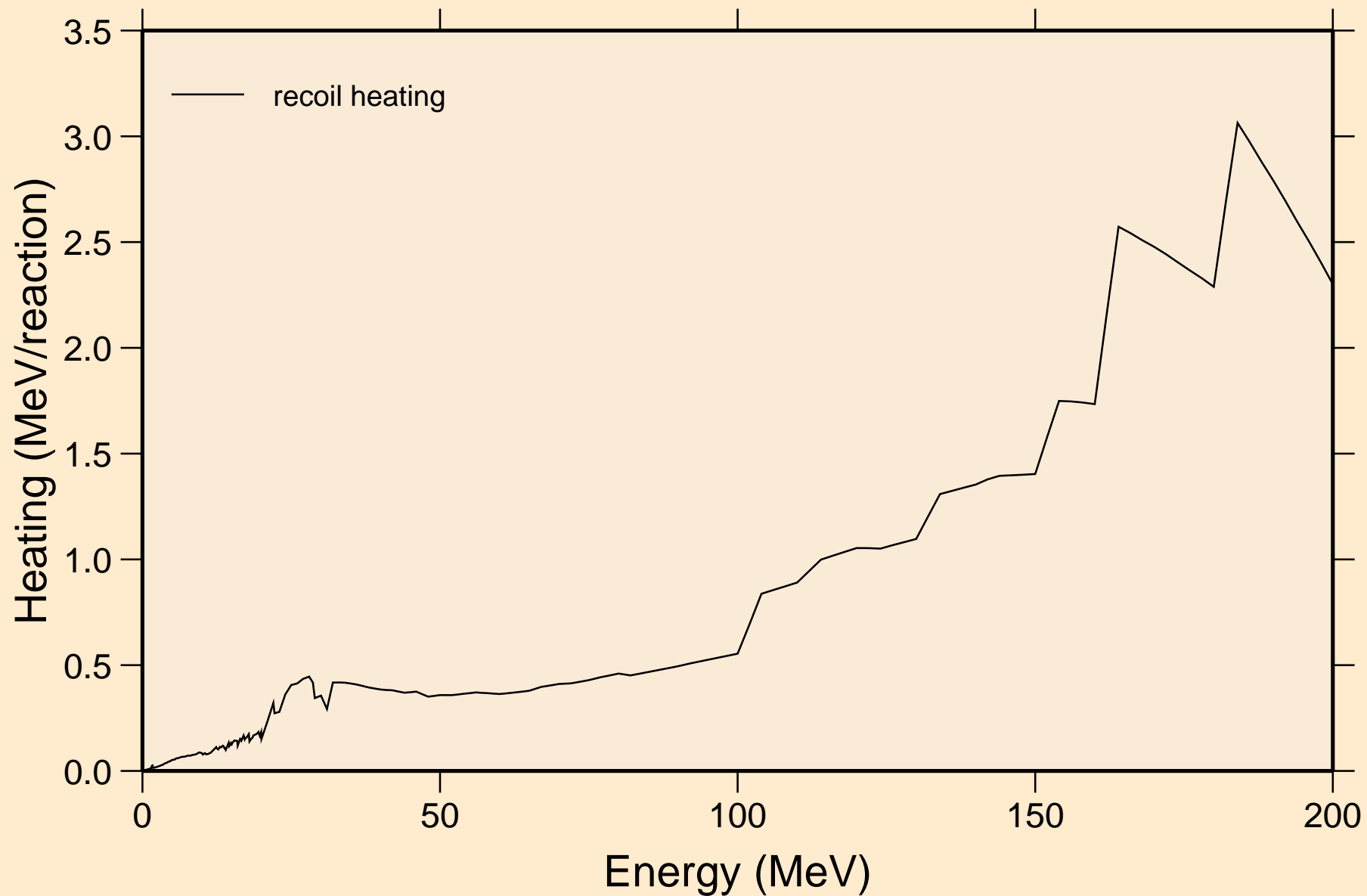

I123 NEUTRON ACER TENDL-2019 LIBRARY; T=293.16K
Particle production cross sections

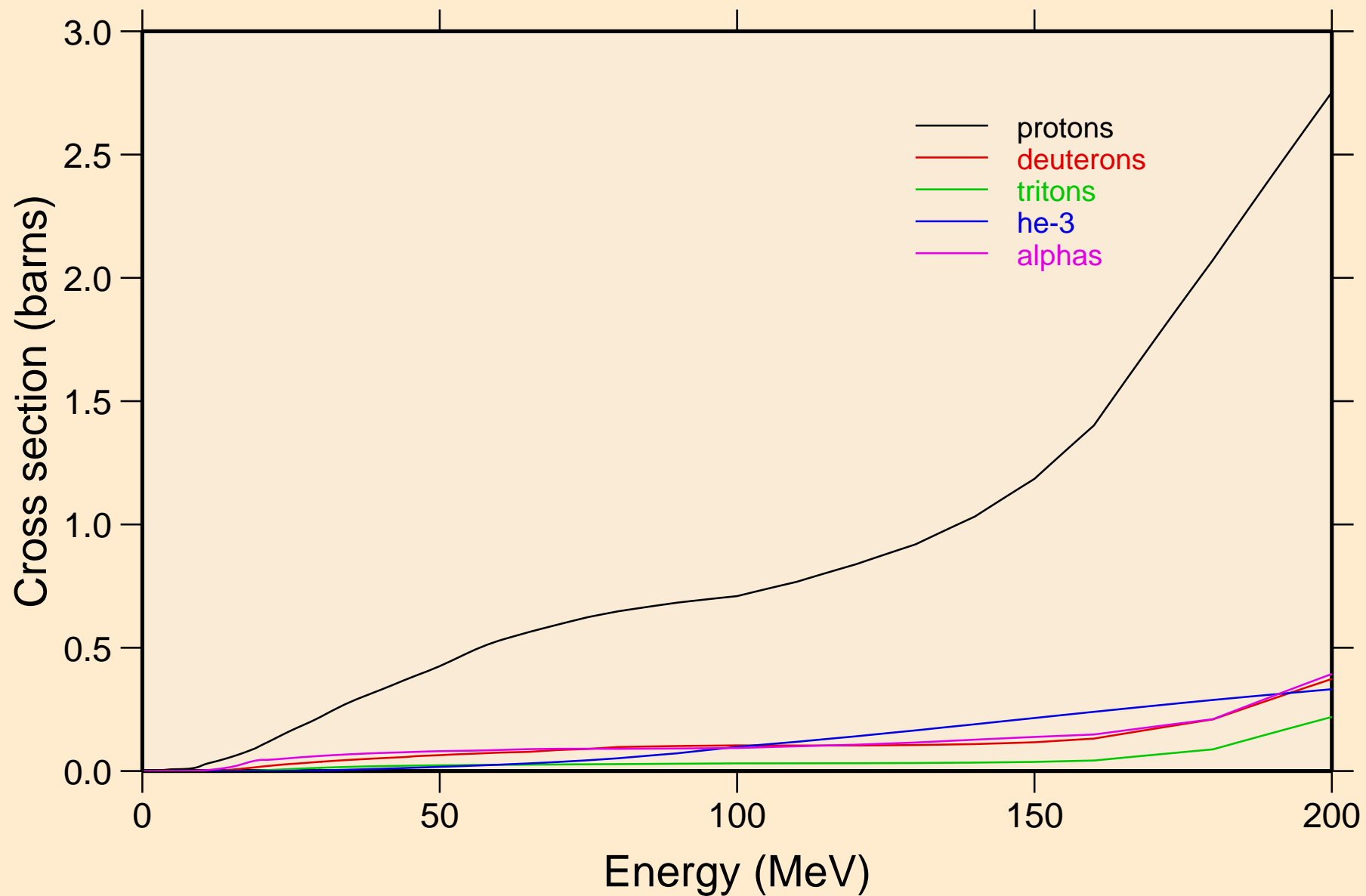

I123 NEUTRON ACER TENDL-2019 LIBRARY; T=293.16K
protons from (n,x)

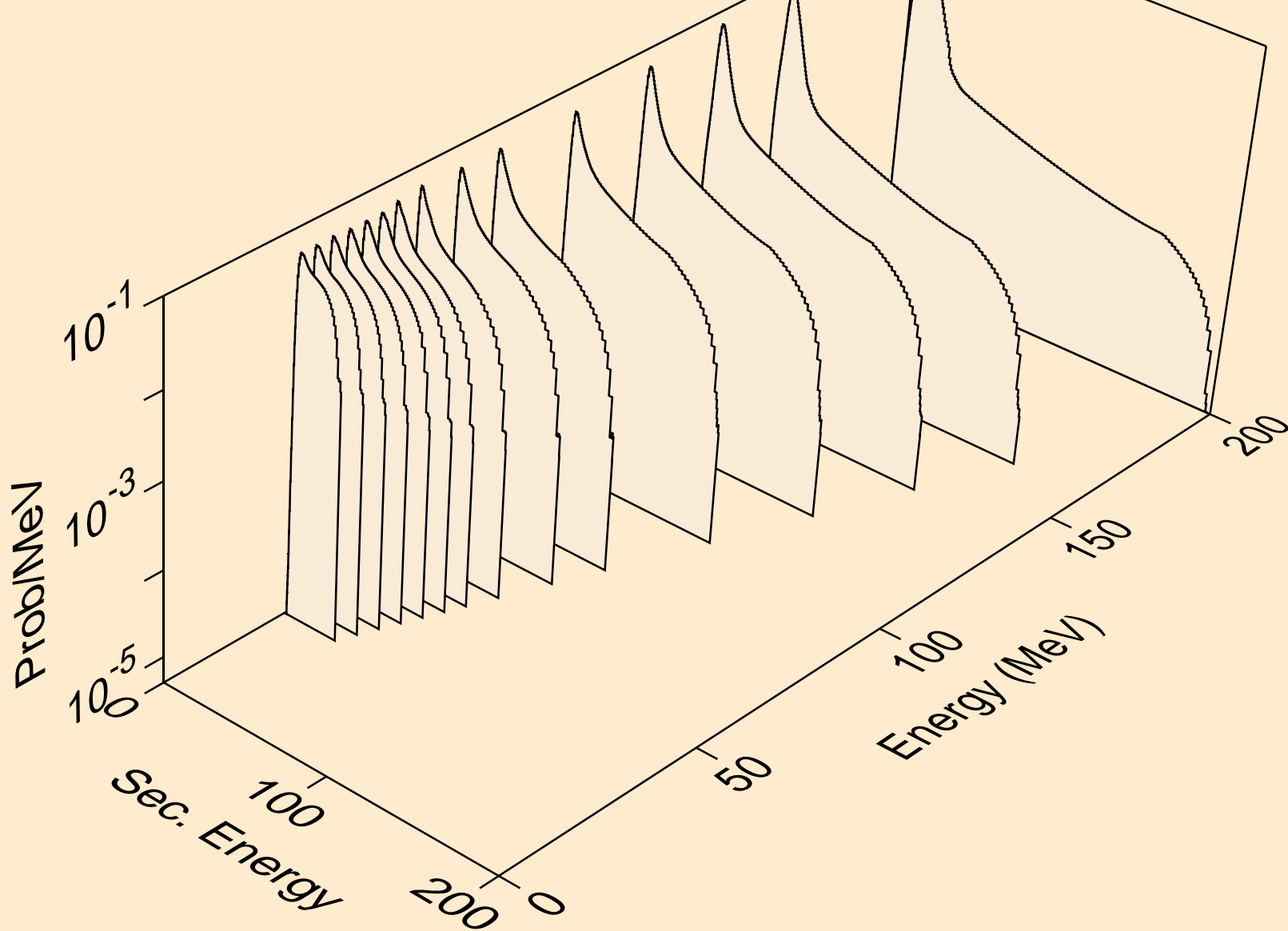

I123 NEUTRON ACER TENDL-2019 LIBRARY; T=293.16K
protons from (n,n*)p

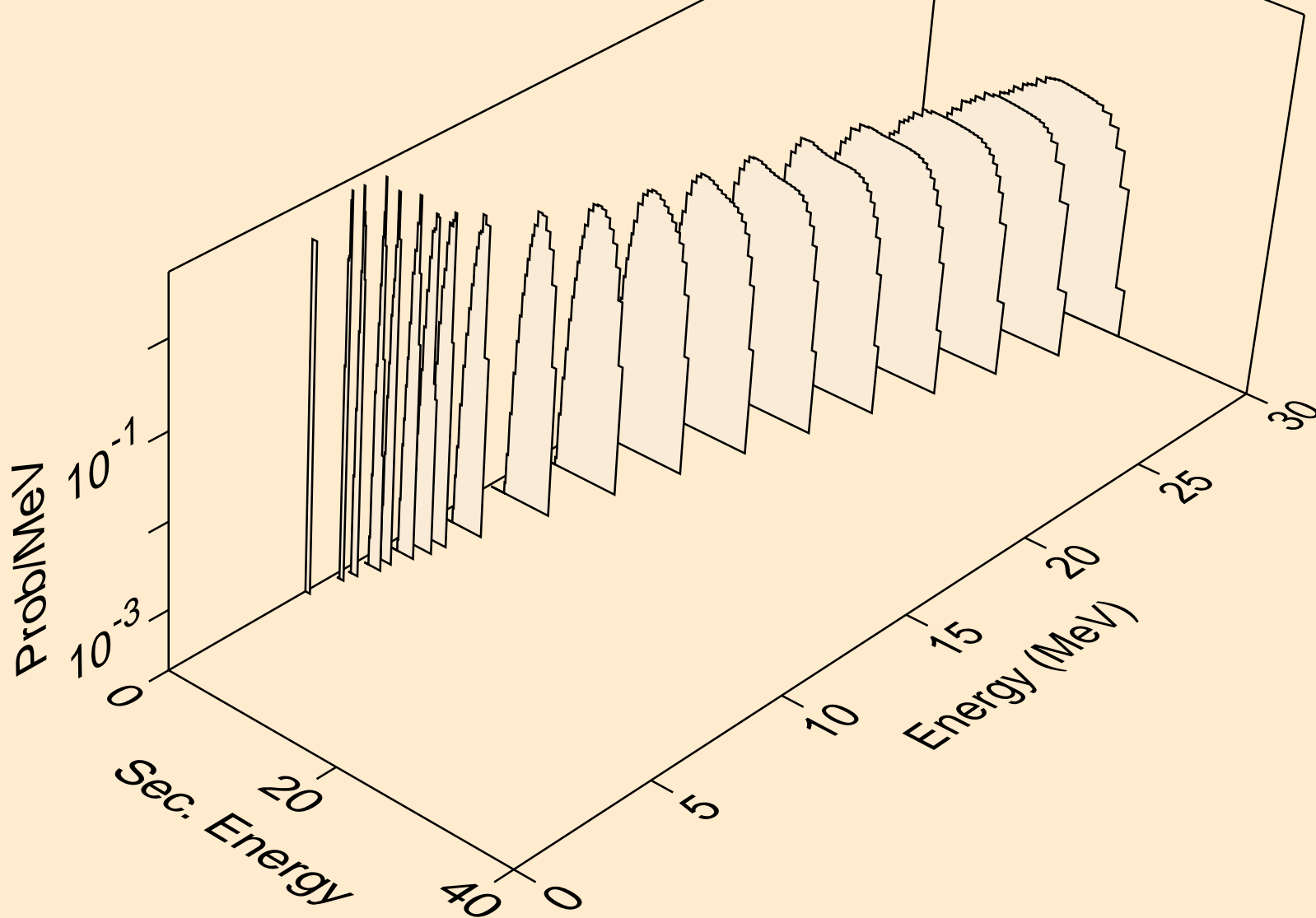

I123 NEUTRON ACER TENDL-2019 LIBRARY; T=293.16K
protons from (n,2np)

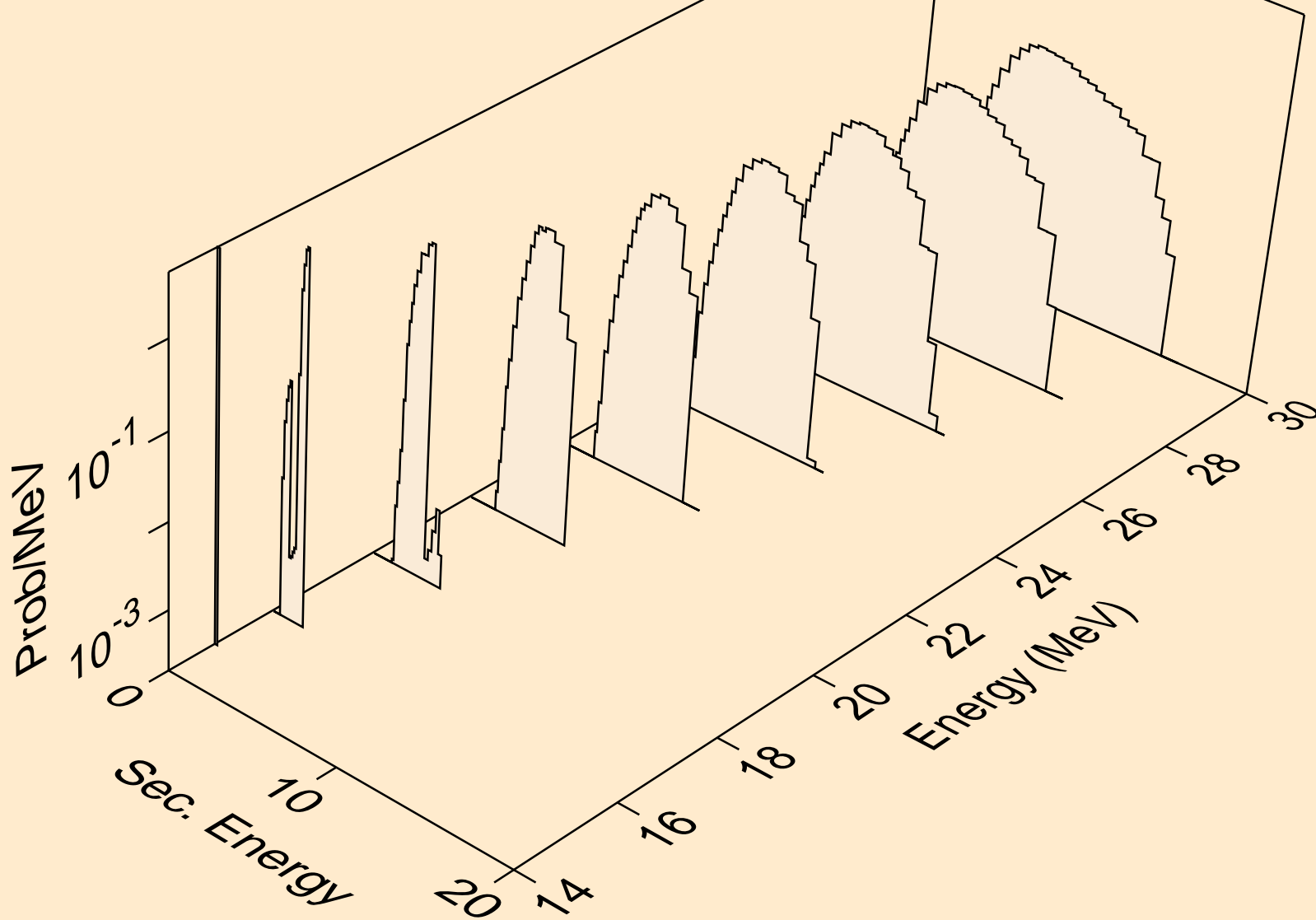

I123 NEUTRON ACER TENDL-2019 LIBRARY; T=293.16K
protons from (n,3np)

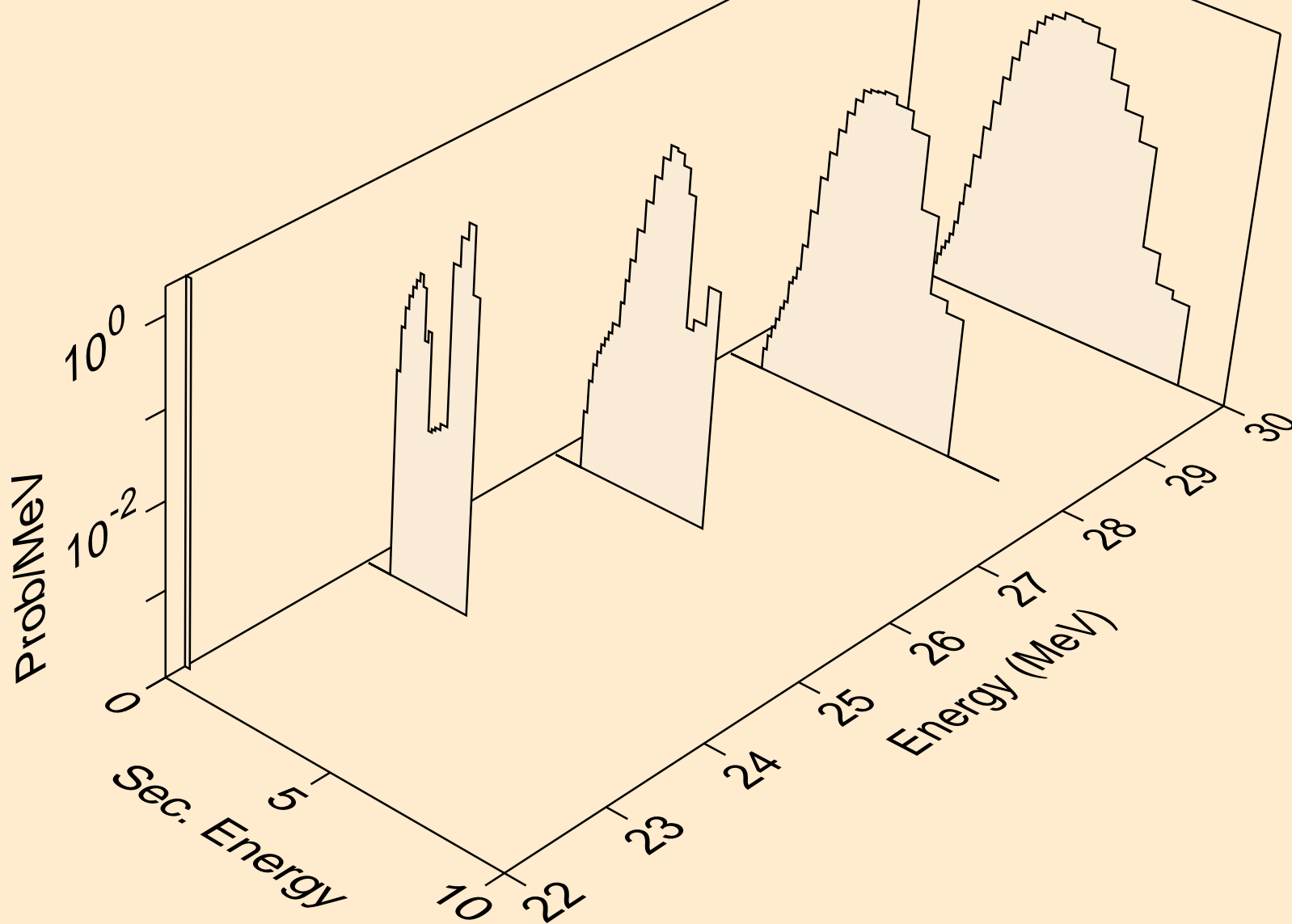

I123 NEUTRON ACER TENDL-2019 LIBRARY; T=293.16K
protons from (n,2np)

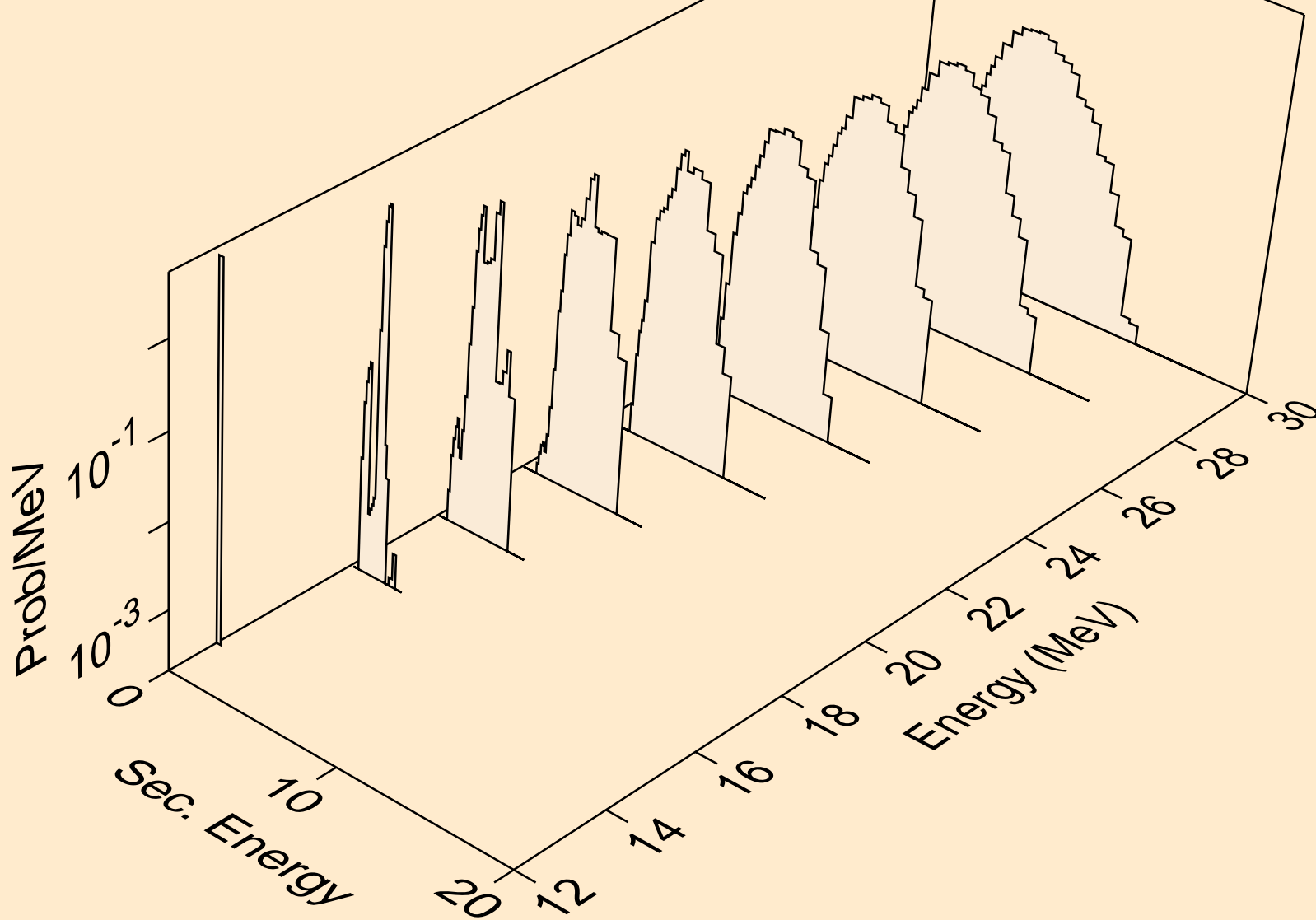

I123 NEUTRON ACER TENDL-2019 LIBRARY; T=293.16K
protons from (n,npa)

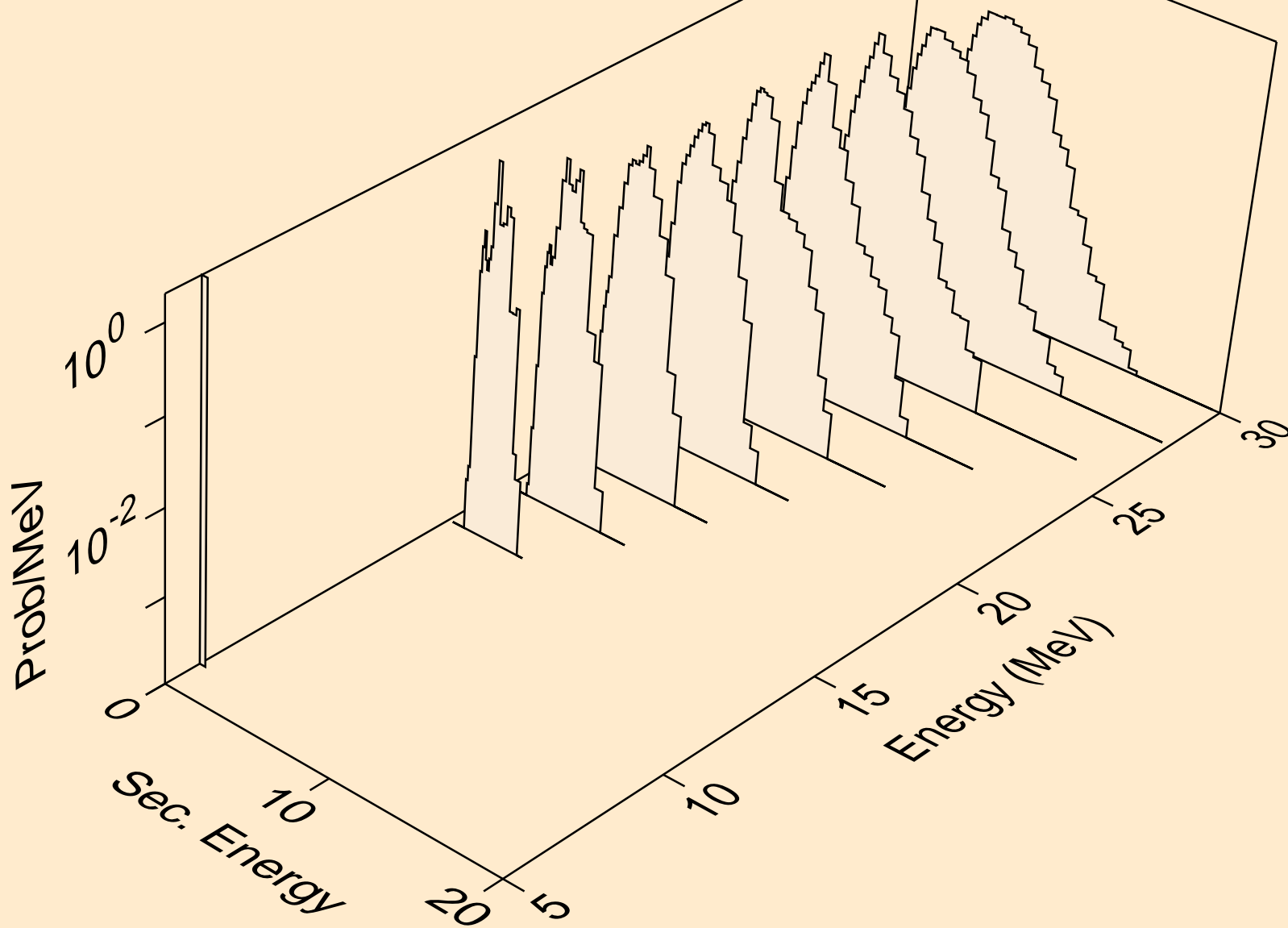

I123 NEUTRON ACER TENDL-2019 LIBRARY; T=293.16K
protons from (n,p)

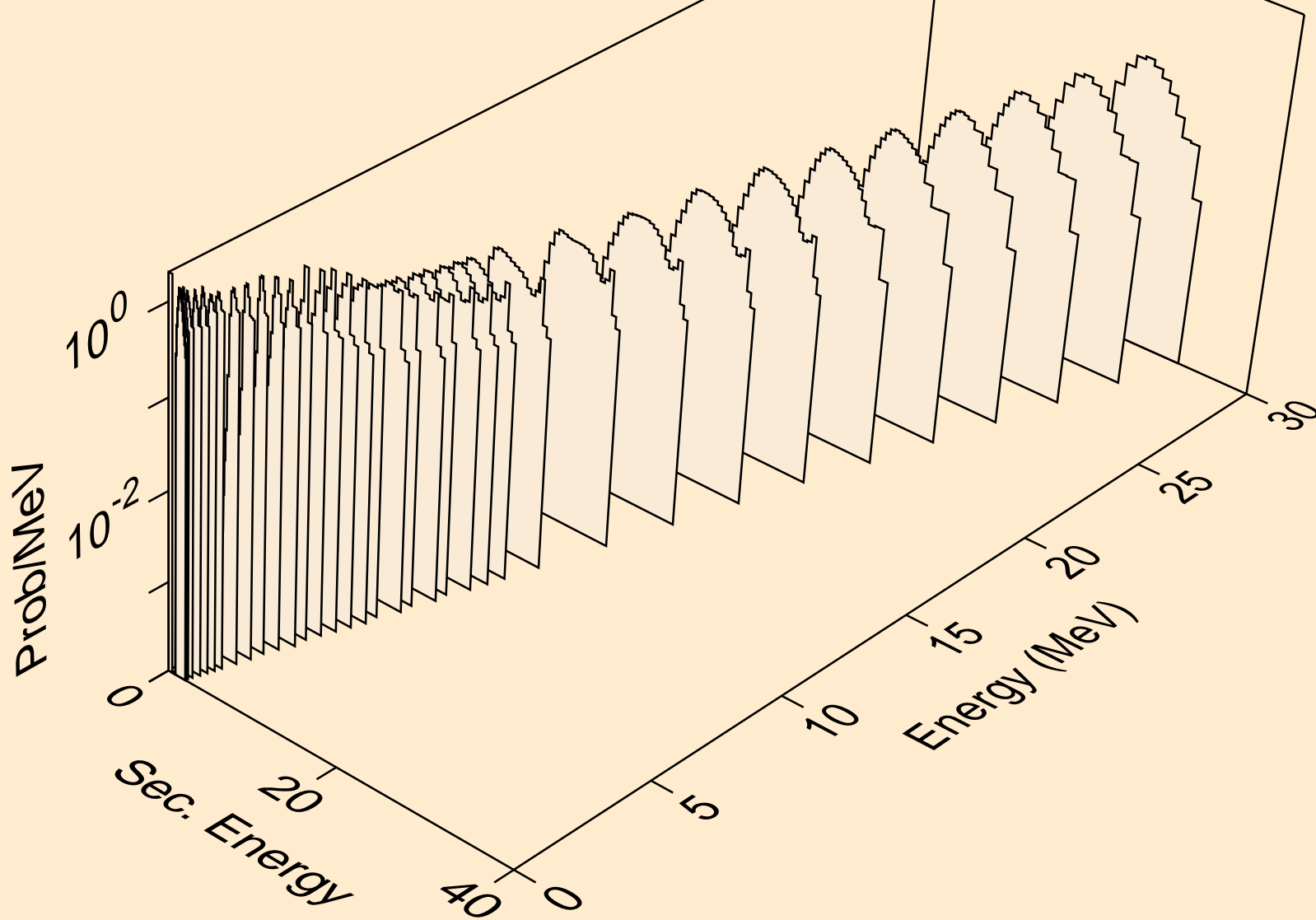

I123 NEUTRON ACER TENDL-2019 LIBRARY; T=293.16K
protons from (n,2p)

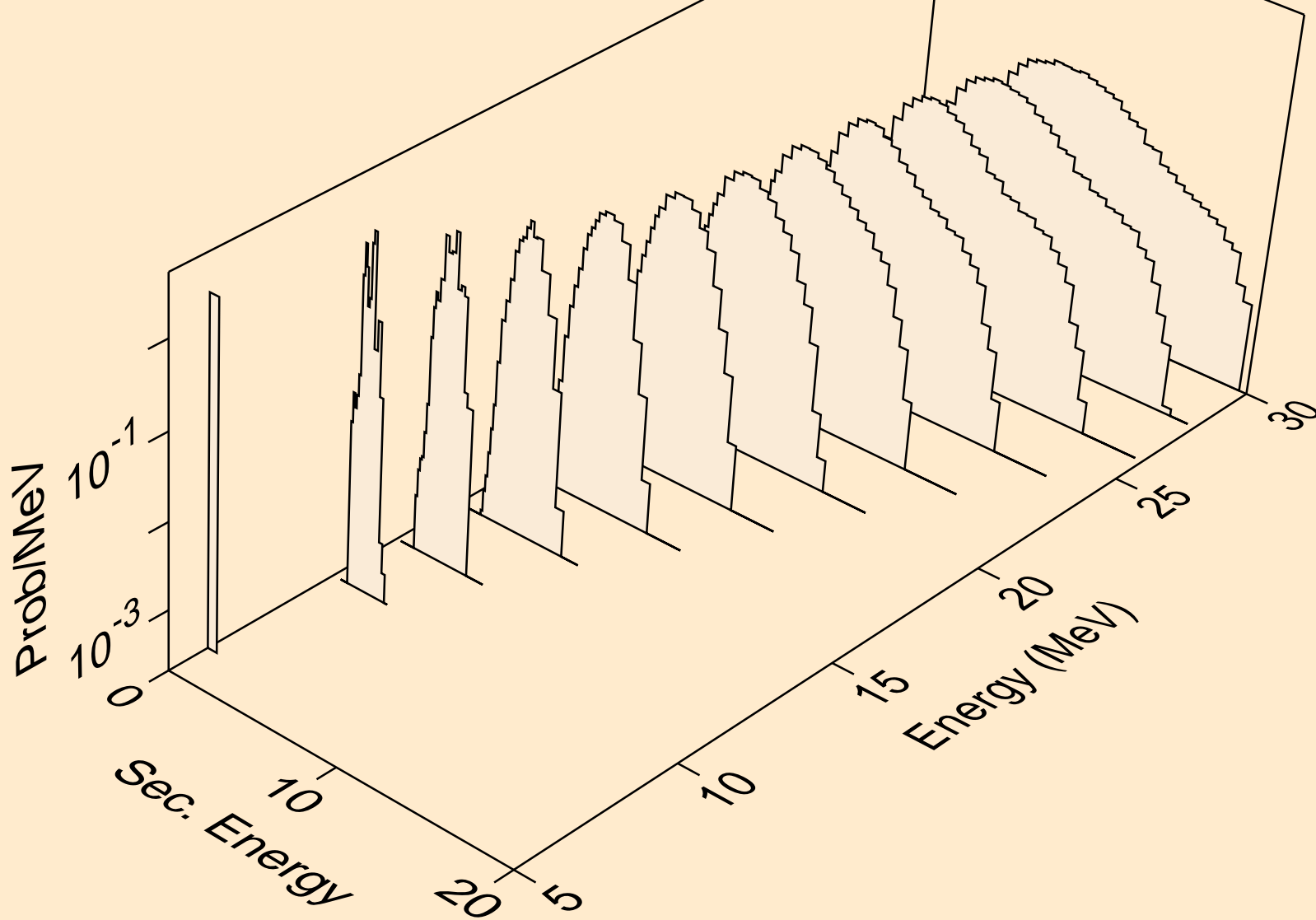

I123 NEUTRON ACER TENDL-2019 LIBRARY; T=293.16K
protons from (n,p)

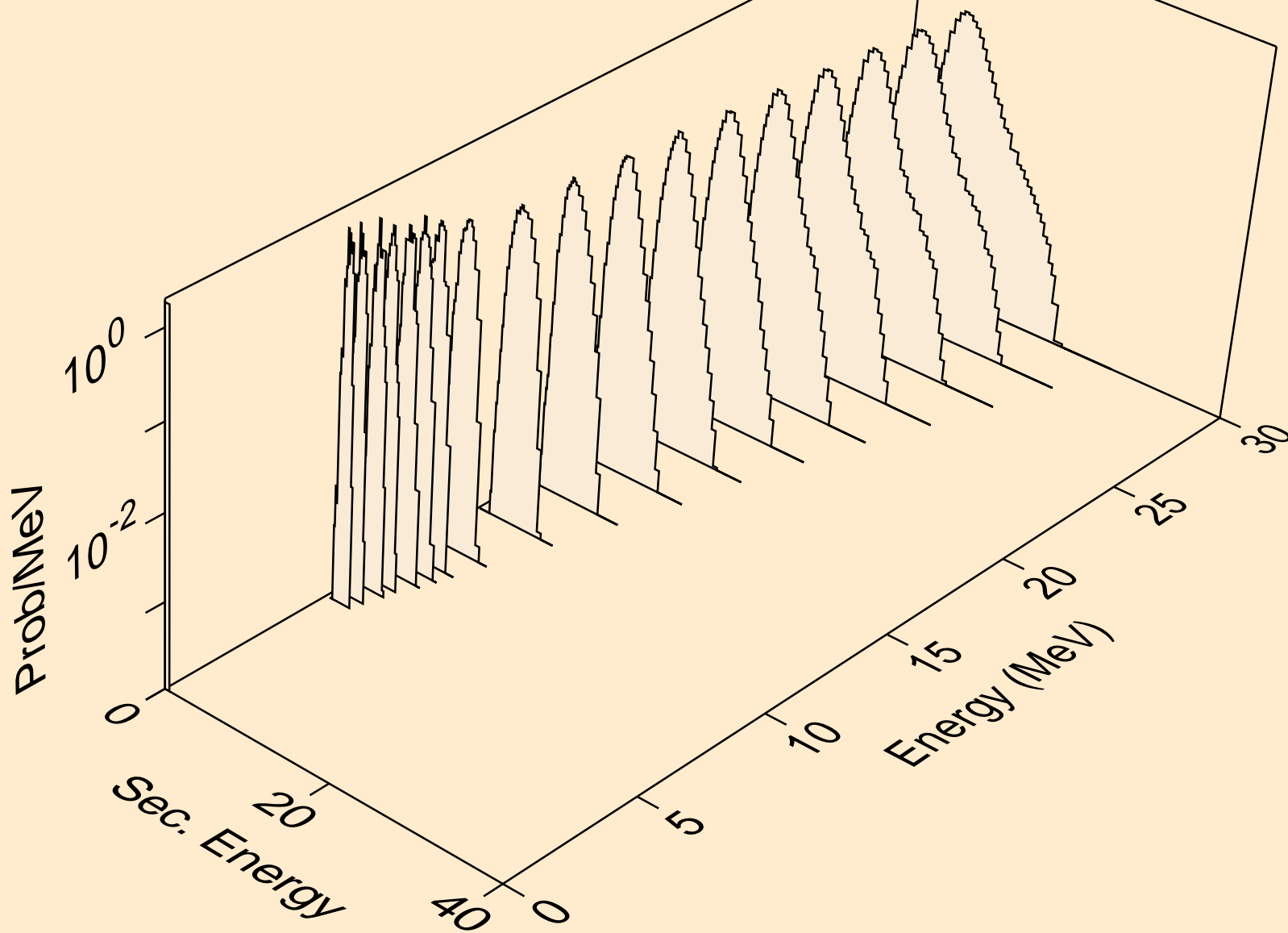

I123 NEUTRON ACER TENDL-2019 LIBRARY; T=293.16K
protons from (n,pd)

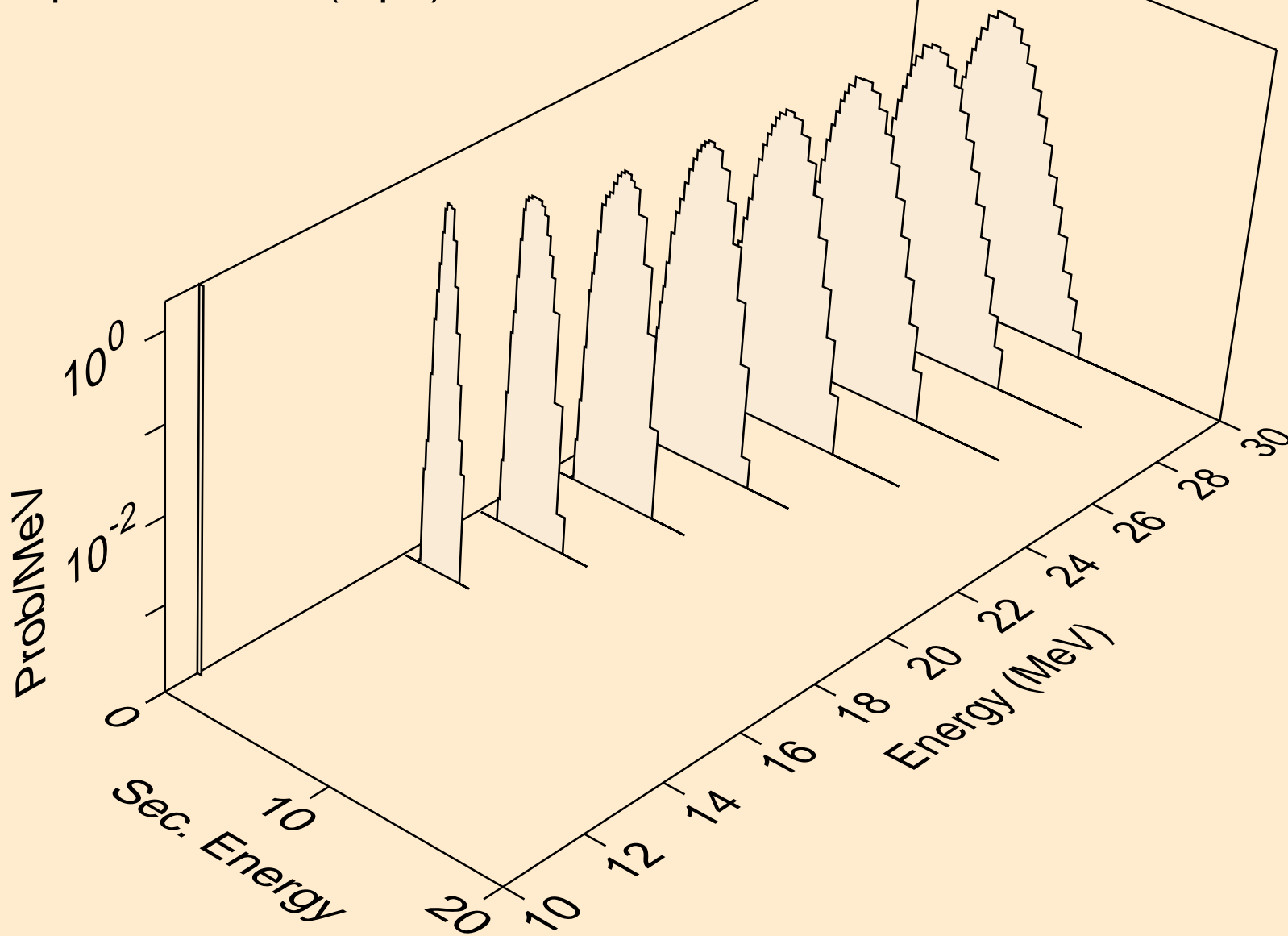

I123 NEUTRON ACER TENDL-2019 LIBRARY; T=293.16K
protons from (n,pt)

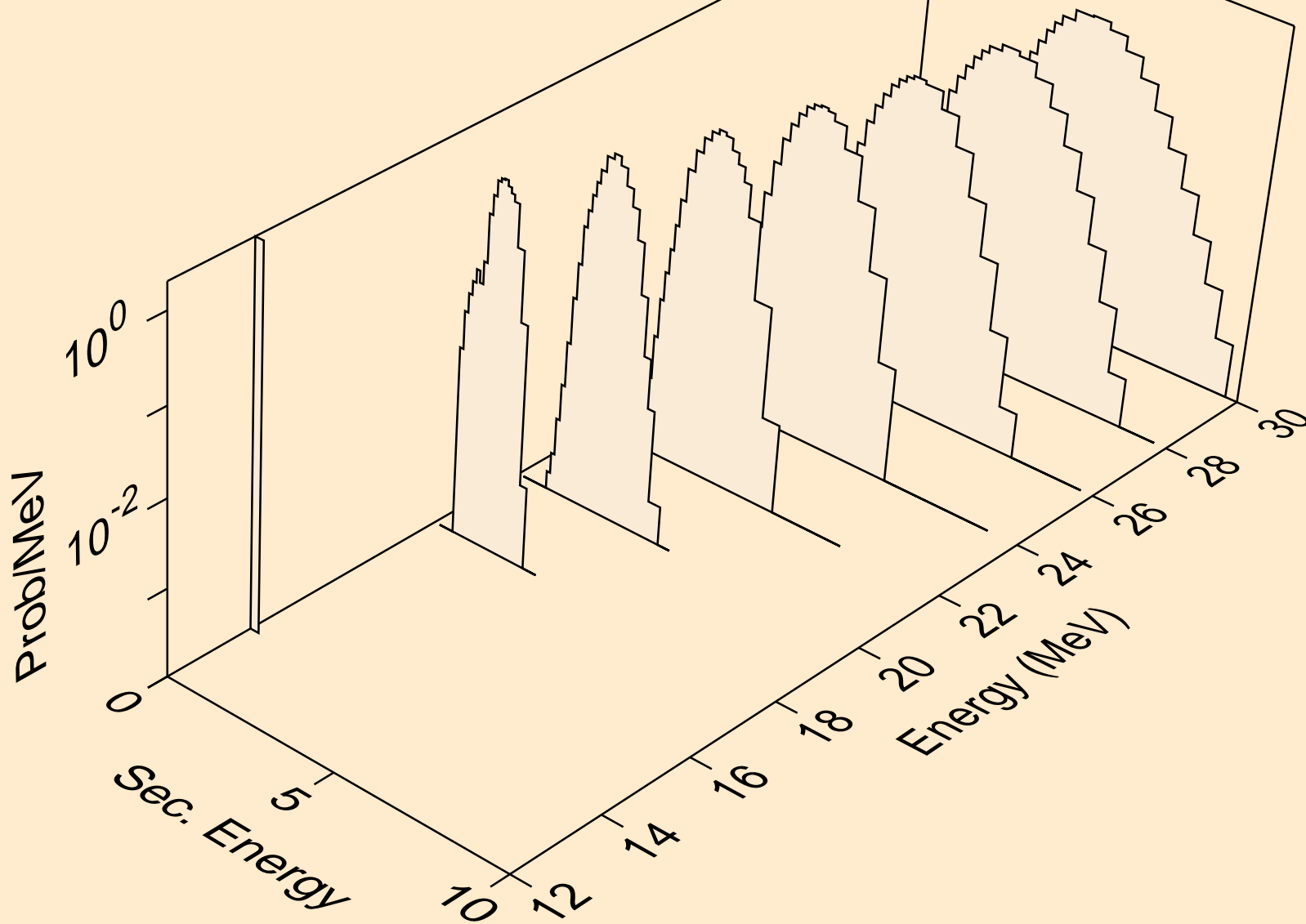

I123 NEUTRON ACER TENDL-2019 LIBRARY; T=293.16K
deuterons from (n,x)

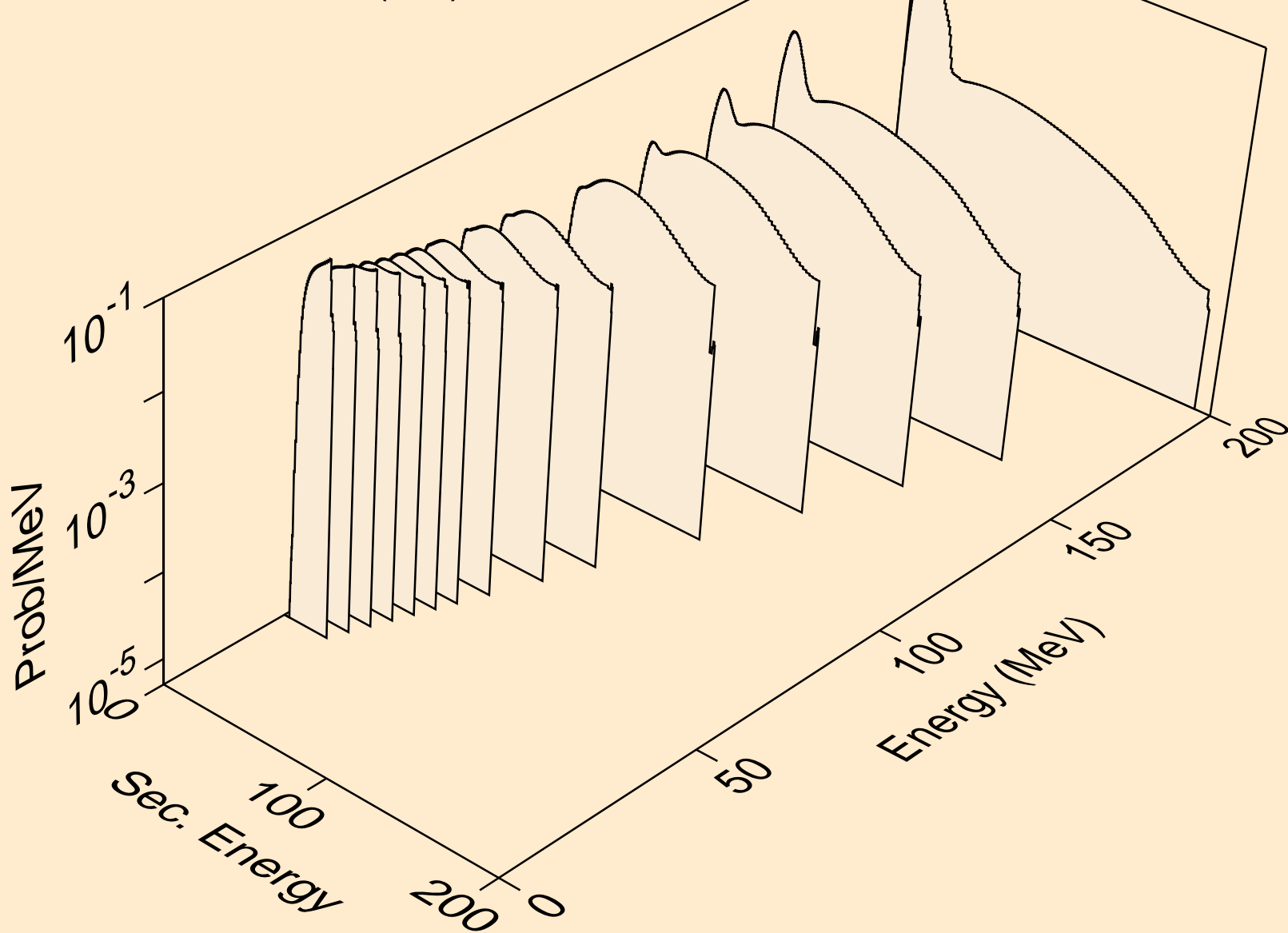

I123 NEUTRON ACER TENDL-2019 LIBRARY; T=293.16K
deuterons from (n,2nd)

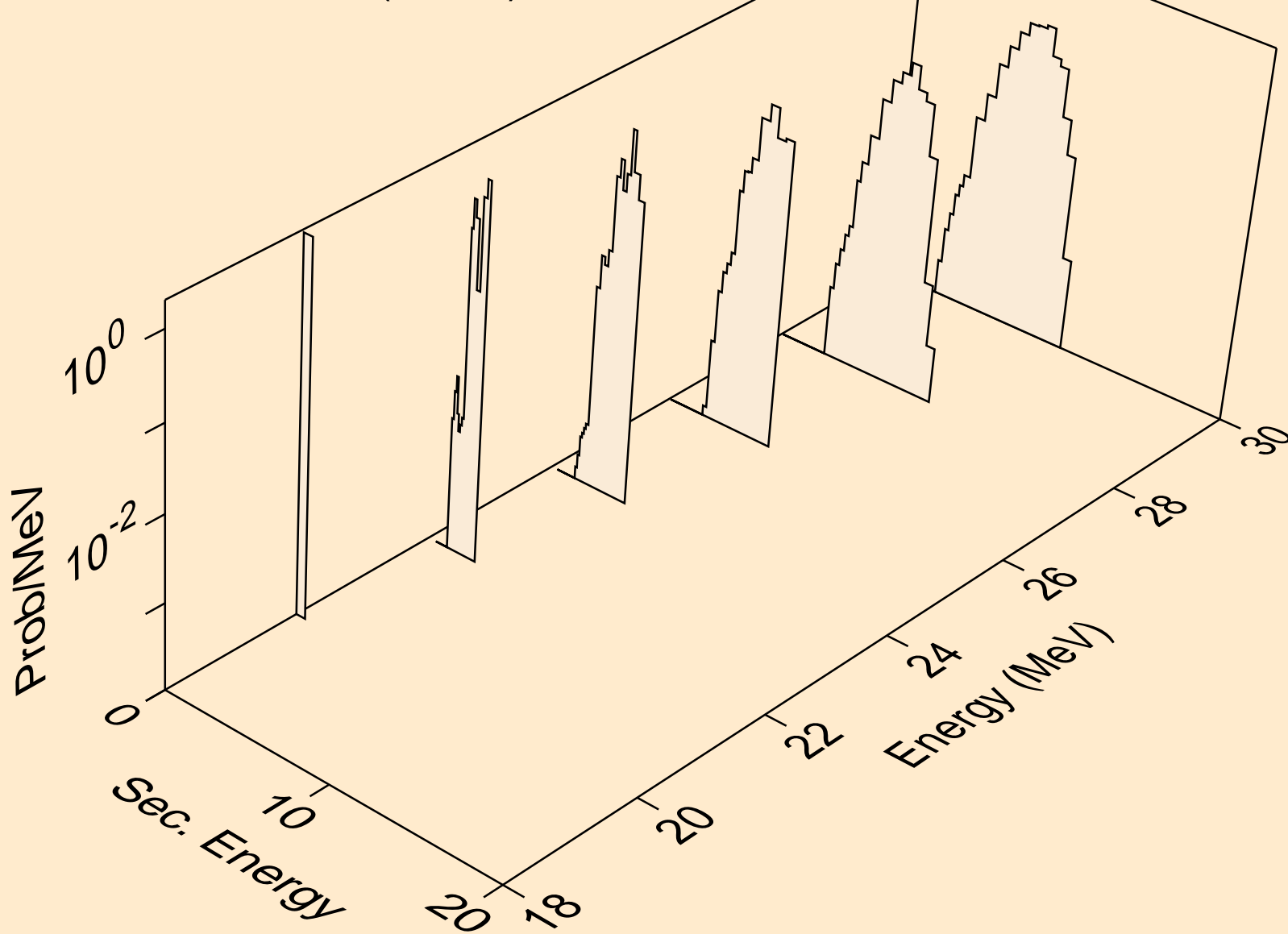

I123 NEUTRON ACER TENDL-2019 LIBRARY; T=293.16K
deuterons from (n,n*)d

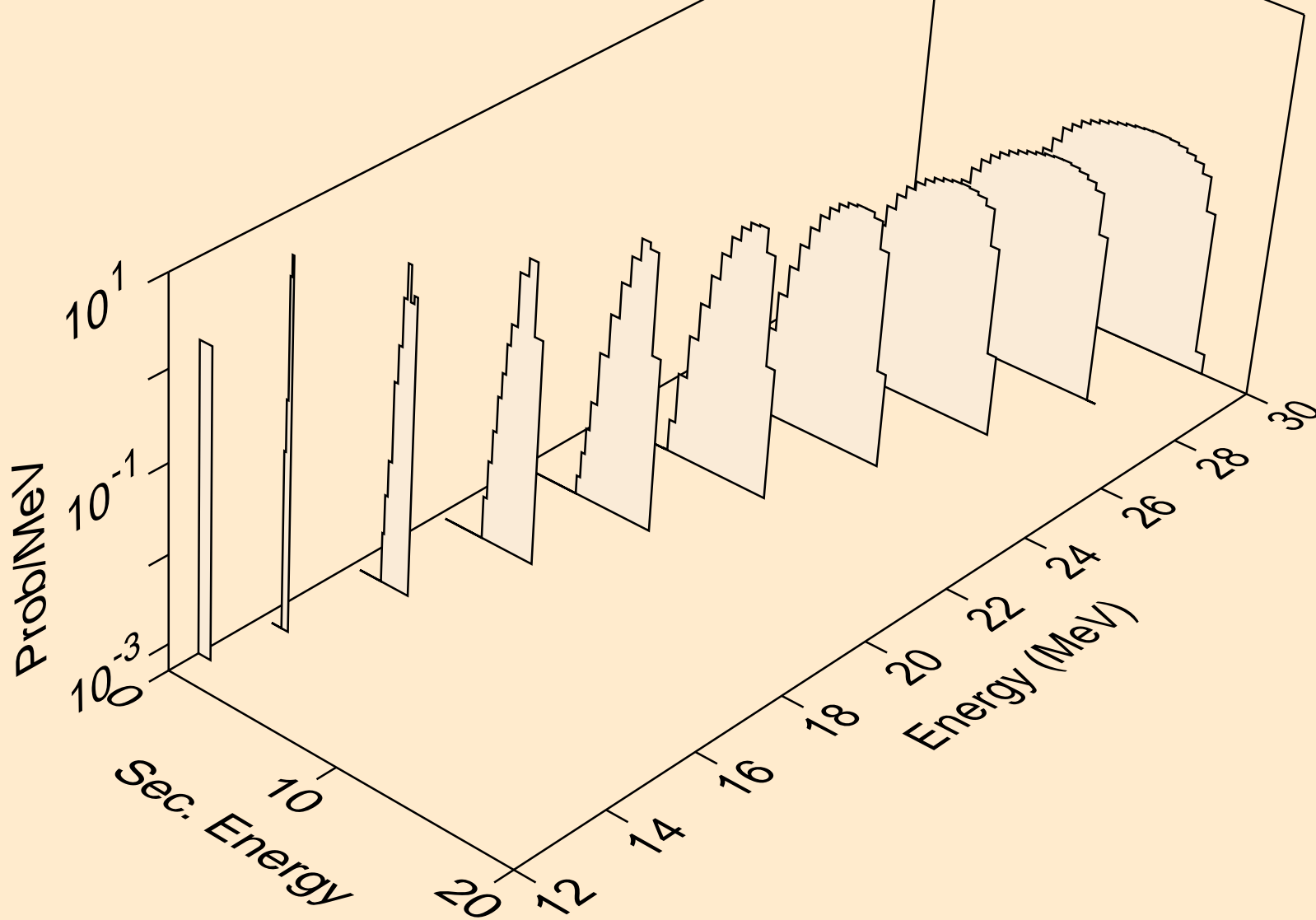

I123 NEUTRON ACER TENDL-2019 LIBRARY; T=293.16K
deuterons from (n,d)

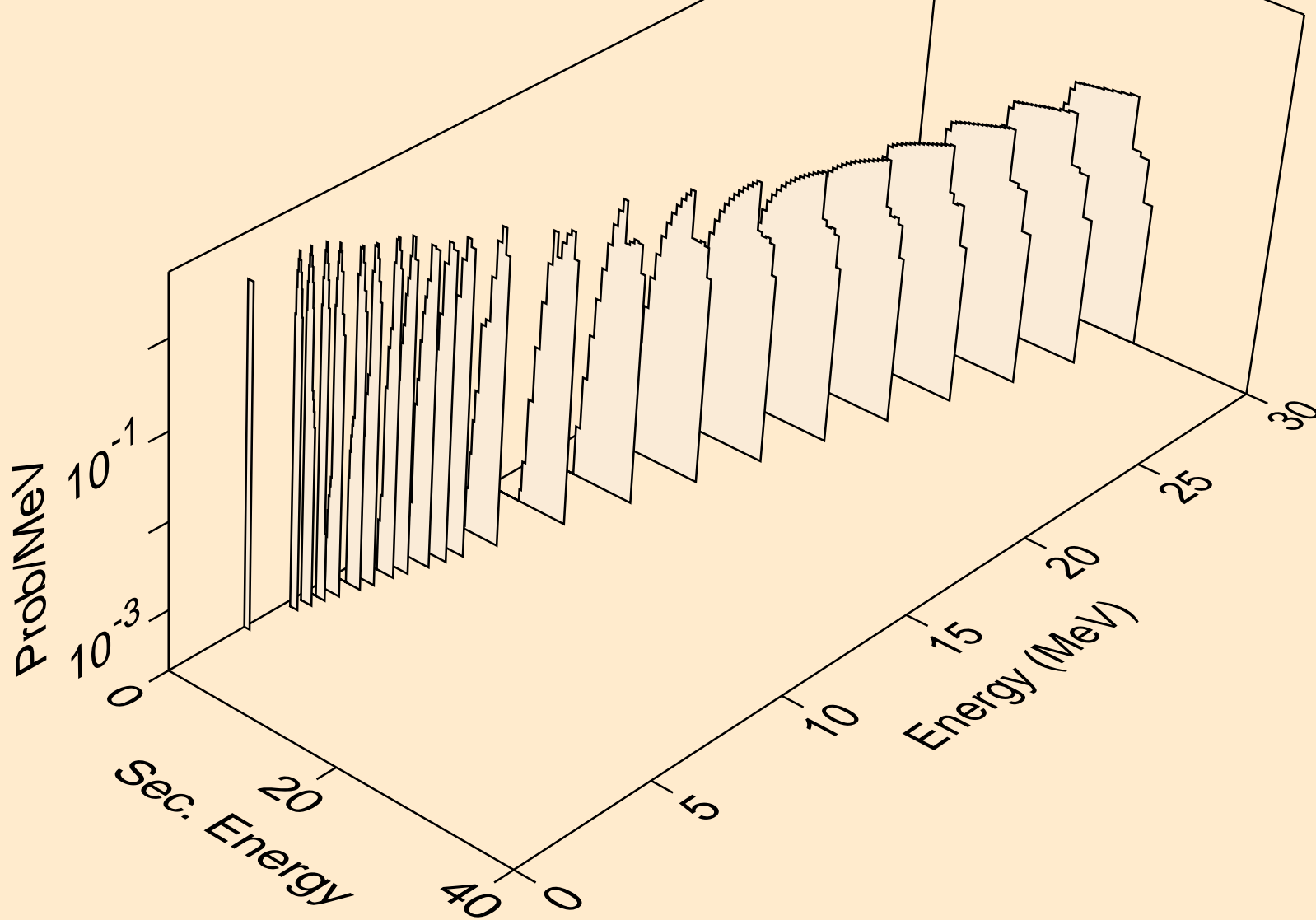

I123 NEUTRON ACER TENDL-2019 LIBRARY; T=293.16K
deuterons from (n,pd)

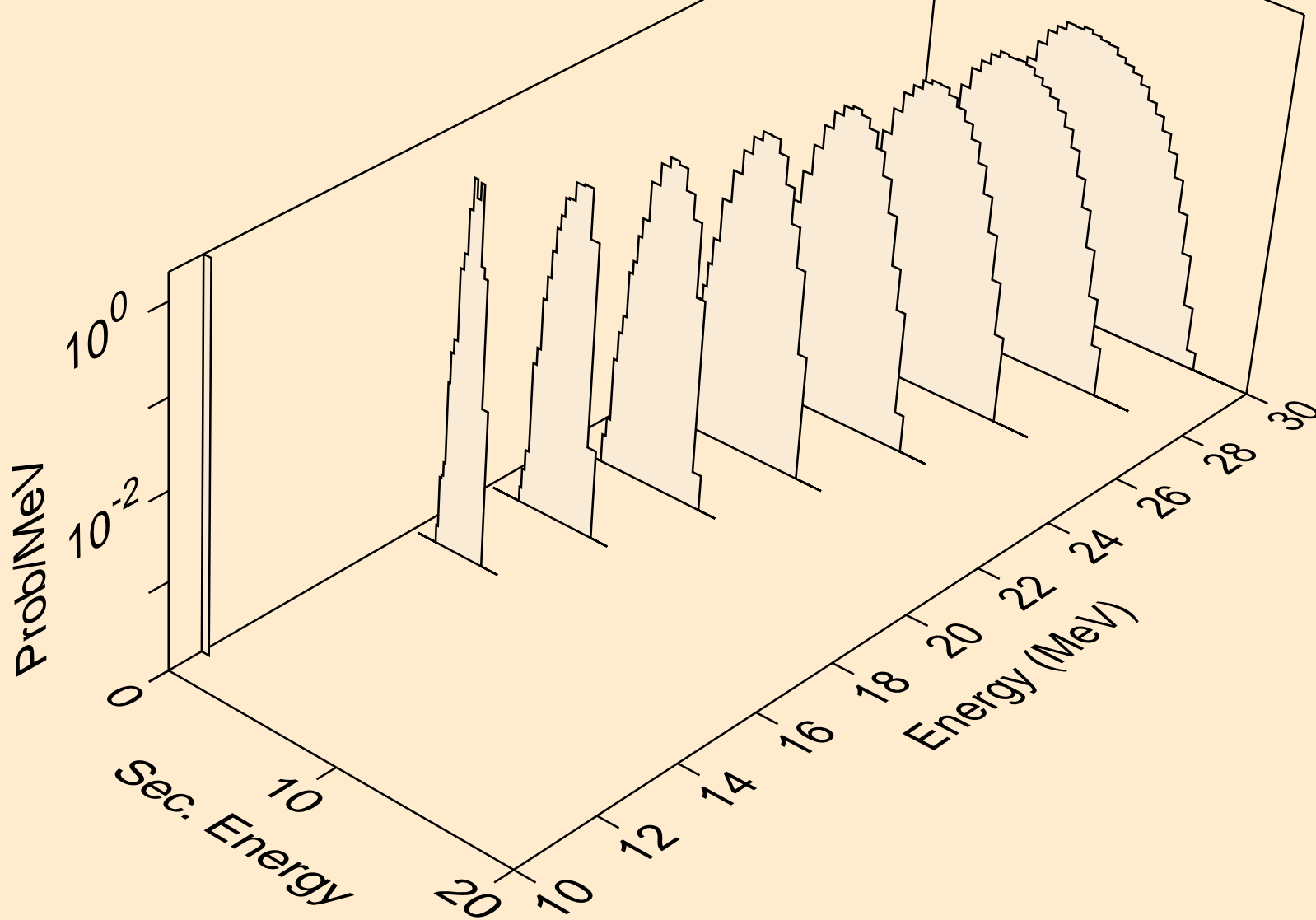

I123 NEUTRON ACER TENDL-2019 LIBRARY; T=293.16K
deuterons from (n,da)

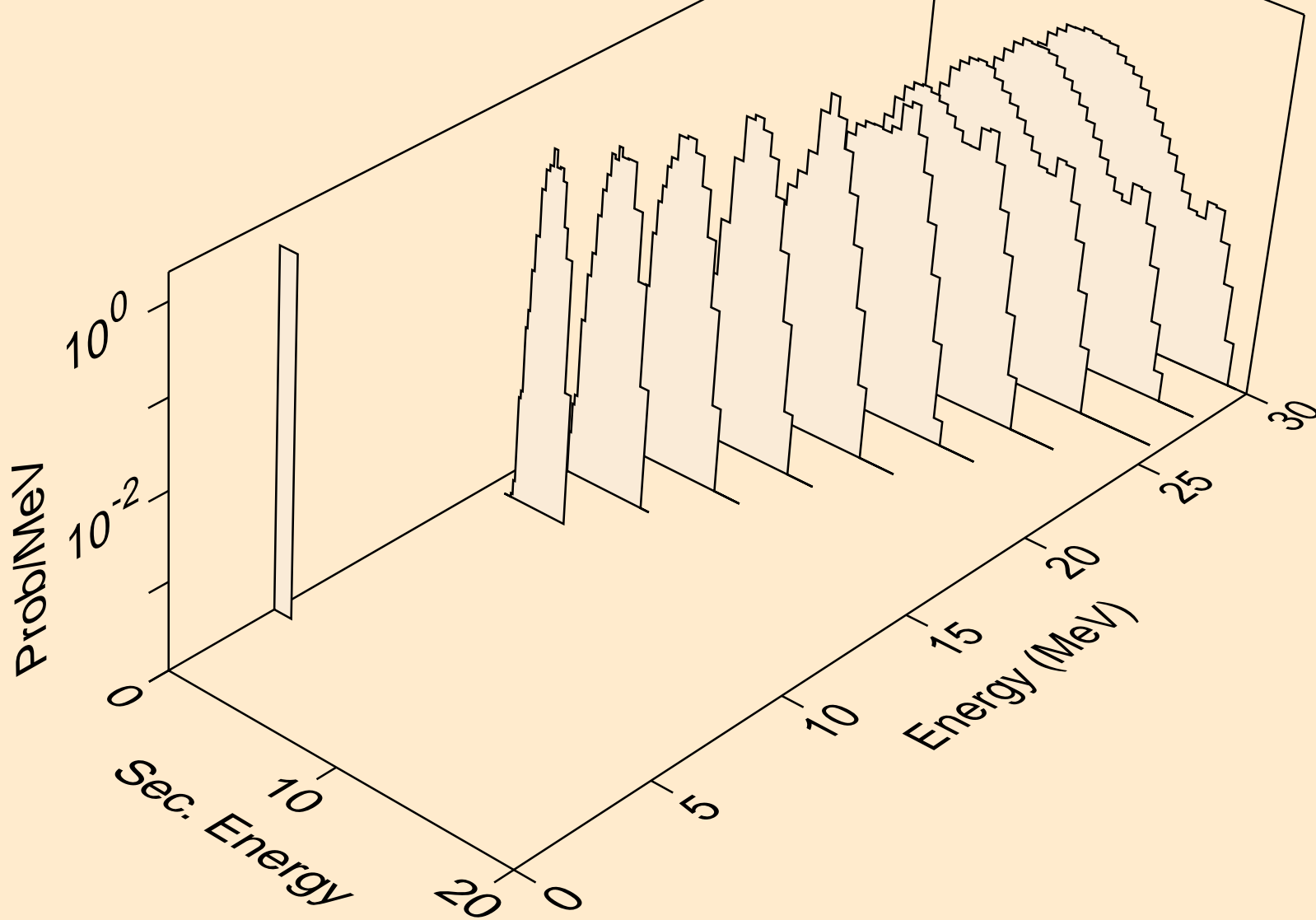

I123 NEUTRON ACER TENDL-2019 LIBRARY; T=293.16K
tritons from (n,x)

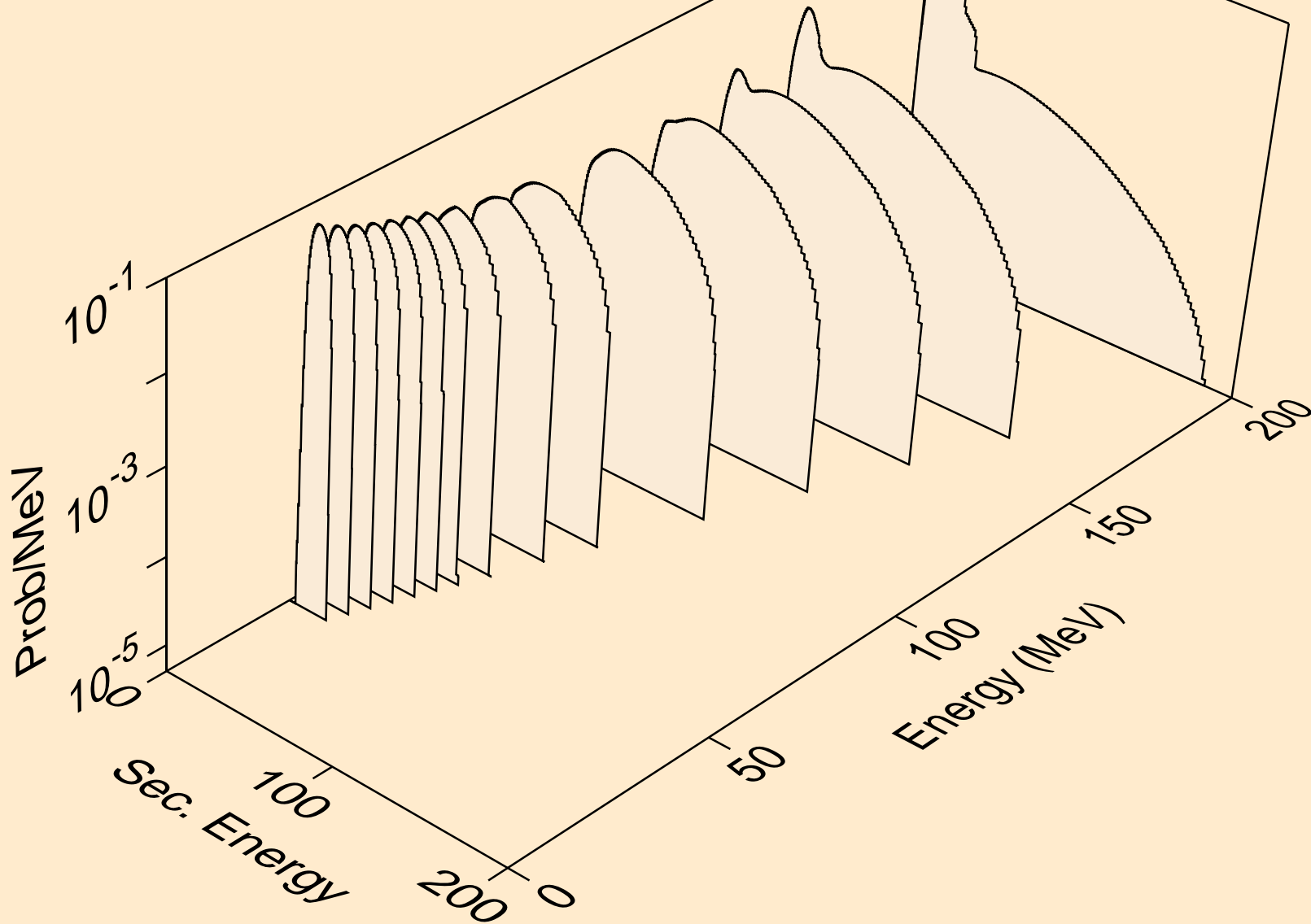

I123 NEUTRON ACER TENDL-2019 LIBRARY; T=293.16K
tritons from (n,n*)t

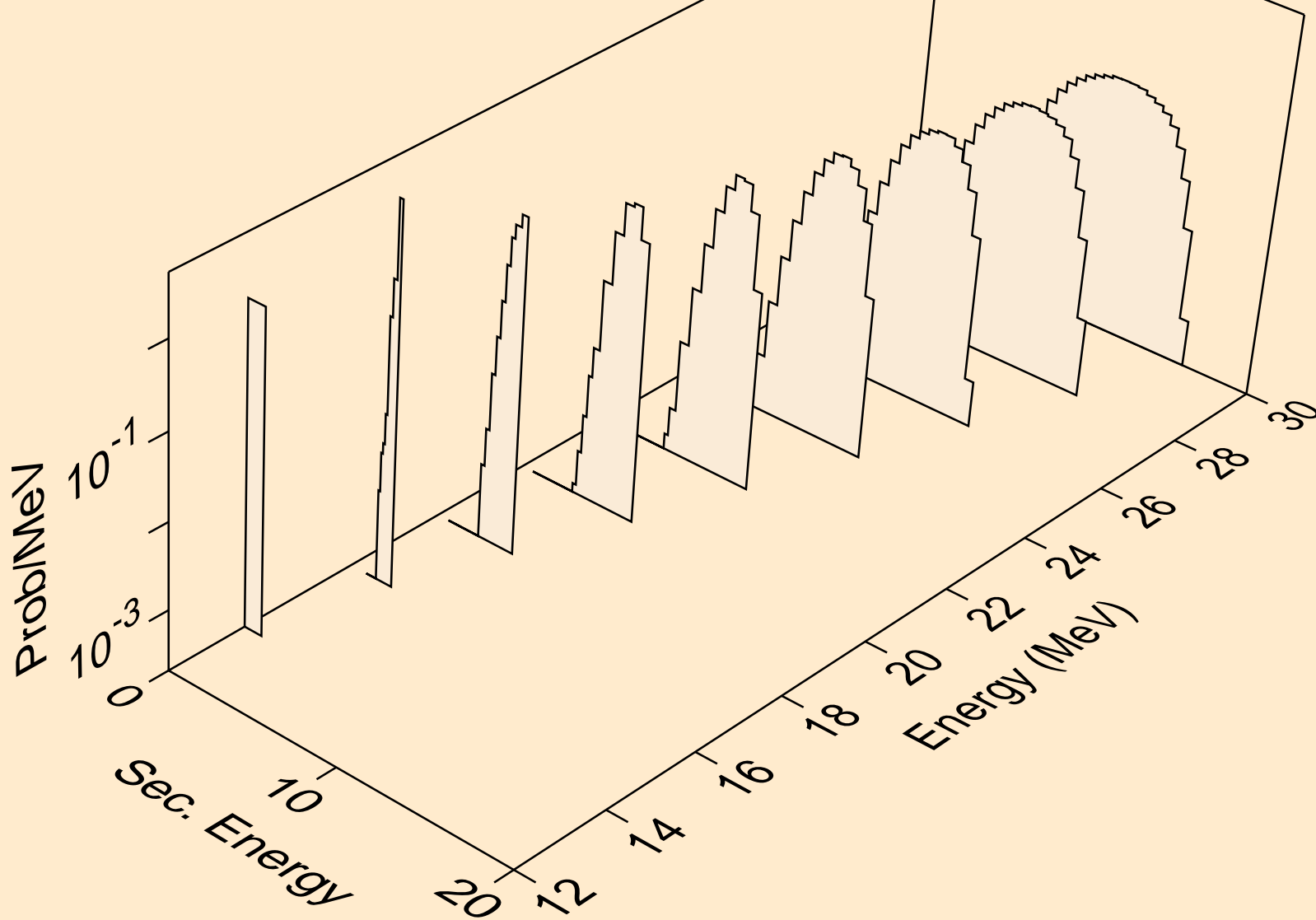

I123 NEUTRON ACER TENDL-2019 LIBRARY; T=293.16K
tritons from (n,t)

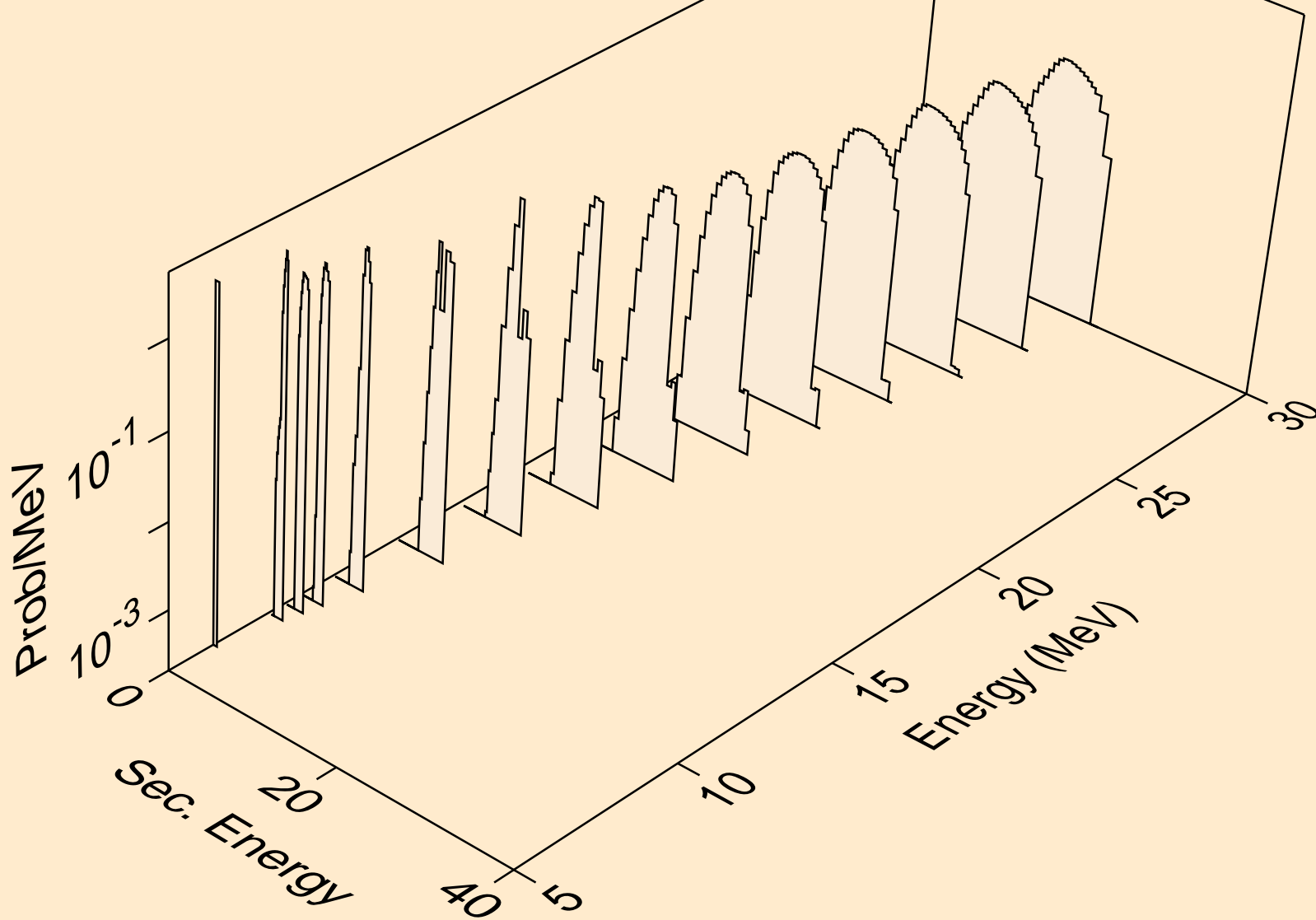

I123 NEUTRON ACER TENDL-2019 LIBRARY; T=293.16K
tritons from (n,pt)

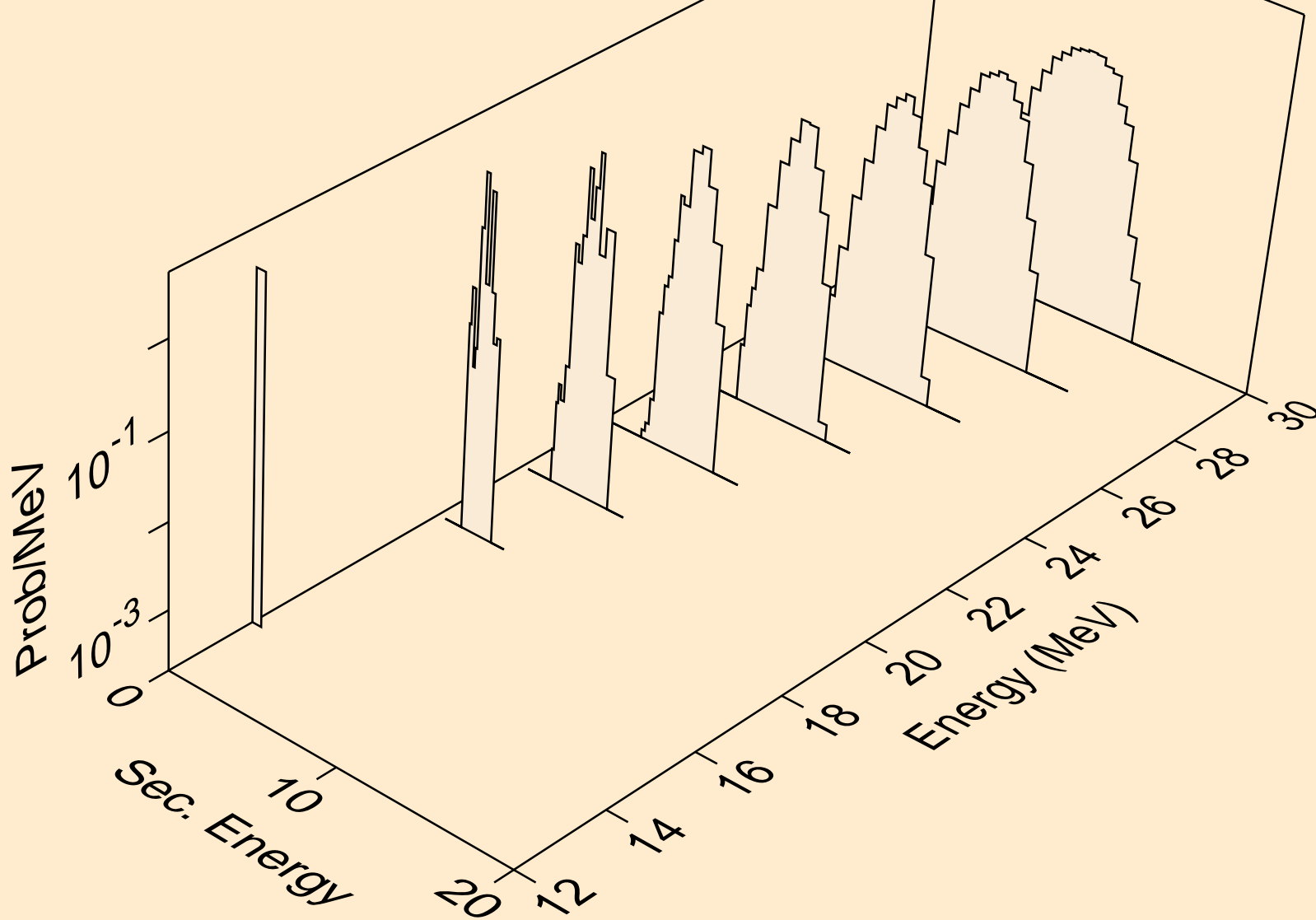

I123 NEUTRON ACER TENDL-2019 LIBRARY; T=293.16K
he3s from (n,x)

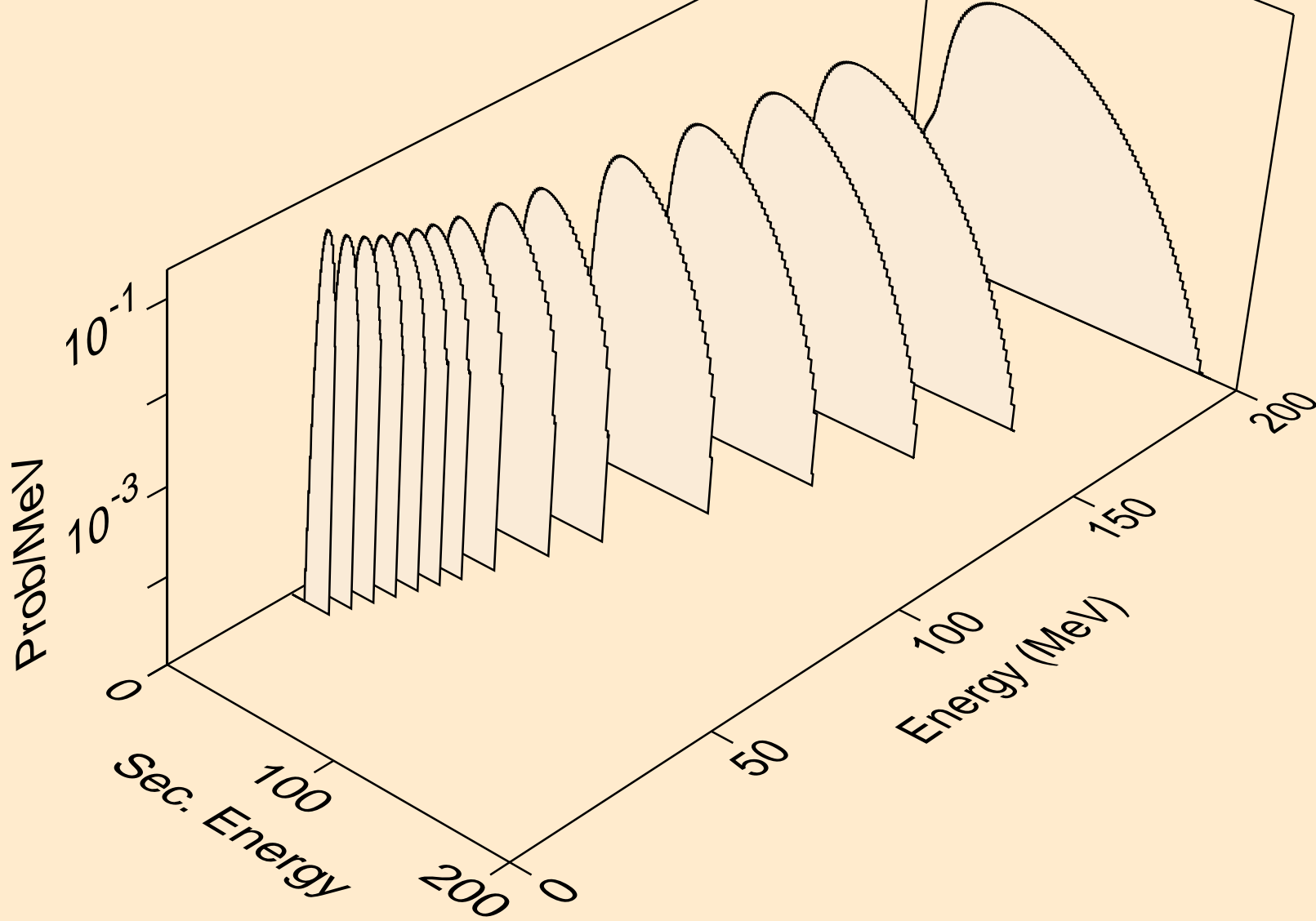

I123 NEUTRON ACER TENDL-2019 LIBRARY; T=293.16K
he3s from (n,n*)he3

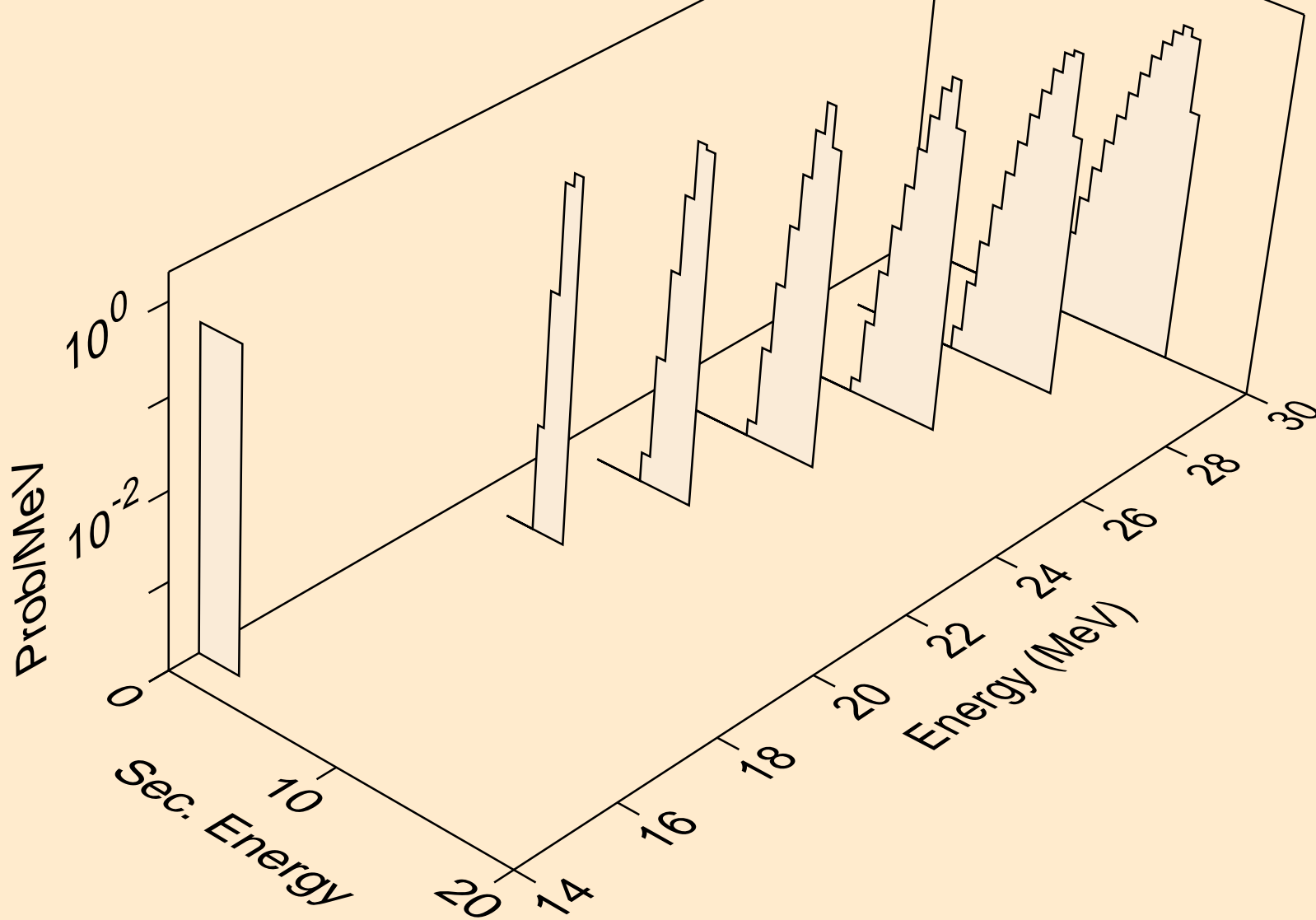

I123 NEUTRON ACER TENDL-2019 LIBRARY; T=293.16K
he3s from (n,he3)

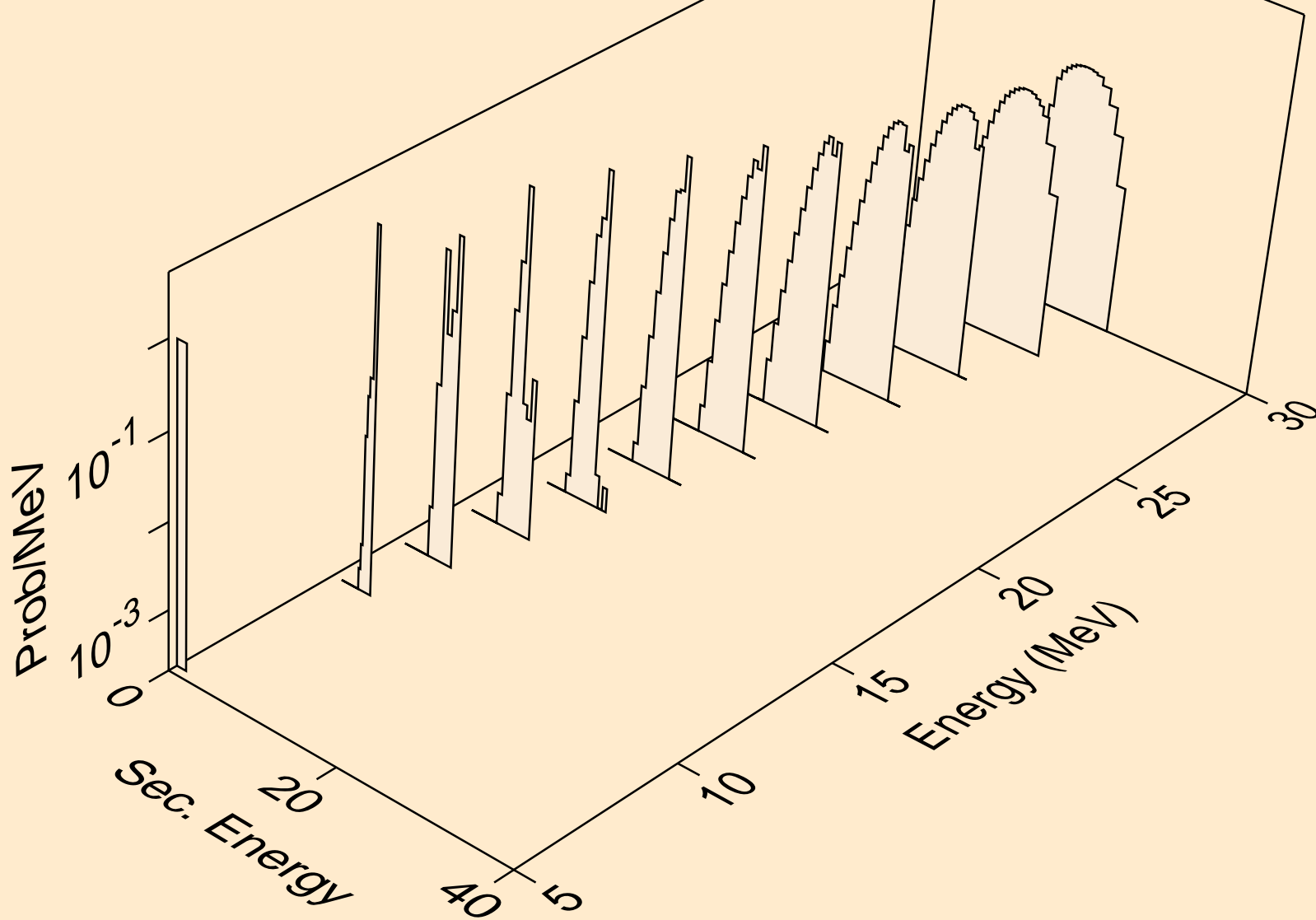

I123 NEUTRON ACER TENDL-2019 LIBRARY; T=293.16K
alphas from (n,x)

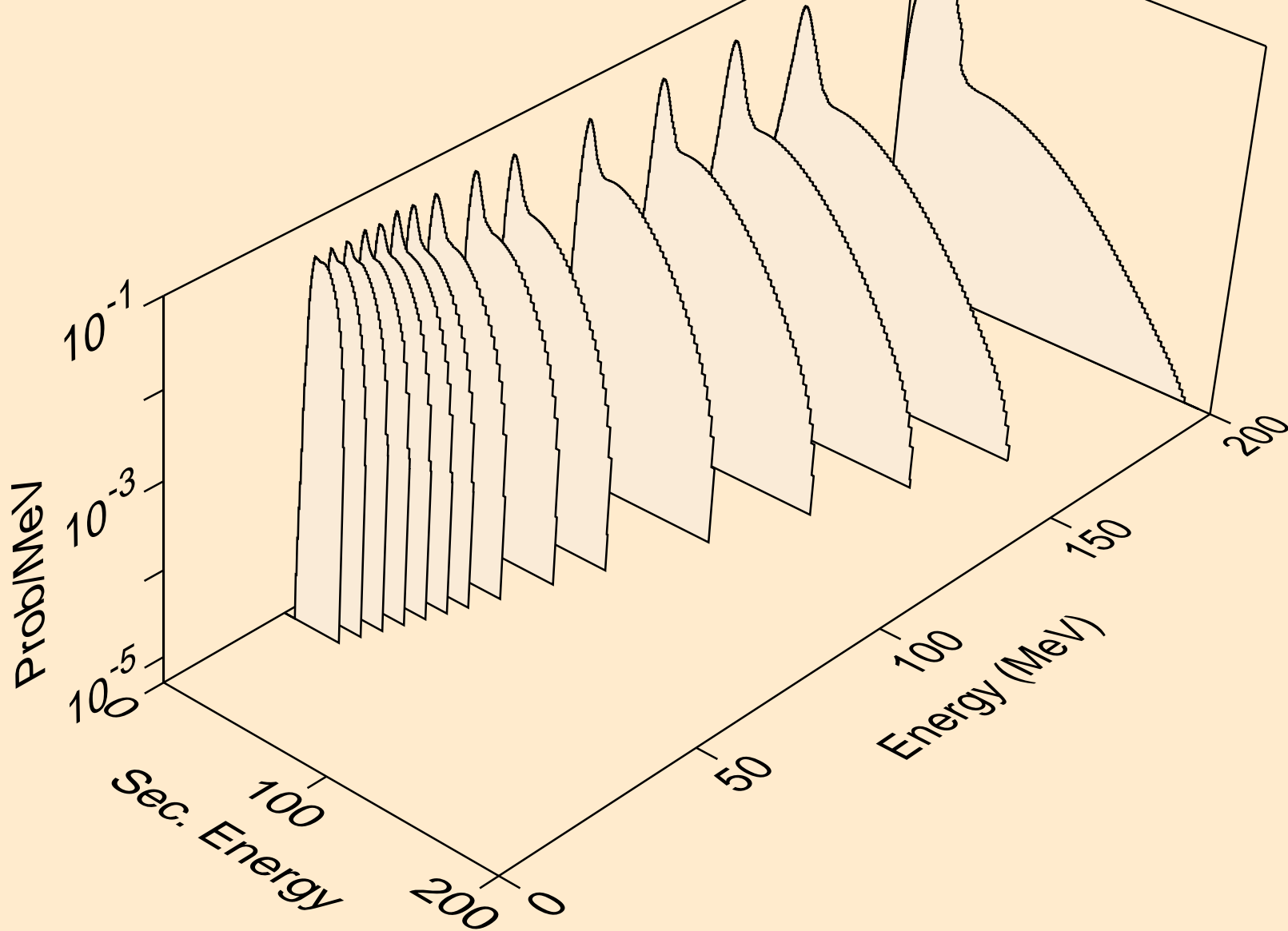

I123 NEUTRON ACER TENDL-2019 LIBRARY; T=293.16K
alphas from (n,n*)a

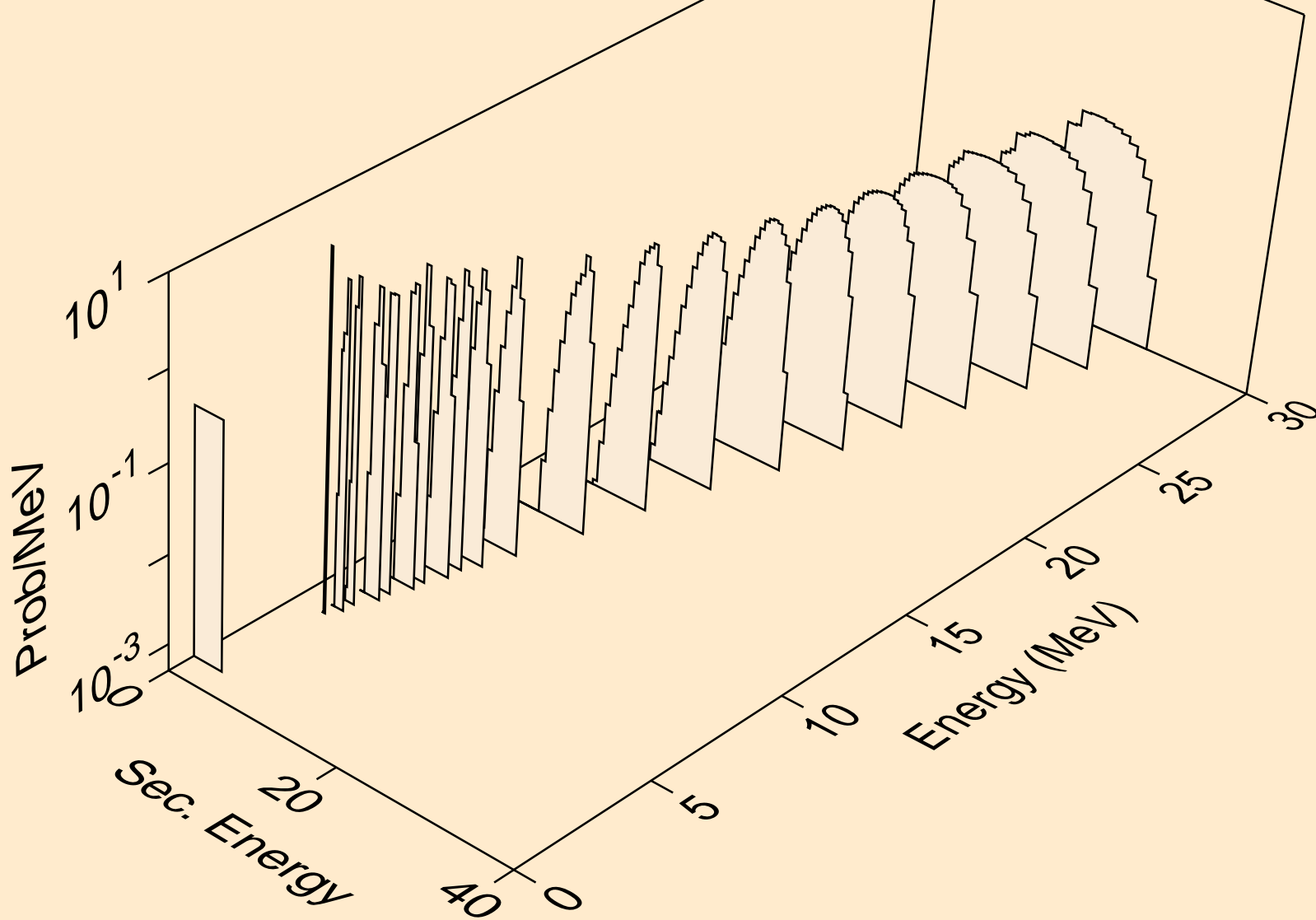

I123 NEUTRON ACER TENDL-2019 LIBRARY; T=293.16K
alphas from (n,2n)a

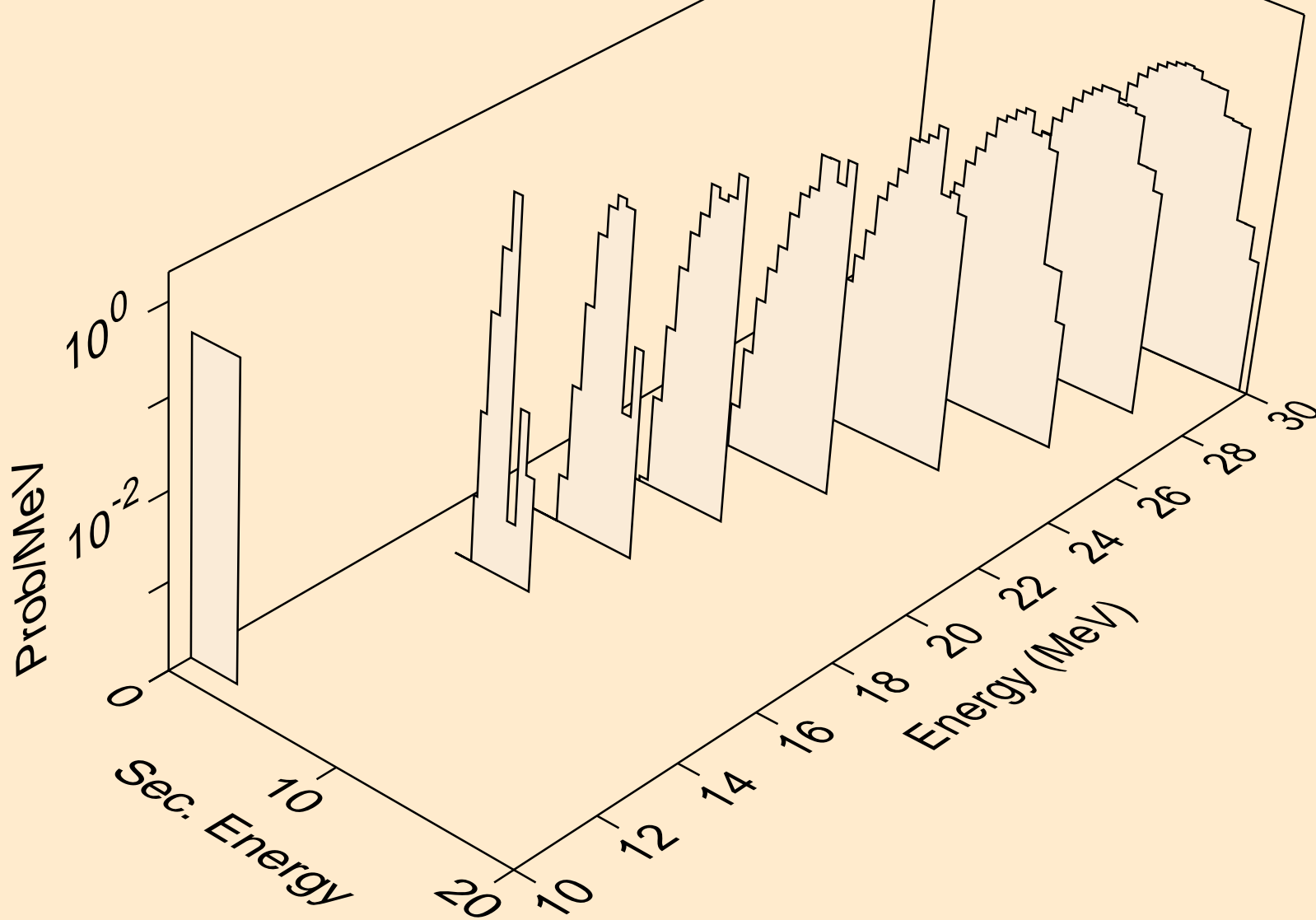

I123 NEUTRON ACER TENDL-2019 LIBRARY; T=293.16K
alphas from (n,3n)a

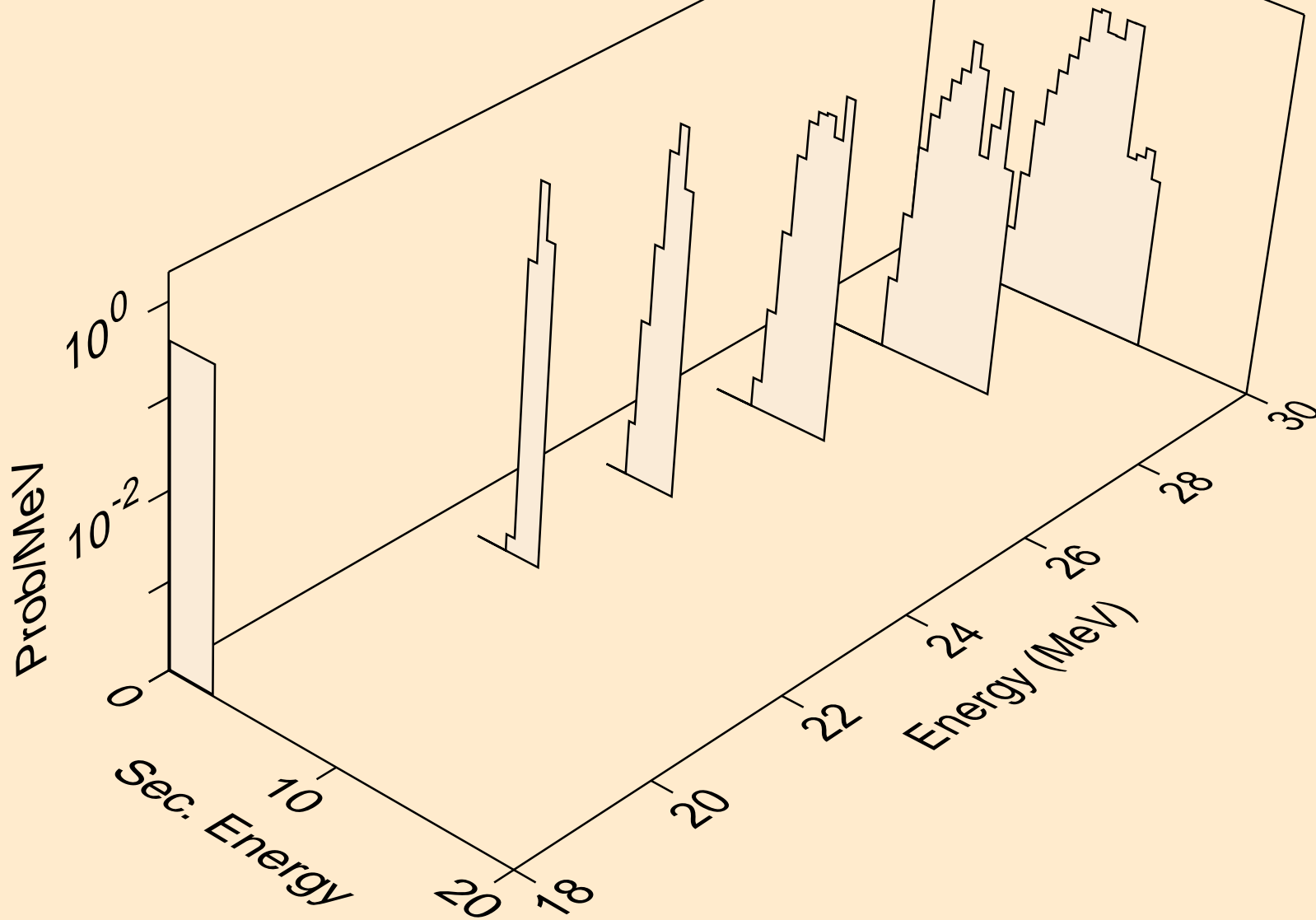

I123 NEUTRON ACER TENDL-2019 LIBRARY; T=293.16K
alphas from (n,n*)2a

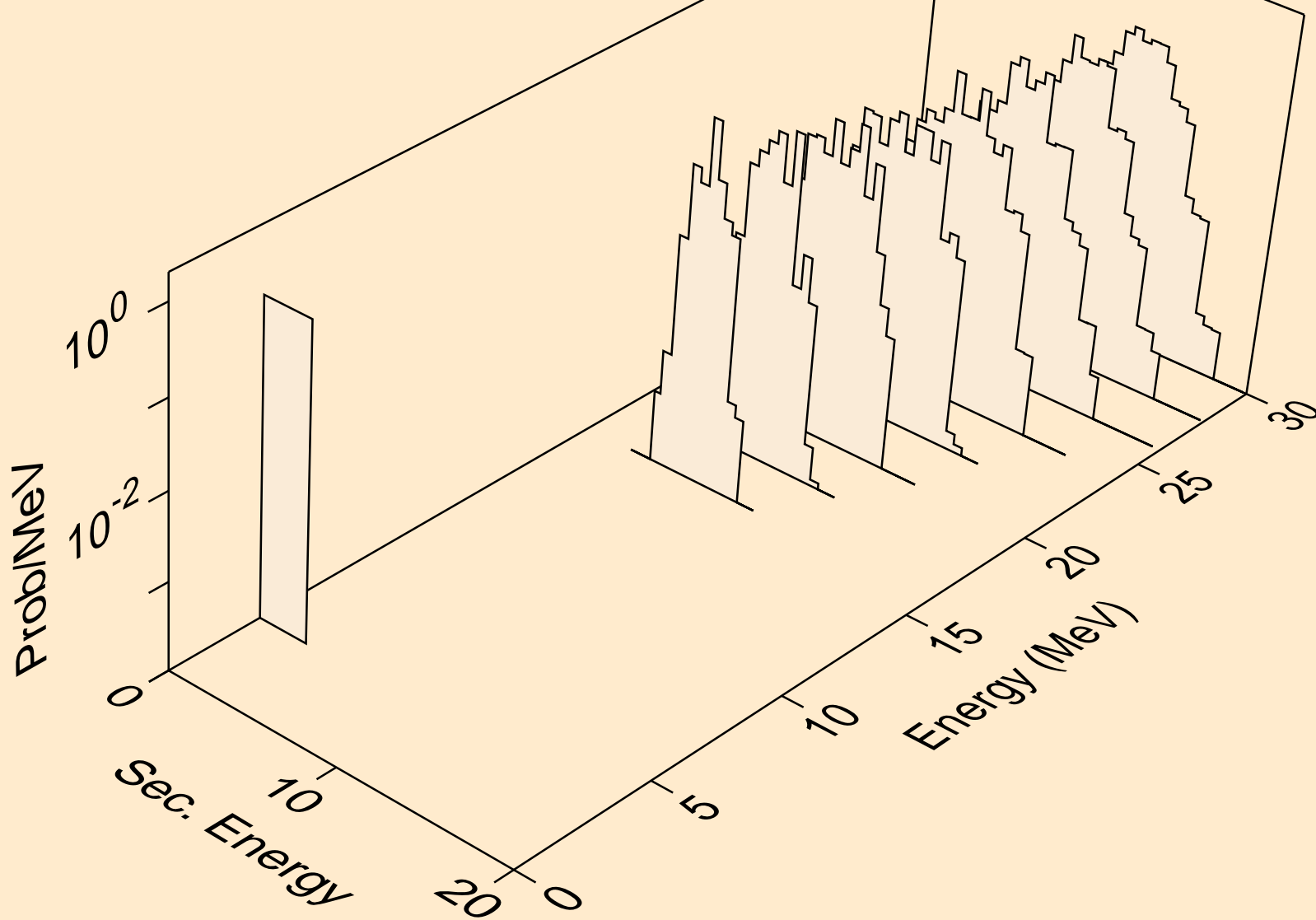

I123 NEUTRON ACER TENDL-2019 LIBRARY; T=293.16K
alphas from (n,npa)

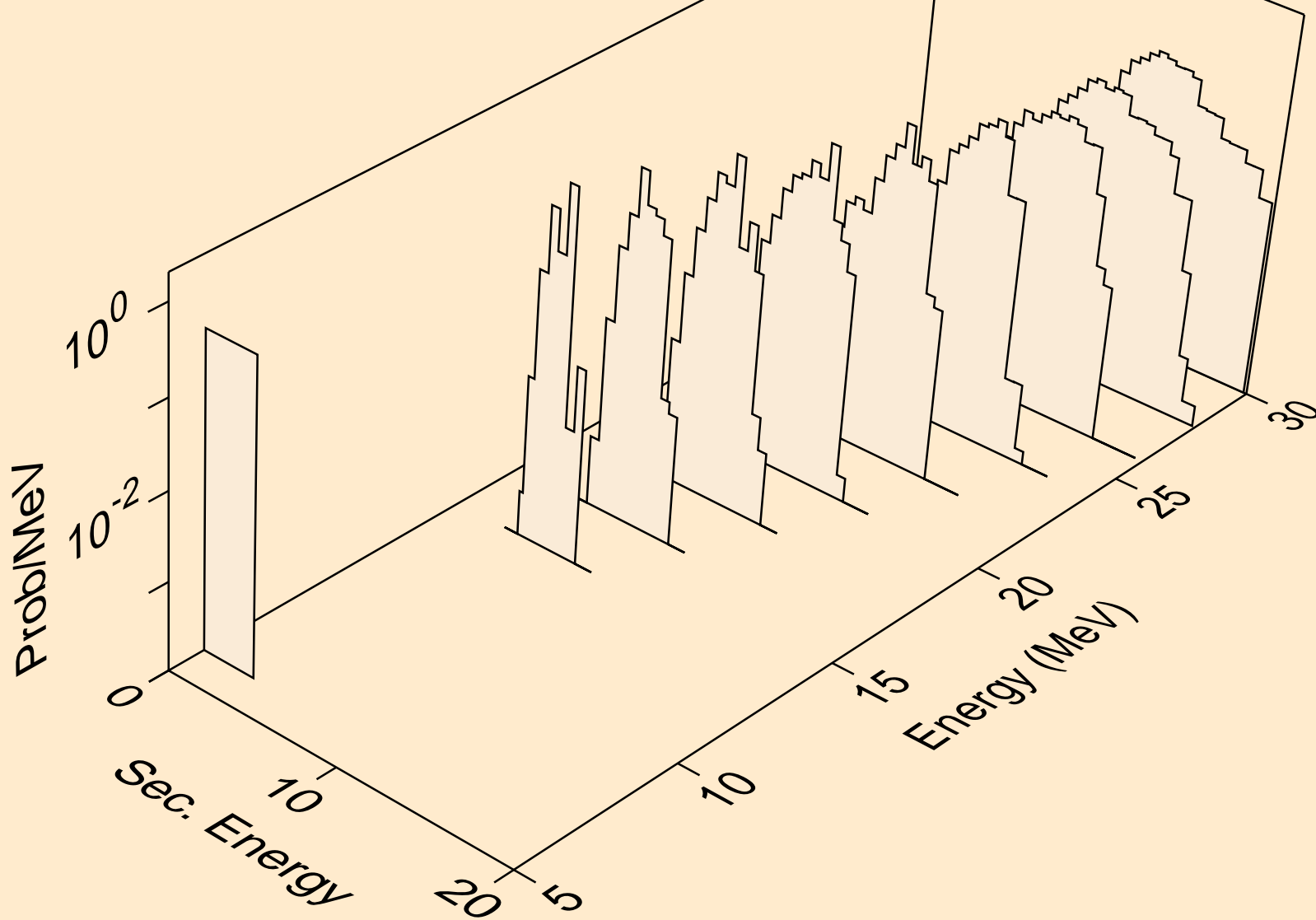

I123 NEUTRON ACER TENDL-2019 LIBRARY; T=293.16K
alphas from (n,a)

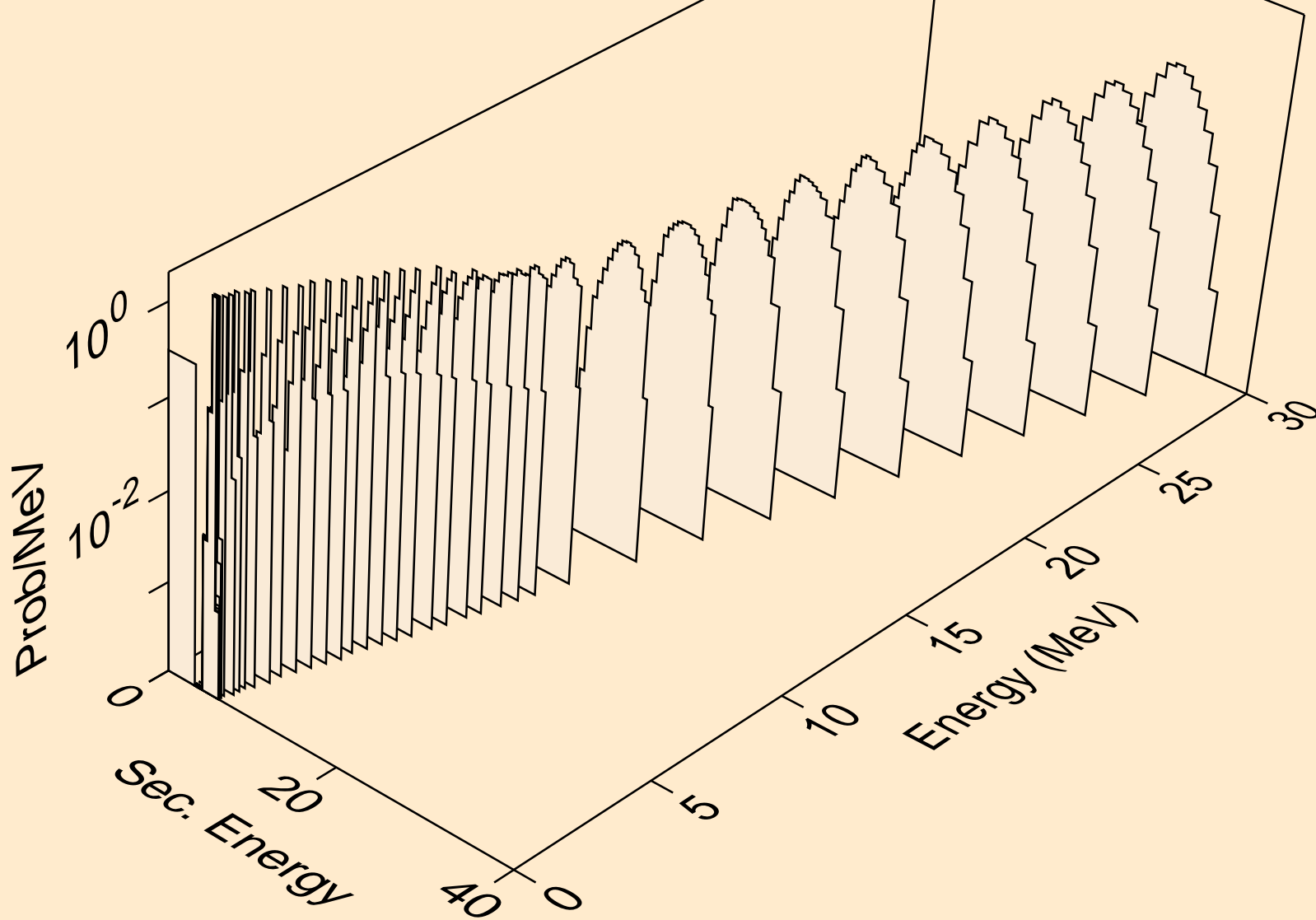

I123 NEUTRON ACER TENDL-2019 LIBRARY; T=293.16K
alphas from (n,2a)

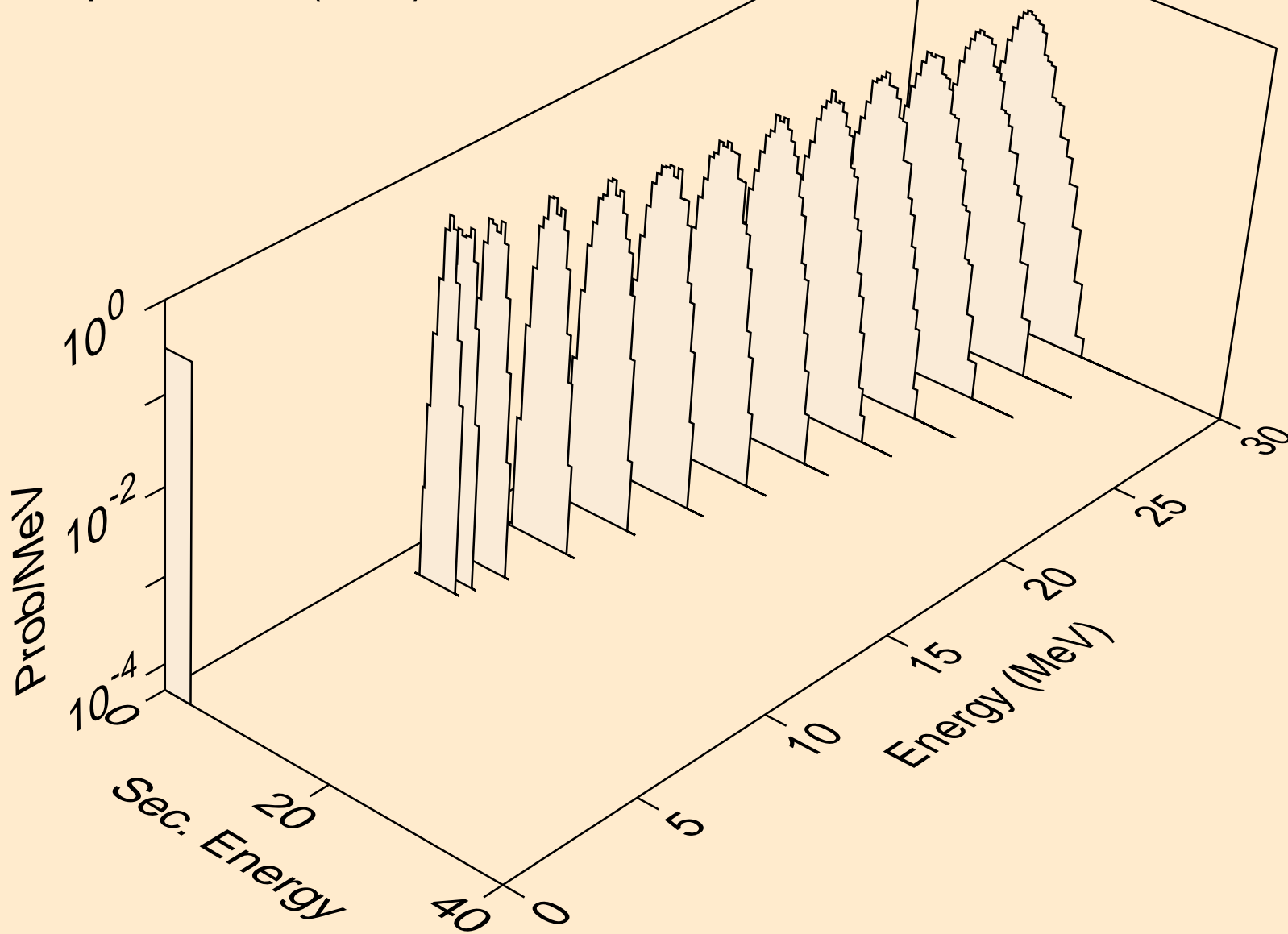

I123 NEUTRON ACER TENDL-2019 LIBRARY; T=293.16K
alphas from (n,pa)

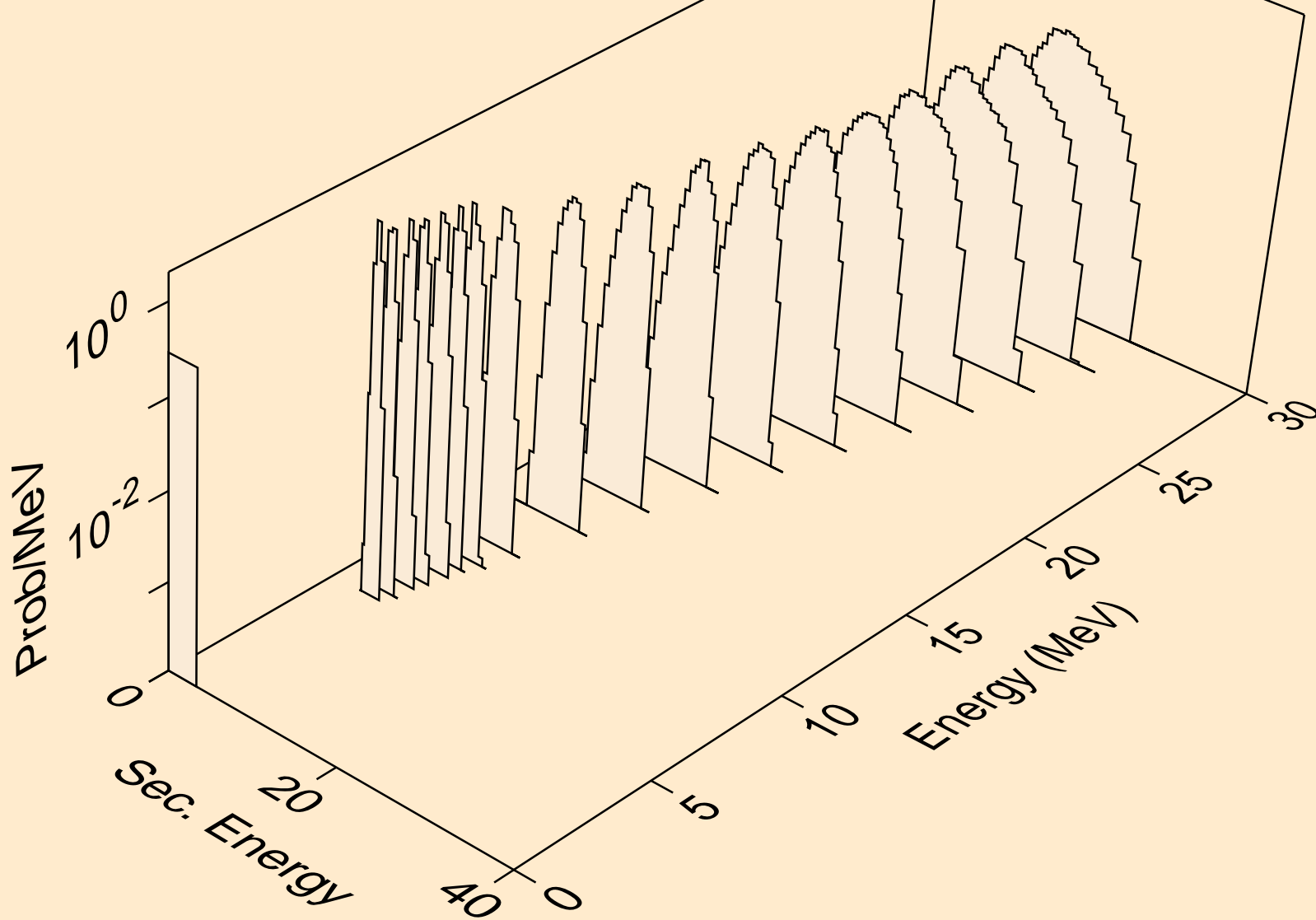

I123 NEUTRON ACER TENDL-2019 LIBRARY; T=293.16K
alphas from (n,da)

