

# I130 NEUTRON ACER TENDL-2019 LIBRARY; T=293.16K

## Principal cross sections

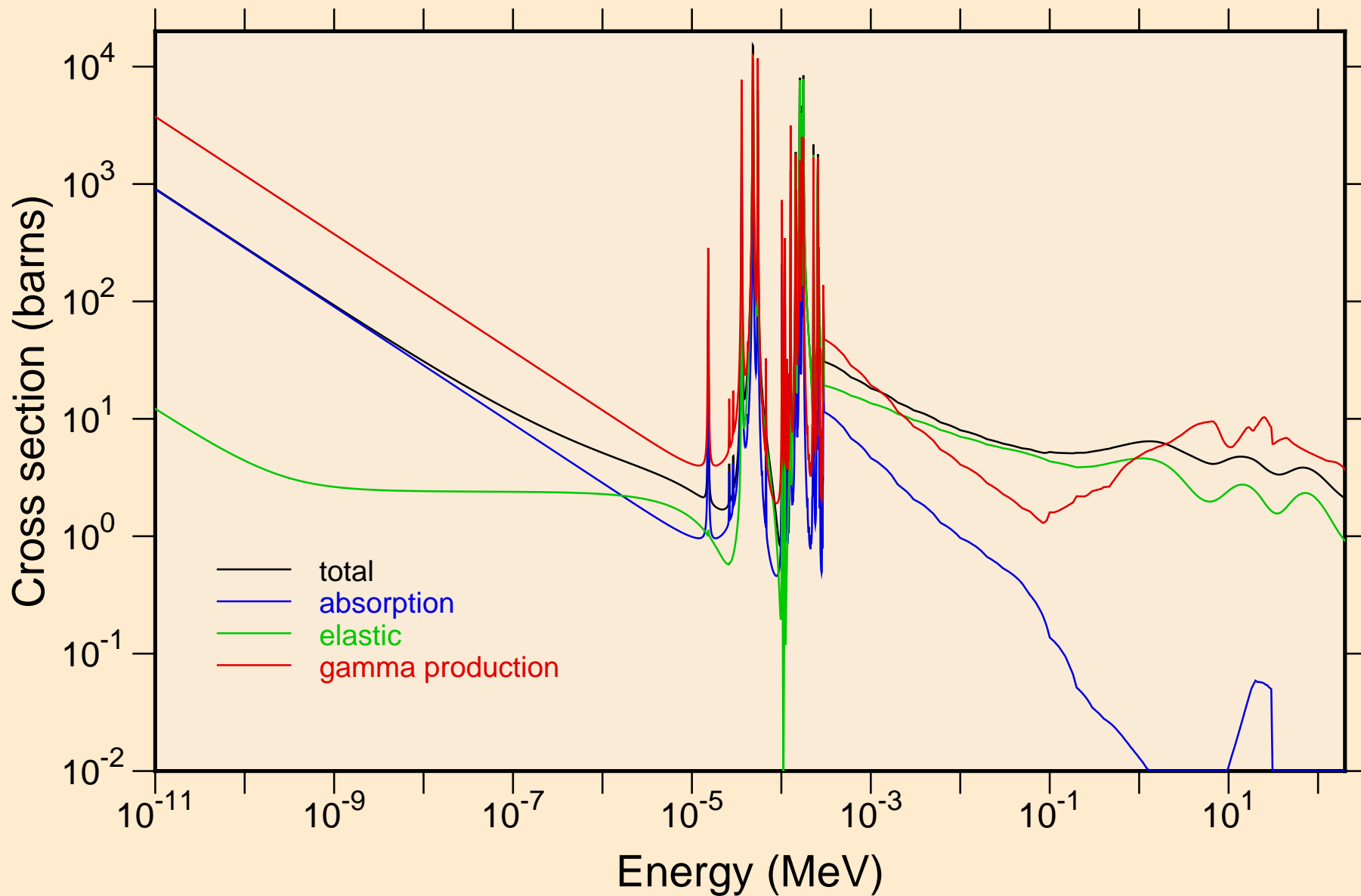

I130 NEUTRON ACER TENDL-2019 LIBRARY; T=293.16K  
resonance total cross section

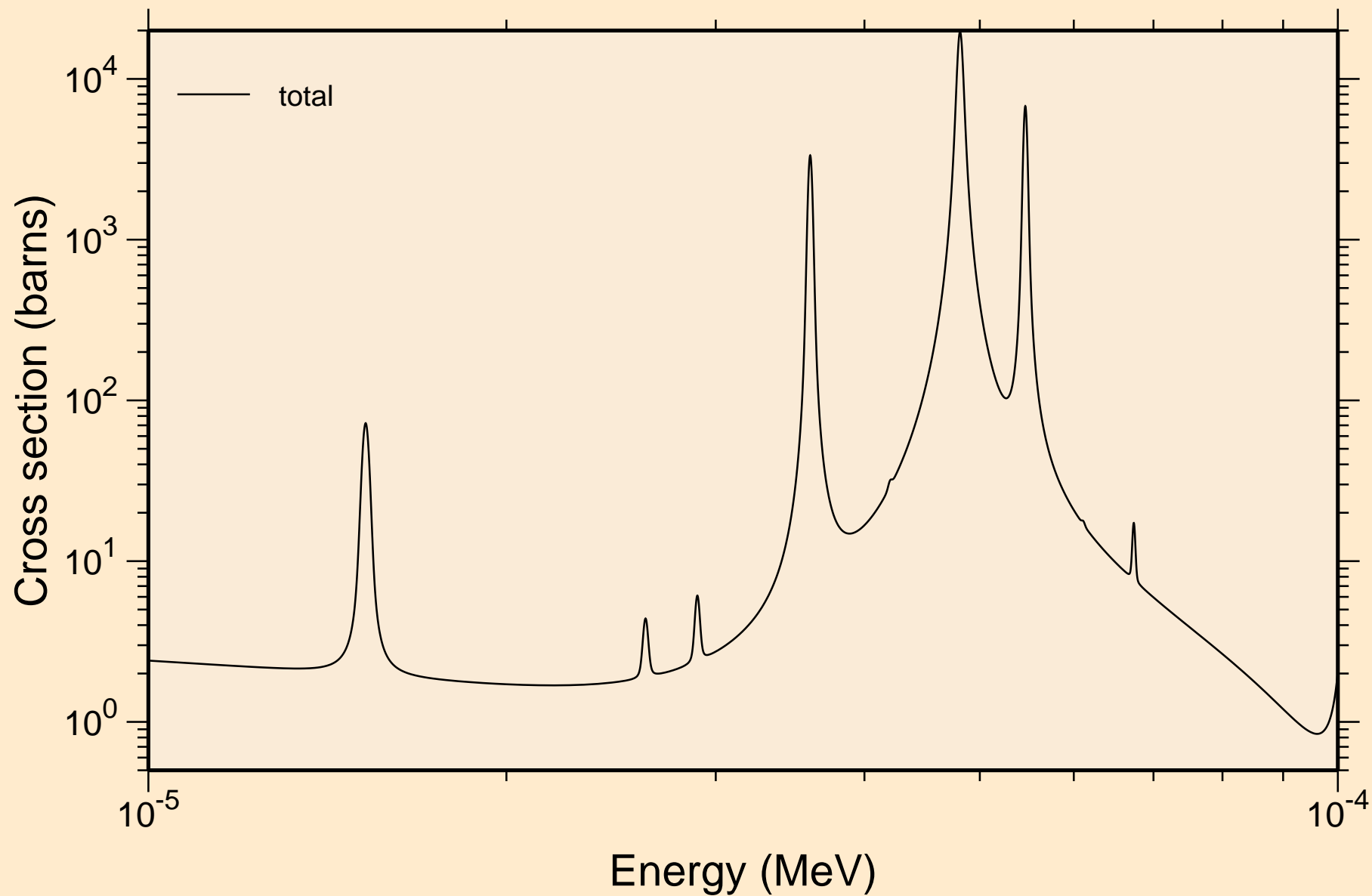

I130 NEUTRON ACER TENDL-2019 LIBRARY; T=293.16K  
resonance total cross section

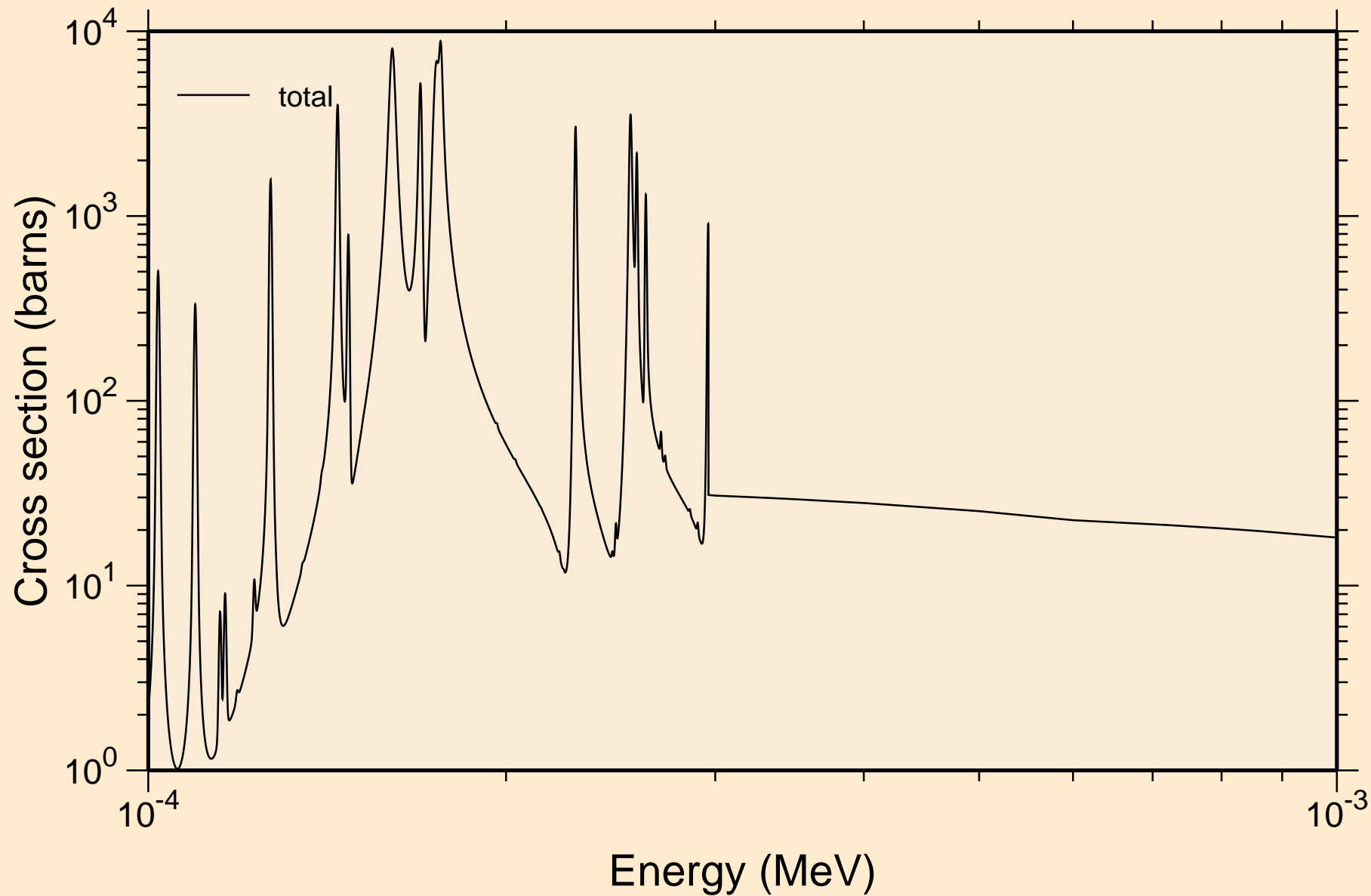

I130 NEUTRON ACER TENDL-2019 LIBRARY; T=293.16K  
resonance total cross section

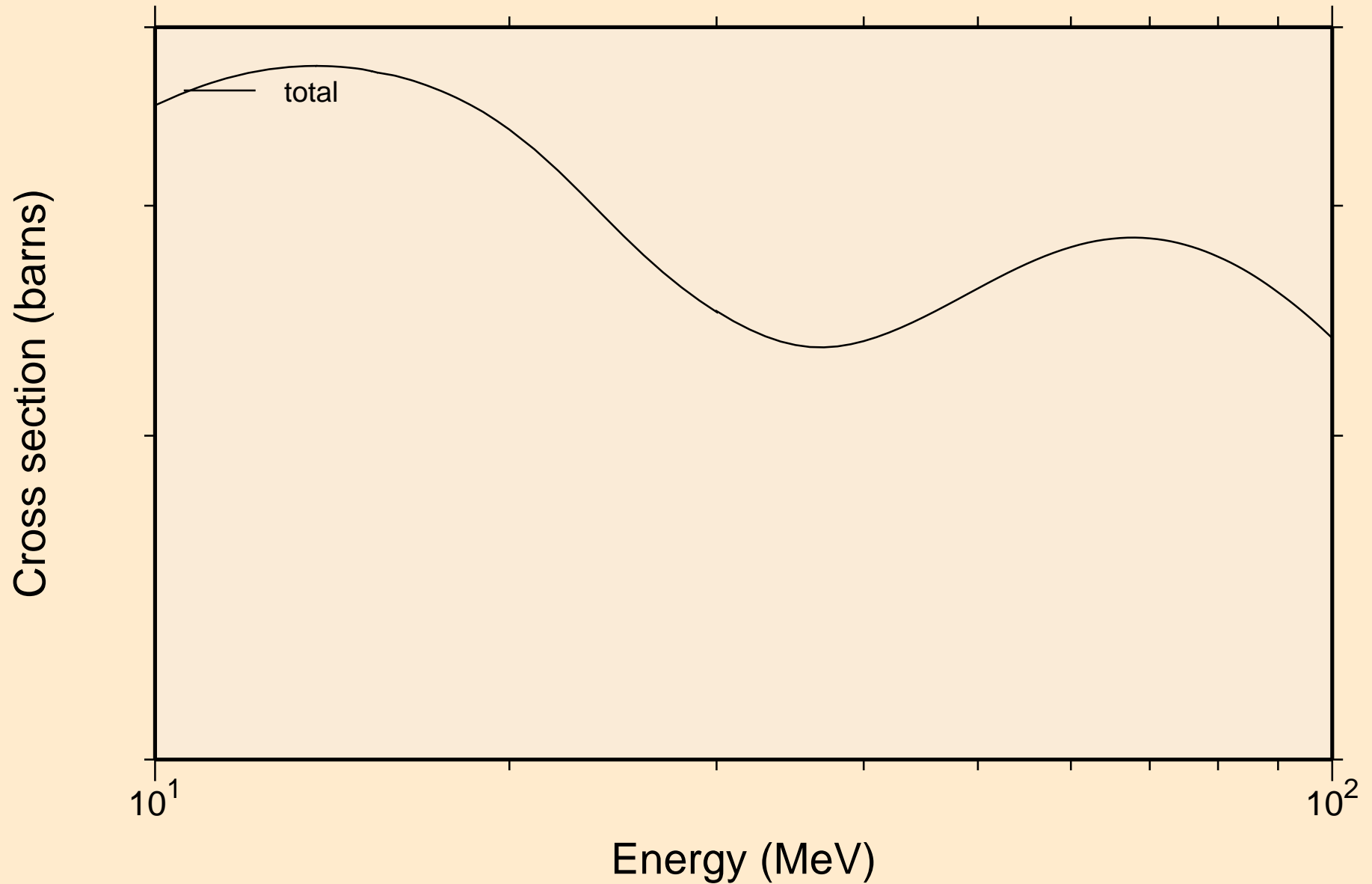

I130 NEUTRON ACER TENDL-2019 LIBRARY; T=293.16K  
resonance absorption cross sections

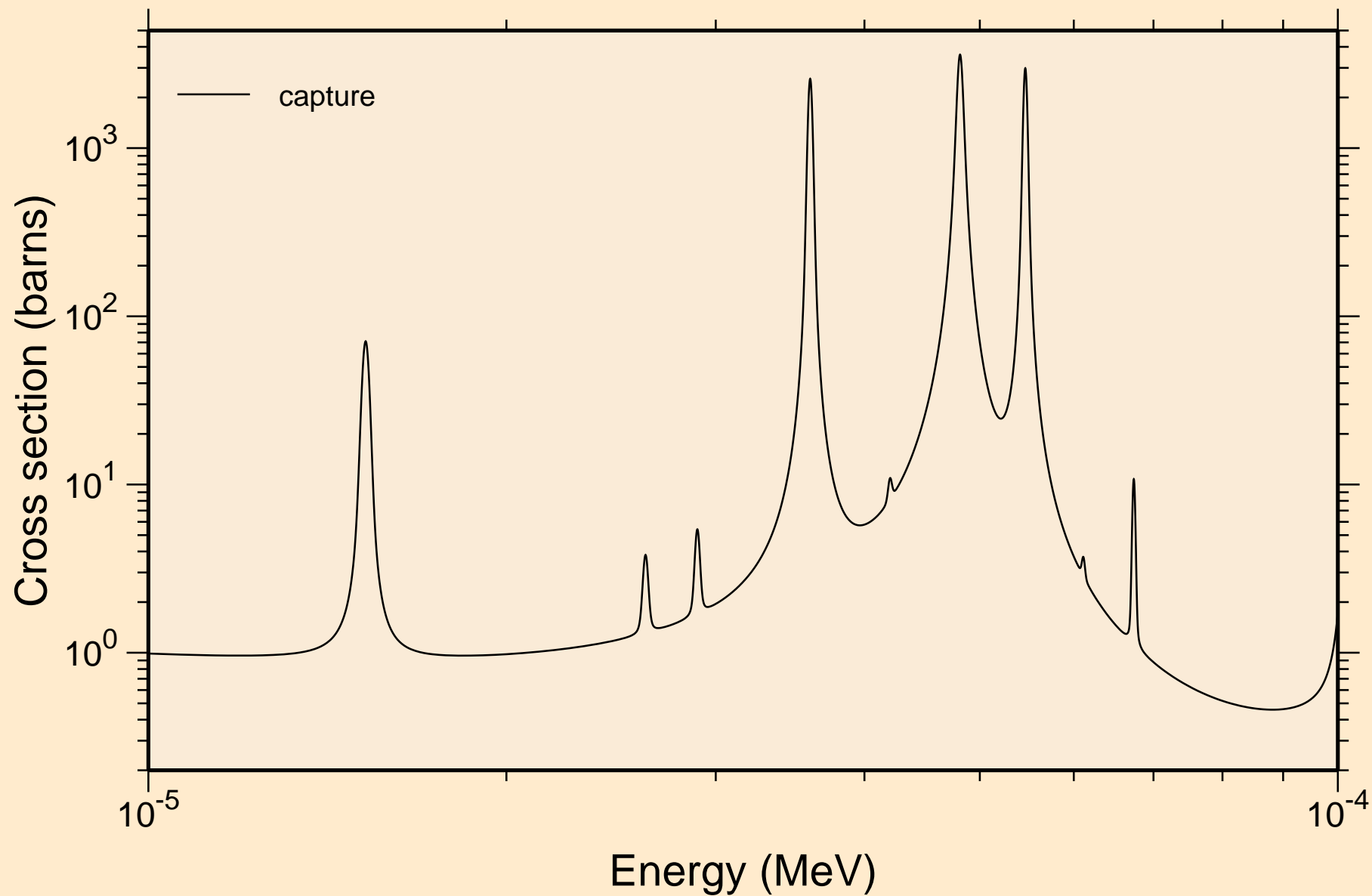

I130 NEUTRON ACER TENDL-2019 LIBRARY; T=293.16K  
resonance absorption cross sections

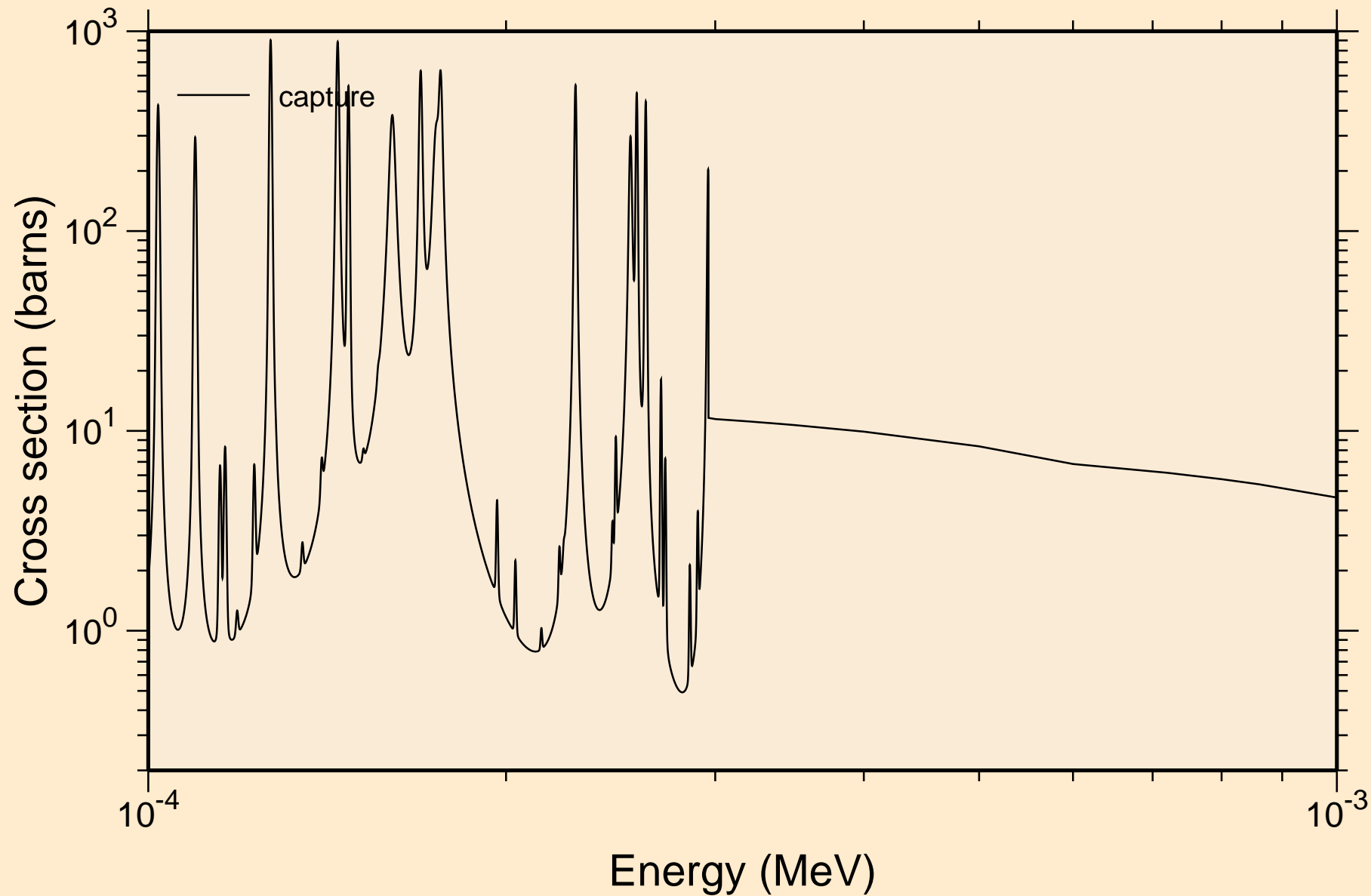

I130 NEUTRON ACER TENDL-2019 LIBRARY; T=293.16K  
resonance absorption cross sections

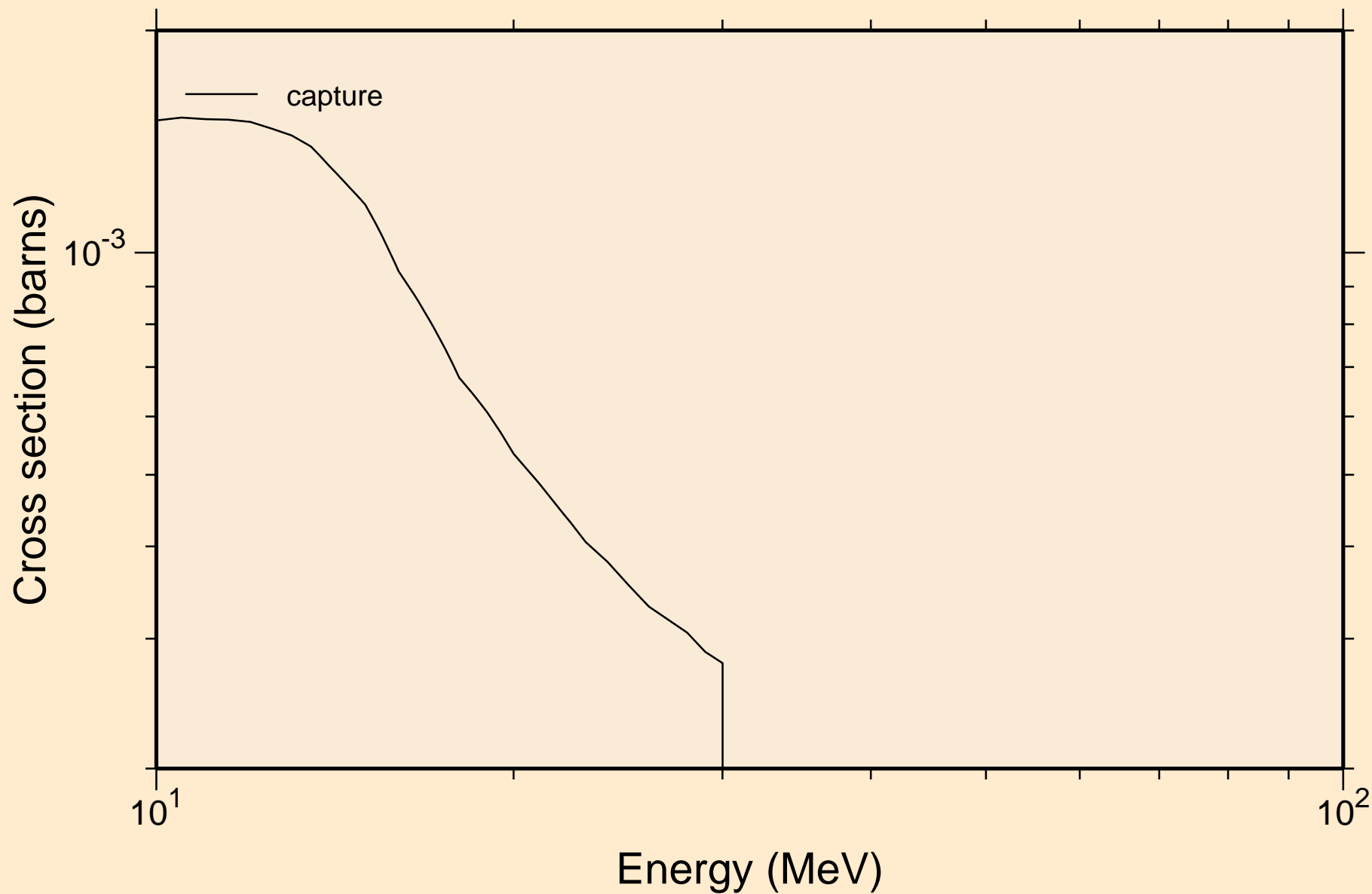

I130 NEUTRON ACER TENDL-2019 LIBRARY; T=293.16K  
Heating

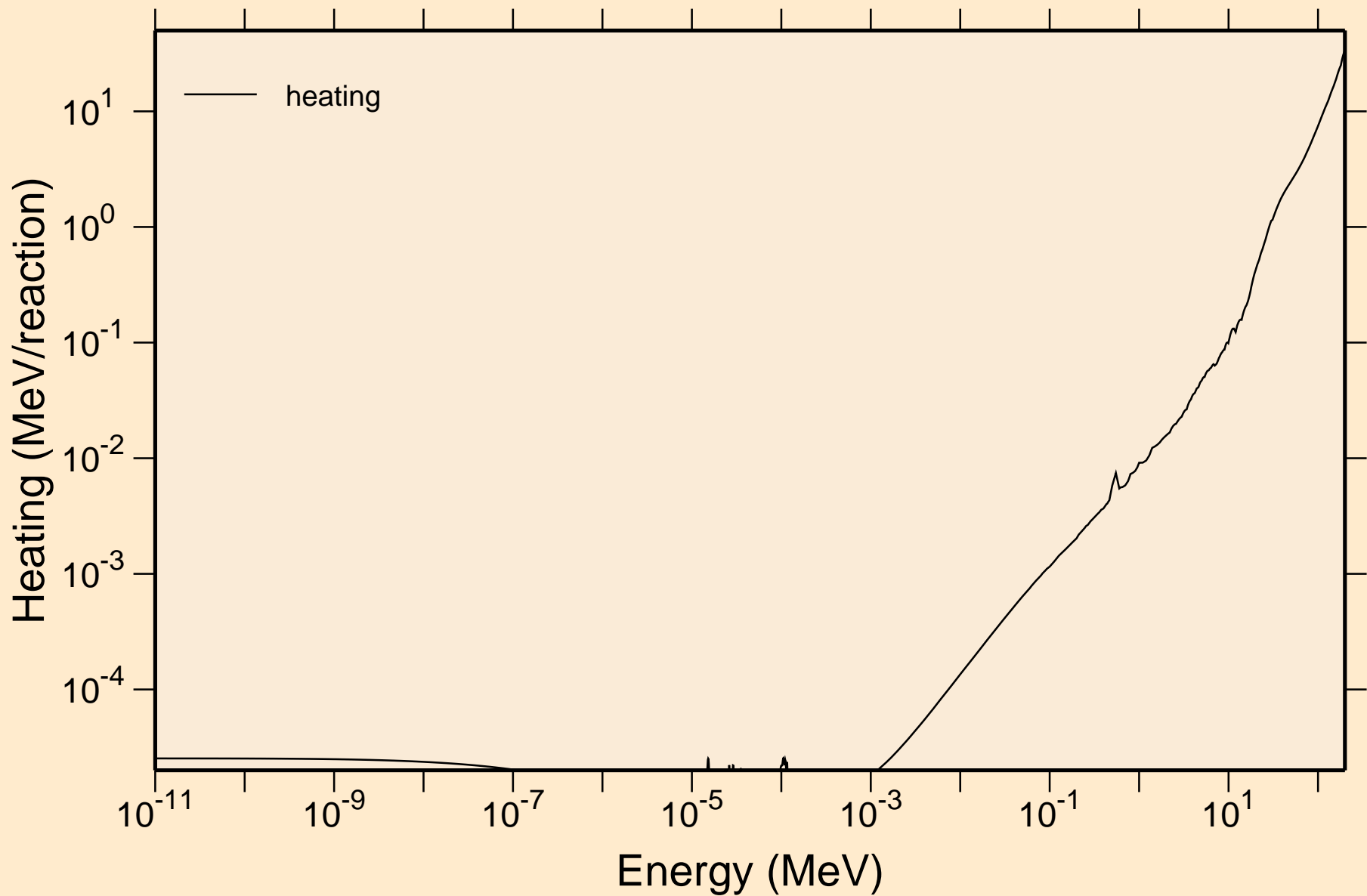



I130 NEUTRON ACER TENDL-2019 LIBRARY; T=293.16K  
Damage

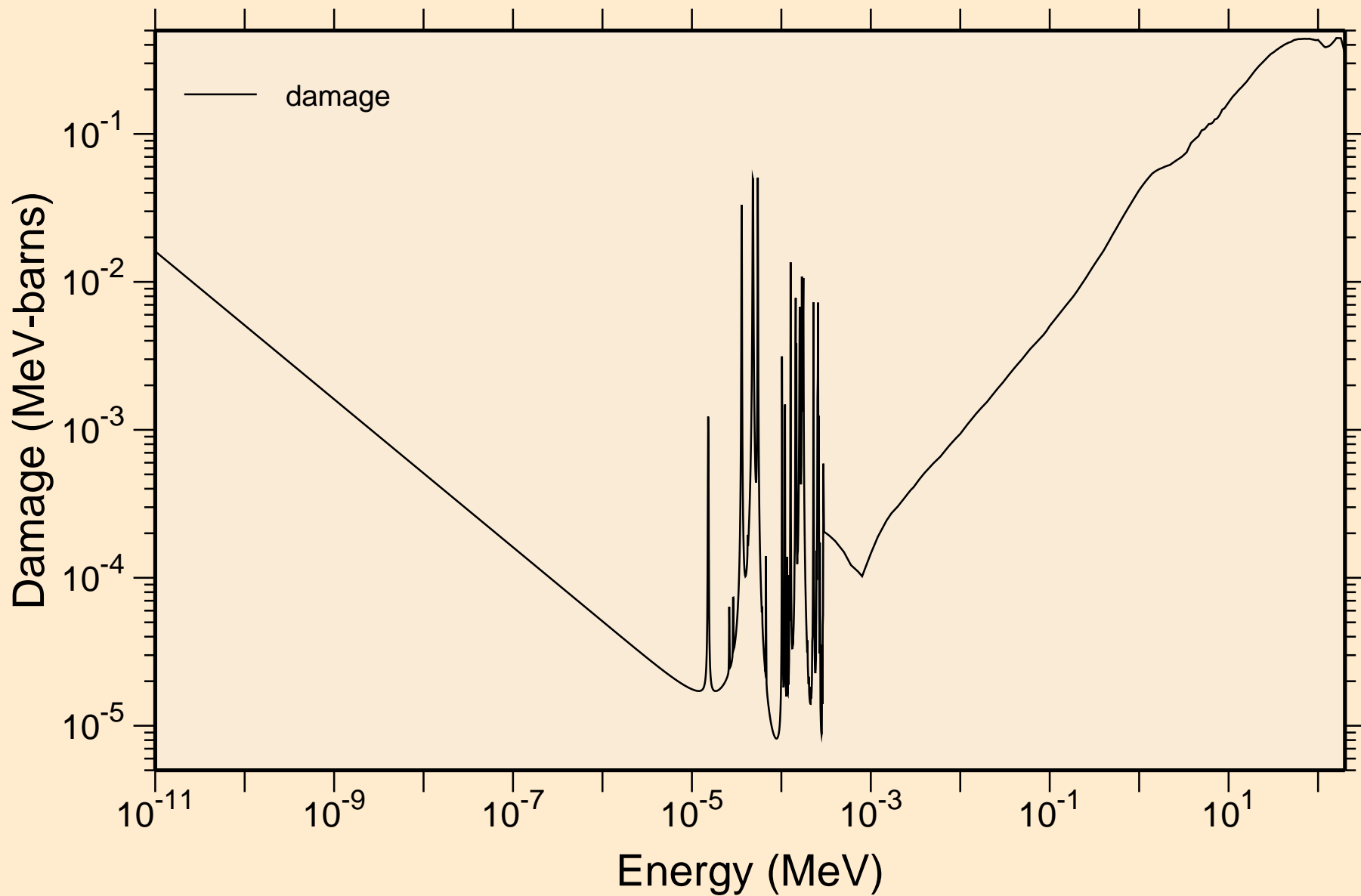

I130 NEUTRON ACER TENDL-2019 LIBRARY; T=293.16K  
Non-threshold reactions

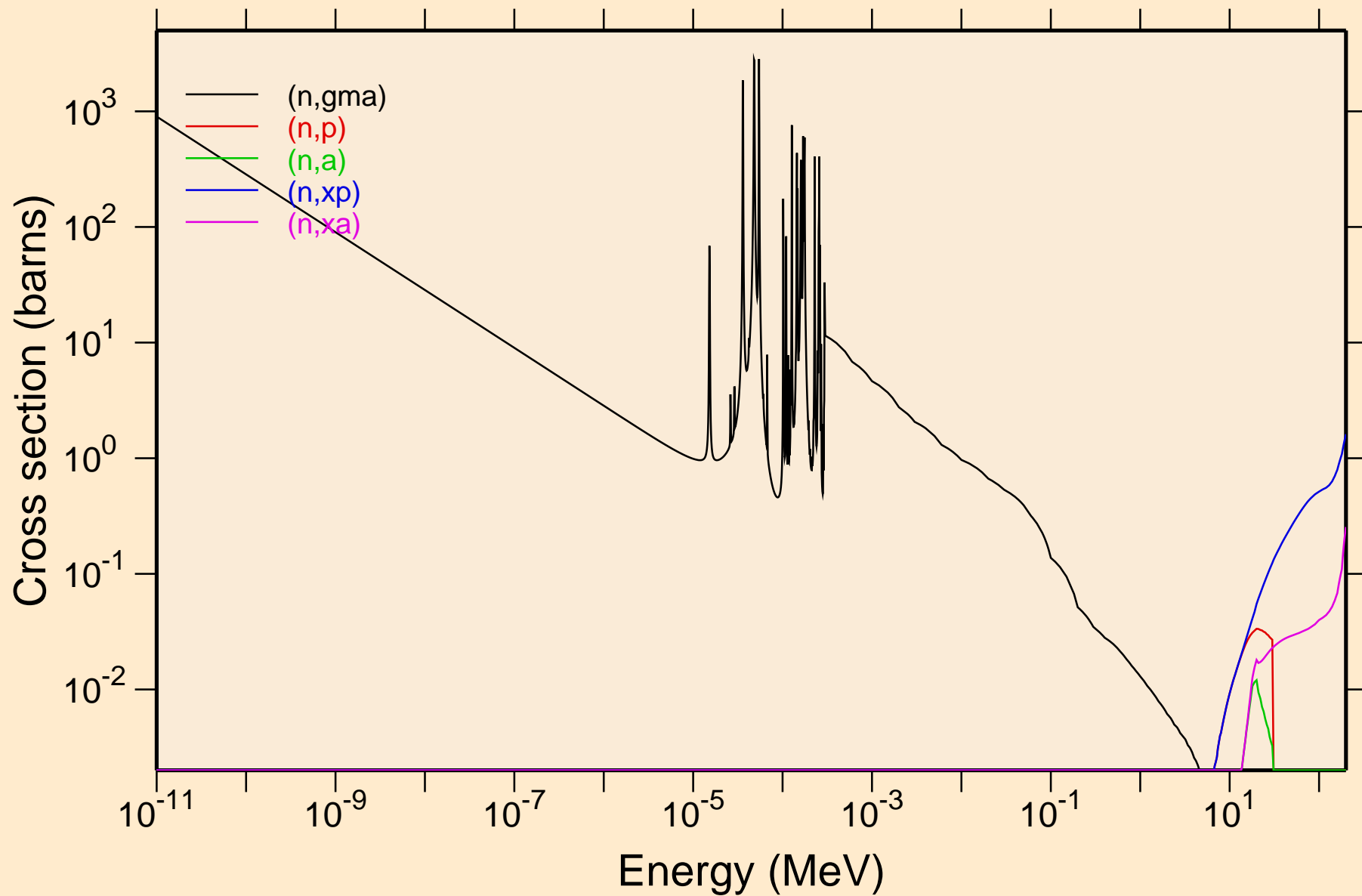

I130 NEUTRON ACER TENDL-2019 LIBRARY; T=293.16K  
Principal cross sections

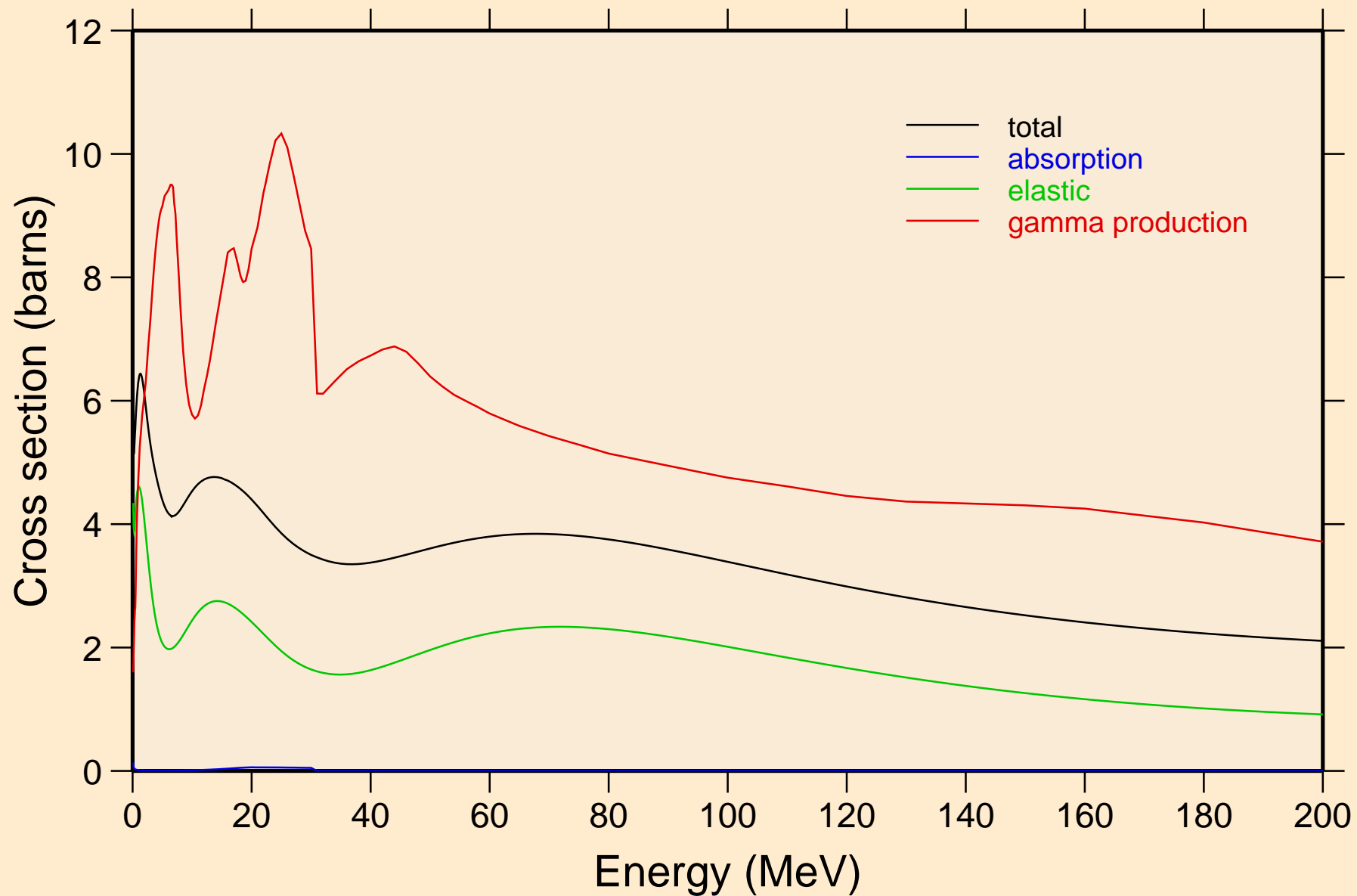

I130 NEUTRON ACER TENDL-2019 LIBRARY; T=293.16K  
Heating

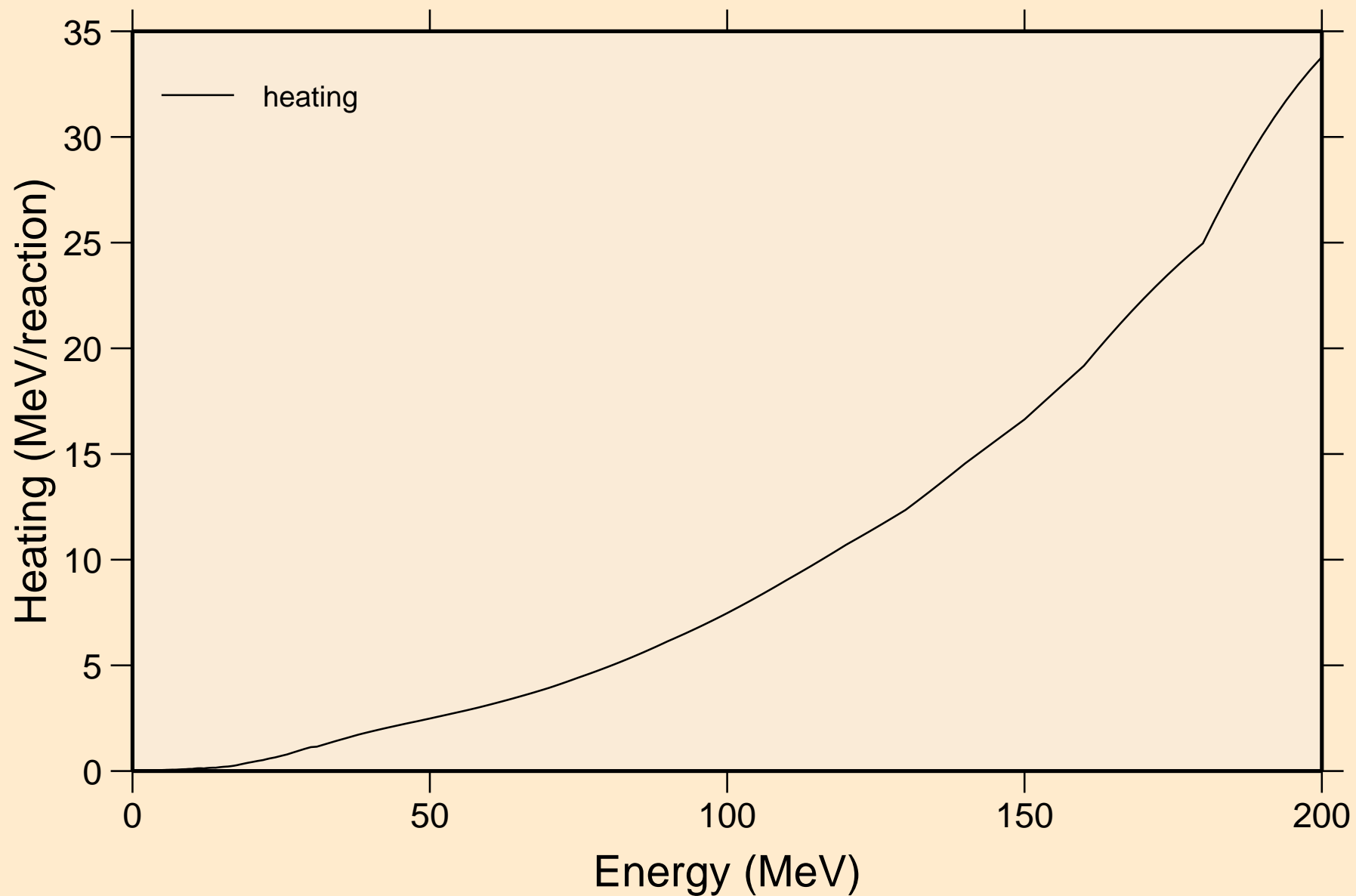

I130 NEUTRON ACER TENDL-2019 LIBRARY; T=293.16K  
Damage

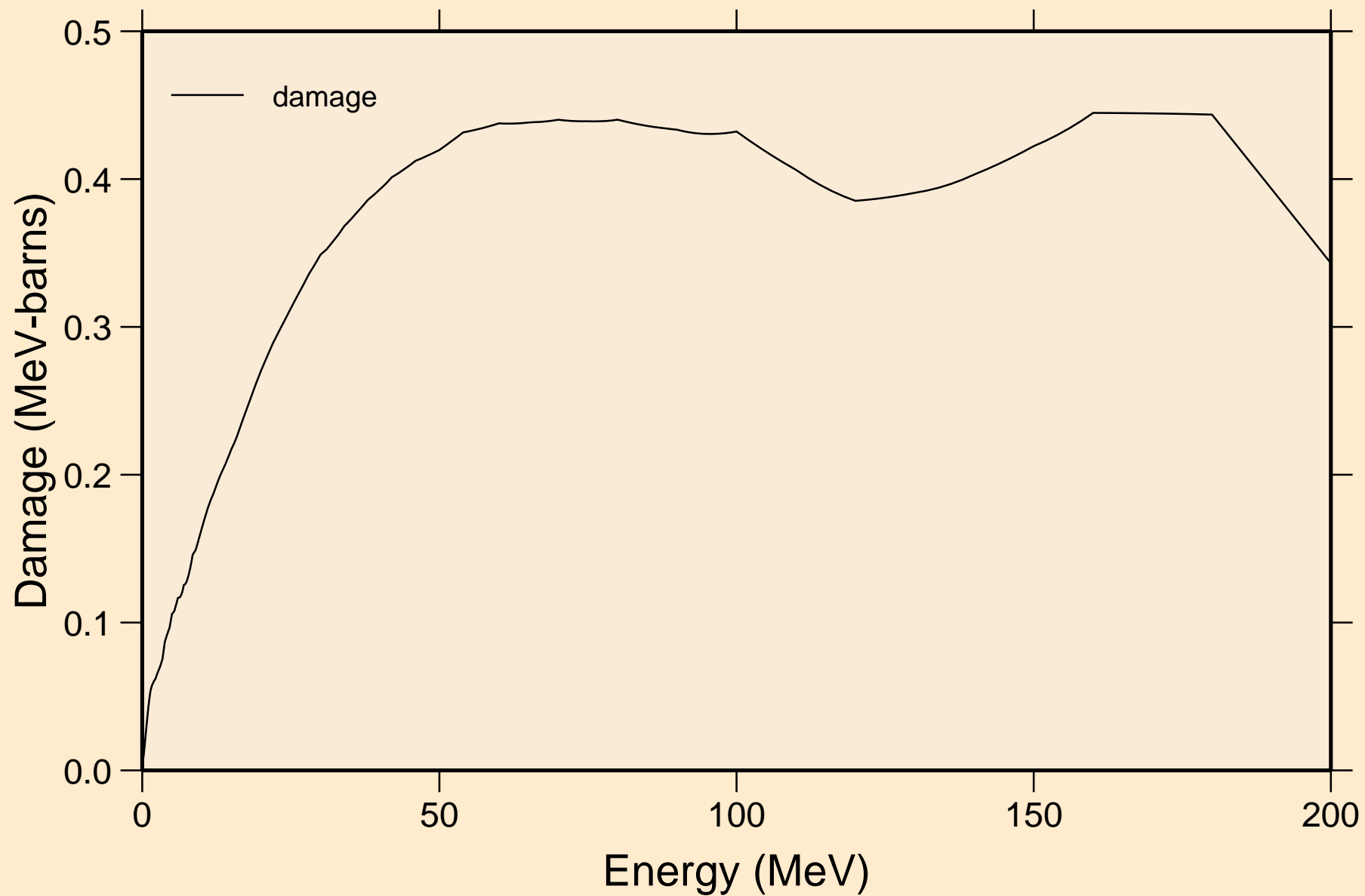

# I130 NEUTRON ACER TENDL-2019 LIBRARY; T=293.16K

## Non-threshold reactions

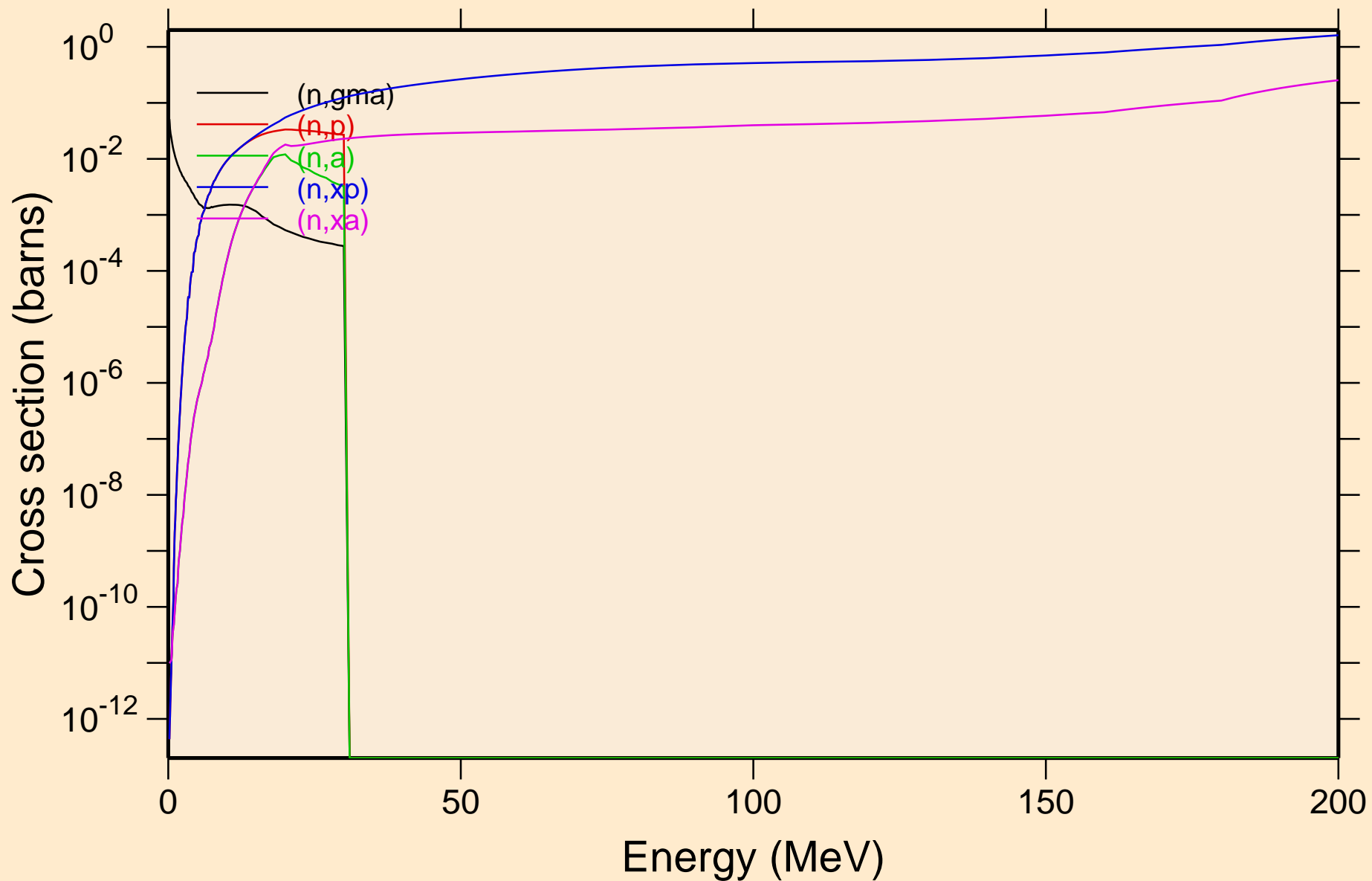

I130 NEUTRON ACER TENDL-2019 LIBRARY; T=293.16K  
Inelastic levels

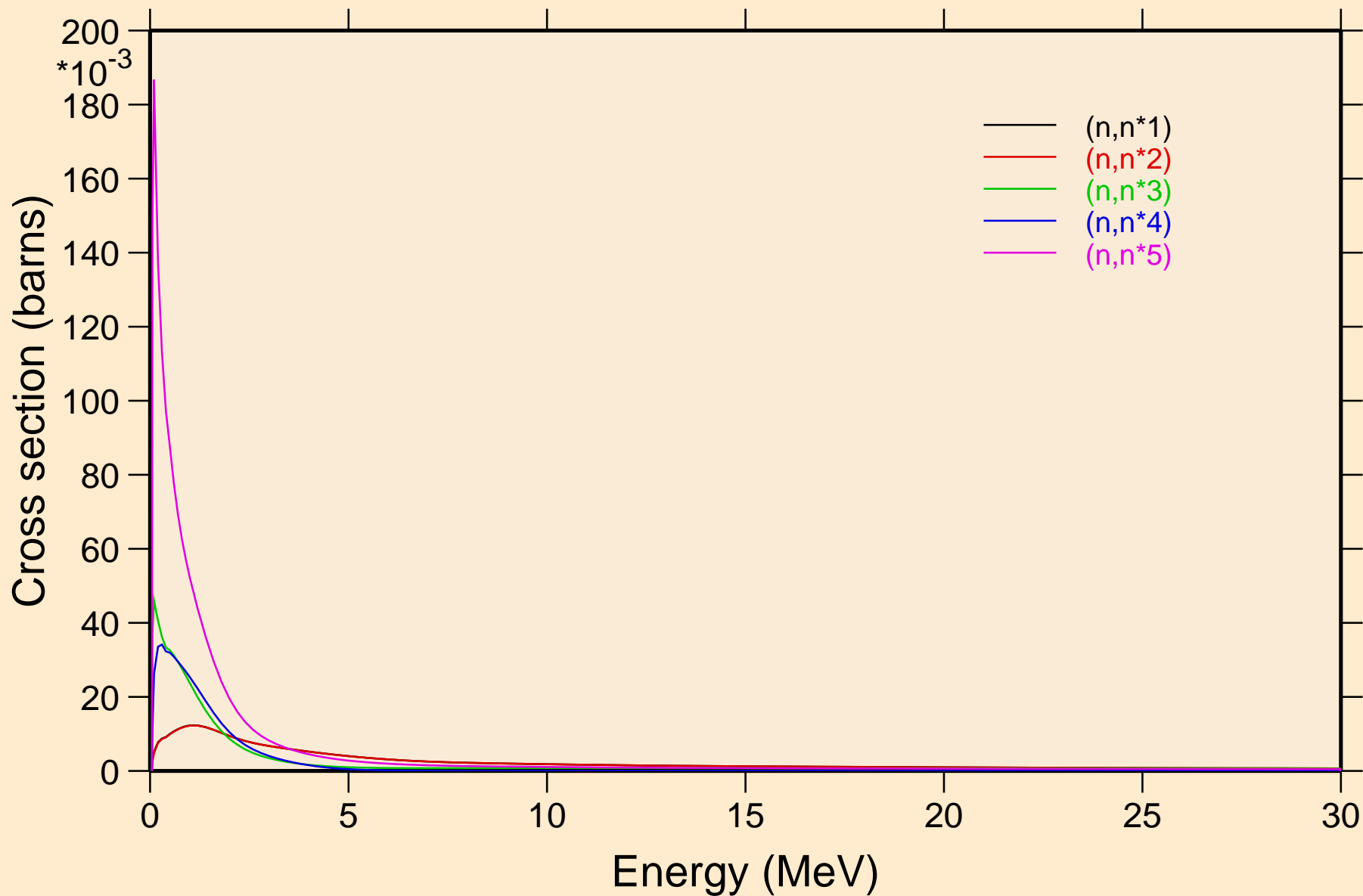

# I130 NEUTRON ACER TENDL-2019 LIBRARY; T=293.16K

## Inelastic levels

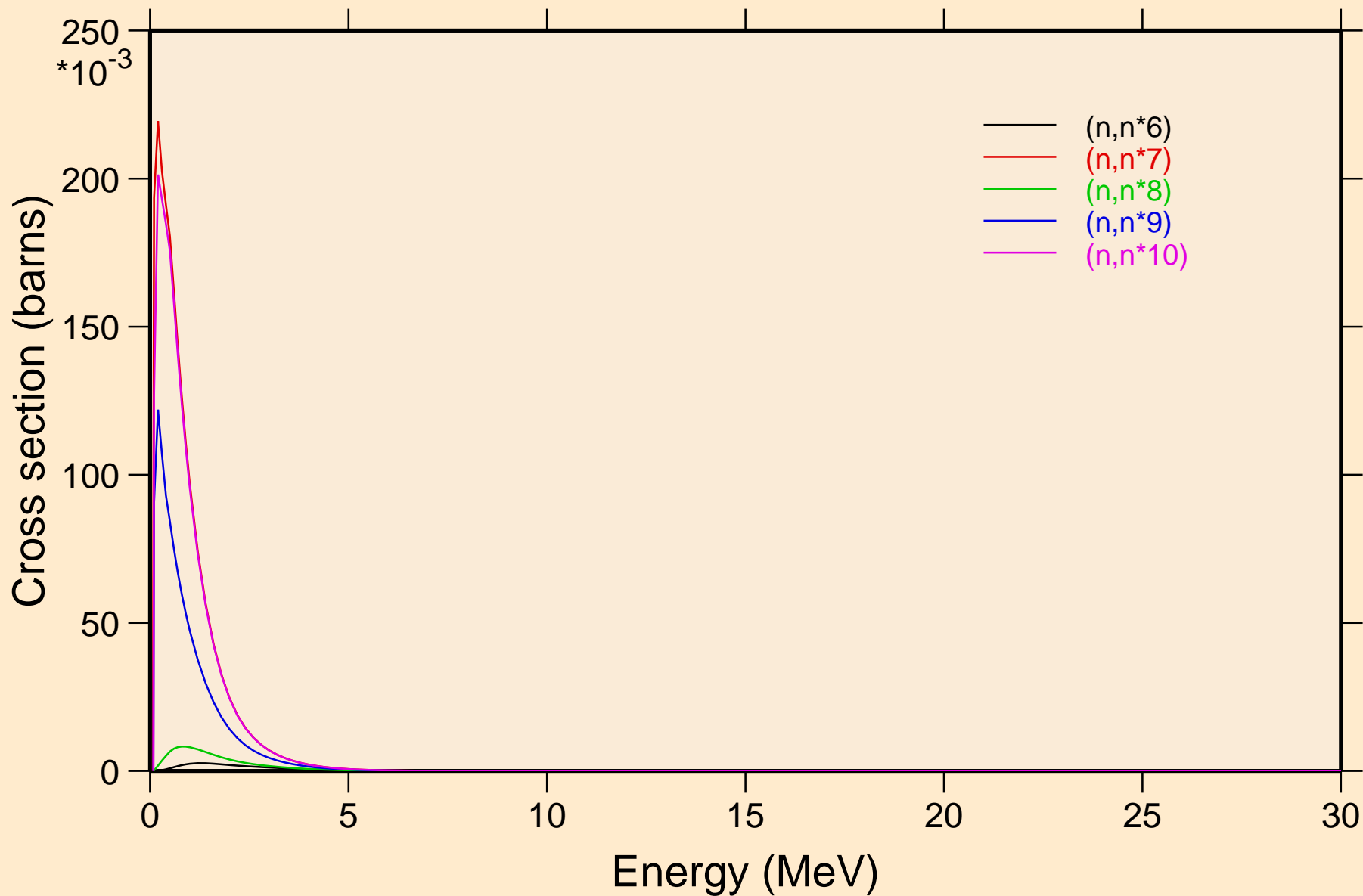



I130 NEUTRON ACER TENDL-2019 LIBRARY; T=293.16K  
Inelastic levels

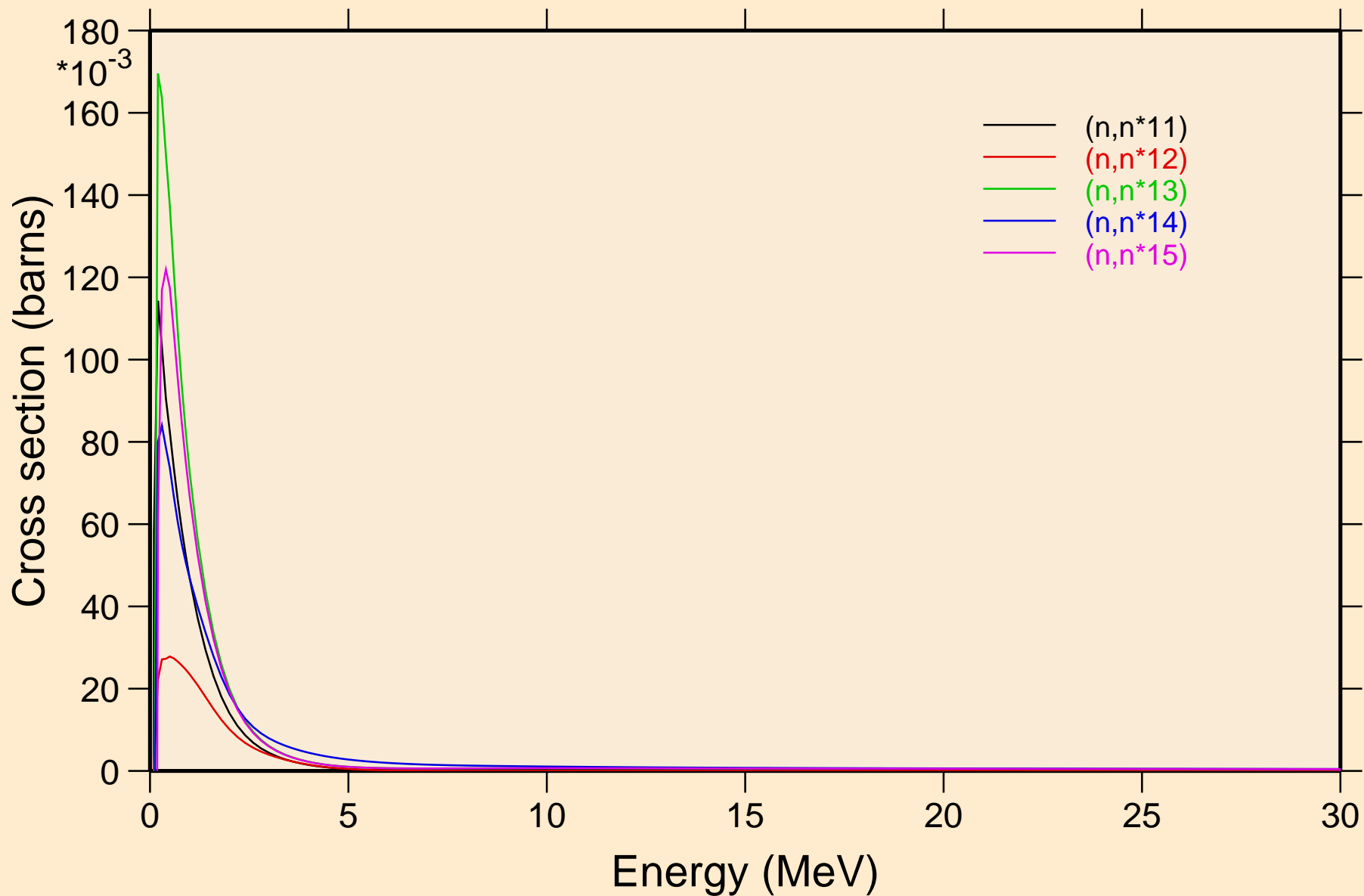

I130 NEUTRON ACER TENDL-2019 LIBRARY; T=293.16K  
Inelastic levels

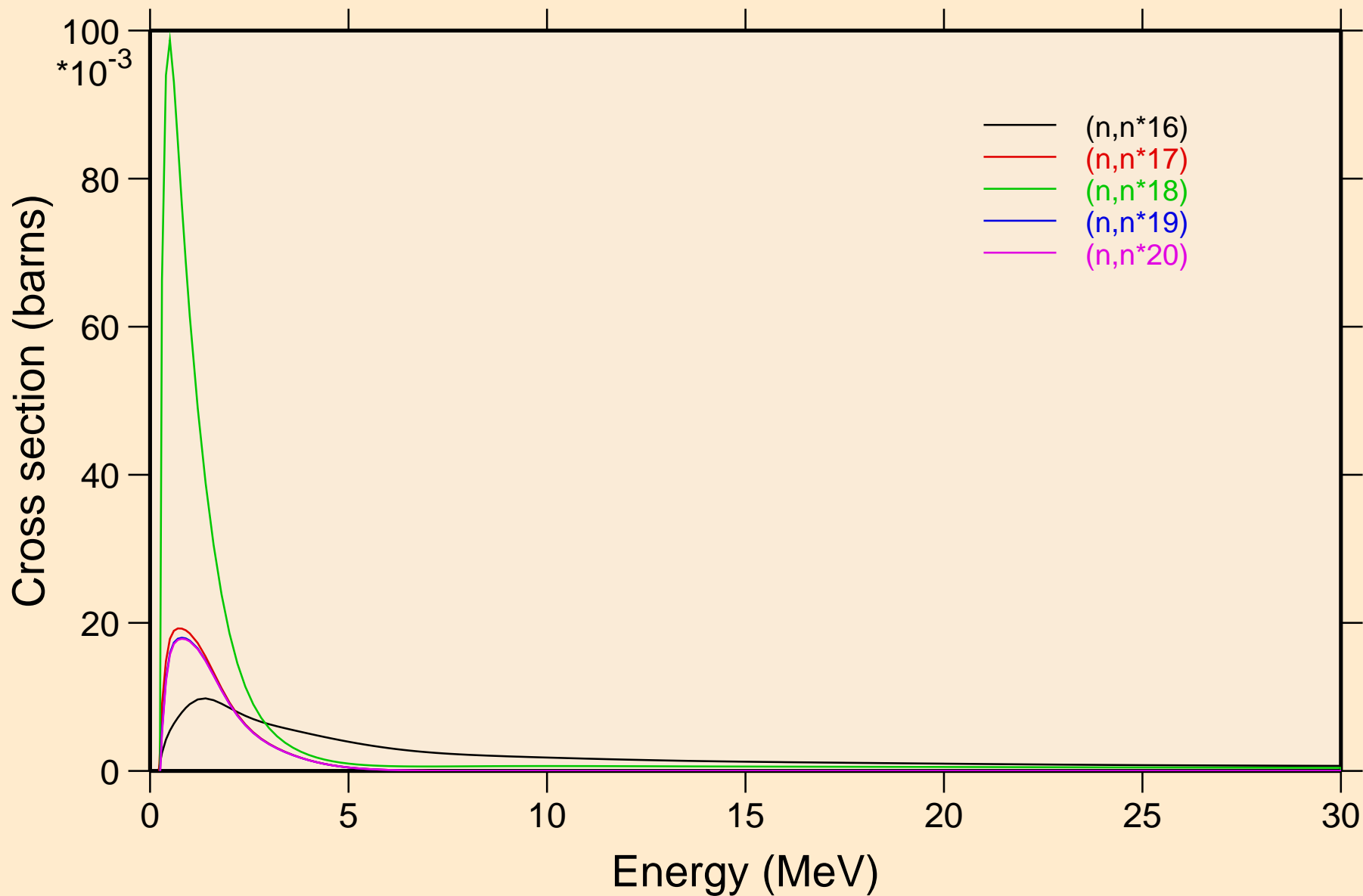

I130 NEUTRON ACER TENDL-2019 LIBRARY; T=293.16K  
Inelastic levels

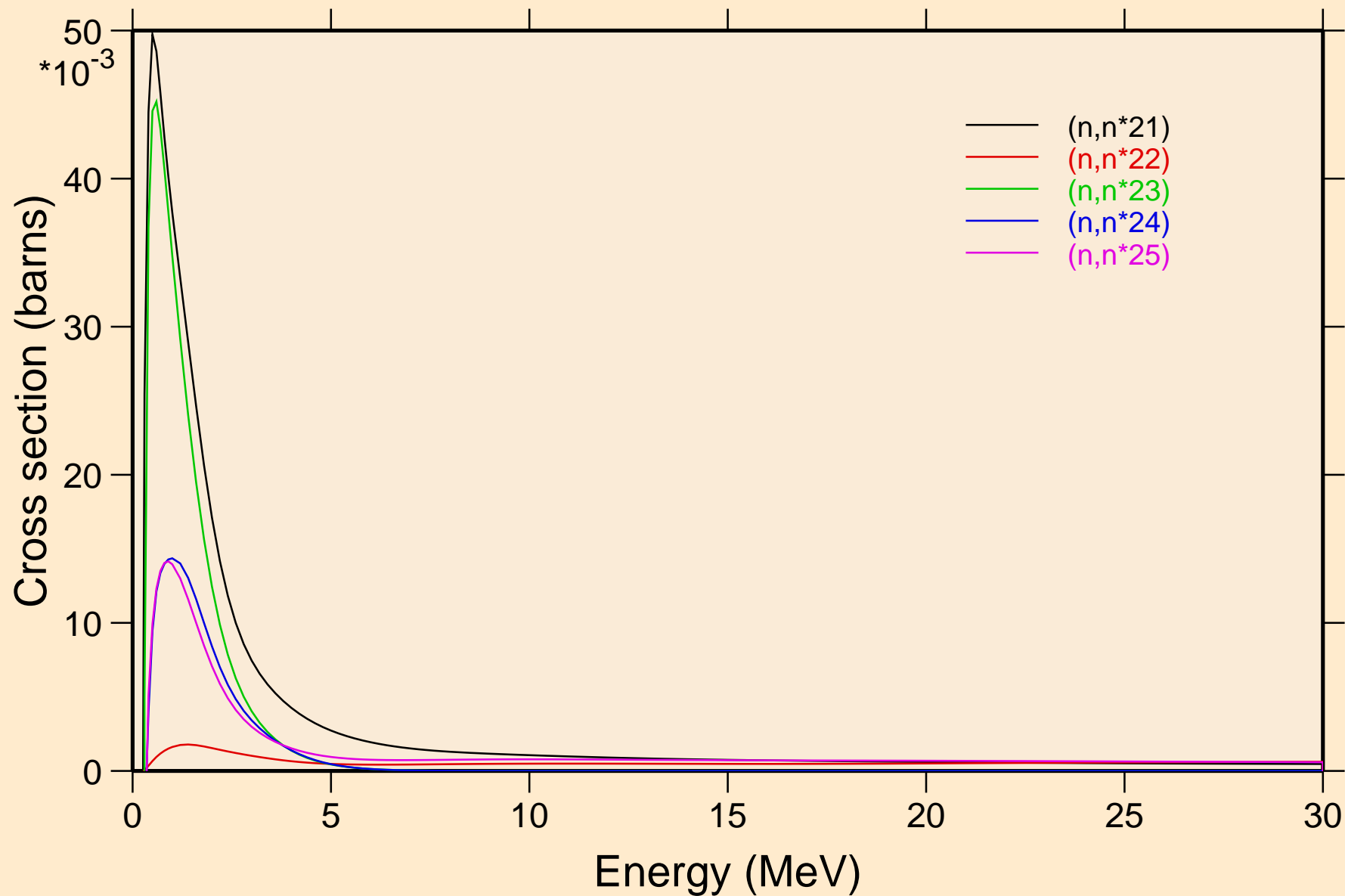

I130 NEUTRON ACER TENDL-2019 LIBRARY; T=293.16K  
Inelastic levels

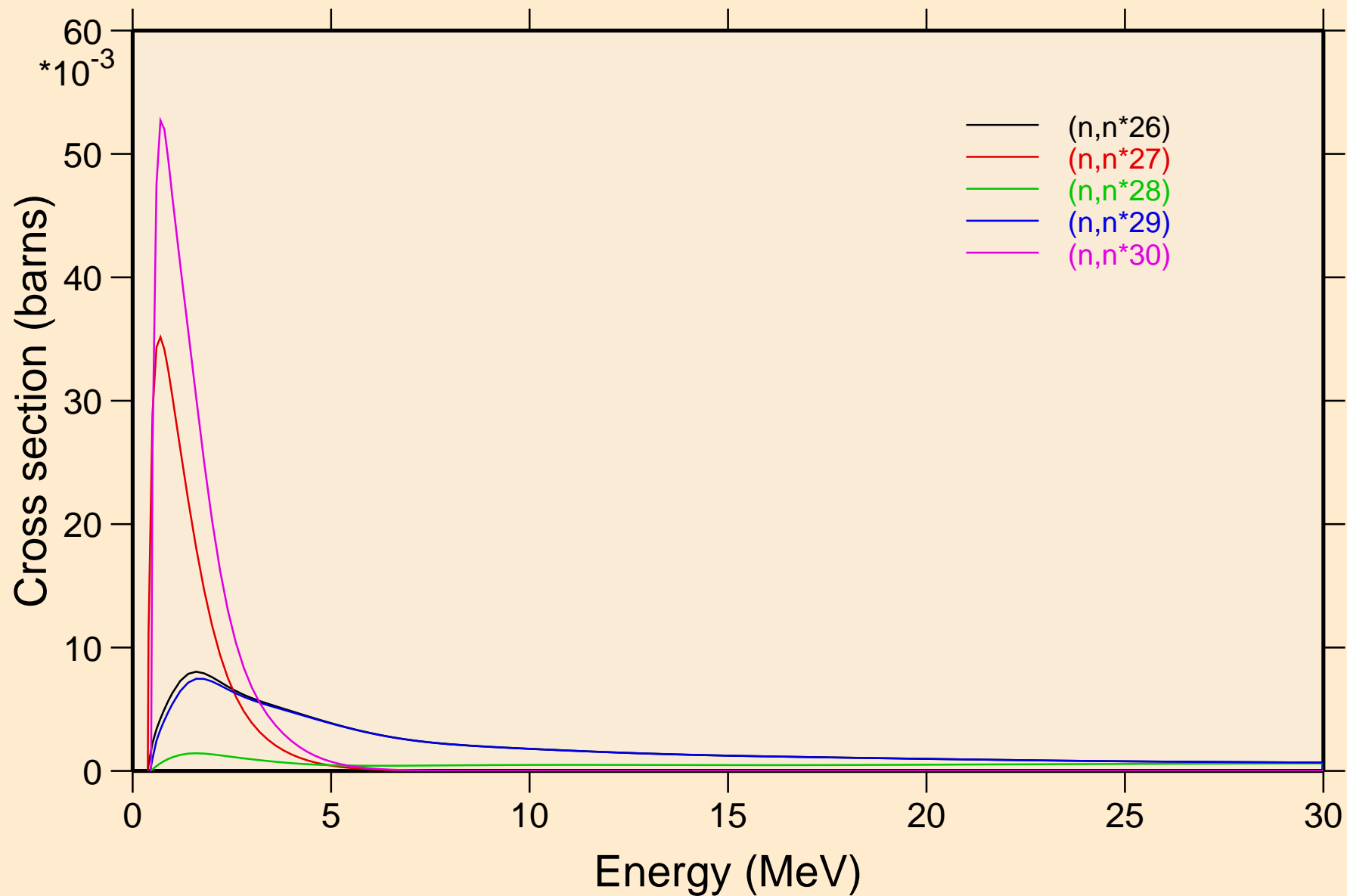

# I130 NEUTRON ACER TENDL-2019 LIBRARY; T=293.16K

## Threshold reactions

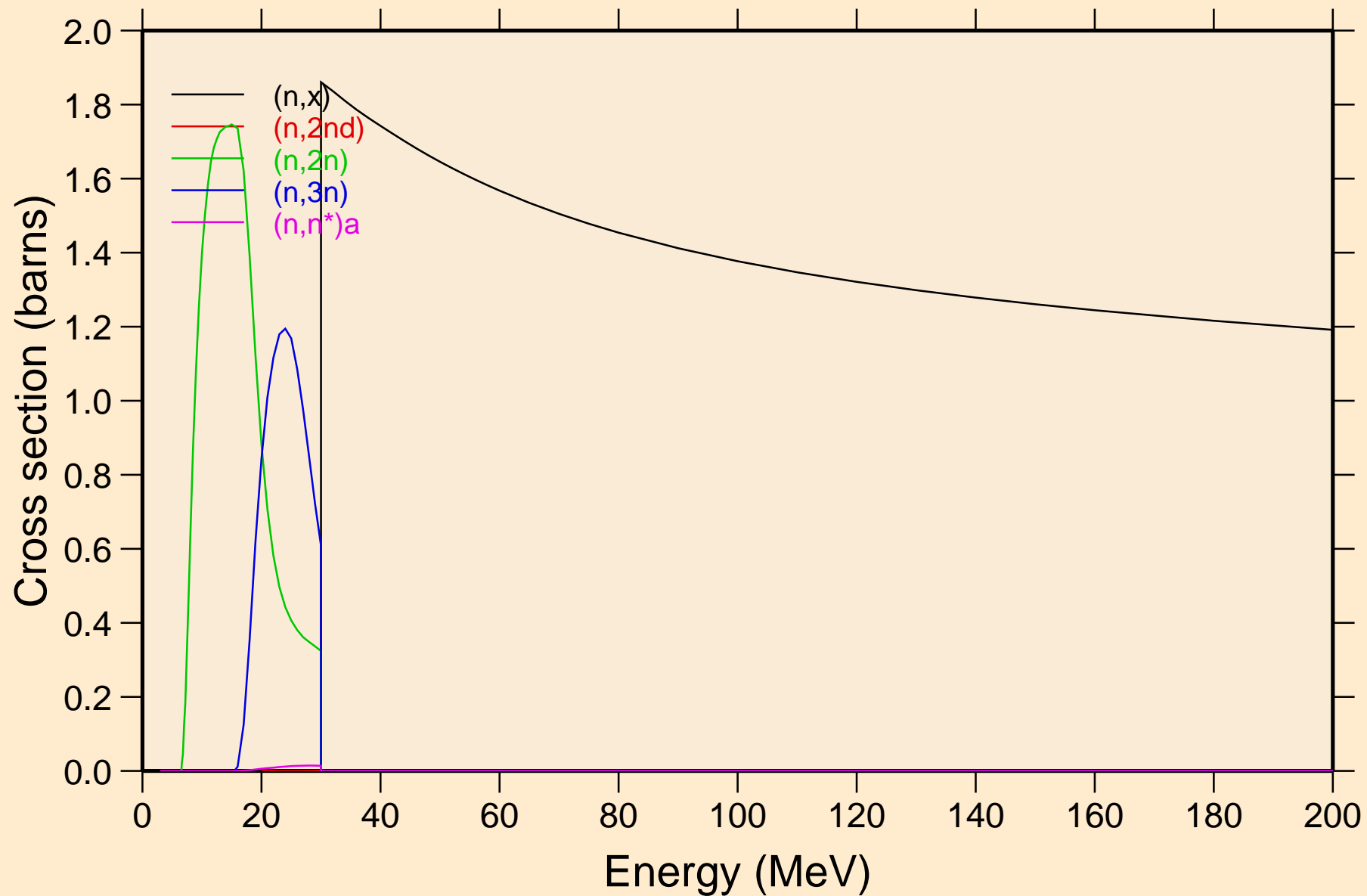

I130 NEUTRON ACER TENDL-2019 LIBRARY; T=293.16K  
Threshold reactions

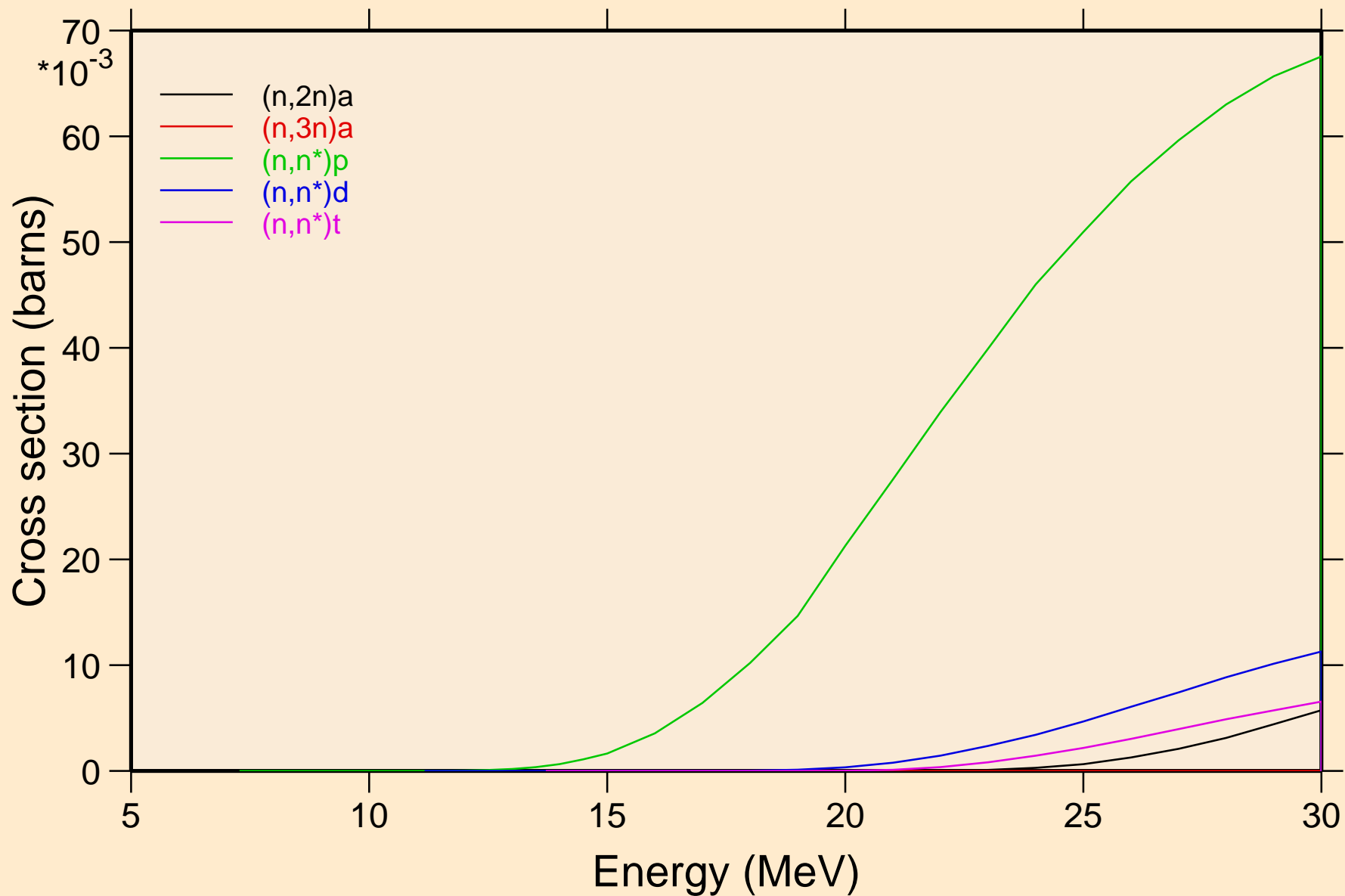

I130 NEUTRON ACER TENDL-2019 LIBRARY; T=293.16K  
Threshold reactions

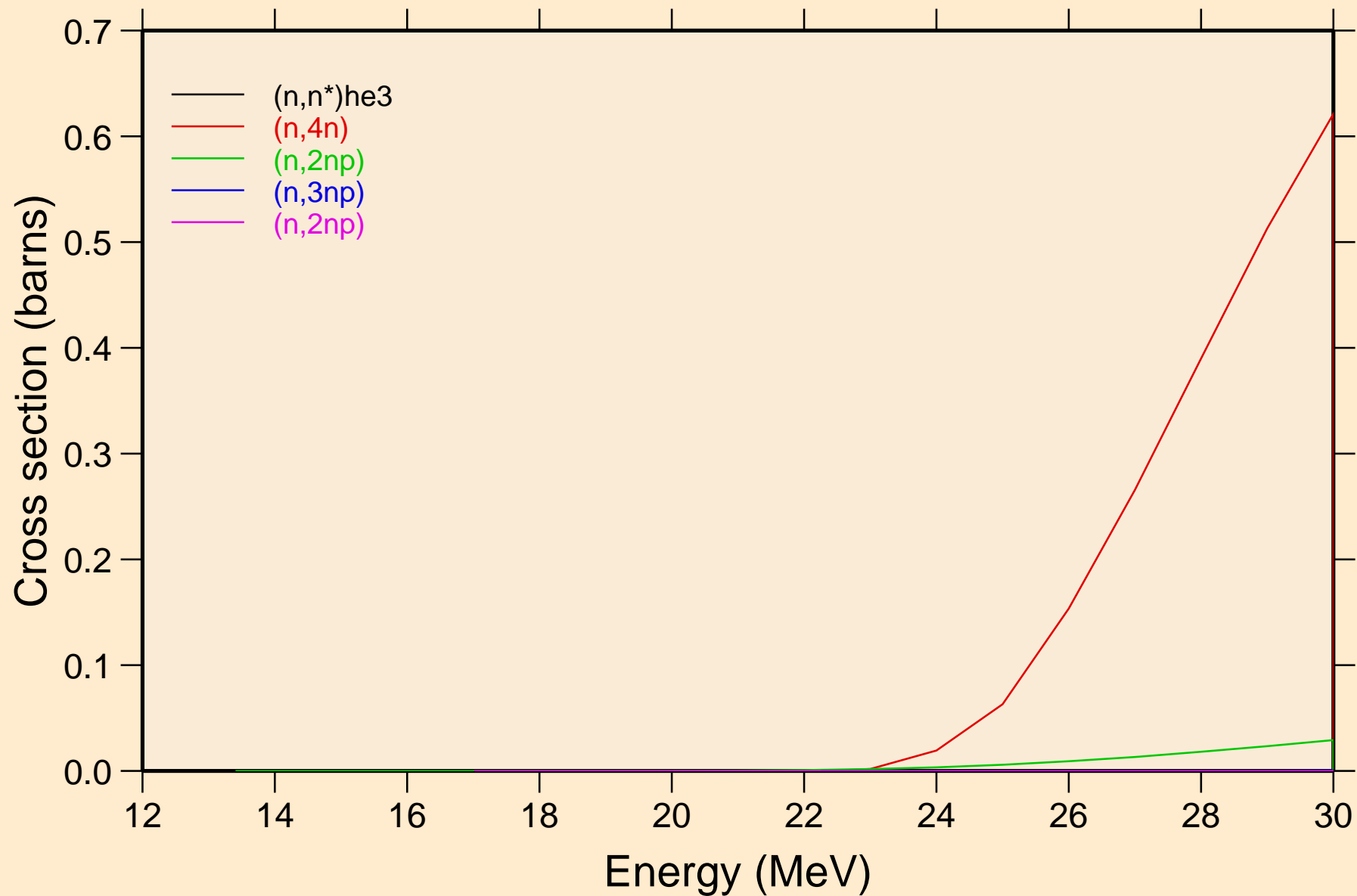

I130 NEUTRON ACER TENDL-2019 LIBRARY; T=293.16K  
Threshold reactions

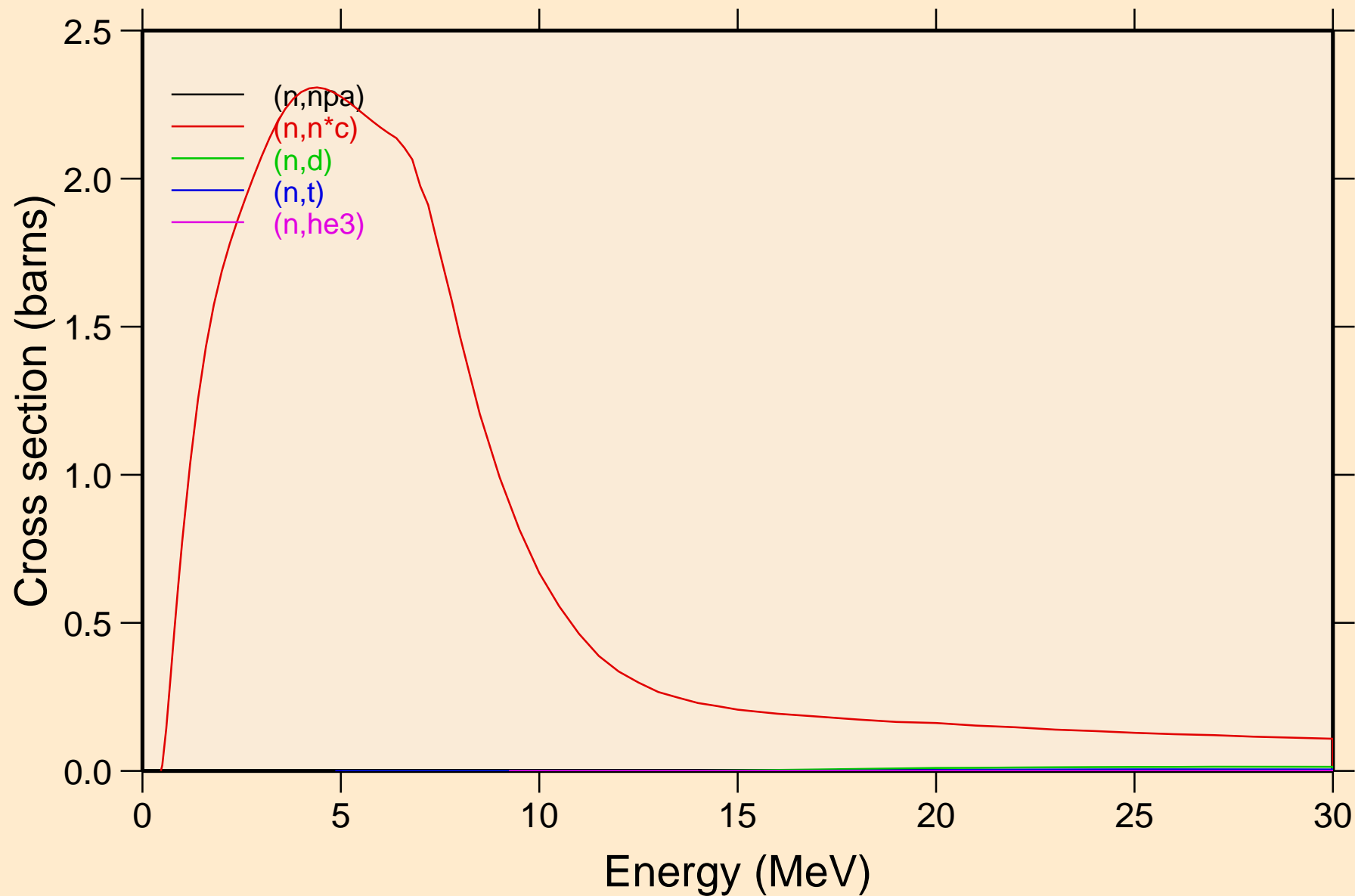



I130 NEUTRON ACER TENDL-2019 LIBRARY; T=293.16K  
Threshold reactions

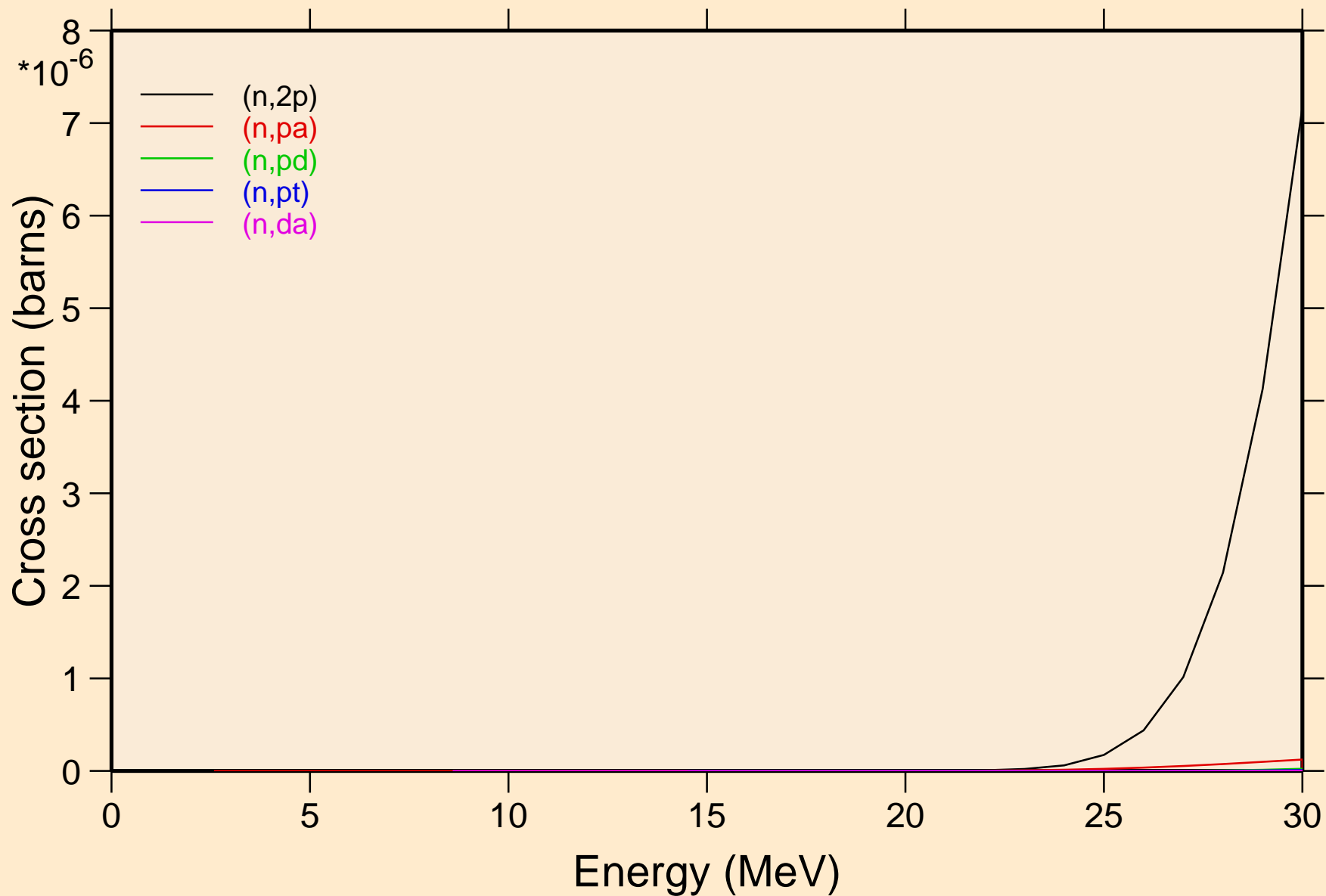

# I130 NEUTRON ACER TENDL-2019 LIBRARY; T=293.16K

## Threshold reactions

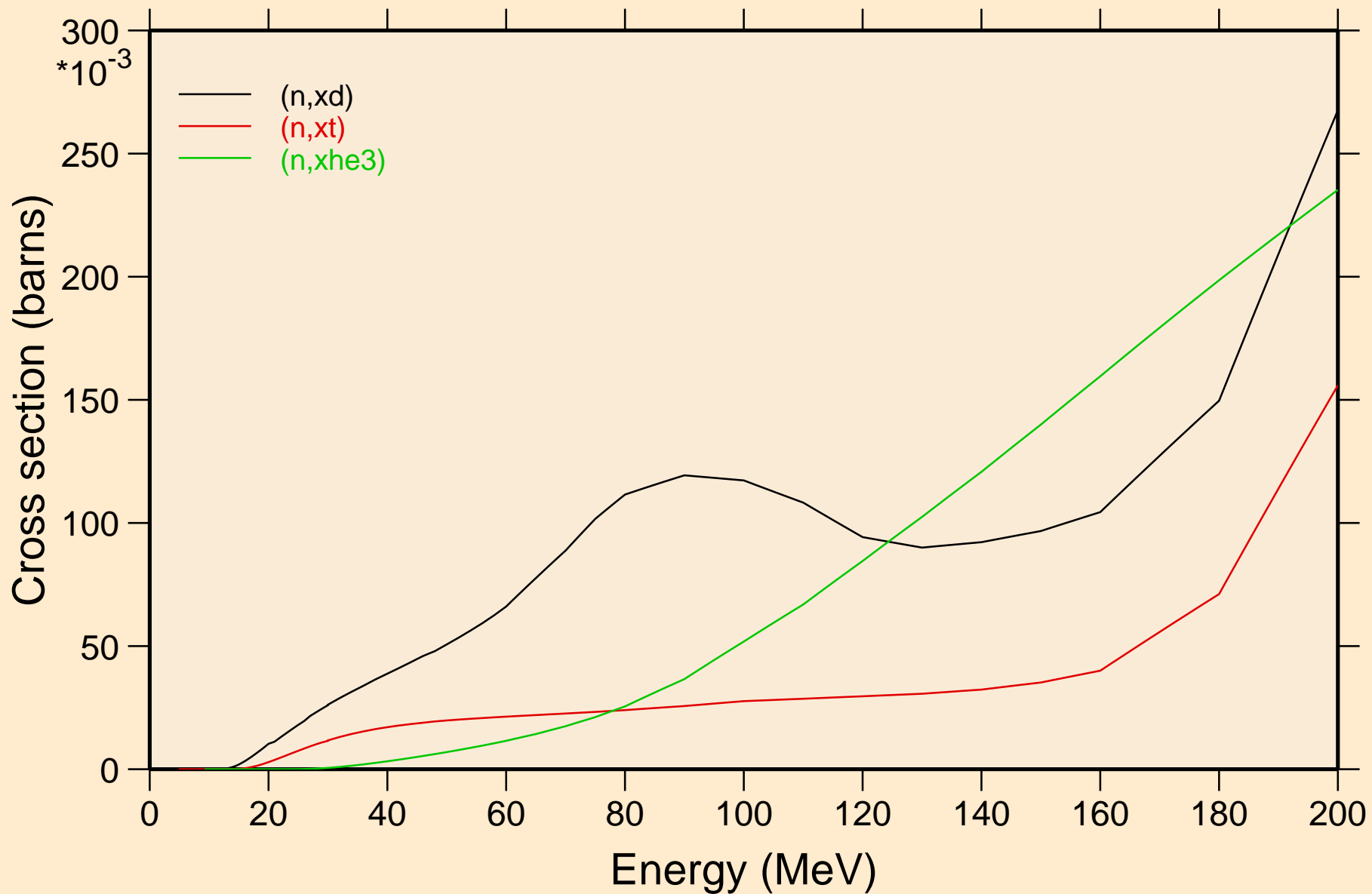

I130 NEUTRON ACER TENDL-2019 LIBRARY; T=293.16K  
angular distribution for elastic

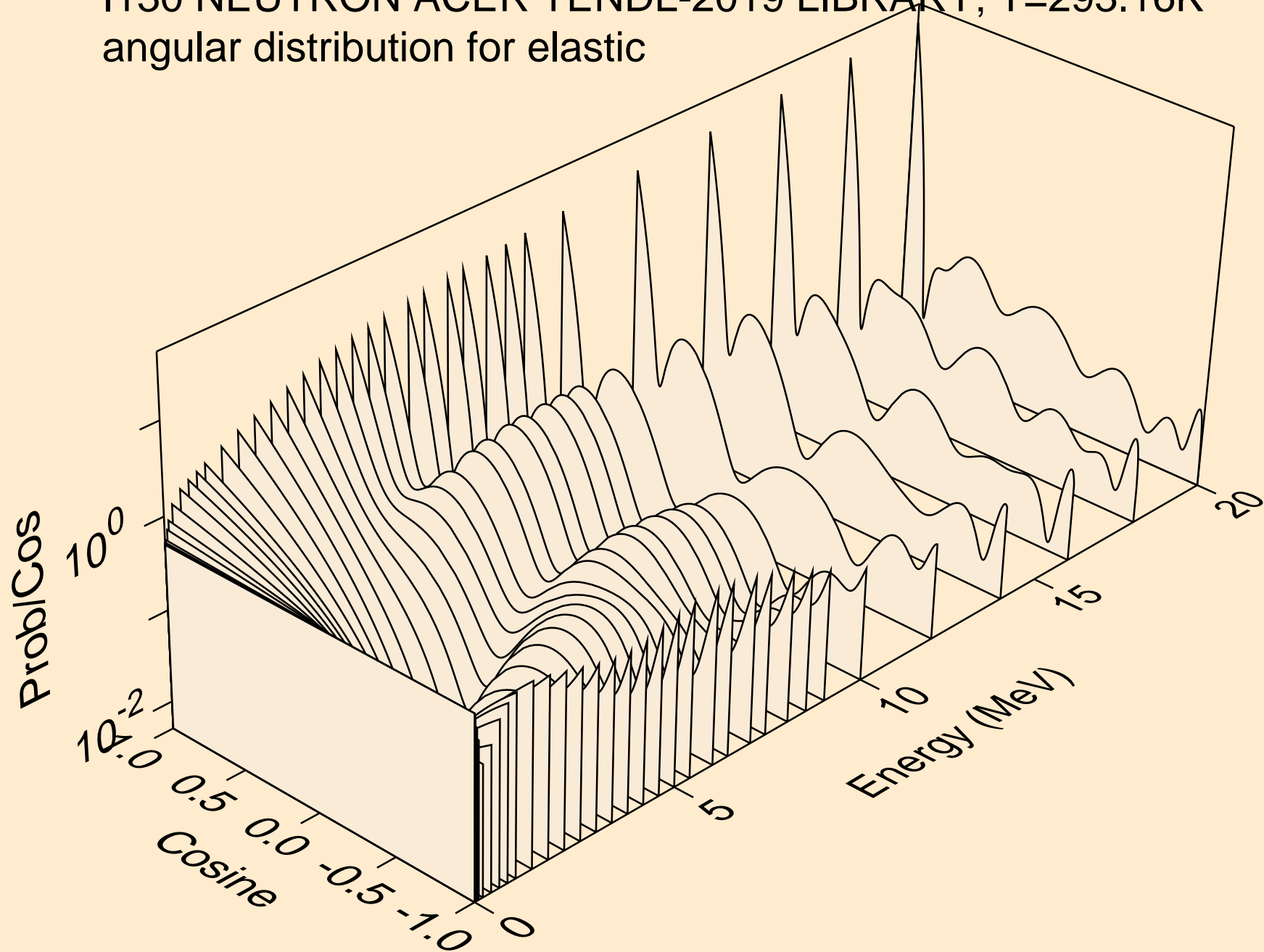

I130 NEUTRON ACER TENDL-2019 LIBRARY; T=293.16K  
angular distribution for elastic

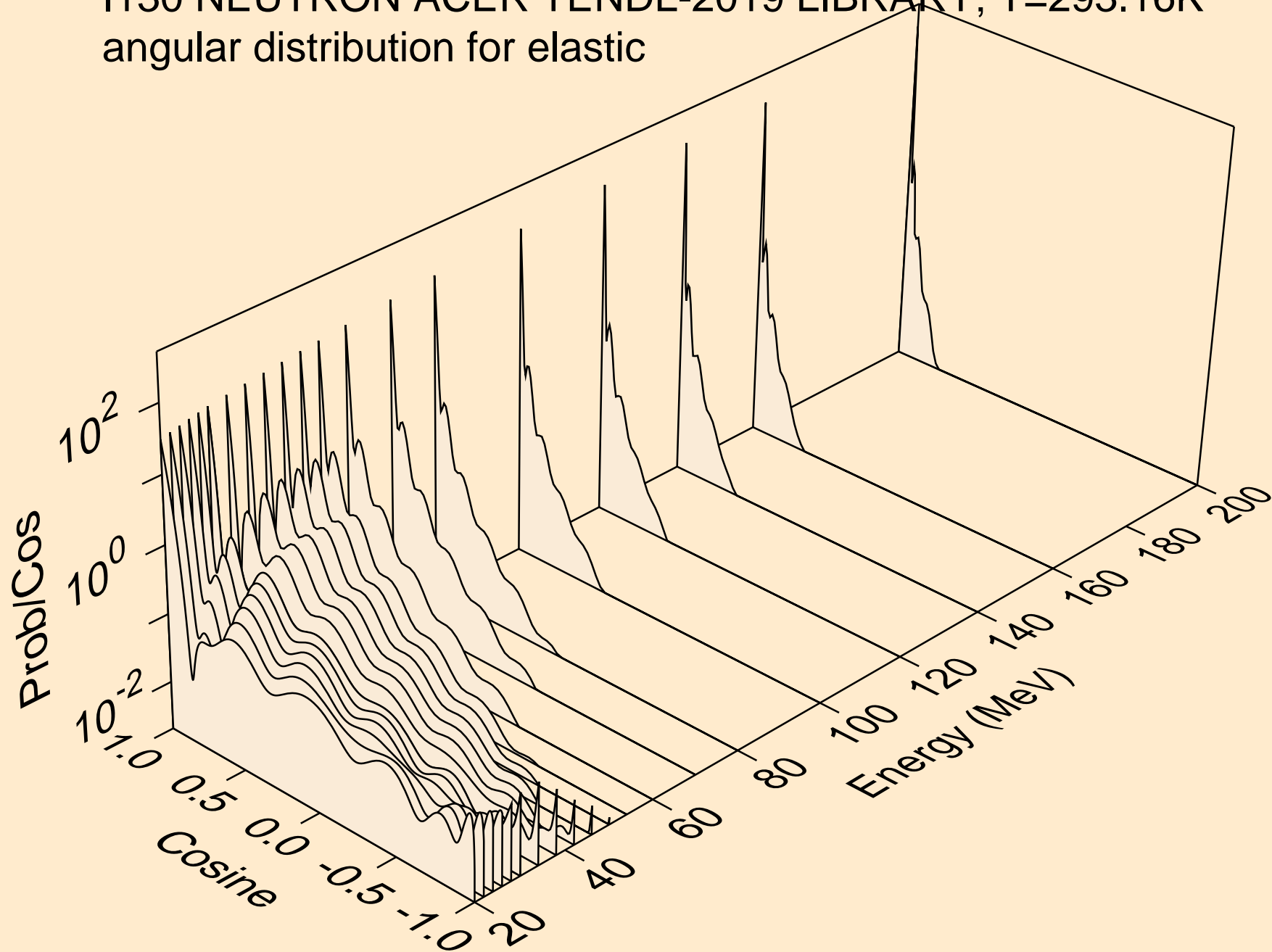

I130 NEUTRON ACER TENDL-2019 LIBRARY; T=293.16K  
angular distribution for (n,n\*1)

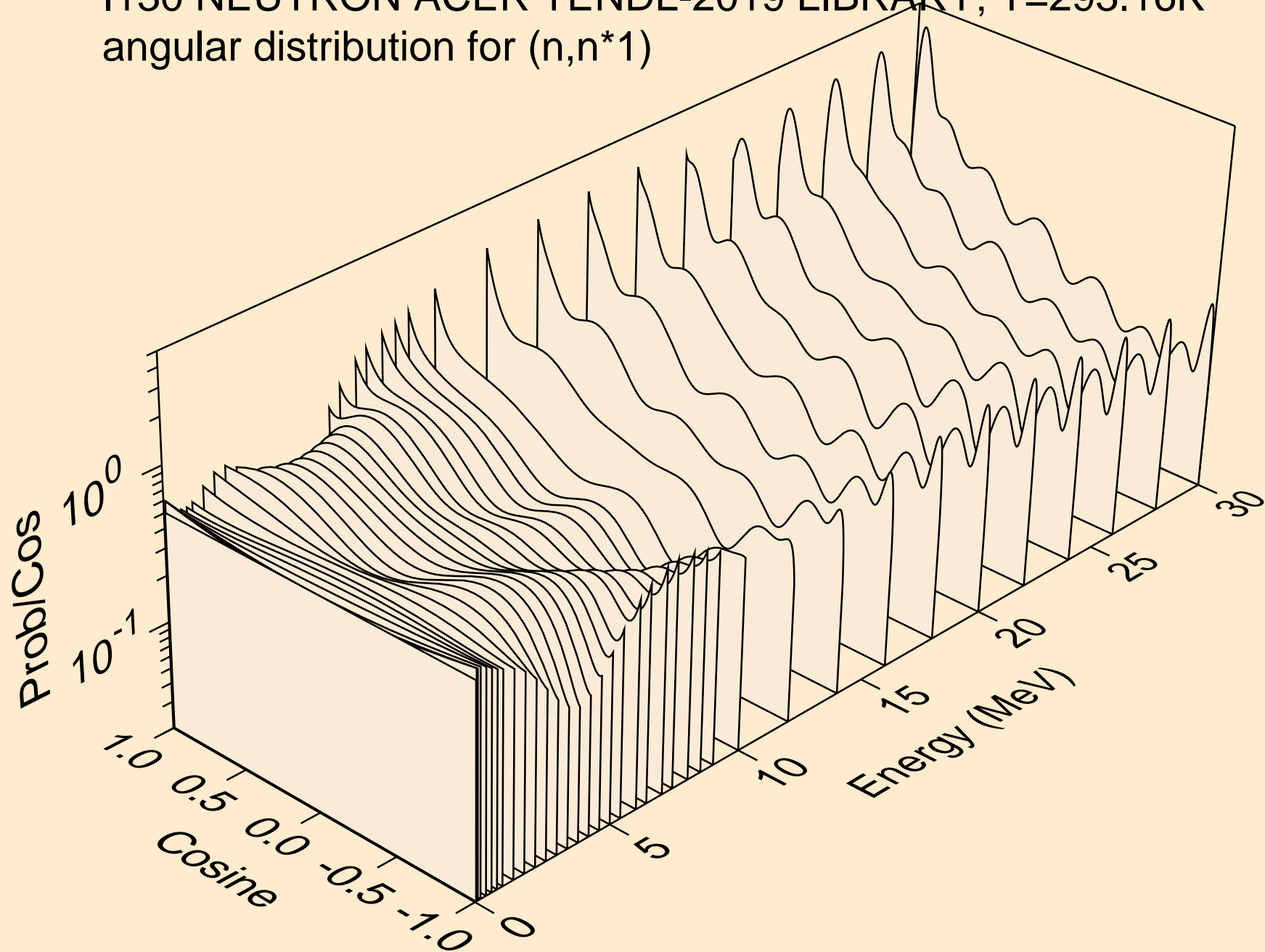

I130 NEUTRON ACER TENDL-2019 LIBRARY; T=293.16K  
angular distribution for (n,n\*2)

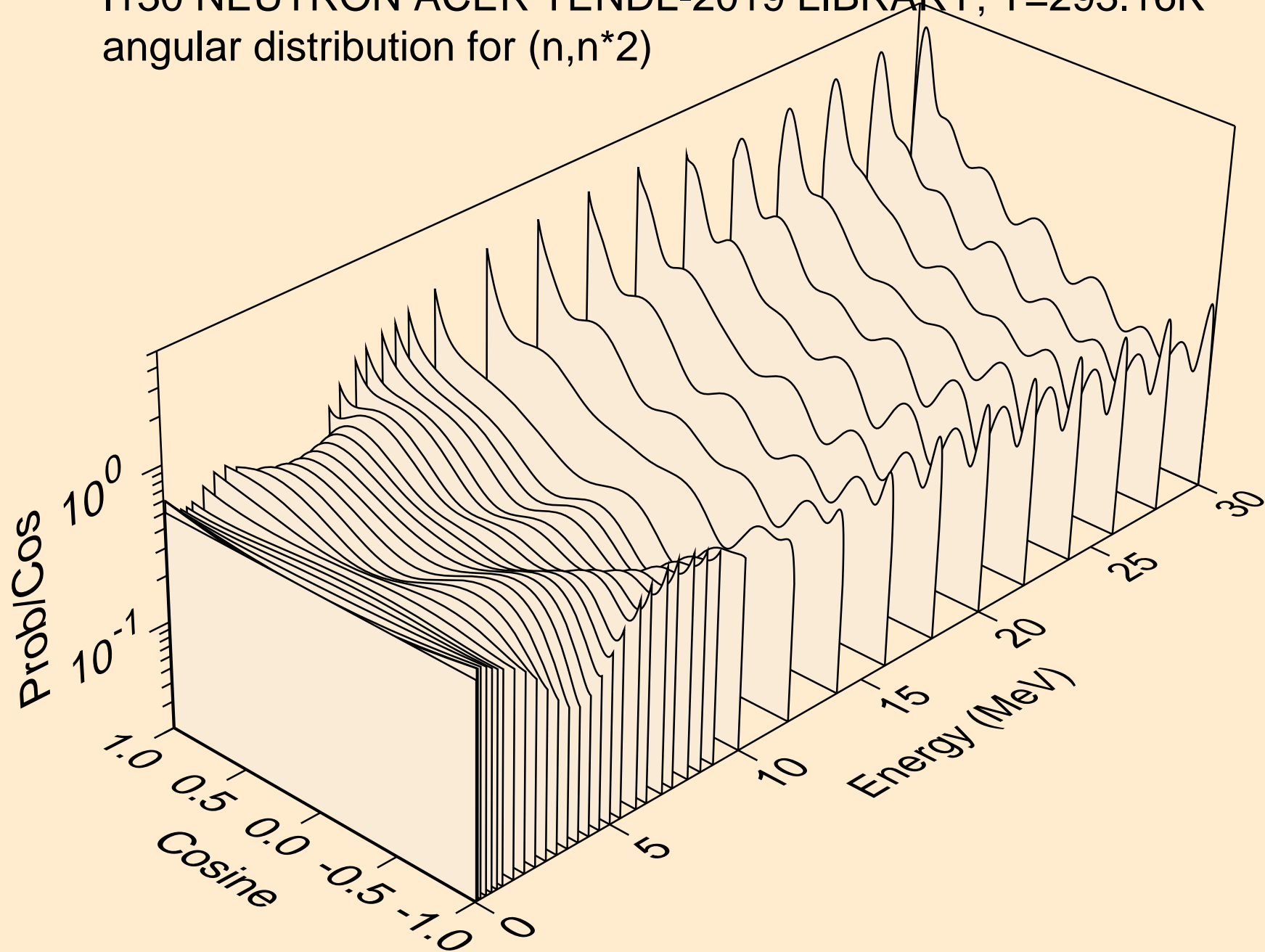

I130 NEUTRON ACER TENDL-2019 LIBRARY; T=293.16K  
angular distribution for (n,n\*3)

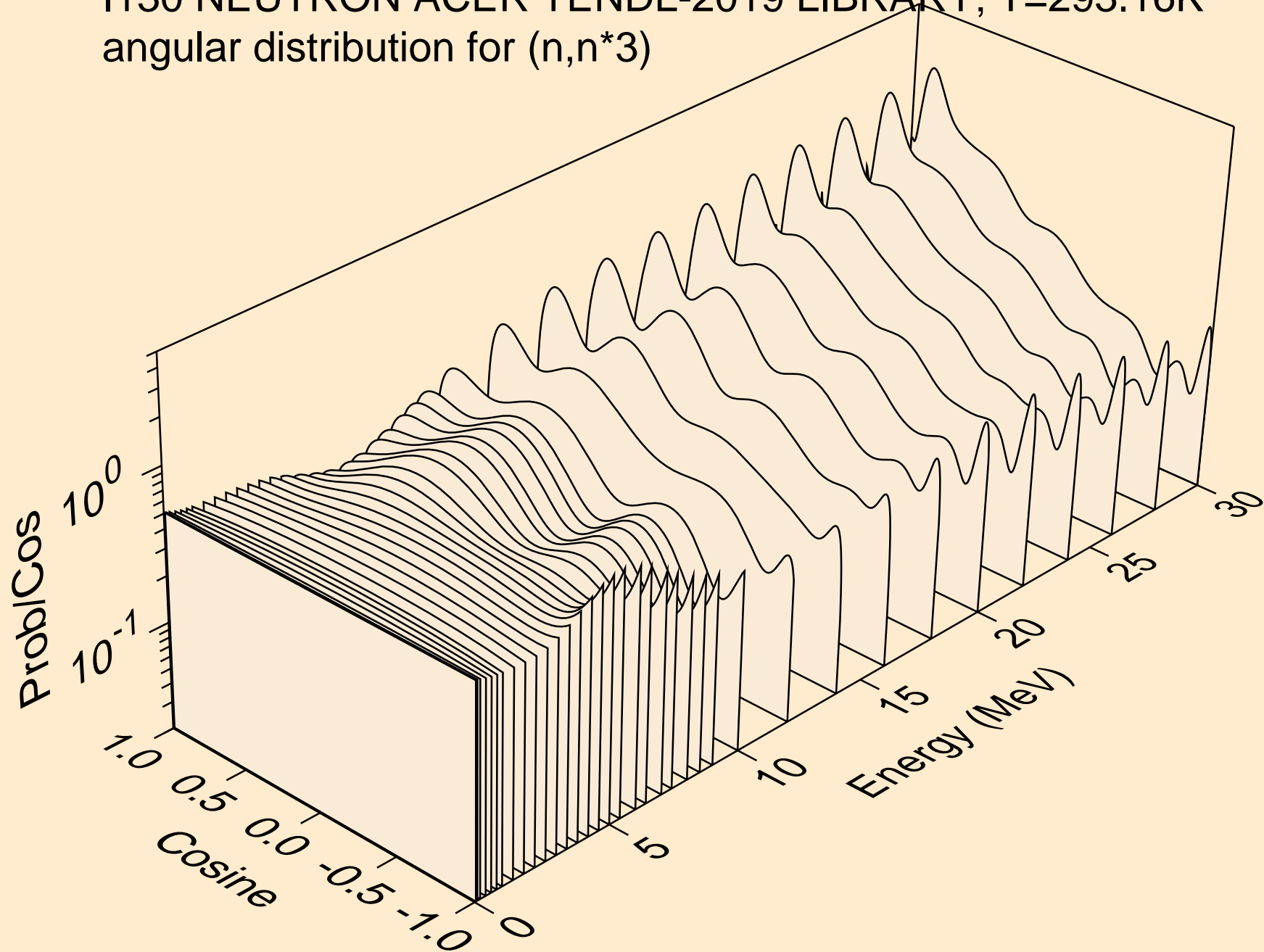

I130 NEUTRON ACER TENDL-2019 LIBRARY; T=293.16K  
angular distribution for (n,n\*4)

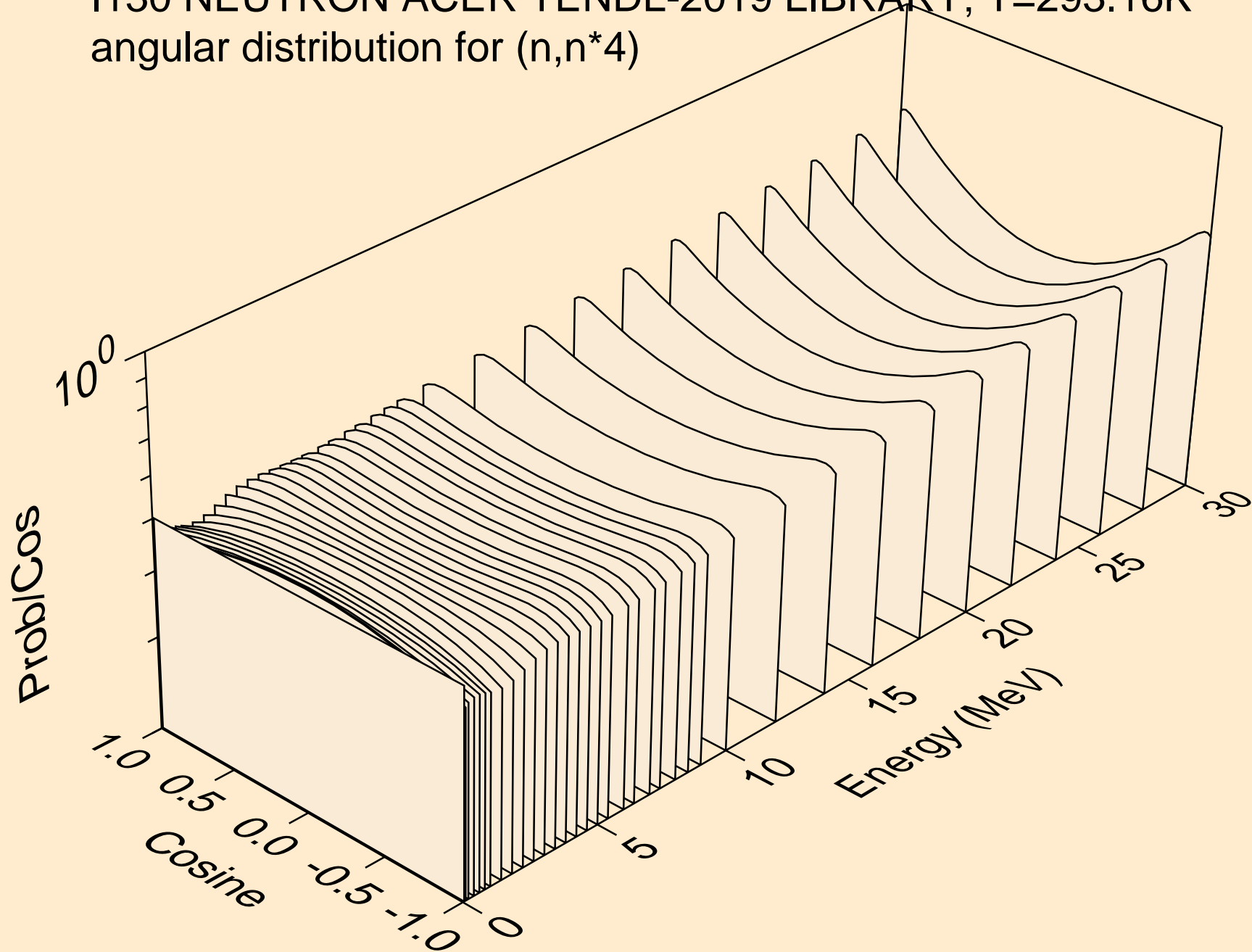



I130 NEUTRON ACER TENDL-2019 LIBRARY; T=293.16K  
angular distribution for (n,n\*5)

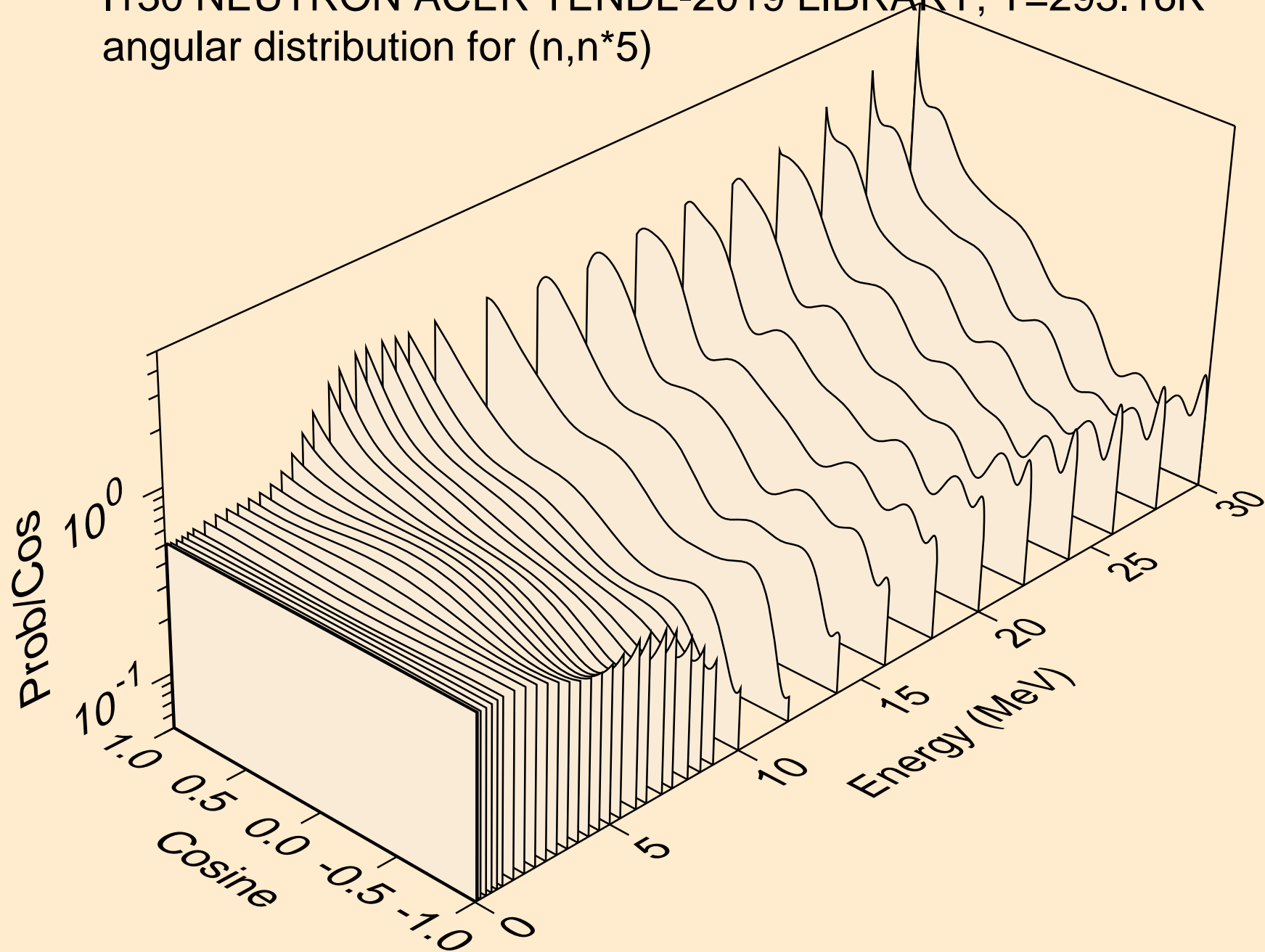

I130 NEUTRON ACER TENDL-2019 LIBRARY; T=293.16K  
angular distribution for (n,n\*6)

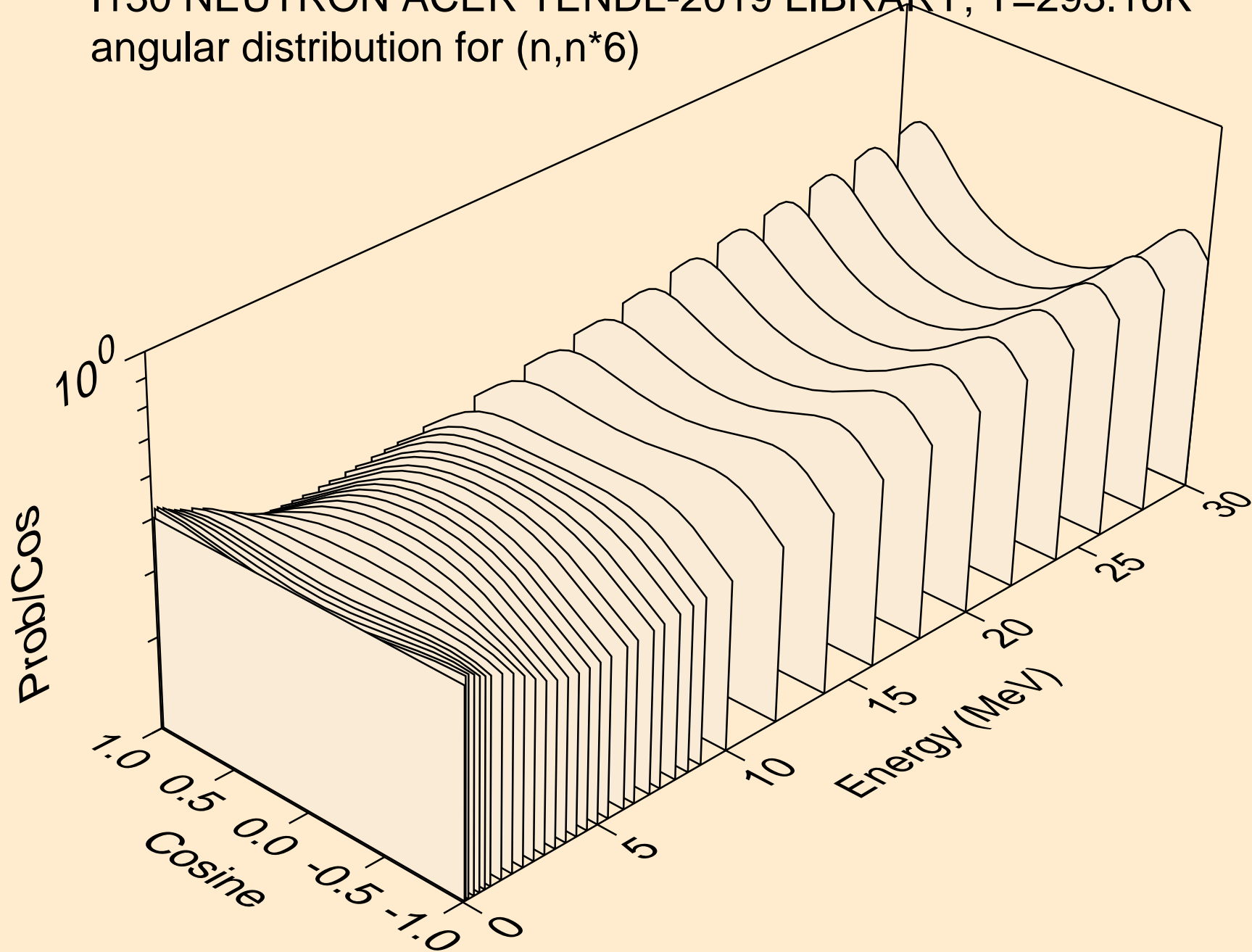

I130 NEUTRON ACER TENDL-2019 LIBRARY; T=293.16K  
angular distribution for (n,n\*7)

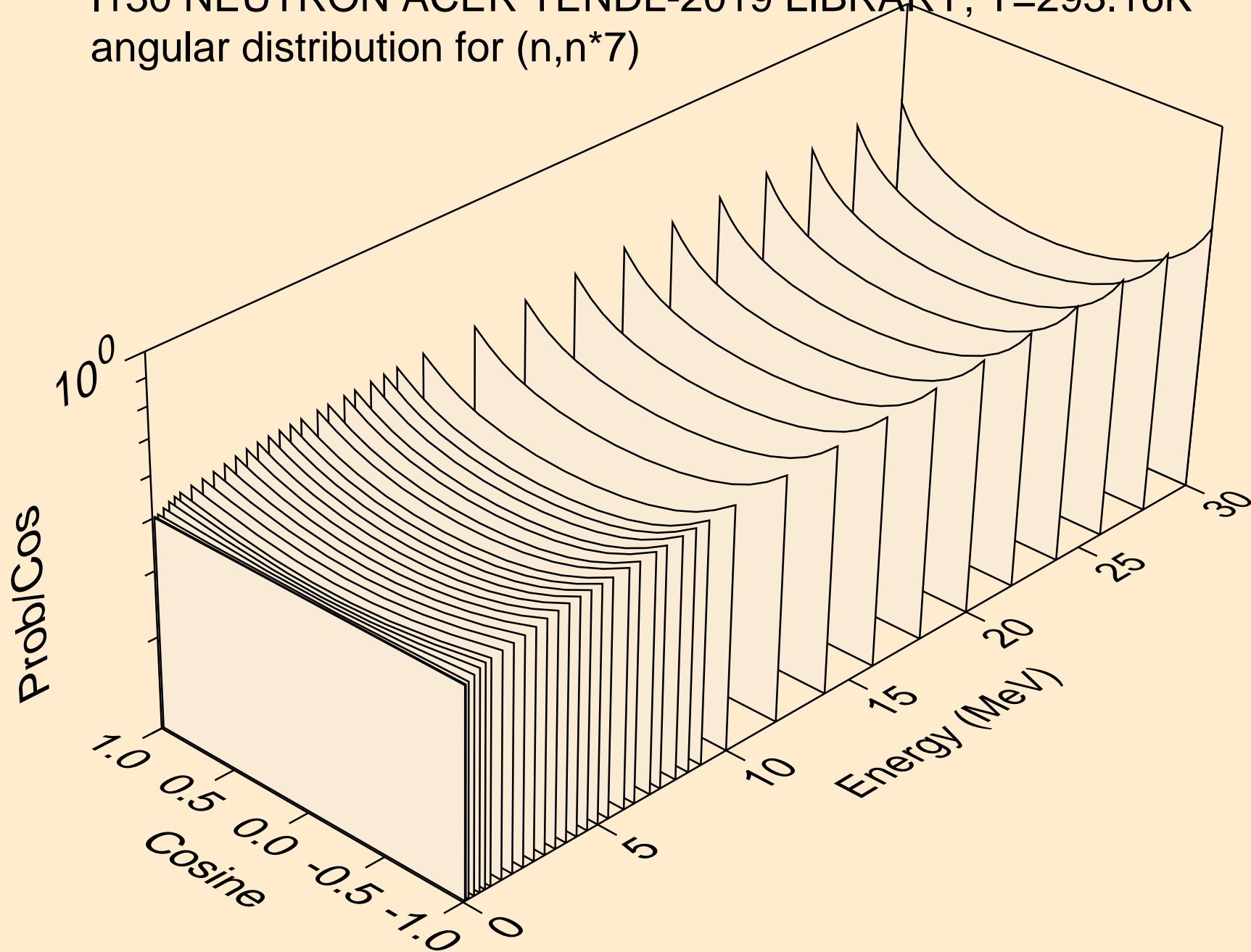

I130 NEUTRON ACER TENDL-2019 LIBRARY; T=293.16K  
angular distribution for (n,n\*8)

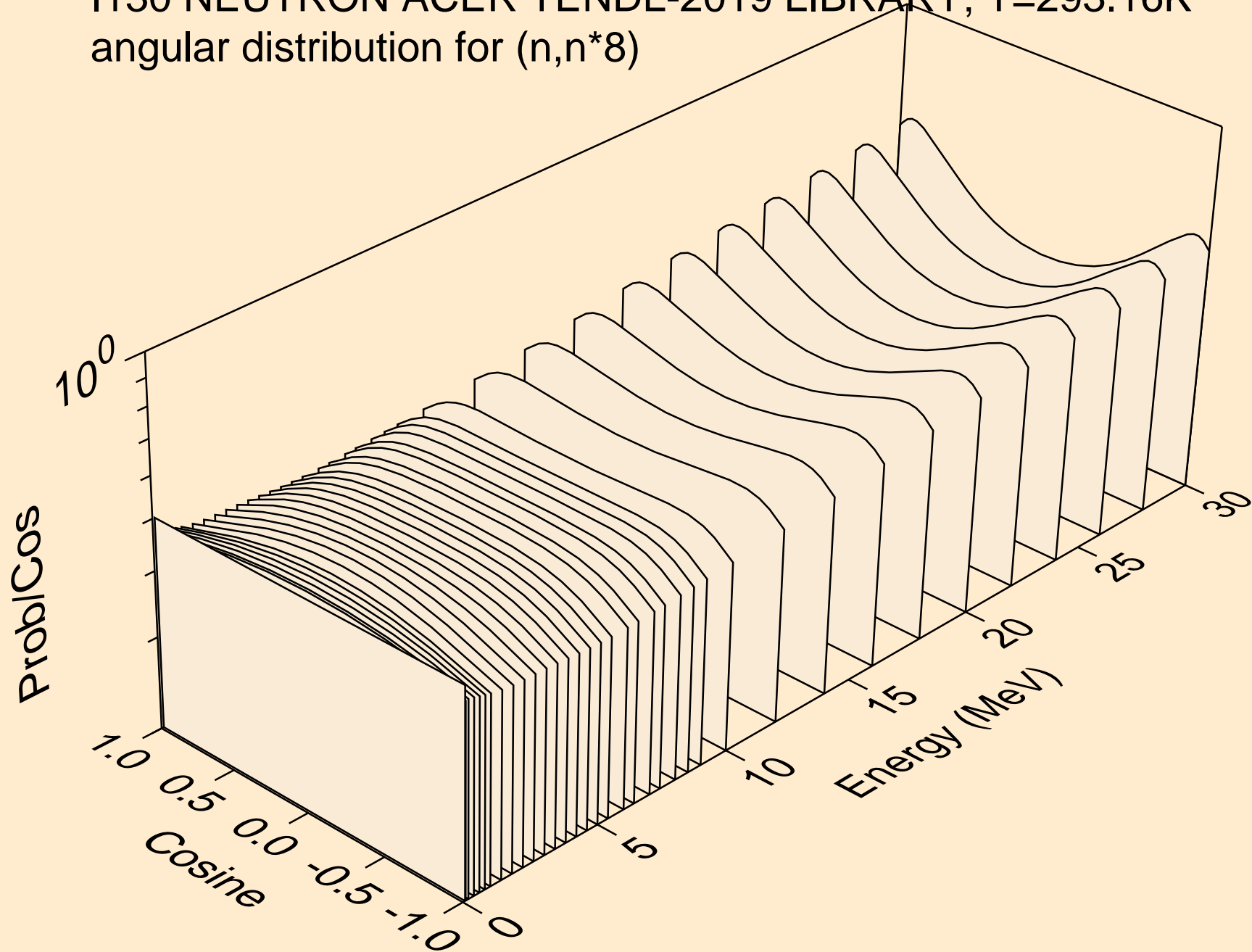

I130 NEUTRON ACER TENDL-2019 LIBRARY; T=293.16K  
angular distribution for (n,n\*9)

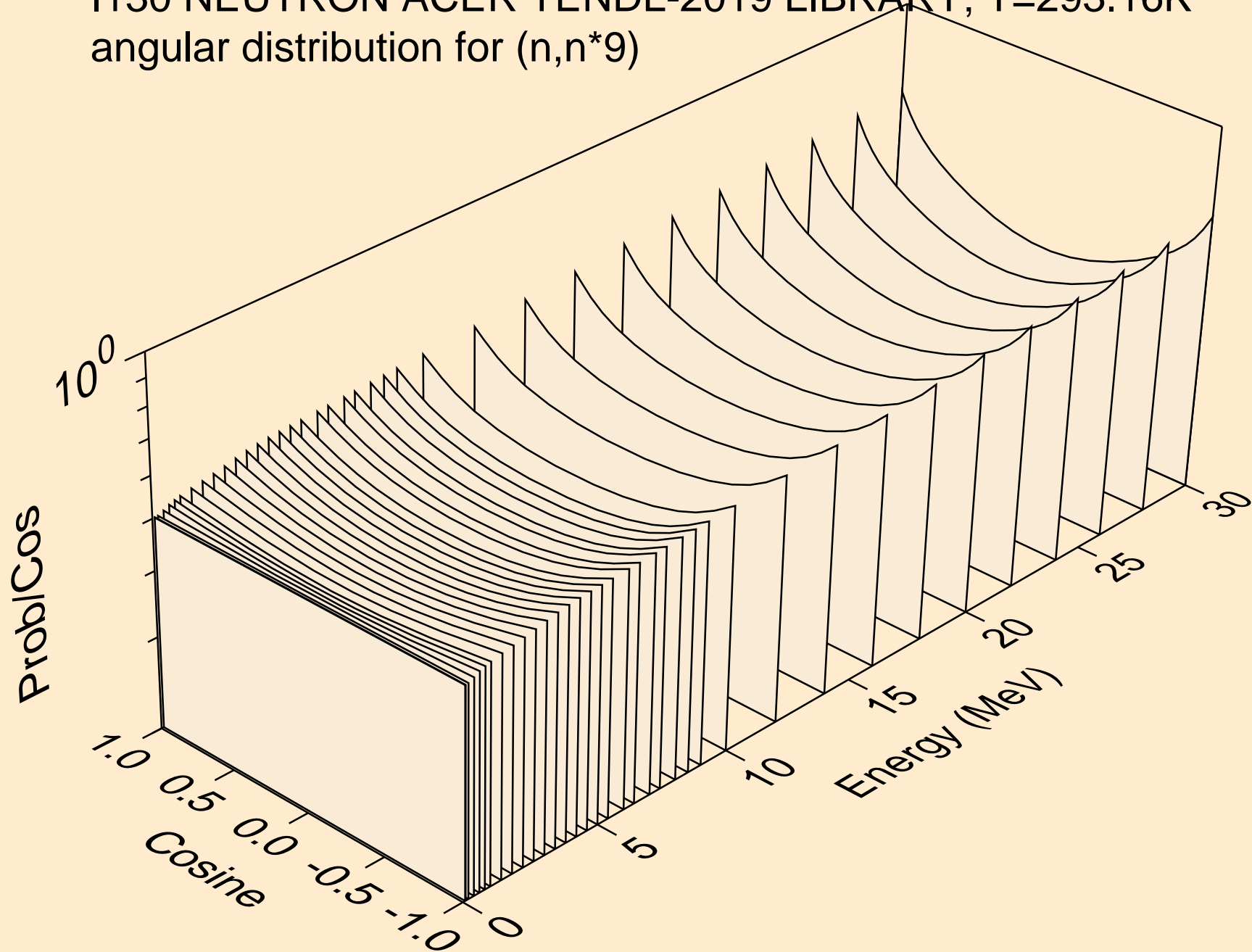

I130 NEUTRON ACER TENDL-2019 LIBRARY; T=293.16K  
angular distribution for (n,n\*10)

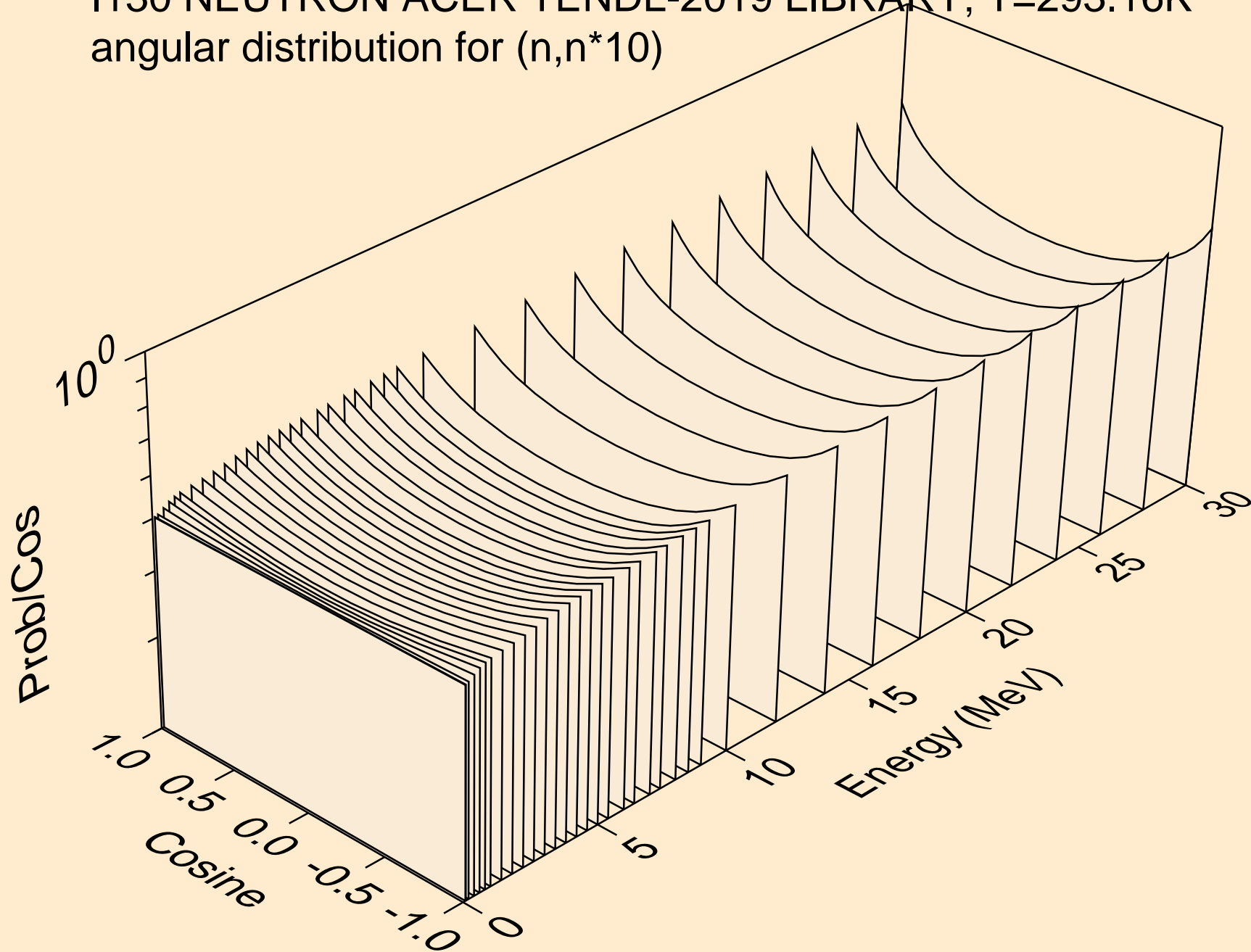

I130 NEUTRON ACER TENDL-2019 LIBRARY; T=293.16K  
angular distribution for (n,n\*11)

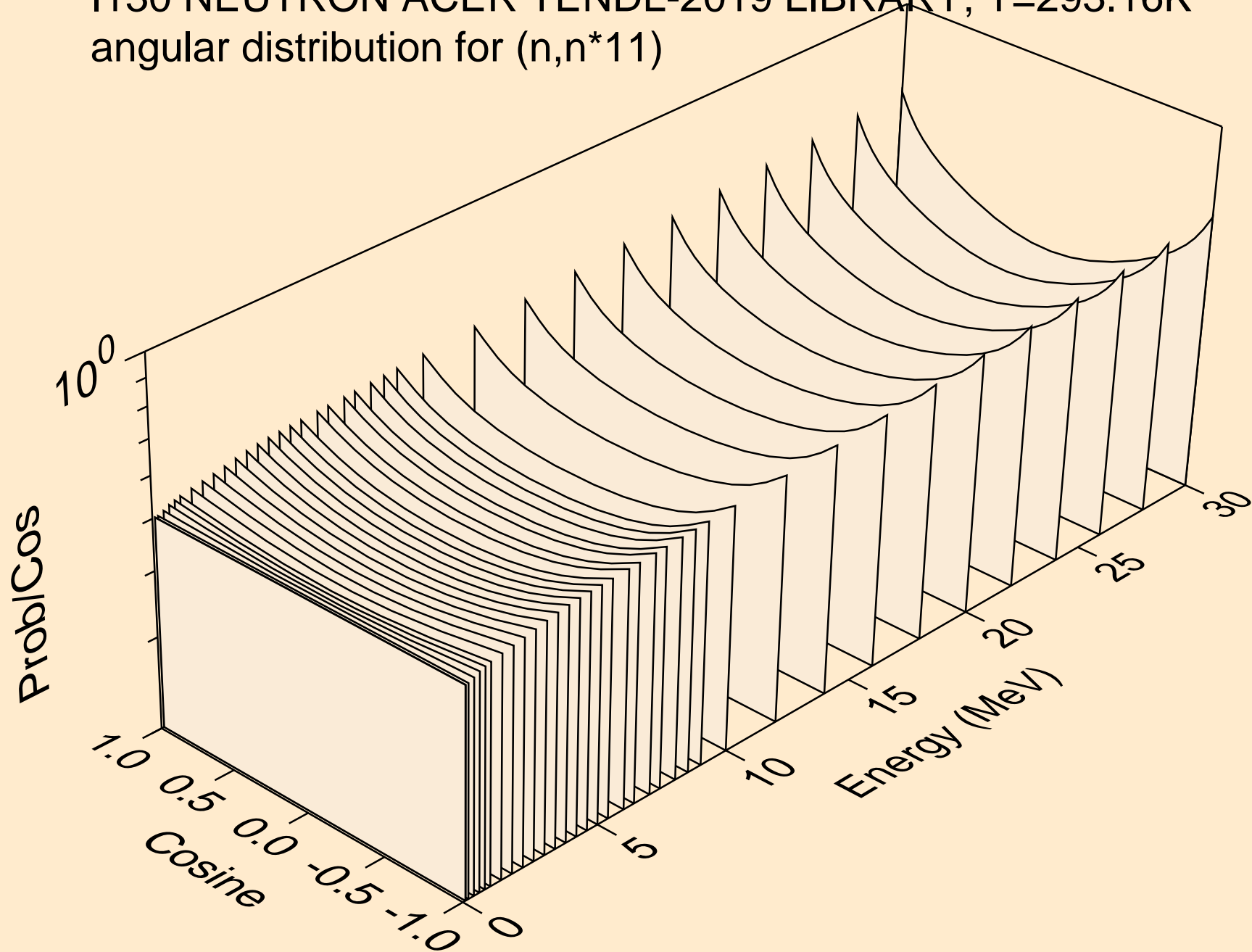

I130 NEUTRON ACER TENDL-2019 LIBRARY; T=293.16K  
angular distribution for (n,n\*12)

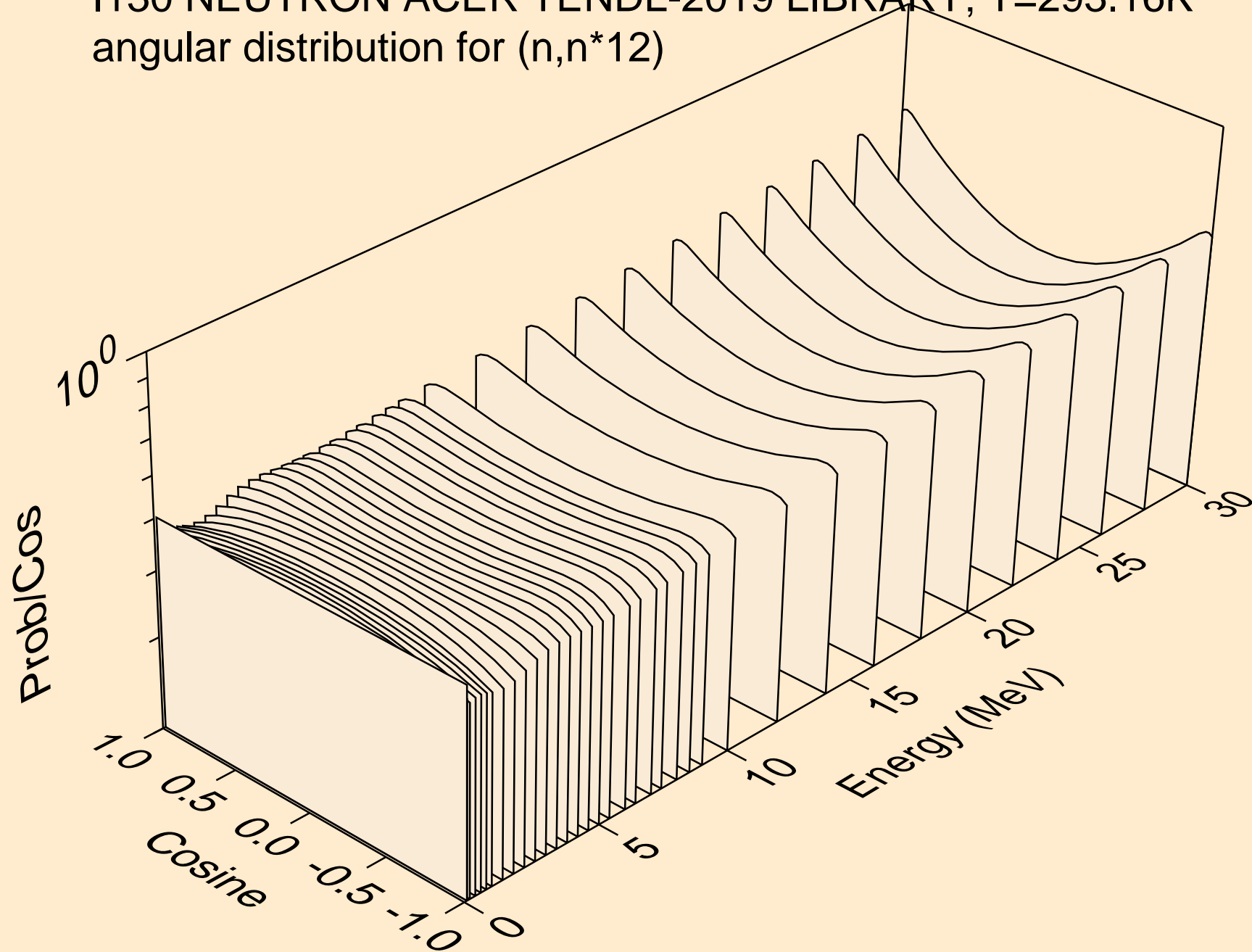



I130 NEUTRON ACER TENDL-2019 LIBRARY; T=293.16K  
angular distribution for (n,n\*13)

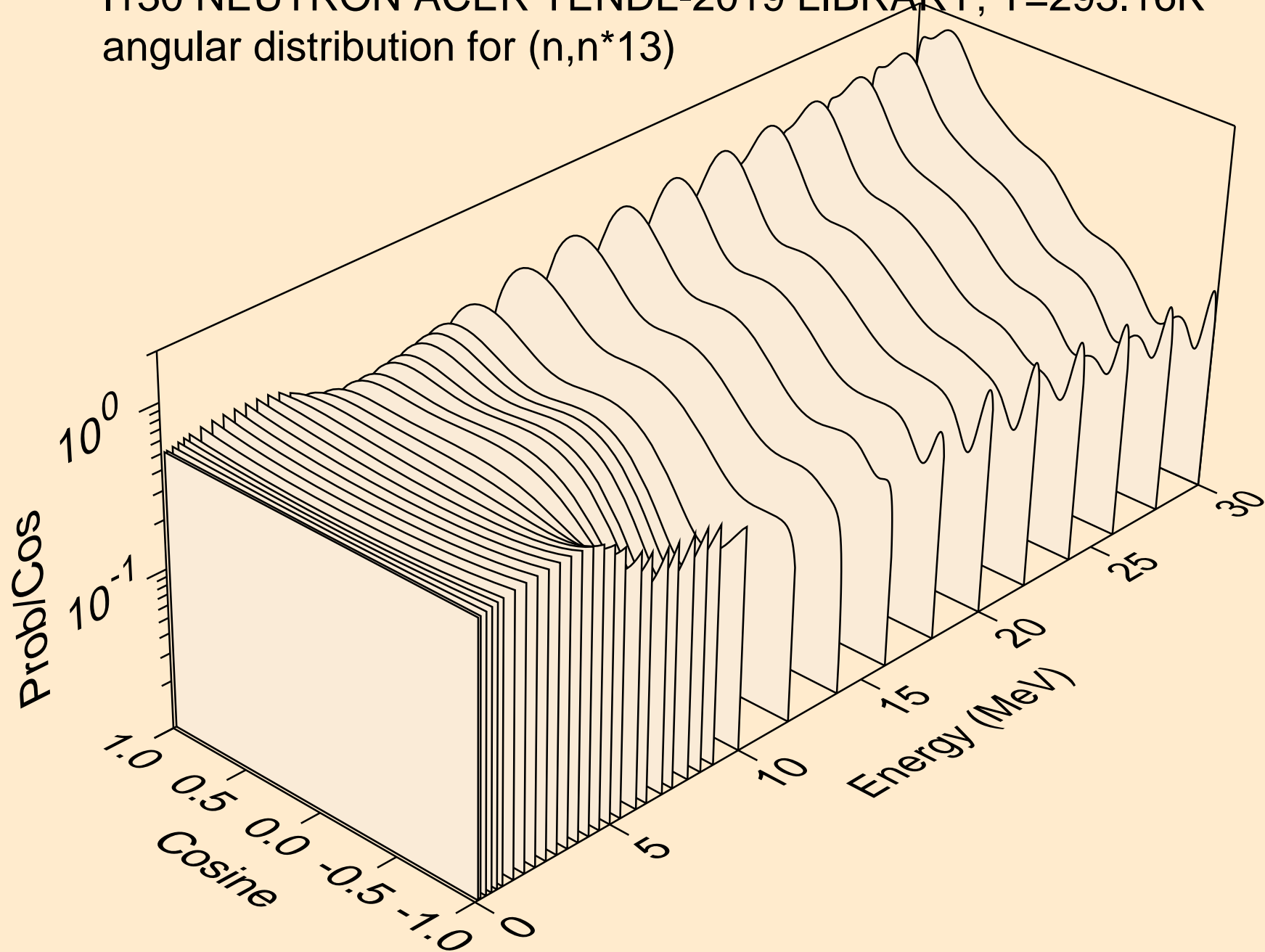

I130 NEUTRON ACER TENDL-2019 LIBRARY; T=293.16K  
angular distribution for (n,n\*14)

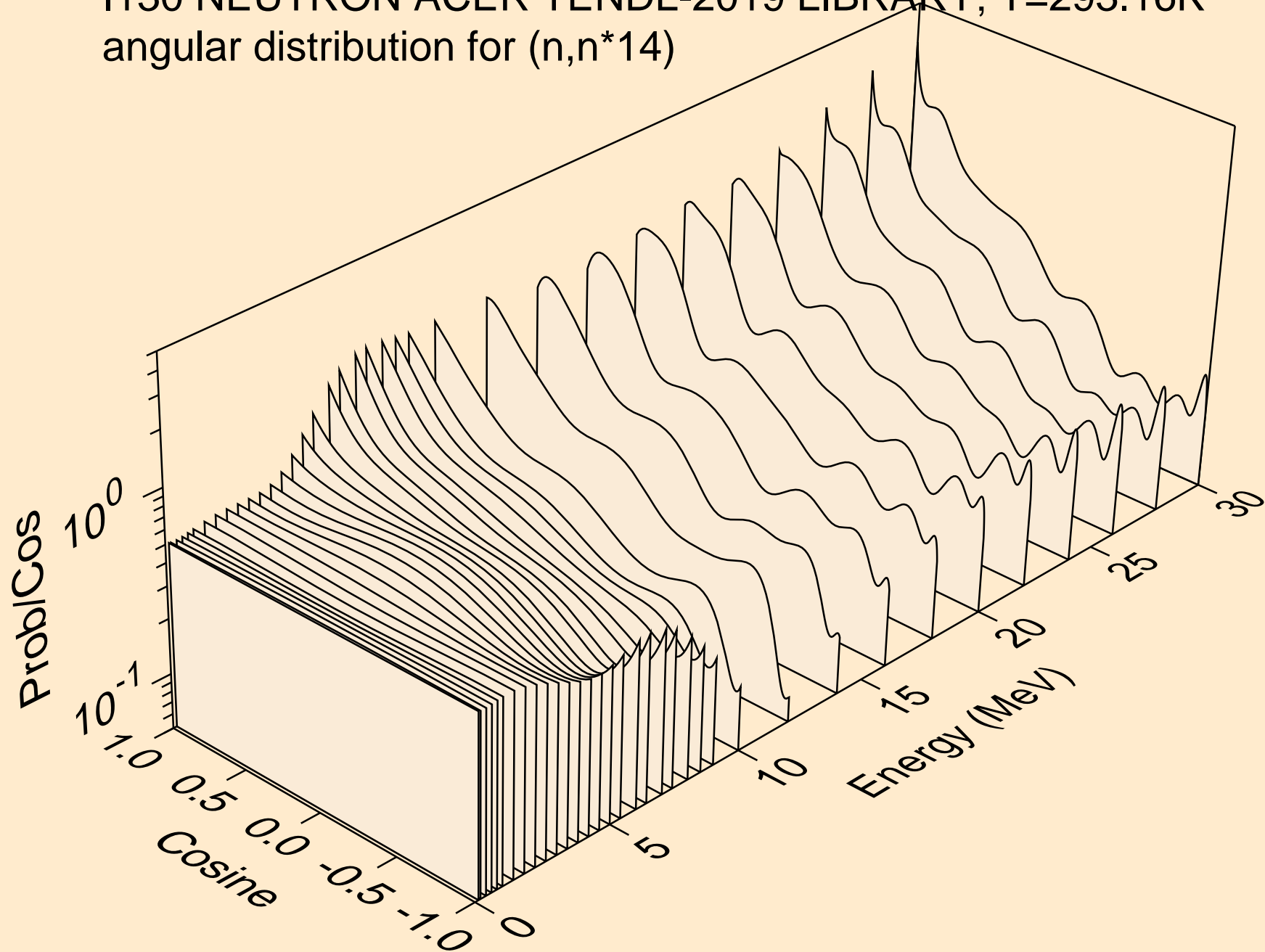

I130 NEUTRON ACER TENDL-2019 LIBRARY; T=293.16K  
angular distribution for (n,n\*15)

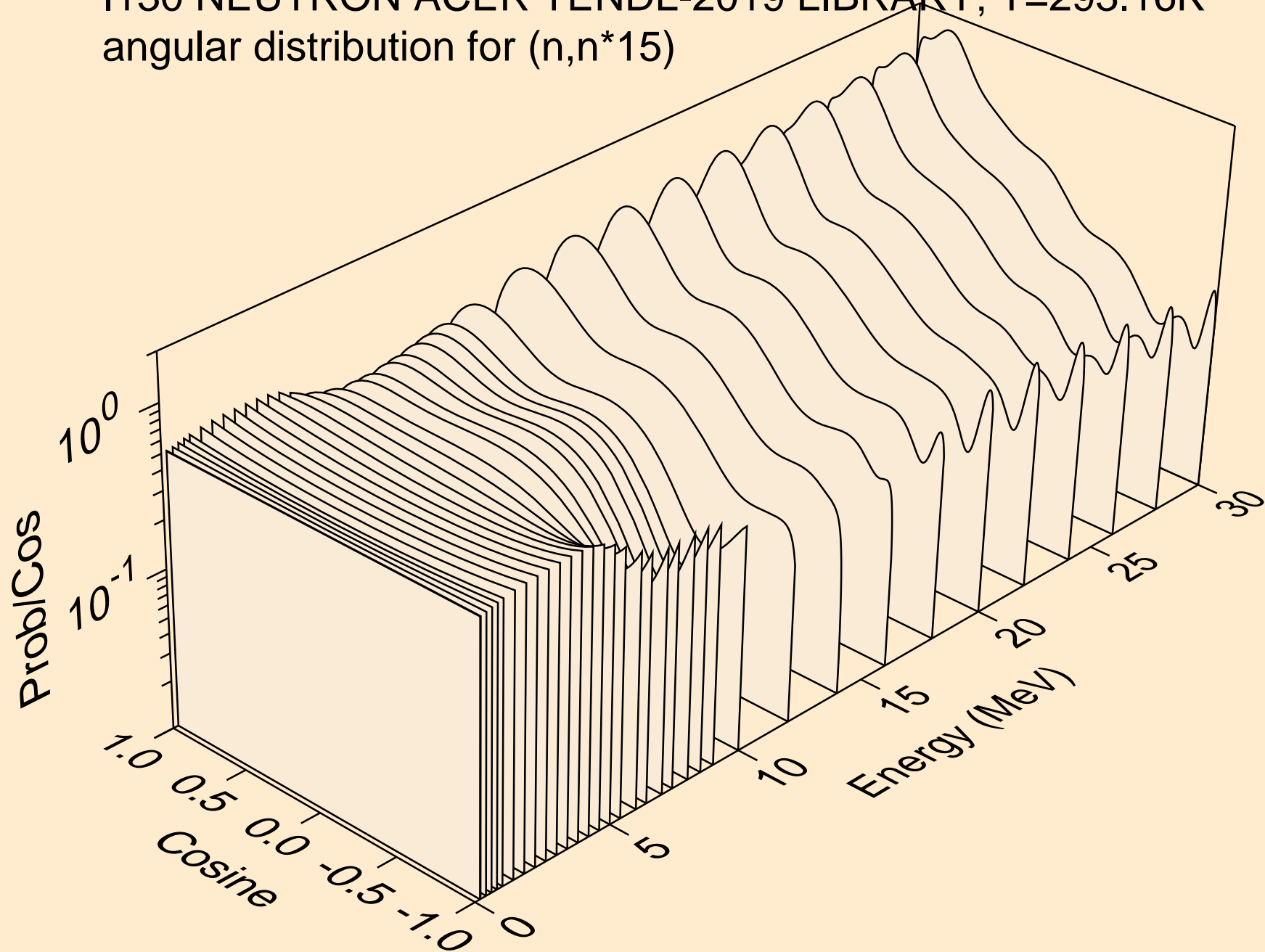

I130 NEUTRON ACER TENDL-2019 LIBRARY; T=293.16K  
angular distribution for (n,n\*16)

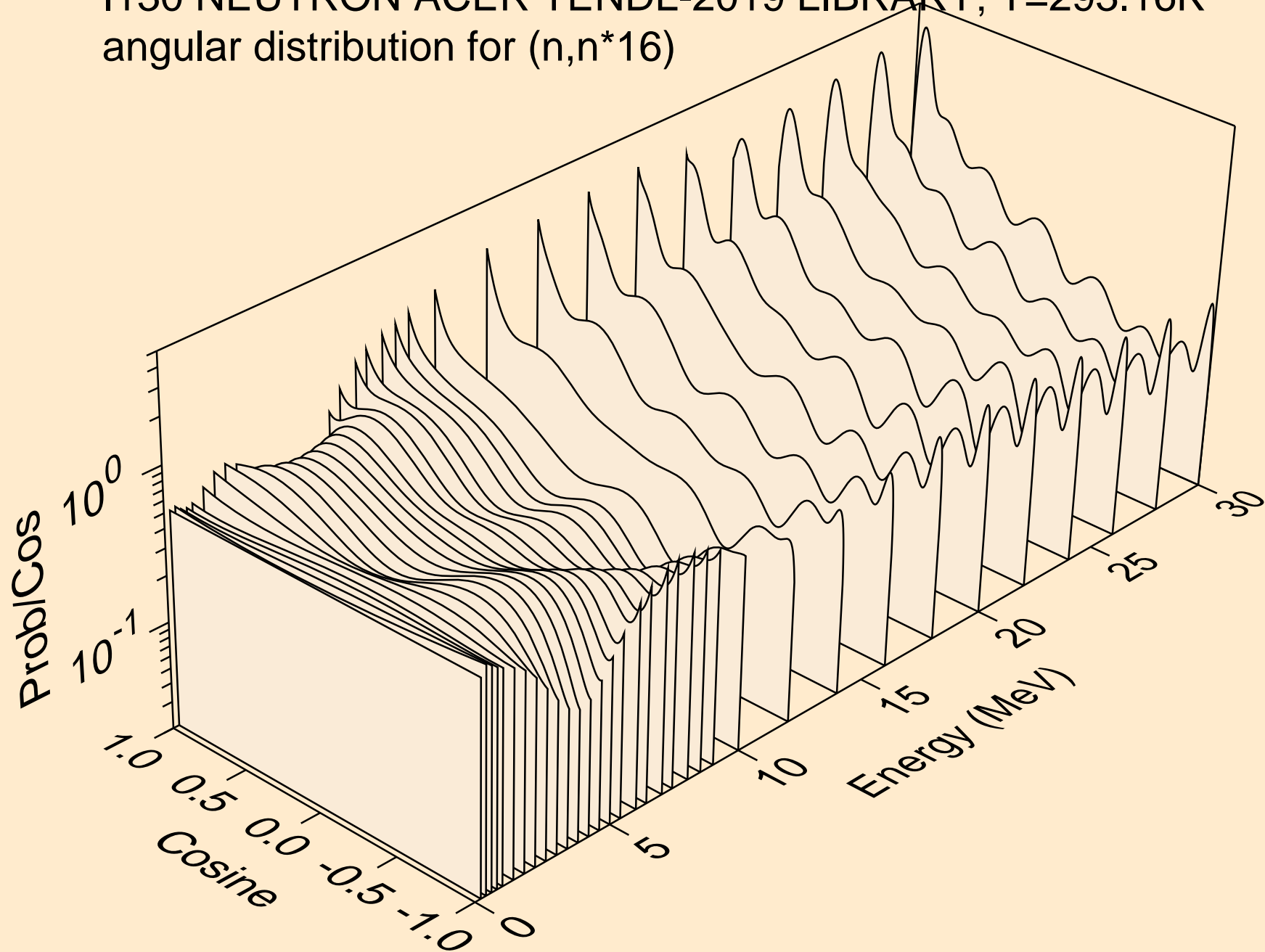

I130 NEUTRON ACER TENDL-2019 LIBRARY; T=293.16K  
angular distribution for (n,n\*17)

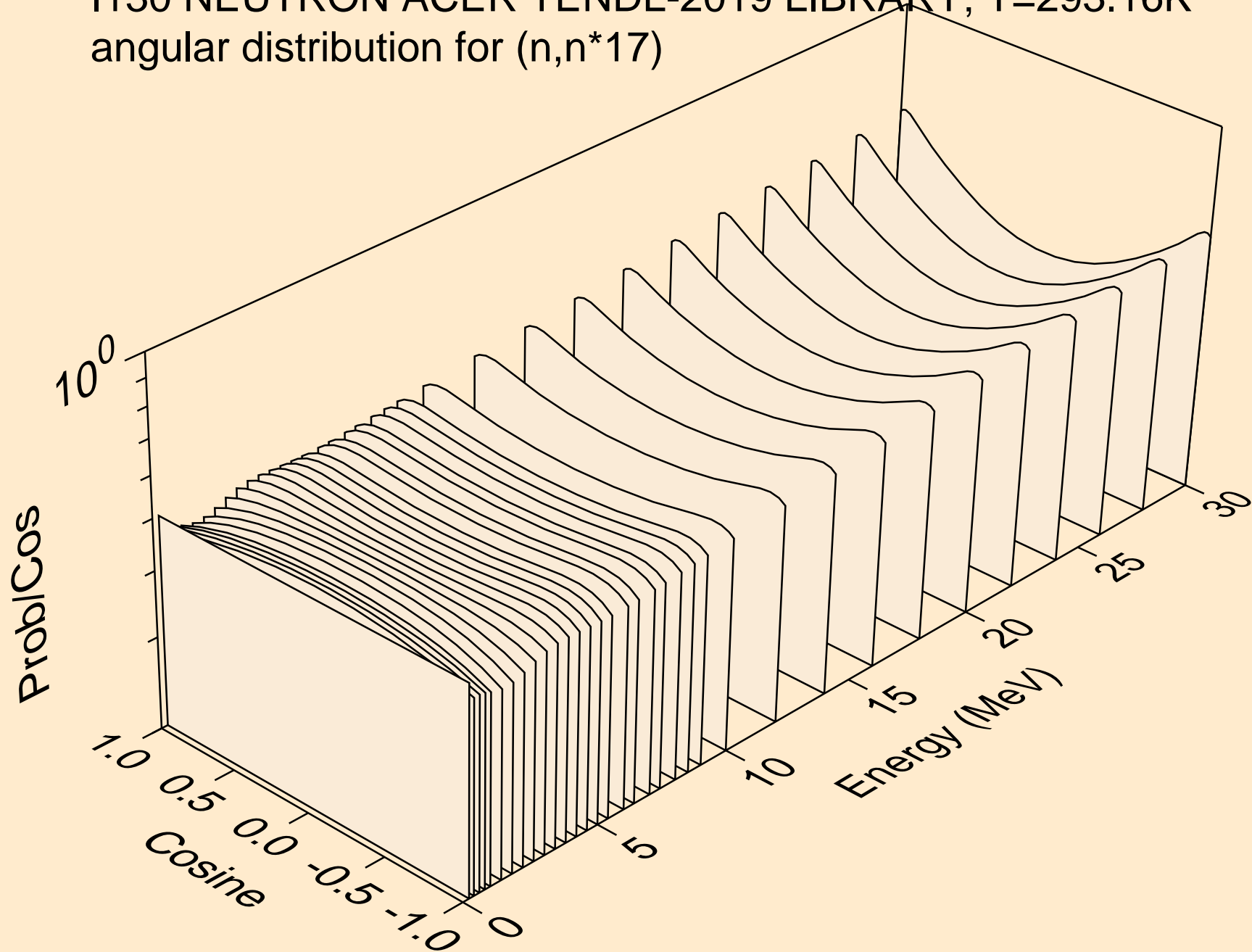

I130 NEUTRON ACER TENDL-2019 LIBRARY; T=293.16K  
angular distribution for (n,n\*18)

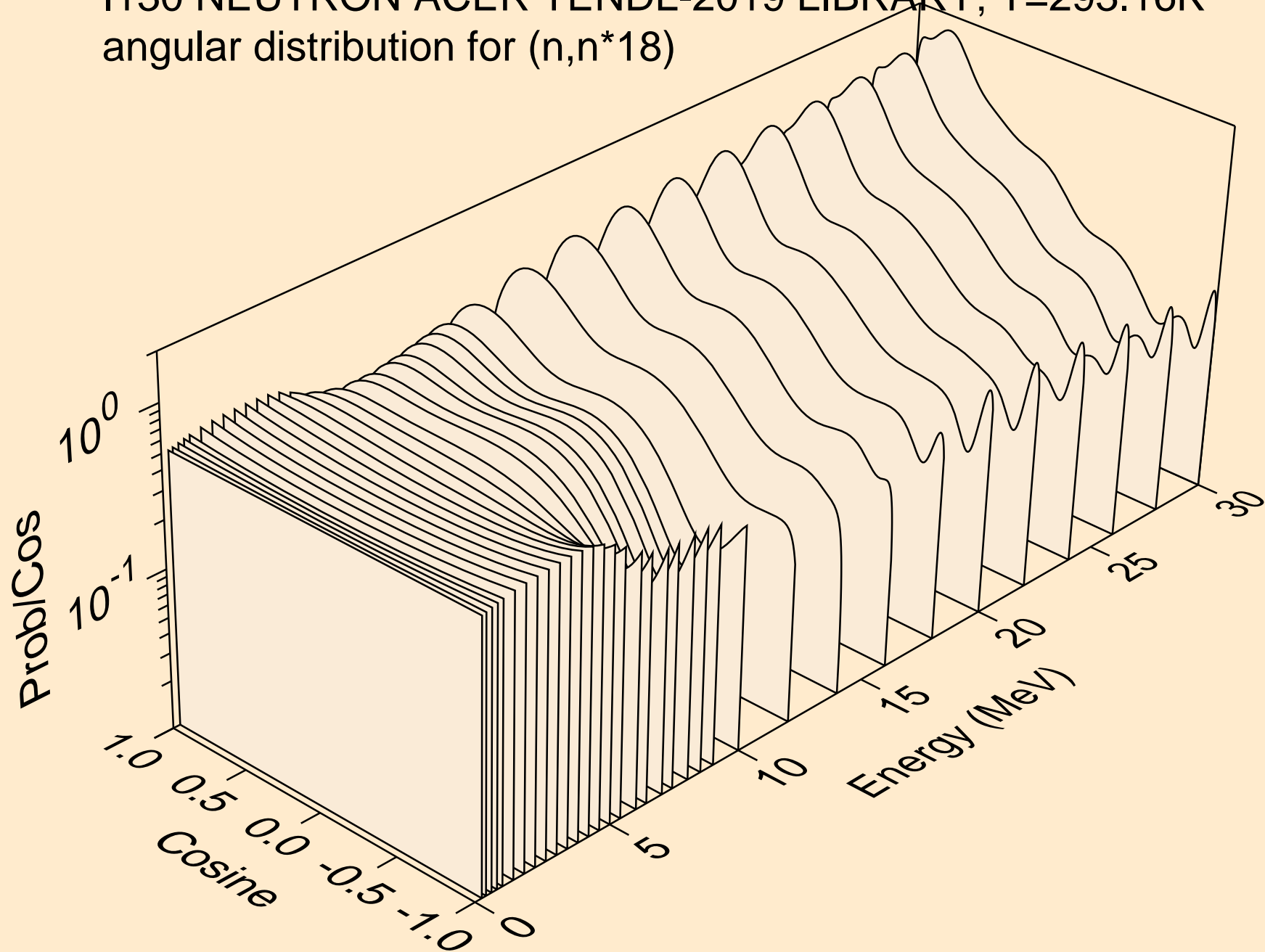

I130 NEUTRON ACER TENDL-2019 LIBRARY; T=293.16K  
angular distribution for (n,n\*19)

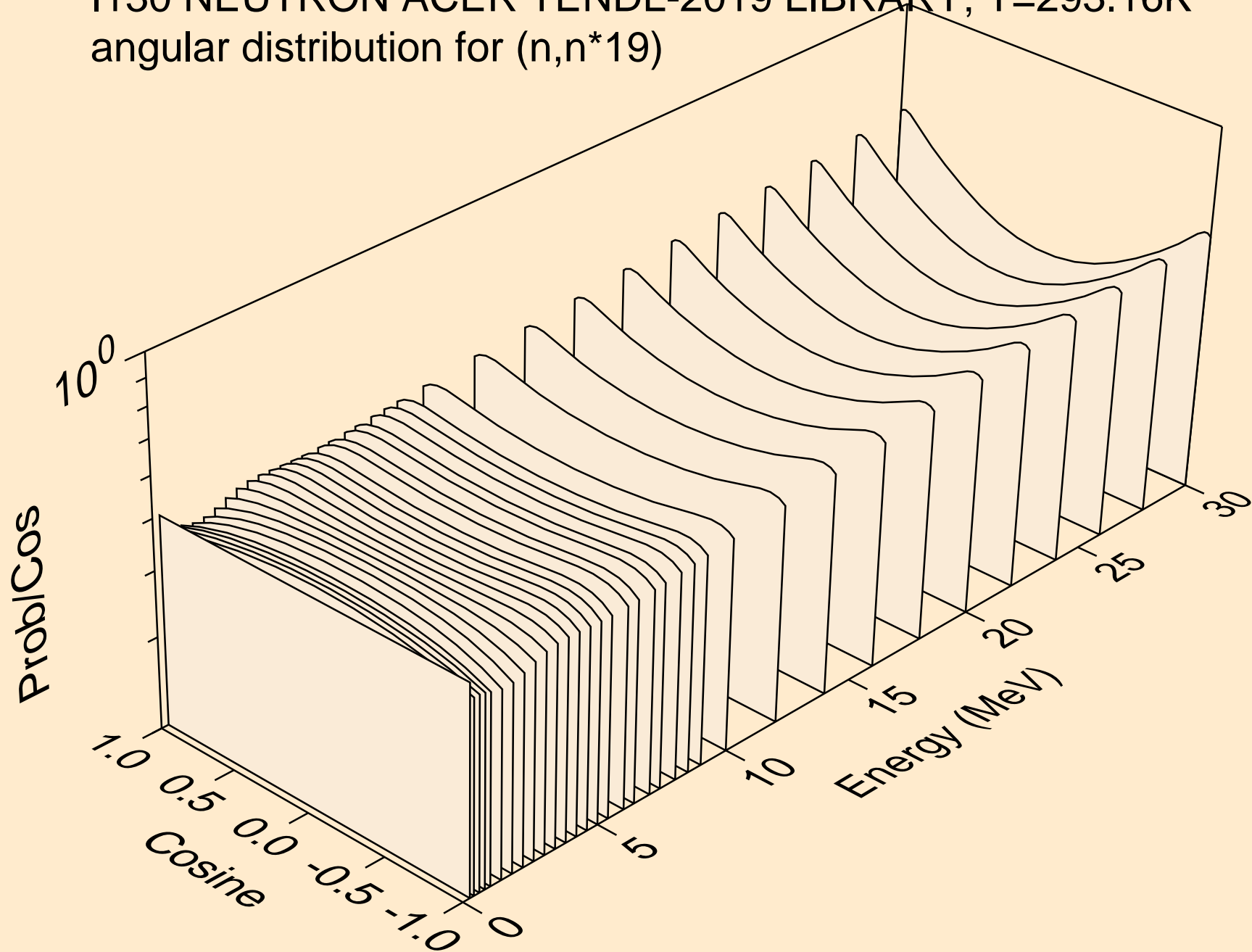

I130 NEUTRON ACER TENDL-2019 LIBRARY; T=293.16K  
angular distribution for (n,n\*20)

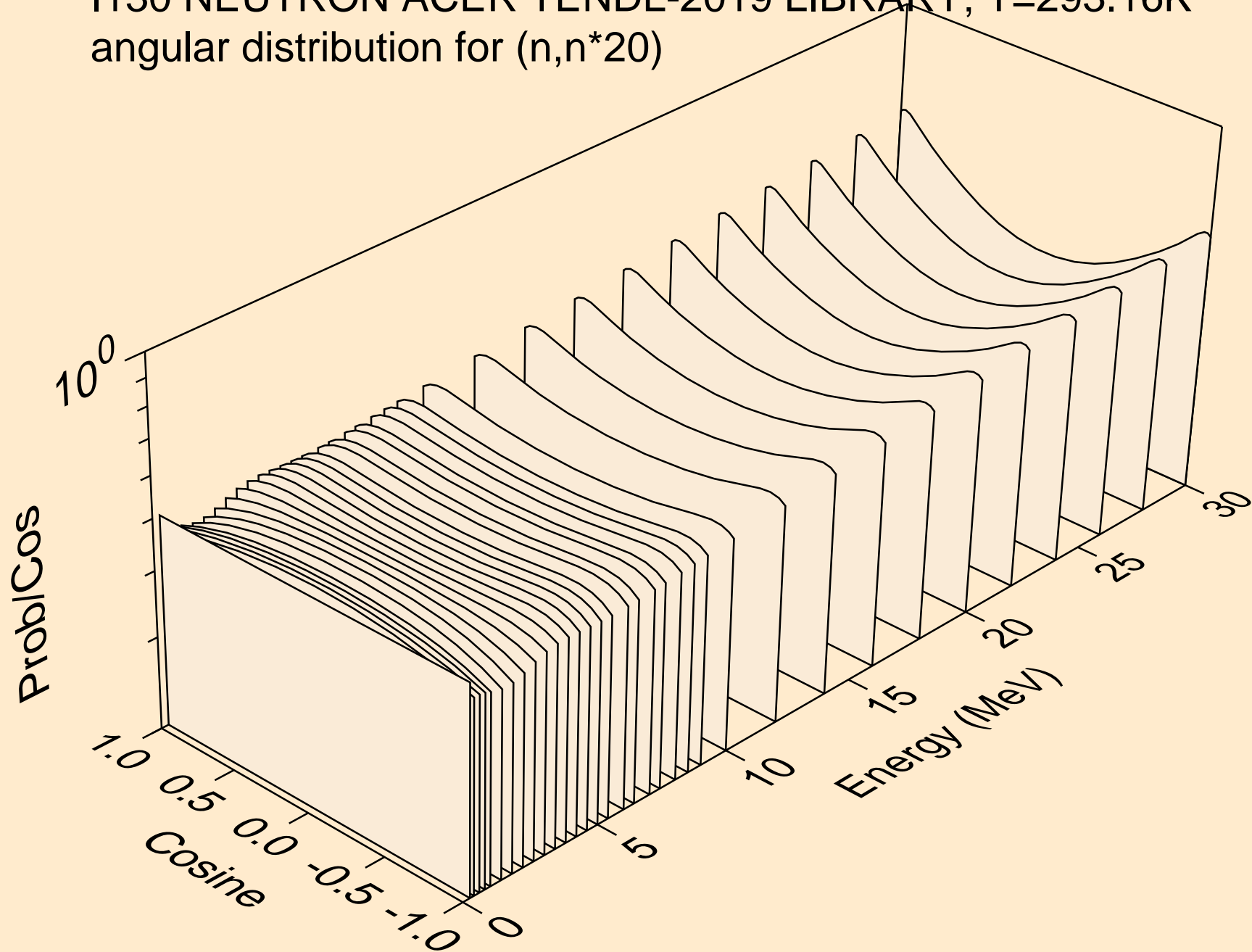



I130 NEUTRON ACER TENDL-2019 LIBRARY; T=293.16K  
angular distribution for (n,n\*21)

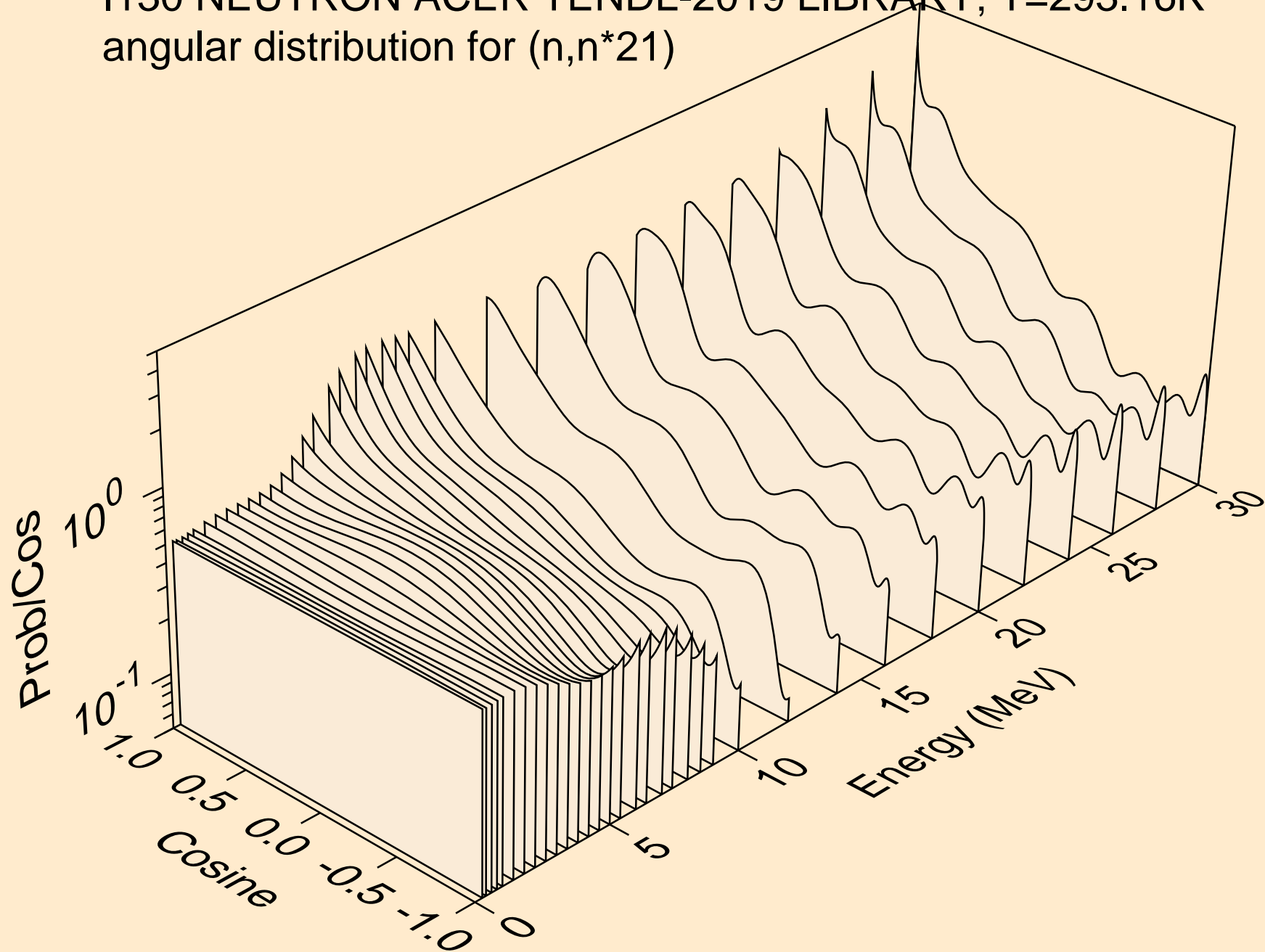

I130 NEUTRON ACER TENDL-2019 LIBRARY; T=293.16K  
angular distribution for (n,n\*22)

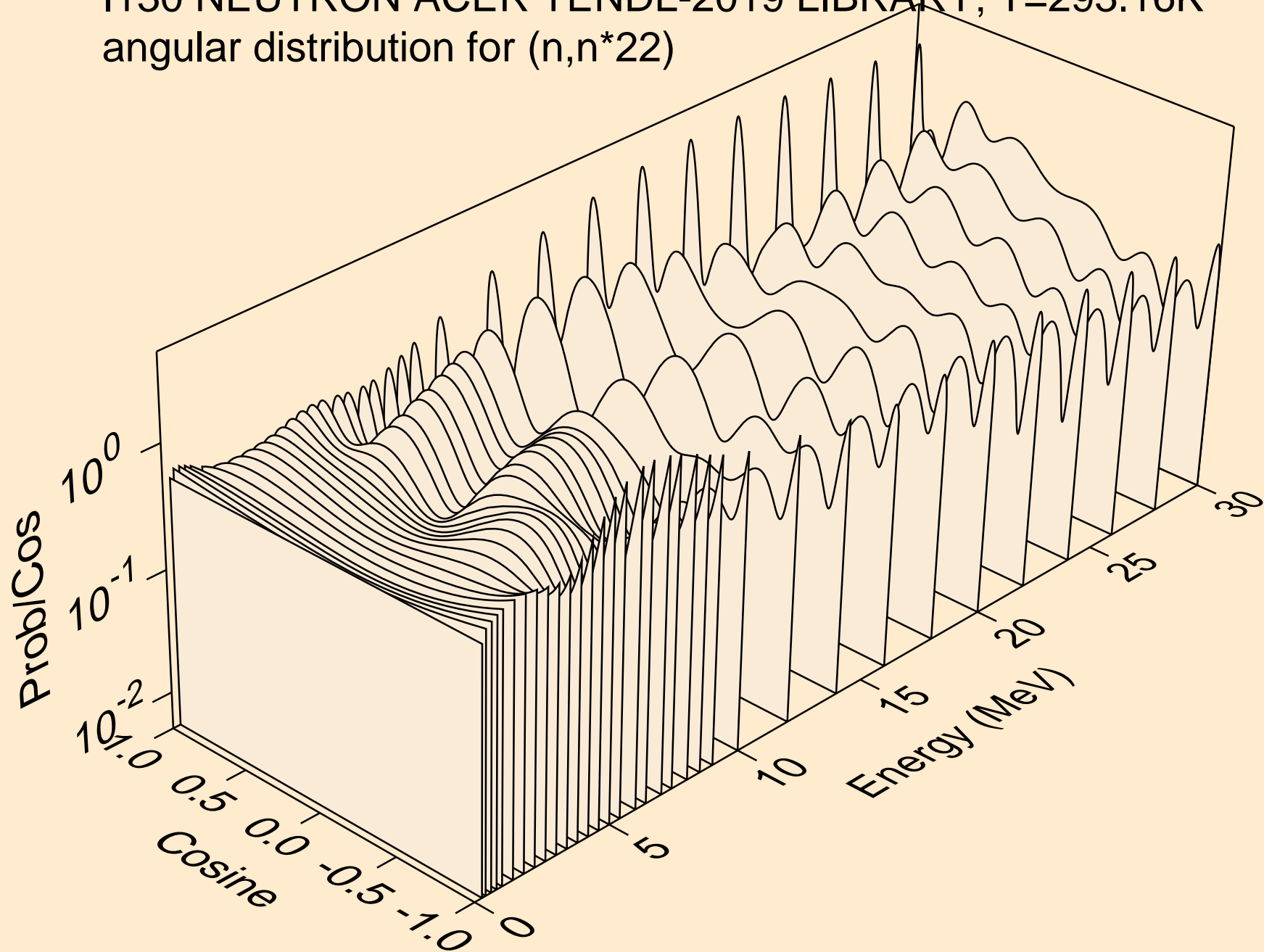

I130 NEUTRON ACER TENDL-2019 LIBRARY; T=293.16K  
angular distribution for (n,n\*23)

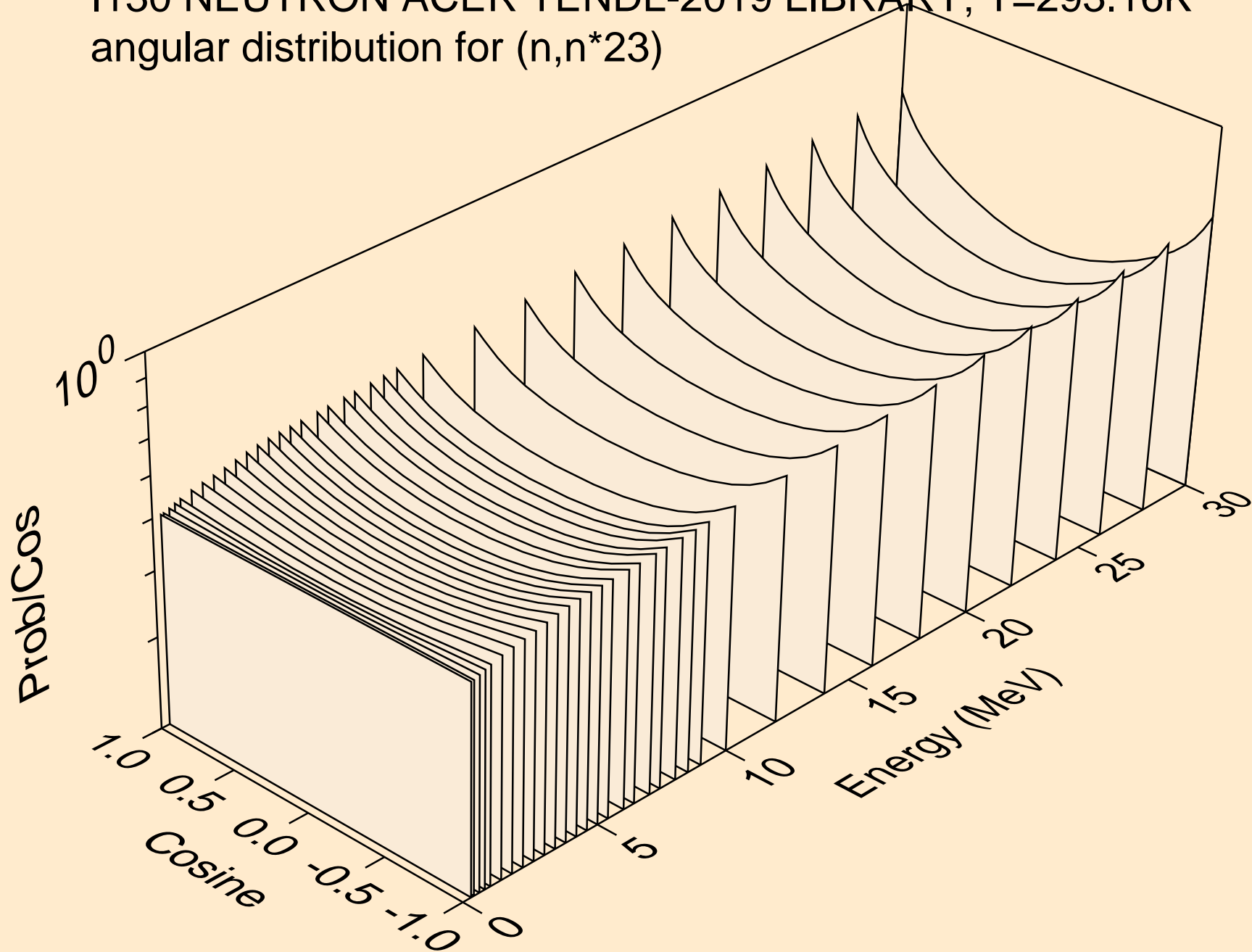

I130 NEUTRON ACER TENDL-2019 LIBRARY; T=293.16K  
angular distribution for (n,n\*24)

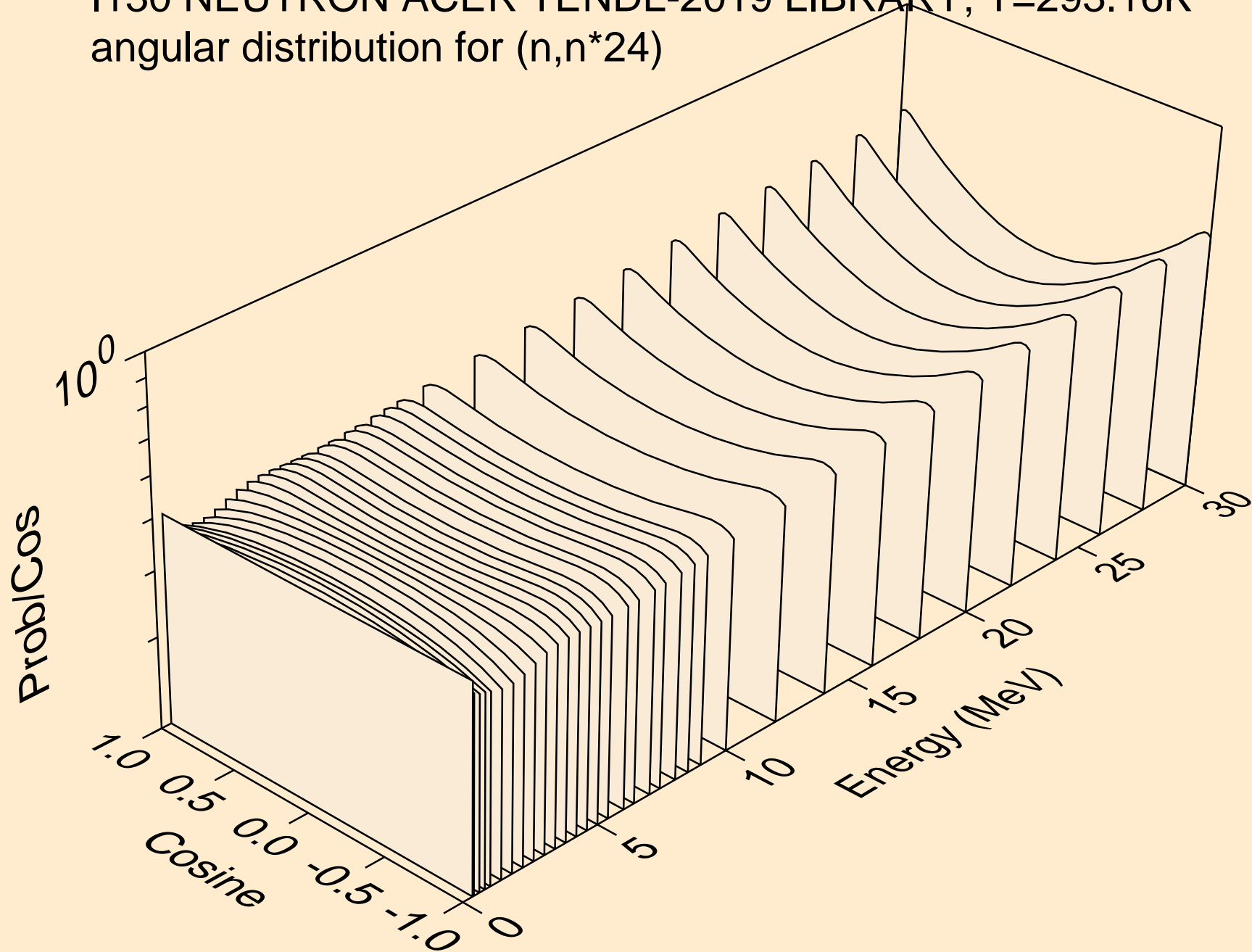

I130 NEUTRON ACER TENDL-2019 LIBRARY; T=293.16K  
angular distribution for (n,n\*25)

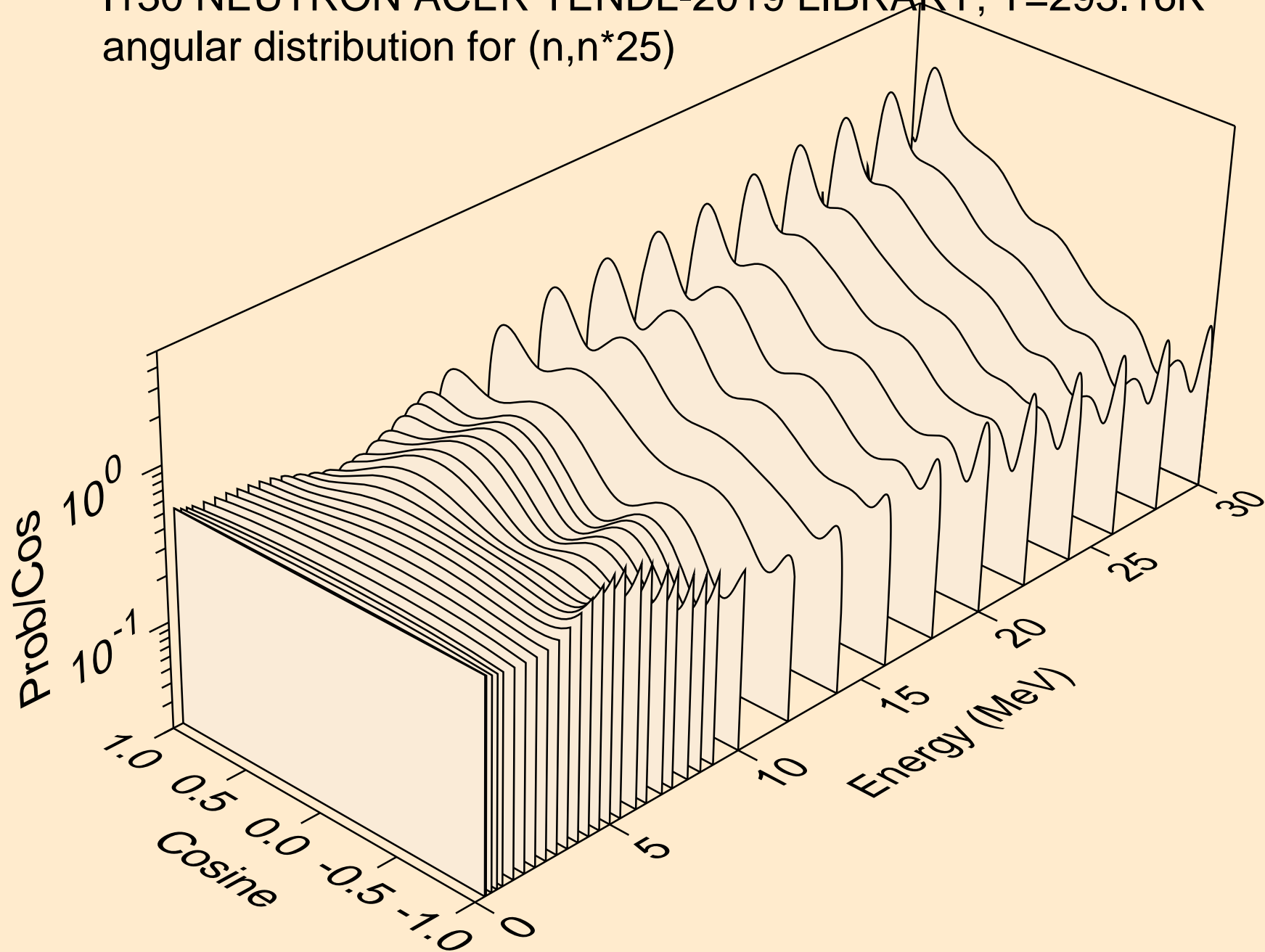

I130 NEUTRON ACER TENDL-2019 LIBRARY; T=293.16K  
angular distribution for (n,n\*26)

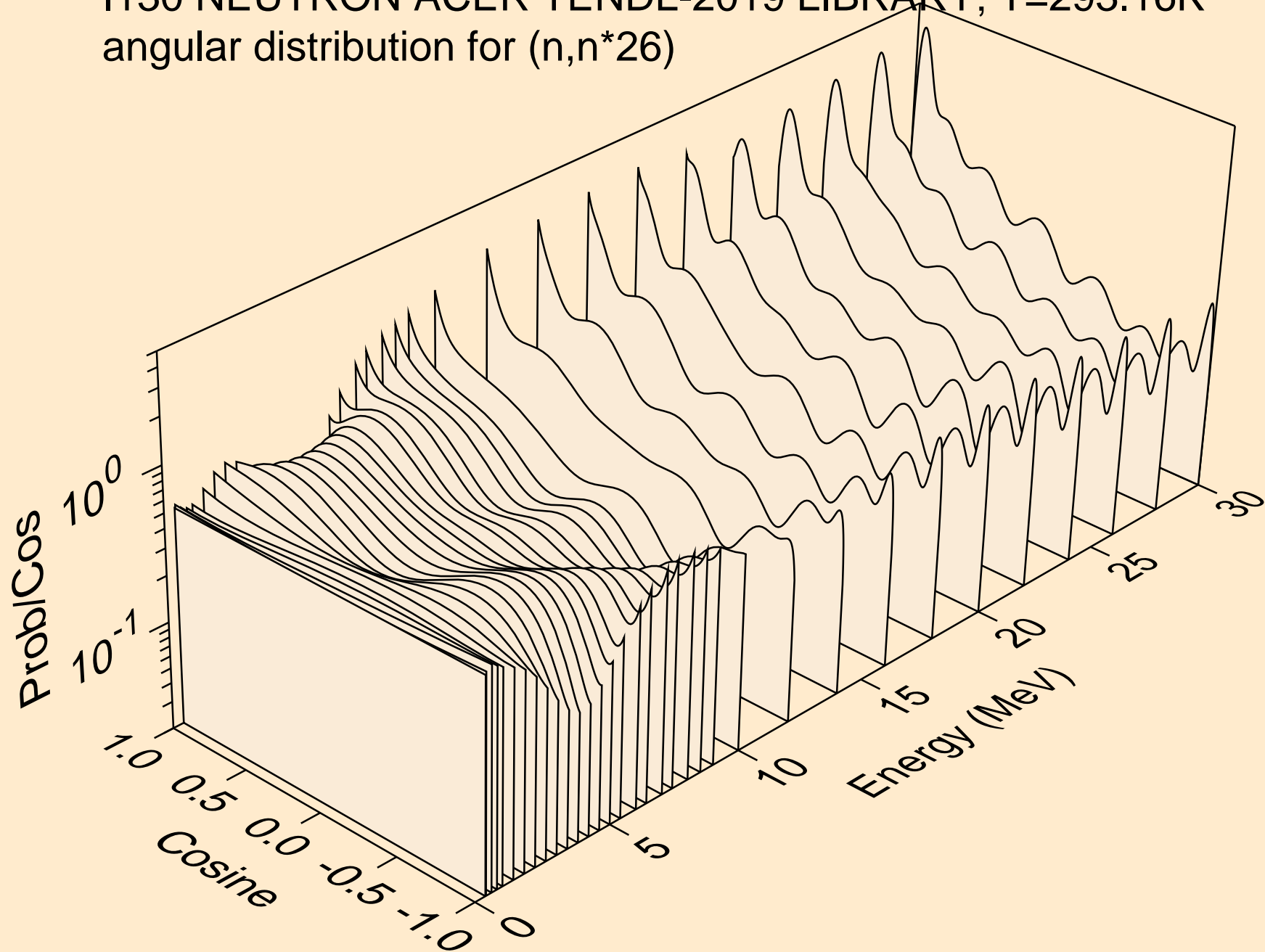

I130 NEUTRON ACER TENDL-2019 LIBRARY; T=293.16K  
angular distribution for (n,n\*27)

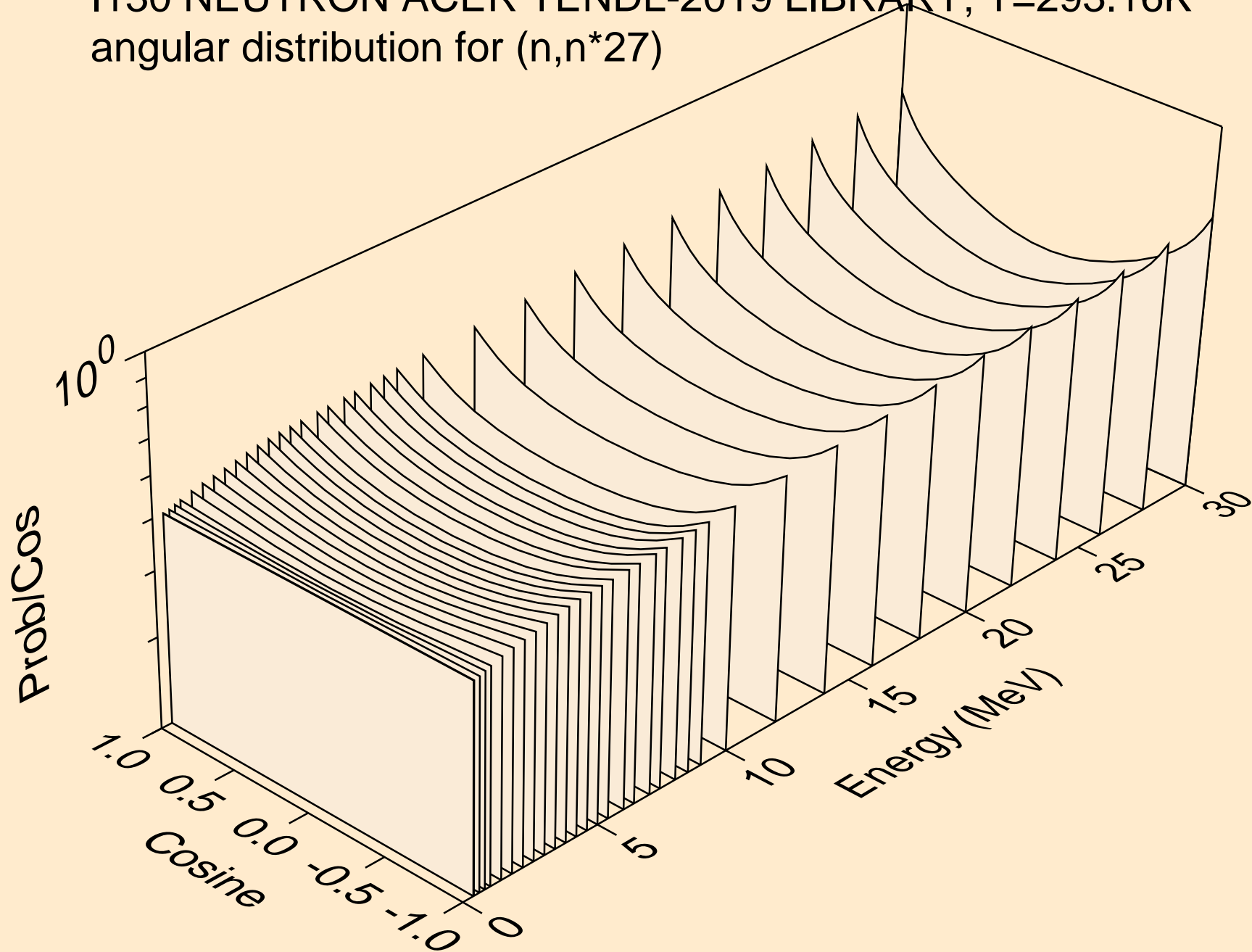

I130 NEUTRON ACER TENDL-2019 LIBRARY; T=293.16K  
angular distribution for (n,n\*28)

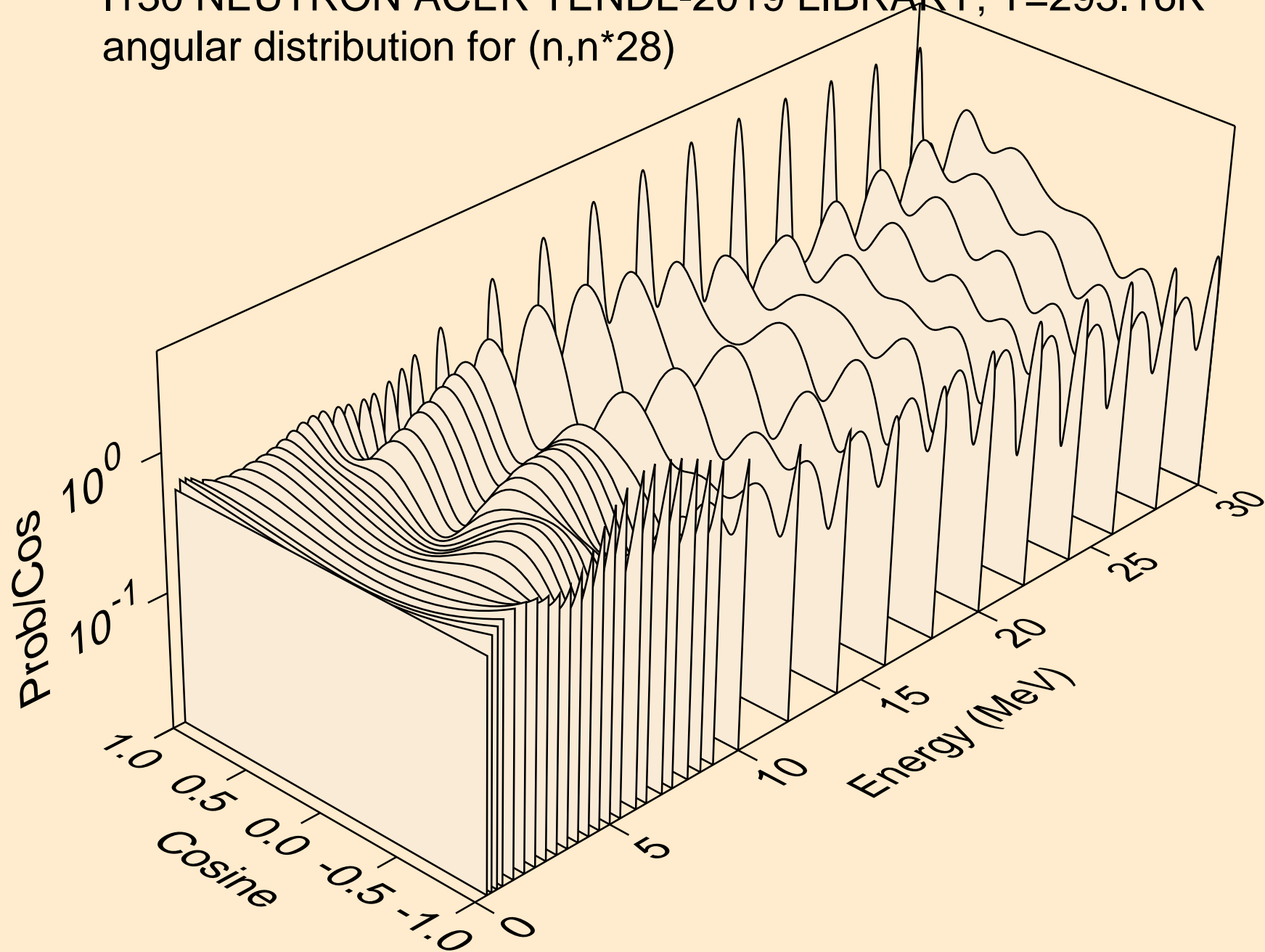



I130 NEUTRON ACER TENDL-2019 LIBRARY; T=293.16K  
angular distribution for (n,n\*29)

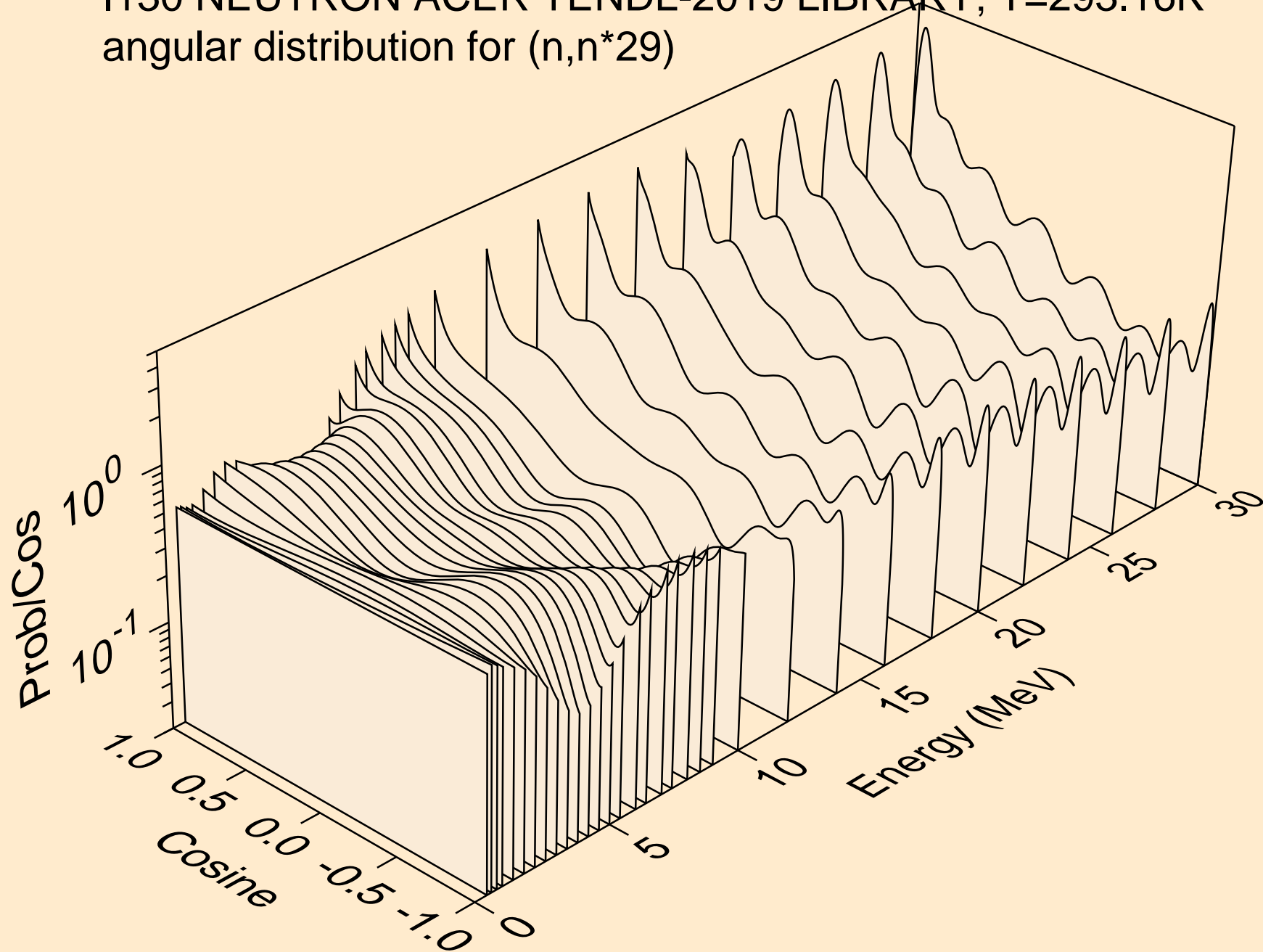

I130 NEUTRON ACER TENDL-2019 LIBRARY; T=293.16K  
angular distribution for (n,n\*30)

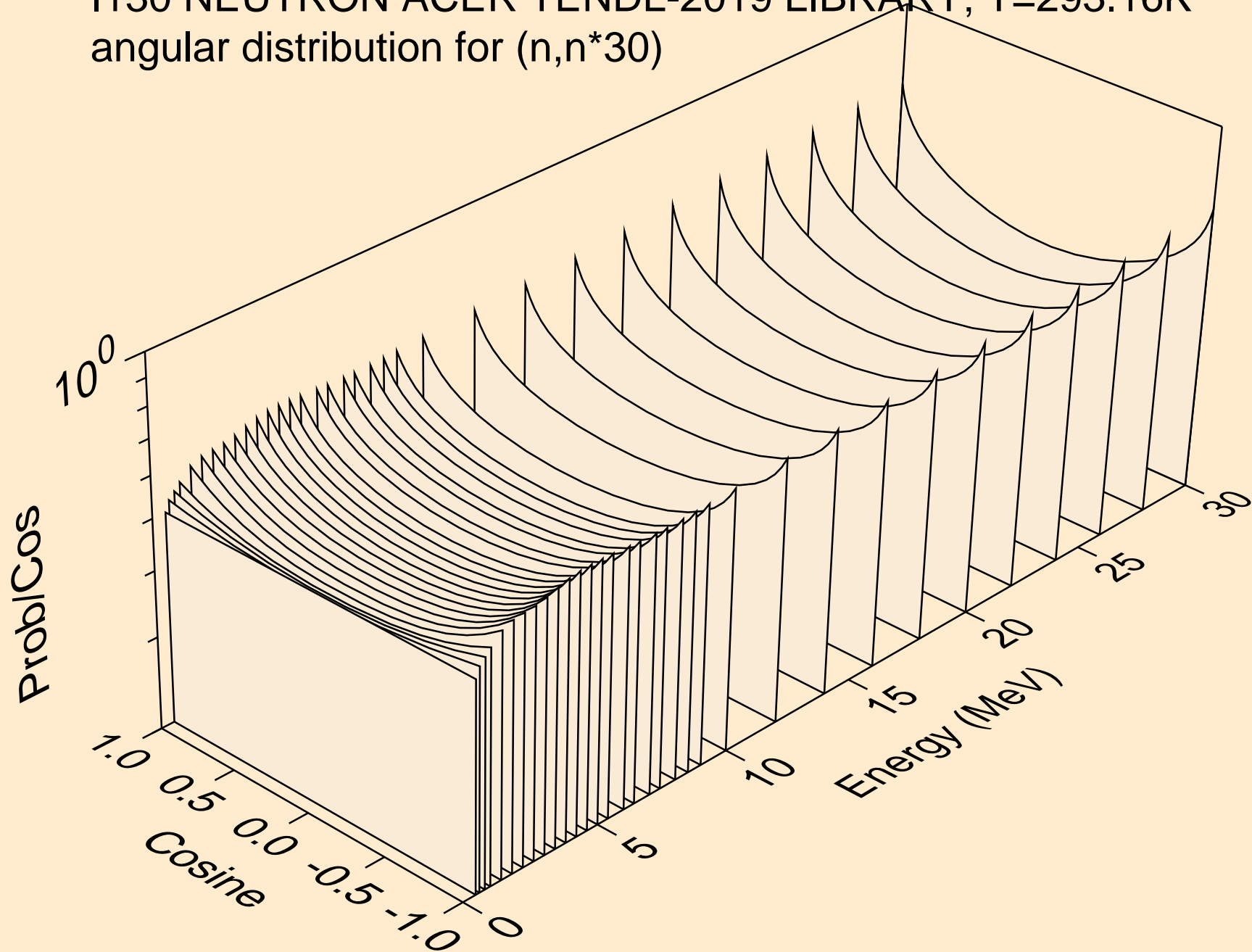

I130 NEUTRON ACER TENDL-2019 LIBRARY; T=293.16K  
Neutron emission for (n,x)

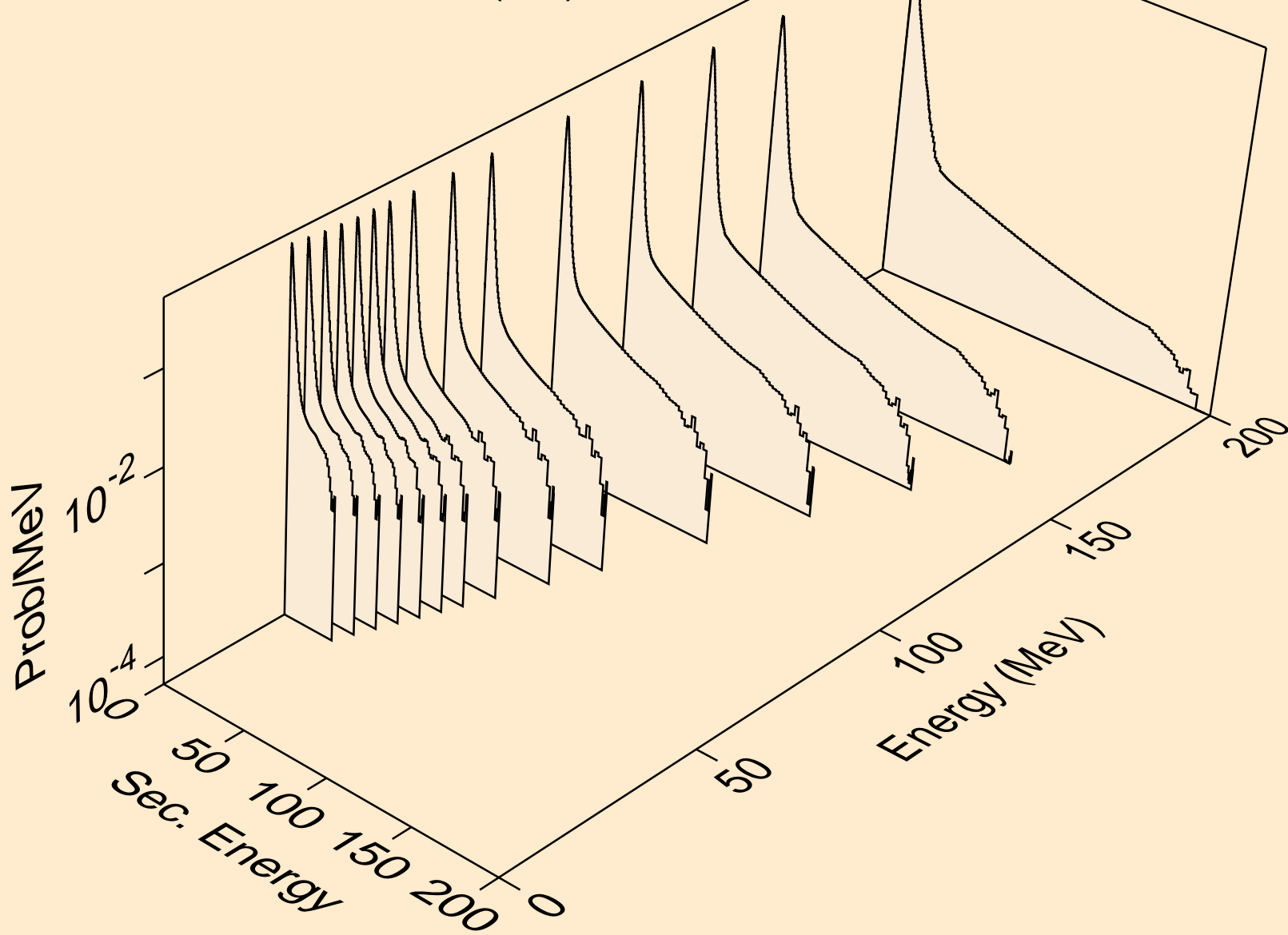

I130 NEUTRON ACER TENDL-2019 LIBRARY; T=293.16K  
Neutron emission for (n,2nd)

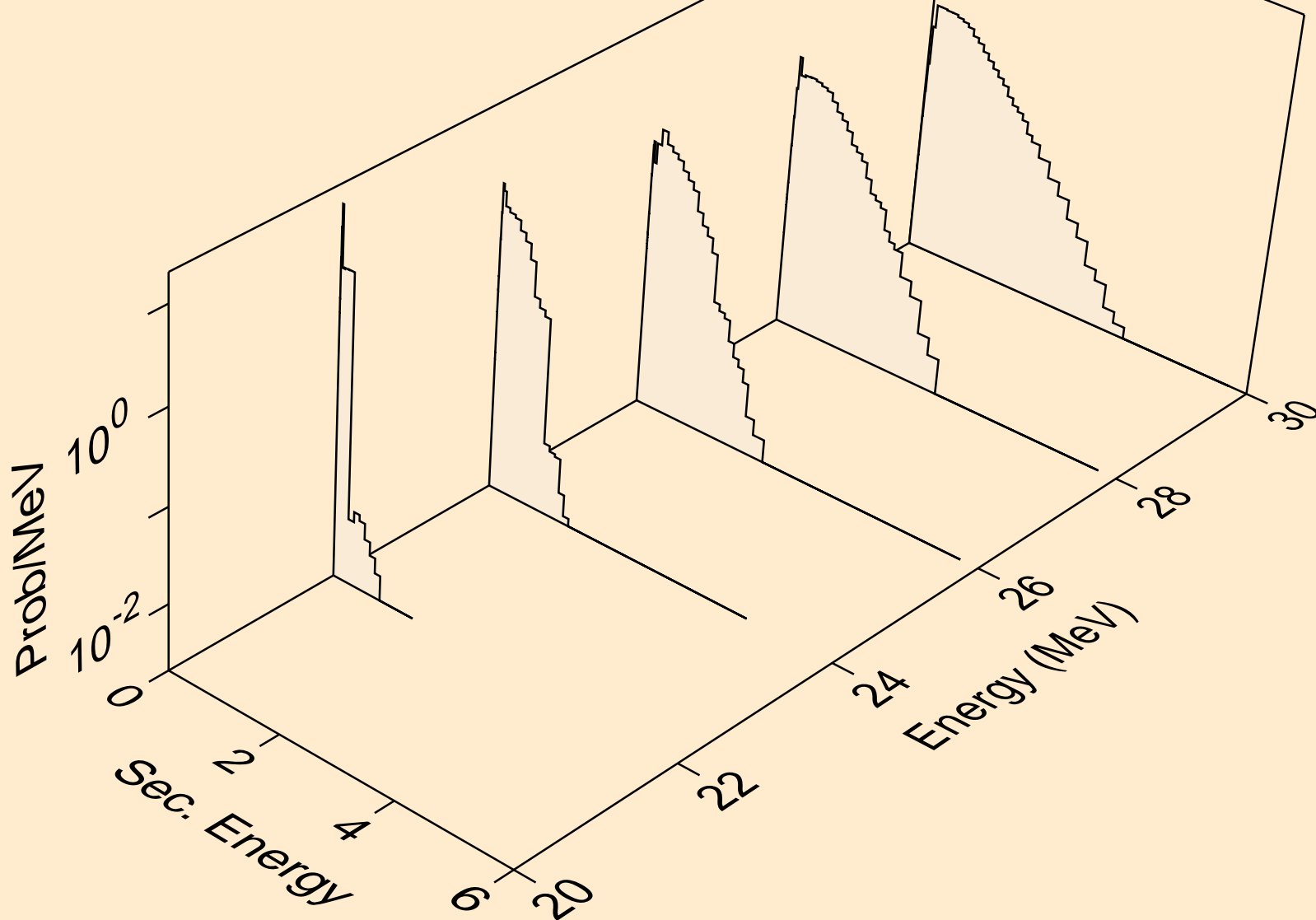

I130 NEUTRON ACER TENDL-2019 LIBRARY; T=293.16K  
Neutron emission for (n,2n)

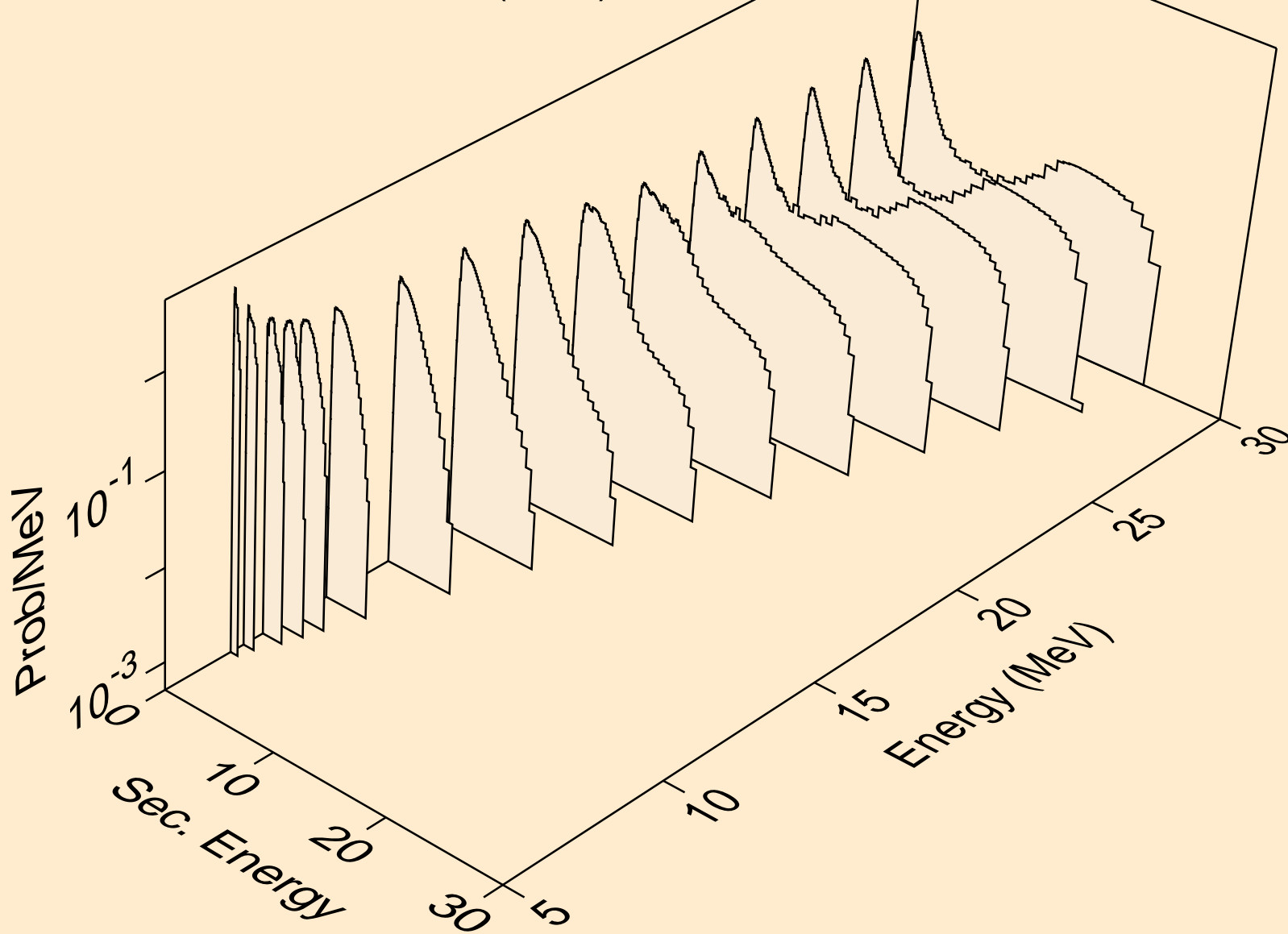

I130 NEUTRON ACER TENDL-2019 LIBRARY; T=293.16K  
Neutron emission for (n,3n)

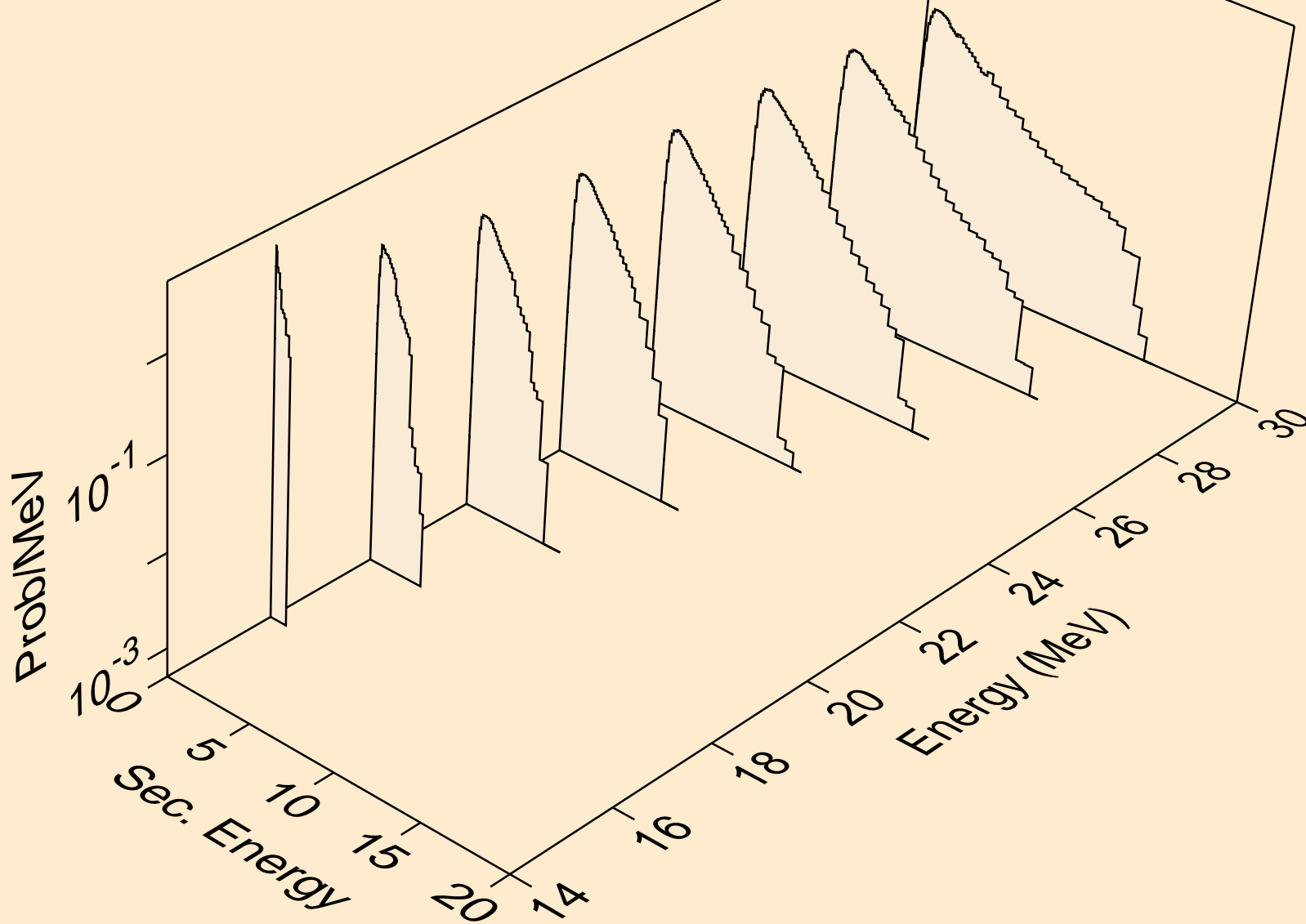

I130 NEUTRON ACER TENDL-2019 LIBRARY; T=293.16K  
Neutron emission for (n,n\*)a

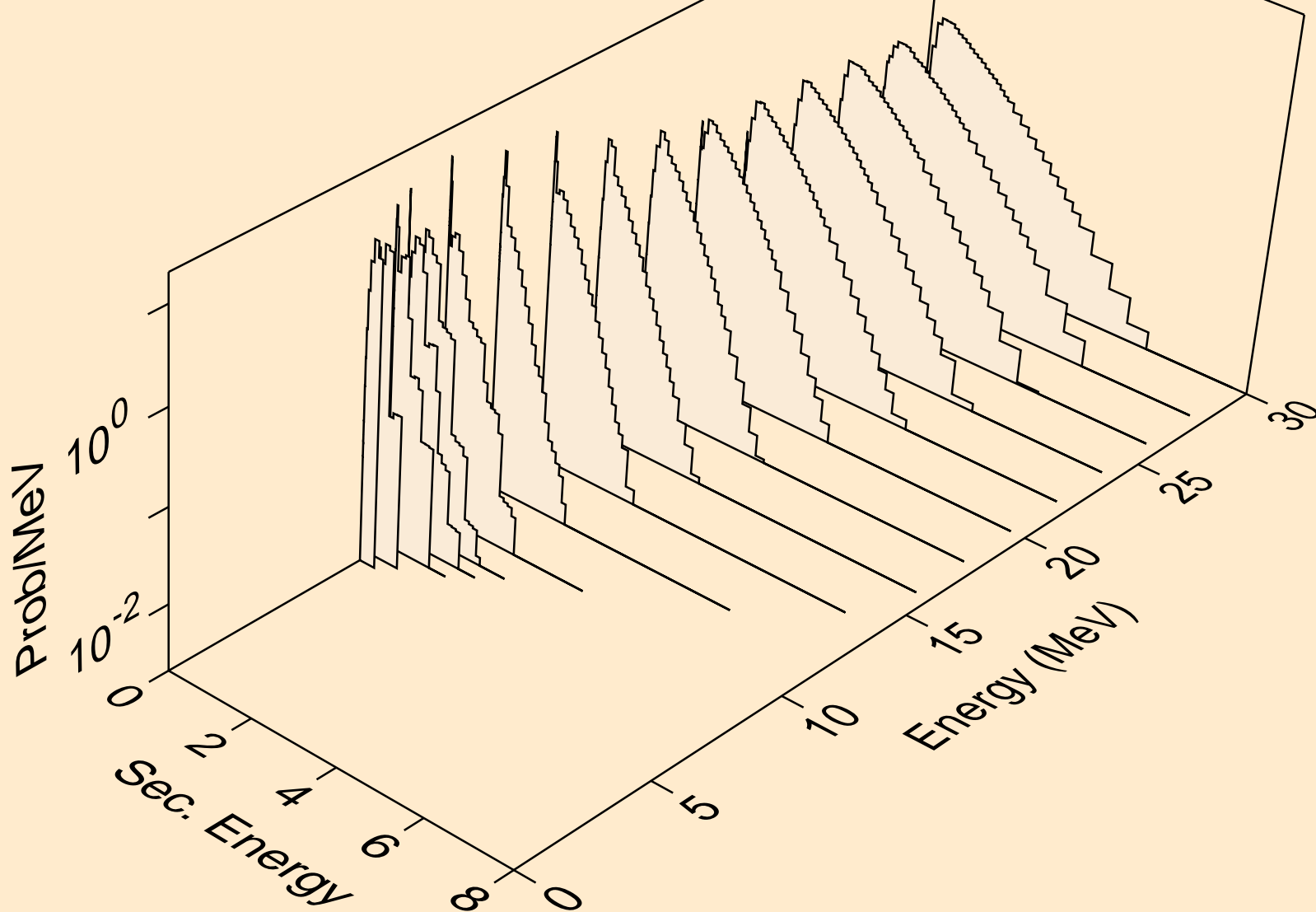

I130 NEUTRON ACER TENDL-2019 LIBRARY; T=293.16K  
Neutron emission for (n,2n)a

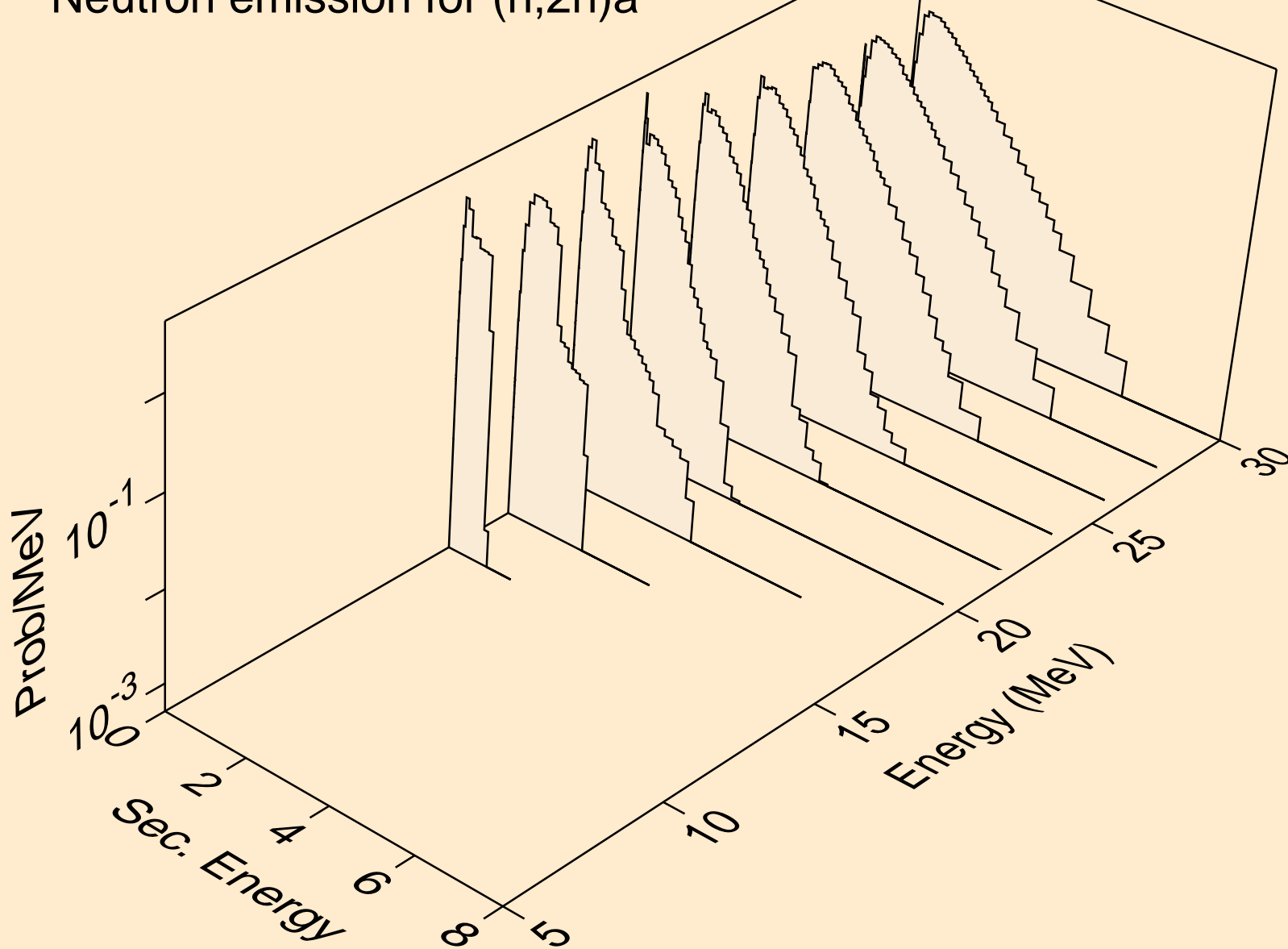



I130 NEUTRON ACER TENDL-2019 LIBRARY; T=293.16K  
Neutron emission for (n,3n)a

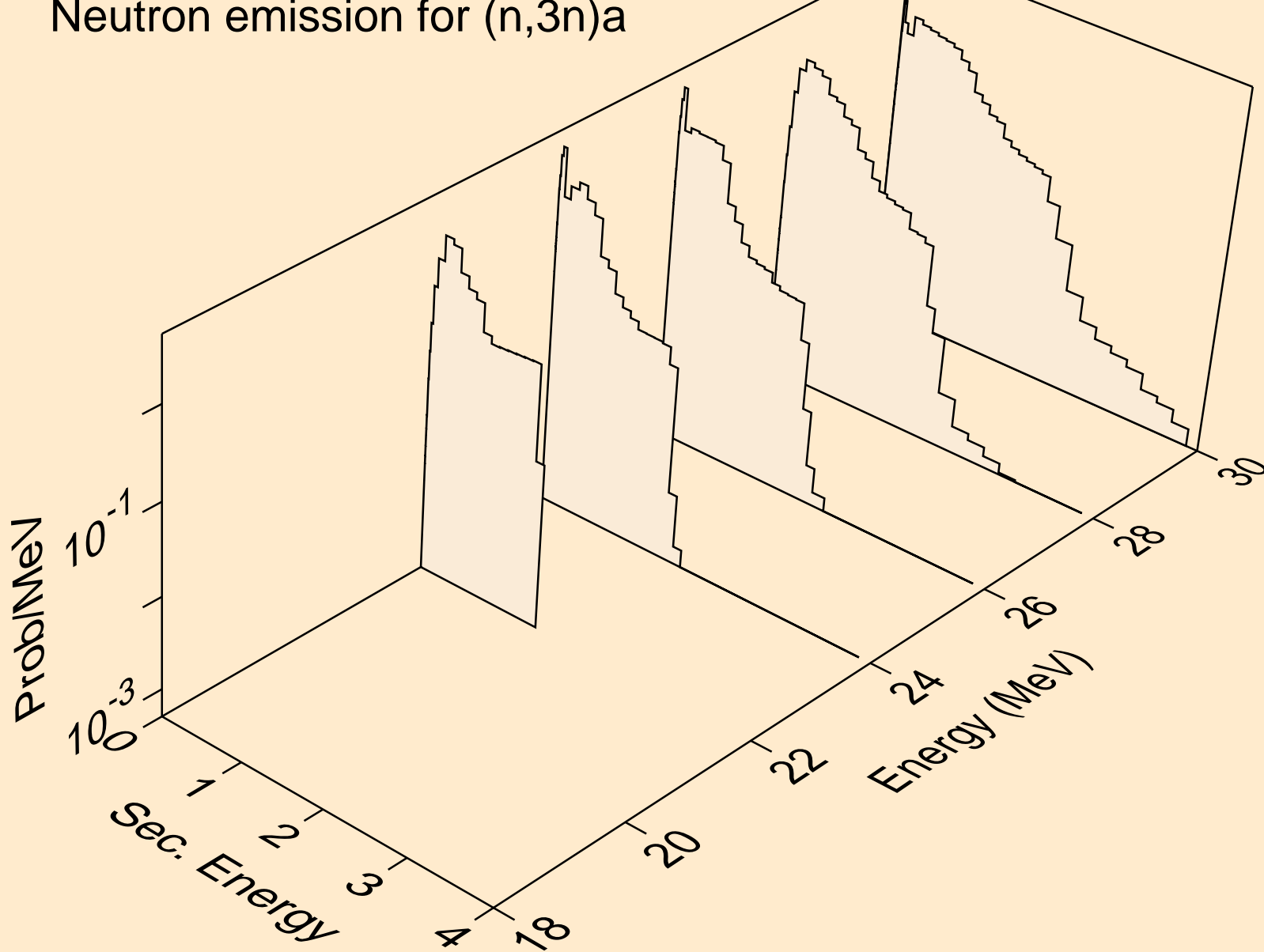

I130 NEUTRON ACER TENDL-2019 LIBRARY; T=293.16K  
Neutron emission for (n,n\*)p

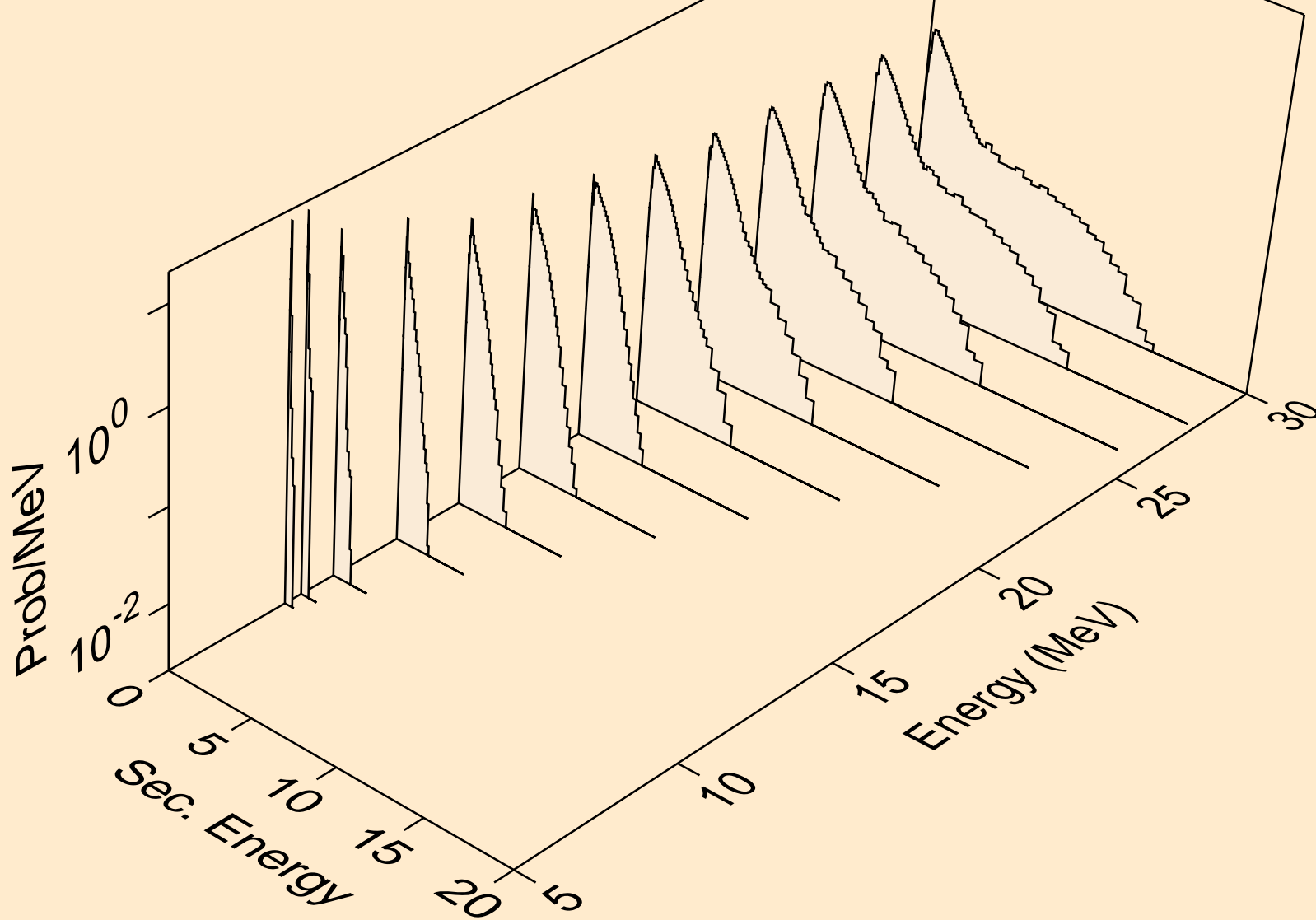

I130 NEUTRON ACER TENDL-2019 LIBRARY; T=293.16K  
Neutron emission for (n,n\*)d

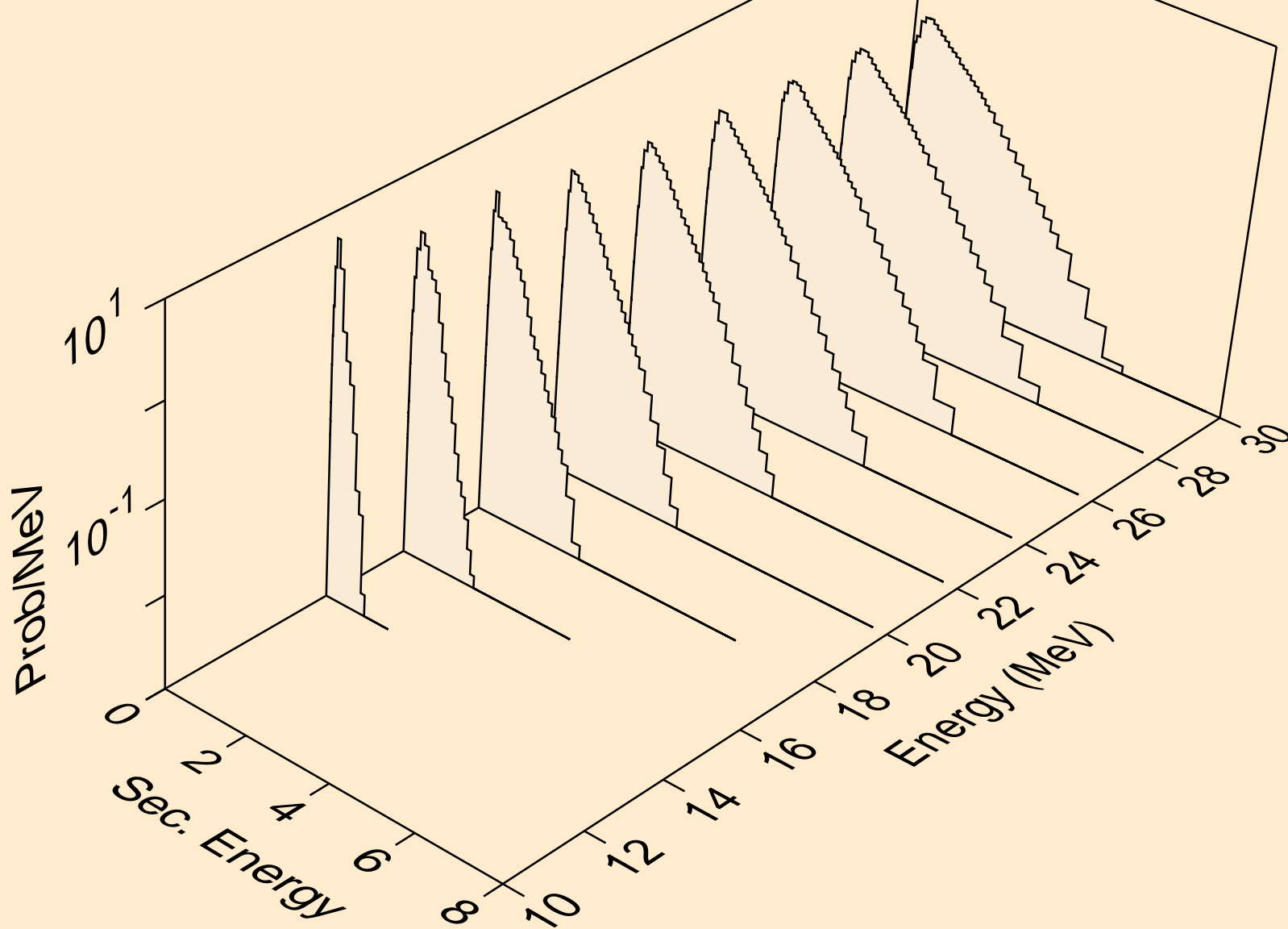

I130 NEUTRON ACER TENDL-2019 LIBRARY; T=293.16K  
Neutron emission for (n,n\*)t

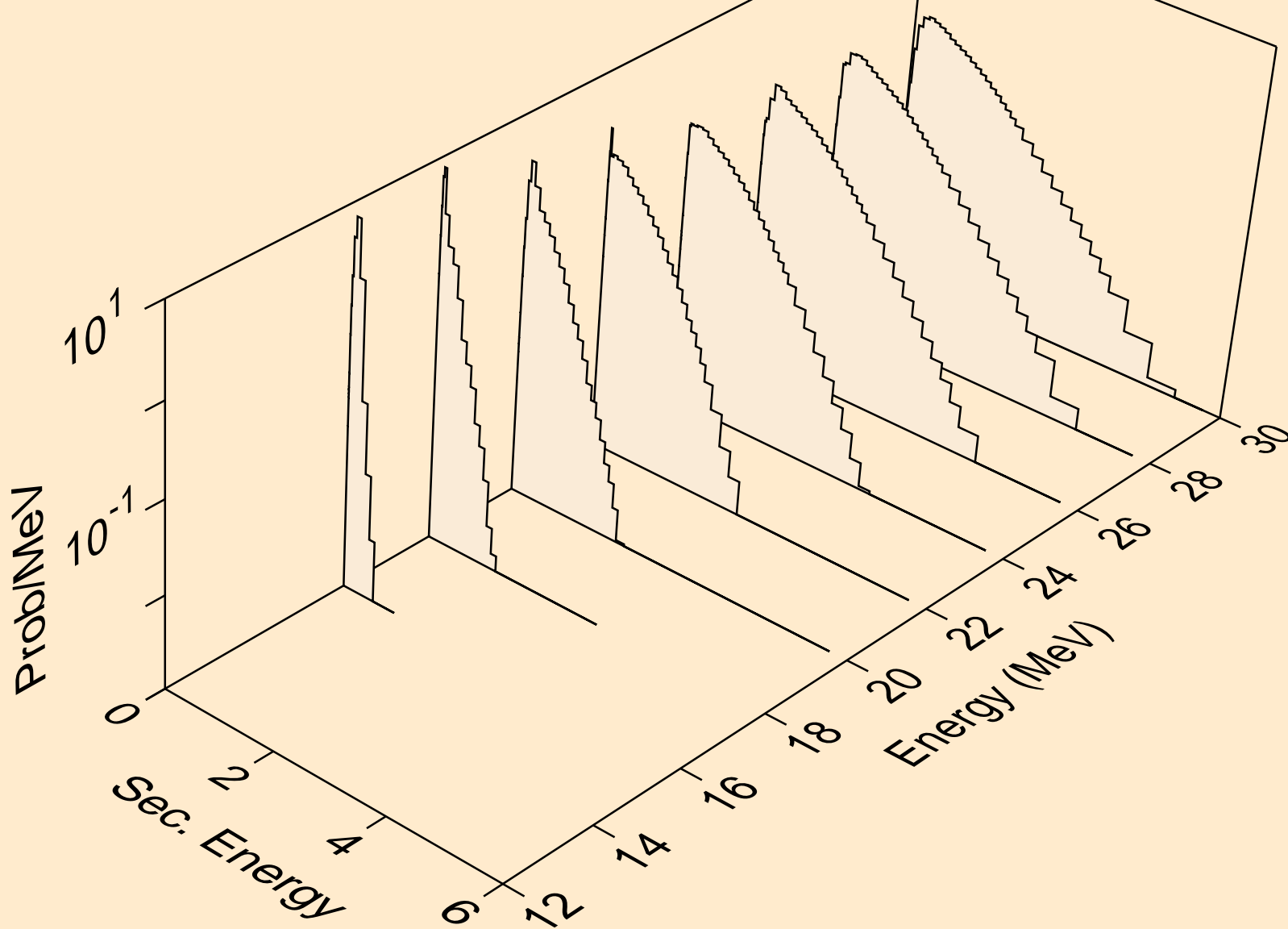

I130 NEUTRON ACER TENDL-2019 LIBRARY; T=293.16K  
Neutron emission for (n,n\*)he3

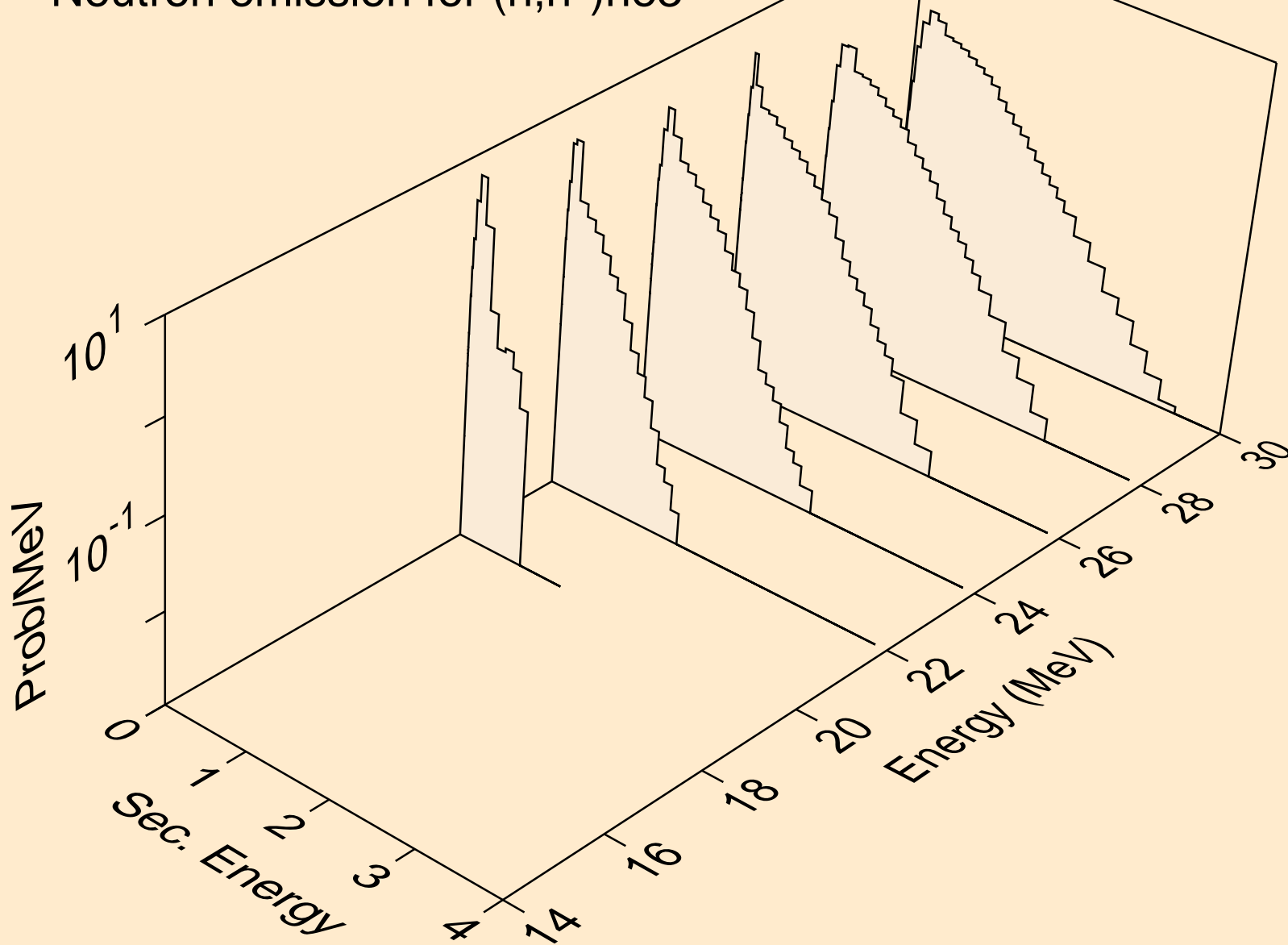

I130 NEUTRON ACER TENDL-2019 LIBRARY; T=293.16K  
Neutron emission for (n,4n)

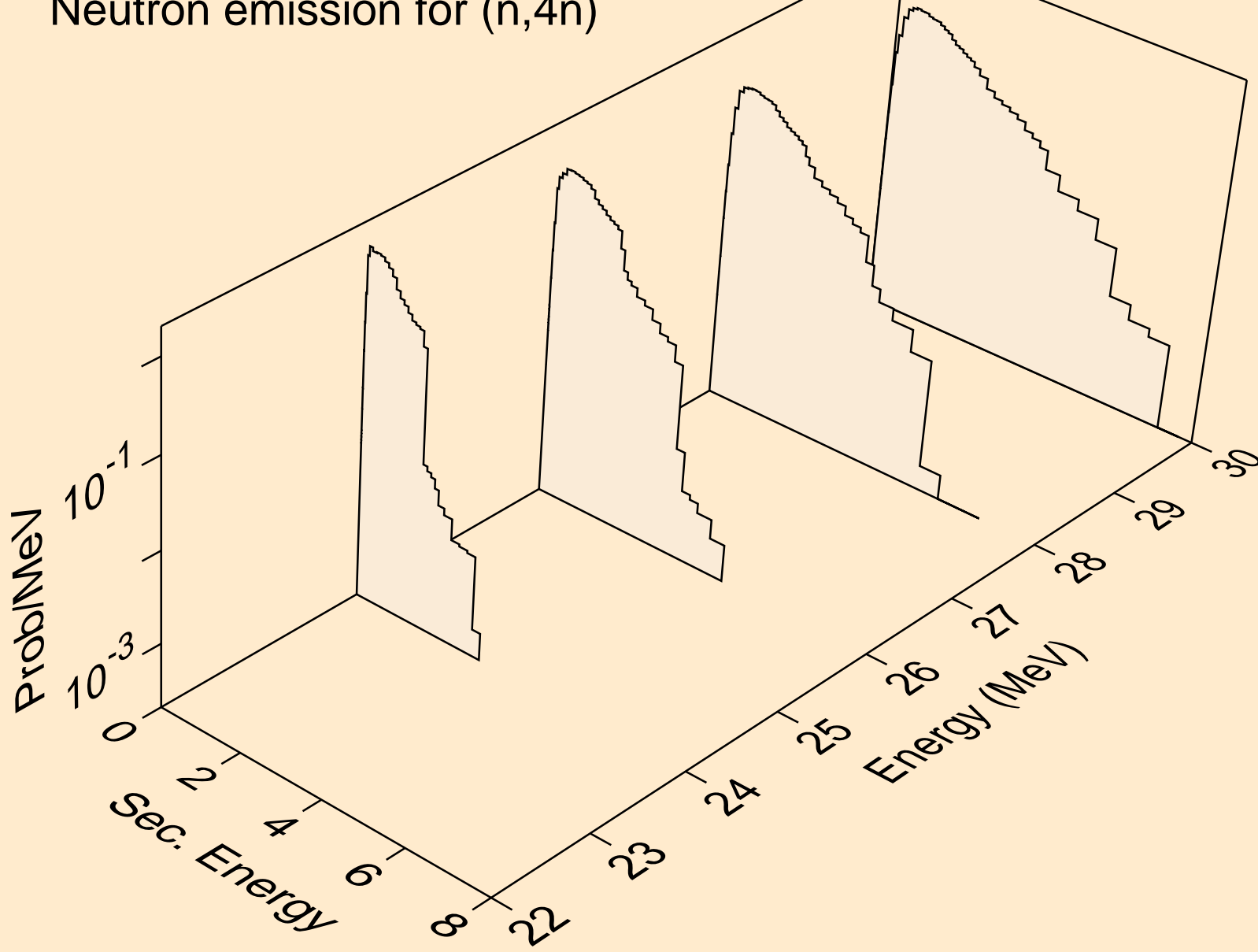

I130 NEUTRON ACER TENDL-2019 LIBRARY; T=293.16K  
Neutron emission for (n,2np)

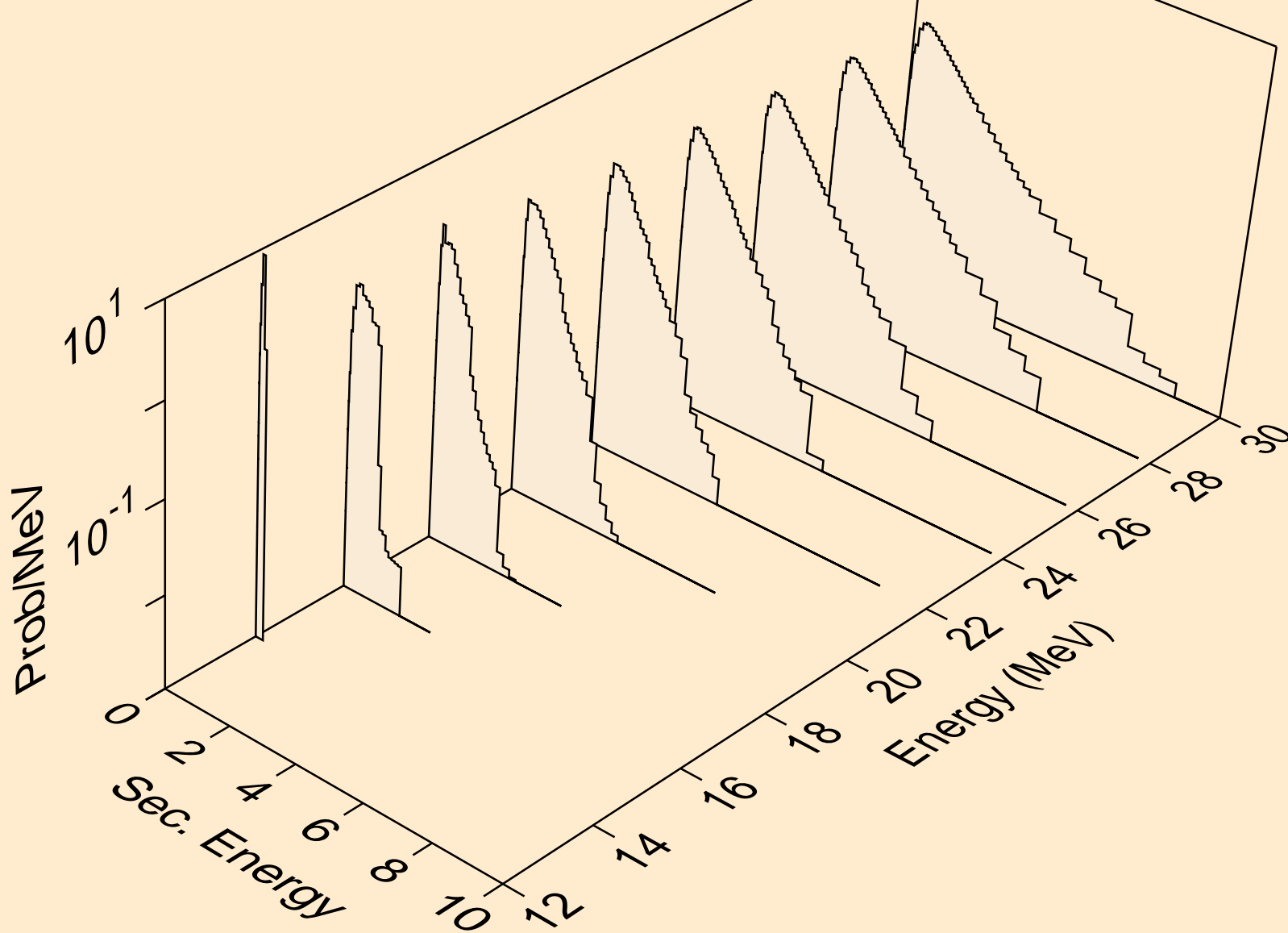

I130 NEUTRON ACER TENDL-2019 LIBRARY; T=293.16K  
Neutron emission for (n,3np)

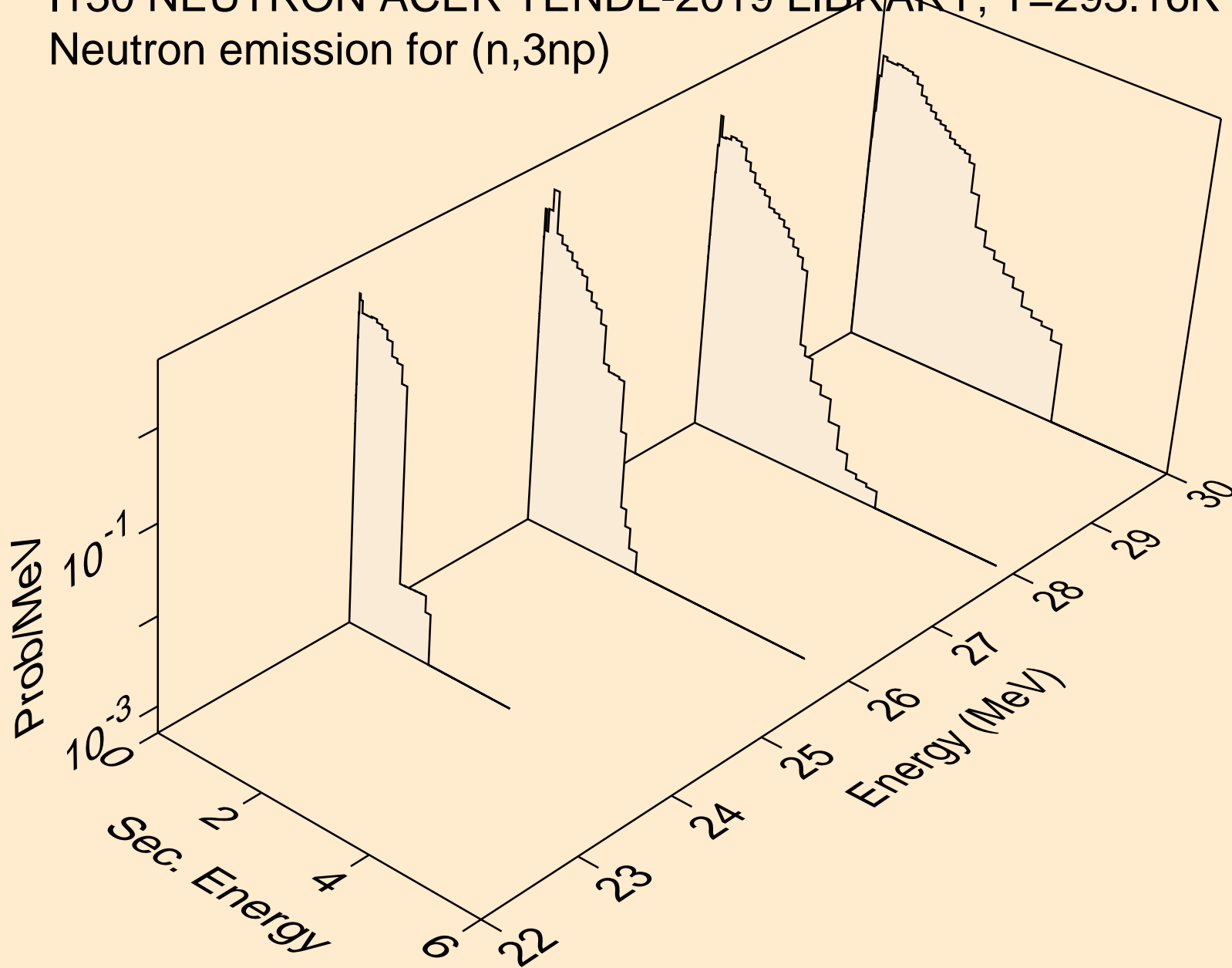



I130 NEUTRON ACER TENDL-2019 LIBRARY; T=293.16K  
Neutron emission for (n,2np)

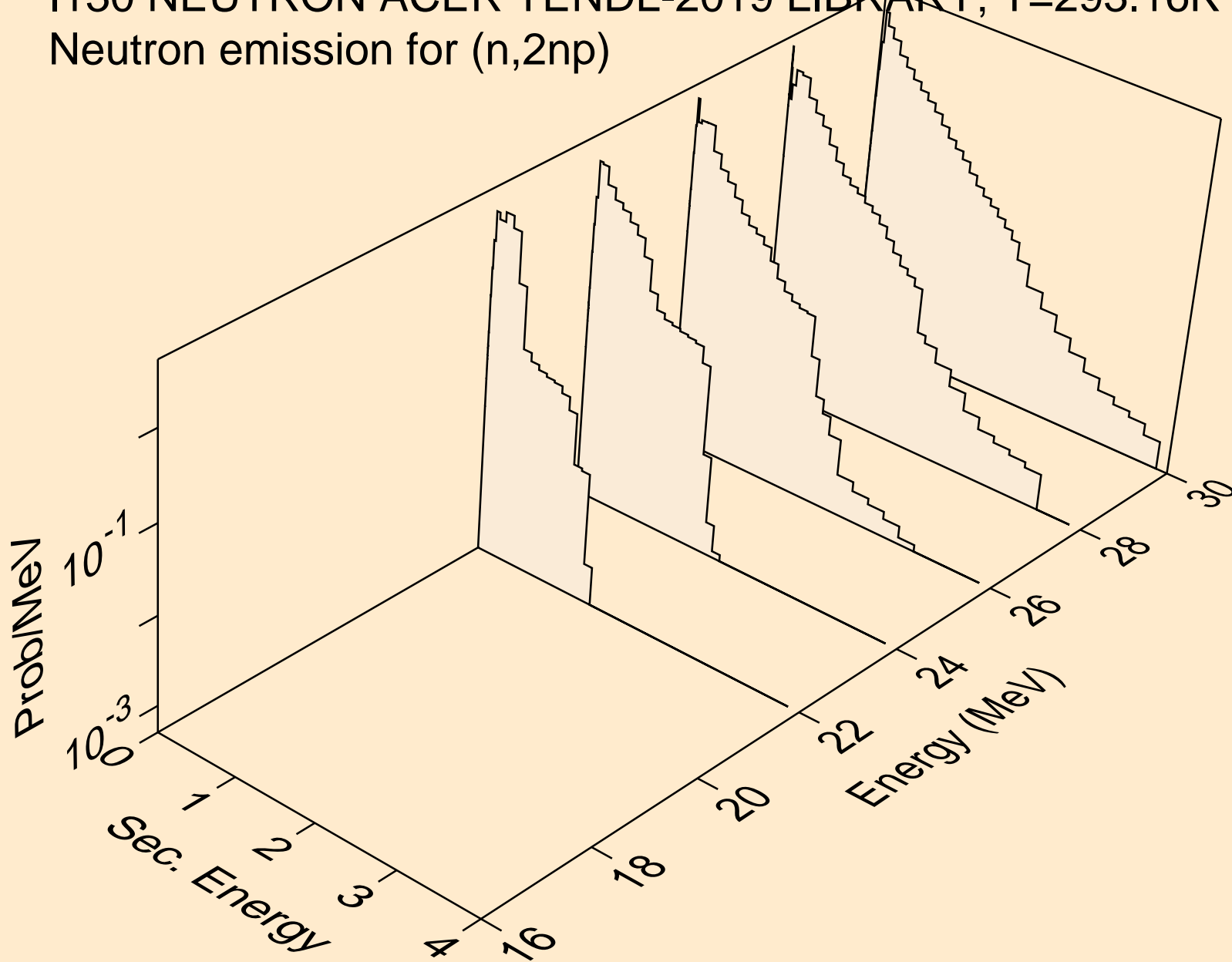

I130 NEUTRON ACER TENDL-2019 LIBRARY; T=293.16K  
Neutron emission for (n,npa)

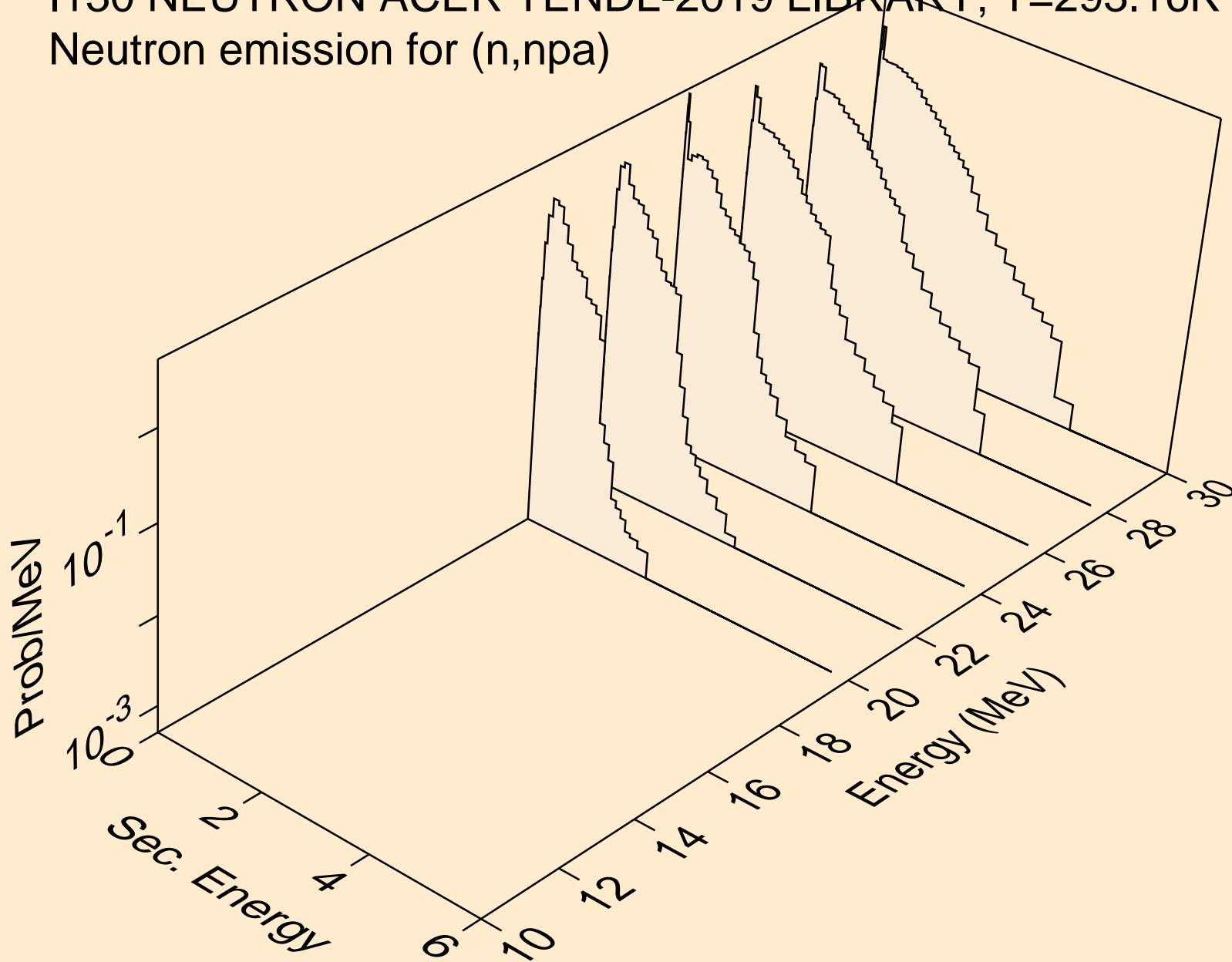

I130 NEUTRON ACER TENDL-2019 LIBRARY; T=293.16K  
Neutron emission for (n,n\*c)

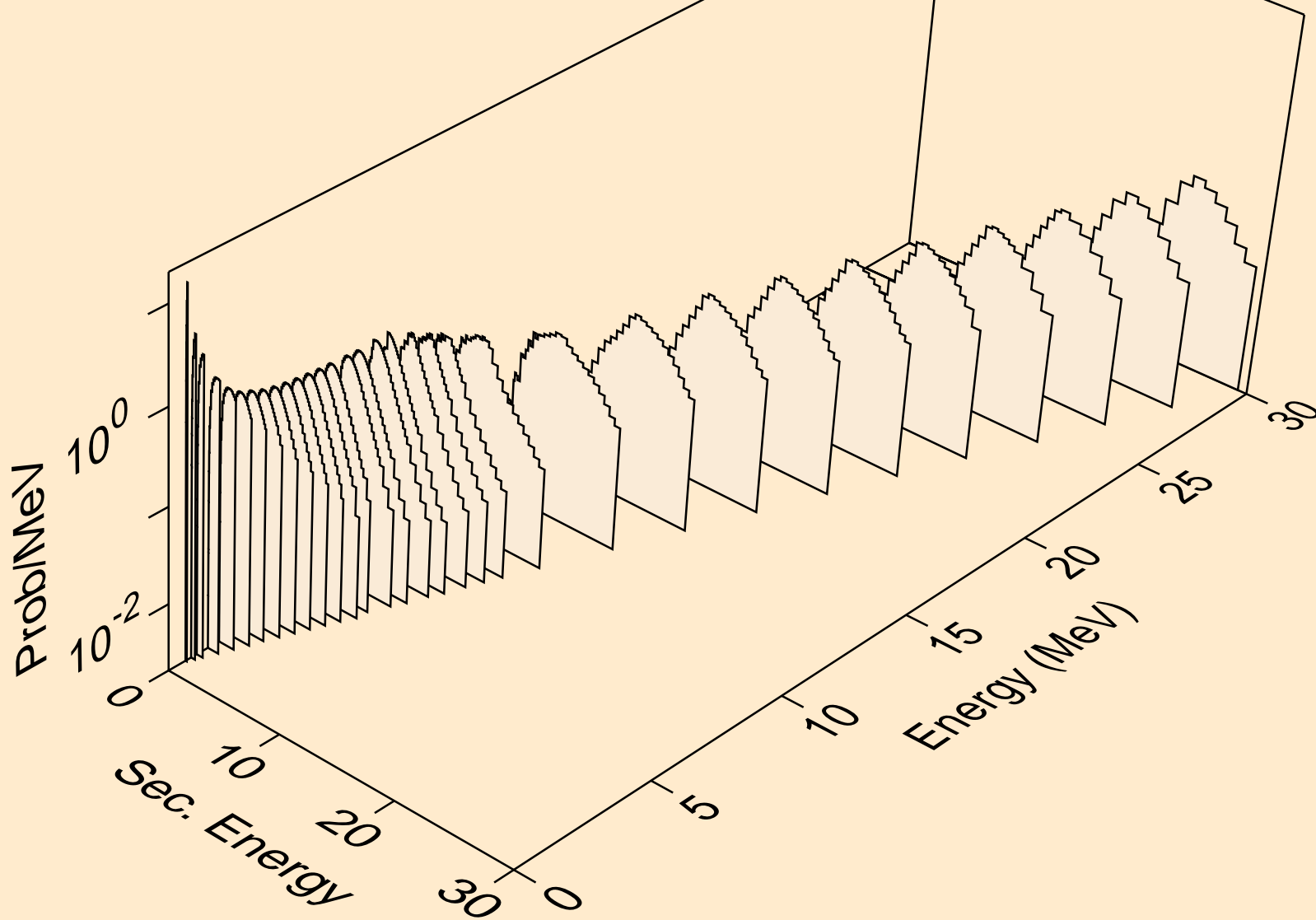

I130 NEUTRON ACER TENDL-2019 LIBRARY; T=293.16K  
Photon emission for (n,x)

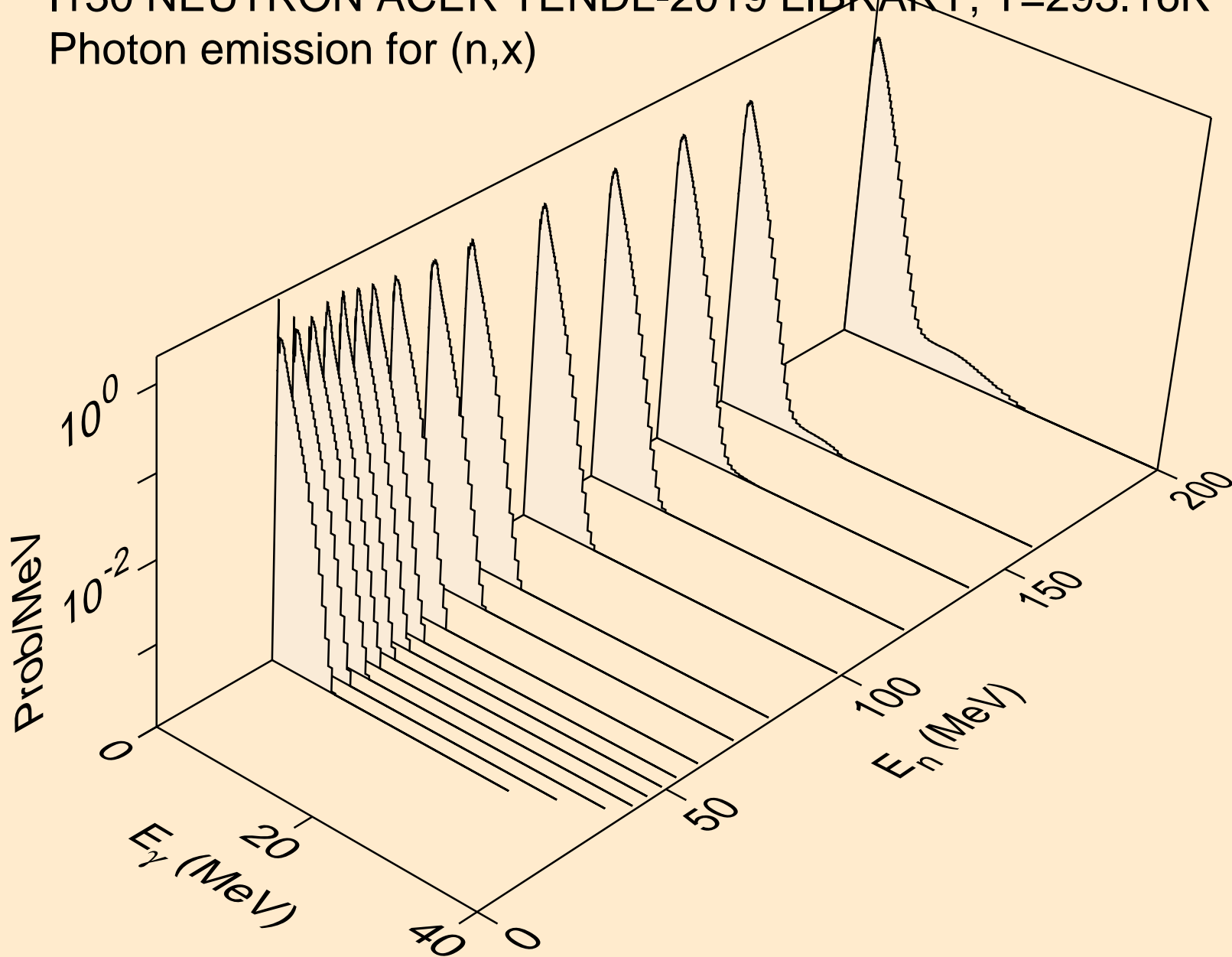

I130 NEUTRON ACER TENDL-2019 LIBRARY; T=293.16K  
Photon emission for (n,2nd)

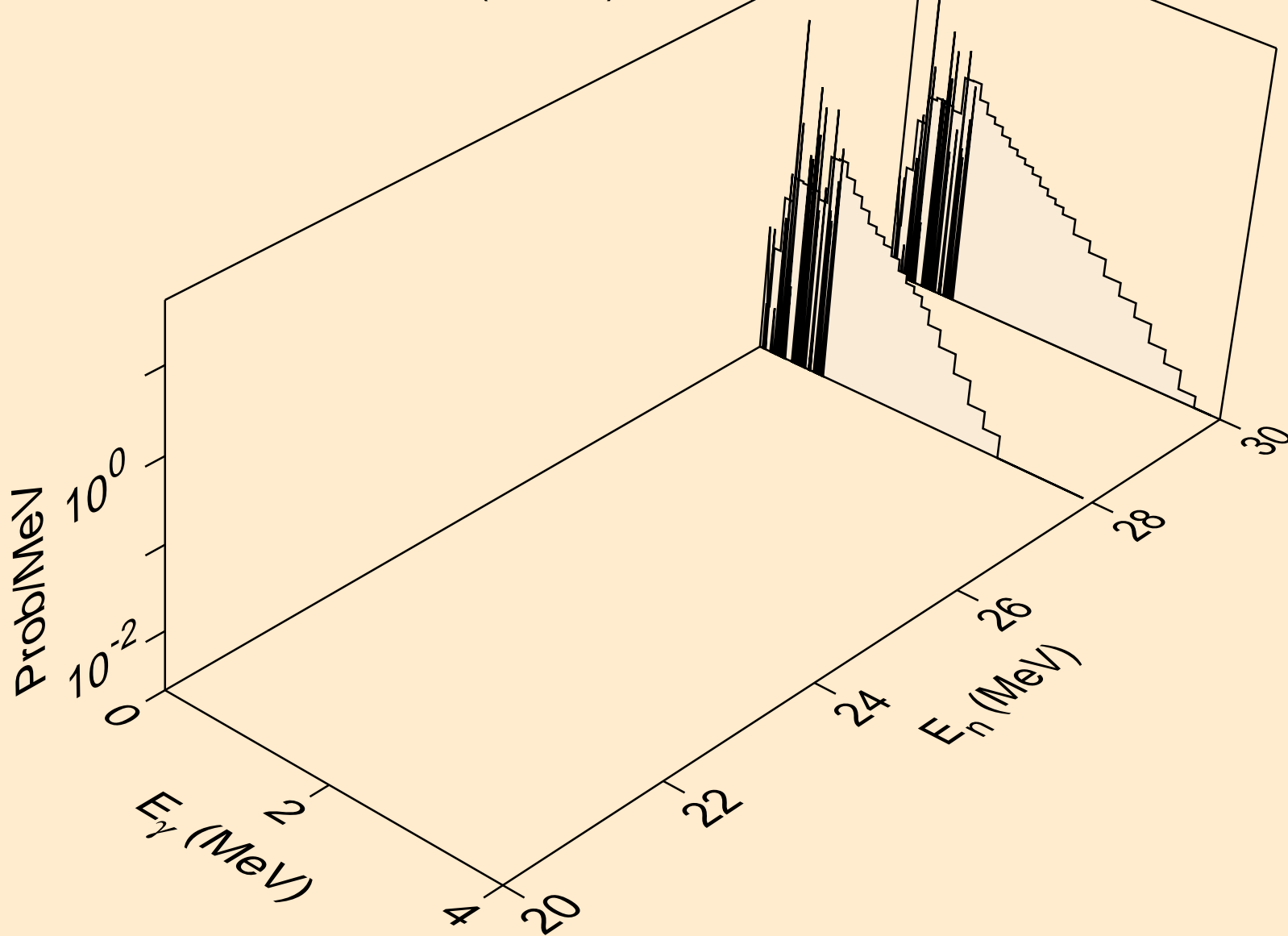

I130 NEUTRON ACER TENDL-2019 LIBRARY; T=293.16K  
Photon emission for (n,2n)

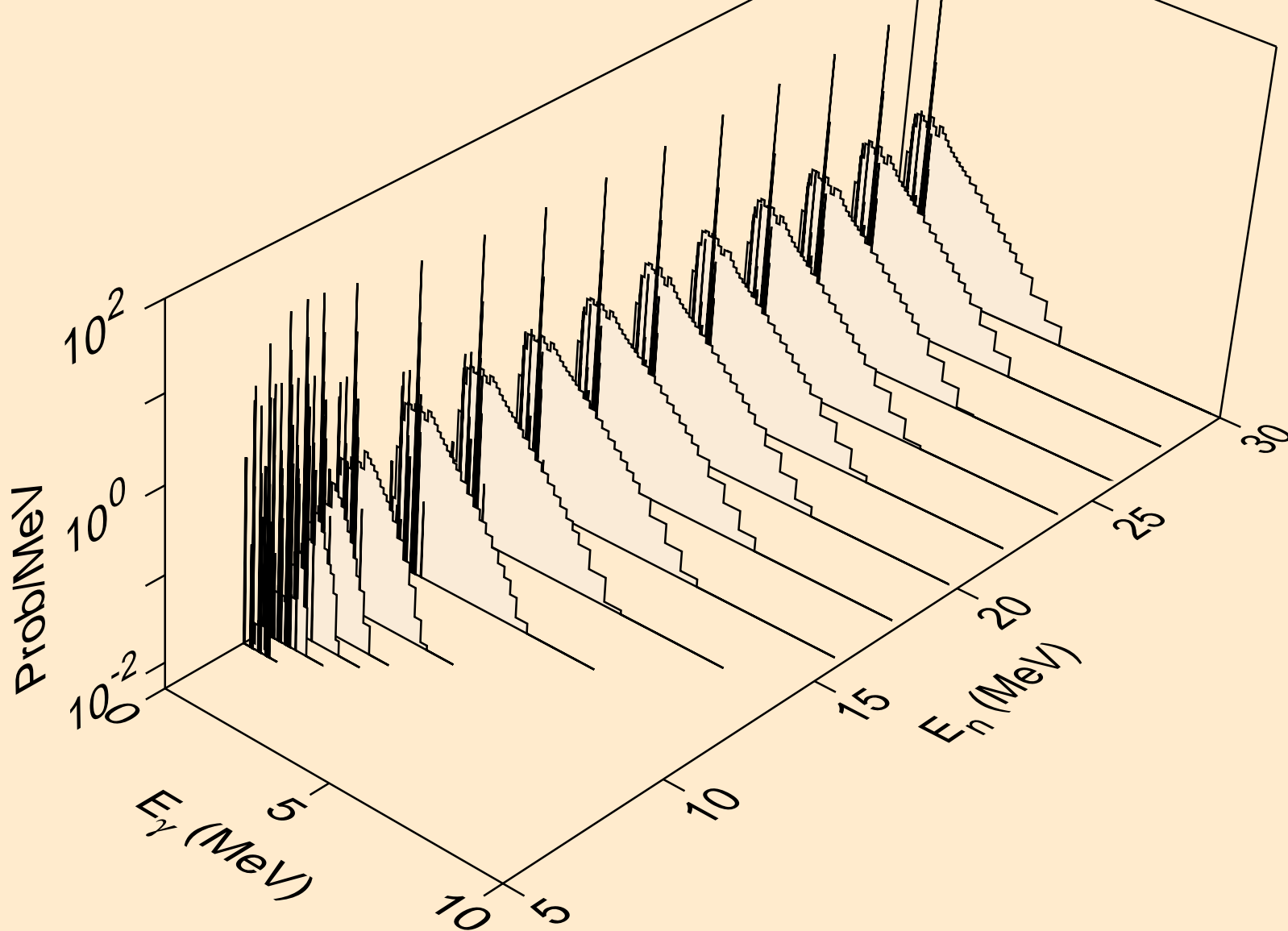

I130 NEUTRON ACER TENDL-2019 LIBRARY; T=293.16K  
Photon emission for (n,3n)

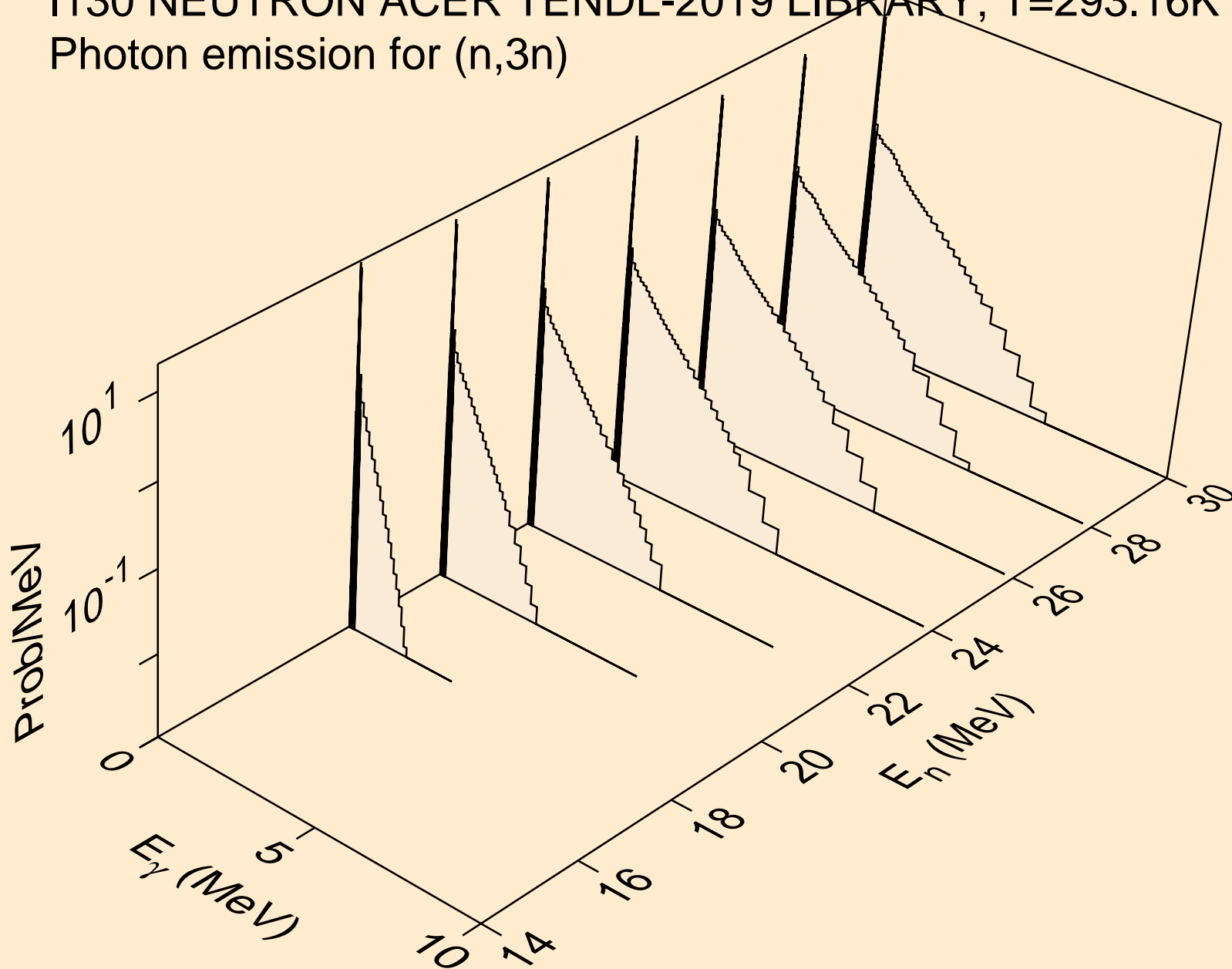

I130 NEUTRON ACER TENDL-2019 LIBRARY; T=293.16K  
Photon emission for (n,n\*)a

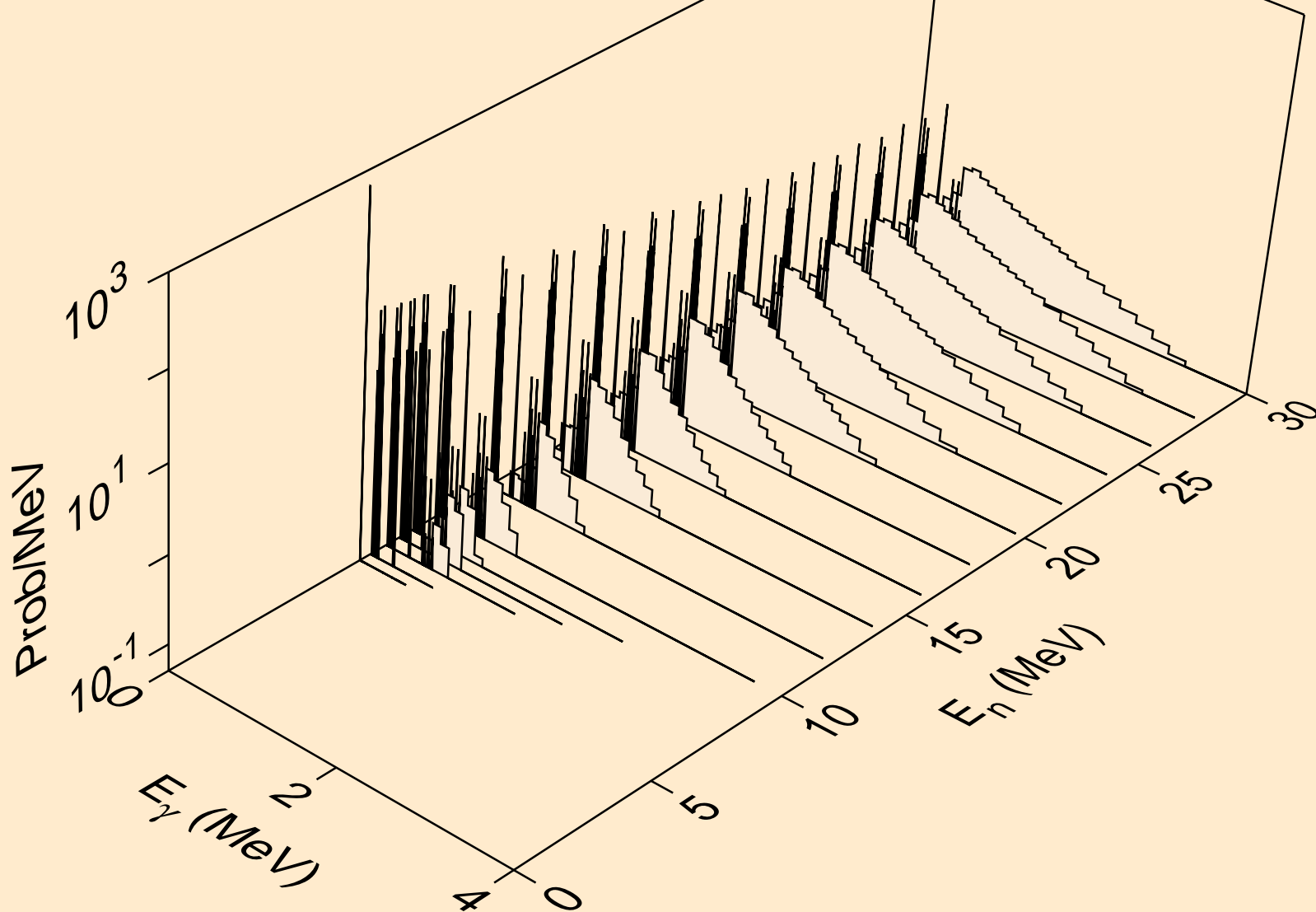



I130 NEUTRON ACER TENDL-2019 LIBRARY; T=293.16K  
Photon emission for (n,2n)a

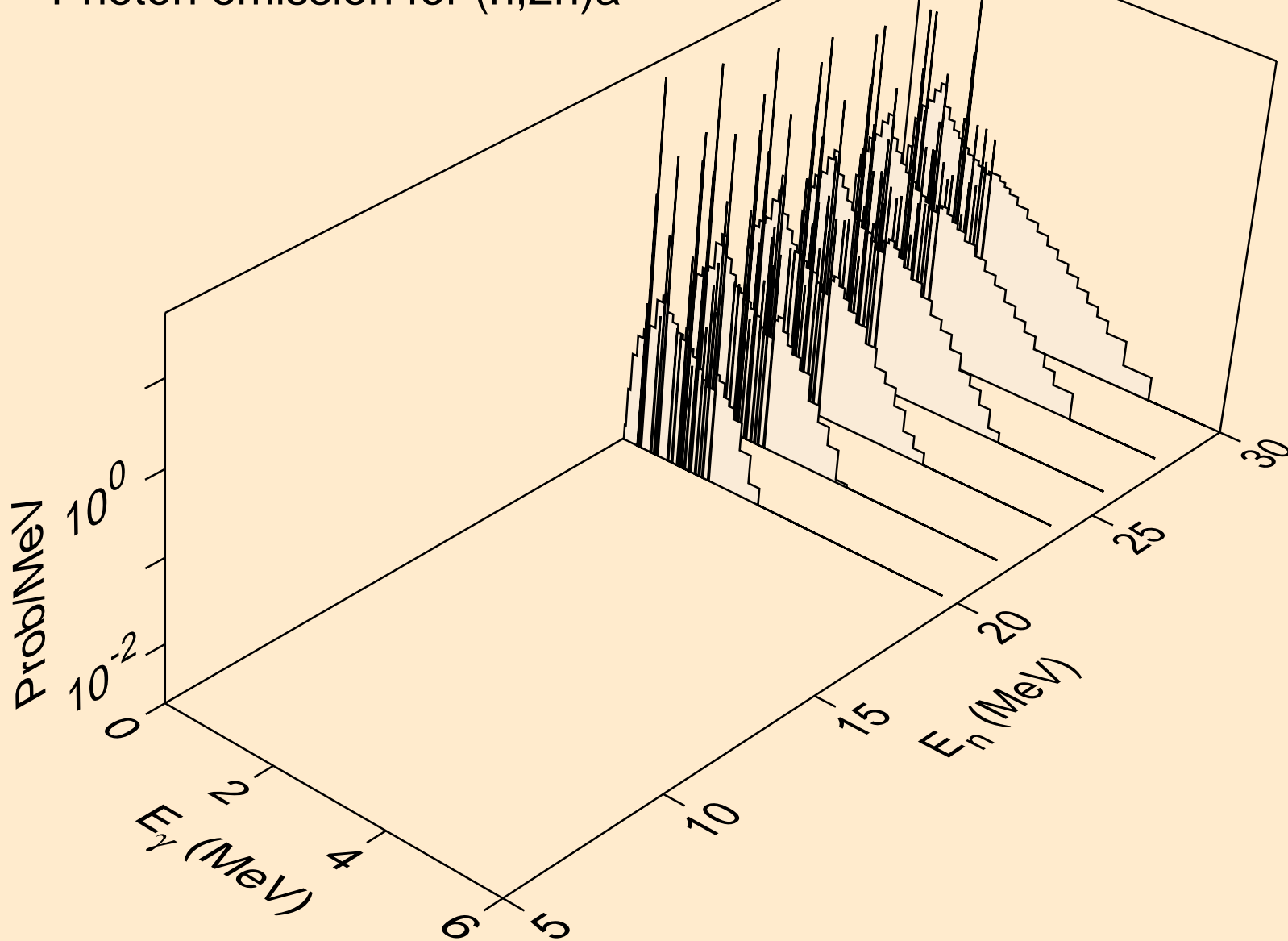

I130 NEUTRON ACER TENDL-2019 LIBRARY; T=293.16K  
Photon emission for (n,3n)a

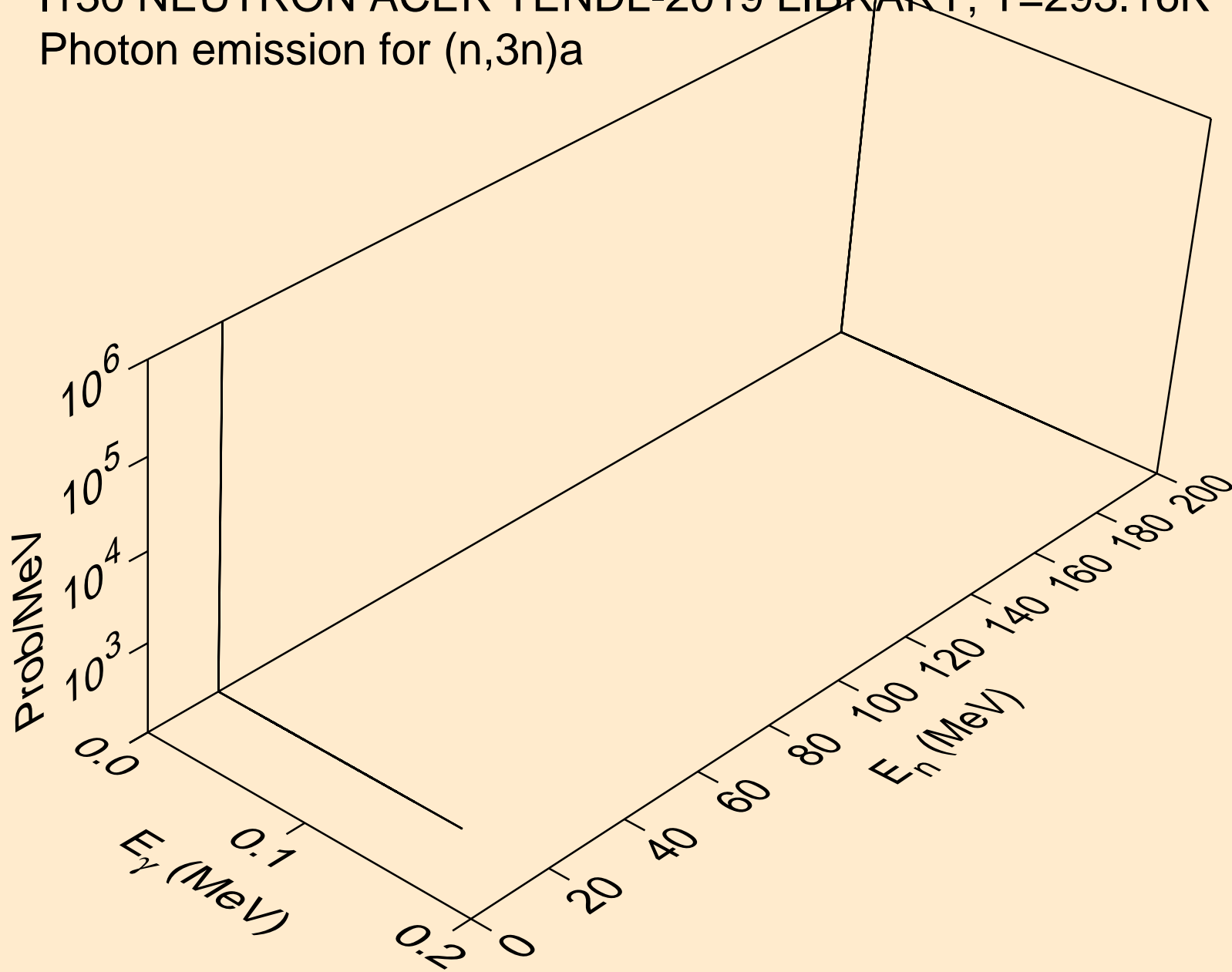

I130 NEUTRON ACER TENDL-2019 LIBRARY; T=293.16K  
Photon emission for (n,n\*)p

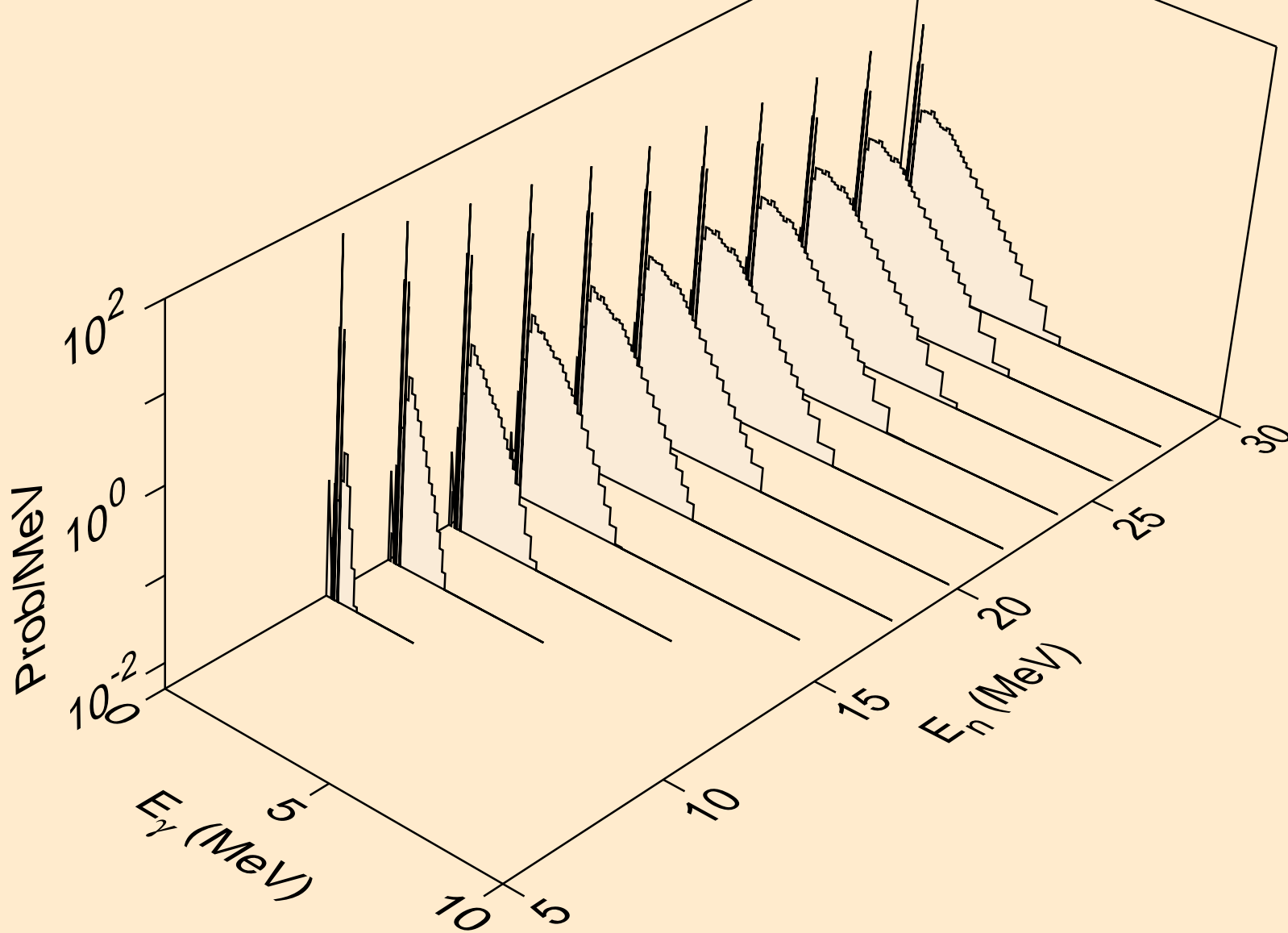

I130 NEUTRON ACER TENDL-2019 LIBRARY; T=293.16K  
Photon emission for (n,n\*)d

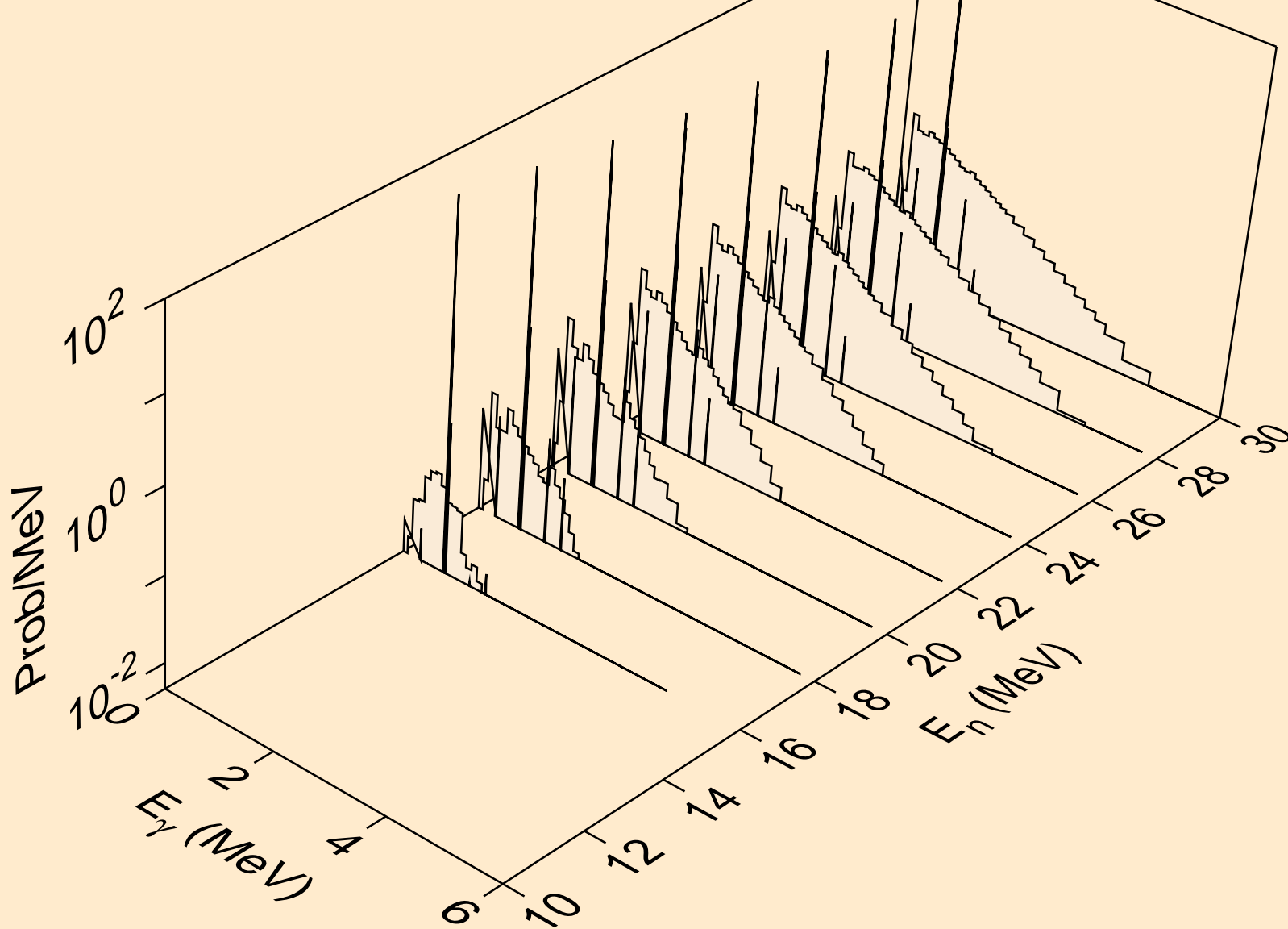

I130 NEUTRON ACER TENDL-2019 LIBRARY; T=293.16K  
Photon emission for (n,n\*)t

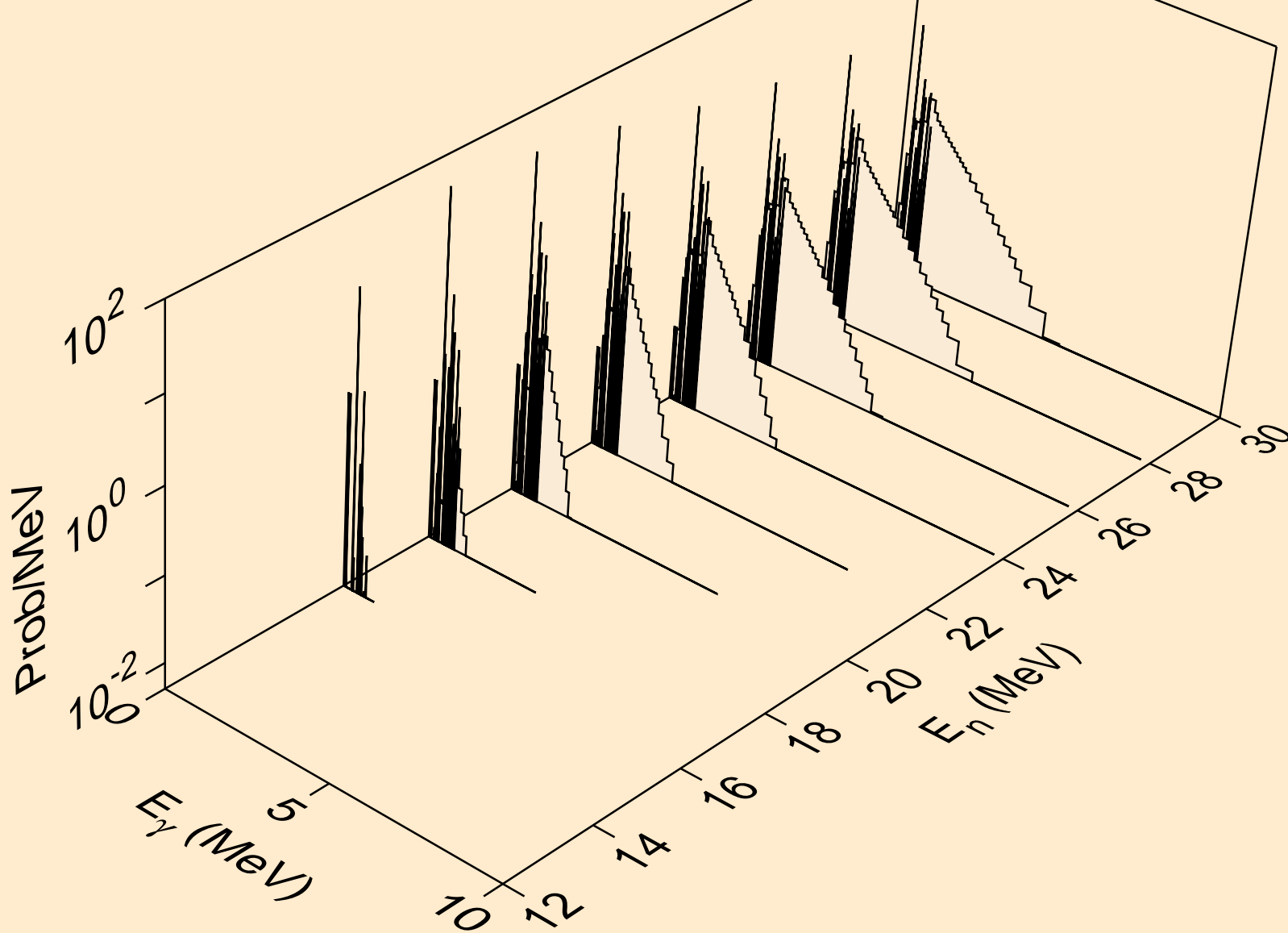

I130 NEUTRON ACER TENDL-2019 LIBRARY; T=293.16K  
Photon emission for (n,n\*)he3

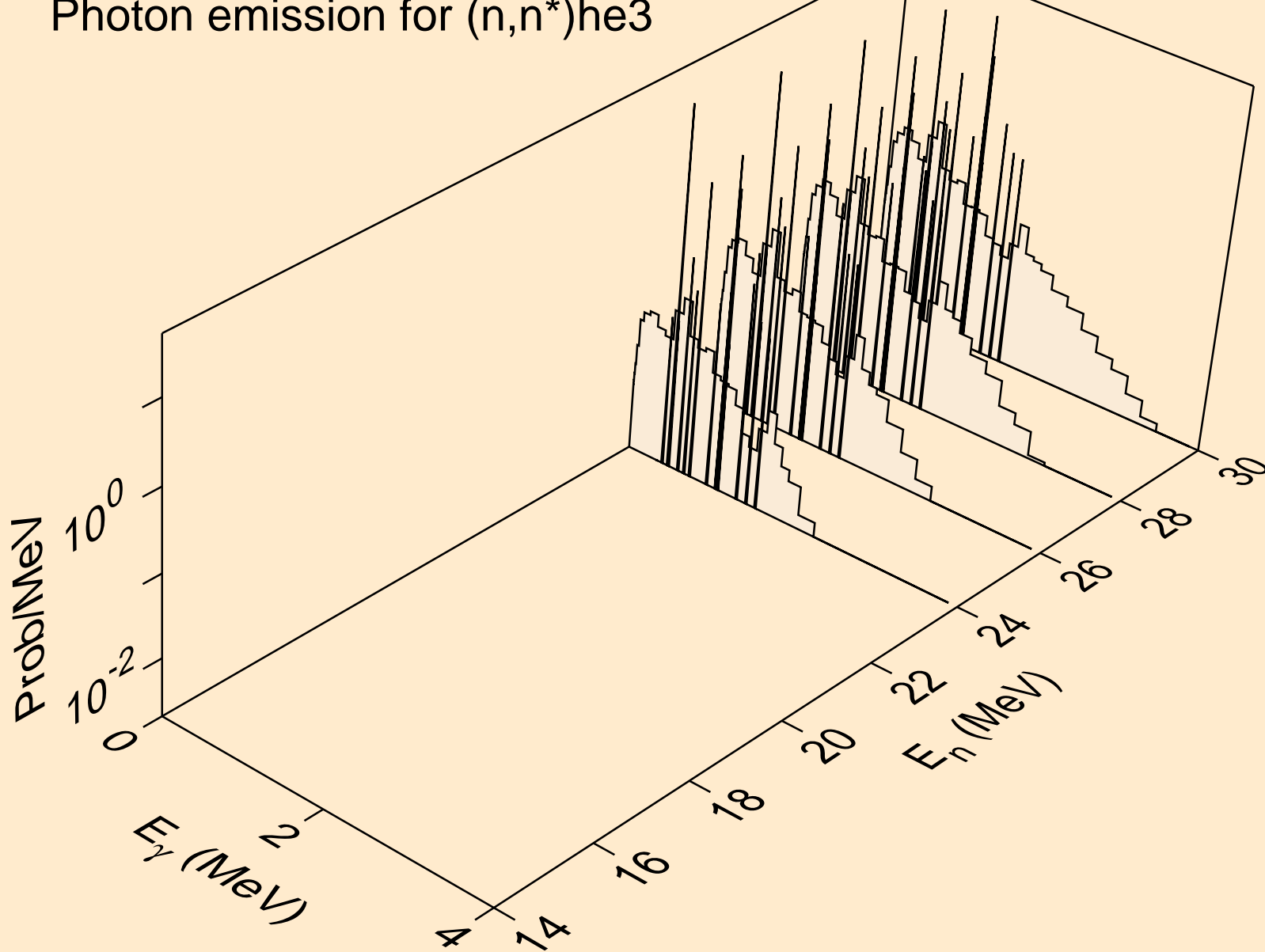

I130 NEUTRON ACER TENDL-2019 LIBRARY; T=293.16K  
Photon emission for (n,4n)

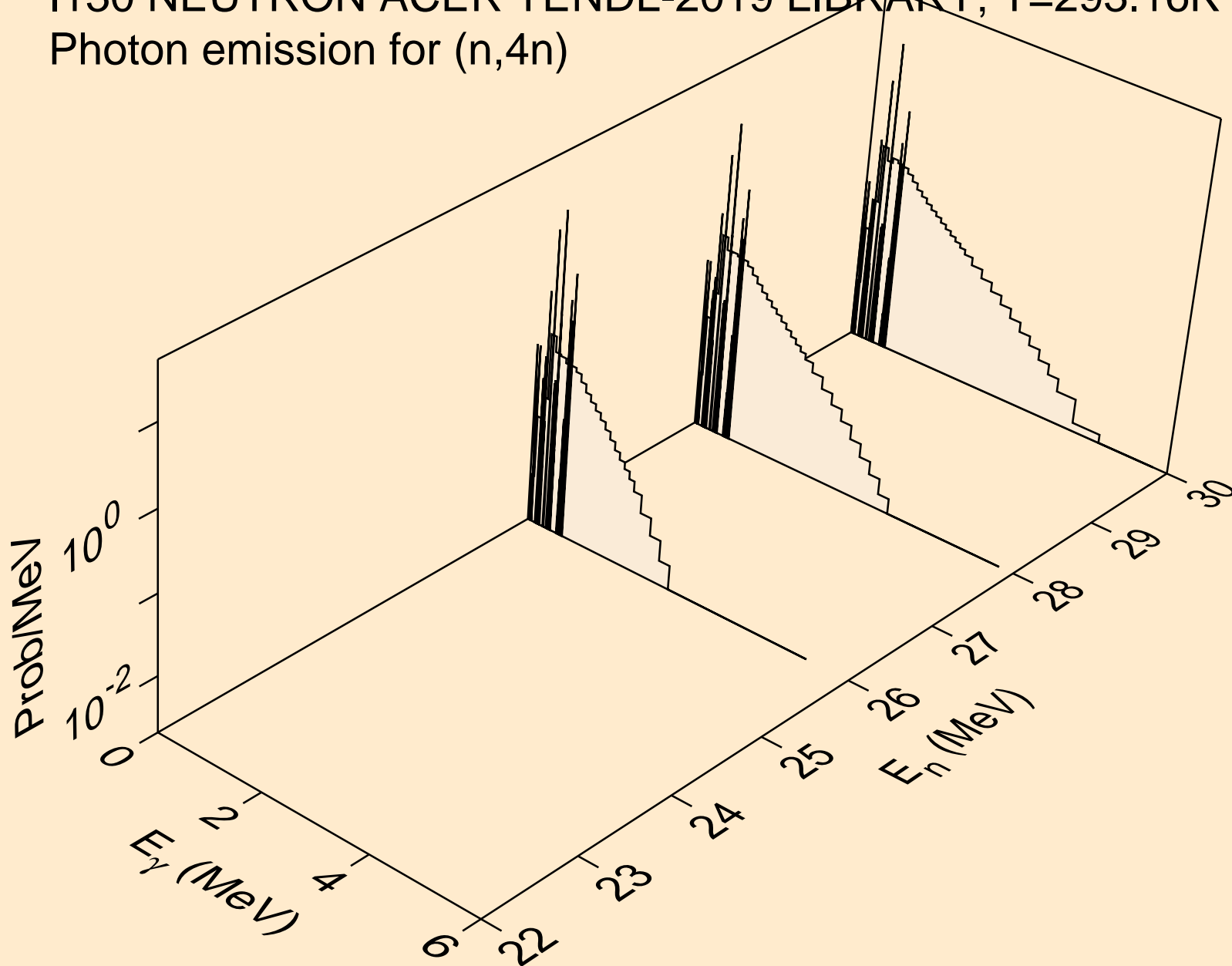

I130 NEUTRON ACER TENDL-2019 LIBRARY; T=293.16K  
Photon emission for (n,2np)

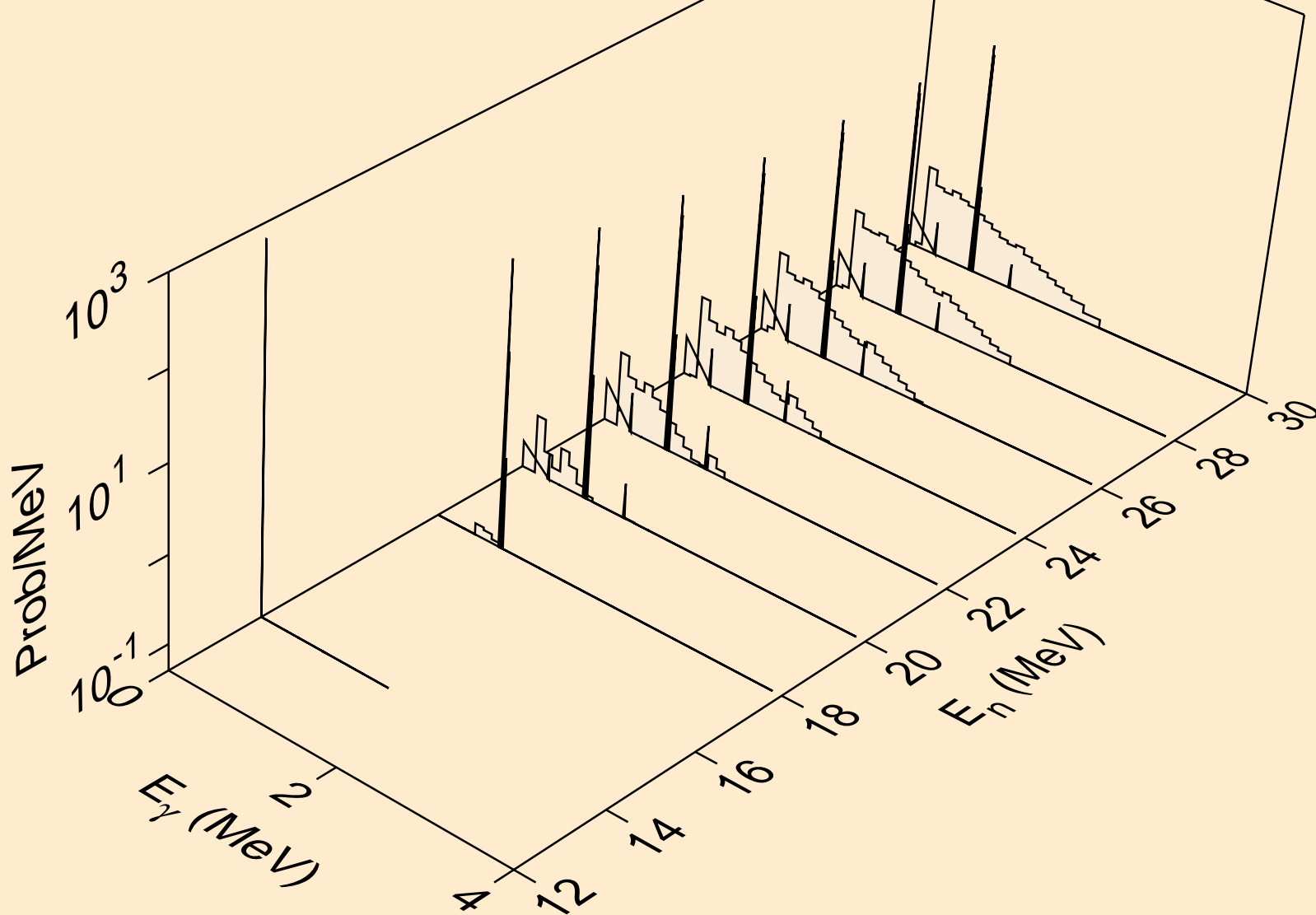



I130 NEUTRON ACER TENDL-2019 LIBRARY; T=293.16K  
Photon emission for (n,3np)

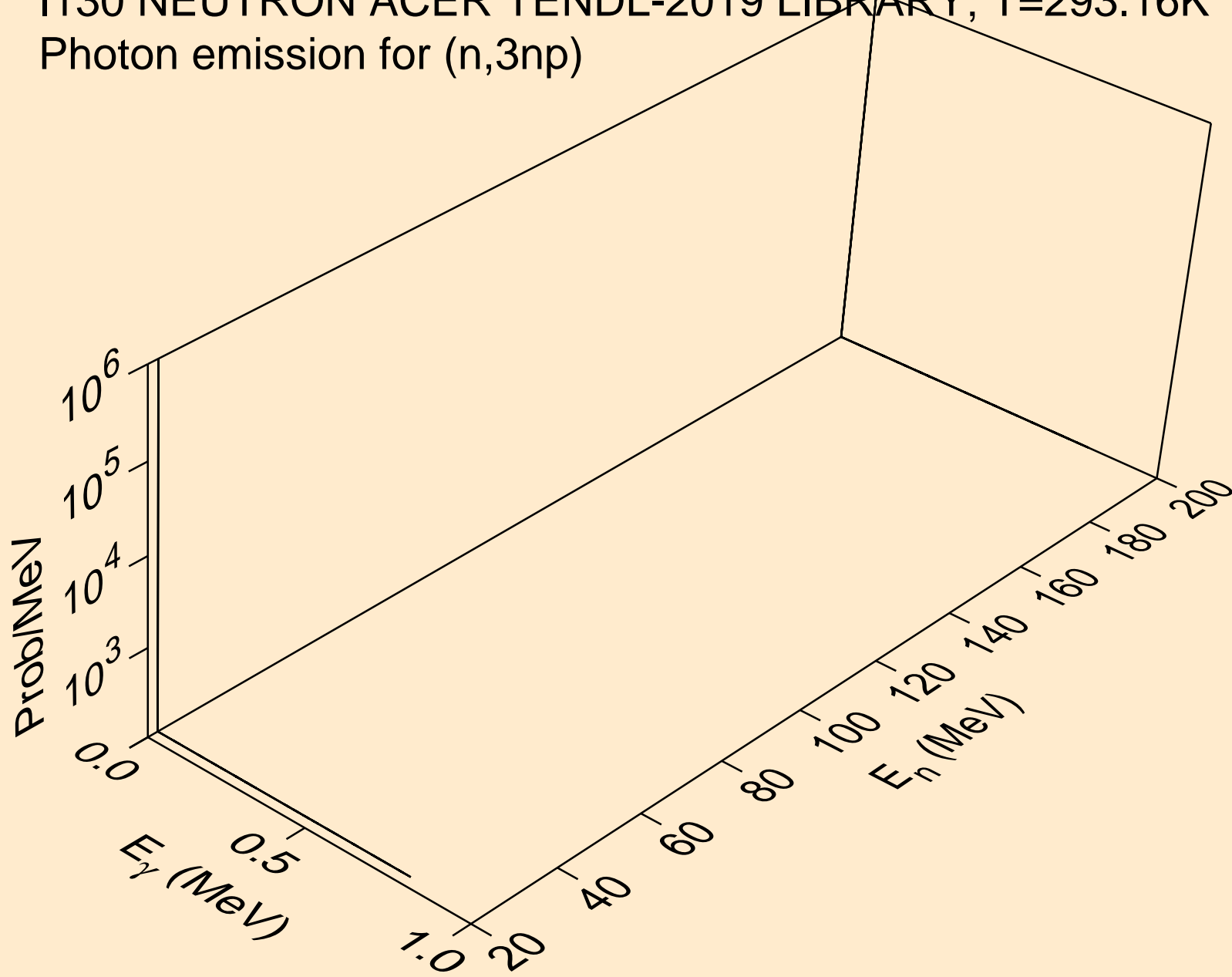

I130 NEUTRON ACER TENDL-2019 LIBRARY; T=293.16K  
Photon emission for (n,2np)

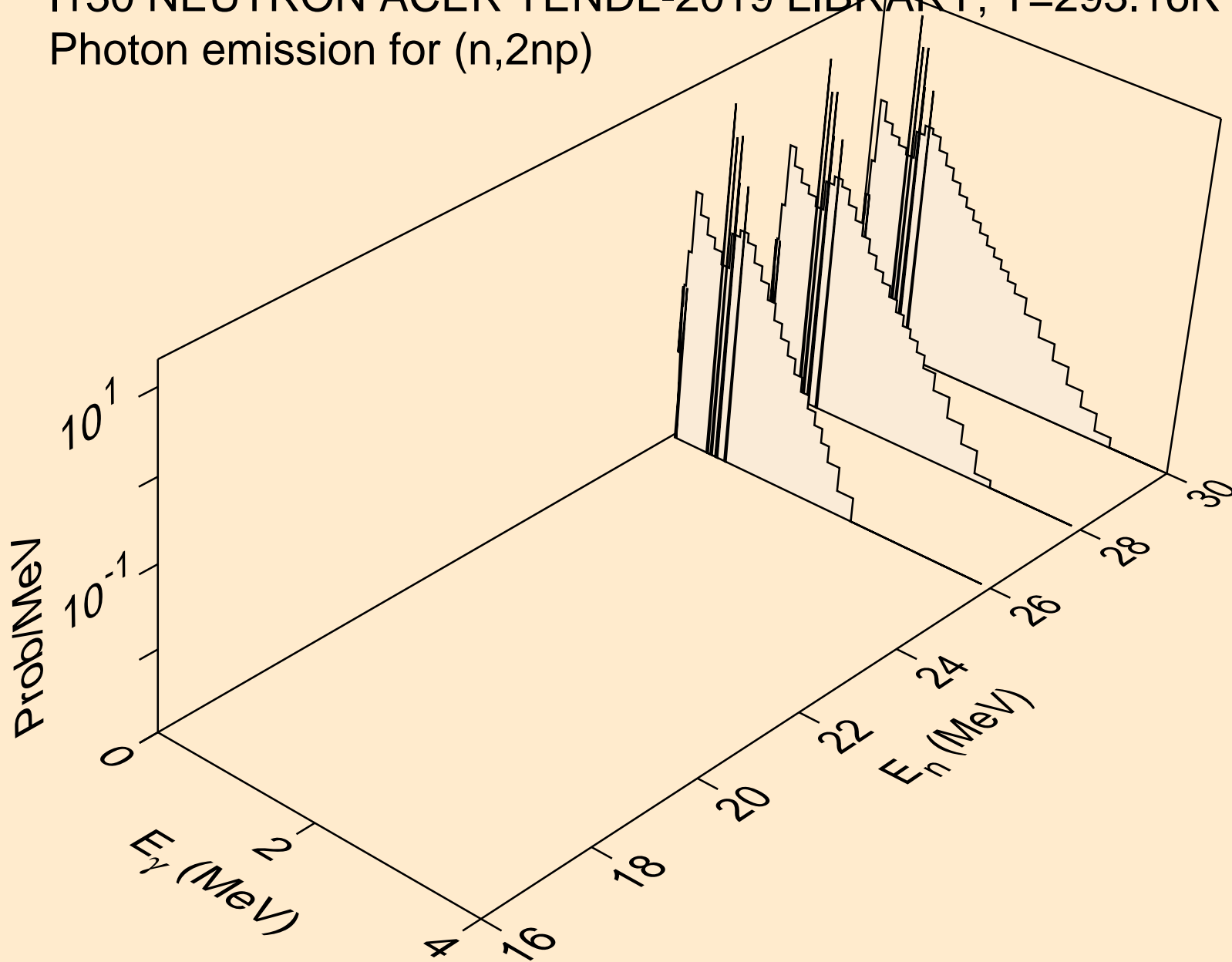

I130 NEUTRON ACER TENDL-2019 LIBRARY; T=293.16K  
Photon emission for (n,npa)

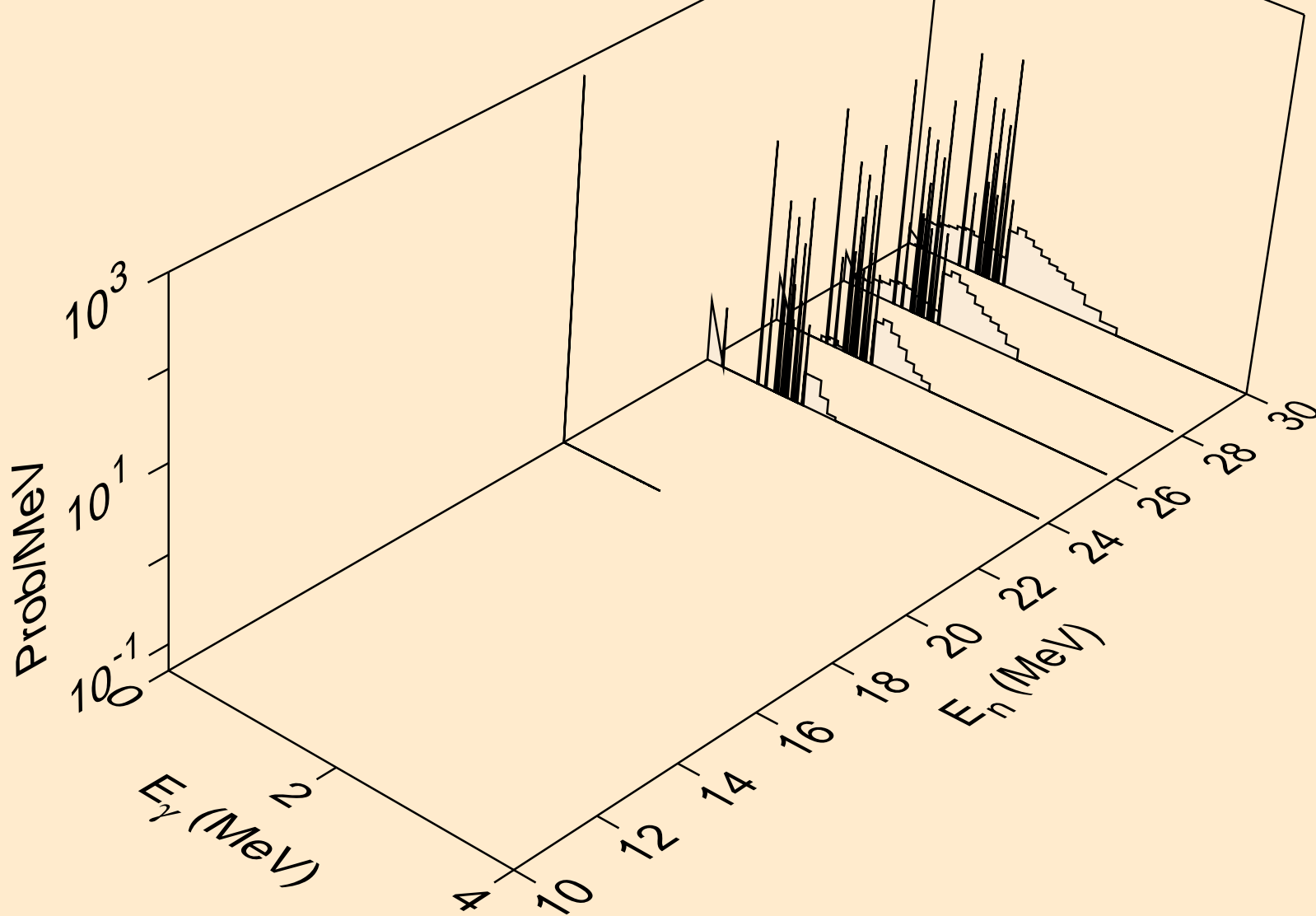

I130 NEUTRON ACER TENDL-2019 LIBRARY; T=293.16K  
Photon emission for (n,n\*c)

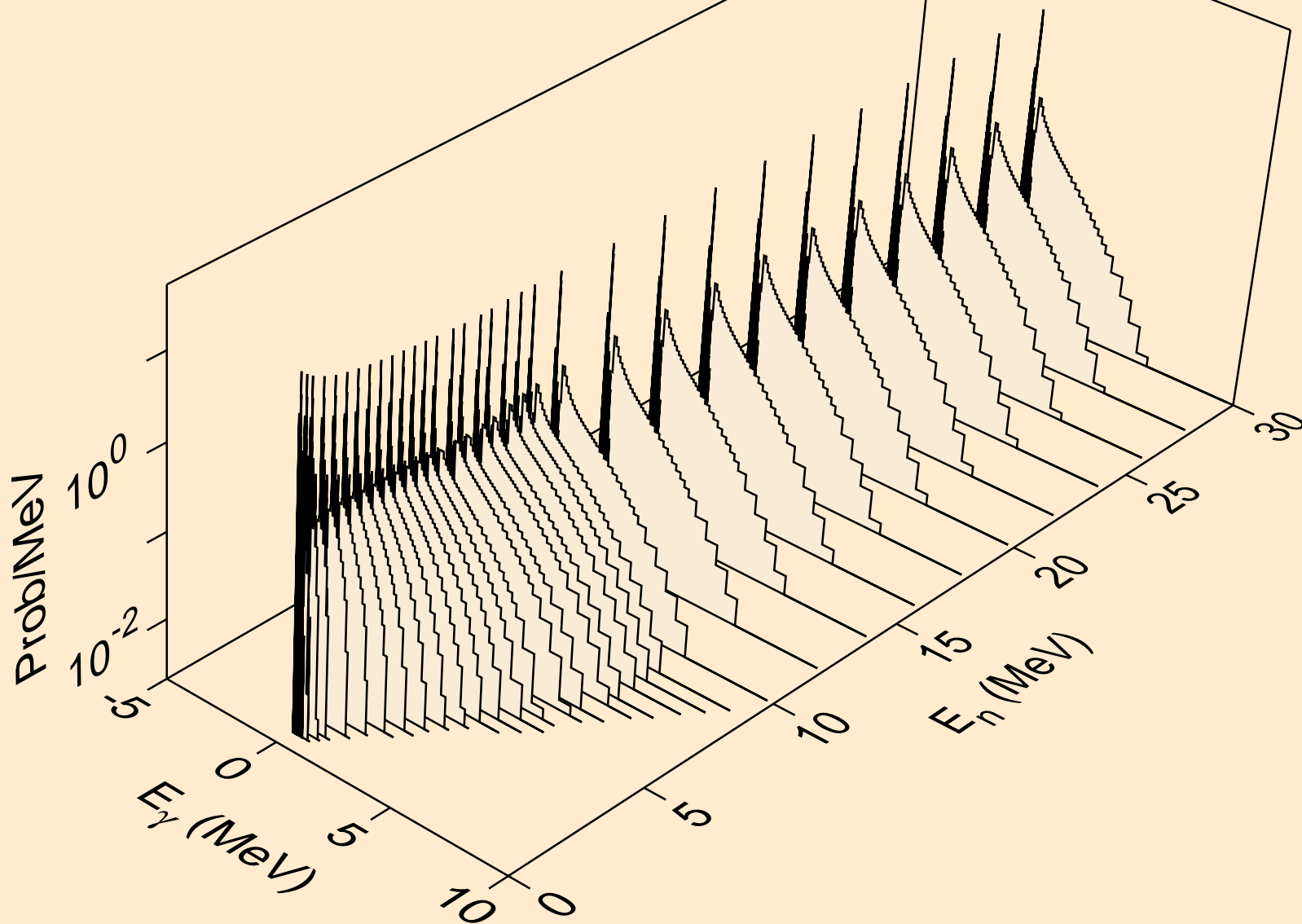

I130 NEUTRON ACER TENDL-2019 LIBRARY; T=293.16K  
Photon emission for (n,gma)

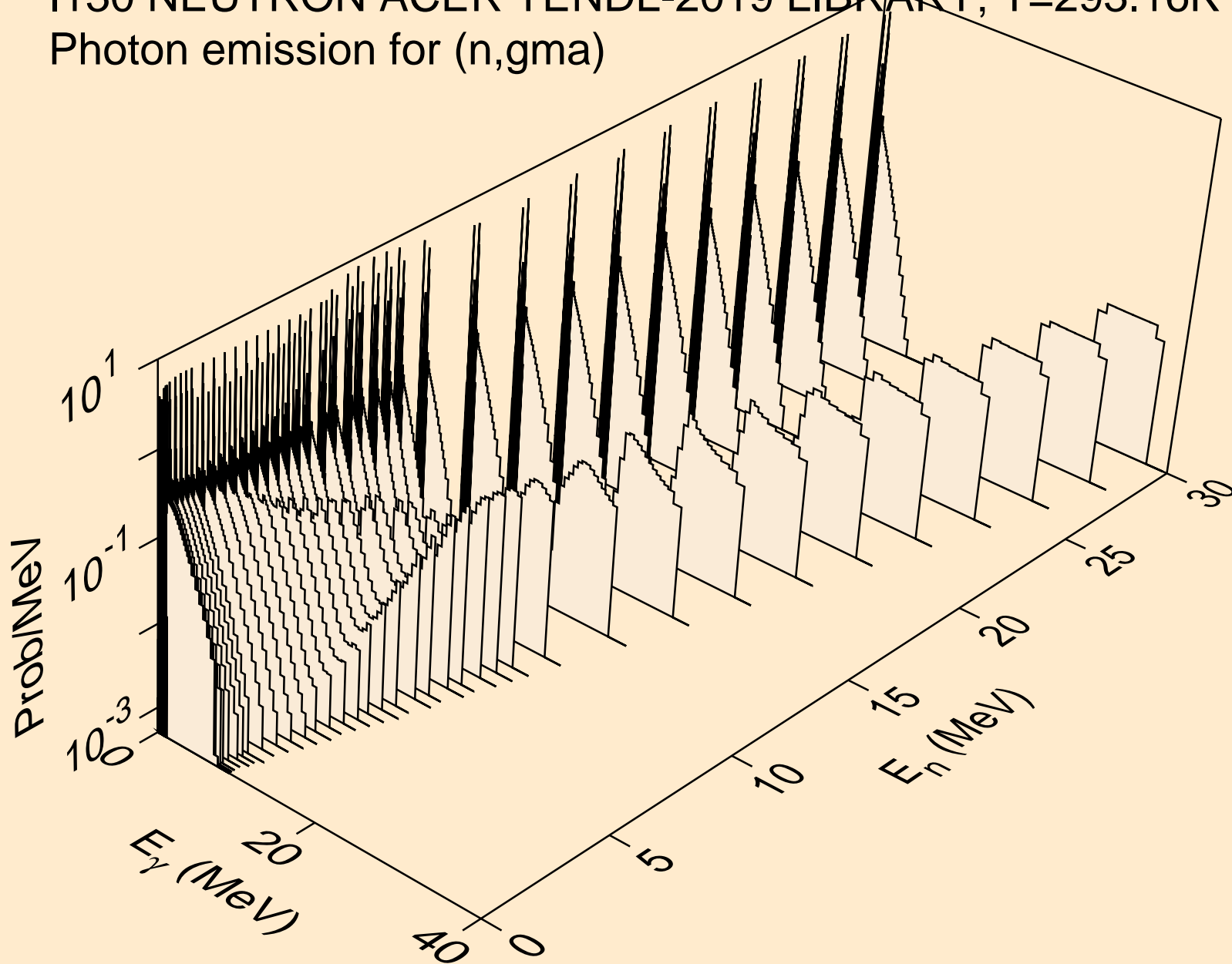

I130 NEUTRON ACER TENDL-2019 LIBRARY; T=293.16K  
Photon emission for (n,p)

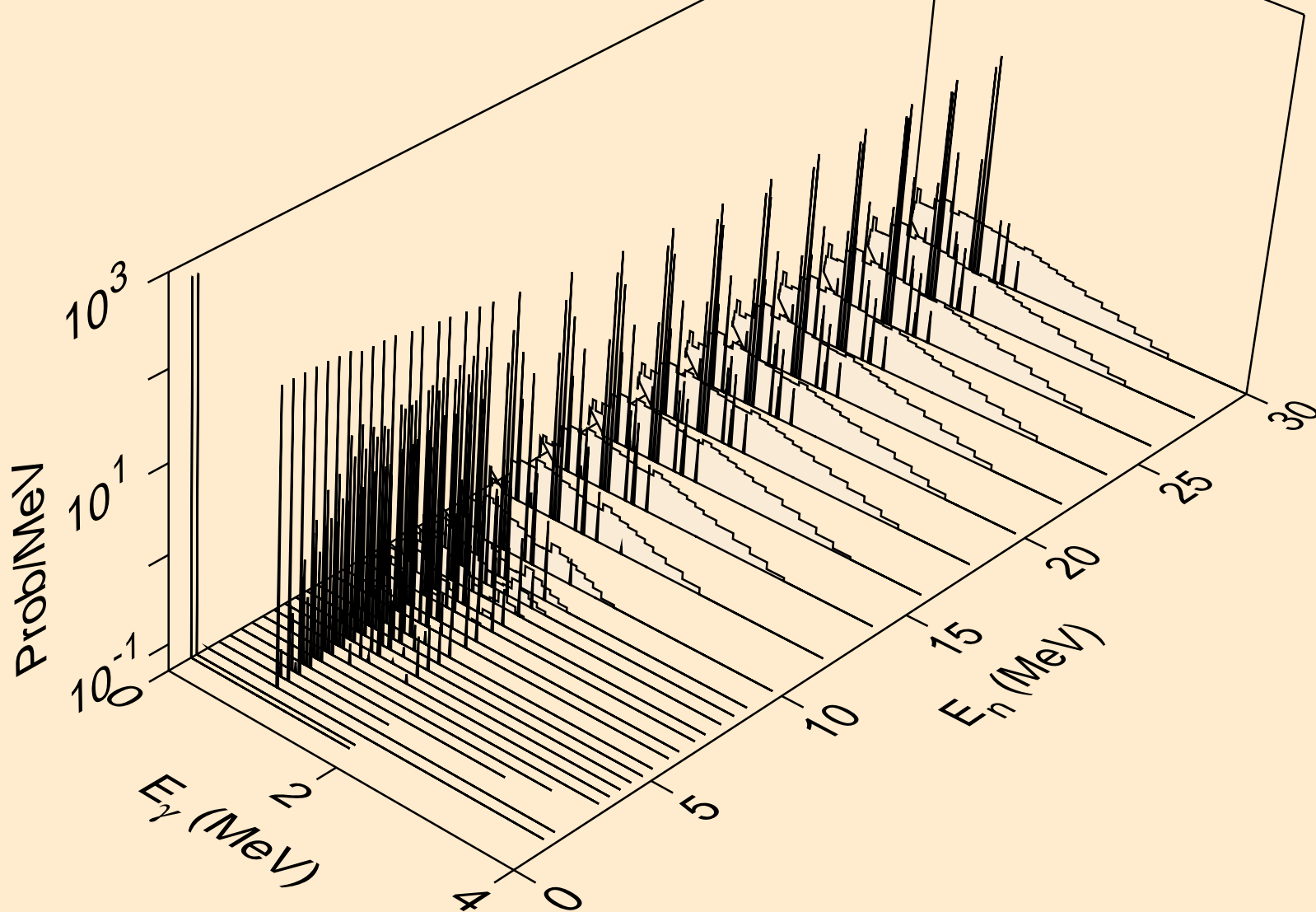

I130 NEUTRON ACER TENDL-2019 LIBRARY; T=293.16K  
Photon emission for (n,d)

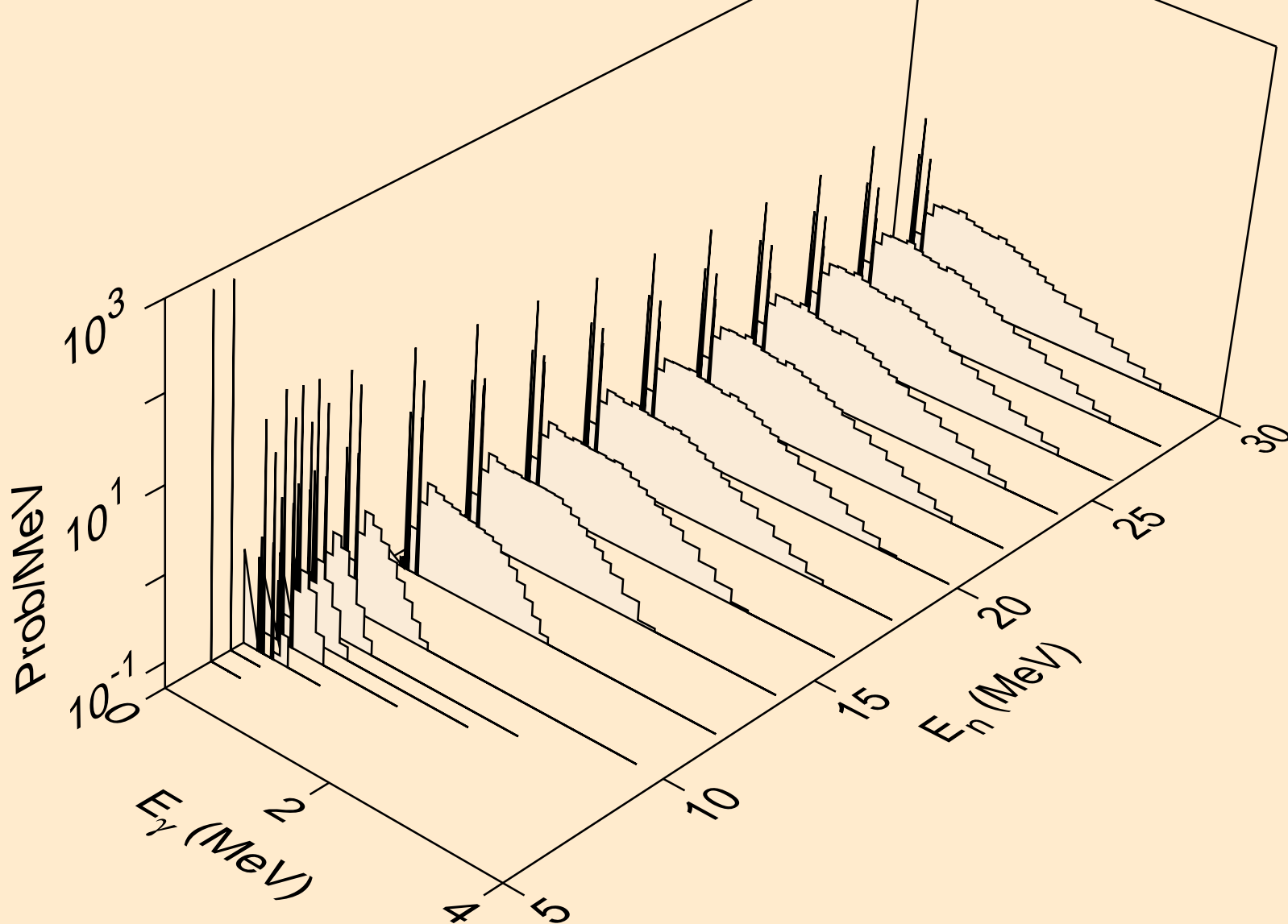

I130 NEUTRON ACER TENDL-2019 LIBRARY; T=293.16K  
Photon emission for (n,t)

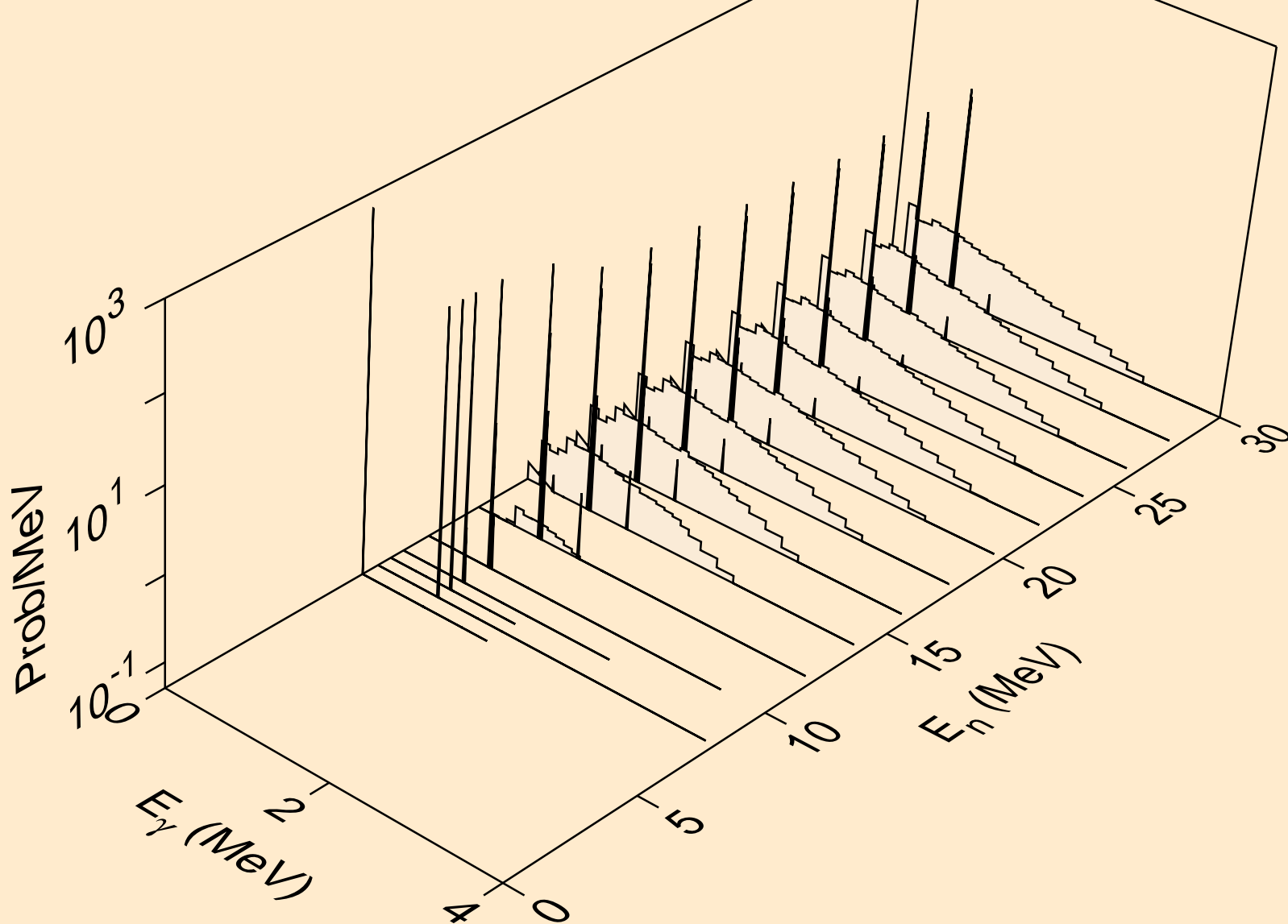



I130 NEUTRON ACER TENDL-2019 LIBRARY; T=293.16K  
Photon emission for (n,he3)

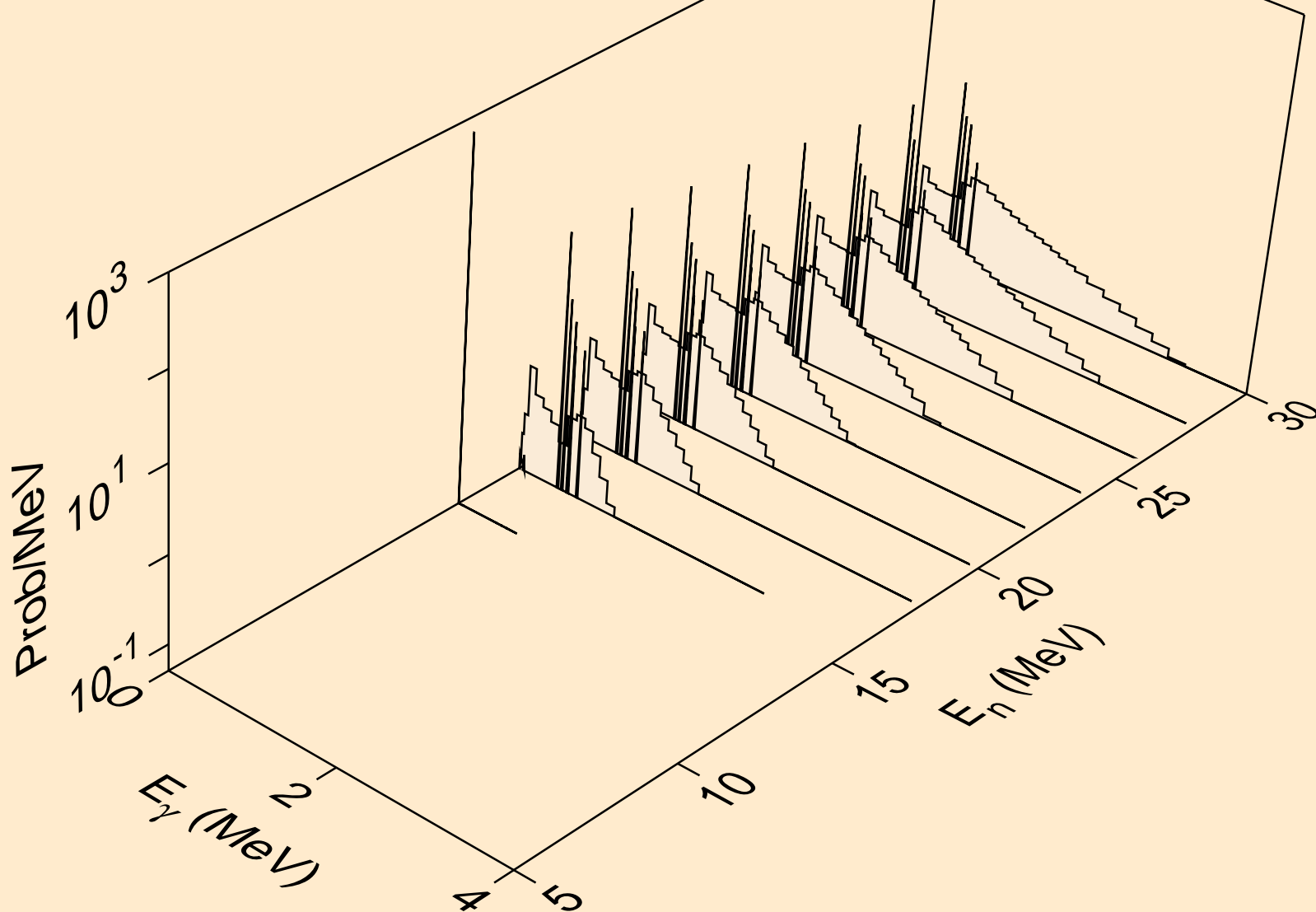

I130 NEUTRON ACER TENDL-2019 LIBRARY; T=293.16K  
Photon emission for (n,a)

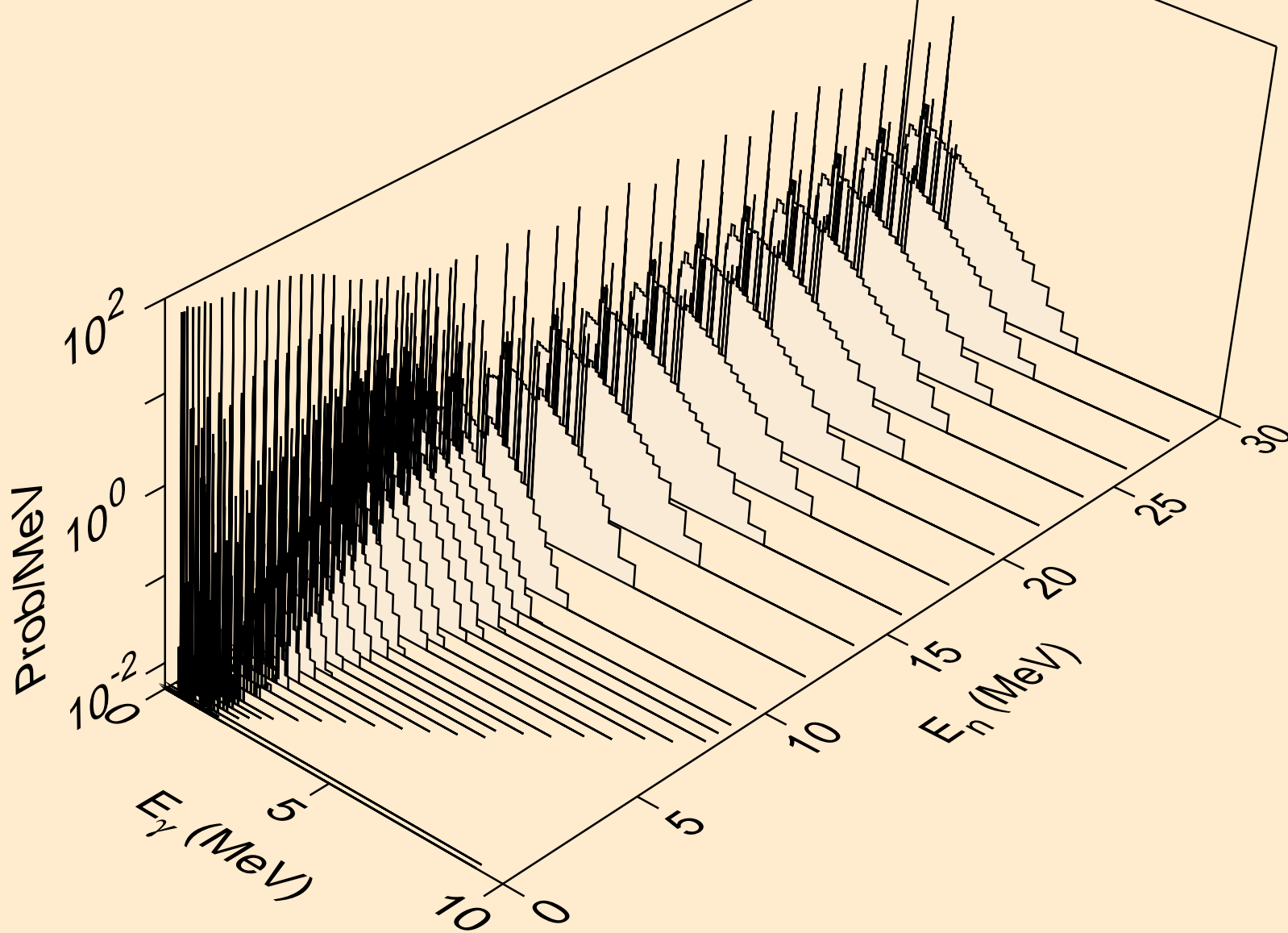

I130 NEUTRON ACER TENDL-2019 LIBRARY; T=293.16K  
Photon emission for (n,2p)

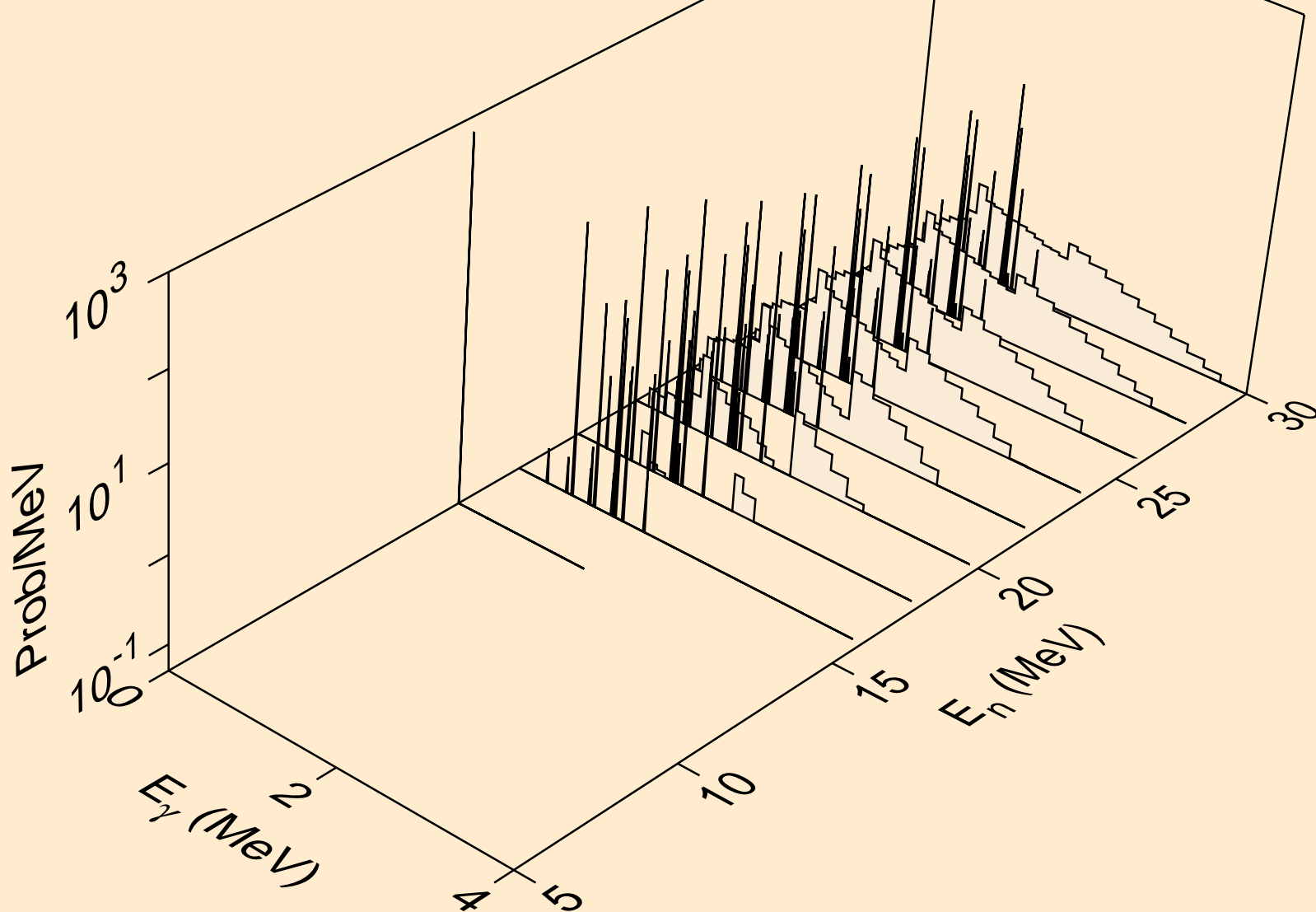

I130 NEUTRON ACER TENDL-2019 LIBRARY; T=293.16K  
Photon emission for (n,p $\alpha$ )

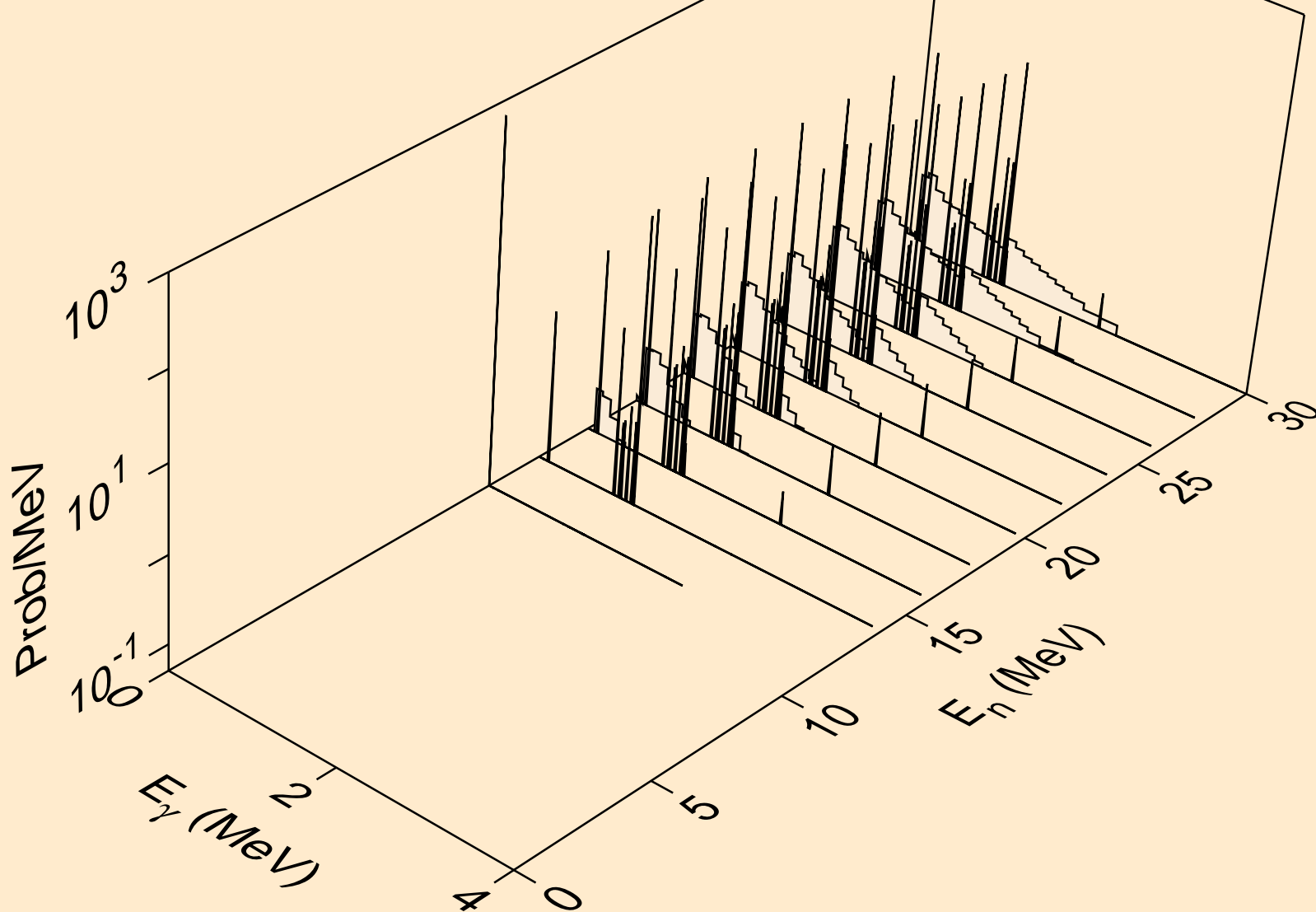

I130 NEUTRON ACER TENDL-2019 LIBRARY; T=293.16K  
Photon emission for (n,pd)

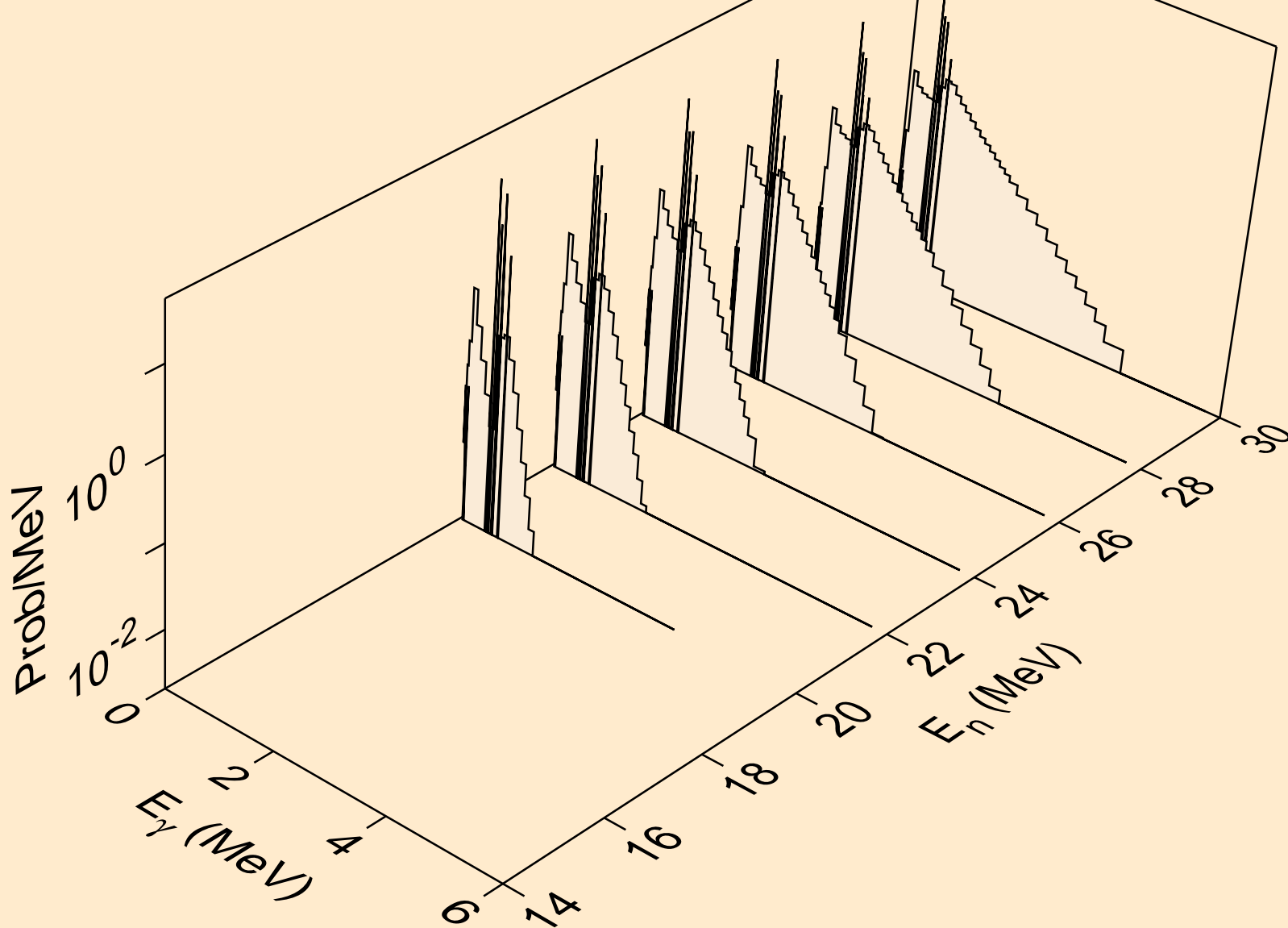

I130 NEUTRON ACER TENDL-2019 LIBRARY; T=293.16K  
Photon emission for (n,pt)

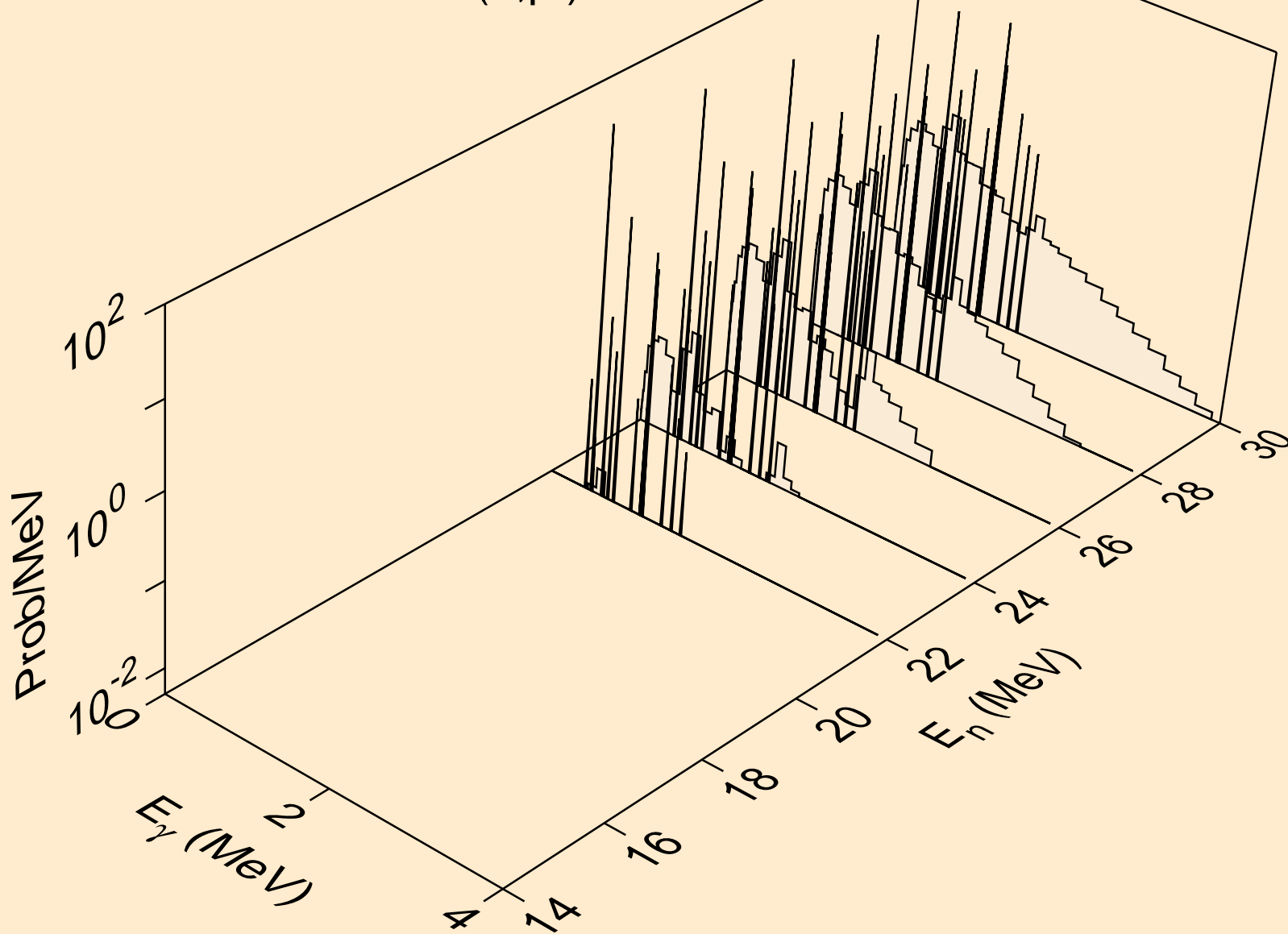

I130 NEUTRON ACER TENDL-2019 LIBRARY; T=293.16K  
Photon emission for (n,da)

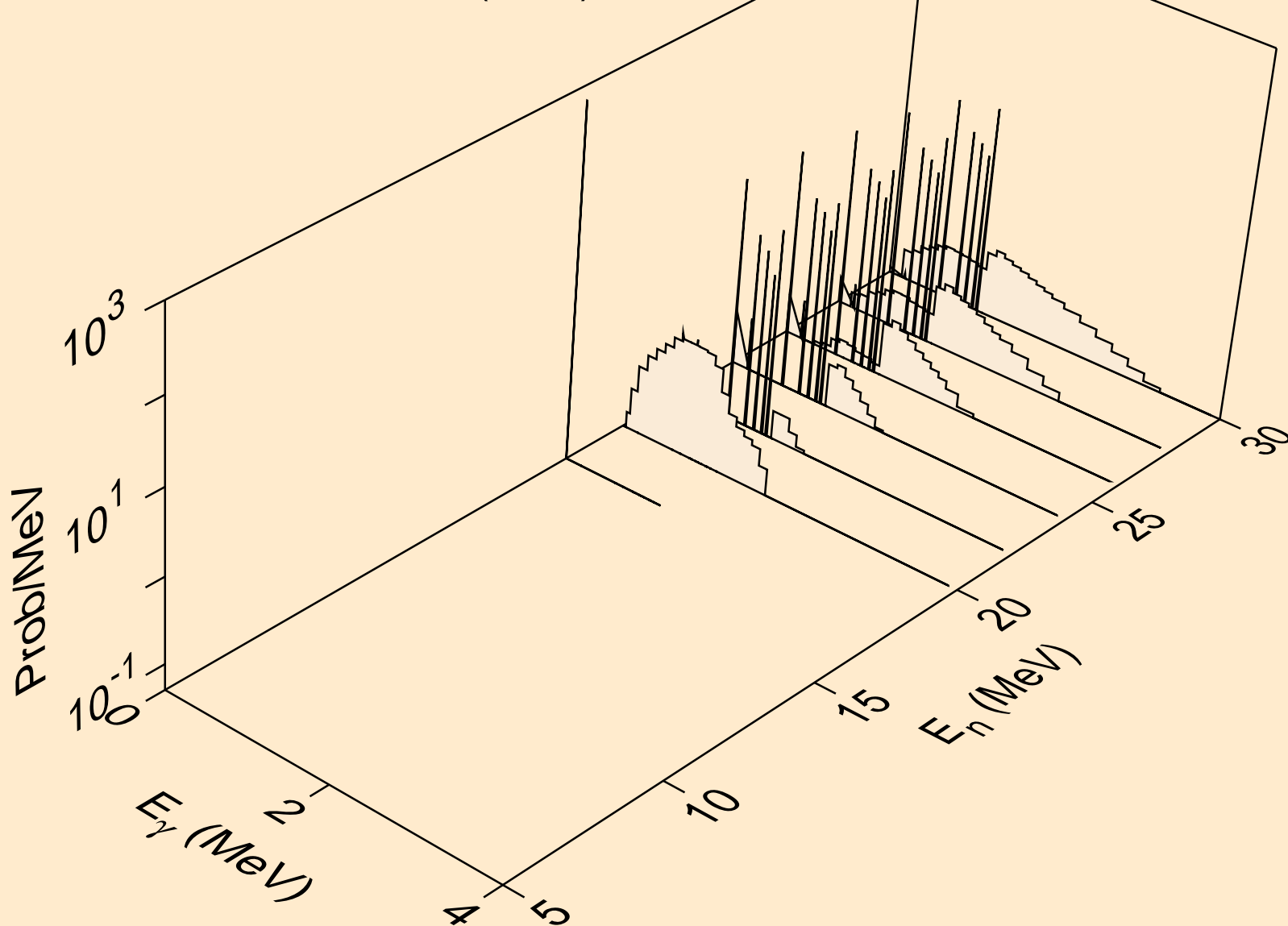

I130 NEUTRON ACER TENDL-2019 LIBRARY; T=293.16K  
thermal capture photon spectrum

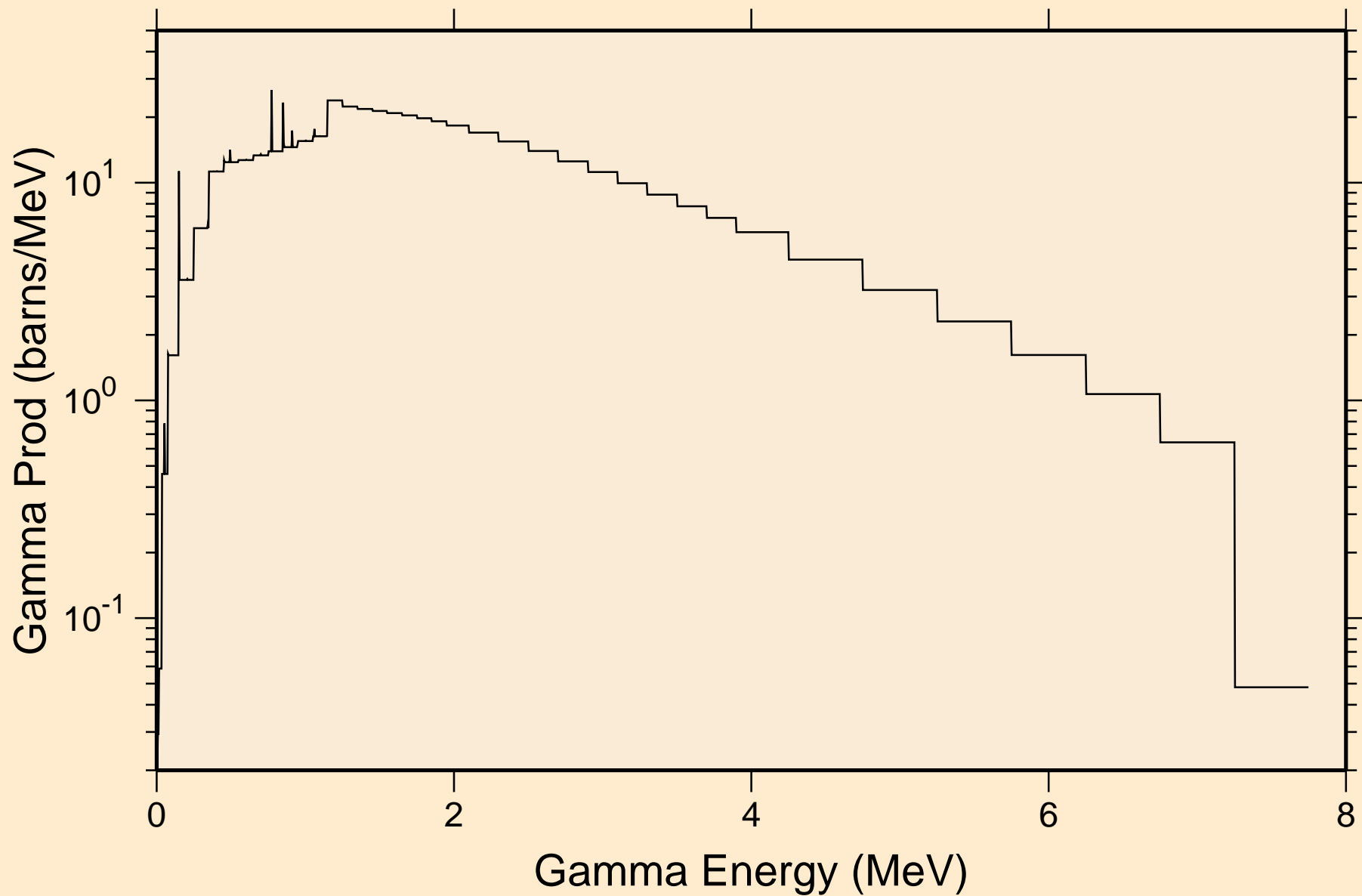



I130 NEUTRON ACER TENDL-2019 LIBRARY; T=293.16K  
14 MeV photon spectrum

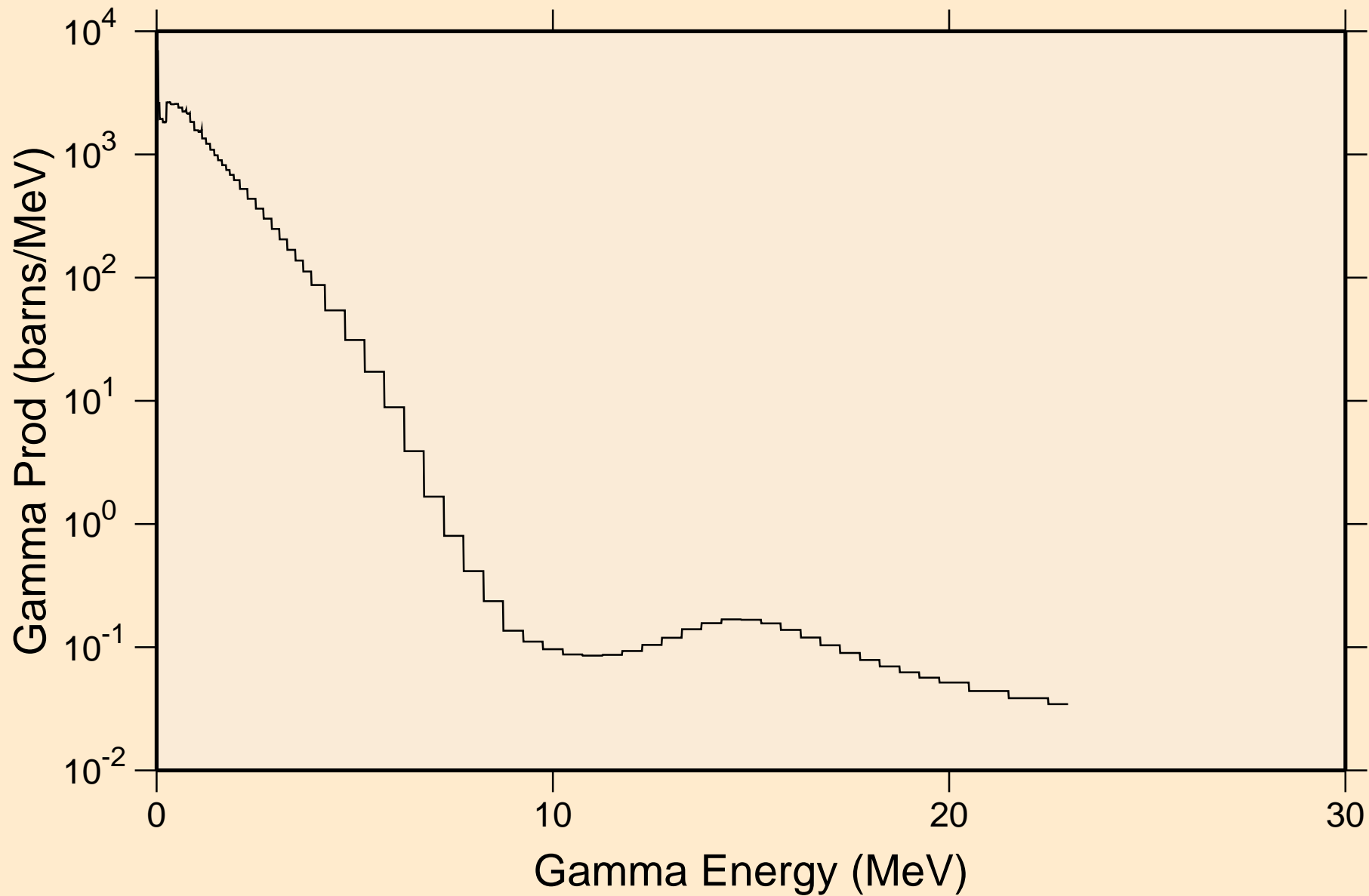

# I130 NEUTRON ACER TENDL-2019 LIBRARY; T=293.16K

## Particle heating contributions

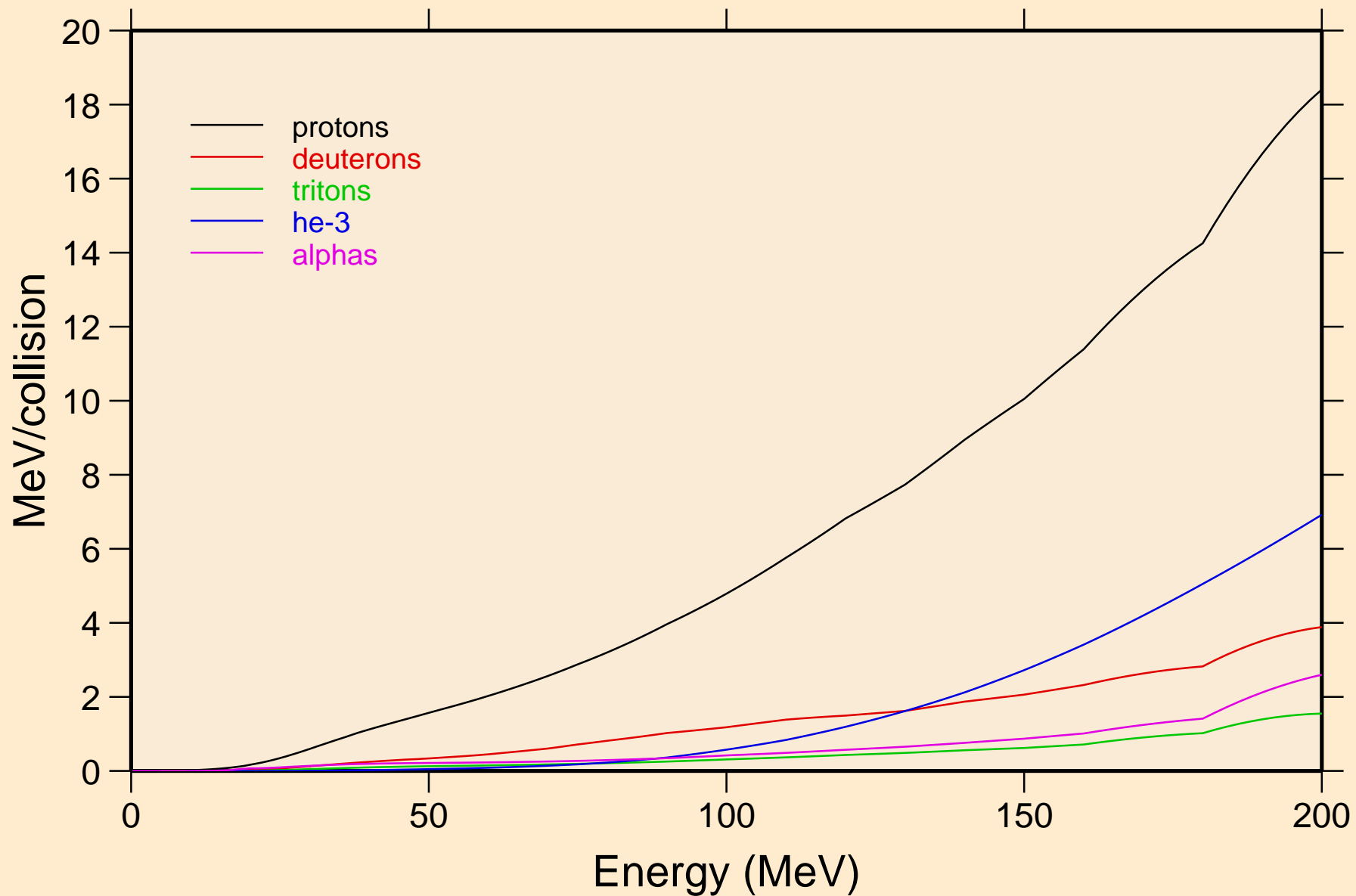

I130 NEUTRON ACER TENDL-2019 LIBRARY; T=293.16K  
Recoil Heating

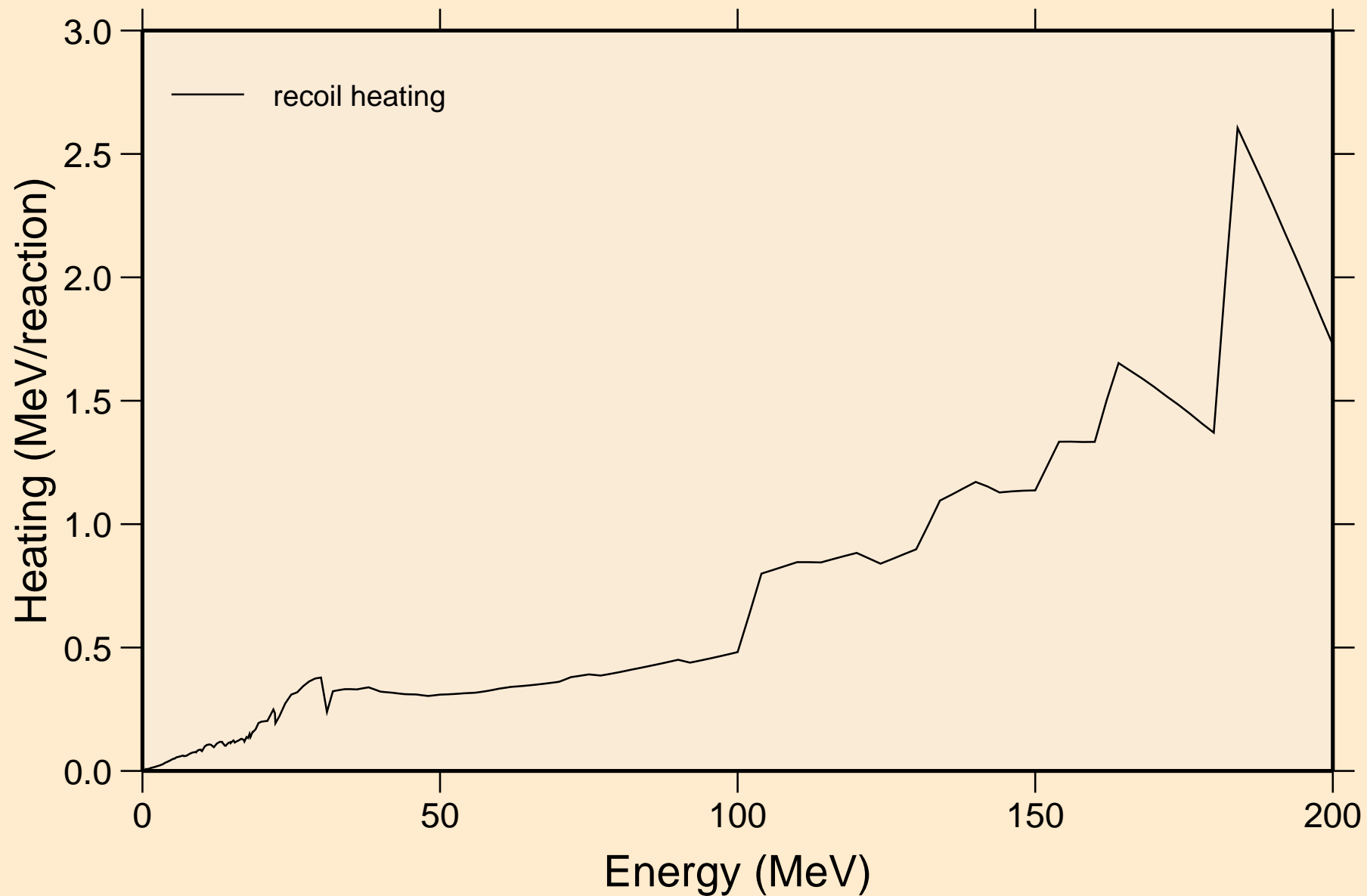

I130 NEUTRON ACER TENDL-2019 LIBRARY; T=293.16K  
Particle production cross sections

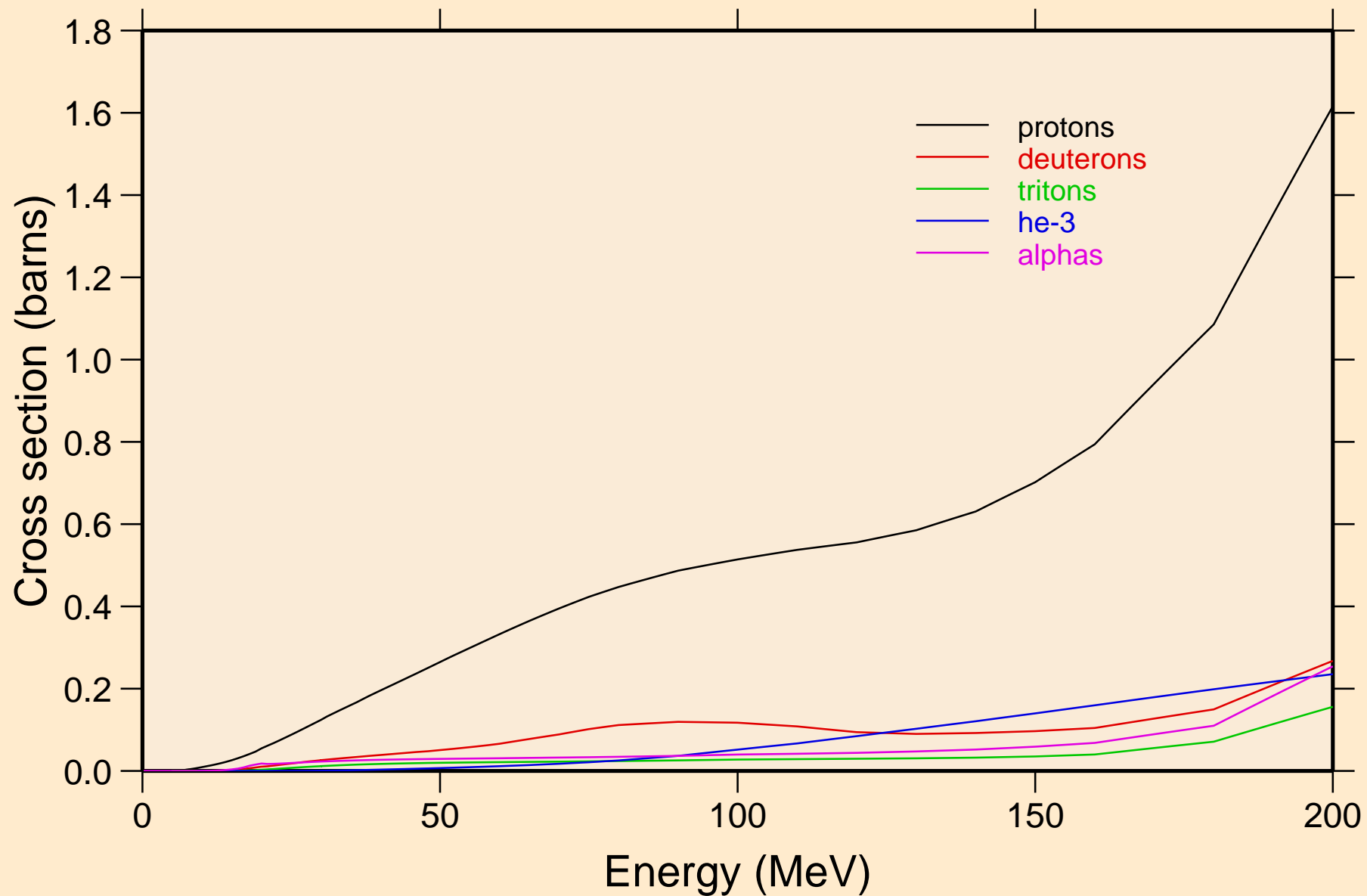

I130 NEUTRON ACER TENDL-2019 LIBRARY; T=293.16K  
protons from (n,x)

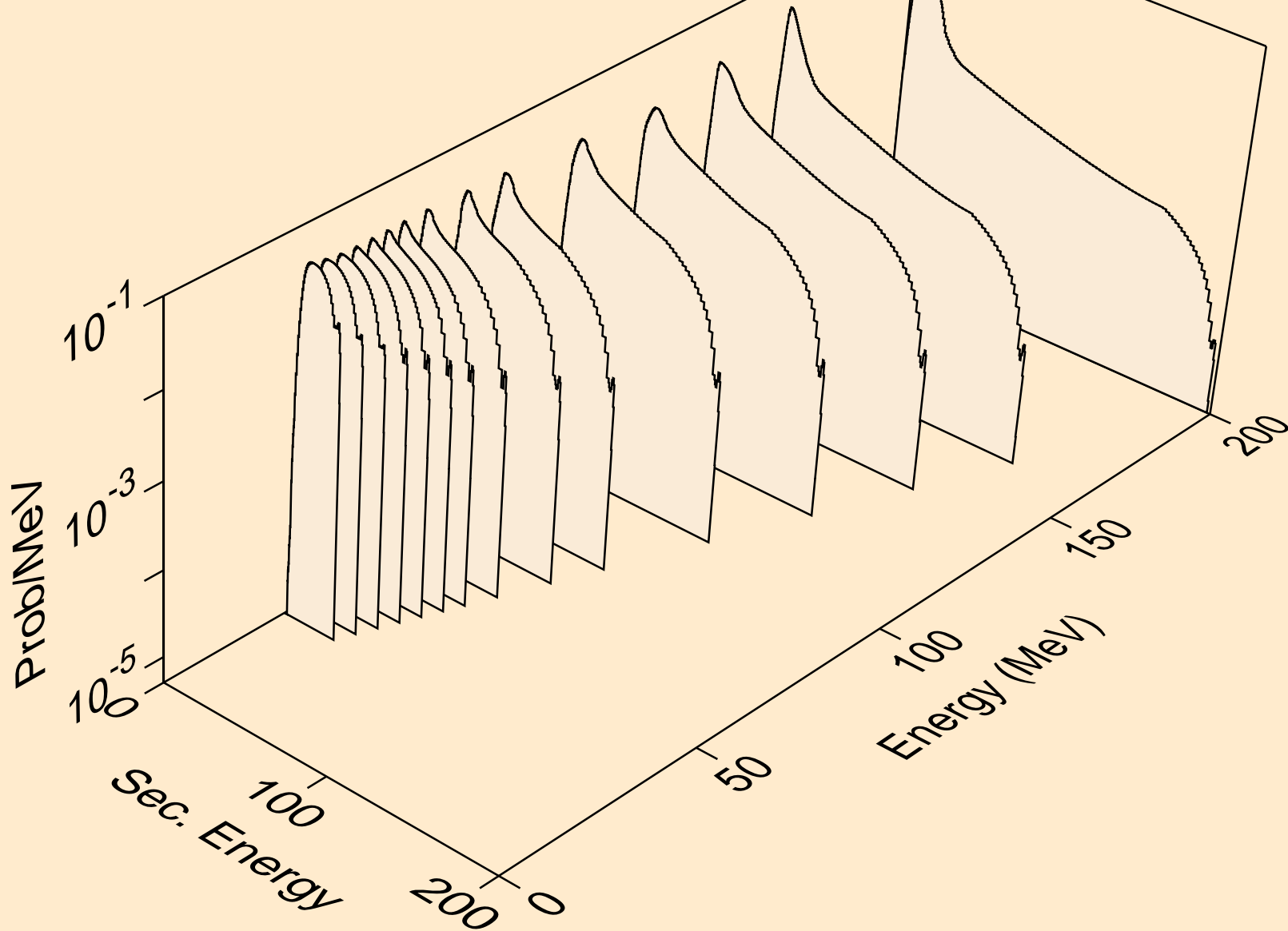

I130 NEUTRON ACER TENDL-2019 LIBRARY; T=293.16K  
protons from (n,n\*)p

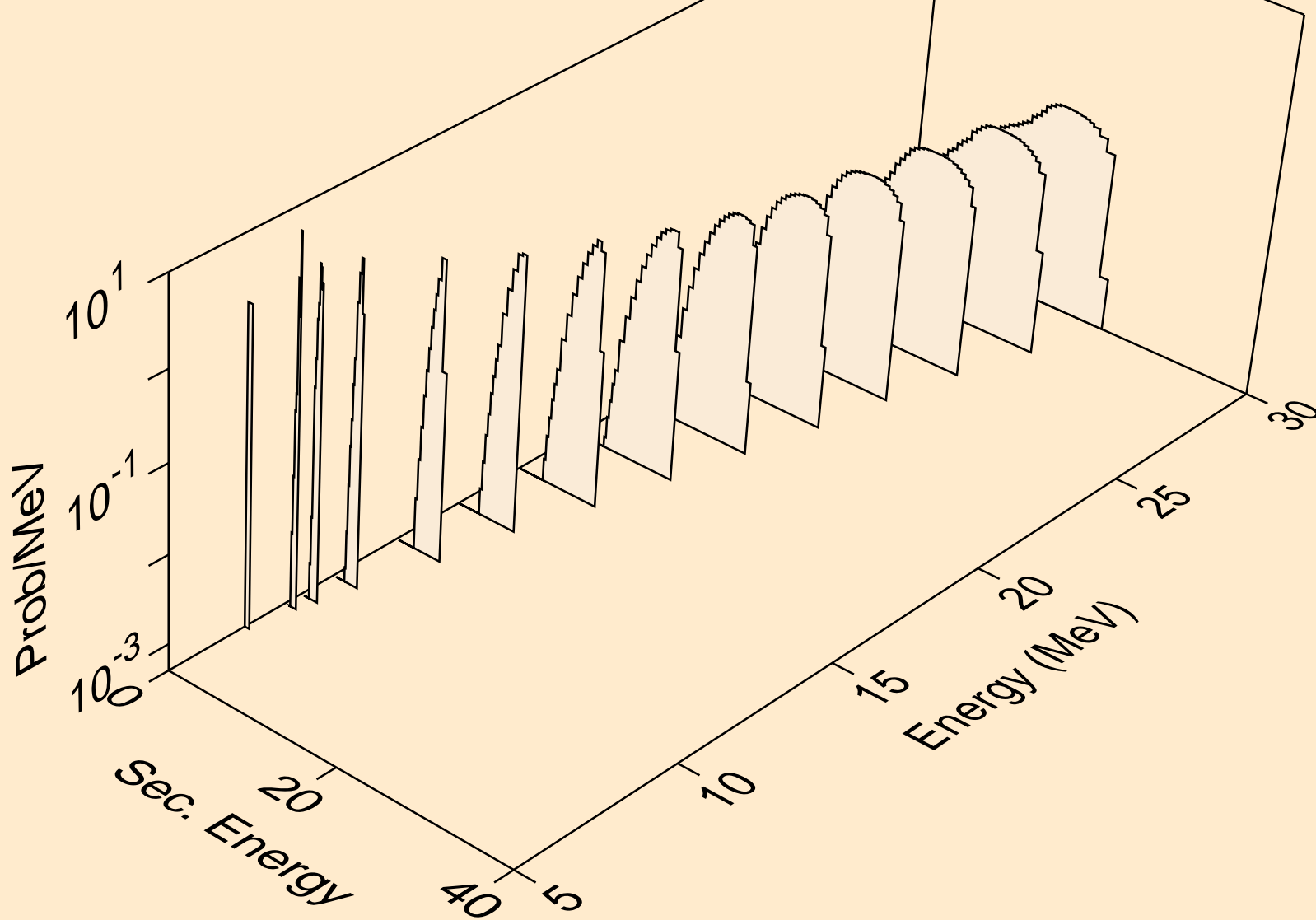

I130 NEUTRON ACER TENDL-2019 LIBRARY; T=293.16K  
protons from (n,2np)

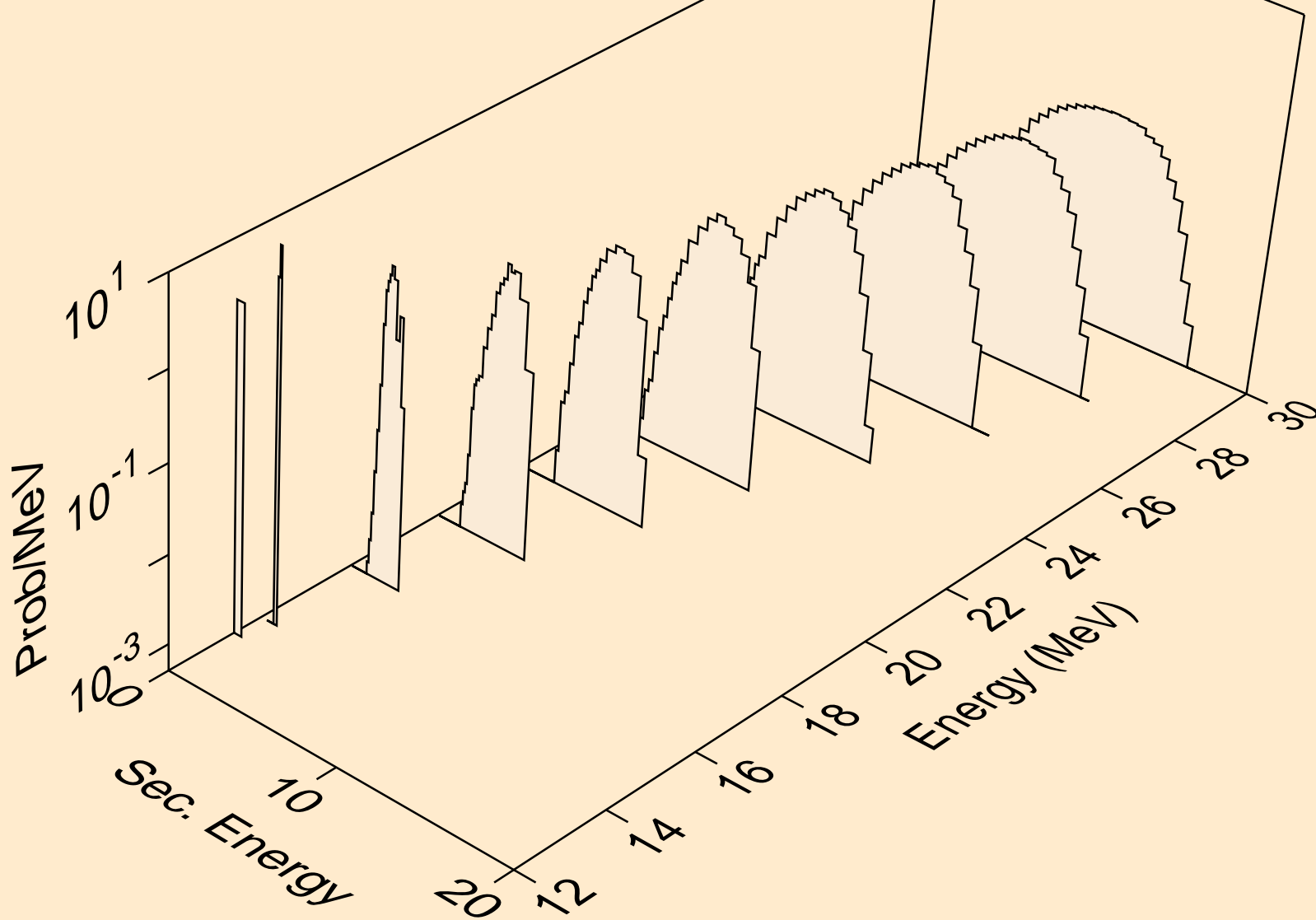

I130 NEUTRON ACER TENDL-2019 LIBRARY; T=293.16K  
protons from (n,3np)

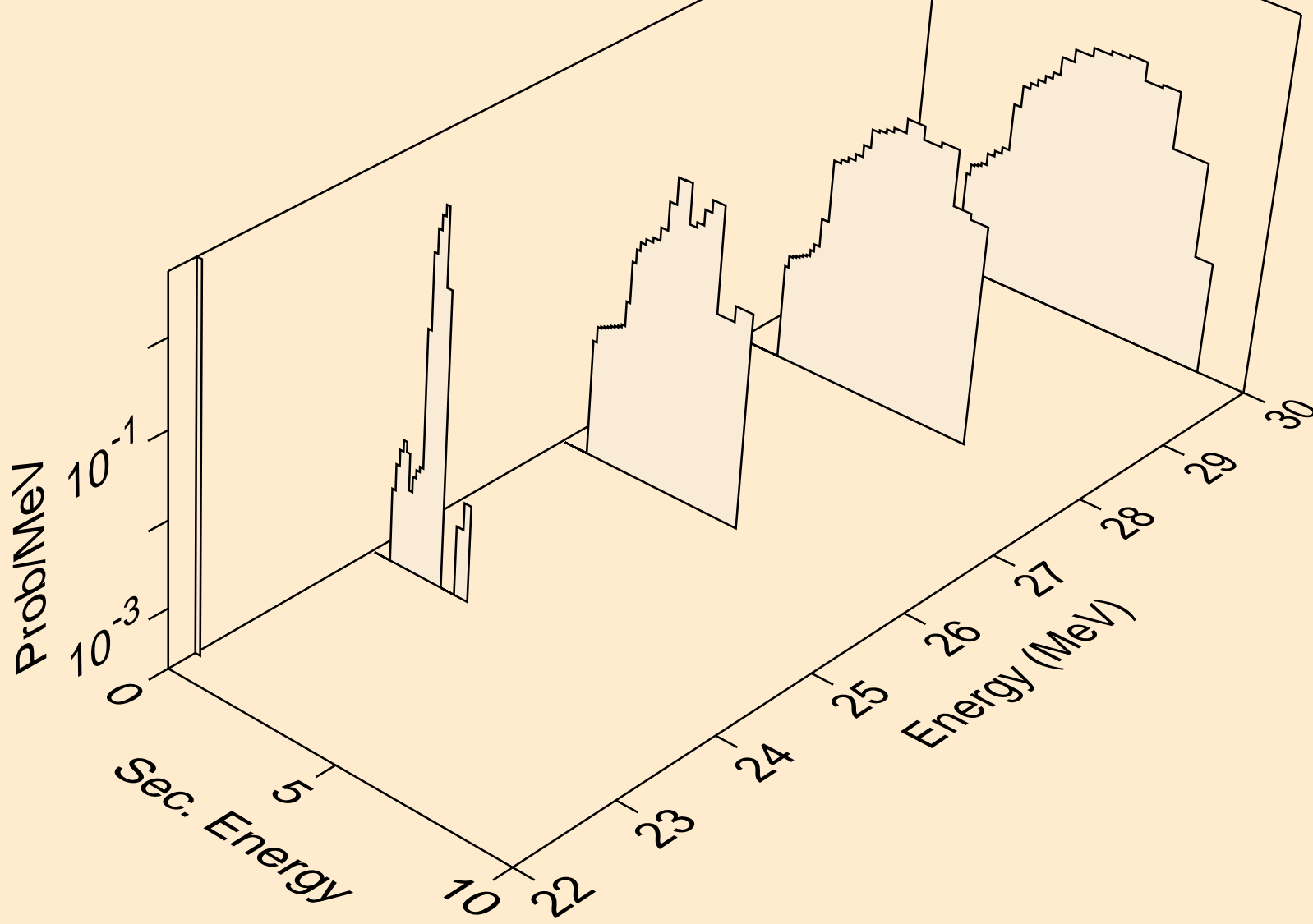



I130 NEUTRON ACER TENDL-2019 LIBRARY; T=293.16K  
protons from (n,2np)

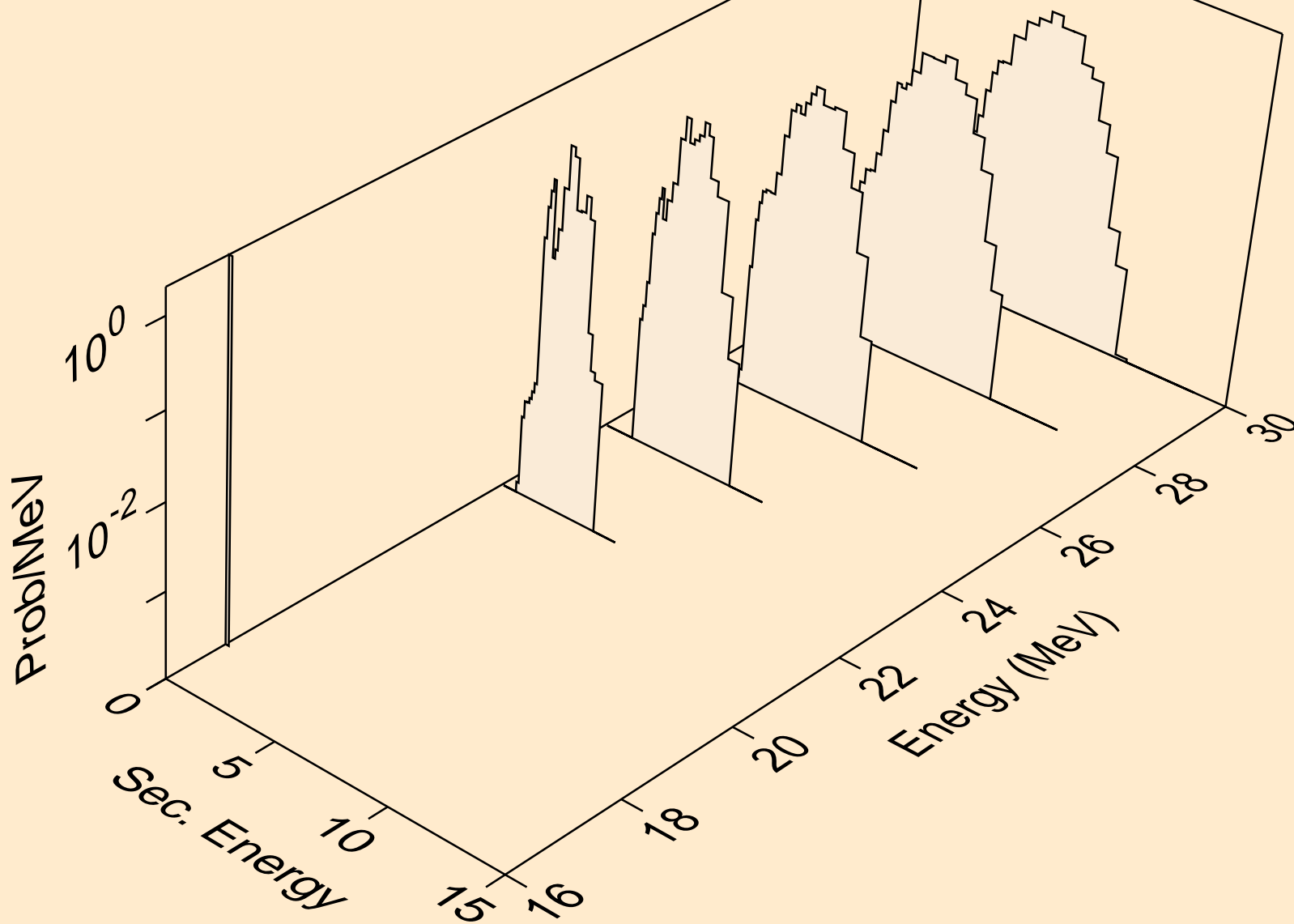

I130 NEUTRON ACER TENDL-2019 LIBRARY; T=293.16K  
protons from (n,npa)

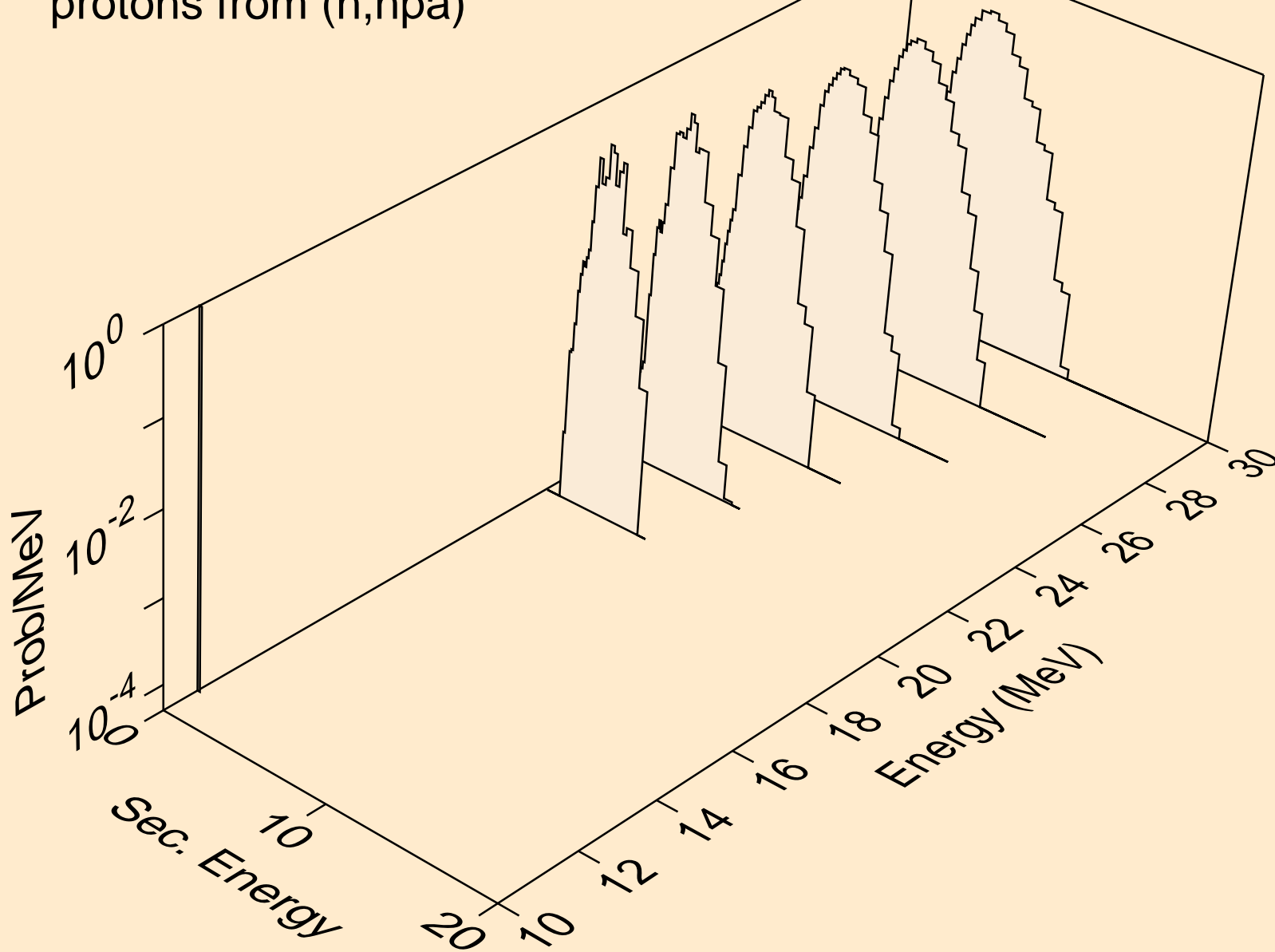

I130 NEUTRON ACER TENDL-2019 LIBRARY; T=293.16K  
protons from (n,p)

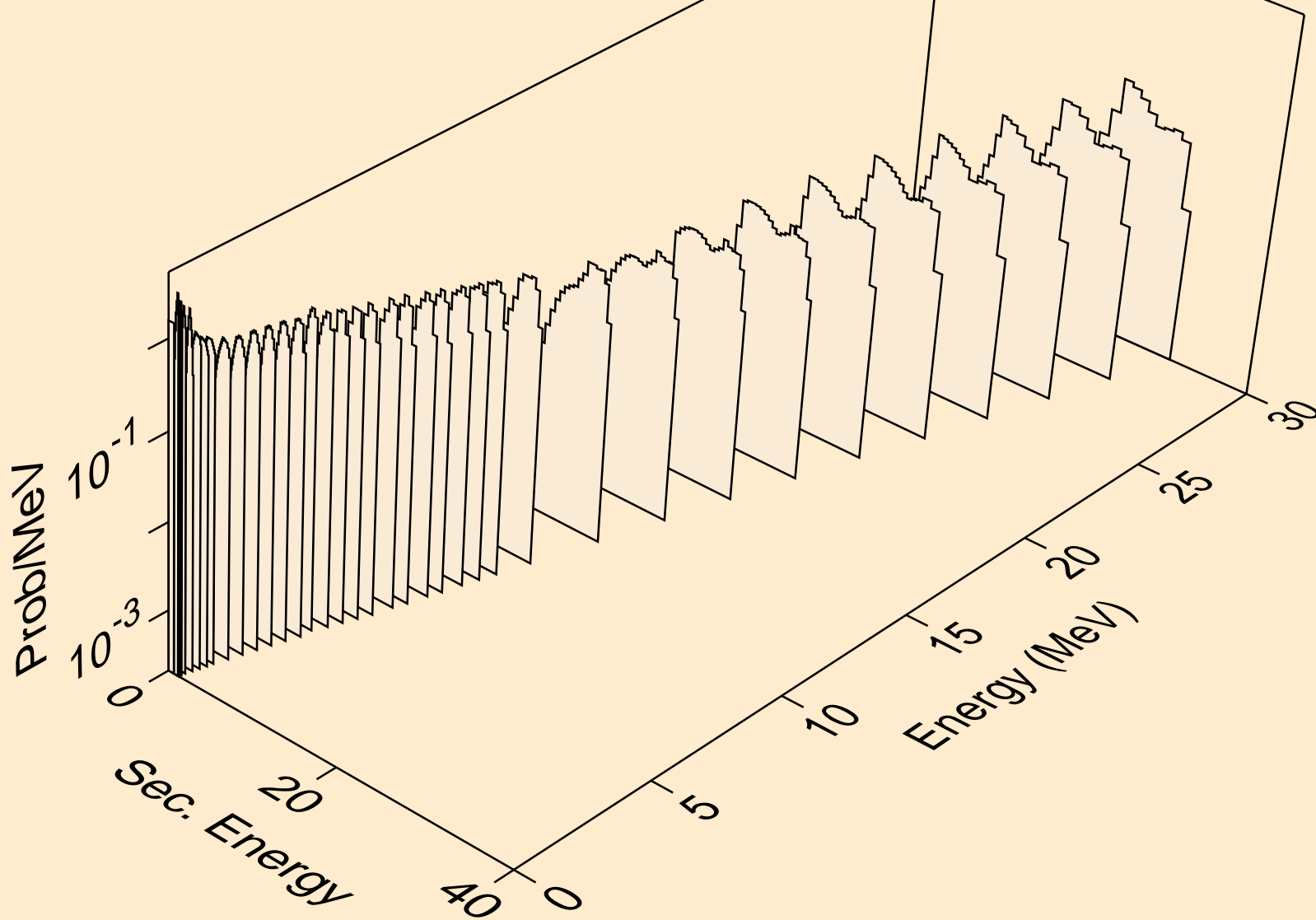

I130 NEUTRON ACER TENDL-2019 LIBRARY; T=293.16K  
protons from (n,2p)

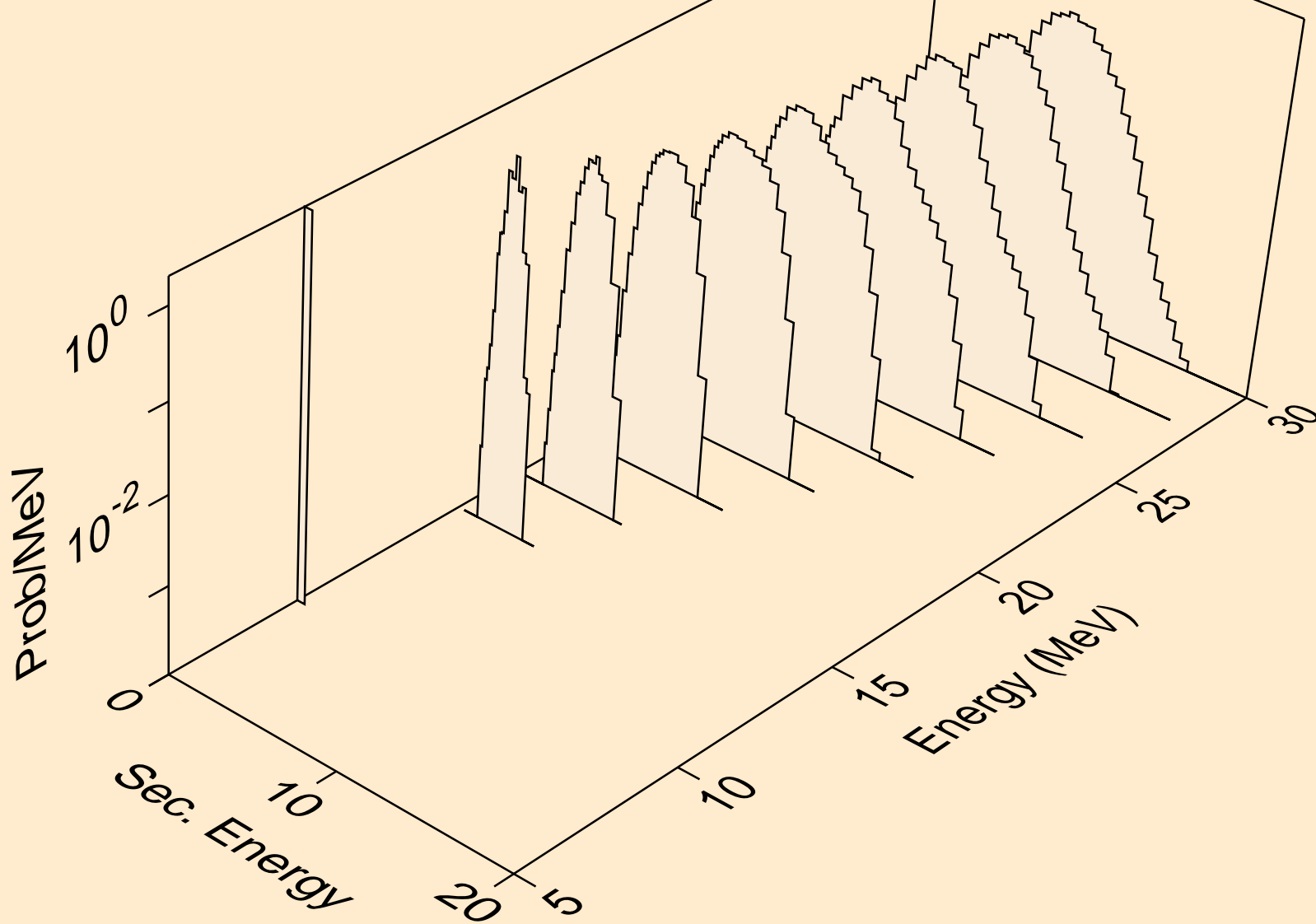

I130 NEUTRON ACER TENDL-2019 LIBRARY; T=293.16K  
protons from (n,p)

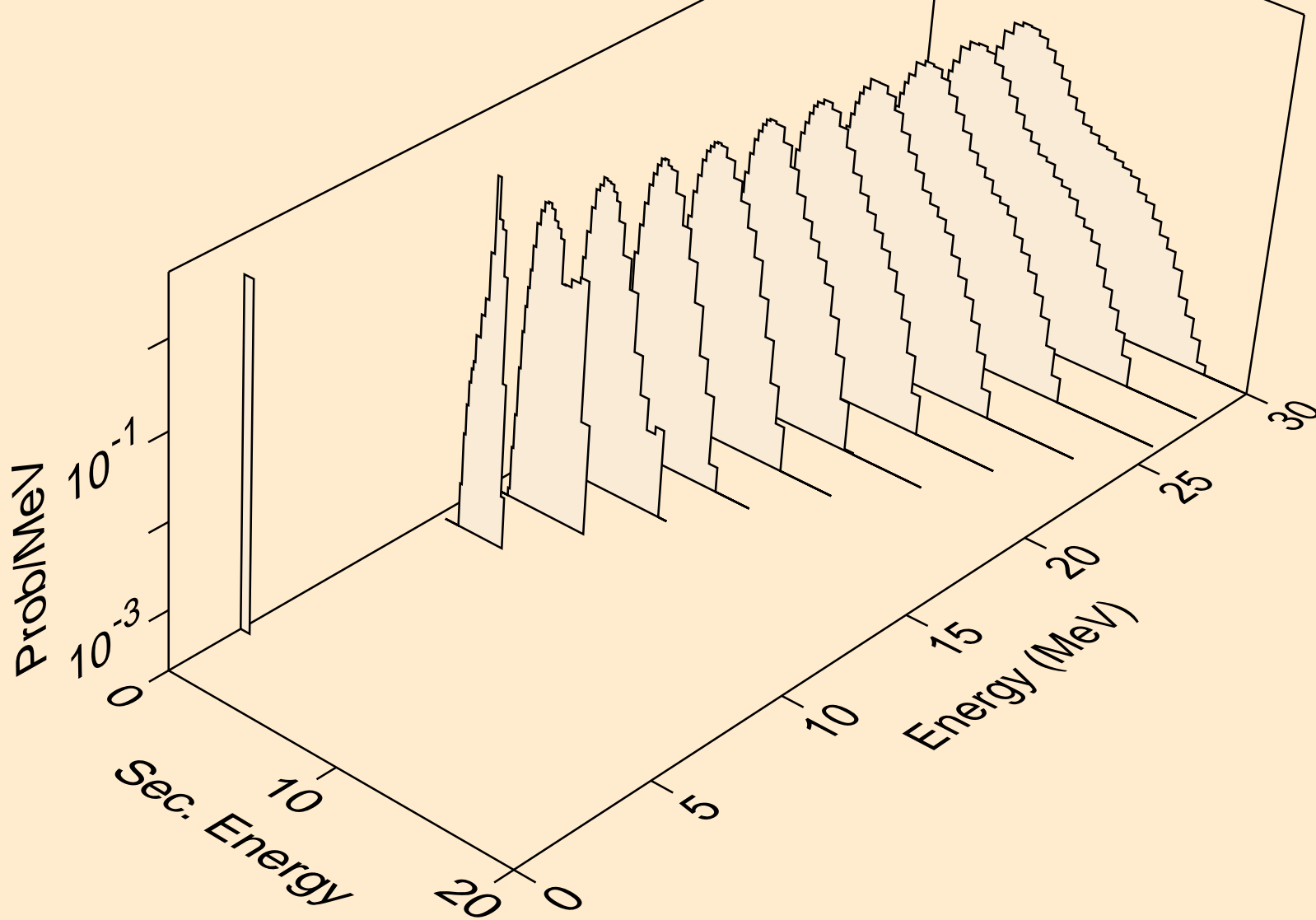

I130 NEUTRON ACER TENDL-2019 LIBRARY; T=293.16K  
protons from (n,pd)

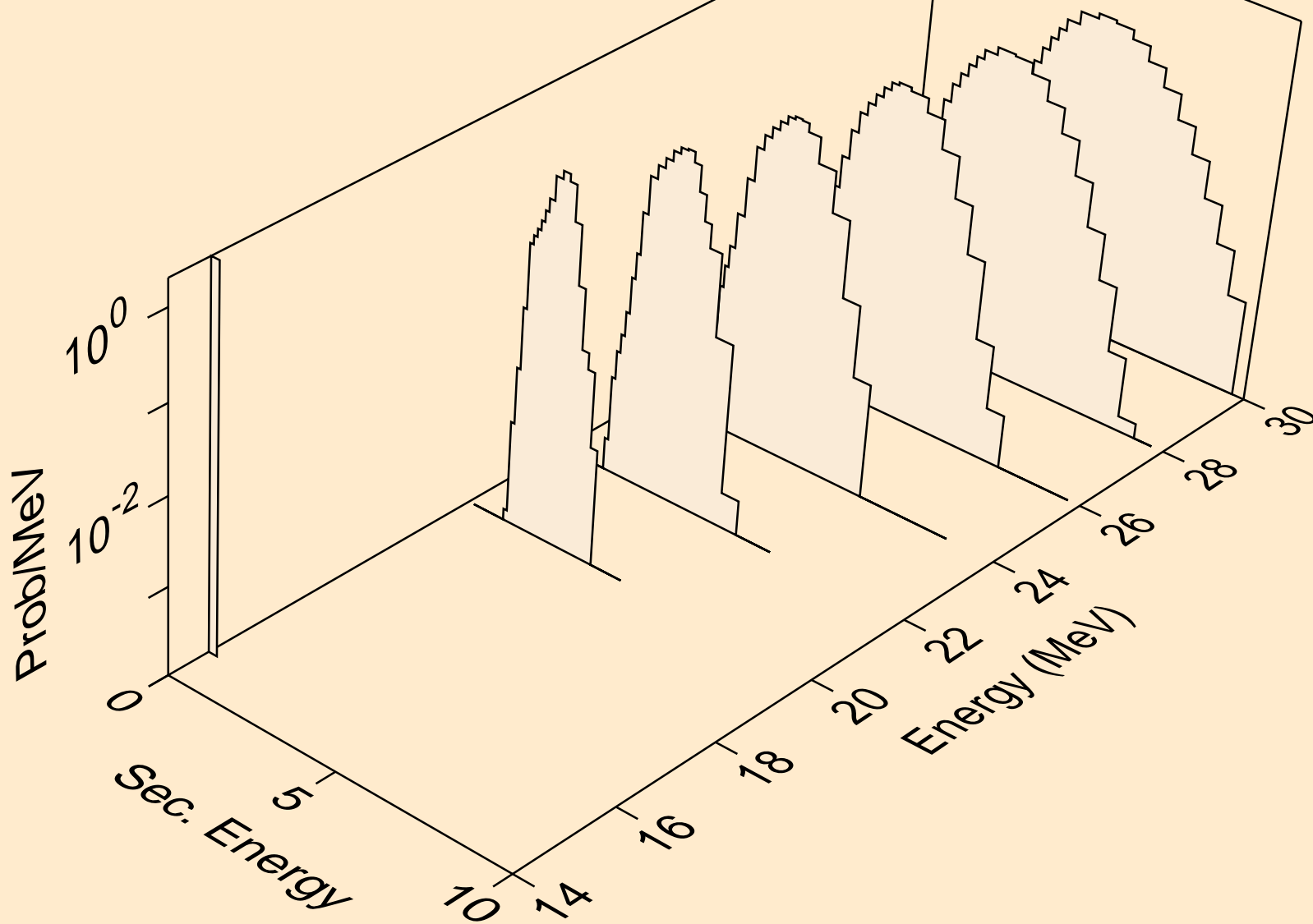

I130 NEUTRON ACER TENDL-2019 LIBRARY; T=293.16K  
protons from (n,pt)

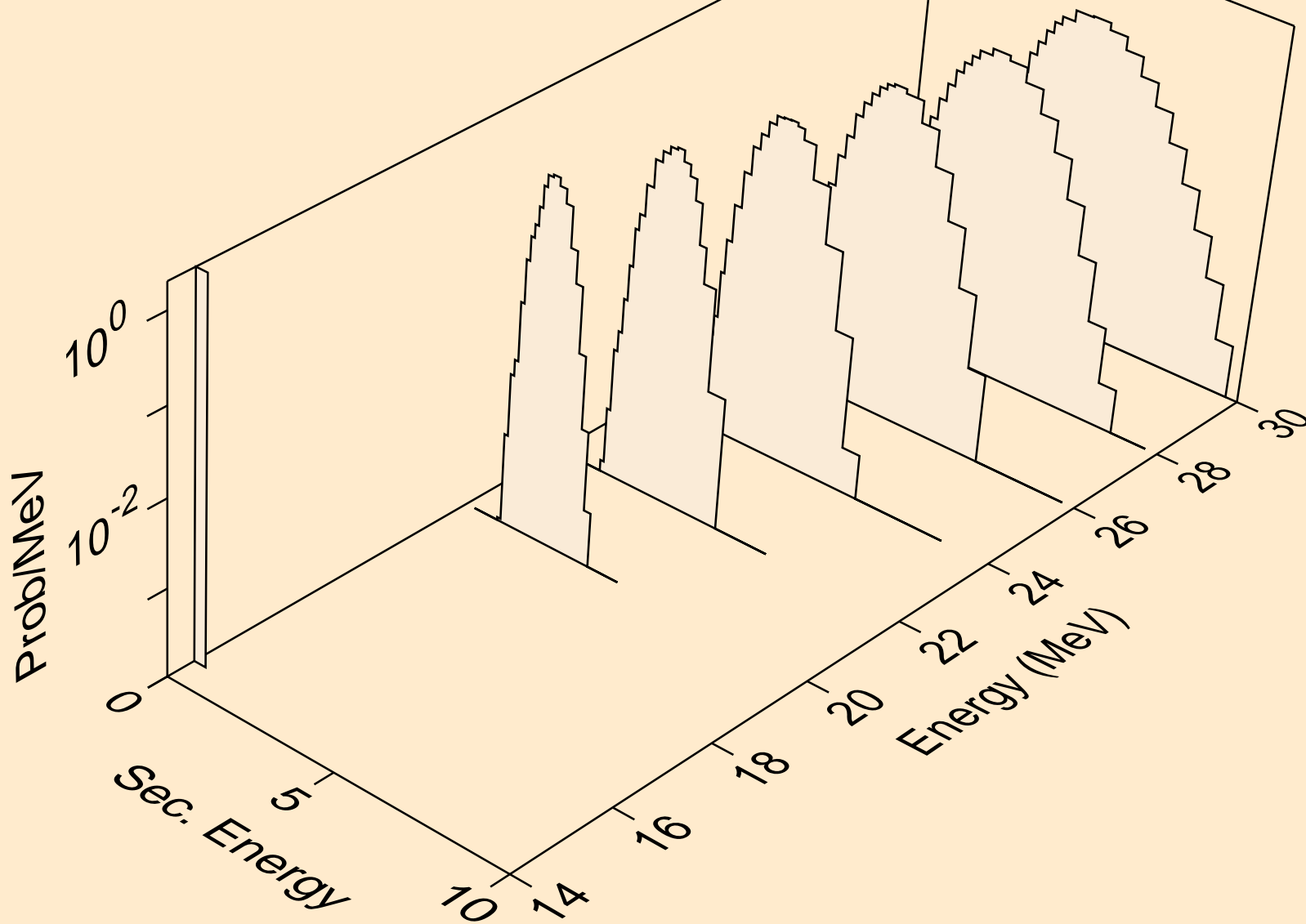

I130 NEUTRON ACER TENDL-2019 LIBRARY; T=293.16K  
deuterons from (n,x)

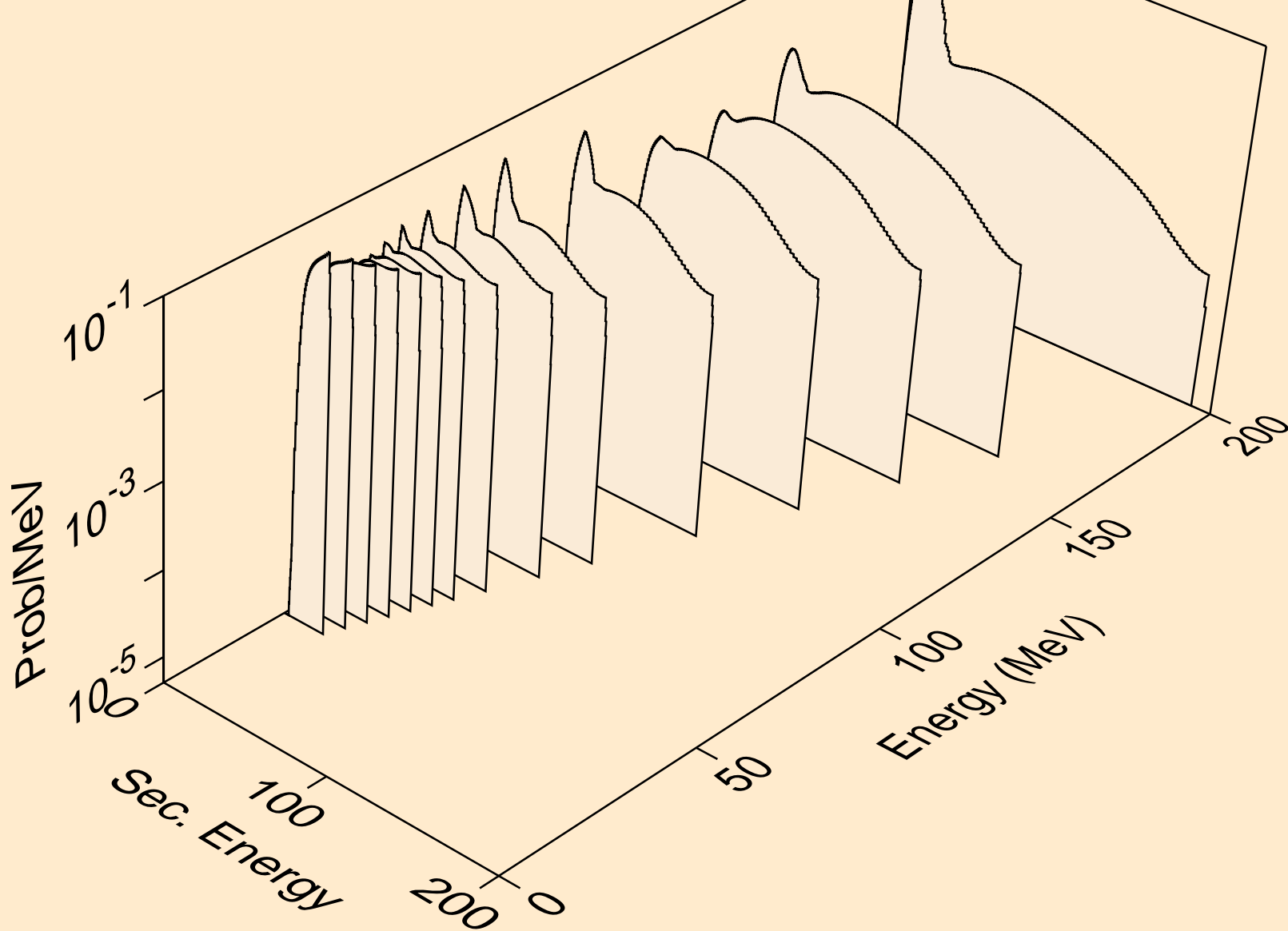



I130 NEUTRON ACER TENDL-2019 LIBRARY; T=293.16K  
deuterons from (n,2nd)

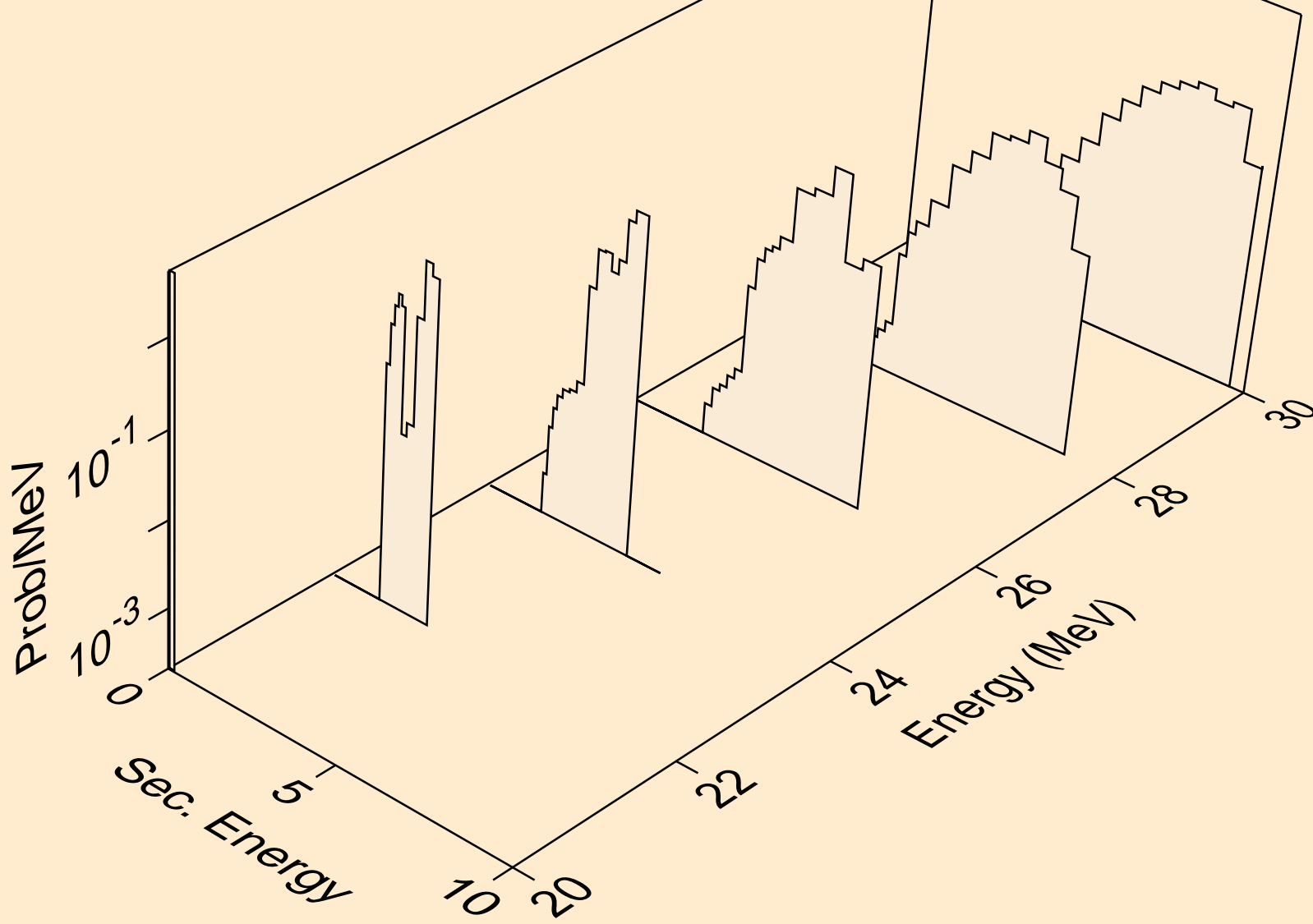

I130 NEUTRON ACER TENDL-2019 LIBRARY; T=293.16K  
deuterons from (n,n\*)d

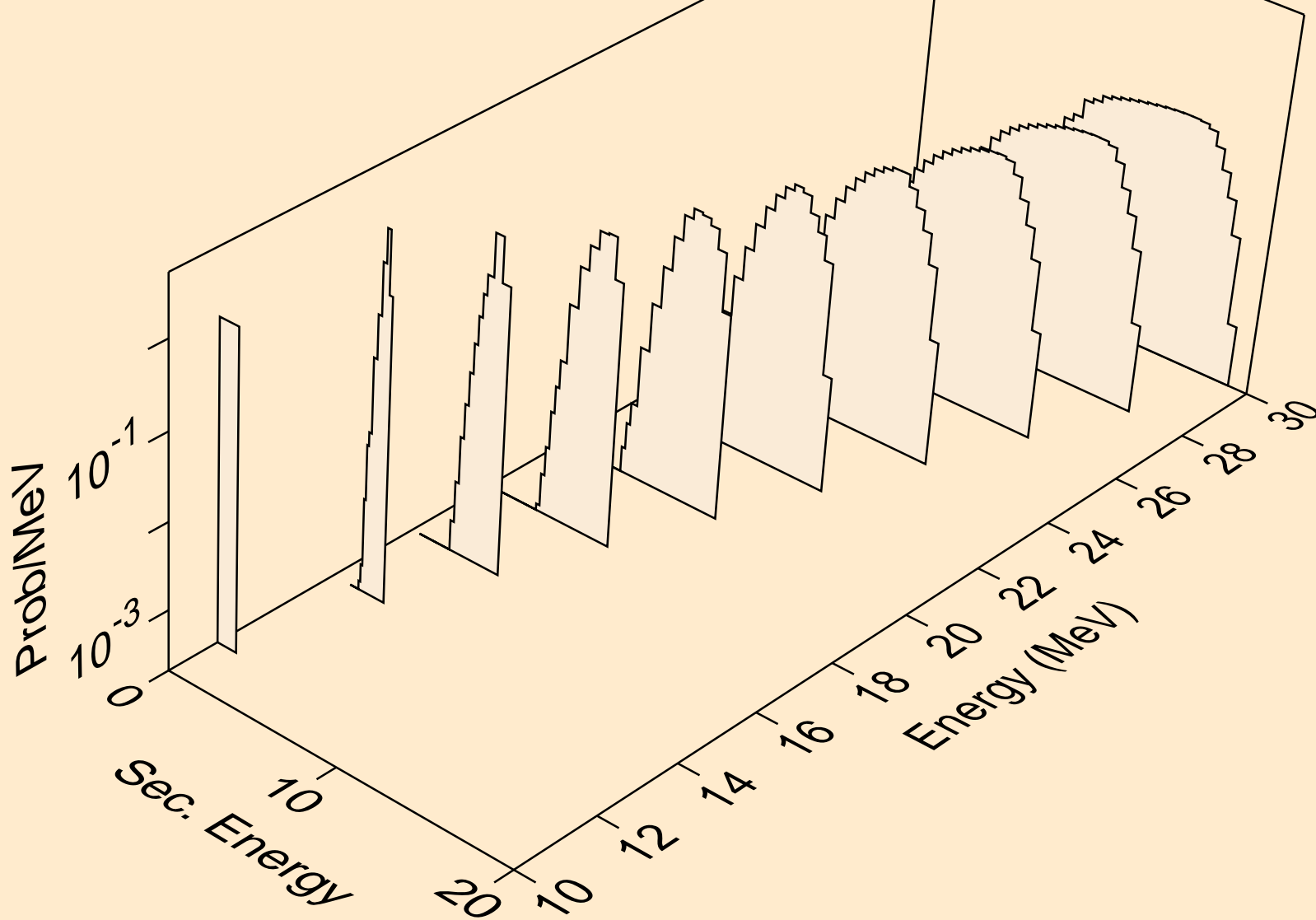

I130 NEUTRON ACER TENDL-2019 LIBRARY; T=293.16K  
deuterons from (n,d)

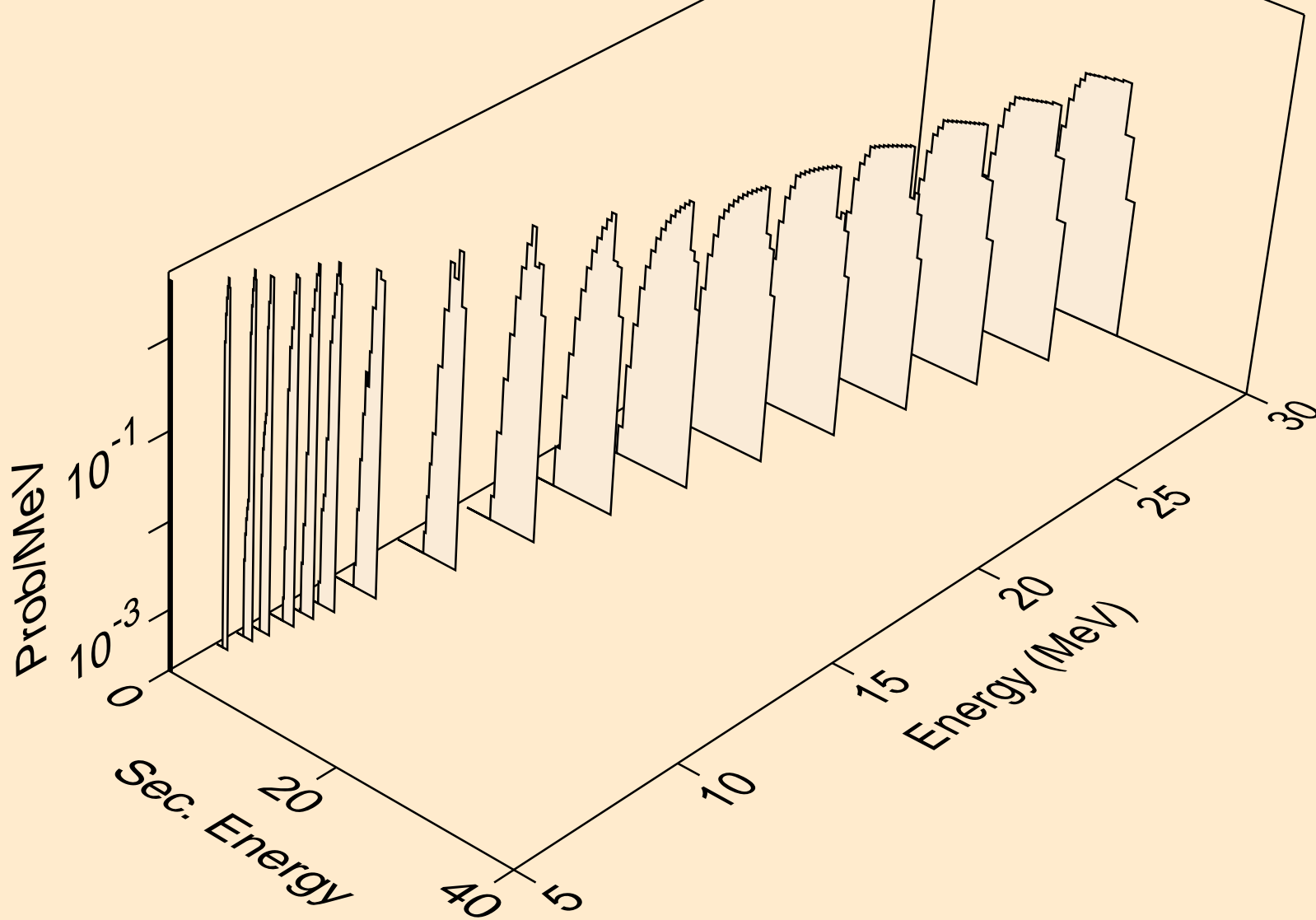

I130 NEUTRON ACER TENDL-2019 LIBRARY; T=293.16K  
deuterons from (n,pd)

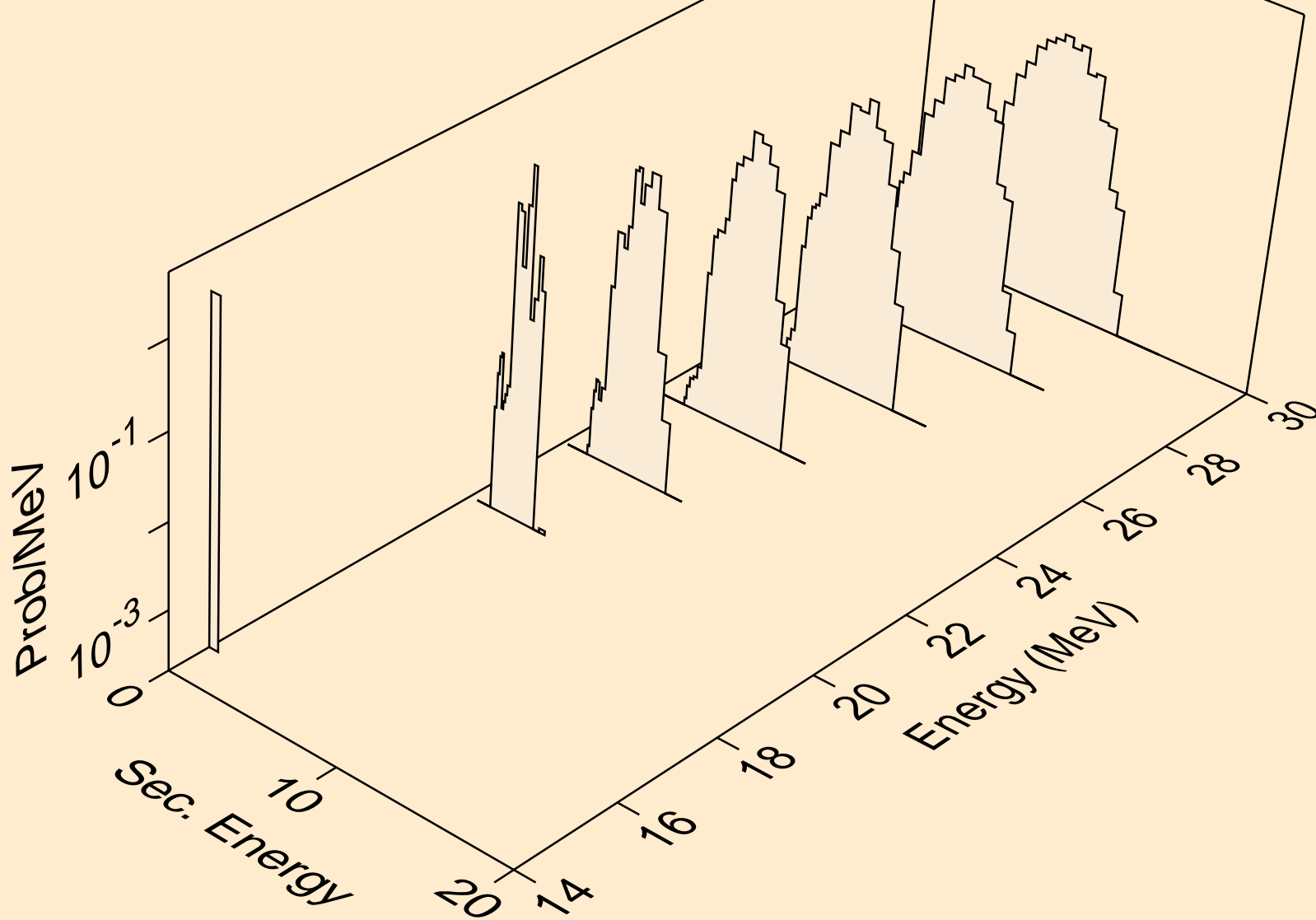

I130 NEUTRON ACER TENDL-2019 LIBRARY; T=293.16K  
deuterons from (n,da)

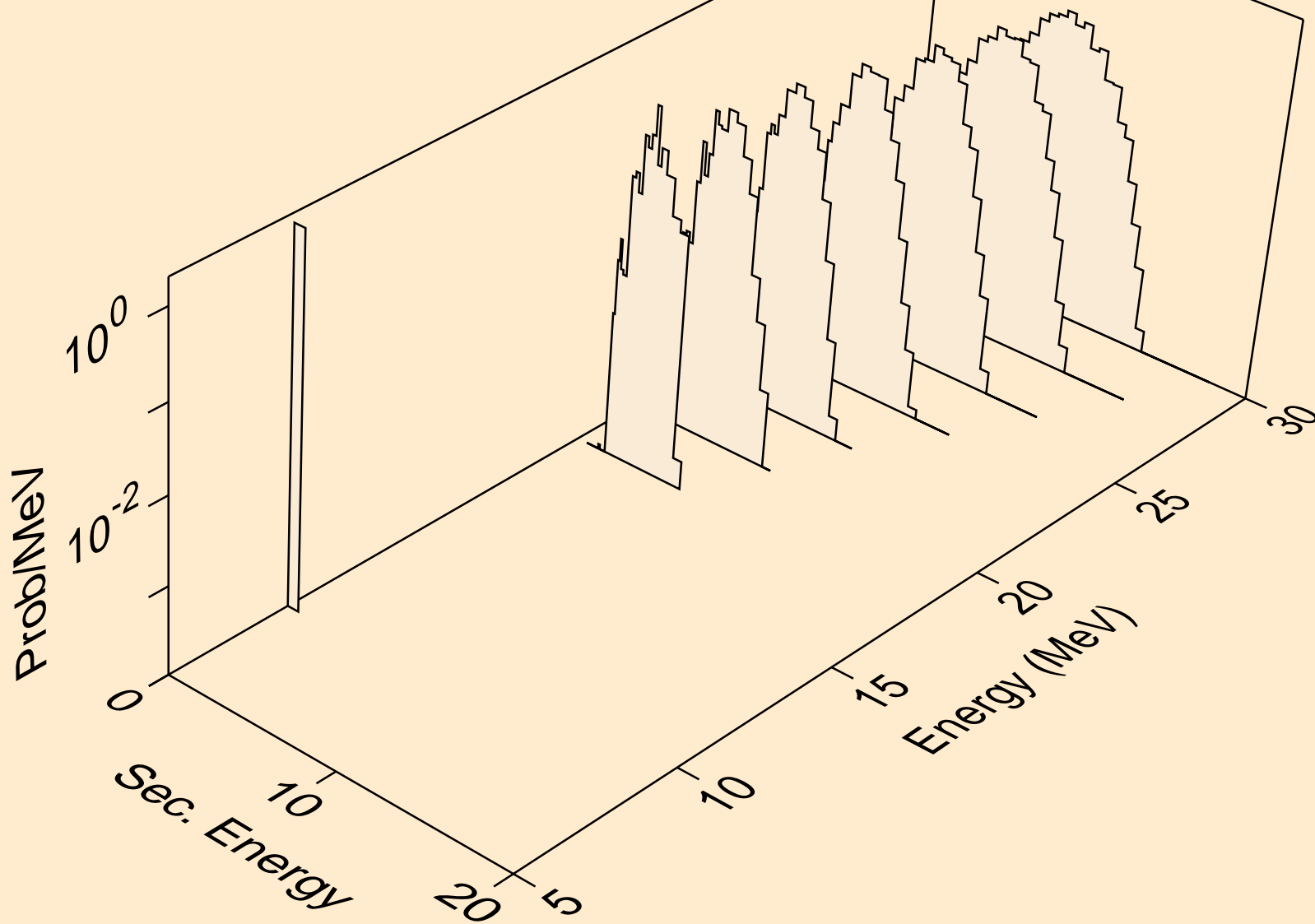

I130 NEUTRON ACER TENDL-2019 LIBRARY; T=293.16K  
tritons from (n,x)

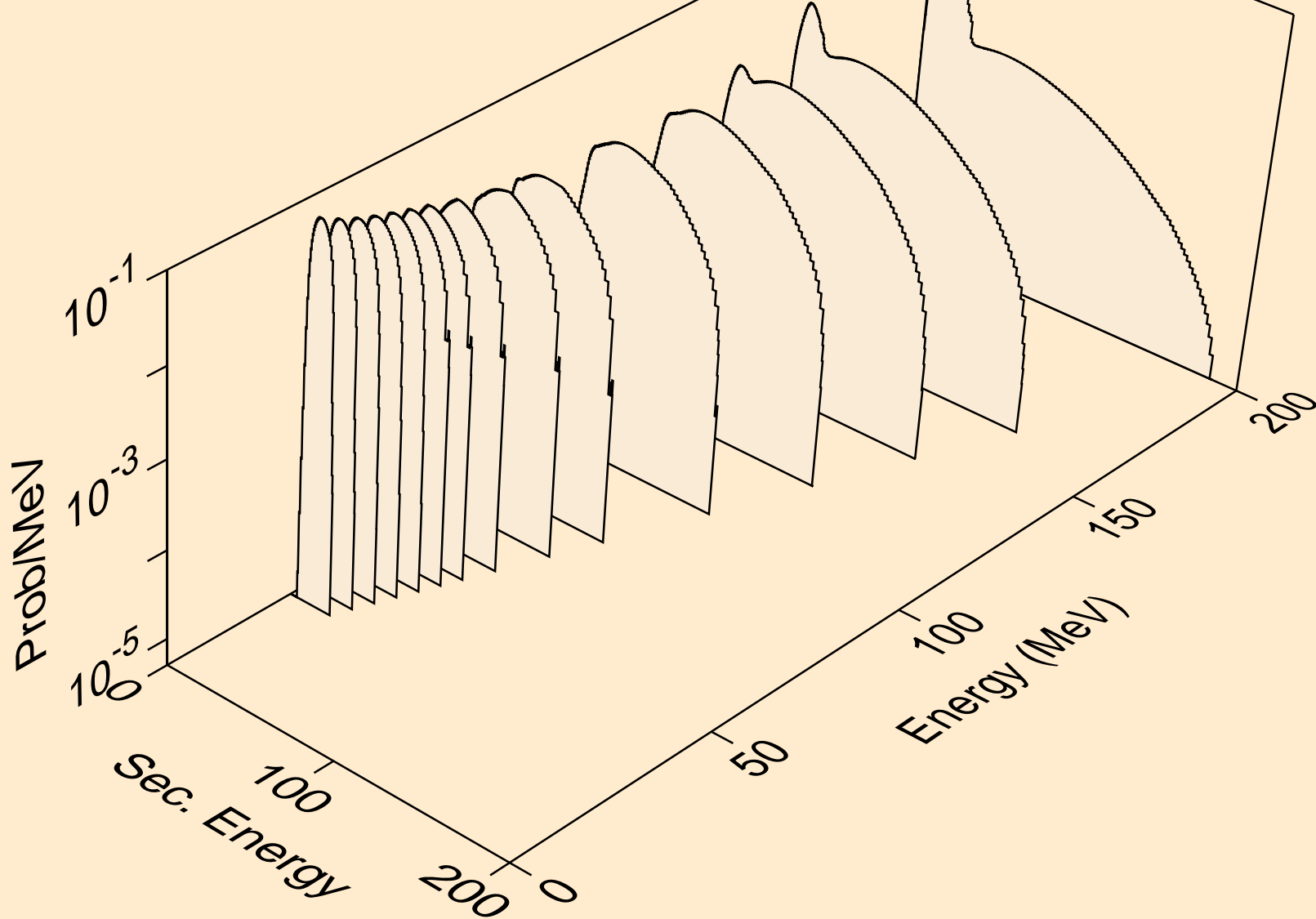

I130 NEUTRON ACER TENDL-2019 LIBRARY; T=293.16K  
tritons from (n,n\*)t

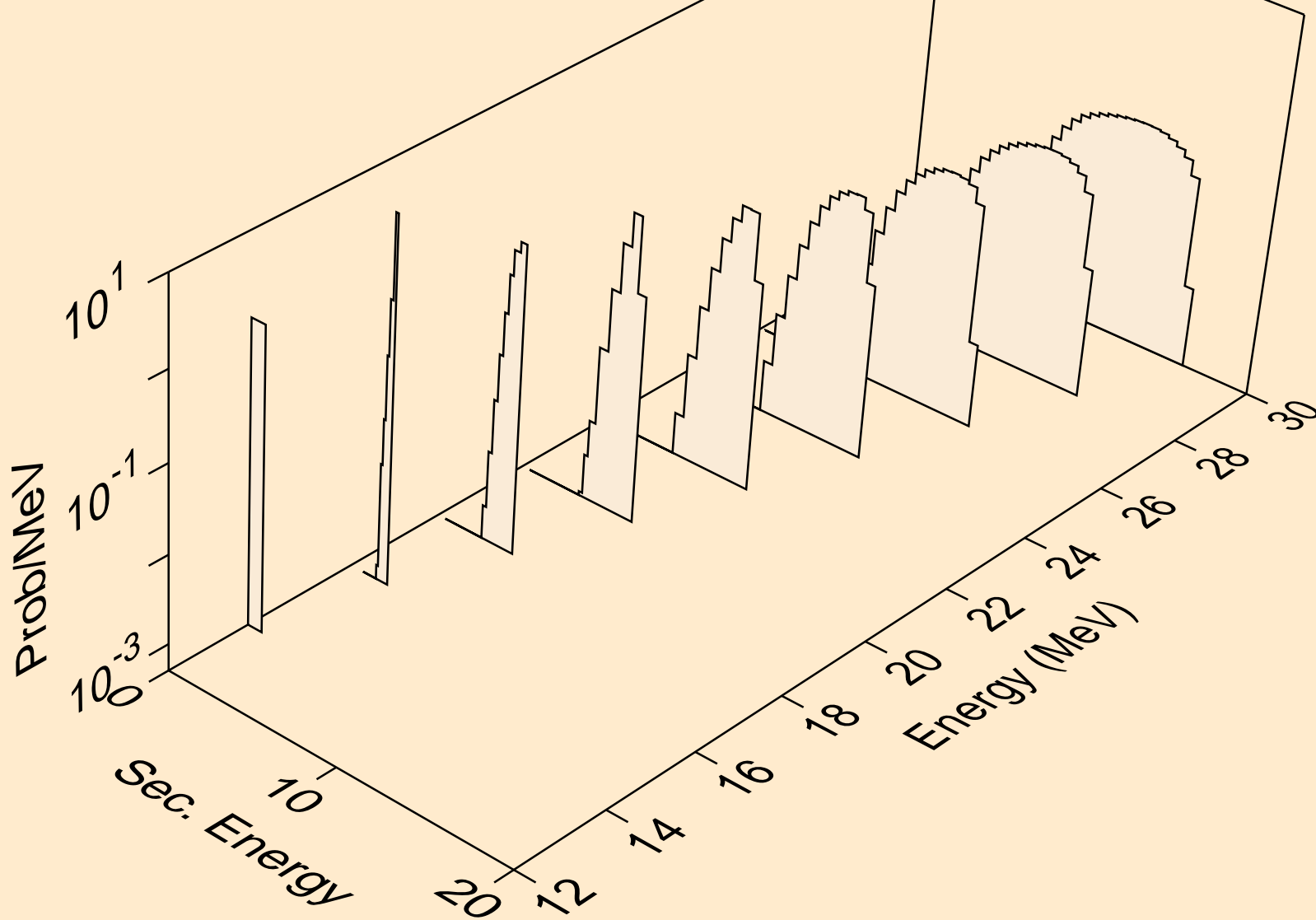

I130 NEUTRON ACER TENDL-2019 LIBRARY; T=293.16K  
tritons from (n,t)

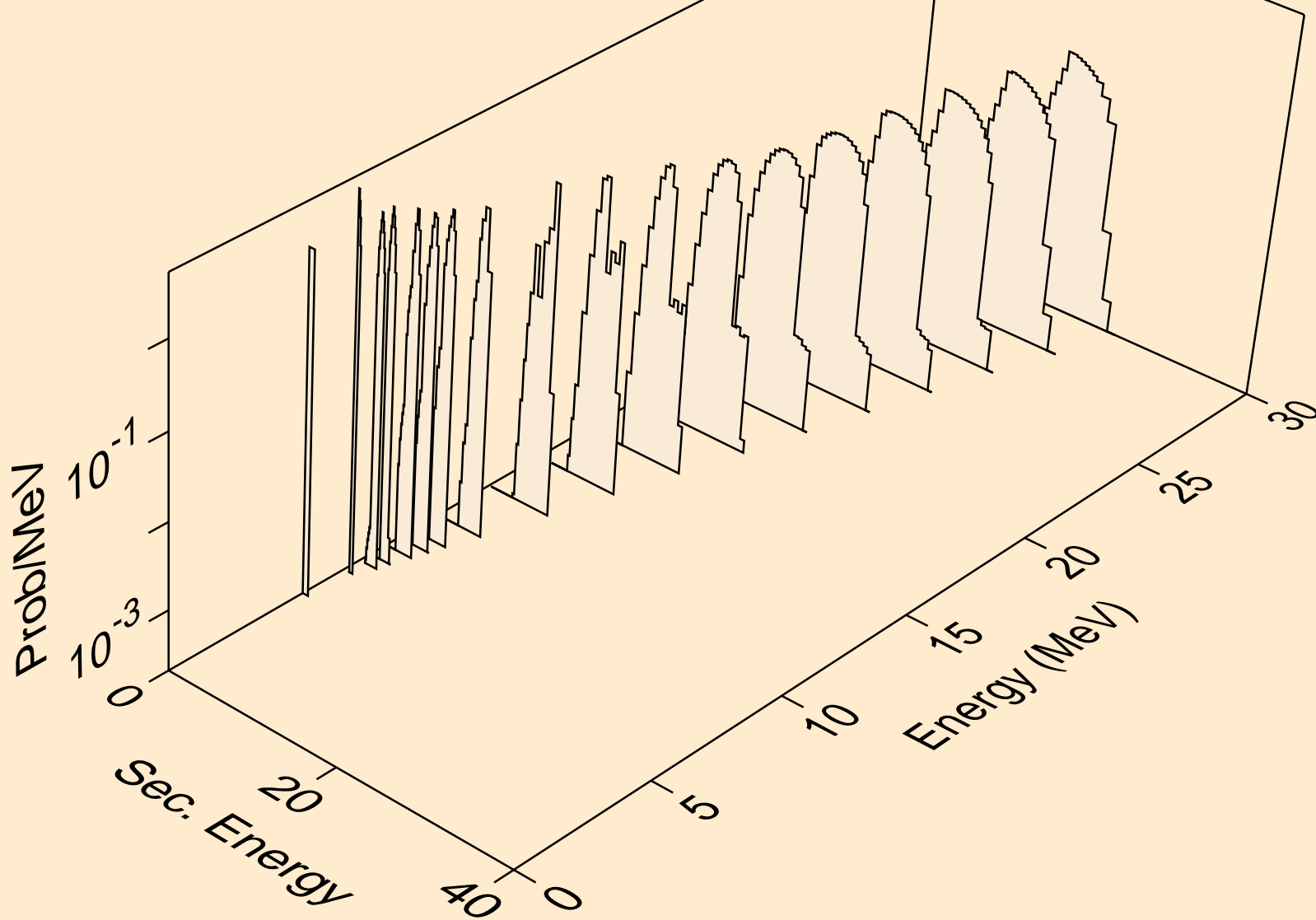



I130 NEUTRON ACER TENDL-2019 LIBRARY; T=293.16K  
tritons from (n,pt)

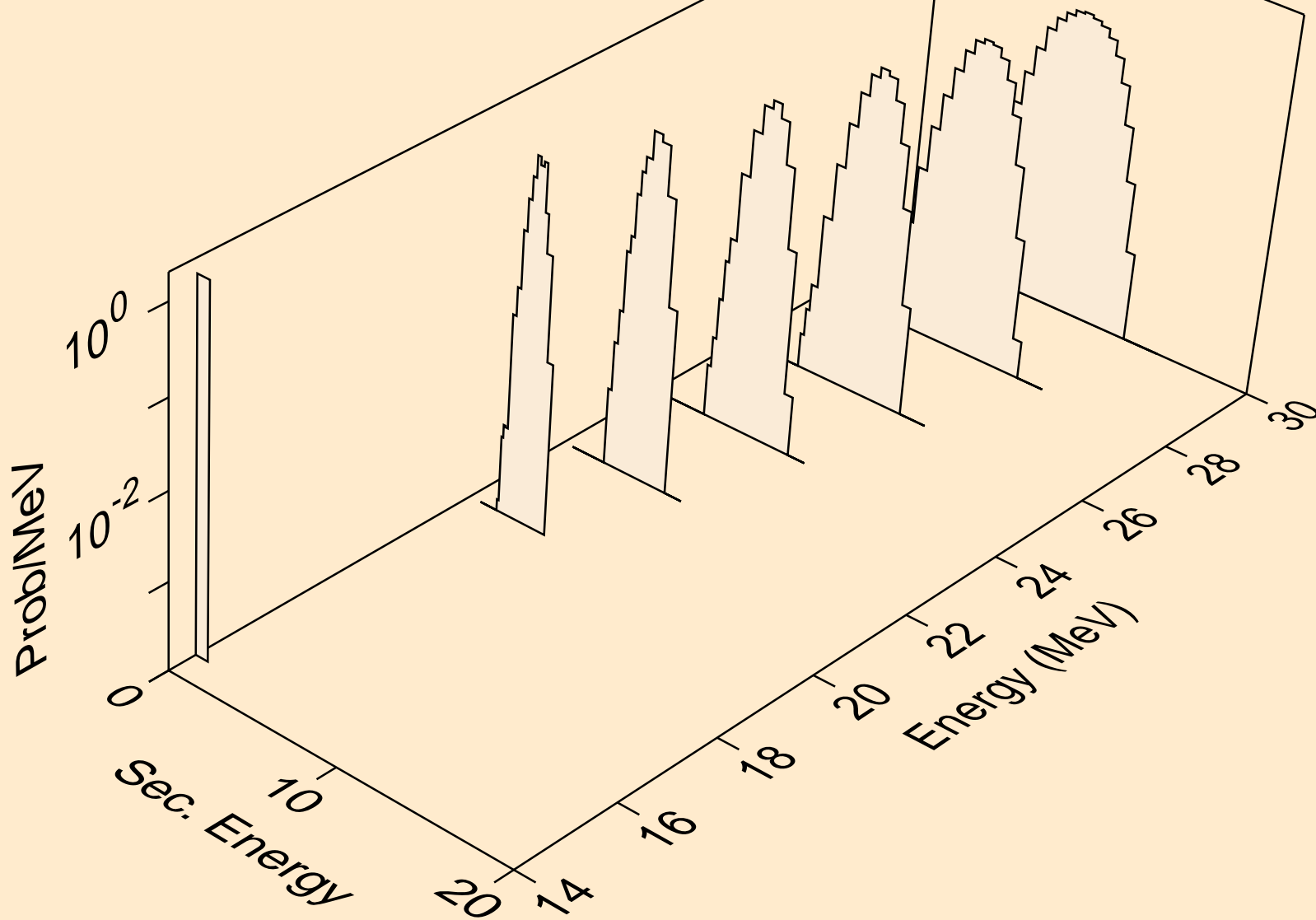

I130 NEUTRON ACER TENDL-2019 LIBRARY; T=293.16K  
he3s from (n,x)

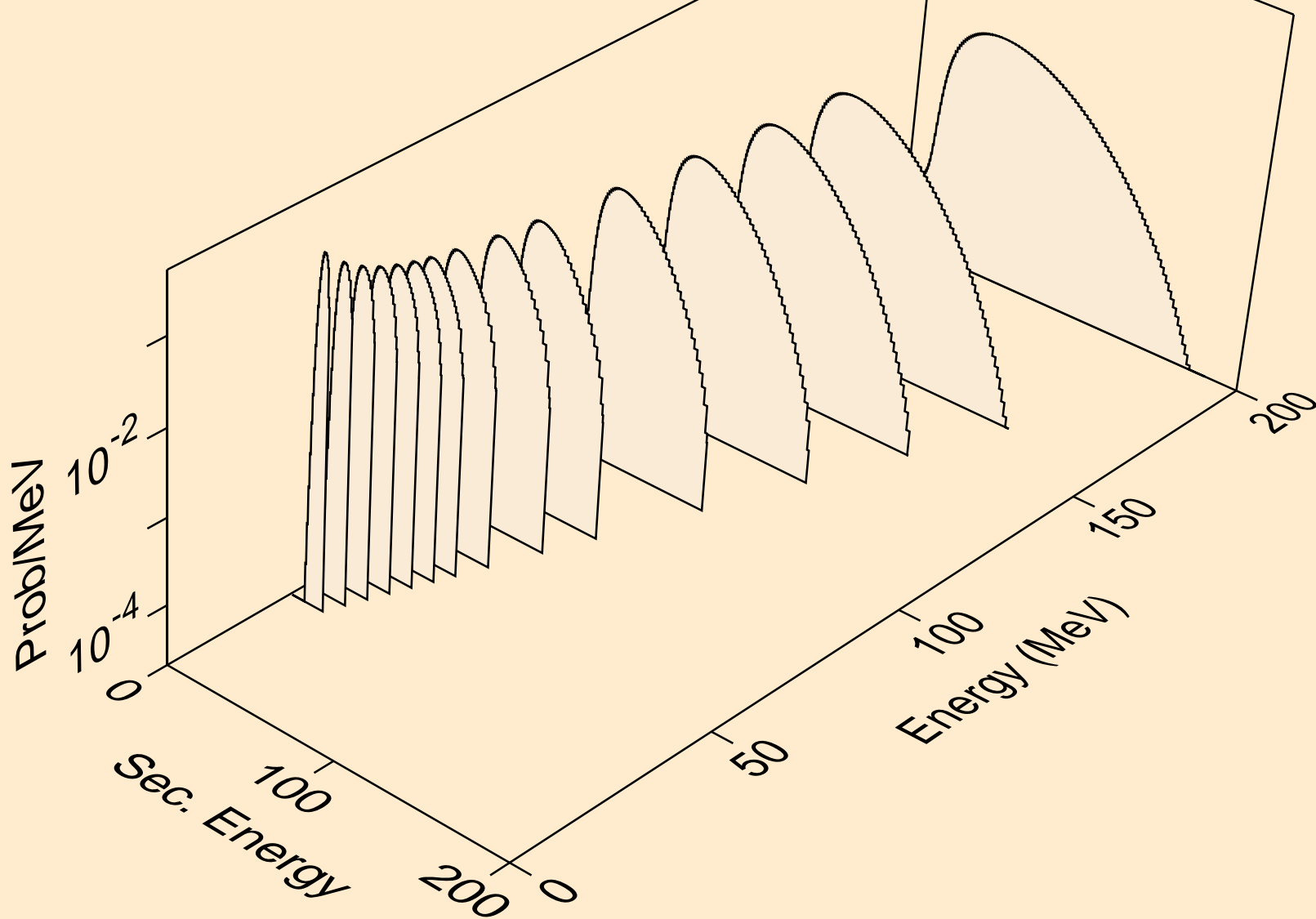

I130 NEUTRON ACER TENDL-2019 LIBRARY; T=293.16K  
he3s from (n,n\*)he3

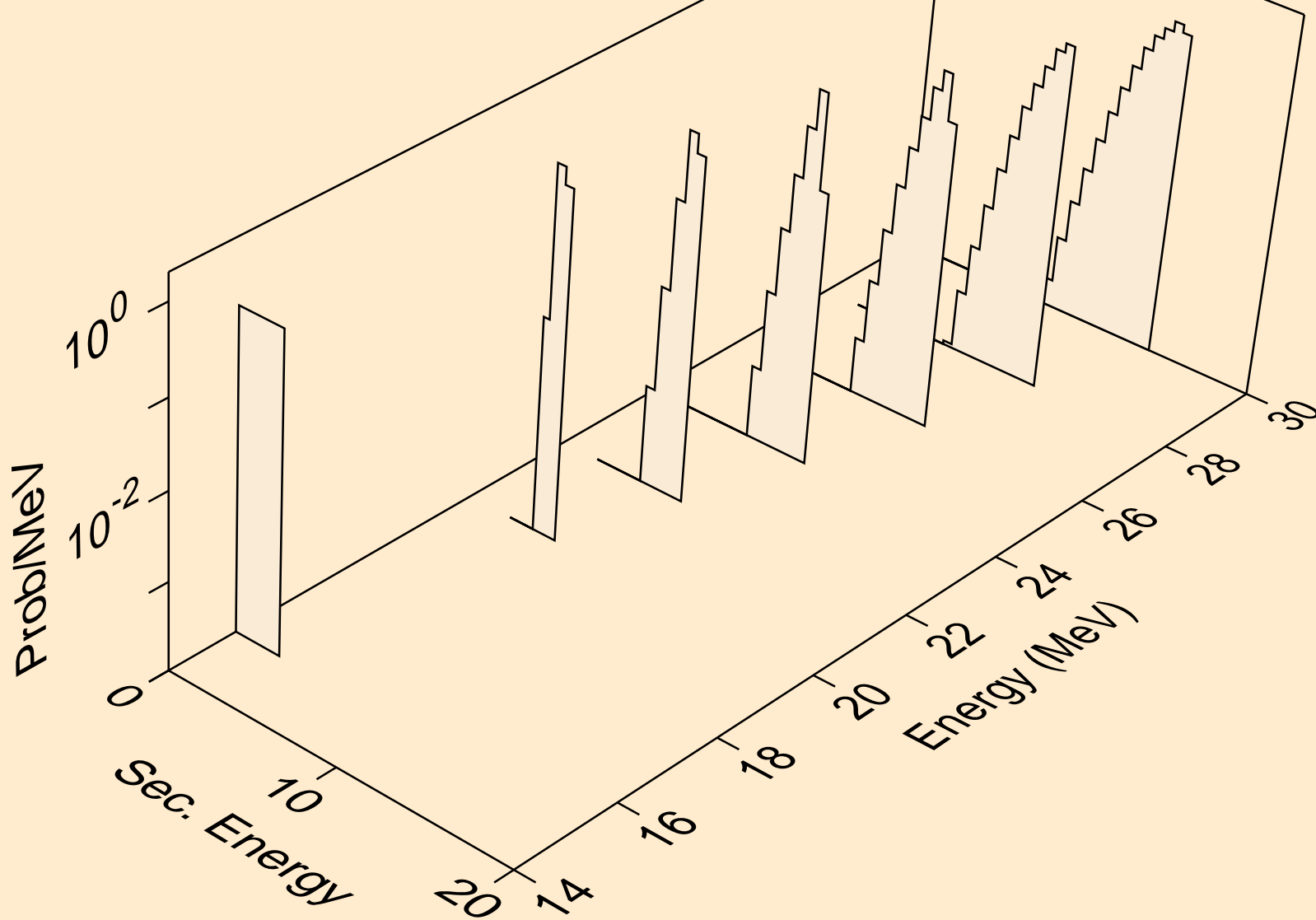

I130 NEUTRON ACER TENDL-2019 LIBRARY; T=293.16K  
he3s from (n,he3)

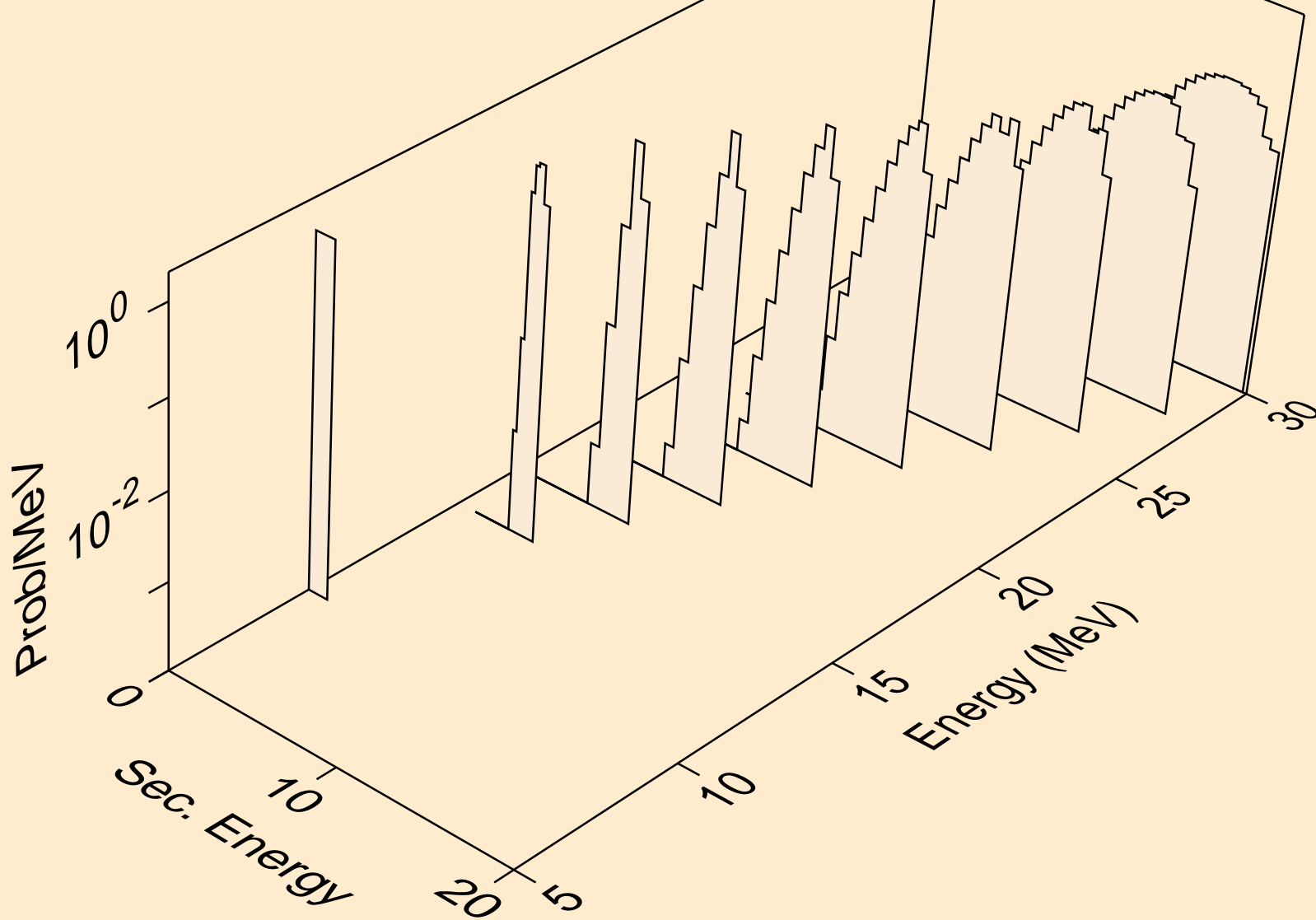

I130 NEUTRON ACER TENDL-2019 LIBRARY; T=293.16K  
alphas from (n,x)

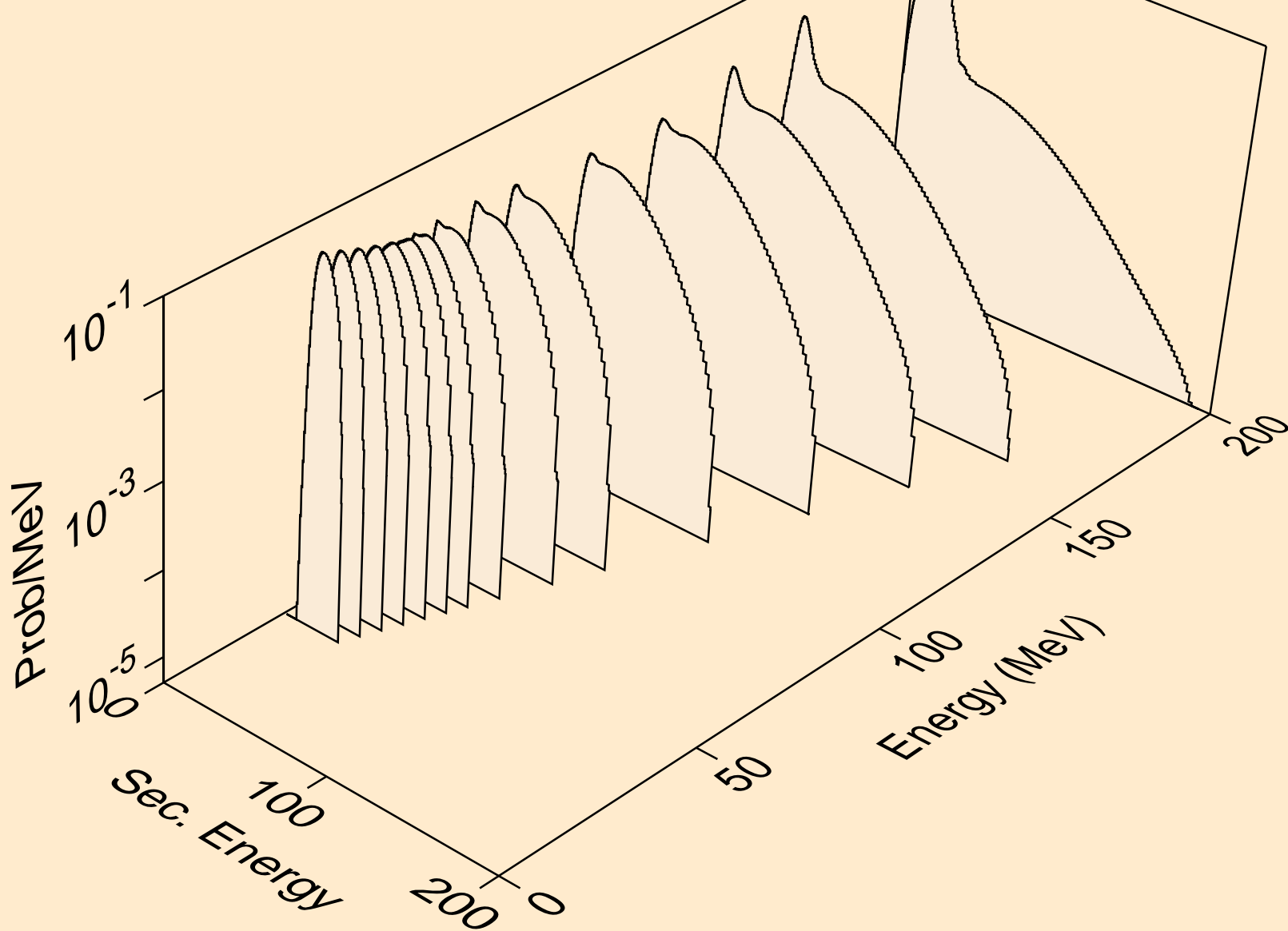

I130 NEUTRON ACER TENDL-2019 LIBRARY; T=293.16K  
alphas from (n,n\*)a

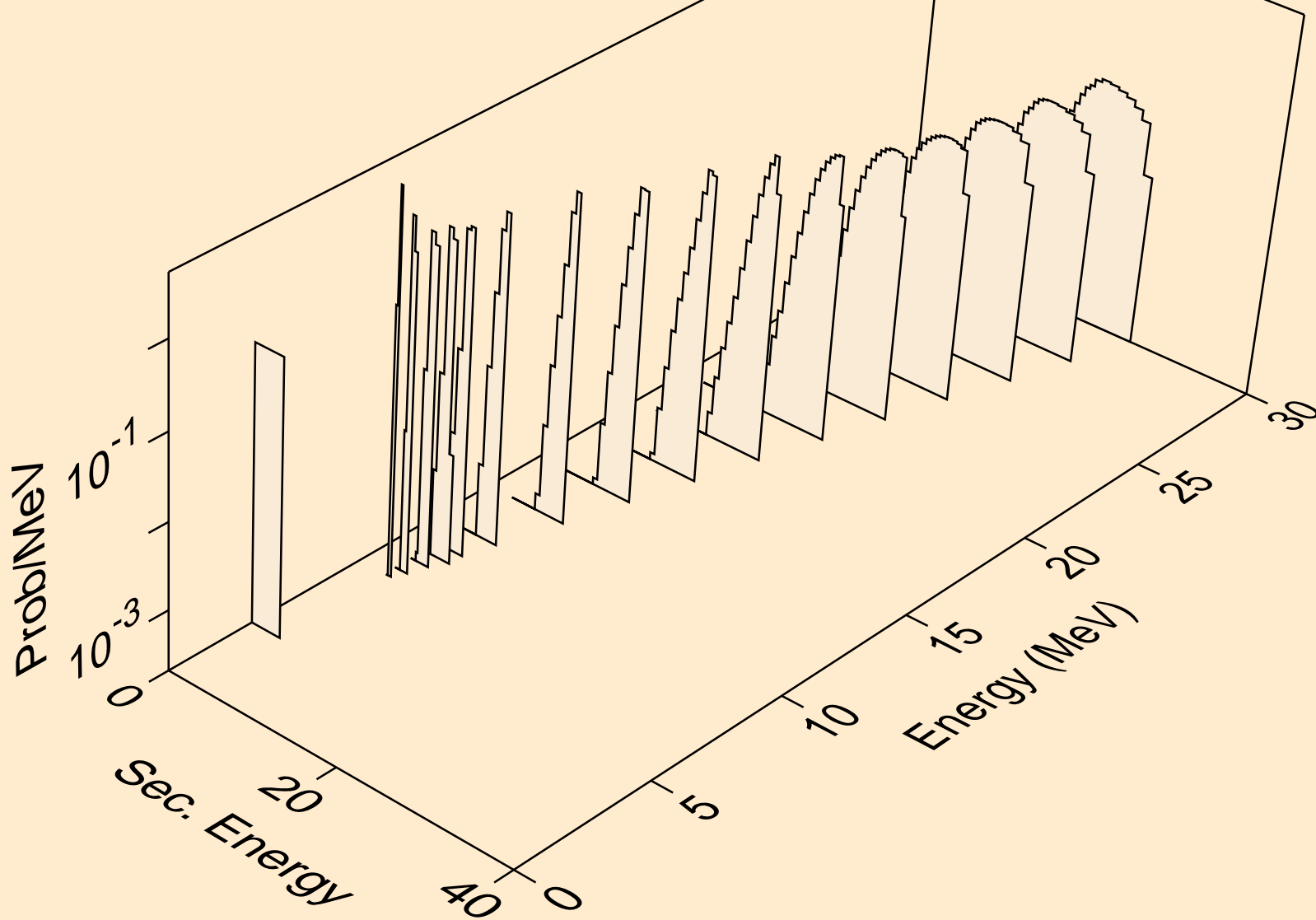

I130 NEUTRON ACER TENDL-2019 LIBRARY; T=293.16K  
alphas from (n,2n)a

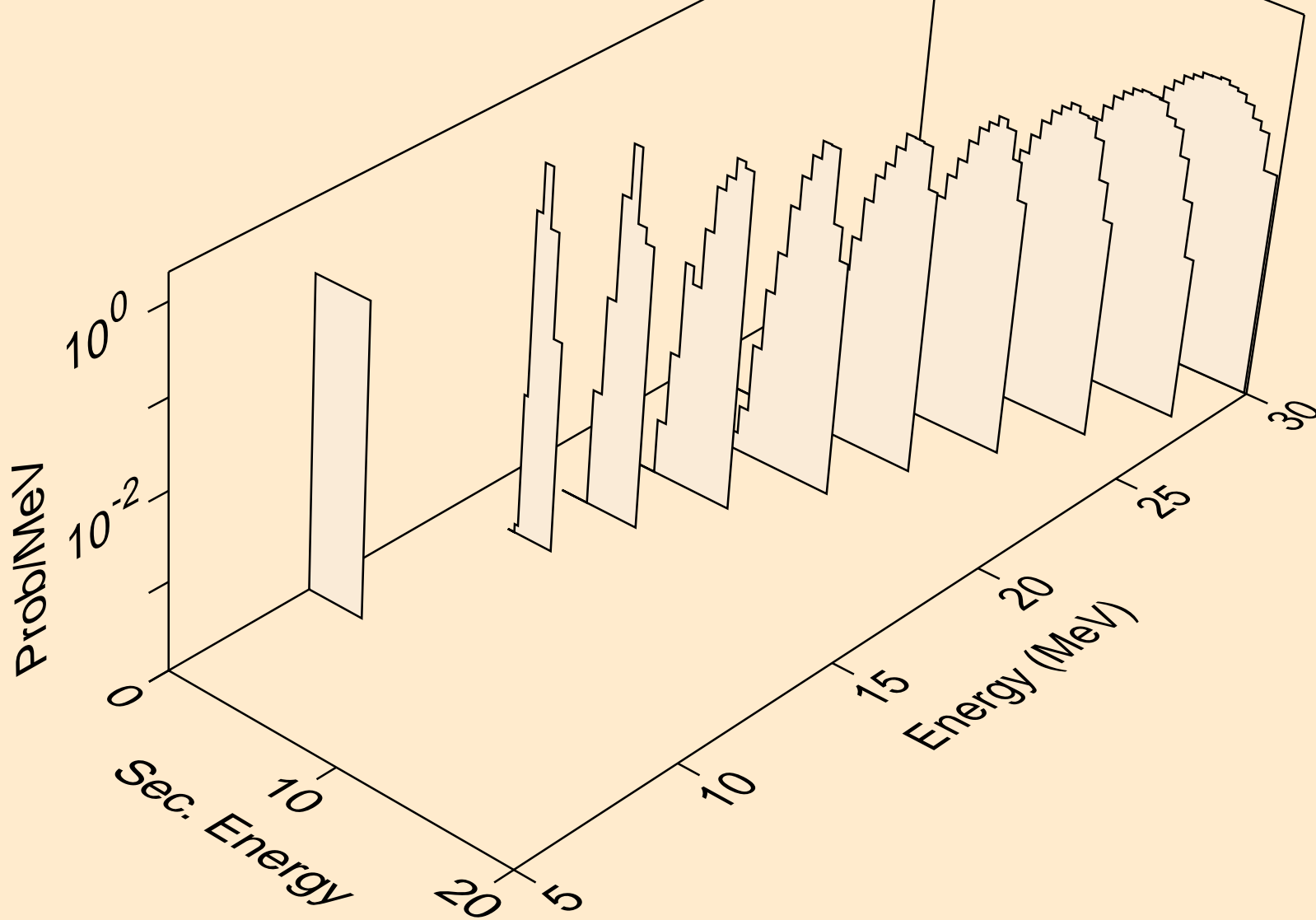

I130 NEUTRON ACER TENDL-2019 LIBRARY; T=293.16K  
alphas from (n,3n)a

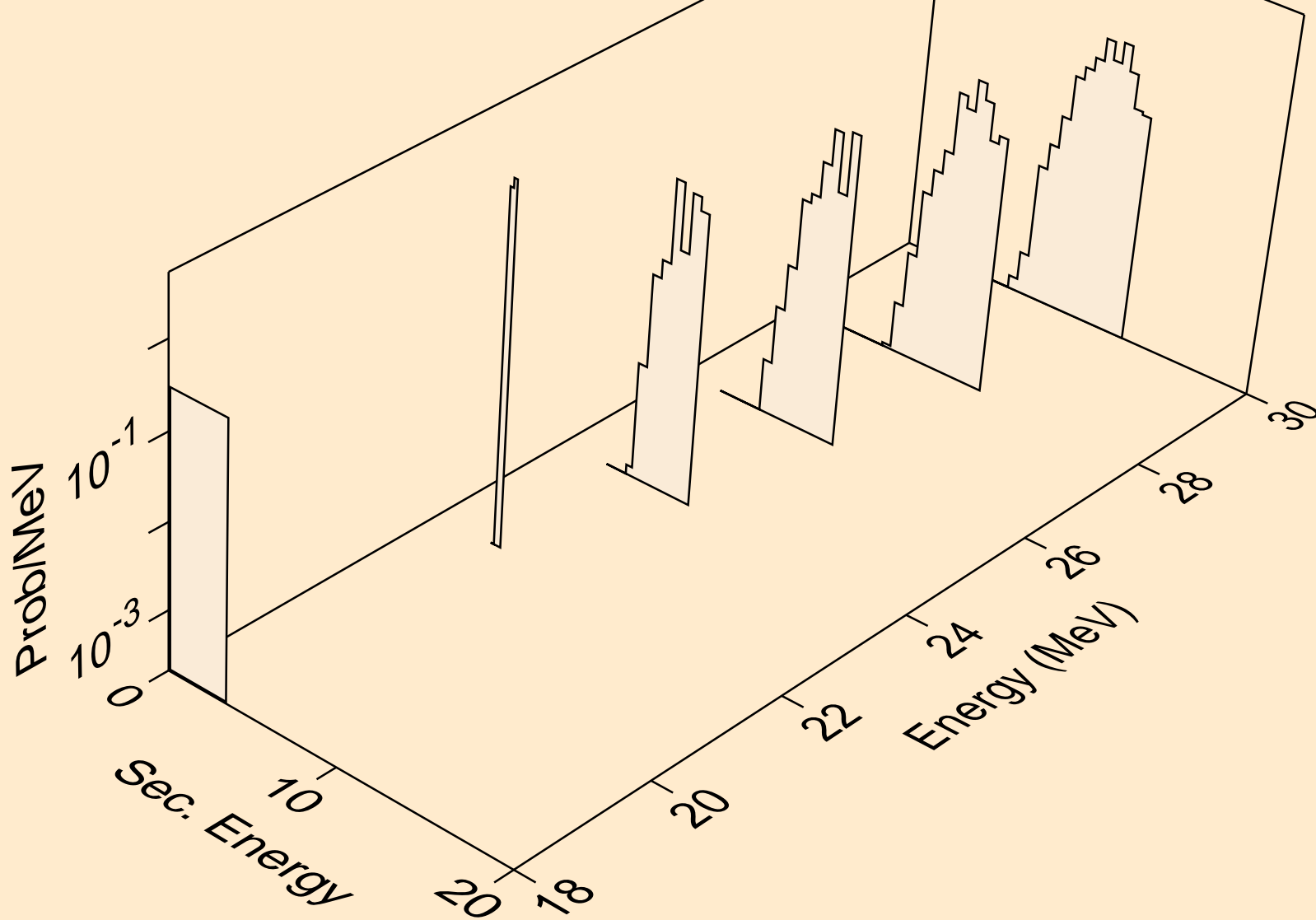



I130 NEUTRON ACER TENDL-2019 LIBRARY; T=293.16K  
alphas from (n,npa)

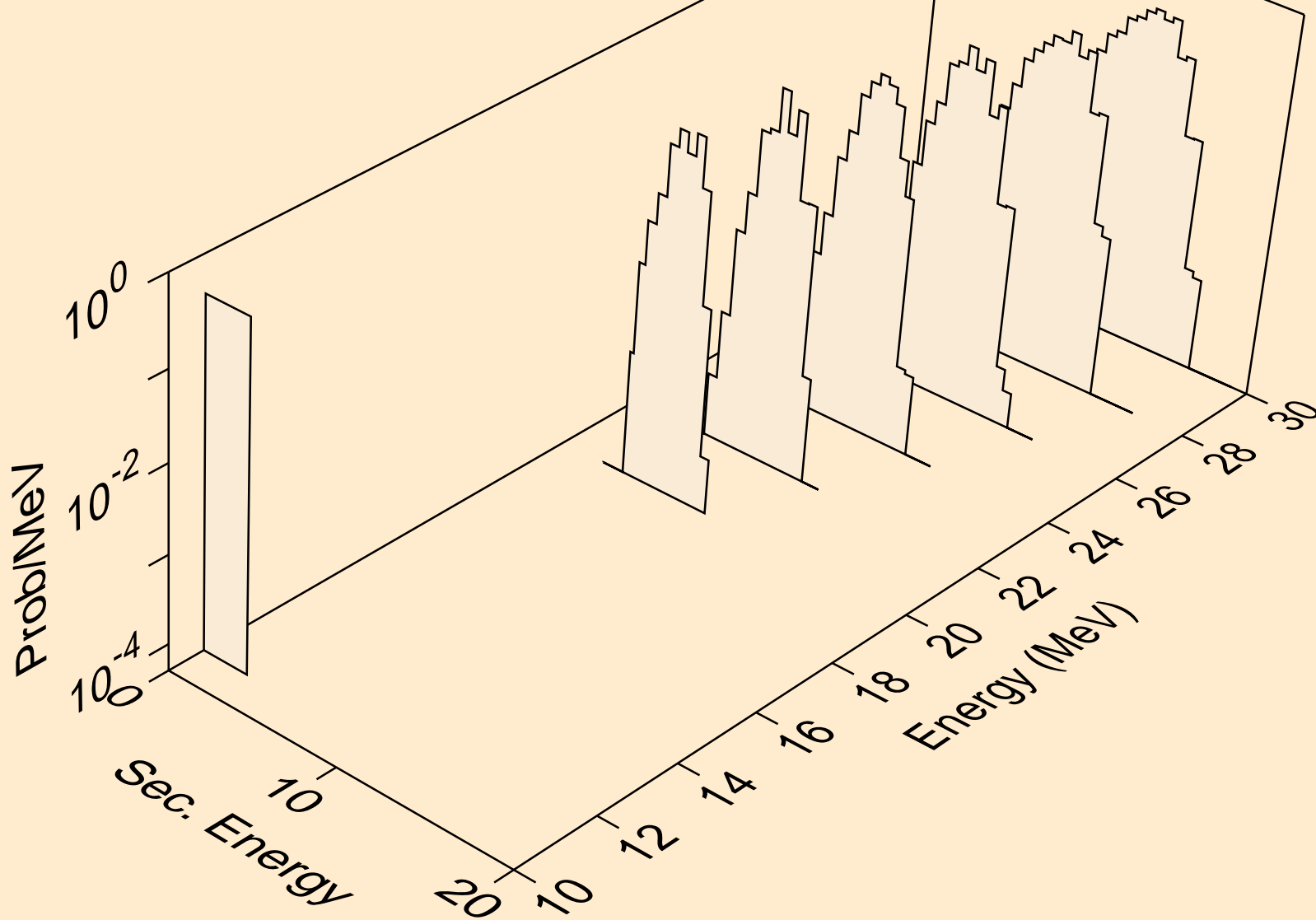

I130 NEUTRON ACER TENDL-2019 LIBRARY; T=293.16K  
alphas from (n,a)

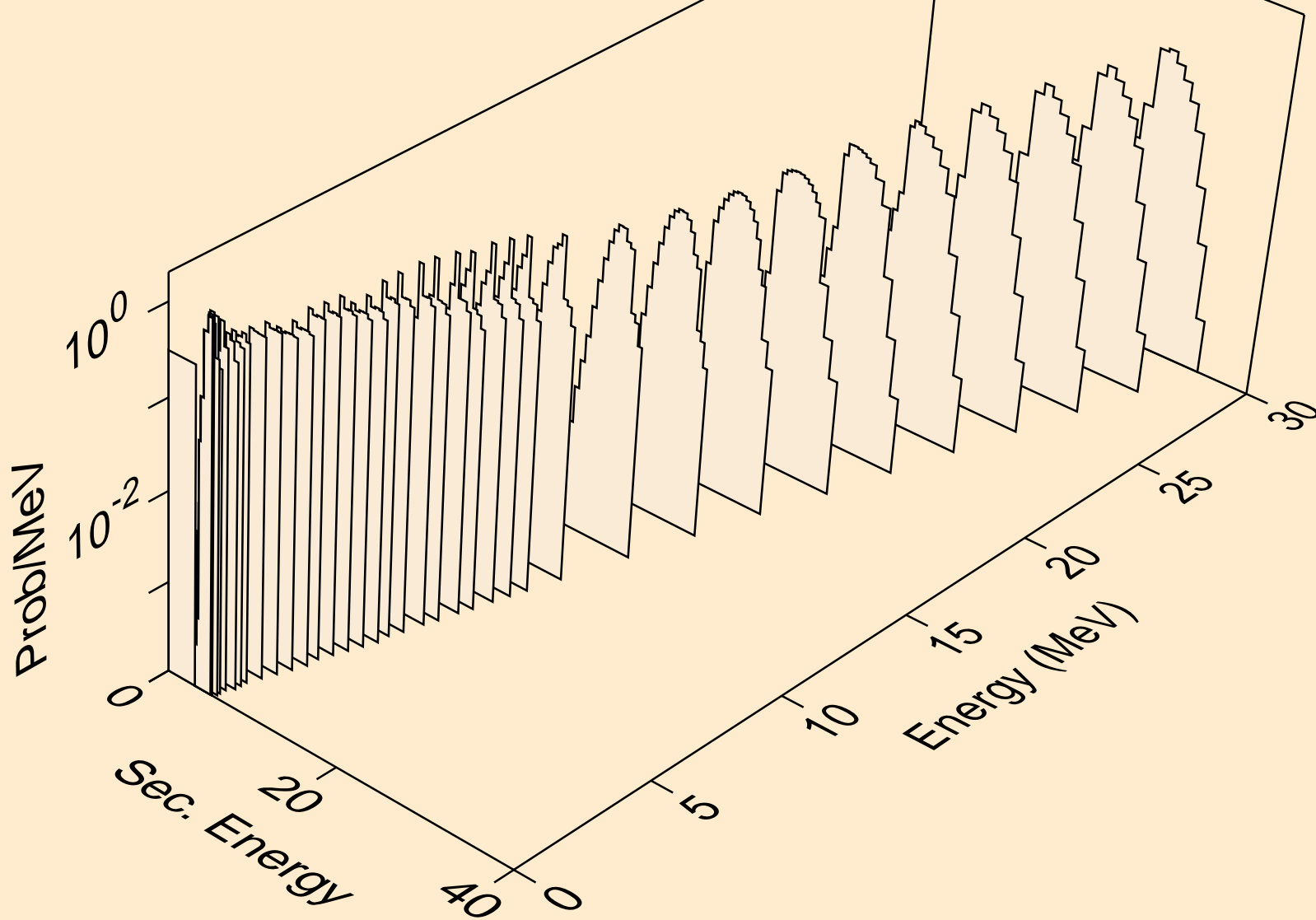

I130 NEUTRON ACER TENDL-2019 LIBRARY; T=293.16K  
alphas from (n,pa)

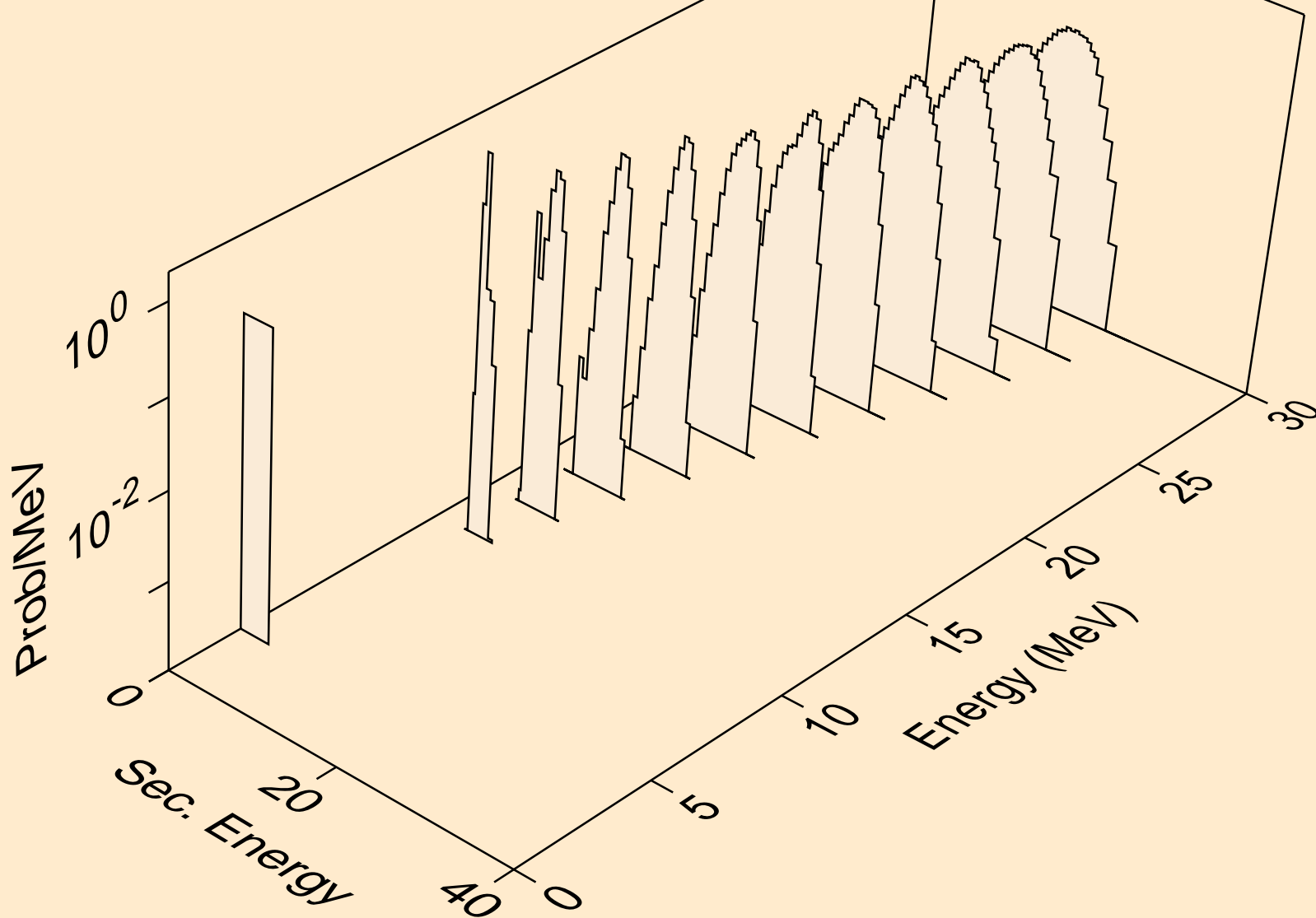

I130 NEUTRON ACER TENDL-2019 LIBRARY; T=293.16K  
alphas from (n,da)

