

# IN110 NEUTRON ACER TENDL-2019 LIBRARY; T=293.16K

## Principal cross sections

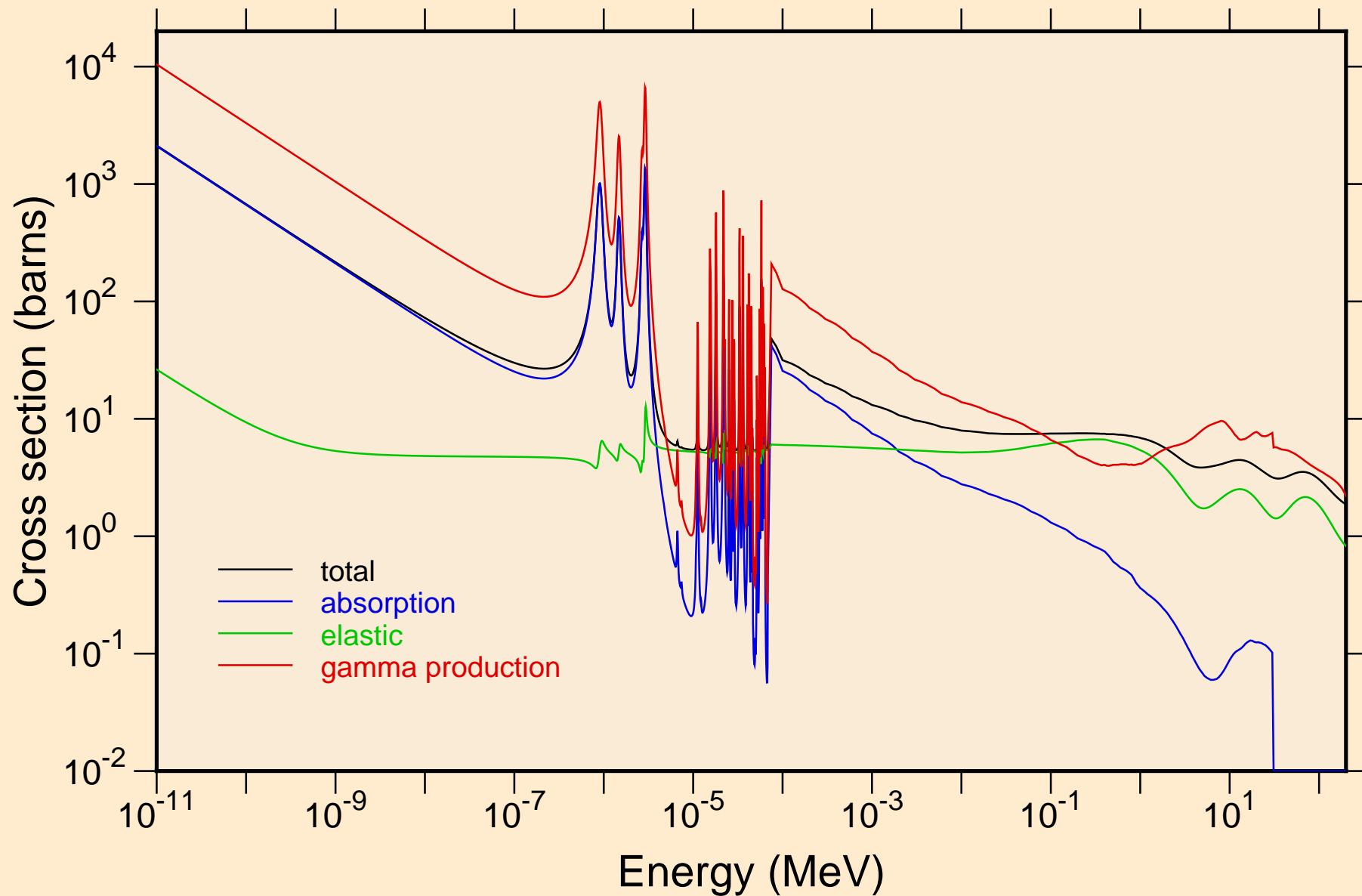

IN110 NEUTRON ACER TENDL-2019 LIBRARY; T=293.16K  
resonance total cross section

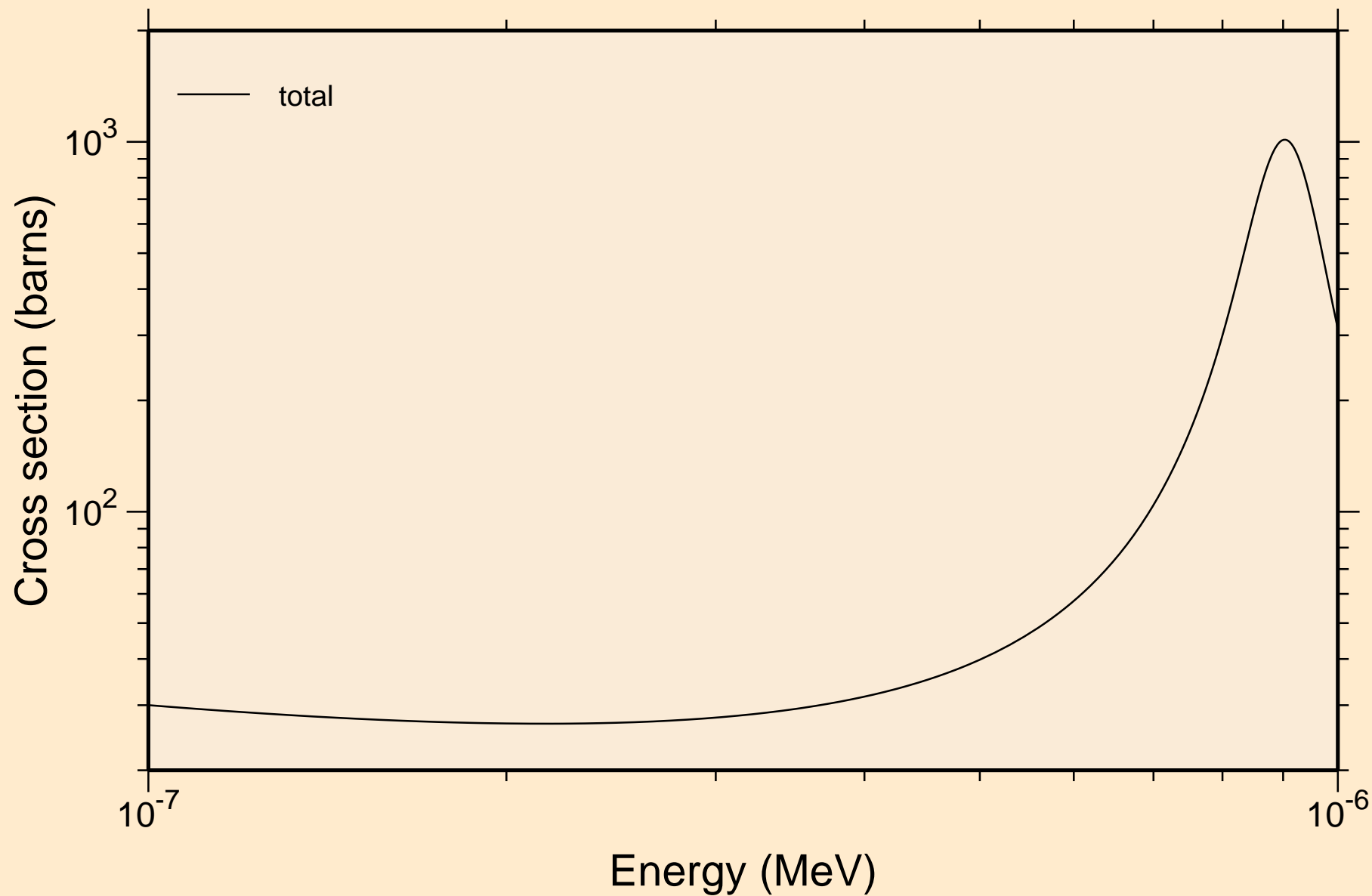

IN110 NEUTRON ACER TENDL-2019 LIBRARY; T=293.16K  
resonance total cross section

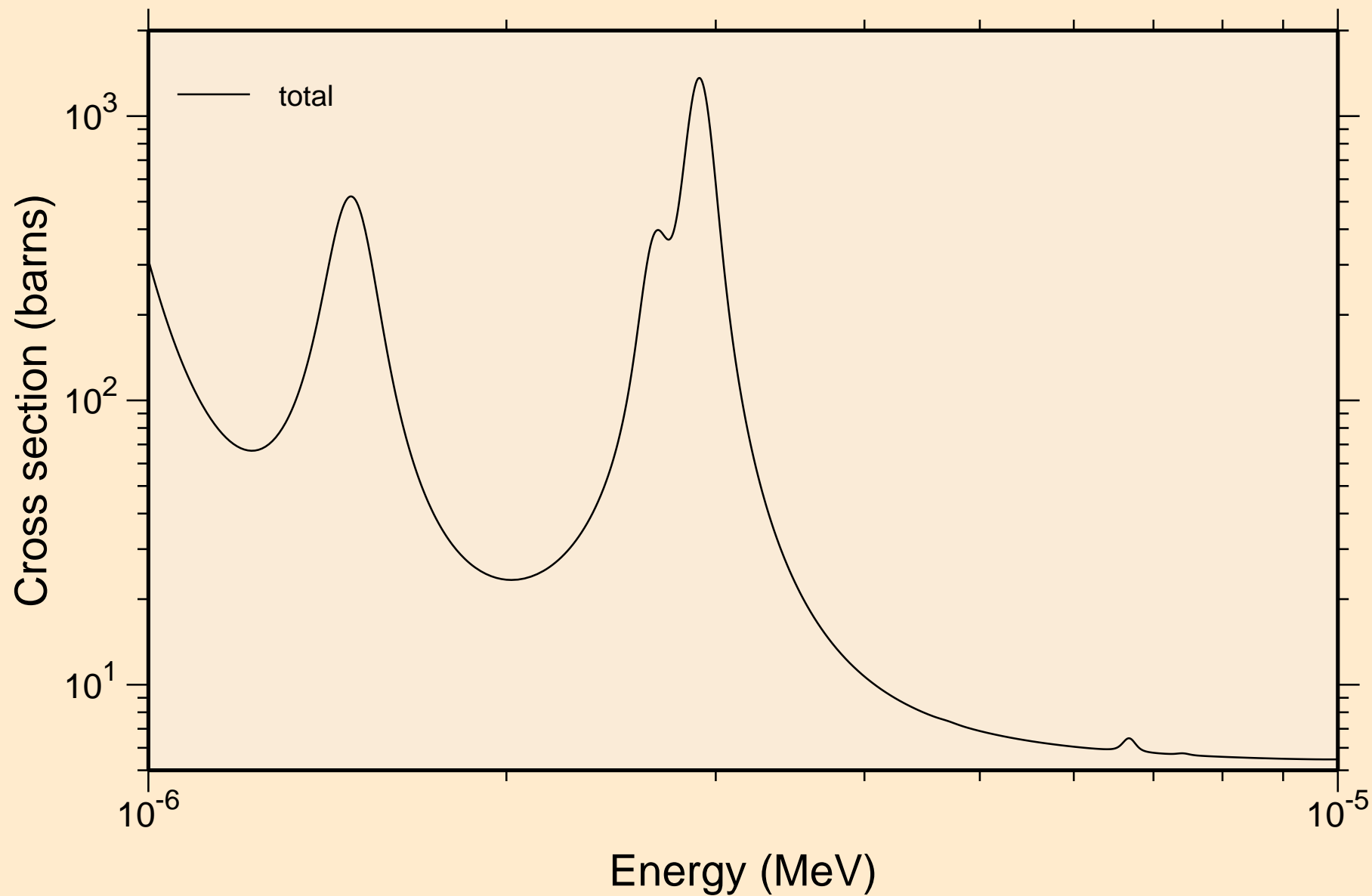

IN110 NEUTRON ACER TENDL-2019 LIBRARY; T=293.16K  
resonance total cross section

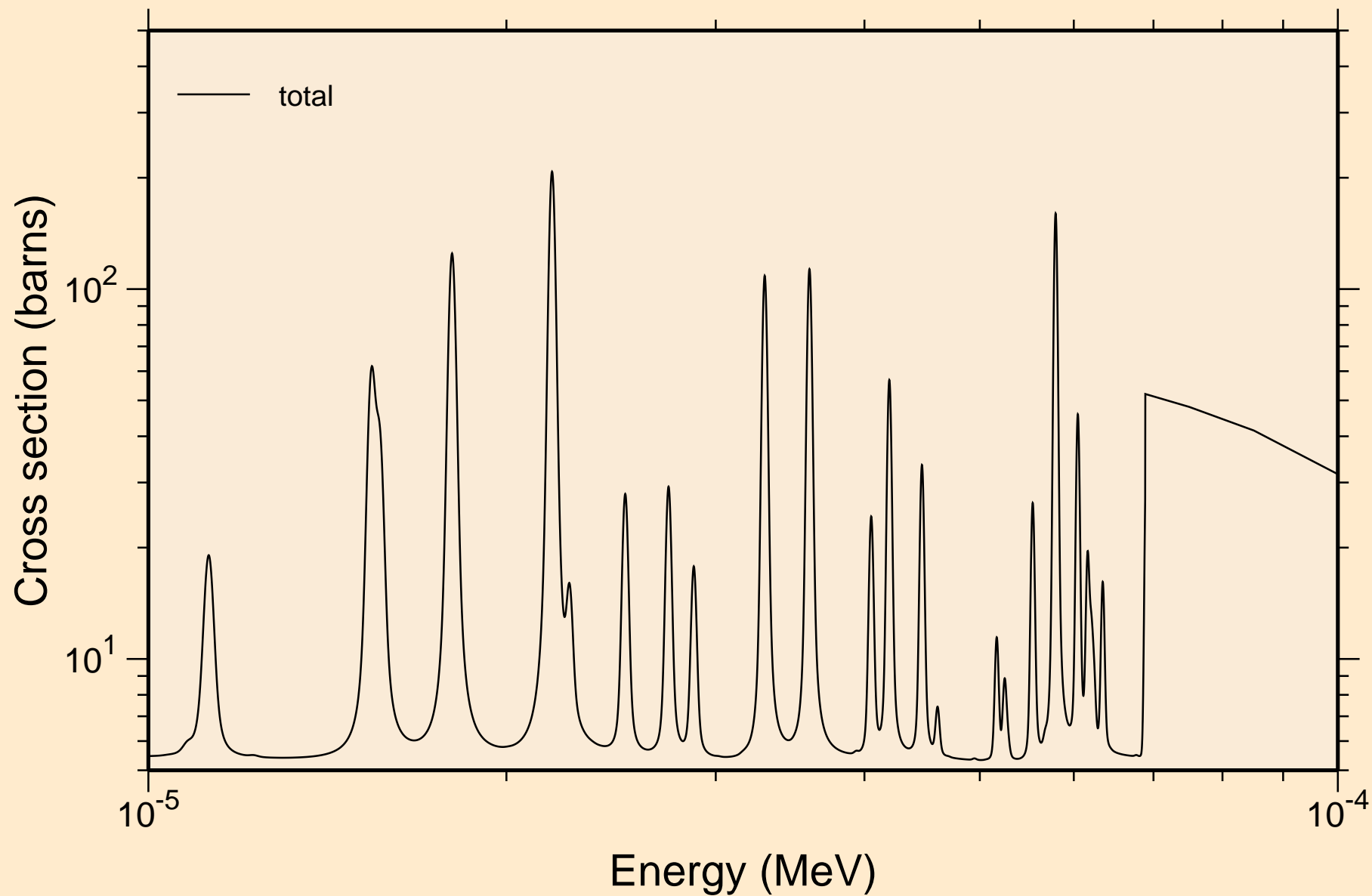

IN110 NEUTRON ACER TENDL-2019 LIBRARY; T=293.16K  
resonance total cross section

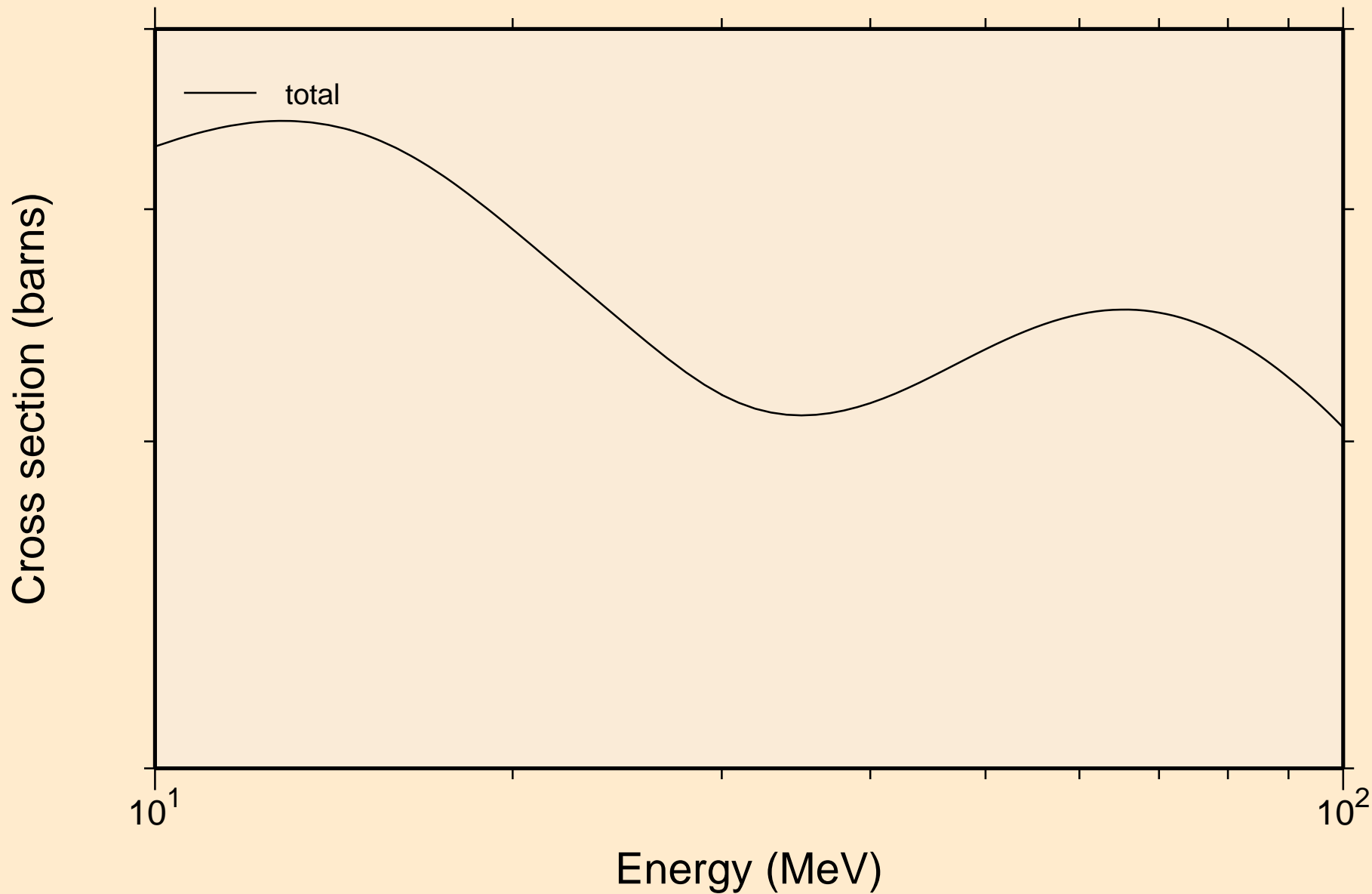

IN110 NEUTRON ACER TENDL-2019 LIBRARY; T=293.16K  
resonance absorption cross sections

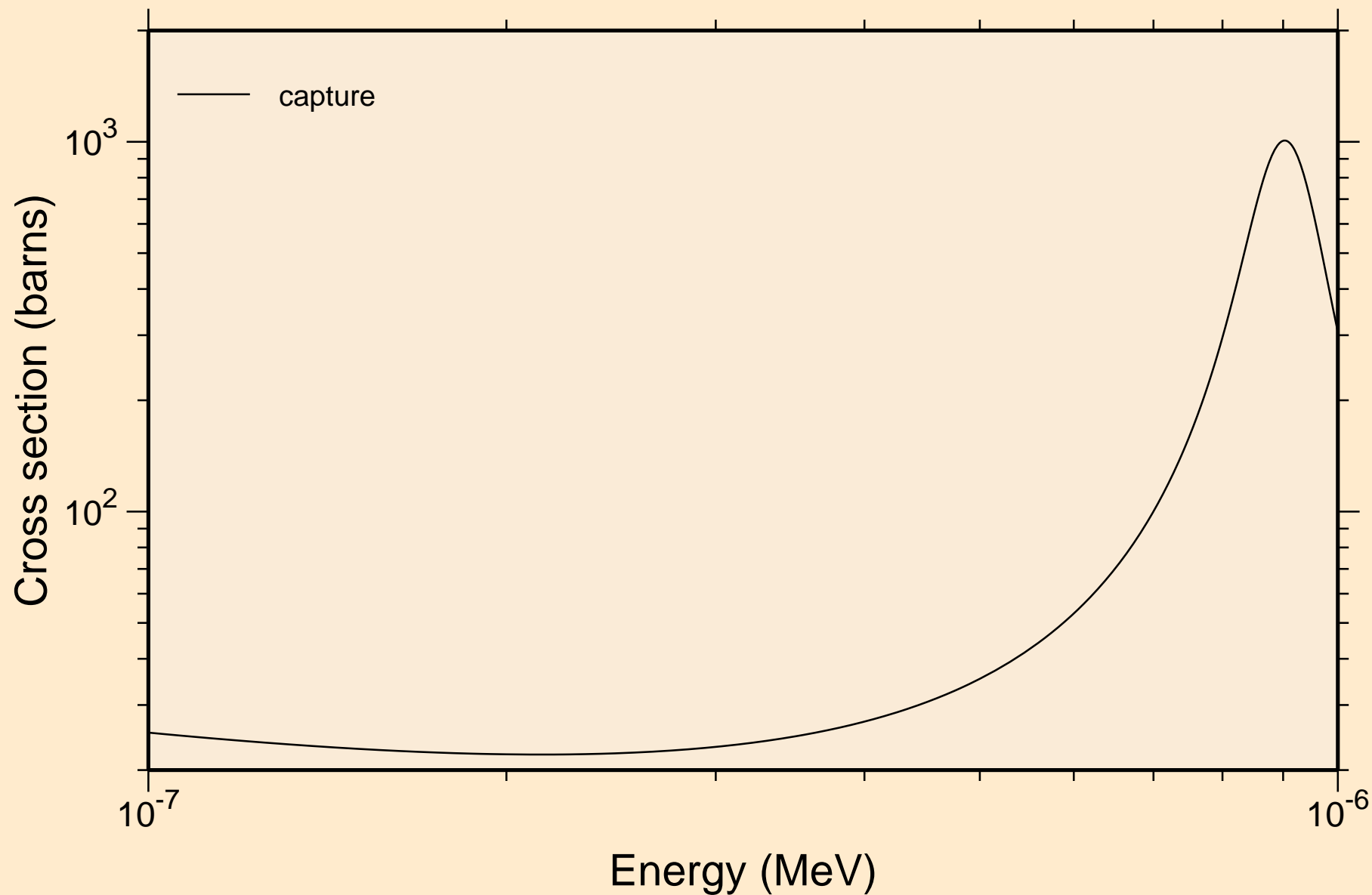

IN110 NEUTRON ACER TENDL-2019 LIBRARY; T=293.16K  
resonance absorption cross sections

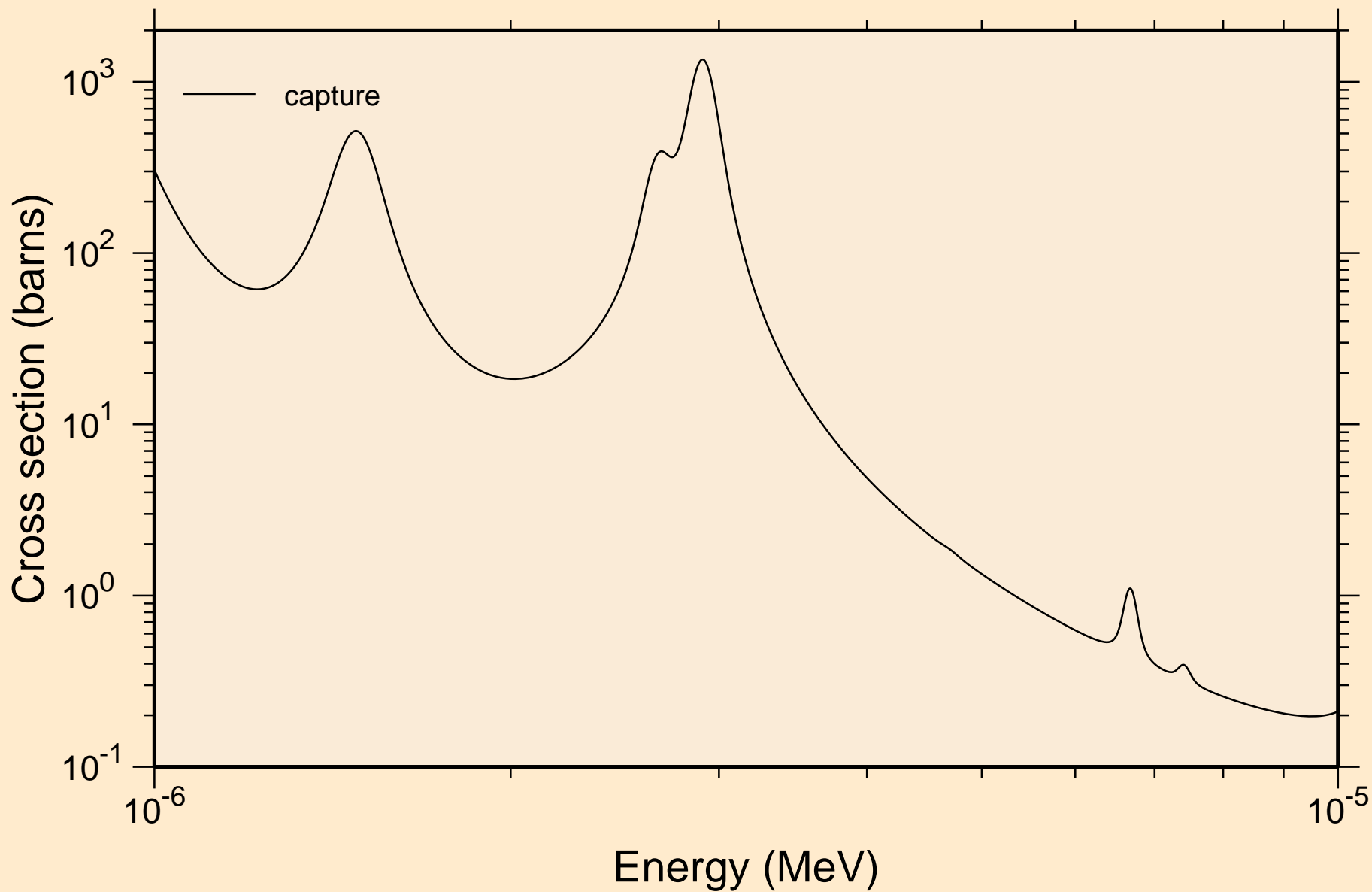

IN110 NEUTRON ACER TENDL-2019 LIBRARY; T=293.16K  
resonance absorption cross sections

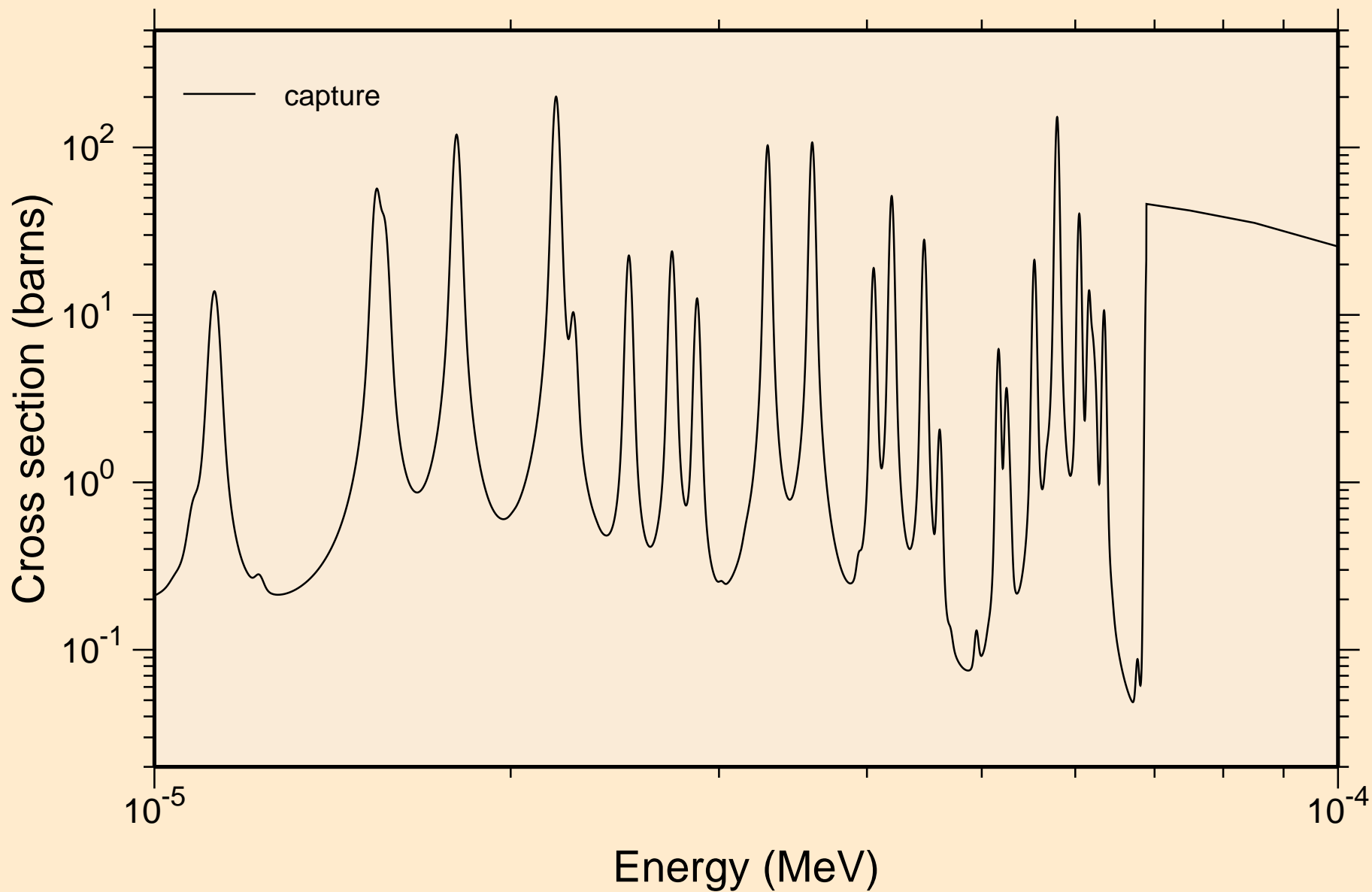



IN110 NEUTRON ACER TENDL-2019 LIBRARY; T=293.16K  
resonance absorption cross sections

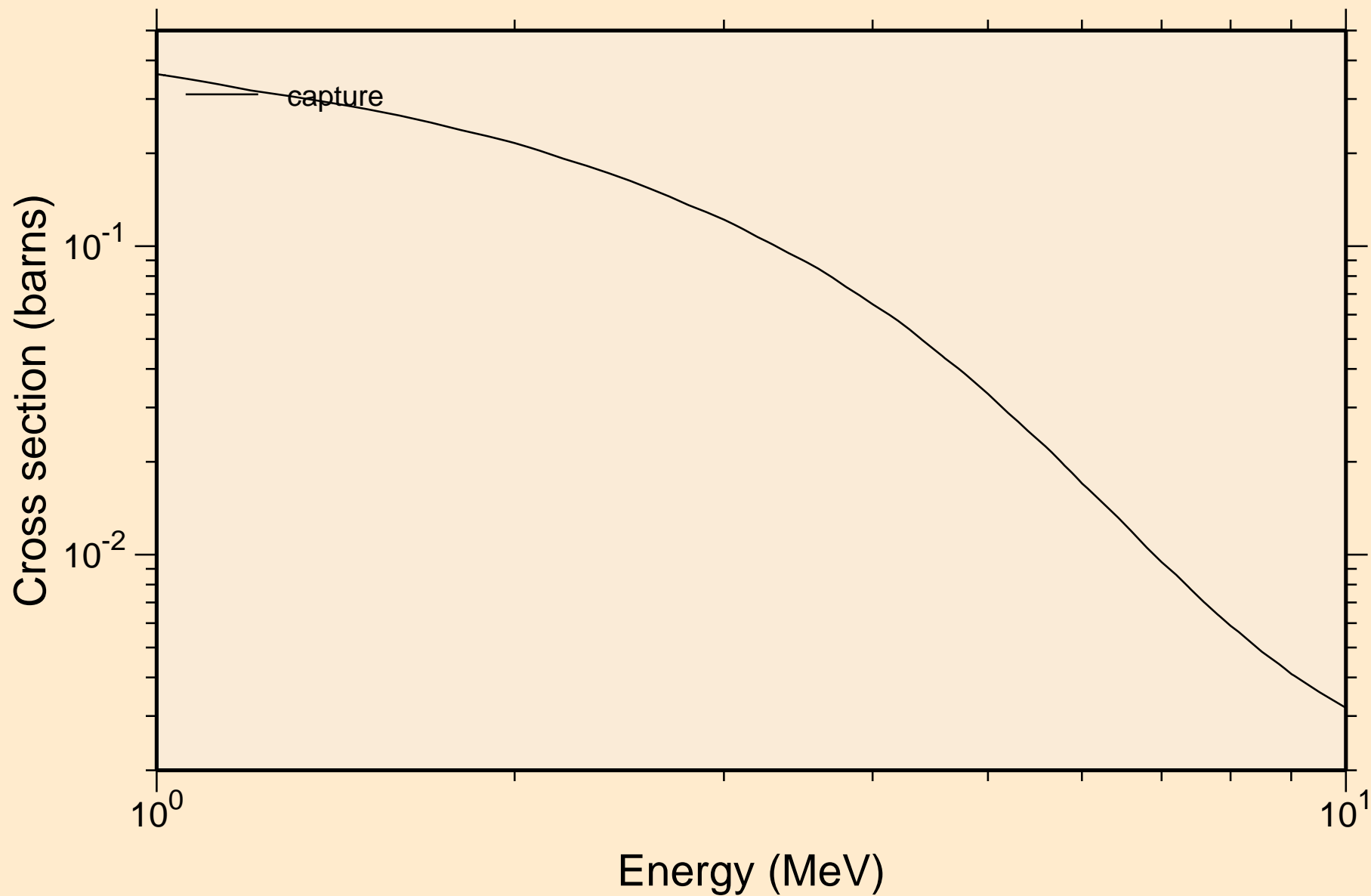

IN110 NEUTRON ACER TENDL-2019 LIBRARY; T=293.16K  
Heating

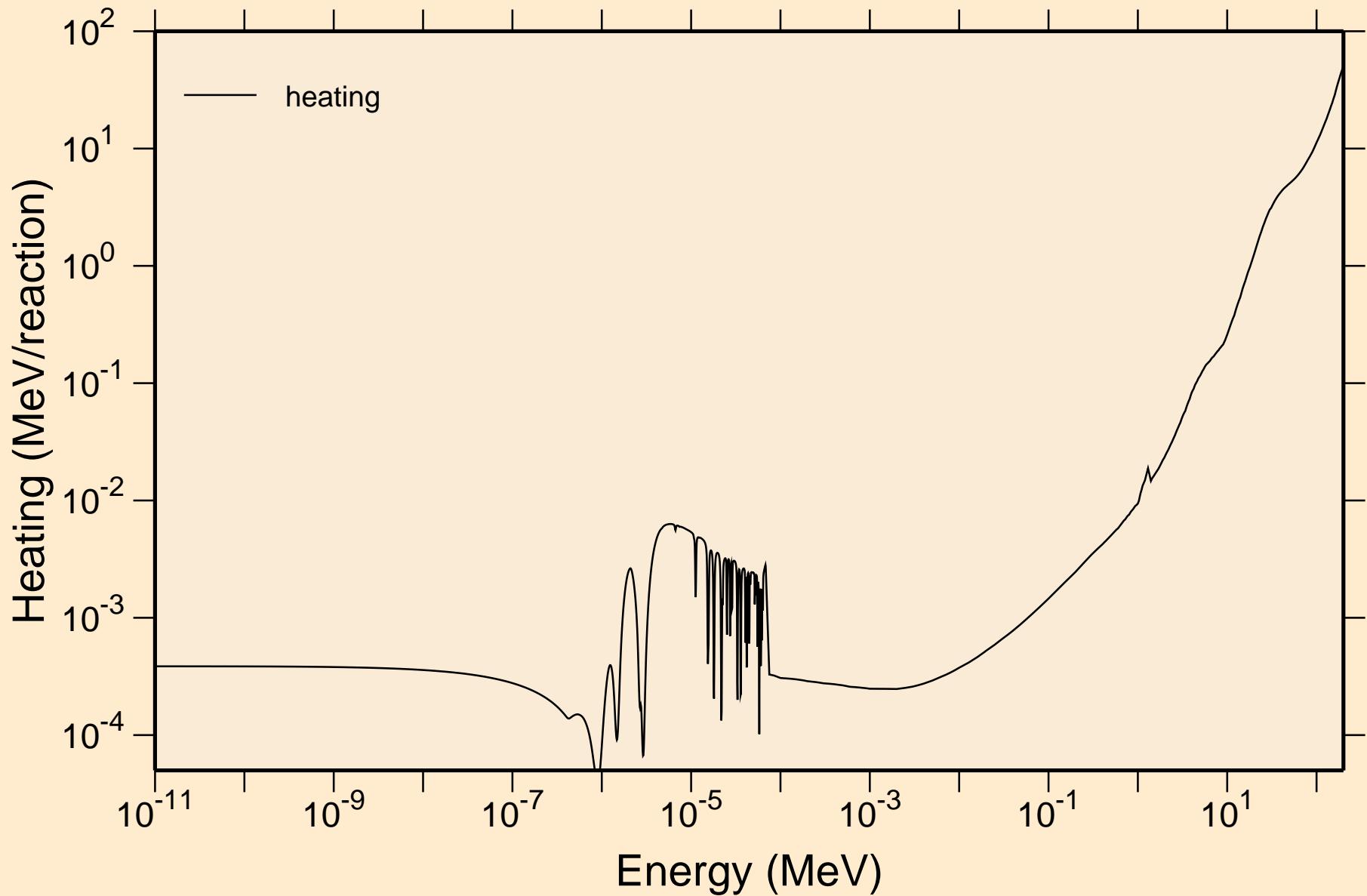

IN110 NEUTRON ACER TENDL-2019 LIBRARY; T=293.16K  
Damage

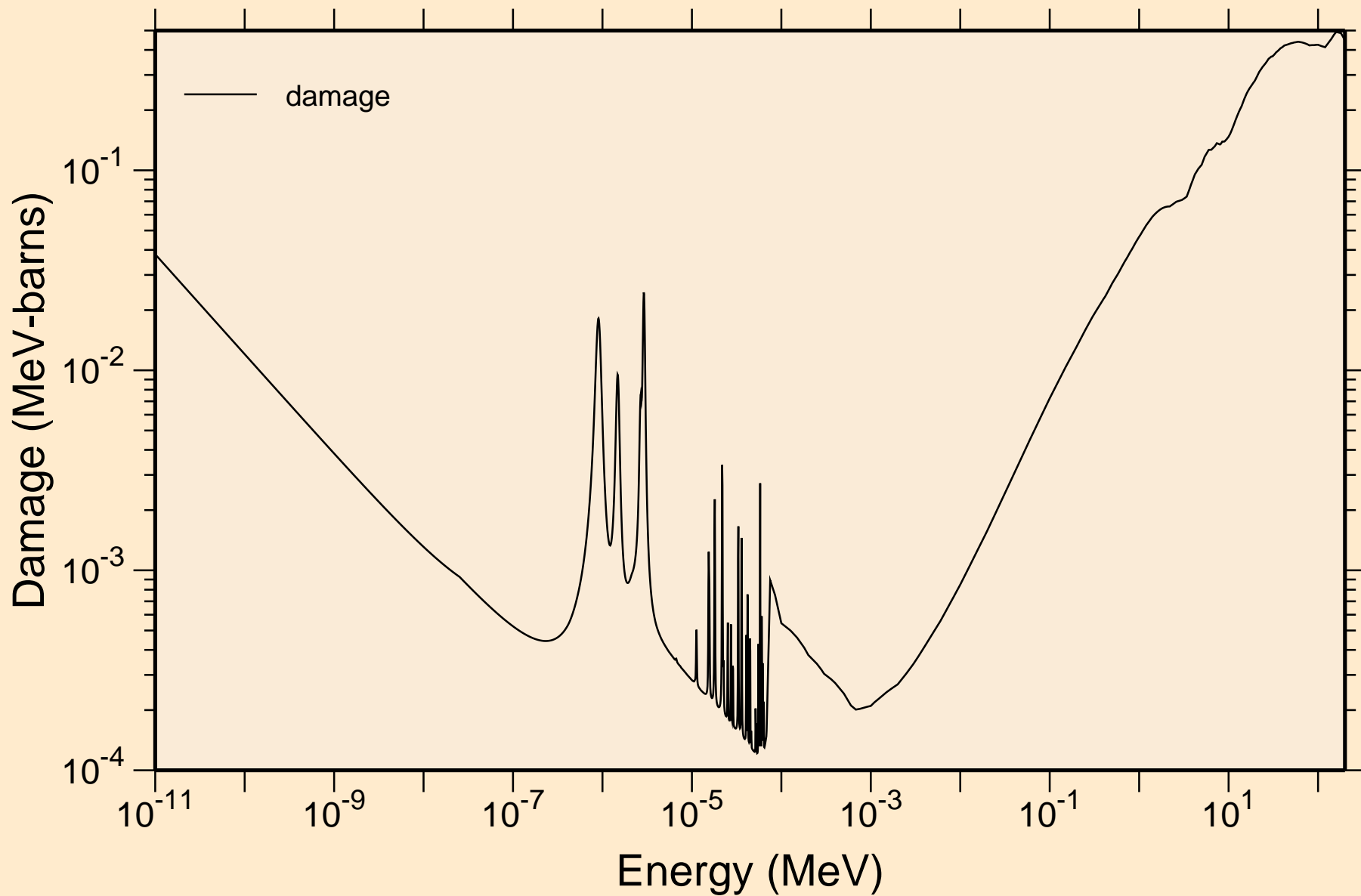

IN110 NEUTRON ACER TENDL-2019 LIBRARY; T=293.16K  
Non-threshold reactions

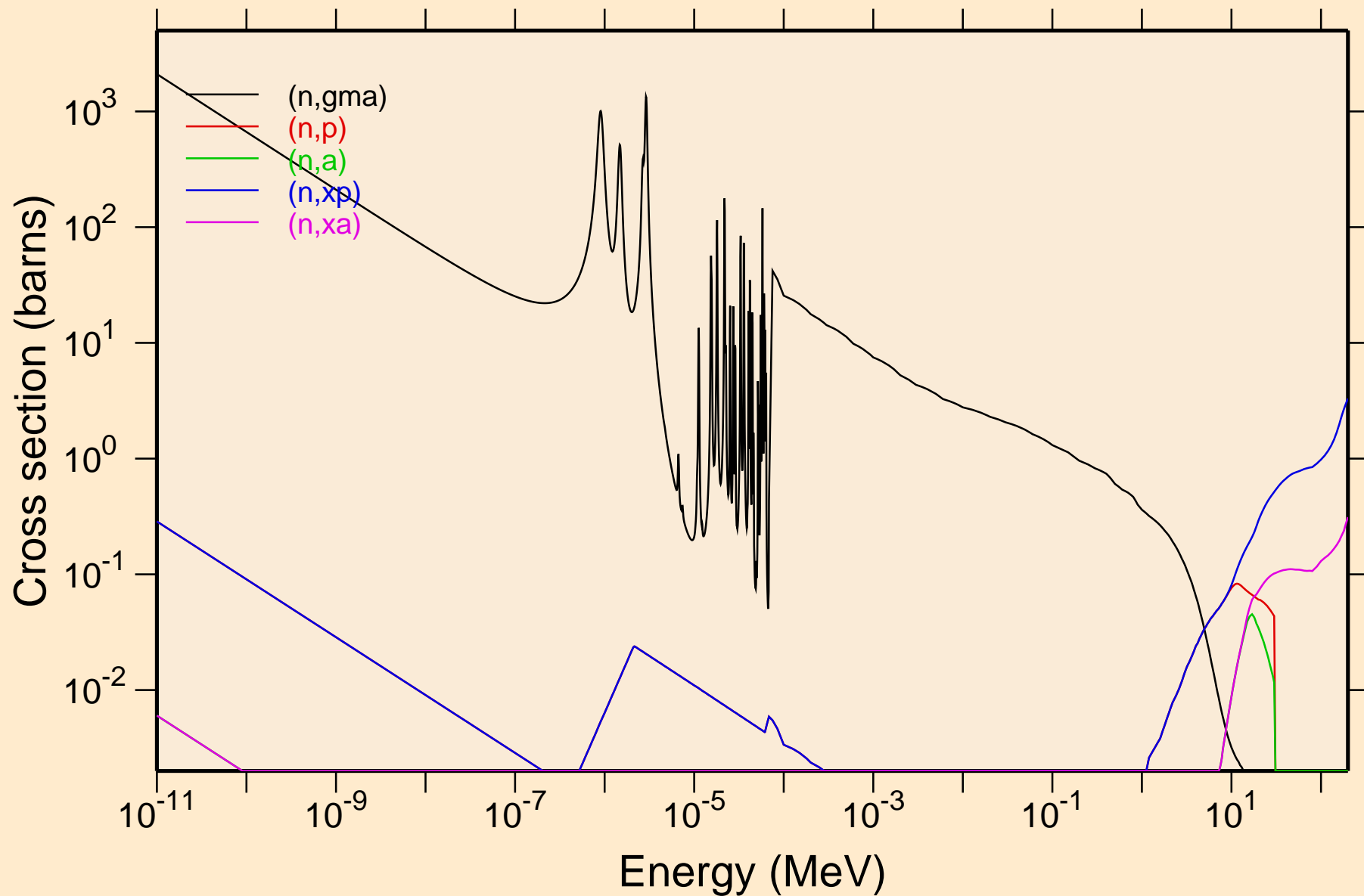

IN110 NEUTRON ACER TENDL-2019 LIBRARY; T=293.16K  
Principal cross sections

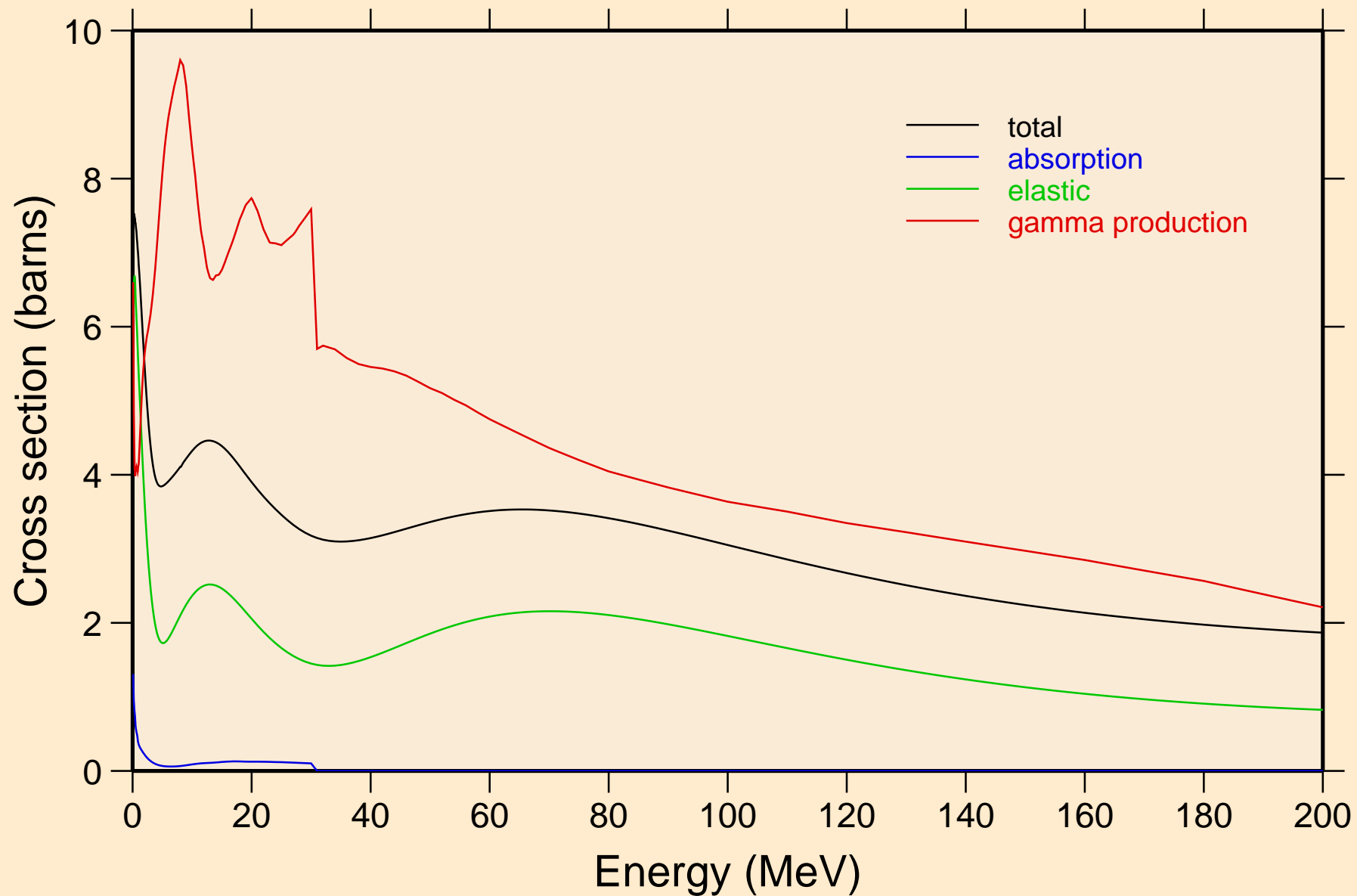

IN110 NEUTRON ACER TENDL-2019 LIBRARY; T=293.16K  
Heating

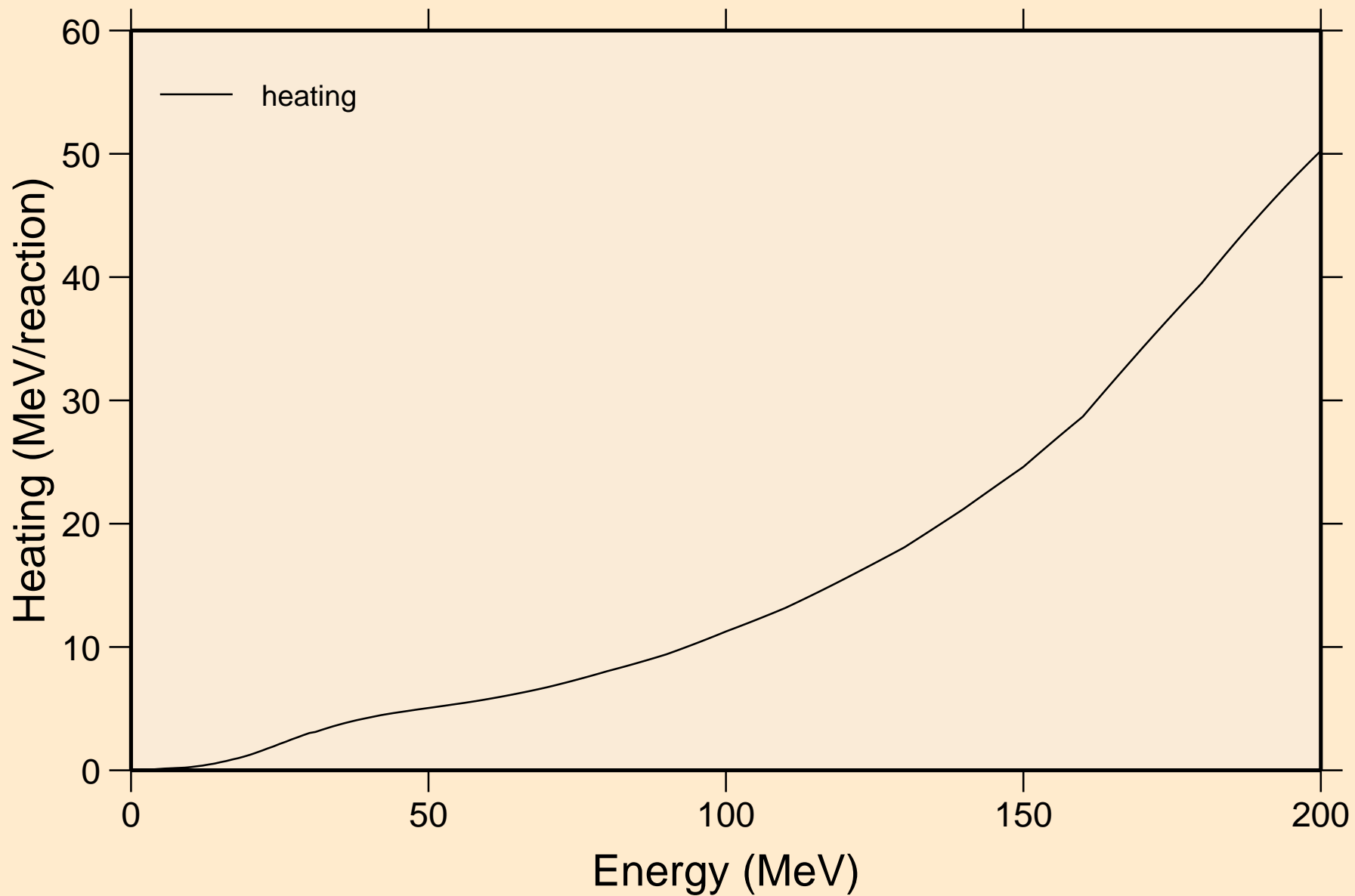

IN110 NEUTRON ACER TENDL-2019 LIBRARY; T=293.16K  
Damage

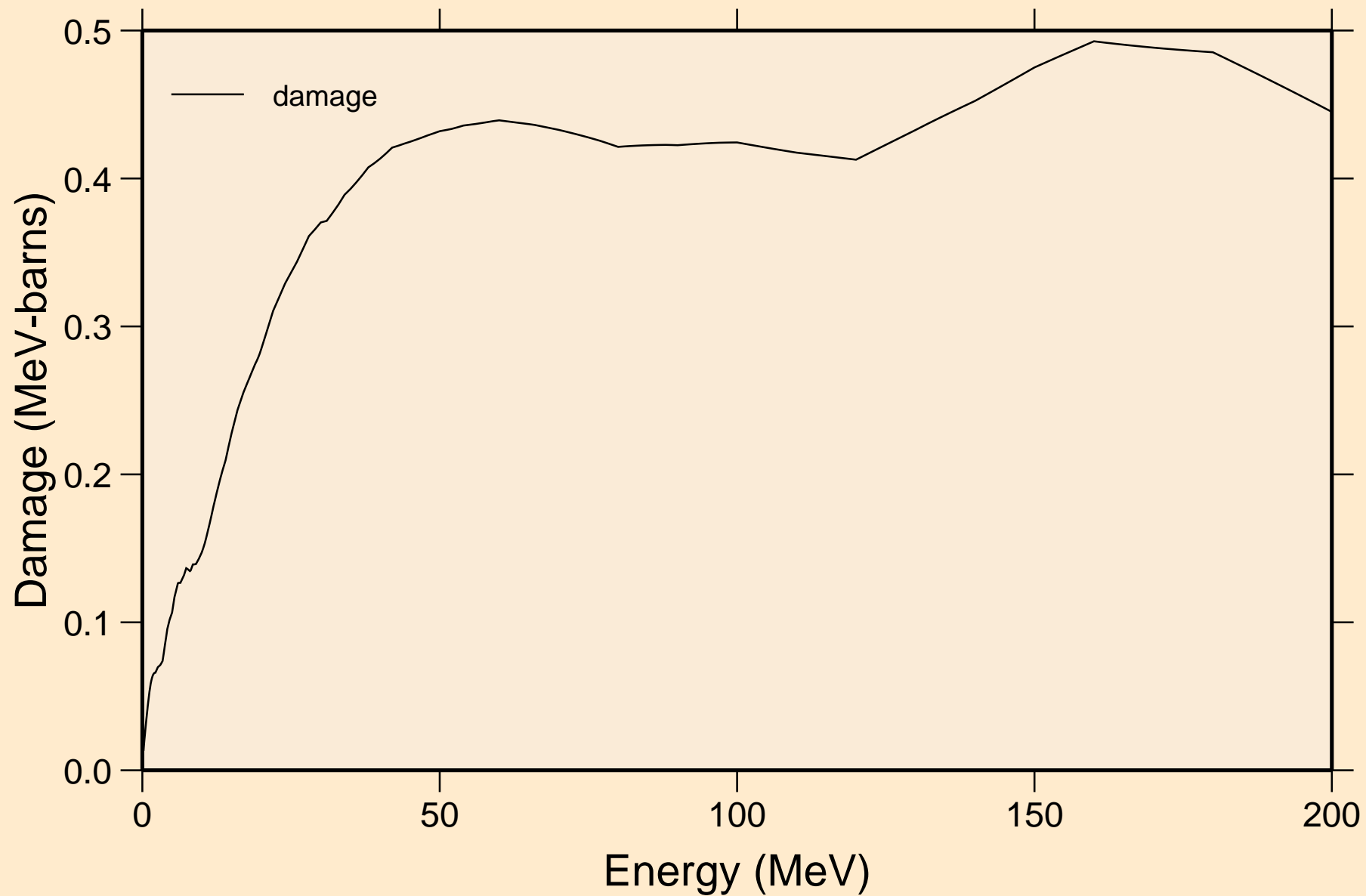

# IN110 NEUTRON ACER TENDL-2019 LIBRARY; T=293.16K

## Non-threshold reactions

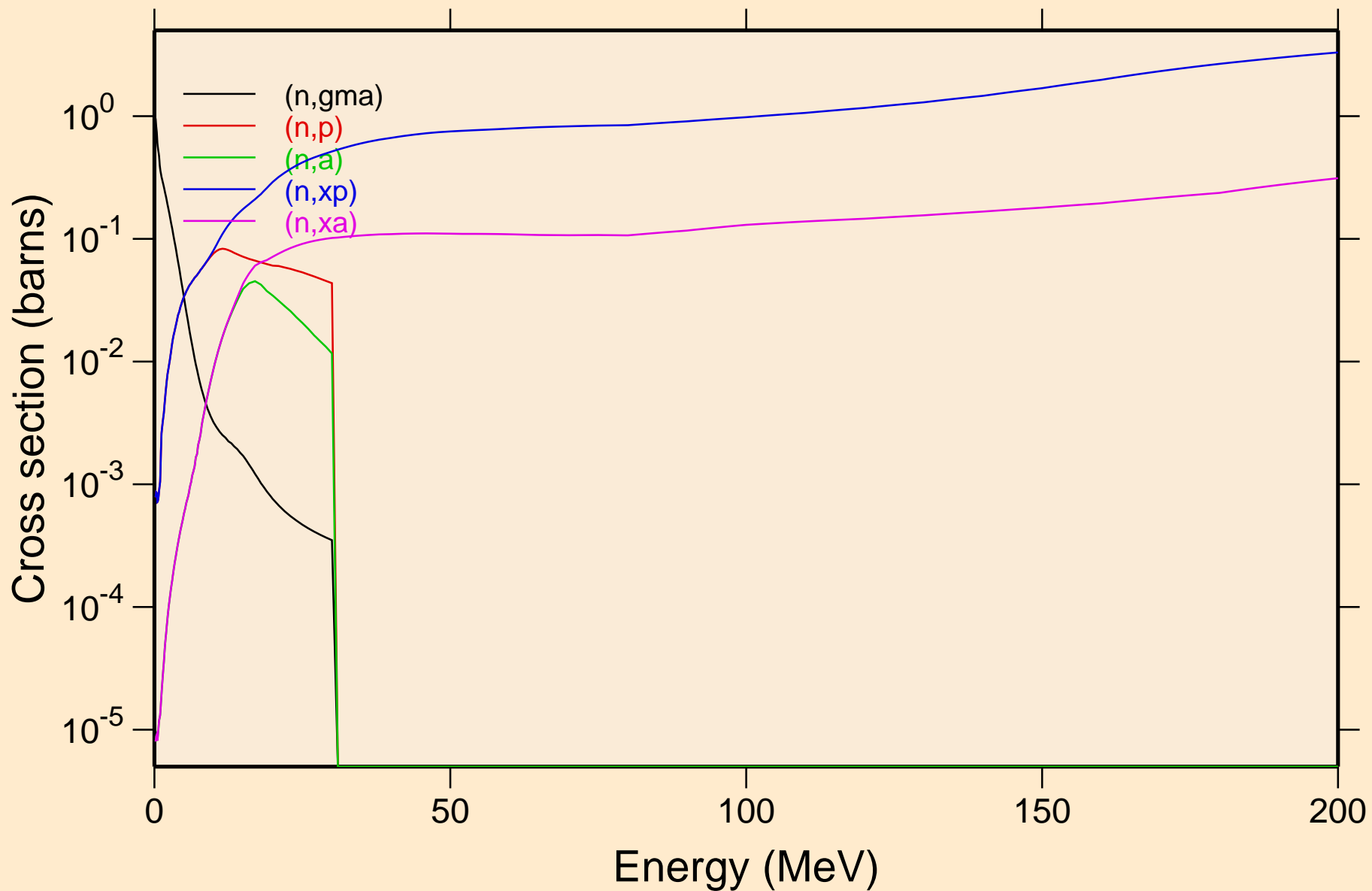



IN110 NEUTRON ACER TENDL-2019 LIBRARY; T=293.16K  
Inelastic levels

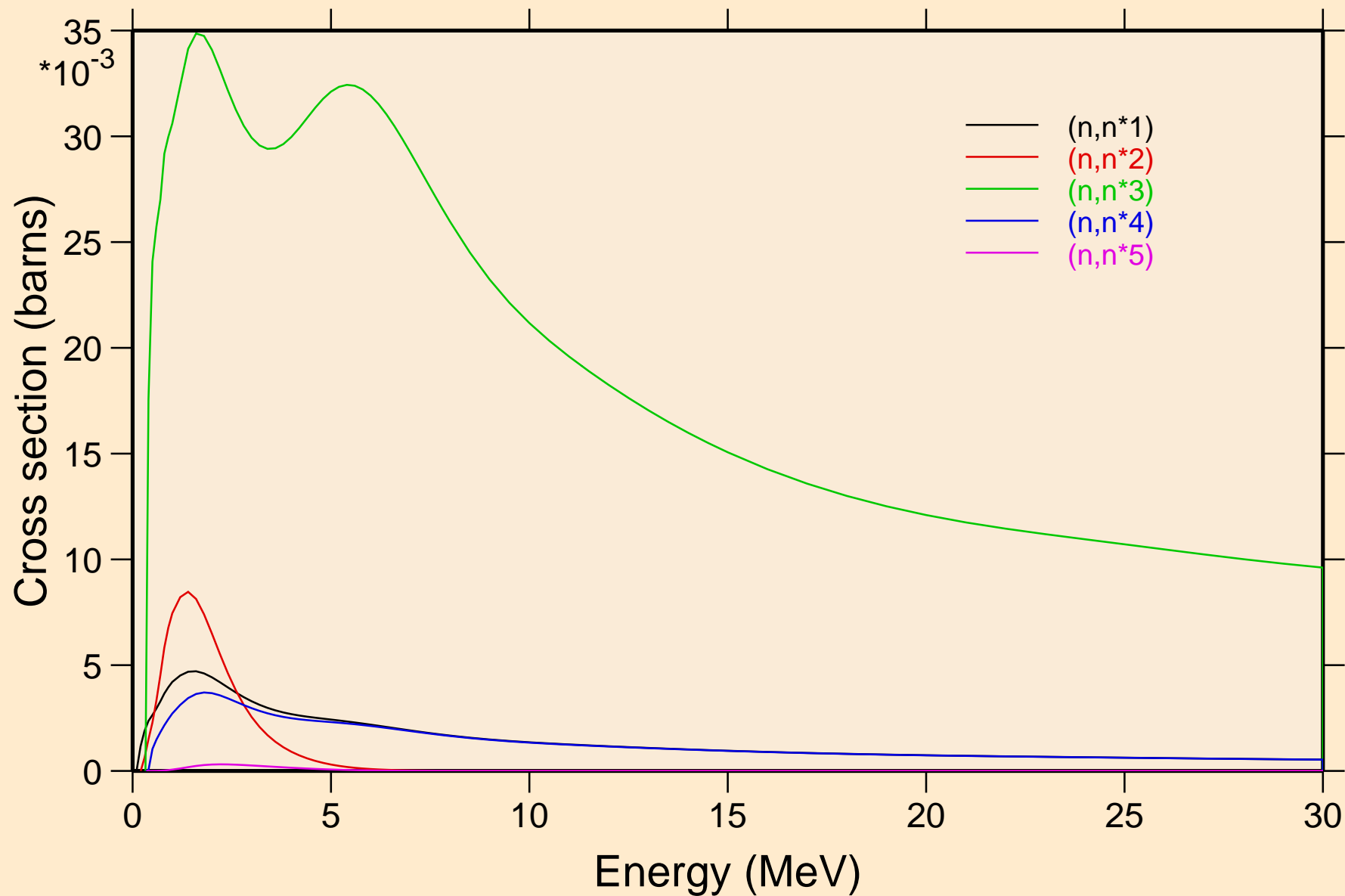

IN110 NEUTRON ACER TENDL-2019 LIBRARY; T=293.16K  
Inelastic levels

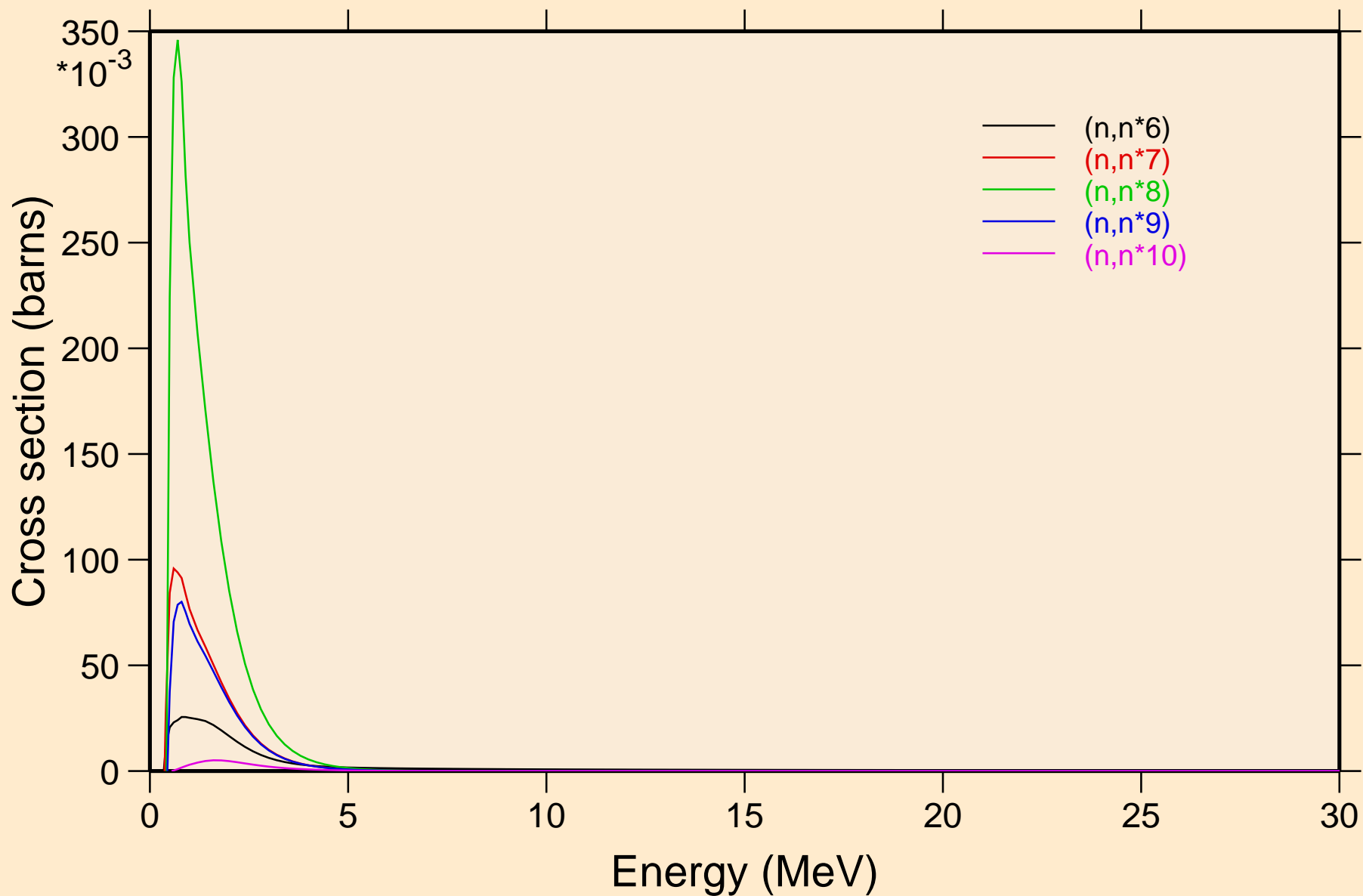

IN110 NEUTRON ACER TENDL-2019 LIBRARY; T=293.16K  
Inelastic levels

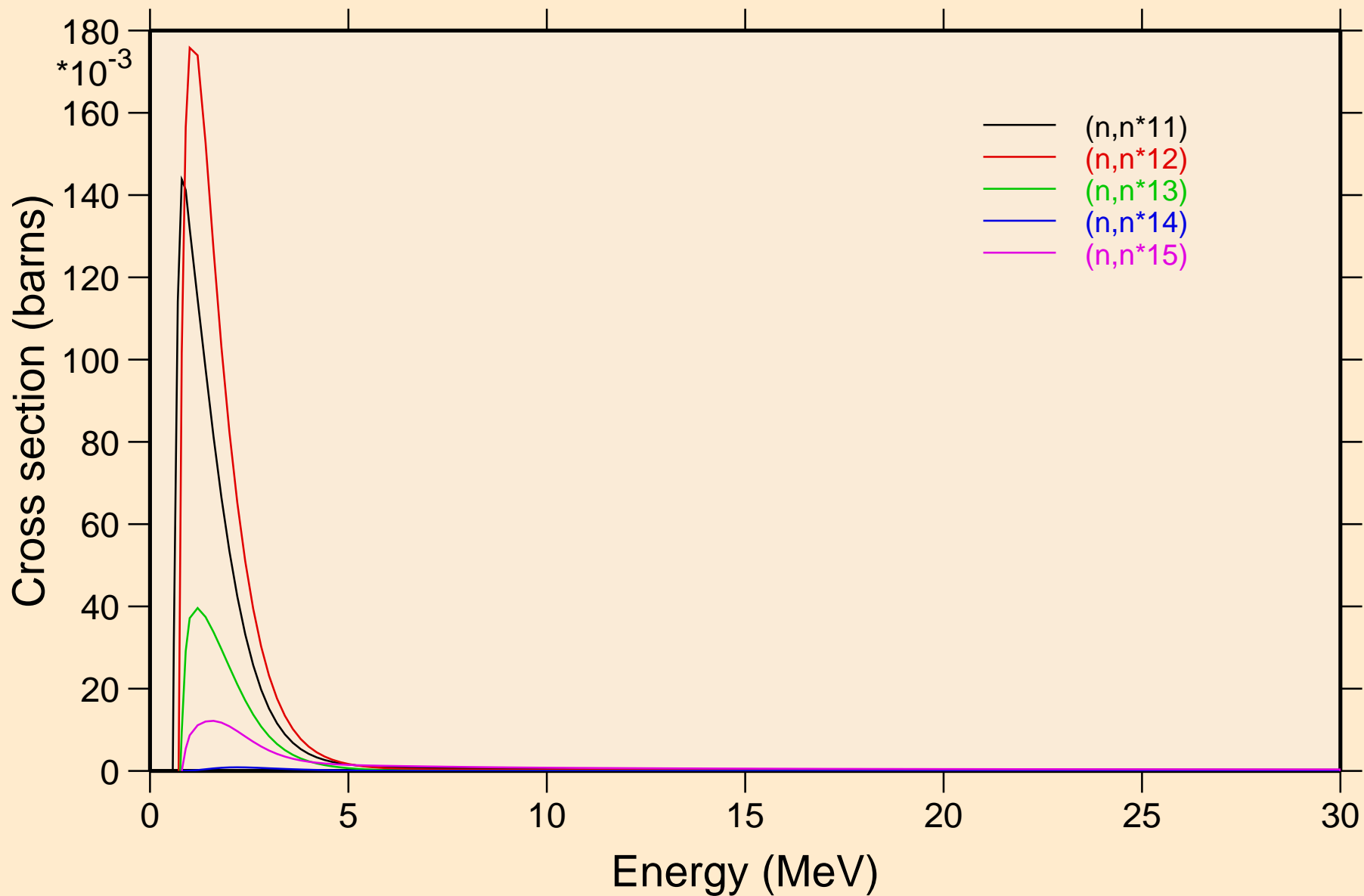

IN110 NEUTRON ACER TENDL-2019 LIBRARY; T=293.16K  
Inelastic levels

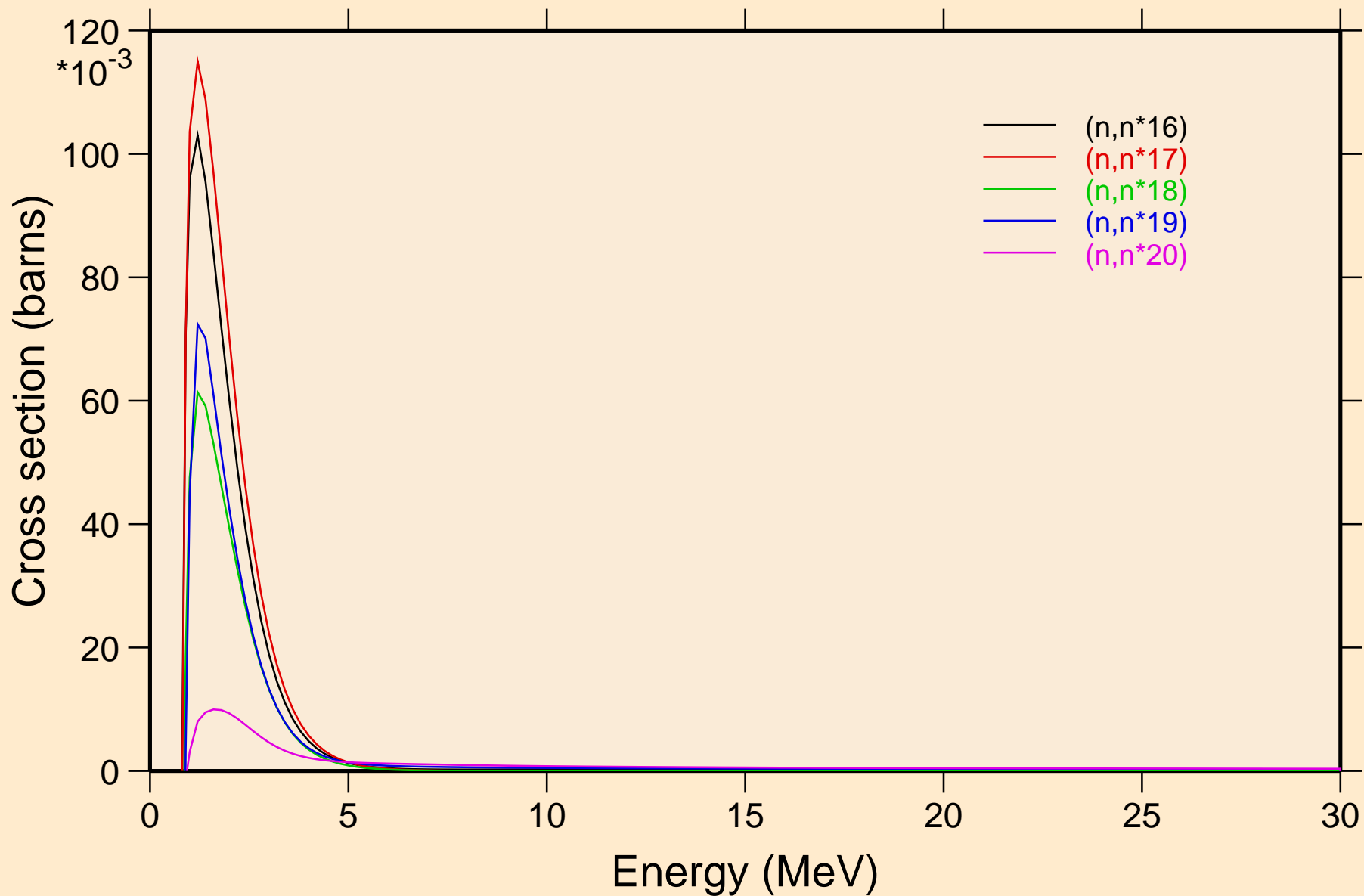

IN110 NEUTRON ACER TENDL-2019 LIBRARY; T=293.16K  
Inelastic levels

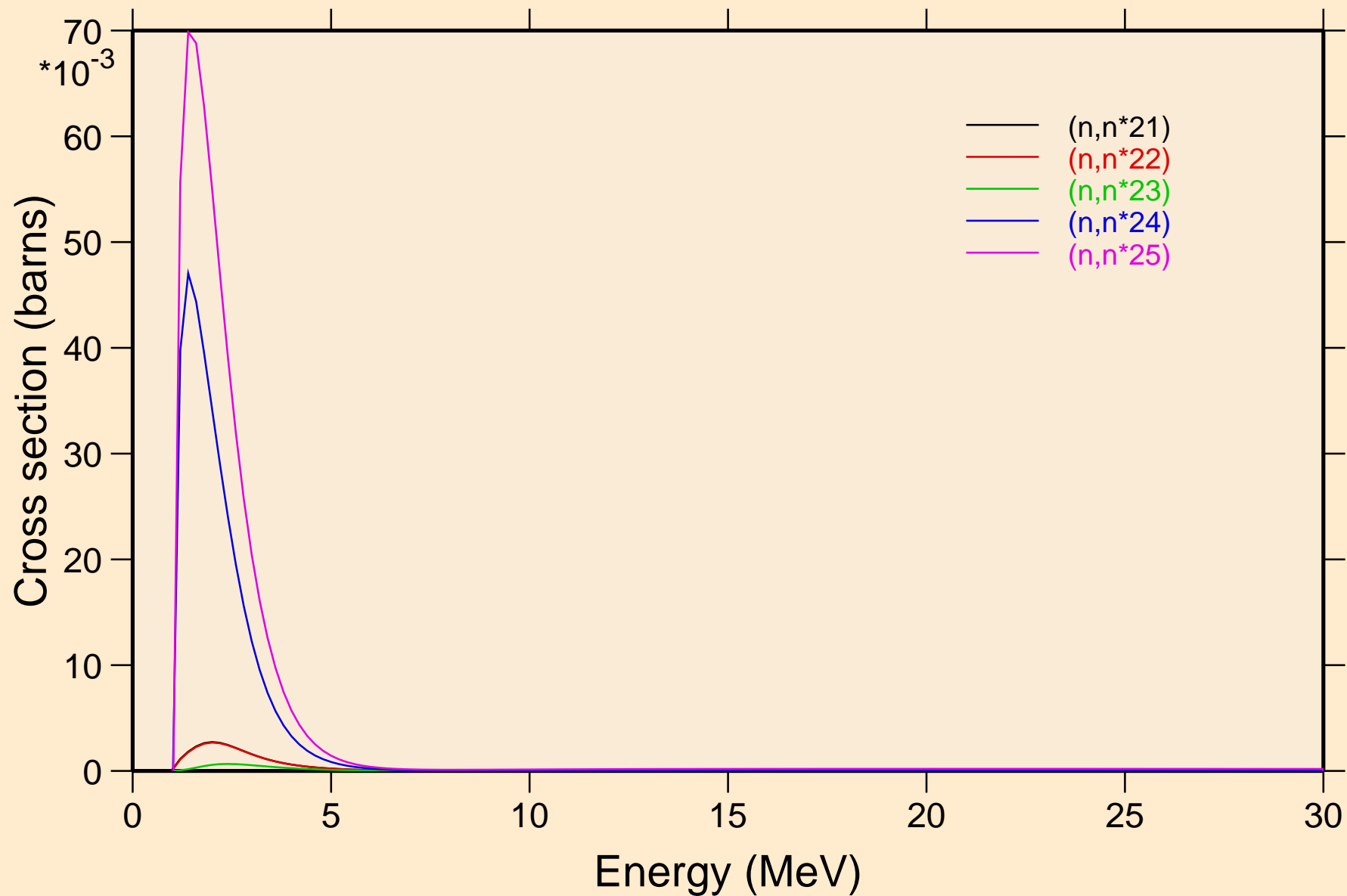

IN110 NEUTRON ACER TENDL-2019 LIBRARY; T=293.16K  
Inelastic levels

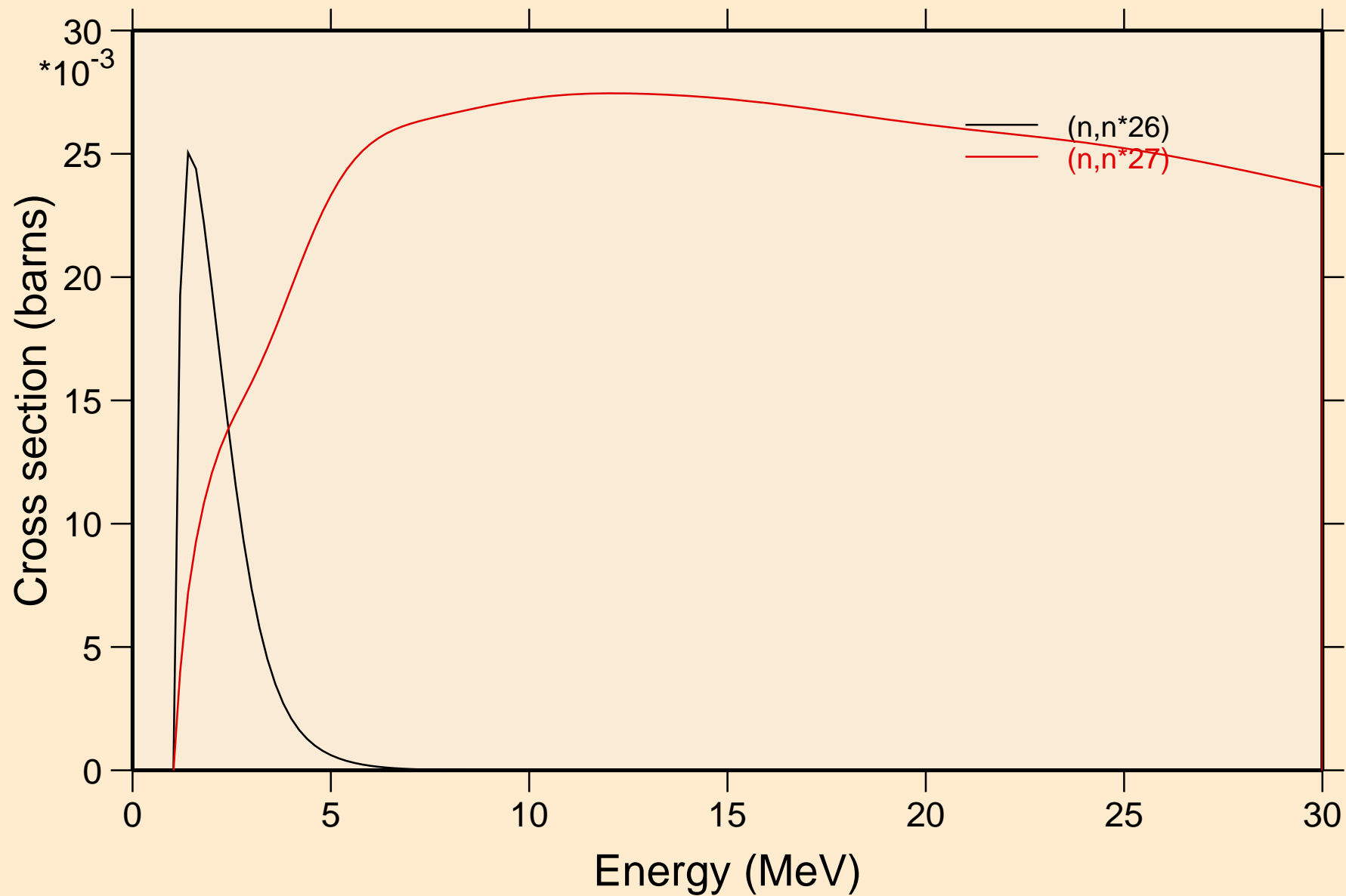

# IN110 NEUTRON ACER TENDL-2019 LIBRARY; T=293.16K

## Threshold reactions

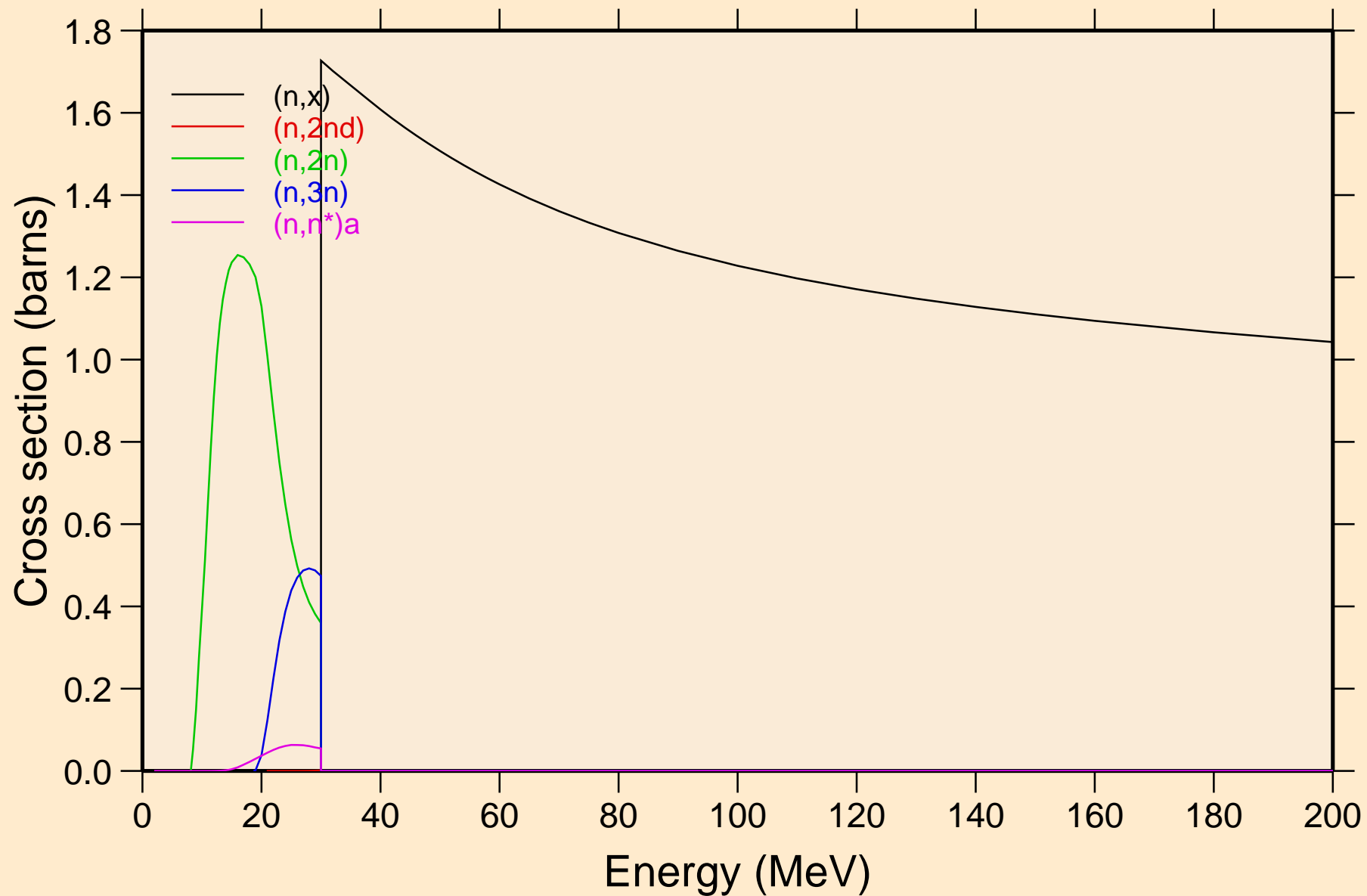

IN110 NEUTRON ACER TENDL-2019 LIBRARY; T=293.16K  
Threshold reactions

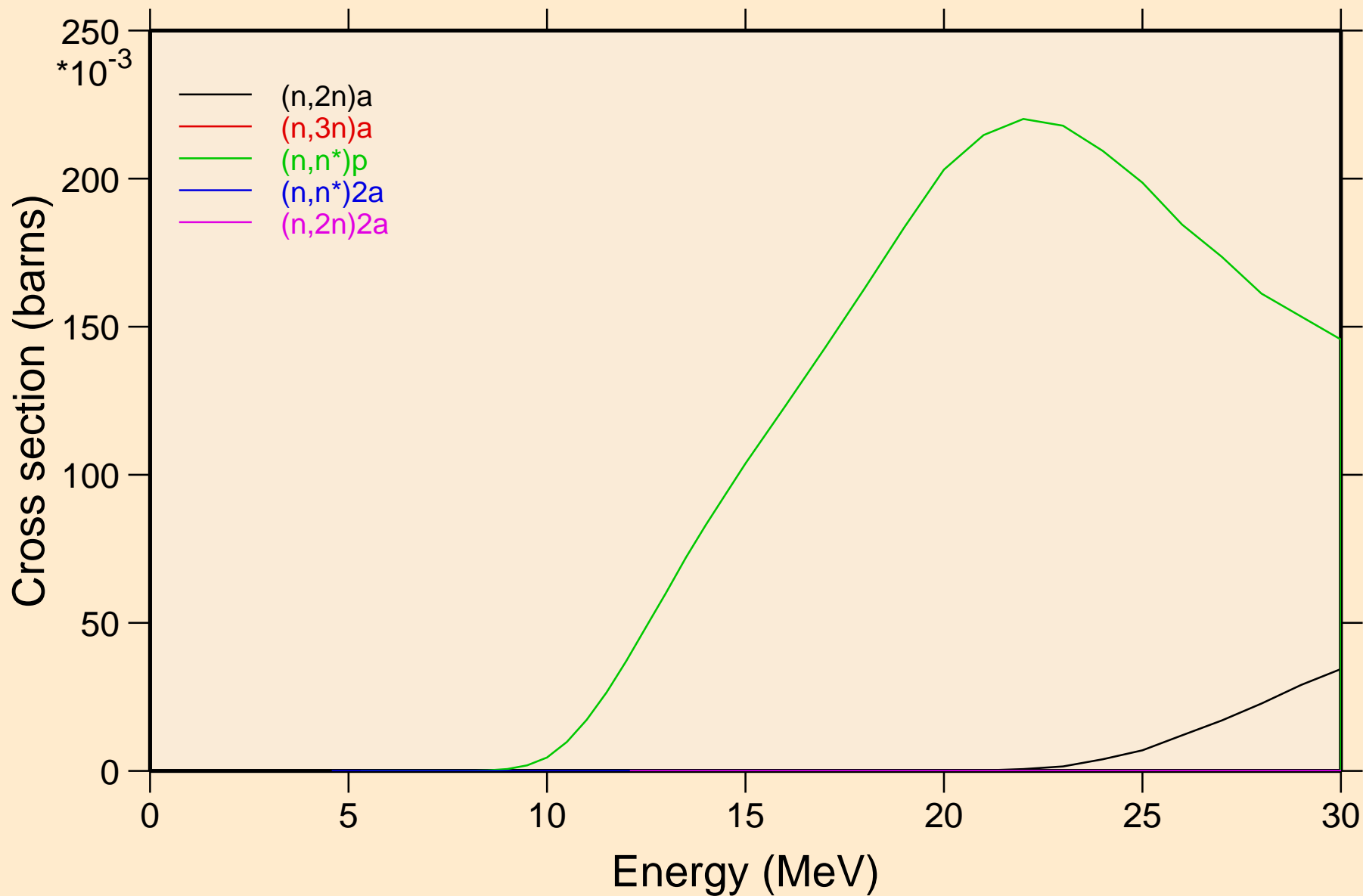



# IN110 NEUTRON ACER TENDL-2019 LIBRARY; T=293.16K

## Threshold reactions

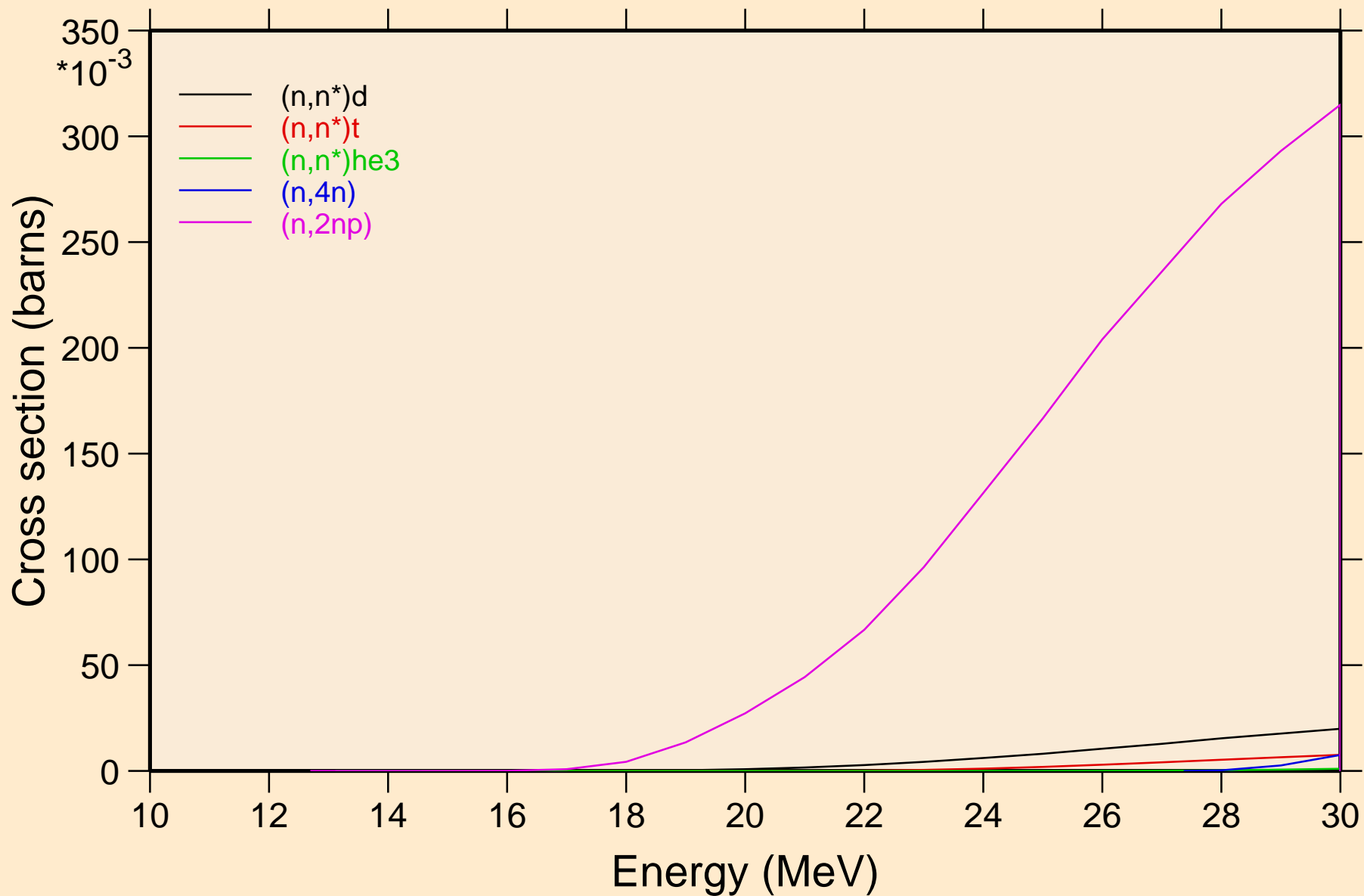

IN110 NEUTRON ACER TENDL-2019 LIBRARY; T=293.16K  
Threshold reactions

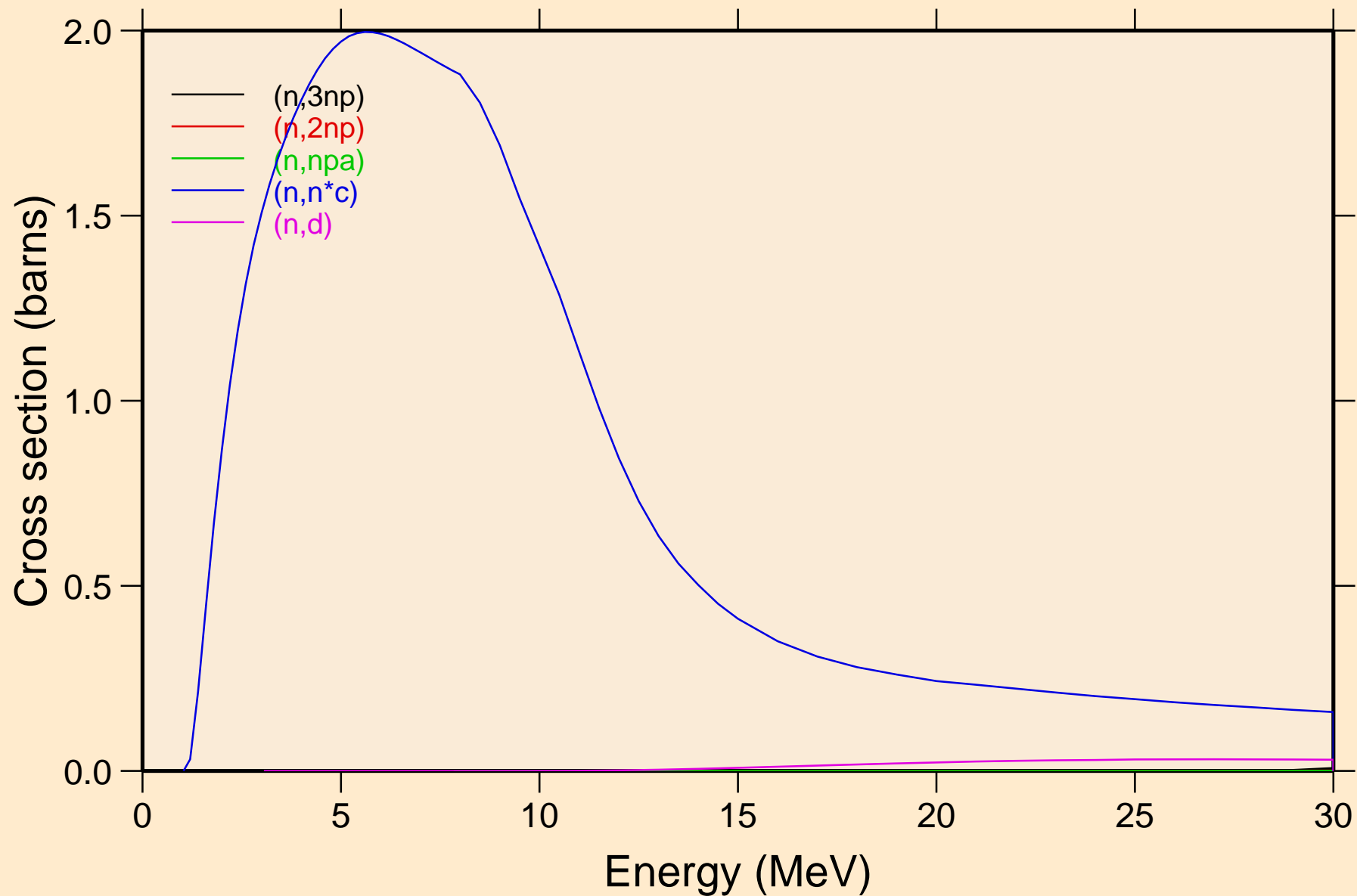

IN110 NEUTRON ACER TENDL-2019 LIBRARY; T=293.16K  
Threshold reactions

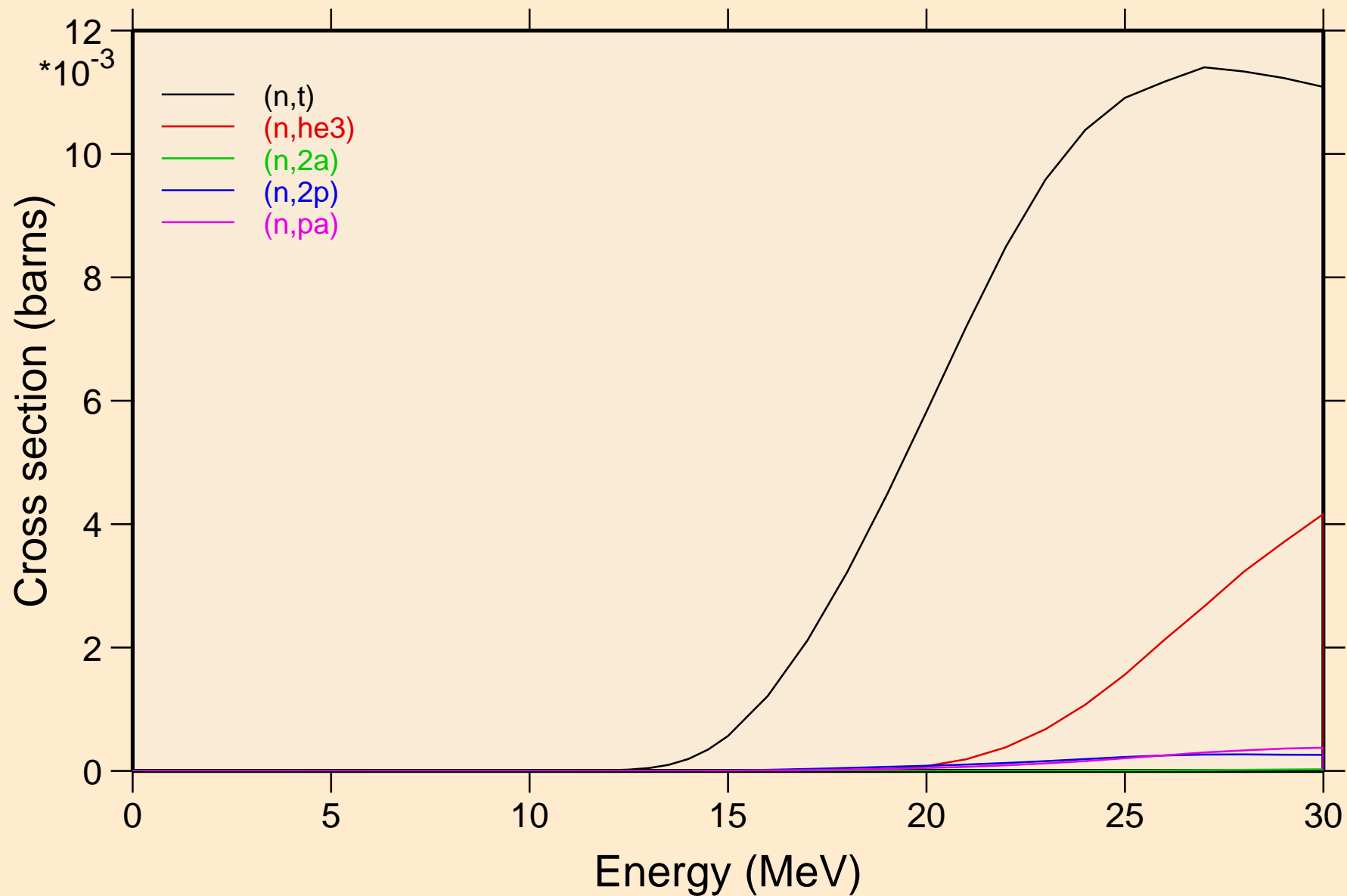

IN110 NEUTRON ACER TENDL-2019 LIBRARY; T=293.16K  
Threshold reactions

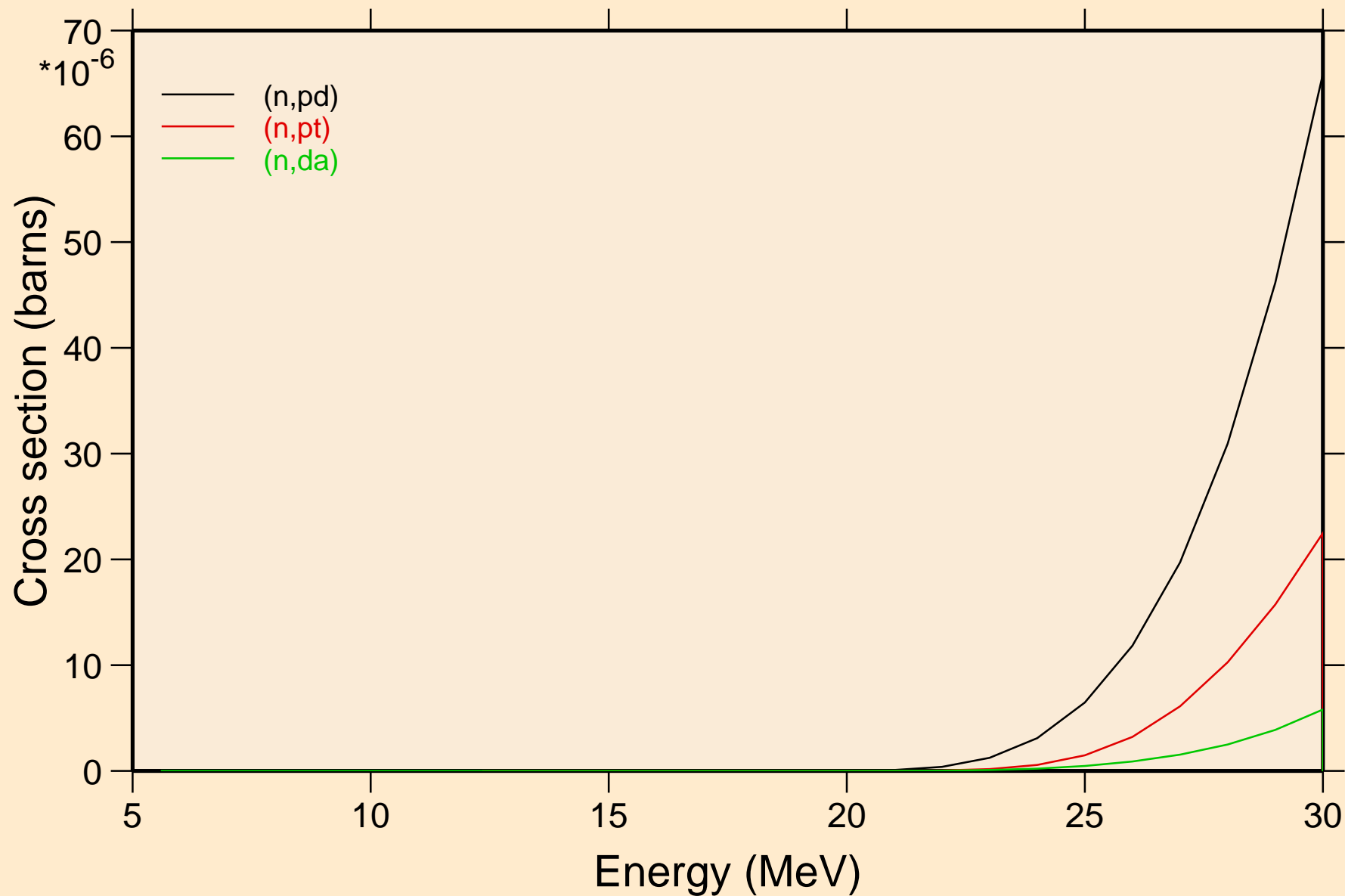

IN110 NEUTRON ACER TENDL-2019 LIBRARY; T=293.16K  
Threshold reactions

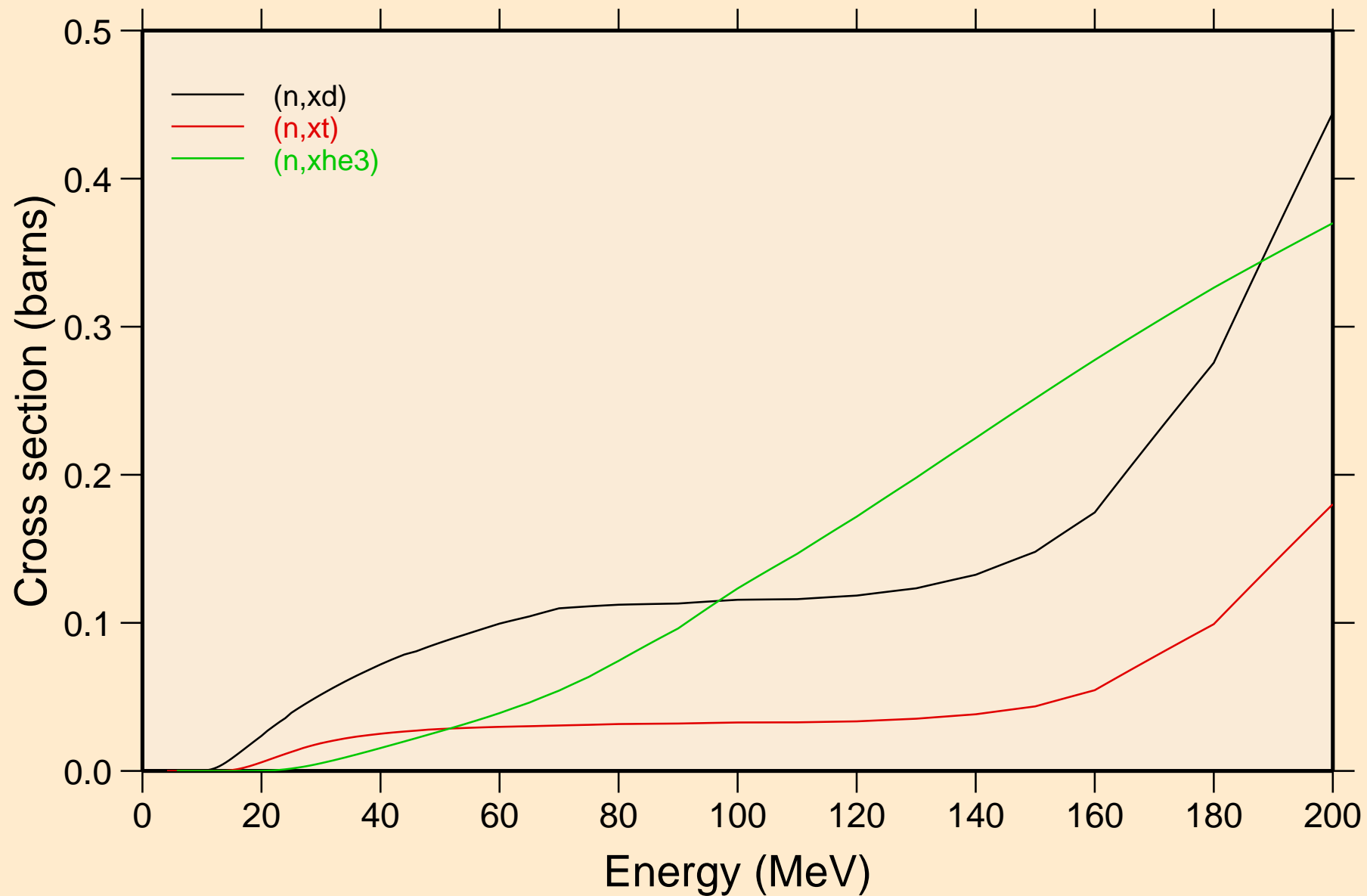

IN110 NEUTRON ACER TENDL-2019 LIBRARY; T=293.16K  
angular distribution for elastic

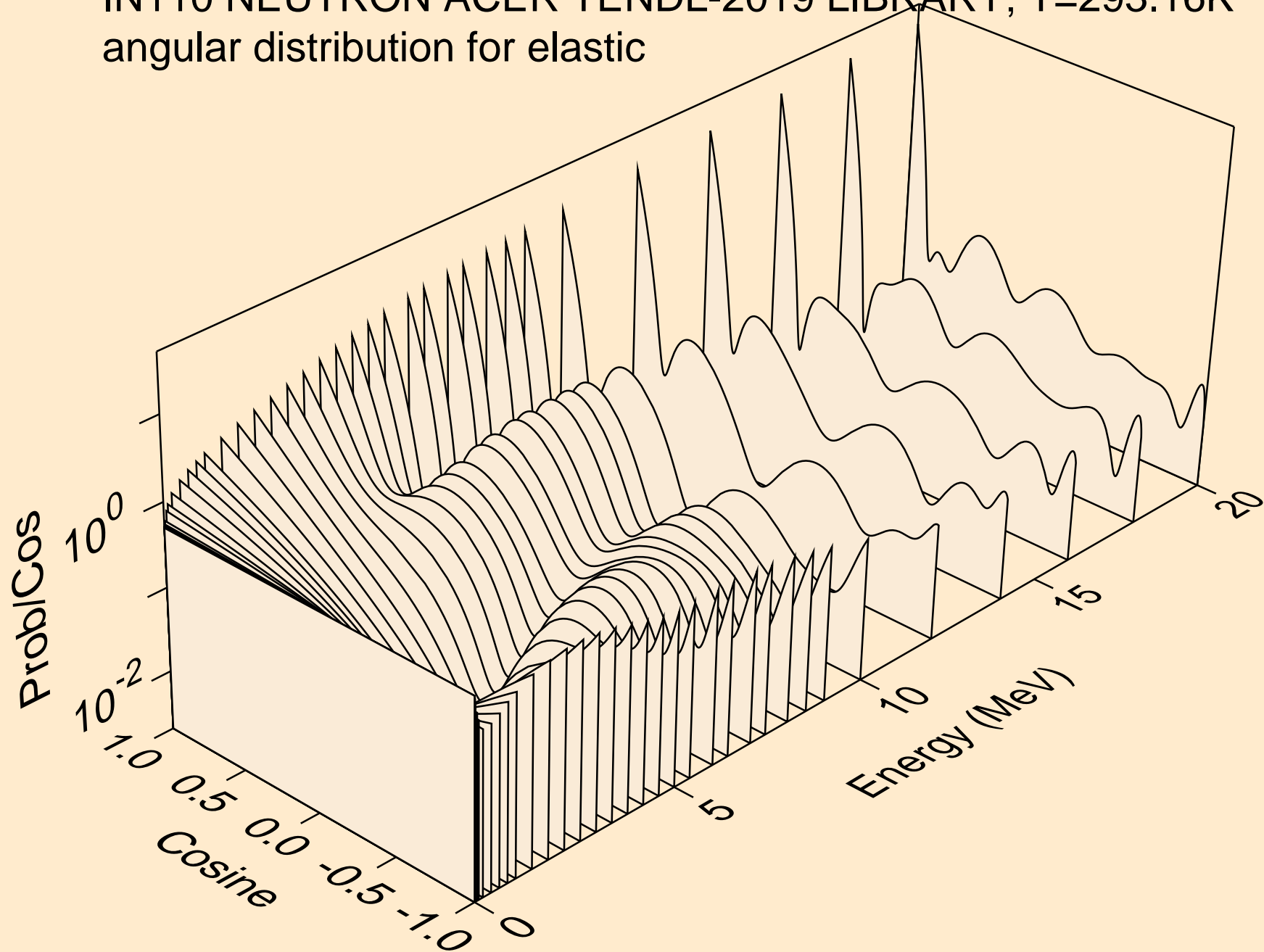

IN110 NEUTRON ACER TENDL-2019 LIBRARY; T=293.16K  
angular distribution for elastic

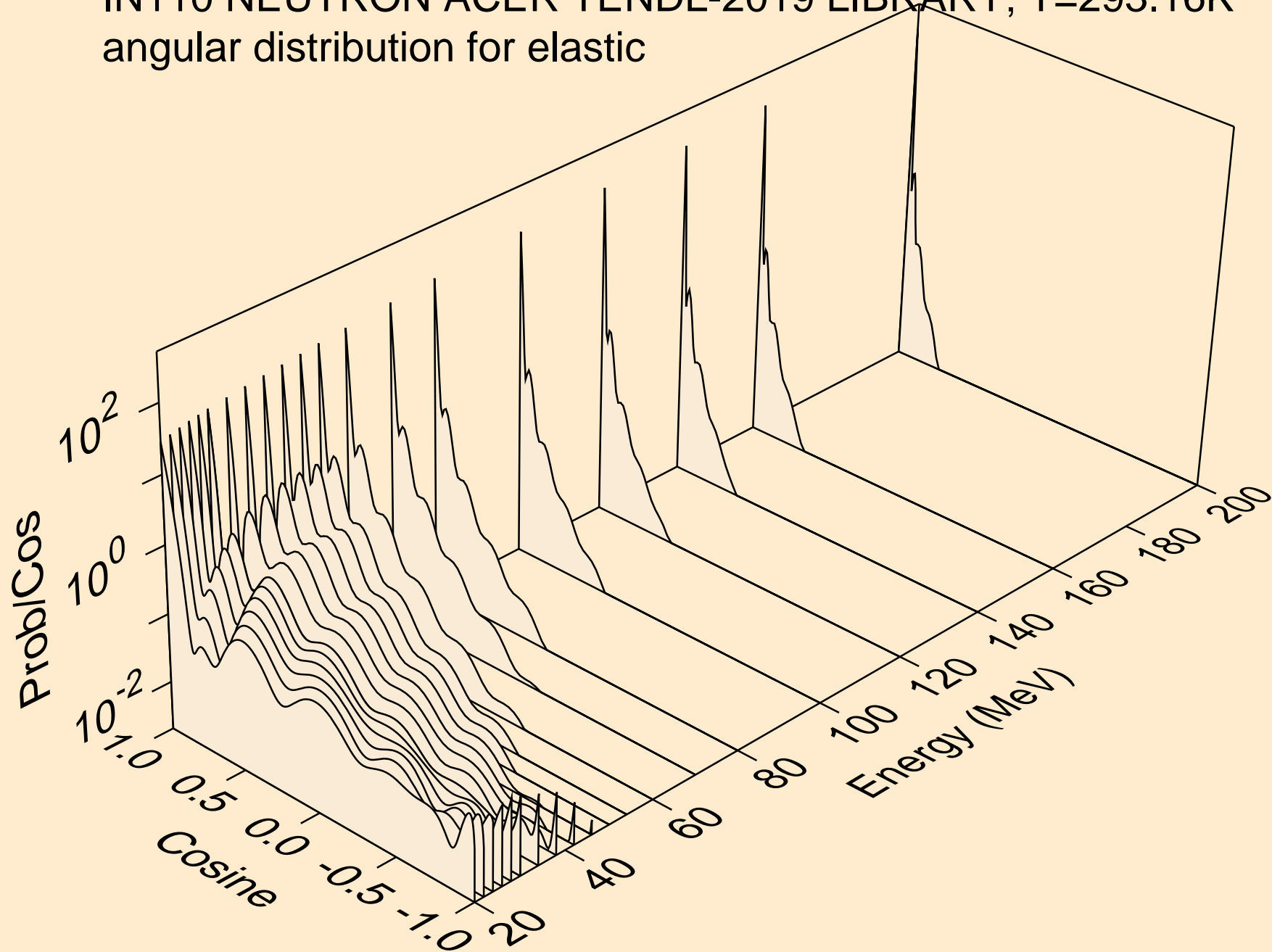

IN110 NEUTRON ACER TENDL-2019 LIBRARY; T=293.16K  
angular distribution for (n,n\*1)

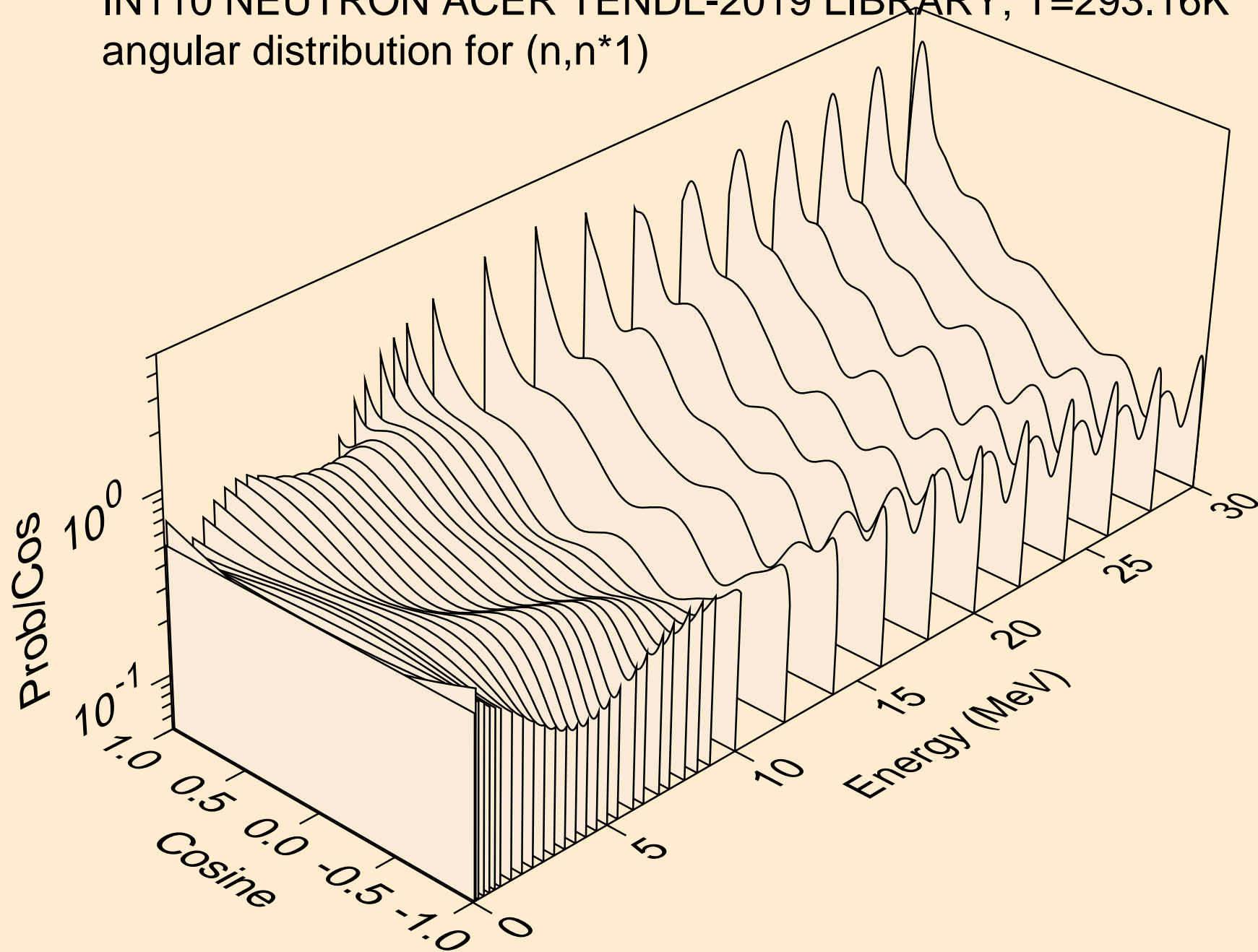



IN110 NEUTRON ACER TENDL-2019 LIBRARY; T=293.16K  
angular distribution for (n,n\*2)

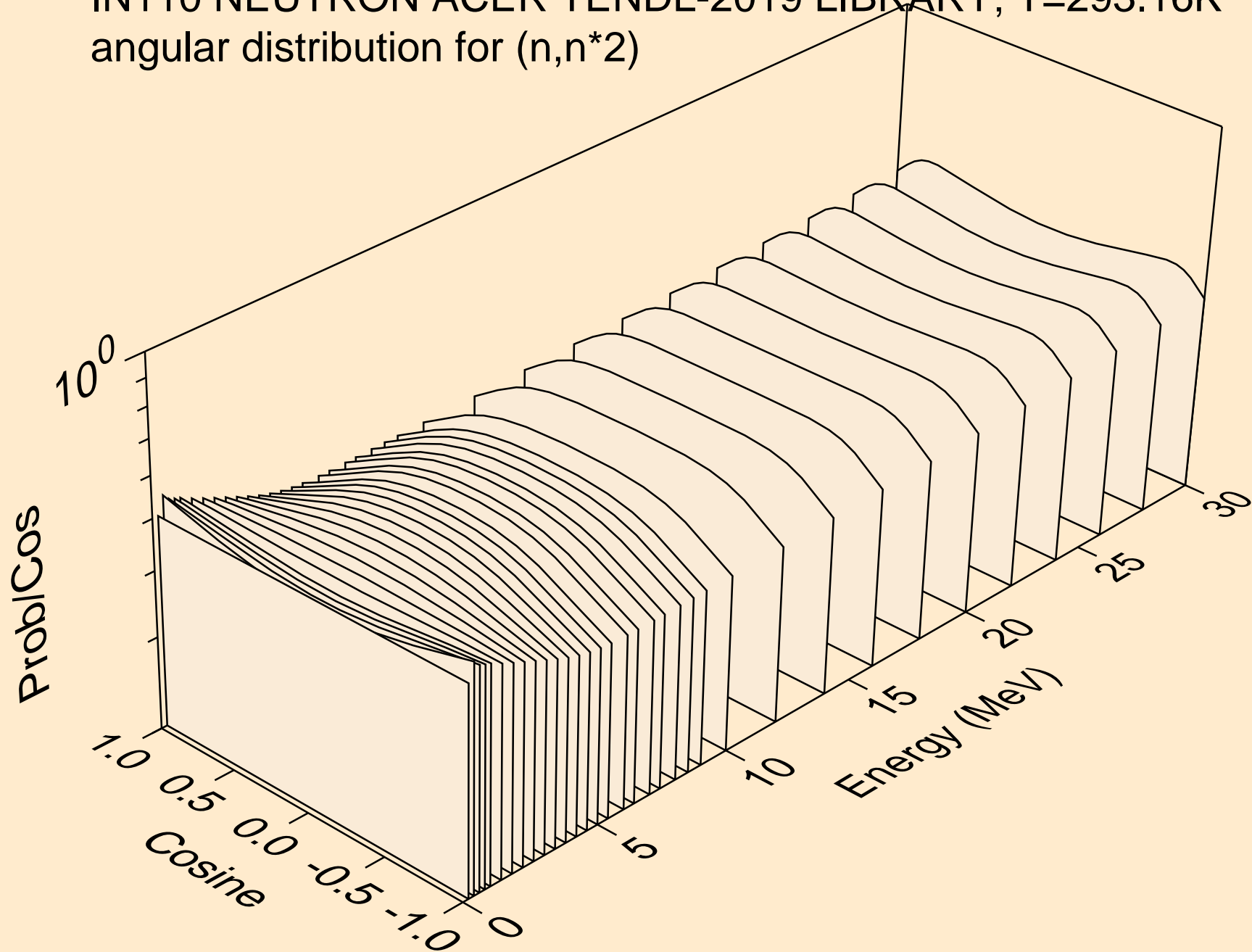

IN110 NEUTRON ACER TENDL-2019 LIBRARY; T=293.16K  
angular distribution for (n,n\*3)

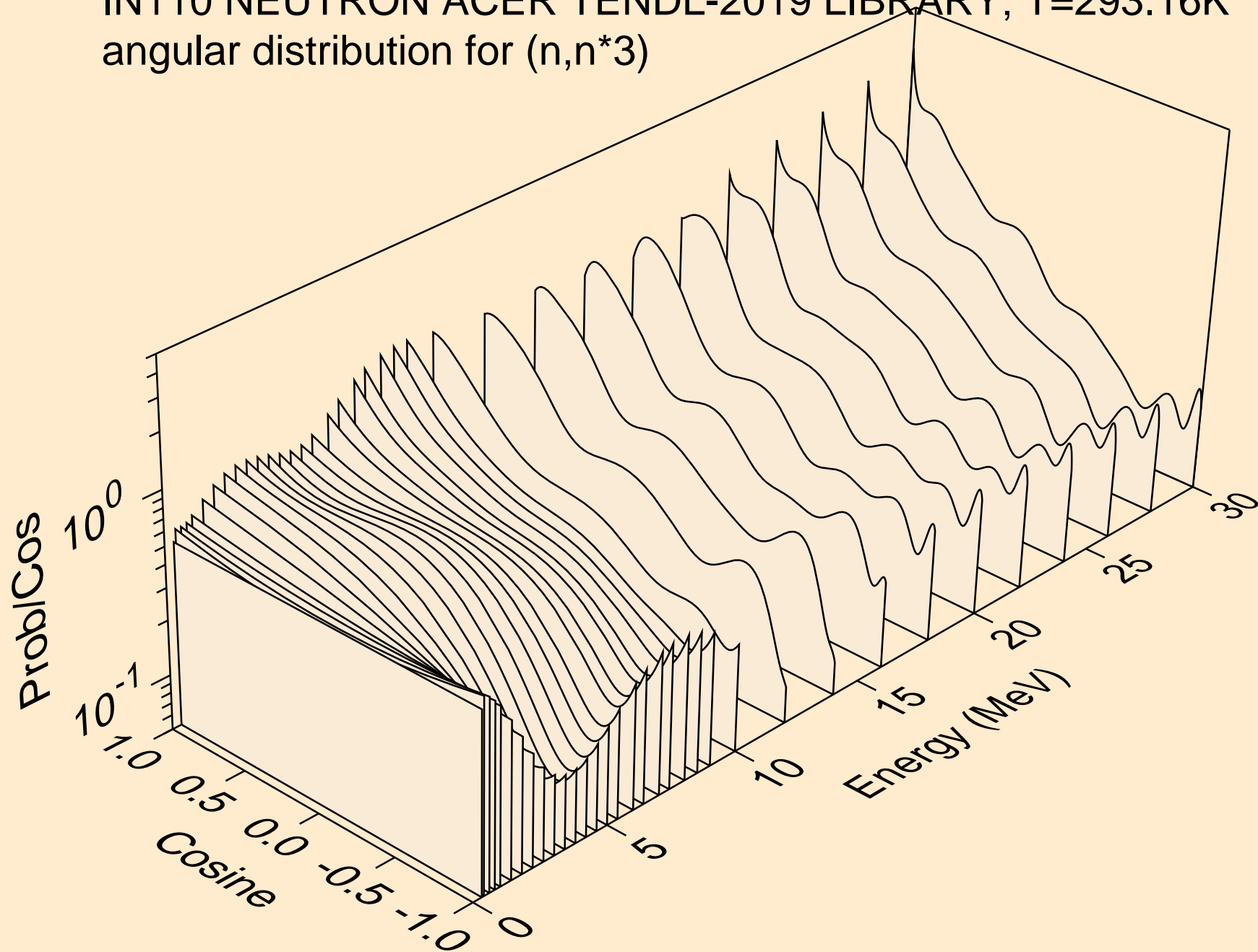

IN110 NEUTRON ACER TENDL-2019 LIBRARY; T=293.16K  
angular distribution for (n,n\*4)

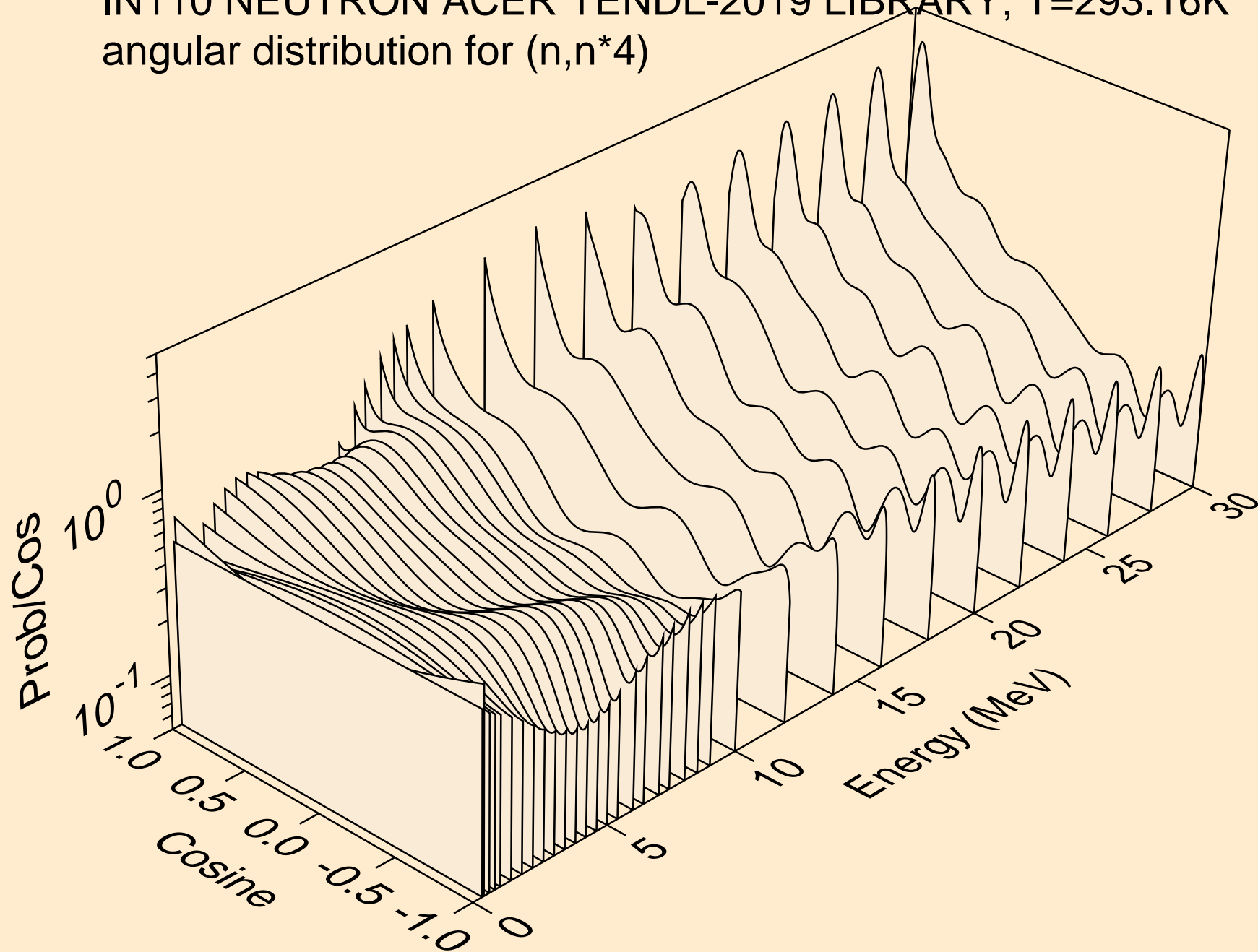

IN110 NEUTRON ACER TENDL-2019 LIBRARY; T=293.16K  
angular distribution for (n,n\*5)

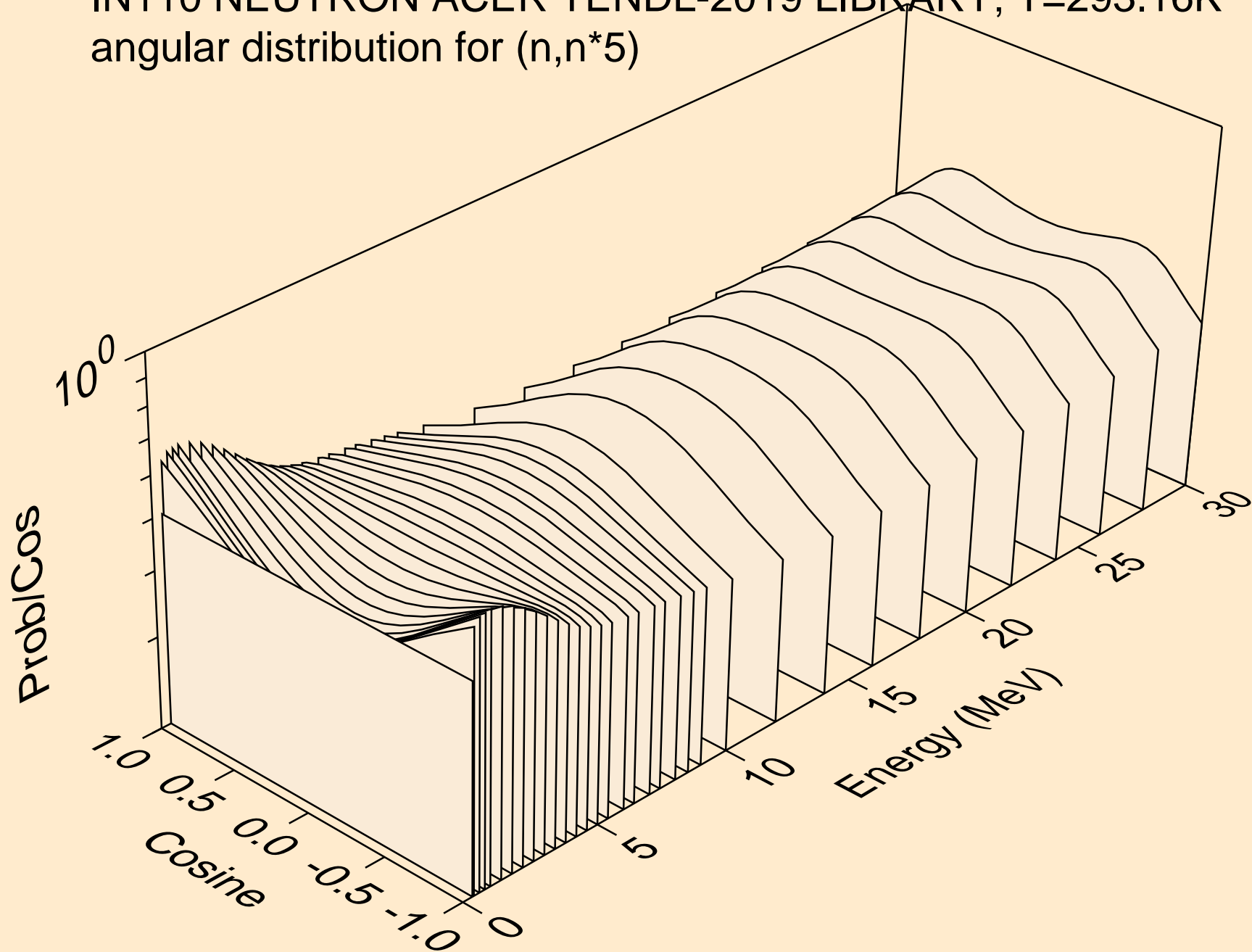

IN110 NEUTRON ACER TENDL-2019 LIBRARY; T=293.16K  
angular distribution for (n,n\*6)

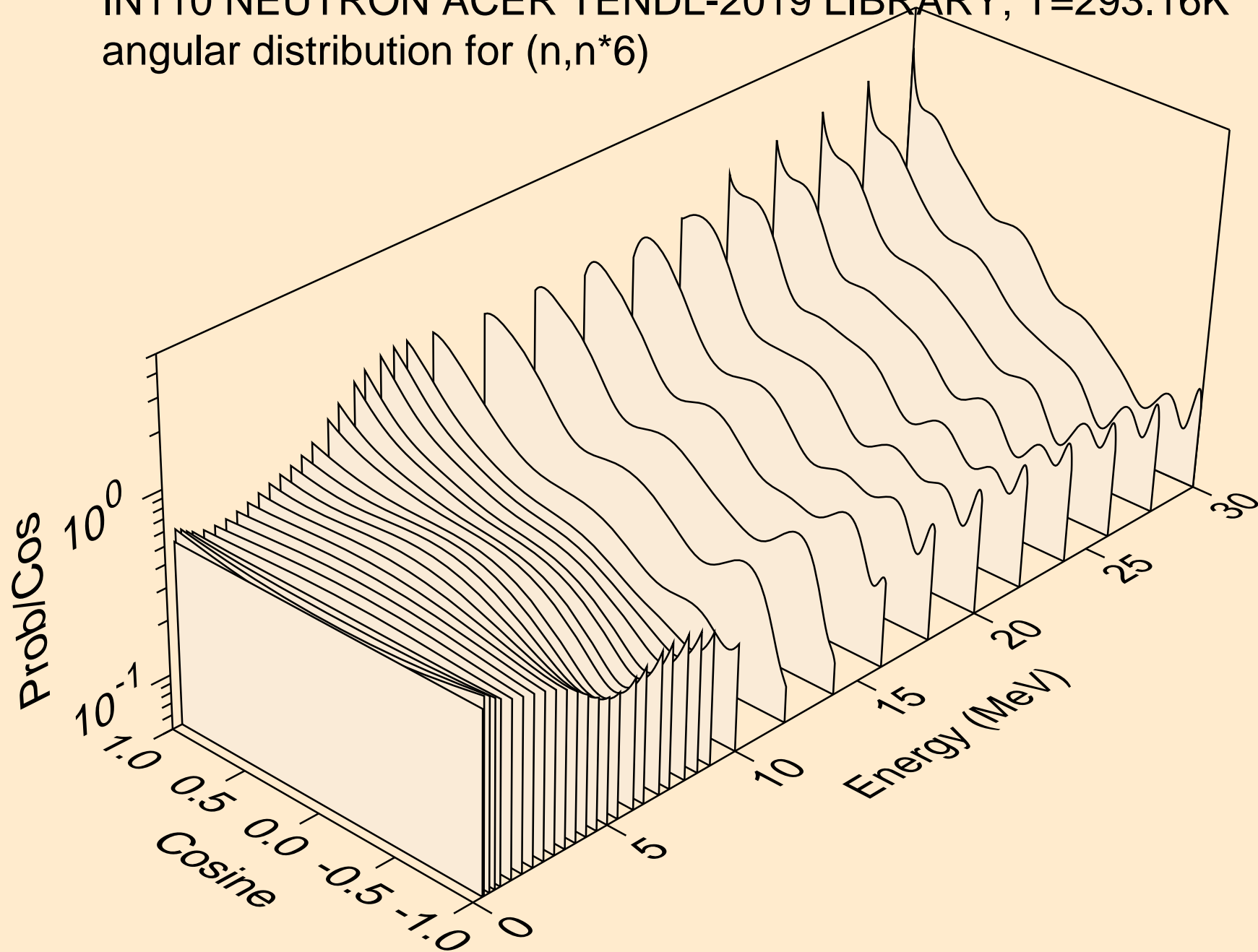

IN110 NEUTRON ACER TENDL-2019 LIBRARY; T=293.16K  
angular distribution for (n,n\*7)

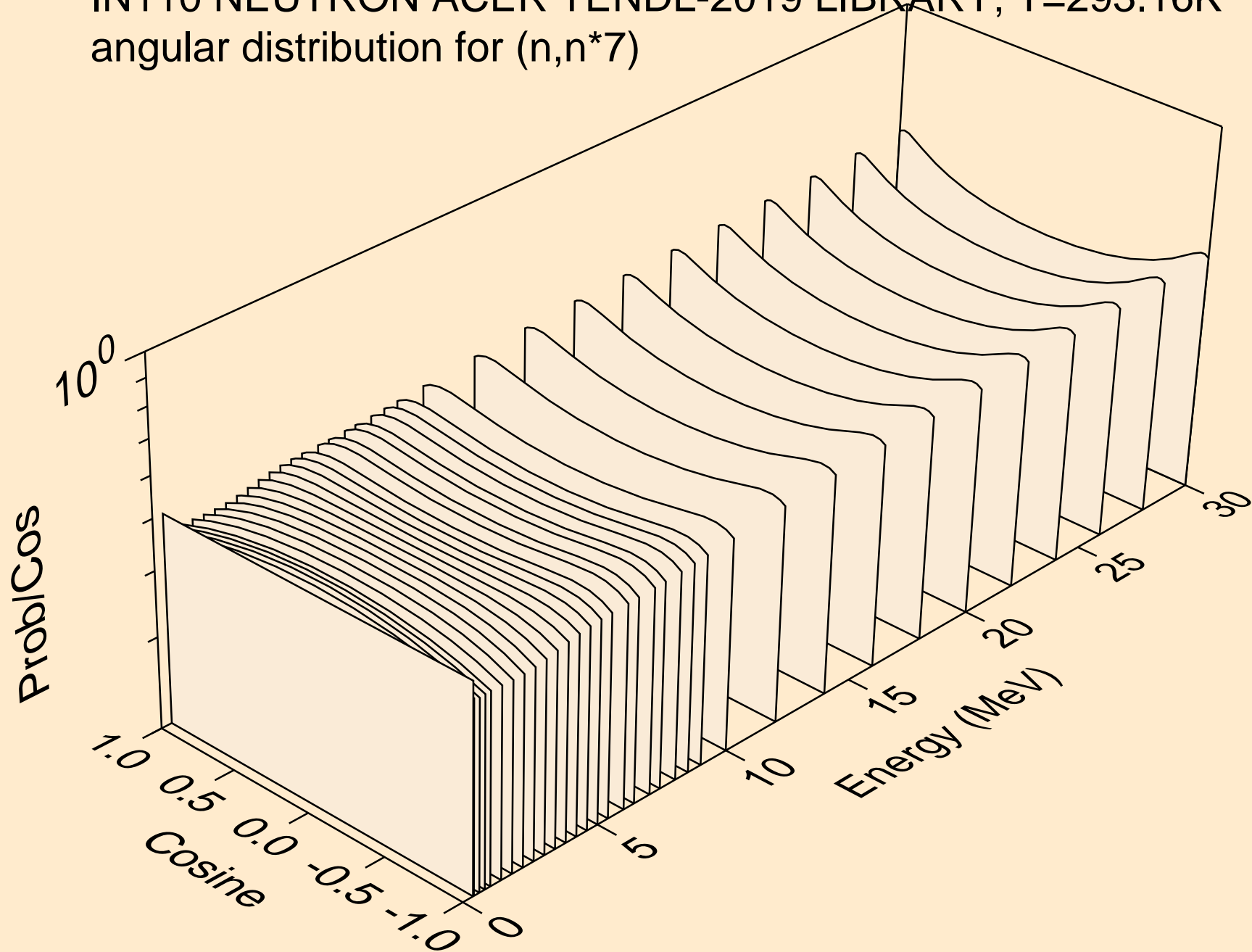

IN110 NEUTRON ACER TENDL-2019 LIBRARY; T=293.16K  
angular distribution for (n,n\*8)

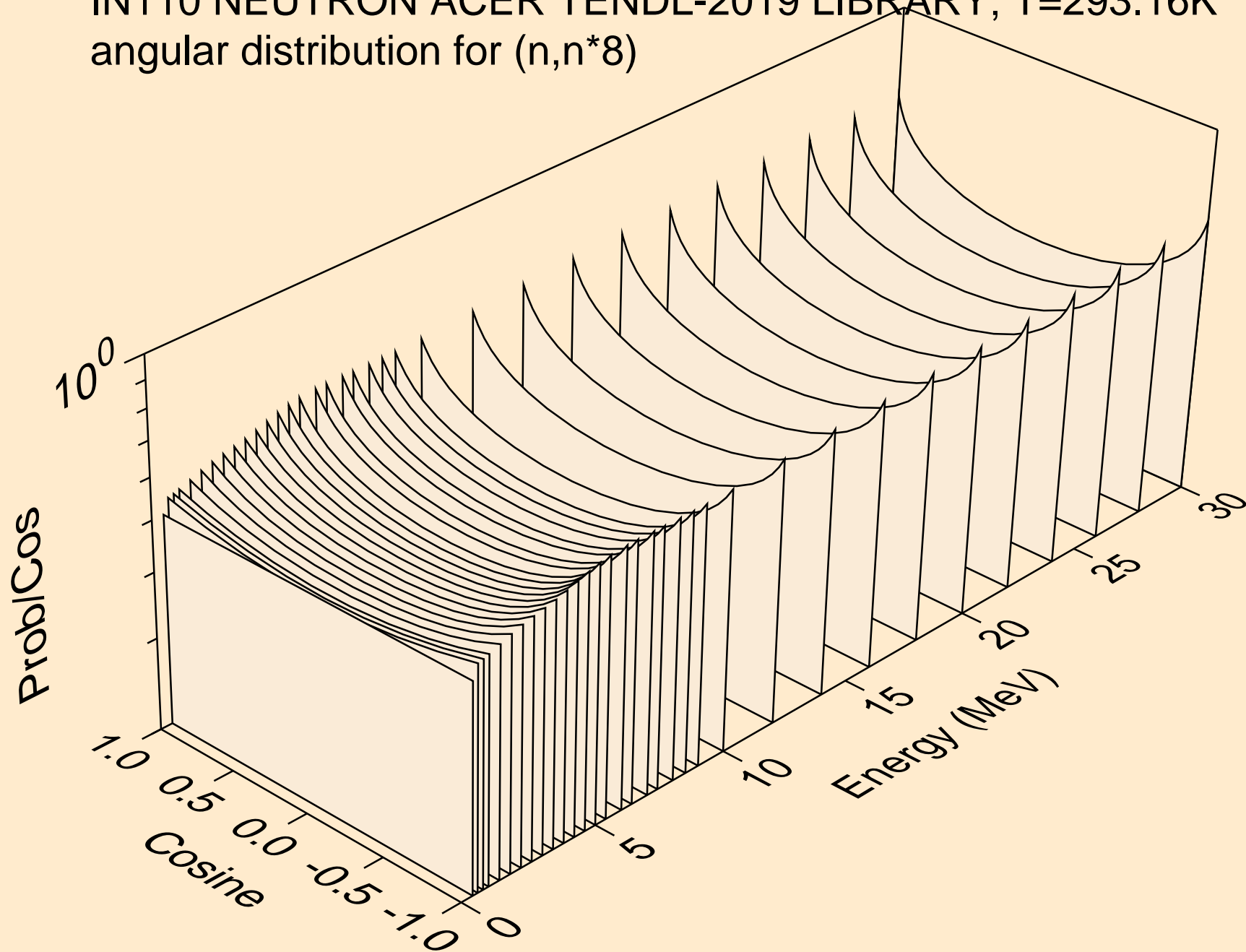

IN110 NEUTRON ACER TENDL-2019 LIBRARY; T=293.16K  
angular distribution for (n,n\*9)

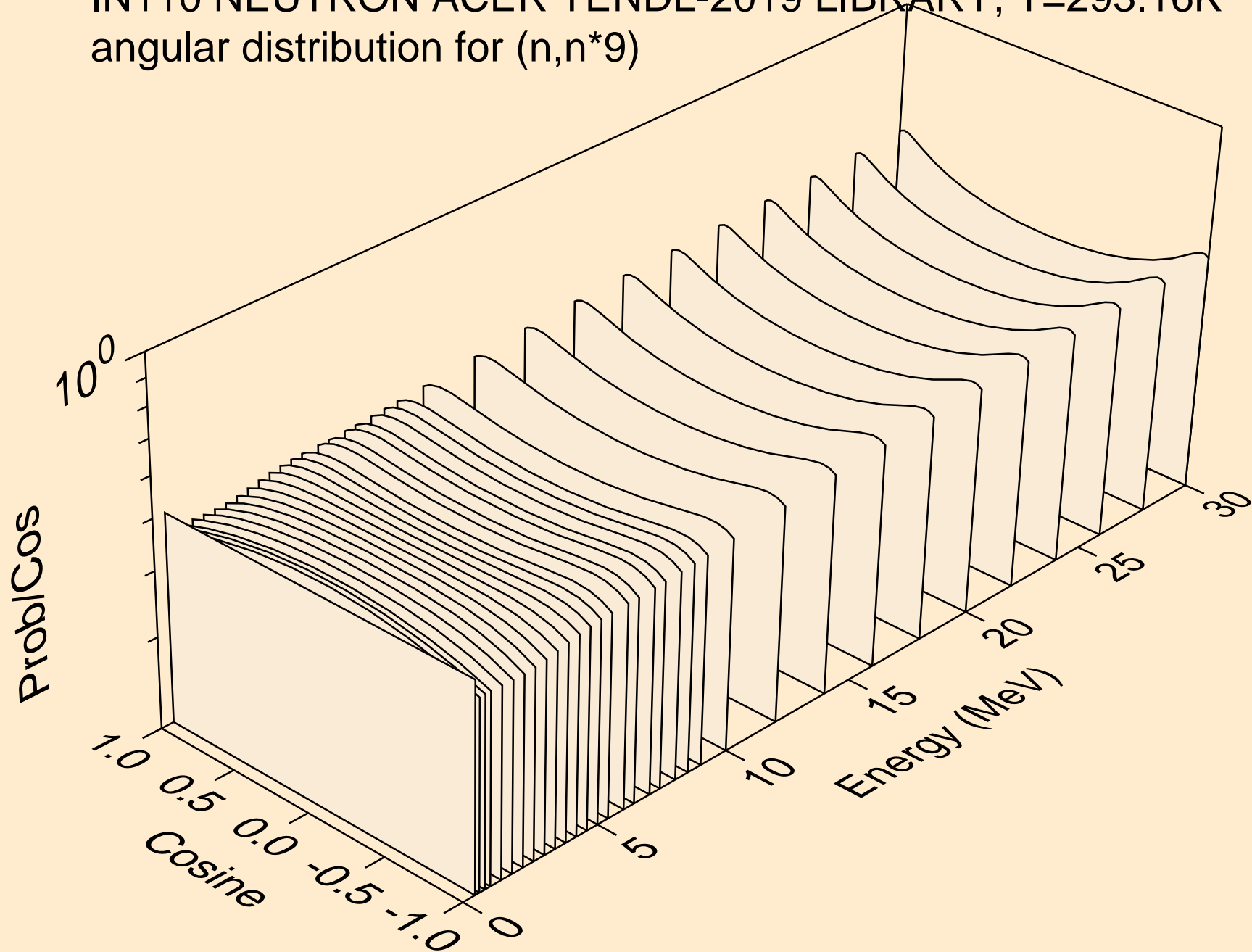



IN110 NEUTRON ACER TENDL-2019 LIBRARY; T=293.16K  
angular distribution for (n,n\*10)

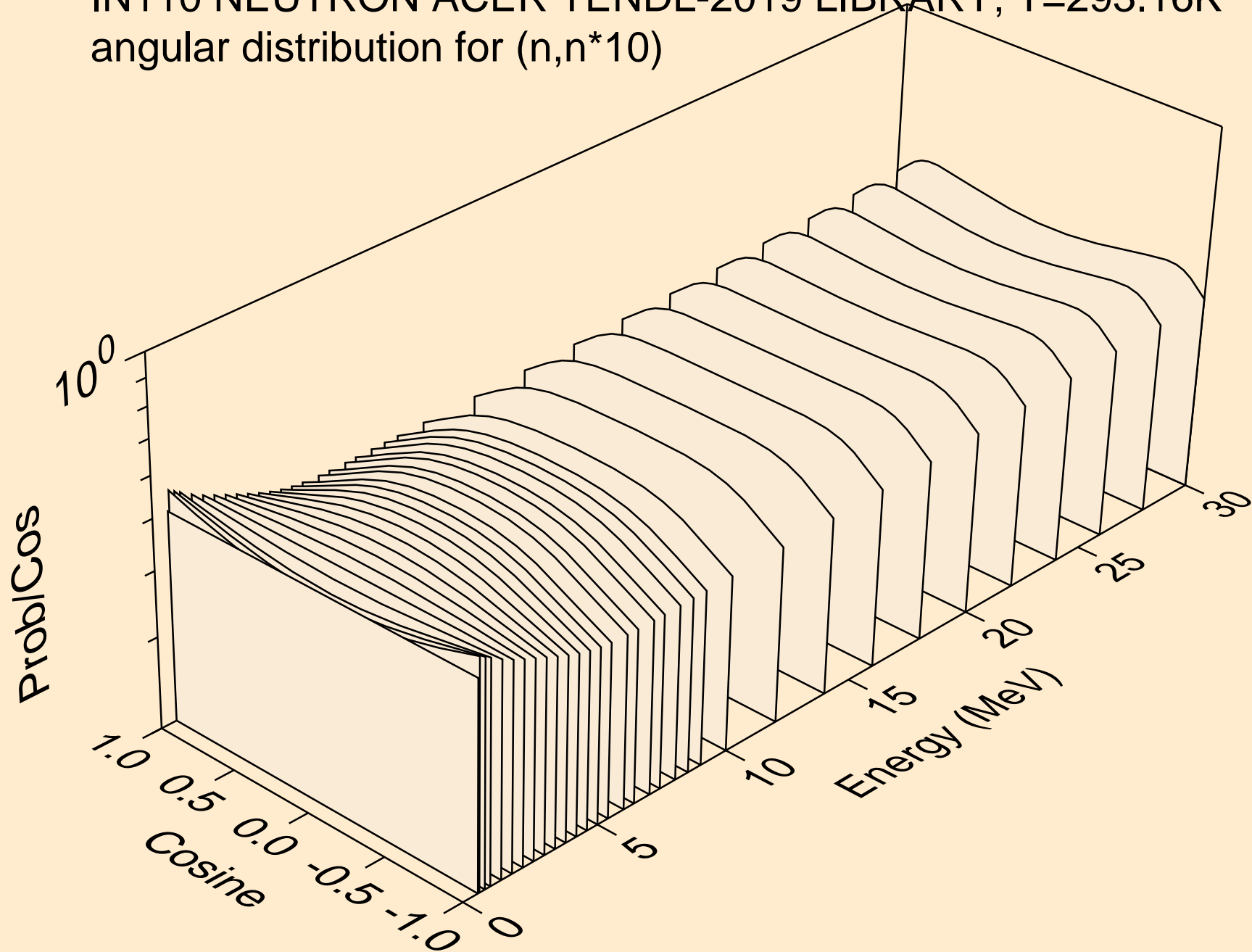

IN110 NEUTRON ACER TENDL-2019 LIBRARY; T=293.16K  
angular distribution for (n,n\*11)

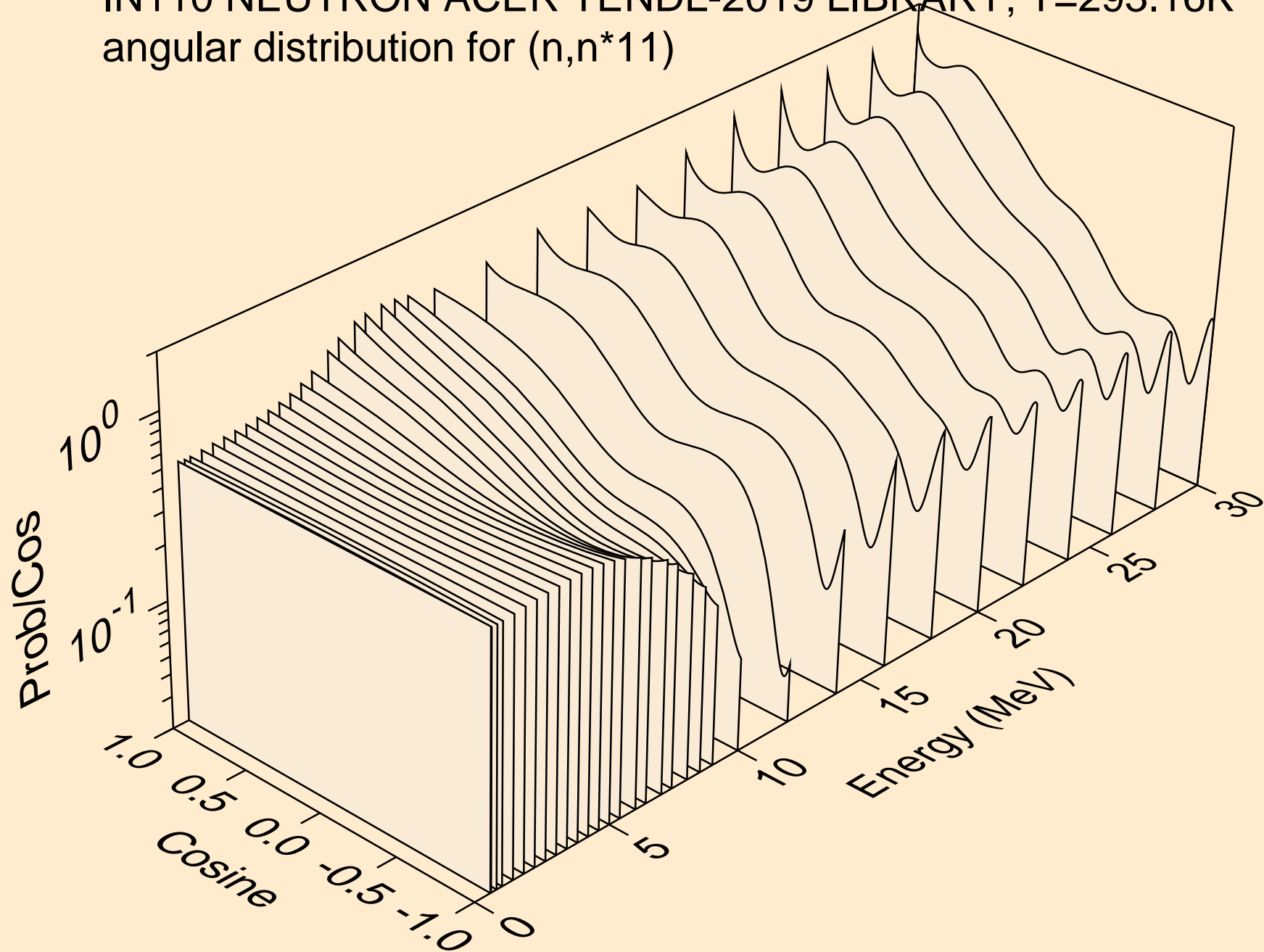

IN110 NEUTRON ACER TENDL-2019 LIBRARY; T=293.16K  
angular distribution for (n,n\*12)

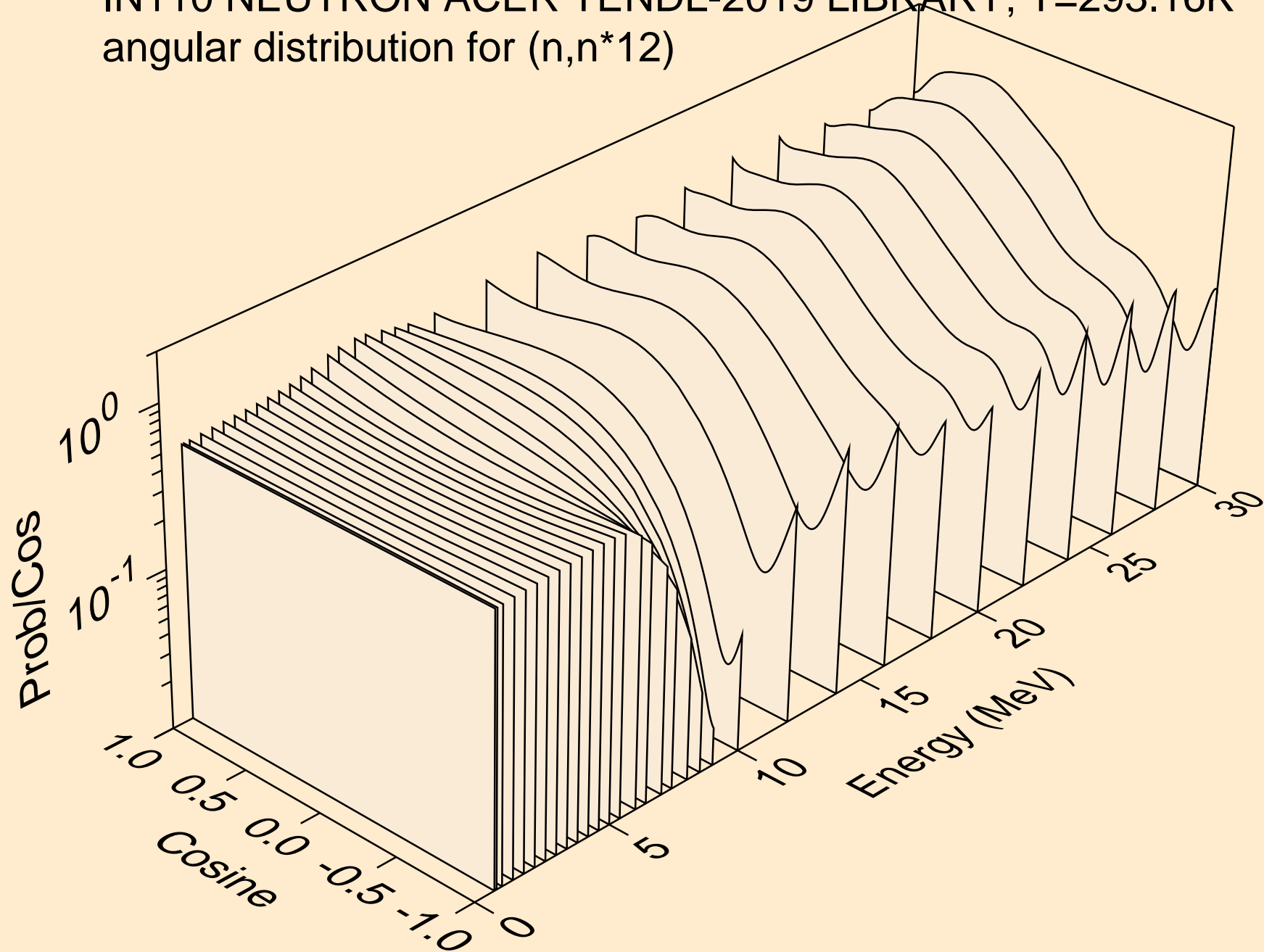

IN110 NEUTRON ACER TENDL-2019 LIBRARY; T=293.16K  
angular distribution for (n,n\*13)

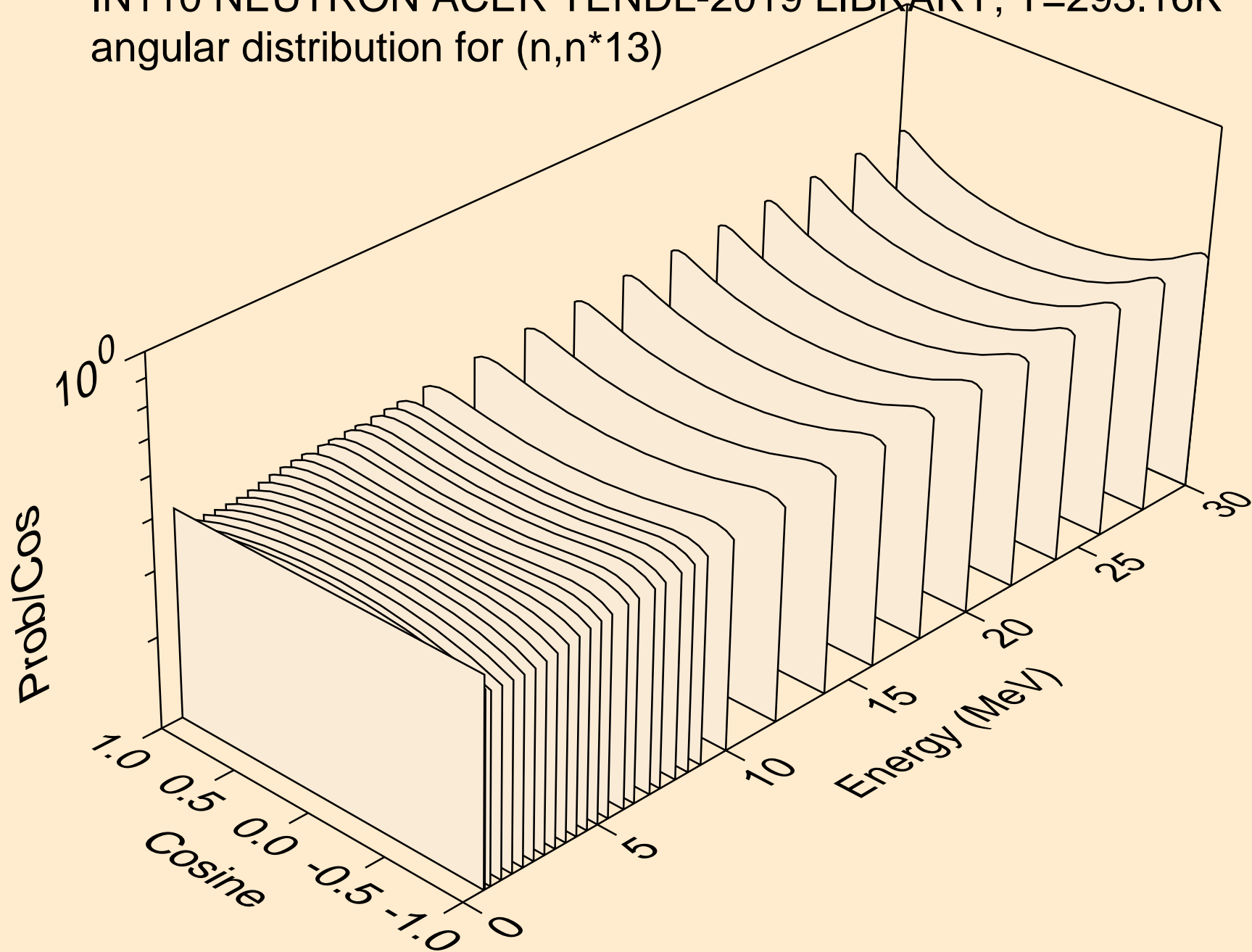

IN110 NEUTRON ACER TENDL-2019 LIBRARY; T=293.16K  
angular distribution for (n,n\*14)

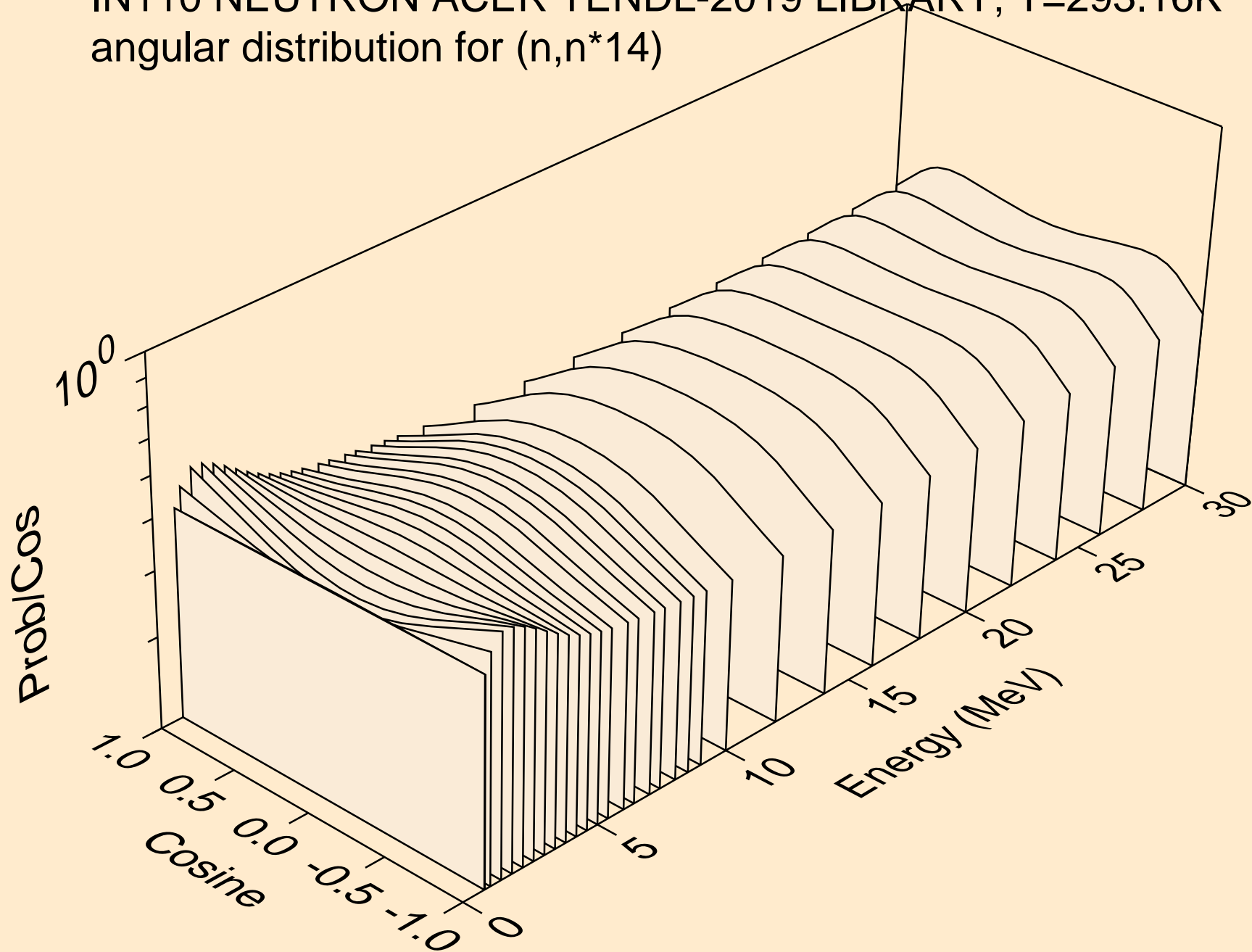

IN110 NEUTRON ACER TENDL-2019 LIBRARY; T=293.16K  
angular distribution for (n,n\*15)

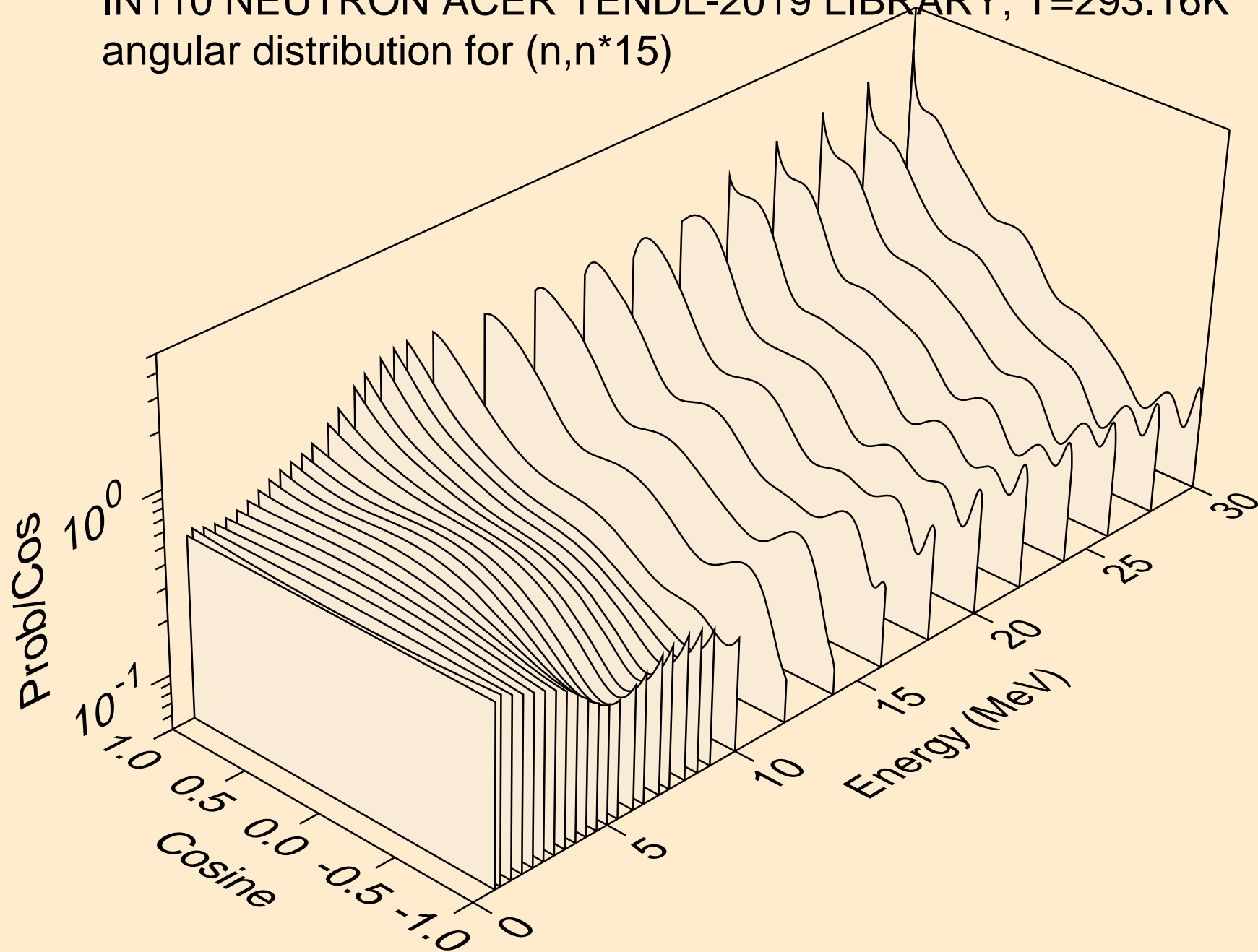

IN110 NEUTRON ACER TENDL-2019 LIBRARY; T=293.16K  
angular distribution for (n,n\*16)

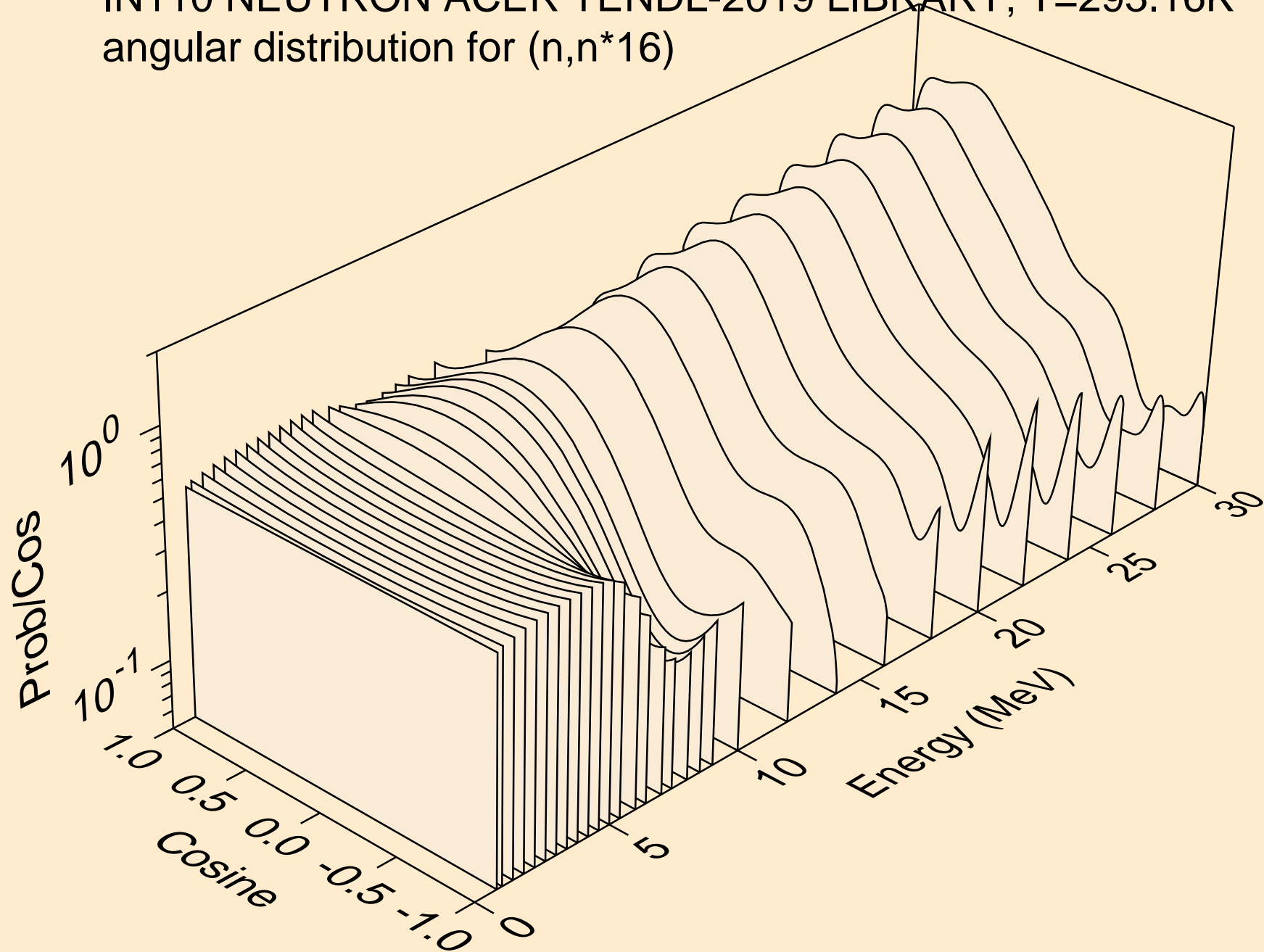

IN110 NEUTRON ACER TENDL-2019 LIBRARY; T=293.16K  
angular distribution for (n,n\*17)

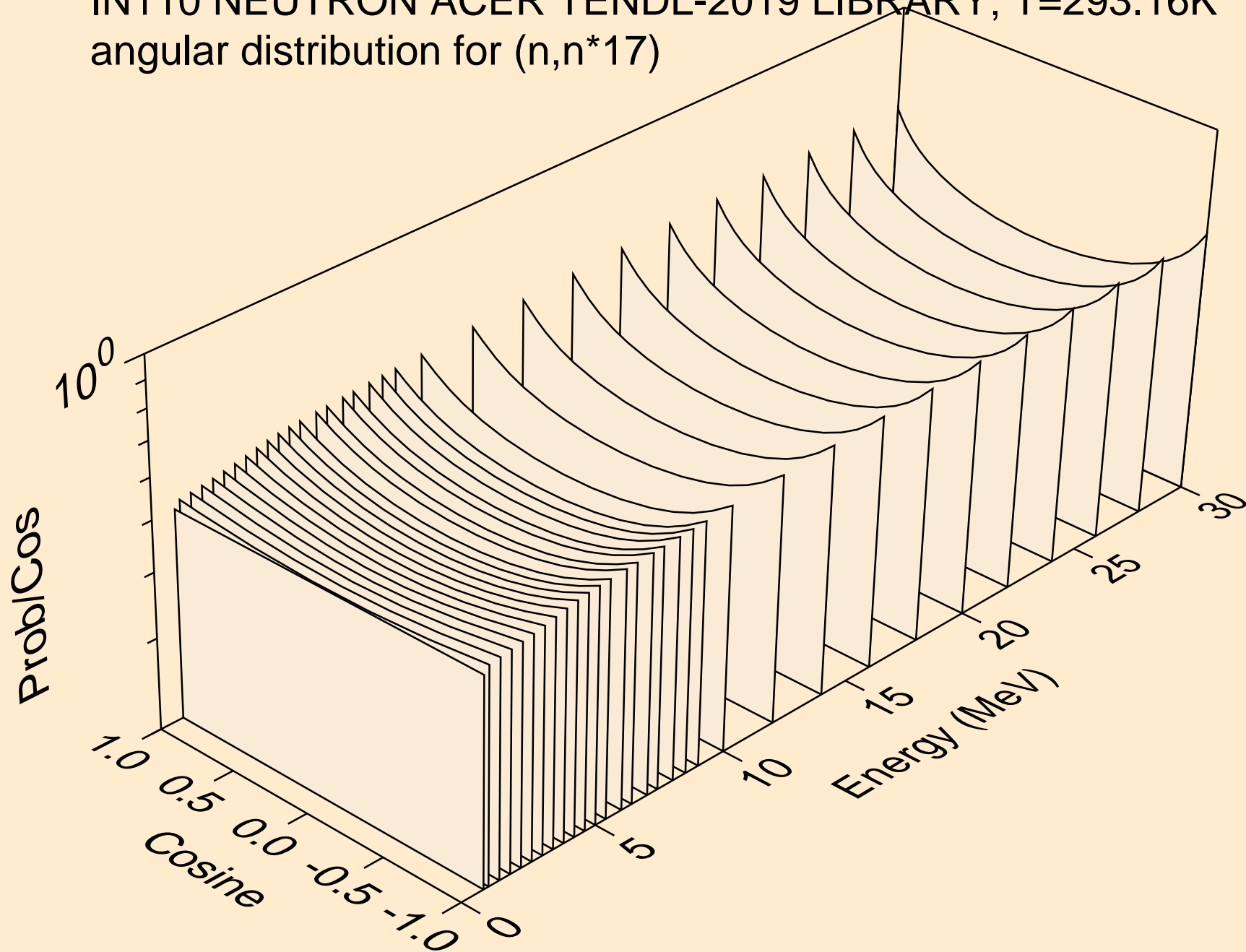



IN110 NEUTRON ACER TENDL-2019 LIBRARY; T=293.16K  
angular distribution for (n,n\*18)

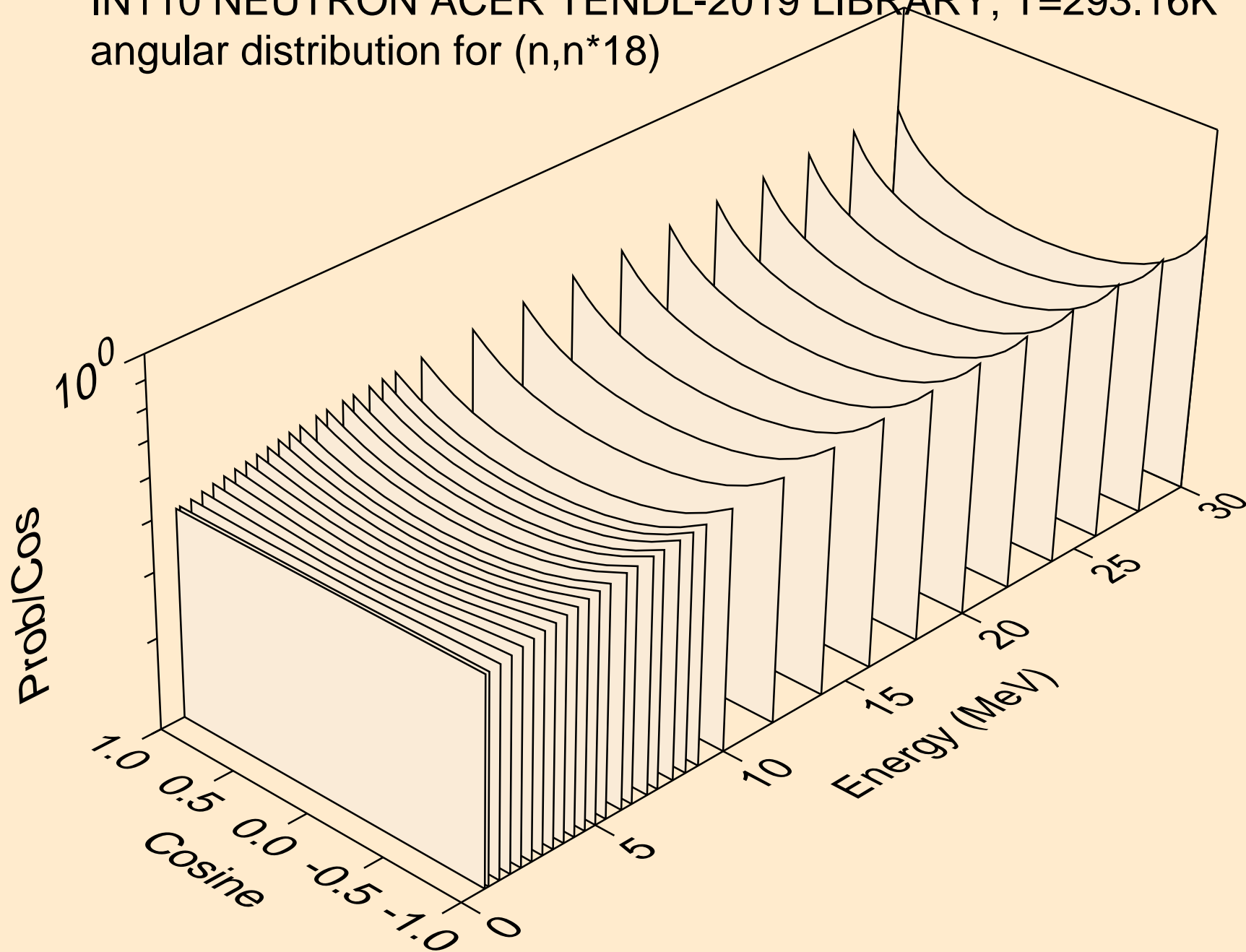

IN110 NEUTRON ACER TENDL-2019 LIBRARY; T=293.16K  
angular distribution for (n,n\*19)

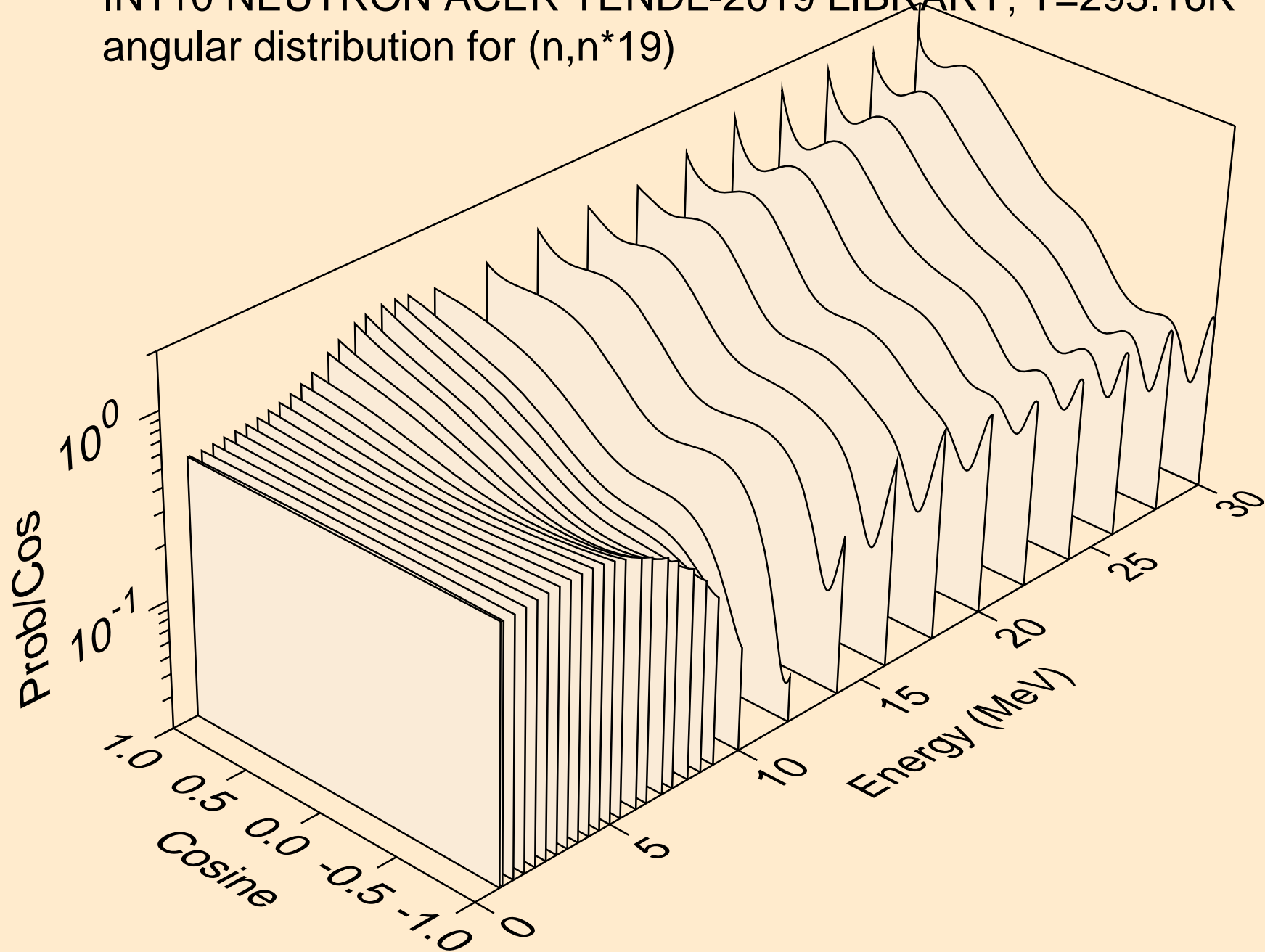

IN110 NEUTRON ACER TENDL-2019 LIBRARY; T=293.16K  
angular distribution for (n,n\*20)

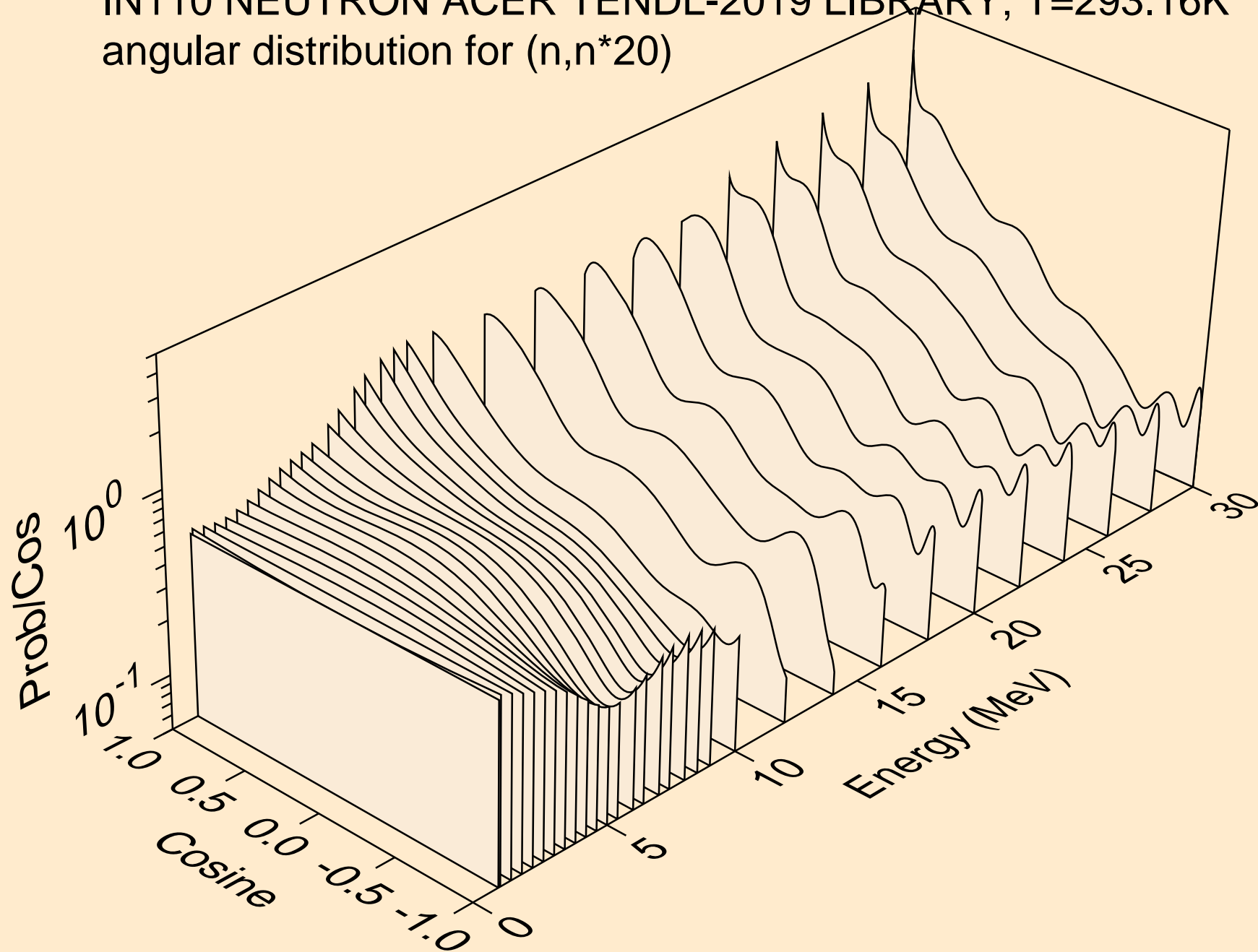

IN110 NEUTRON ACER TENDL-2019 LIBRARY; T=293.16K  
angular distribution for (n,n\*21)

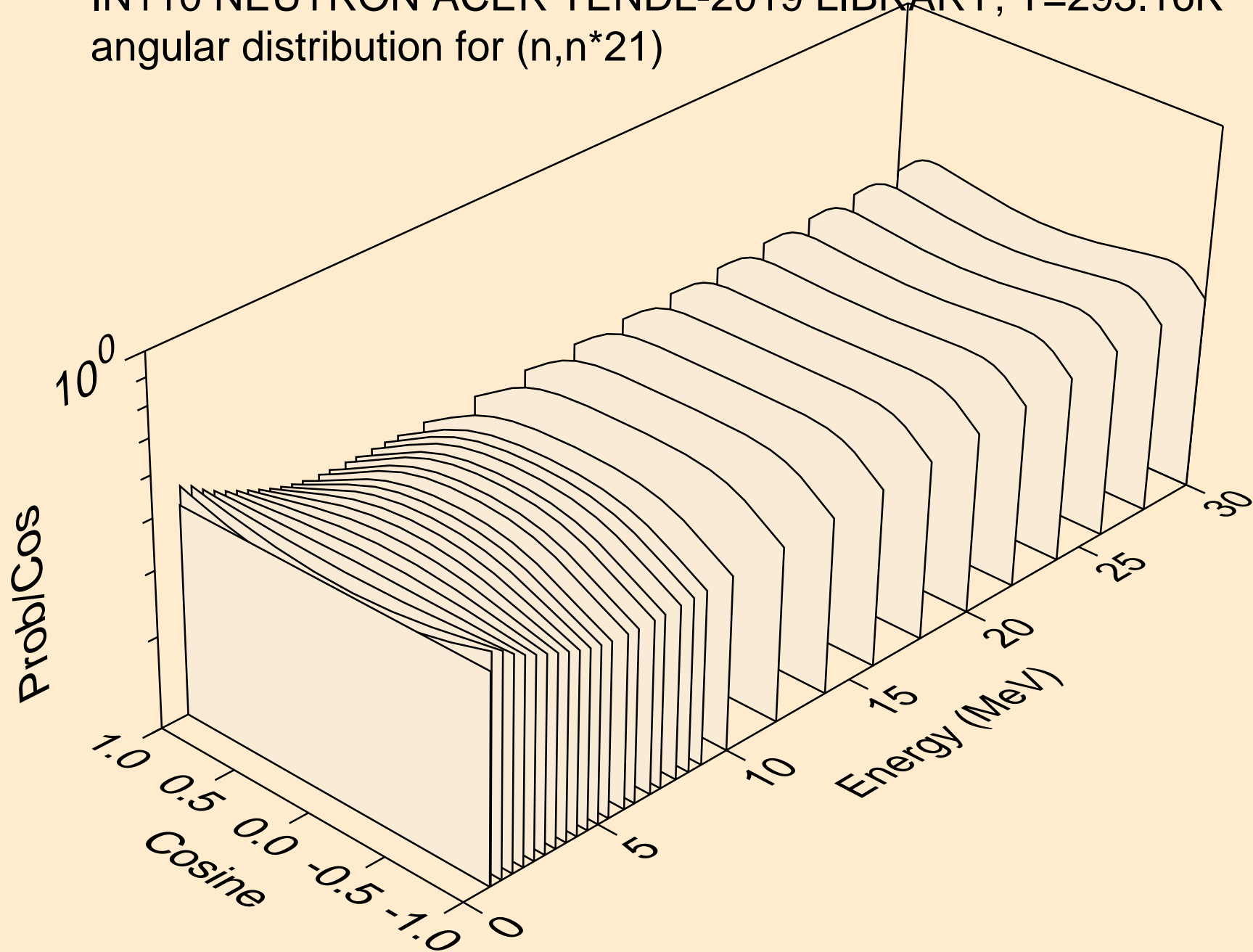

IN110 NEUTRON ACER TENDL-2019 LIBRARY; T=293.16K  
angular distribution for (n,n\*22)

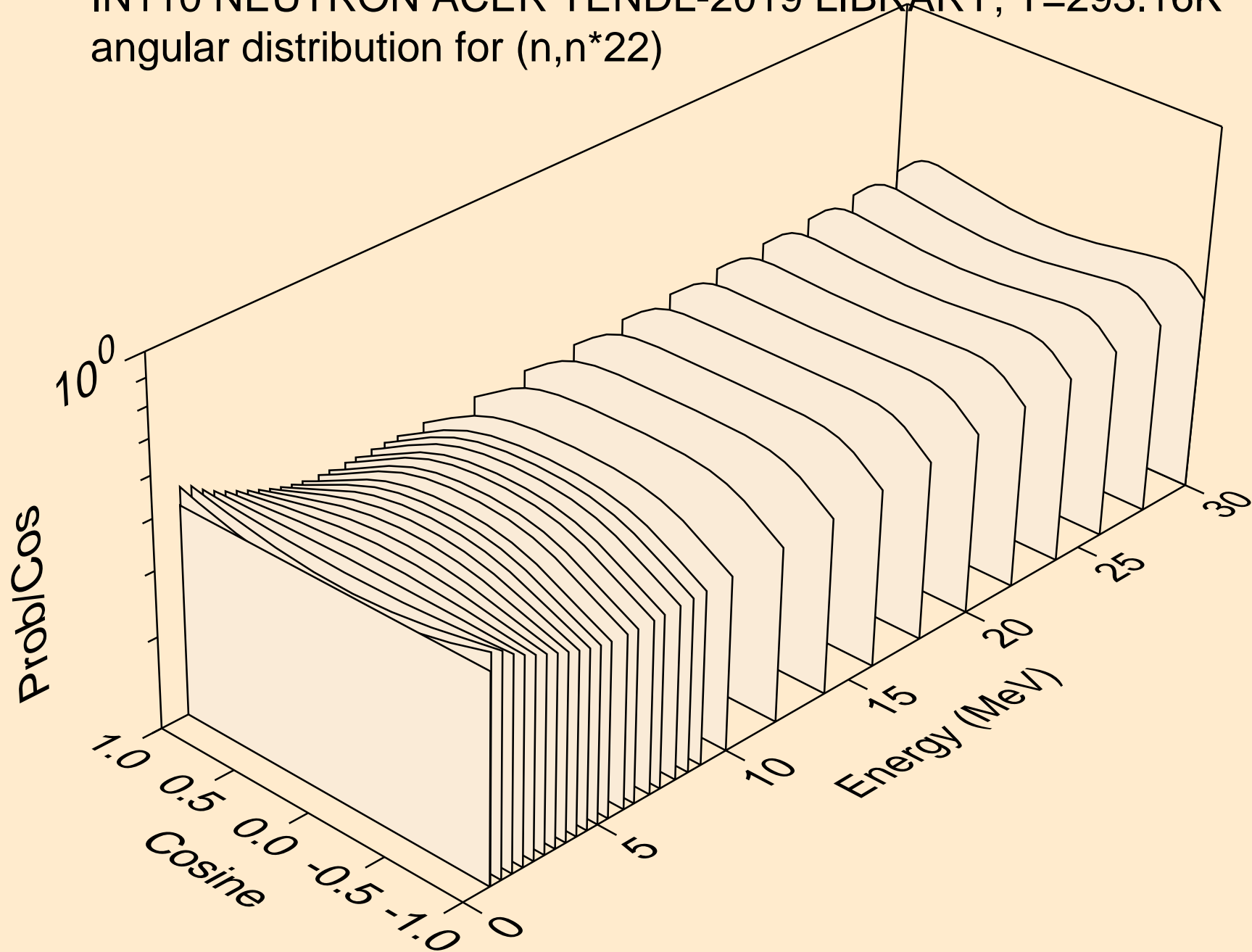

IN110 NEUTRON ACER TENDL-2019 LIBRARY; T=293.16K  
angular distribution for (n,n\*23)

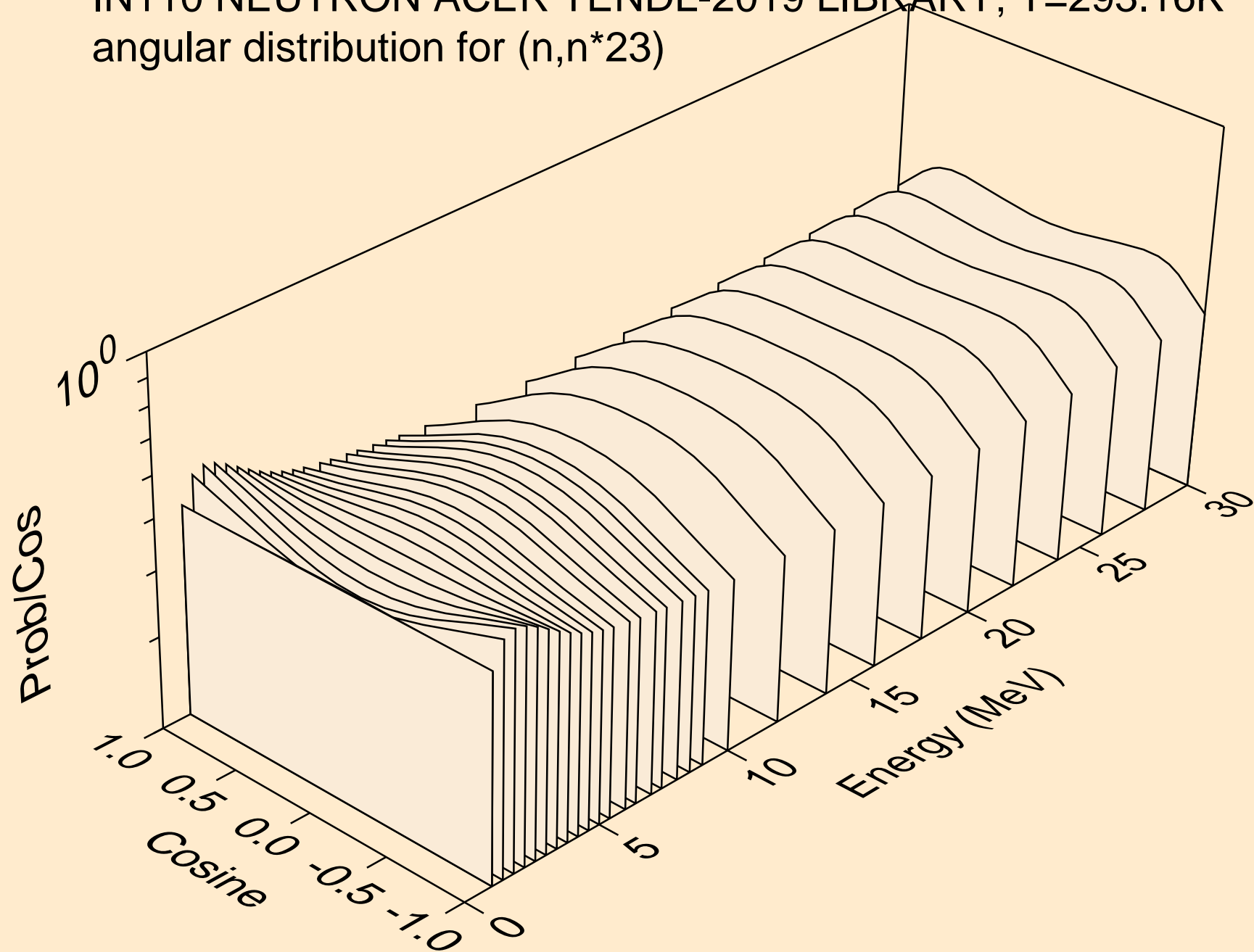

IN110 NEUTRON ACER TENDL-2019 LIBRARY; T=293.16K  
angular distribution for (n,n\*24)

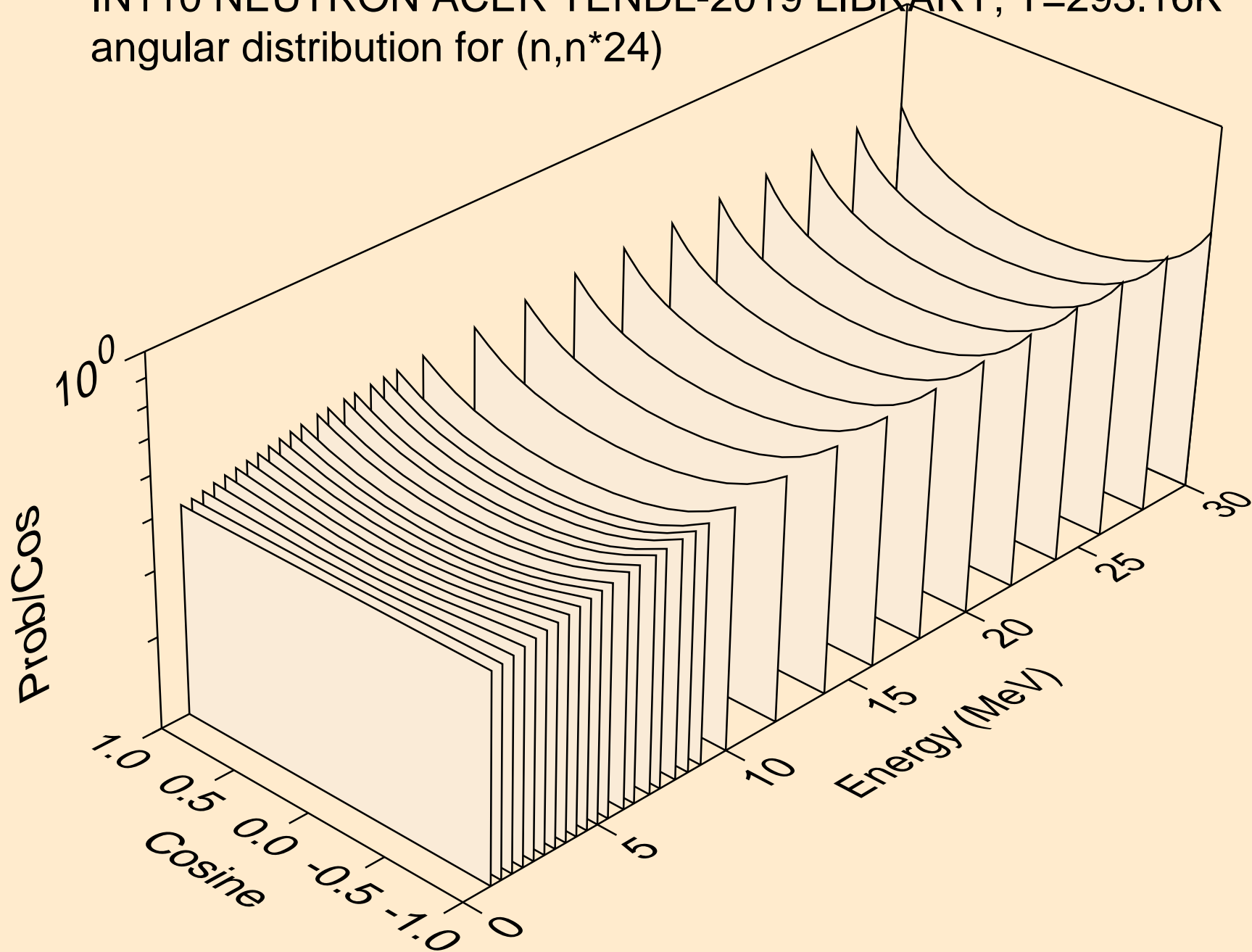

IN110 NEUTRON ACER TENDL-2019 LIBRARY; T=293.16K  
angular distribution for (n,n\*25)

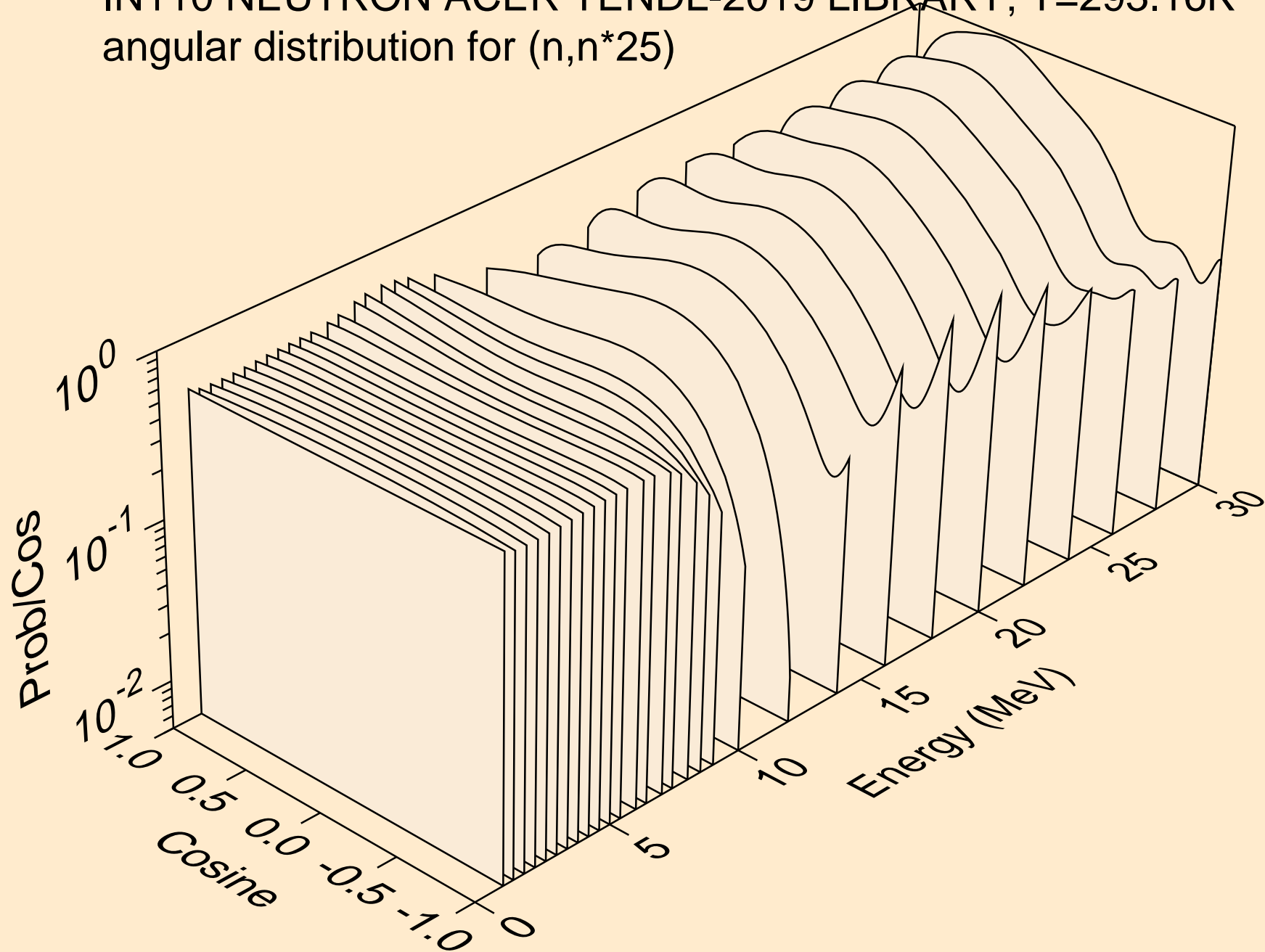



IN110 NEUTRON ACER TENDL-2019 LIBRARY; T=293.16K  
angular distribution for (n,n\*26)

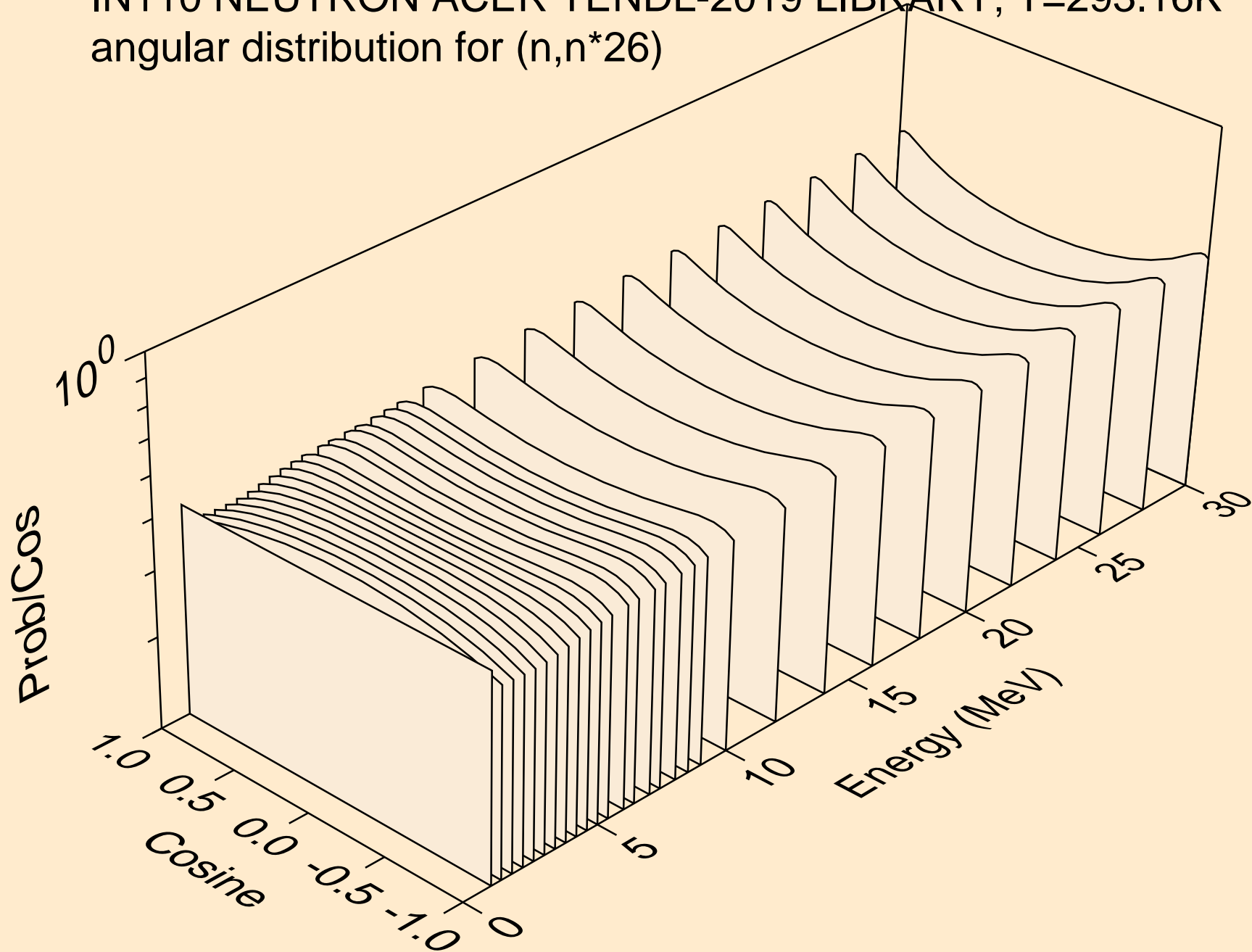

IN110 NEUTRON ACER TENDL-2019 LIBRARY; T=293.16K  
angular distribution for (n,n\*27)

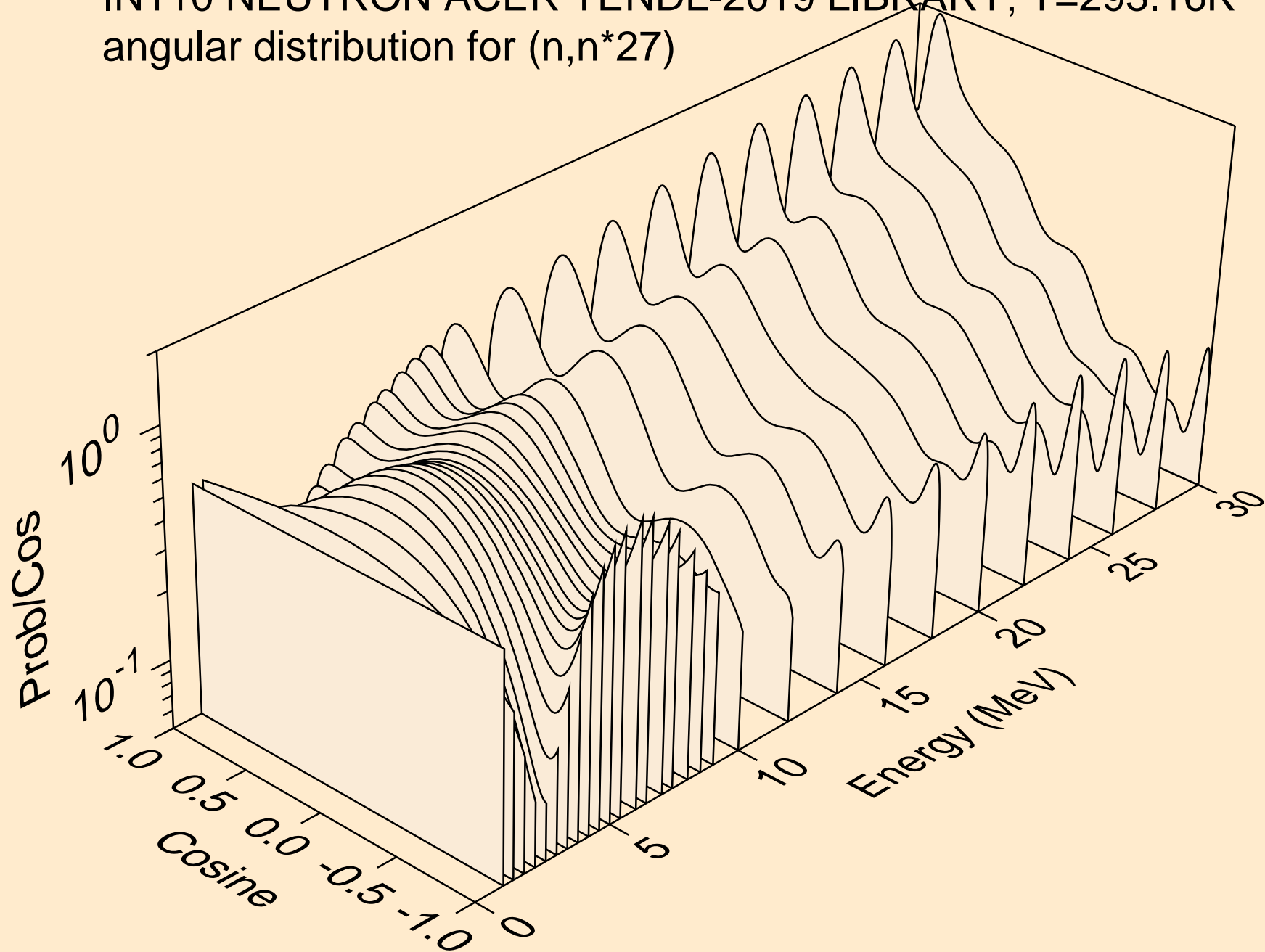

IN110 NEUTRON ACER TENDL-2019 LIBRARY; T=293.16K  
Neutron emission for (n,x)

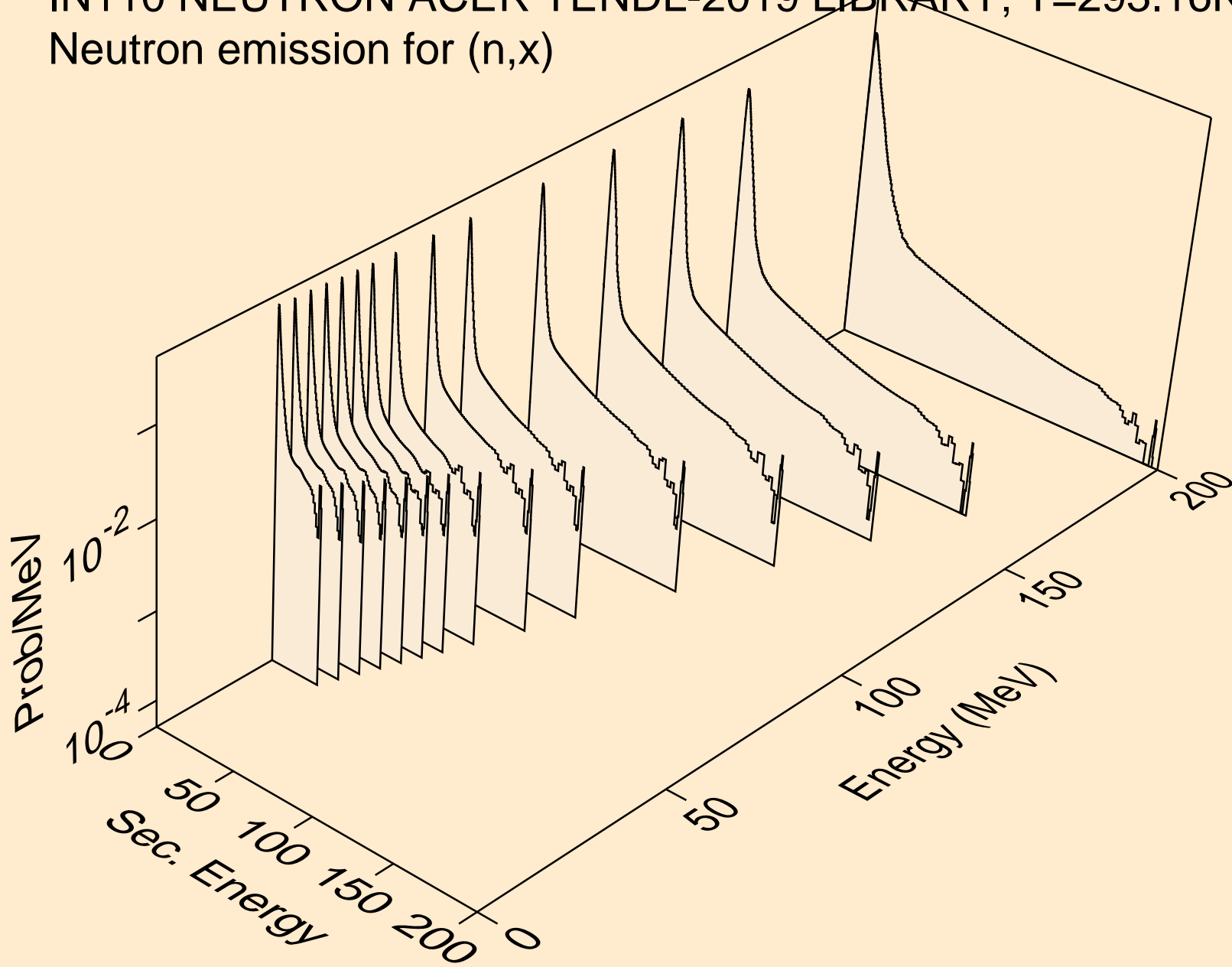

IN110 NEUTRON ACER TENDL-2019 LIBRARY; T=293.16K  
Neutron emission for (n,2nd)

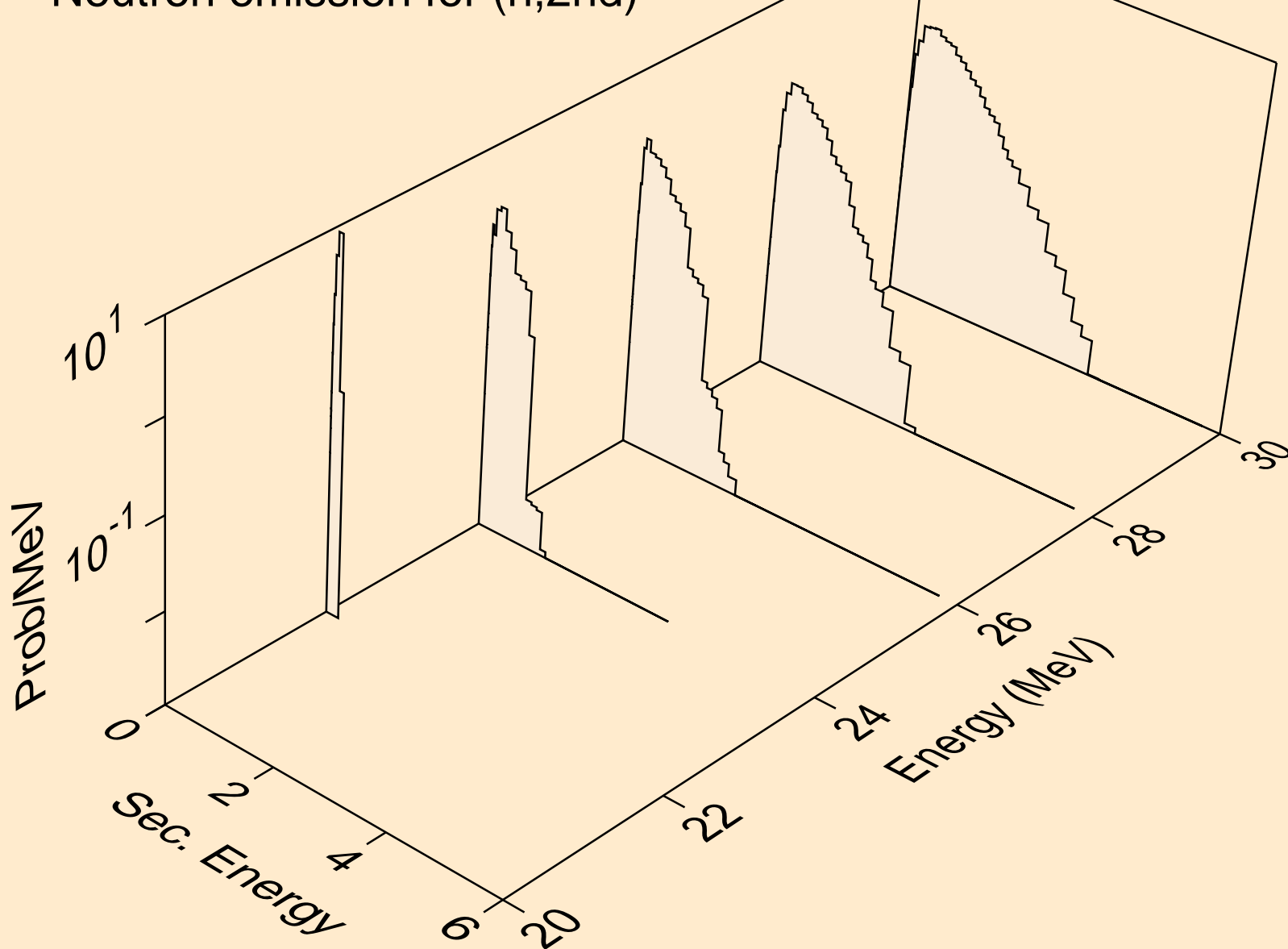

IN110 NEUTRON ACER TENDL-2019 LIBRARY; T=293.16K  
Neutron emission for (n,2n)

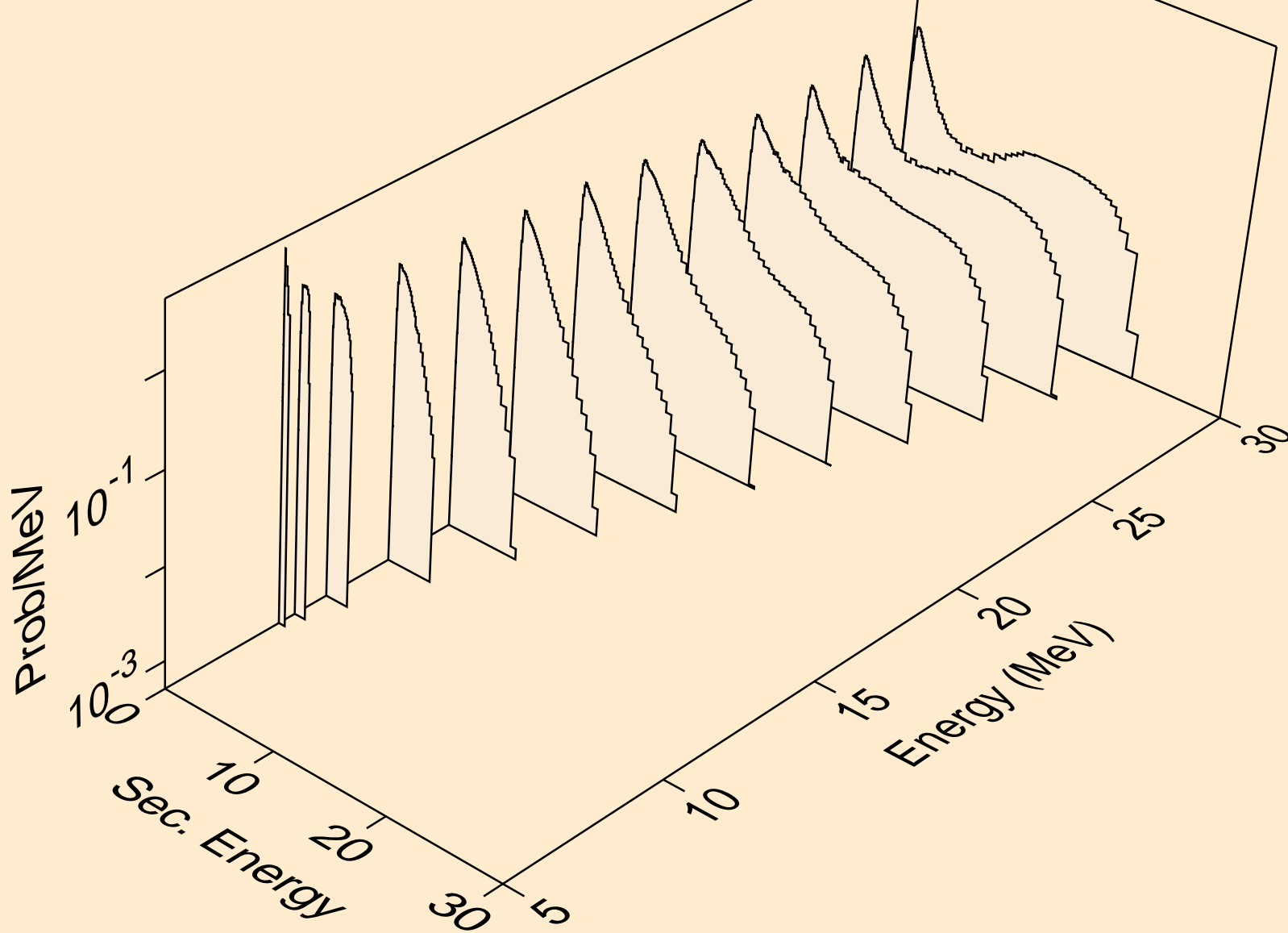

IN110 NEUTRON ACER TENDL-2019 LIBRARY; T=293.16K  
Neutron emission for (n,3n)

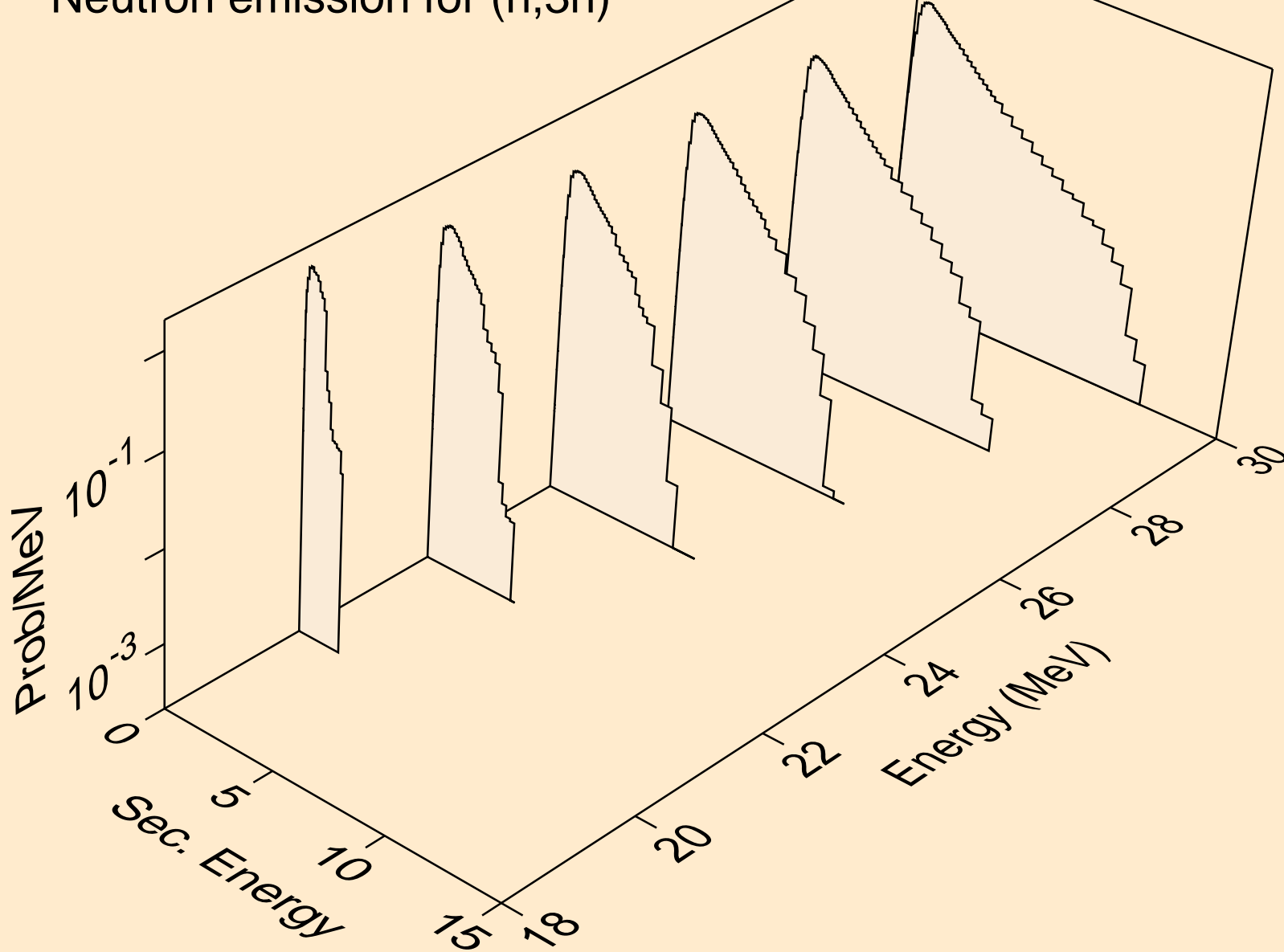

IN110 NEUTRON ACER TENDL-2019 LIBRARY; T=293.16K  
Neutron emission for (n,n\*)a

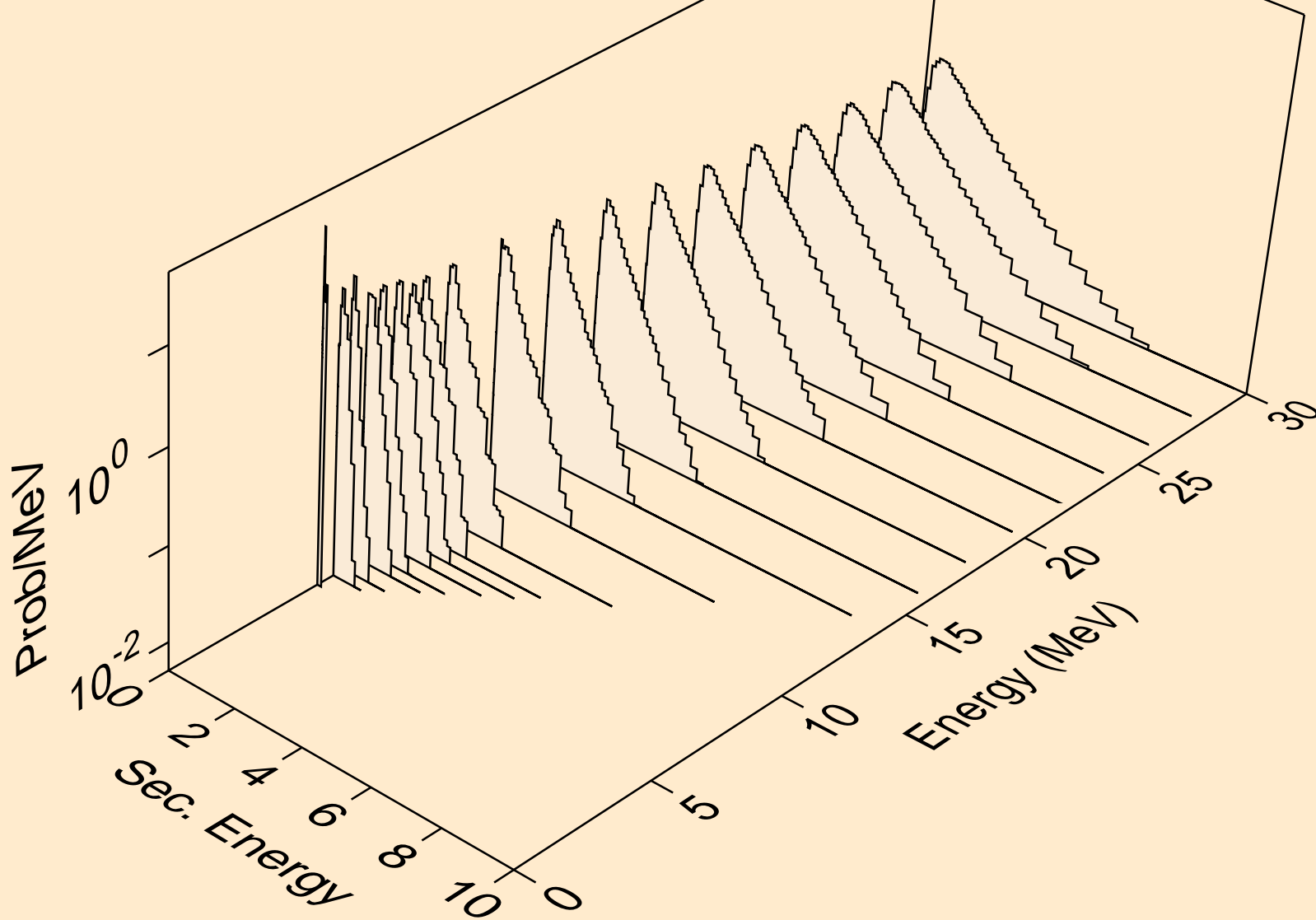

IN110 NEUTRON ACER TENDL-2019 LIBRARY; T=293.16K  
Neutron emission for (n,2n)a

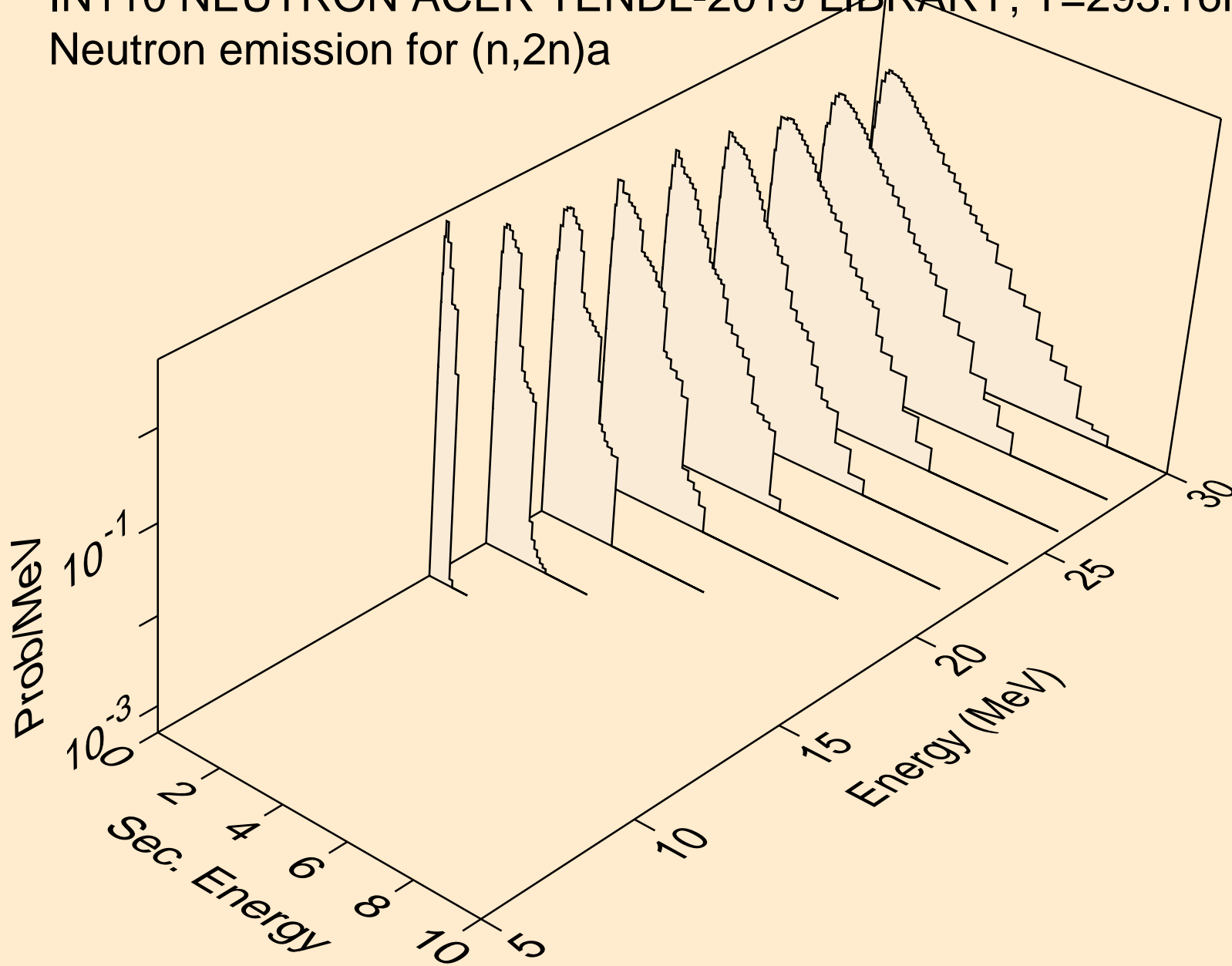



IN110 NEUTRON ACER TENDL-2019 LIBRARY; T=293.16K  
Neutron emission for (n,3n)a

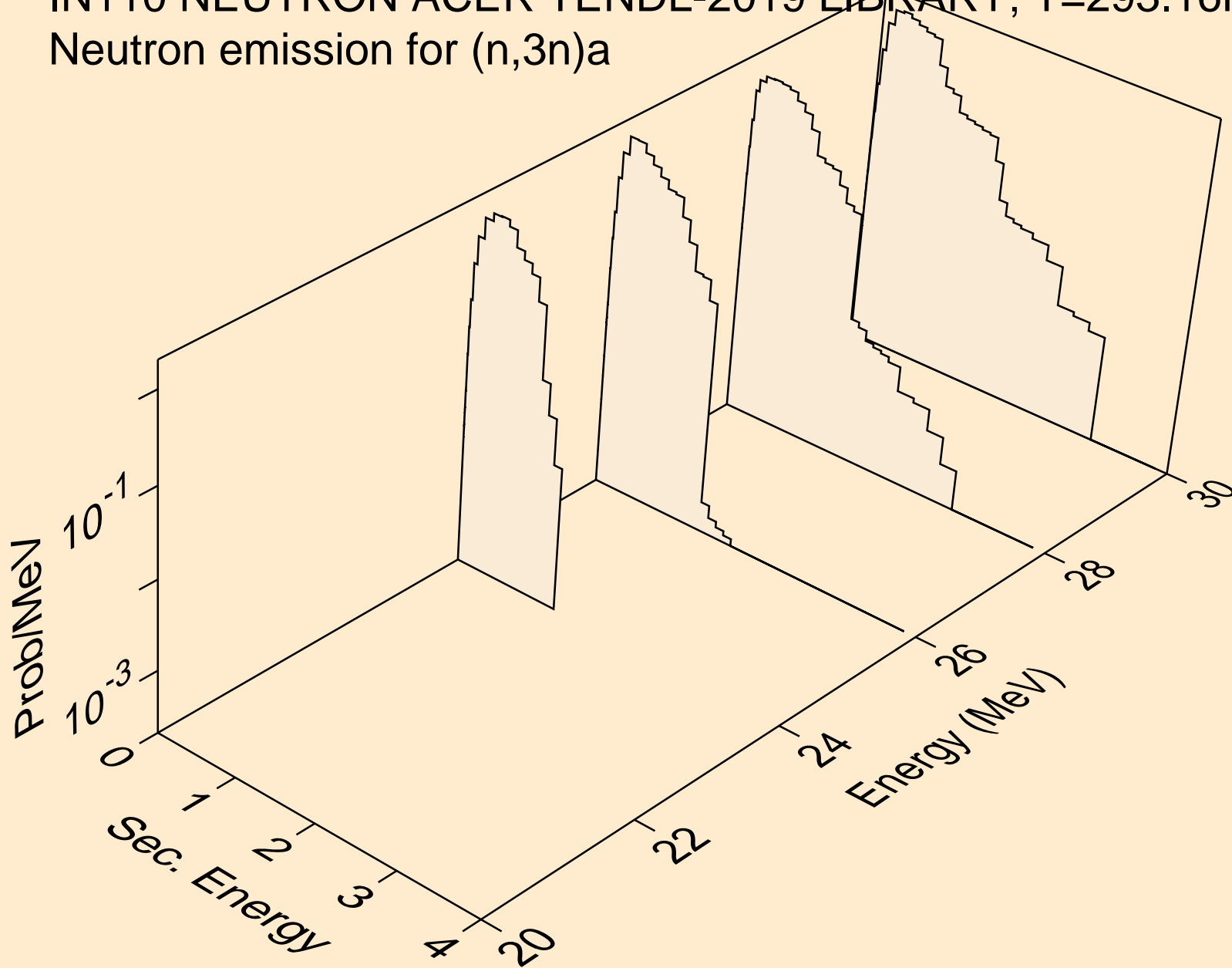

IN110 NEUTRON ACER TENDL-2019 LIBRARY; T=293.16K  
Neutron emission for (n,n\*)p

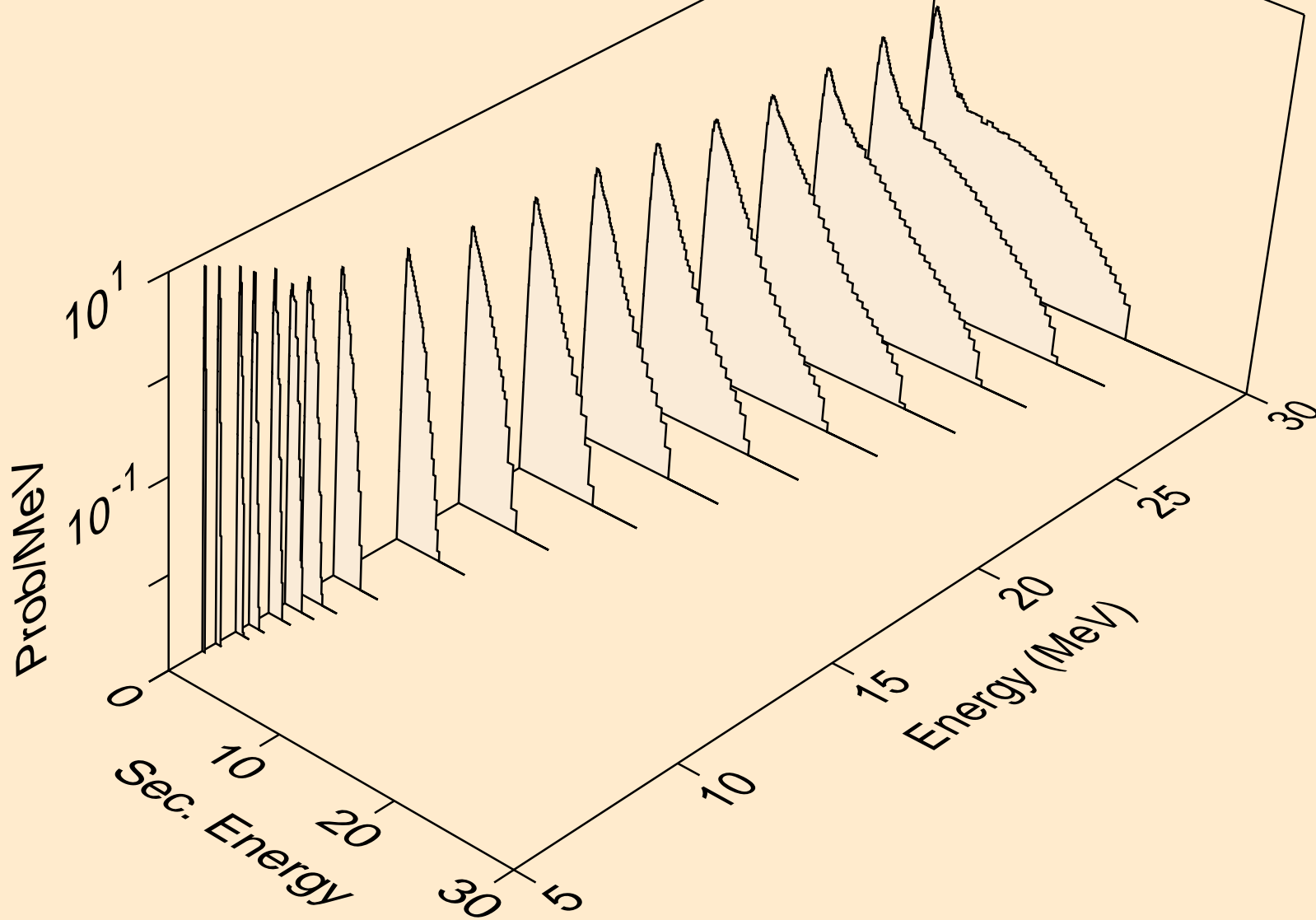

IN110 NEUTRON ACER TENDL-2019 LIBRARY; T=293.16K  
Neutron emission for (n,n\*)2a

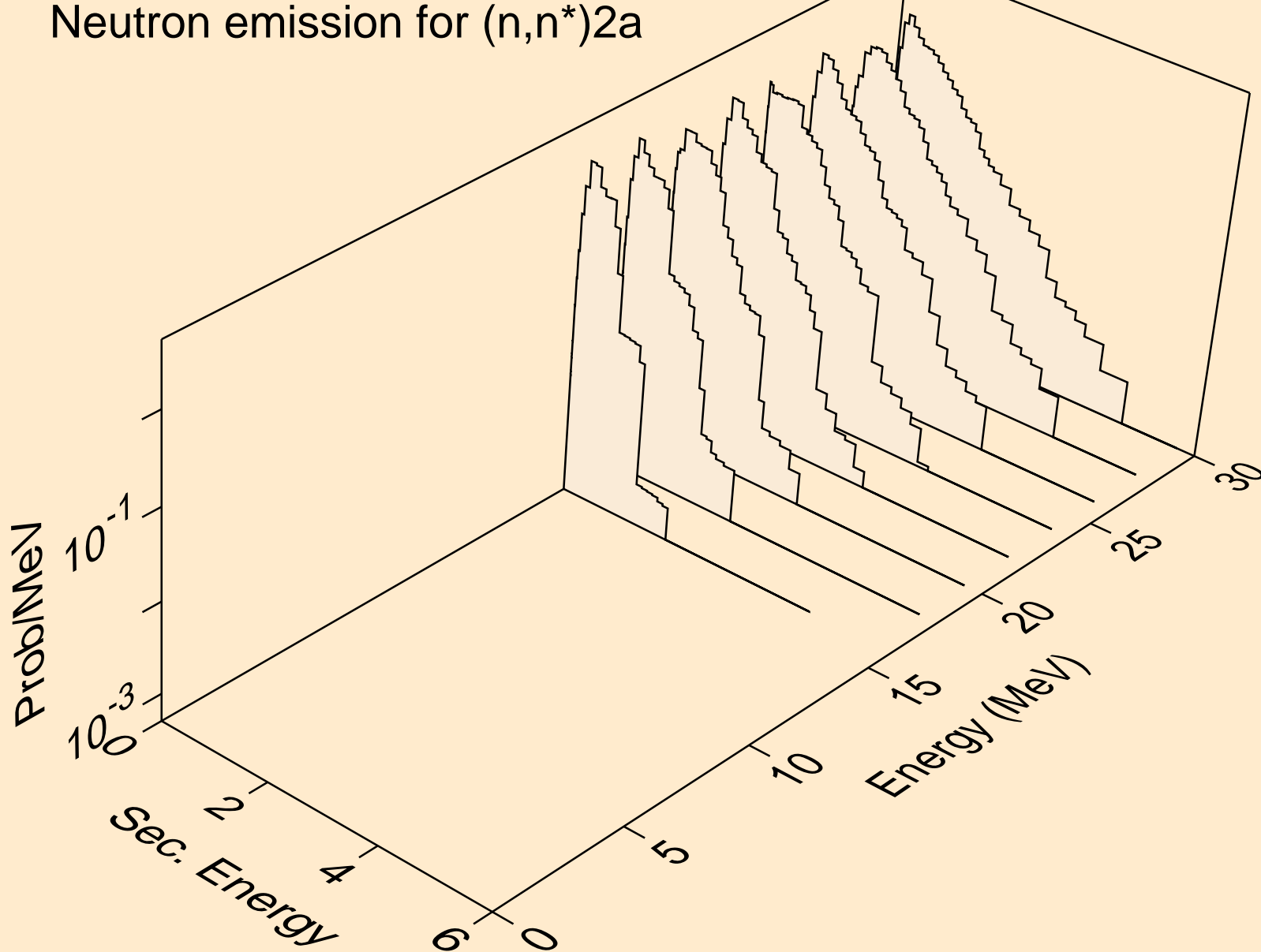

IN110 NEUTRON ACER TENDL-2019 LIBRARY; T=293.16K  
Neutron emission for (n,2n)2a

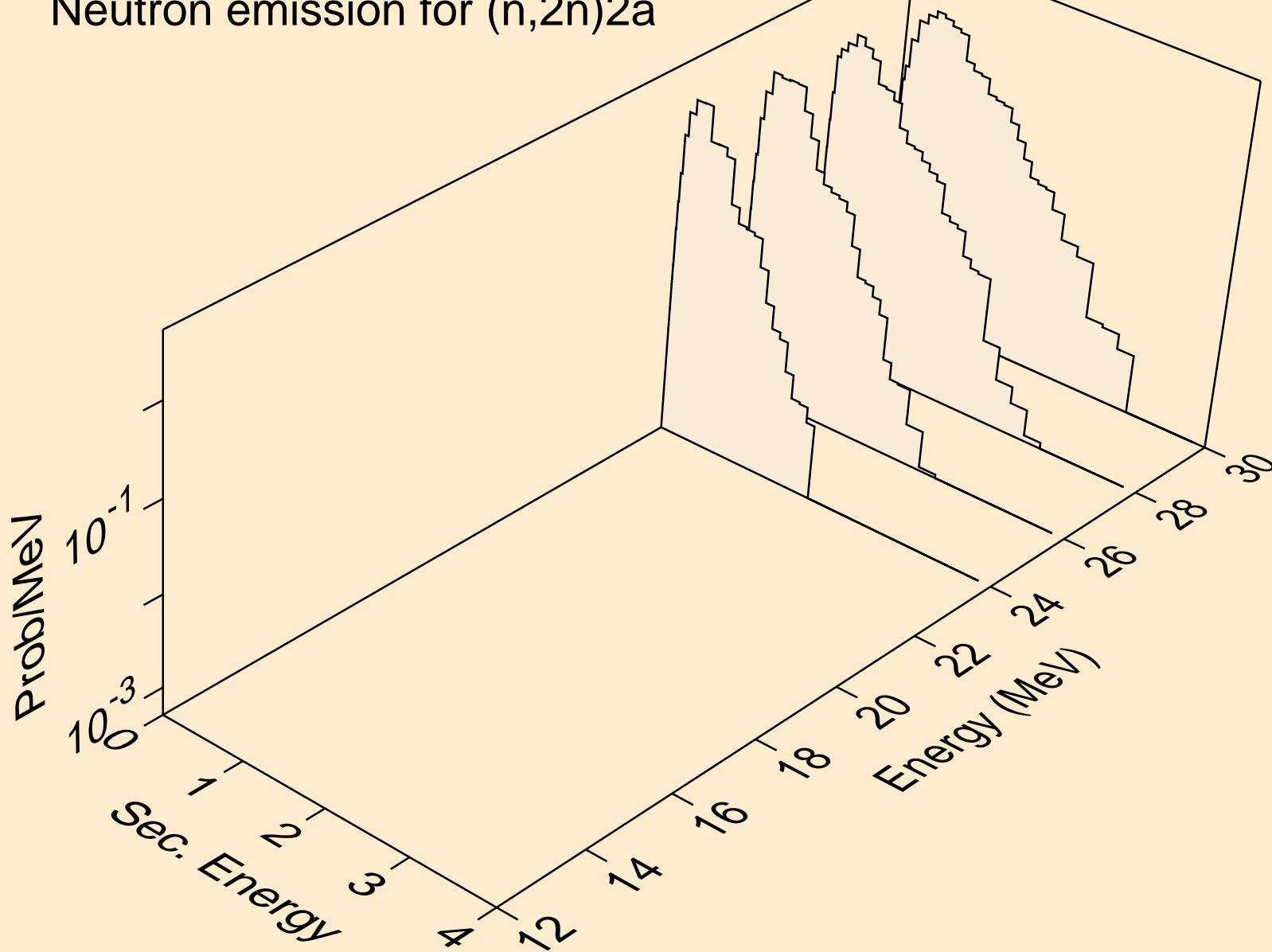

IN110 NEUTRON ACER TENDL-2019 LIBRARY; T=293.16K  
Neutron emission for (n,n\*)d

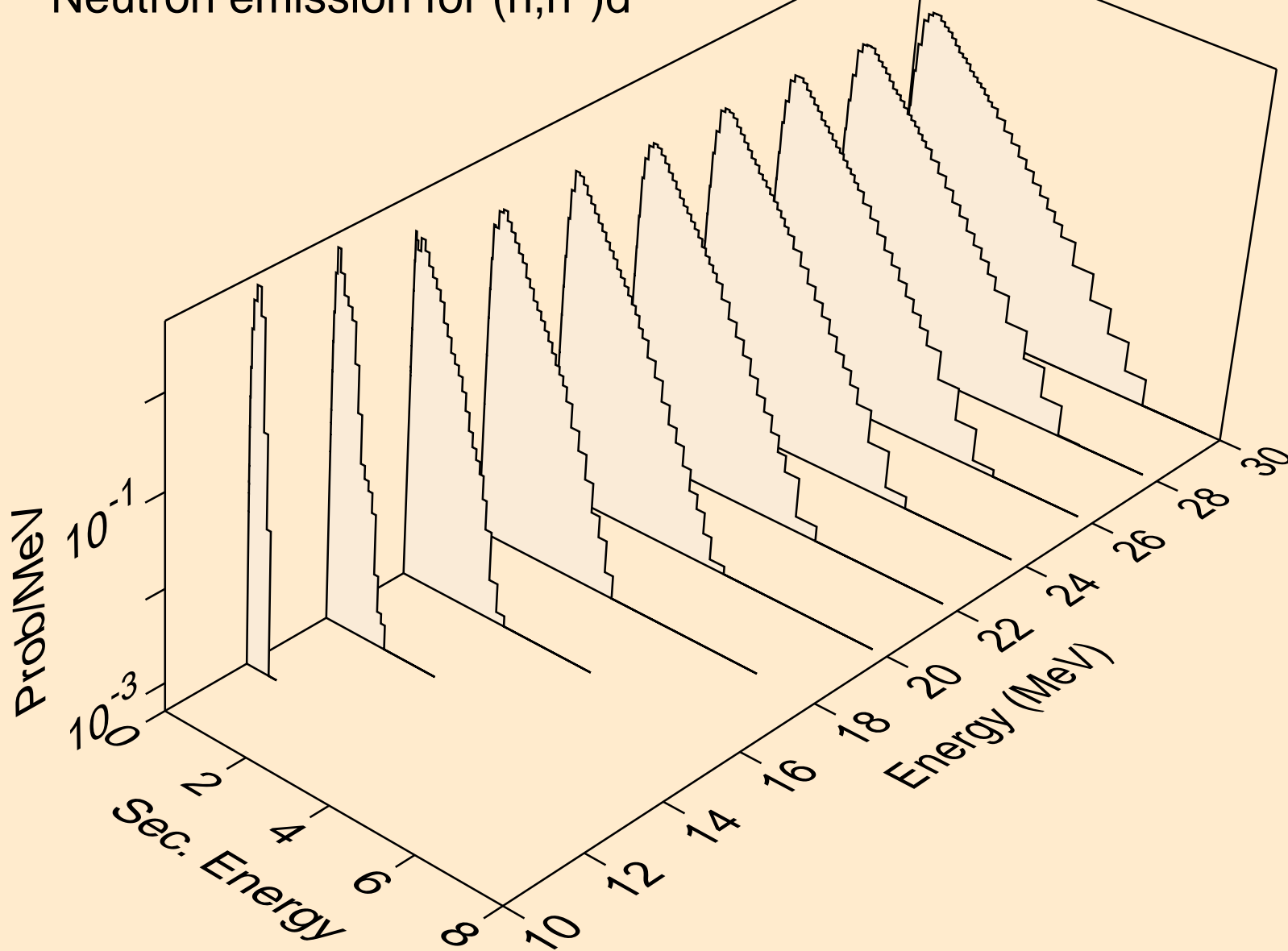

IN110 NEUTRON ACER TENDL-2019 LIBRARY; T=293.16K  
Neutron emission for (n,n\*)t

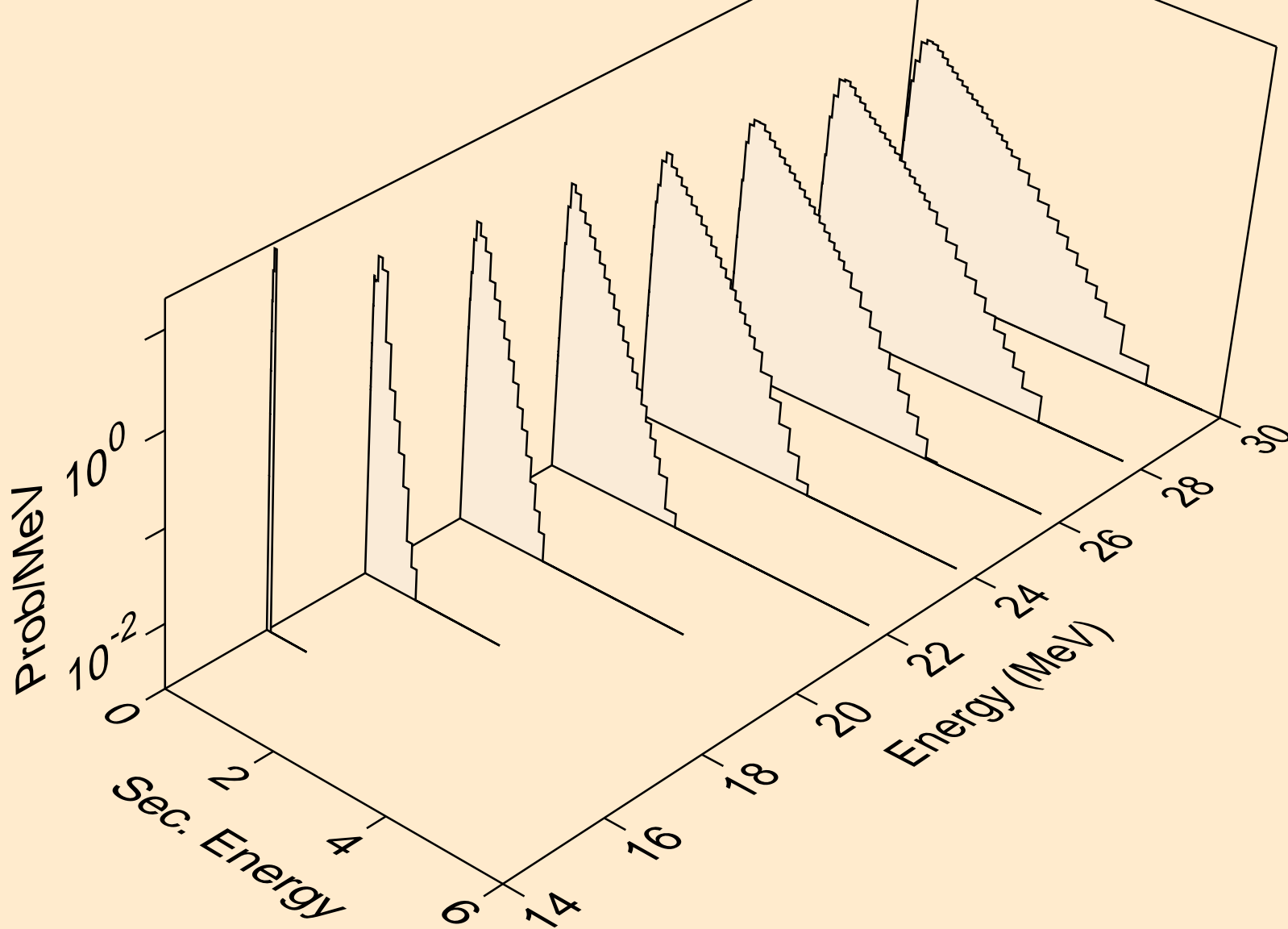

IN110 NEUTRON ACER TENDL-2019 LIBRARY; T=293.16K  
Neutron emission for (n,n\*)he3

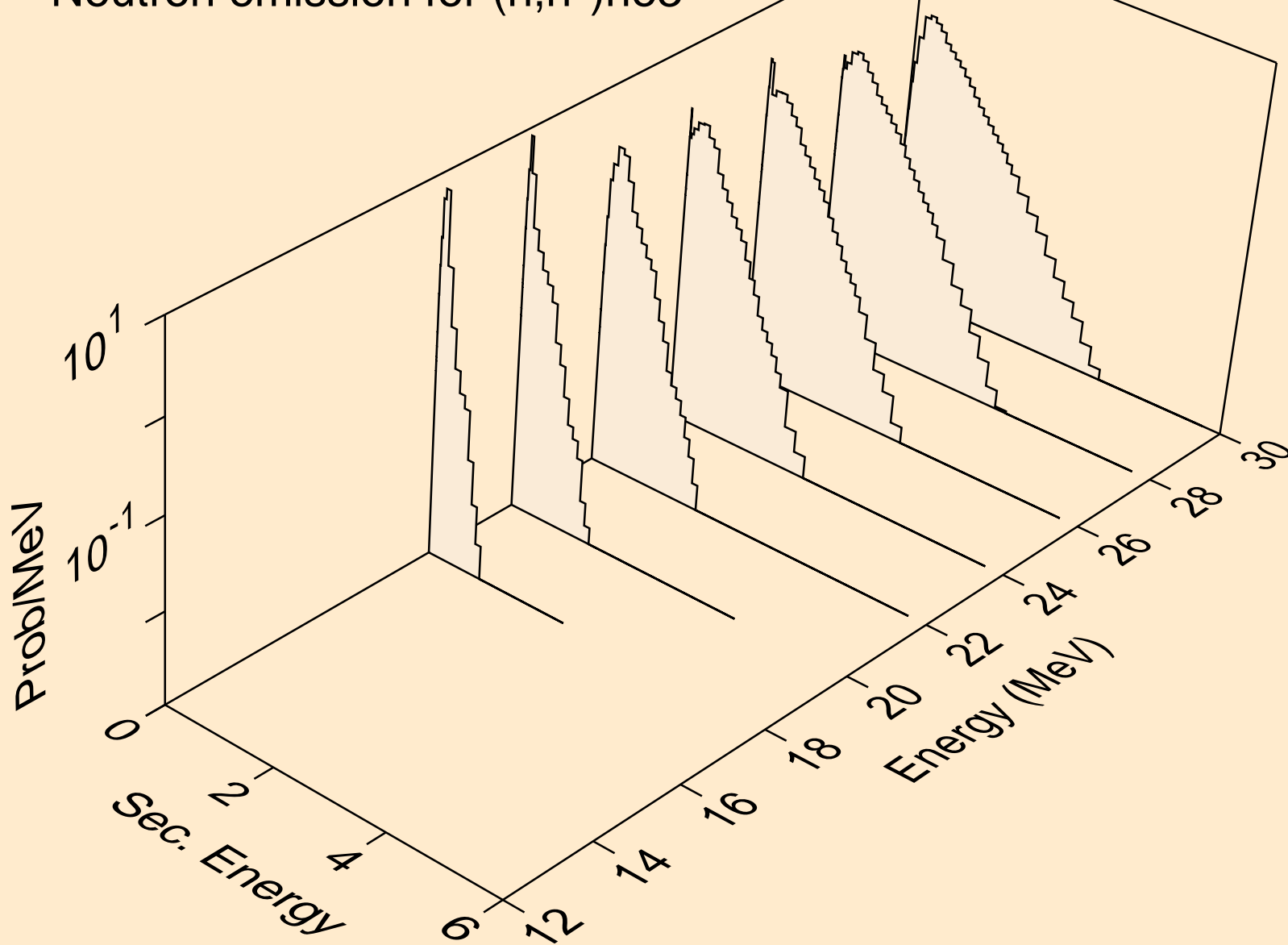

IN110 NEUTRON ACER TENDL-2019 LIBRARY; T=293.16K  
Neutron emission for (n,4n)

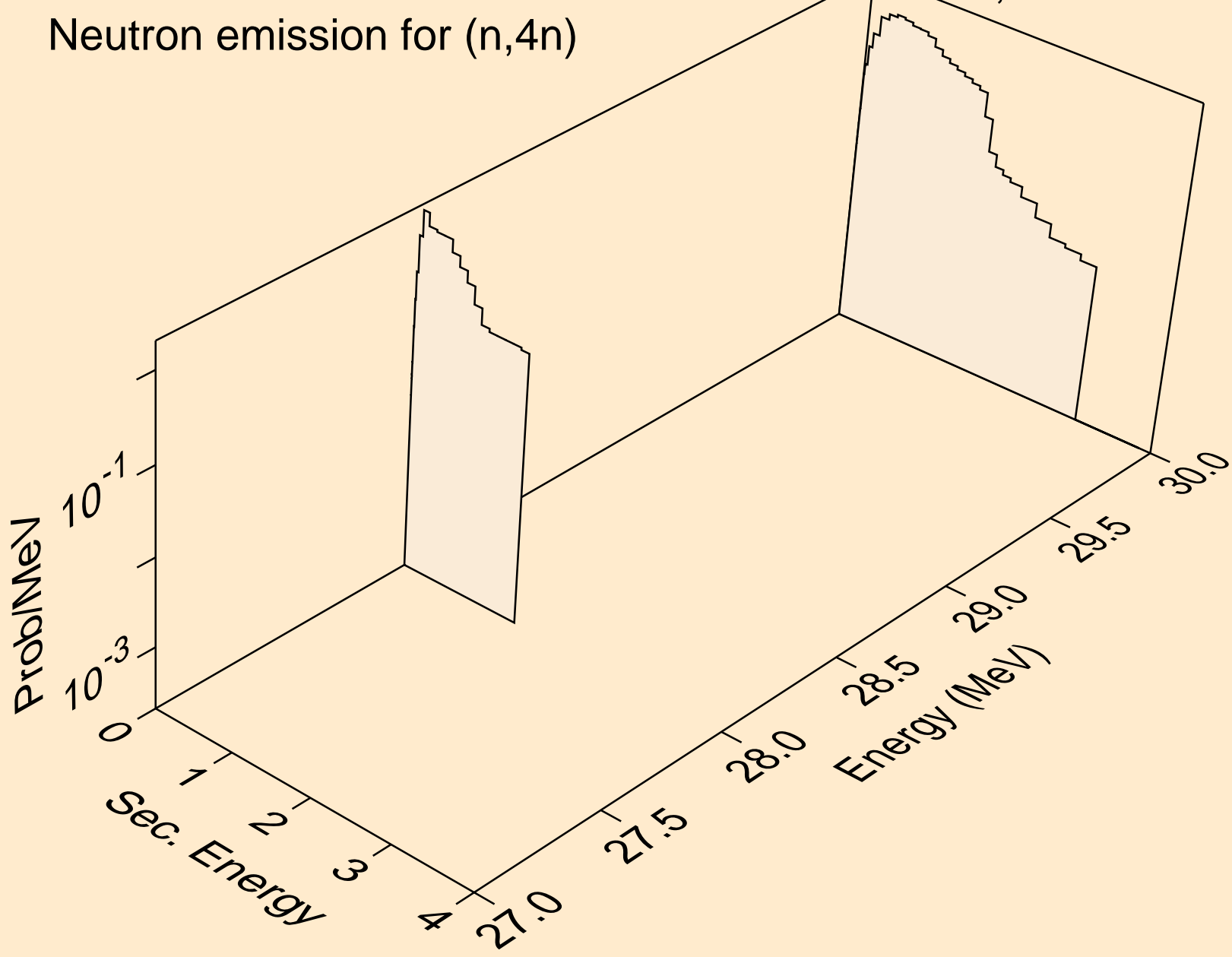



IN110 NEUTRON ACER TENDL-2019 LIBRARY; T=293.16K  
Neutron emission for (n,2np)

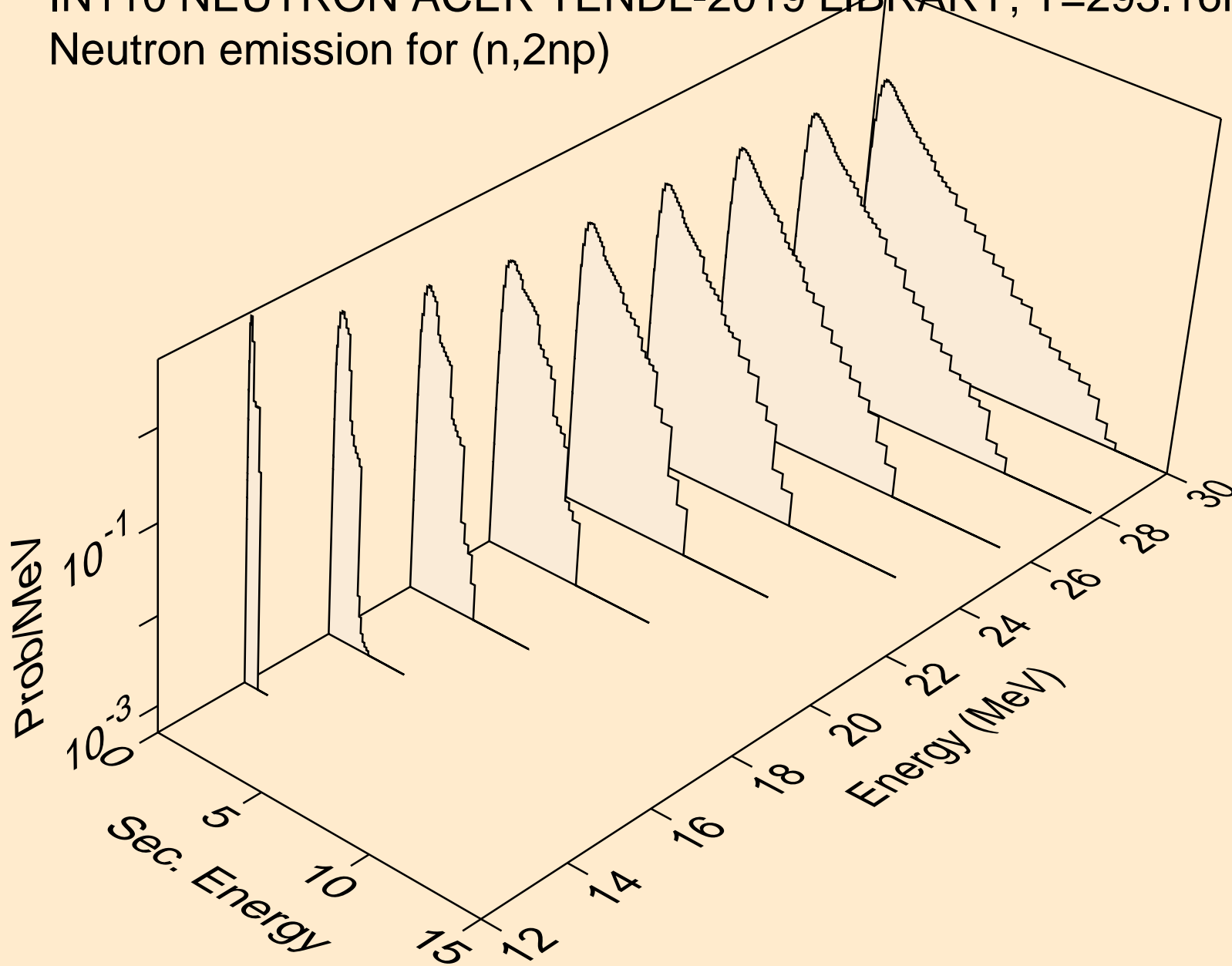

IN110 NEUTRON ACER TENDL-2019 LIBRARY; T=293.16K  
Neutron emission for (n,3np)

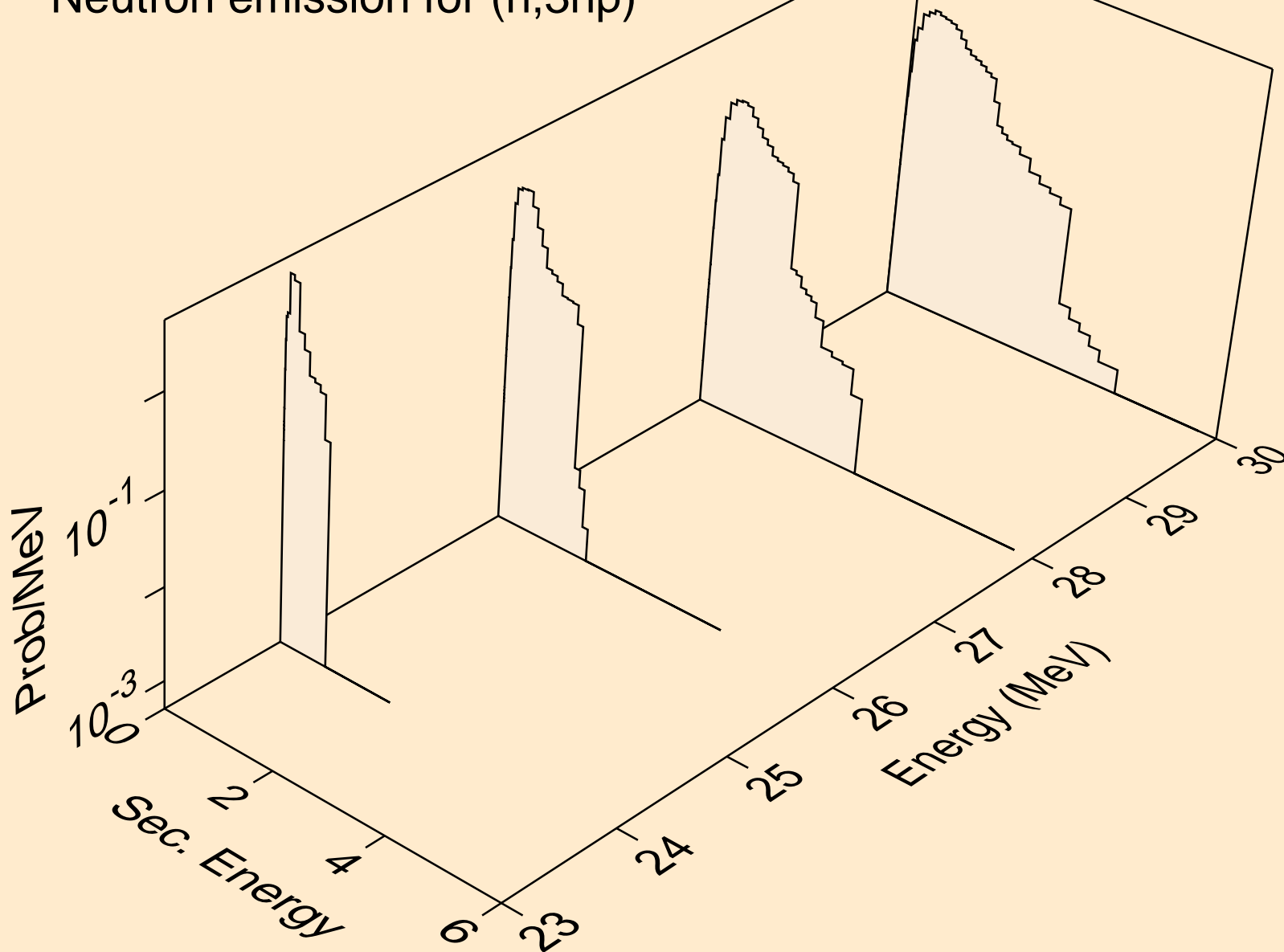

IN110 NEUTRON ACER TENDL-2019 LIBRARY; T=293.16K  
Neutron emission for (n,2np)

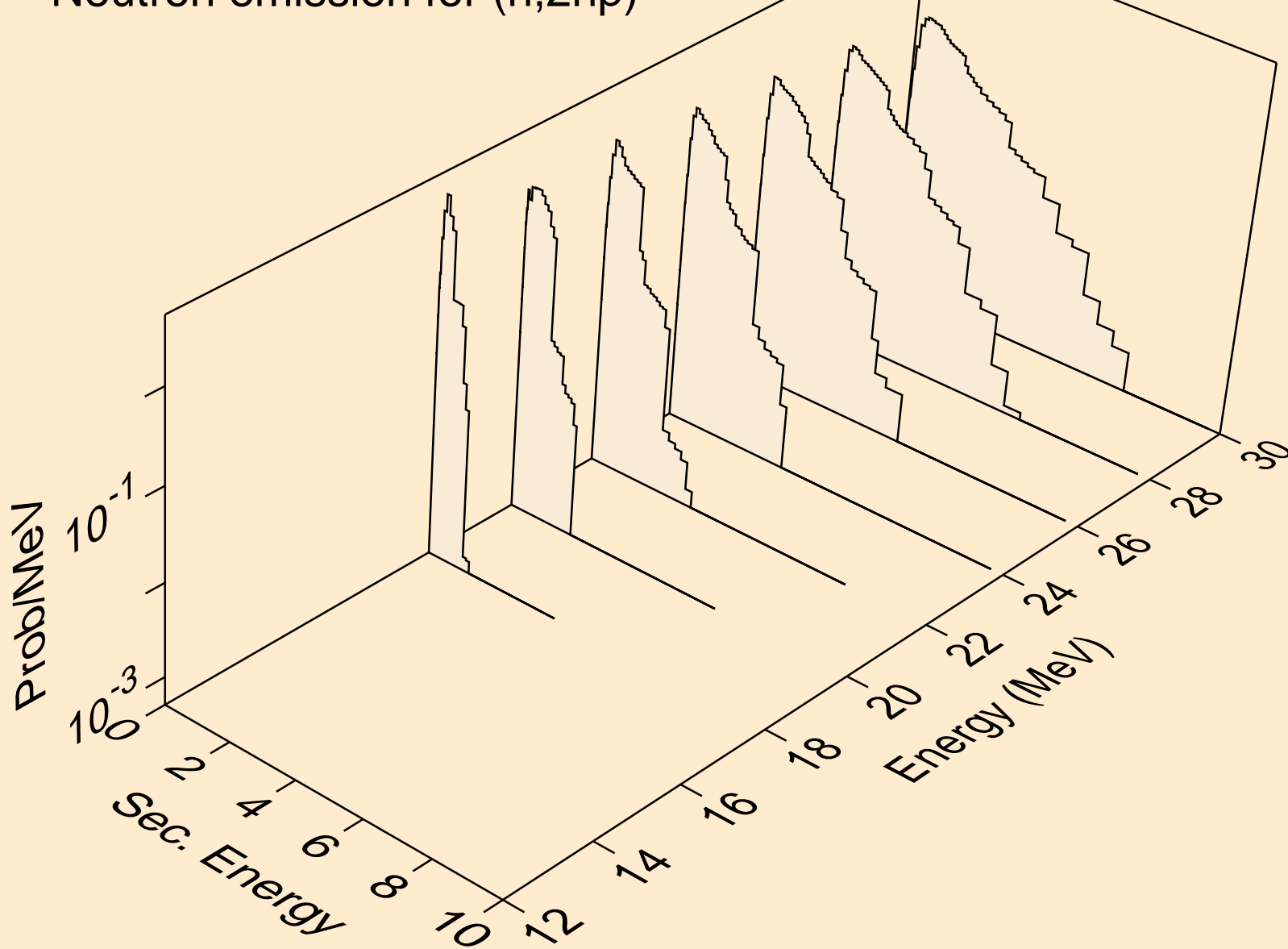

IN110 NEUTRON ACER TENDL-2019 LIBRARY; T=293.16K  
Neutron emission for (n,npa)

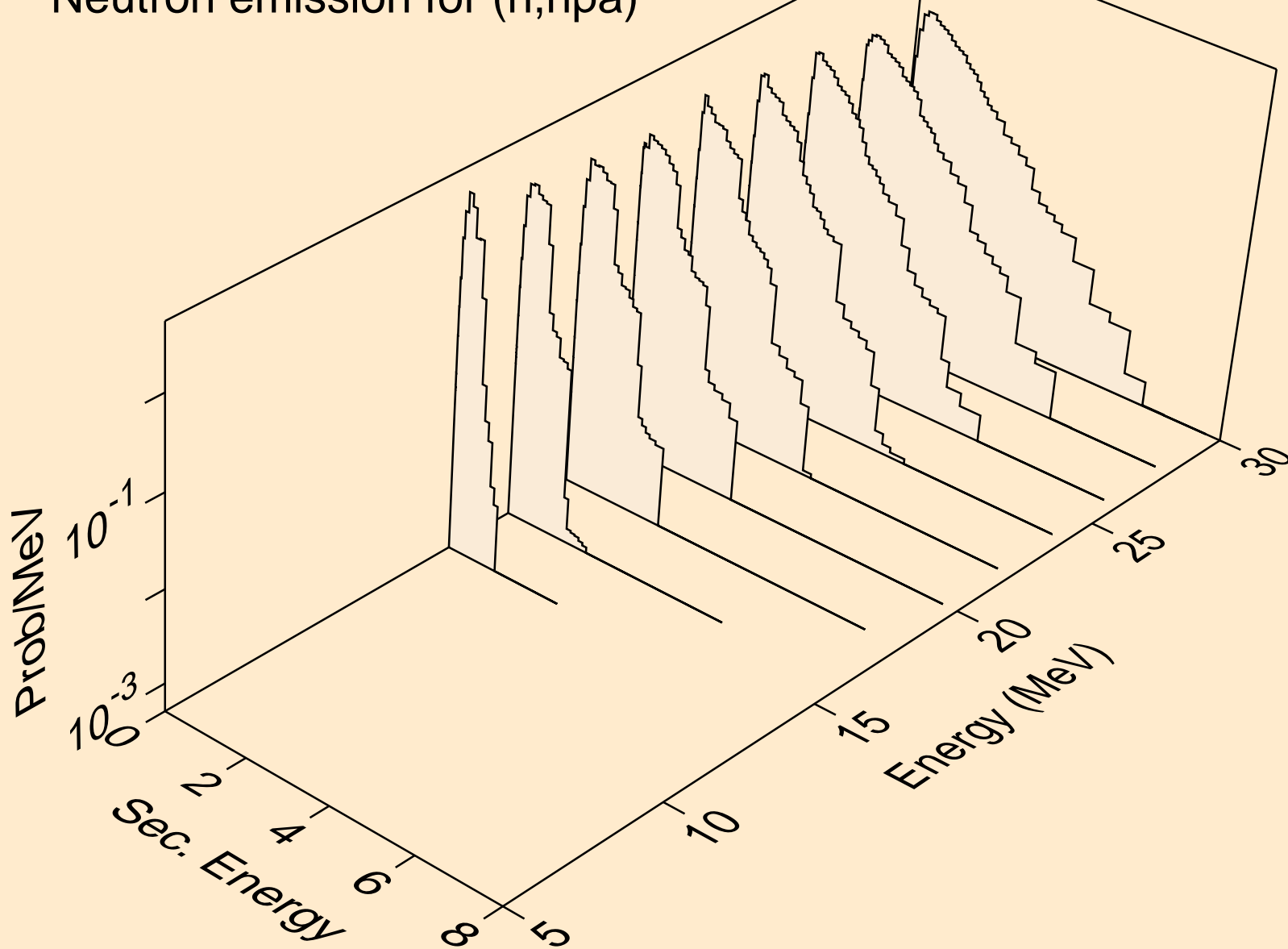

IN110 NEUTRON ACER TENDL-2019 LIBRARY; T=293.16K  
Neutron emission for (n,n\*c)

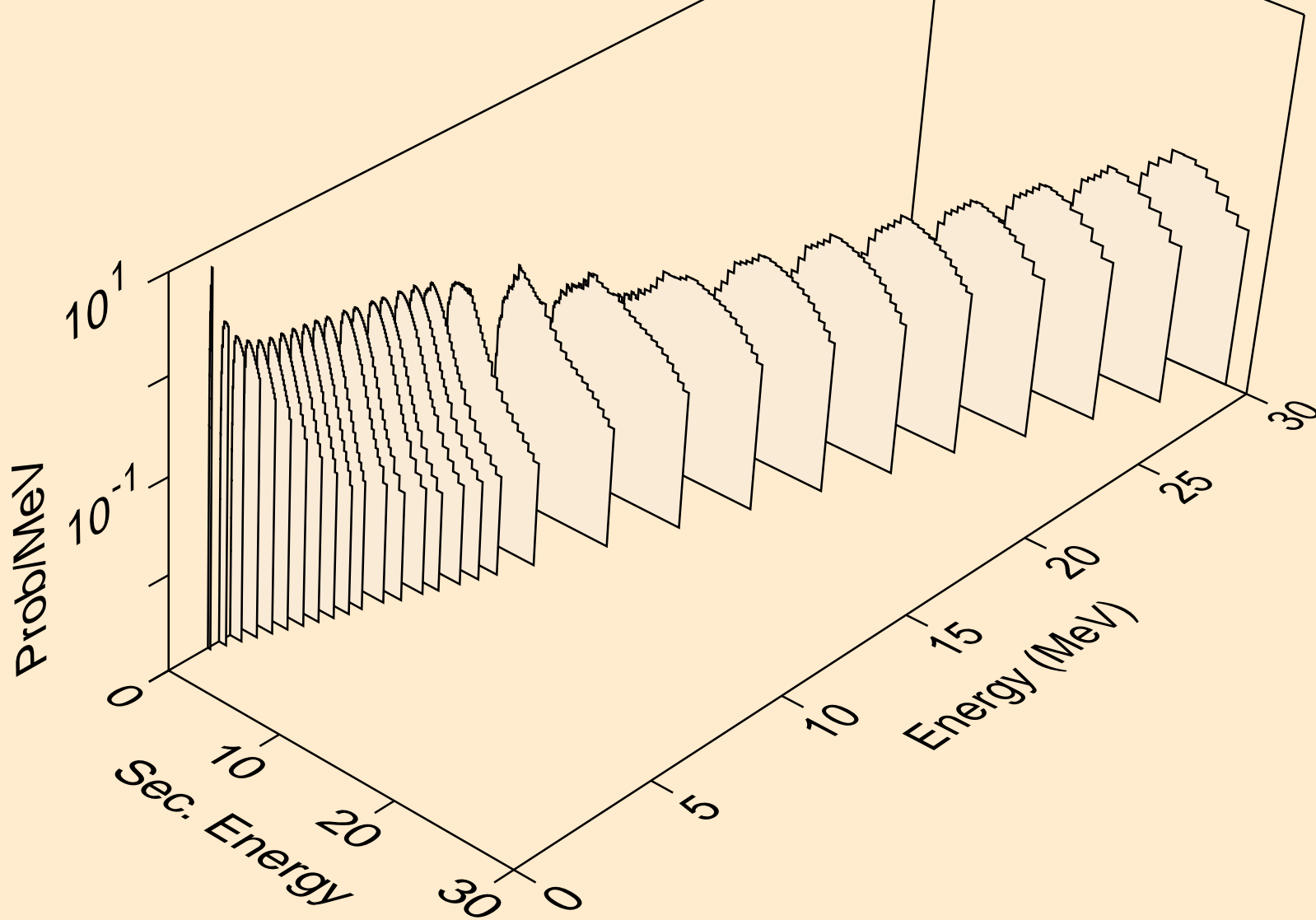

IN110 NEUTRON ACER TENDL-2019 LIBRARY; T=293.16K  
Photon emission for (n,x)

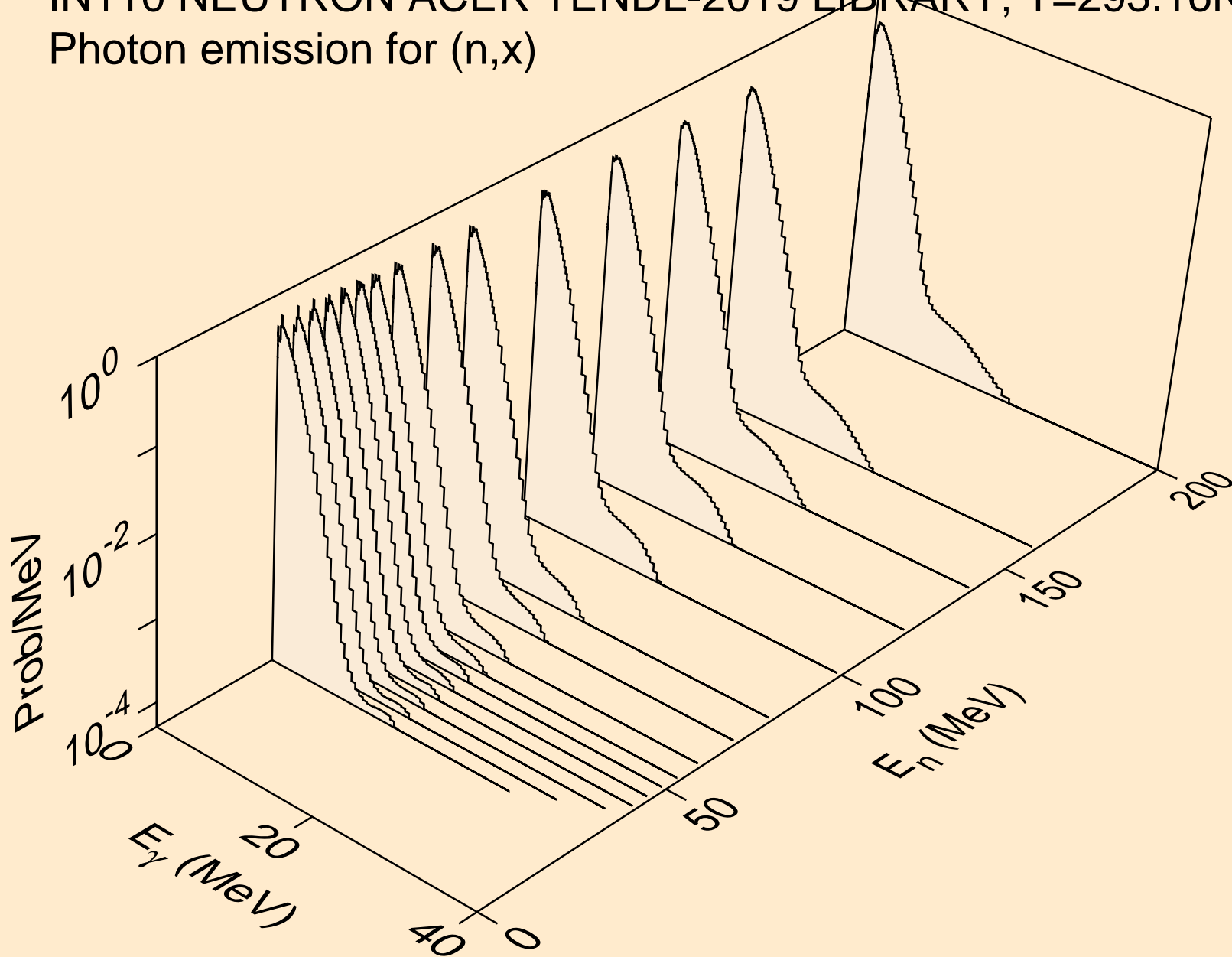

IN110 NEUTRON ACER TENDL-2019 LIBRARY; T=293.16K  
Photon emission for (n,2nd)

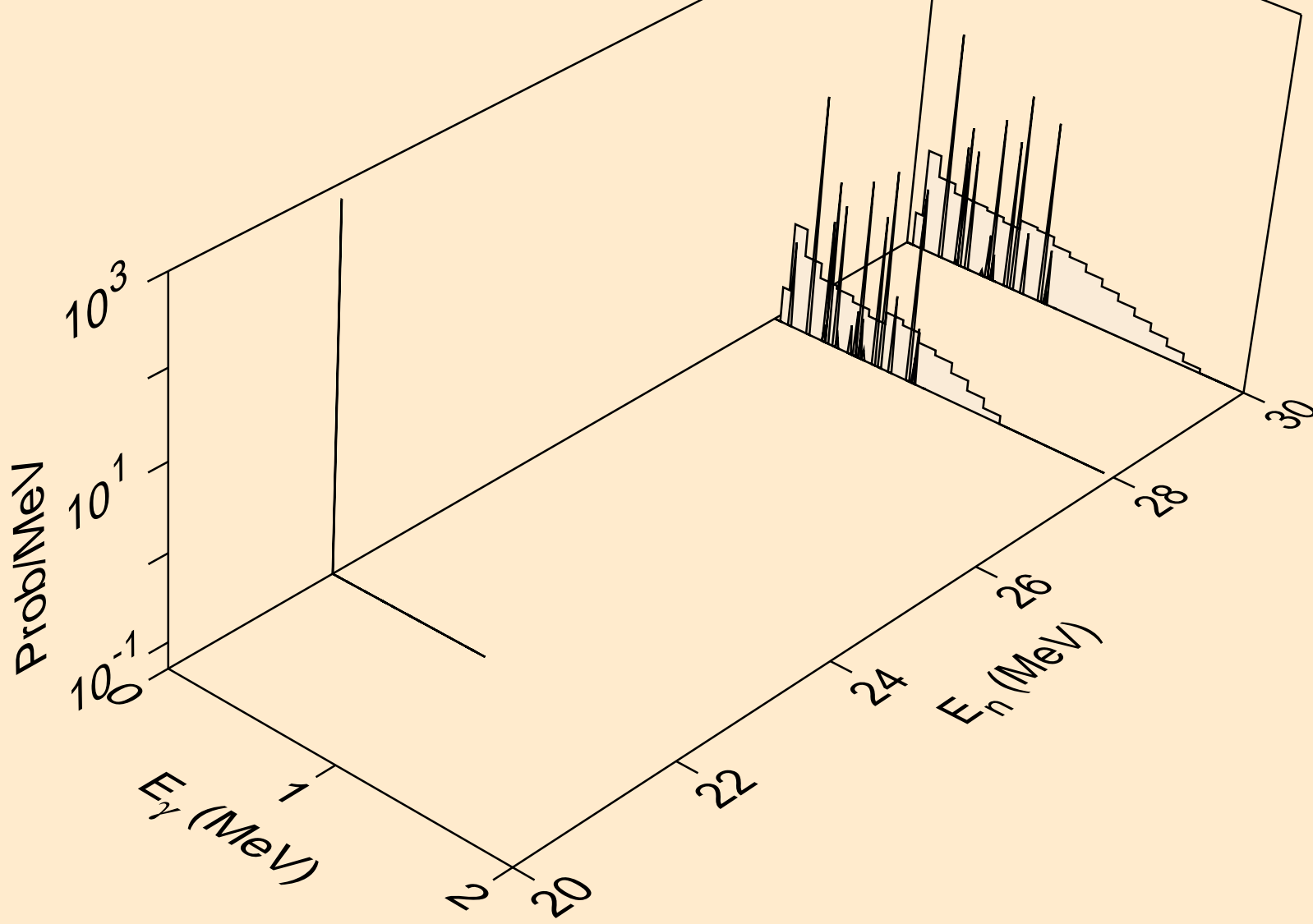

IN110 NEUTRON ACER TENDL-2019 LIBRARY; T=293.16K  
Photon emission for (n,2n)

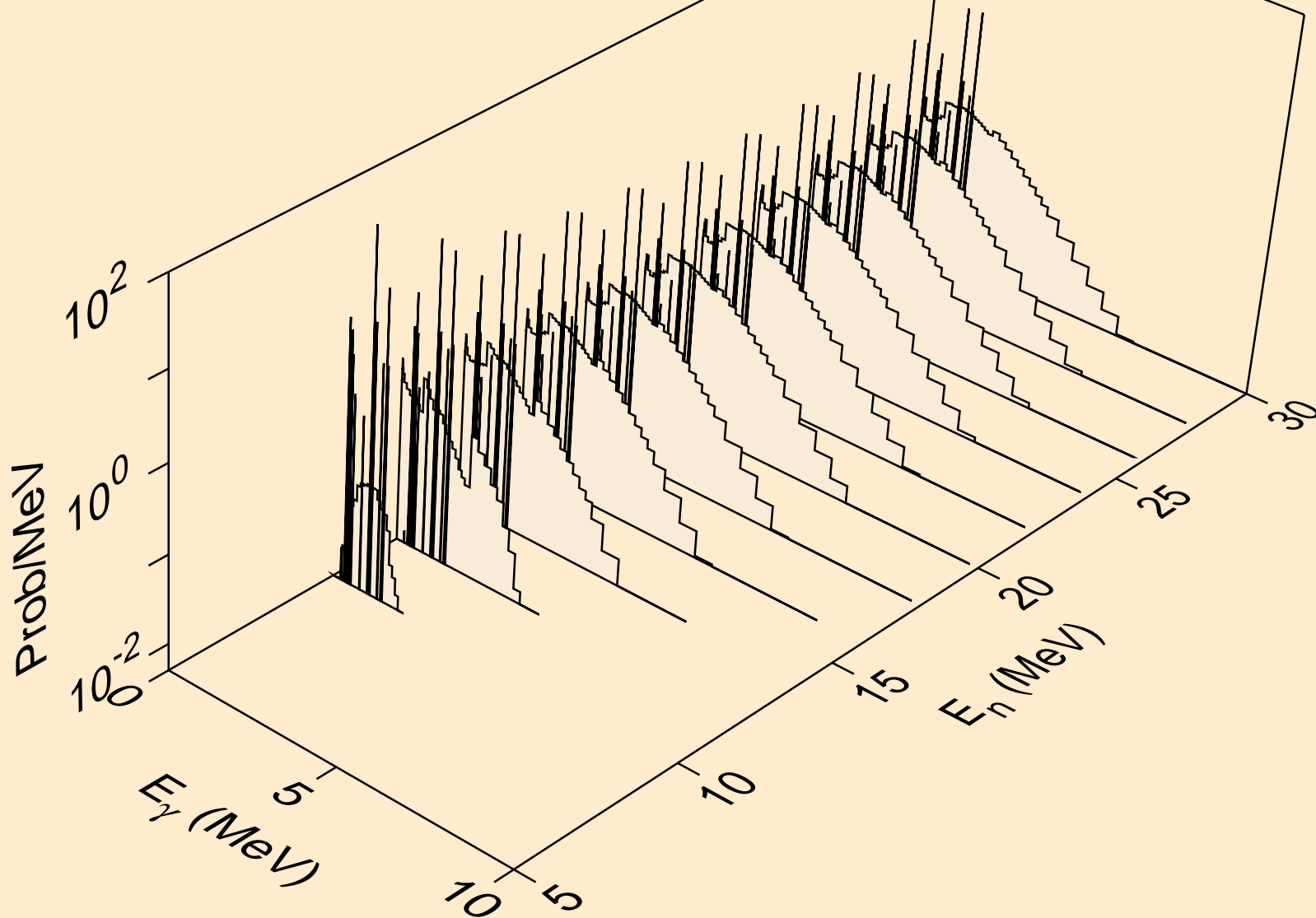



IN110 NEUTRON ACER TENDL-2019 LIBRARY; T=293.16K  
Photon emission for (n,3n)

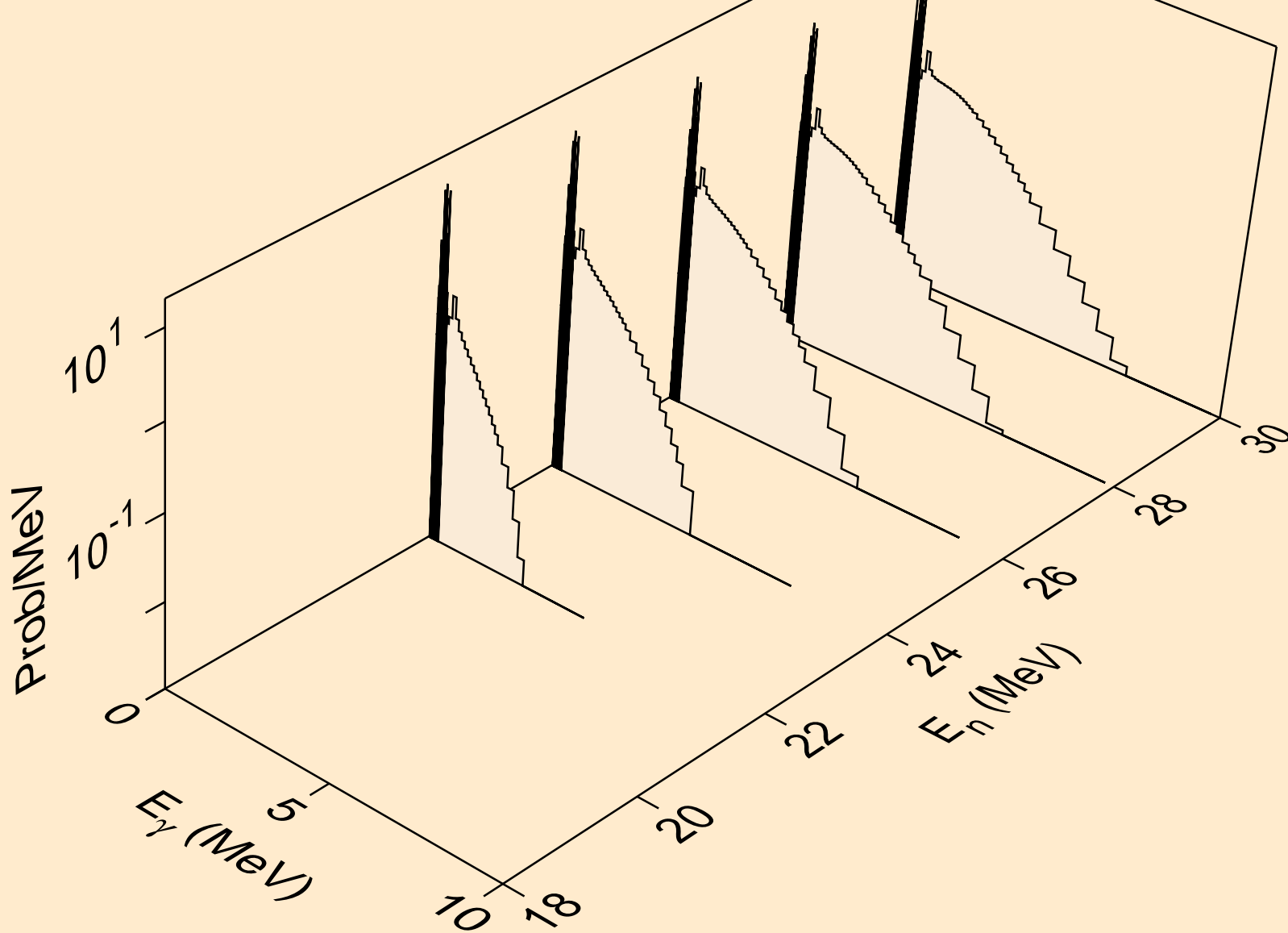

IN110 NEUTRON ACER TENDL-2019 LIBRARY; T=293.16K  
Photon emission for (n,n\*)a

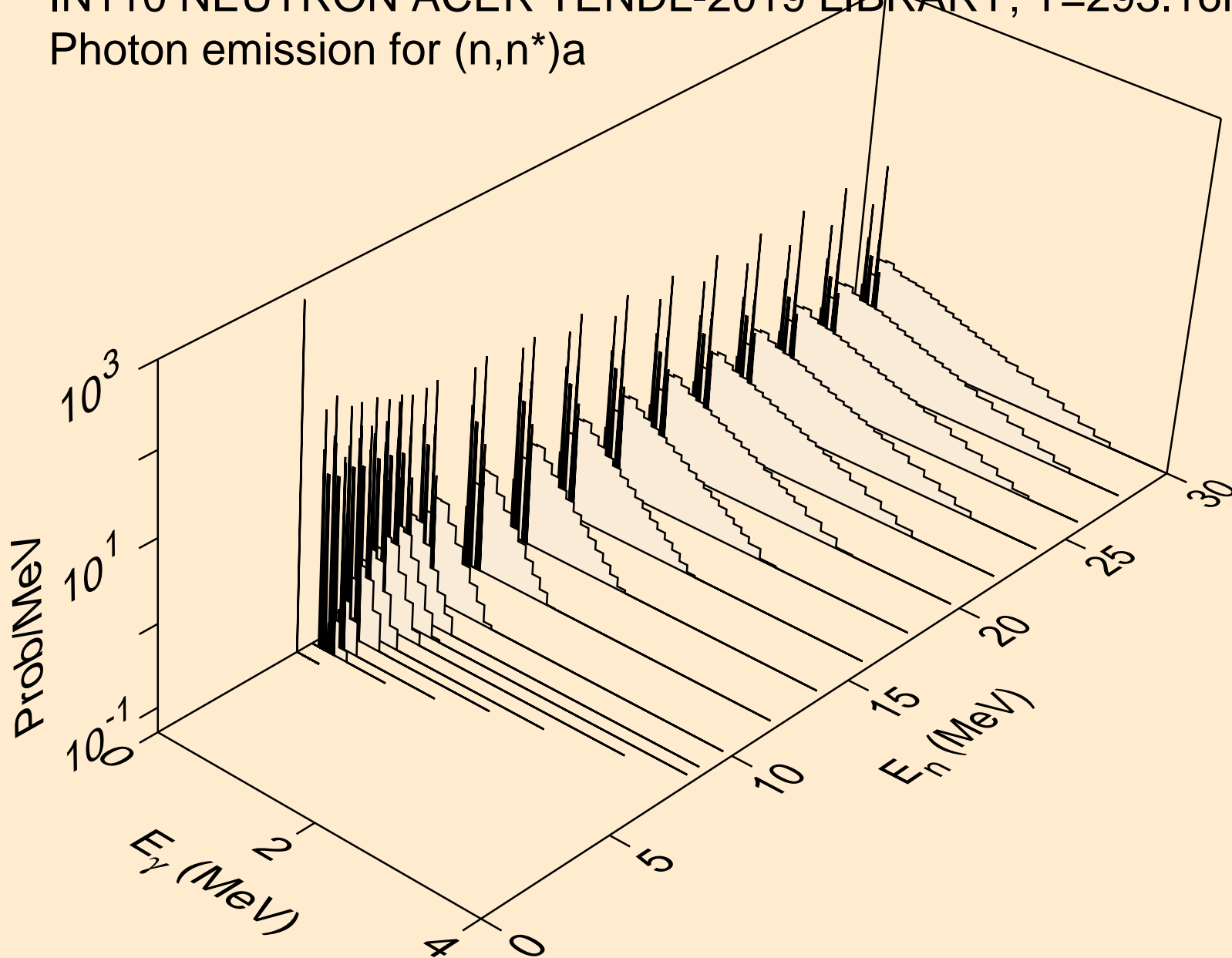

IN110 NEUTRON ACER TENDL-2019 LIBRARY; T=293.16K  
Photon emission for (n,2n)a

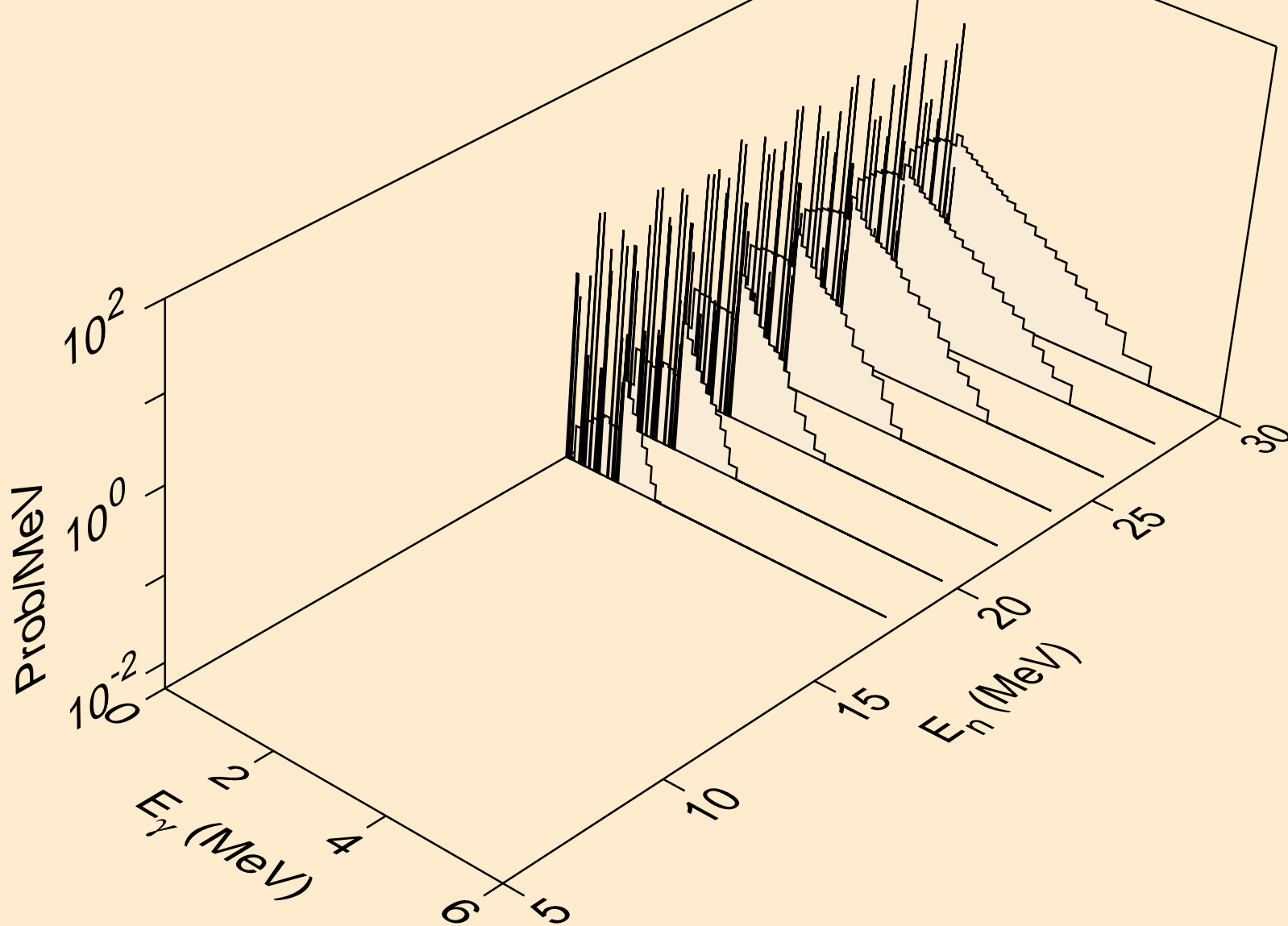

IN110 NEUTRON ACER TENDL-2019 LIBRARY; T=293.16K  
Photon emission for (n,3n)a

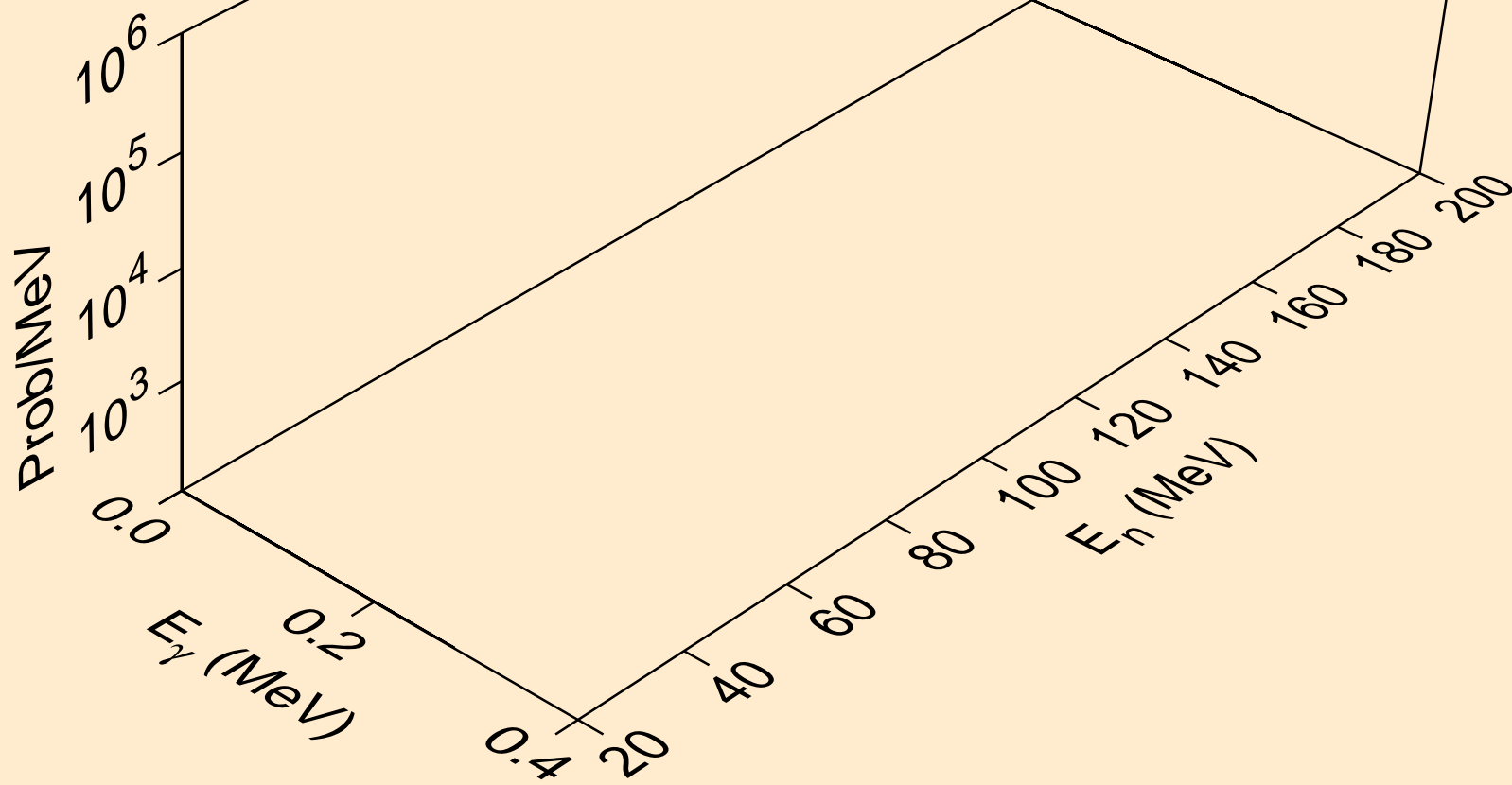

IN110 NEUTRON ACER TENDL-2019 LIBRARY; T=293.16K  
Photon emission for (n,n\*)p

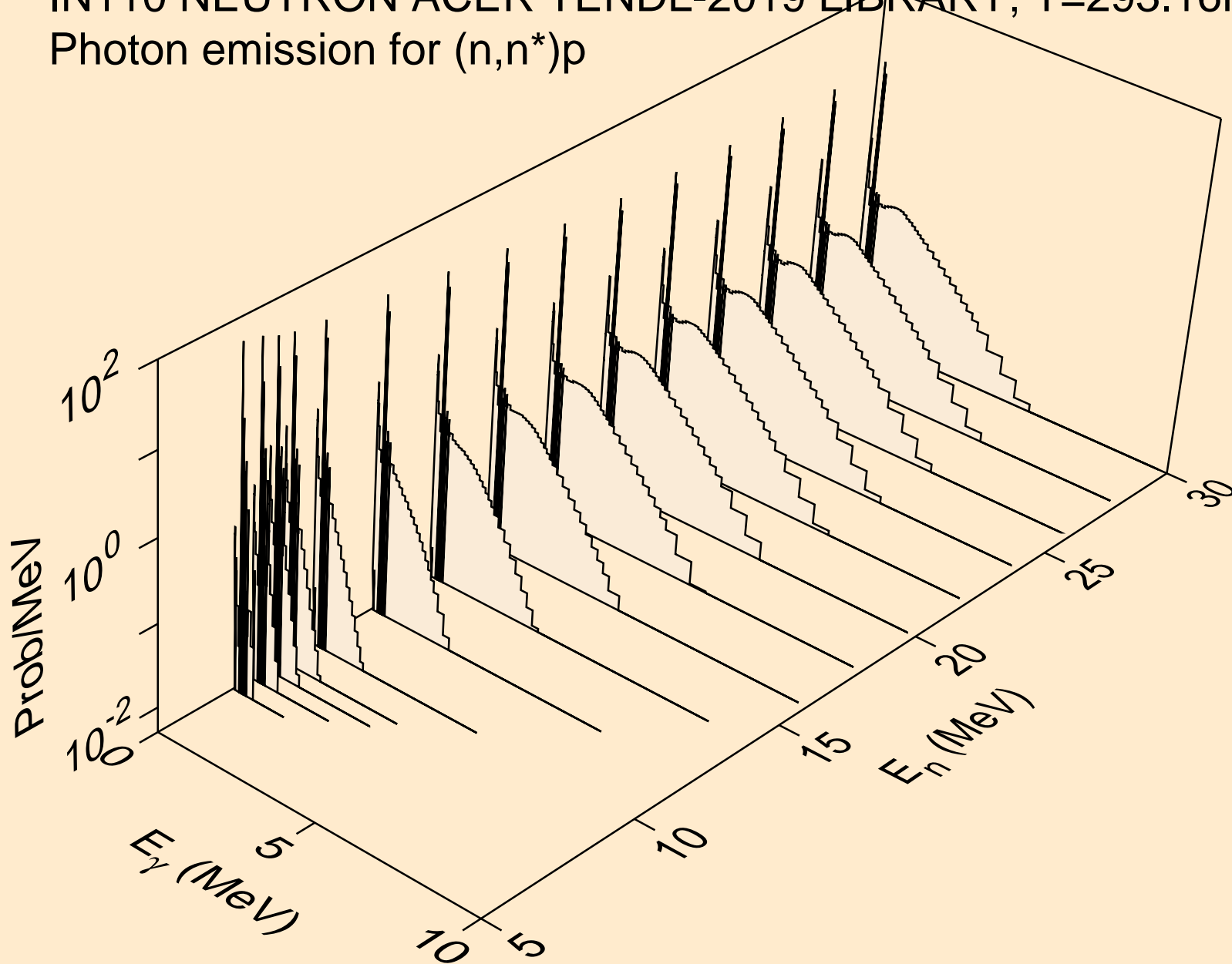

IN110 NEUTRON ACER TENDL-2019 LIBRARY; T=293.16K  
Photon emission for (n,n\*)2a

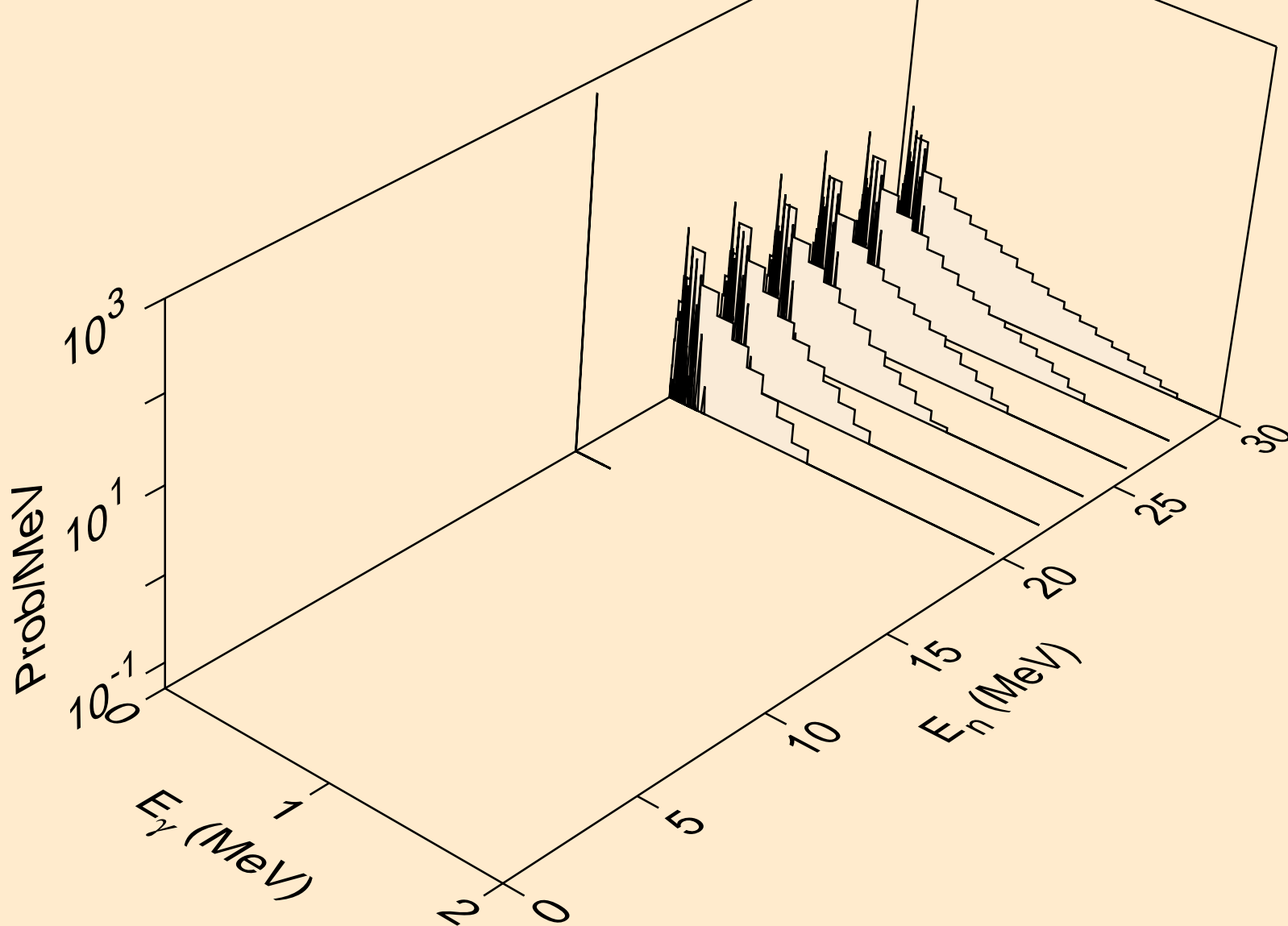

IN110 NEUTRON ACER TENDL-2019 LIBRARY; T=293.16K  
Photon emission for (n,2n)2a

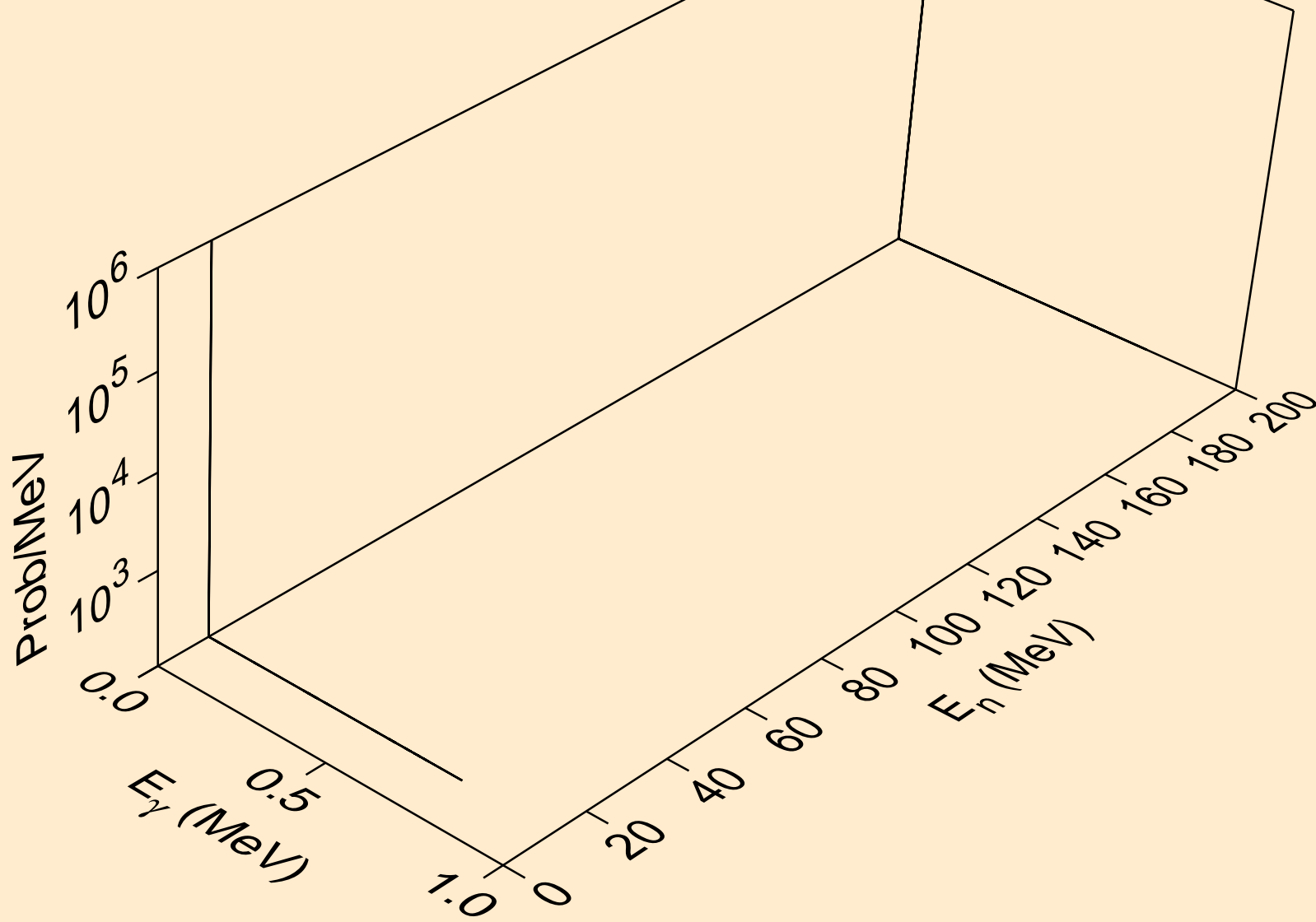

IN110 NEUTRON ACER TENDL-2019 LIBRARY; T=293.16K  
Photon emission for (n,n\*)d

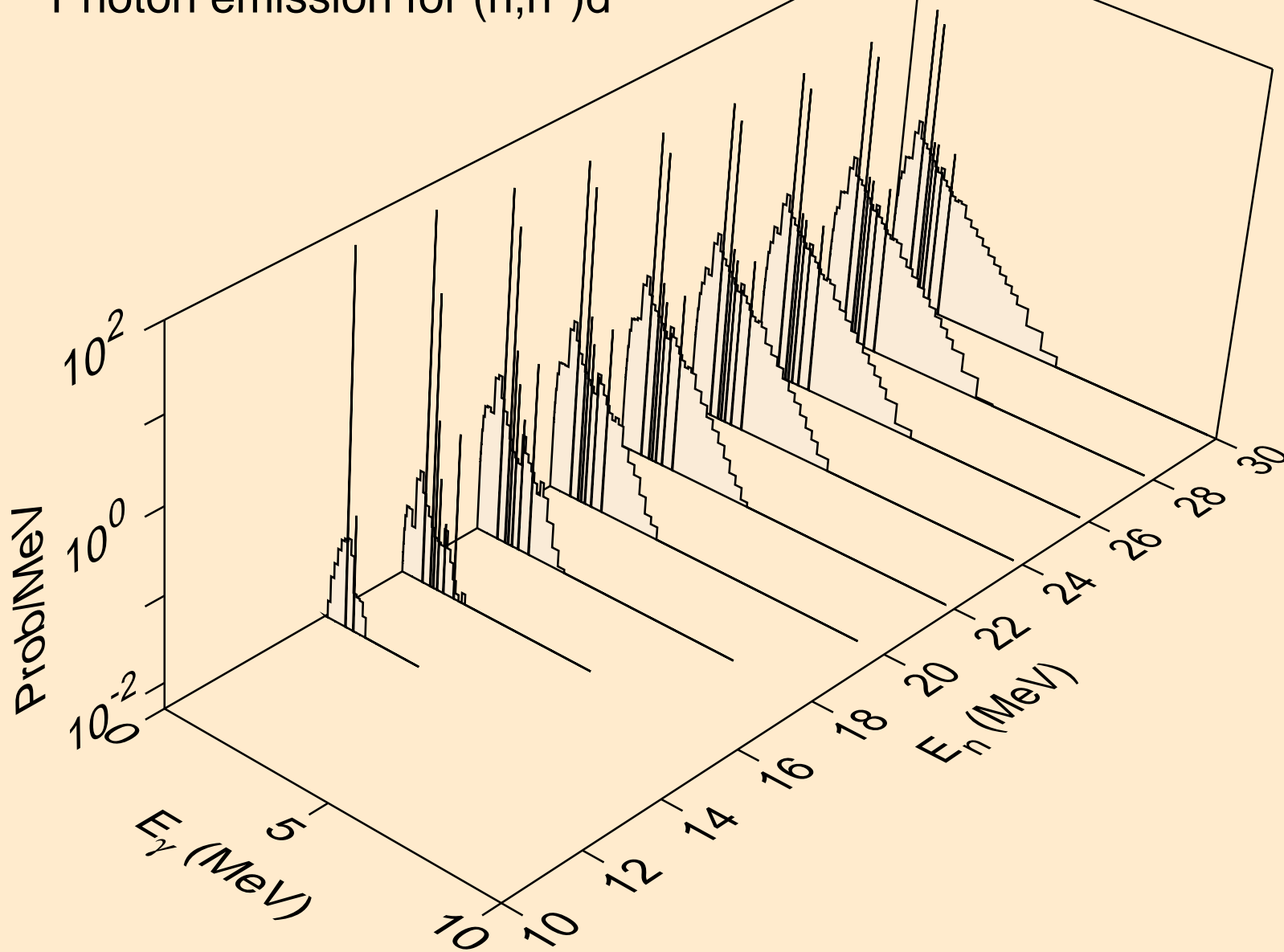



IN110 NEUTRON ACER TENDL-2019 LIBRARY; T=293.16K  
Photon emission for (n,n\*)t

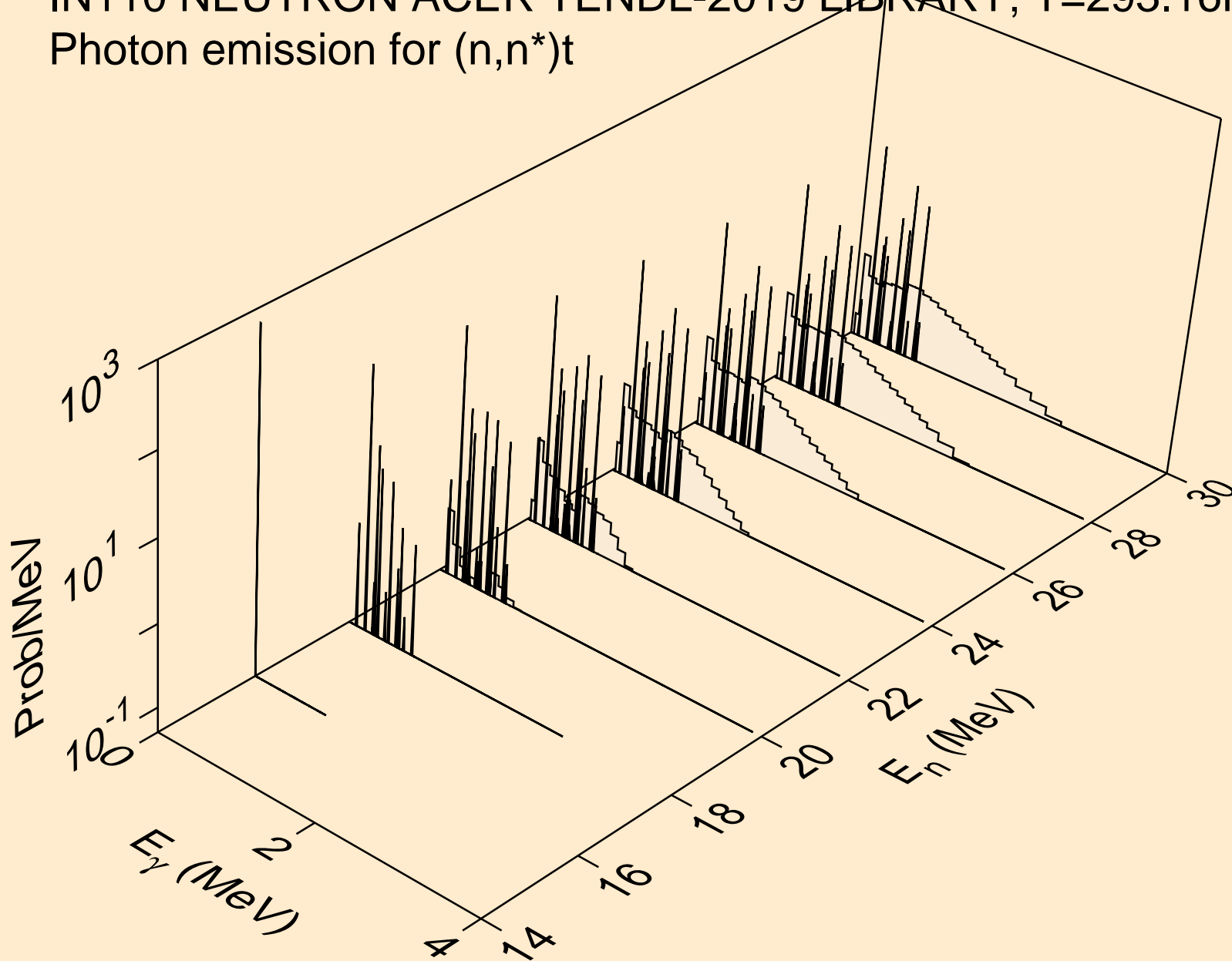

IN110 NEUTRON ACER TENDL-2019 LIBRARY; T=293.16K  
Photon emission for (n,n\*)he3

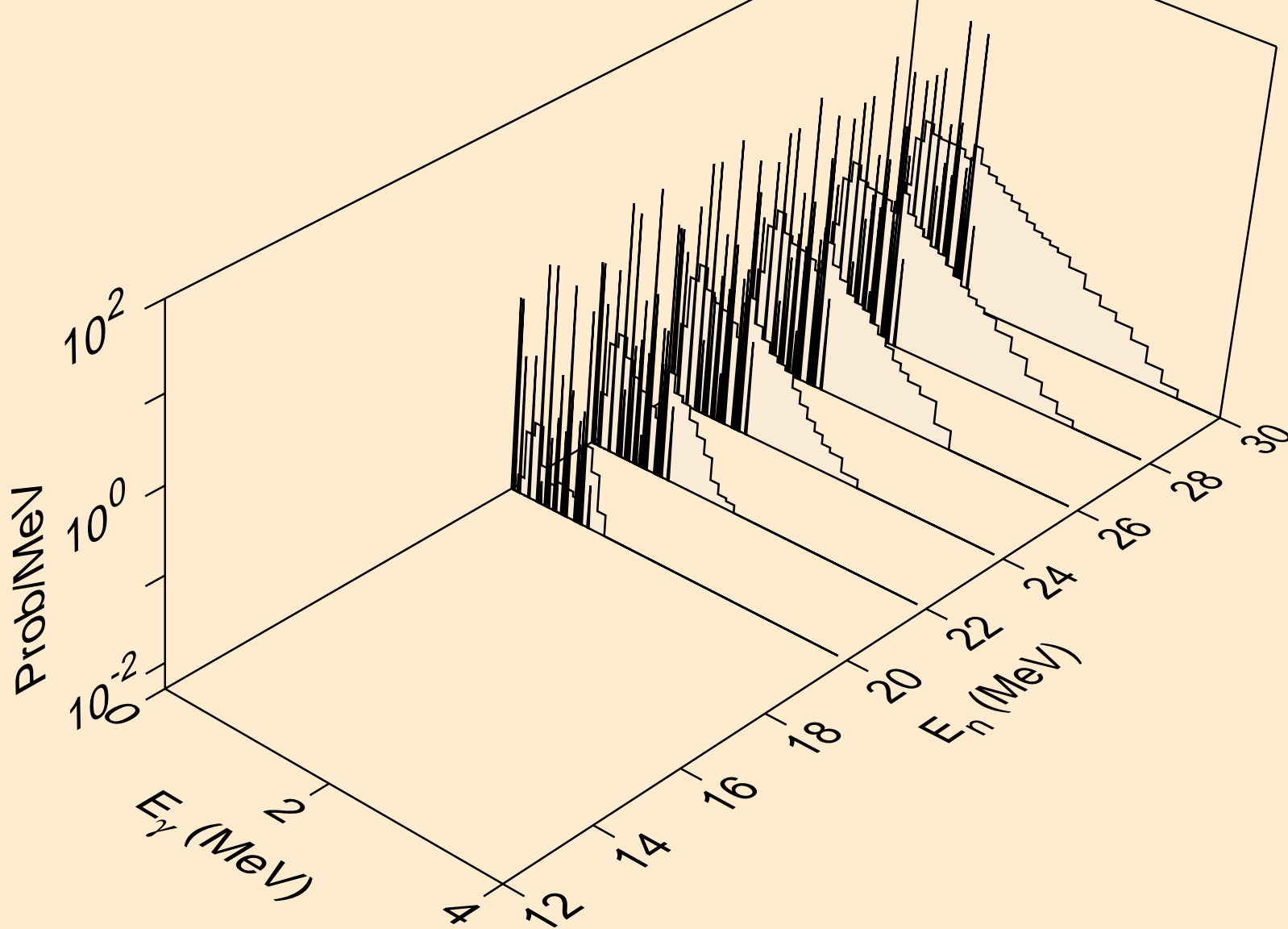

IN110 NEUTRON ACER TENDL-2019 LIBRARY; T=293.16K  
Photon emission for (n,4n)

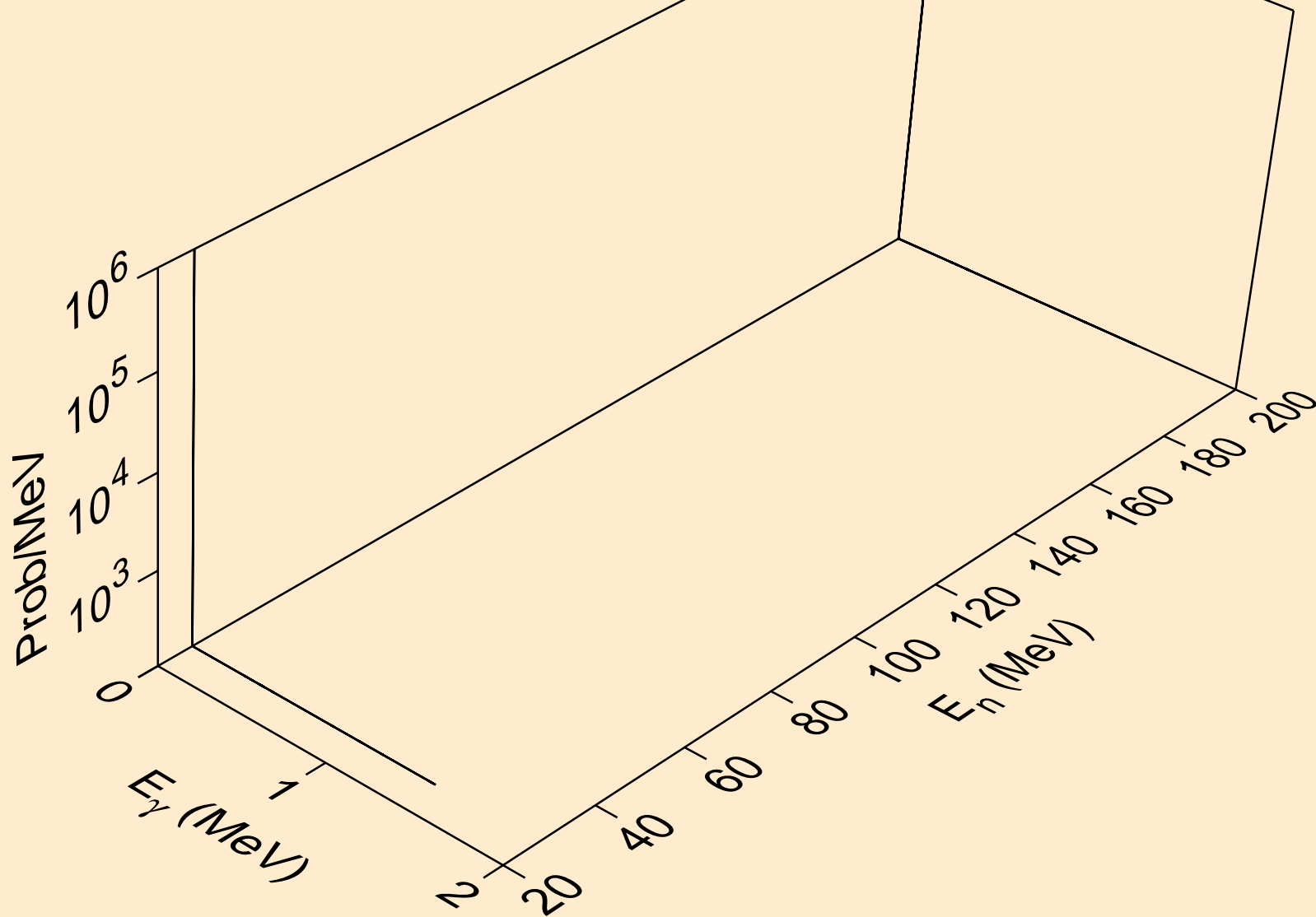

IN110 NEUTRON ACER TENDL-2019 LIBRARY; T=293.16K  
Photon emission for (n,2np)

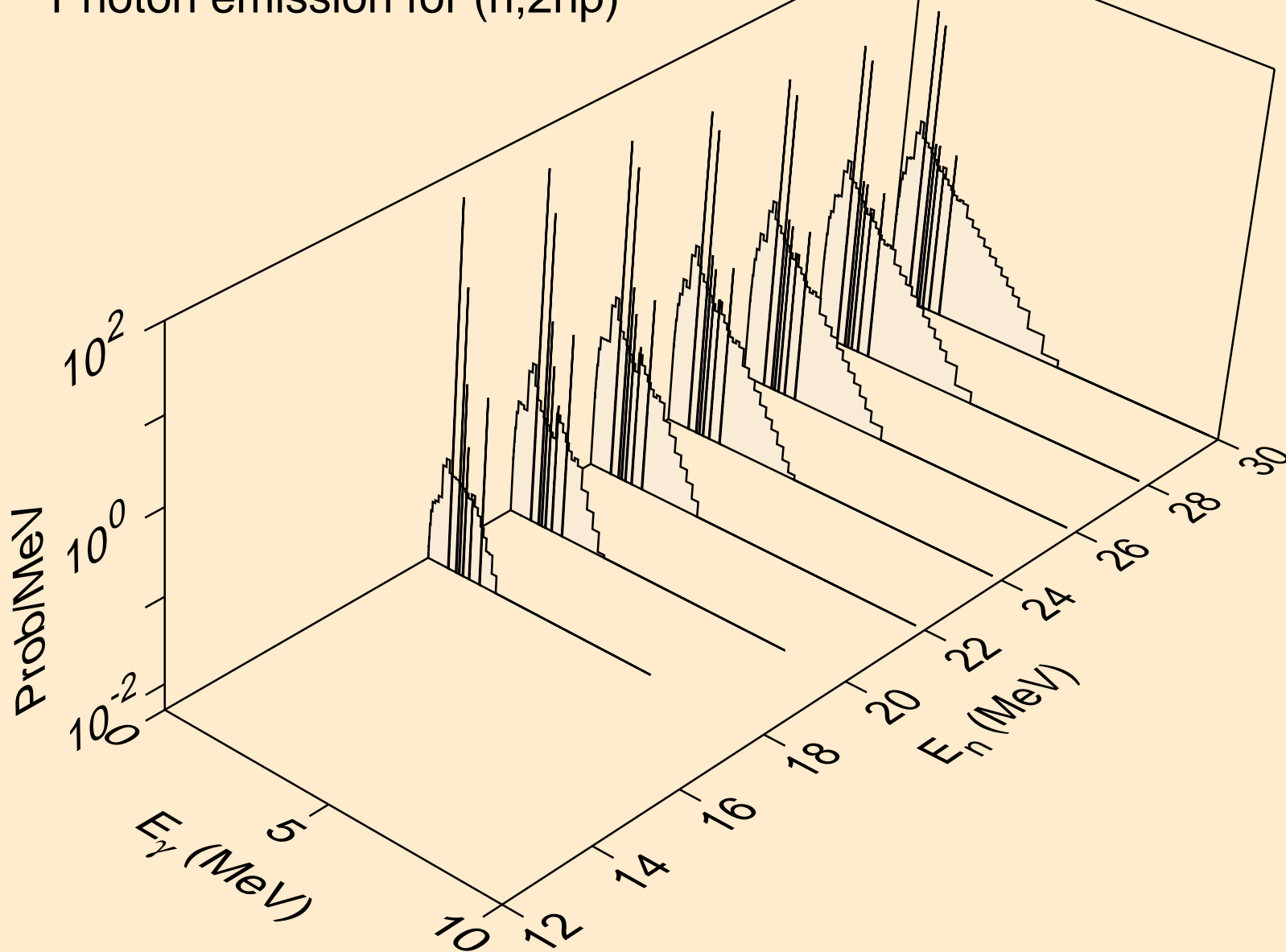

IN110 NEUTRON ACER TENDL-2019 LIBRARY; T=293.16K  
Photon emission for (n,3np)

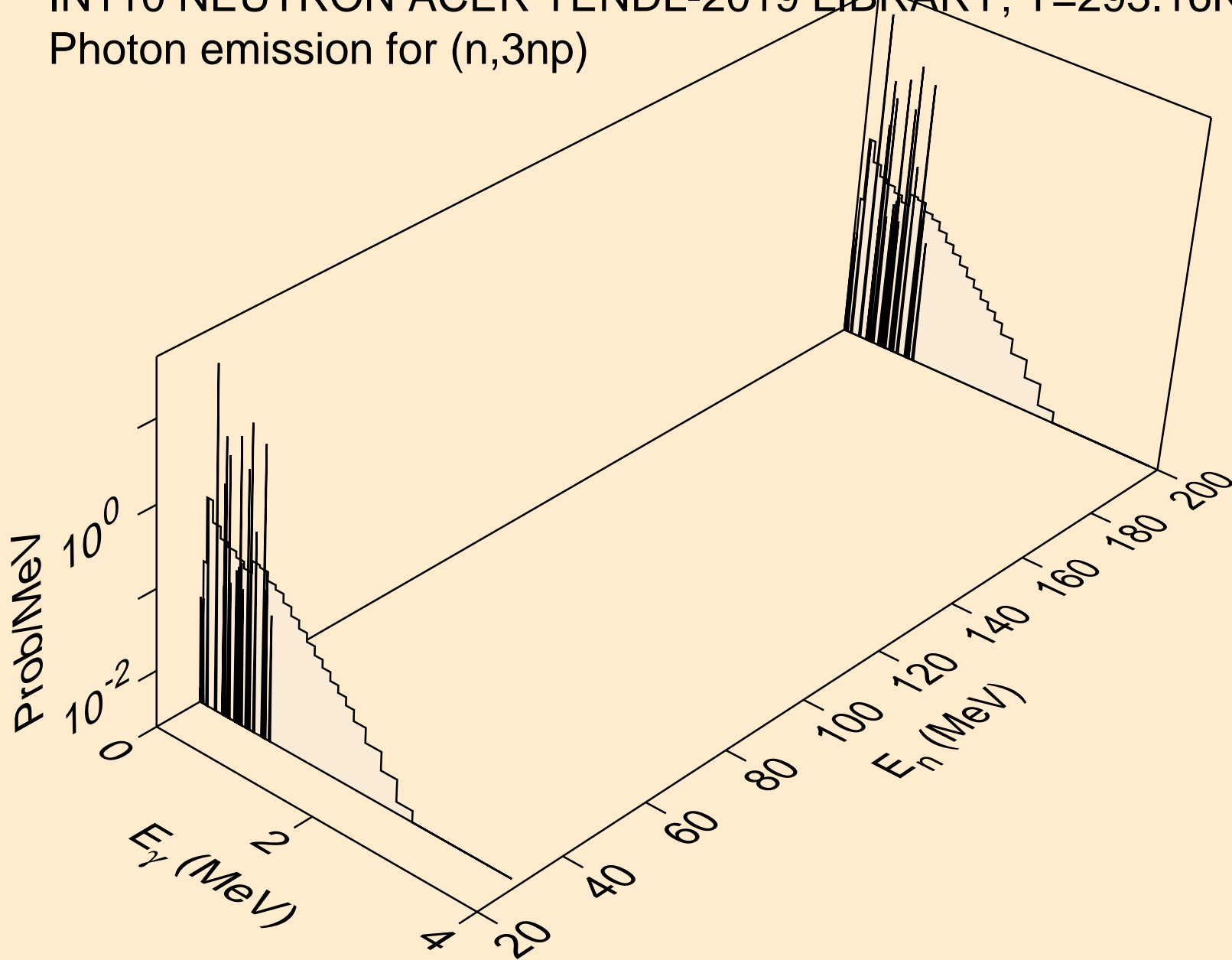

IN110 NEUTRON ACER TENDL-2019 LIBRARY; T=293.16K  
Photon emission for (n,2np)

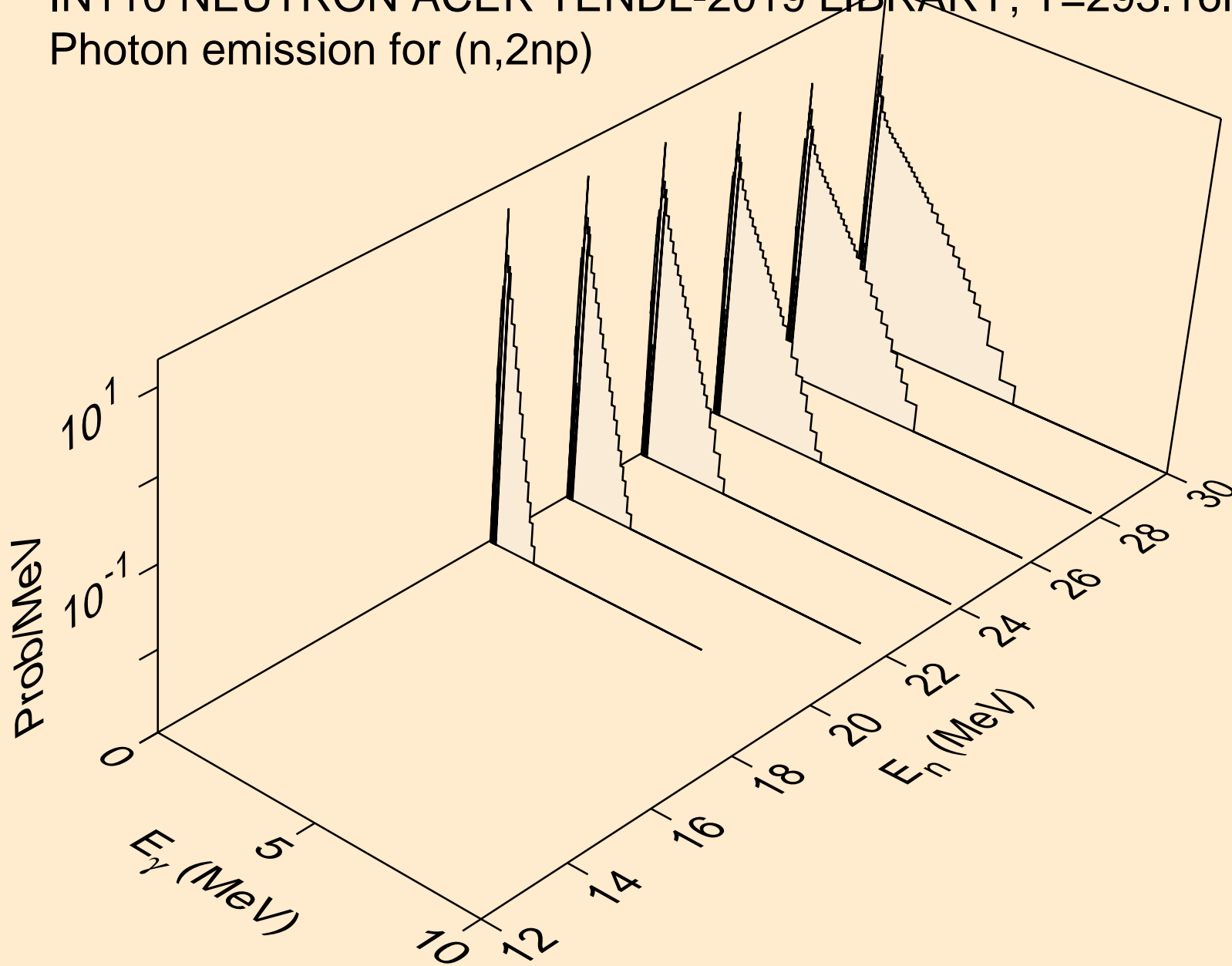

IN110 NEUTRON ACER TENDL-2019 LIBRARY; T=293.16K  
Photon emission for (n,npa)

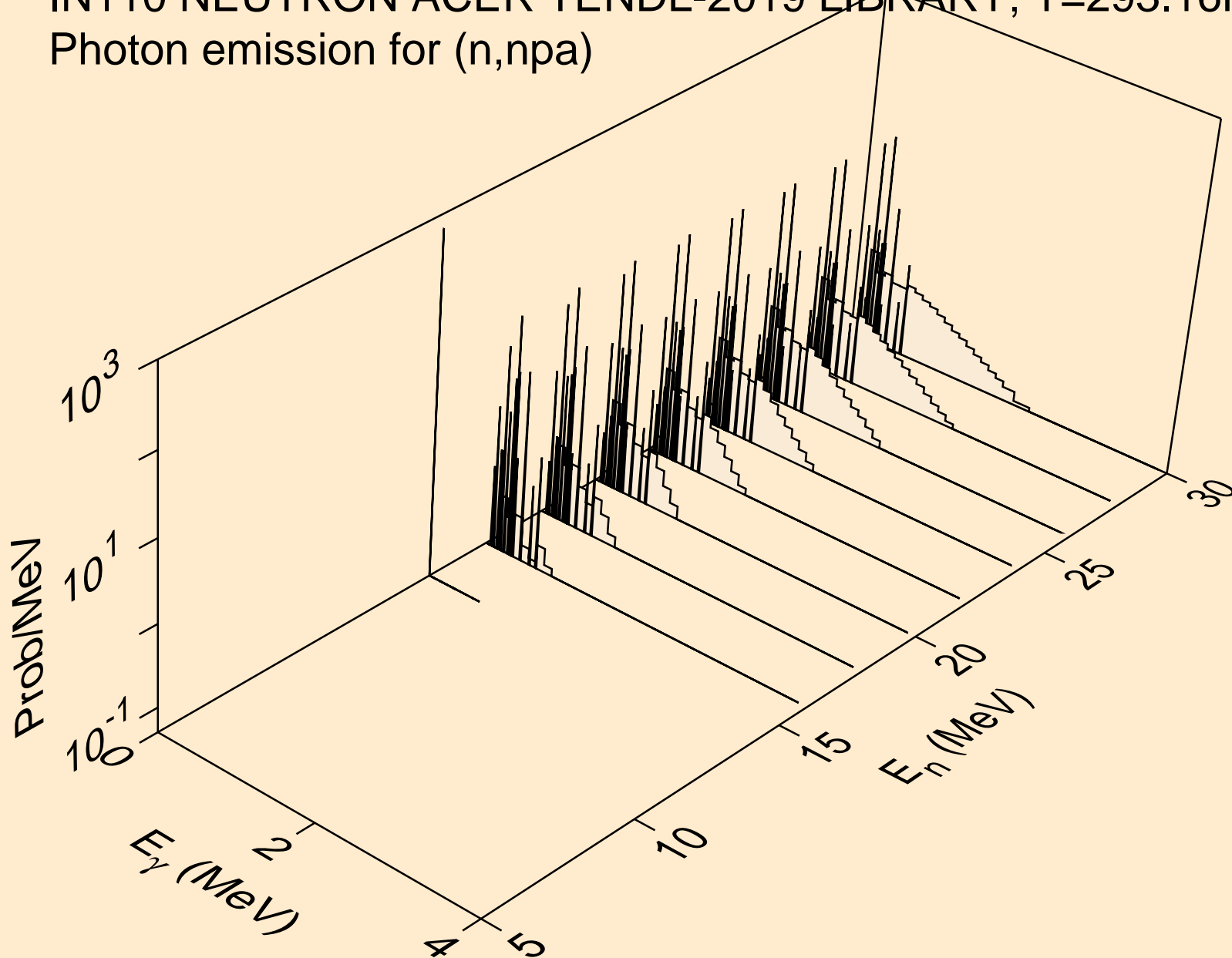

IN110 NEUTRON ACER TENDL-2019 LIBRARY; T=293.16K  
Photon emission for (n,n\*c)

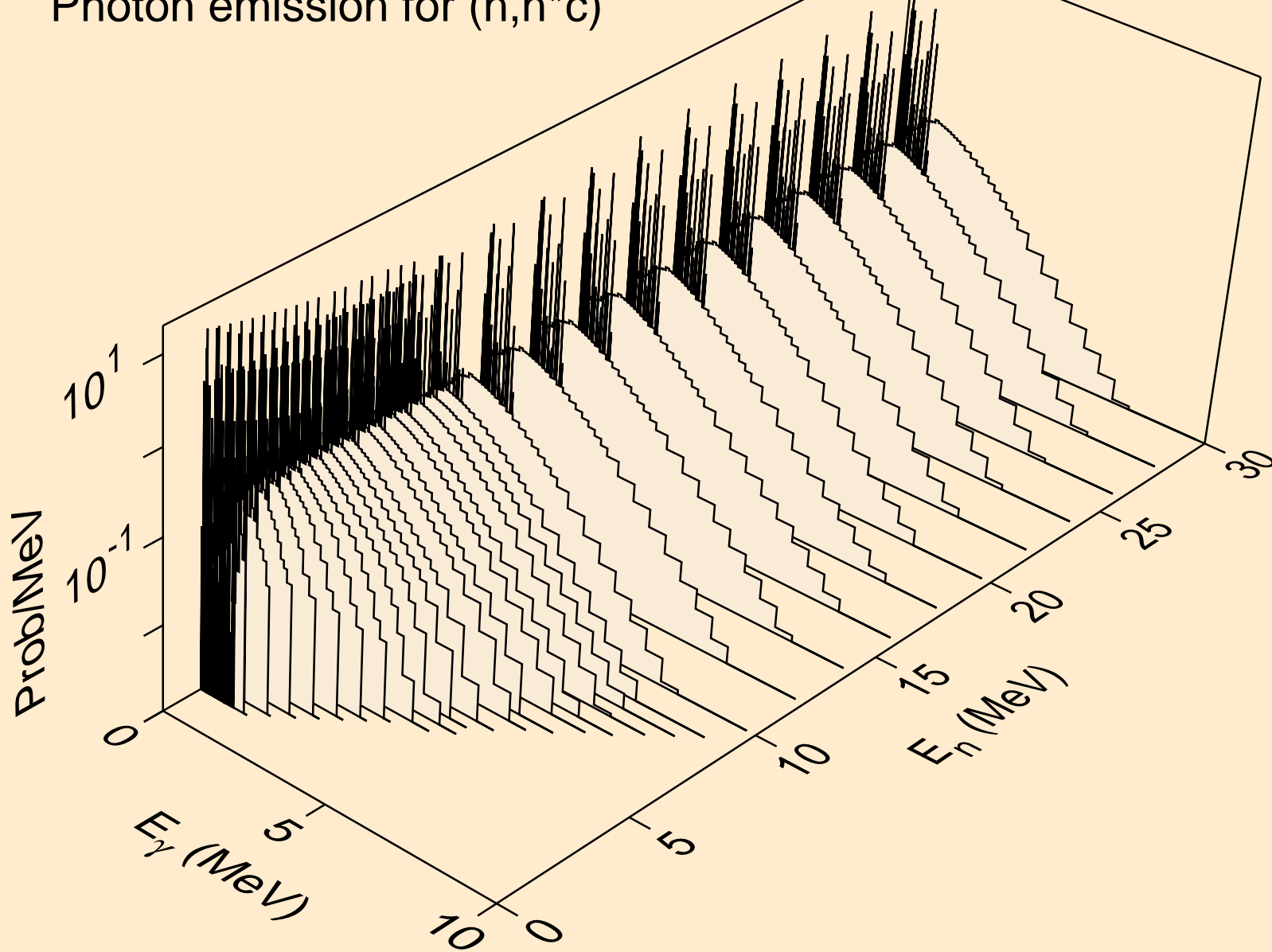



IN110 NEUTRON ACER TENDL-2019 LIBRARY; T=293.16K  
Photon emission for (n,gma)

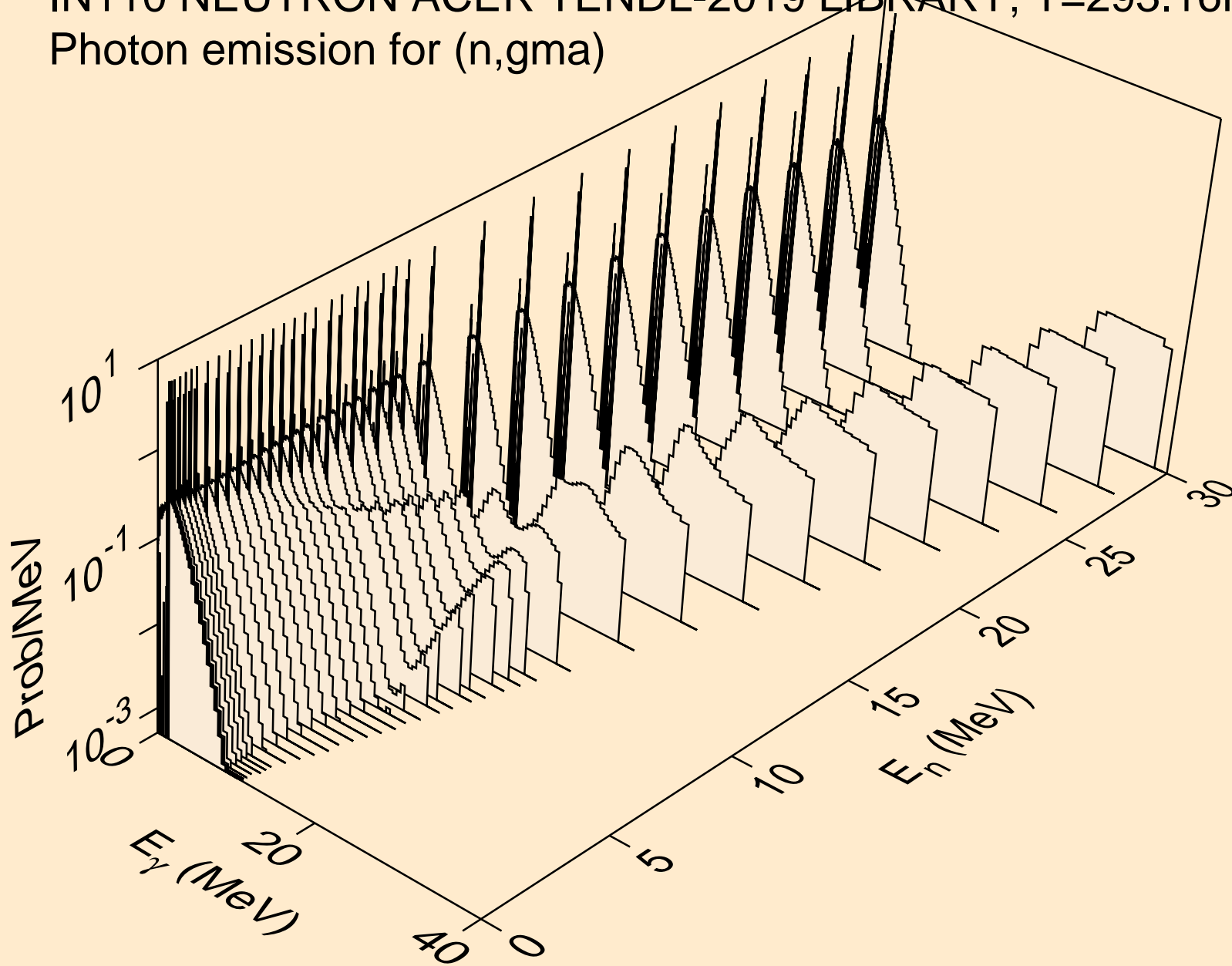

IN110 NEUTRON ACER TENDL-2019 LIBRARY; T=293.16K  
Photon emission for (n,p)

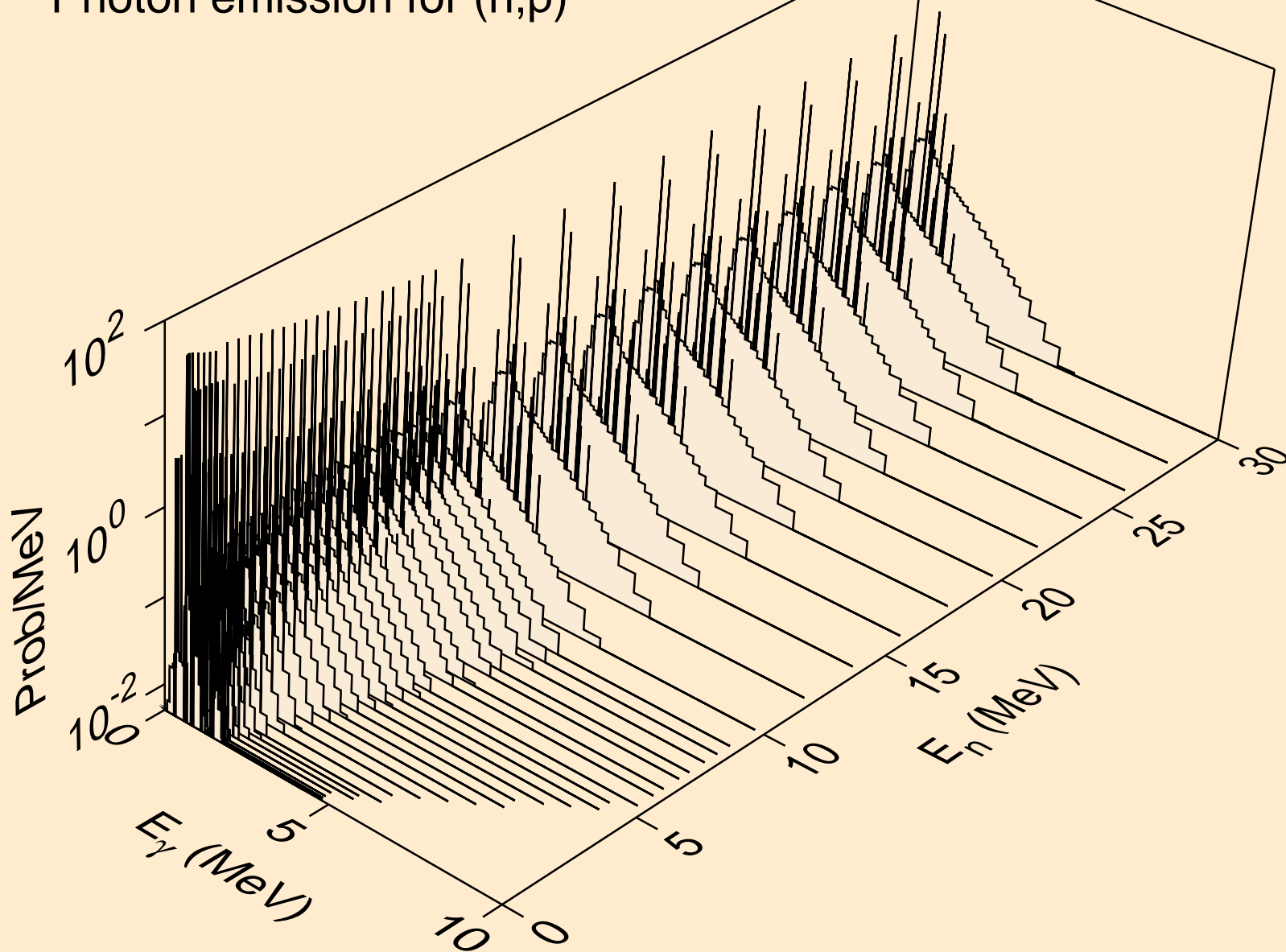

IN110 NEUTRON ACER TENDL-2019 LIBRARY; T=293.16K  
Photon emission for (n,d)

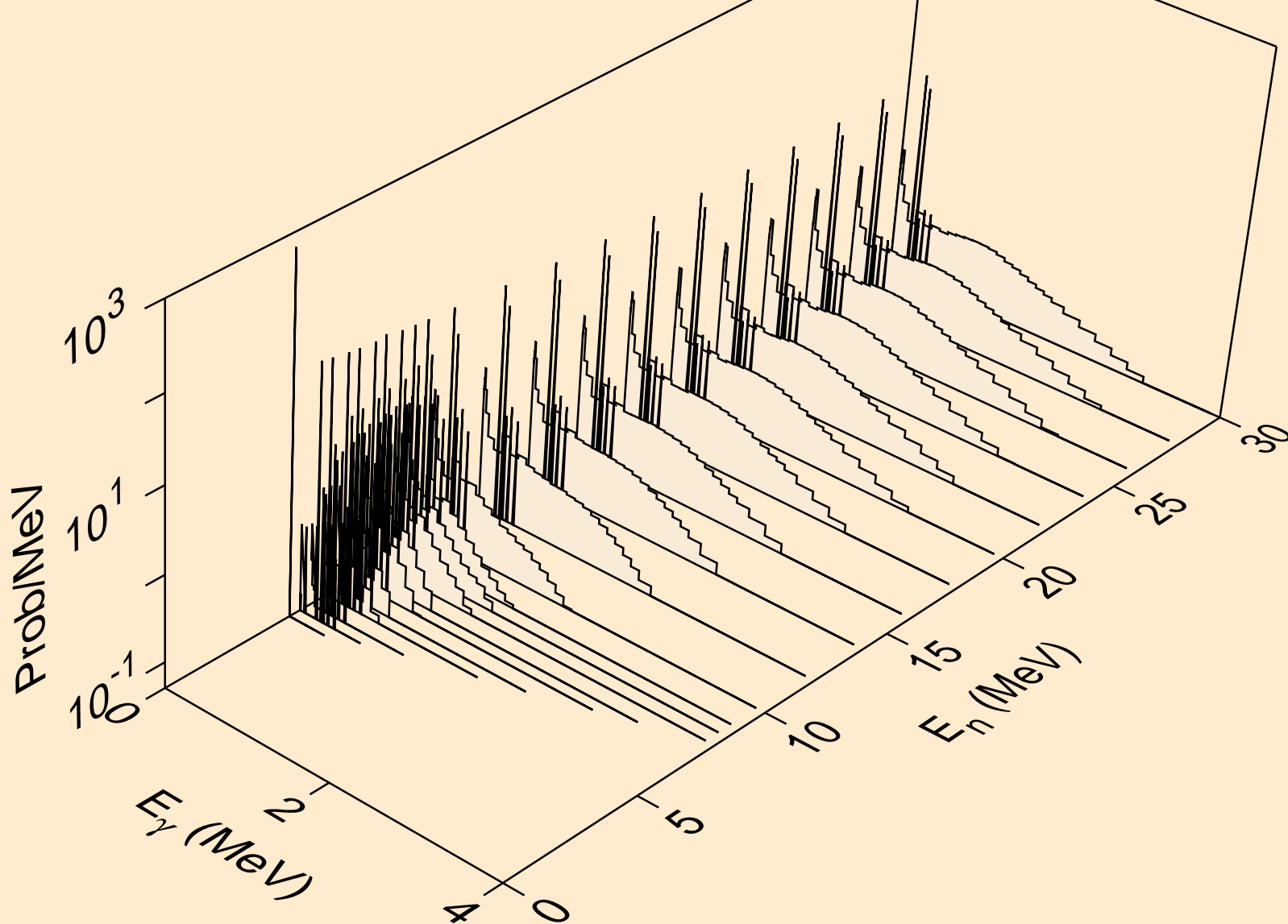

IN110 NEUTRON ACER TENDL-2019 LIBRARY; T=293.16K  
Photon emission for (n,t)

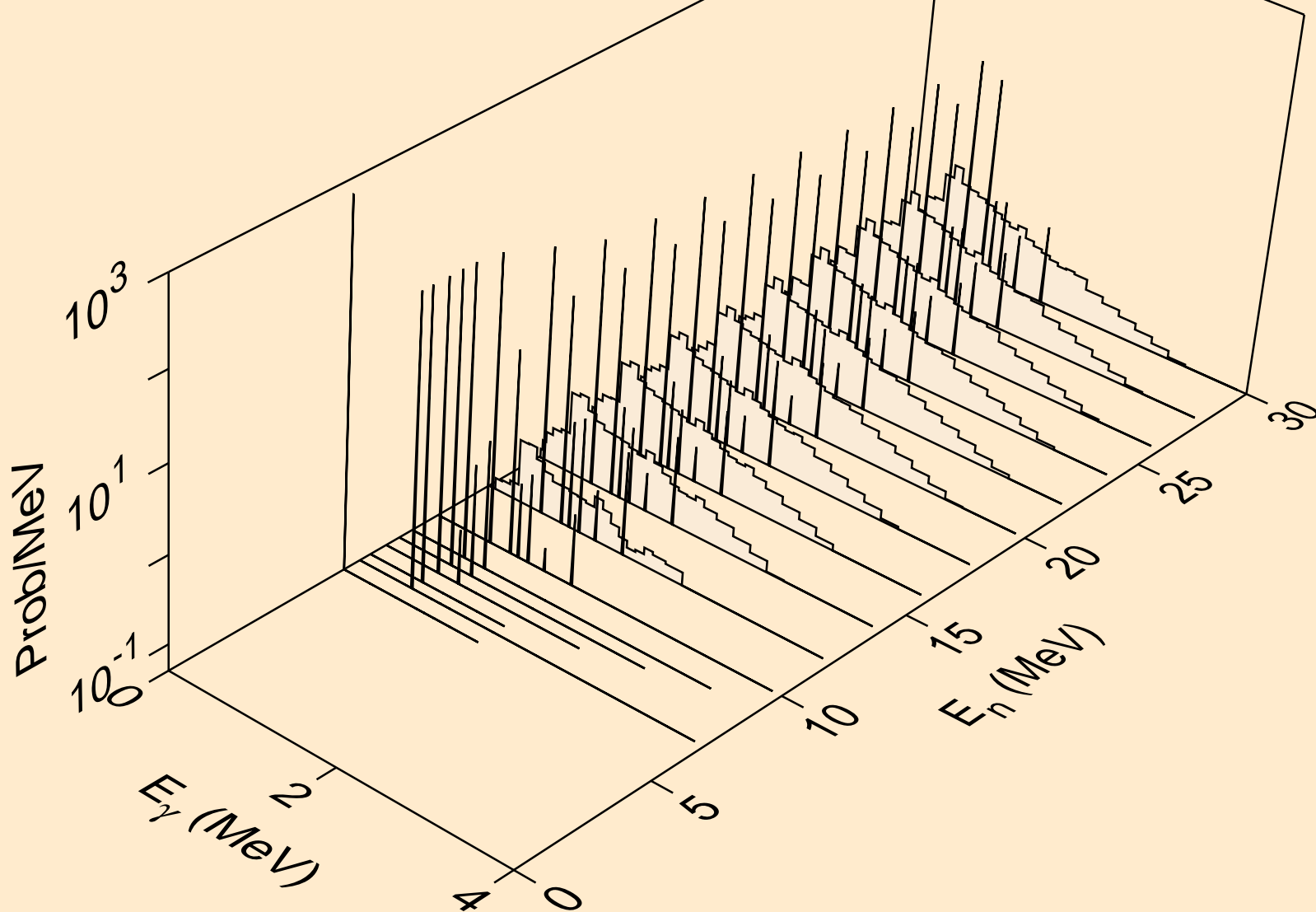

IN110 NEUTRON ACER TENDL-2019 LIBRARY; T=293.16K  
Photon emission for (n,he3)

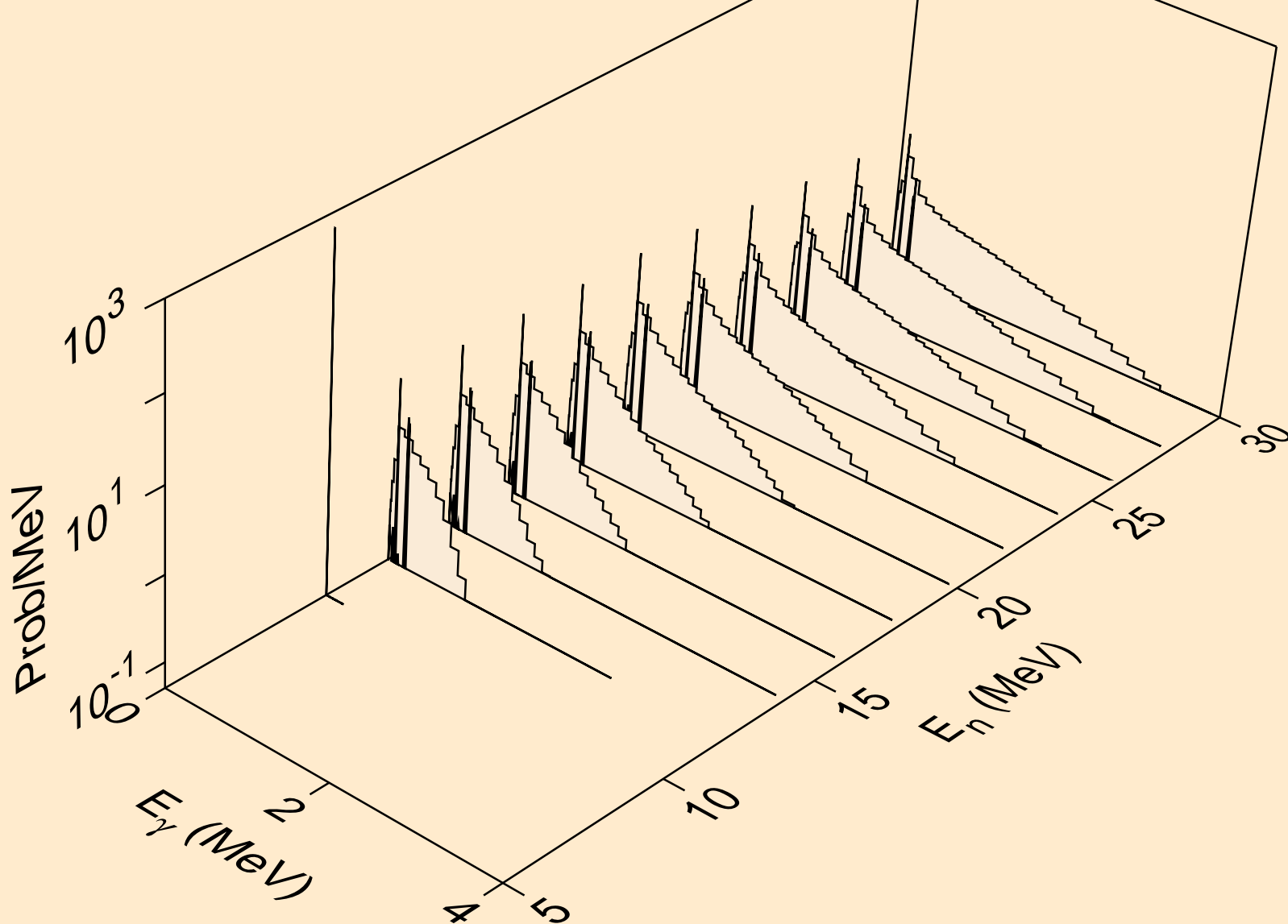

IN110 NEUTRON ACER TENDL-2019 LIBRARY; T=293.16K  
Photon emission for (n,a)

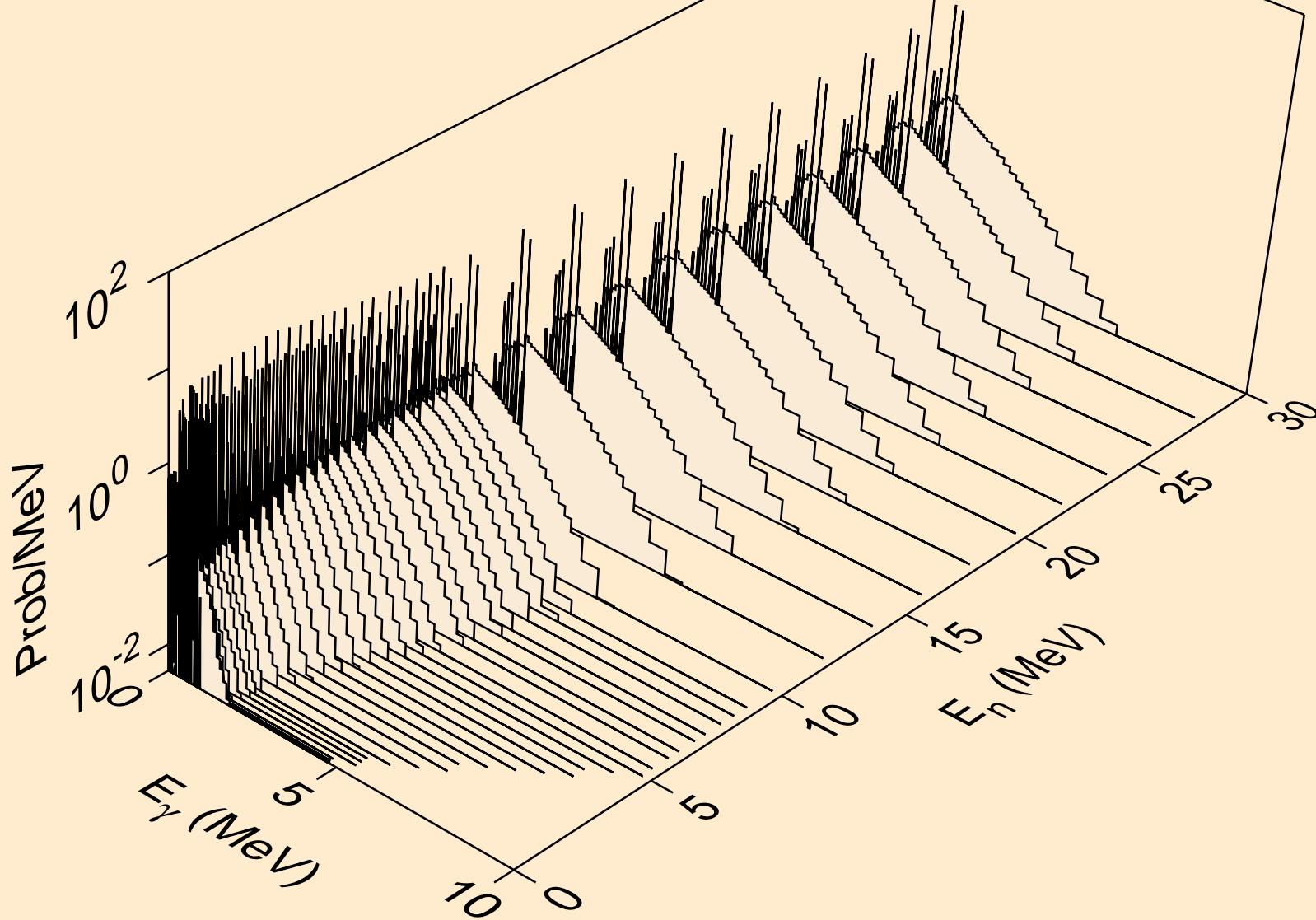

IN110 NEUTRON ACER TENDL-2019 LIBRARY; T=293.16K  
Photon emission for (n,2a)

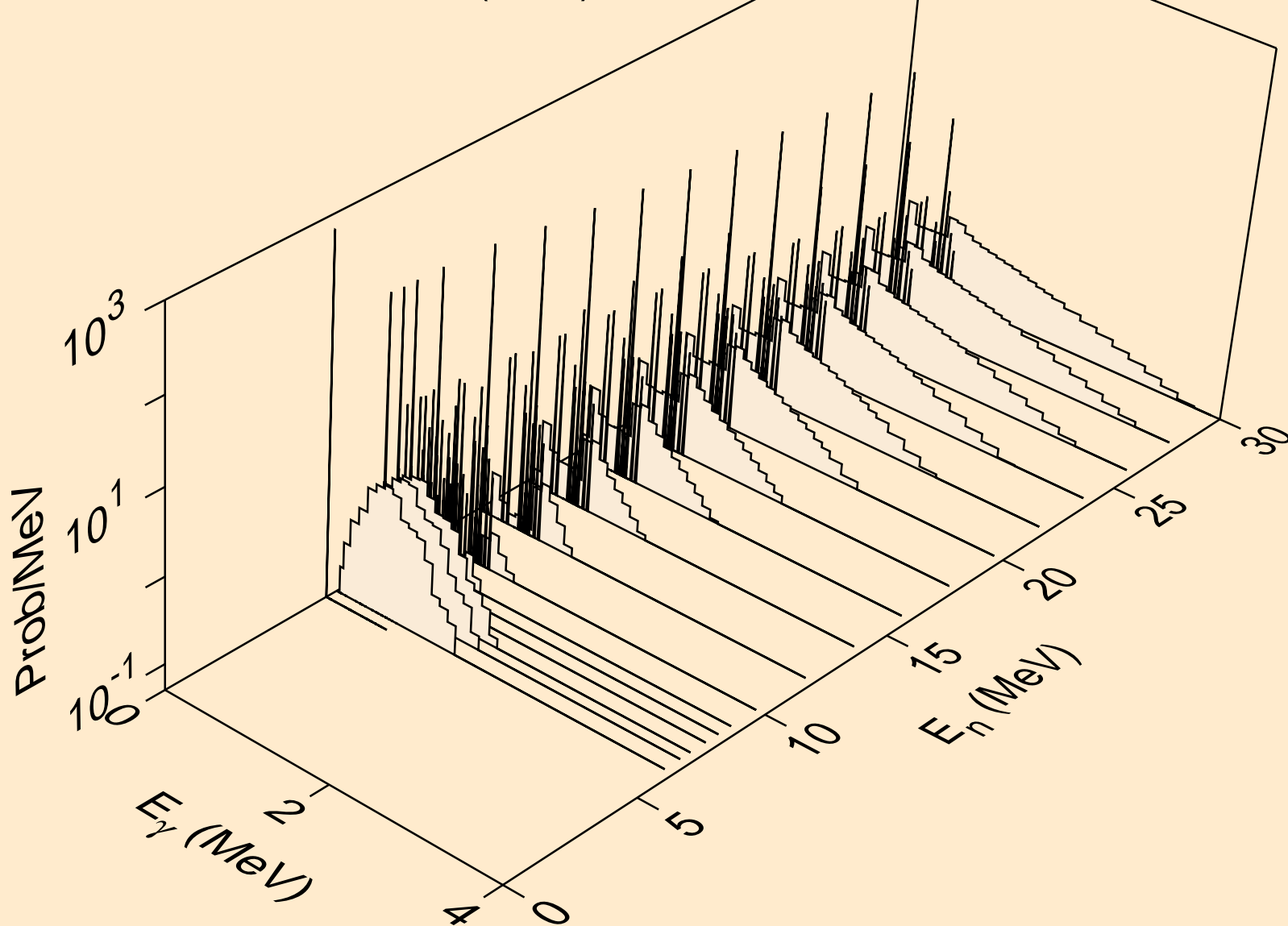

IN110 NEUTRON ACER TENDL-2019 LIBRARY; T=293.16K  
Photon emission for (n,2p)

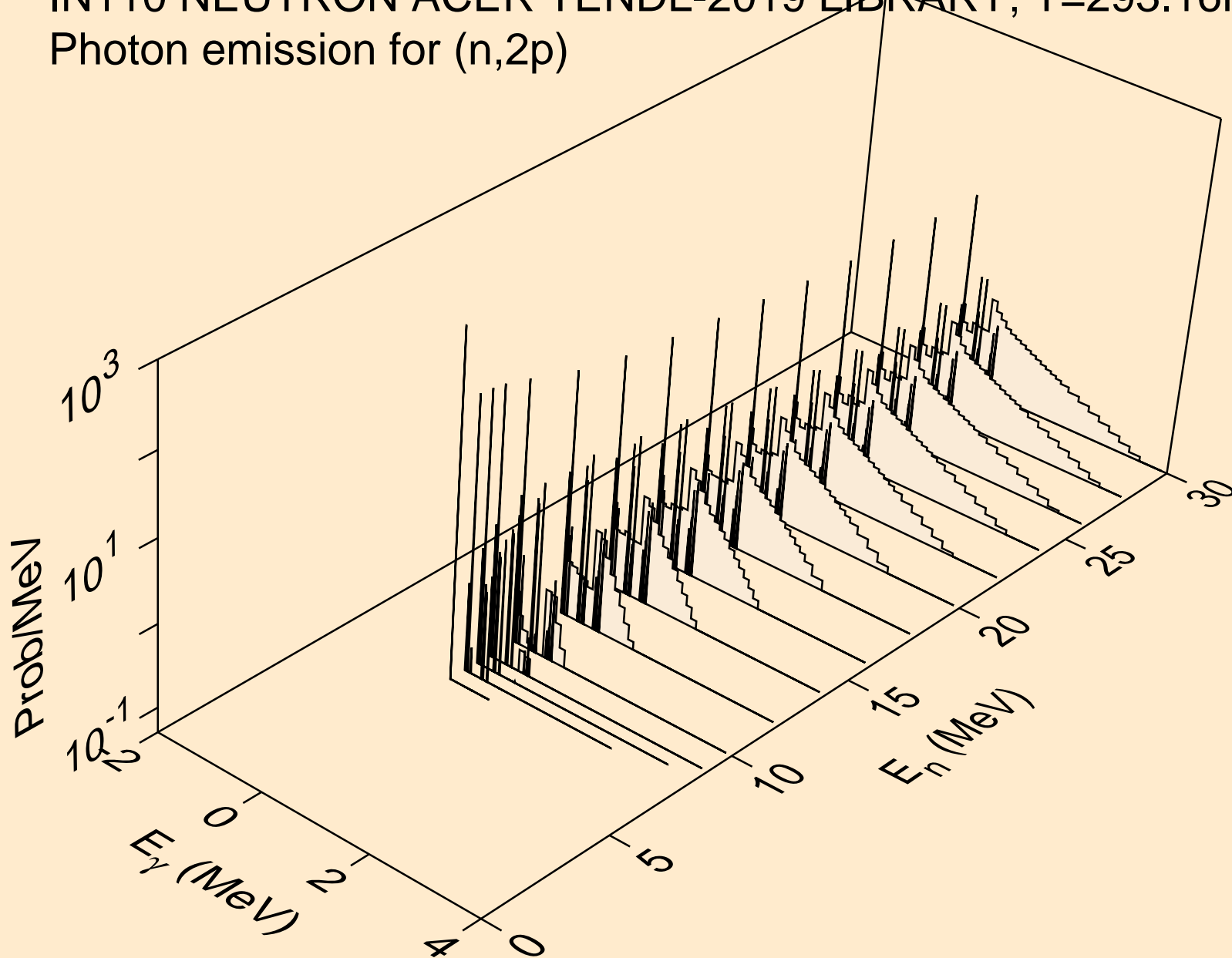



IN110 NEUTRON ACER TENDL-2019 LIBRARY; T=293.16K  
Photon emission for (n,p $\alpha$ )

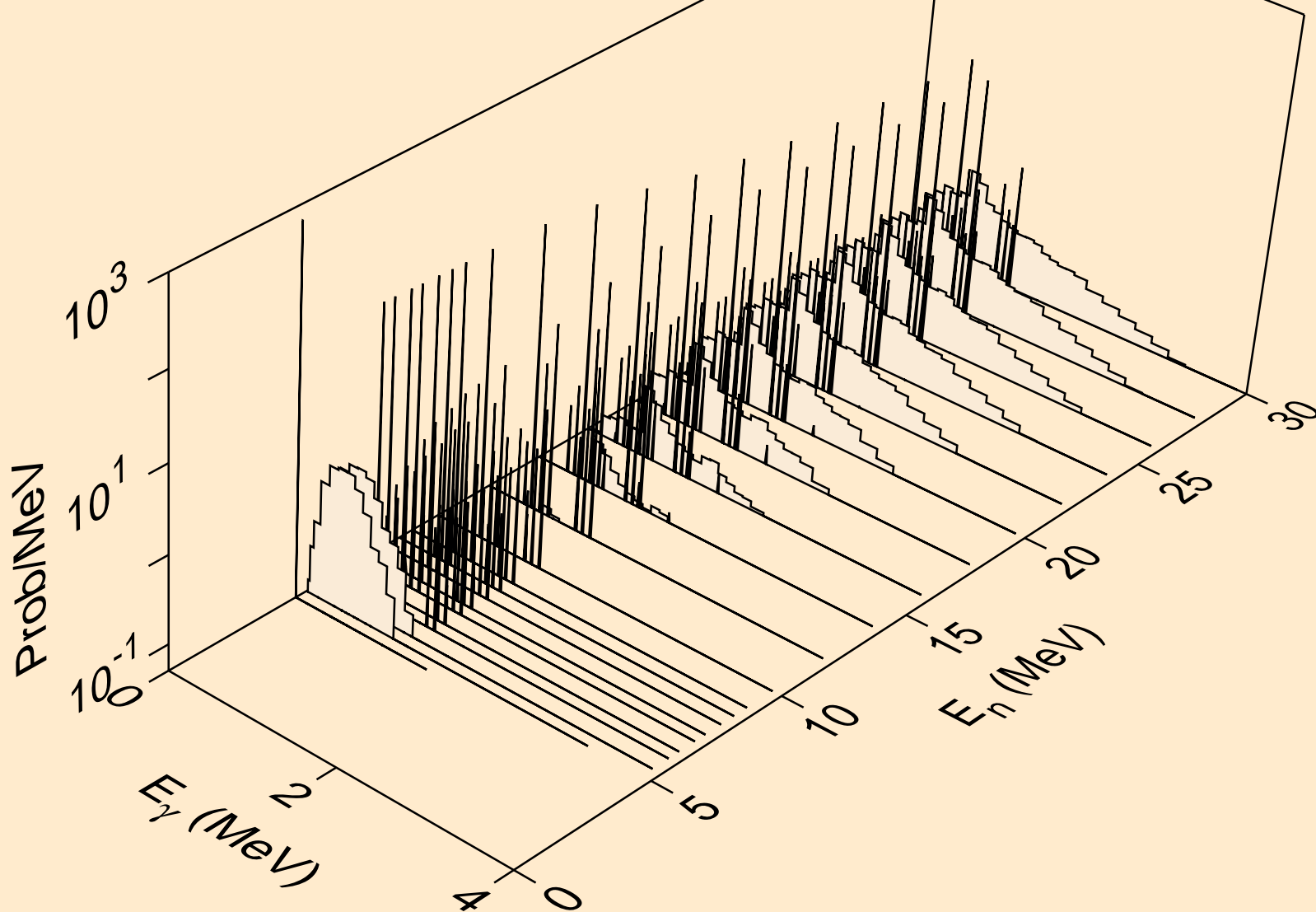

IN110 NEUTRON ACER TENDL-2019 LIBRARY; T=293.16K  
Photon emission for (n,pd)

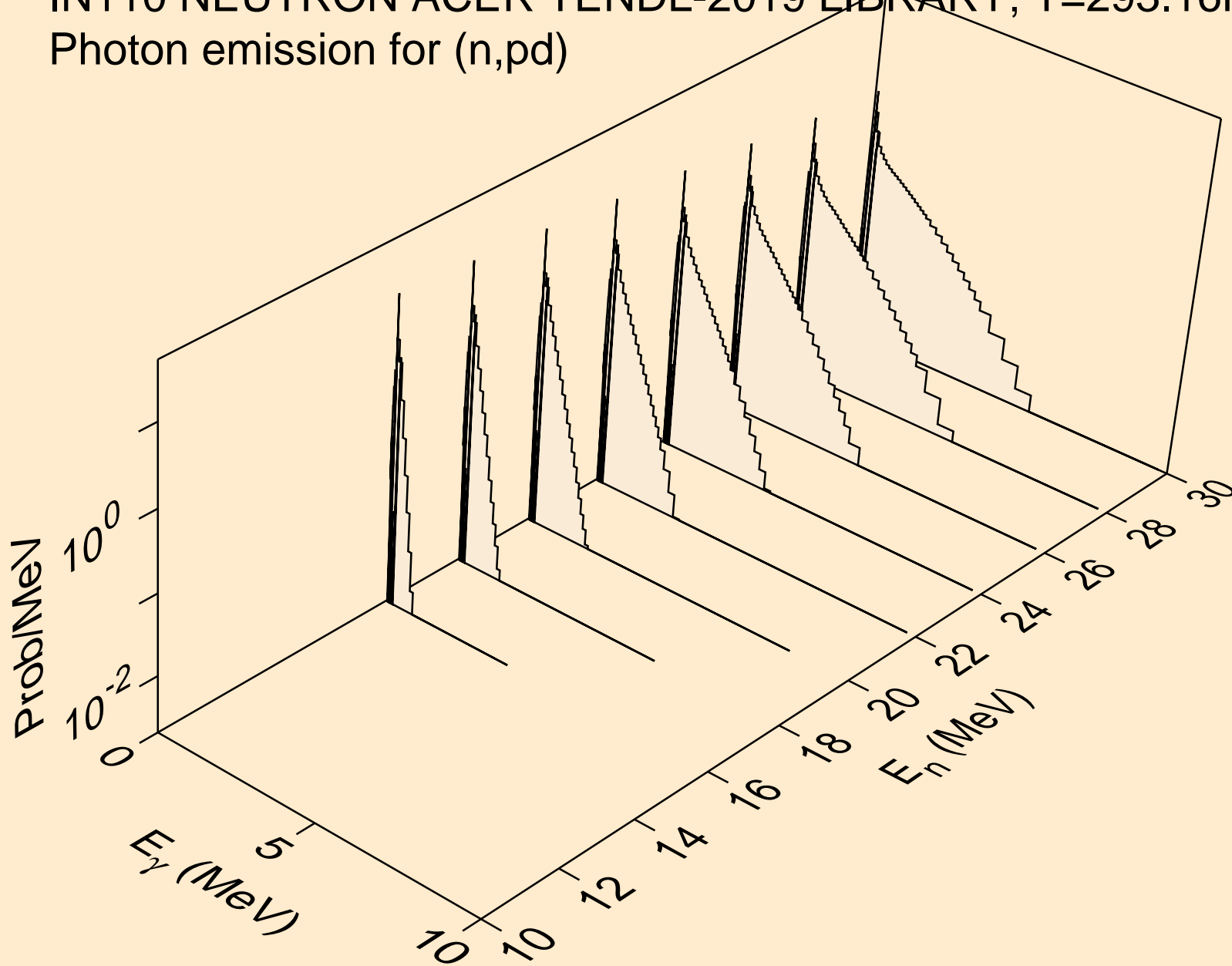

IN110 NEUTRON ACER TENDL-2019 LIBRARY; T=293.16K  
Photon emission for (n,pt)

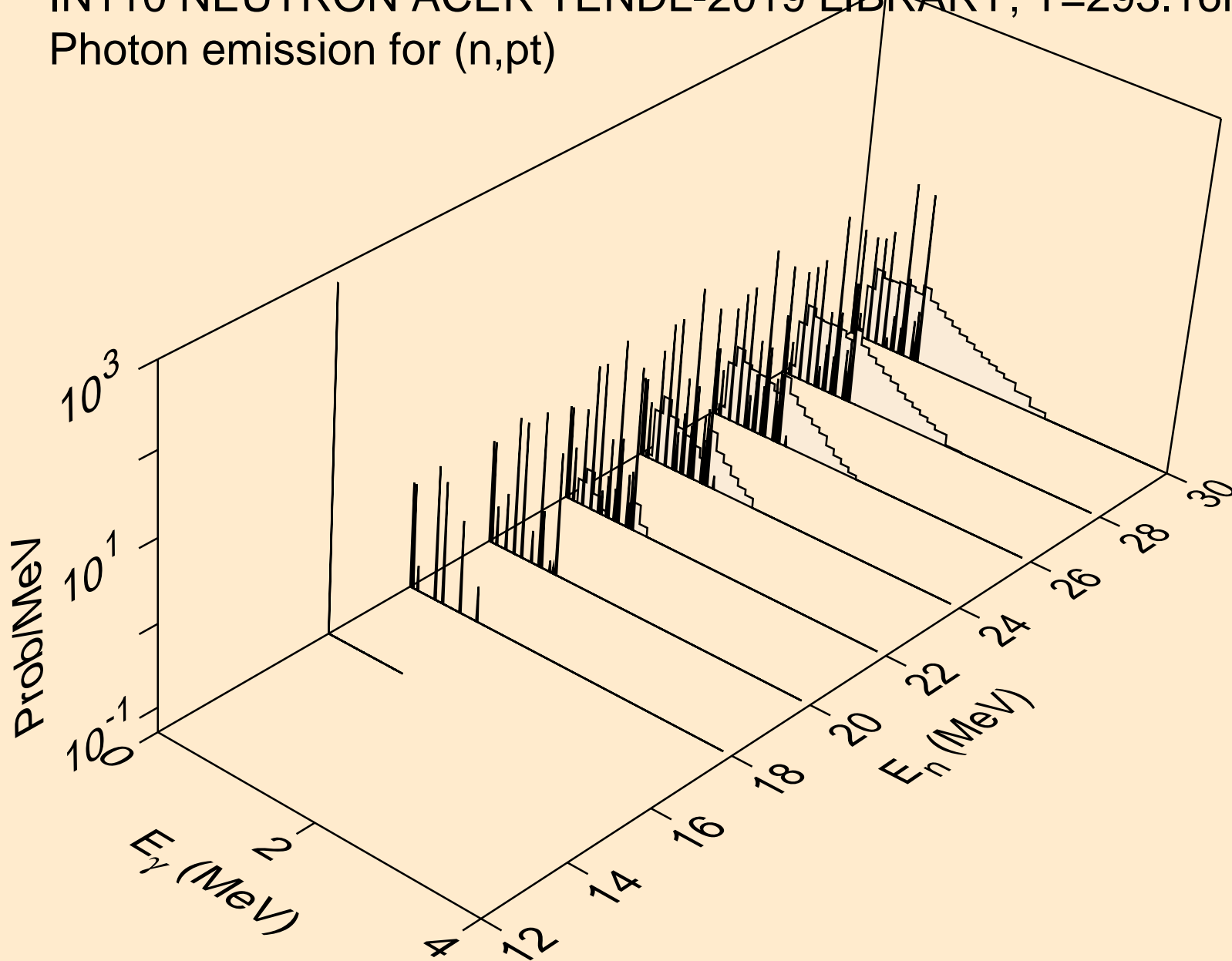

IN110 NEUTRON ACER TENDL-2019 LIBRARY; T=293.16K  
Photon emission for (n,da)

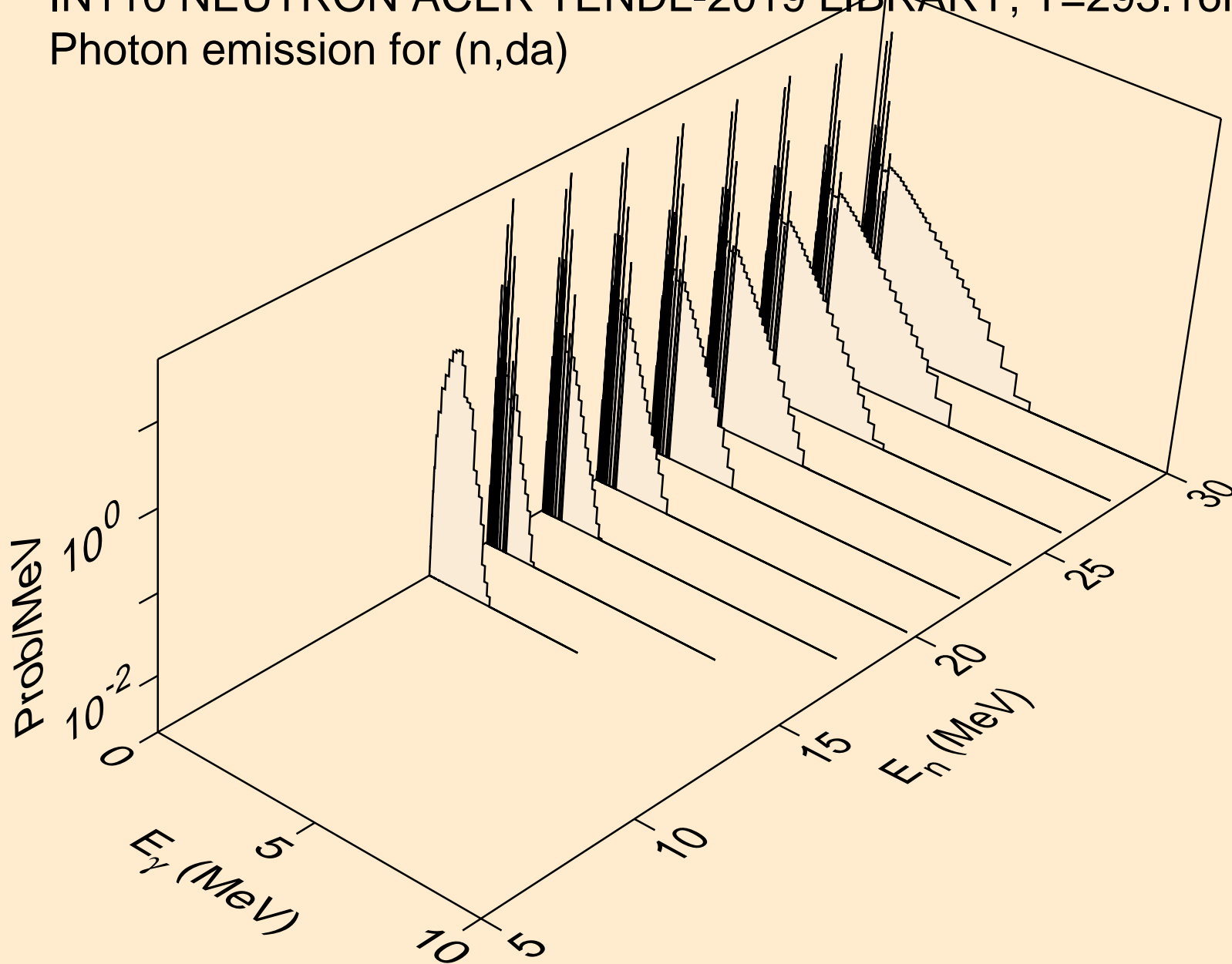

IN110 NEUTRON ACER TENDL-2019 LIBRARY; T=293.16K  
thermal capture photon spectrum

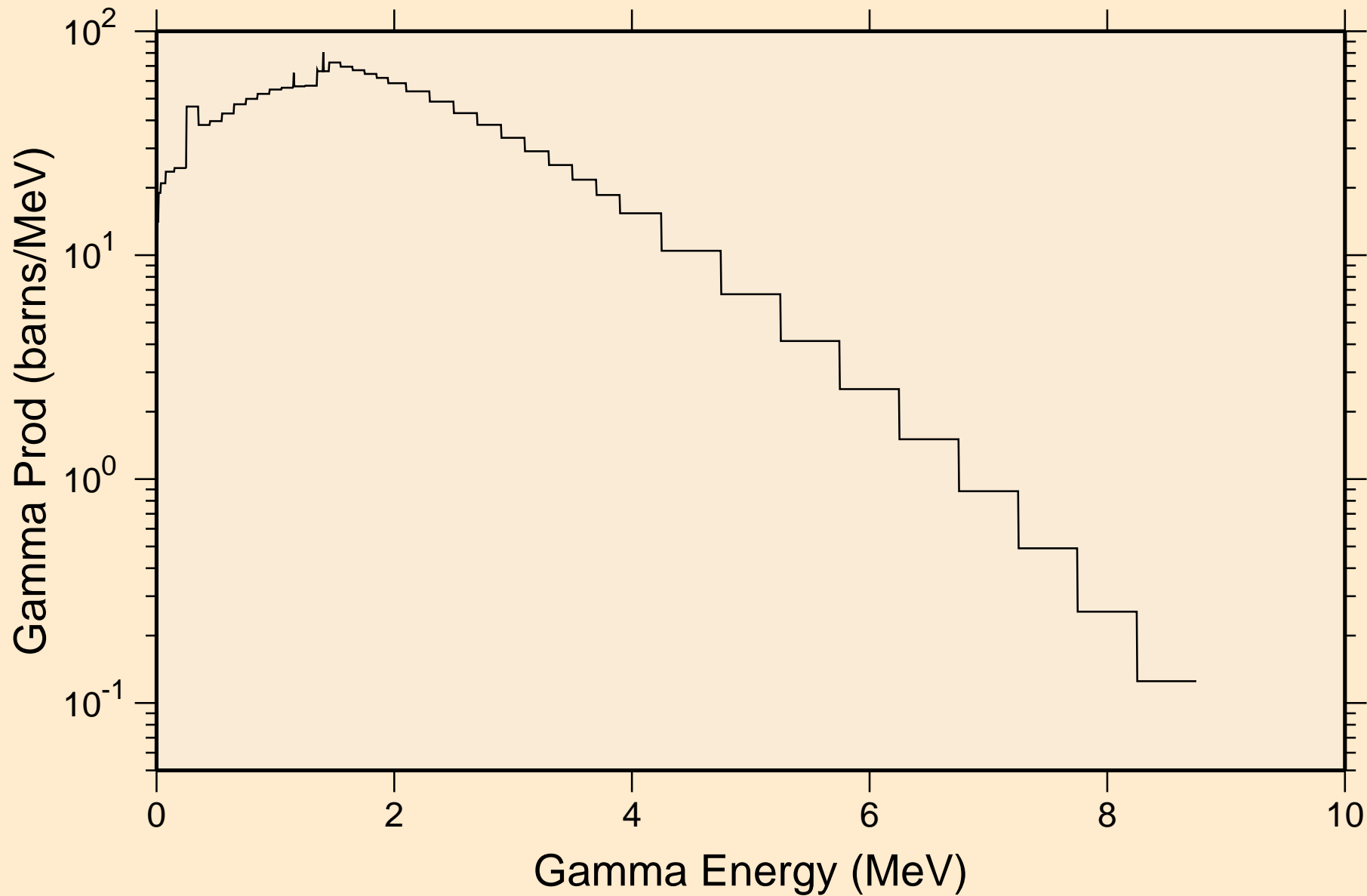

IN110 NEUTRON ACER TENDL-2019 LIBRARY; T=293.16K  
14 MeV photon spectrum

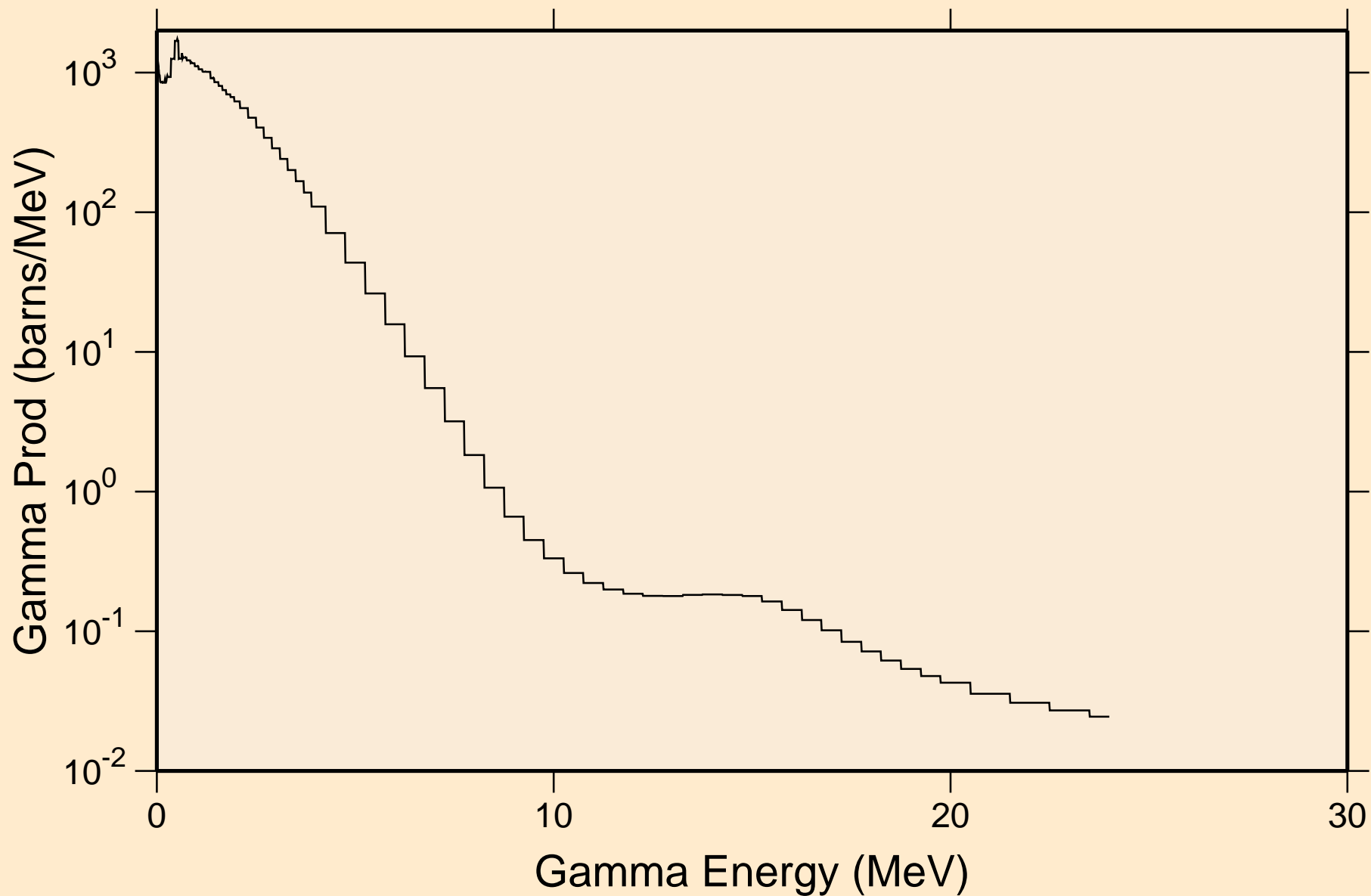

IN110 NEUTRON ACER TENDL-2019 LIBRARY; T=293.16K  
Particle heating contributions

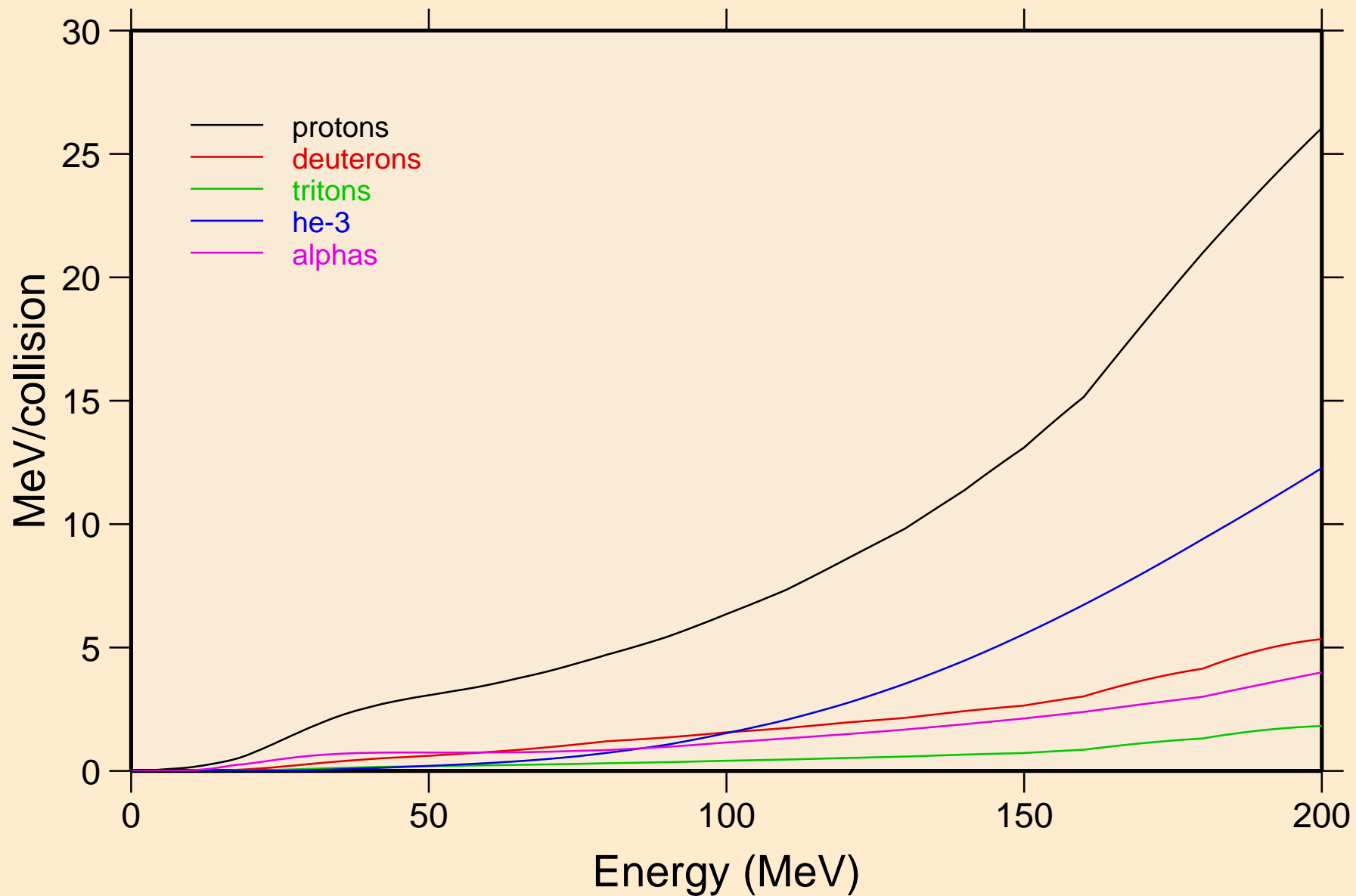

IN110 NEUTRON ACER TENDL-2019 LIBRARY; T=293.16K  
Recoil Heating

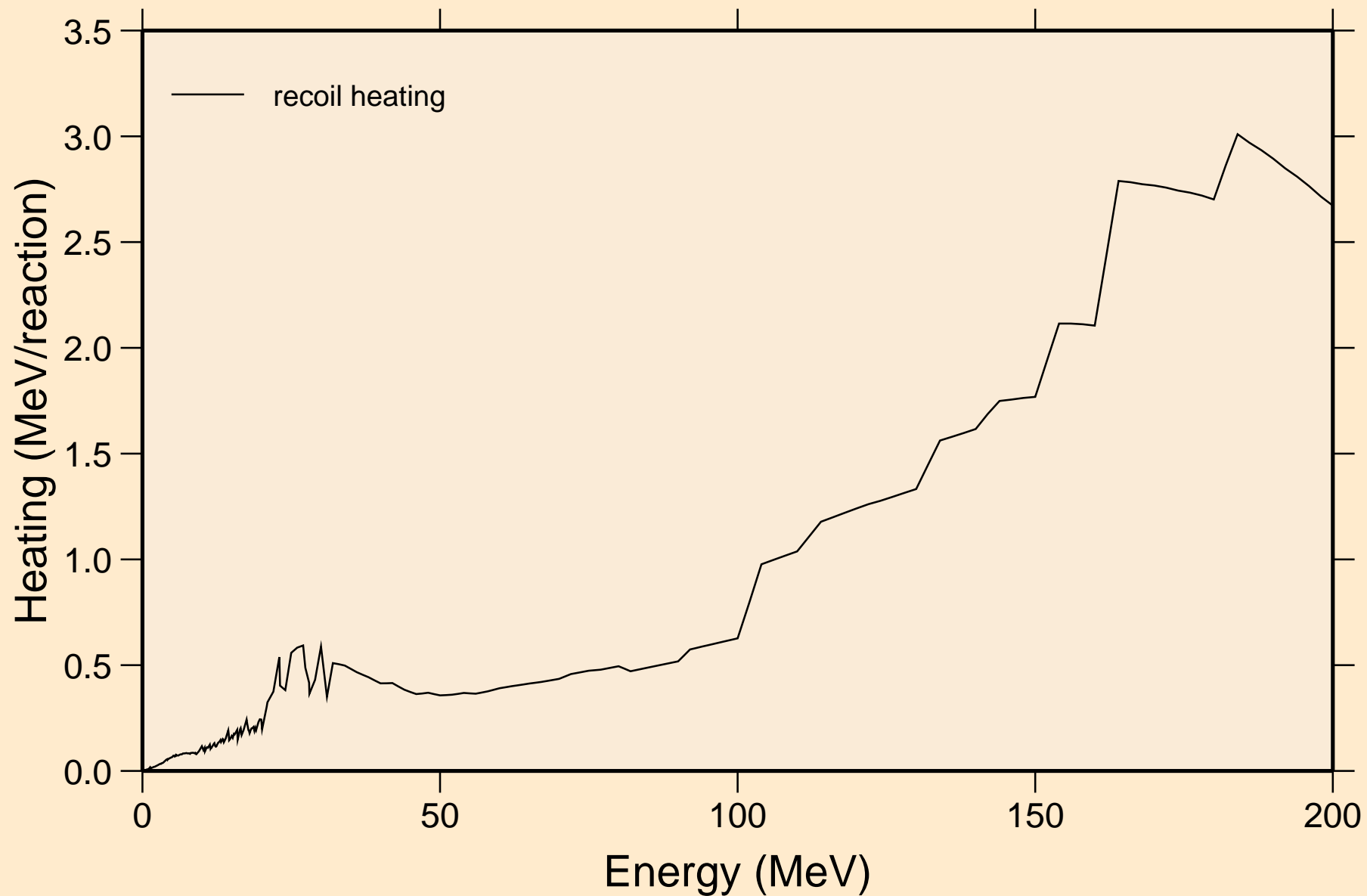



IN110 NEUTRON ACER TENDL-2019 LIBRARY; T=293.16K  
Particle production cross sections

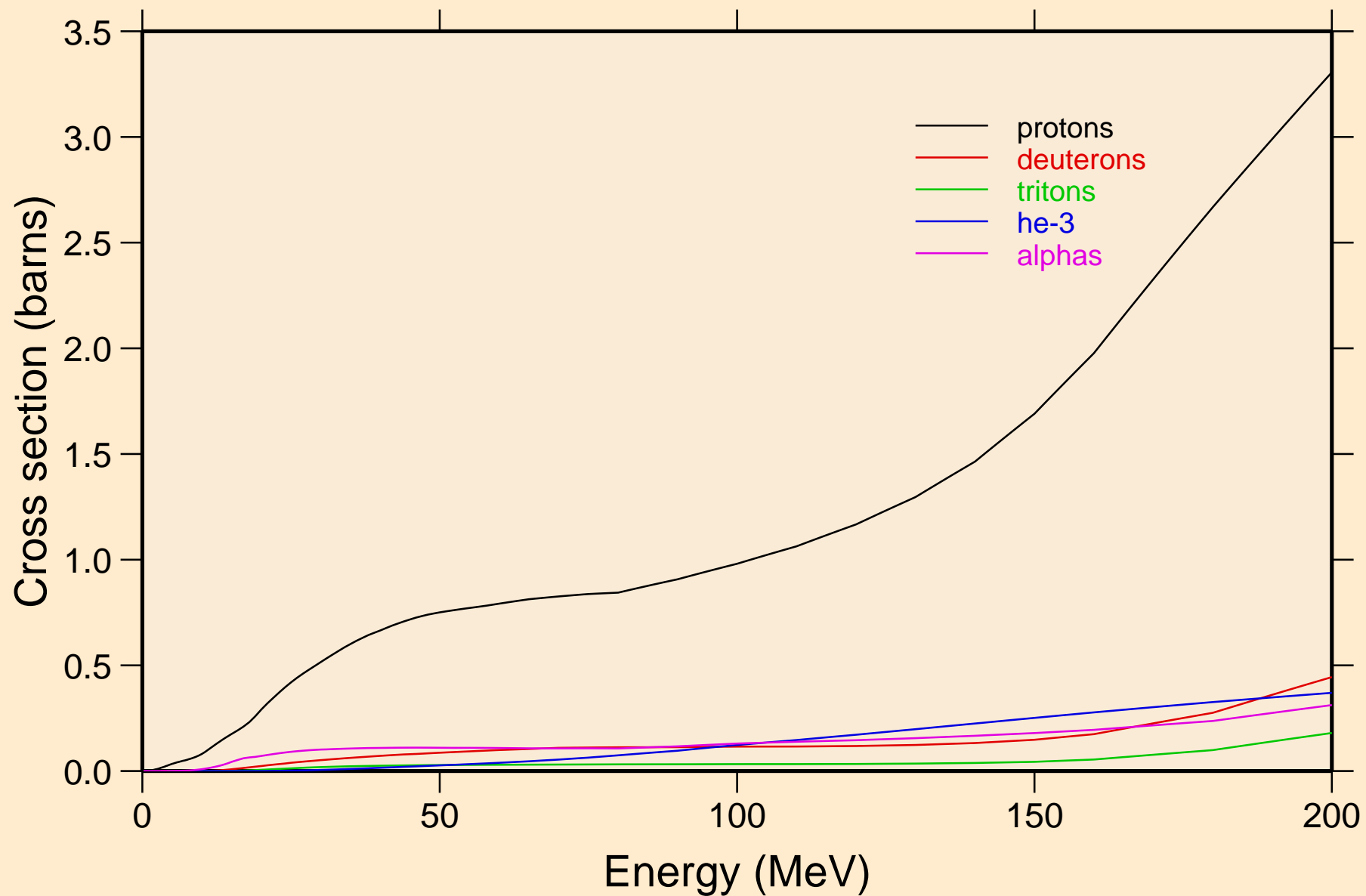

IN110 NEUTRON ACER TENDL-2019 LIBRARY; T=293.16K  
protons from (n,x)

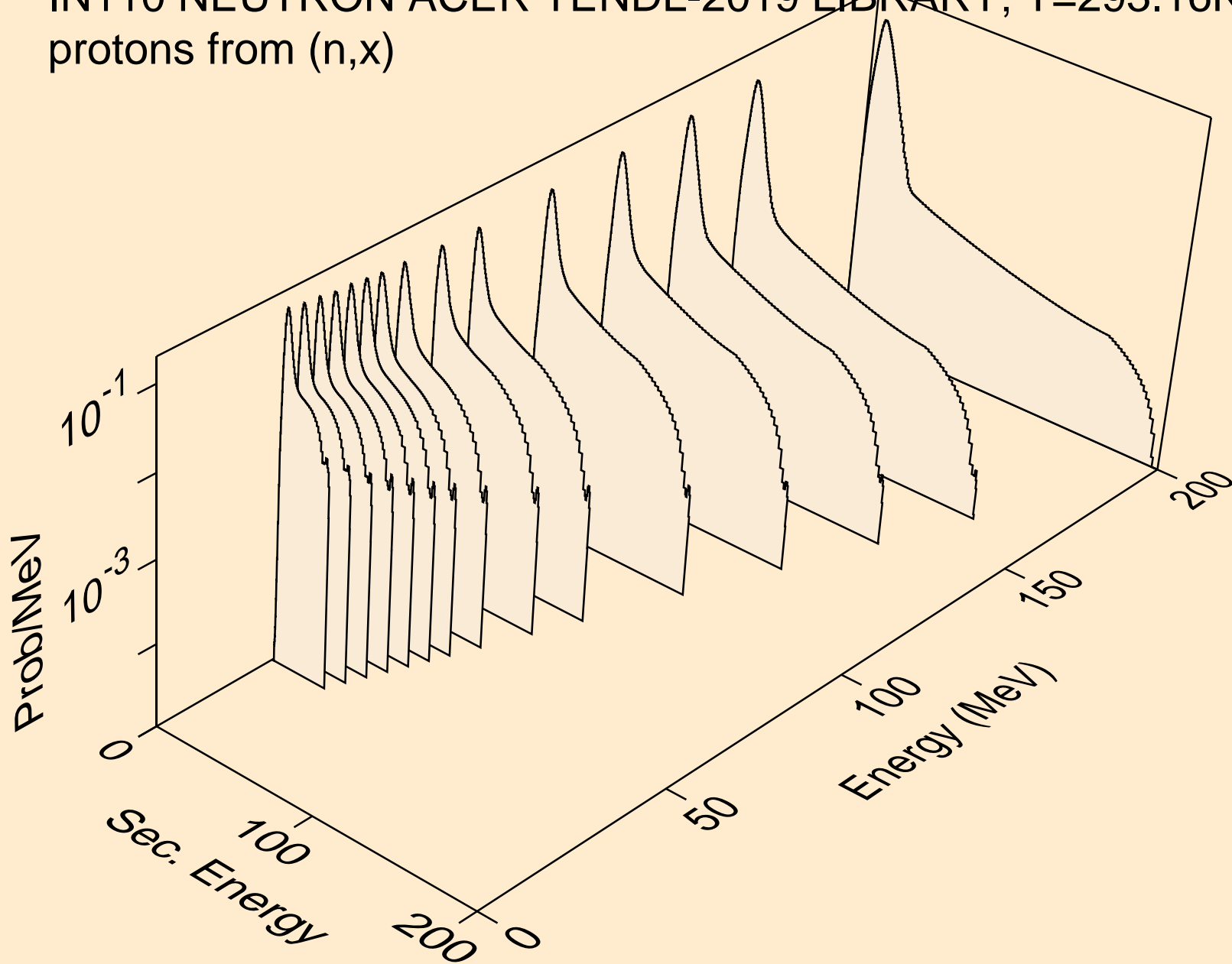

IN110 NEUTRON ACER TENDL-2019 LIBRARY; T=293.16K  
protons from (n,n\*)p

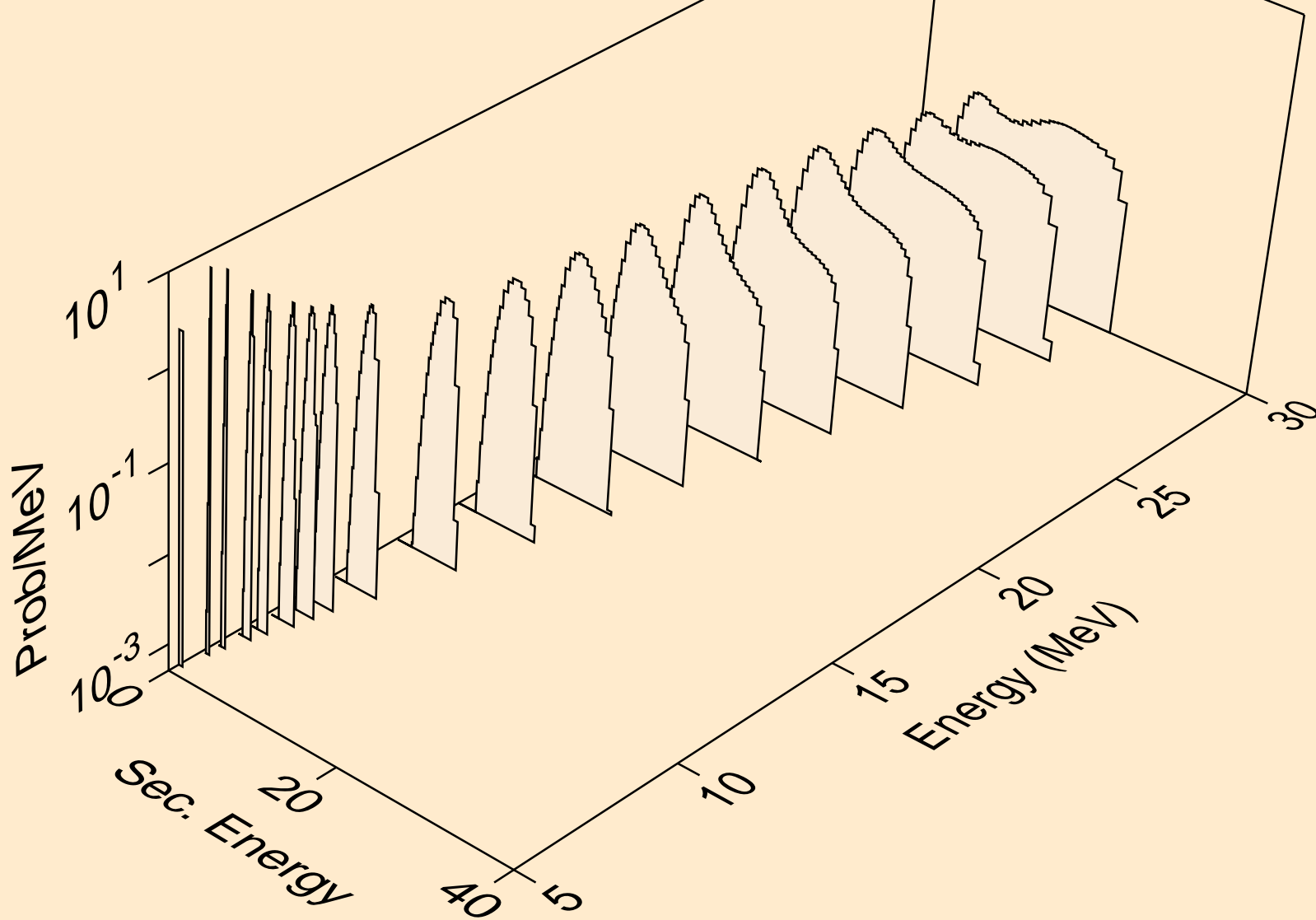

IN110 NEUTRON ACER TENDL-2019 LIBRARY; T=293.16K  
protons from (n,2np)

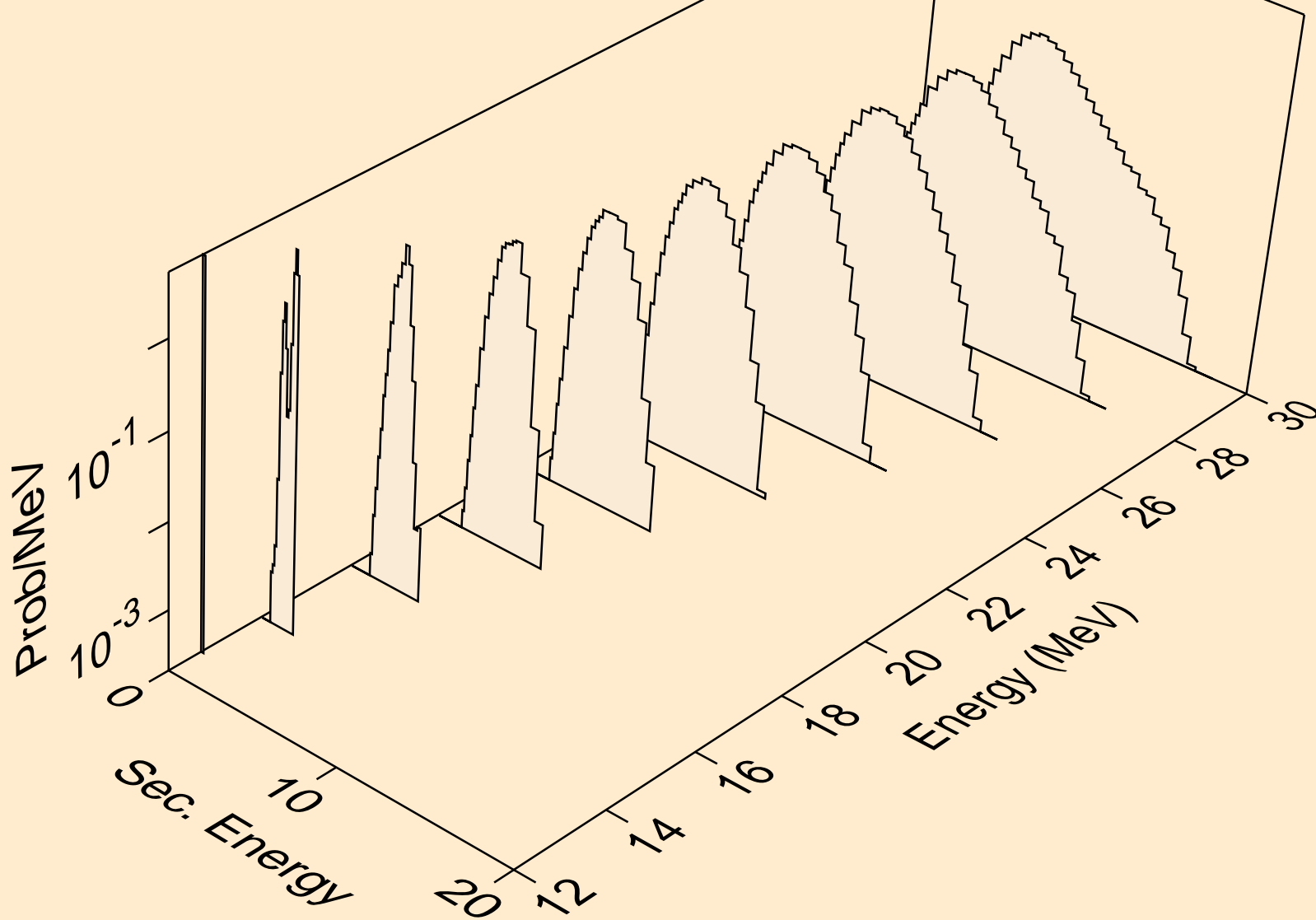

IN110 NEUTRON ACER TENDL-2019 LIBRARY; T=293.16K  
protons from (n,3np)

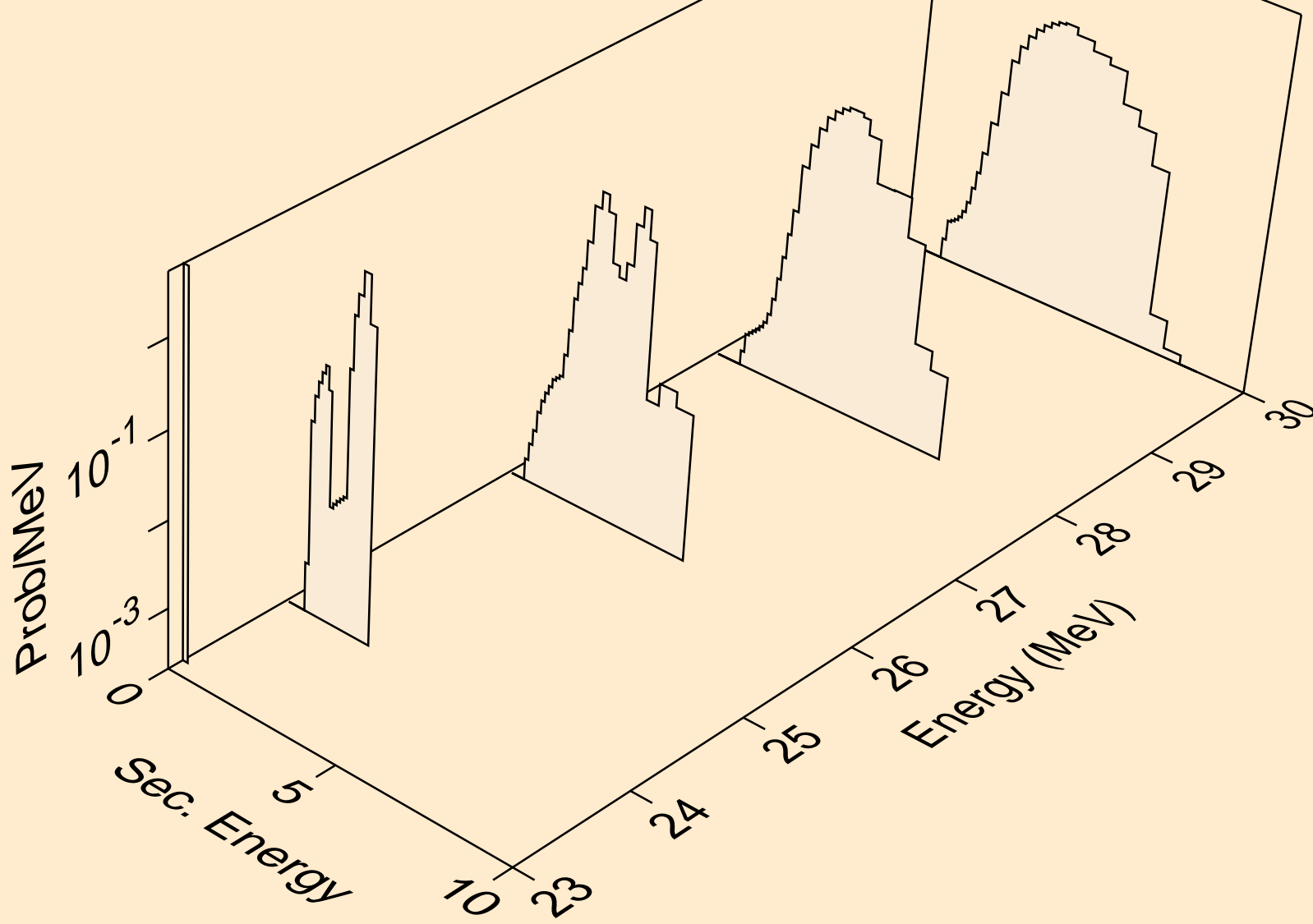

IN110 NEUTRON ACER TENDL-2019 LIBRARY; T=293.16K  
protons from (n,2np)

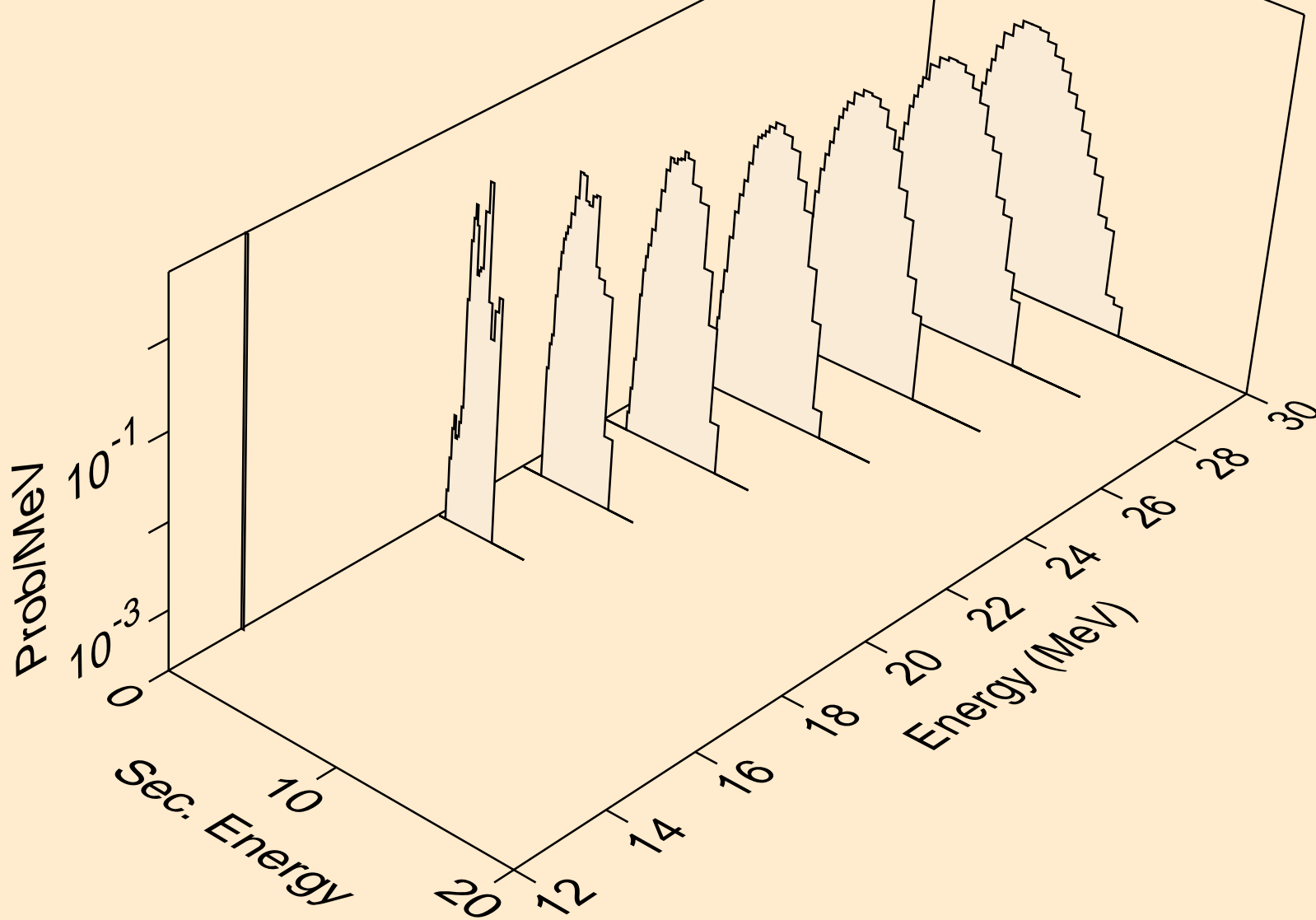

IN110 NEUTRON ACER TENDL-2019 LIBRARY; T=293.16K  
protons from (n,npa)

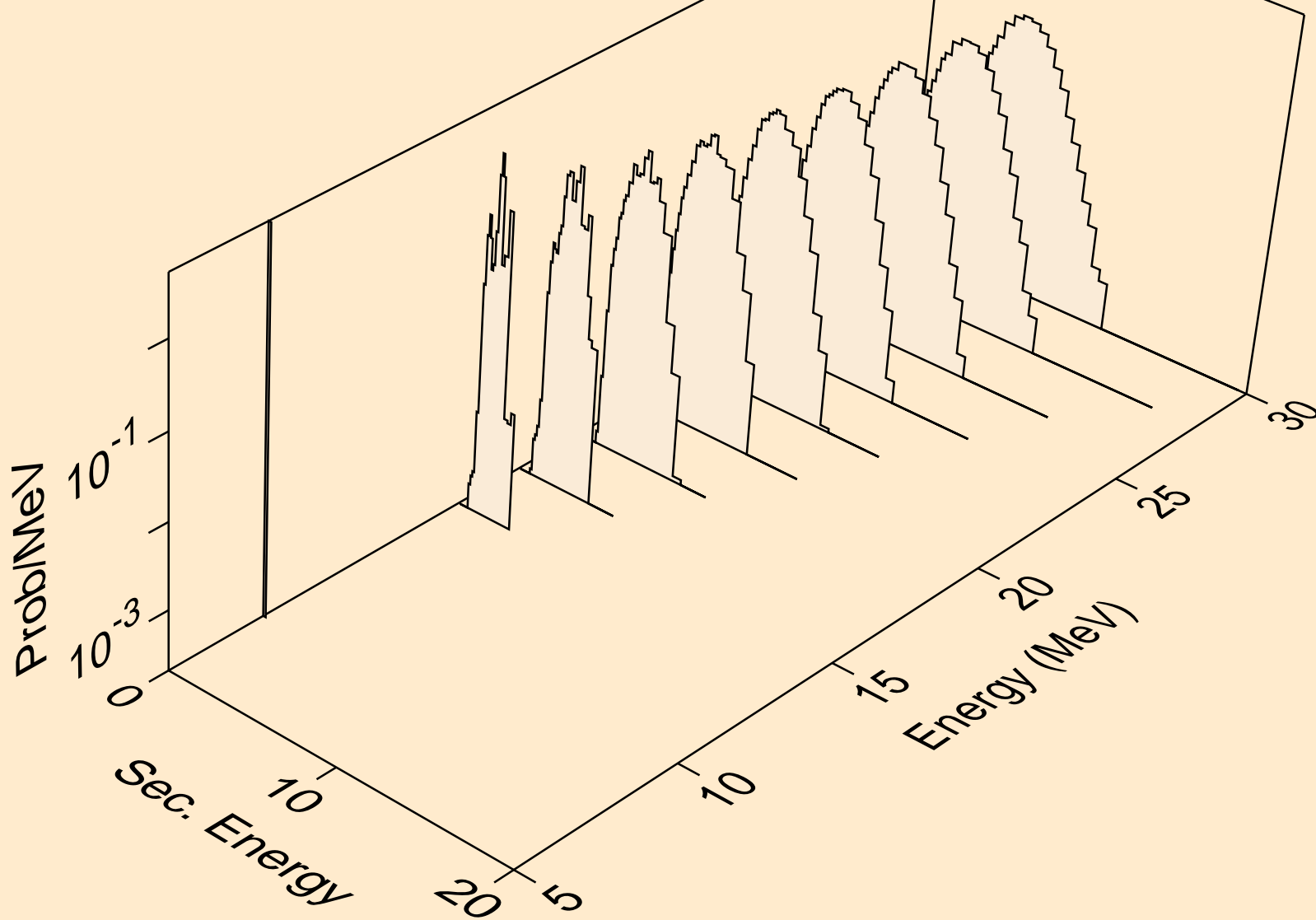

IN110 NEUTRON ACER TENDL-2019 LIBRARY; T=293.16K  
protons from (n,p)

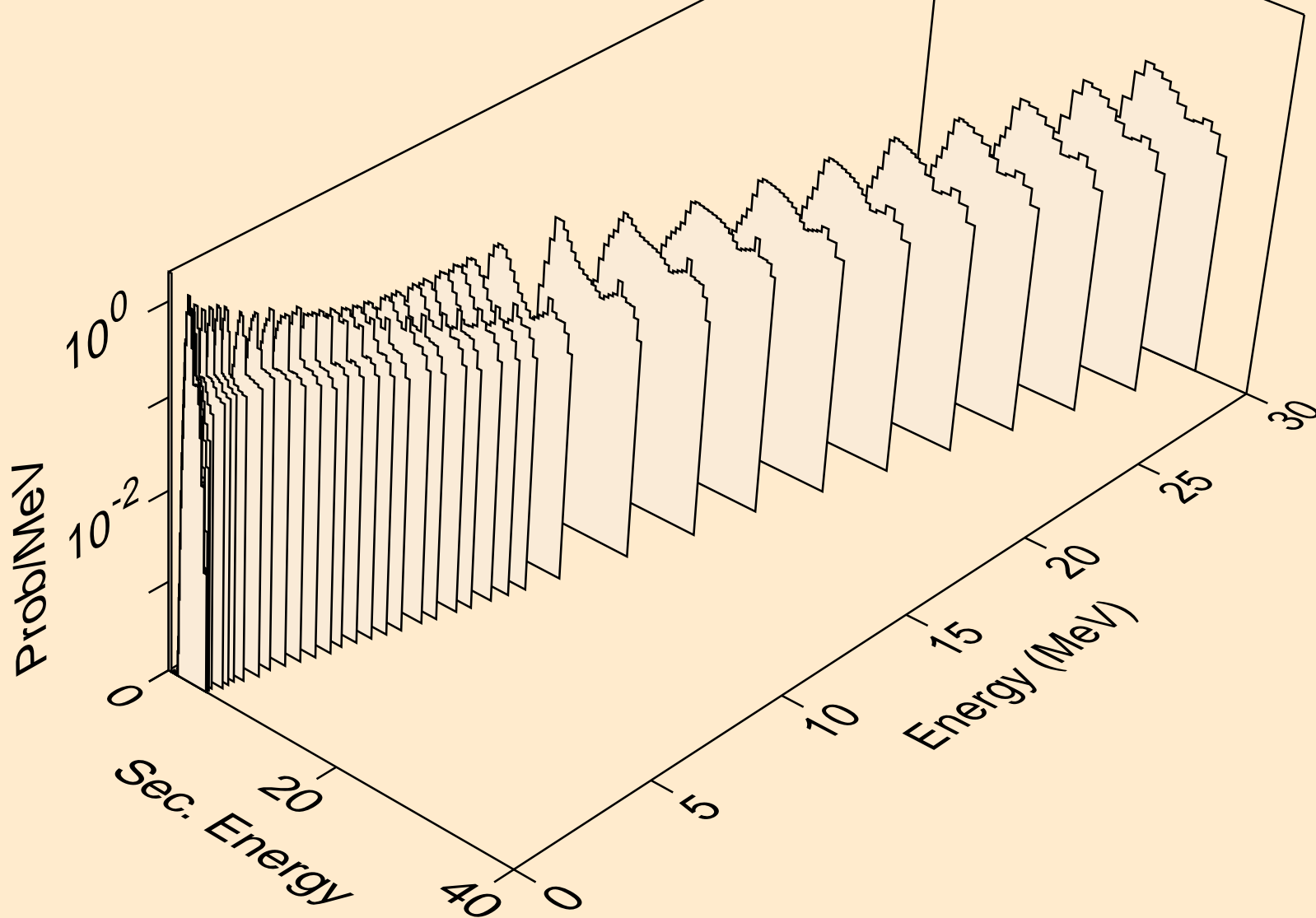



IN110 NEUTRON ACER TENDL-2019 LIBRARY; T=293.16K  
protons from (n,2p)

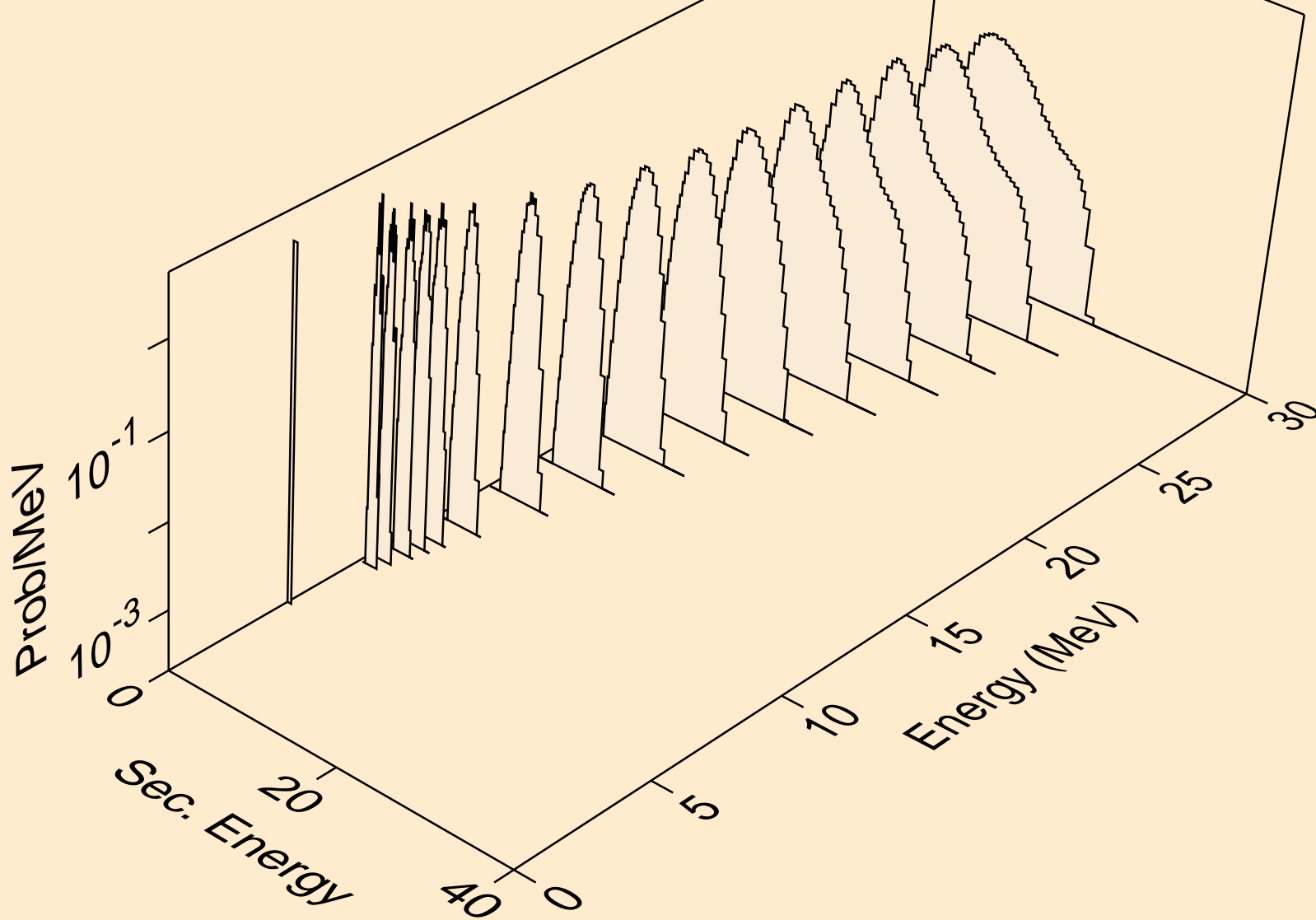

IN110 NEUTRON ACER TENDL-2019 LIBRARY; T=293.16K  
protons from (n,p)

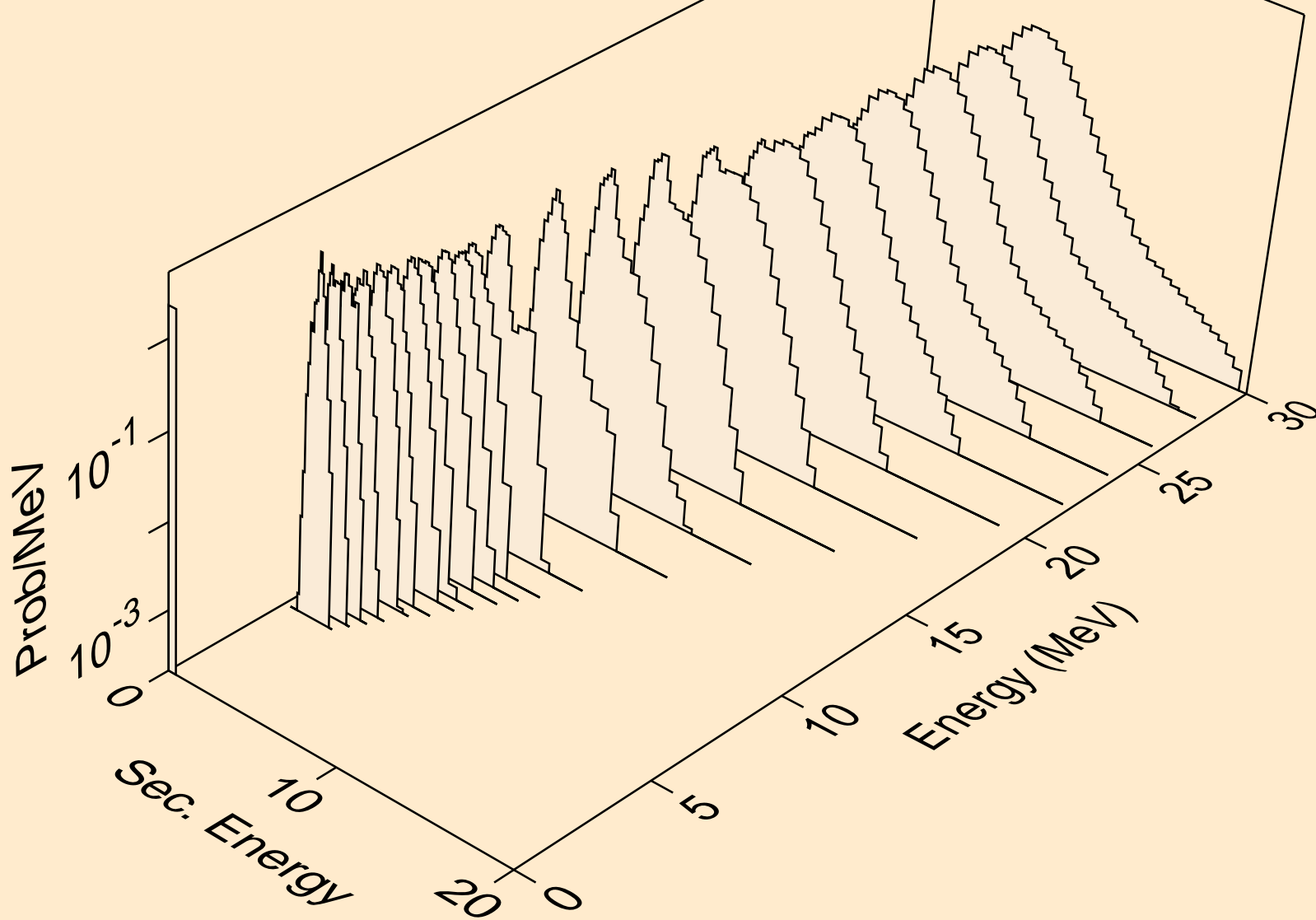

IN110 NEUTRON ACER TENDL-2019 LIBRARY; T=293.16K  
protons from (n,pd)

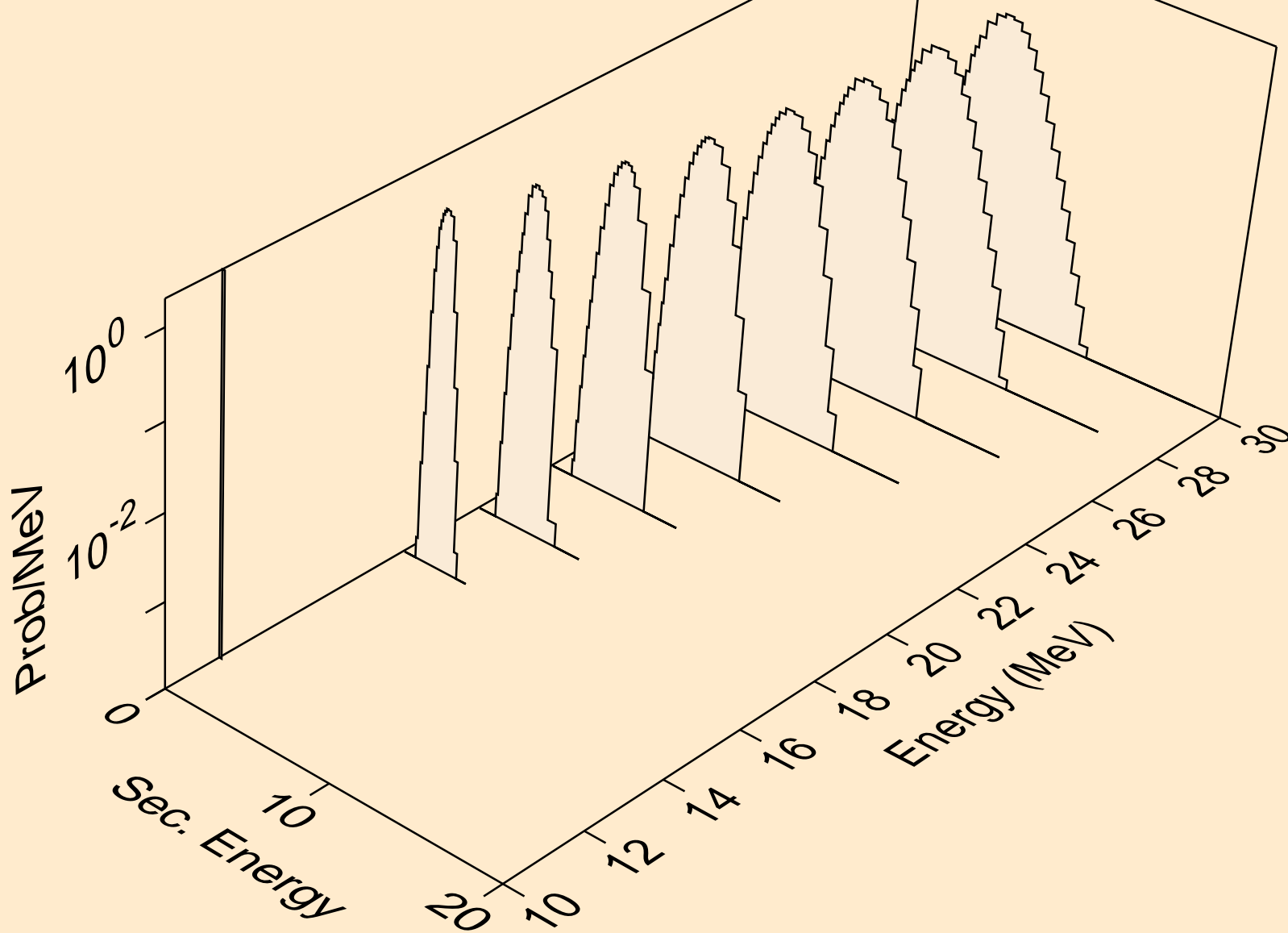

IN110 NEUTRON ACER TENDL-2019 LIBRARY; T=293.16K  
protons from (n,pt)

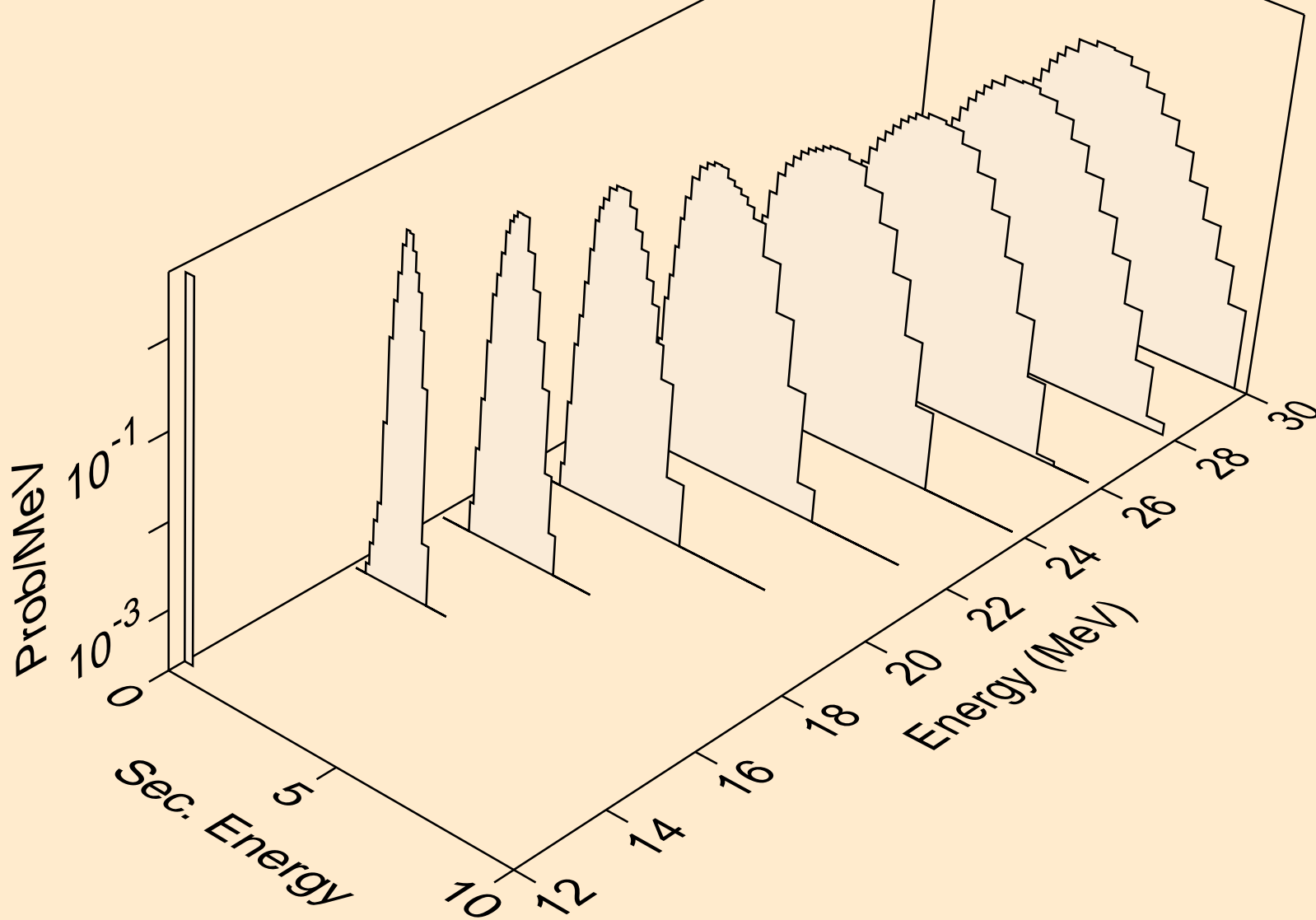

IN110 NEUTRON ACER TENDL-2019 LIBRARY; T=293.16K  
deuterons from (n,x)

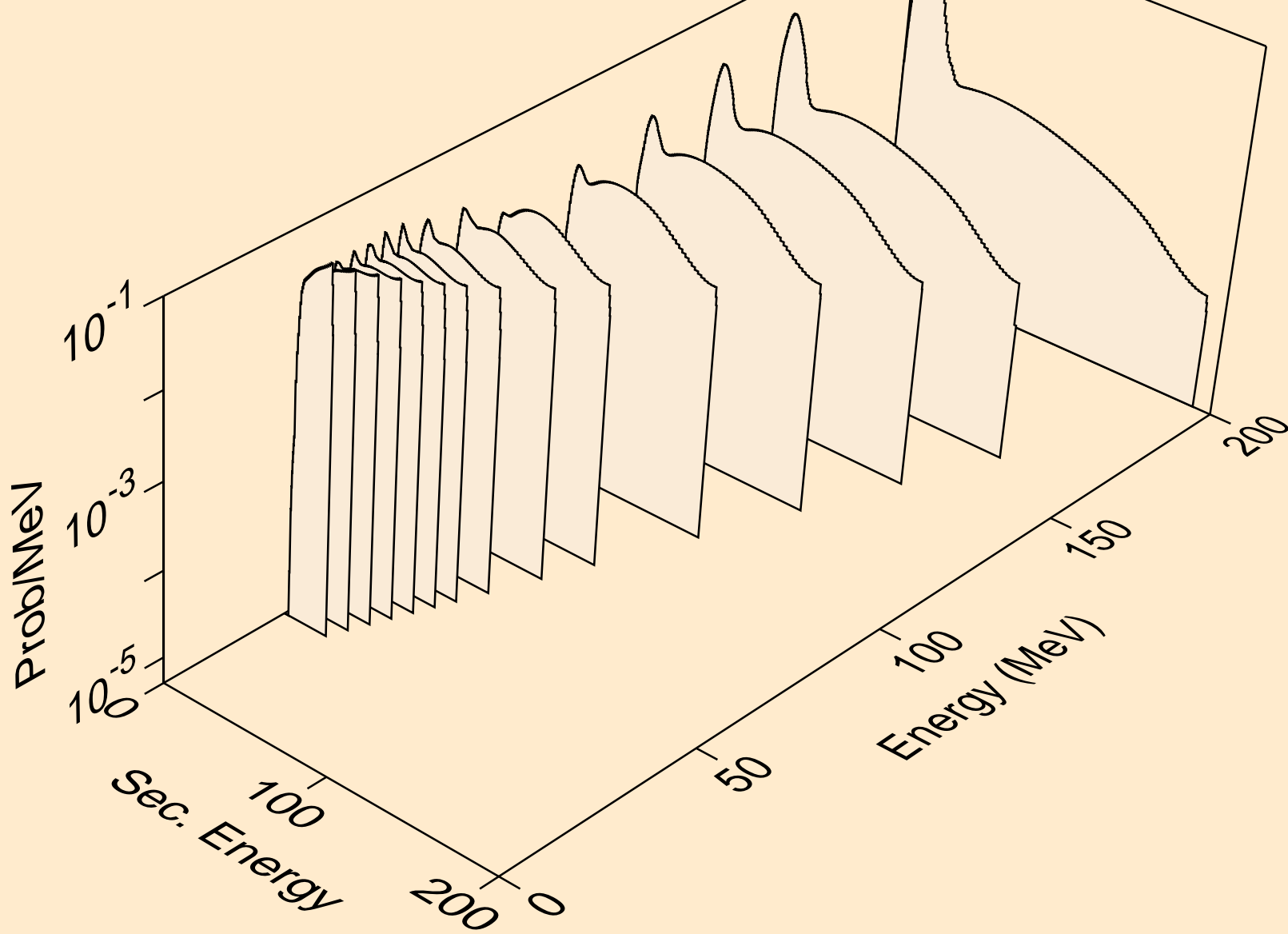

IN110 NEUTRON ACER TENDL-2019 LIBRARY; T=293.16K  
deuterons from (n,2nd)

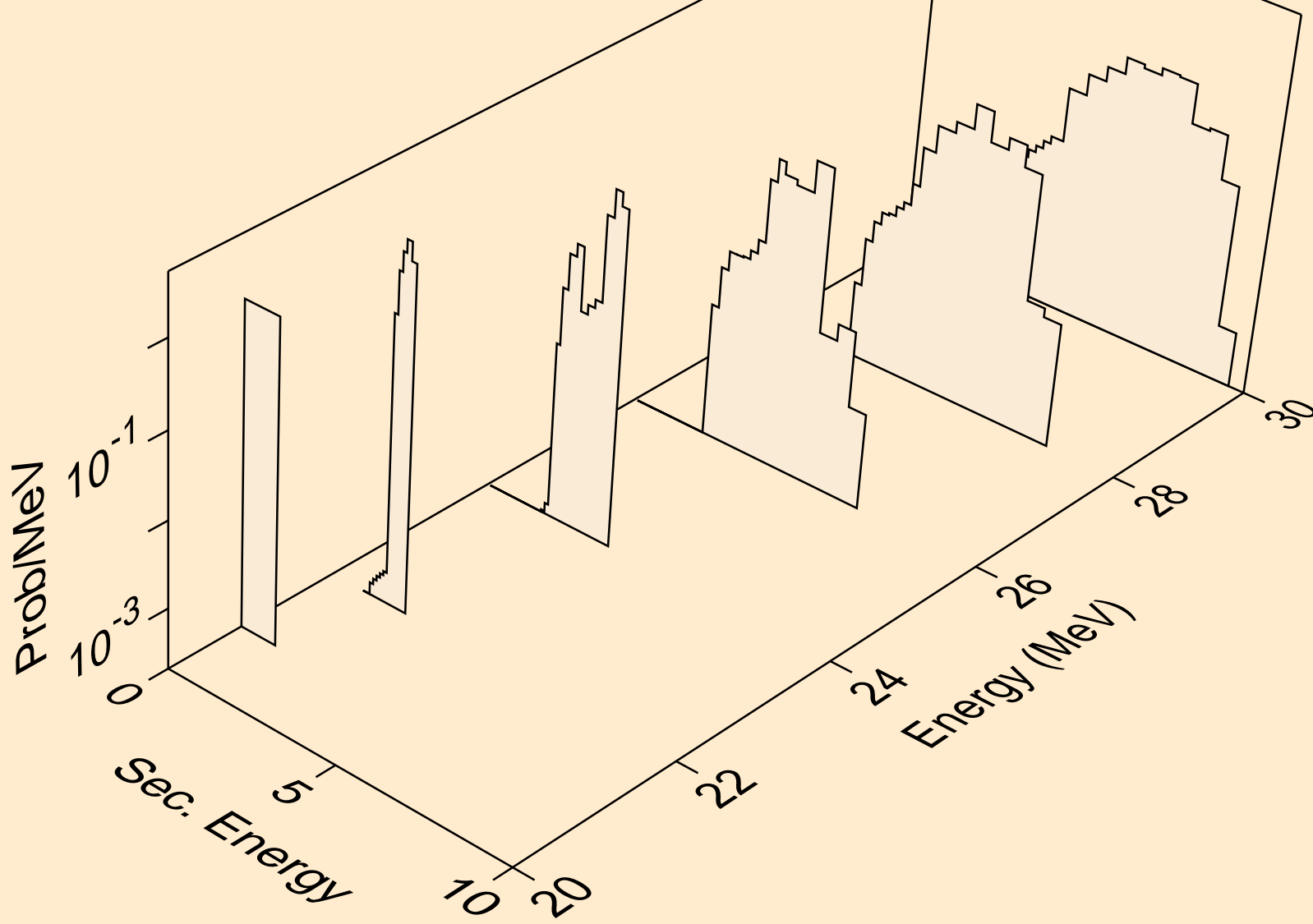

IN110 NEUTRON ACER TENDL-2019 LIBRARY; T=293.16K  
deuterons from (n,n\*)d

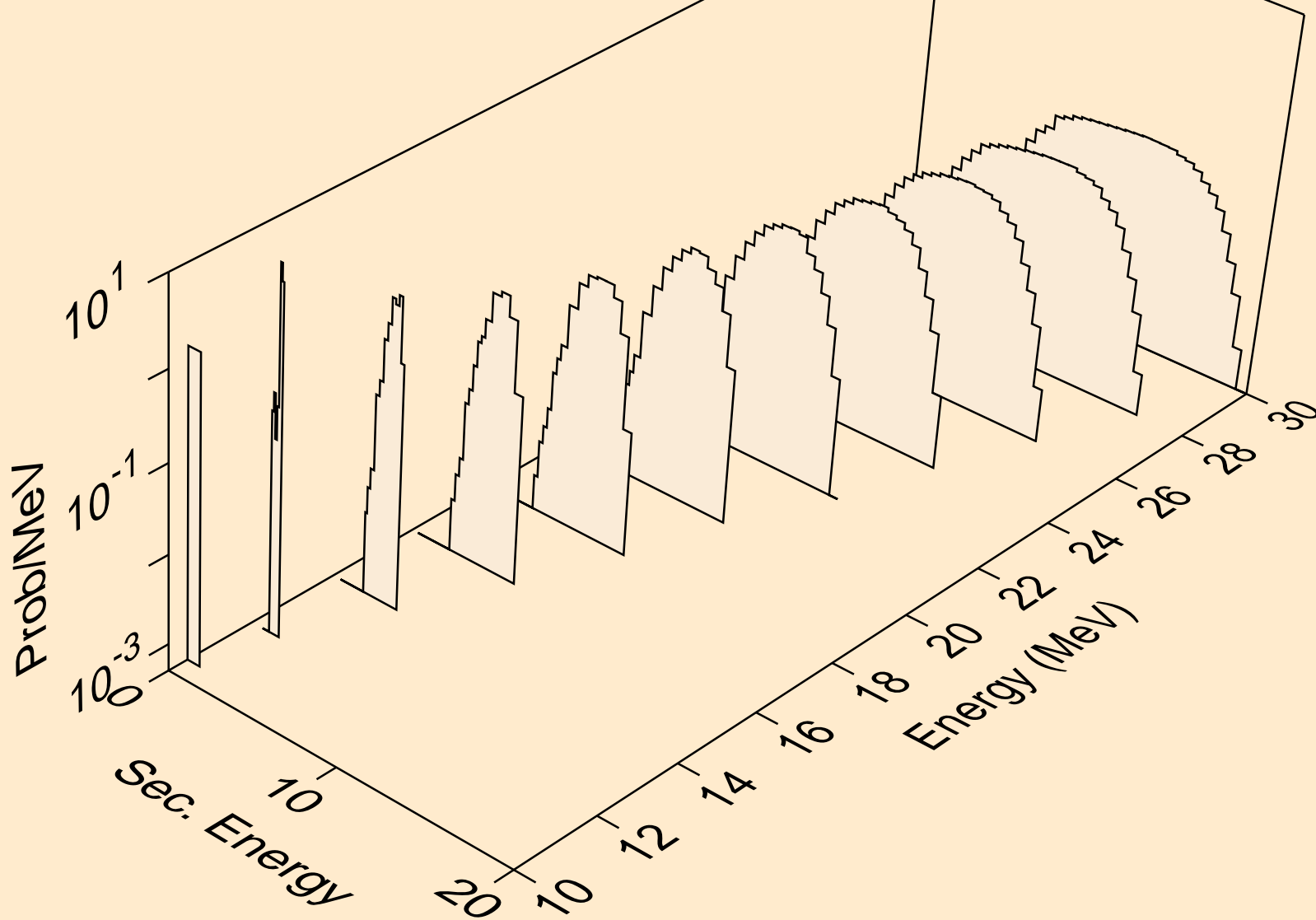

IN110 NEUTRON ACER TENDL-2019 LIBRARY; T=293.16K  
deuterons from (n,d)

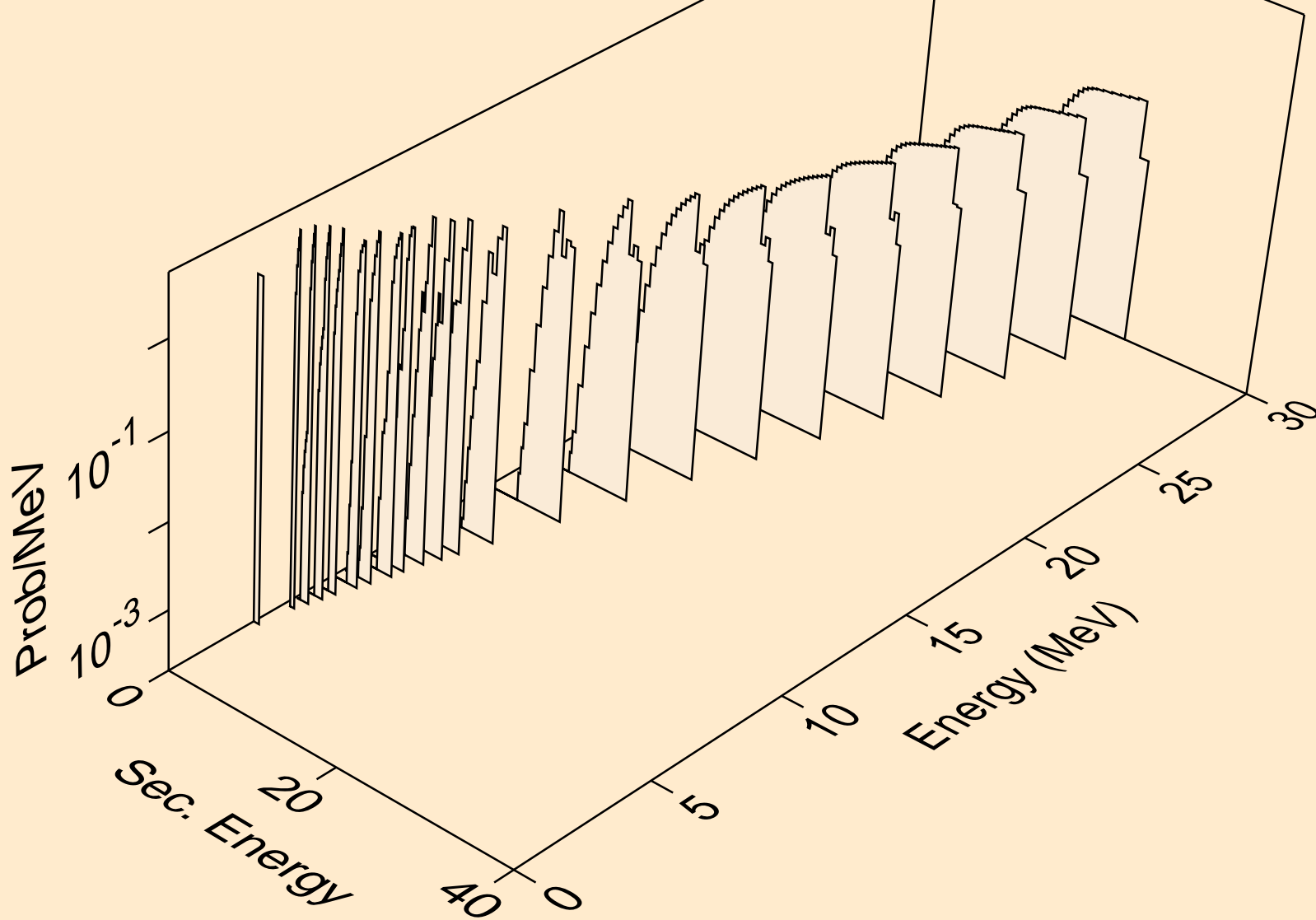



IN110 NEUTRON ACER TENDL-2019 LIBRARY; T=293.16K  
deuterons from (n,pd)

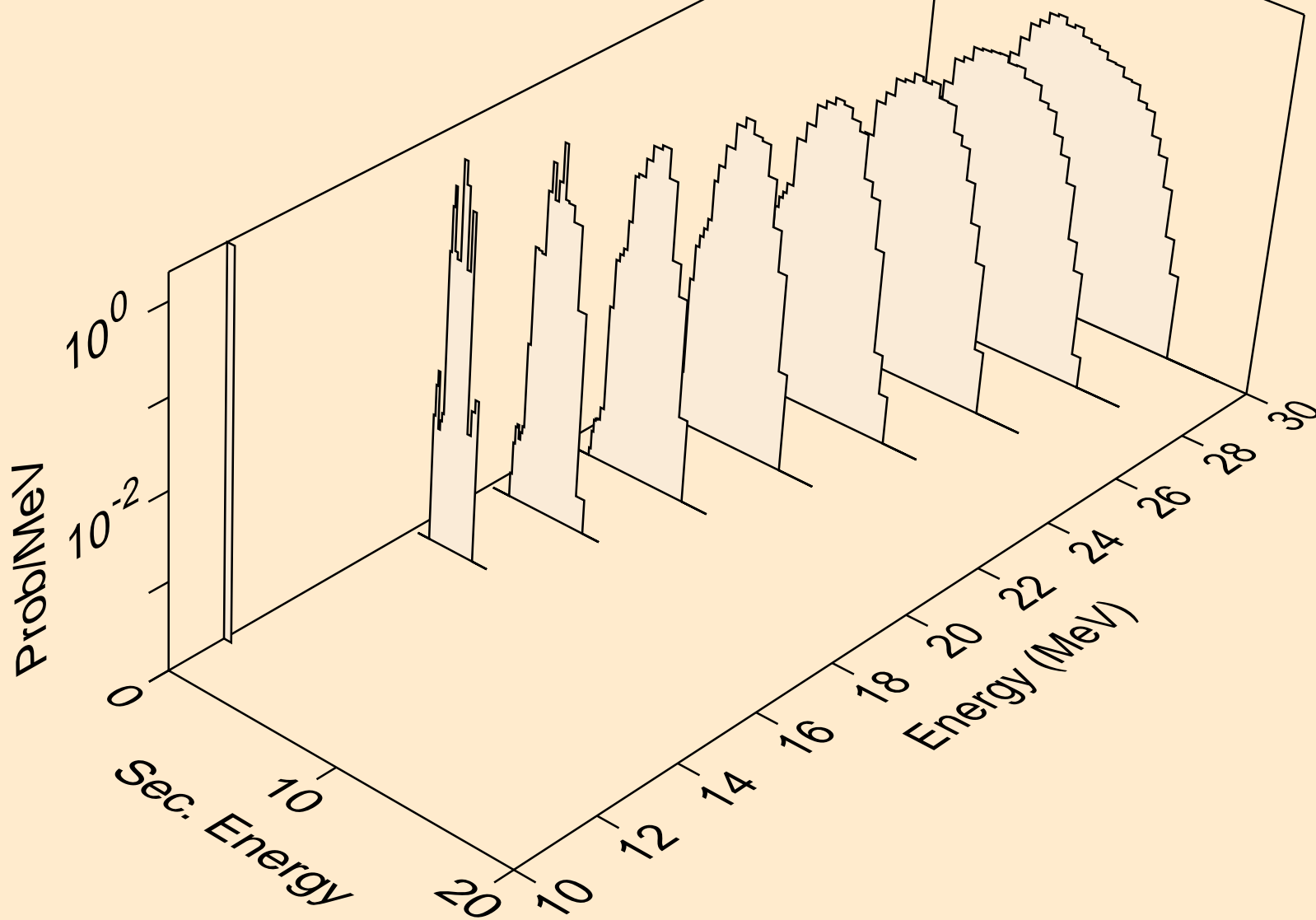

IN110 NEUTRON ACER TENDL-2019 LIBRARY; T=293.16K  
deuterons from (n,da)

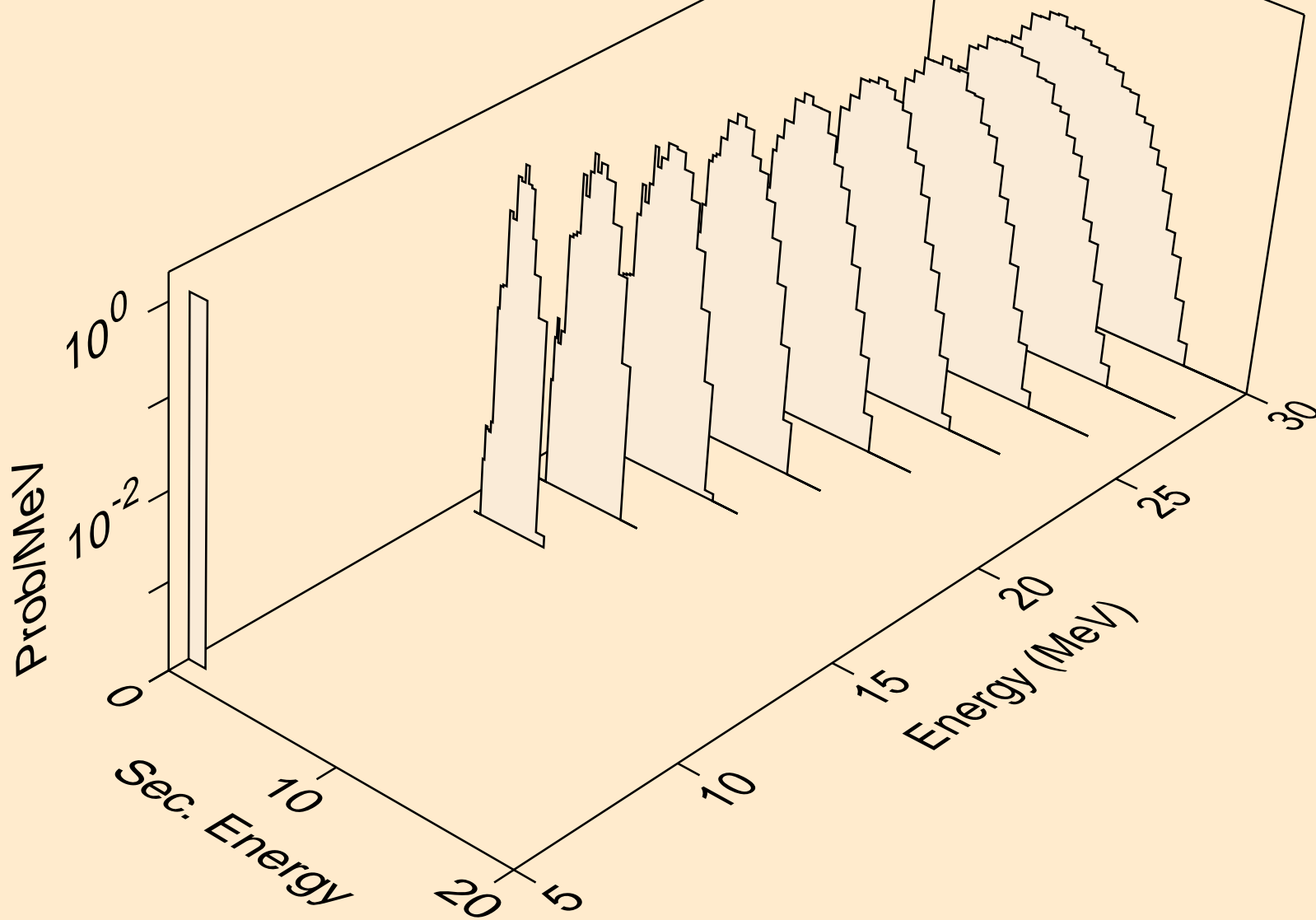

IN110 NEUTRON ACER TENDL-2019 LIBRARY; T=293.16K  
tritons from (n,x)

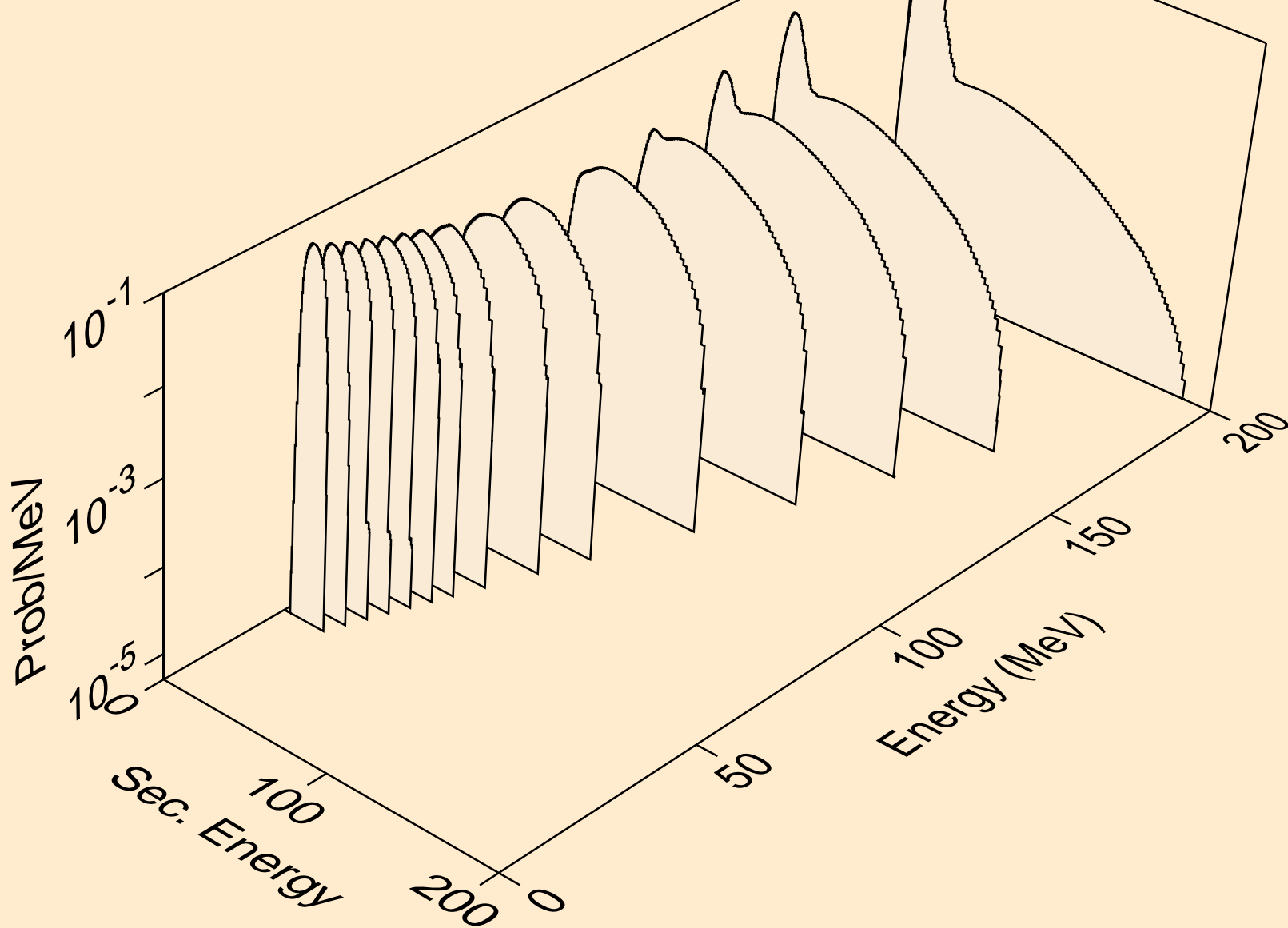

IN110 NEUTRON ACER TENDL-2019 LIBRARY; T=293.16K  
tritons from (n,n\*)t

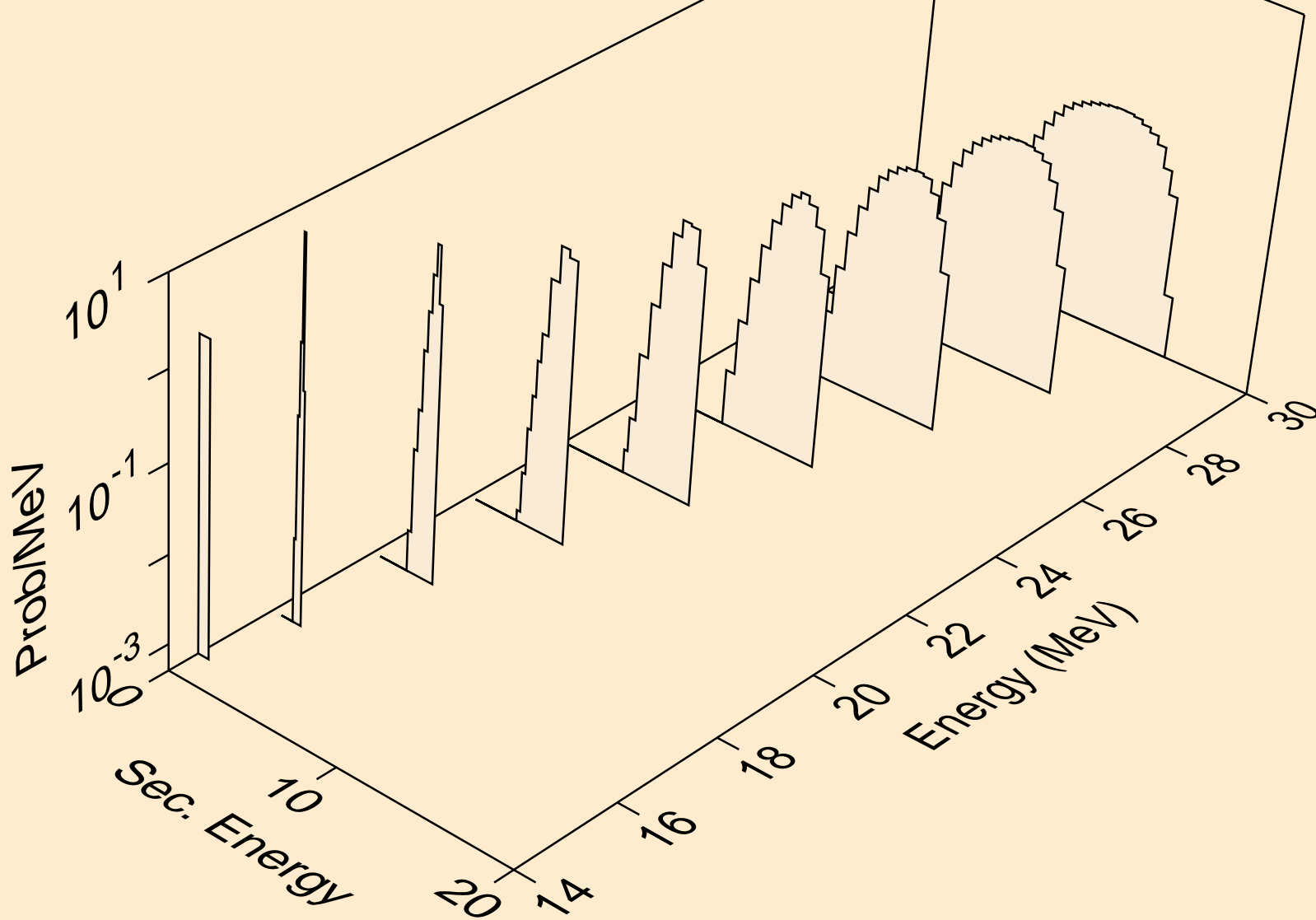

IN110 NEUTRON ACER TENDL-2019 LIBRARY; T=293.16K  
tritons from (n,t)

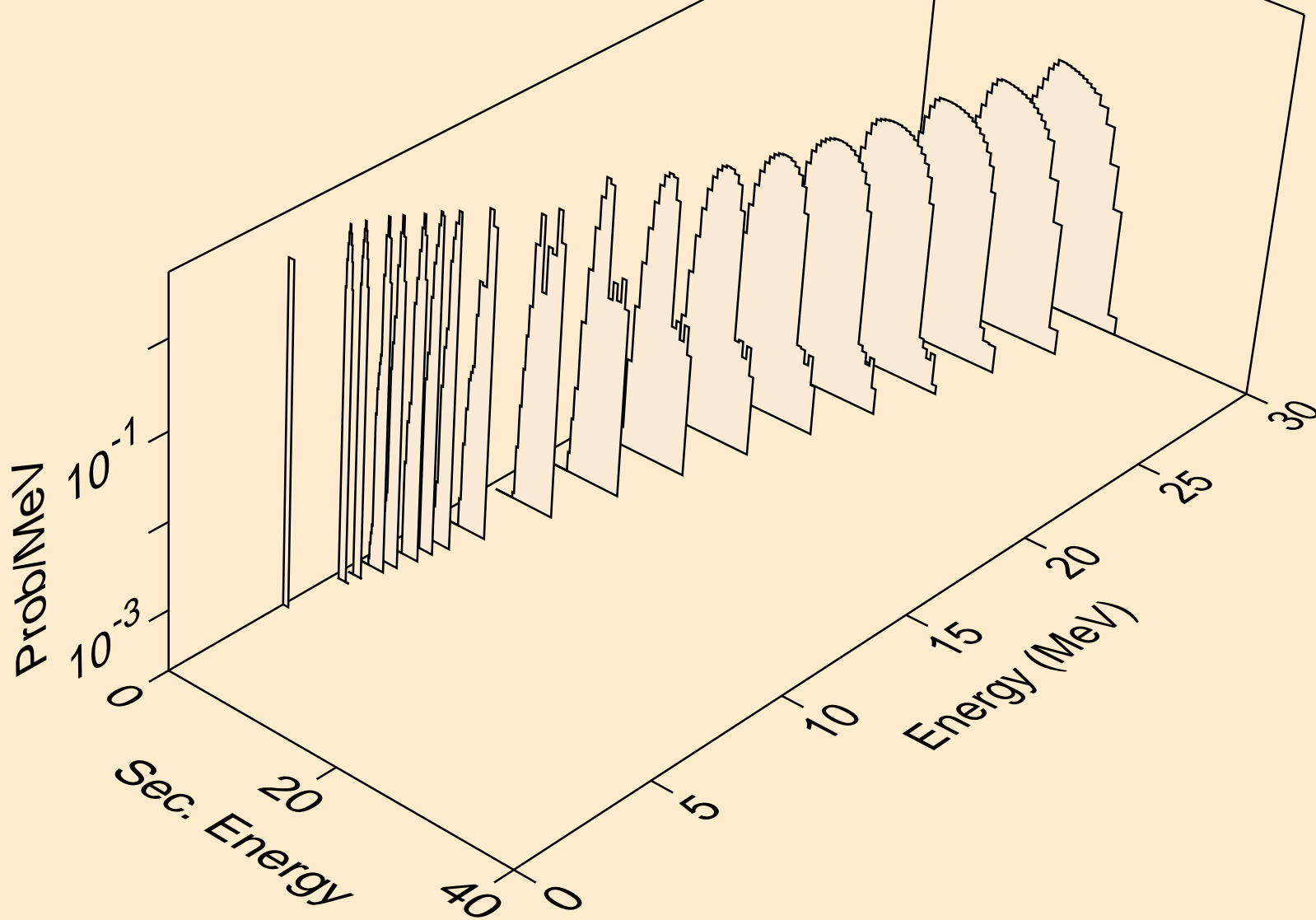

IN110 NEUTRON ACER TENDL-2019 LIBRARY; T=293.16K  
tritons from (n,pt)

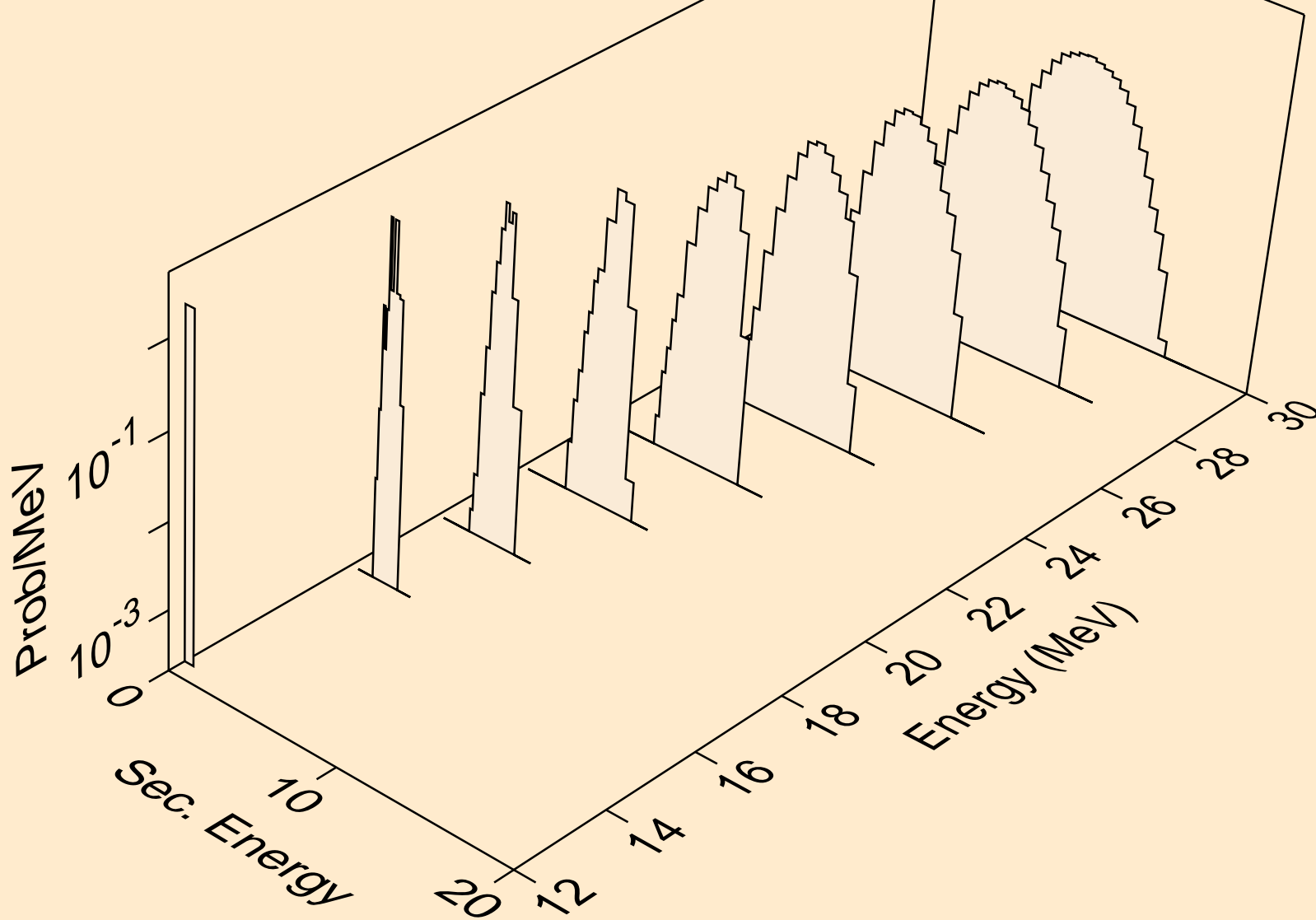

IN110 NEUTRON ACER TENDL-2019 LIBRARY; T=293.16K  
he3s from (n,x)

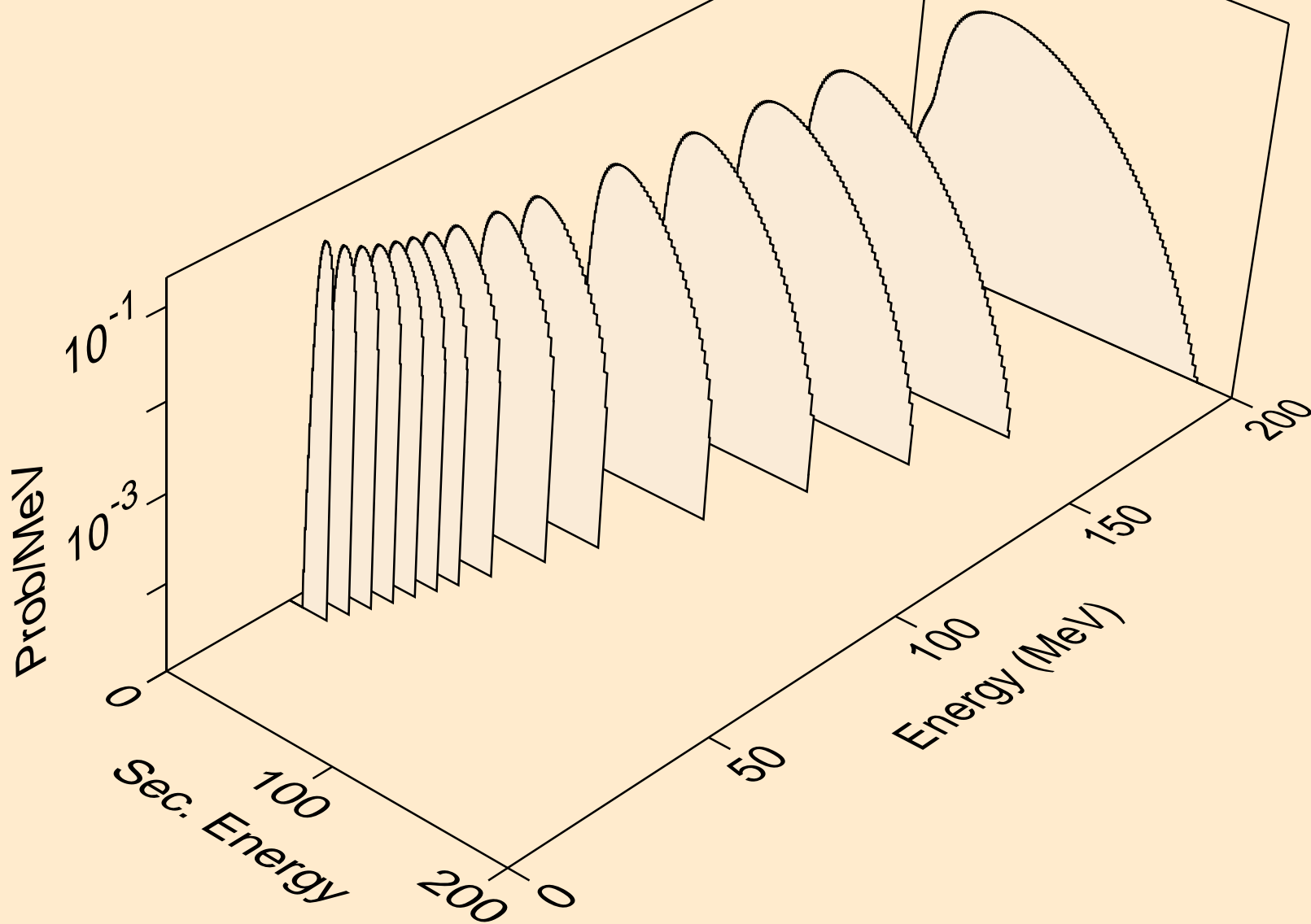

IN110 NEUTRON ACER TENDL-2019 LIBRARY; T=293.16K  
he3s from (n,n\*)he3

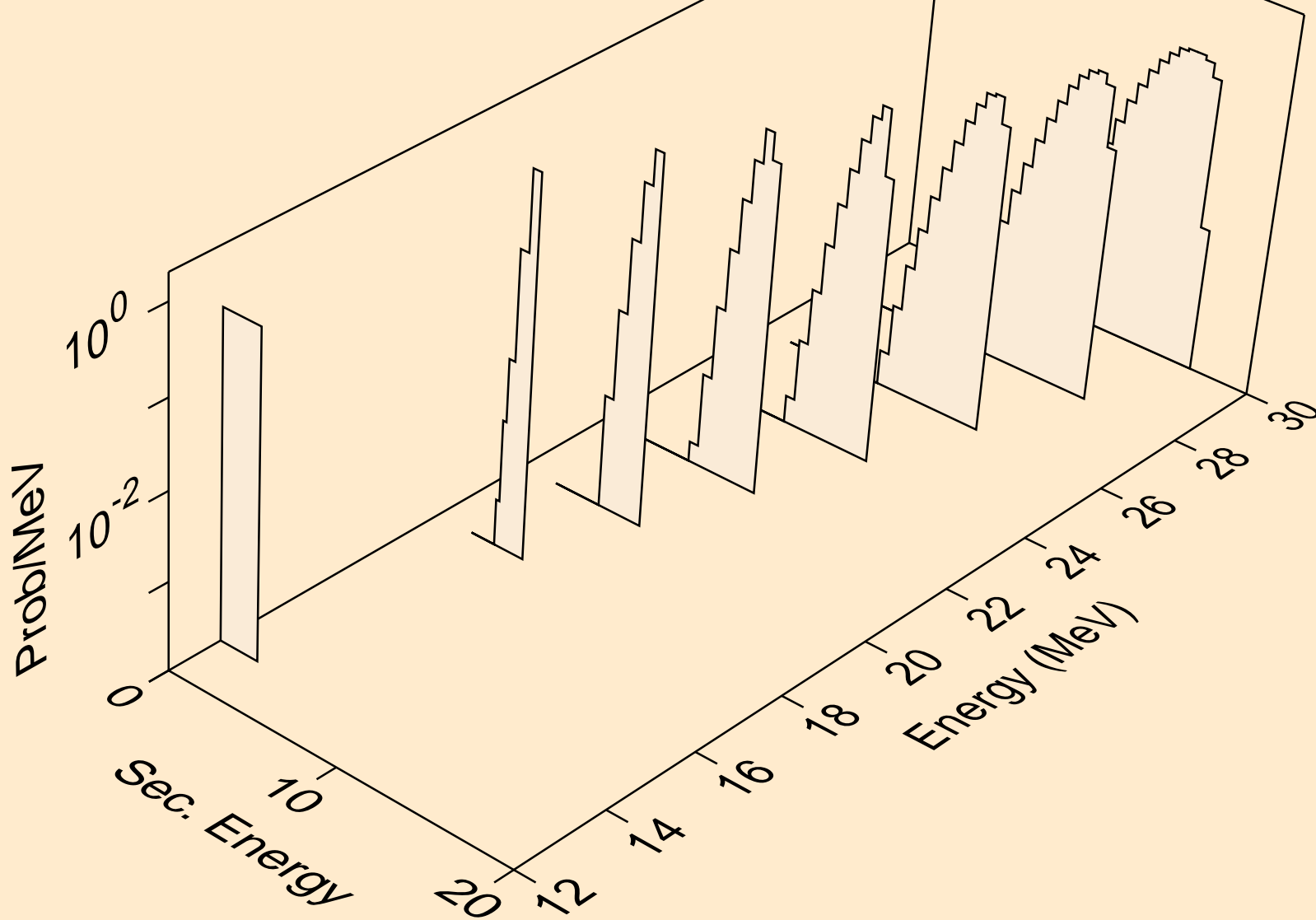



IN110 NEUTRON ACER TENDL-2019 LIBRARY; T=293.16K  
he3s from (n,he3)

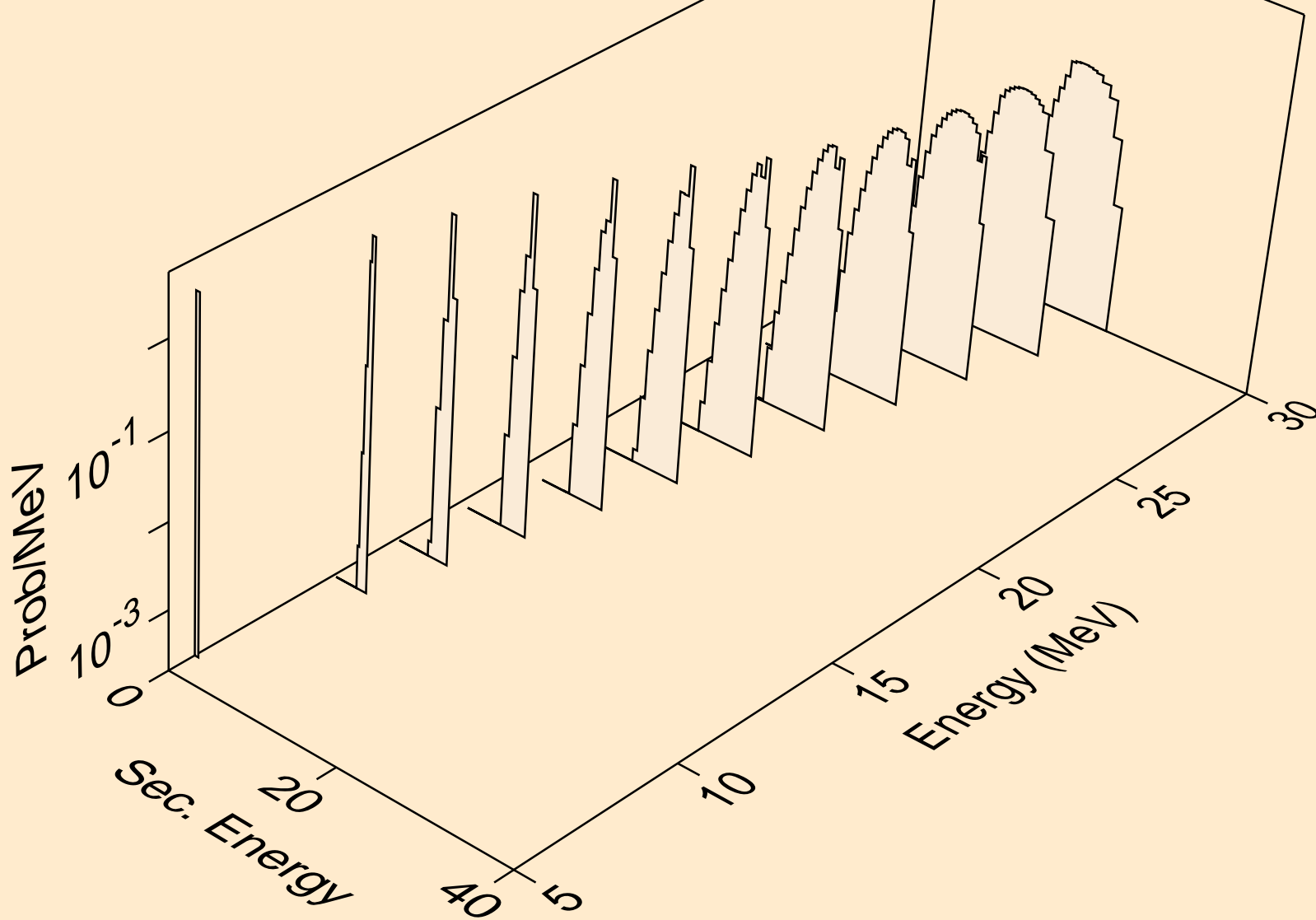

IN110 NEUTRON ACER TENDL-2019 LIBRARY; T=293.16K  
alphas from (n,x)

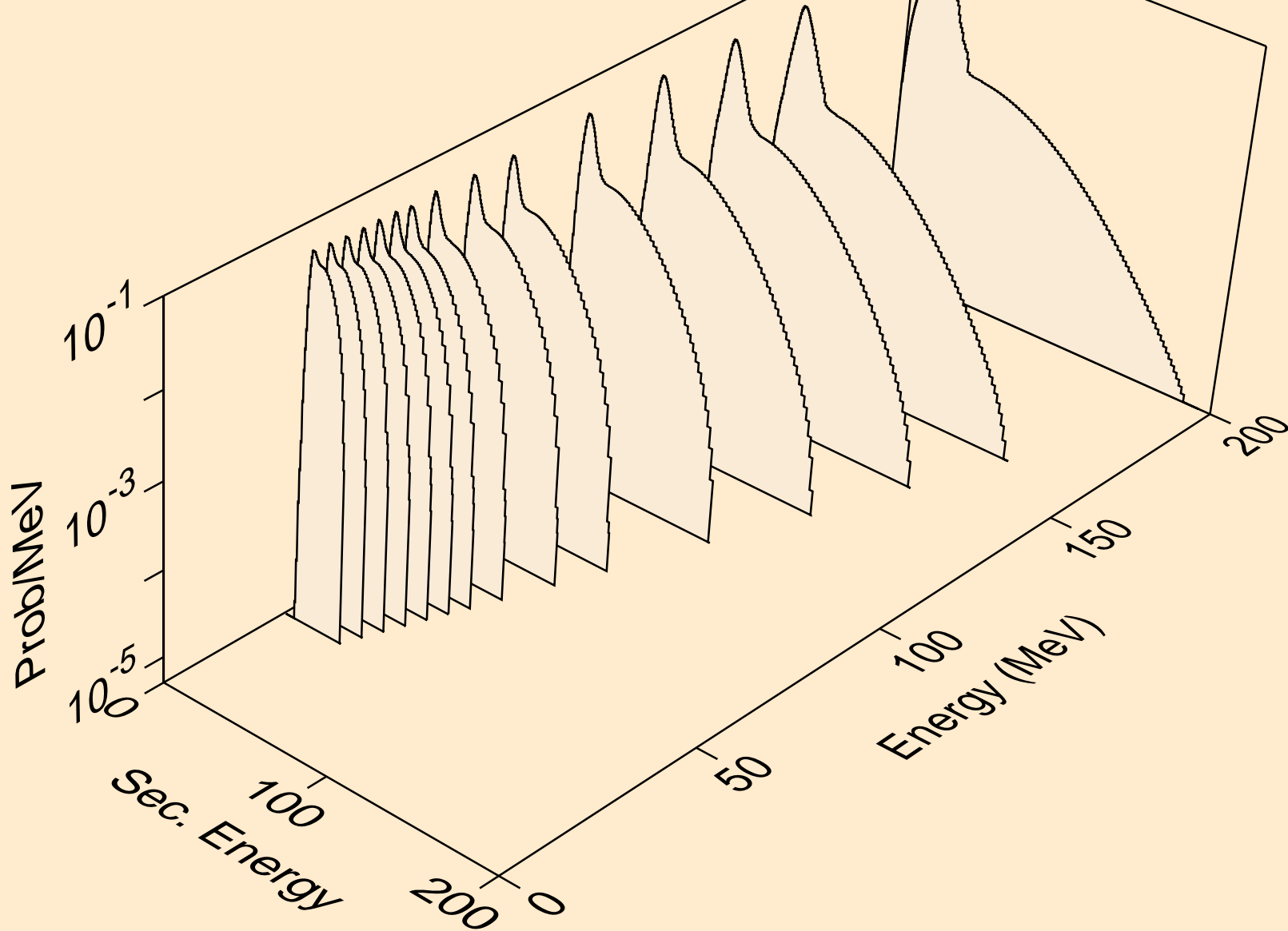

IN110 NEUTRON ACER TENDL-2019 LIBRARY; T=293.16K  
alphas from (n,n\*)a

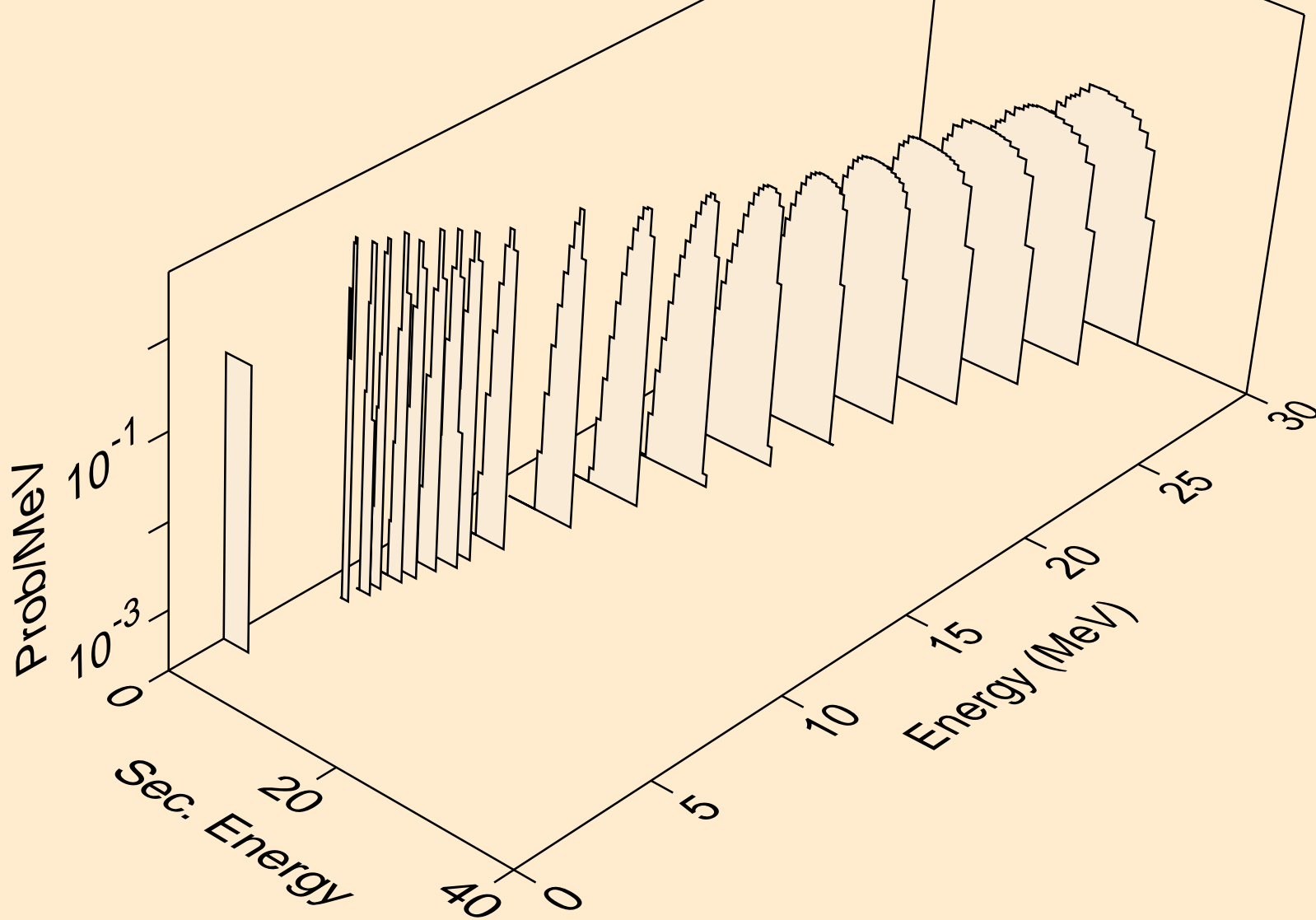

IN110 NEUTRON ACER TENDL-2019 LIBRARY; T=293.16K  
alphas from (n,2n)a

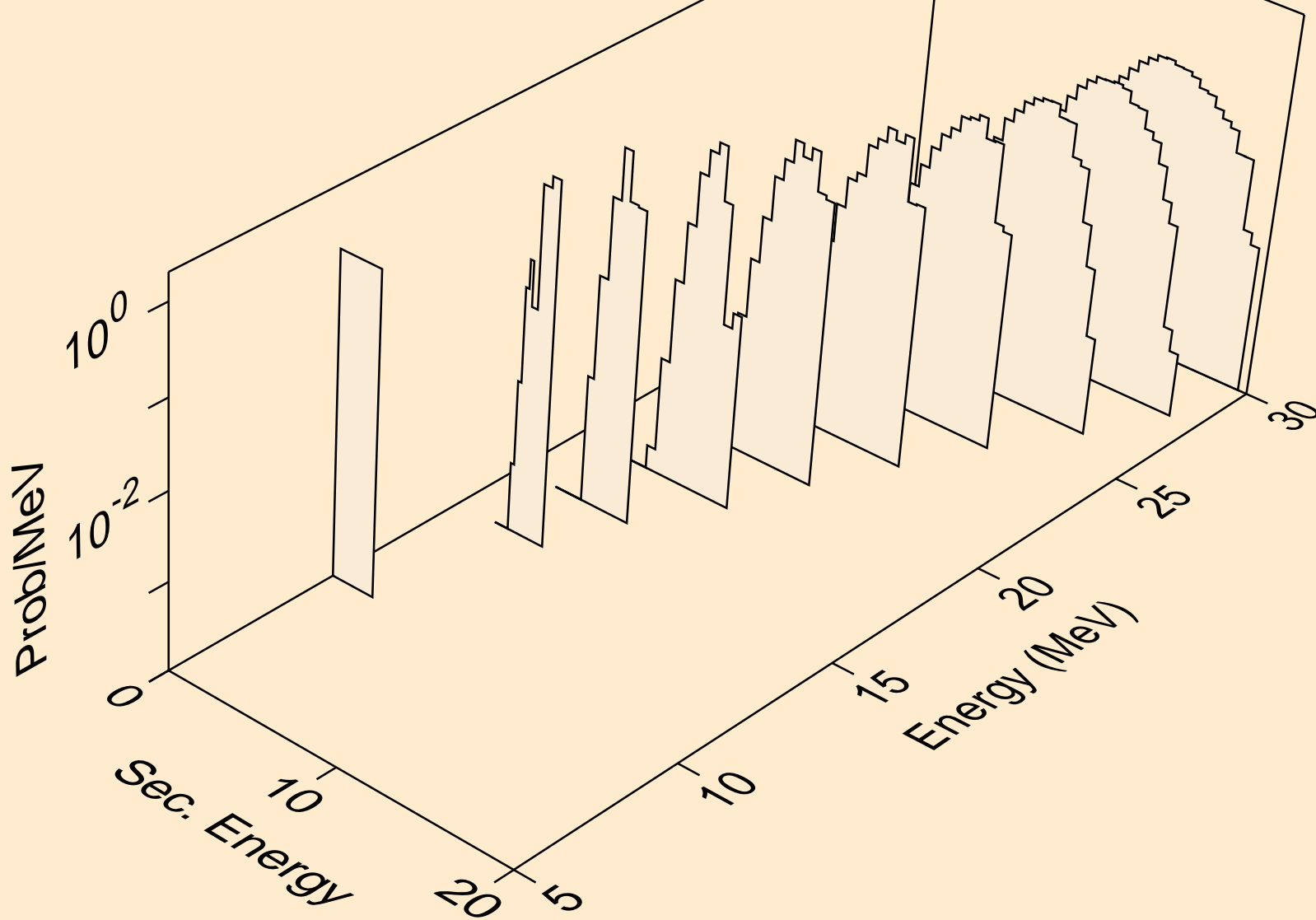

IN110 NEUTRON ACER TENDL-2019 LIBRARY; T=293.16K  
alphas from (n,3n)a

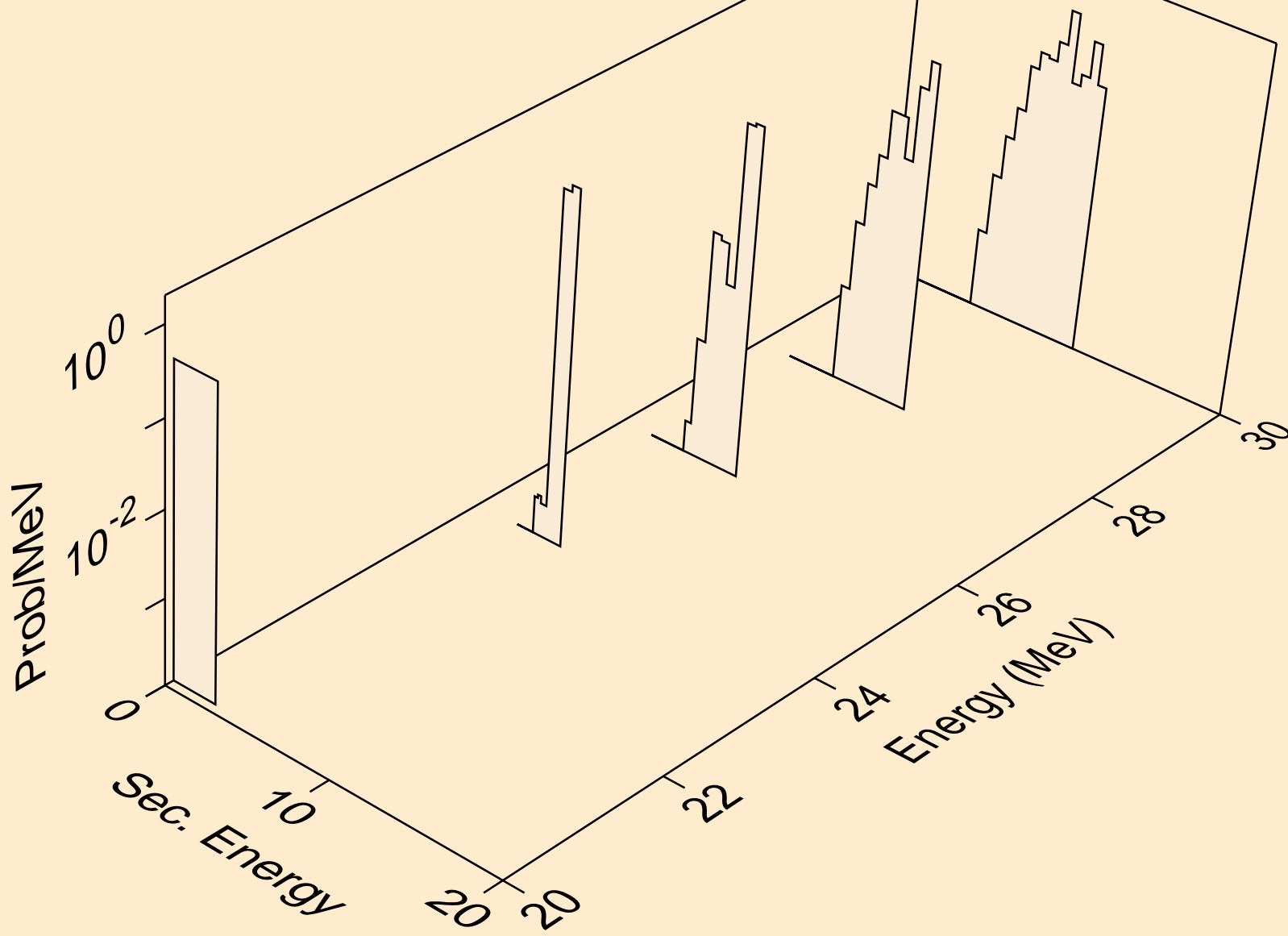

IN110 NEUTRON ACER TENDL-2019 LIBRARY; T=293.16K  
alphas from (n,n\*)2a

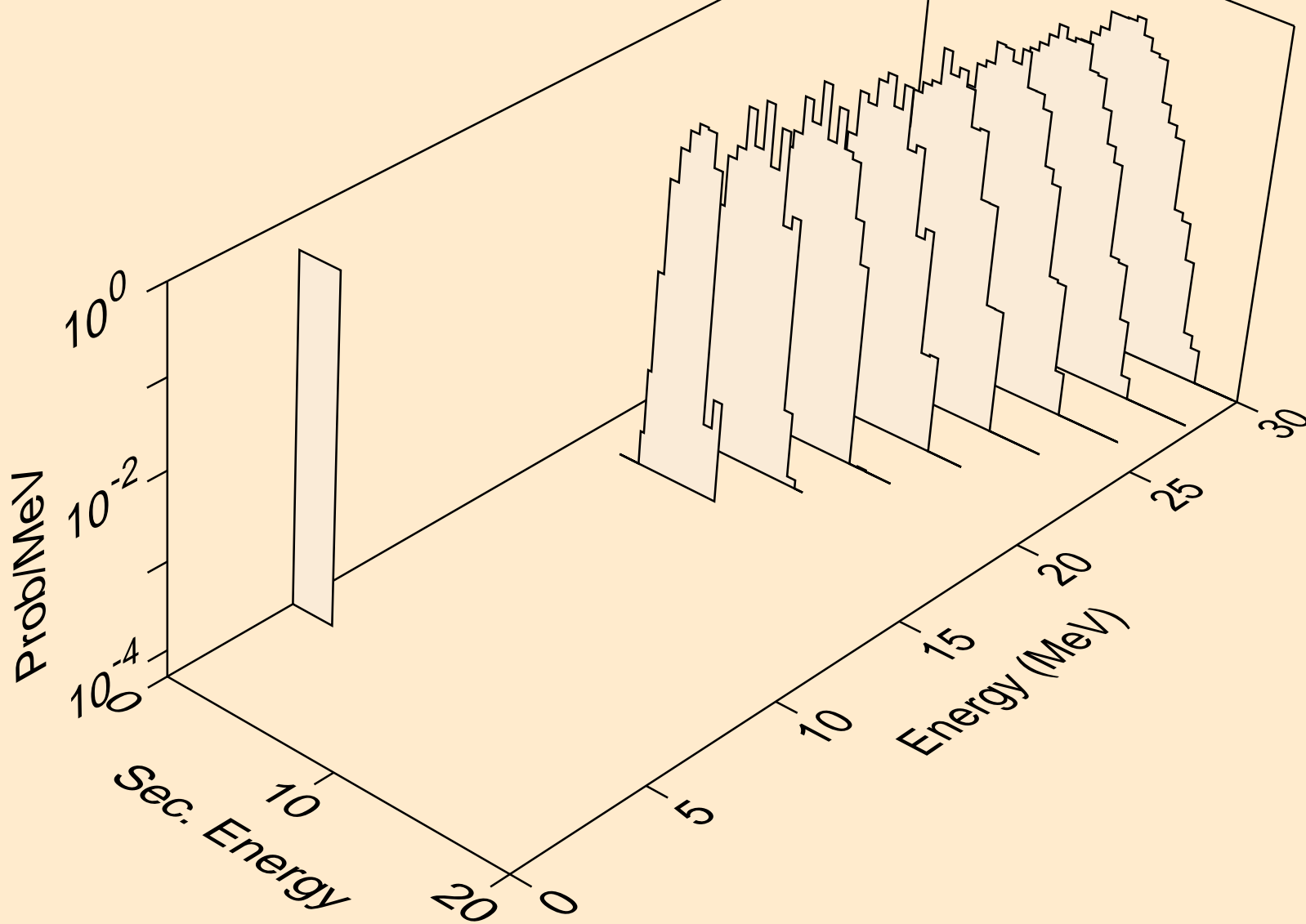

IN110 NEUTRON ACER TENDL-2019 LIBRARY; T=293.16K  
alphas from (n,2n)2a

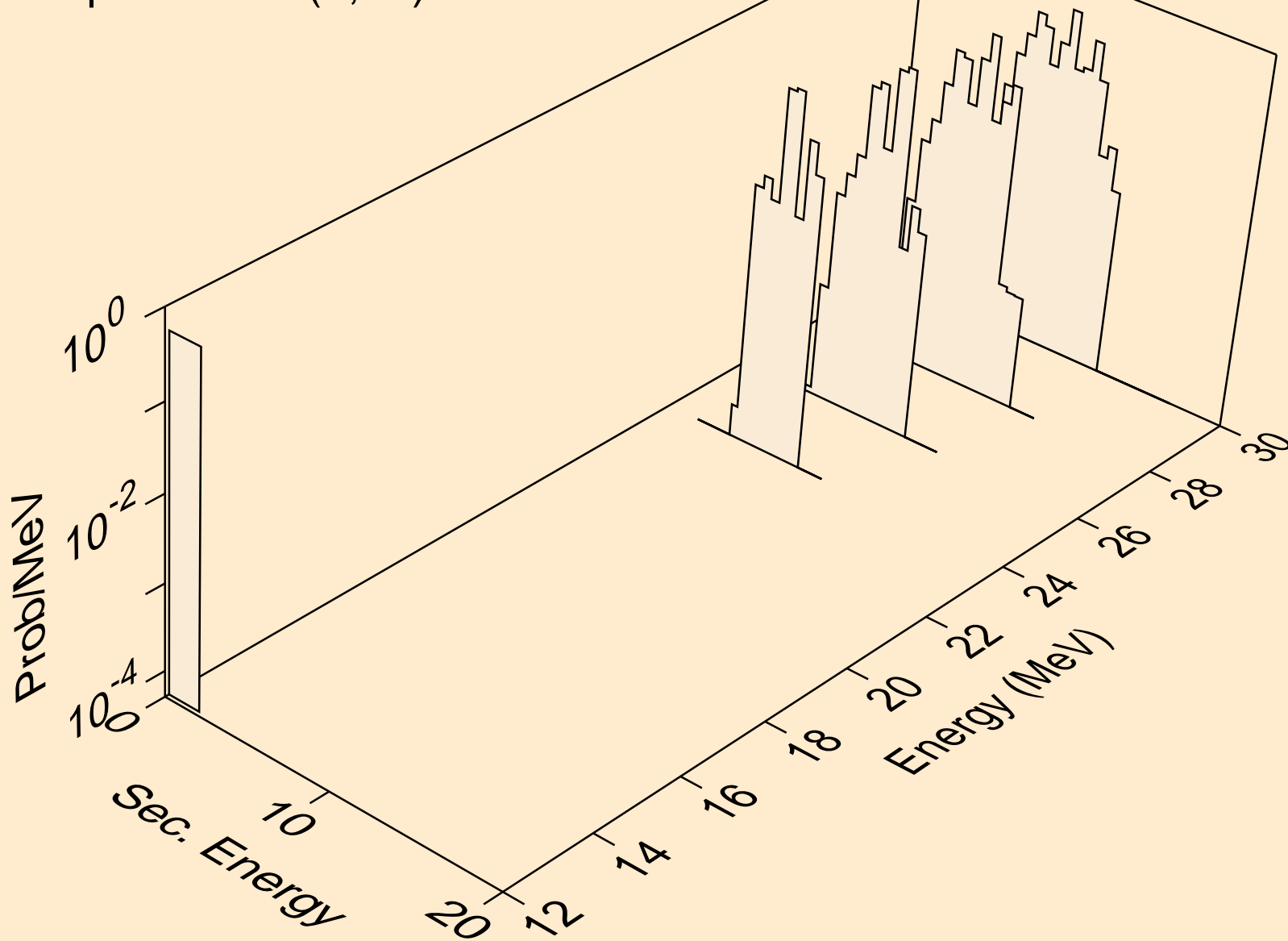

IN110 NEUTRON ACER TENDL-2019 LIBRARY; T=293.16K  
alphas from (n,npa)

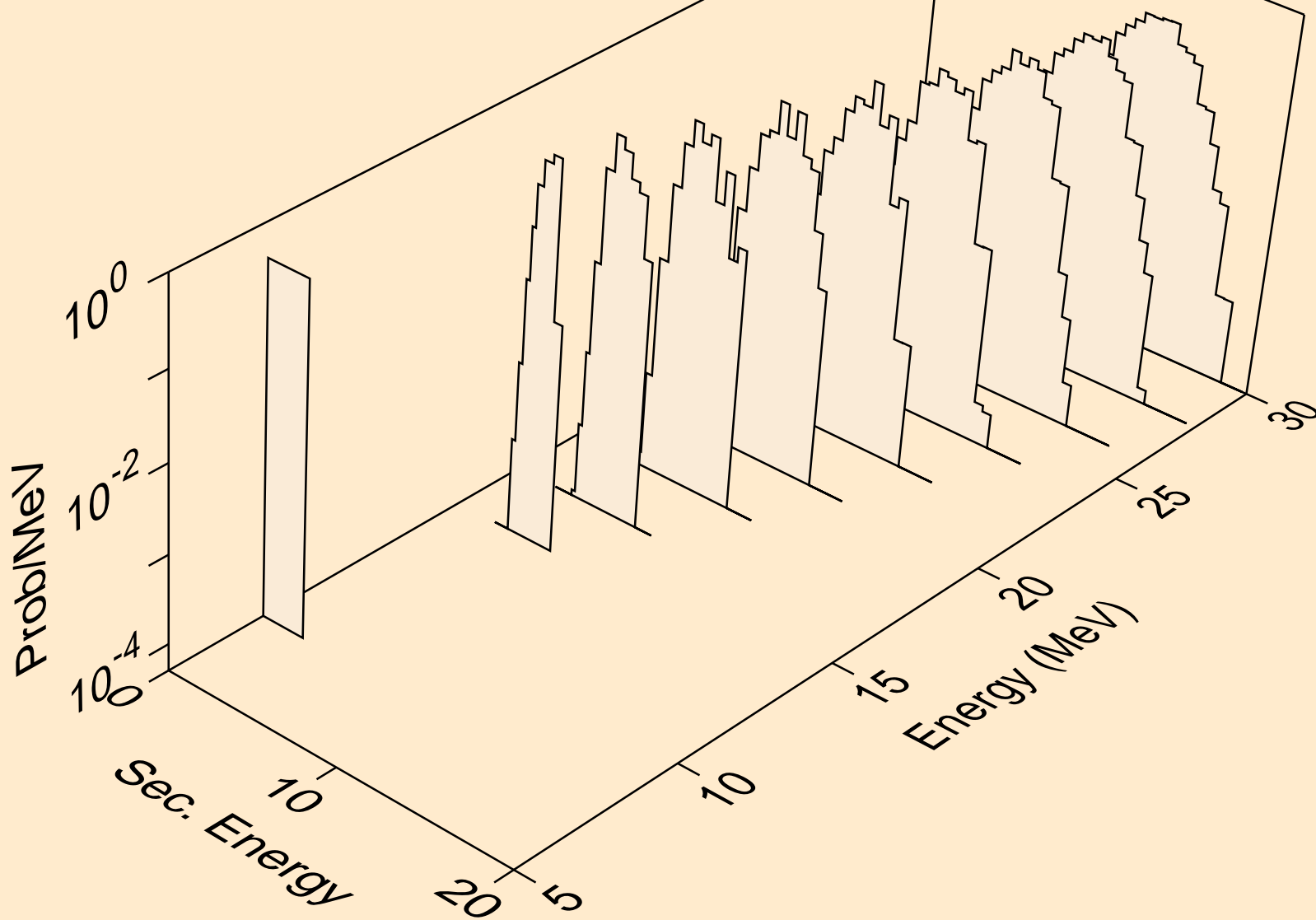



IN110 NEUTRON ACER TENDL-2019 LIBRARY; T=293.16K  
alphas from (n,a)

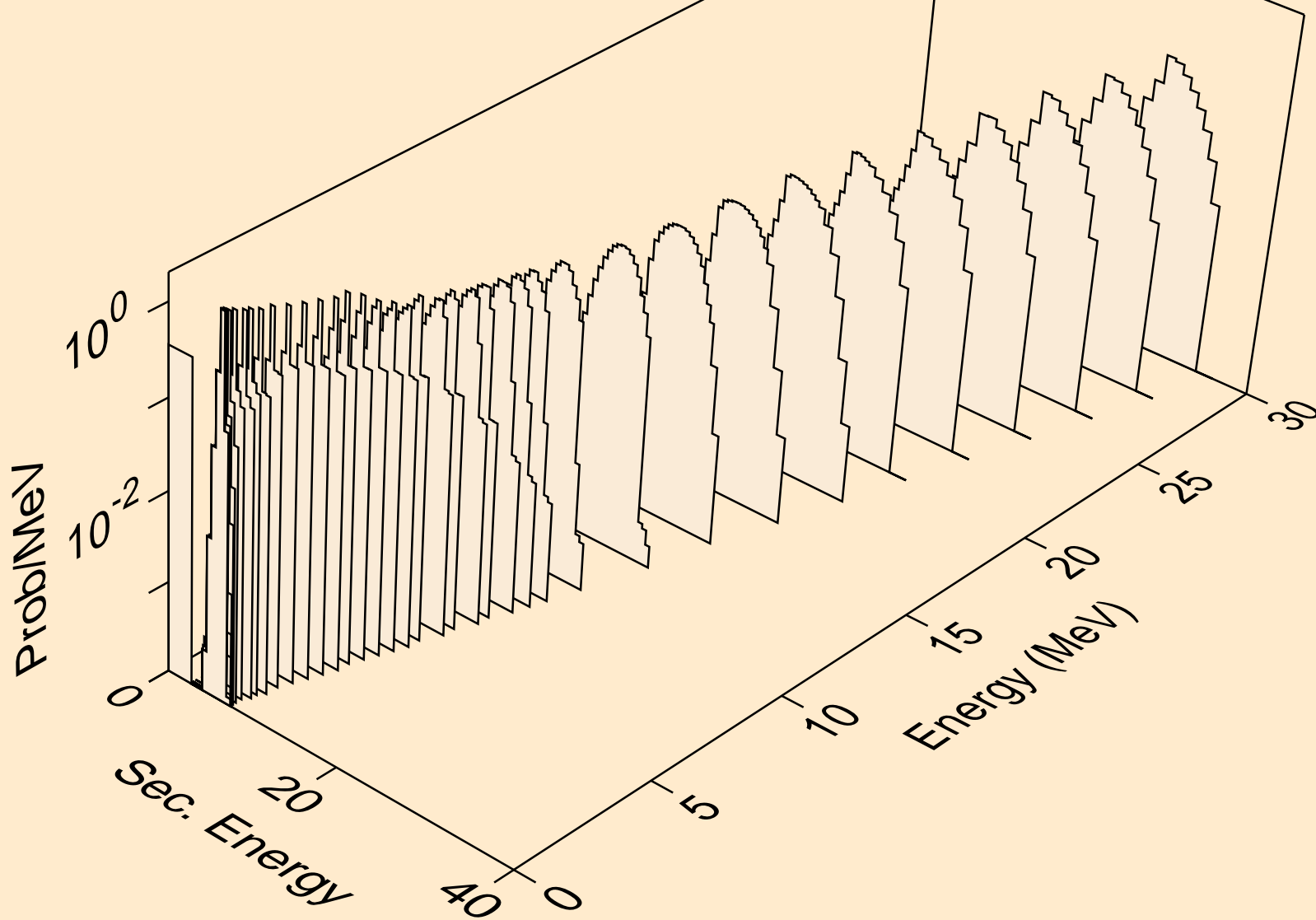

IN110 NEUTRON ACER TENDL-2019 LIBRARY; T=293.16K  
alphas from (n,2a)

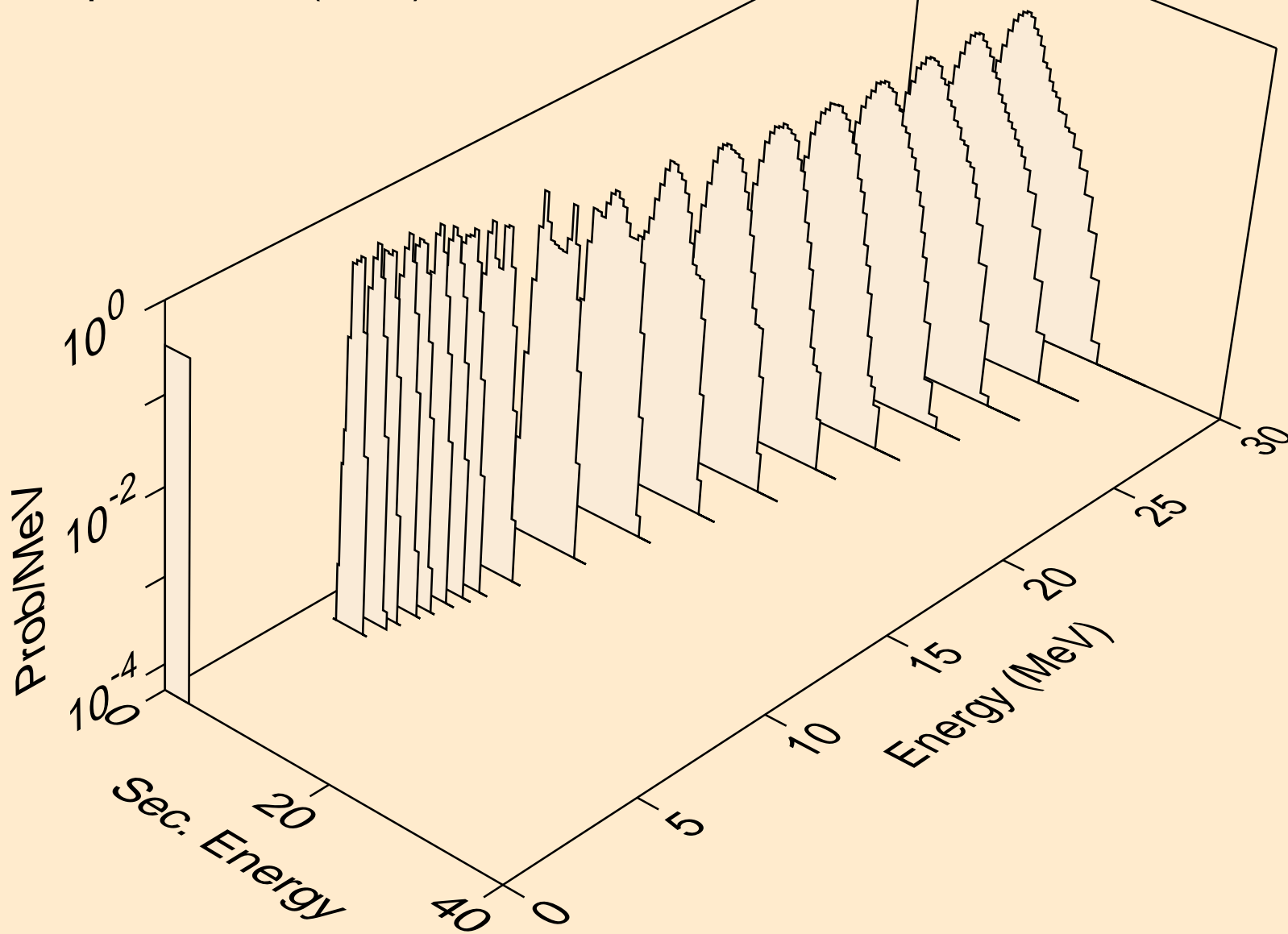

IN110 NEUTRON ACER TENDL-2019 LIBRARY; T=293.16K  
alphas from (n,pa)

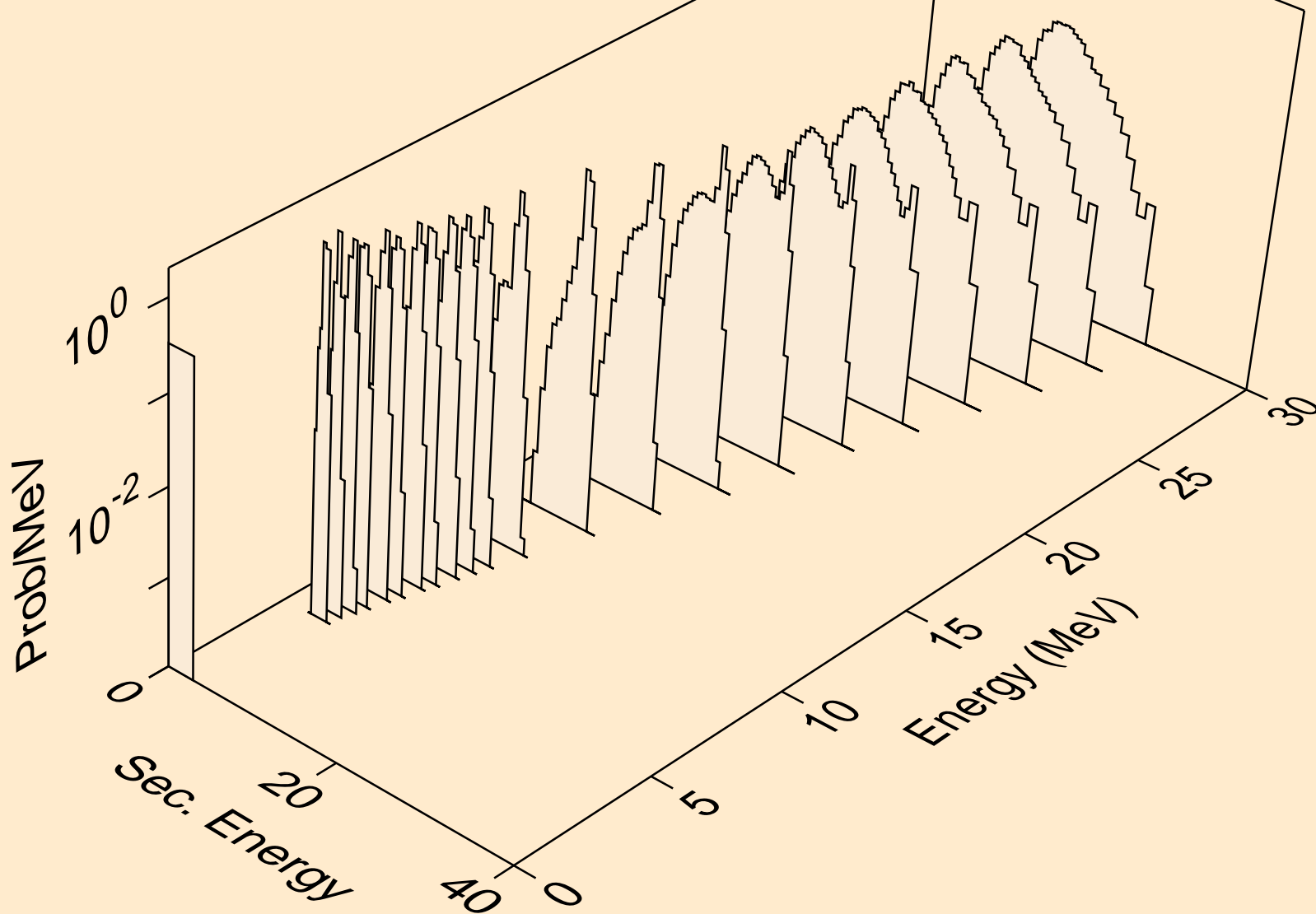

IN110 NEUTRON ACER TENDL-2019 LIBRARY; T=293.16K  
alphas from (n,da)

