

IN118N NEUTRON ACER TENDL-2019 LIBRARY; T=293.16K

Principal cross sections

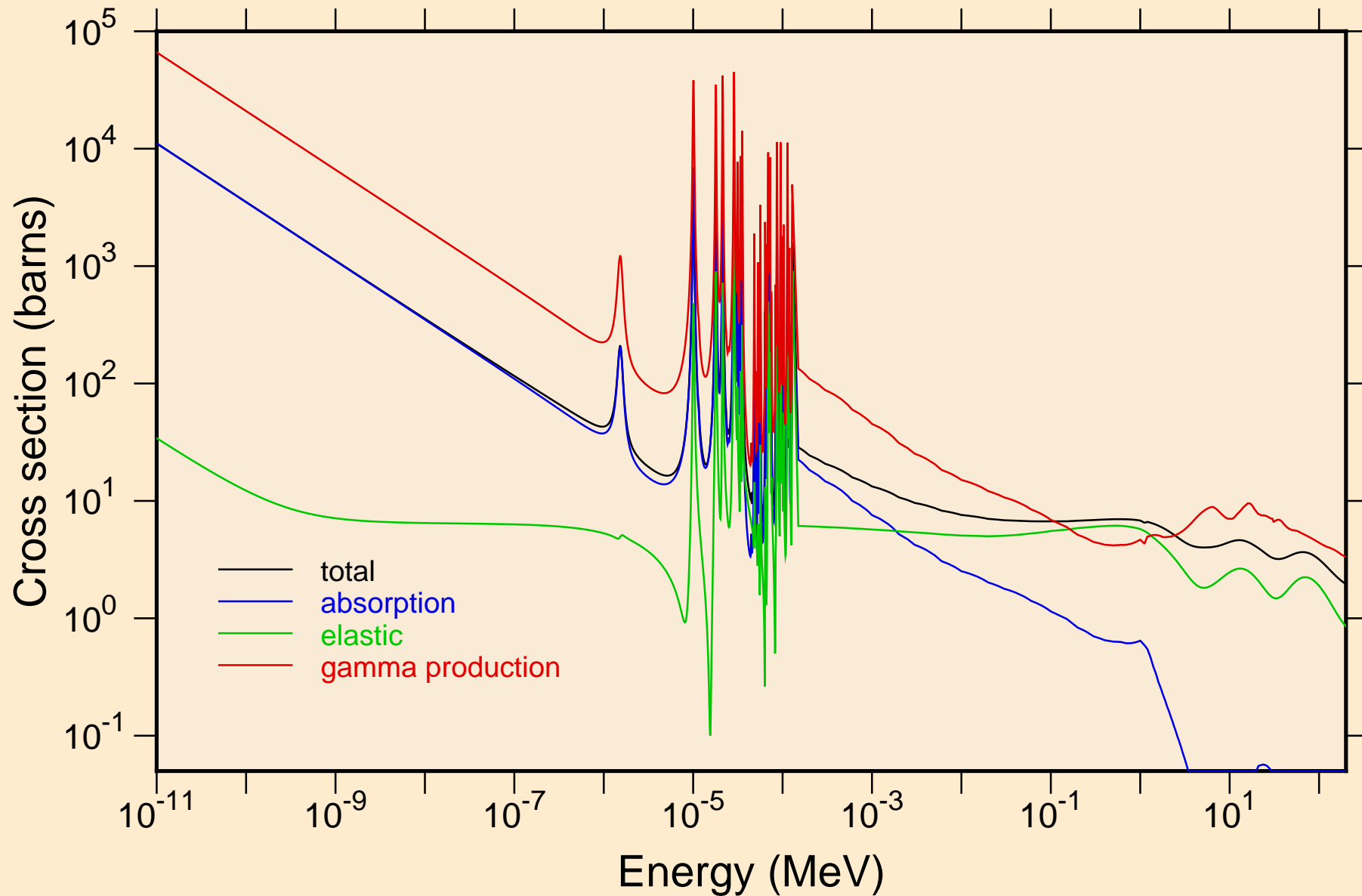

IN118N NEUTRON ACER TENDL-2019 LIBRARY; T=293.16K
resonance total cross section

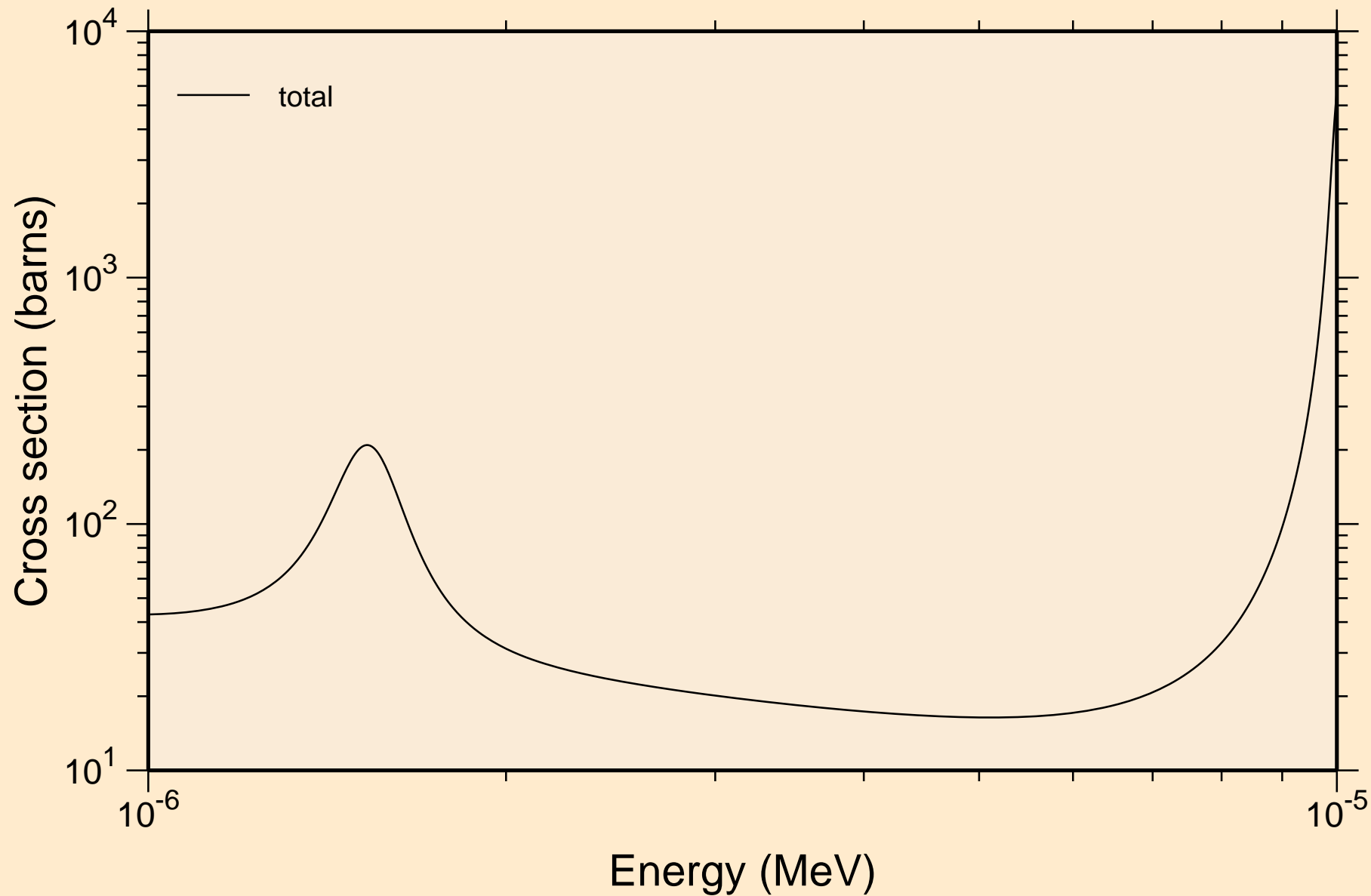

IN118N NEUTRON ACER TENDL-2019 LIBRARY; T=293.16K
resonance total cross section

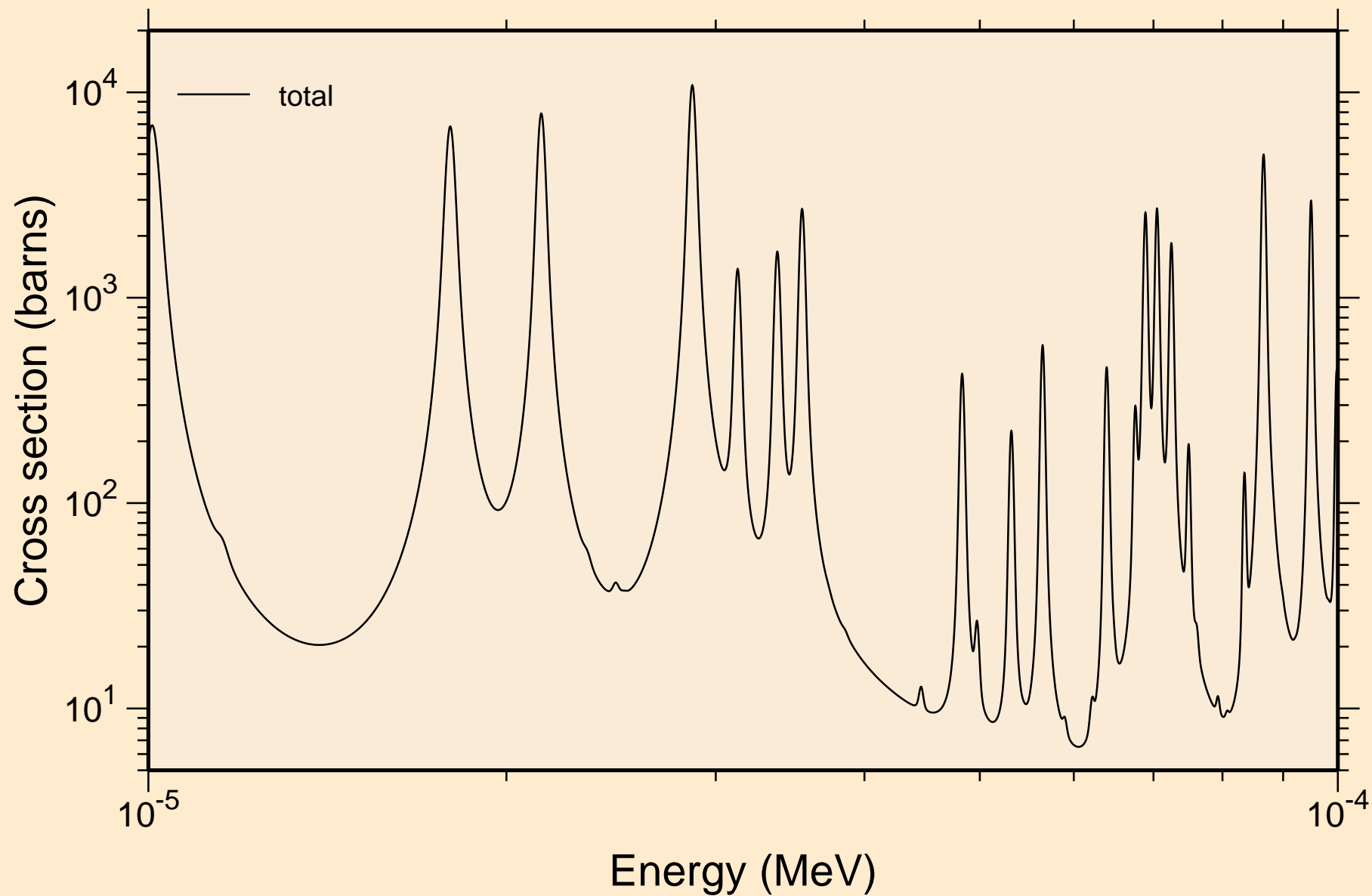

IN118N NEUTRON ACER TENDL-2019 LIBRARY; T=293.16K
resonance total cross section

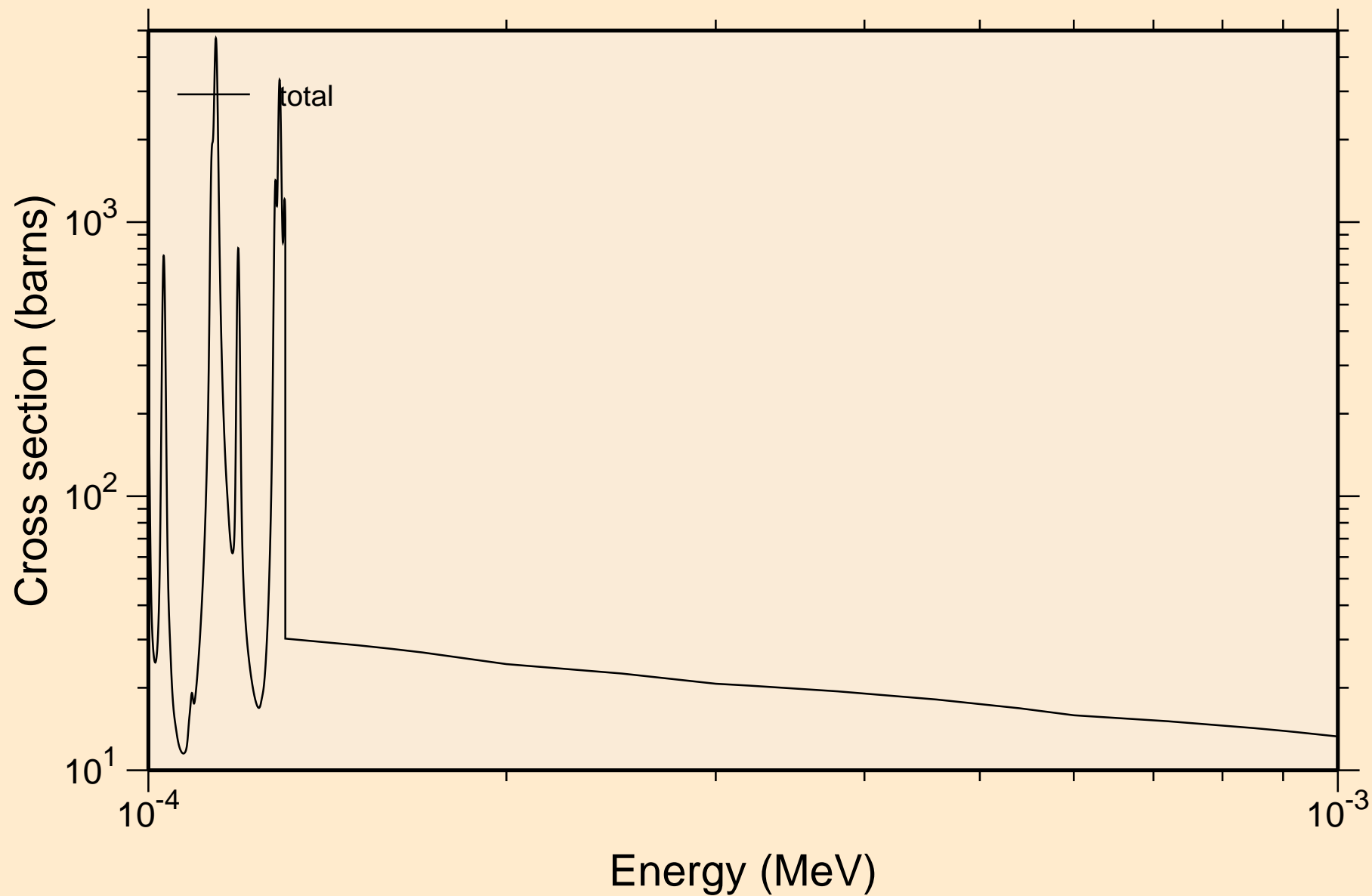

IN118N NEUTRON ACER TENDL-2019 LIBRARY; T=293.16K
resonance total cross section

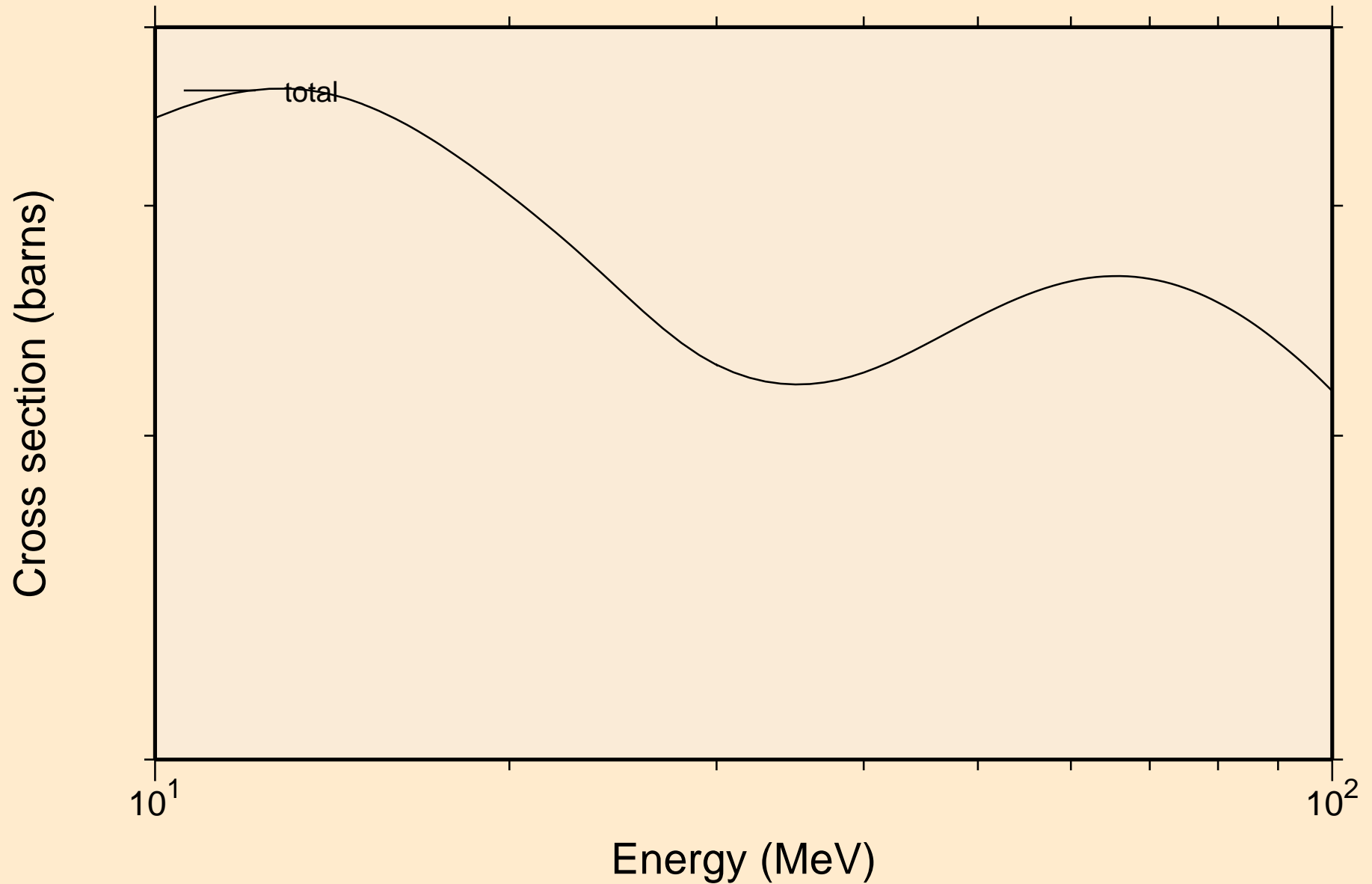

IN118N NEUTRON ACER TENDL-2019 LIBRARY; T=293.16K
resonance absorption cross sections

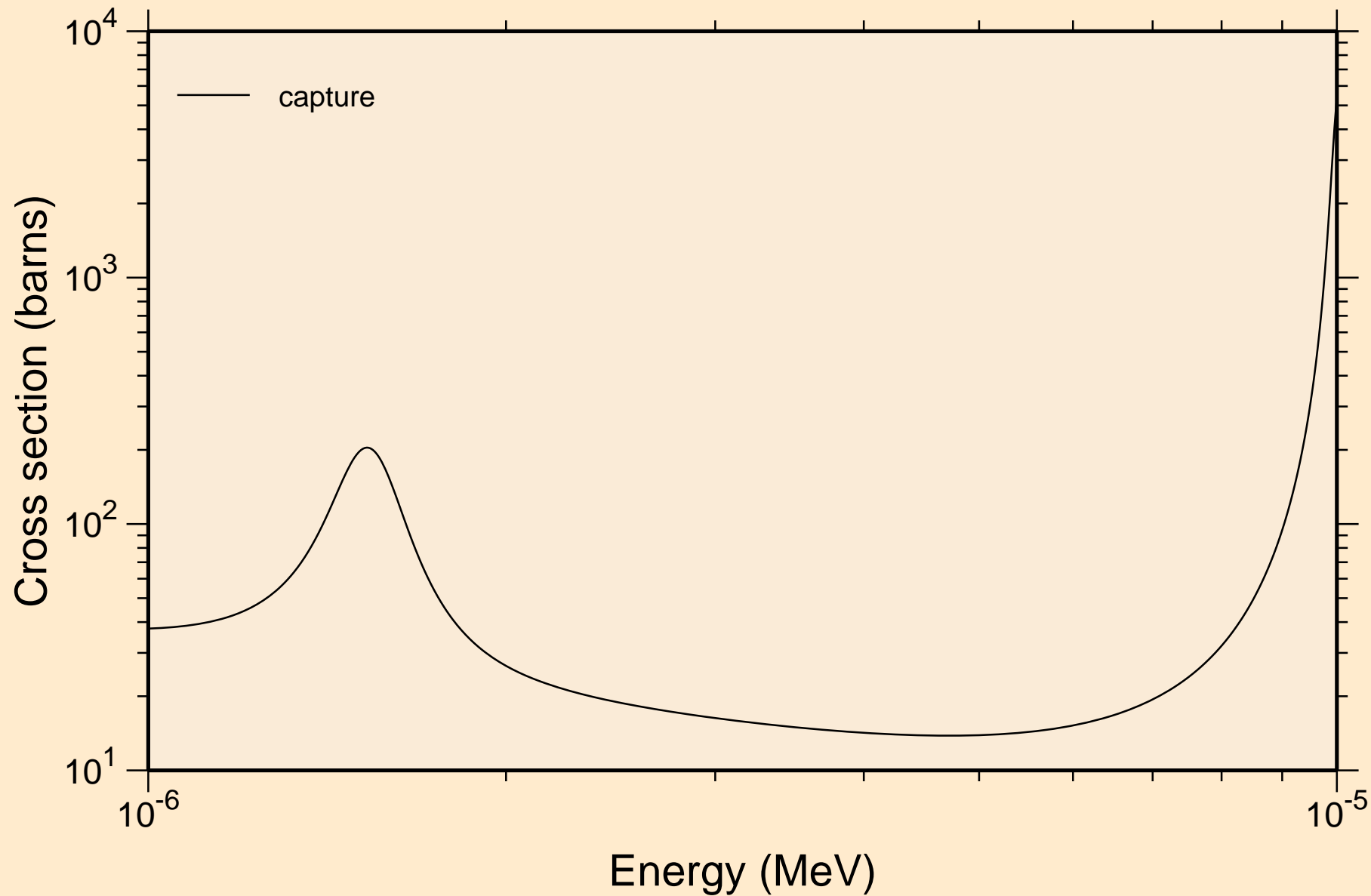

IN118N NEUTRON ACER TENDL-2019 LIBRARY; T=293.16K
resonance absorption cross sections

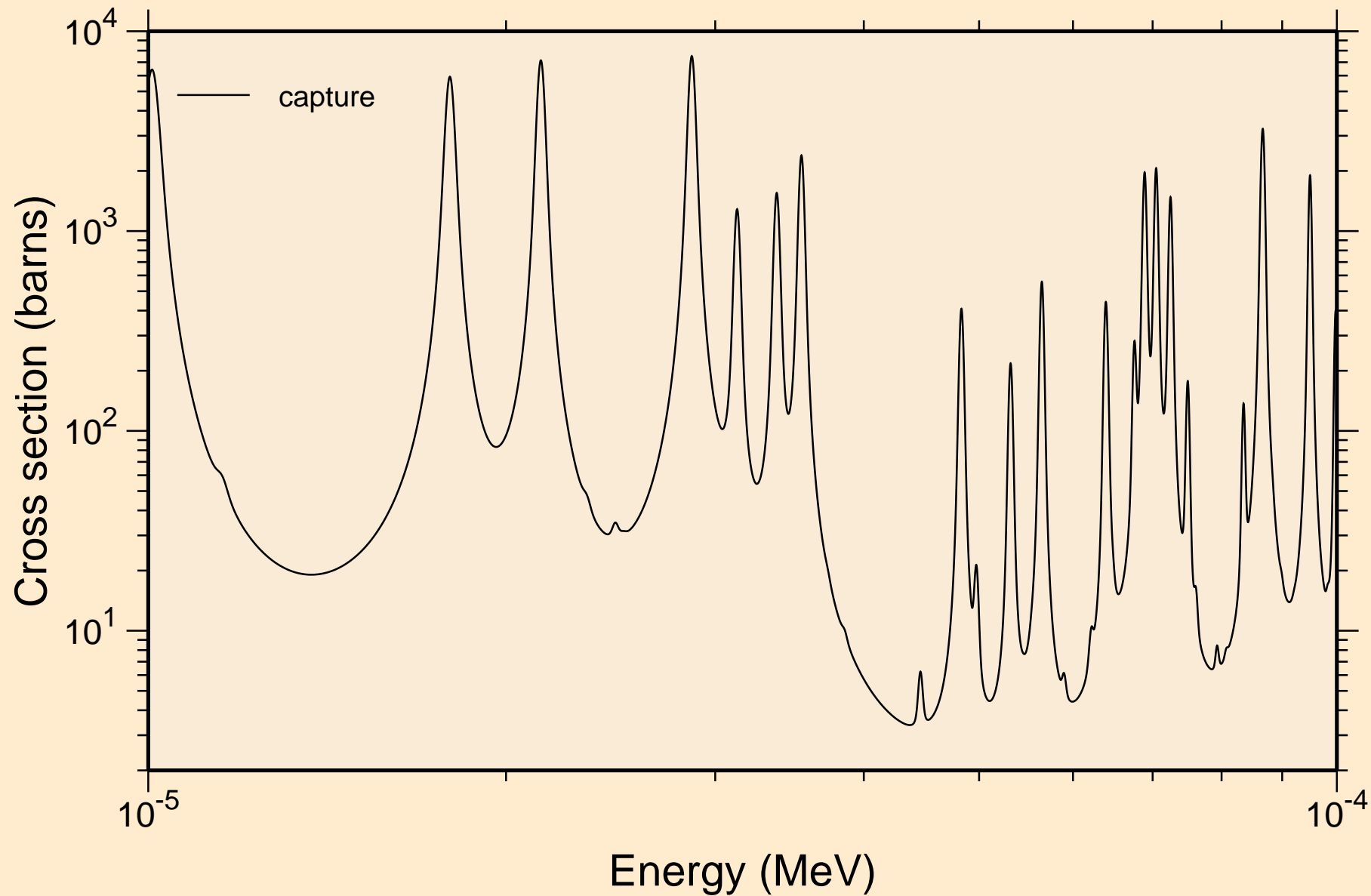

IN118N NEUTRON ACER TENDL-2019 LIBRARY; T=293.16K
resonance absorption cross sections

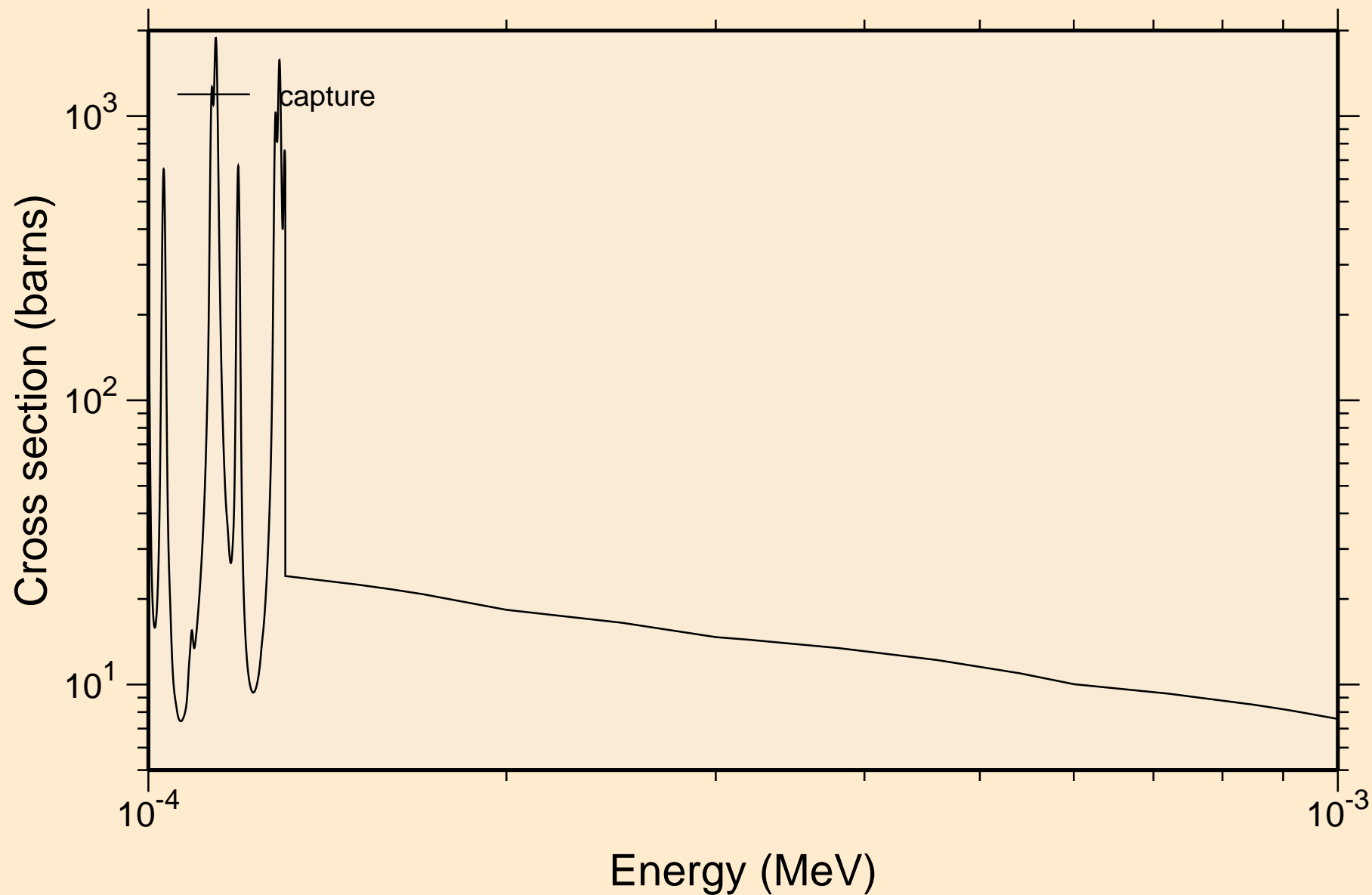

IN118N NEUTRON ACER TENDL-2019 LIBRARY; T=293.16K
resonance absorption cross sections

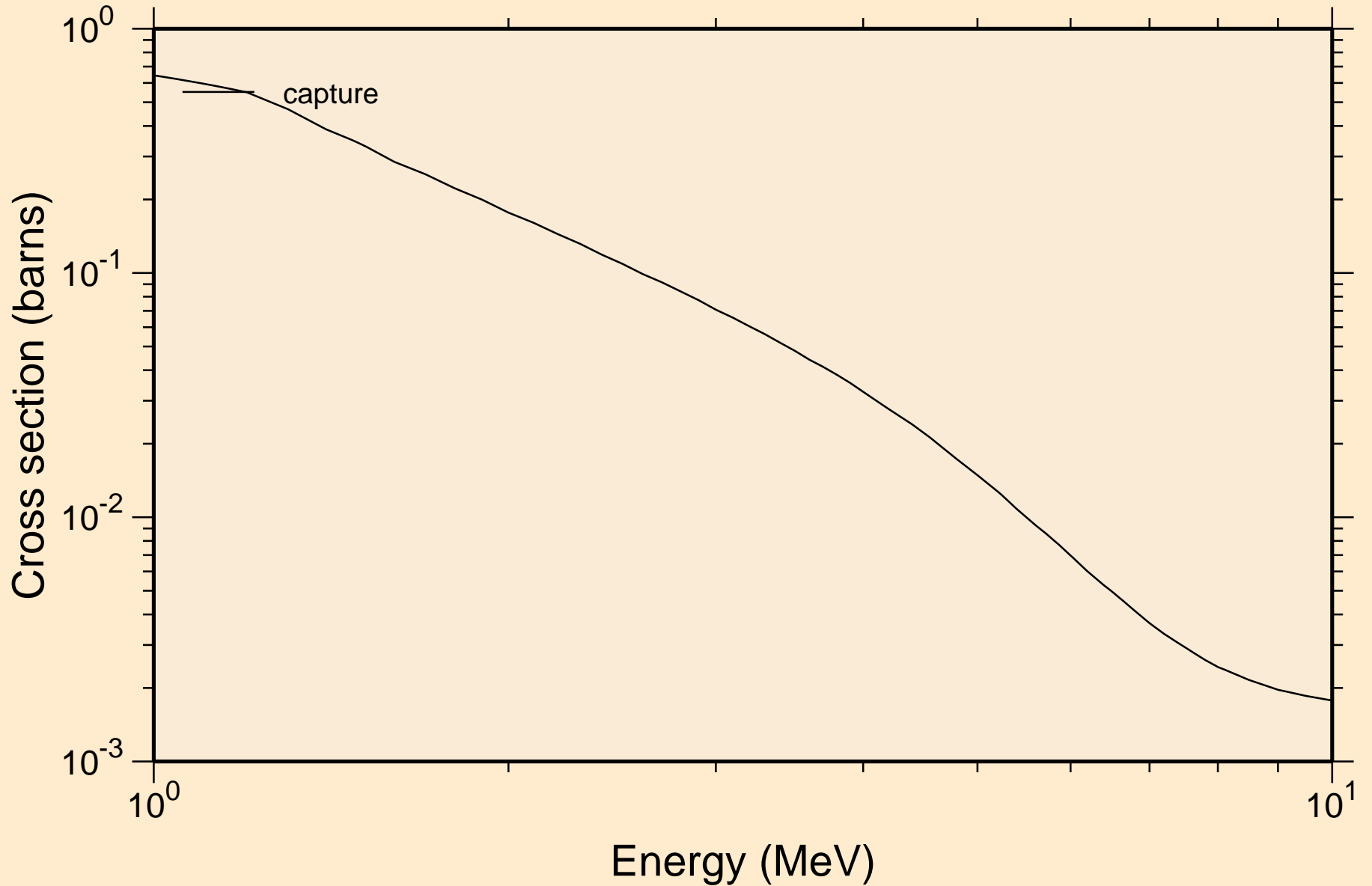

IN118N NEUTRON ACER TENDL-2019 LIBRARY; T=293.16K
Heating

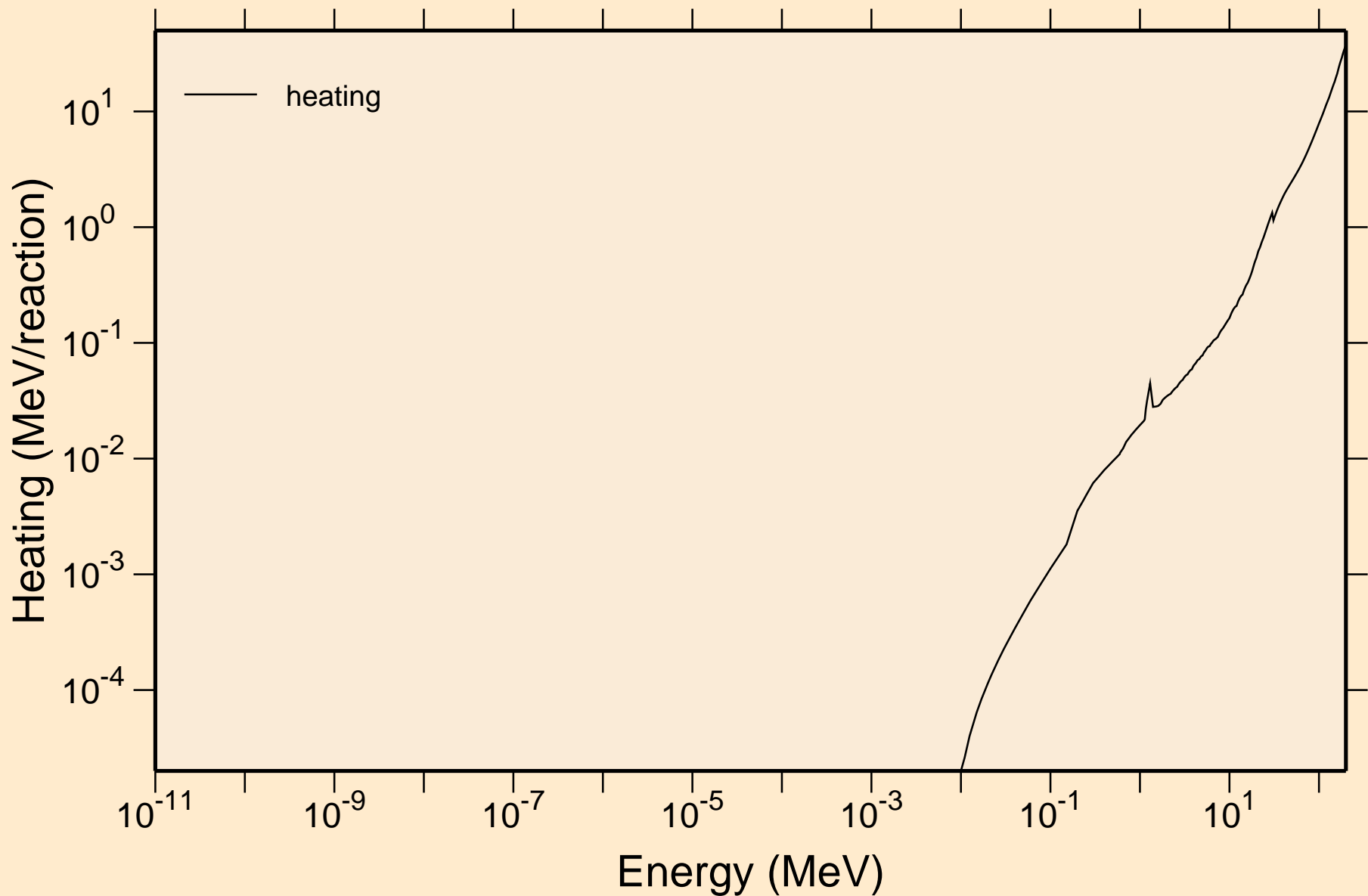

IN118N NEUTRON ACER TENDL-2019 LIBRARY; T=293.16K
Damage

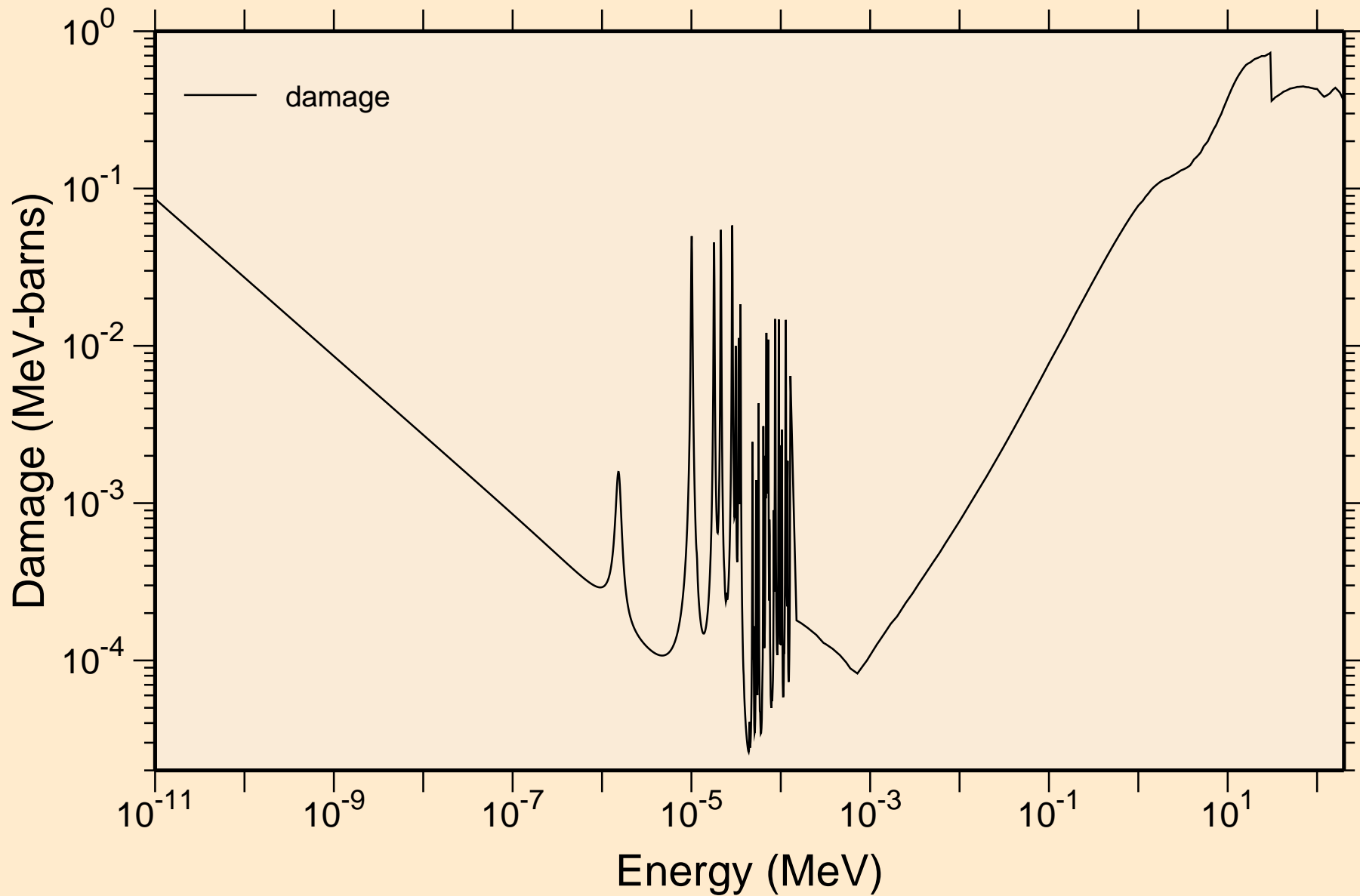

IN118N NEUTRON ACER TENDL-2019 LIBRARY; T=293.16K
Non-threshold reactions

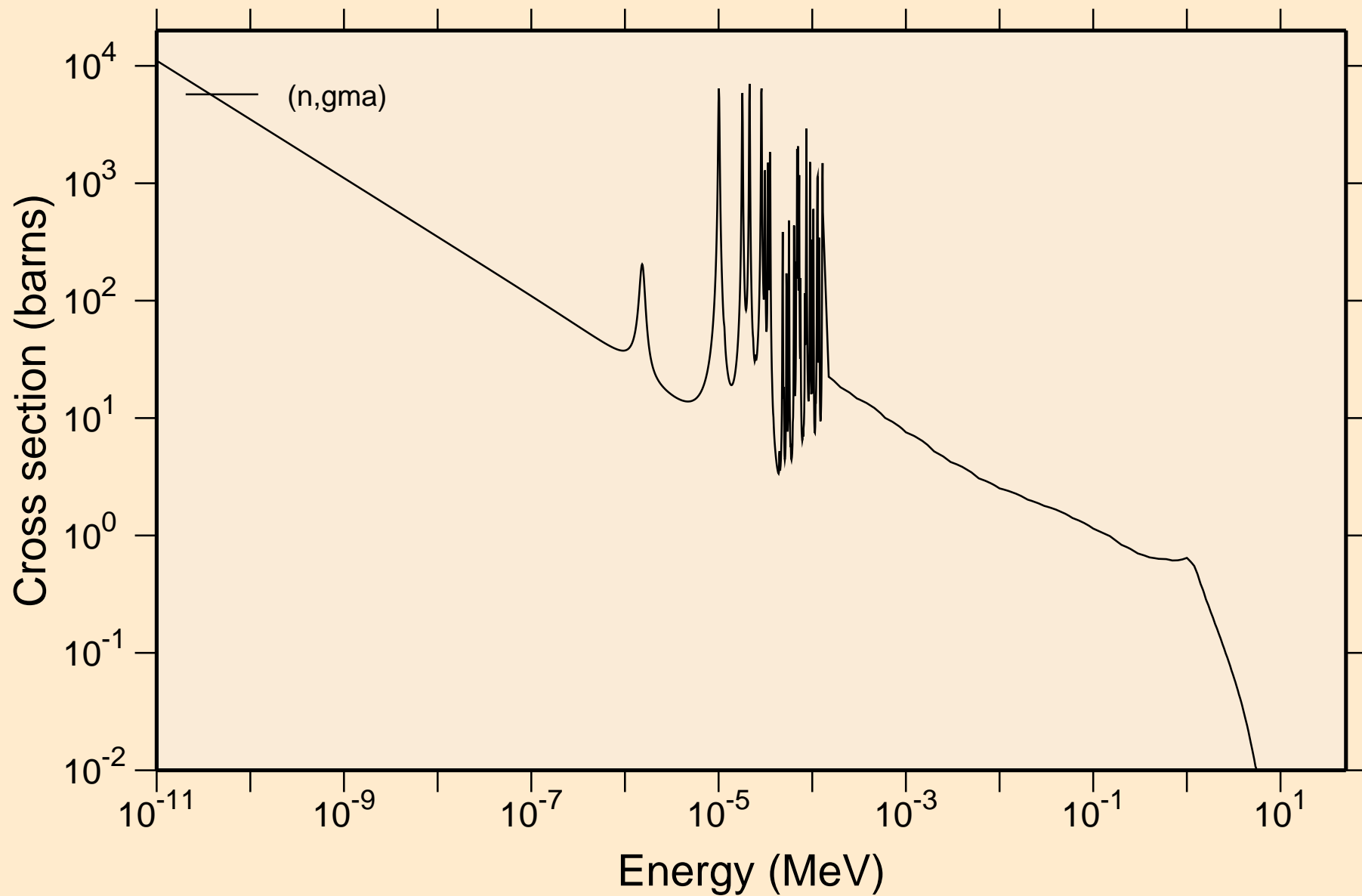

IN118N NEUTRON ACER TENDL-2019 LIBRARY; T=293.16K
Principal cross sections

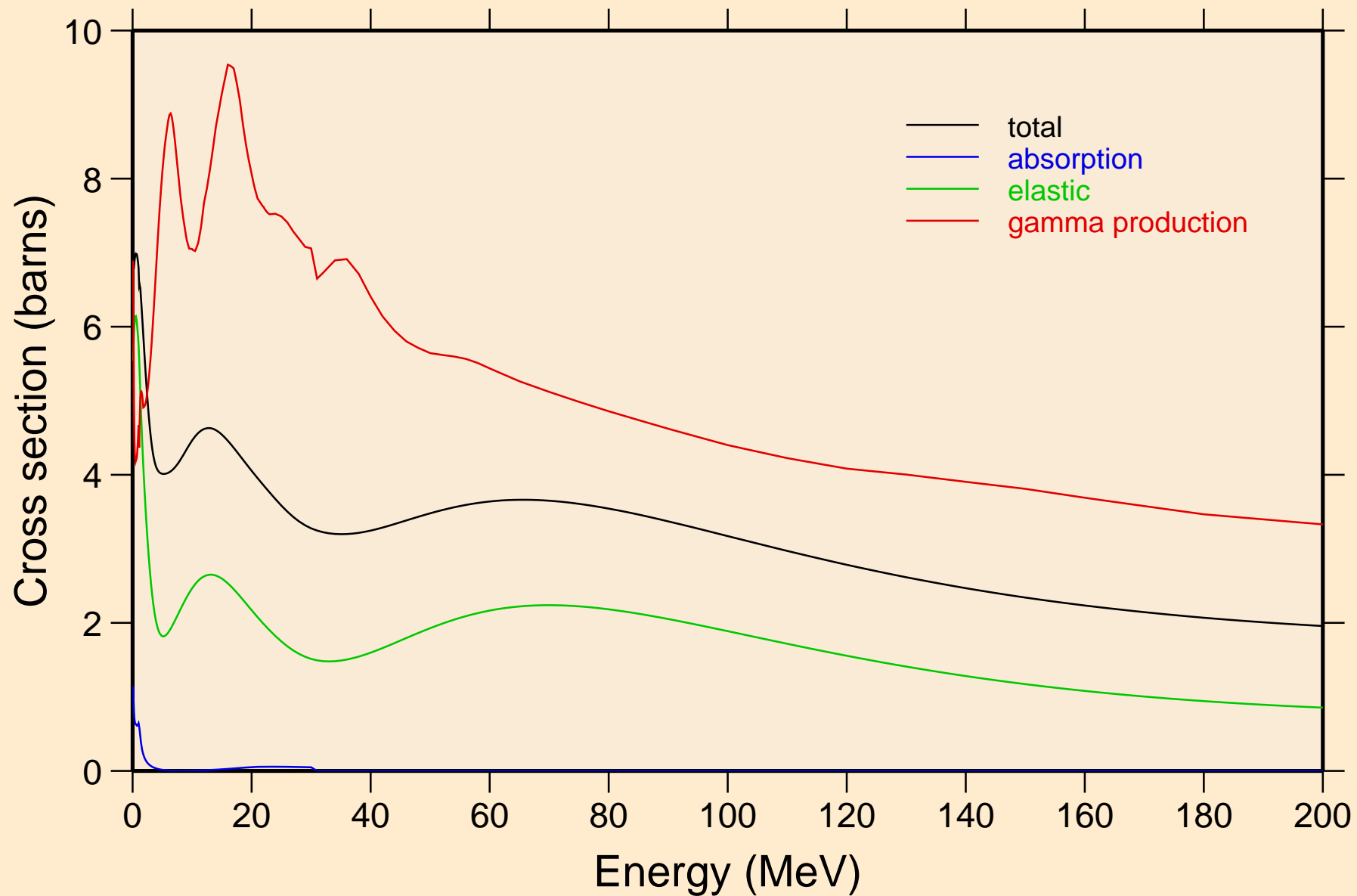

IN118N NEUTRON ACER TENDL-2019 LIBRARY; T=293.16K
Heating

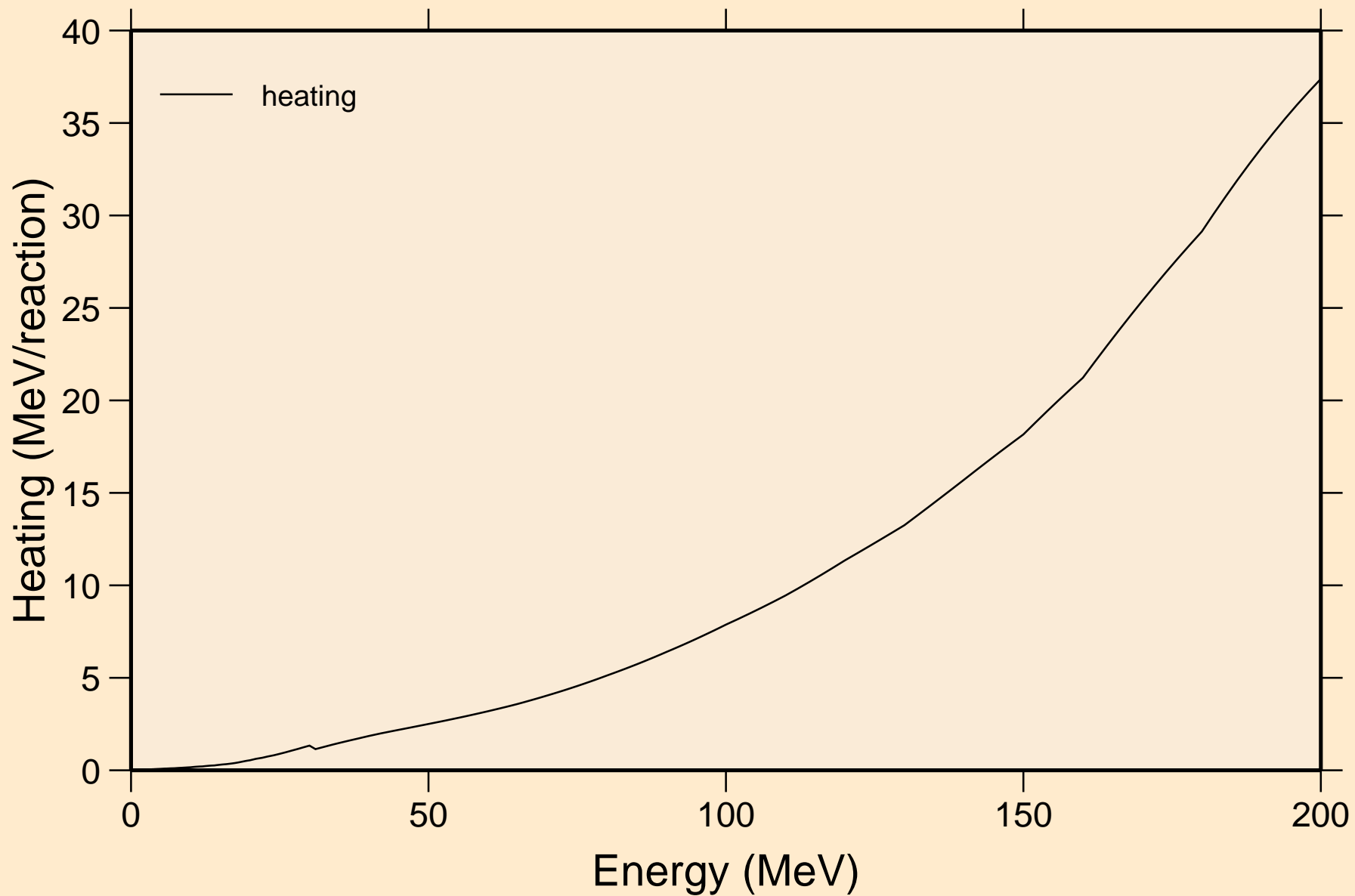

IN118N NEUTRON ACER TENDL-2019 LIBRARY; T=293.16K
Damage

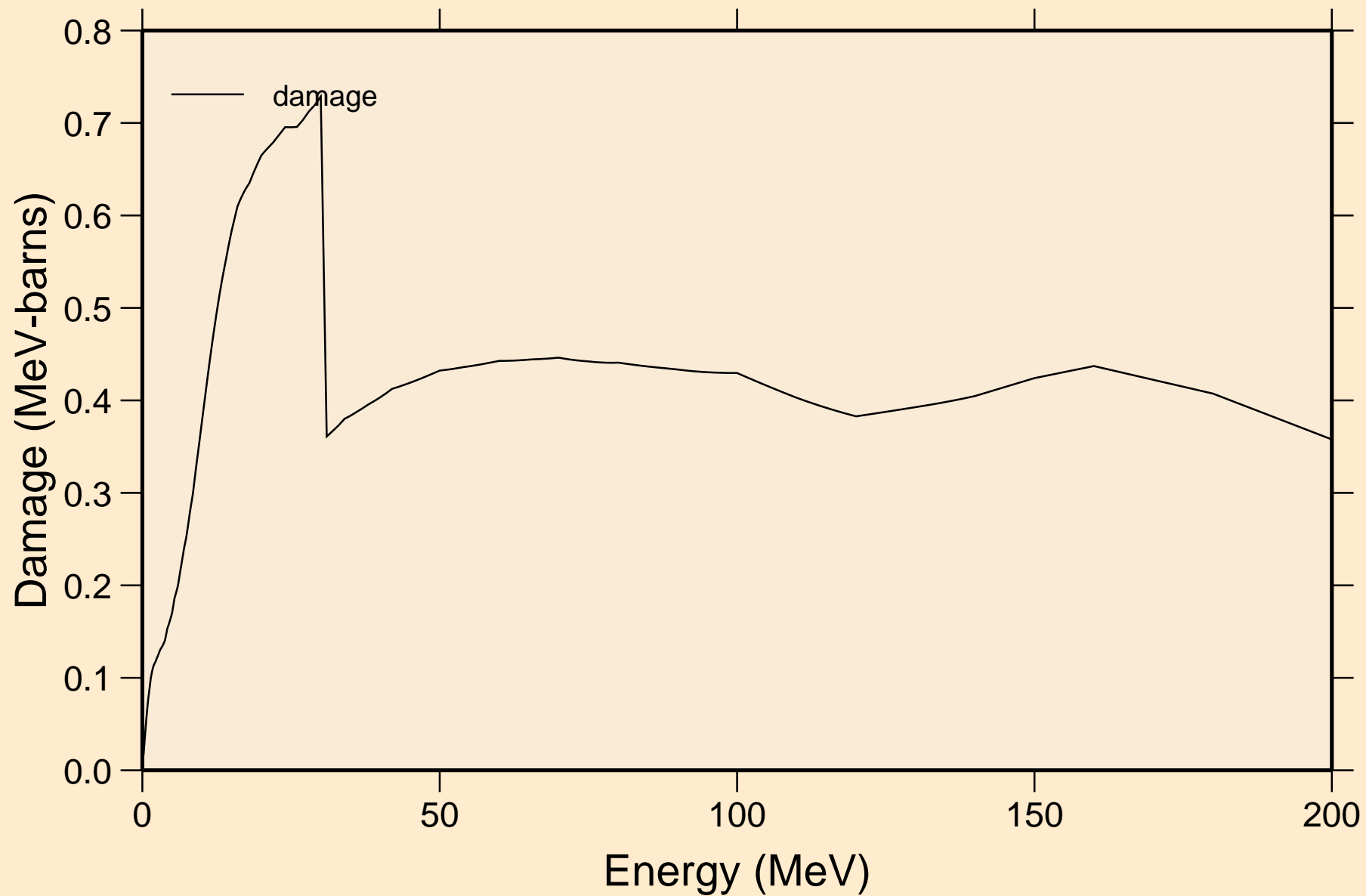

IN118N NEUTRON ACER TENDL-2019 LIBRARY; T=293.16K
Non-threshold reactions

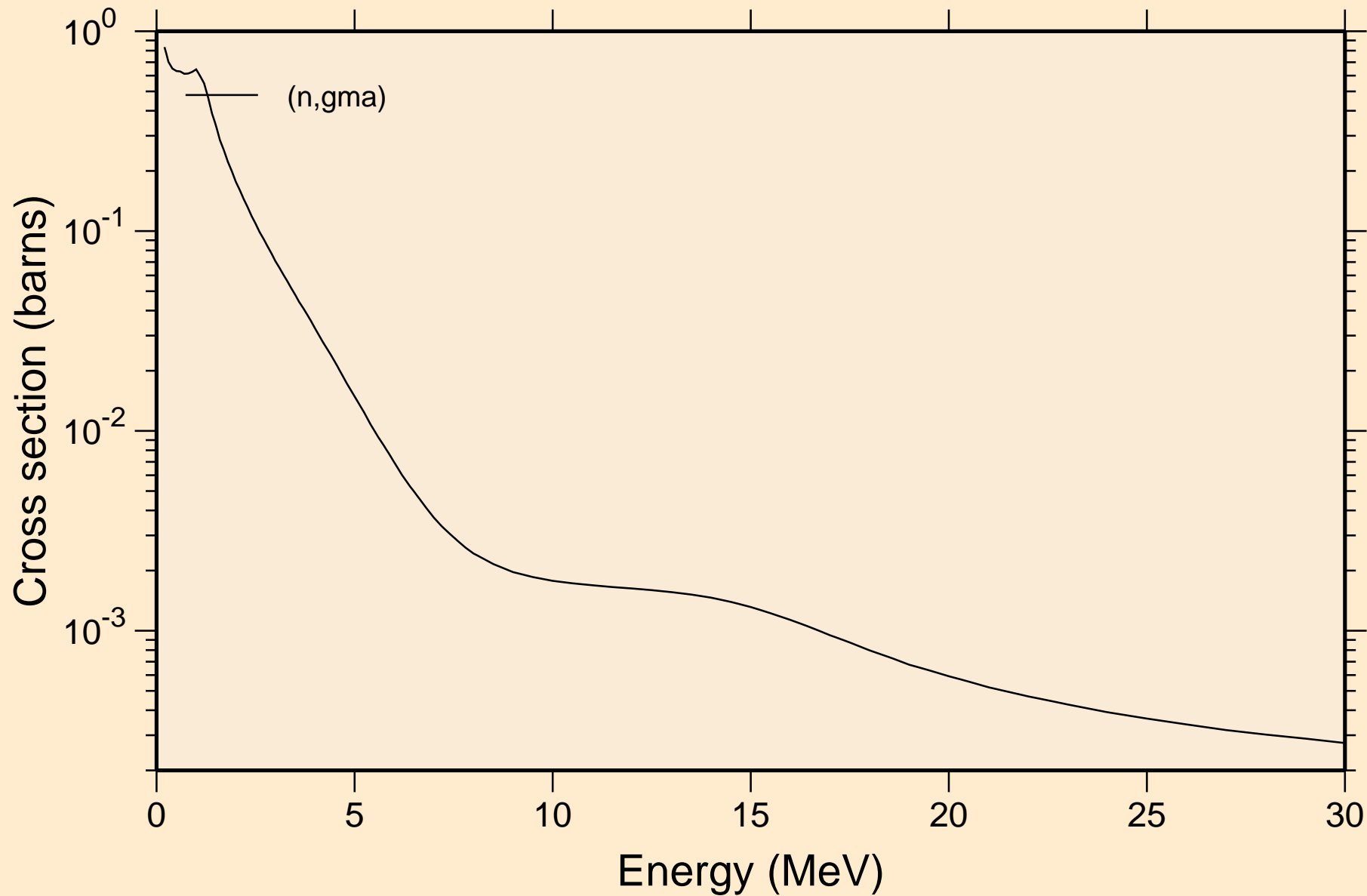

IN118N NEUTRON ACER TENDL-2019 LIBRARY; T=293.16K
Inelastic levels

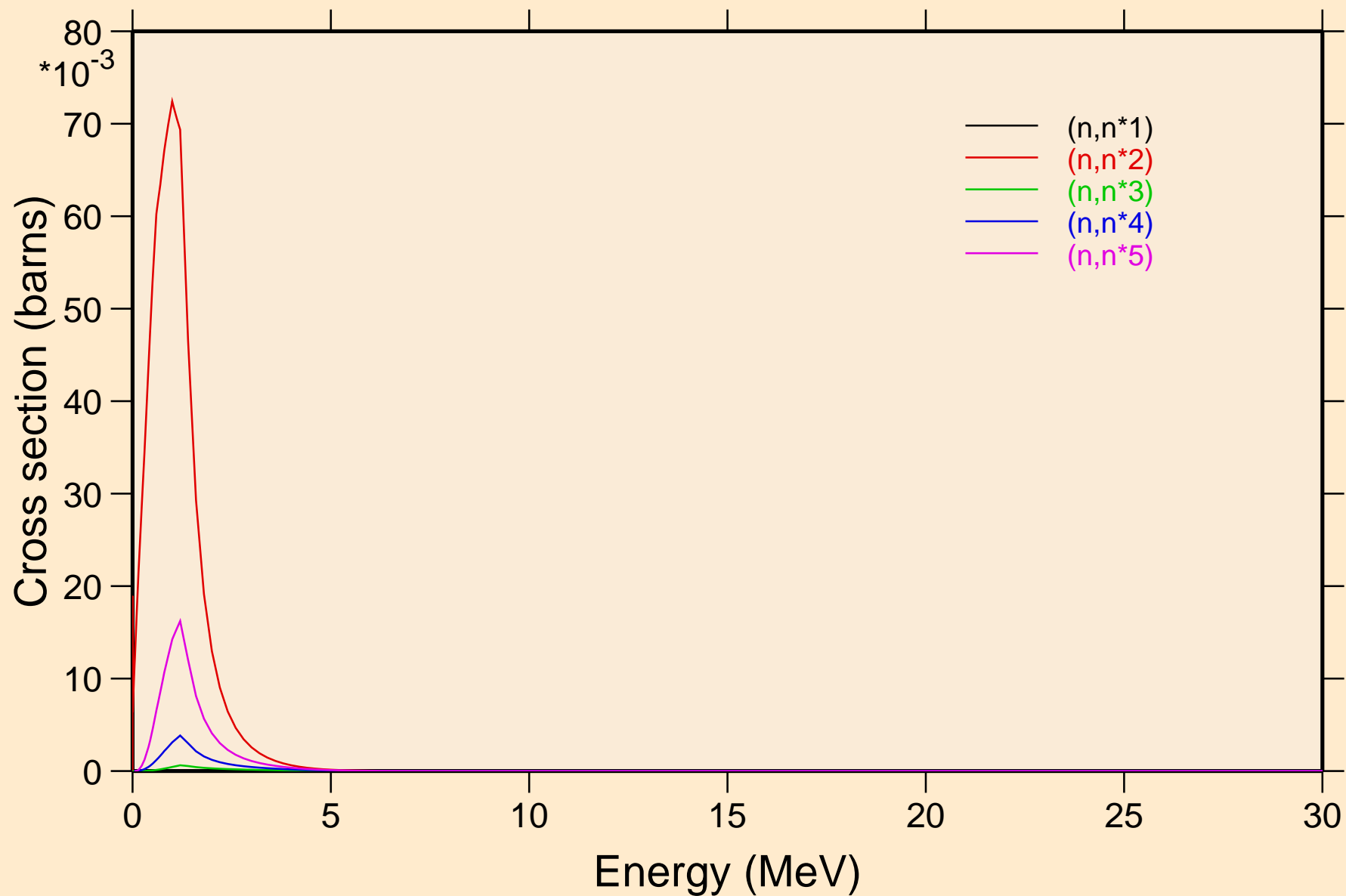

IN118N NEUTRON ACER TENDL-2019 LIBRARY; T=293.16K
Inelastic levels

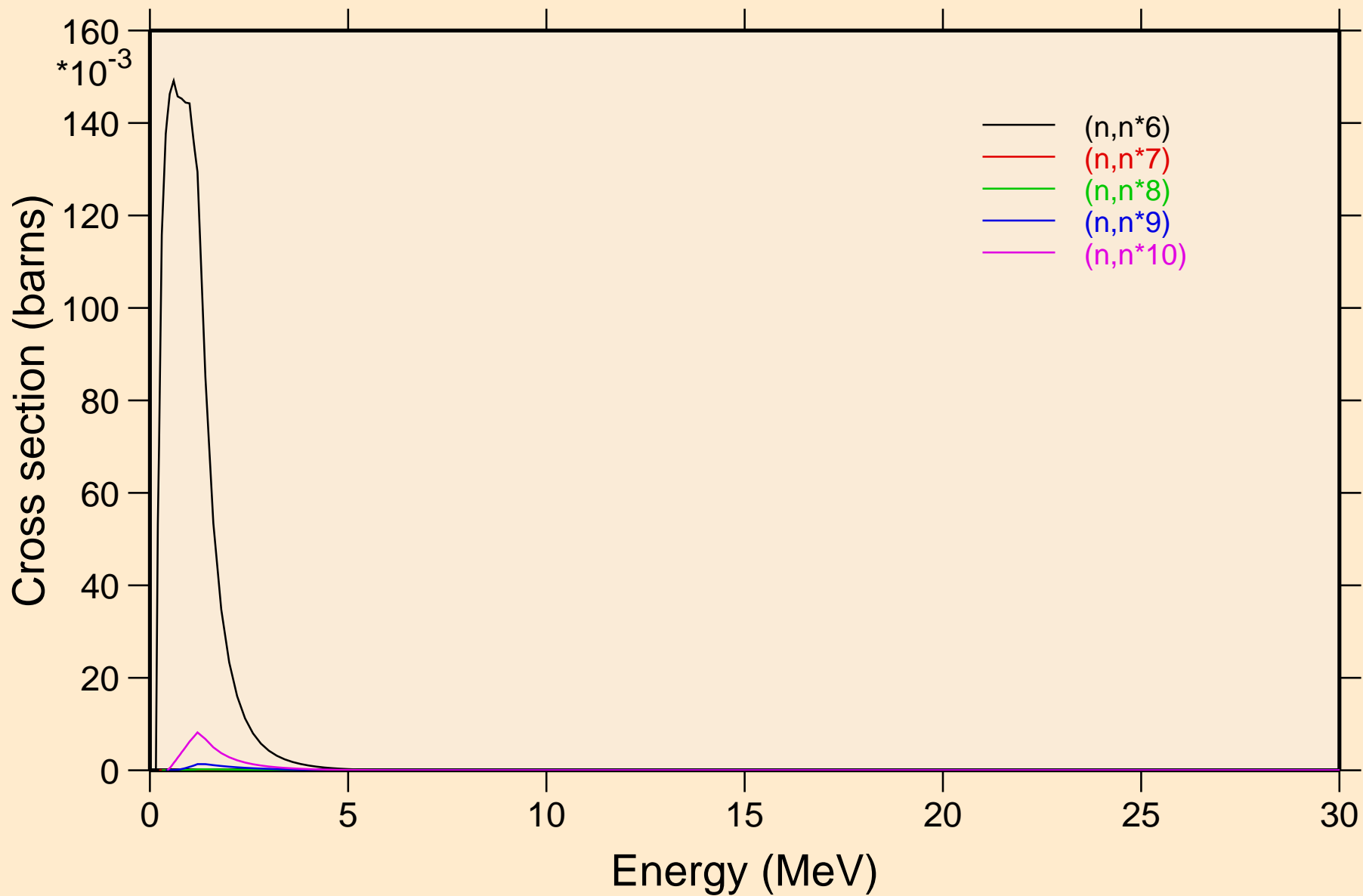

IN118N NEUTRON ACER TENDL-2019 LIBRARY; T=293.16K
Inelastic levels

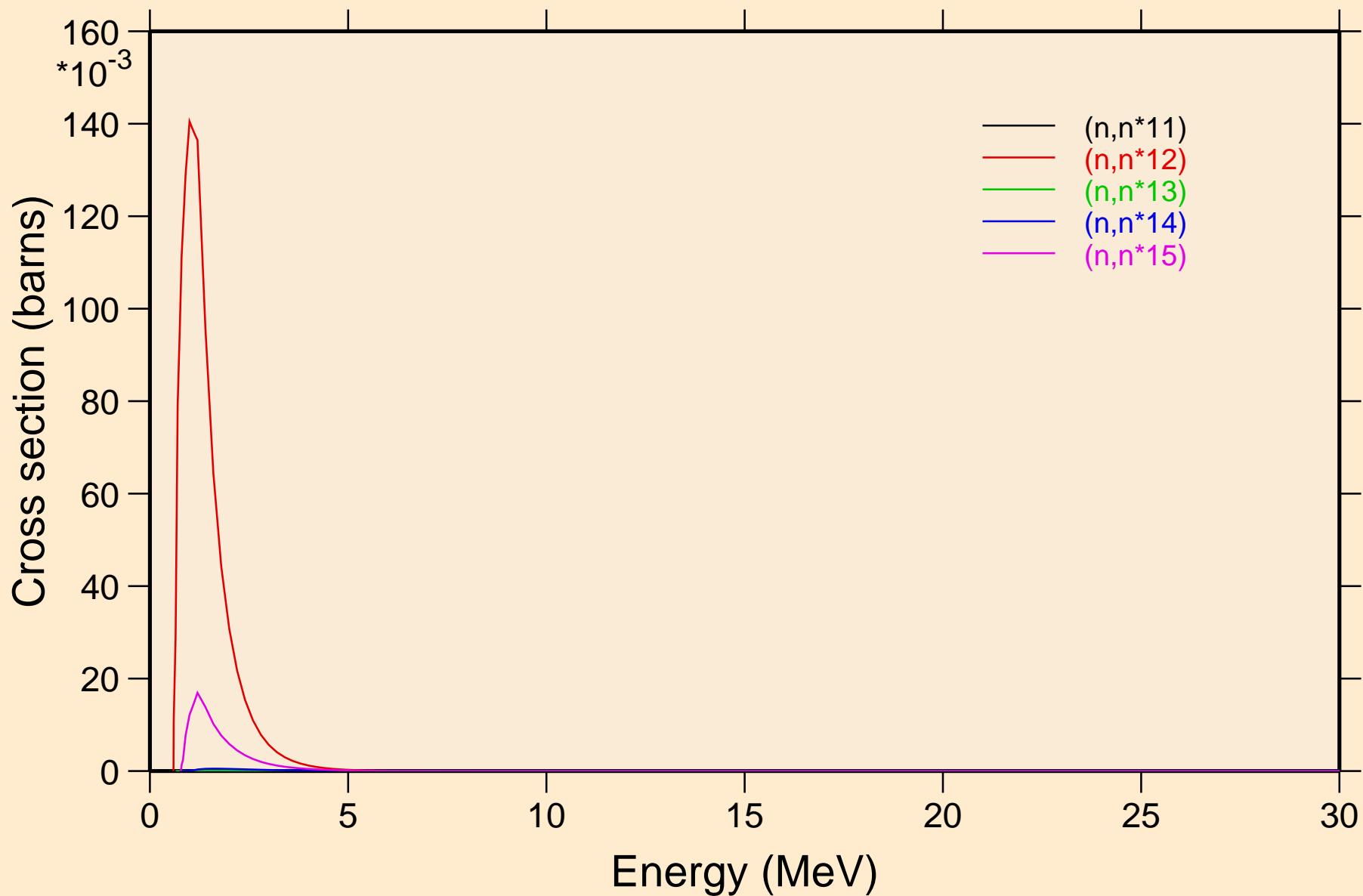

IN118N NEUTRON ACER TENDL-2019 LIBRARY; T=293.16K
Inelastic levels

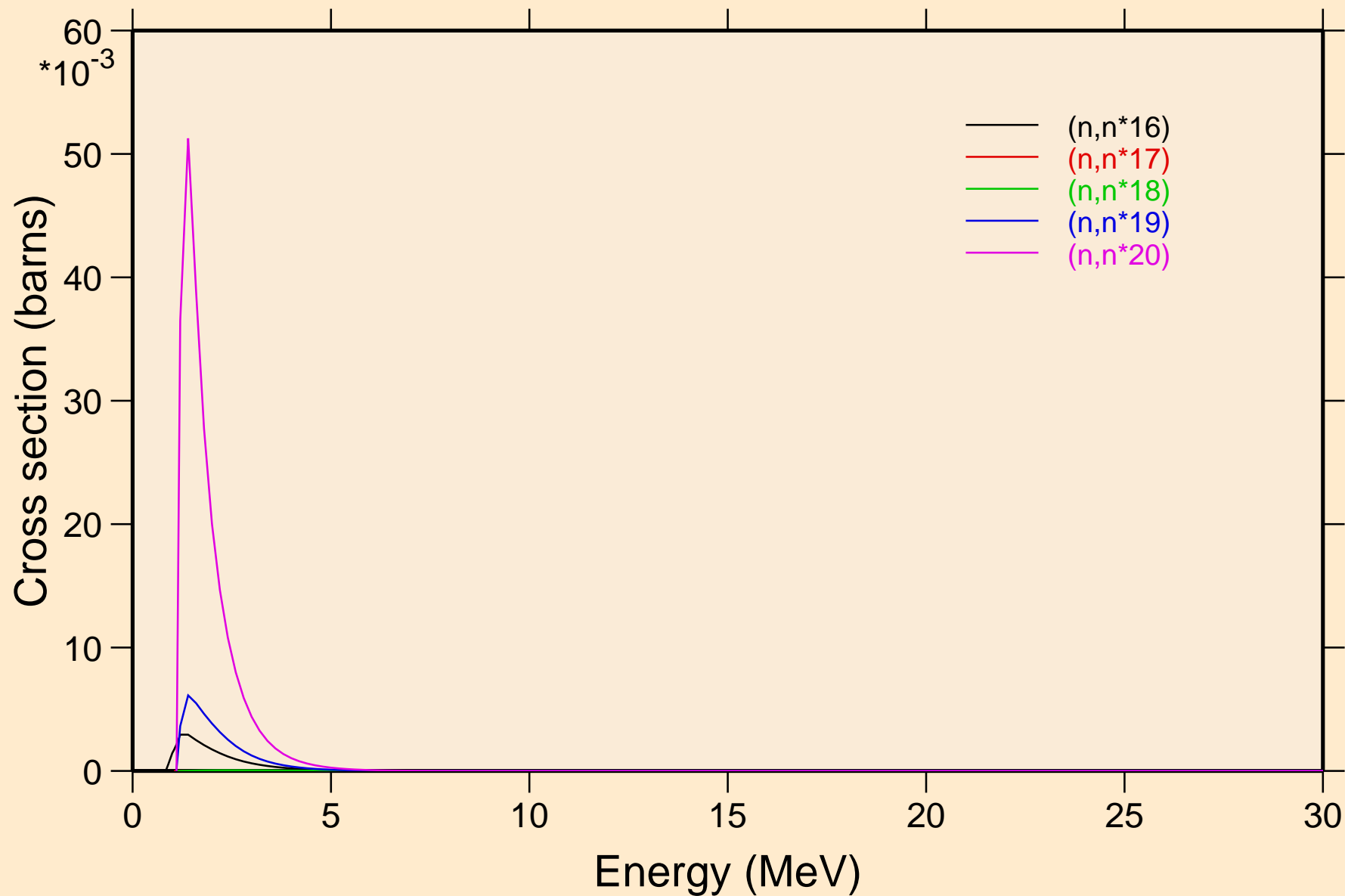

IN118N NEUTRON ACER TENDL-2019 LIBRARY; T=293.16K
Inelastic levels

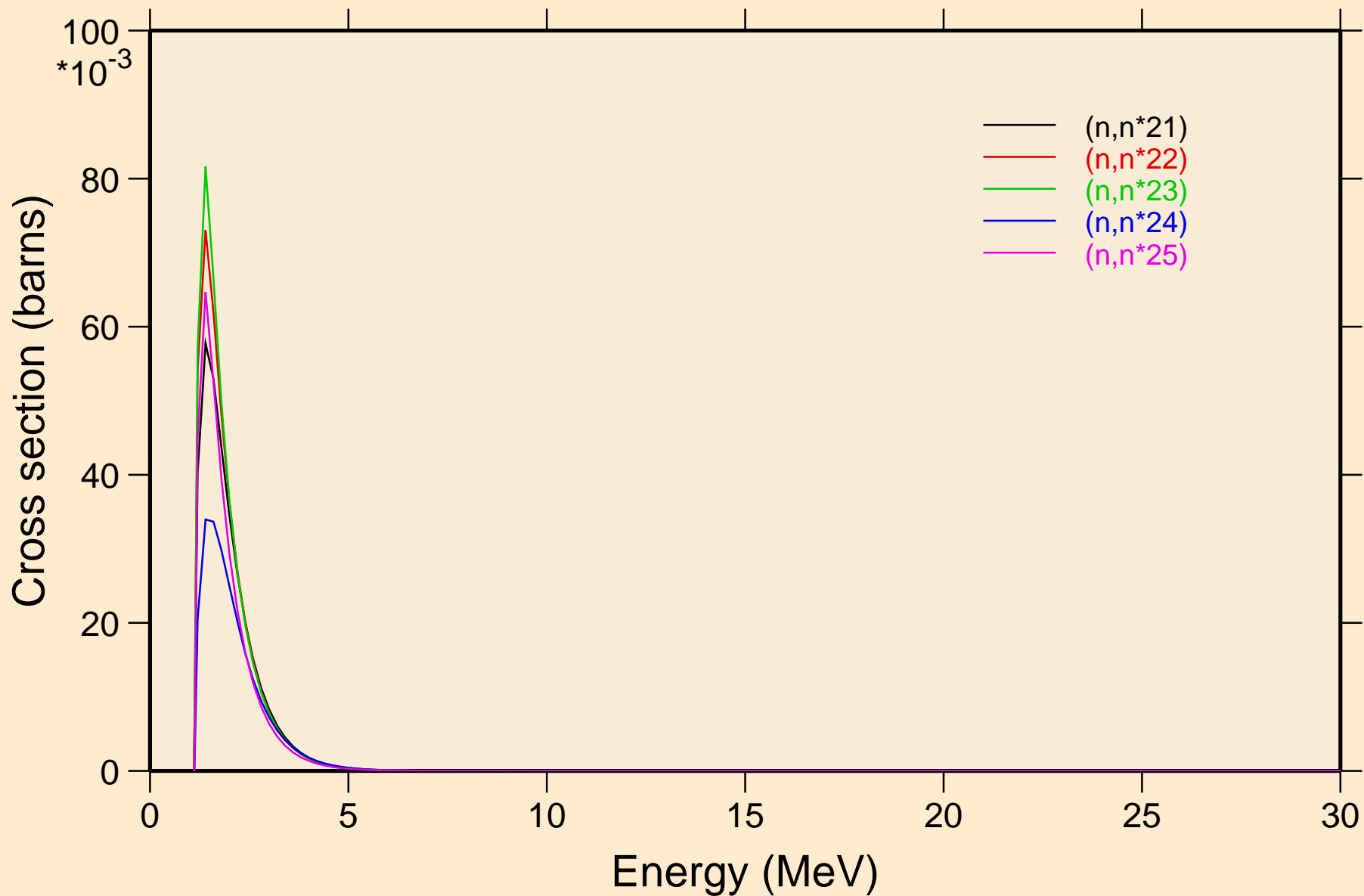

IN118N NEUTRON ACER TENDL-2019 LIBRARY; T=293.16K
Inelastic levels

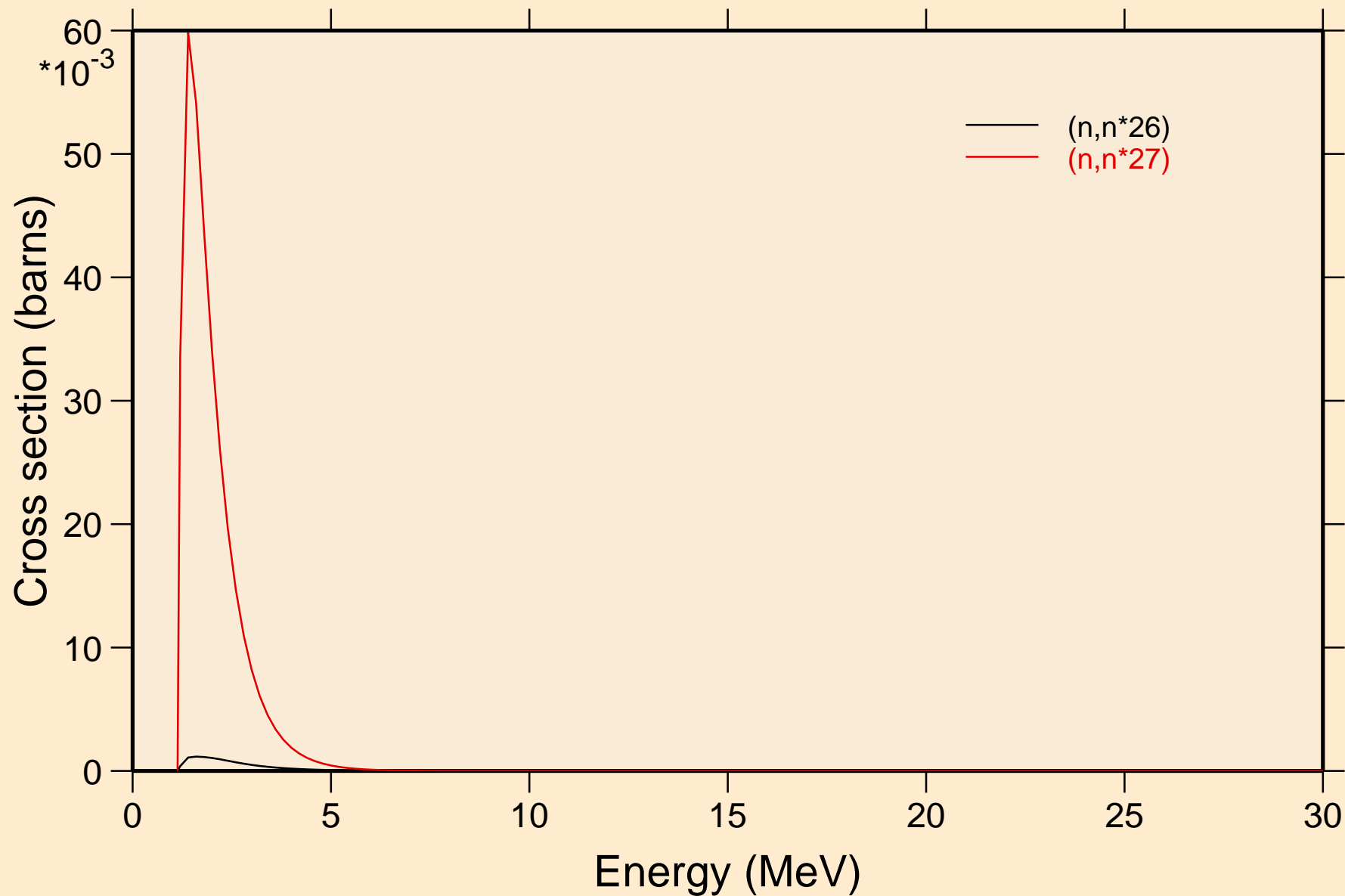

IN118N NEUTRON ACER TENDL-2019 LIBRARY; T=293.16K

Threshold reactions

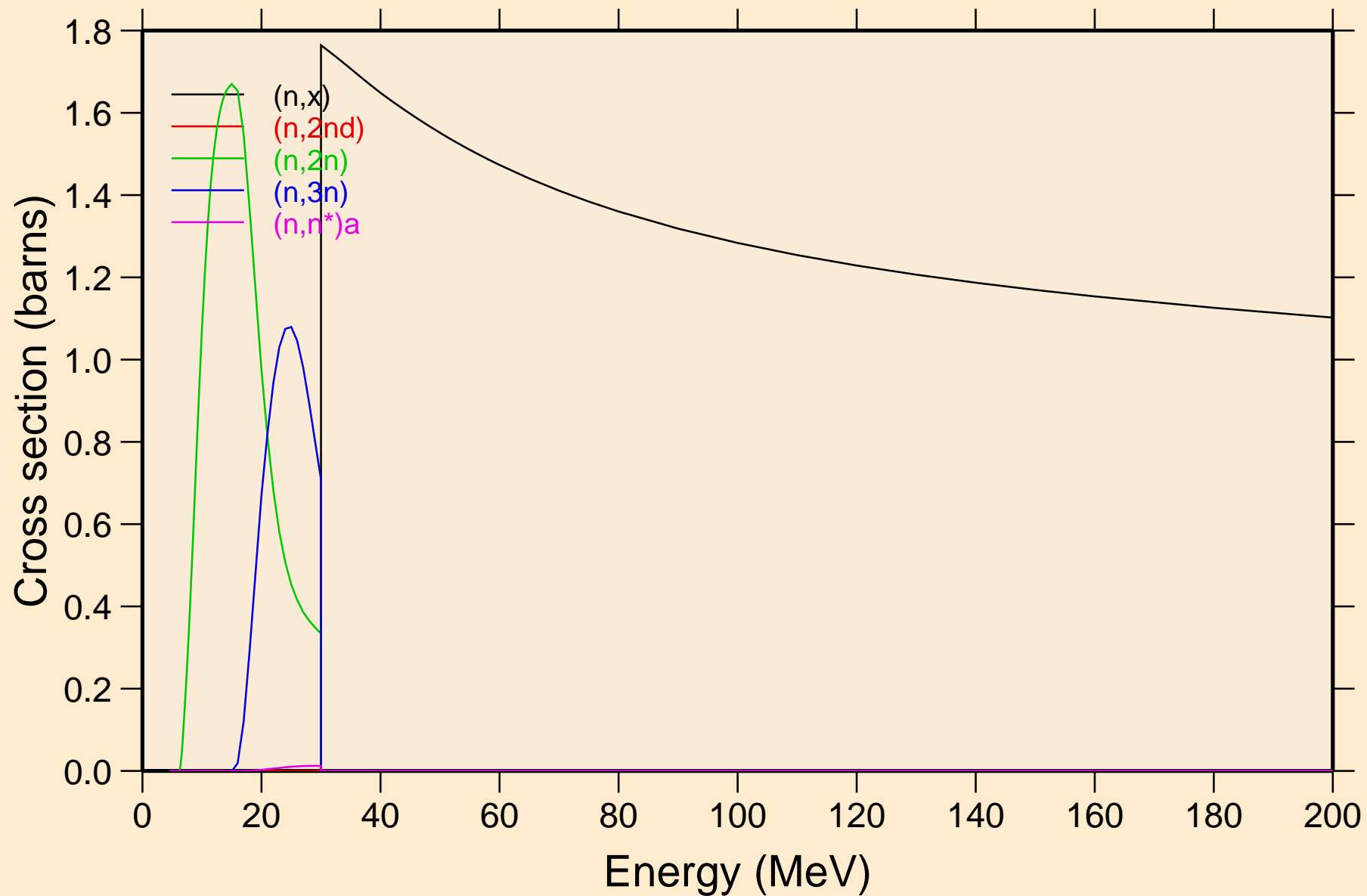

IN118N NEUTRON ACER TENDL-2019 LIBRARY; T=293.16K
Threshold reactions

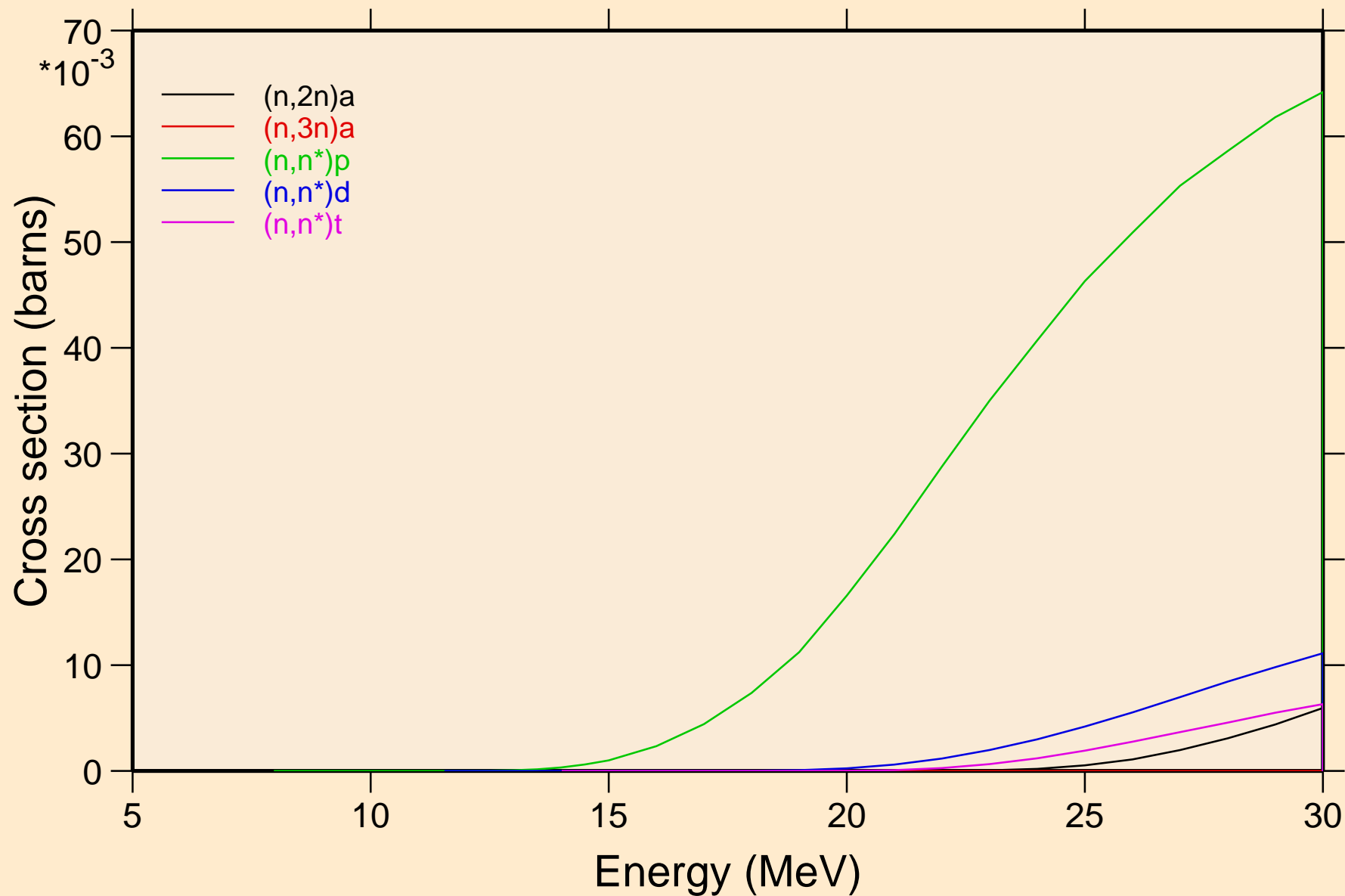

IN118N NEUTRON ACER TENDL-2019 LIBRARY; T=293.16K
Threshold reactions

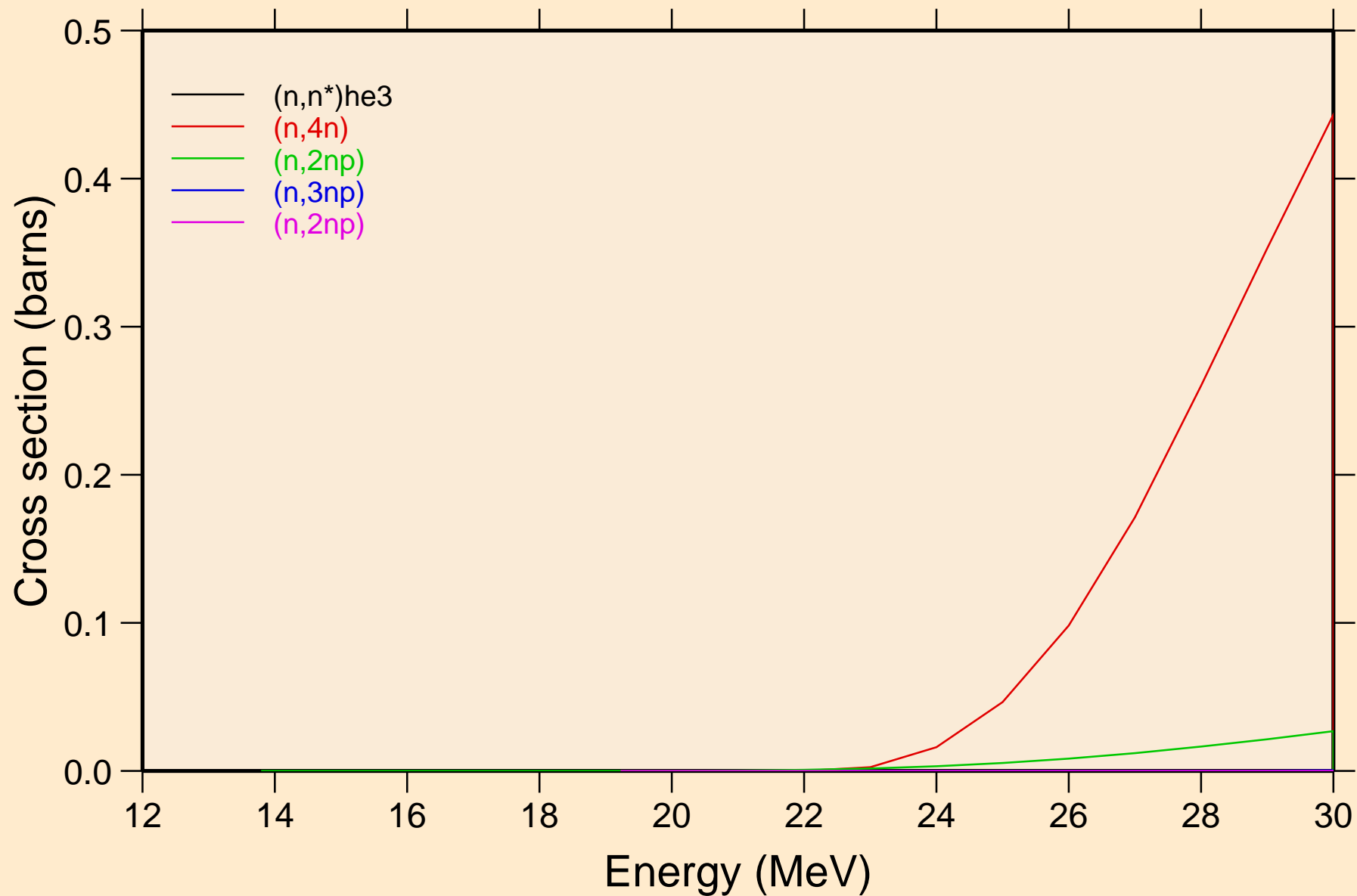

IN118N NEUTRON ACER TENDL-2019 LIBRARY; T=293.16K
Threshold reactions

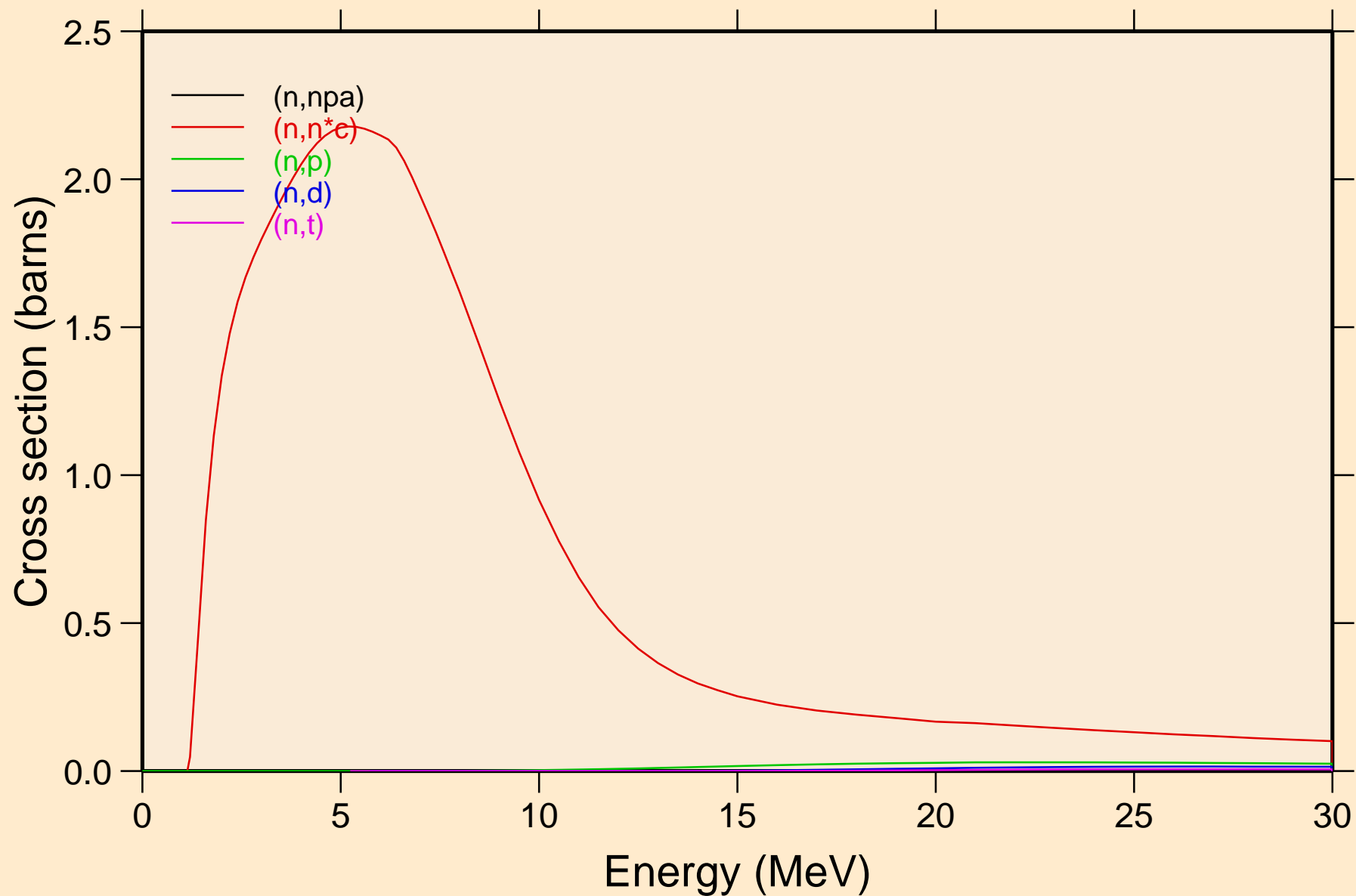

IN118N NEUTRON ACER TENDL-2019 LIBRARY; T=293.16K
Threshold reactions

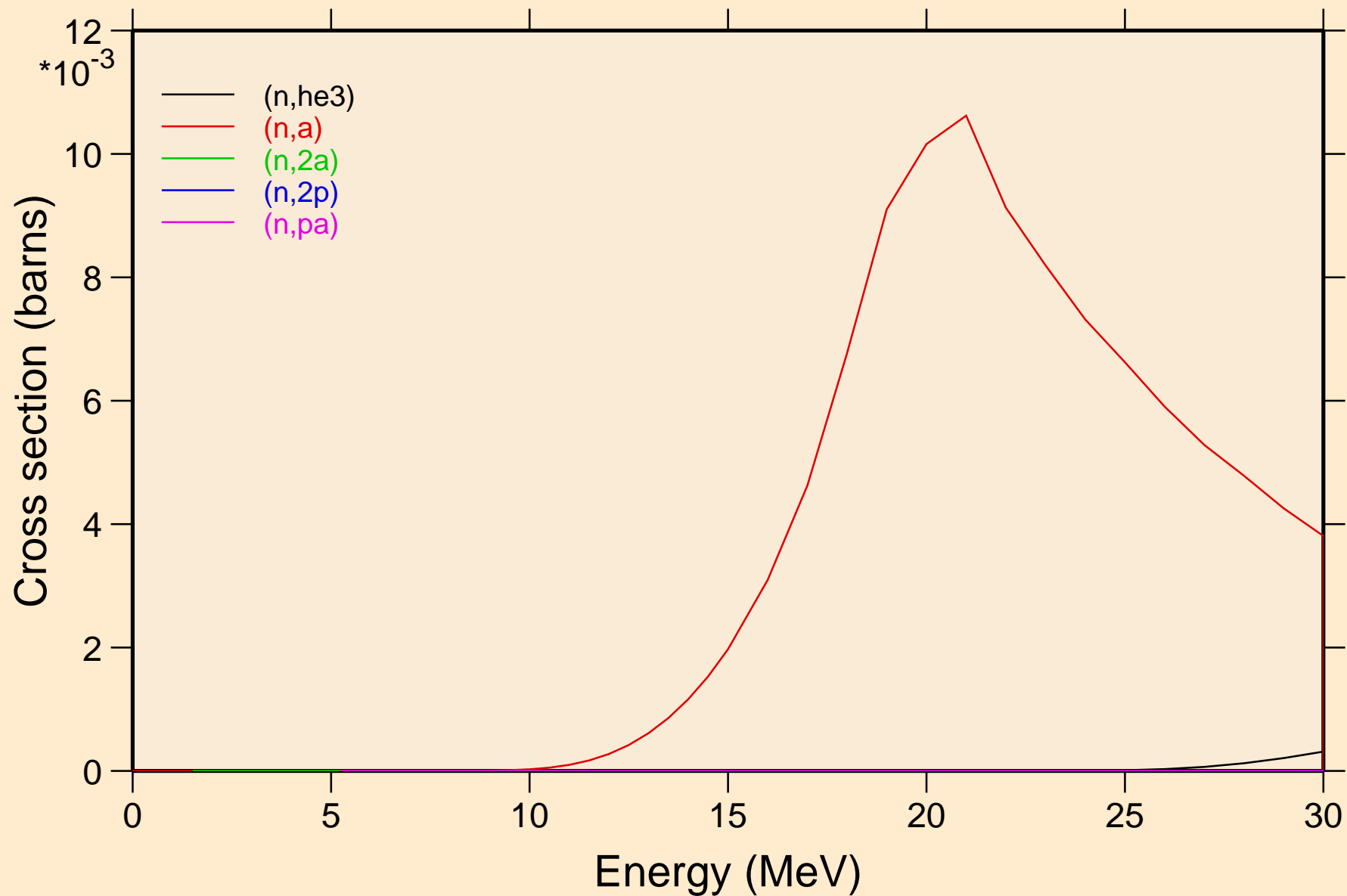

IN118N NEUTRON ACER TENDL-2019 LIBRARY; T=293.16K
Threshold reactions

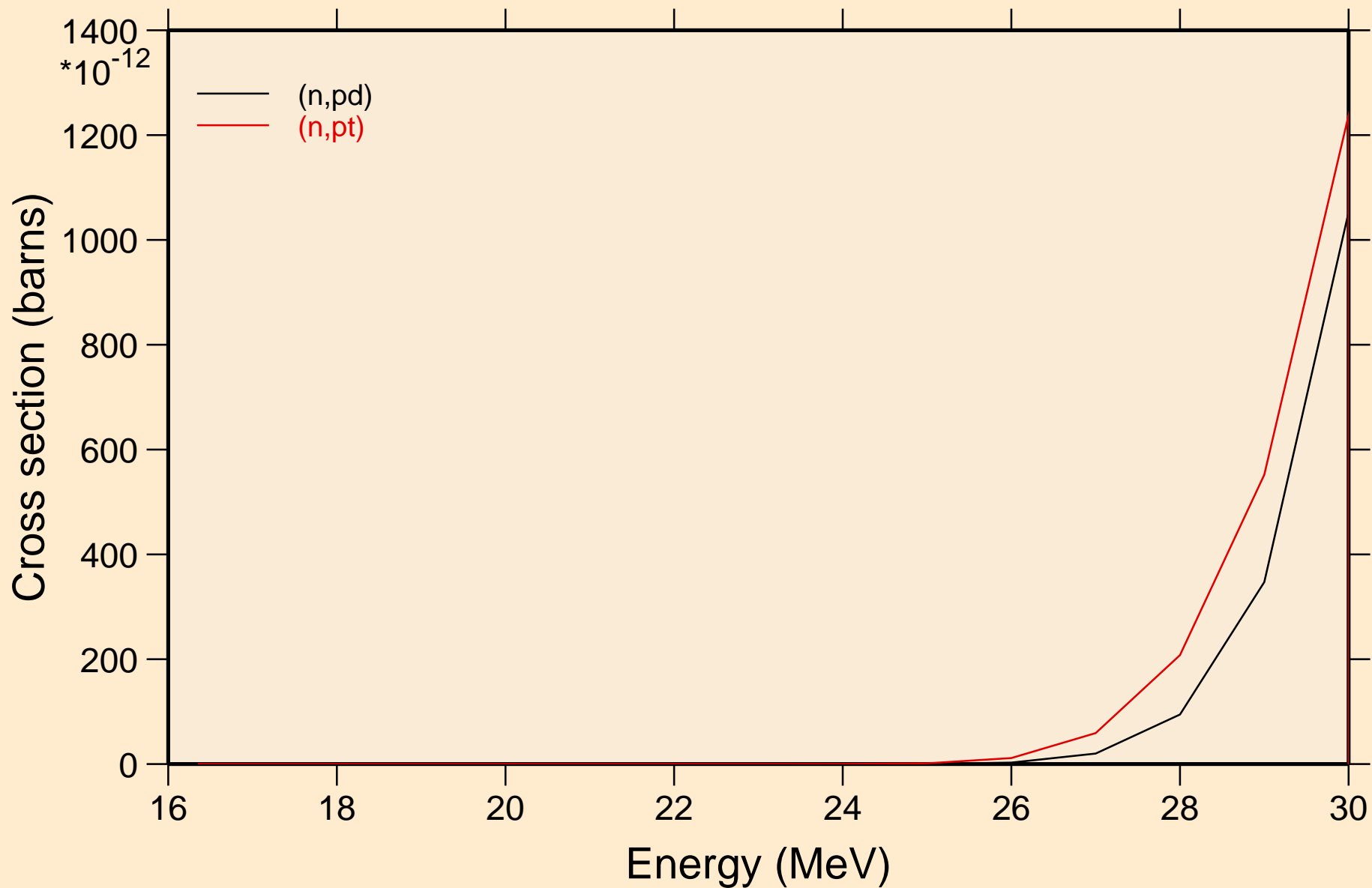

IN118N NEUTRON ACER TENDL-2019 LIBRARY; T=293.16K
Threshold reactions

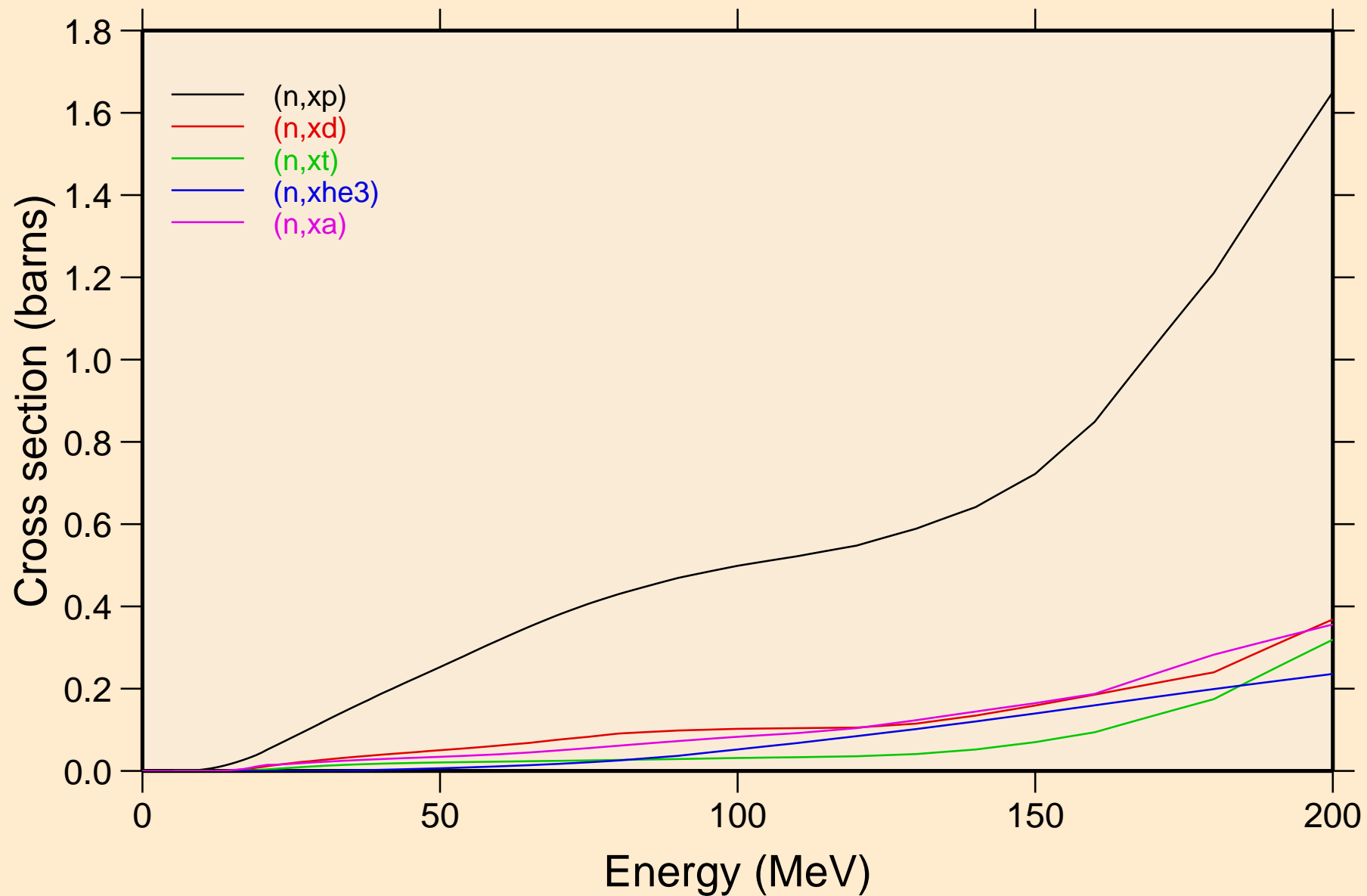

IN118N NEUTRON ACER TENDL-2019 LIBRARY; T=293.16K
angular distribution for elastic

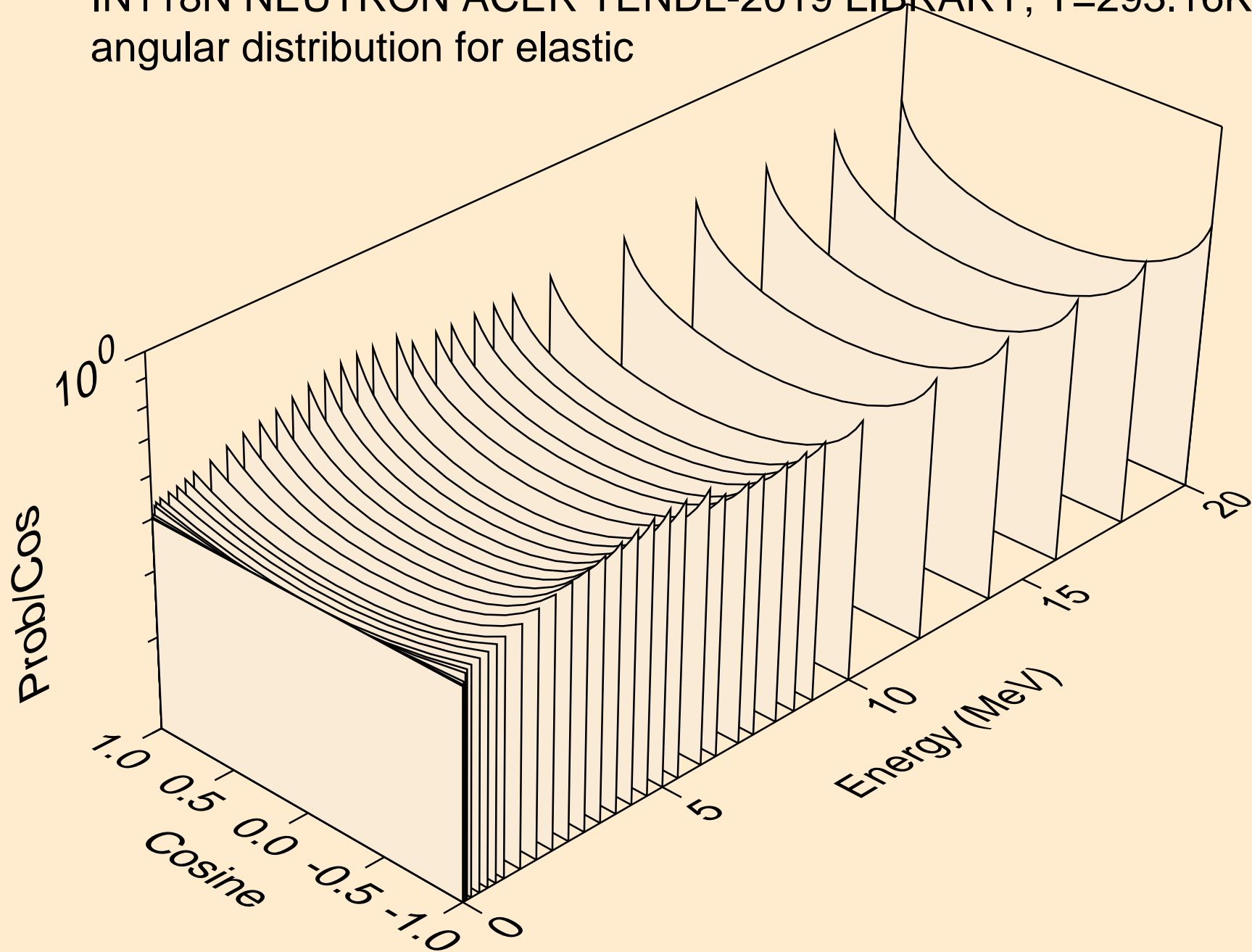

IN118N NEUTRON ACER TENDL-2019 LIBRARY; T=293.16K
angular distribution for elastic

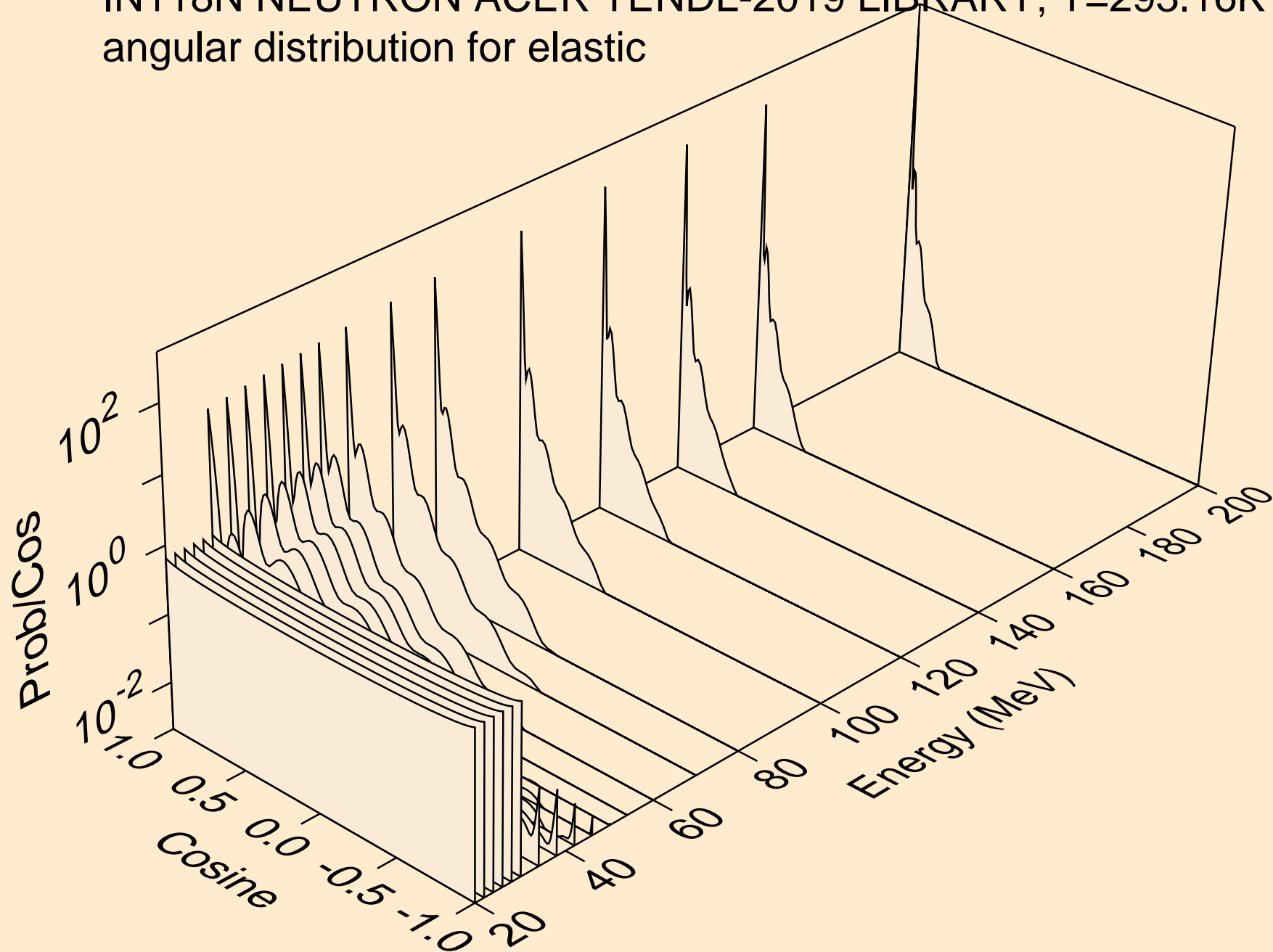

IN118N NEUTRON ACER TENDL-2019 LIBRARY; T=293.16K
angular distribution for (n,n*1)

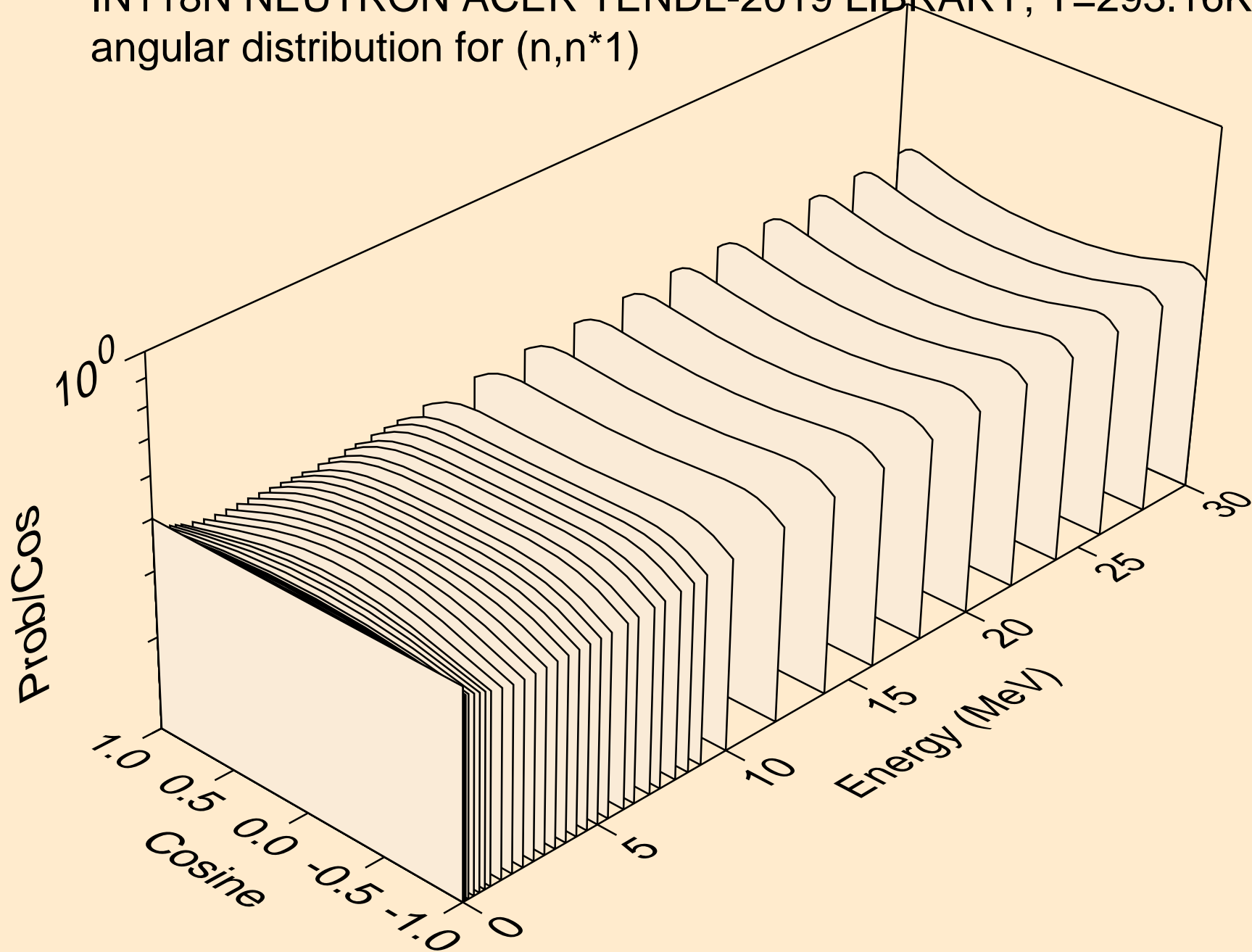

IN118N NEUTRON ACER TENDL-2019 LIBRARY; T=293.16K
angular distribution for (n,n*2)

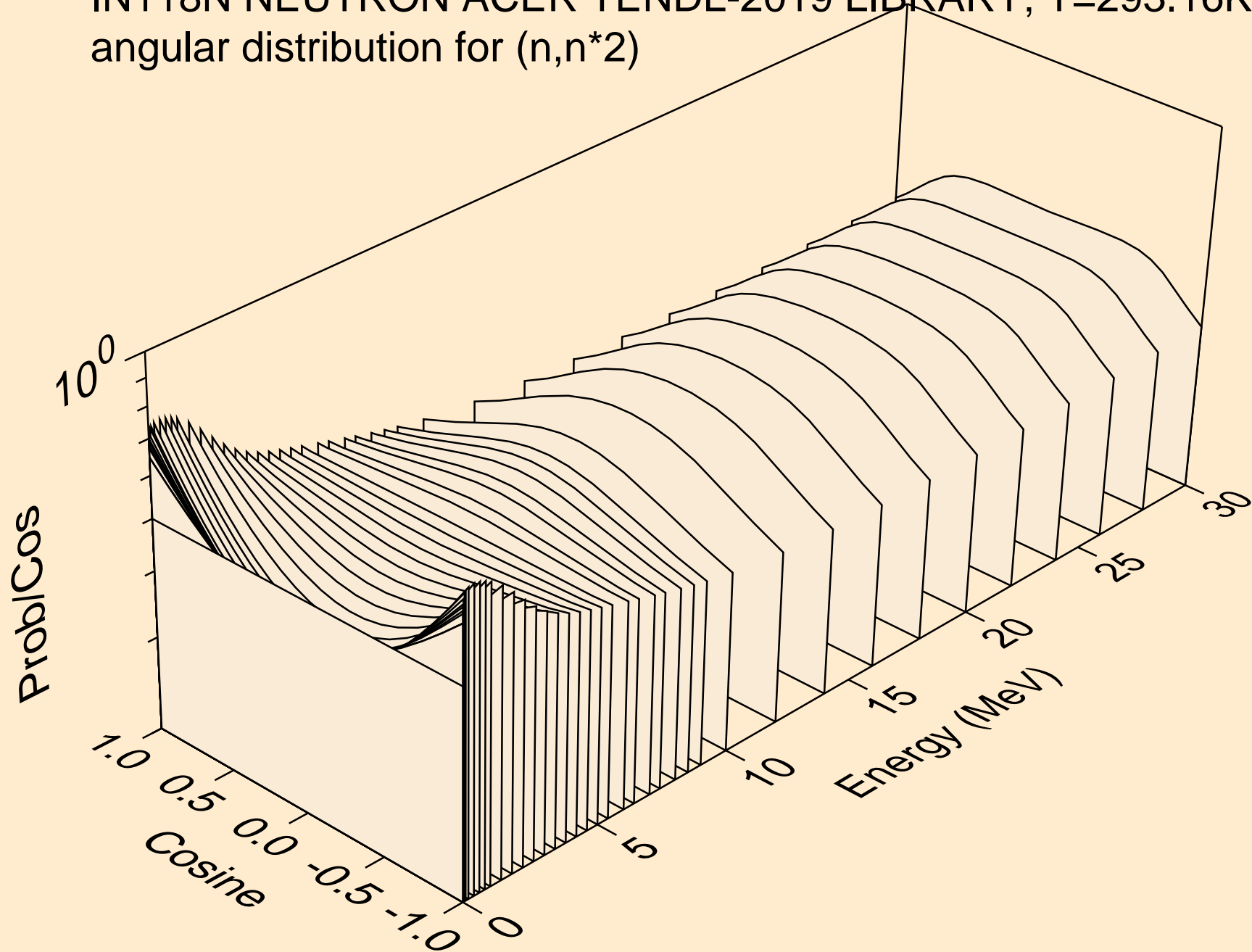

IN118N NEUTRON ACER TENDL-2019 LIBRARY; T=293.16K
angular distribution for (n,n*3)

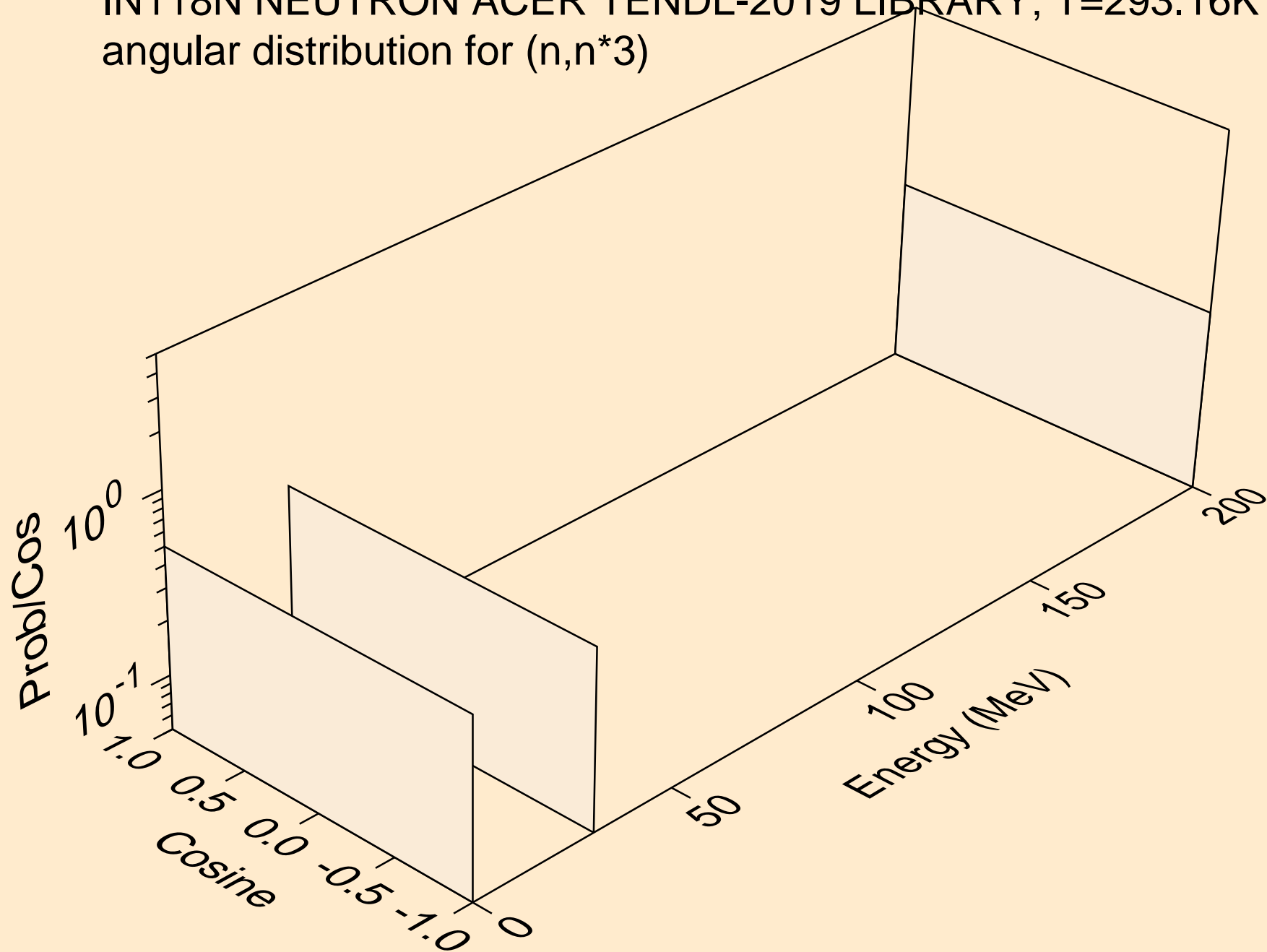

IN118N NEUTRON ACER TENDL-2019 LIBRARY; T=293.16K
angular distribution for (n,n*4)

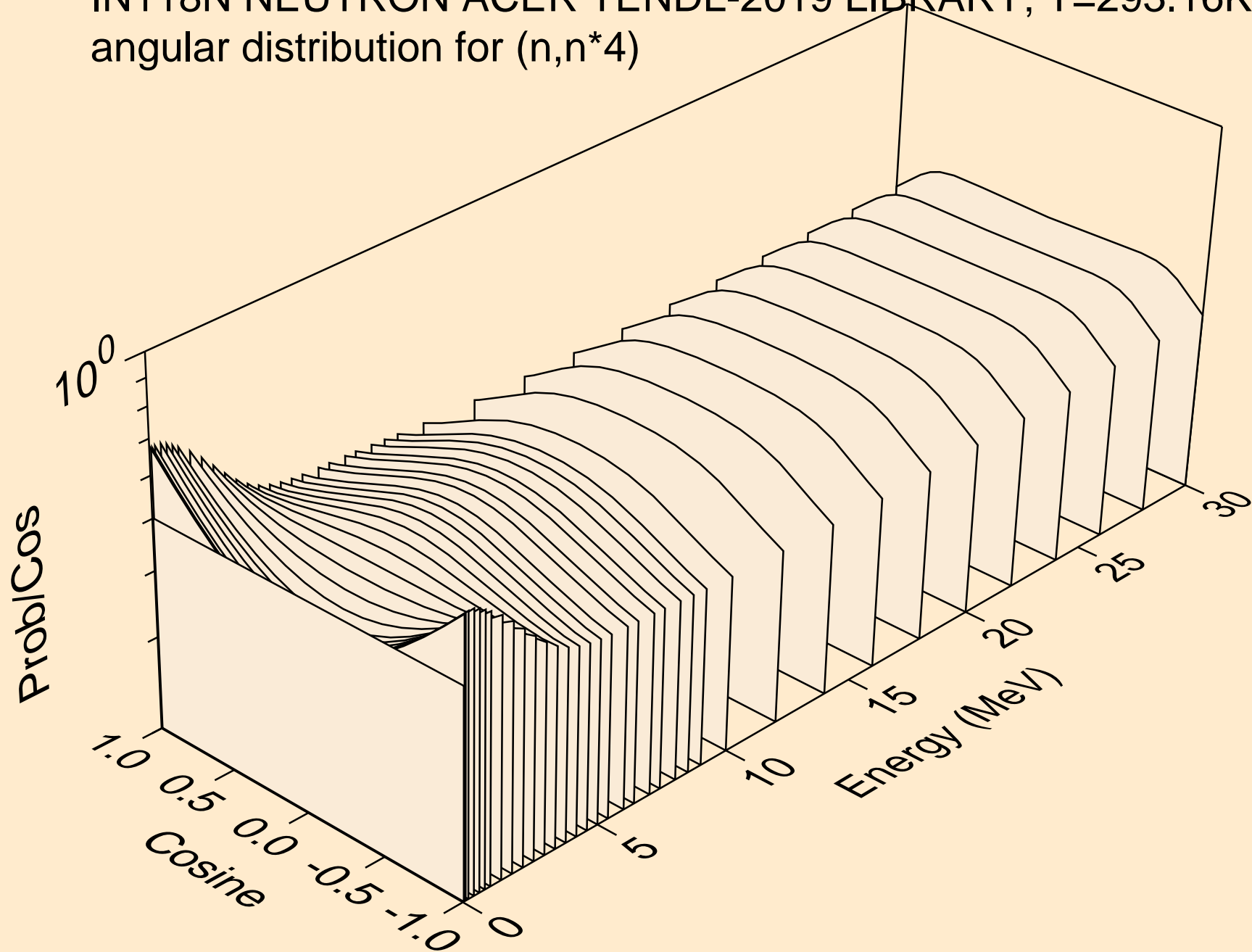

IN118N NEUTRON ACER TENDL-2019 LIBRARY; T=293.16K
angular distribution for (n,n*5)

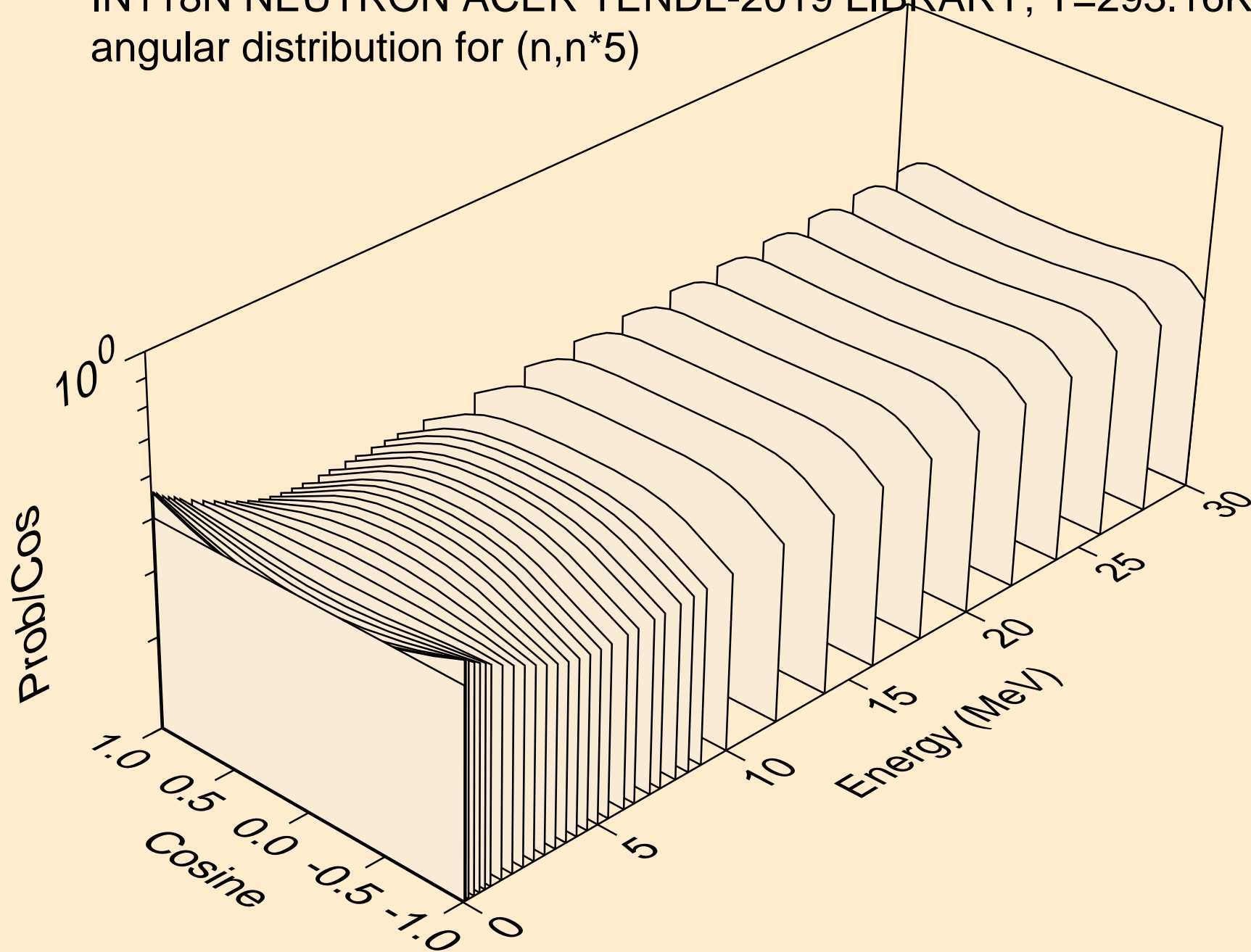

IN118N NEUTRON ACER TENDL-2019 LIBRARY; T=293.16K
angular distribution for (n,n*6)

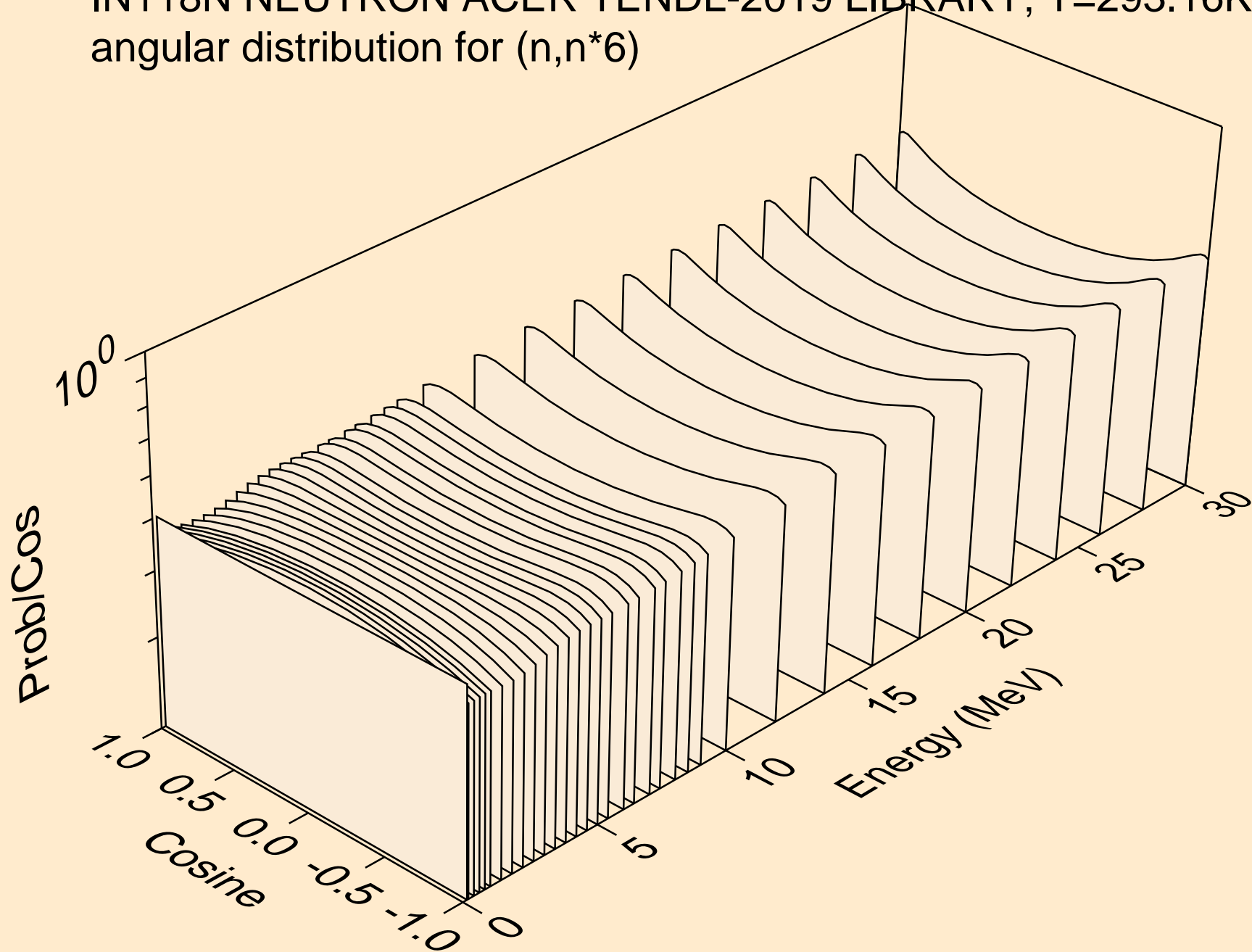

IN118N NEUTRON ACER TENDL-2019 LIBRARY; T=293.16K
angular distribution for (n,n*7)

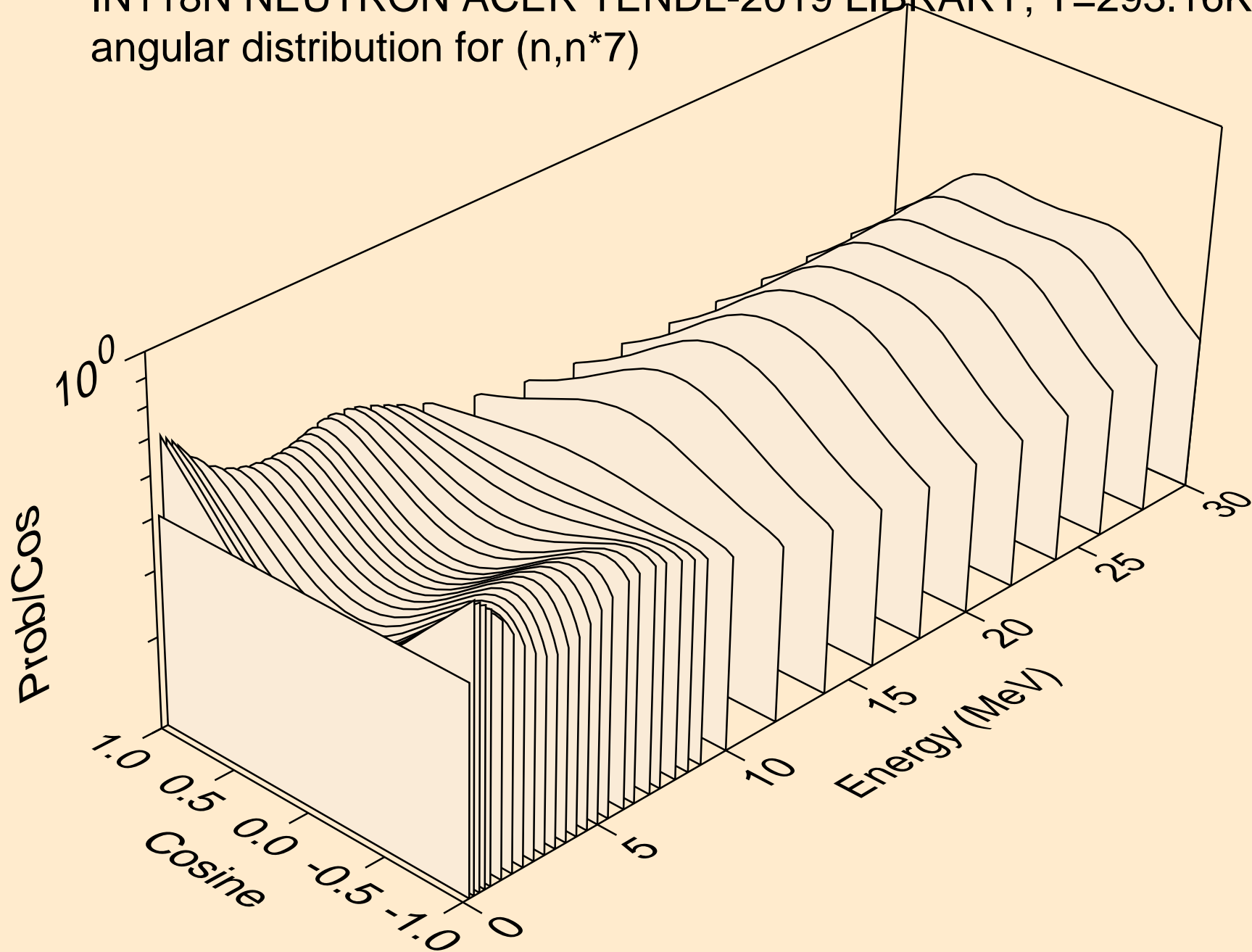

IN118N NEUTRON ACER TENDL-2019 LIBRARY; T=293.16K
angular distribution for (n,n*8)

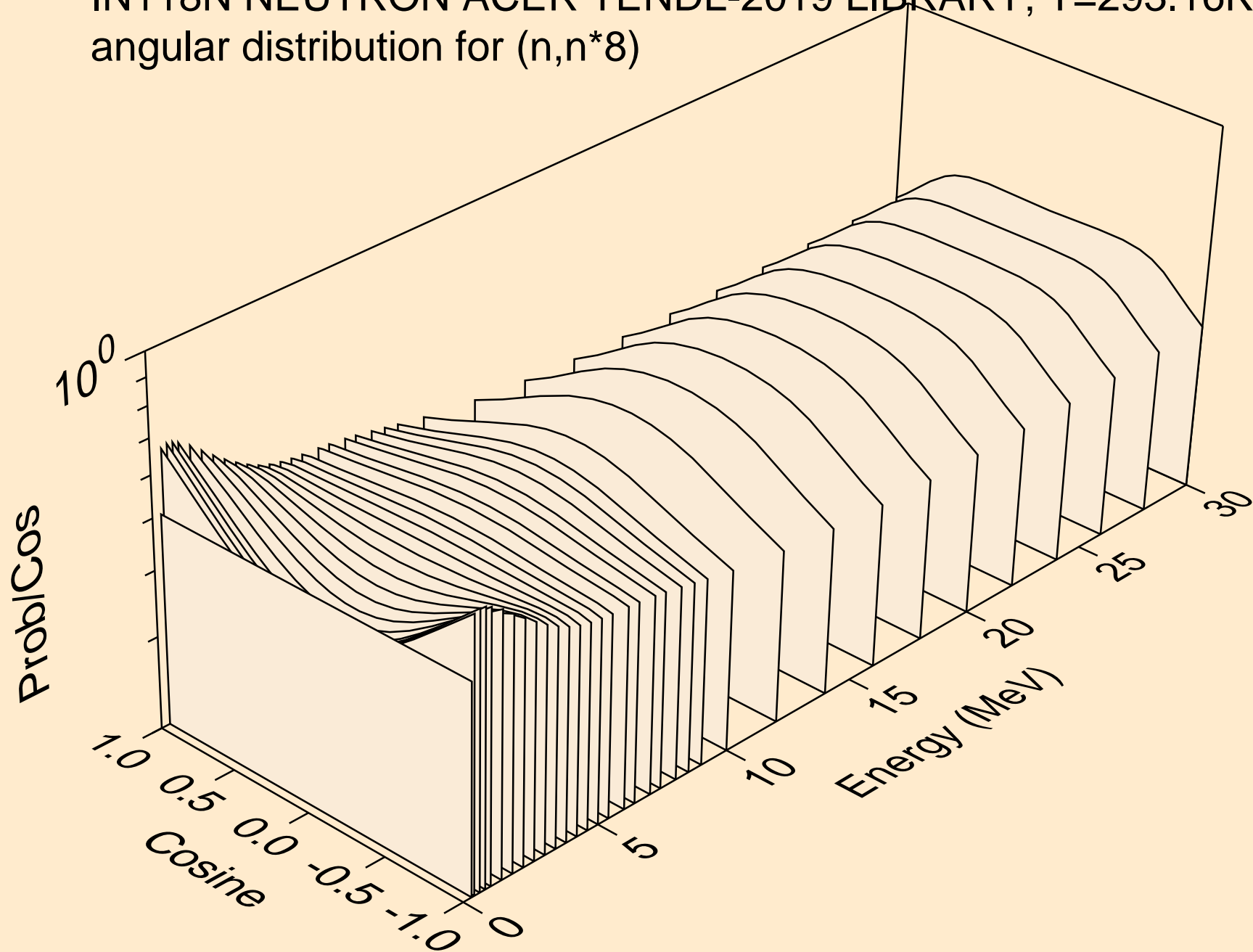

IN118N NEUTRON ACER TENDL-2019 LIBRARY; T=293.16K
angular distribution for (n,n*9)

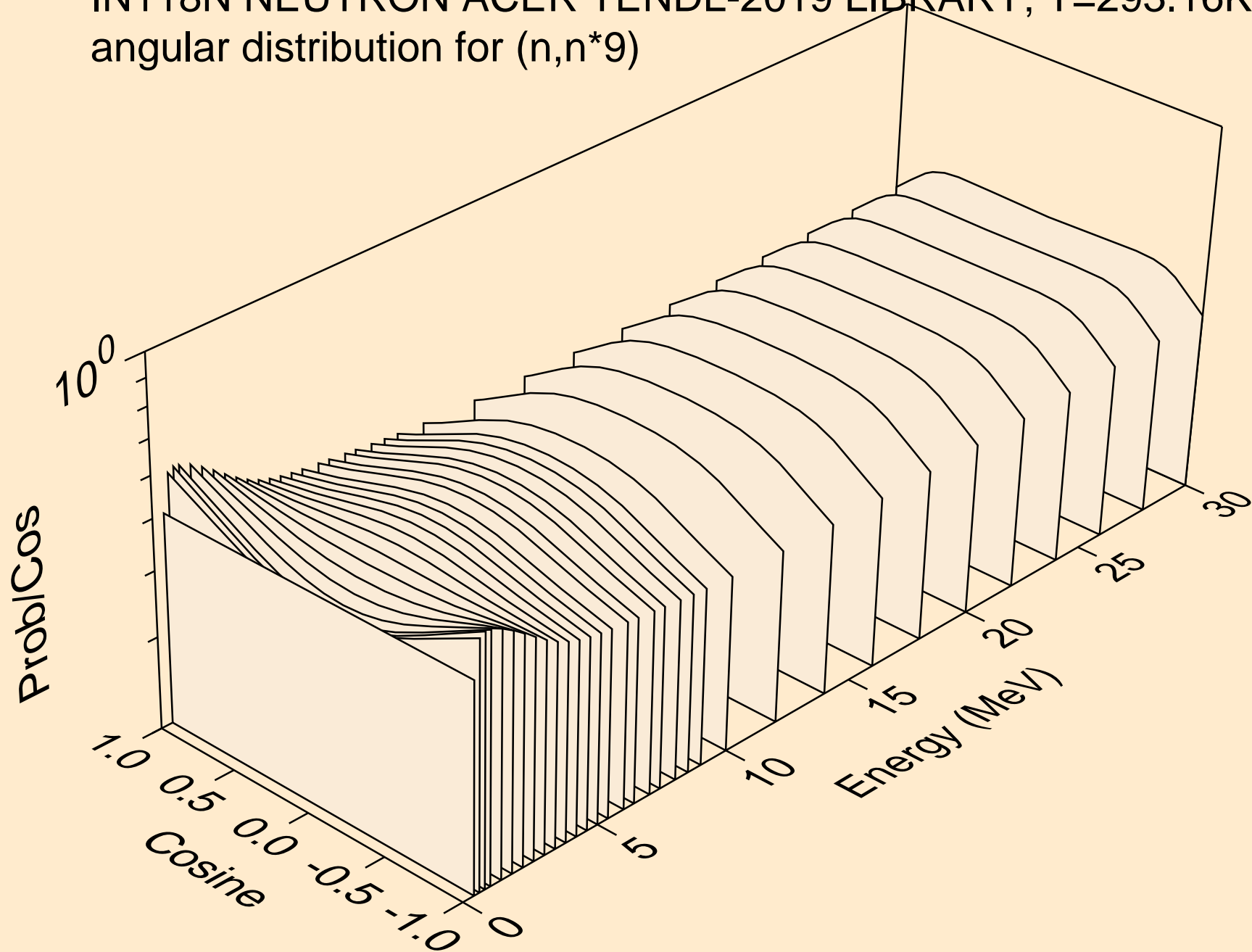

IN118N NEUTRON ACER TENDL-2019 LIBRARY; T=293.16K
angular distribution for (n,n*10)

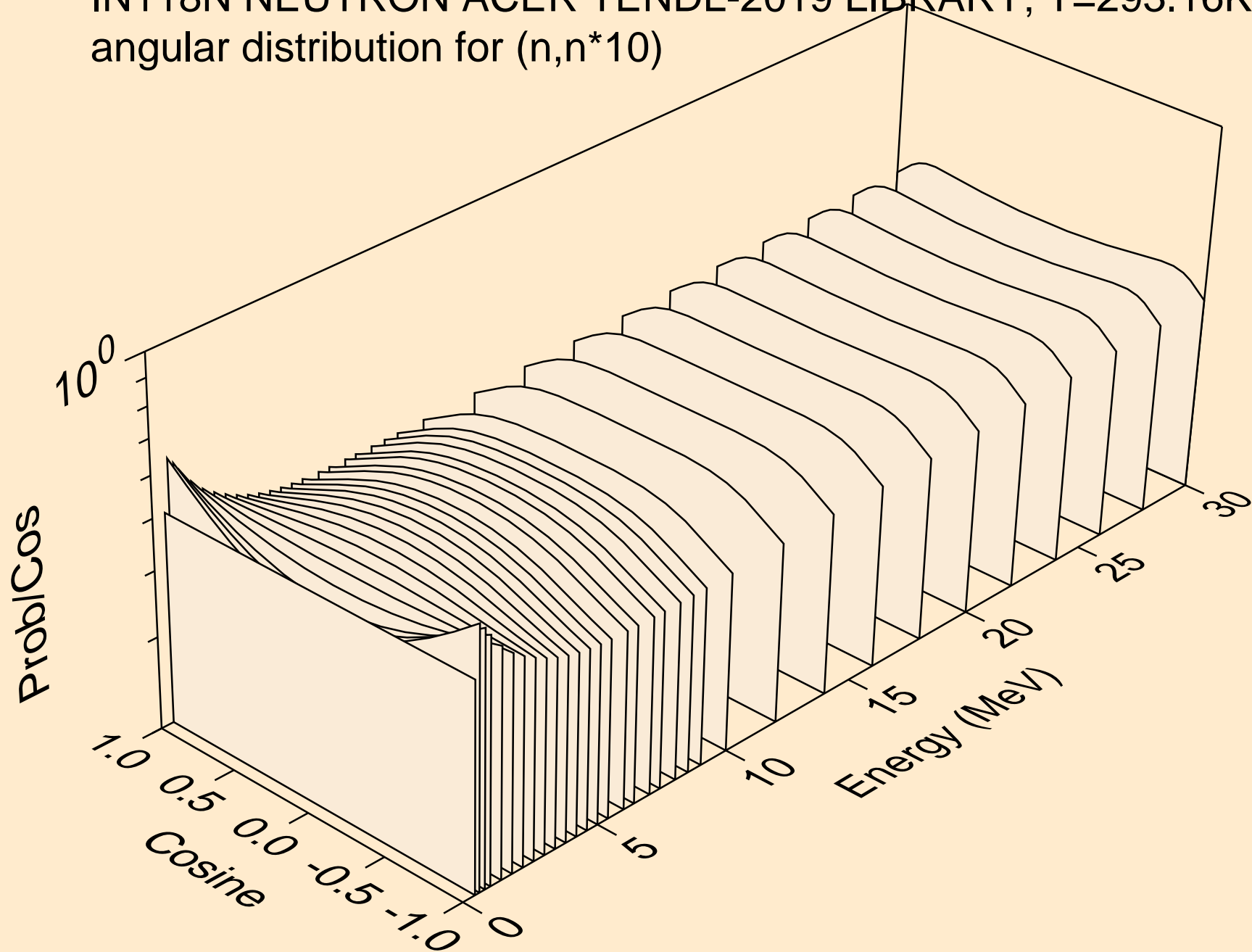

IN118N NEUTRON ACER TENDL-2019 LIBRARY; T=293.16K
angular distribution for (n,n*11)

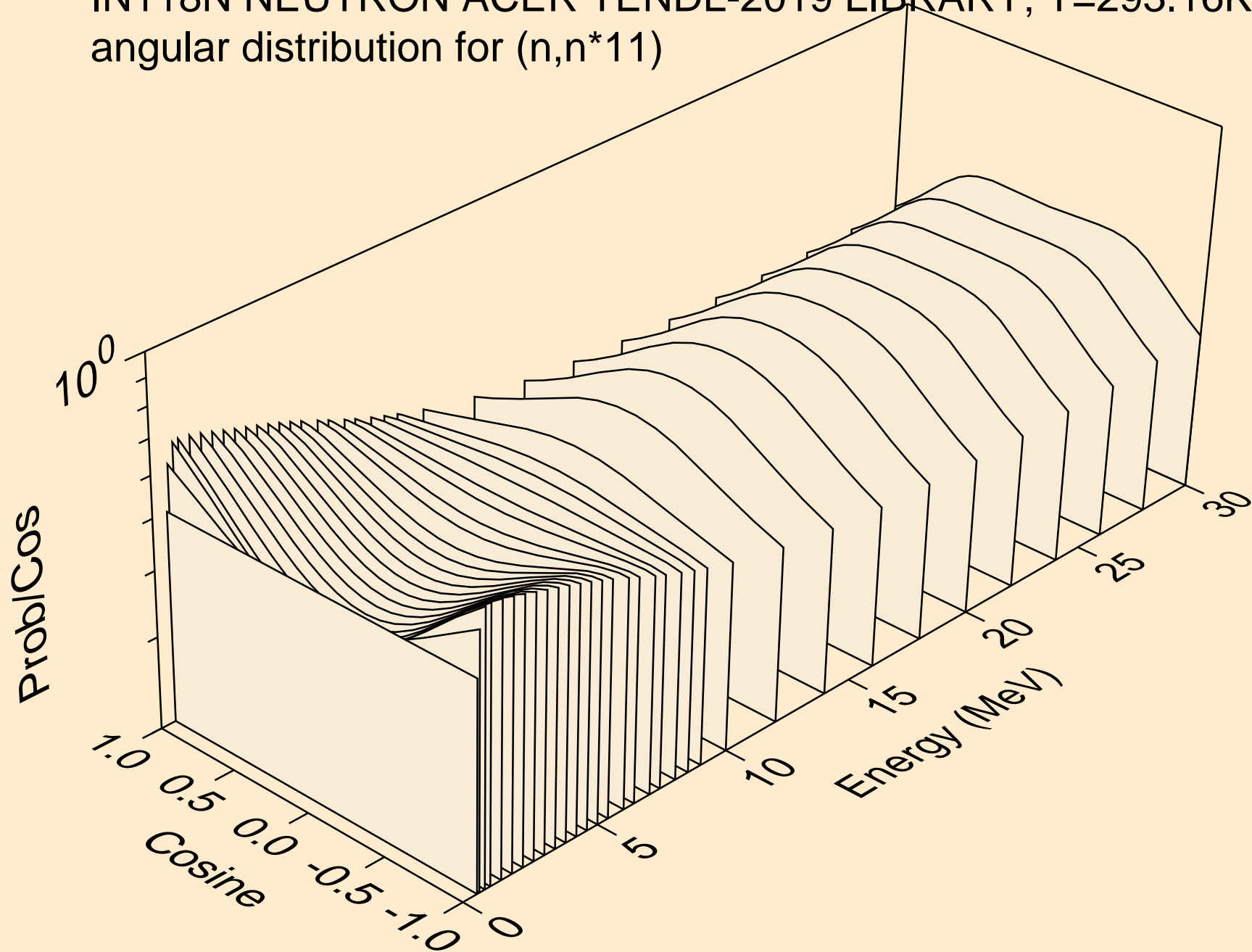

IN118N NEUTRON ACER TENDL-2019 LIBRARY; T=293.16K
angular distribution for (n,n*12)

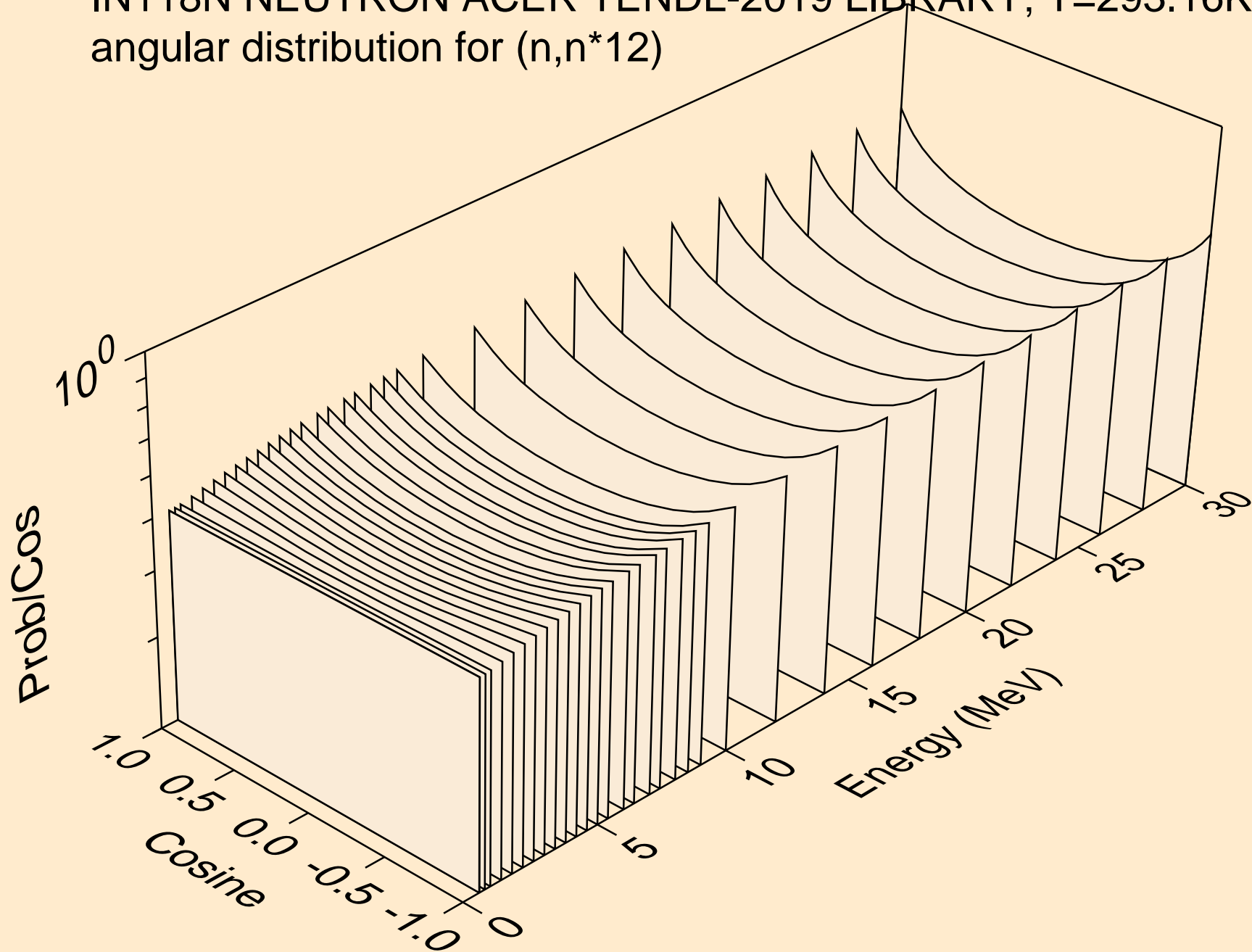

IN118N NEUTRON ACER TENDL-2019 LIBRARY; T=293.16K
angular distribution for (n,n*13)

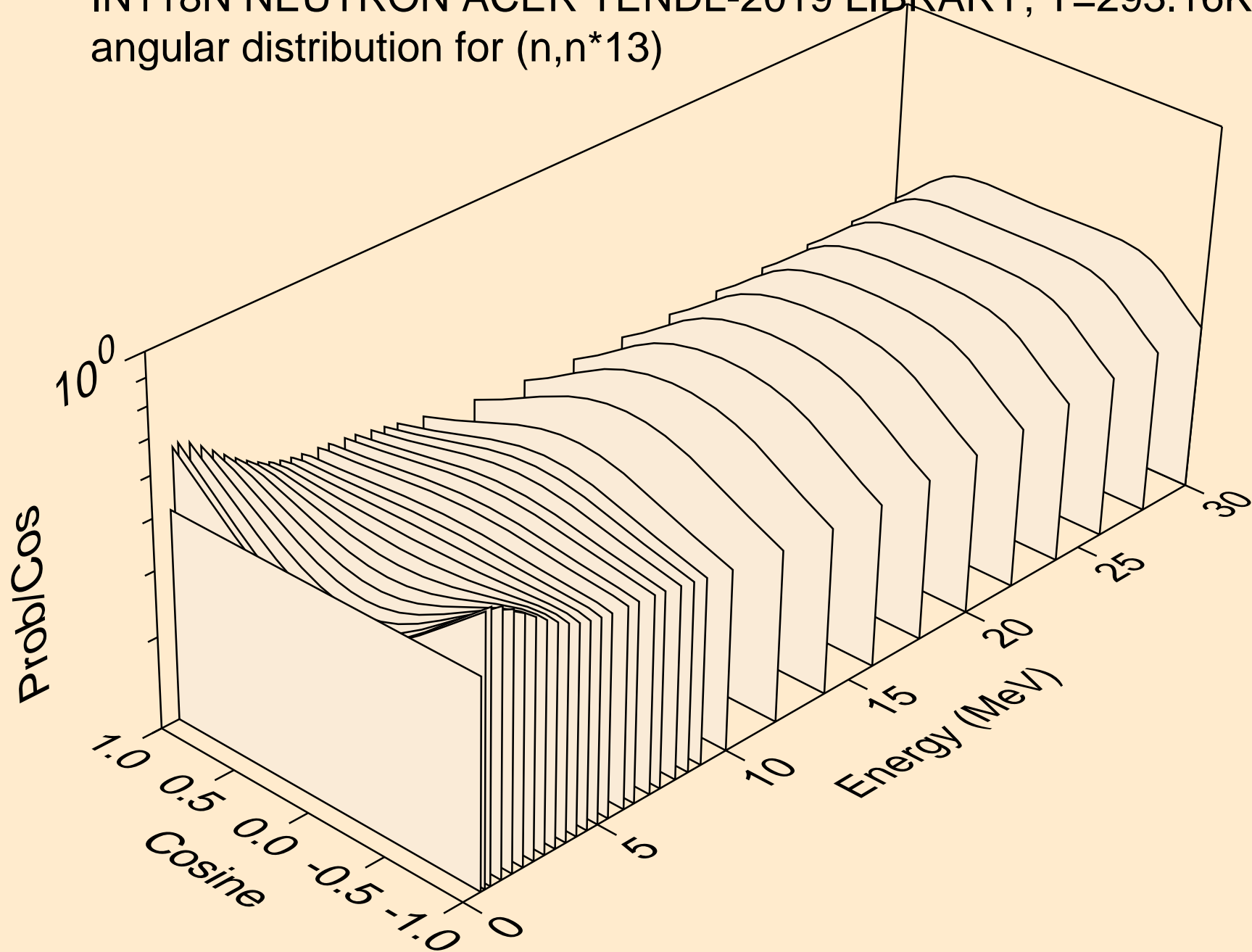

IN118N NEUTRON ACER TENDL-2019 LIBRARY; T=293.16K
angular distribution for (n,n*14)

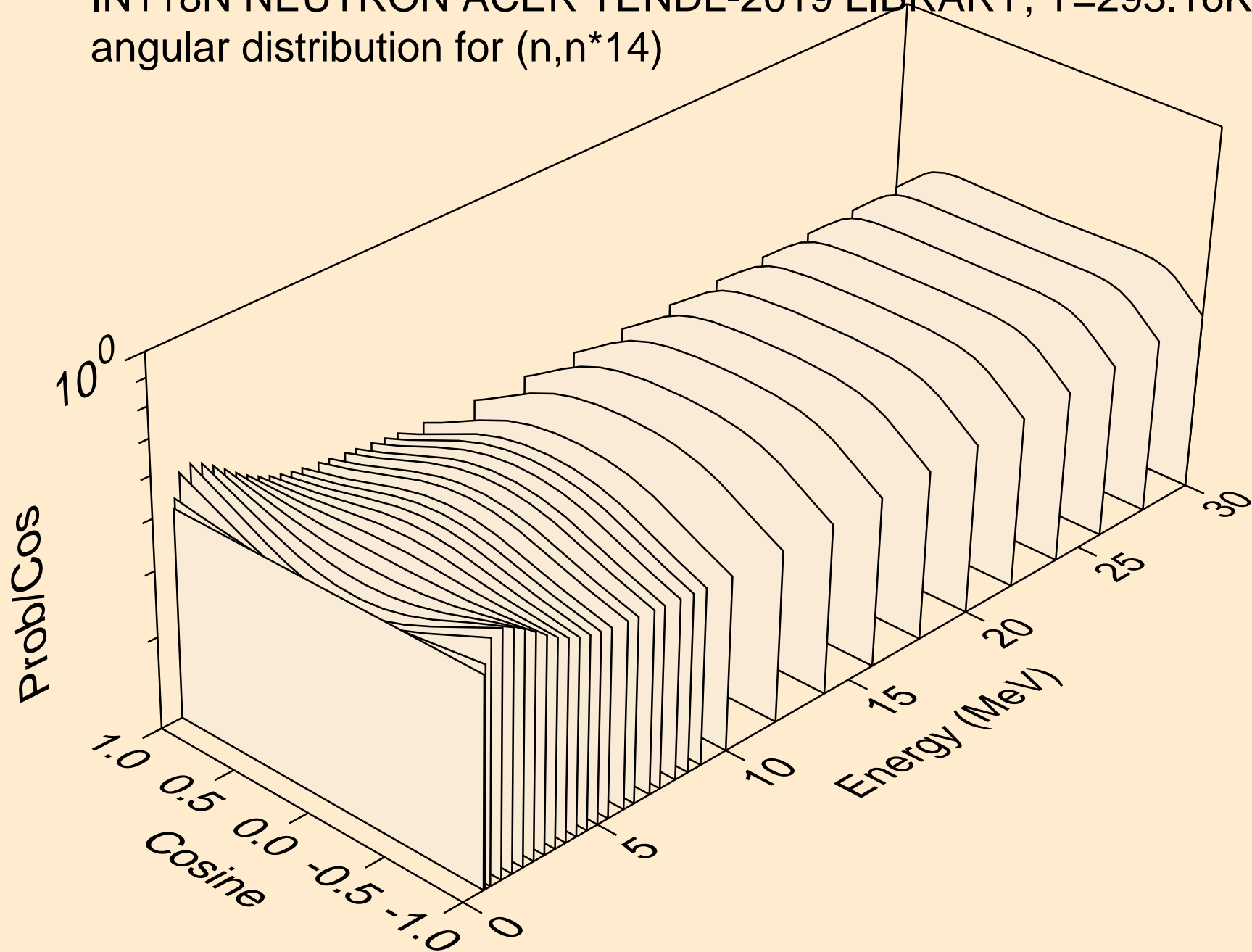

IN118N NEUTRON ACER TENDL-2019 LIBRARY; T=293.16K
angular distribution for (n,n*15)

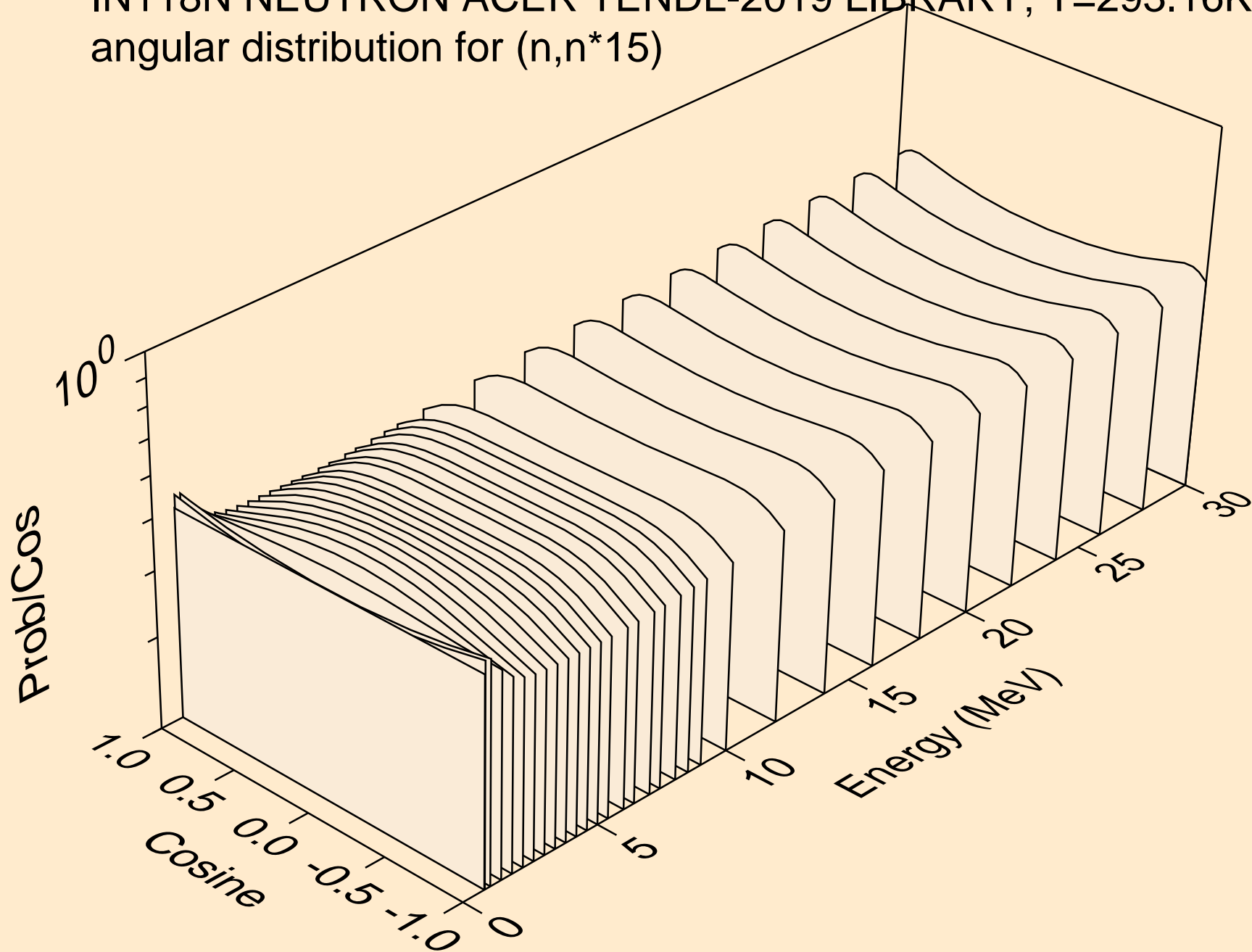

IN118N NEUTRON ACER TENDL-2019 LIBRARY; T=293.16K
angular distribution for (n,n*16)

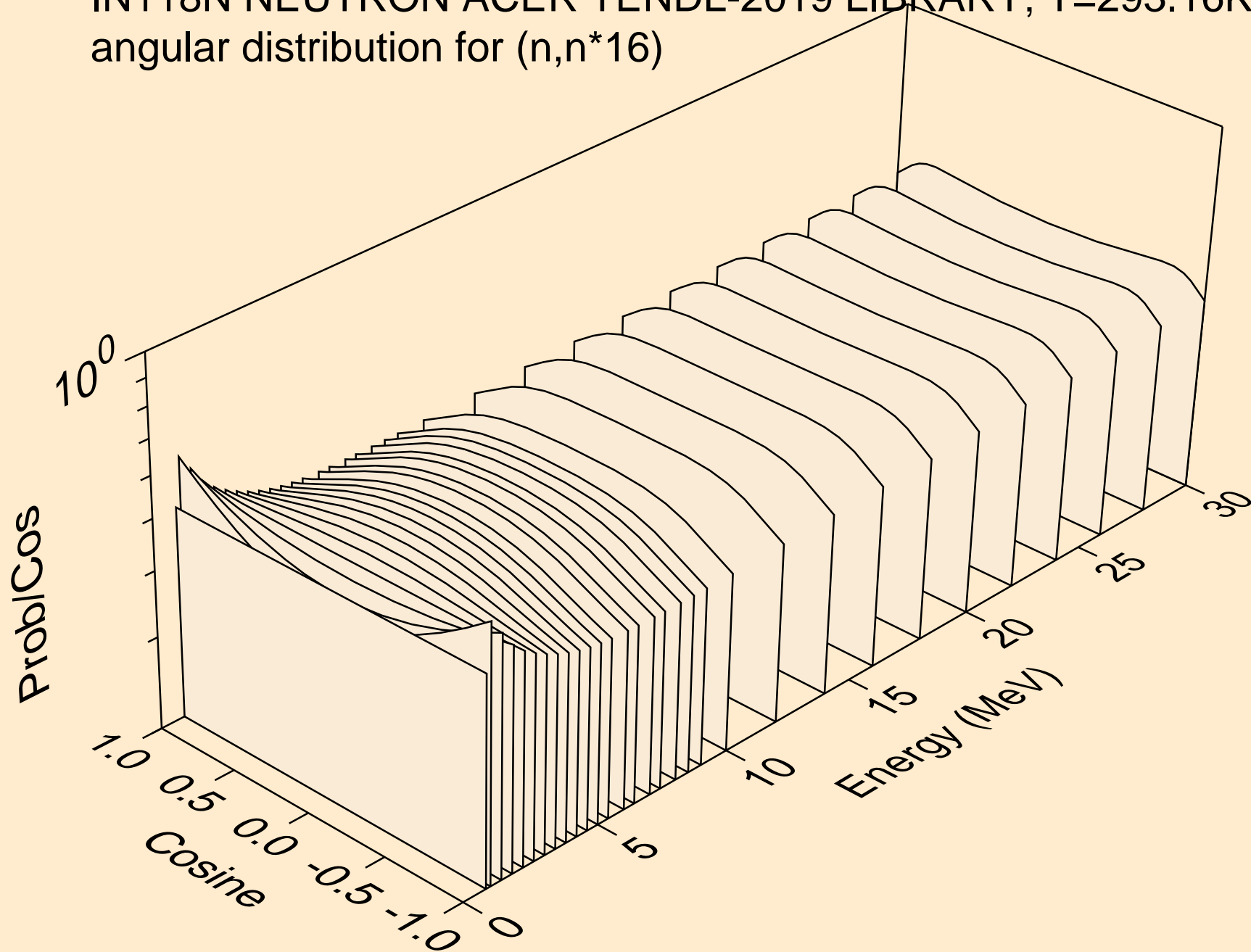

IN118N NEUTRON ACER TENDL-2019 LIBRARY; T=293.16K
angular distribution for (n,n*17)

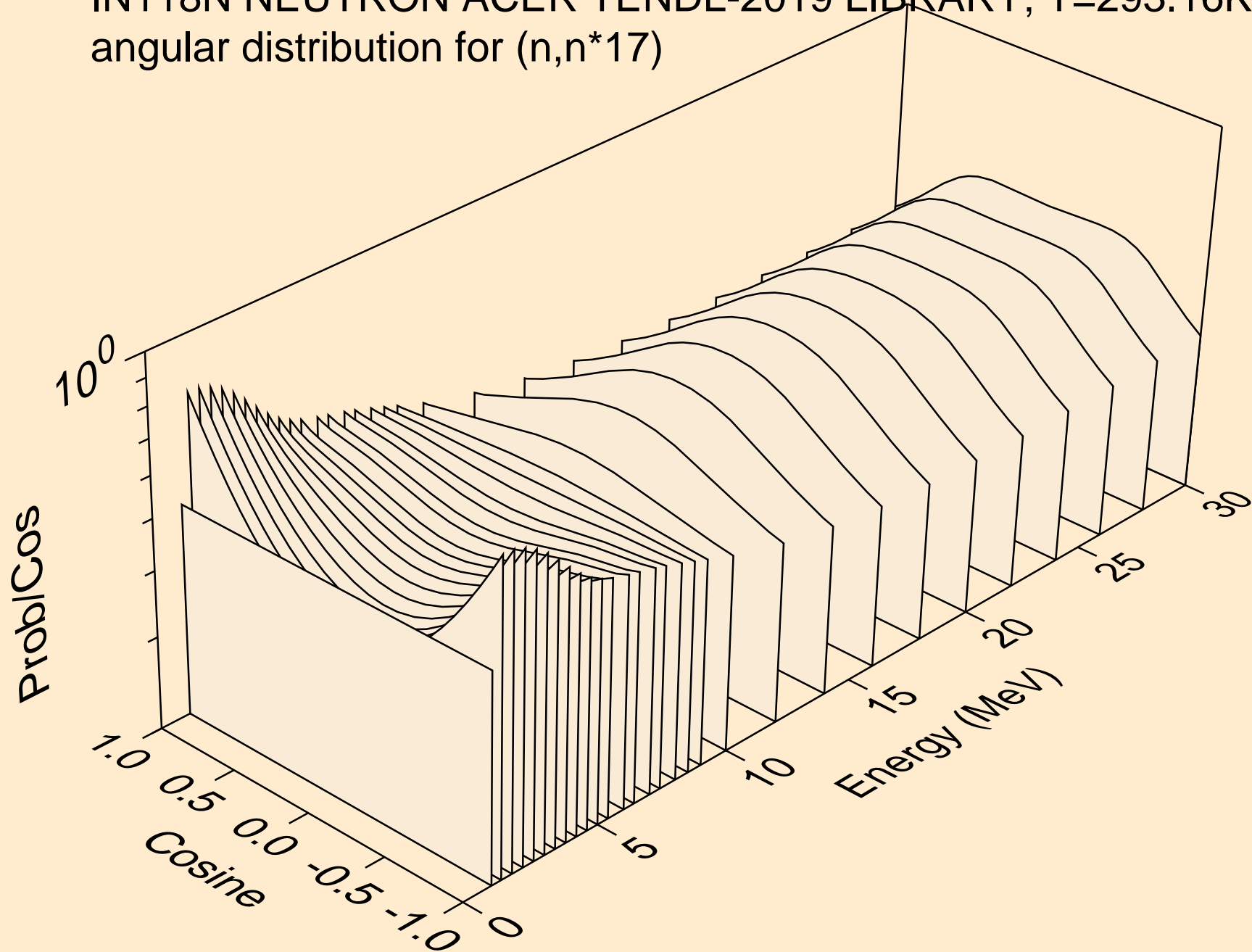

IN118N NEUTRON ACER TENDL-2019 LIBRARY; T=293.16K
angular distribution for (n,n*18)

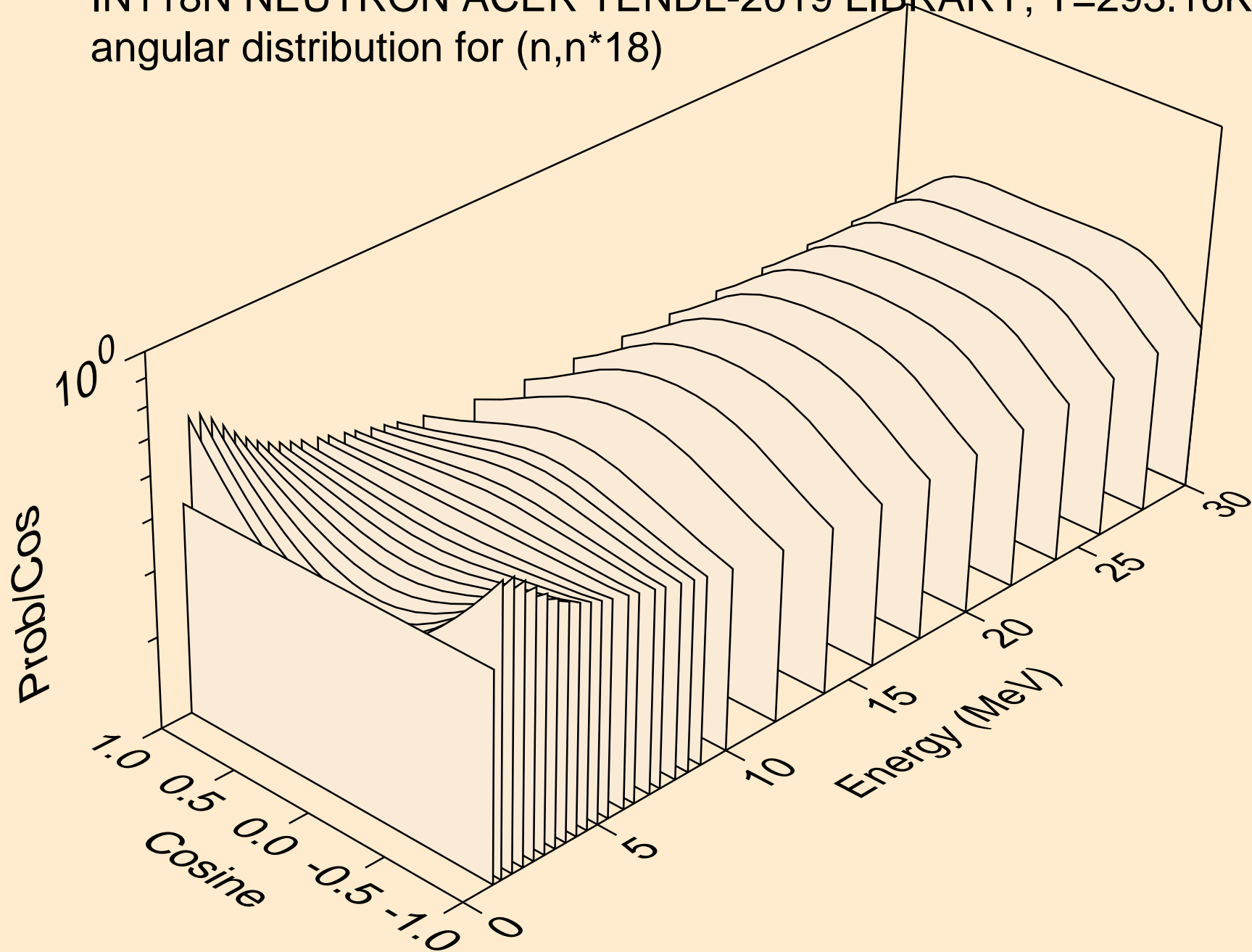

IN118N NEUTRON ACER TENDL-2019 LIBRARY; T=293.16K
angular distribution for (n,n*19)

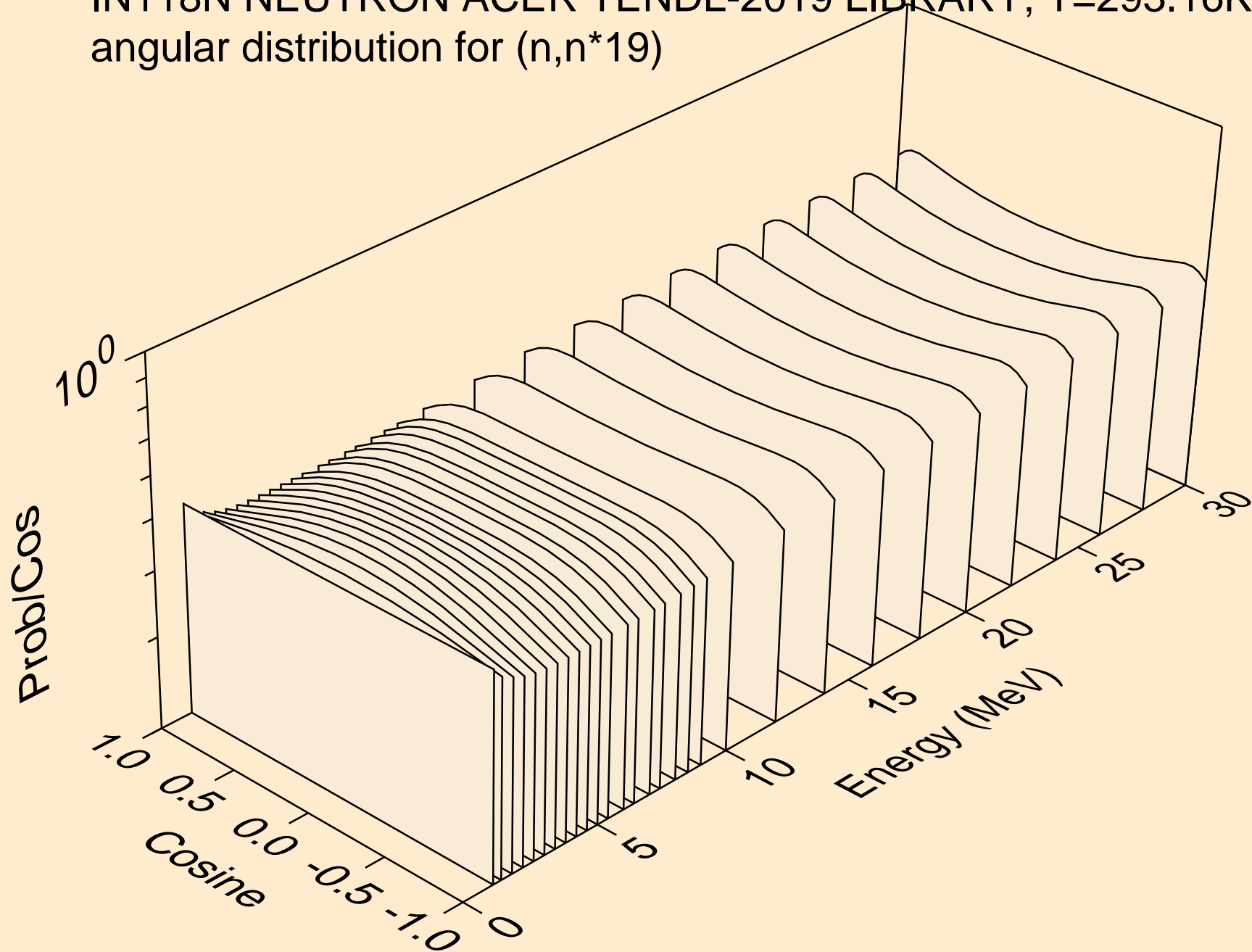

IN118N NEUTRON ACER TENDL-2019 LIBRARY; T=293.16K
angular distribution for (n,n*20)

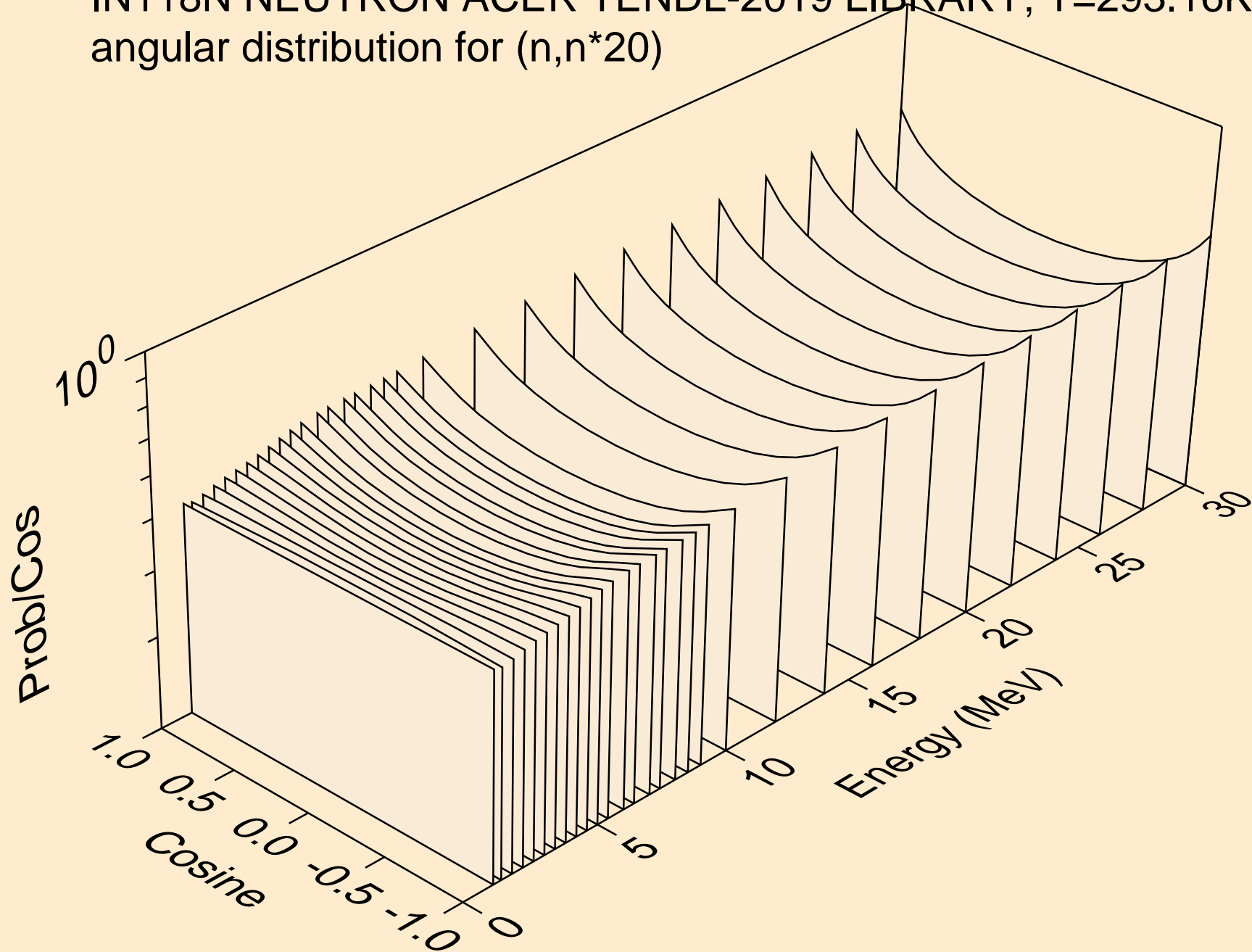

IN118N NEUTRON ACER TENDL-2019 LIBRARY; T=293.16K
angular distribution for (n,n*21)

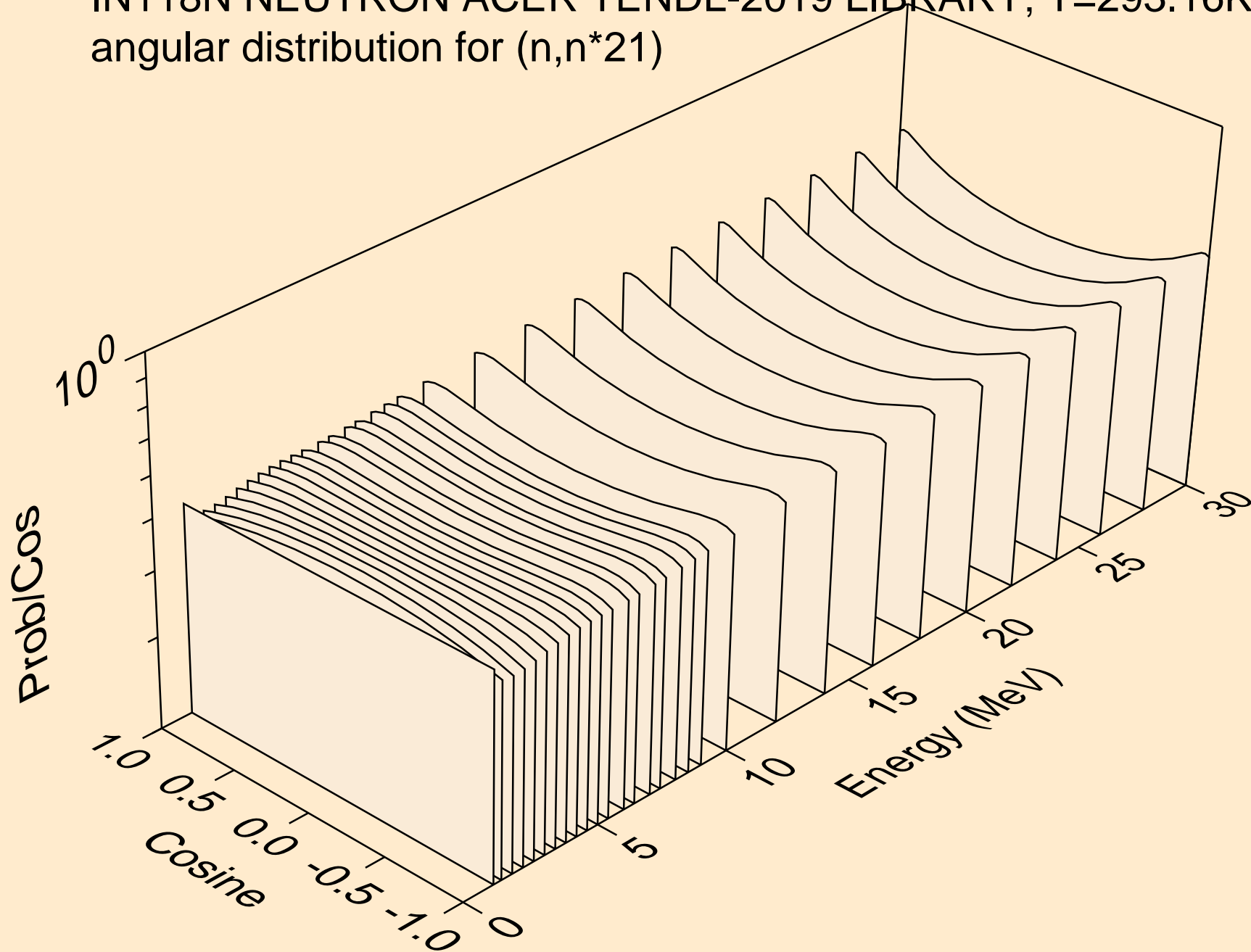

IN118N NEUTRON ACER TENDL-2019 LIBRARY; T=293.16K
angular distribution for (n,n*22)

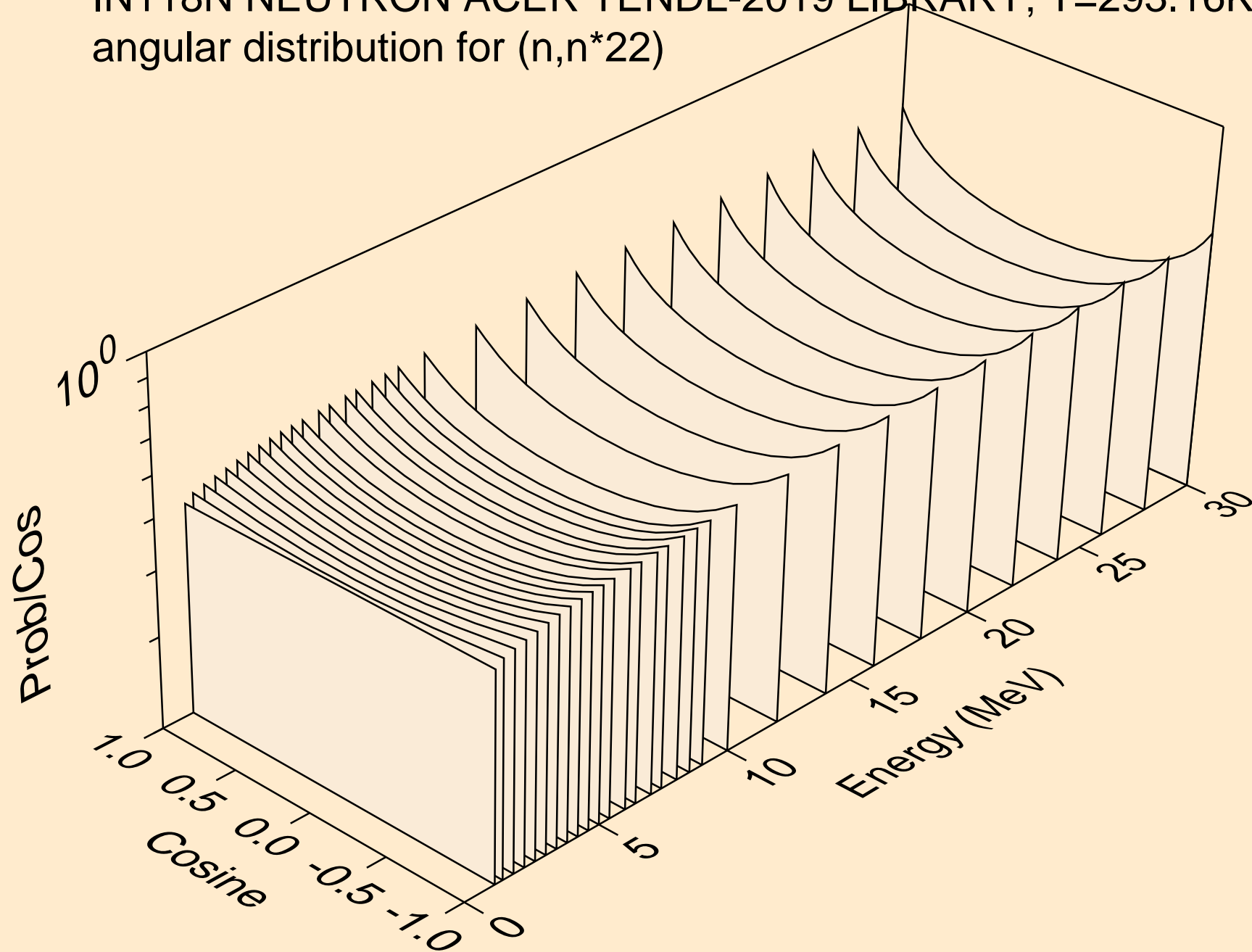

IN118N NEUTRON ACER TENDL-2019 LIBRARY; T=293.16K
angular distribution for (n,n*23)

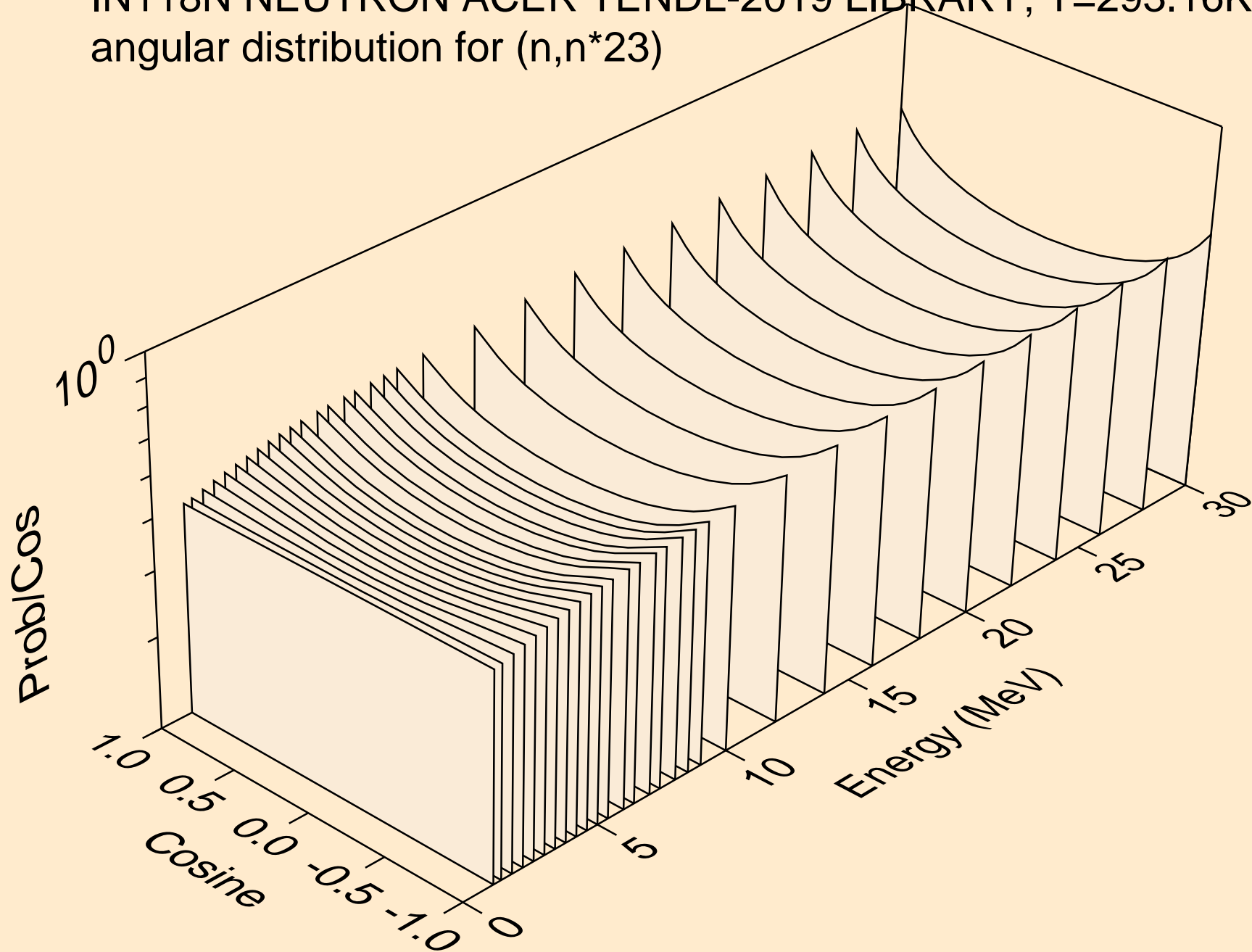

IN118N NEUTRON ACER TENDL-2019 LIBRARY; T=293.16K
angular distribution for (n,n*24)

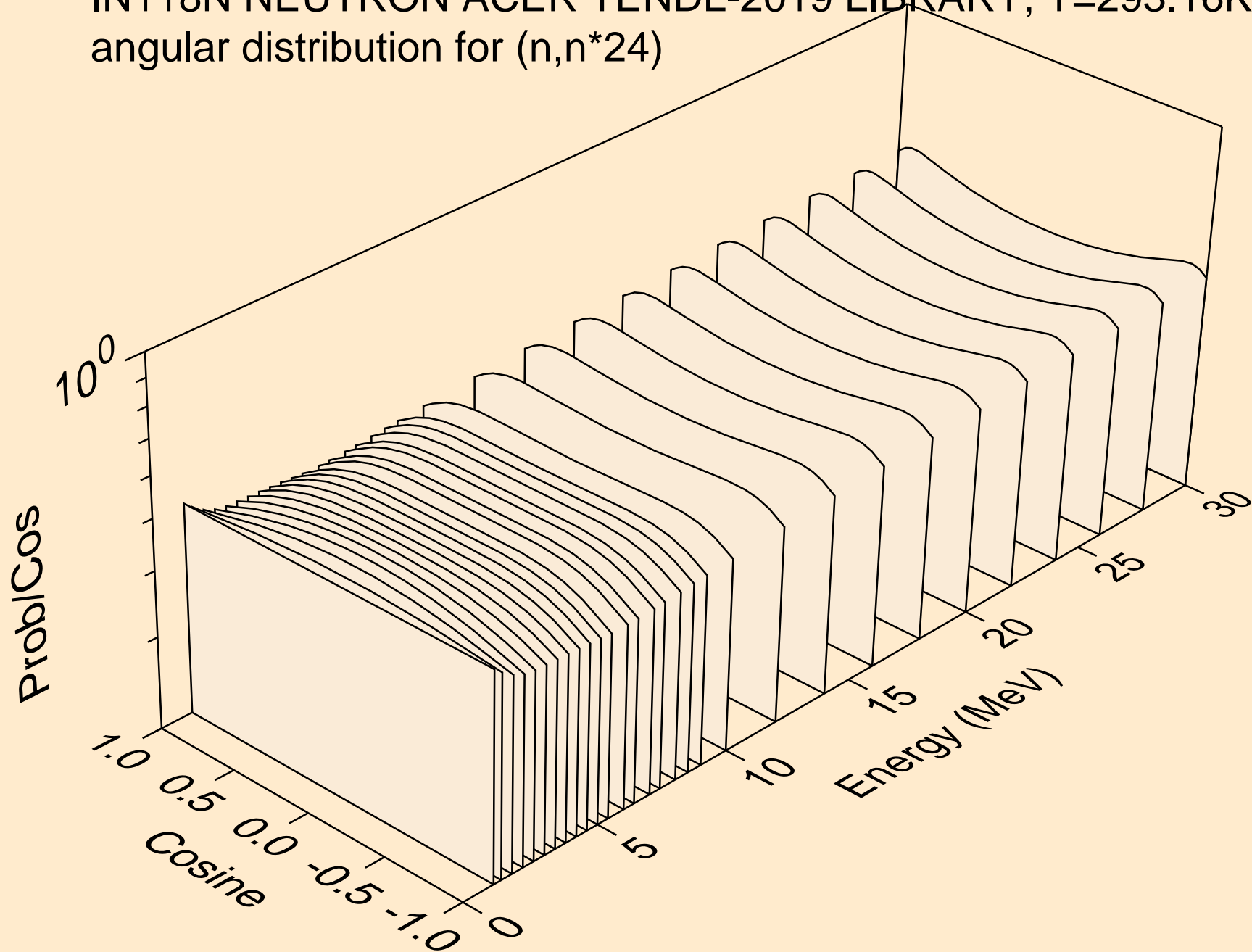

IN118N NEUTRON ACER TENDL-2019 LIBRARY; T=293.16K
angular distribution for (n,n*25)

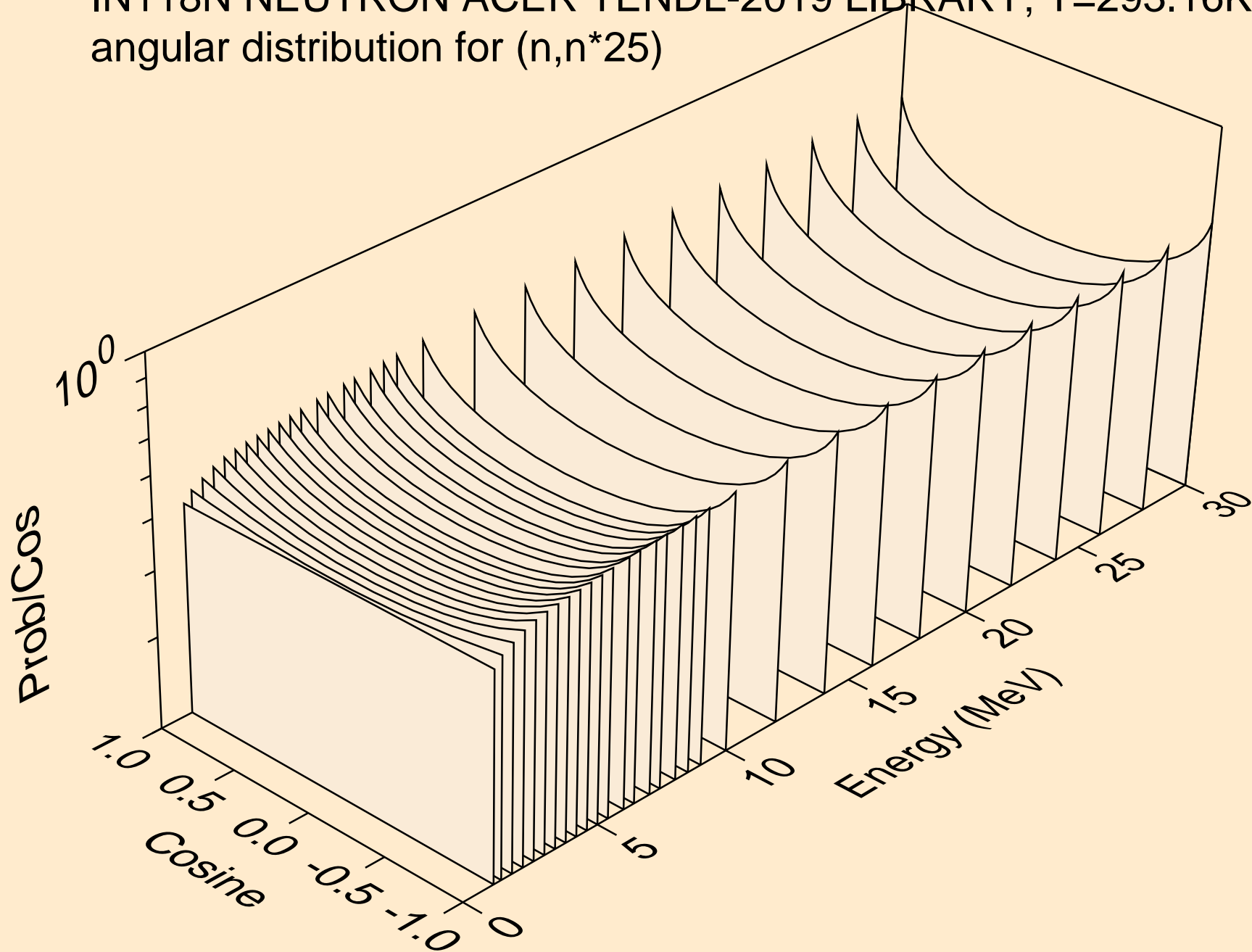

IN118N NEUTRON ACER TENDL-2019 LIBRARY; T=293.16K
angular distribution for (n,n*26)

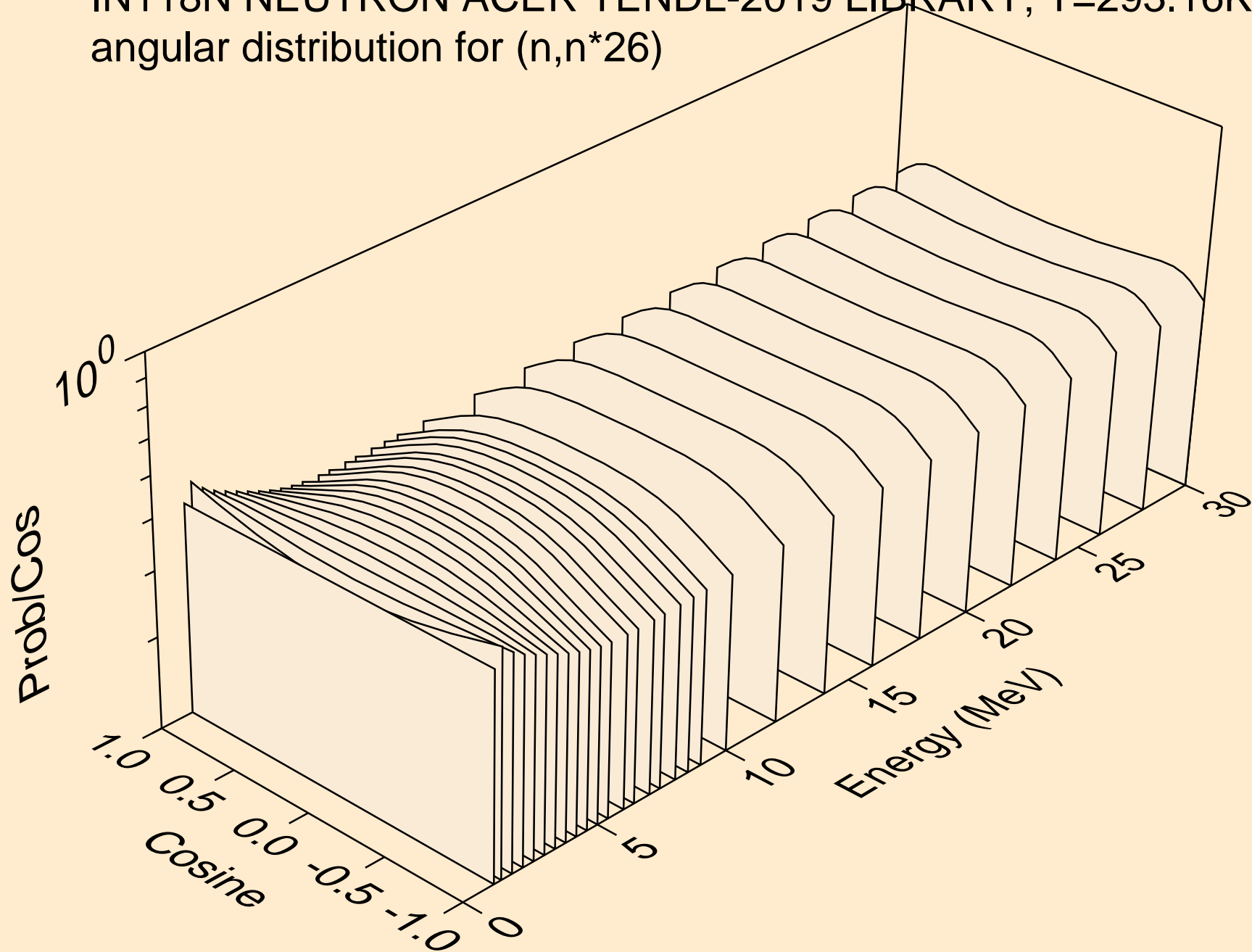

IN118N NEUTRON ACER TENDL-2019 LIBRARY; T=293.16K
angular distribution for (n,n*27)

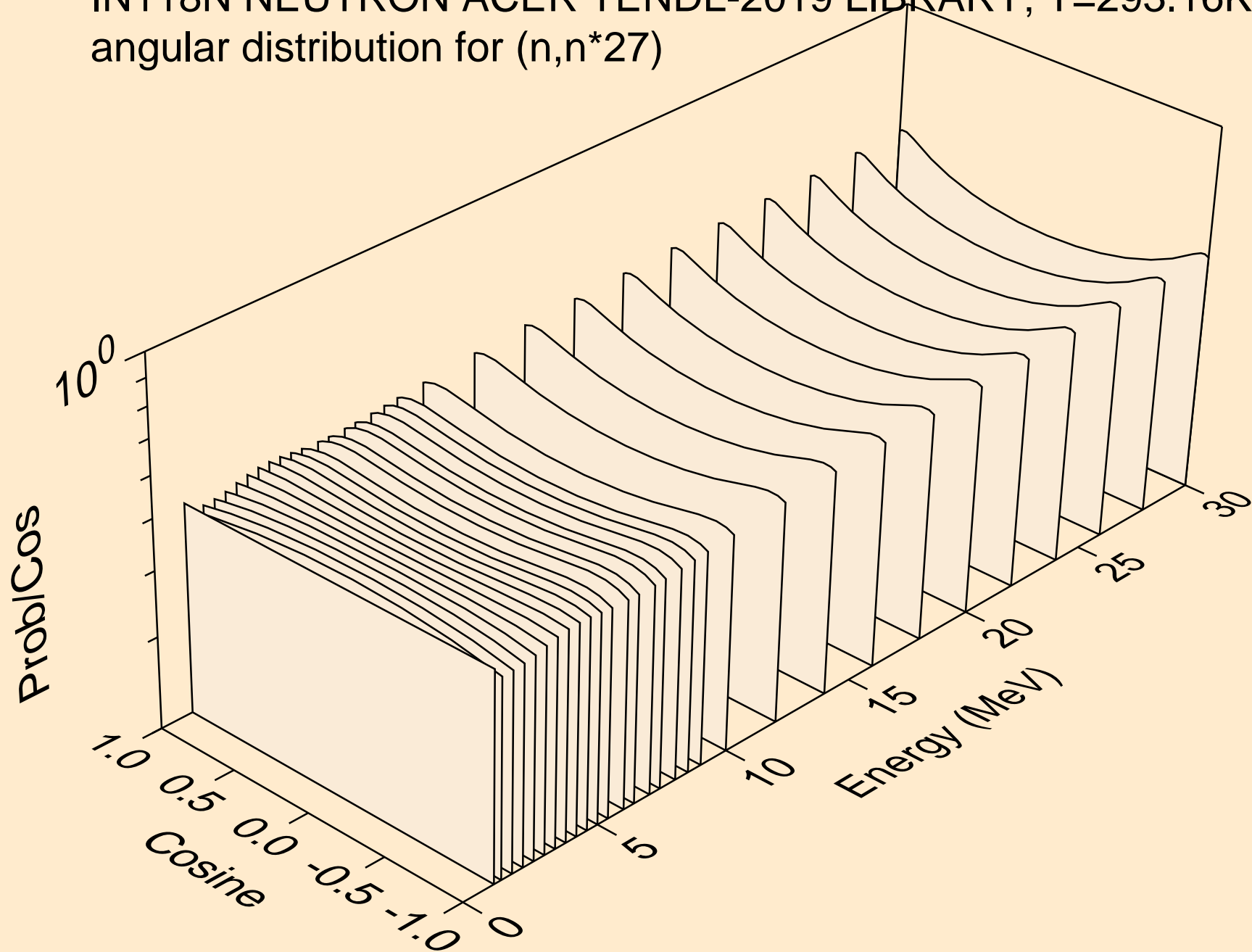

IN118N NEUTRON ACER TENDL-2019 LIBRARY; T=293.16K
Neutron emission for (n,x)

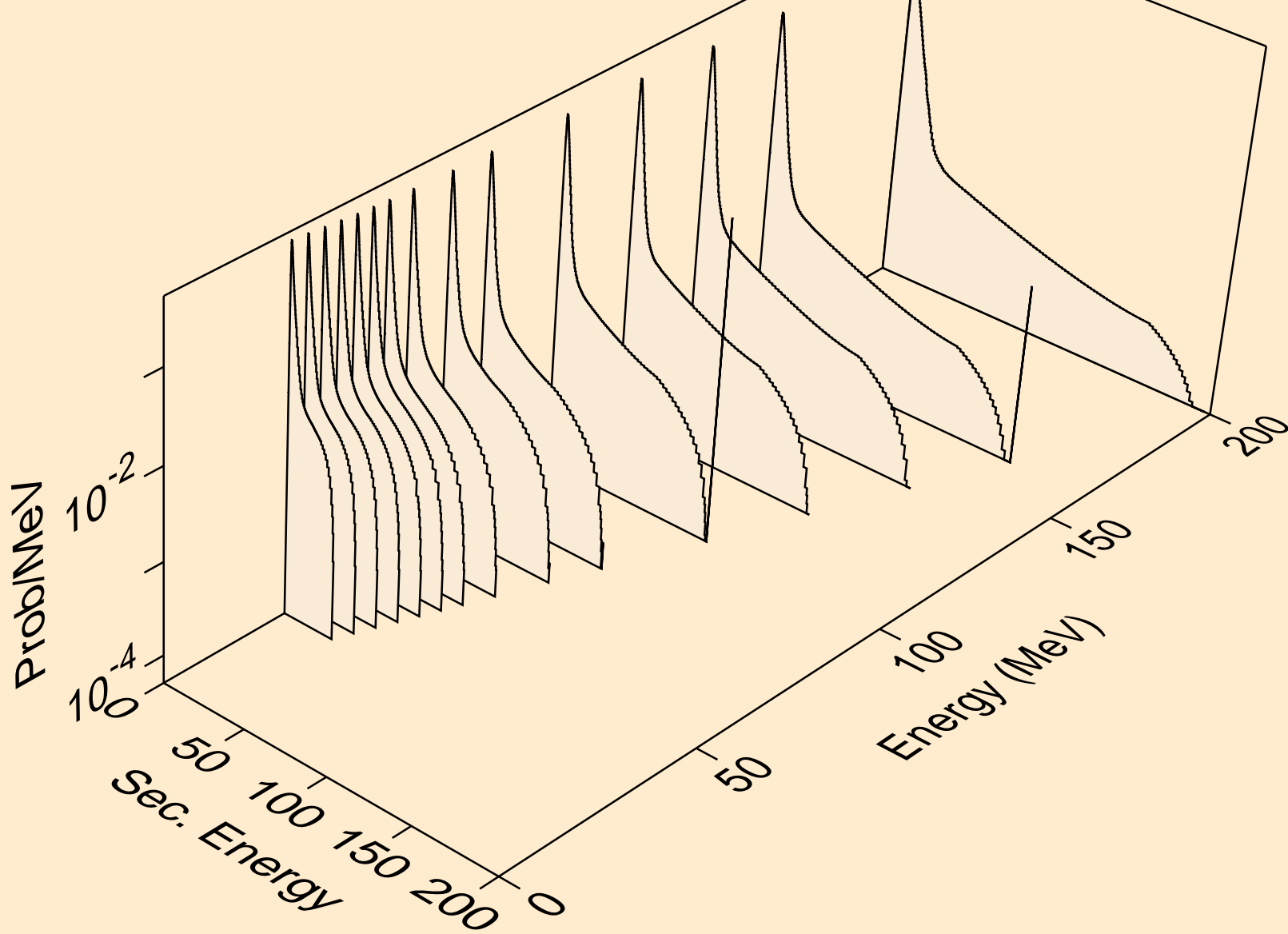

IN118N NEUTRON ACER TENDL-2019 LIBRARY; T=293.16K
Neutron emission for (n,2nd)

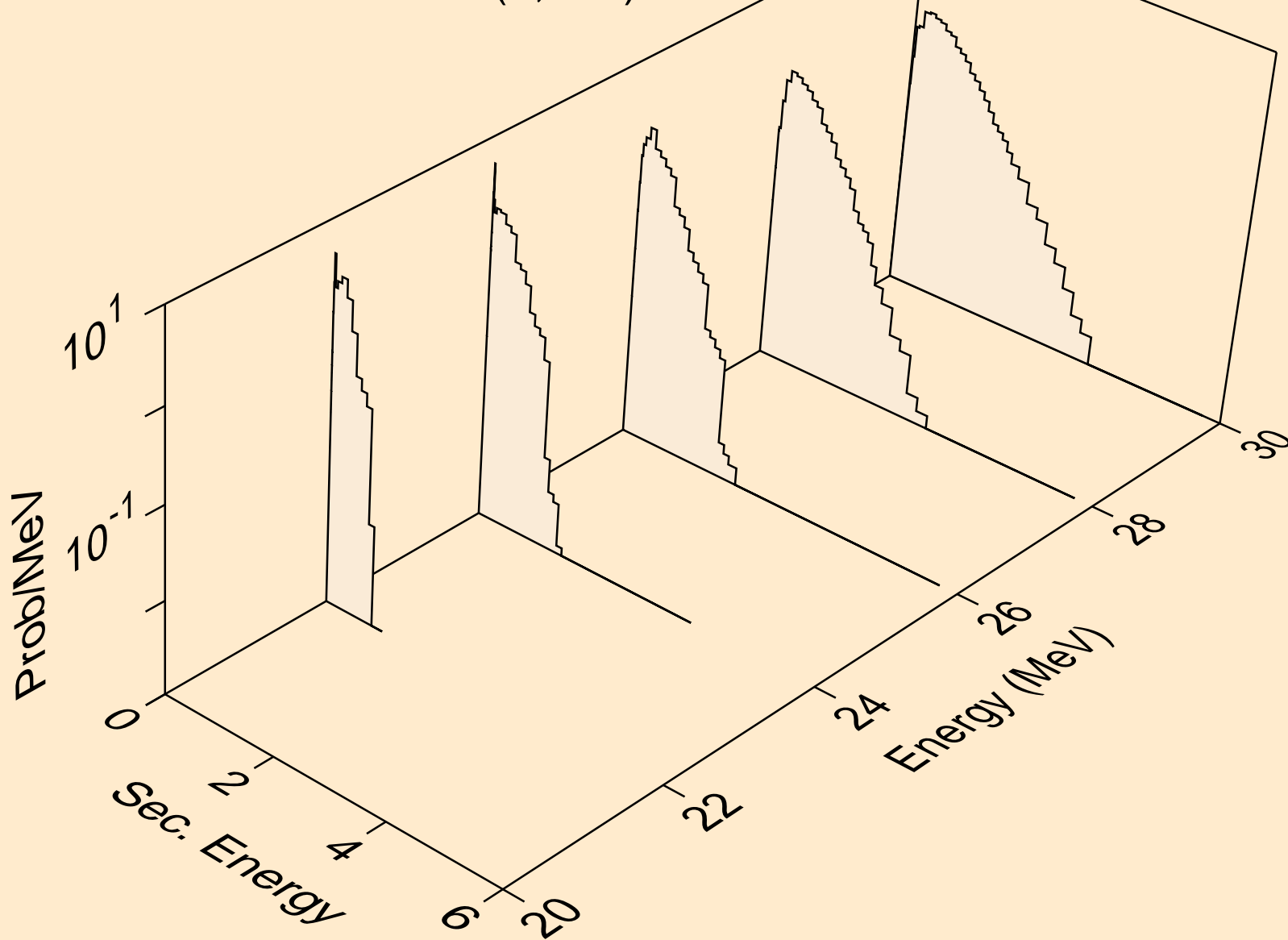

IN118N NEUTRON ACER TENDL-2019 LIBRARY; T=293.16K
Neutron emission for (n,2n)

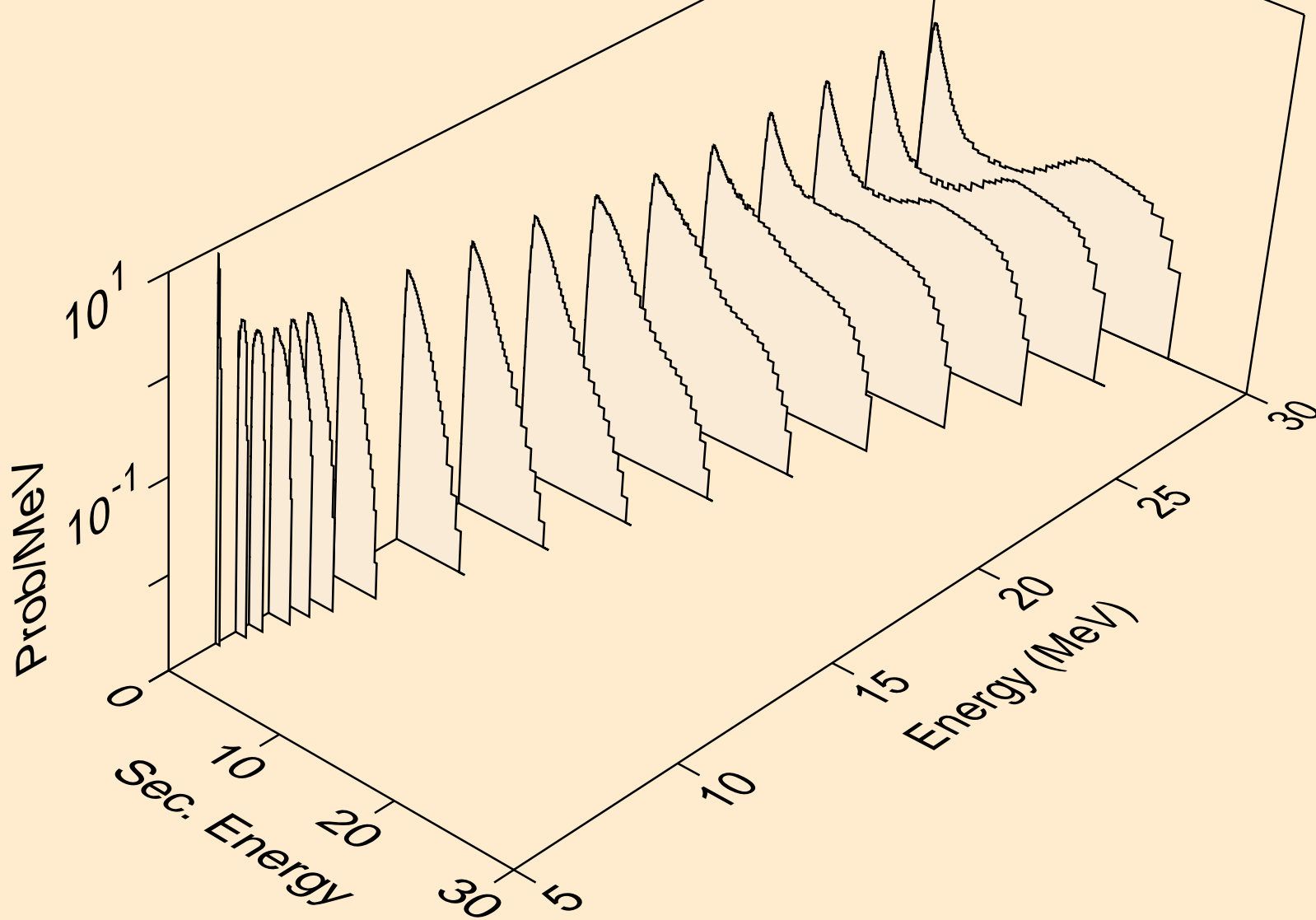

IN118N NEUTRON ACER TENDL-2019 LIBRARY; T=293.16K
Neutron emission for (n,3n)

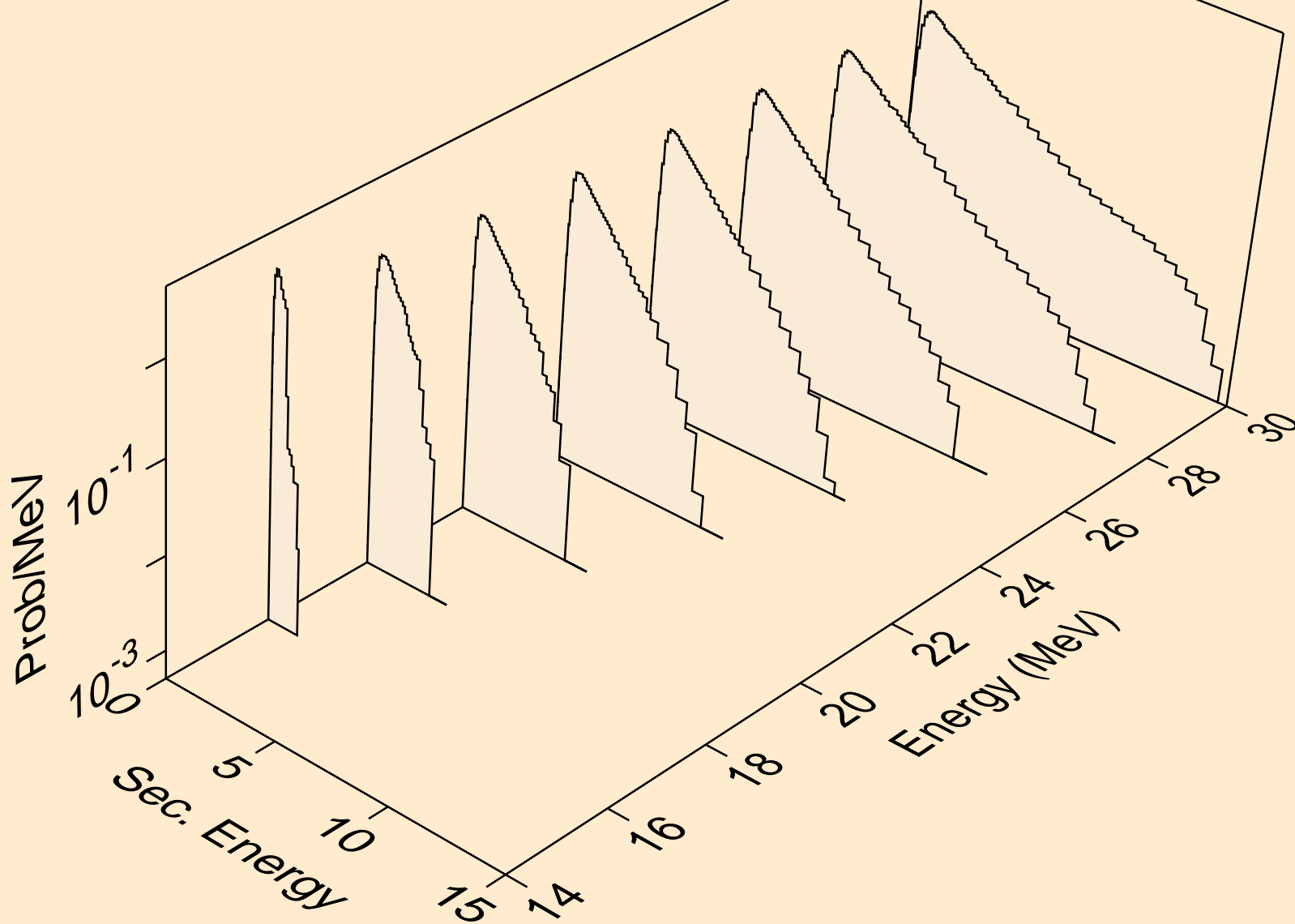

IN118N NEUTRON ACER TENDL-2019 LIBRARY; T=293.16K
Neutron emission for (n,n*)a

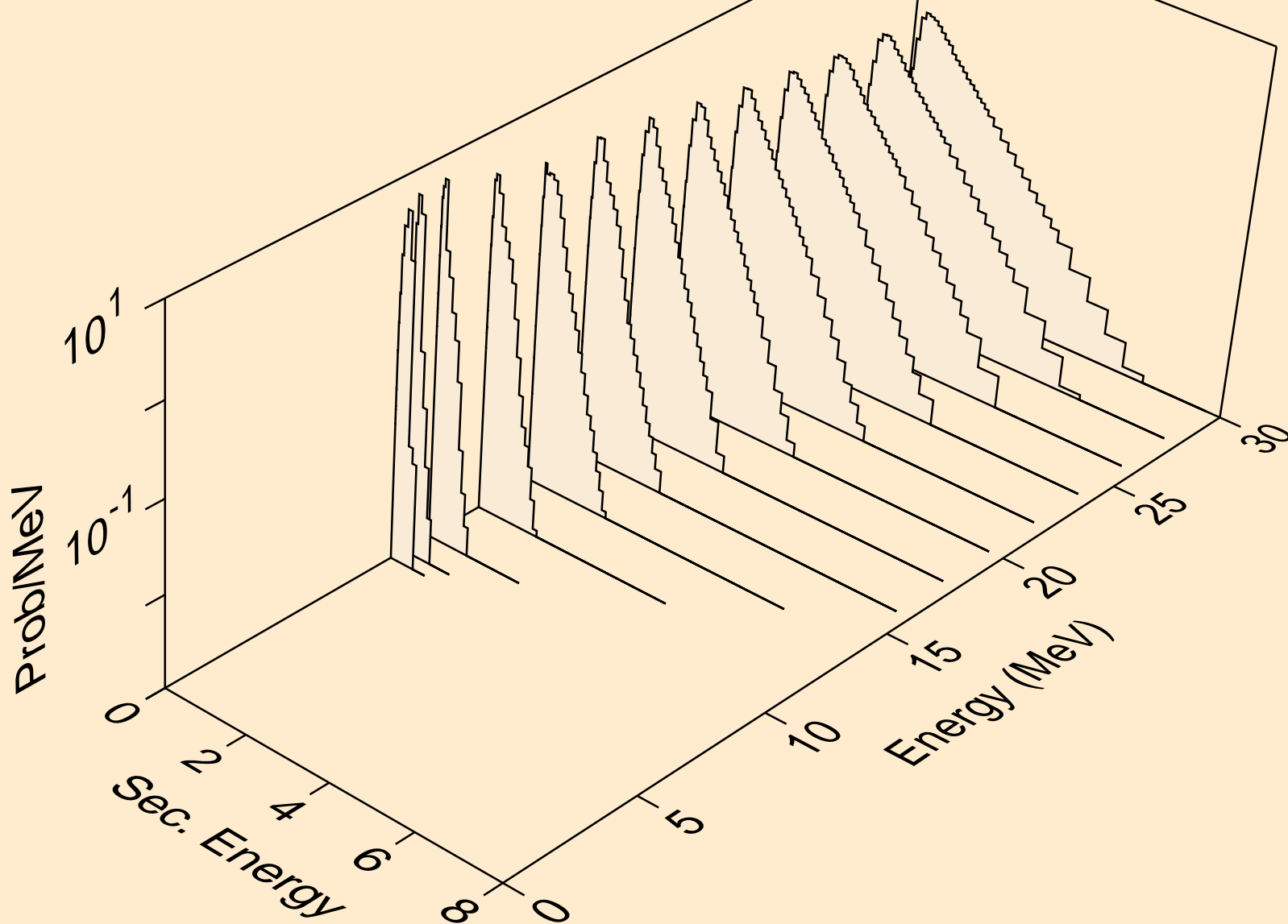

IN118N NEUTRON ACER TENDL-2019 LIBRARY; T=293.16K
Neutron emission for (n,2n)a

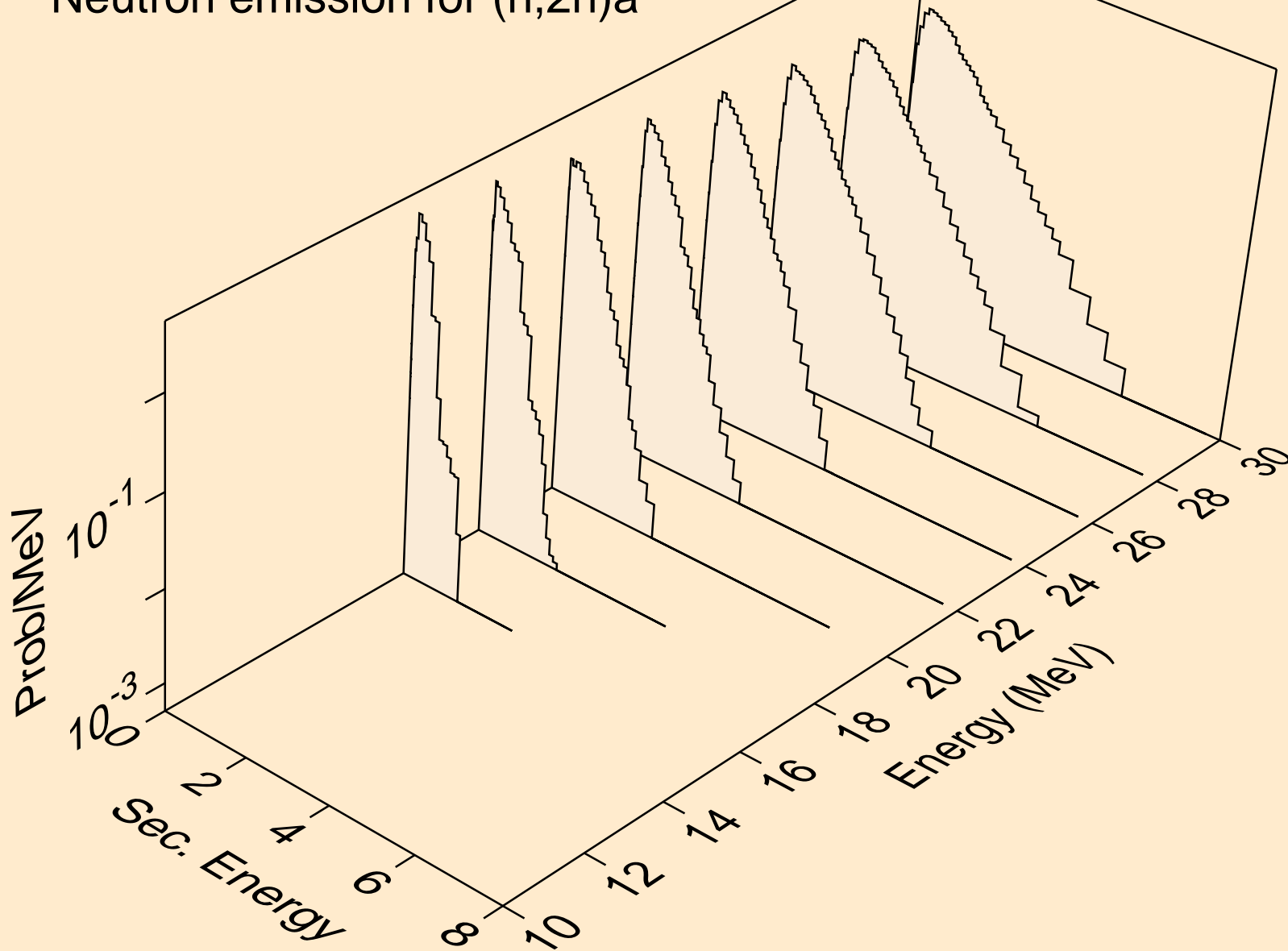

IN118N NEUTRON ACER TENDL-2019 LIBRARY; T=293.16K
Neutron emission for (n,3n)a

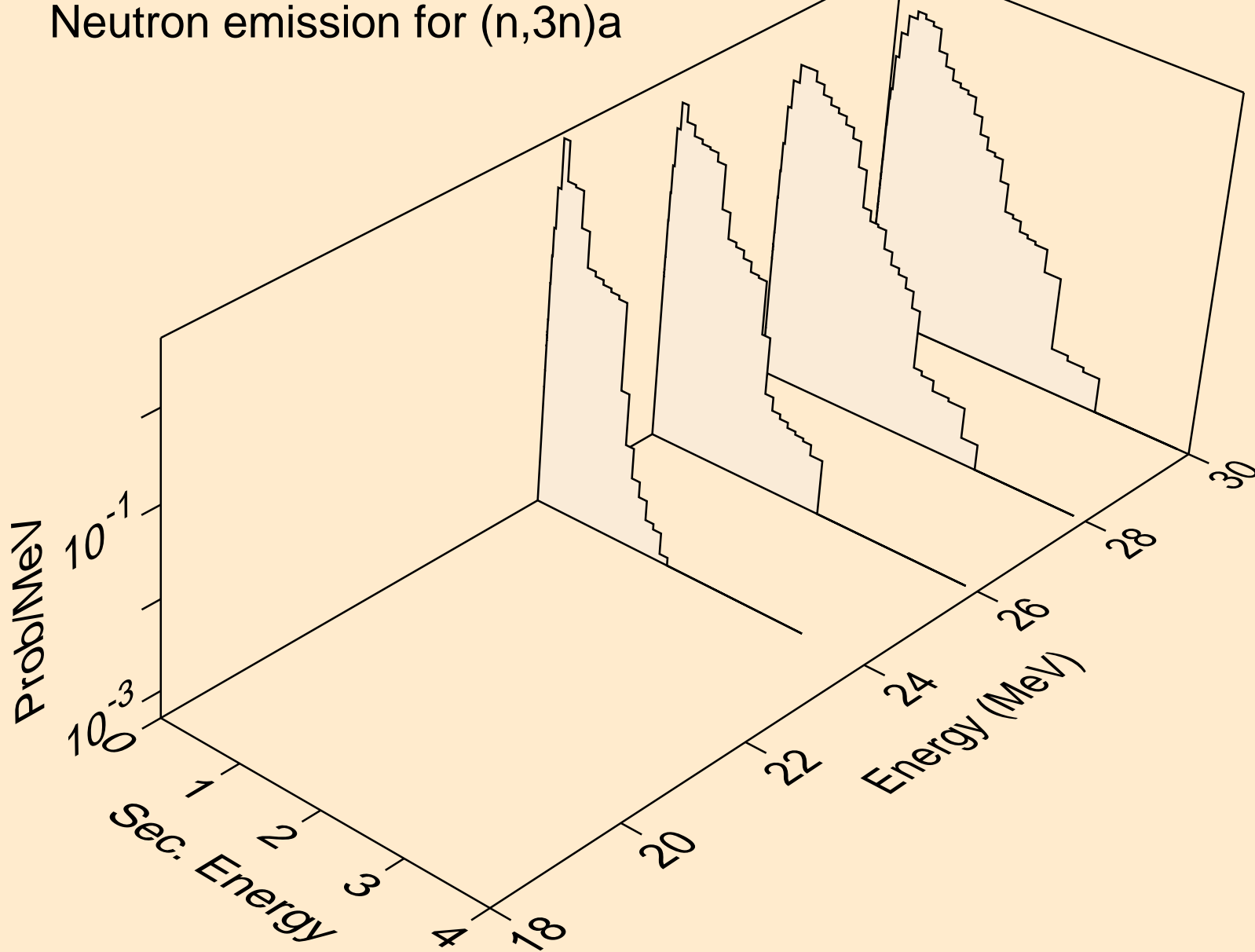

IN118N NEUTRON ACER TENDL-2019 LIBRARY; T=293.16K
Neutron emission for (n,n*)p

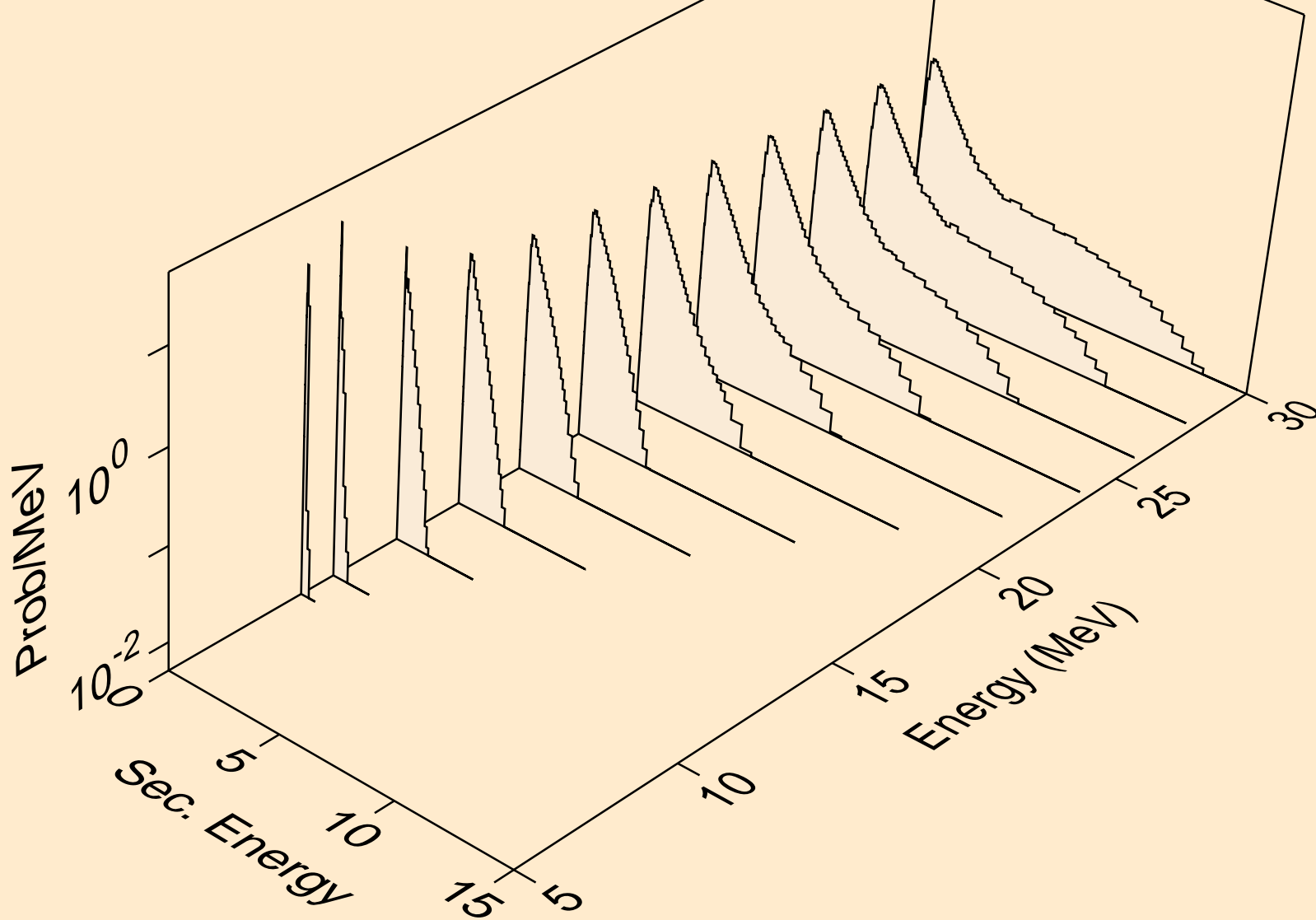

IN118N NEUTRON ACER TENDL-2019 LIBRARY; T=293.16K
Neutron emission for (n,n*)d

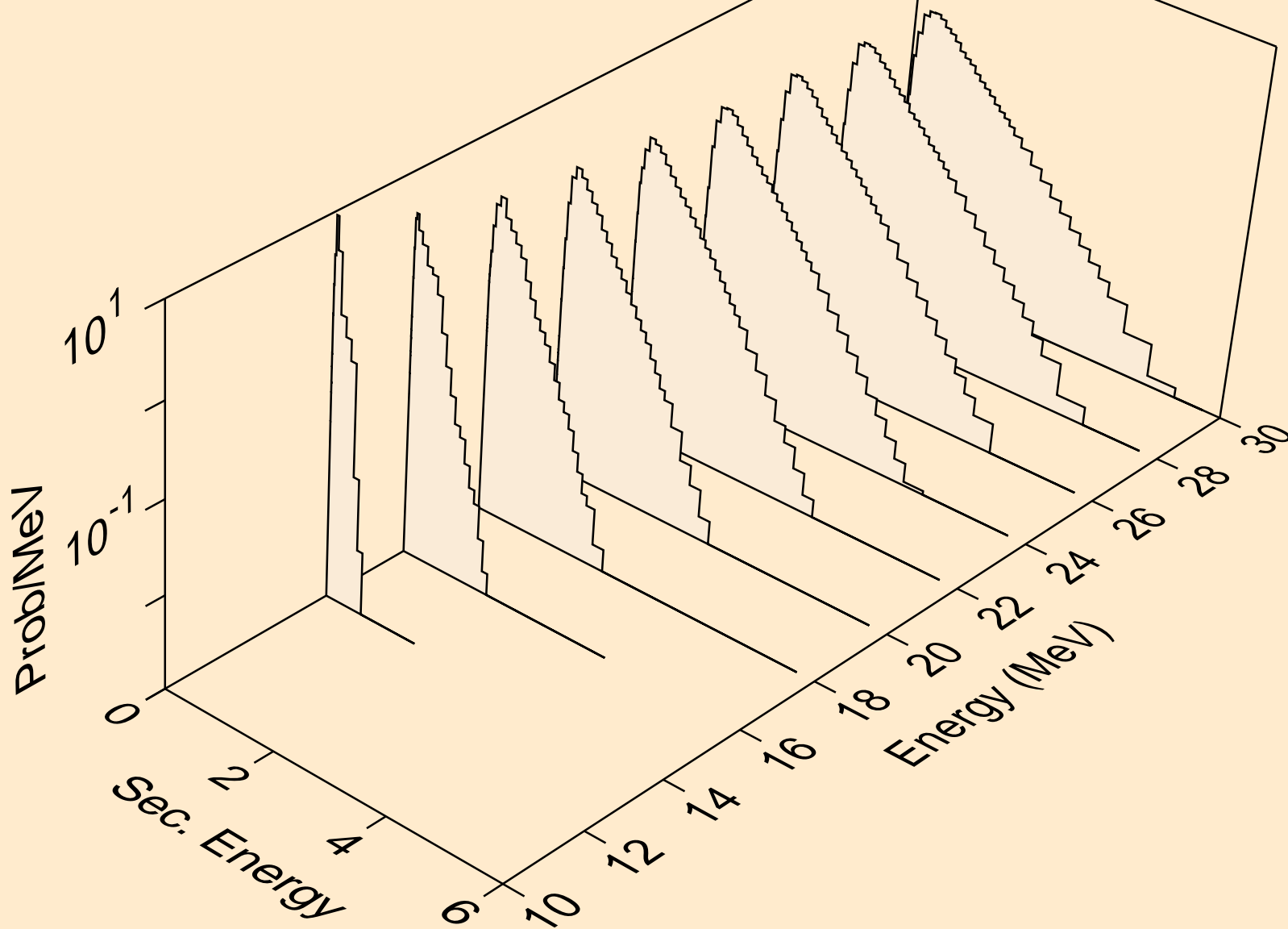

IN118N NEUTRON ACER TENDL-2019 LIBRARY; T=293.16K
Neutron emission for (n,n*)t

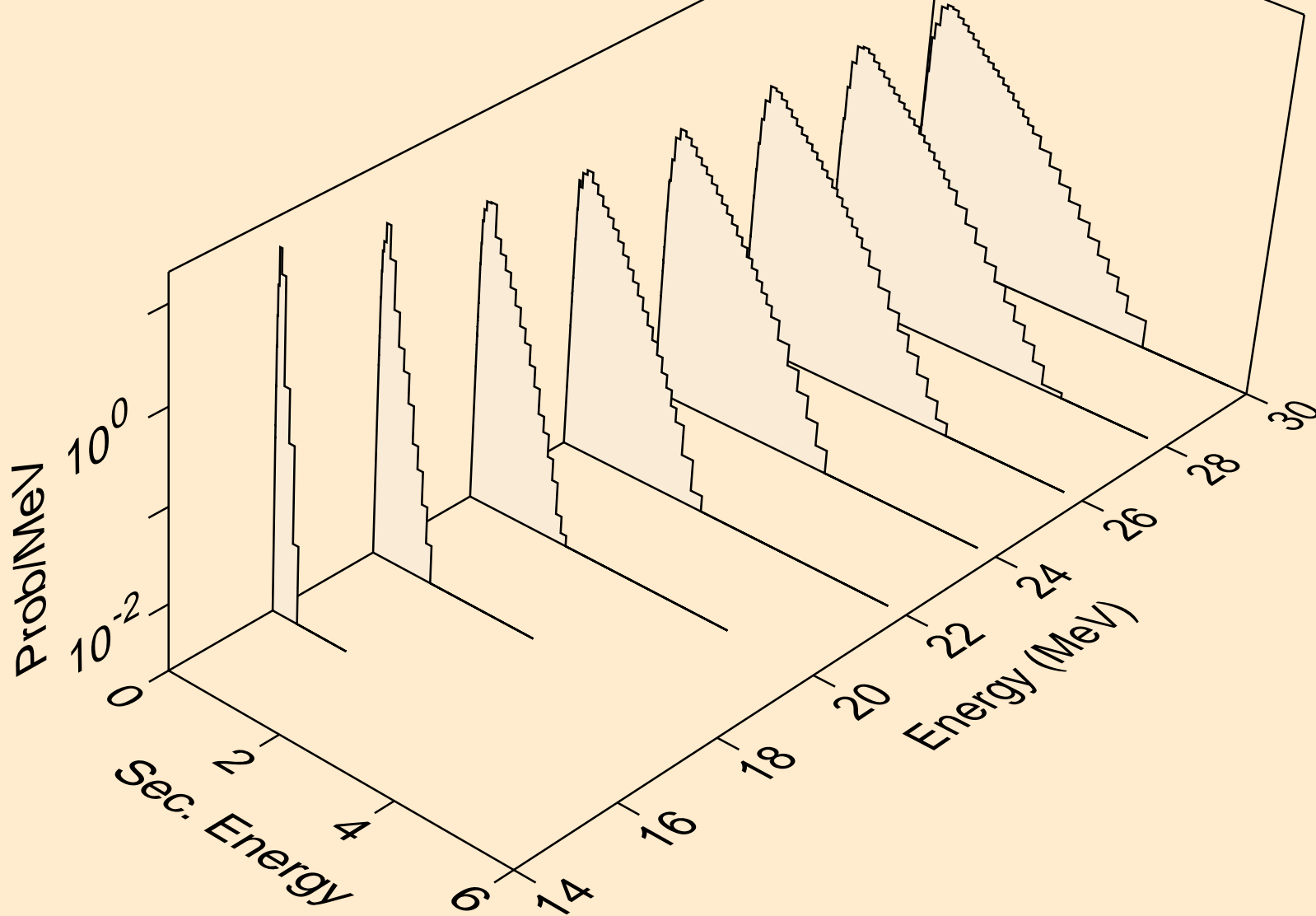

IN118N NEUTRON ACER TENDL-2019 LIBRARY; T=293.16K
Neutron emission for (n,n*)he3

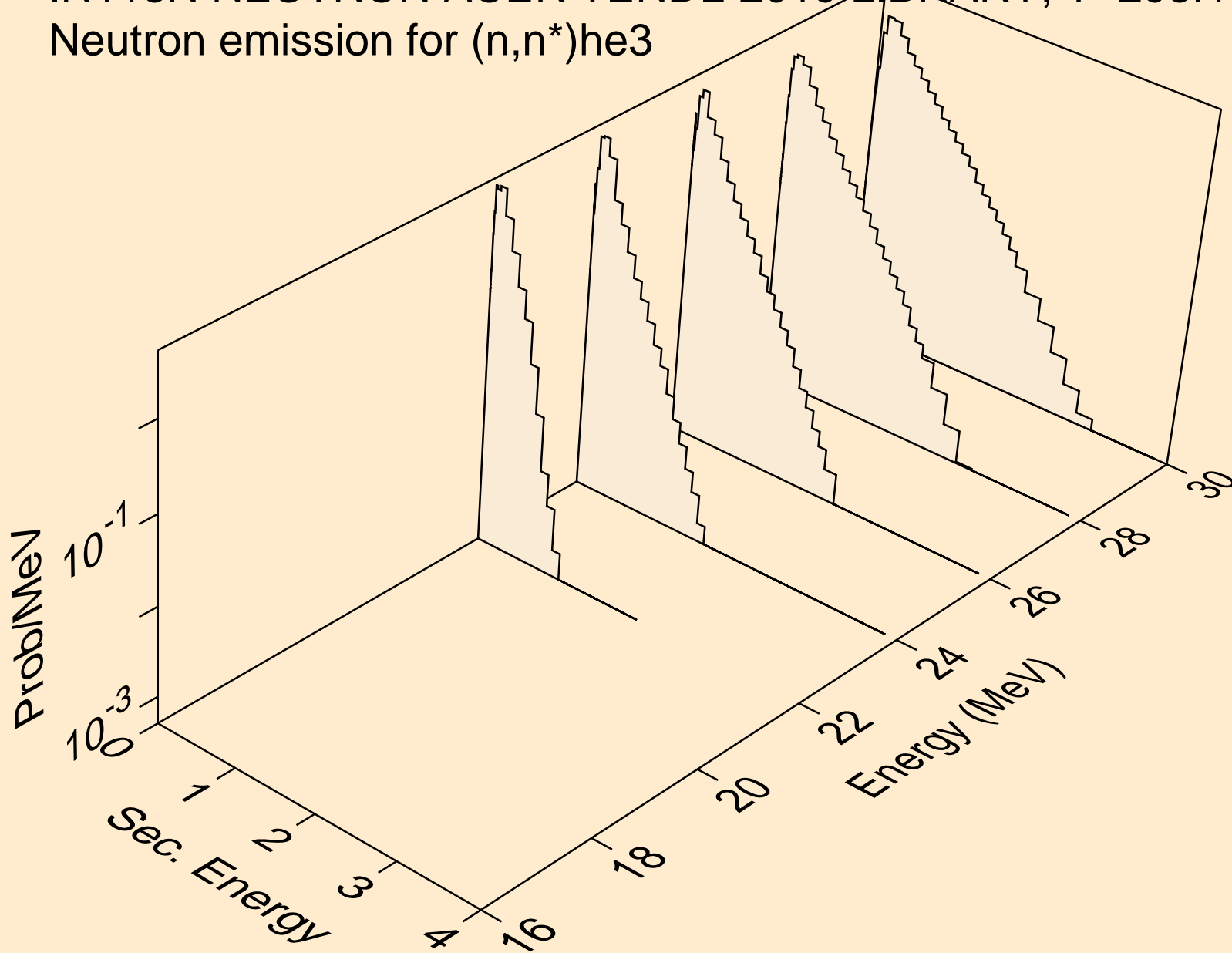

IN118N NEUTRON ACER TENDL-2019 LIBRARY; T=293.16K
Neutron emission for (n,4n)

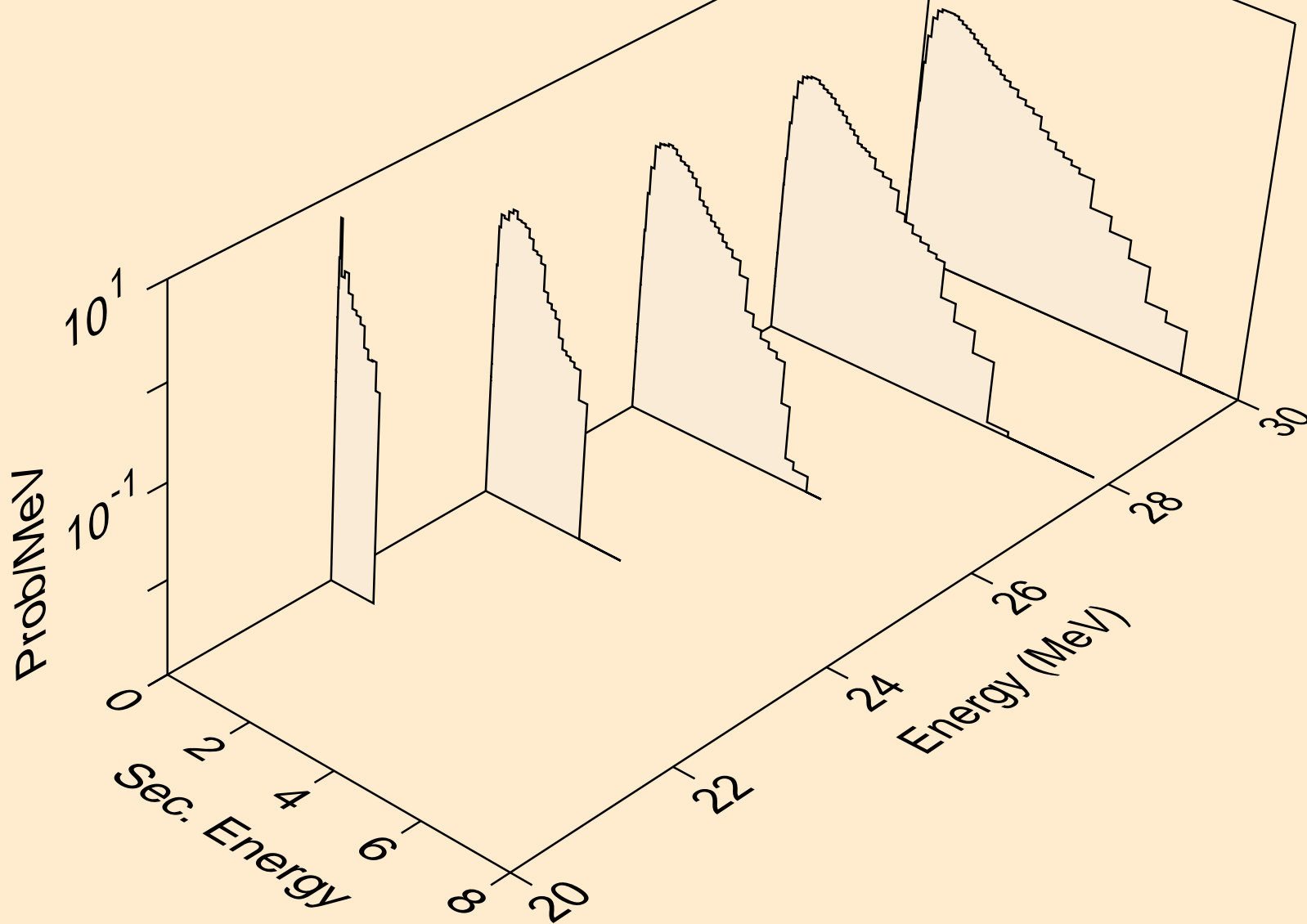

IN118N NEUTRON ACER TENDL-2019 LIBRARY; T=293.16K
Neutron emission for (n,2np)

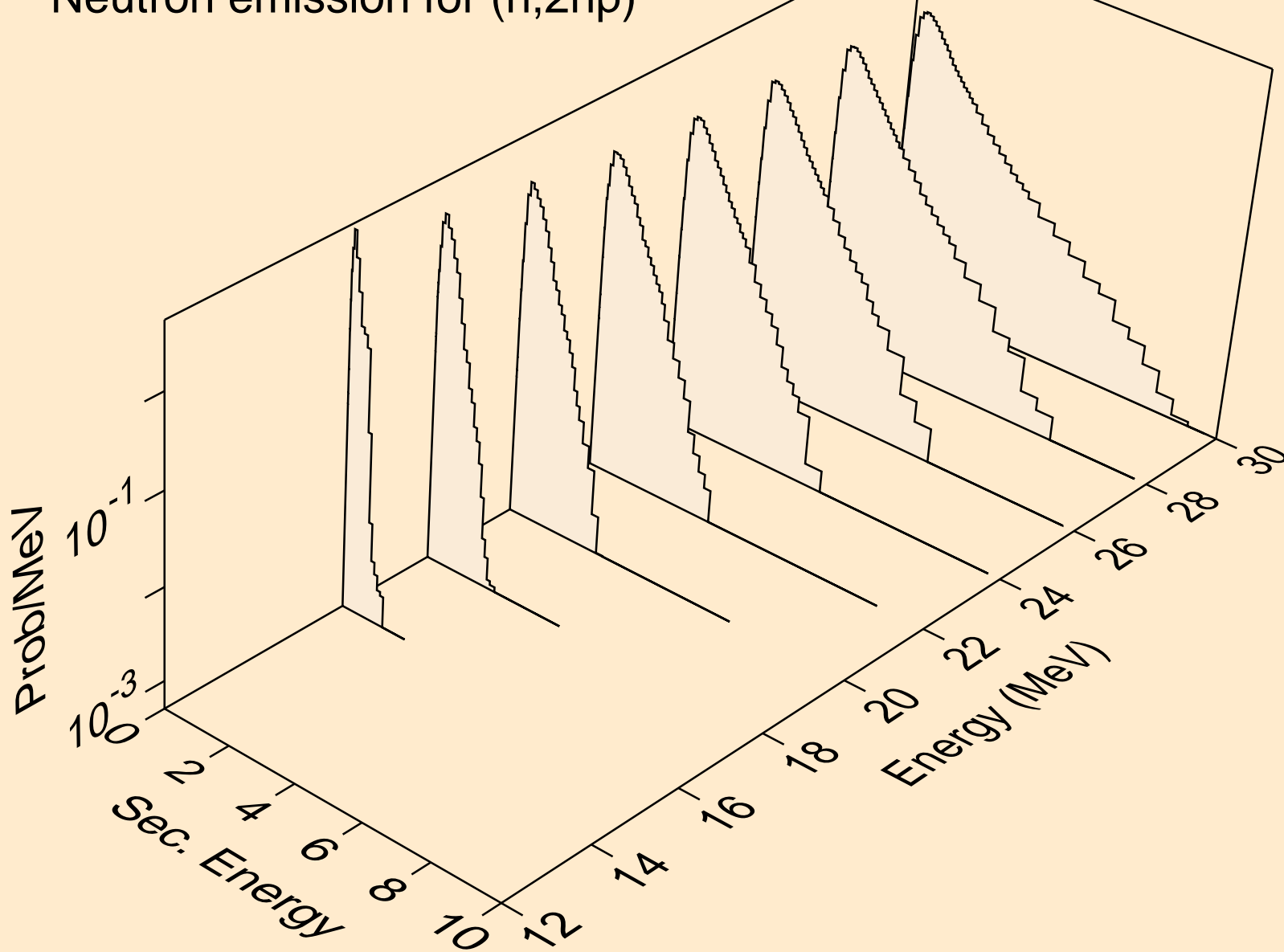

IN118N NEUTRON ACER TENDL-2019 LIBRARY; T=293.16K
Neutron emission for (n,3np)

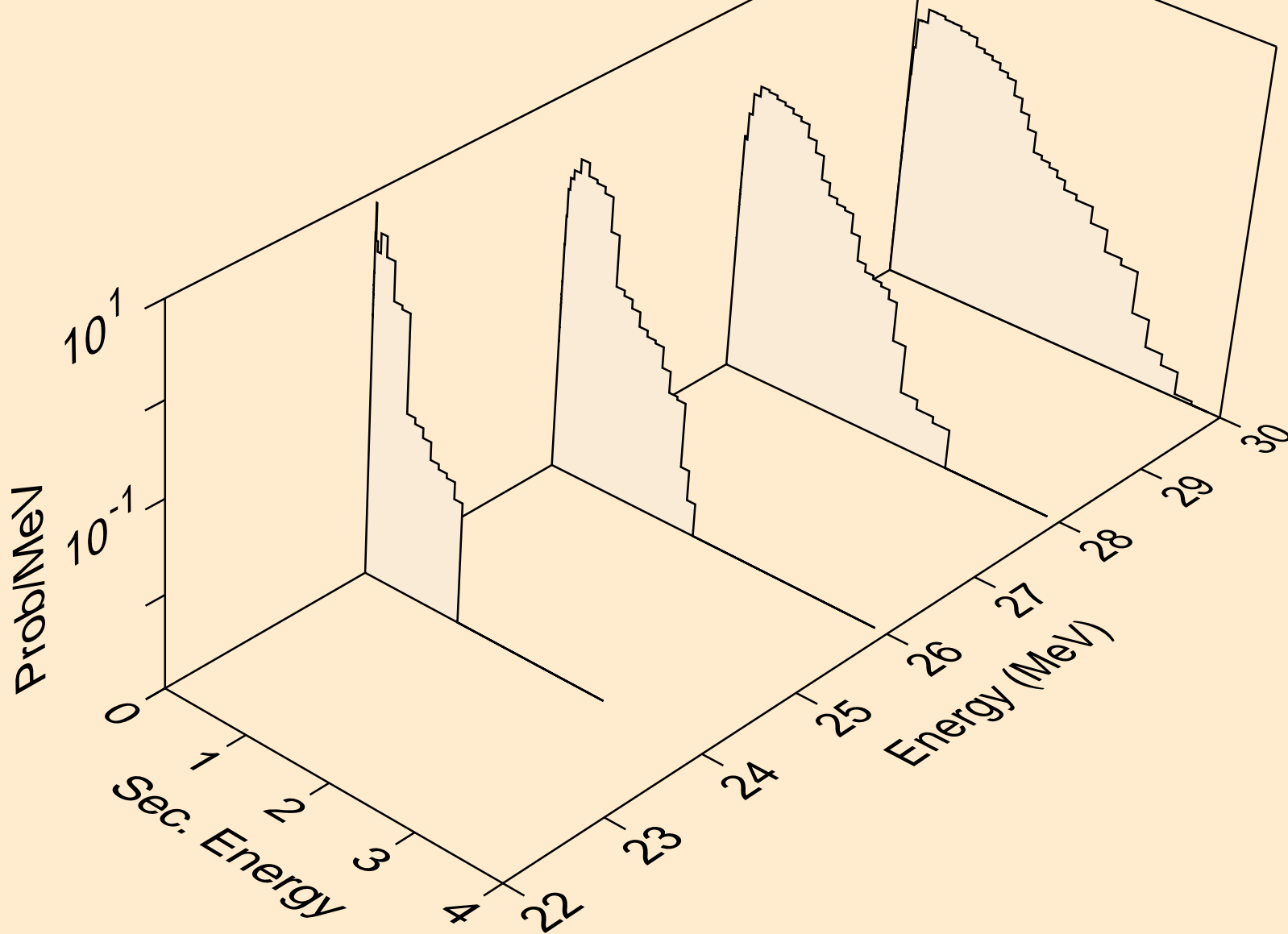

IN118N NEUTRON ACER TENDL-2019 LIBRARY; T=293.16K
Neutron emission for (n,2np)

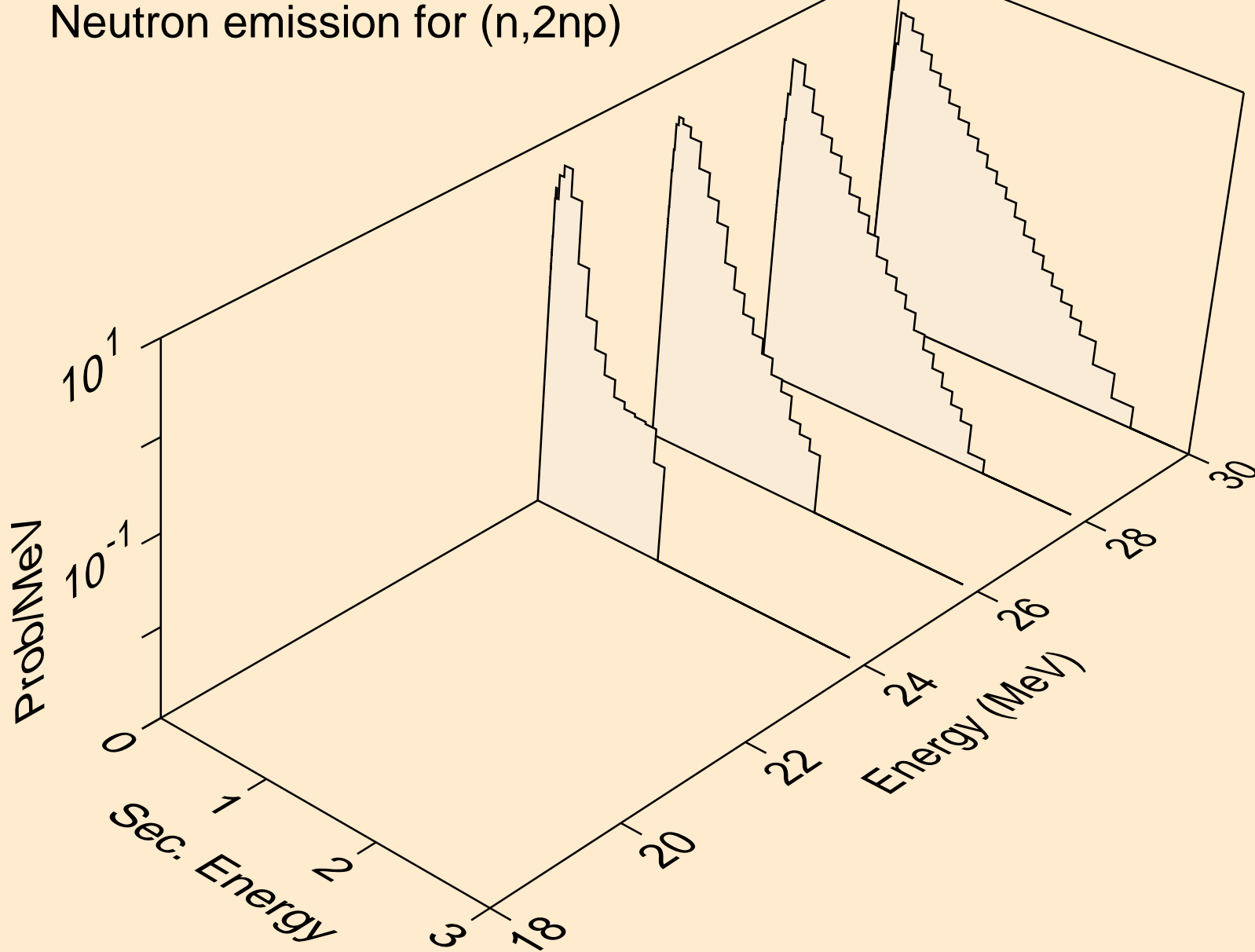

IN118N NEUTRON ACER TENDL-2019 LIBRARY; T=293.16K
Neutron emission for (n,npa)

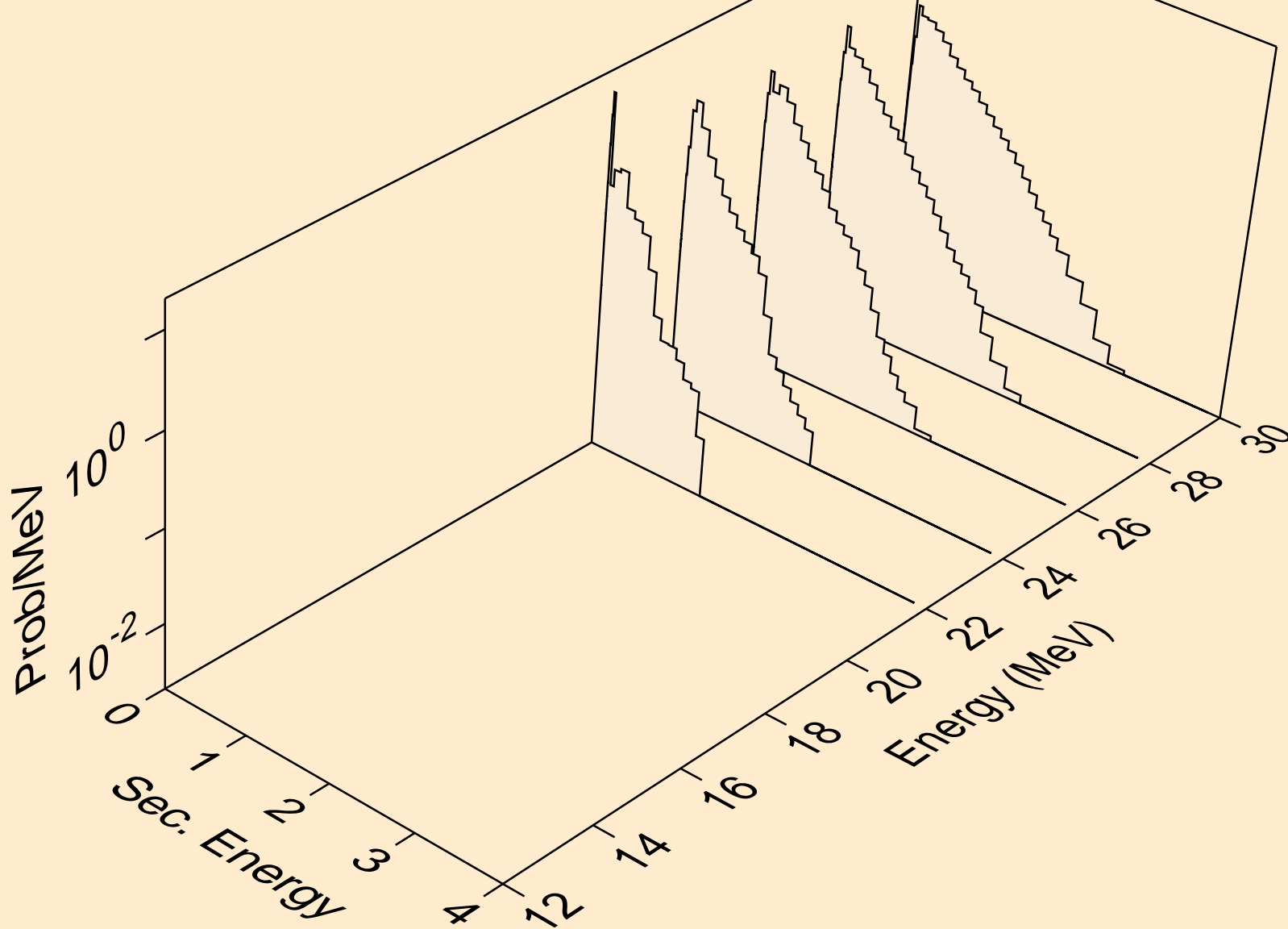

IN118N NEUTRON ACER TENDL-2019 LIBRARY; T=293.16K
Neutron emission for (n,n*c)

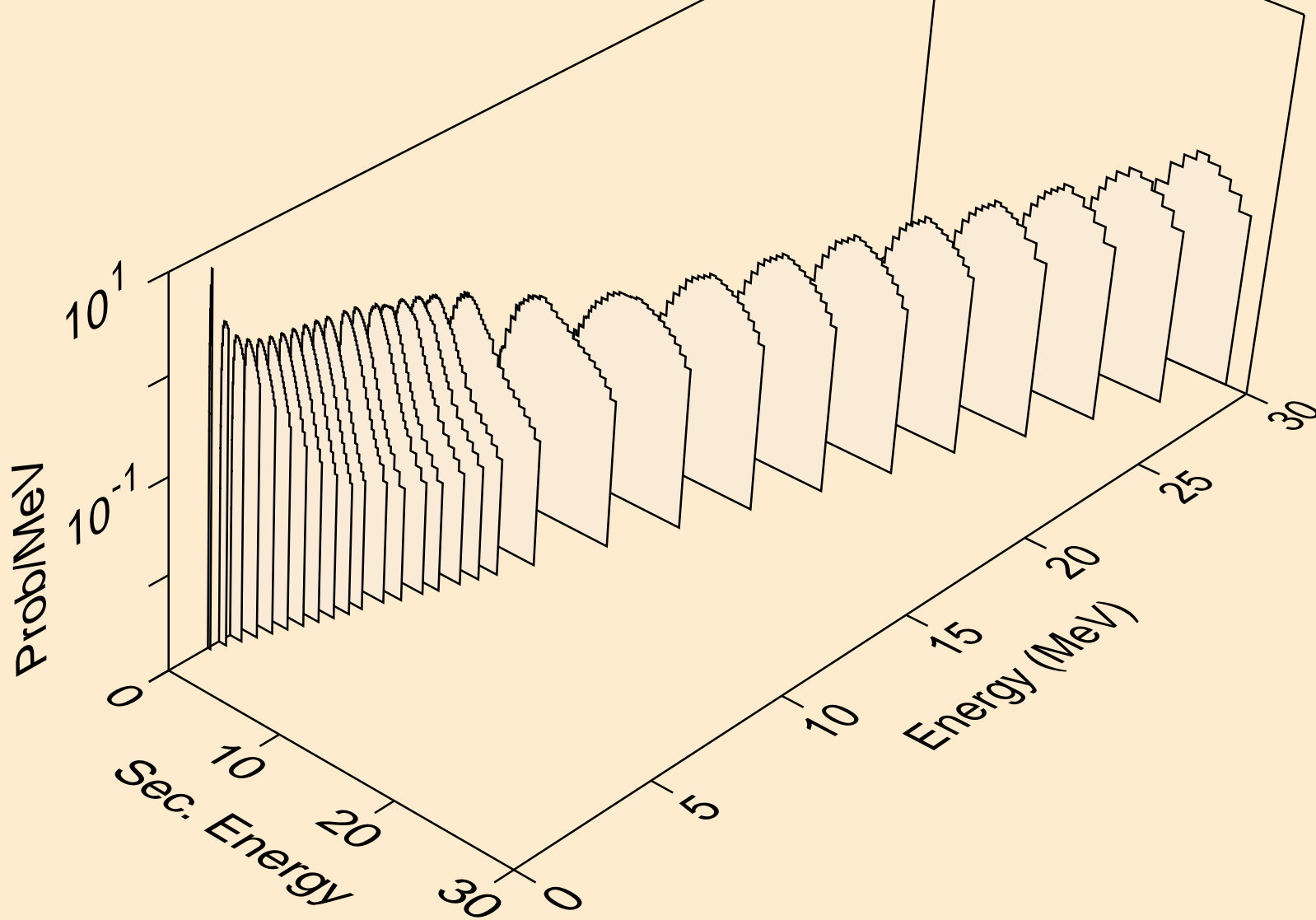

IN118N NEUTRON ACER TENDL-2019 LIBRARY; T=293.16K
Photon emission for (n,x)

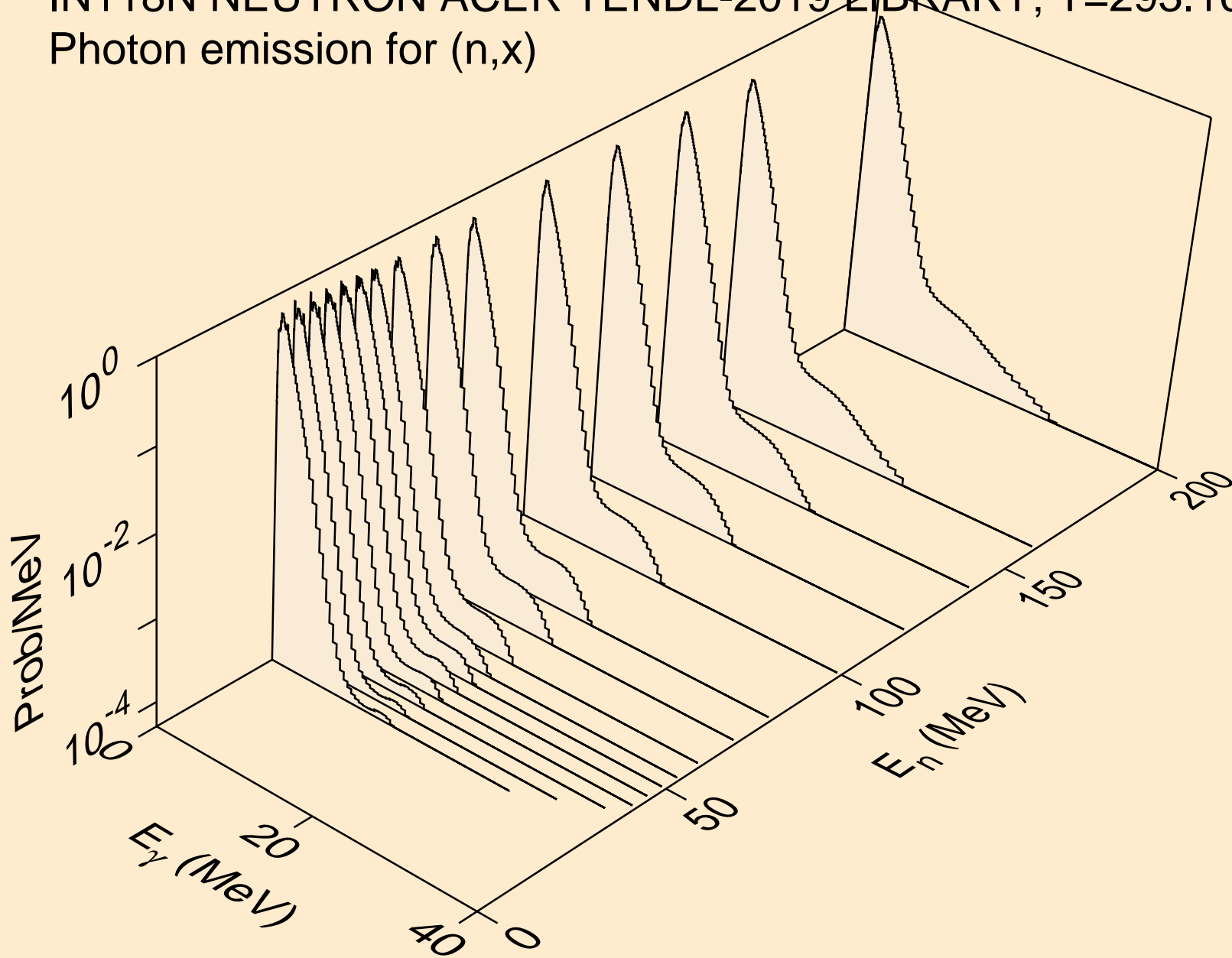

IN118N NEUTRON ACER TENDL-2019 LIBRARY; T=293.16K
Photon emission for (n,2nd)

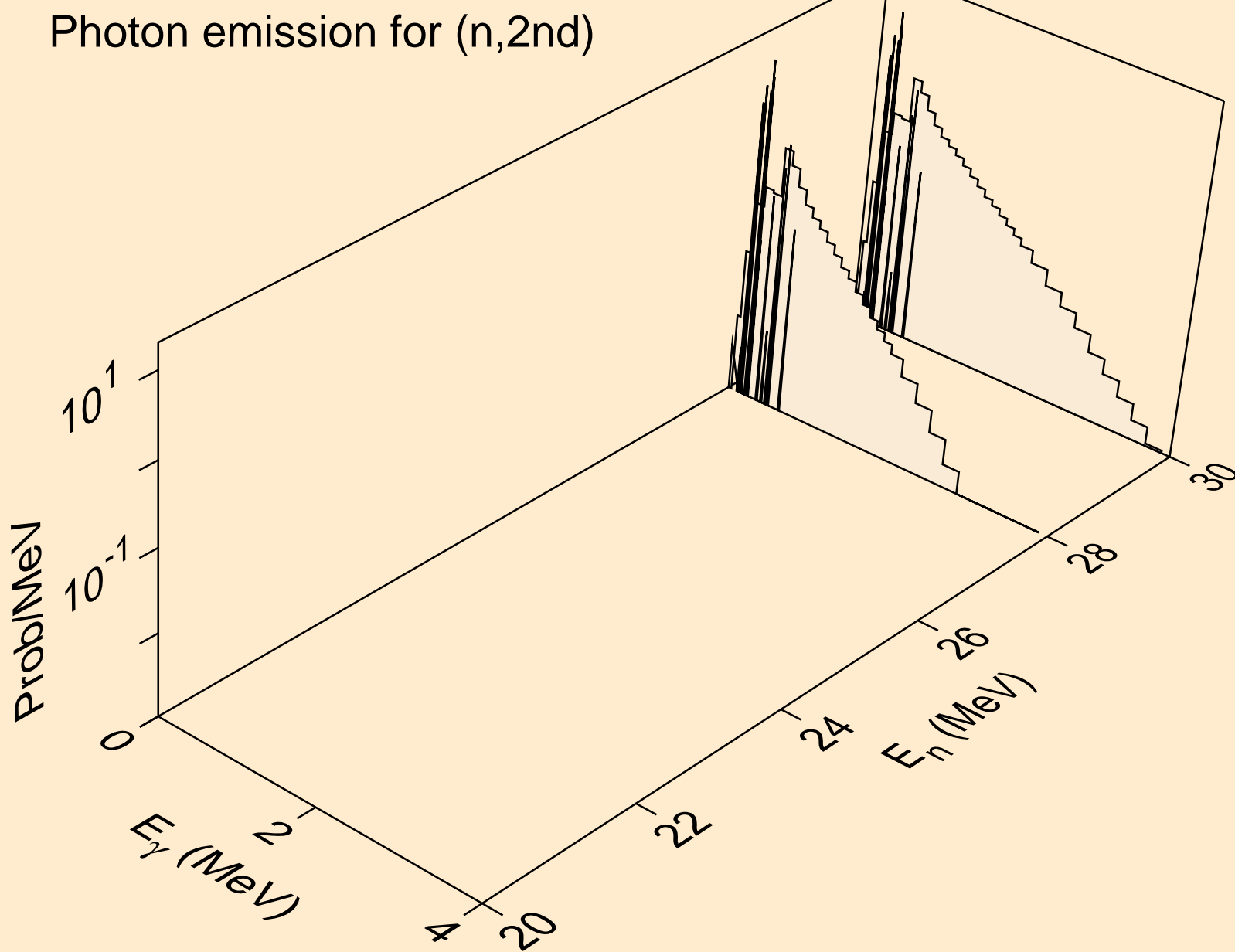

IN118N NEUTRON ACER TENDL-2019 LIBRARY; T=293.16K
Photon emission for (n,2n)

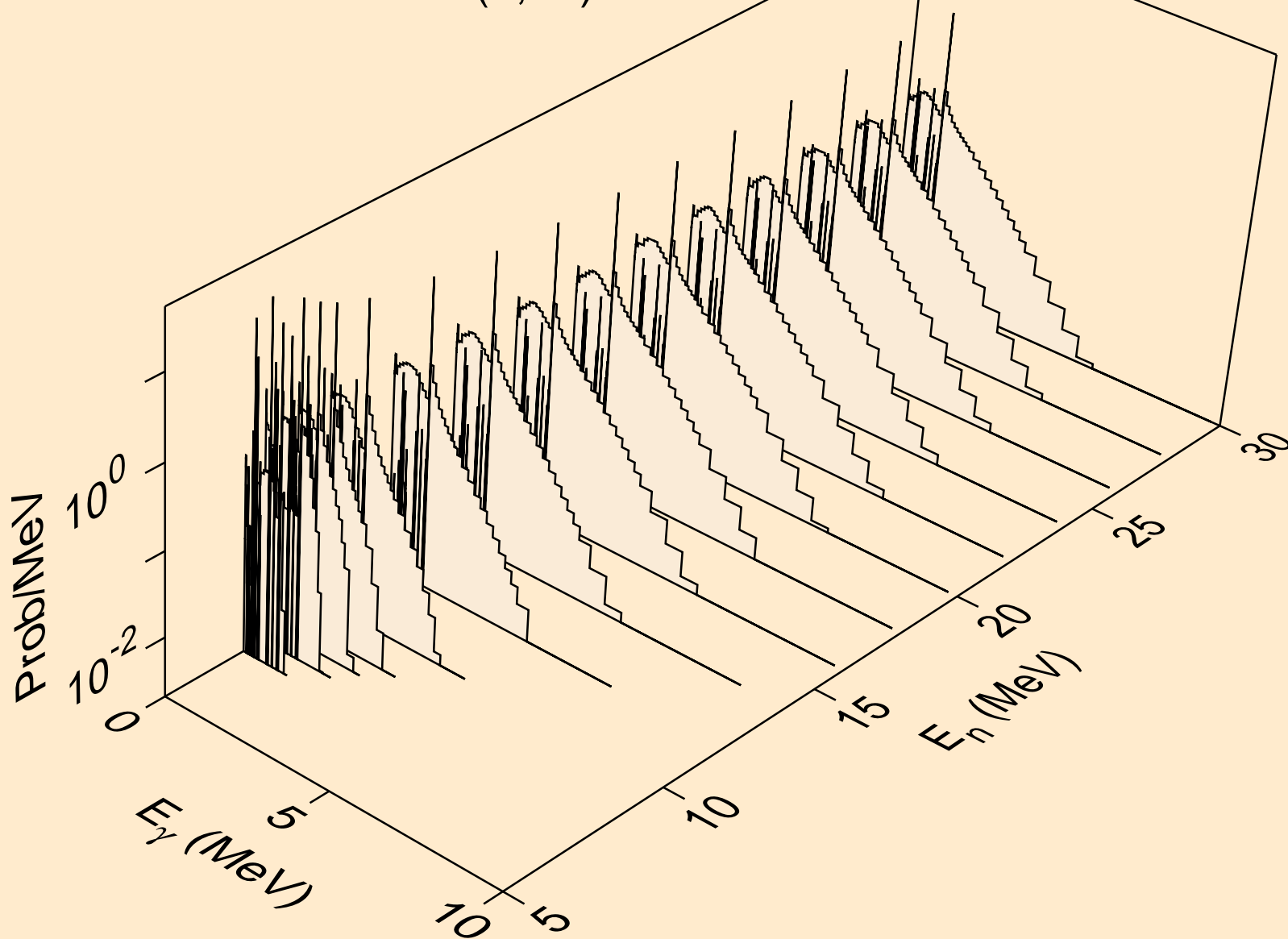

IN118N NEUTRON ACER TENDL-2019 LIBRARY; T=293.16K
Photon emission for (n,3n)

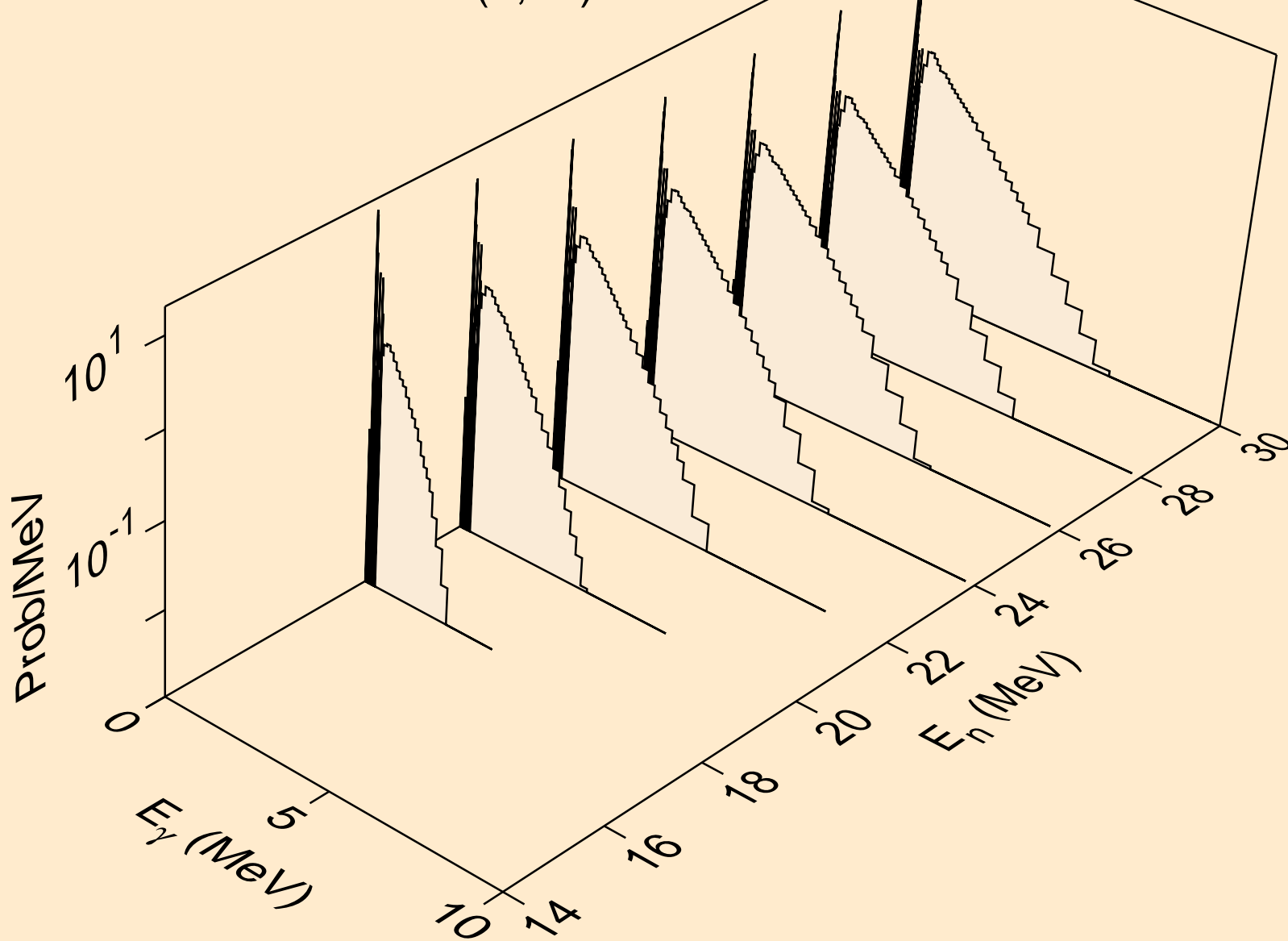

IN118N NEUTRON ACER TENDL-2019 LIBRARY; T=293.16K
Photon emission for (n,n*)a

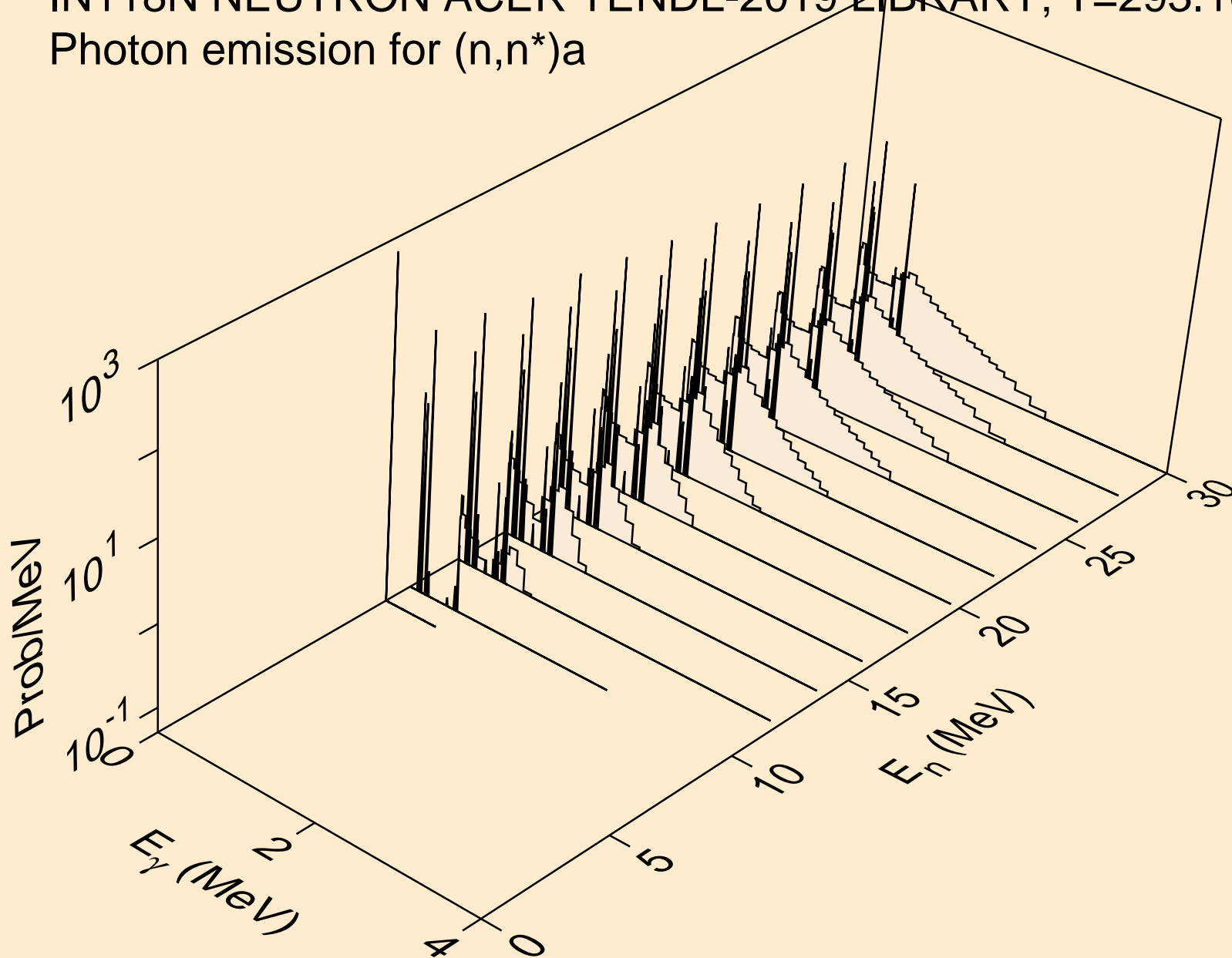

IN118N NEUTRON ACER TENDL-2019 LIBRARY; T=293.16K
Photon emission for (n,2n)a

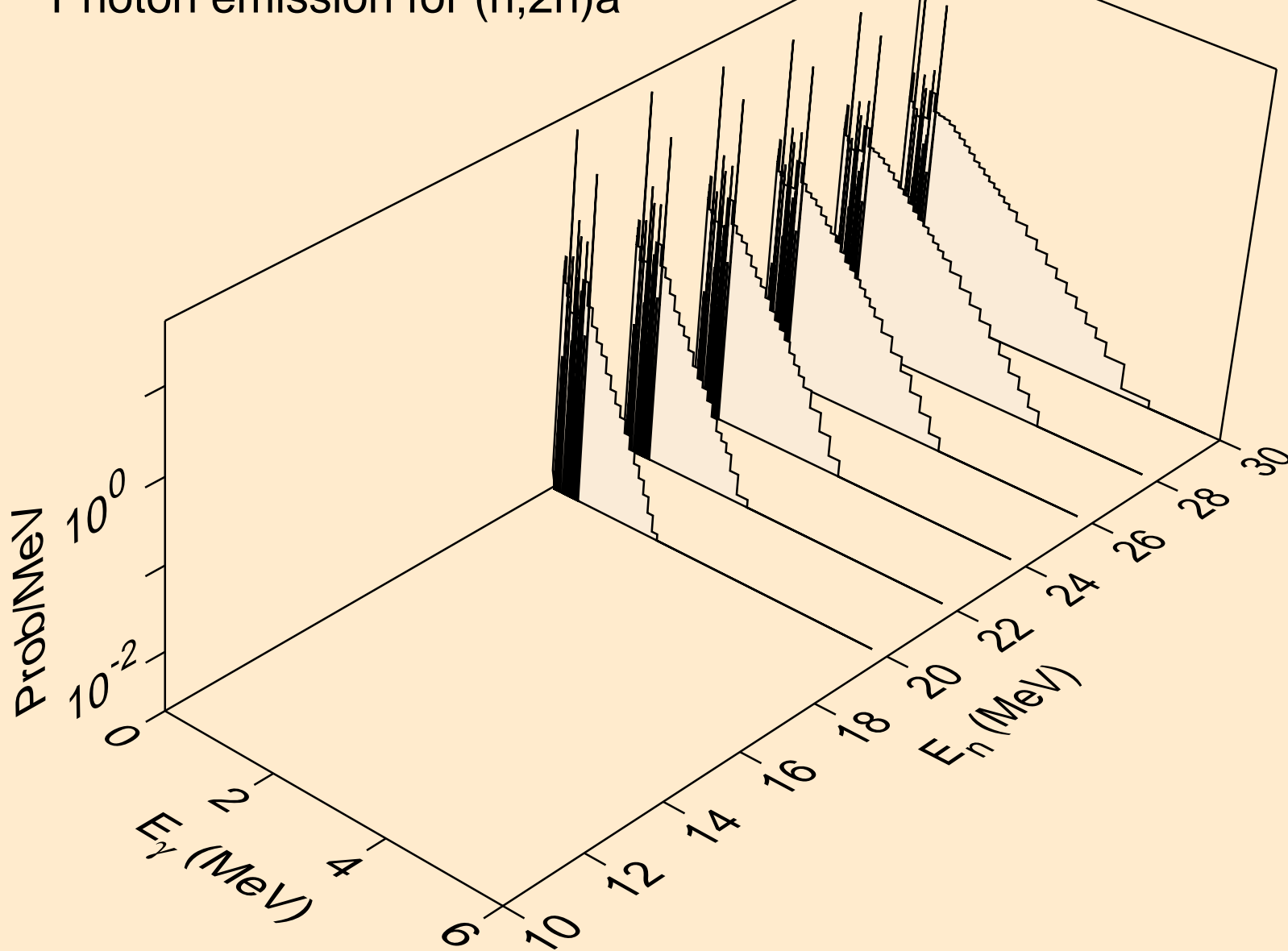

IN118N NEUTRON ACER TENDL-2019 LIBRARY; T=293.16K
Photon emission for (n,3n)a

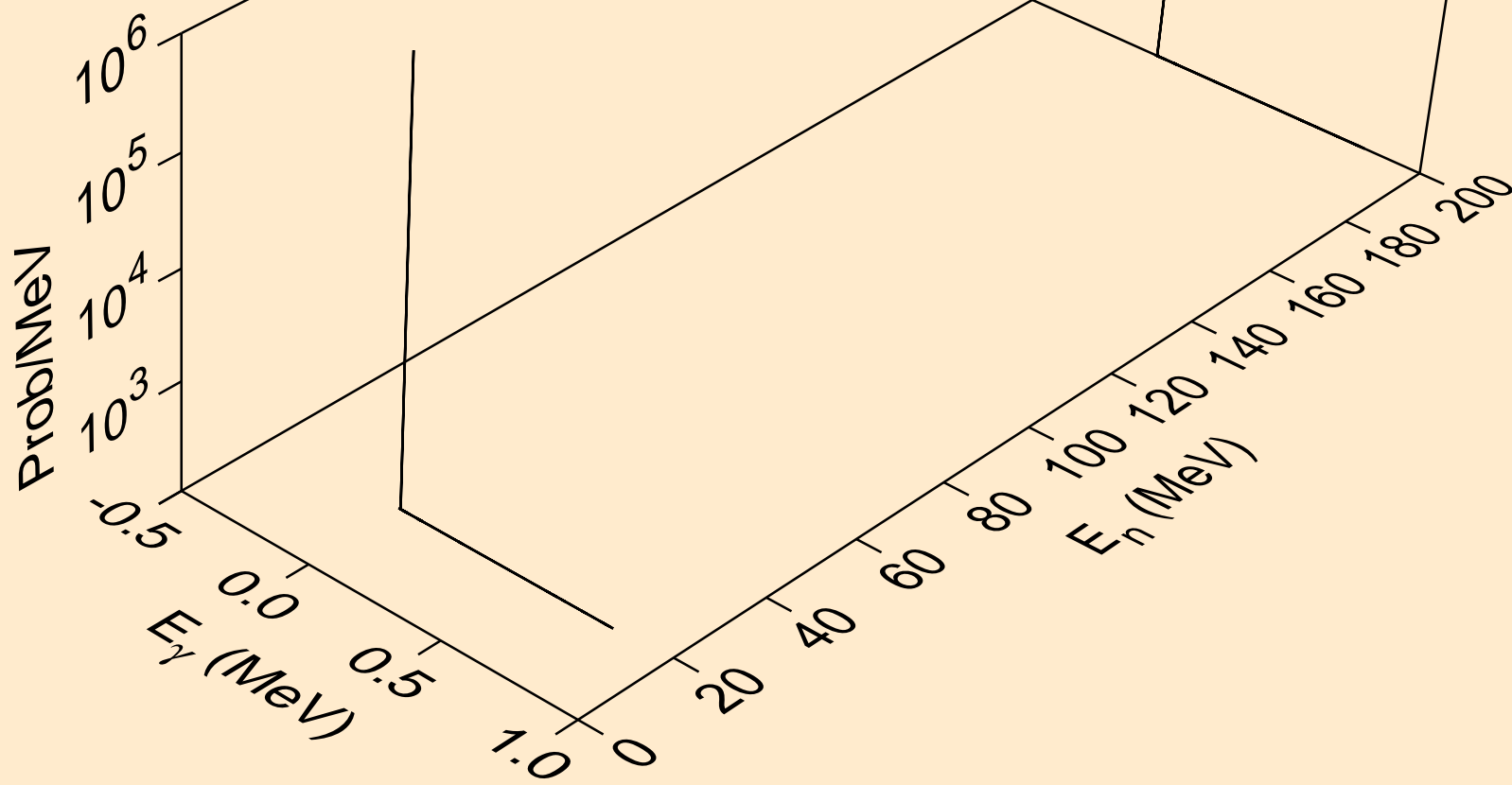

IN118N NEUTRON ACER TENDL-2019 LIBRARY; T=293.16K
Photon emission for (n,n*)p

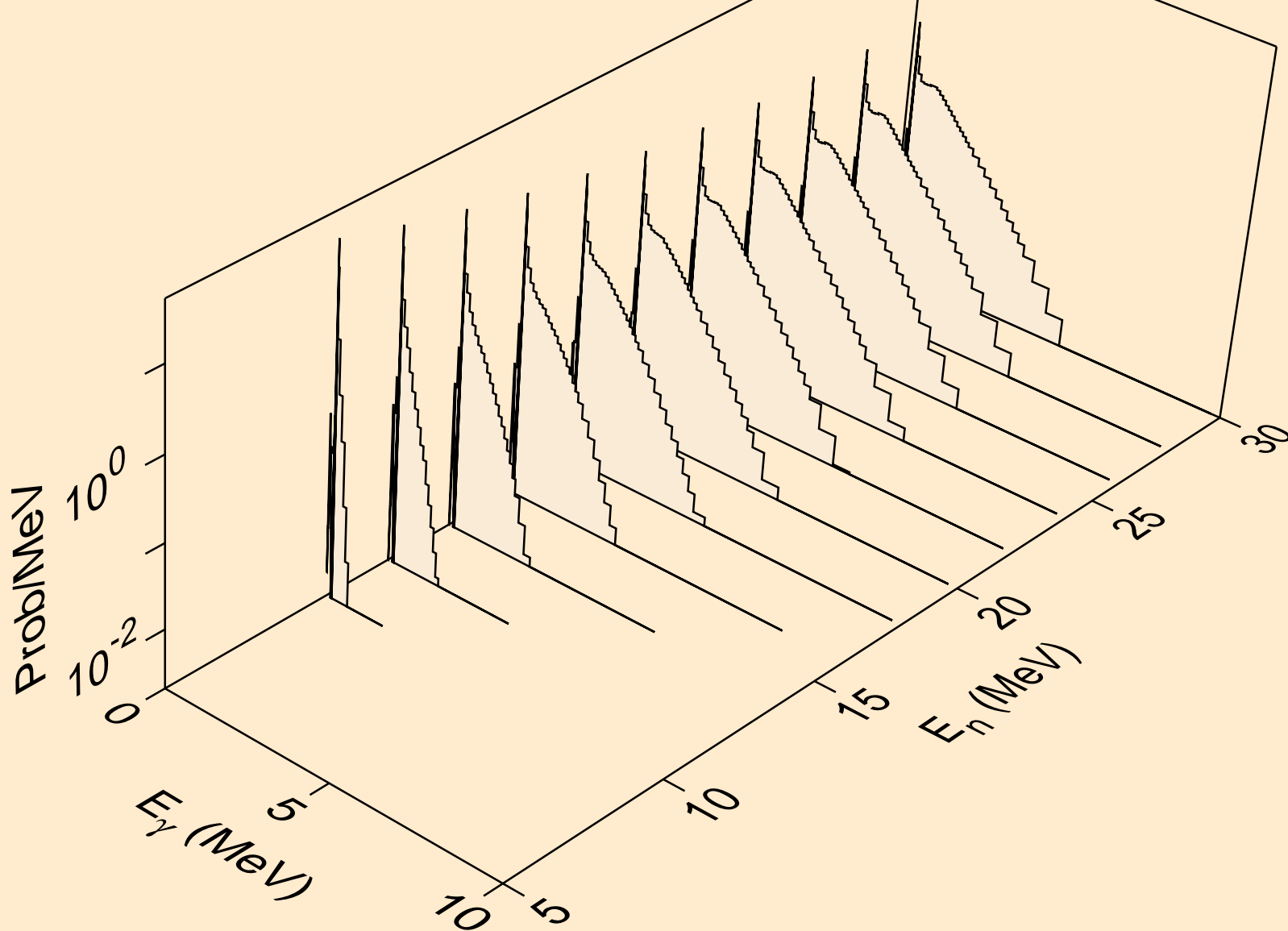

IN118N NEUTRON ACER TENDL-2019 LIBRARY; T=293.16K
Photon emission for (n,n*)d

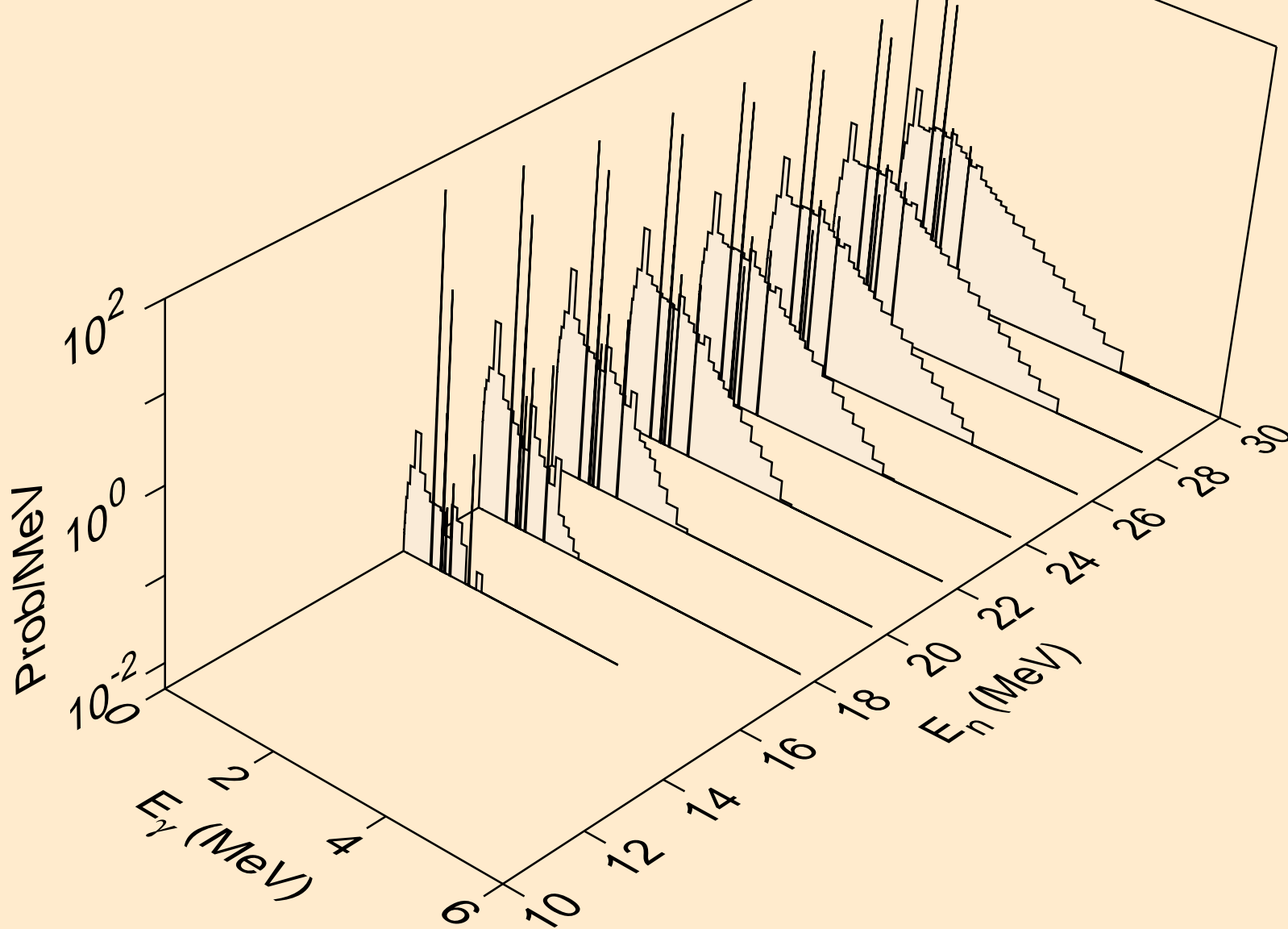

IN118N NEUTRON ACER TENDL-2019 LIBRARY; T=293.16K
Photon emission for (n,n*)t

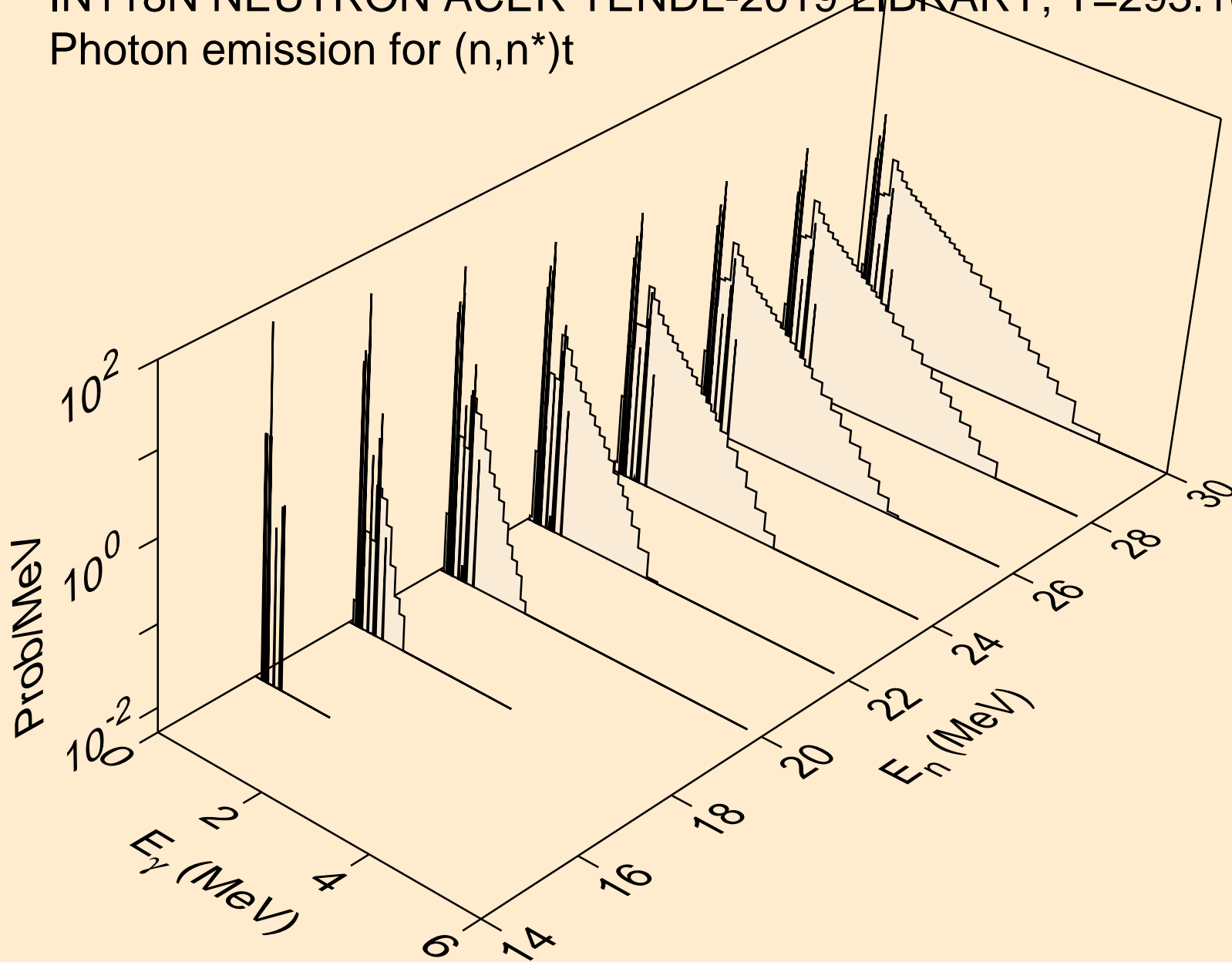

IN118N NEUTRON ACER TENDL-2019 LIBRARY; T=293.16K
Photon emission for (n,n*)he3

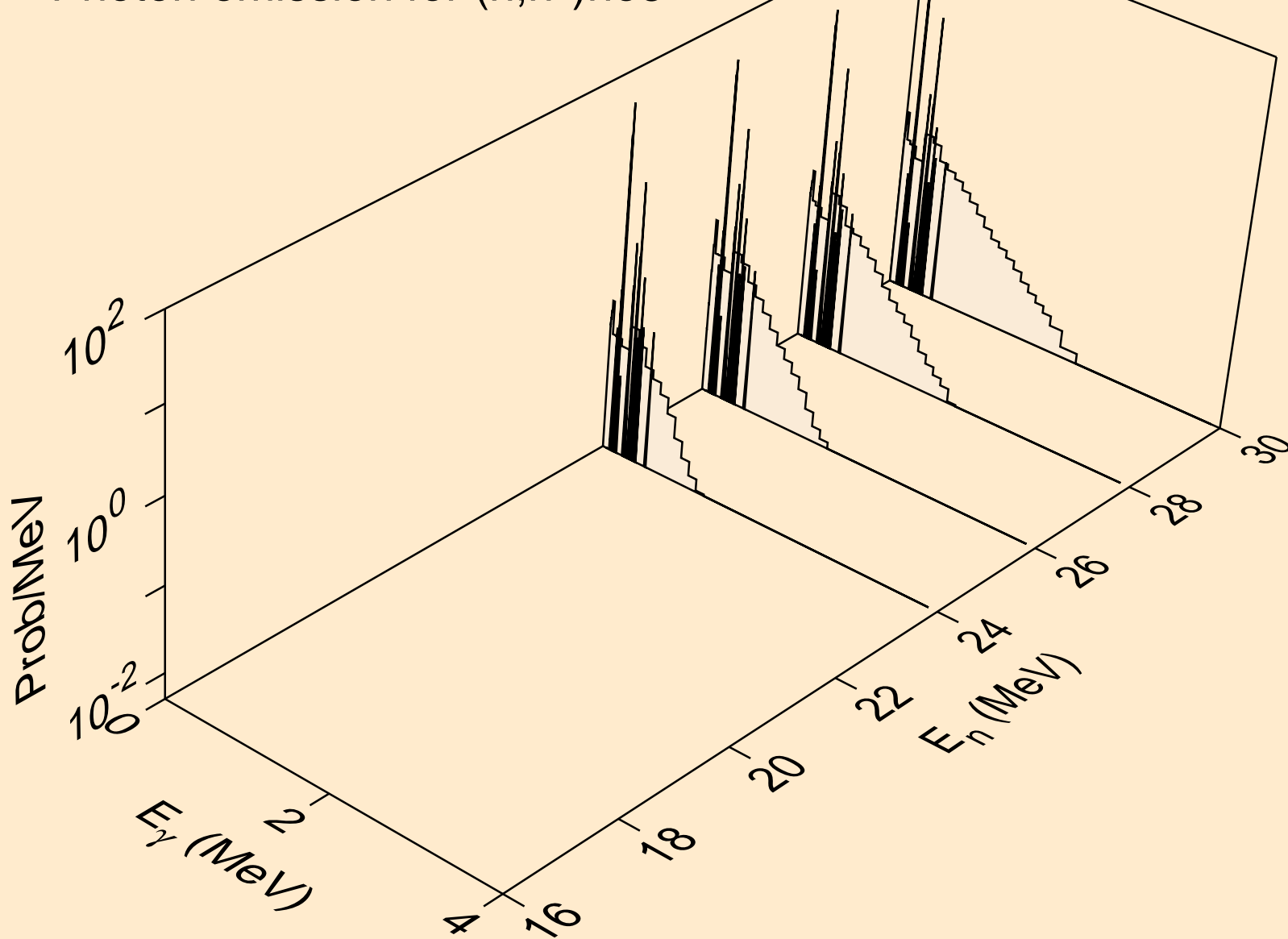

IN118N NEUTRON ACER TENDL-2019 LIBRARY; T=293.16K
Photon emission for (n,4n)

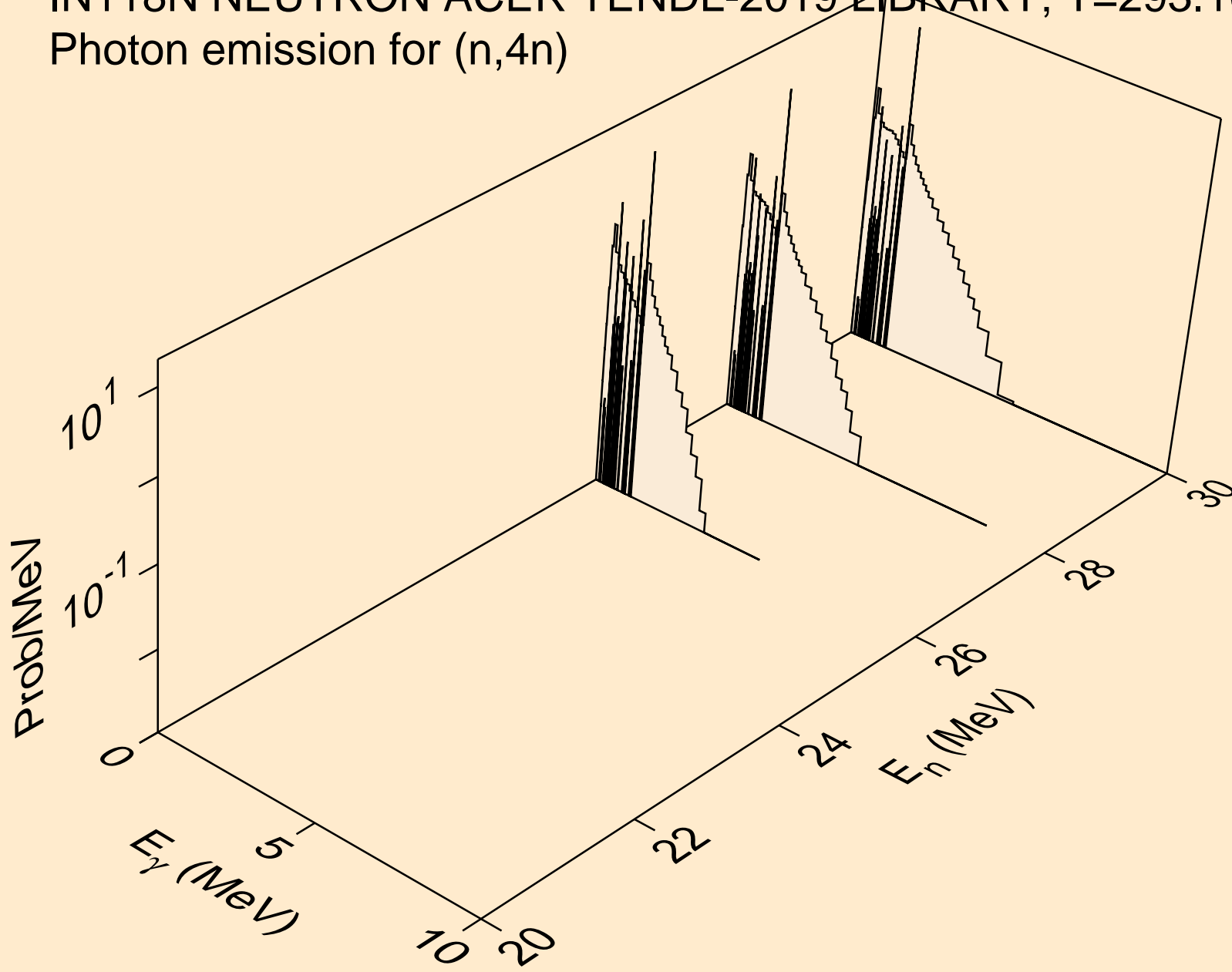

IN118N NEUTRON ACER TENDL-2019 LIBRARY; T=293.16K
Photon emission for (n,2np)

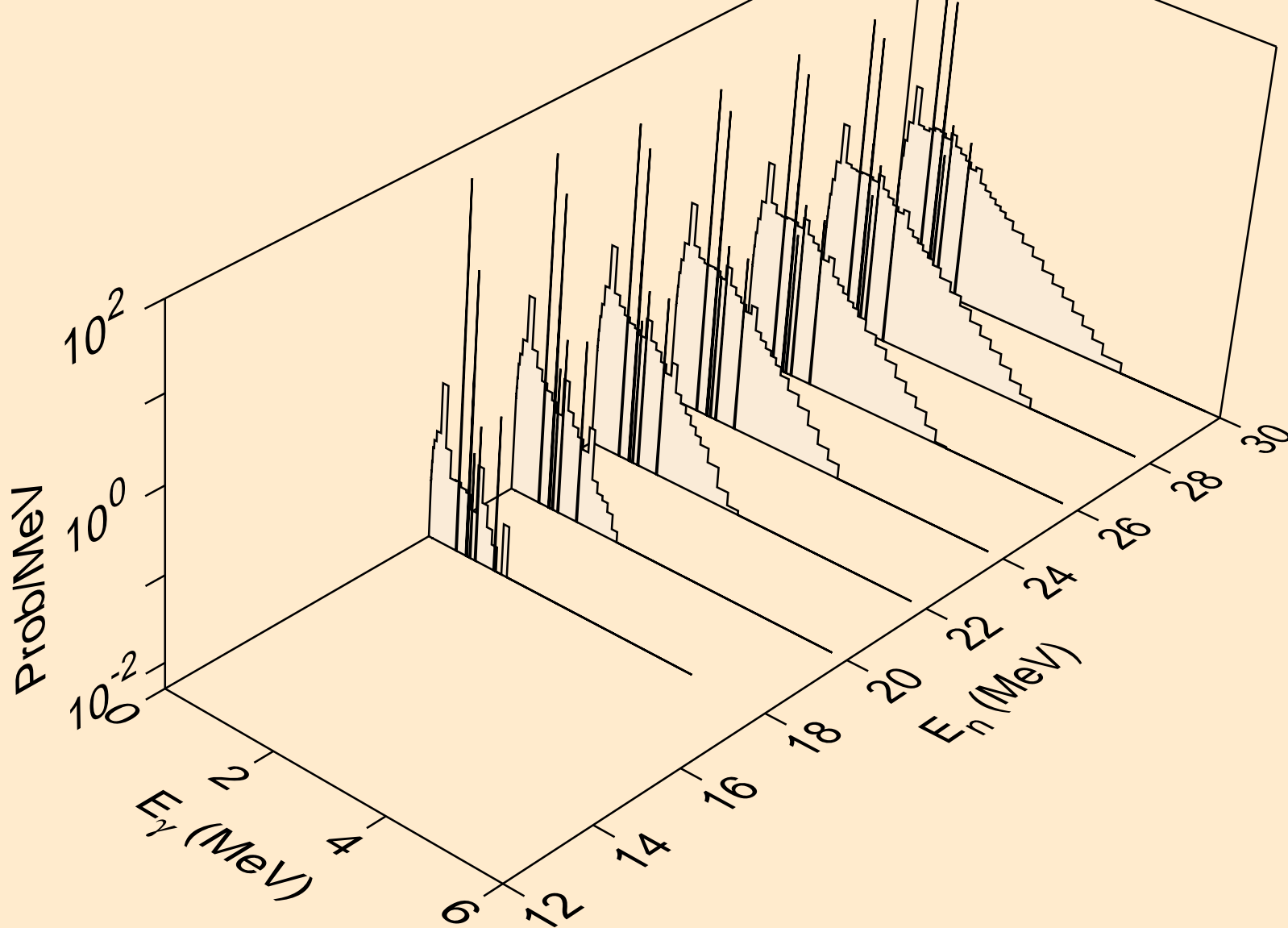

IN118N NEUTRON ACER TENDL-2019 LIBRARY; T=293.16K
Photon emission for (n,3np)

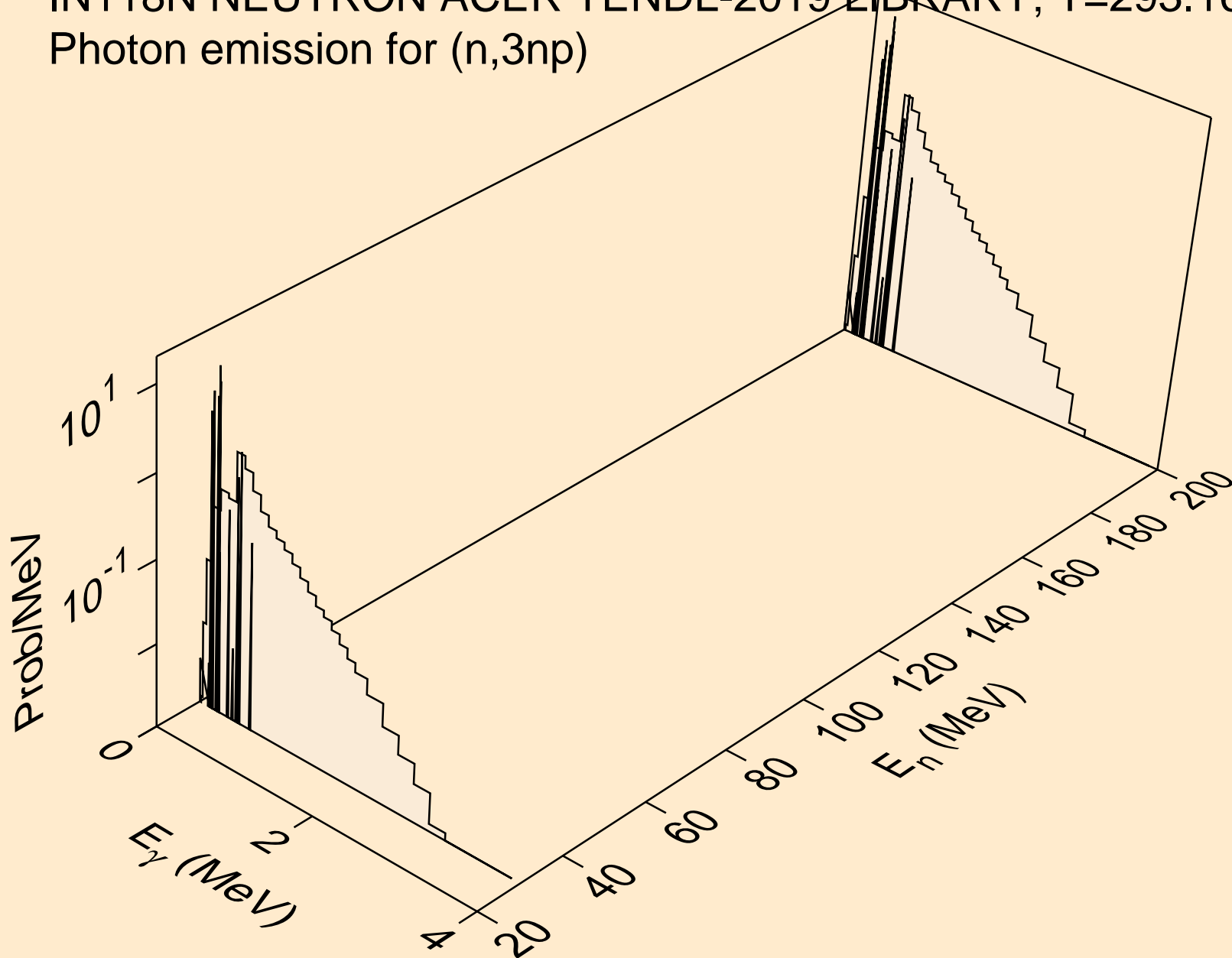

IN118N NEUTRON ACER TENDL-2019 LIBRARY; T=293.16K
Photon emission for (n,2np)

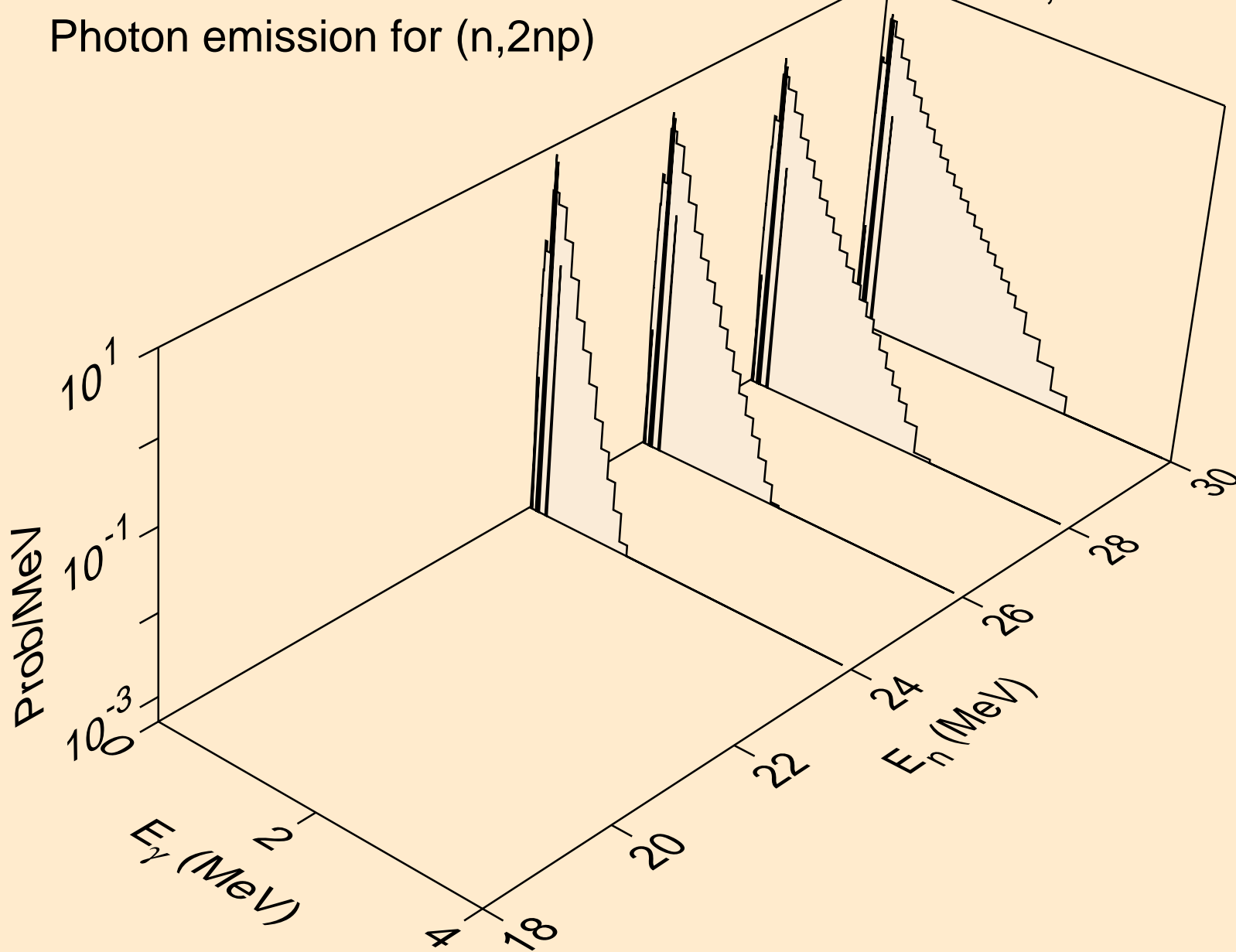

IN118N NEUTRON ACER TENDL-2019 LIBRARY; T=293.16K
Photon emission for (n,npa)

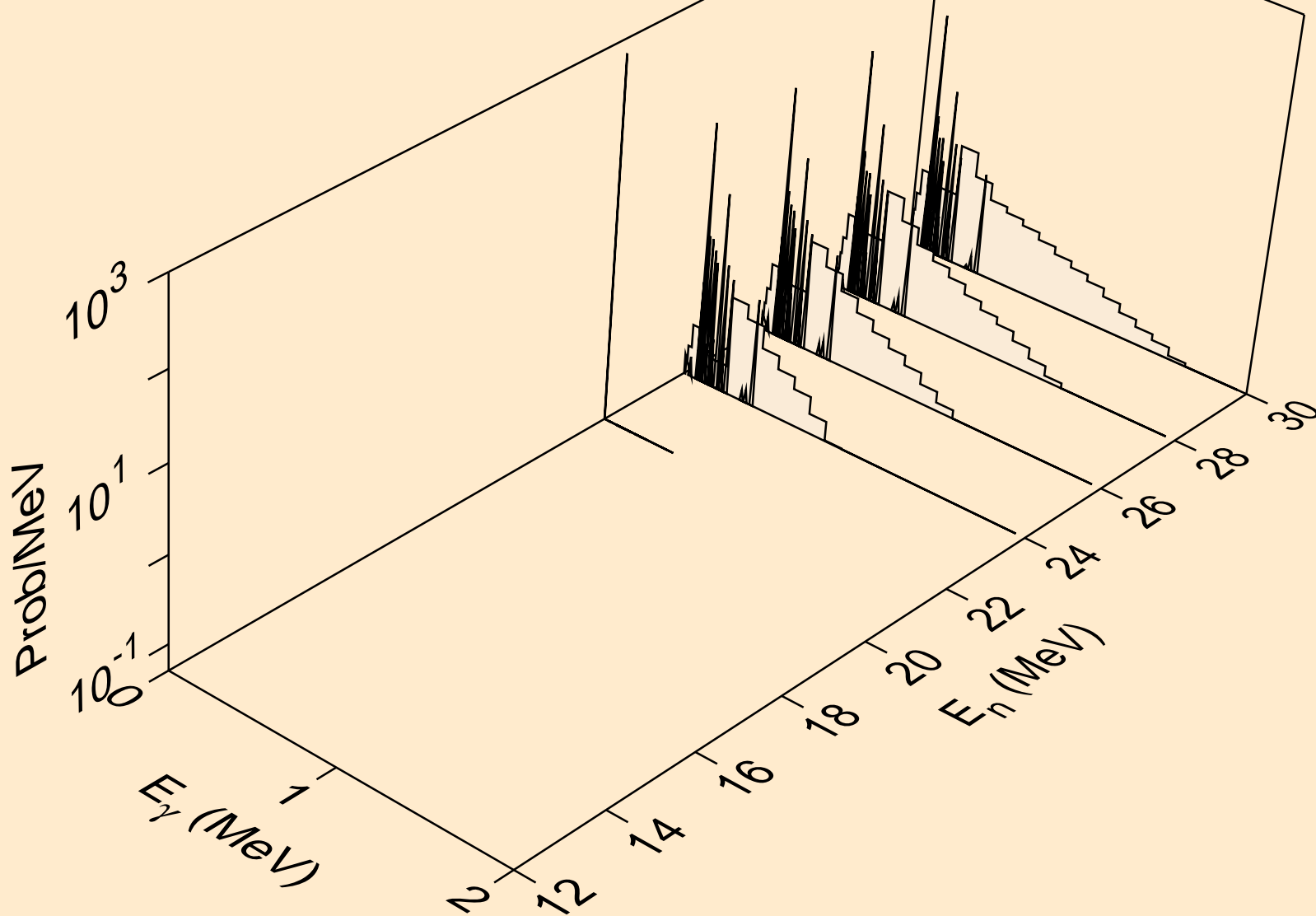

IN118N NEUTRON ACER TENDL-2019 LIBRARY; T=293.16K
Photon emission for (n,n*2)

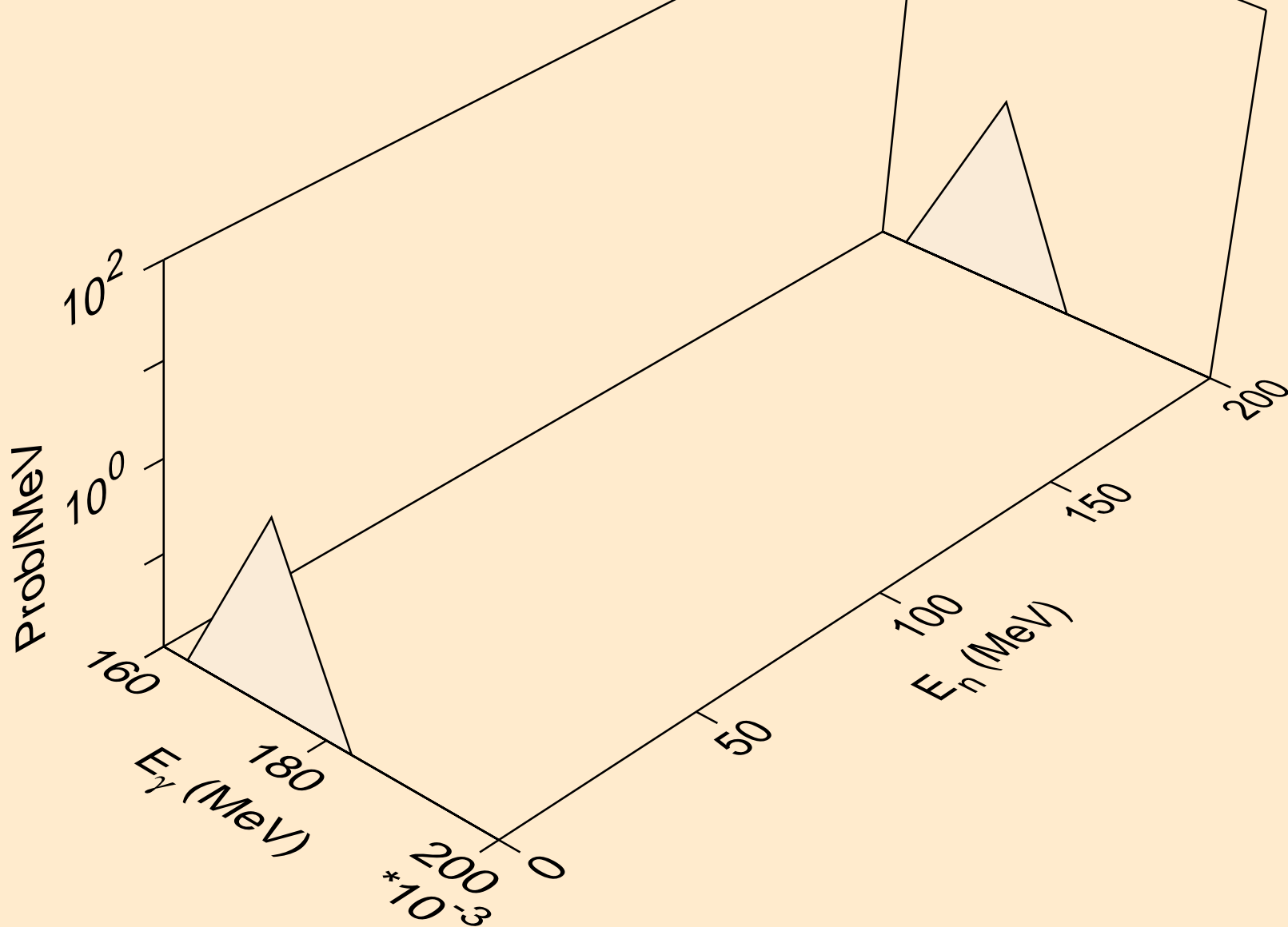

IN118N NEUTRON ACER TENDL-2019 LIBRARY; T=293.16K
Photon emission for (n,n*4)

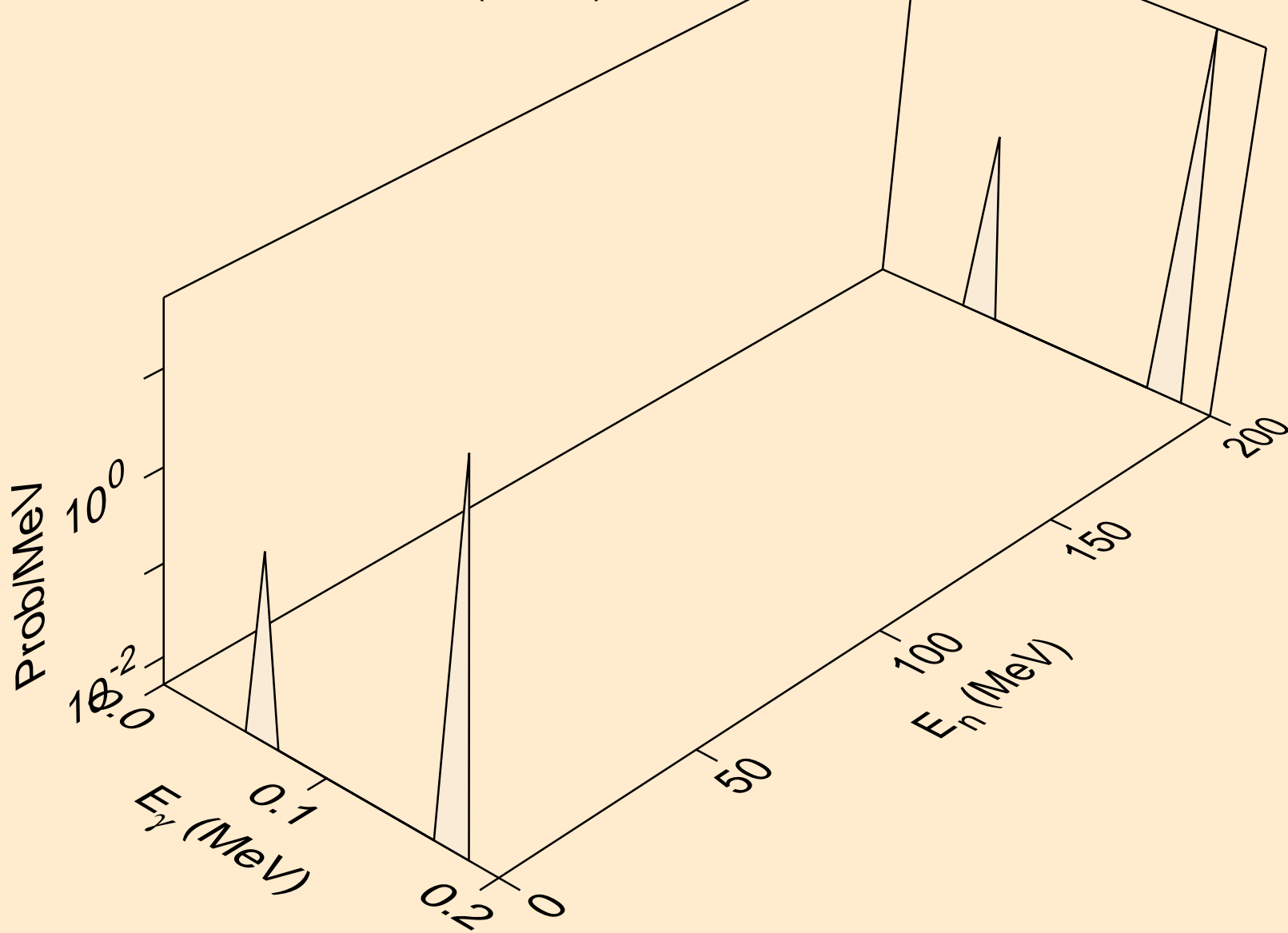

IN118N NEUTRON ACER TENDL-2019 LIBRARY; T=293.16K
Photon emission for (n,n*5)

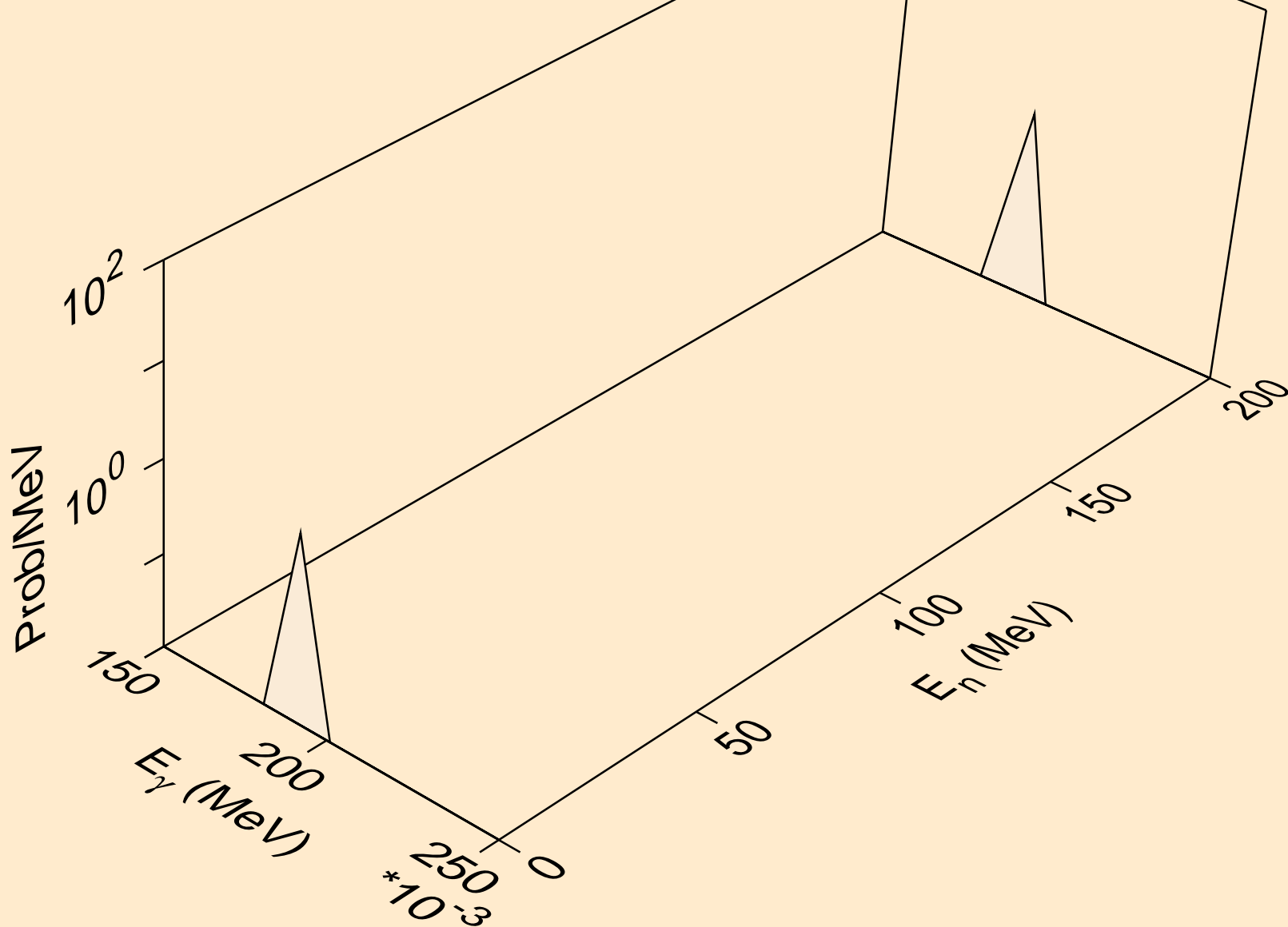

IN118N NEUTRON ACER TENDL-2019 LIBRARY; T=293.16K
Photon emission for (n,n*6)

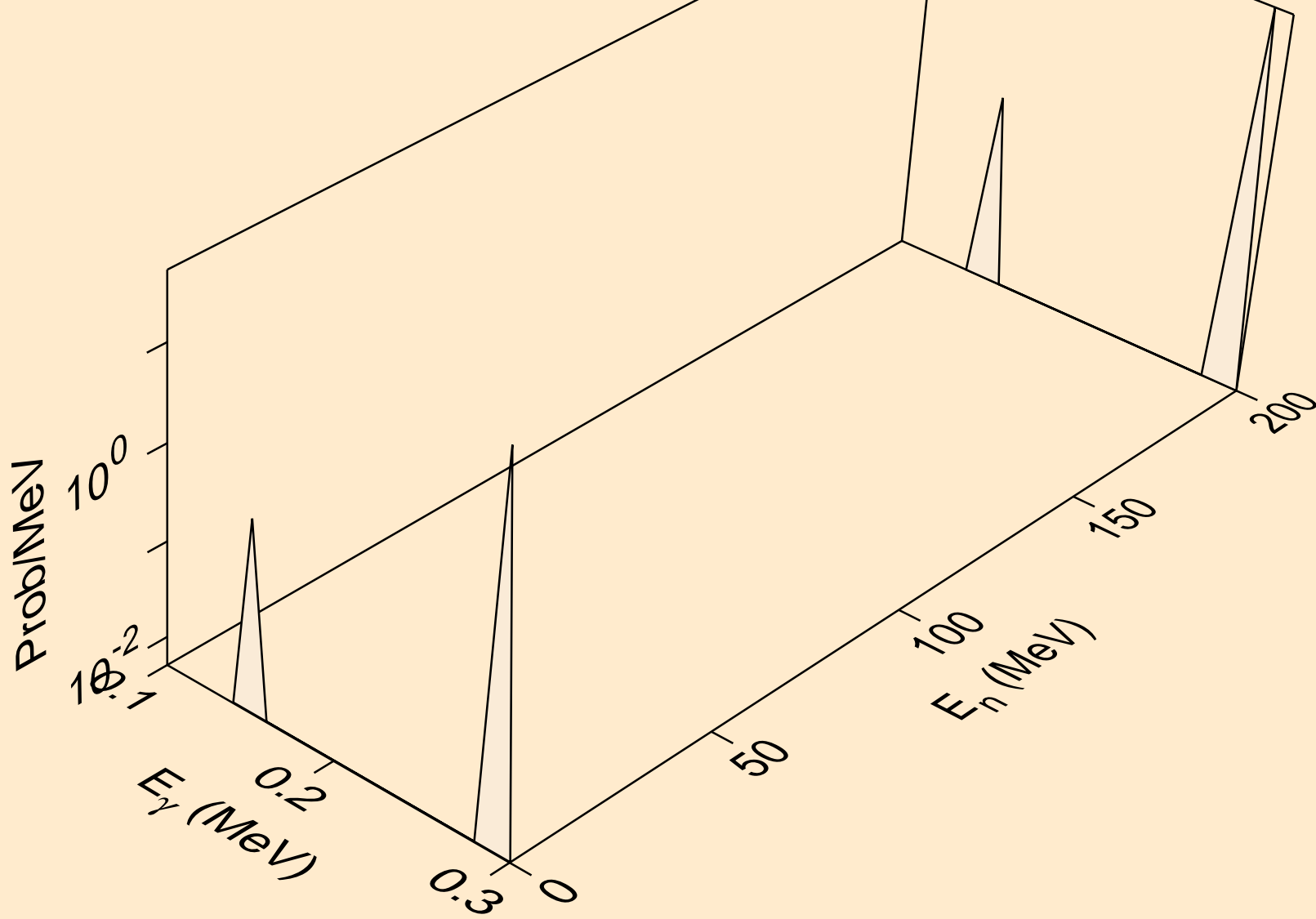

IN118N NEUTRON ACER TENDL-2019 LIBRARY; T=293.16K
Photon emission for (n,n*7)

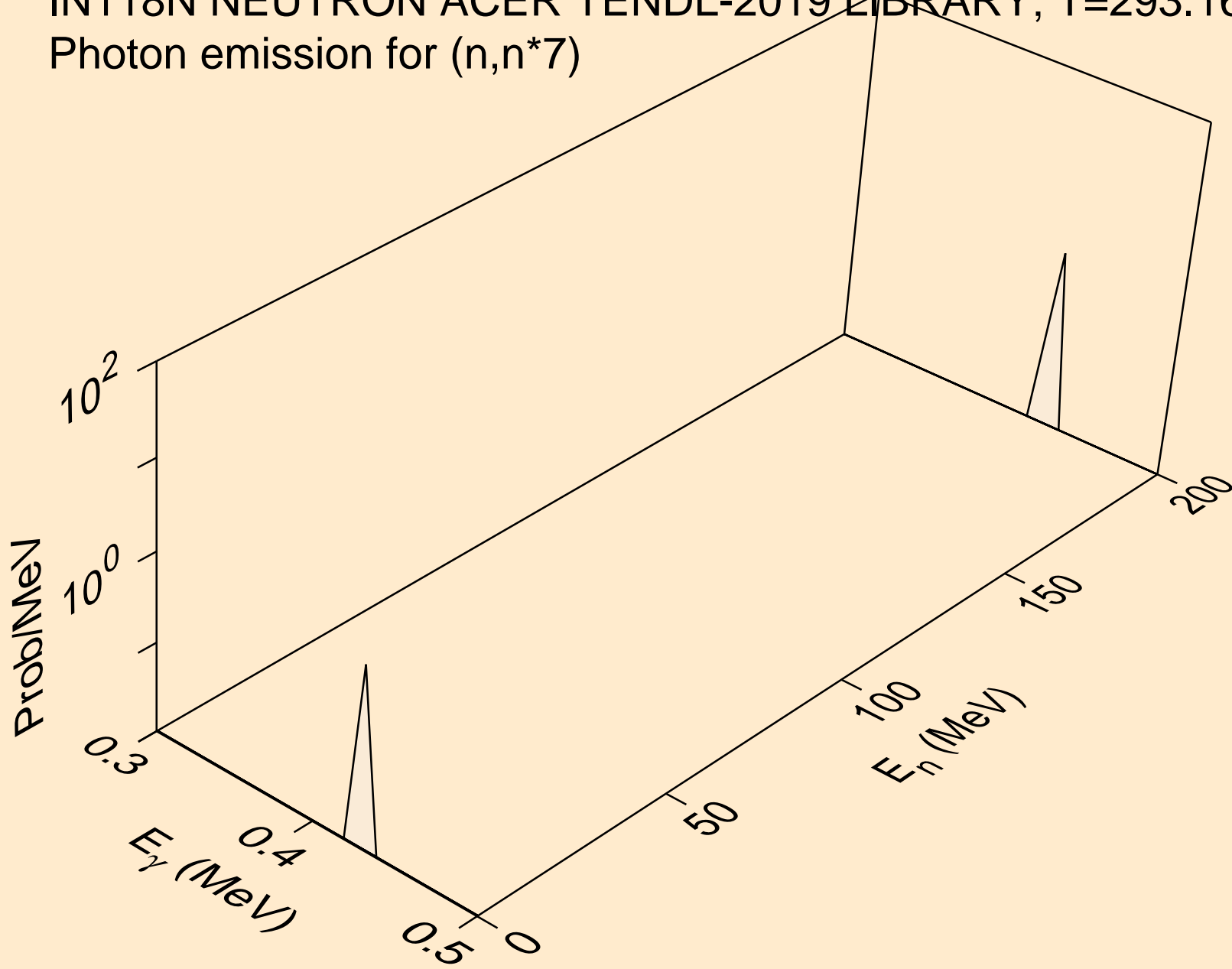

IN118N NEUTRON ACER TENDL-2019 LIBRARY; T=293.16K
Photon emission for (n,n*8)

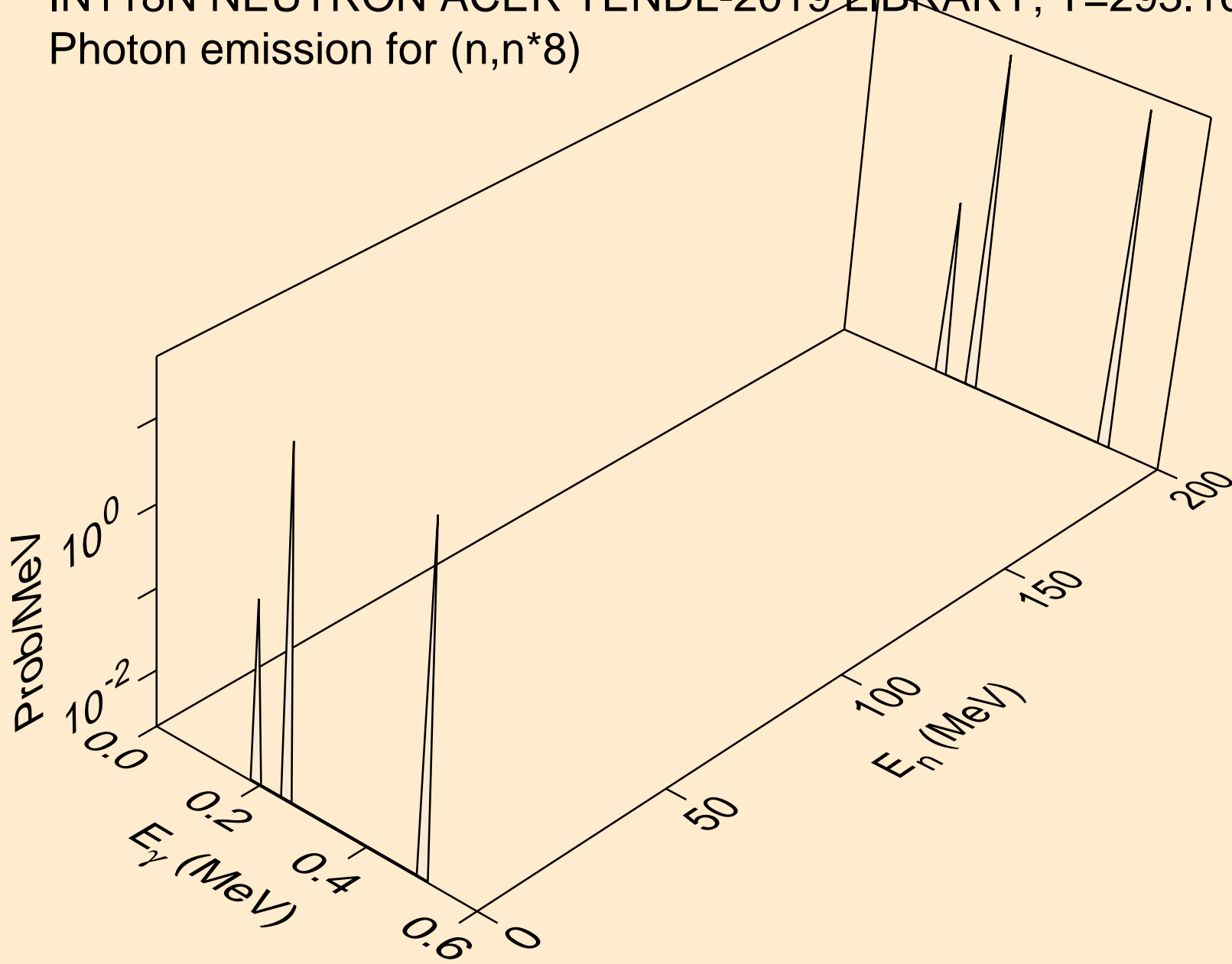

IN118N NEUTRON ACER TENDL-2019 LIBRARY; T=293.16K
Photon emission for (n,n*9)

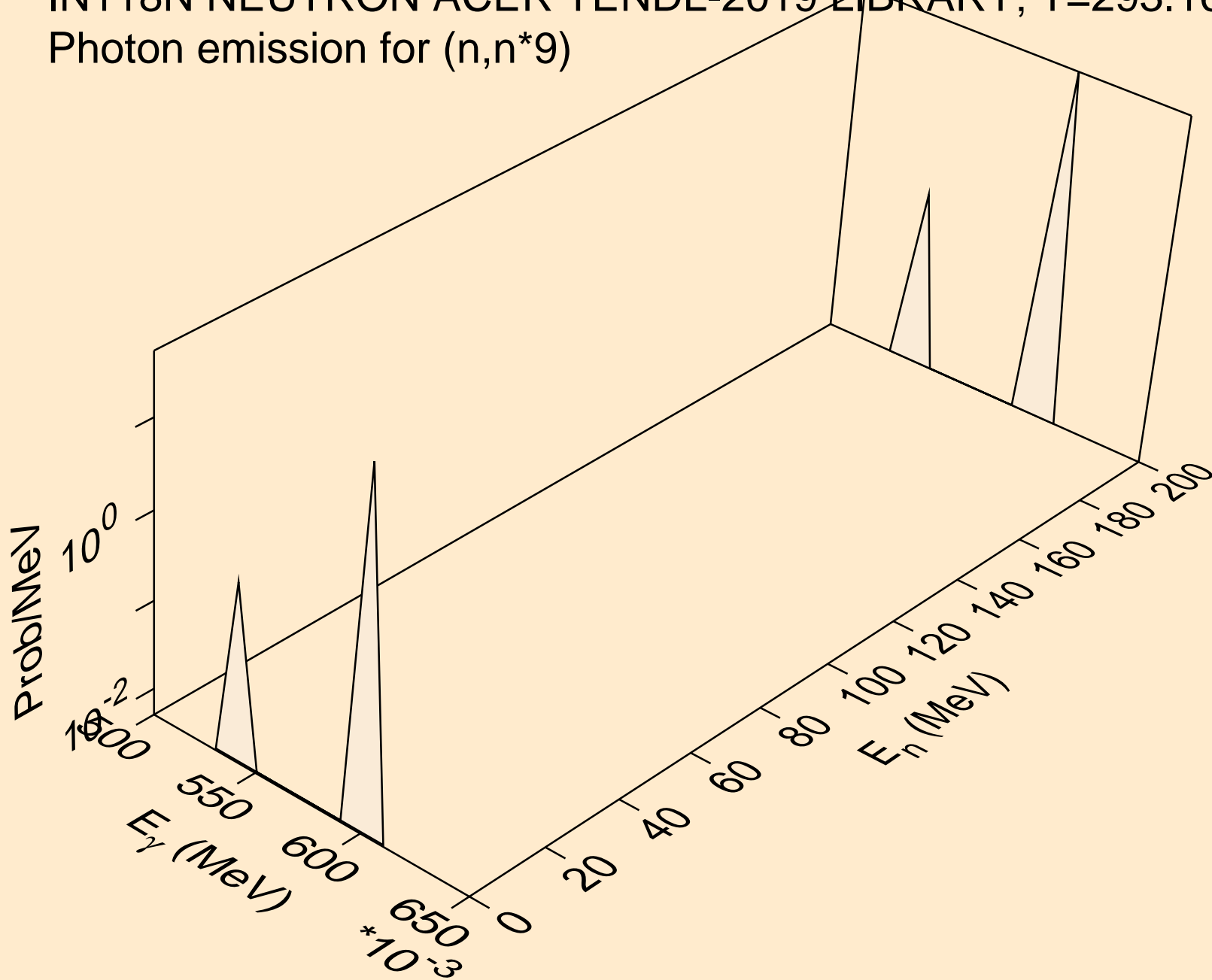

IN118N NEUTRON ACER TENDL-2019 LIBRARY; T=293.16K
Photon emission for (n,n*10)

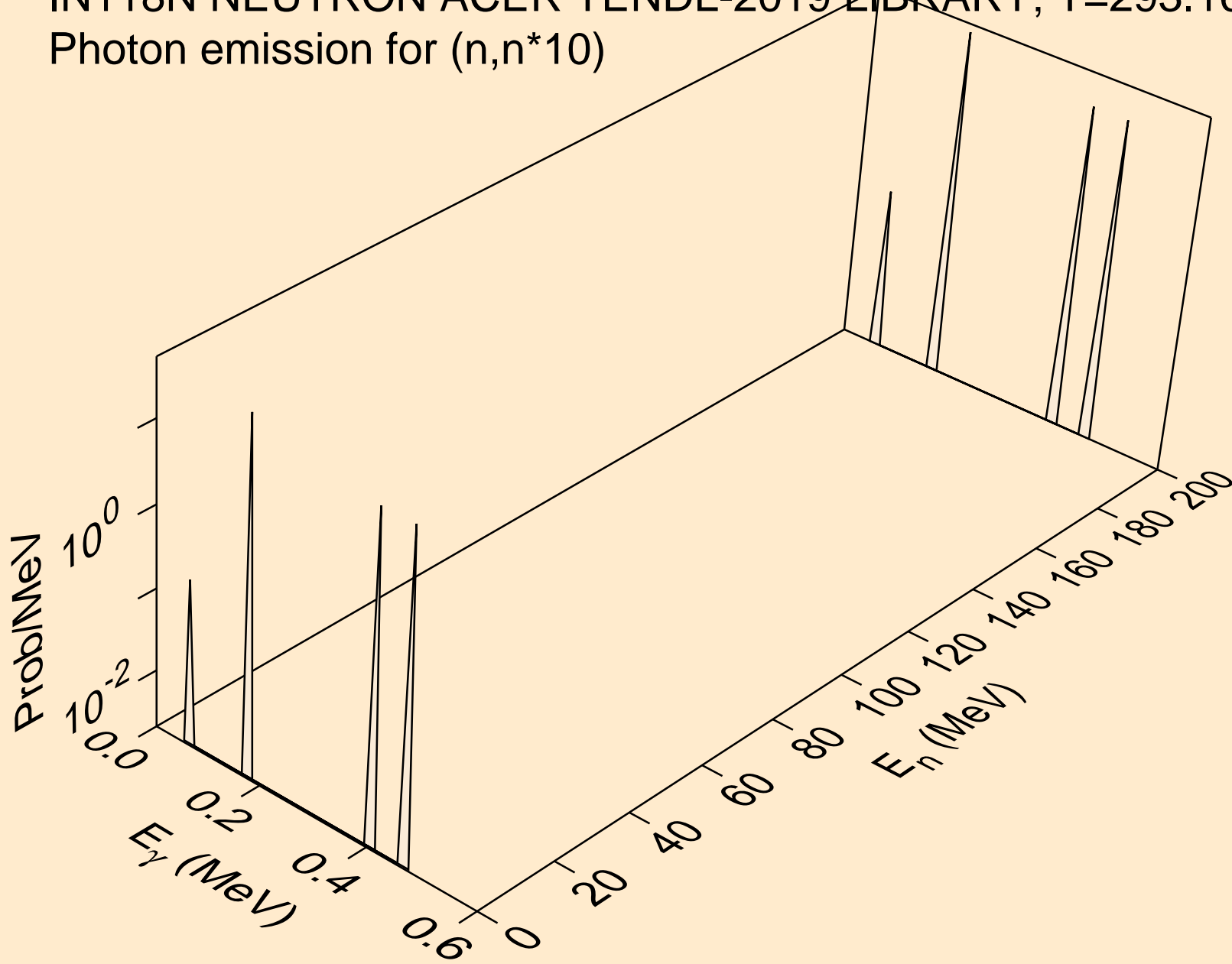

IN118N NEUTRON ACER TENDL-2019 LIBRARY; T=293.16K
Photon emission for (n,n*11)

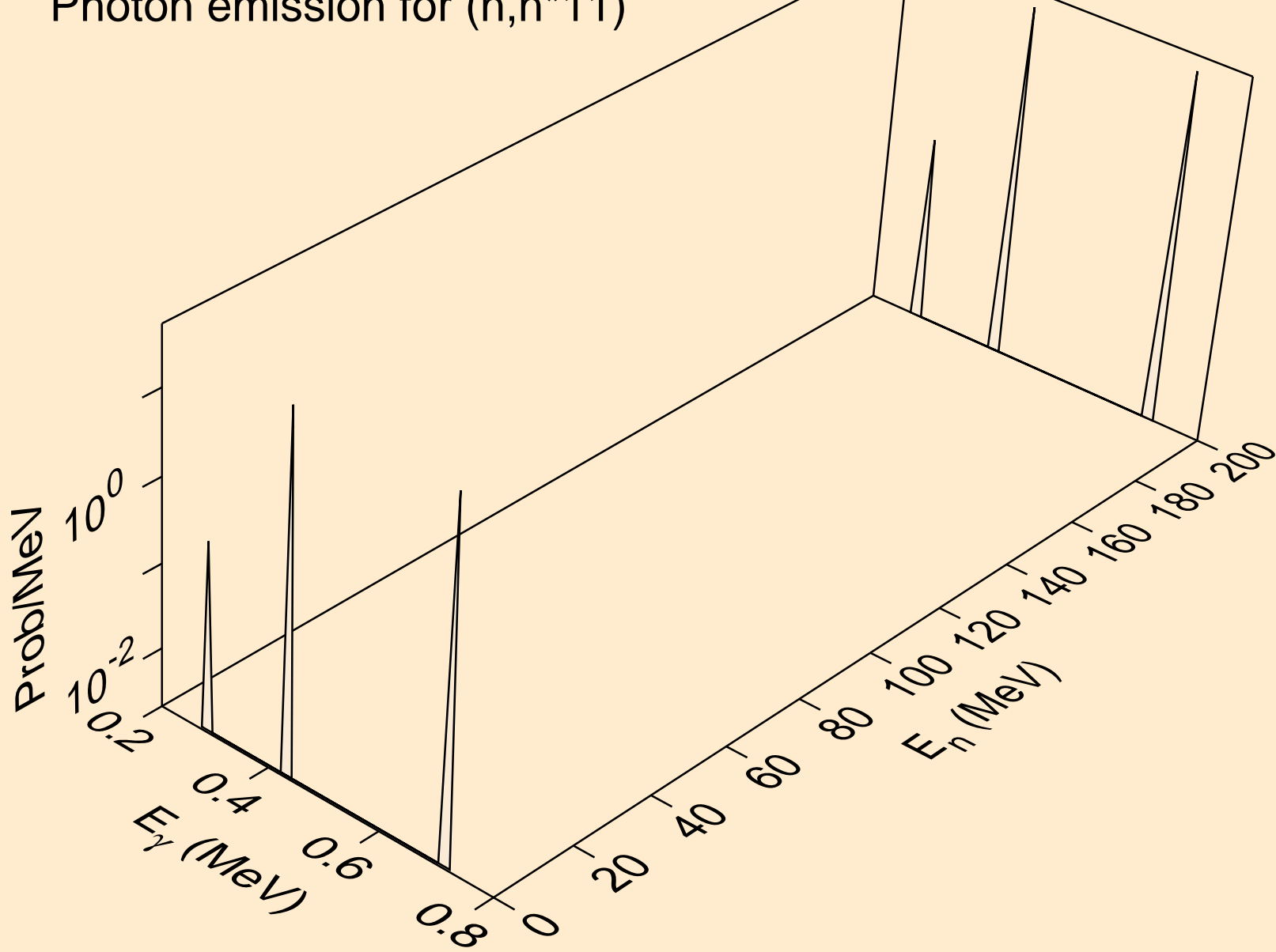

IN118N NEUTRON ACER TENDL-2019 LIBRARY; T=293.16K
Photon emission for (n,n*12)

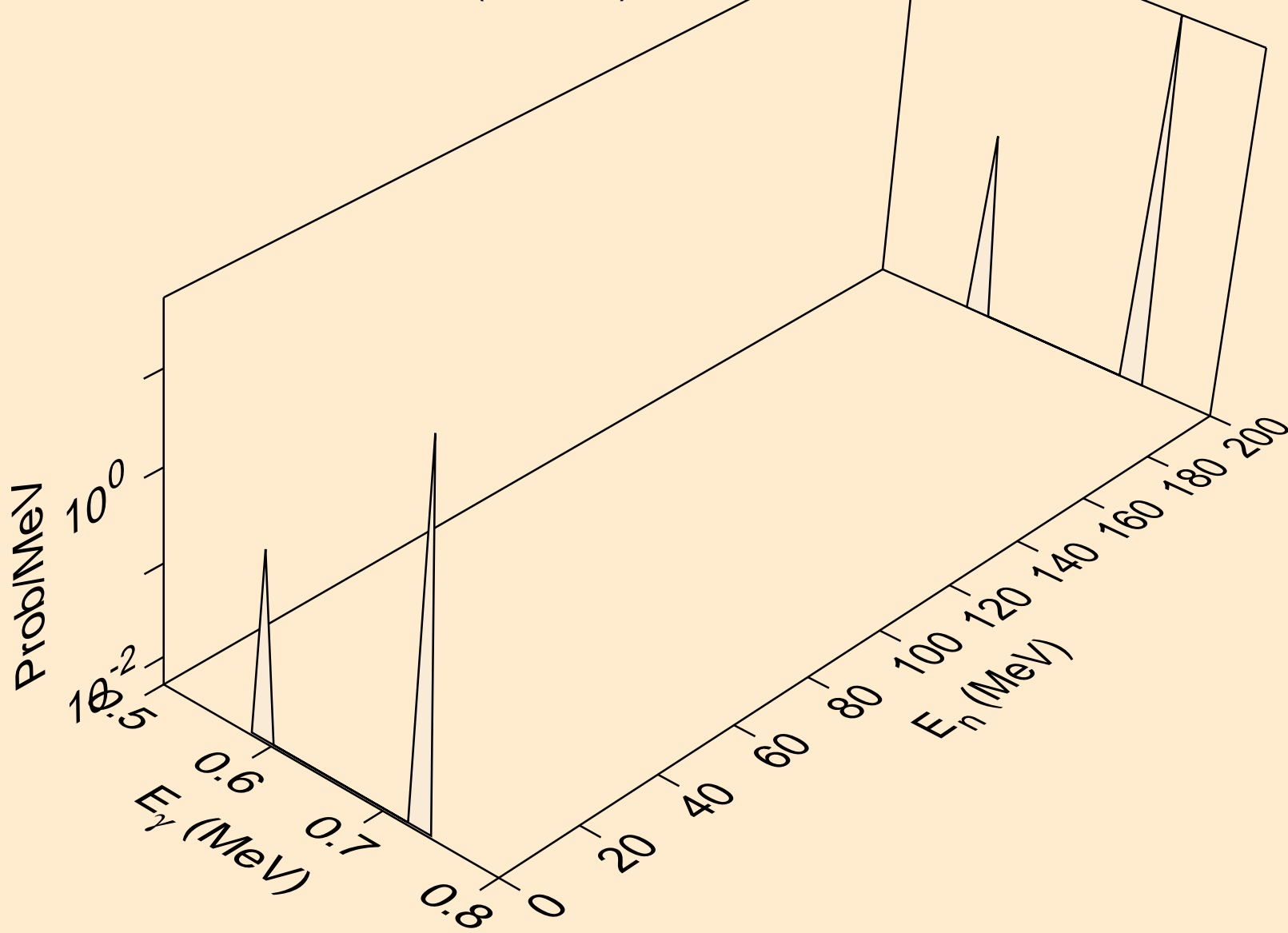

IN118N NEUTRON ACER TENDL-2019 LIBRARY; T=293.16K
Photon emission for (n,n*13)

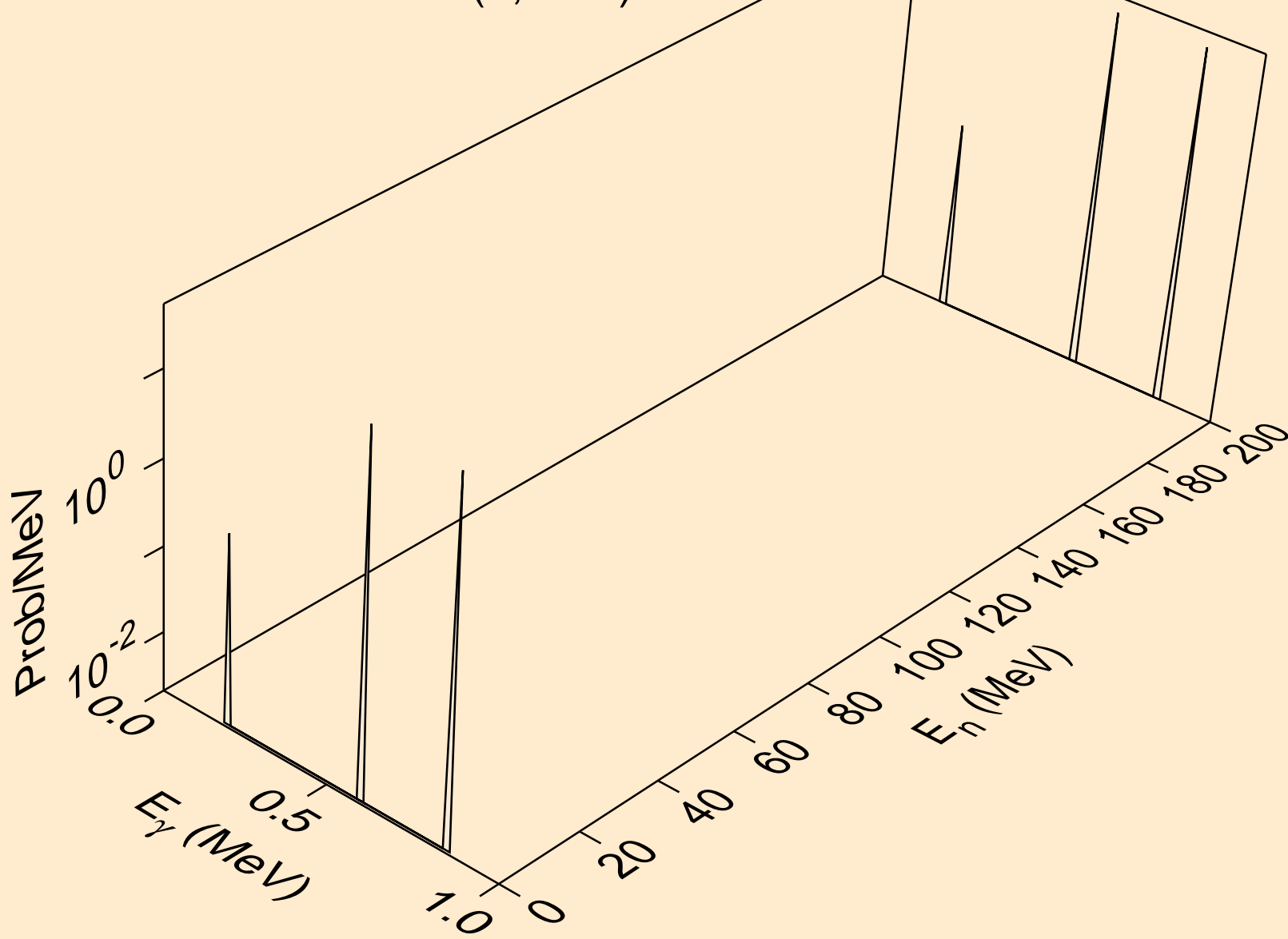

IN118N NEUTRON ACER TENDL-2019 LIBRARY; T=293.16K
Photon emission for (n,n*14)

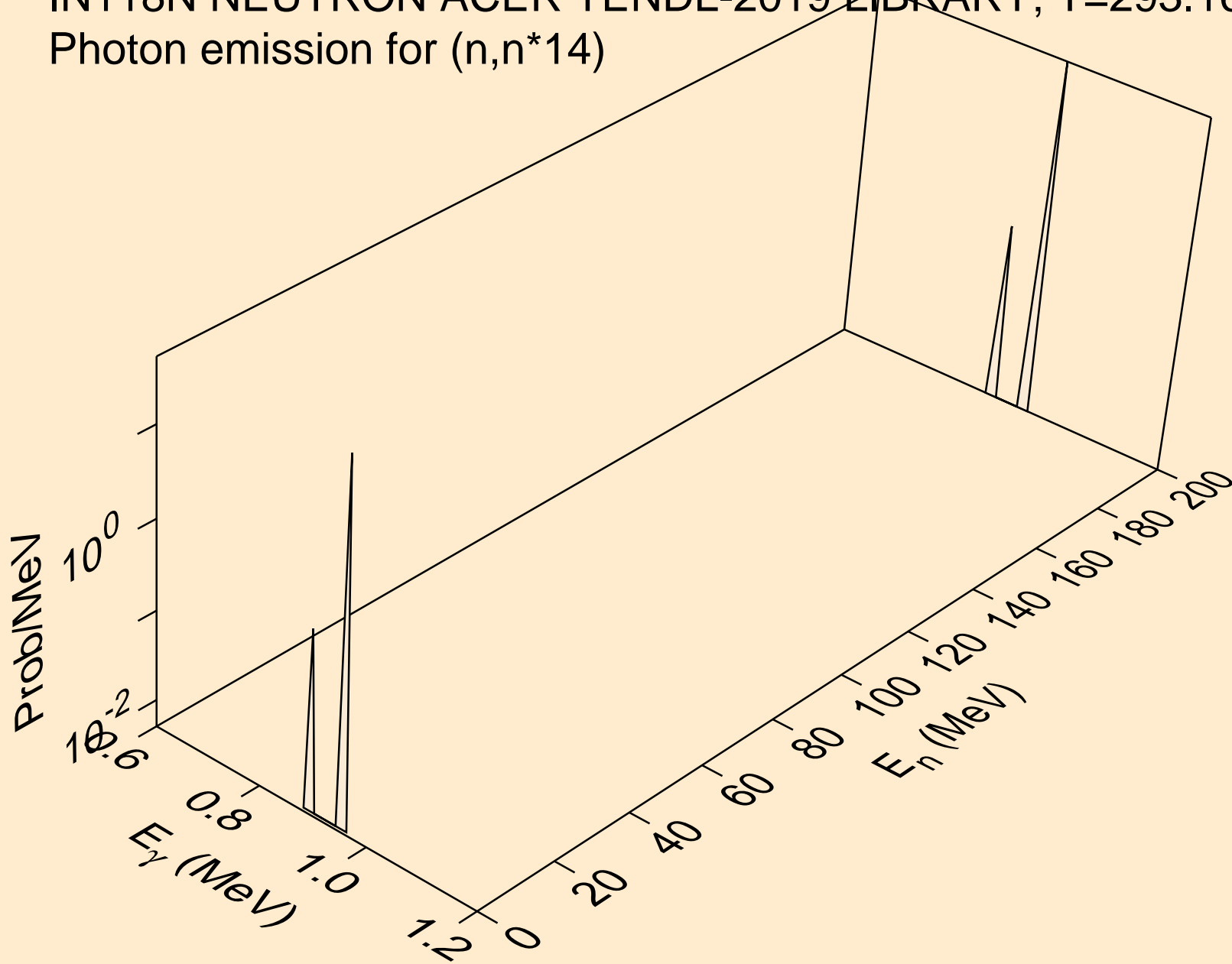

IN118N NEUTRON ACER TENDL-2019 LIBRARY; T=293.16K
Photon emission for (n,n*15)

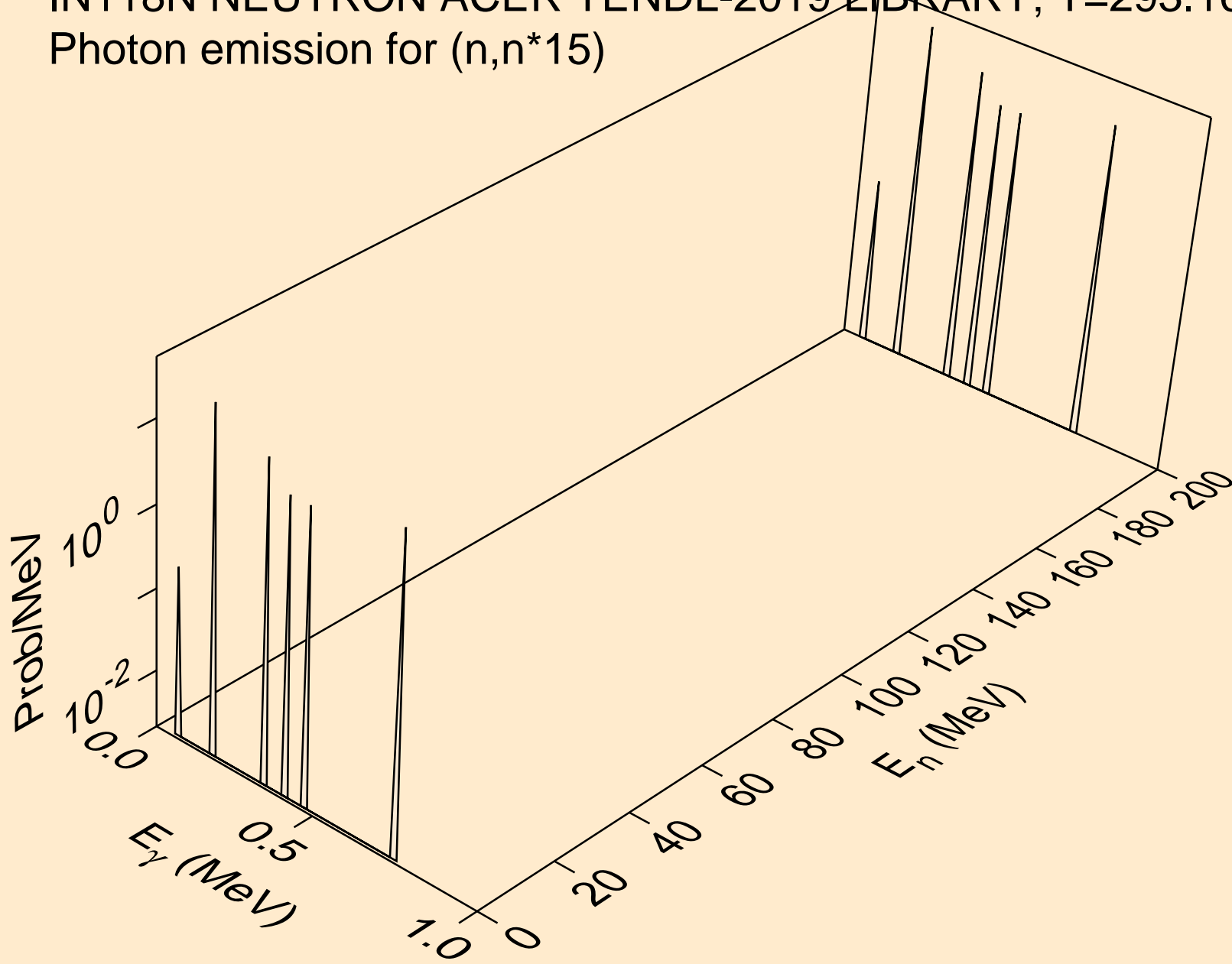

IN118N NEUTRON ACER TENDL-2019 LIBRARY; T=293.16K
Photon emission for (n,n*16)

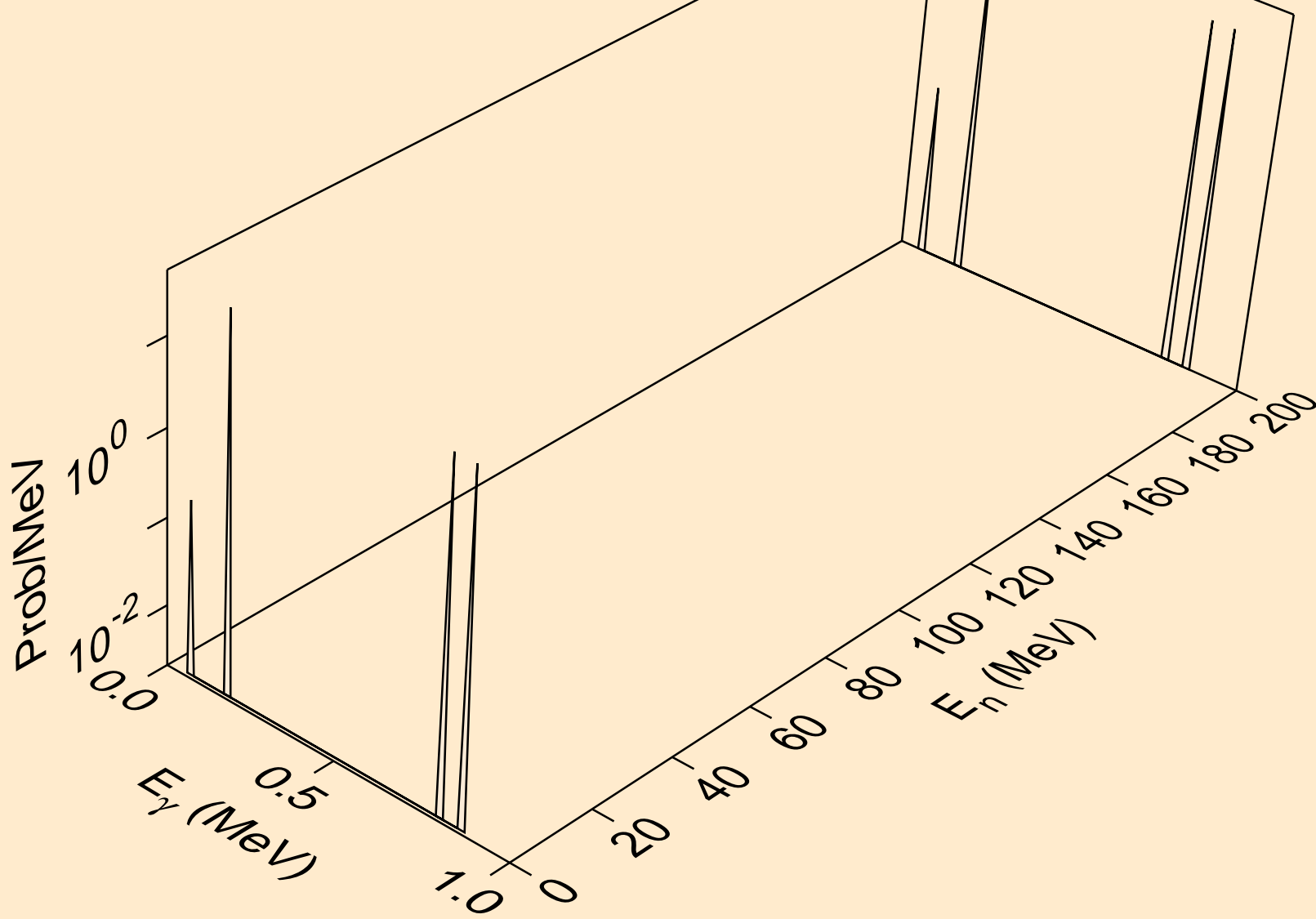

IN118N NEUTRON ACER TENDL-2019 LIBRARY; T=293.16K
Photon emission for (n,n*17)

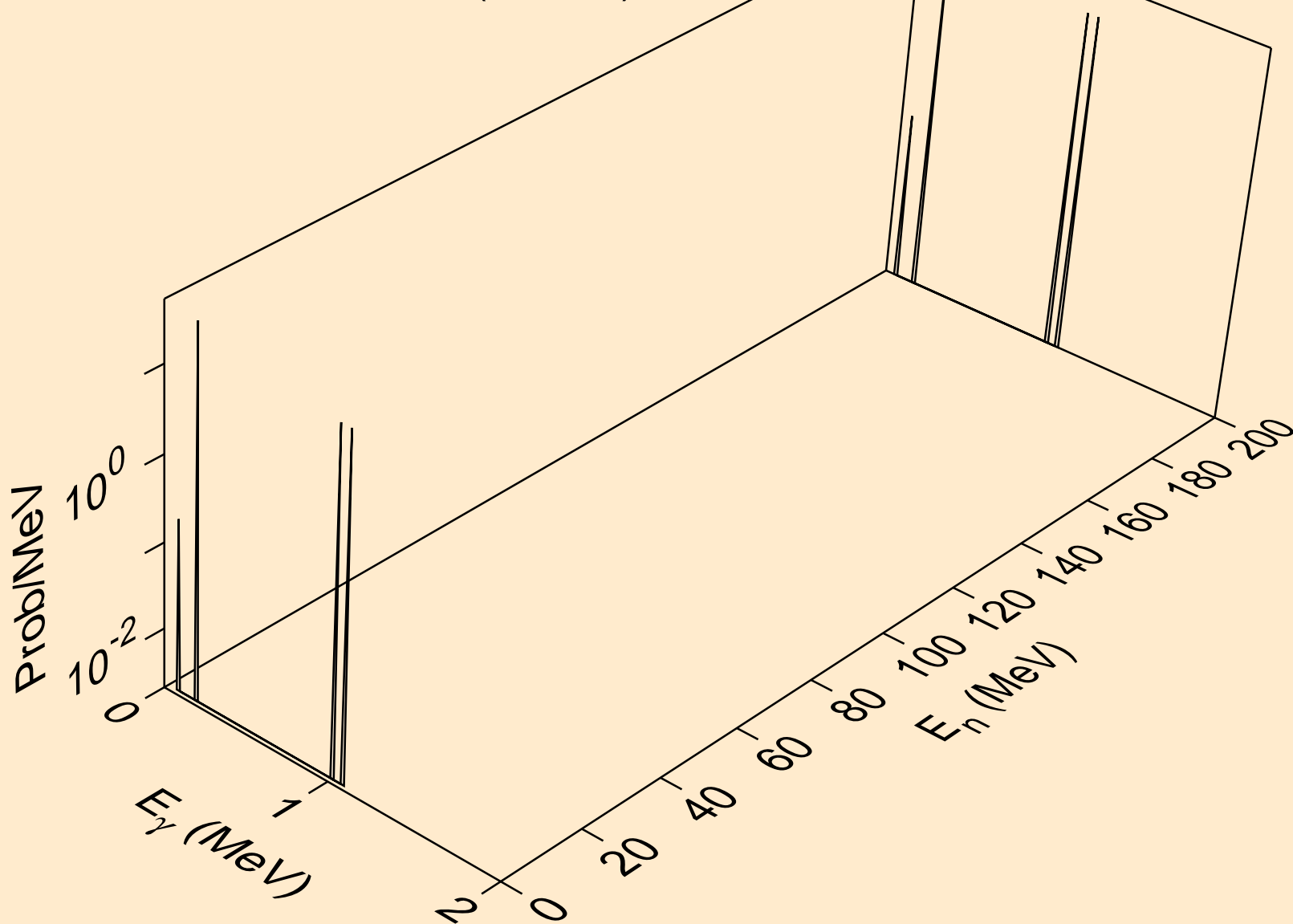

IN118N NEUTRON ACER TENDL-2019 LIBRARY; T=293.16K
Photon emission for (n,n*18)

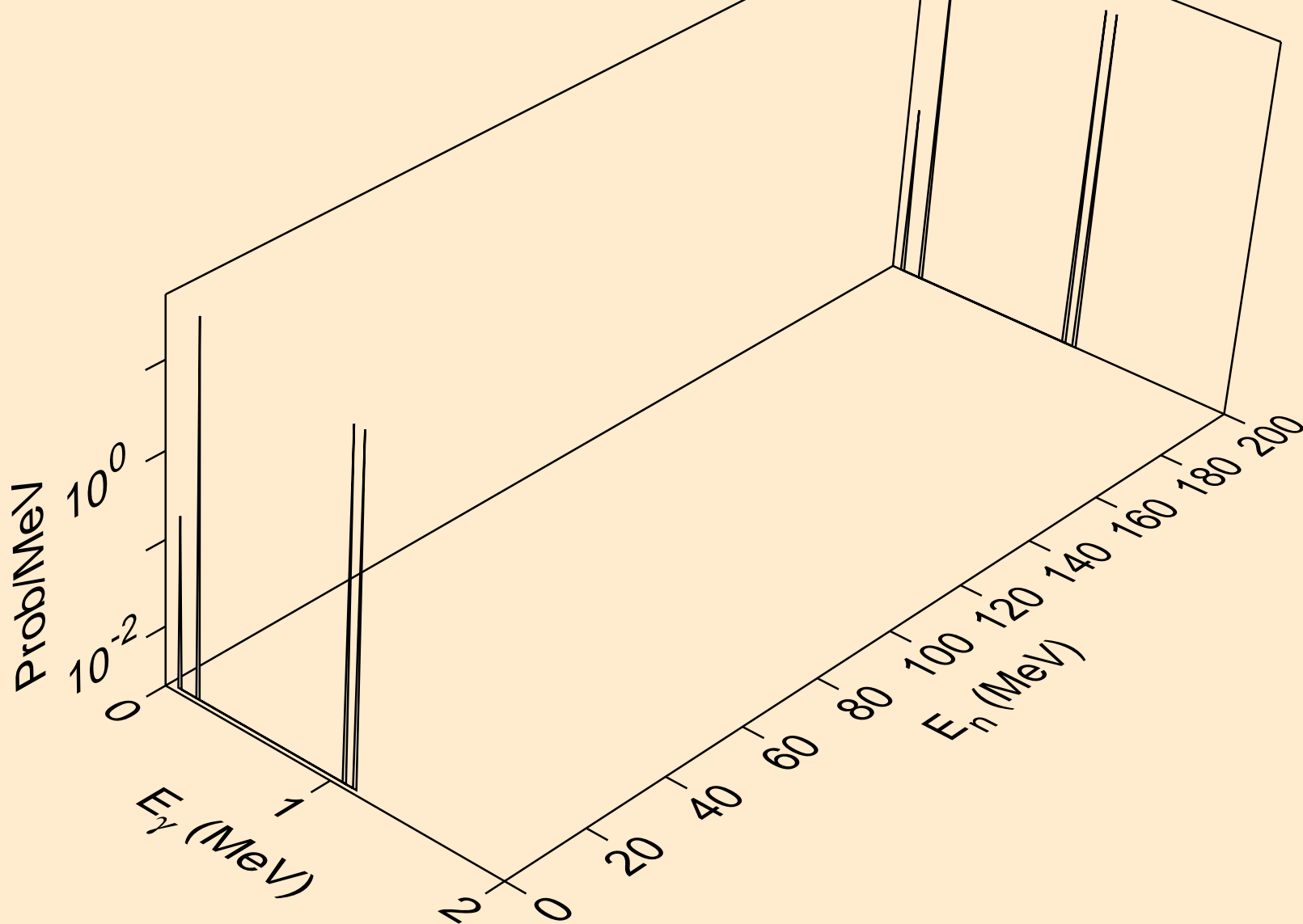

IN118N NEUTRON ACER TENDL-2019 LIBRARY; T=293.16K
Photon emission for (n,n*19)

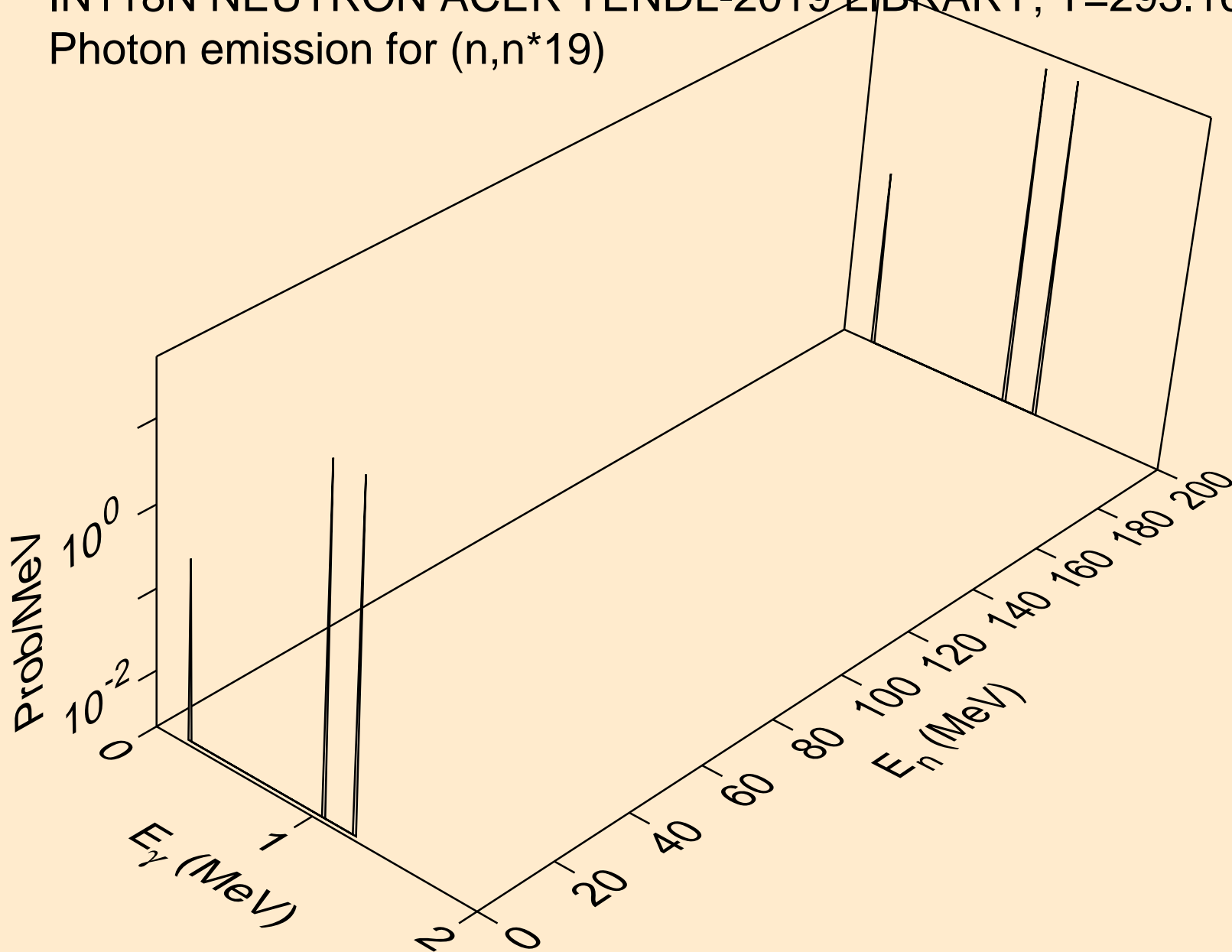

IN118N NEUTRON ACER TENDL-2019 LIBRARY; T=293.16K
Photon emission for (n,n*20)

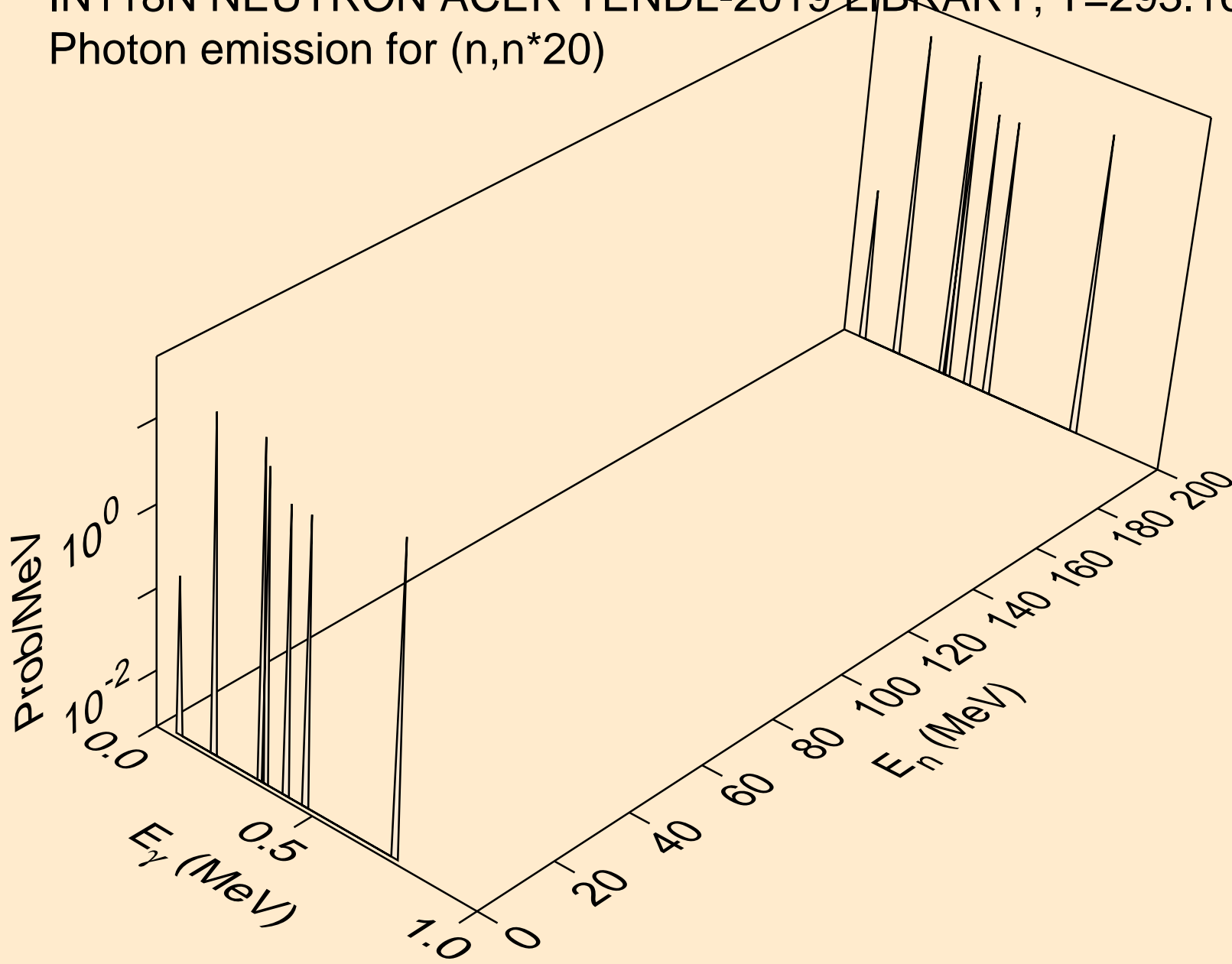

IN118N NEUTRON ACER TENDL-2019 LIBRARY; T=293.16K
Photon emission for (n,n*21)

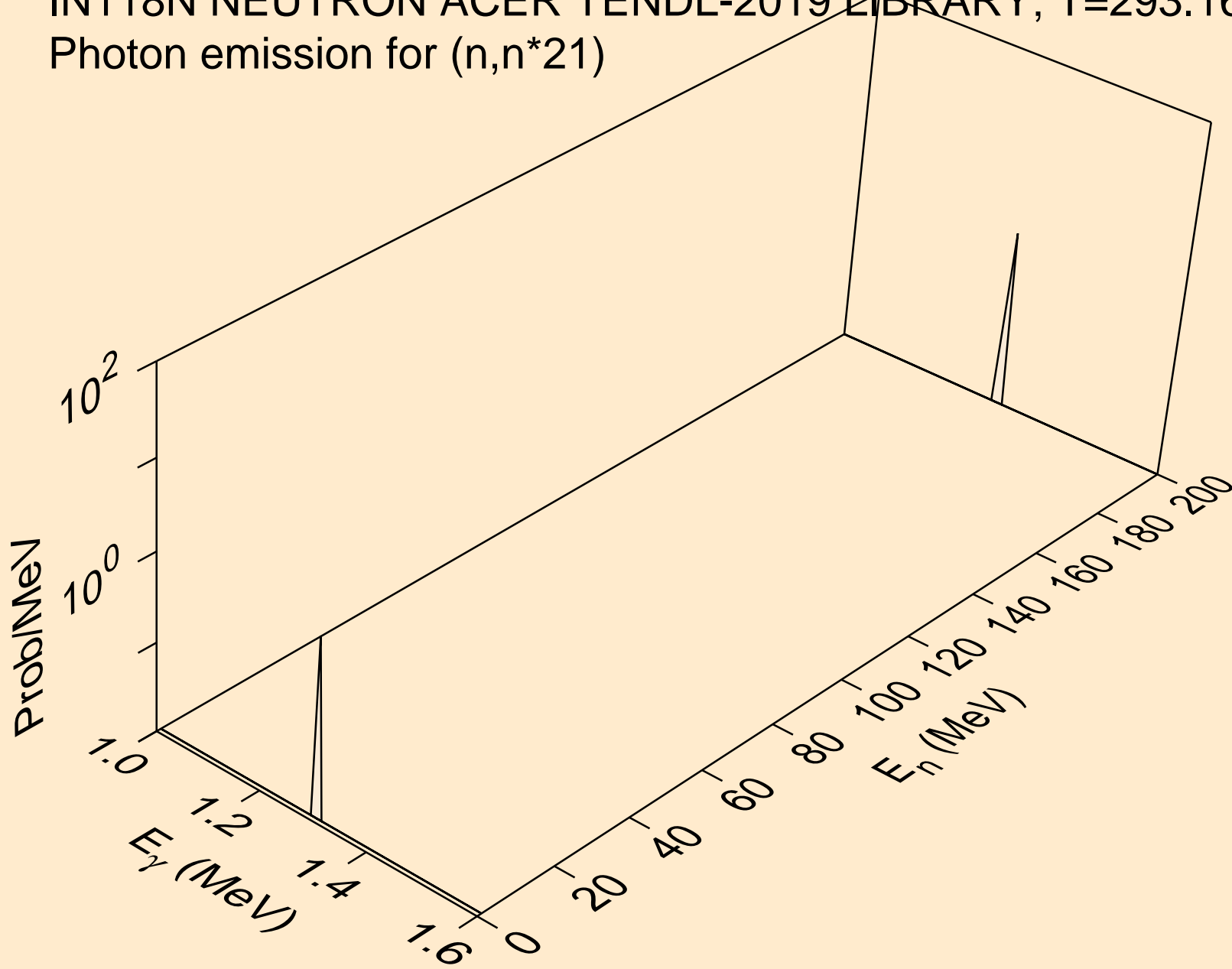

IN118N NEUTRON ACER TENDL-2019 LIBRARY; T=293.16K
Photon emission for (n,n*22)

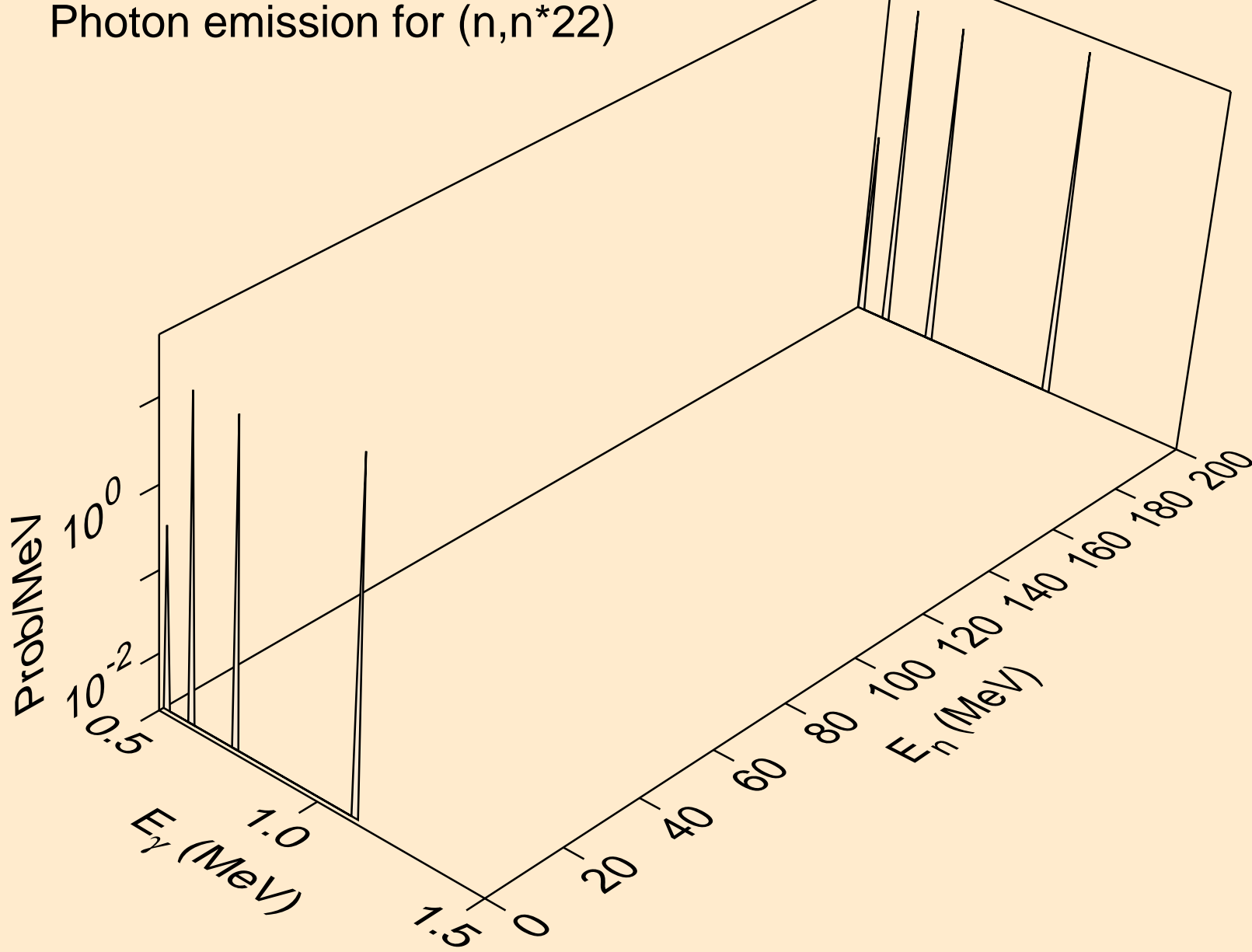

IN118N NEUTRON ACER TENDL-2019 LIBRARY; T=293.16K
Photon emission for (n,n*23)

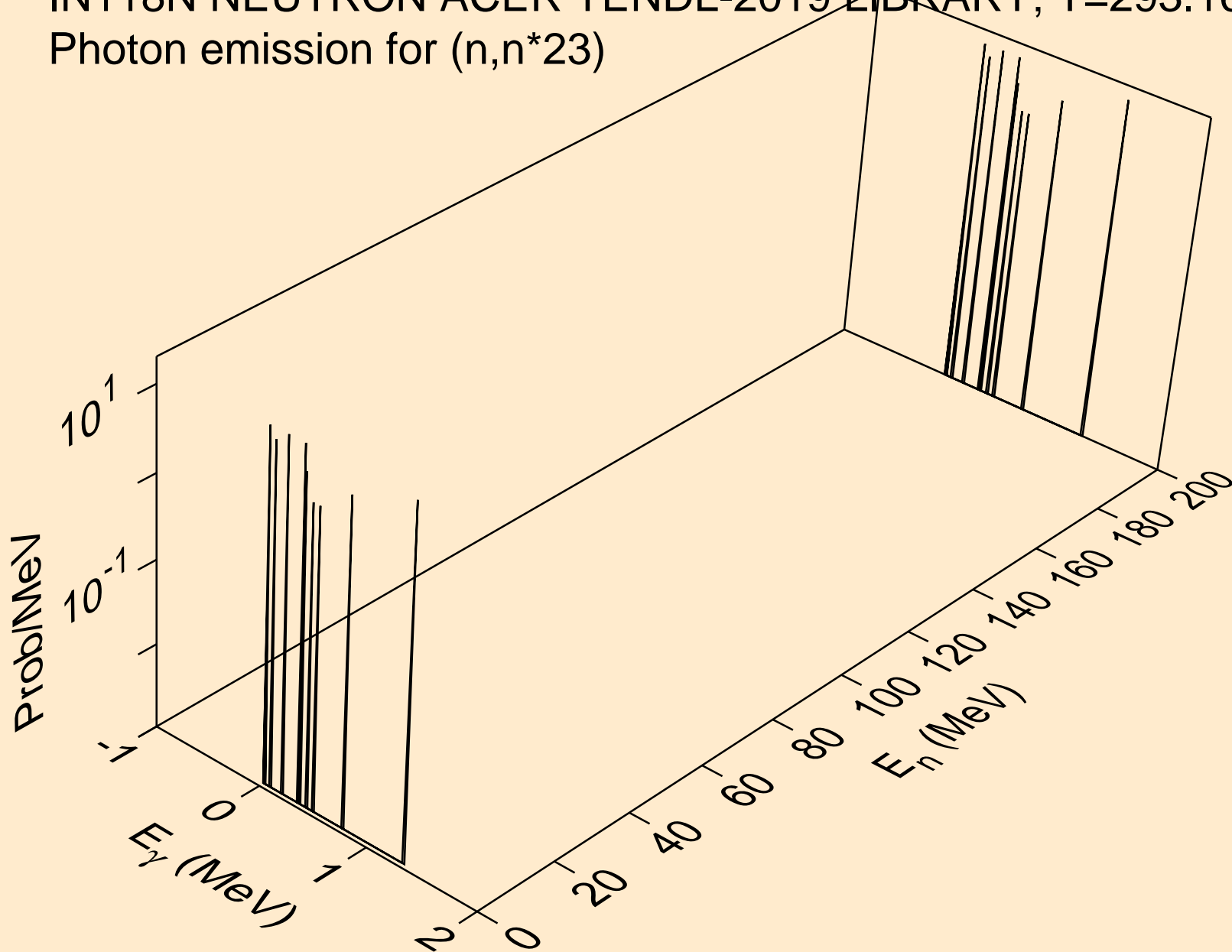

IN118N NEUTRON ACER TENDL-2019 LIBRARY; T=293.16K
Photon emission for (n,n*24)

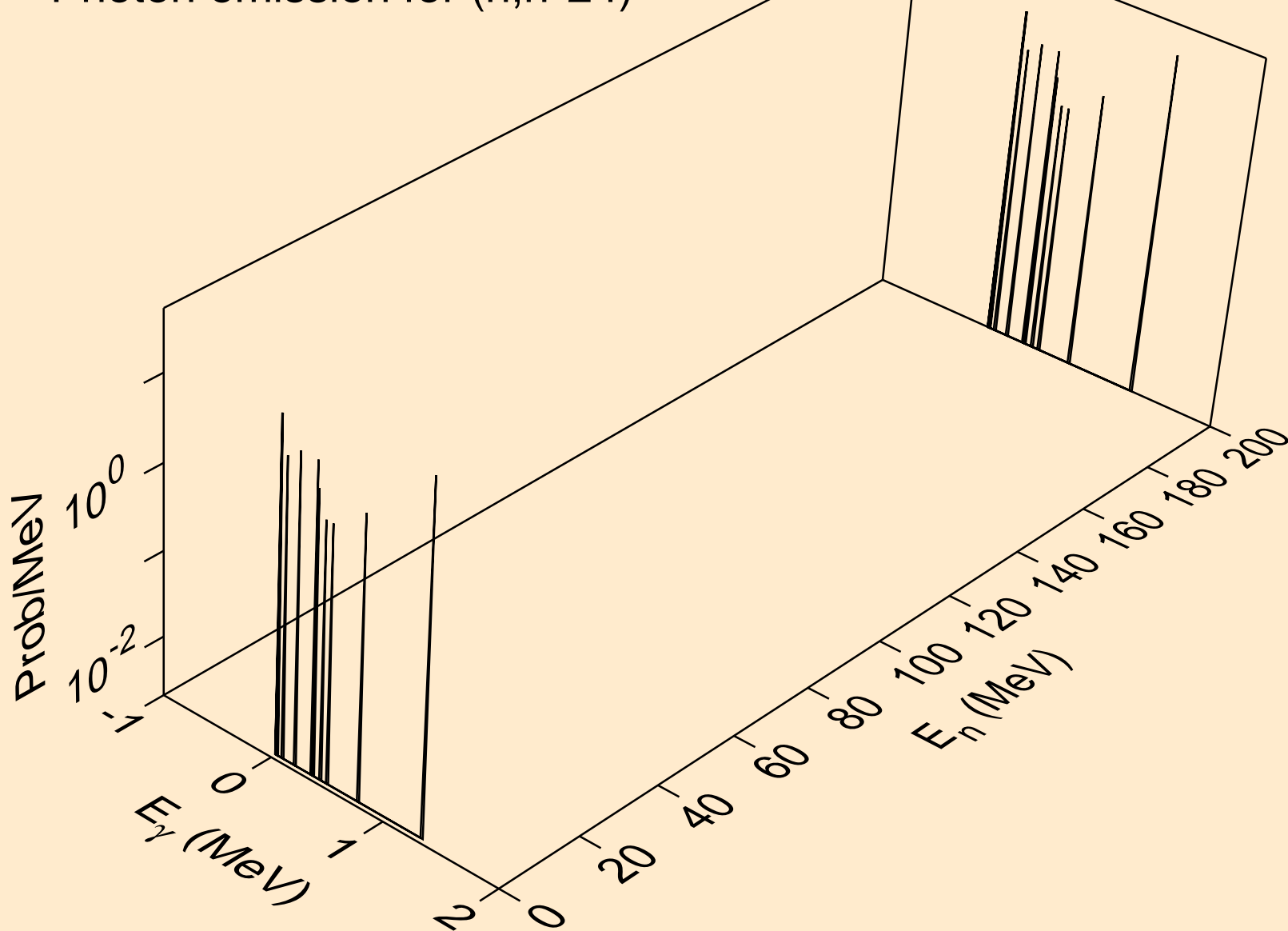

IN118N NEUTRON ACER TENDL-2019 LIBRARY; T=293.16K
Photon emission for (n,n*25)

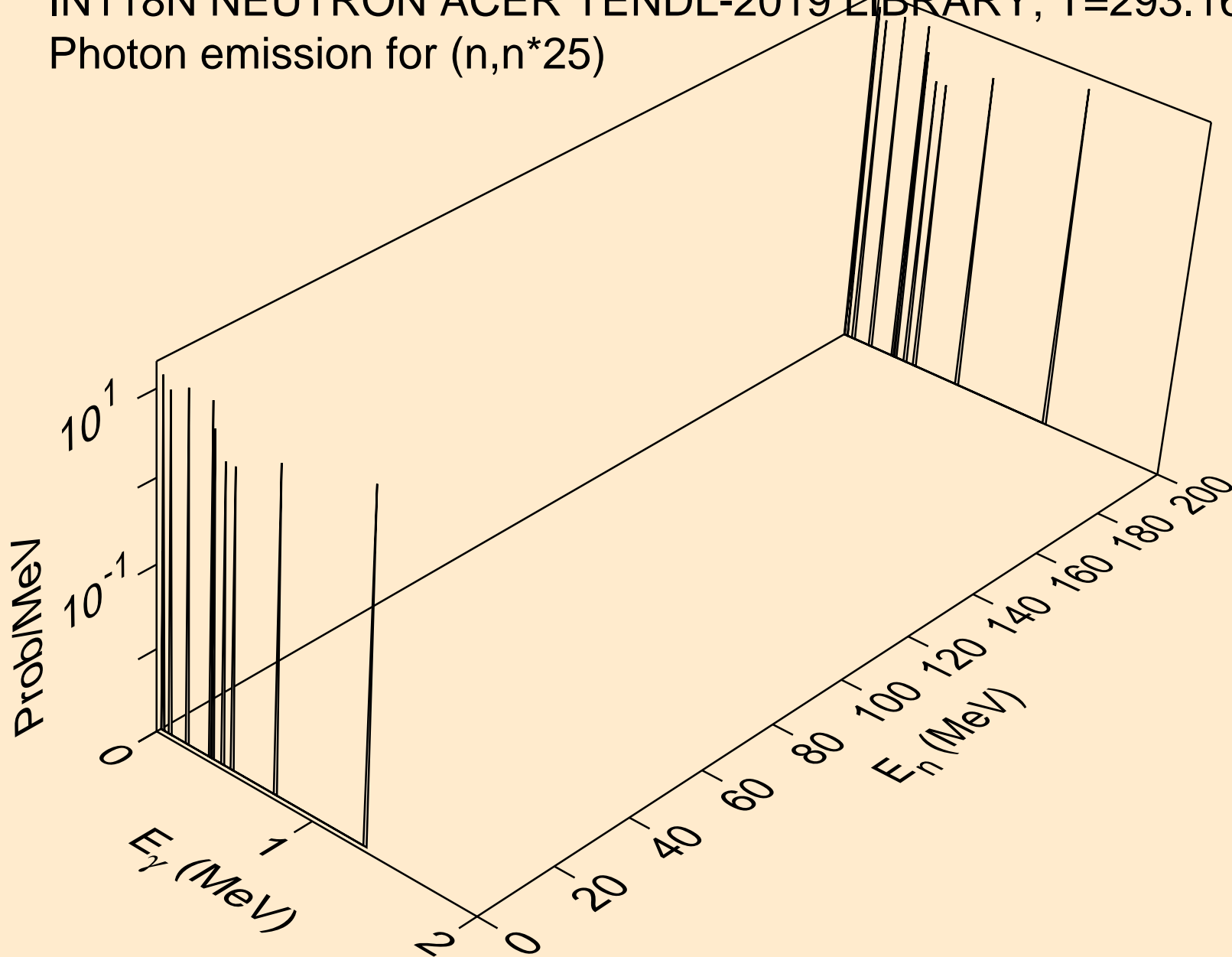

IN118N NEUTRON ACER TENDL-2019 LIBRARY; T=293.16K
Photon emission for (n,n*26)

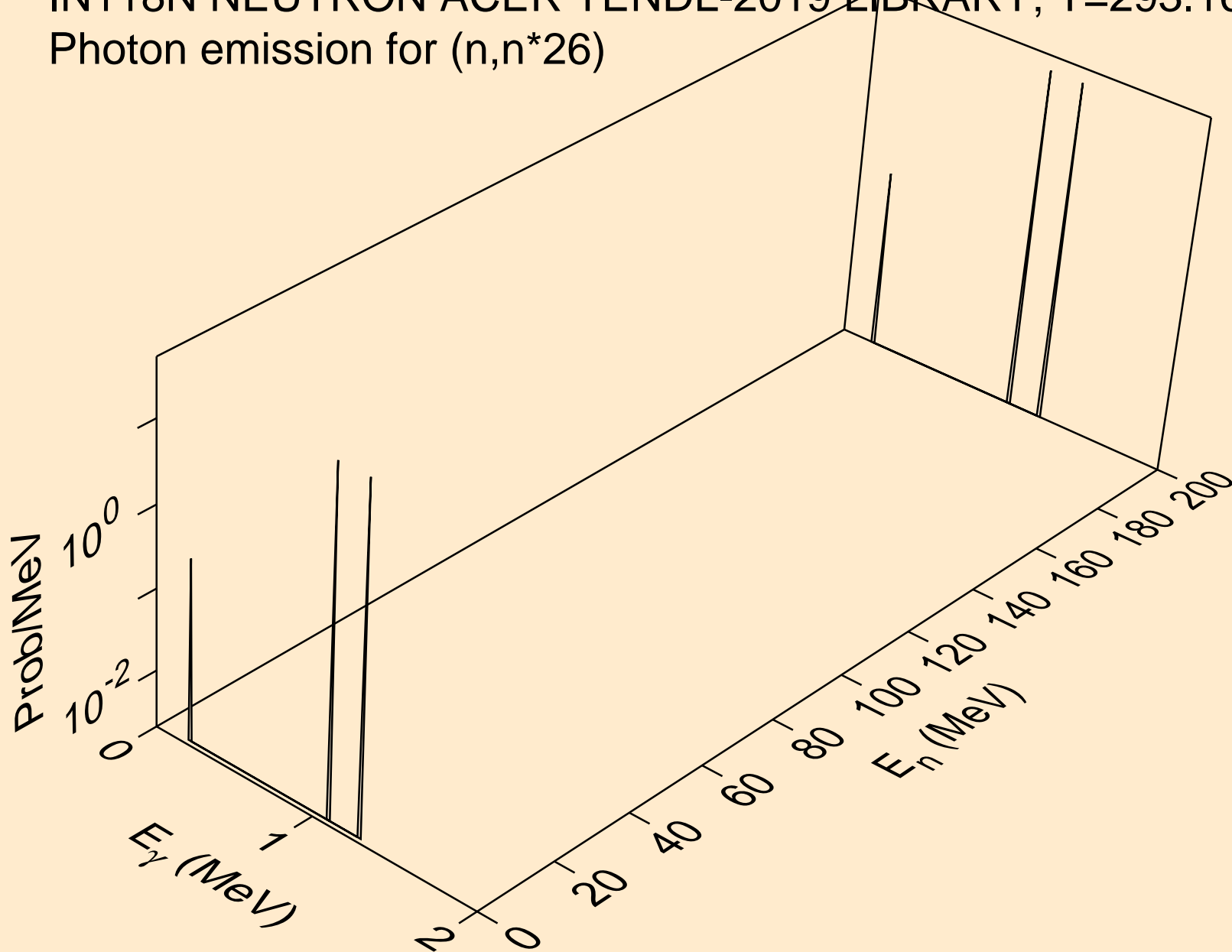

IN118N NEUTRON ACER TENDL-2019 LIBRARY; T=293.16K
Photon emission for (n,n*27)

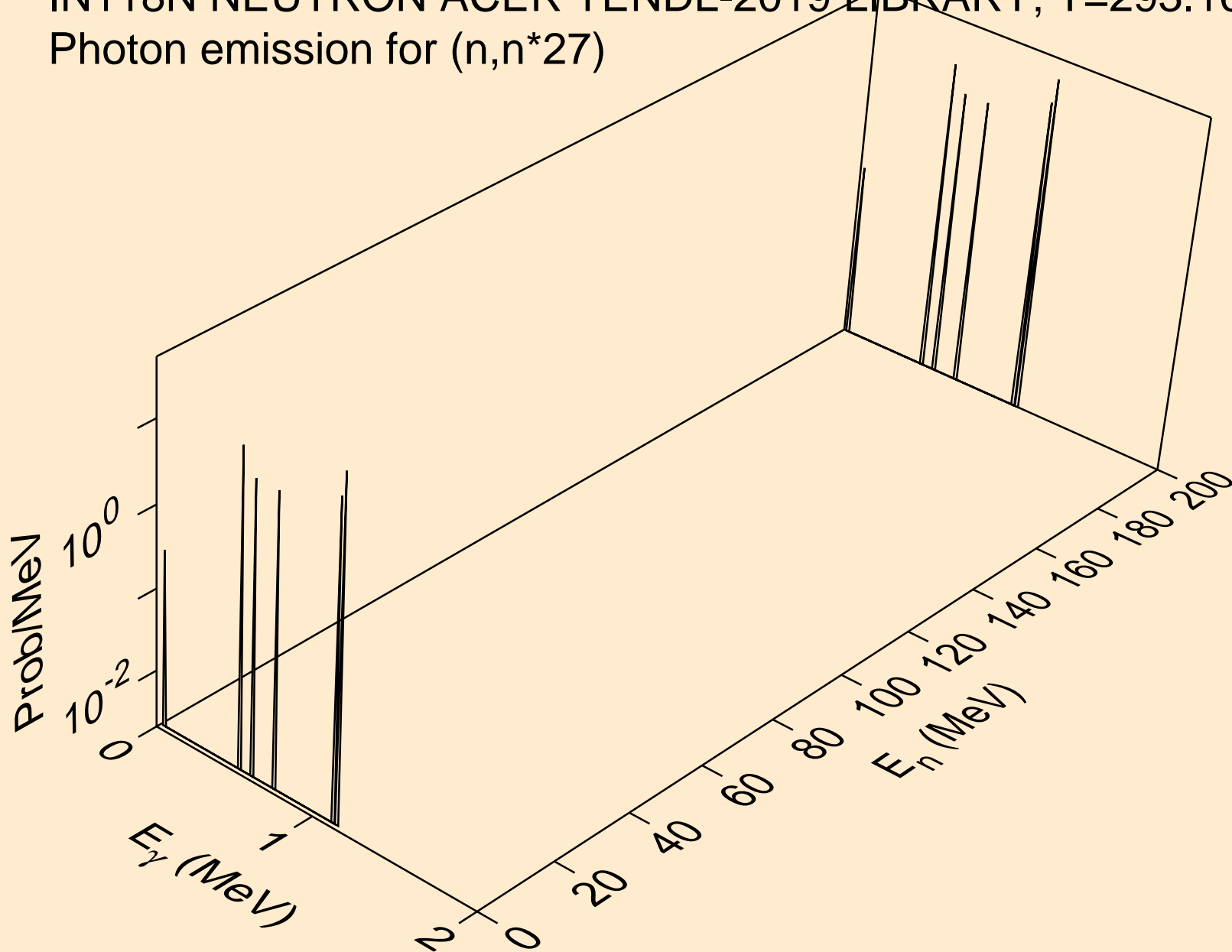

IN118N NEUTRON ACER TENDL-2019 LIBRARY; T=293.16K
Photon emission for (n,n*c)

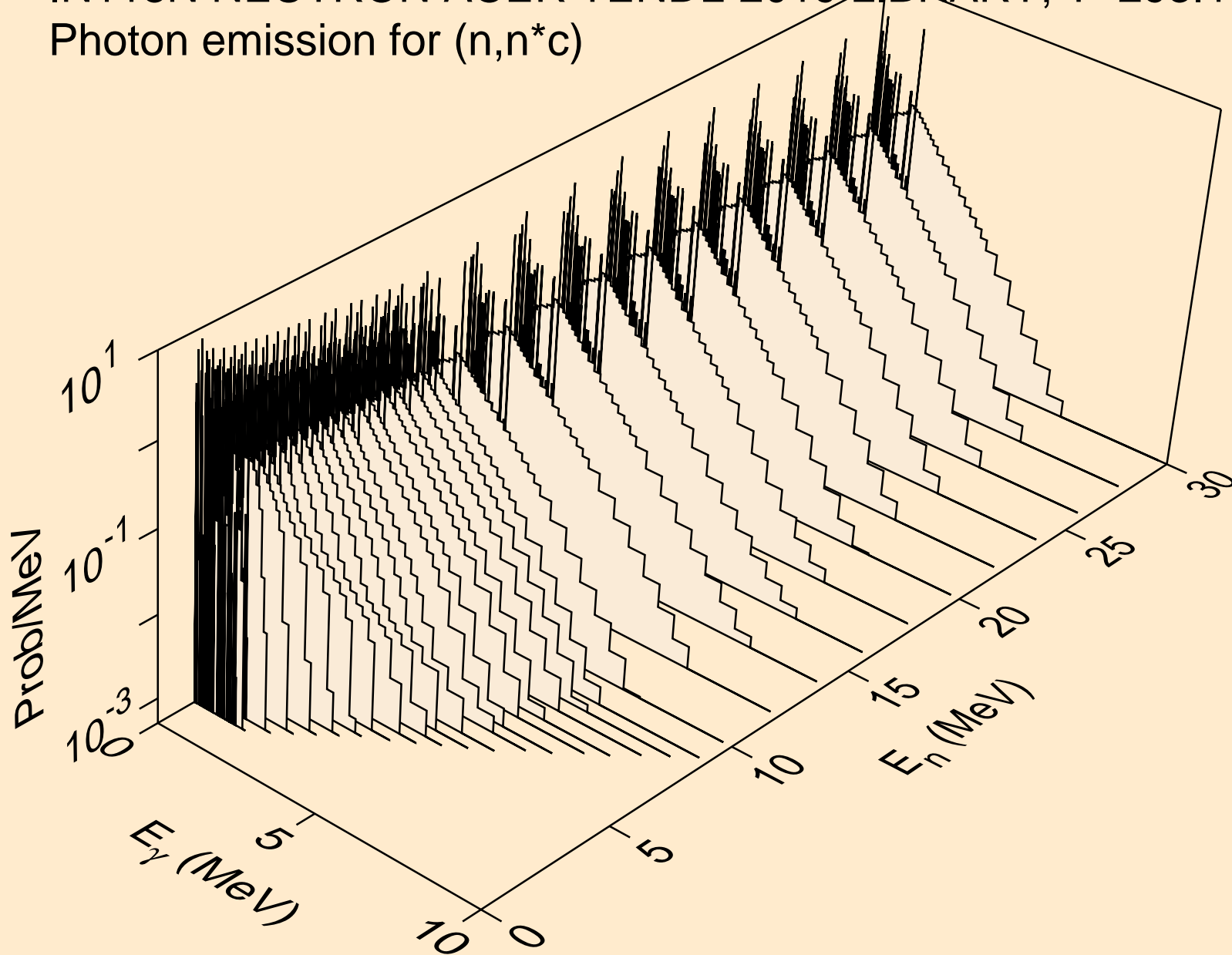

IN118N NEUTRON ACER TENDL-2019 LIBRARY; T=293.16K
Photon emission for (n,gma)

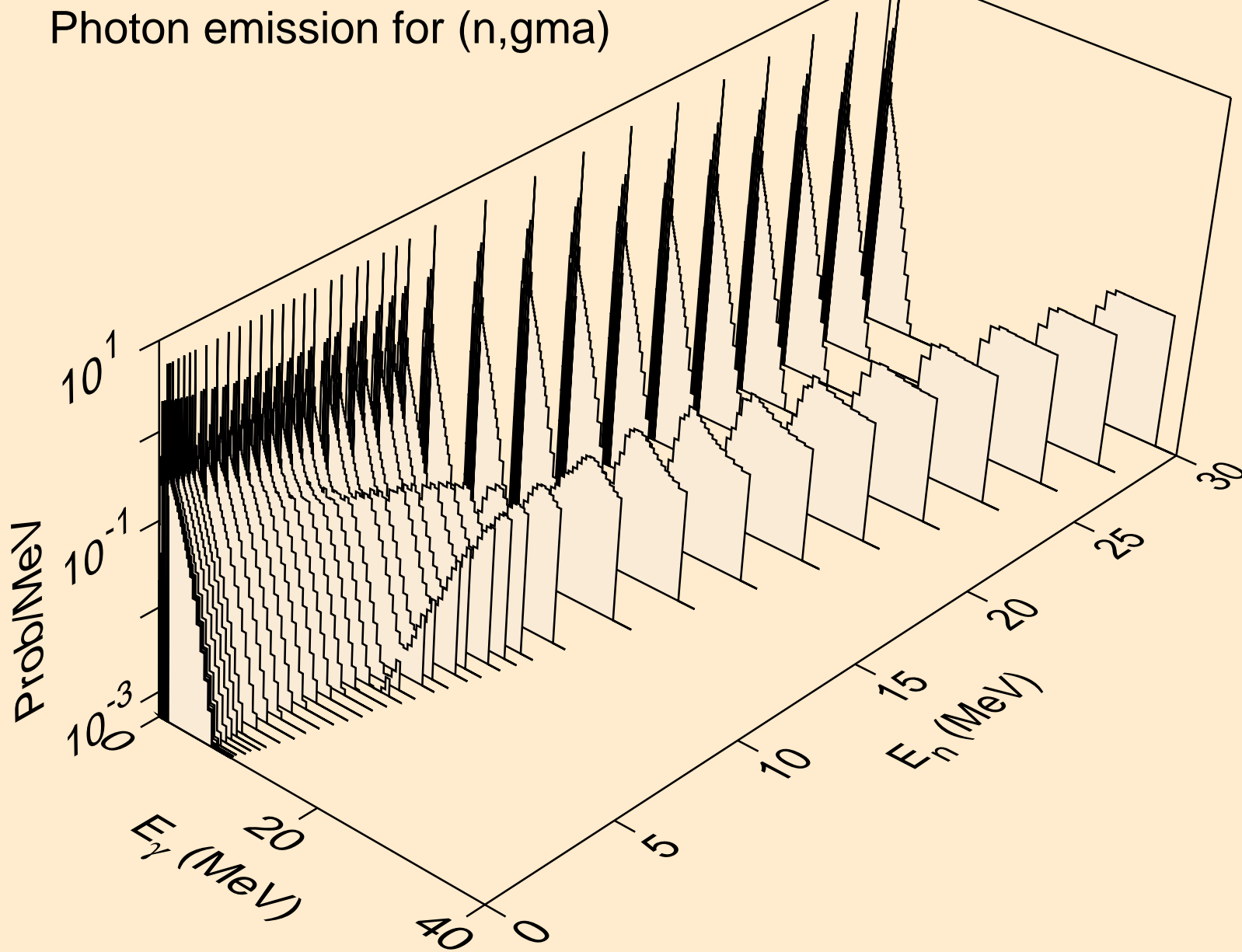

IN118N NEUTRON ACER TENDL-2019 LIBRARY; T=293.16K
Photon emission for (n,p)

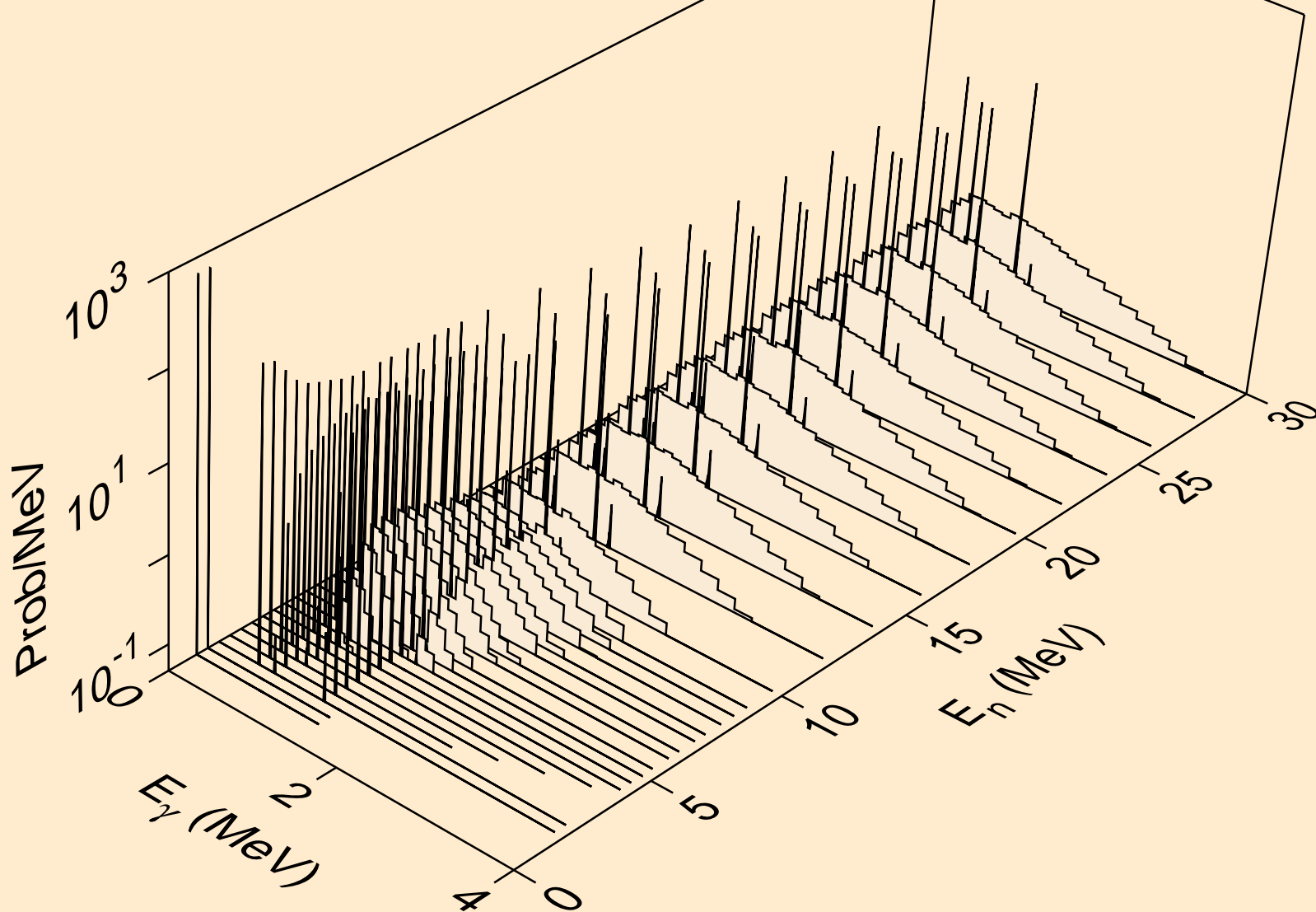

IN118N NEUTRON ACER TENDL-2019 LIBRARY; T=293.16K
Photon emission for (n,d)

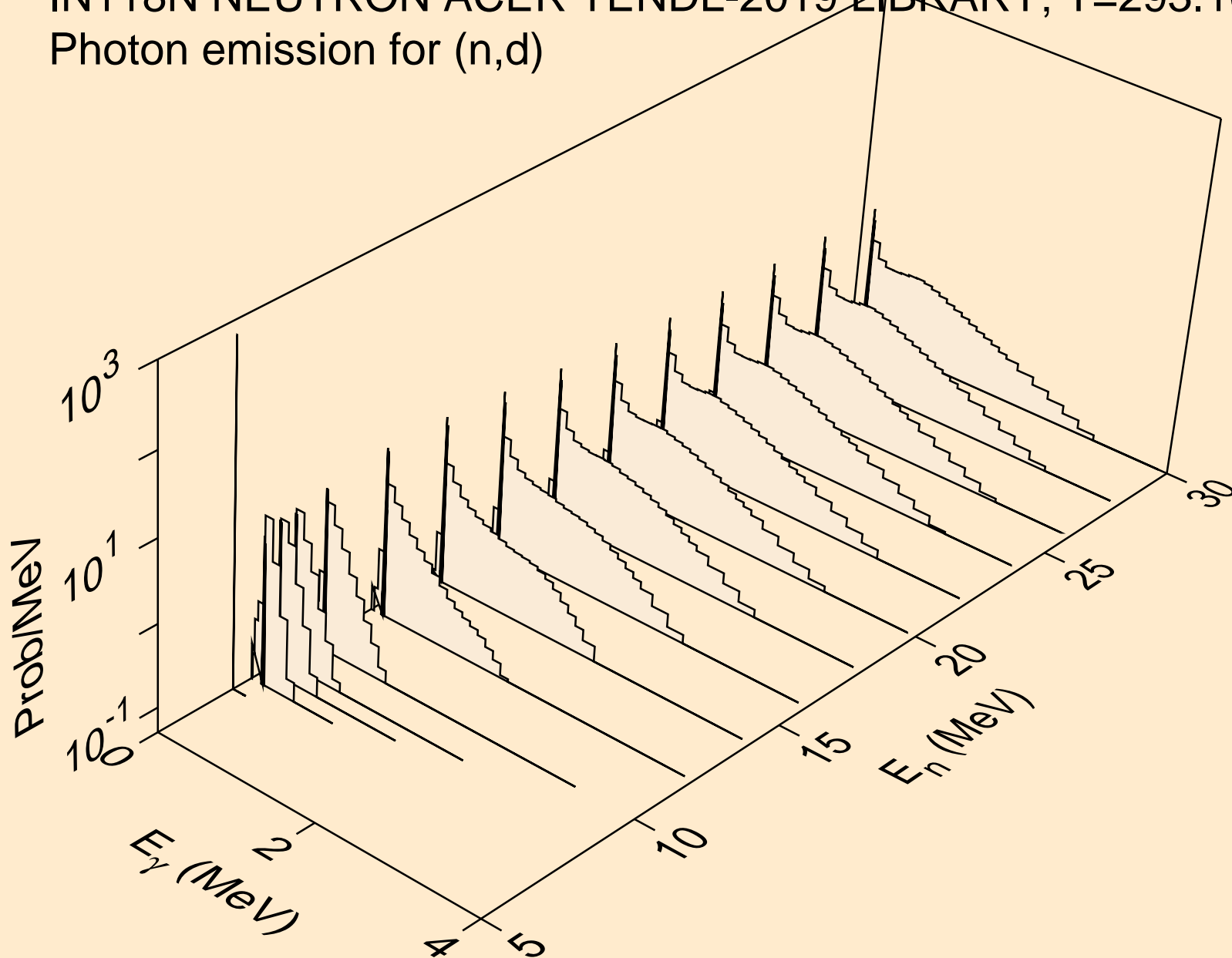

IN118N NEUTRON ACER TENDL-2019 LIBRARY; T=293.16K
Photon emission for (n,t)

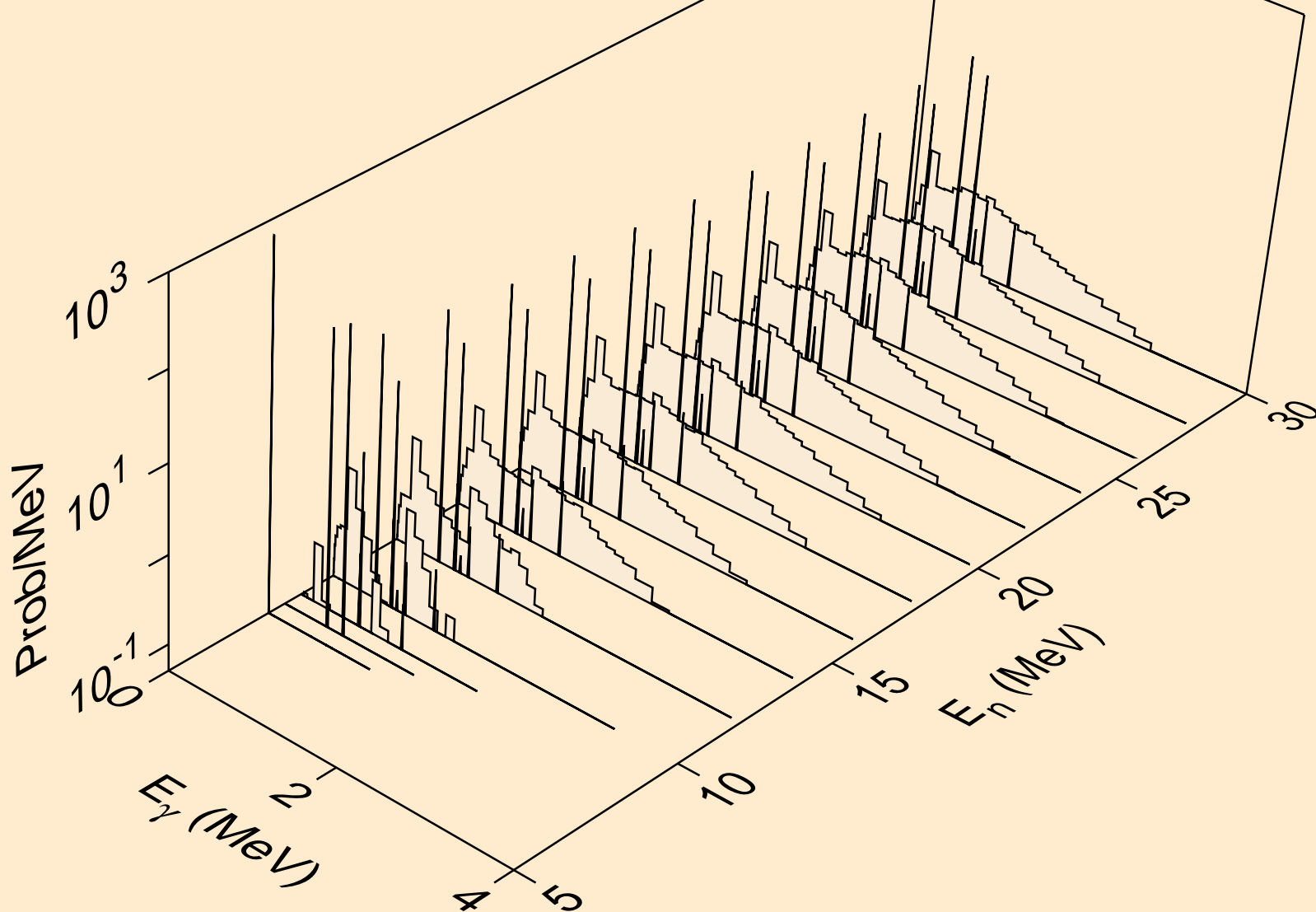

IN118N NEUTRON ACER TENDL-2019 LIBRARY; T=293.16K
Photon emission for (n,he3)

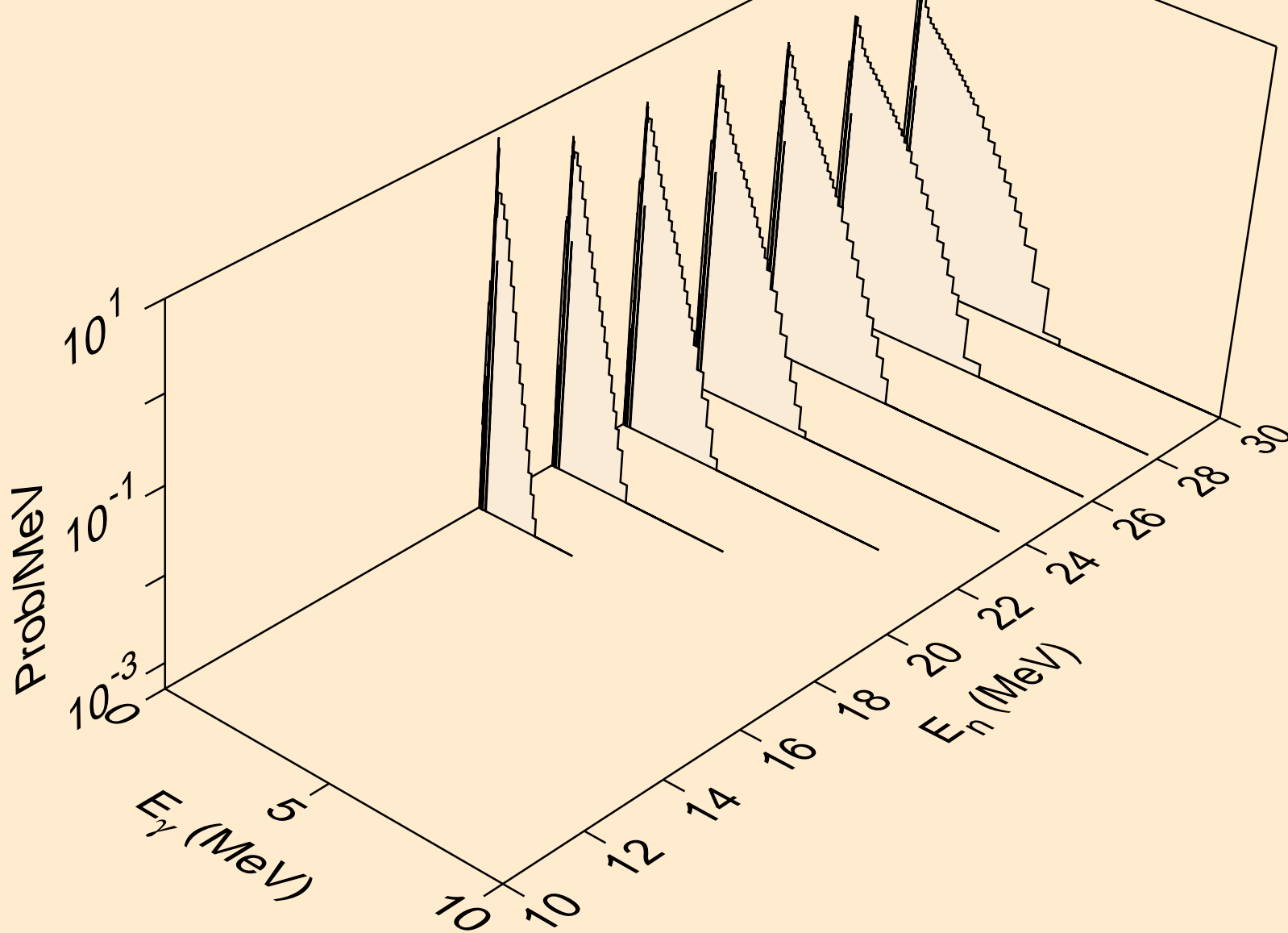

IN118N NEUTRON ACER TENDL-2019 LIBRARY; T=293.16K
Photon emission for (n,a)

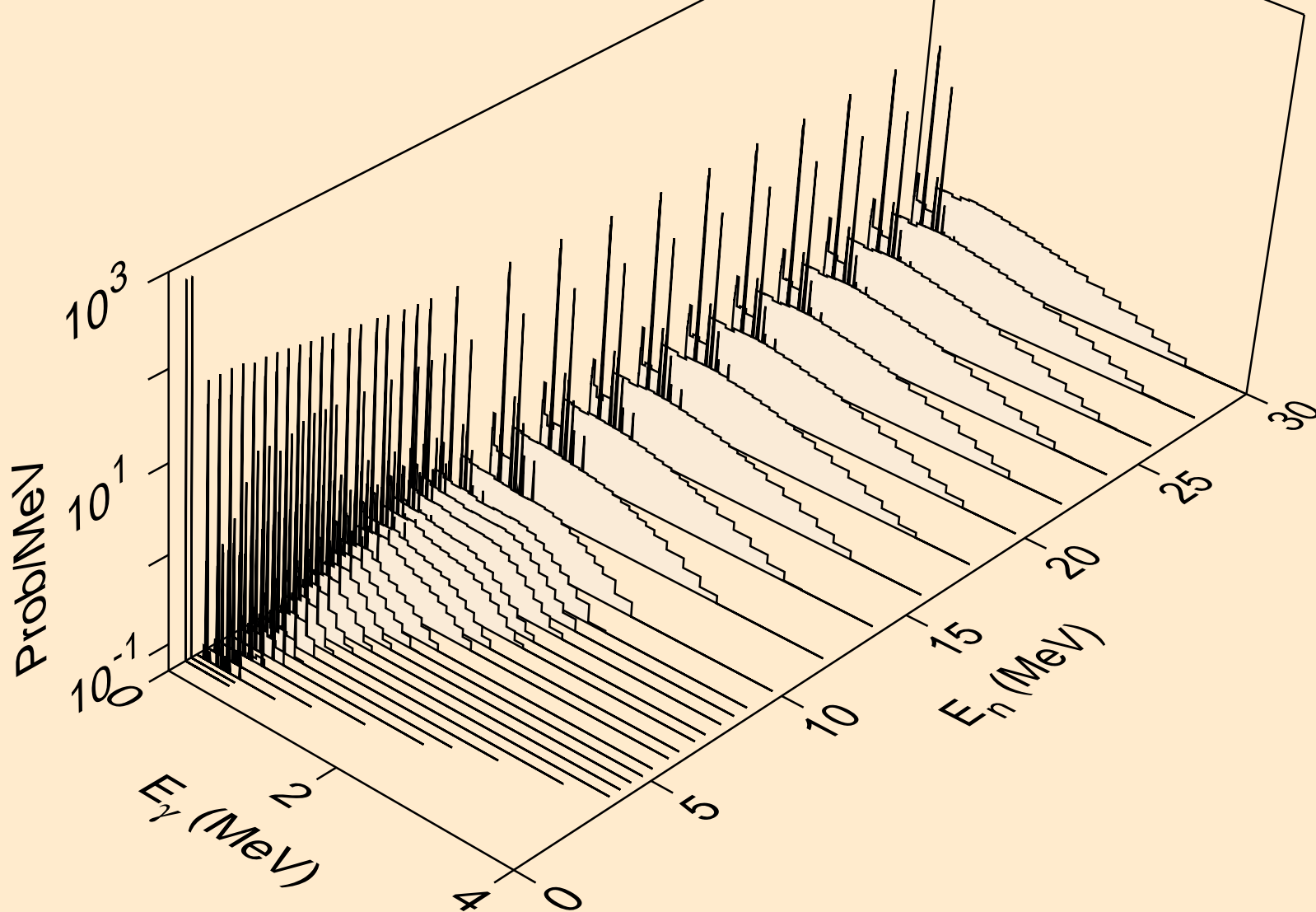

IN118N NEUTRON ACER TENDL-2019 LIBRARY; T=293.16K
Photon emission for (n,2a)

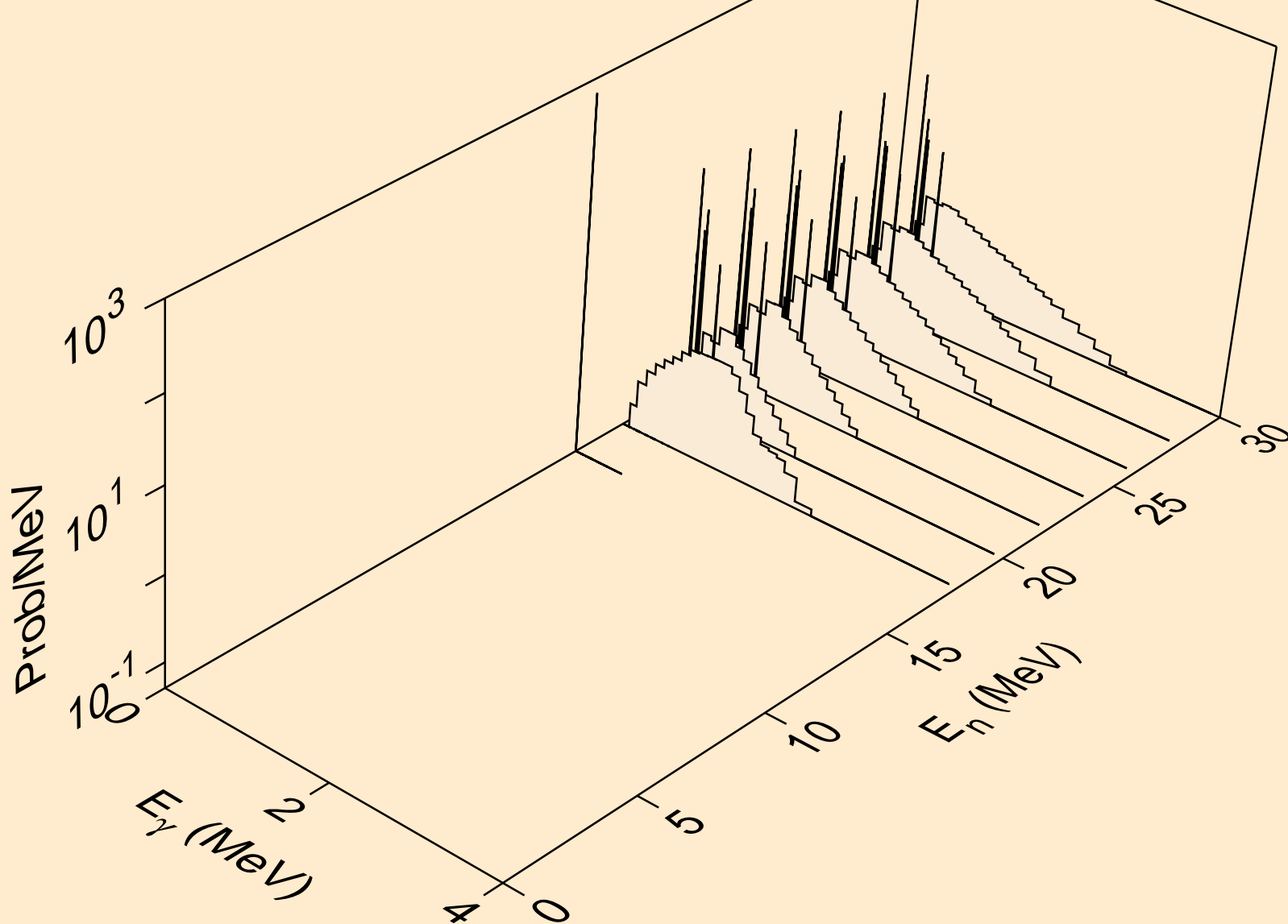

IN118N NEUTRON ACER TENDL-2019 LIBRARY; T=293.16K
Photon emission for (n,2p)

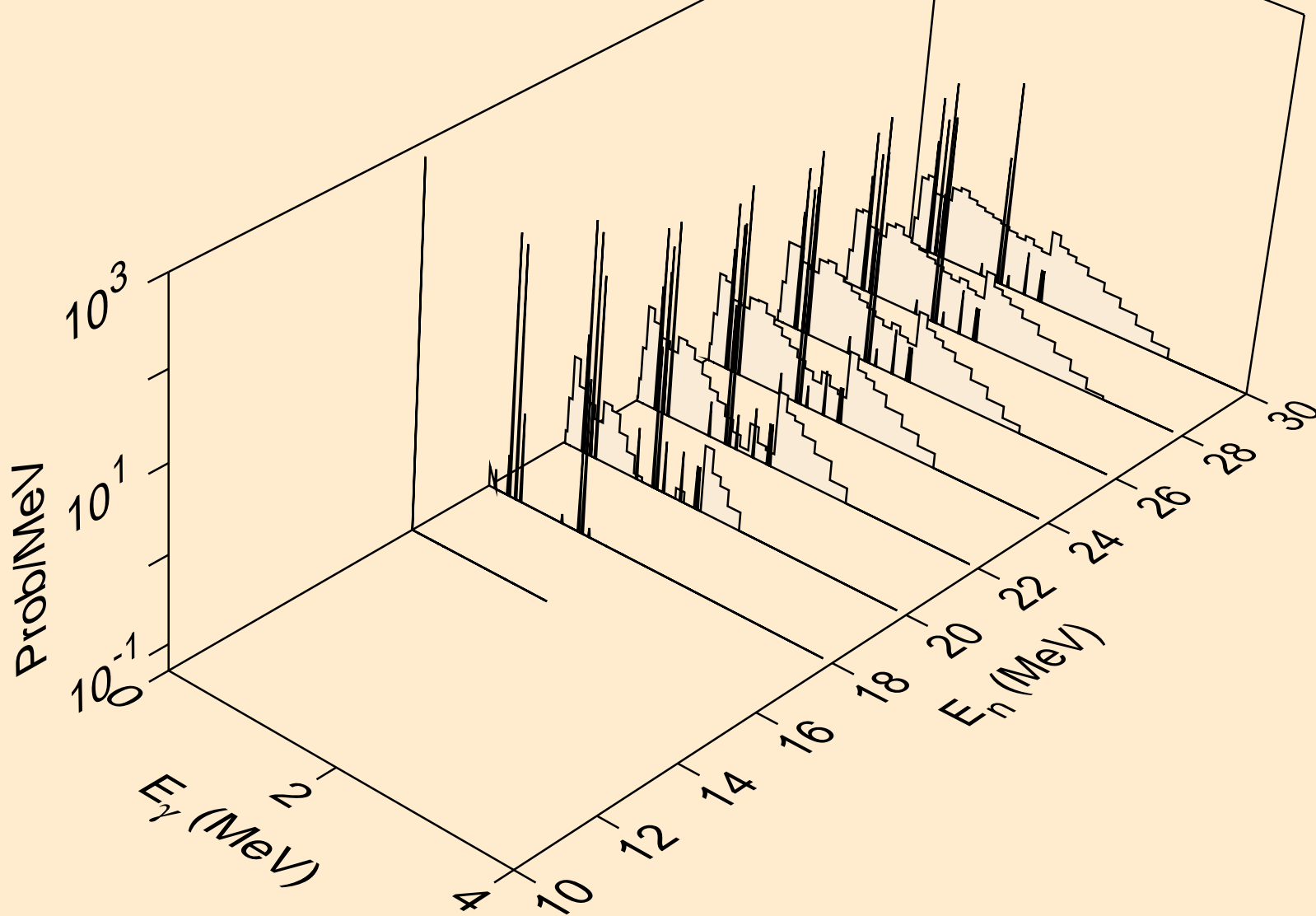

IN118N NEUTRON ACER TENDL-2019 LIBRARY; T=293.16K
Photon emission for (n,p α)

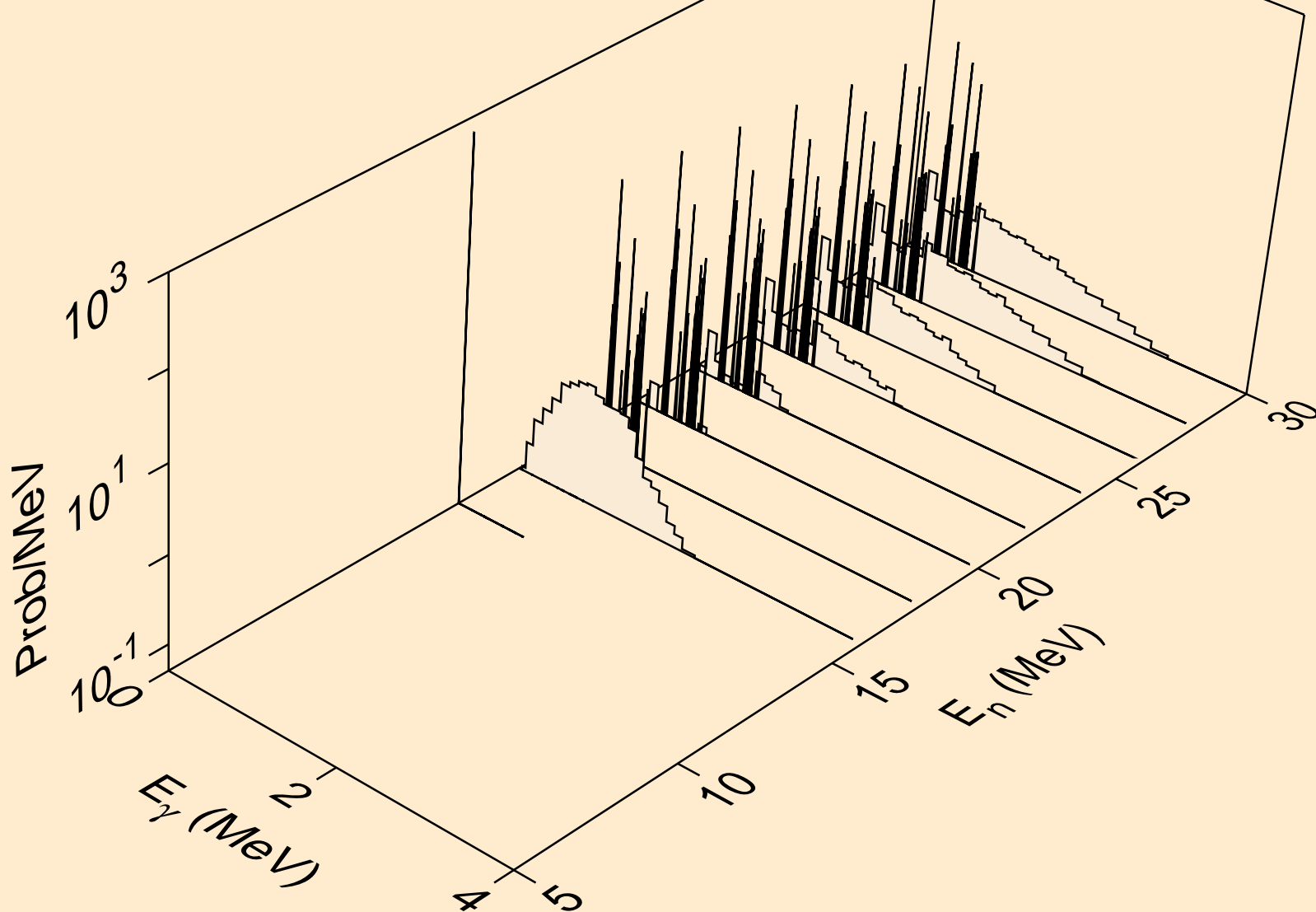

IN118N NEUTRON ACER TENDL-2019 LIBRARY; T=293.16K
Photon emission for (n,pd)

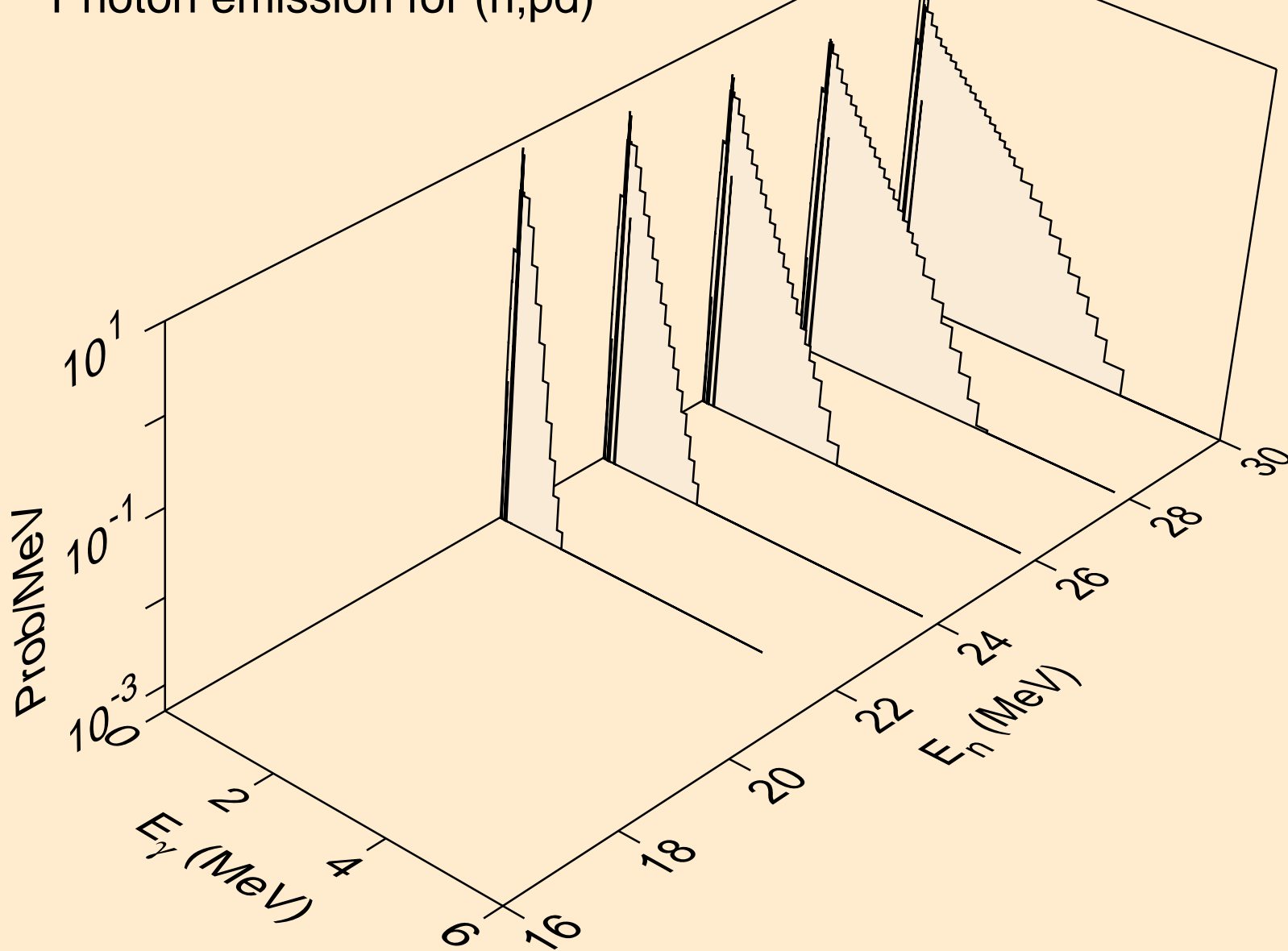

IN118N NEUTRON ACER TENDL-2019 LIBRARY; T=293.16K
Photon emission for (n,pt)

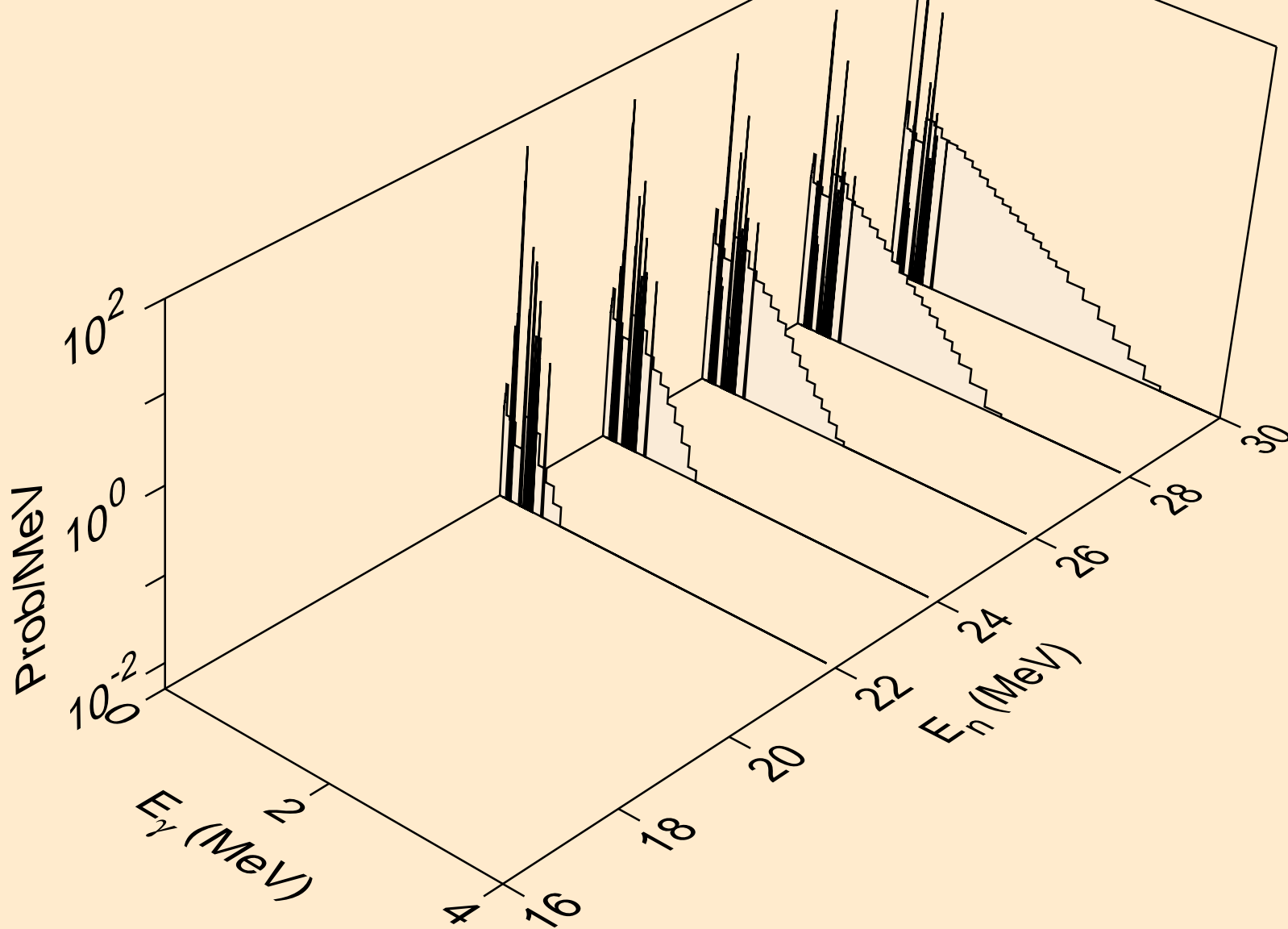

IN118N NEUTRON ACER TENDL-2019 LIBRARY; T=293.16K
thermal capture photon spectrum

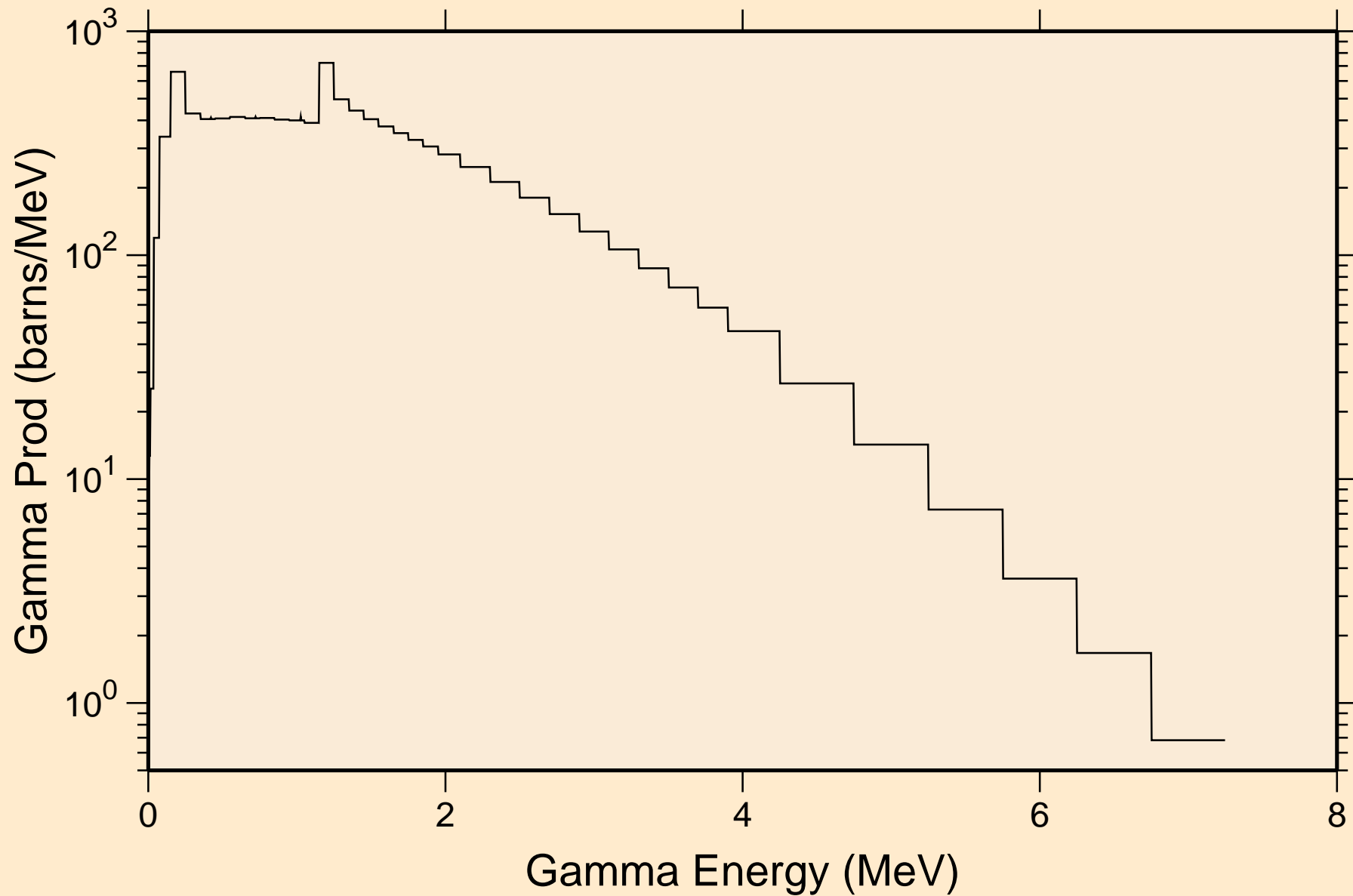

IN118N NEUTRON ACER TENDL-2019 LIBRARY; T=293.16K
14 MeV photon spectrum

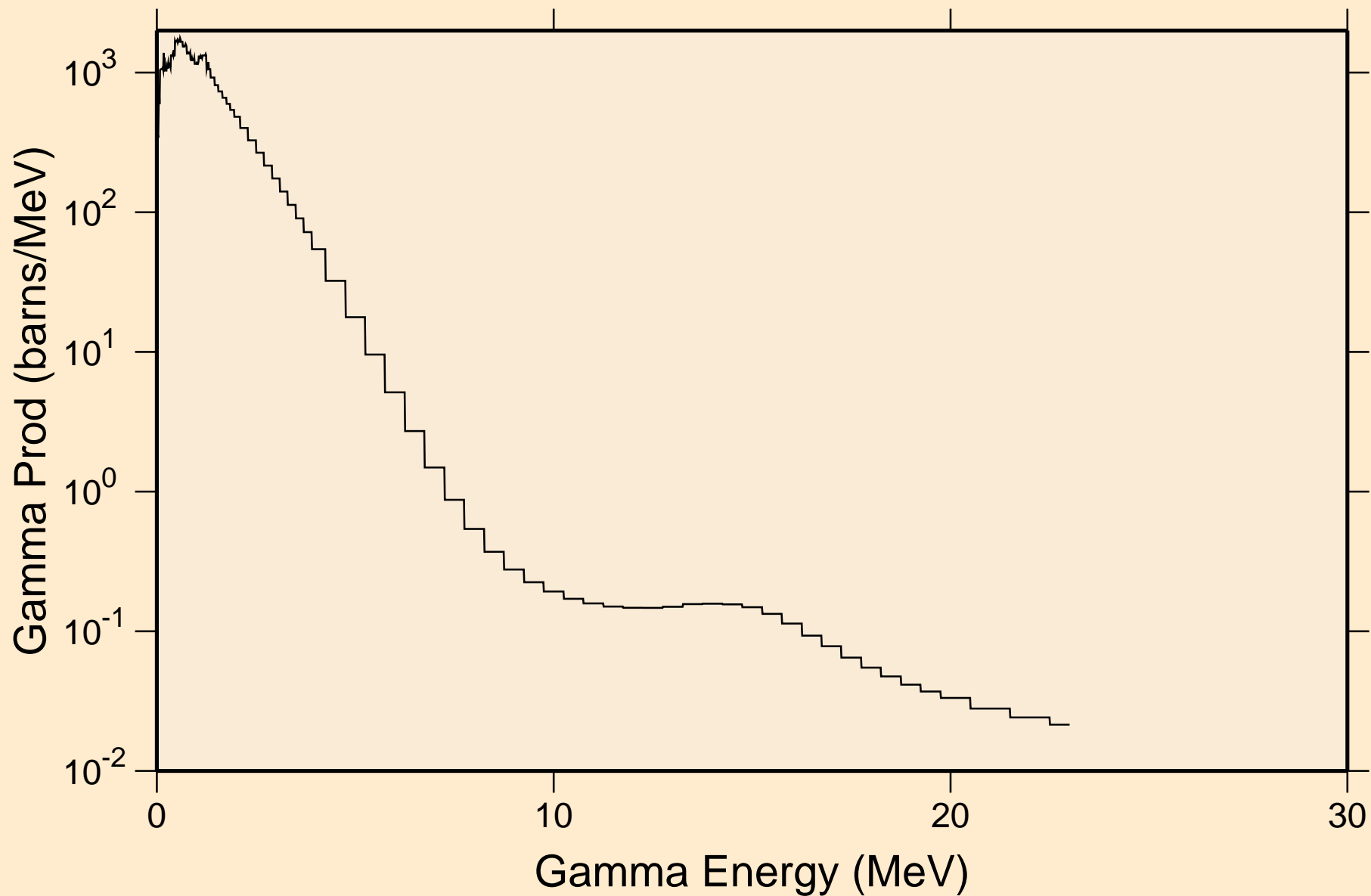

IN118N NEUTRON ACER TENDL-2019 LIBRARY; T=293.16K

Particle heating contributions

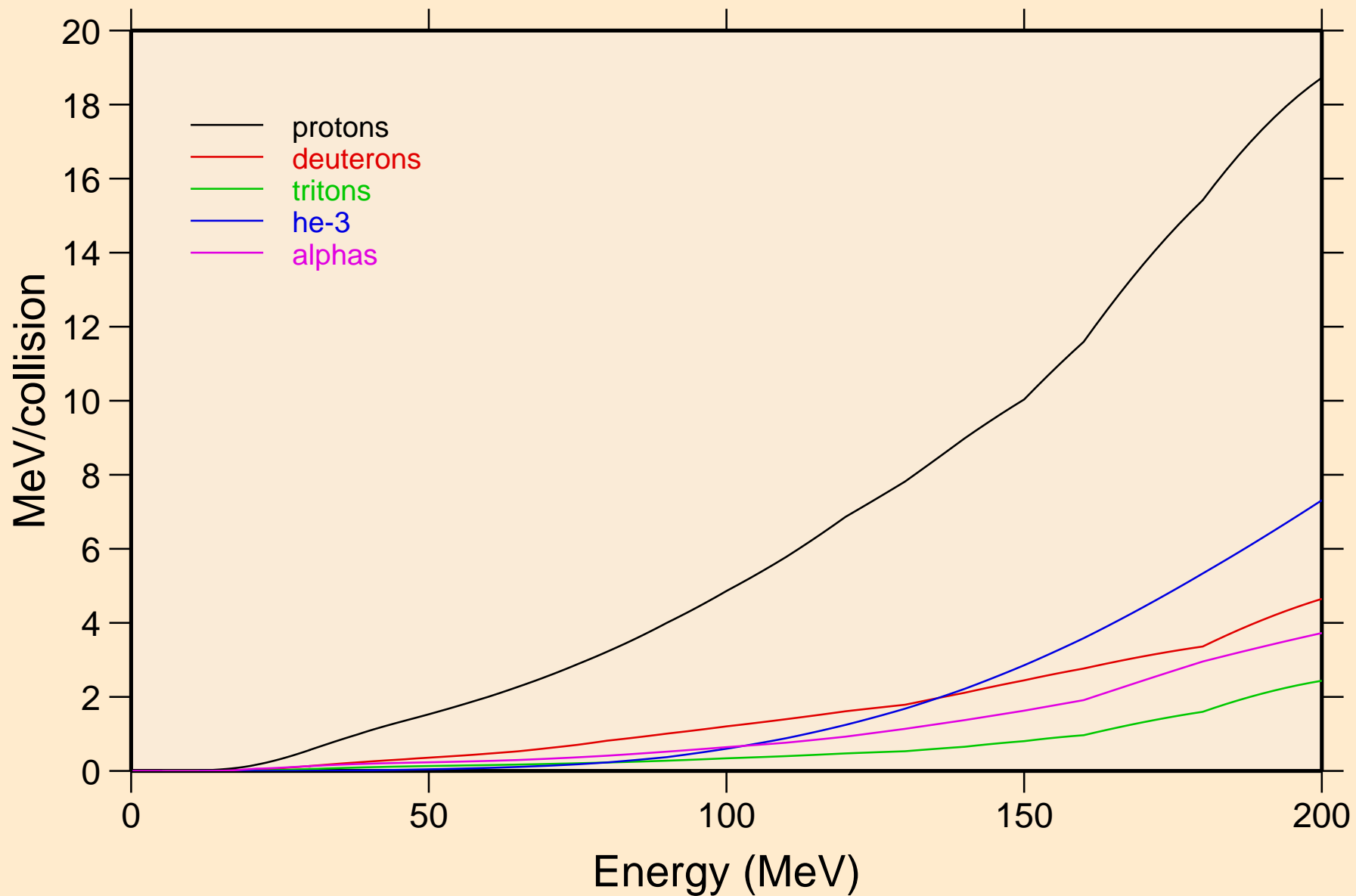

IN118N NEUTRON ACER TENDL-2019 LIBRARY; T=293.16K
Recoil Heating

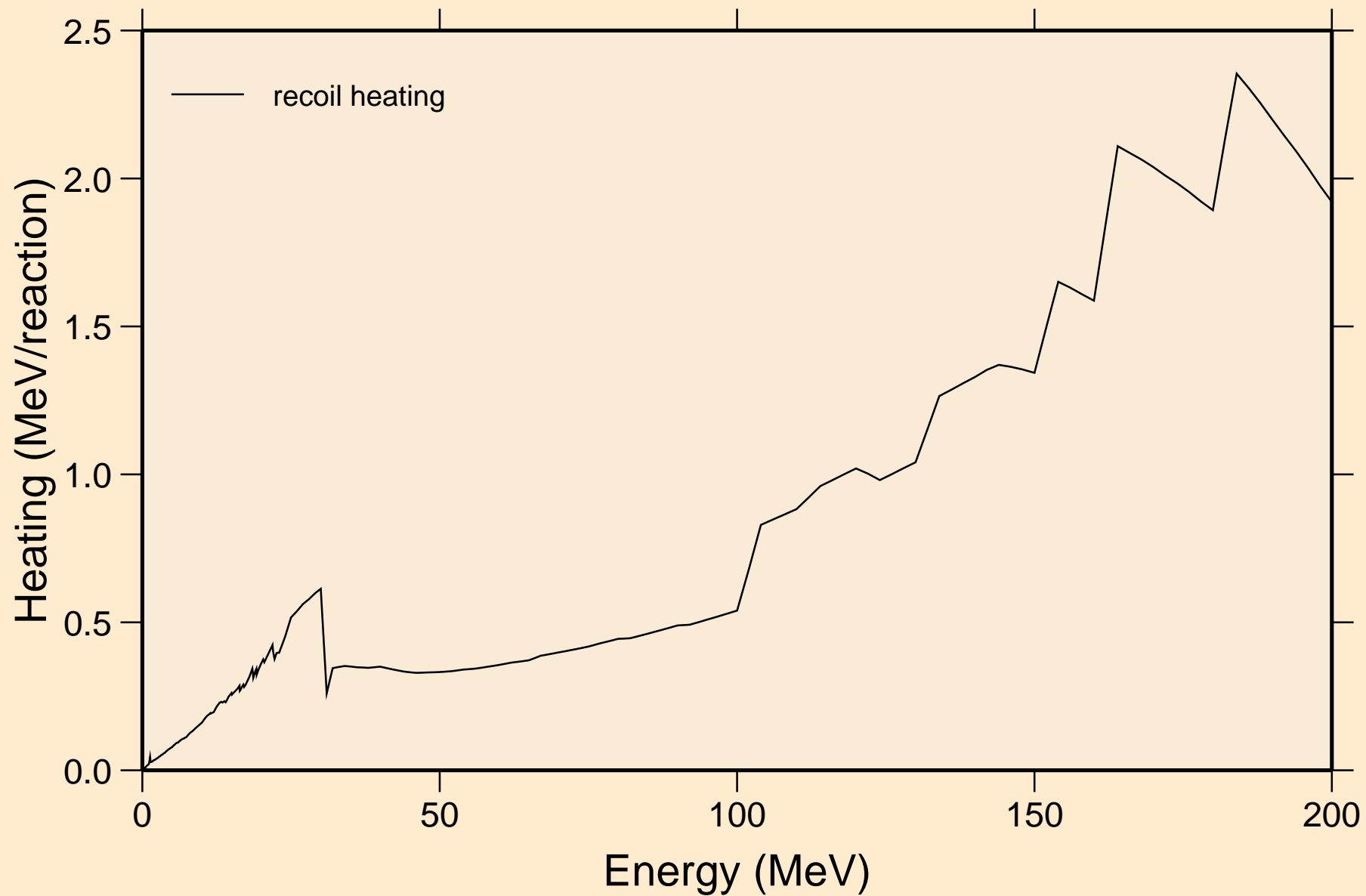

IN118N NEUTRON ACER TENDL-2019 LIBRARY; T=293.16K
Particle production cross sections

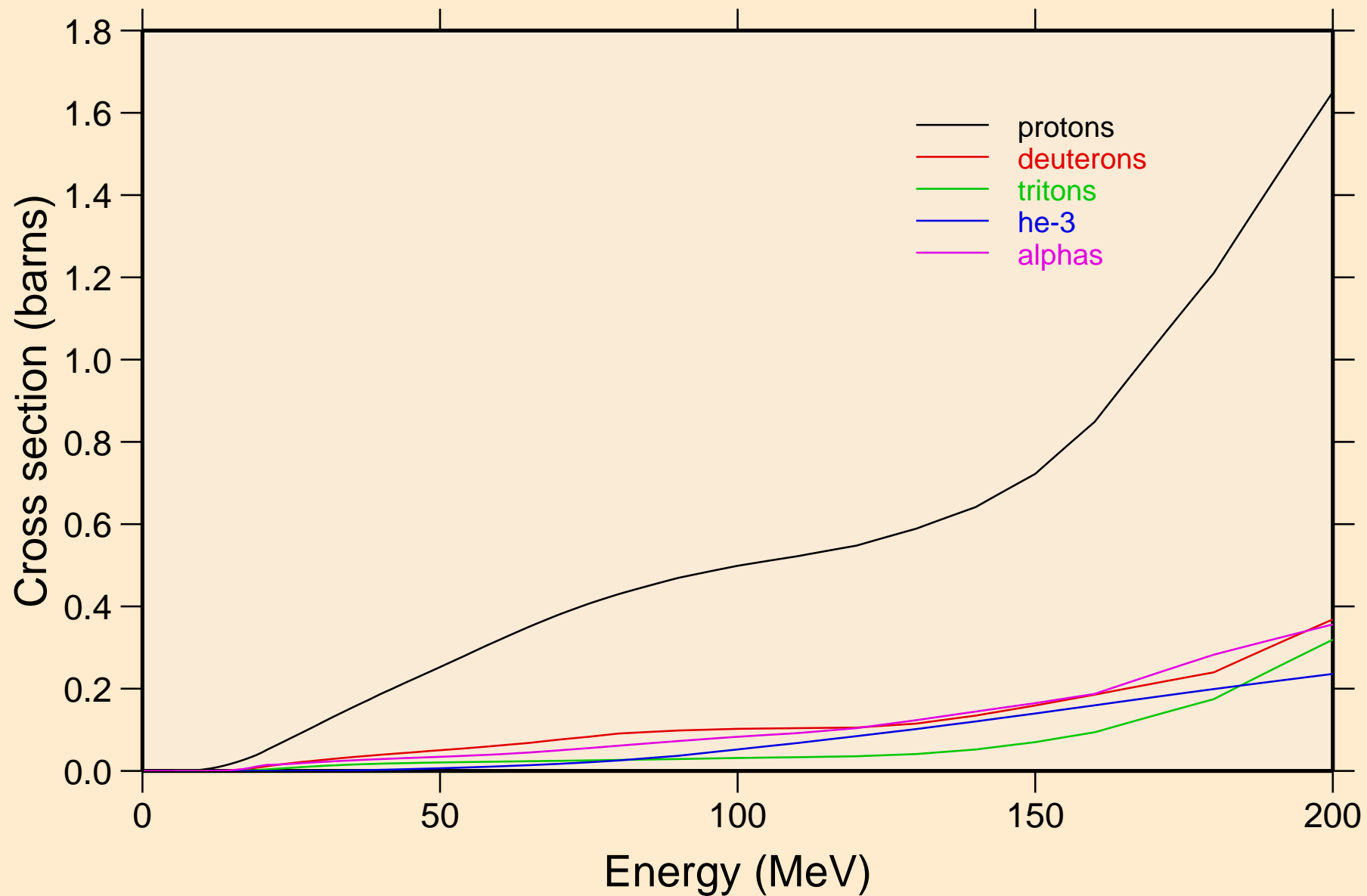

IN118N NEUTRON ACER TENDL-2019 LIBRARY; T=293.16K
protons from (n,x)

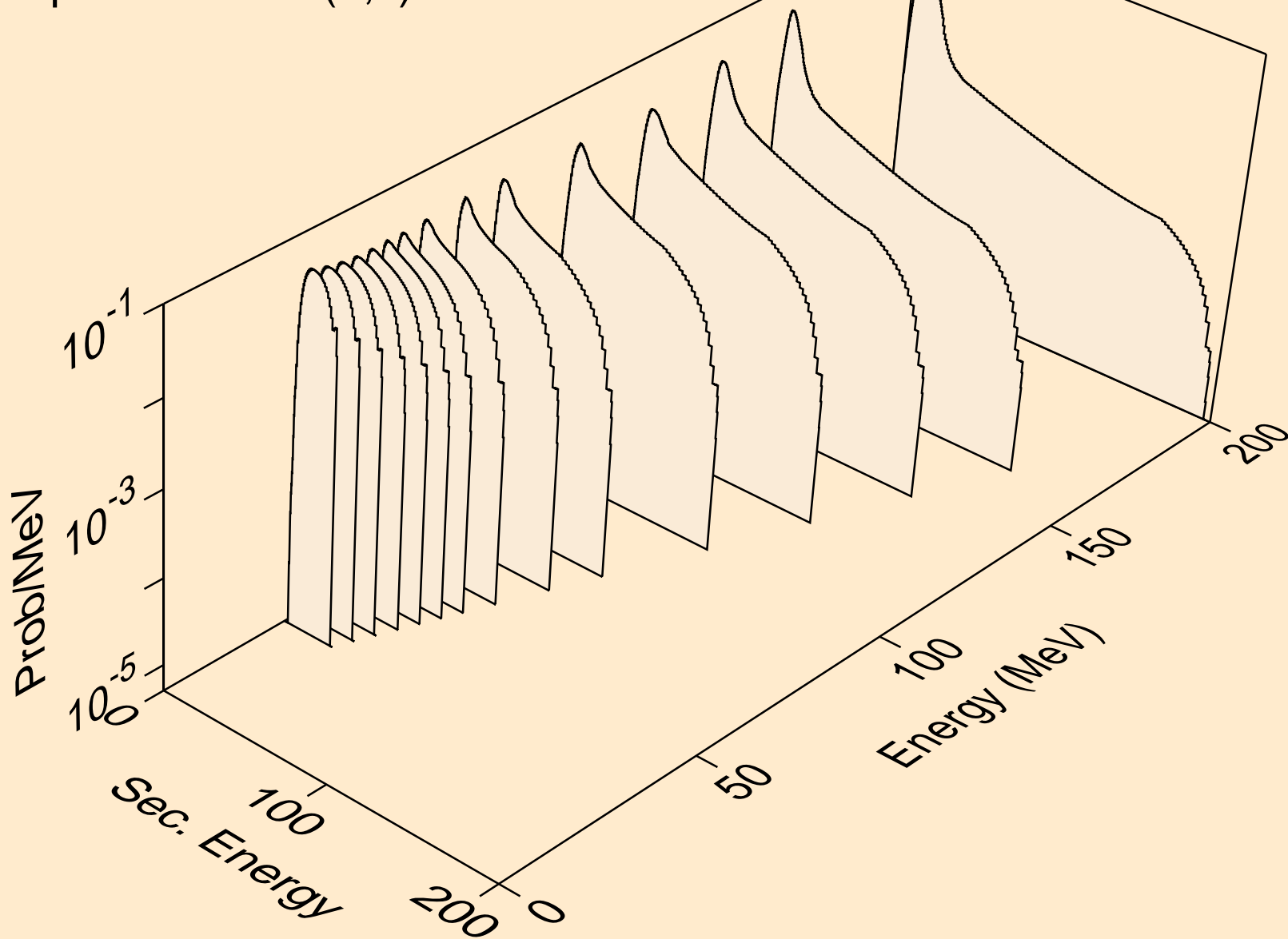

IN118N NEUTRON ACER TENDL-2019 LIBRARY; T=293.16K
protons from (n,n*)p

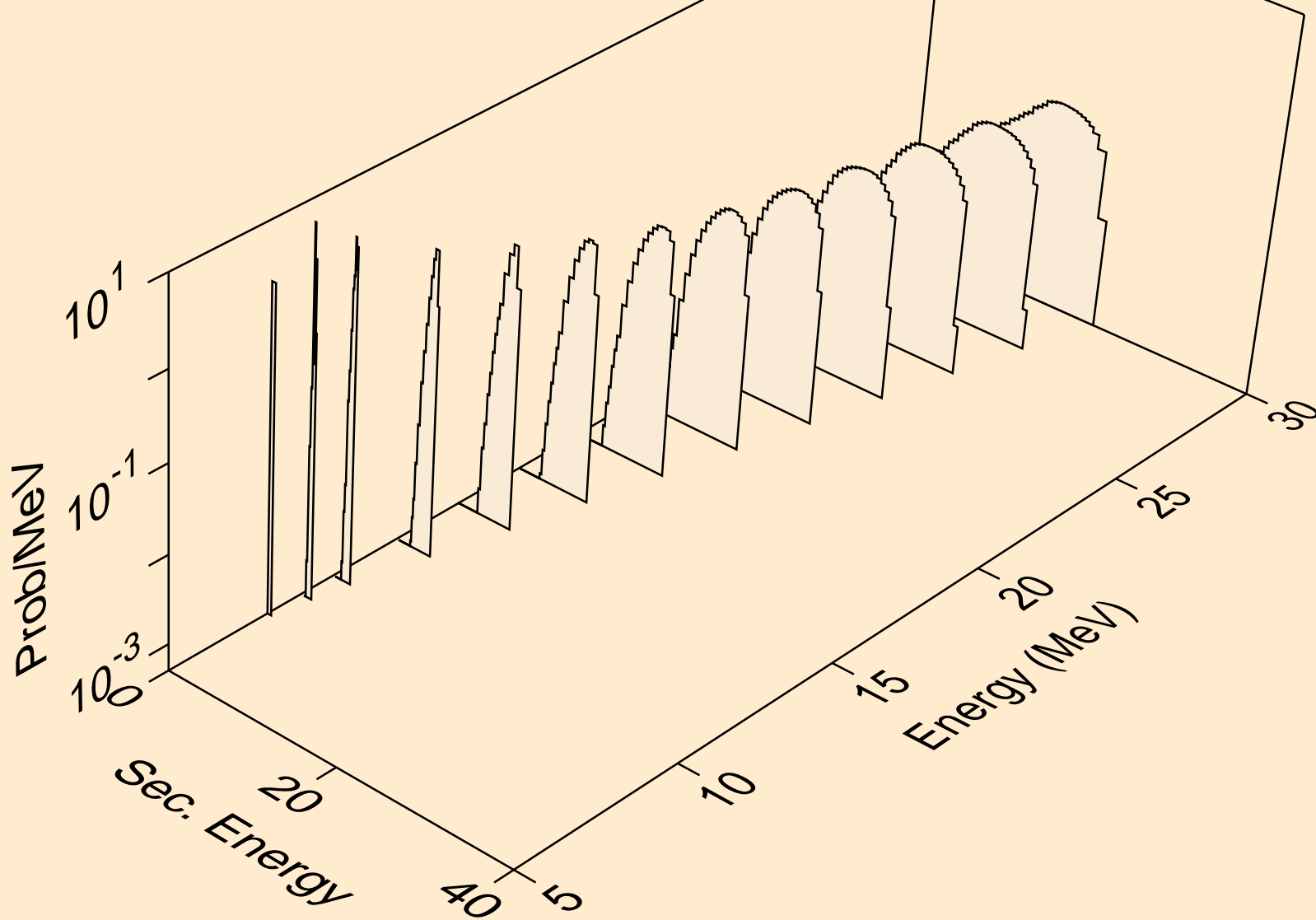

IN118N NEUTRON ACER TENDL-2019 LIBRARY; T=293.16K
protons from (n,2np)

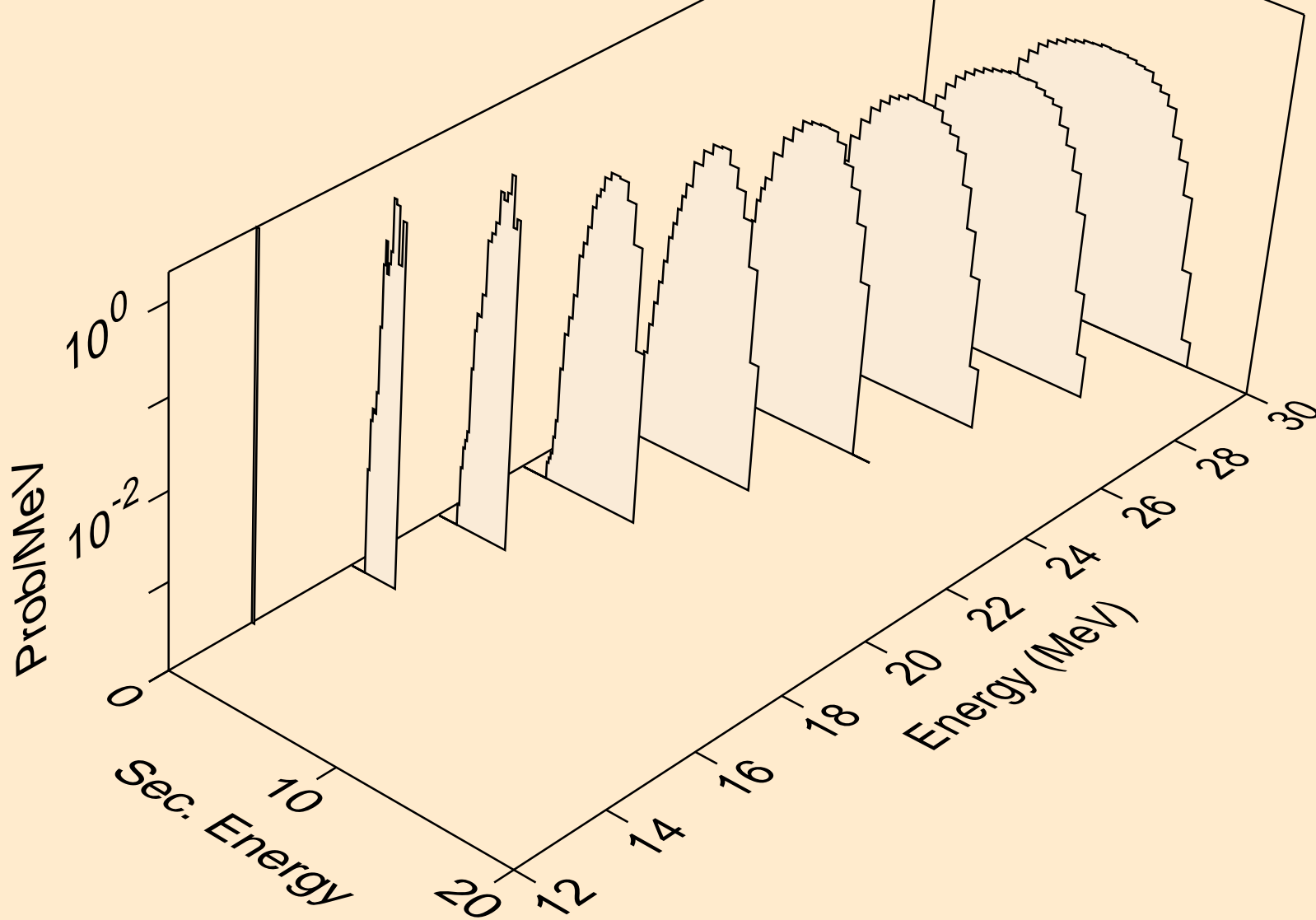

IN118N NEUTRON ACER TENDL-2019 LIBRARY; T=293.16K
protons from (n,3np)

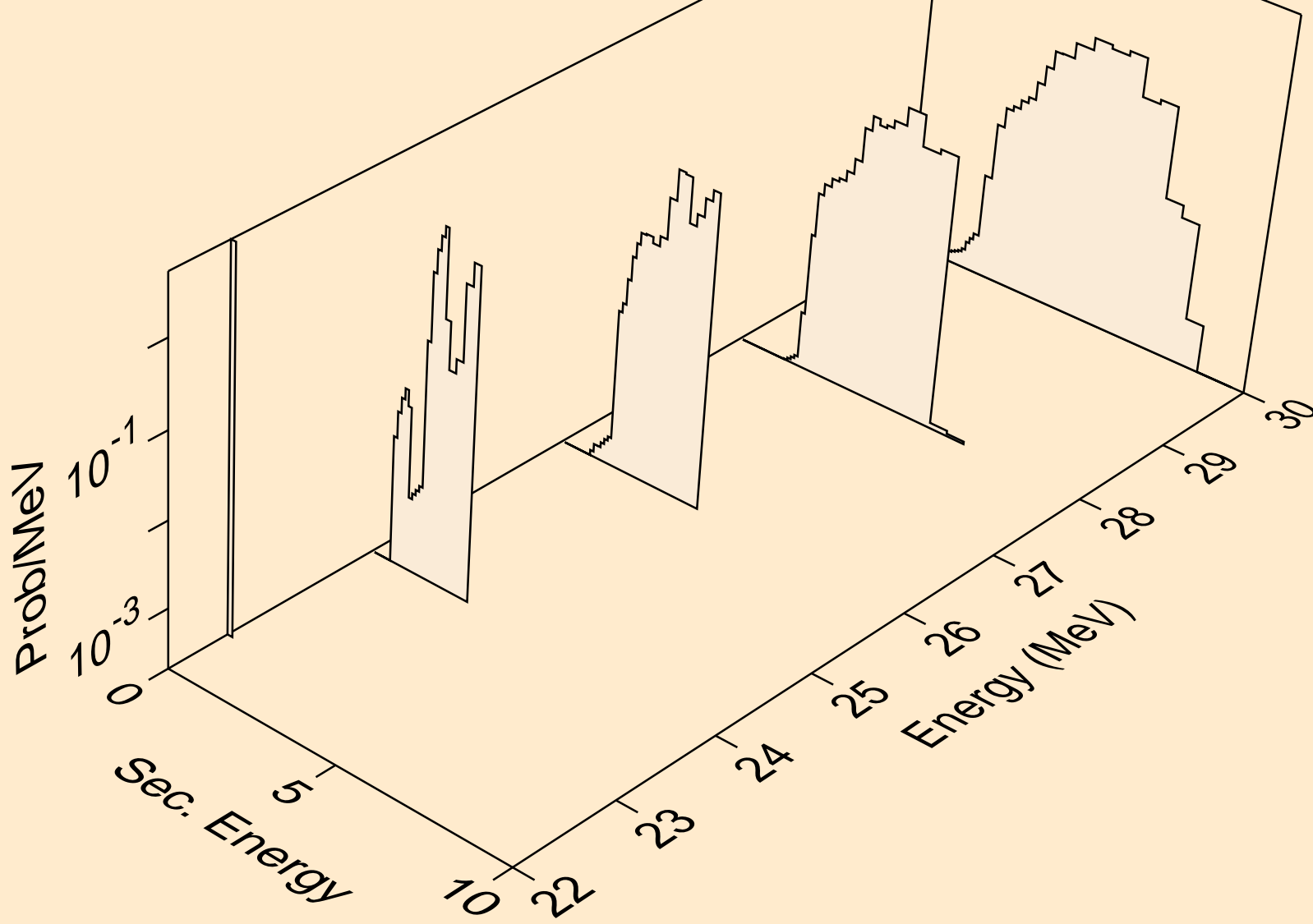

IN118N NEUTRON ACER TENDL-2019 LIBRARY; T=293.16K
protons from (n,2np)

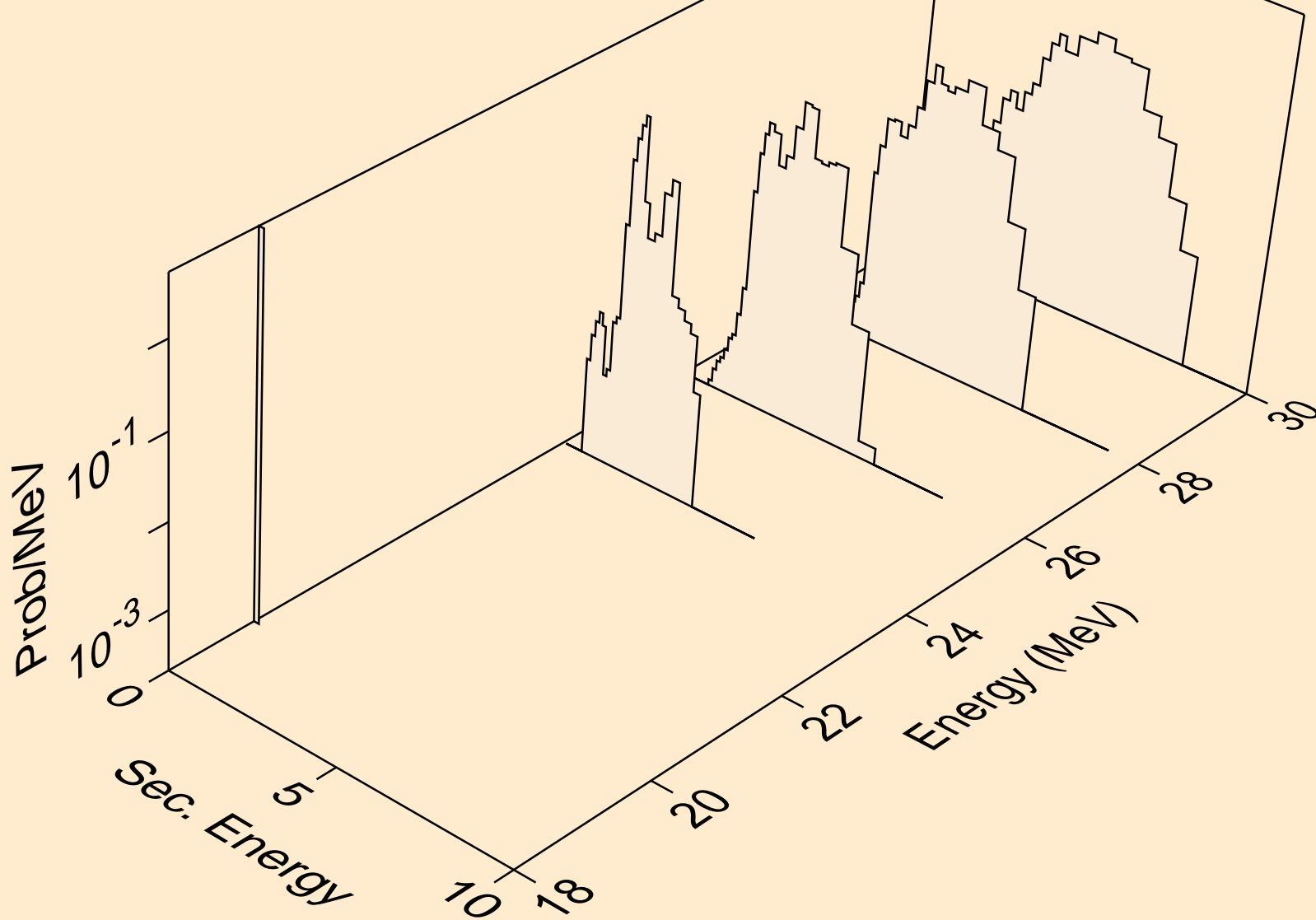

IN118N NEUTRON ACER TENDL-2019 LIBRARY; T=293.16K
protons from (n,npa)

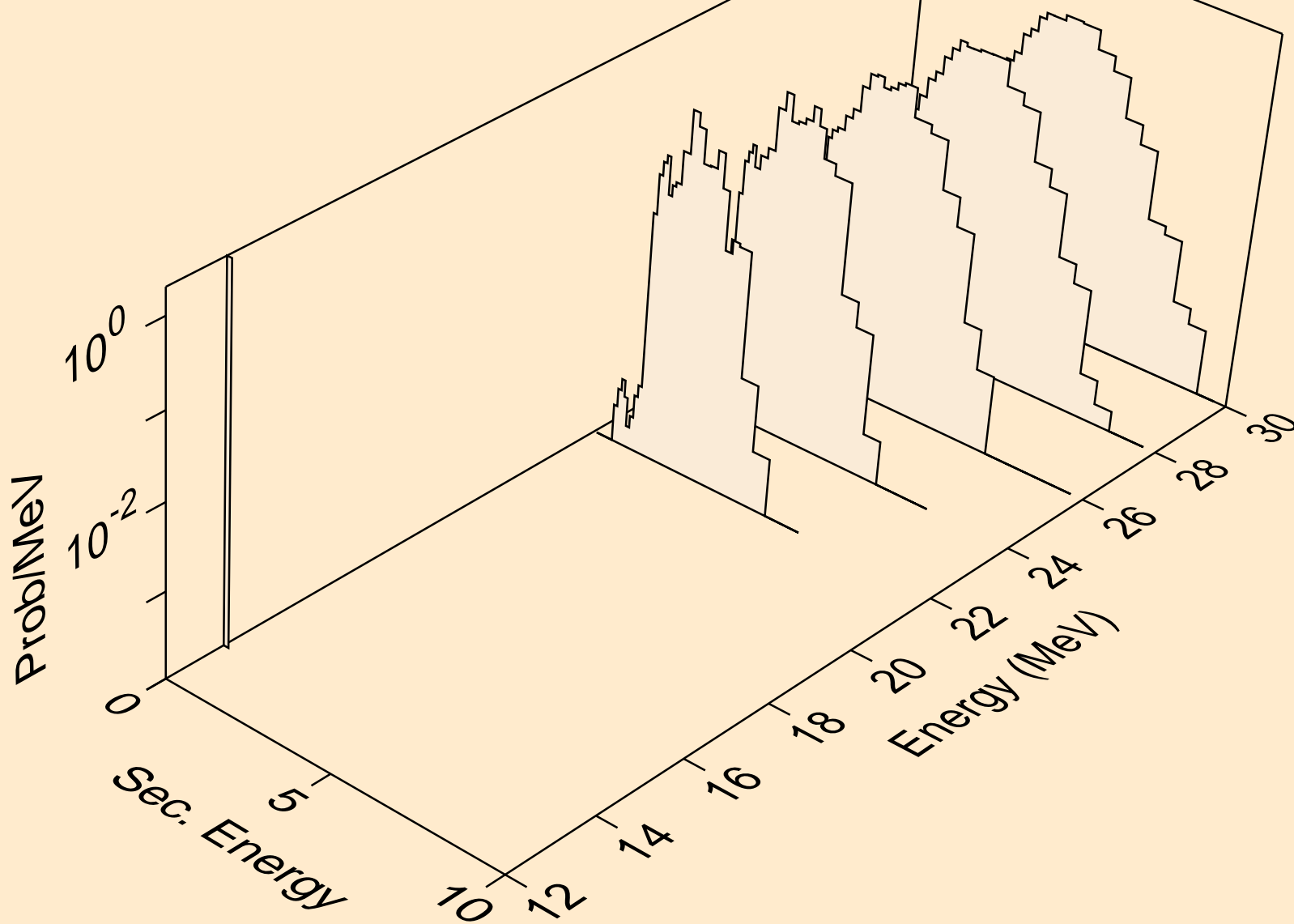

IN118N NEUTRON ACER TENDL-2019 LIBRARY; T=293.16K
protons from (n,p)

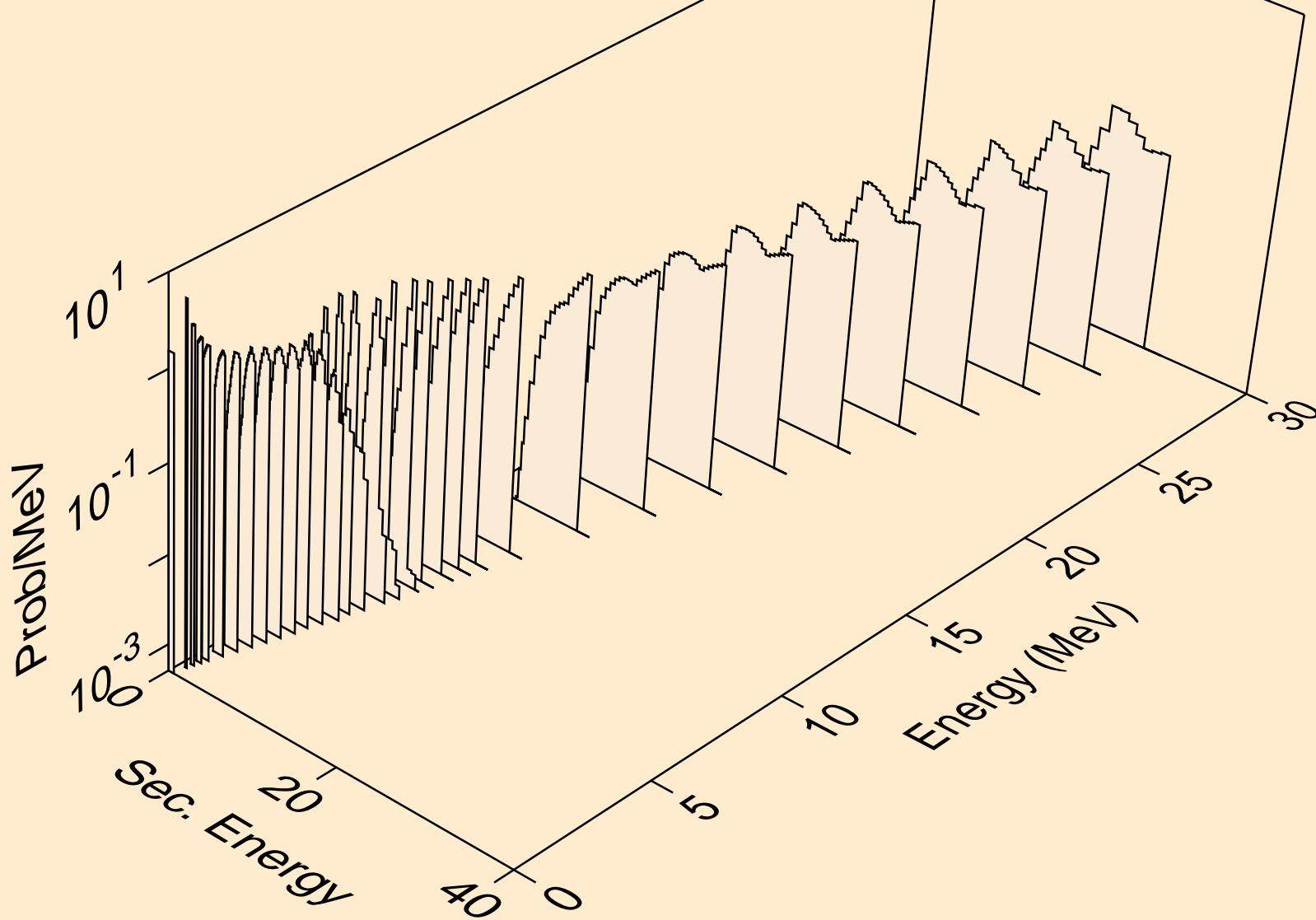

IN118N NEUTRON ACER TENDL-2019 LIBRARY; T=293.16K
protons from (n,2p)

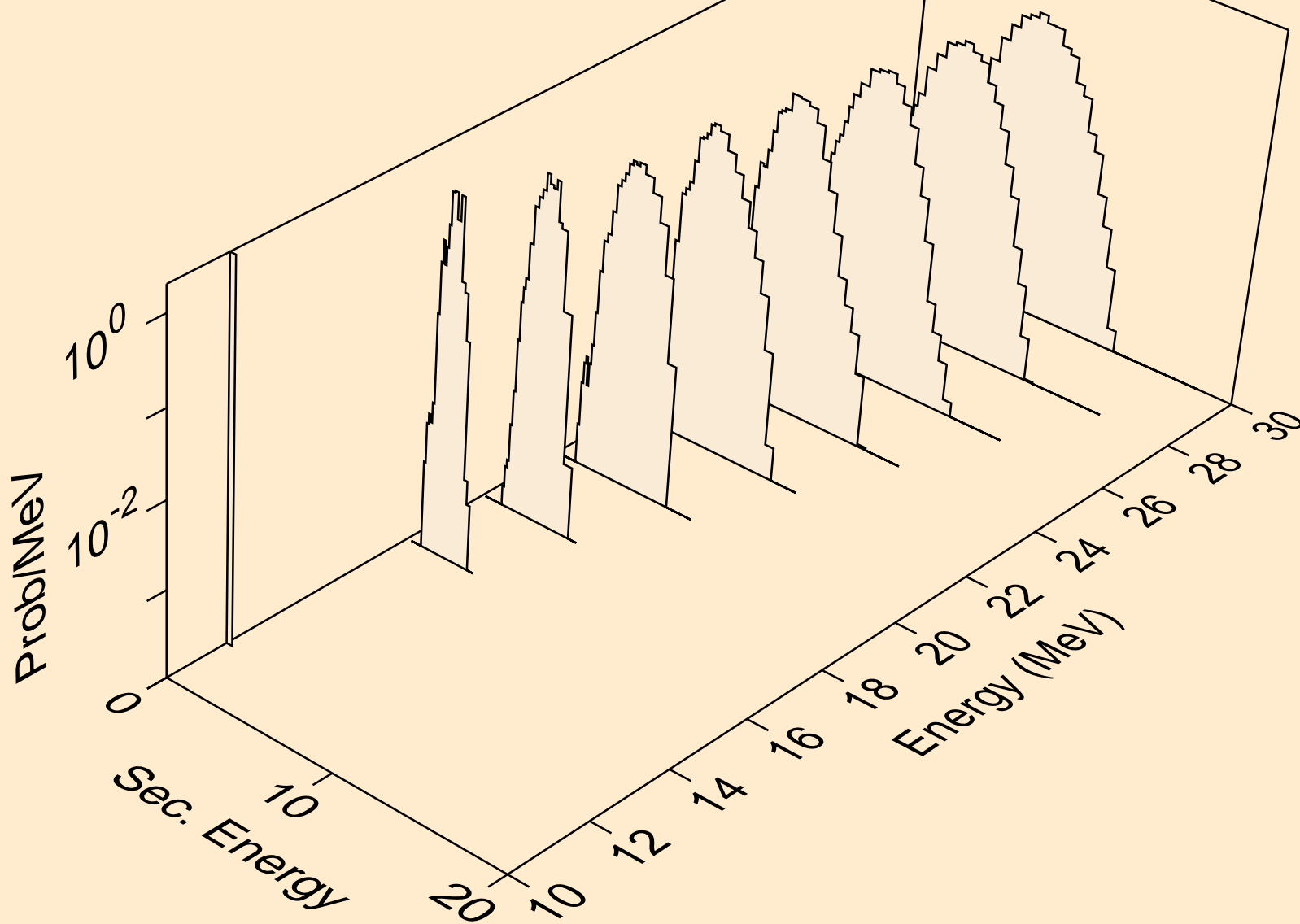

IN118N NEUTRON ACER TENDL-2019 LIBRARY; T=293.16K
protons from (n,p)

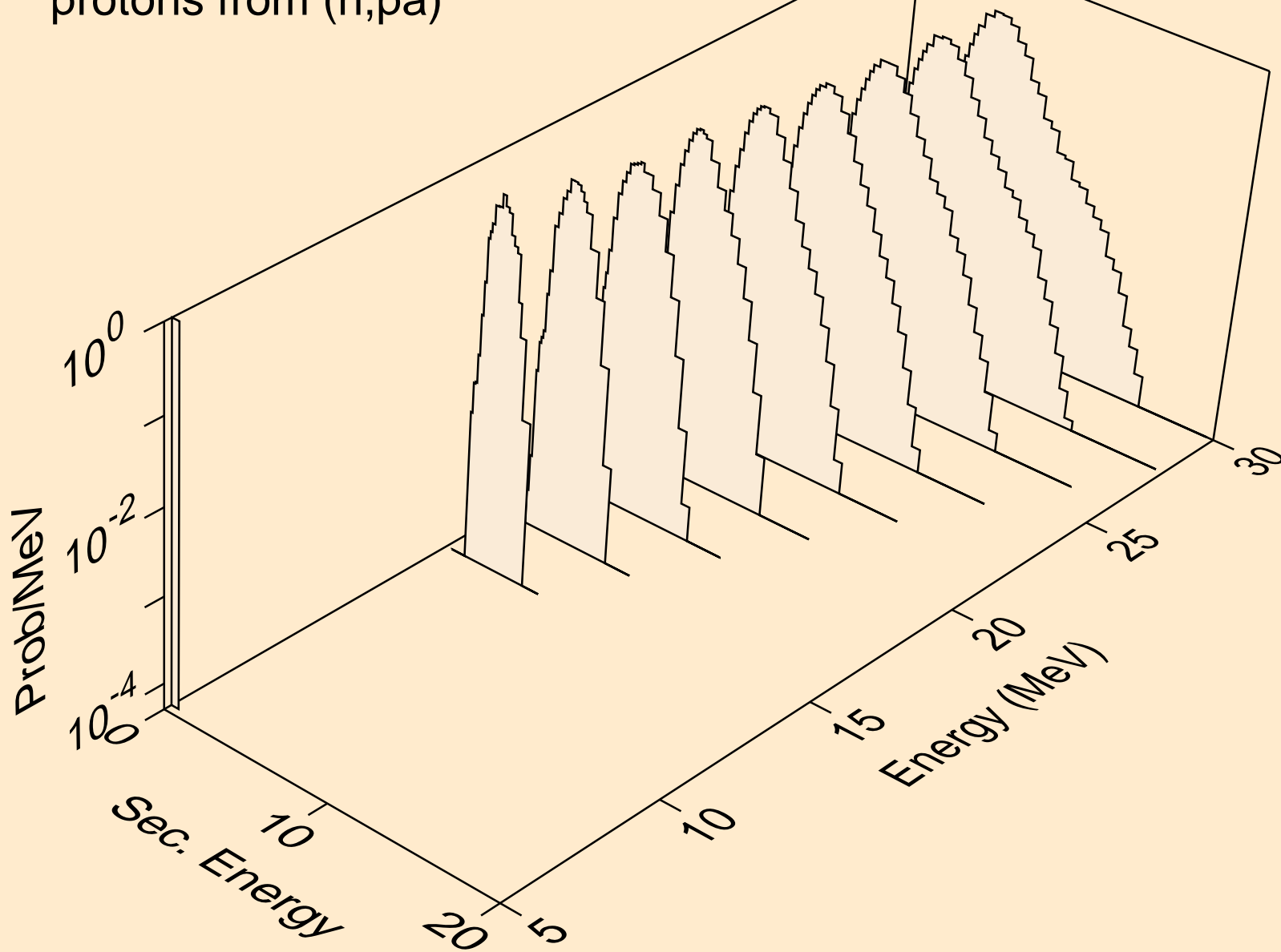

IN118N NEUTRON ACER TENDL-2019 LIBRARY; T=293.16K
protons from (n,pd)

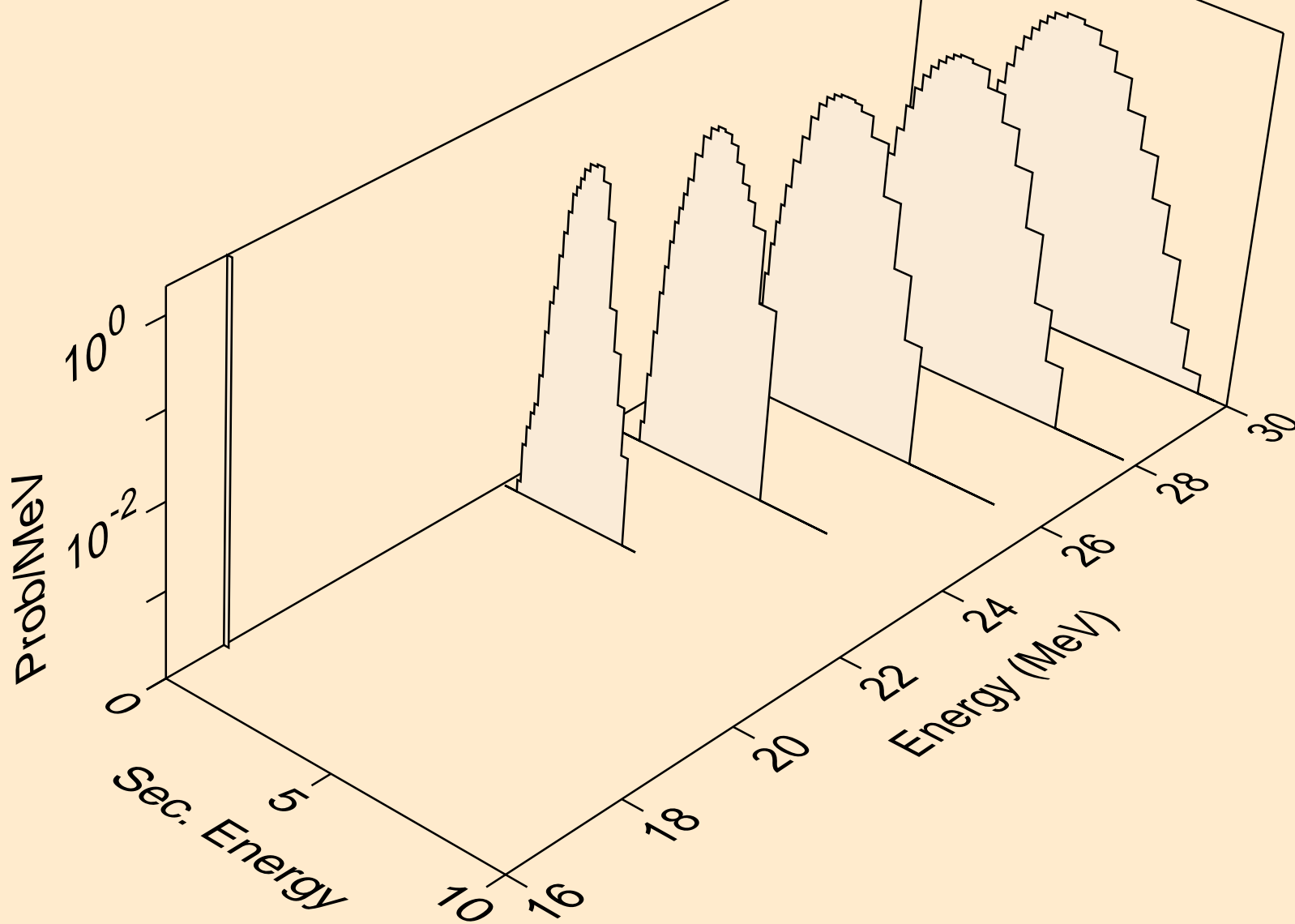

IN118N NEUTRON ACER TENDL-2019 LIBRARY; T=293.16K
protons from (n,pt)

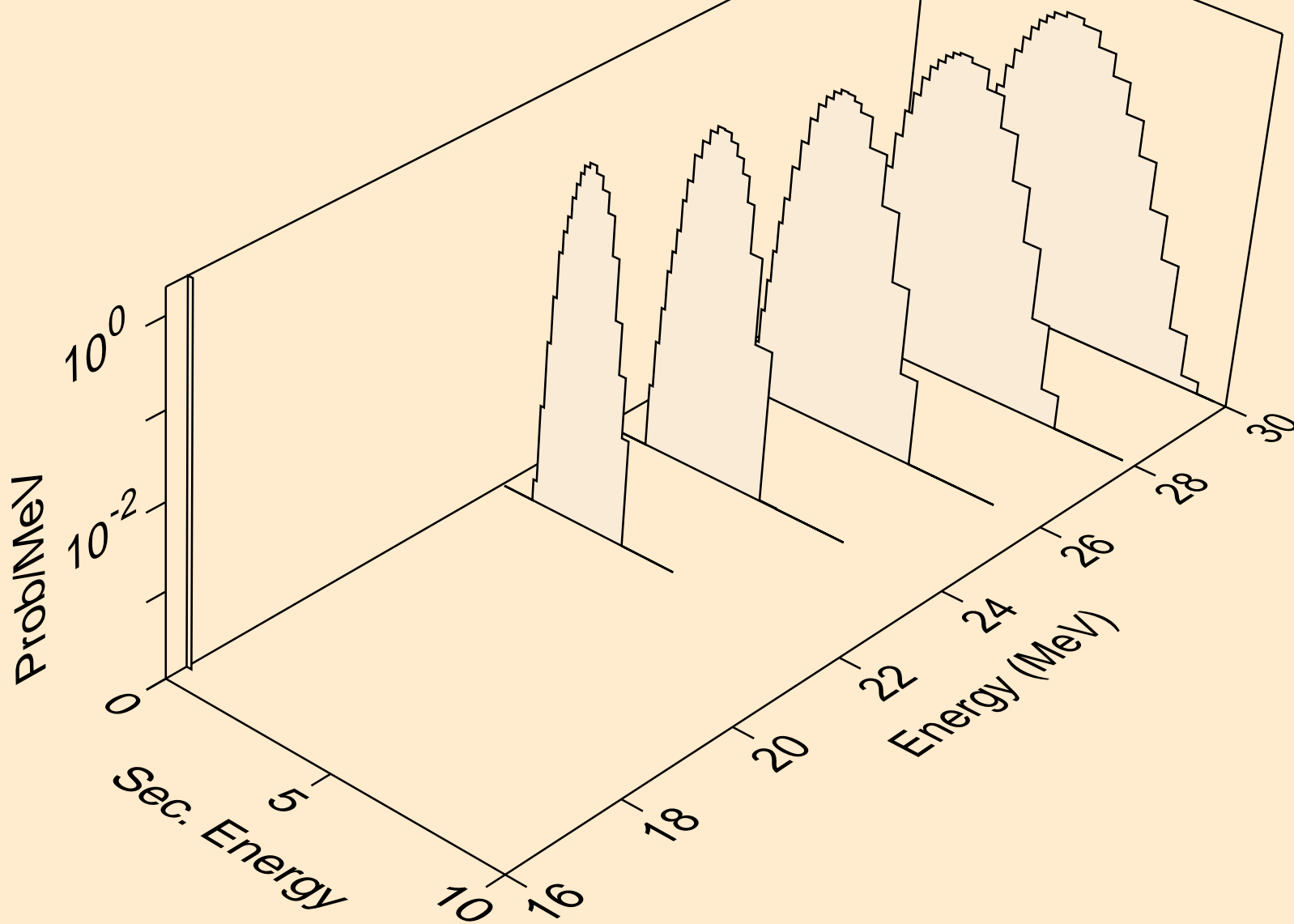

IN118N NEUTRON ACER TENDL-2019 LIBRARY; T=293.16K
deuterons from (n,x)

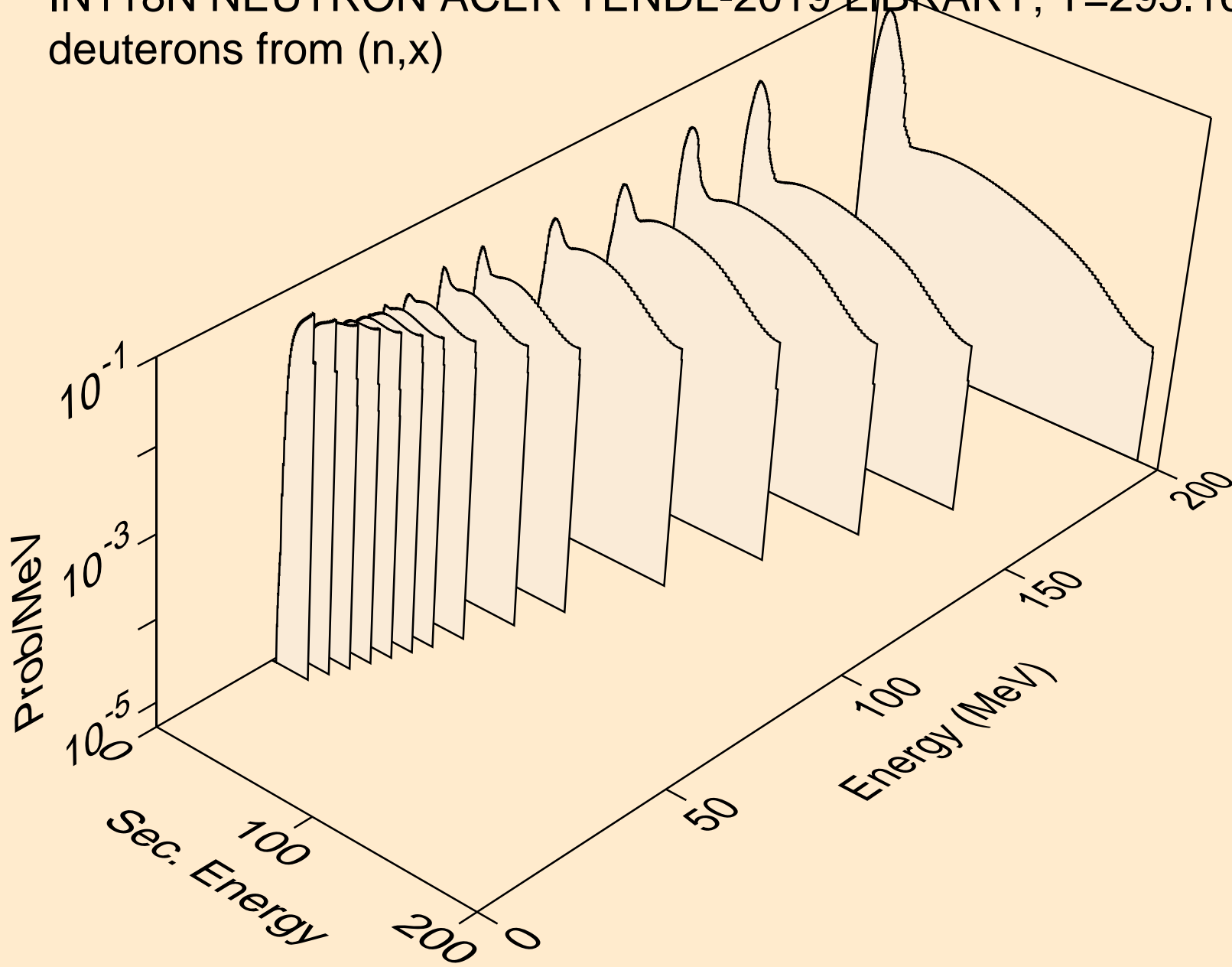

IN118N NEUTRON ACER TENDL-2019 LIBRARY; T=293.16K
deuterons from (n,2nd)

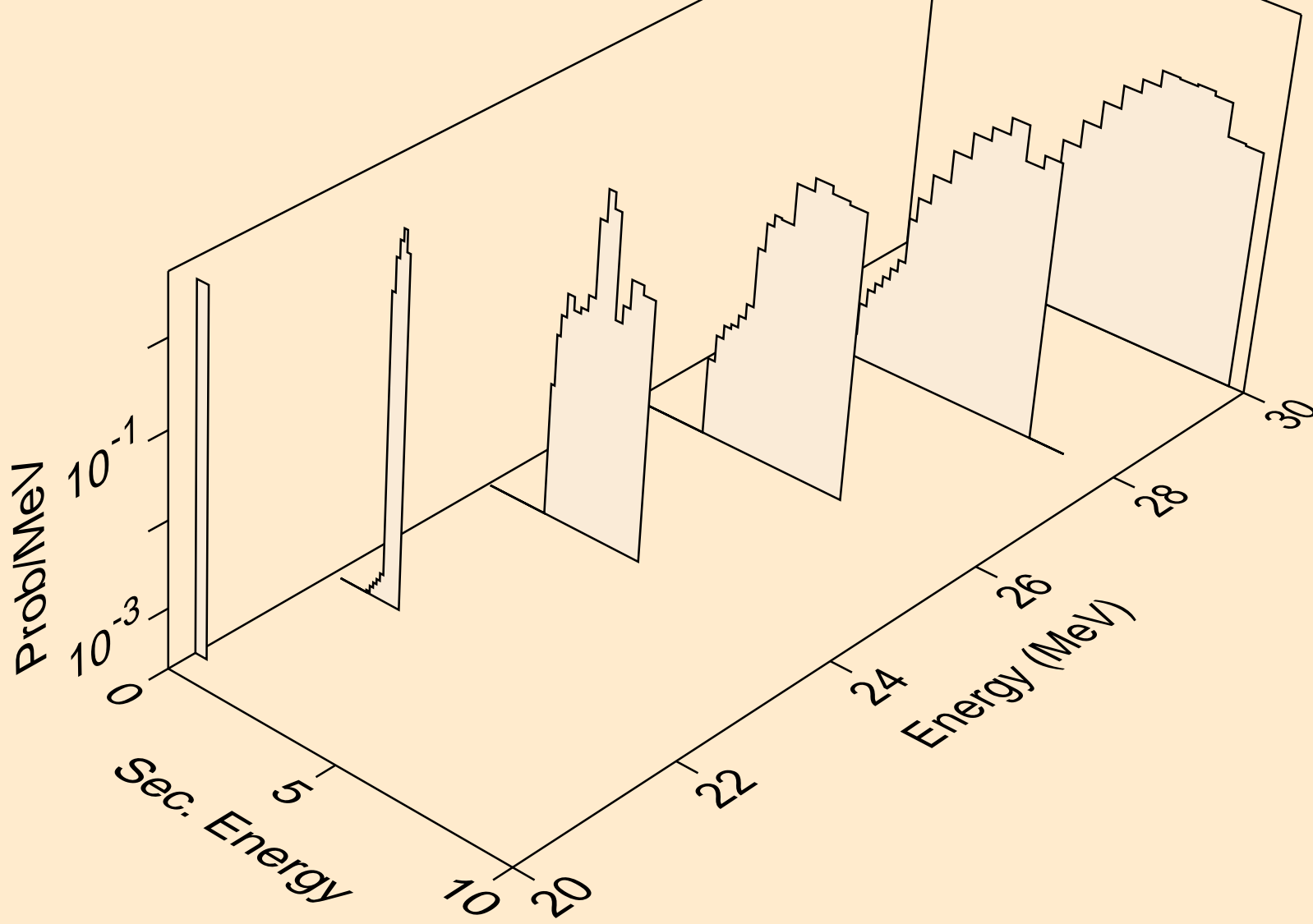

IN118N NEUTRON ACER TENDL-2019 LIBRARY; T=293.16K
deuterons from (n,n*)d

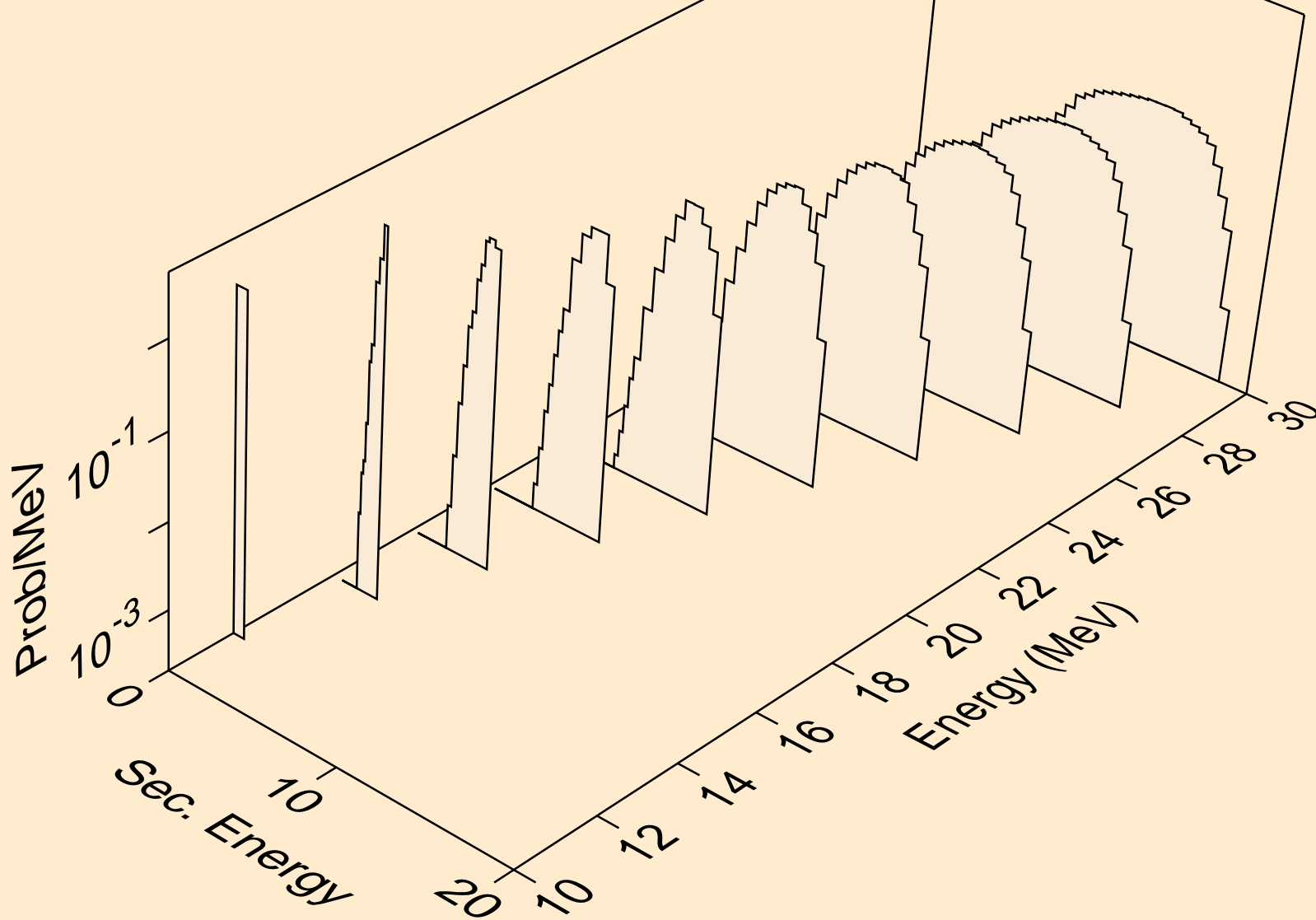

IN118N NEUTRON ACER TENDL-2019 LIBRARY; T=293.16K
deuterons from (n,d)

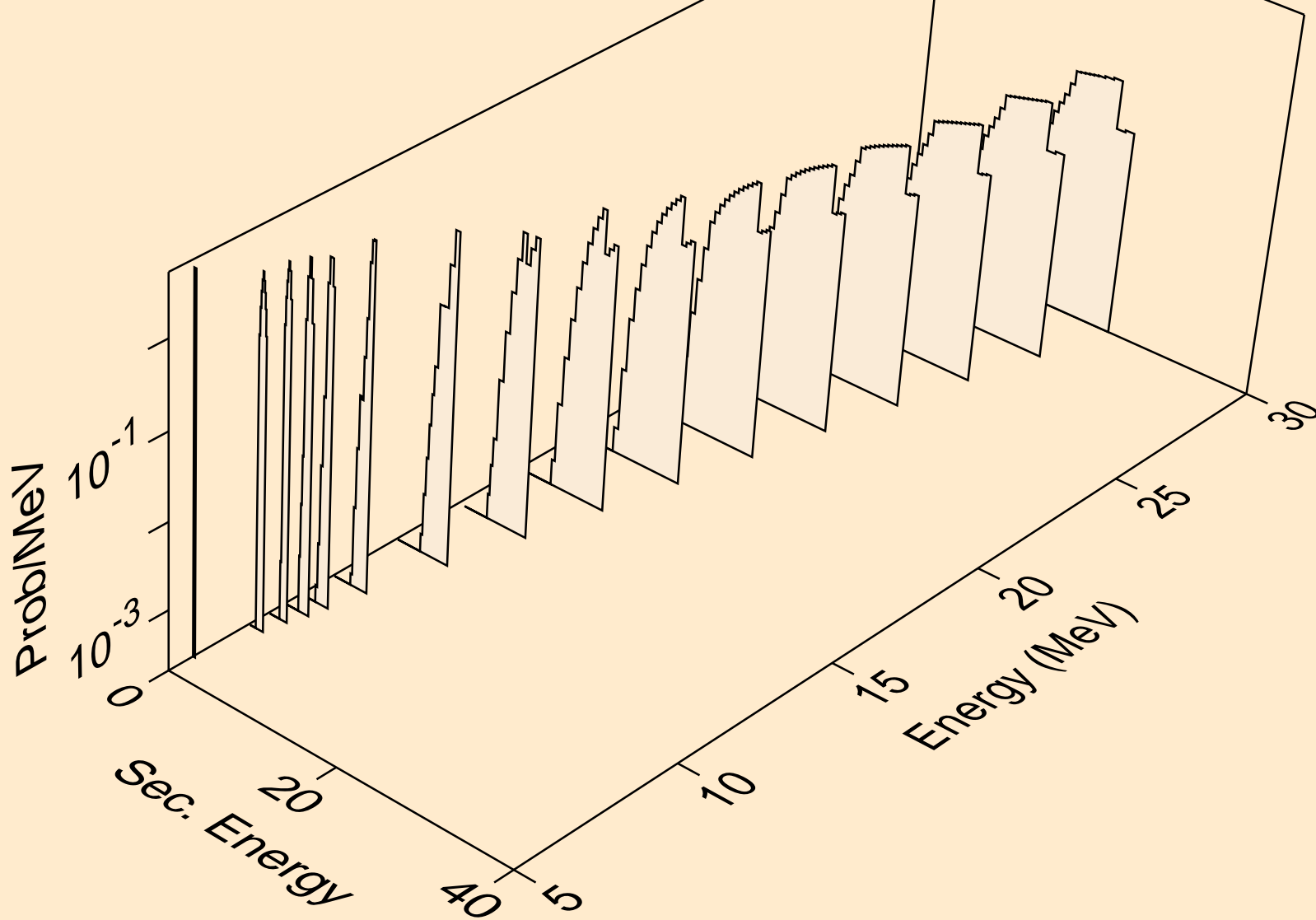

IN118N NEUTRON ACER TENDL-2019 LIBRARY; T=293.16K
deuterons from (n,pd)

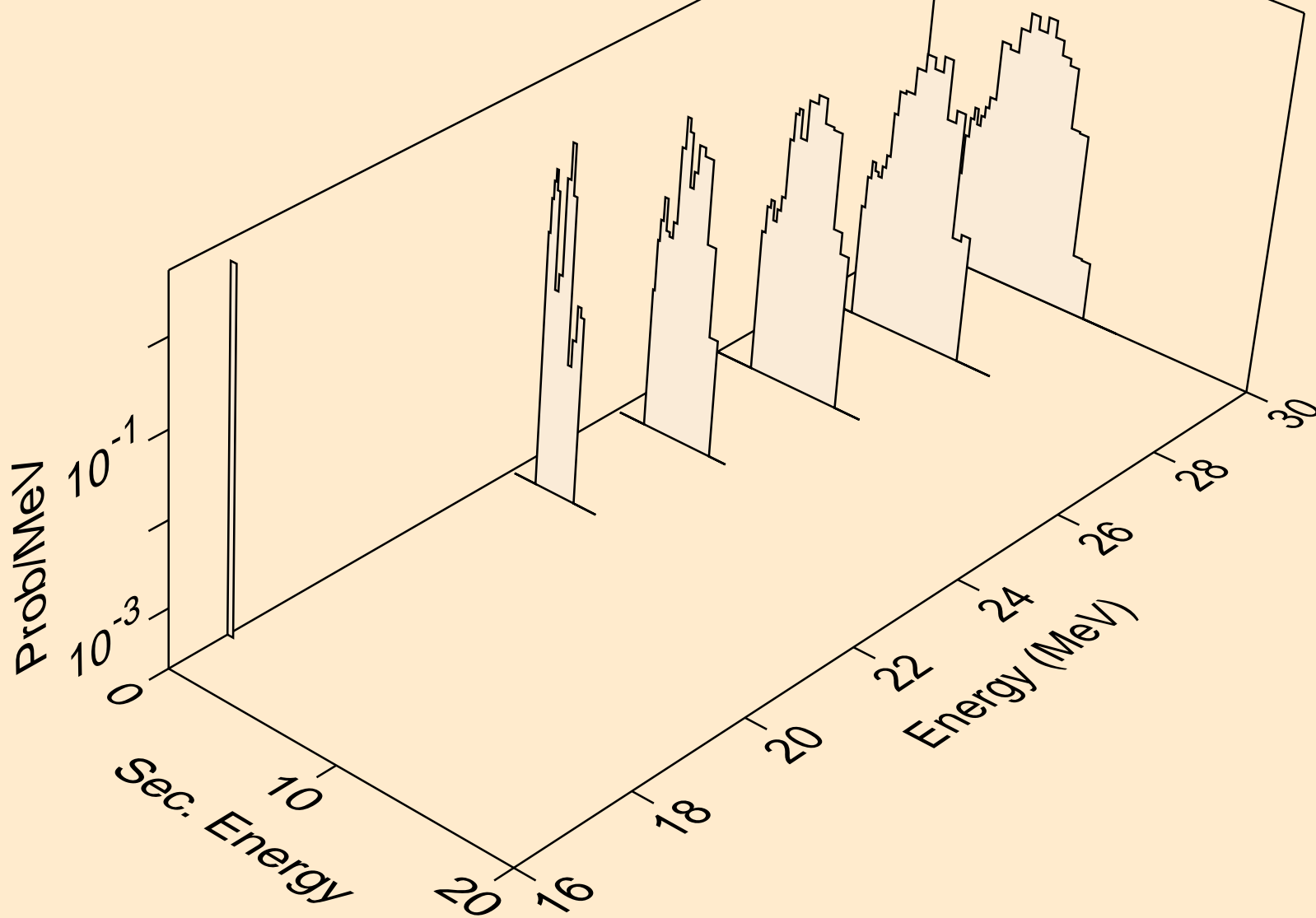

IN18N NEUTRON ACER TENDL-2019 LIBRARY; T=293.16K
tritons from (n,x)

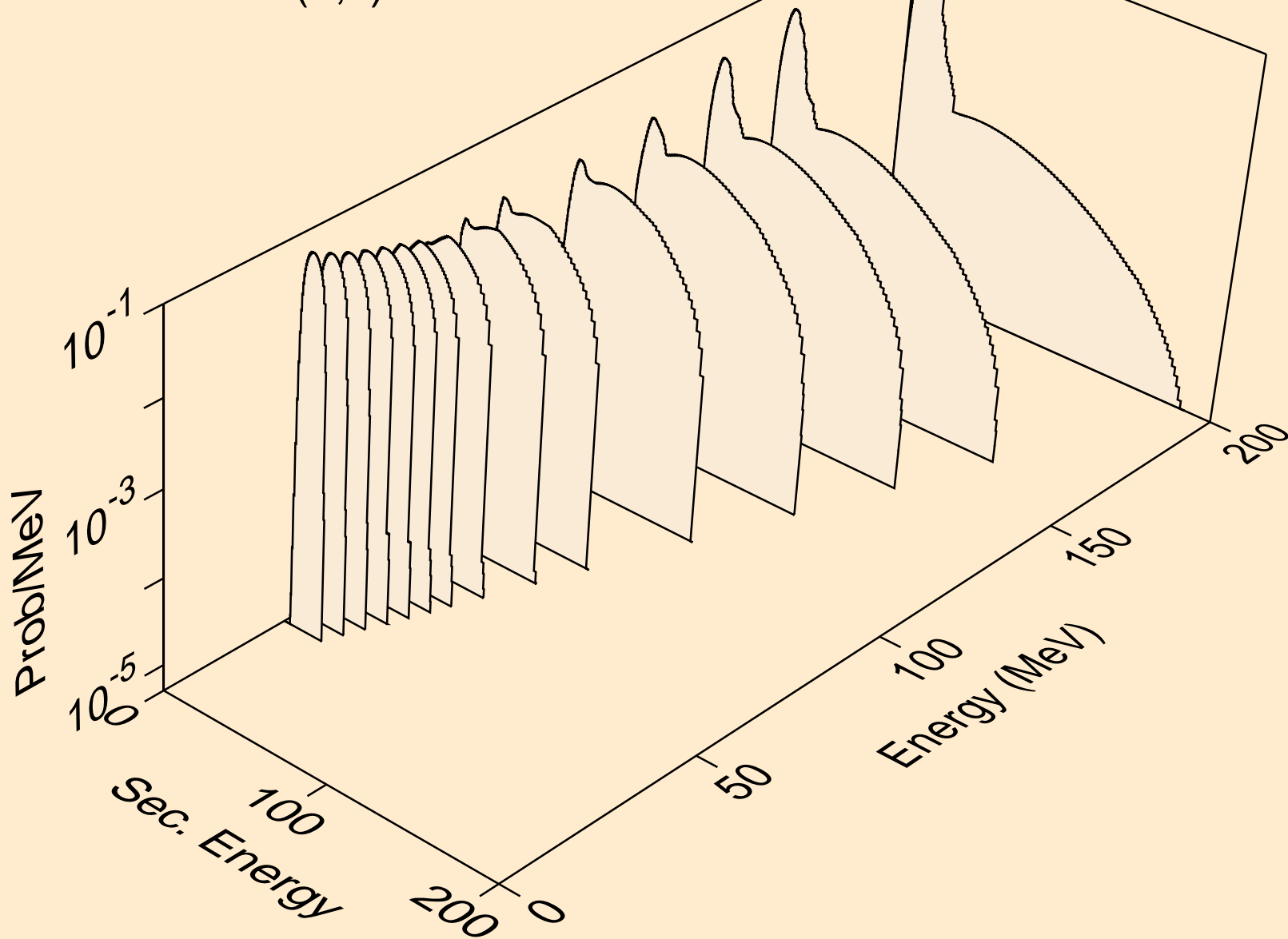

IN118N NEUTRON ACER TENDL-2019 LIBRARY; T=293.16K
tritons from (n,n*)t

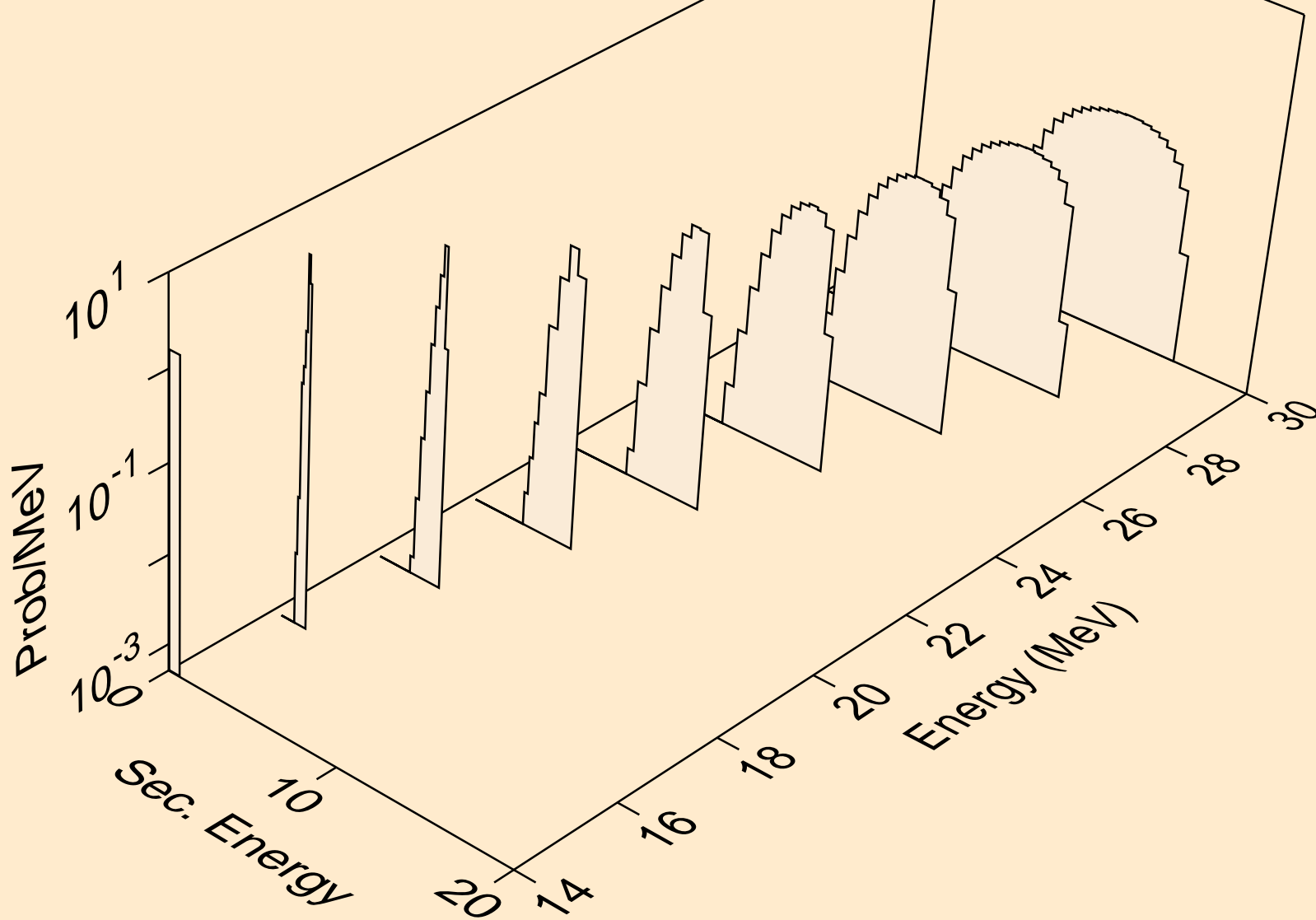

IN118N NEUTRON ACER TENDL-2019 LIBRARY; T=293.16K
tritons from (n,t)

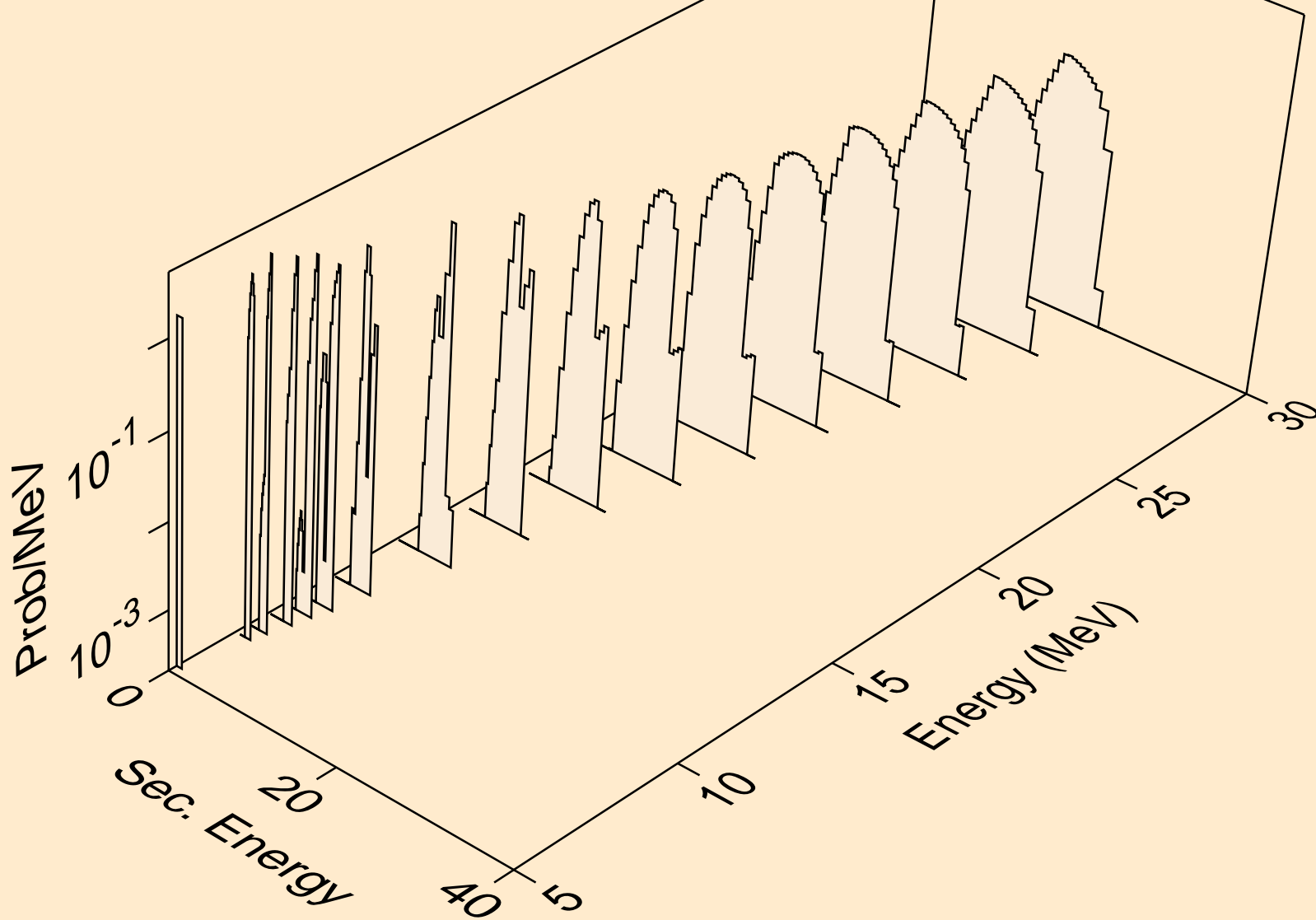

IN118N NEUTRON ACER TENDL-2019 LIBRARY; T=293.16K
tritons from (n,pt)

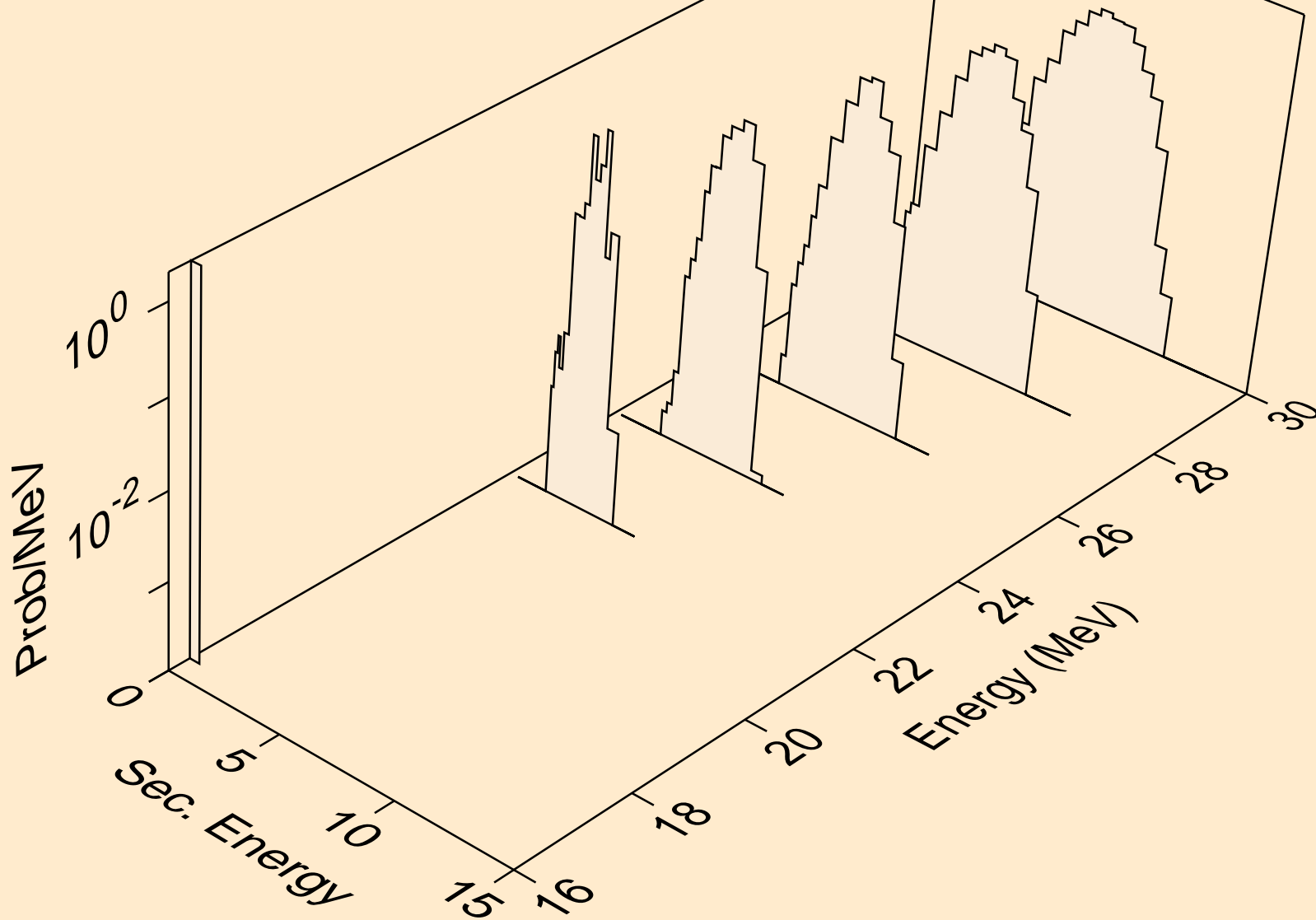

IN118N NEUTRON ACER TENDL-2019 LIBRARY; T=293.16K
he3s from (n,x)

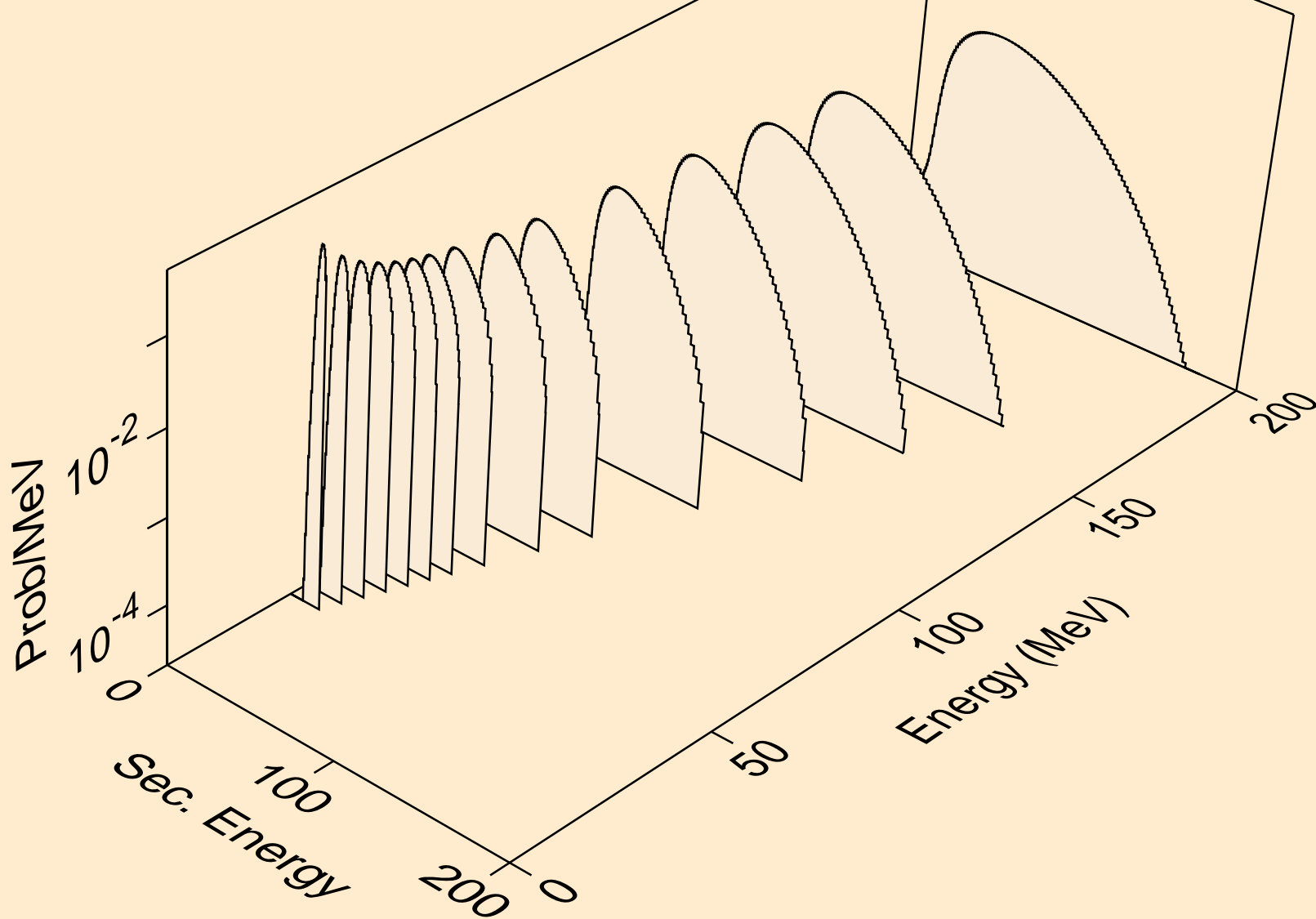

IN118N NEUTRON ACER TENDL-2019 LIBRARY; T=293.16K
he3s from (n,n*)he3

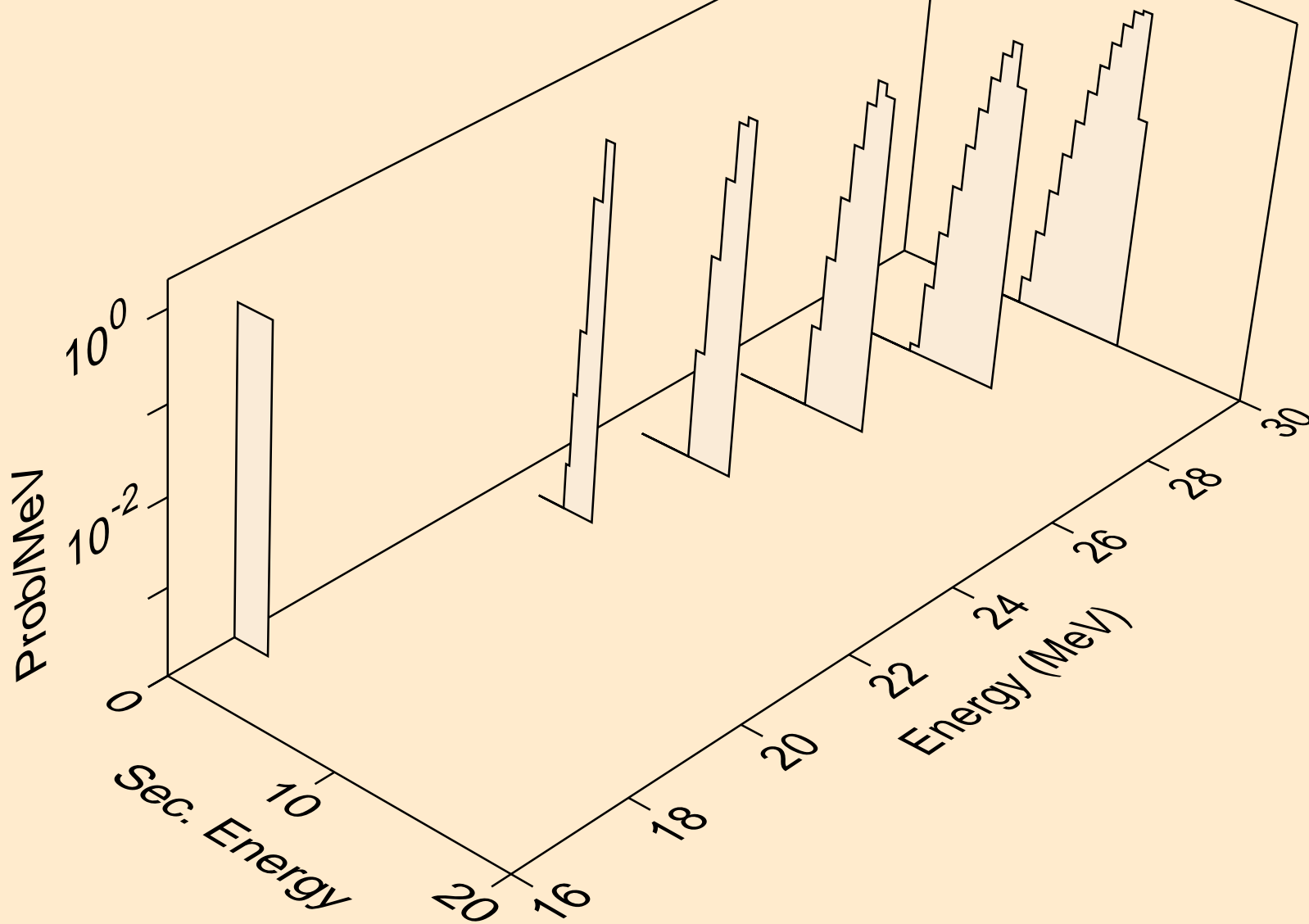

IN118N NEUTRON ACER TENDL-2019 LIBRARY; T=293.16K
he3s from (n,he3)

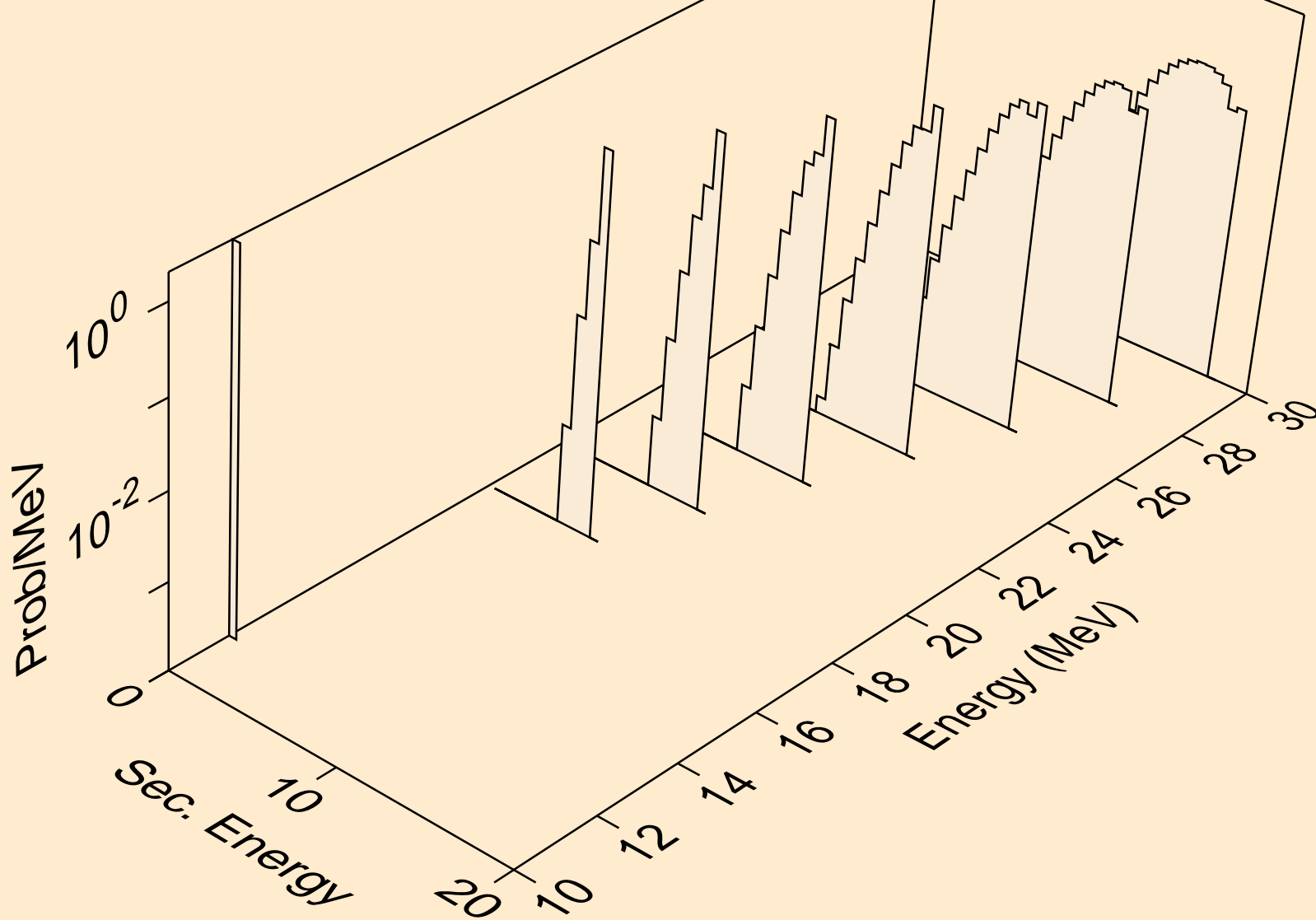

IN118N NEUTRON ACER TENDL-2019 LIBRARY; T=293.16K
alphas from (n,x)

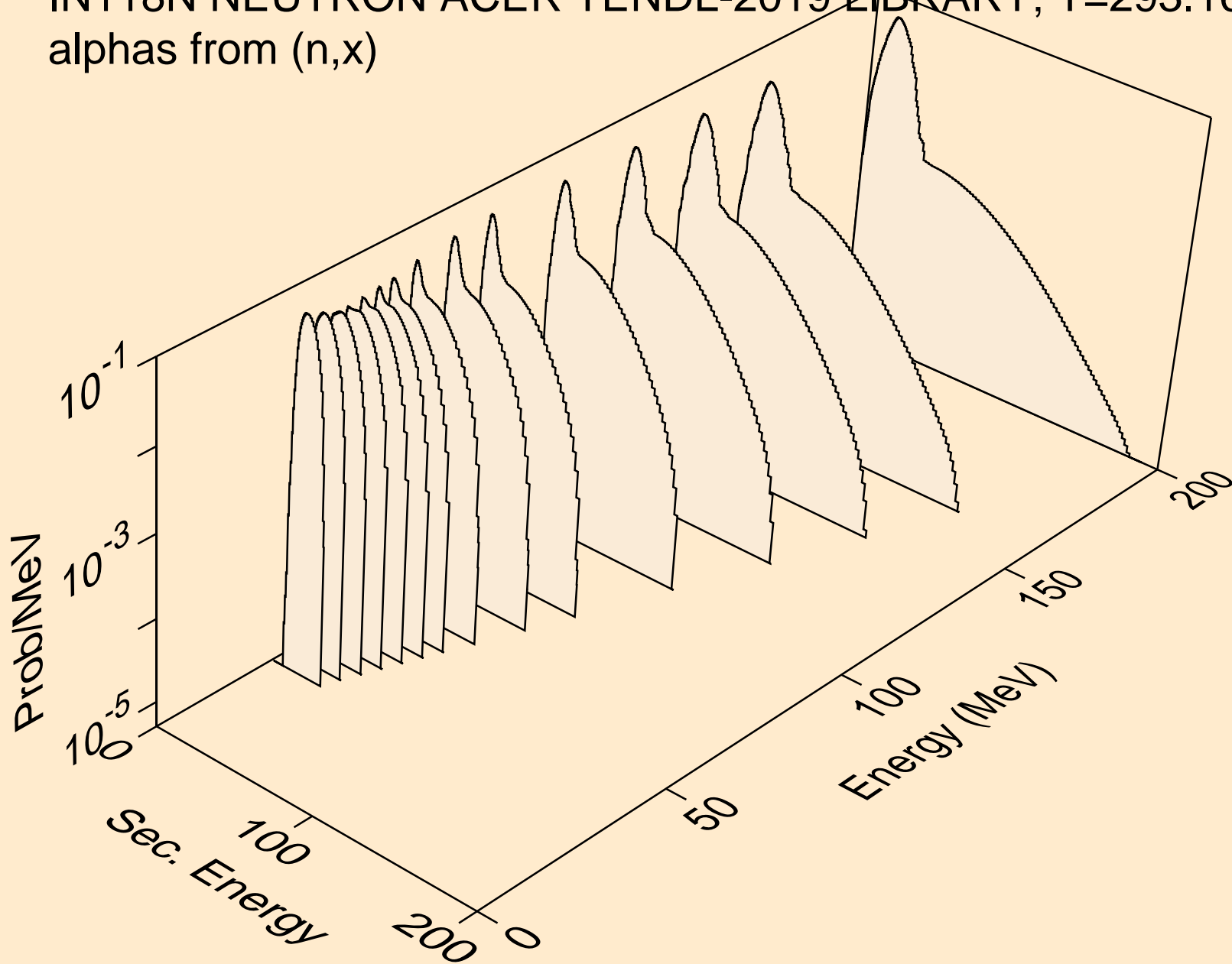

IN118N NEUTRON ACER TENDL-2019 LIBRARY; T=293.16K
alphas from (n,n*)a

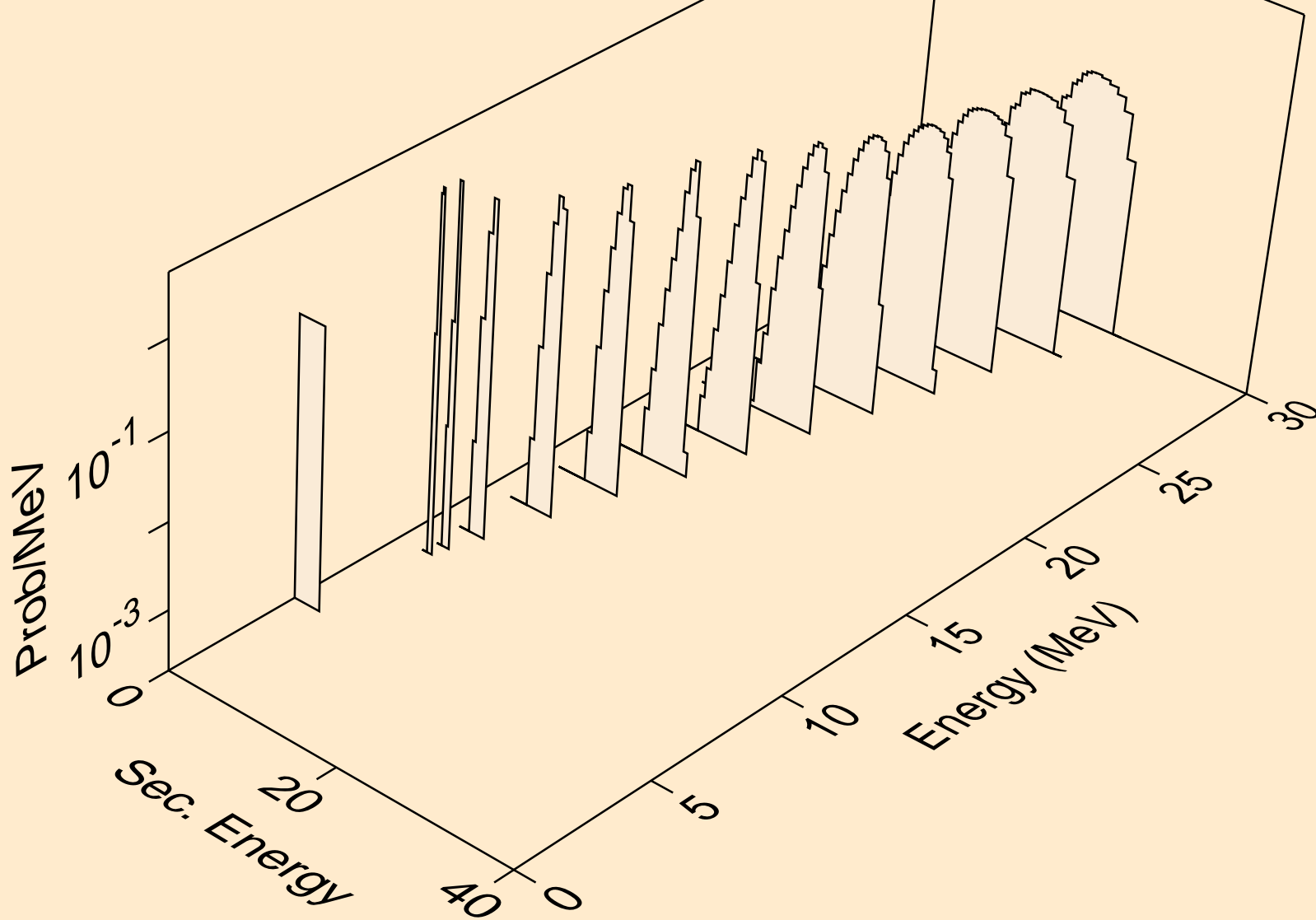

IN118N NEUTRON ACER TENDL-2019 LIBRARY; T=293.16K
alphas from (n,2n)a

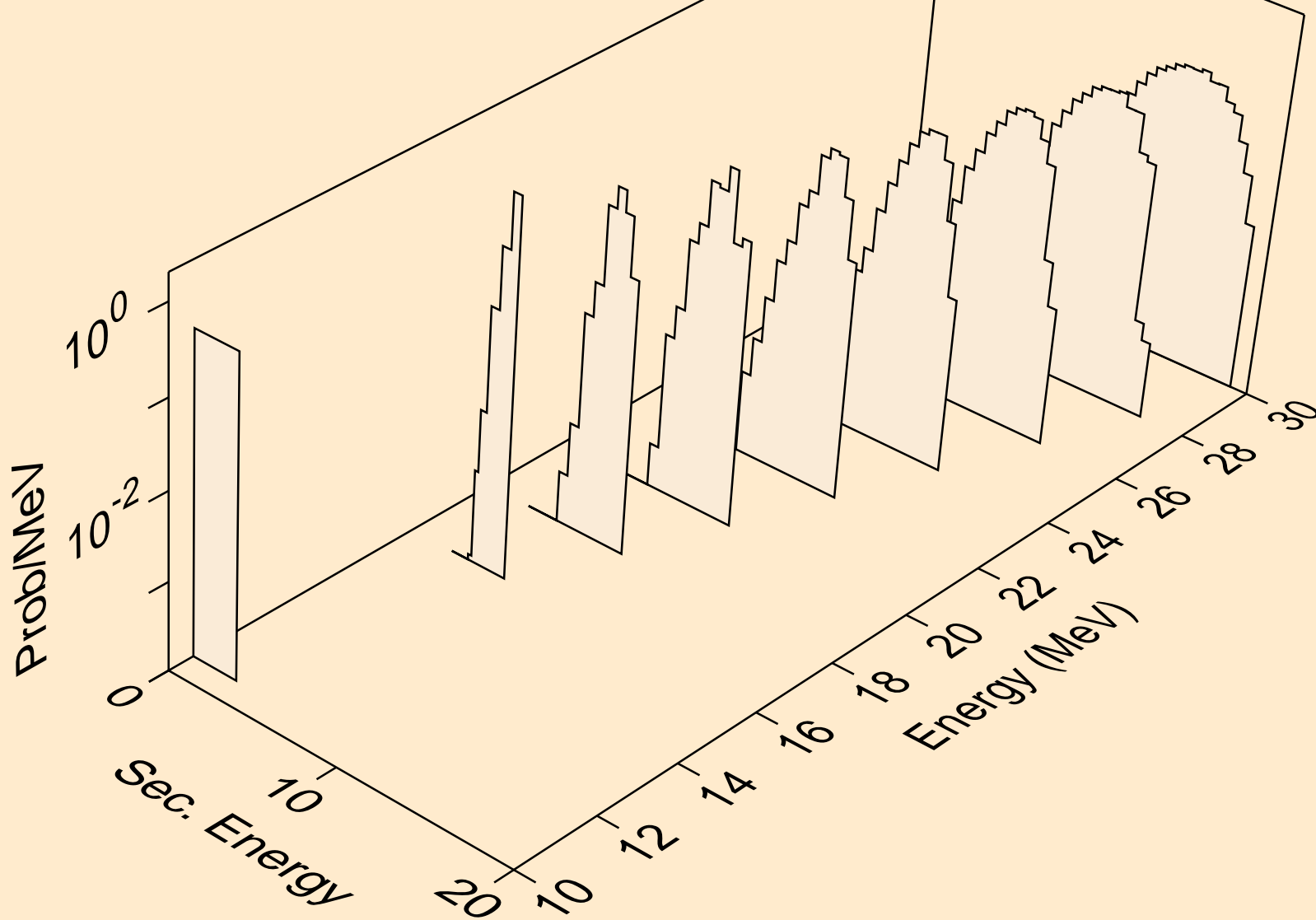

IN118N NEUTRON ACER TENDL-2019 LIBRARY; T=293.16K
alphas from (n,3n)a

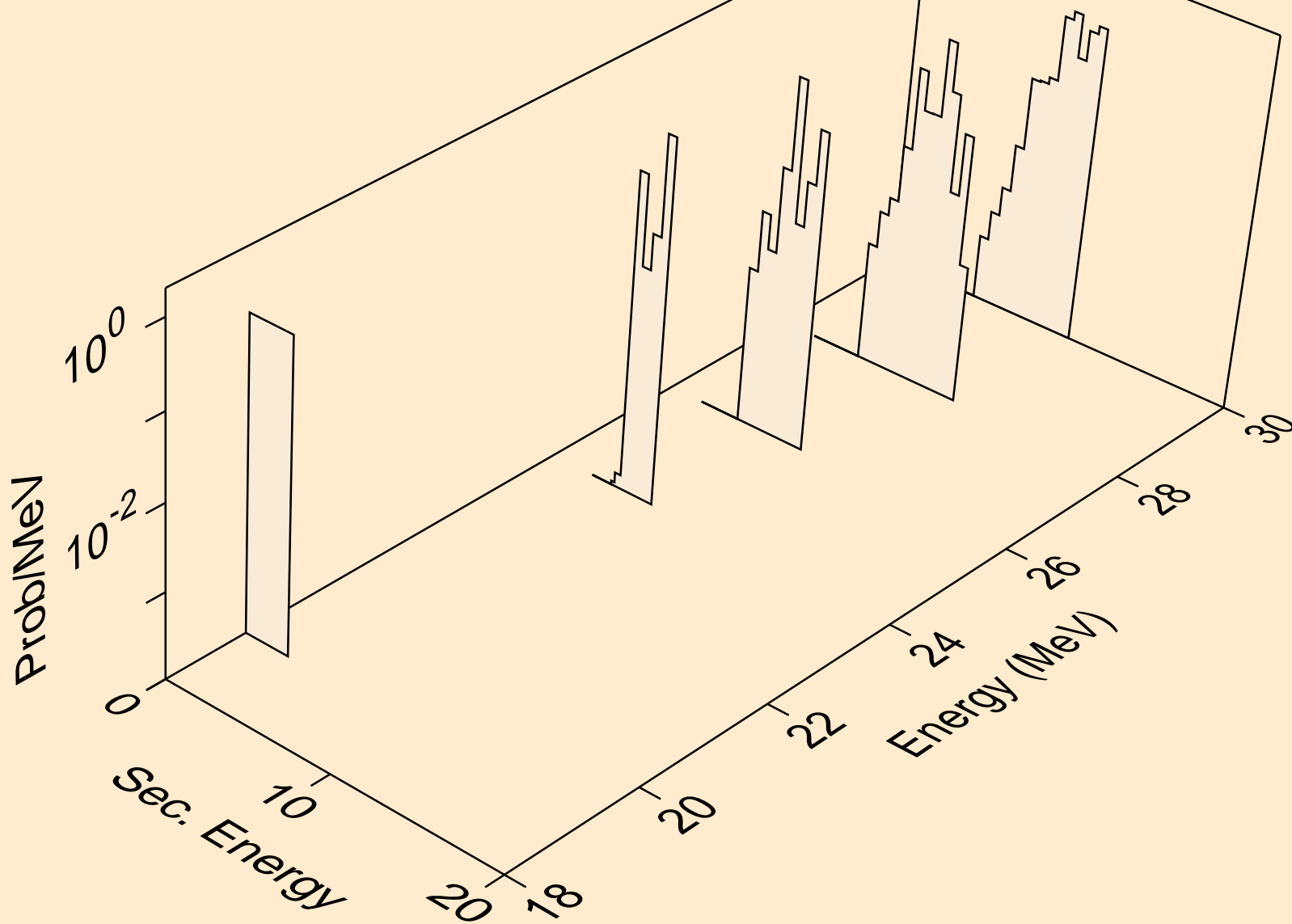

IN118N NEUTRON ACER TENDL-2019 LIBRARY; T=293.16K
alphas from (n,npa)

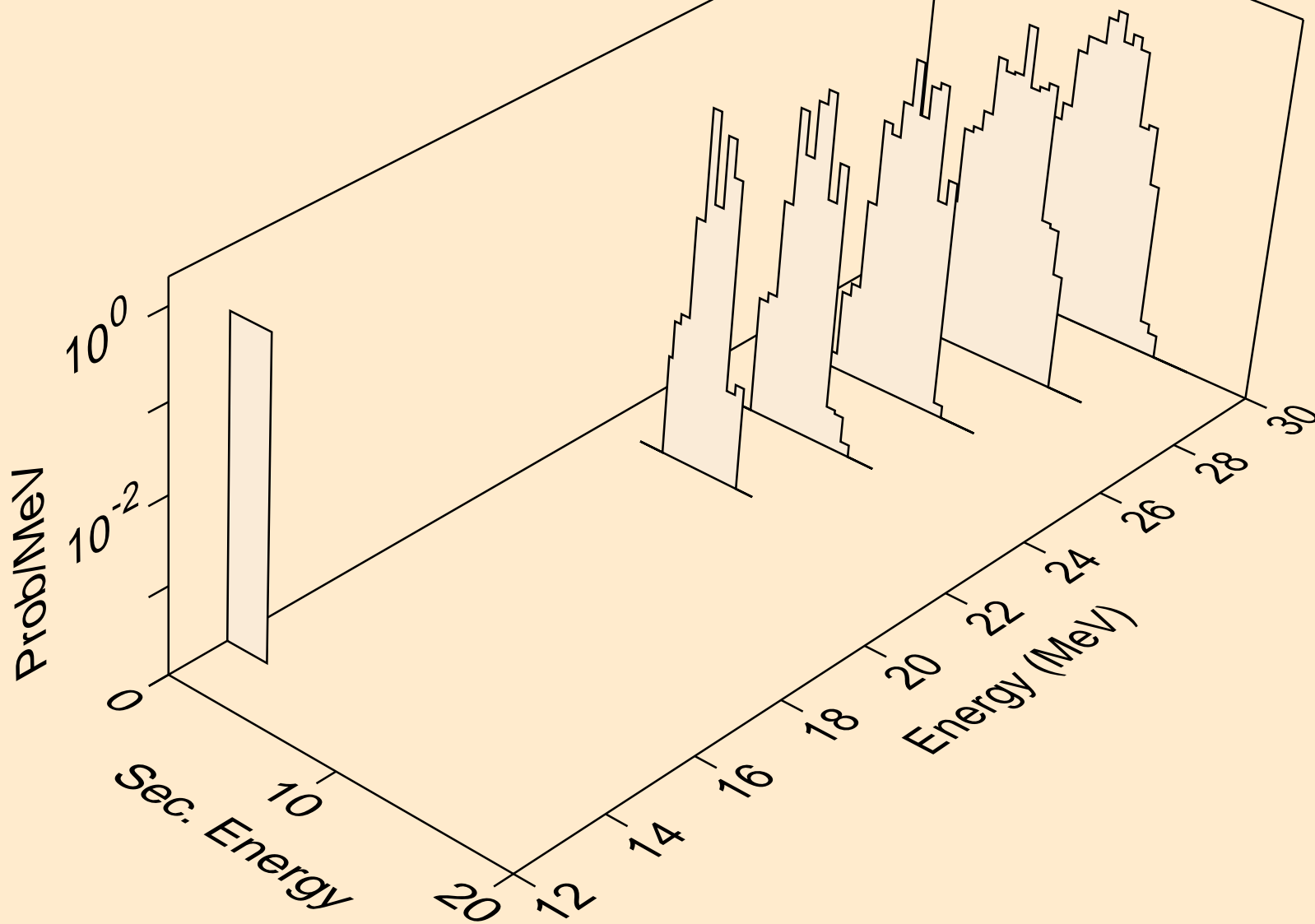

IN118N NEUTRON ACER TENDL-2019 LIBRARY; T=293.16K
alphas from (n,a)

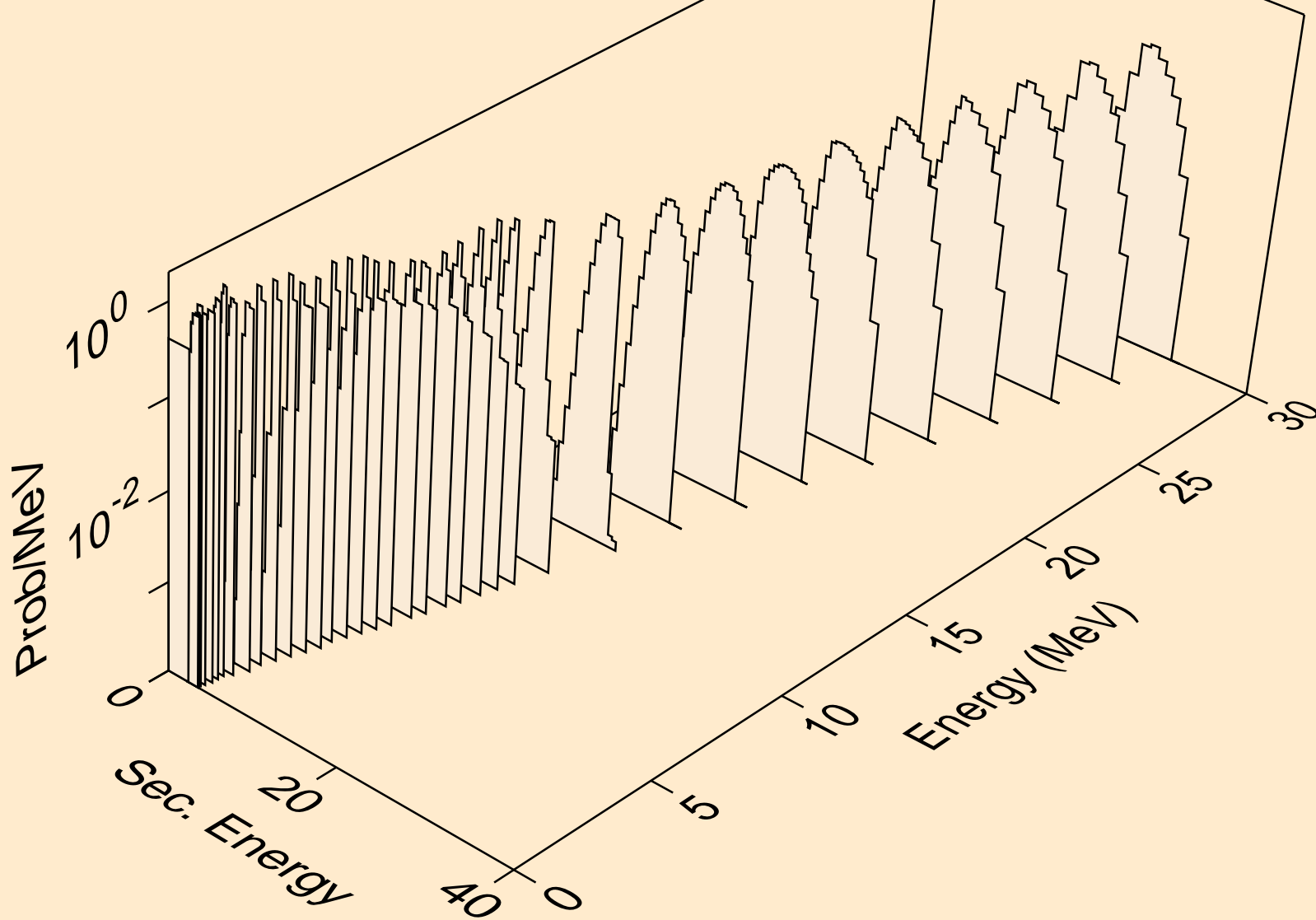

IN118N NEUTRON ACER TENDL-2019 LIBRARY; T=293.16K
alphas from (n,2a)

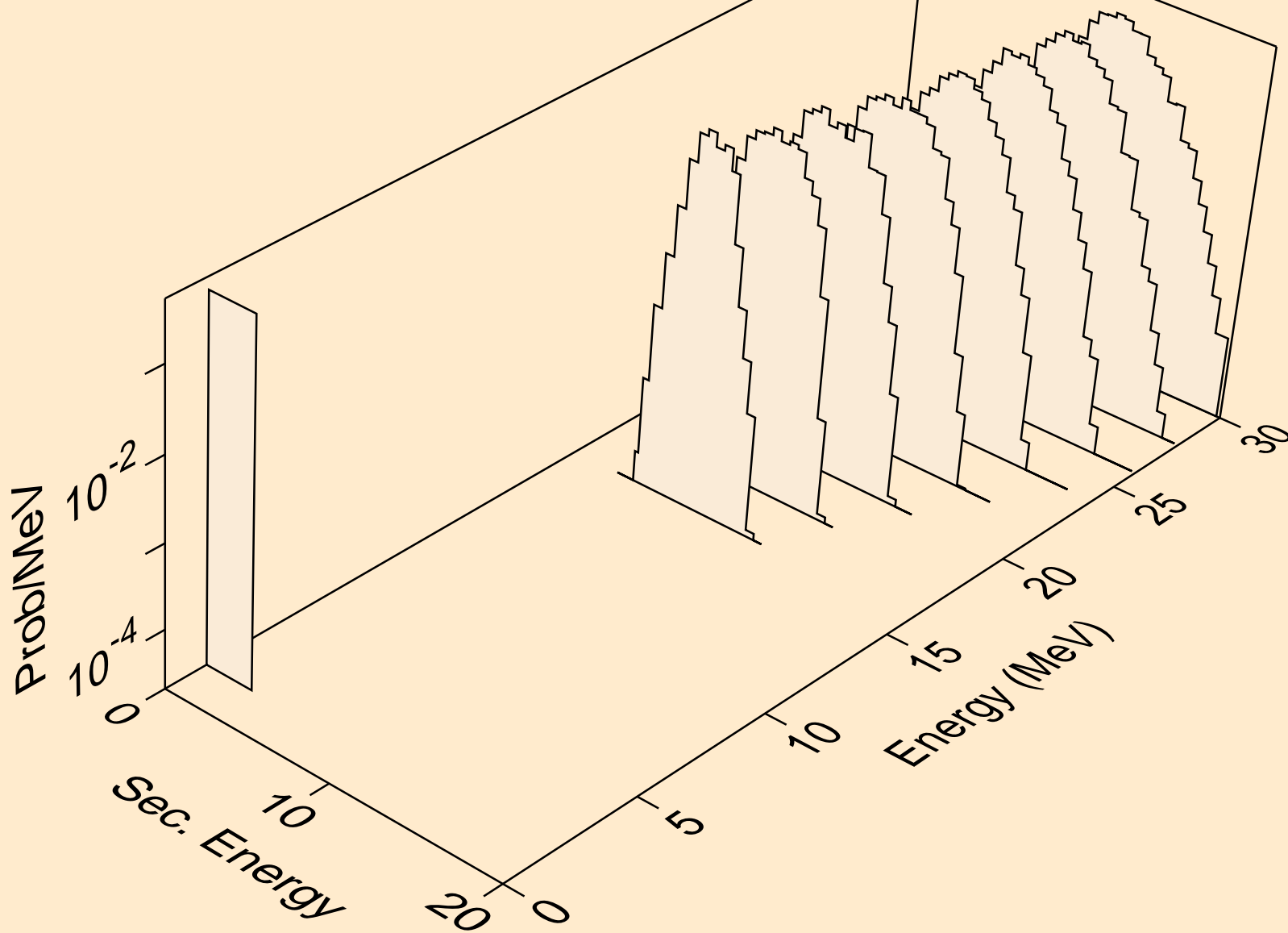

IN118N NEUTRON ACER TENDL-2019 LIBRARY; T=293.16K
alphas from (n,pa)

