

IN119 NEUTRON ACER TENDL-2019 LIBRARY; T=293.16K
Principal cross sections

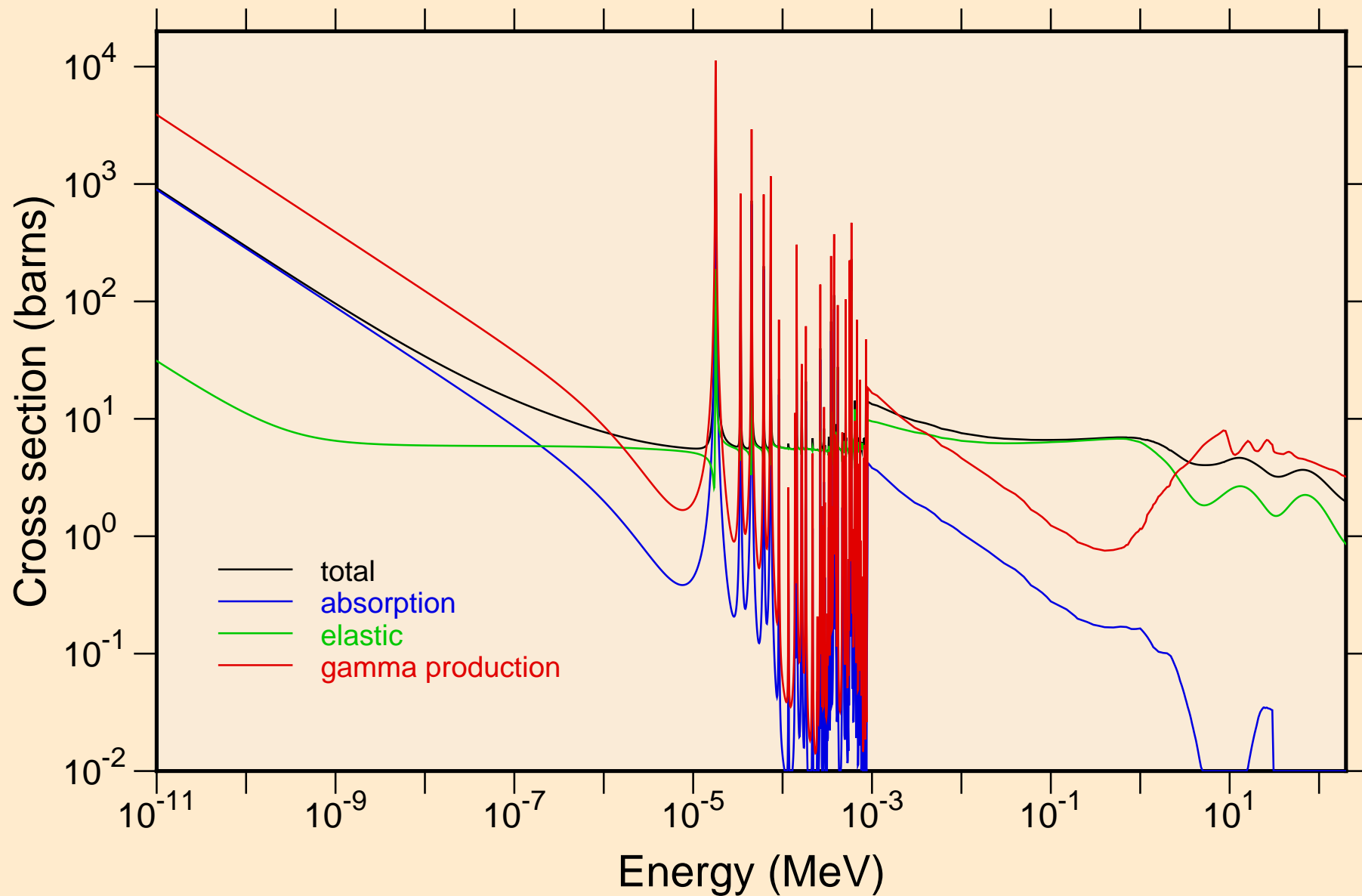

IN119 NEUTRON ACER TENDL-2019 LIBRARY; T=293.16K
resonance total cross section

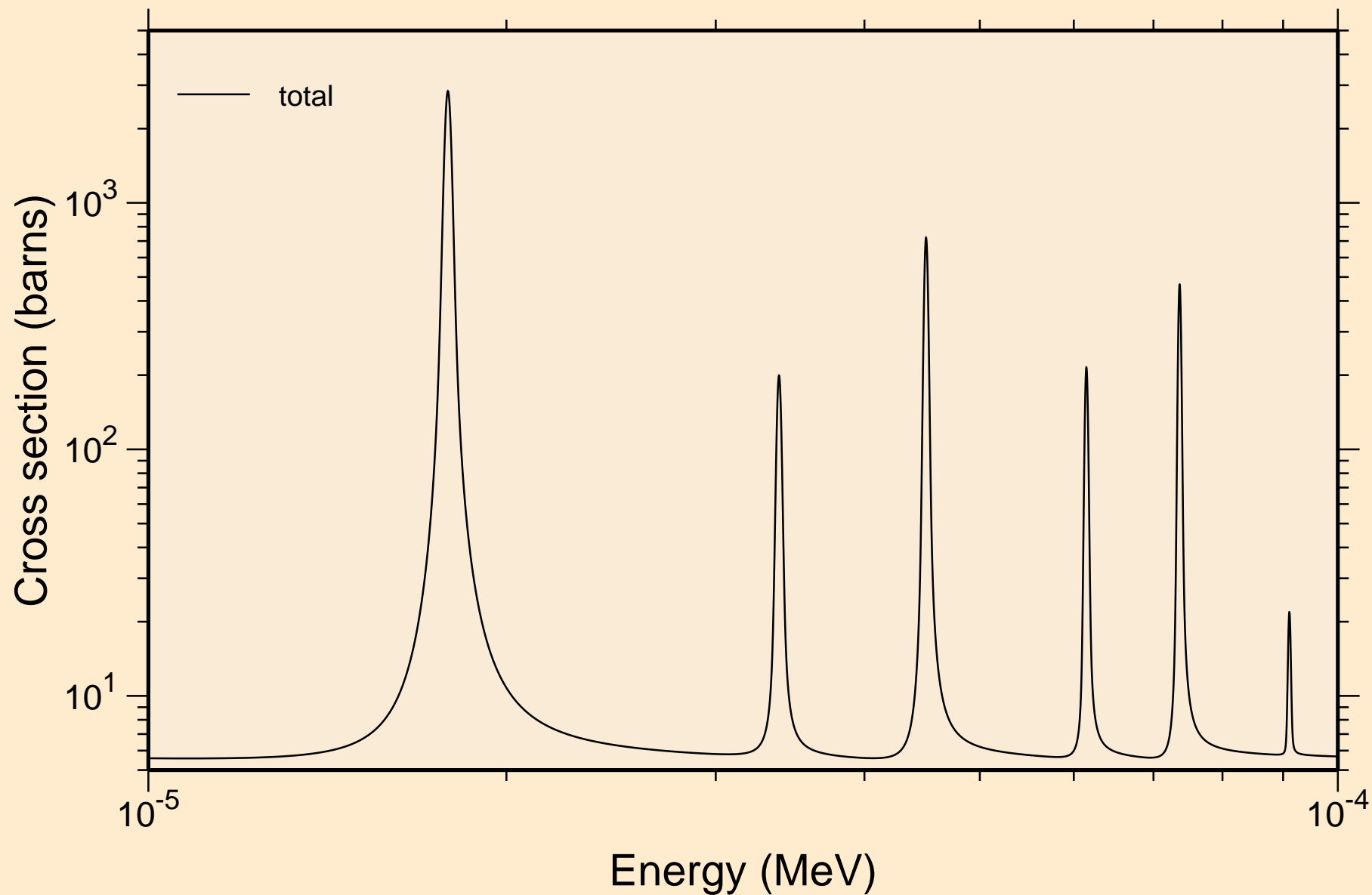

IN119 NEUTRON ACER TENDL-2019 LIBRARY; T=293.16K
resonance total cross section

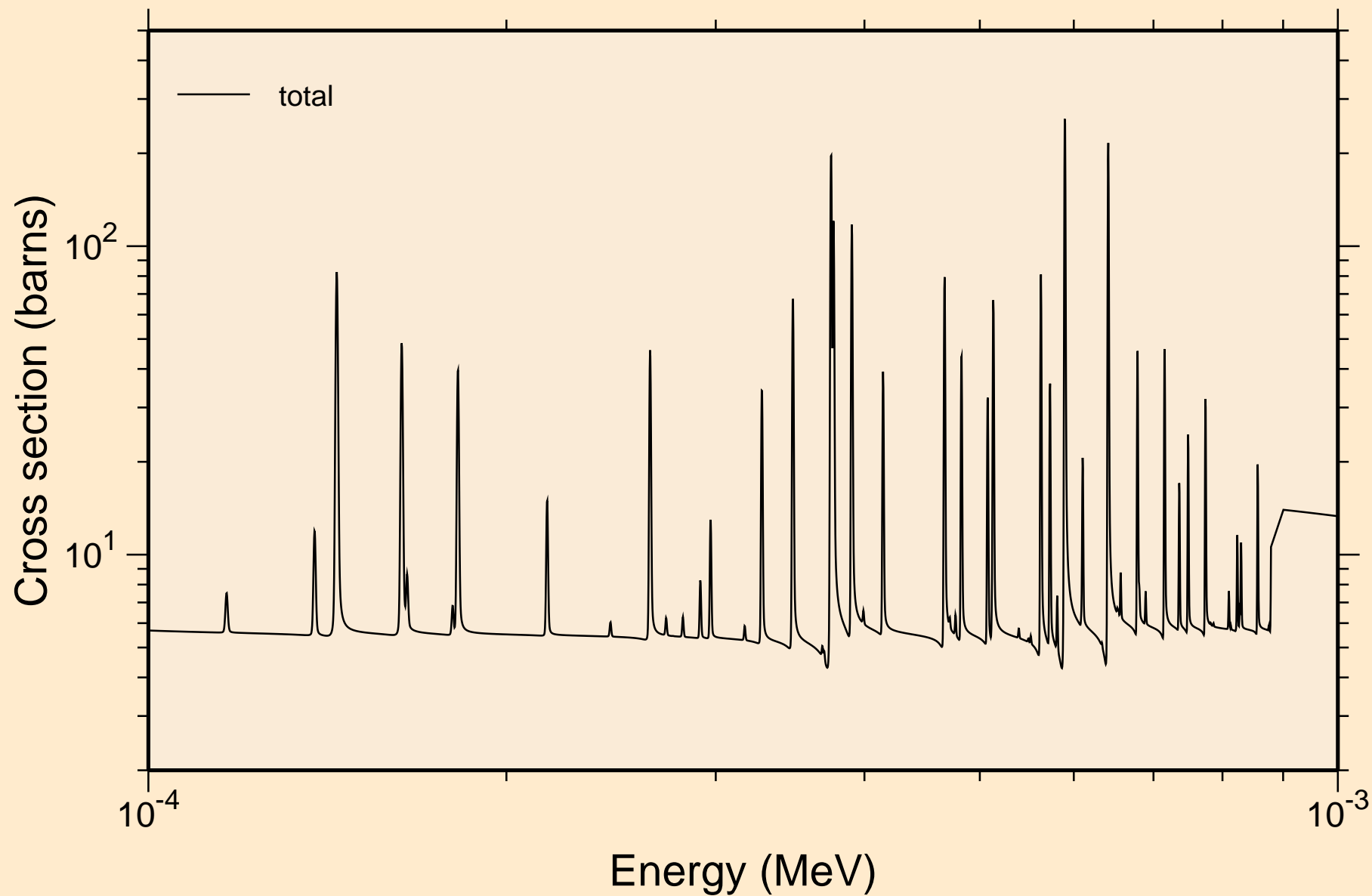

IN119 NEUTRON ACER TENDL-2019 LIBRARY; T=293.16K
resonance total cross section

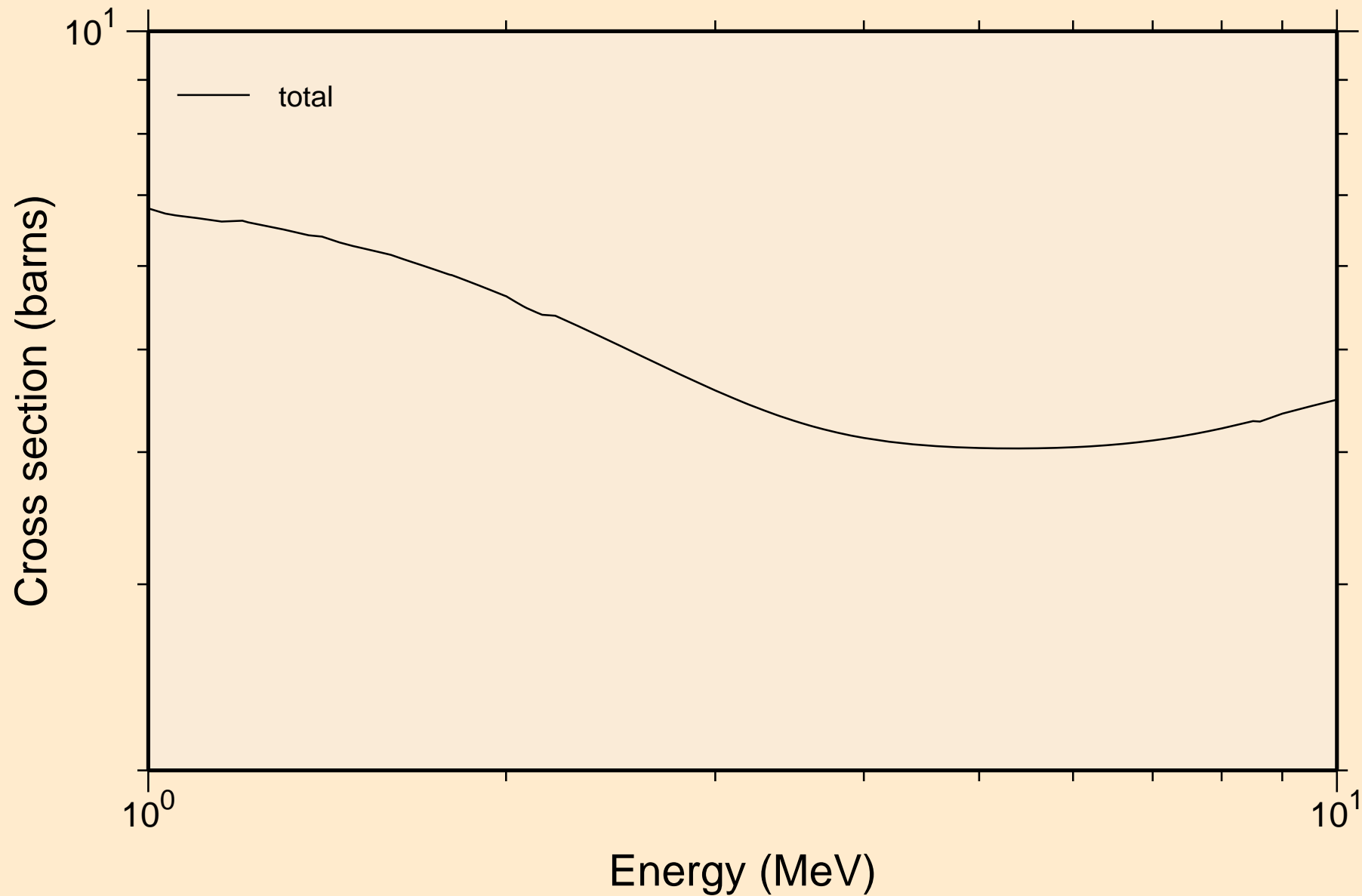

IN119 NEUTRON ACER TENDL-2019 LIBRARY; T=293.16K
resonance absorption cross sections

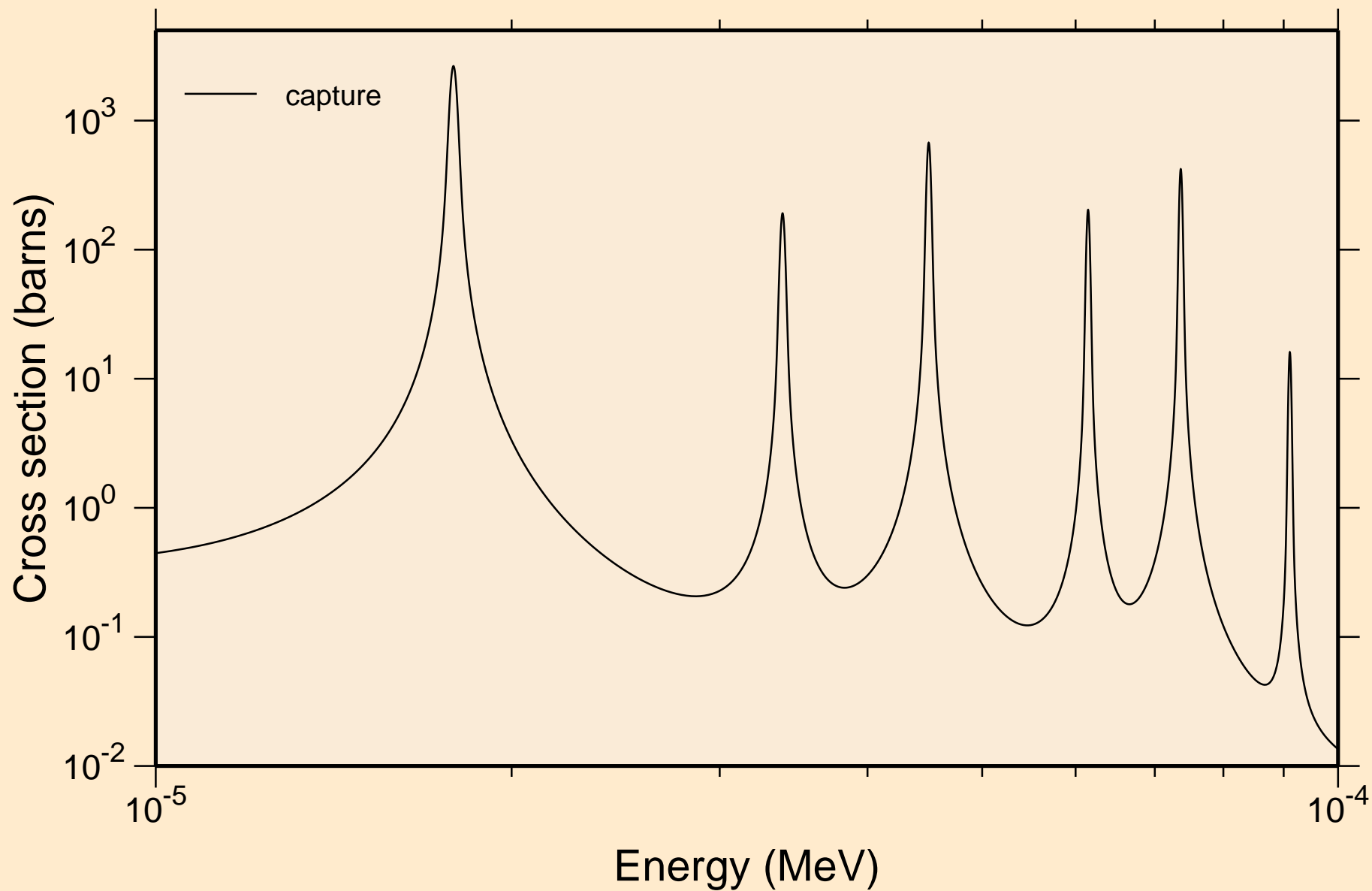

IN119 NEUTRON ACER TENDL-2019 LIBRARY; T=293.16K
resonance absorption cross sections

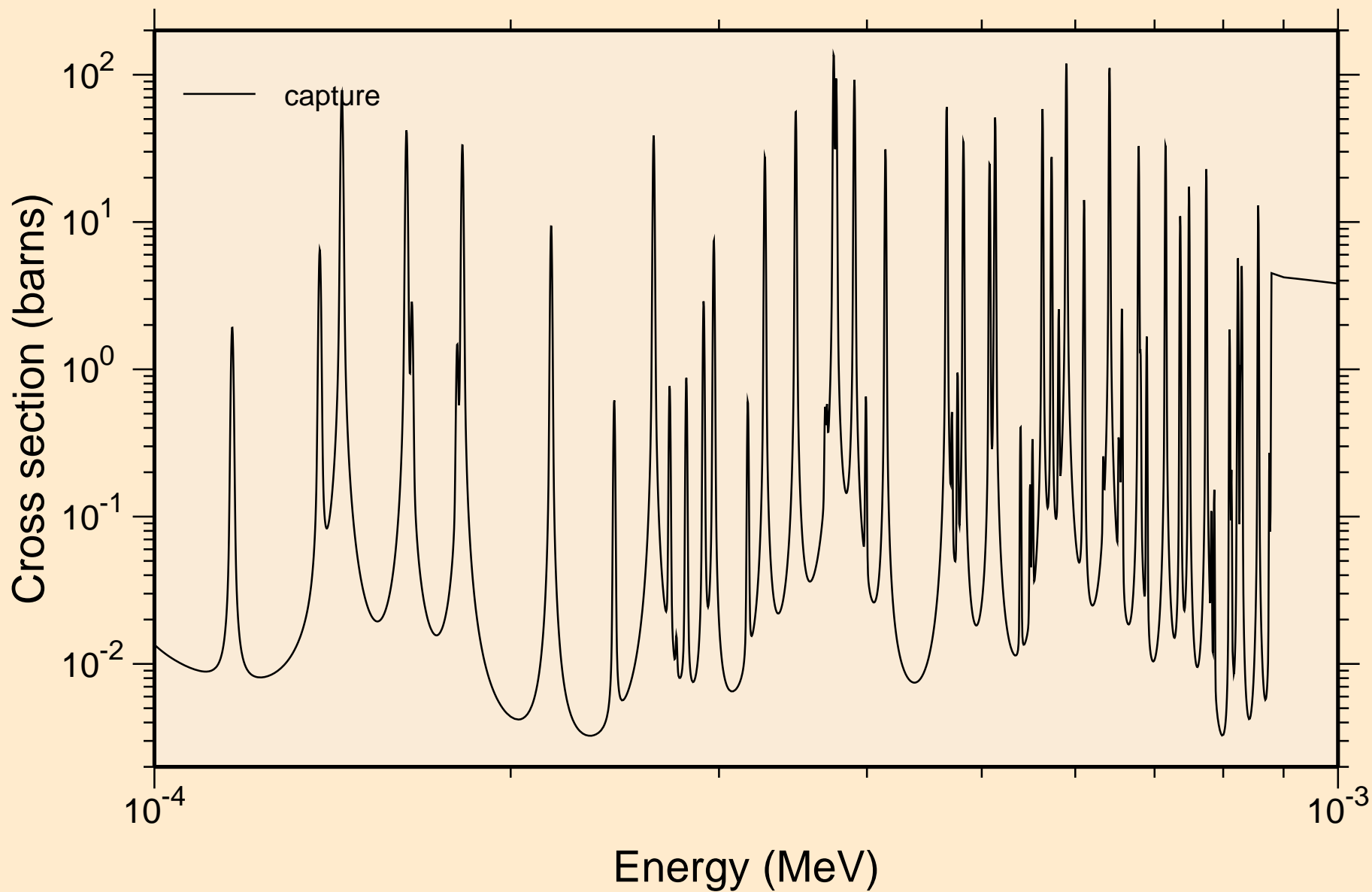

IN119 NEUTRON ACER TENDL-2019 LIBRARY; T=293.16K
resonance absorption cross sections

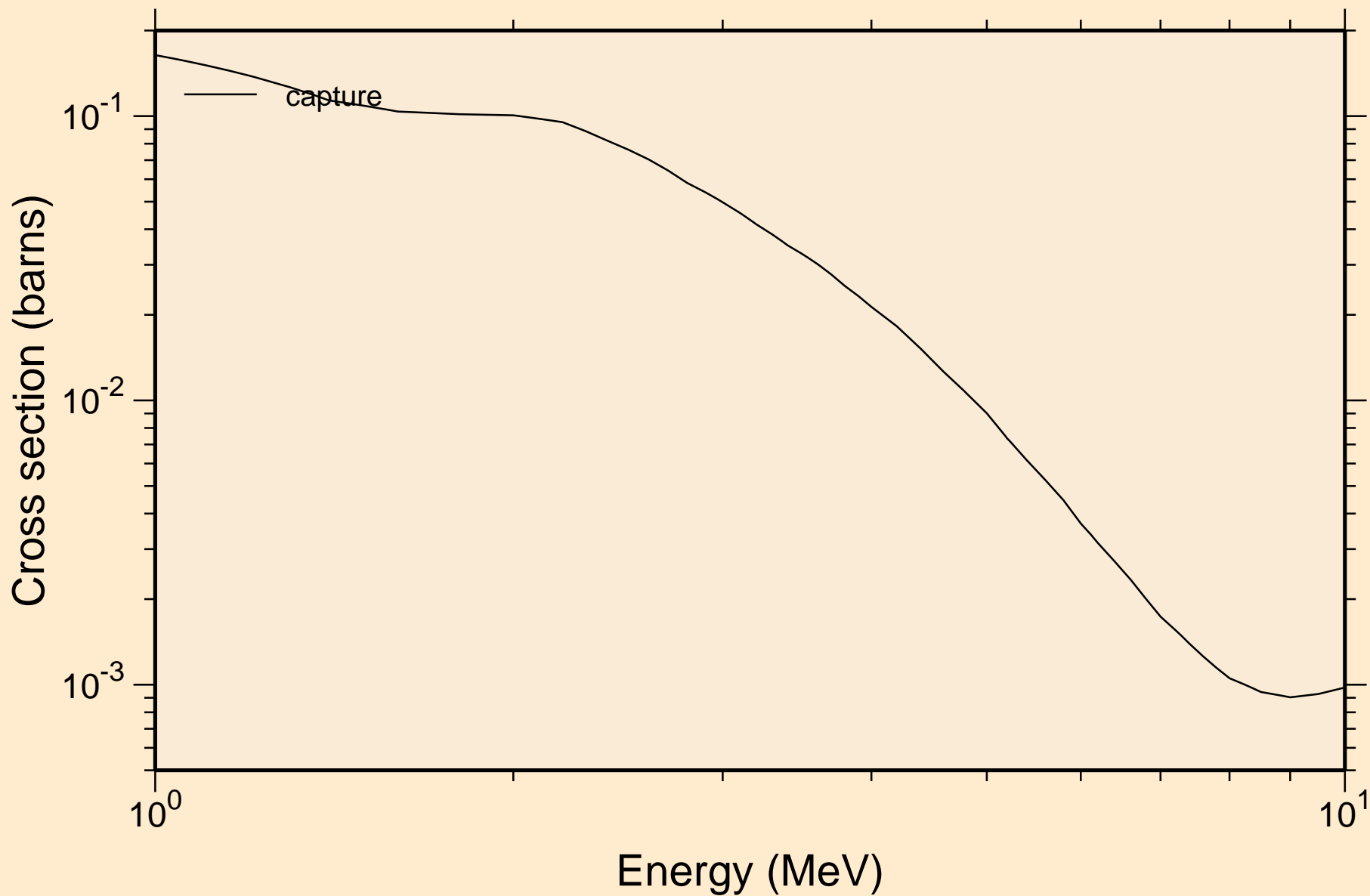

IN119 NEUTRON ACER TENDL-2019 LIBRARY; T=293.16K
Heating

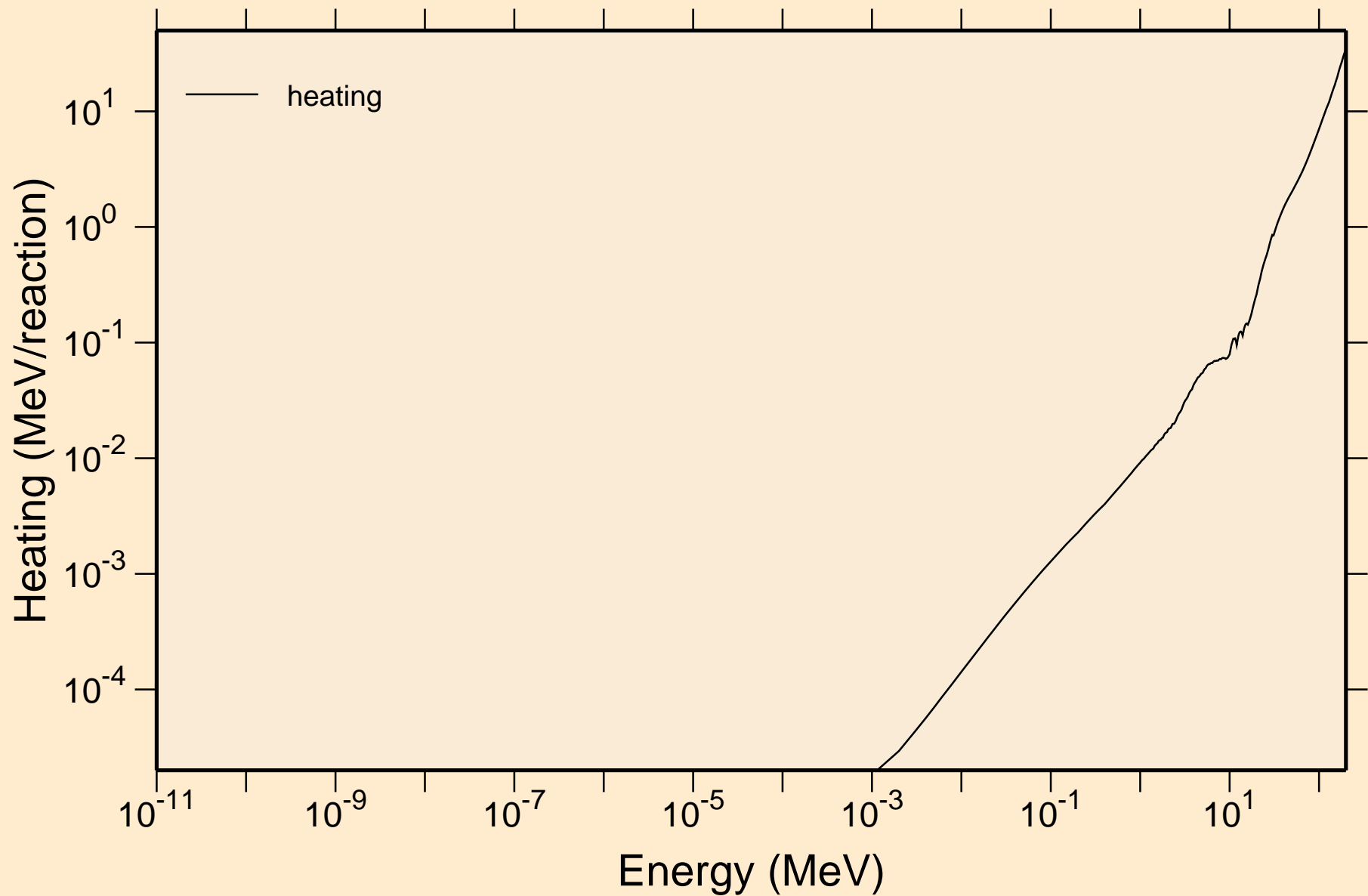

IN119 NEUTRON ACER TENDL-2019 LIBRARY; T=293.16K
Damage

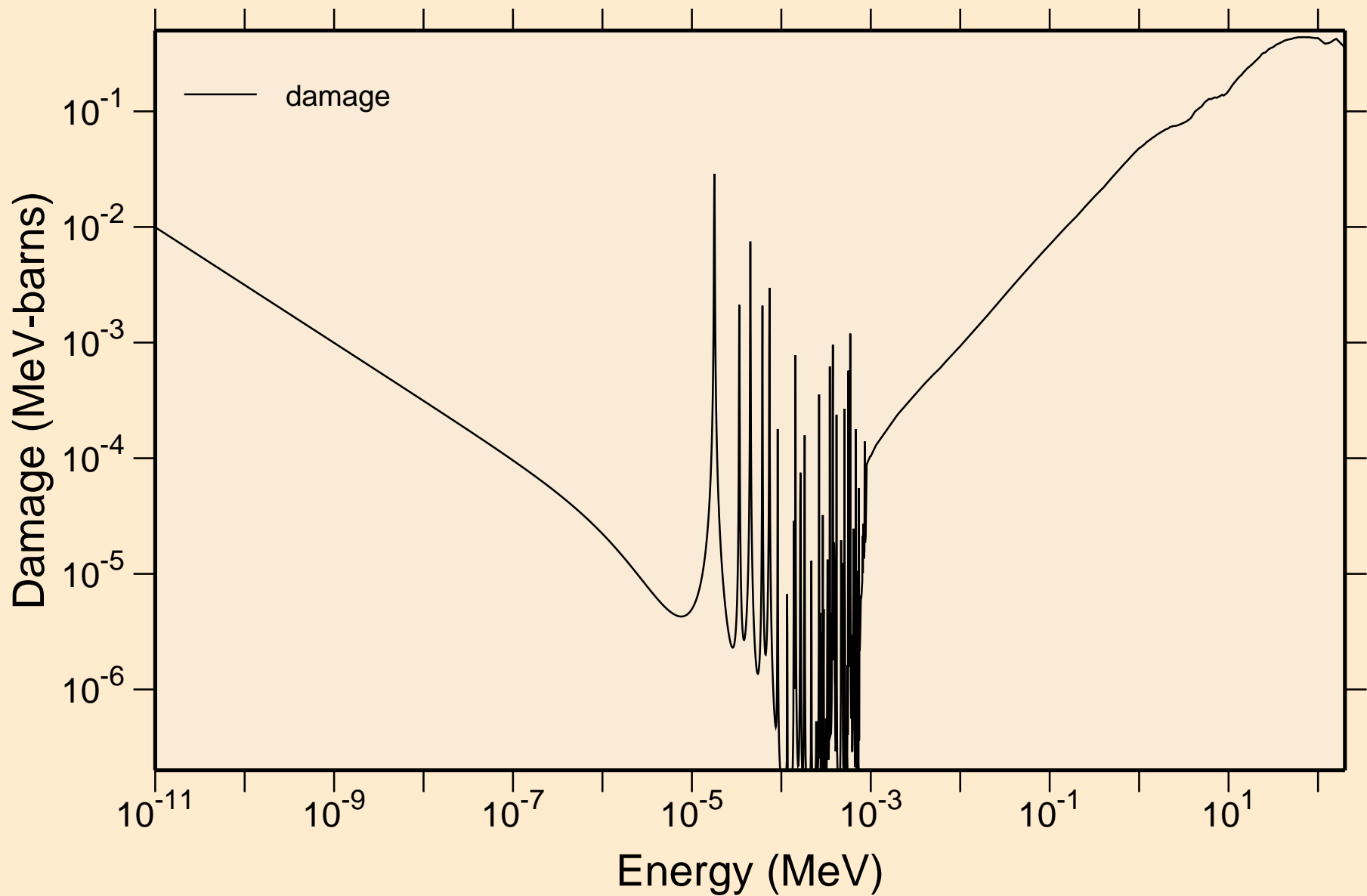

IN119 NEUTRON ACER TENDL-2019 LIBRARY; T=293.16K
Non-threshold reactions

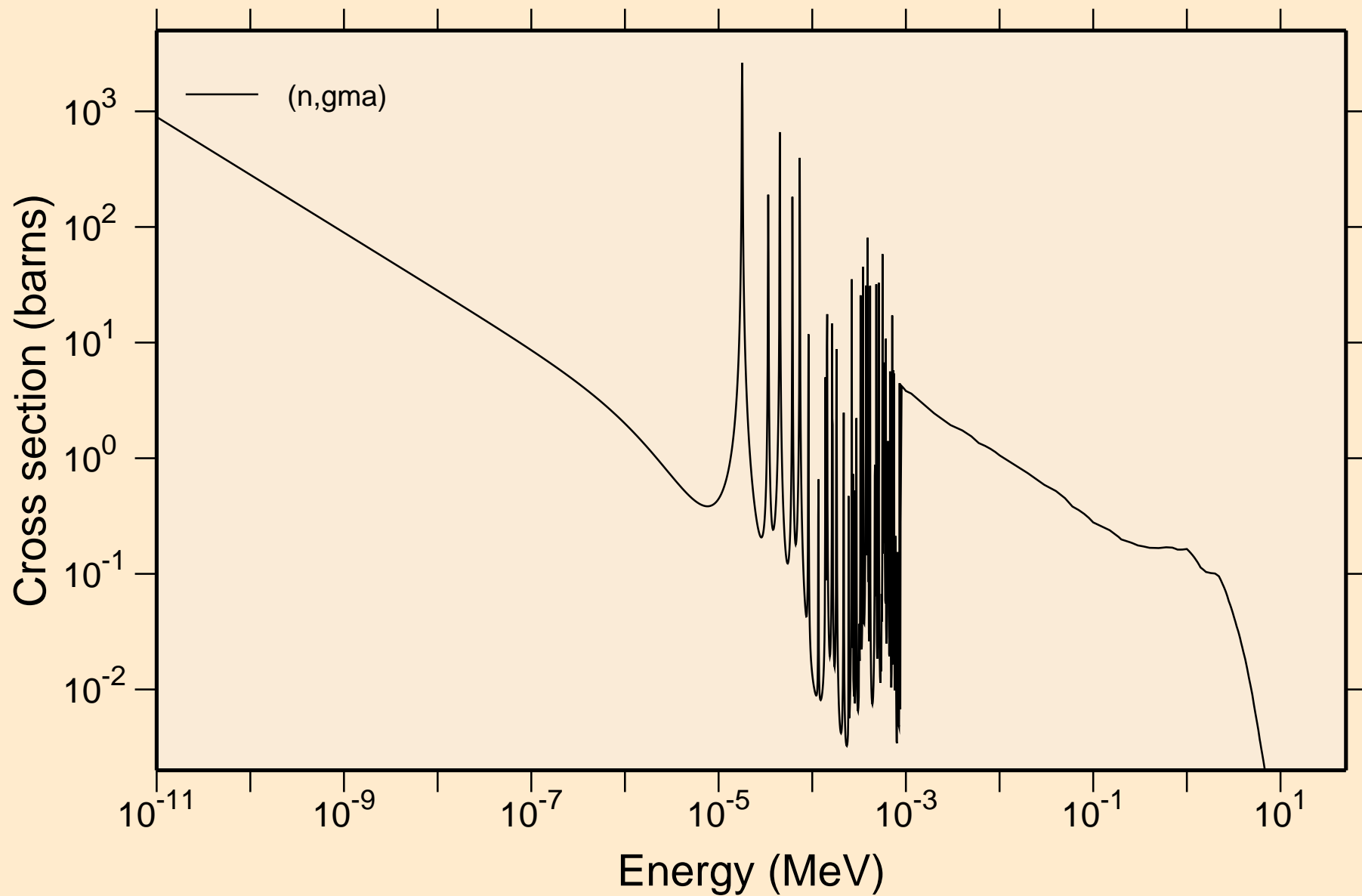

IN119 NEUTRON ACER TENDL-2019 LIBRARY; T=293.16K
Principal cross sections

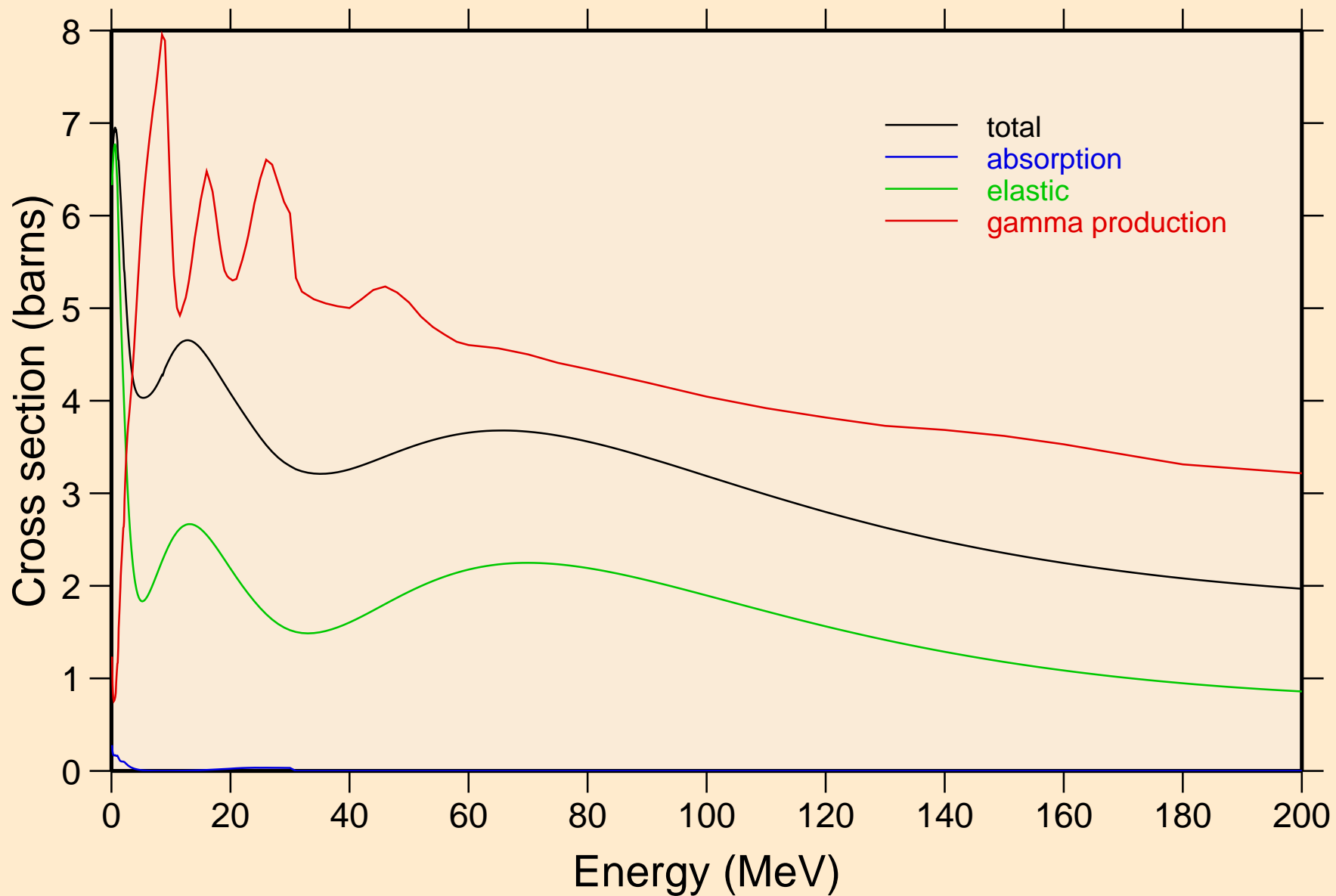

IN119 NEUTRON ACER TENDL-2019 LIBRARY; T=293.16K
Heating

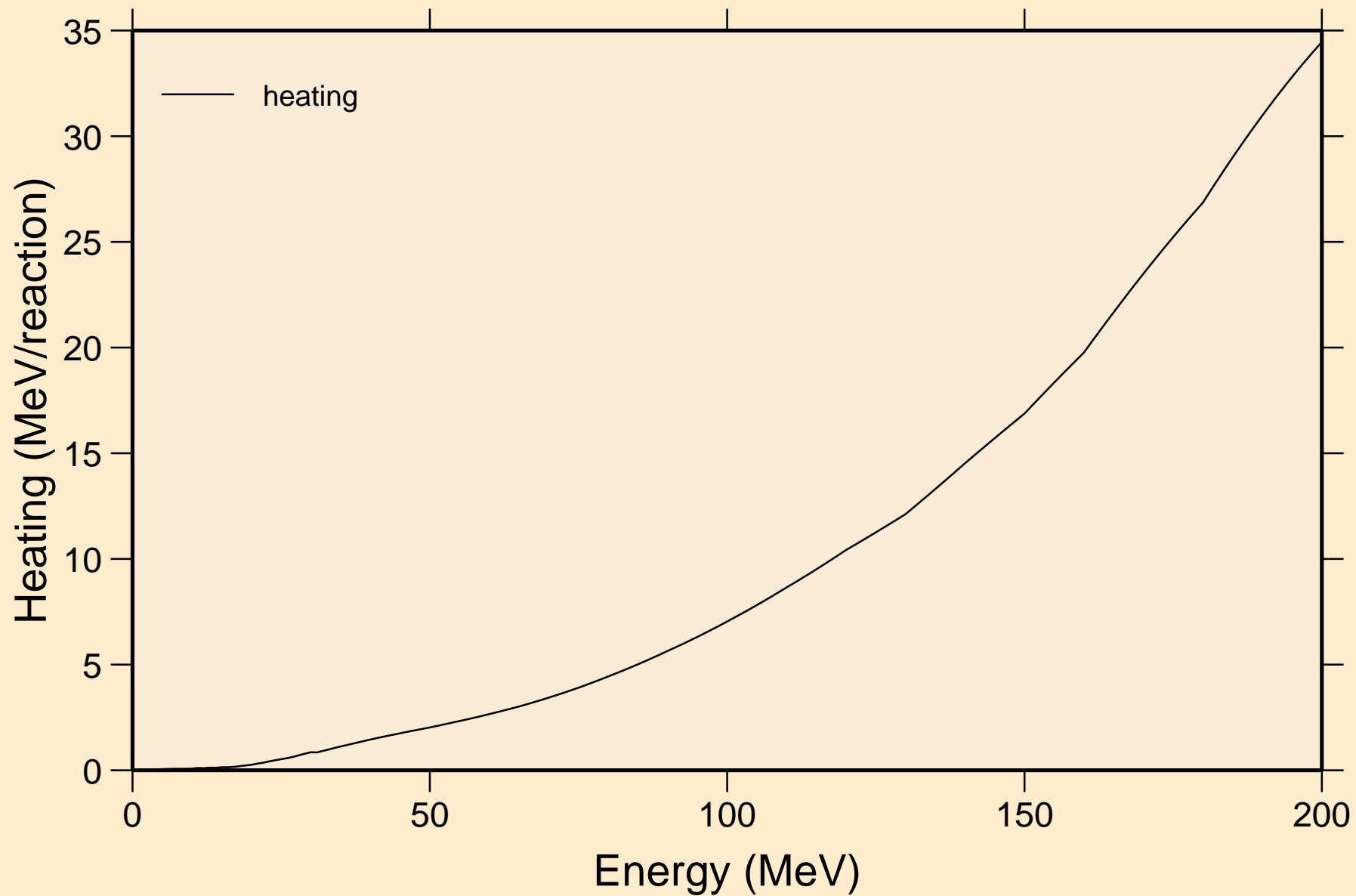

IN119 NEUTRON ACER TENDL-2019 LIBRARY; T=293.16K
Damage

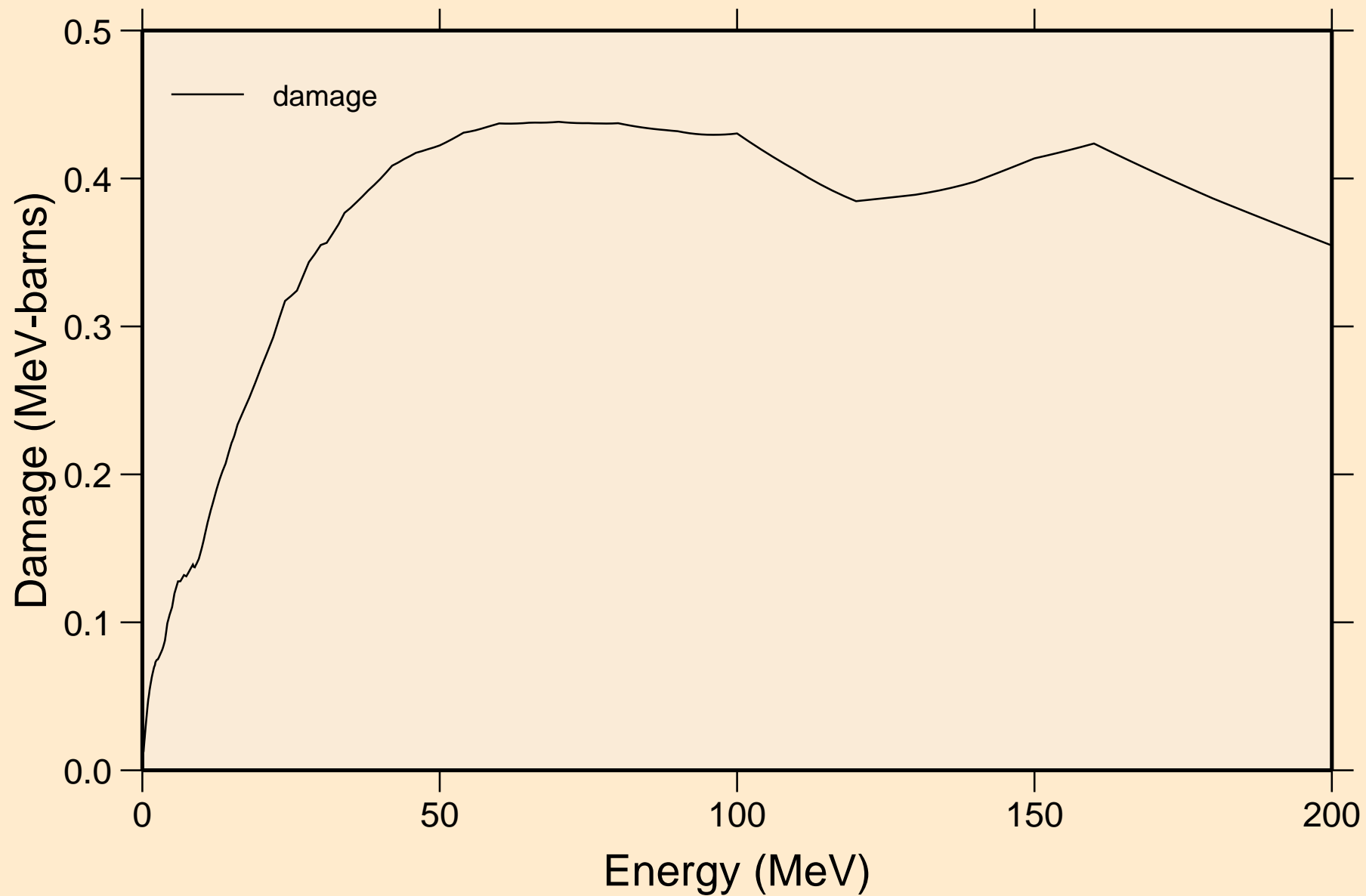

IN119 NEUTRON ACER TENDL-2019 LIBRARY; T=293.16K
Non-threshold reactions

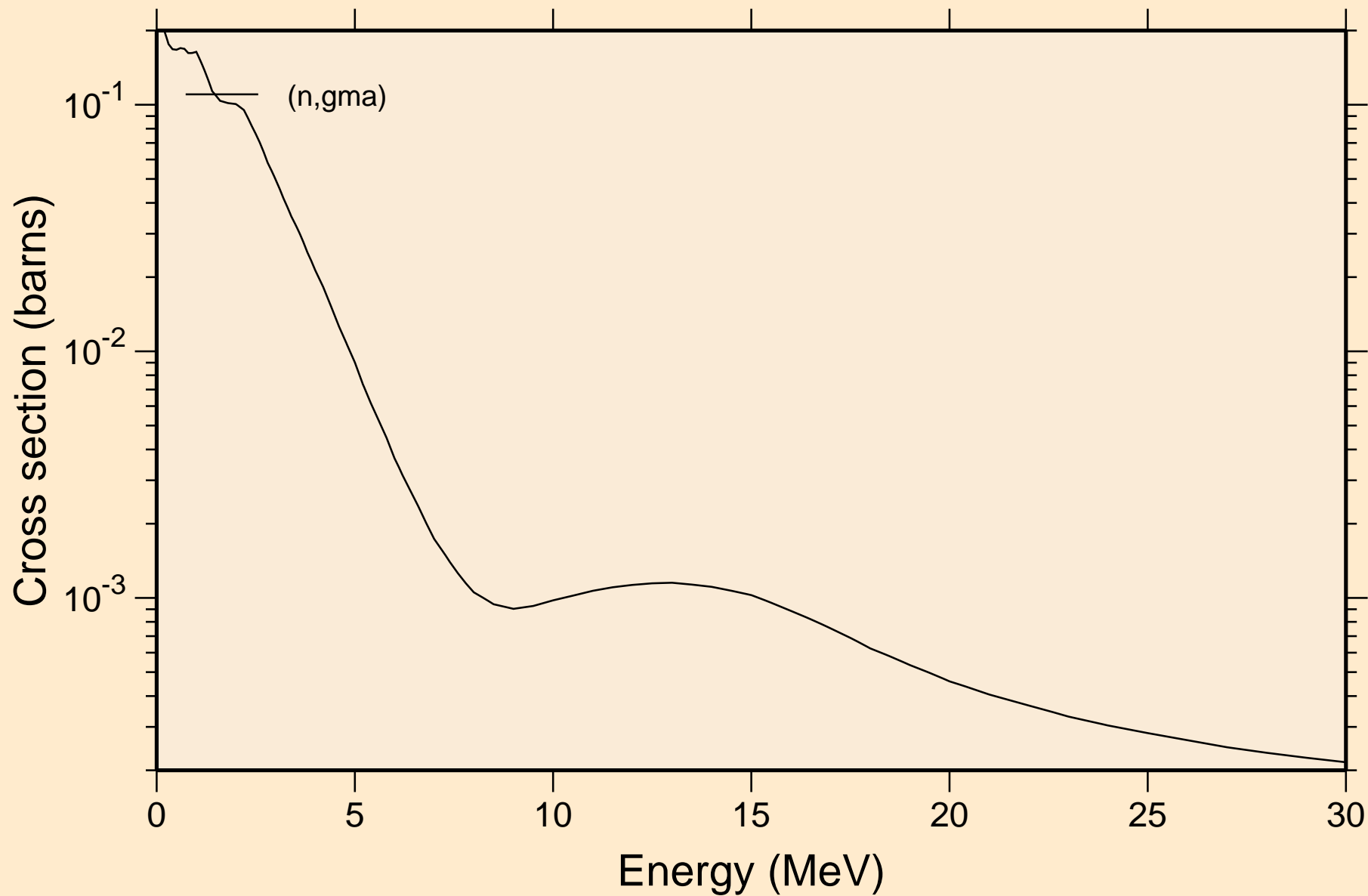

IN119 NEUTRON ACER TENDL-2019 LIBRARY; T=293.16K
Inelastic levels

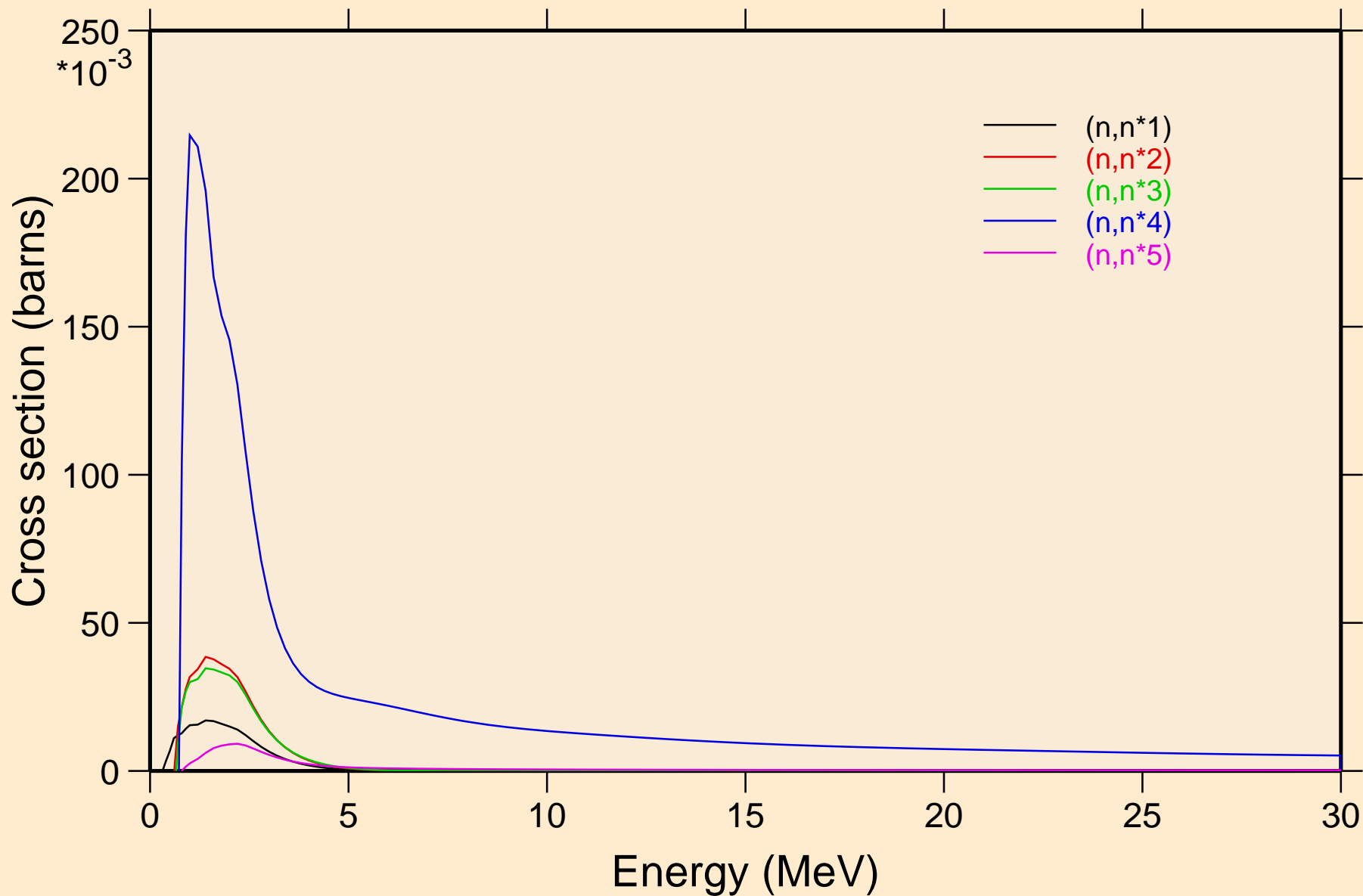

IN119 NEUTRON ACER TENDL-2019 LIBRARY; T=293.16K
Inelastic levels

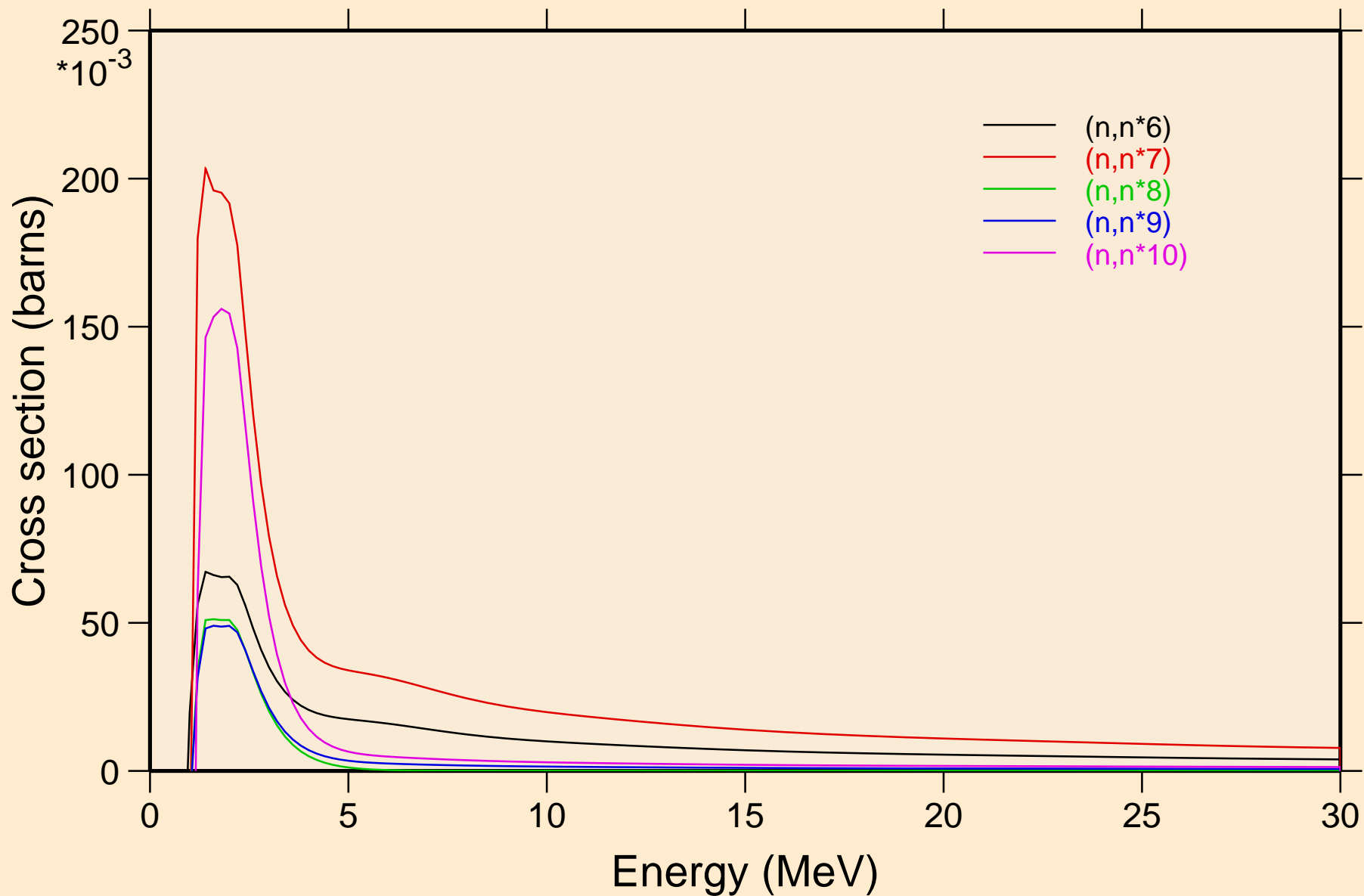

IN119 NEUTRON ACER TENDL-2019 LIBRARY; T=293.16K
Inelastic levels

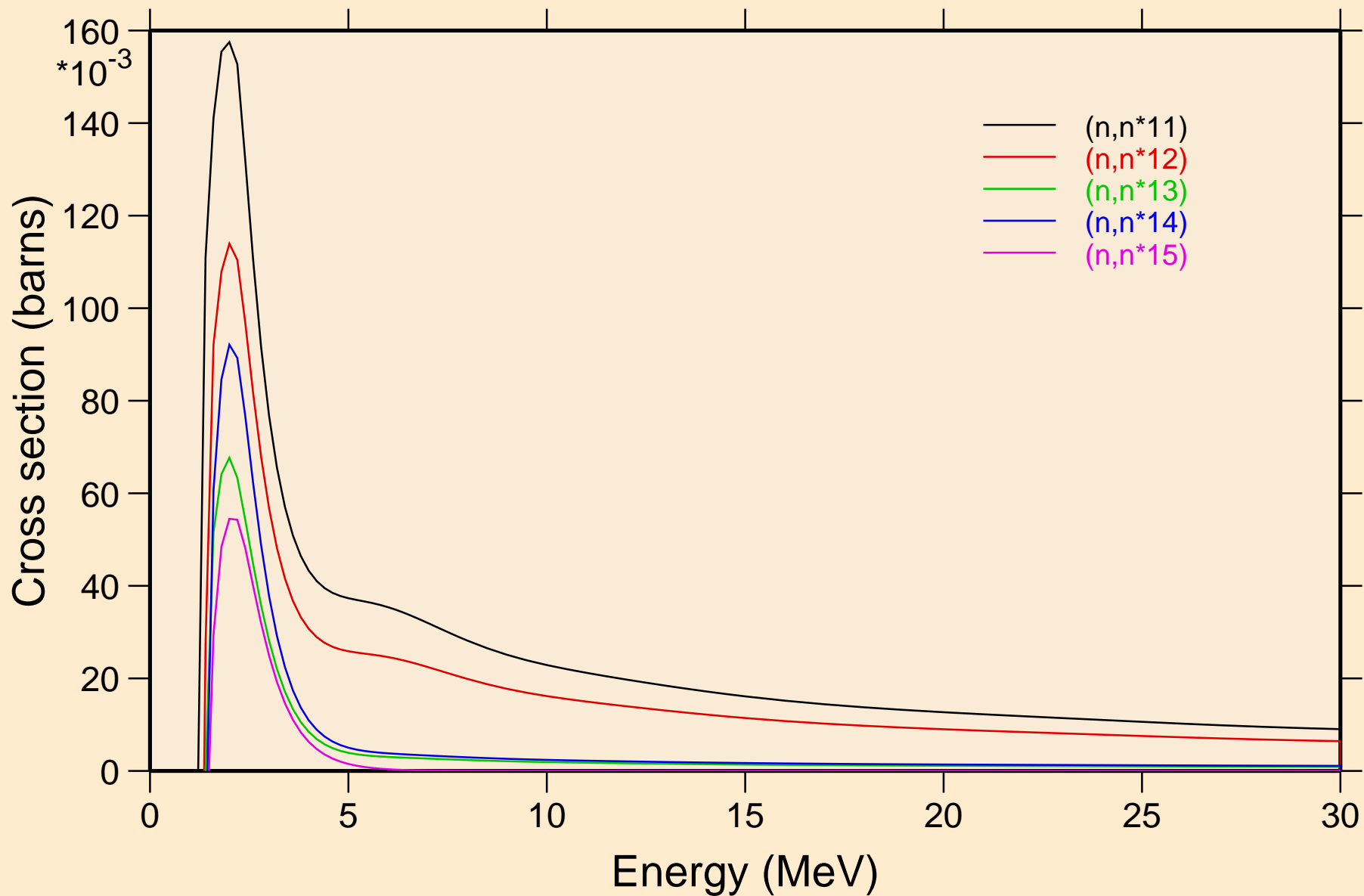

IN119 NEUTRON ACER TENDL-2019 LIBRARY; T=293.16K
Inelastic levels

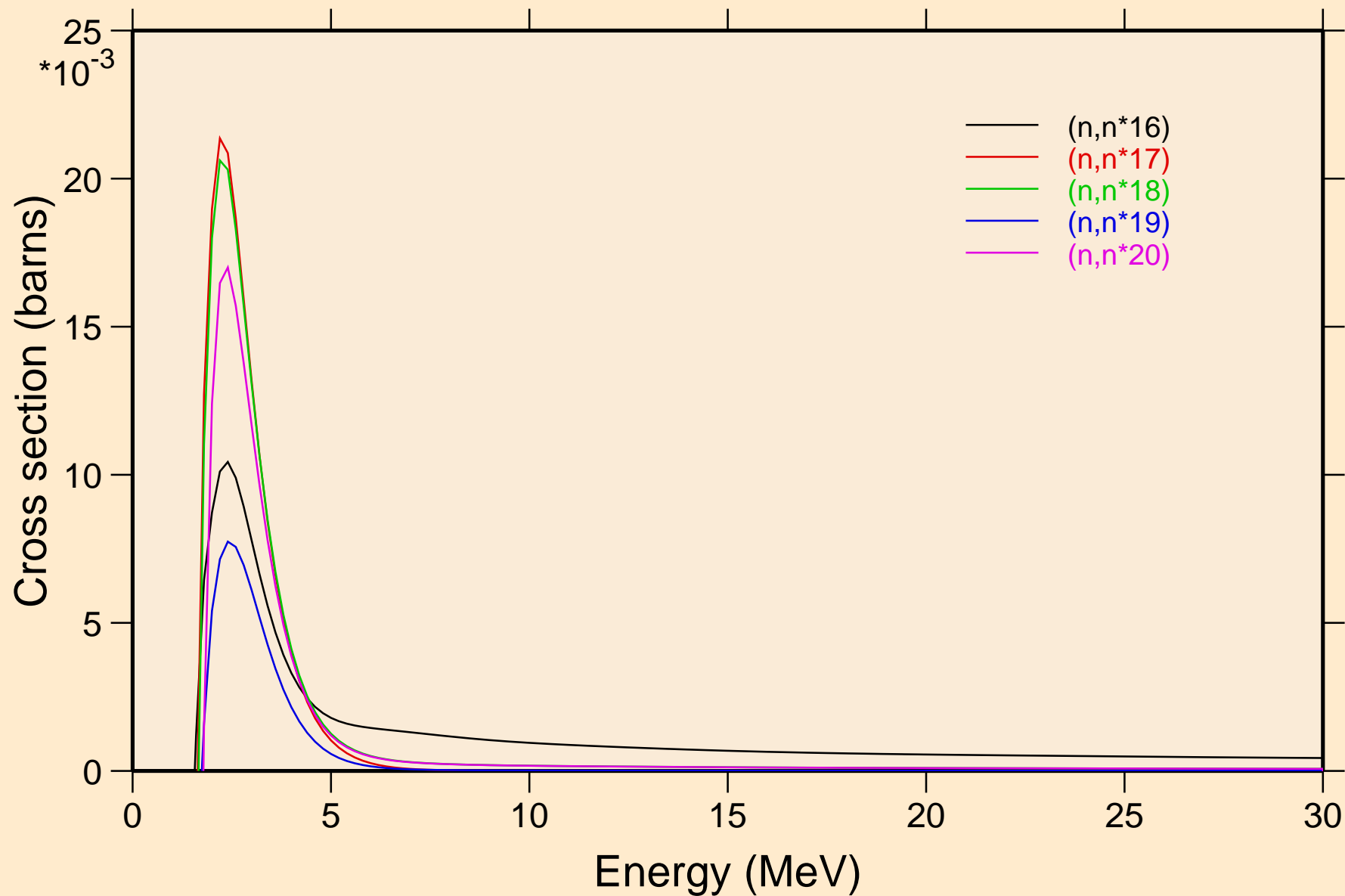

IN119 NEUTRON ACER TENDL-2019 LIBRARY; T=293.16K
Inelastic levels

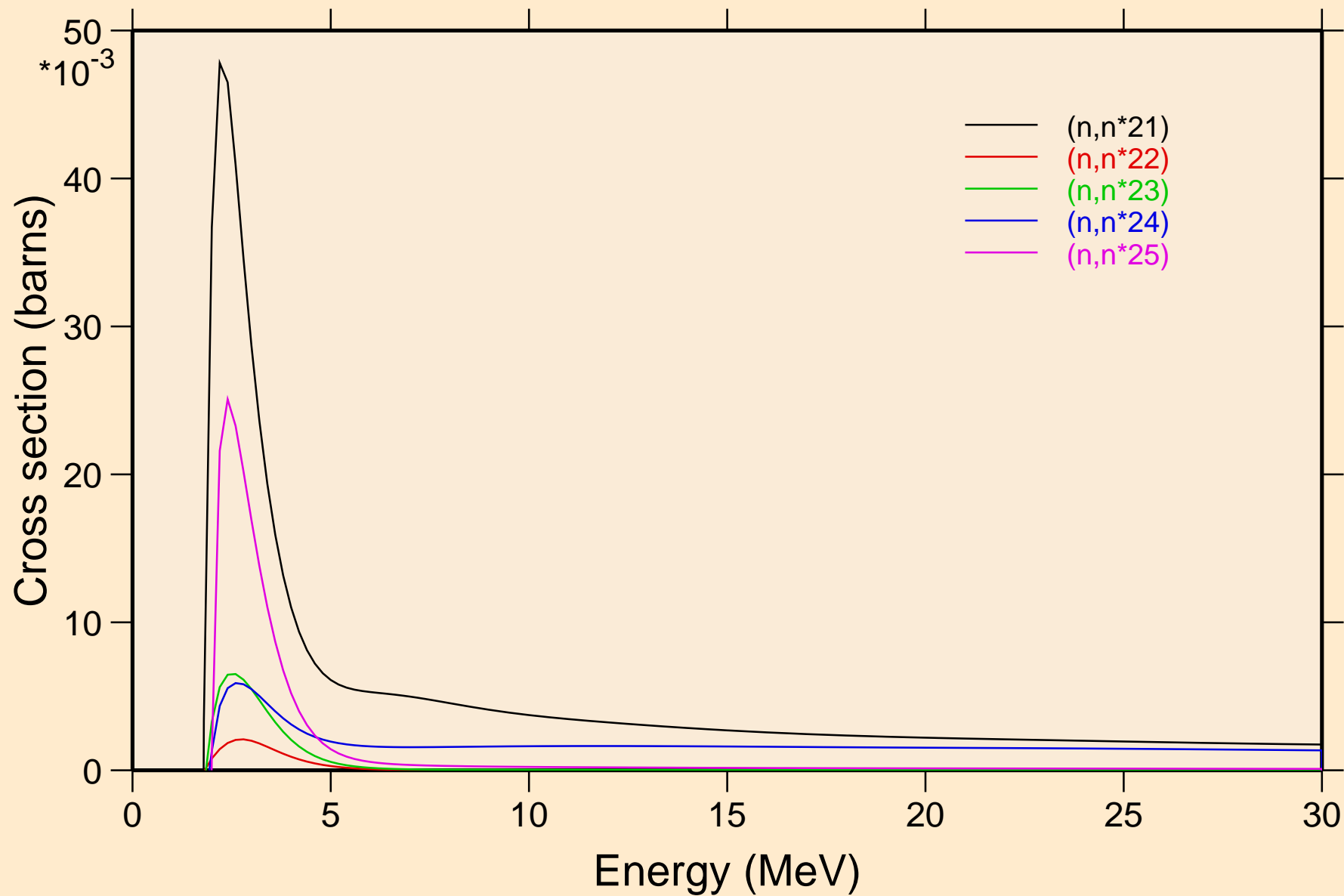

IN119 NEUTRON ACER TENDL-2019 LIBRARY; T=293.16K
Inelastic levels

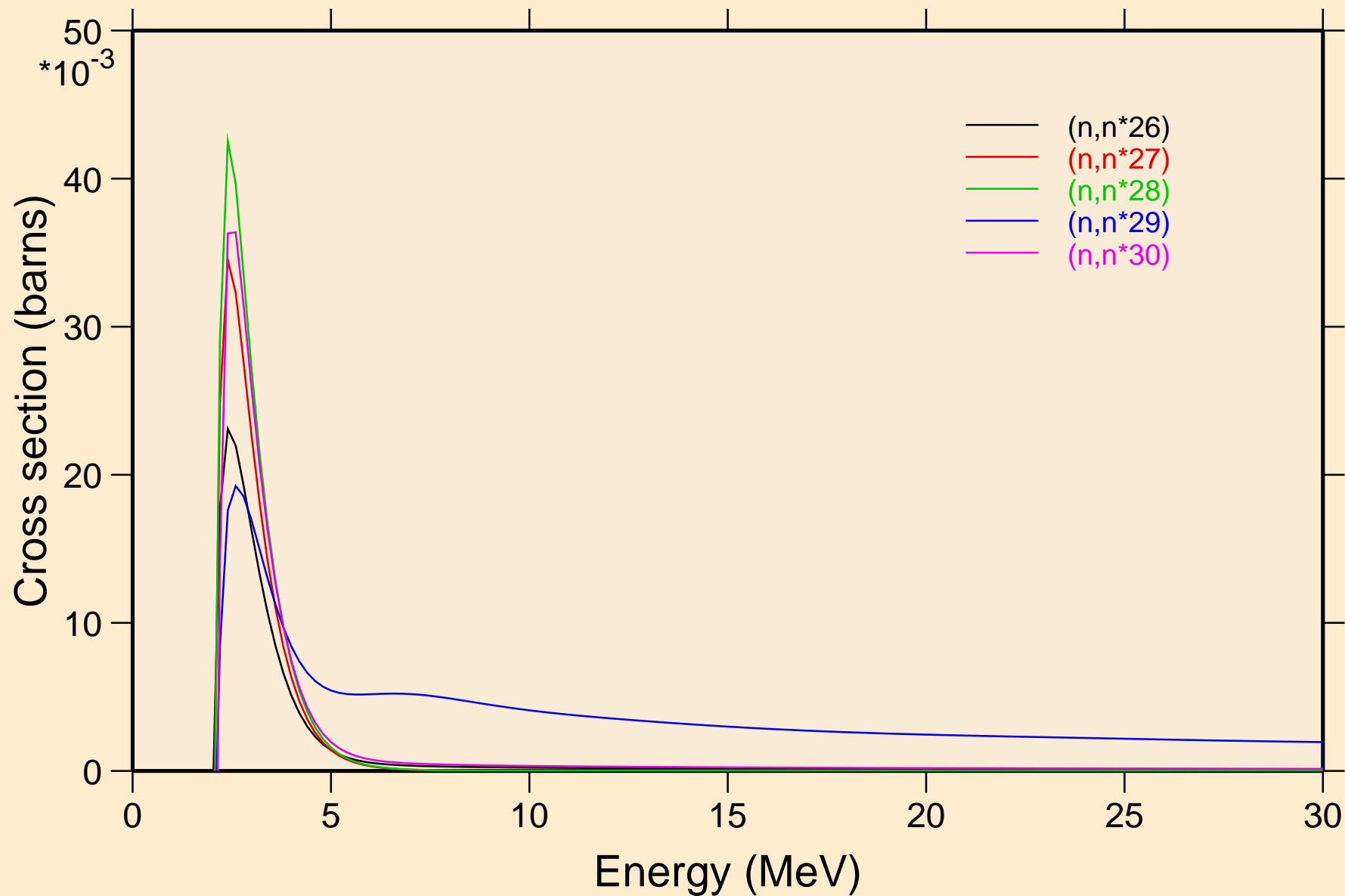

IN119 NEUTRON ACER TENDL-2019 LIBRARY; T=293.16K
Threshold reactions

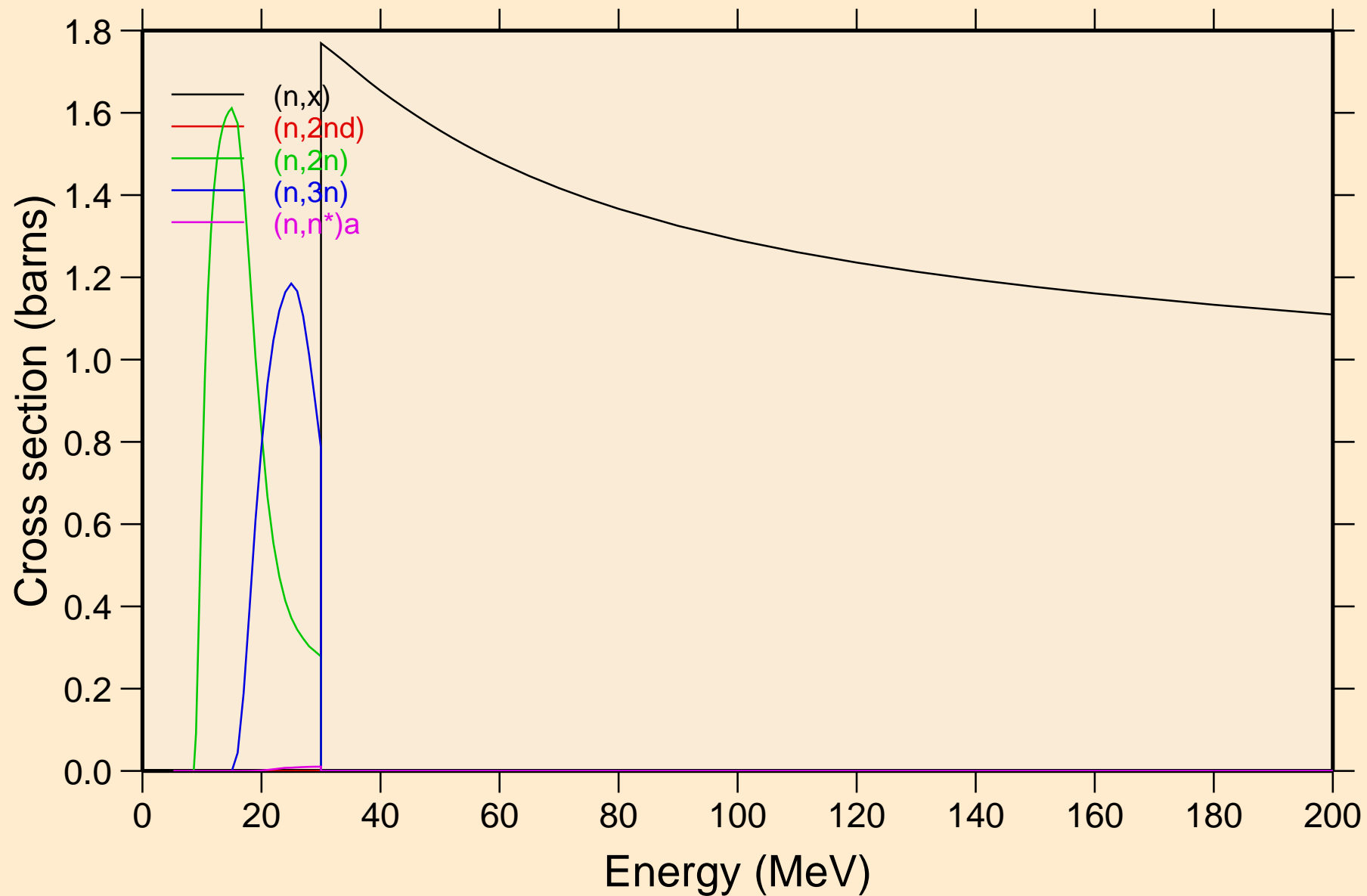

IN119 NEUTRON ACER TENDL-2019 LIBRARY; T=293.16K
Threshold reactions

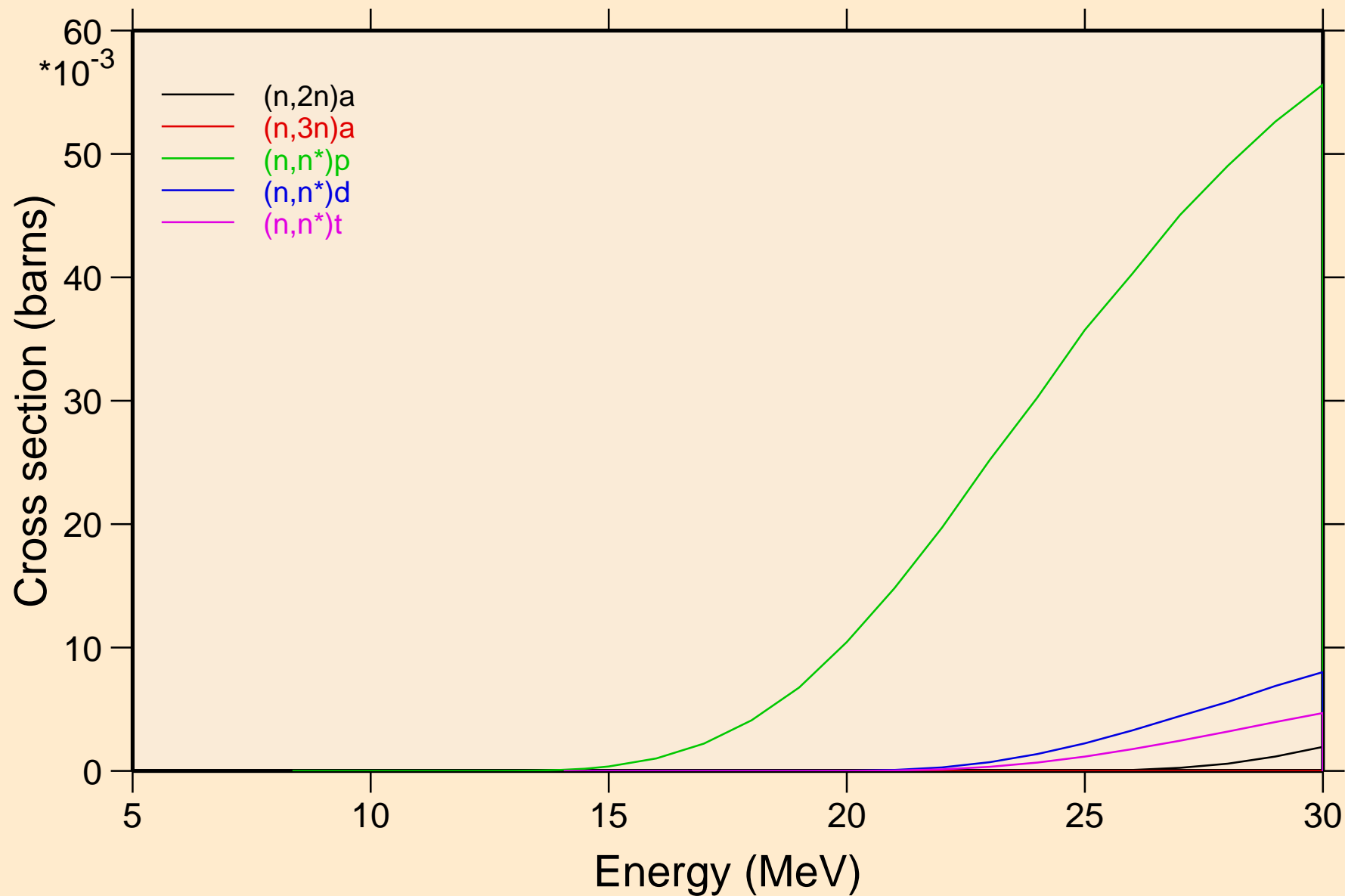

IN119 NEUTRON ACER TENDL-2019 LIBRARY; T=293.16K
Threshold reactions

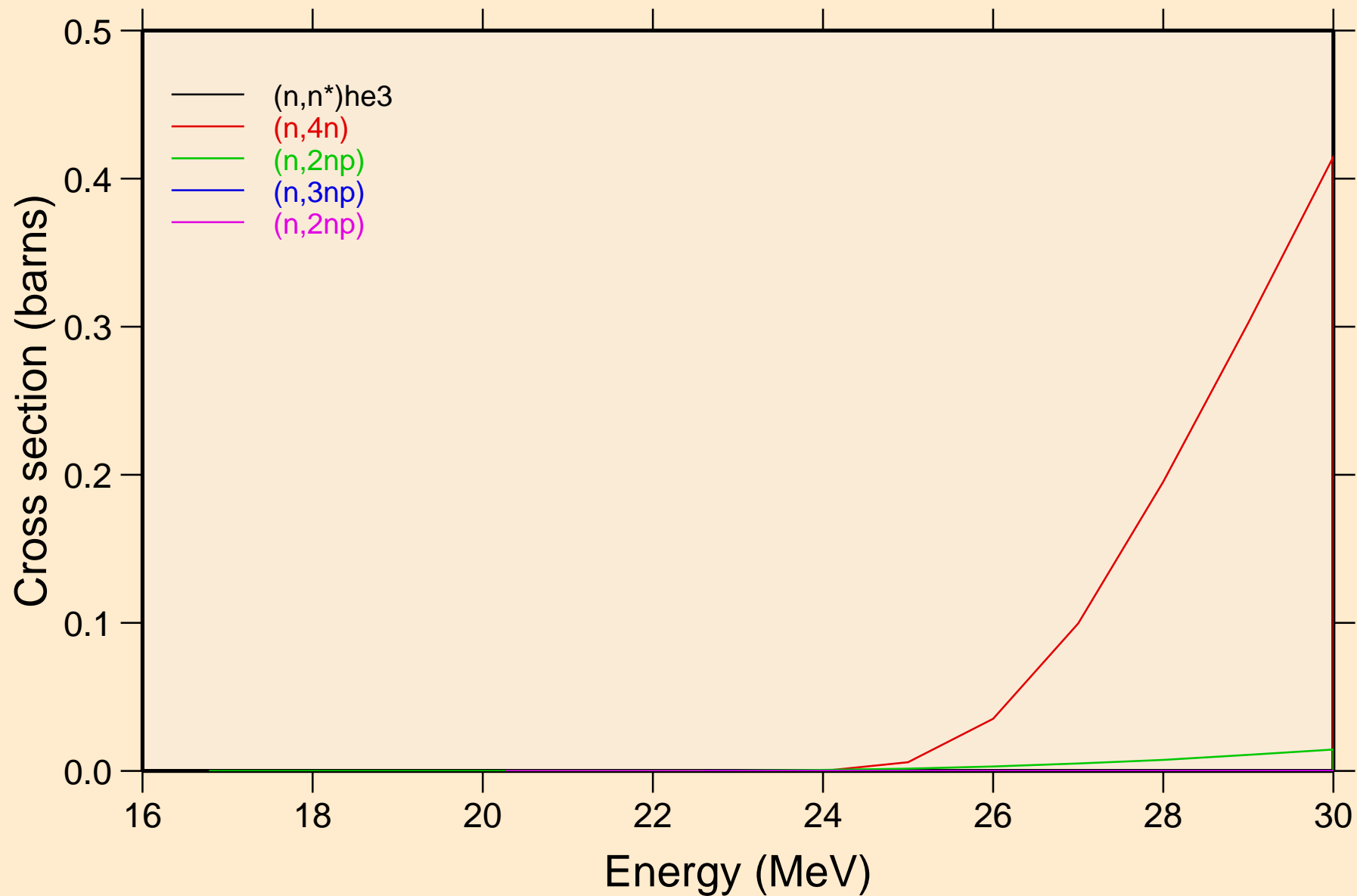

IN119 NEUTRON ACER TENDL-2019 LIBRARY; T=293.16K
Threshold reactions

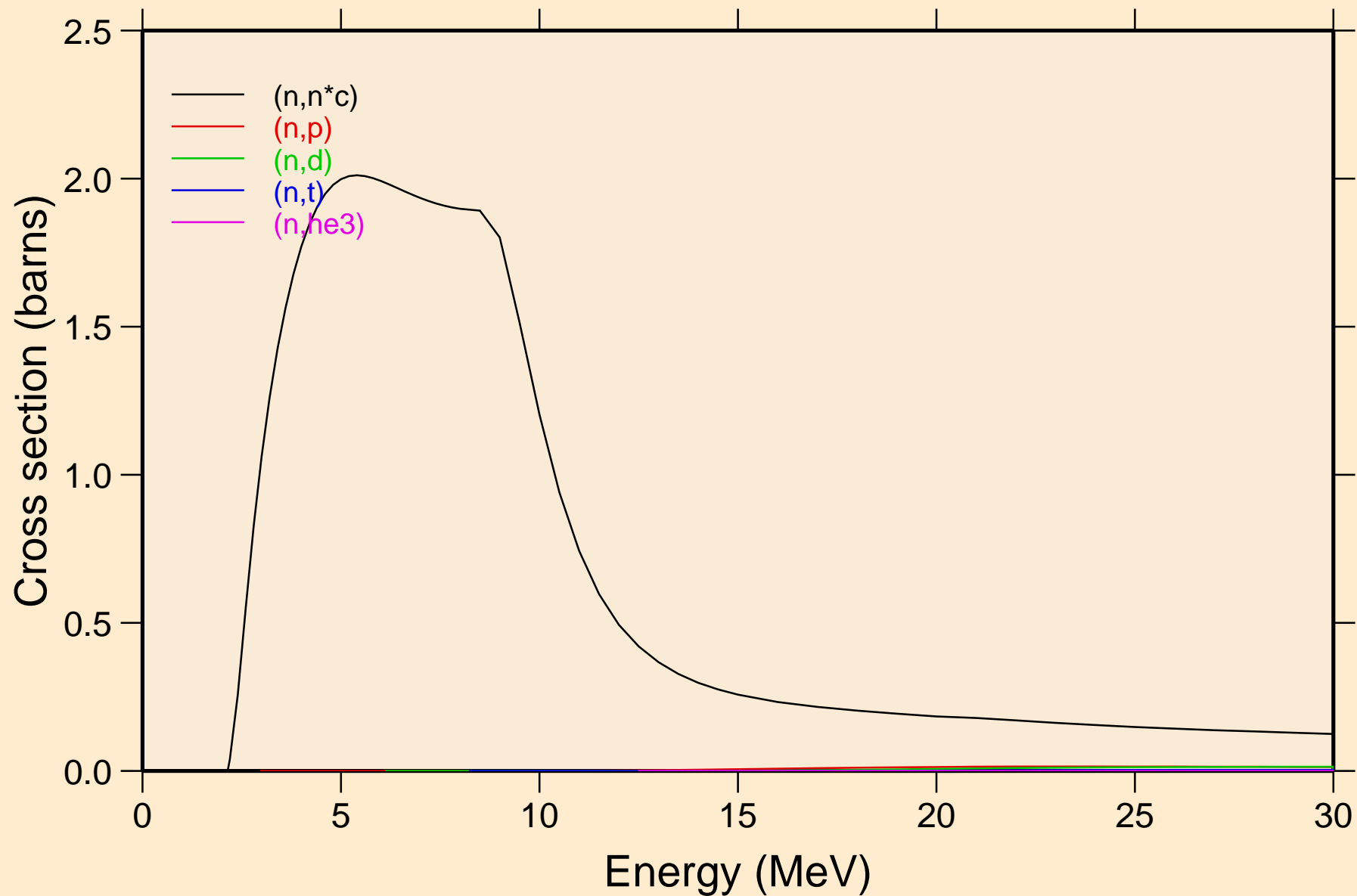

IN119 NEUTRON ACER TENDL-2019 LIBRARY; T=293.16K
Threshold reactions

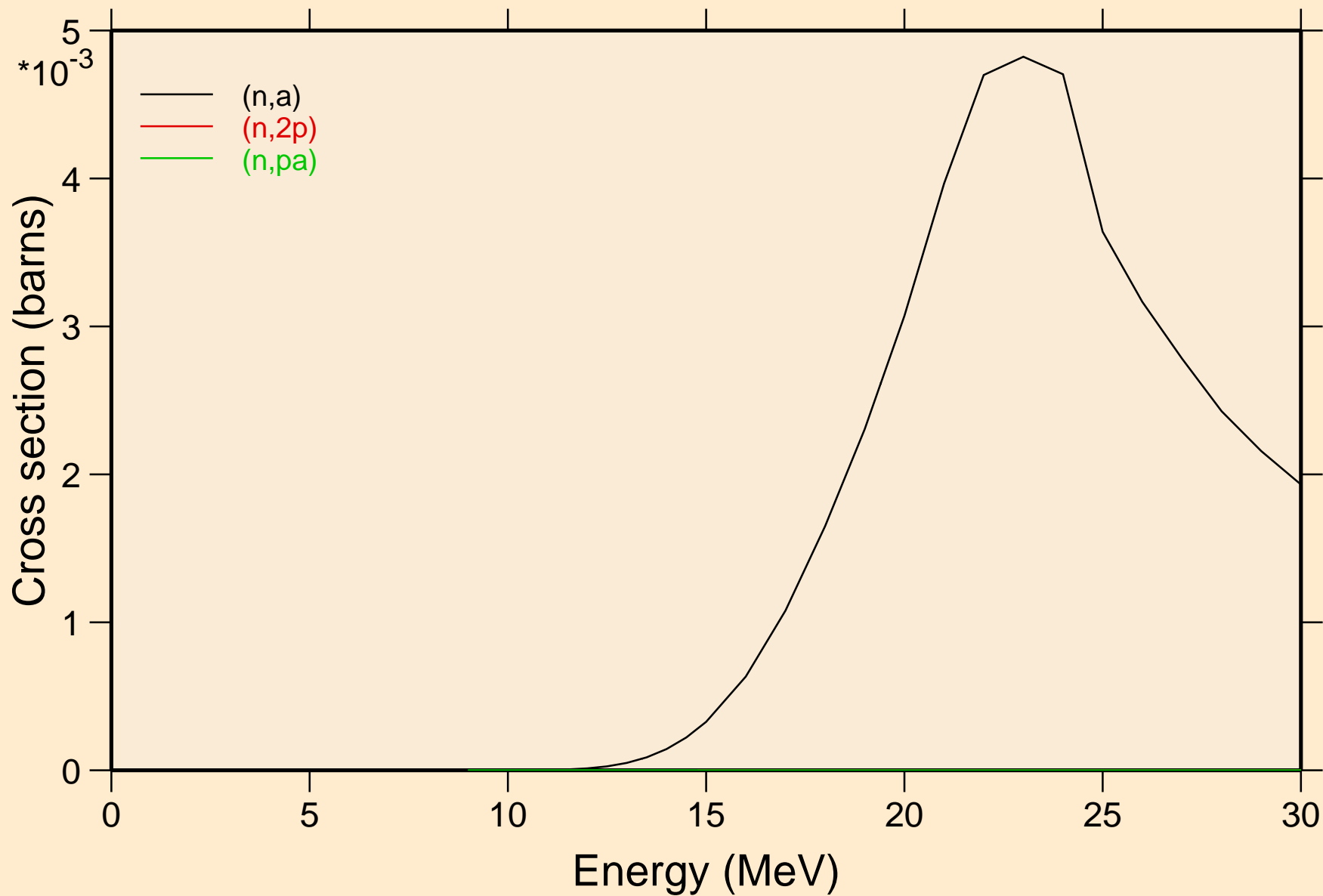

IN119 NEUTRON ACER TENDL-2019 LIBRARY; T=293.16K
Threshold reactions

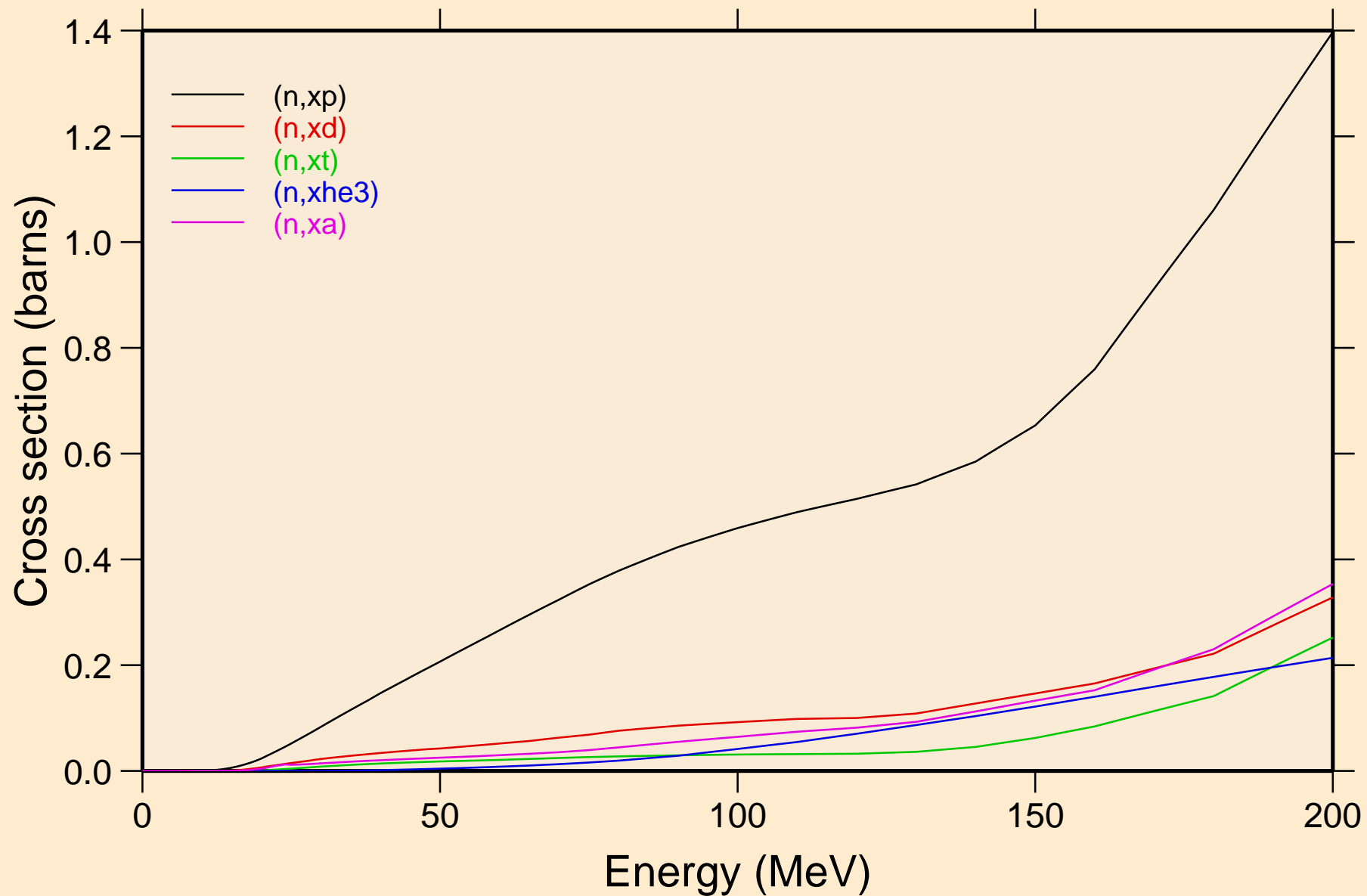

IN119 NEUTRON ACER TENDL-2019 LIBRARY; T=293.16K
angular distribution for elastic

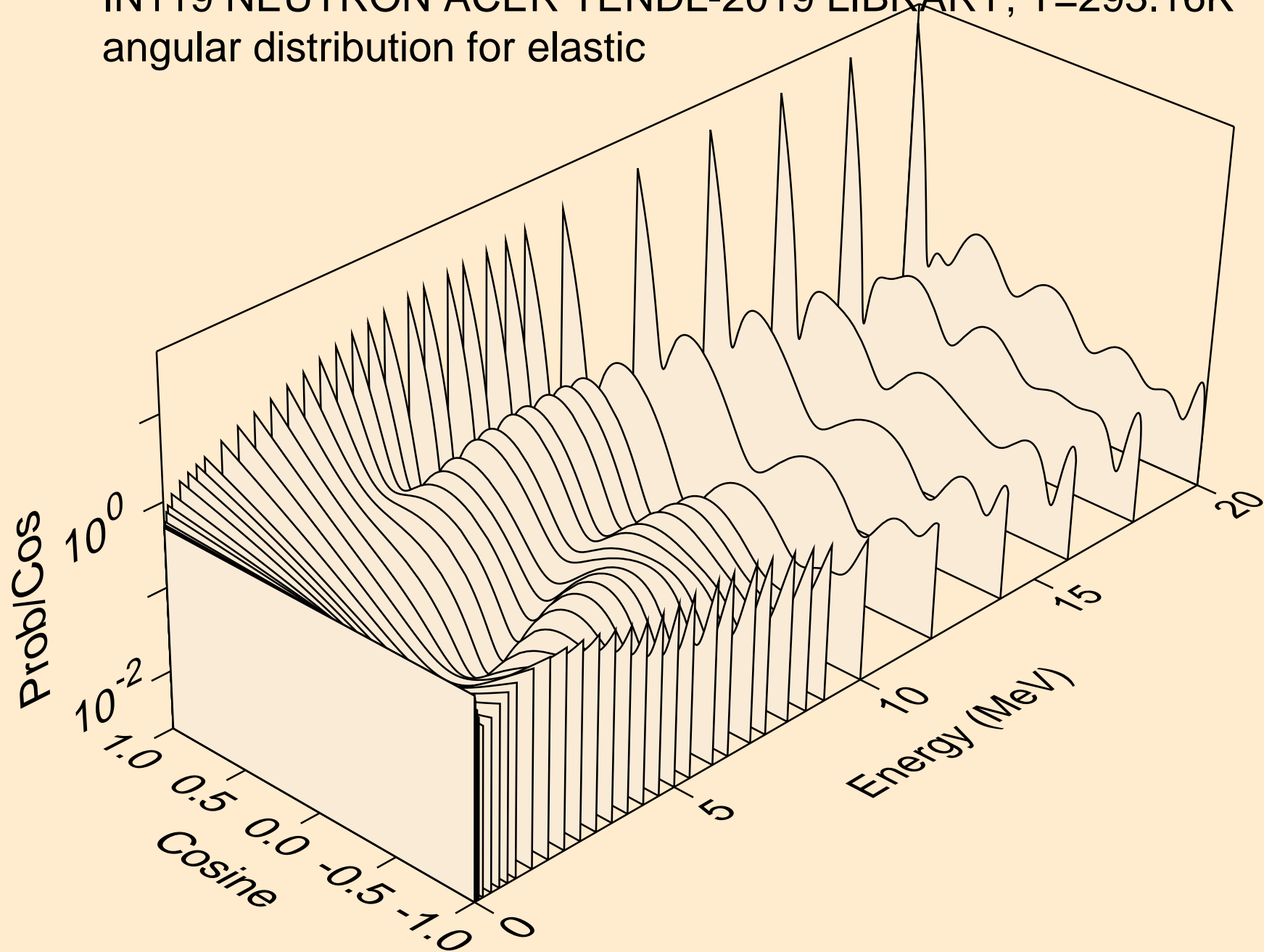

IN119 NEUTRON ACER TENDL-2019 LIBRARY; T=293.16K
angular distribution for elastic

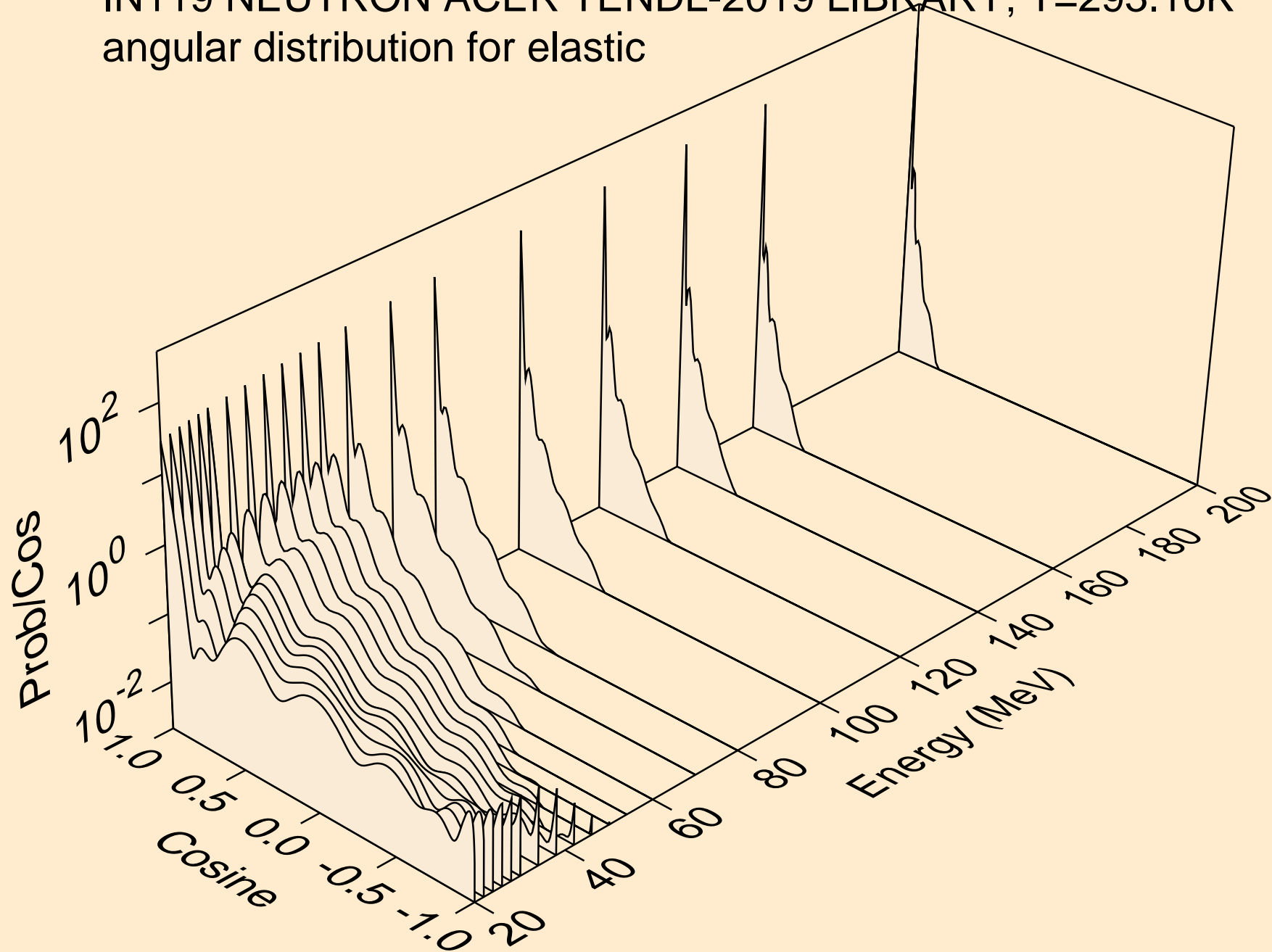

IN119 NEUTRON ACER TENDL-2019 LIBRARY; T=293.16K
angular distribution for (n,n*1)

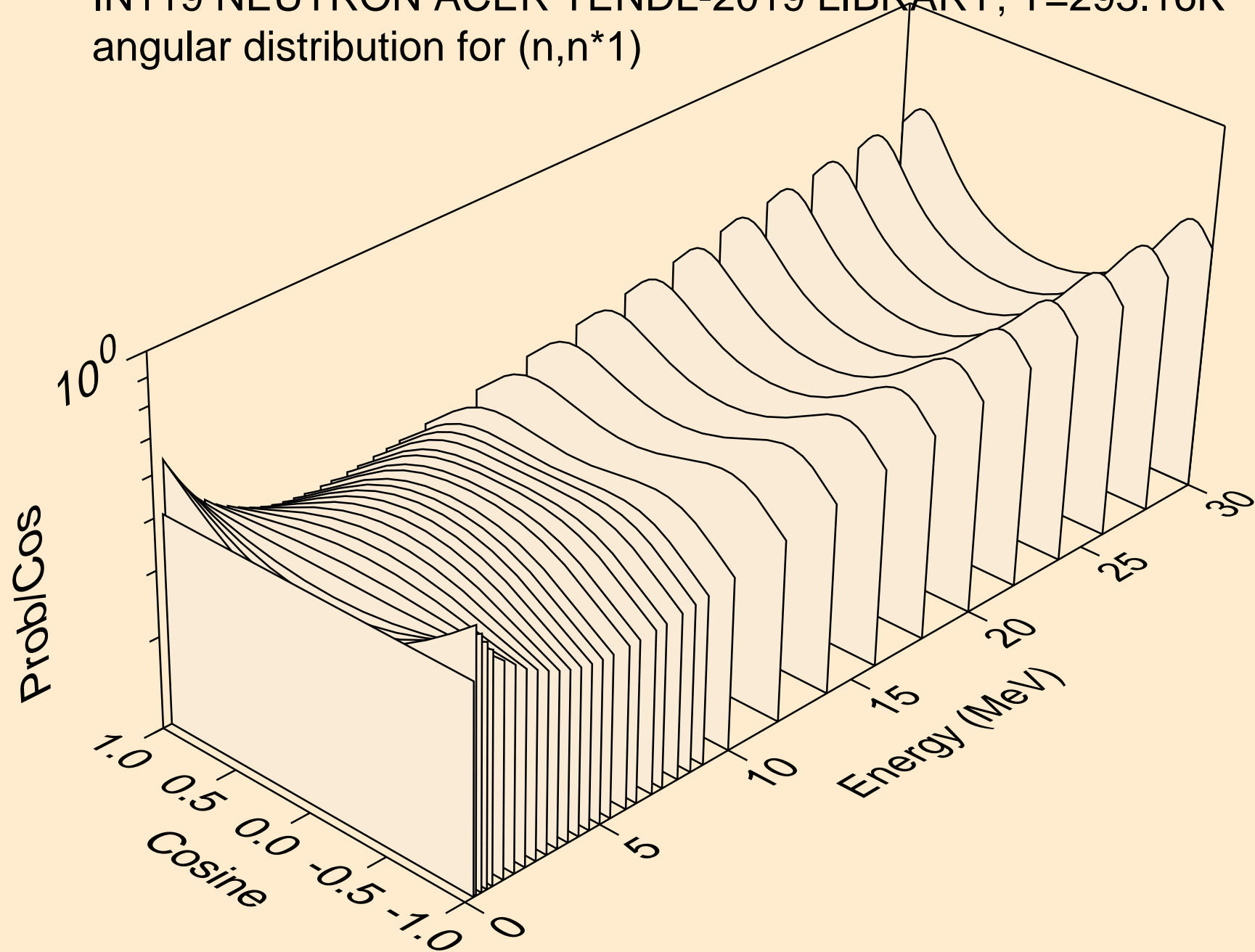

IN119 NEUTRON ACER TENDL-2019 LIBRARY; T=293.16K
angular distribution for (n,n*2)

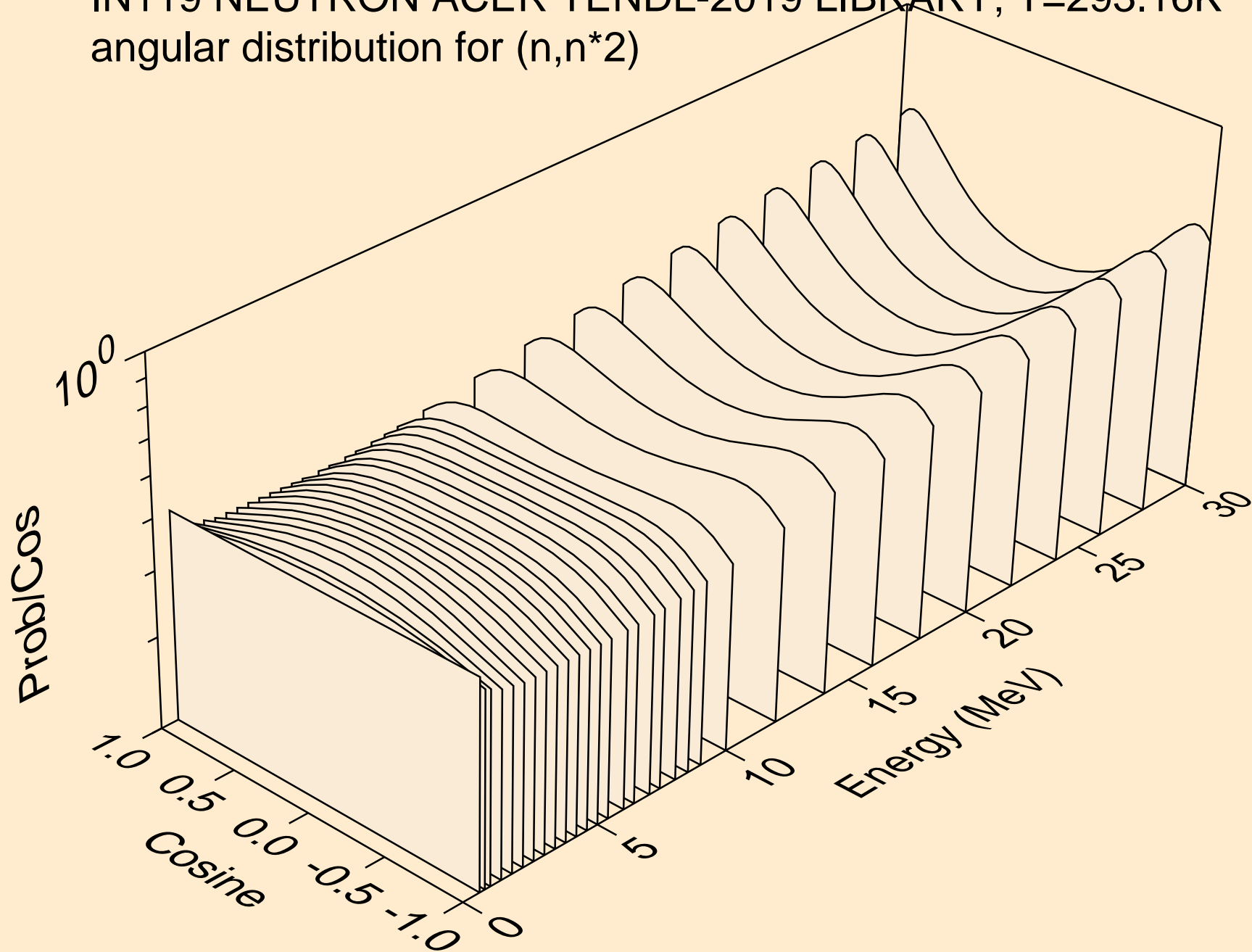

IN119 NEUTRON ACER TENDL-2019 LIBRARY; T=293.16K
angular distribution for (n,n*3)

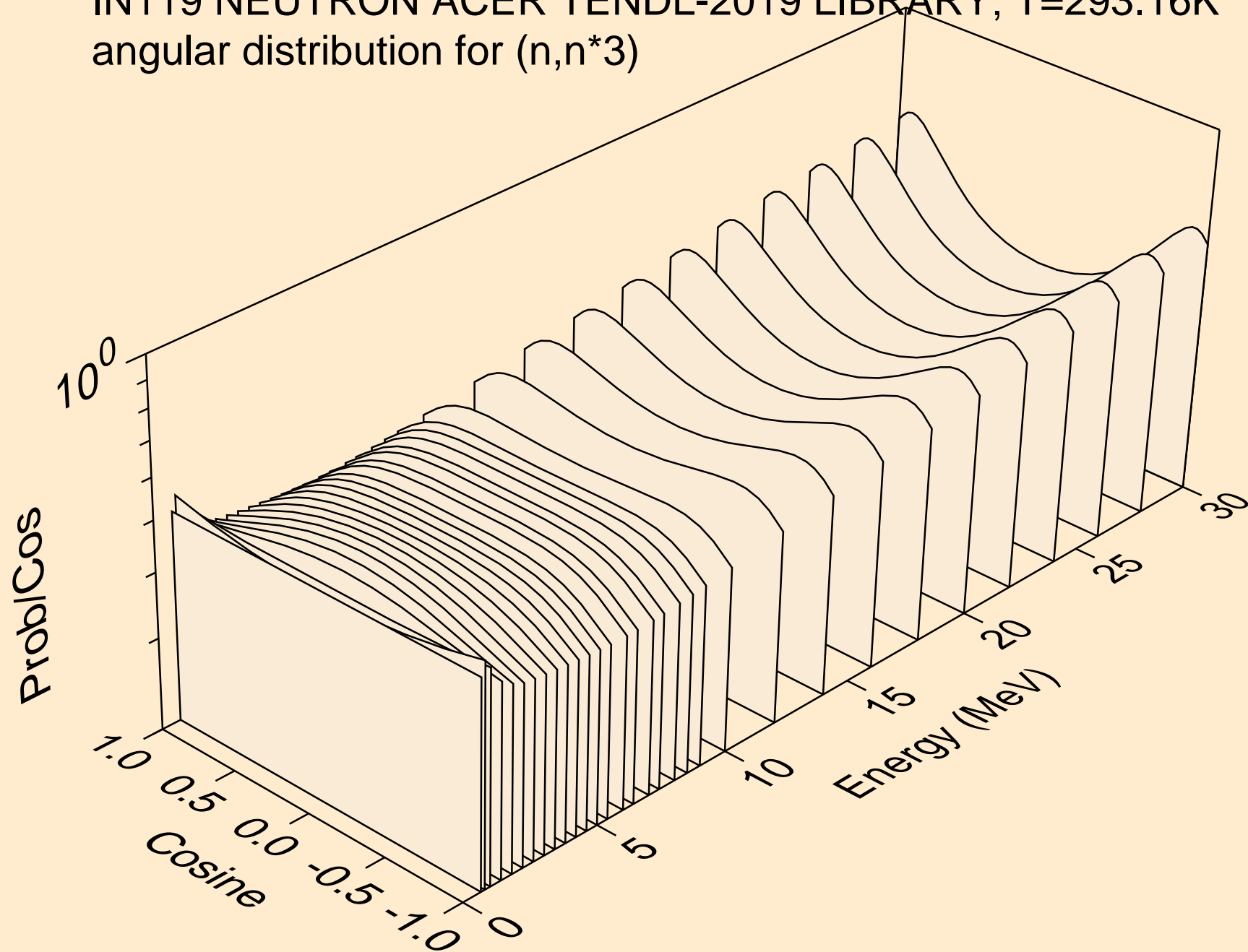

IN119 NEUTRON ACER TENDL-2019 LIBRARY; T=293.16K
angular distribution for (n,n*4)

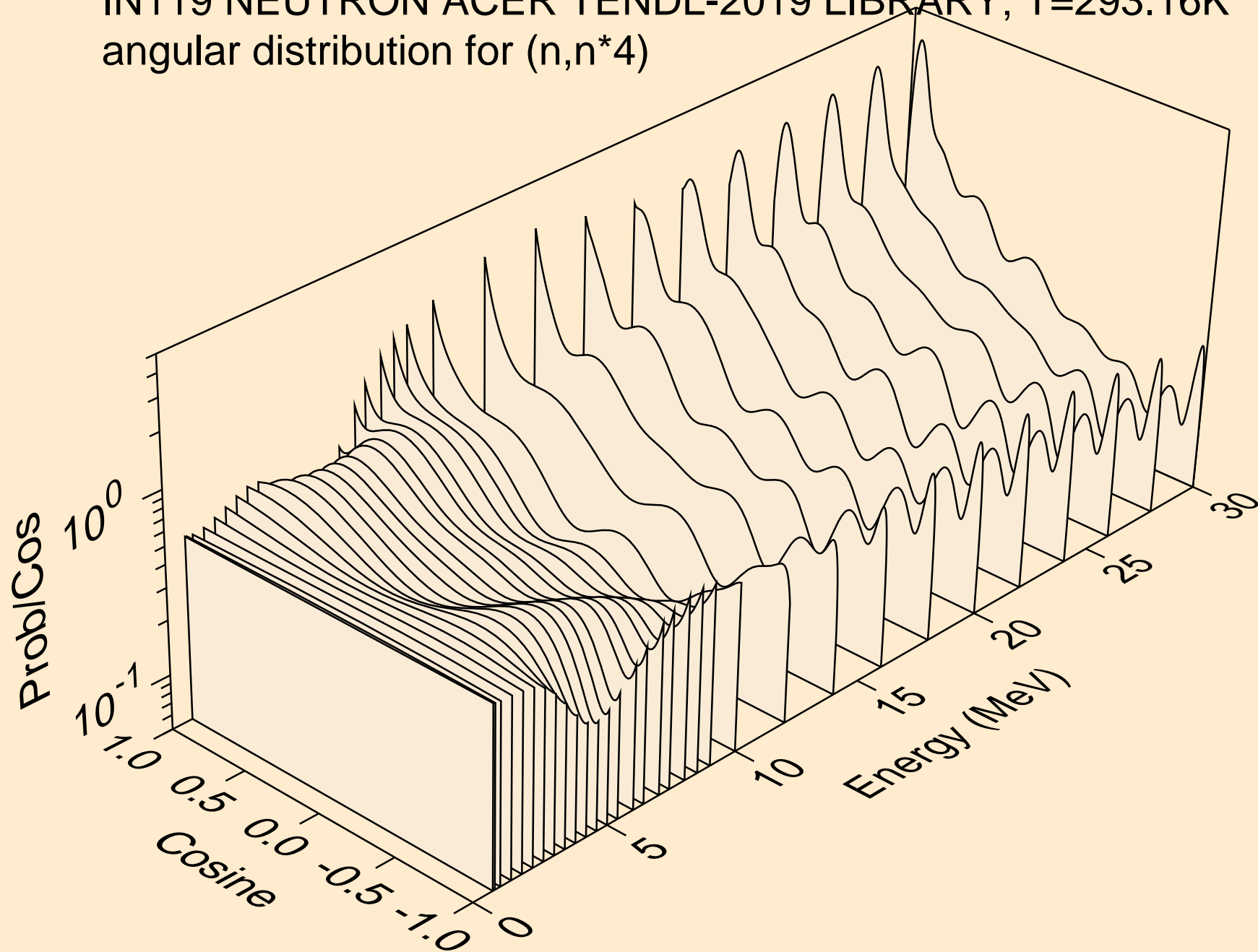

IN119 NEUTRON ACER TENDL-2019 LIBRARY; T=293.16K
angular distribution for (n,n*5)

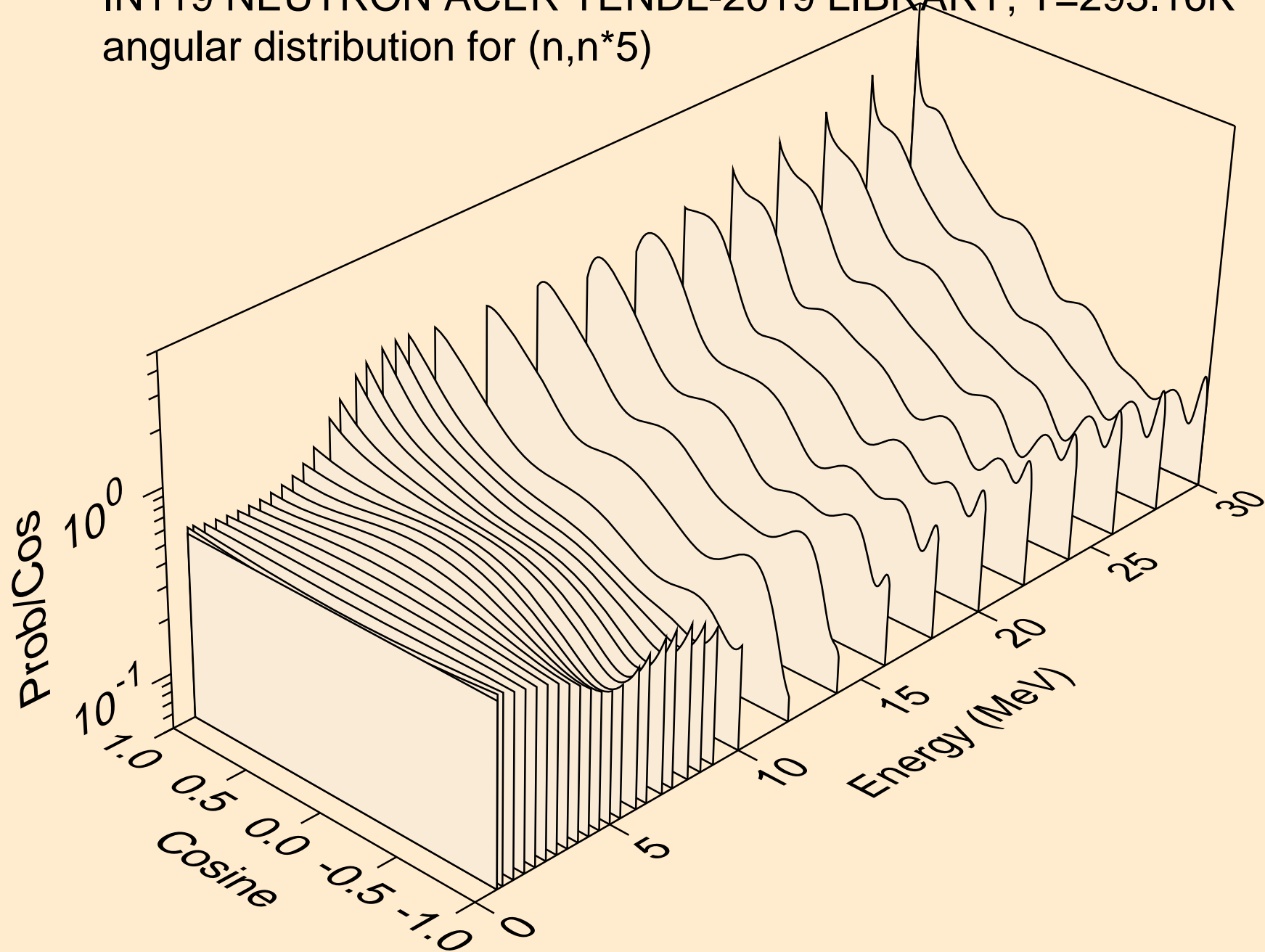

IN119 NEUTRON ACER TENDL-2019 LIBRARY; T=293.16K
angular distribution for (n,n*6)

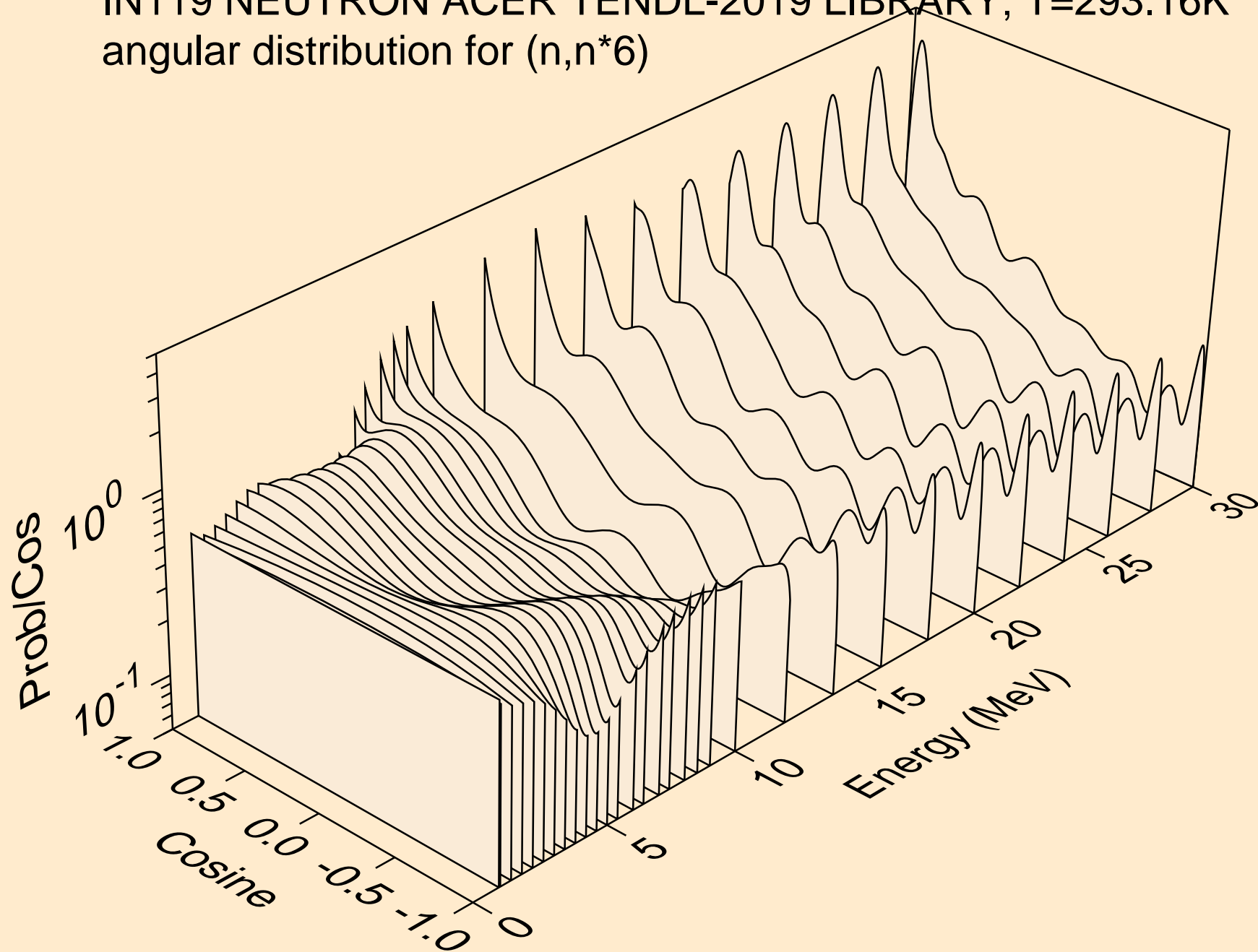

IN119 NEUTRON ACER TENDL-2019 LIBRARY; T=293.16K
angular distribution for (n,n*7)

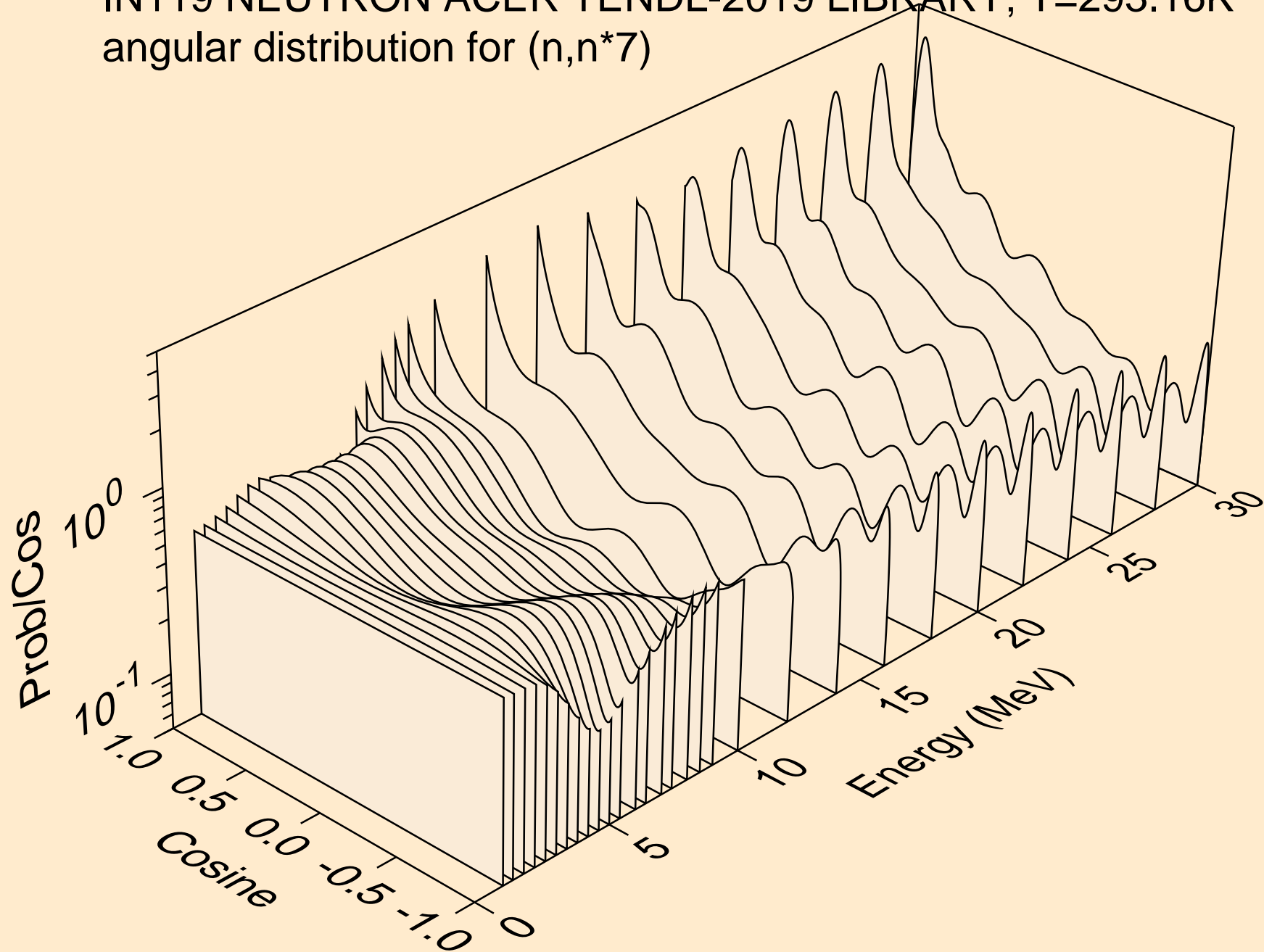

IN119 NEUTRON ACER TENDL-2019 LIBRARY; T=293.16K
angular distribution for (n,n*8)

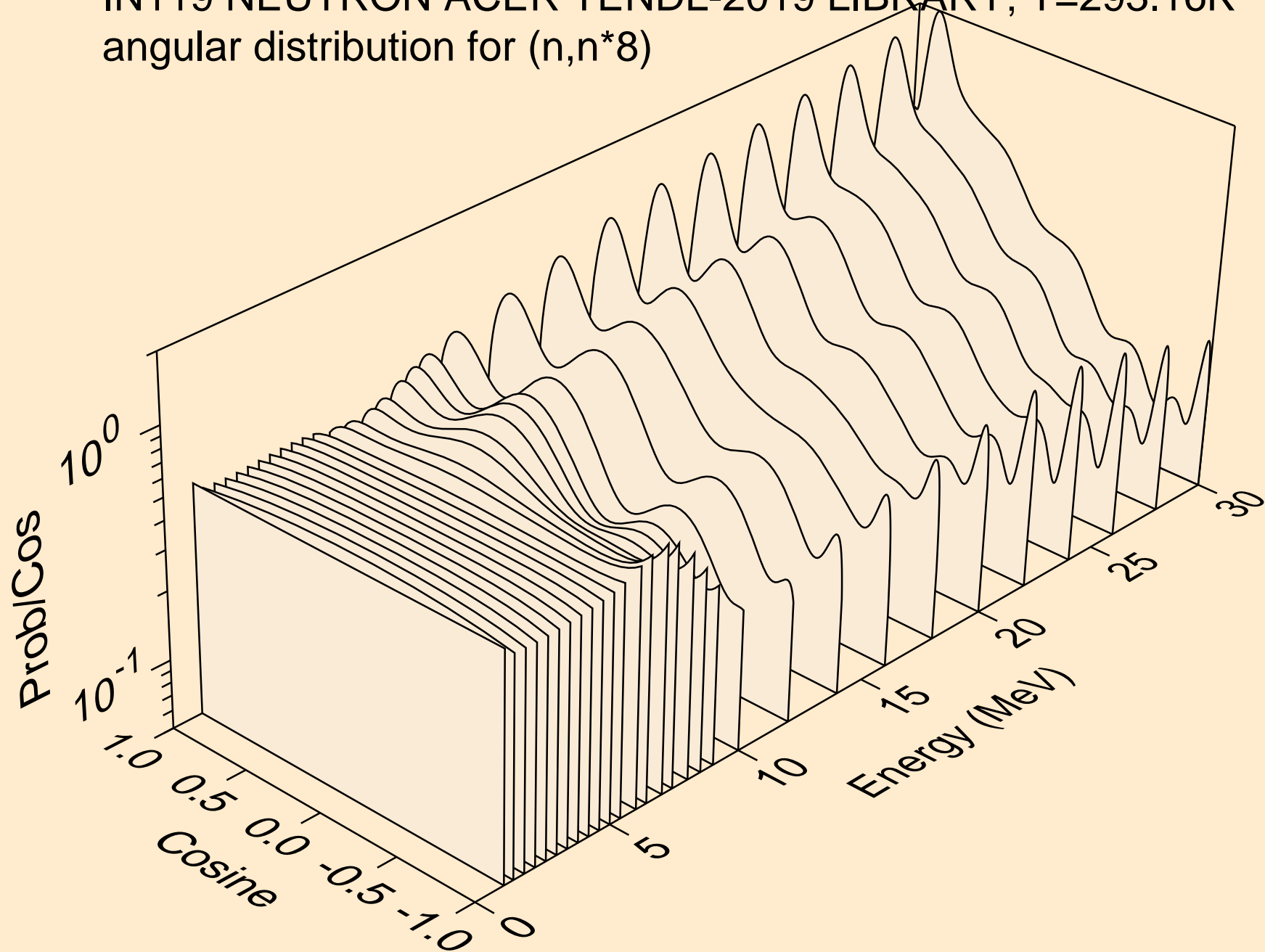

IN119 NEUTRON ACER TENDL-2019 LIBRARY; T=293.16K
angular distribution for (n,n*9)

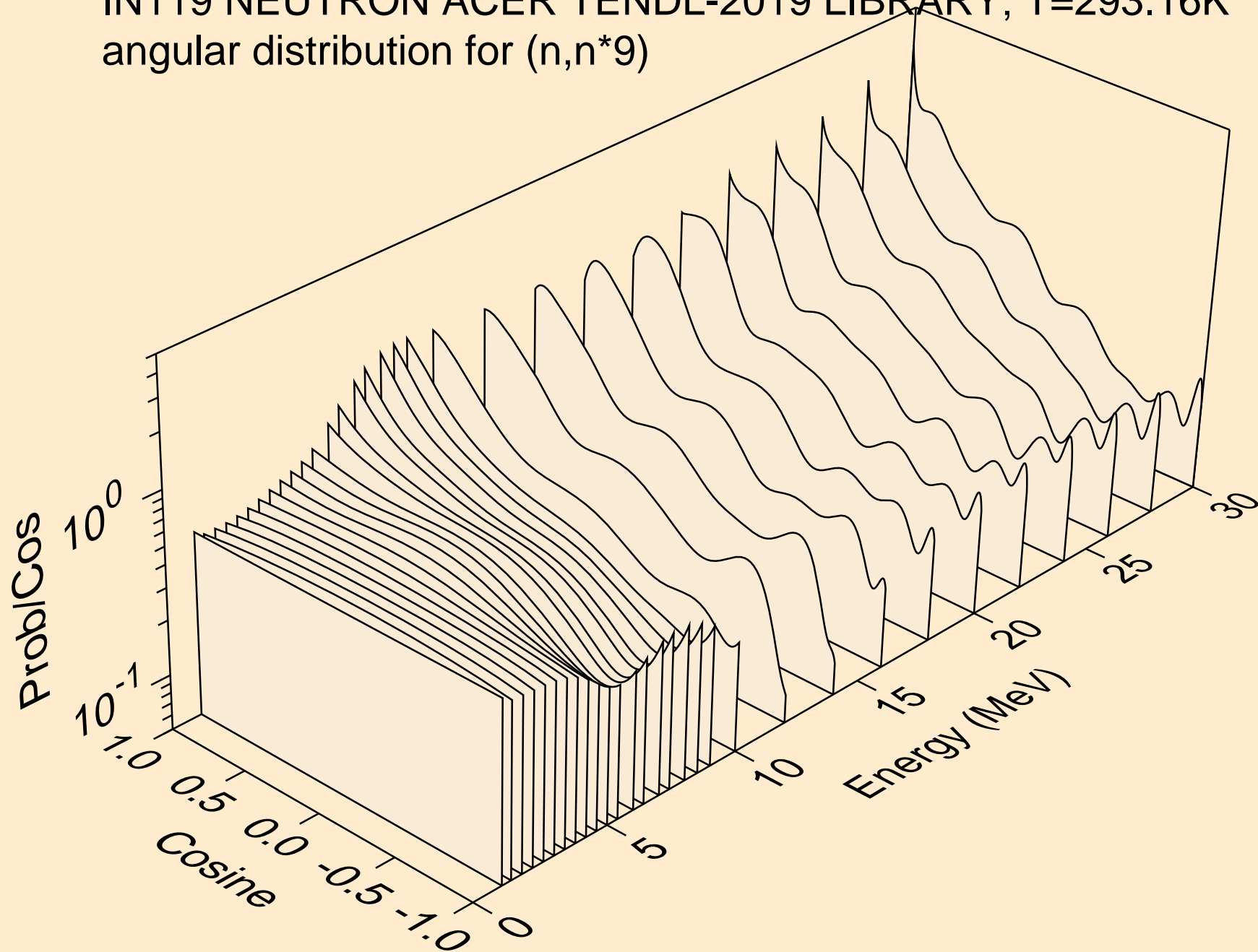

IN119 NEUTRON ACER TENDL-2019 LIBRARY; T=293.16K
angular distribution for (n,n*10)

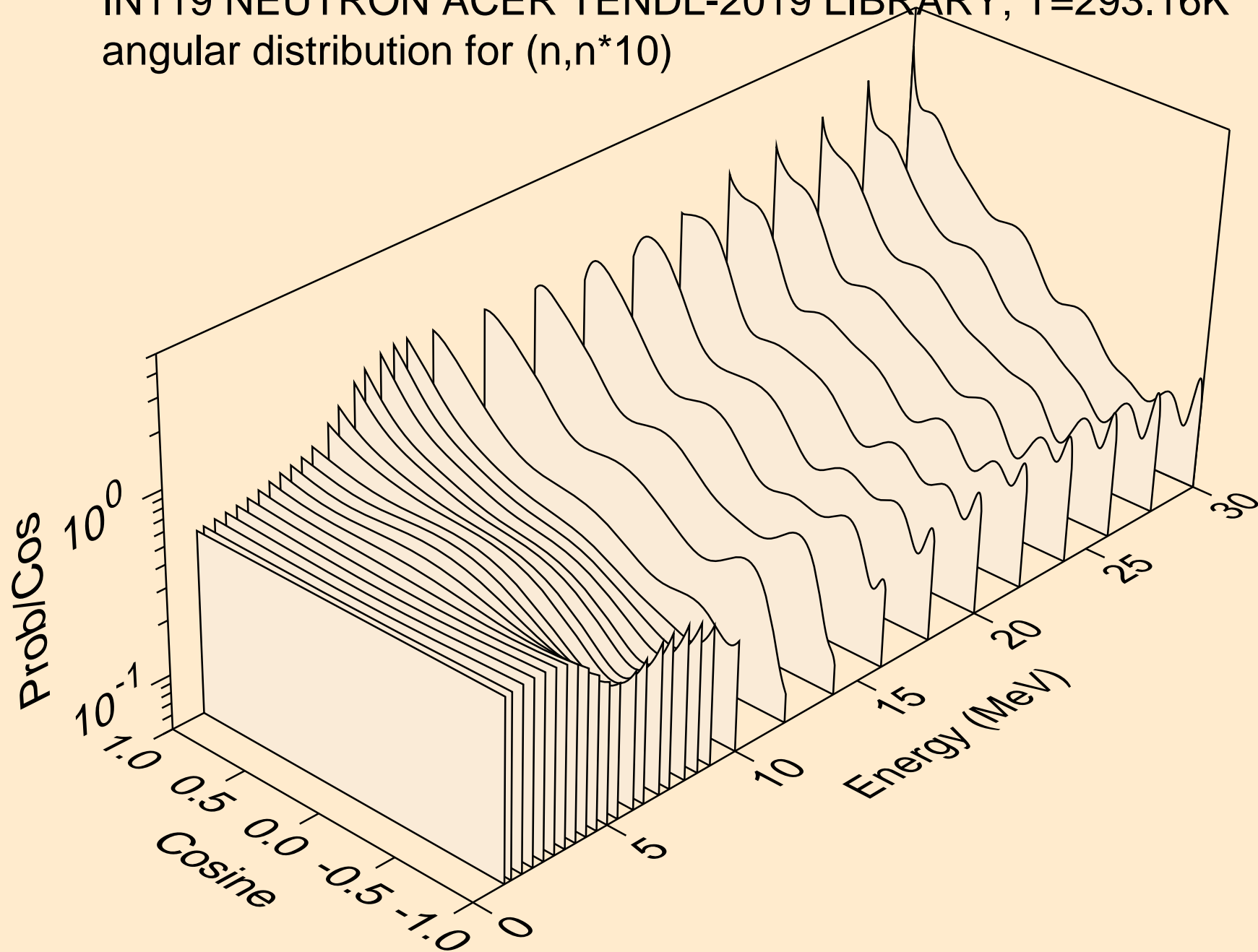

IN119 NEUTRON ACER TENDL-2019 LIBRARY; T=293.16K
angular distribution for (n,n*11)

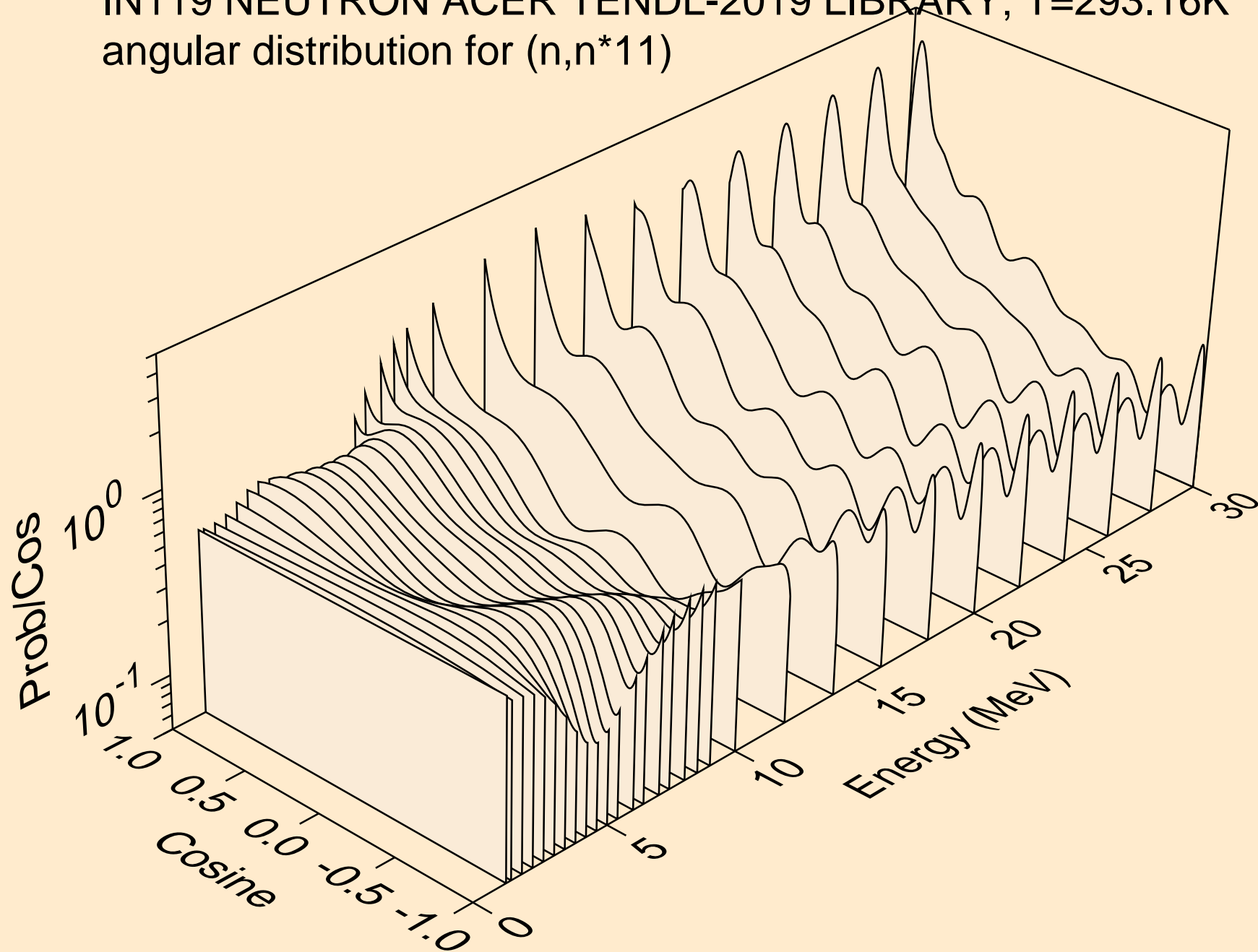

IN119 NEUTRON ACER TENDL-2019 LIBRARY; T=293.16K
angular distribution for (n,n*12)

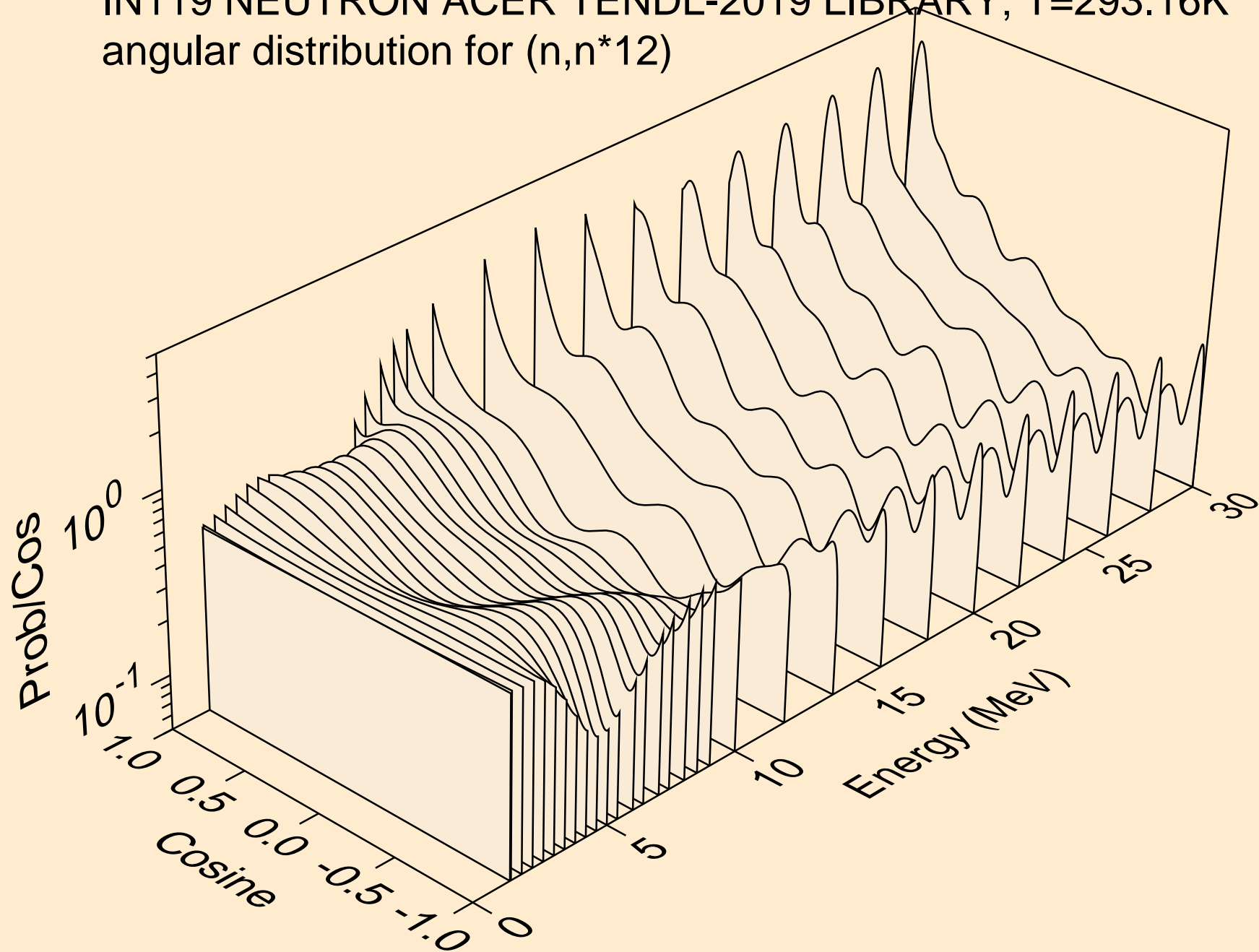

IN119 NEUTRON ACER TENDL-2019 LIBRARY; T=293.16K
angular distribution for (n,n*13)

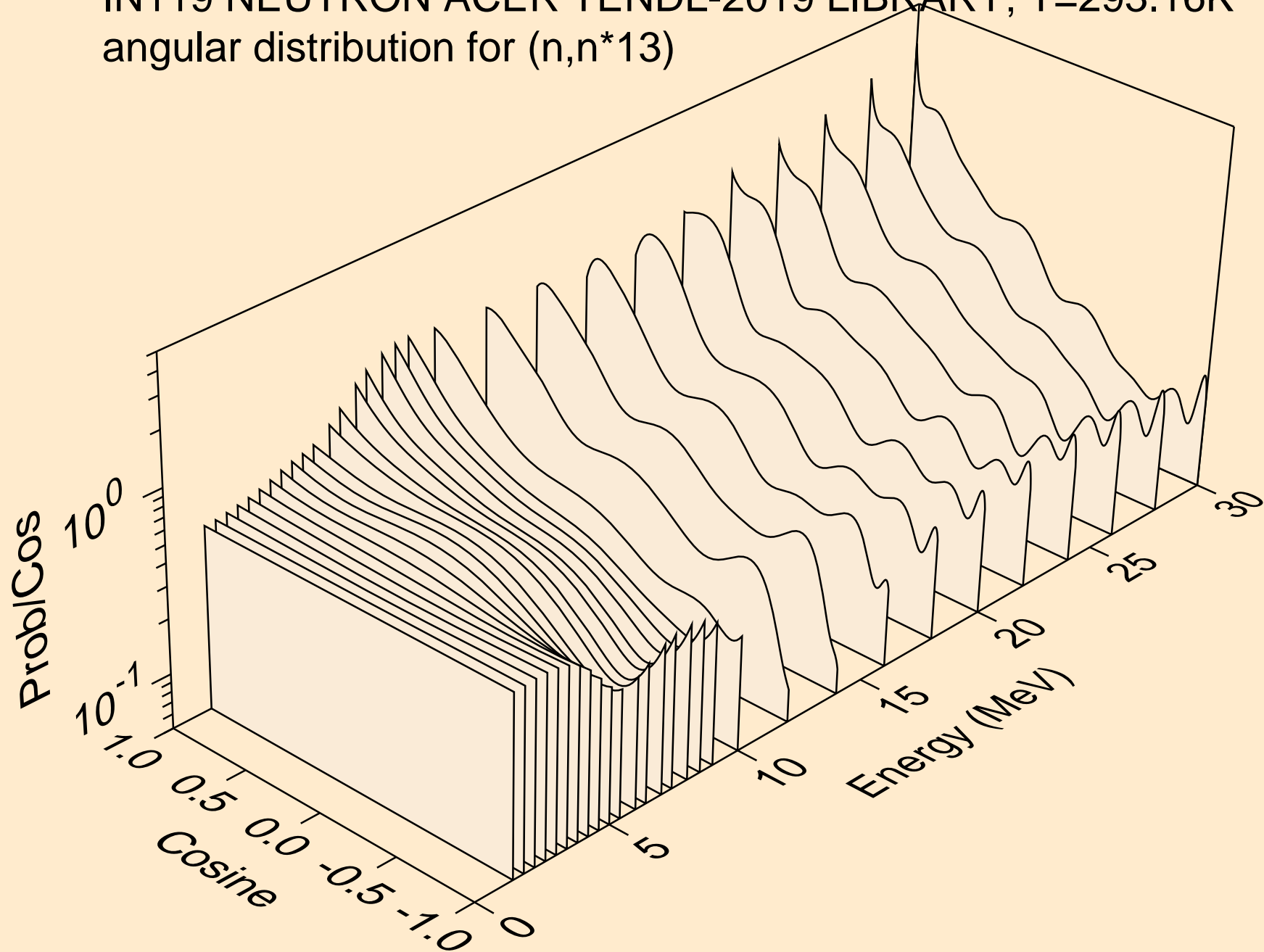

IN119 NEUTRON ACER TENDL-2019 LIBRARY; T=293.16K
angular distribution for (n,n*14)

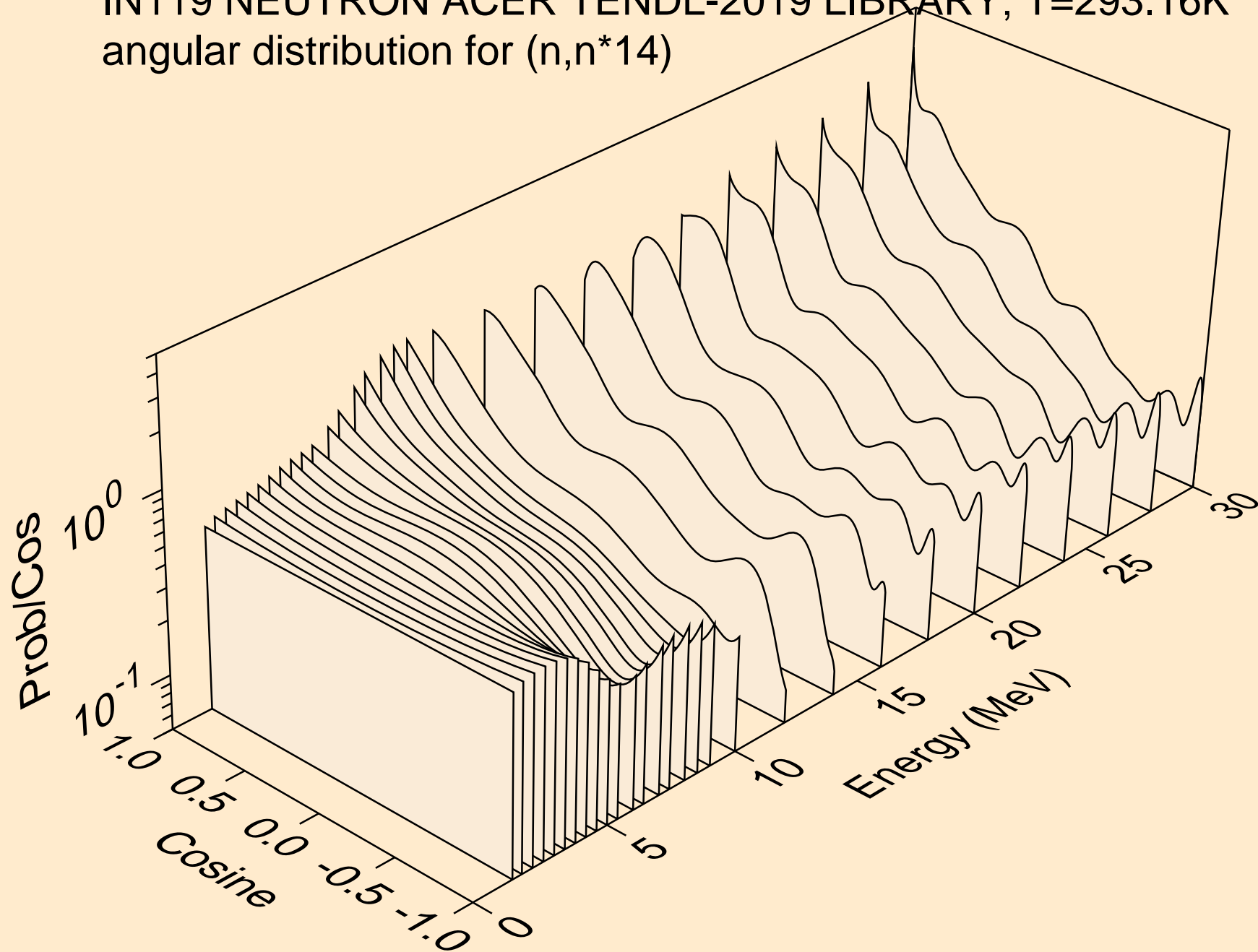

IN119 NEUTRON ACER TENDL-2019 LIBRARY; T=293.16K
angular distribution for (n,n*15)

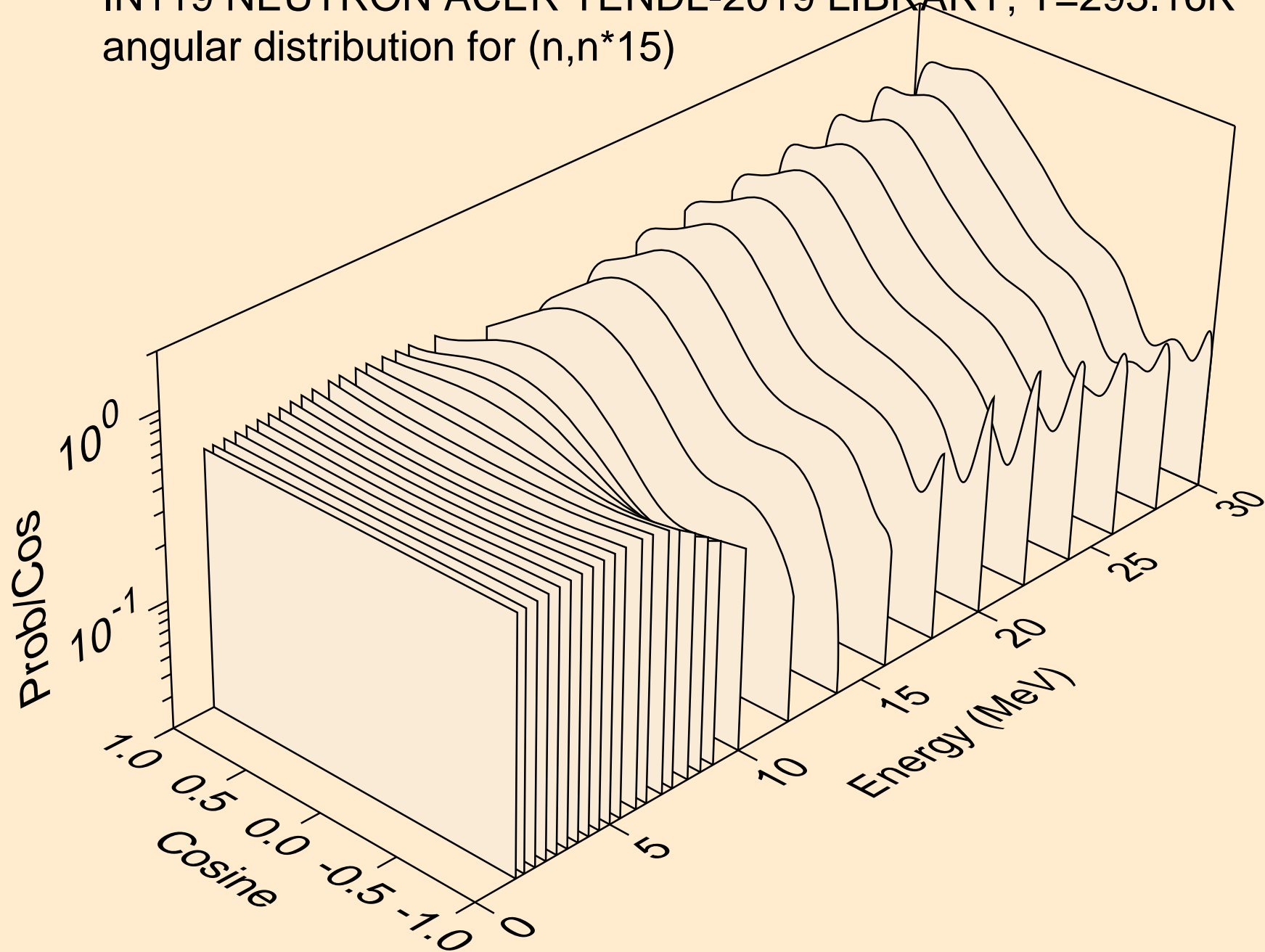

IN119 NEUTRON ACER TENDL-2019 LIBRARY; T=293.16K
angular distribution for (n,n*16)

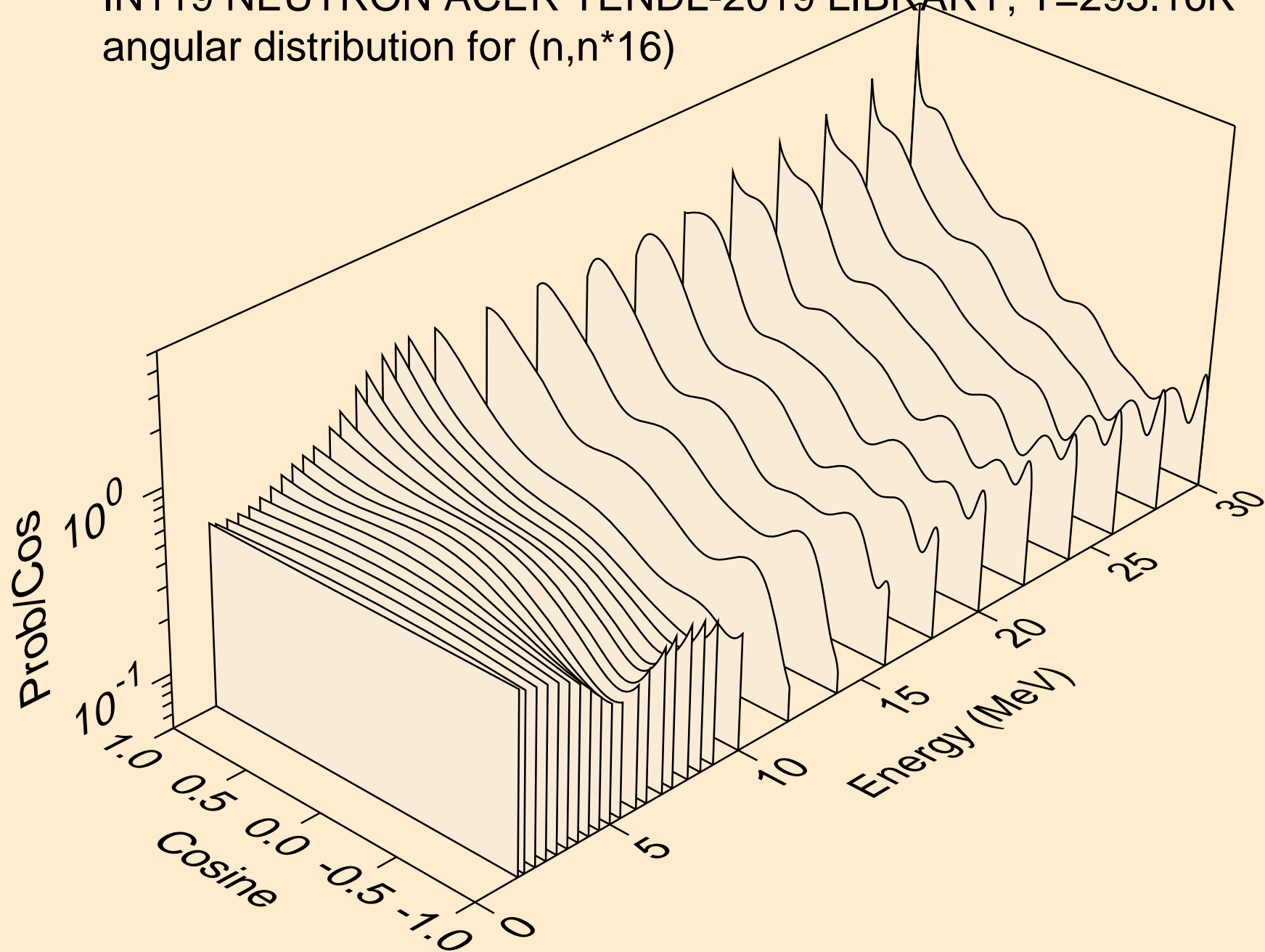

IN119 NEUTRON ACER TENDL-2019 LIBRARY; T=293.16K
angular distribution for (n,n*17)

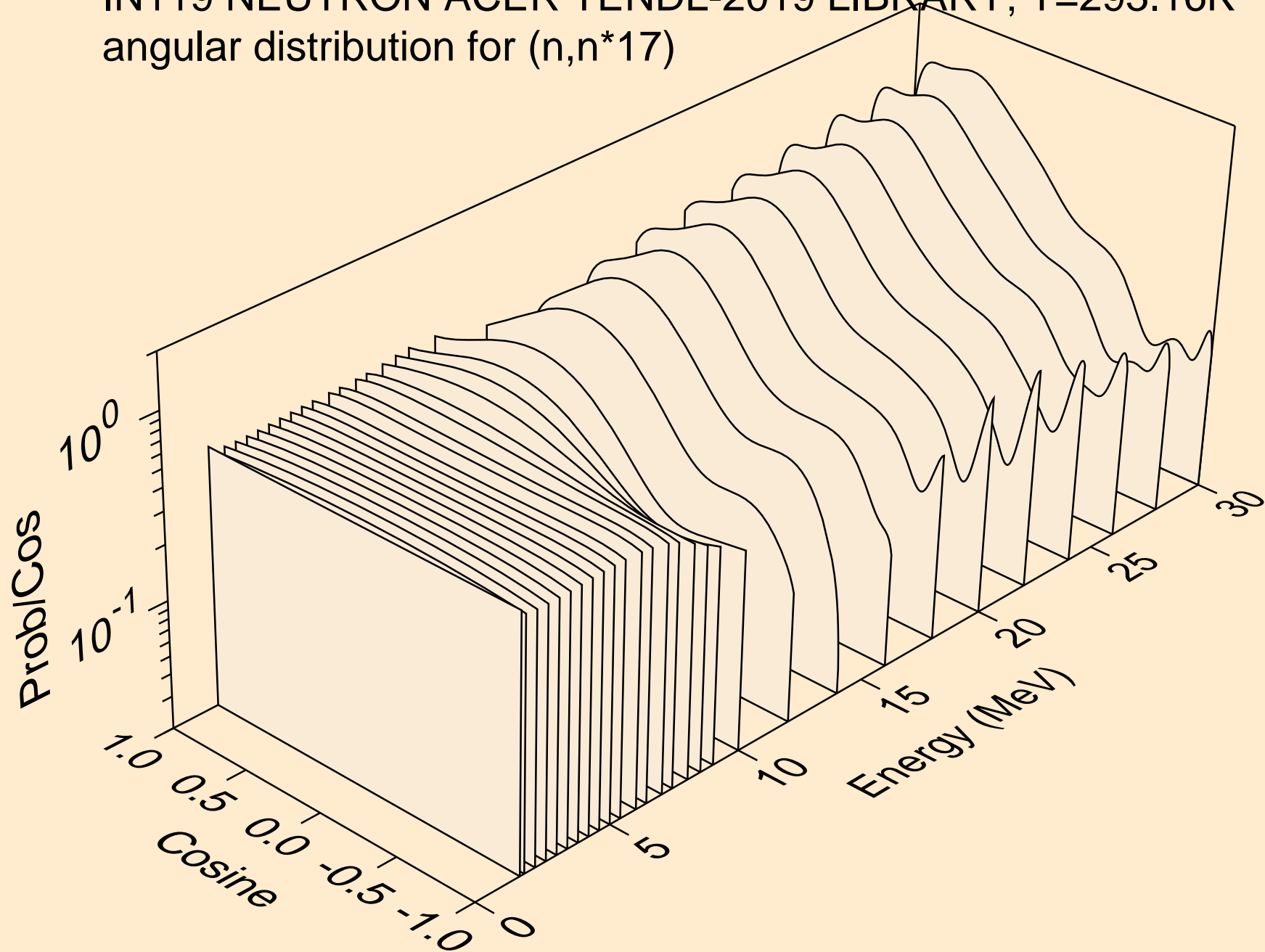

IN119 NEUTRON ACER TENDL-2019 LIBRARY; T=293.16K
angular distribution for (n,n*18)

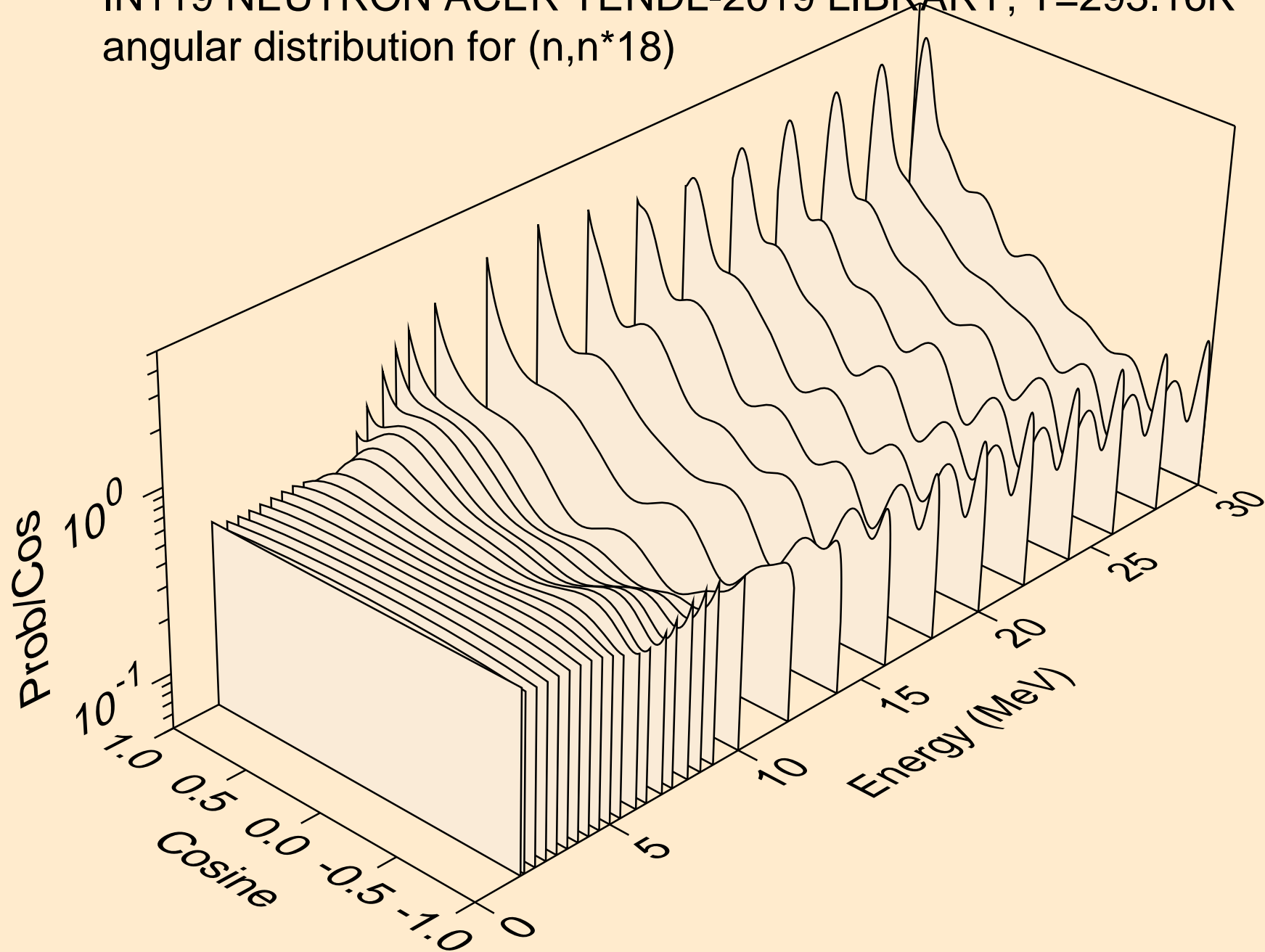

IN119 NEUTRON ACER TENDL-2019 LIBRARY; T=293.16K
angular distribution for (n,n*19)

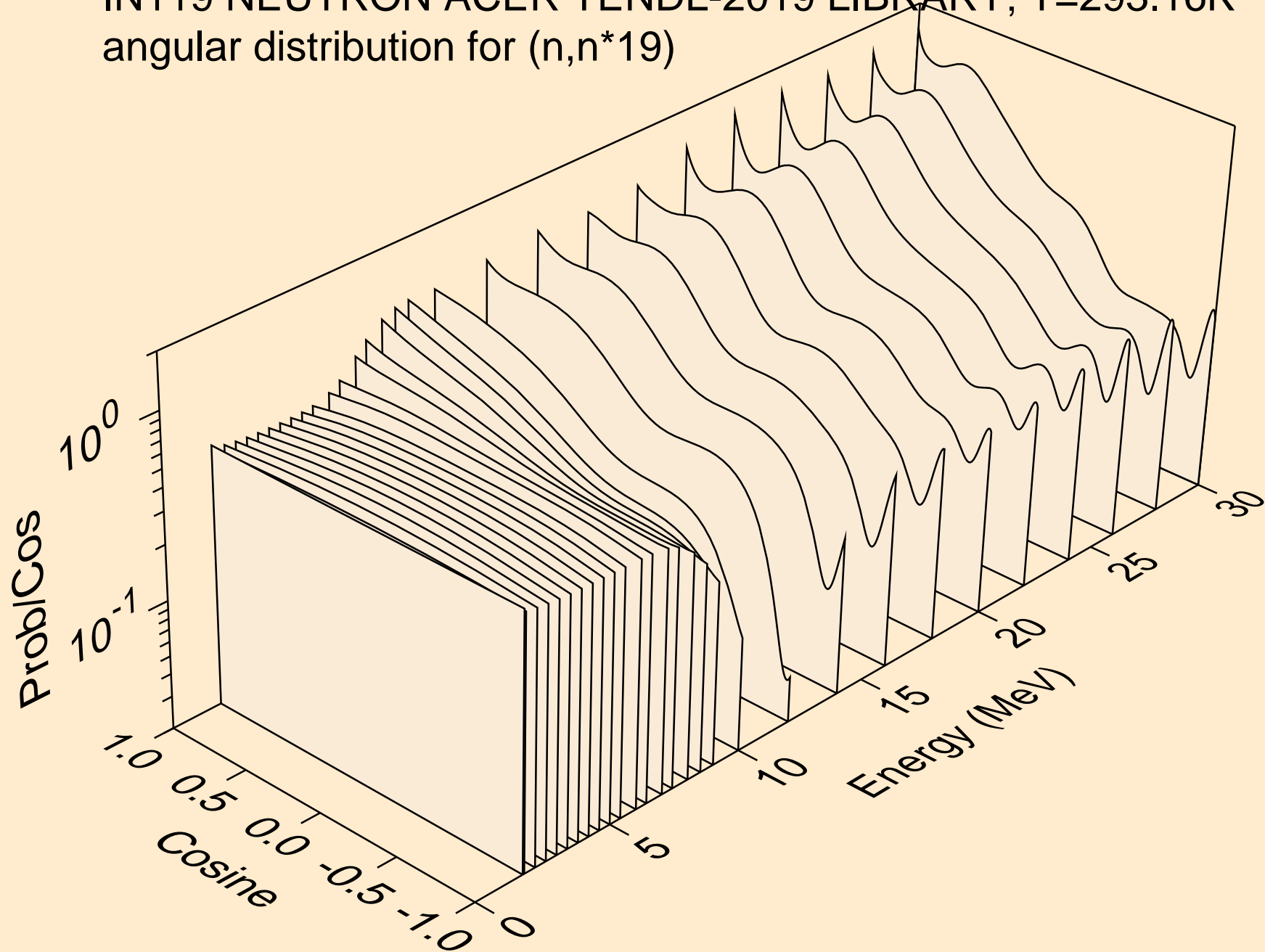

IN119 NEUTRON ACER TENDL-2019 LIBRARY; T=293.16K
angular distribution for (n,n*20)

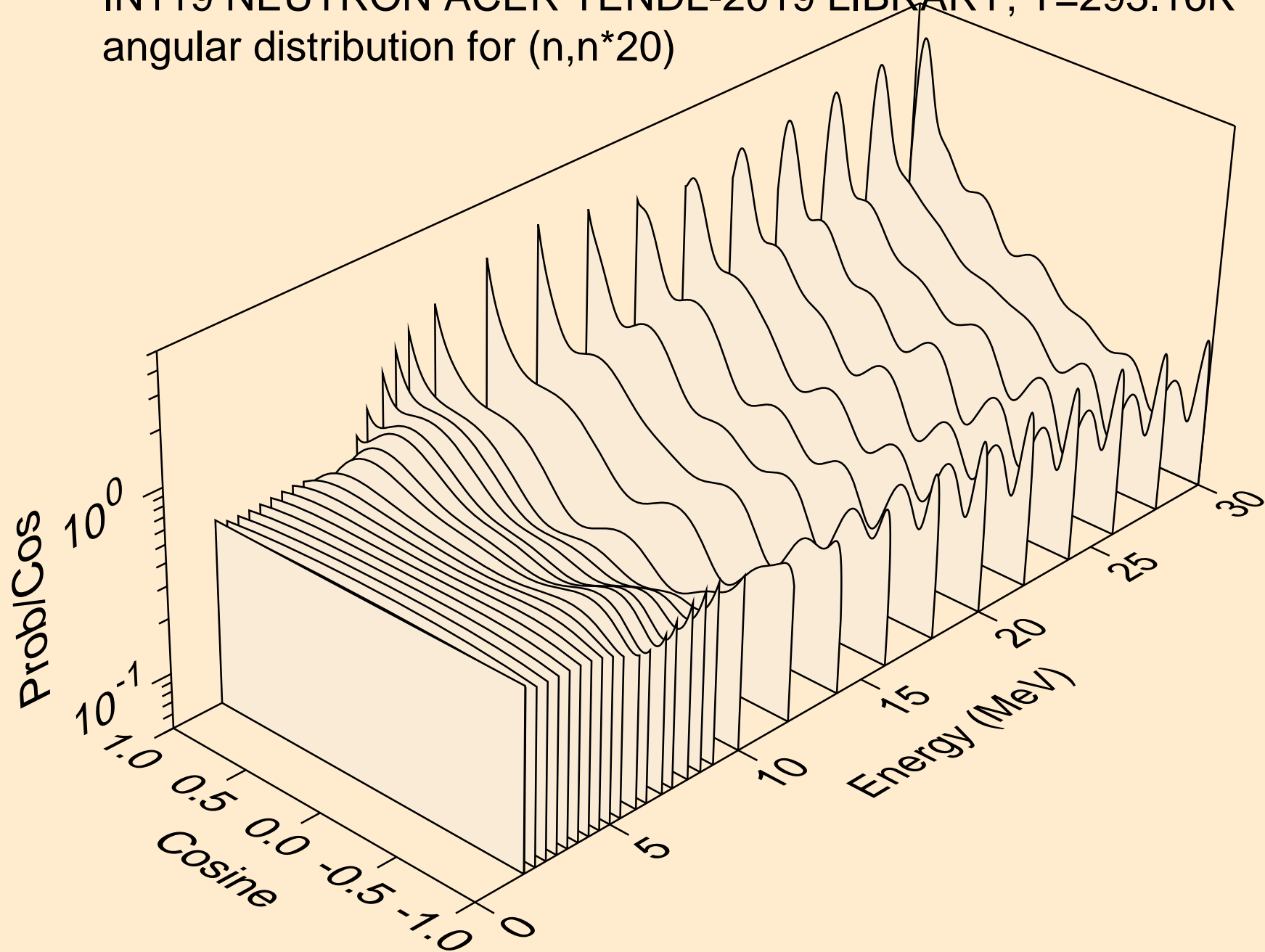

IN119 NEUTRON ACER TENDL-2019 LIBRARY; T=293.16K
angular distribution for (n,n*21)

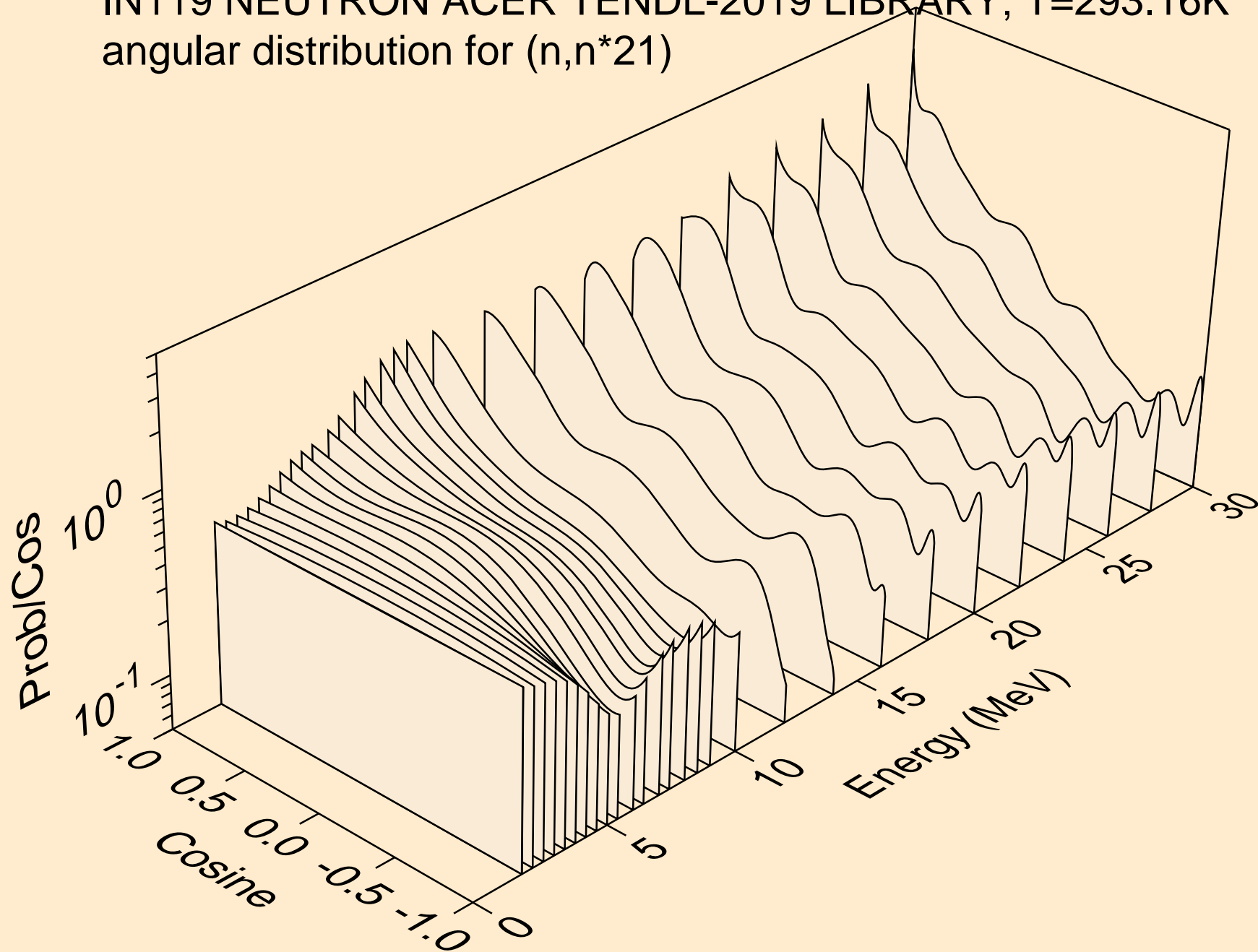

IN119 NEUTRON ACER TENDL-2019 LIBRARY; T=293.16K
angular distribution for (n,n*22)

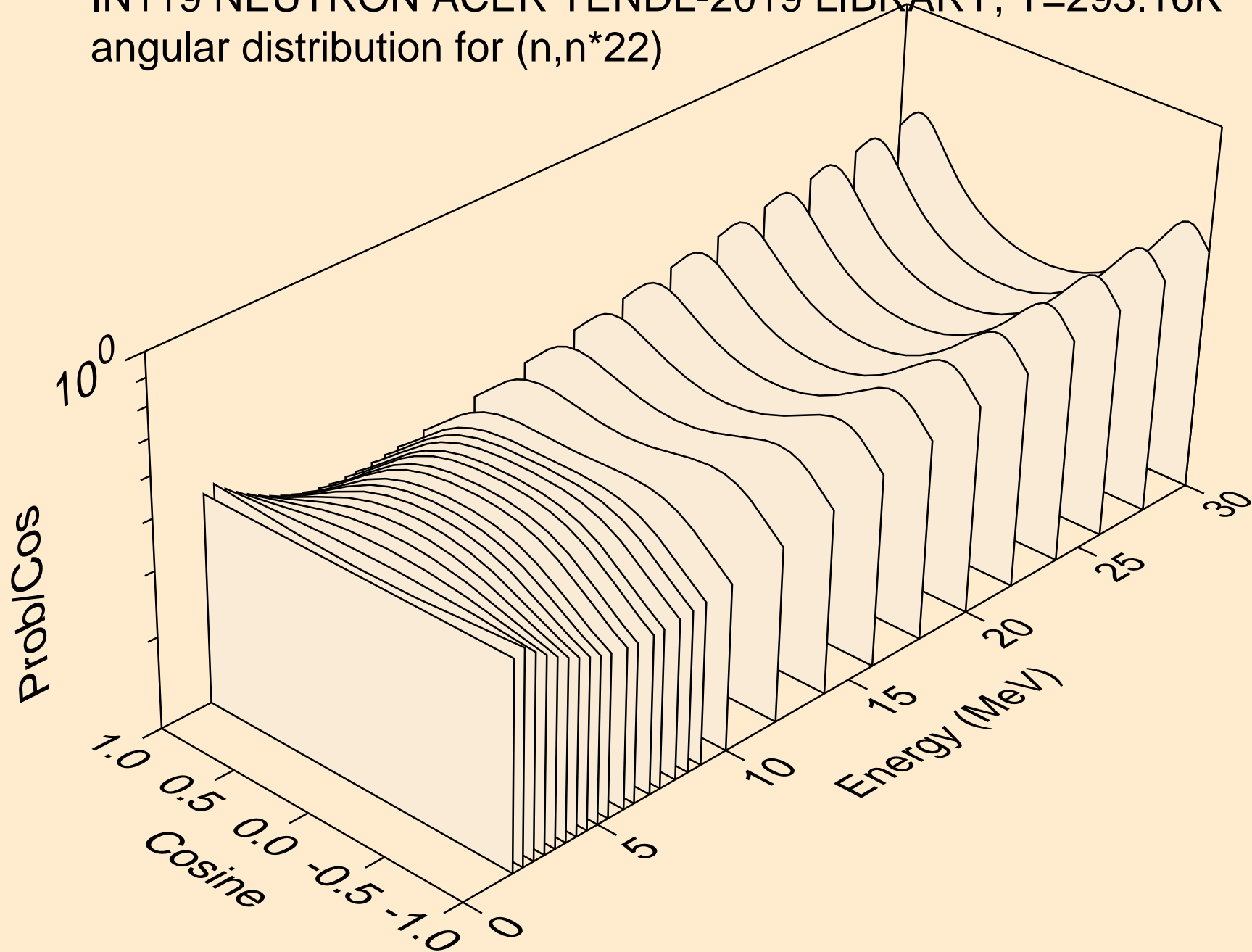

IN119 NEUTRON ACER TENDL-2019 LIBRARY; T=293.16K
angular distribution for (n,n*23)

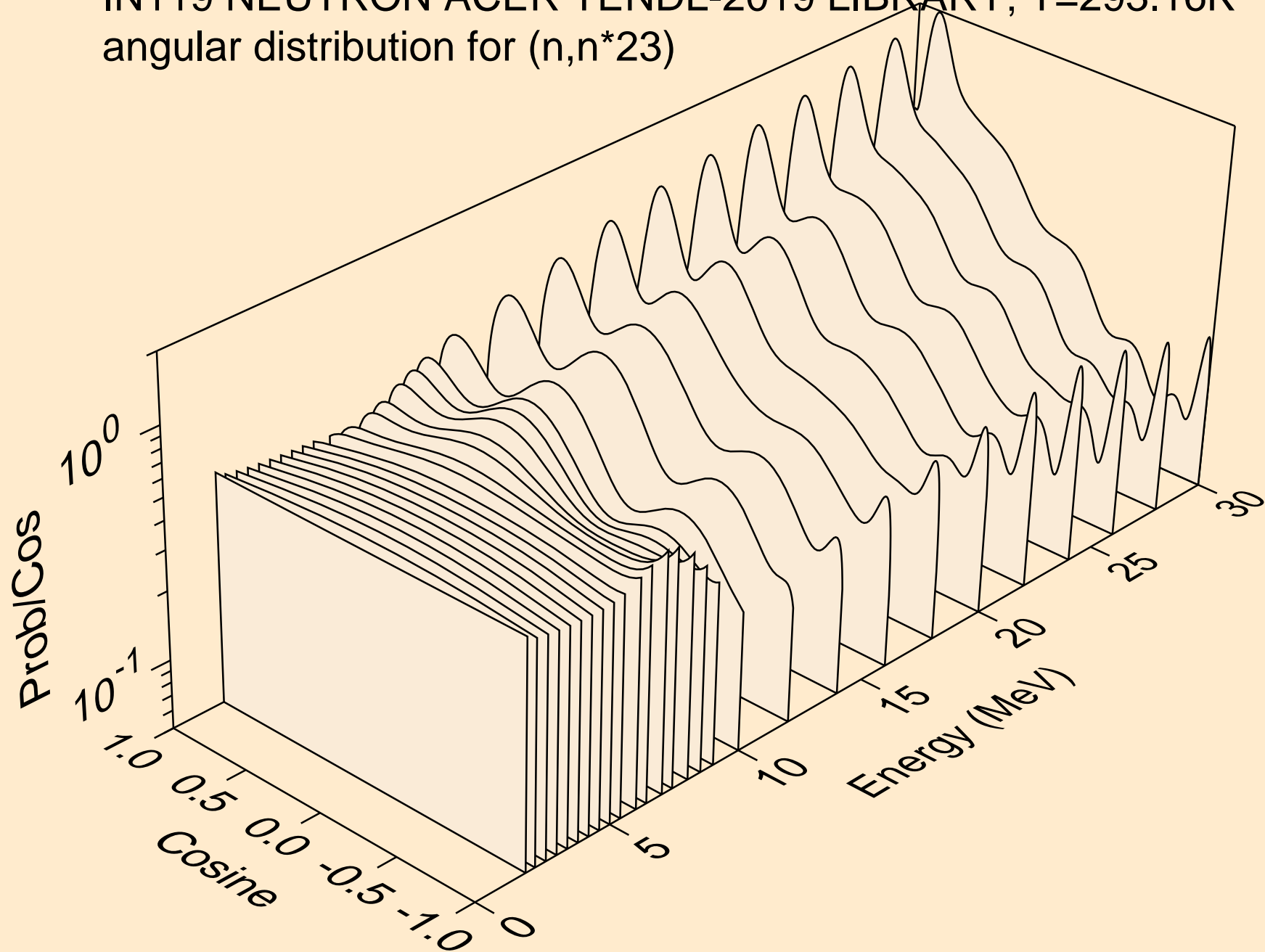

IN119 NEUTRON ACER TENDL-2019 LIBRARY; T=293.16K
angular distribution for (n,n*24)

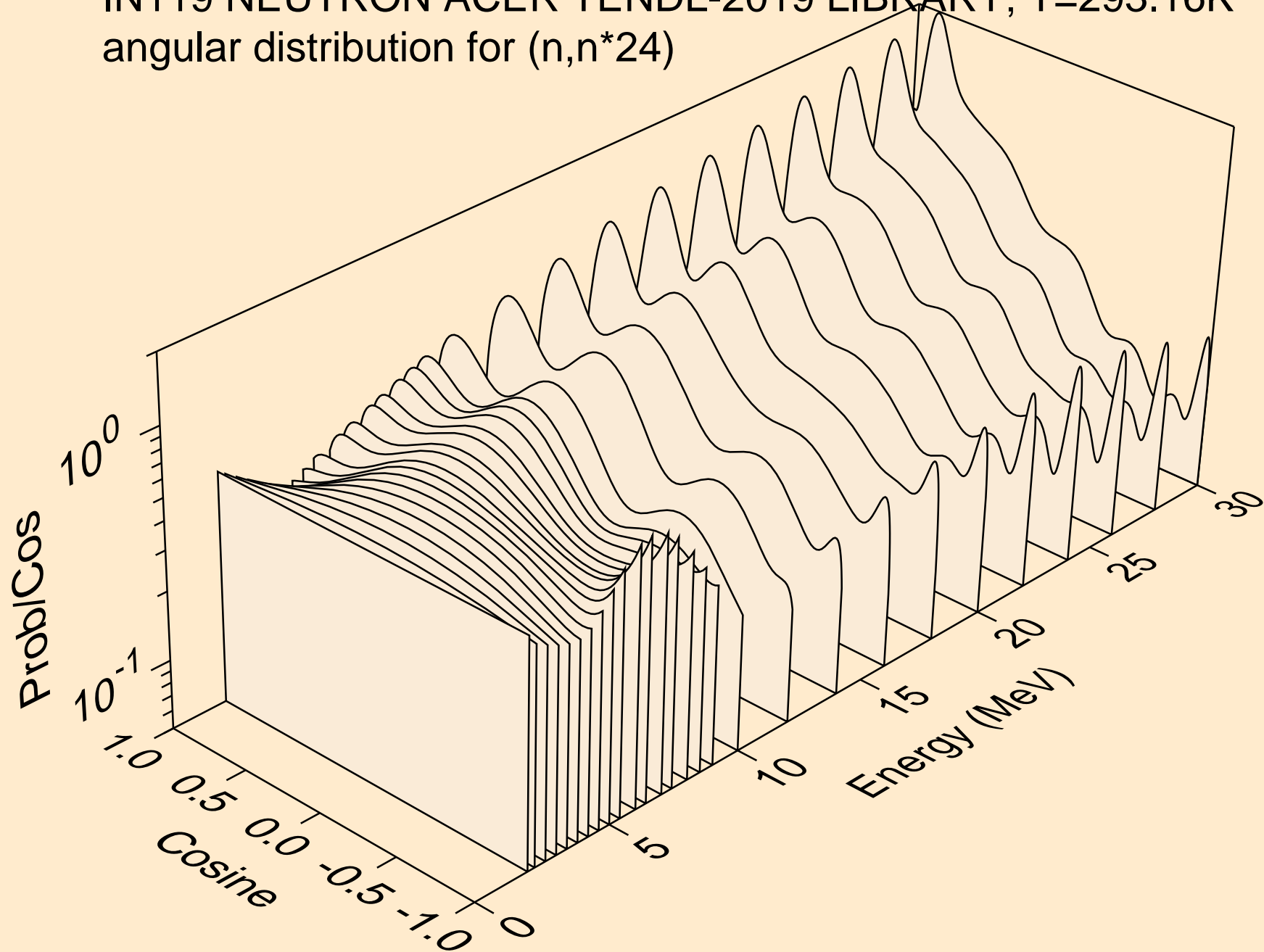

IN119 NEUTRON ACER TENDL-2019 LIBRARY; T=293.16K
angular distribution for (n,n*25)

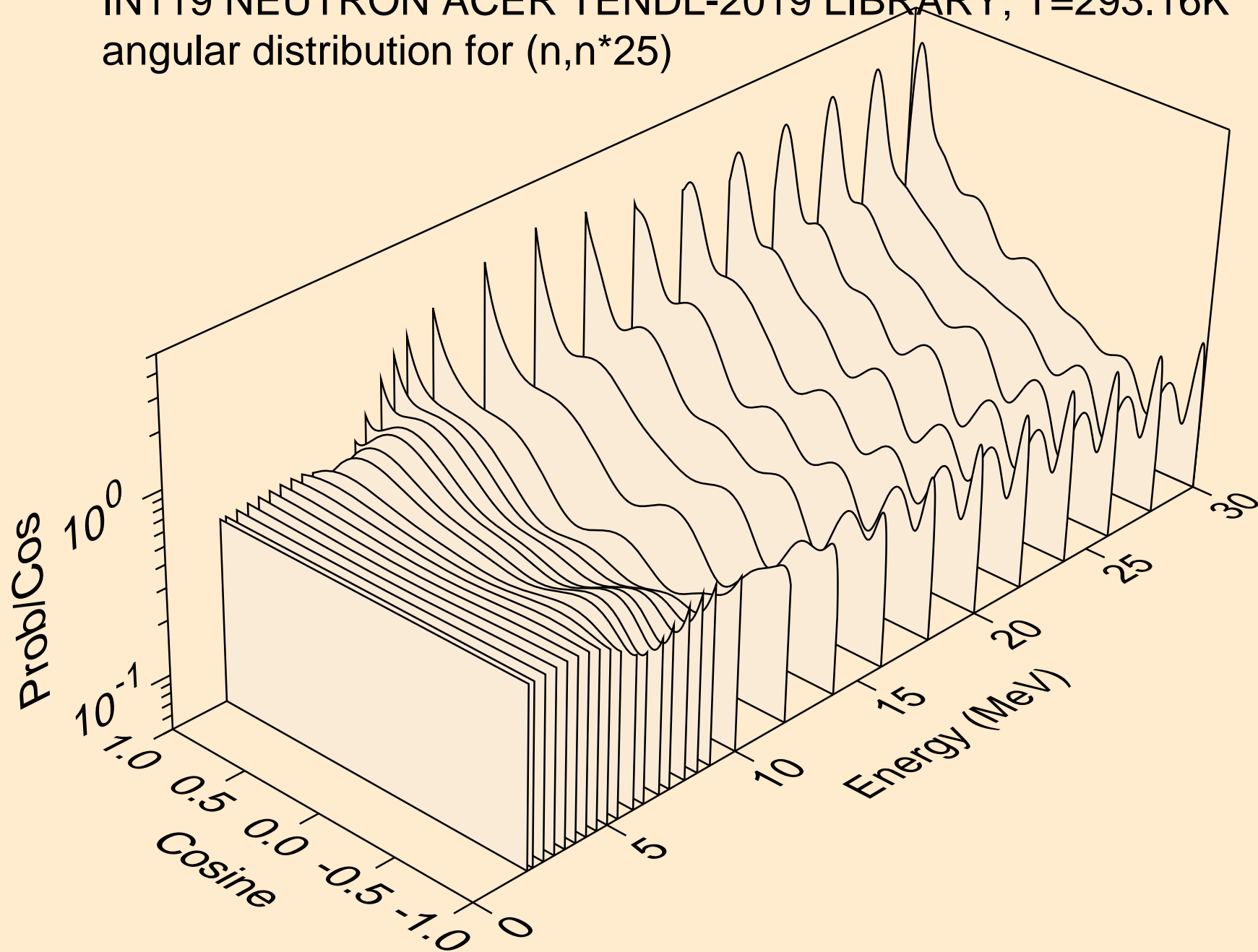

IN119 NEUTRON ACER TENDL-2019 LIBRARY; T=293.16K
angular distribution for (n,n*26)

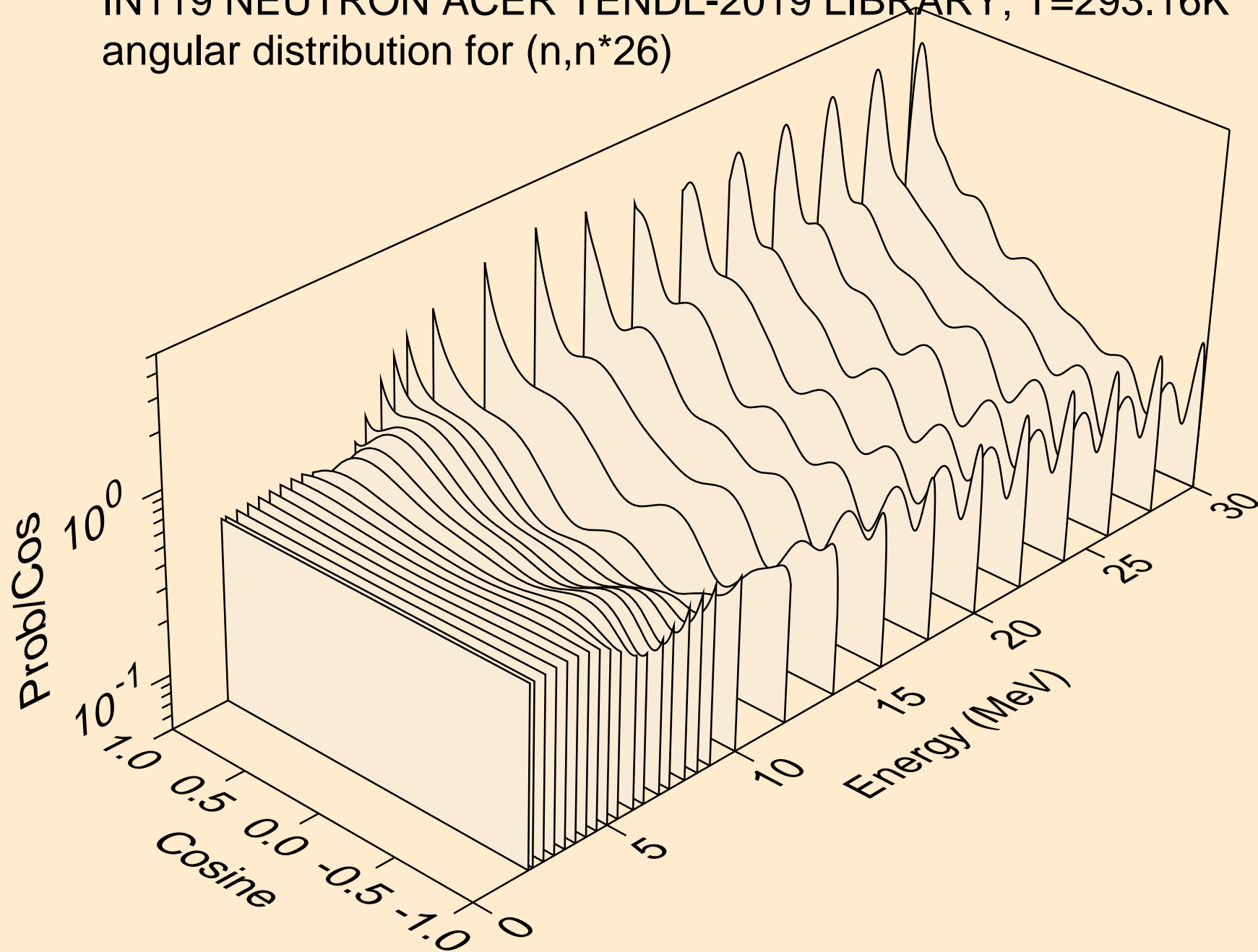

IN119 NEUTRON ACER TENDL-2019 LIBRARY; T=293.16K
angular distribution for (n,n*27)

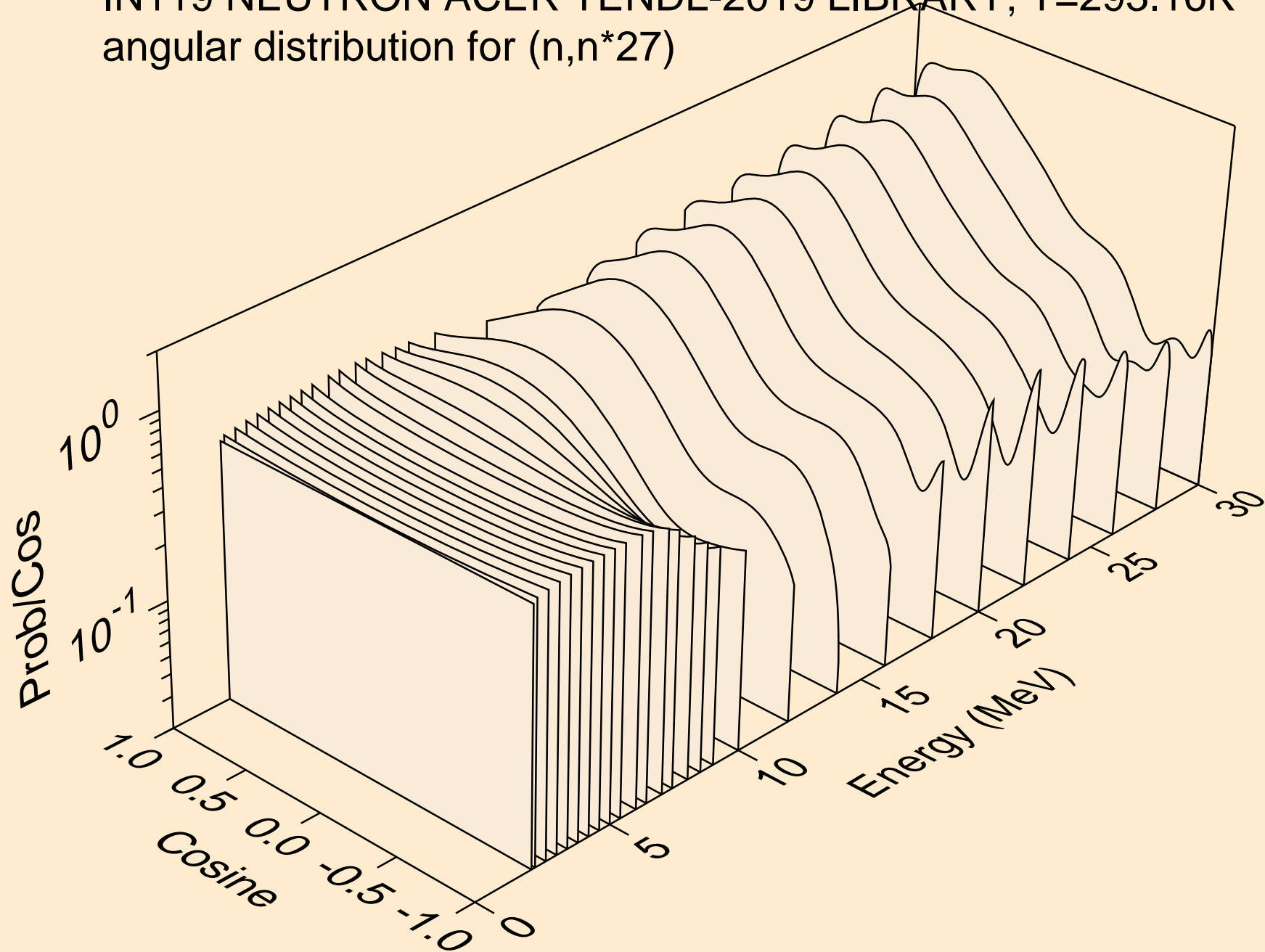

IN119 NEUTRON ACER TENDL-2019 LIBRARY; T=293.16K
angular distribution for (n,n*28)

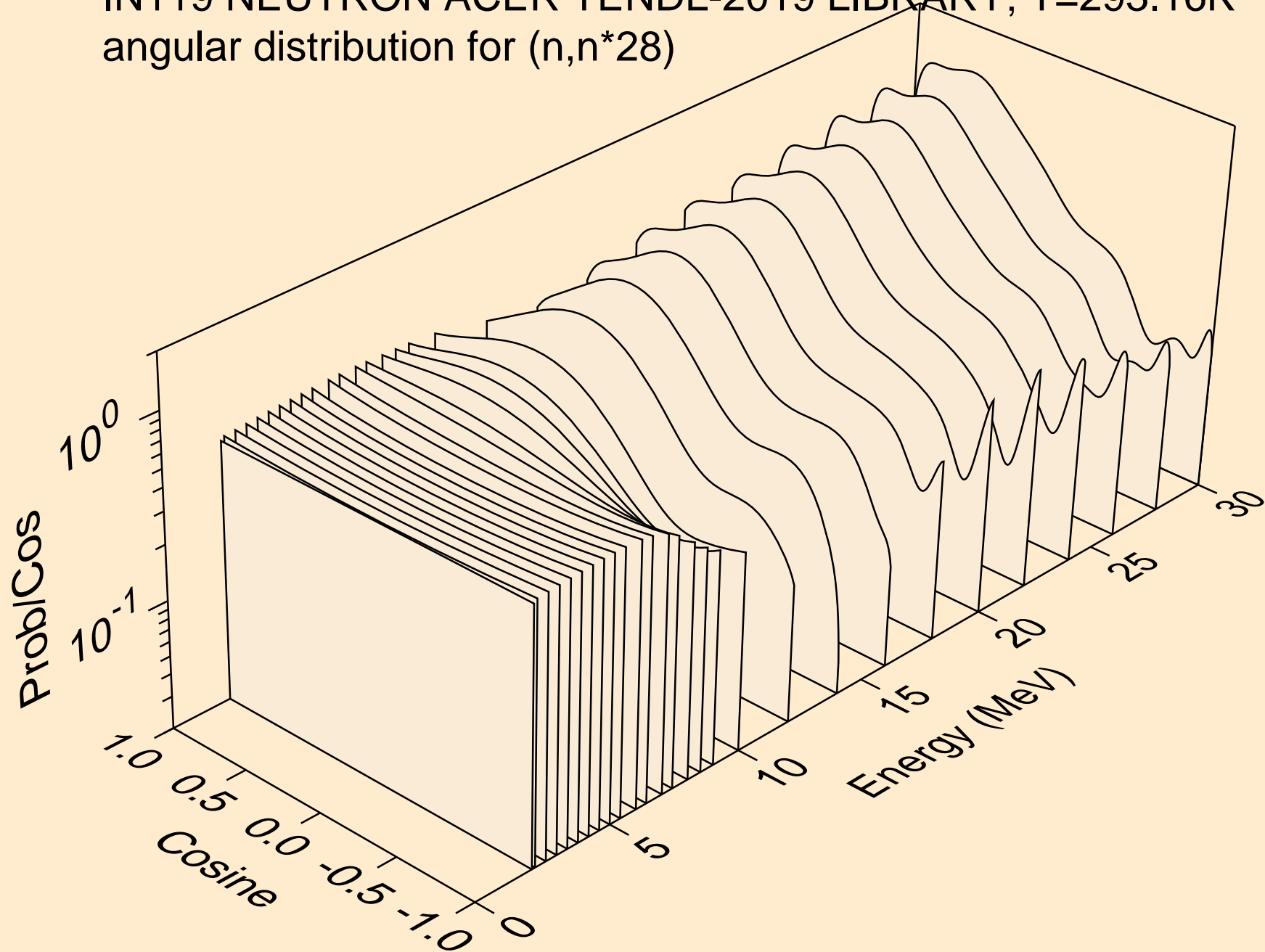

IN119 NEUTRON ACER TENDL-2019 LIBRARY; T=293.16K
angular distribution for (n,n*29)

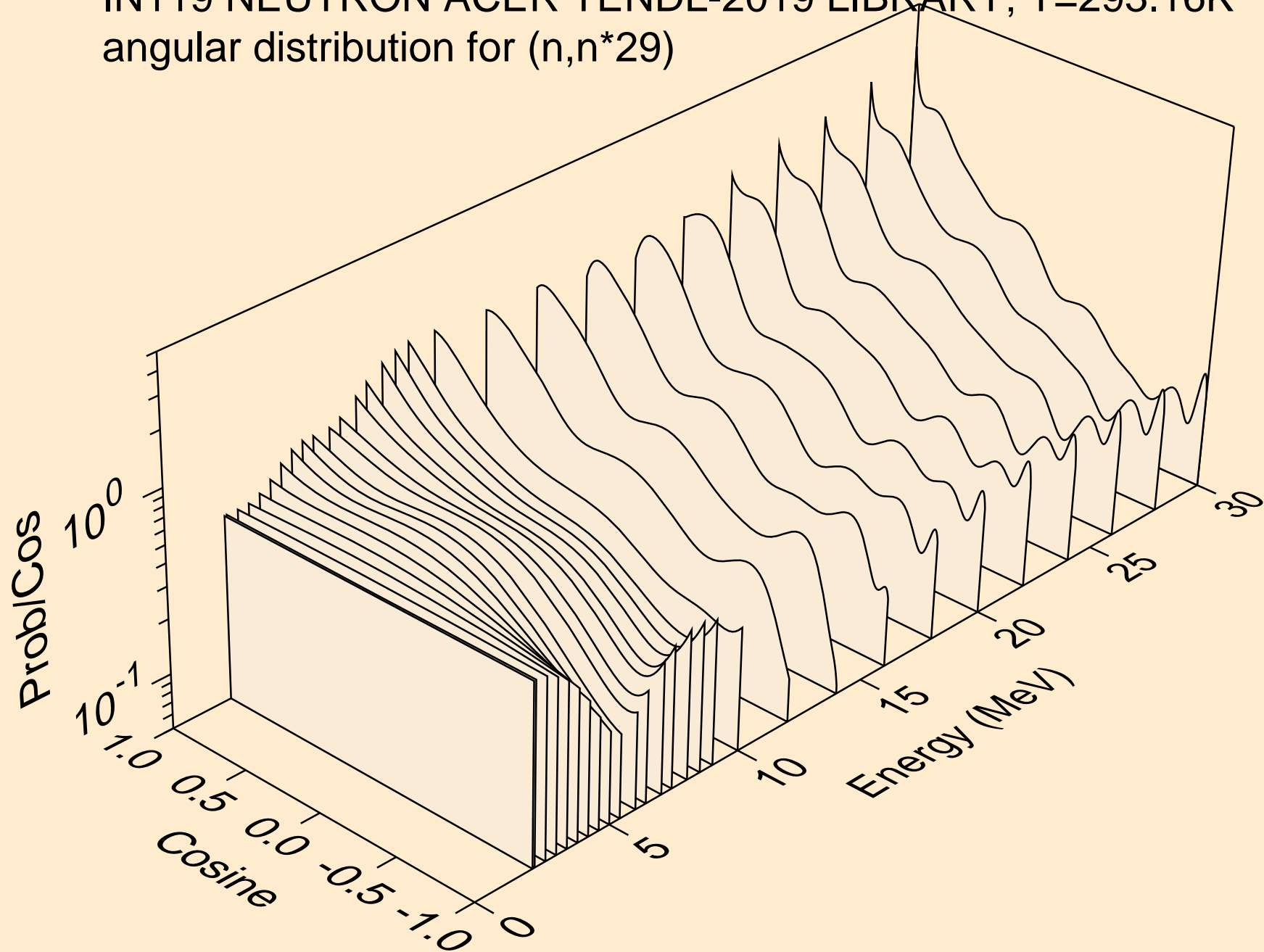

IN119 NEUTRON ACER TENDL-2019 LIBRARY; T=293.16K
angular distribution for (n,n*30)

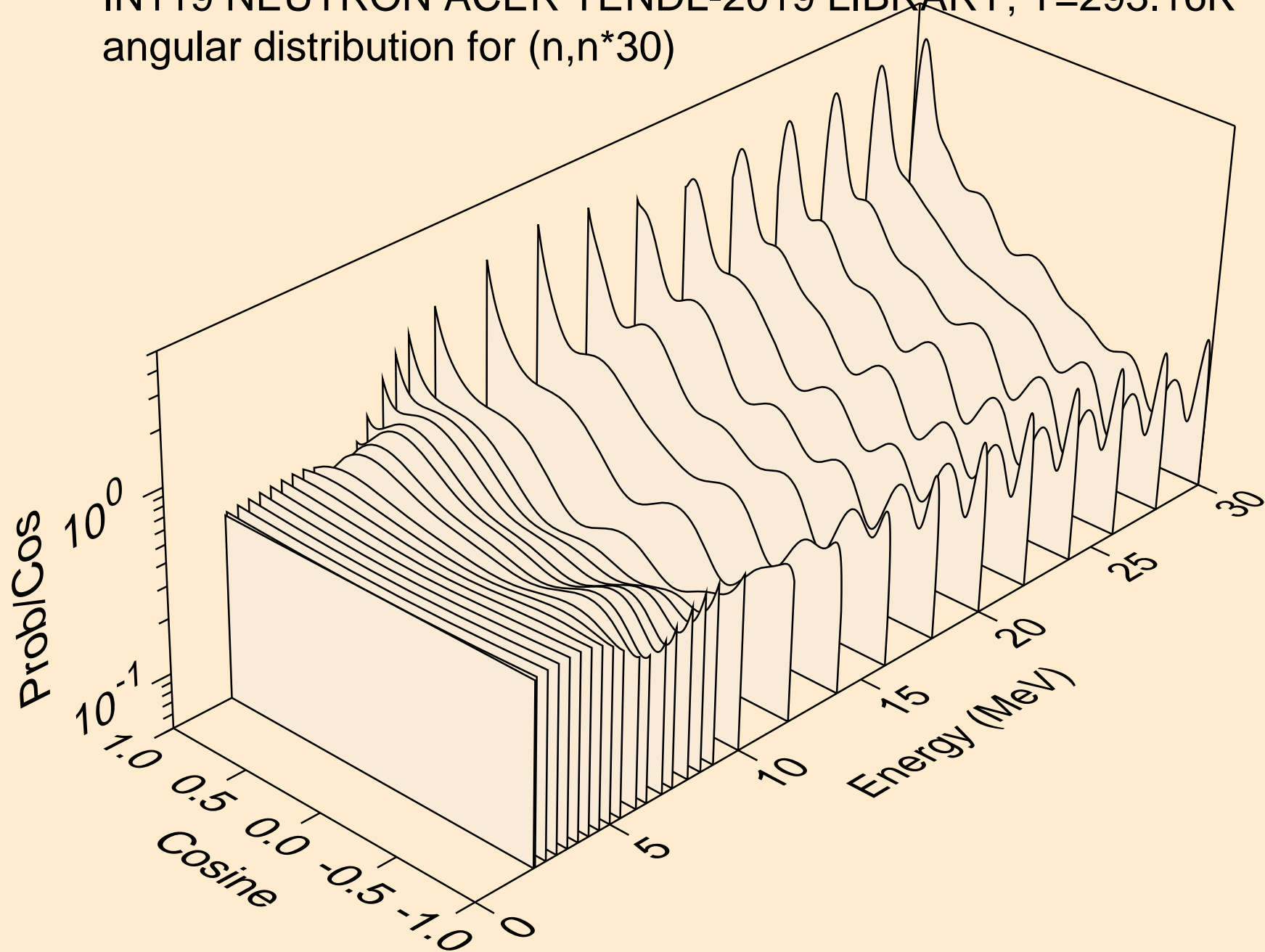

IN119 NEUTRON ACER TENDL-2019 LIBRARY; T=293.16K
Neutron emission for (n,x)

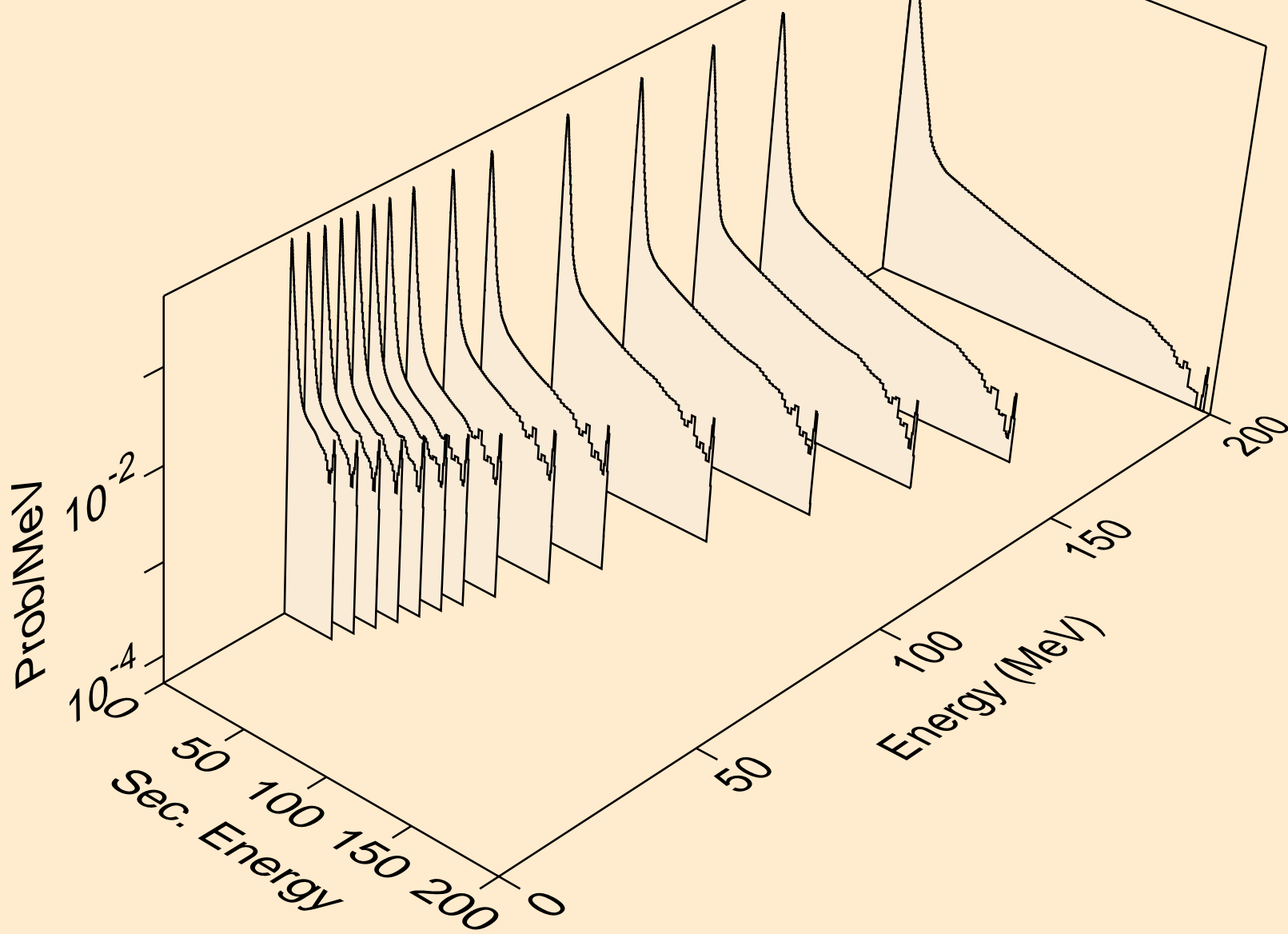

IN119 NEUTRON ACER TENDL-2019 LIBRARY; T=293.16K
Neutron emission for (n,2nd)

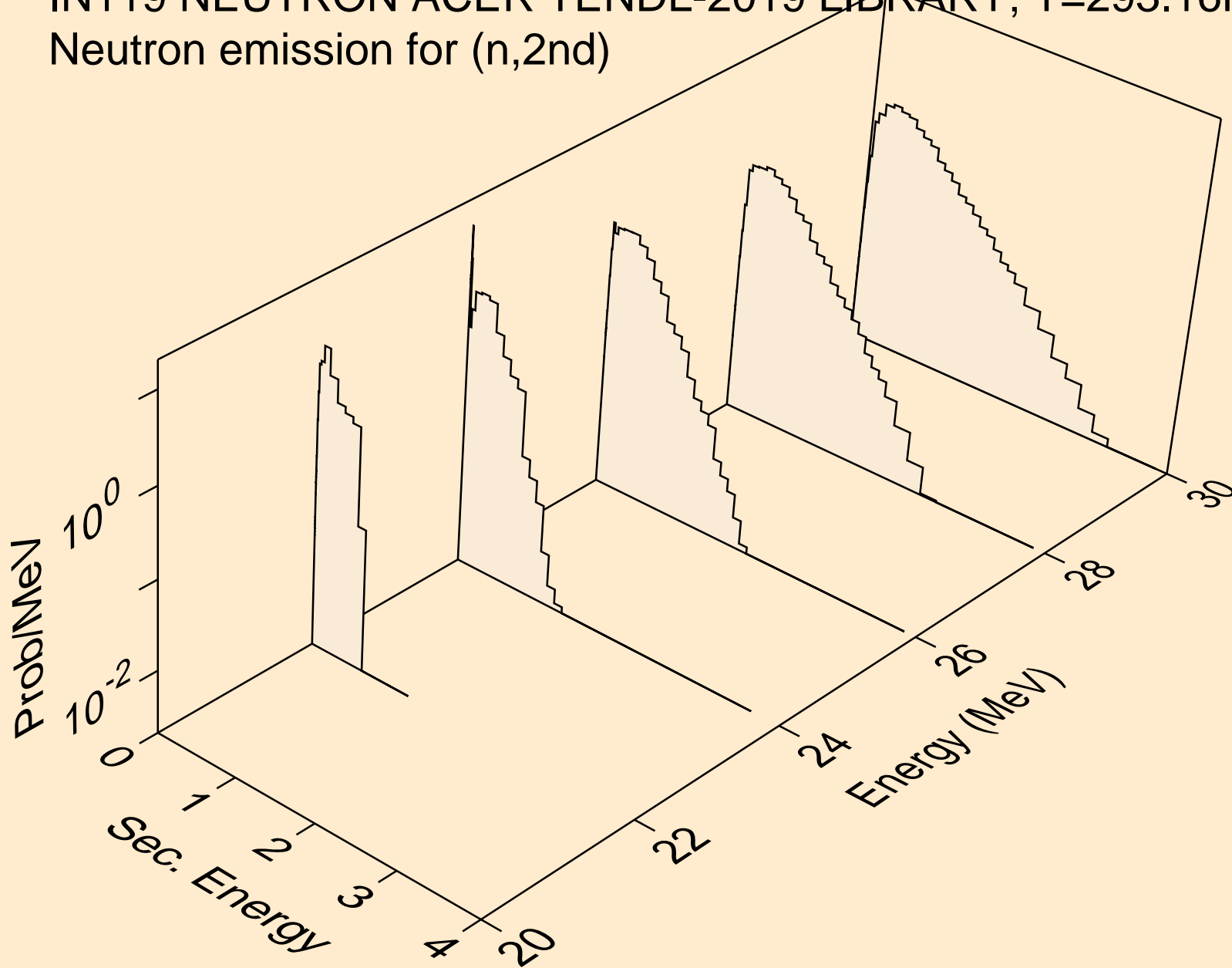

IN119 NEUTRON ACER TENDL-2019 LIBRARY; T=293.16K
Neutron emission for (n,2n)

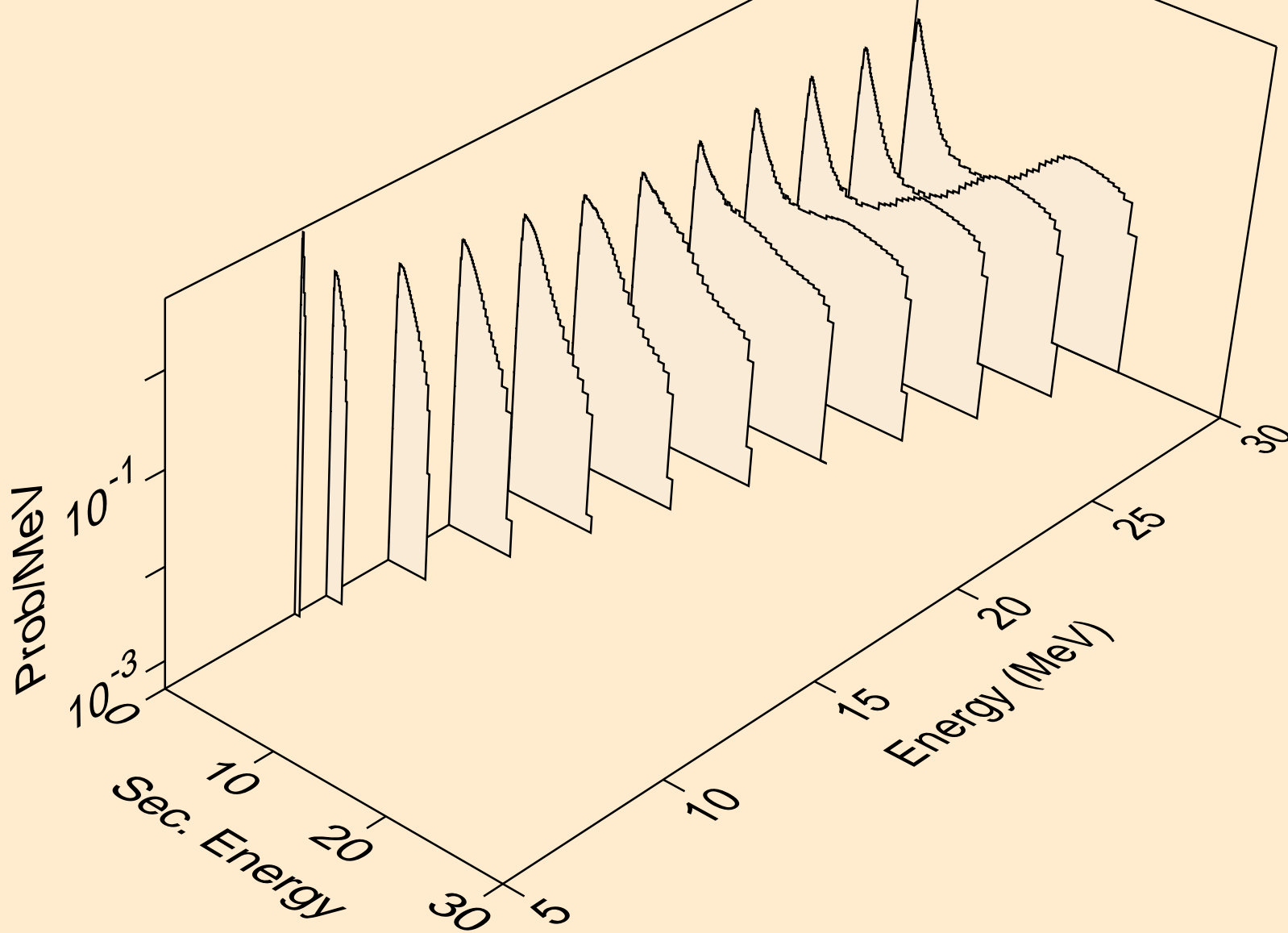

IN119 NEUTRON ACER TENDL-2019 LIBRARY; T=293.16K
Neutron emission for (n,3n)

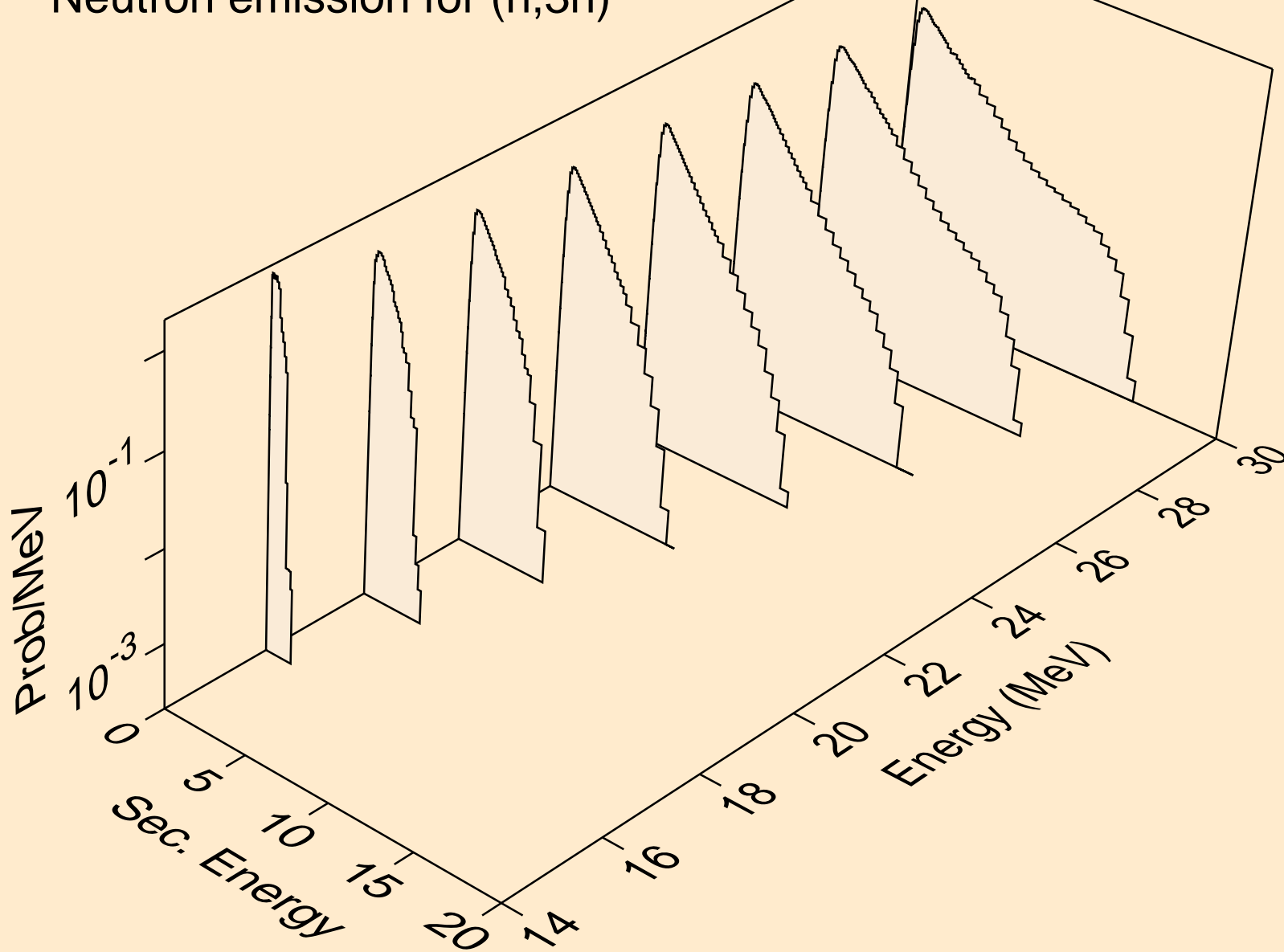

IN119 NEUTRON ACER TENDL-2019 LIBRARY; T=293.16K
Neutron emission for (n,n*)a

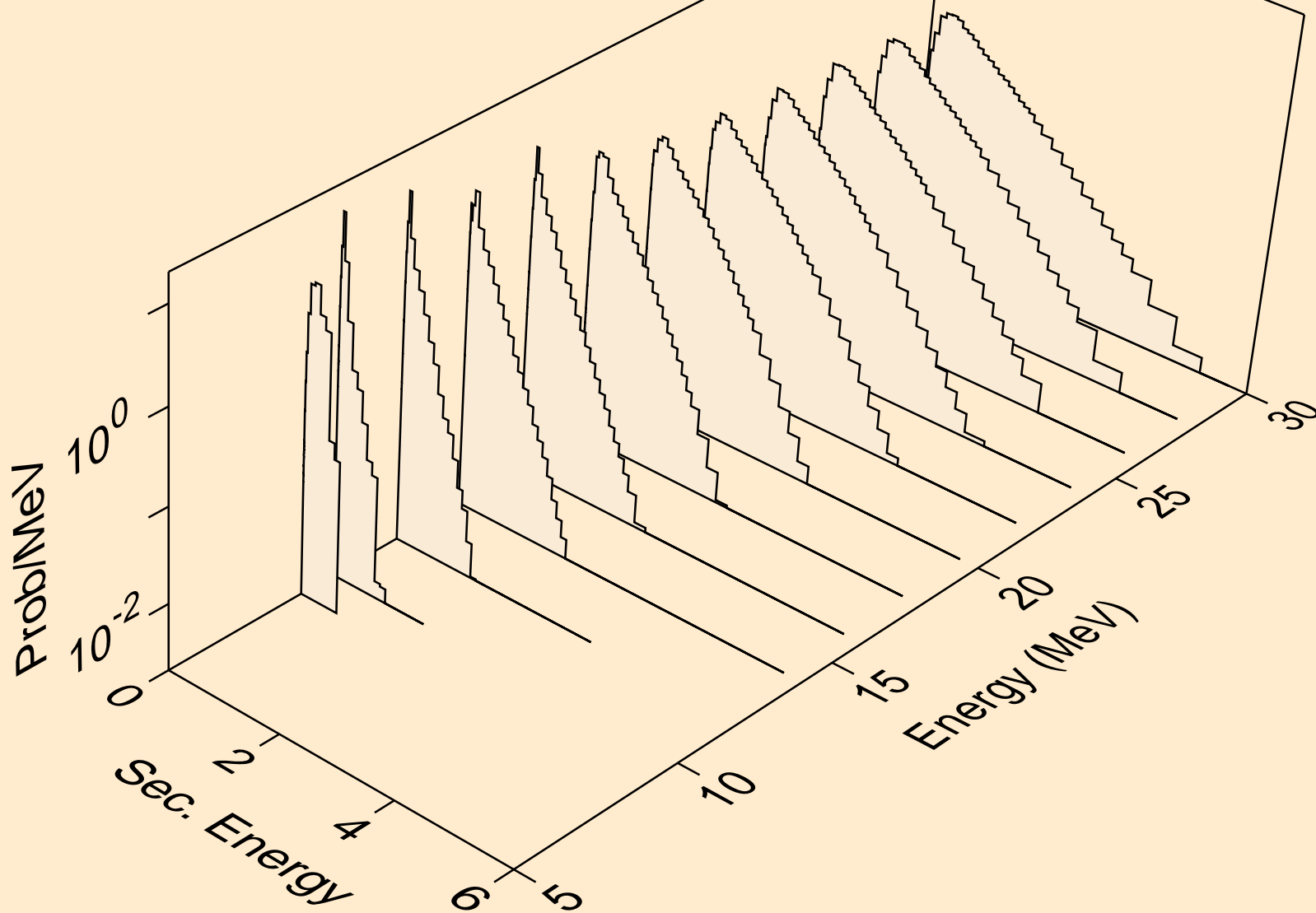

IN119 NEUTRON ACER TENDL-2019 LIBRARY; T=293.16K
Neutron emission for (n,2n)a

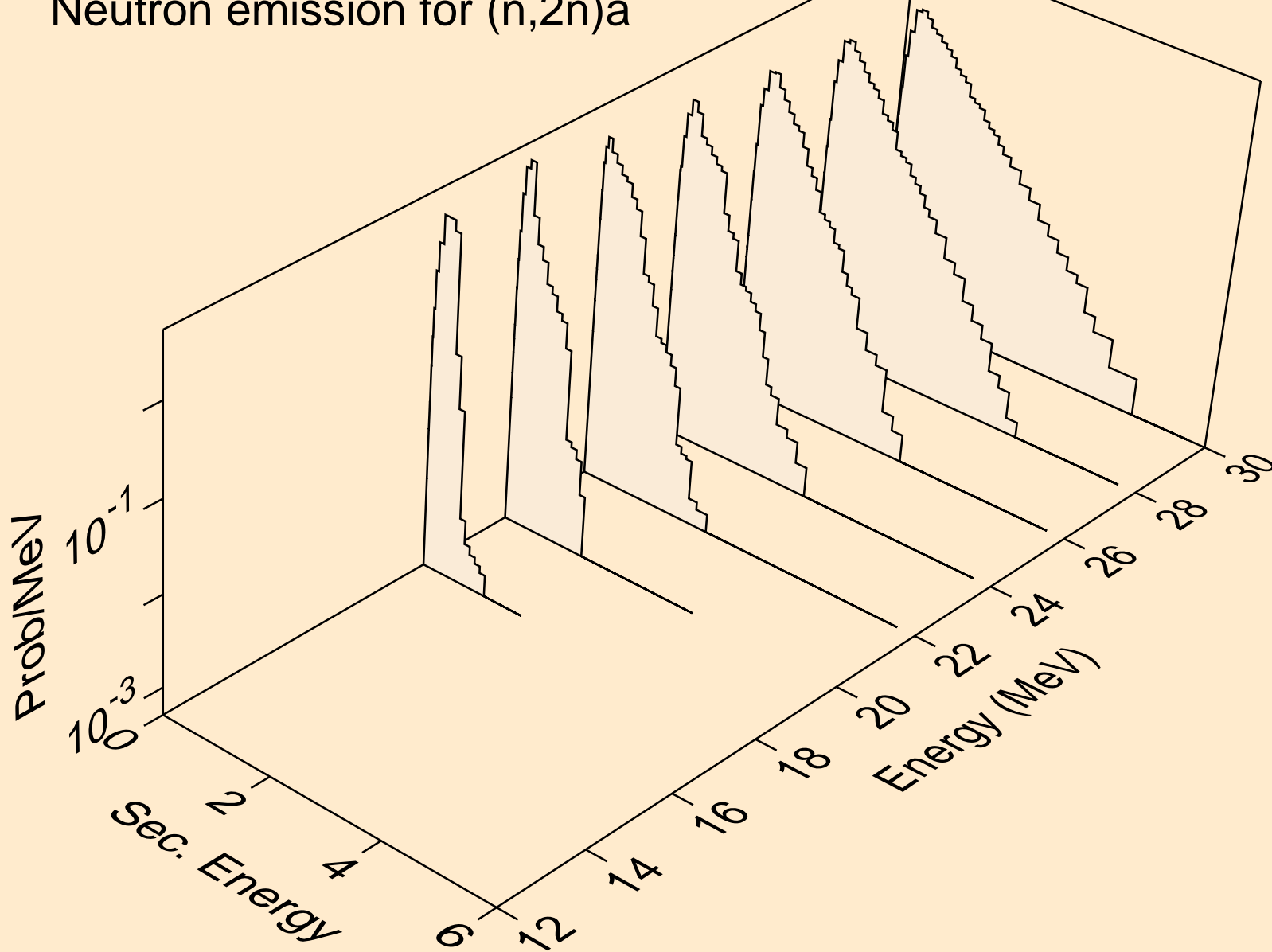

IN119 NEUTRON ACER TENDL-2019 LIBRARY; T=293.16K
Neutron emission for (n,3n)a

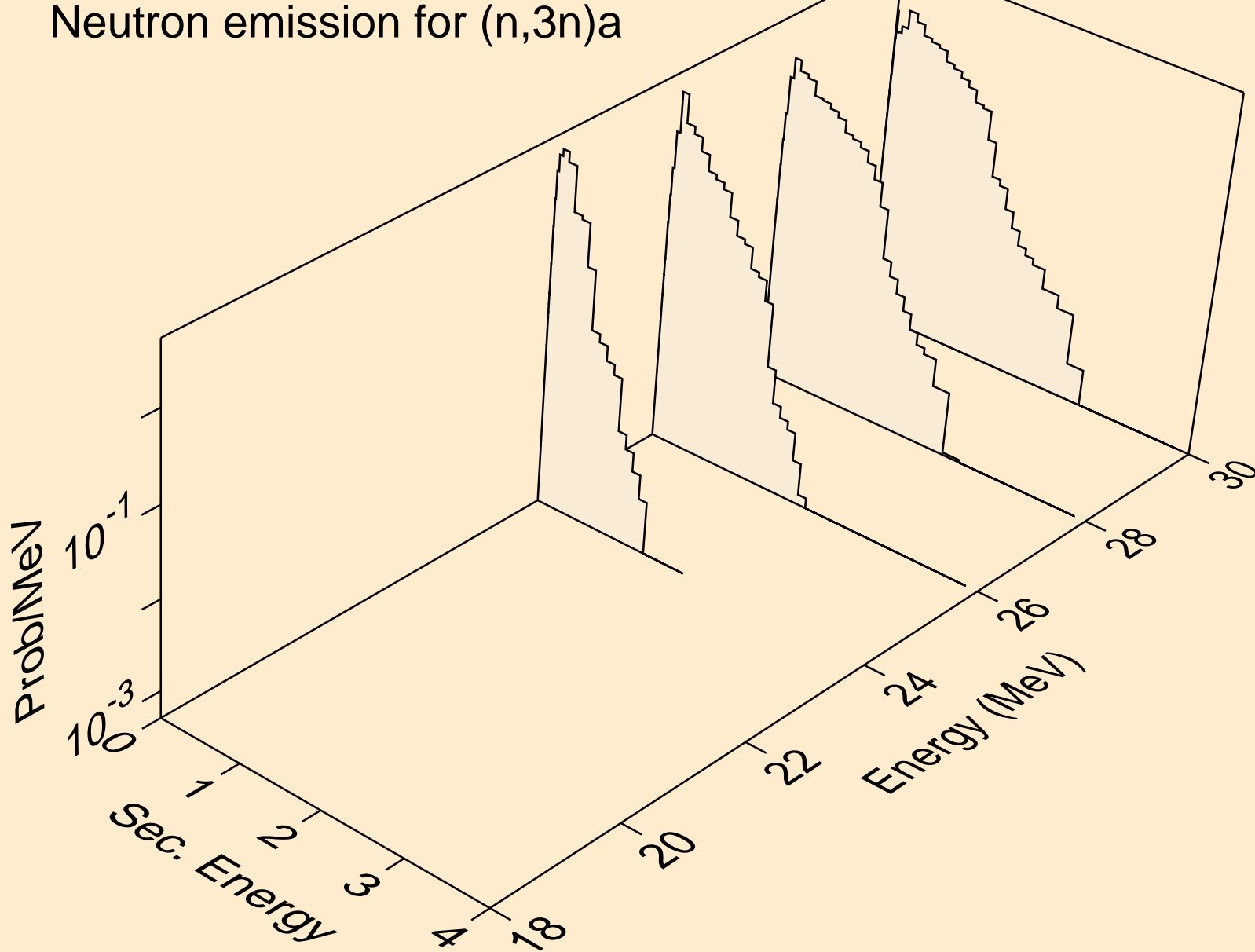

IN119 NEUTRON ACER TENDL-2019 LIBRARY; T=293.16K
Neutron emission for (n,n*)p

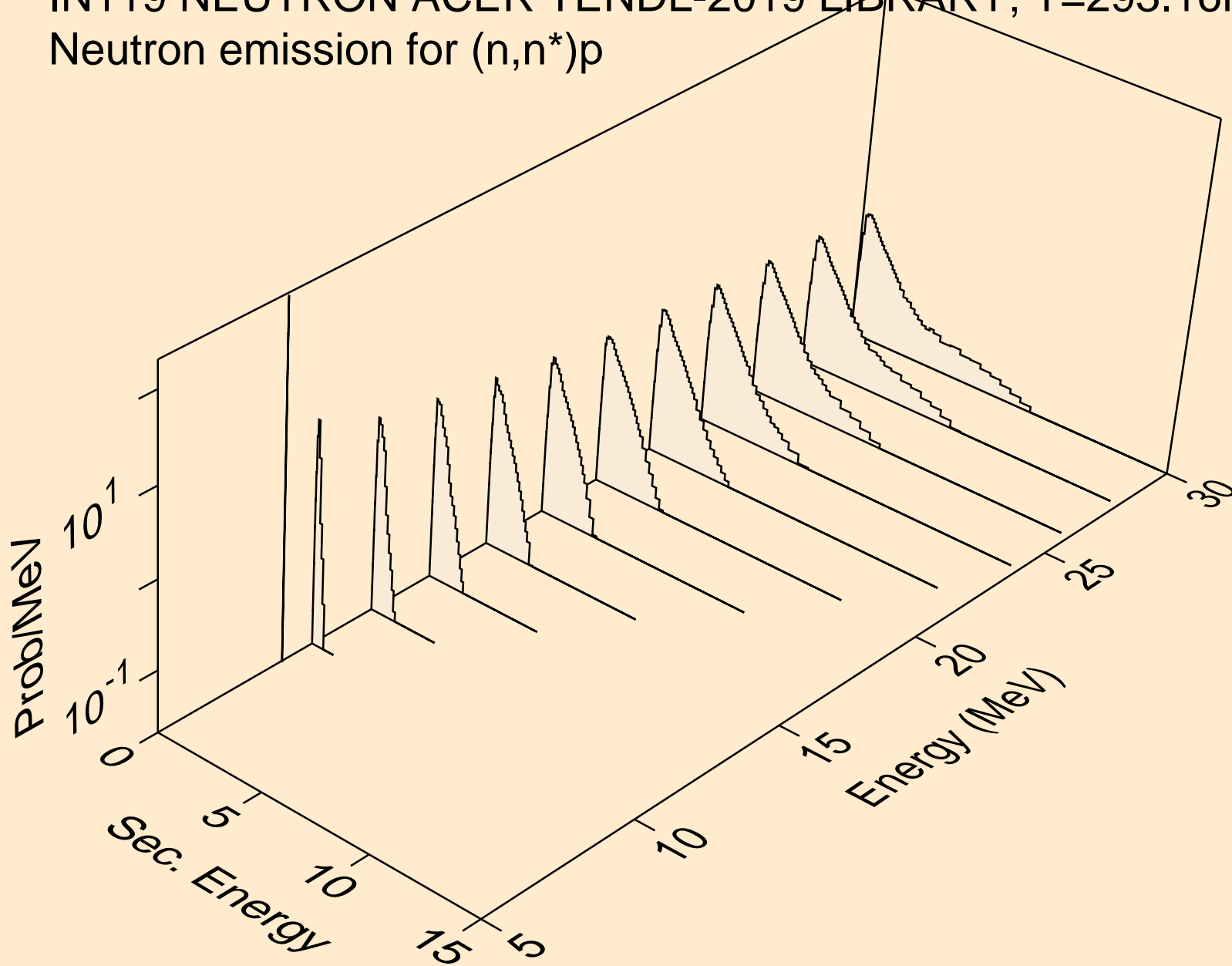

IN119 NEUTRON ACER TENDL-2019 LIBRARY; T=293.16K
Neutron emission for (n,n*)d

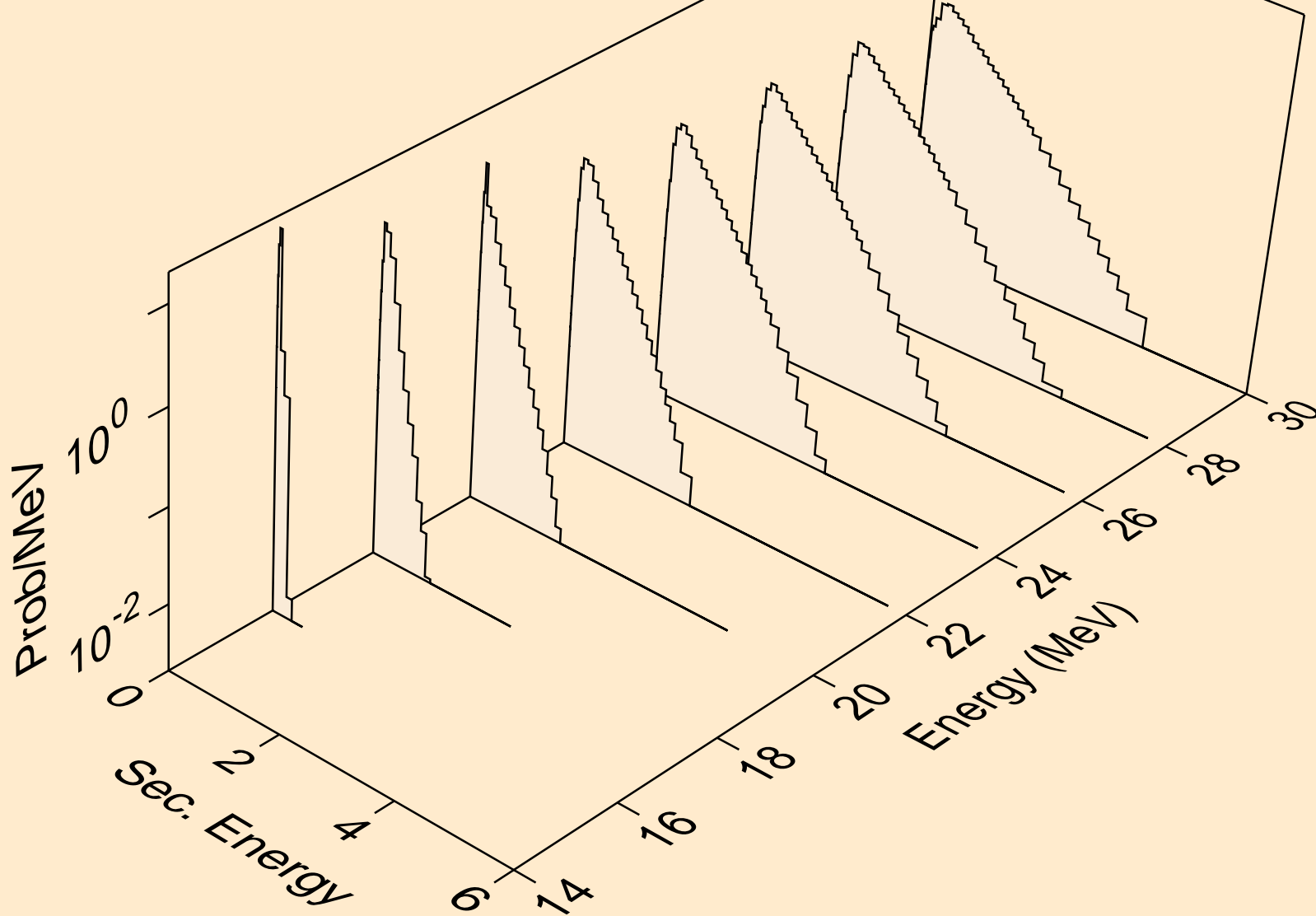

IN119 NEUTRON ACER TENDL-2019 LIBRARY; T=293.16K
Neutron emission for (n,n*)t

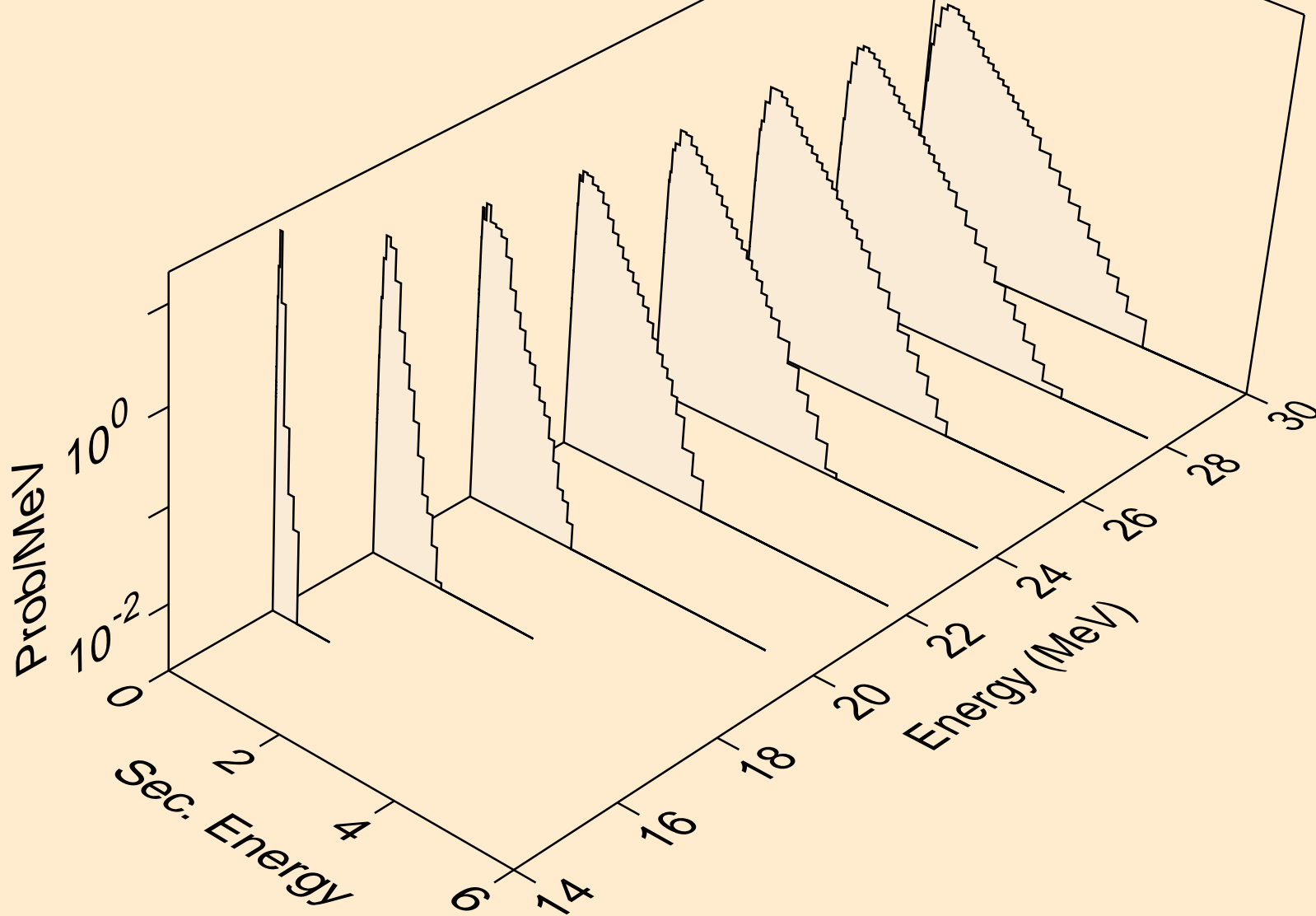

IN119 NEUTRON ACER TENDL-2019 LIBRARY; T=293.16K
Neutron emission for (n,n*)he3

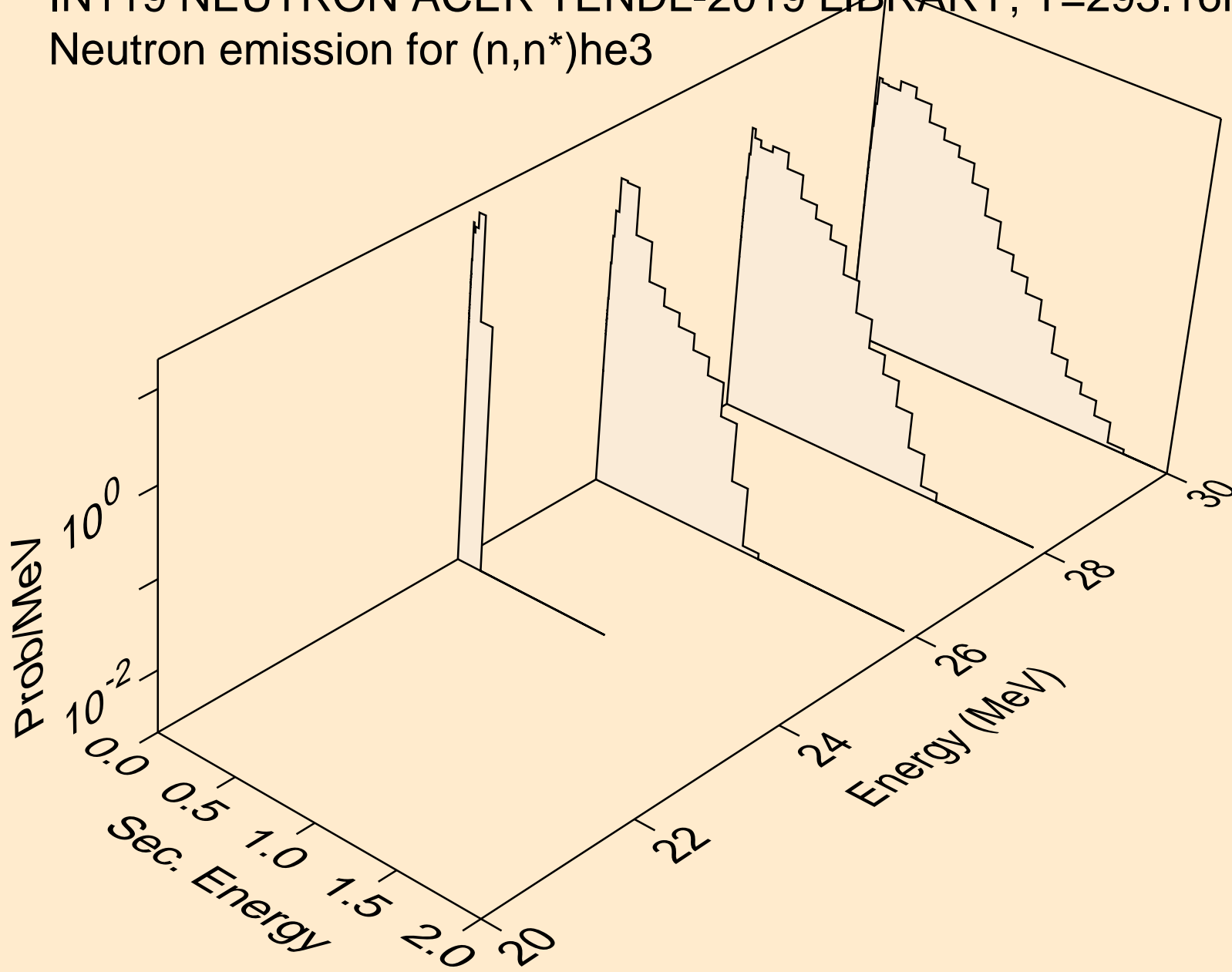

IN119 NEUTRON ACER TENDL-2019 LIBRARY; T=293.16K
Neutron emission for (n,4n)

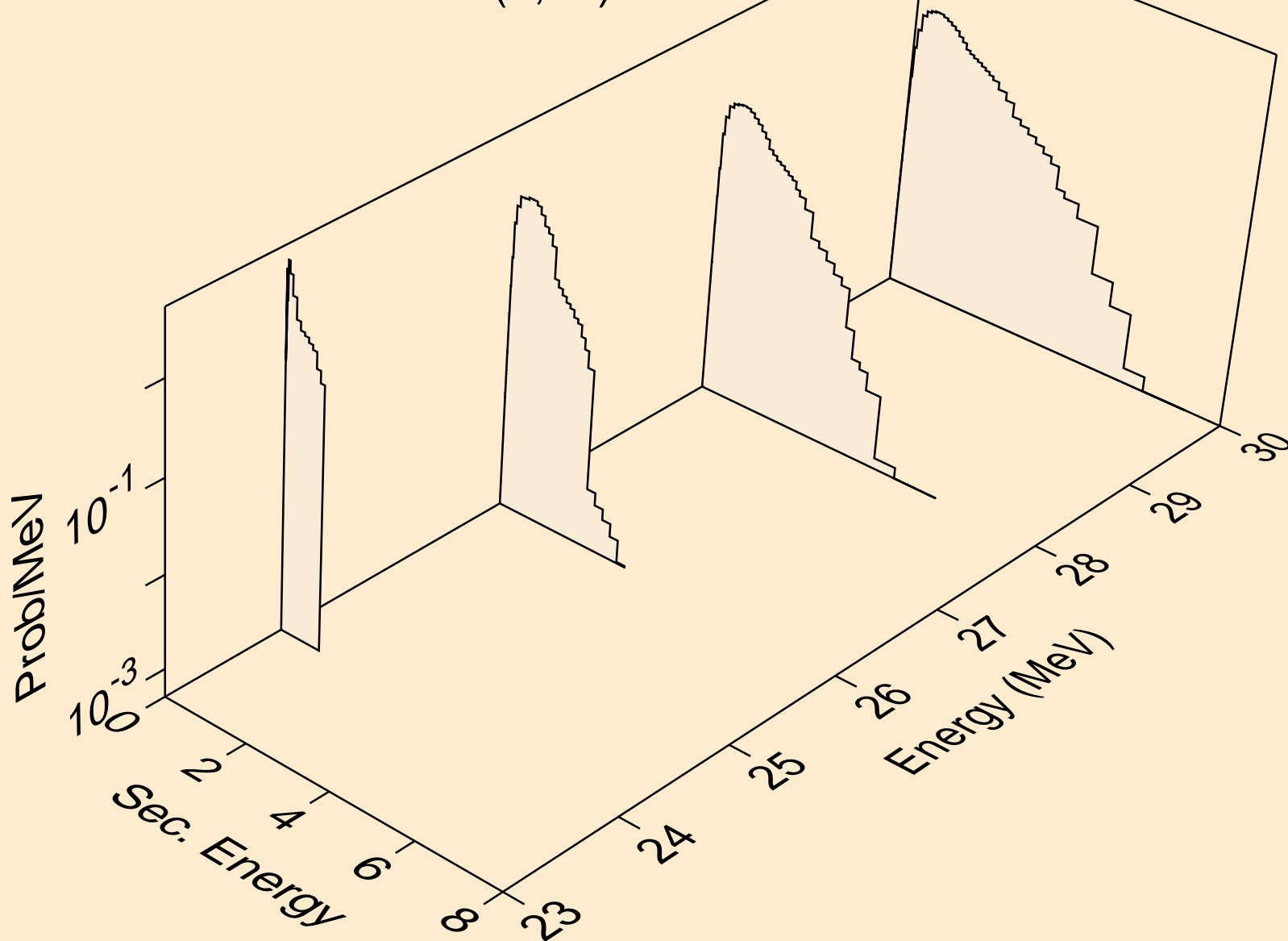

IN119 NEUTRON ACER TENDL-2019 LIBRARY; T=293.16K
Neutron emission for (n,2np)

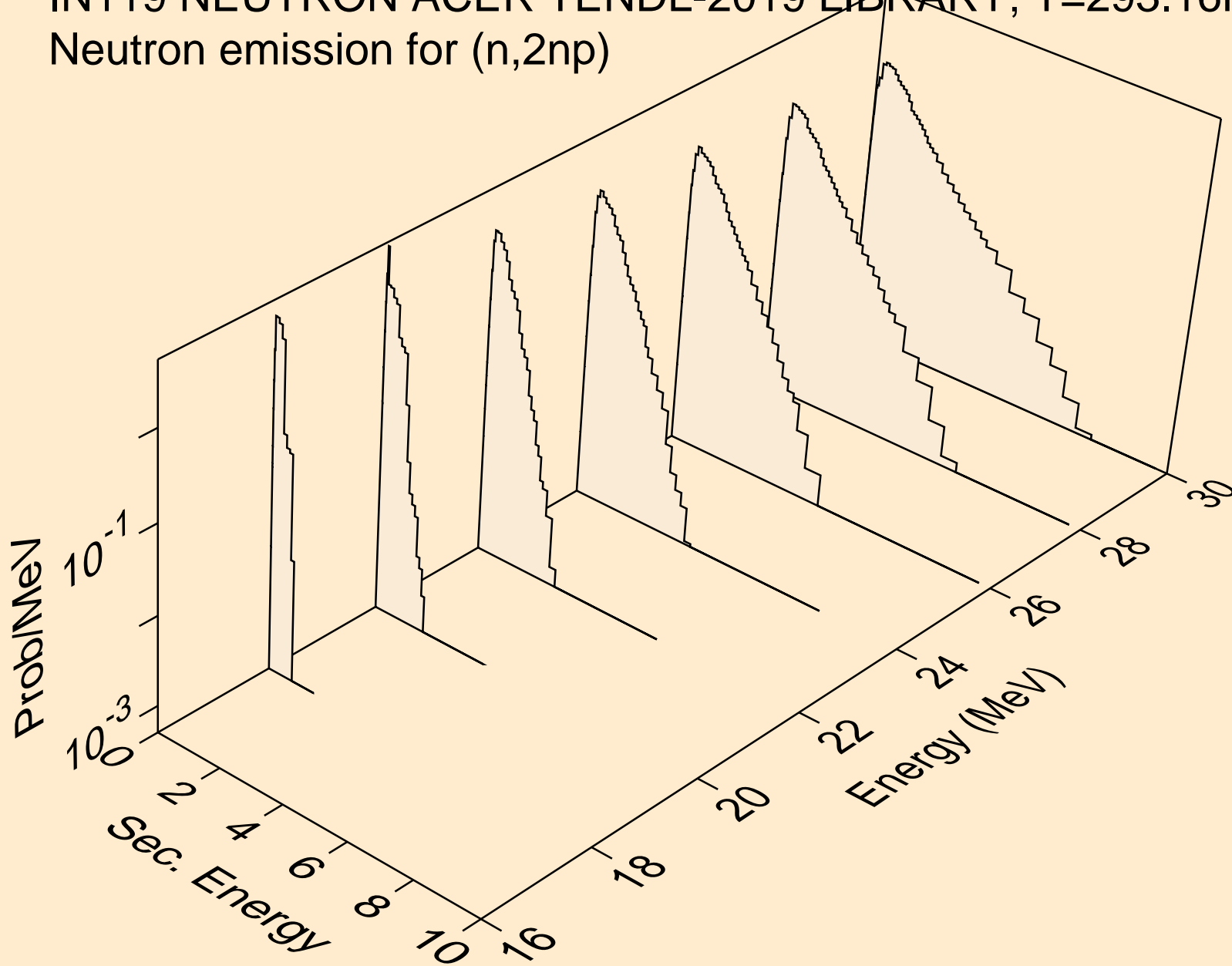

IN119 NEUTRON ACER TENDL-2019 LIBRARY; T=293.16K
Neutron emission for (n,3np)

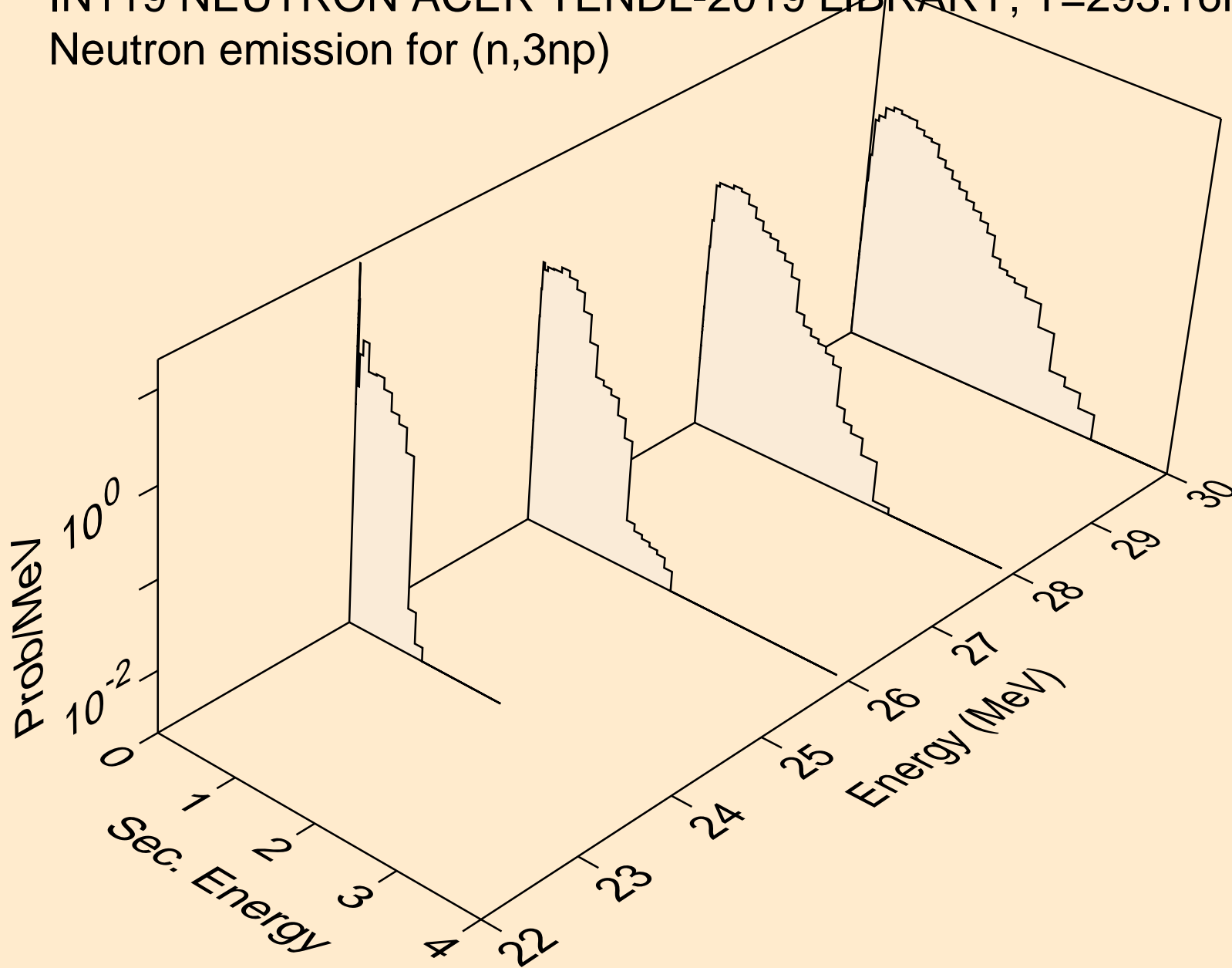

IN119 NEUTRON ACER TENDL-2019 LIBRARY; T=293.16K
Neutron emission for (n,2np)

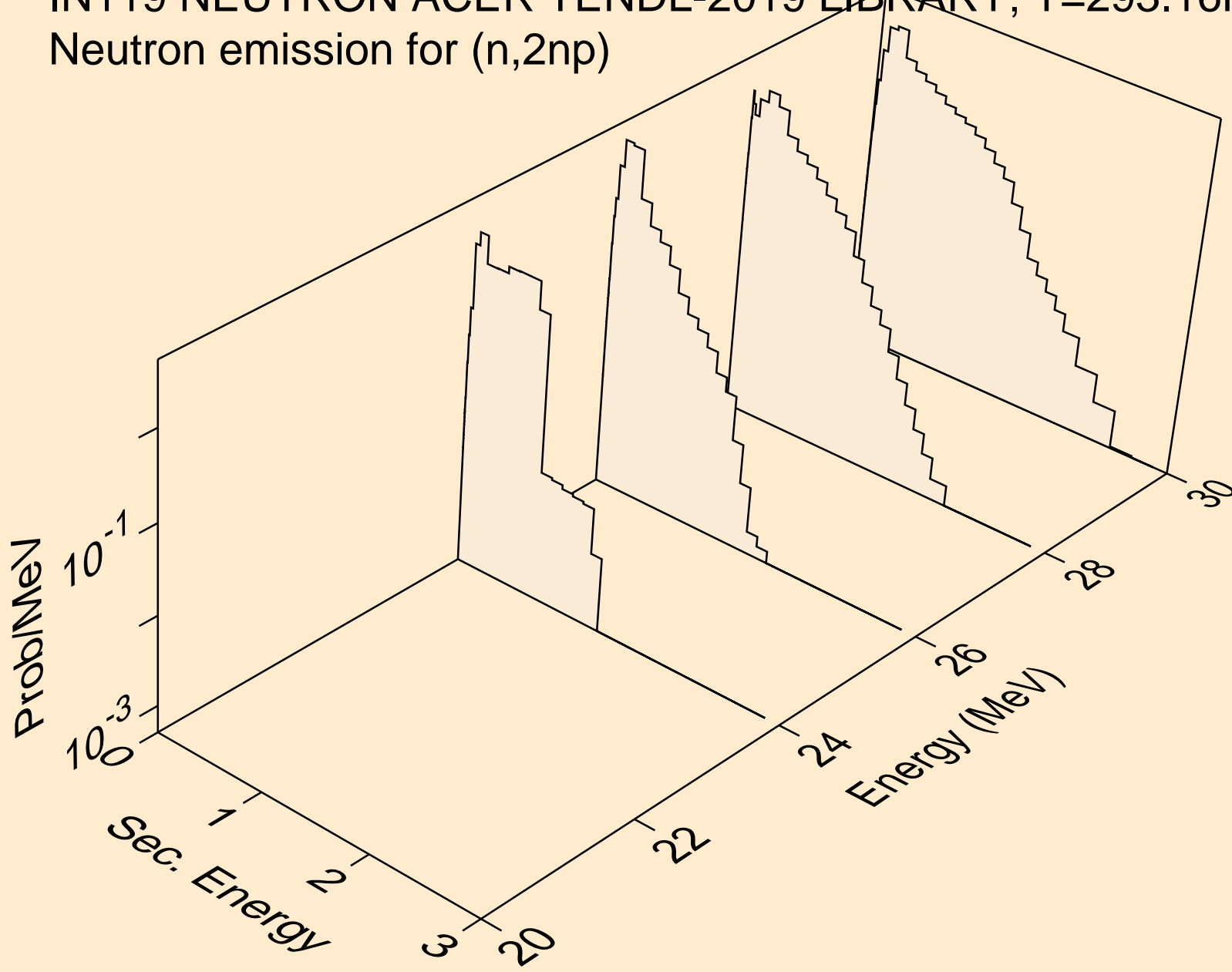

IN119 NEUTRON ACER TENDL-2019 LIBRARY; T=293.16K
Neutron emission for (n,n*c)

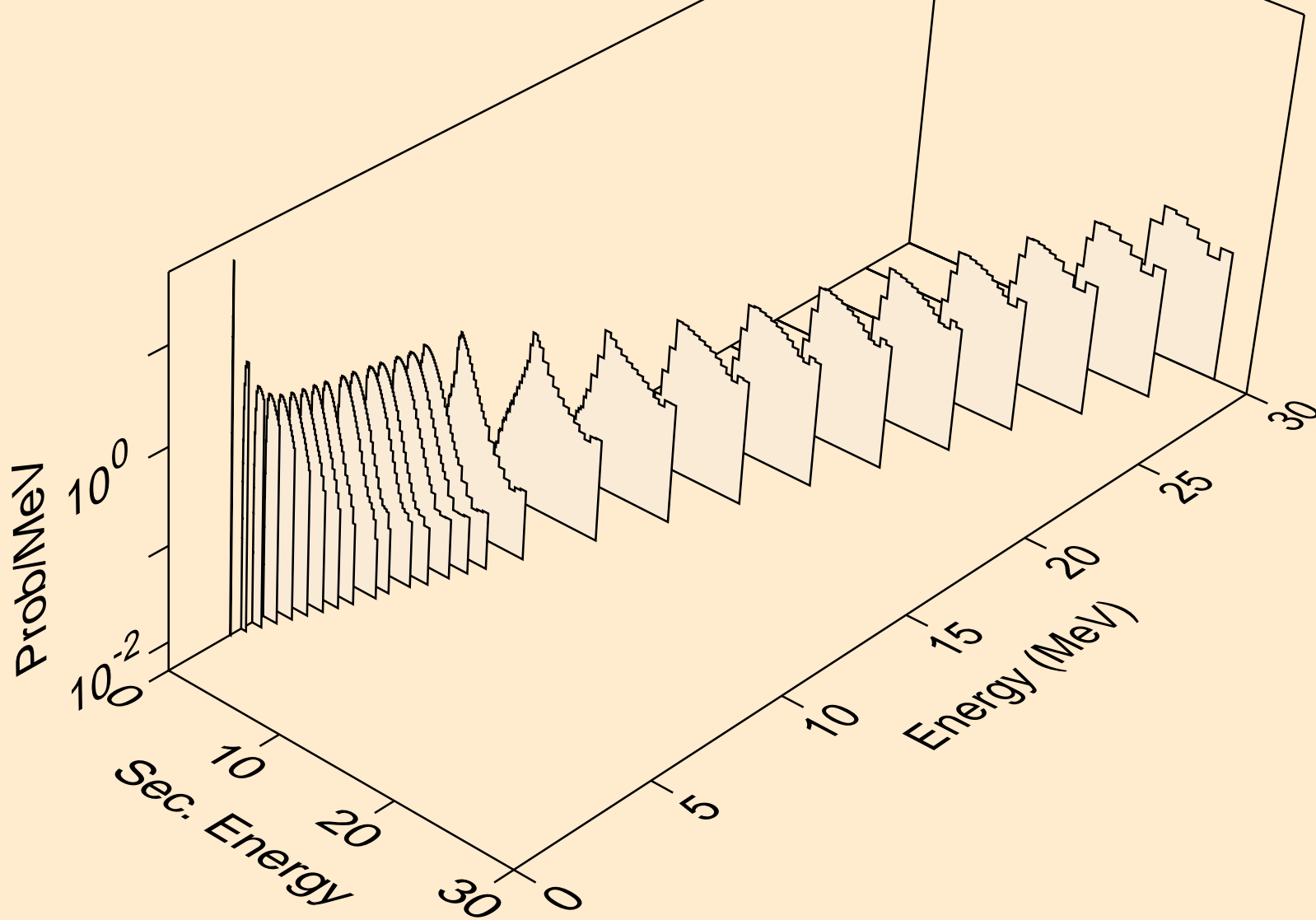

IN119 NEUTRON ACER TENDL-2019 LIBRARY; T=293.16K
Photon emission for (n,x)

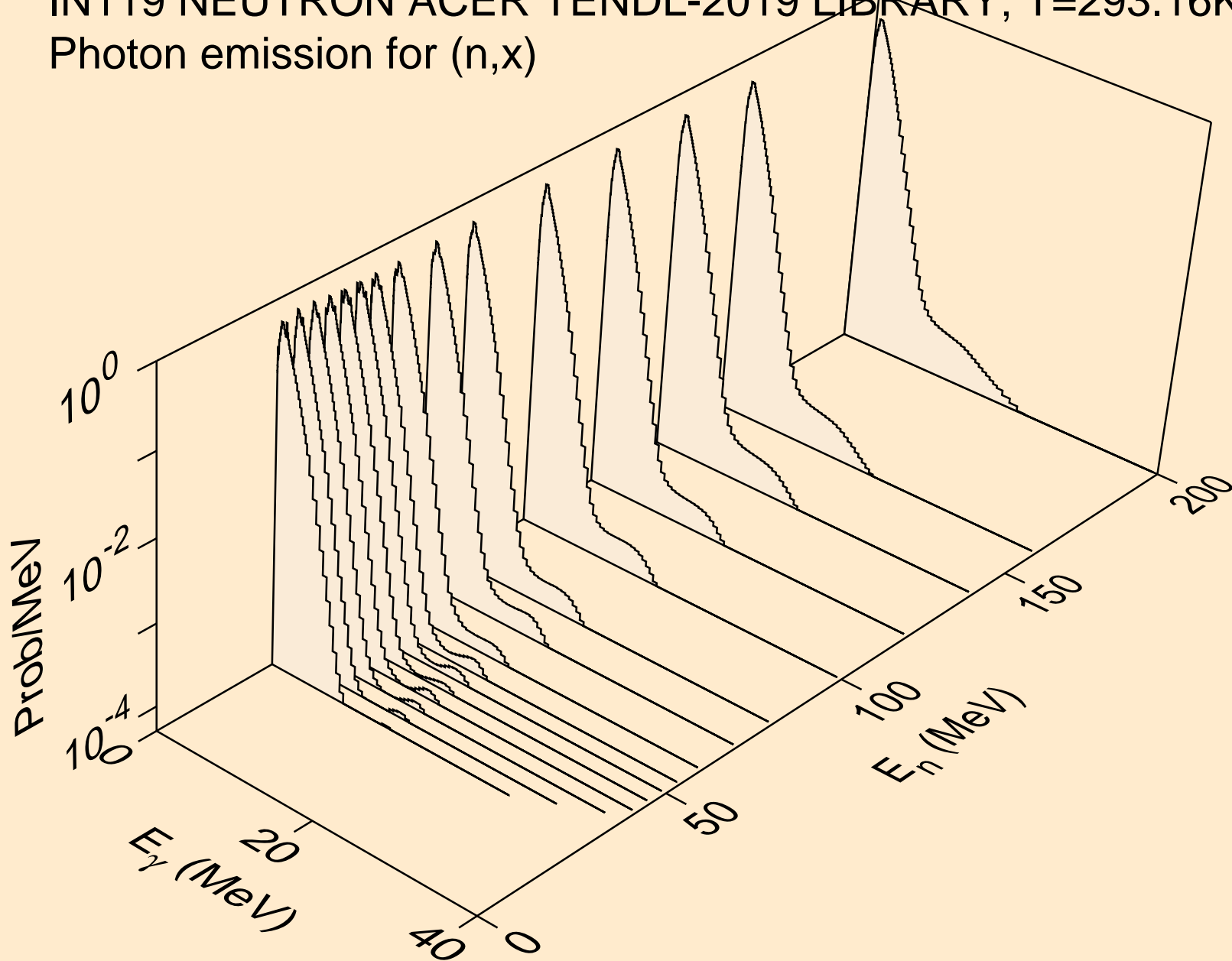

IN119 NEUTRON ACER TENDL-2019 LIBRARY; T=293.16K
Photon emission for (n,2nd)

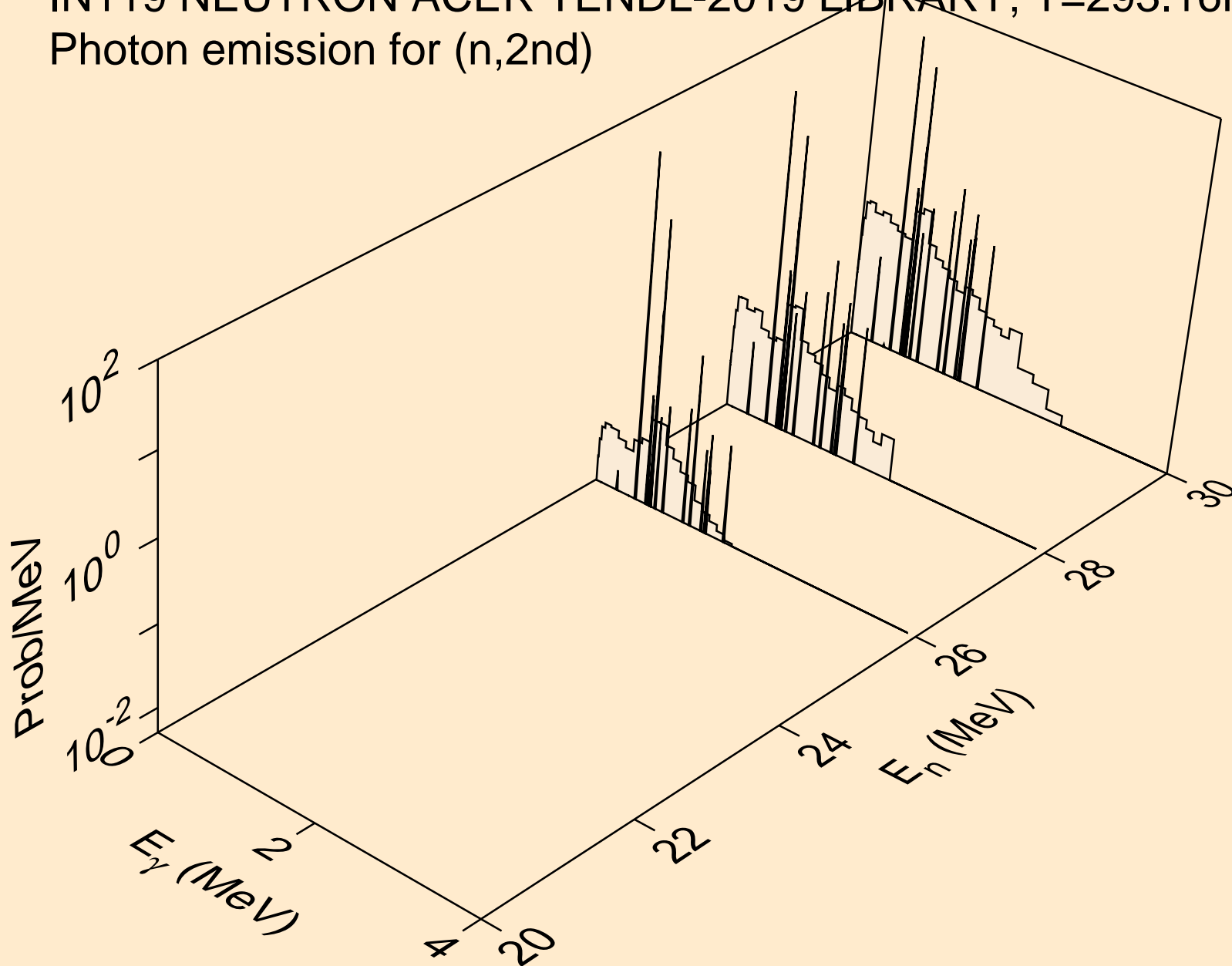

IN119 NEUTRON ACER TENDL-2019 LIBRARY; T=293.16K
Photon emission for (n,2n)

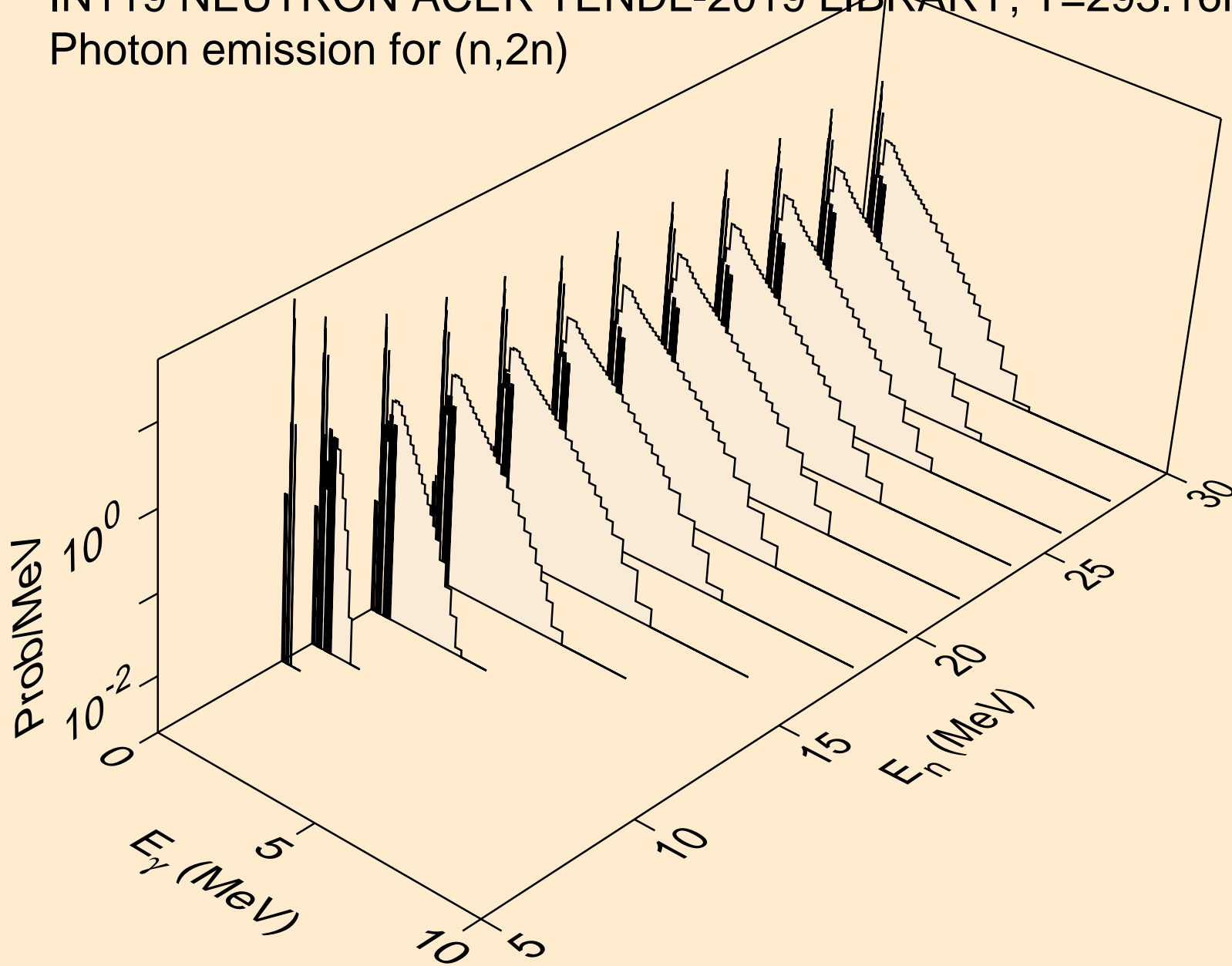

IN119 NEUTRON ACER TENDL-2019 LIBRARY; T=293.16K
Photon emission for (n,3n)

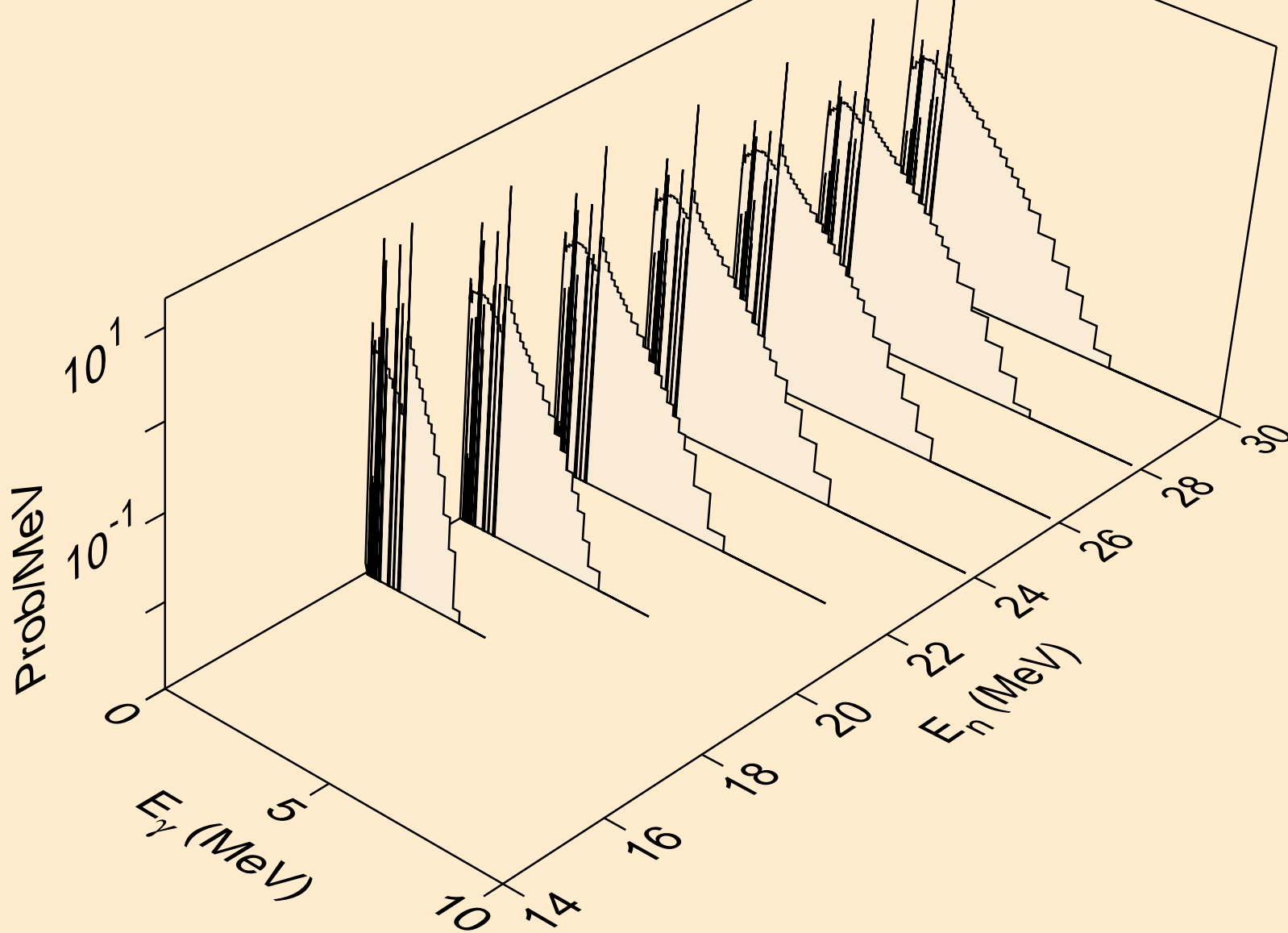

IN119 NEUTRON ACER TENDL-2019 LIBRARY; T=293.16K
Photon emission for (n,n*)a

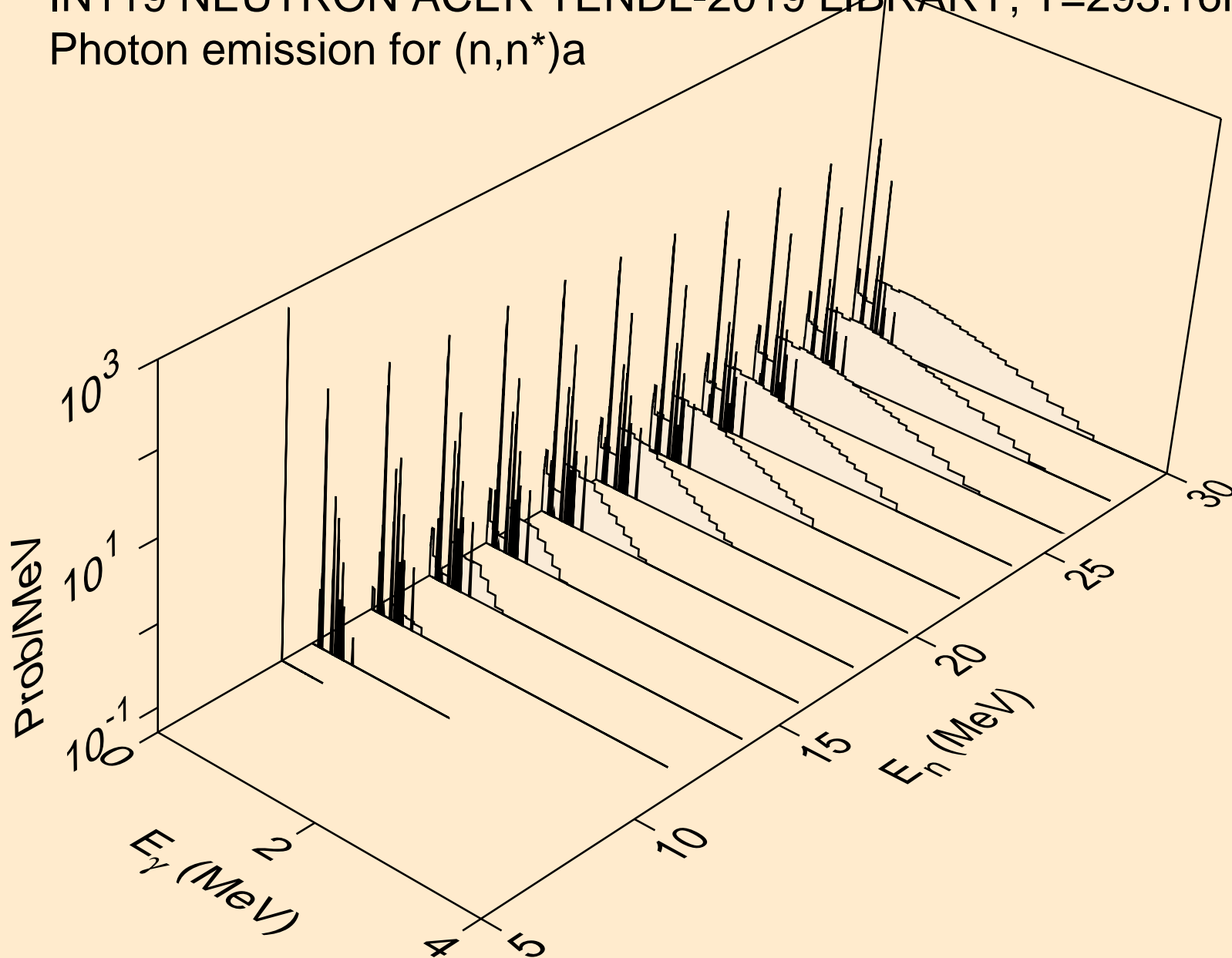

IN119 NEUTRON ACER TENDL-2019 LIBRARY; T=293.16K
Photon emission for (n,2n)a

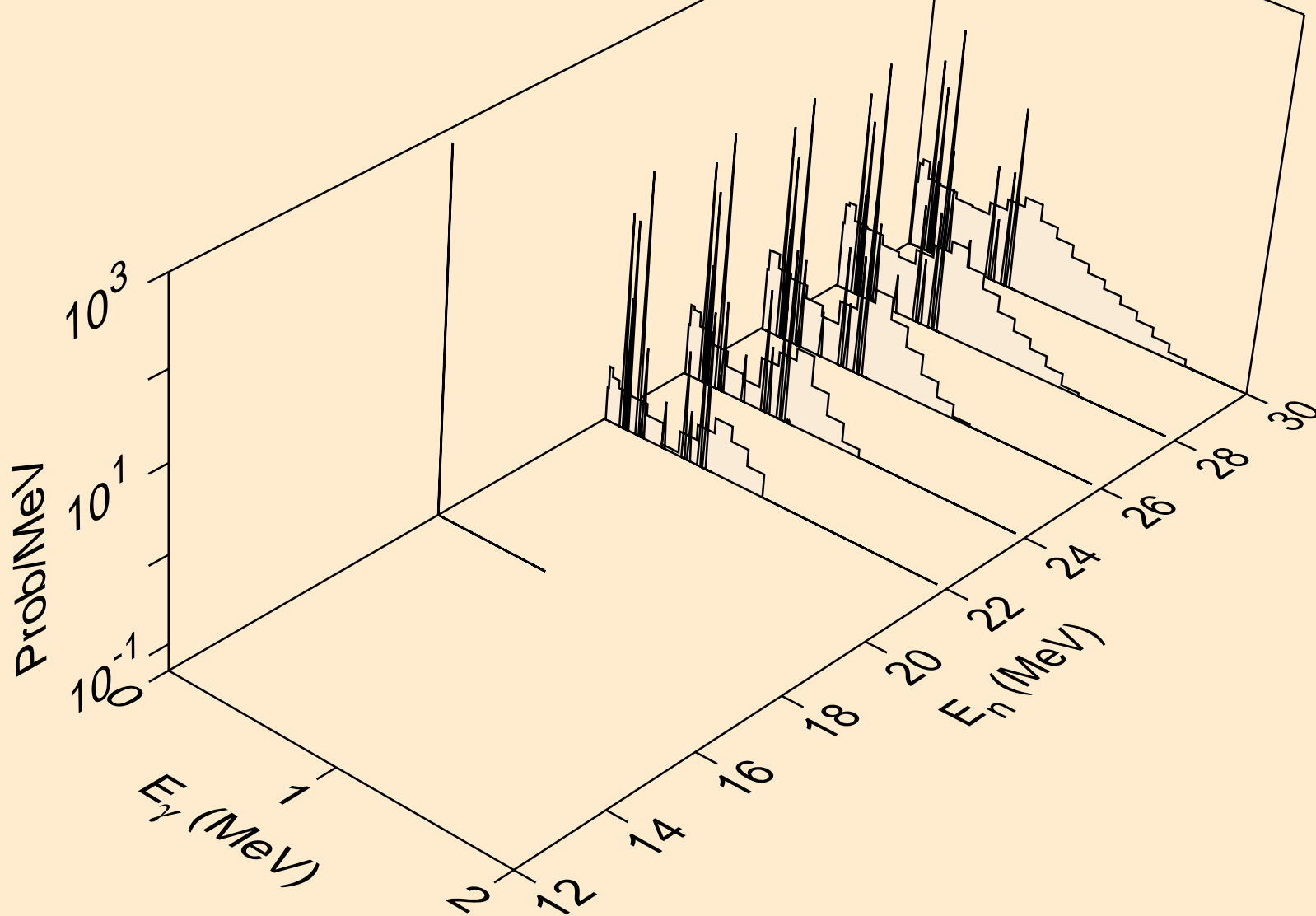

IN119 NEUTRON ACER TENDL-2019 LIBRARY; T=293.16K
Photon emission for (n,3n)a

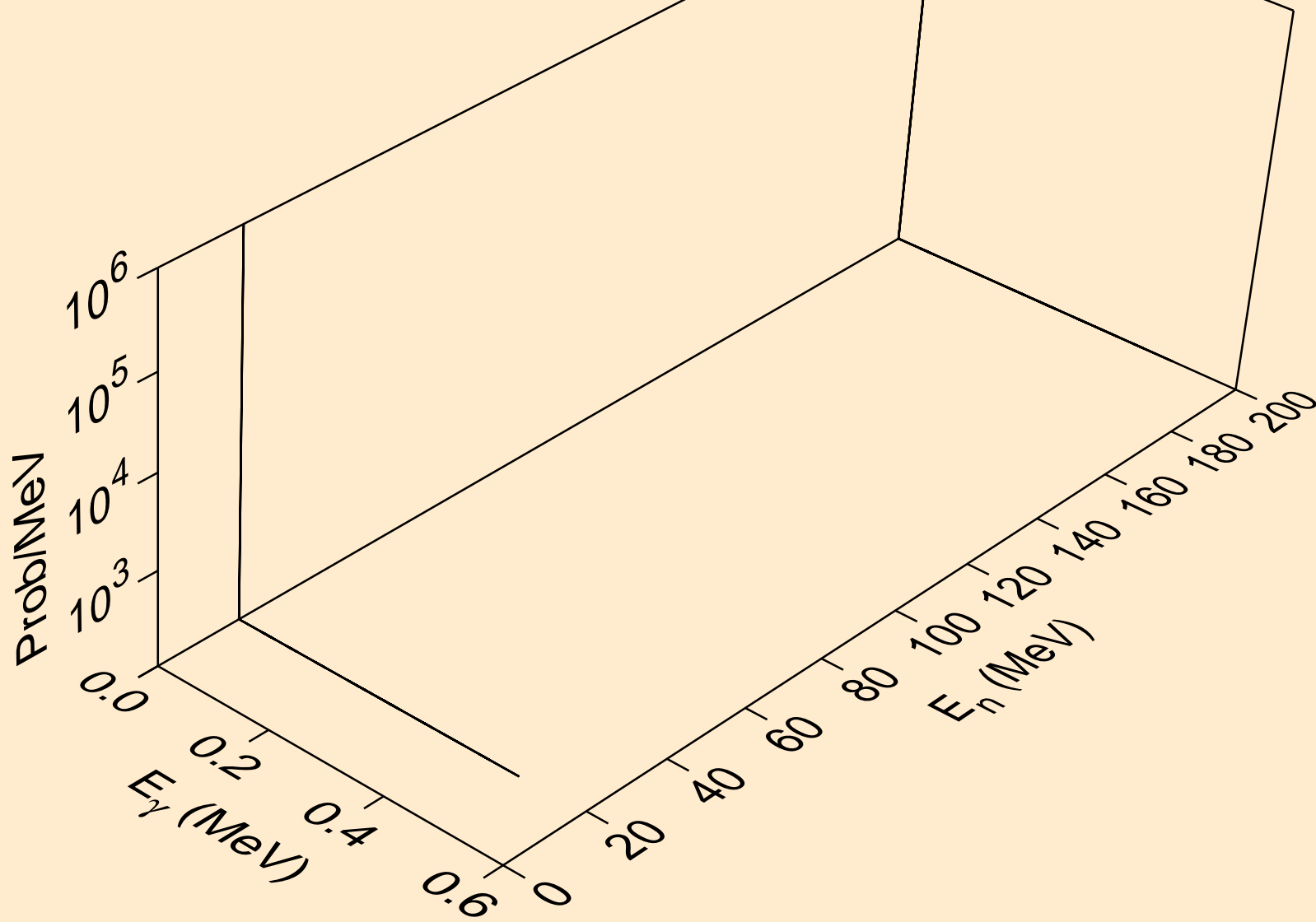

IN119 NEUTRON ACER TENDL-2019 LIBRARY; T=293.16K
Photon emission for (n,n*)p

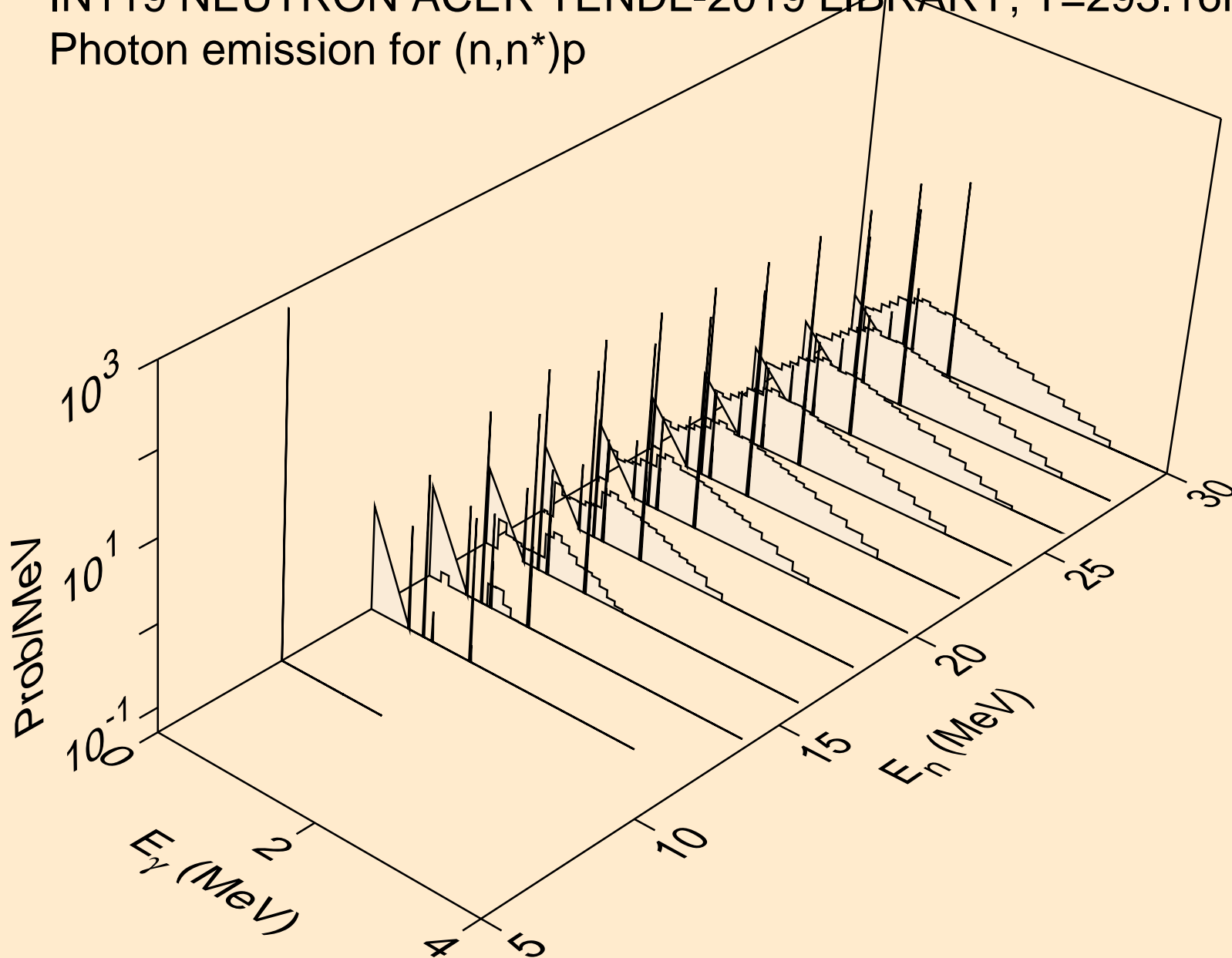

IN119 NEUTRON ACER TENDL-2019 LIBRARY; T=293.16K
Photon emission for (n,n*)d

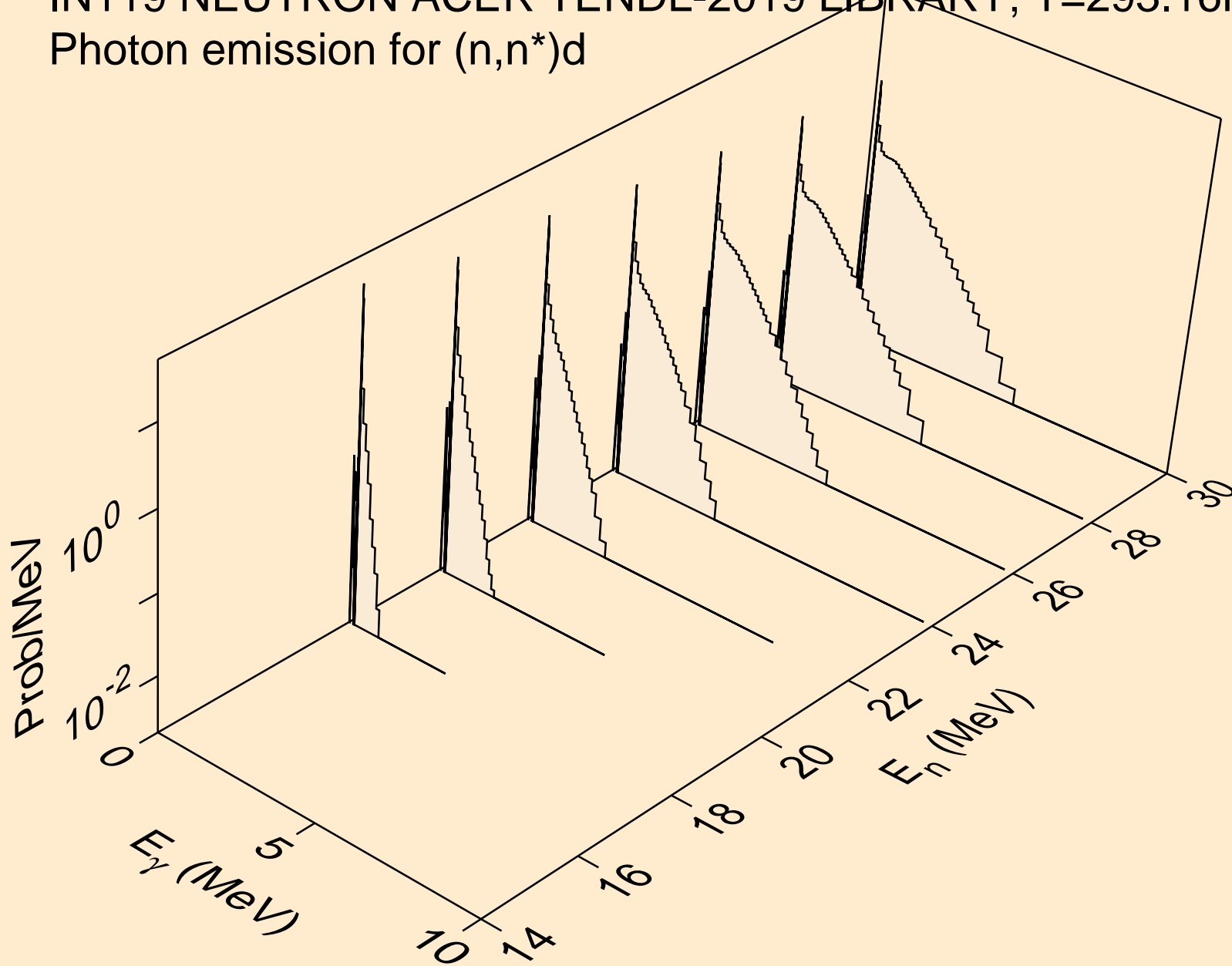

IN119 NEUTRON ACER TENDL-2019 LIBRARY; T=293.16K
Photon emission for (n,n*)t

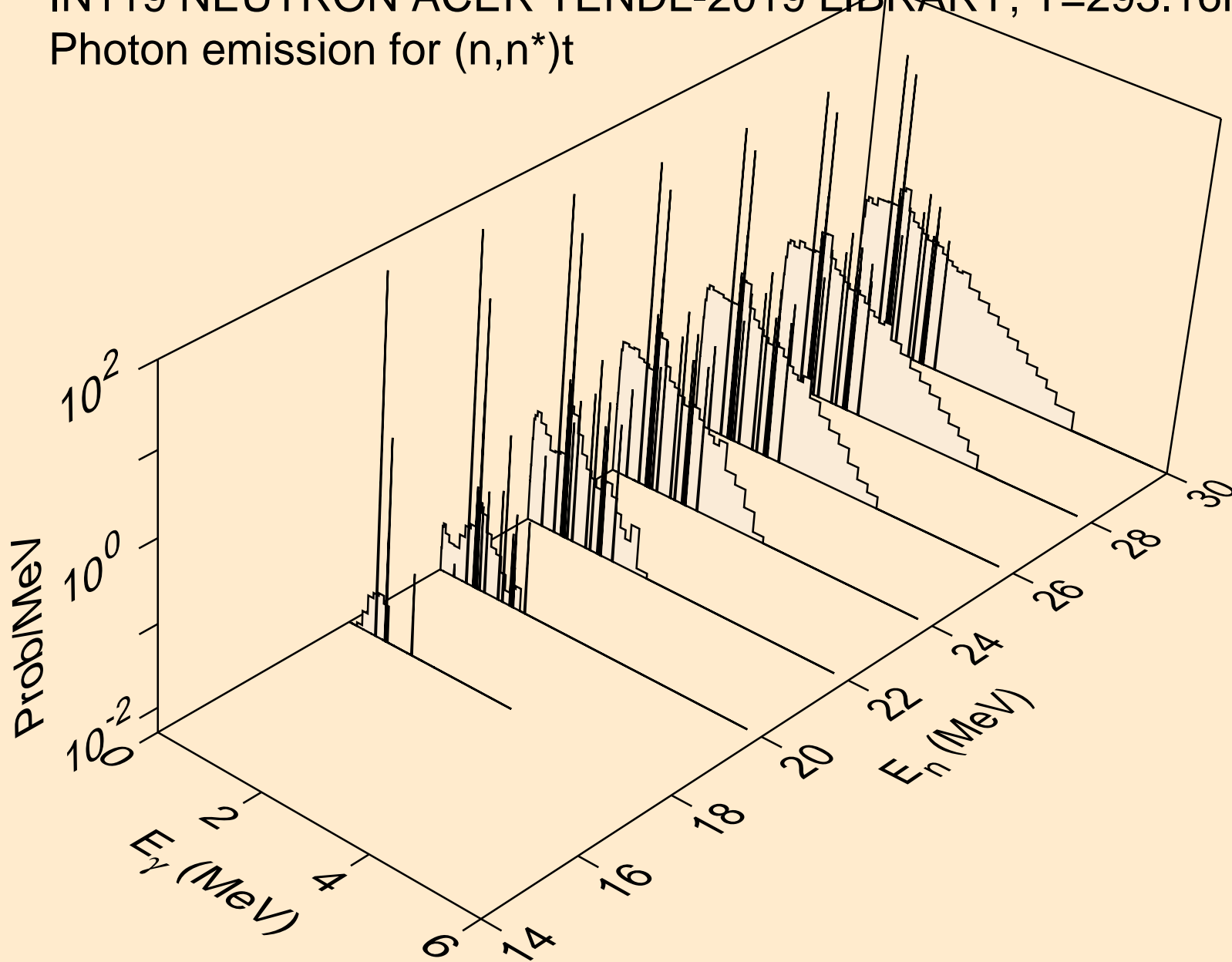

IN119 NEUTRON ACER TENDL-2019 LIBRARY; T=293.16K
Photon emission for (n,n*)he3

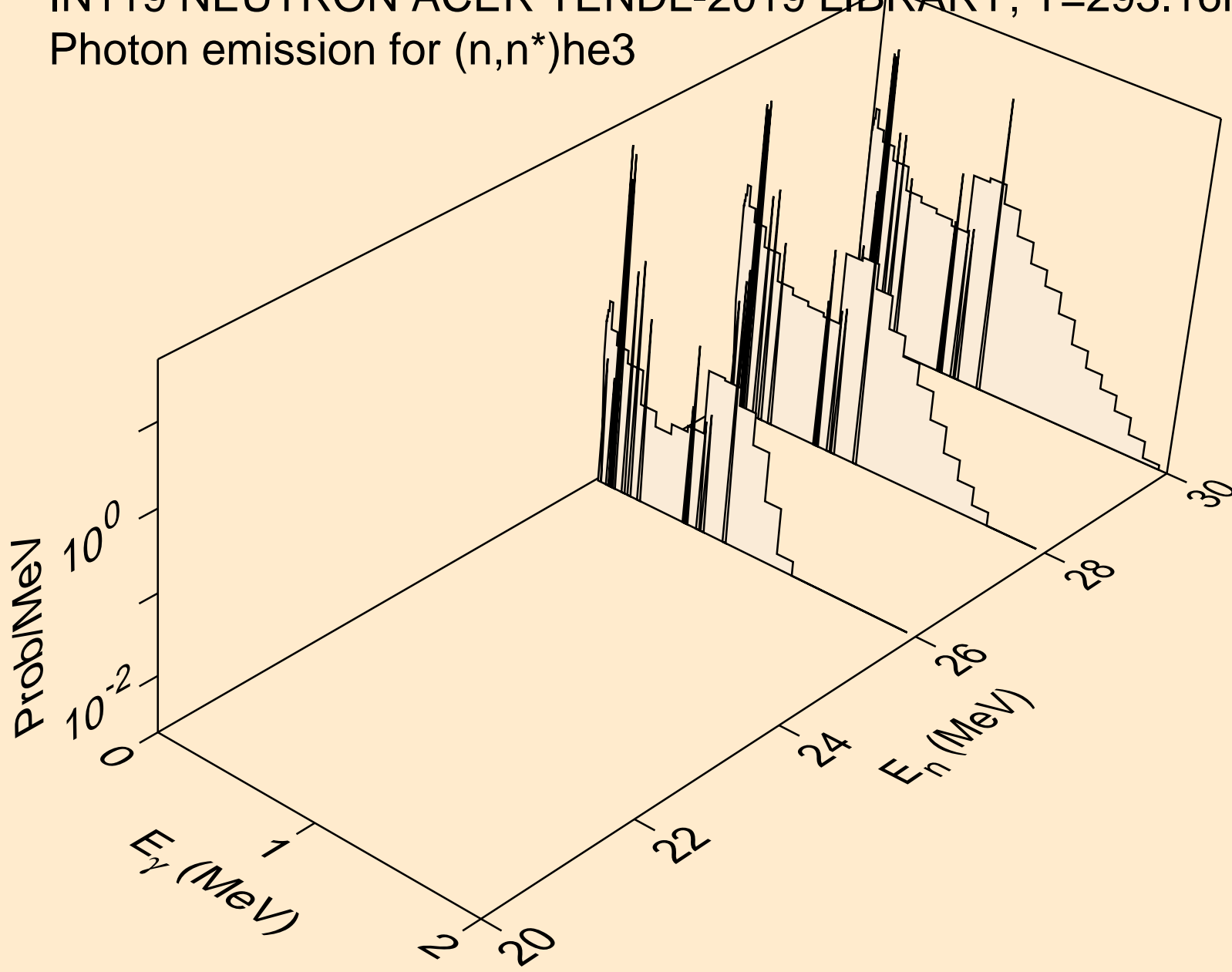

IN119 NEUTRON ACER TENDL-2019 LIBRARY; T=293.16K
Photon emission for (n,4n)

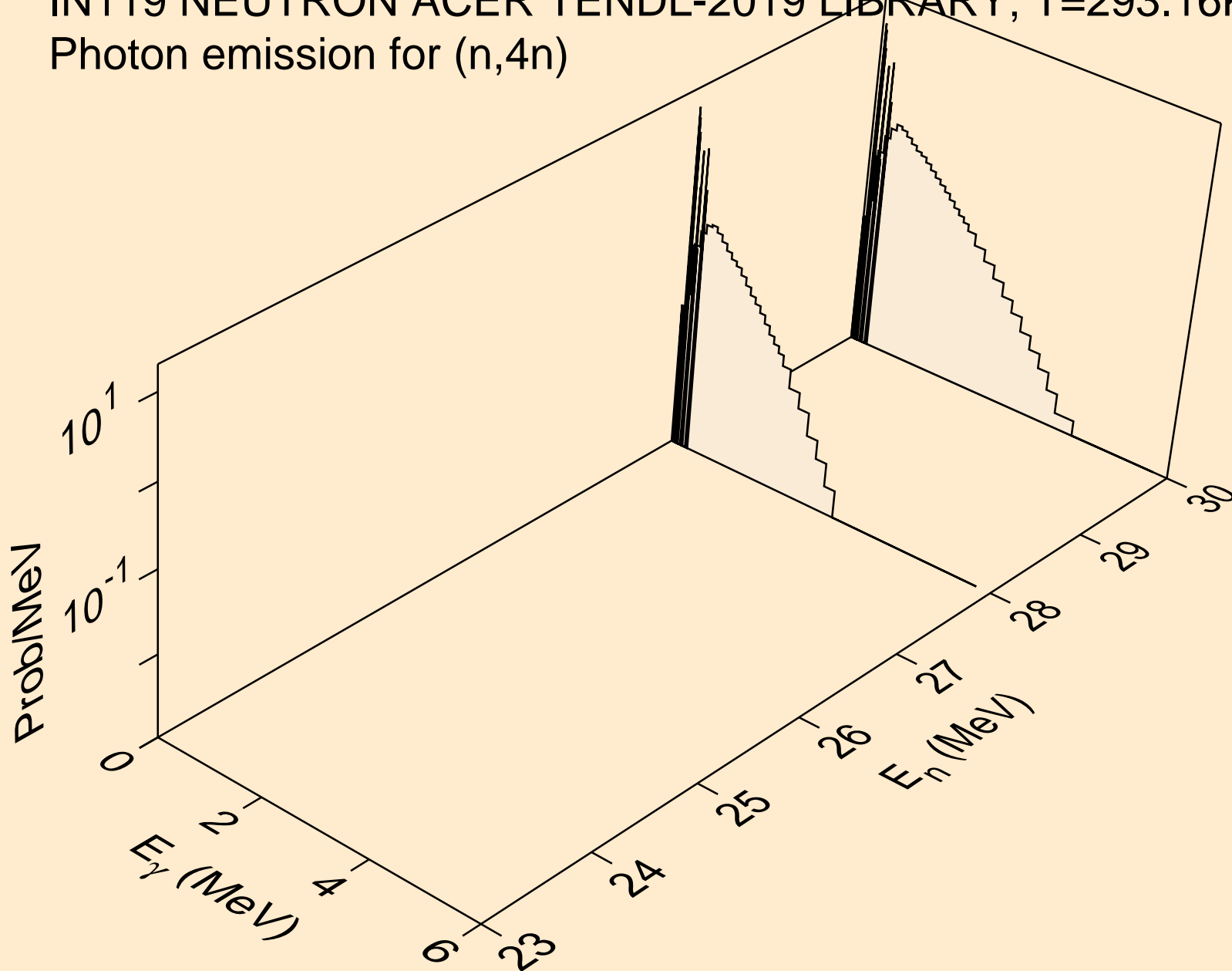

IN119 NEUTRON ACER TENDL-2019 LIBRARY; T=293.16K
Photon emission for (n,2np)

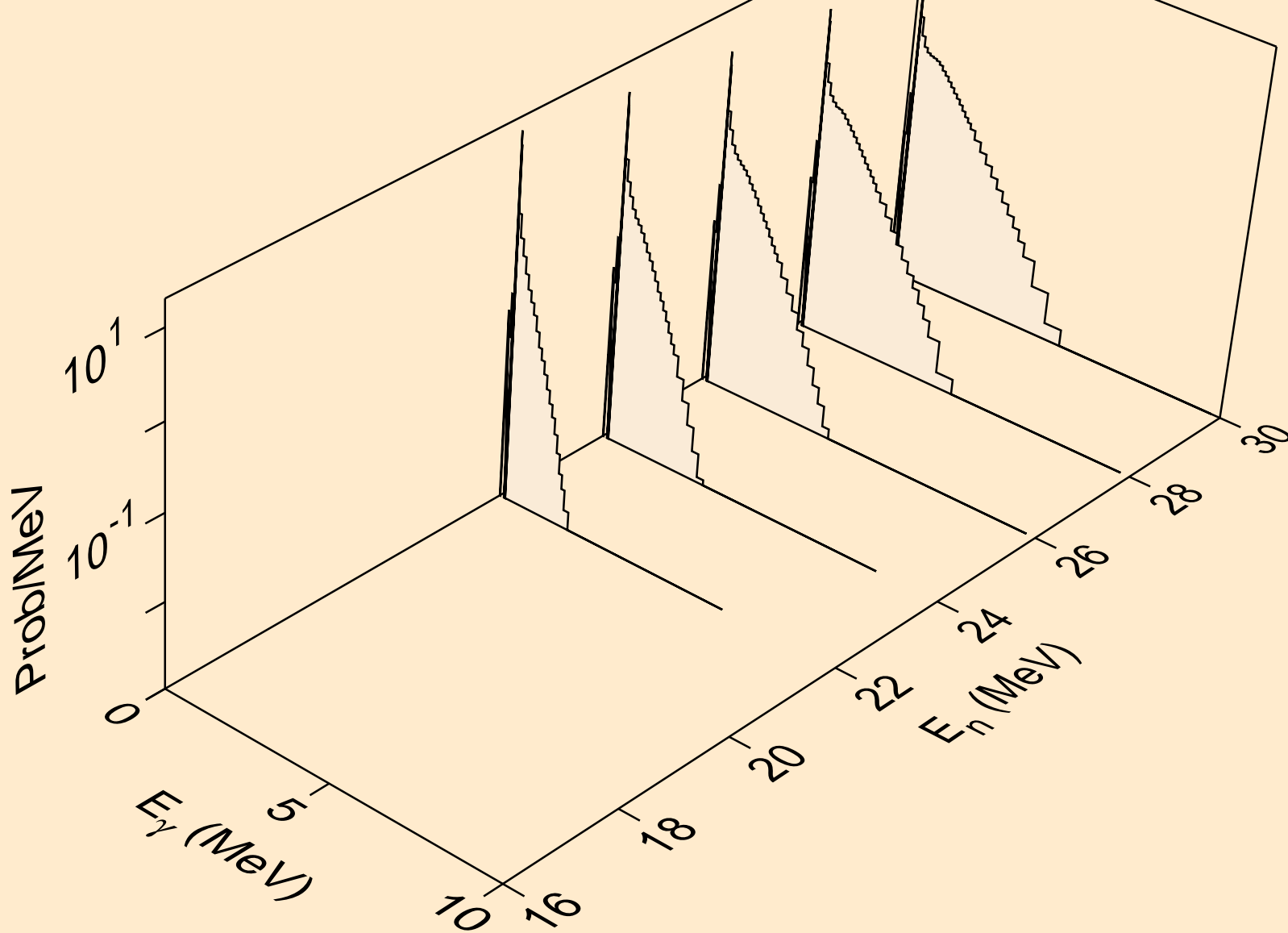

IN119 NEUTRON ACER TENDL-2019 LIBRARY; T=293.16K
Photon emission for (n,3np)

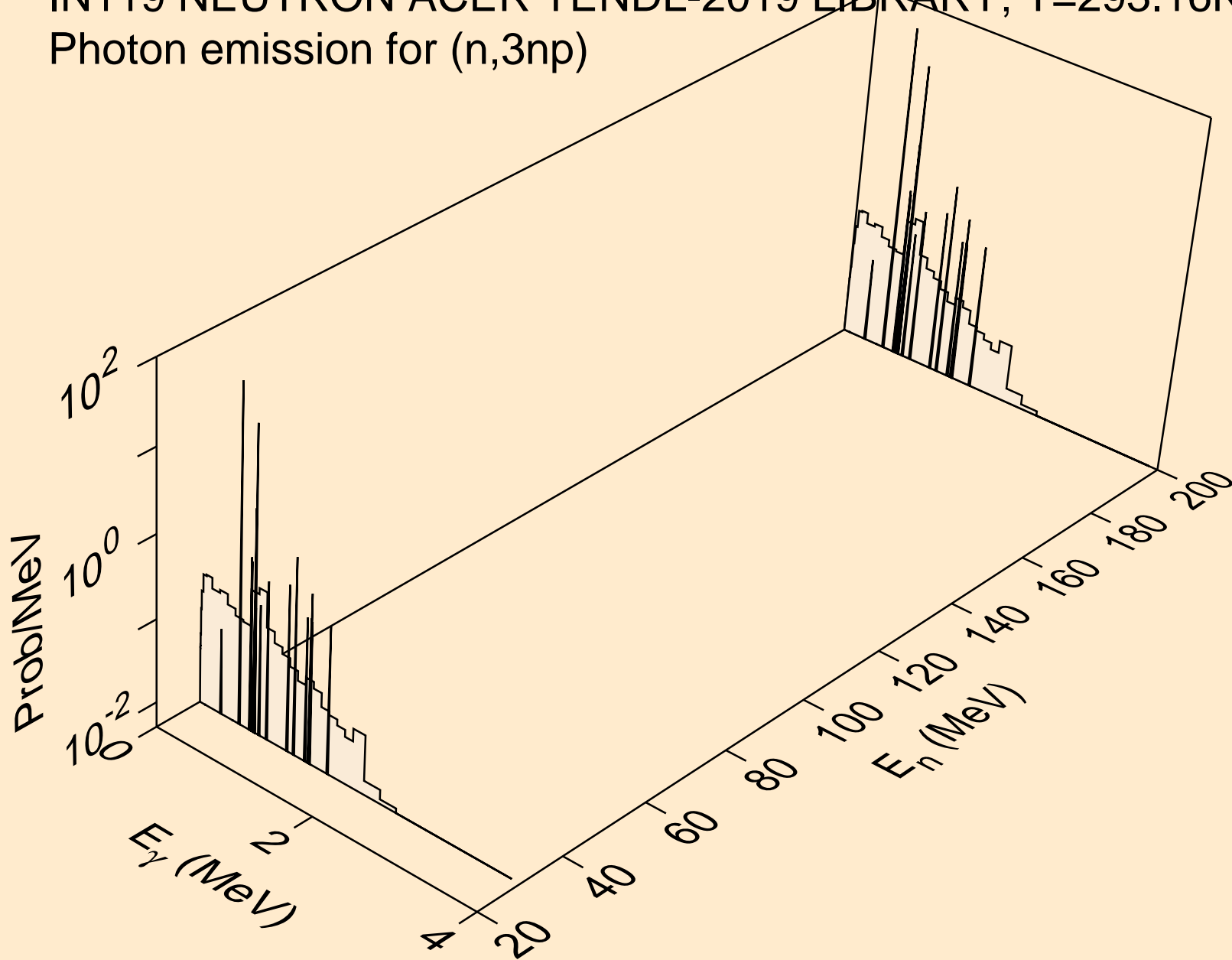

IN119 NEUTRON ACER TENDL-2019 LIBRARY; T=293.16K
Photon emission for (n,2np)

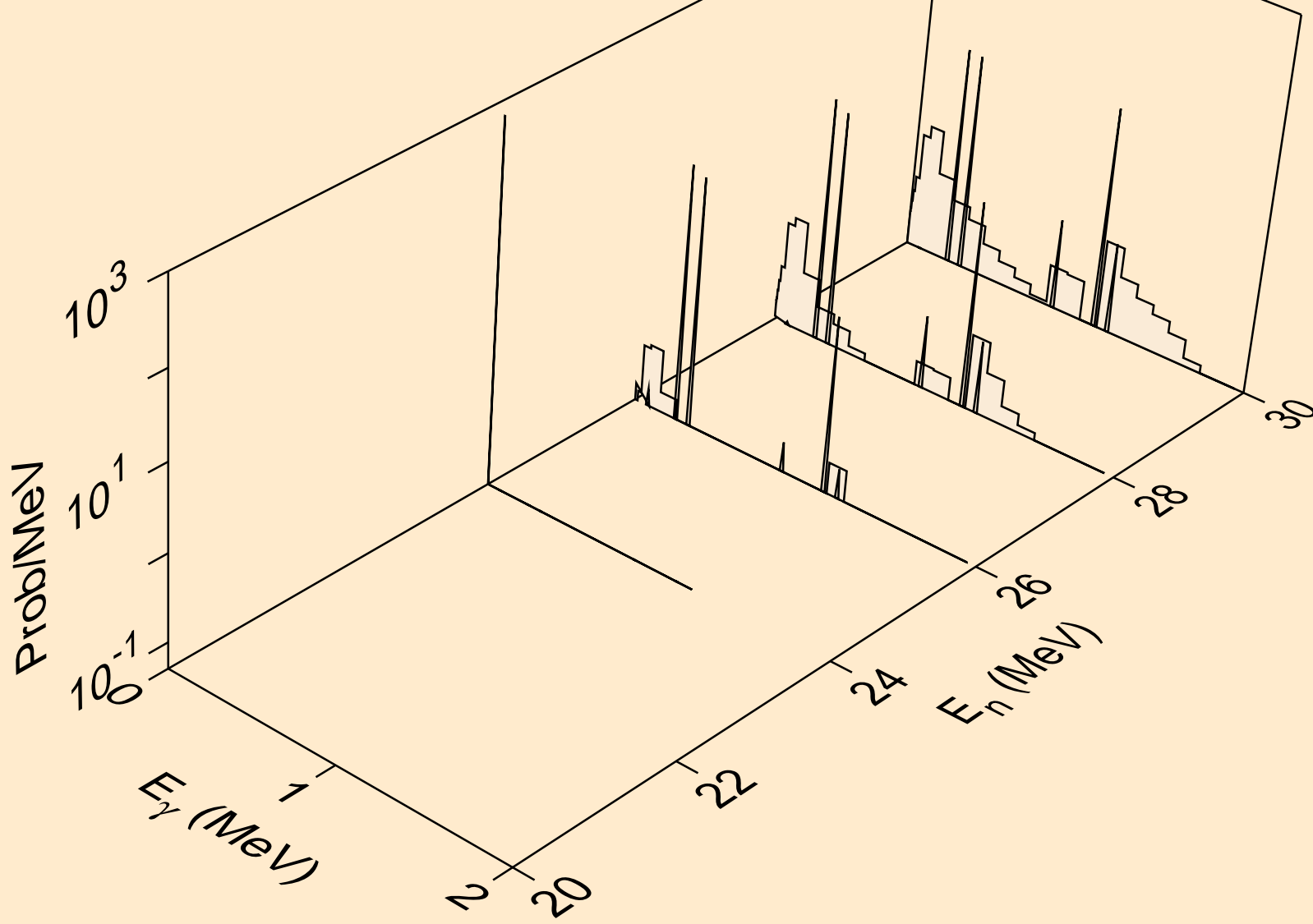

IN119 NEUTRON ACER TENDL-2019 LIBRARY; T=293.16K
Photon emission for (n,n*c)

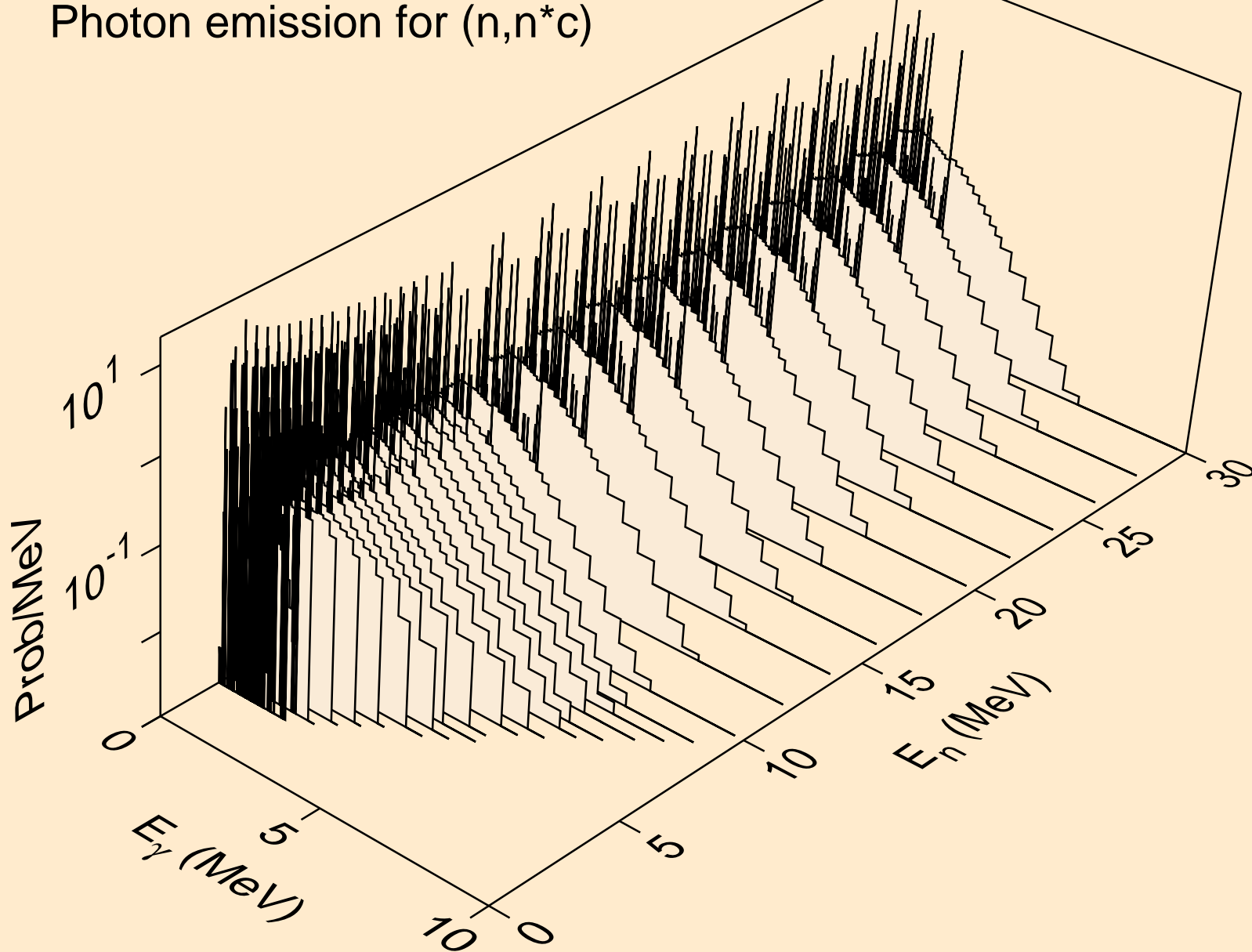

IN119 NEUTRON ACER TENDL-2019 LIBRARY; T=293.16K
Photon emission for (n,gma)

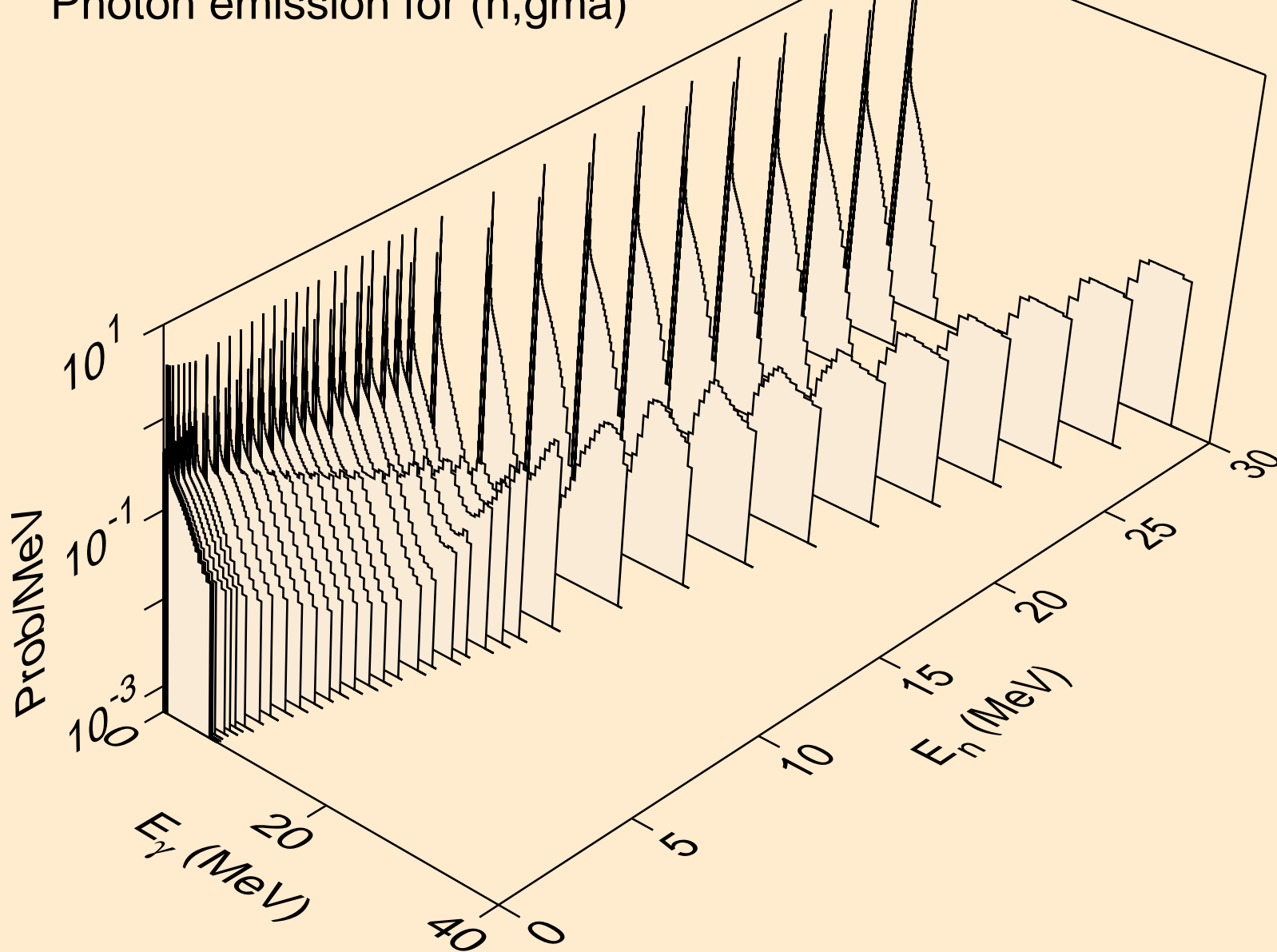

IN119 NEUTRON ACER TENDL-2019 LIBRARY; T=293.16K
Photon emission for (n,p)

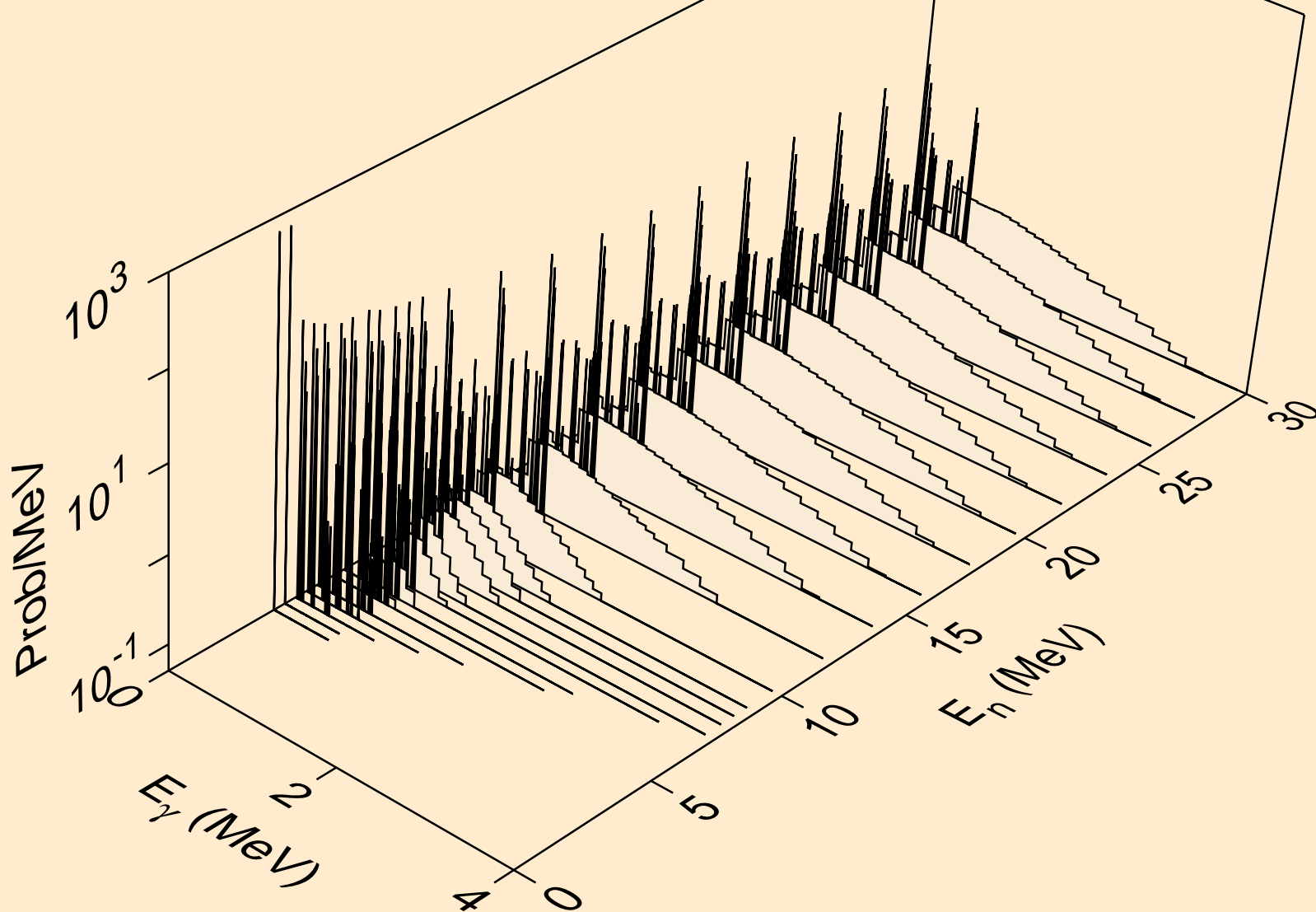

IN119 NEUTRON ACER TENDL-2019 LIBRARY; T=293.16K
Photon emission for (n,d)

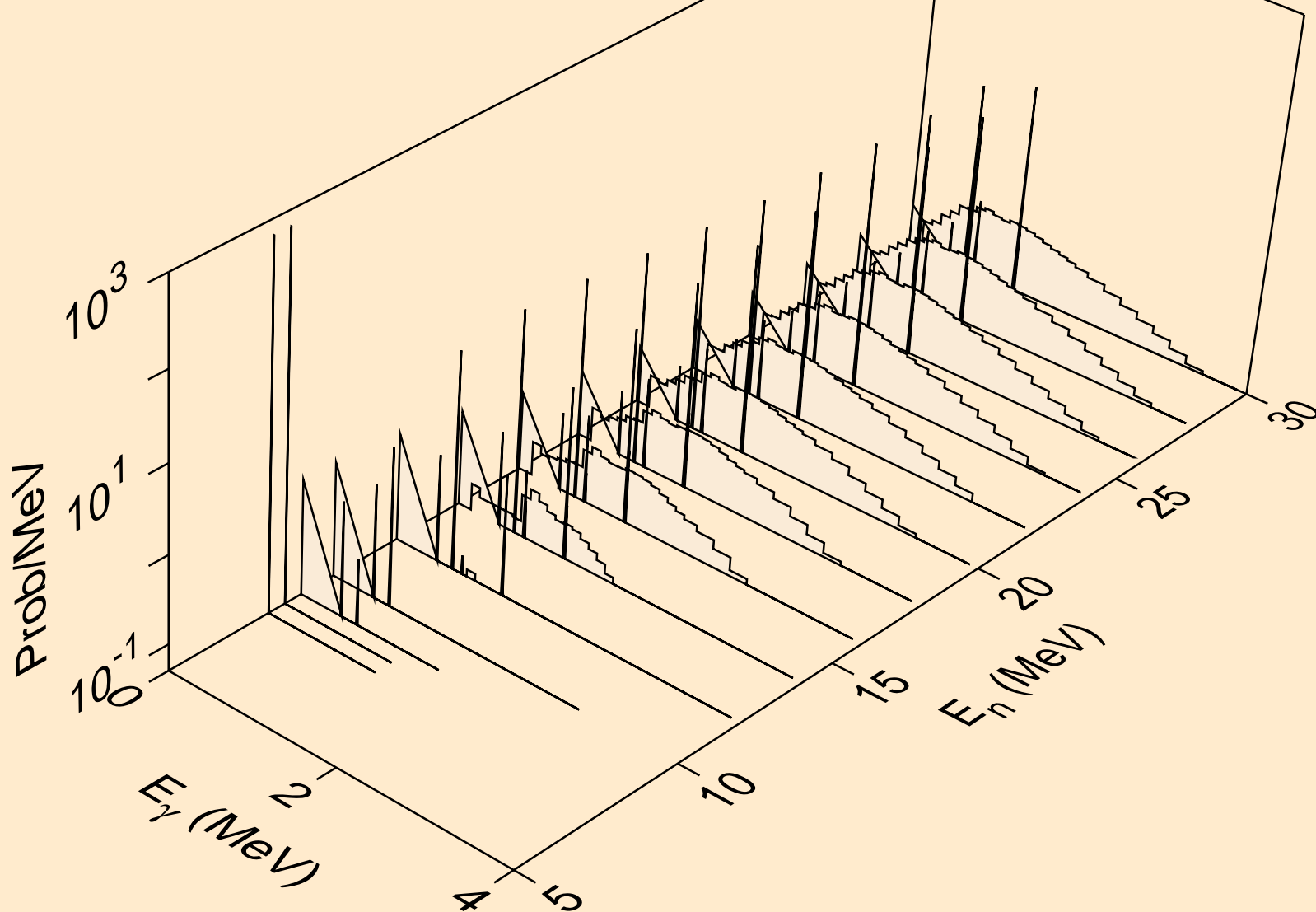

IN119 NEUTRON ACER TENDL-2019 LIBRARY; T=293.16K
Photon emission for (n,t)

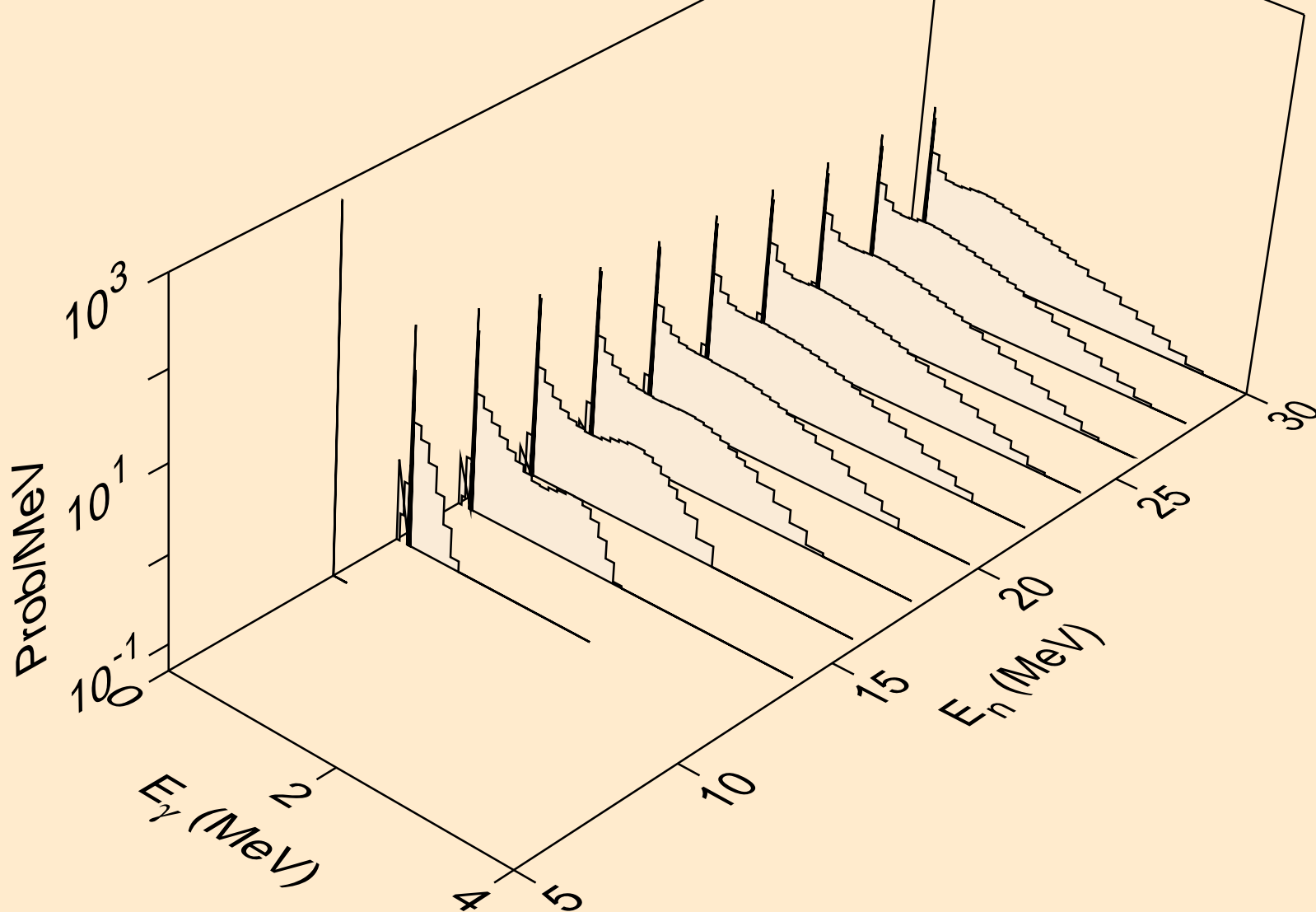

IN119 NEUTRON ACER TENDL-2019 LIBRARY; T=293.16K
Photon emission for (n,he3)

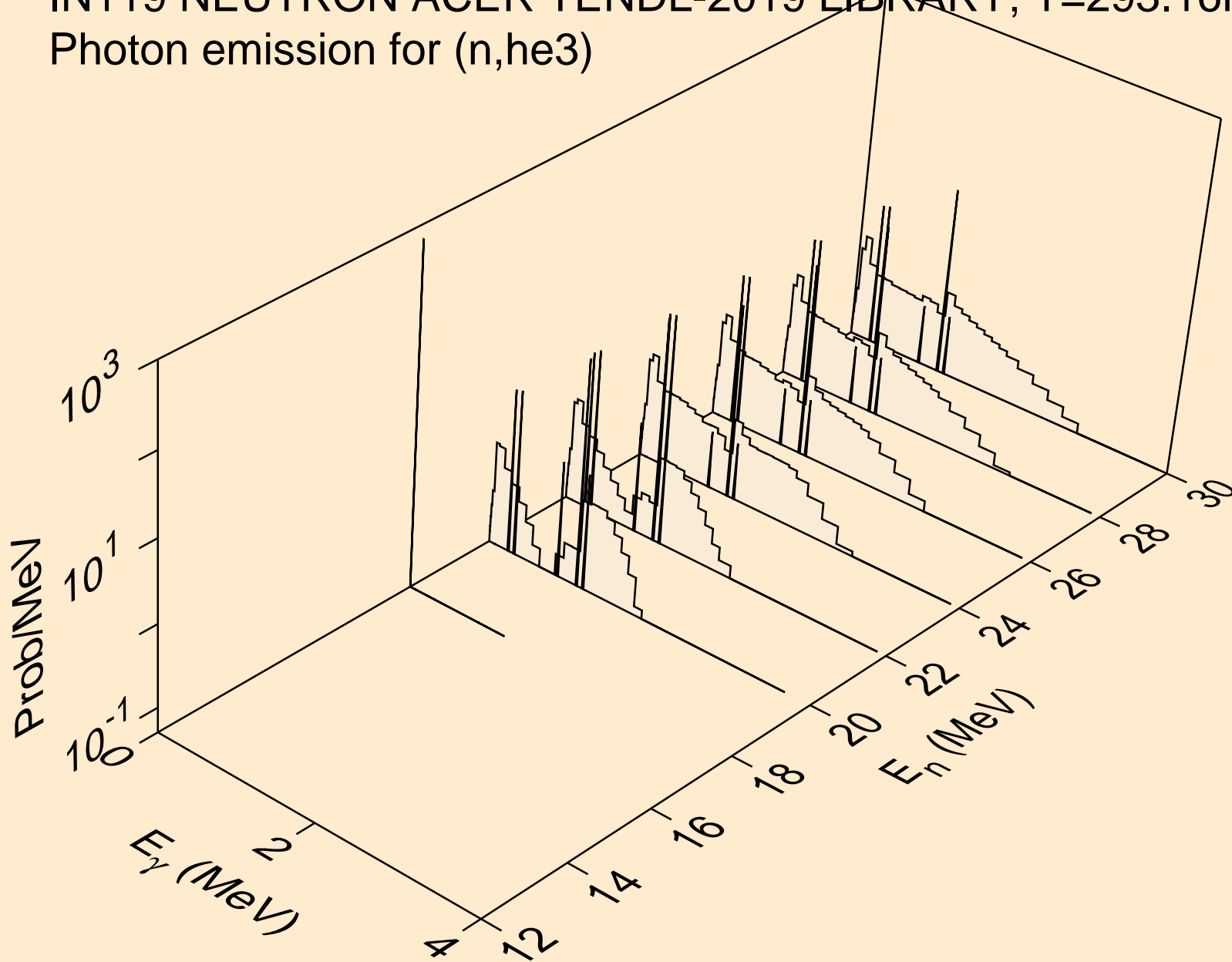

IN119 NEUTRON ACER TENDL-2019 LIBRARY; T=293.16K
Photon emission for (n,a)

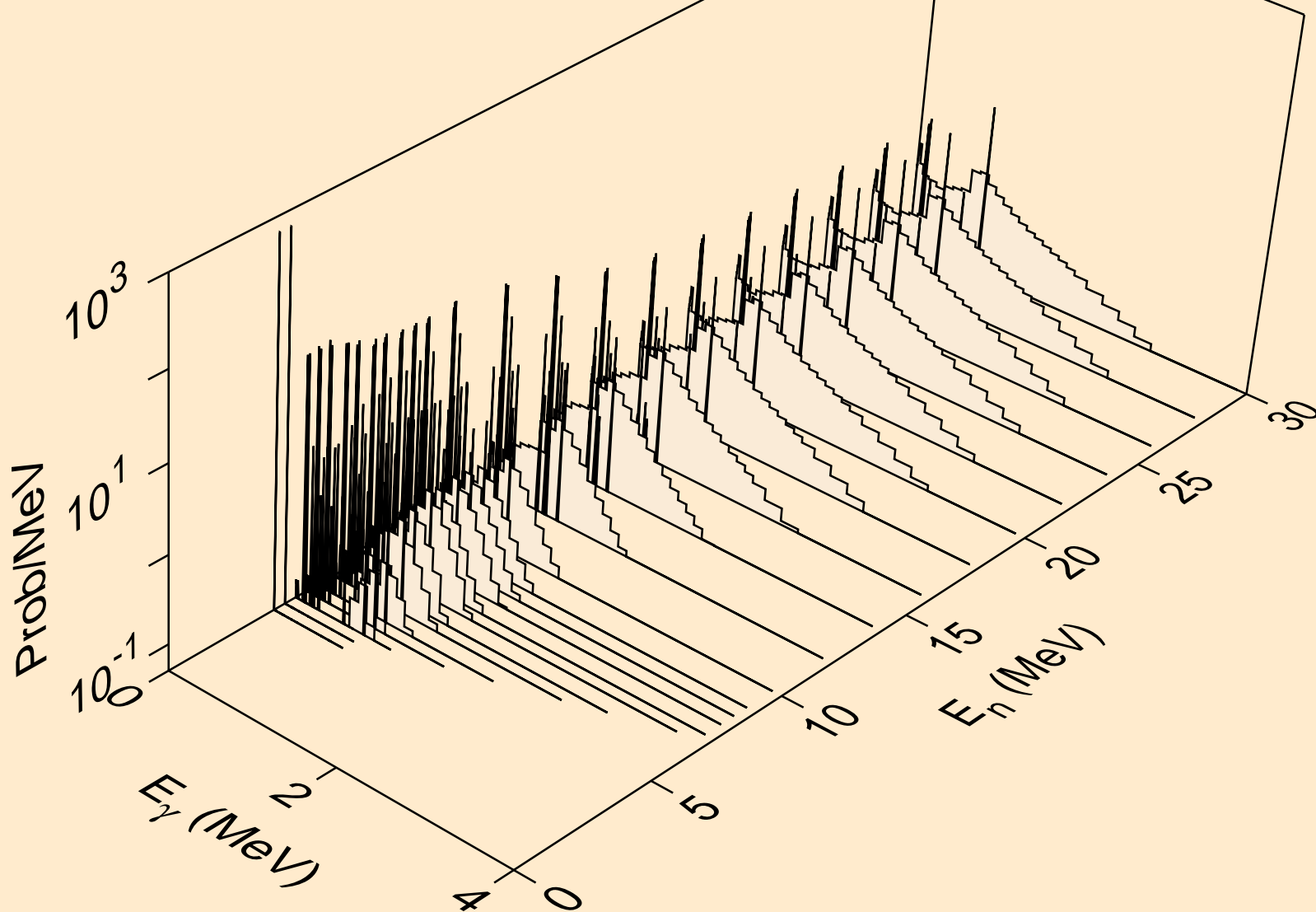

IN119 NEUTRON ACER TENDL-2019 LIBRARY; T=293.16K
Photon emission for (n,2p)

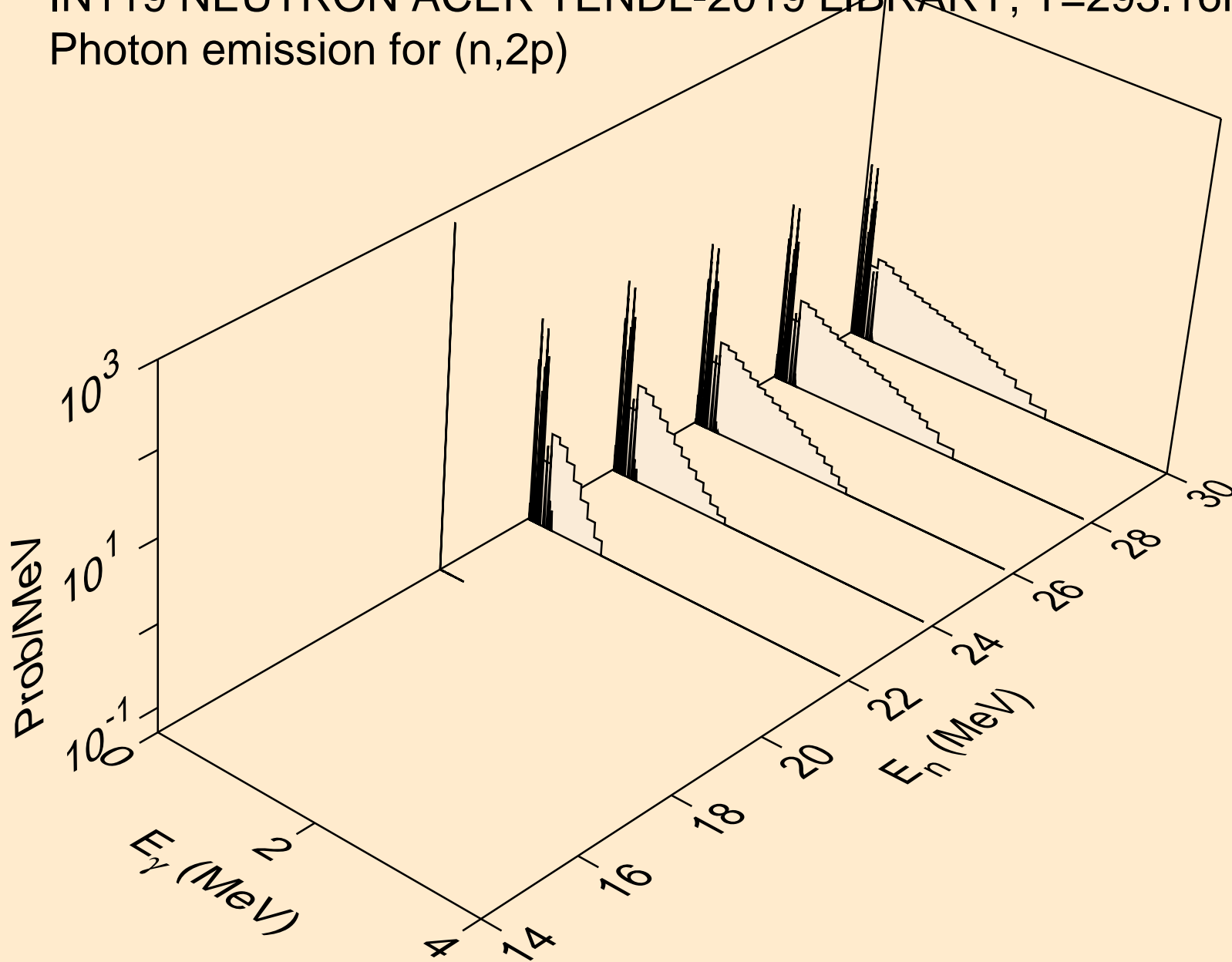

IN119 NEUTRON ACER TENDL-2019 LIBRARY; T=293.16K
Photon emission for (n,p α)

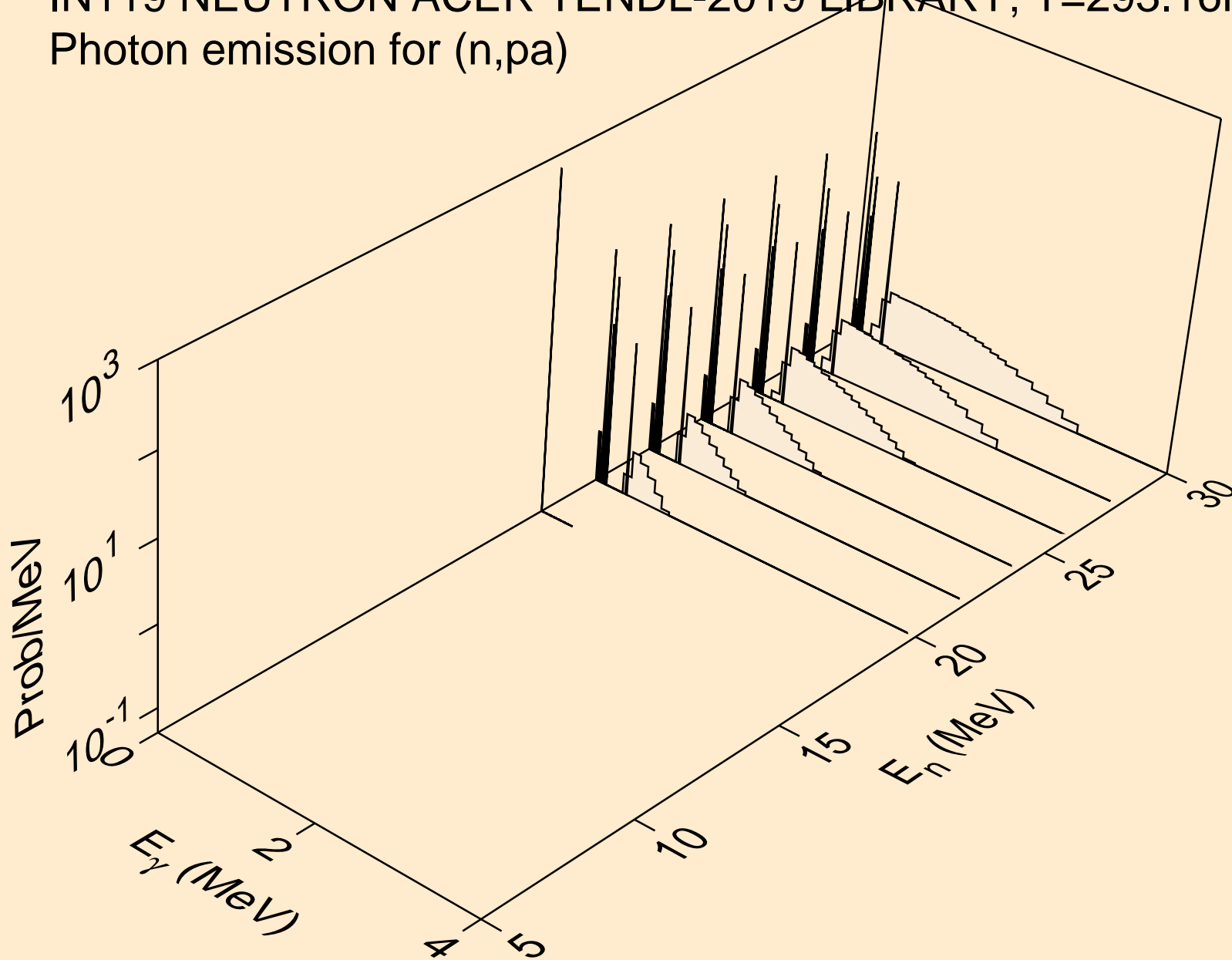

IN119 NEUTRON ACER TENDL-2019 LIBRARY; T=293.16K
thermal capture photon spectrum

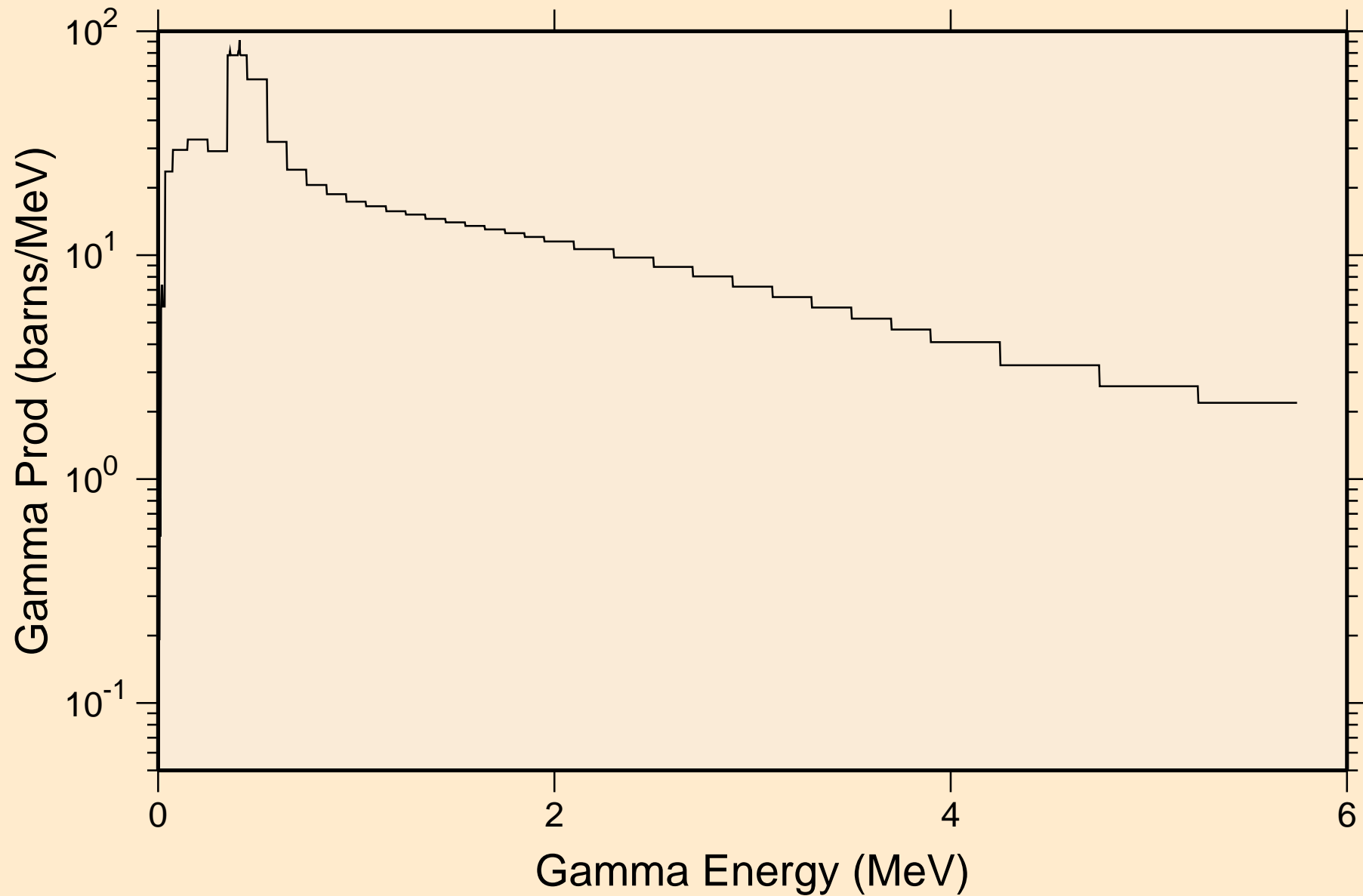

IN119 NEUTRON ACER TENDL-2019 LIBRARY; T=293.16K
14 MeV photon spectrum

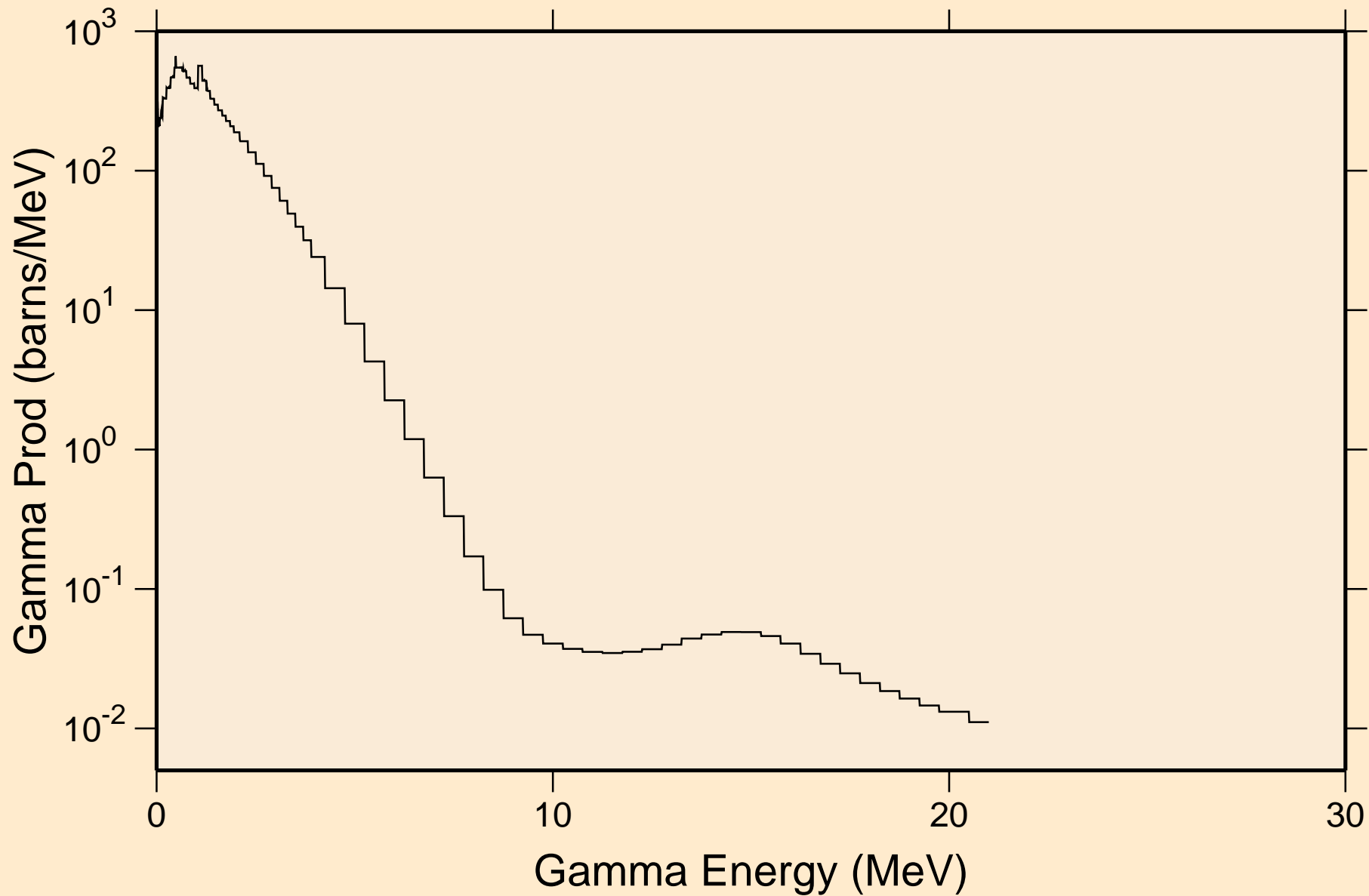

IN119 NEUTRON ACER TENDL-2019 LIBRARY; T=293.16K
Particle heating contributions

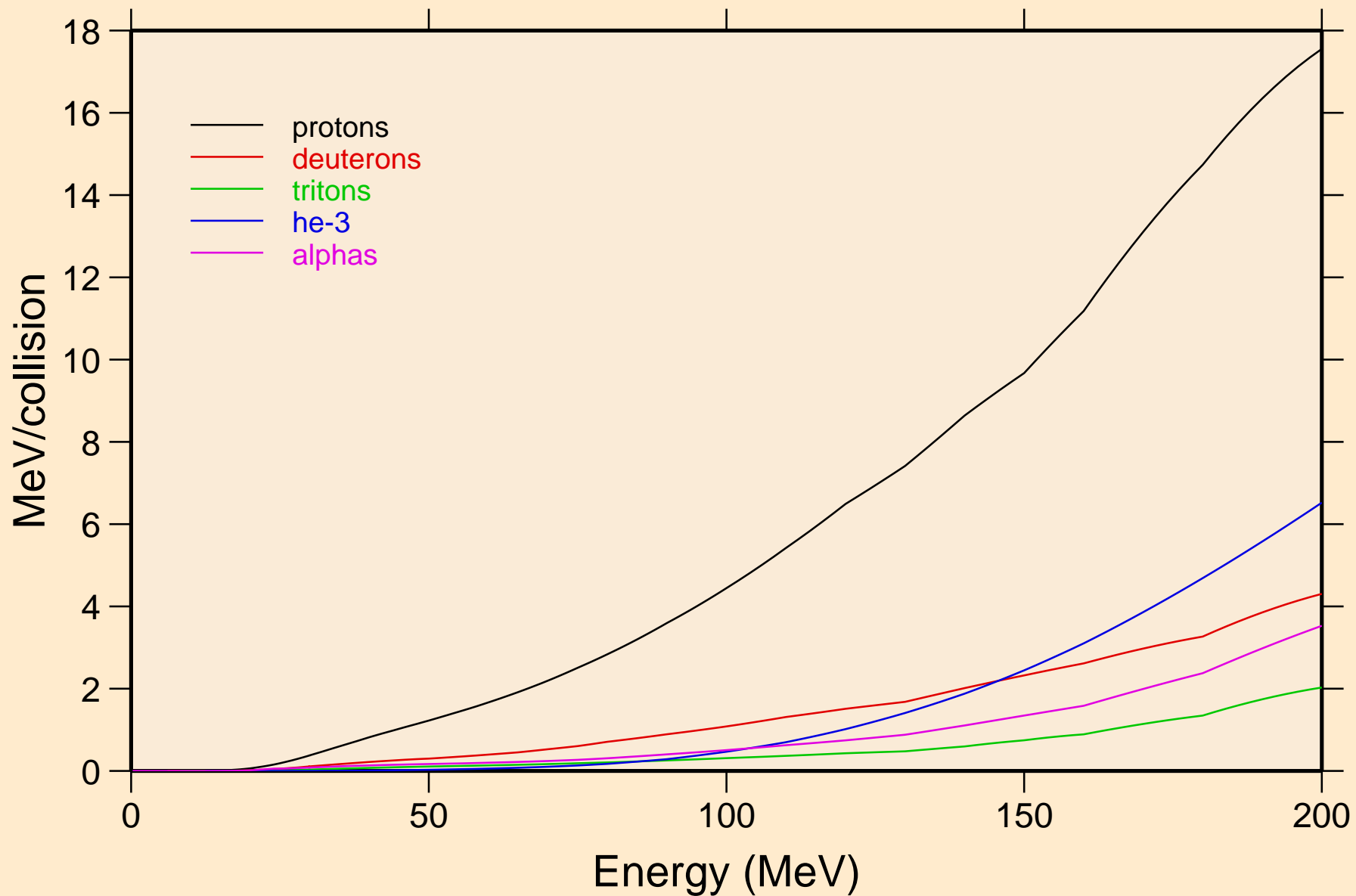

IN119 NEUTRON ACER TENDL-2019 LIBRARY; T=293.16K
Recoil Heating

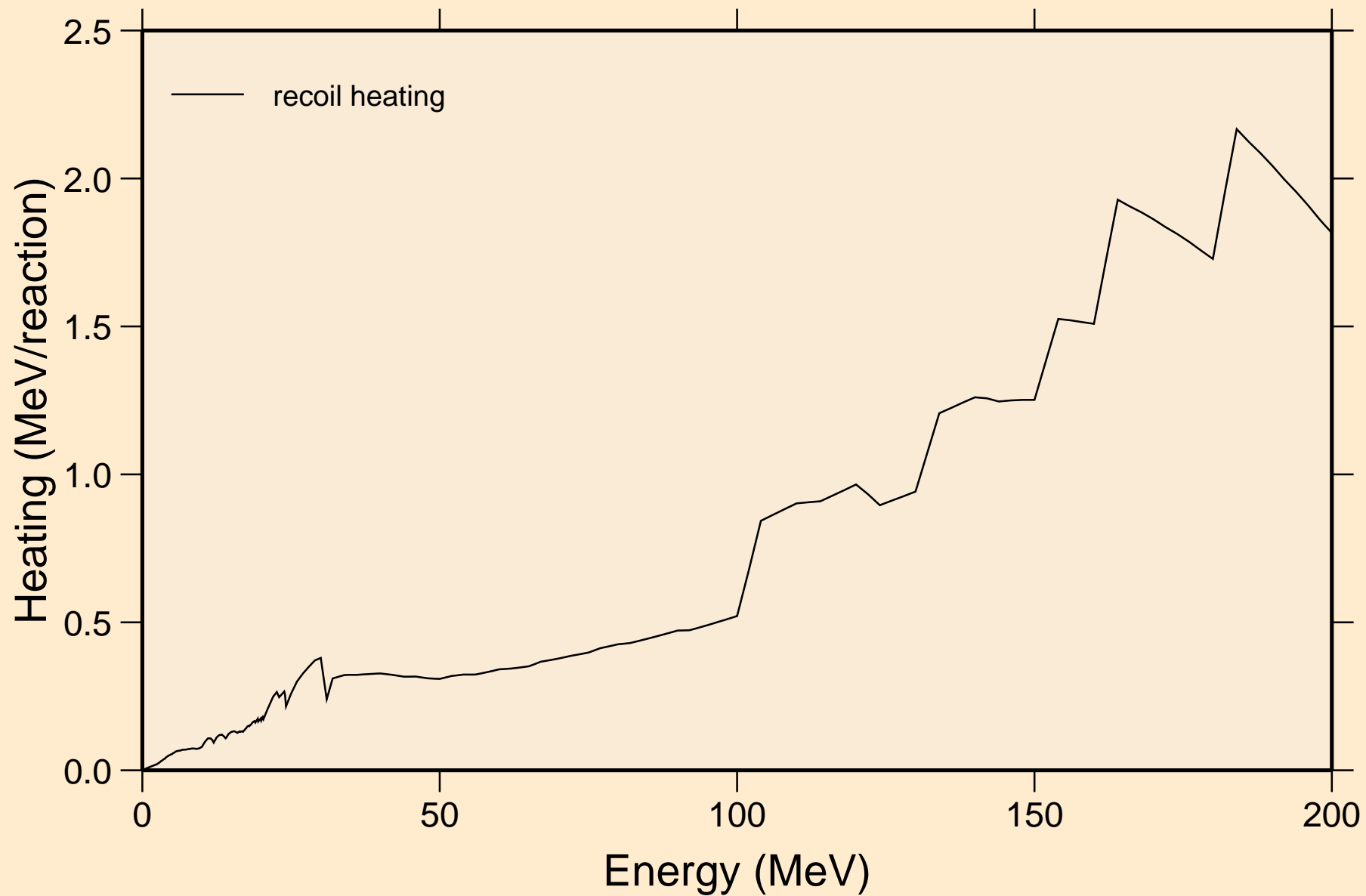

IN119 NEUTRON ACER TENDL-2019 LIBRARY; T=293.16K
Particle production cross sections

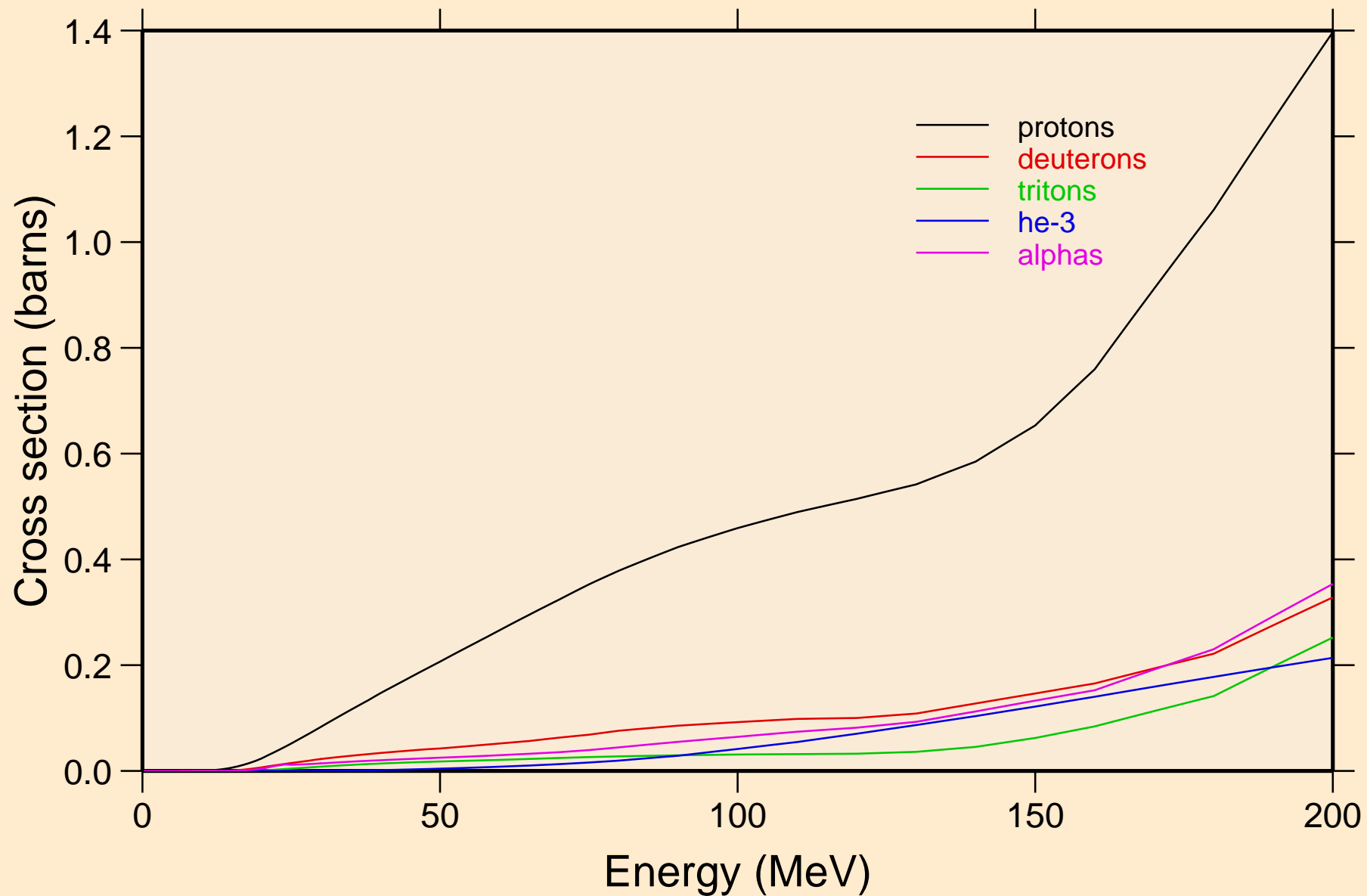

IN119 NEUTRON ACER TENDL-2019 LIBRARY; T=293.16K
protons from (n,x)

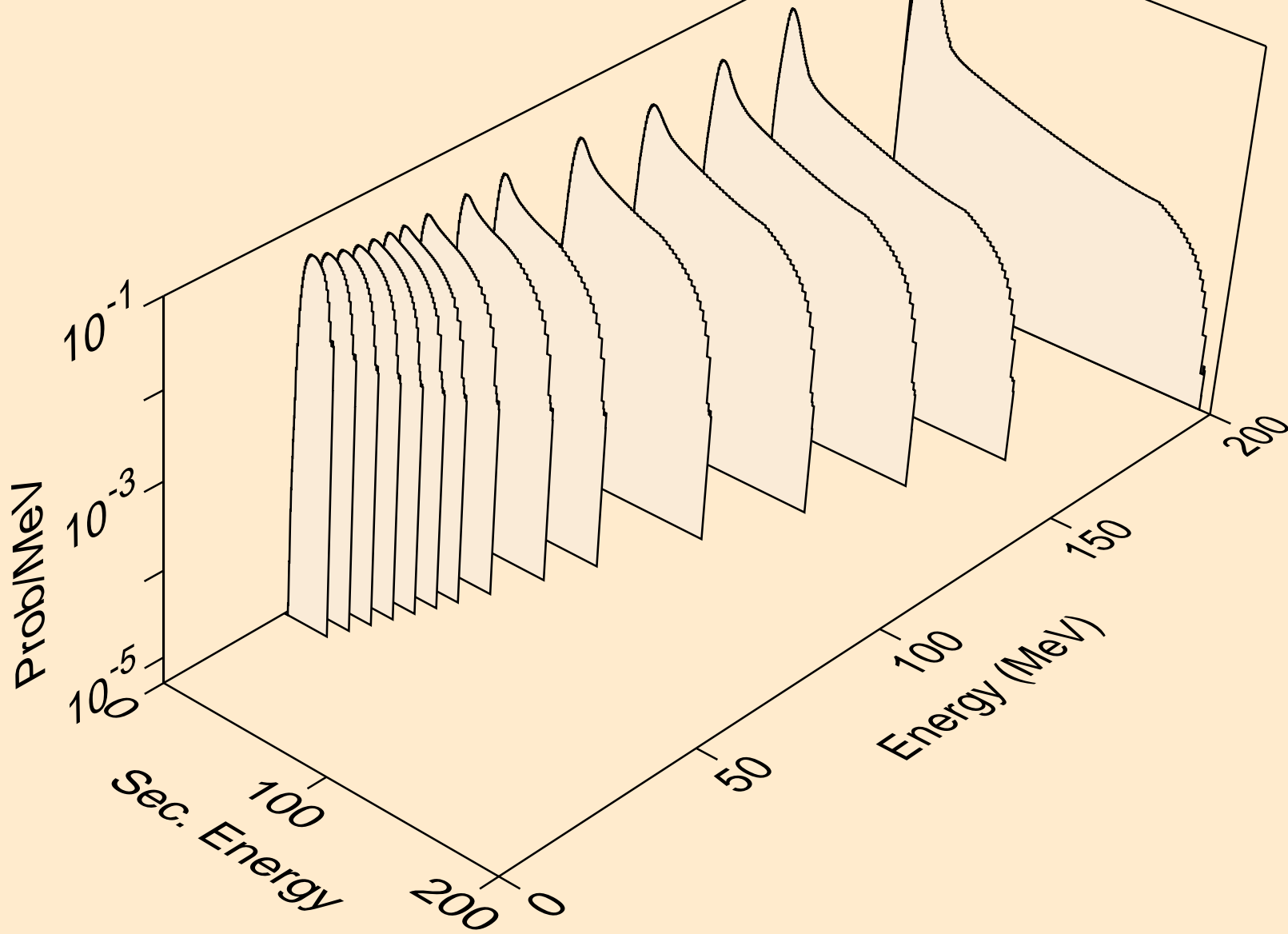

IN119 NEUTRON ACER TENDL-2019 LIBRARY; T=293.16K
protons from (n,n*)p

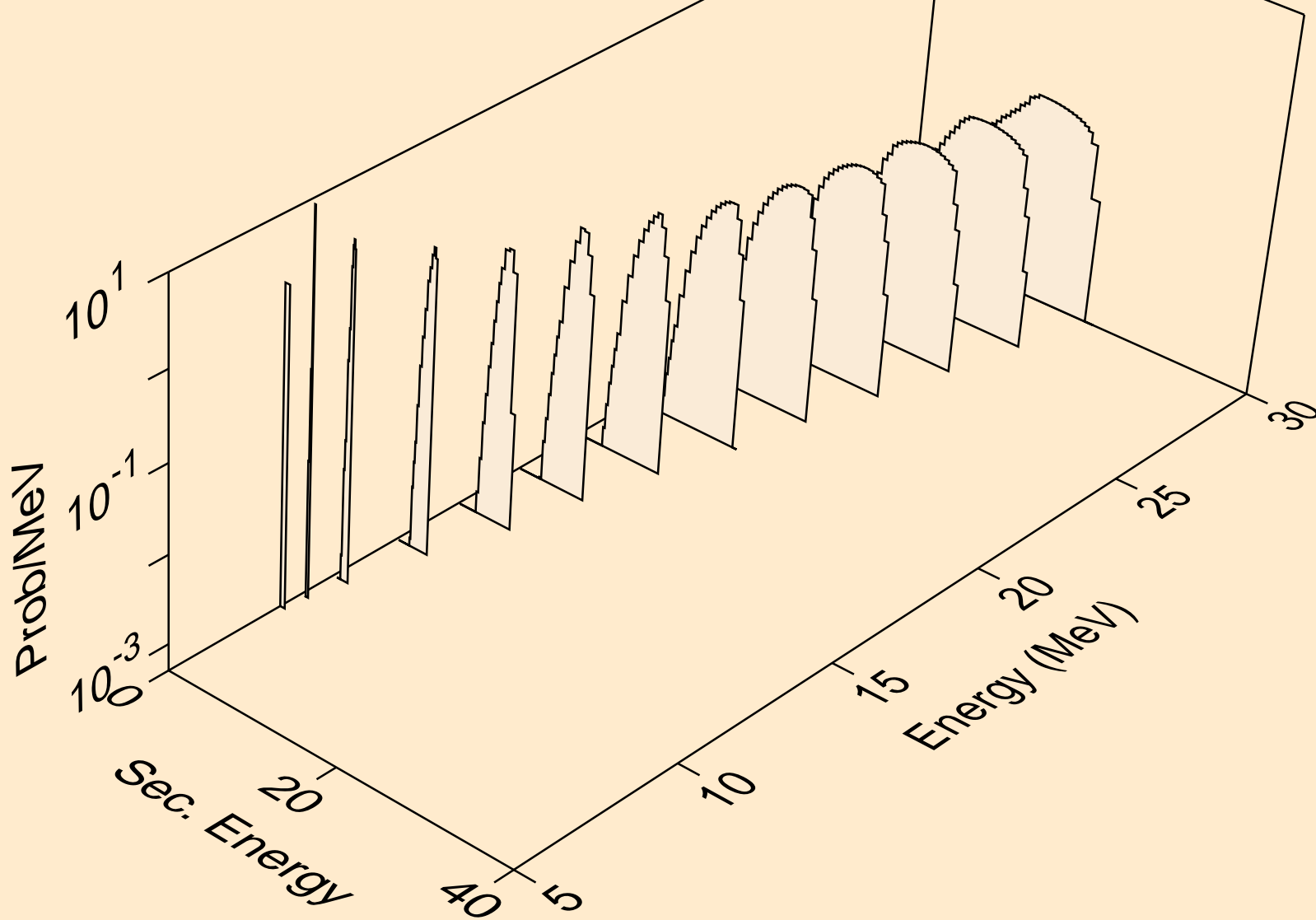

IN119 NEUTRON ACER TENDL-2019 LIBRARY; T=293.16K
protons from (n,2np)

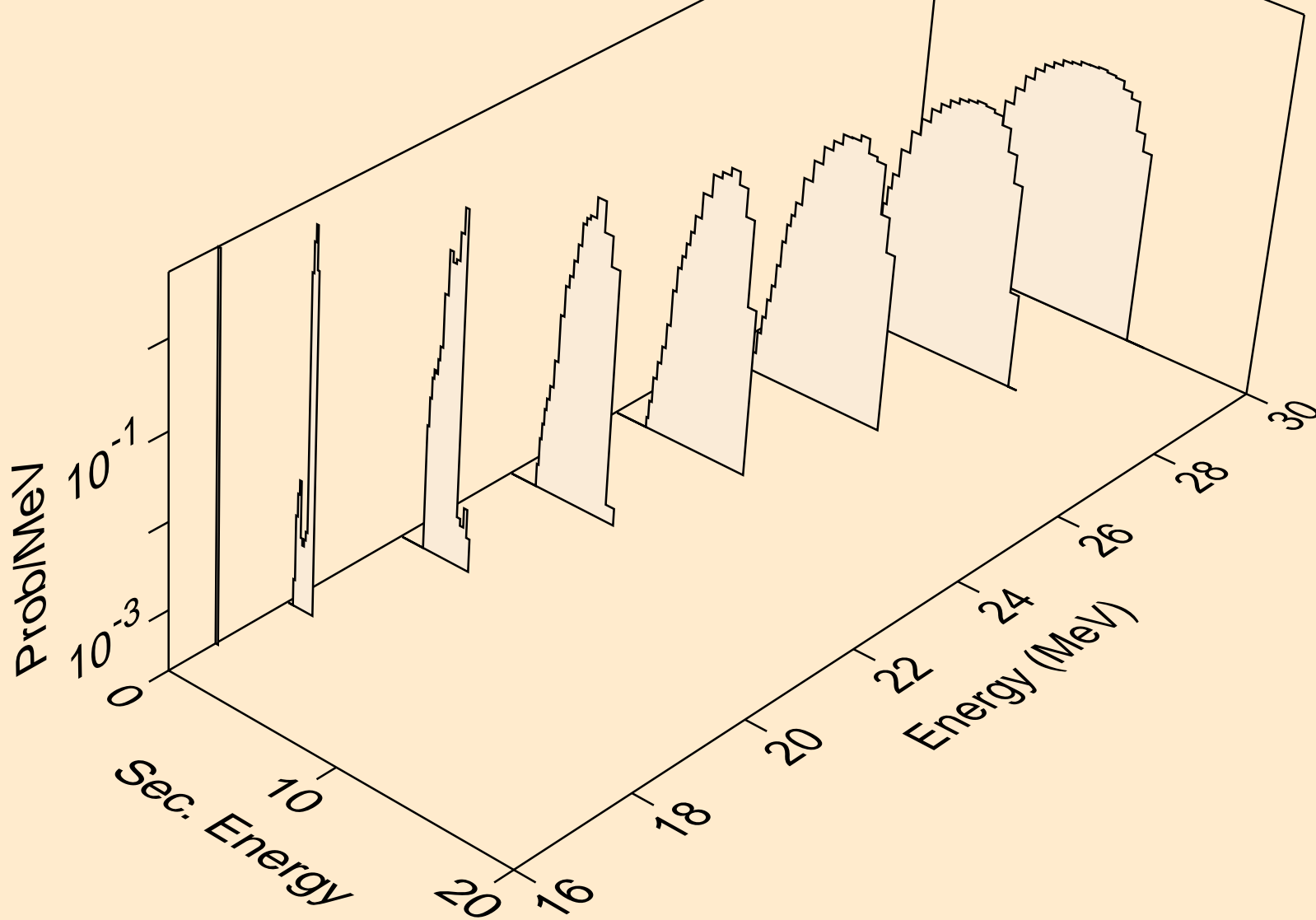

IN119 NEUTRON ACER TENDL-2019 LIBRARY; T=293.16K
protons from (n,3np)

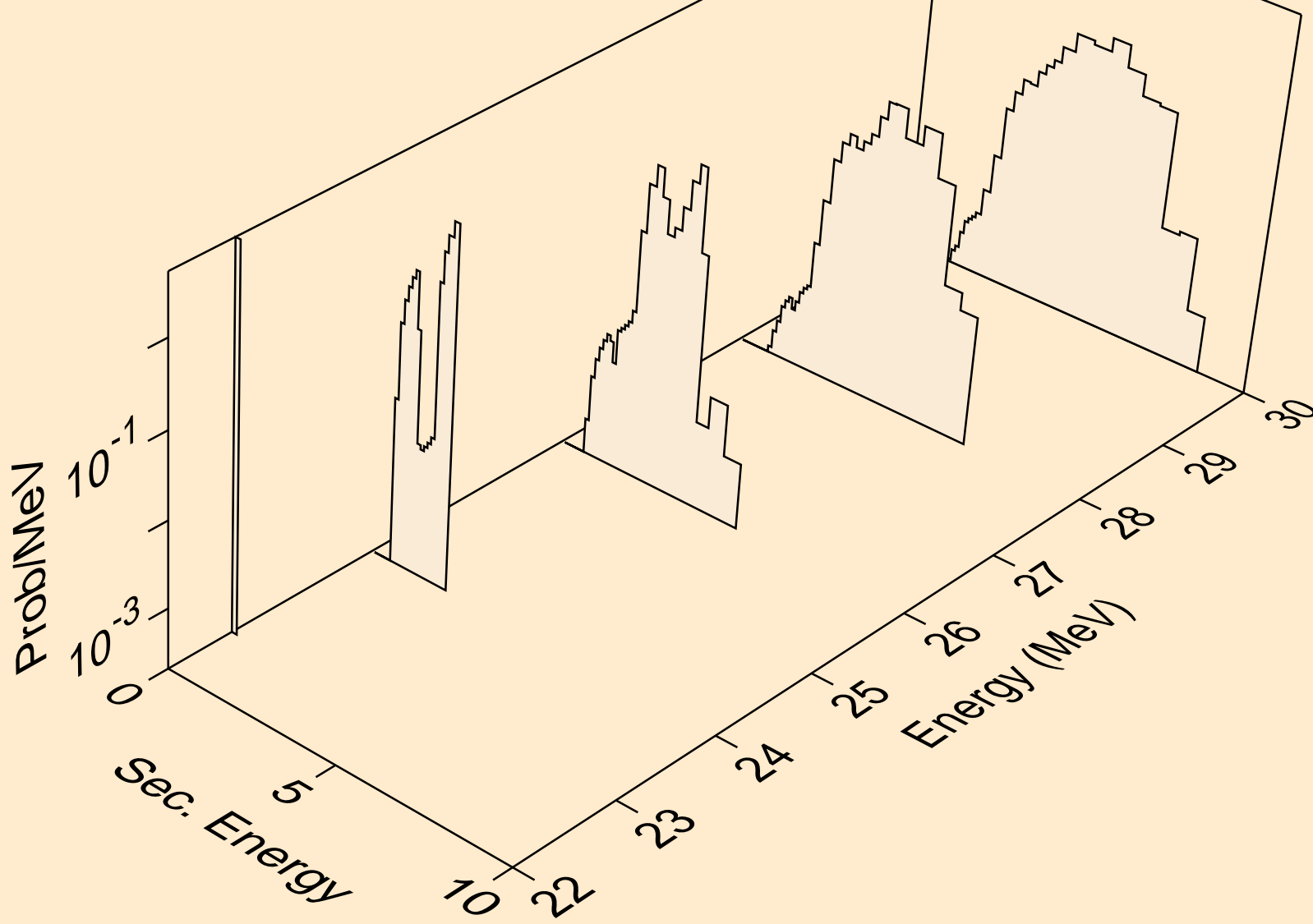

IN119 NEUTRON ACER TENDL-2019 LIBRARY; T=293.16K
protons from (n,2np)

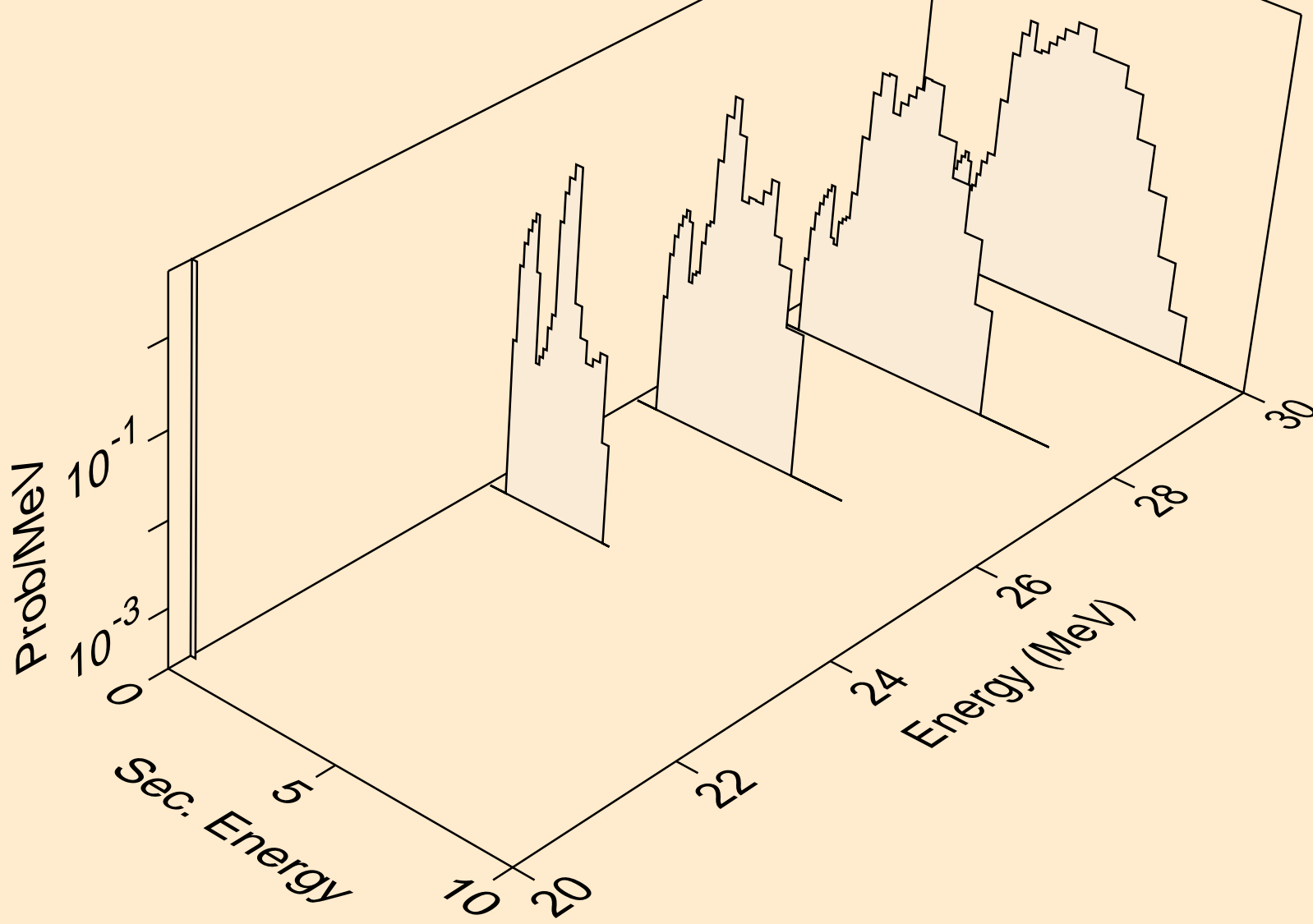

IN119 NEUTRON ACER TENDL-2019 LIBRARY; T=293.16K
protons from (n,p)

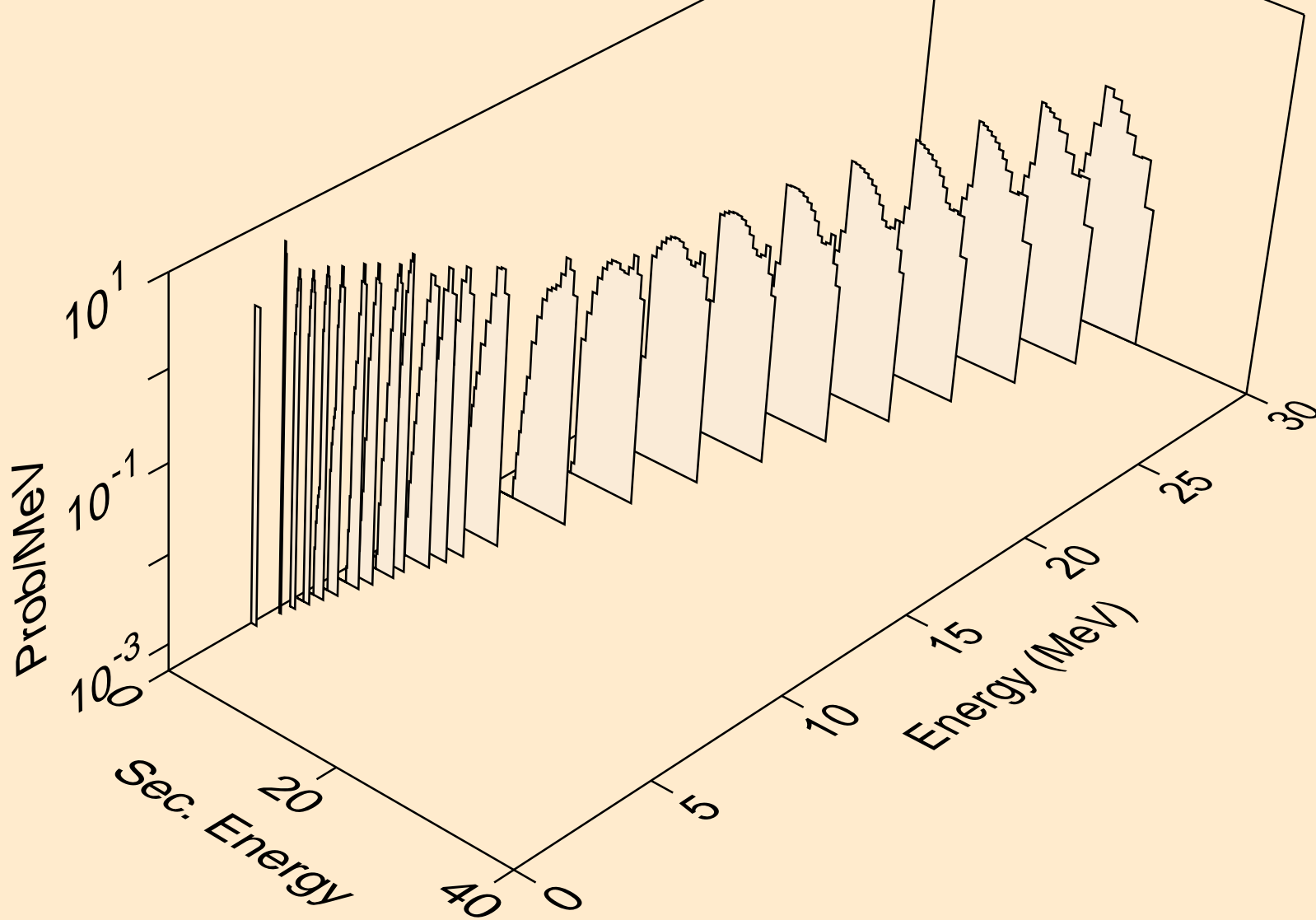

IN119 NEUTRON ACER TENDL-2019 LIBRARY; T=293.16K
protons from (n,2p)

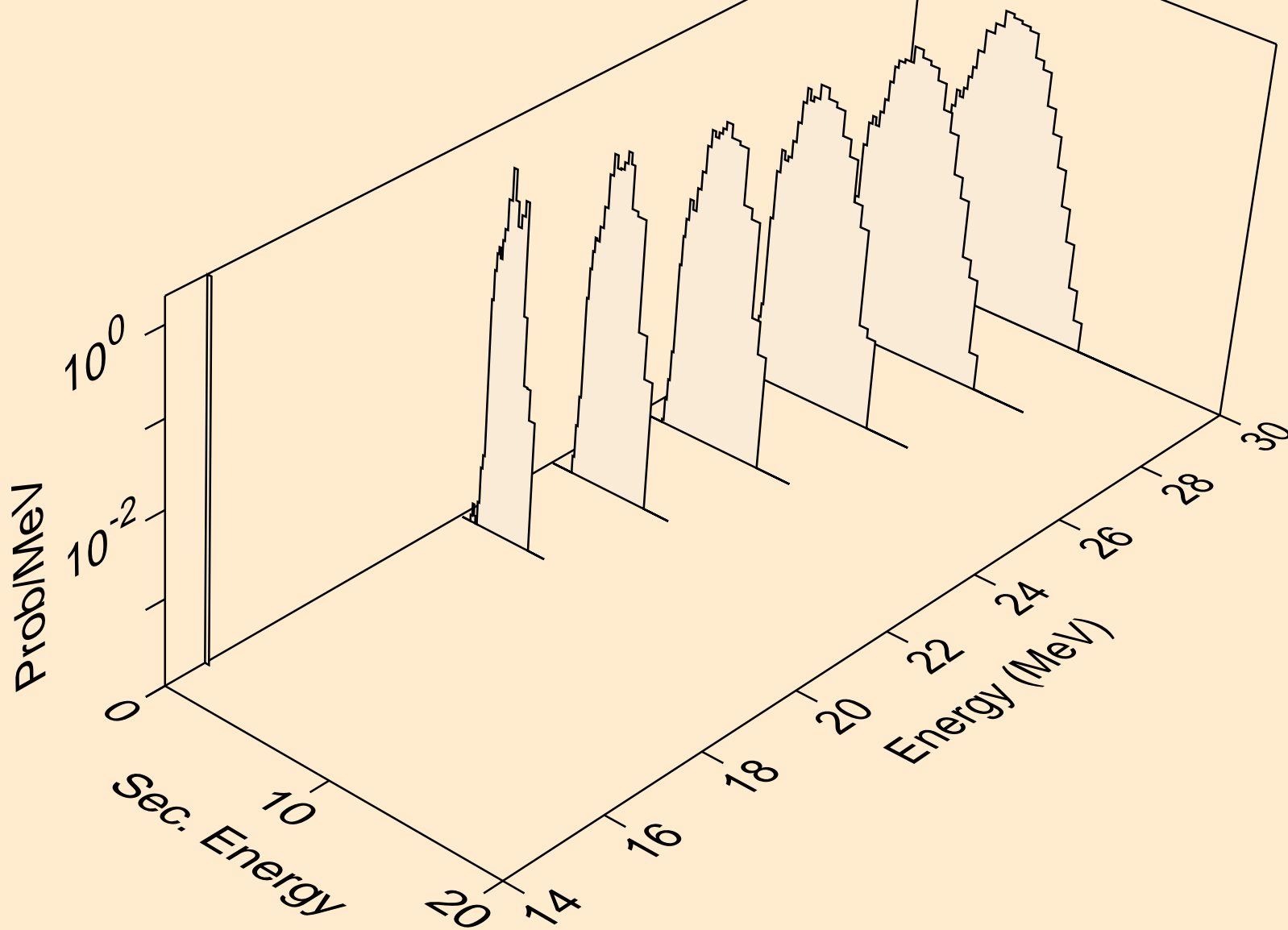

IN119 NEUTRON ACER TENDL-2019 LIBRARY; T=293.16K
protons from (n,pa)

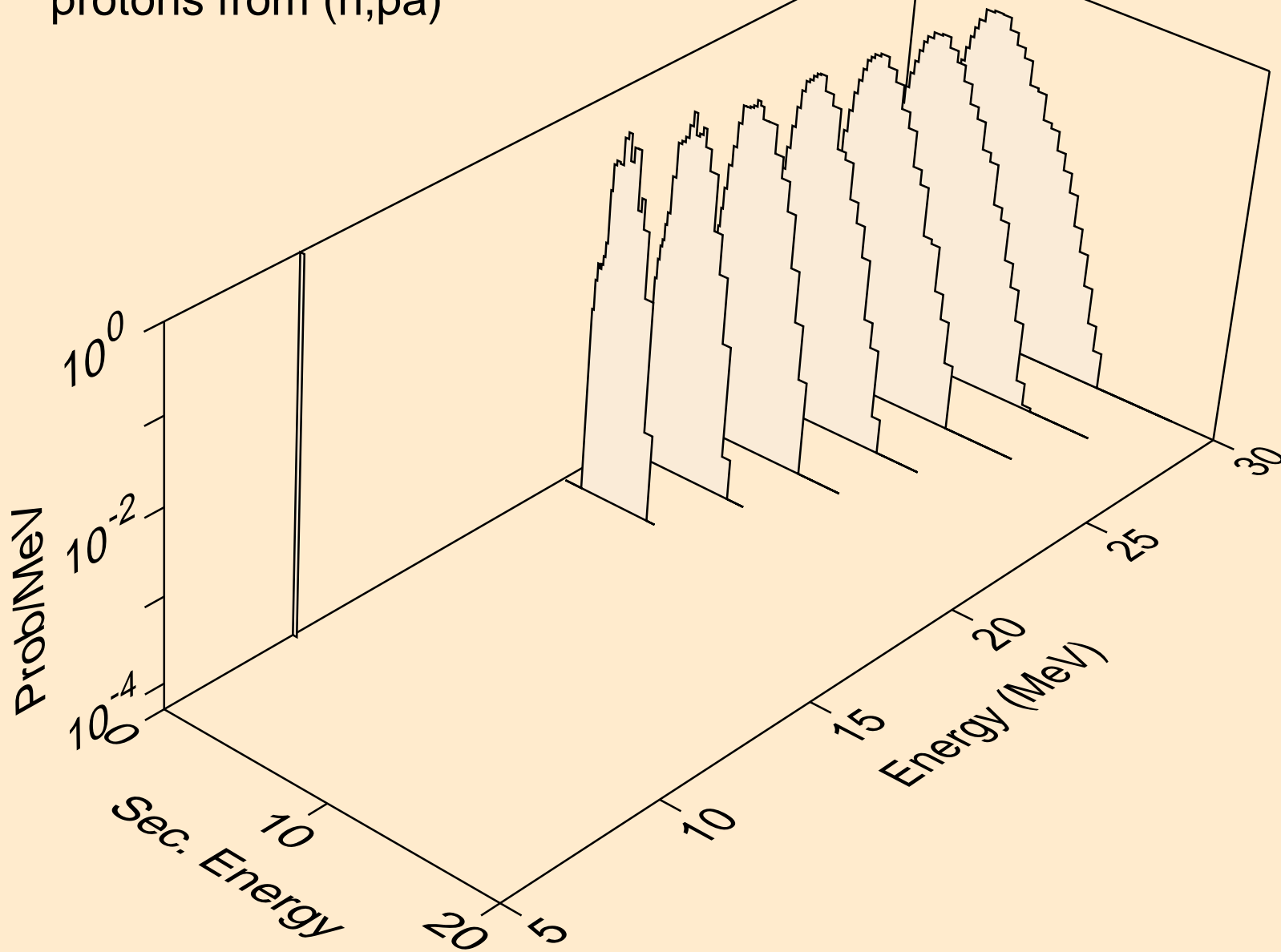

IN119 NEUTRON ACER TENDL-2019 LIBRARY; T=293.16K
deuterons from (n,x)

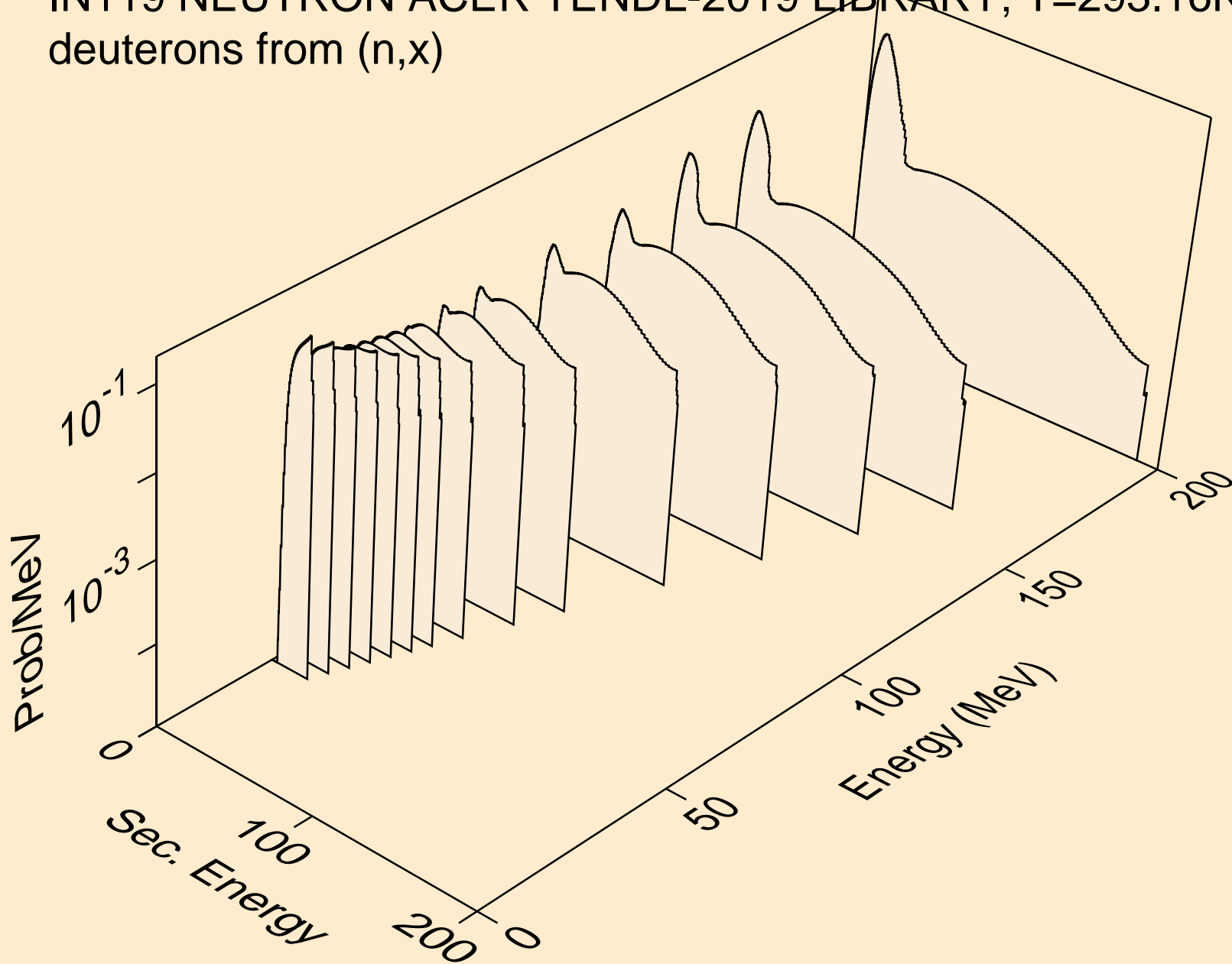

IN119 NEUTRON ACER TENDL-2019 LIBRARY; T=293.16K
deuterons from (n,2nd)

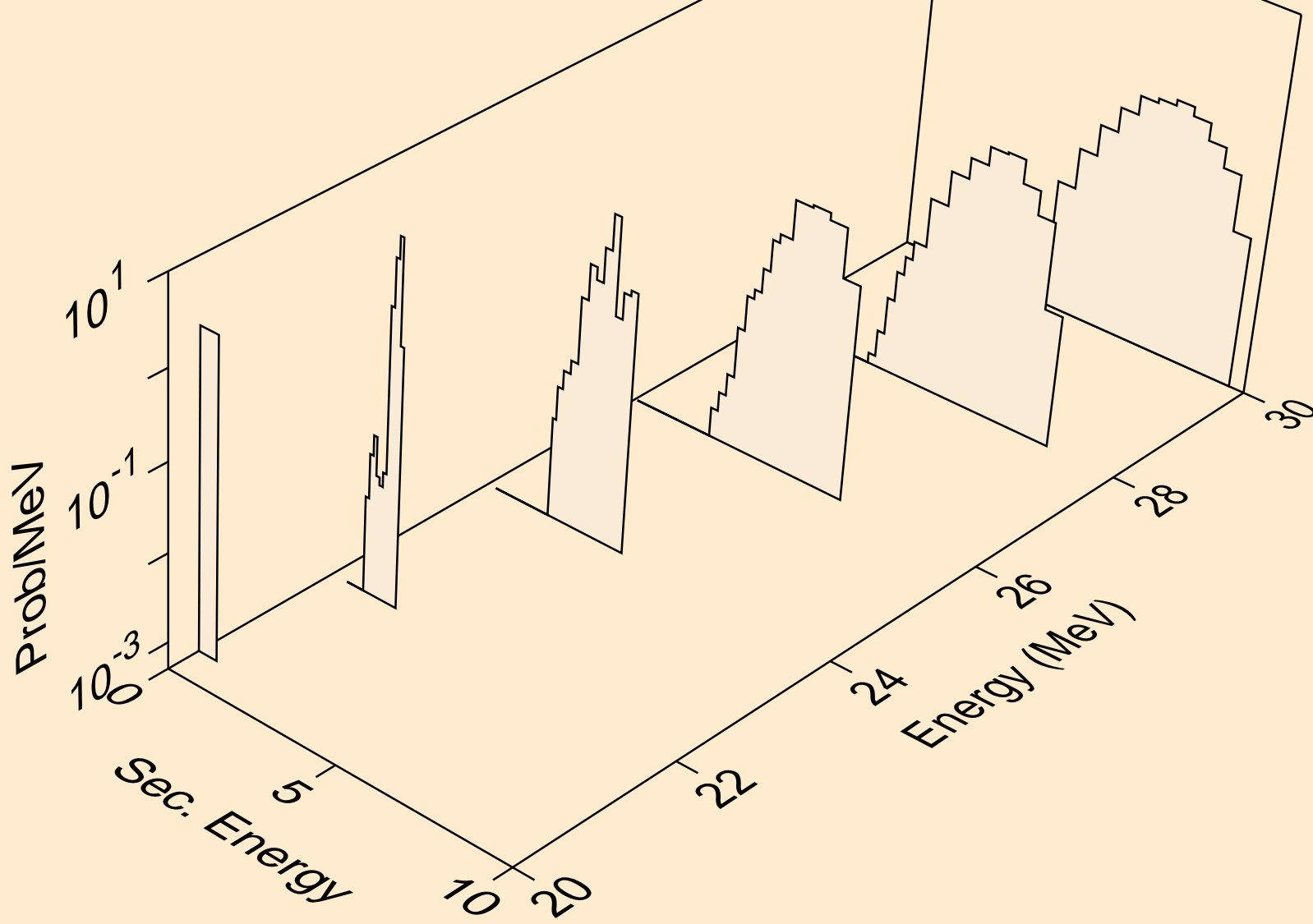

IN119 NEUTRON ACER TENDL-2019 LIBRARY; T=293.16K
deuterons from (n,n*)d

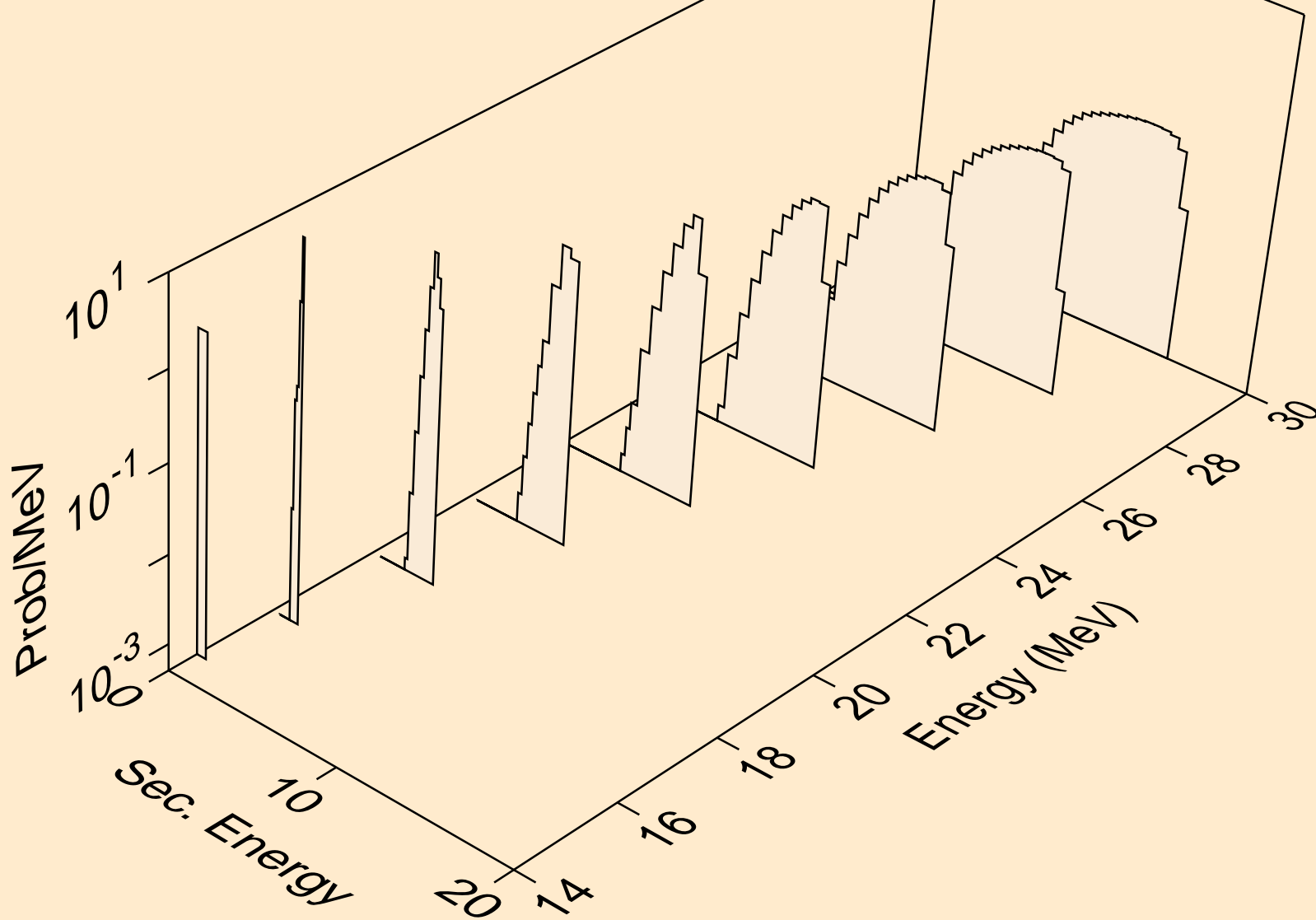

IN119 NEUTRON ACER TENDL-2019 LIBRARY; T=293.16K
deuterons from (n,d)

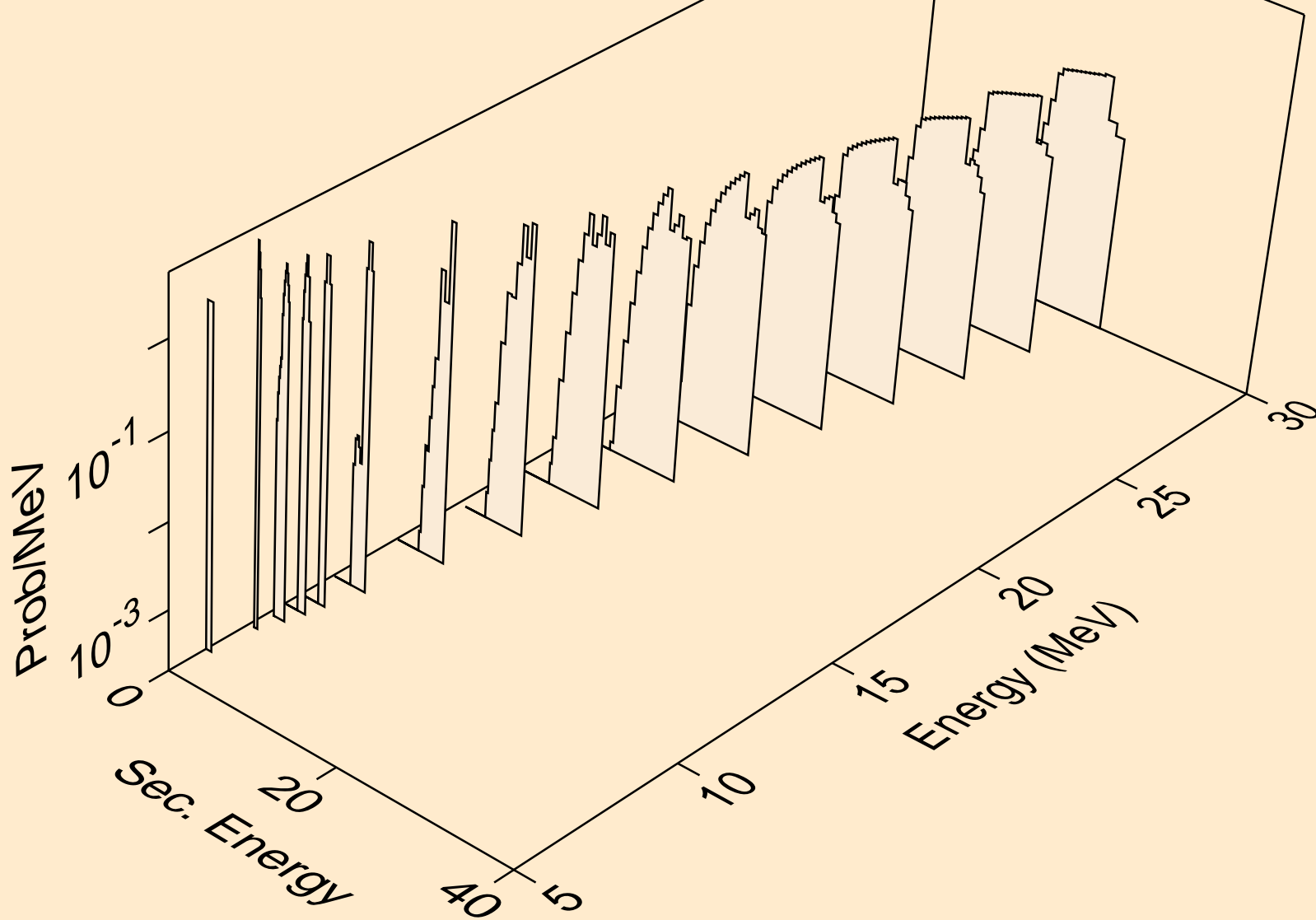

IN119 NEUTRON ACER TENDL-2019 LIBRARY; T=293.16K
tritons from (n,x)

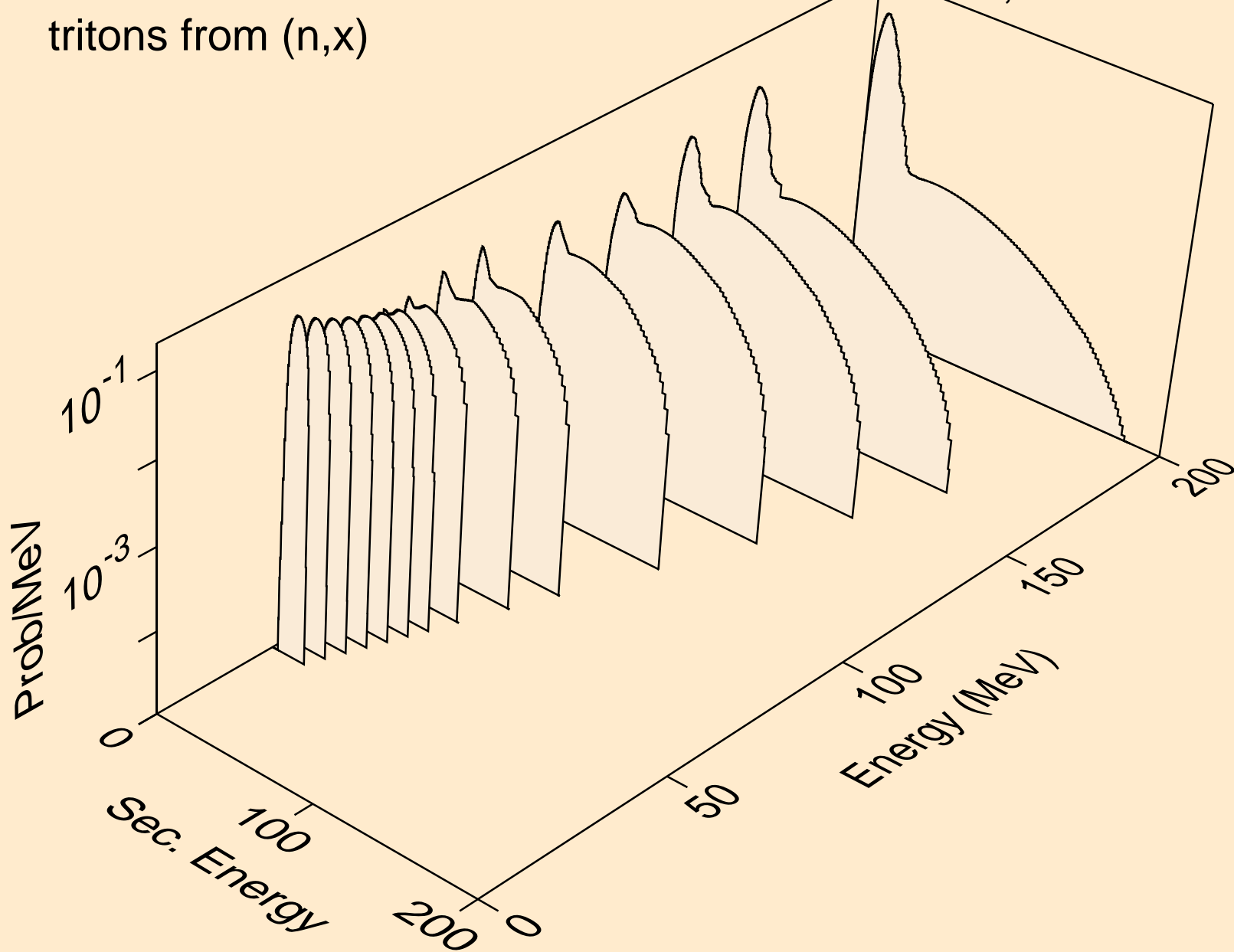

IN119 NEUTRON ACER TENDL-2019 LIBRARY; T=293.16K
tritons from (n,n*)t

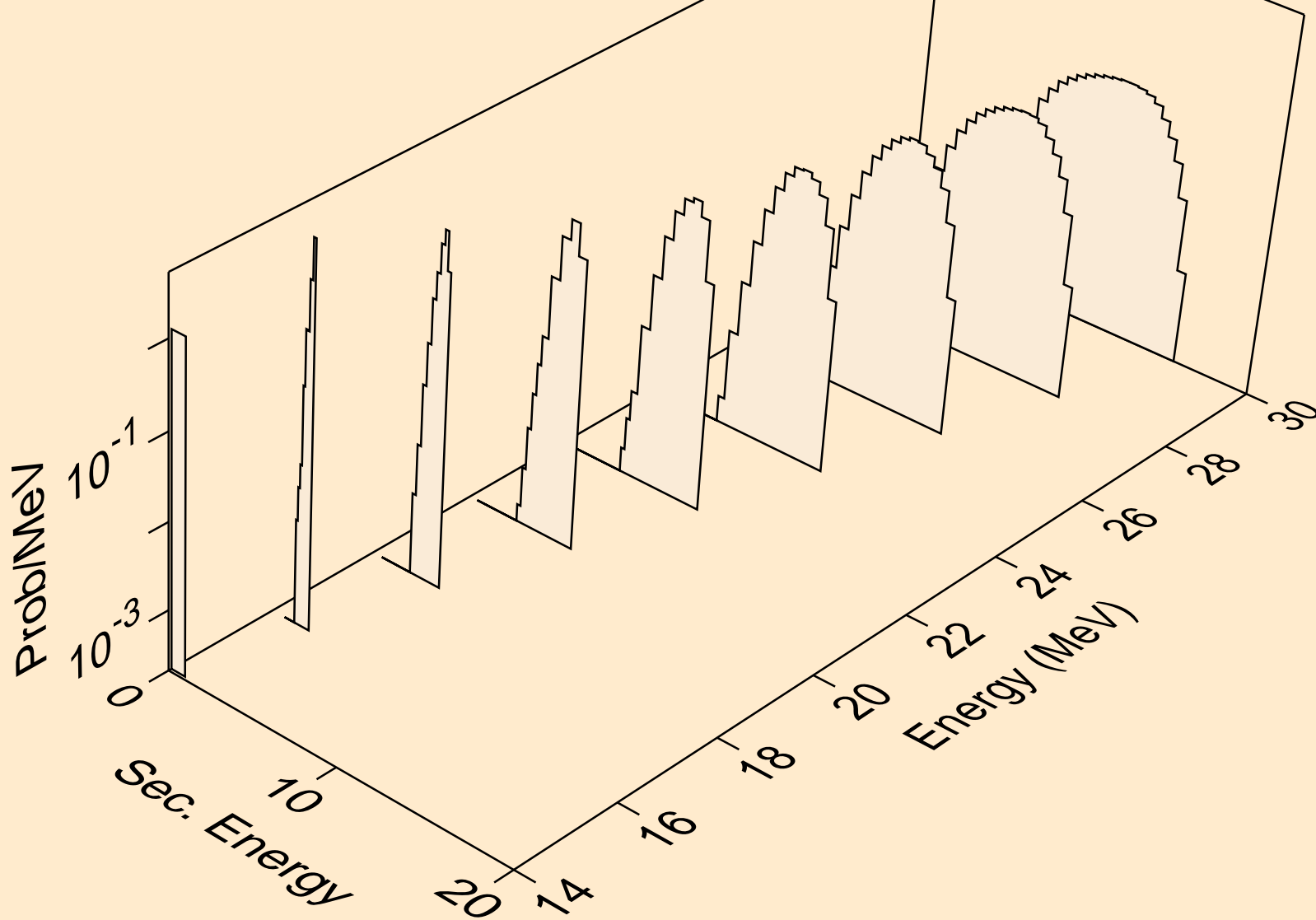

IN119 NEUTRON ACER TENDL-2019 LIBRARY; T=293.16K
tritons from (n,t)

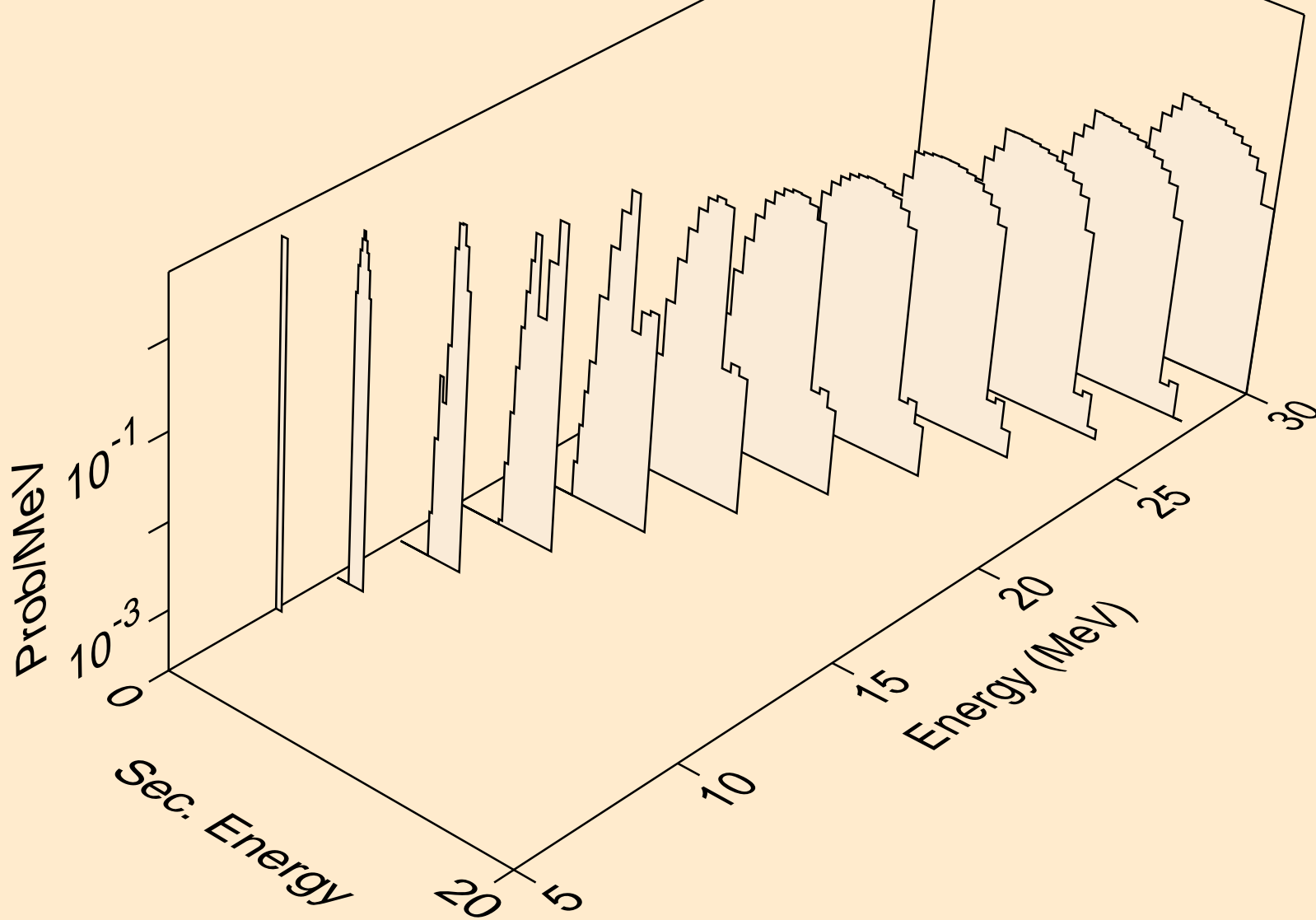

IN119 NEUTRON ACER TENDL-2019 LIBRARY; T=293.16K
he3s from (n,x)

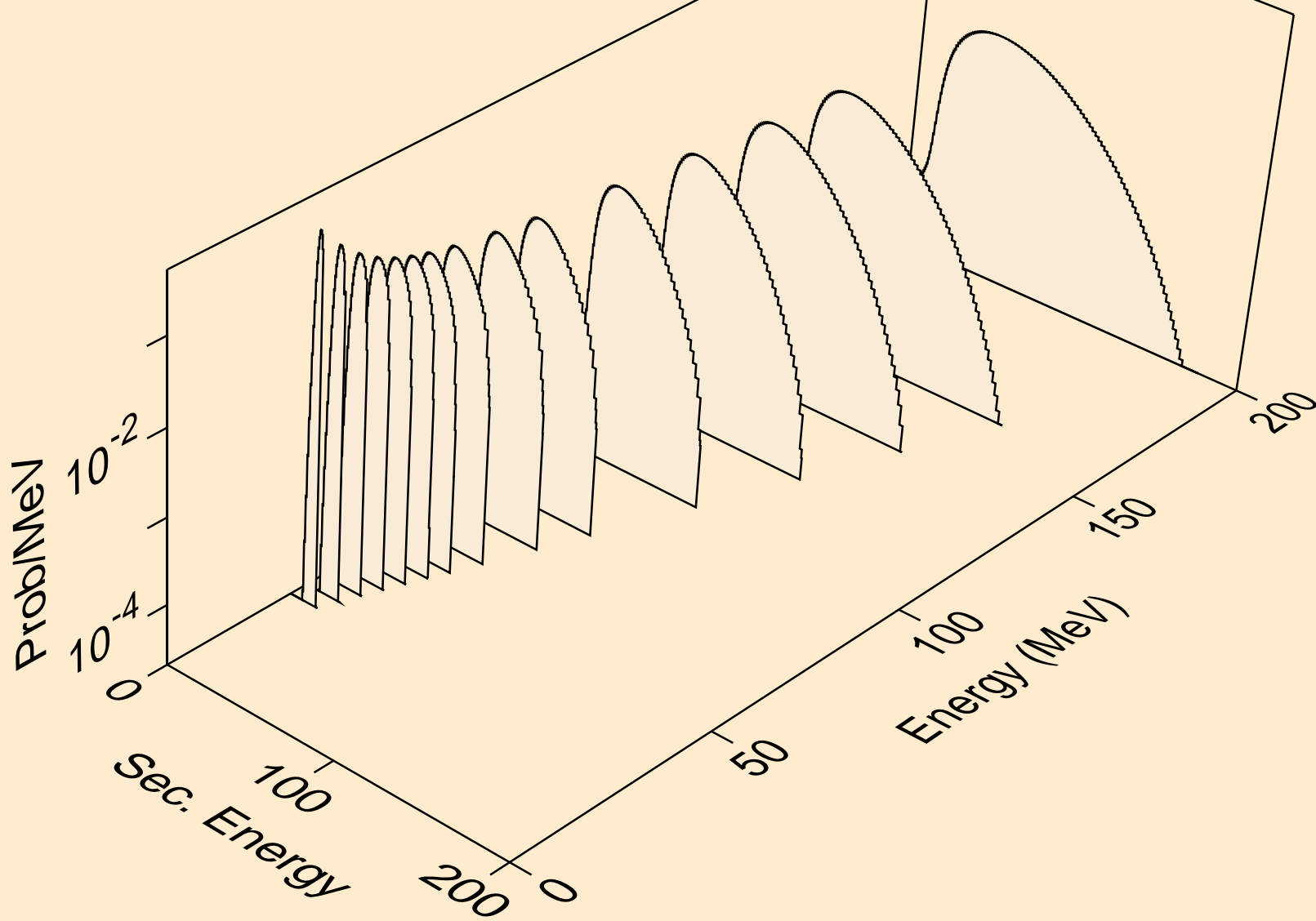

IN119 NEUTRON ACER TENDL-2019 LIBRARY; T=293.16K
he3s from (n,n*)he3

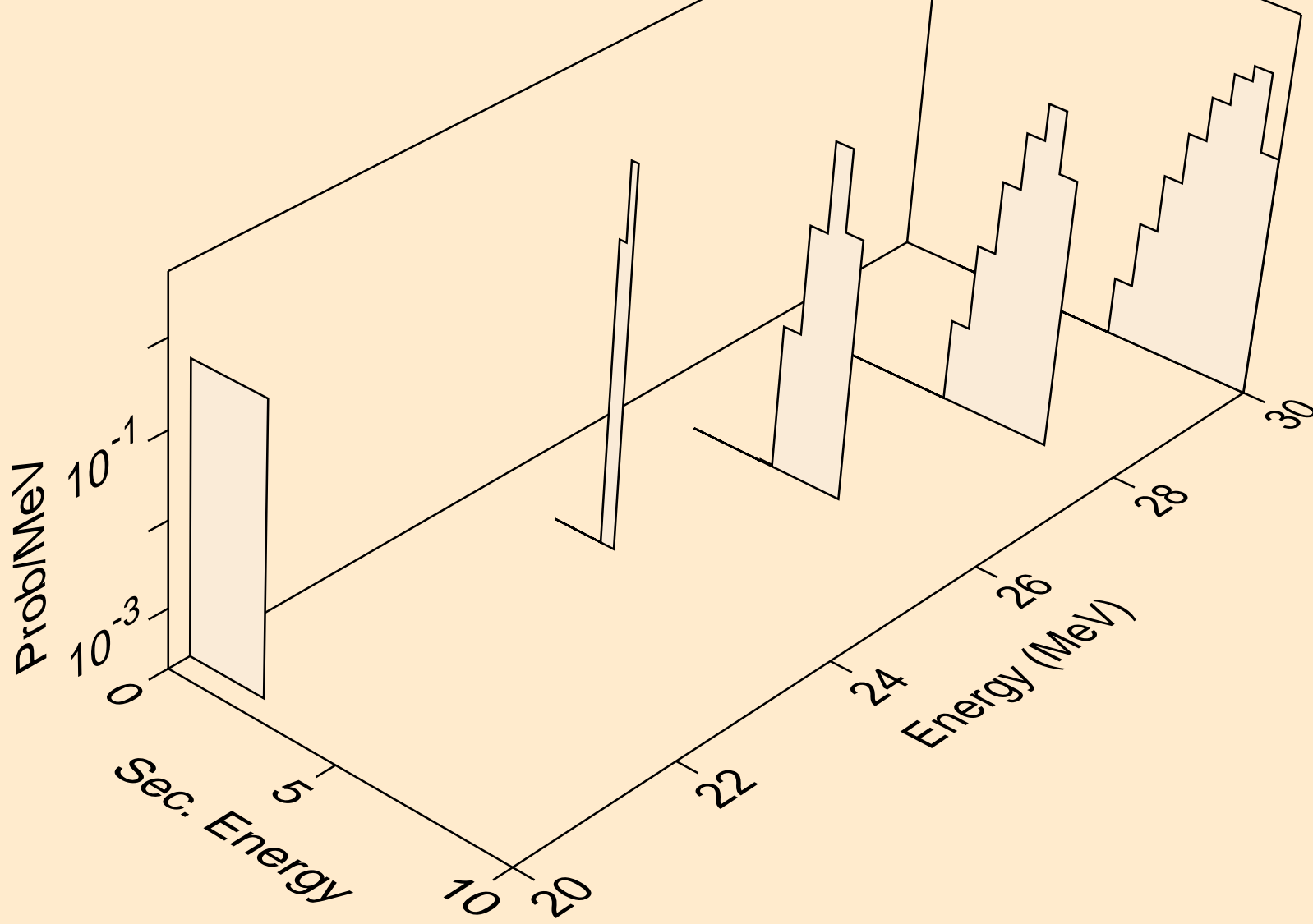

IN119 NEUTRON ACER TENDL-2019 LIBRARY; T=293.16K
he3s from (n,he3)

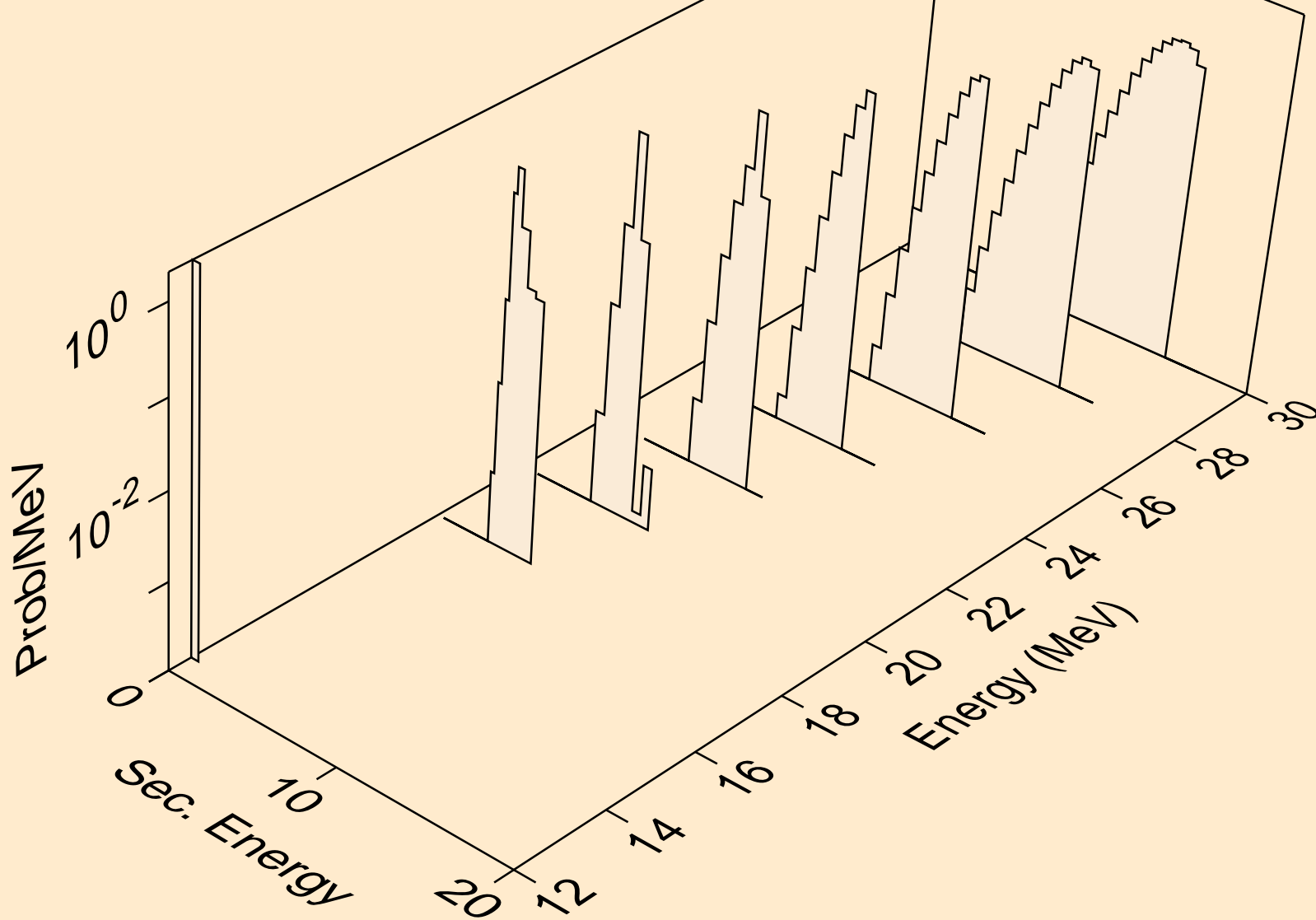

IN119 NEUTRON ACER TENDL-2019 LIBRARY; T=293.16K
alphas from (n,x)

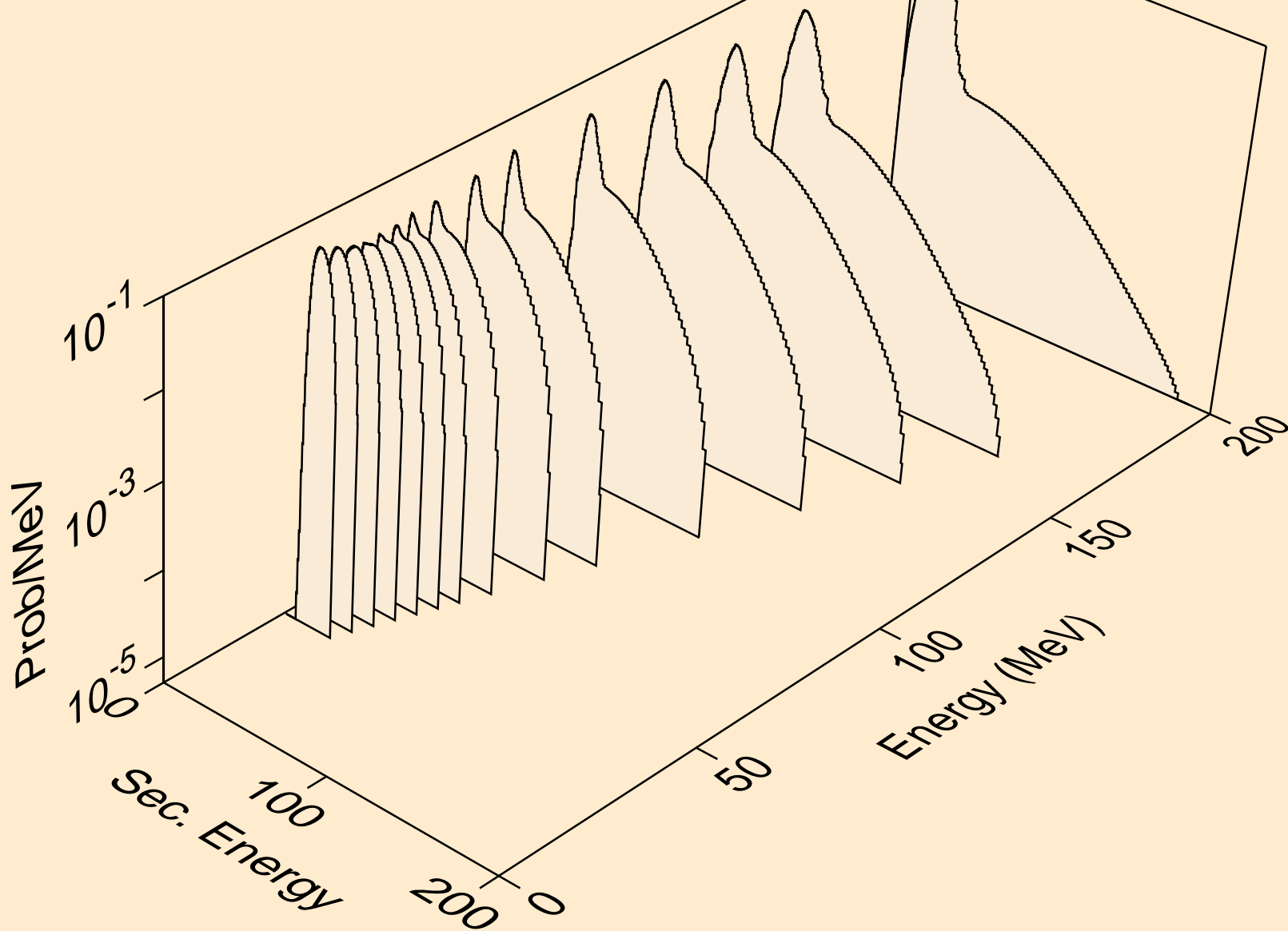

IN119 NEUTRON ACER TENDL-2019 LIBRARY; T=293.16K
alphas from (n,n*)a

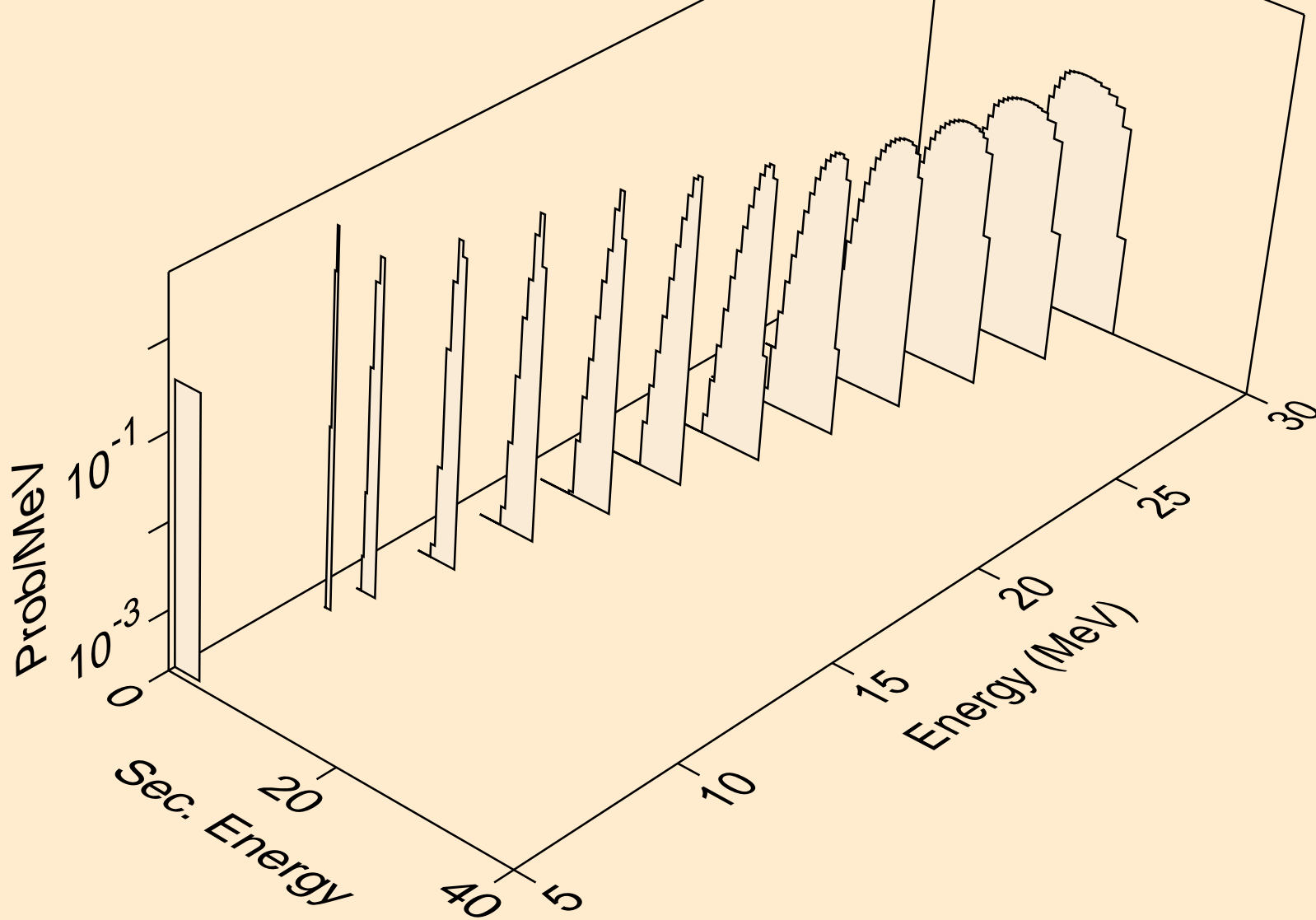

IN119 NEUTRON ACER TENDL-2019 LIBRARY; T=293.16K
alphas from (n,2n)a

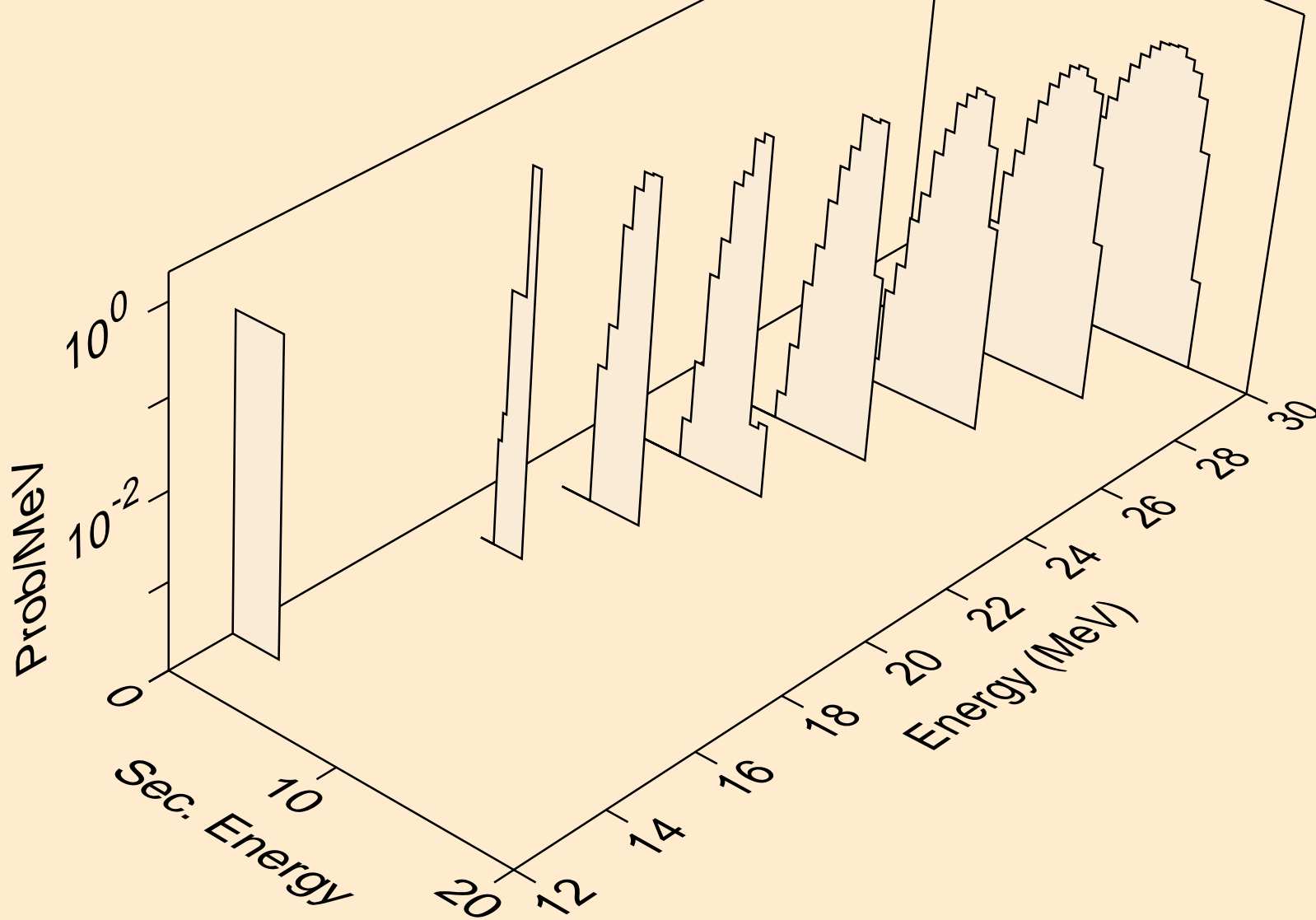

IN119 NEUTRON ACER TENDL-2019 LIBRARY; T=293.16K
alphas from (n,3n)a

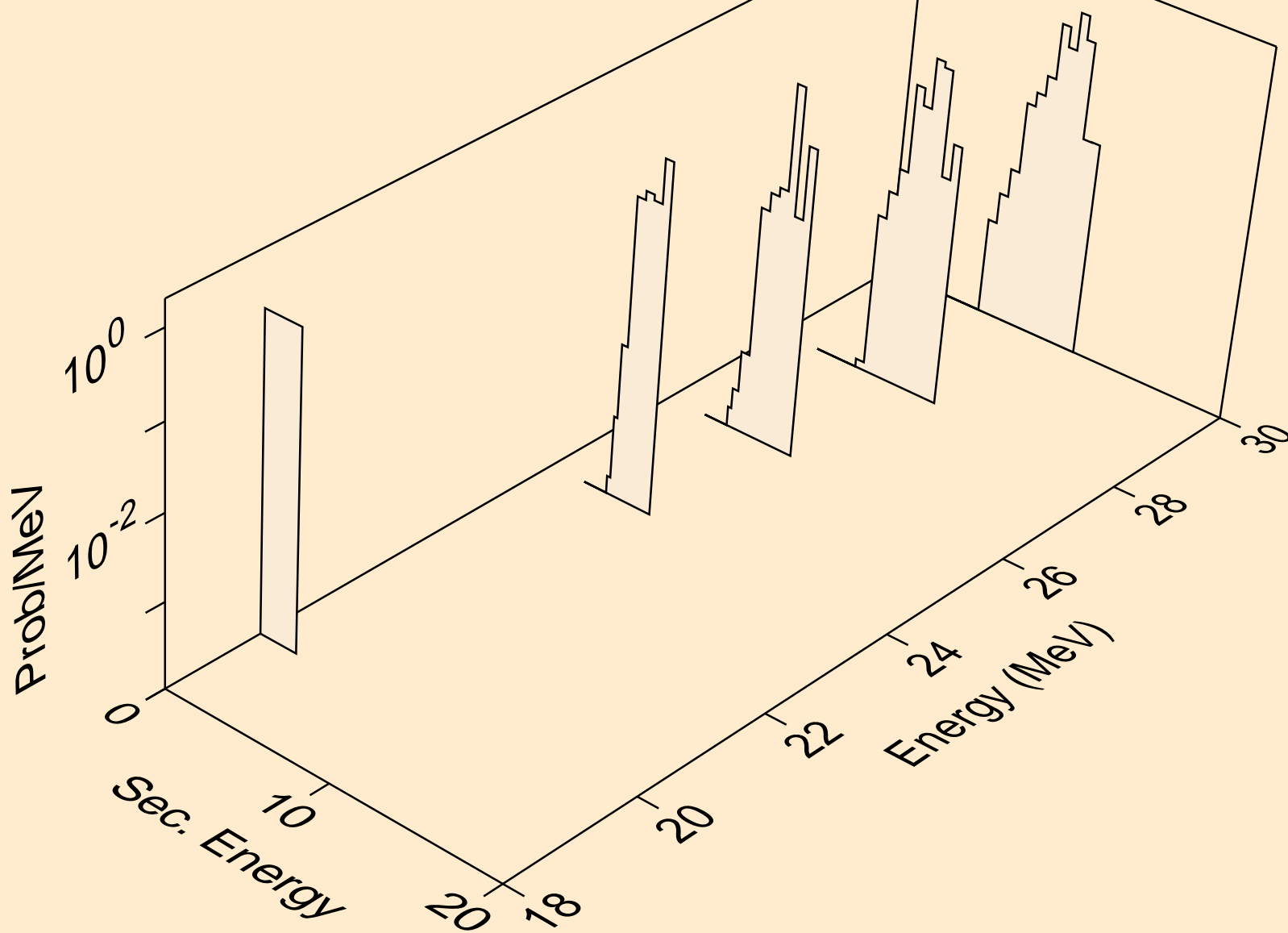

IN119 NEUTRON ACER TENDL-2019 LIBRARY; T=293.16K
alphas from (n,a)

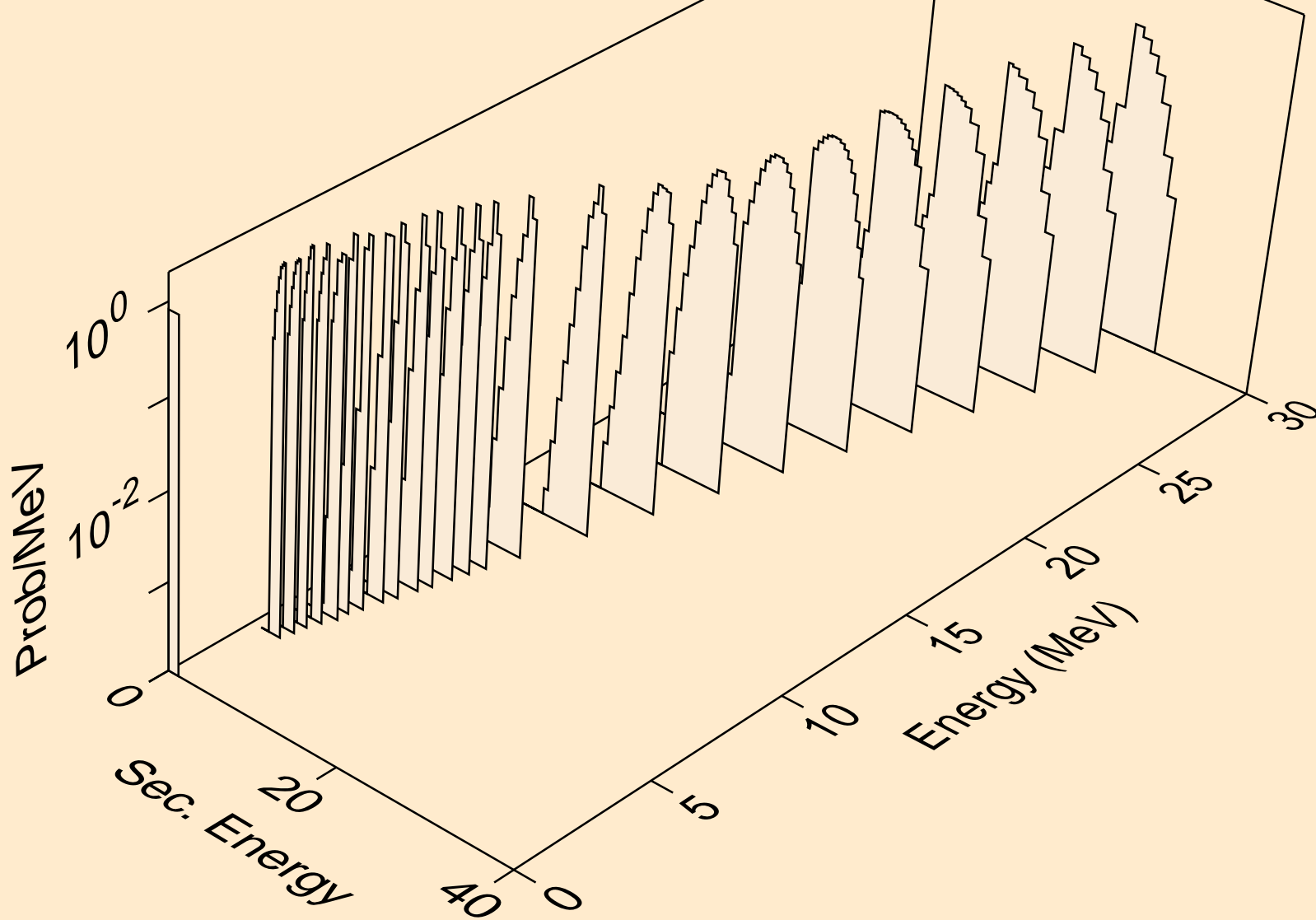

IN119 NEUTRON ACER TENDL-2019 LIBRARY; T=293.16K
alphas from (n,pa)

