

IN120 NEUTRON ACER TENDL-2019 LIBRARY; T=293.16K  
Principal cross sections

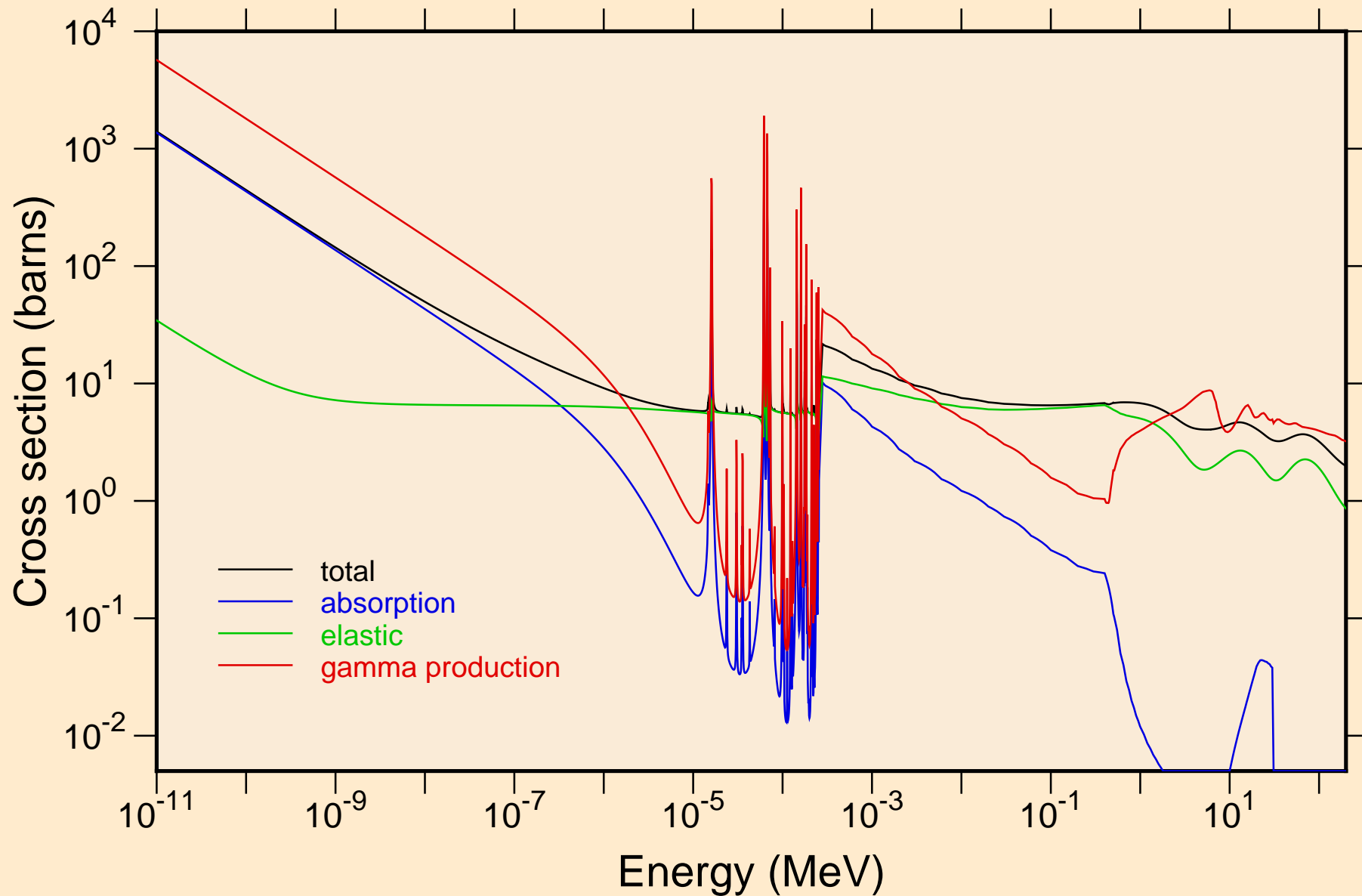

IN120 NEUTRON ACER TENDL-2019 LIBRARY; T=293.16K  
resonance total cross section

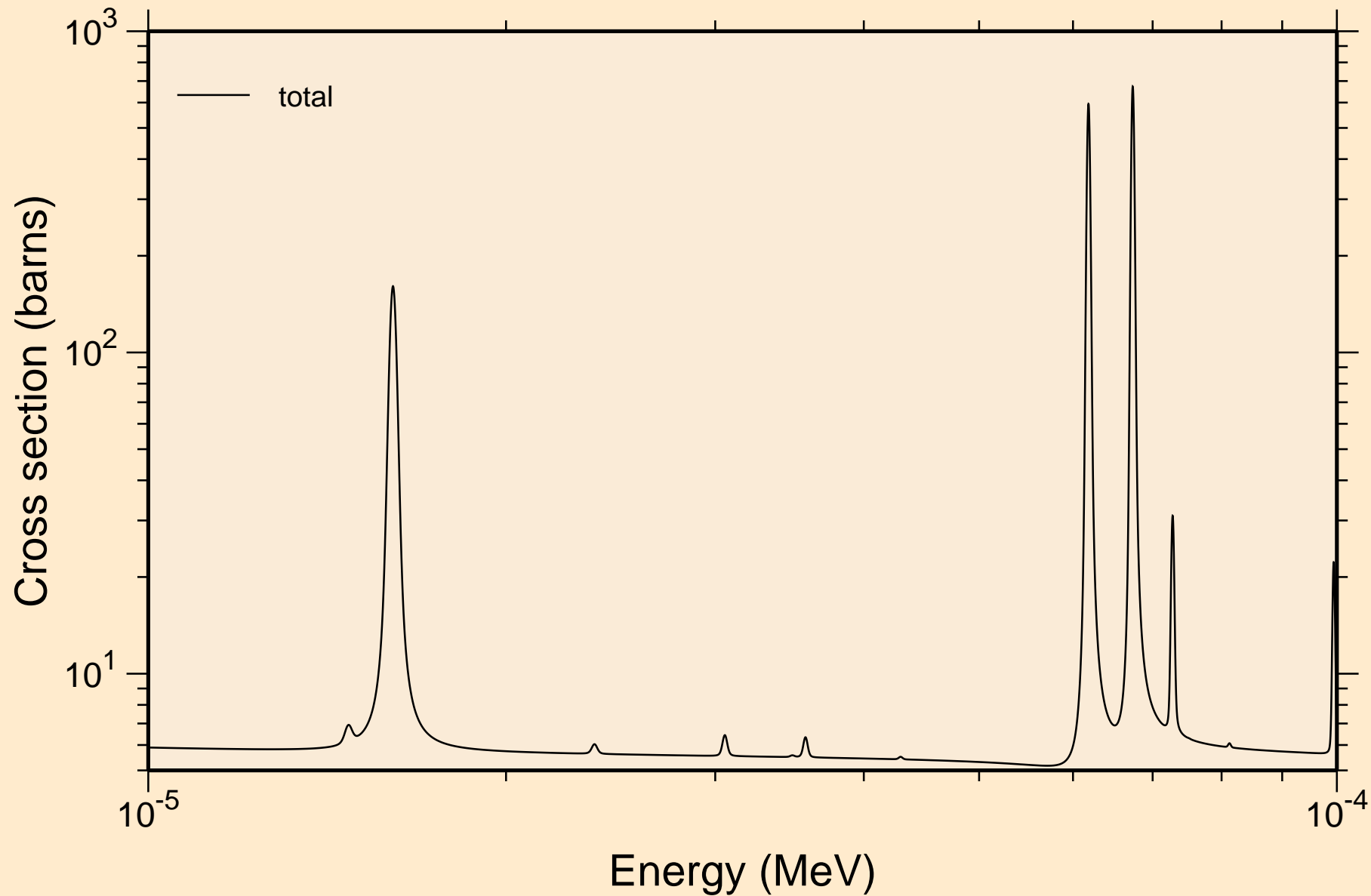

IN120 NEUTRON ACER TENDL-2019 LIBRARY; T=293.16K  
resonance total cross section

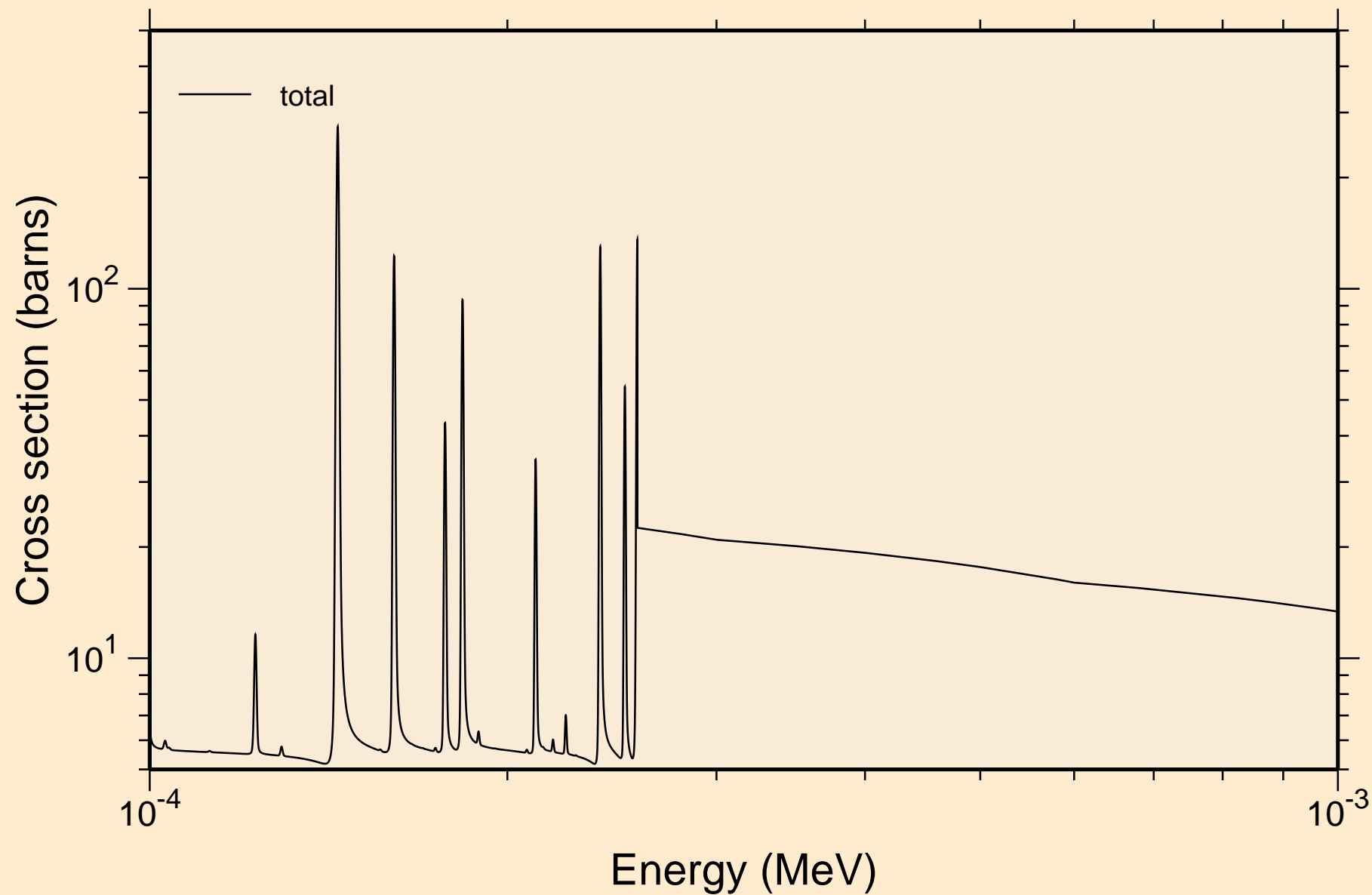

IN120 NEUTRON ACER TENDL-2019 LIBRARY; T=293.16K  
resonance total cross section

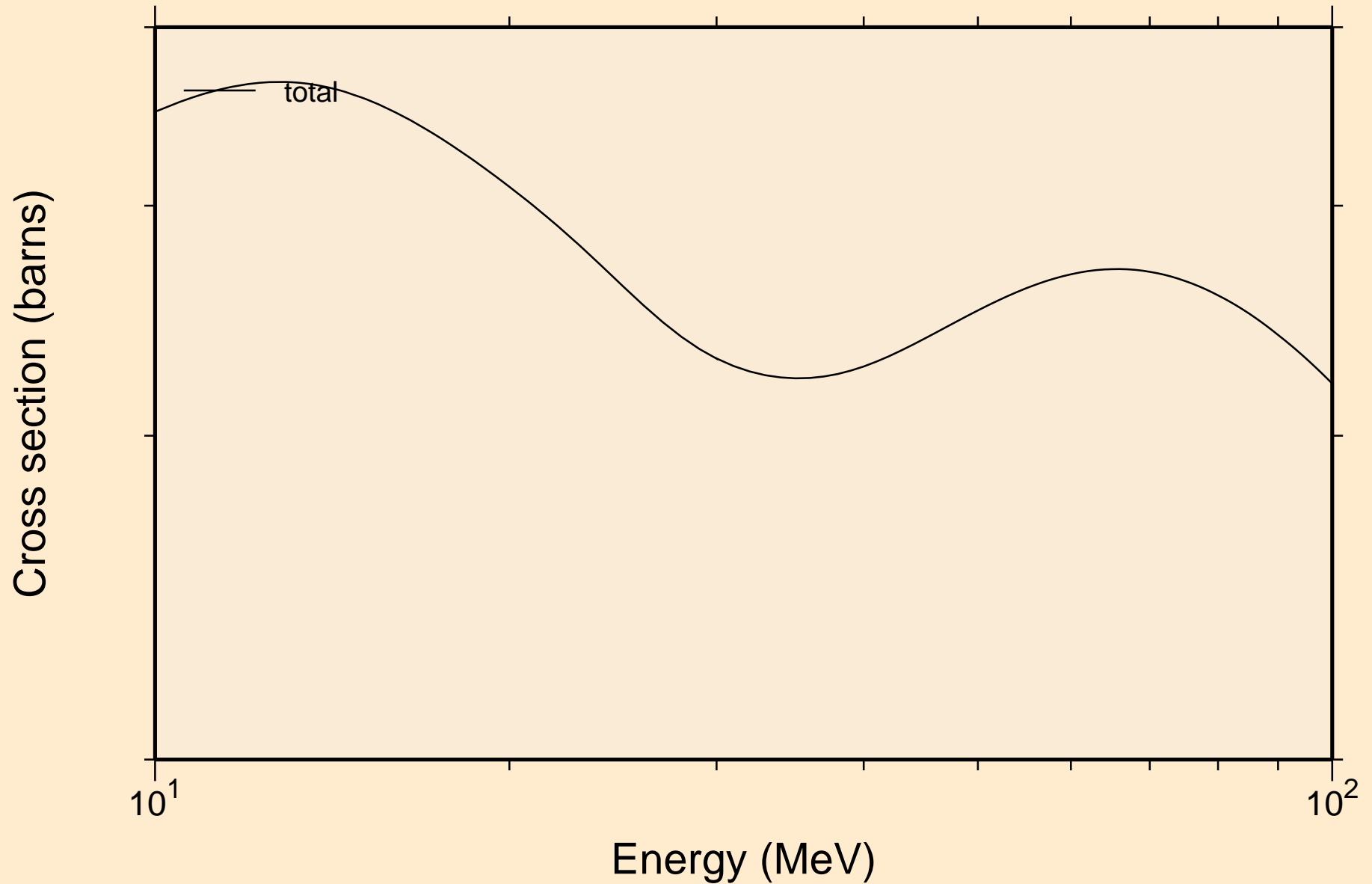

IN120 NEUTRON ACER TENDL-2019 LIBRARY; T=293.16K  
resonance absorption cross sections

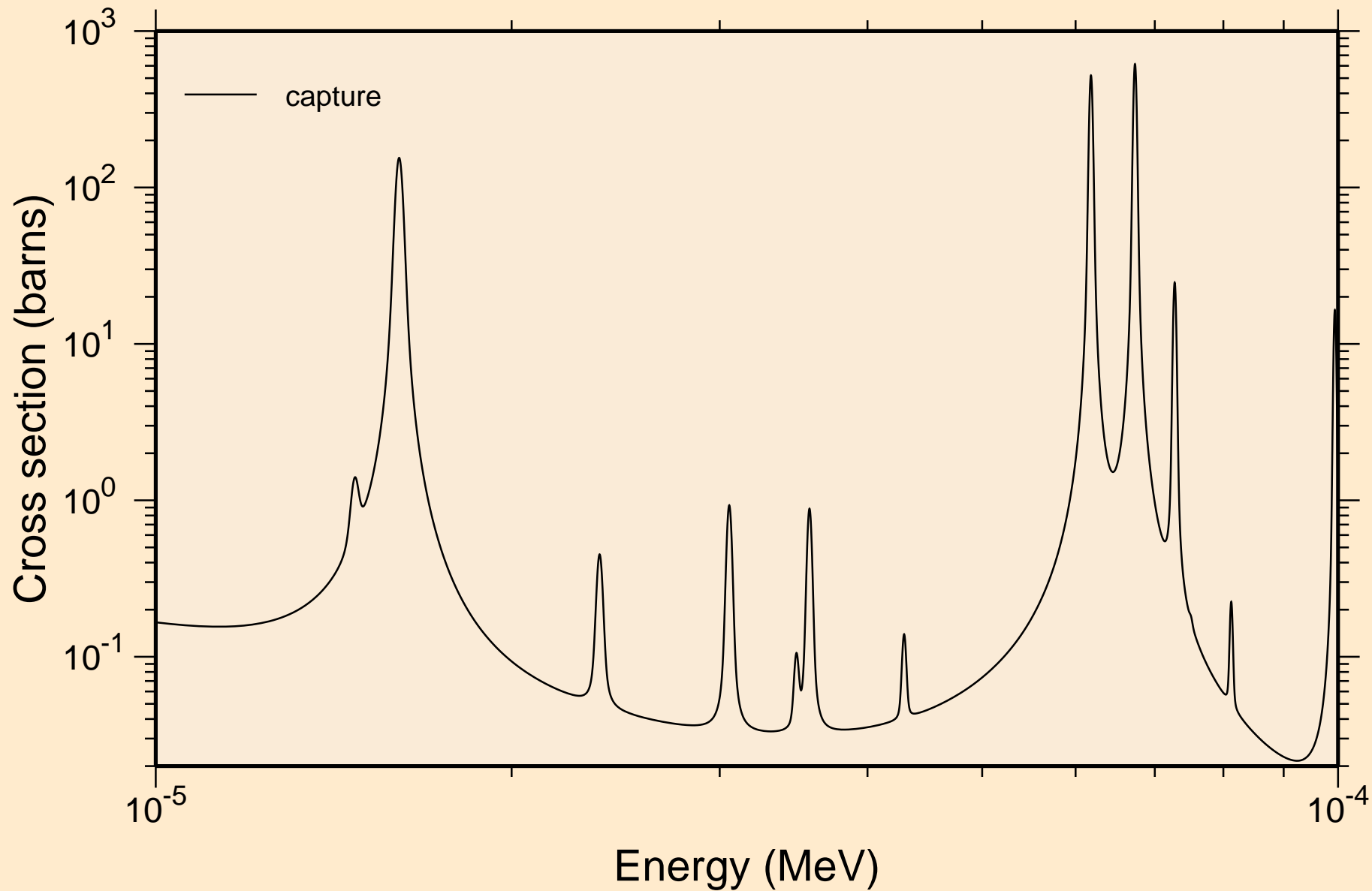

IN120 NEUTRON ACER TENDL-2019 LIBRARY; T=293.16K  
resonance absorption cross sections

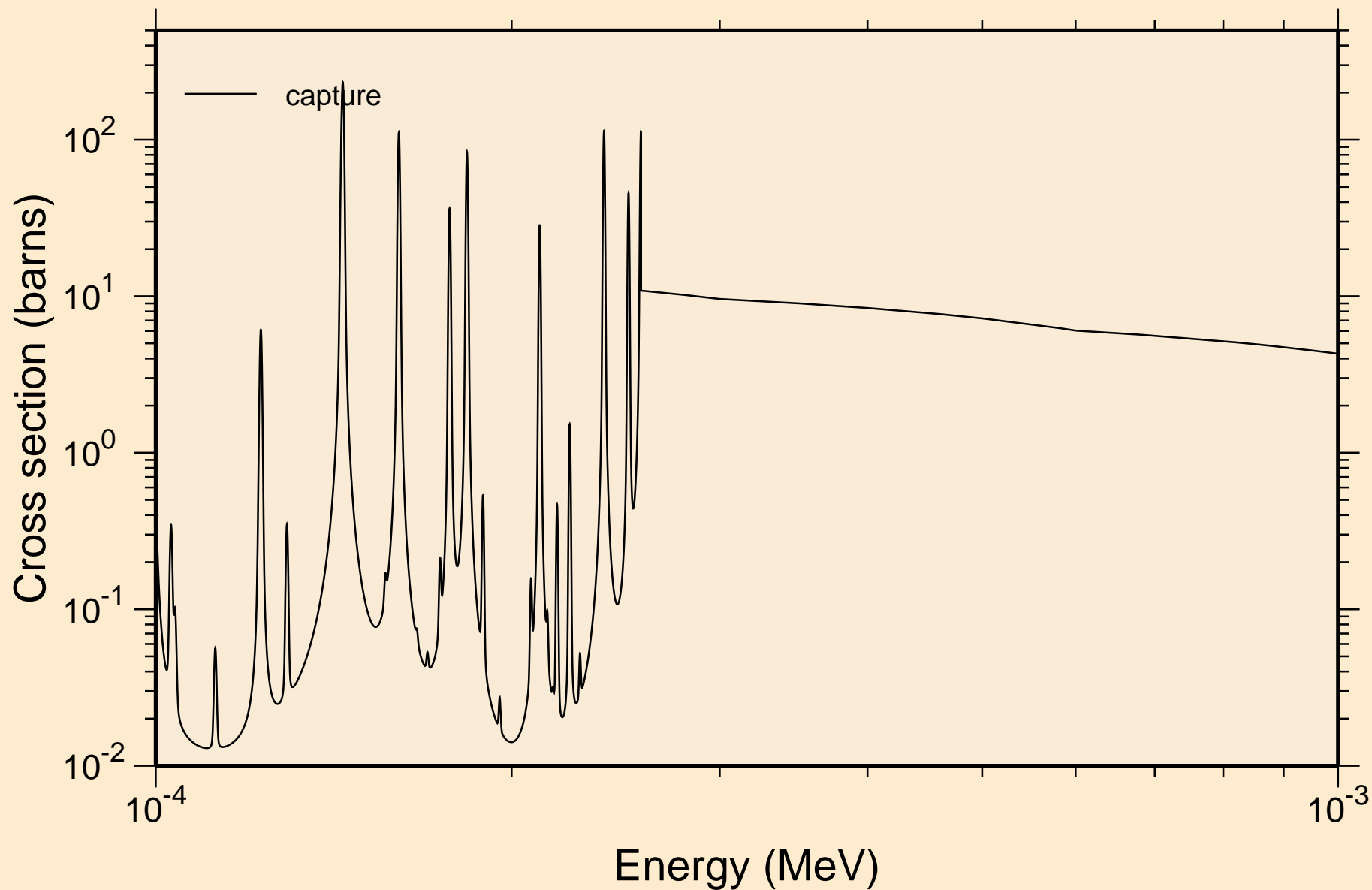

IN120 NEUTRON ACER TENDL-2019 LIBRARY; T=293.16K  
resonance absorption cross sections

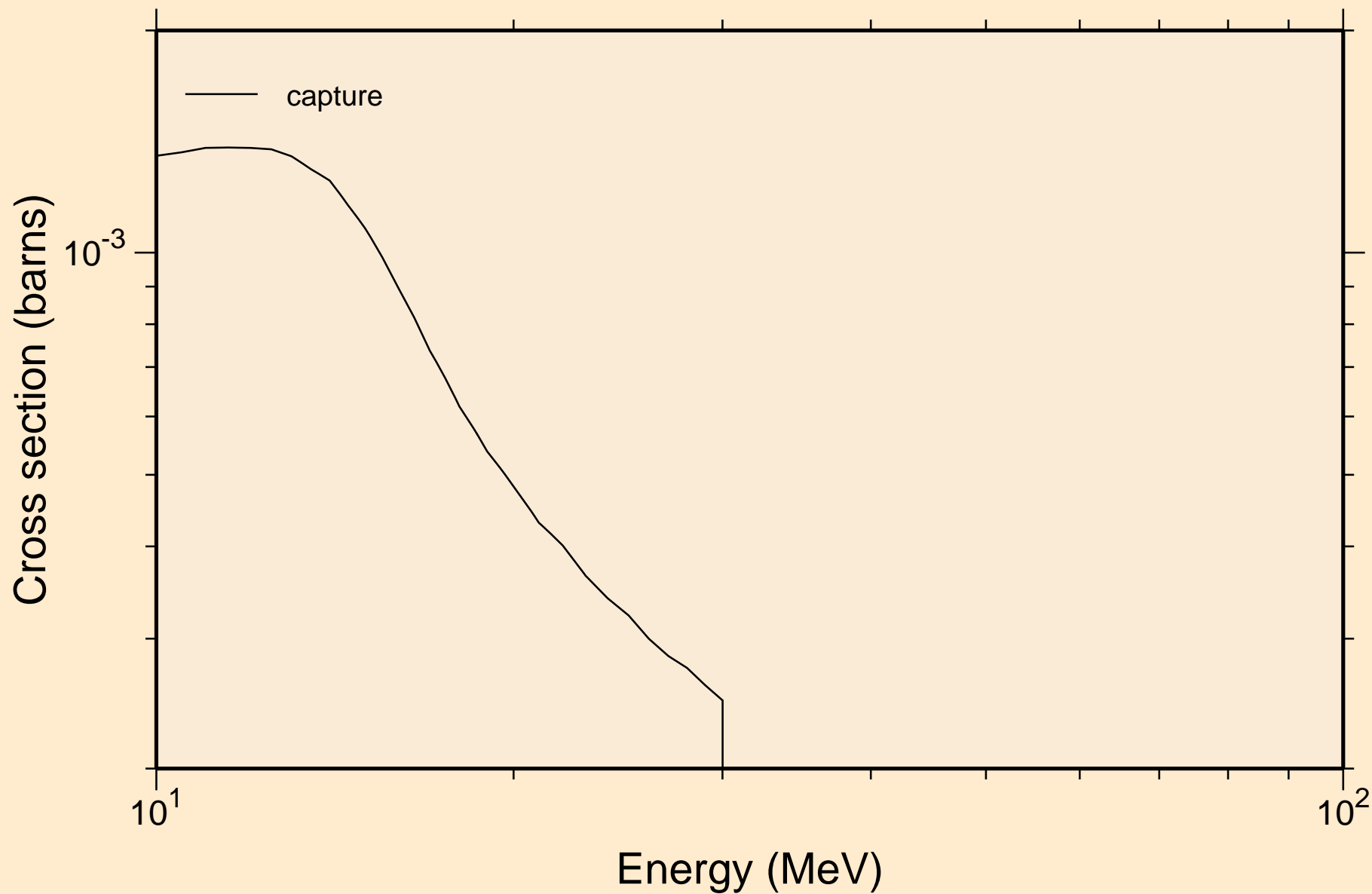

IN120 NEUTRON ACER TENDL-2019 LIBRARY; T=293.16K  
Heating

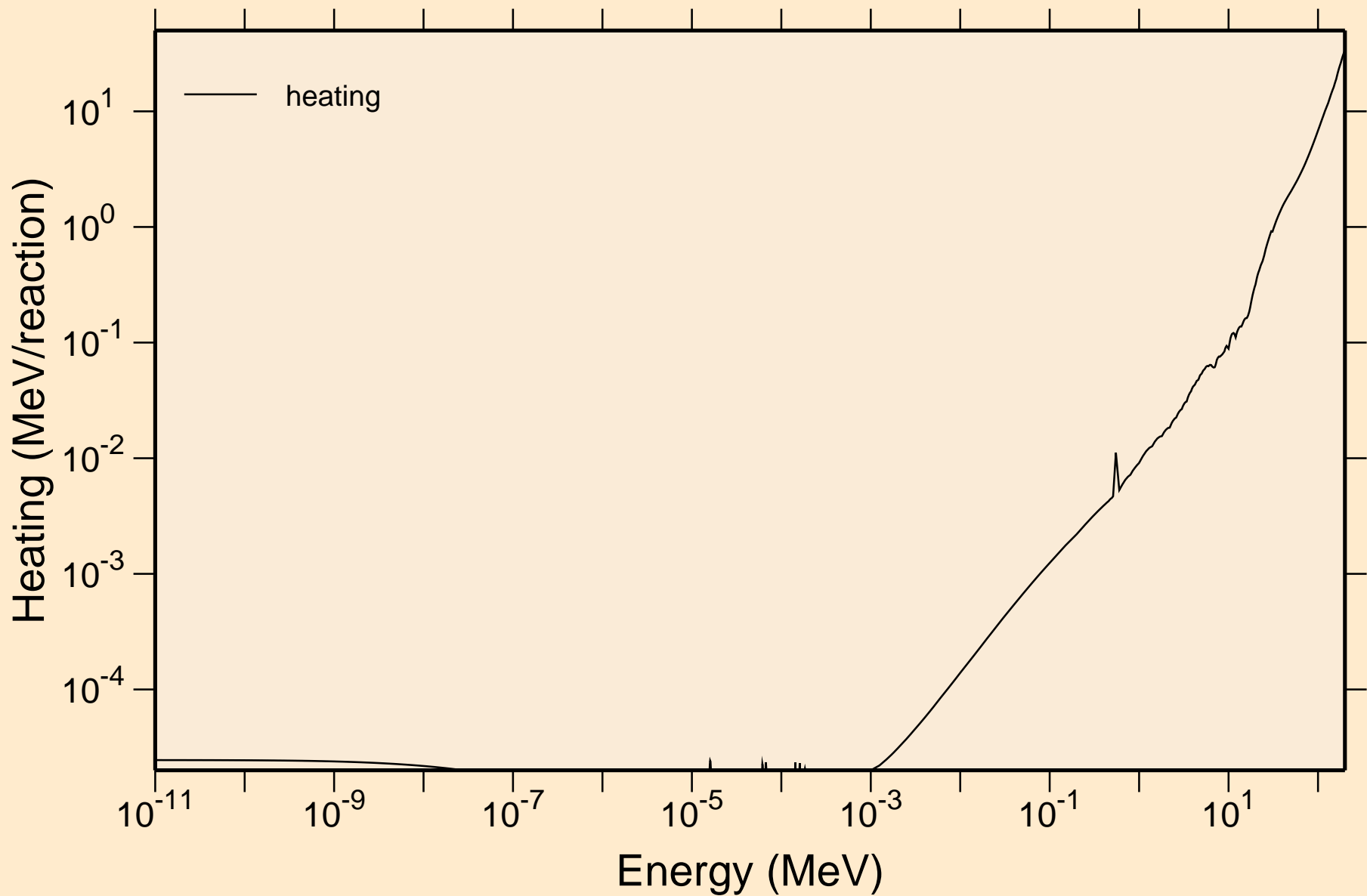



IN120 NEUTRON ACER TENDL-2019 LIBRARY; T=293.16K  
Damage

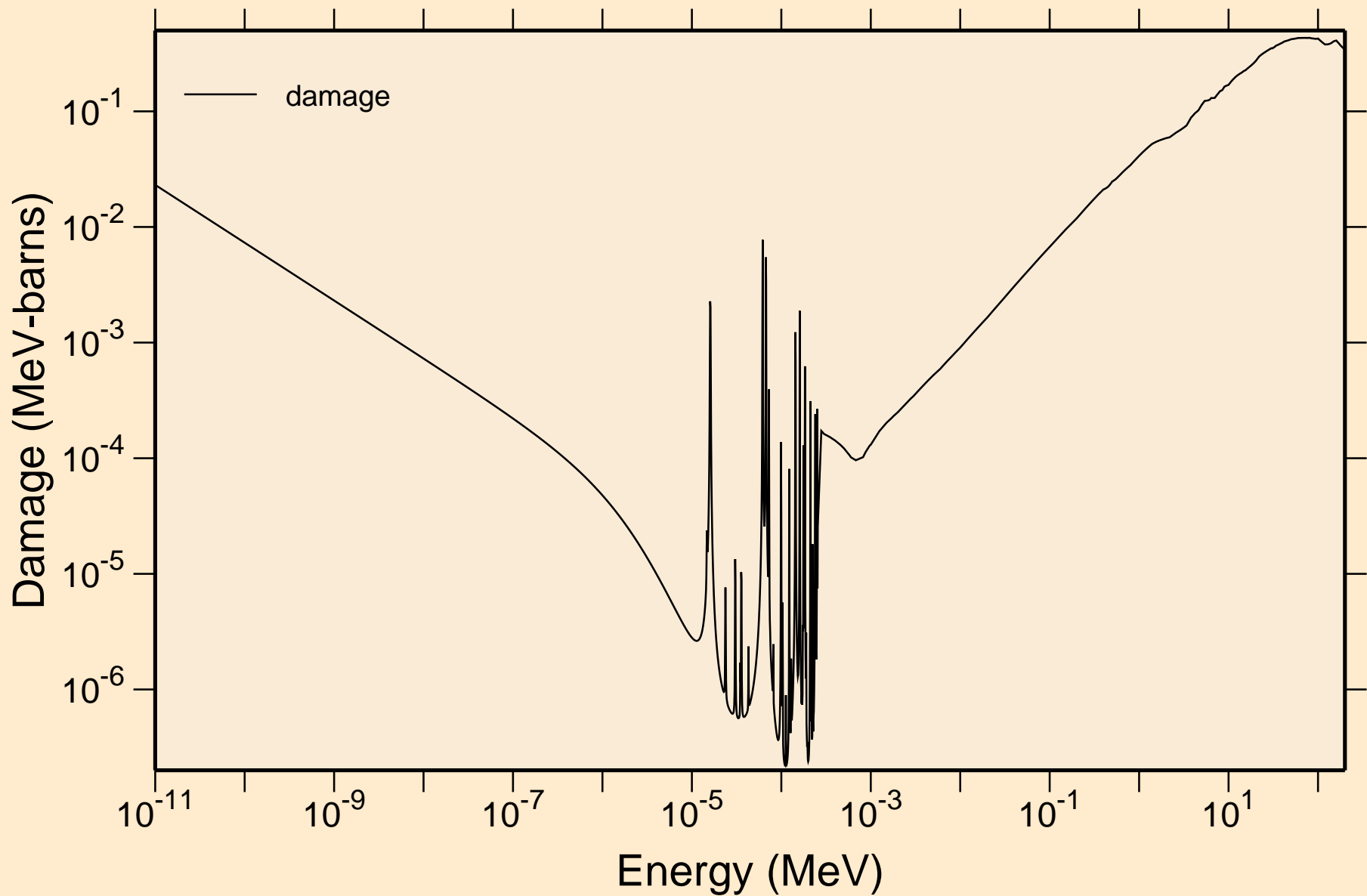

IN120 NEUTRON ACER TENDL-2019 LIBRARY; T=293.16K  
Non-threshold reactions

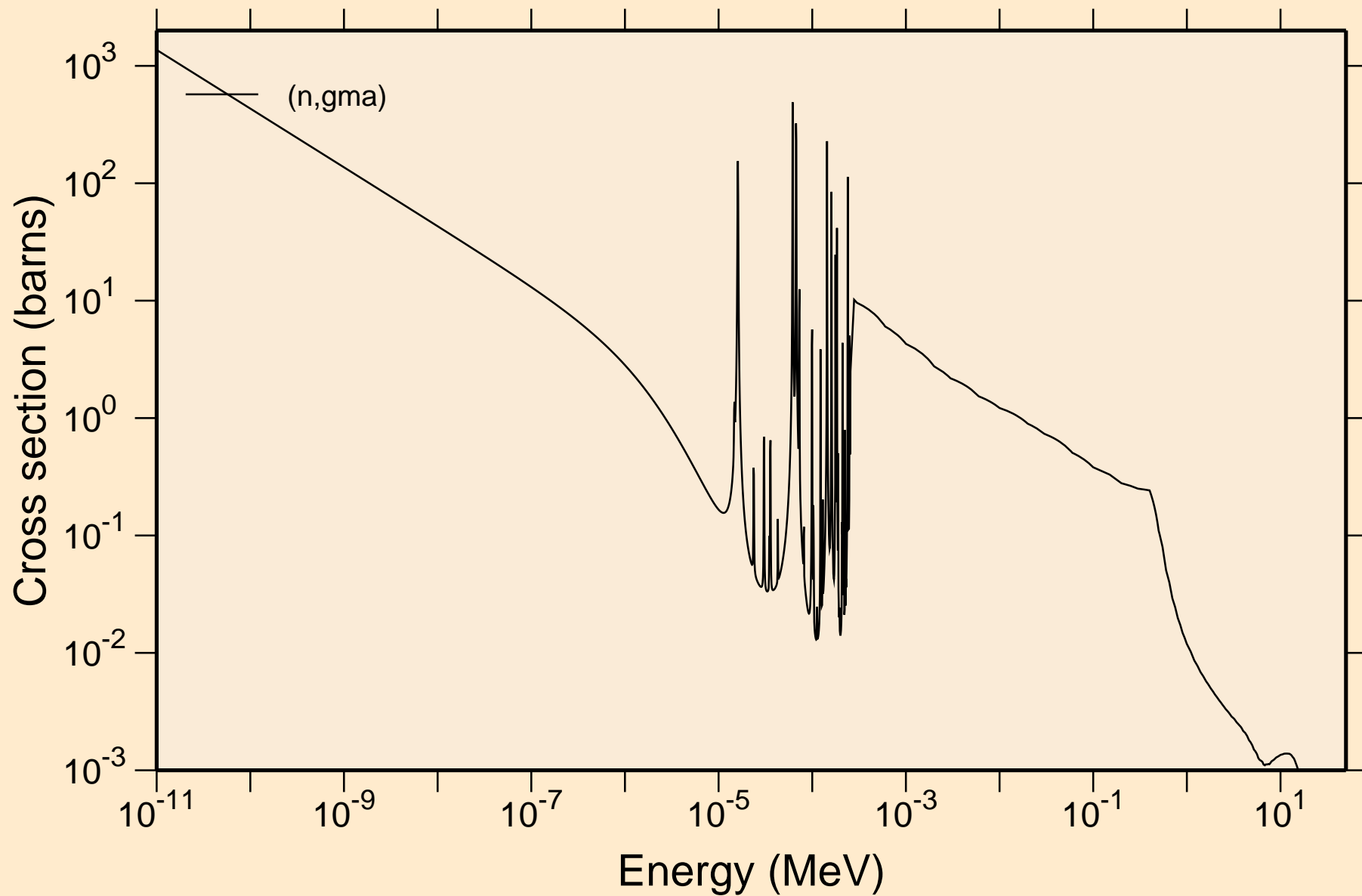

IN120 NEUTRON ACER TENDL-2019 LIBRARY; T=293.16K  
Principal cross sections

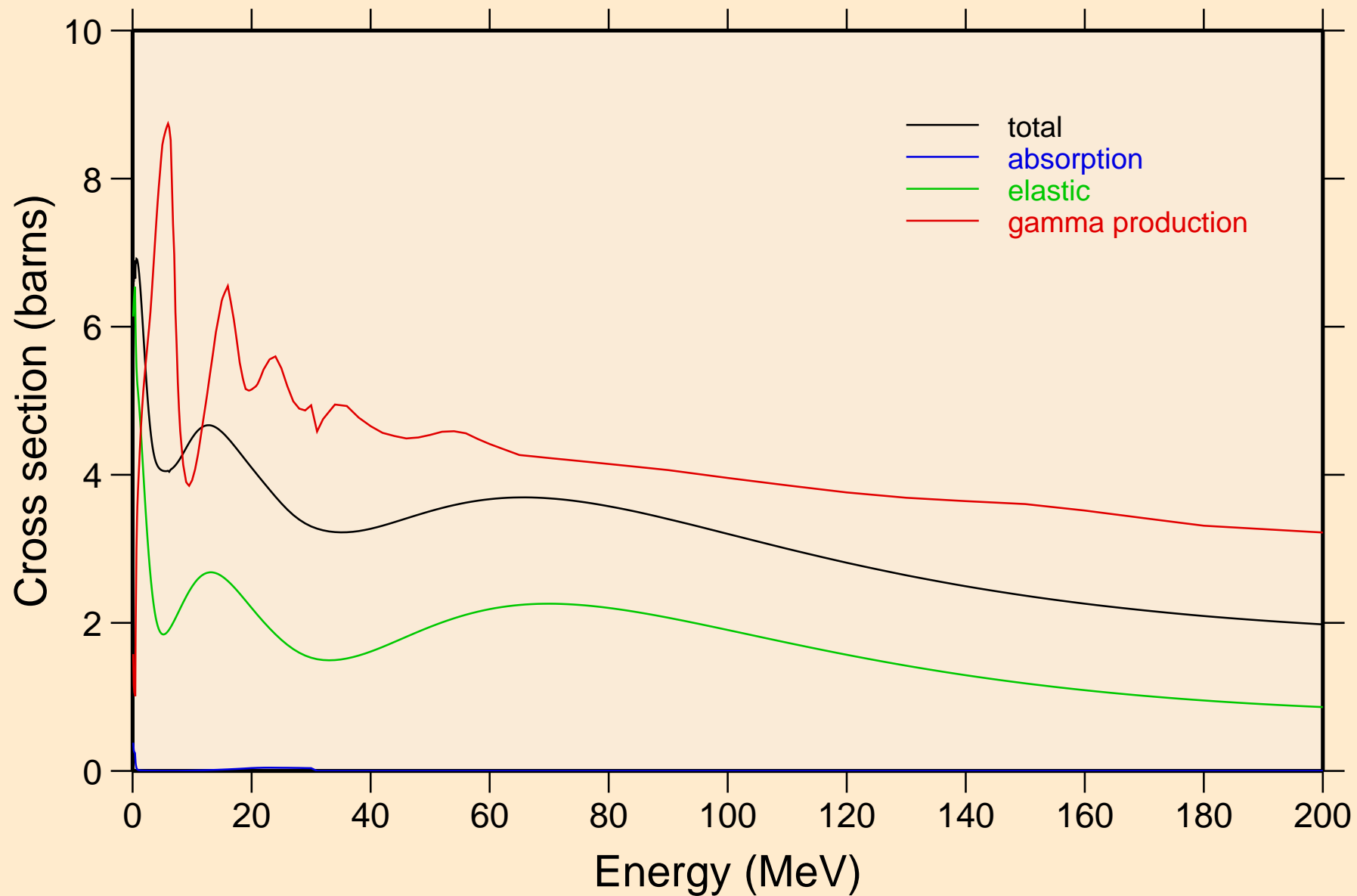

IN120 NEUTRON ACER TENDL-2019 LIBRARY; T=293.16K  
Heating

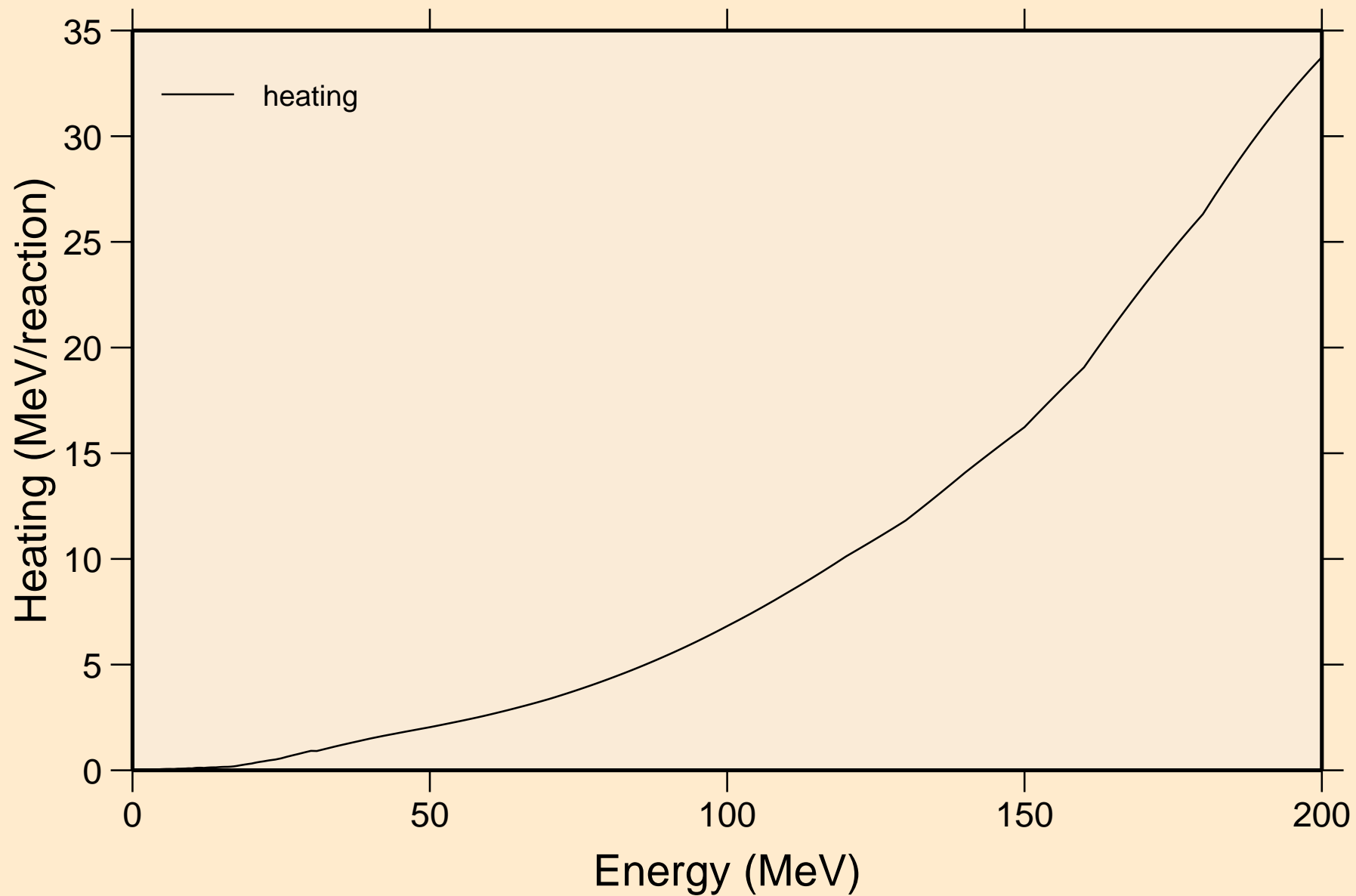

IN120 NEUTRON ACER TENDL-2019 LIBRARY; T=293.16K  
Damage

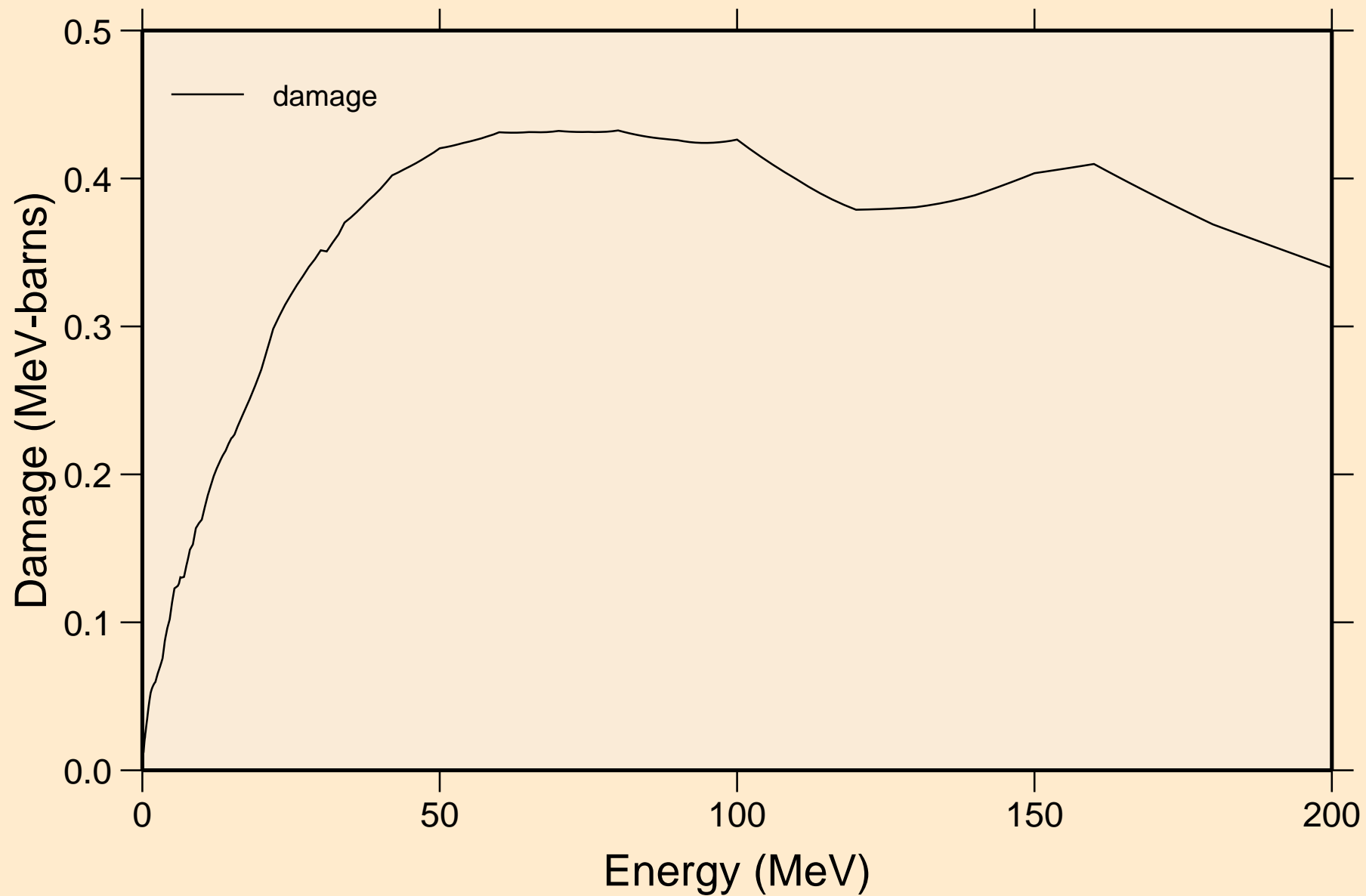

IN120 NEUTRON ACER TENDL-2019 LIBRARY; T=293.16K  
Non-threshold reactions

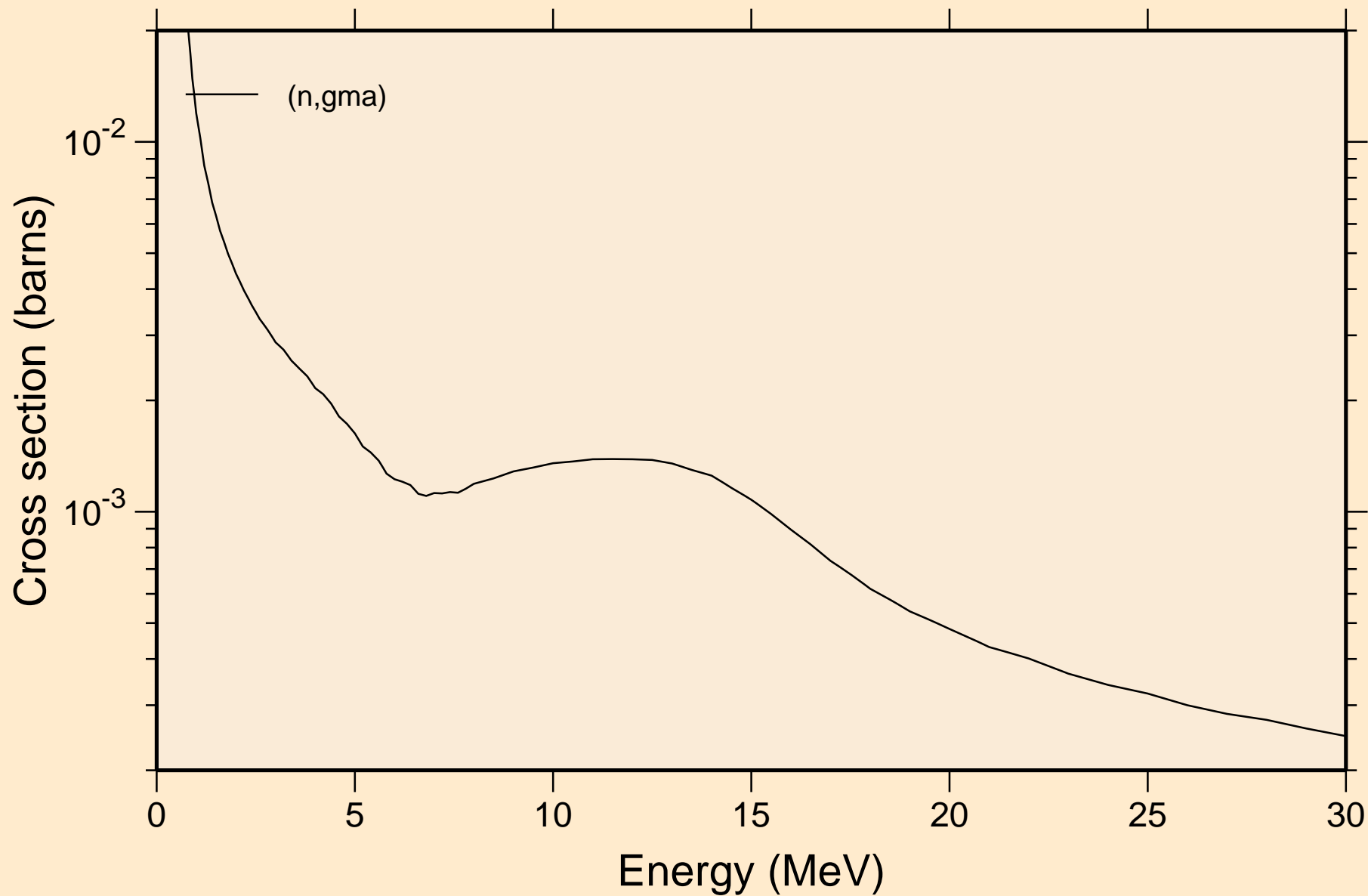

IN120 NEUTRON ACER TENDL-2019 LIBRARY; T=293.16K  
Inelastic levels

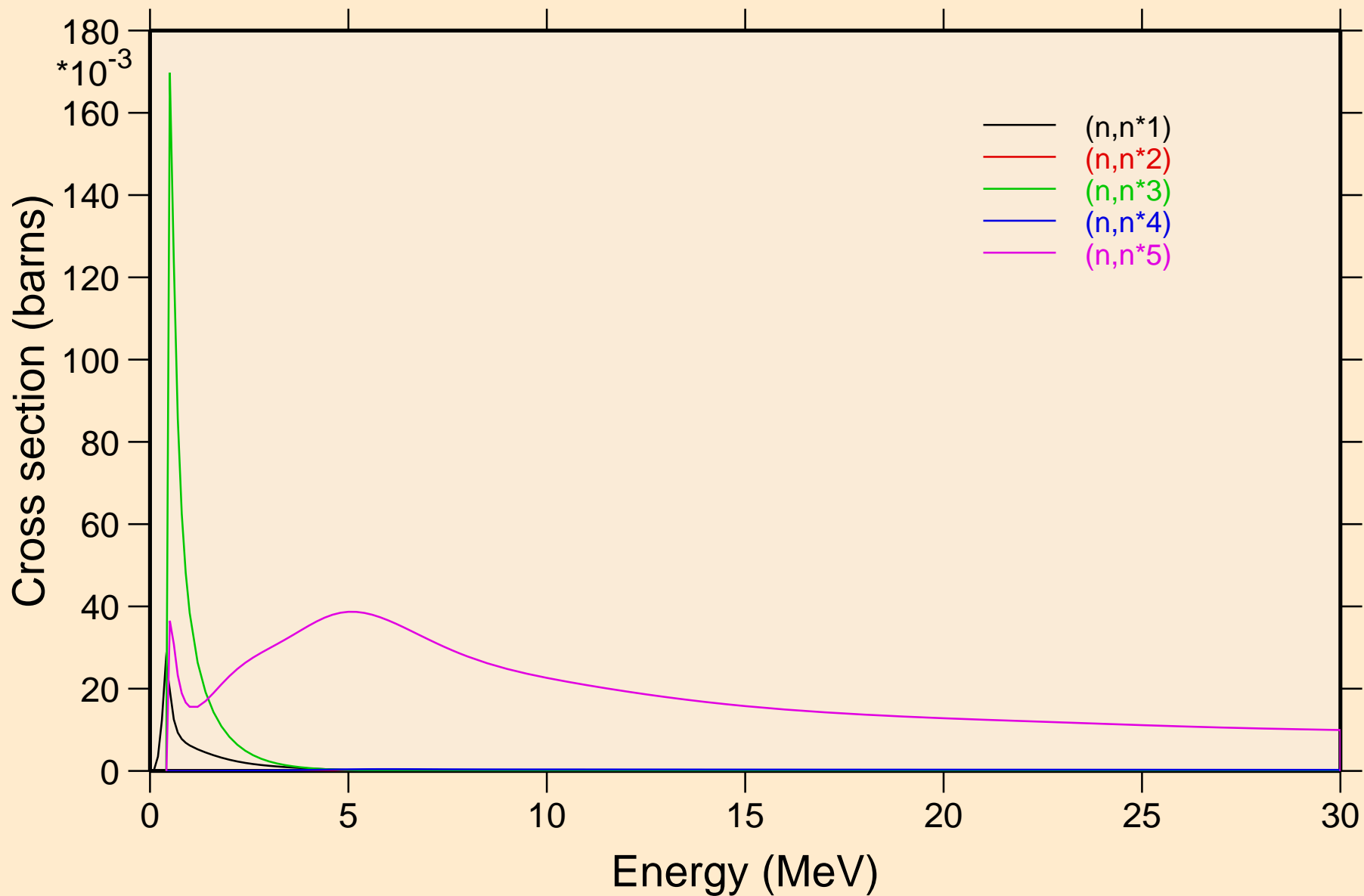

IN120 NEUTRON ACER TENDL-2019 LIBRARY; T=293.16K  
Inelastic levels

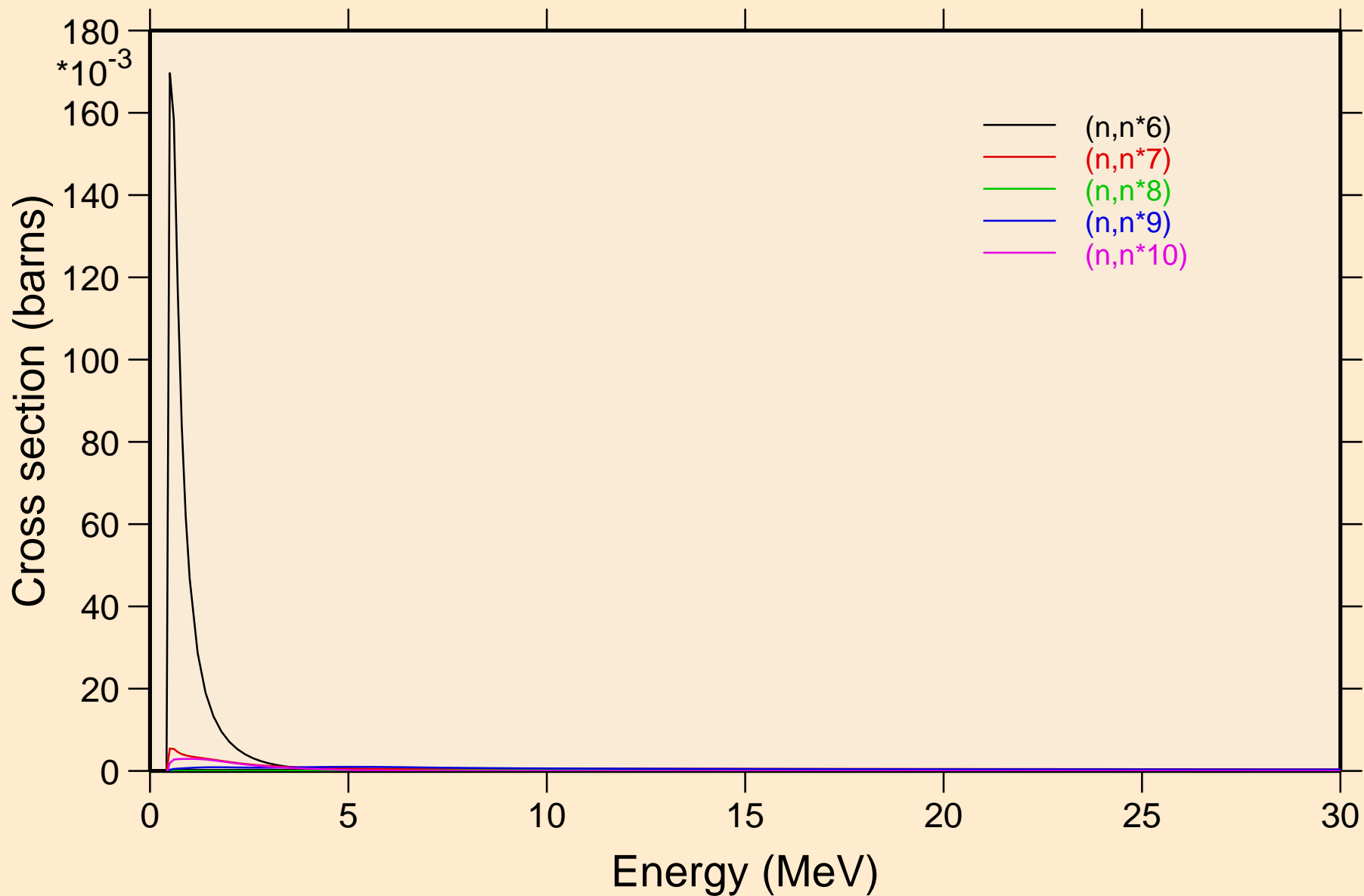



IN120 NEUTRON ACER TENDL-2019 LIBRARY; T=293.16K  
Inelastic levels

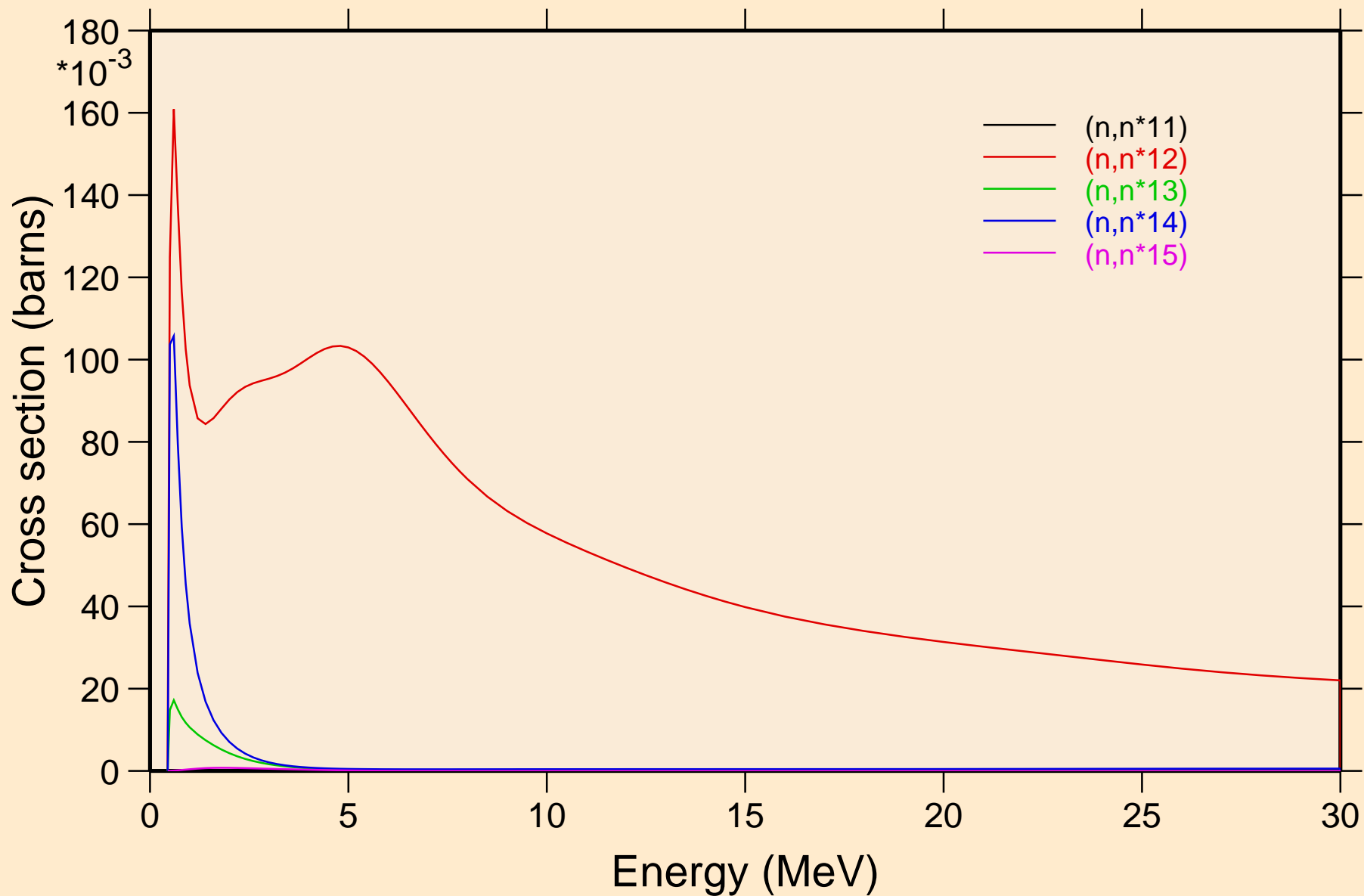

IN120 NEUTRON ACER TENDL-2019 LIBRARY; T=293.16K  
Inelastic levels

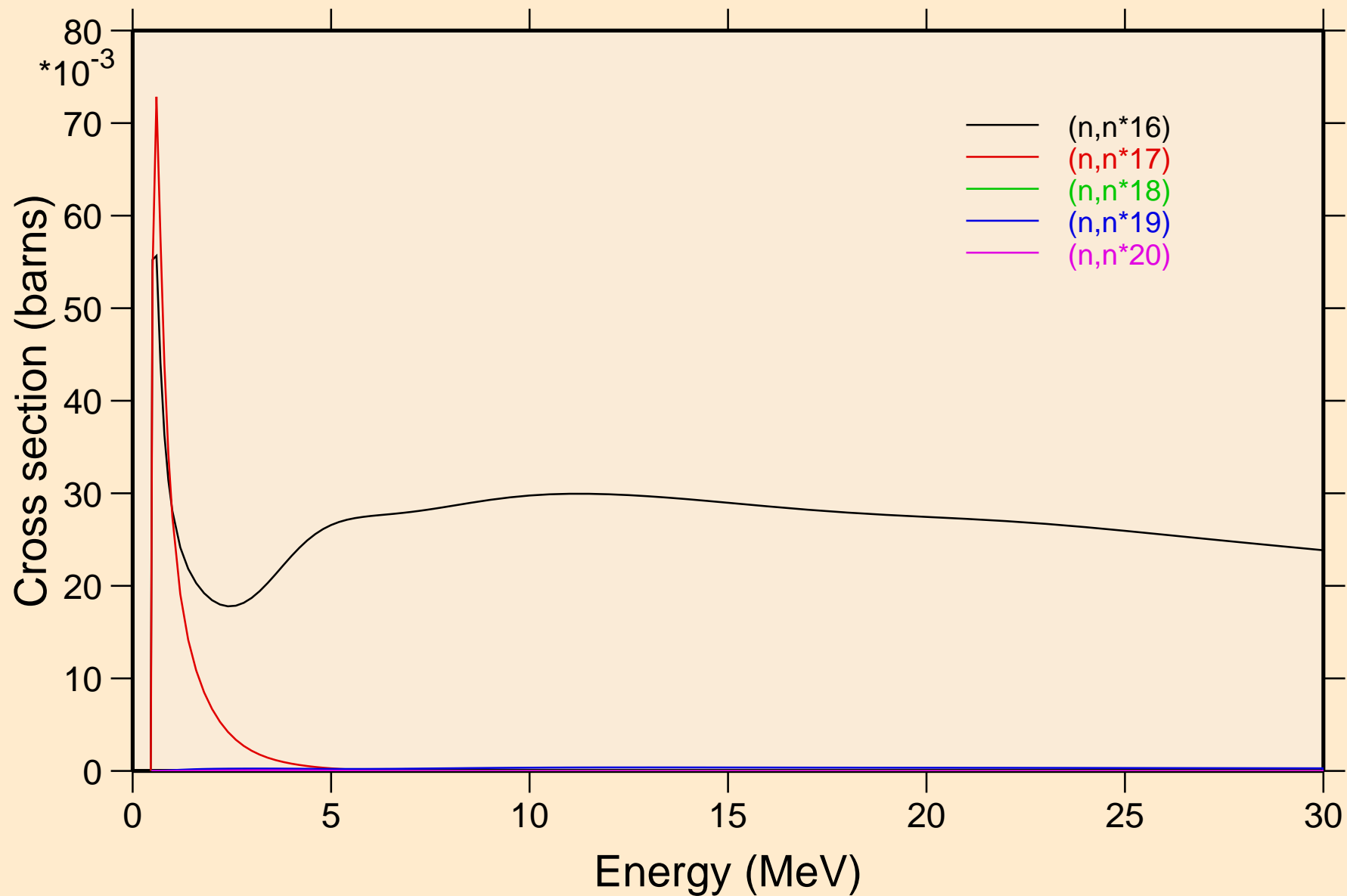

IN120 NEUTRON ACER TENDL-2019 LIBRARY; T=293.16K  
Inelastic levels

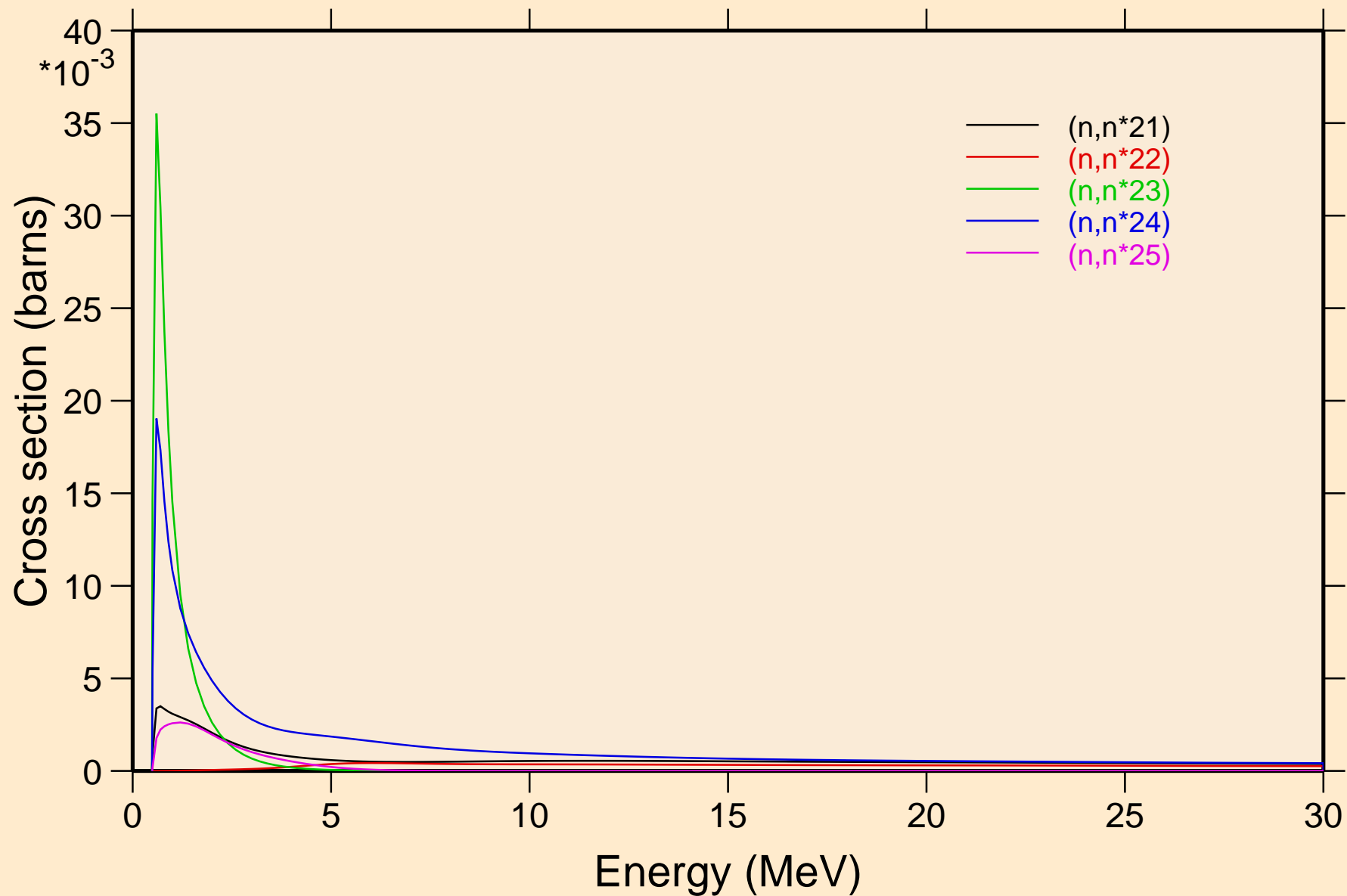

IN120 NEUTRON ACER TENDL-2019 LIBRARY; T=293.16K  
Inelastic levels

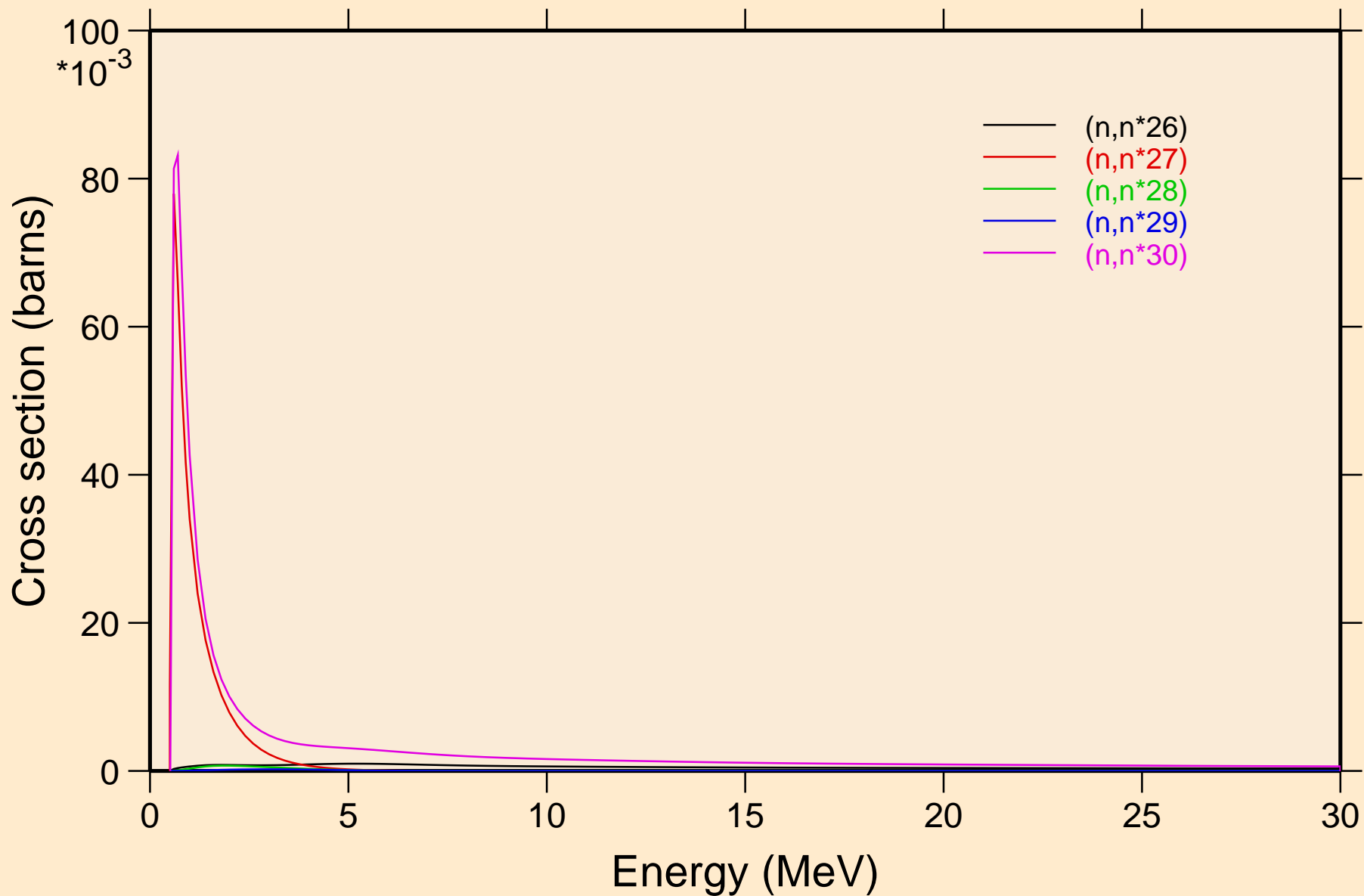

IN120 NEUTRON ACER TENDL-2019 LIBRARY; T=293.16K  
Threshold reactions

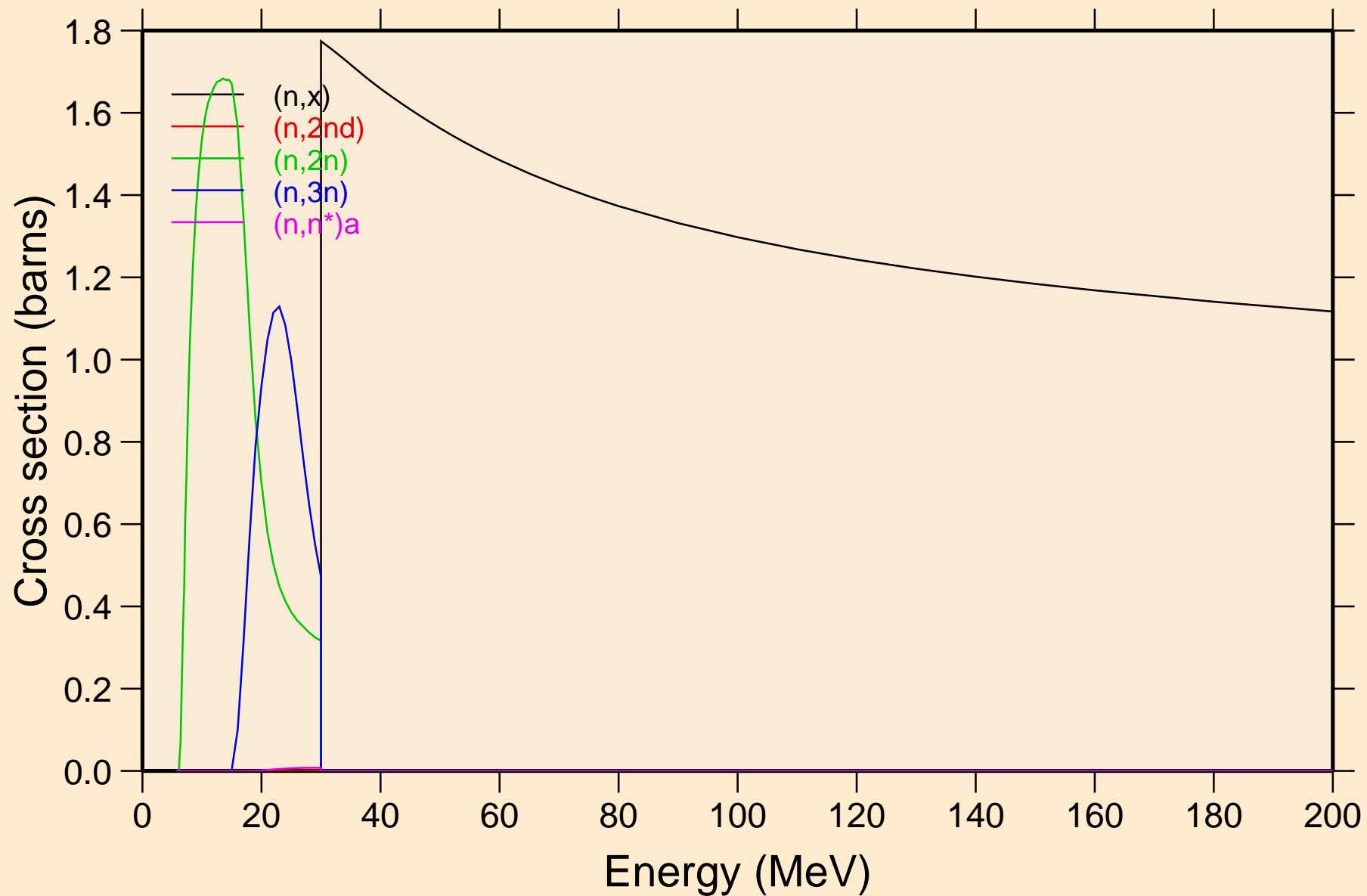

IN120 NEUTRON ACER TENDL-2019 LIBRARY; T=293.16K  
Threshold reactions

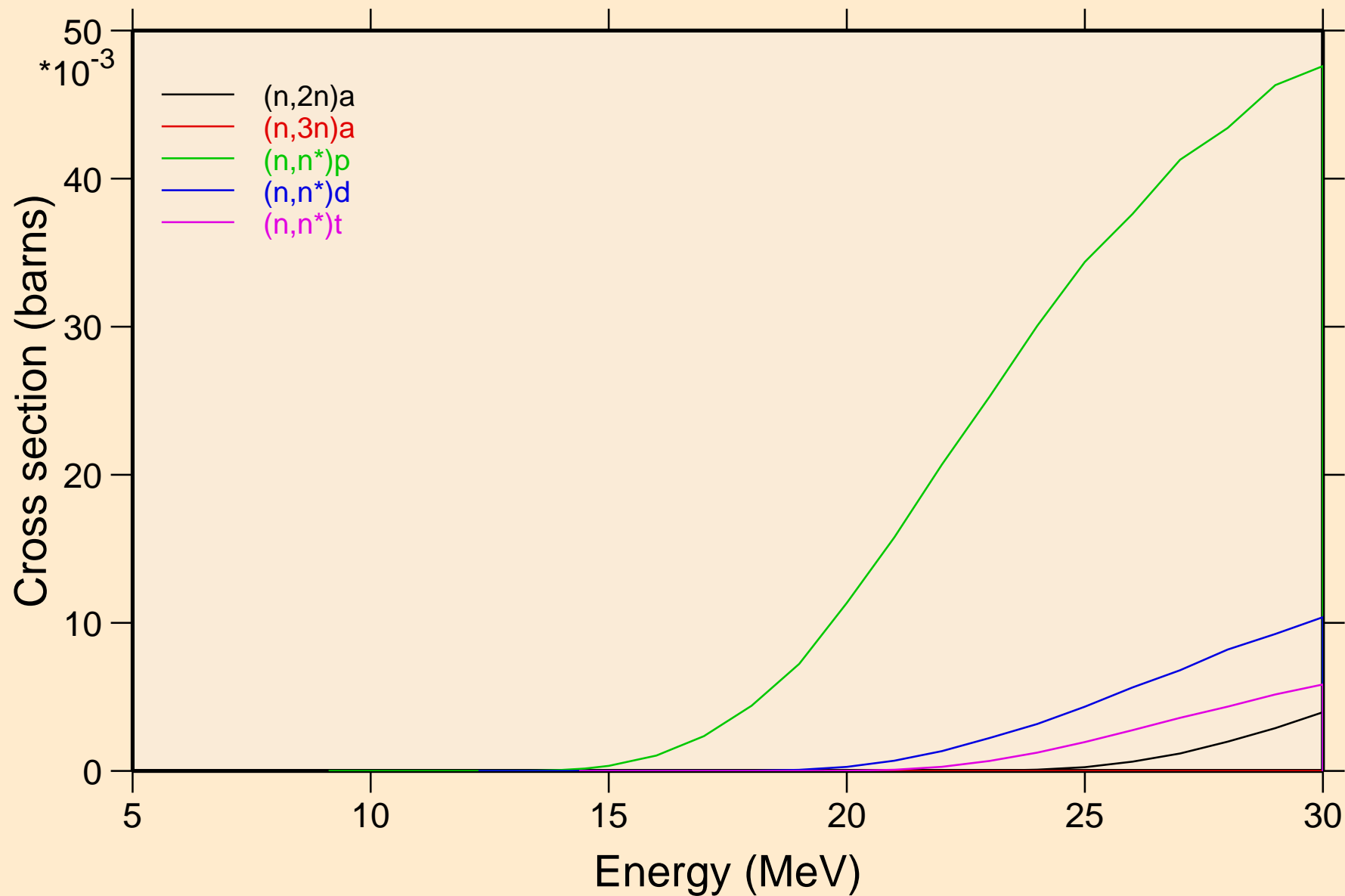

IN120 NEUTRON ACER TENDL-2019 LIBRARY; T=293.16K  
Threshold reactions

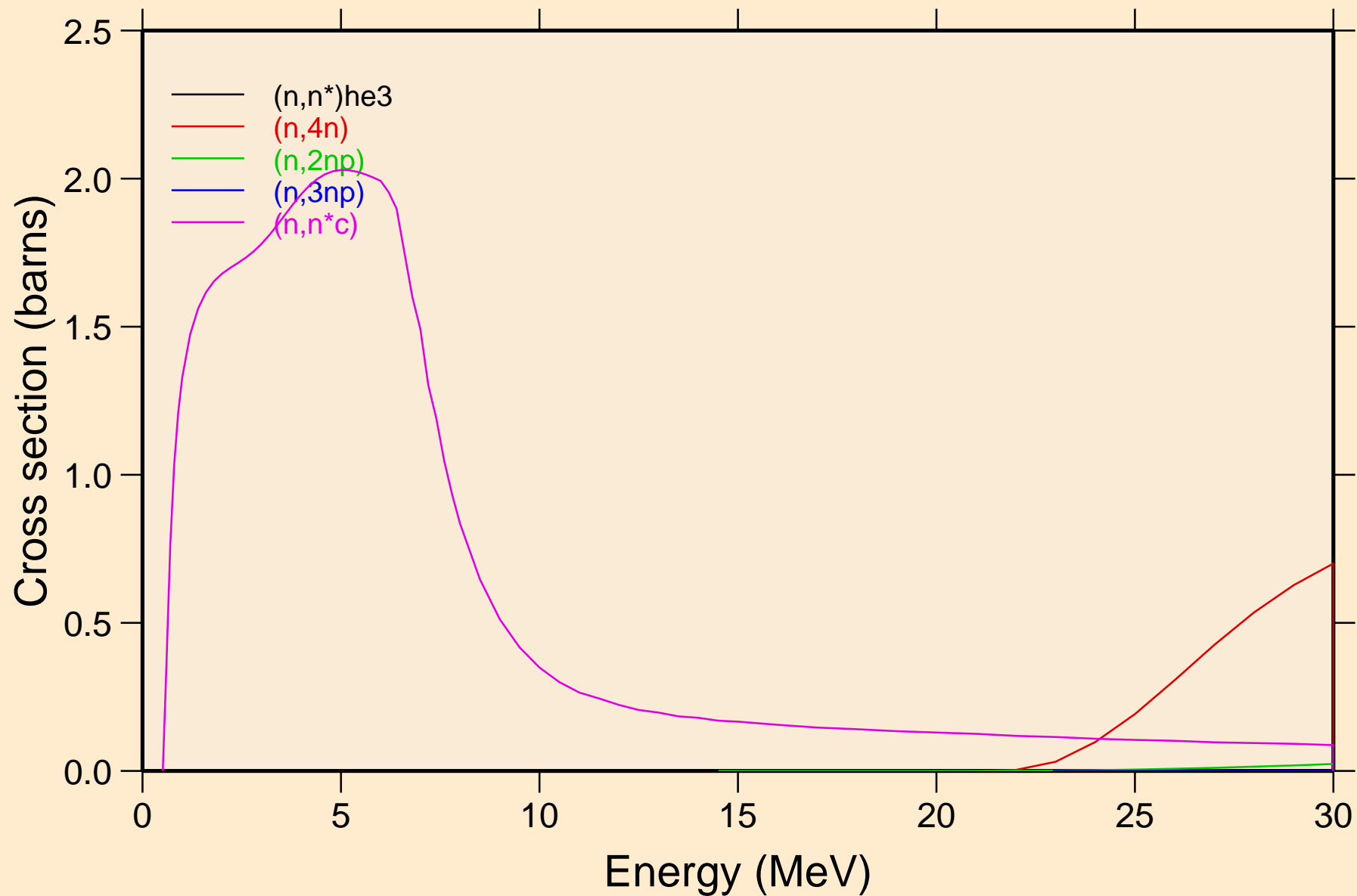

IN120 NEUTRON ACER TENDL-2019 LIBRARY; T=293.16K  
Threshold reactions

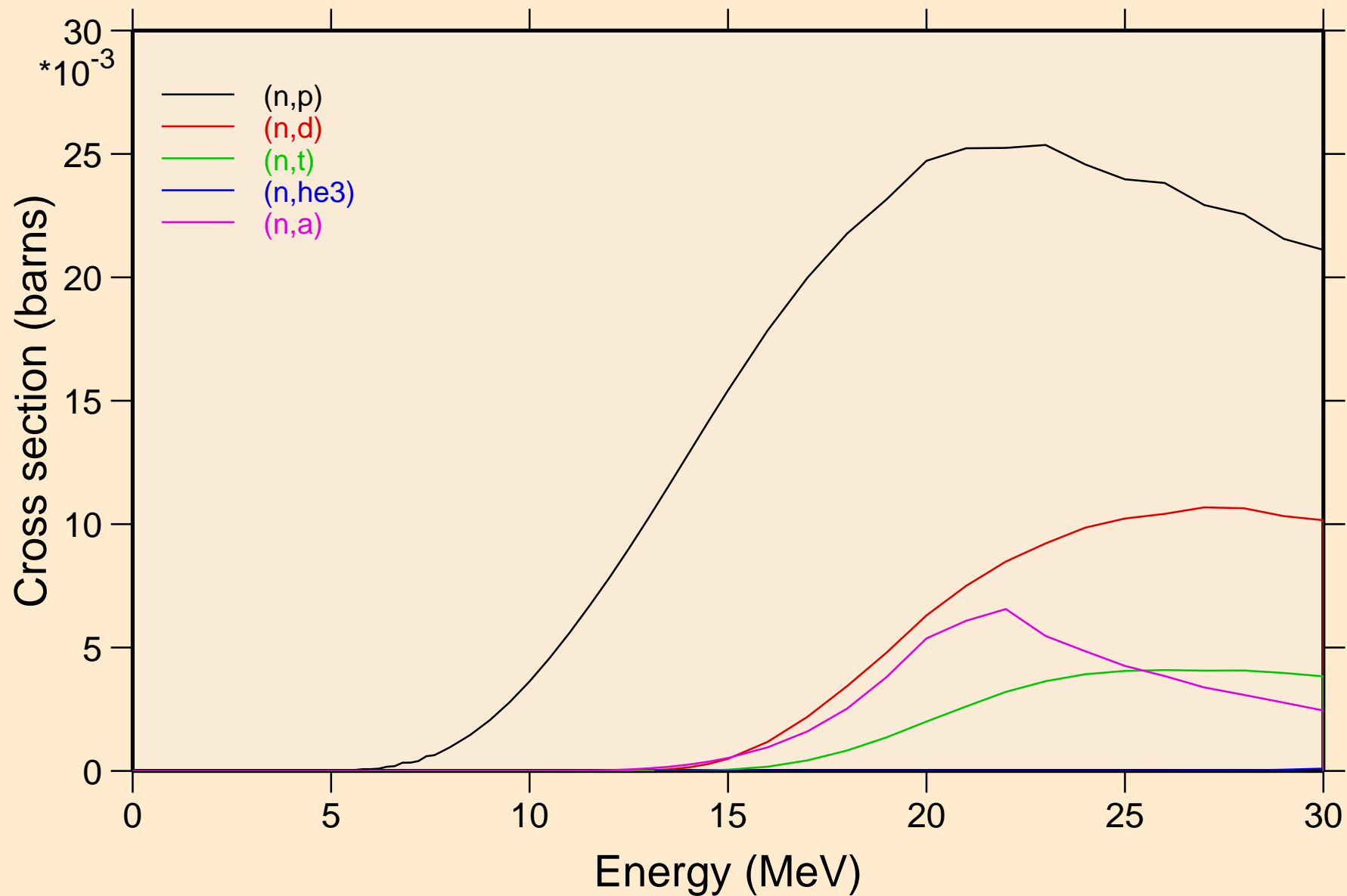



IN120 NEUTRON ACER TENDL-2019 LIBRARY; T=293.16K  
Threshold reactions

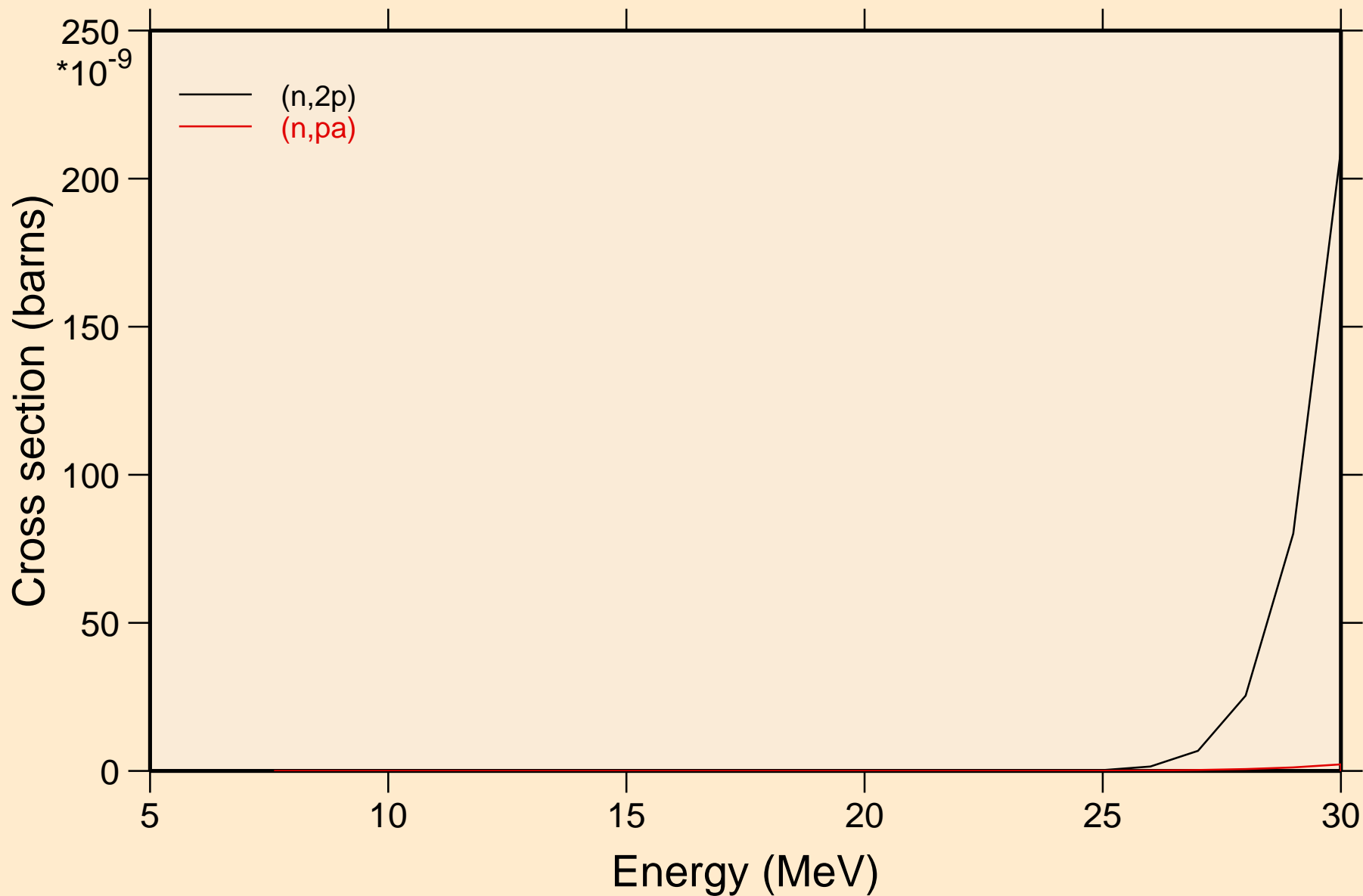

IN120 NEUTRON ACER TENDL-2019 LIBRARY; T=293.16K  
Threshold reactions

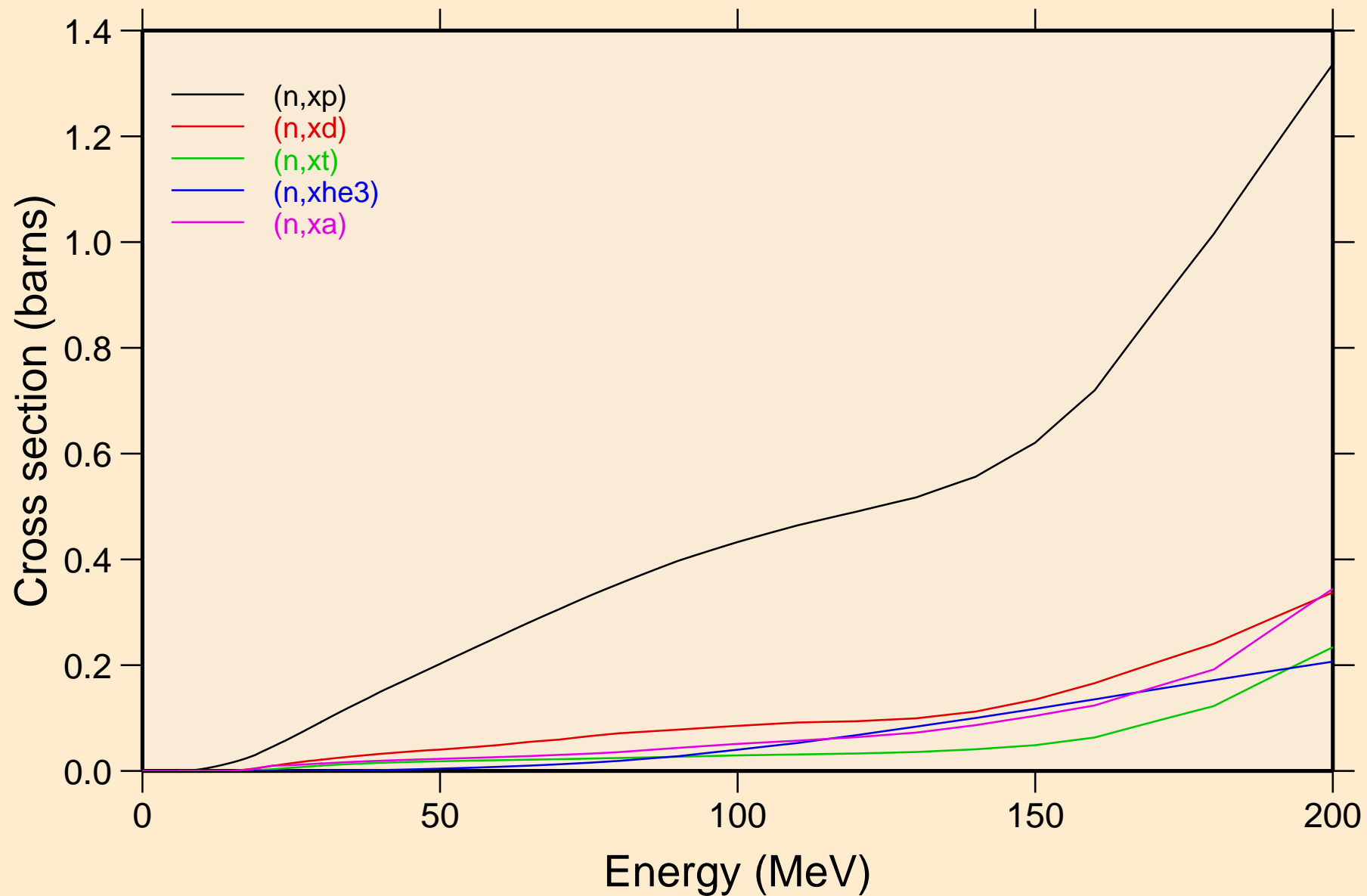

IN120 NEUTRON ACER TENDL-2019 LIBRARY; T=293.16K  
angular distribution for elastic

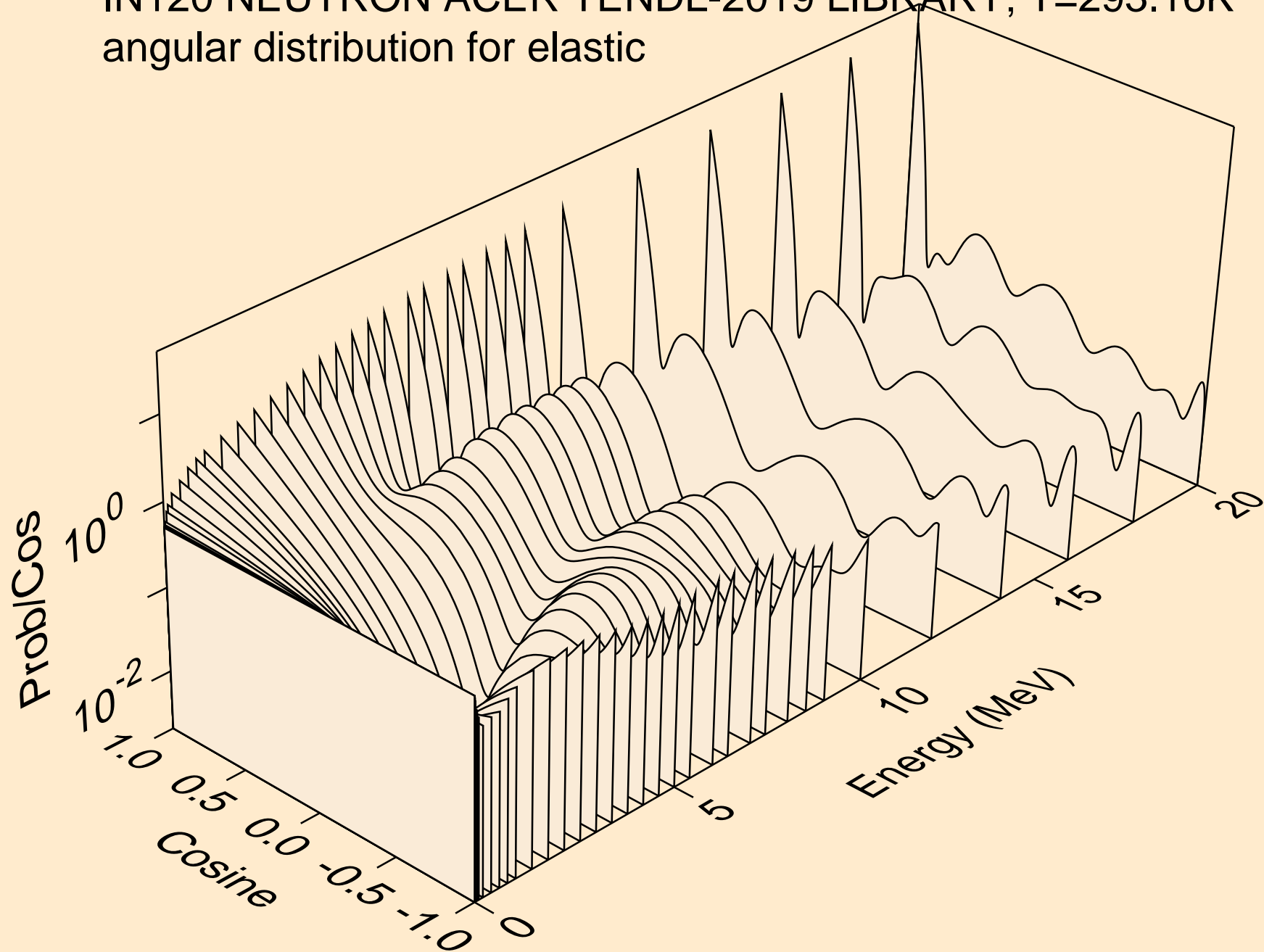

IN120 NEUTRON ACER TENDL-2019 LIBRARY; T=293.16K  
angular distribution for elastic

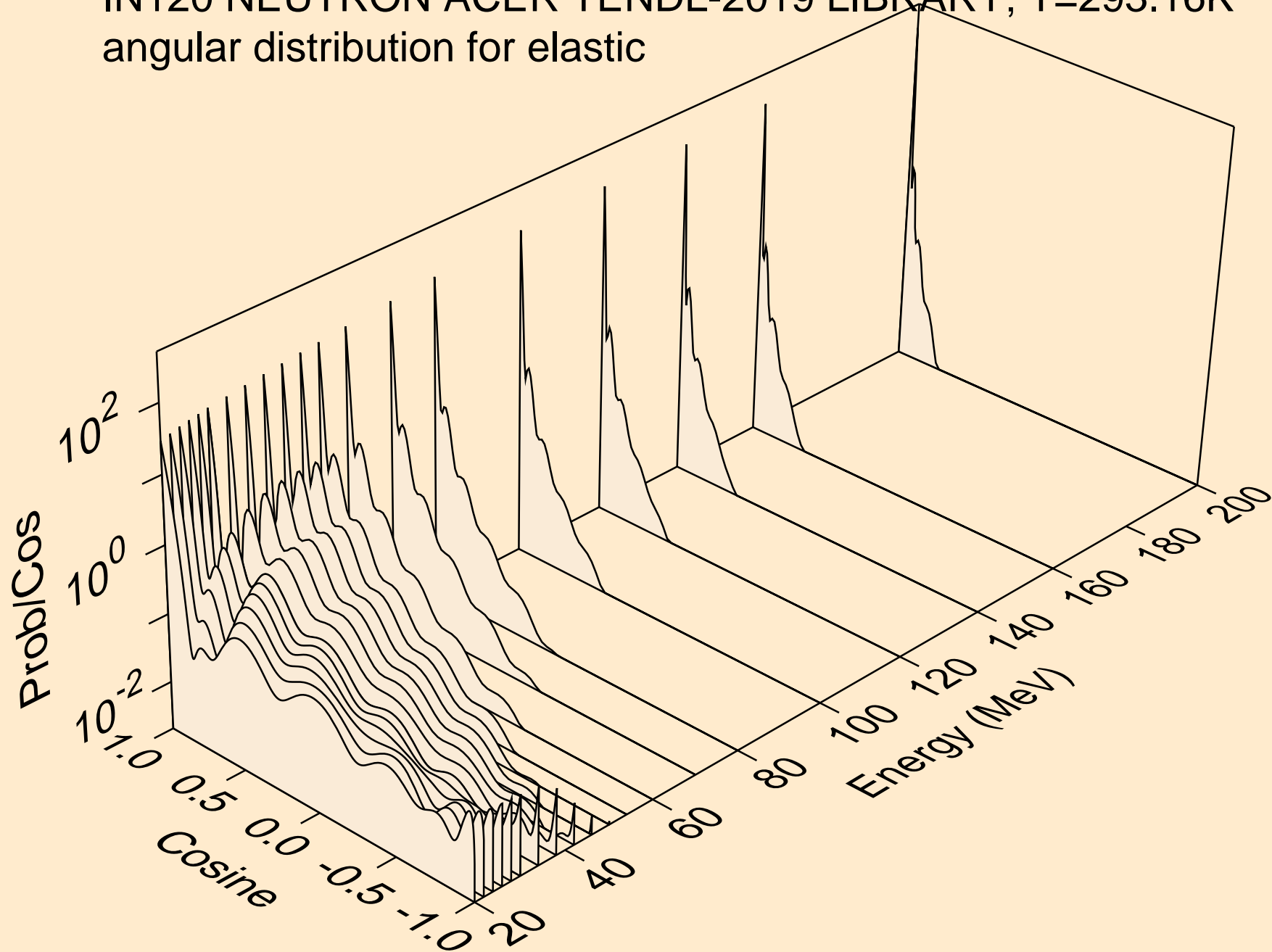

IN120 NEUTRON ACER TENDL-2019 LIBRARY; T=293.16K  
angular distribution for (n,n\*1)

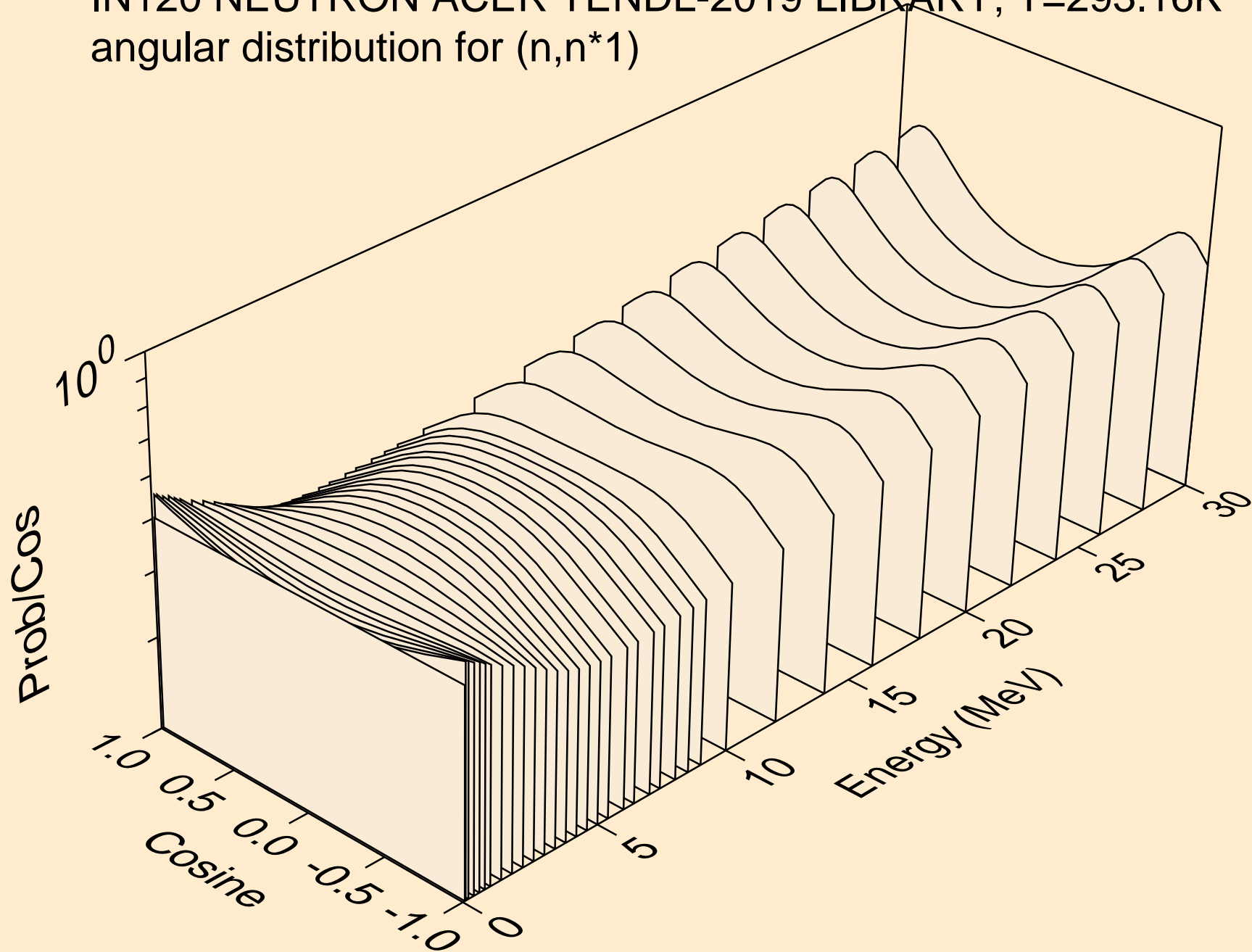

IN120 NEUTRON ACER TENDL-2019 LIBRARY; T=293.16K  
angular distribution for (n,n\*2)

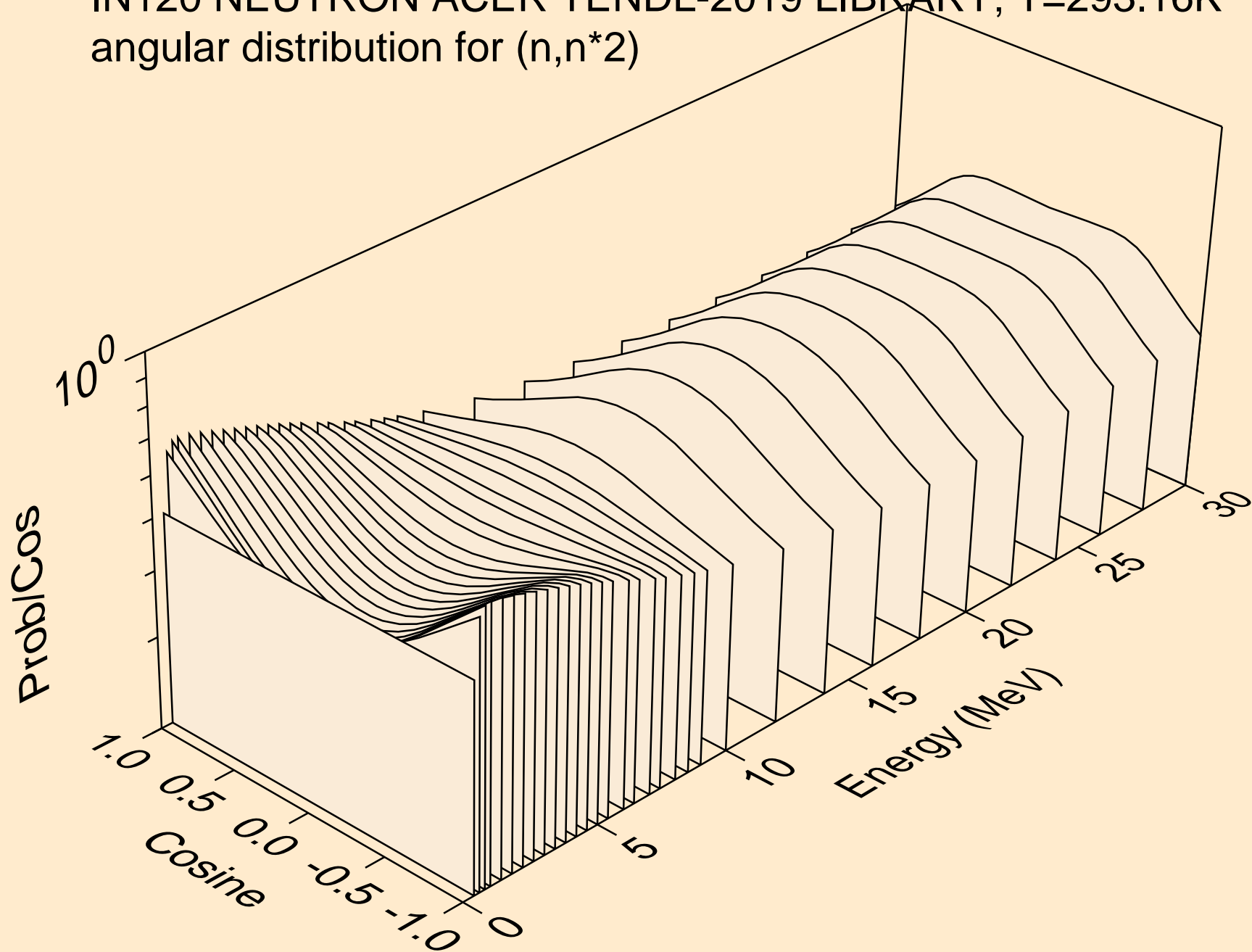

IN120 NEUTRON ACER TENDL-2019 LIBRARY; T=293.16K  
angular distribution for (n,n\*3)

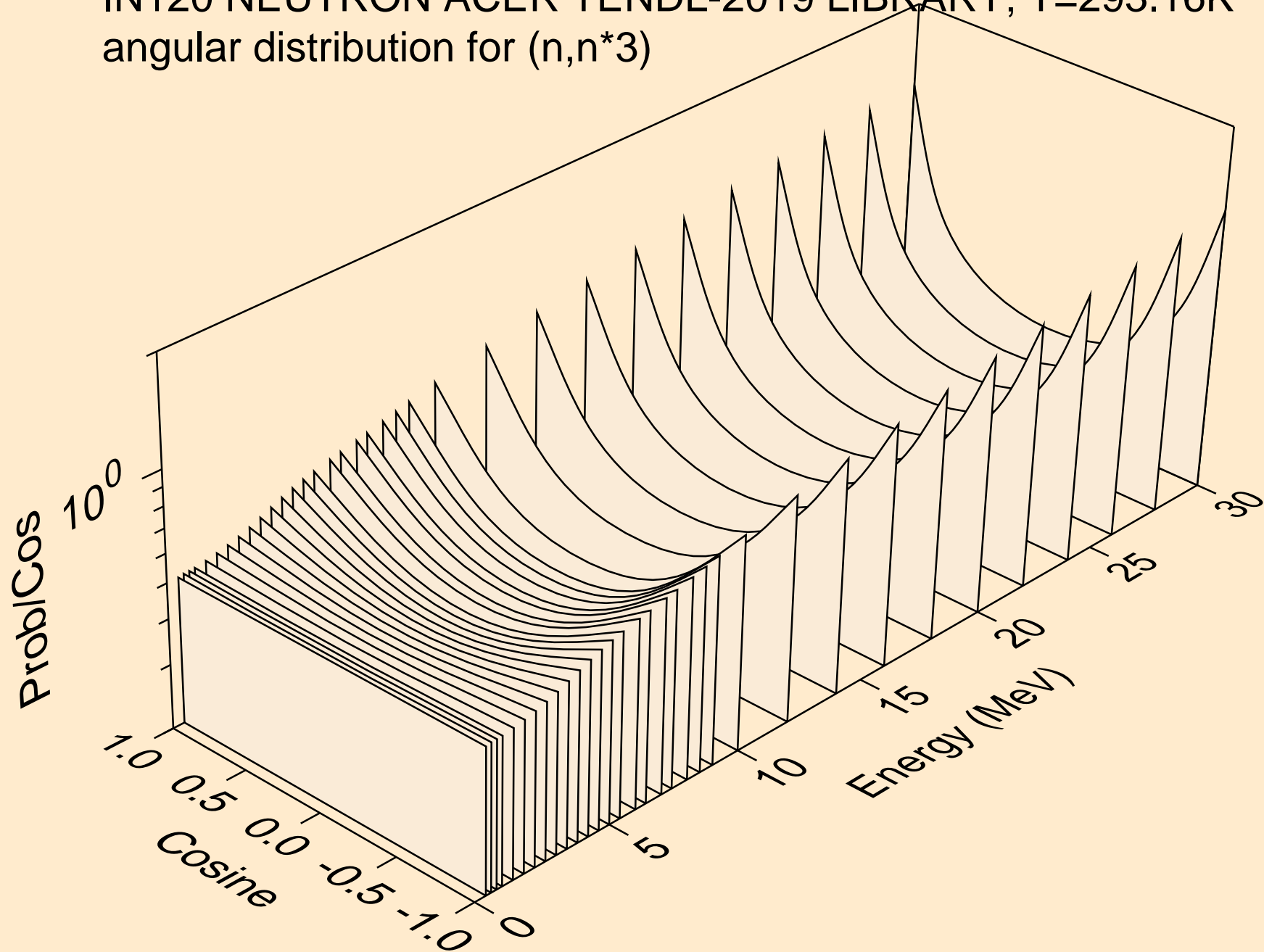

IN120 NEUTRON ACER TENDL-2019 LIBRARY; T=293.16K  
angular distribution for (n,n\*4)

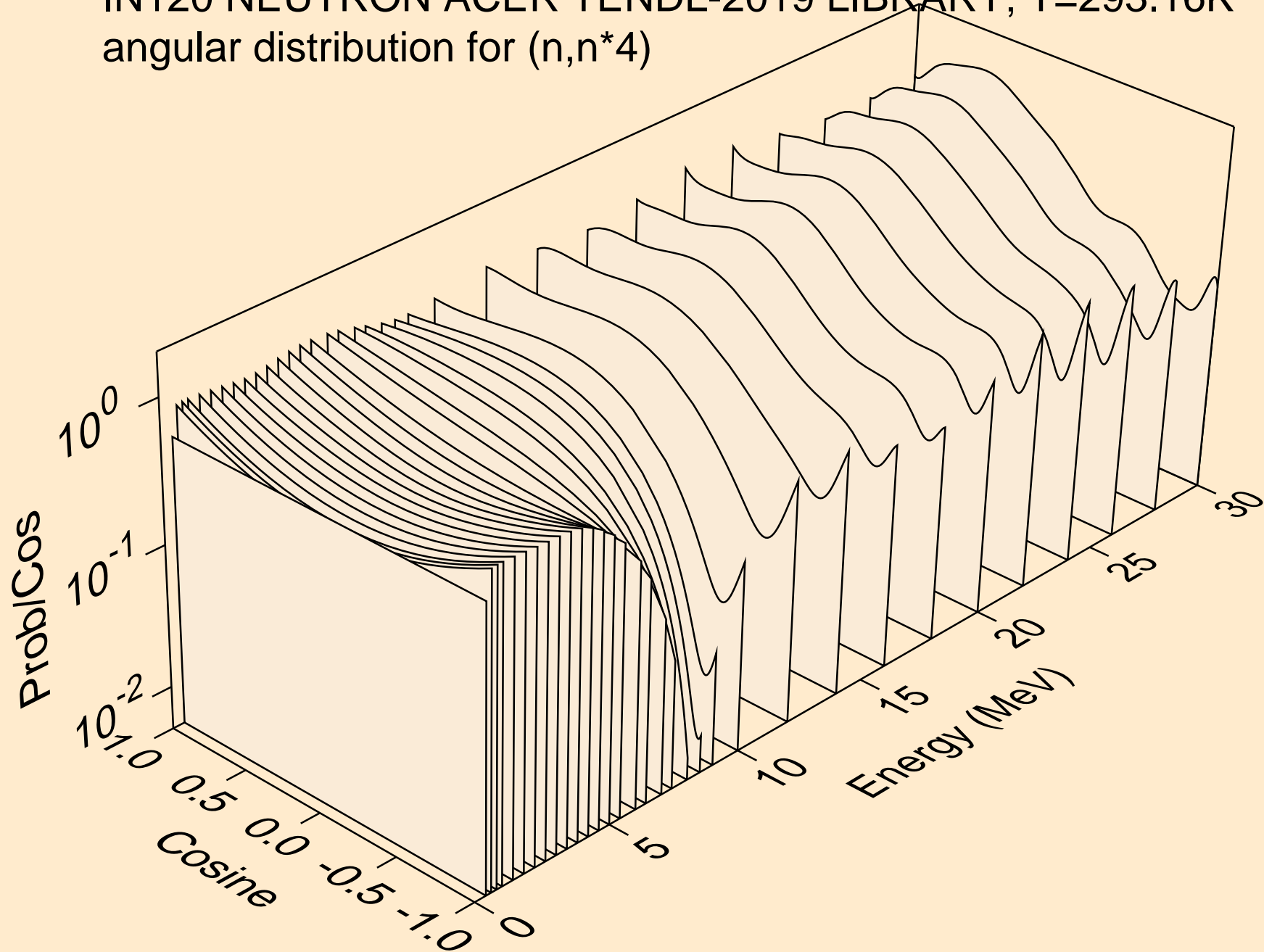



IN120 NEUTRON ACER TENDL-2019 LIBRARY; T=293.16K  
angular distribution for (n,n\*5)

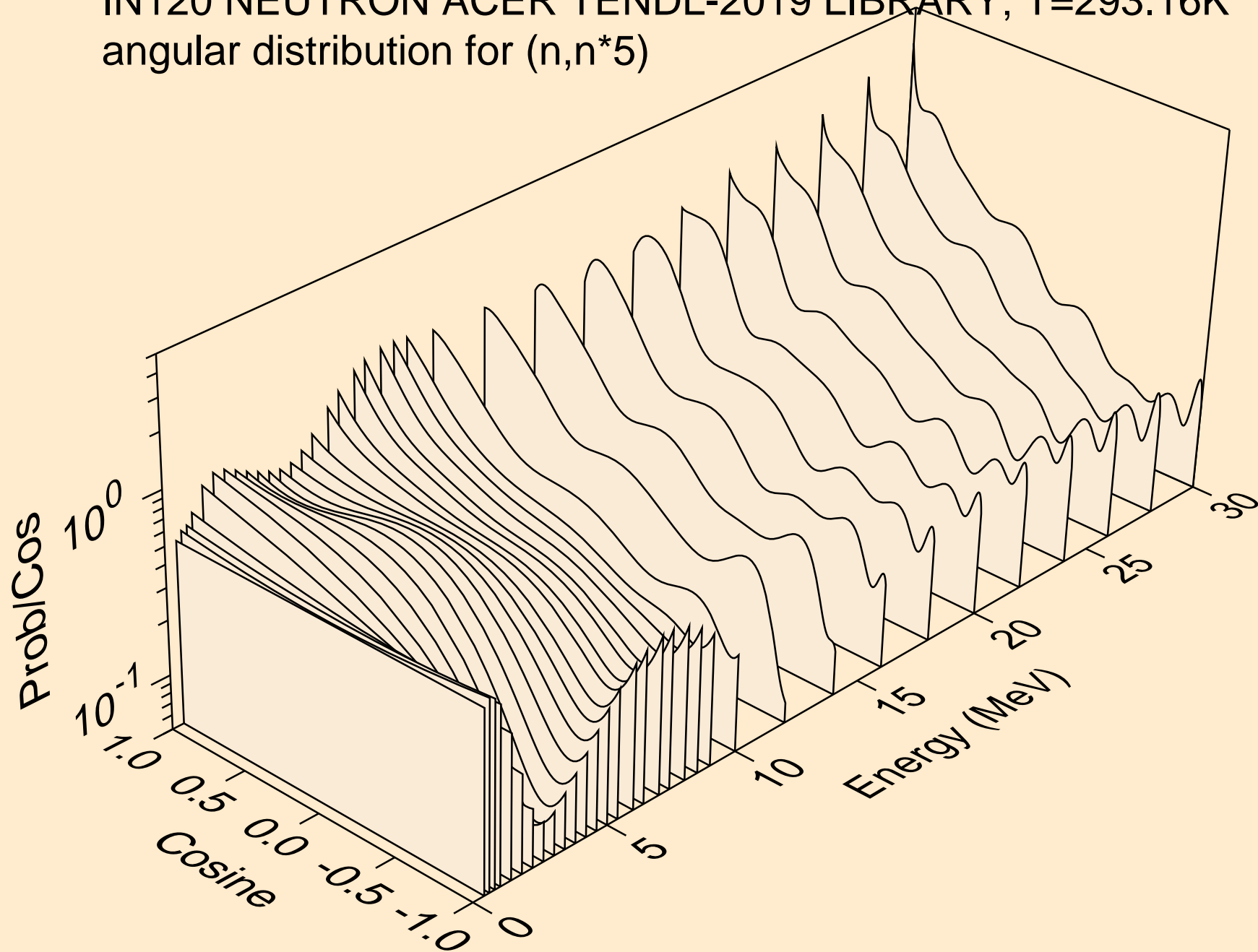

IN120 NEUTRON ACER TENDL-2019 LIBRARY; T=293.16K  
angular distribution for (n,n\*6)

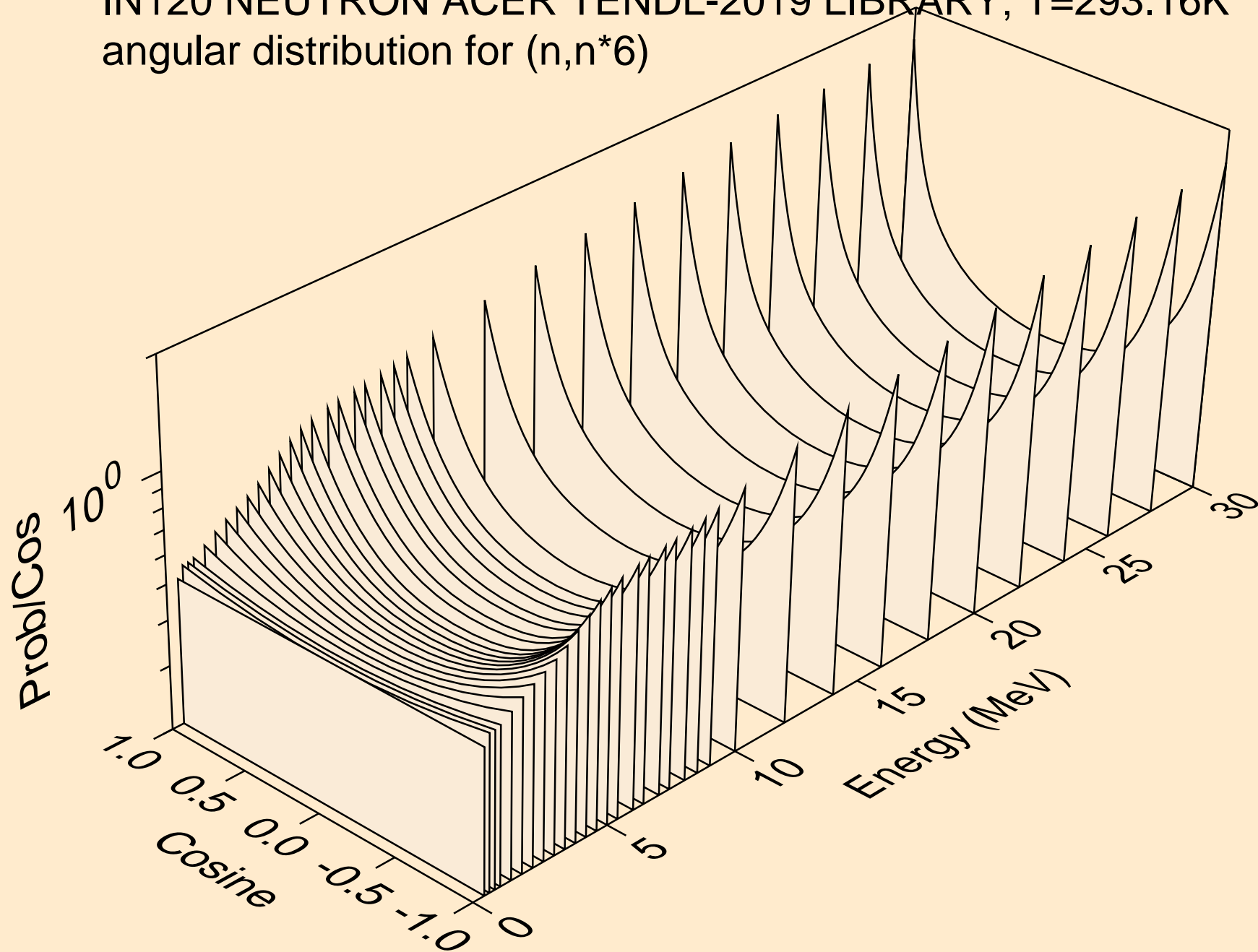

IN120 NEUTRON ACER TENDL-2019 LIBRARY; T=293.16K  
angular distribution for (n,n\*7)

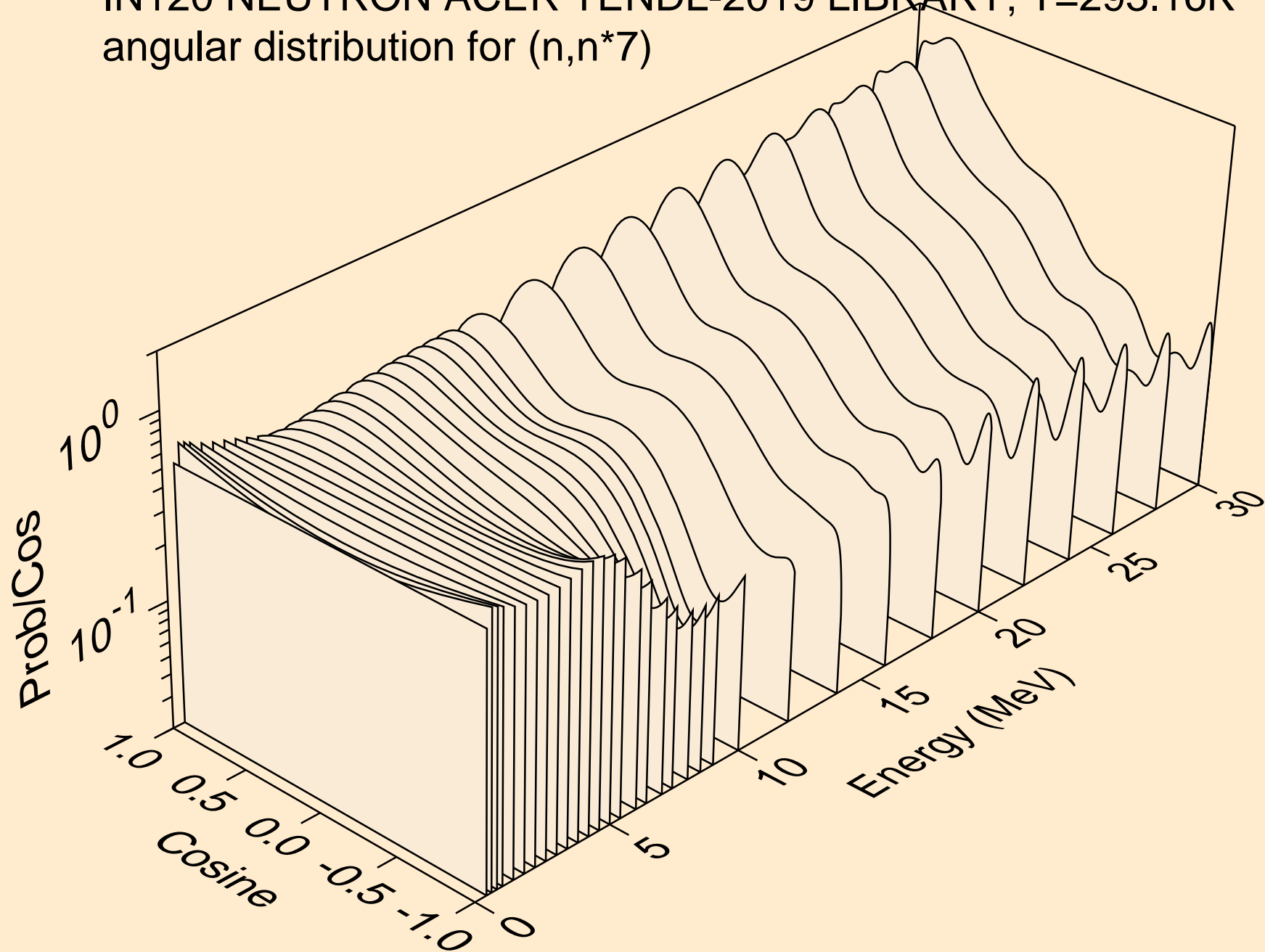

IN120 NEUTRON ACER TENDL-2019 LIBRARY; T=293.16K  
angular distribution for (n,n\*8)

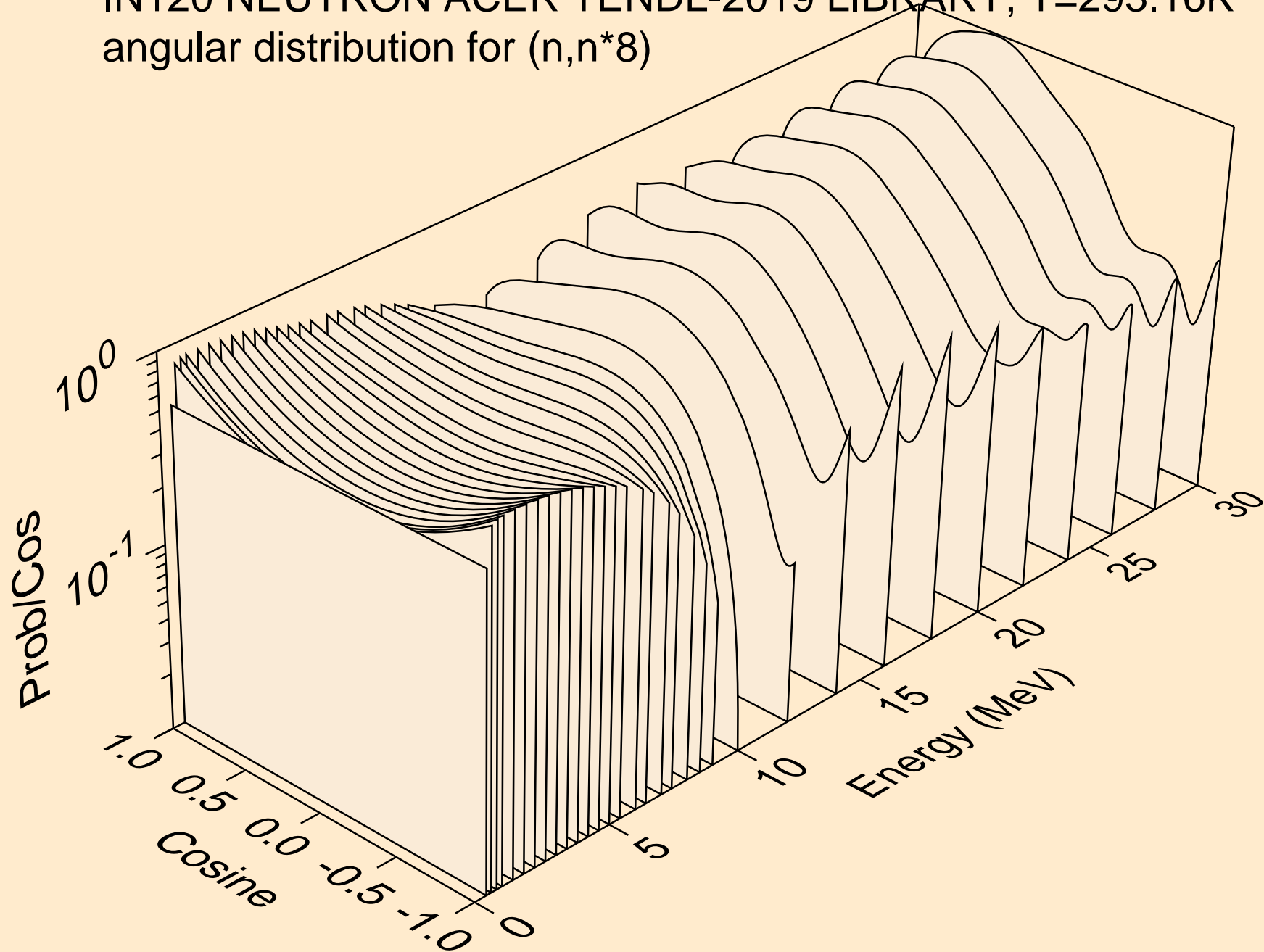

IN120 NEUTRON ACER TENDL-2019 LIBRARY; T=293.16K  
angular distribution for (n,n\*9)

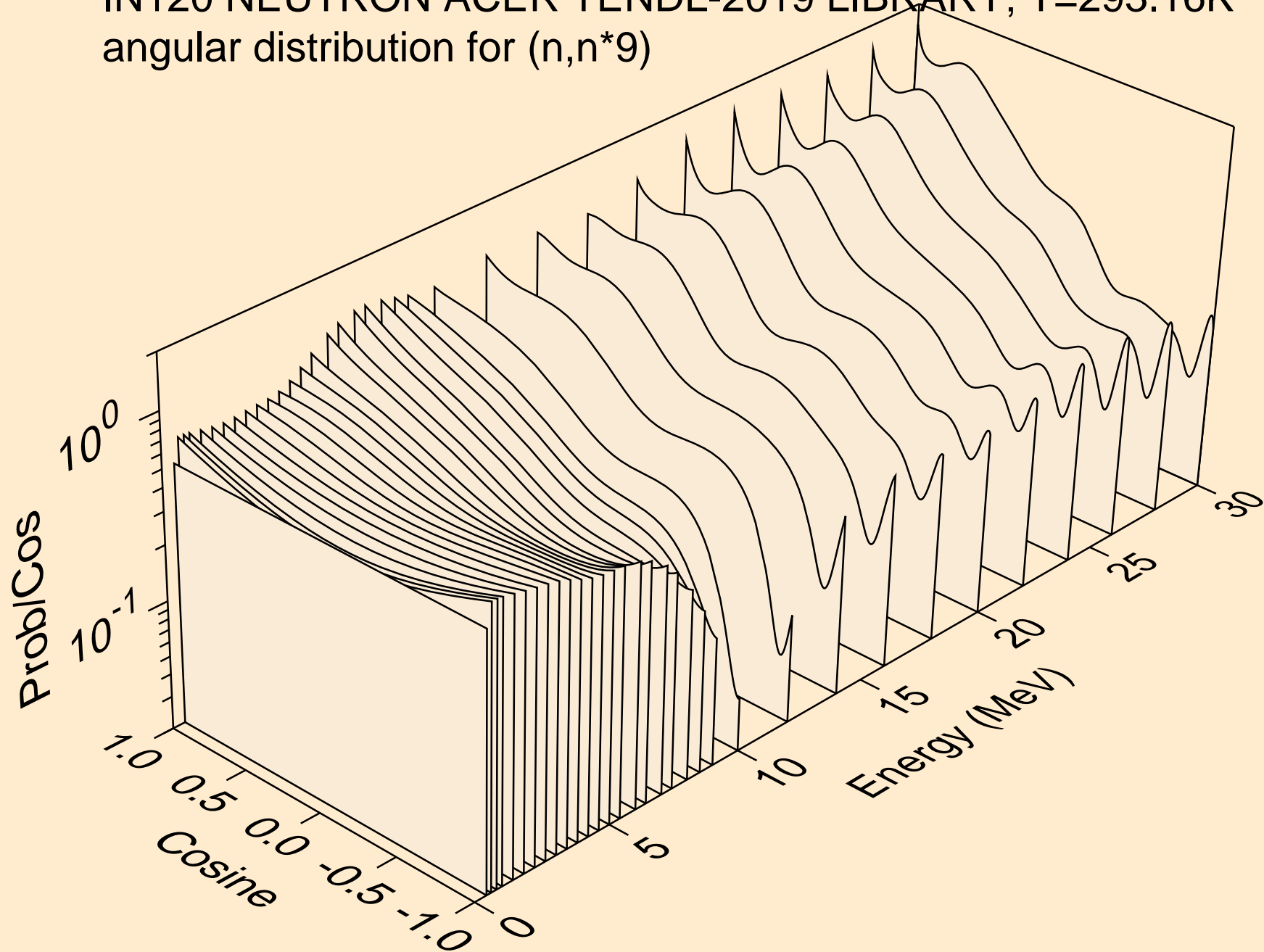

IN120 NEUTRON ACER TENDL-2019 LIBRARY; T=293.16K  
angular distribution for (n,n\*10)

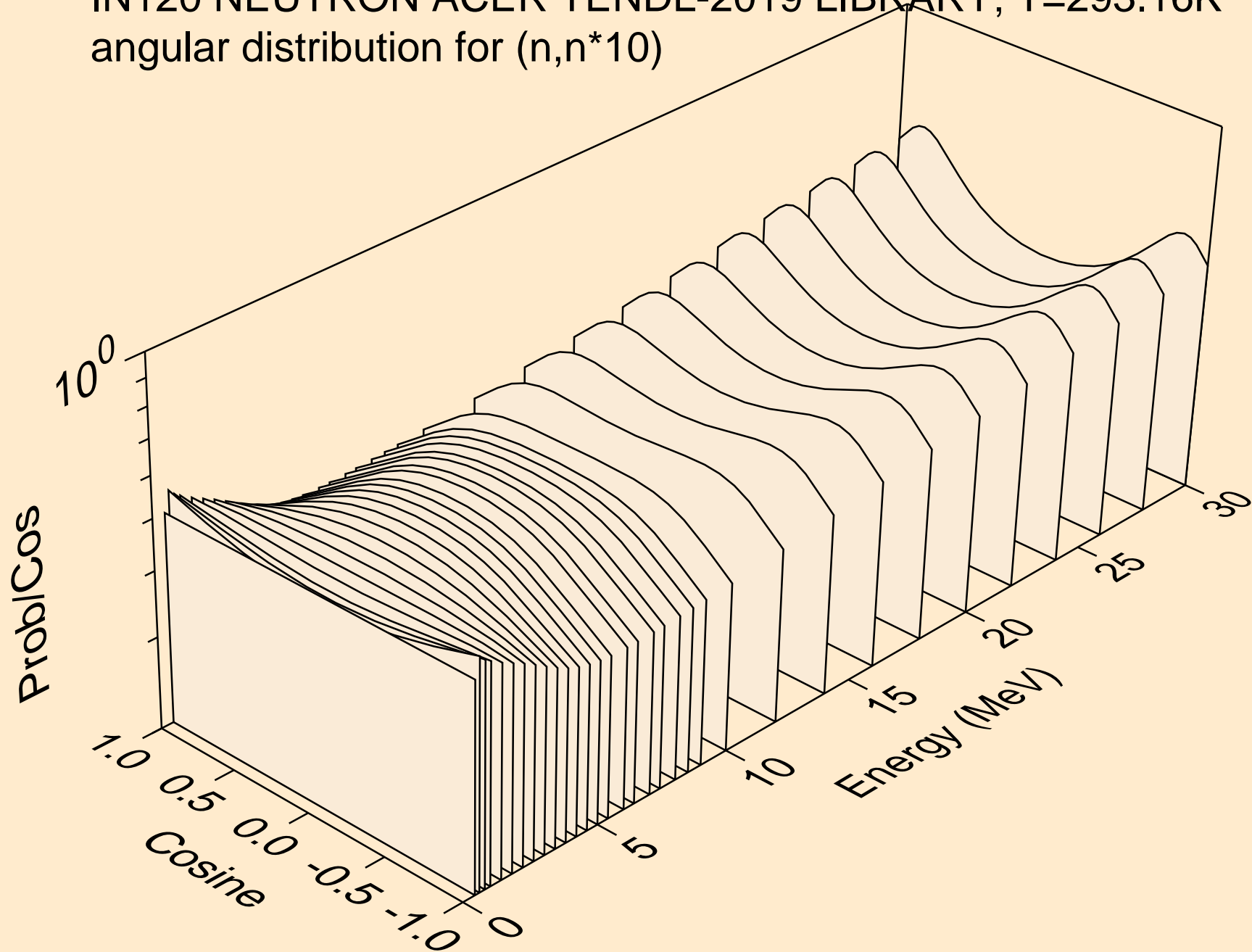

IN120 NEUTRON ACER TENDL-2019 LIBRARY; T=293.16K  
angular distribution for (n,n\*11)

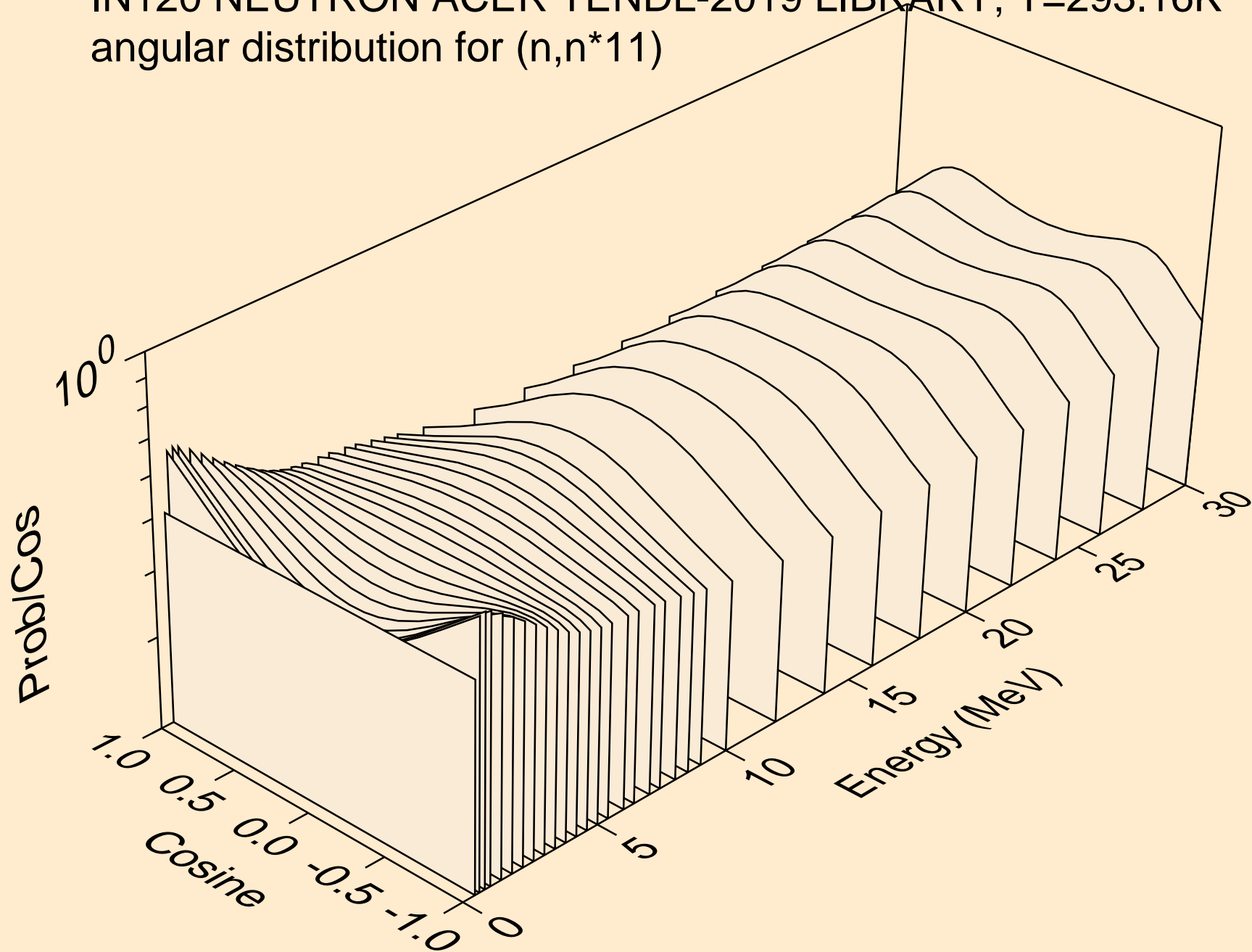

IN120 NEUTRON ACER TENDL-2019 LIBRARY; T=293.16K  
angular distribution for (n,n\*12)

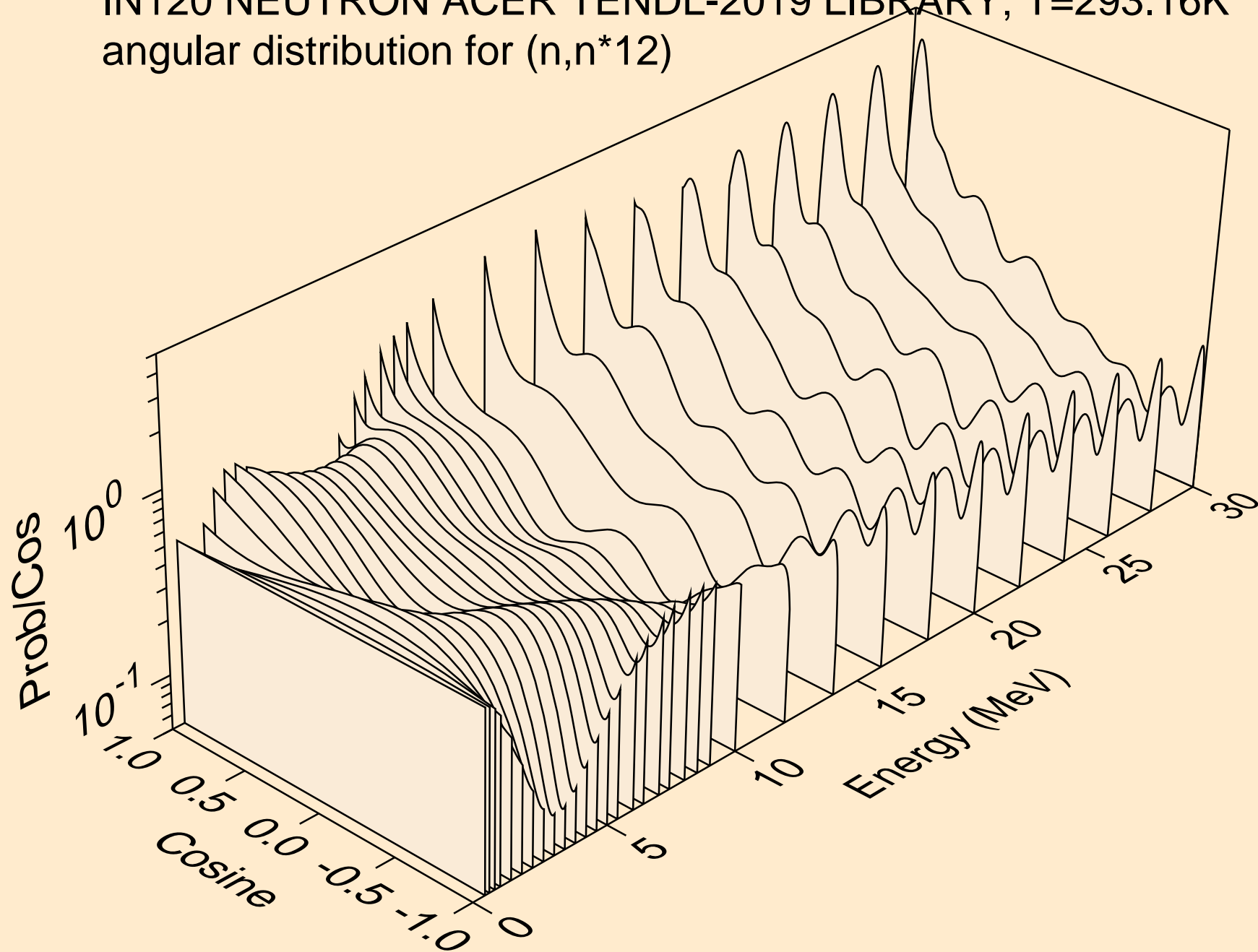



IN120 NEUTRON ACER TENDL-2019 LIBRARY; T=293.16K  
angular distribution for (n,n\*13)

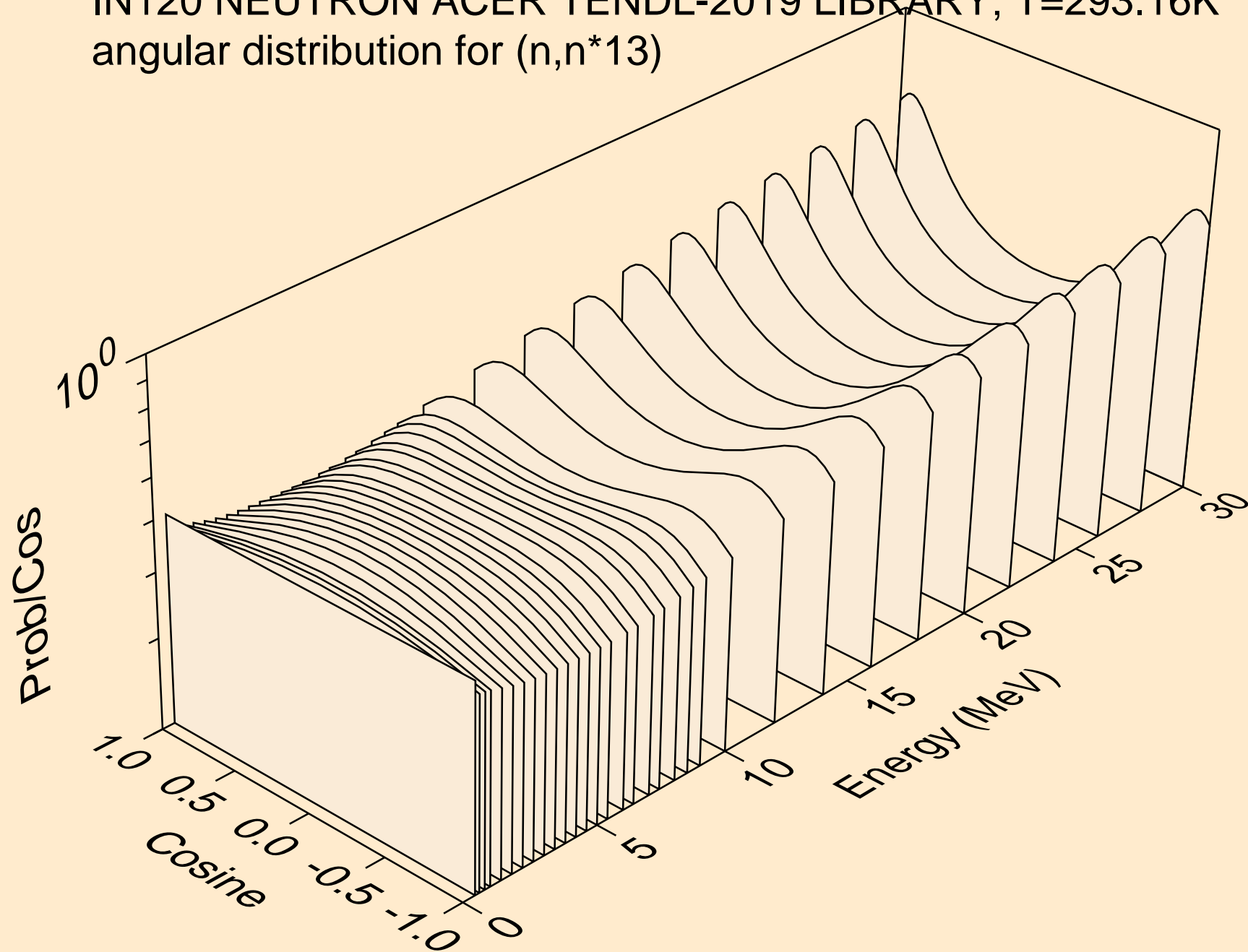

IN120 NEUTRON ACER TENDL-2019 LIBRARY; T=293.16K  
angular distribution for (n,n\*14)

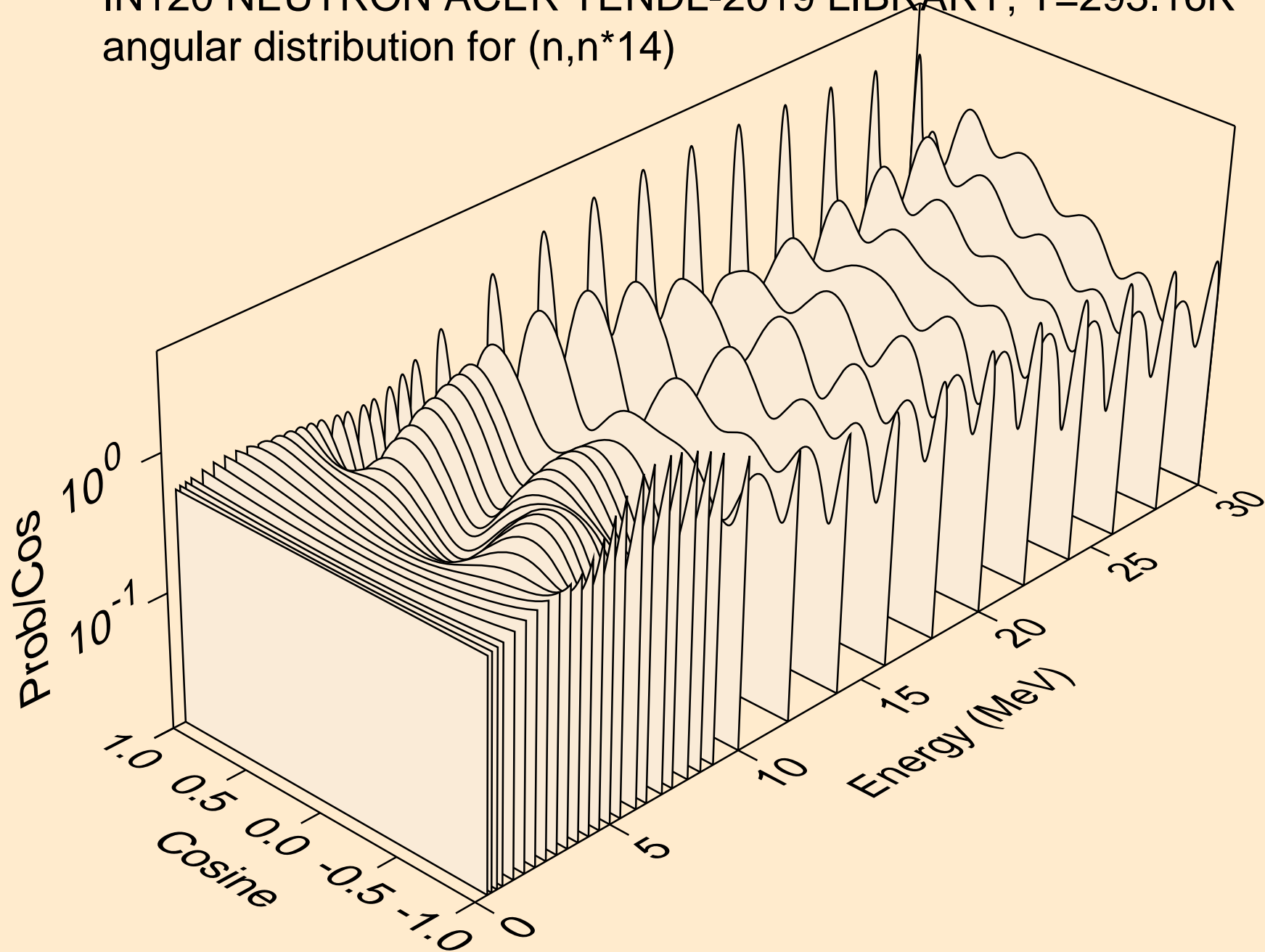

IN120 NEUTRON ACER TENDL-2019 LIBRARY; T=293.16K  
angular distribution for (n,n\*15)

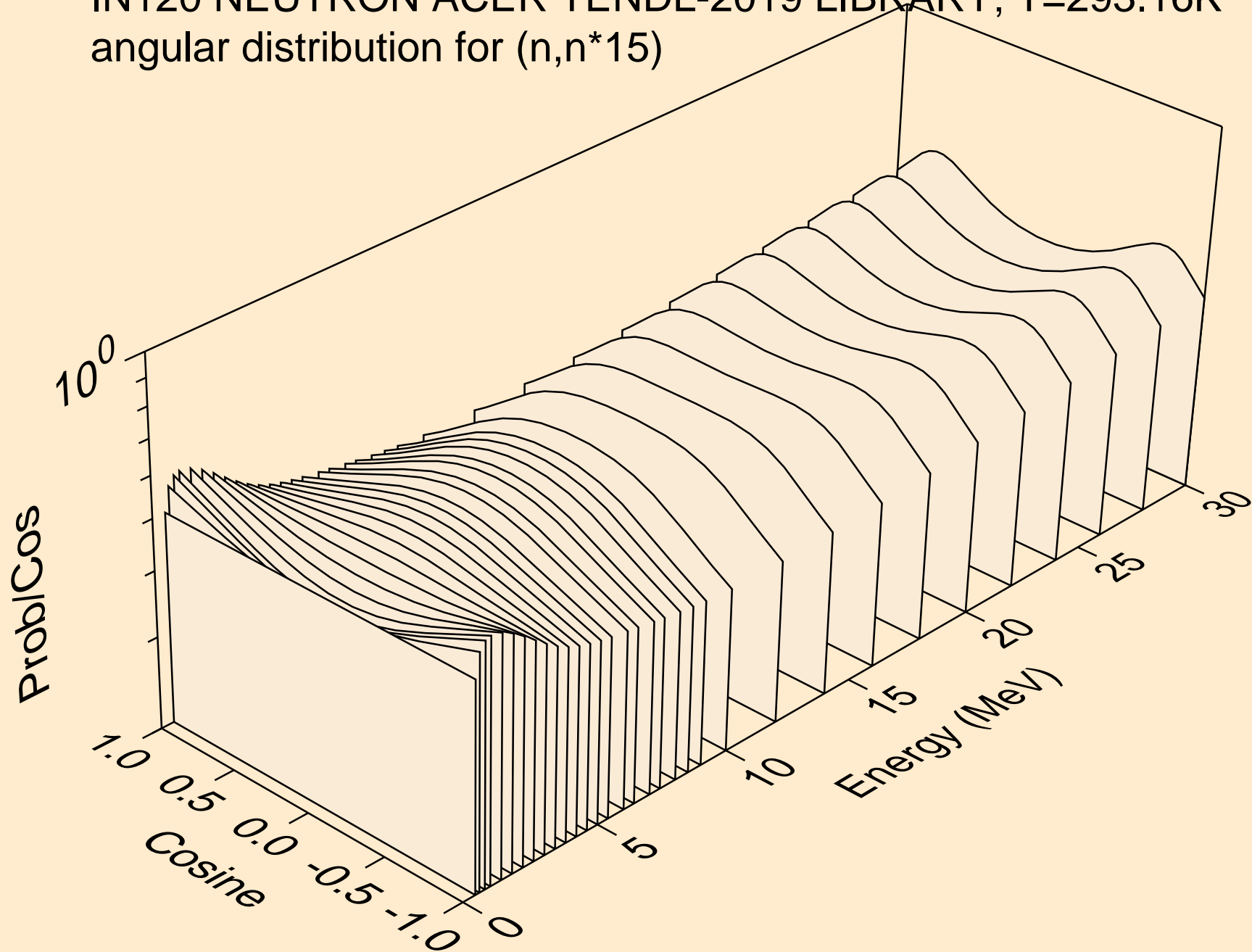

IN120 NEUTRON ACER TENDL-2019 LIBRARY; T=293.16K  
angular distribution for (n,n\*16)

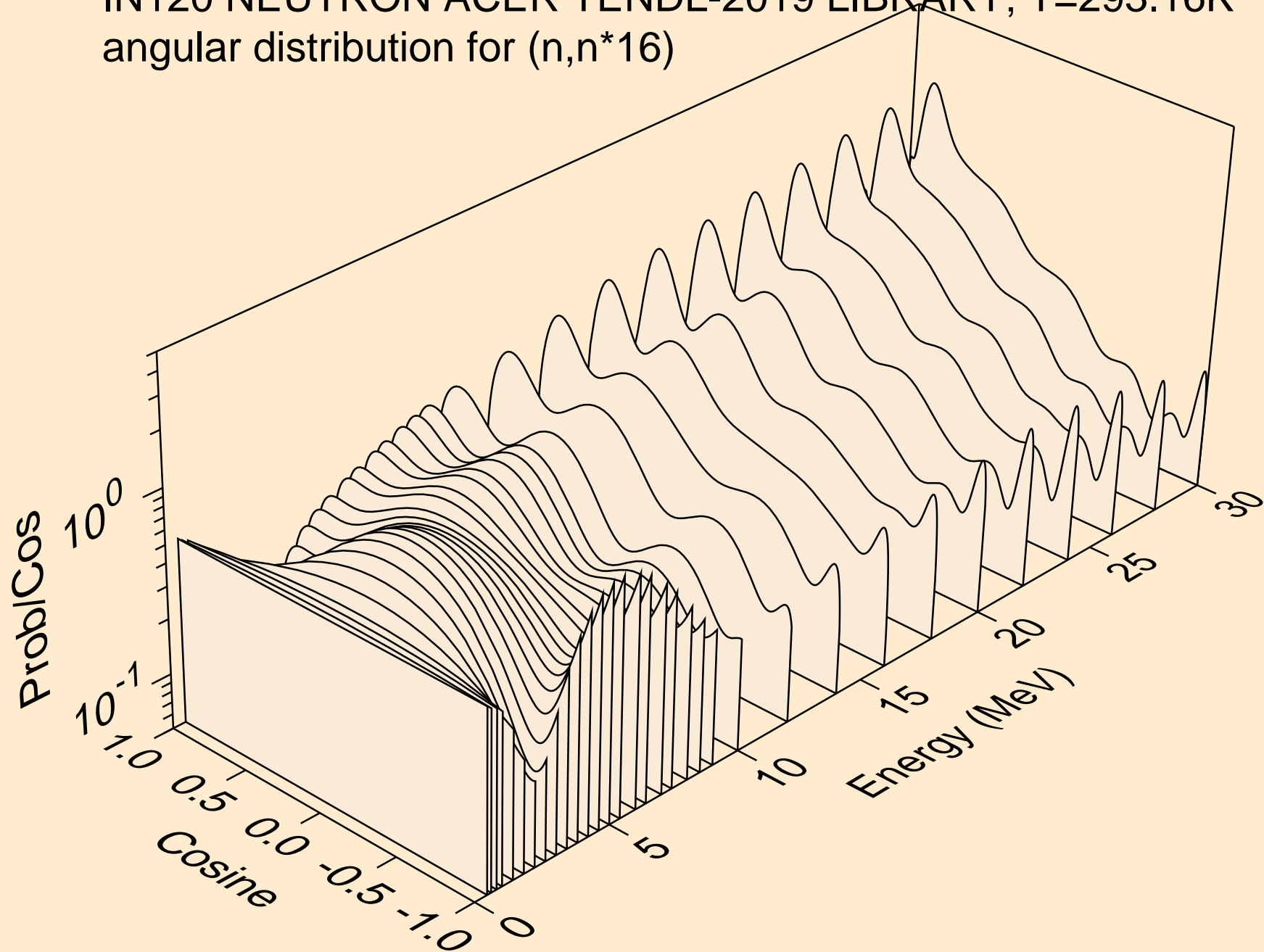

IN120 NEUTRON ACER TENDL-2019 LIBRARY; T=293.16K  
angular distribution for (n,n\*17)

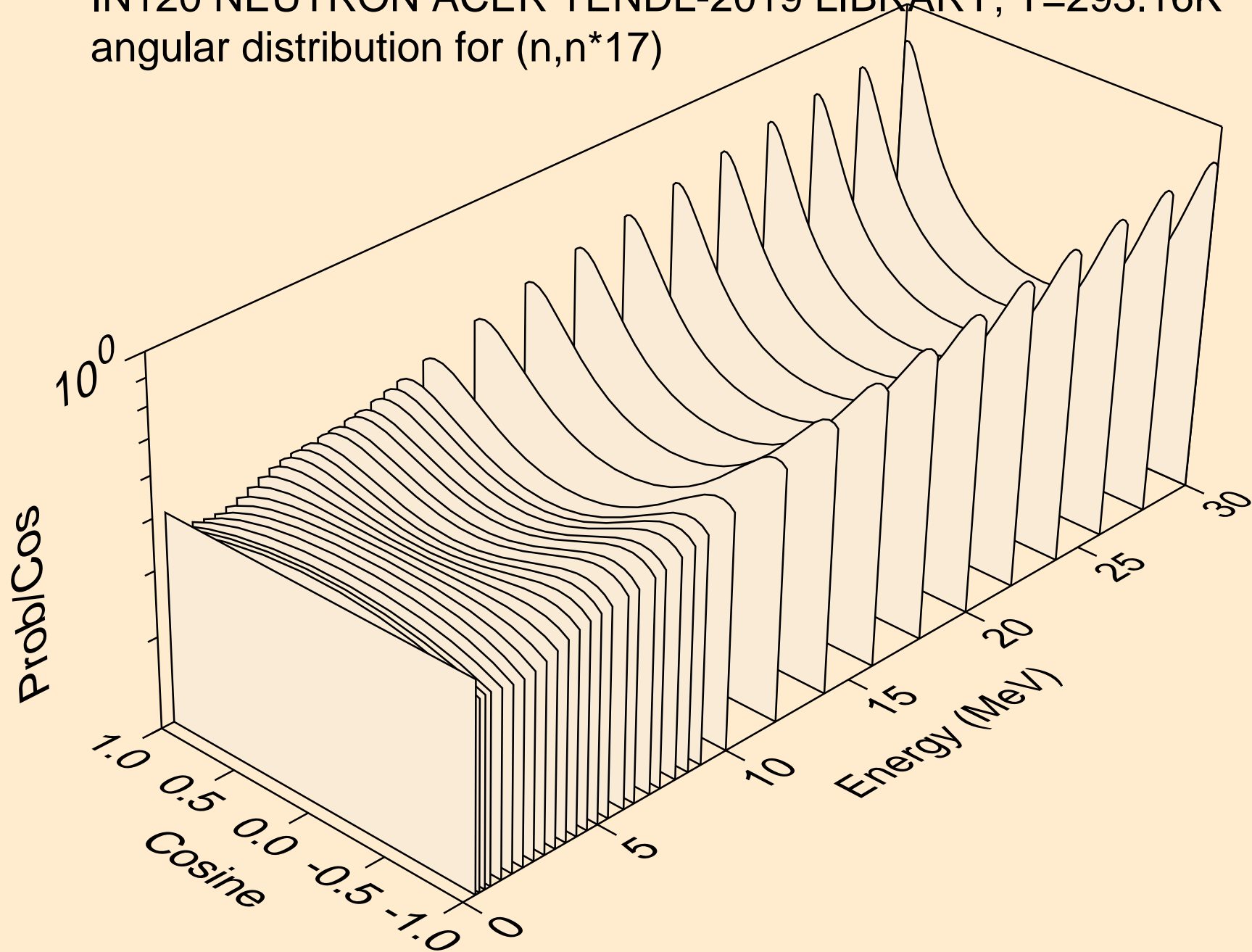

IN120 NEUTRON ACER TENDL-2019 LIBRARY; T=293.16K  
angular distribution for (n,n\*18)

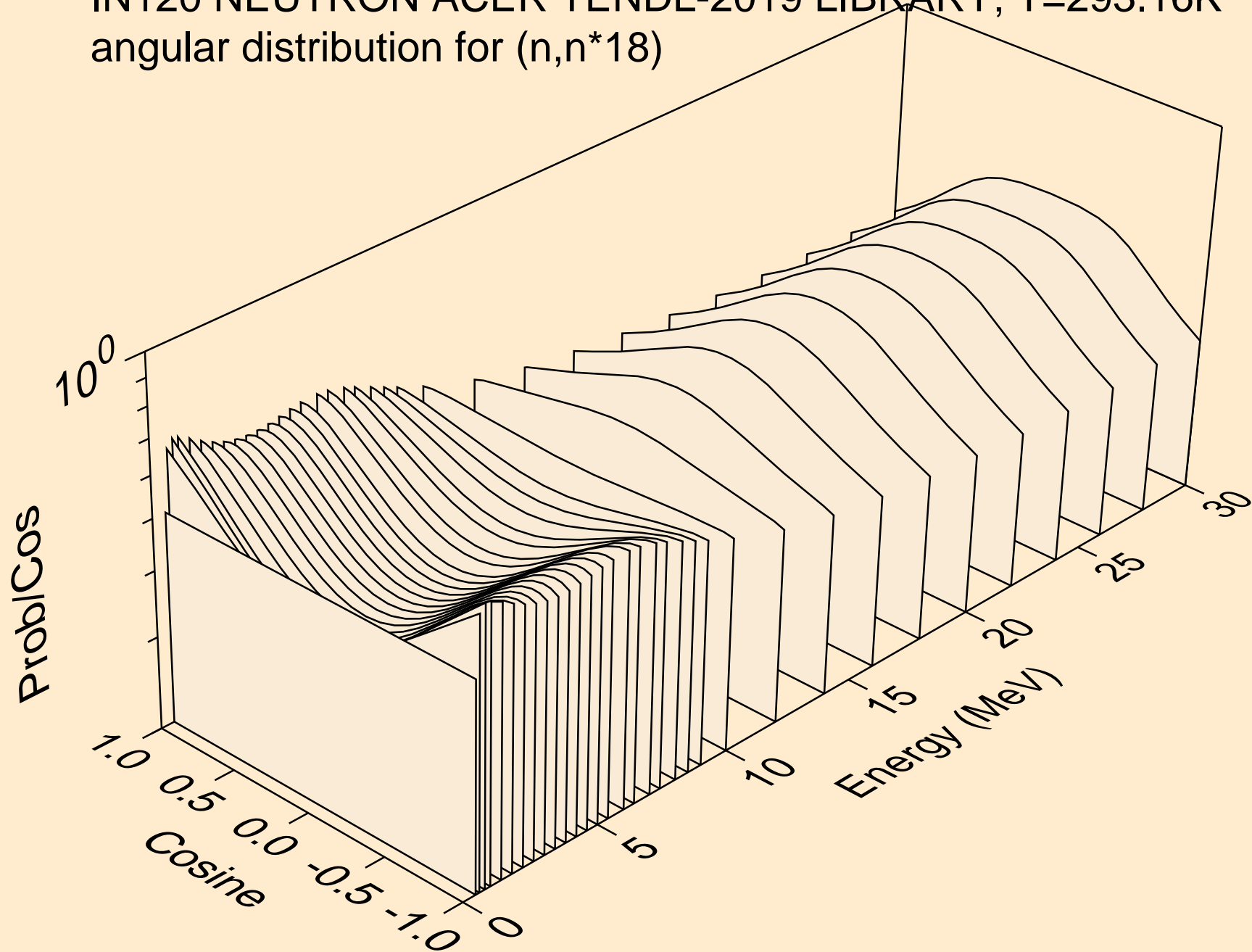

IN120 NEUTRON ACER TENDL-2019 LIBRARY; T=293.16K  
angular distribution for (n,n\*19)

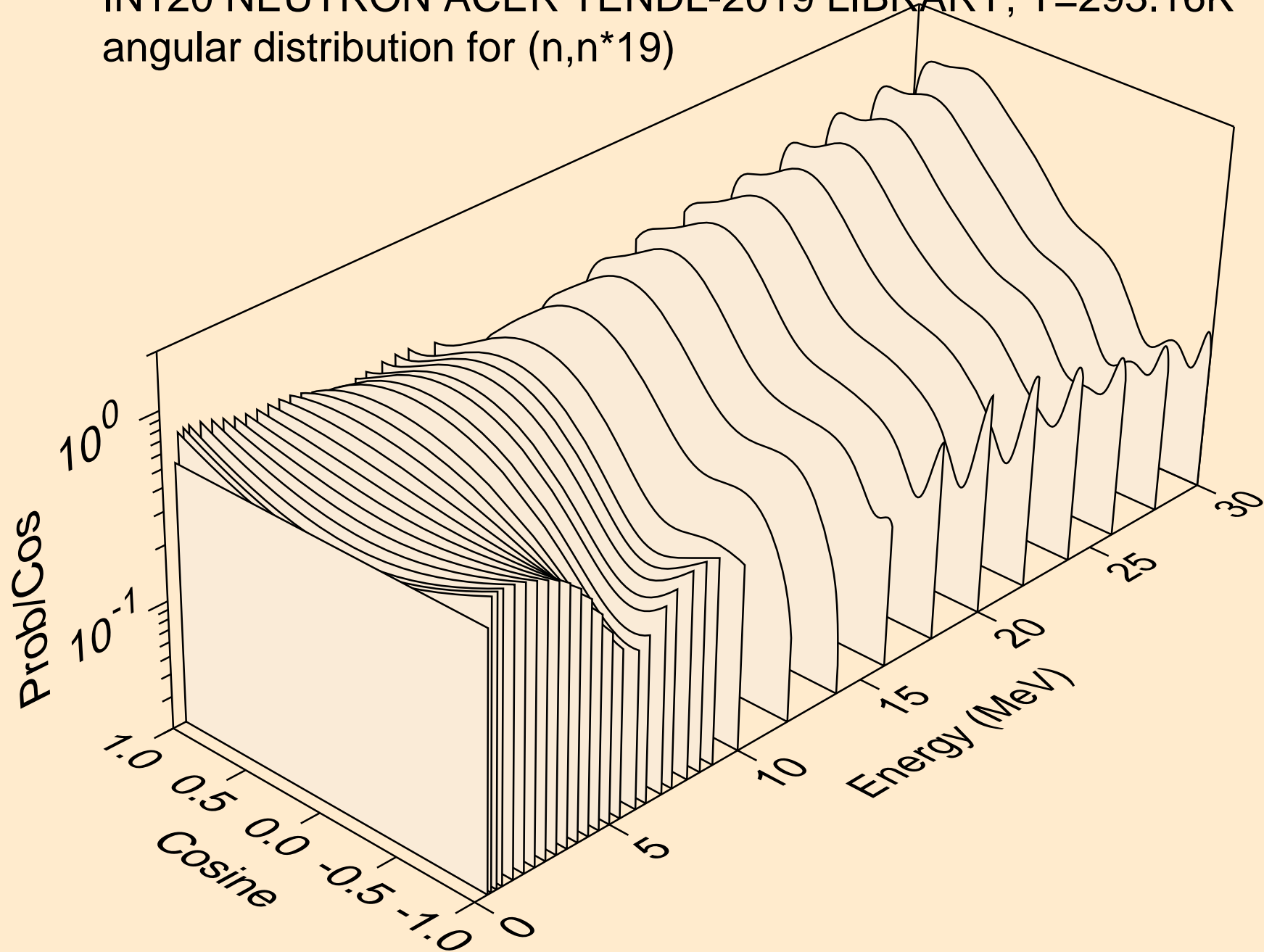

IN120 NEUTRON ACER TENDL-2019 LIBRARY; T=293.16K  
angular distribution for (n,n\*20)

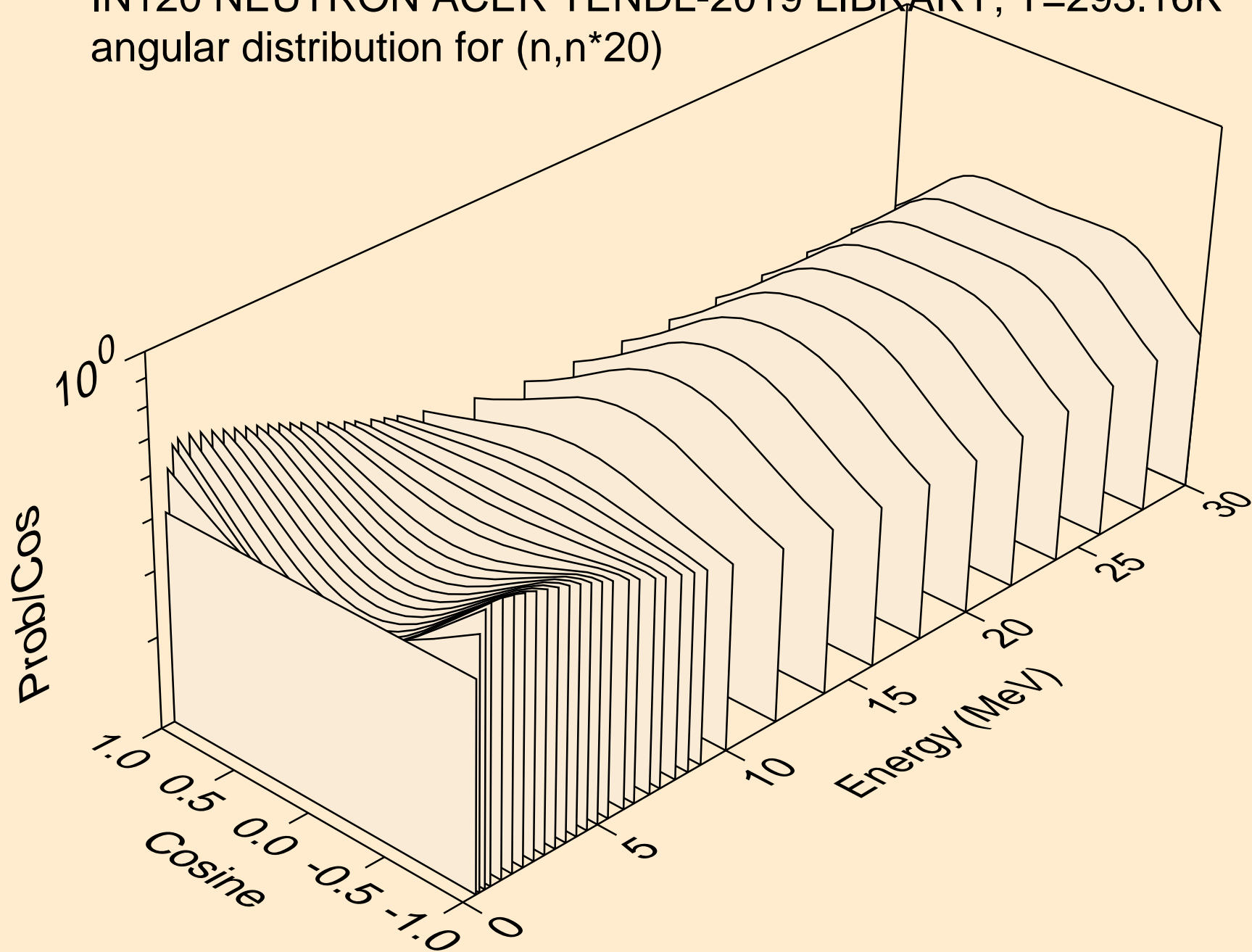



IN120 NEUTRON ACER TENDL-2019 LIBRARY; T=293.16K  
angular distribution for (n,n\*21)

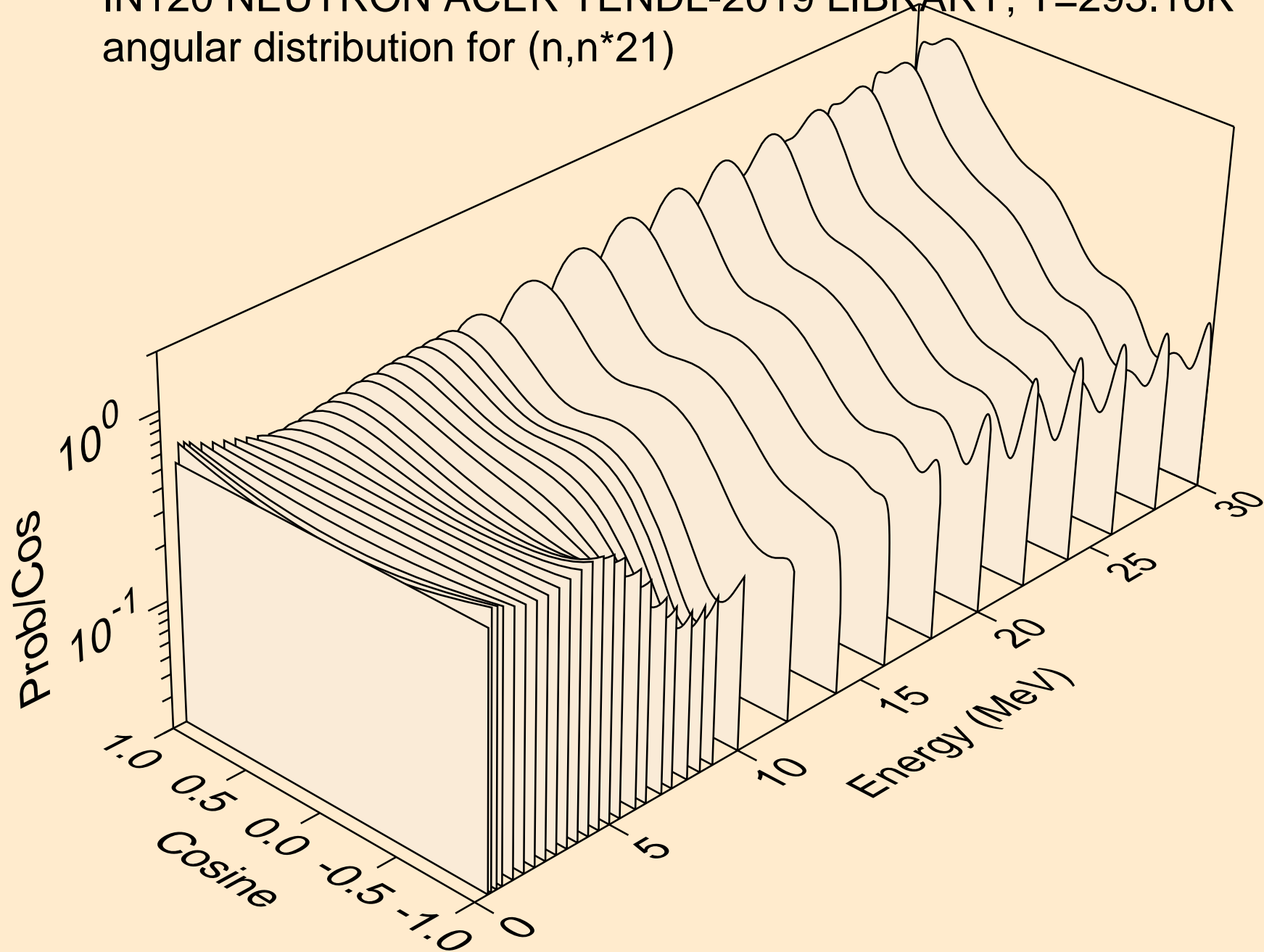

IN120 NEUTRON ACER TENDL-2019 LIBRARY; T=293.16K  
angular distribution for (n,n\*22)

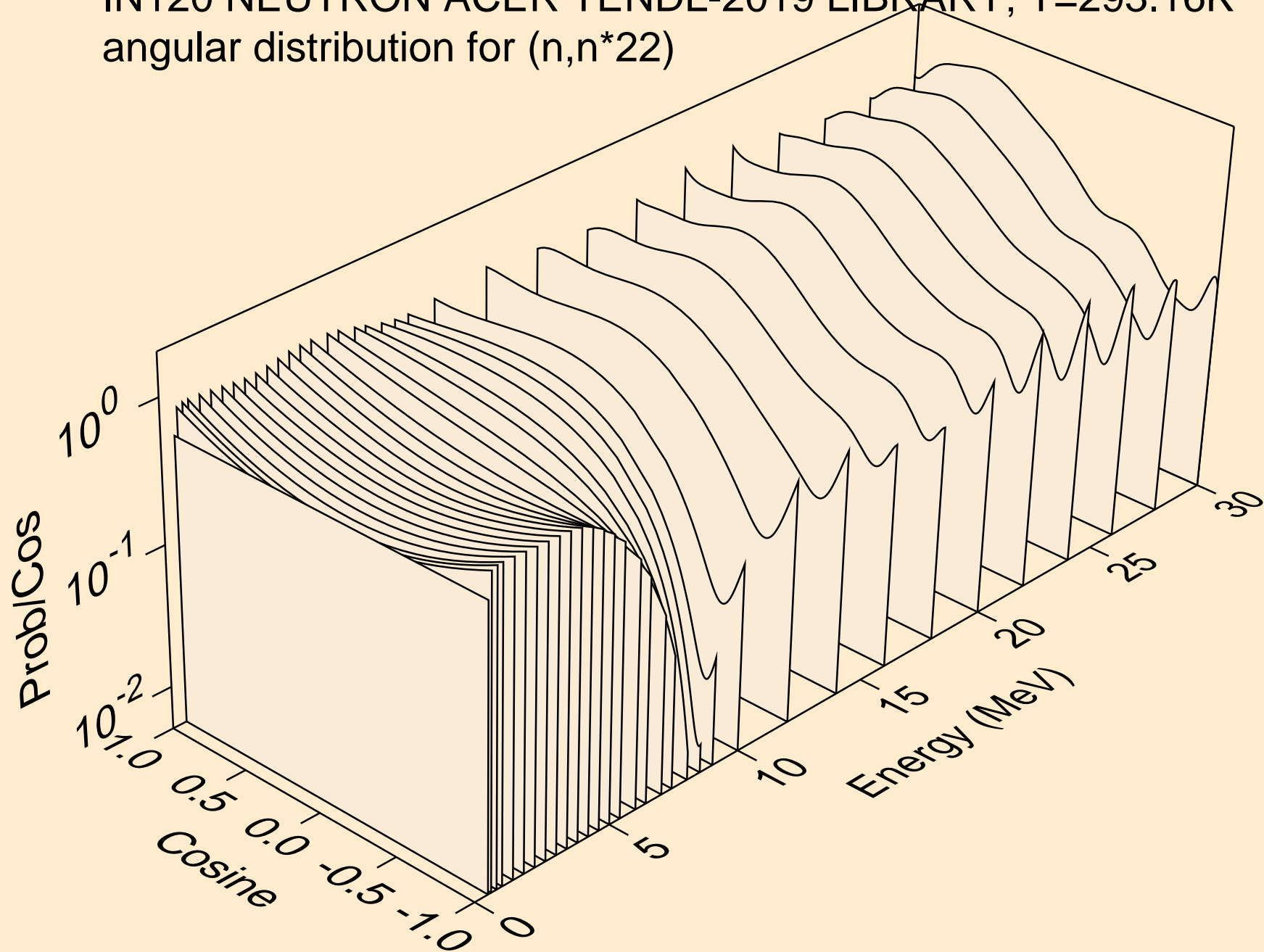

IN120 NEUTRON ACER TENDL-2019 LIBRARY; T=293.16K  
angular distribution for (n,n\*23)

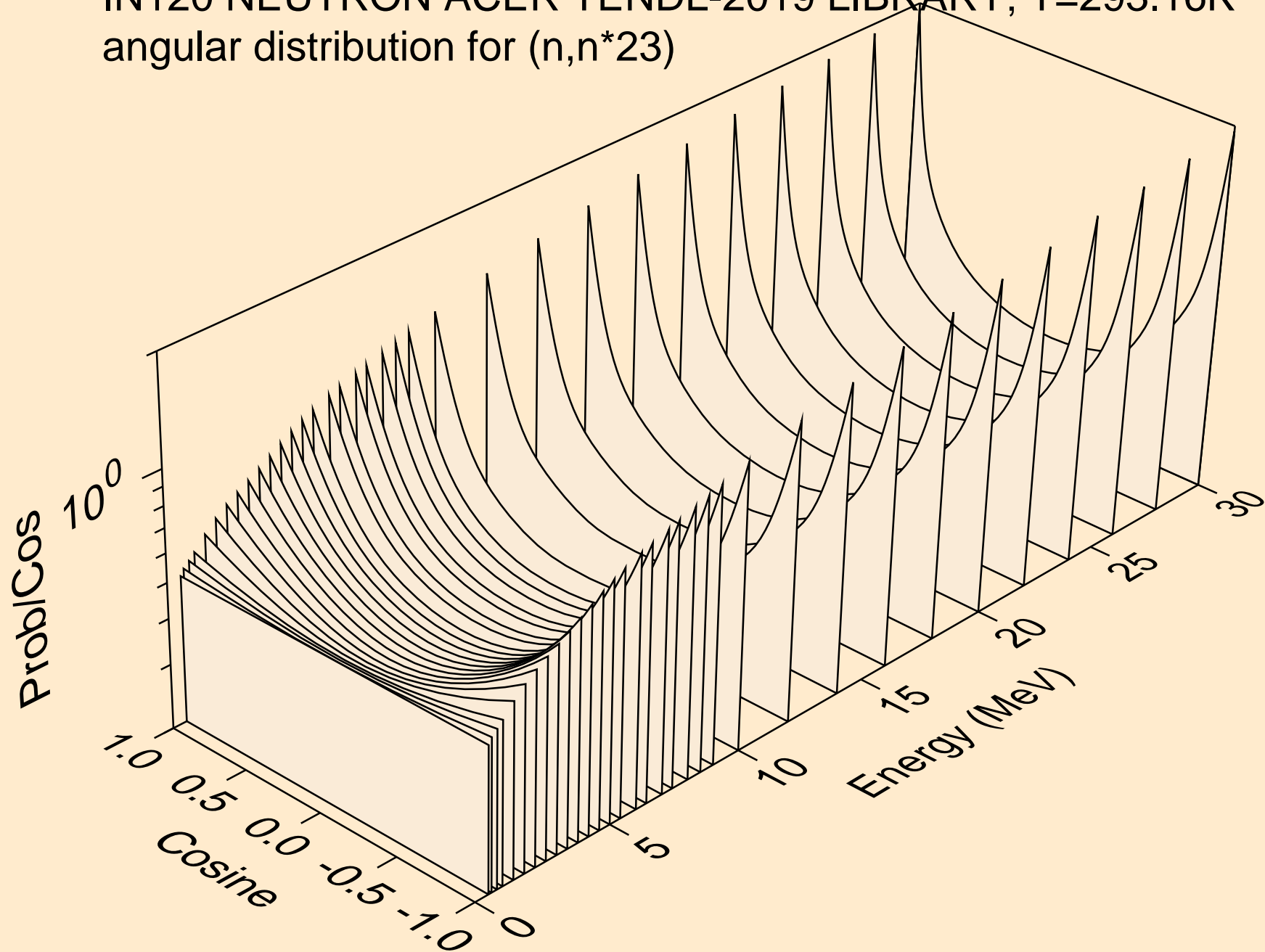

IN120 NEUTRON ACER TENDL-2019 LIBRARY; T=293.16K  
angular distribution for (n,n\*24)

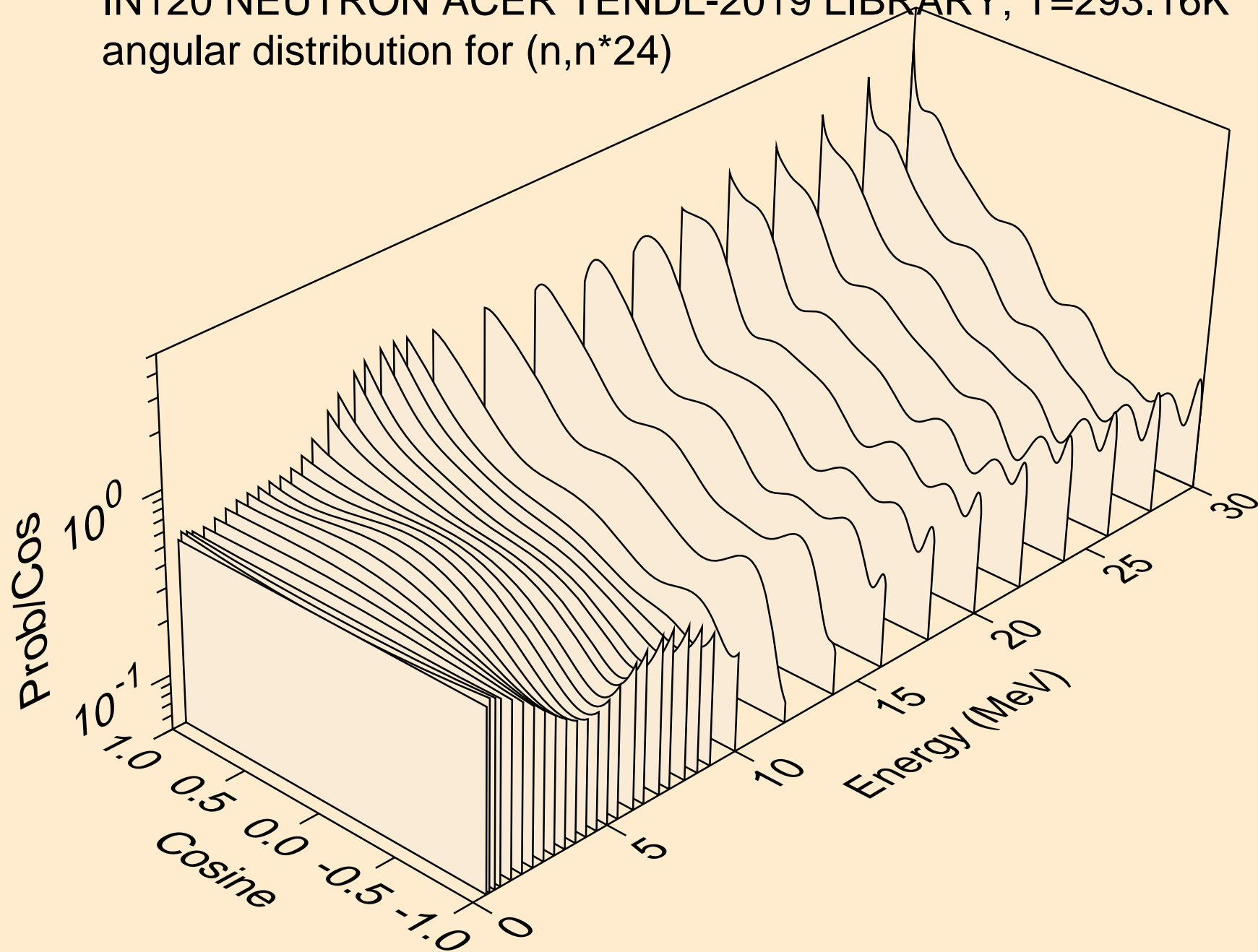

IN120 NEUTRON ACER TENDL-2019 LIBRARY; T=293.16K  
angular distribution for (n,n\*25)

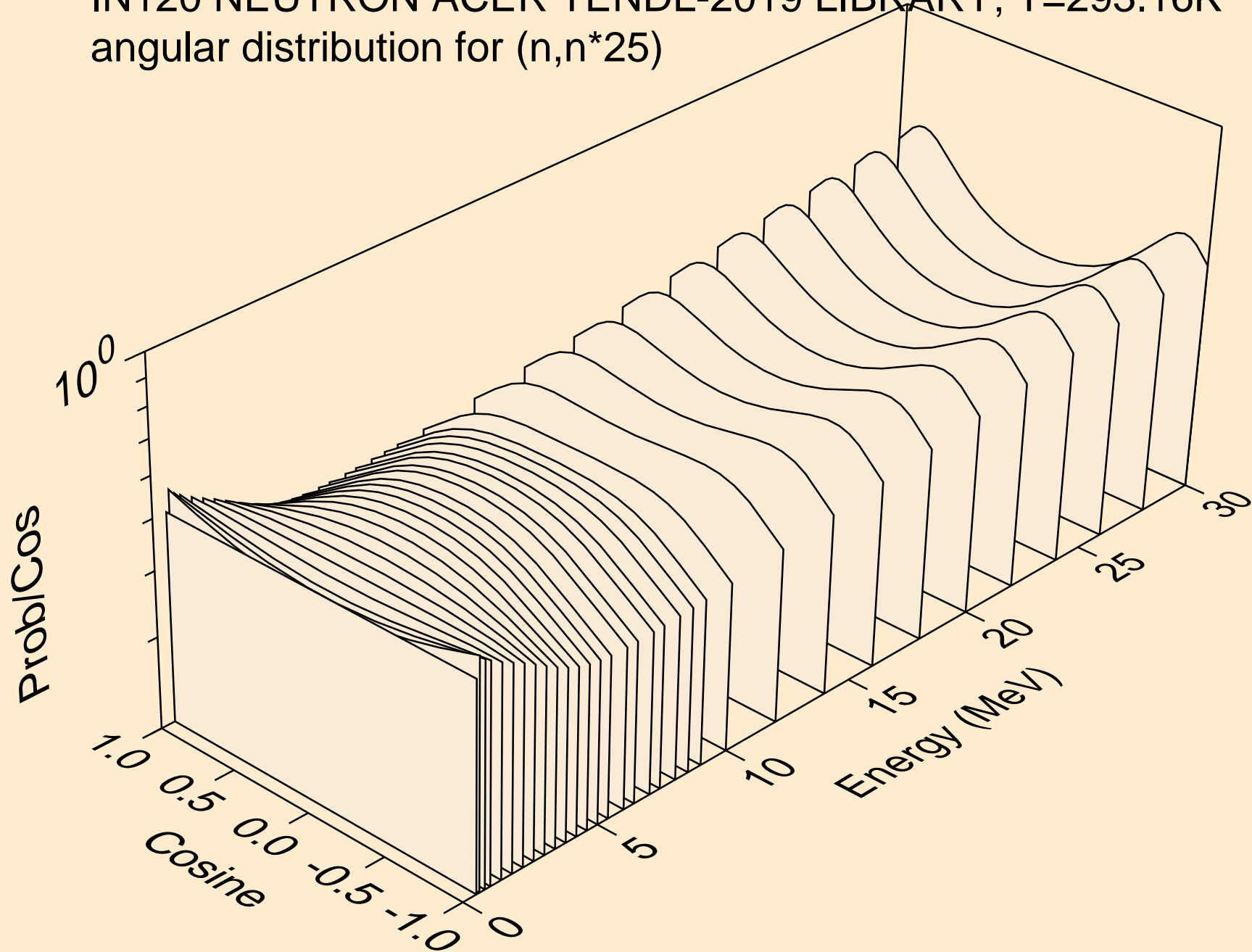

IN120 NEUTRON ACER TENDL-2019 LIBRARY; T=293.16K  
angular distribution for (n,n\*26)

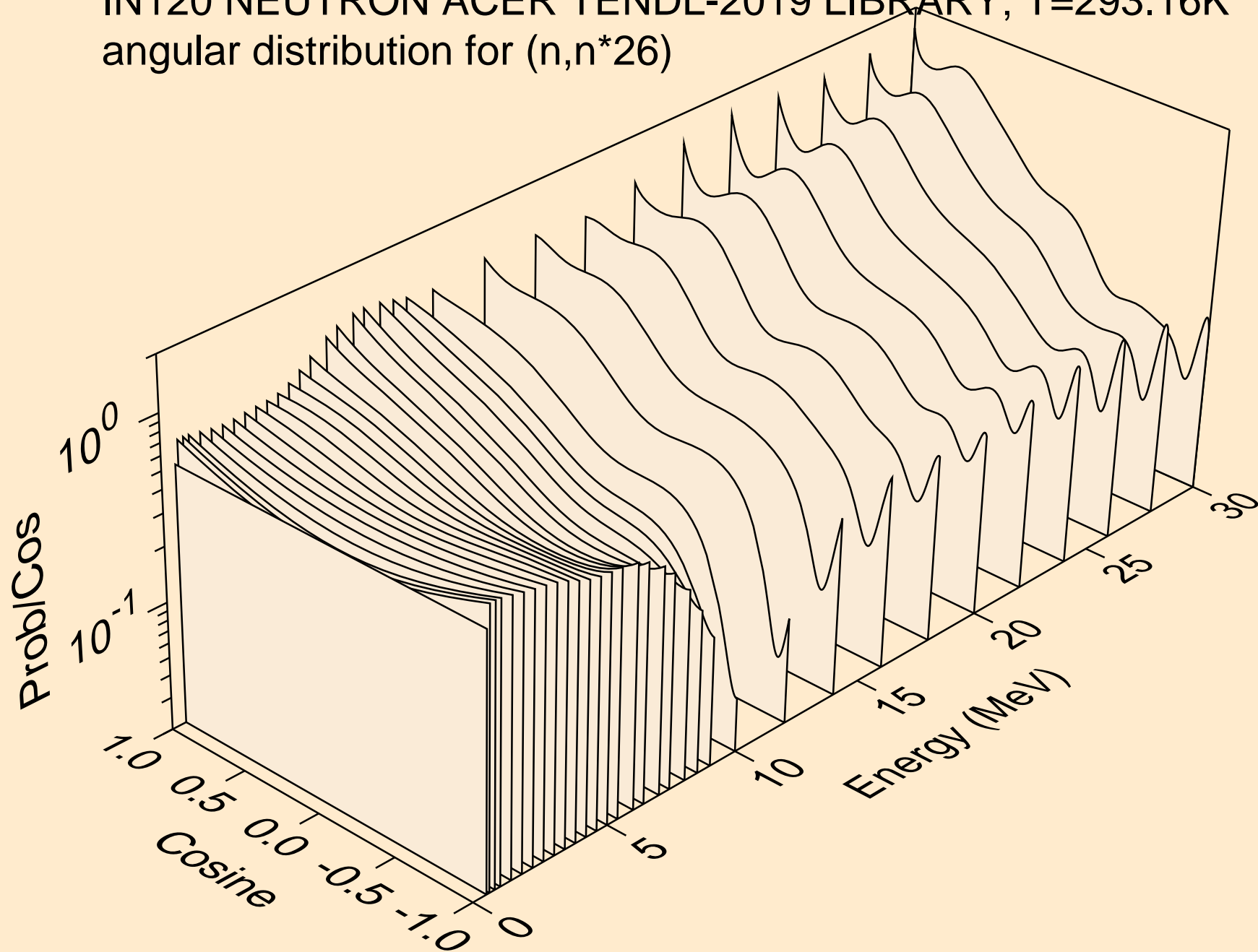

IN120 NEUTRON ACER TENDL-2019 LIBRARY; T=293.16K  
angular distribution for (n,n\*27)

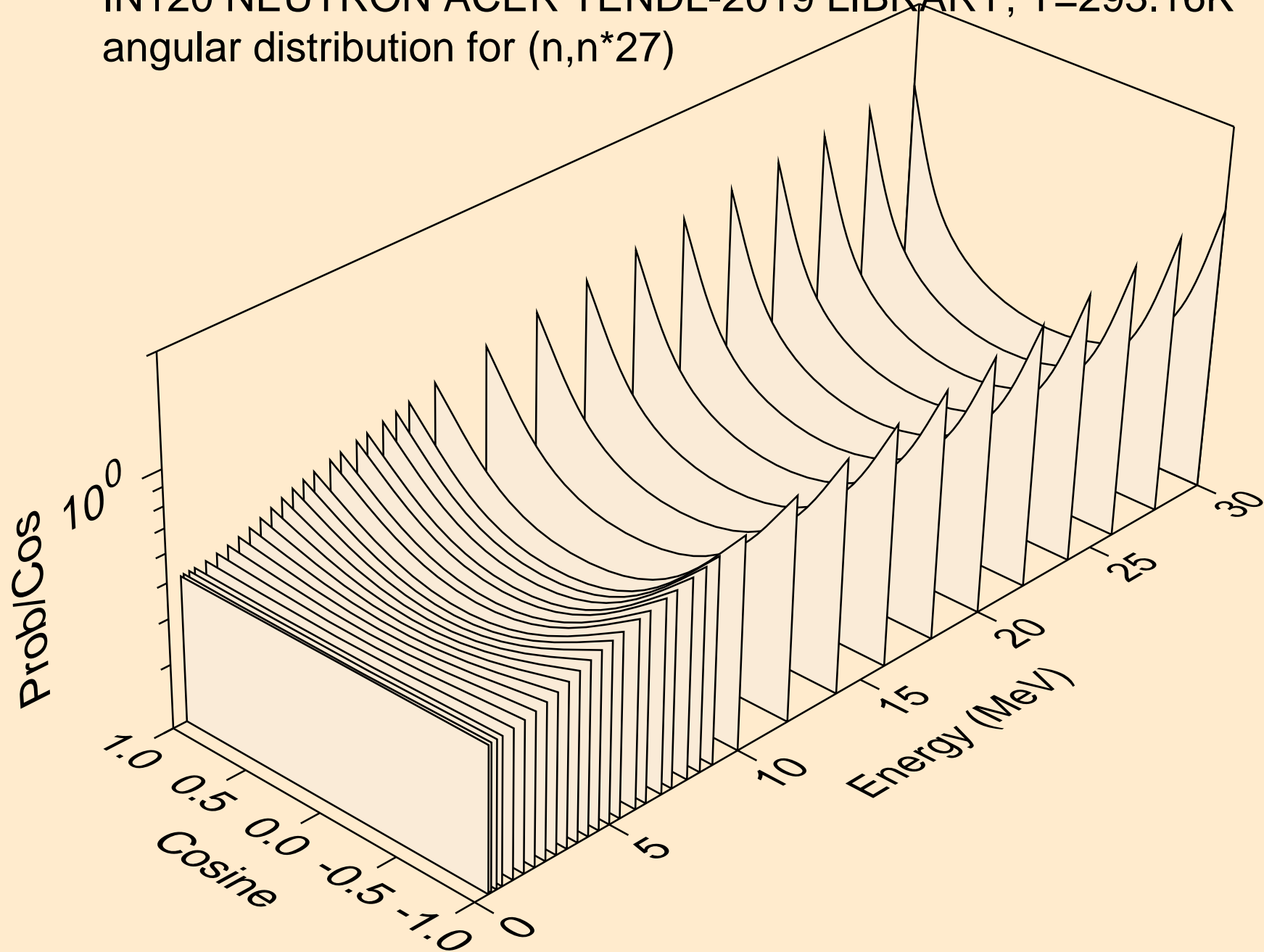

IN120 NEUTRON ACER TENDL-2019 LIBRARY; T=293.16K  
angular distribution for (n,n\*28)

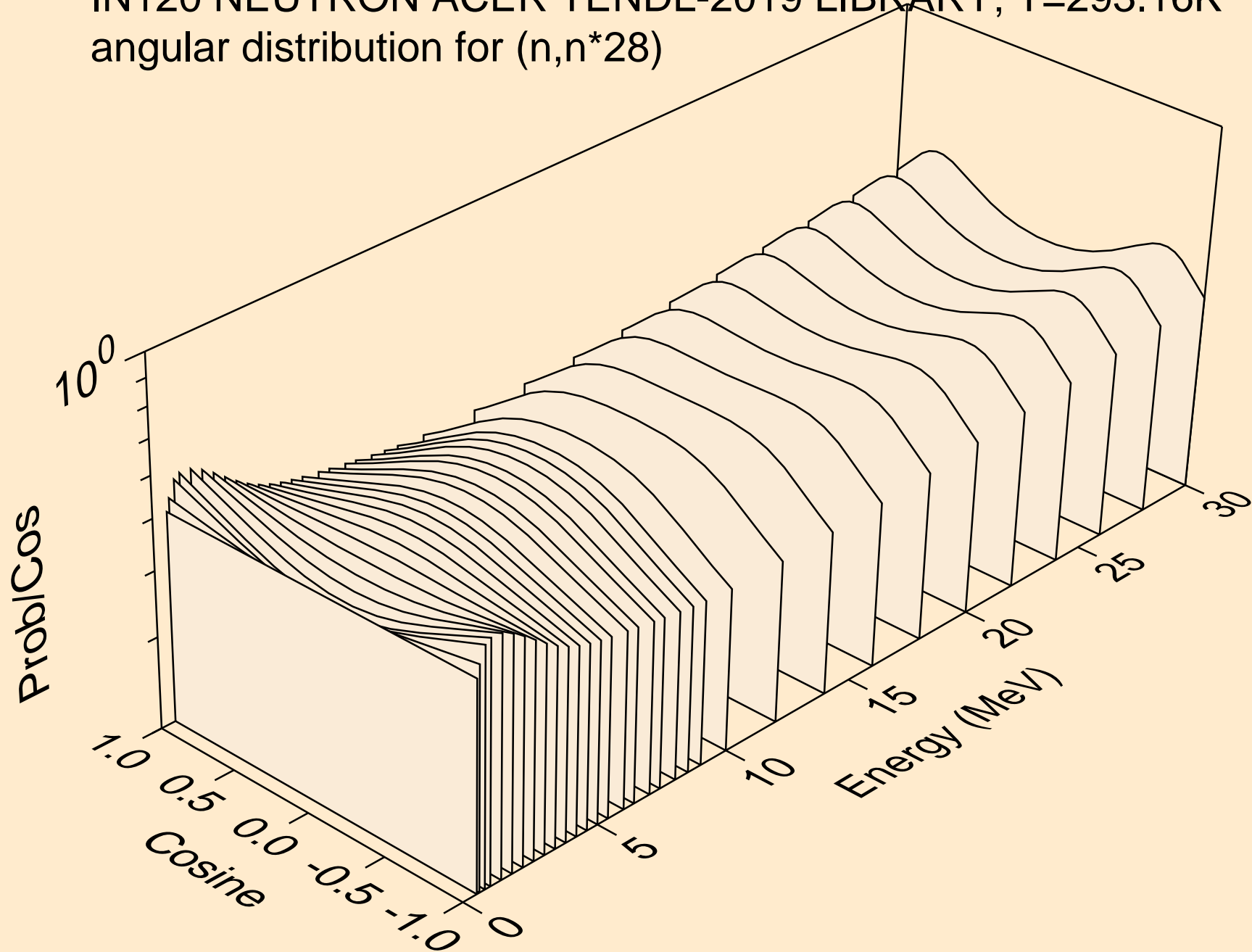



IN120 NEUTRON ACER TENDL-2019 LIBRARY; T=293.16K  
angular distribution for (n,n\*29)

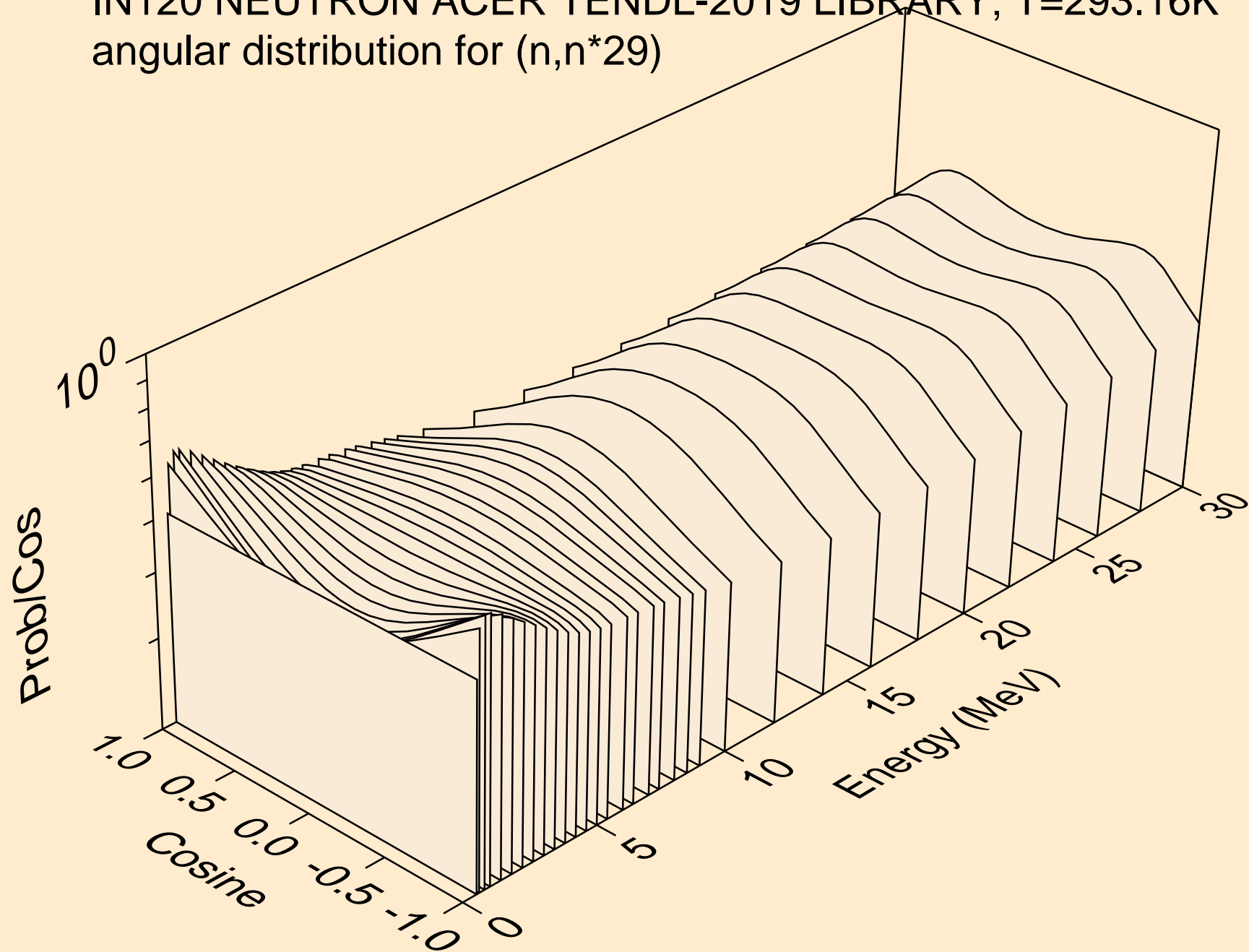

IN120 NEUTRON ACER TENDL-2019 LIBRARY; T=293.16K  
angular distribution for (n,n\*30)

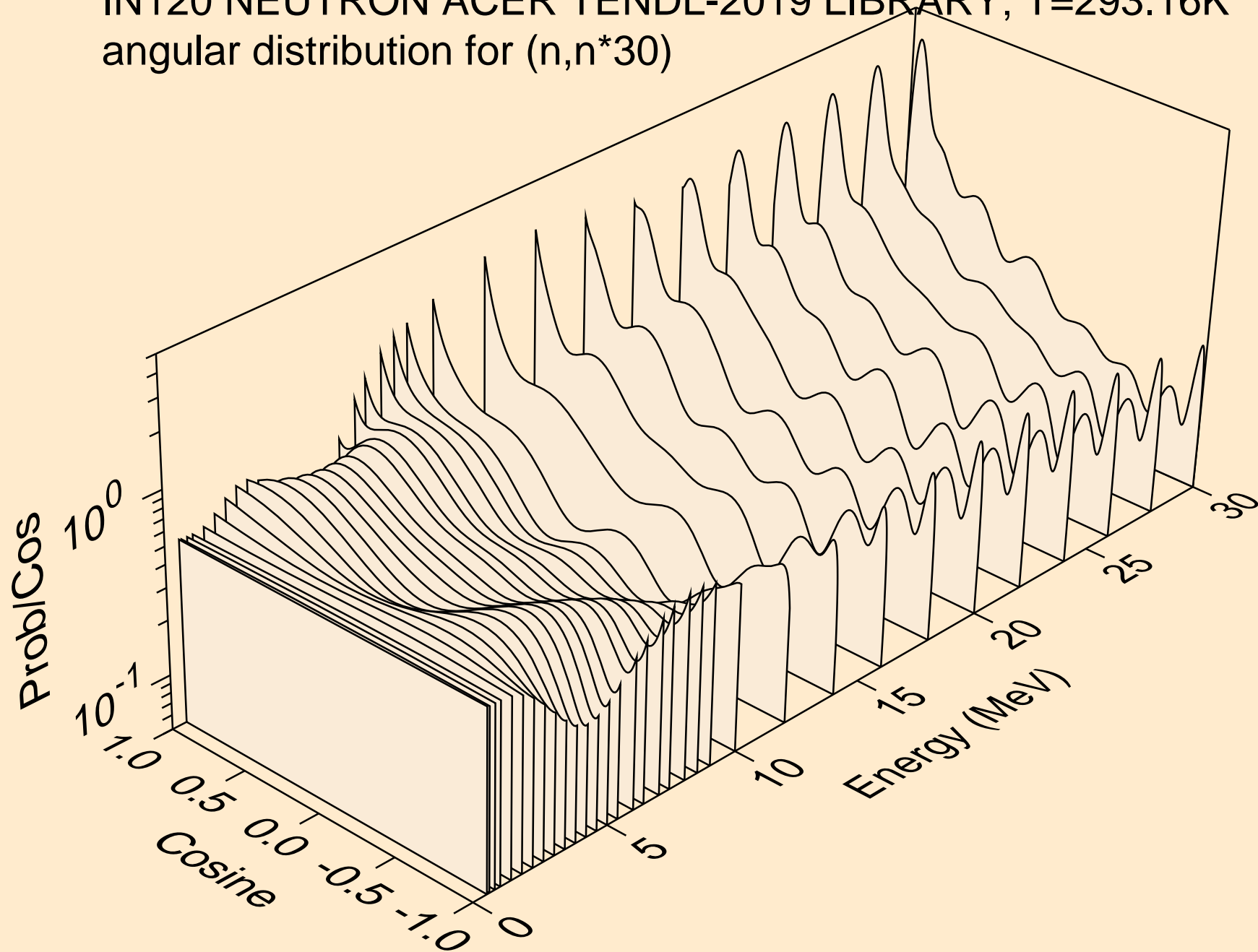

IN120 NEUTRON ACER TENDL-2019 LIBRARY; T=293.16K  
Neutron emission for (n,x)

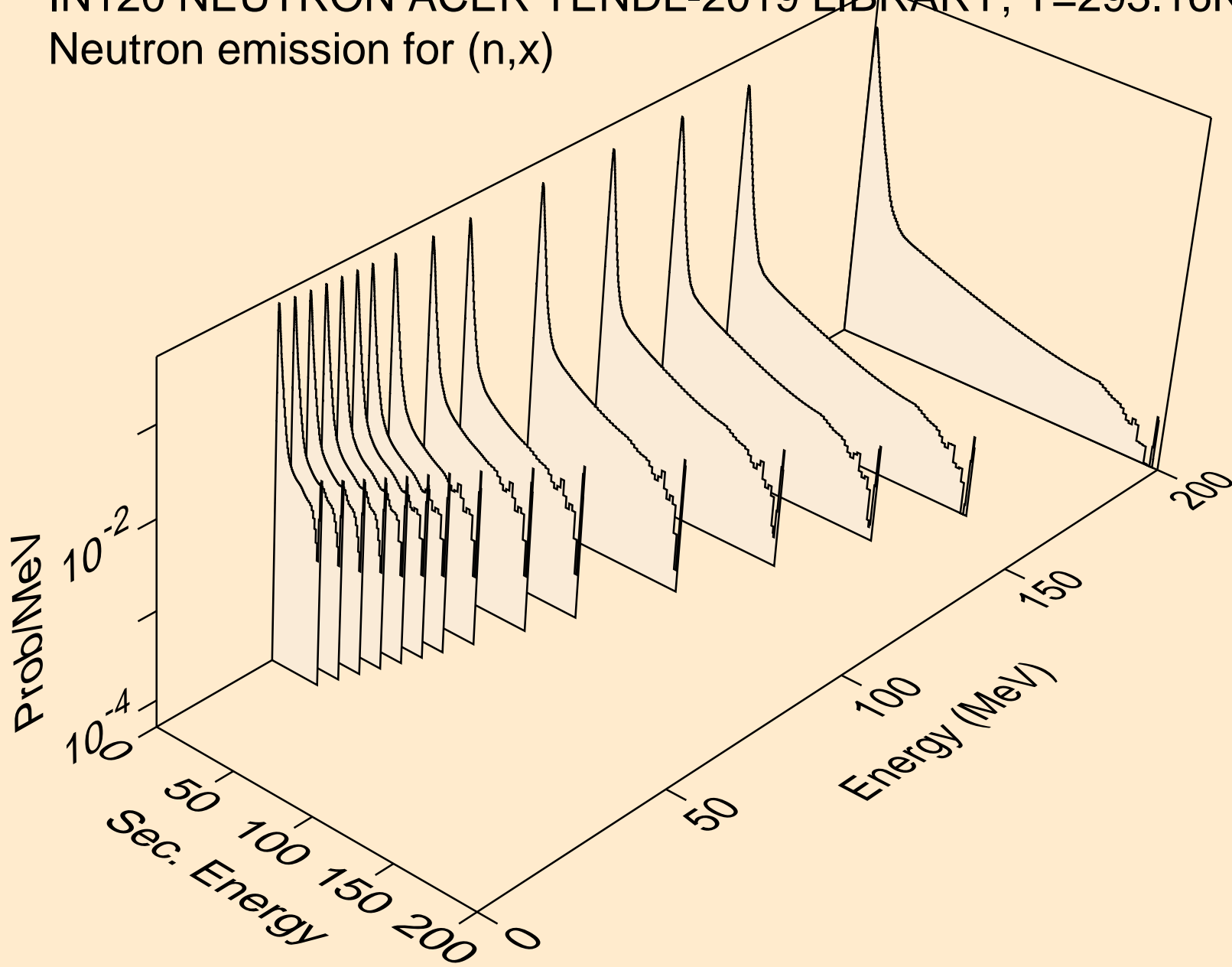

IN120 NEUTRON ACER TENDL-2019 LIBRARY; T=293.16K  
Neutron emission for (n,2nd)

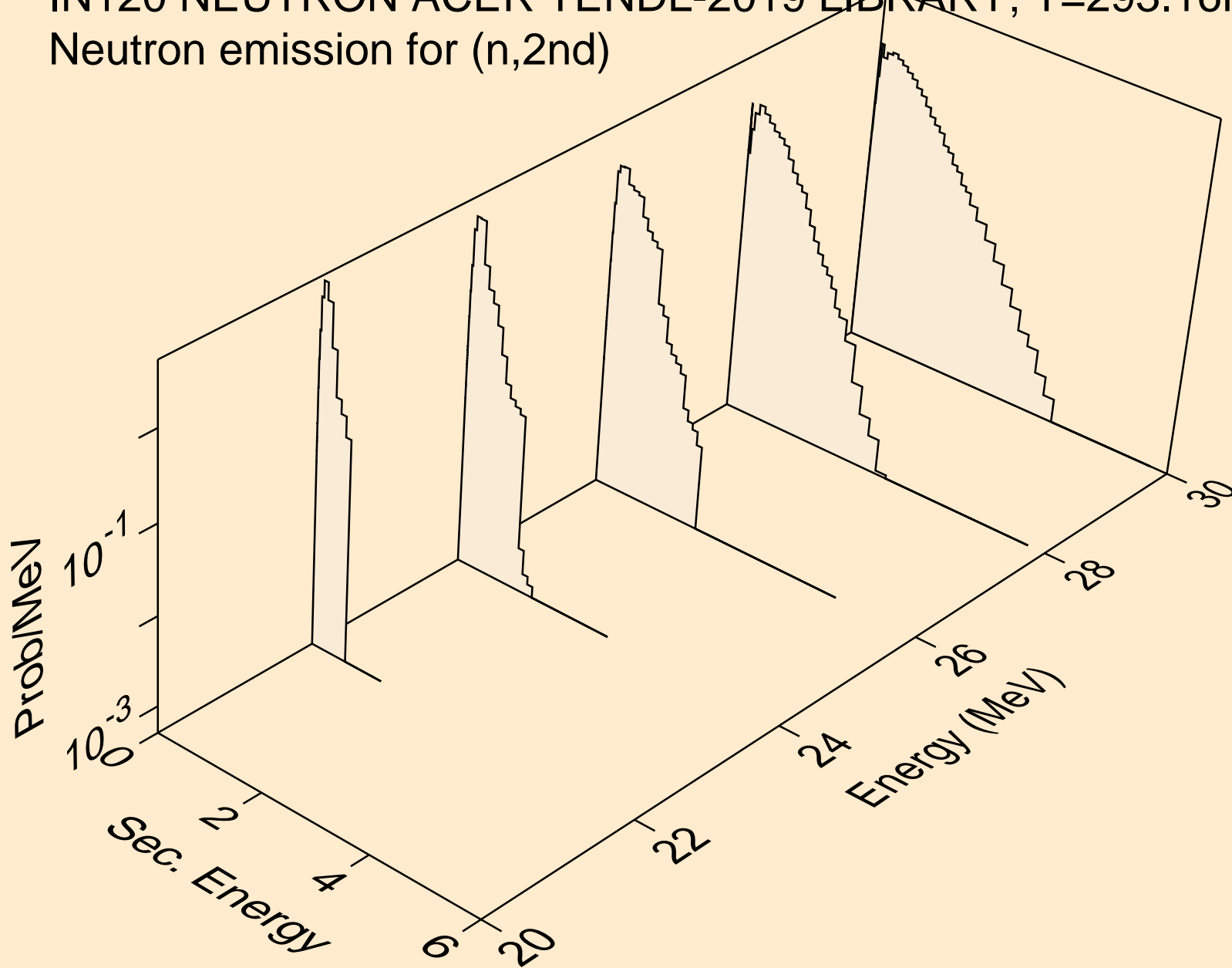

IN120 NEUTRON ACER TENDL-2019 LIBRARY; T=293.16K  
Neutron emission for (n,2n)

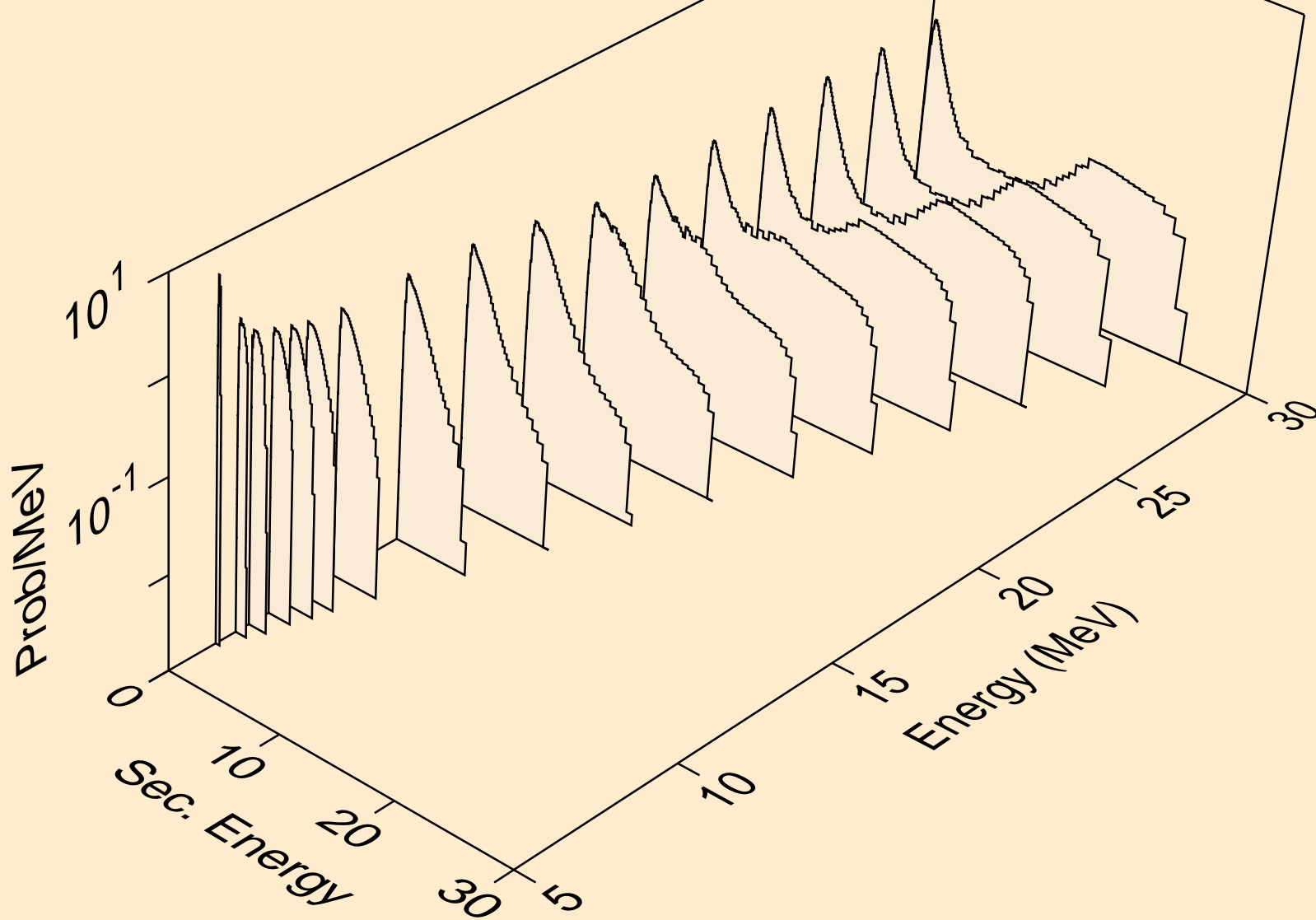

IN120 NEUTRON ACER TENDL-2019 LIBRARY; T=293.16K  
Neutron emission for (n,3n)

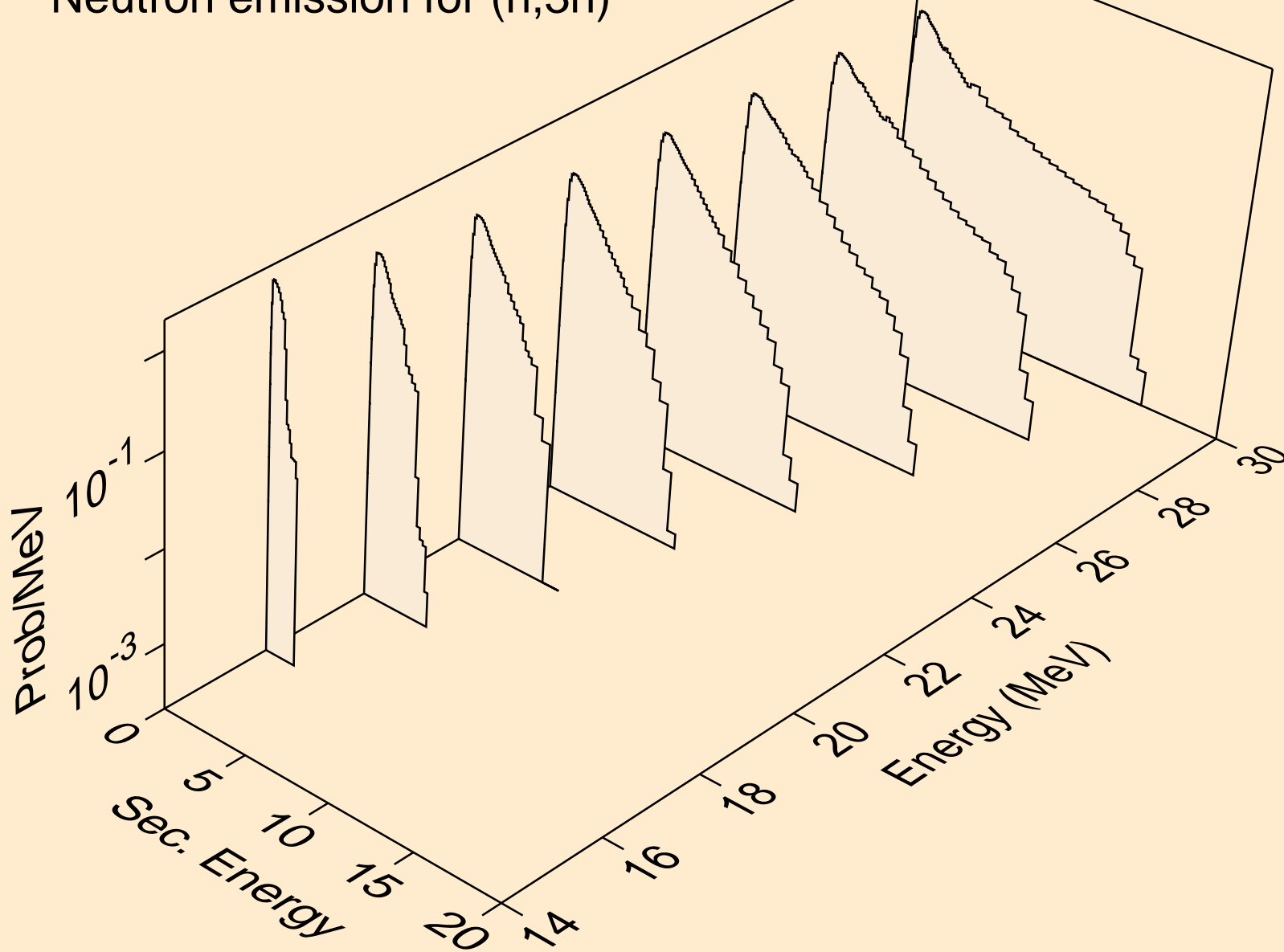

IN120 NEUTRON ACER TENDL-2019 LIBRARY; T=293.16K  
Neutron emission for (n,n\*)a

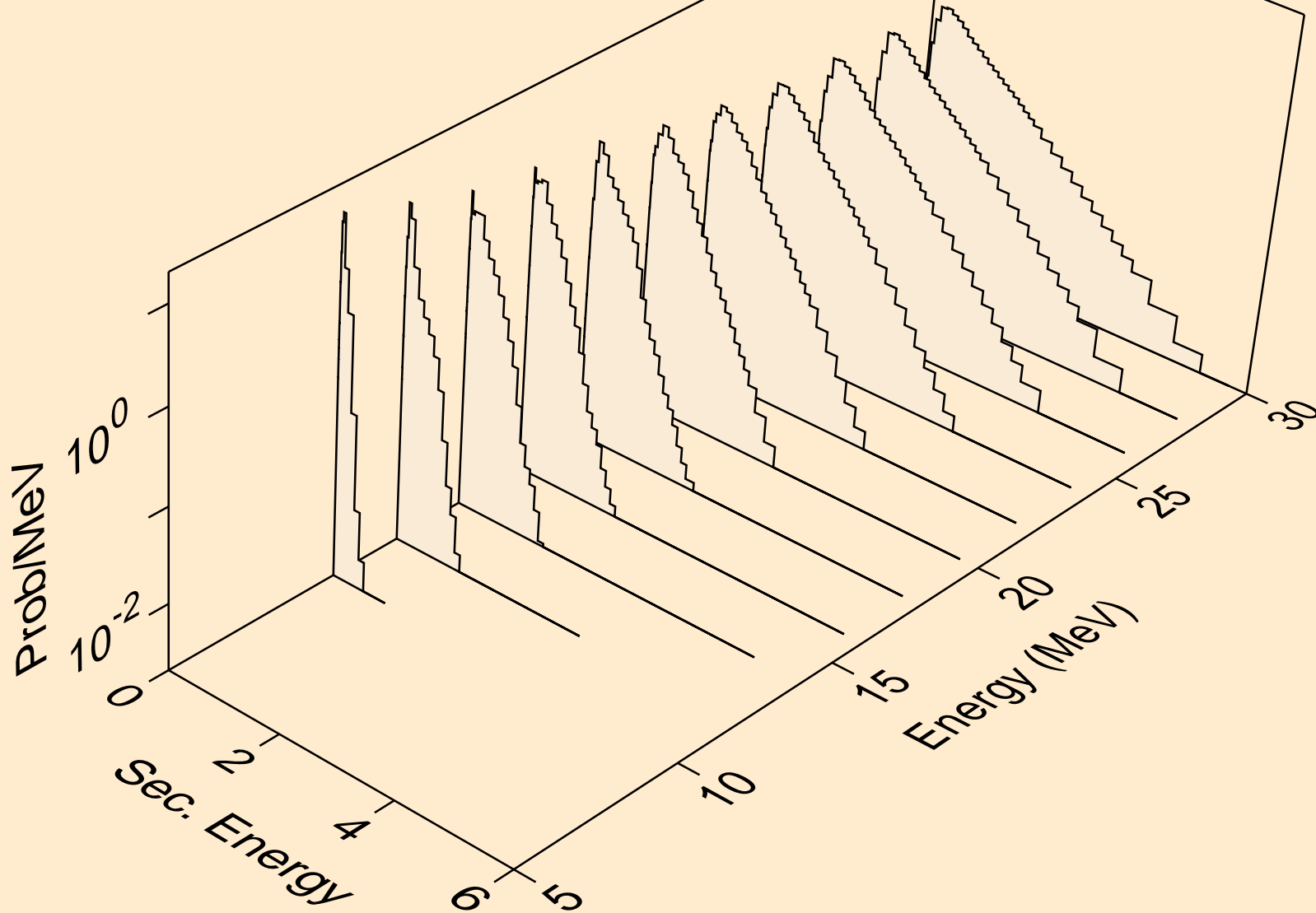

IN120 NEUTRON ACER TENDL-2019 LIBRARY; T=293.16K  
Neutron emission for (n,2n)a

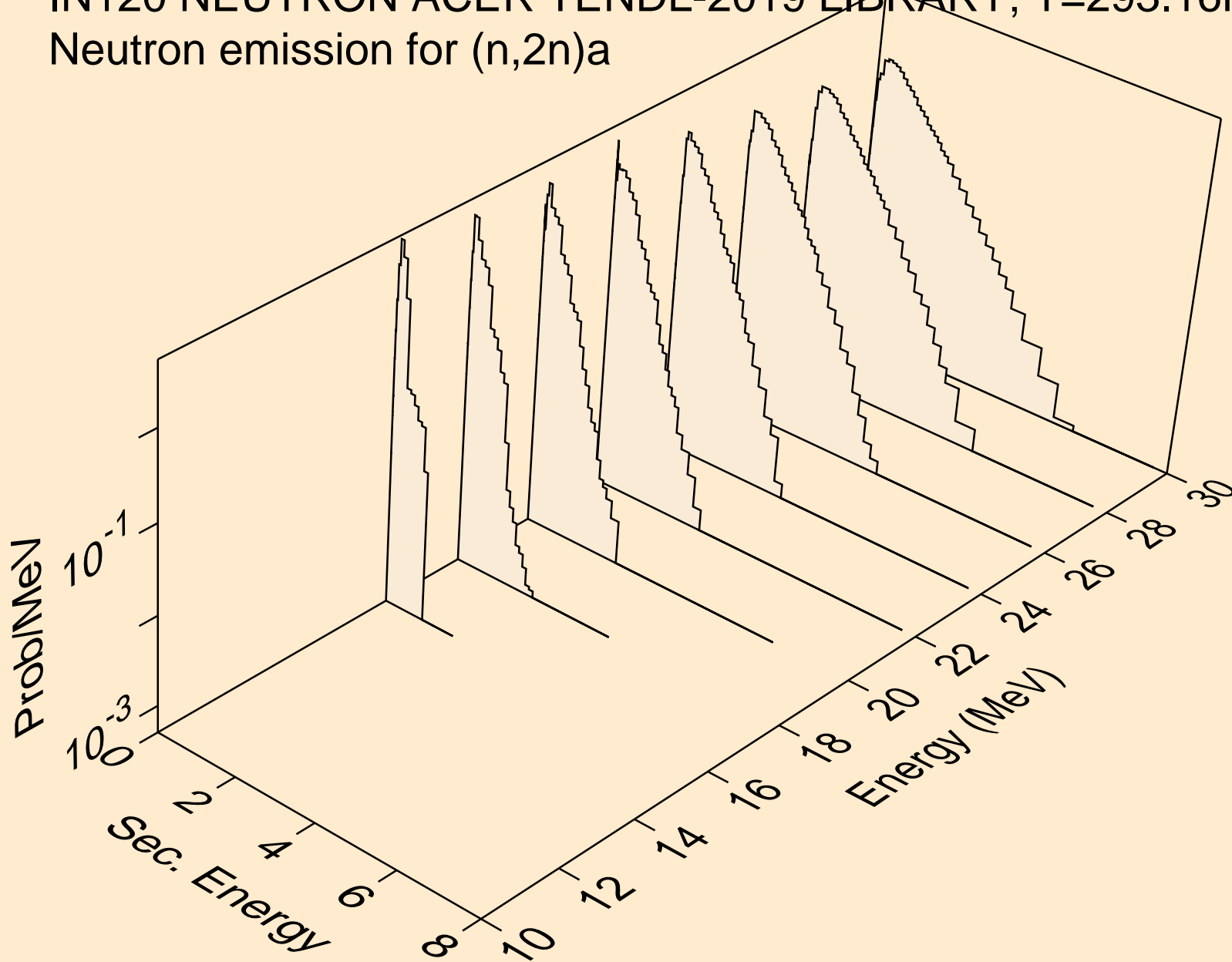



IN120 NEUTRON ACER TENDL-2019 LIBRARY; T=293.16K  
Neutron emission for (n,3n)a

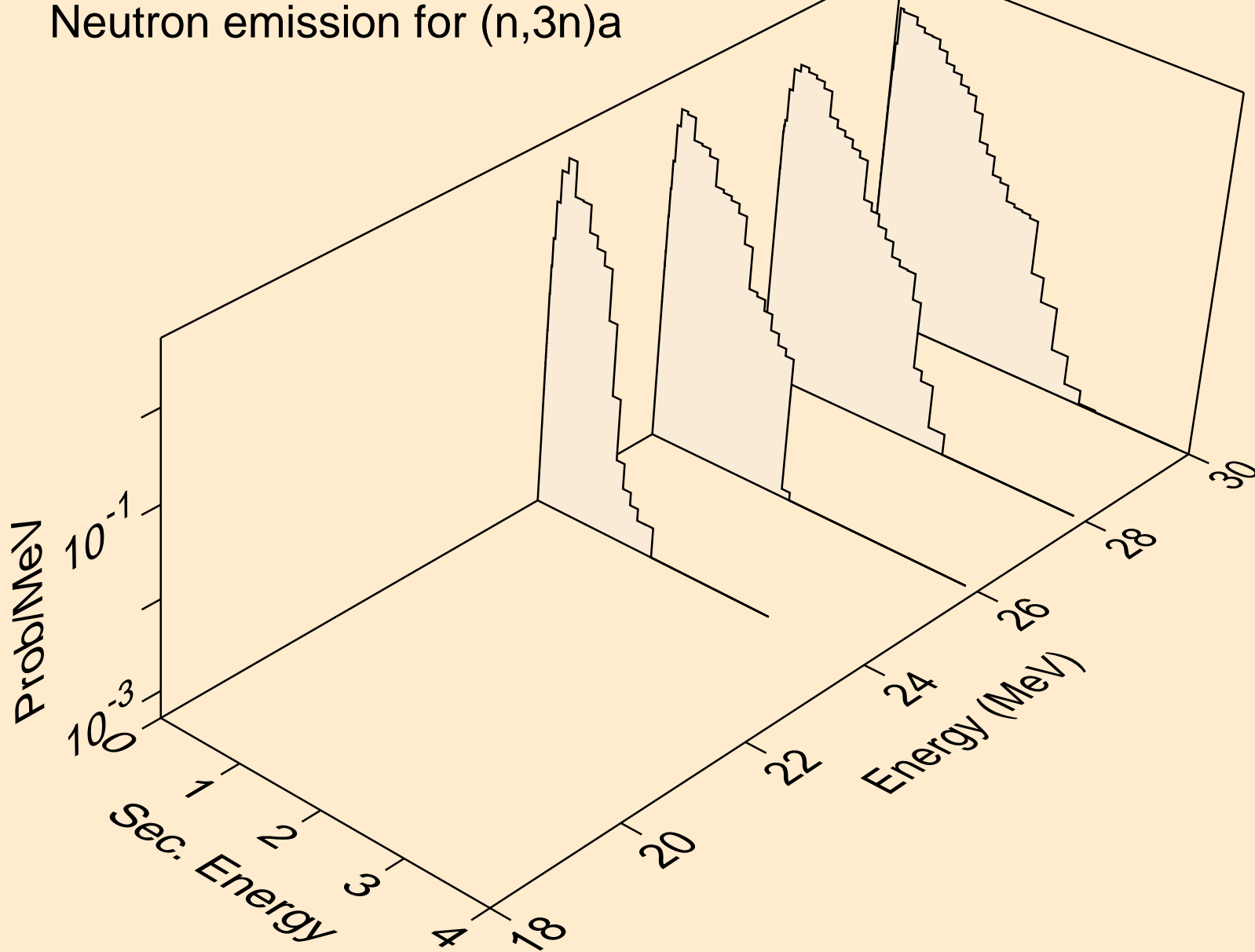

IN120 NEUTRON ACER TENDL-2019 LIBRARY; T=293.16K  
Neutron emission for (n,n\*)p

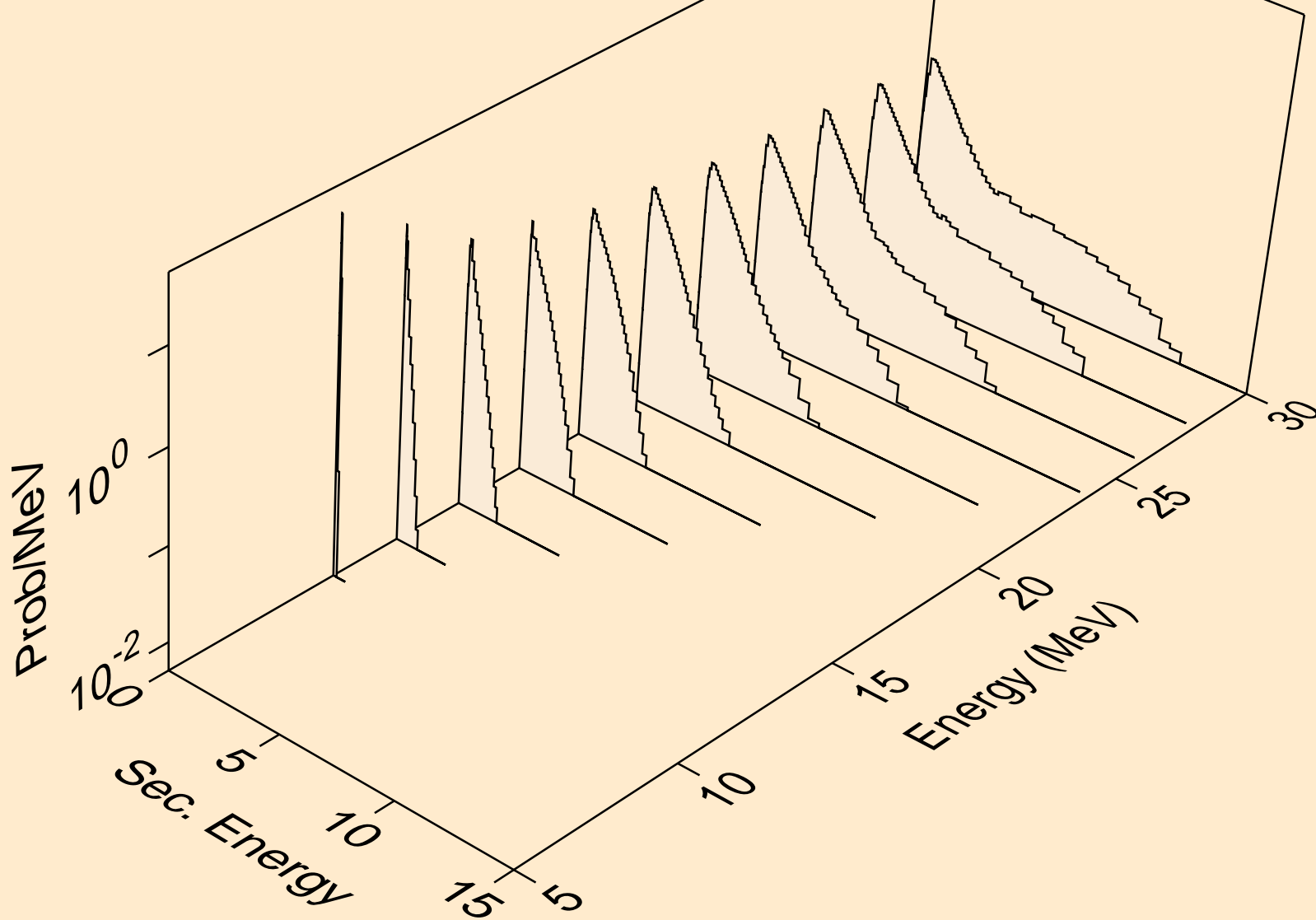

IN120 NEUTRON ACER TENDL-2019 LIBRARY; T=293.16K  
Neutron emission for (n,n\*)d

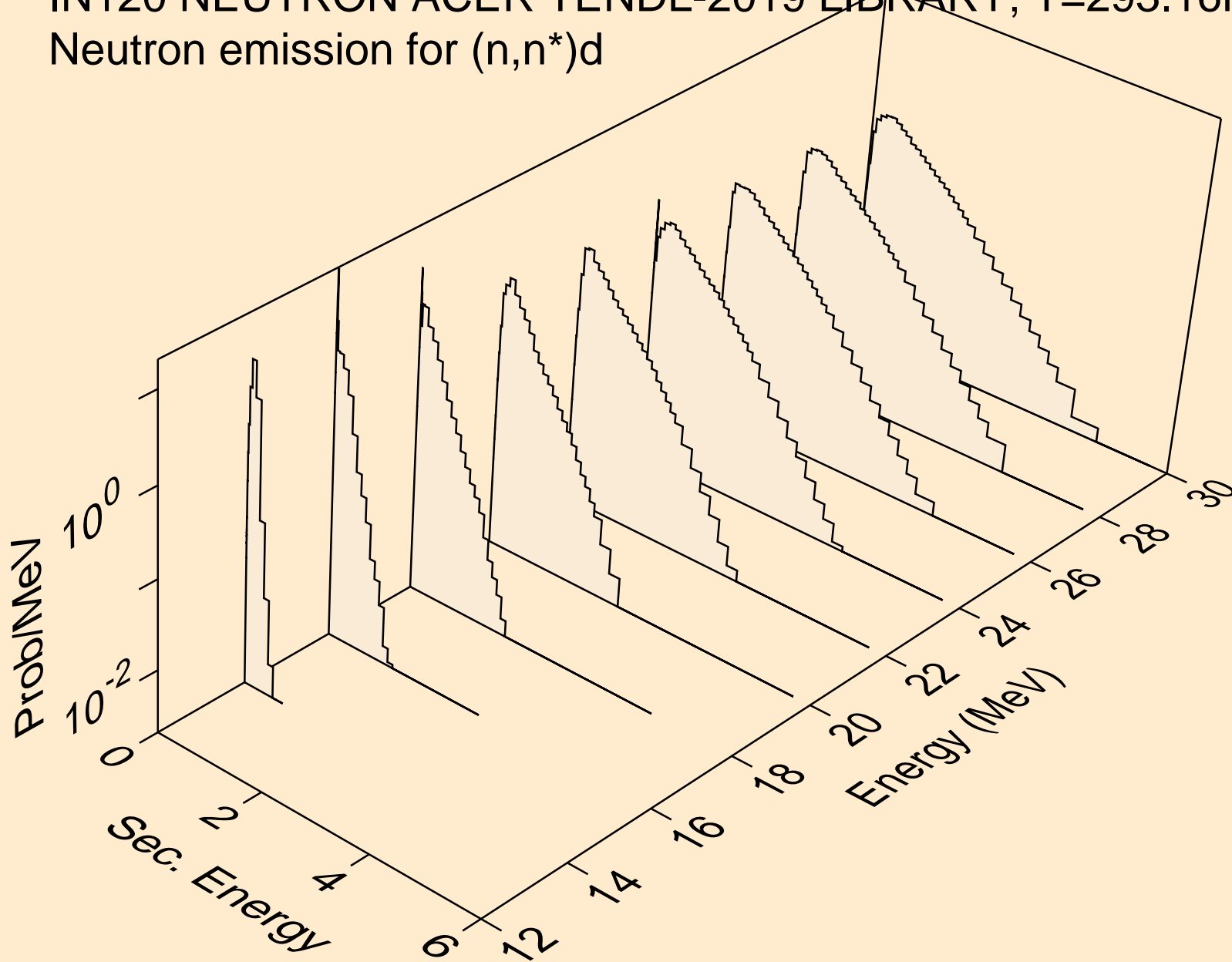

IN120 NEUTRON ACER TENDL-2019 LIBRARY; T=293.16K  
Neutron emission for (n,n\*)t

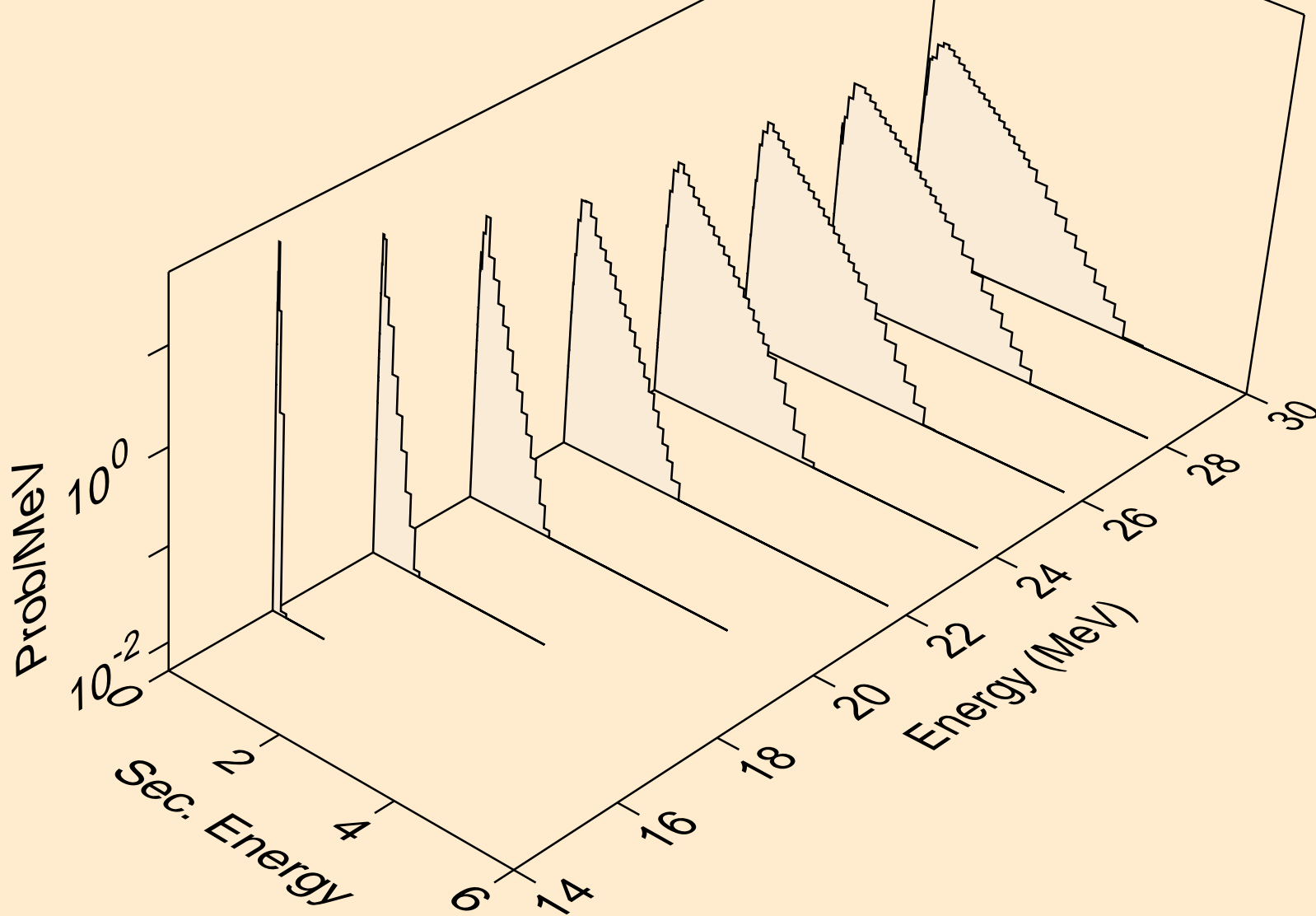

IN120 NEUTRON ACER TENDL-2019 LIBRARY; T=293.16K  
Neutron emission for (n,n\*)he3

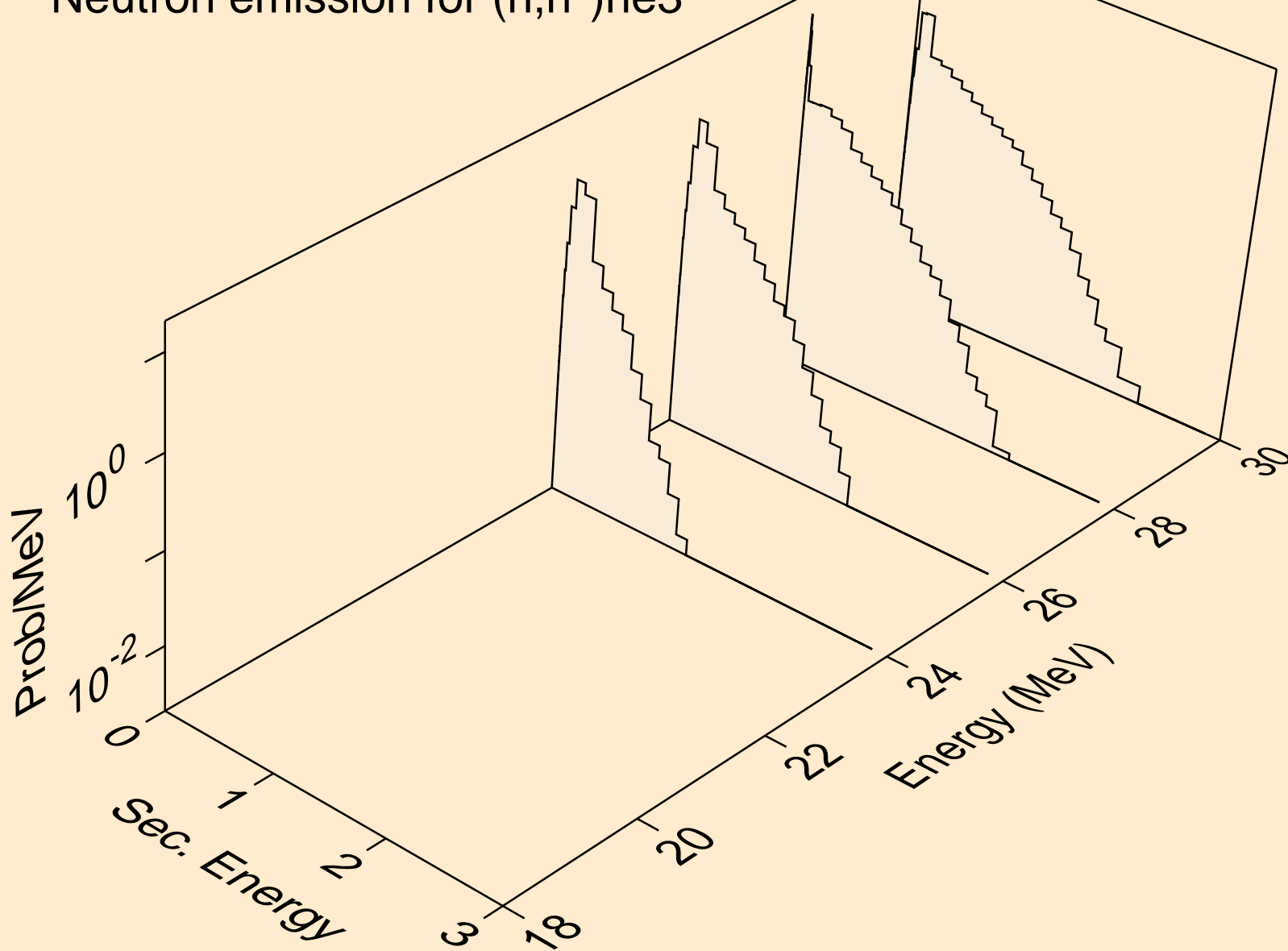

IN120 NEUTRON ACER TENDL-2019 LIBRARY; T=293.16K  
Neutron emission for (n,4n)

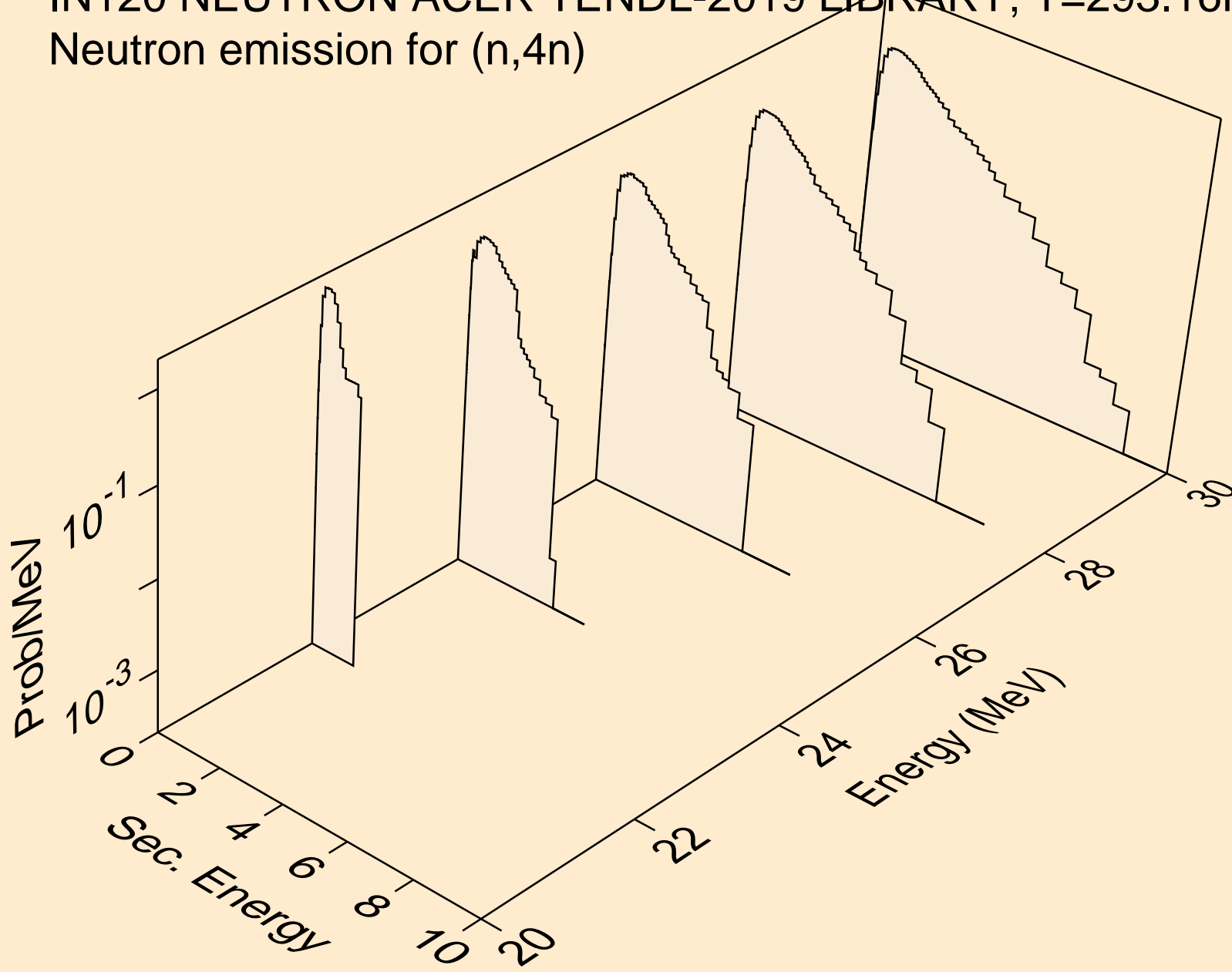

IN120 NEUTRON ACER TENDL-2019 LIBRARY; T=293.16K  
Neutron emission for (n,2np)

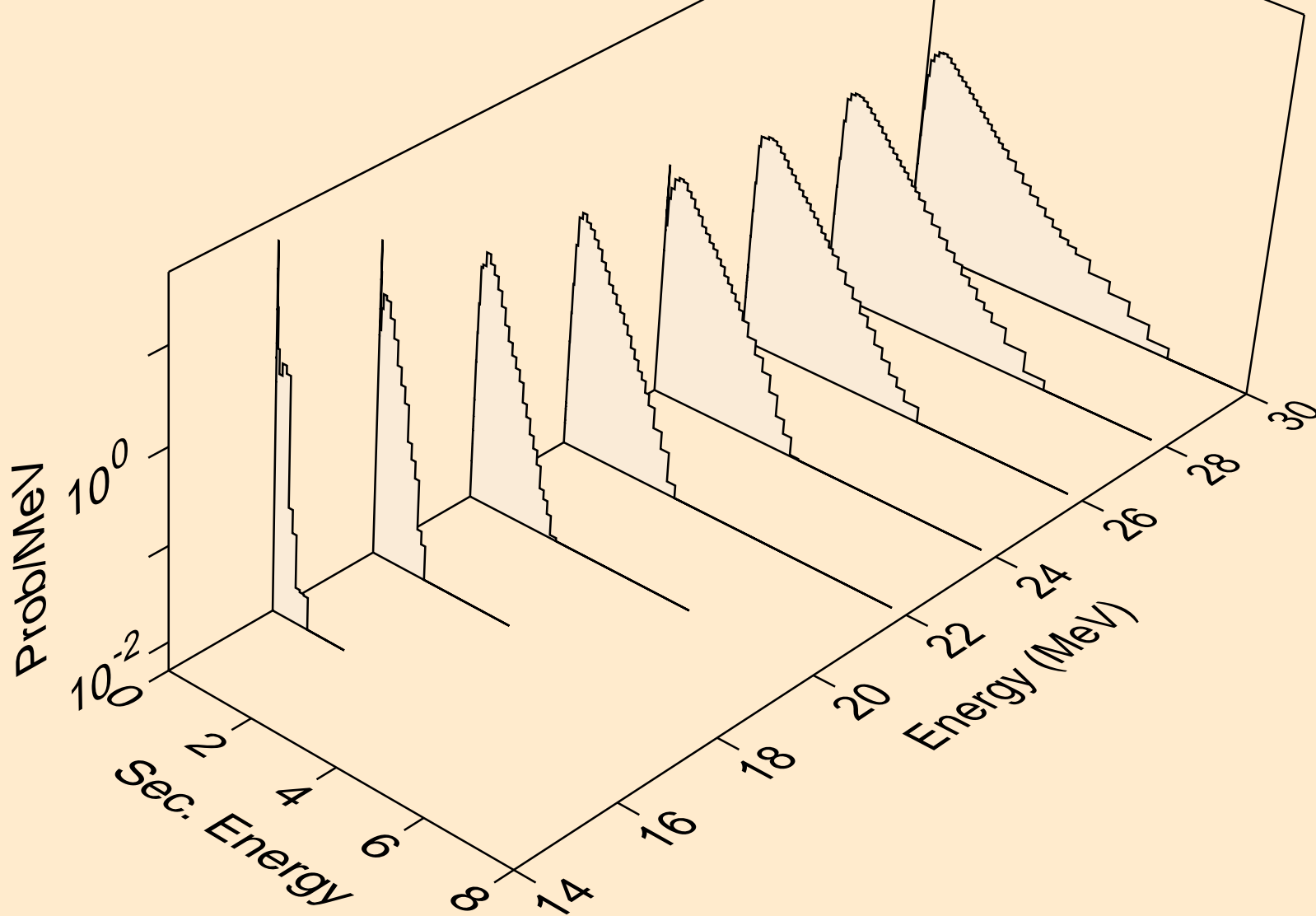

IN120 NEUTRON ACER TENDL-2019 LIBRARY; T=293.16K  
Neutron emission for (n,3np)

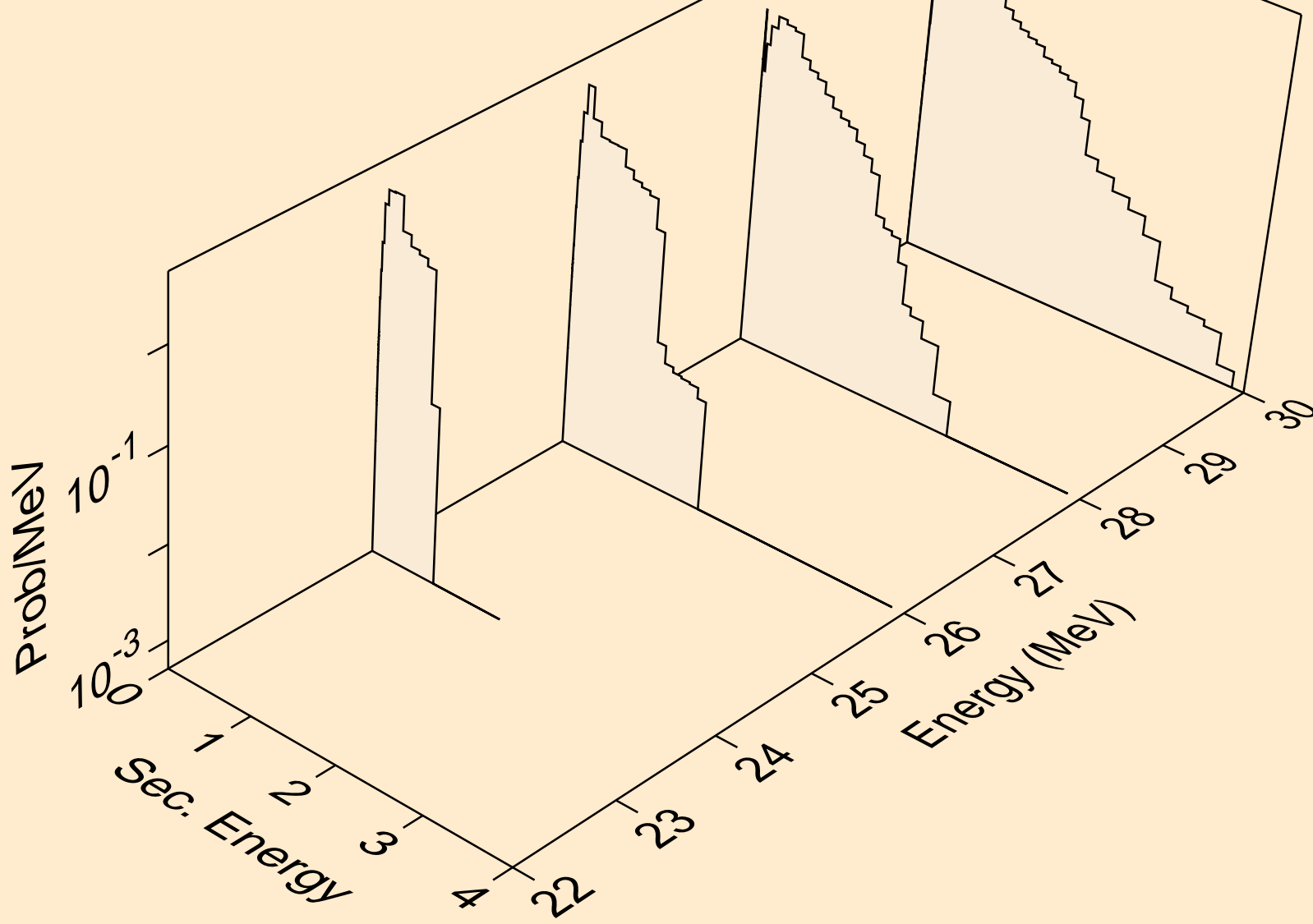



IN120 NEUTRON ACER TENDL-2019 LIBRARY; T=293.16K  
Neutron emission for (n,n\*c)

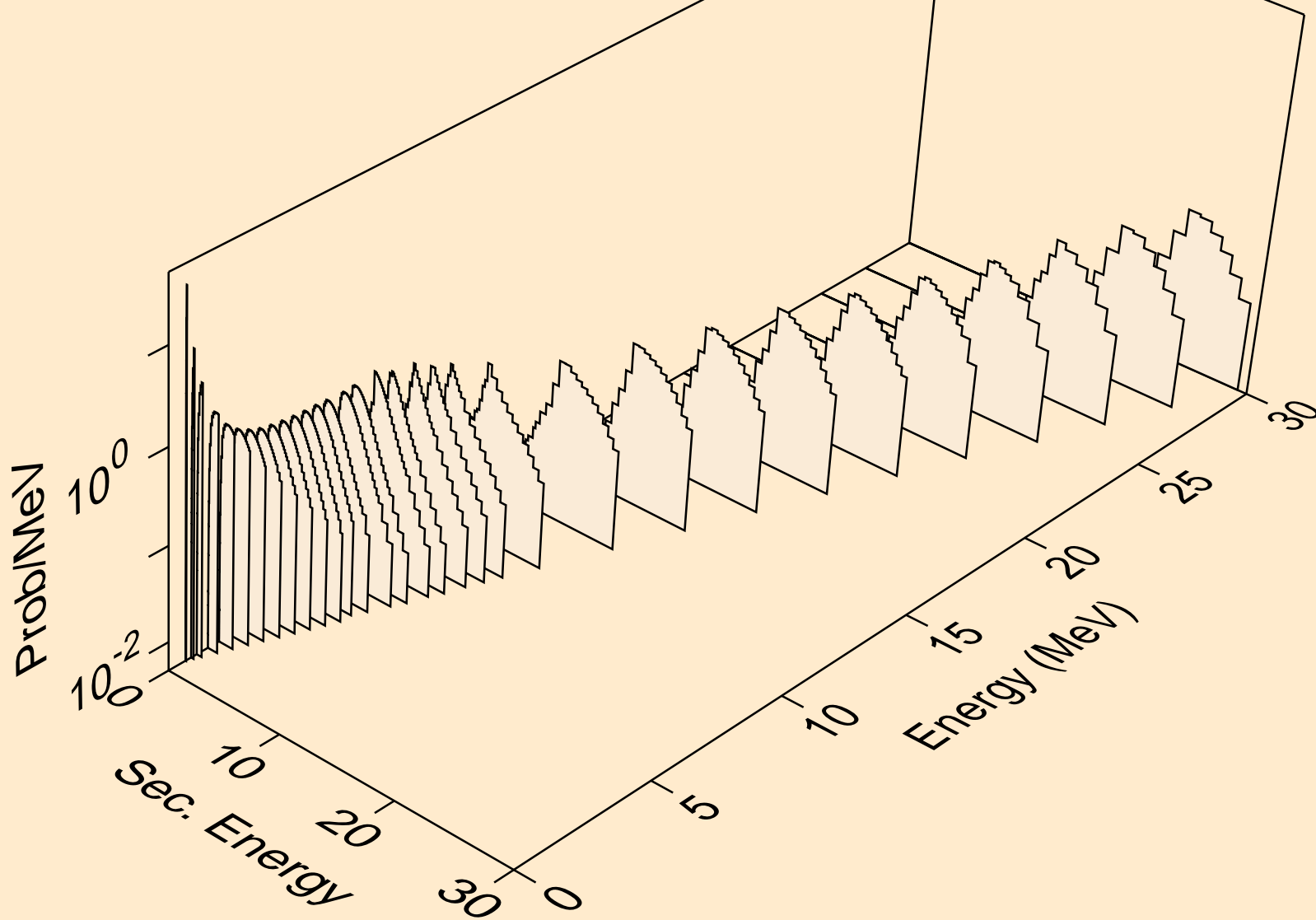

IN120 NEUTRON ACER TENDL-2019 LIBRARY; T=293.16K  
Photon emission for (n,x)

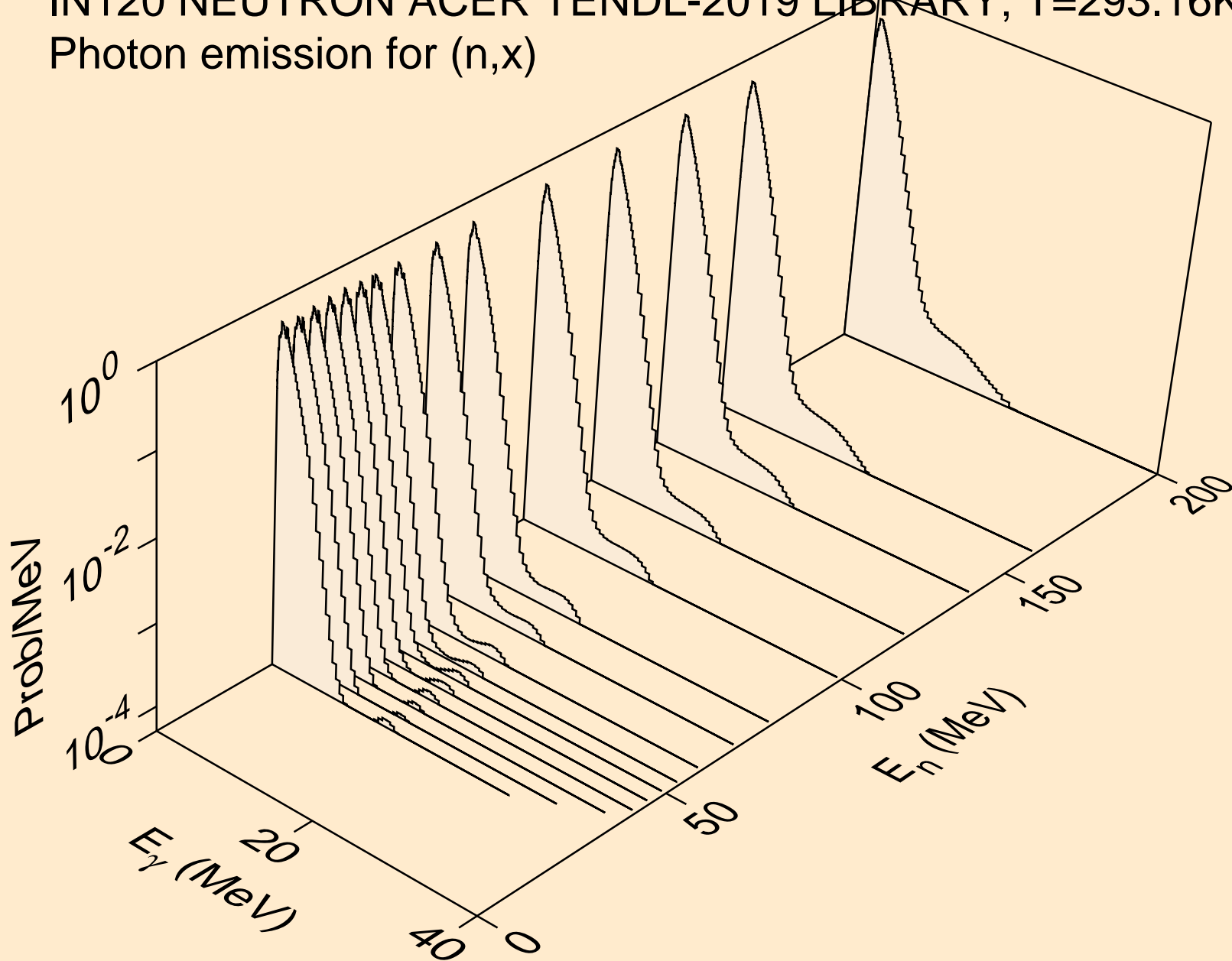

IN120 NEUTRON ACER TENDL-2019 LIBRARY; T=293.16K  
Photon emission for (n,2nd)

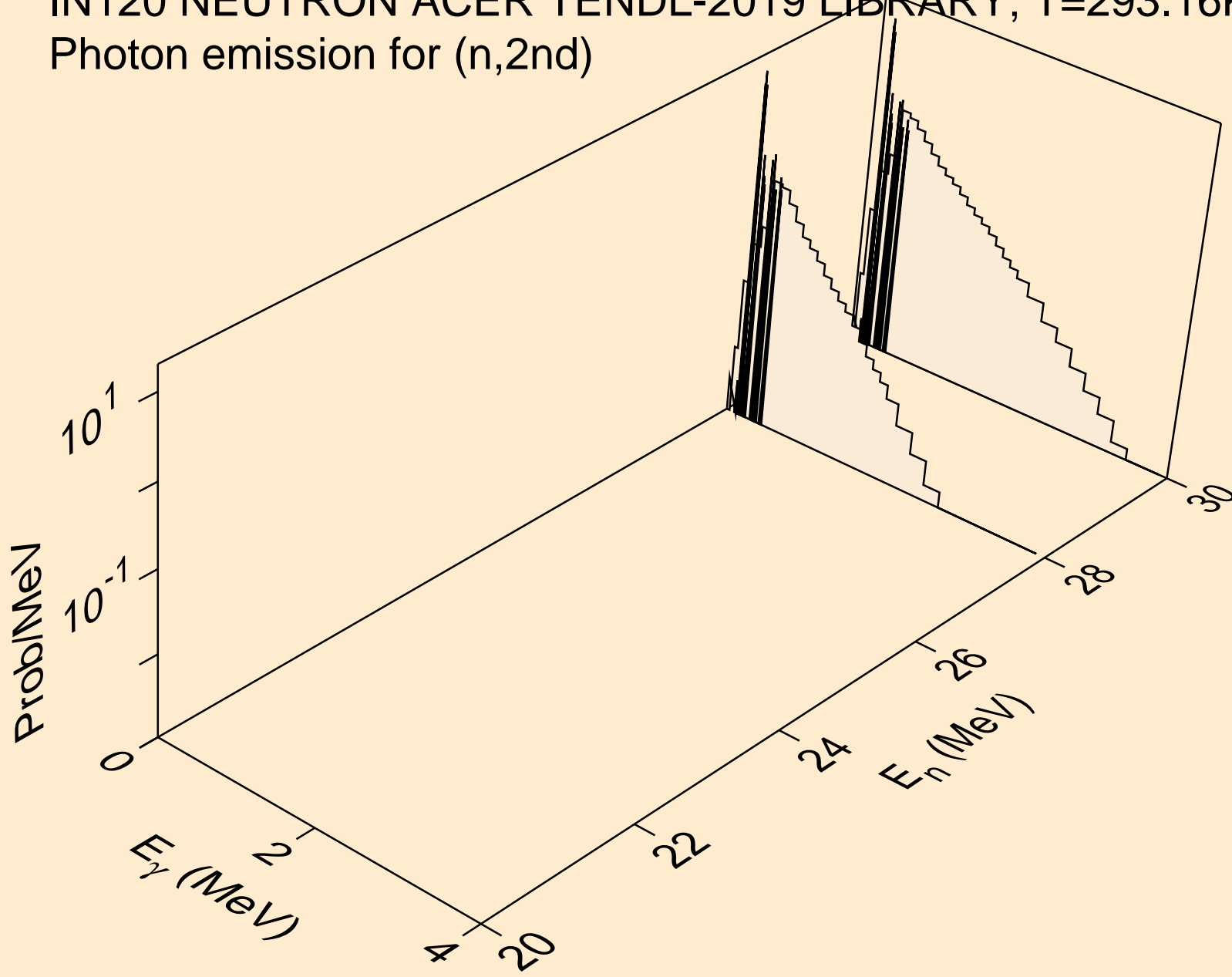

IN120 NEUTRON ACER TENDL-2019 LIBRARY; T=293.16K  
Photon emission for (n,2n)

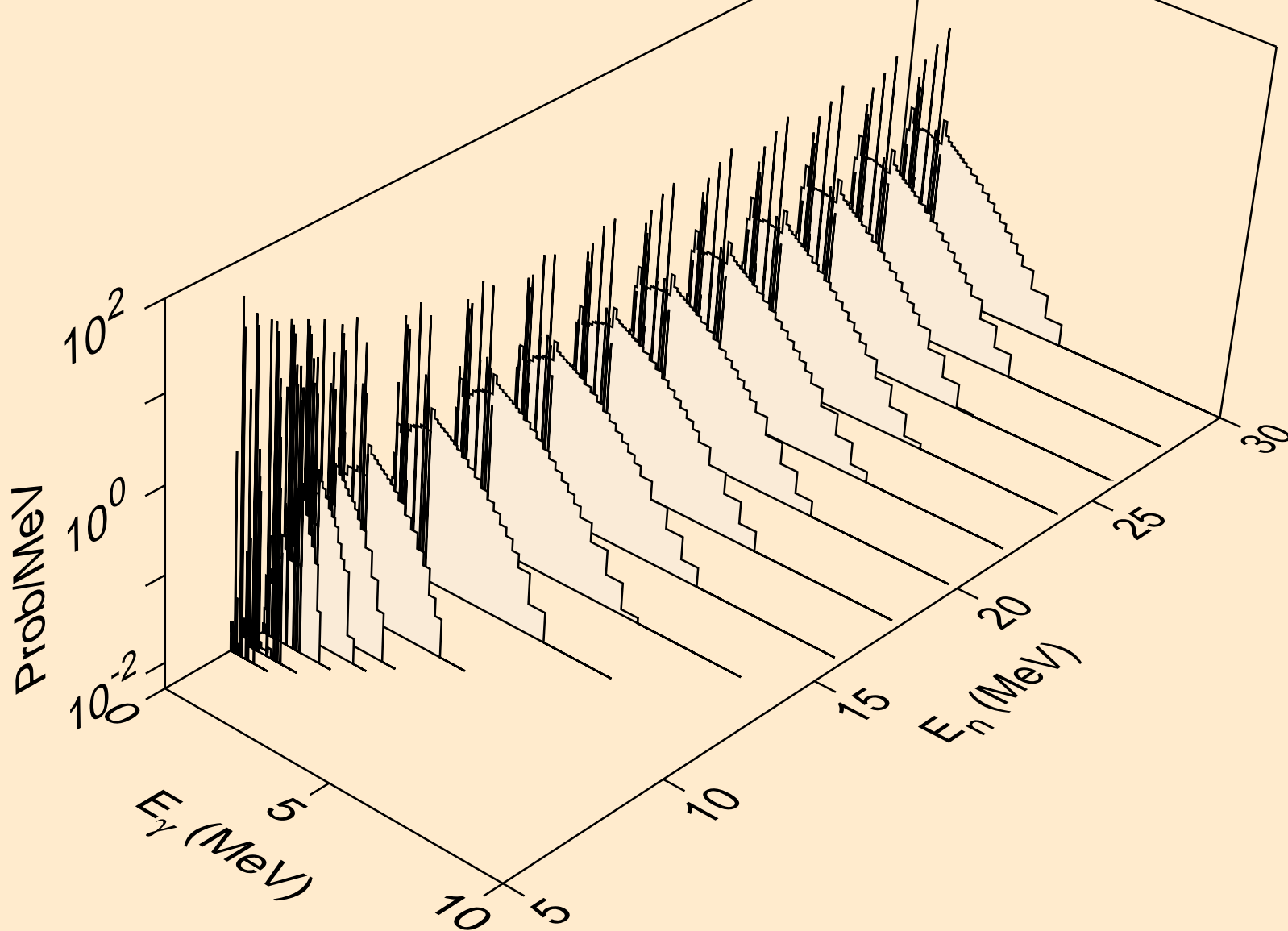

IN120 NEUTRON ACER TENDL-2019 LIBRARY; T=293.16K  
Photon emission for (n,3n)

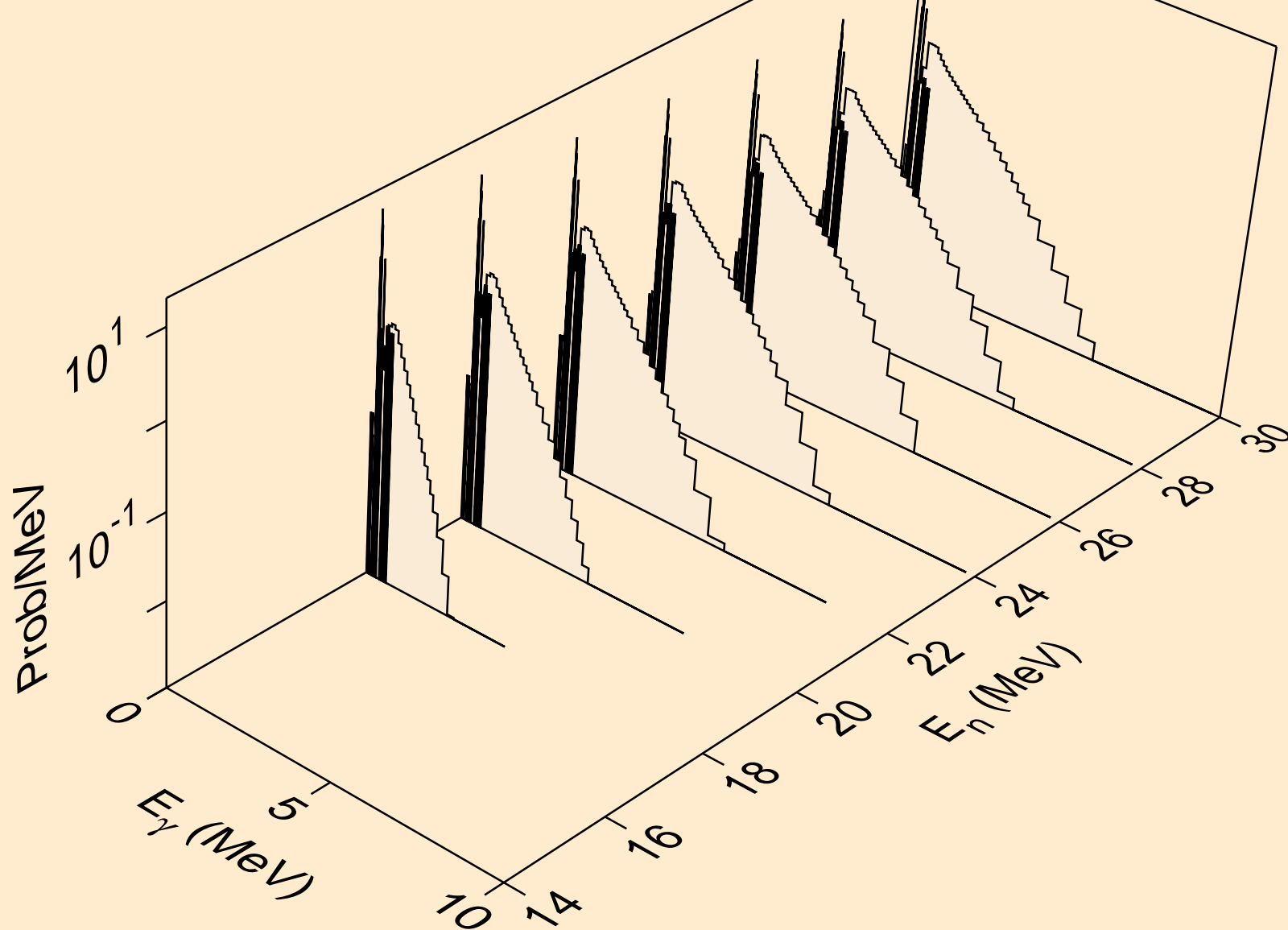

IN120 NEUTRON ACER TENDL-2019 LIBRARY; T=293.16K  
Photon emission for (n,n\*)a

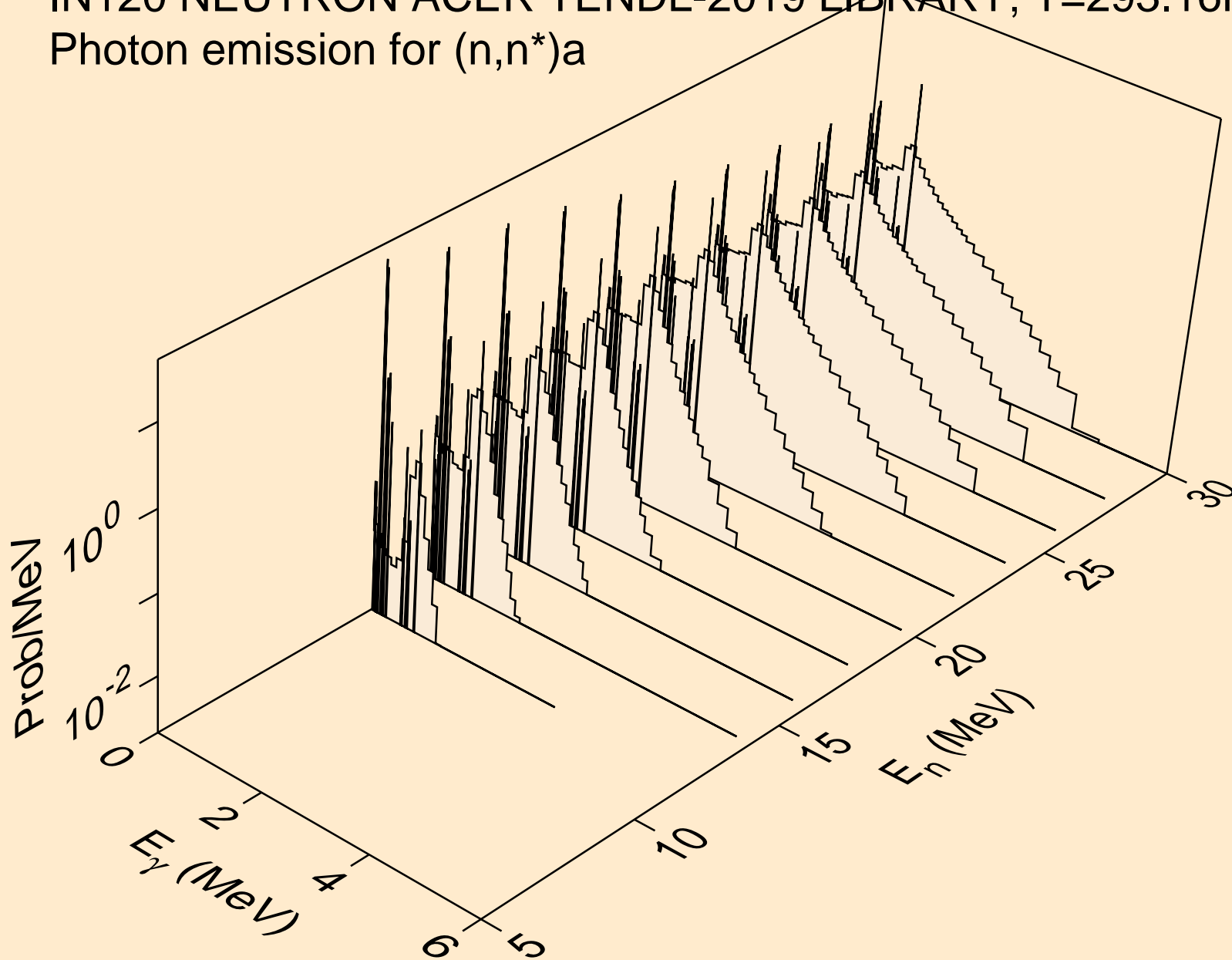

IN120 NEUTRON ACER TENDL-2019 LIBRARY; T=293.16K  
Photon emission for (n,2n)a

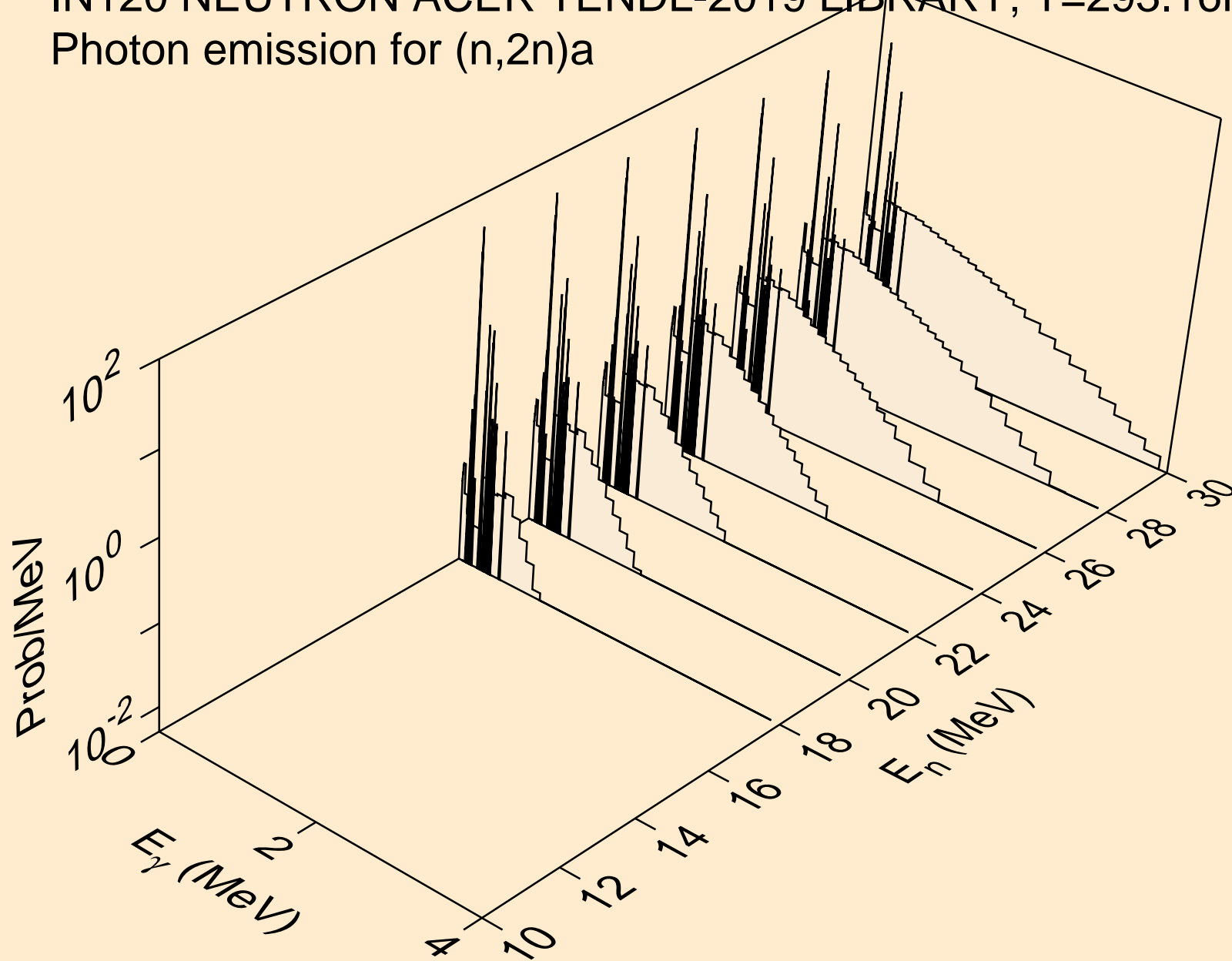

IN120 NEUTRON ACER TENDL-2019 LIBRARY; T=293.16K  
Photon emission for (n,3n)a

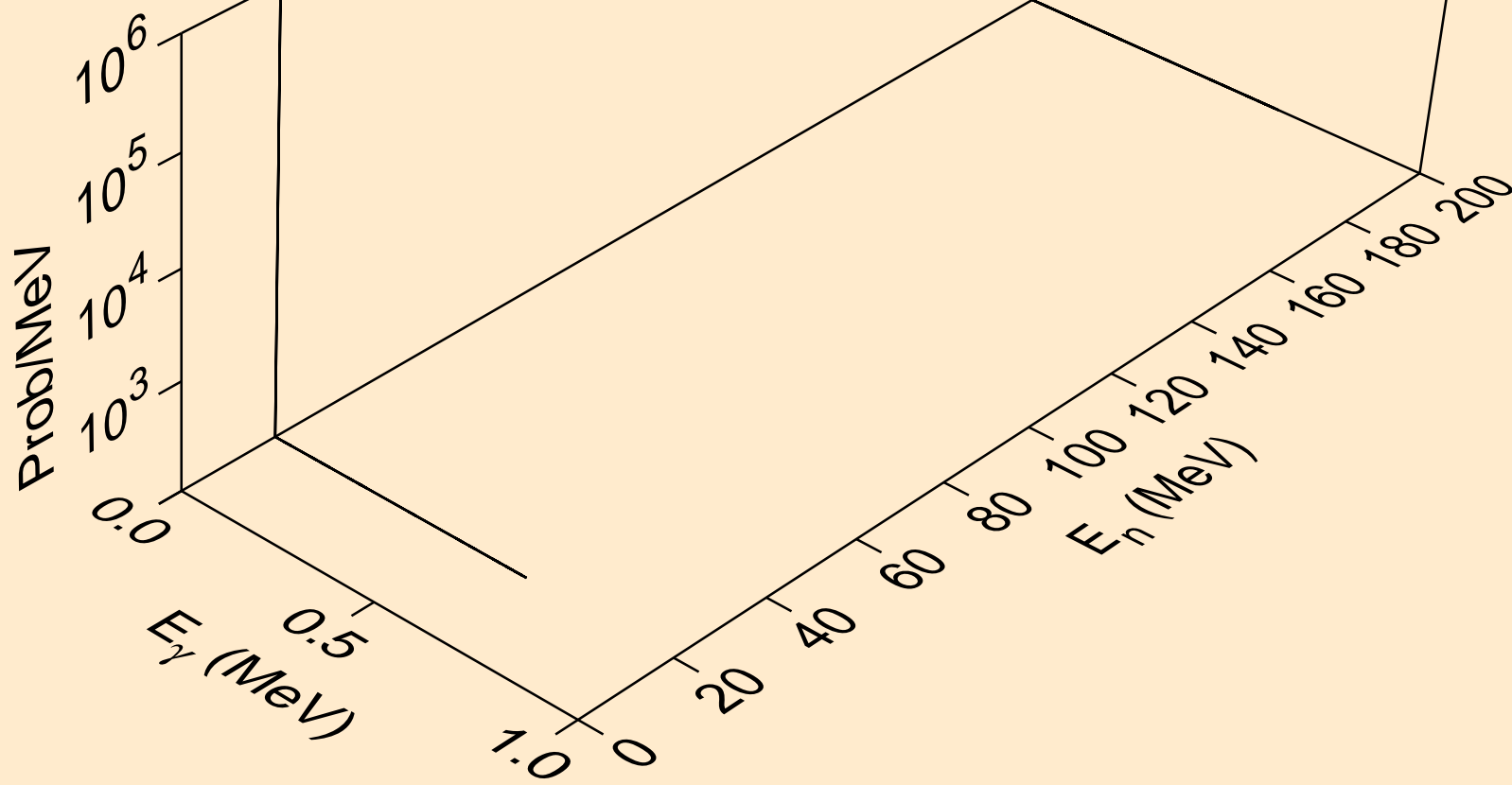



IN120 NEUTRON ACER TENDL-2019 LIBRARY; T=293.16K  
Photon emission for (n,n\*)p

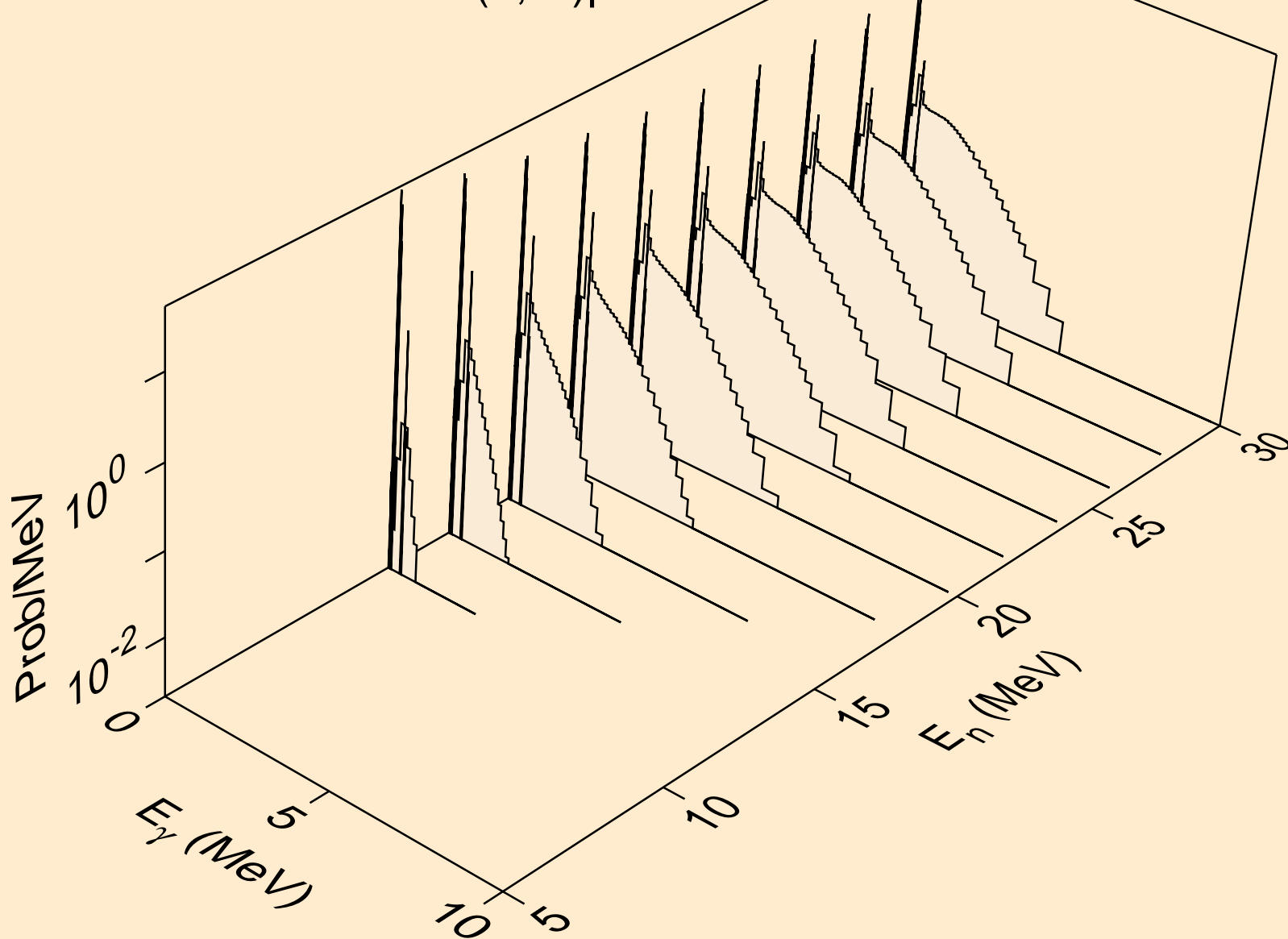

IN120 NEUTRON ACER TENDL-2019 LIBRARY; T=293.16K  
Photon emission for (n,n\*)d

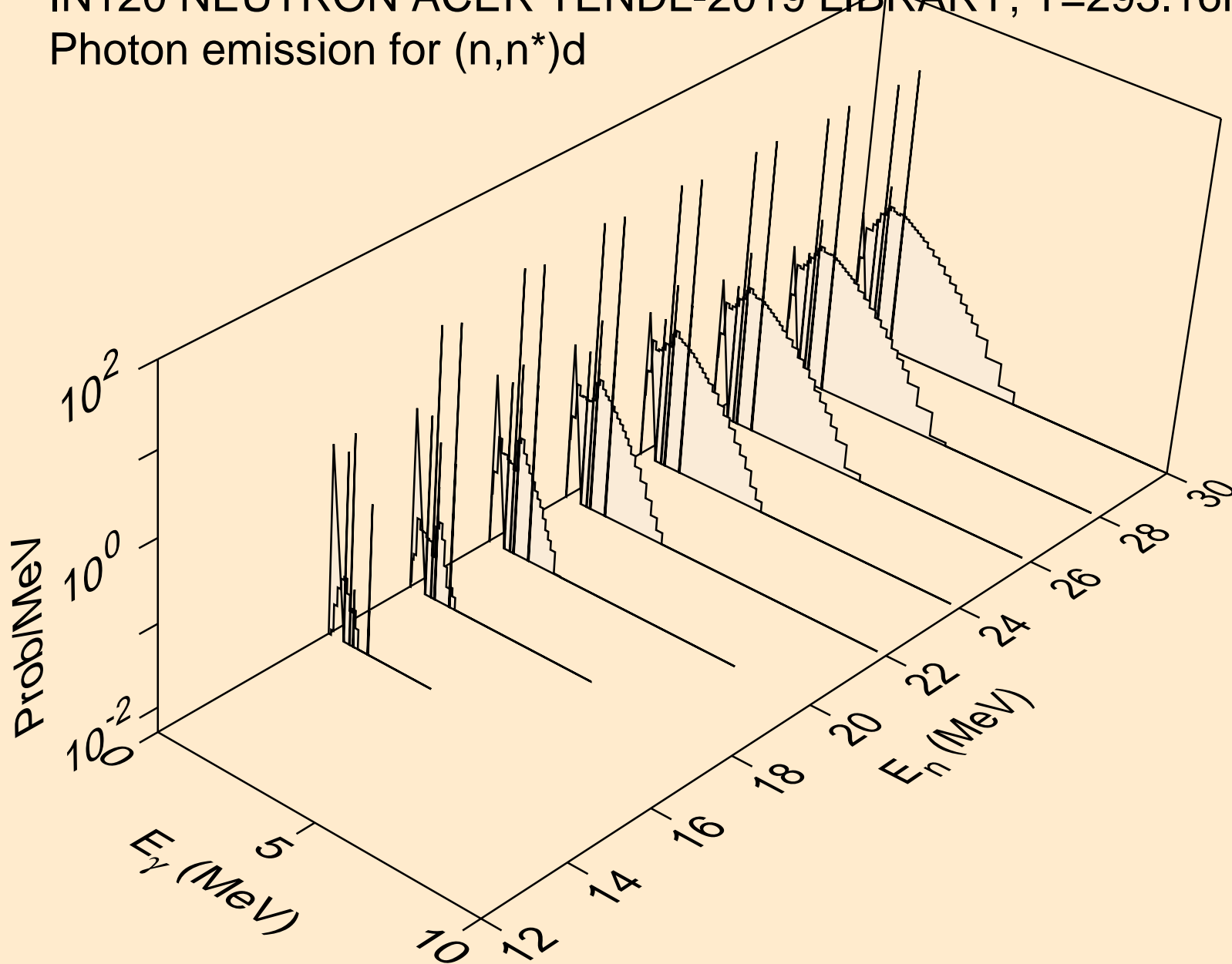

IN120 NEUTRON ACER TENDL-2019 LIBRARY; T=293.16K  
Photon emission for (n,n\*)t

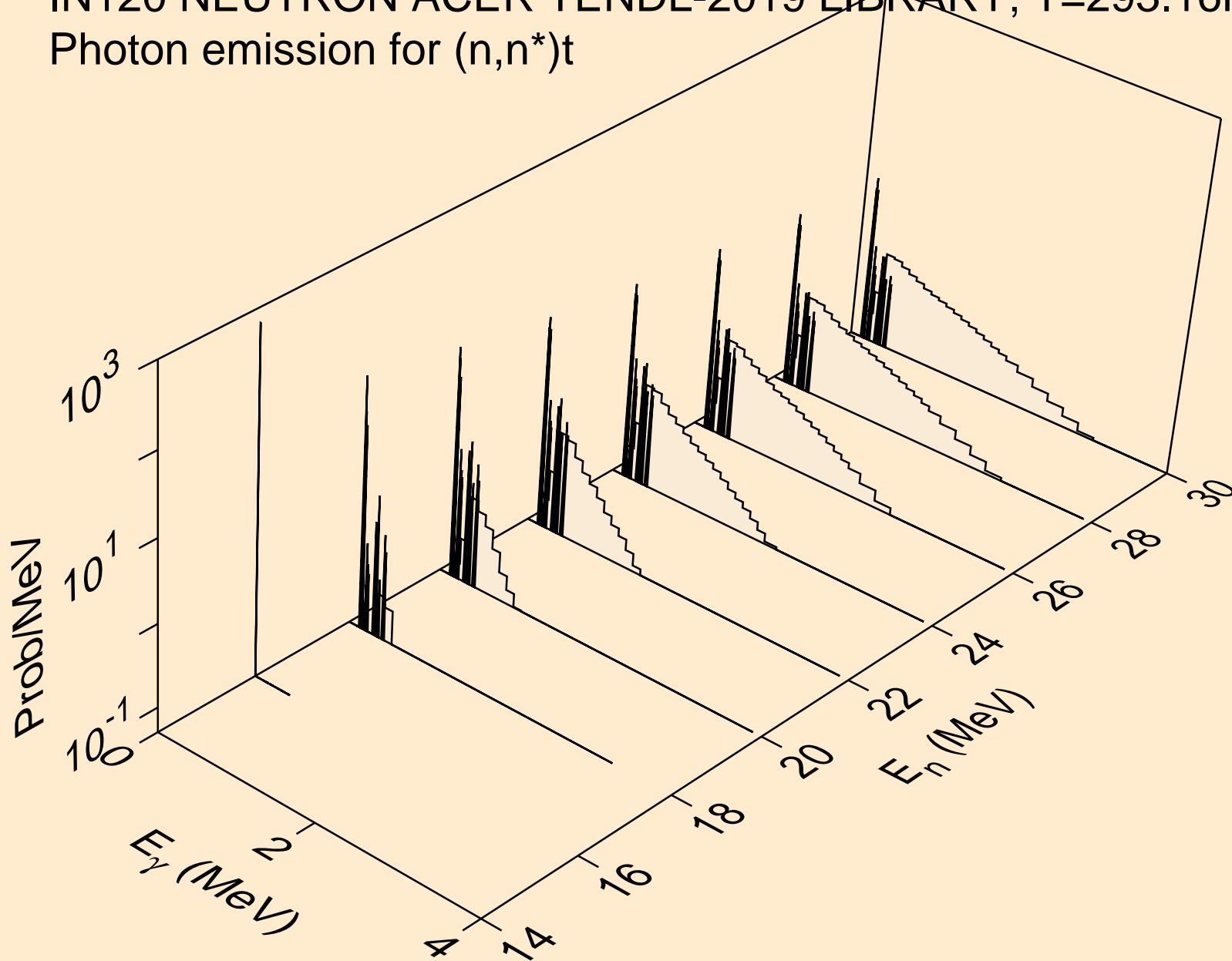

IN120 NEUTRON ACER TENDL-2019 LIBRARY; T=293.16K  
Photon emission for (n,n\*)he3

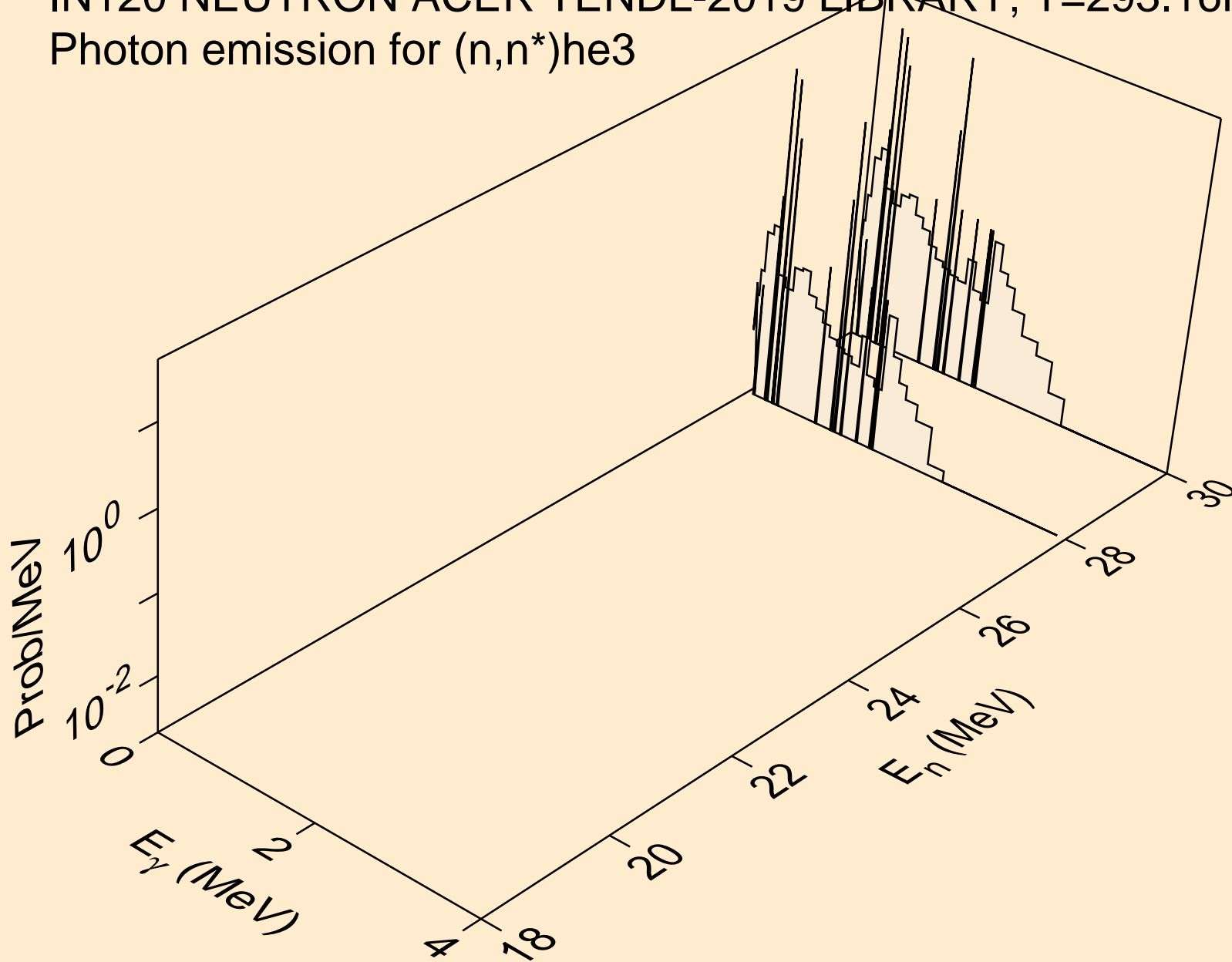

IN120 NEUTRON ACER TENDL-2019 LIBRARY; T=293.16K  
Photon emission for (n,4n)

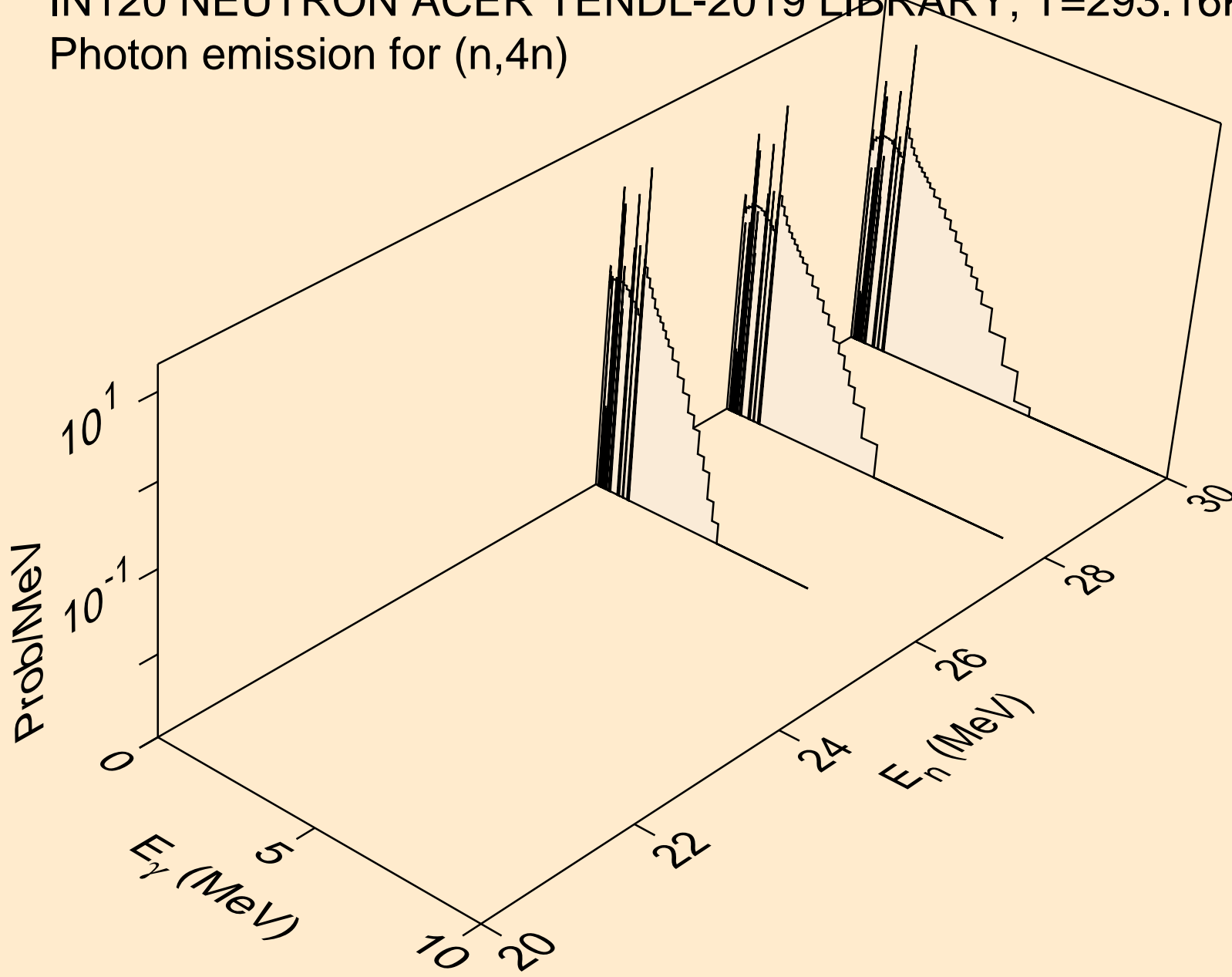

IN120 NEUTRON ACER TENDL-2019 LIBRARY; T=293.16K  
Photon emission for (n,2np)

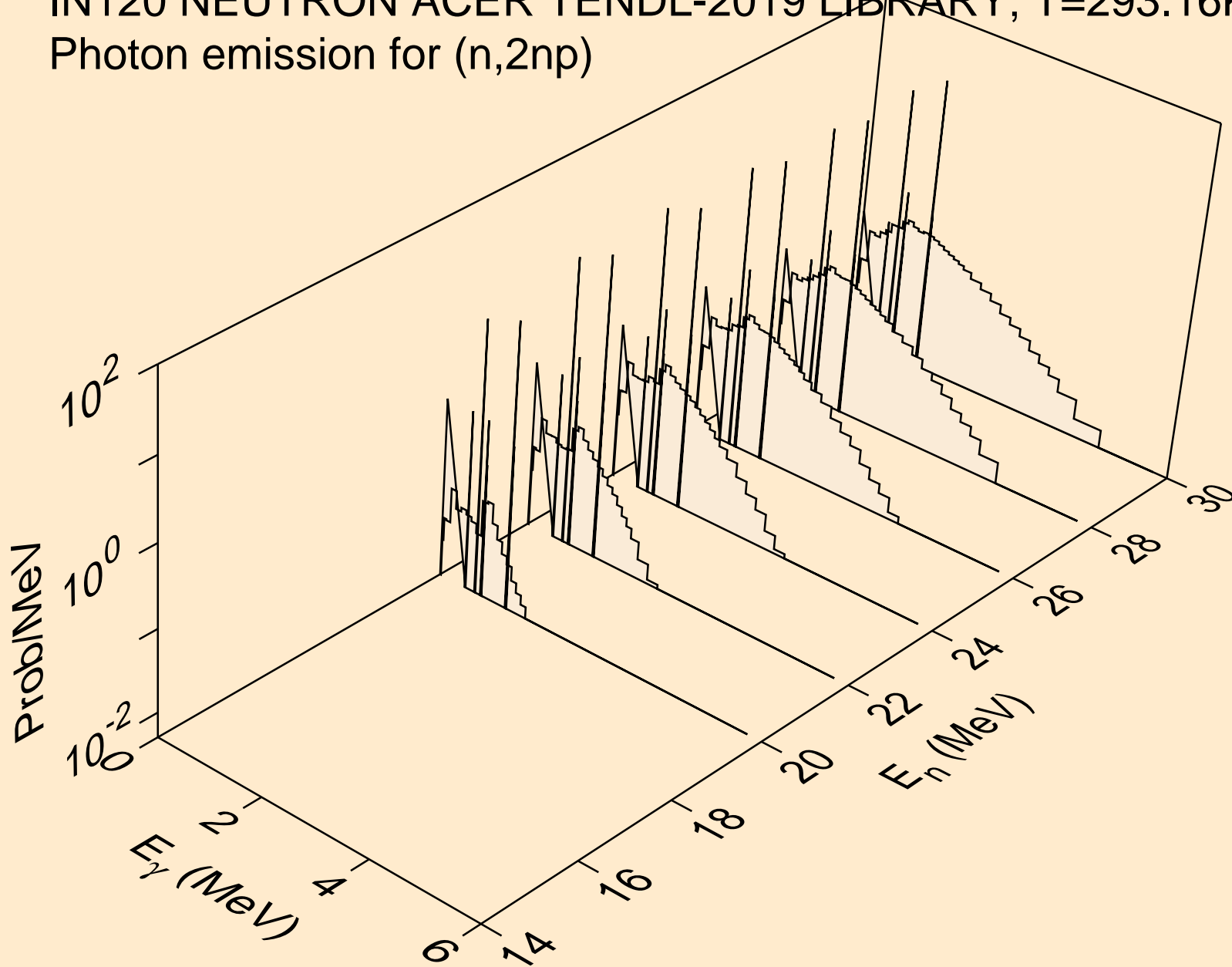

IN120 NEUTRON ACER TENDL-2019 LIBRARY; T=293.16K  
Photon emission for (n,3np)

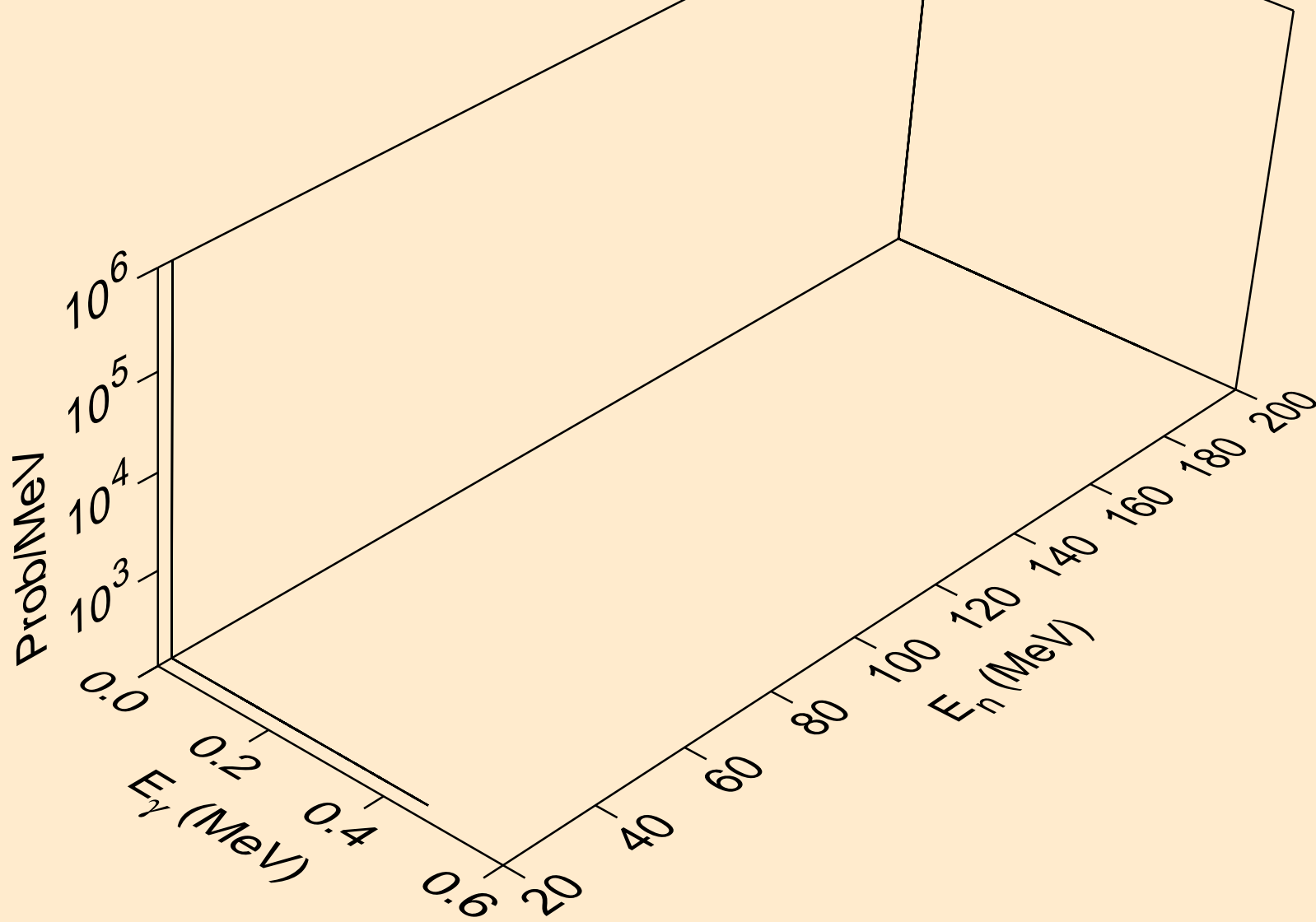

IN120 NEUTRON ACER TENDL-2019 LIBRARY; T=293.16K  
Photon emission for (n,n\*c)

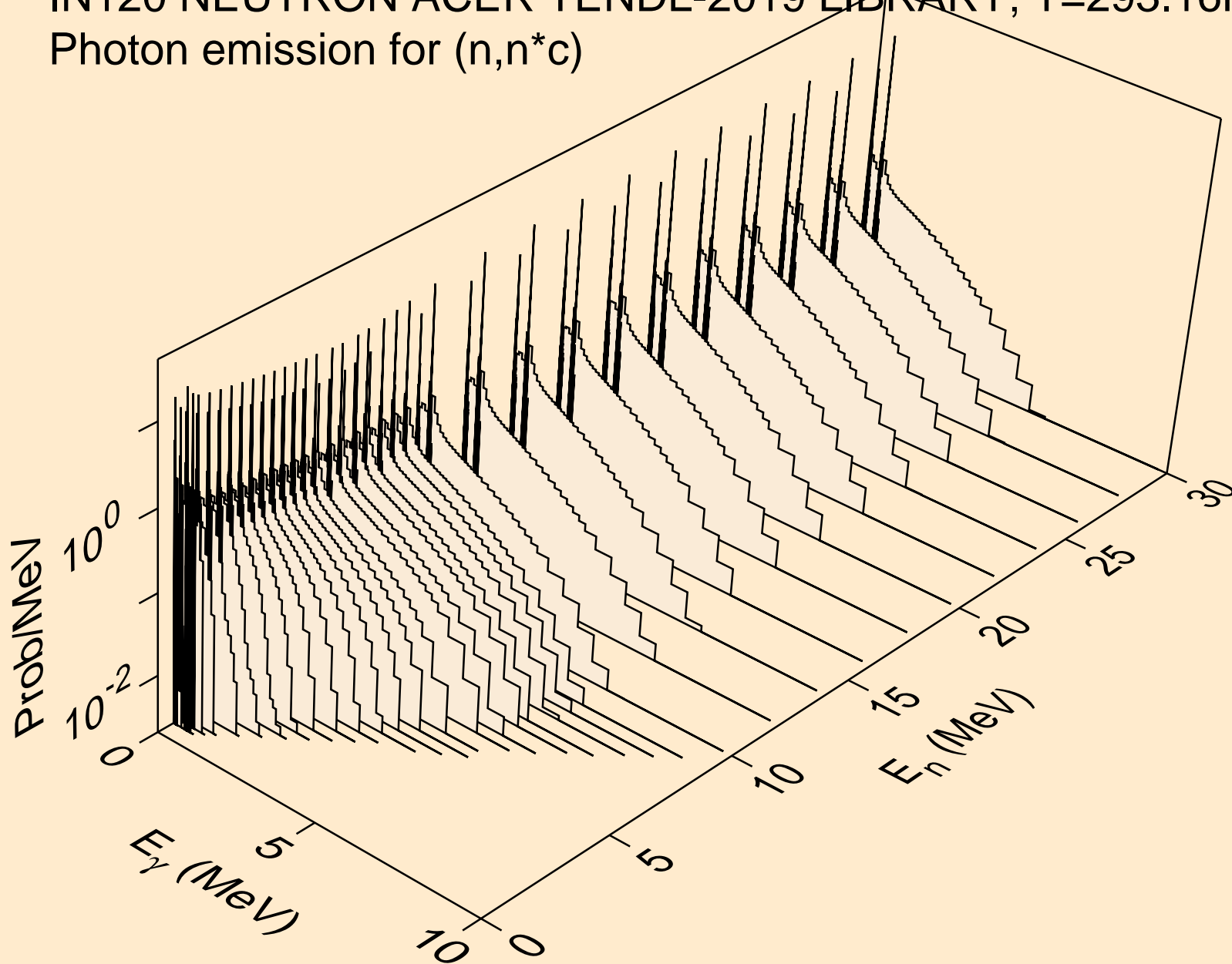



IN120 NEUTRON ACER TENDL-2019 LIBRARY; T=293.16K  
Photon emission for (n,gma)

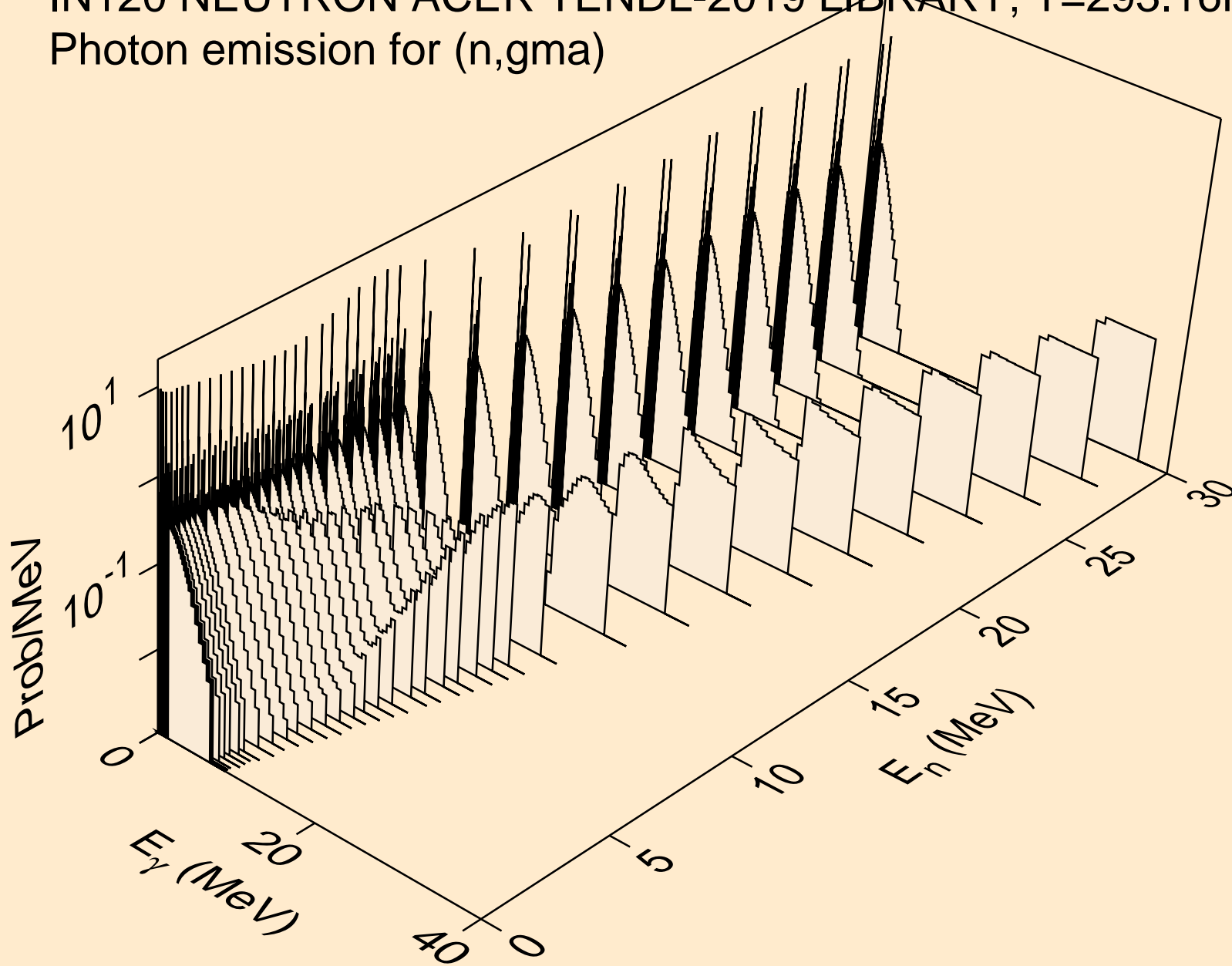

IN120 NEUTRON ACER TENDL-2019 LIBRARY; T=293.16K  
Photon emission for (n,p)

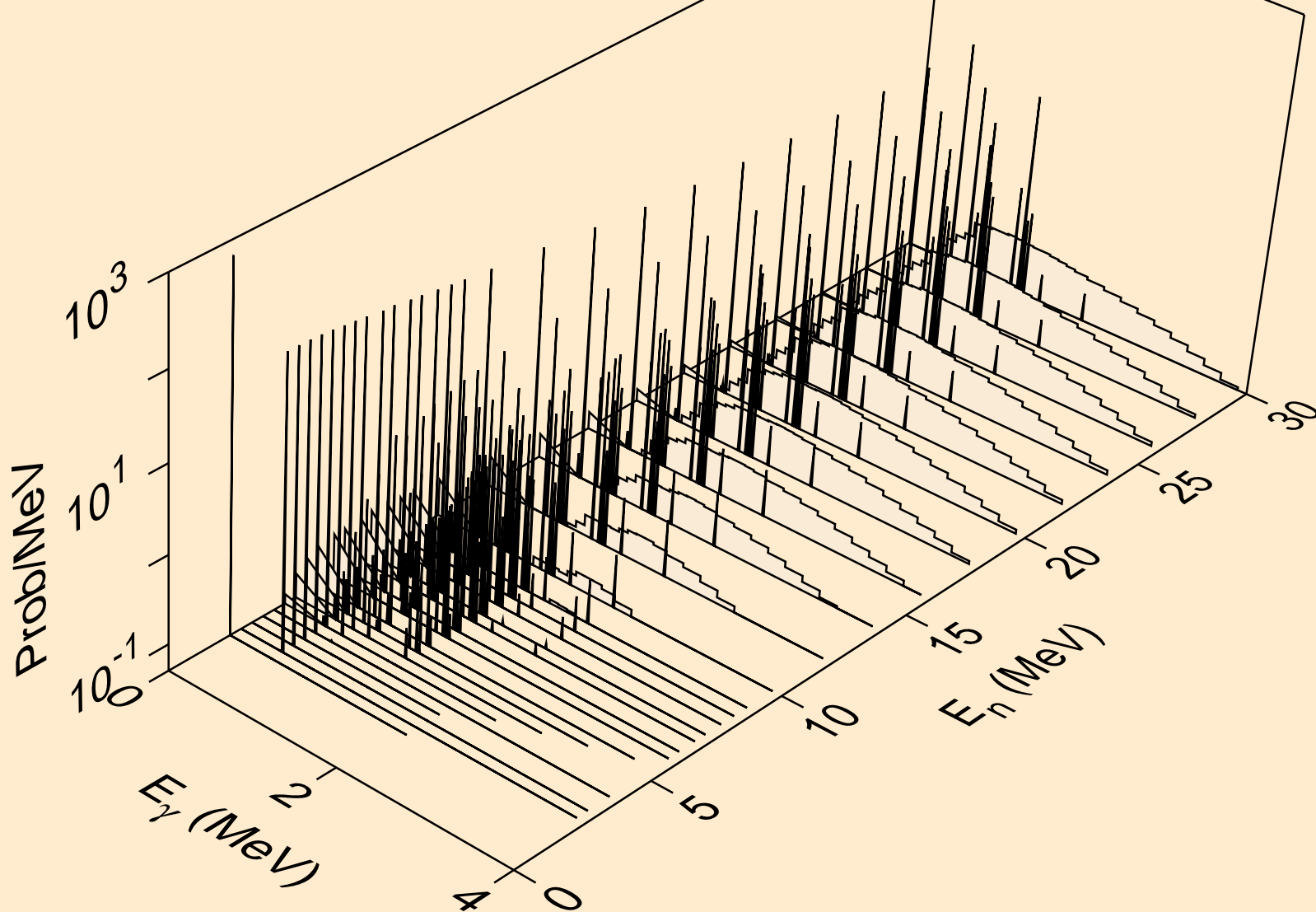

IN120 NEUTRON ACER TENDL-2019 LIBRARY; T=293.16K  
Photon emission for (n,d)

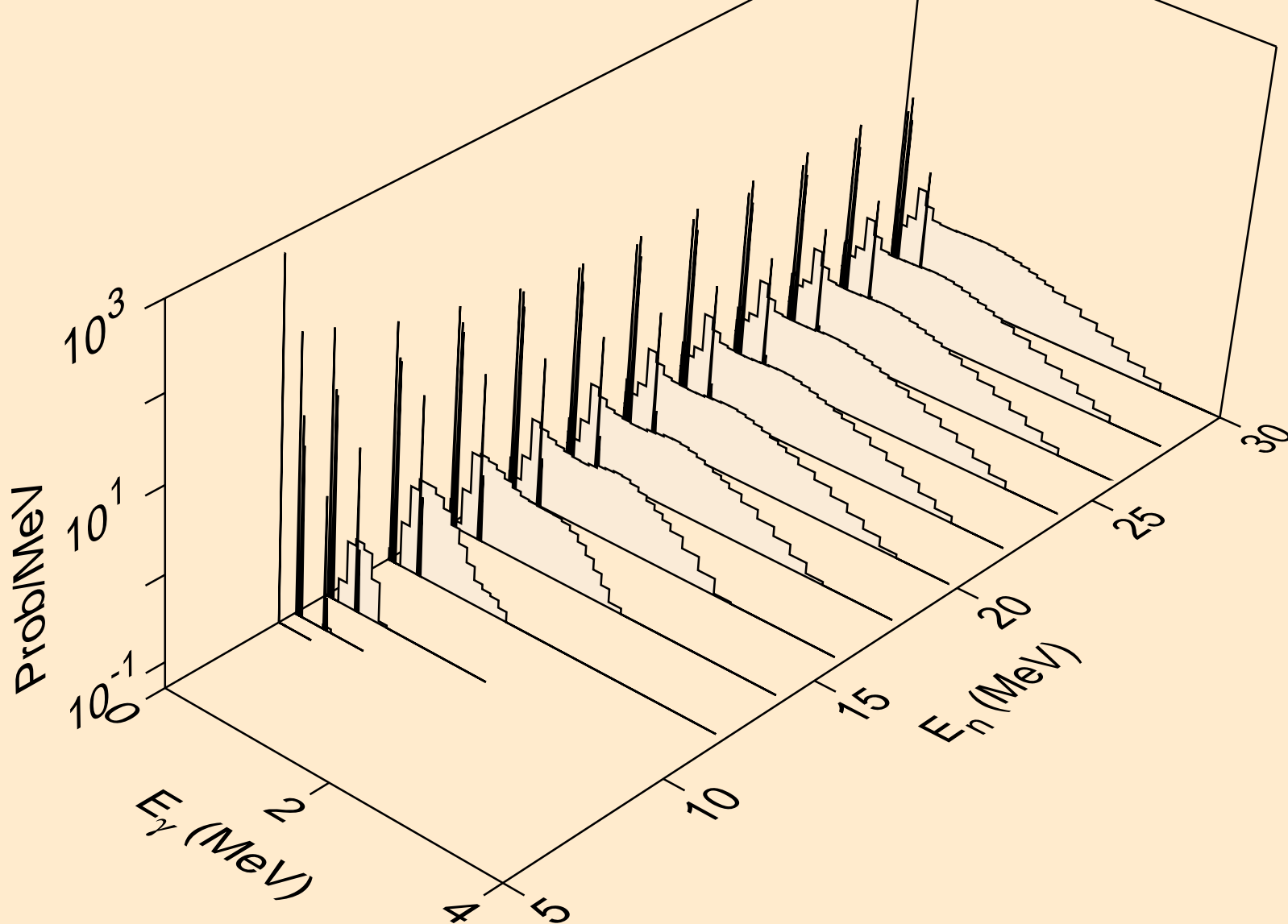

IN120 NEUTRON ACER TENDL-2019 LIBRARY; T=293.16K  
Photon emission for (n,t)

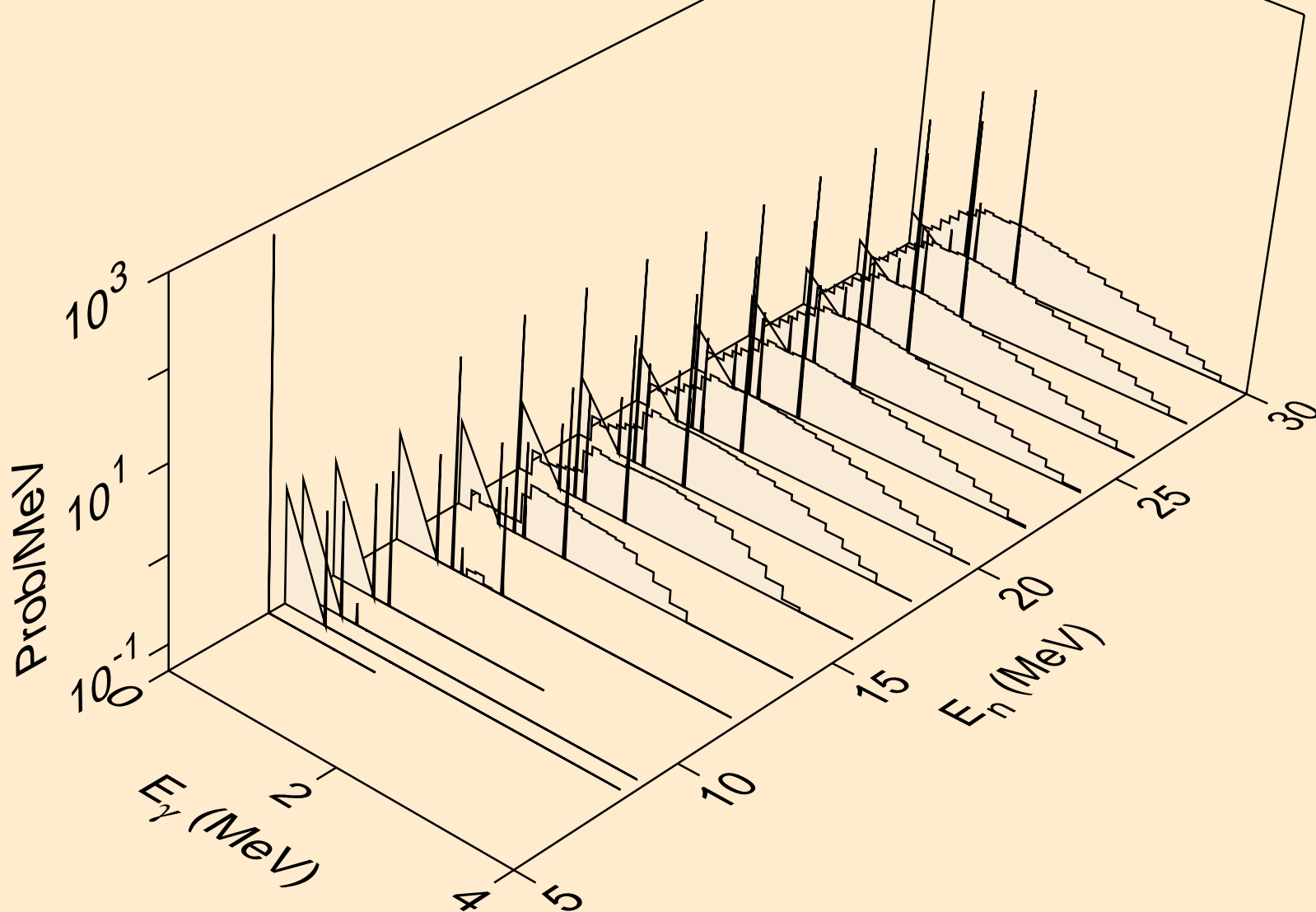

IN120 NEUTRON ACER TENDL-2019 LIBRARY; T=293.16K  
Photon emission for (n,he3)

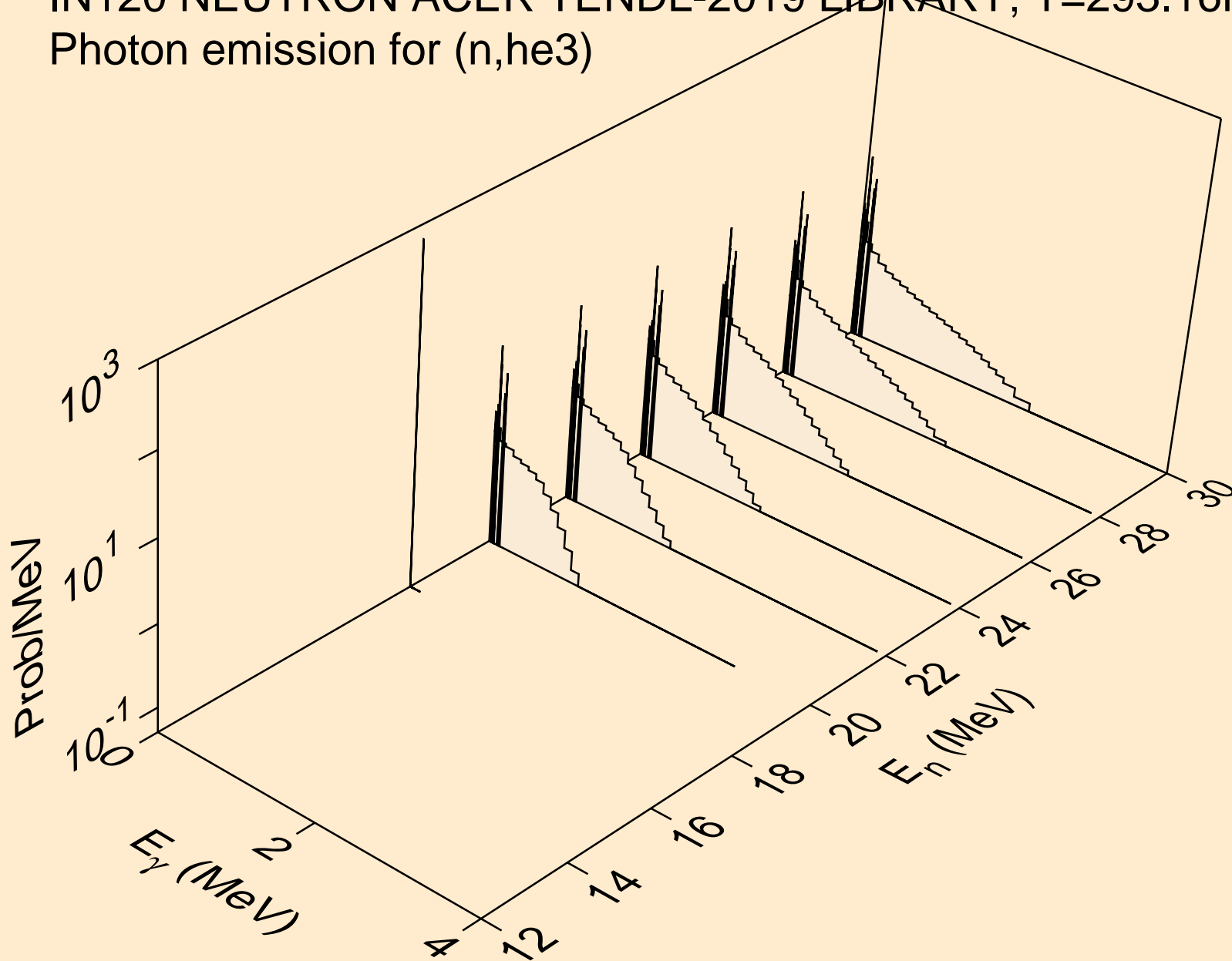

IN120 NEUTRON ACER TENDL-2019 LIBRARY; T=293.16K  
Photon emission for (n,a)

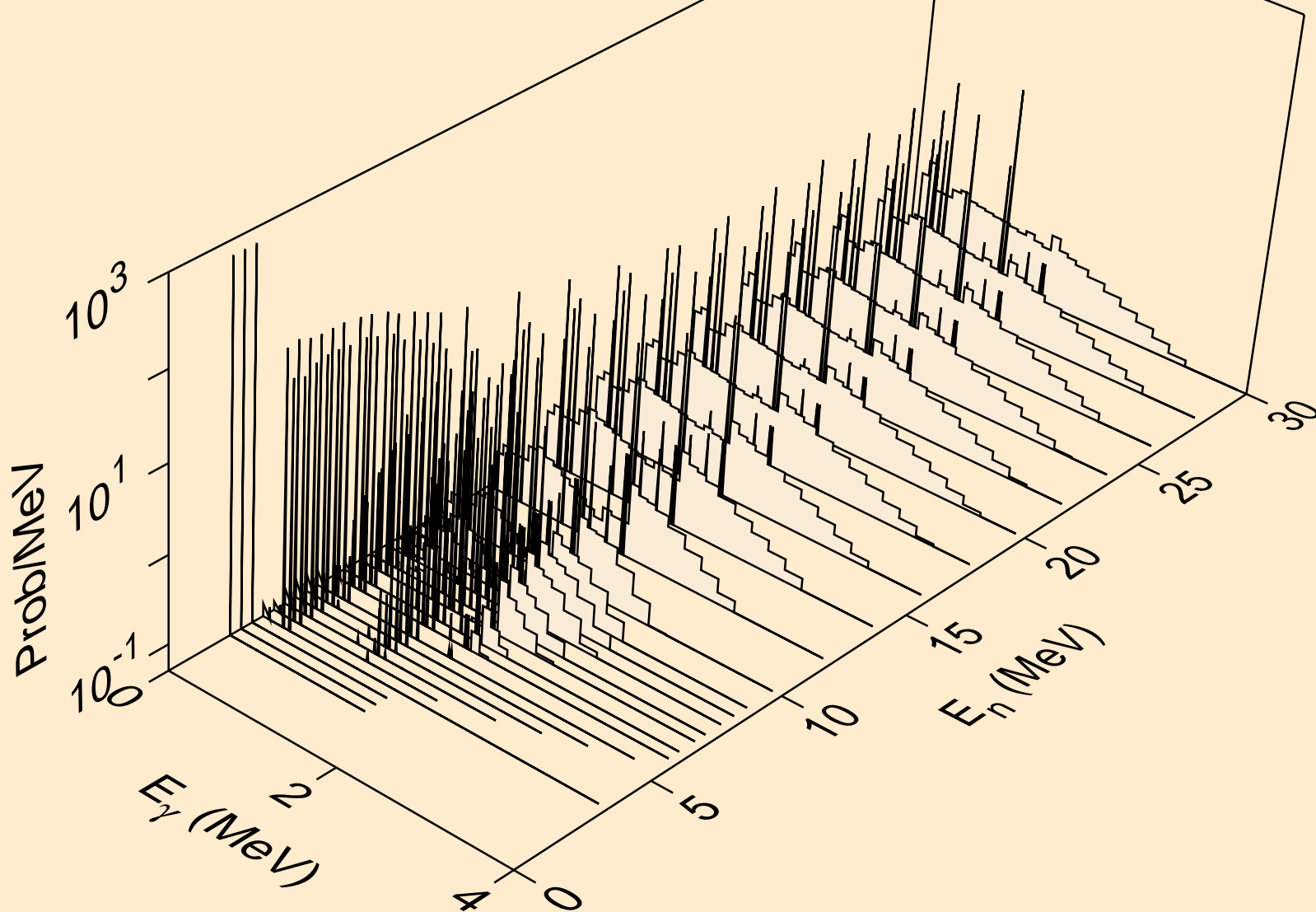

IN120 NEUTRON ACER TENDL-2019 LIBRARY; T=293.16K  
Photon emission for (n,2p)

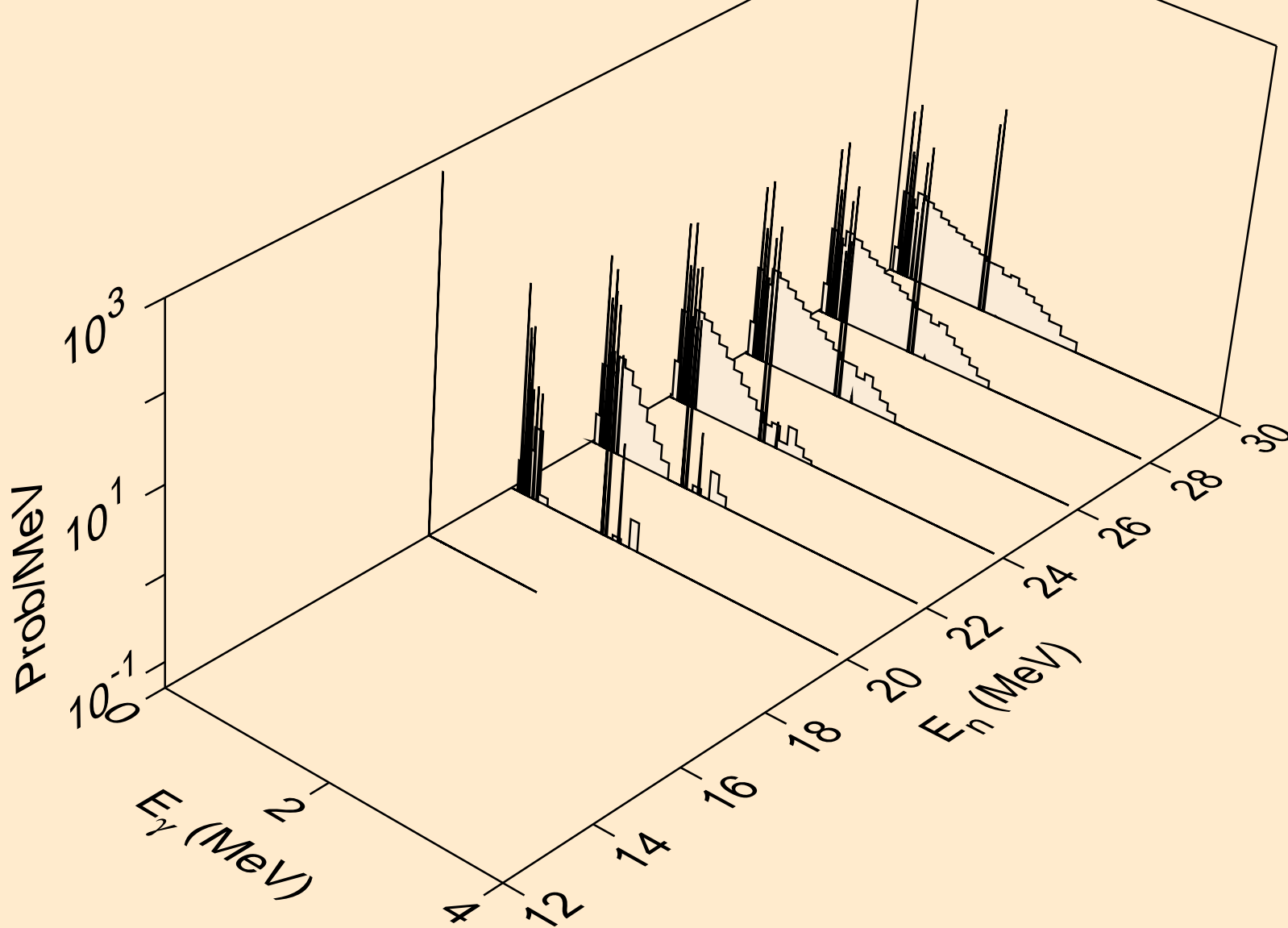

IN120 NEUTRON ACER TENDL-2019 LIBRARY; T=293.16K  
Photon emission for (n,p)

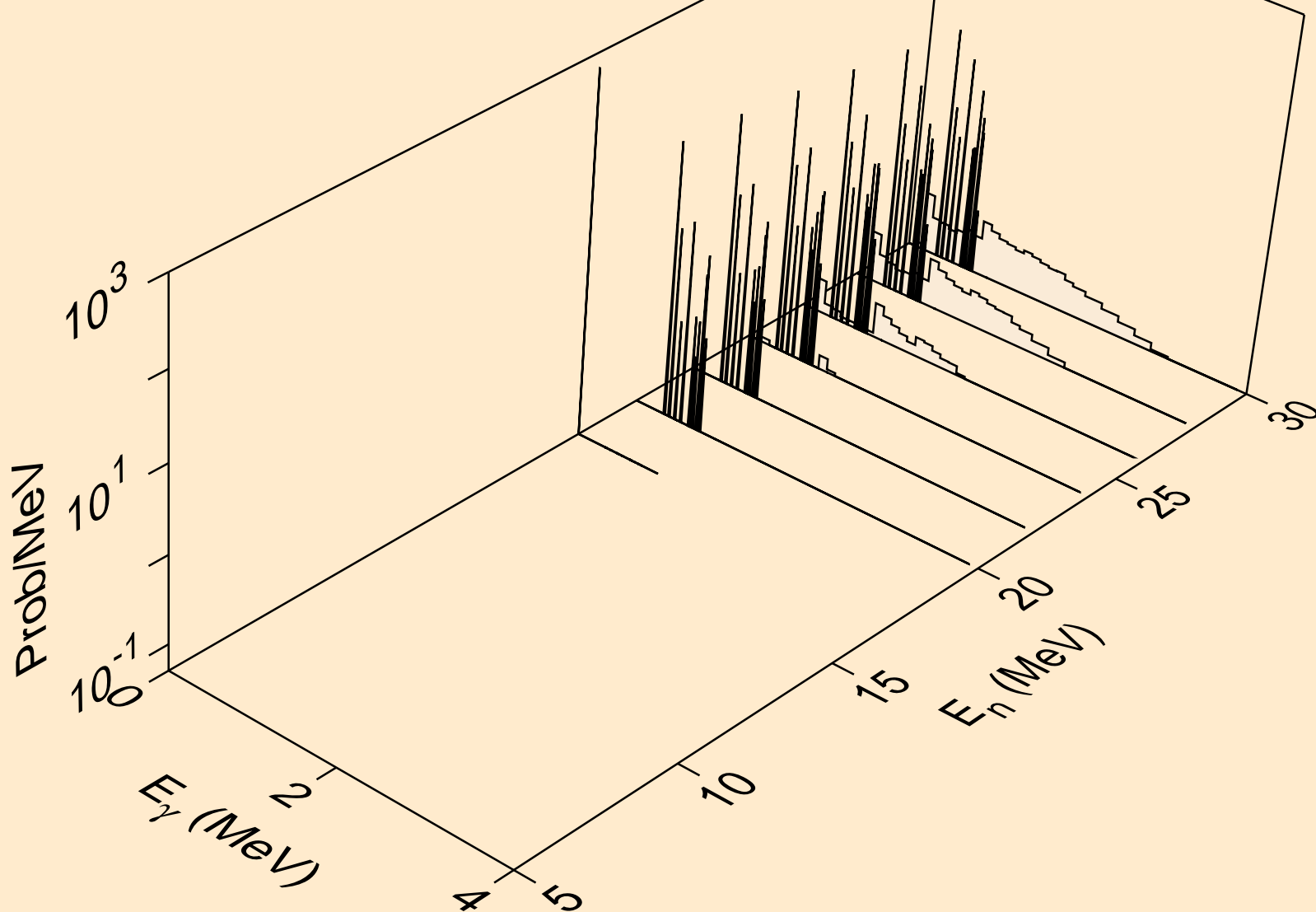



IN120 NEUTRON ACER TENDL-2019 LIBRARY; T=293.16K  
thermal capture photon spectrum

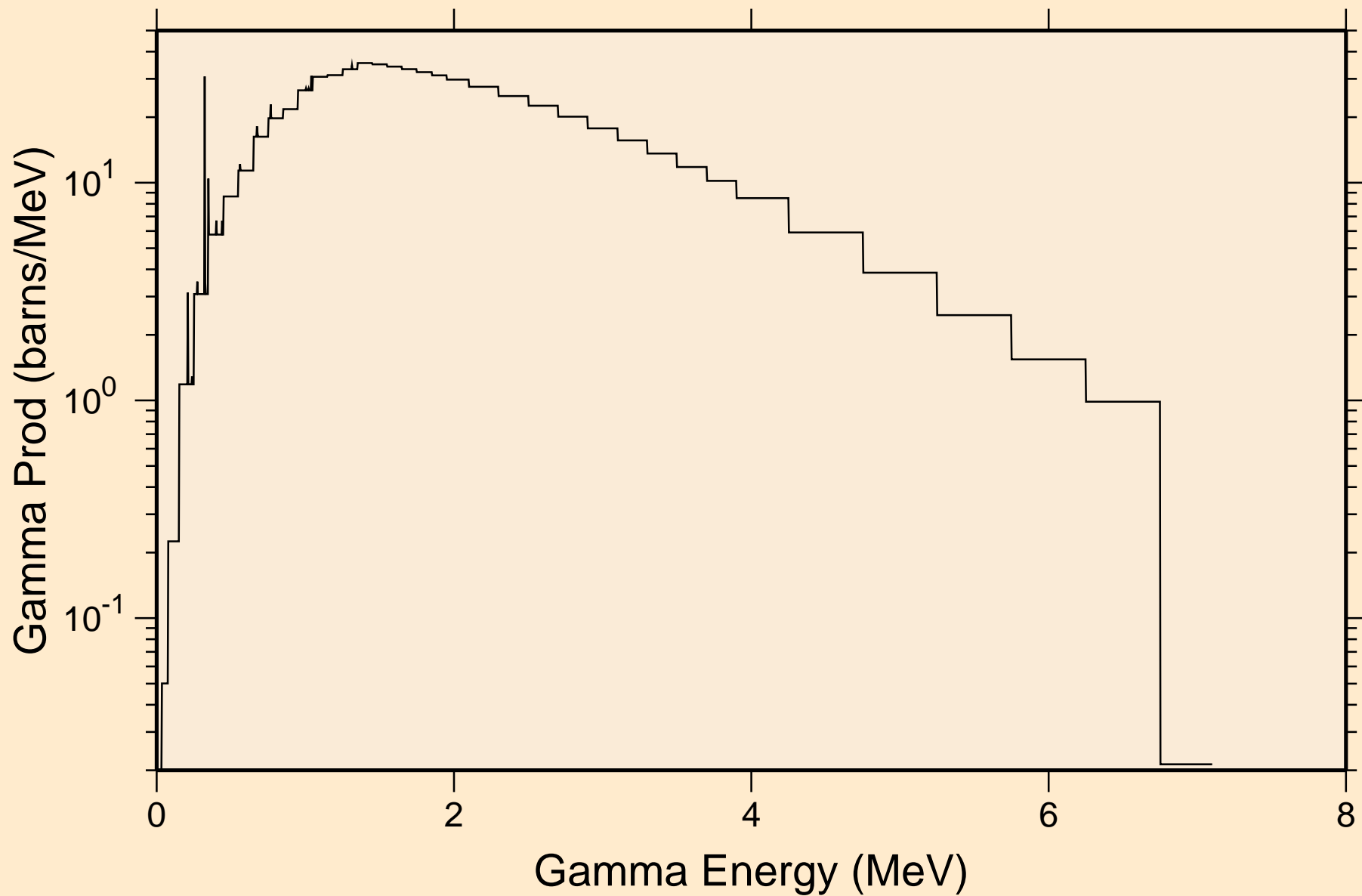

IN120 NEUTRON ACER TENDL-2019 LIBRARY; T=293.16K  
14 MeV photon spectrum

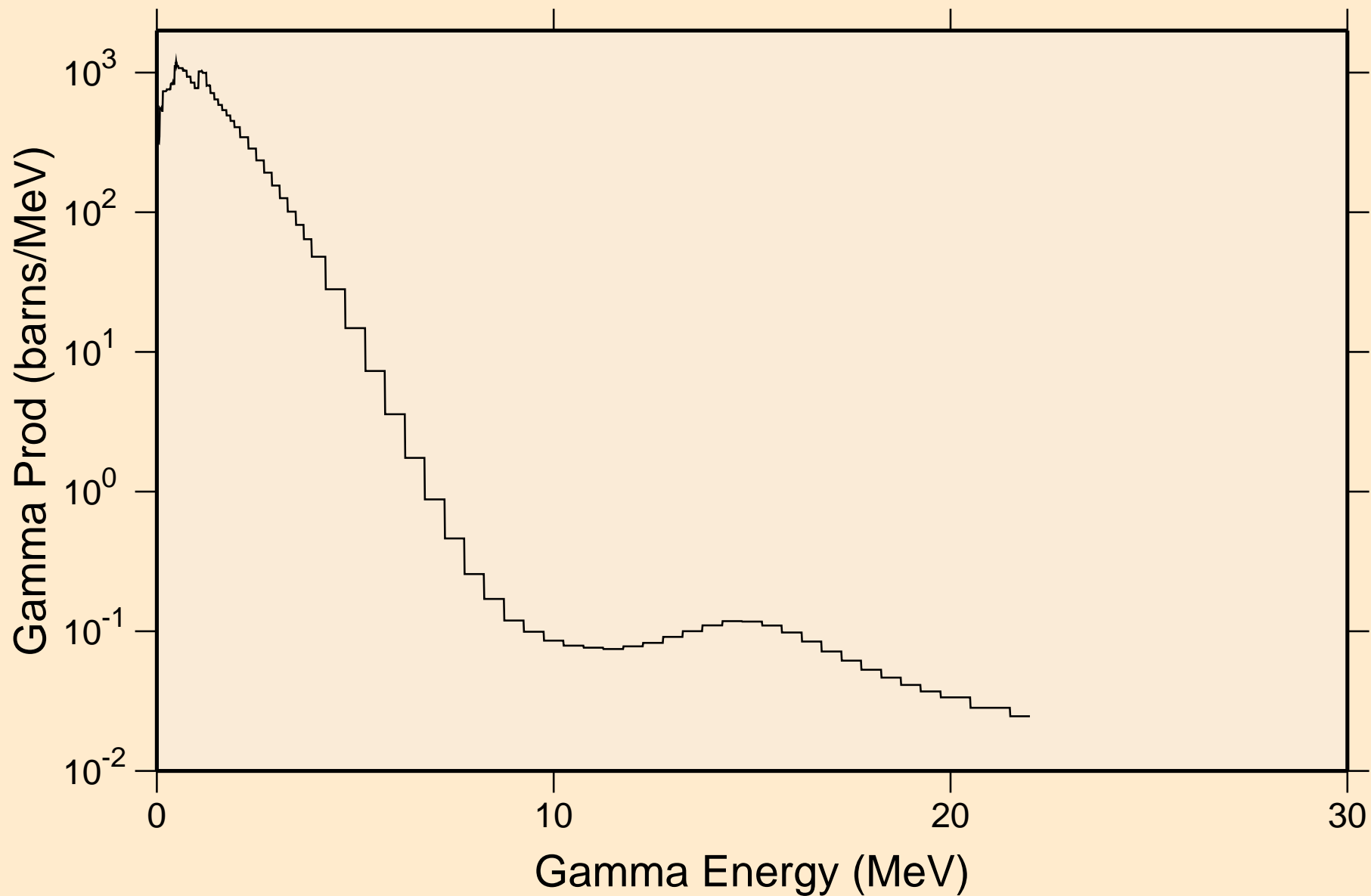

# IN120 NEUTRON ACER TENDL-2019 LIBRARY; T=293.16K

## Particle heating contributions

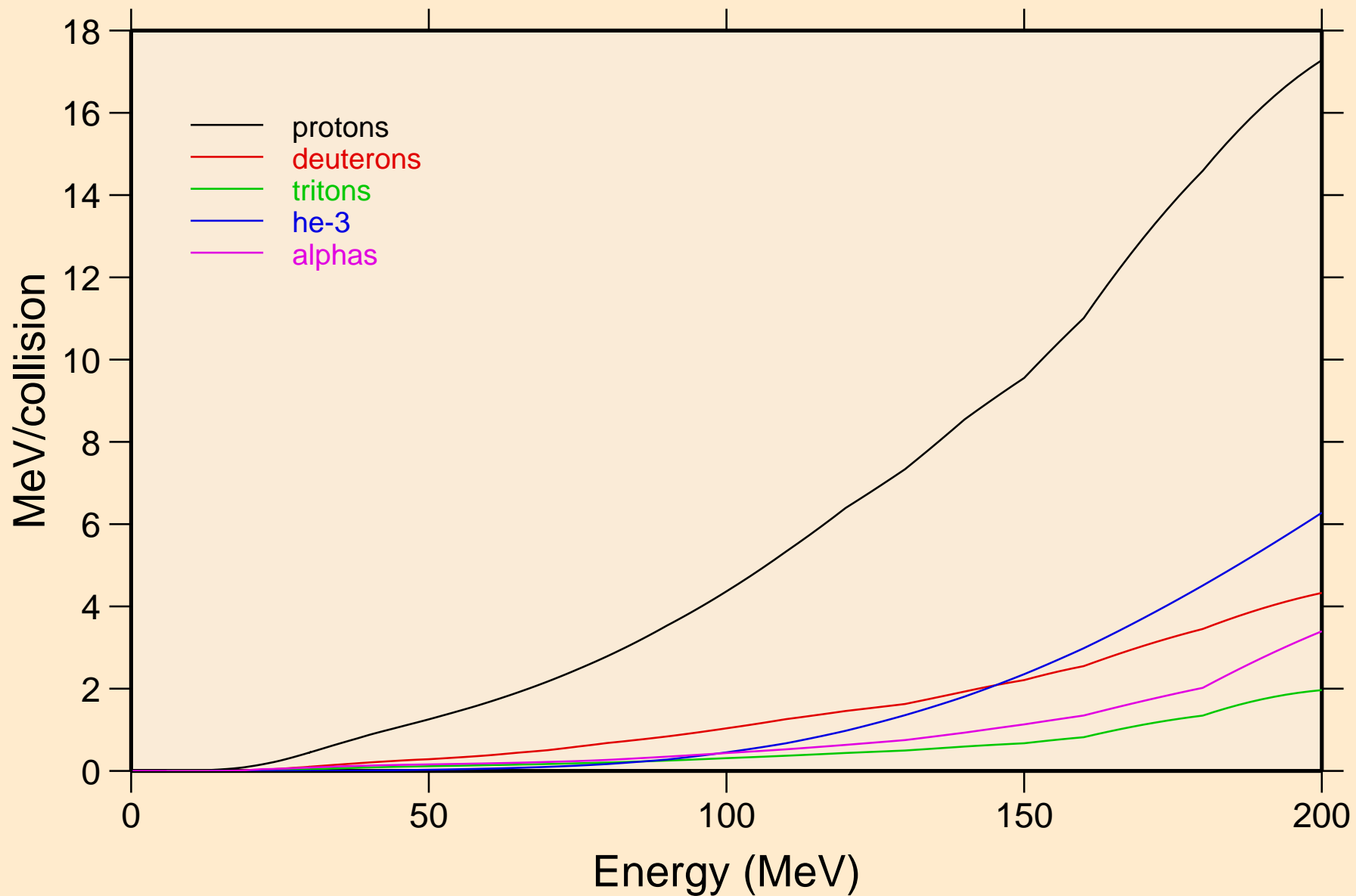

IN120 NEUTRON ACER TENDL-2019 LIBRARY; T=293.16K  
Recoil Heating

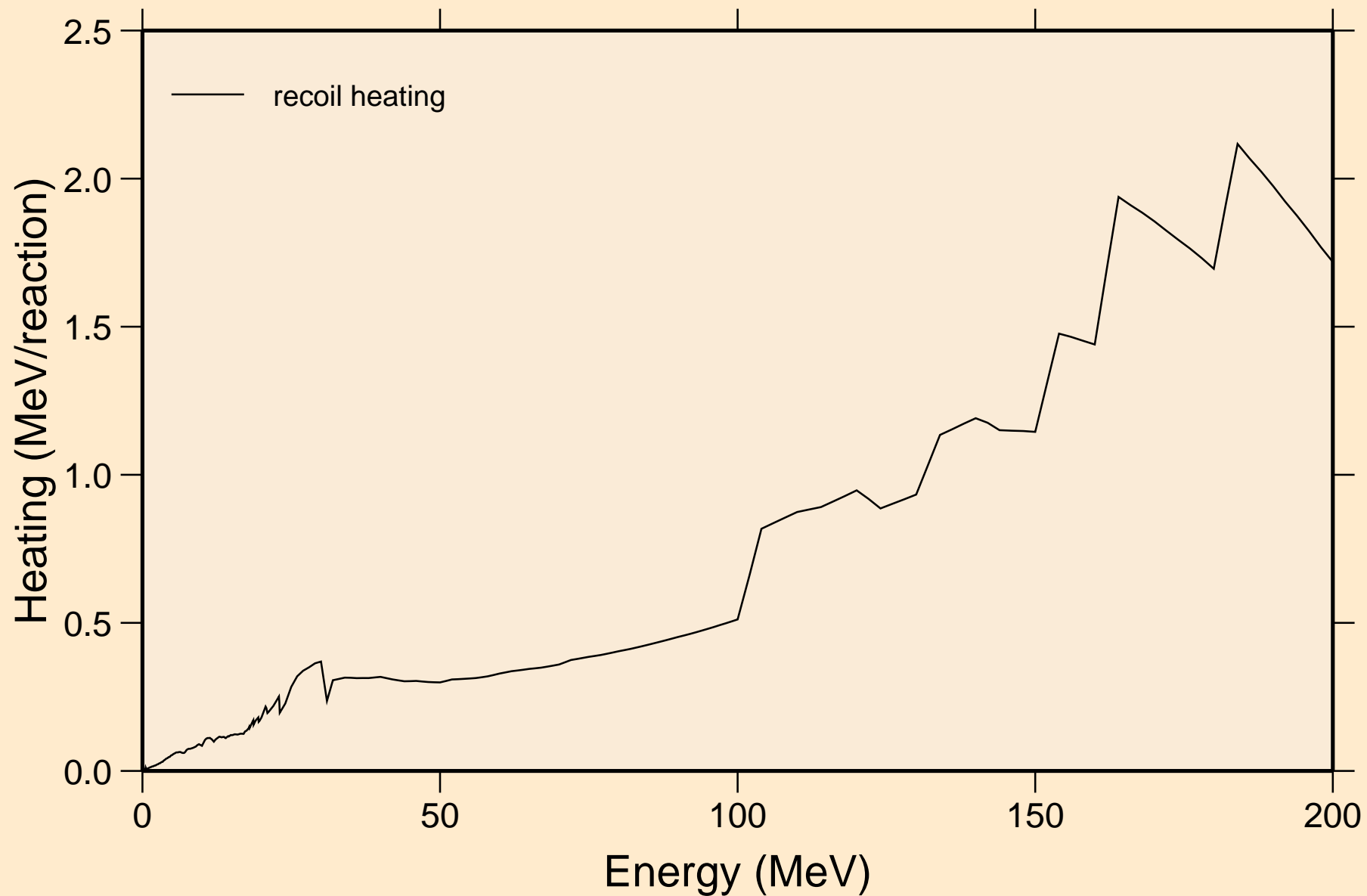

IN120 NEUTRON ACER TENDL-2019 LIBRARY; T=293.16K  
Particle production cross sections

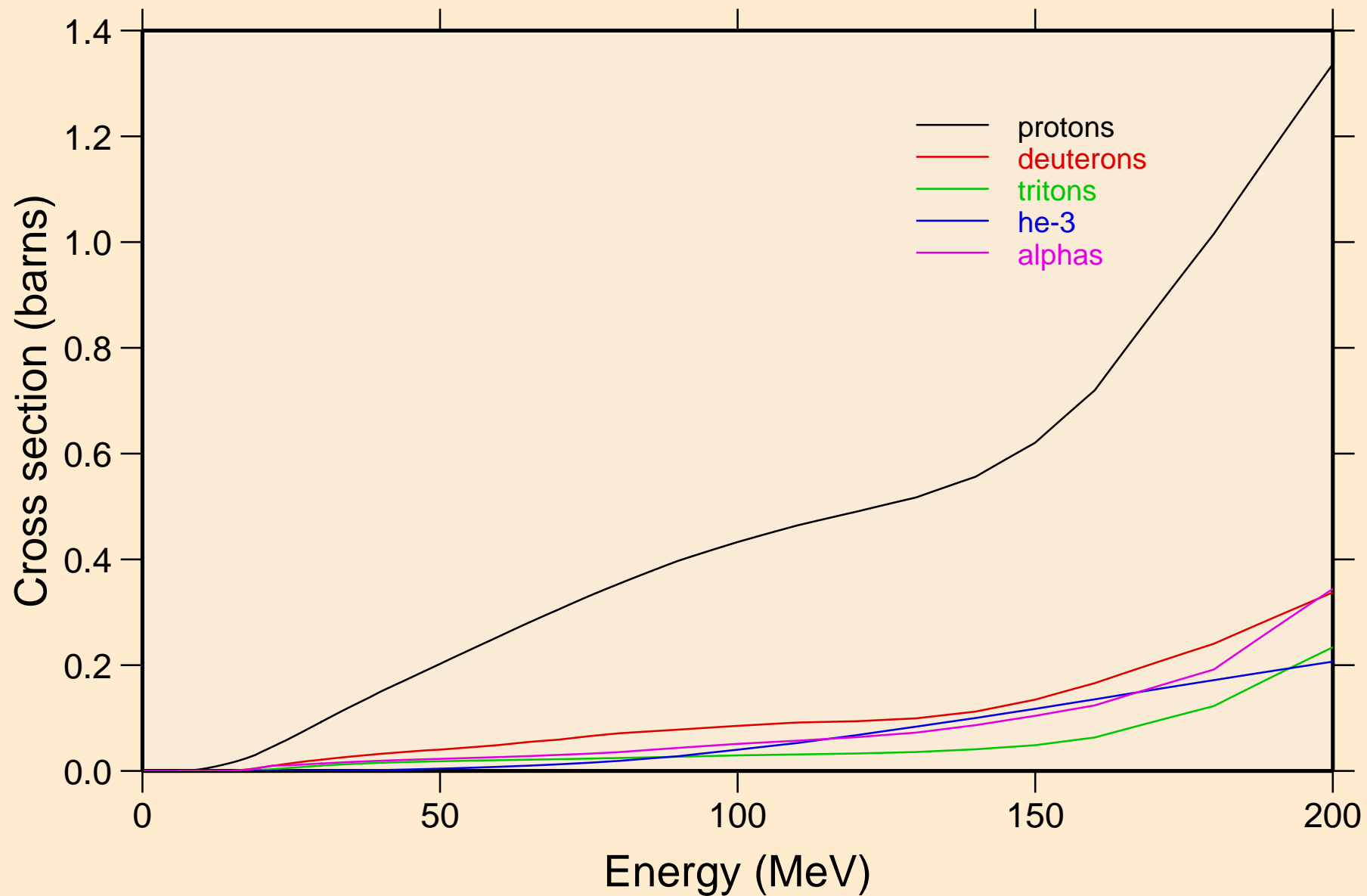

IN120 NEUTRON ACER TENDL-2019 LIBRARY; T=293.16K  
protons from (n,x)

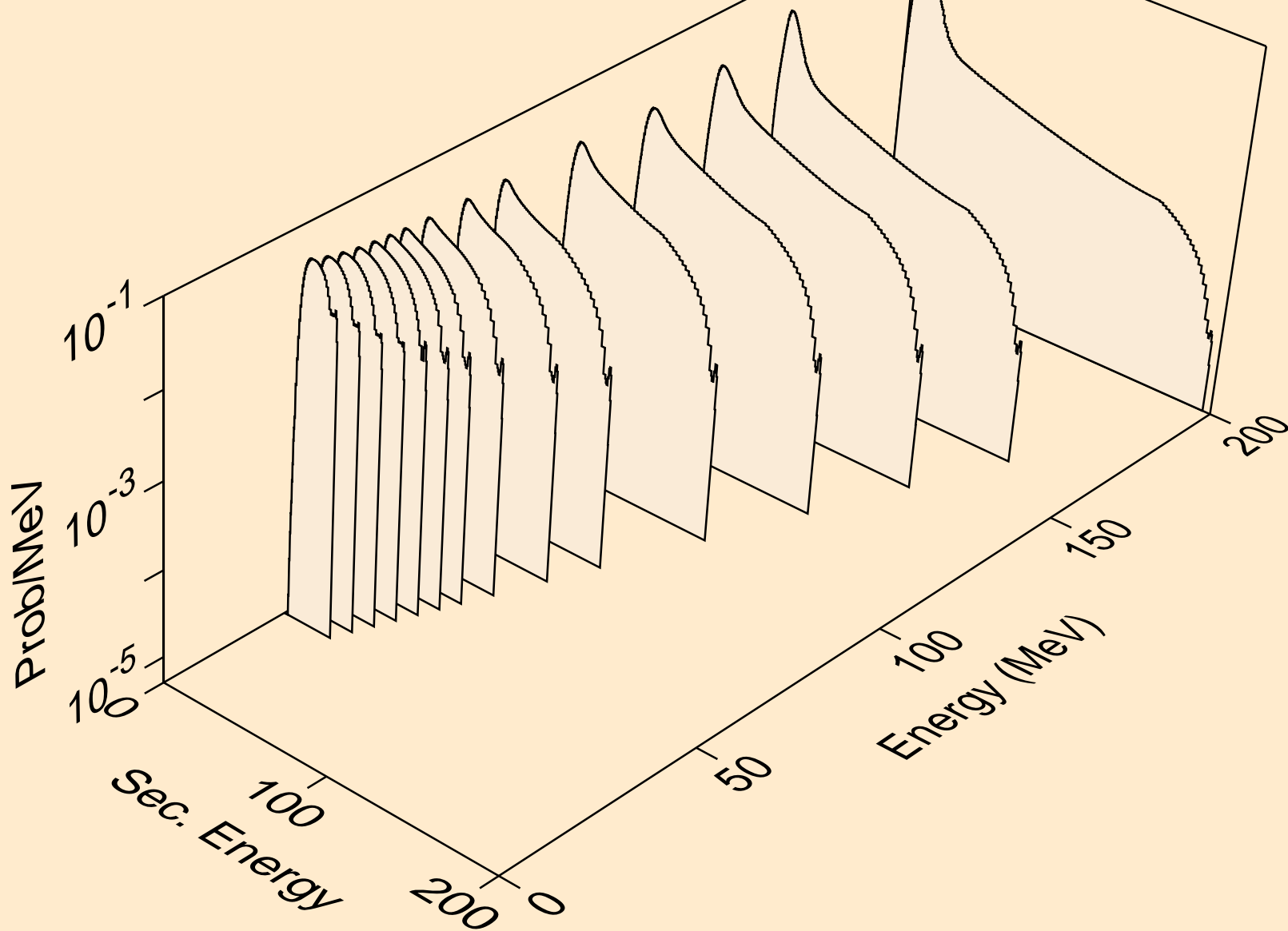

IN120 NEUTRON ACER TENDL-2019 LIBRARY; T=293.16K  
protons from (n,n\*)p

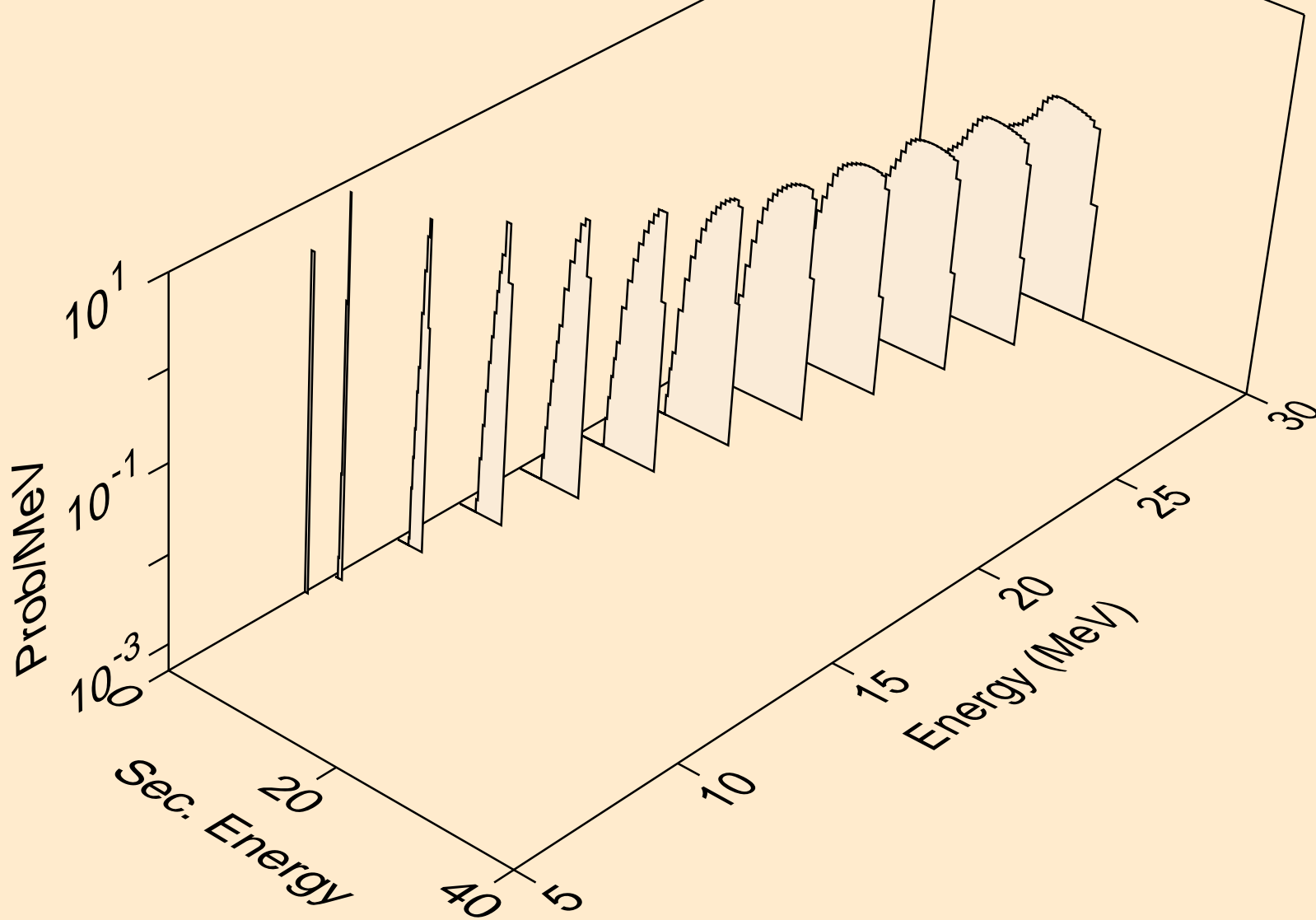

IN120 NEUTRON ACER TENDL-2019 LIBRARY; T=293.16K  
protons from (n,2np)

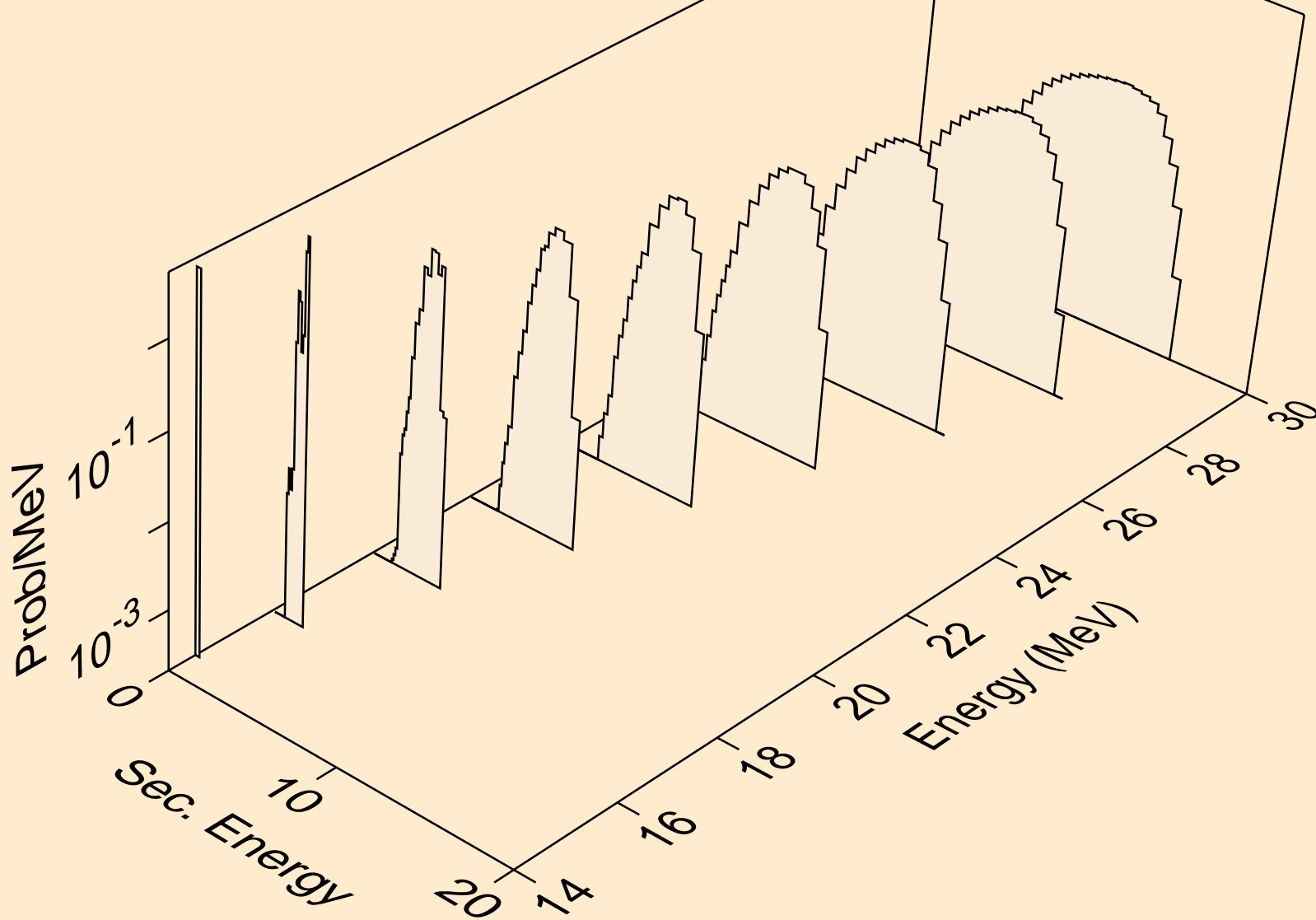



IN120 NEUTRON ACER TENDL-2019 LIBRARY; T=293.16K  
protons from (n,3np)

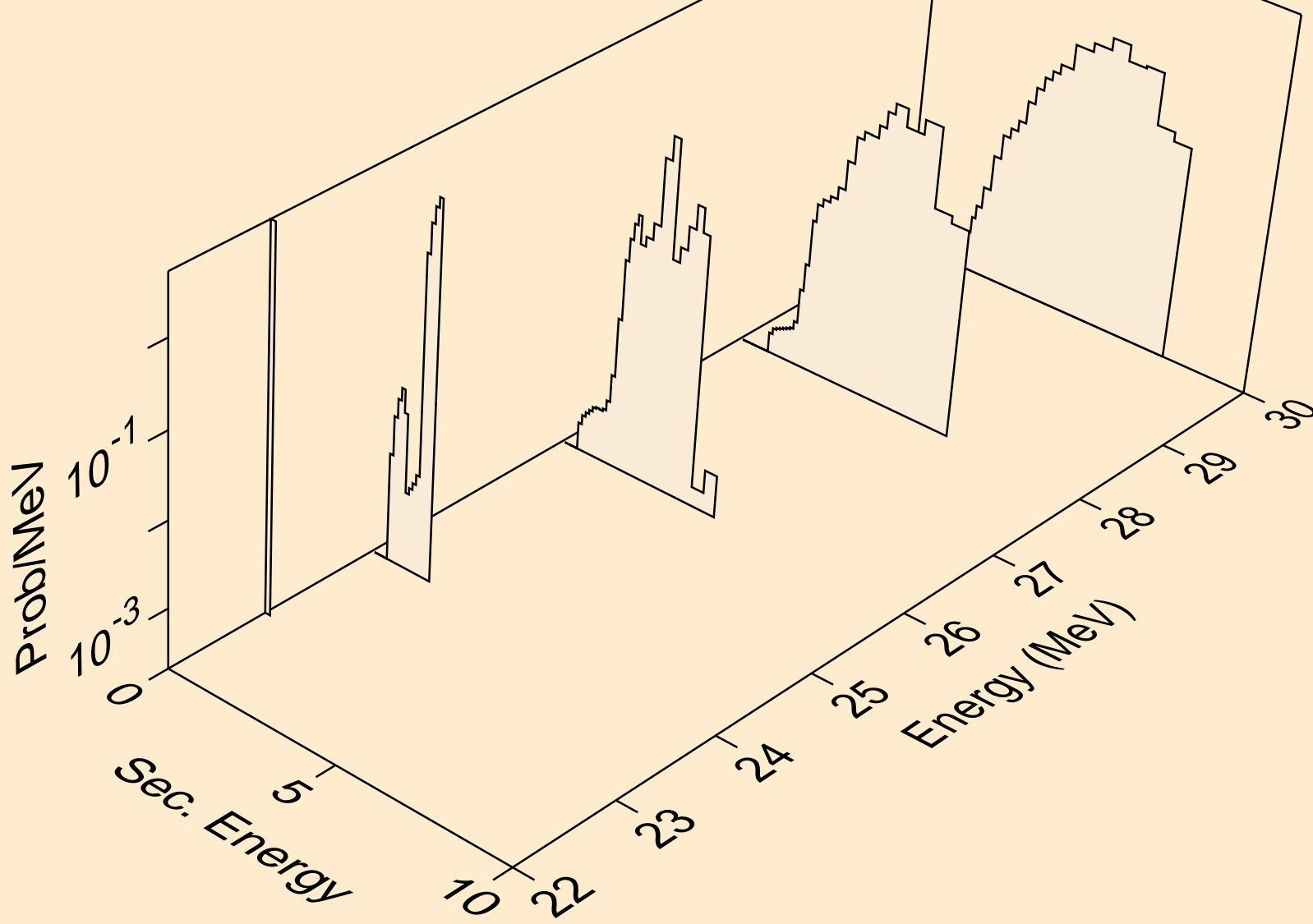

IN120 NEUTRON ACER TENDL-2019 LIBRARY; T=293.16K  
protons from (n,p)

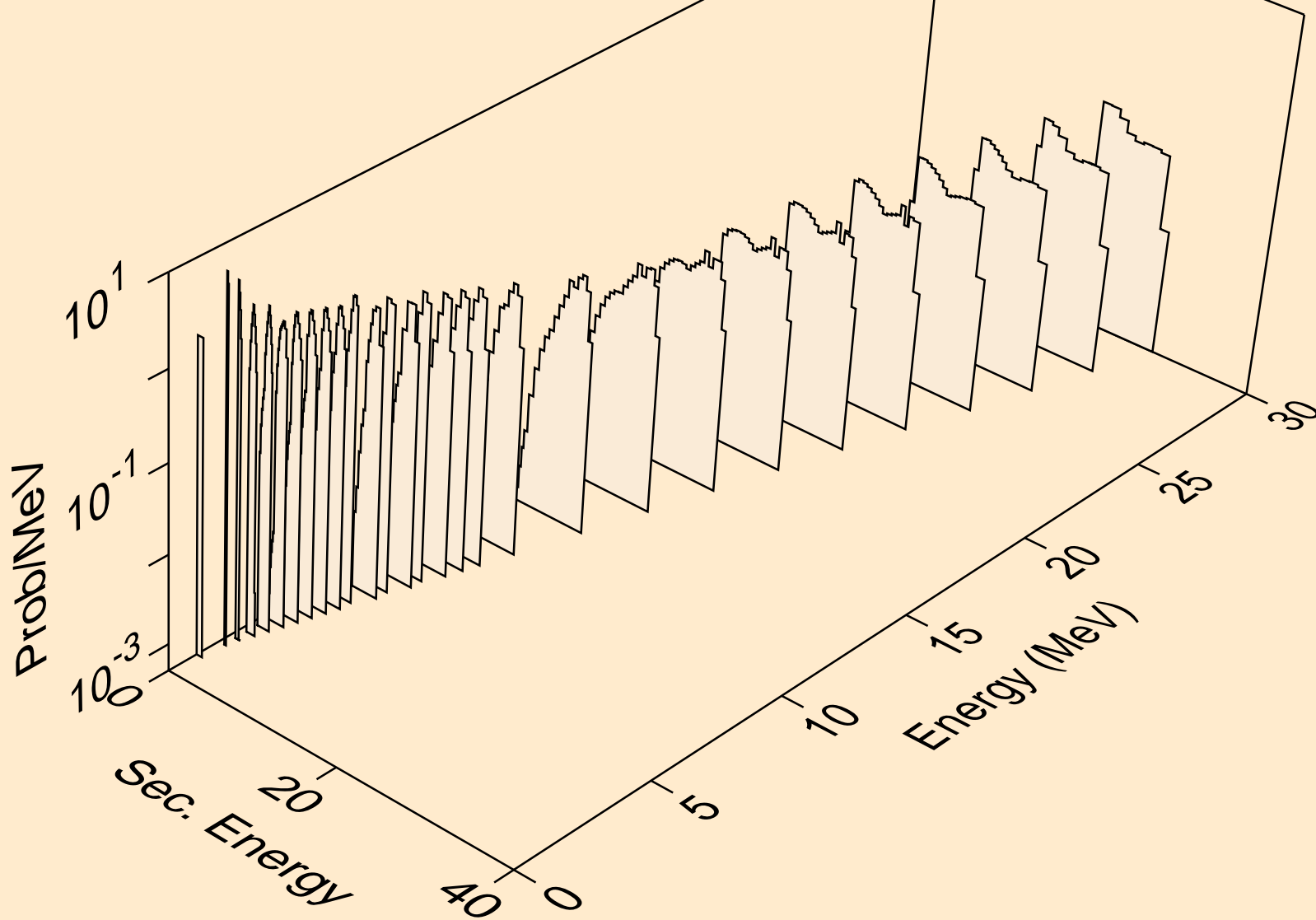

IN120 NEUTRON ACER TENDL-2019 LIBRARY; T=293.16K  
protons from (n,2p)

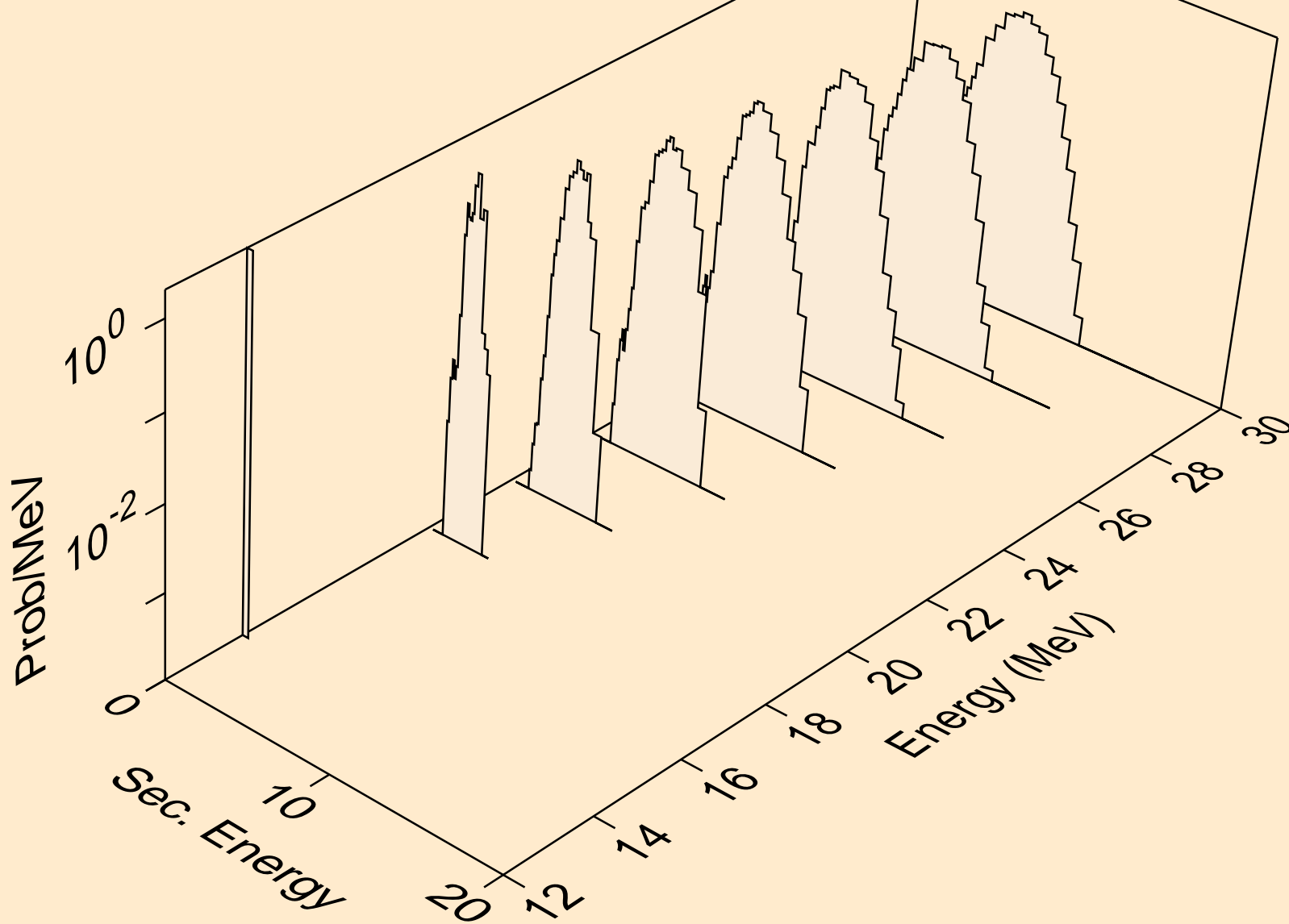

IN120 NEUTRON ACER TENDL-2019 LIBRARY; T=293.16K  
protons from (n,p)

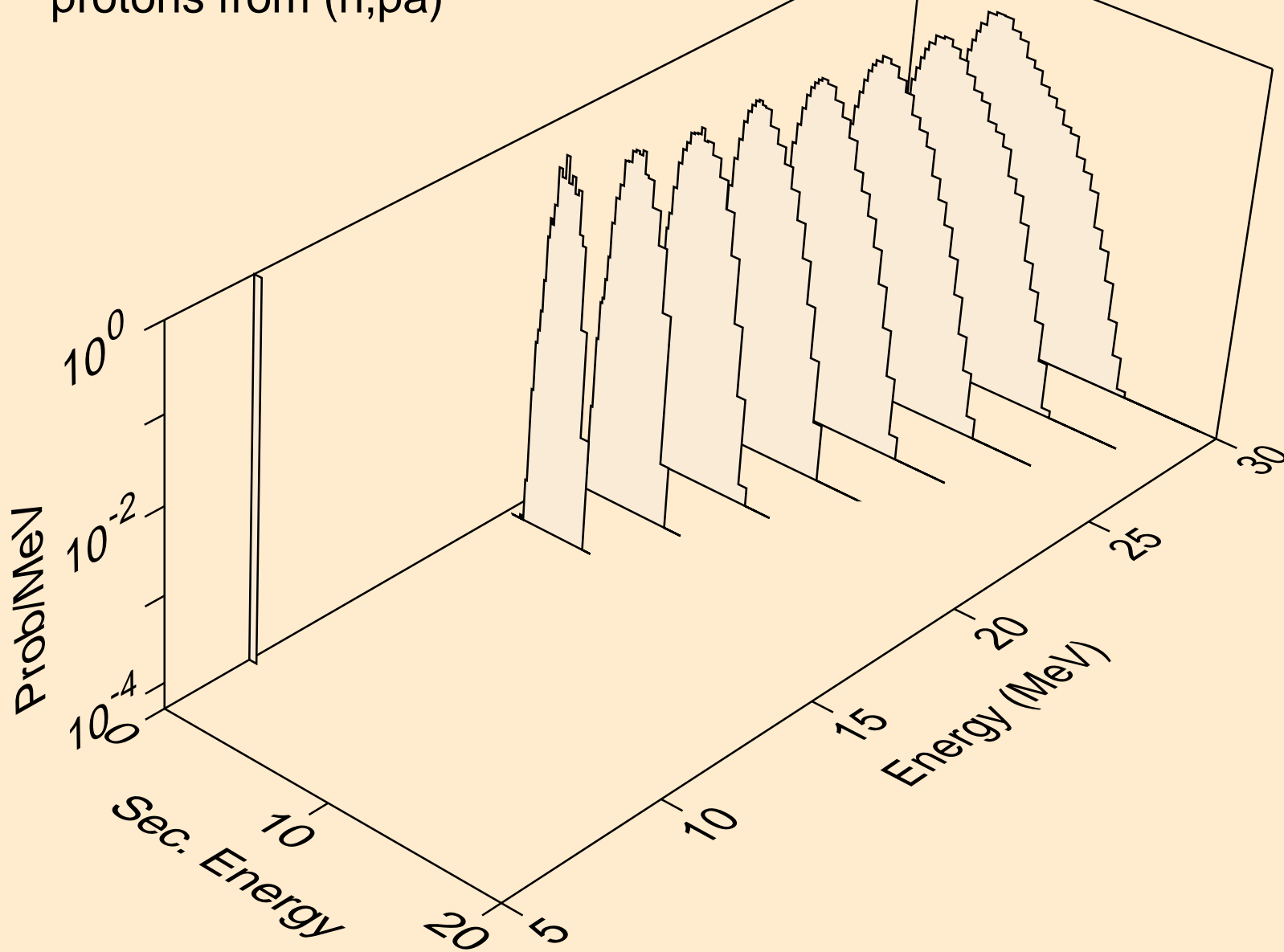

IN120 NEUTRON ACER TENDL-2019 LIBRARY; T=293.16K  
deuterons from (n,x)

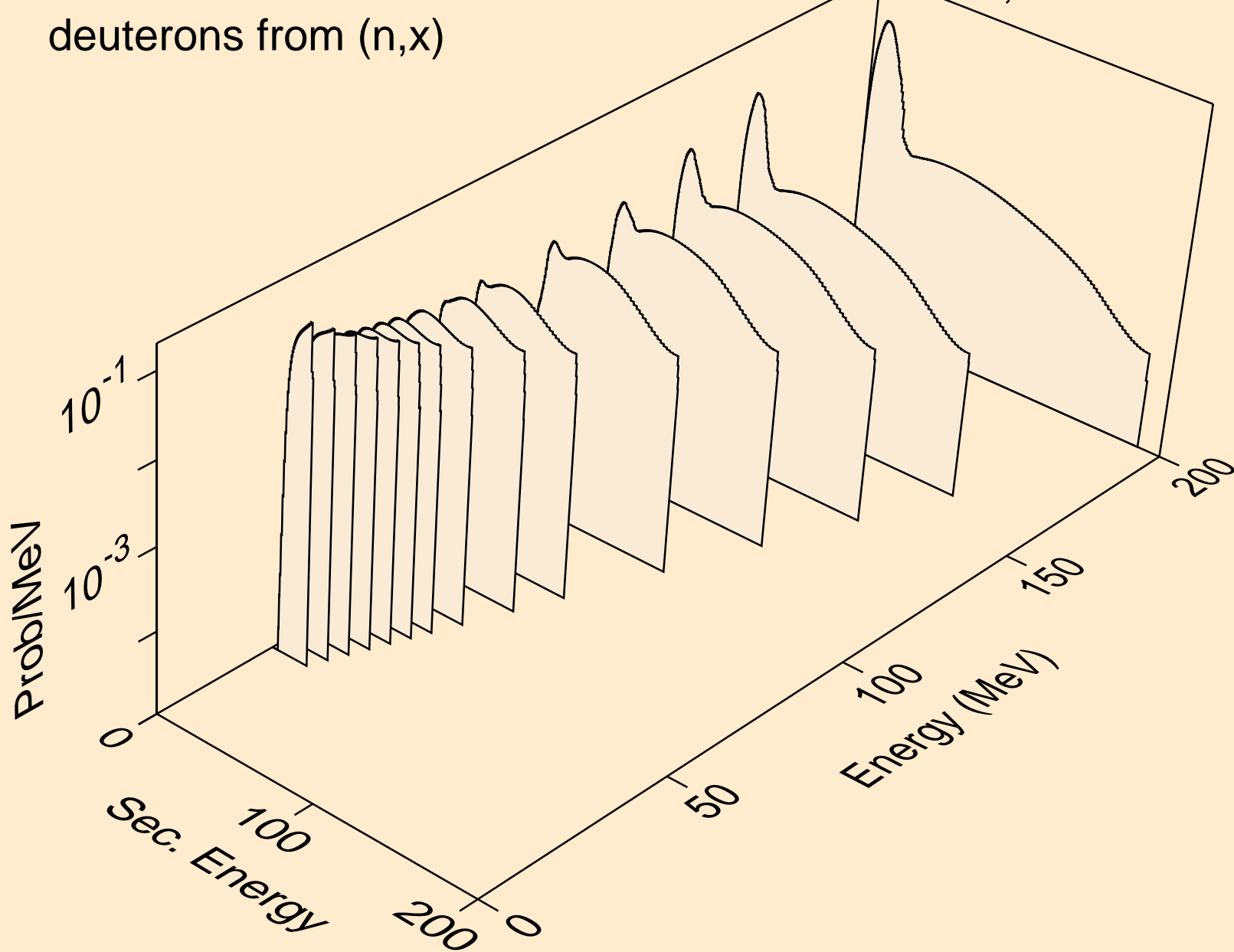

IN120 NEUTRON ACER TENDL-2019 LIBRARY; T=293.16K  
deuterons from (n,2nd)

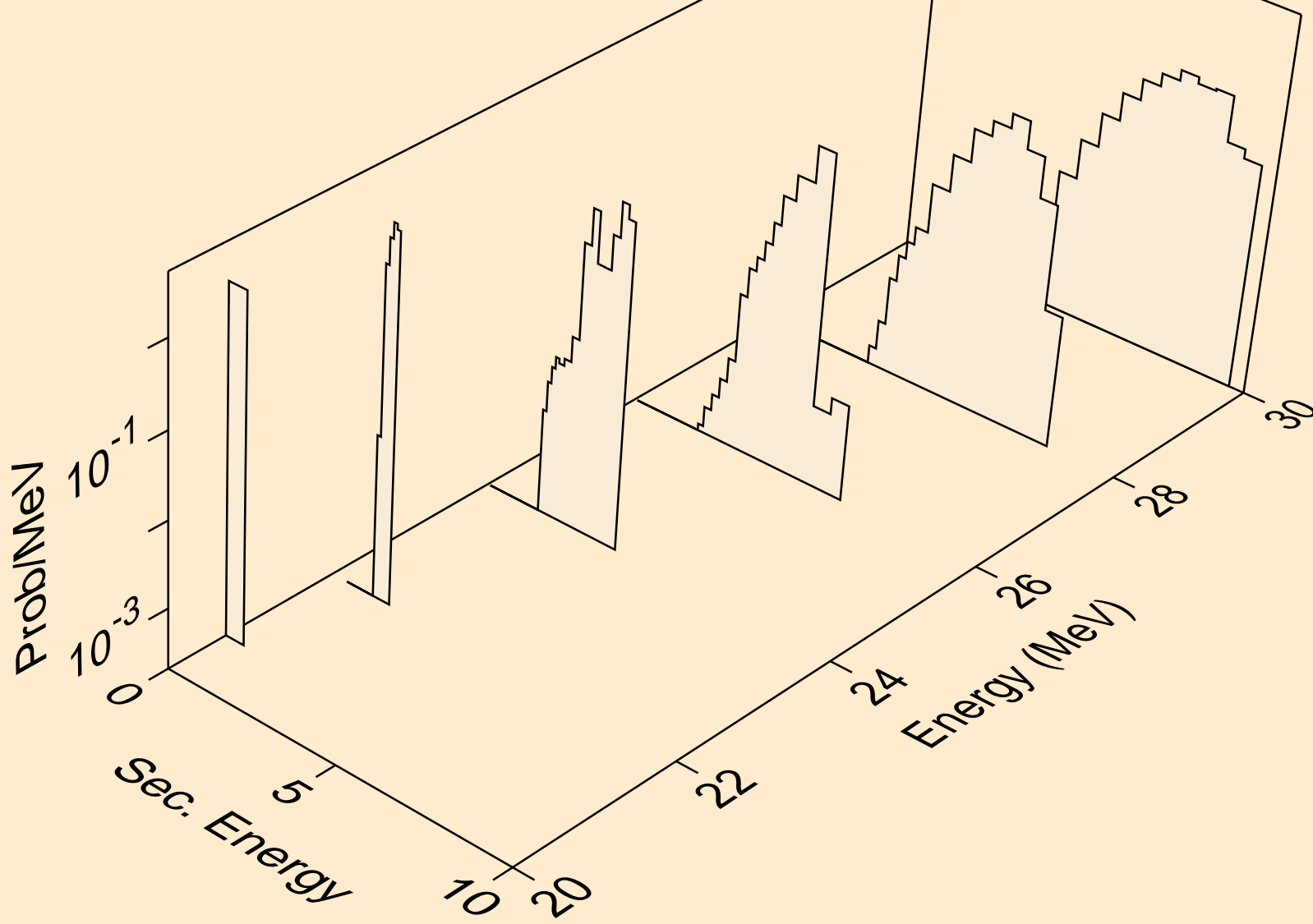

IN120 NEUTRON ACER TENDL-2019 LIBRARY; T=293.16K  
deuterons from (n,n\*)d

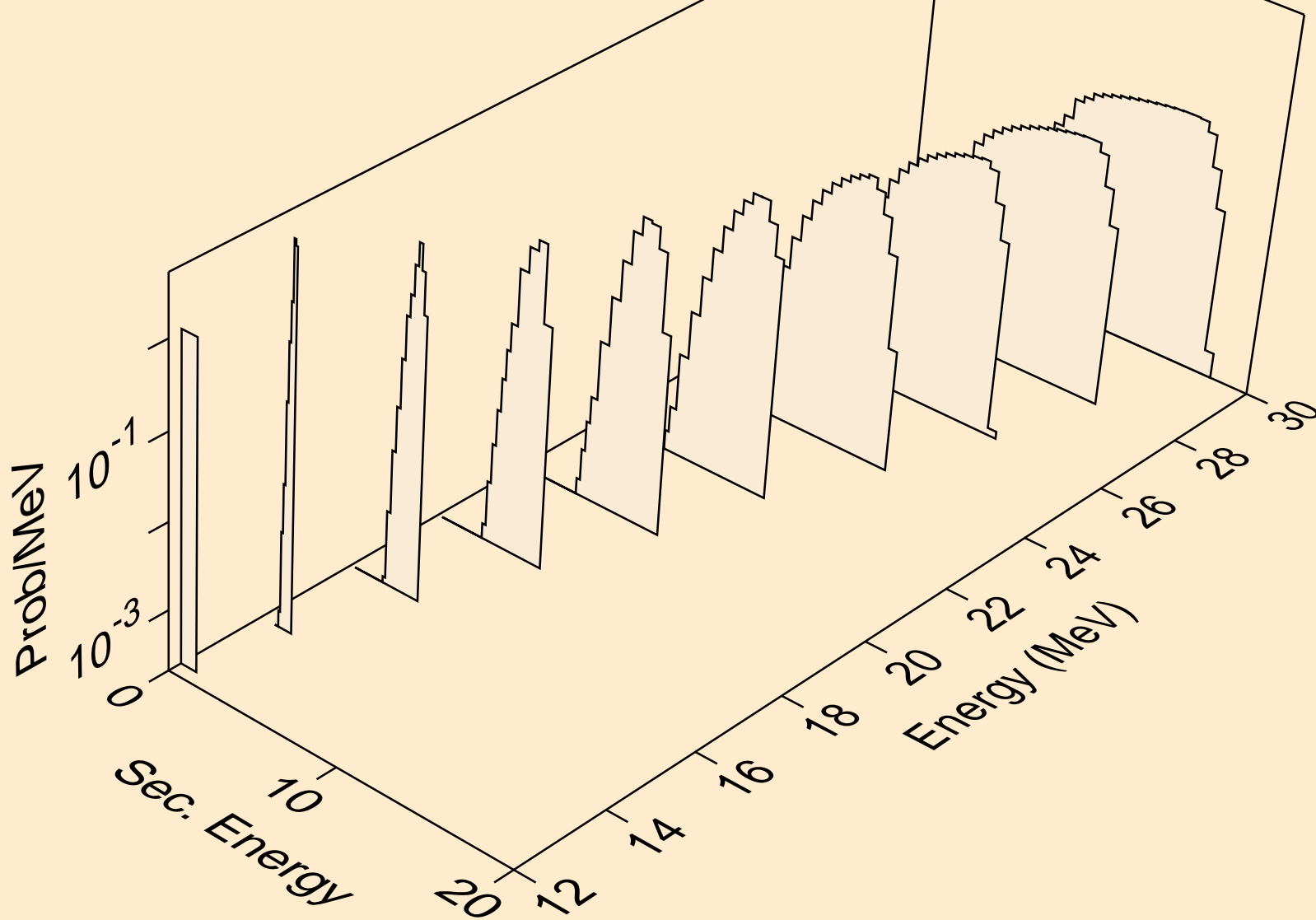

IN120 NEUTRON ACER TENDL-2019 LIBRARY; T=293.16K  
deuterons from (n,d)

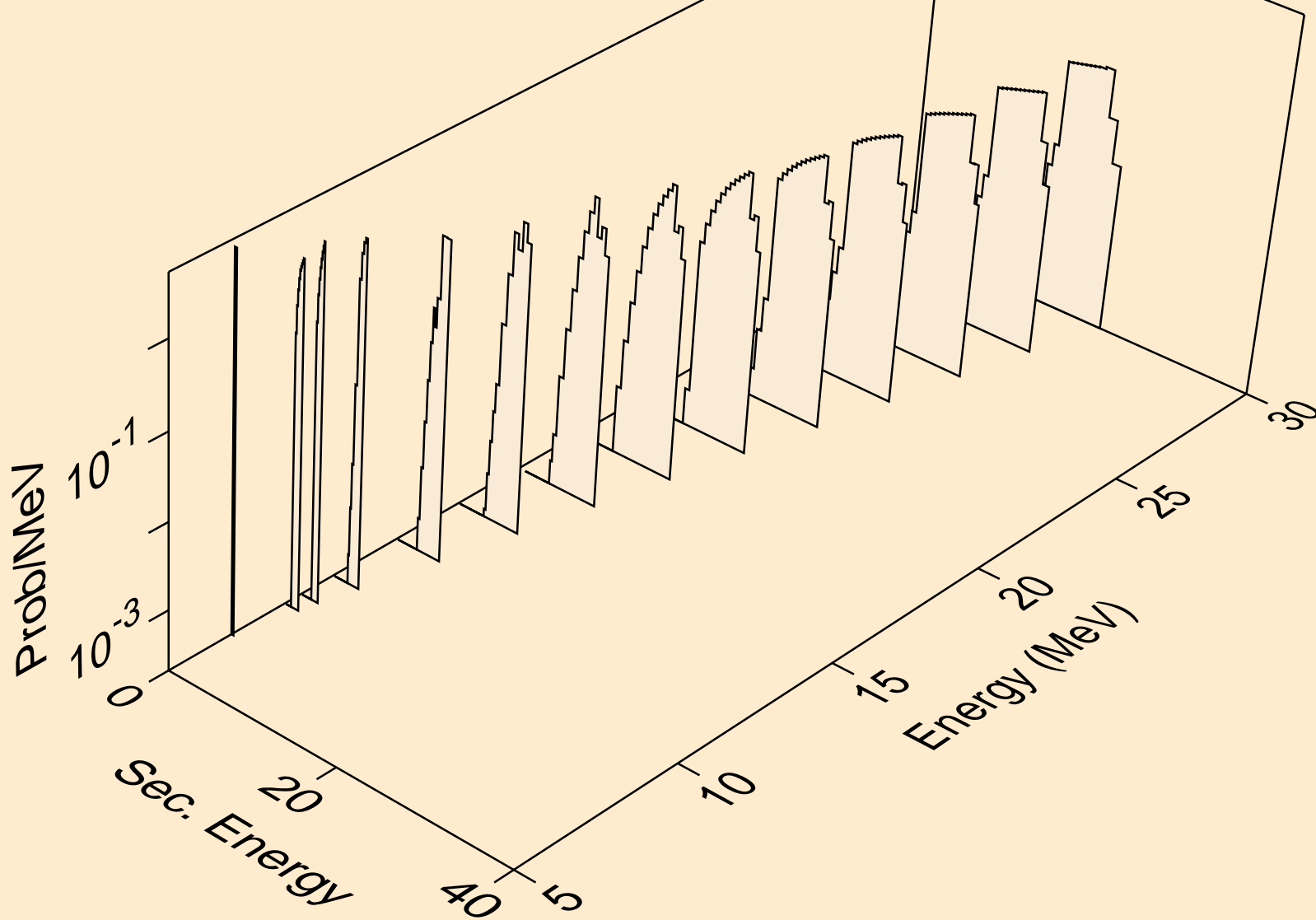



IN120 NEUTRON ACER TENDL-2019 LIBRARY; T=293.16K  
tritons from (n,x)

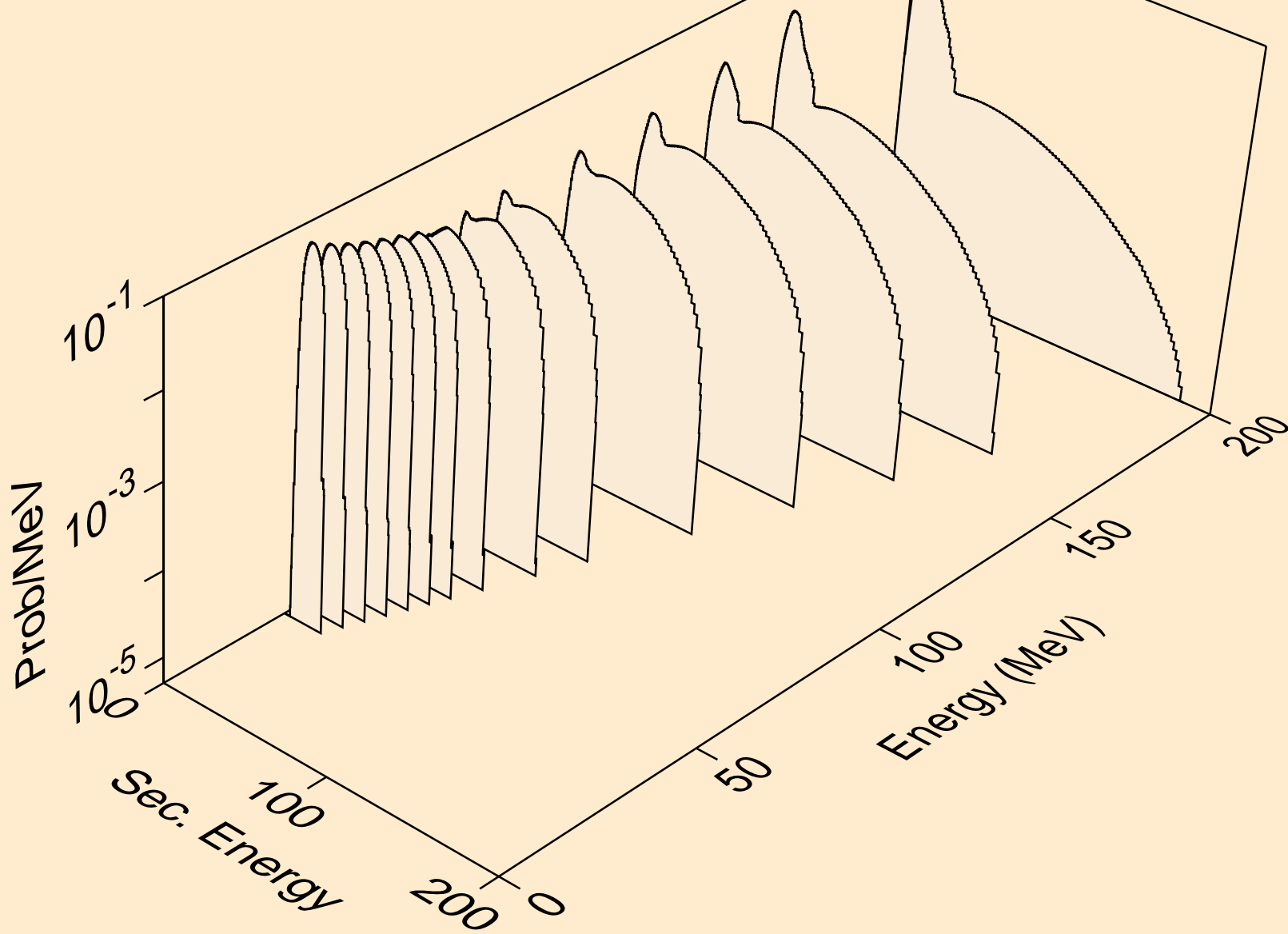

IN120 NEUTRON ACER TENDL-2019 LIBRARY; T=293.16K  
tritons from (n,n\*)t

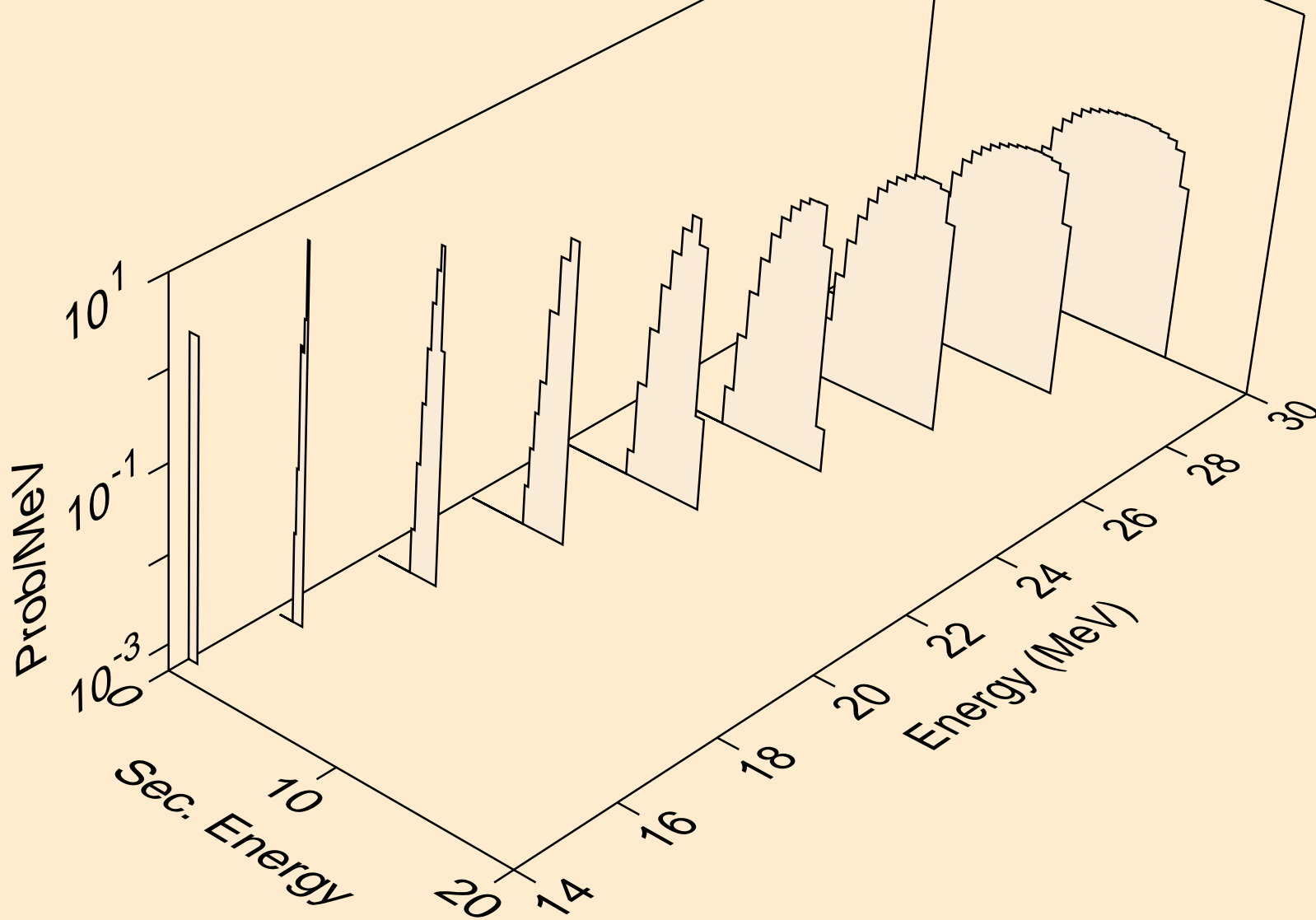

IN120 NEUTRON ACER TENDL-2019 LIBRARY; T=293.16K  
tritons from (n,t)

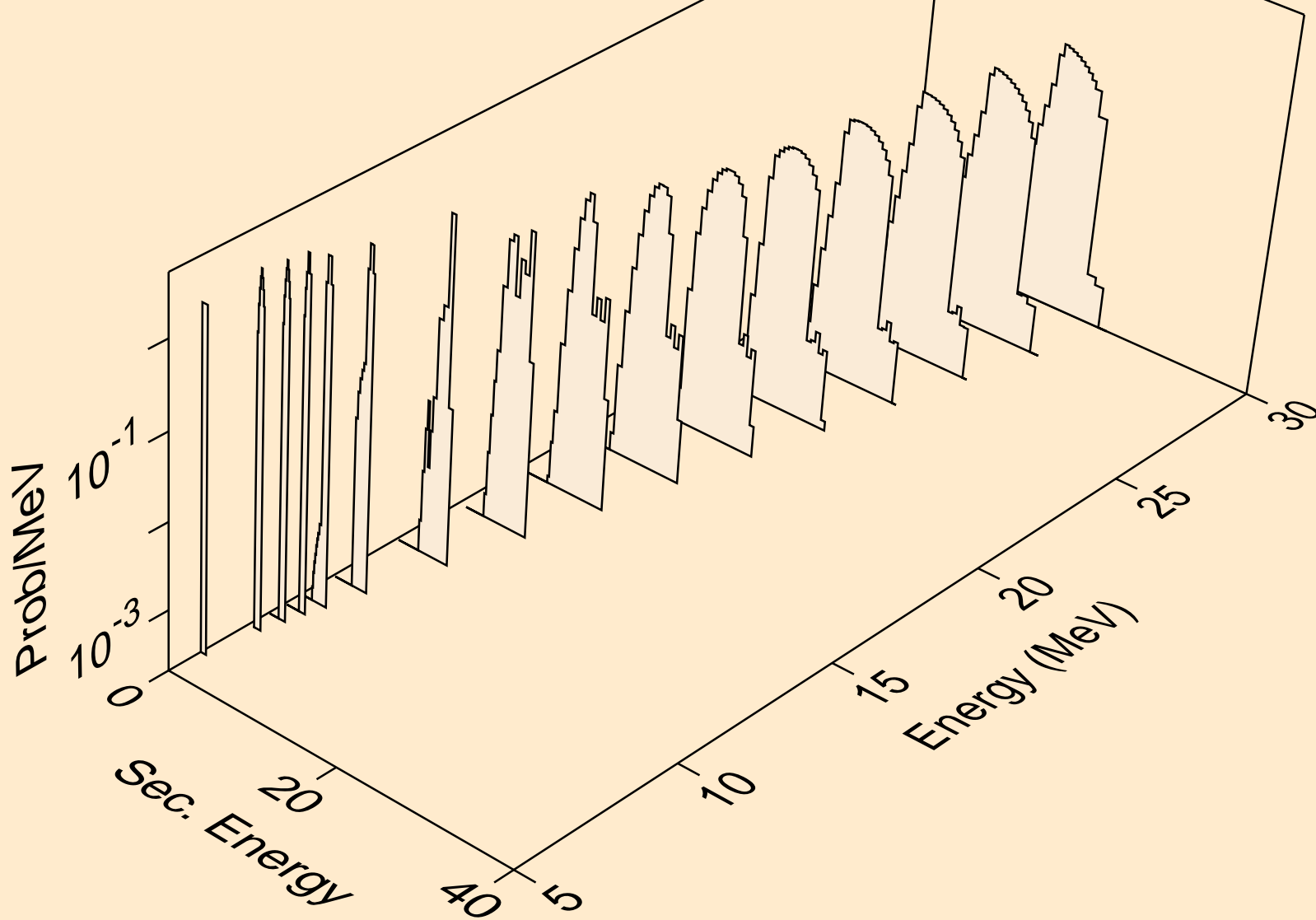

IN120 NEUTRON ACER TENDL-2019 LIBRARY; T=293.16K  
he3s from (n,x)

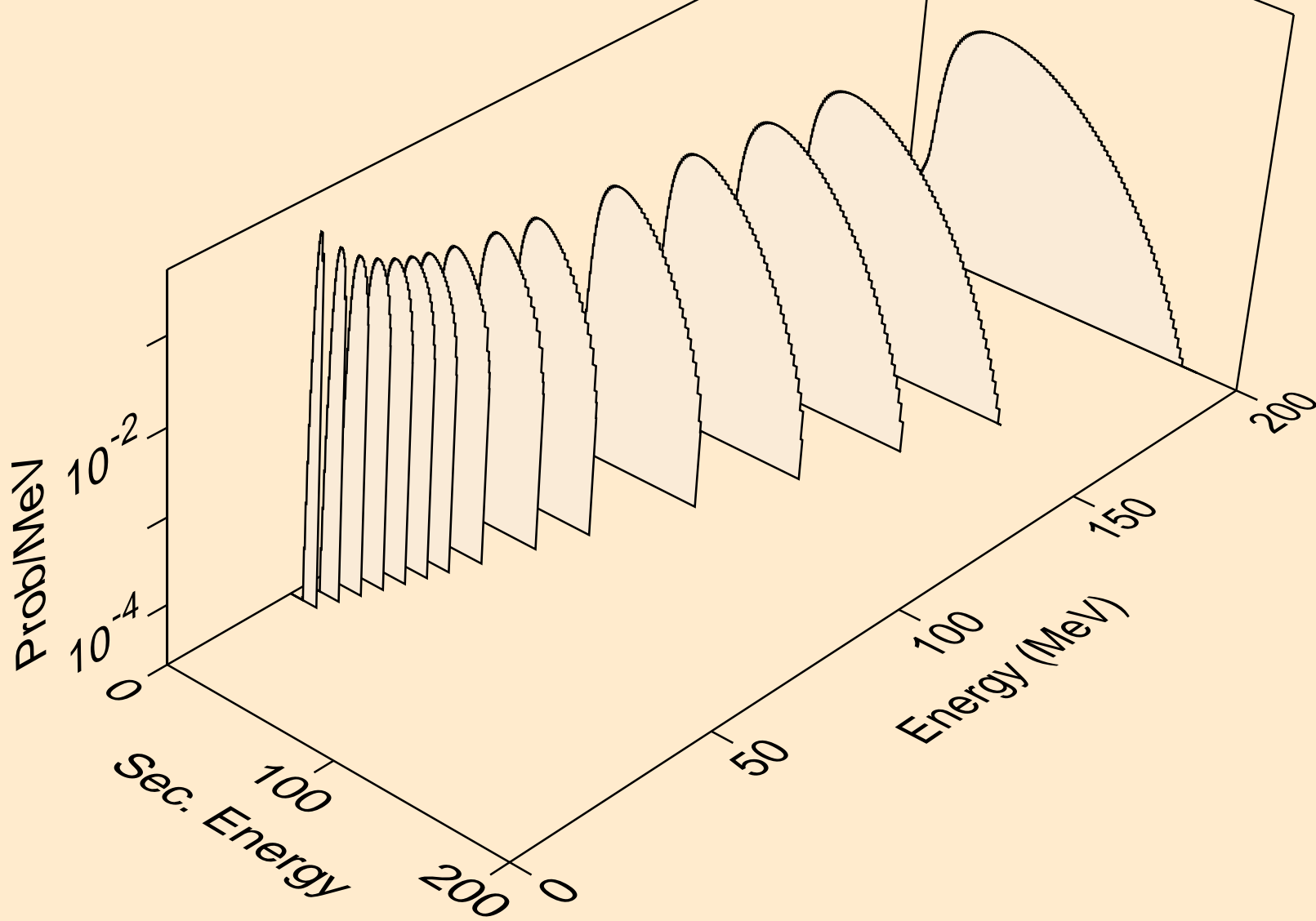

IN120 NEUTRON ACER TENDL-2019 LIBRARY; T=293.16K  
he3s from (n,n\*)he3

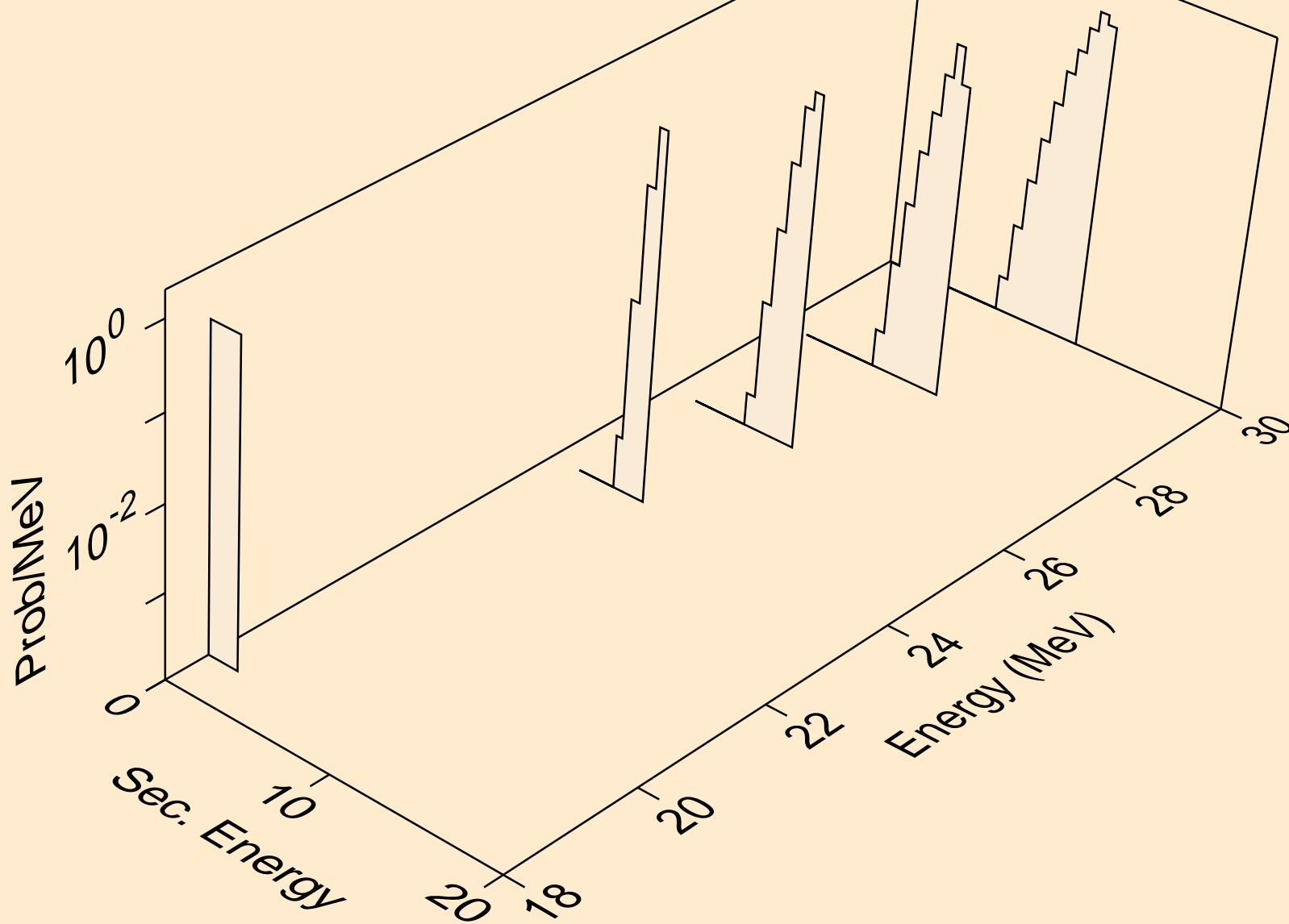

IN120 NEUTRON ACER TENDL-2019 LIBRARY; T=293.16K  
he3s from (n,he3)

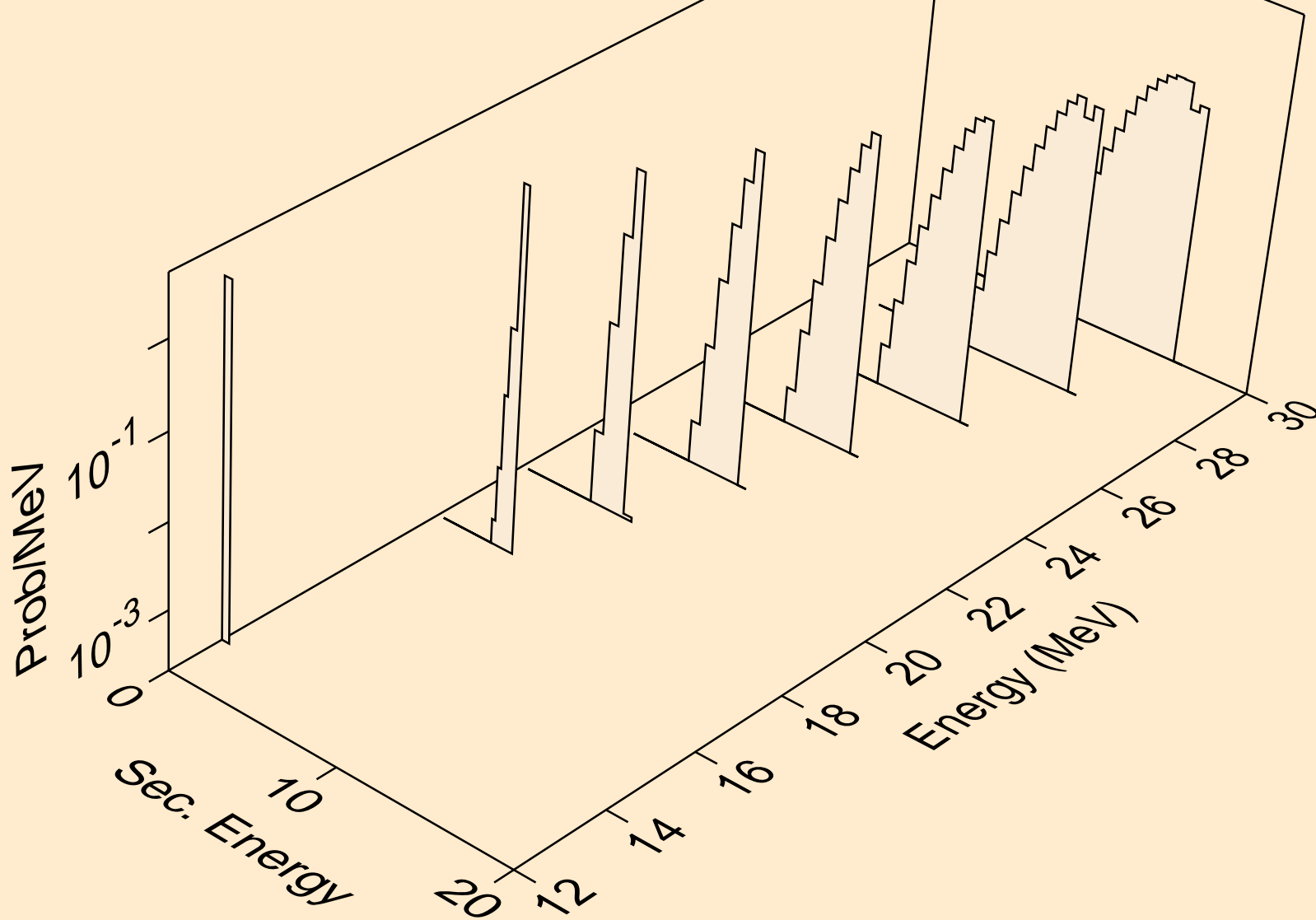

IN120 NEUTRON ACER TENDL-2019 LIBRARY; T=293.16K  
alphas from (n,x)

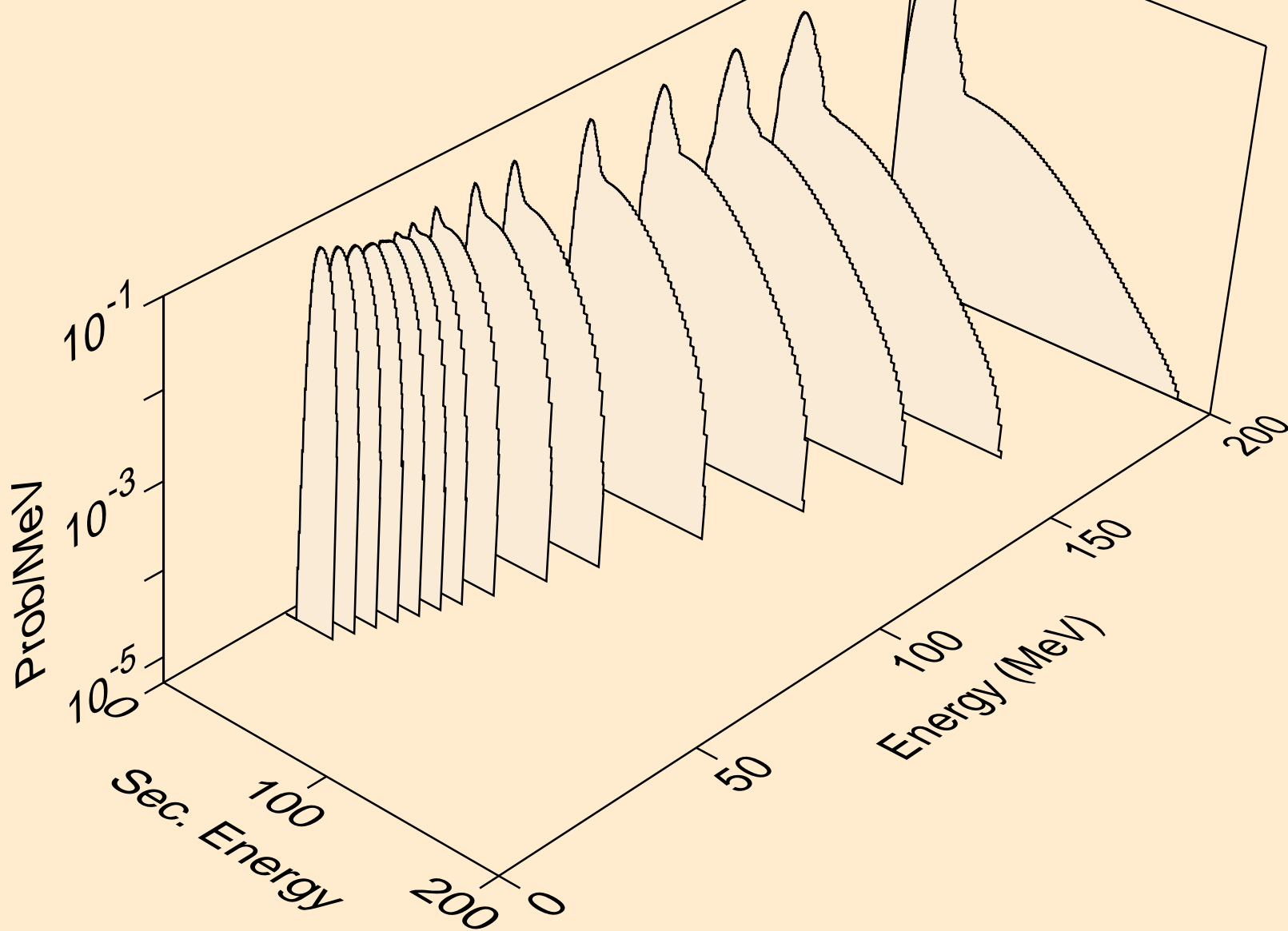

IN120 NEUTRON ACER TENDL-2019 LIBRARY; T=293.16K  
alphas from (n,n\*)a

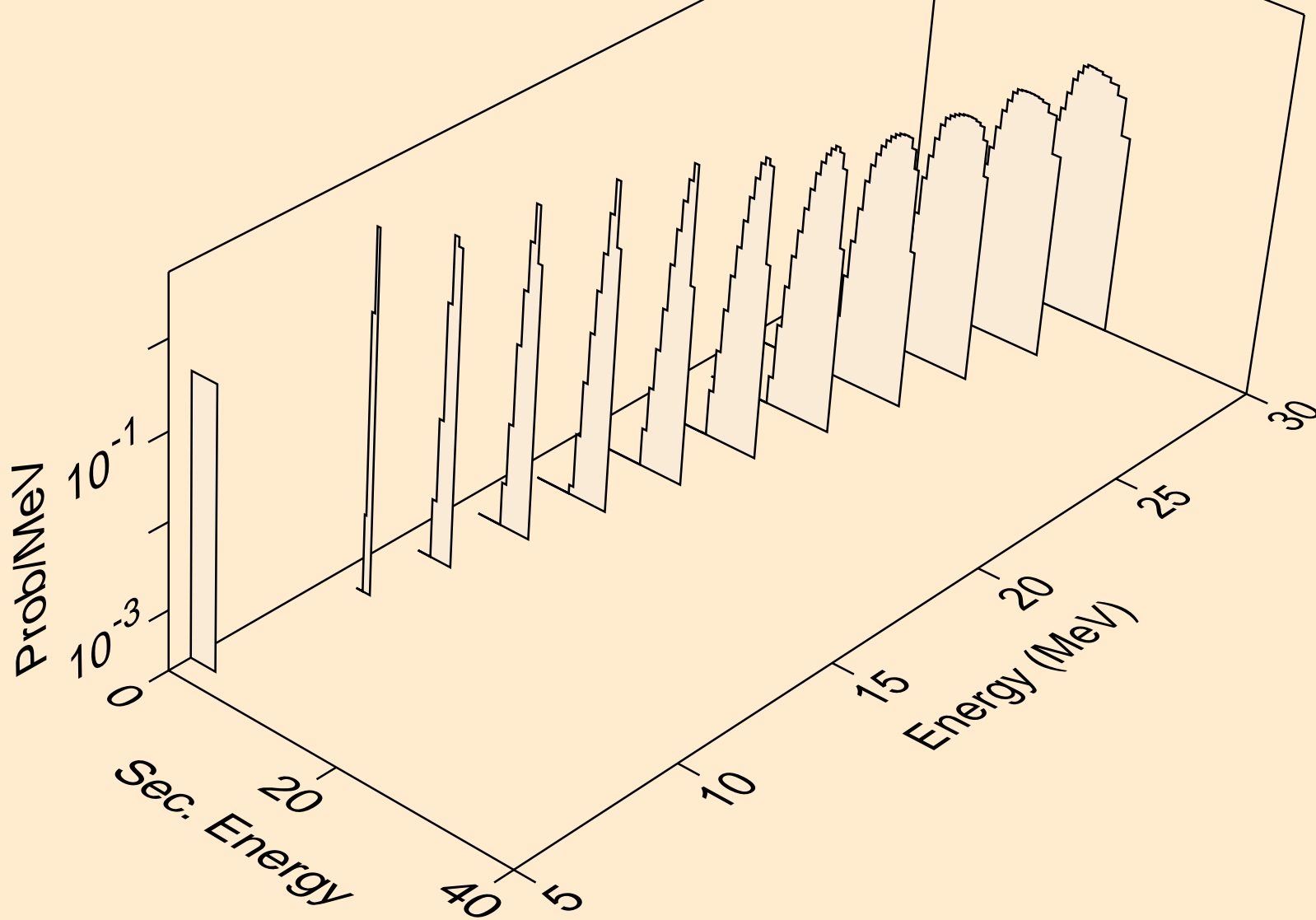



IN120 NEUTRON ACER TENDL-2019 LIBRARY; T=293.16K  
alphas from (n,2n)a

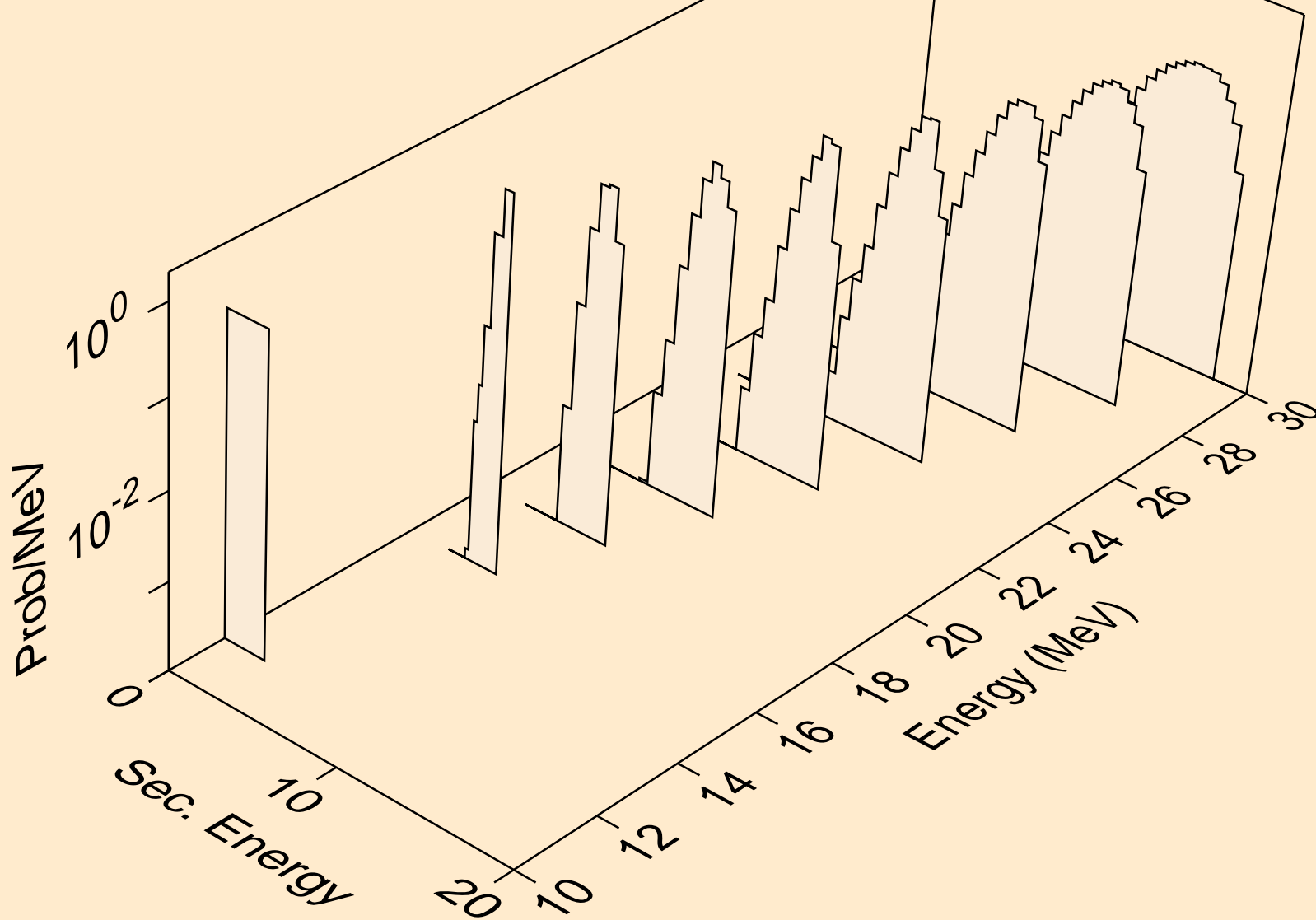

IN120 NEUTRON ACER TENDL-2019 LIBRARY; T=293.16K  
alphas from (n,3n)a

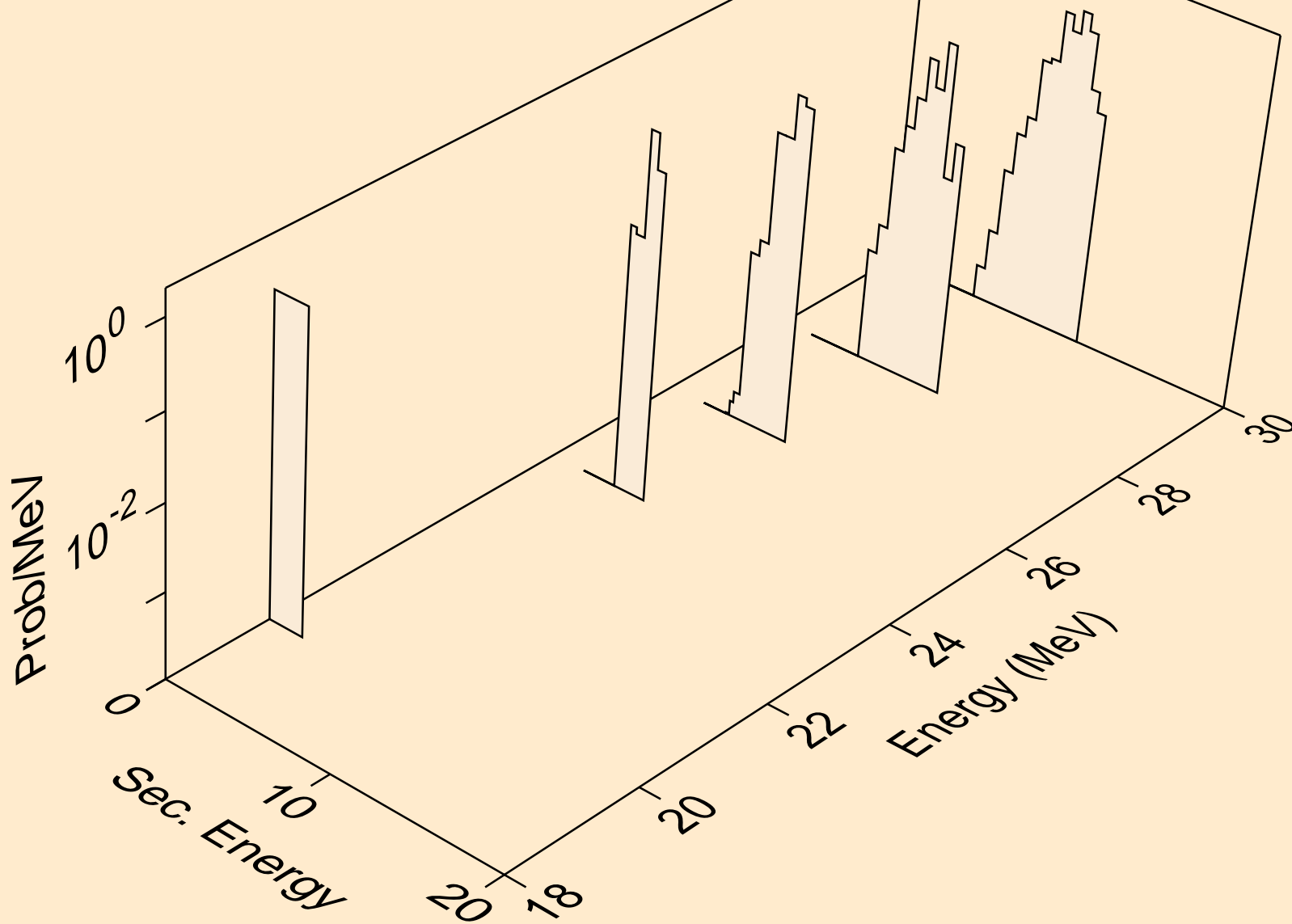

IN120 NEUTRON ACER TENDL-2019 LIBRARY; T=293.16K  
alphas from (n,a)

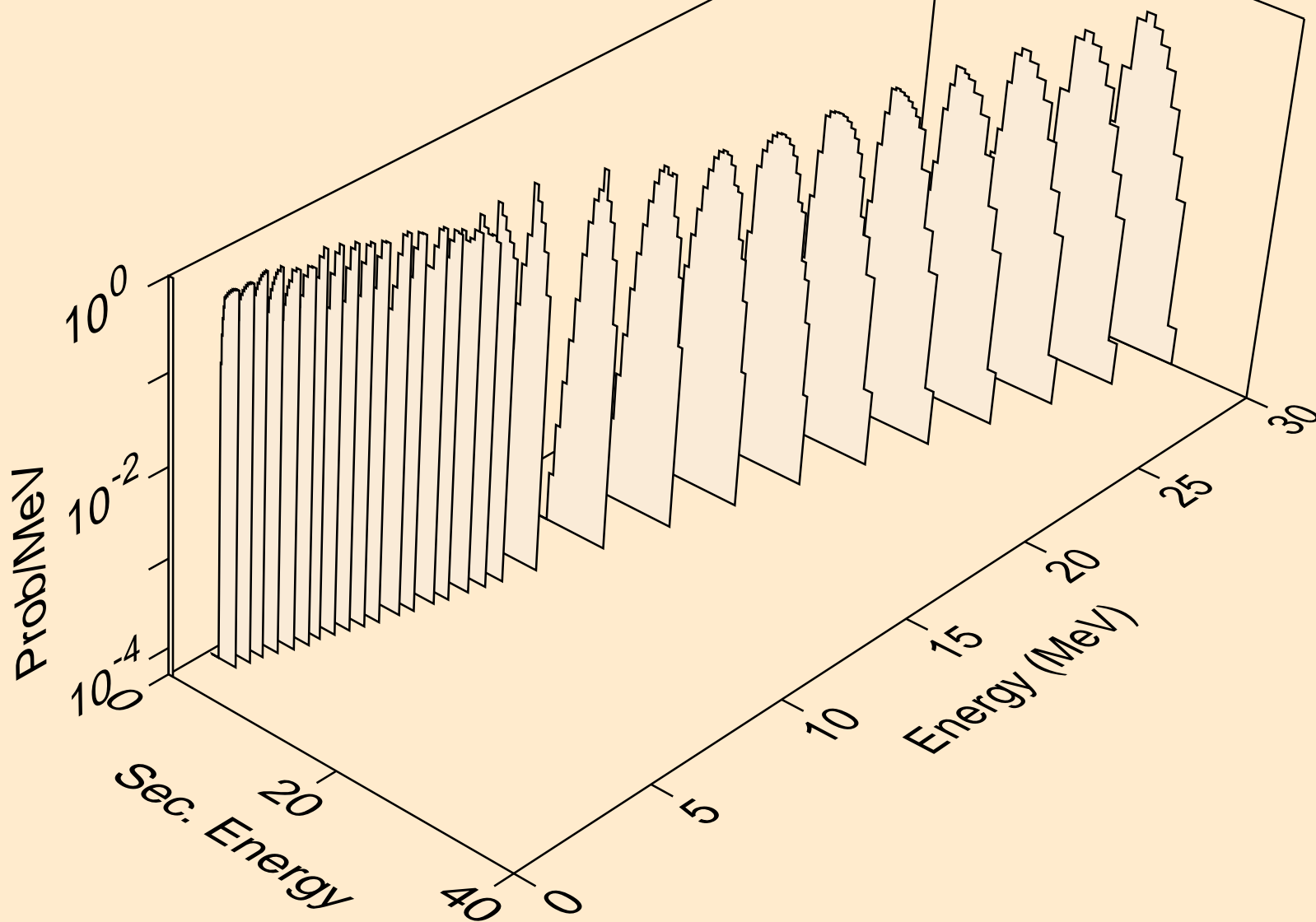

IN120 NEUTRON ACER TENDL-2019 LIBRARY; T=293.16K  
alphas from (n,pa)

