

IN127N NEUTRON ACER TENDL-2019 LIBRARY; T=293.16K  
Principal cross sections

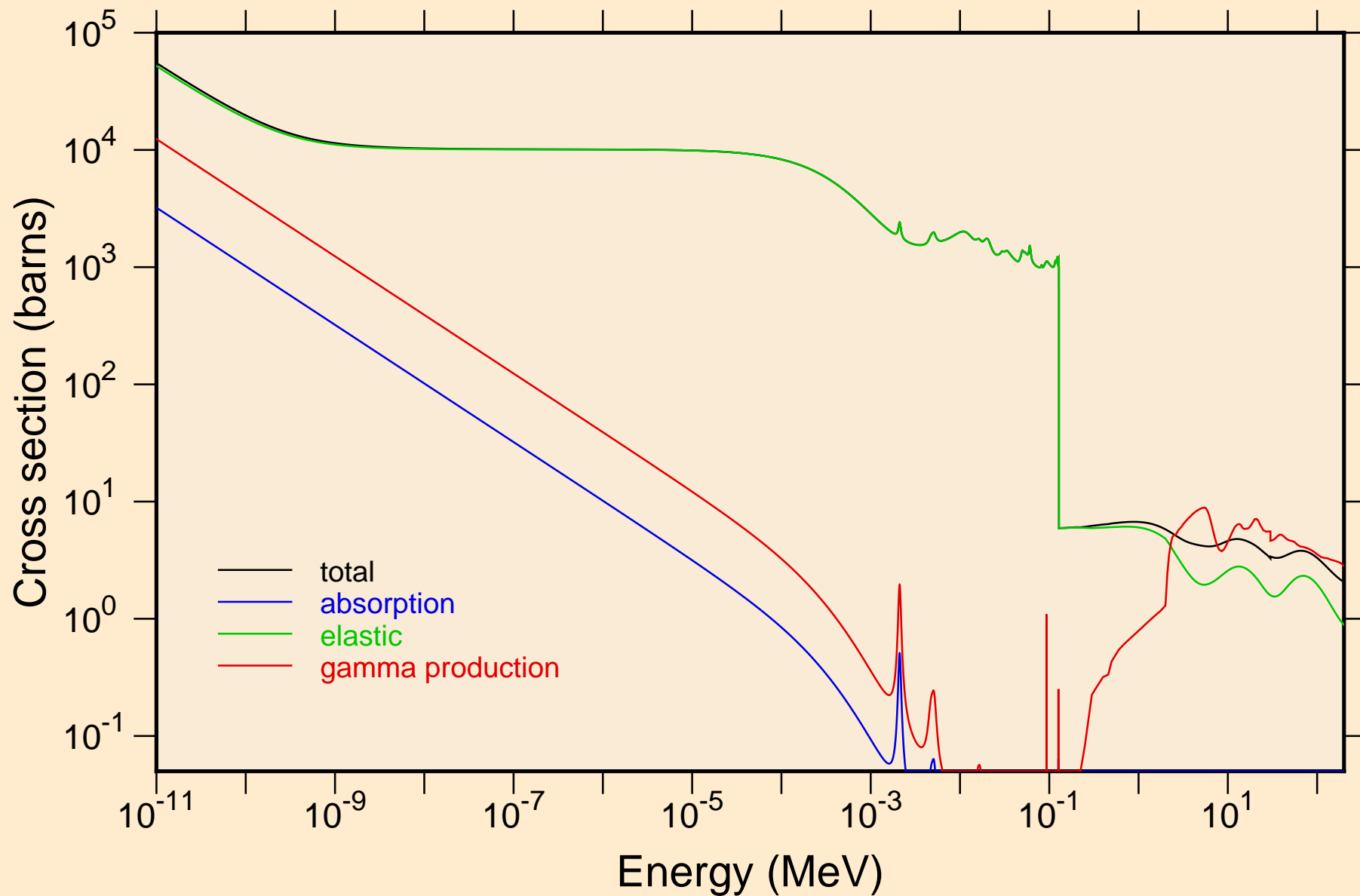

IN127N NEUTRON ACER TENDL-2019 LIBRARY; T=293.16K  
resonance total cross section

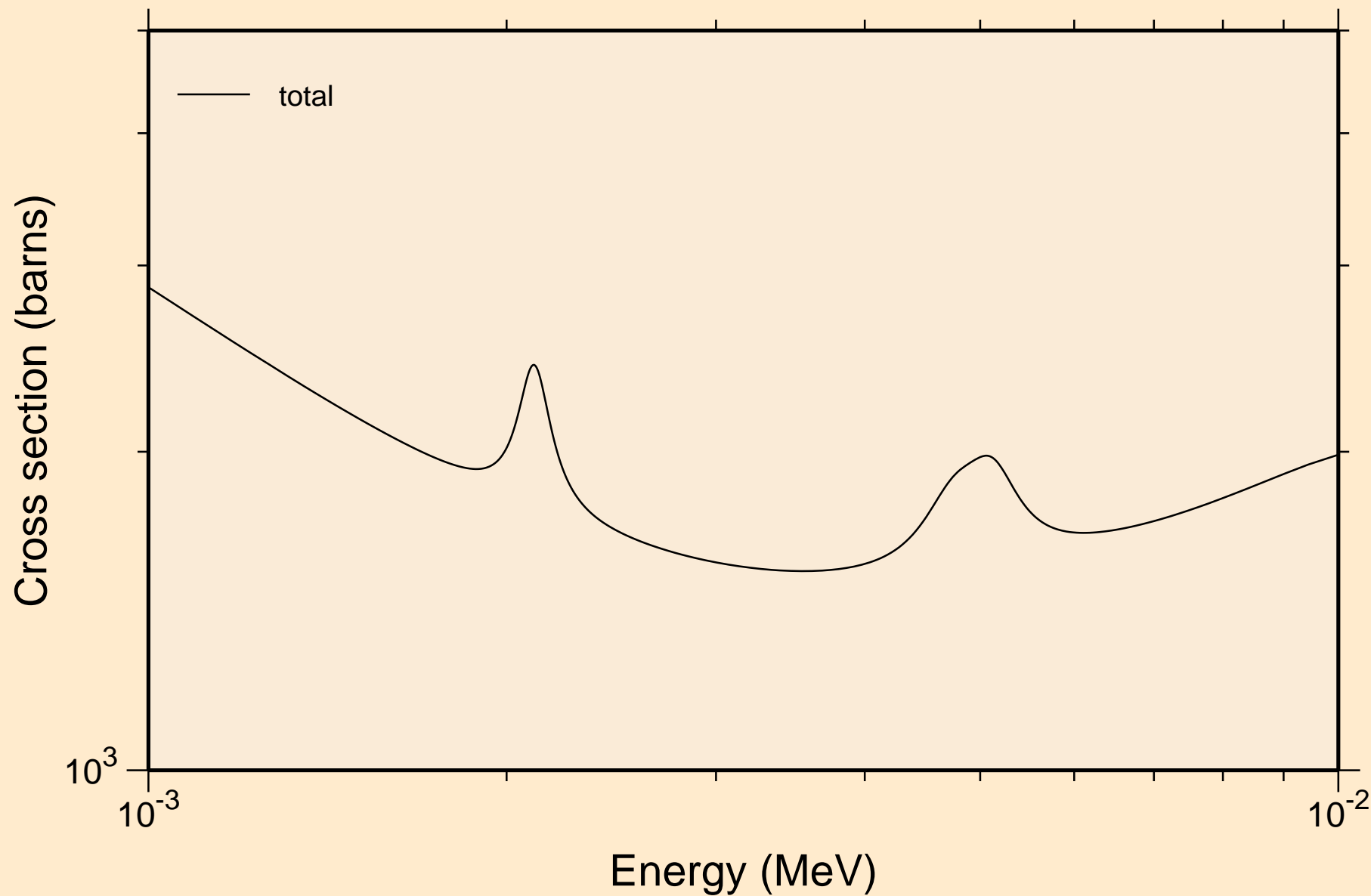

IN127N NEUTRON ACER TENDL-2019 LIBRARY; T=293.16K  
resonance total cross section

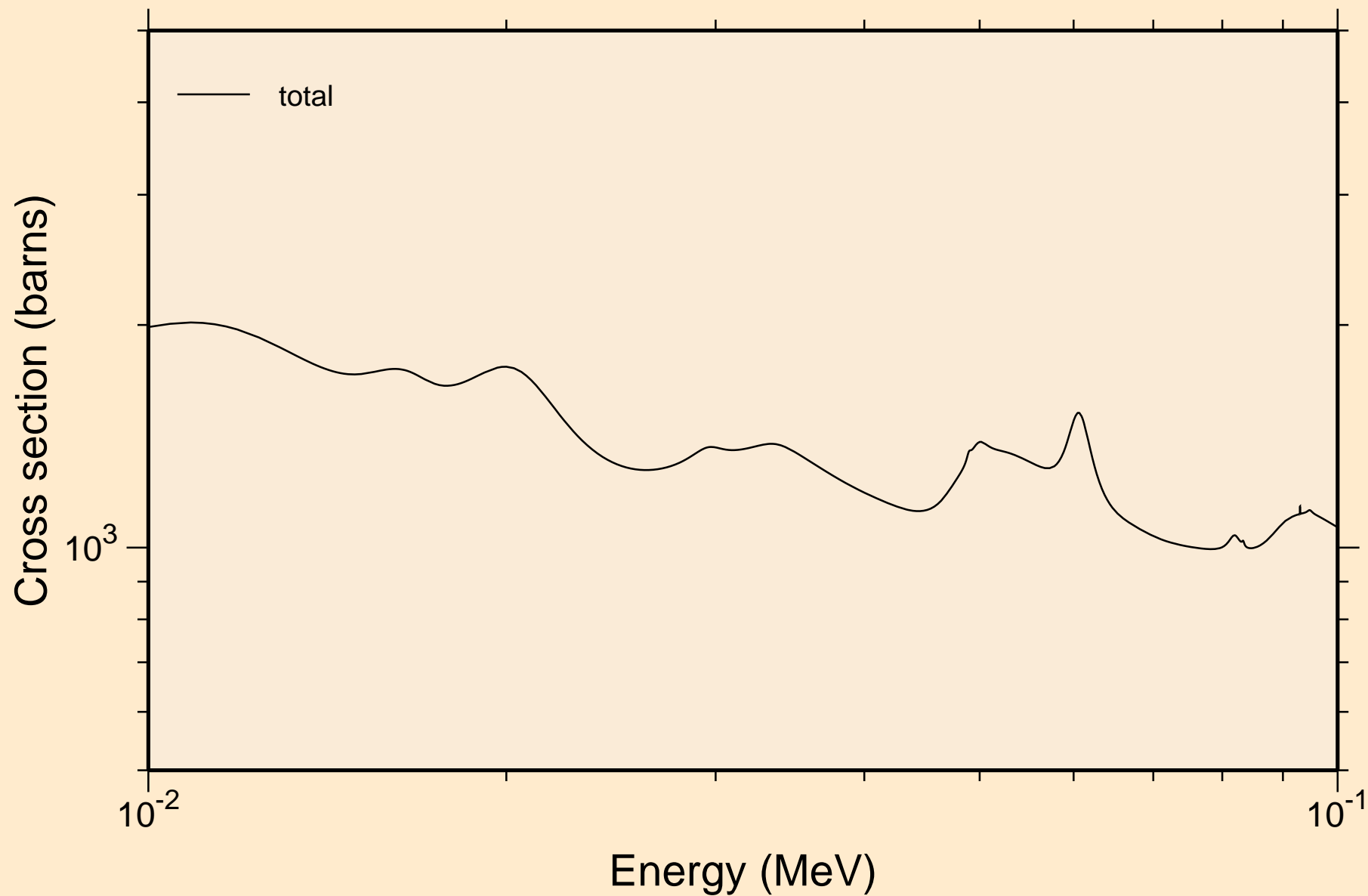

IN127N NEUTRON ACER TENDL-2019 LIBRARY; T=293.16K  
resonance total cross section

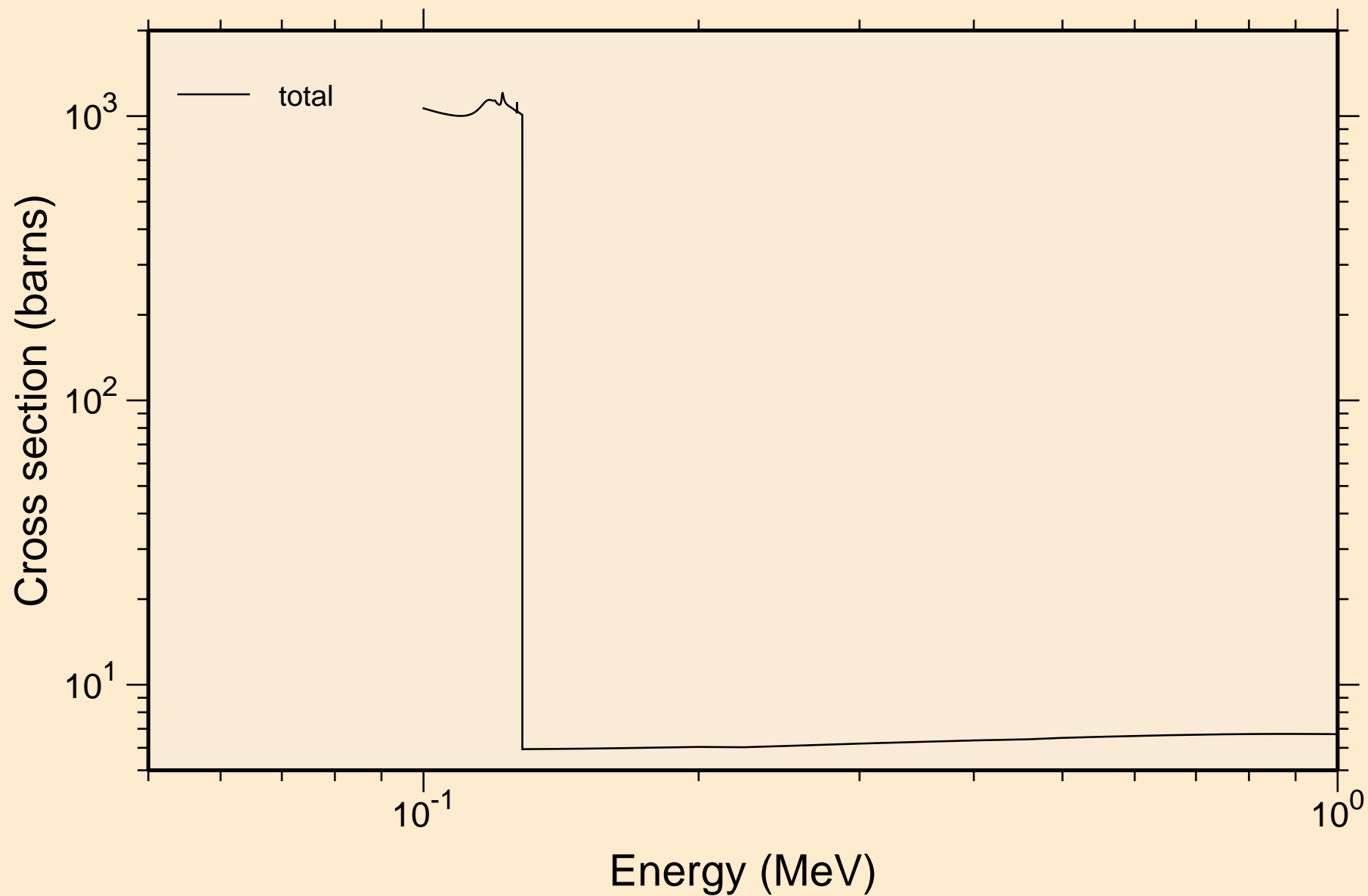

IN127N NEUTRON ACER TENDL-2019 LIBRARY; T=293.16K  
resonance total cross section

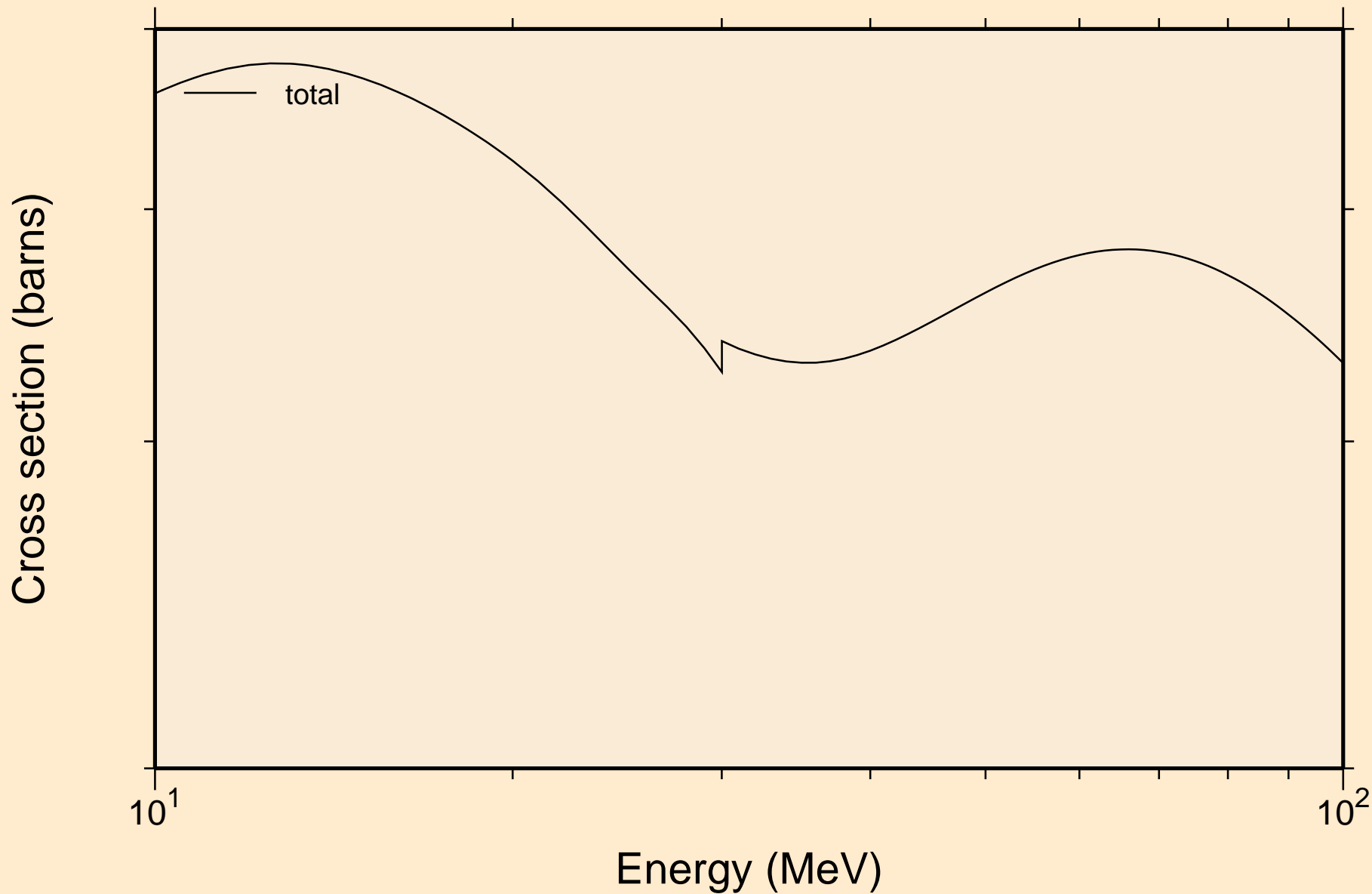

IN127N NEUTRON ACER TENDL-2019 LIBRARY; T=293.16K  
resonance absorption cross sections

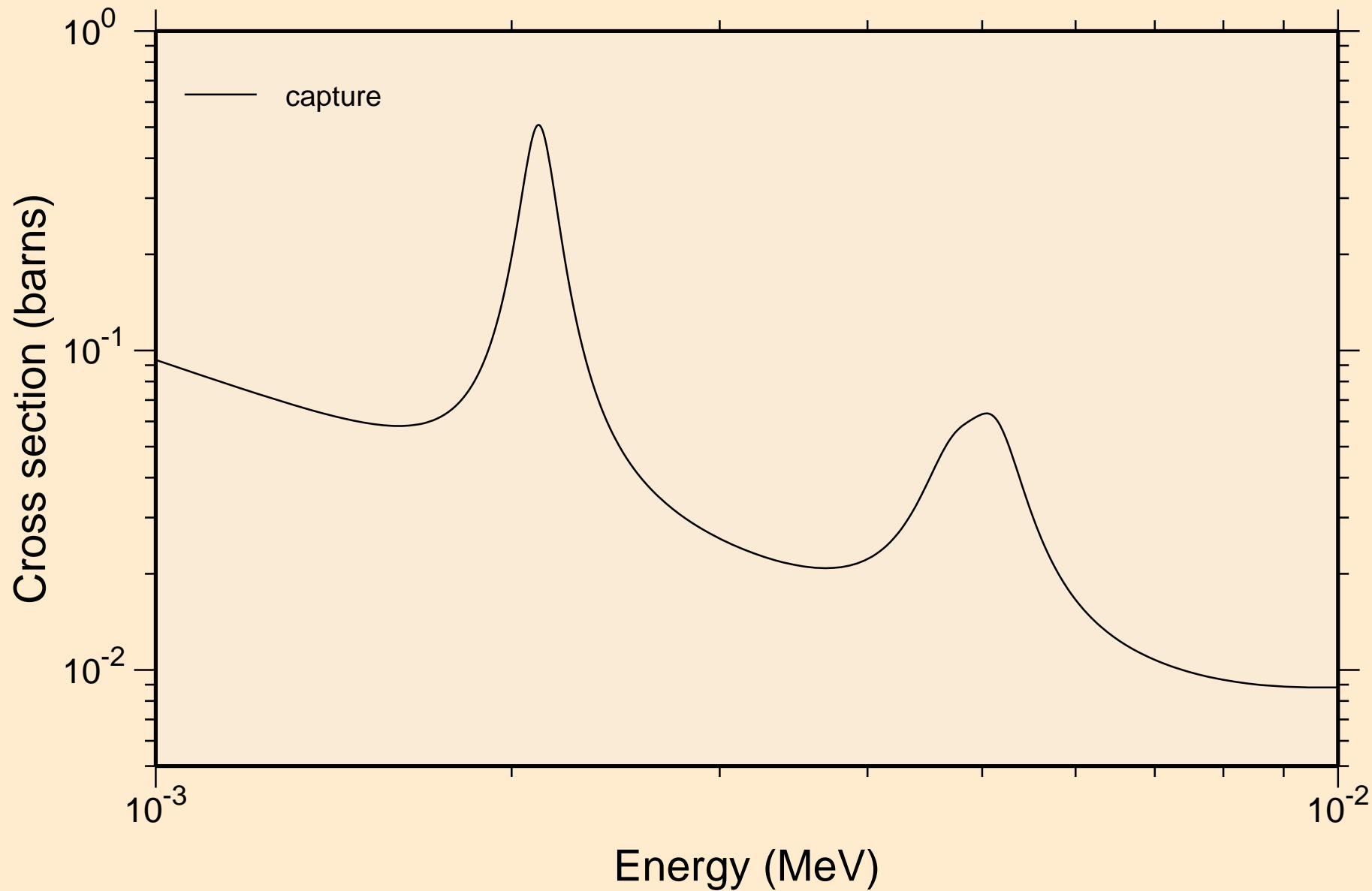

IN127N NEUTRON ACER TENDL-2019 LIBRARY; T=293.16K  
resonance absorption cross sections

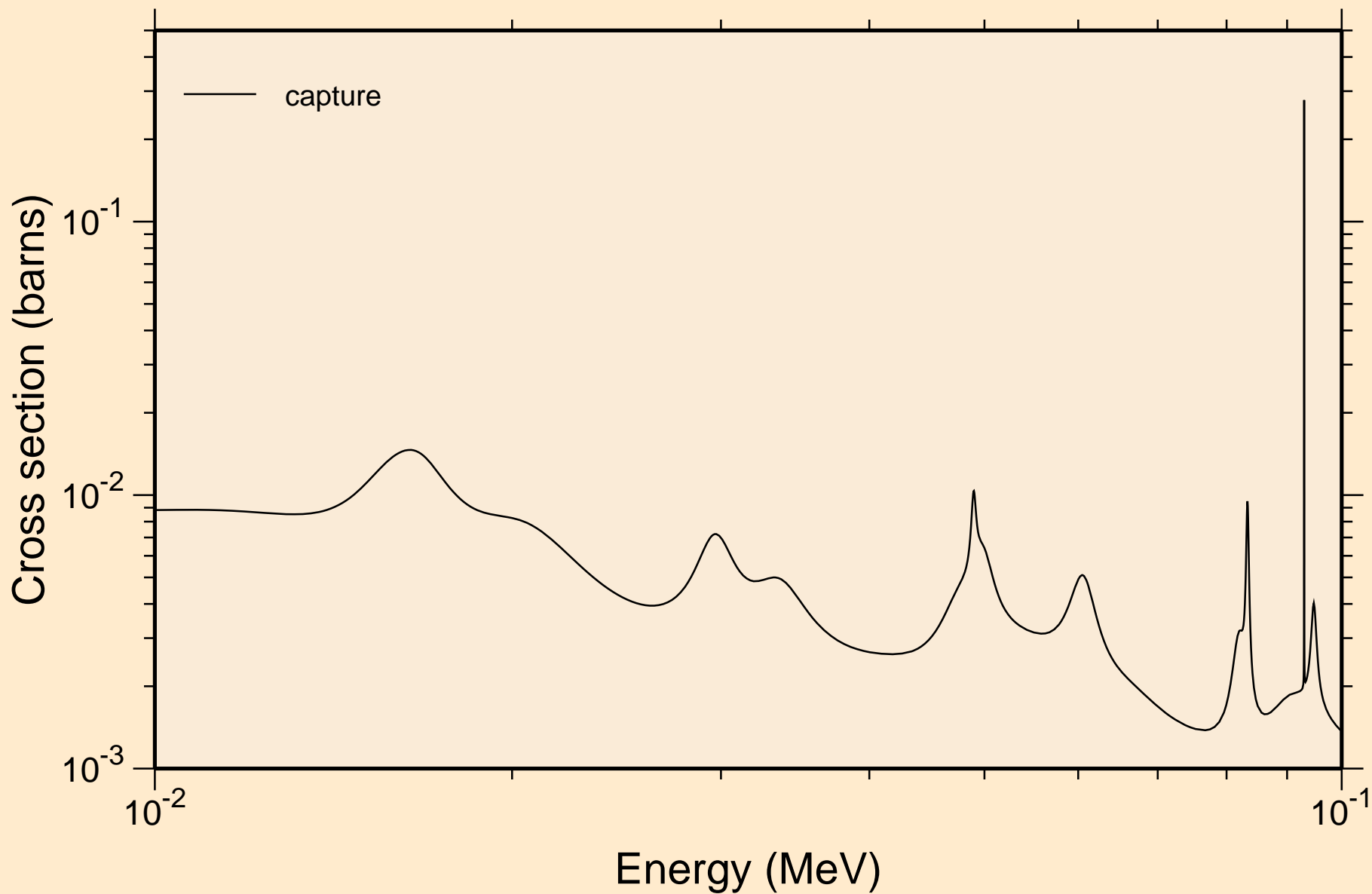

IN127N NEUTRON ACER TENDL-2019 LIBRARY; T=293.16K  
resonance absorption cross sections

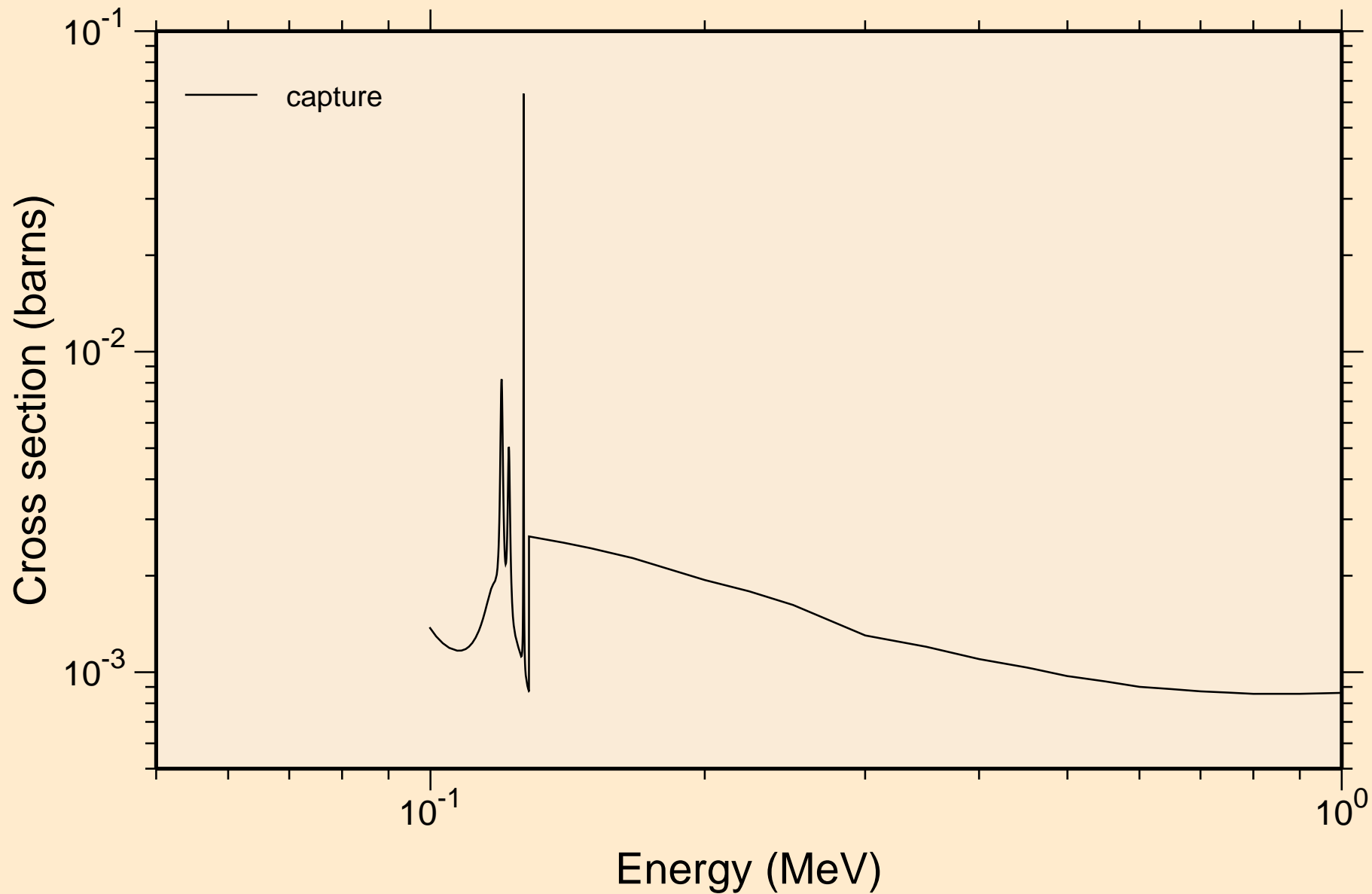



IN127N NEUTRON ACER TENDL-2019 LIBRARY; T=293.16K  
resonance absorption cross sections

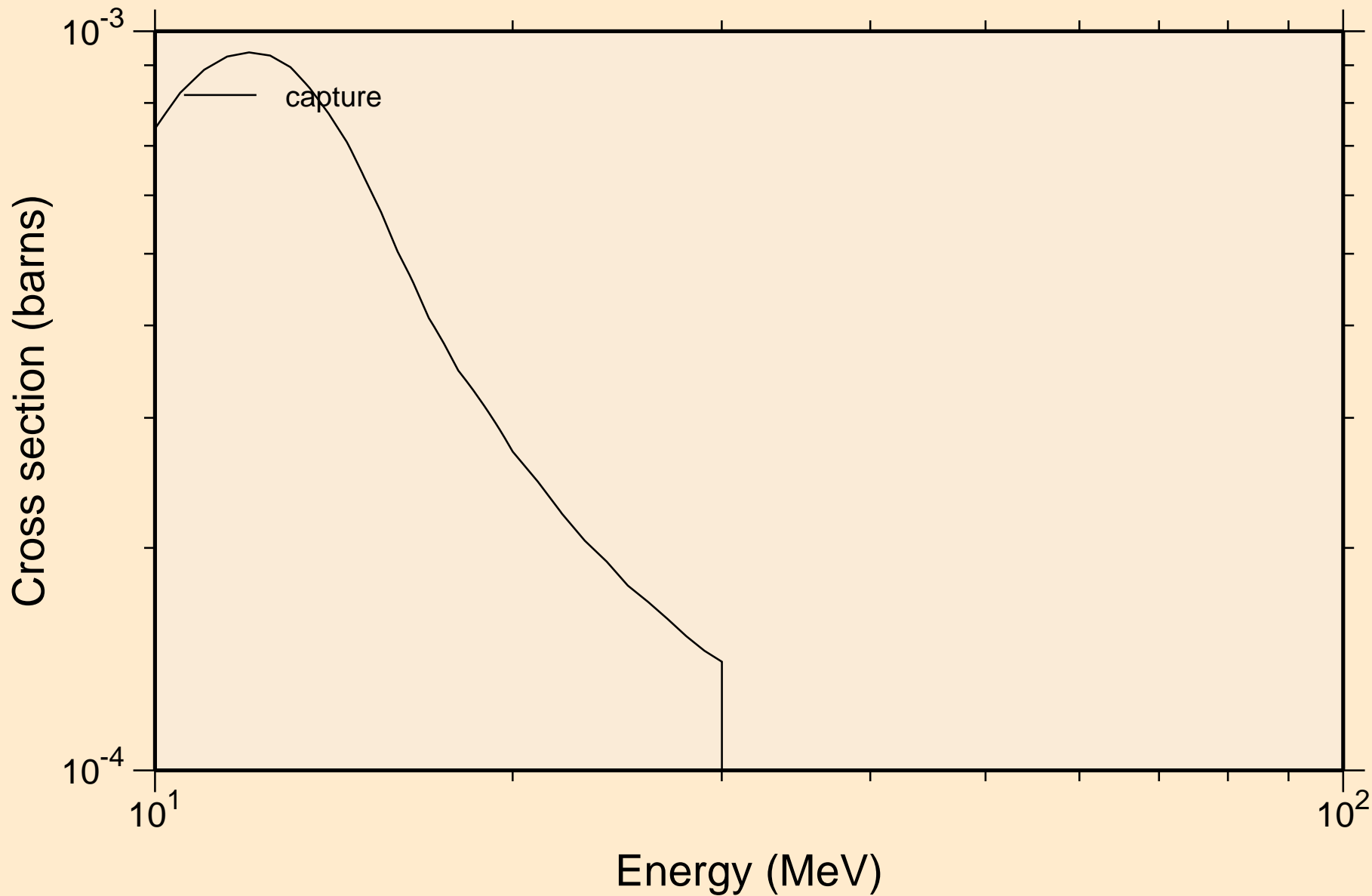

IN127N NEUTRON ACER TENDL-2019 LIBRARY; T=293.16K  
Heating

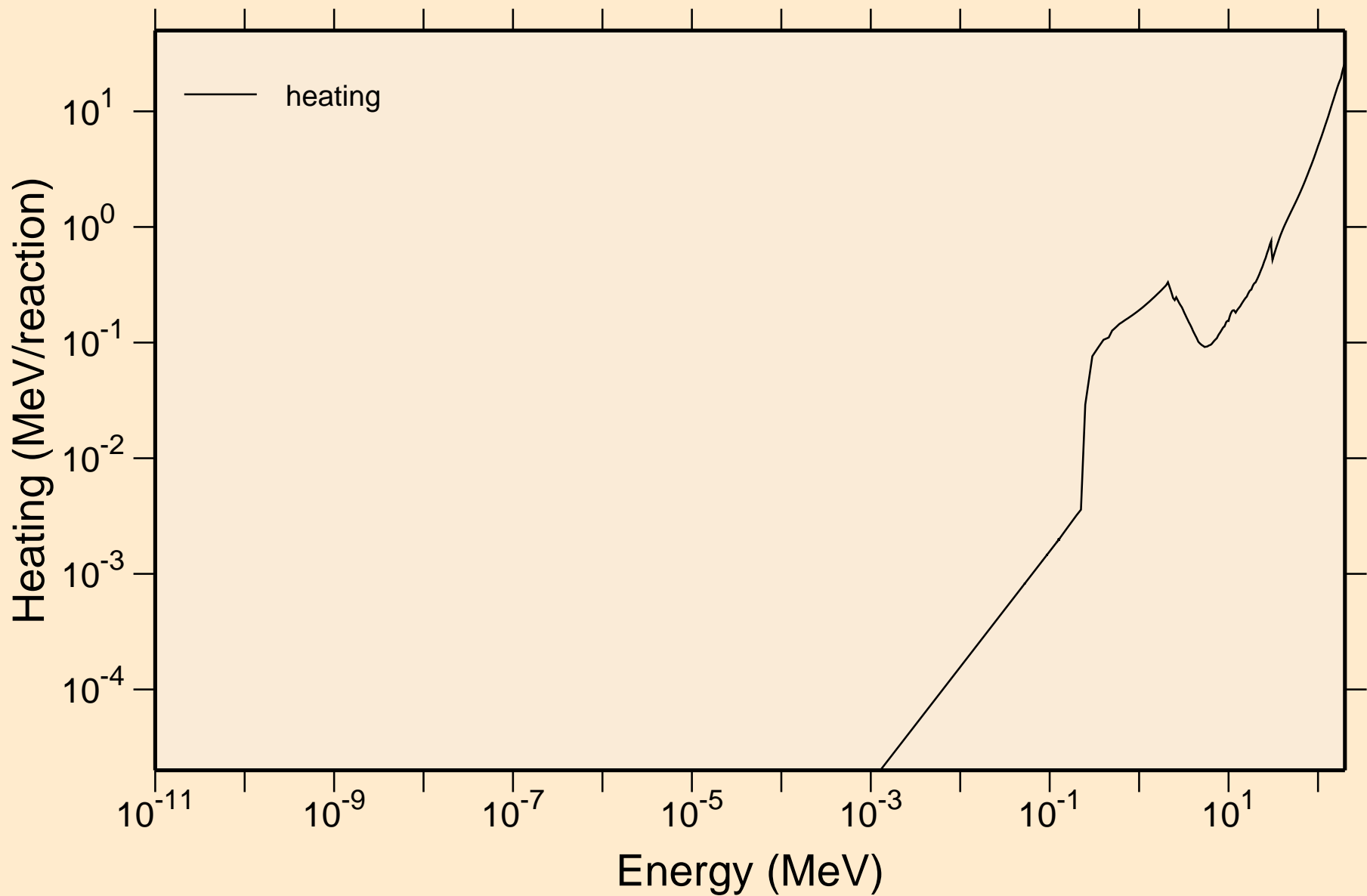

IN127N NEUTRON ACER TENDL-2019 LIBRARY; T=293.16K  
Damage

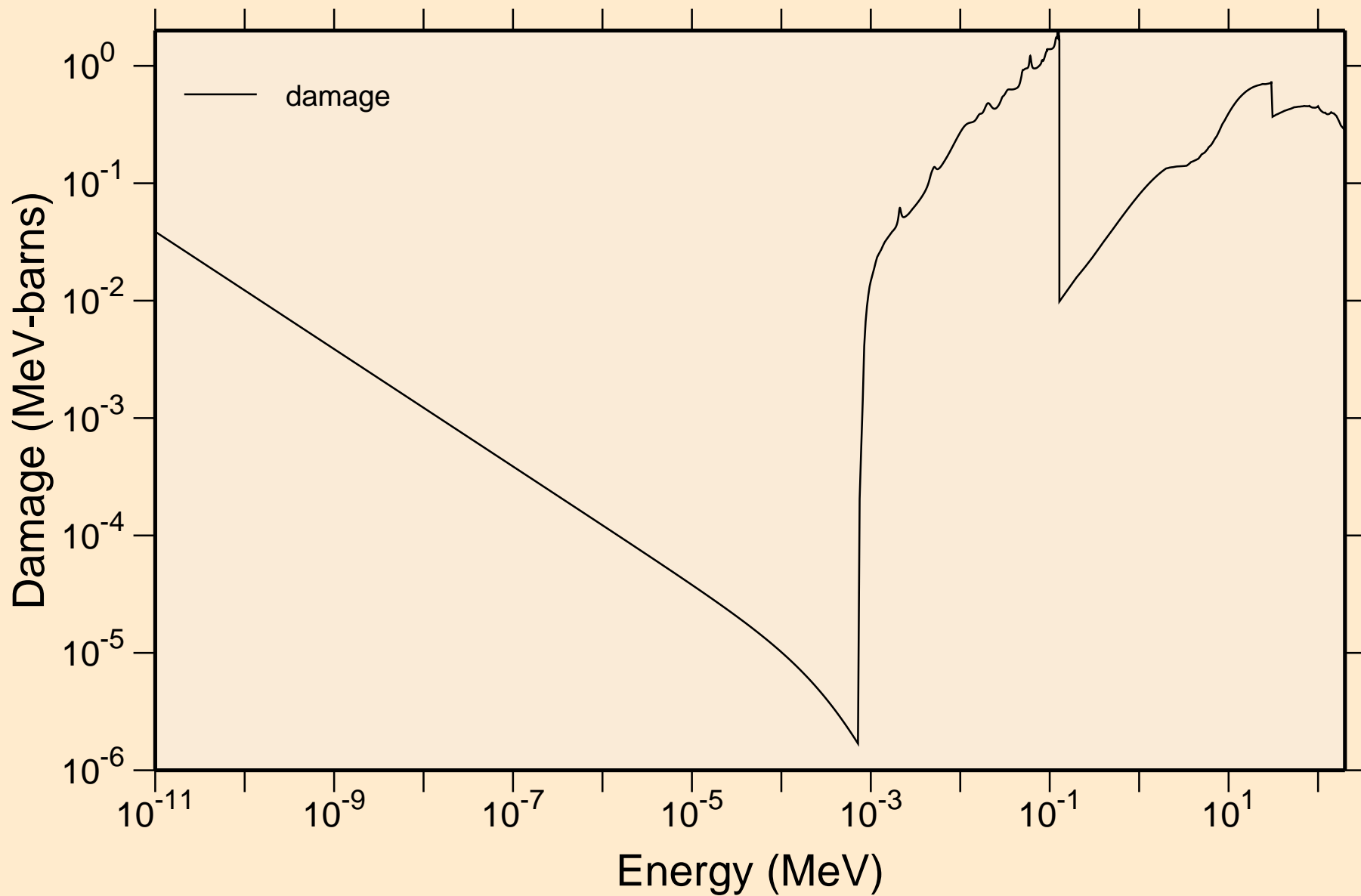

IN127N NEUTRON ACER TENDL-2019 LIBRARY; T=293.16K  
Non-threshold reactions

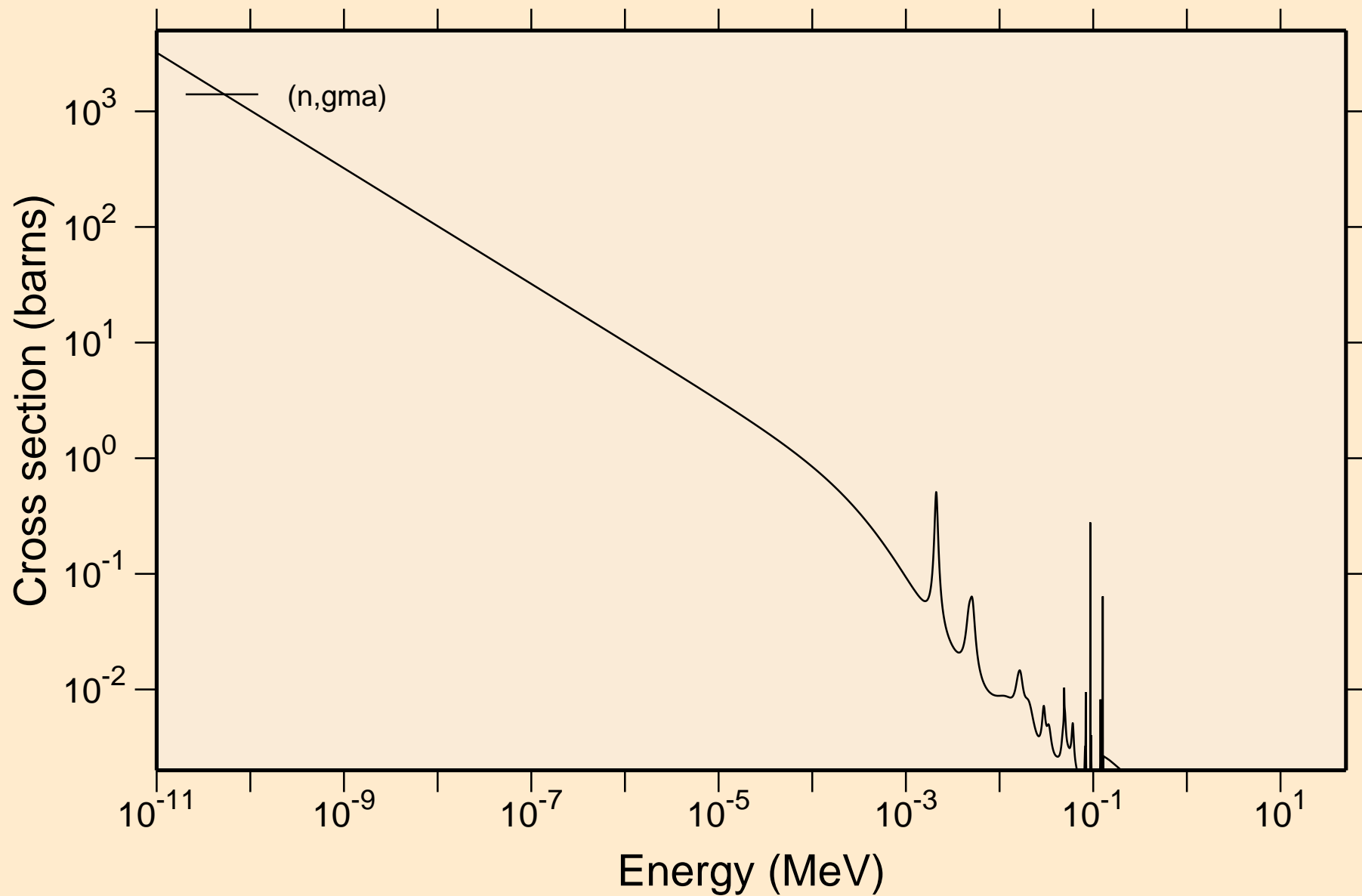

IN127N NEUTRON ACER TENDL-2019 LIBRARY; T=293.16K  
Principal cross sections

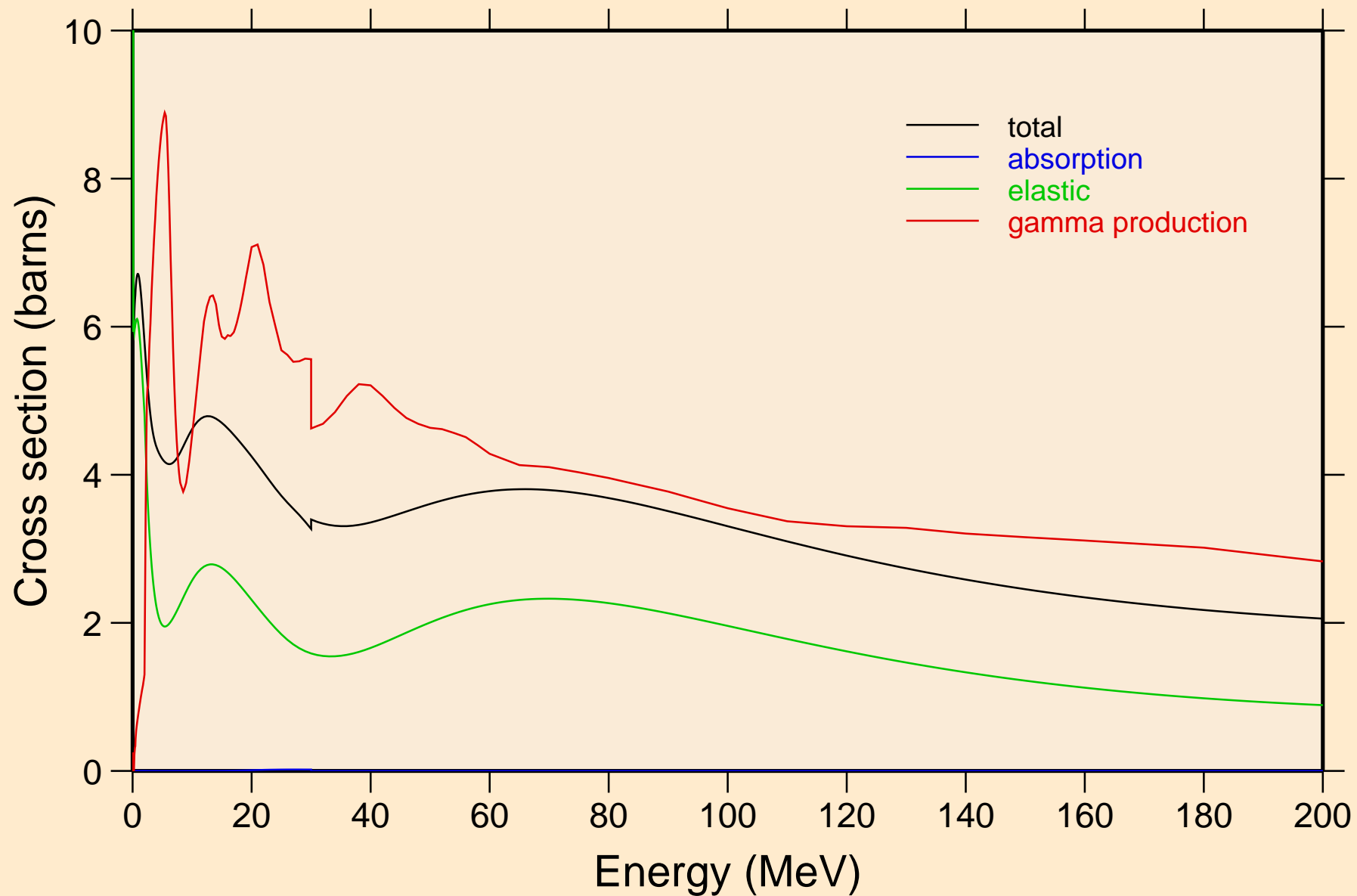

IN127N NEUTRON ACER TENDL-2019 LIBRARY; T=293.16K  
Heating

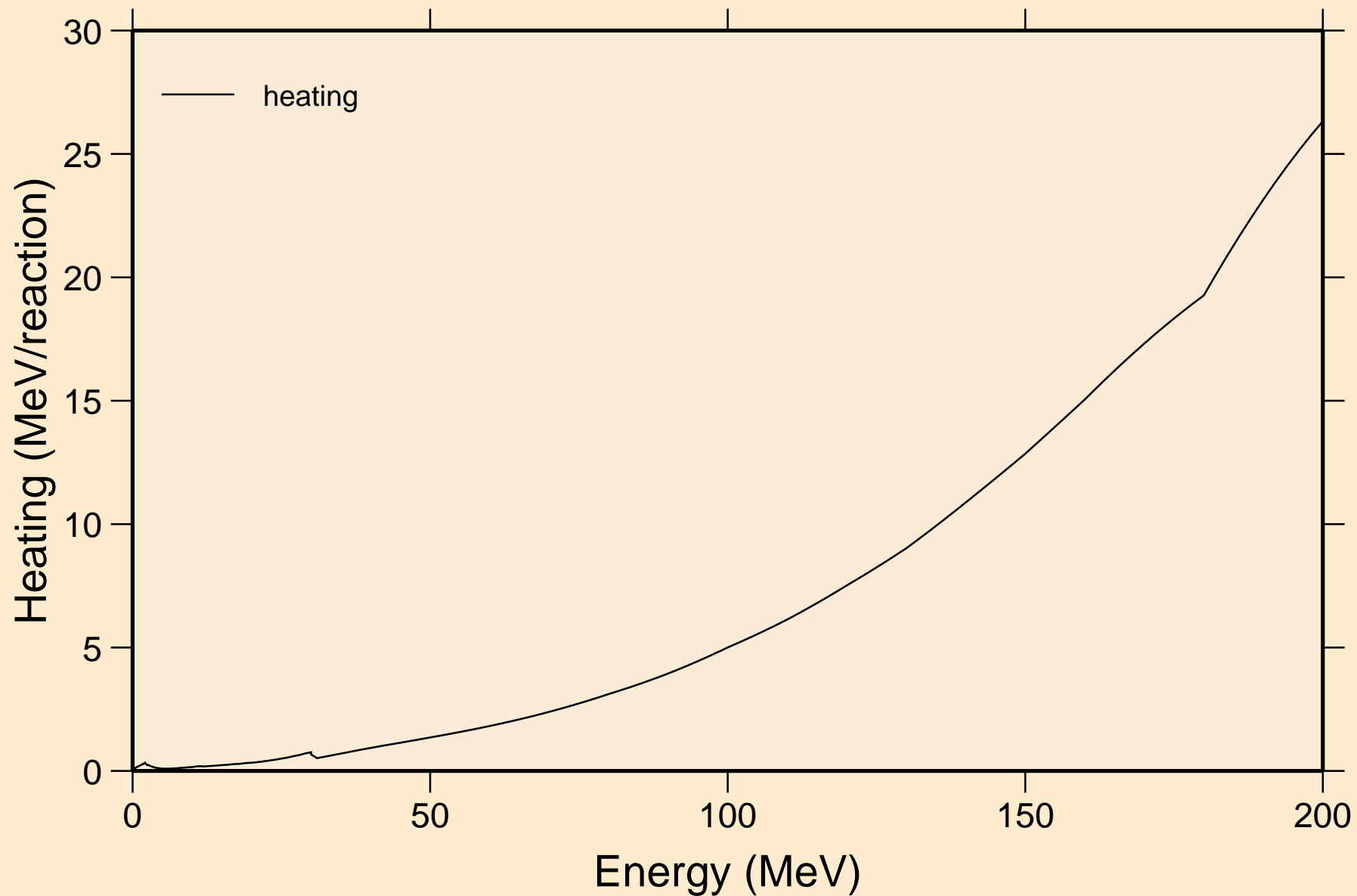

IN127N NEUTRON ACER TENDL-2019 LIBRARY; T=293.16K  
Damage

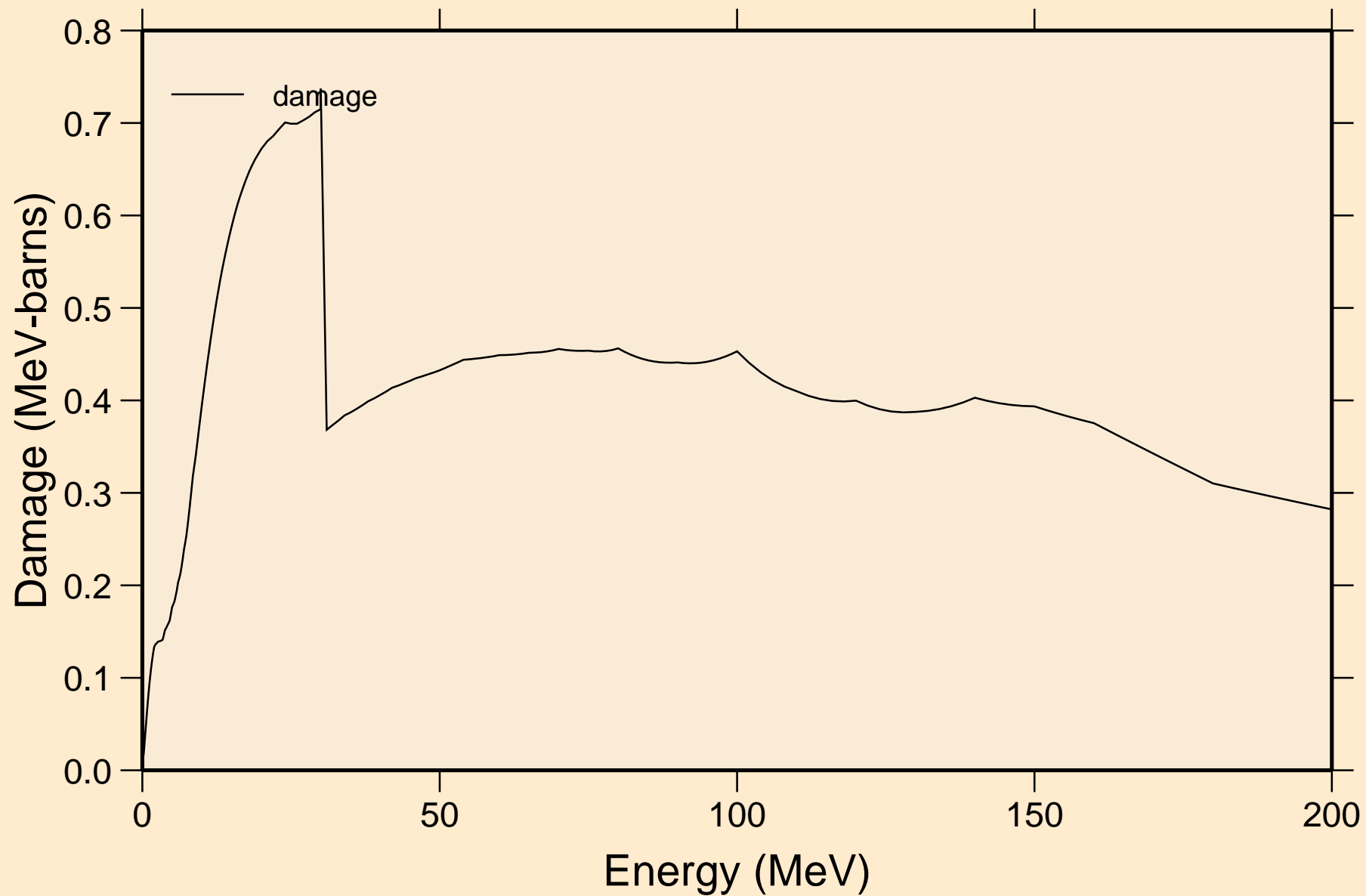

IN127N NEUTRON ACER TENDL-2019 LIBRARY; T=293.16K  
Non-threshold reactions

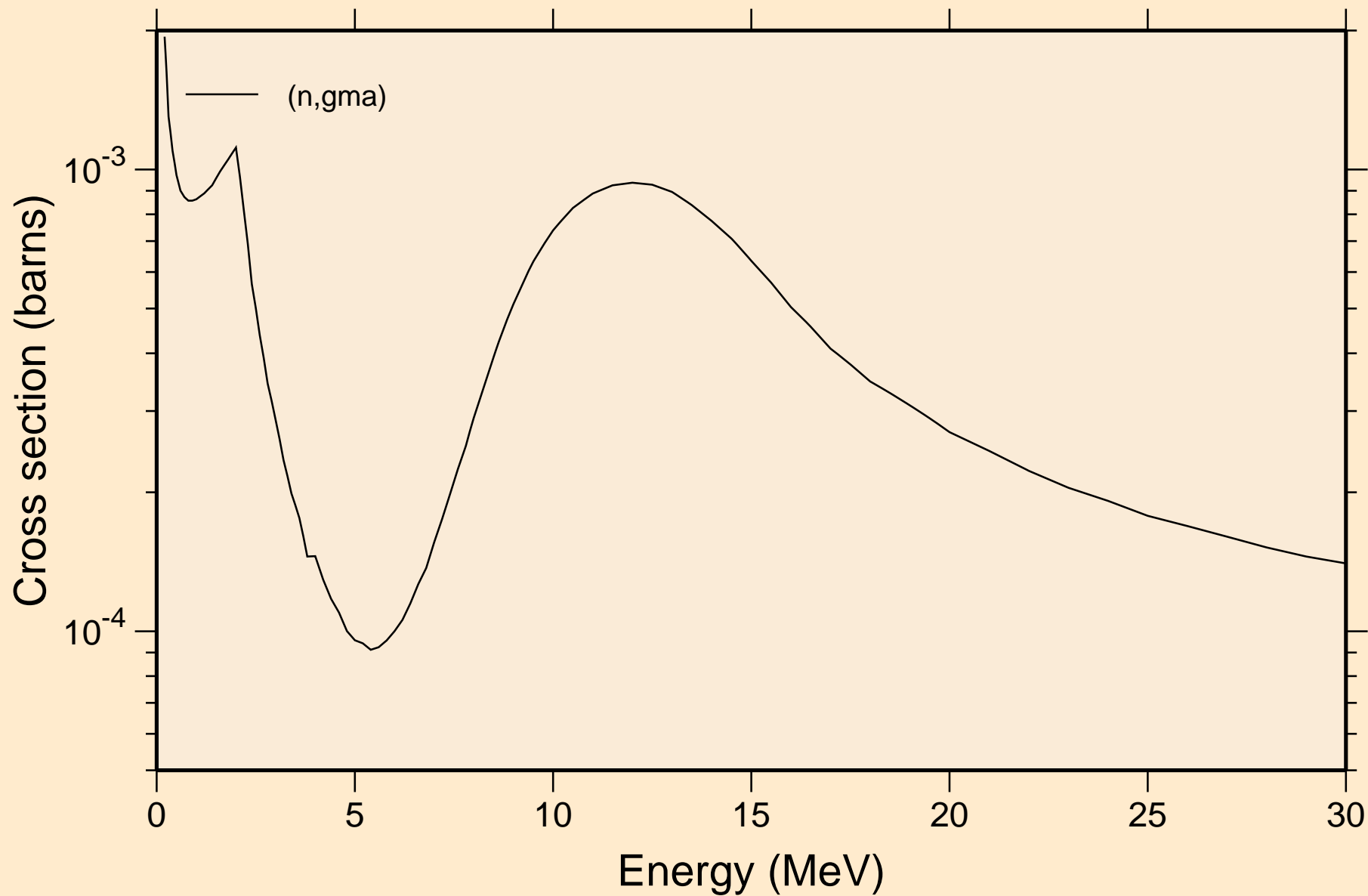



IN127N NEUTRON ACER TENDL-2019 LIBRARY; T=293.16K  
Inelastic levels

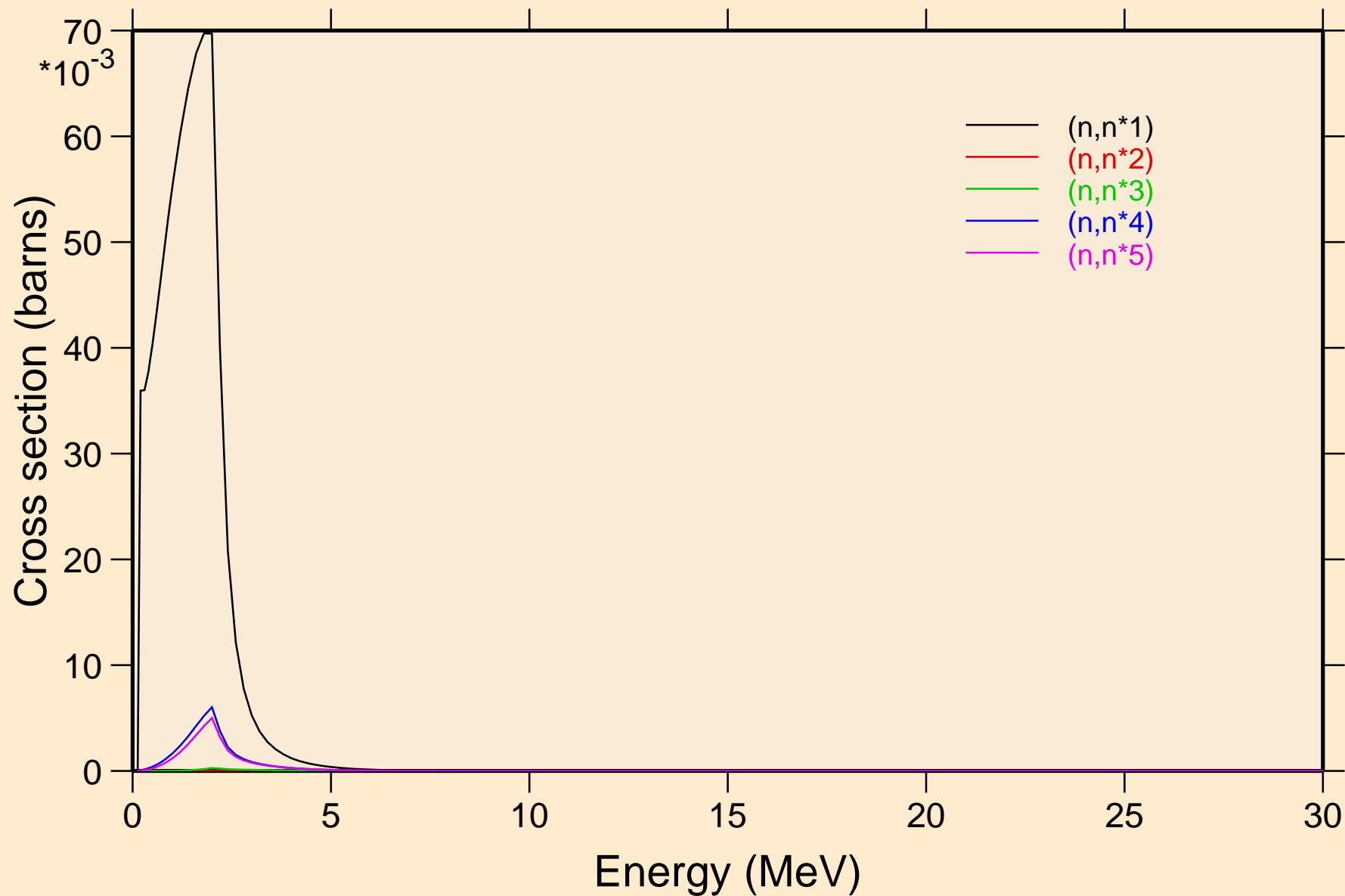

IN127N NEUTRON ACER TENDL-2019 LIBRARY; T=293.16K  
Inelastic levels

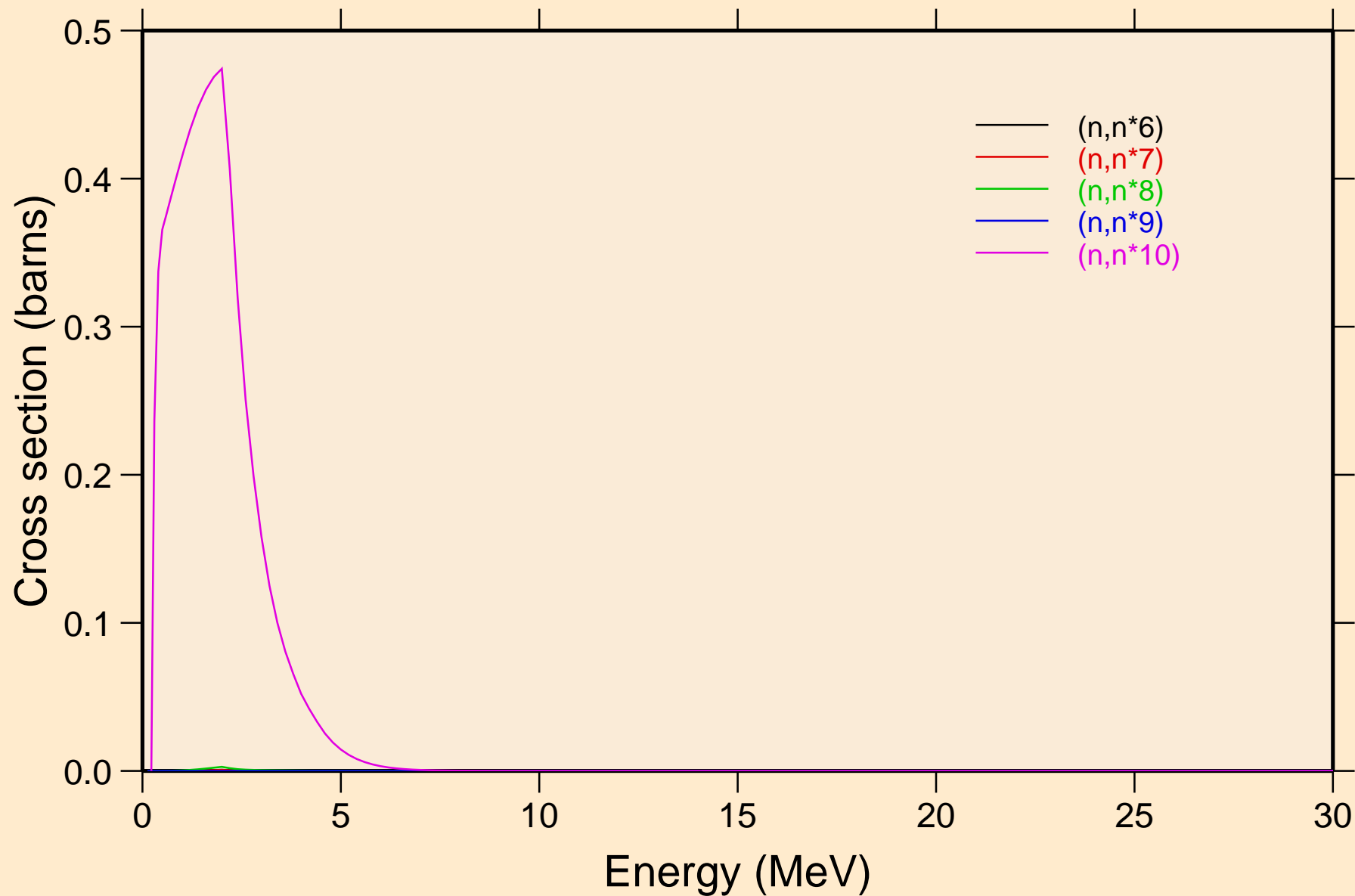

IN127N NEUTRON ACER TENDL-2019 LIBRARY; T=293.16K  
Inelastic levels

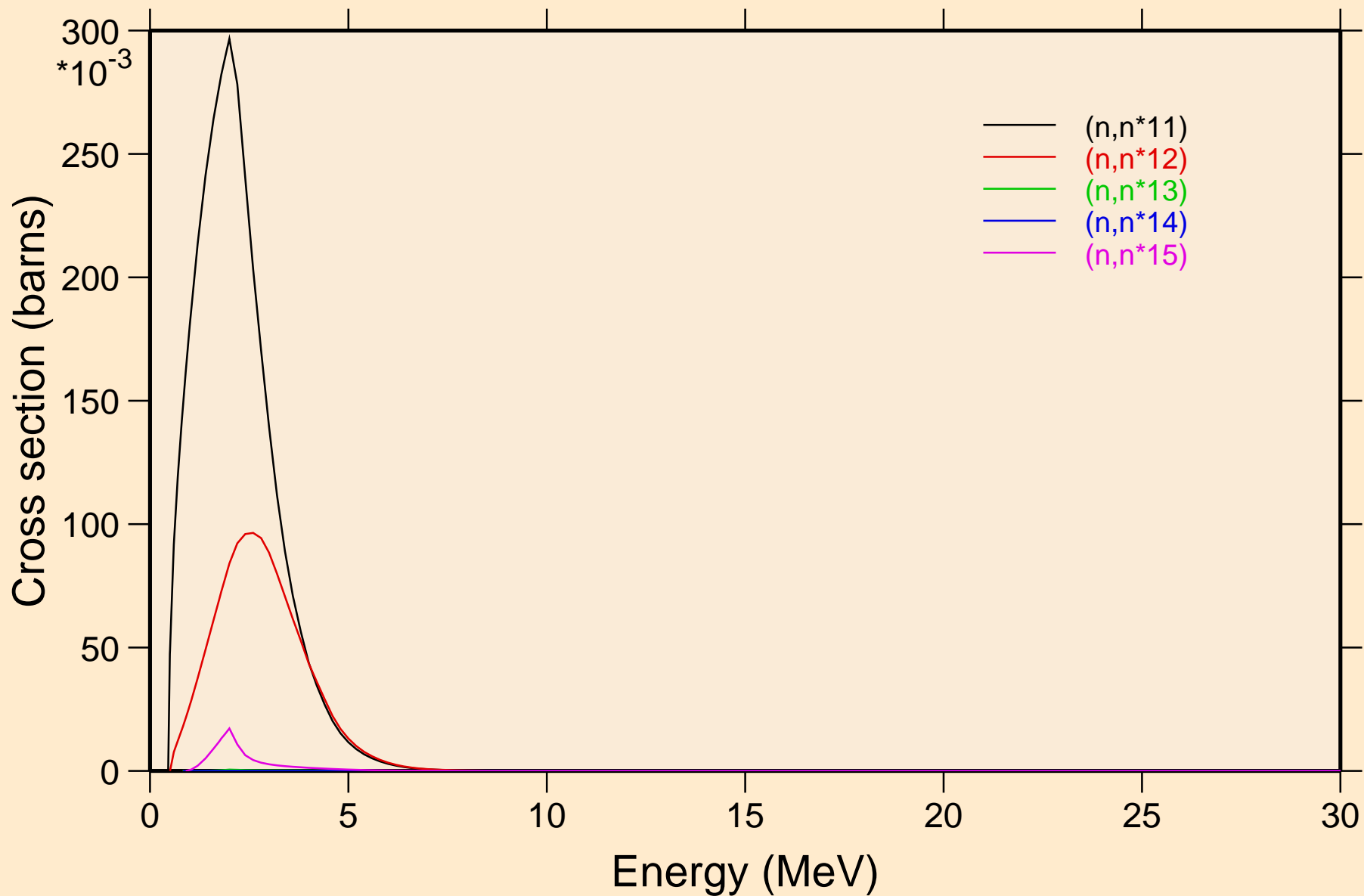

IN127N NEUTRON ACER TENDL-2019 LIBRARY; T=293.16K  
Inelastic levels

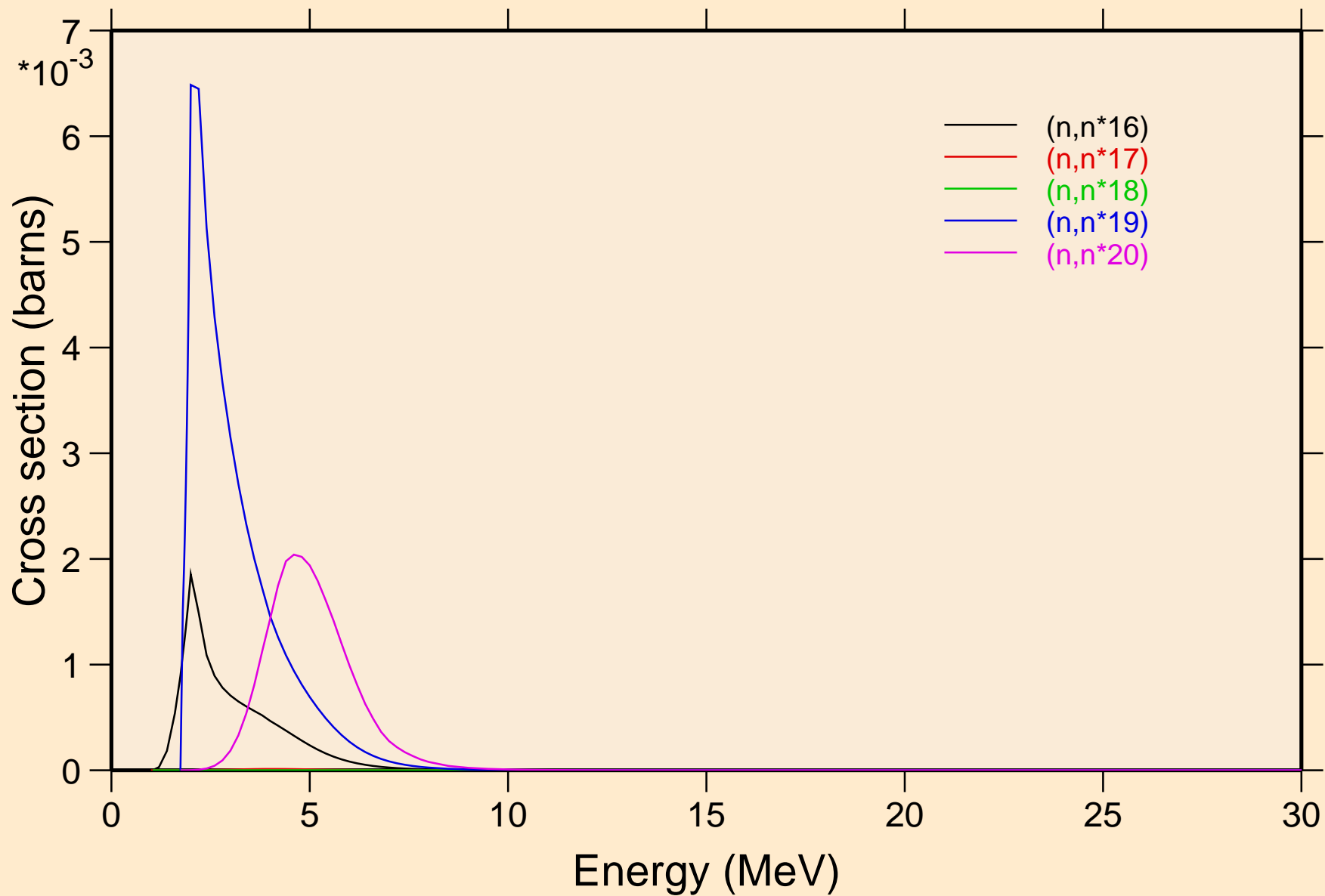

IN127N NEUTRON ACER TENDL-2019 LIBRARY; T=293.16K  
Inelastic levels

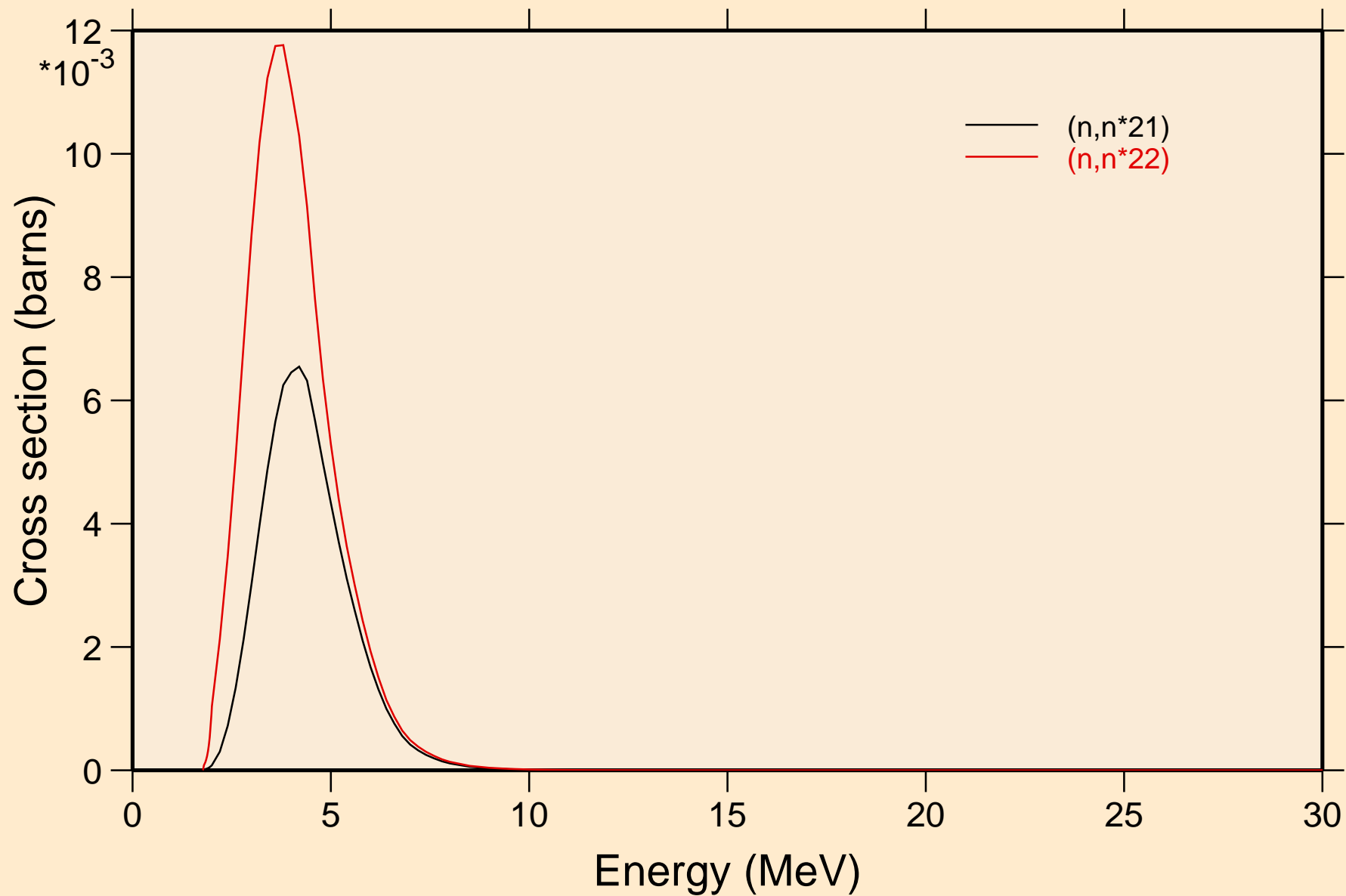

IN127N NEUTRON ACER TENDL-2019 LIBRARY; T=293.16K  
Threshold reactions

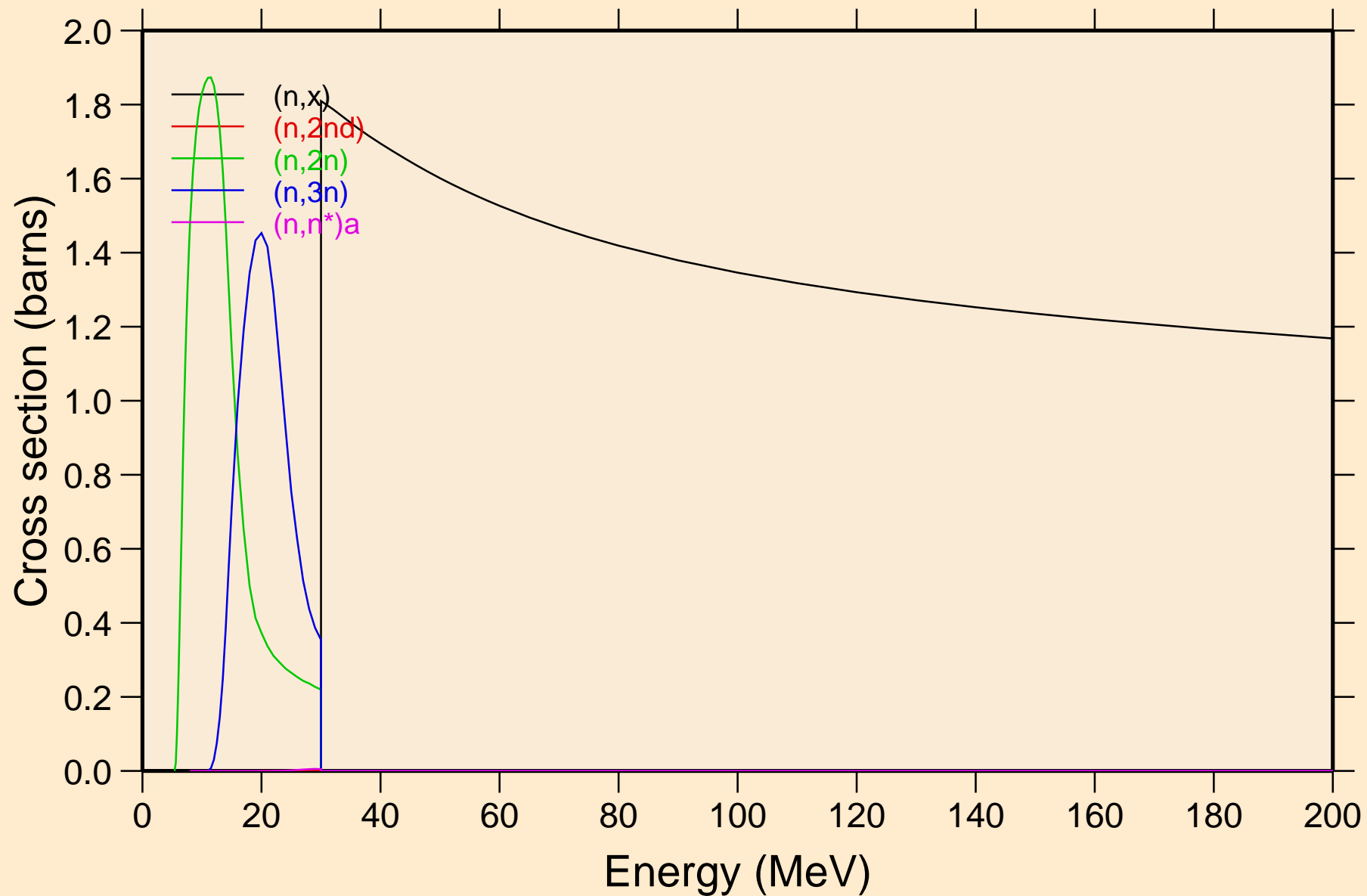

IN127N NEUTRON ACER TENDL-2019 LIBRARY; T=293.16K  
Threshold reactions

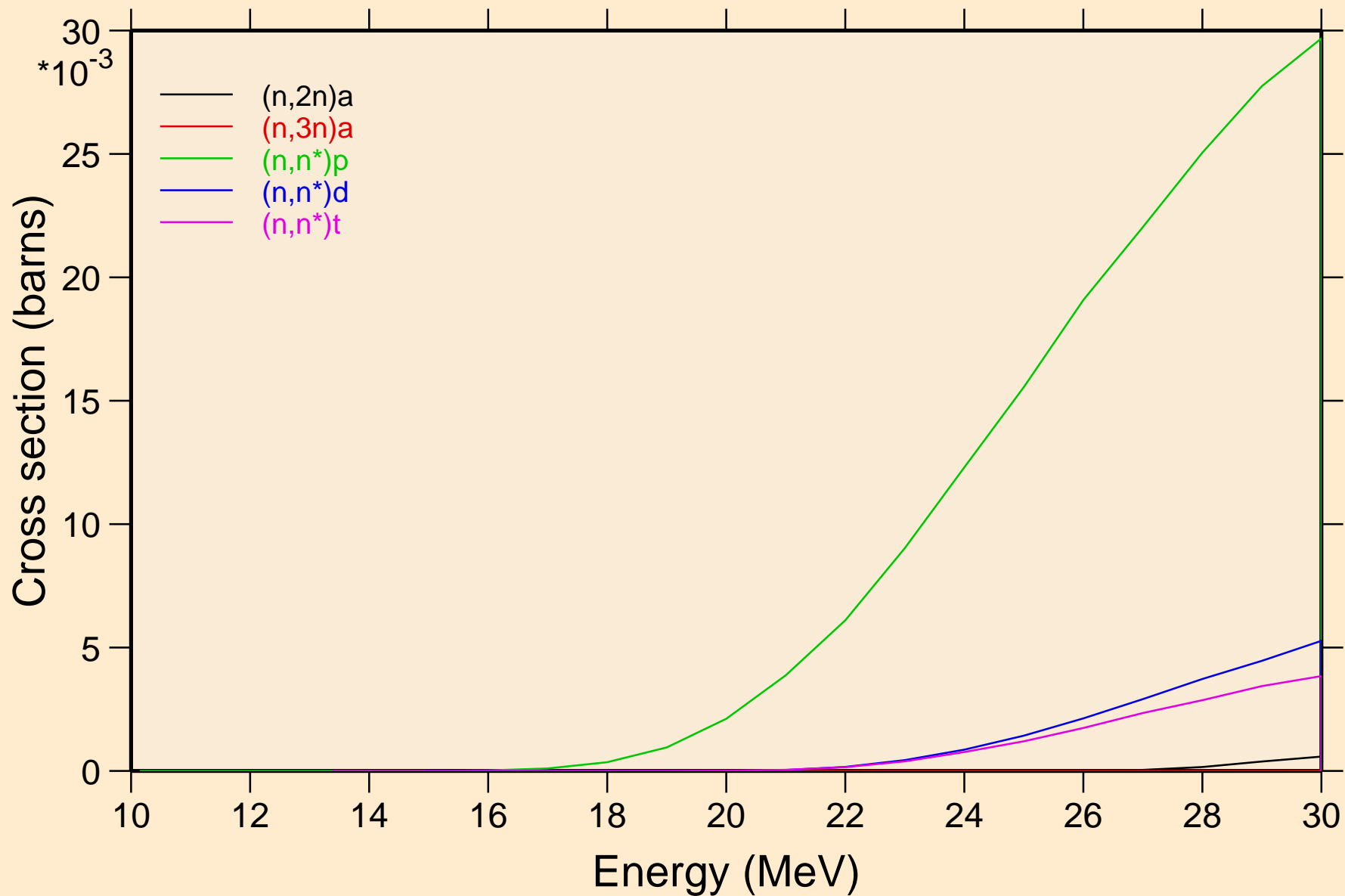

IN127N NEUTRON ACER TENDL-2019 LIBRARY; T=293.16K  
Threshold reactions

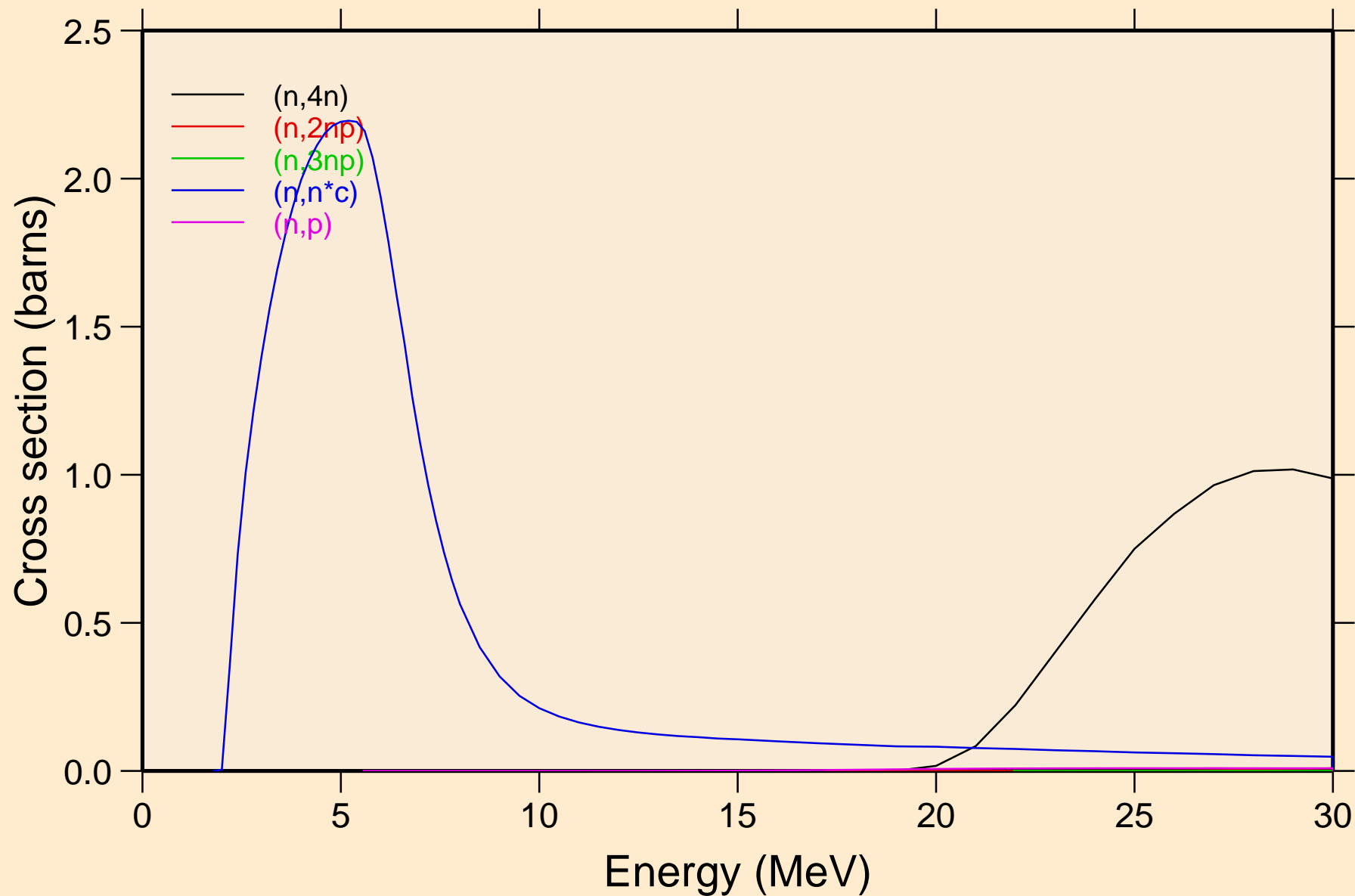



IN127N NEUTRON ACER TENDL-2019 LIBRARY; T=293.16K  
Threshold reactions

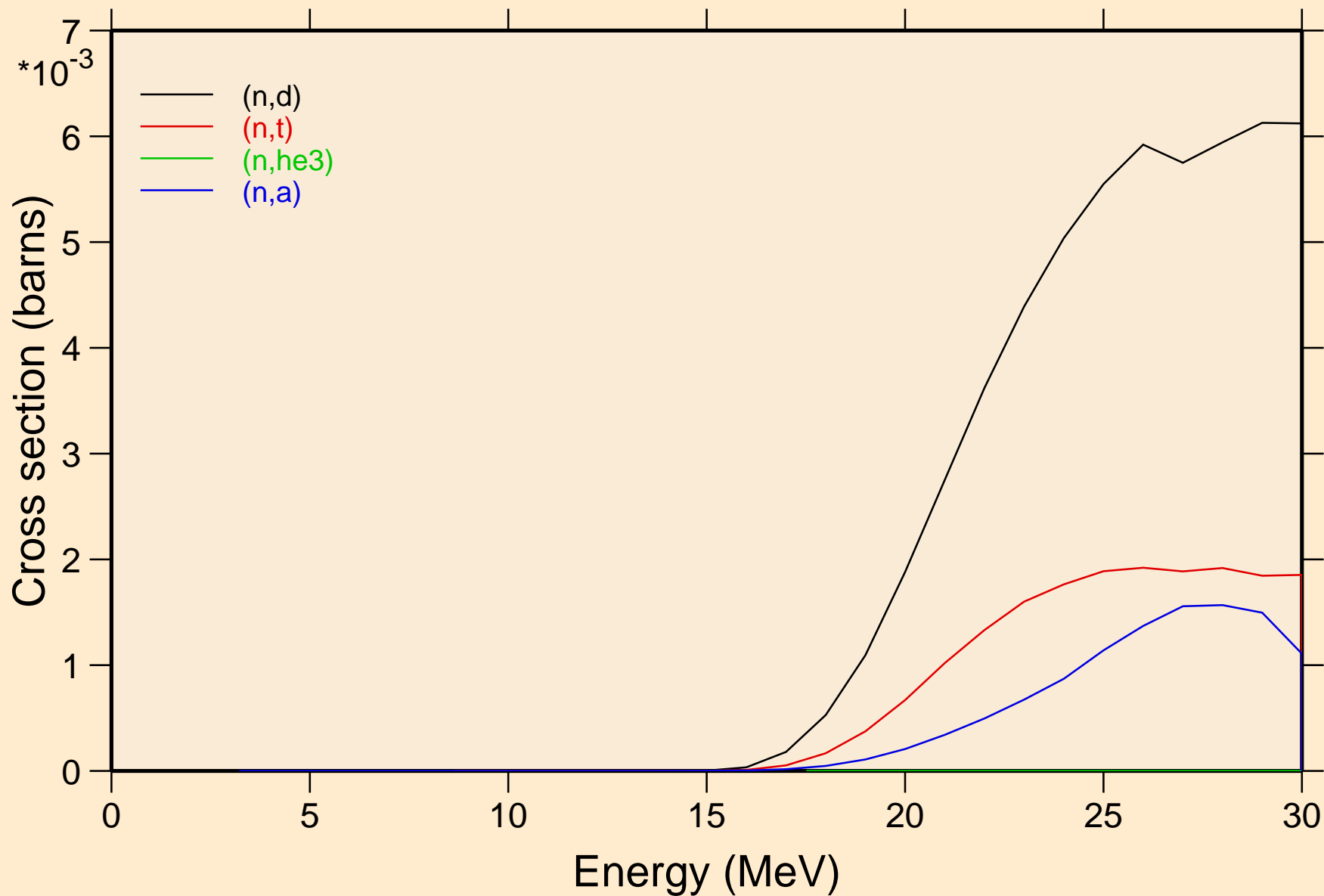

IN127N NEUTRON ACER TENDL-2019 LIBRARY; T=293.16K  
Threshold reactions

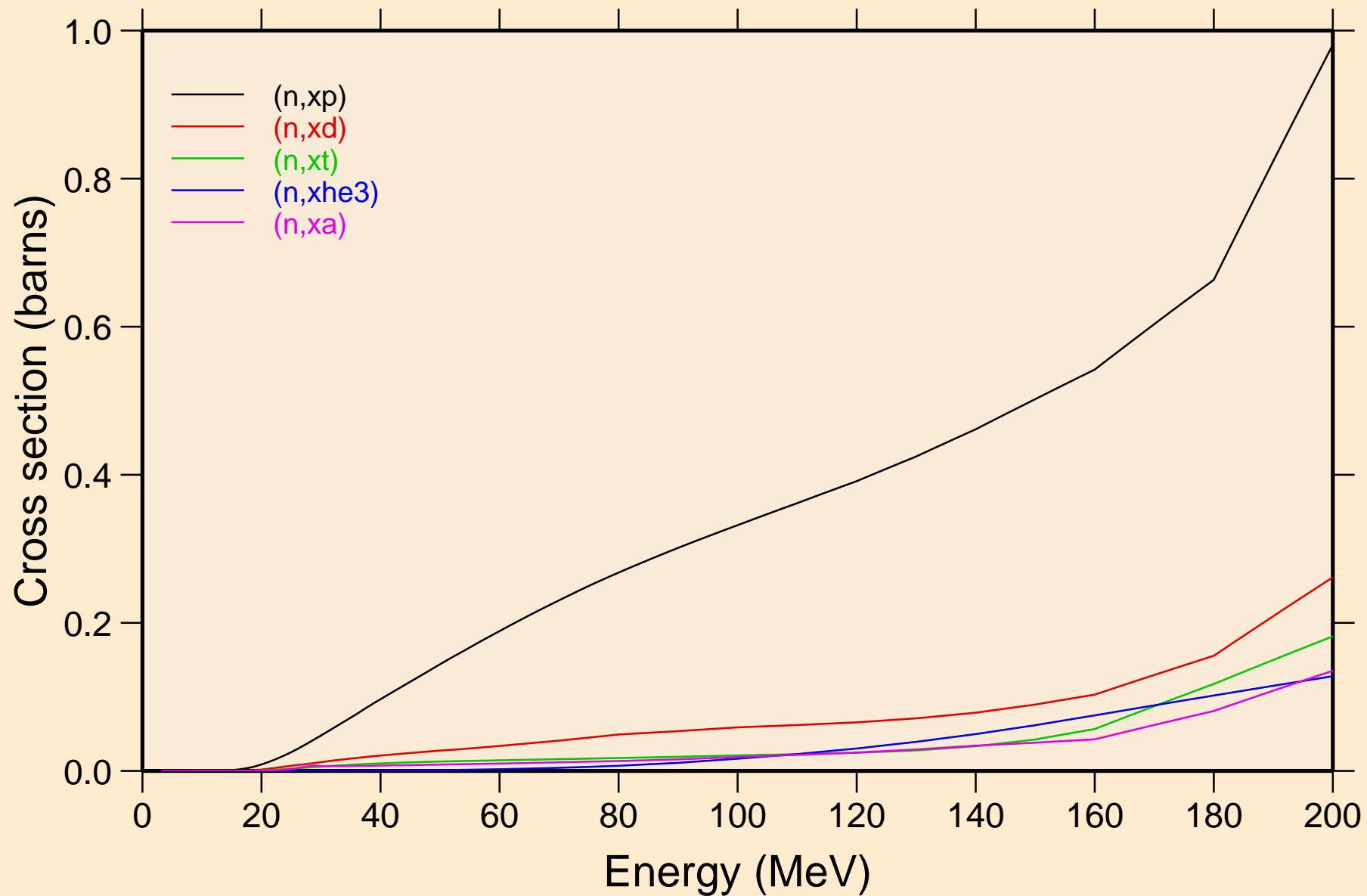

IN127N NEUTRON ACER TENDL-2019 LIBRARY; T=293.16K  
angular distribution for elastic

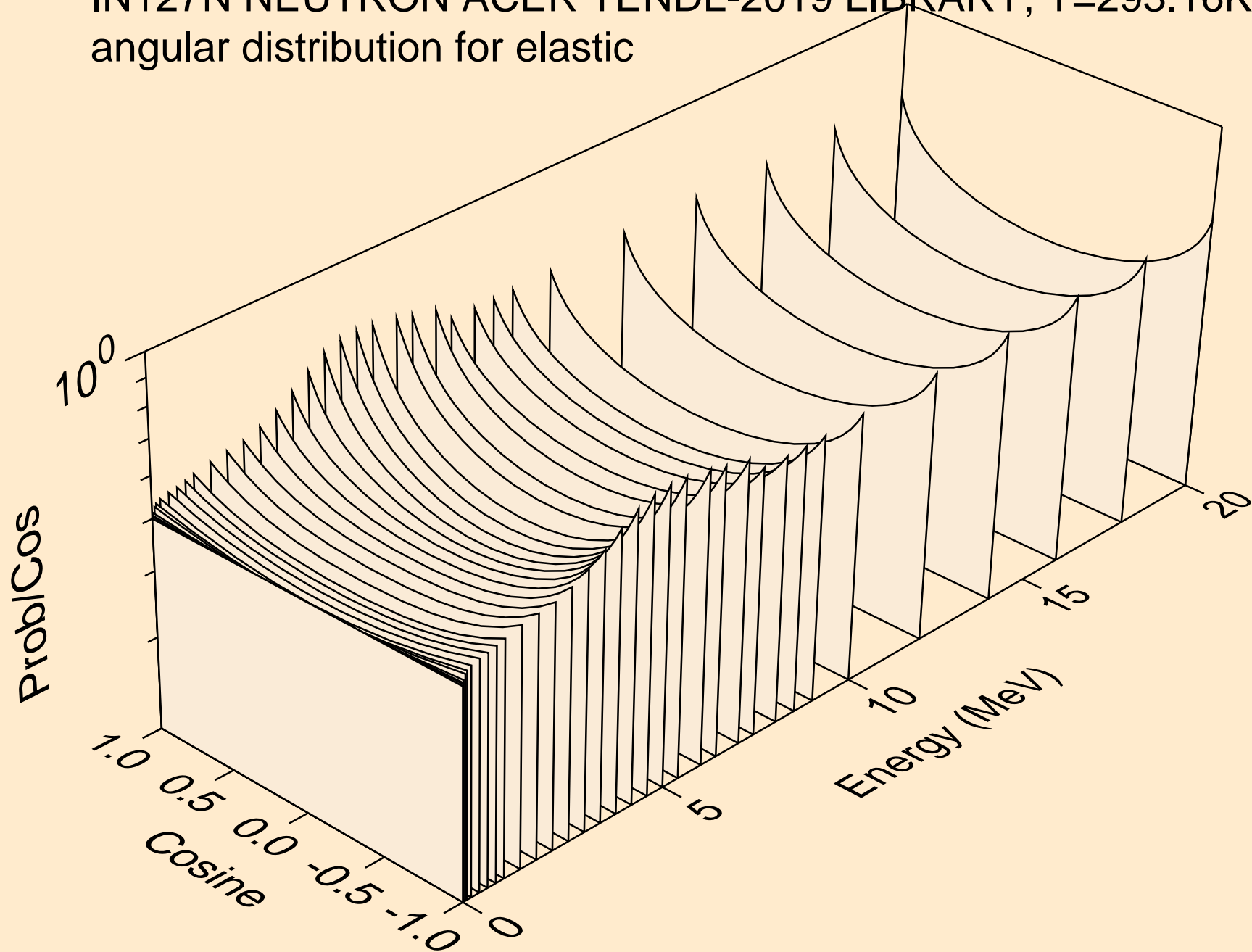

IN127N NEUTRON ACER TENDL-2019 LIBRARY; T=293.16K  
angular distribution for elastic

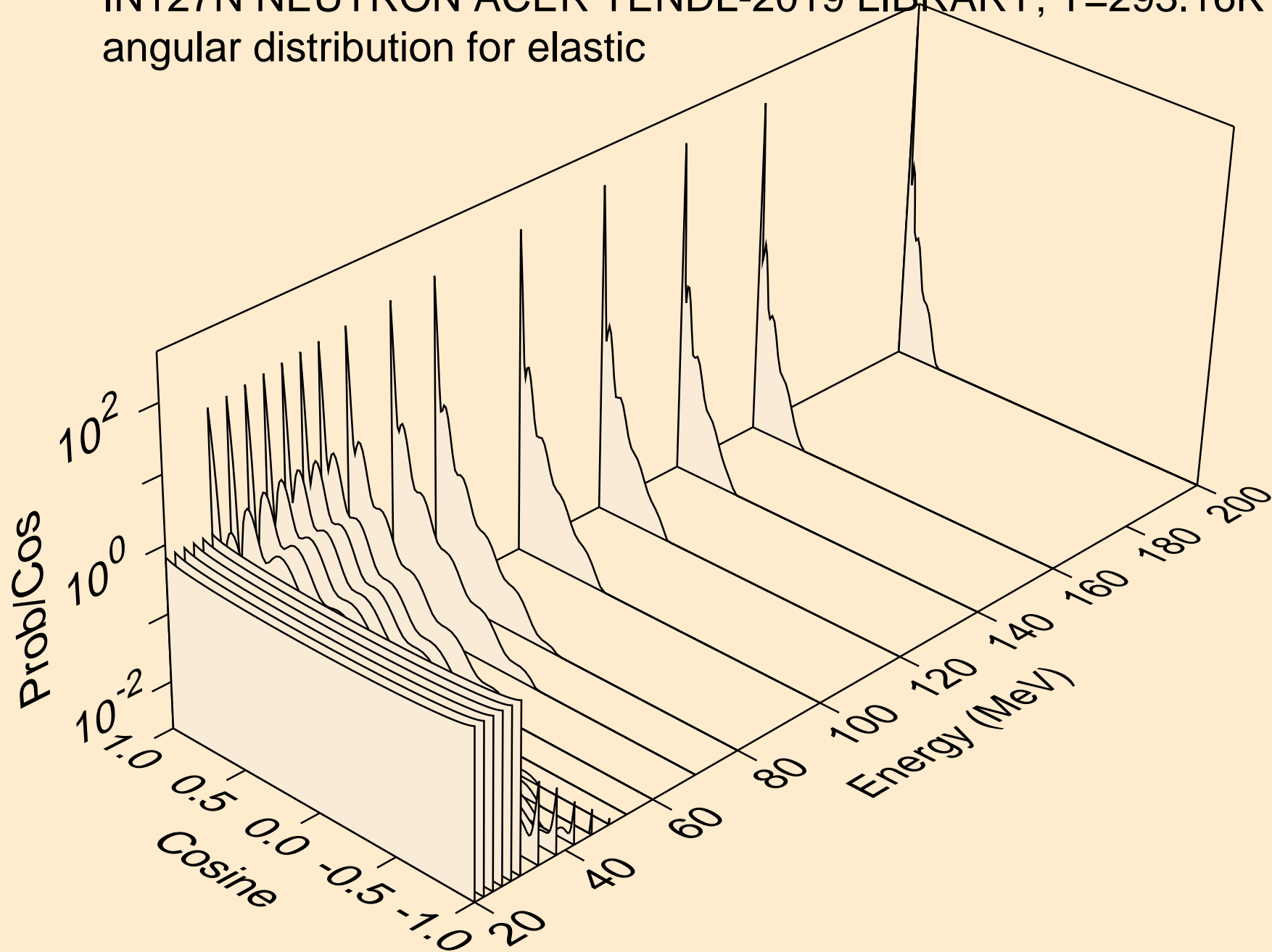

IN127N NEUTRON ACER TENDL-2019 LIBRARY; T=293.16K  
angular distribution for (n,n\*1)

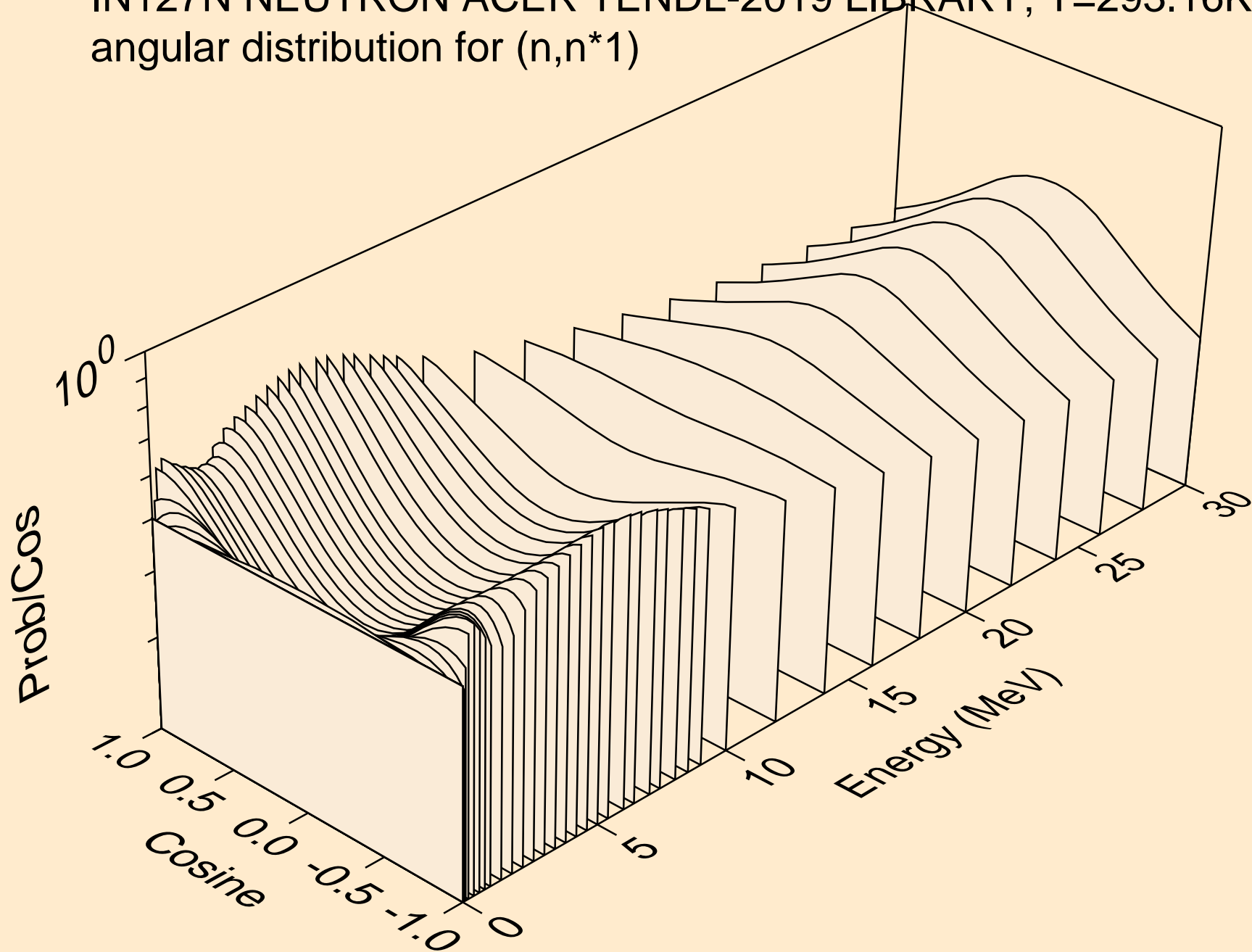

IN127N NEUTRON ACER TENDL-2019 LIBRARY; T=293.16K  
angular distribution for (n,n\*2)

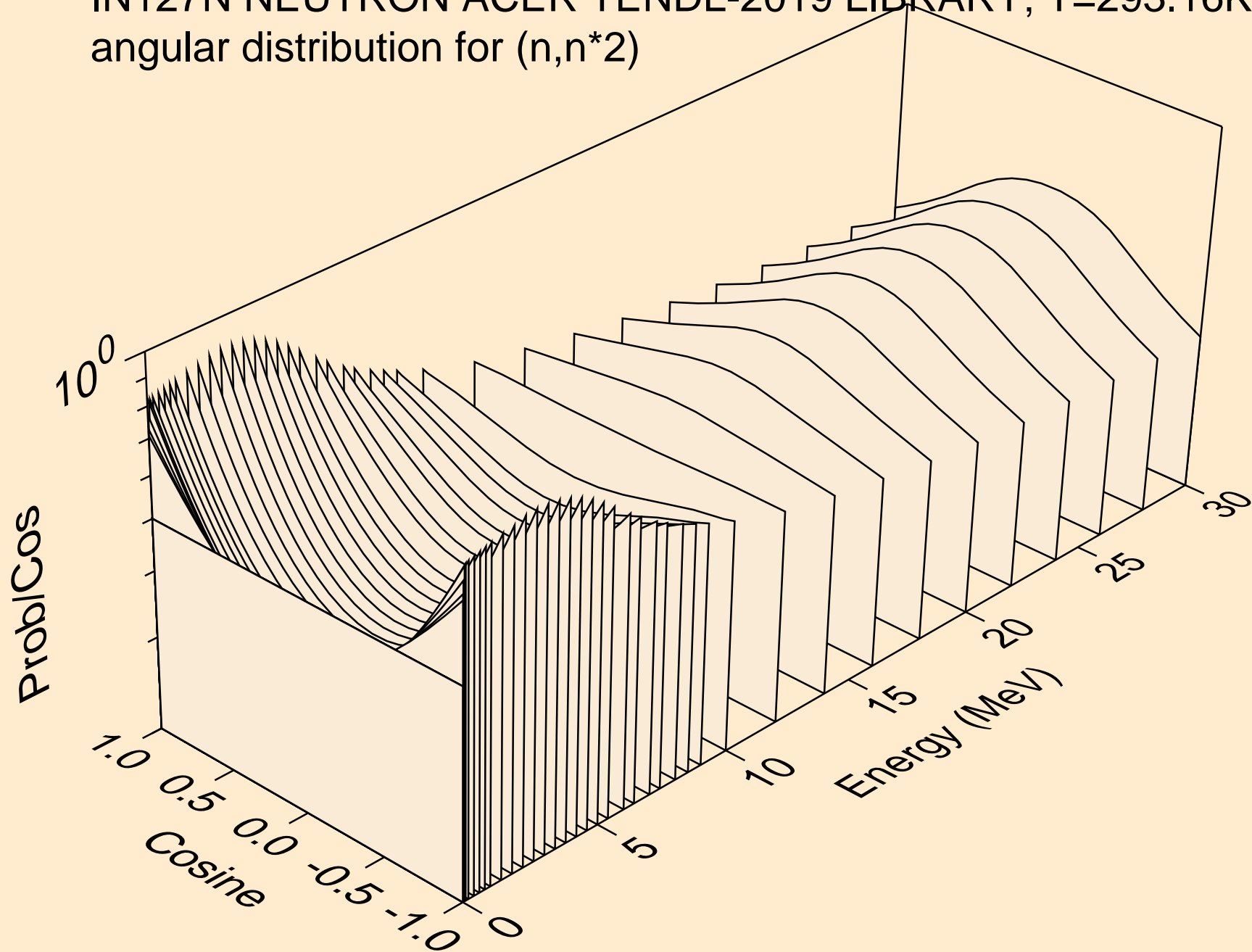

IN127N NEUTRON ACER TENDL-2019 LIBRARY; T=293.16K  
angular distribution for (n,n\*3)

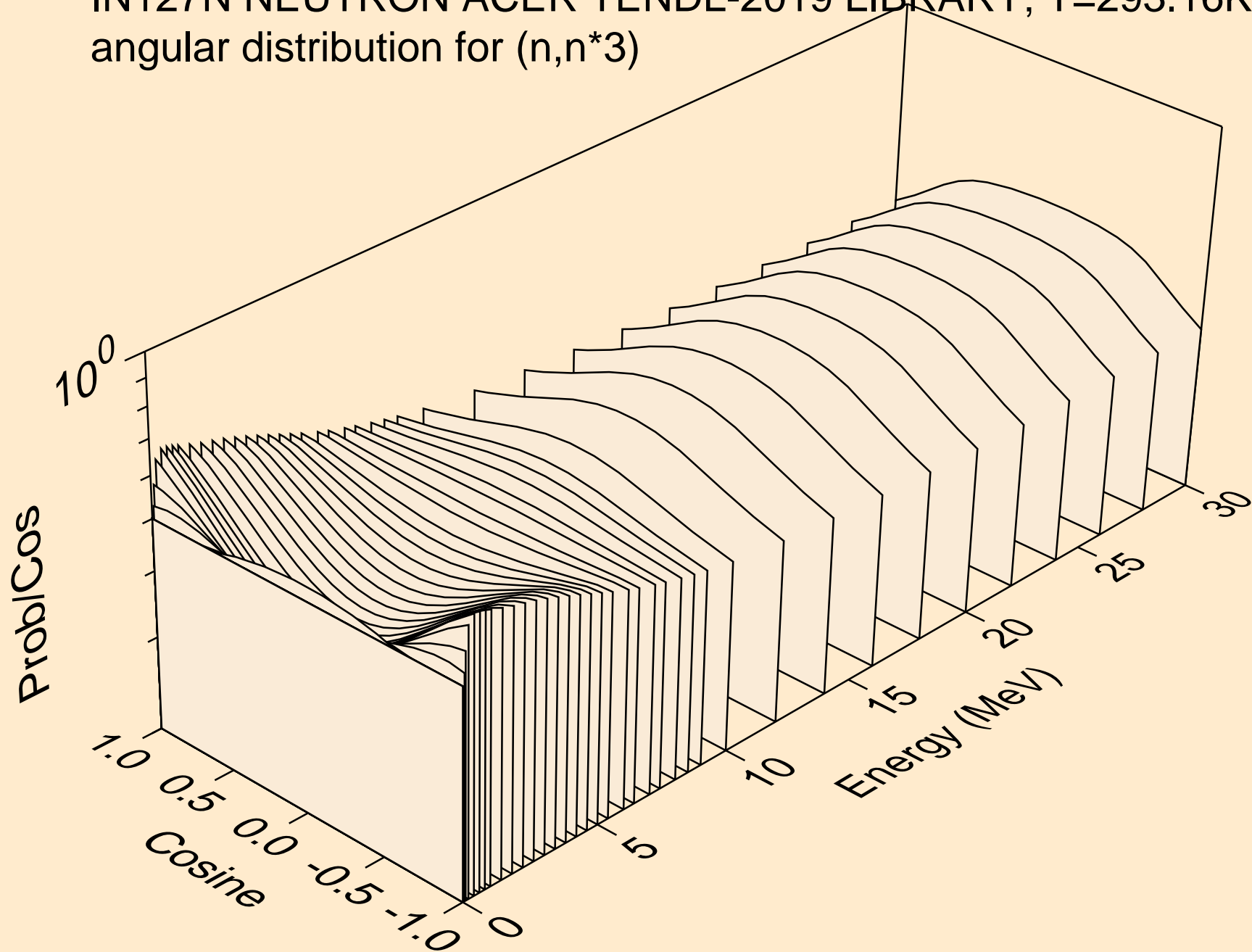

IN127N NEUTRON ACER TENDL-2019 LIBRARY; T=293.16K  
angular distribution for (n,n\*4)

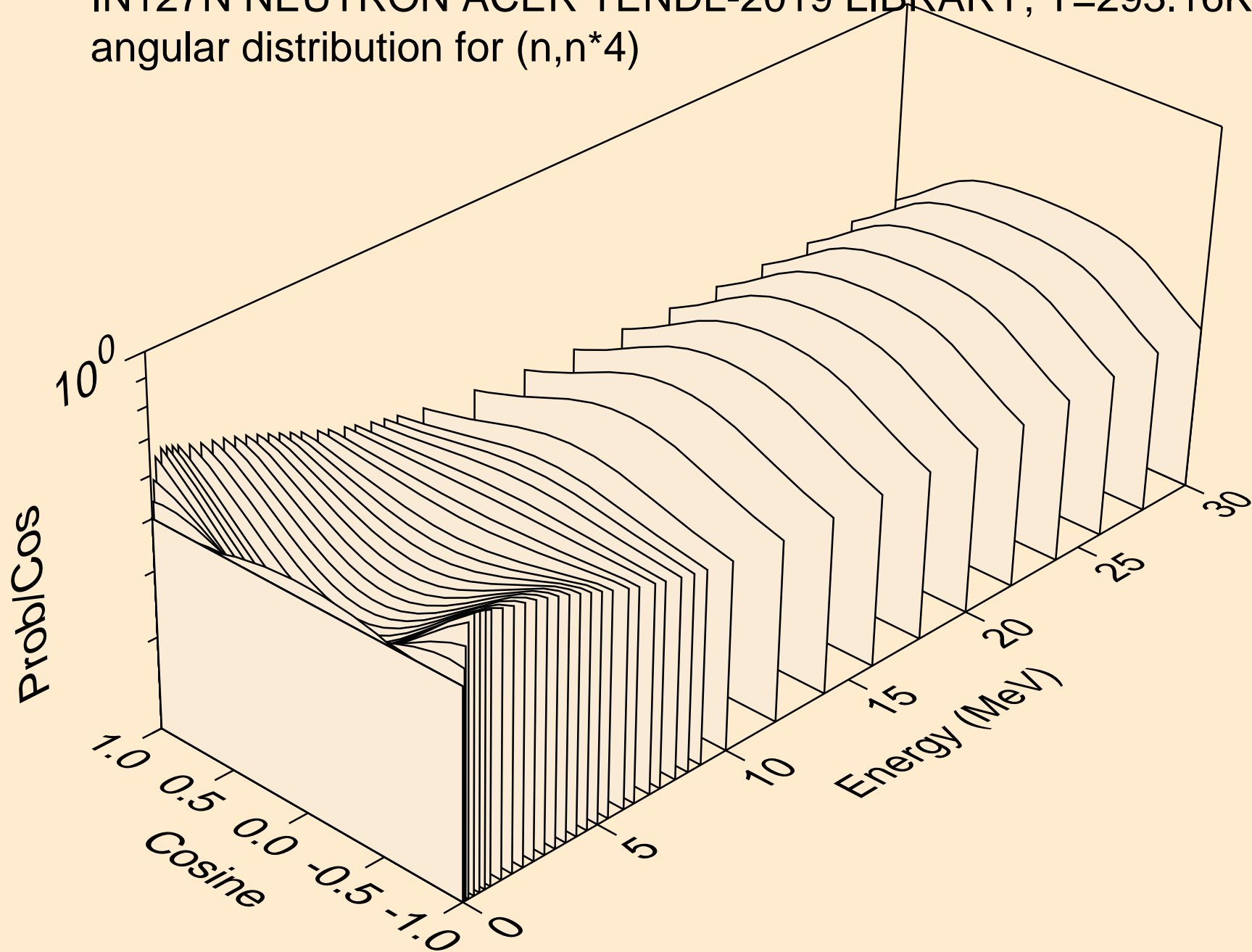



IN127N NEUTRON ACER TENDL-2019 LIBRARY; T=293.16K  
angular distribution for (n,n\*5)

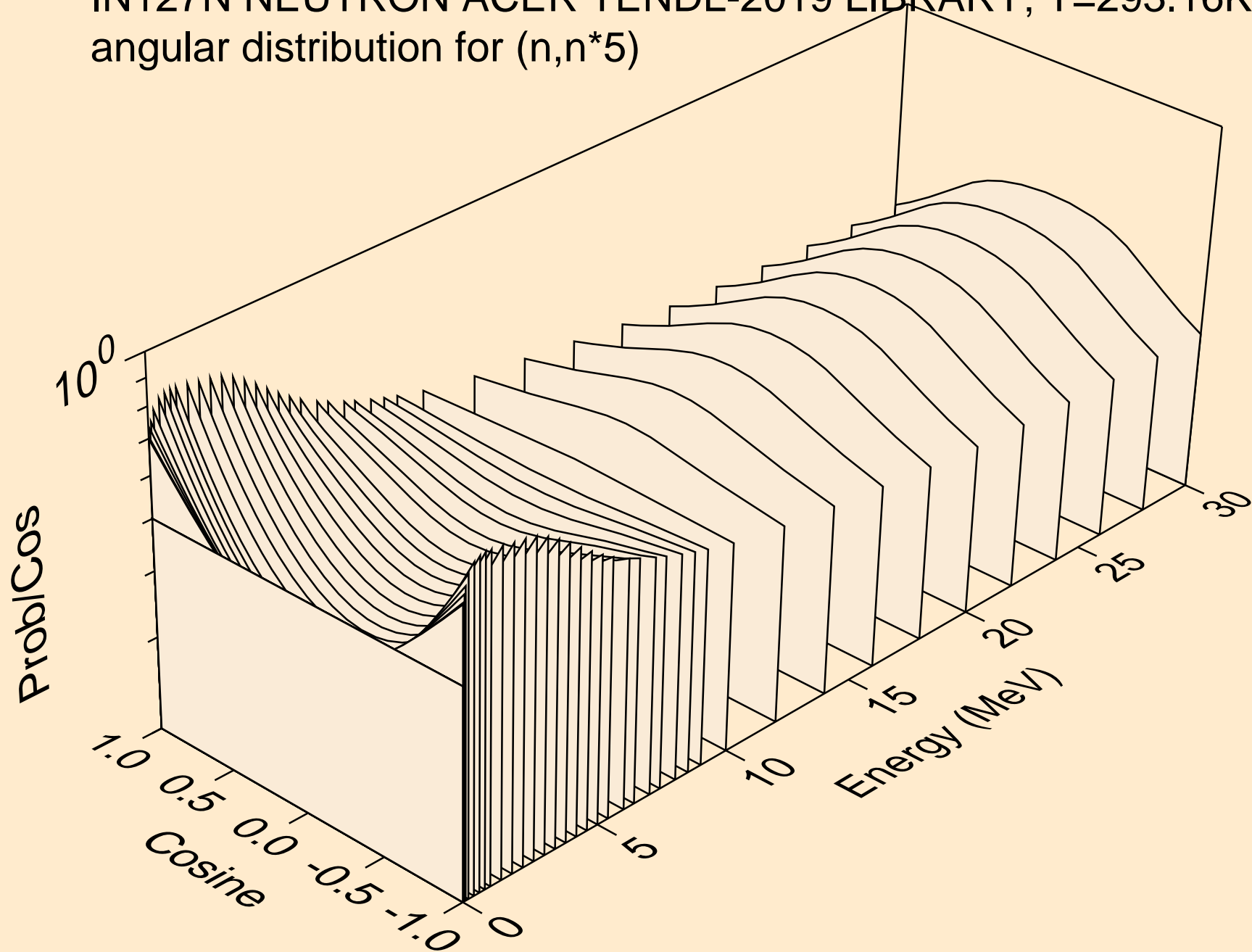

IN127N NEUTRON ACER TENDL-2019 LIBRARY; T=293.16K  
angular distribution for (n,n\*6)

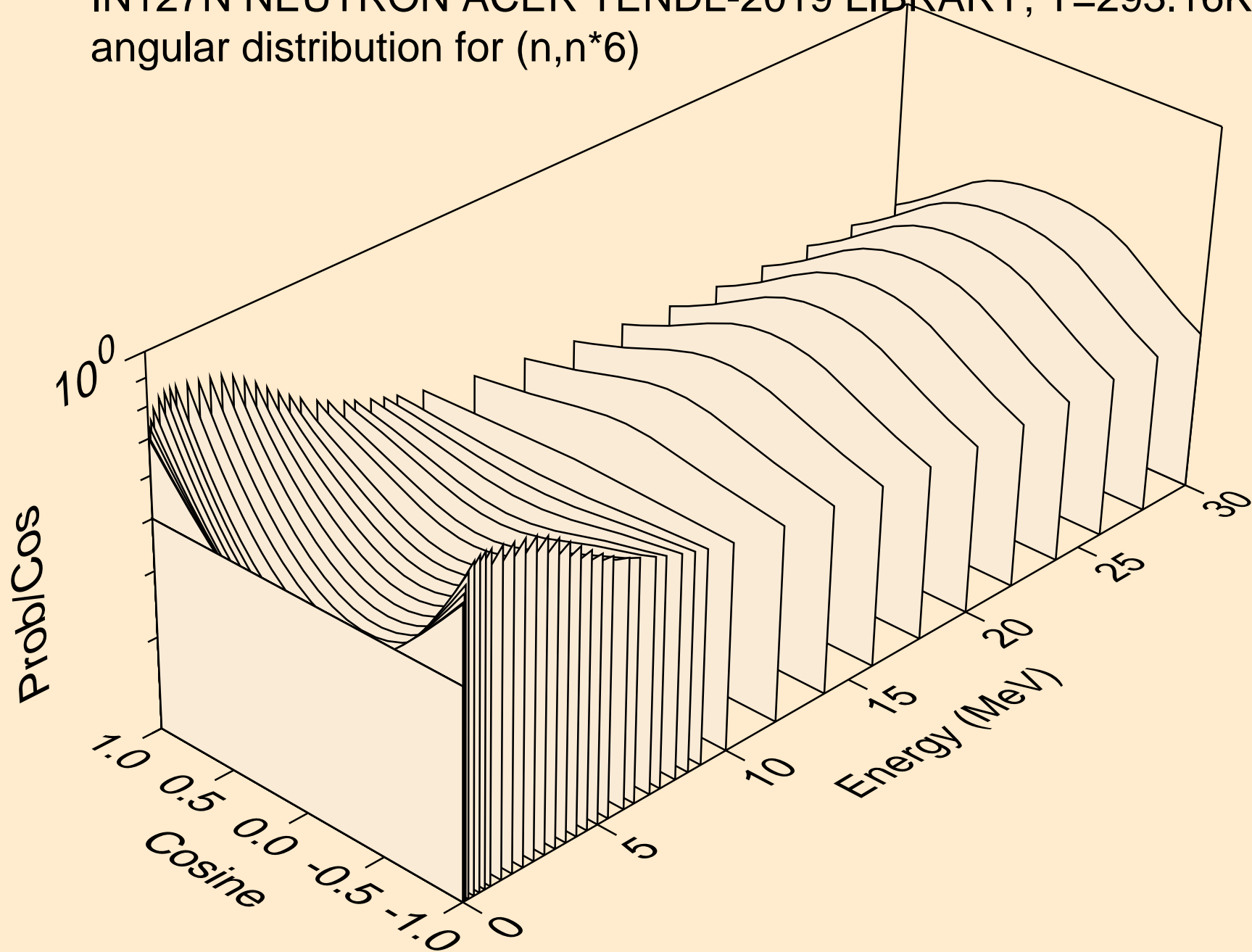

IN127N NEUTRON ACER TENDL-2019 LIBRARY; T=293.16K  
angular distribution for (n,n\*7)

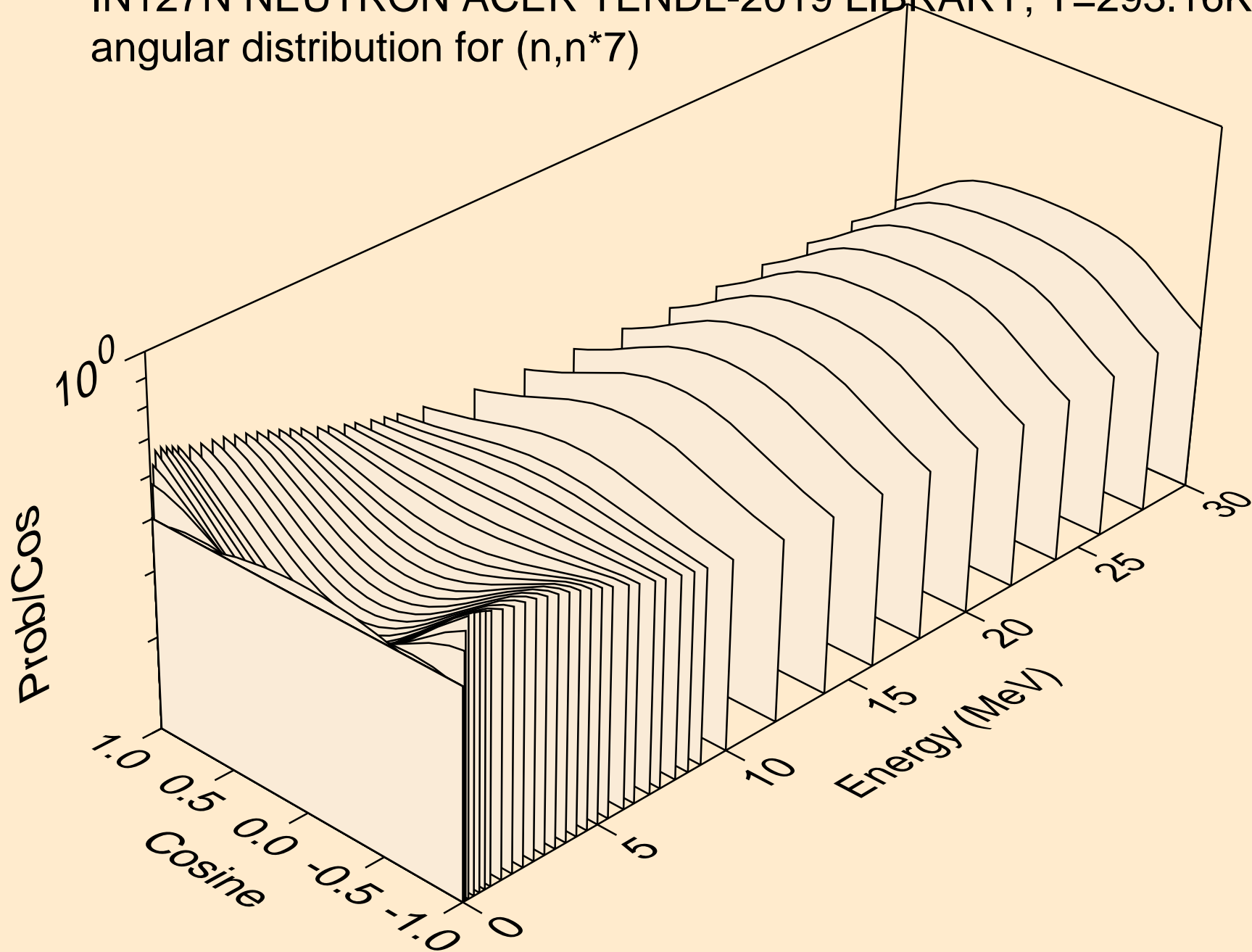

IN127N NEUTRON ACER TENDL-2019 LIBRARY; T=293.16K  
angular distribution for (n,n\*8)

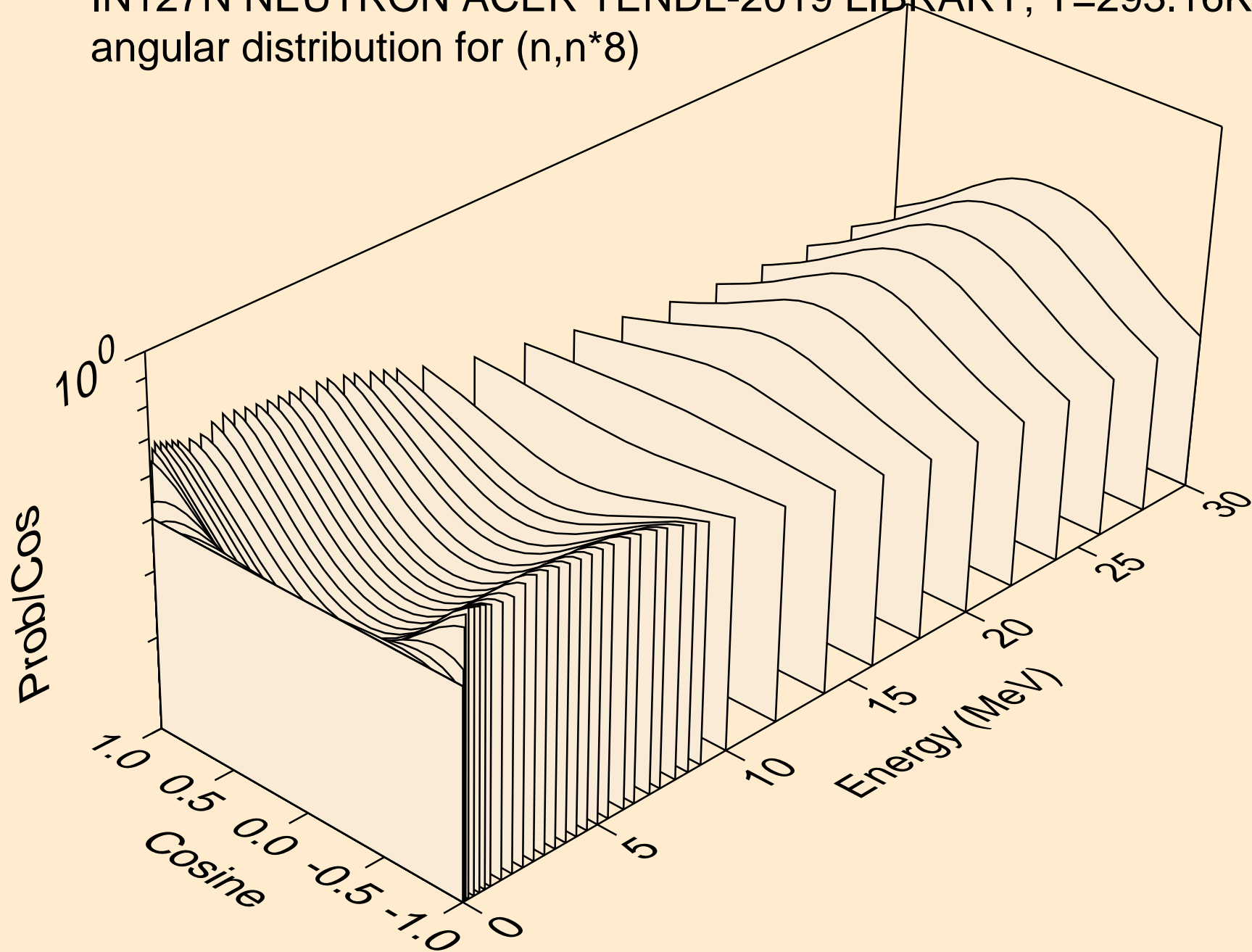

IN127N NEUTRON ACER TENDL-2019 LIBRARY; T=293.16K  
angular distribution for (n,n\*9)

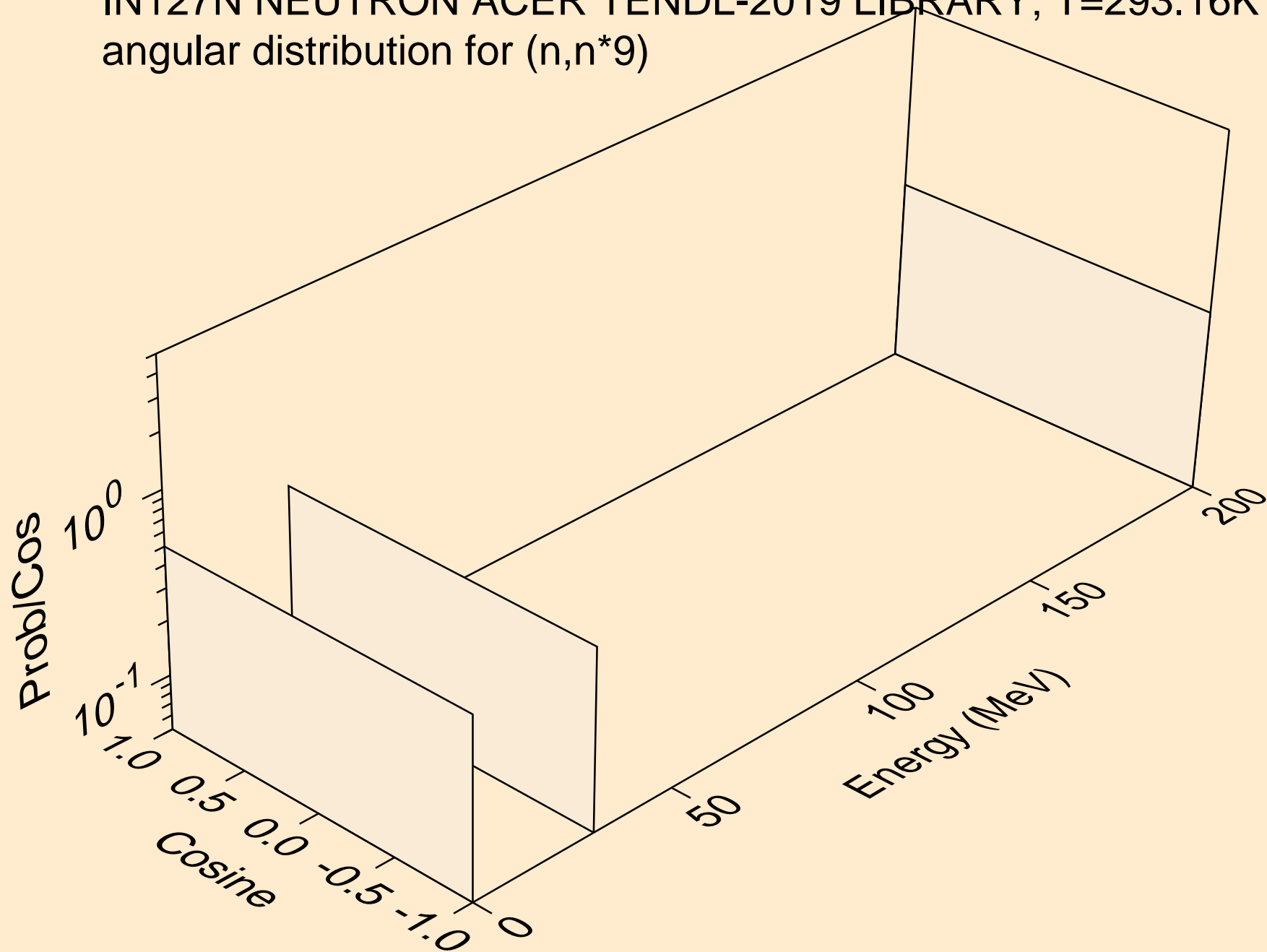

IN127N NEUTRON ACER TENDL-2019 LIBRARY; T=293.16K  
angular distribution for (n,n\*10)

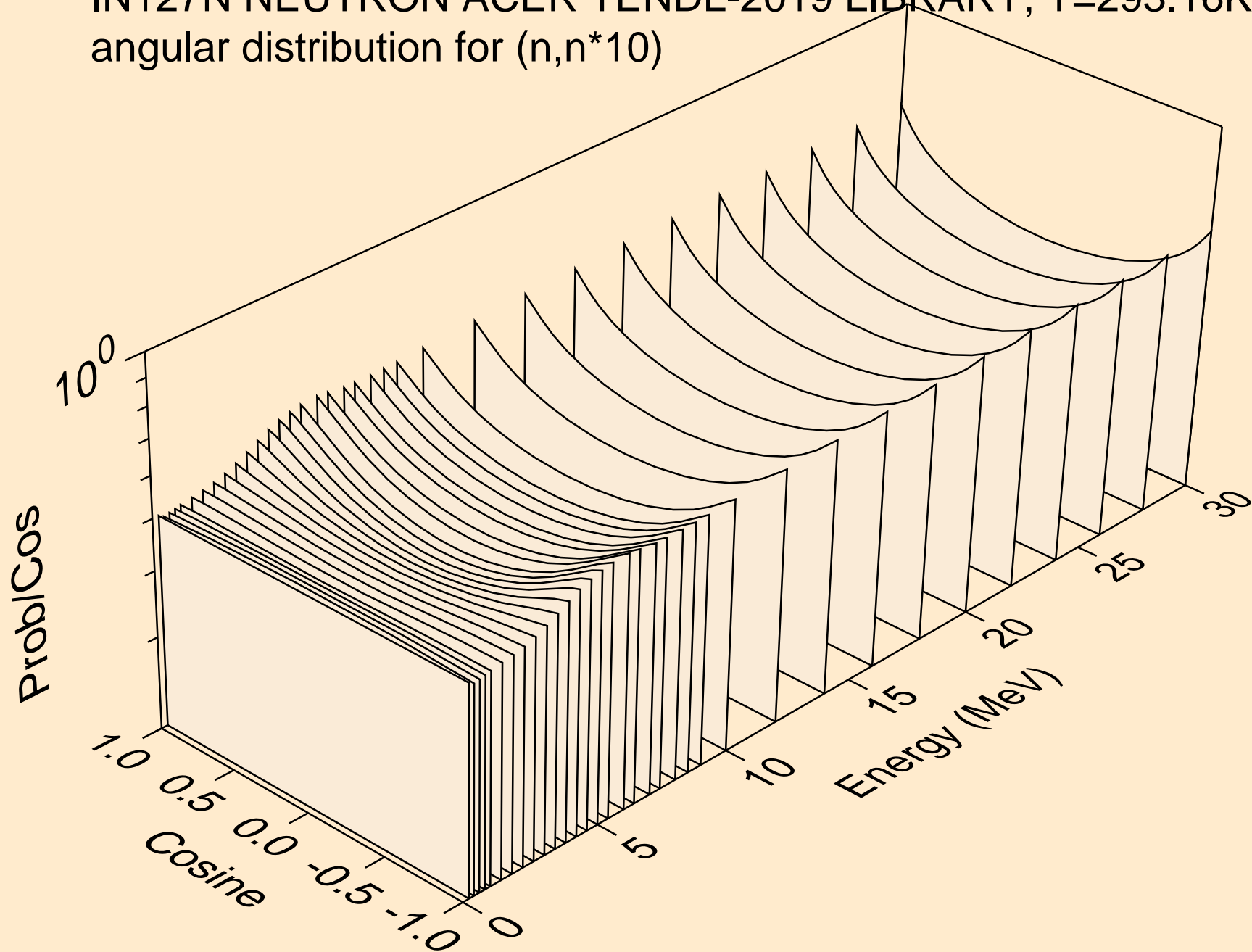

IN127N NEUTRON ACER TENDL-2019 LIBRARY; T=293.16K  
angular distribution for (n,n\*11)

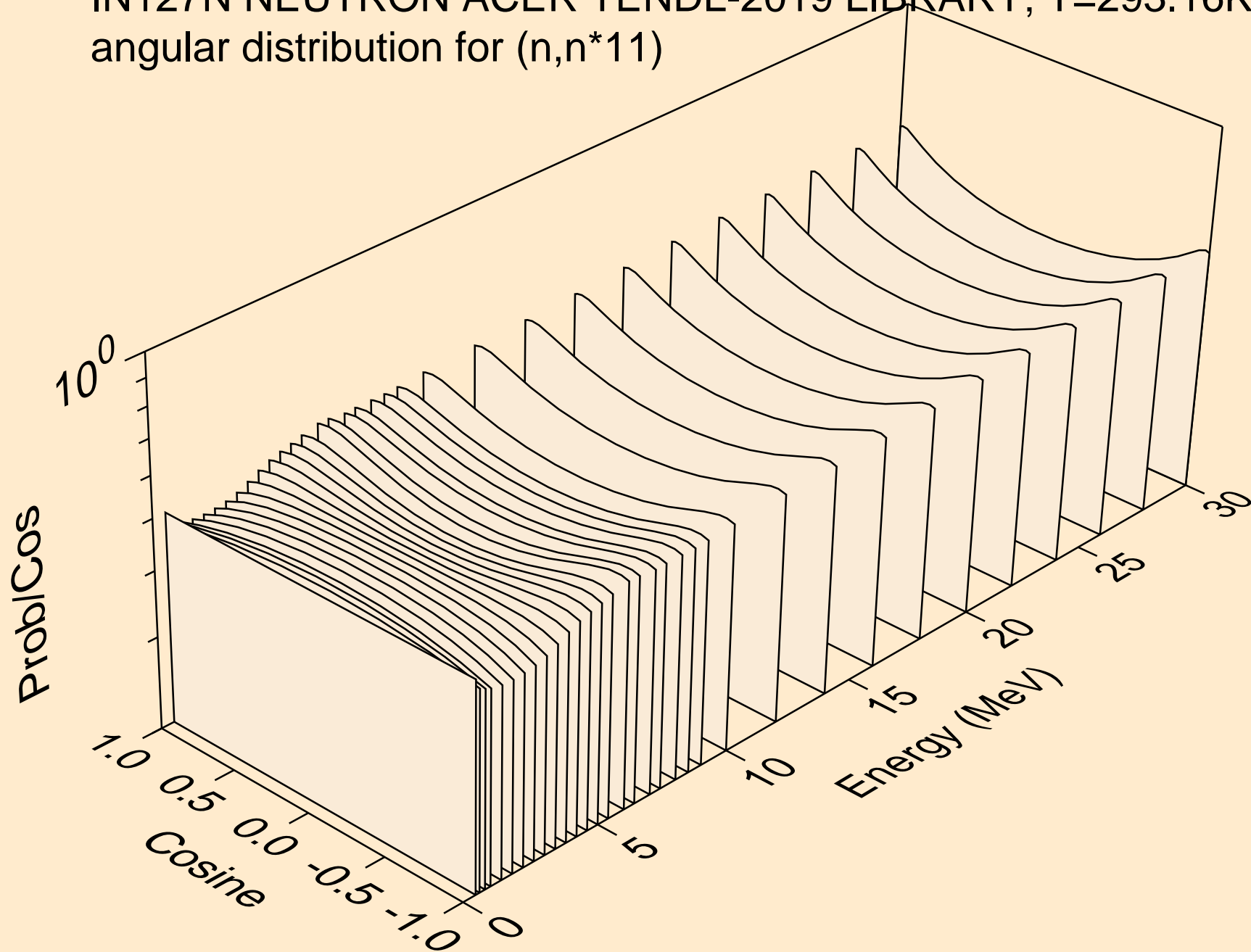

IN127N NEUTRON ACER TENDL-2019 LIBRARY; T=293.16K  
angular distribution for (n,n\*12)

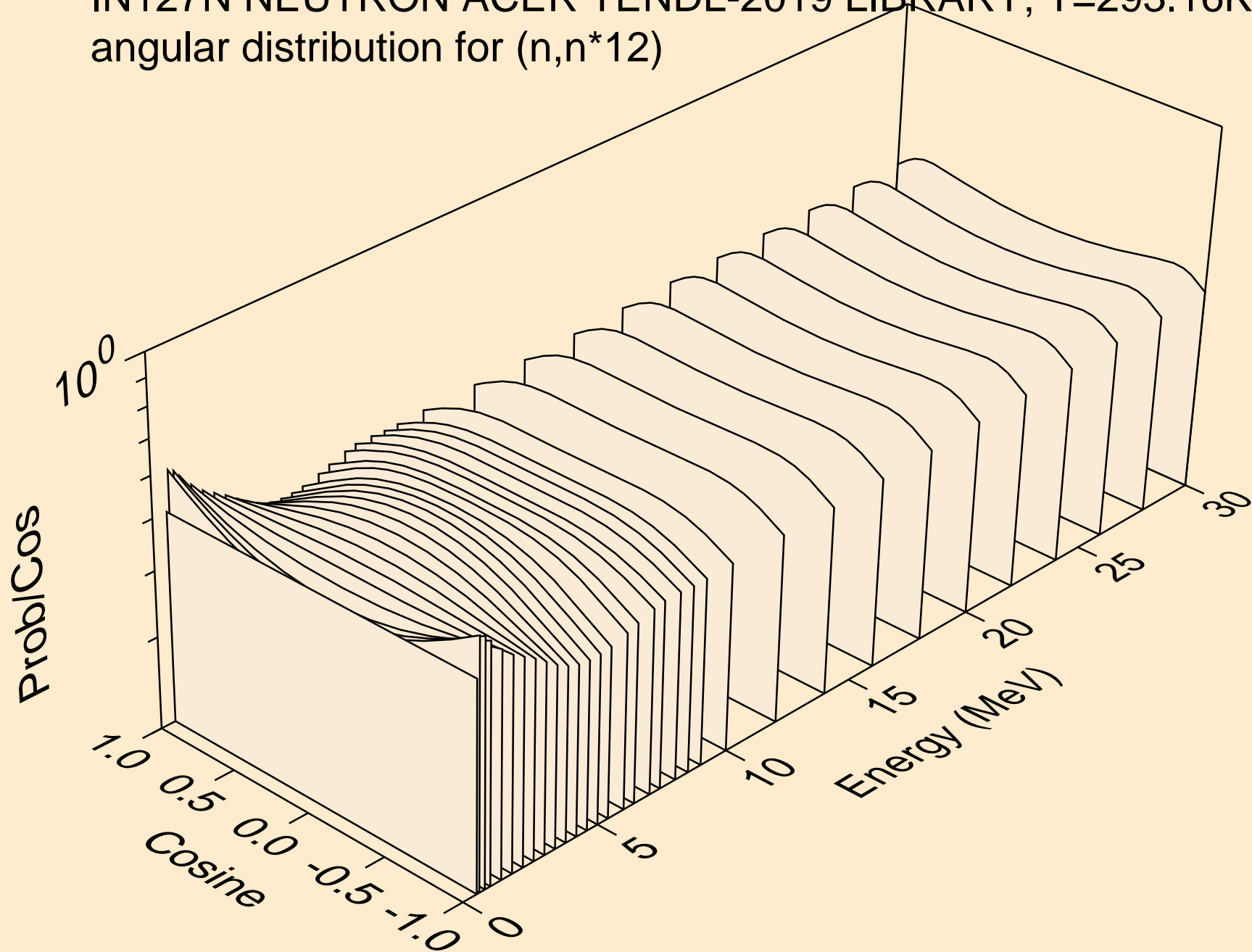



IN127N NEUTRON ACER TENDL-2019 LIBRARY; T=293.16K  
angular distribution for (n,n\*13)

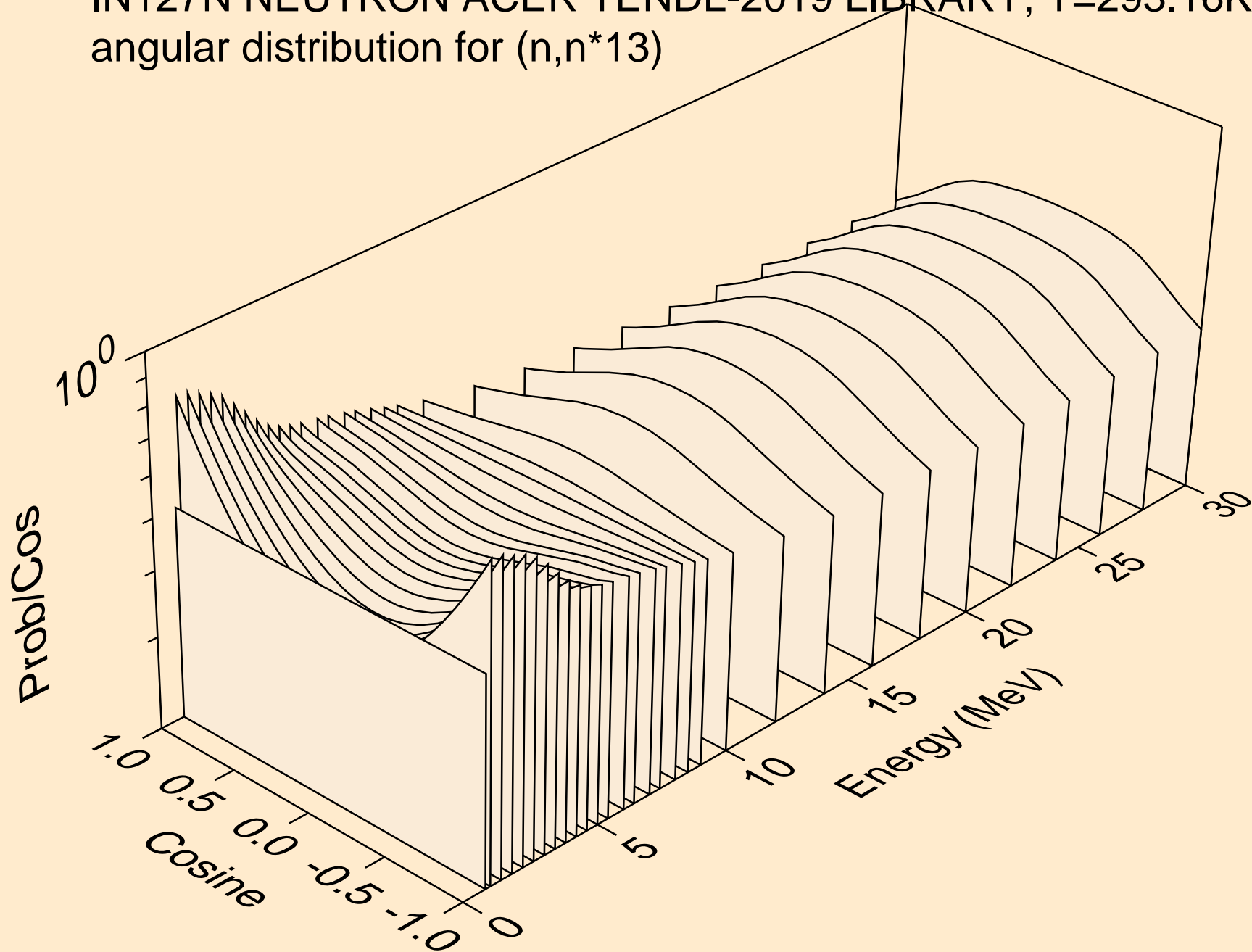

IN127N NEUTRON ACER TENDL-2019 LIBRARY; T=293.16K  
angular distribution for (n,n\*14)

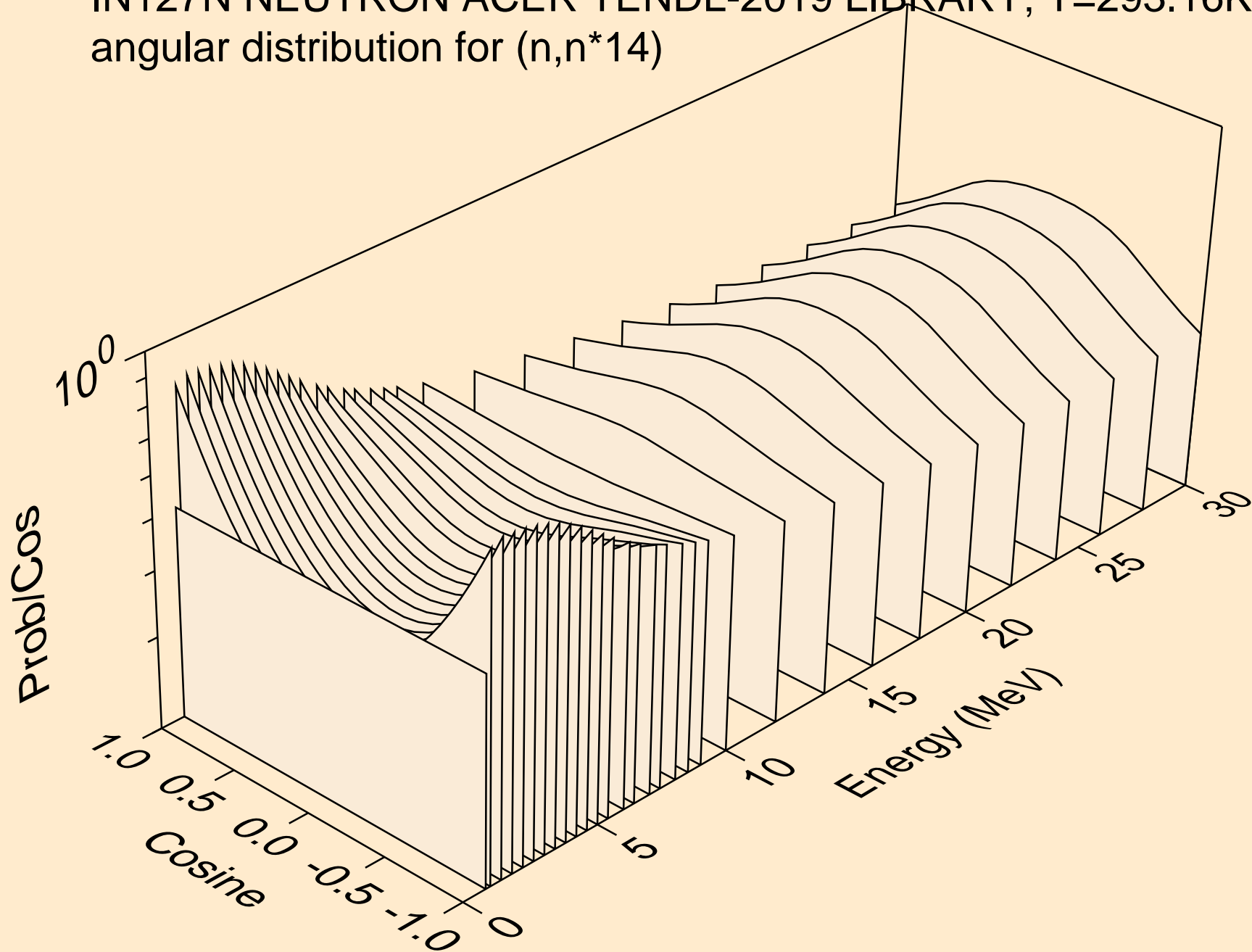

IN127N NEUTRON ACER TENDL-2019 LIBRARY; T=293.16K  
angular distribution for (n,n\*15)

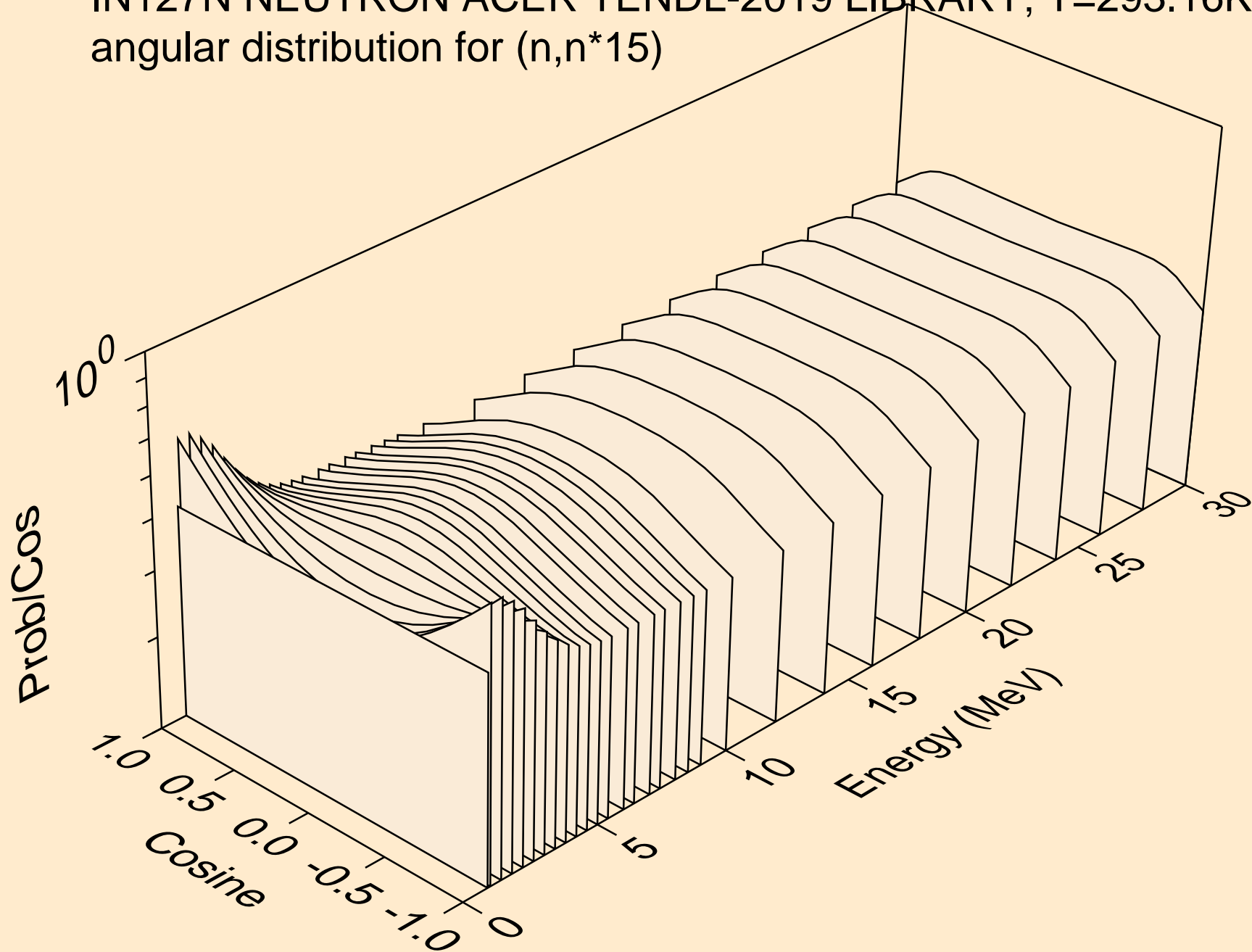

IN127N NEUTRON ACER TENDL-2019 LIBRARY; T=293.16K  
angular distribution for (n,n\*16)

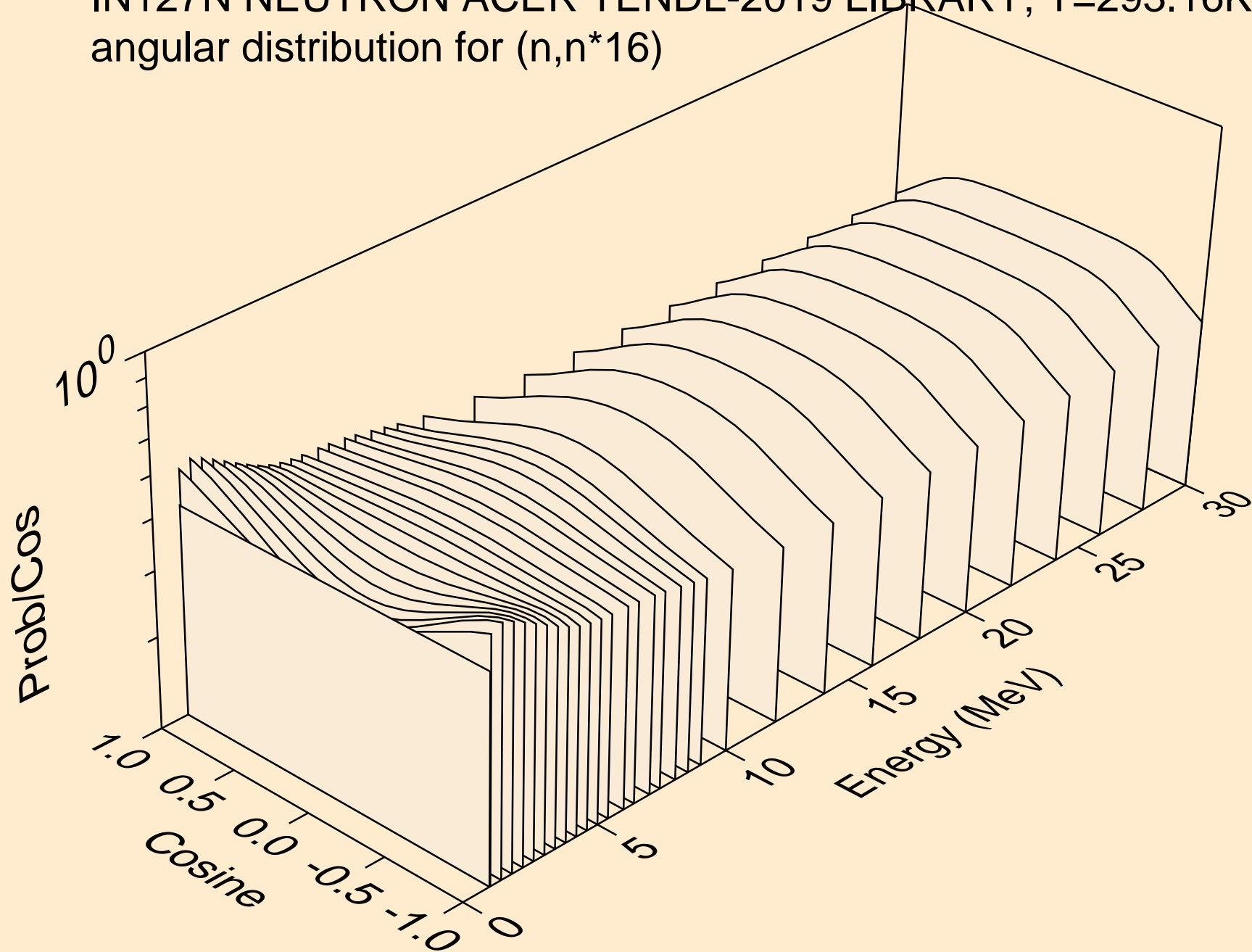

IN127N NEUTRON ACER TENDL-2019 LIBRARY; T=293.16K  
angular distribution for (n,n\*17)

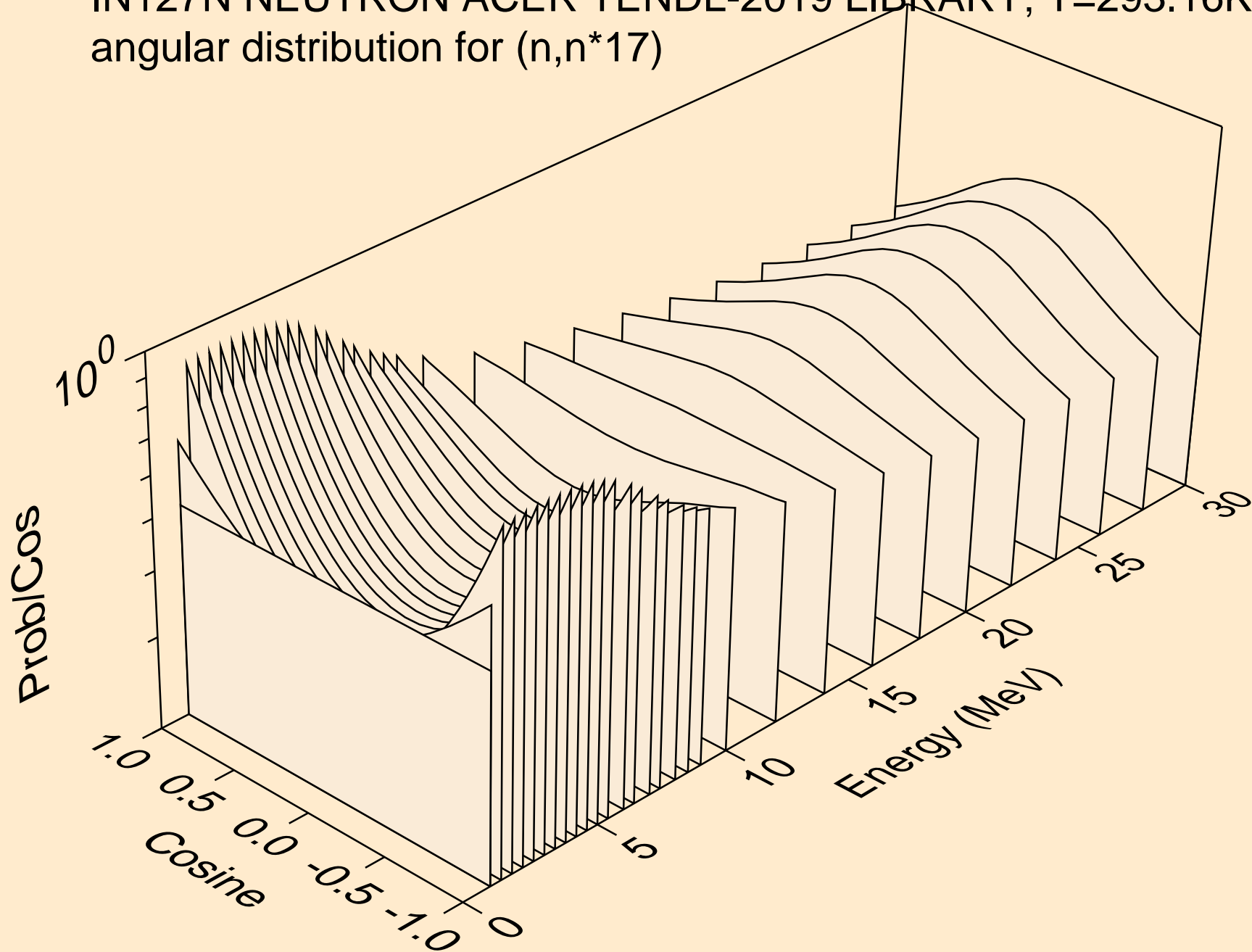

IN127N NEUTRON ACER TENDL-2019 LIBRARY; T=293.16K  
angular distribution for (n,n\*18)

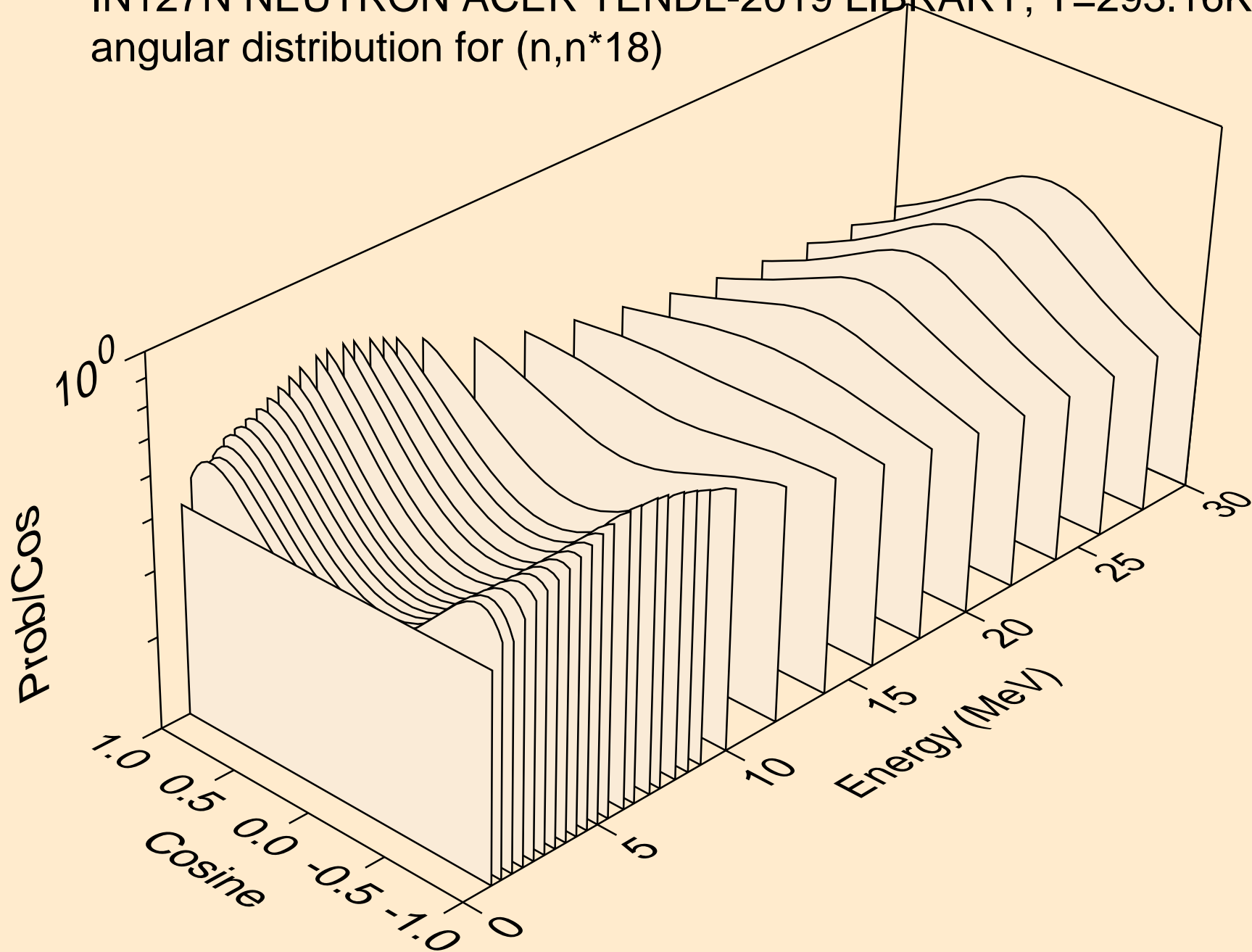

IN127N NEUTRON ACER TENDL-2019 LIBRARY; T=293.16K  
angular distribution for (n,n\*19)

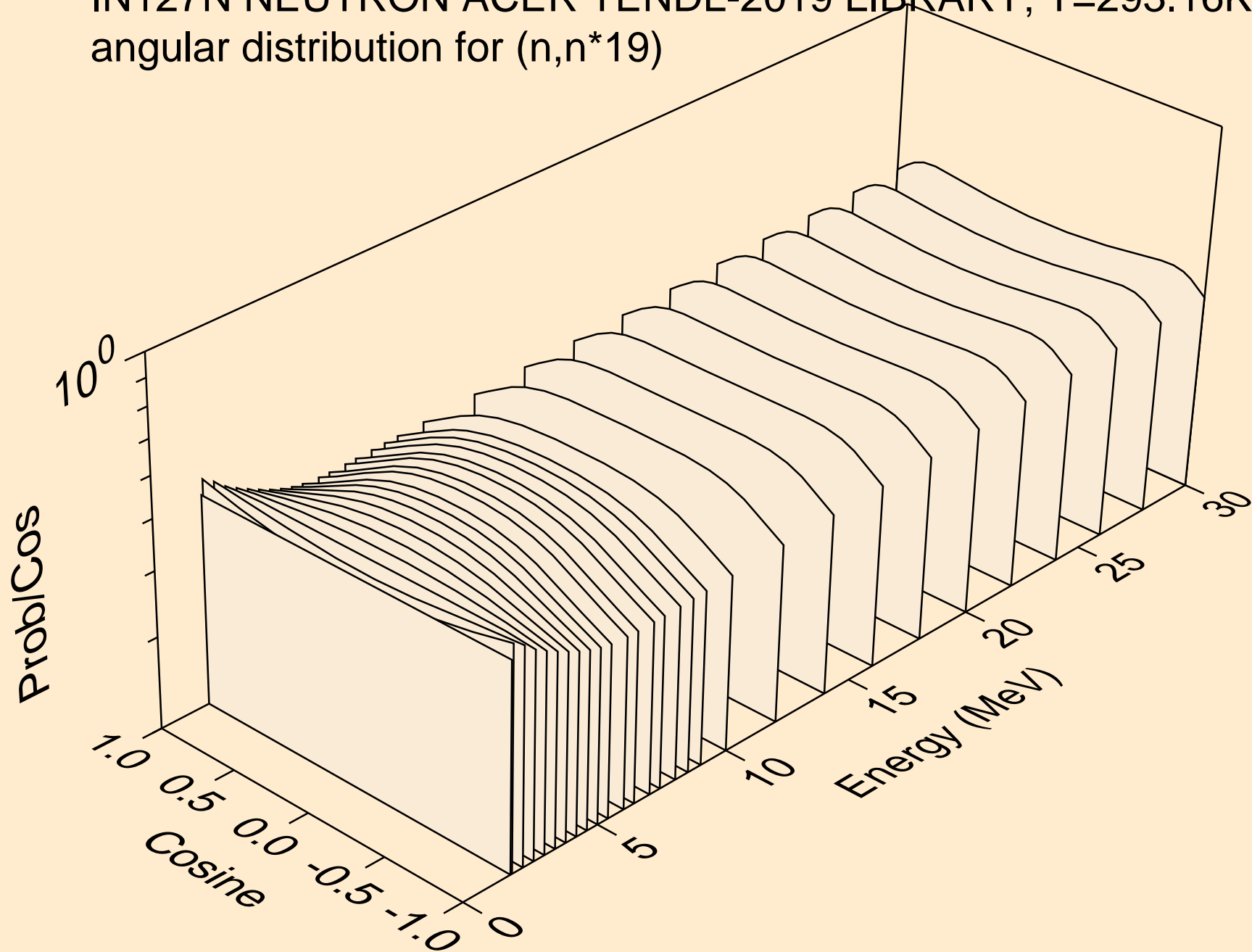

IN127N NEUTRON ACER TENDL-2019 LIBRARY; T=293.16K  
angular distribution for (n,n\*20)

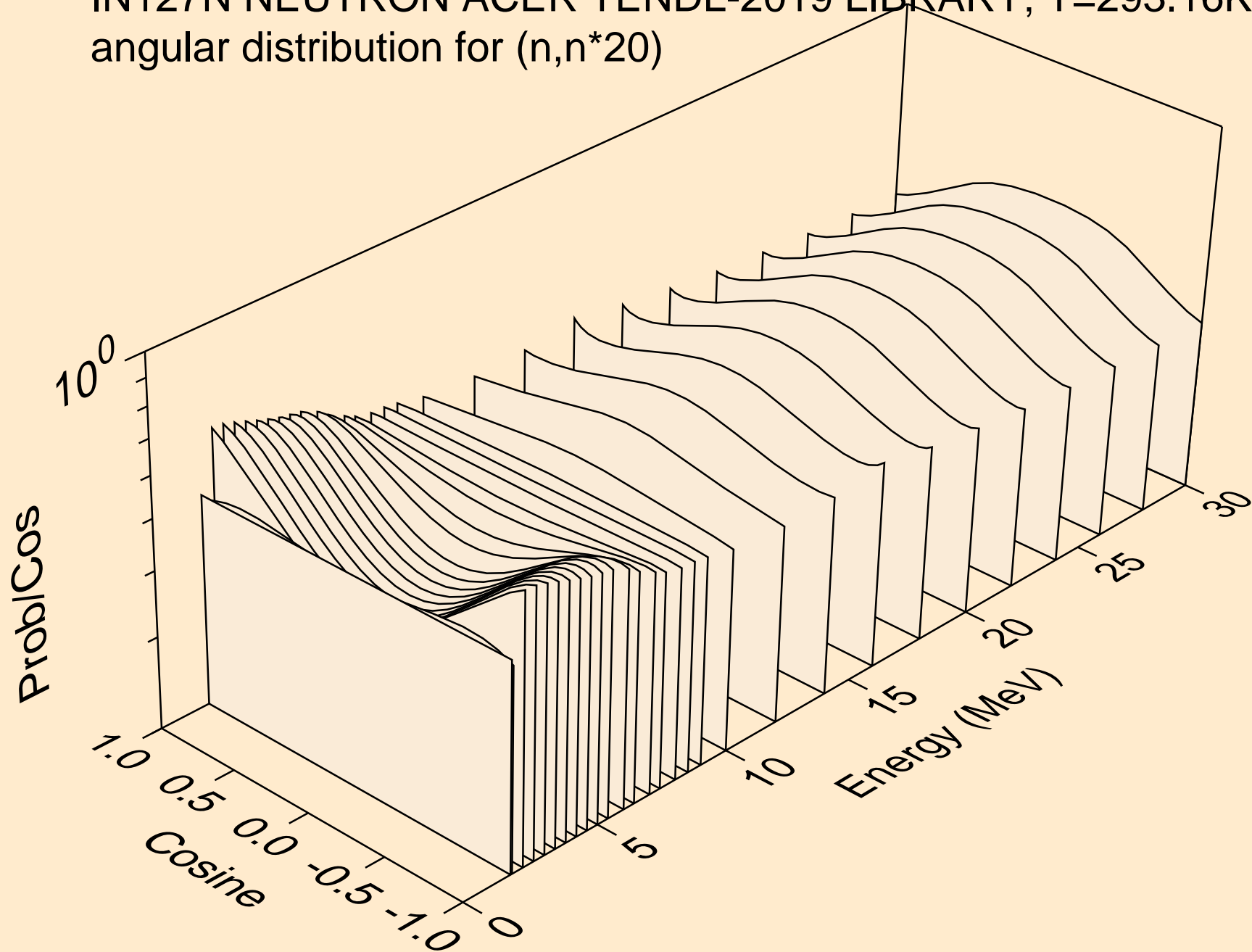



IN127N NEUTRON ACER TENDL-2019 LIBRARY; T=293.16K  
angular distribution for (n,n\*21)

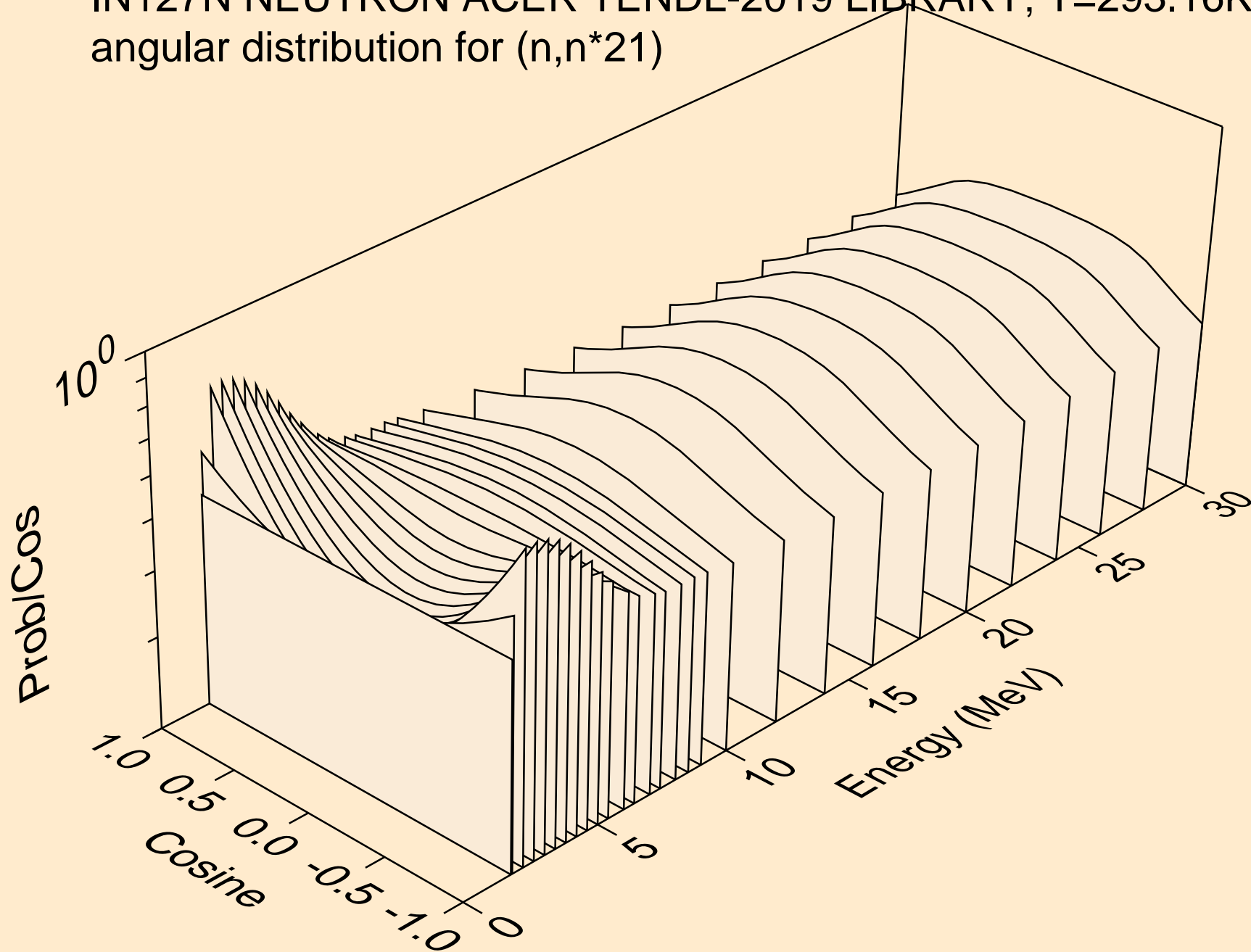

IN127N NEUTRON ACER TENDL-2019 LIBRARY; T=293.16K  
angular distribution for (n,n\*22)

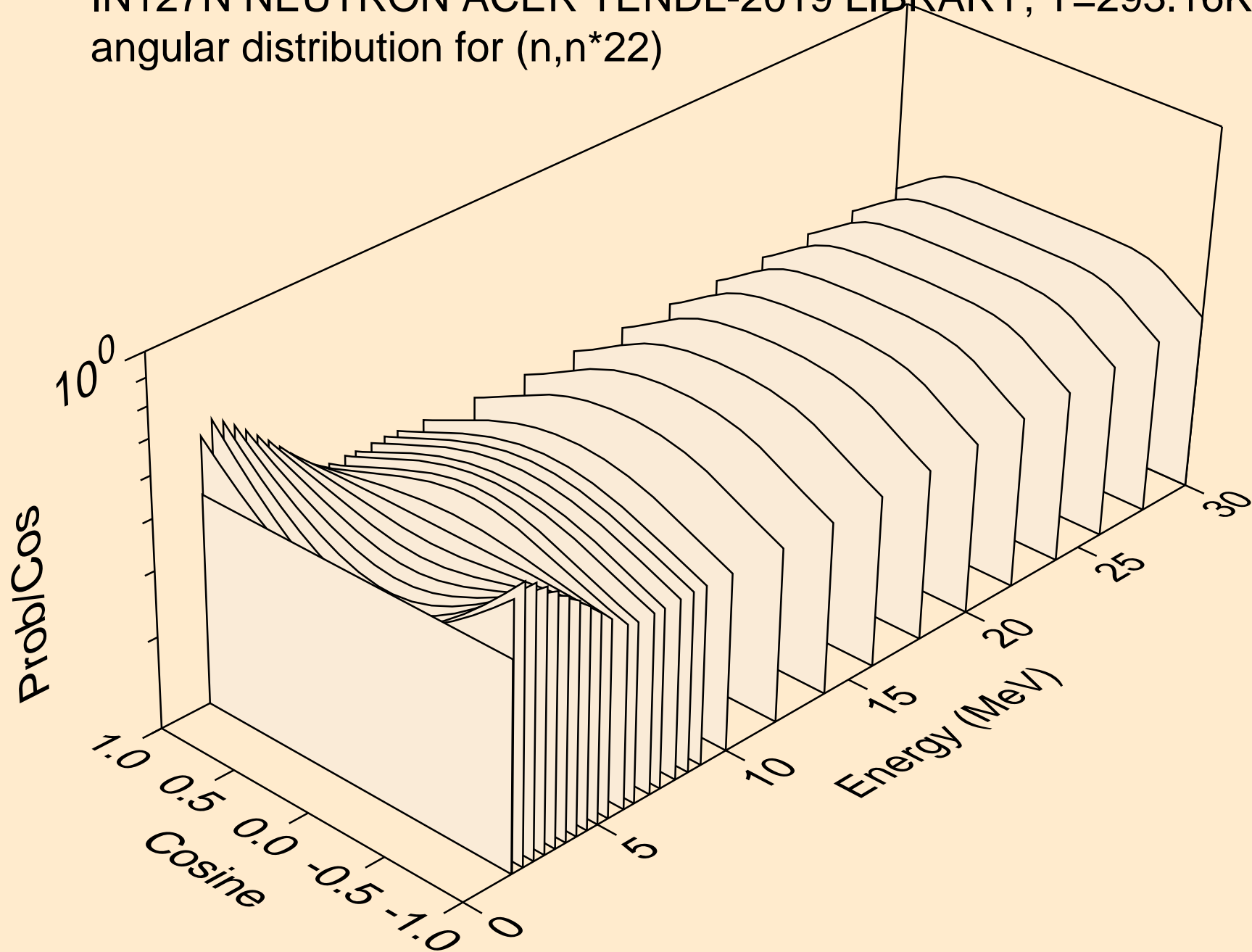

IN127N NEUTRON ACER TENDL-2019 LIBRARY; T=293.16K  
Neutron emission for (n,x)

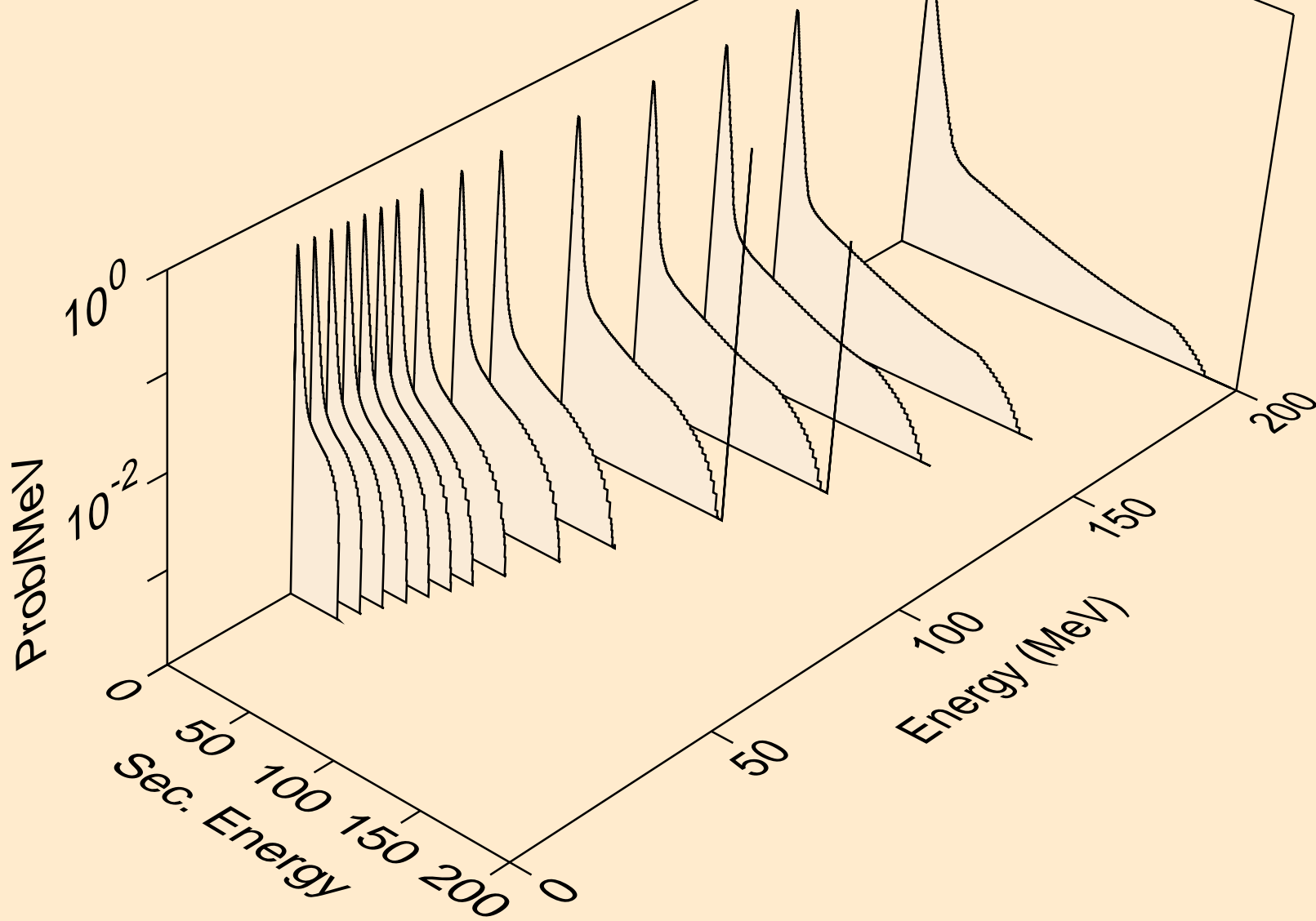

IN127N NEUTRON ACER TENDL-2019 LIBRARY; T=293.16K  
Neutron emission for (n,2nd)

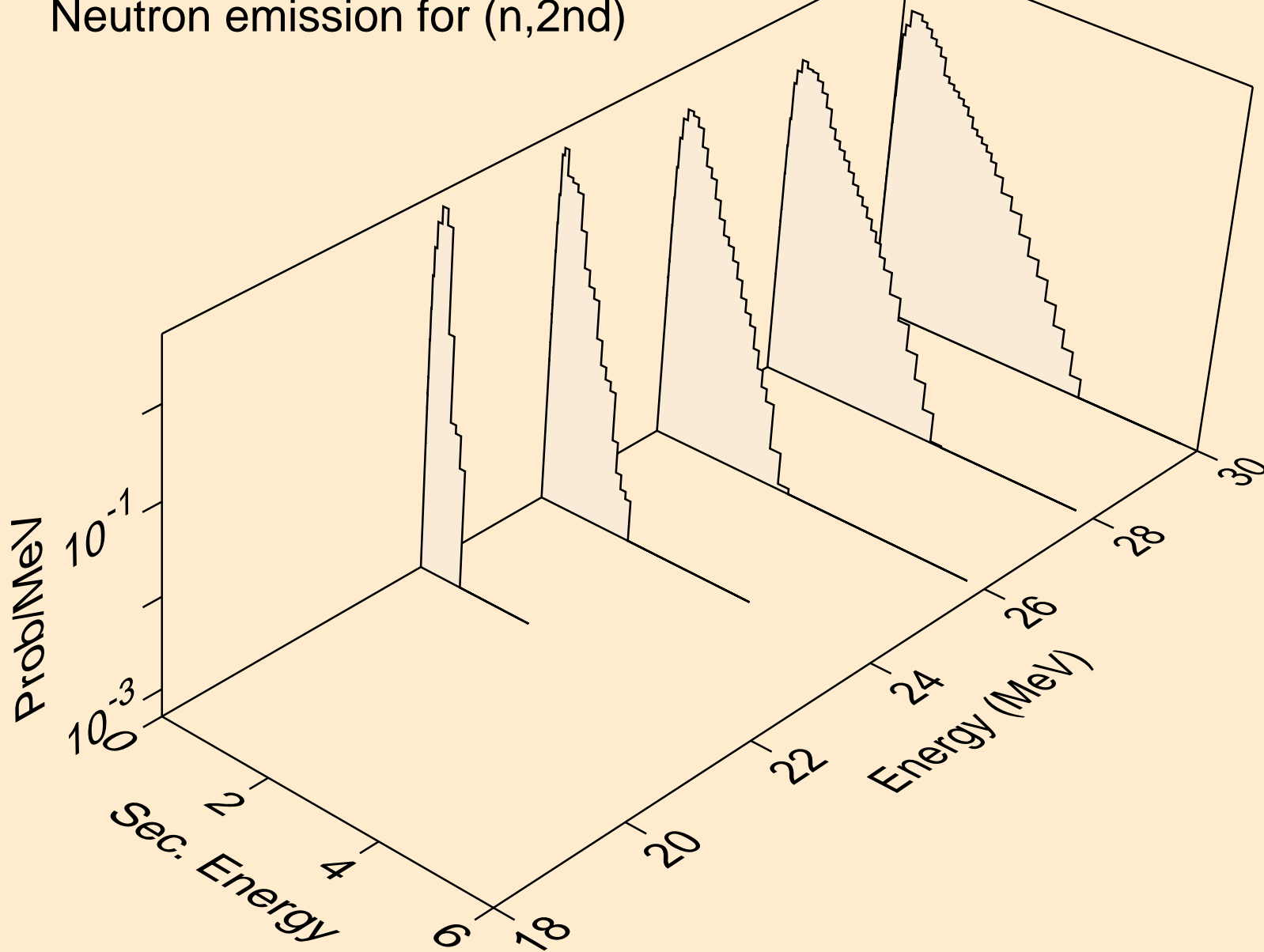

IN127N NEUTRON ACER TENDL-2019 LIBRARY; T=293.16K  
Neutron emission for (n,2n)

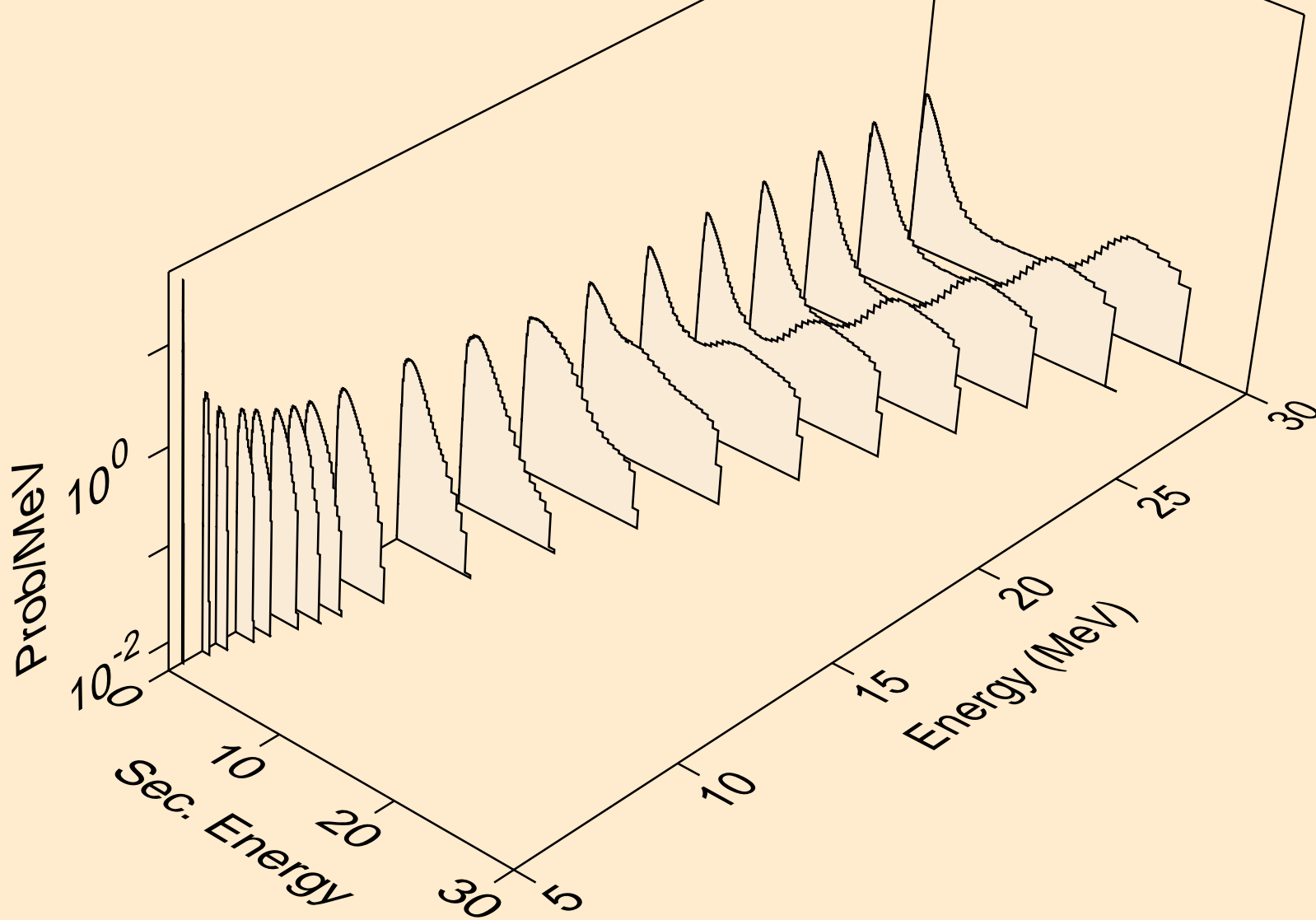

IN127N NEUTRON ACER TENDL-2019 LIBRARY; T=293.16K  
Neutron emission for (n,3n)

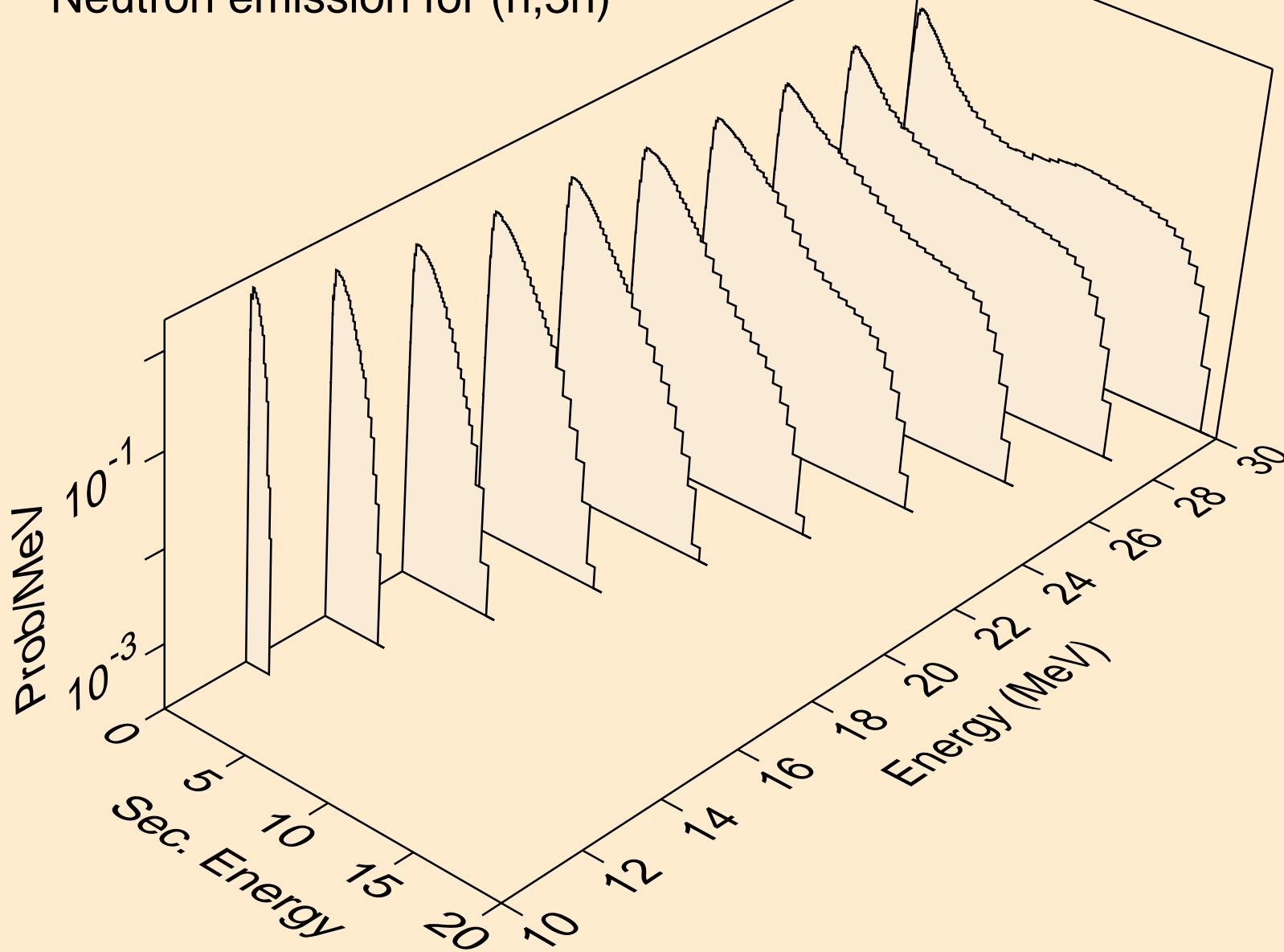

IN127N NEUTRON ACER TENDL-2019 LIBRARY; T=293.16K  
Neutron emission for (n,n\*)a

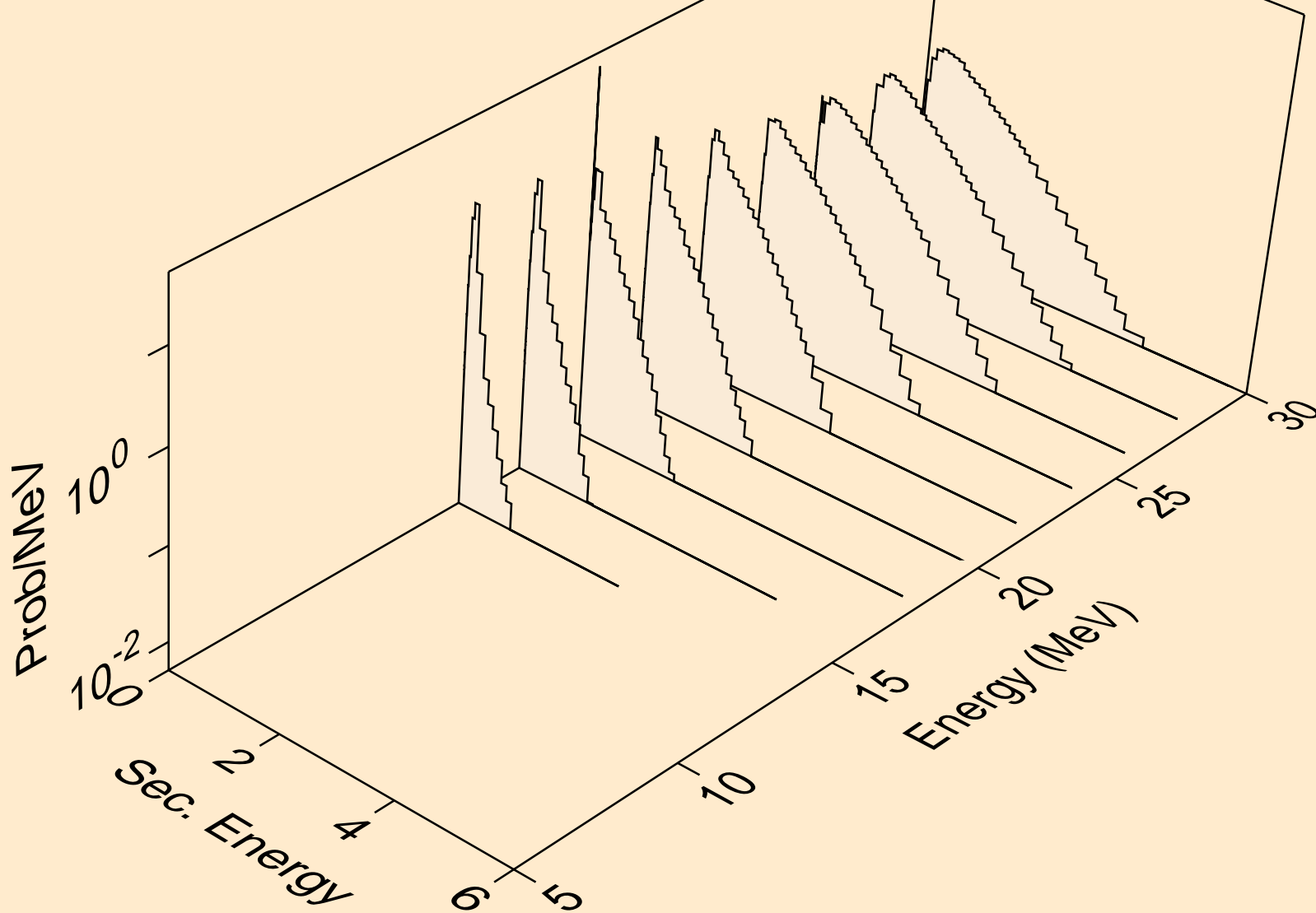

IN127N NEUTRON ACER TENDL-2019 LIBRARY; T=293.16K  
Neutron emission for (n,2n)a

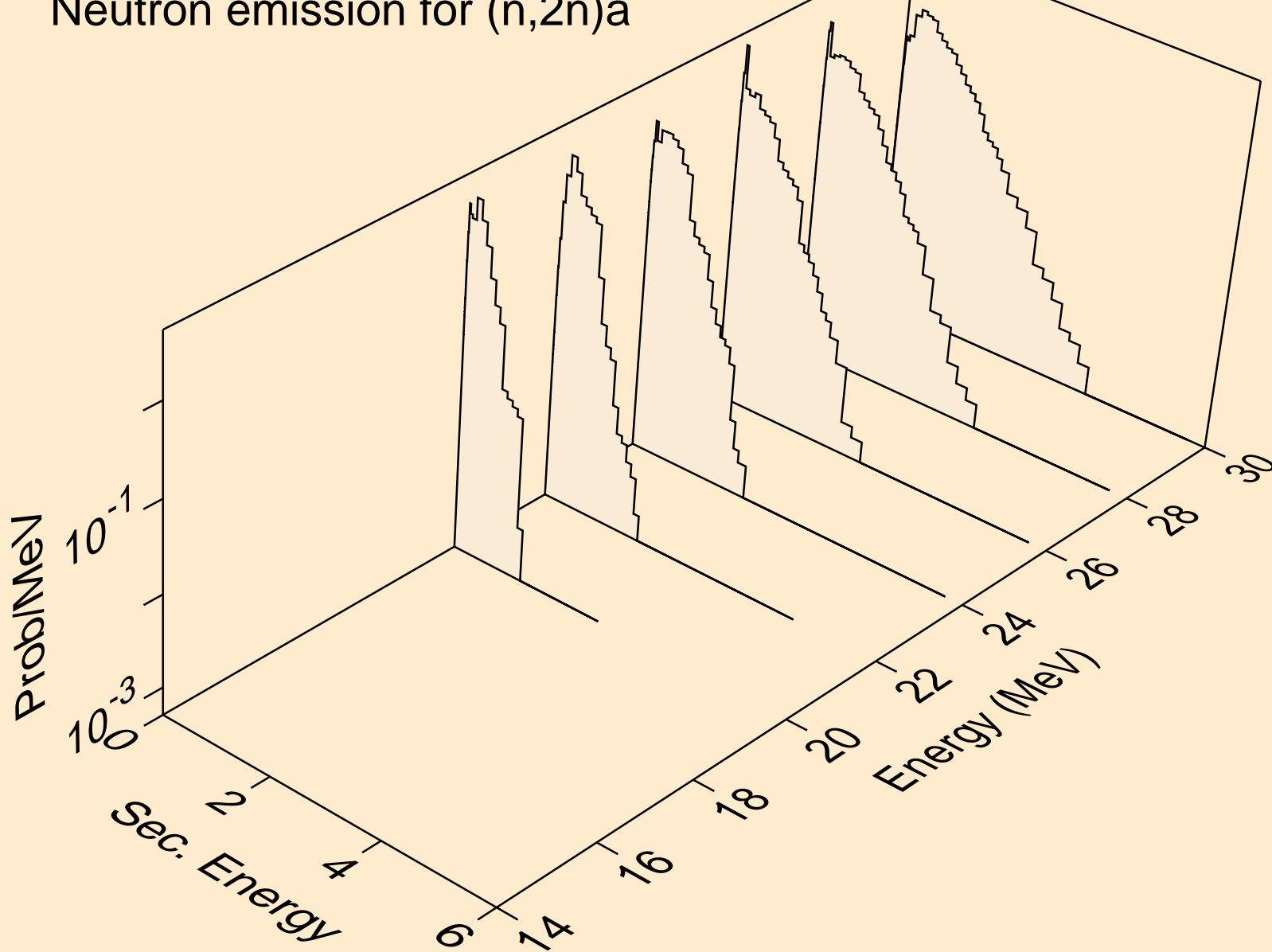



IN127N NEUTRON ACER TENDL-2019 LIBRARY; T=293.16K  
Neutron emission for (n,3n)a

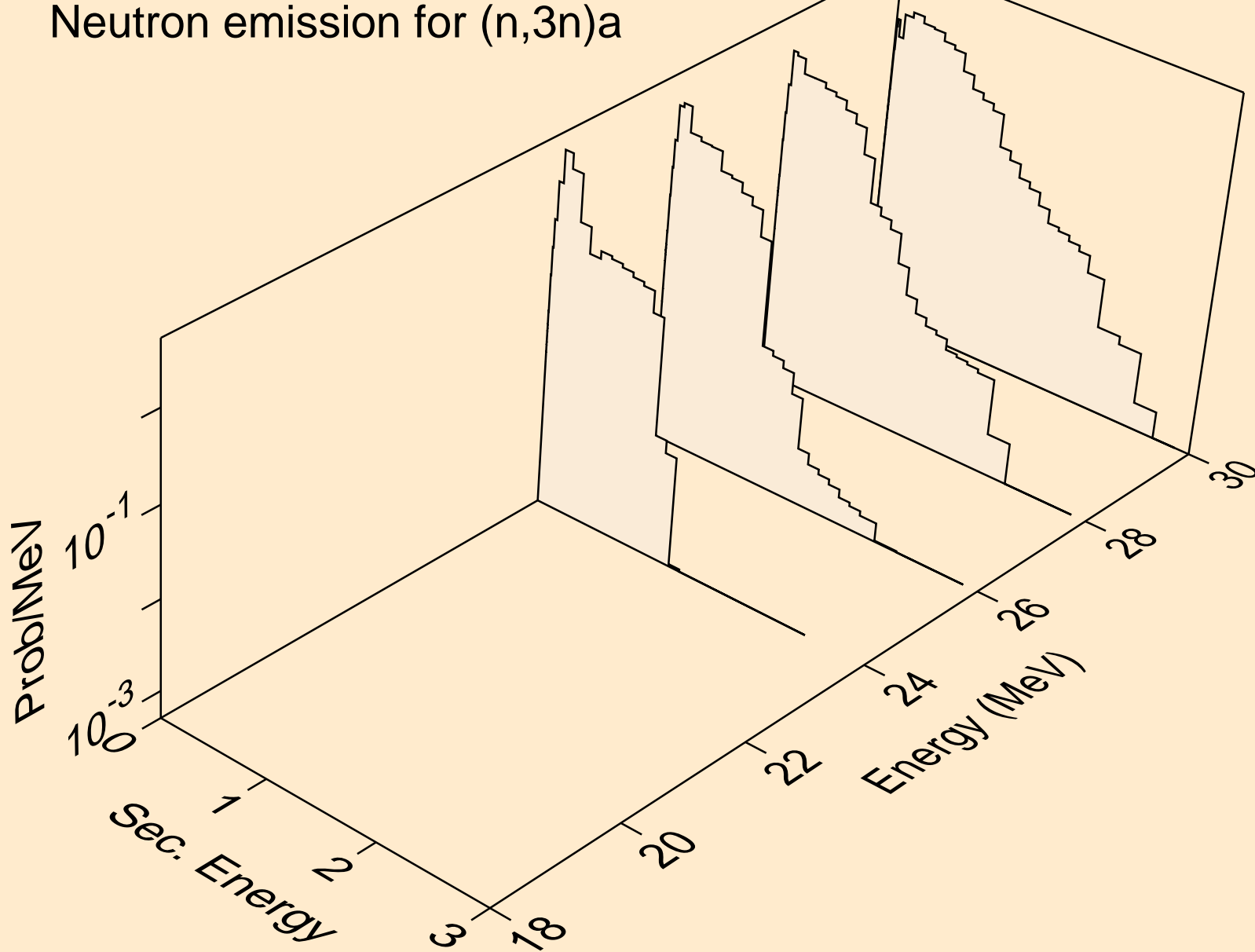

IN127N NEUTRON ACER TENDL-2019 LIBRARY; T=293.16K  
Neutron emission for (n,n\*)p

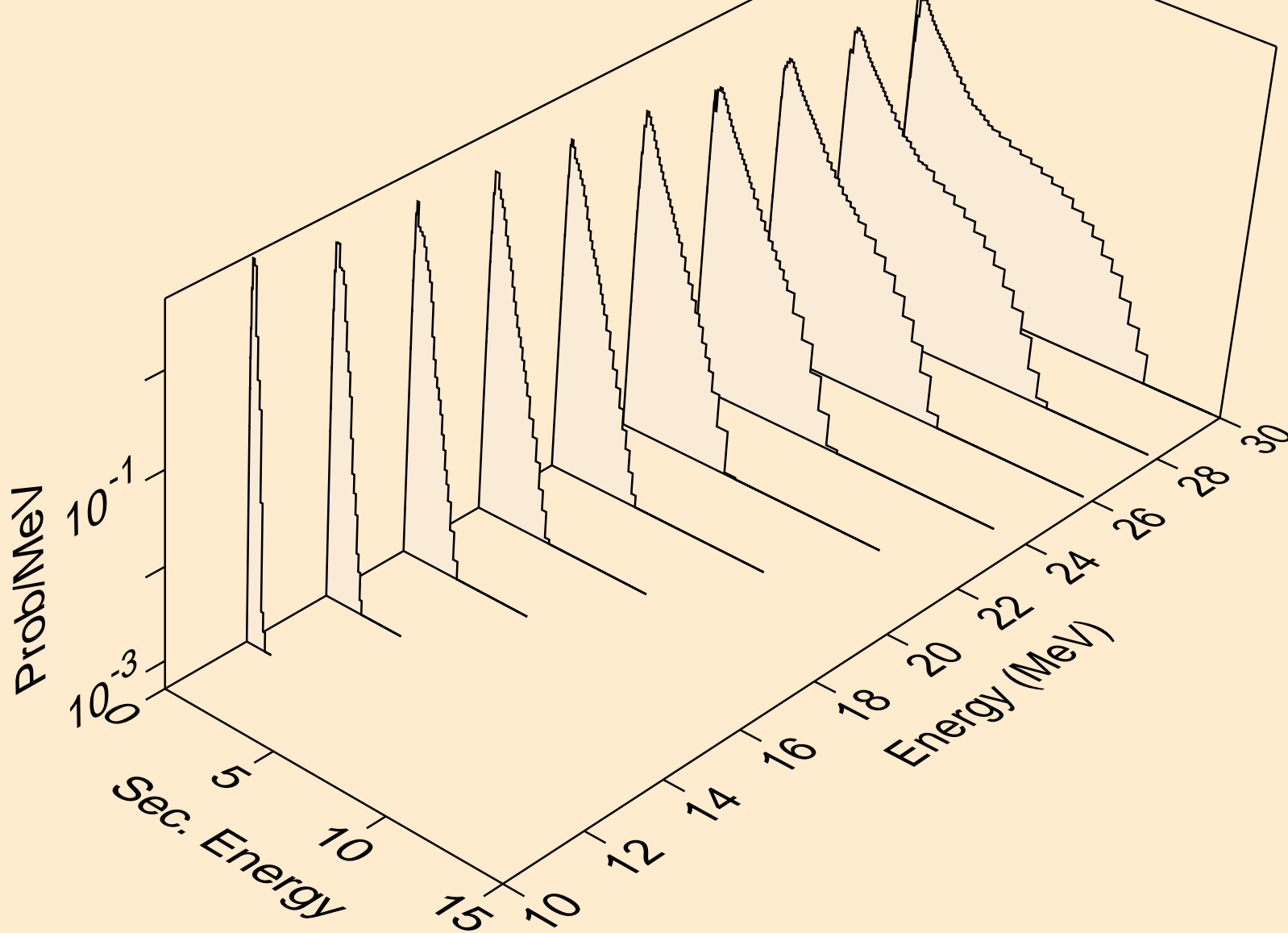

IN127N NEUTRON ACER TENDL-2019 LIBRARY; T=293.16K  
Neutron emission for (n,n\*)d

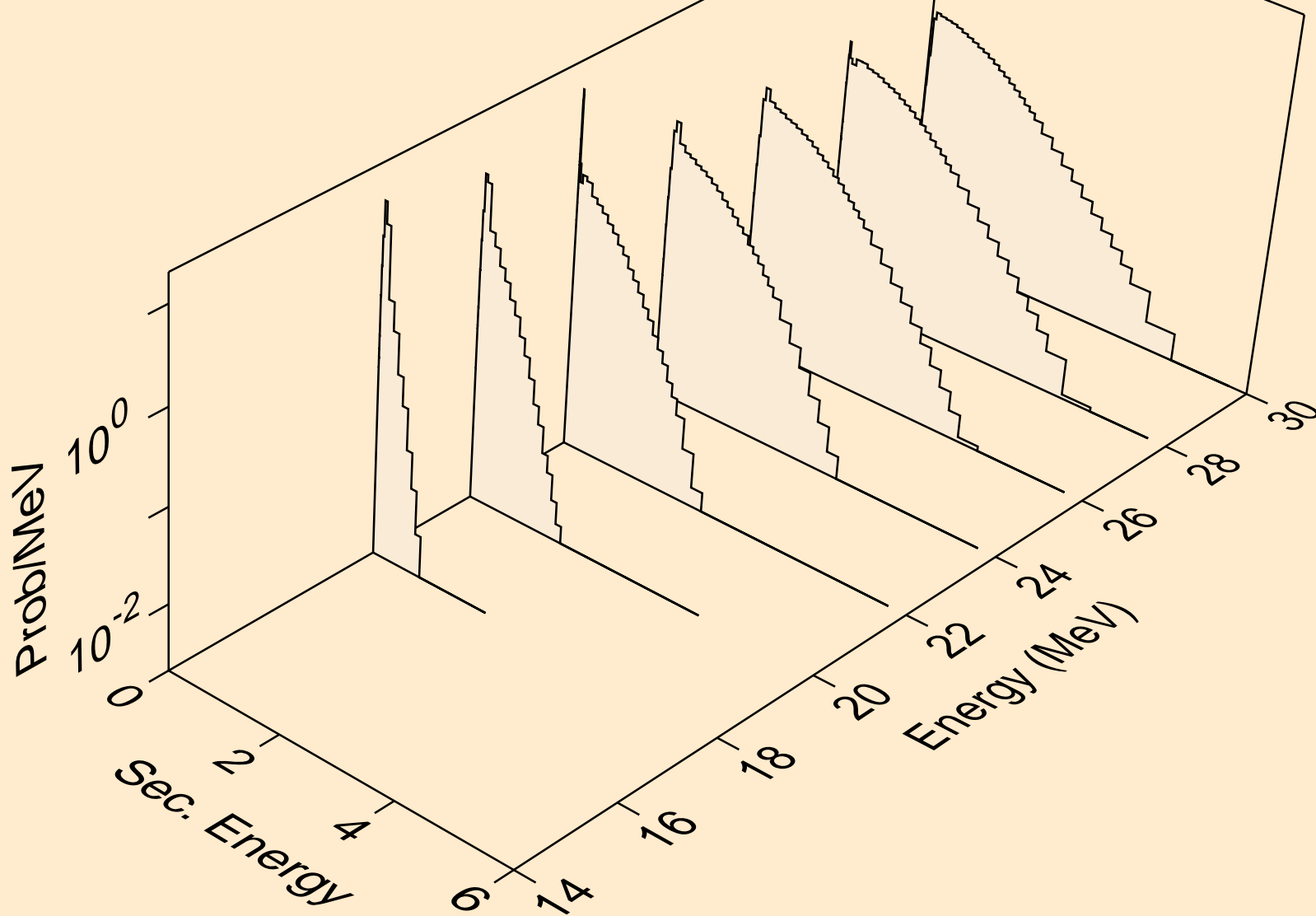

IN127N NEUTRON ACER TENDL-2019 LIBRARY; T=293.16K  
Neutron emission for (n,n\*)t

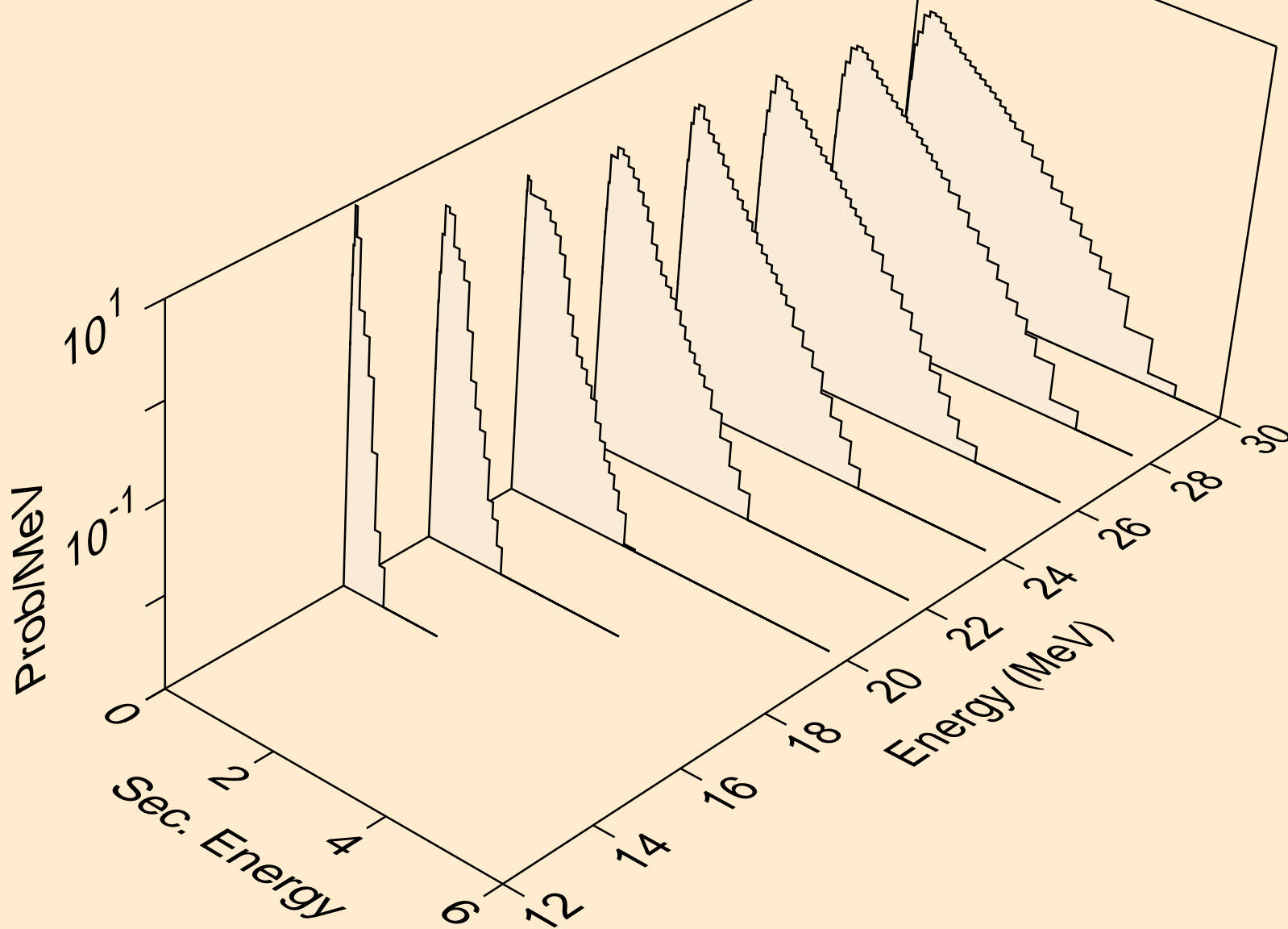

IN127N NEUTRON ACER TENDL-2019 LIBRARY; T=293.16K  
Neutron emission for (n,4n)

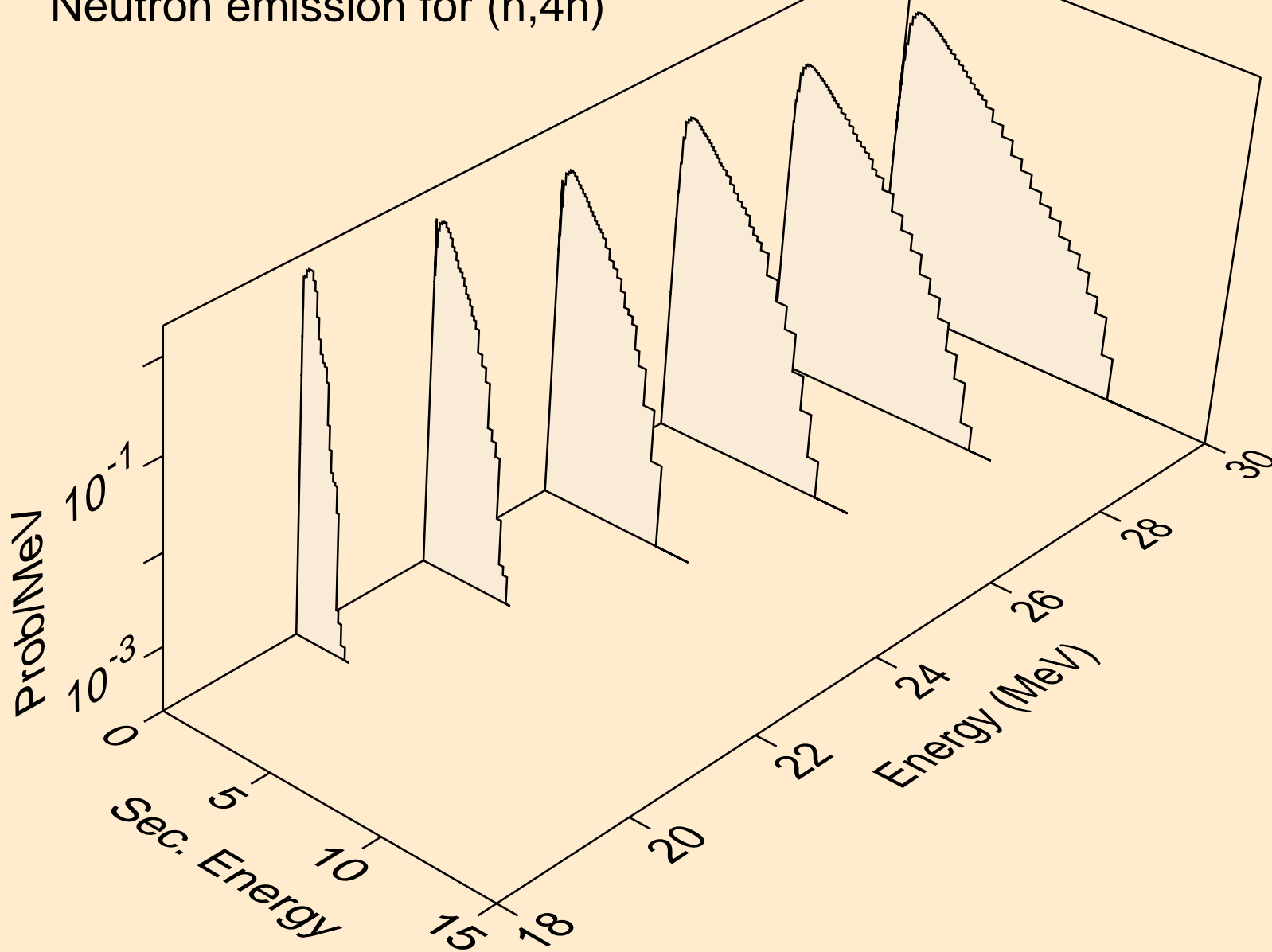

IN127N NEUTRON ACER TENDL-2019 LIBRARY; T=293.16K  
Neutron emission for (n,2np)

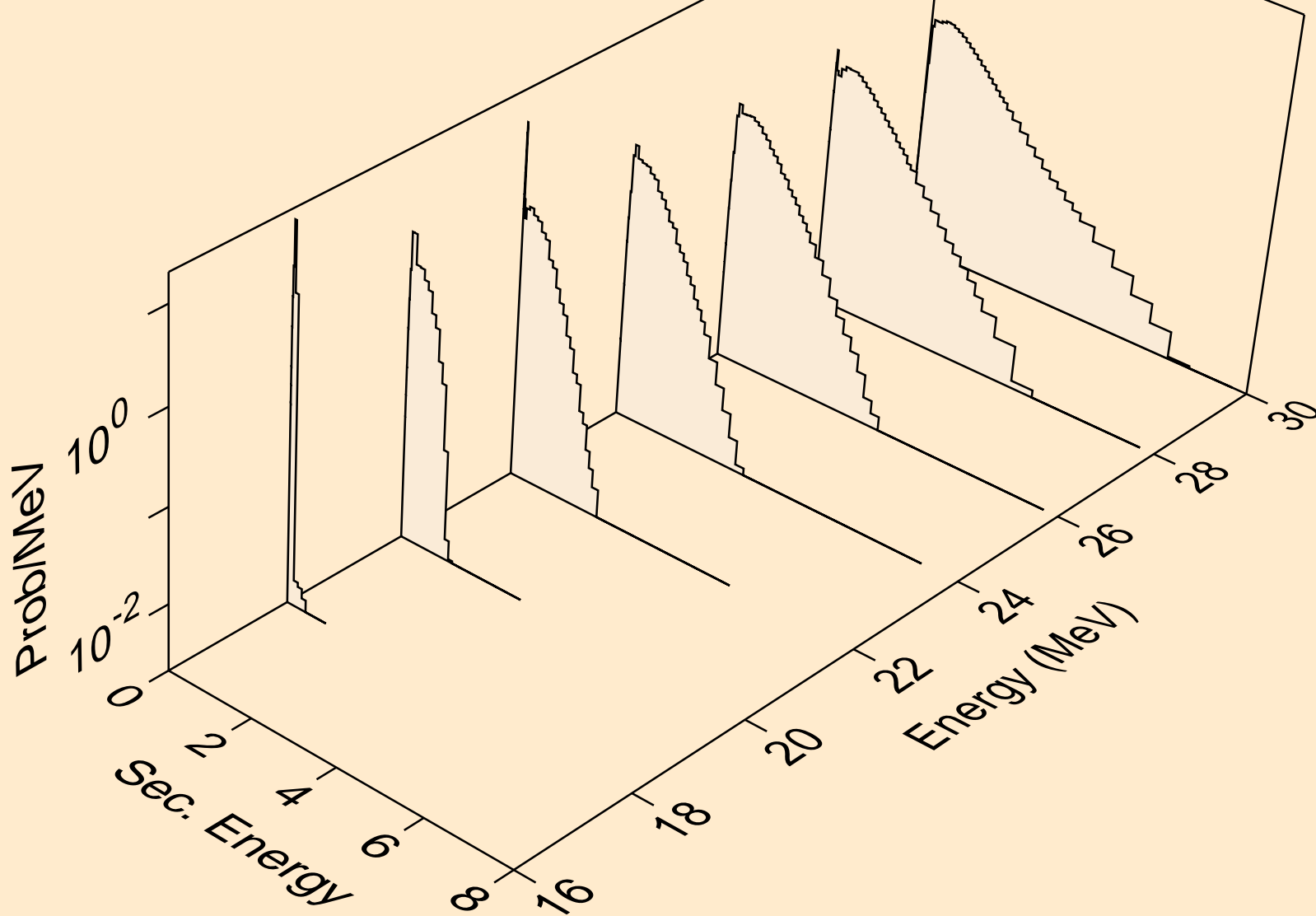

IN127N NEUTRON ACER TENDL-2019 LIBRARY; T=293.16K  
Neutron emission for (n,3np)

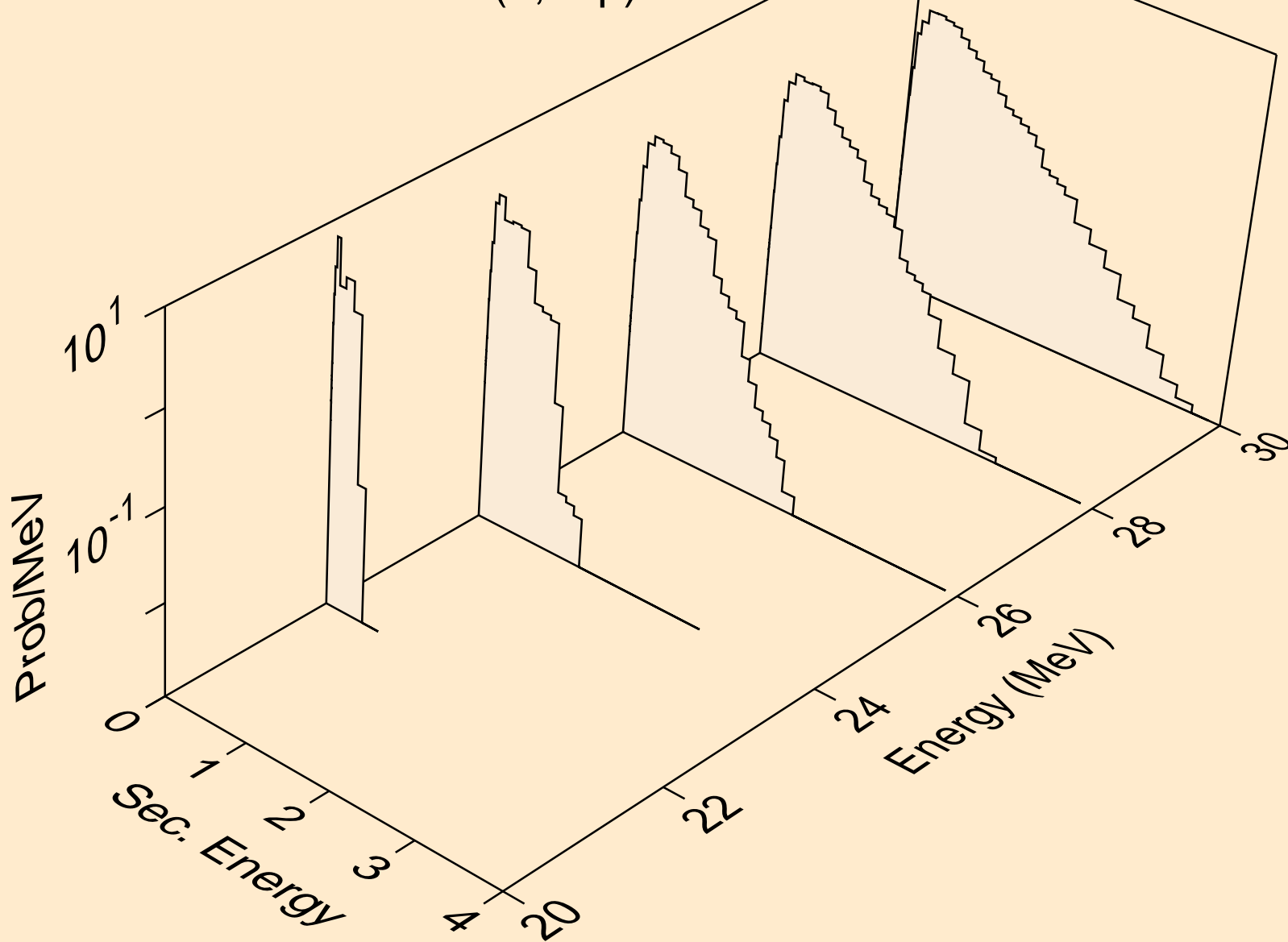

IN127N NEUTRON ACER TENDL-2019 LIBRARY; T=293.16K  
Neutron emission for (n,n\*c)

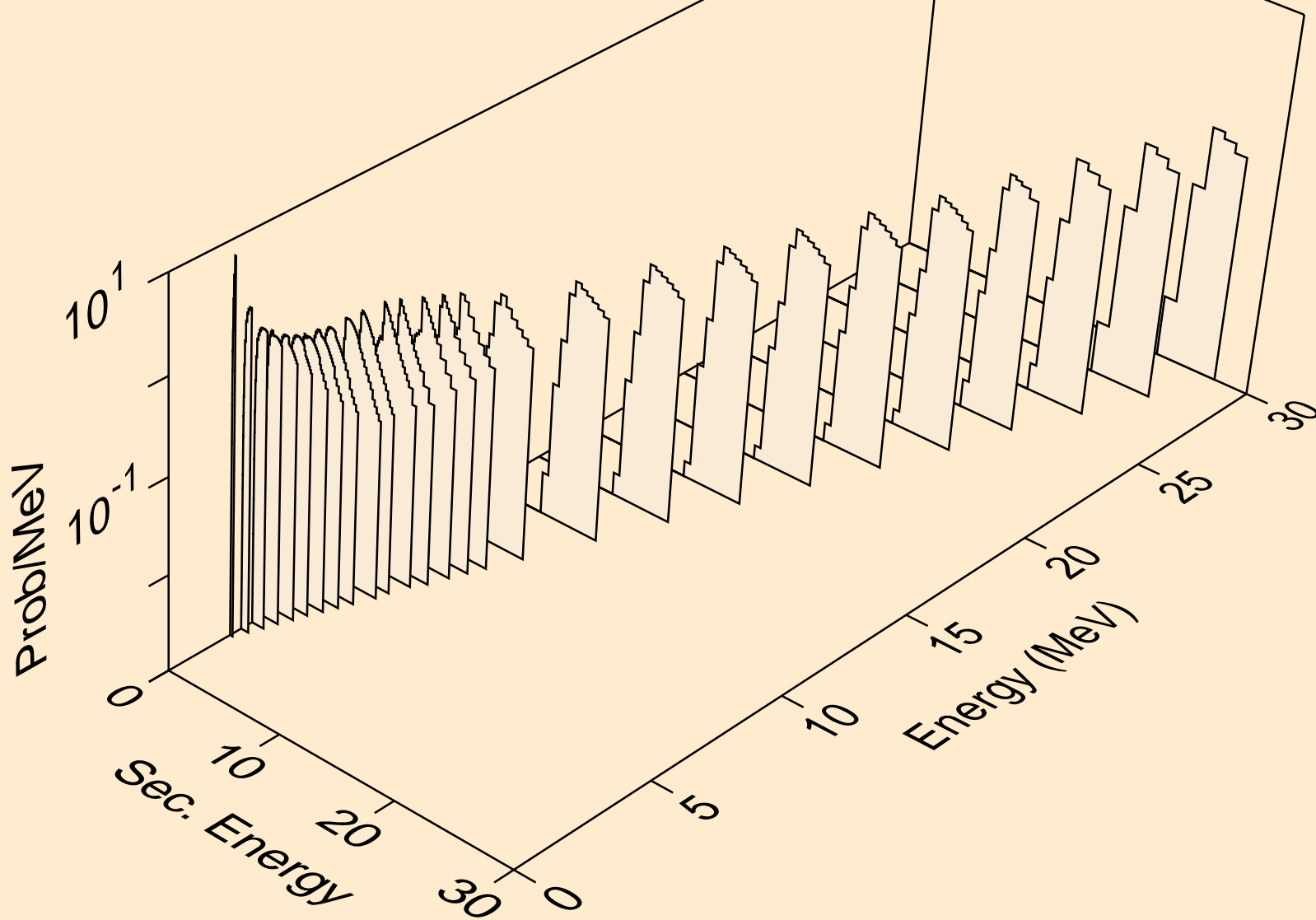



IN127N NEUTRON ACER TENDL-2019 LIBRARY; T=293.16K  
Photon emission for (n,x)

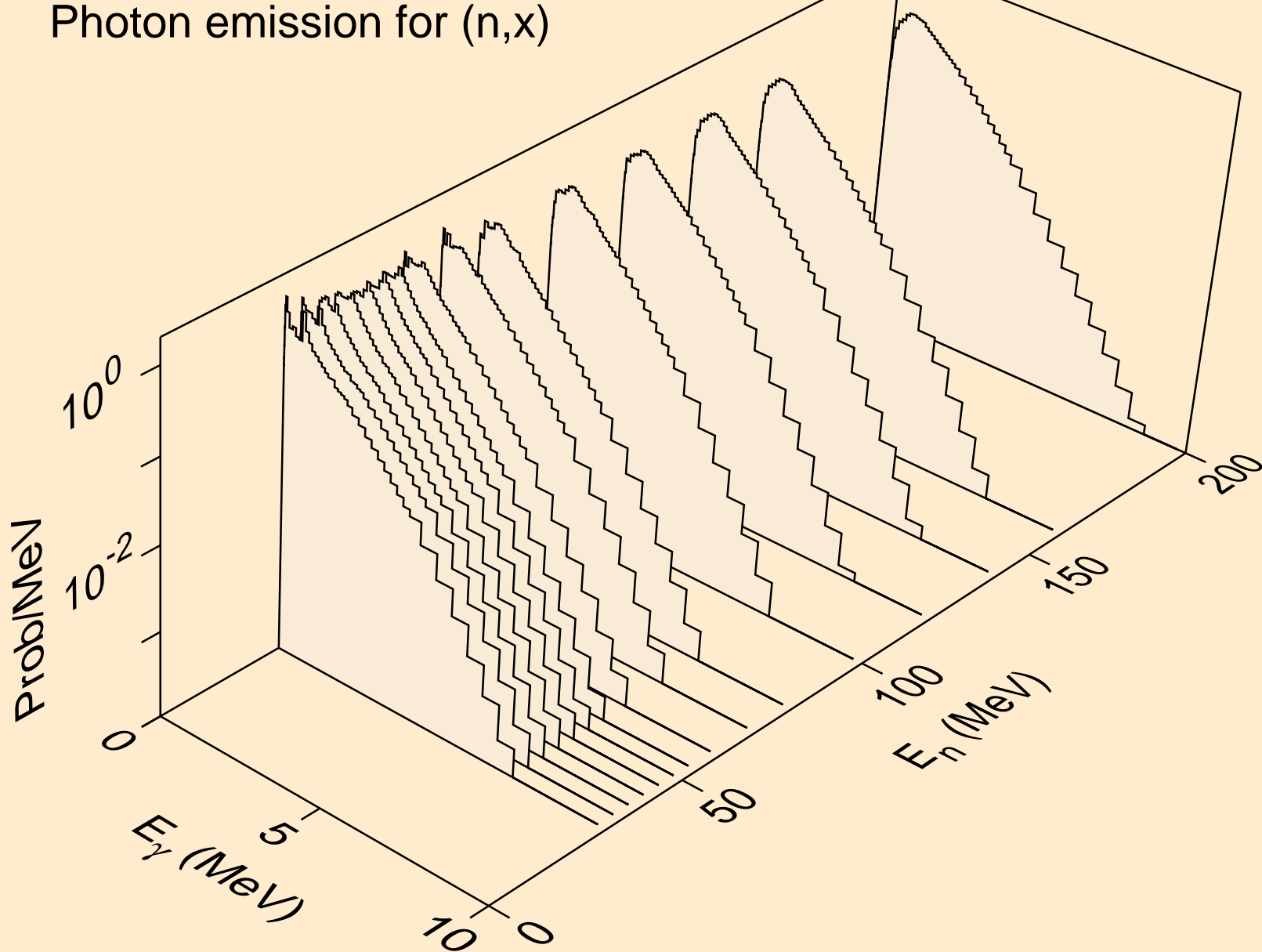

IN127N NEUTRON ACER TENDL-2019 LIBRARY; T=293.16K  
Photon emission for (n,2nd)

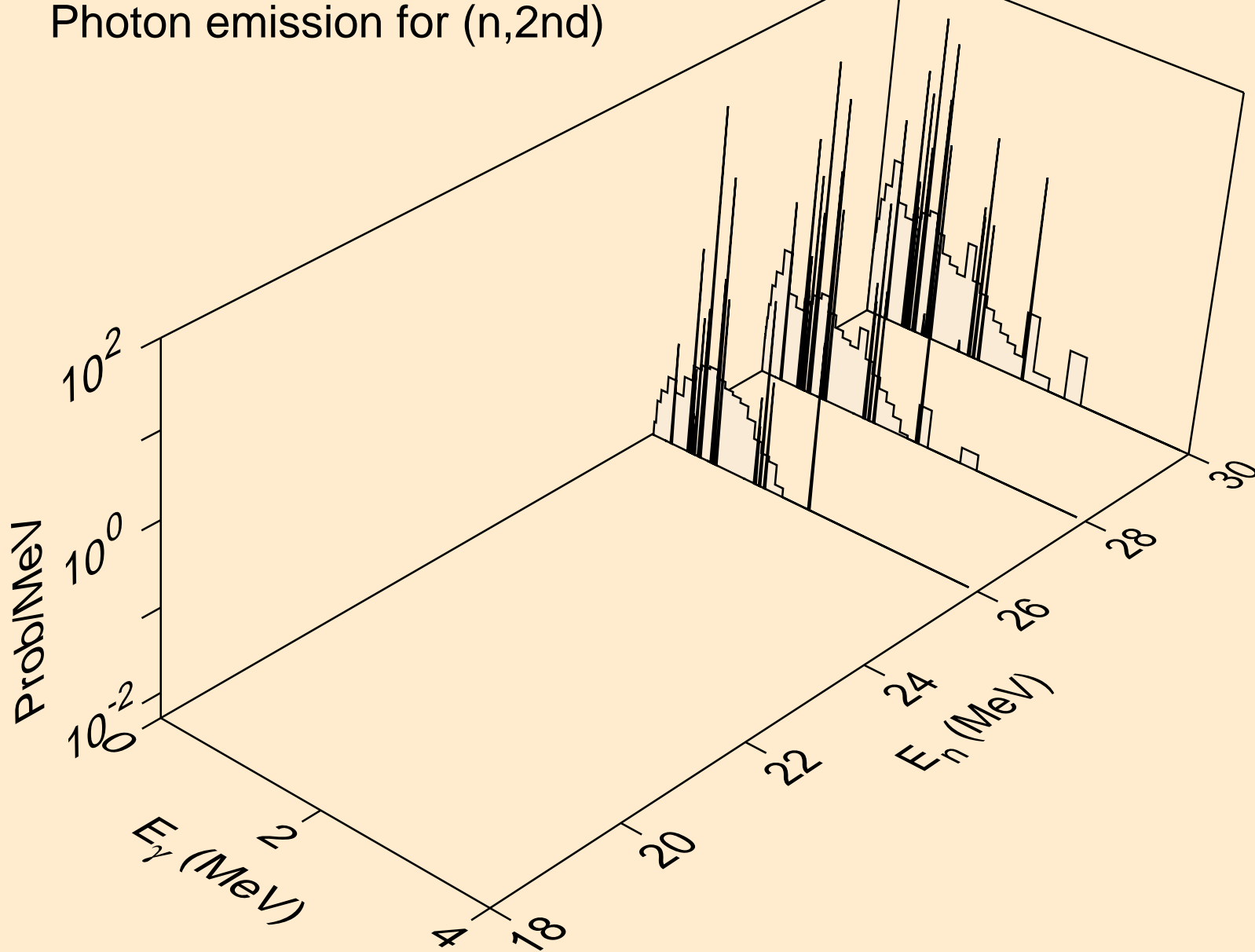

IN127N NEUTRON ACER TENDL-2019 LIBRARY; T=293.16K  
Photon emission for (n,2n)

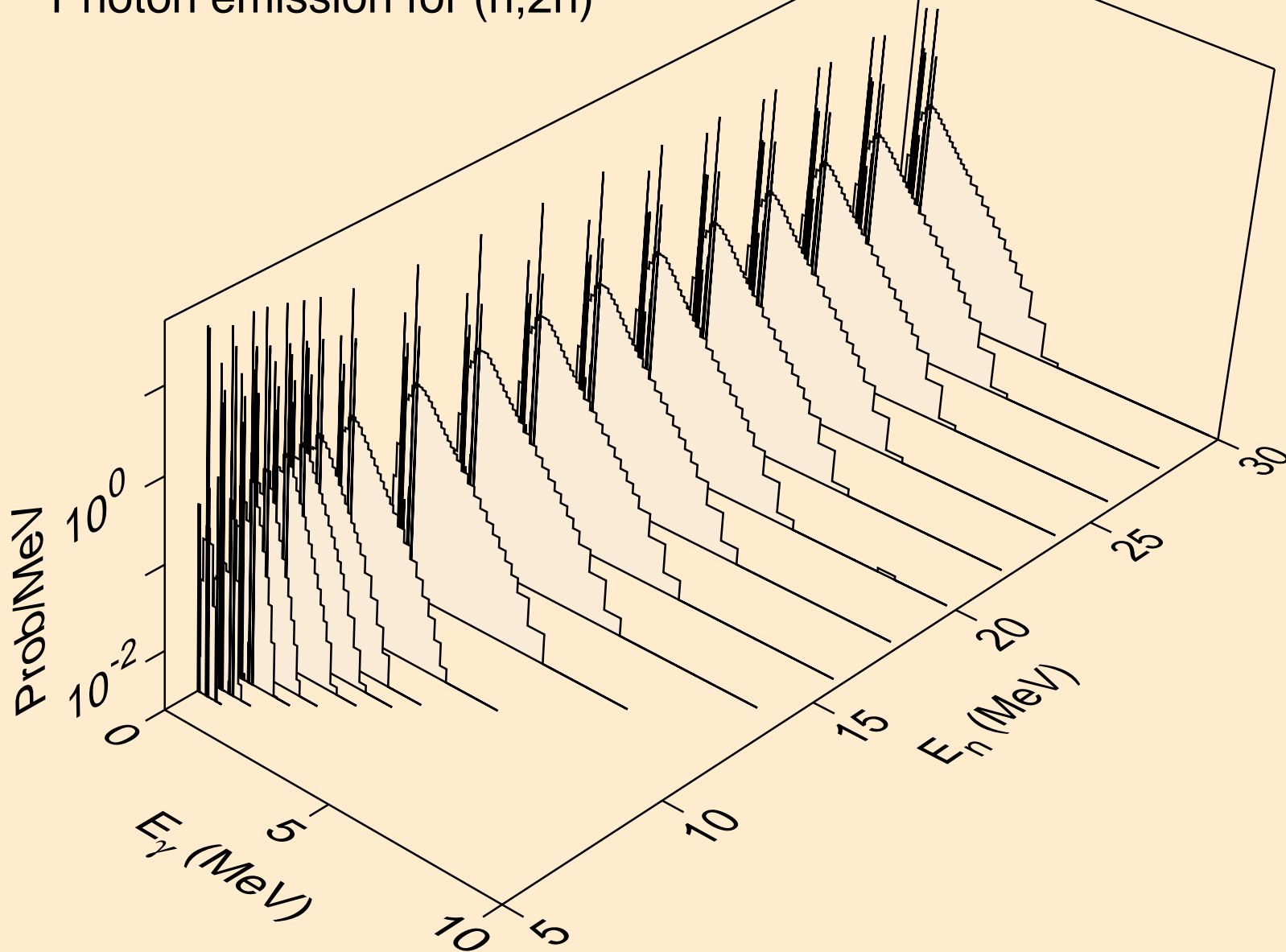

IN127N NEUTRON ACER TENDL-2019 LIBRARY; T=293.16K  
Photon emission for (n,3n)

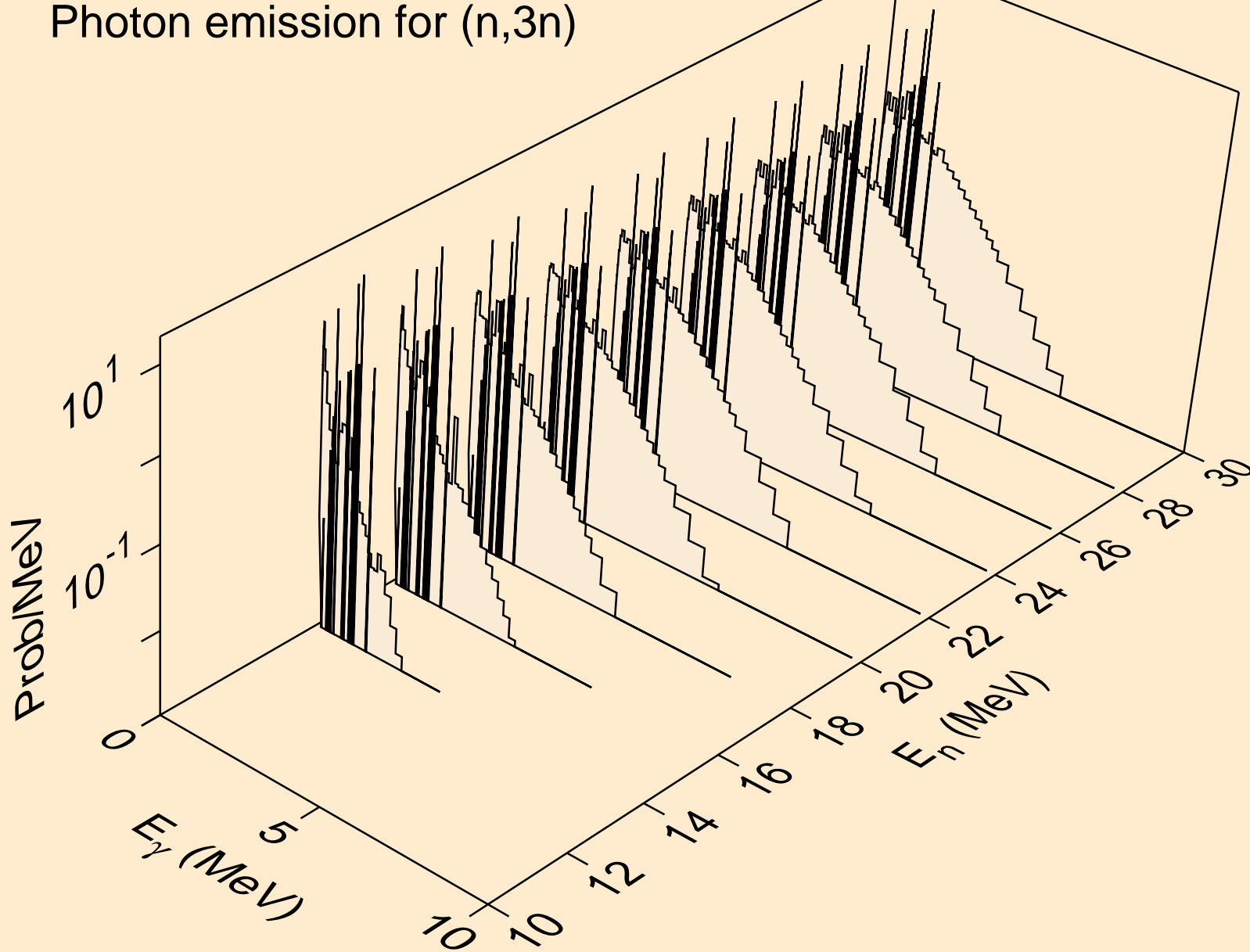

IN127N NEUTRON ACER TENDL-2019 LIBRARY; T=293.16K  
Photon emission for (n,n\*)a

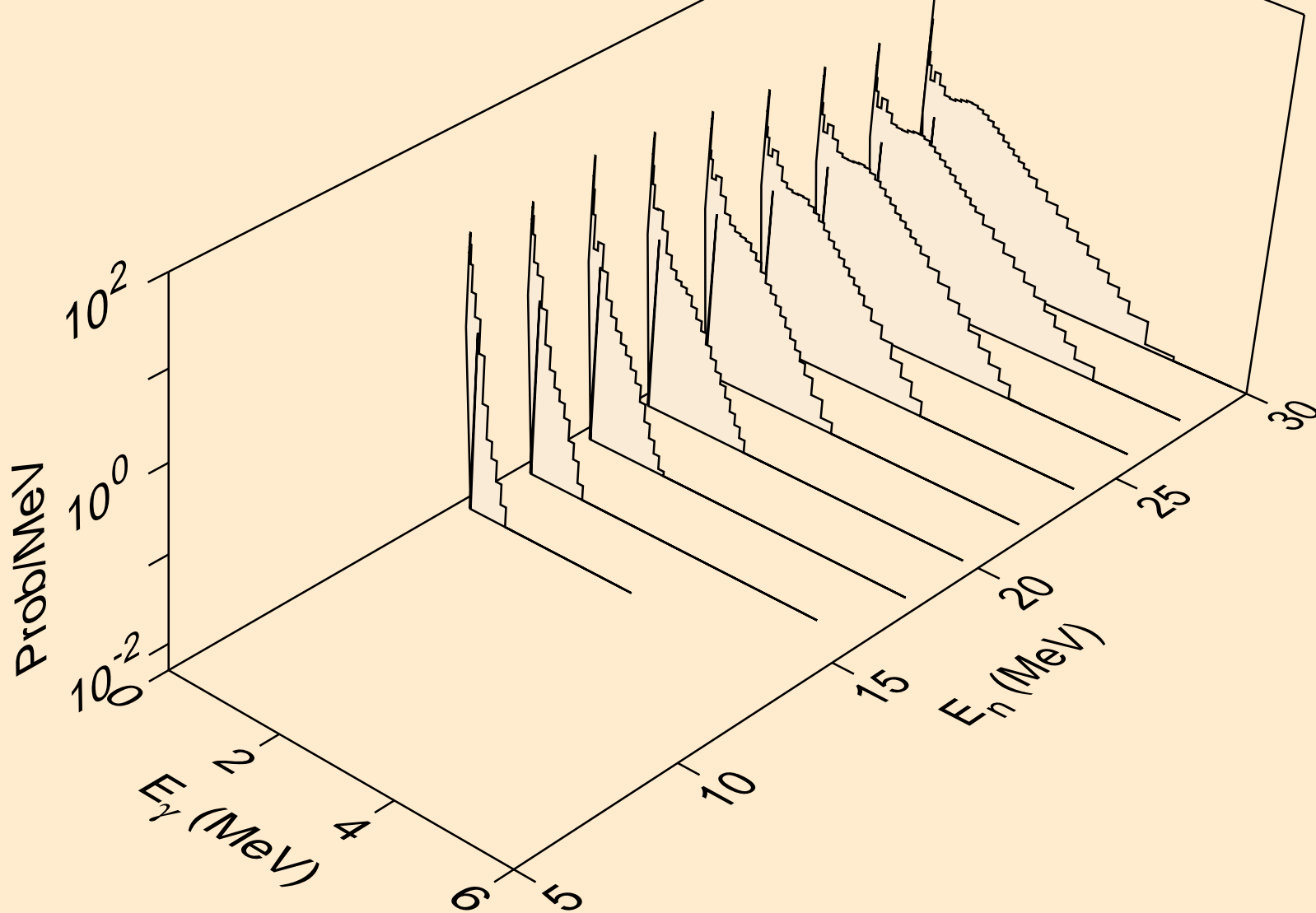

IN127N NEUTRON ACER TENDL-2019 LIBRARY; T=293.16K  
Photon emission for (n,2n)a

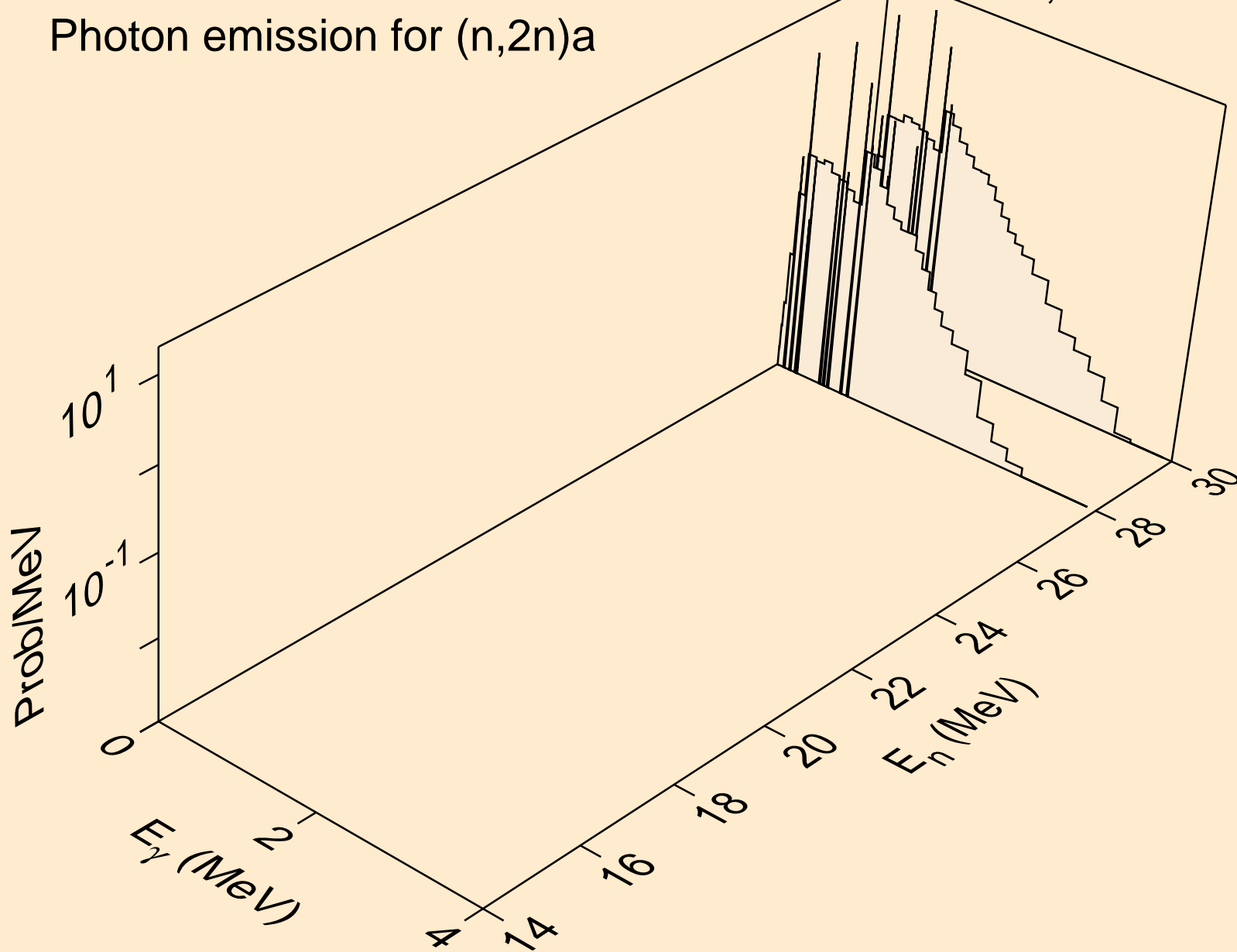

IN127N NEUTRON ACER TENDL-2019 LIBRARY; T=293.16K  
Photon emission for (n,3n)a

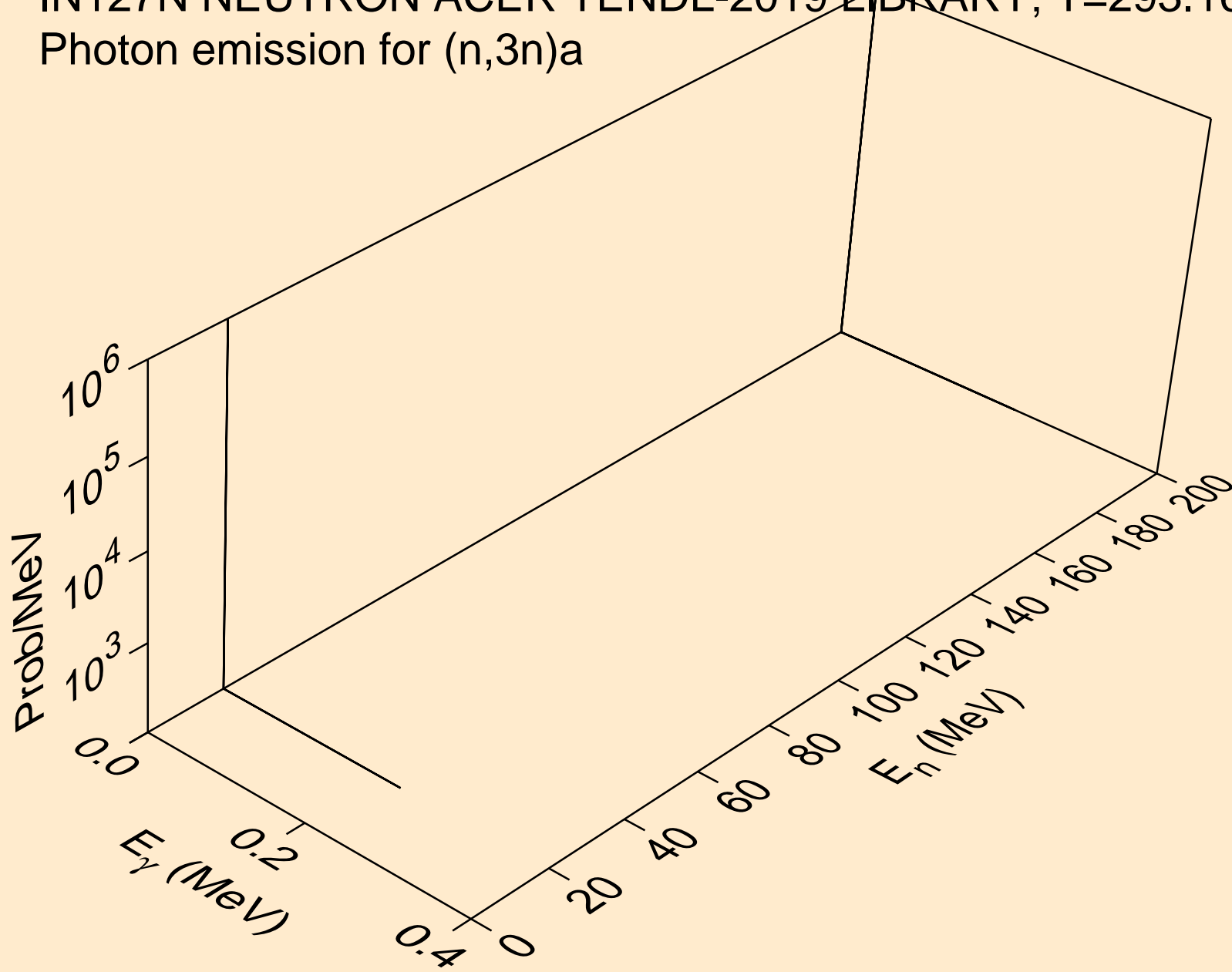

IN127N NEUTRON ACER TENDL-2019 LIBRARY; T=293.16K  
Photon emission for (n,n\*)p

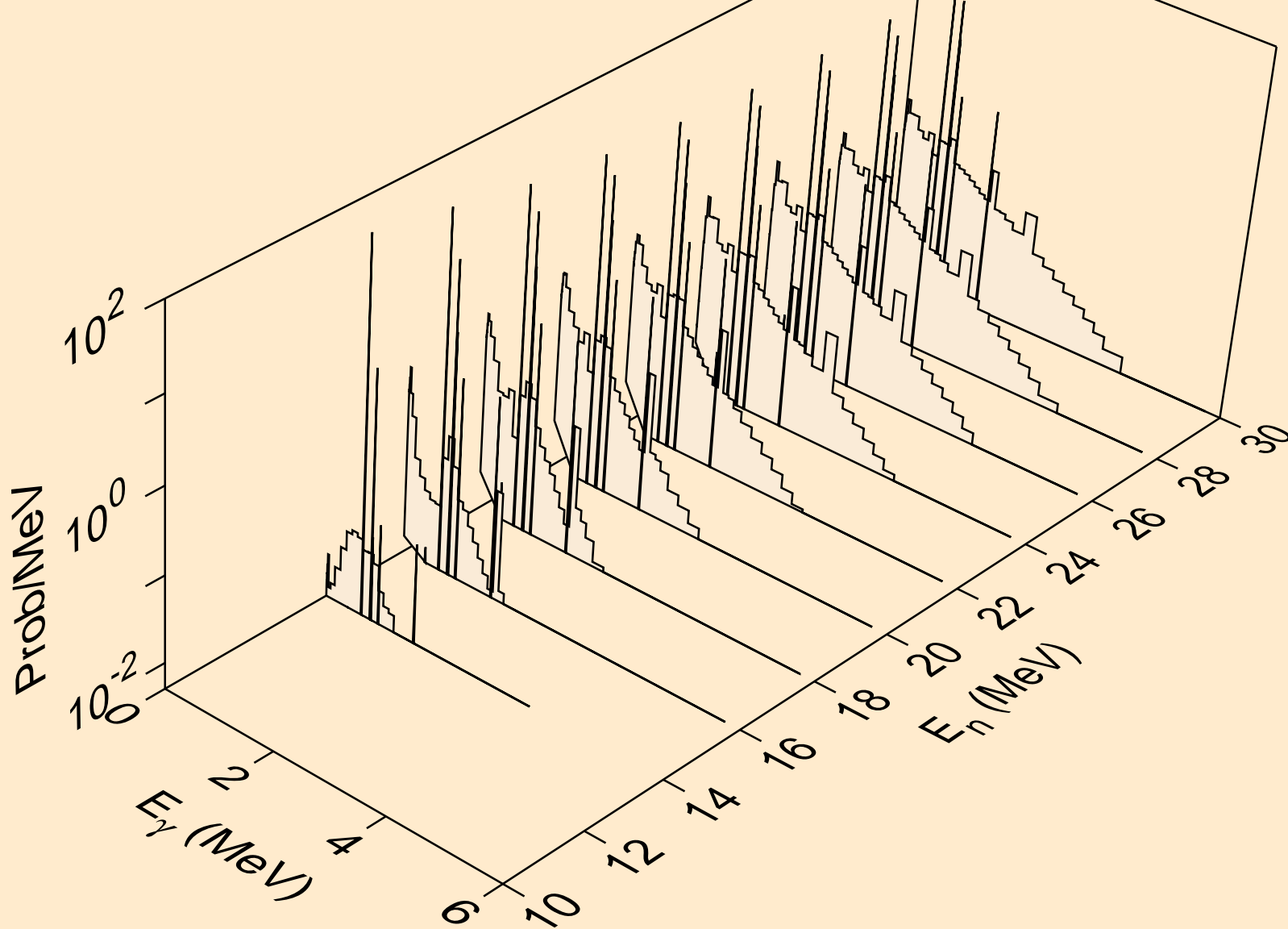



IN127N NEUTRON ACER TENDL-2019 LIBRARY; T=293.16K  
Photon emission for (n,n\*)d

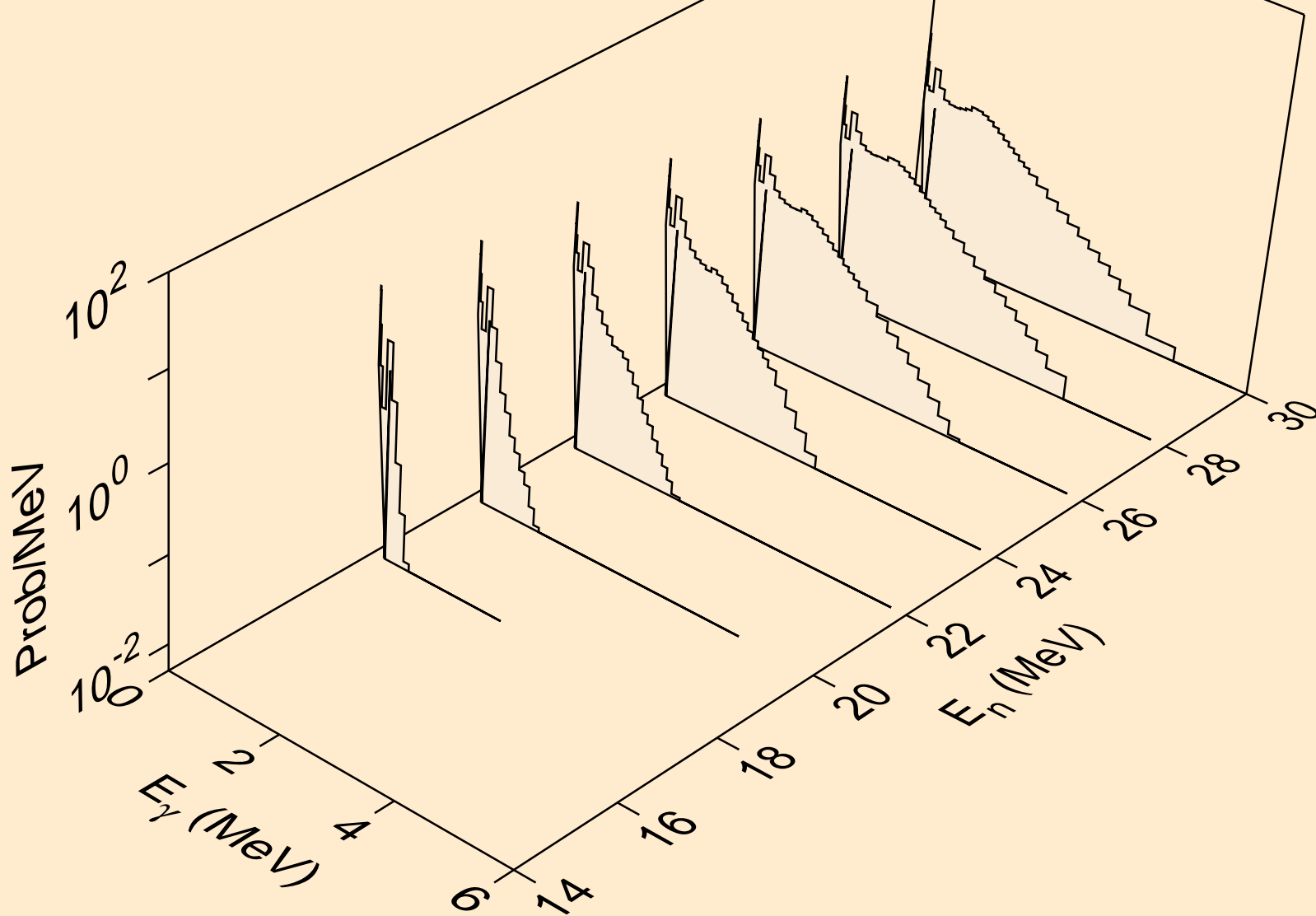

IN127N NEUTRON ACER TENDL-2019 LIBRARY; T=293.16K  
Photon emission for (n,n\*)t

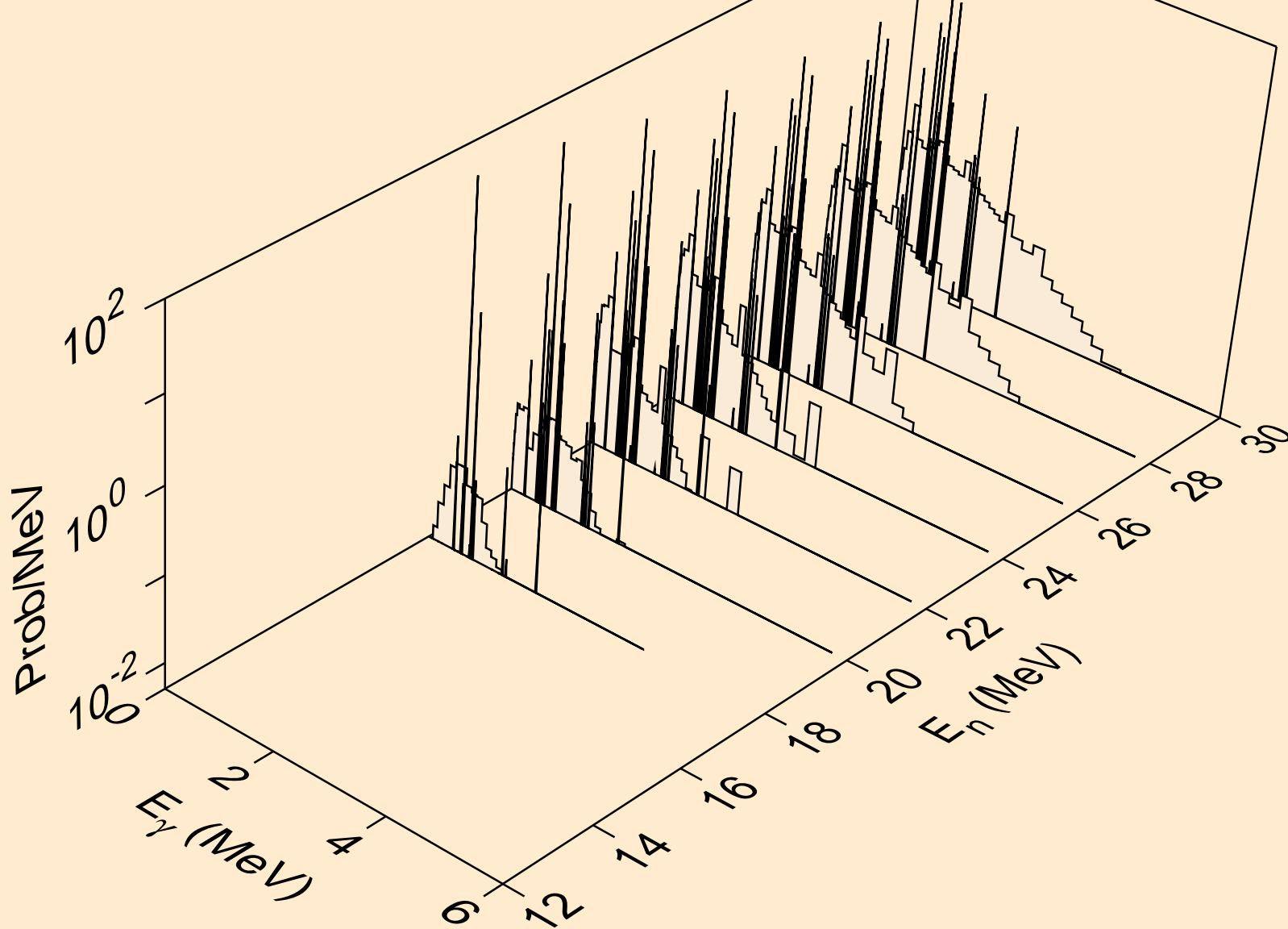

IN127N NEUTRON ACER TENDL-2019 LIBRARY; T=293.16K  
Photon emission for (n,4n)

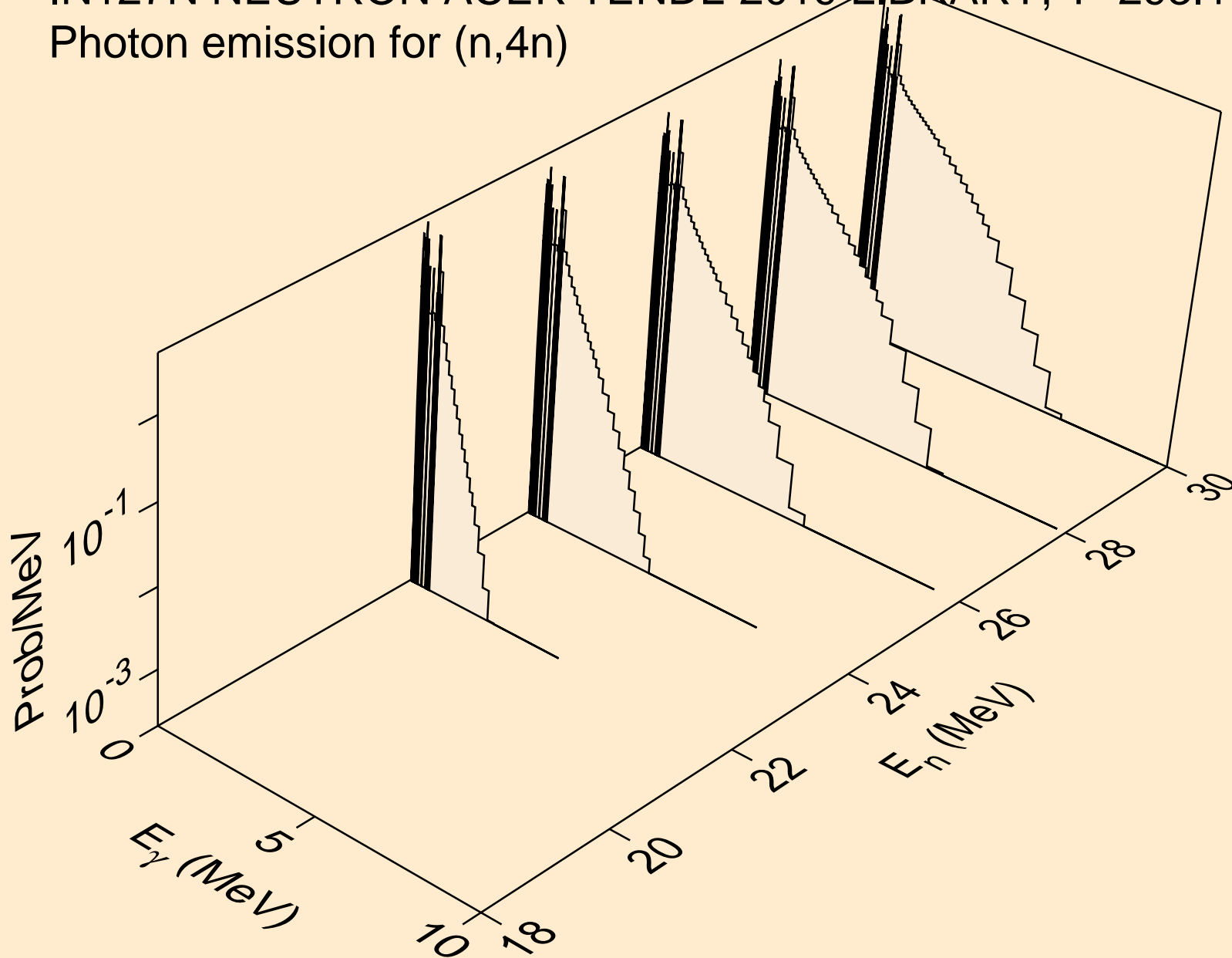

IN127N NEUTRON ACER TENDL-2019 LIBRARY; T=293.16K  
Photon emission for (n,2np)

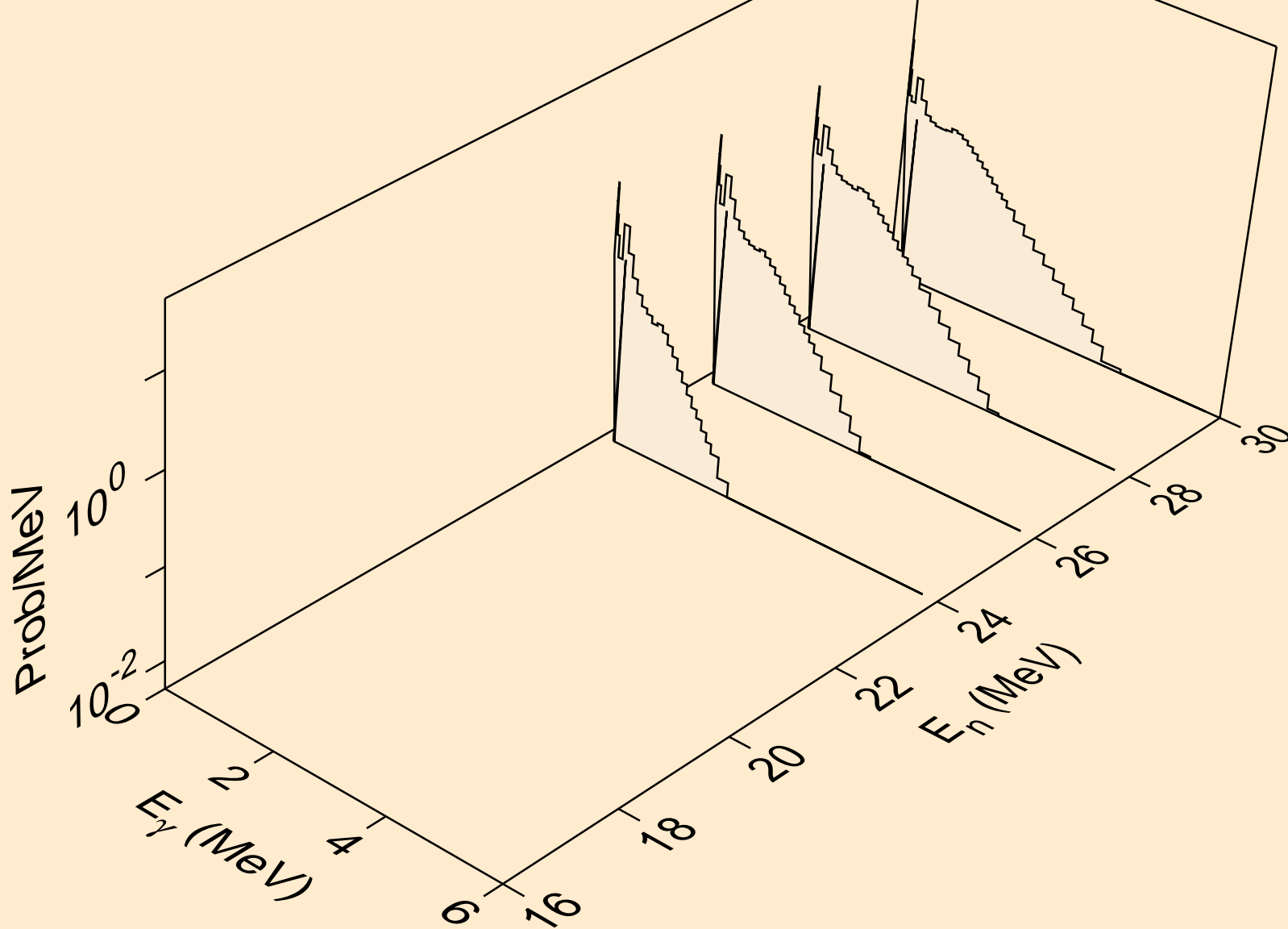

IN127N NEUTRON ACER TENDL-2019 LIBRARY; T=293.16K  
Photon emission for (n,3np)

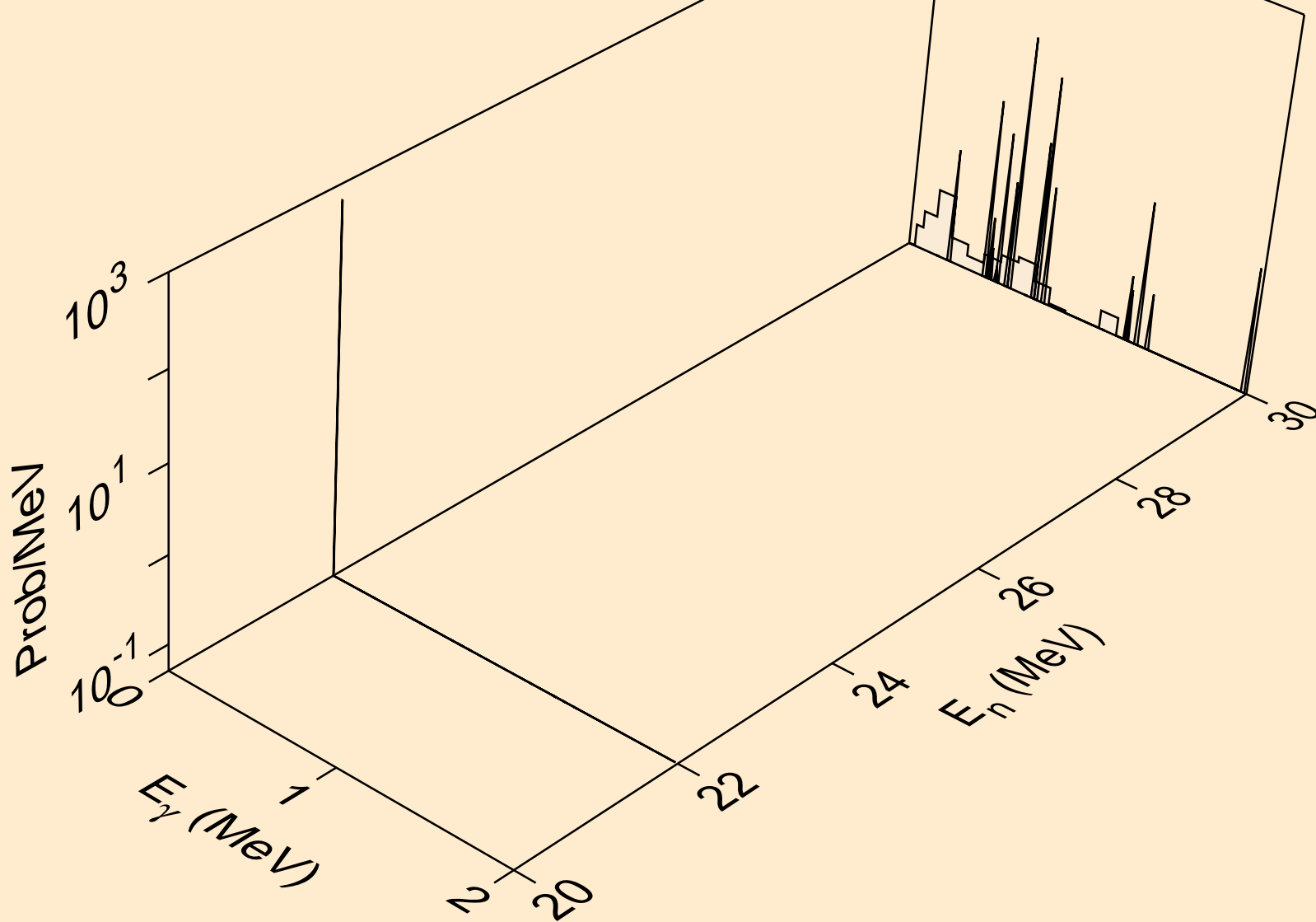

IN127N NEUTRON ACER TENDL-2019 LIBRARY; T=293.16K  
Photon emission for (n,n\*2)

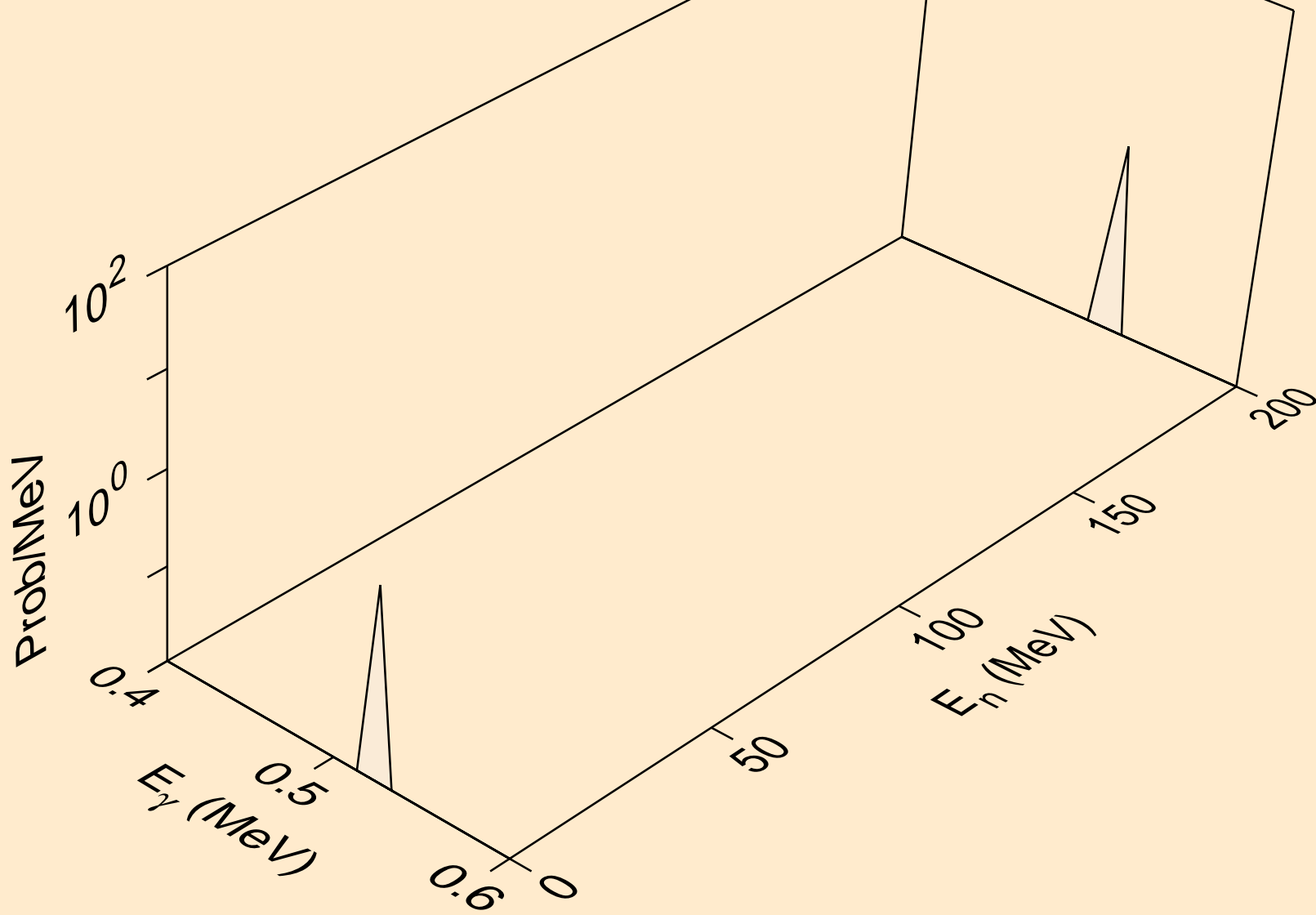

IN127N NEUTRON ACER TENDL-2019 LIBRARY; T=293.16K  
Photon emission for (n,n\*3)

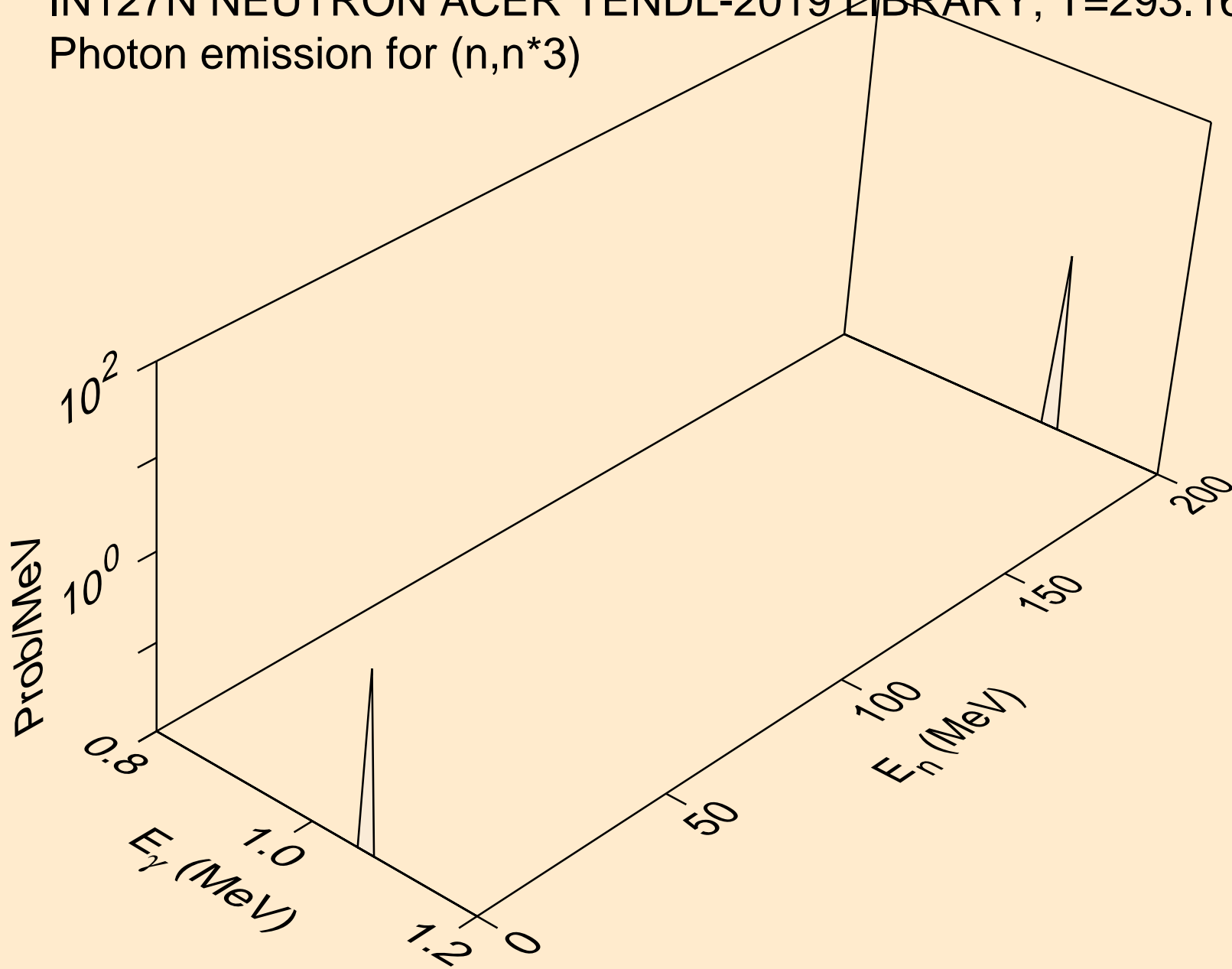

IN127N NEUTRON ACER TENDL-2019 LIBRARY; T=293.16K  
Photon emission for (n,n\*4)

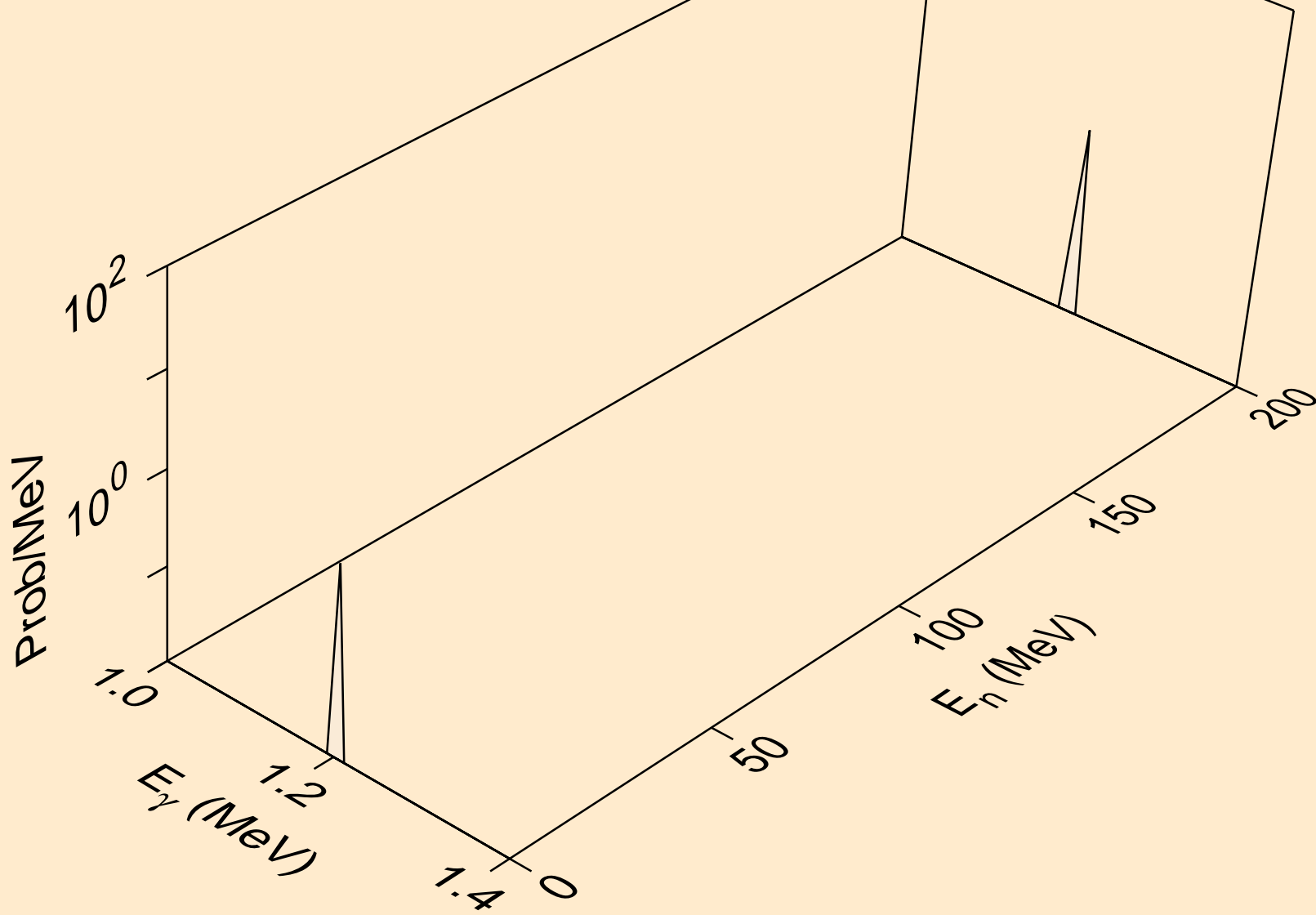



IN127N NEUTRON ACER TENDL-2019 LIBRARY; T=293.16K  
Photon emission for (n,n\*5)

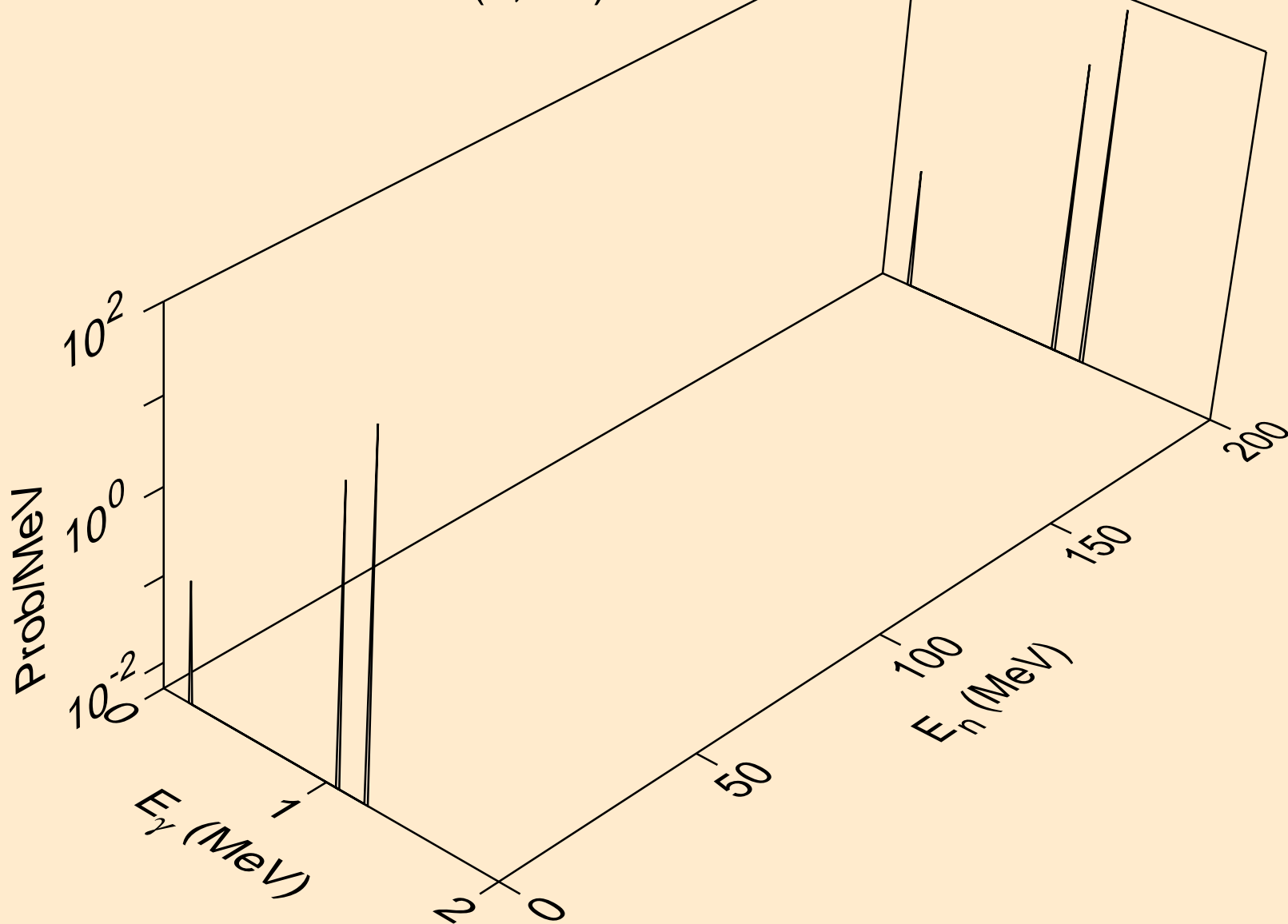

IN127N NEUTRON ACER TENDL-2019 LIBRARY; T=293.16K  
Photon emission for (n,n\*6)

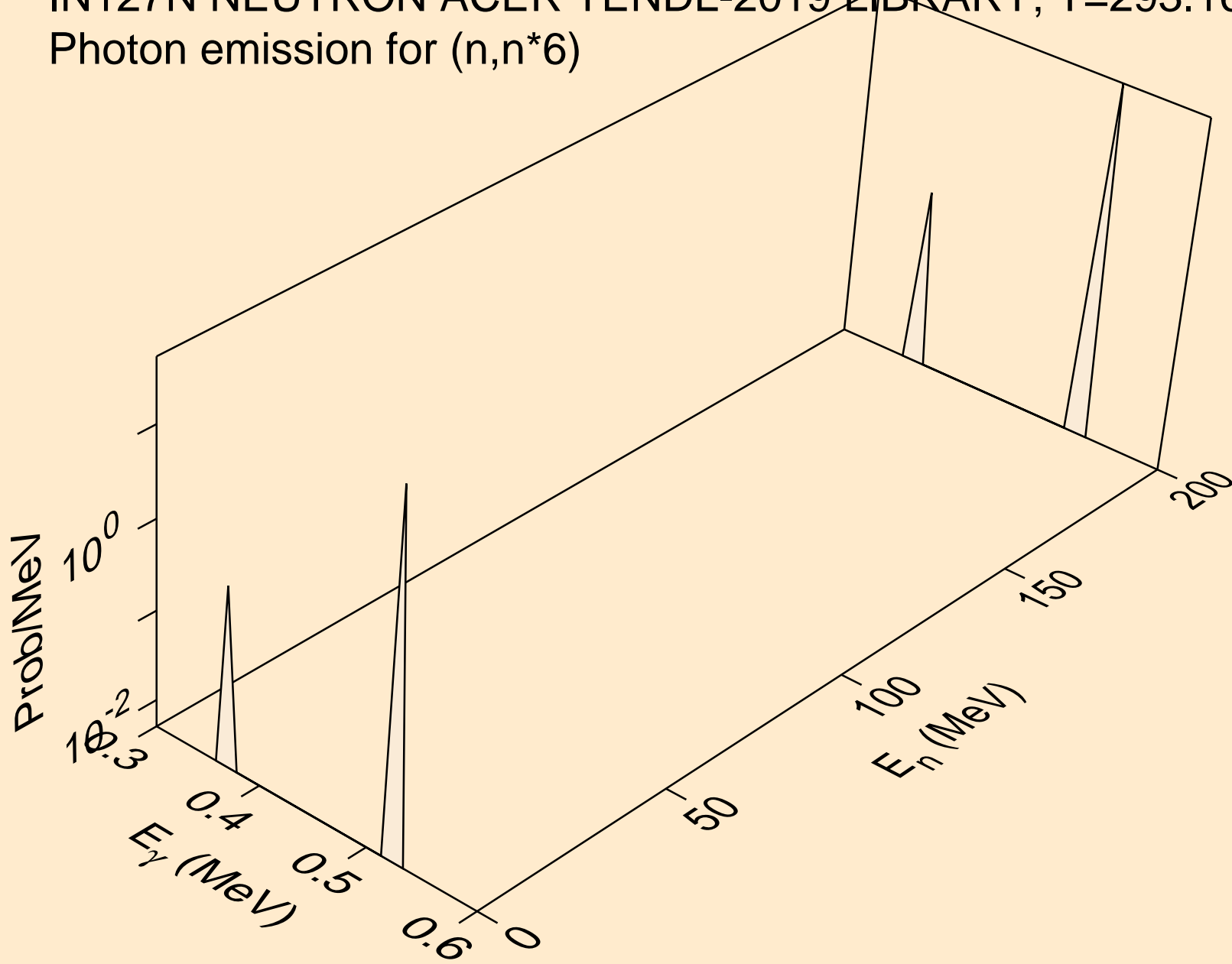

IN127N NEUTRON ACER TENDL-2019 LIBRARY; T=293.16K  
Photon emission for (n,n\*7)

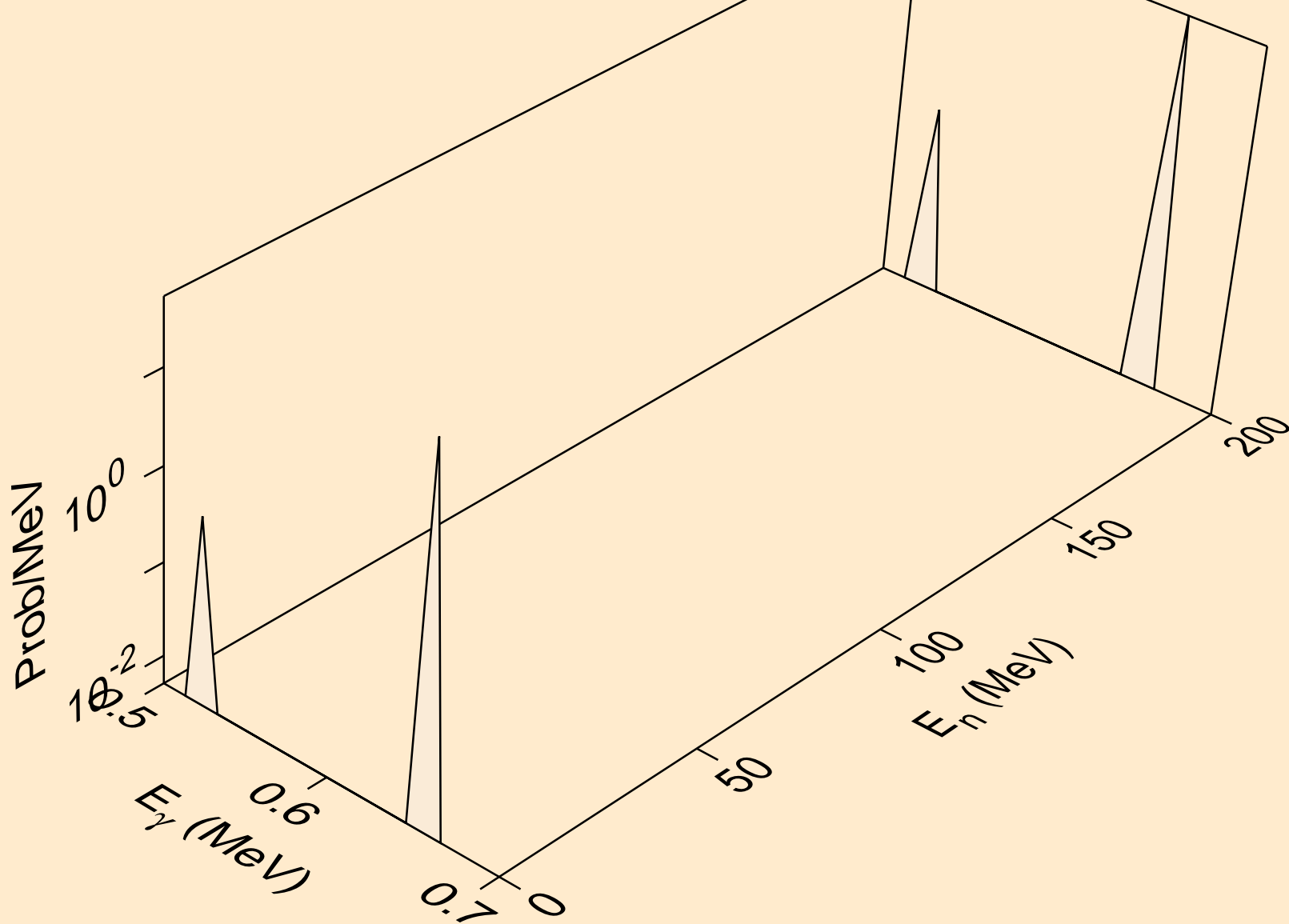

IN127N NEUTRON ACER TENDL-2019 LIBRARY; T=293.16K  
Photon emission for (n,n\*8)

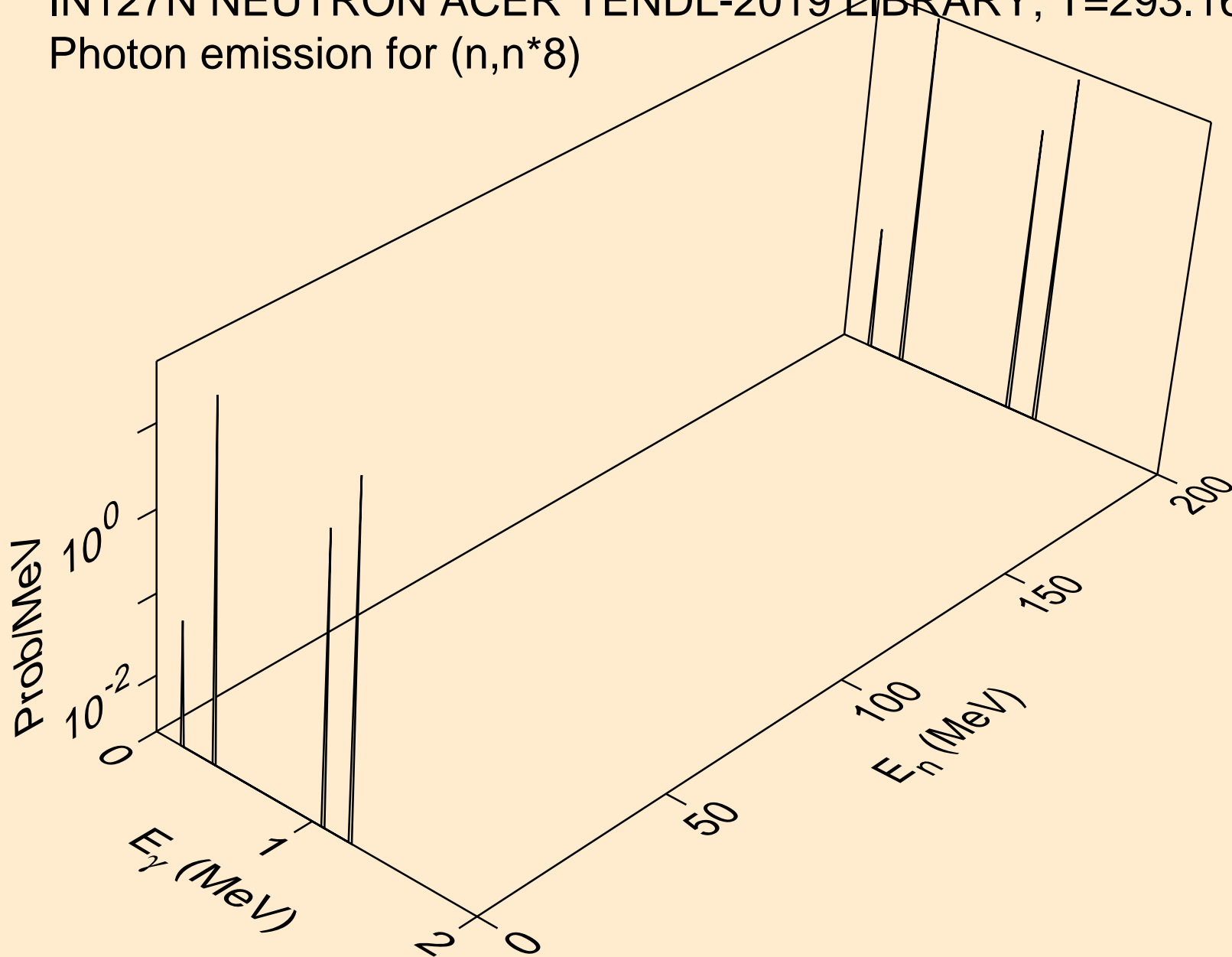

IN127N NEUTRON ACER TENDL-2019 LIBRARY; T=293.16K  
Photon emission for (n,n\*10)

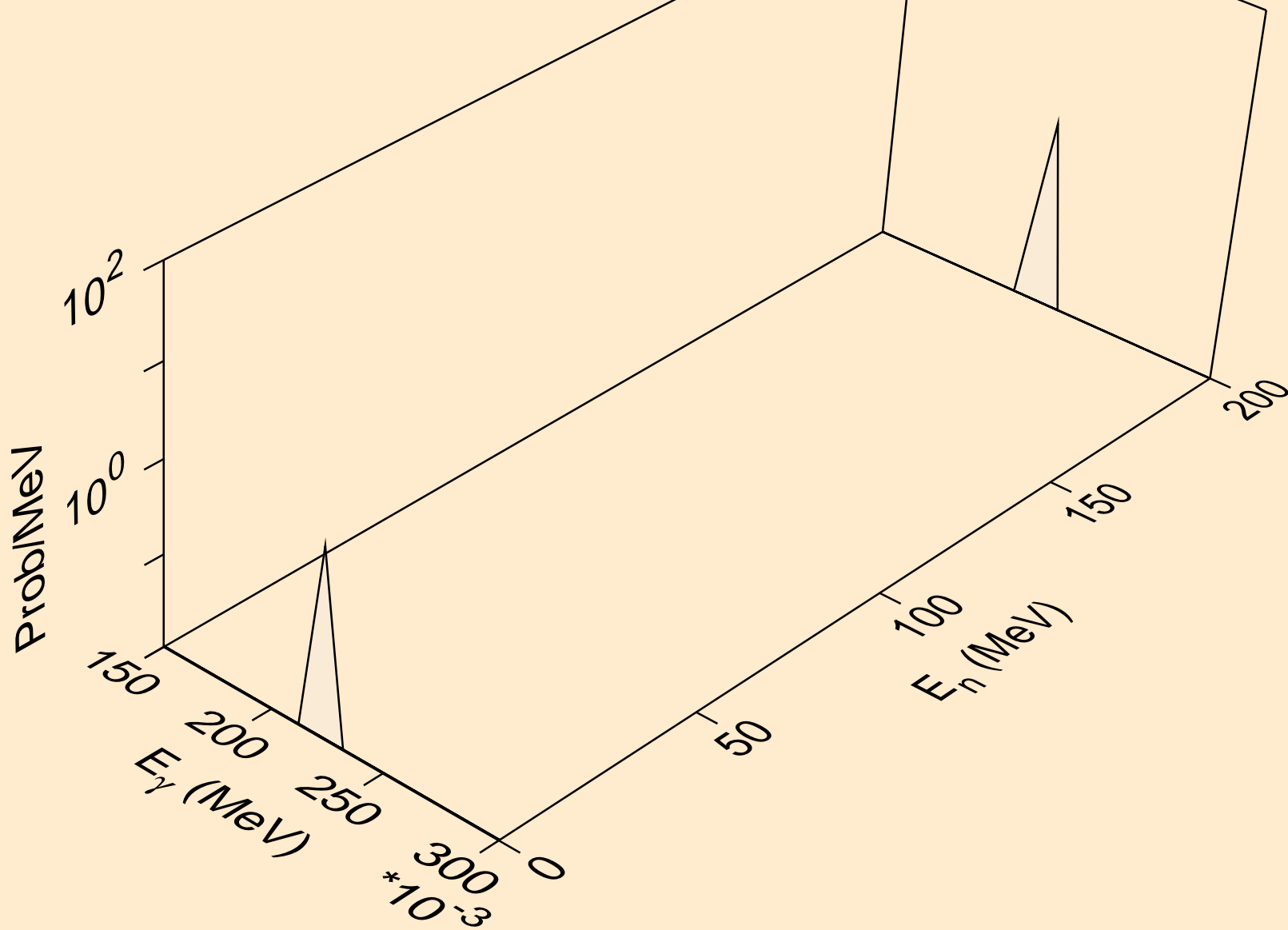

IN127N NEUTRON ACER TENDL-2019 LIBRARY; T=293.16K  
Photon emission for (n,n\*11)

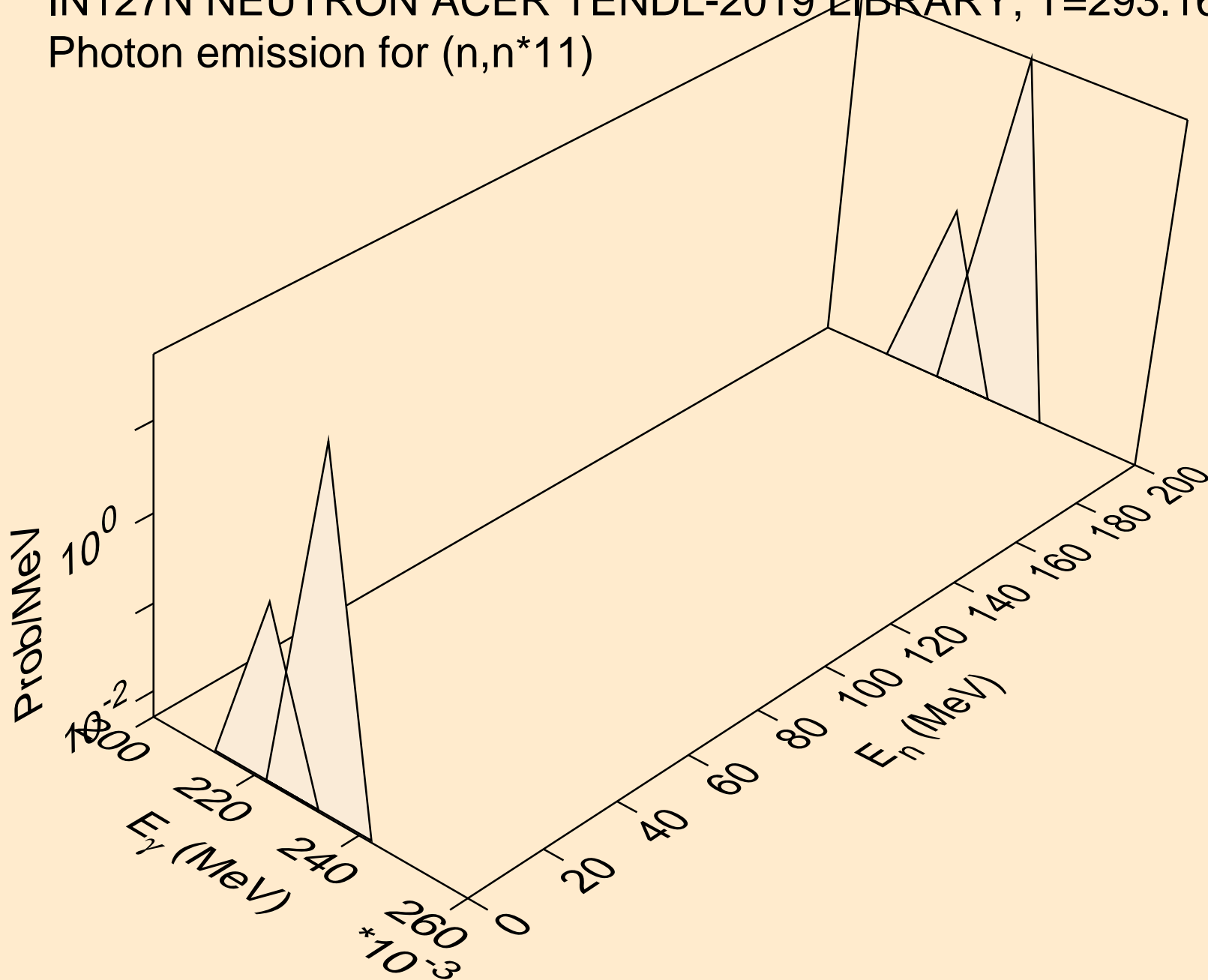

IN127N NEUTRON ACER TENDL-2019 LIBRARY; T=293.16K  
Photon emission for (n,n\*12)

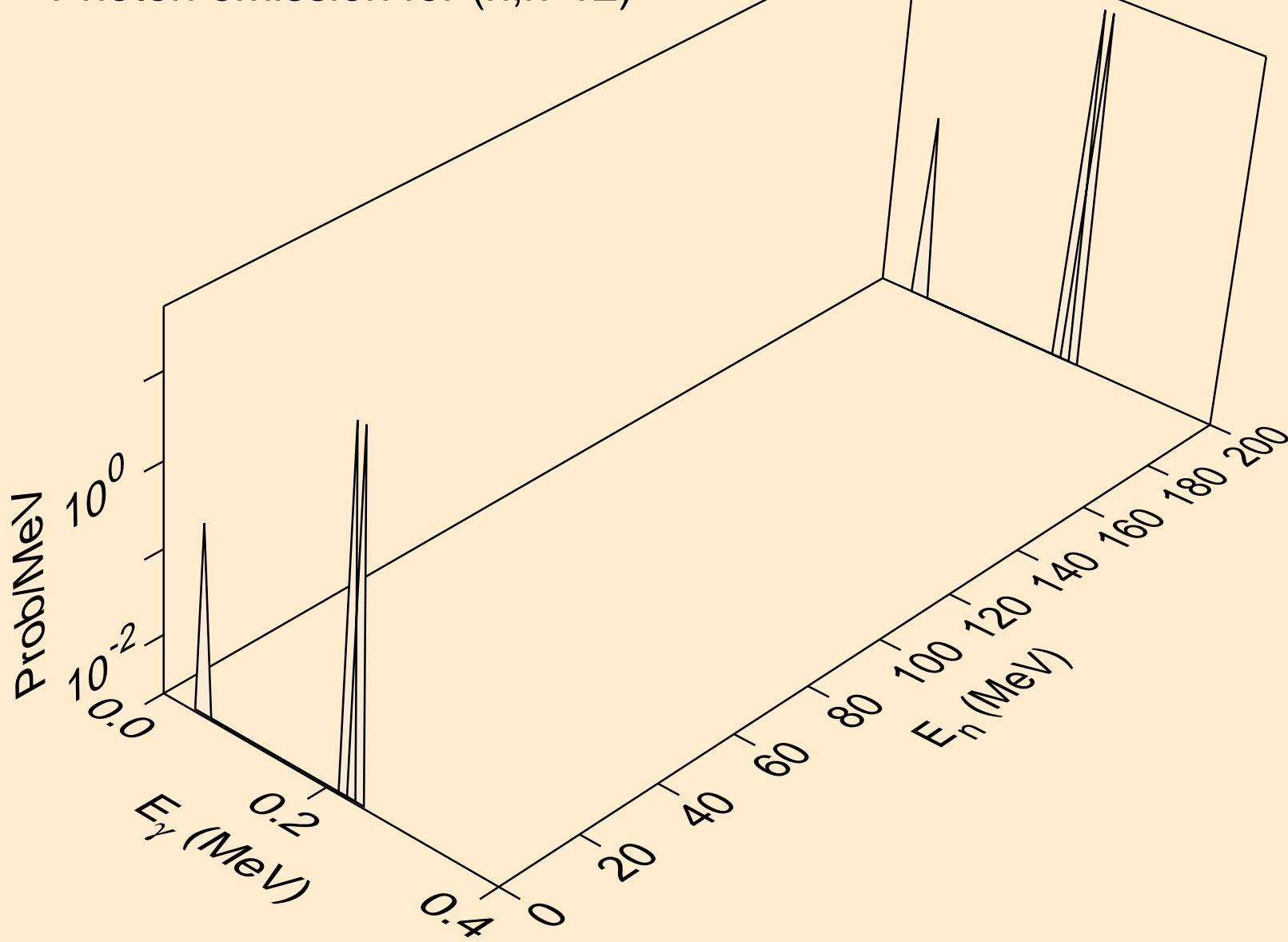

IN127N NEUTRON ACER TENDL-2019 LIBRARY; T=293.16K  
Photon emission for (n,n\*13)

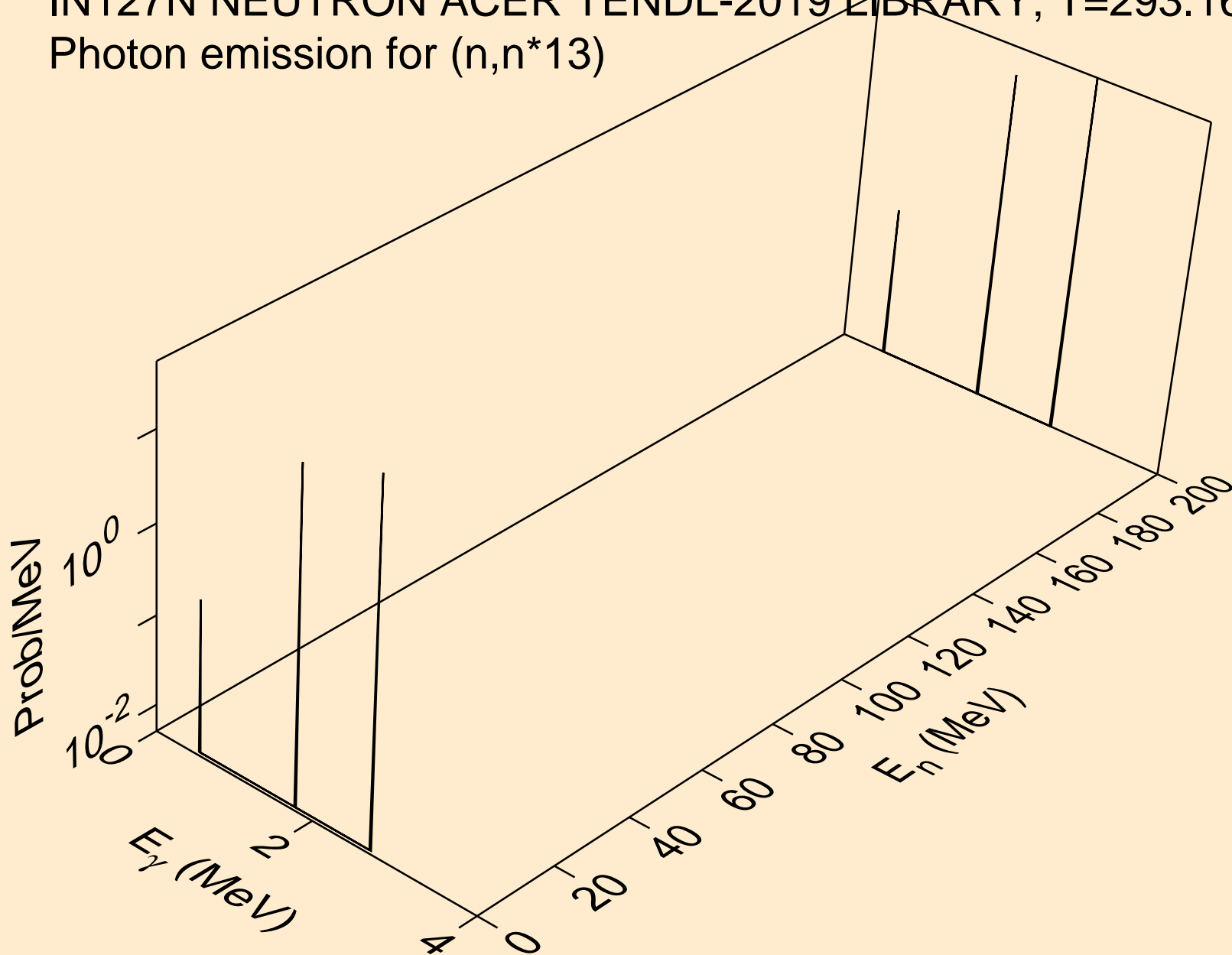



IN127N NEUTRON ACER TENDL-2019 LIBRARY; T=293.16K  
Photon emission for (n,n\*14)

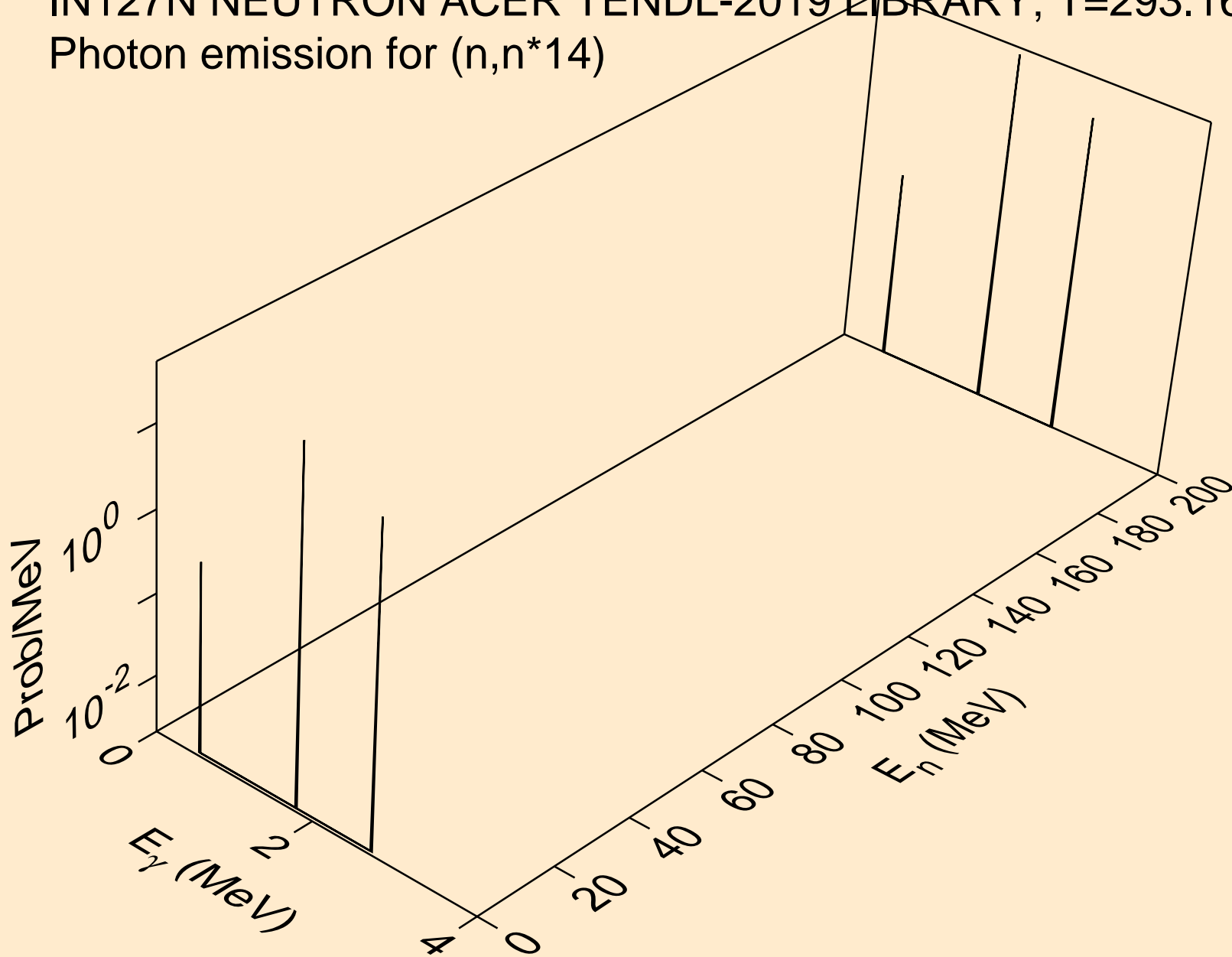

IN127N NEUTRON ACER TENDL-2019 LIBRARY; T=293.16K  
Photon emission for (n,n\*15)

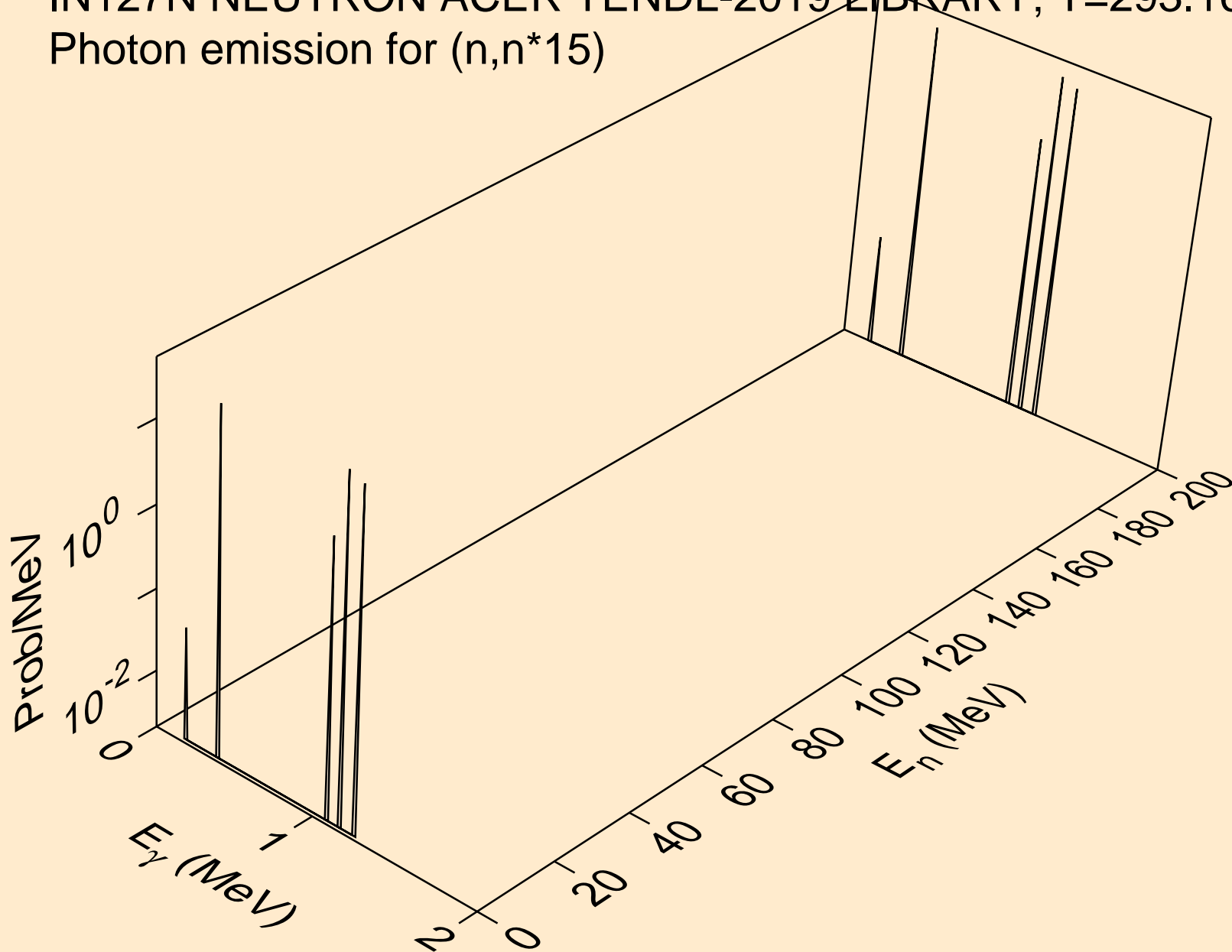

IN127N NEUTRON ACER TENDL-2019 LIBRARY; T=293.16K  
Photon emission for (n,n\*16)

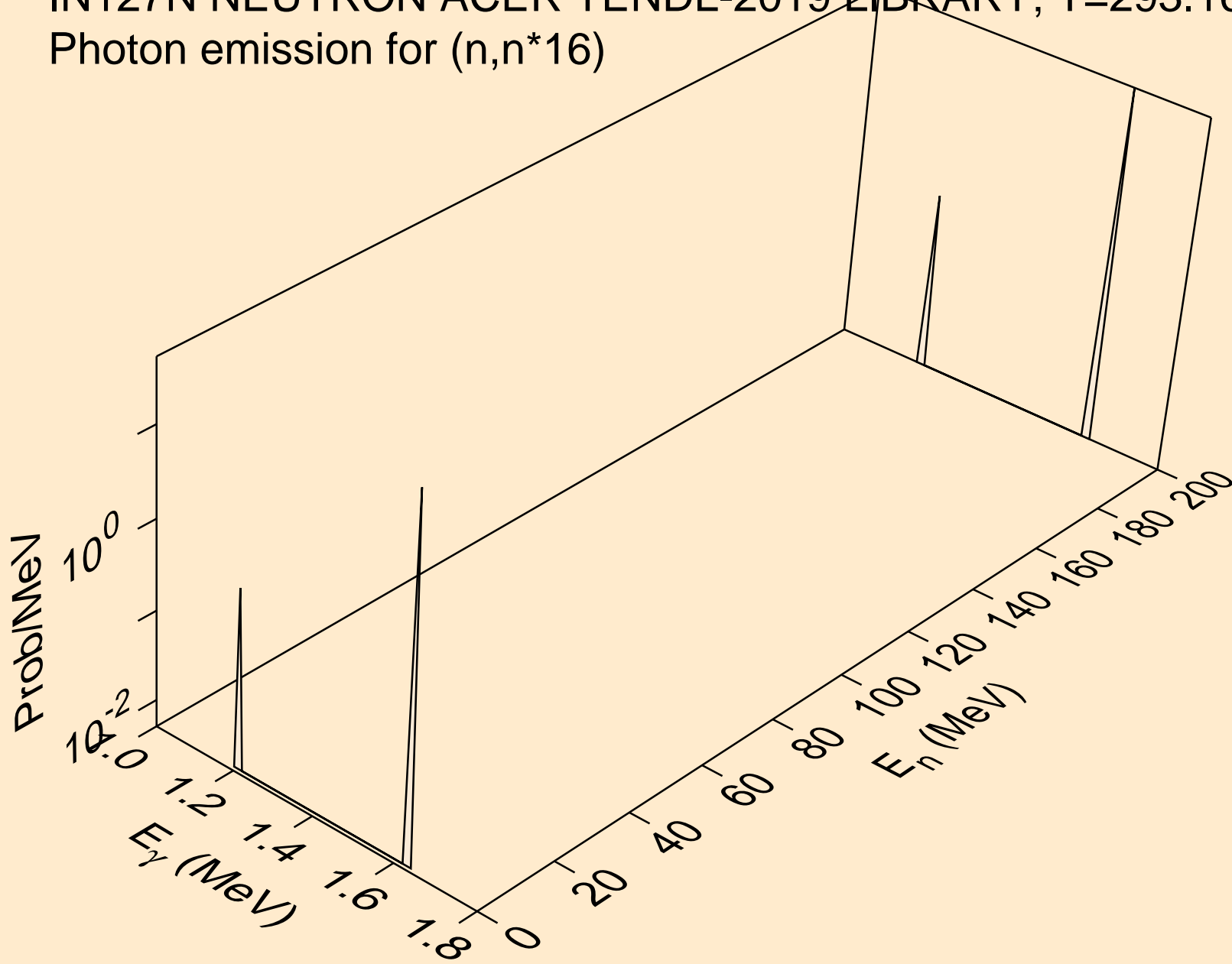

IN127N NEUTRON ACER TENDL-2019 LIBRARY; T=293.16K  
Photon emission for (n,n\*17)

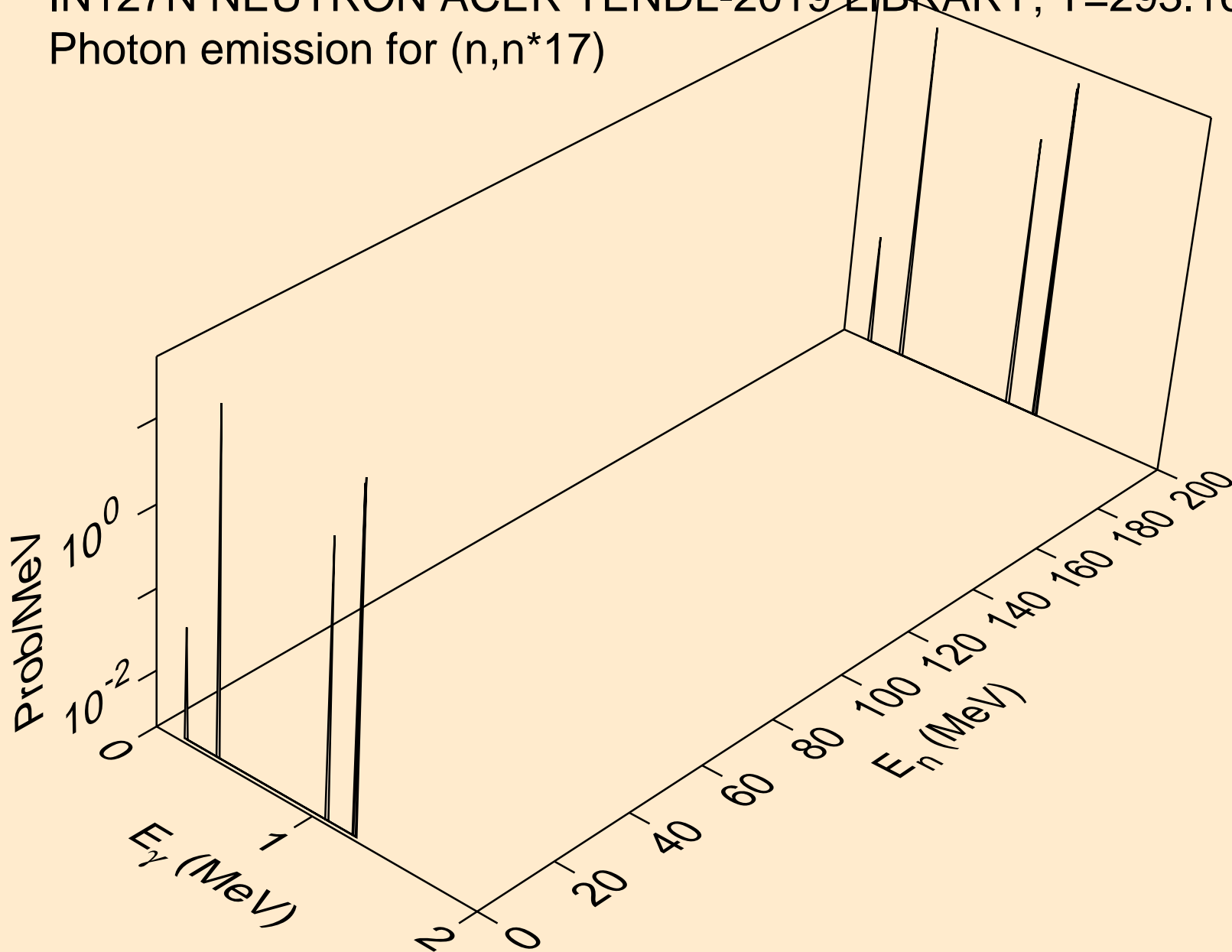

IN127N NEUTRON ACER TENDL-2019 LIBRARY; T=293.16K  
Photon emission for (n,n\*18)

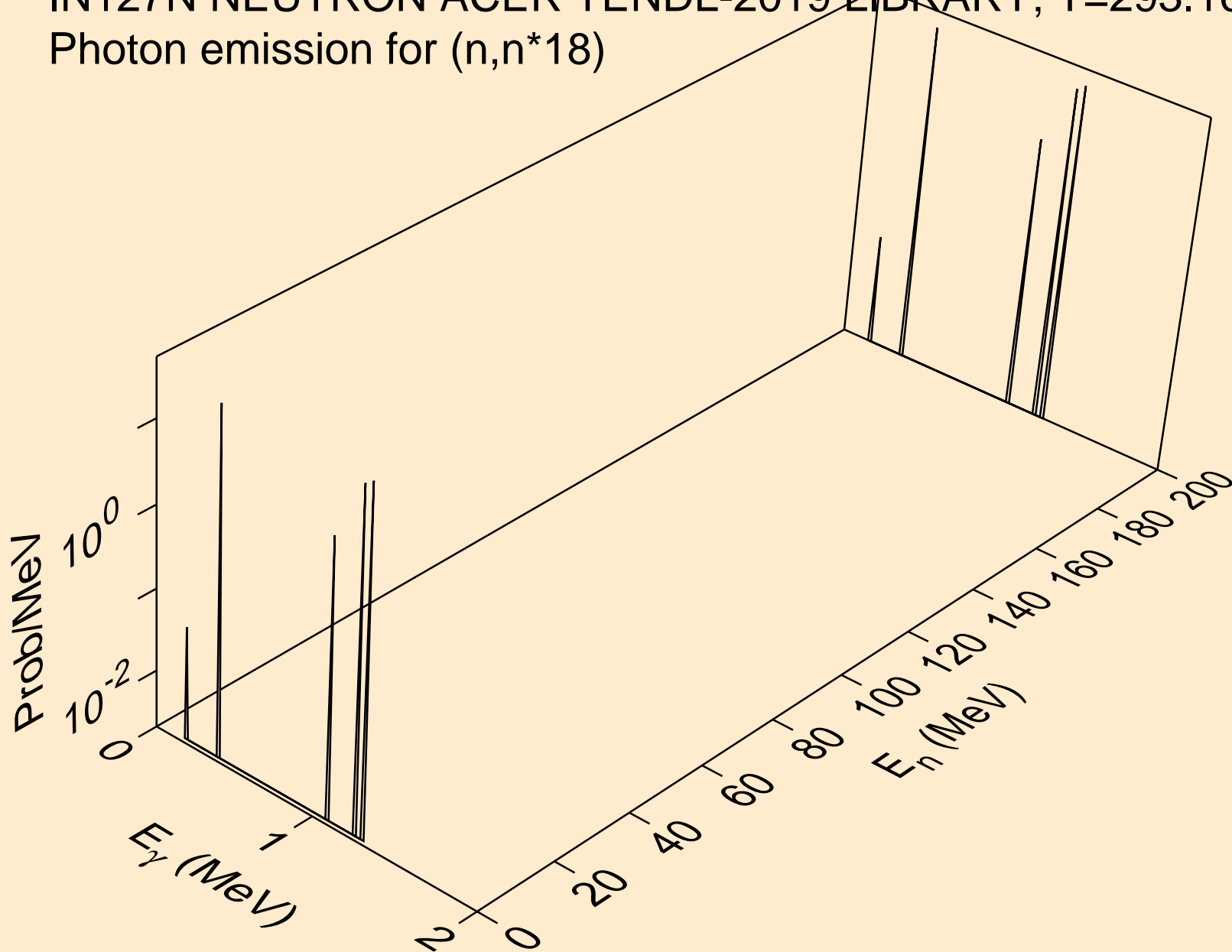

IN127N NEUTRON ACER TENDL-2019 LIBRARY; T=293.16K  
Photon emission for (n,n\*19)

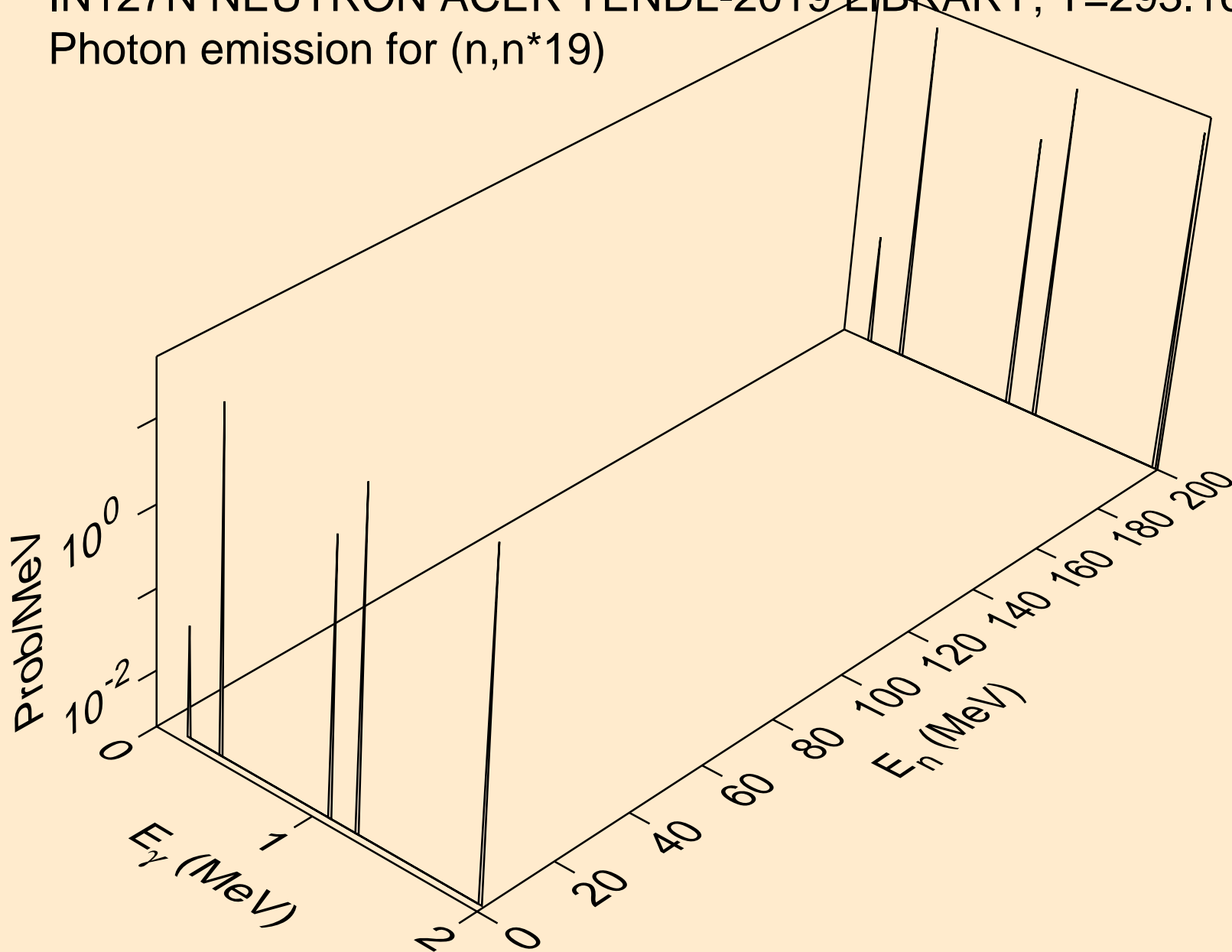

IN127N NEUTRON ACER TENDL-2019 LIBRARY; T=293.16K  
Photon emission for (n,n\*20)

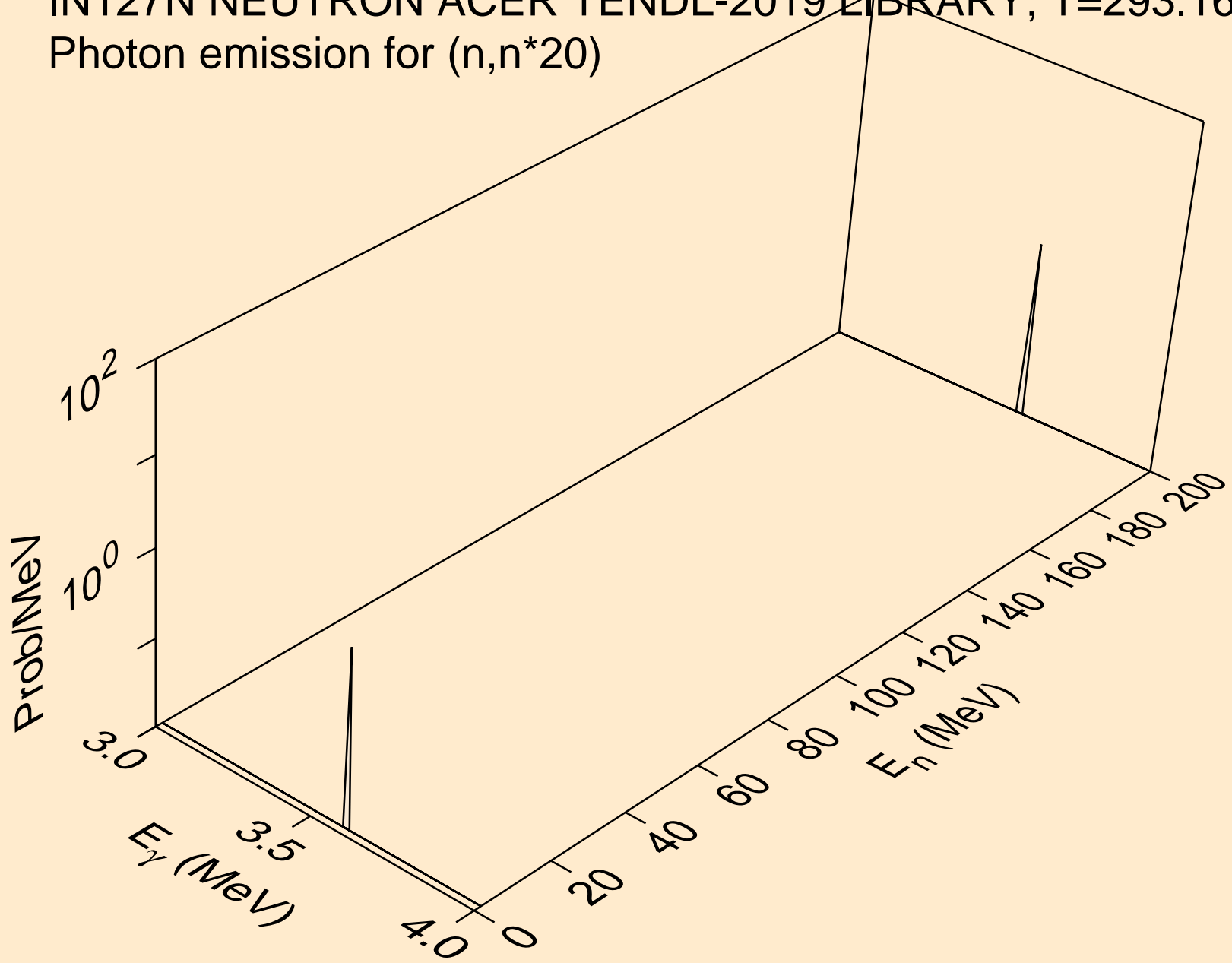

IN127N NEUTRON ACER TENDL-2019 LIBRARY; T=293.16K  
Photon emission for (n,n\*21)

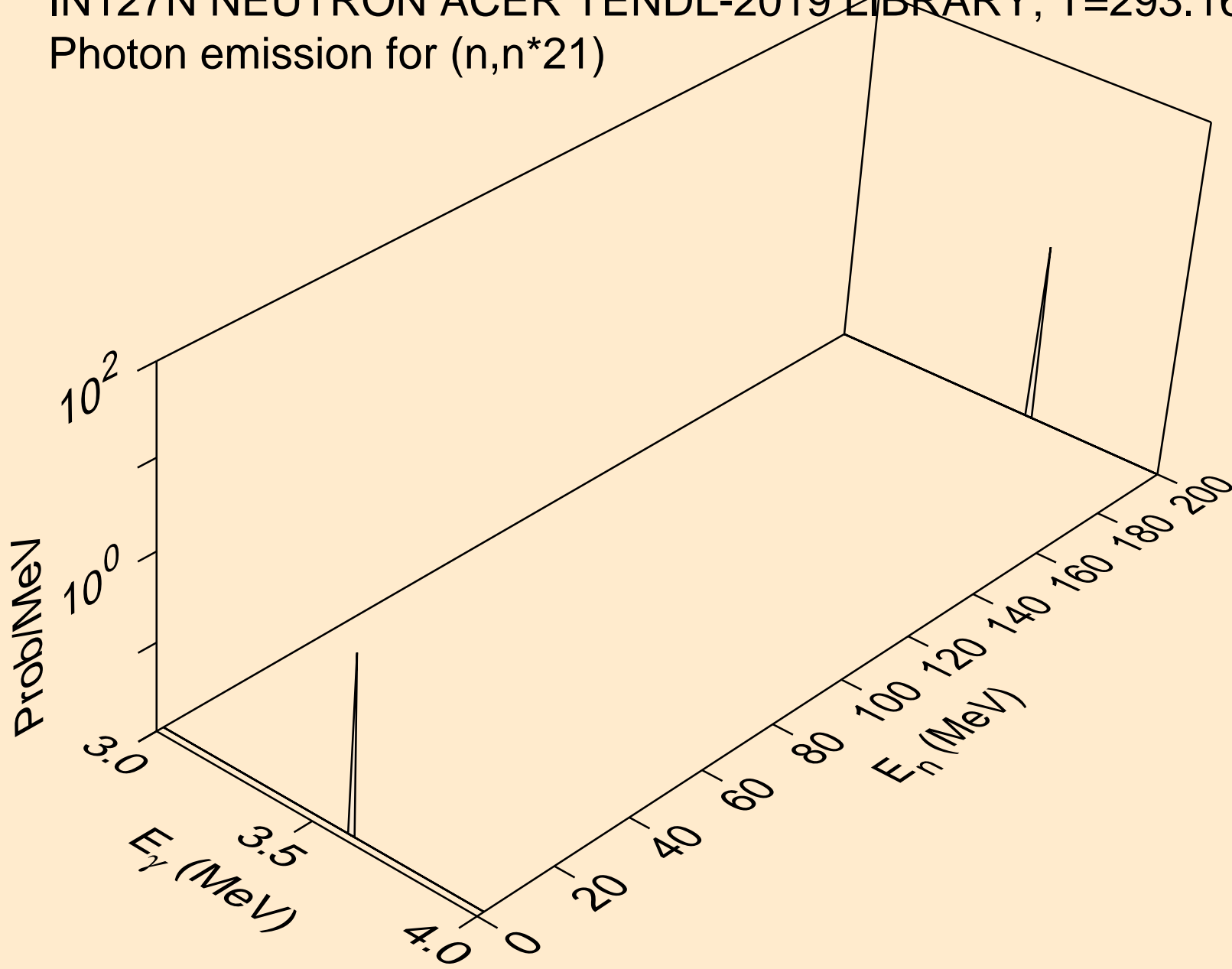



IN127N NEUTRON ACER TENDL-2019 LIBRARY; T=293.16K  
Photon emission for (n,n\*22)

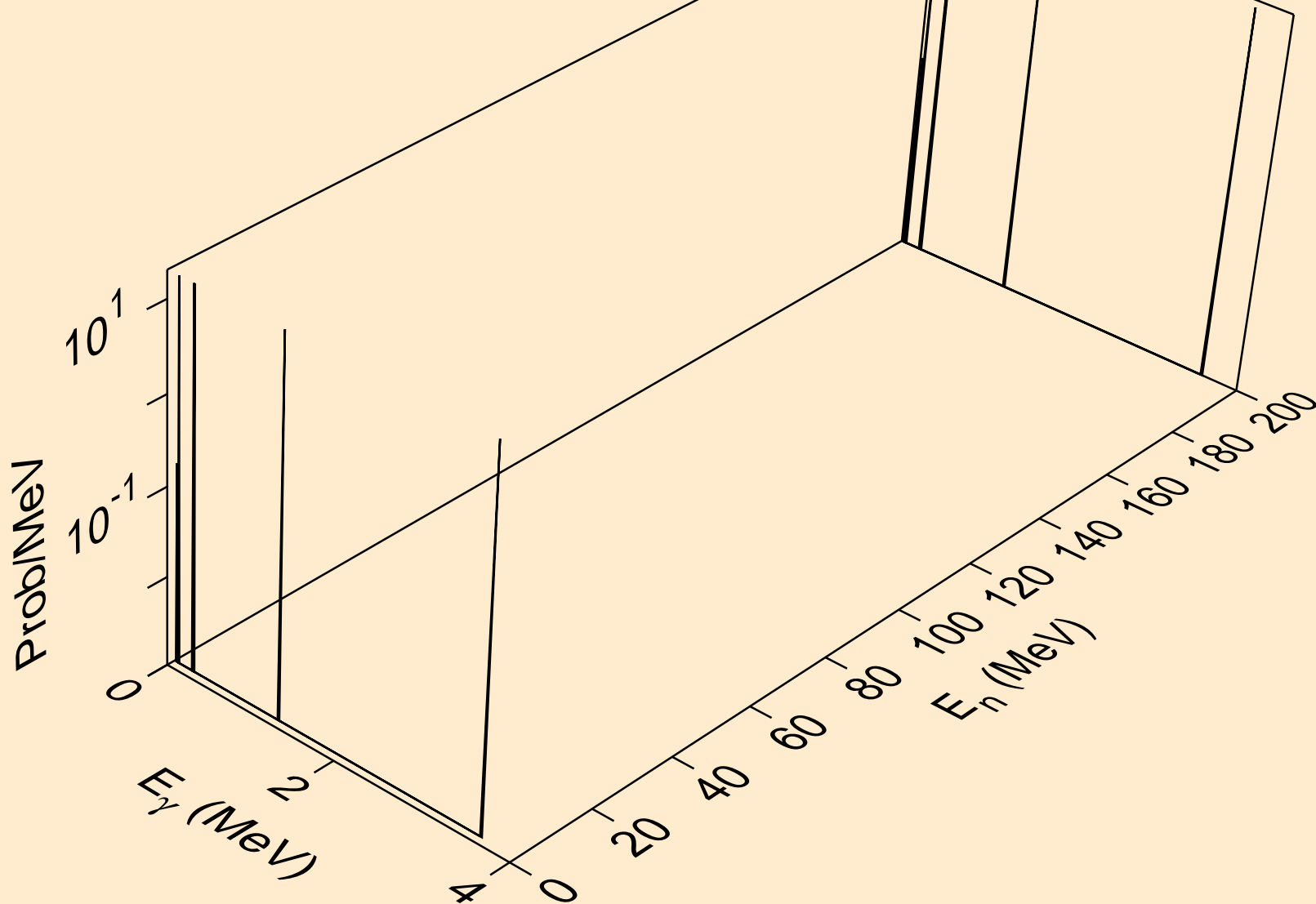

IN127N NEUTRON ACER TENDL-2019 LIBRARY; T=293.16K  
Photon emission for (n,n\*c)

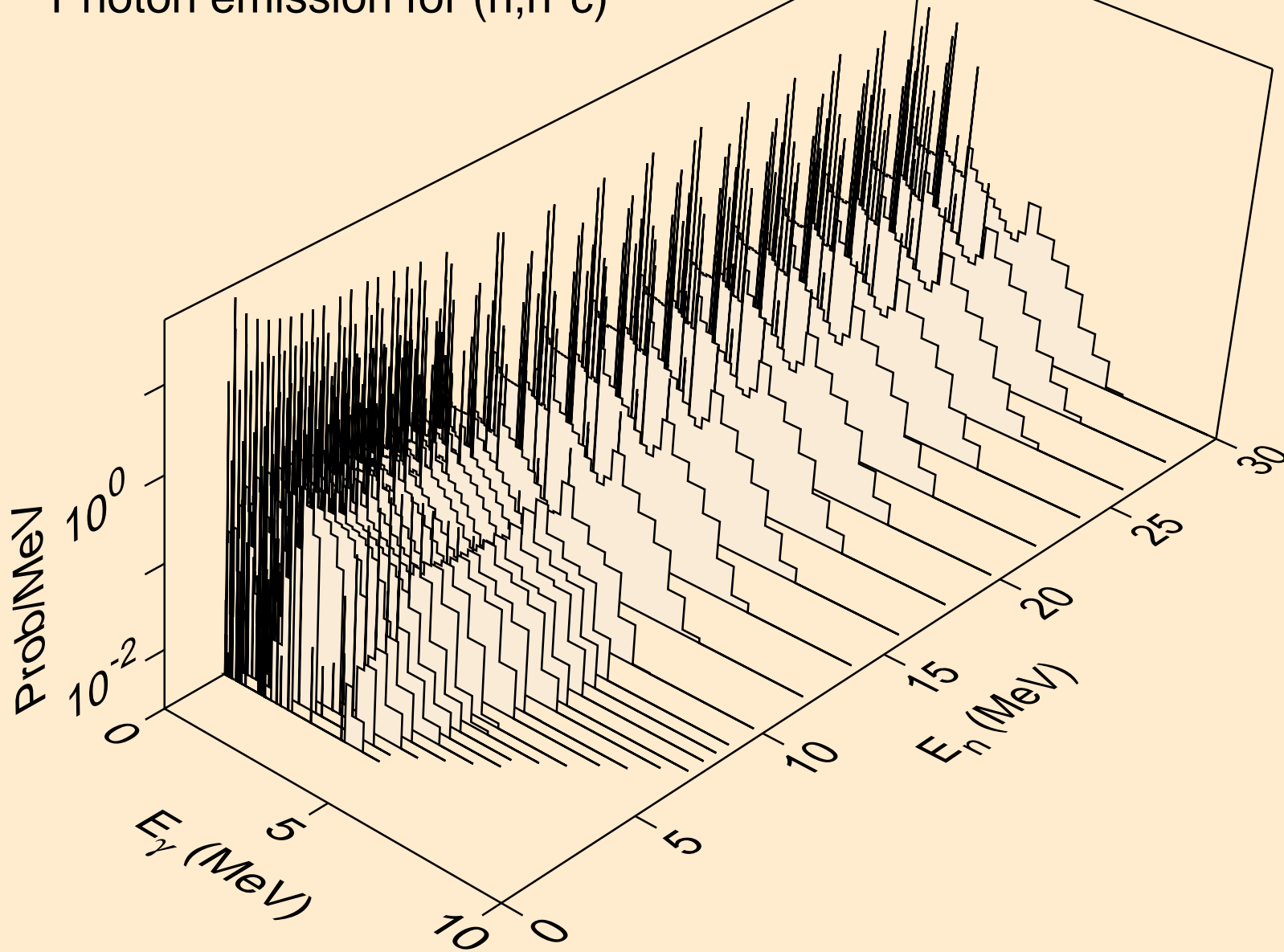

IN127N NEUTRON ACER TENDL-2019 LIBRARY; T=293.16K  
Photon emission for (n,gma)

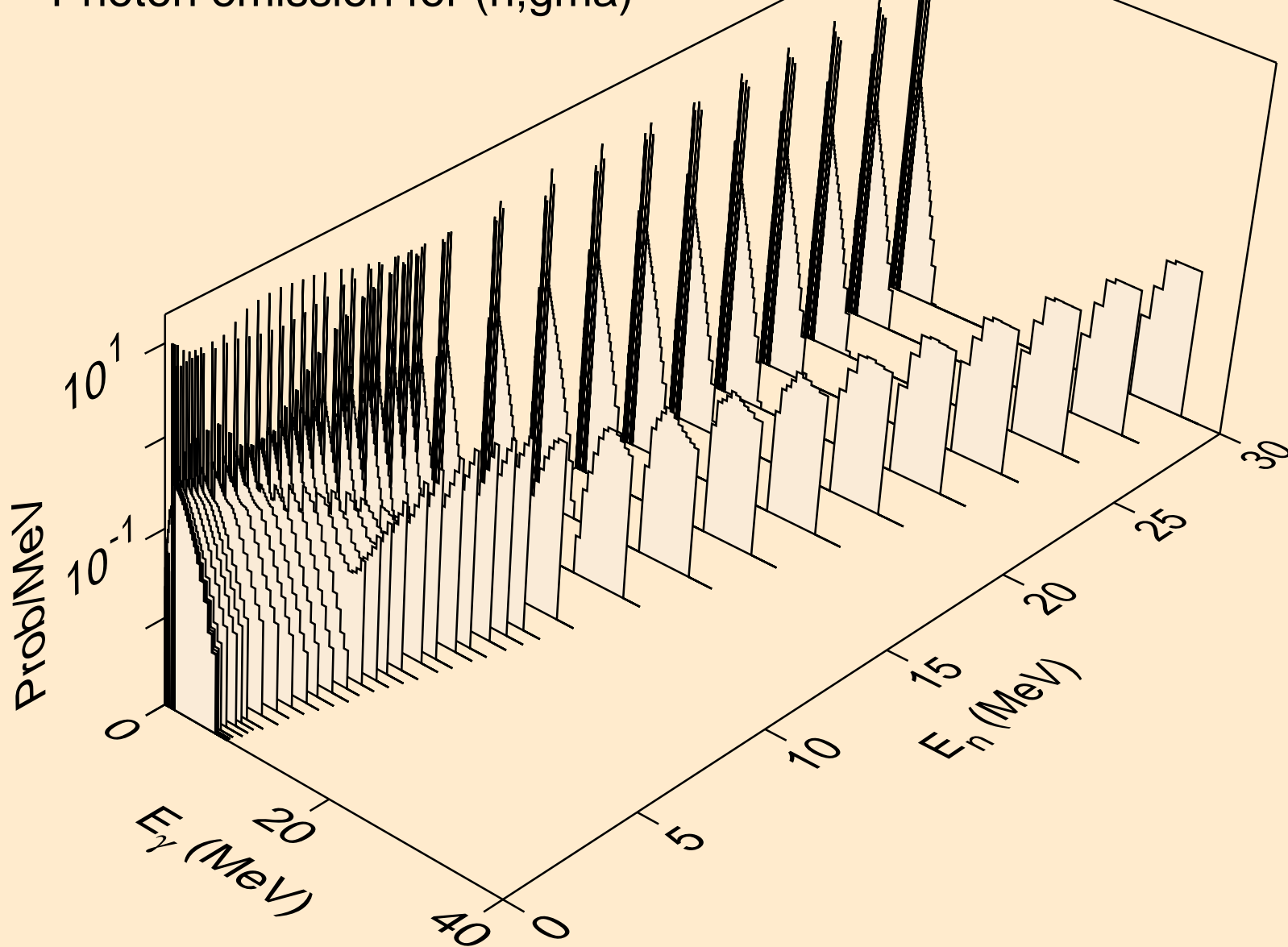

IN127N NEUTRON ACER TENDL-2019 LIBRARY; T=293.16K  
Photon emission for (n,p)

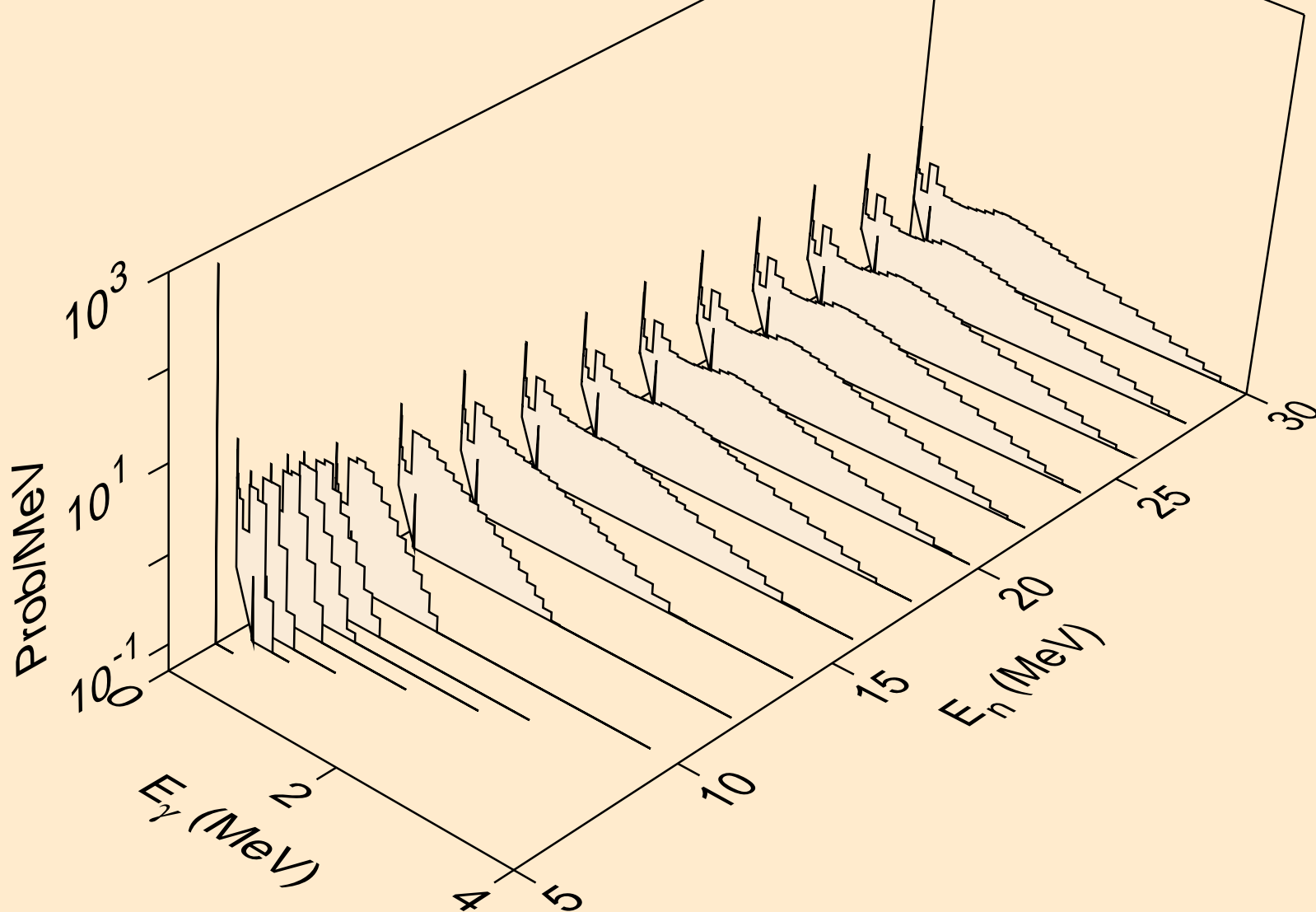

IN127N NEUTRON ACER TENDL-2019 LIBRARY; T=293.16K  
Photon emission for (n,d)

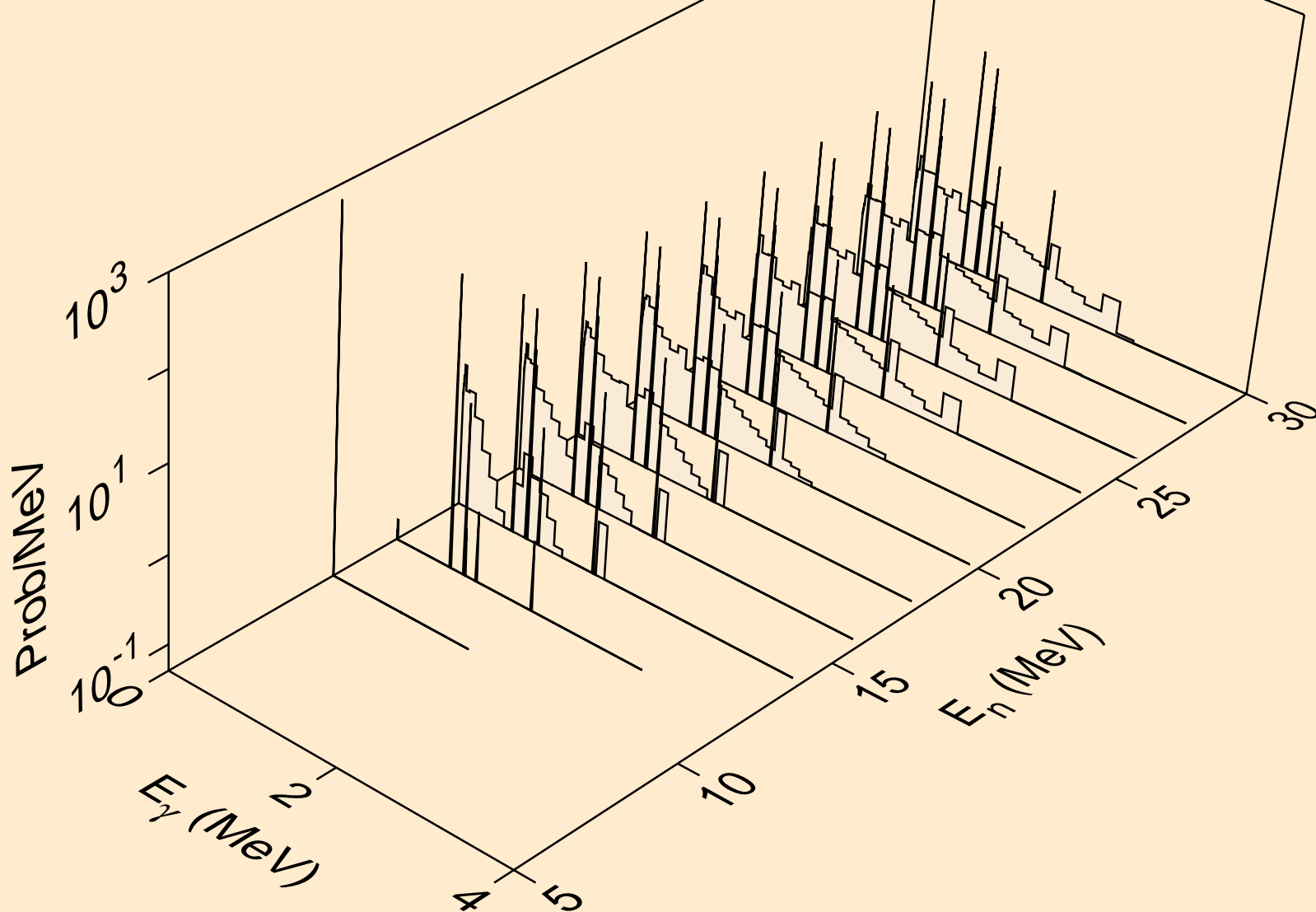

IN127N NEUTRON ACER TENDL-2019 LIBRARY; T=293.16K  
Photon emission for (n,t)

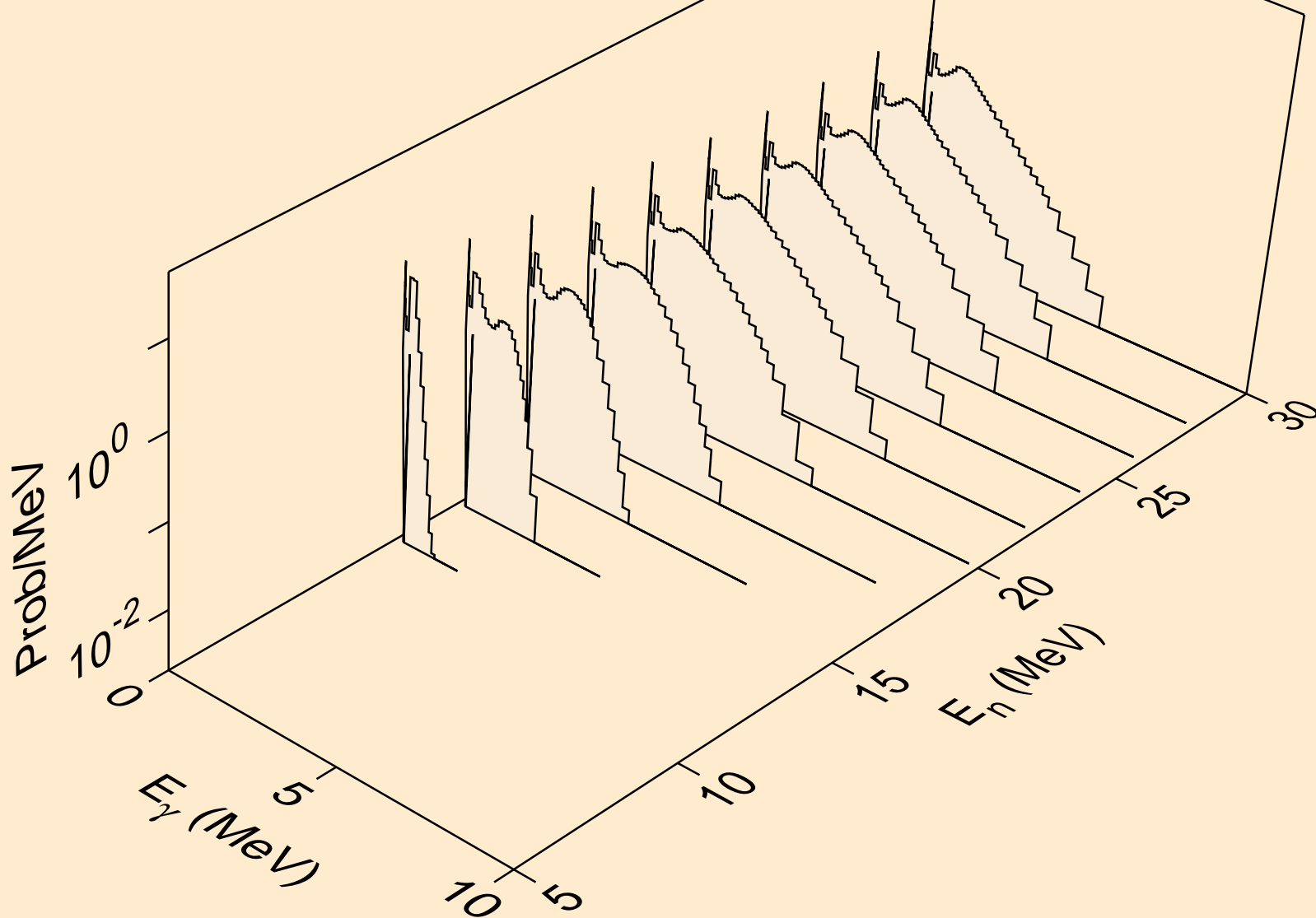

IN127N NEUTRON ACER TENDL-2019 LIBRARY; T=293.16K  
Photon emission for (n,he3)

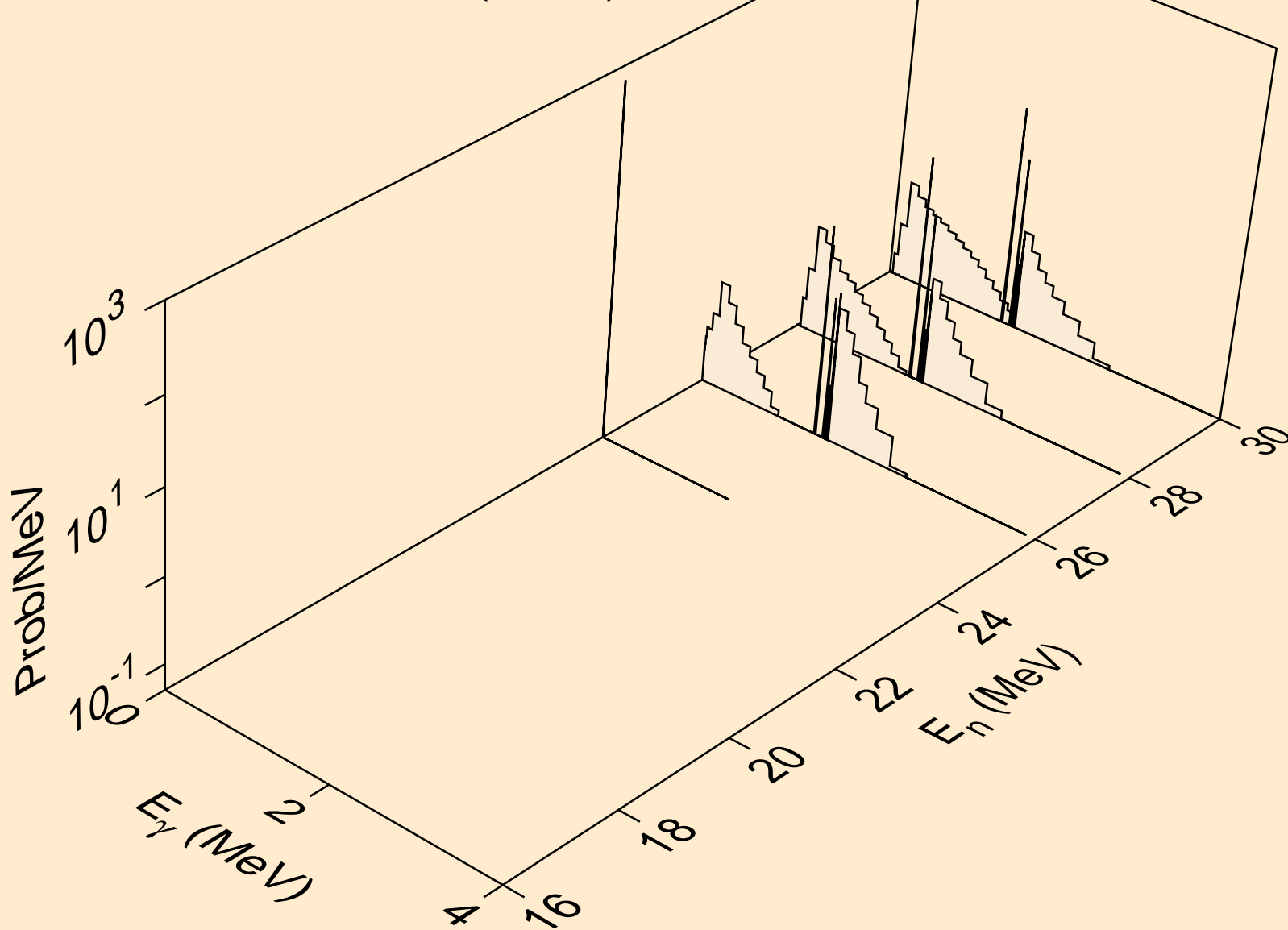

IN127N NEUTRON ACER TENDL-2019 LIBRARY; T=293.16K  
Photon emission for (n,a)

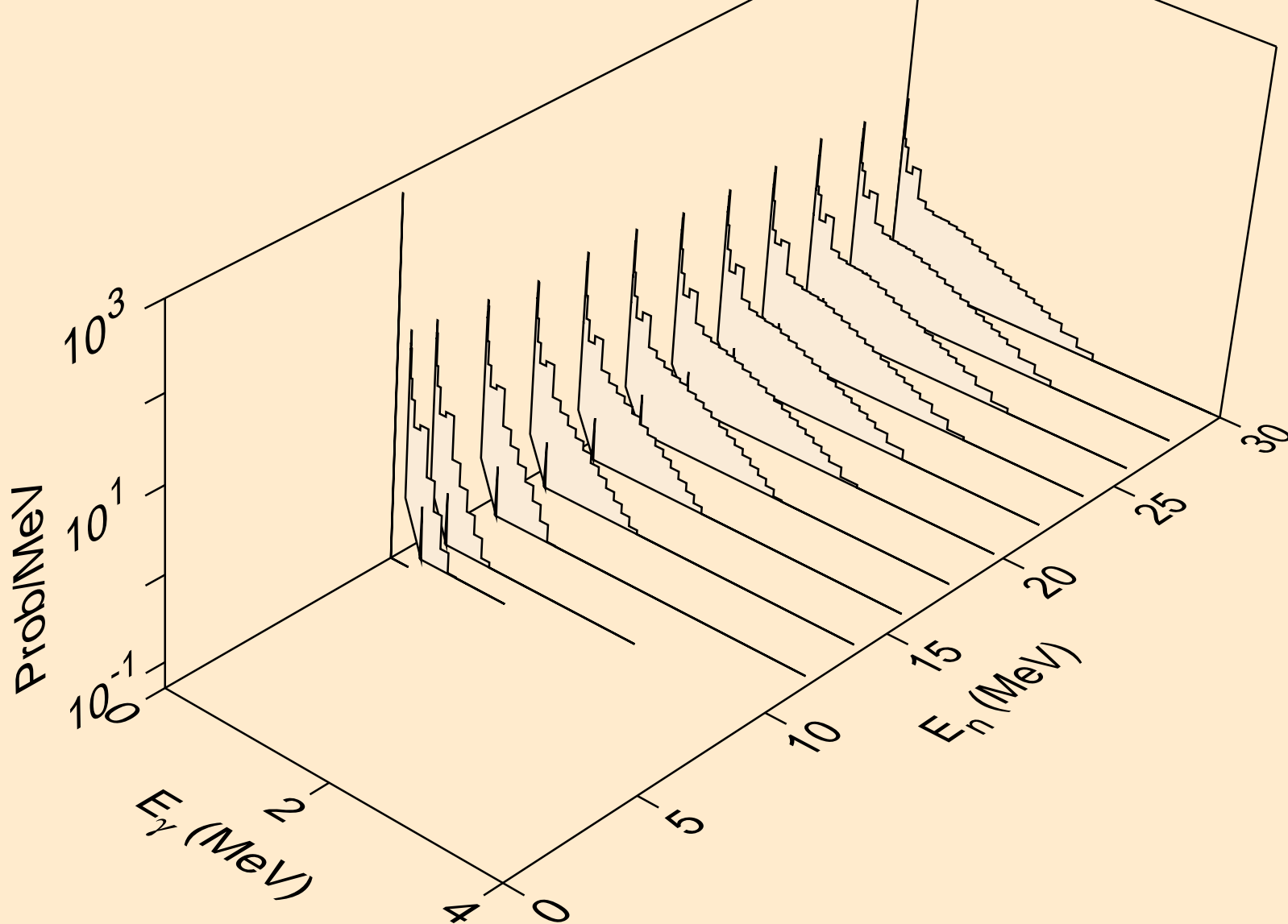



IN127N NEUTRON ACER TENDL-2019 LIBRARY; T=293.16K  
thermal capture photon spectrum

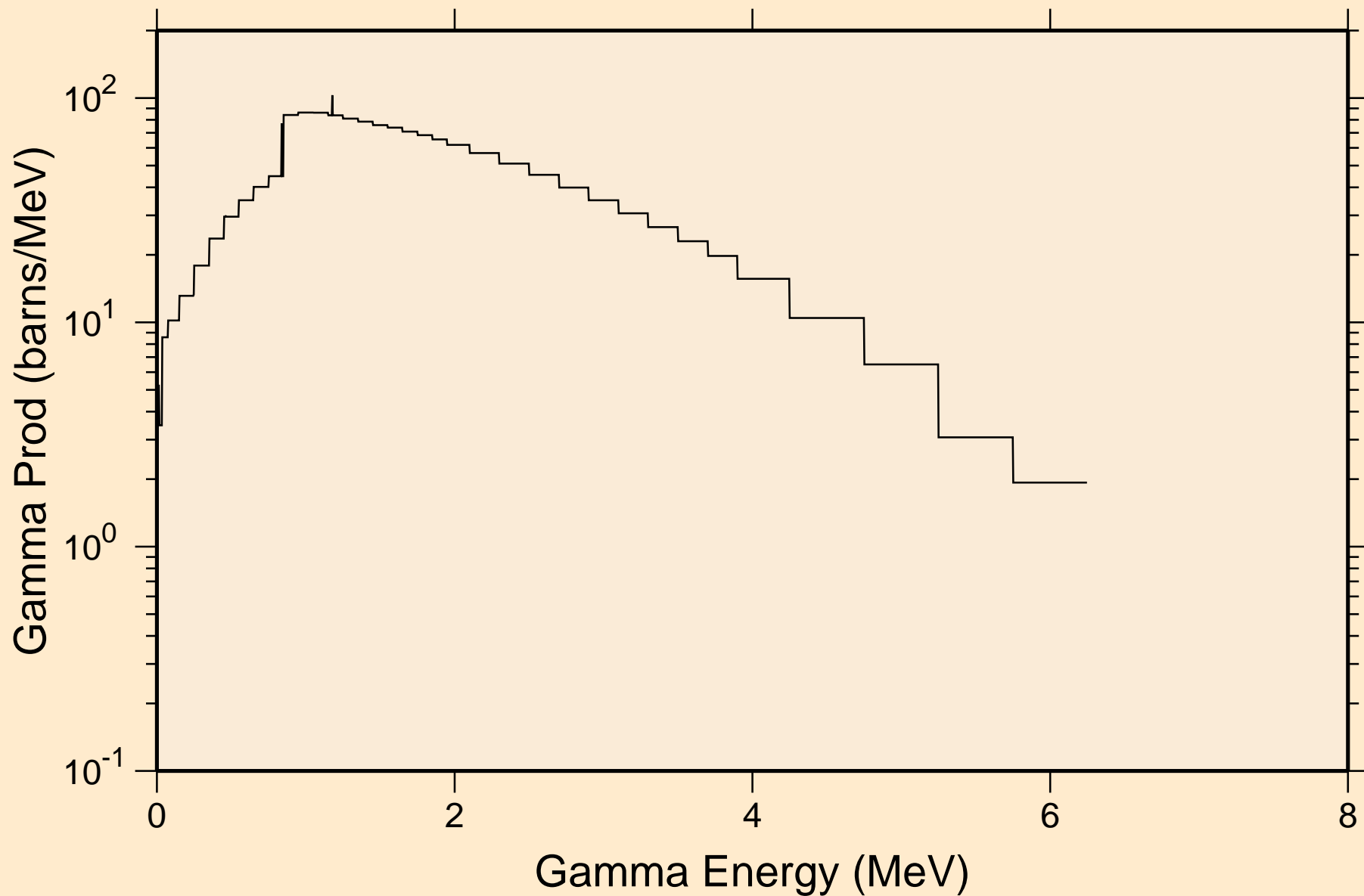

IN127N NEUTRON ACER TENDL-2019 LIBRARY; T=293.16K  
14 MeV photon spectrum

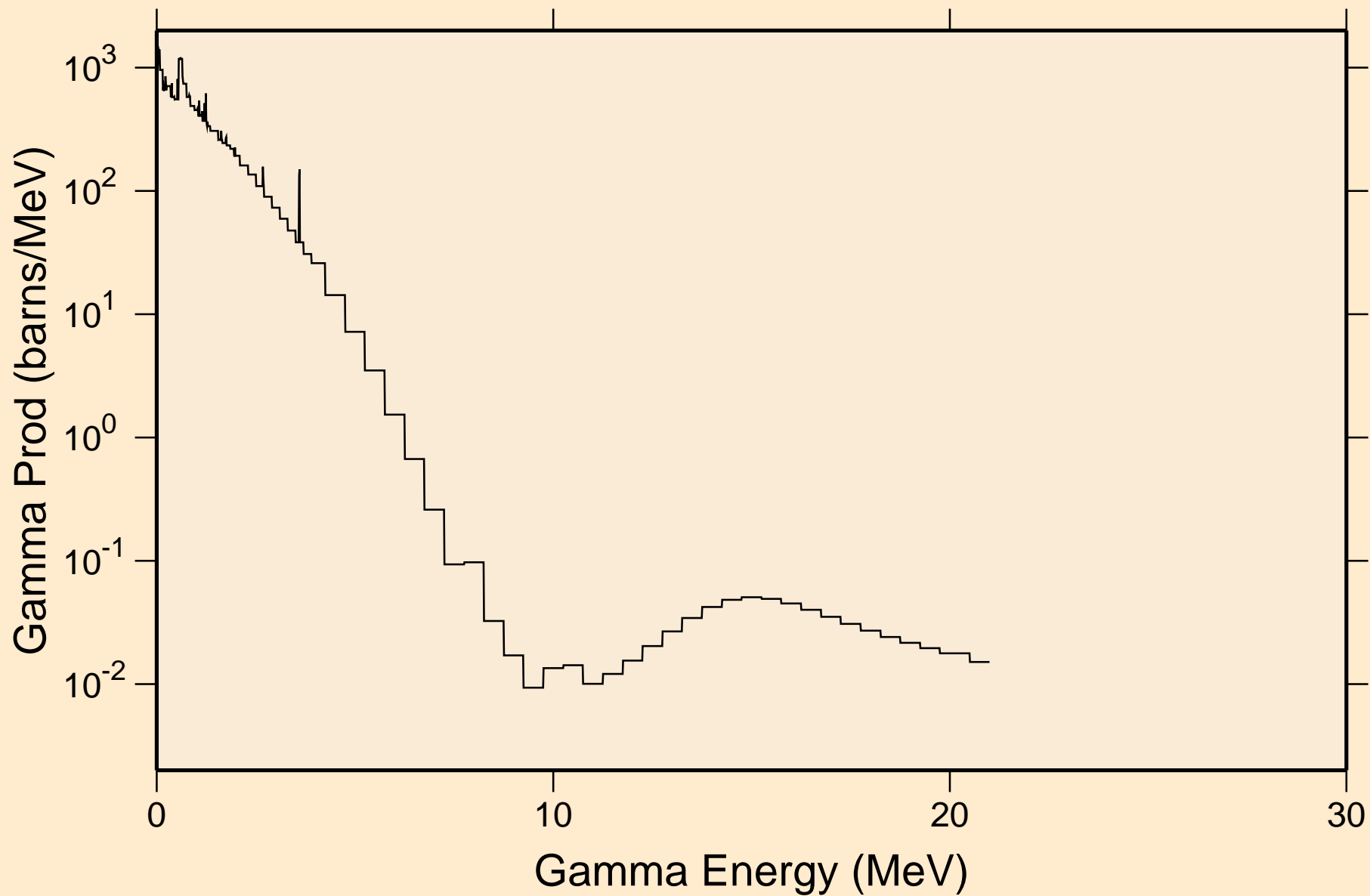

IN127N NEUTRON ACER TENDL-2019 LIBRARY; T=293.16K  
Particle heating contributions

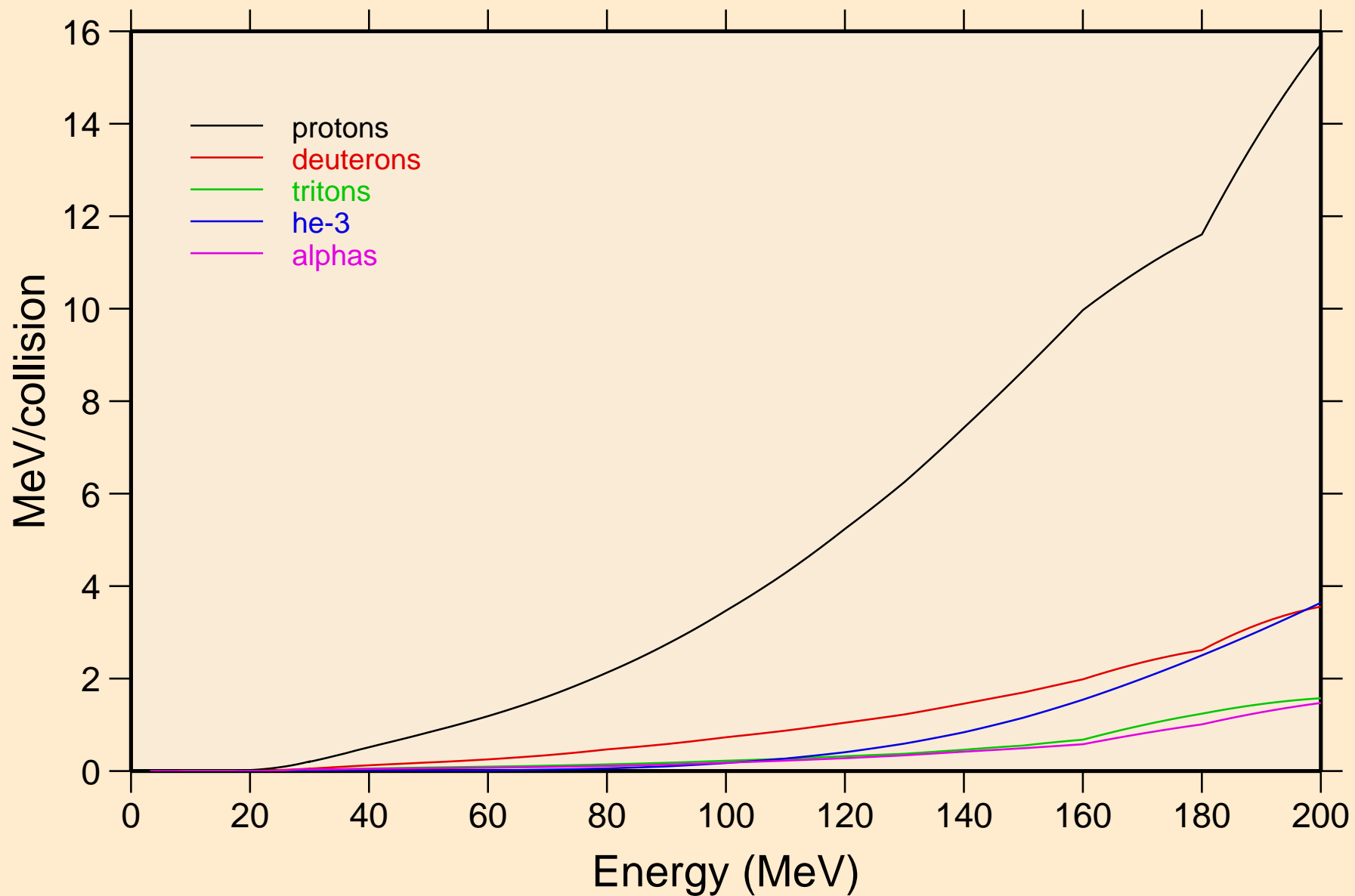

IN127N NEUTRON ACER TENDL-2019 LIBRARY; T=293.16K  
Recoil Heating

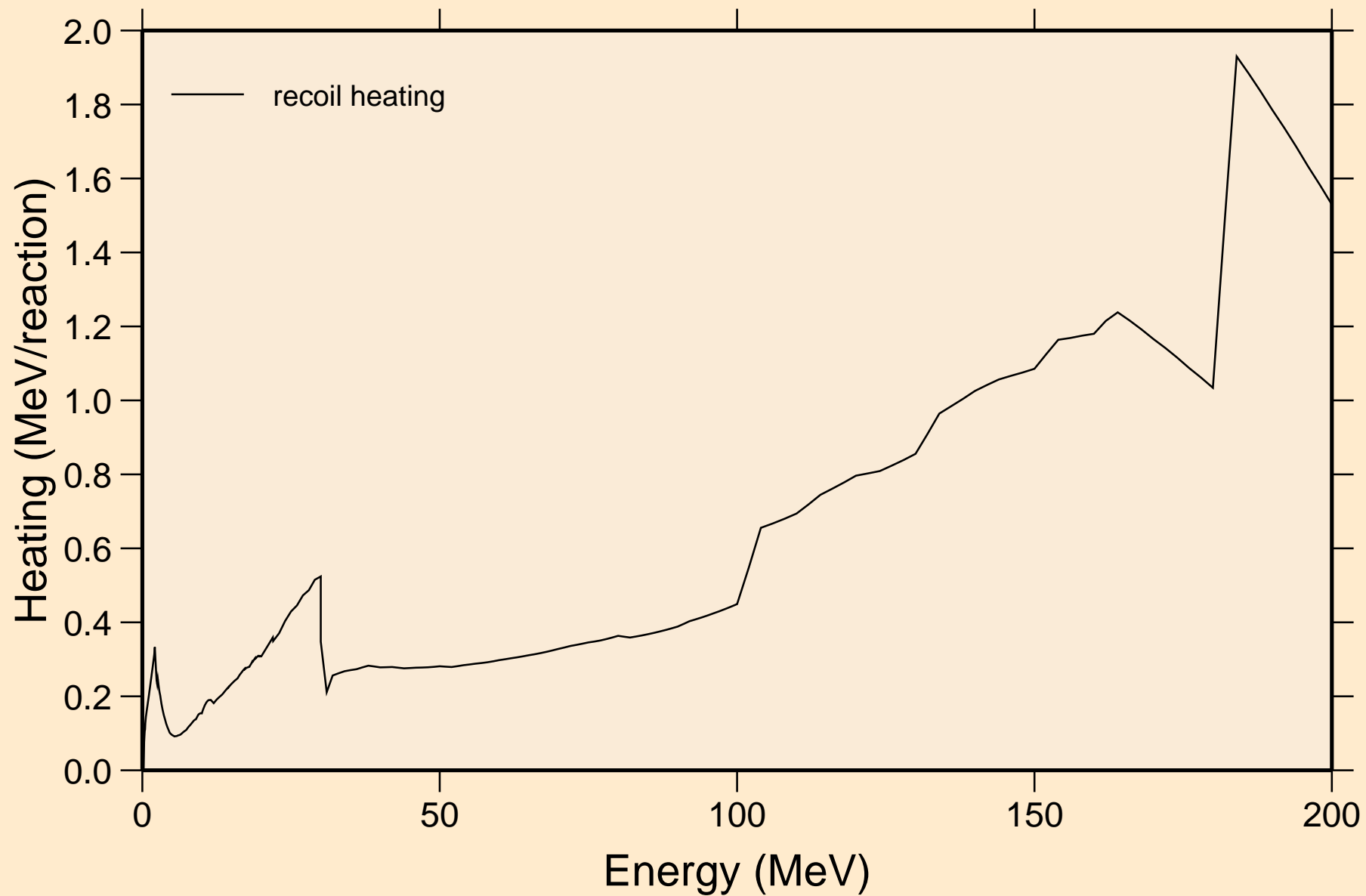

IN127N NEUTRON ACER TENDL-2019 LIBRARY; T=293.16K  
Particle production cross sections

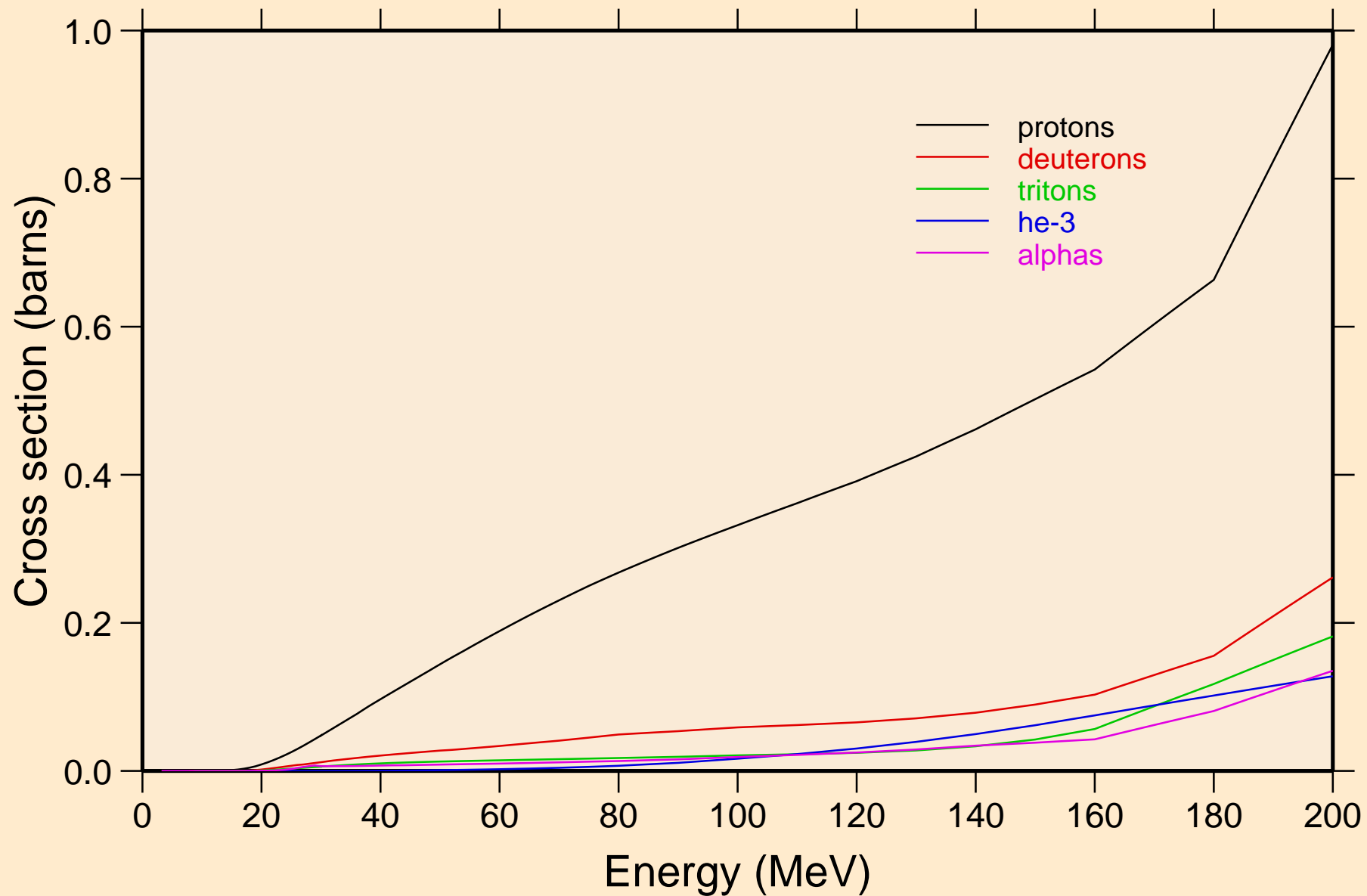

IN127N NEUTRON ACER TENDL-2019 LIBRARY; T=293.16K  
protons from (n,x)

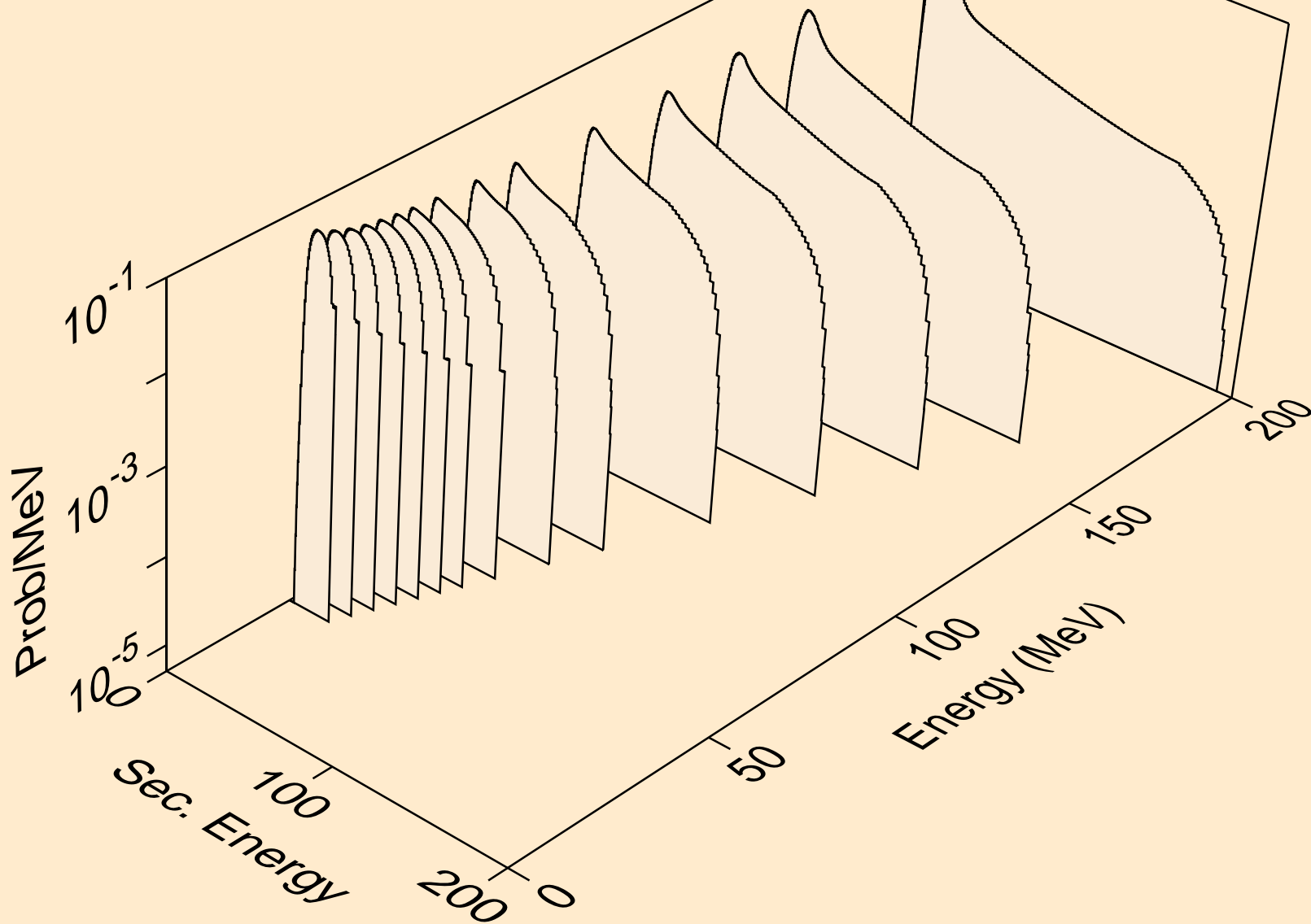

IN127N NEUTRON ACER TENDL-2019 LIBRARY; T=293.16K  
protons from (n,n\*)p

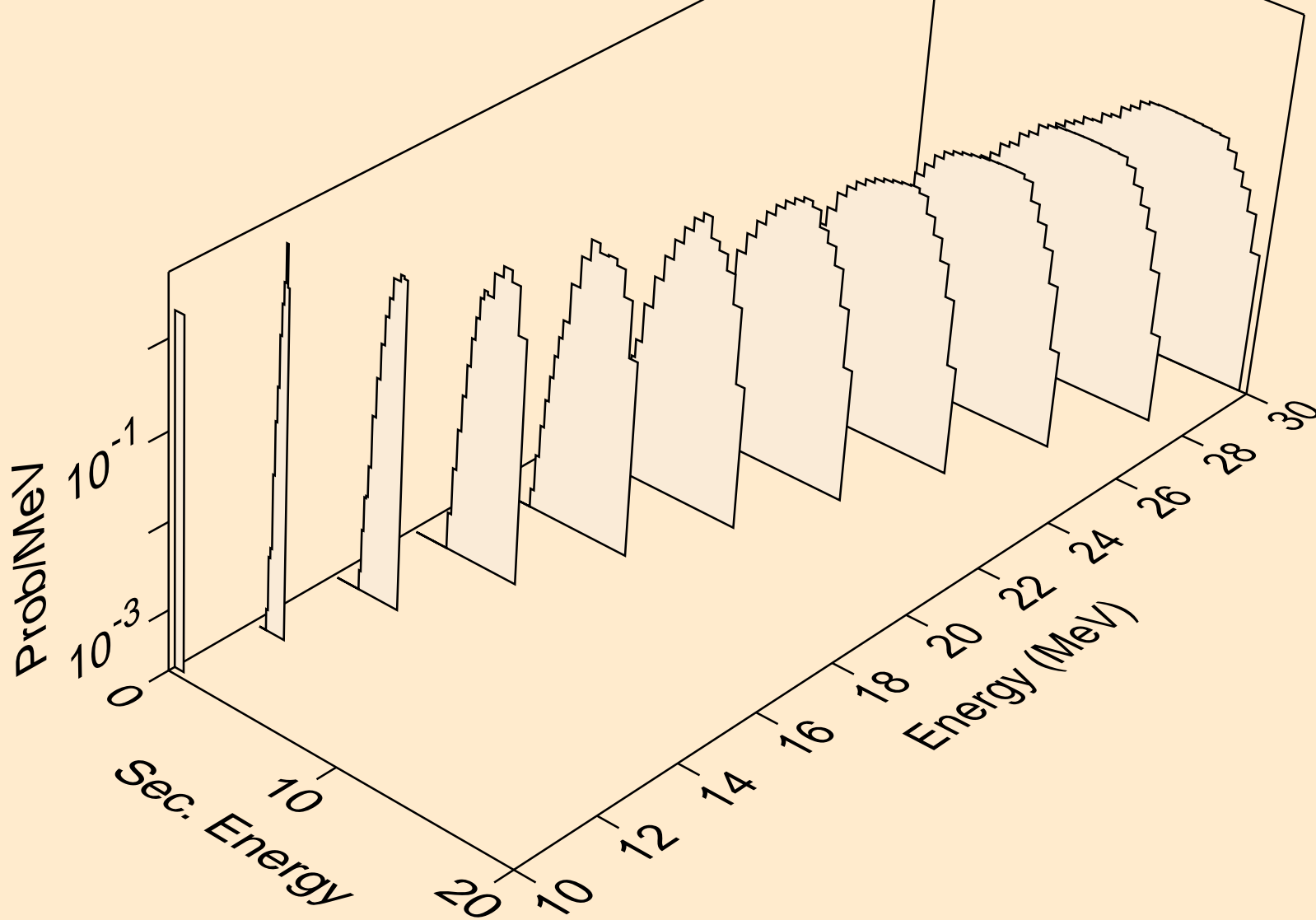

IN127N NEUTRON ACER TENDL-2019 LIBRARY; T=293.16K  
protons from (n,2np)

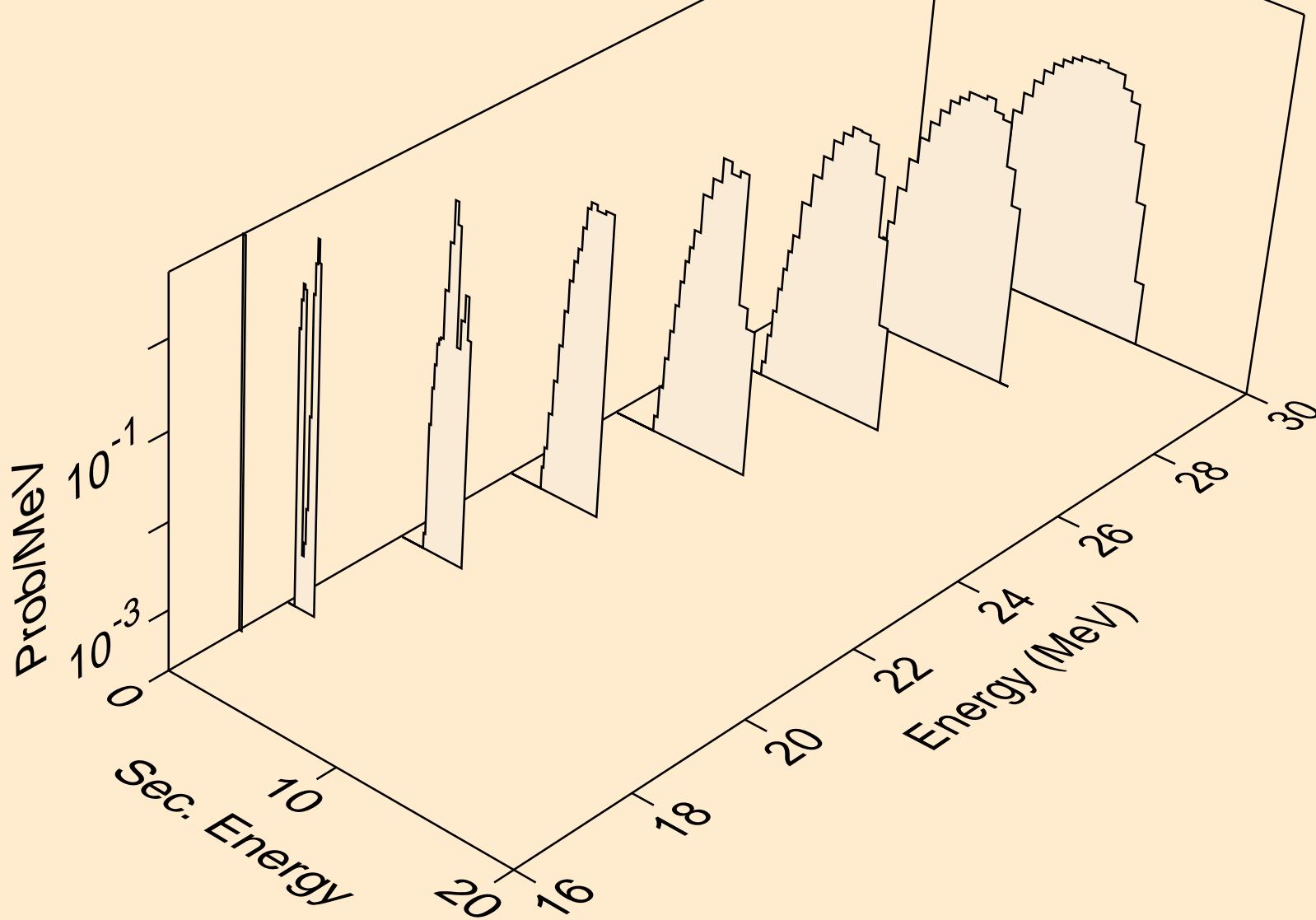



IN127N NEUTRON ACER TENDL-2019 LIBRARY; T=293.16K  
protons from (n,3np)

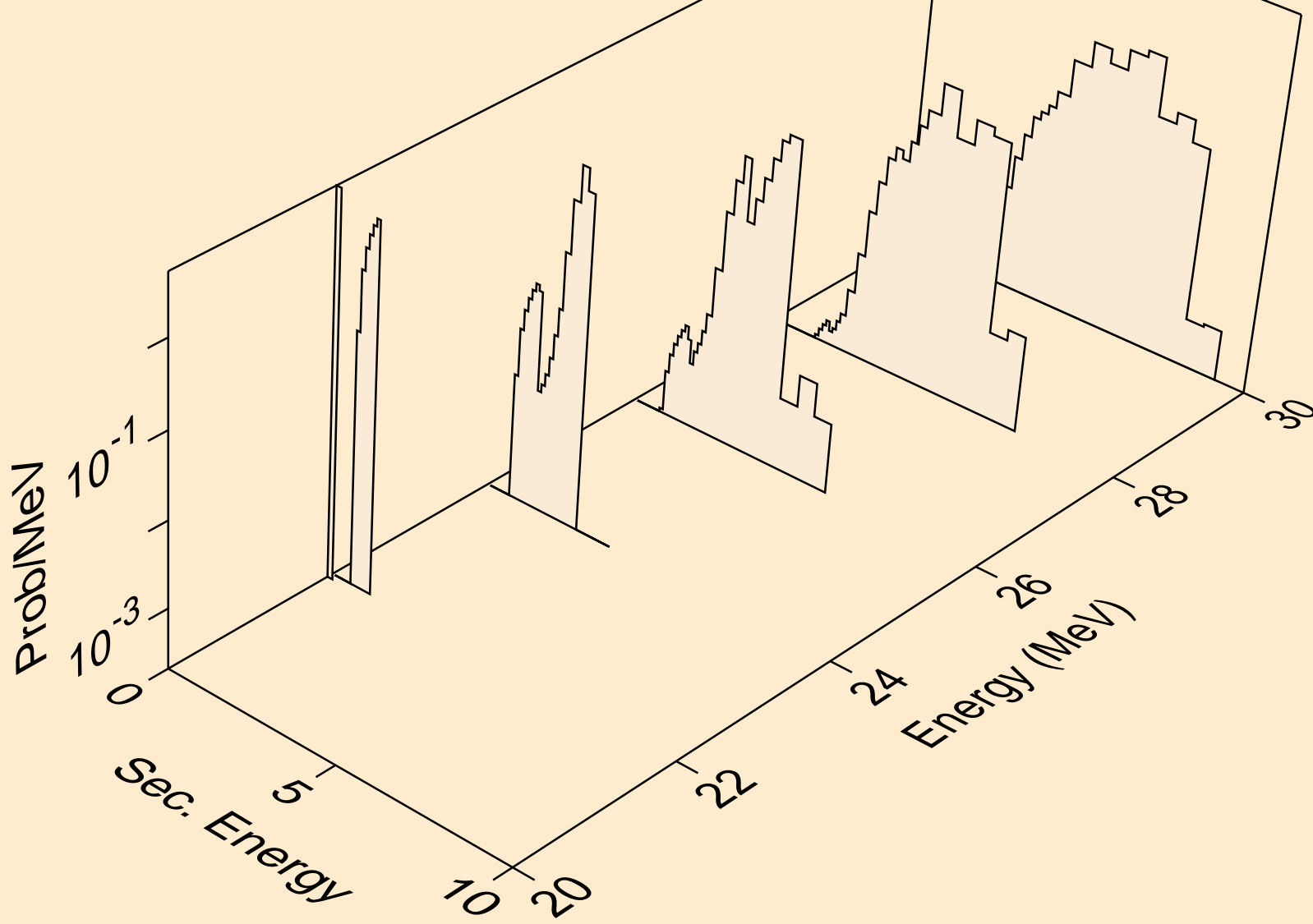

IN127N NEUTRON ACER TENDL-2019 LIBRARY; T=293.16K  
protons from (n,p)

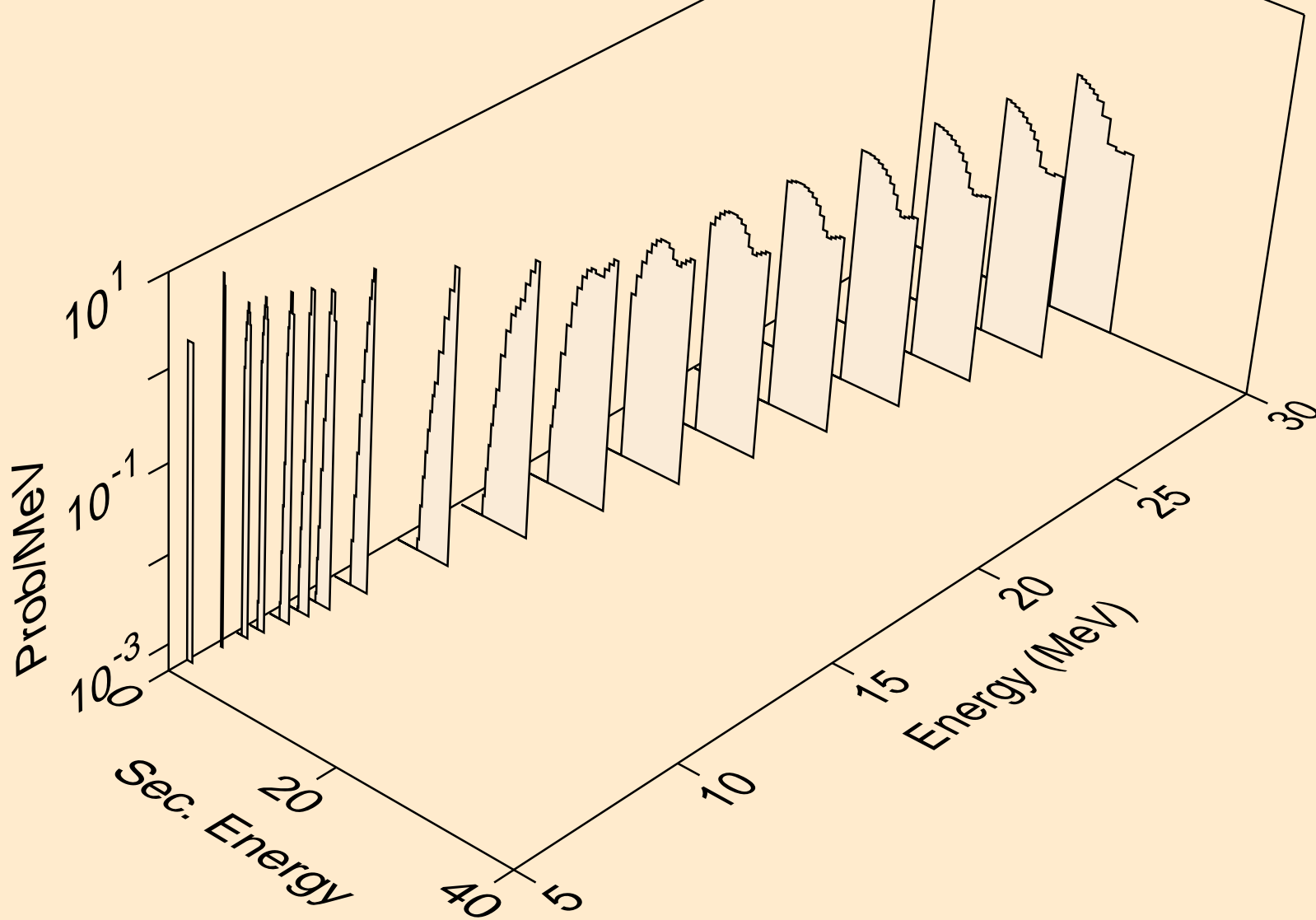

IN127N NEUTRON ACER TENDL-2019 LIBRARY; T=293.16K  
deuterons from (n,x)

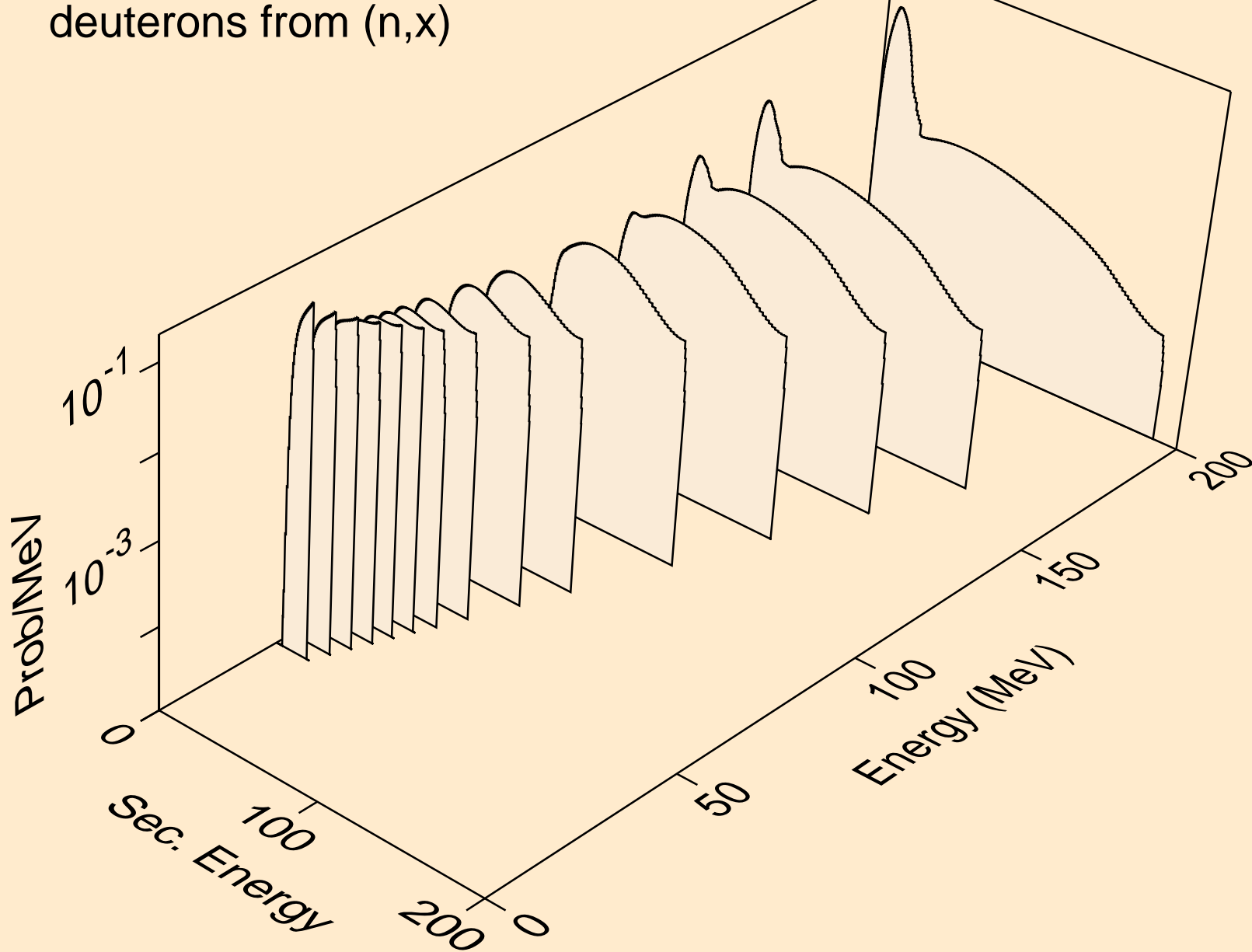

IN127N NEUTRON ACER TENDL-2019 LIBRARY; T=293.16K  
deuterons from (n,2nd)

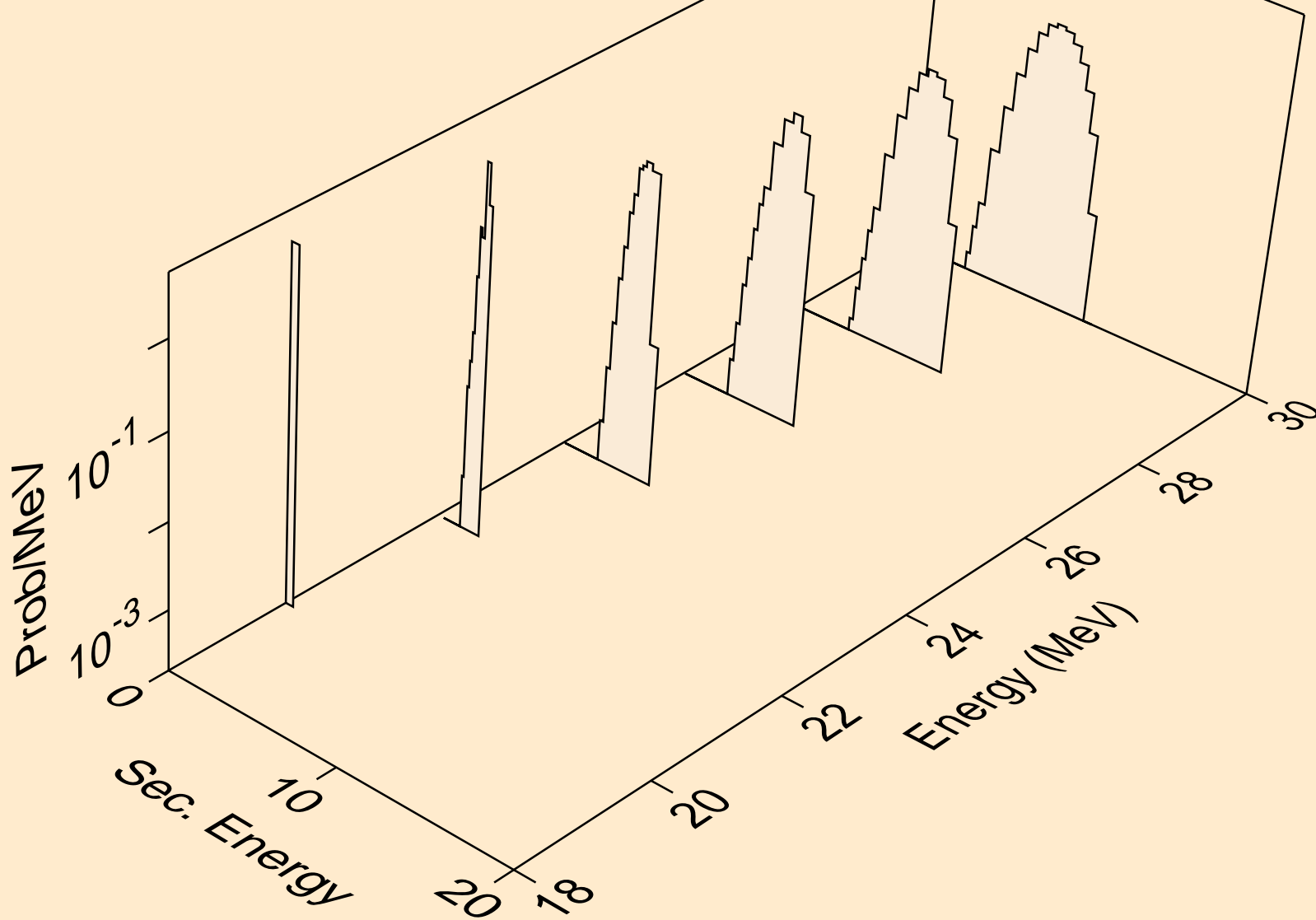

IN127N NEUTRON ACER TENDL-2019 LIBRARY; T=293.16K  
deuterons from (n,n\*)d

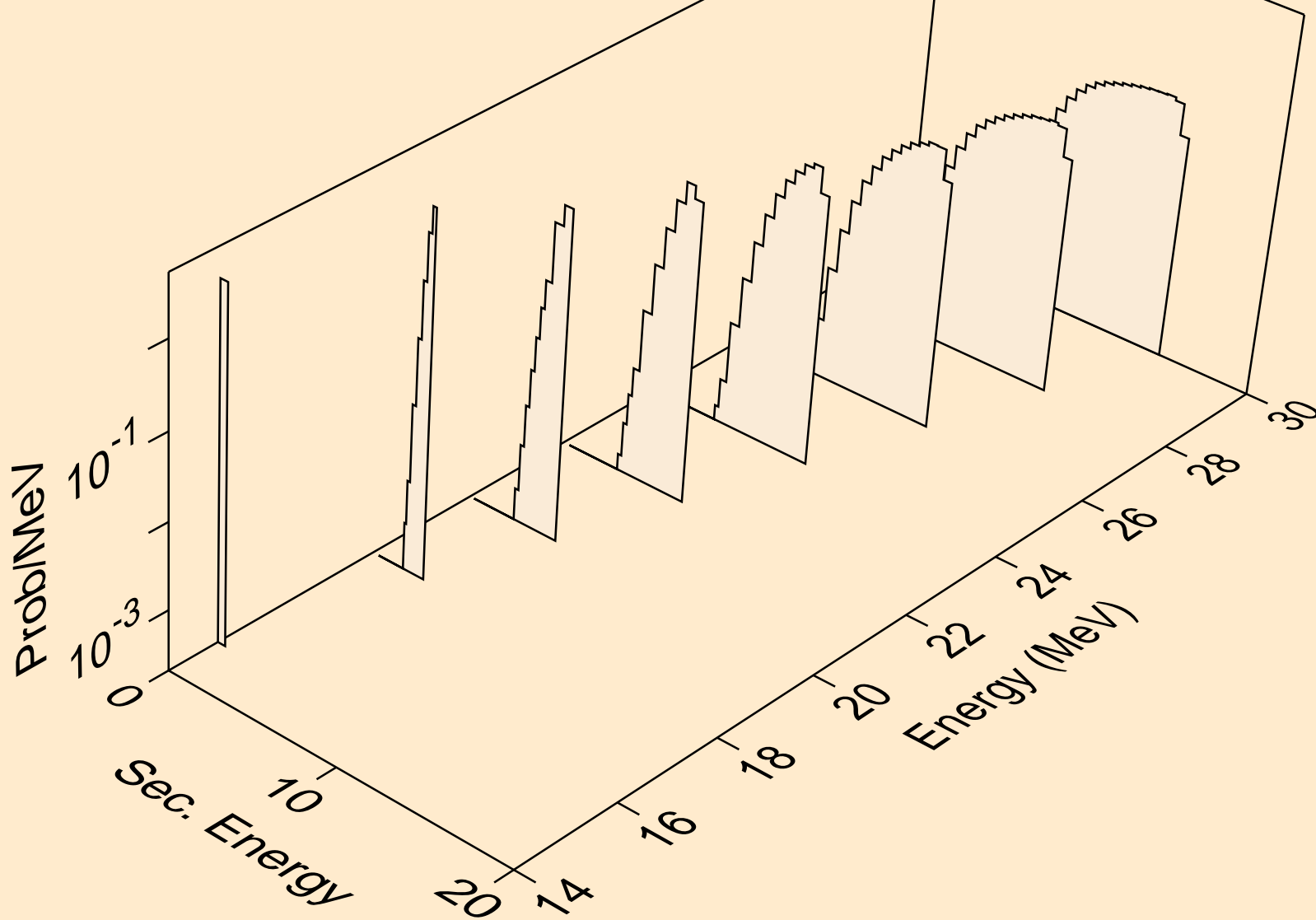

IN127N NEUTRON ACER TENDL-2019 LIBRARY; T=293.16K  
deuterons from (n,d)

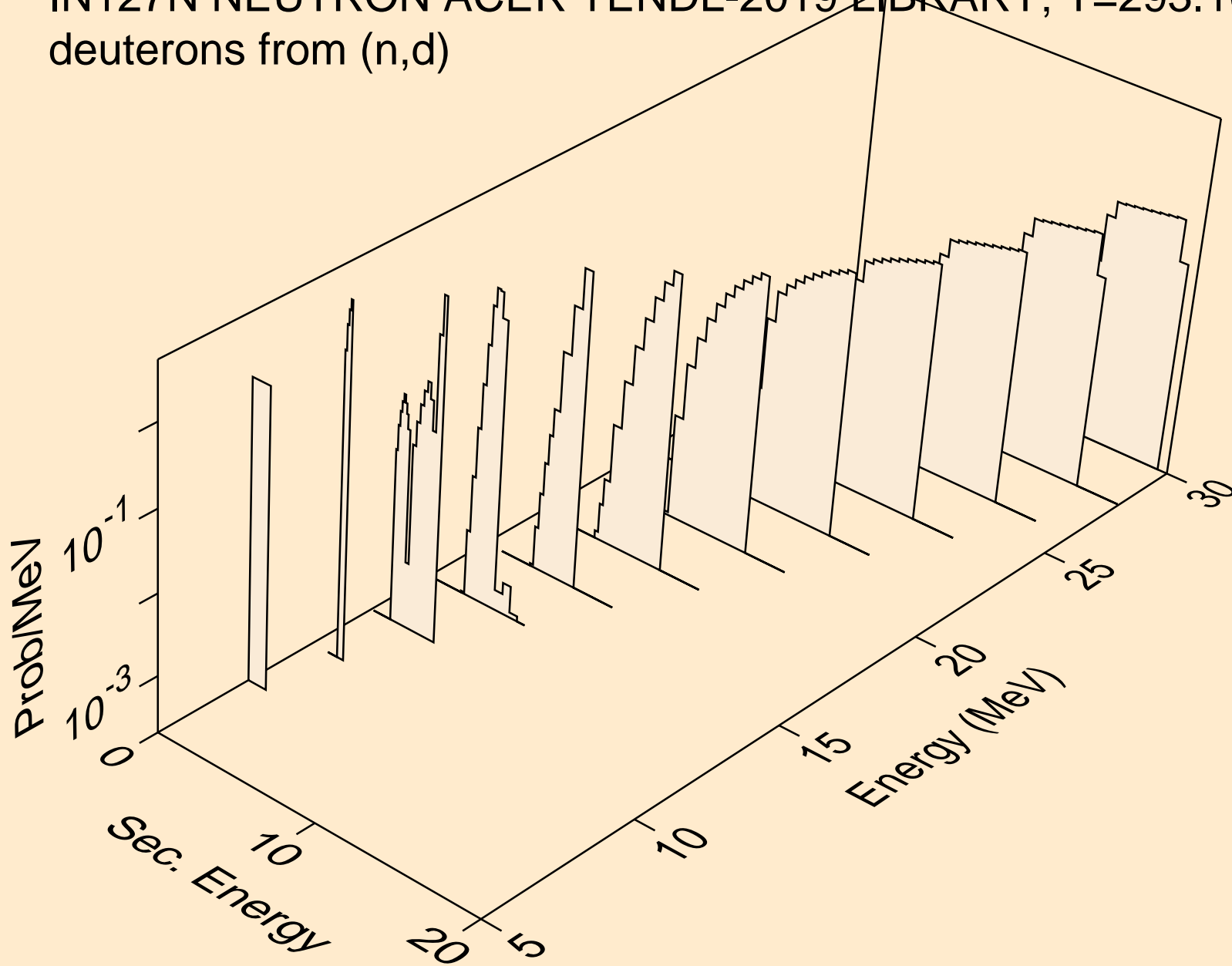

IN127N NEUTRON ACER TENDL-2019 LIBRARY; T=293.16K  
tritons from (n,x)

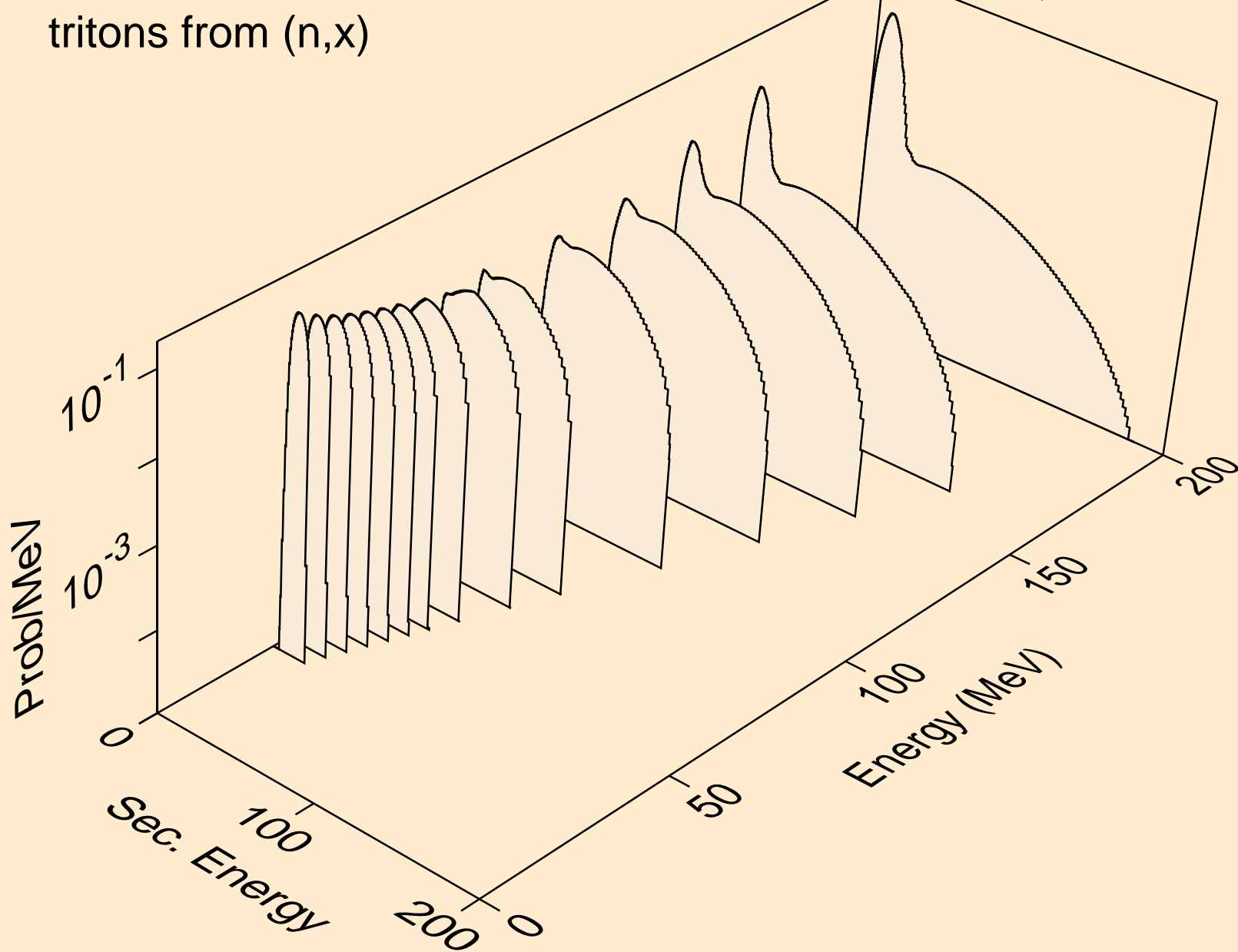

IN127N NEUTRON ACER TENDL-2019 LIBRARY; T=293.16K  
tritons from (n,n\*)t

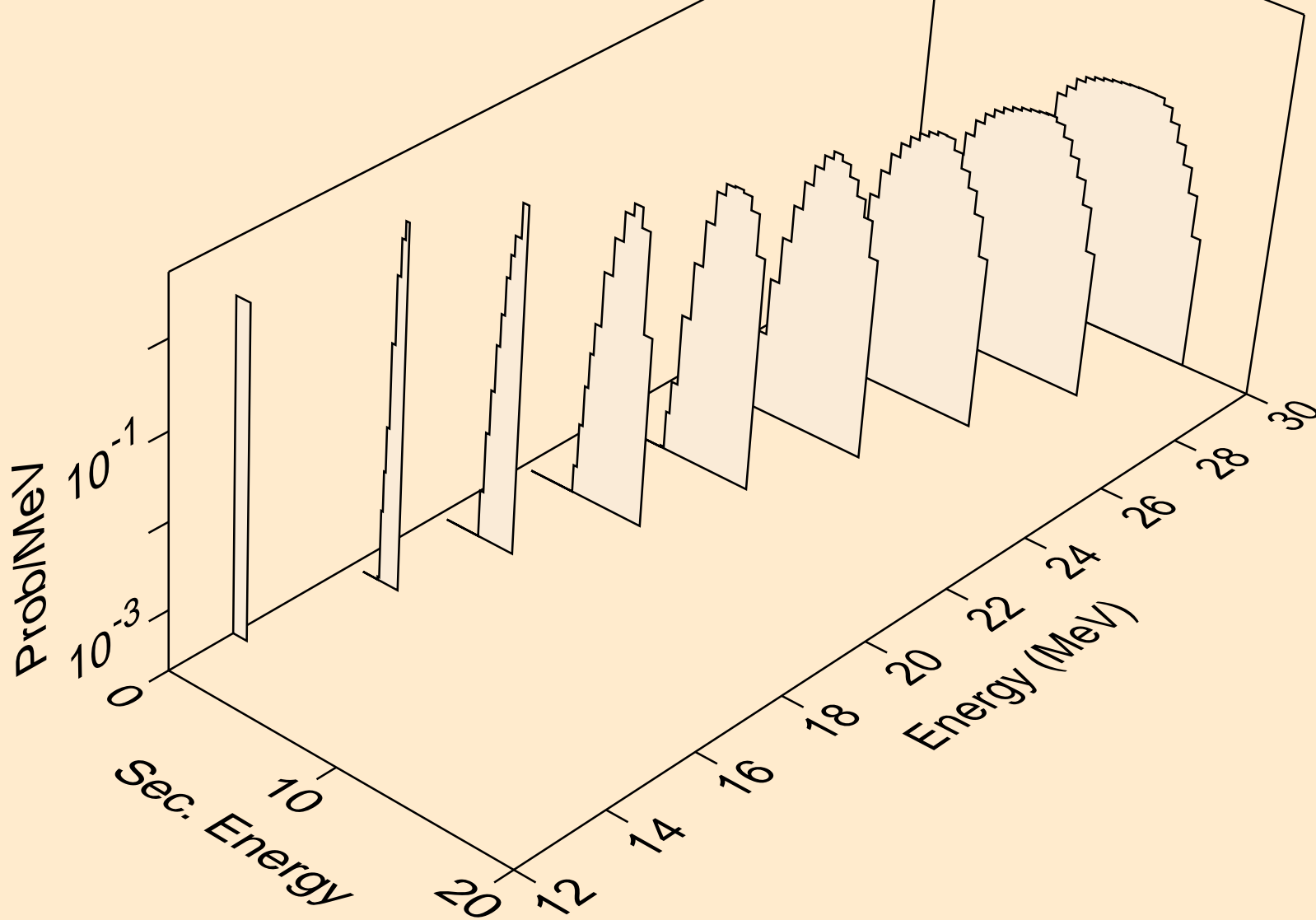



IN127N NEUTRON ACER TENDL-2019 LIBRARY; T=293.16K  
tritons from (n,t)

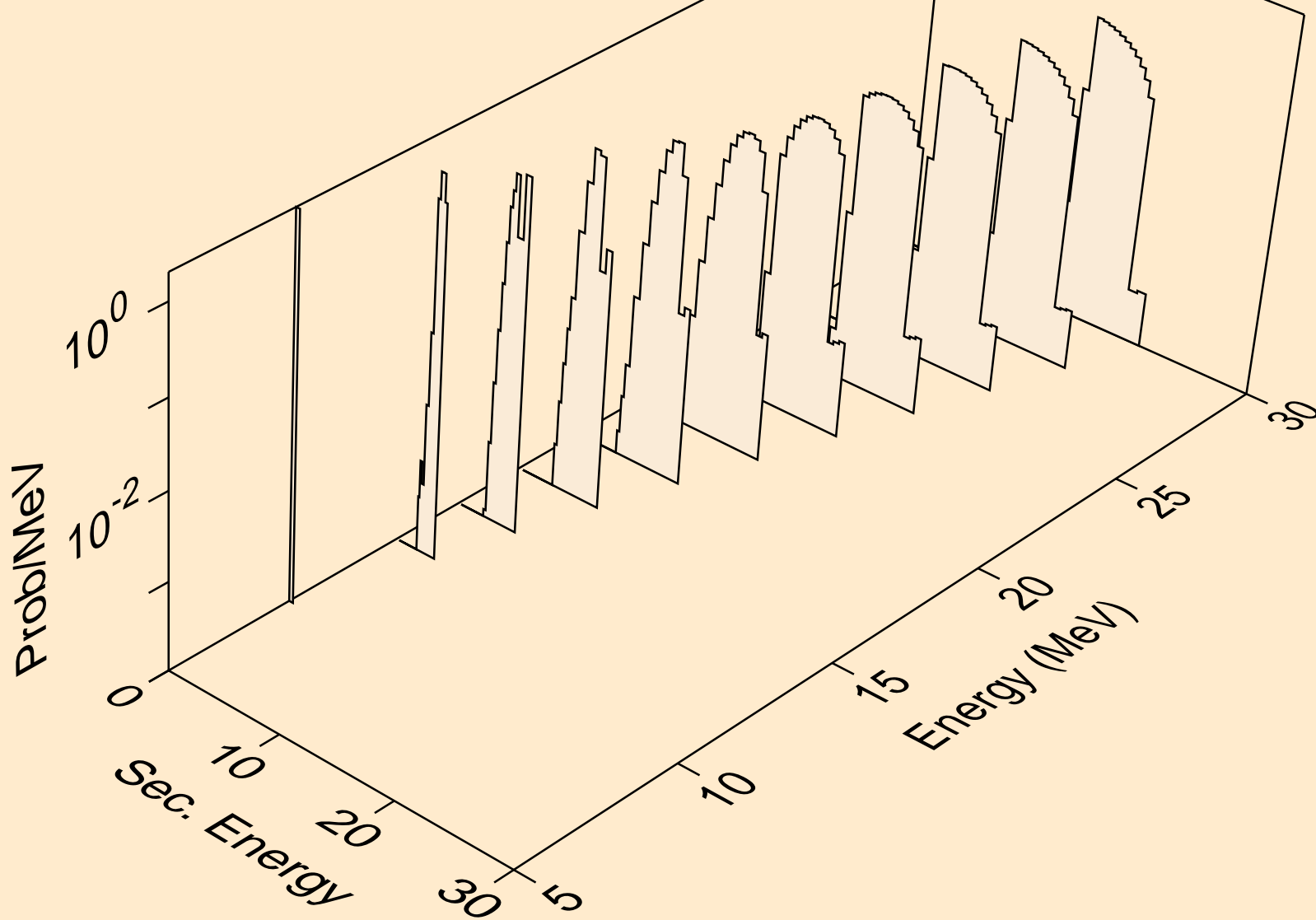

IN127N NEUTRON ACER TENDL-2019 LIBRARY; T=293.16K  
he3s from (n,x)

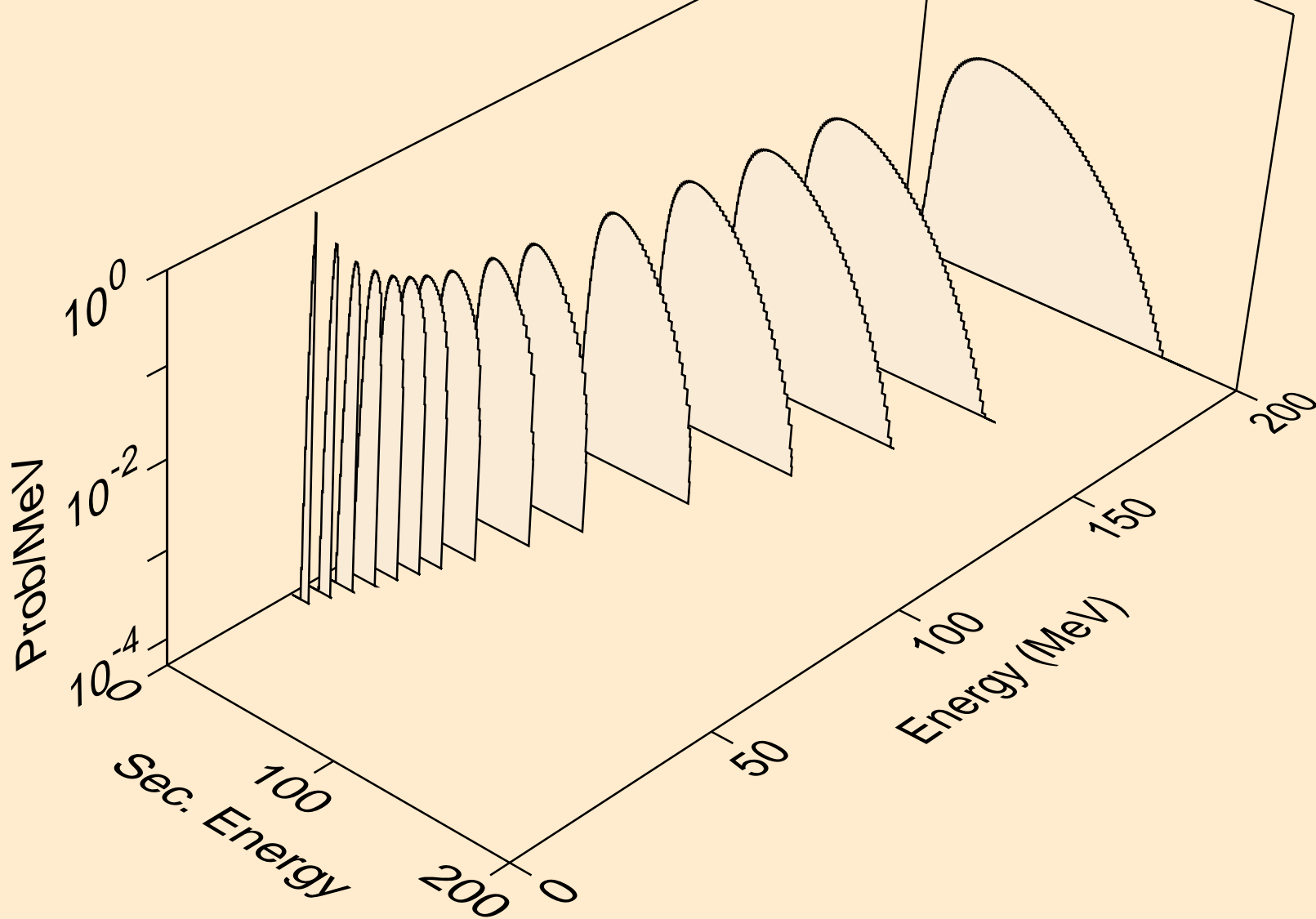

IN127N NEUTRON ACER TENDL-2019 LIBRARY; T=293.16K  
he3s from (n,he3)

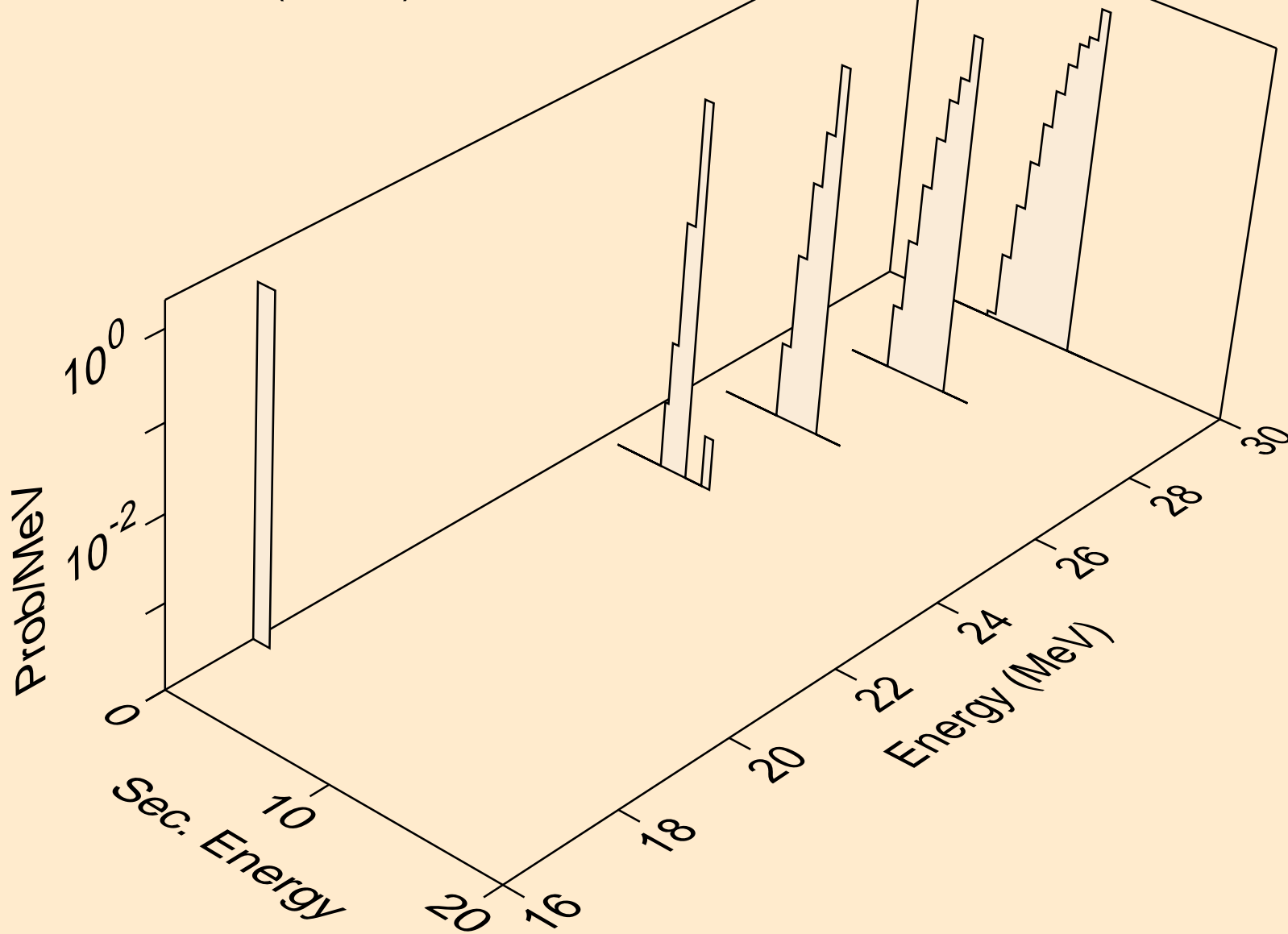

IN127N NEUTRON ACER TENDL-2019 LIBRARY; T=293.16K  
alphas from (n,x)

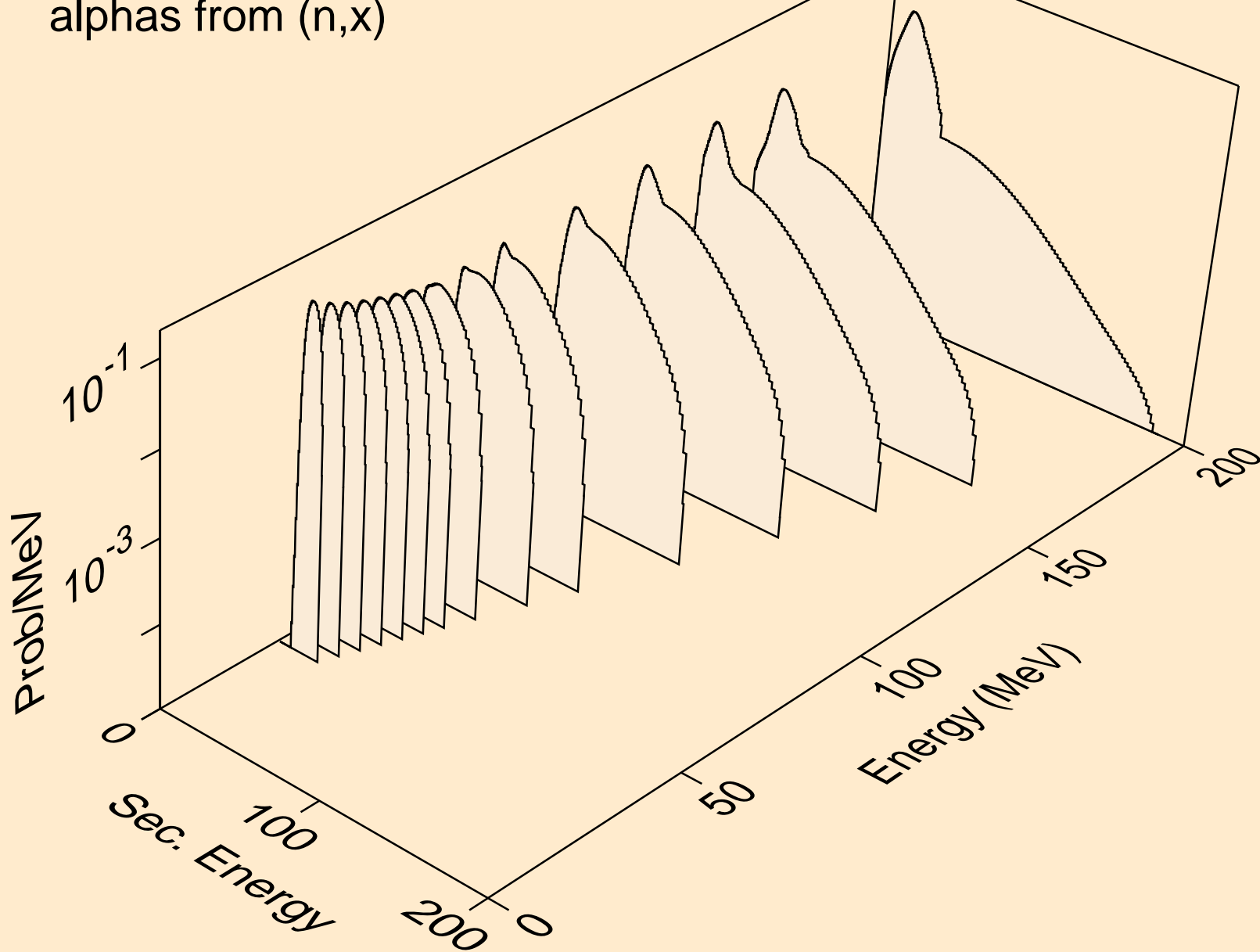

IN127N NEUTRON ACER TENDL-2019 LIBRARY; T=293.16K  
alphas from (n,n\*)a

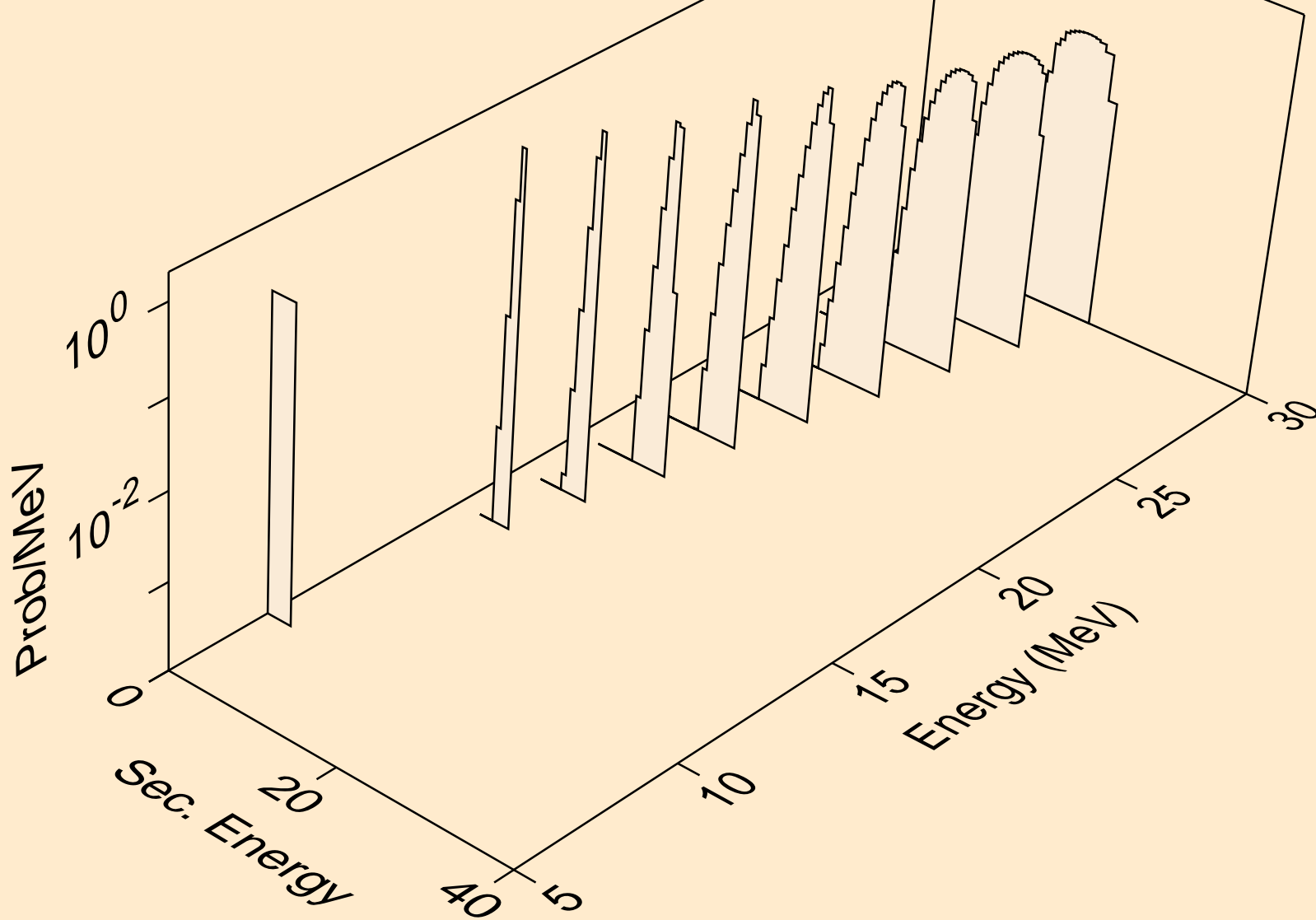

IN127N NEUTRON ACER TENDL-2019 LIBRARY; T=293.16K  
alphas from (n,2n)a

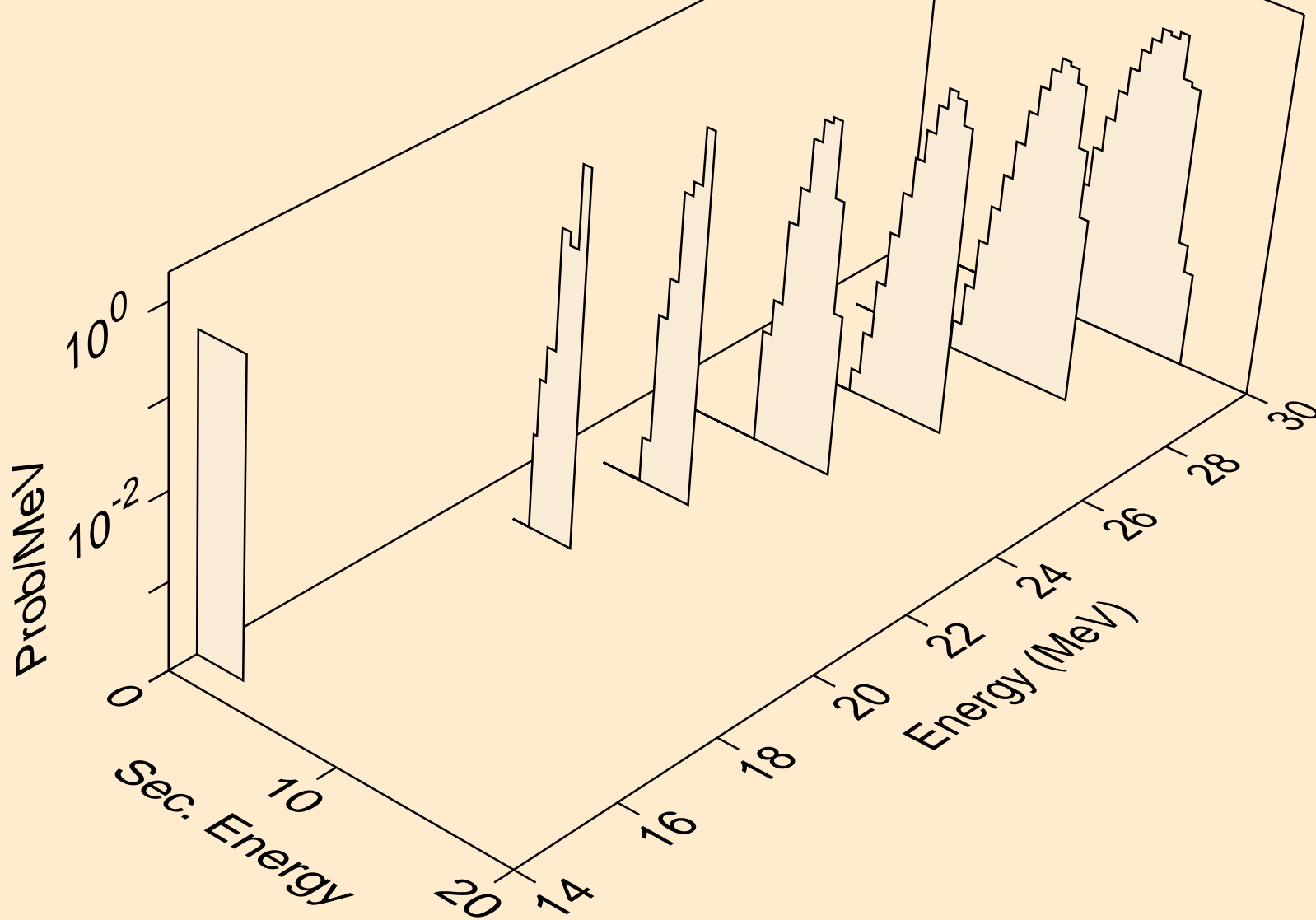

IN127N NEUTRON ACER TENDL-2019 LIBRARY; T=293.16K  
alphas from (n,3n)a

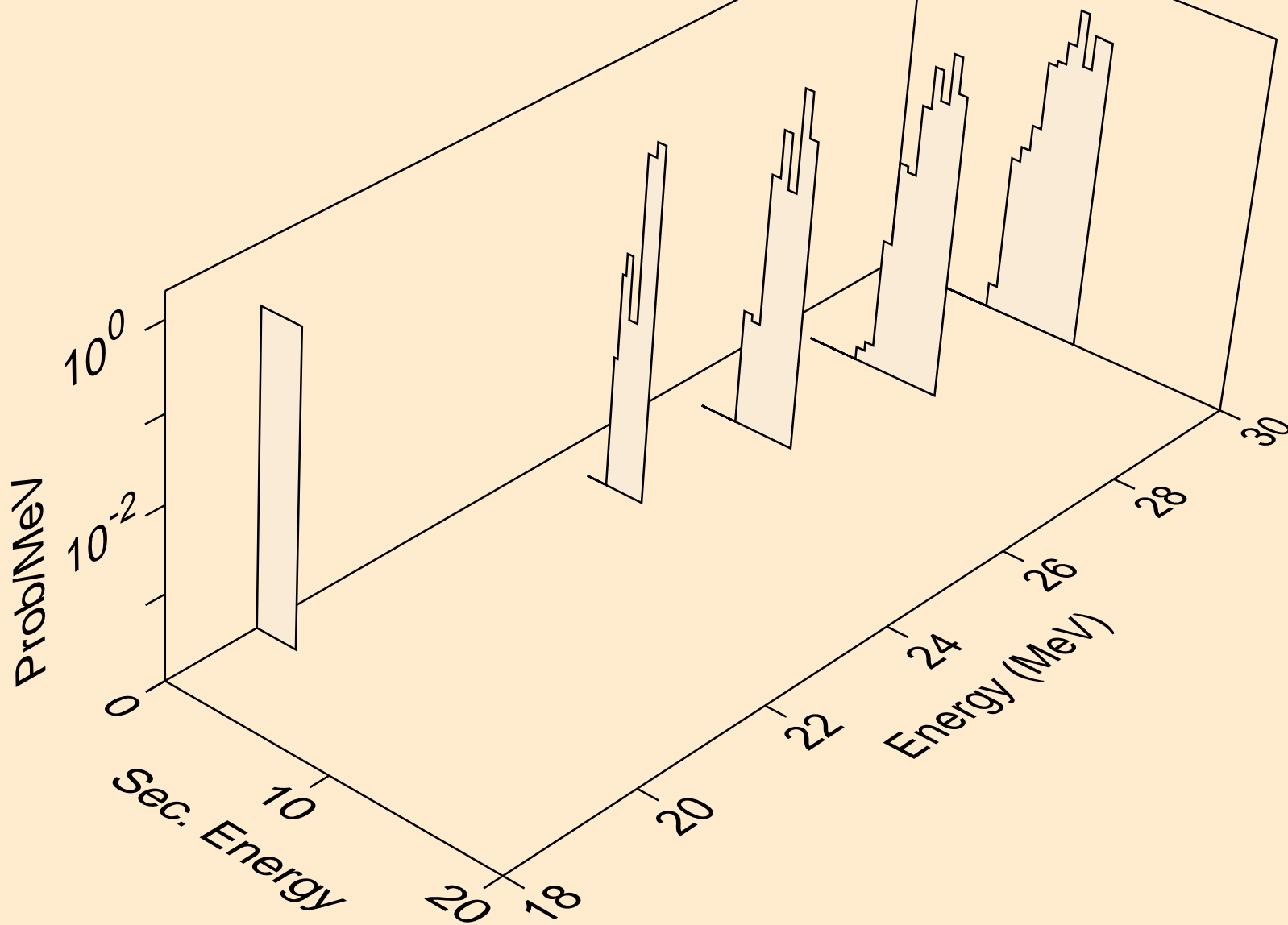

IN127N NEUTRON ACER TENDL-2019 LIBRARY; T=293.16K  
alphas from (n,a)

