

IR188 NEUTRON ACER TENDL-2019 LIBRARY; T=293.16K
Principal cross sections

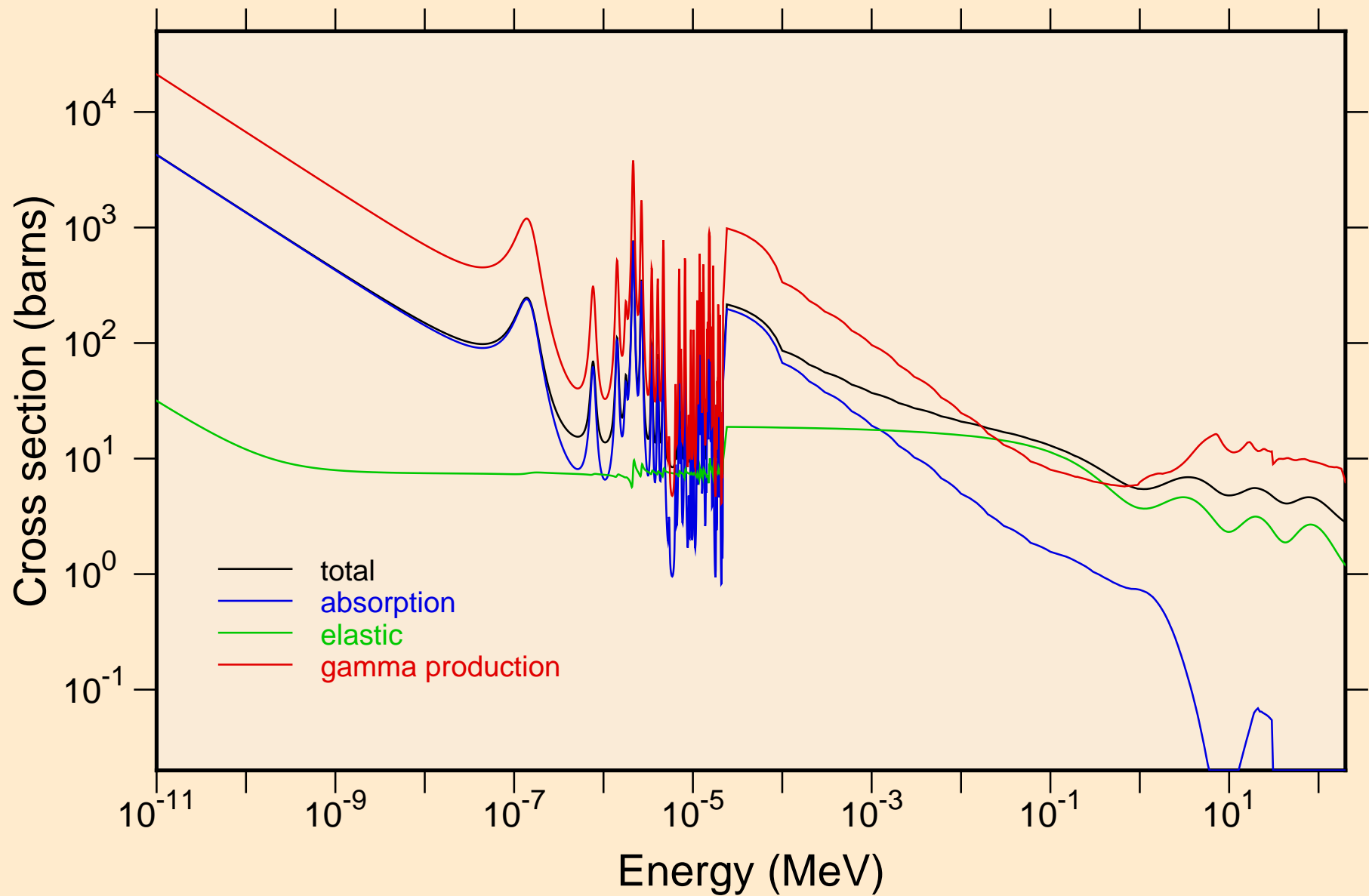

IR188 NEUTRON ACER TENDL-2019 LIBRARY; T=293.16K
resonance total cross section

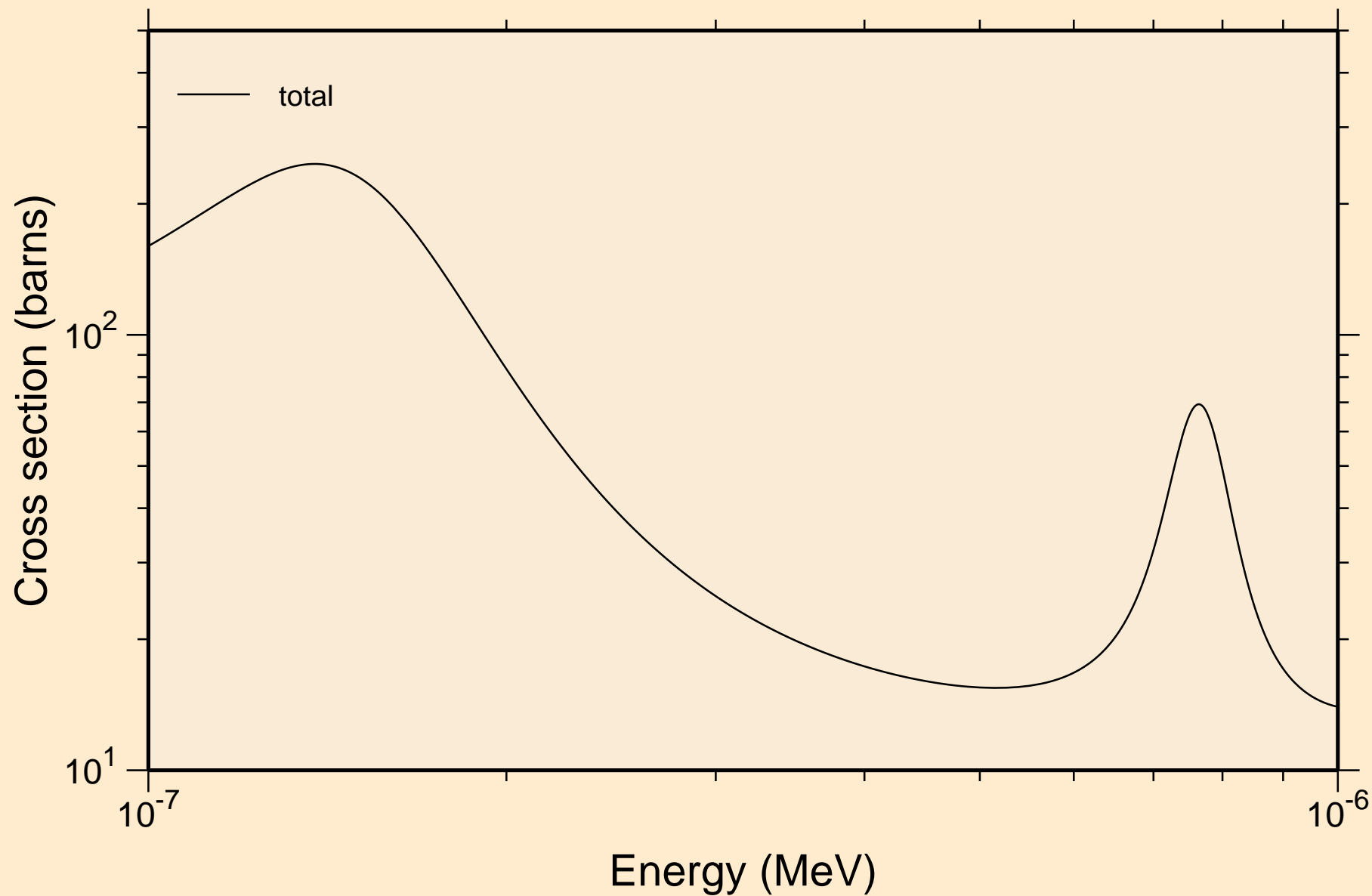

IR188 NEUTRON ACER TENDL-2019 LIBRARY; T=293.16K
resonance total cross section

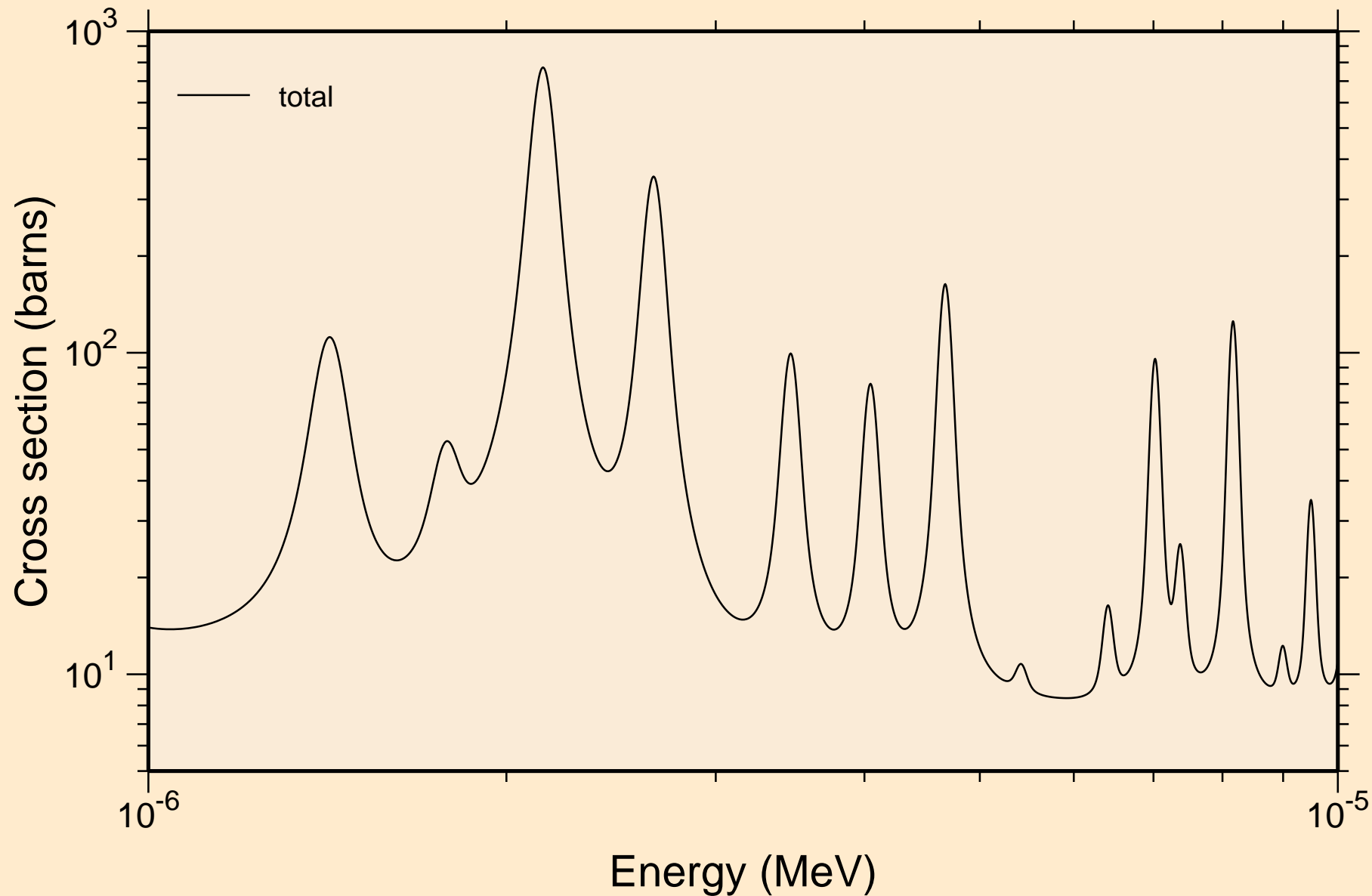

IR188 NEUTRON ACER TENDL-2019 LIBRARY; T=293.16K
resonance total cross section

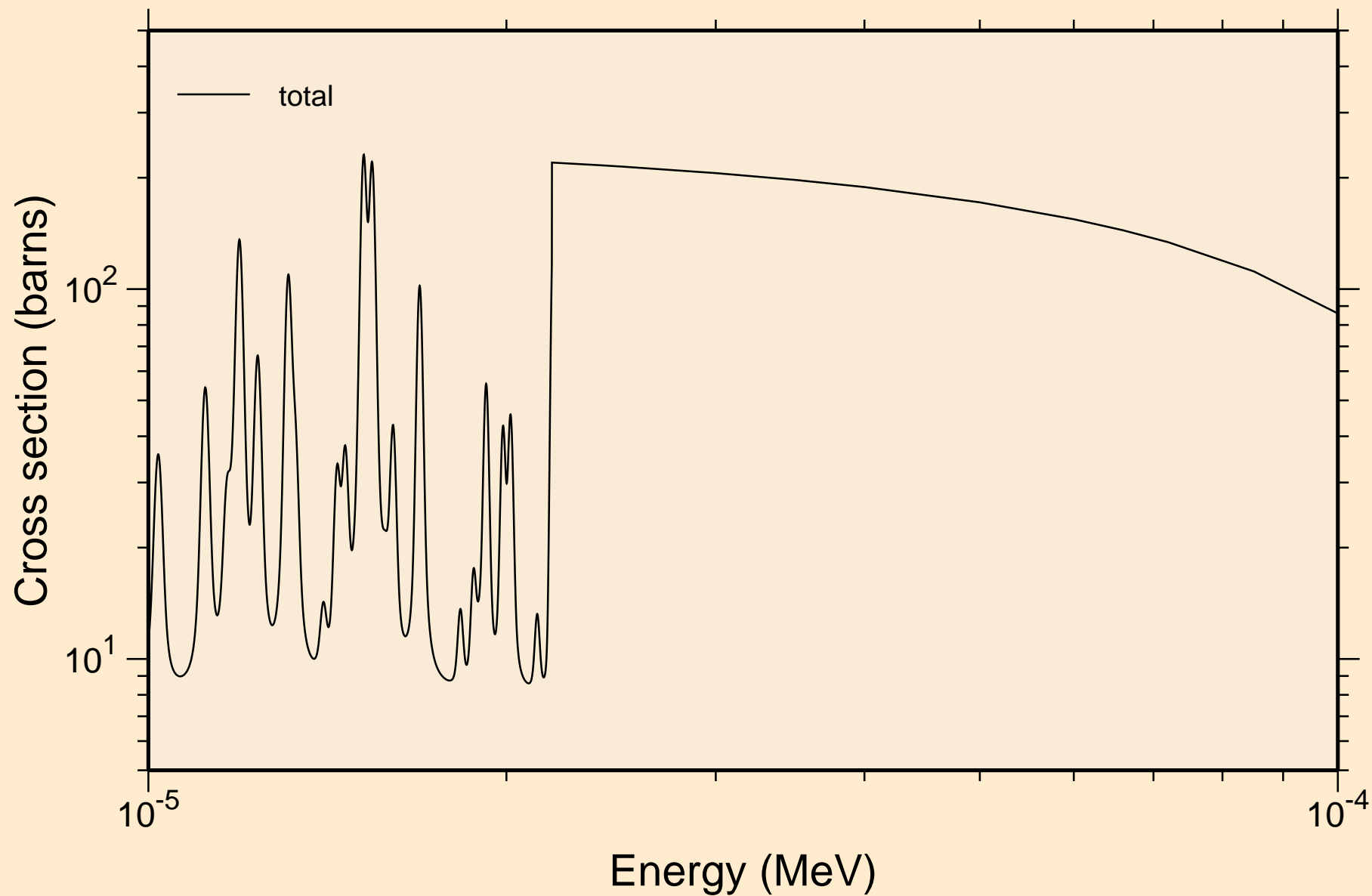

IR188 NEUTRON ACER TENDL-2019 LIBRARY; T=293.16K
resonance total cross section

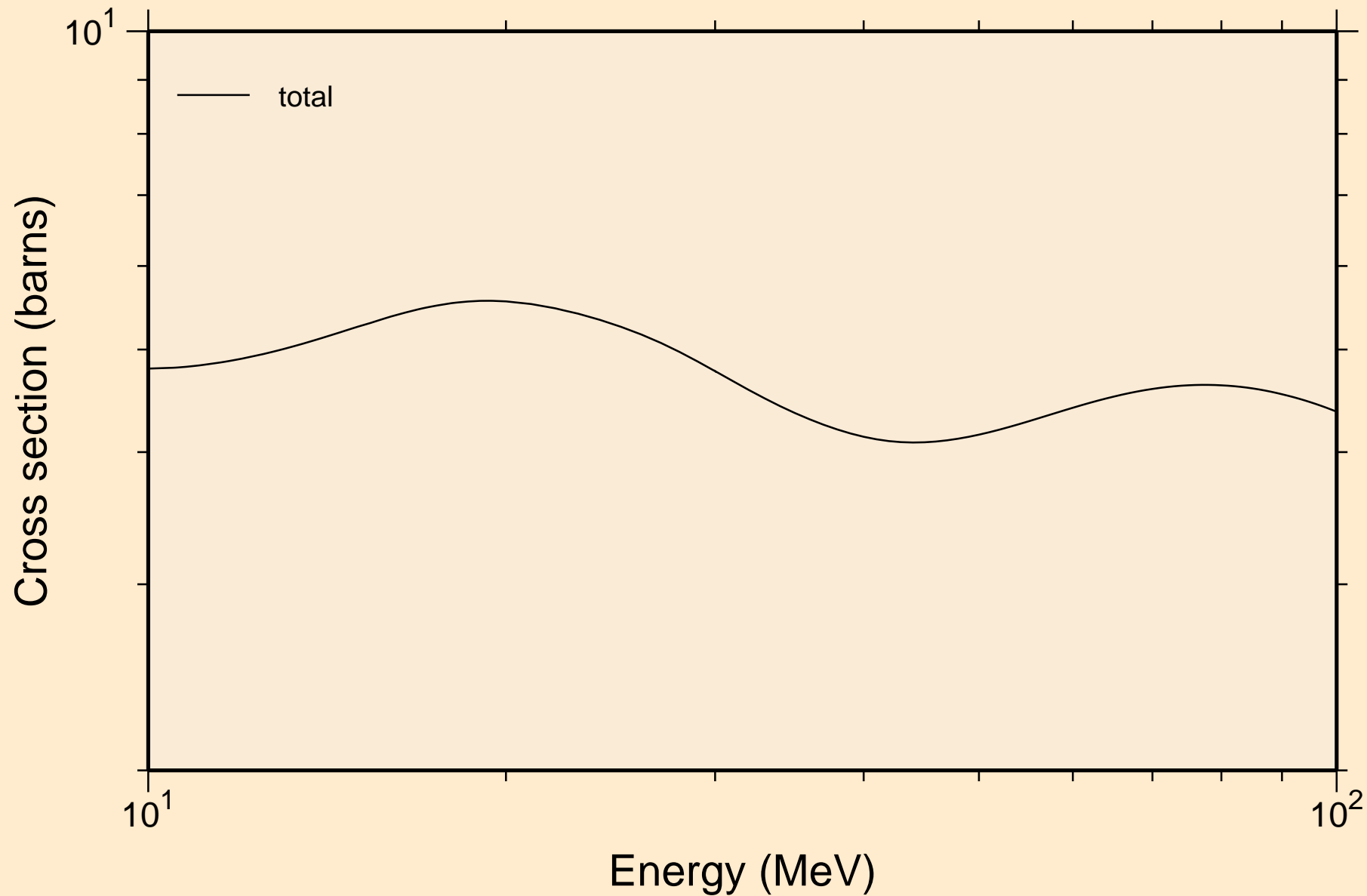

IR188 NEUTRON ACER TENDL-2019 LIBRARY; T=293.16K
resonance absorption cross sections

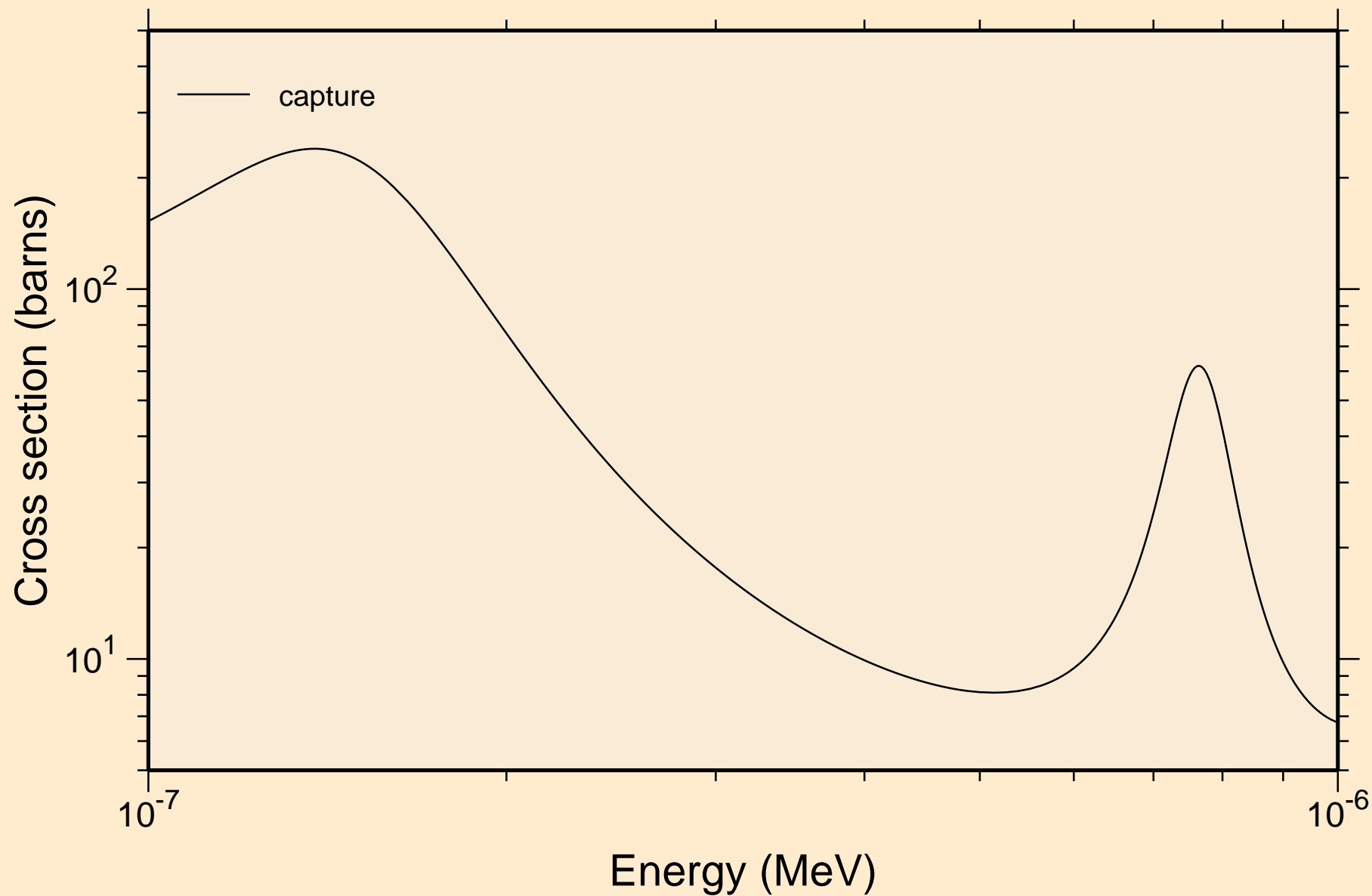

IR188 NEUTRON ACER TENDL-2019 LIBRARY; T=293.16K
resonance absorption cross sections

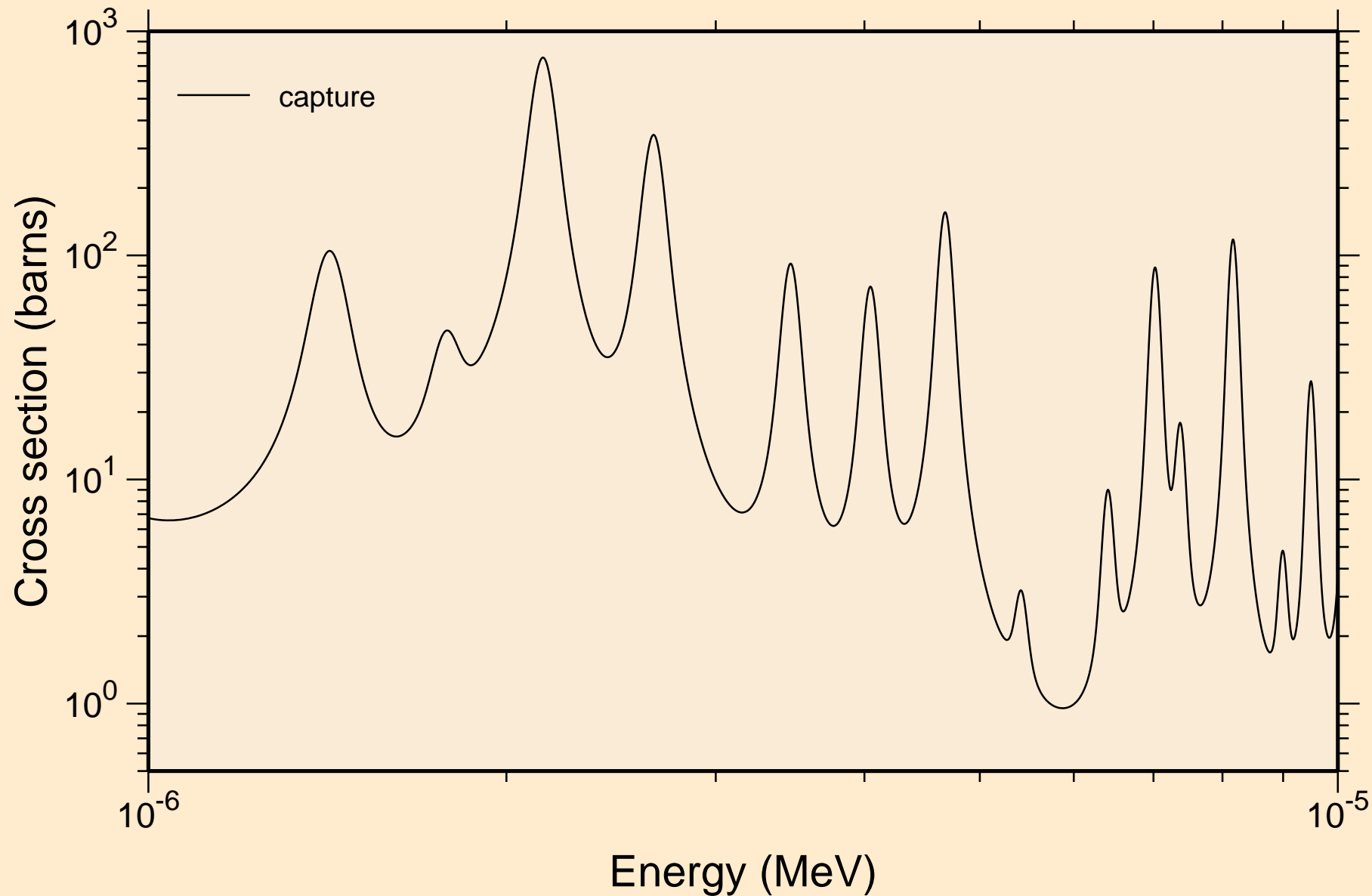

IR188 NEUTRON ACER TENDL-2019 LIBRARY; T=293.16K
resonance absorption cross sections

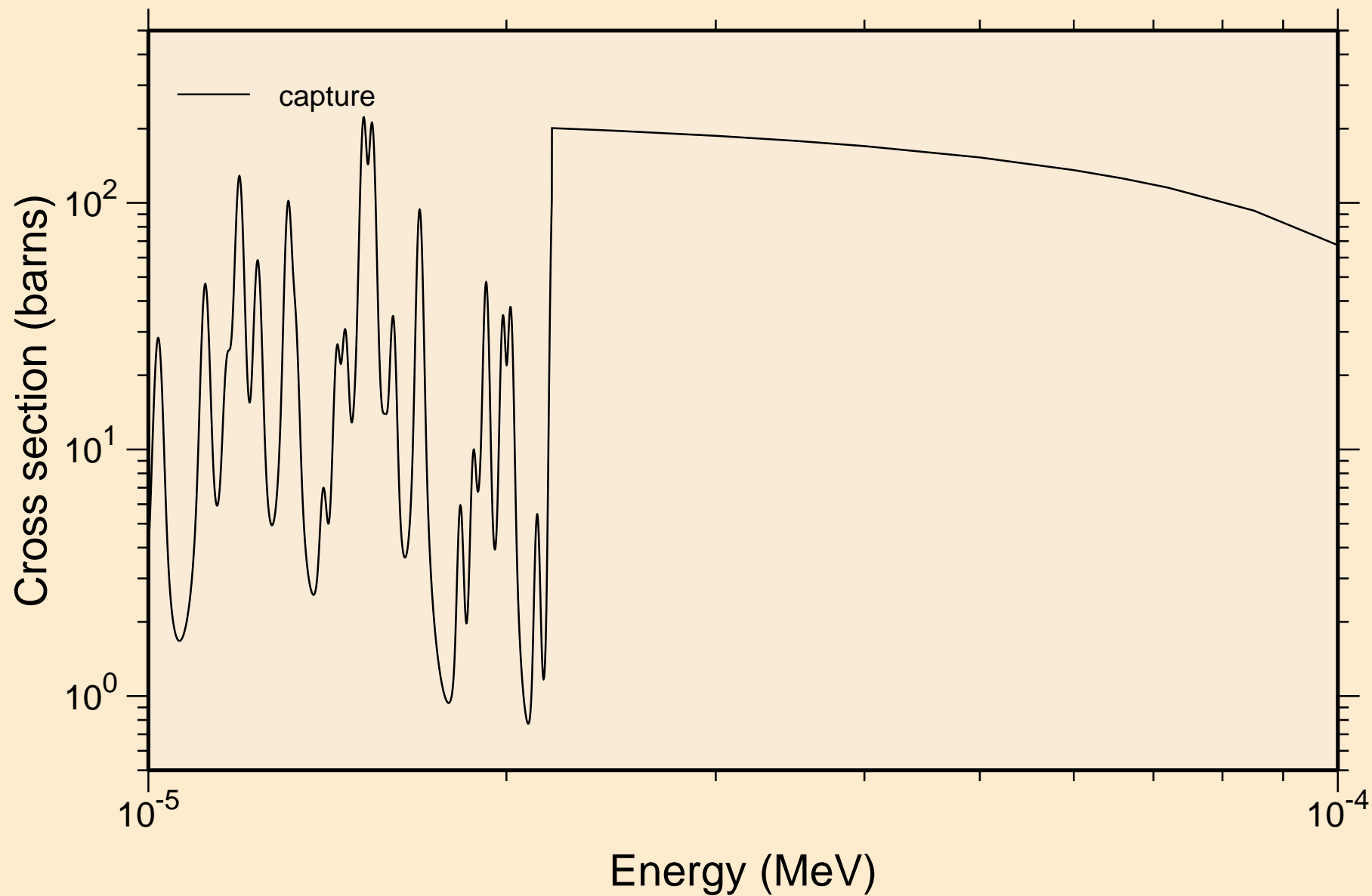

IR188 NEUTRON ACER TENDL-2019 LIBRARY; T=293.16K
resonance absorption cross sections

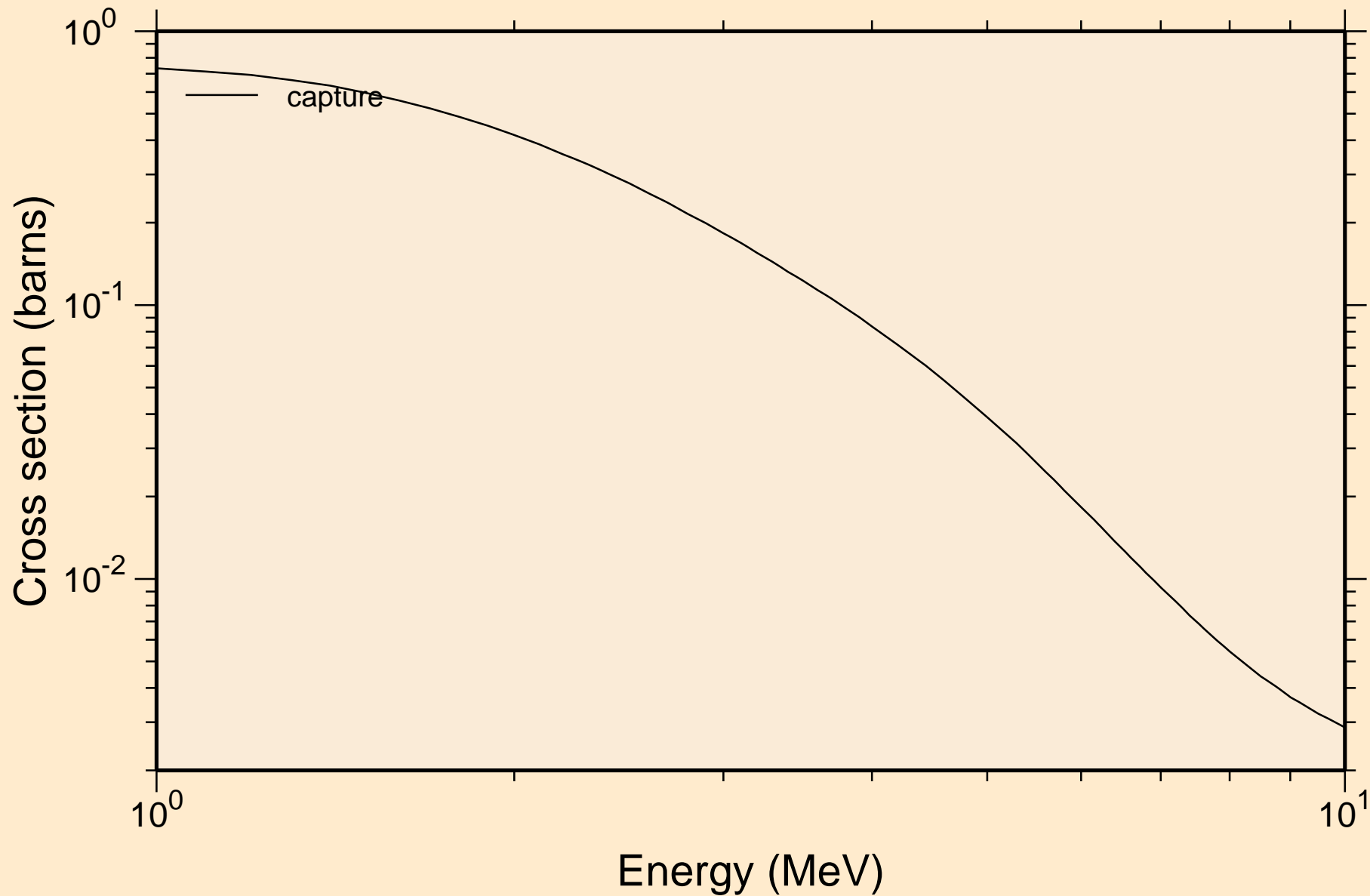

IR188 NEUTRON ACER TENDL-2019 LIBRARY; T=293.16K
Heating

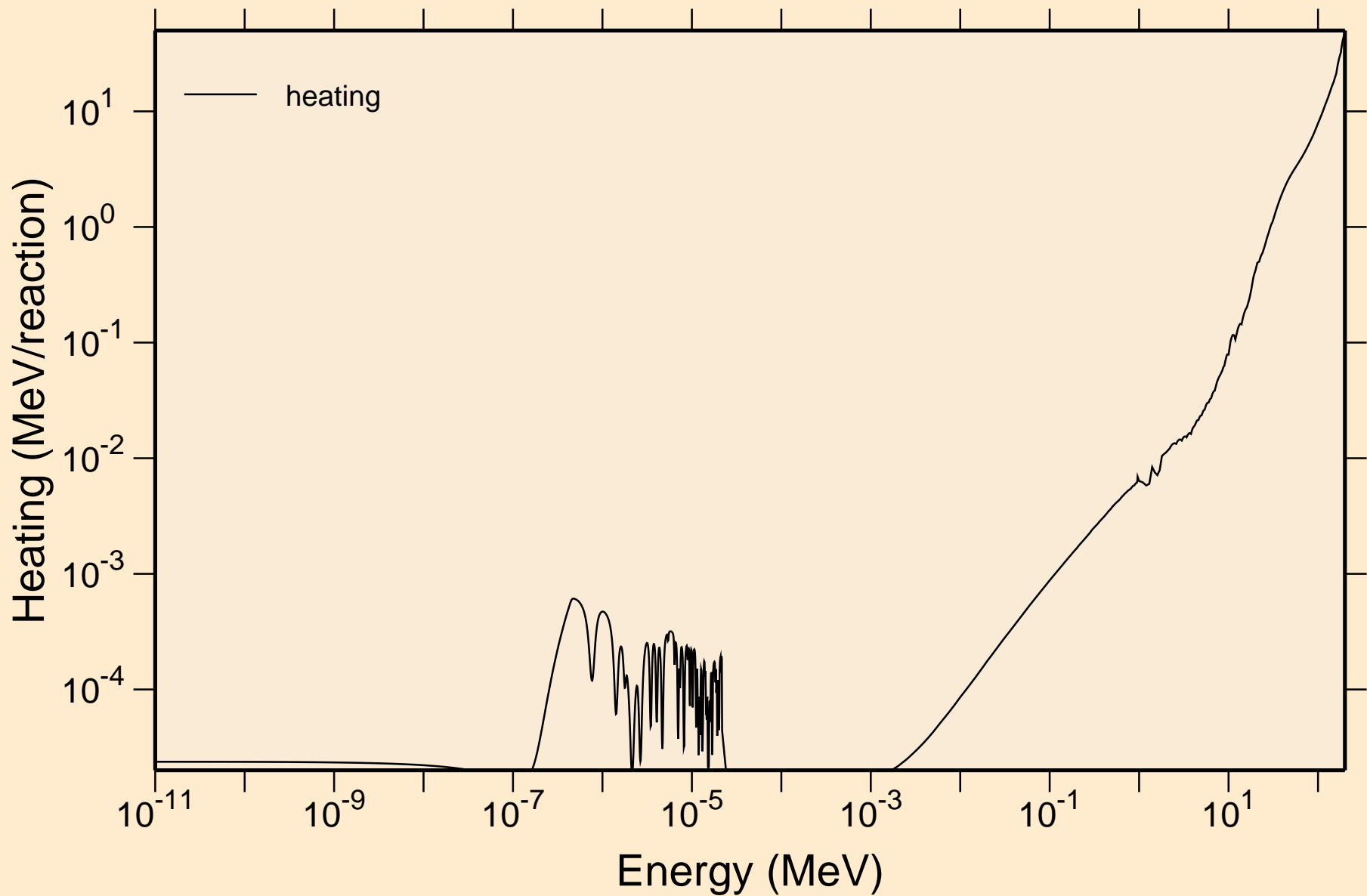

IR188 NEUTRON ACER TENDL-2019 LIBRARY; T=293.16K
Damage

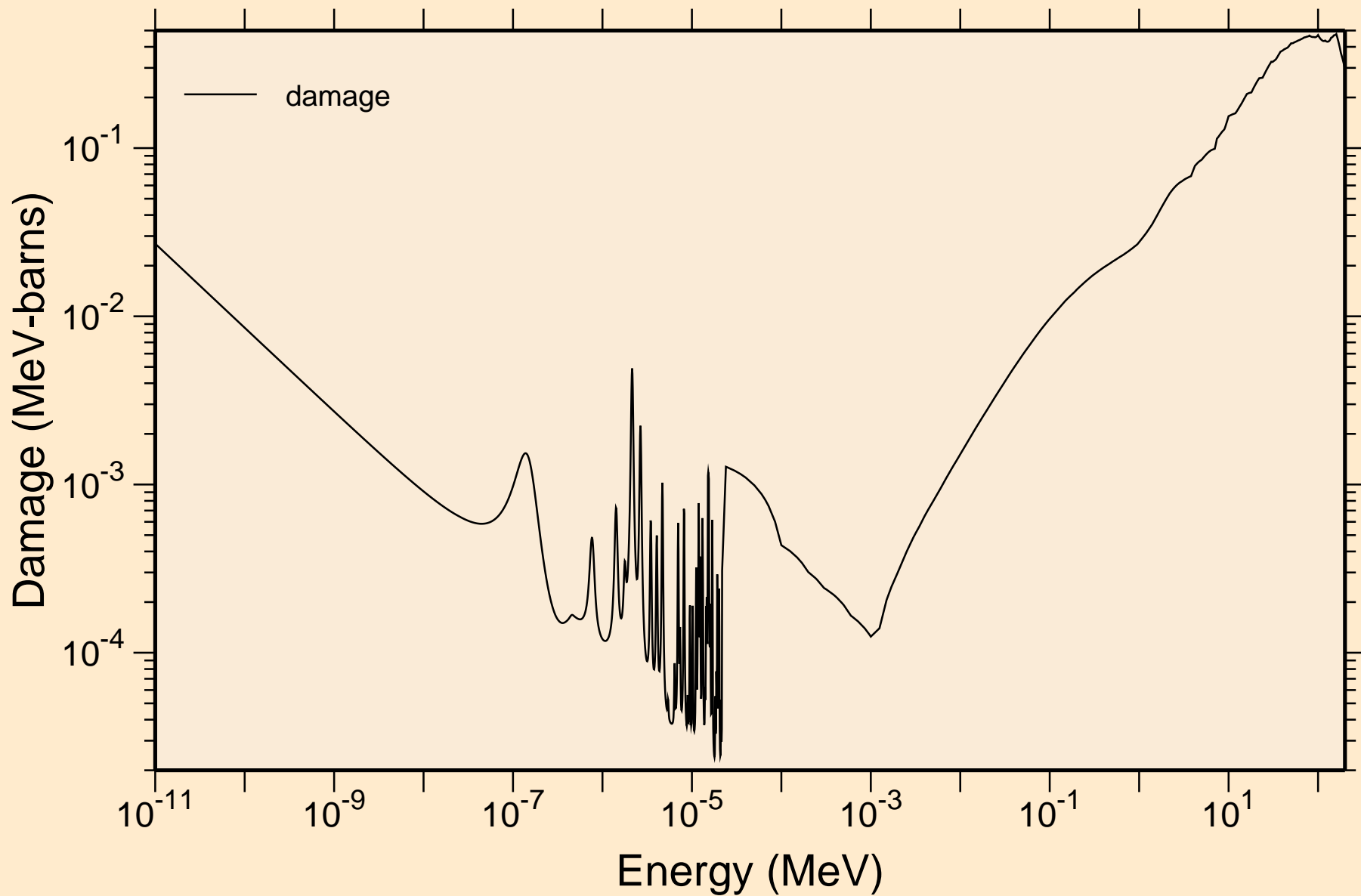

IR188 NEUTRON ACER TENDL-2019 LIBRARY; T=293.16K
Non-threshold reactions

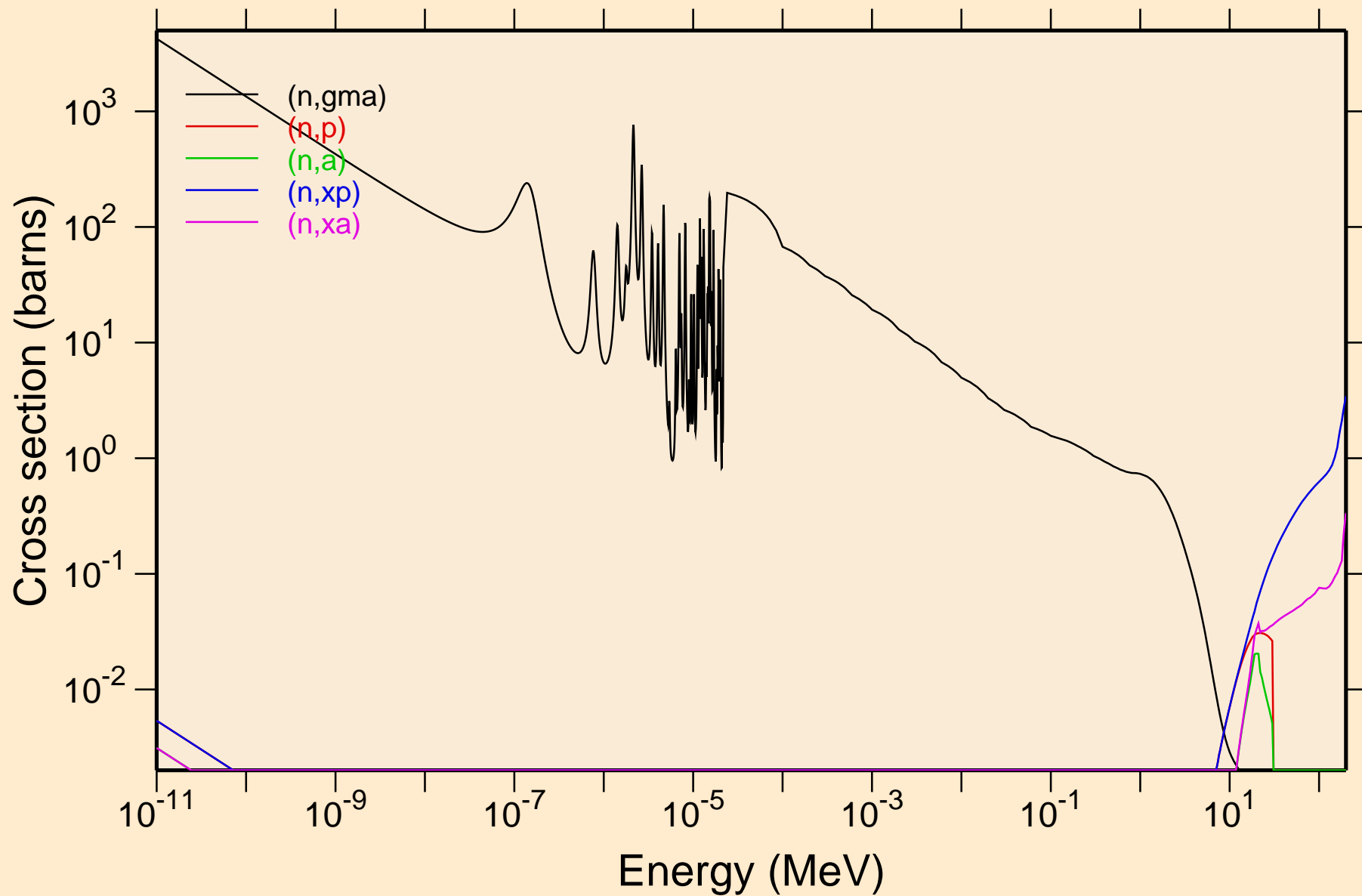

IR188 NEUTRON ACER TENDL-2019 LIBRARY; T=293.16K
Principal cross sections

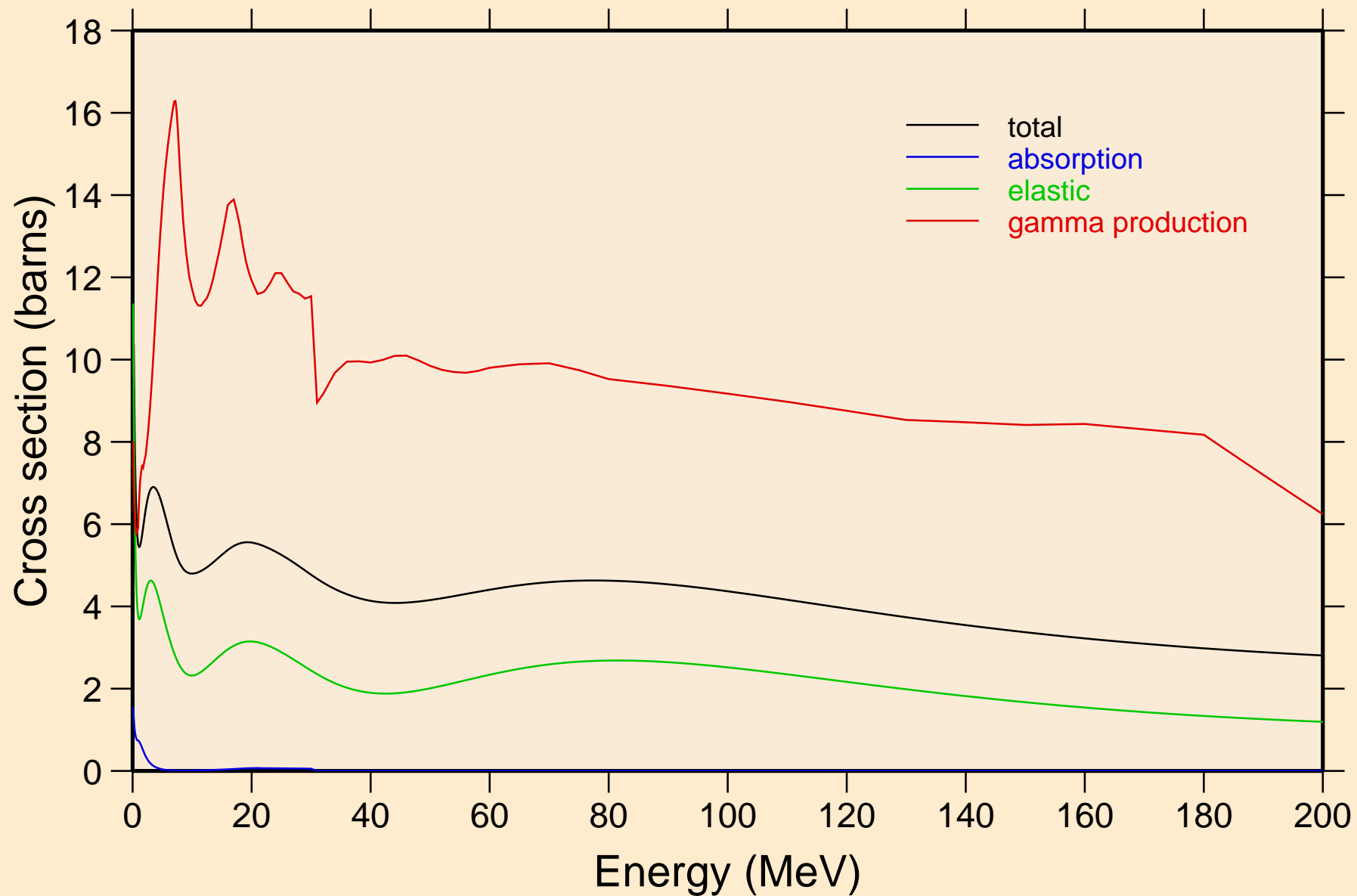

IR188 NEUTRON ACER TENDL-2019 LIBRARY; T=293.16K
Heating

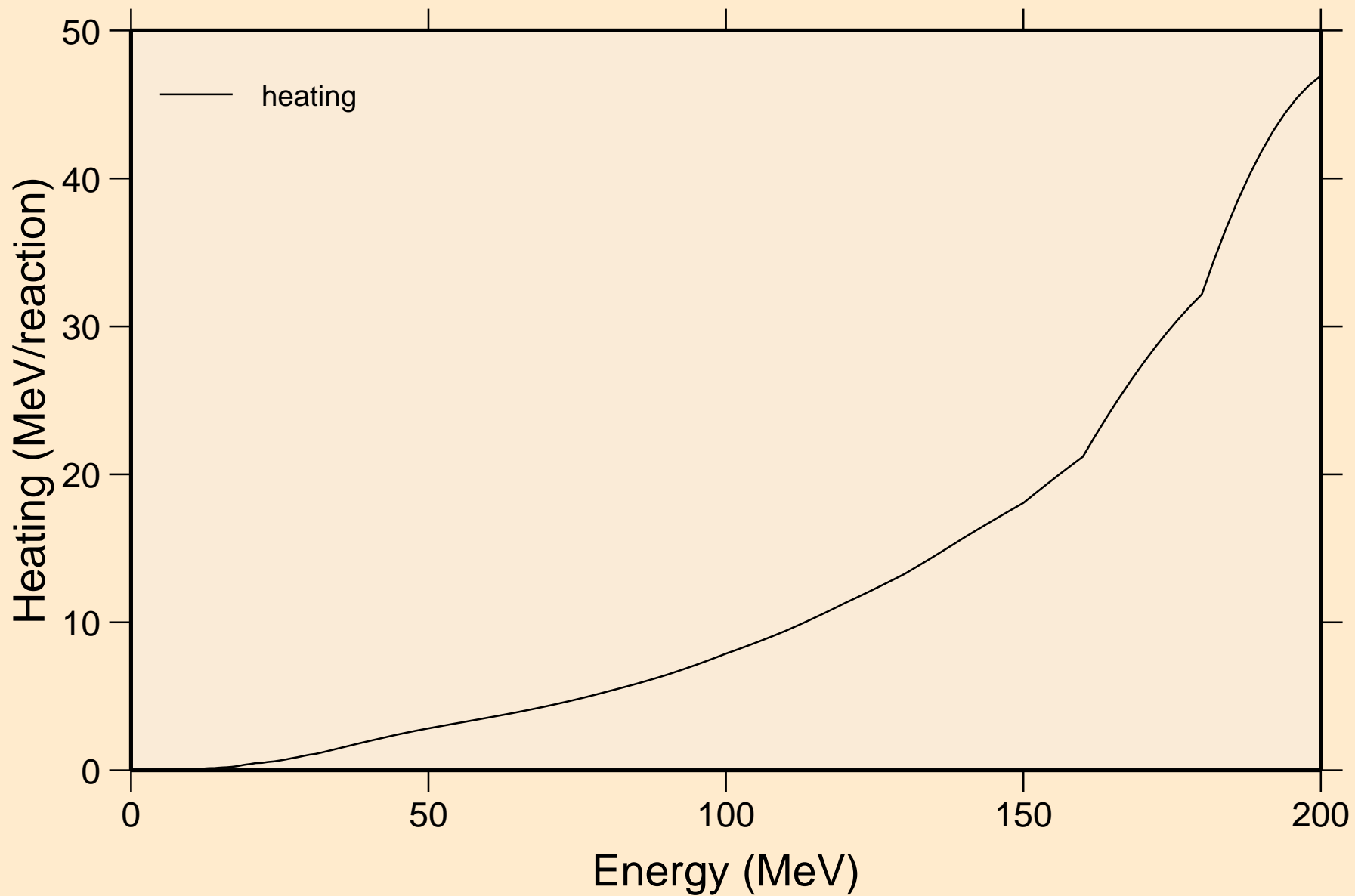

IR188 NEUTRON ACER TENDL-2019 LIBRARY; T=293.16K
Damage

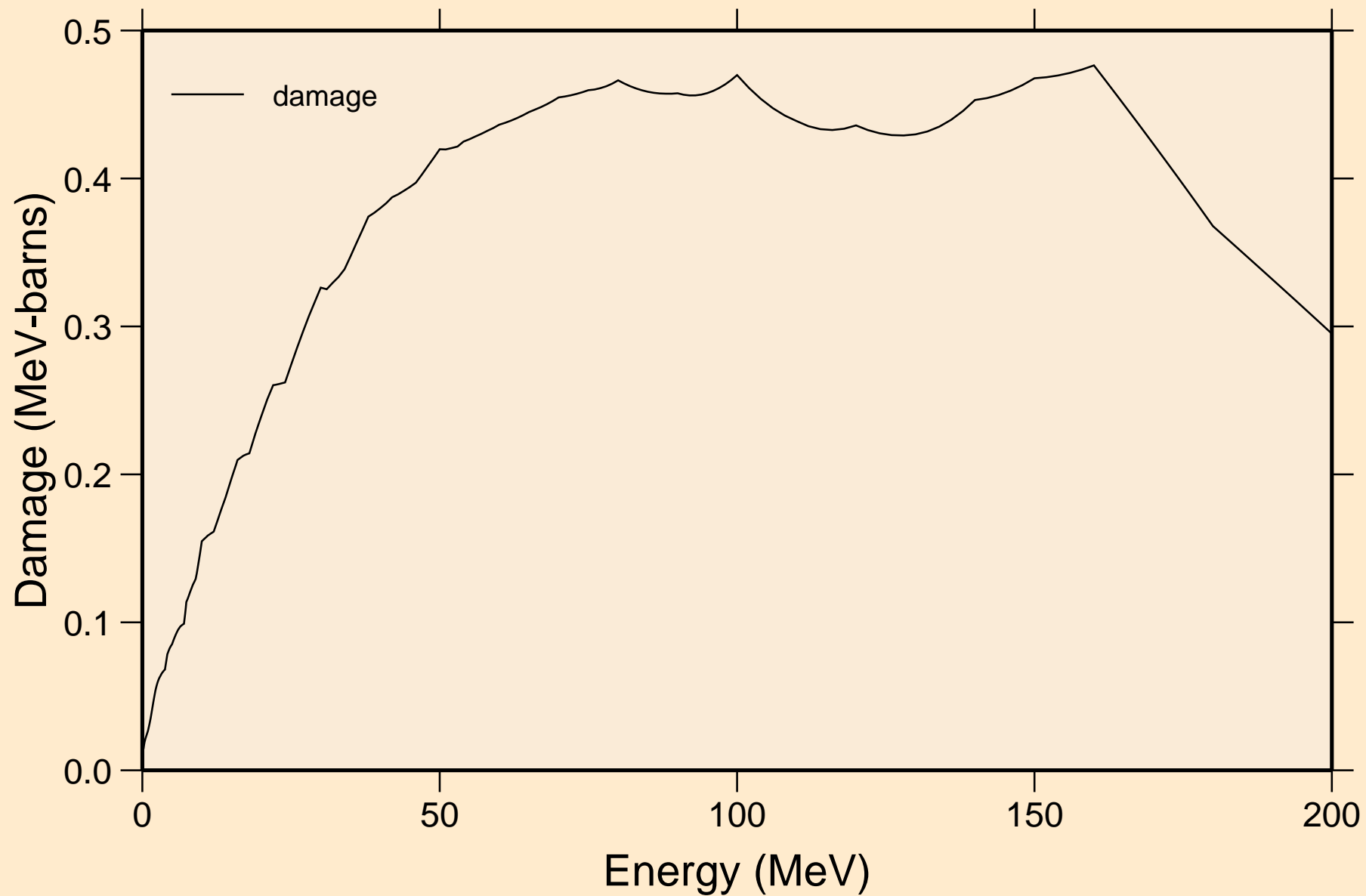

IR188 NEUTRON ACER TENDL-2019 LIBRARY; T=293.16K
Non-threshold reactions

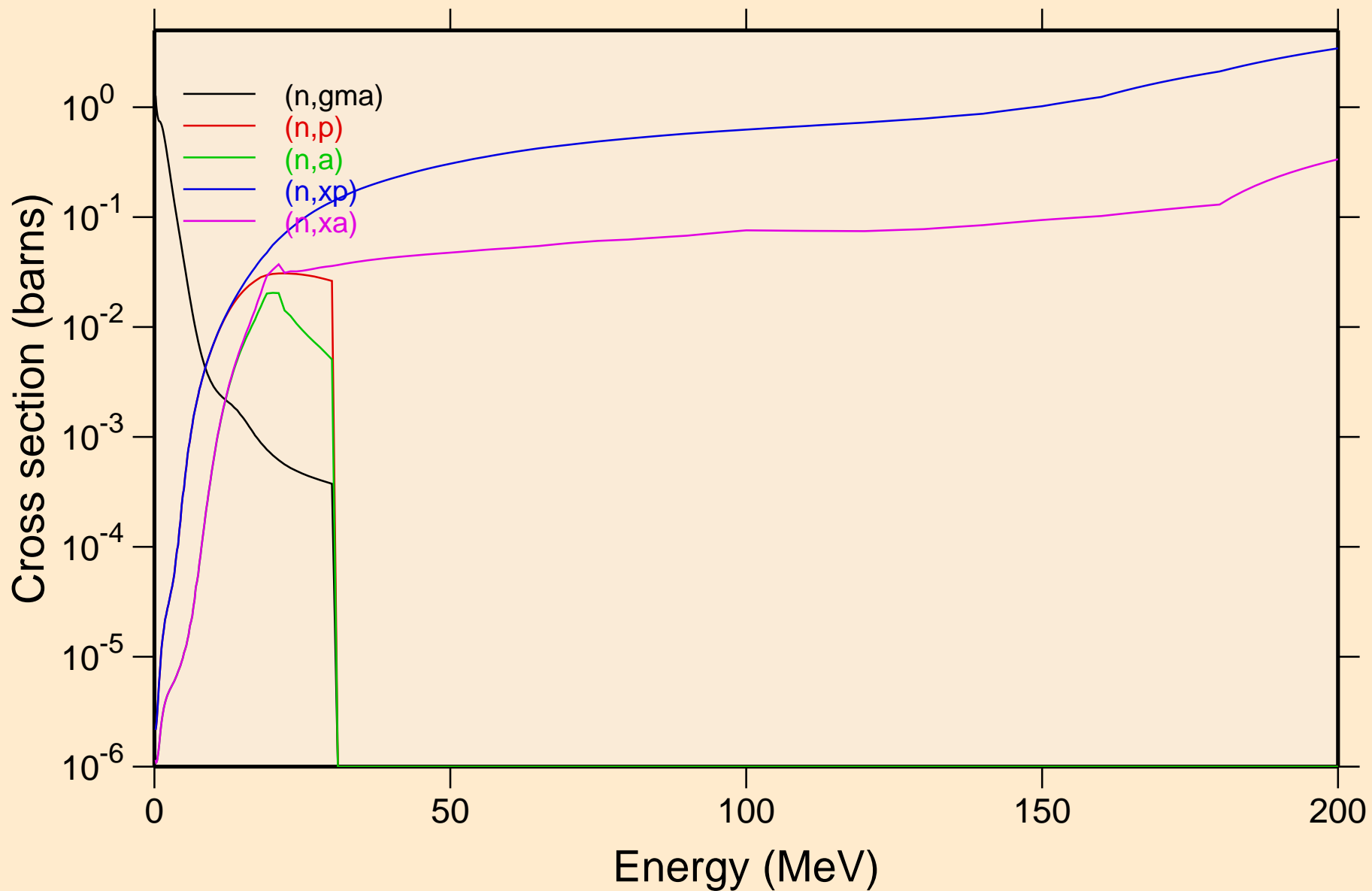

IR188 NEUTRON ACER TENDL-2019 LIBRARY; T=293.16K
Inelastic levels

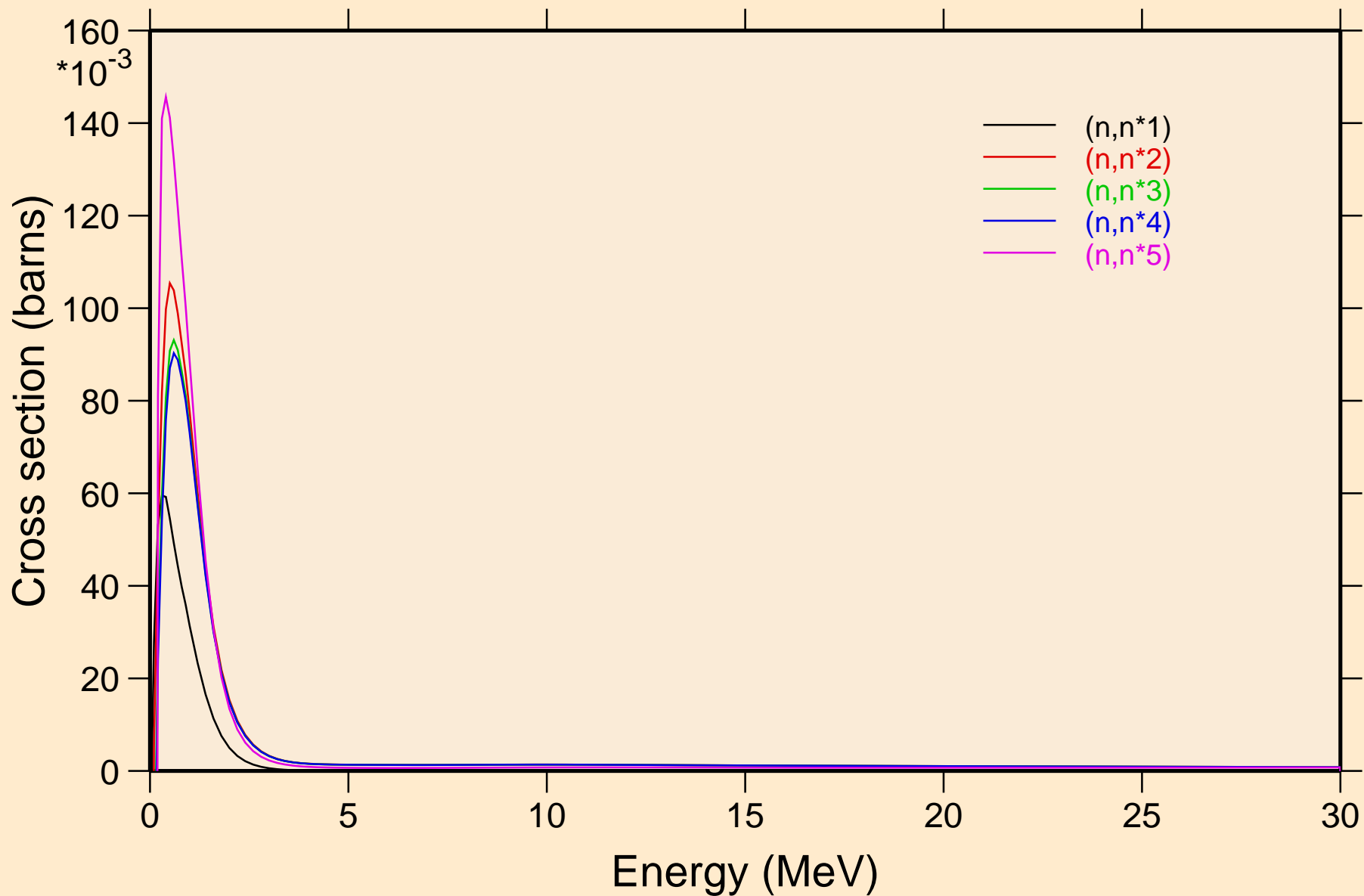

IR188 NEUTRON ACER TENDL-2019 LIBRARY; T=293.16K
Inelastic levels

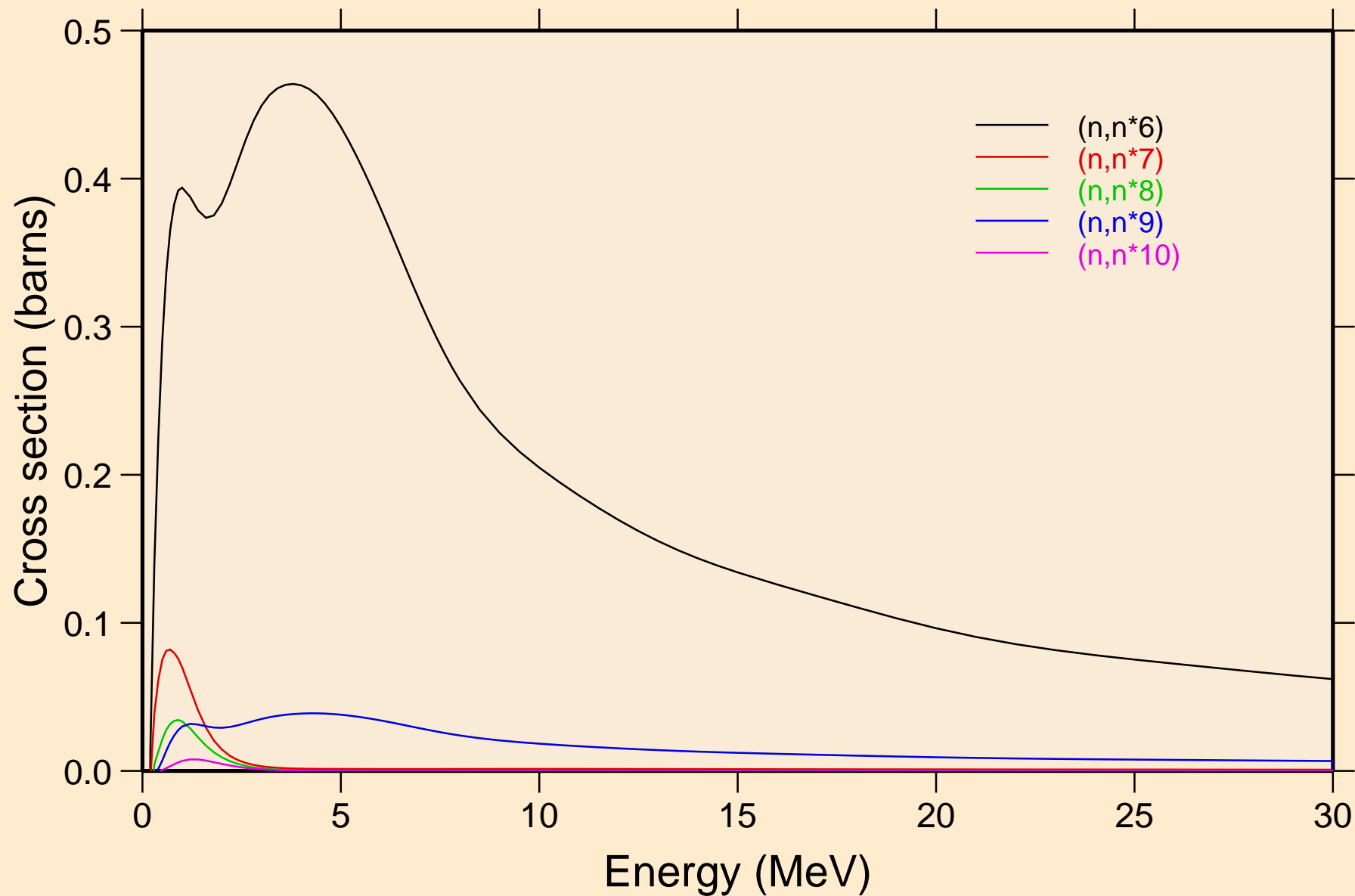

IR188 NEUTRON ACER TENDL-2019 LIBRARY; T=293.16K
Inelastic levels

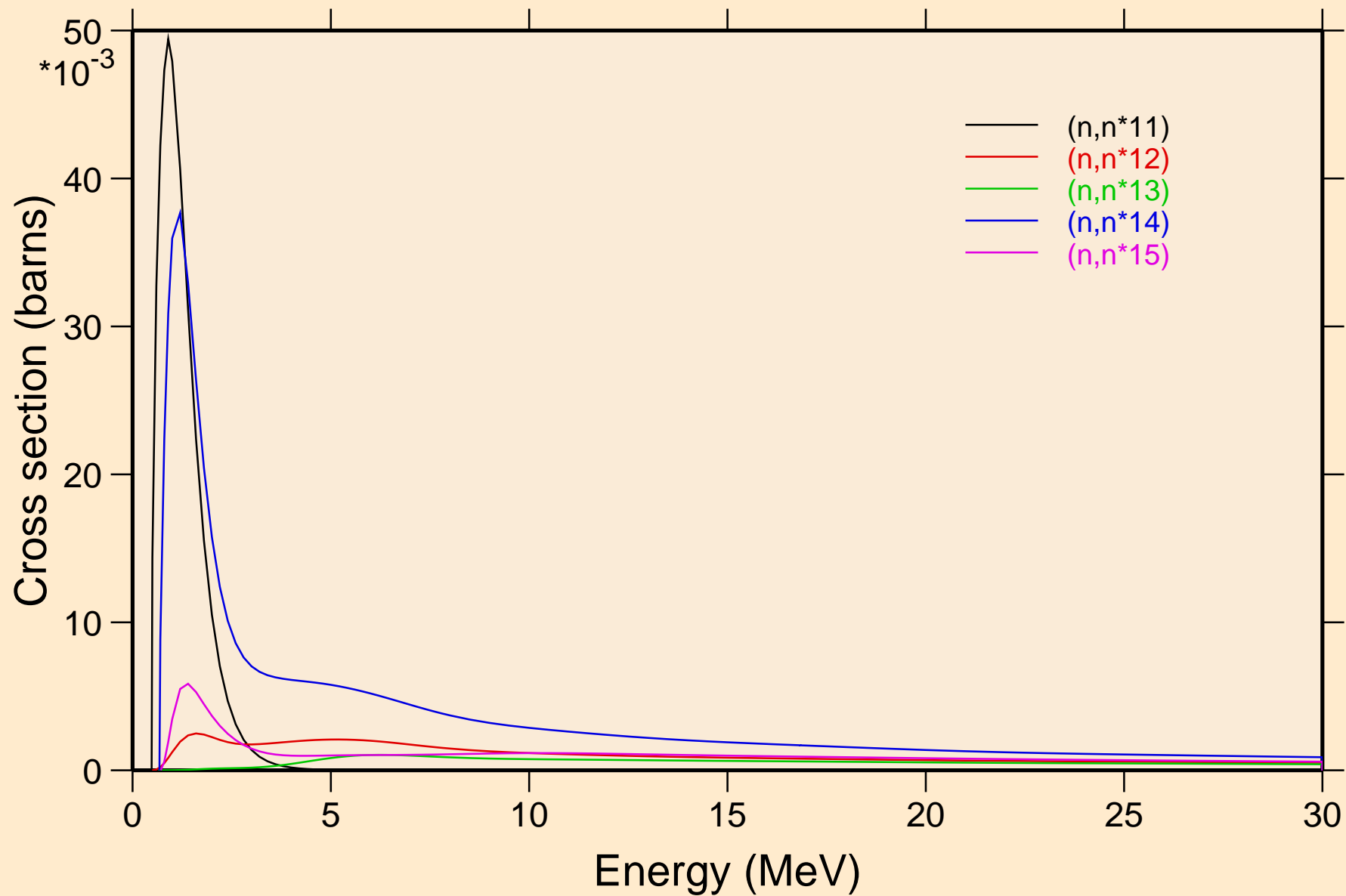

IR188 NEUTRON ACER TENDL-2019 LIBRARY; T=293.16K
Inelastic levels

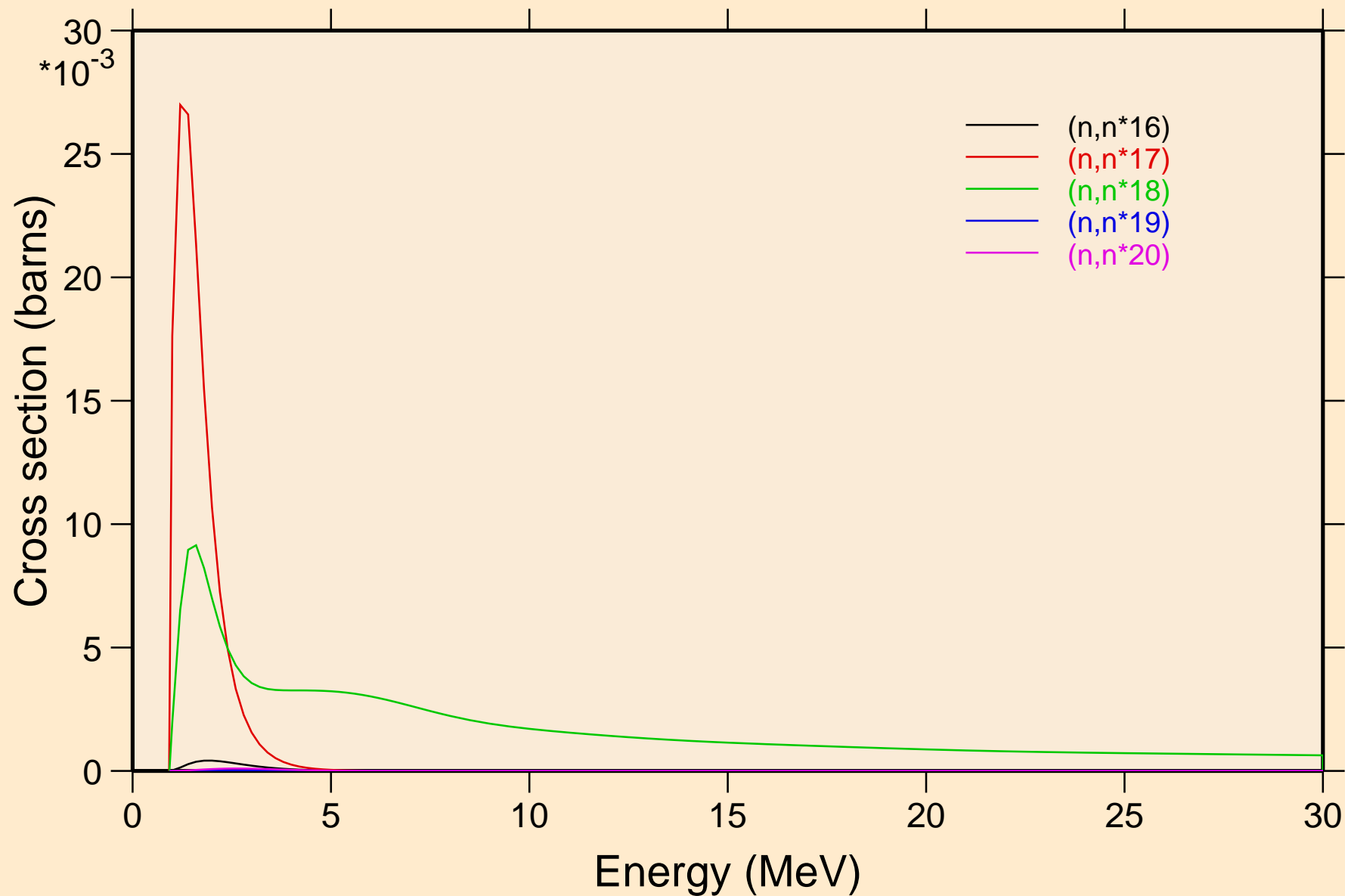

IR188 NEUTRON ACER TENDL-2019 LIBRARY; T=293.16K
Inelastic levels

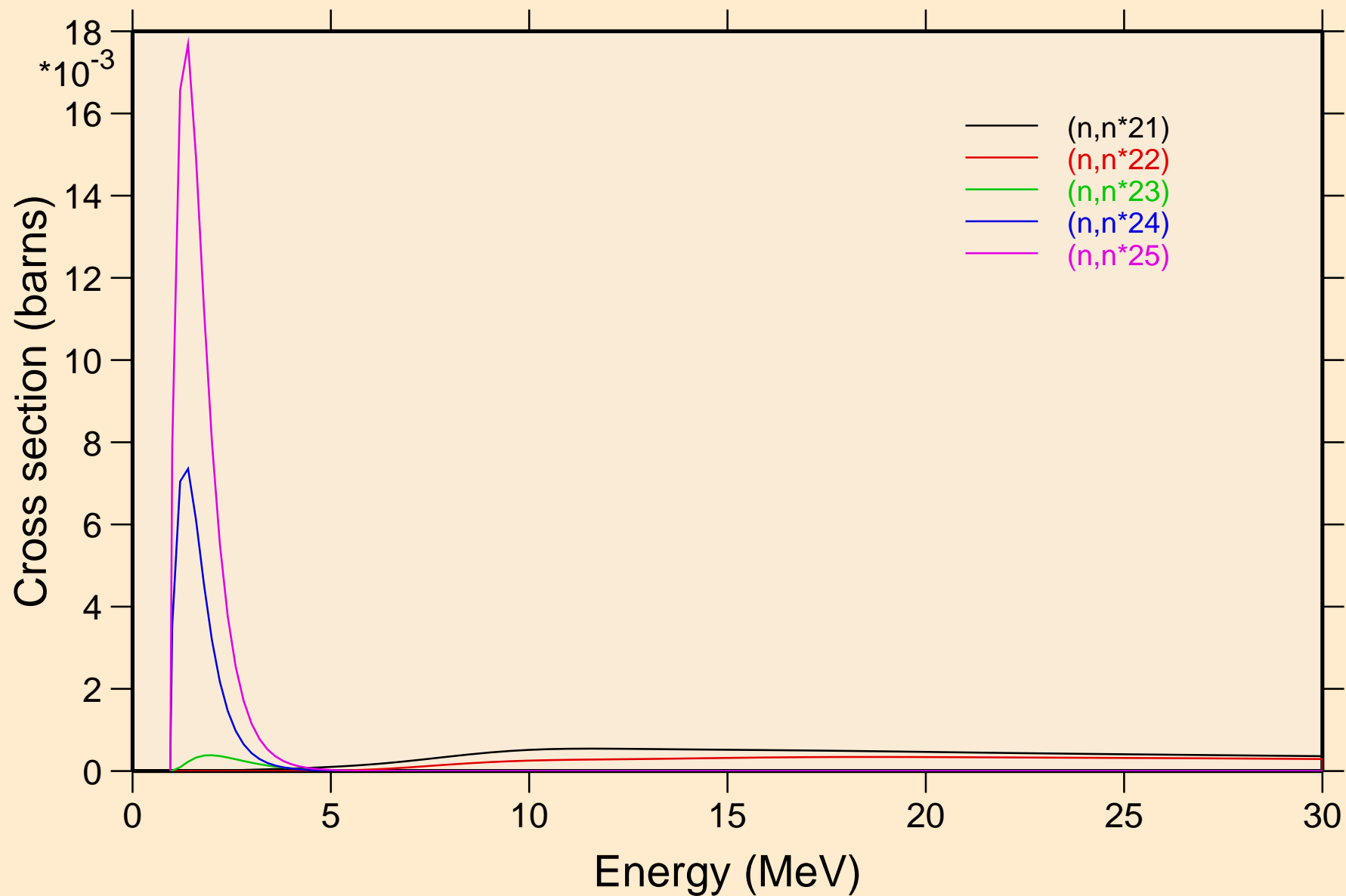

IR188 NEUTRON ACER TENDL-2019 LIBRARY; T=293.16K
Threshold reactions

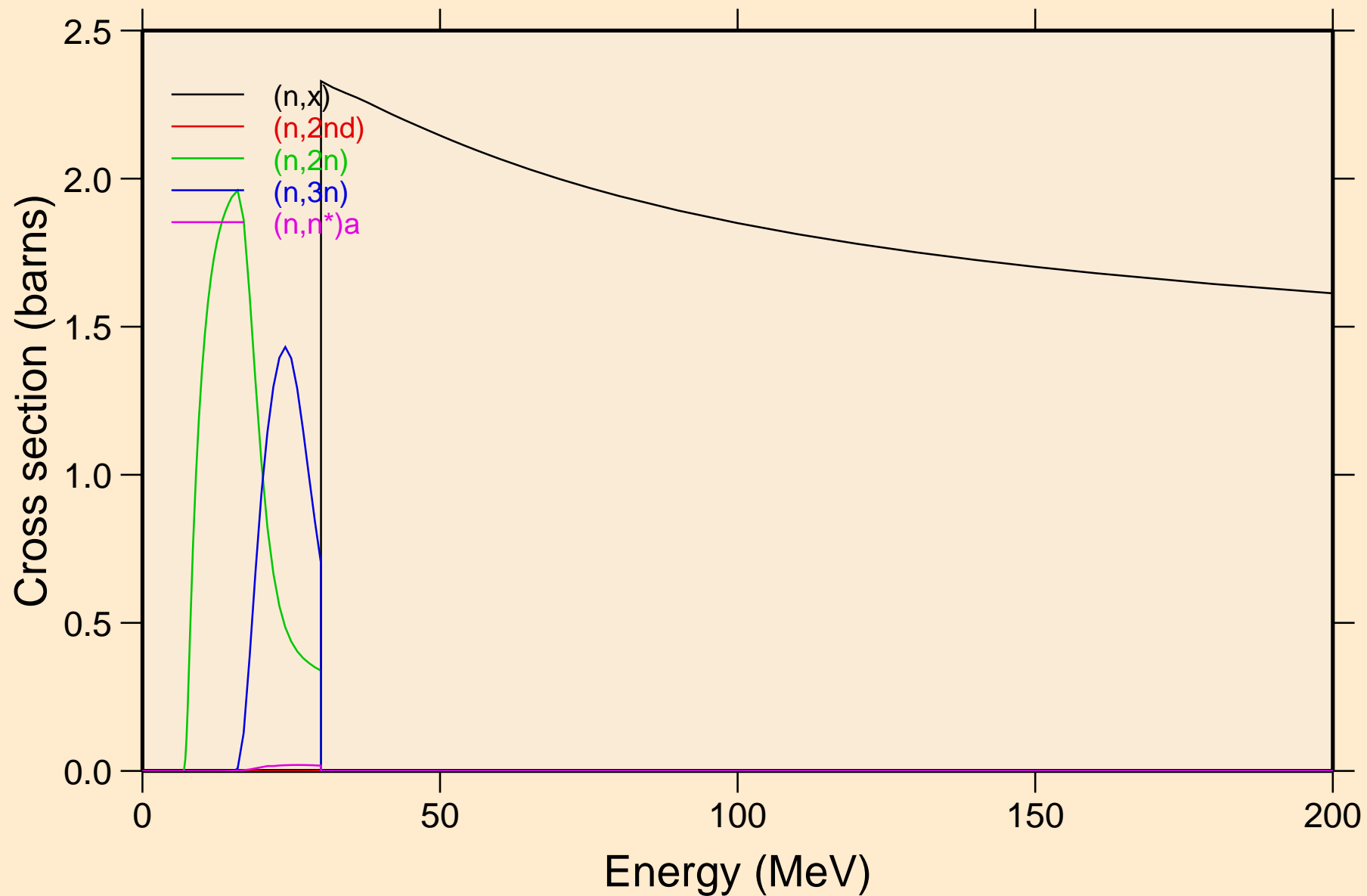

IR188 NEUTRON ACER TENDL-2019 LIBRARY; T=293.16K
Threshold reactions

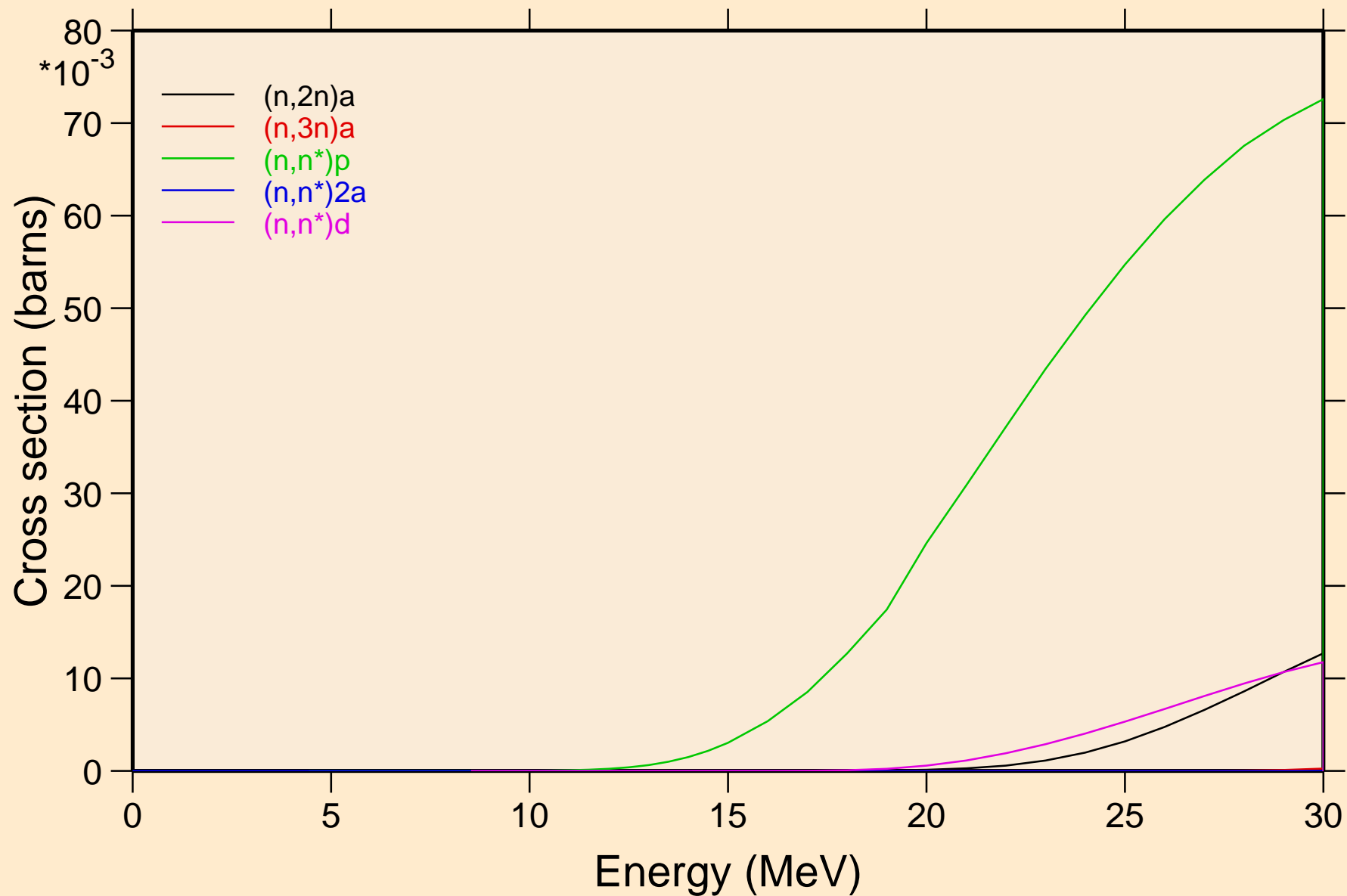

IR188 NEUTRON ACER TENDL-2019 LIBRARY; T=293.16K
Threshold reactions

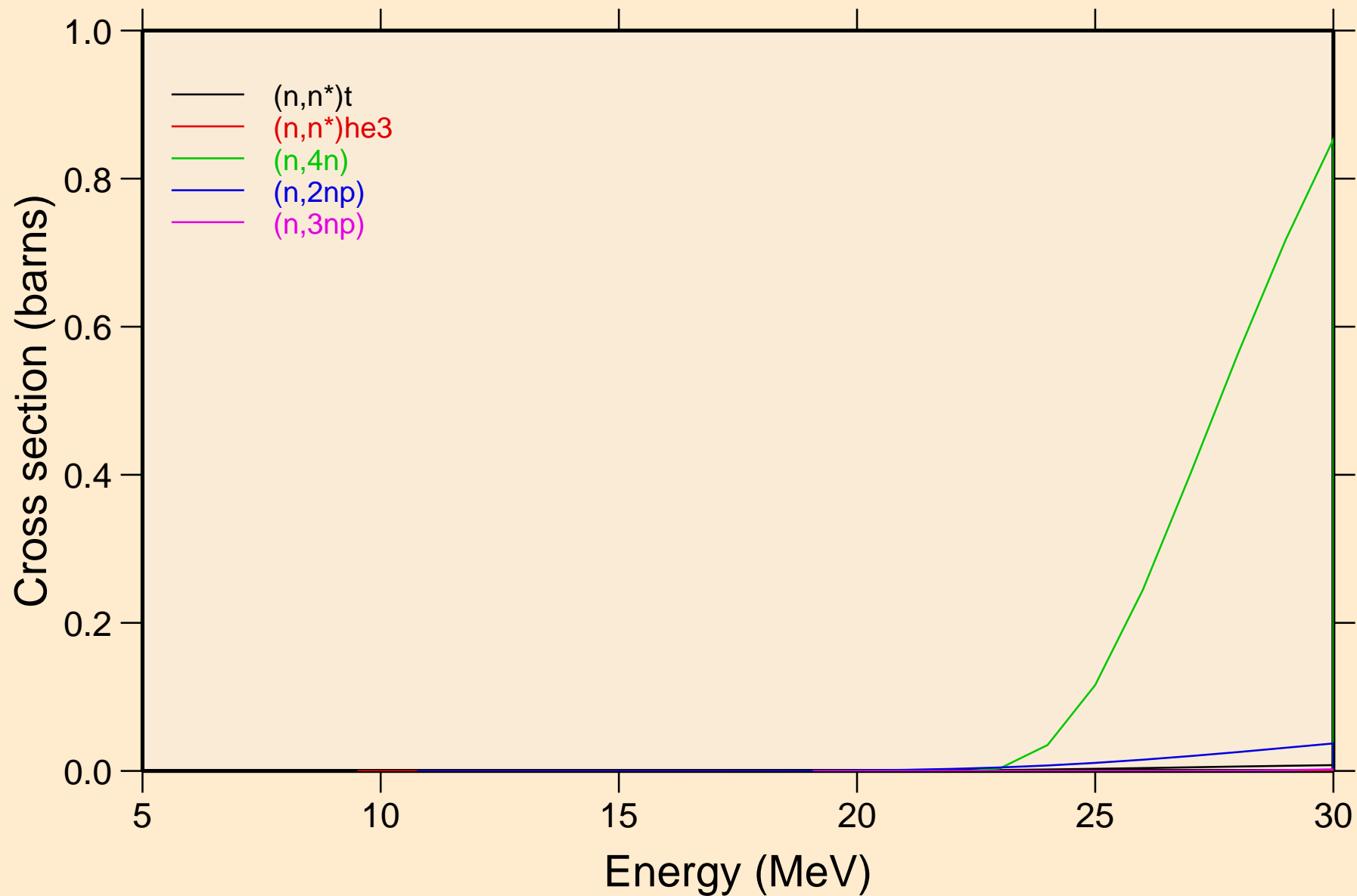

IR188 NEUTRON ACER TENDL-2019 LIBRARY; T=293.16K
Threshold reactions

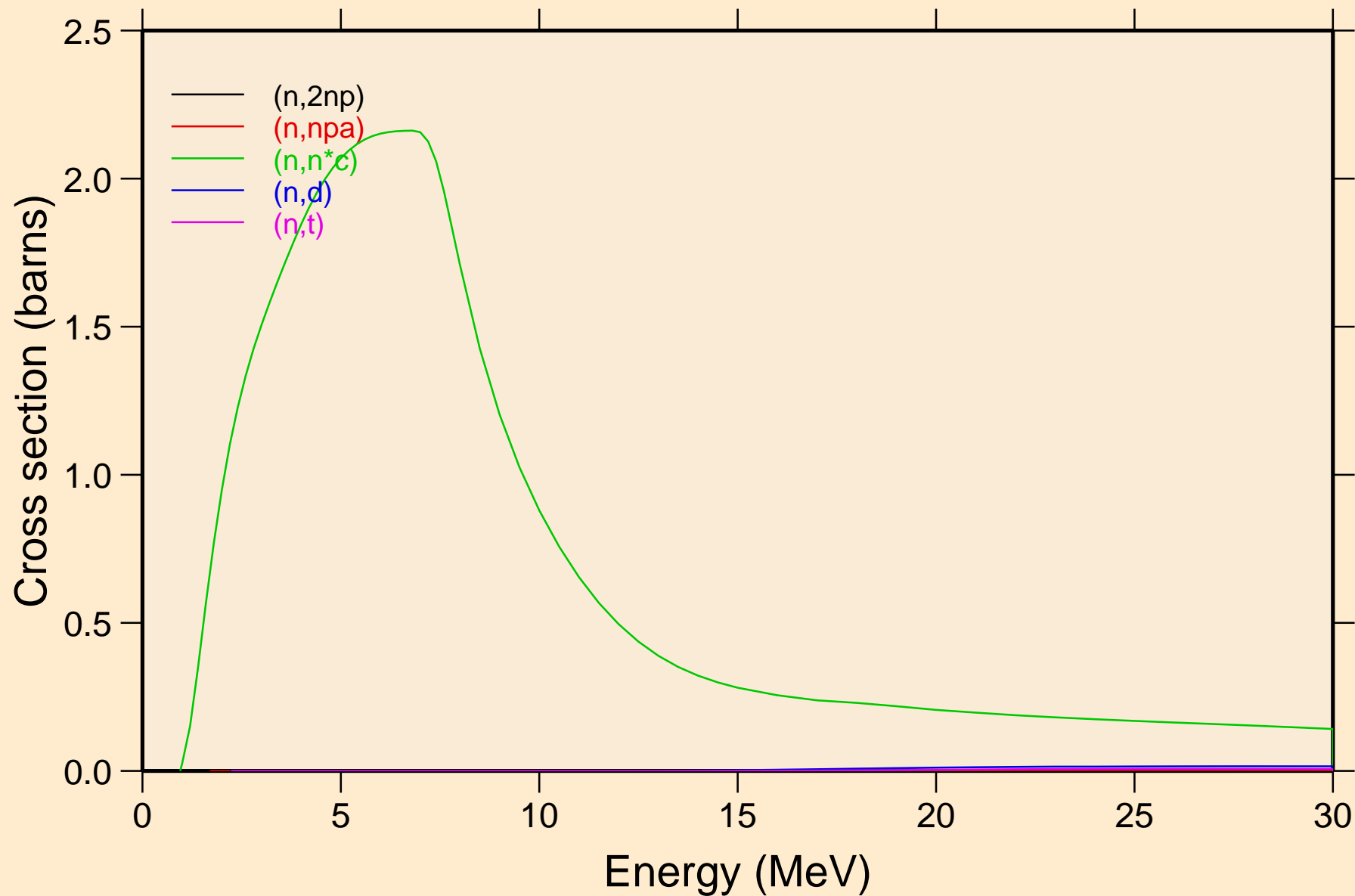

IR188 NEUTRON ACER TENDL-2019 LIBRARY; T=293.16K
Threshold reactions

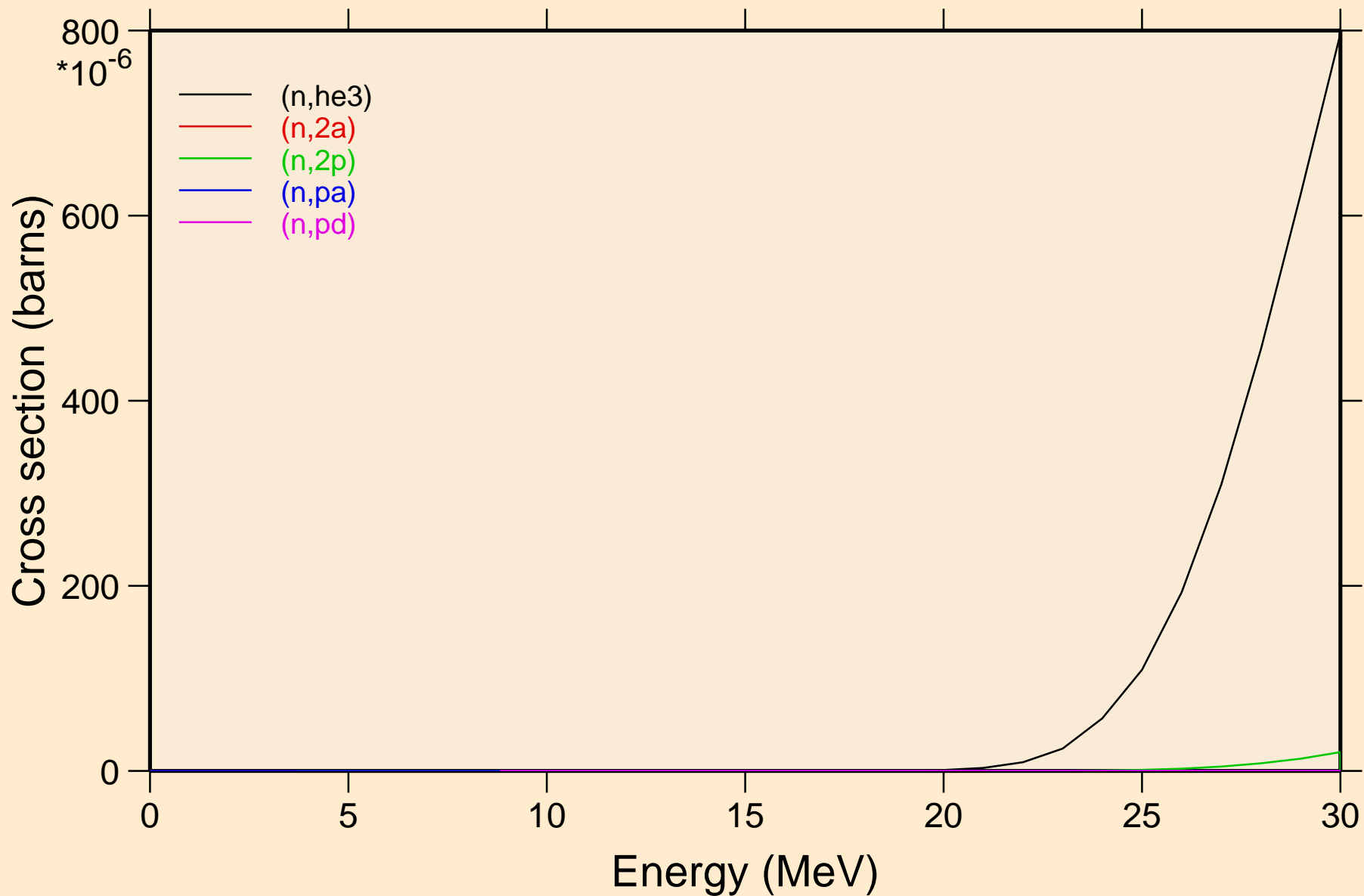

IR188 NEUTRON ACER TENDL-2019 LIBRARY; T=293.16K
Threshold reactions

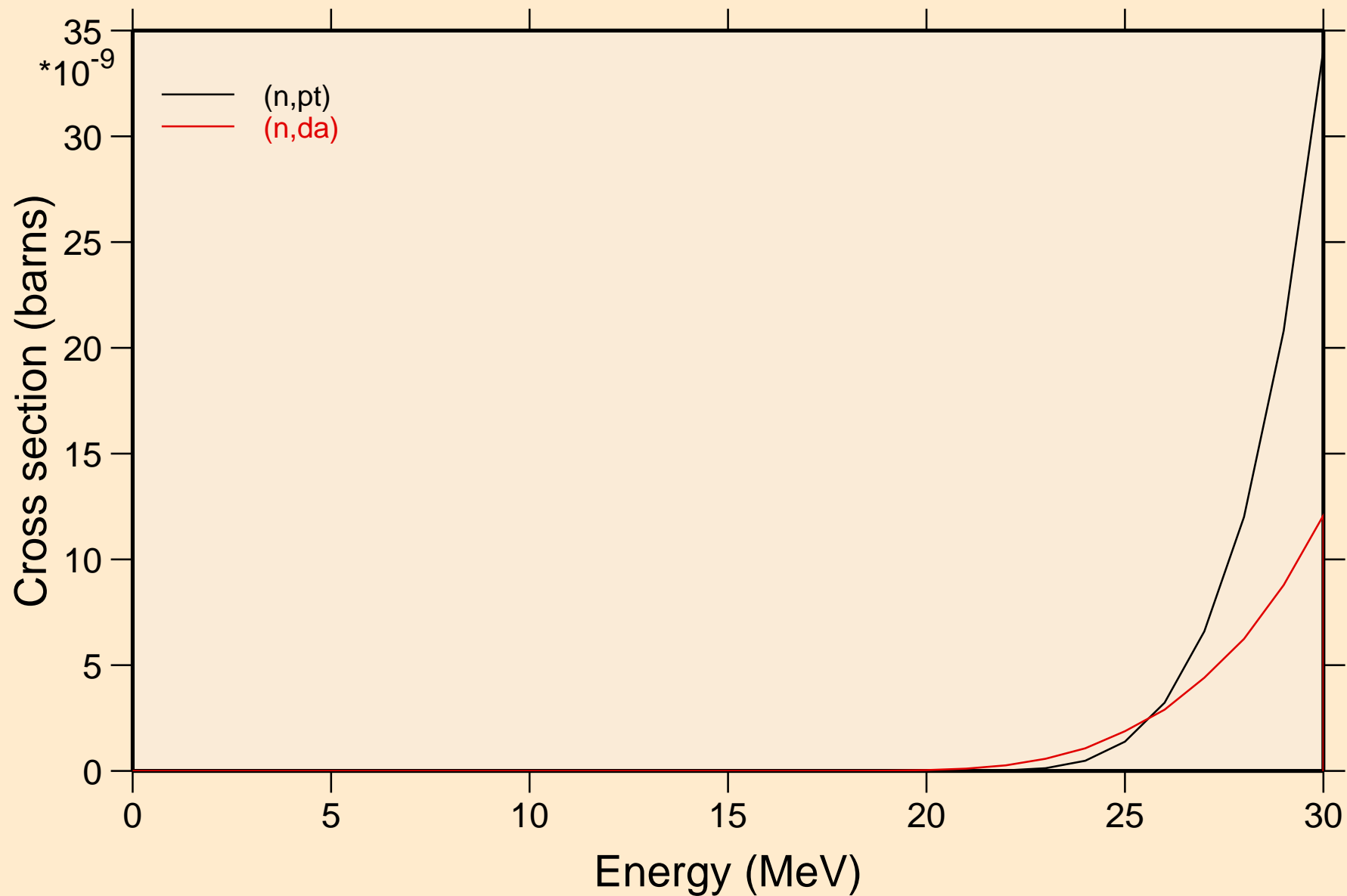

IR188 NEUTRON ACER TENDL-2019 LIBRARY; T=293.16K
Threshold reactions

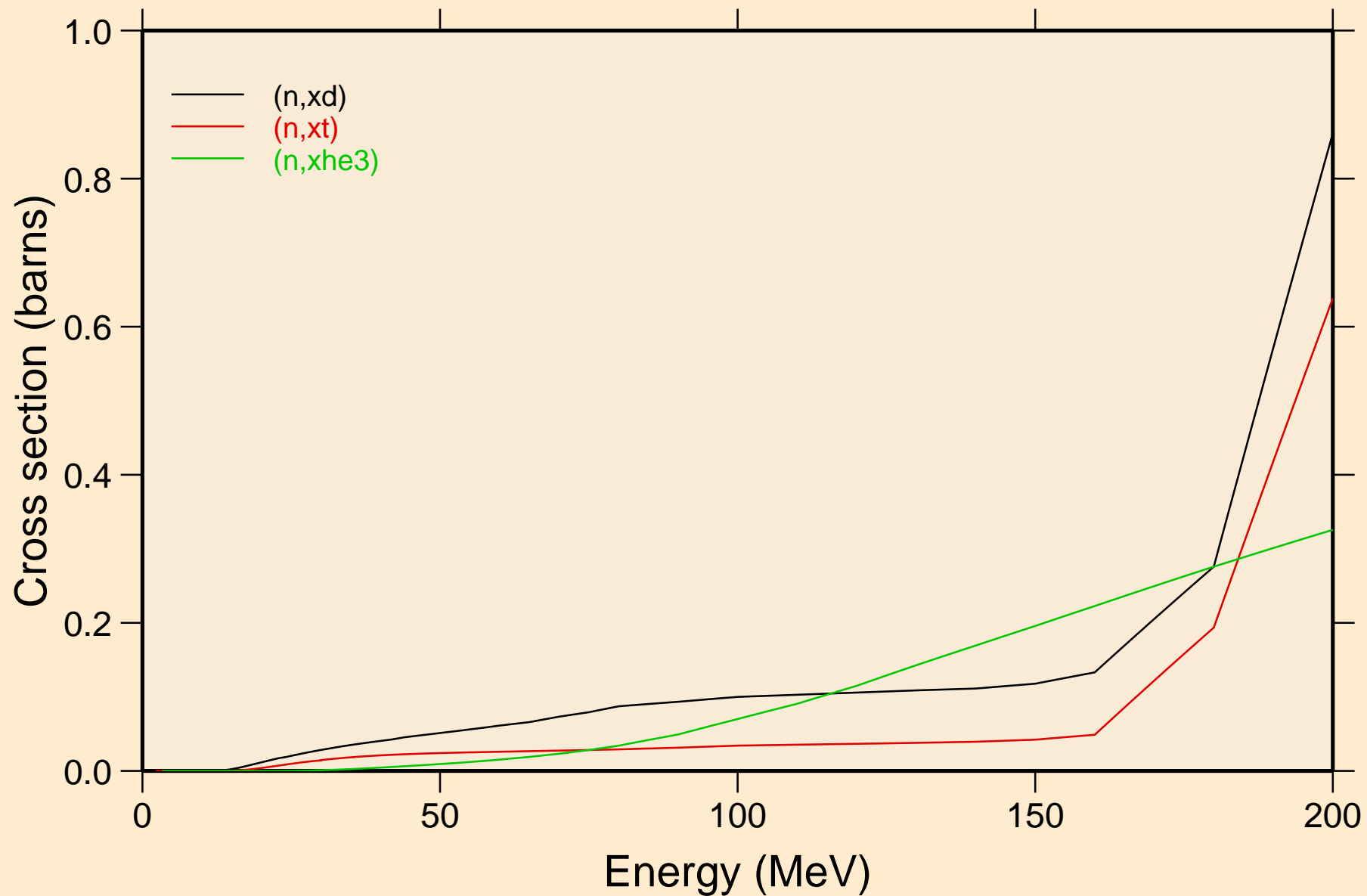

IR188 NEUTRON ACER TENDL-2019 LIBRARY; T=293.16K
angular distribution for elastic

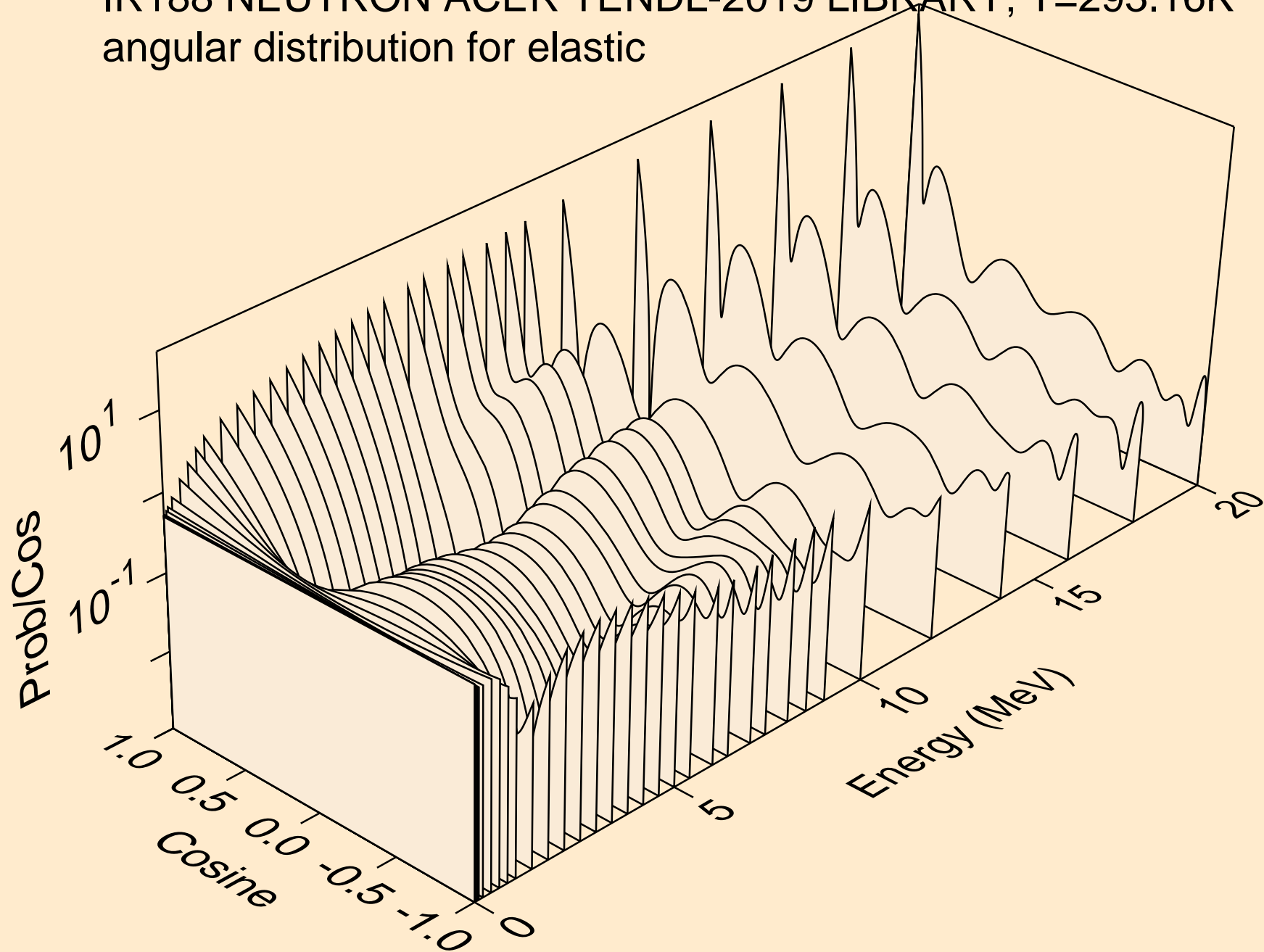

IR188 NEUTRON ACER TENDL-2019 LIBRARY; T=293.16K
angular distribution for elastic

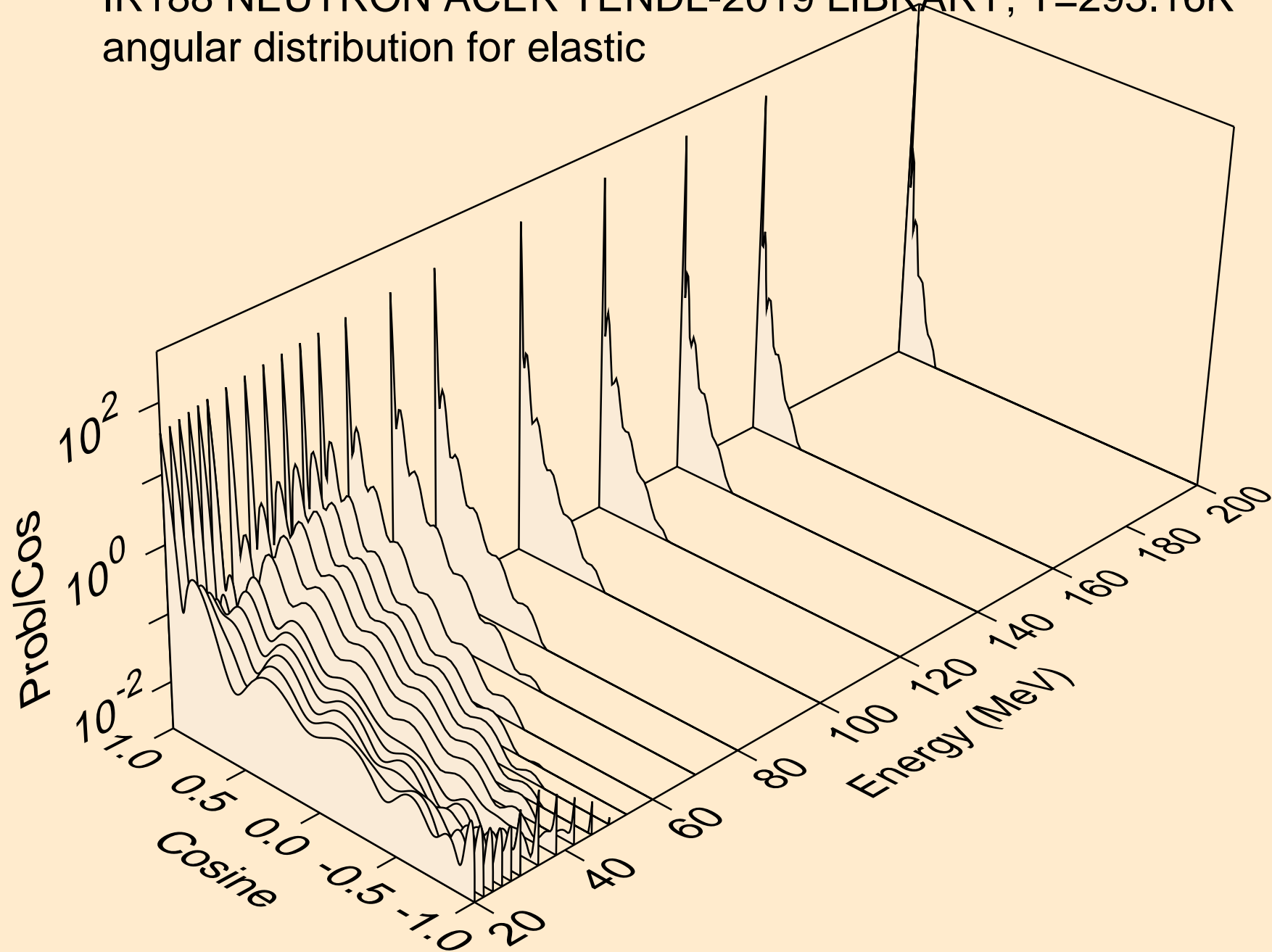

IR188 NEUTRON ACER TENDL-2019 LIBRARY; T=293.16K
angular distribution for (n,n*1)

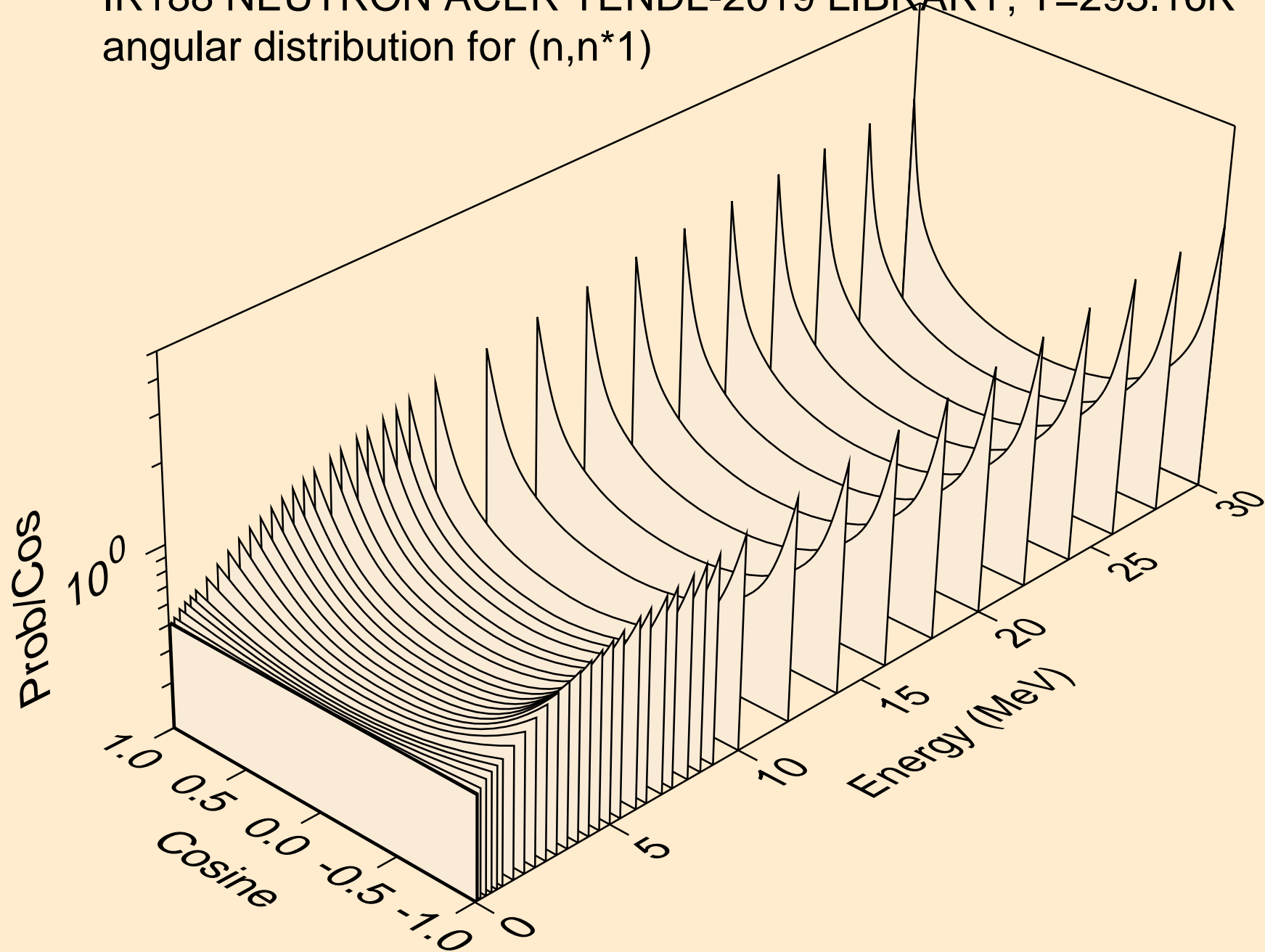

IR188 NEUTRON ACER TENDL-2019 LIBRARY; T=293.16K
angular distribution for (n,n*2)

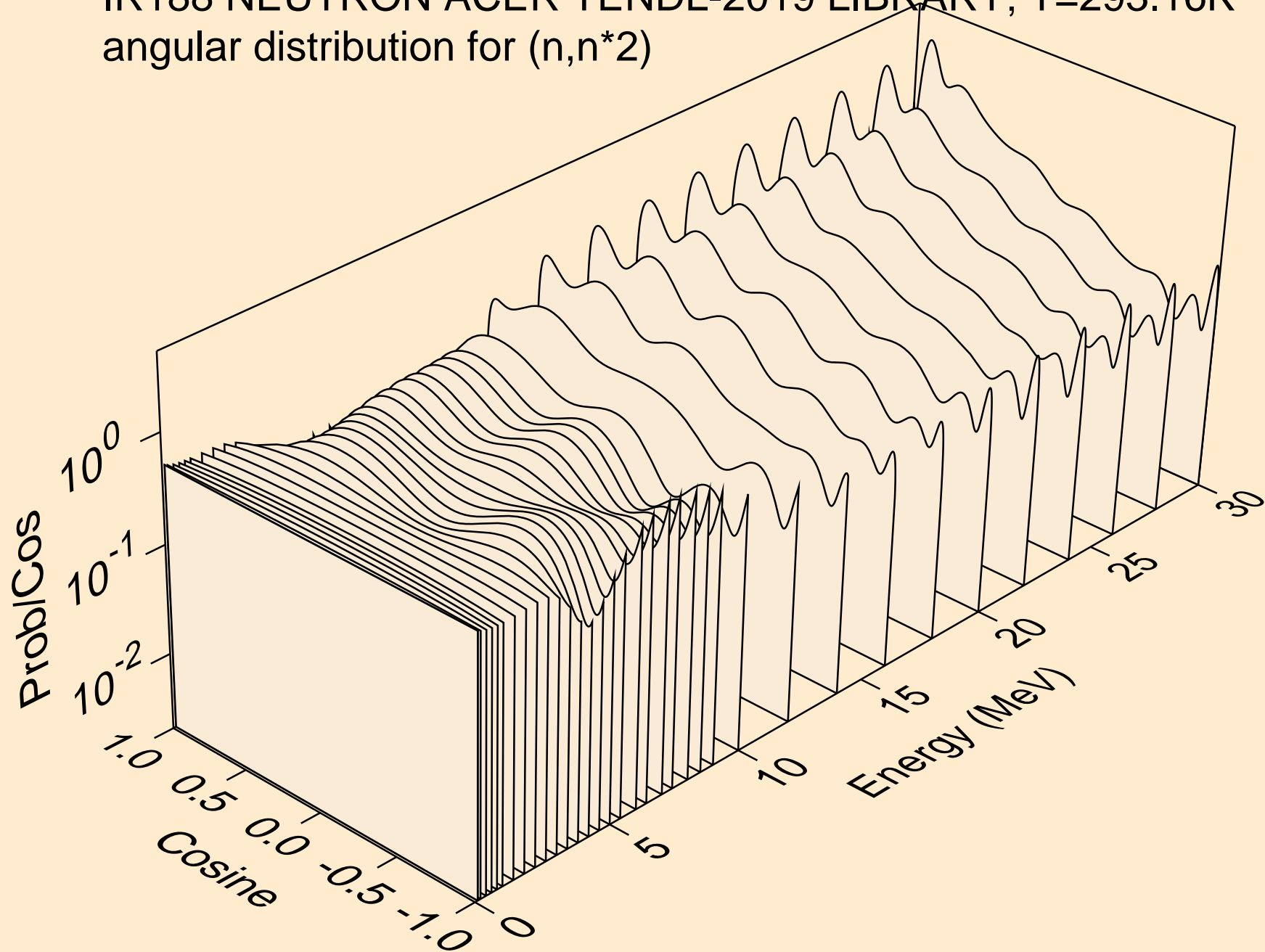

IR188 NEUTRON ACER TENDL-2019 LIBRARY; T=293.16K
angular distribution for (n,n*3)

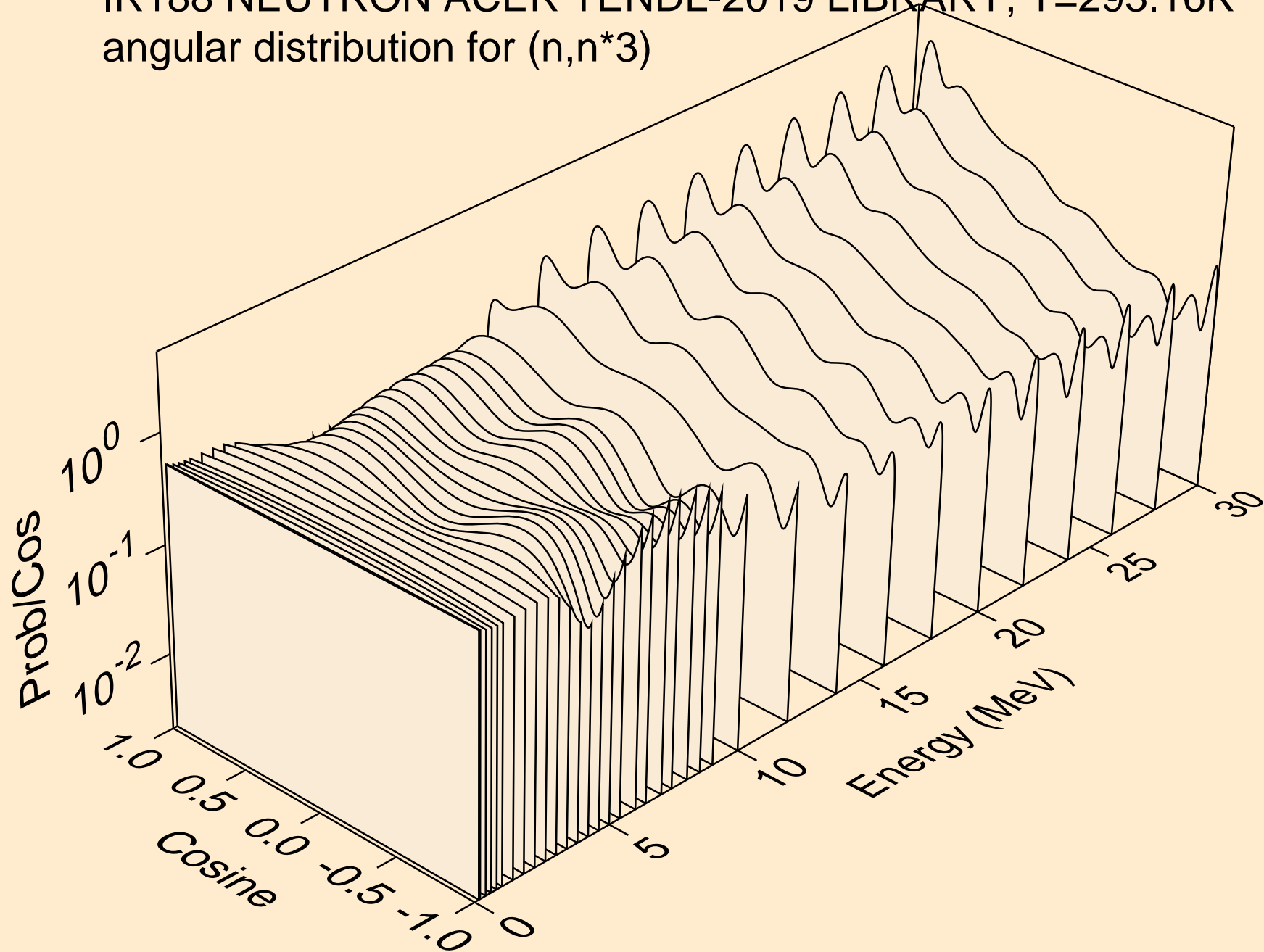

IR188 NEUTRON ACER TENDL-2019 LIBRARY; T=293.16K
angular distribution for (n,n*4)

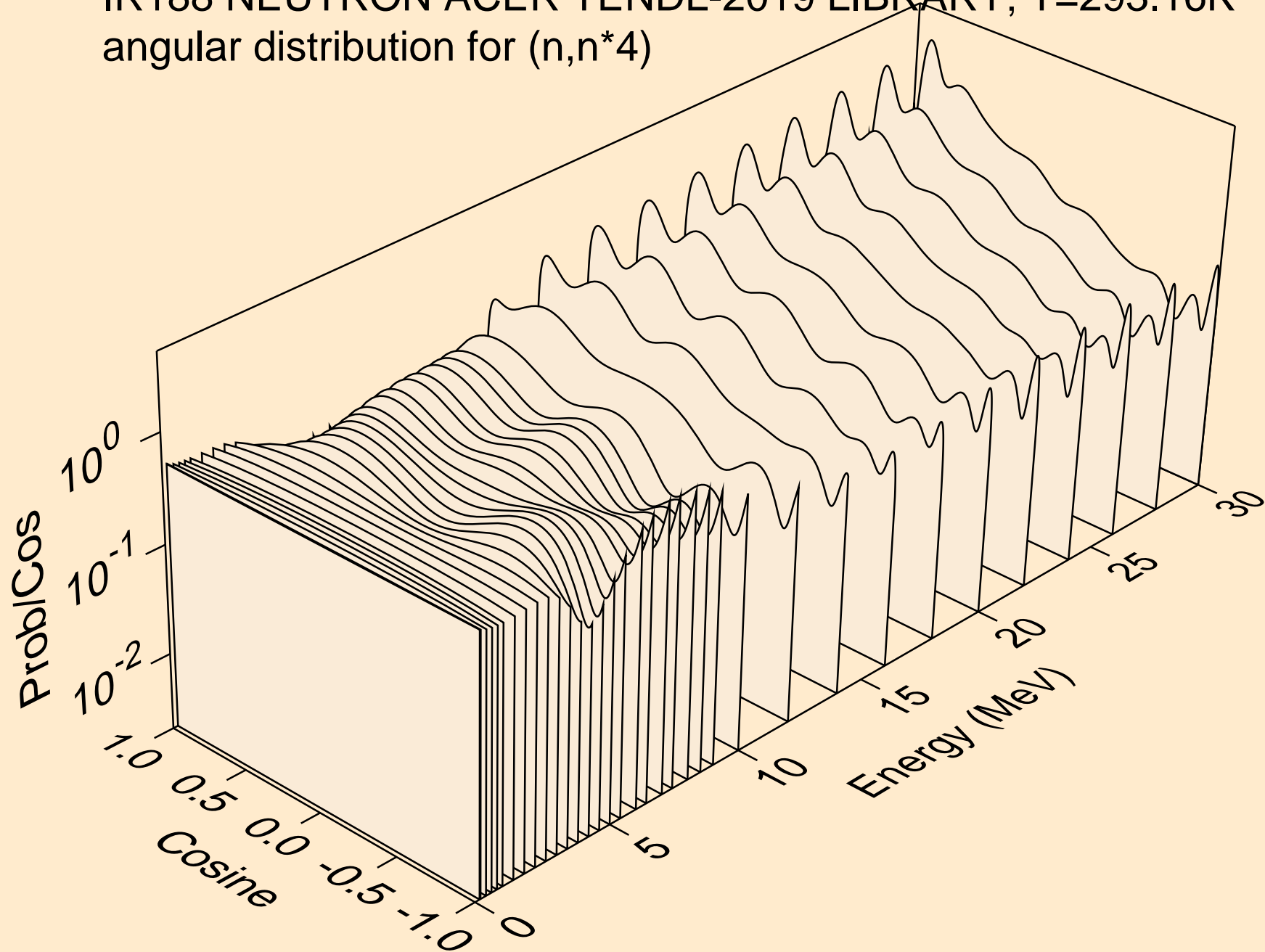

IR188 NEUTRON ACER TENDL-2019 LIBRARY; T=293.16K
angular distribution for (n,n*5)

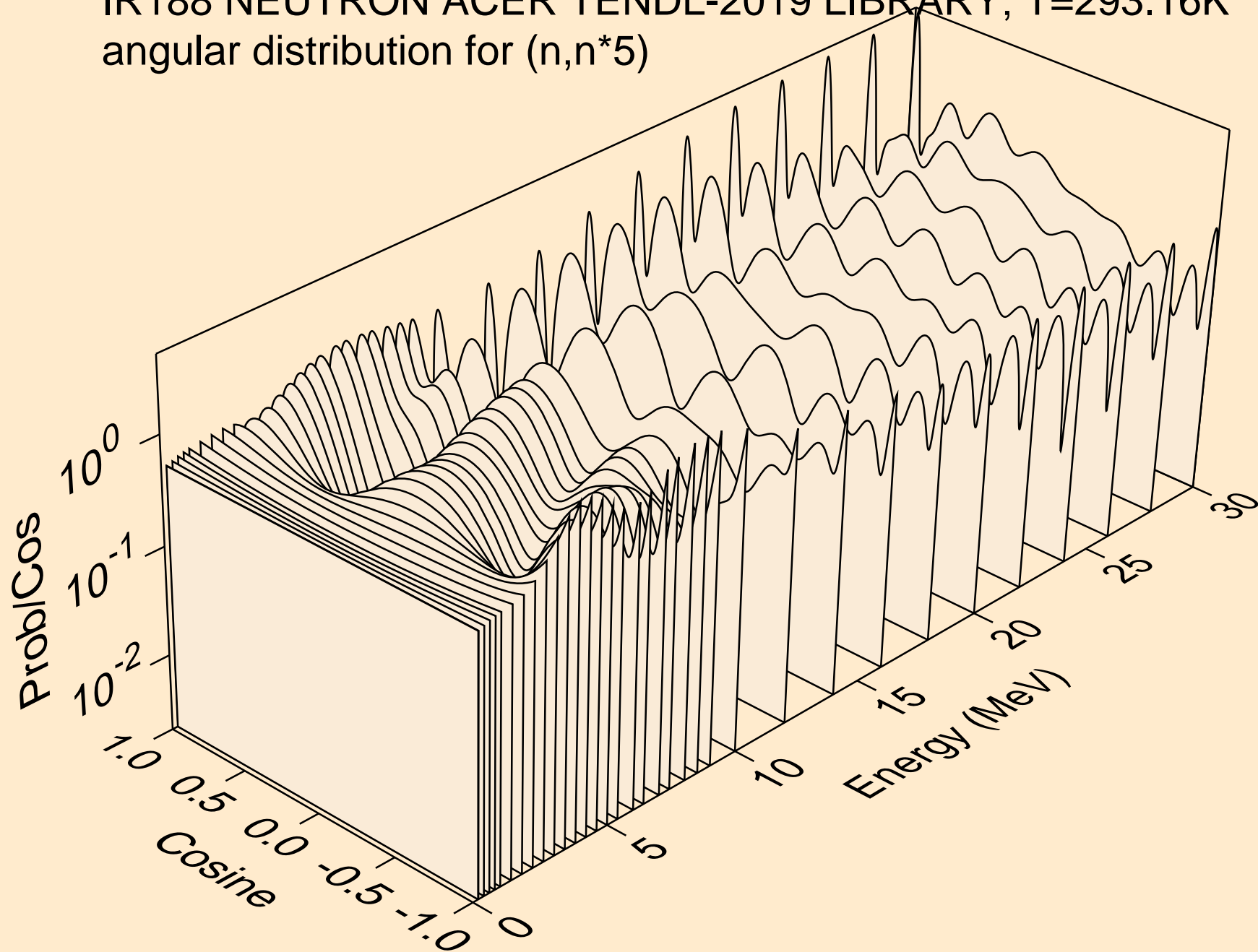

IR188 NEUTRON ACER TENDL-2019 LIBRARY; T=293.16K
angular distribution for (n,n*6)

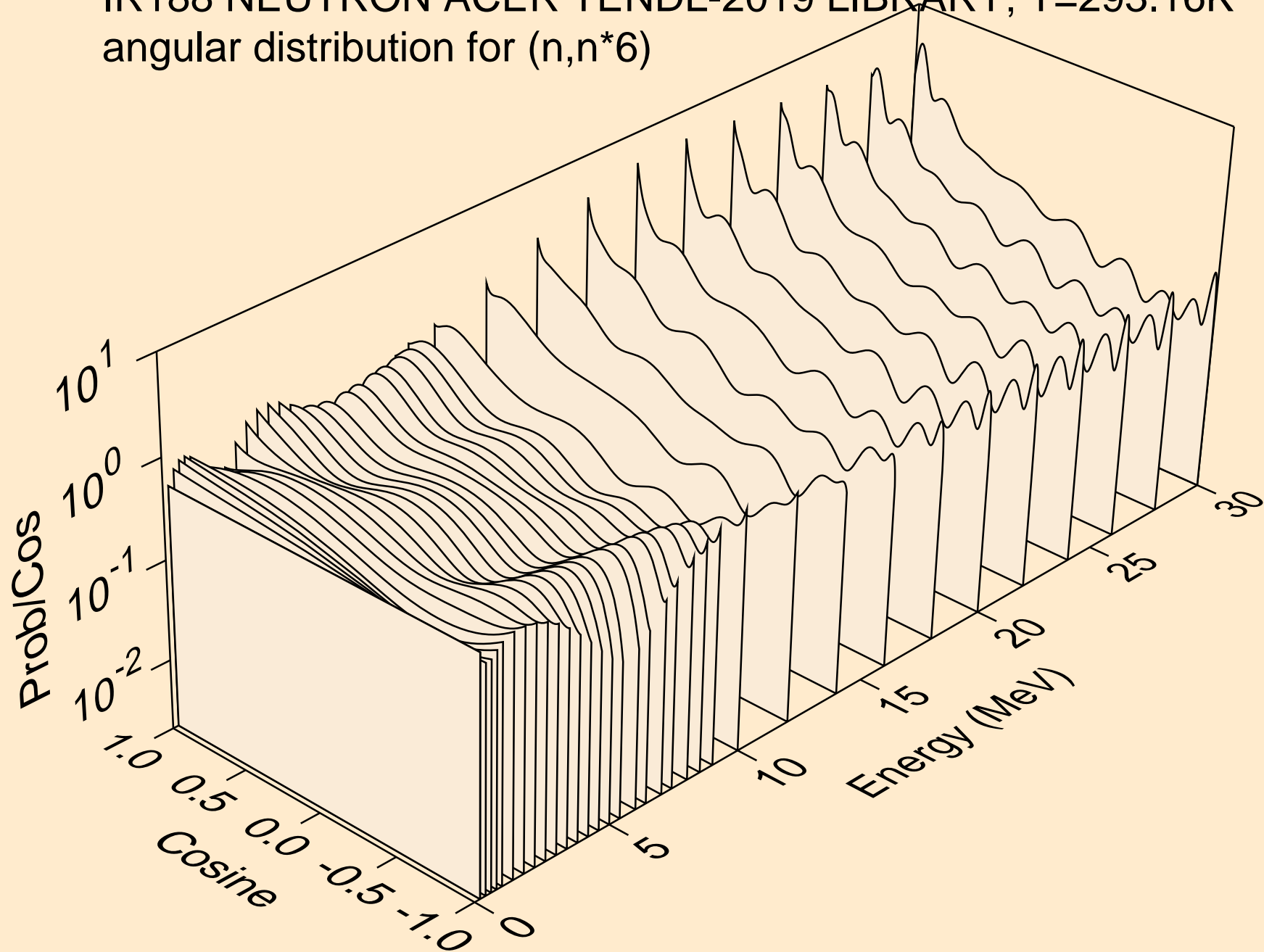

IR188 NEUTRON ACER TENDL-2019 LIBRARY; T=293.16K
angular distribution for (n,n*7)

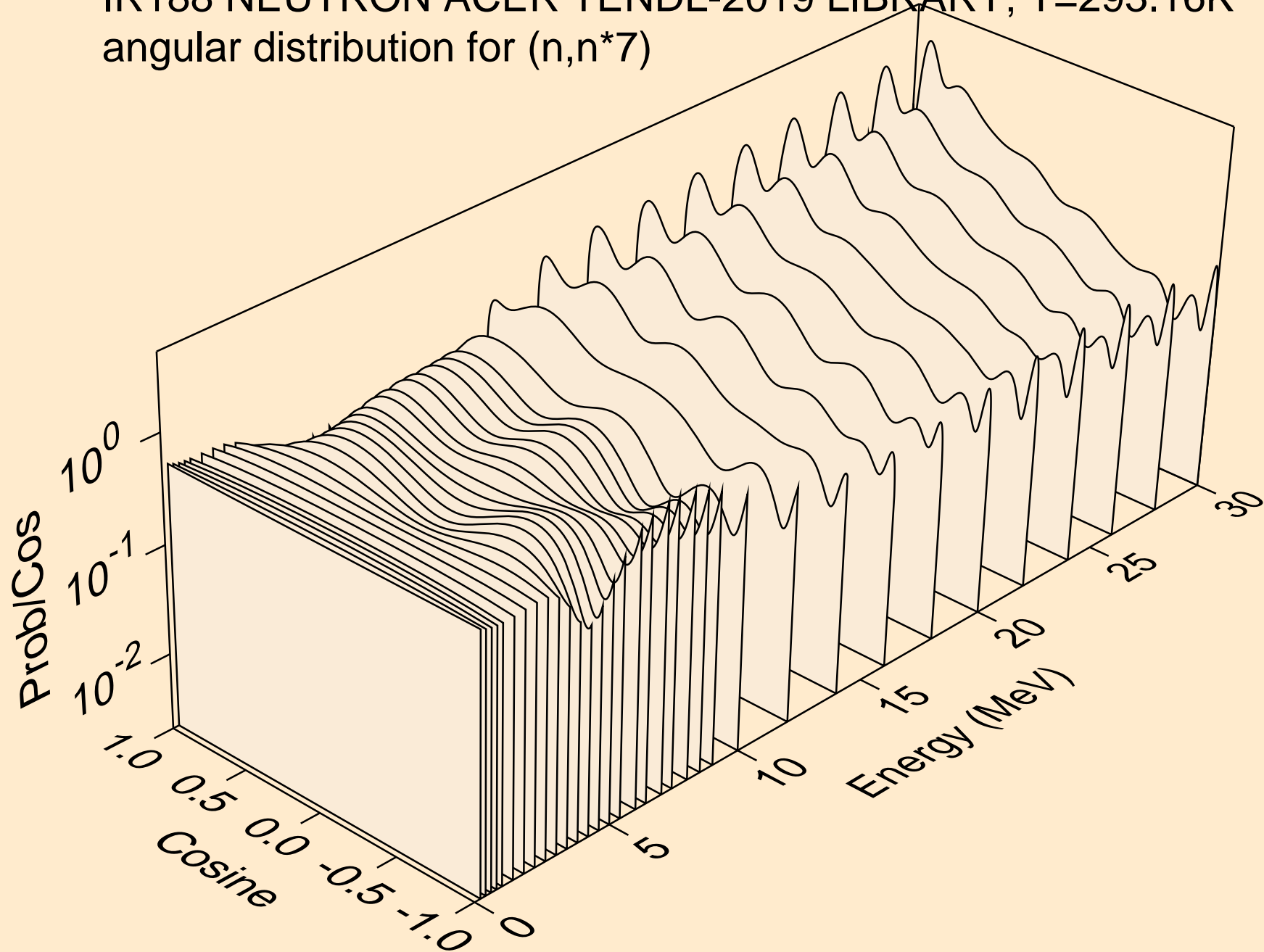

IR188 NEUTRON ACER TENDL-2019 LIBRARY; T=293.16K
angular distribution for (n,n*8)

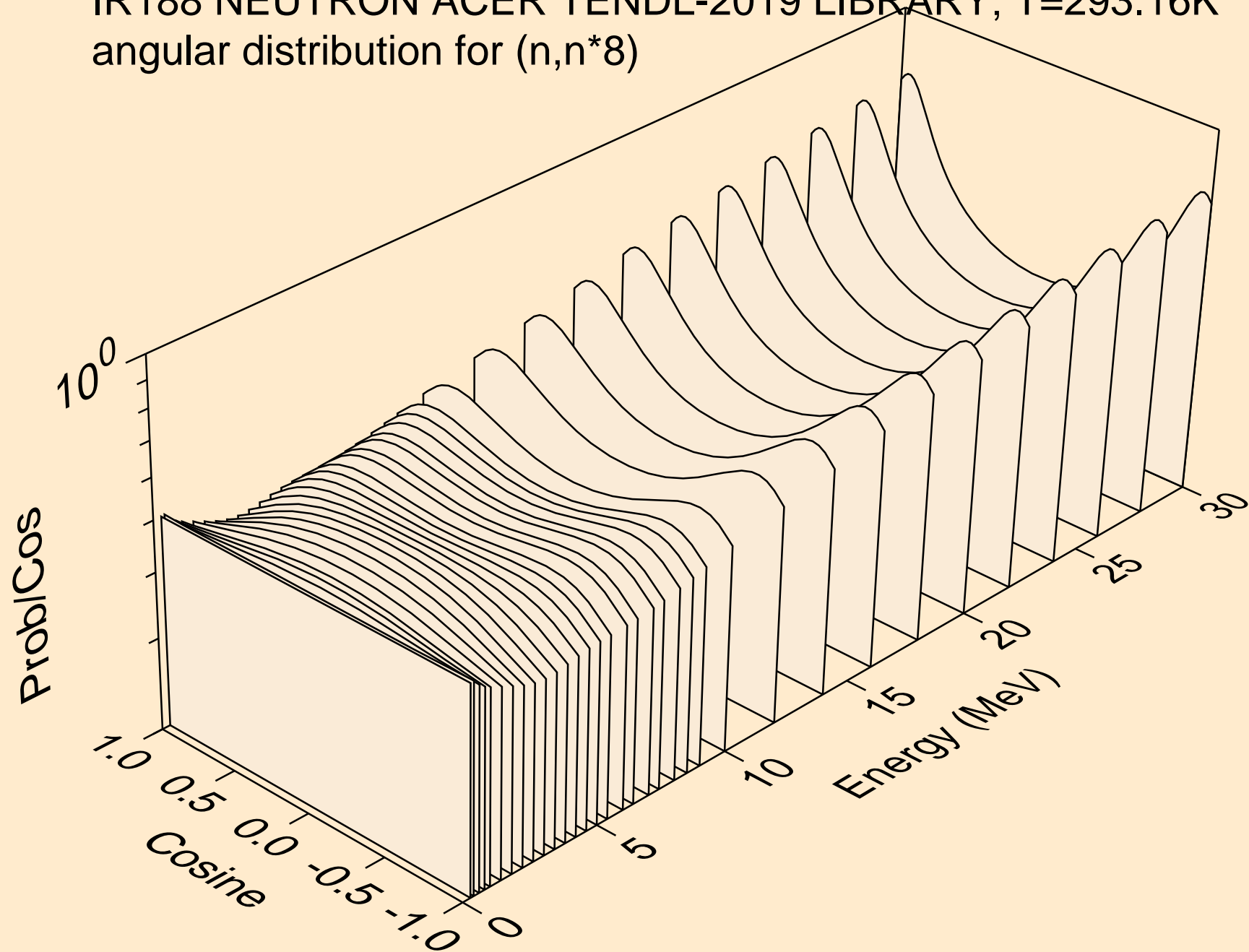

IR188 NEUTRON ACER TENDL-2019 LIBRARY; T=293.16K
angular distribution for (n,n*9)

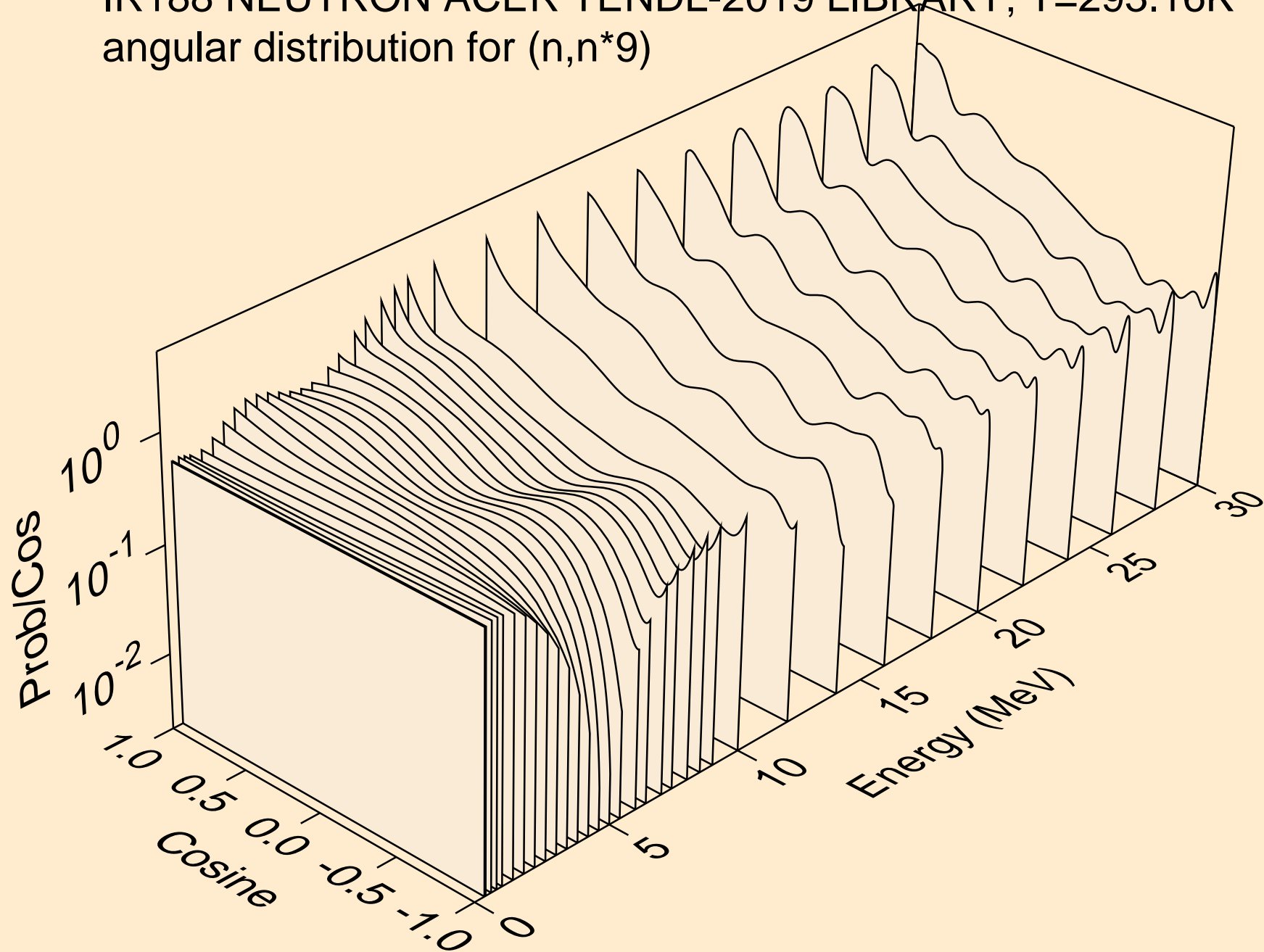

IR188 NEUTRON ACER TENDL-2019 LIBRARY; T=293.16K
angular distribution for (n,n*10)

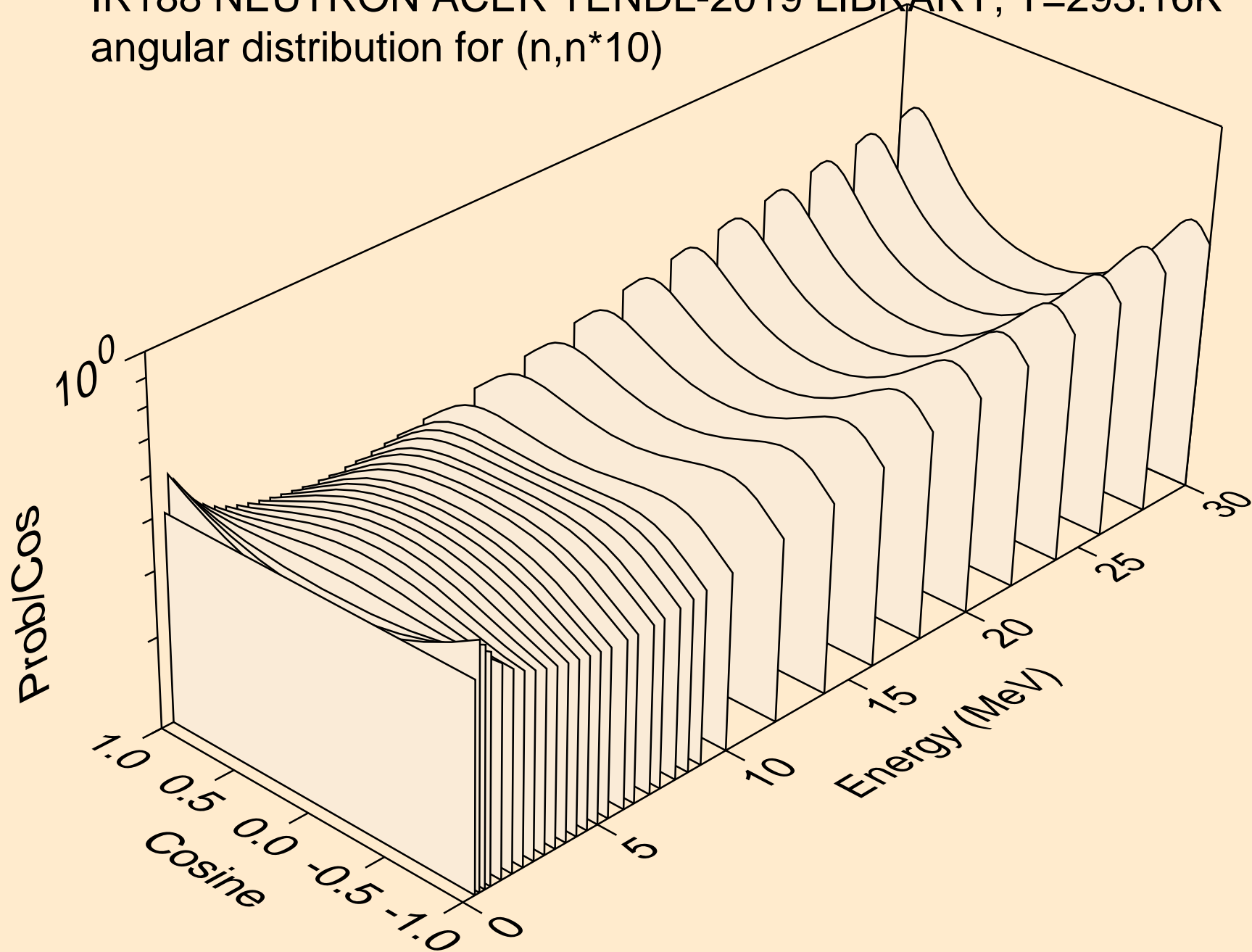

IR188 NEUTRON ACER TENDL-2019 LIBRARY; T=293.16K
angular distribution for (n,n*11)

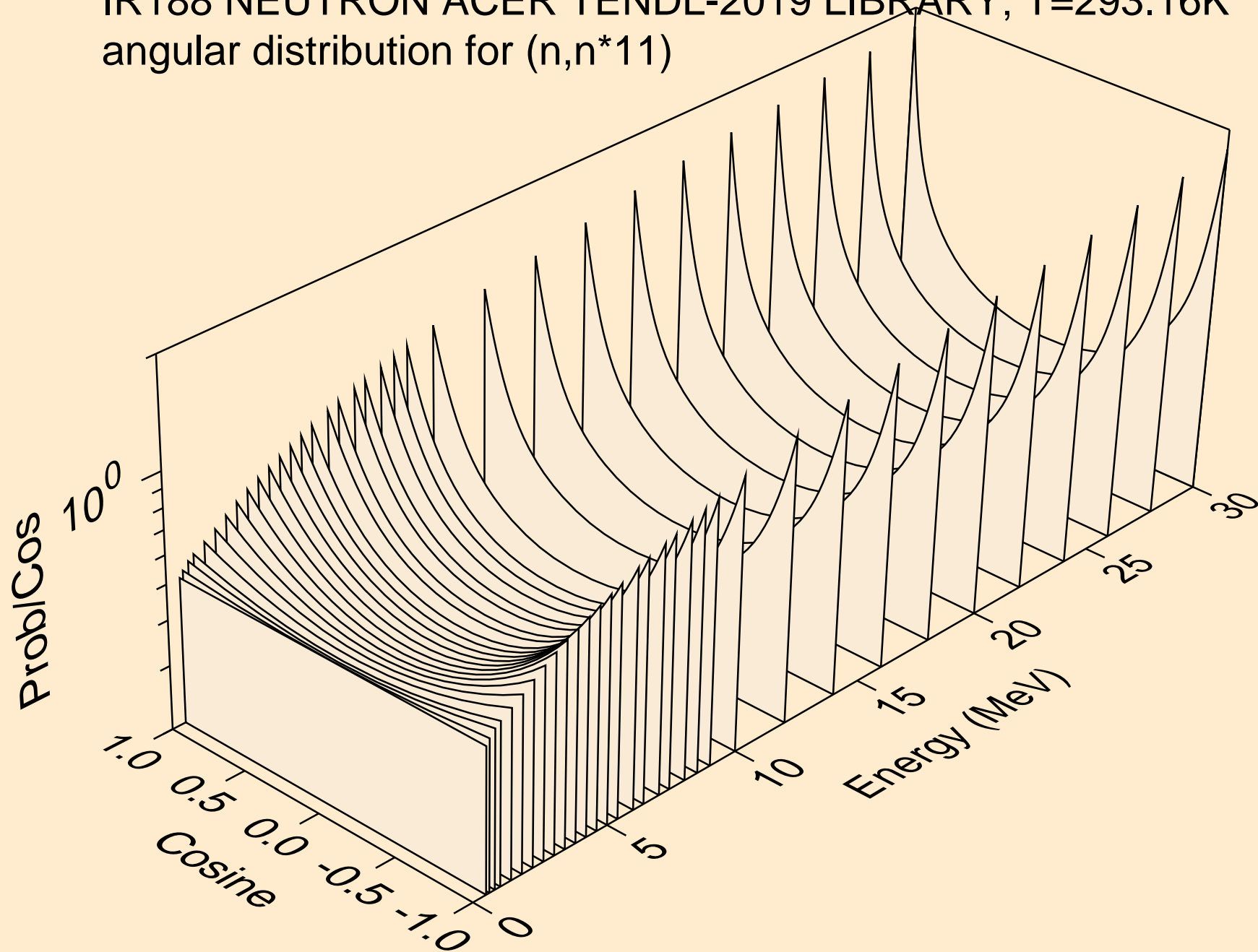

IR188 NEUTRON ACER TENDL-2019 LIBRARY; T=293.16K
angular distribution for (n,n*12)

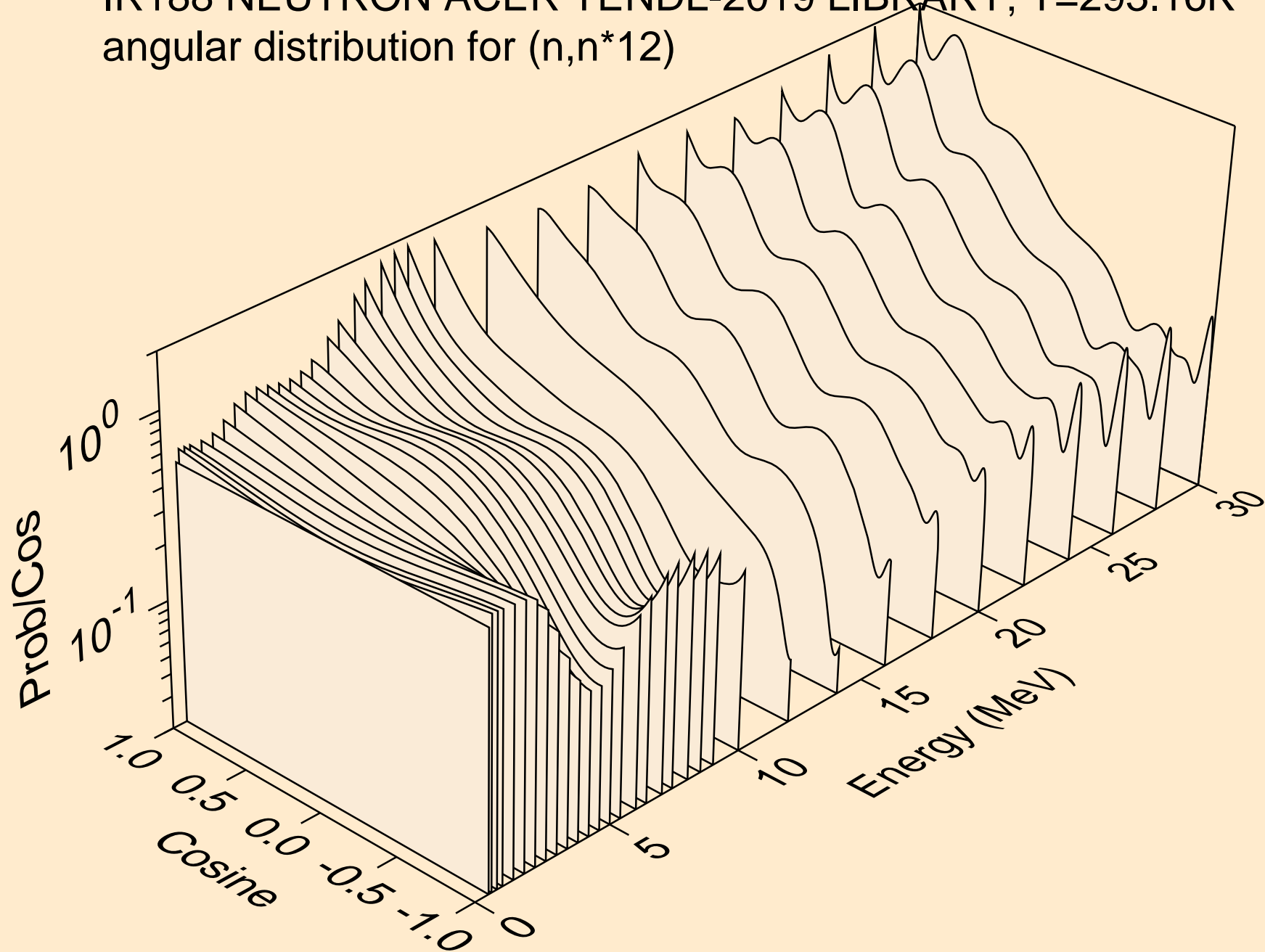

IR188 NEUTRON ACER TENDL-2019 LIBRARY; T=293.16K
angular distribution for (n,n*13)

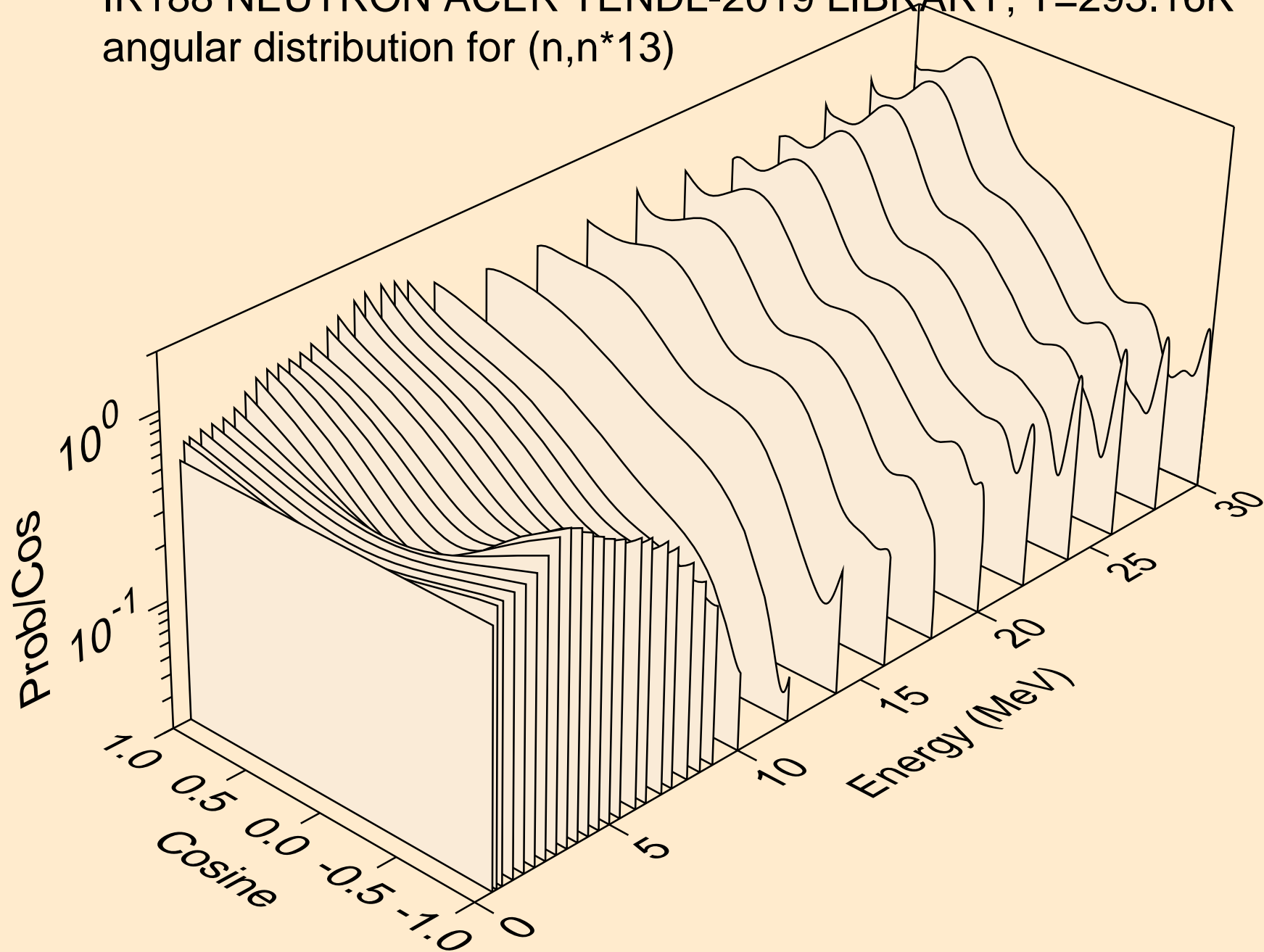

IR188 NEUTRON ACER TENDL-2019 LIBRARY; T=293.16K
angular distribution for (n,n*14)

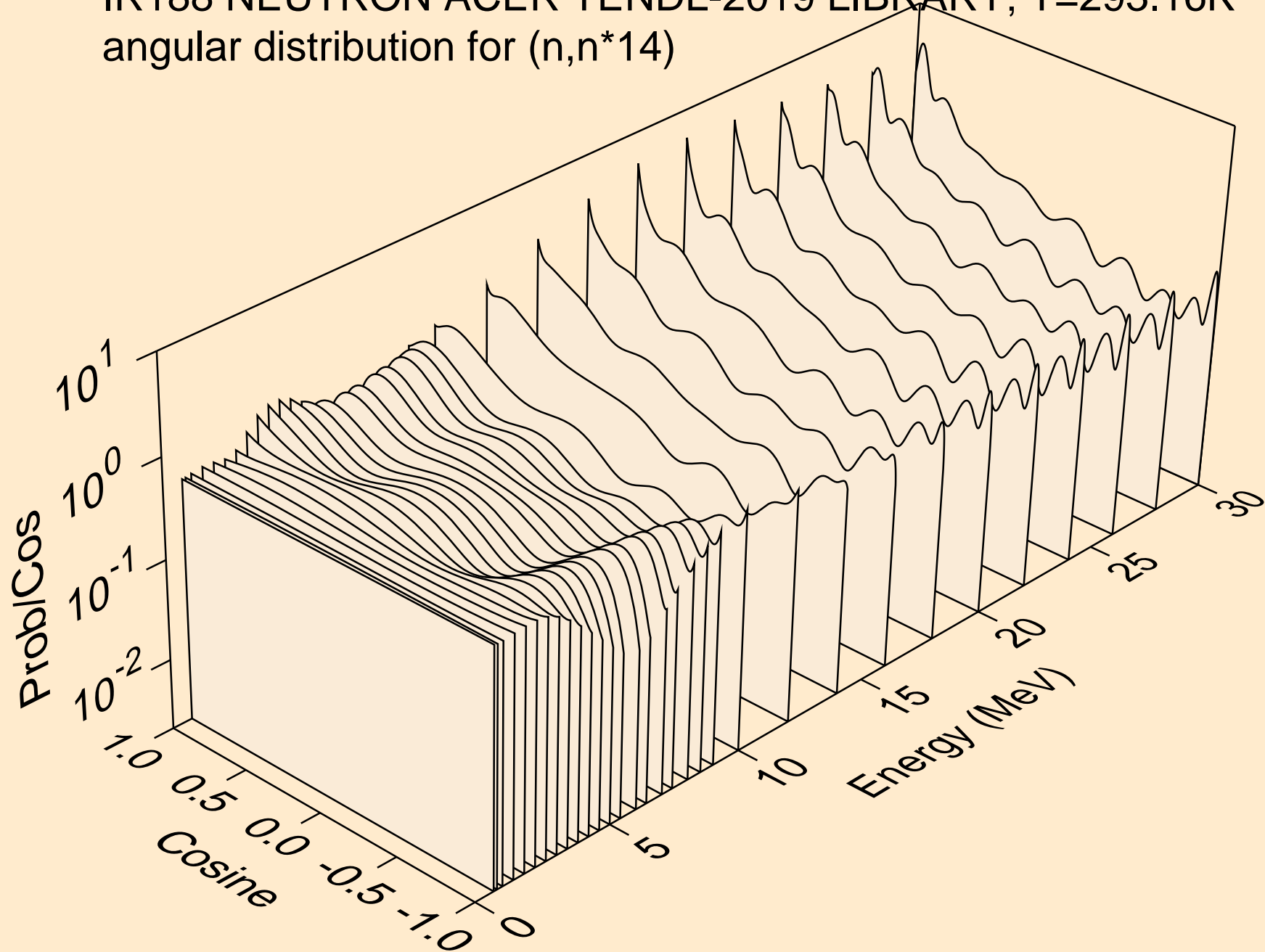

IR188 NEUTRON ACER TENDL-2019 LIBRARY; T=293.16K
angular distribution for (n,n*15)

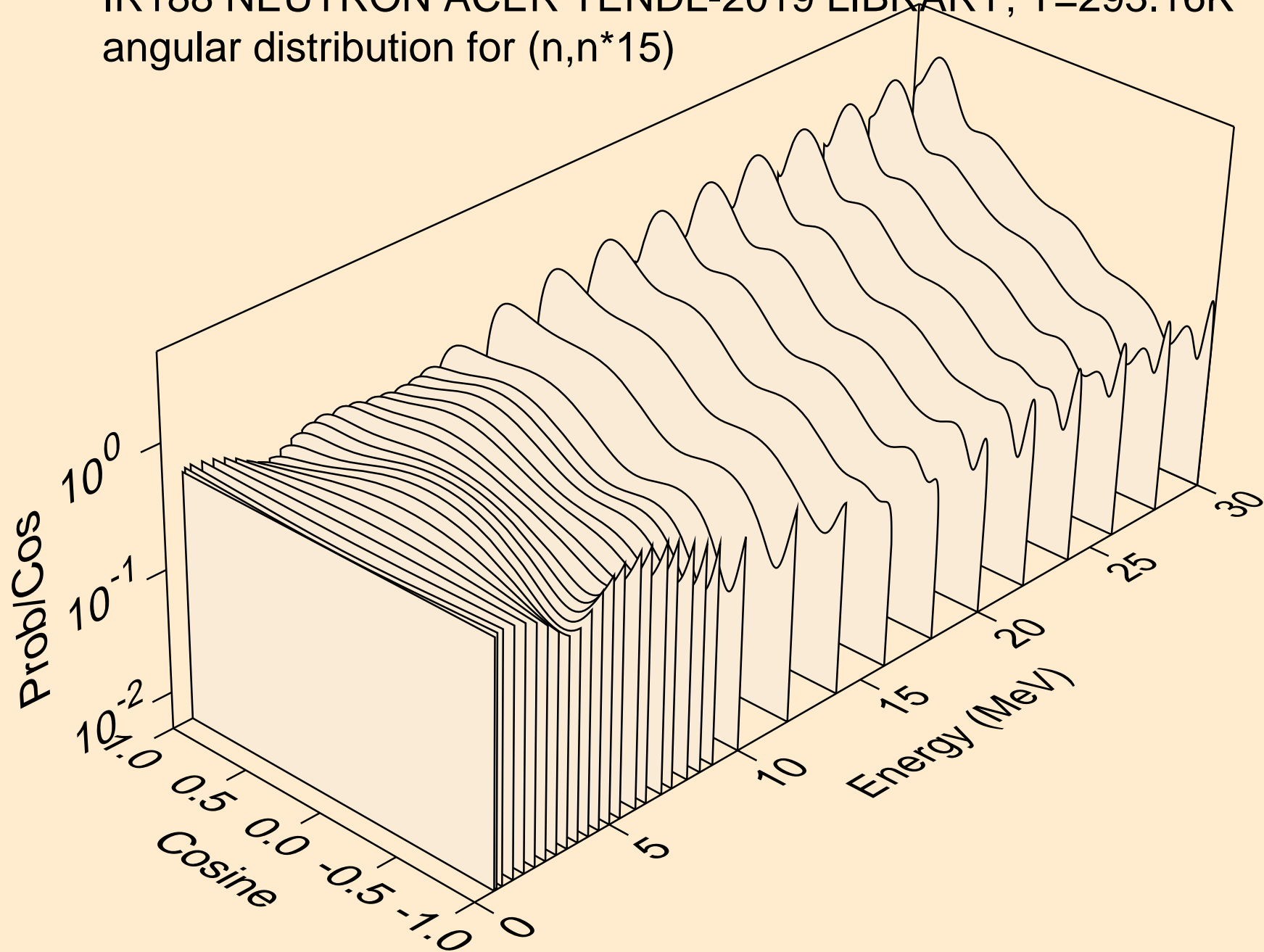

IR188 NEUTRON ACER TENDL-2019 LIBRARY; T=293.16K
angular distribution for (n,n*16)

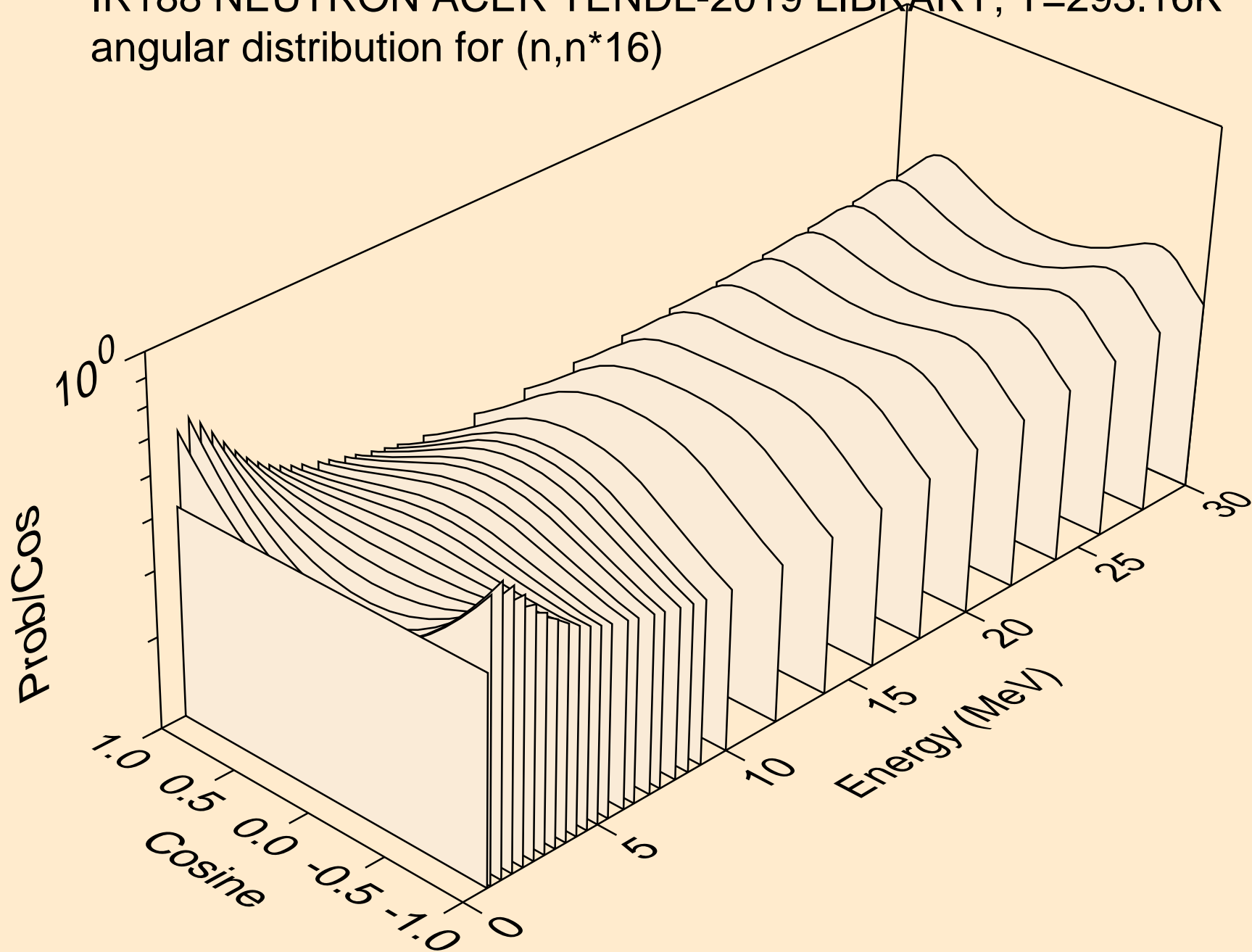

IR188 NEUTRON ACER TENDL-2019 LIBRARY; T=293.16K
angular distribution for (n,n*17)

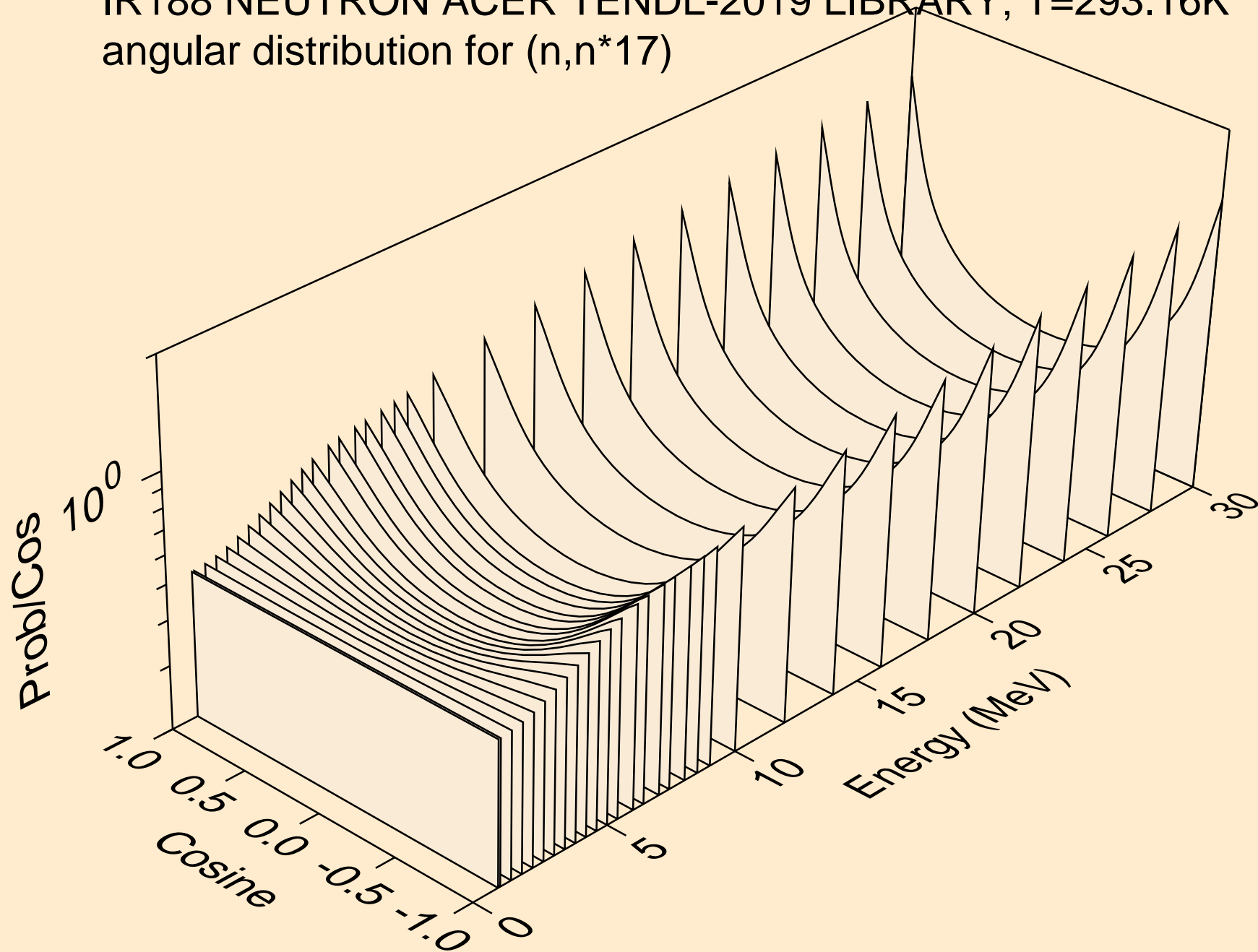

IR188 NEUTRON ACER TENDL-2019 LIBRARY; T=293.16K
angular distribution for (n,n*18)

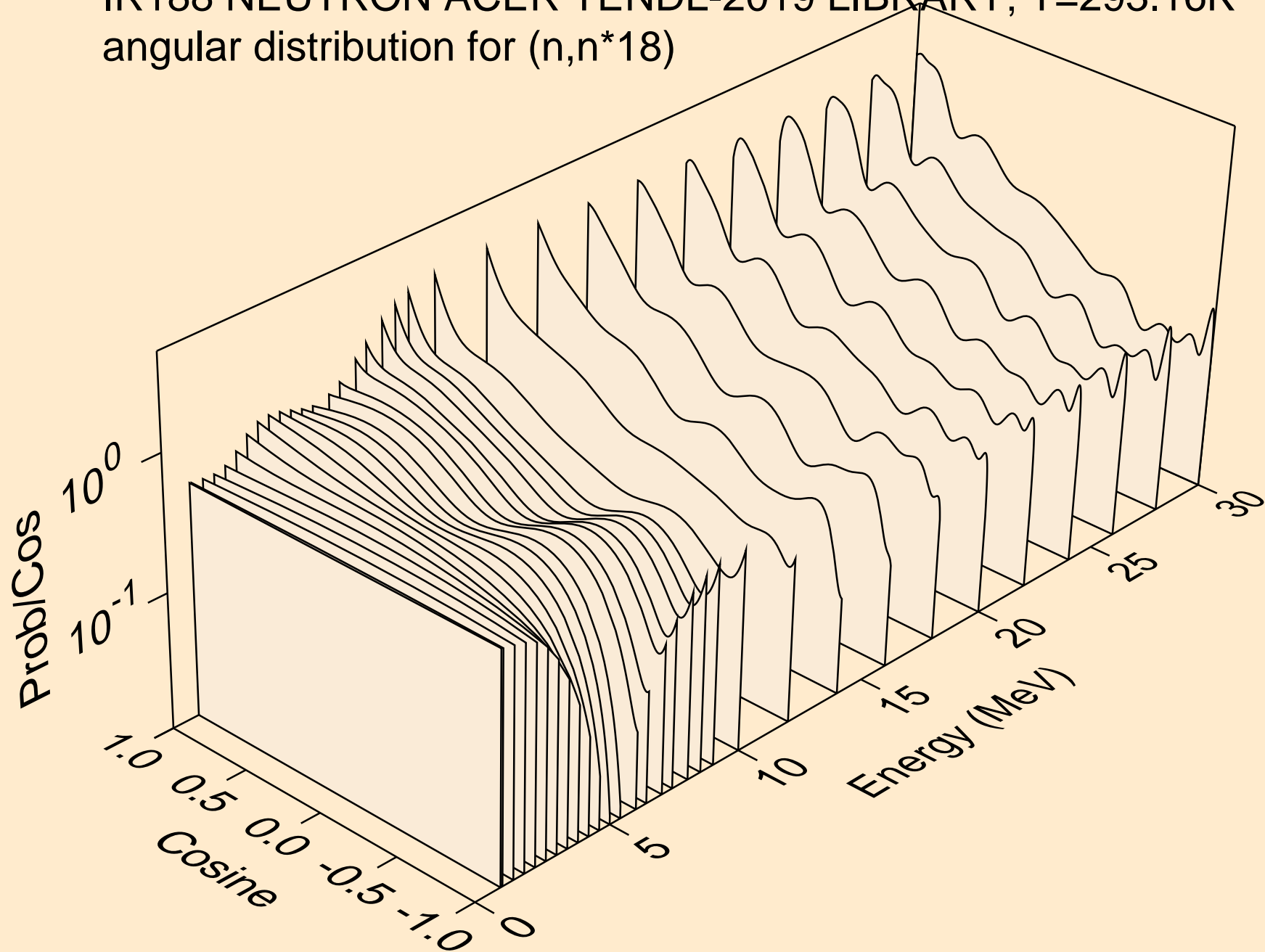

IR188 NEUTRON ACER TENDL-2019 LIBRARY; T=293.16K
angular distribution for (n,n*19)

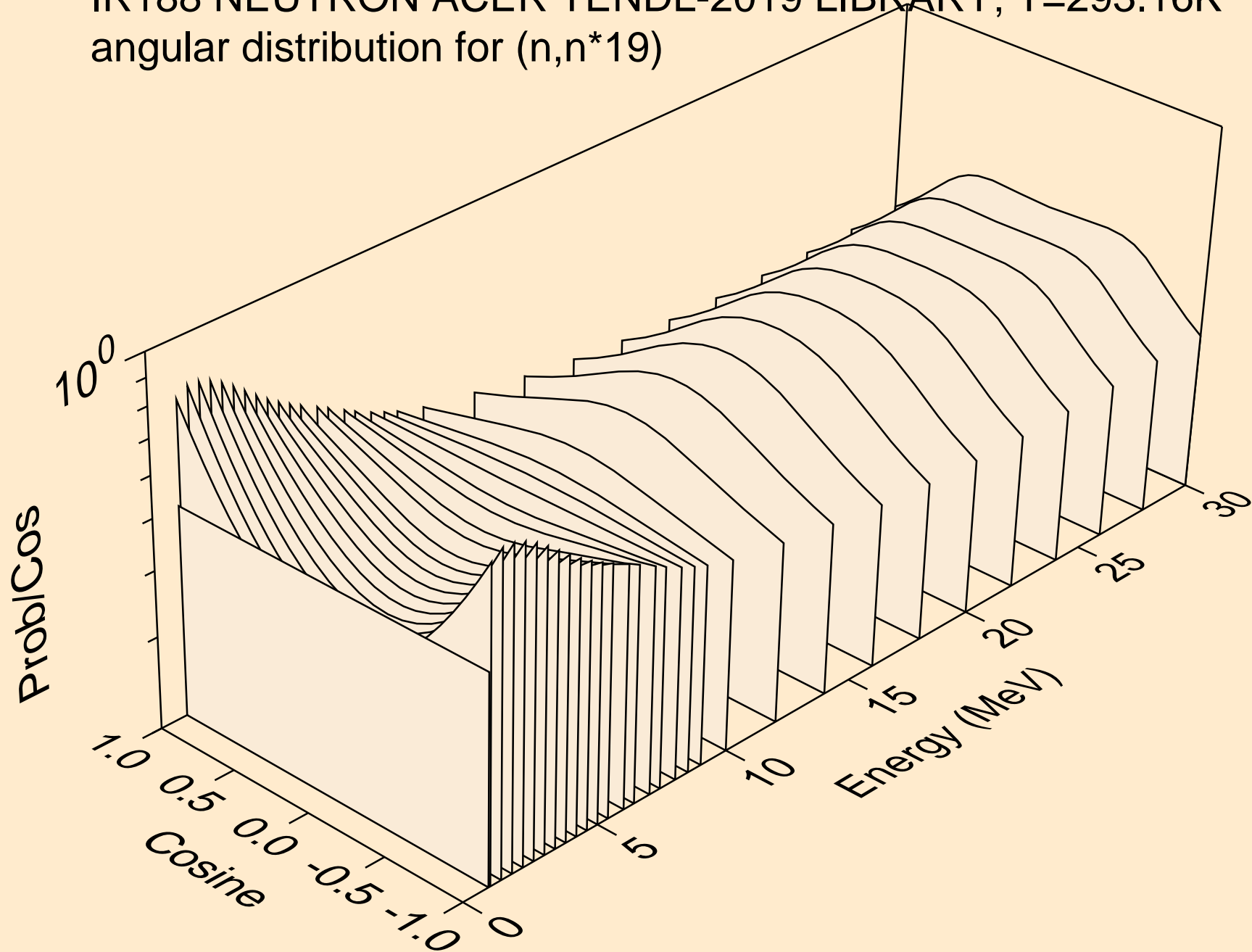

IR188 NEUTRON ACER TENDL-2019 LIBRARY; T=293.16K
angular distribution for (n,n*20)

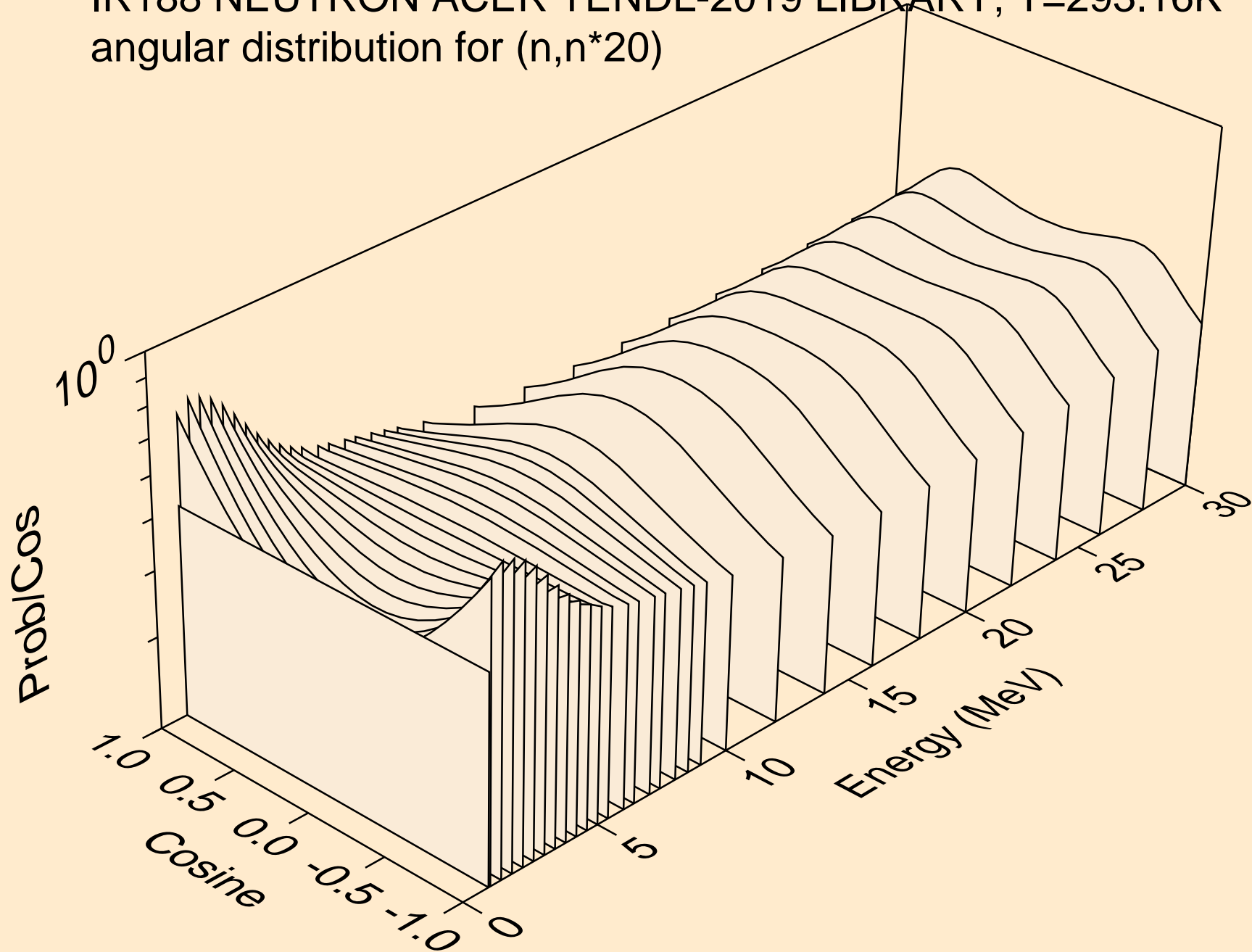

IR188 NEUTRON ACER TENDL-2019 LIBRARY; T=293.16K
angular distribution for (n,n*21)

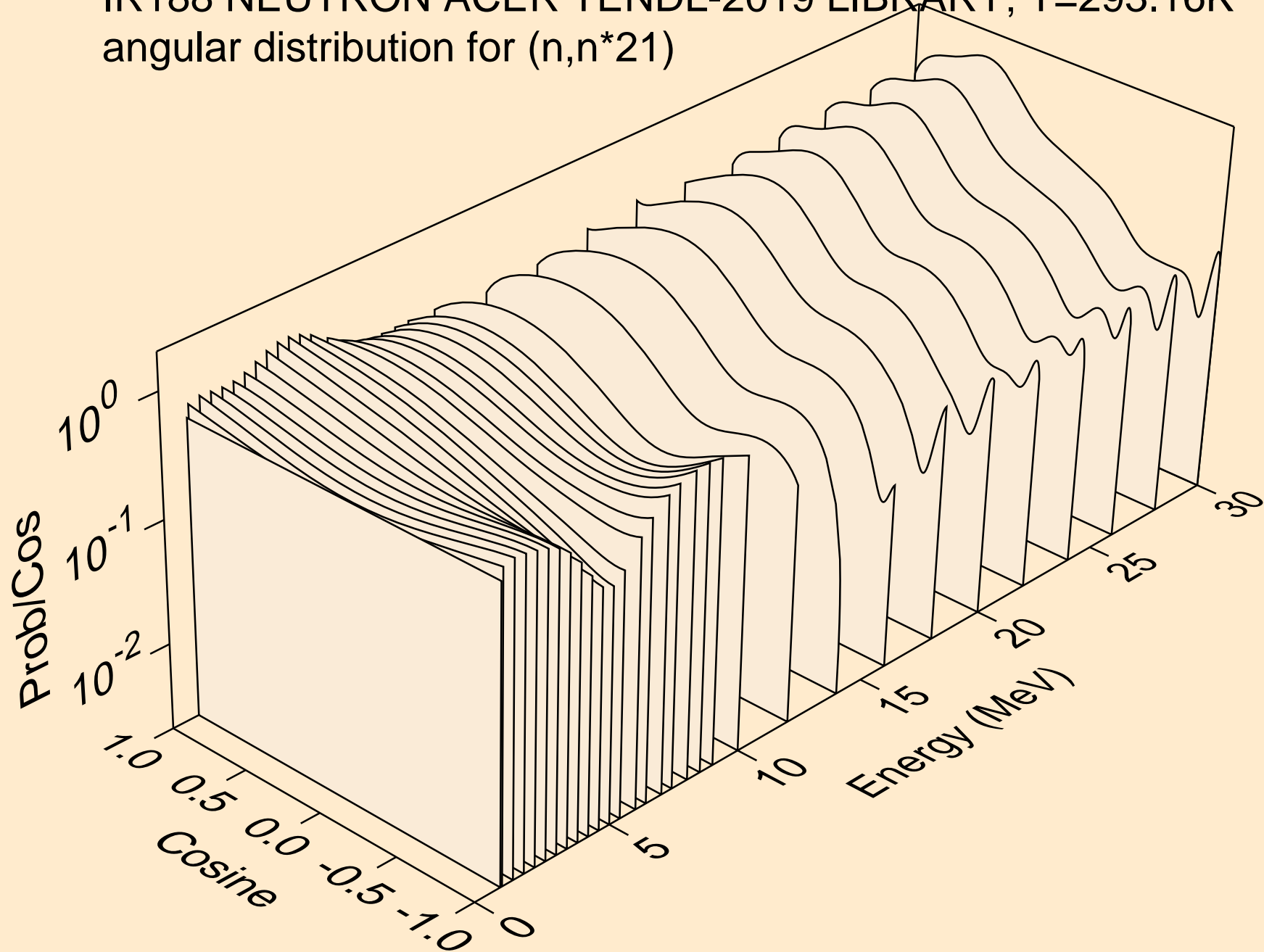

IR188 NEUTRON ACER TENDL-2019 LIBRARY; T=293.16K
angular distribution for (n,n*22)

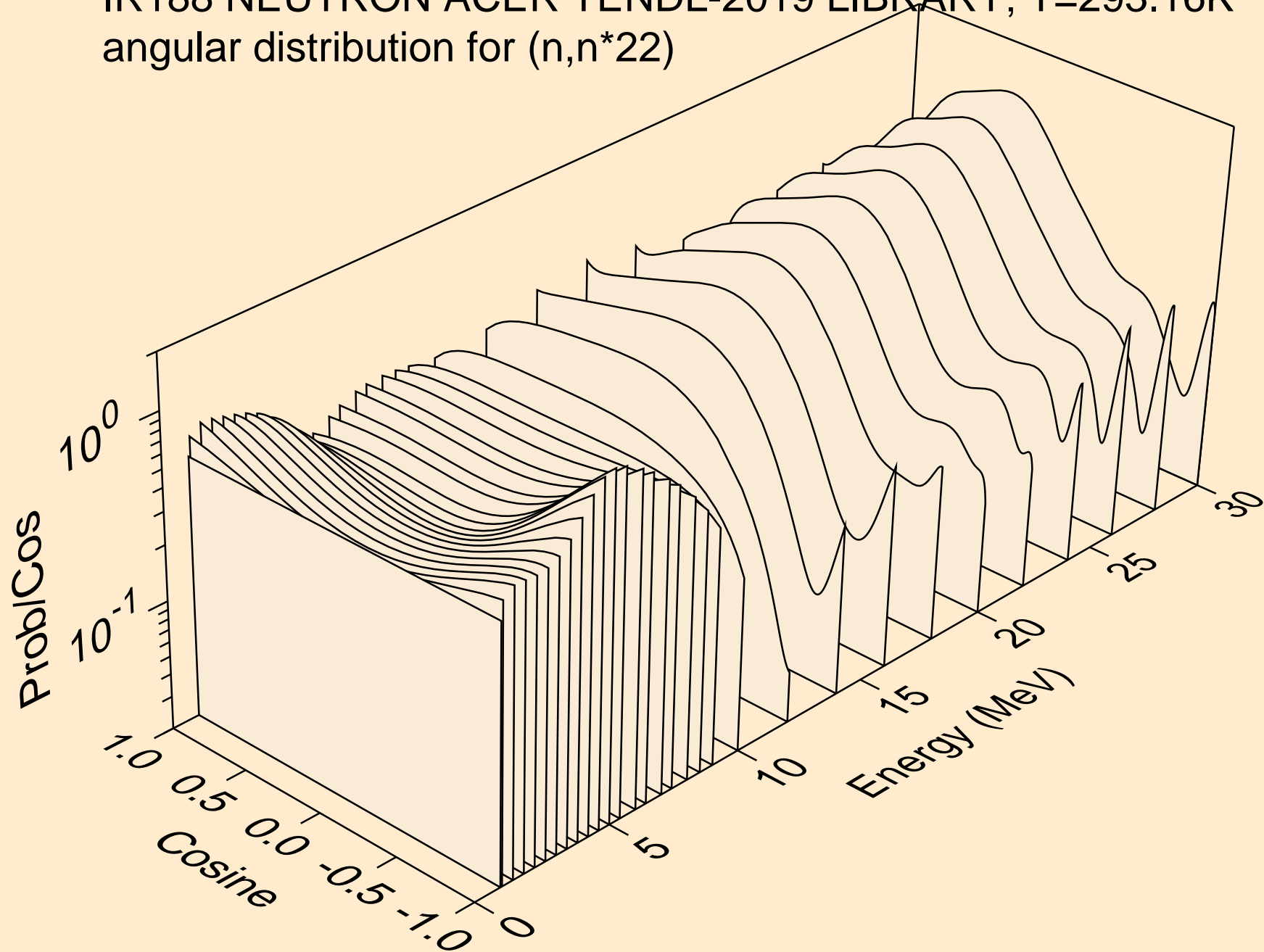

IR188 NEUTRON ACER TENDL-2019 LIBRARY; T=293.16K
angular distribution for (n,n*23)

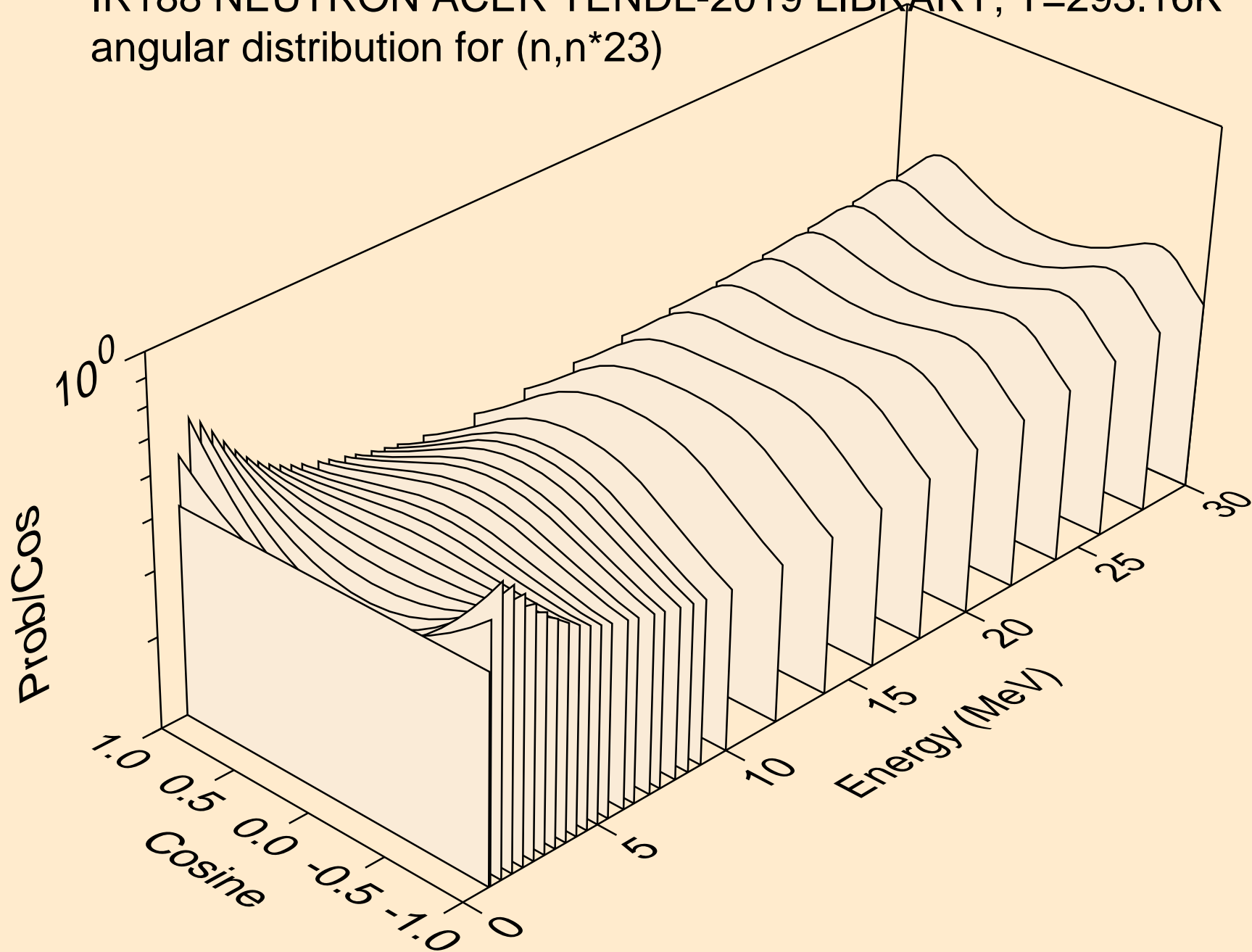

IR188 NEUTRON ACER TENDL-2019 LIBRARY; T=293.16K
angular distribution for (n,n*24)

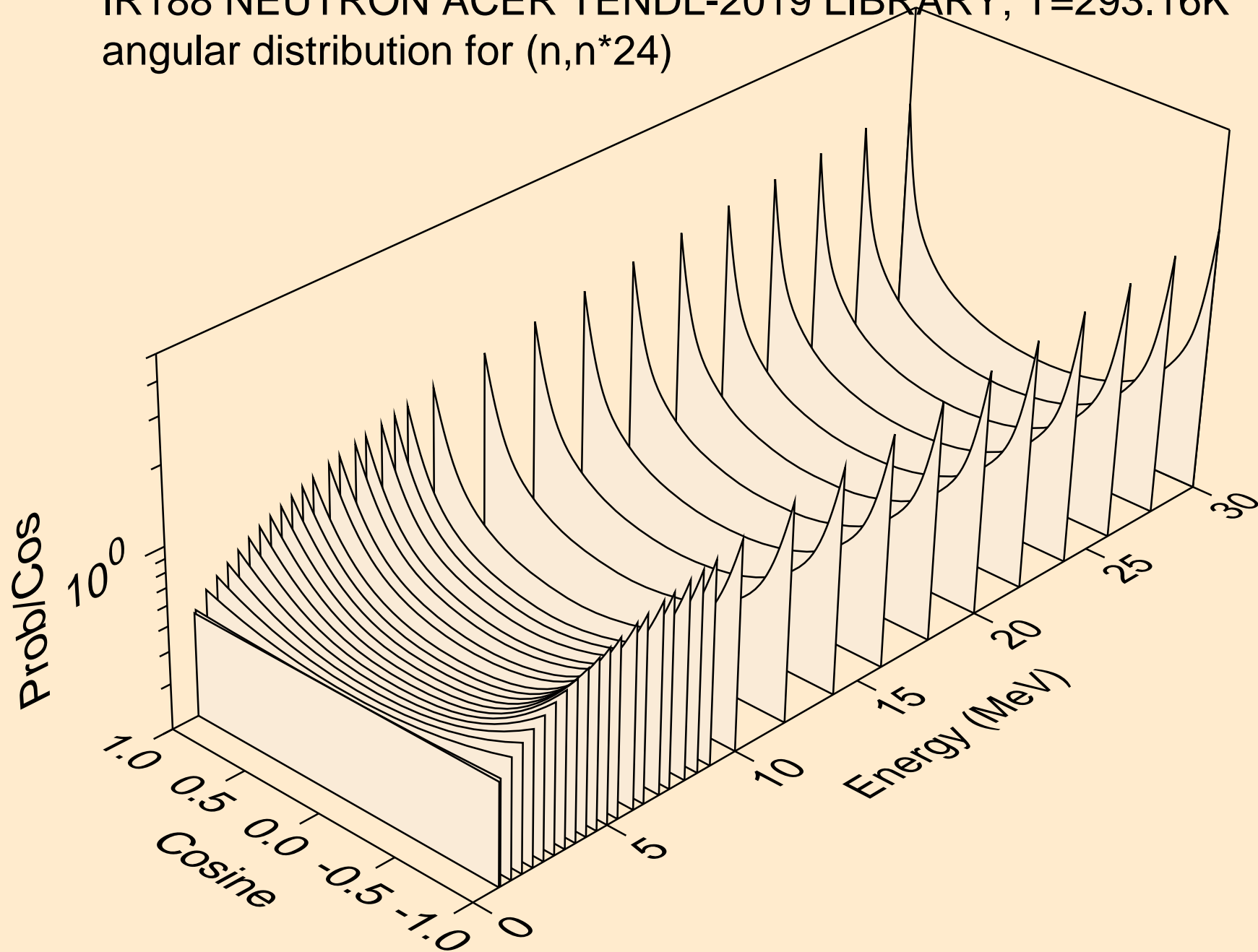

IR188 NEUTRON ACER TENDL-2019 LIBRARY; T=293.16K
angular distribution for (n,n*25)

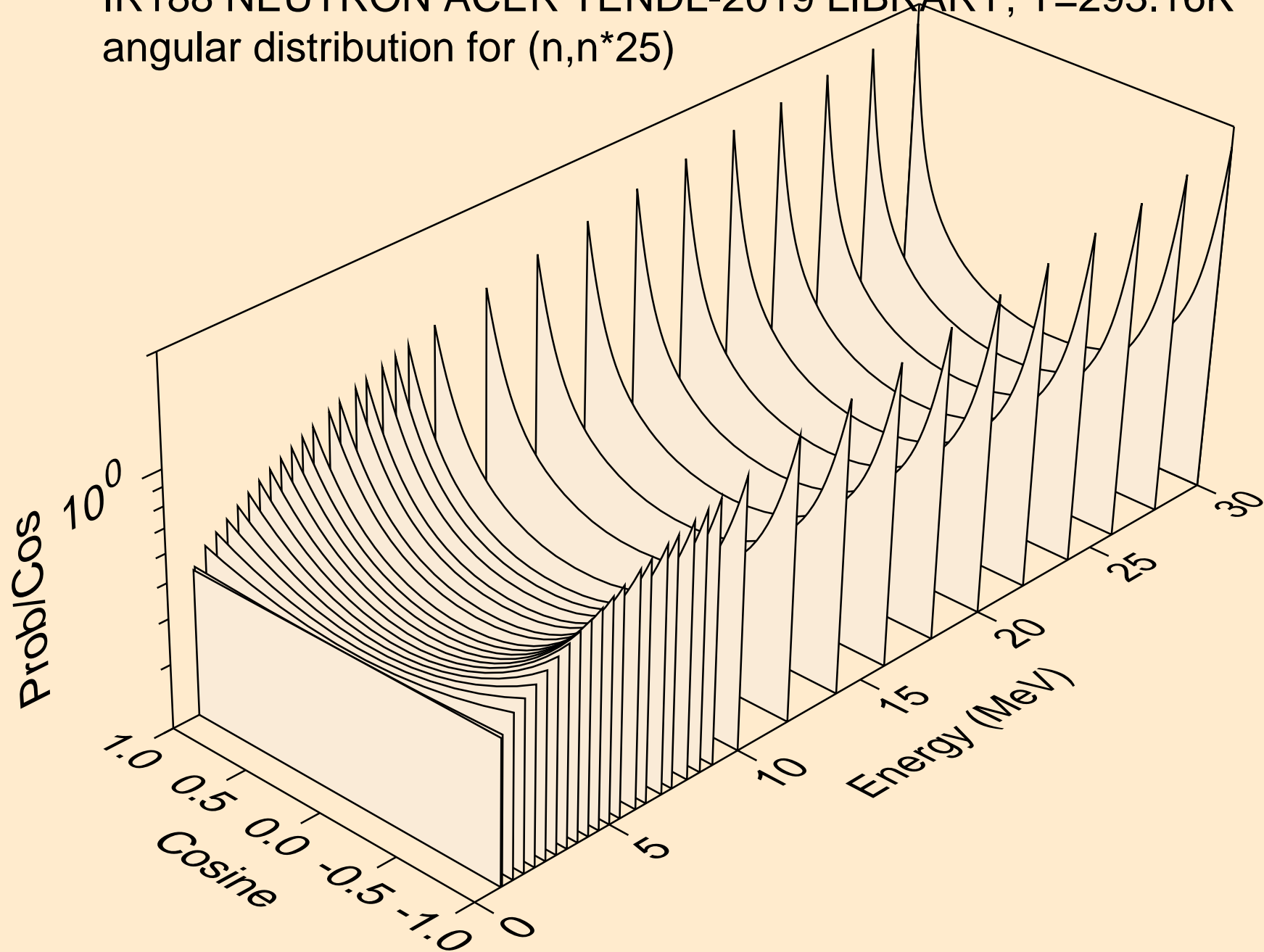

IR188 NEUTRON ACER TENDL-2019 LIBRARY; T=293.16K
Neutron emission for (n,x)

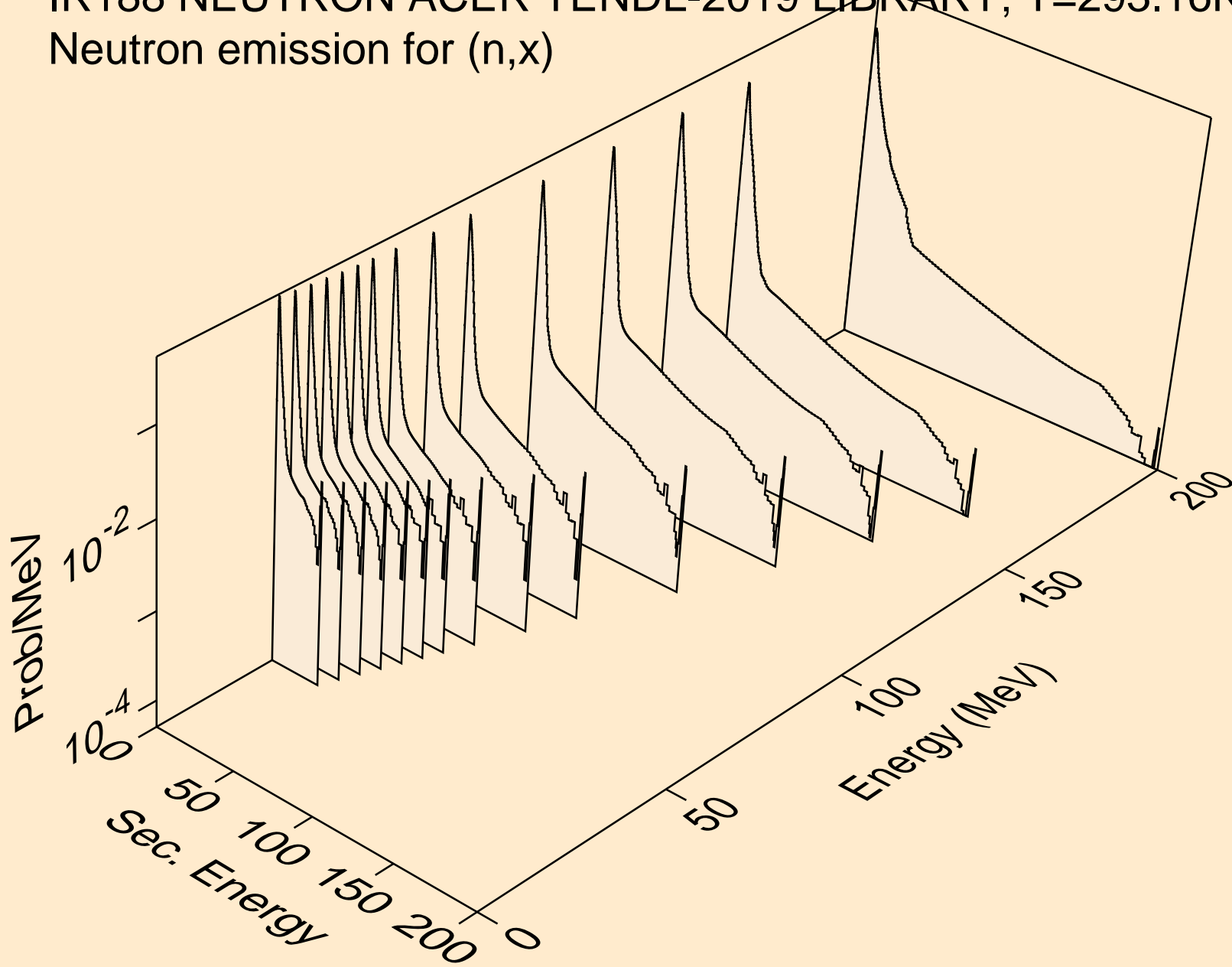

IR188 NEUTRON ACER TENDL-2019 LIBRARY; T=293.16K
Neutron emission for (n,2nd)

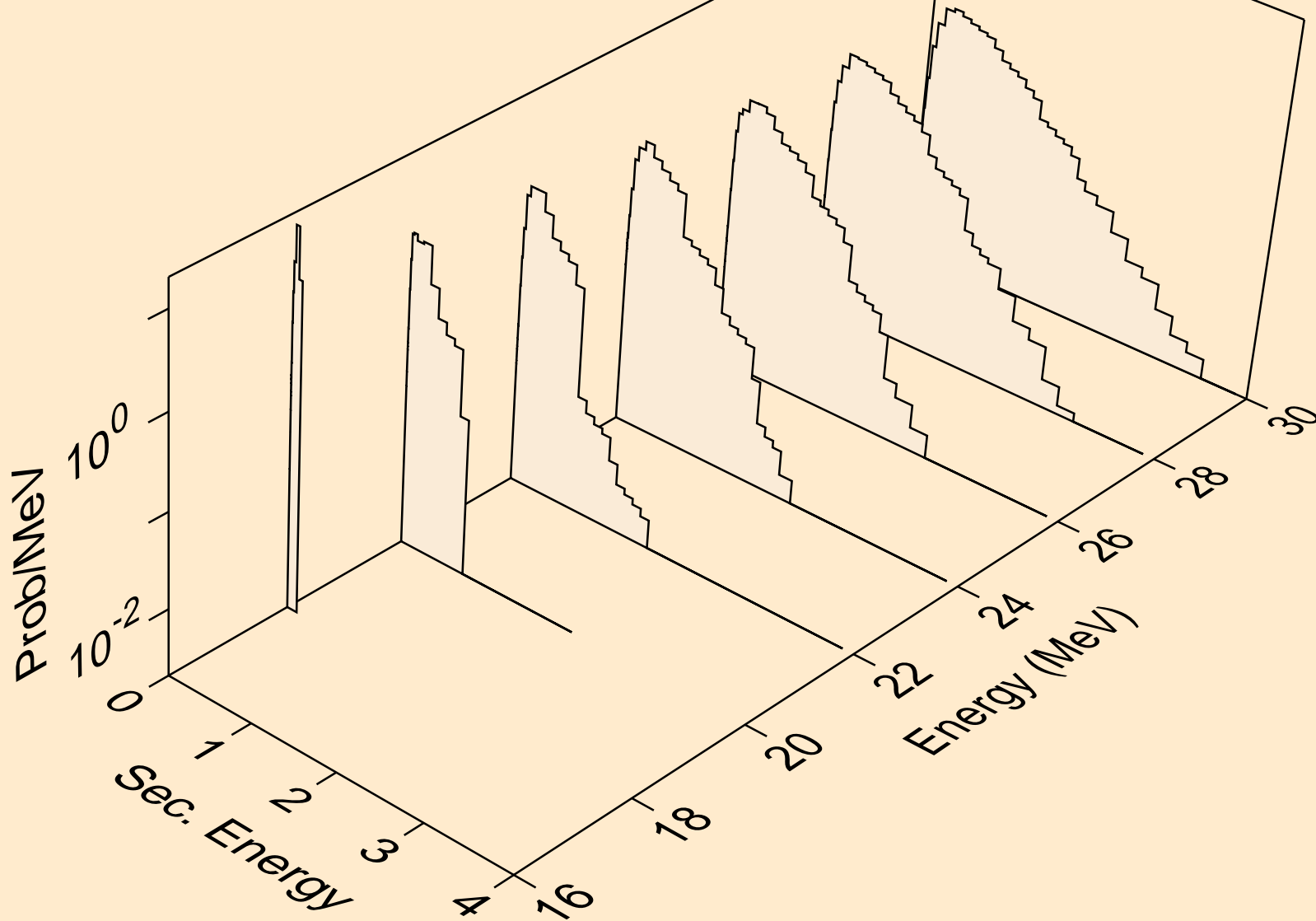

IR188 NEUTRON ACER TENDL-2019 LIBRARY; T=293.16K
Neutron emission for (n,2n)

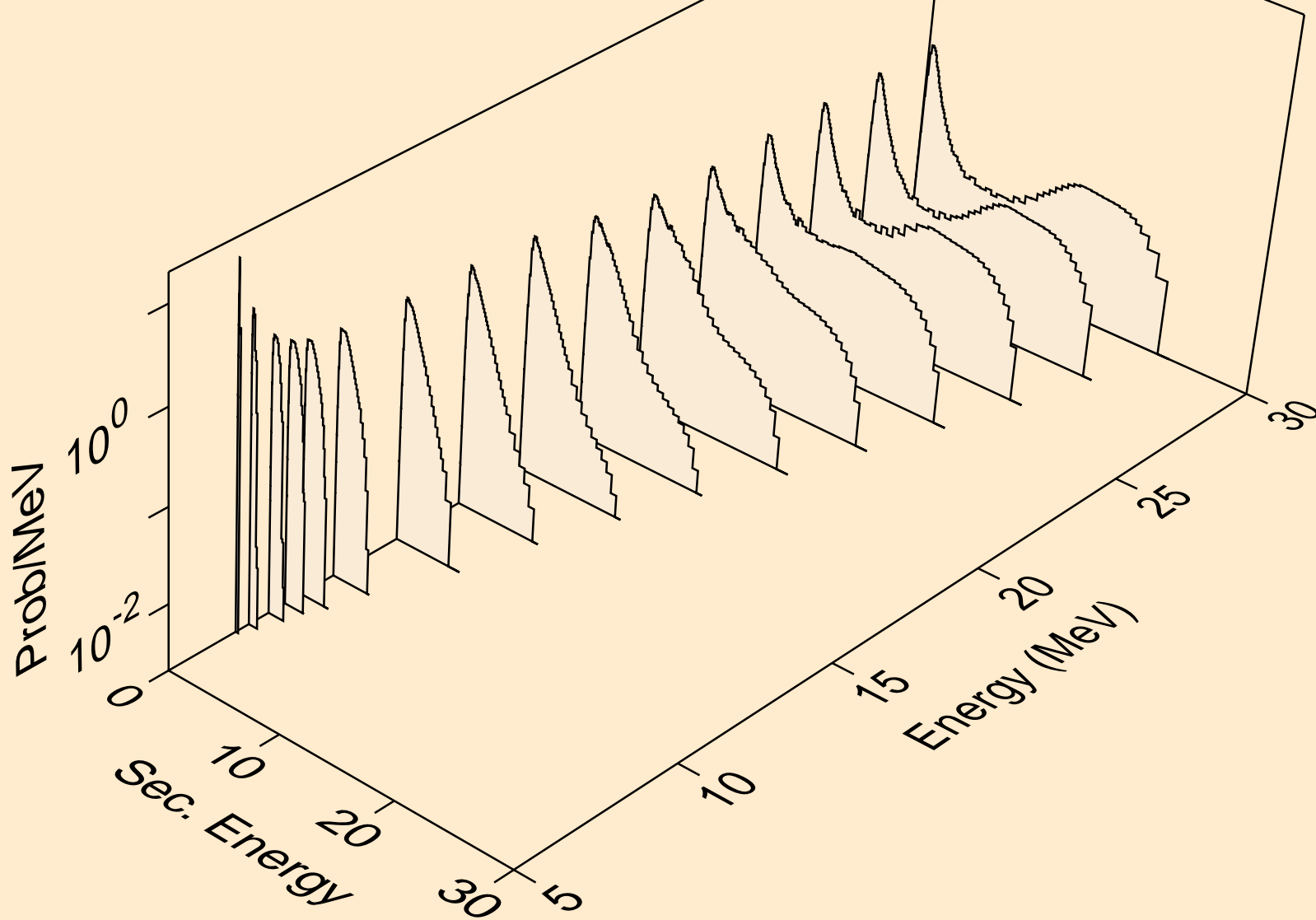

IR188 NEUTRON ACER TENDL-2019 LIBRARY; T=293.16K
Neutron emission for (n,3n)

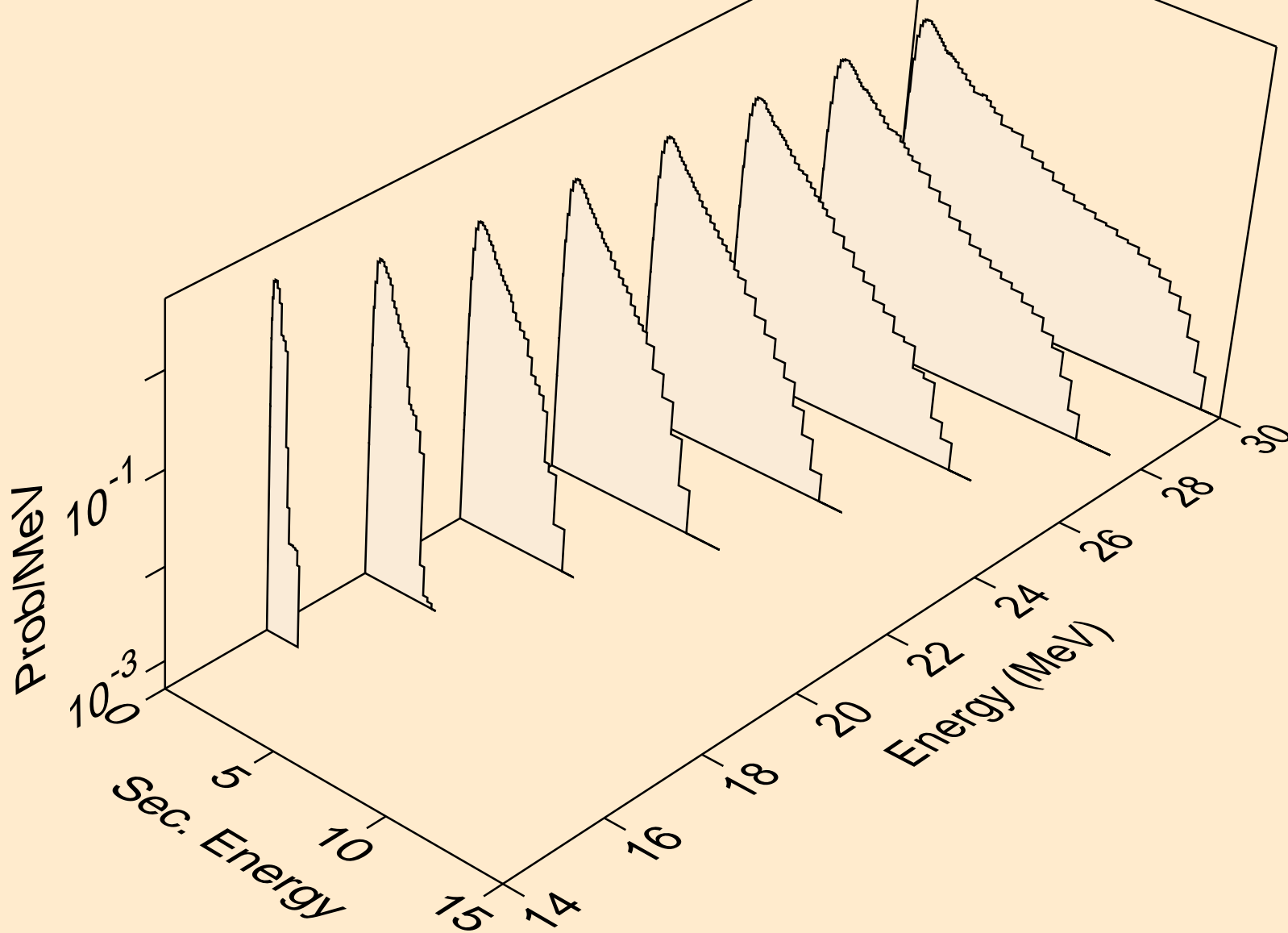

IR188 NEUTRON ACER TENDL-2019 LIBRARY; T=293.16K
Neutron emission for (n,n*)a

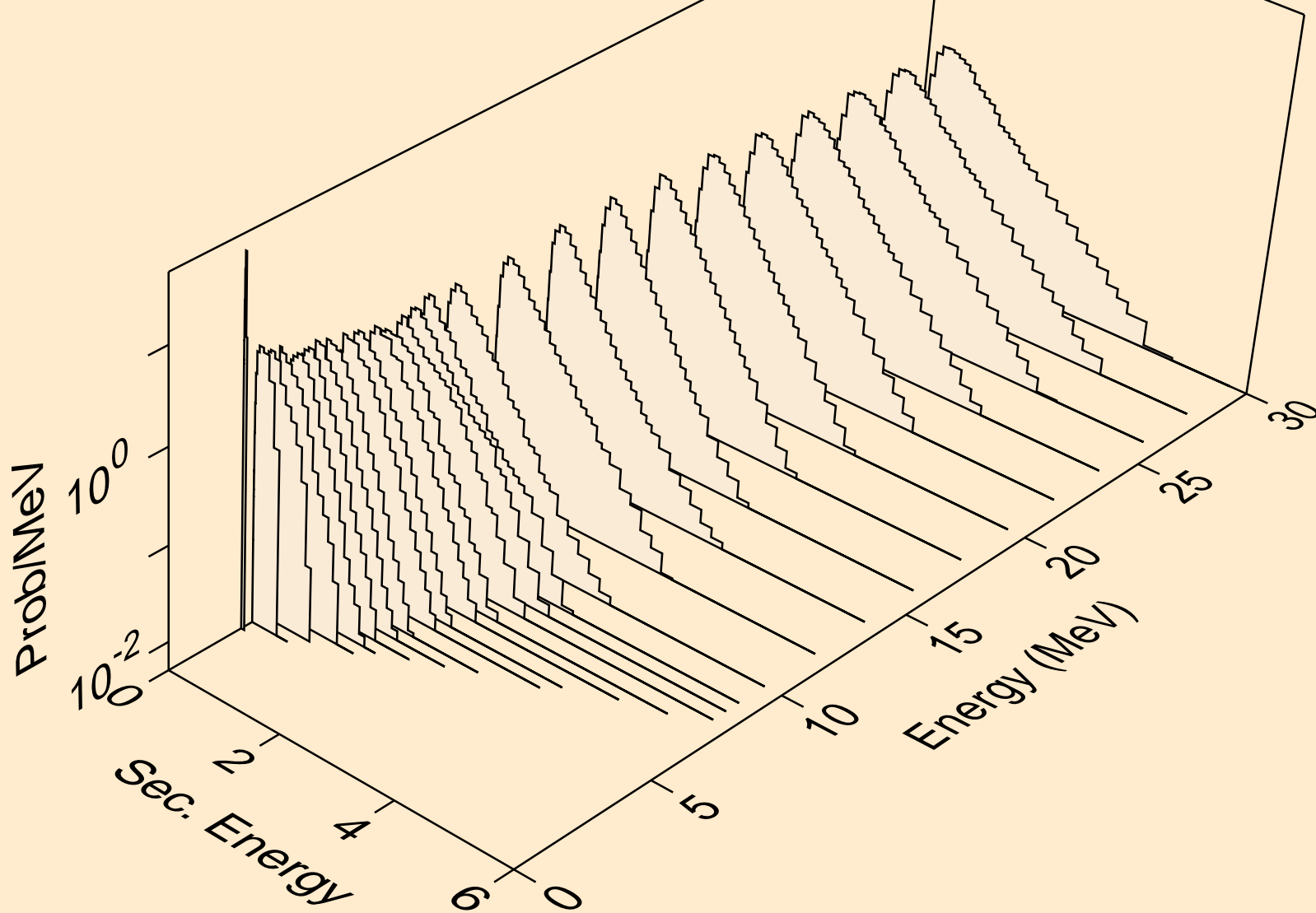

IR188 NEUTRON ACER TENDL-2019 LIBRARY; T=293.16K
Neutron emission for (n,2n)_a

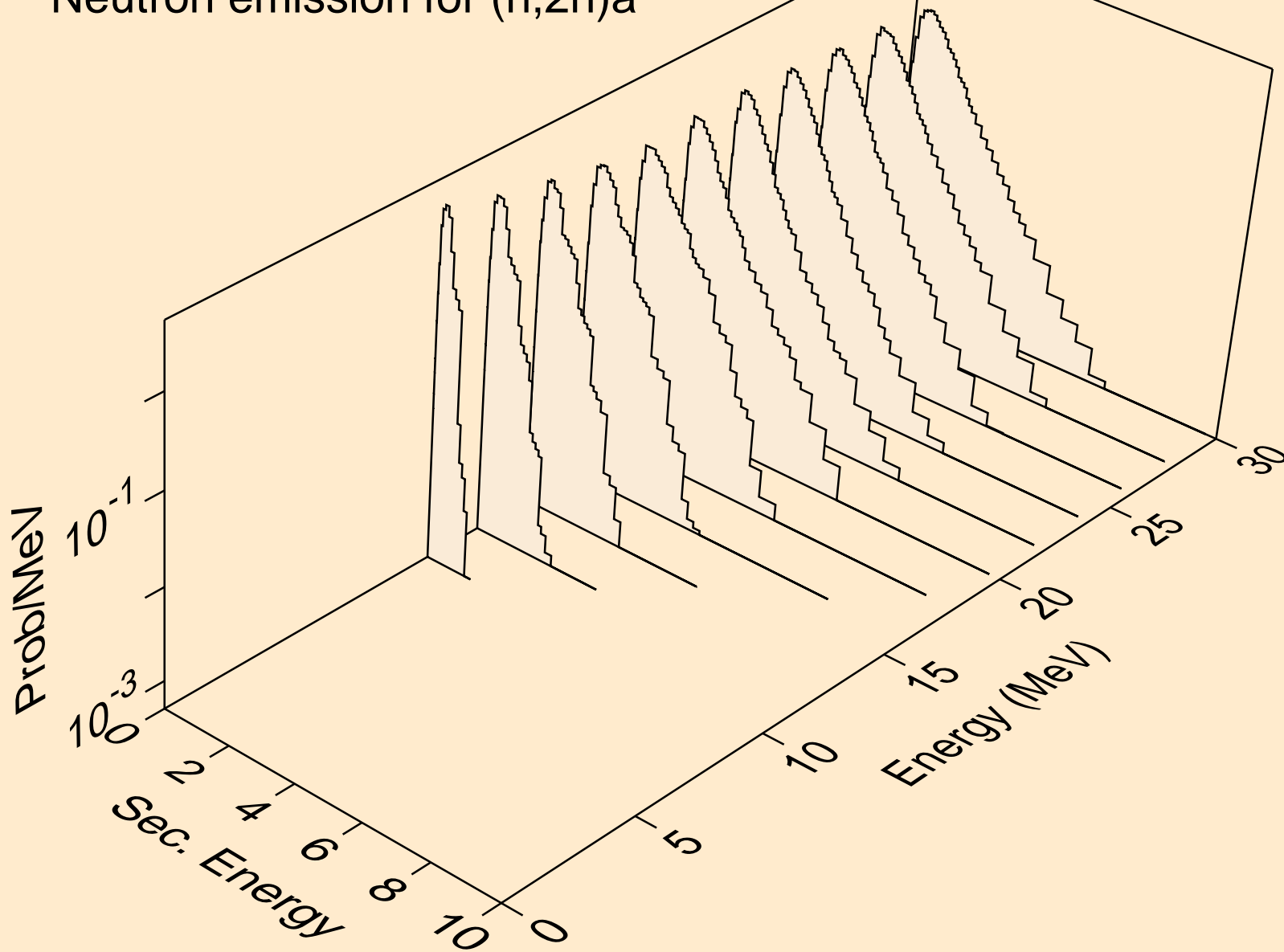

IR188 NEUTRON ACER TENDL-2019 LIBRARY; T=293.16K
Neutron emission for (n,3n)a

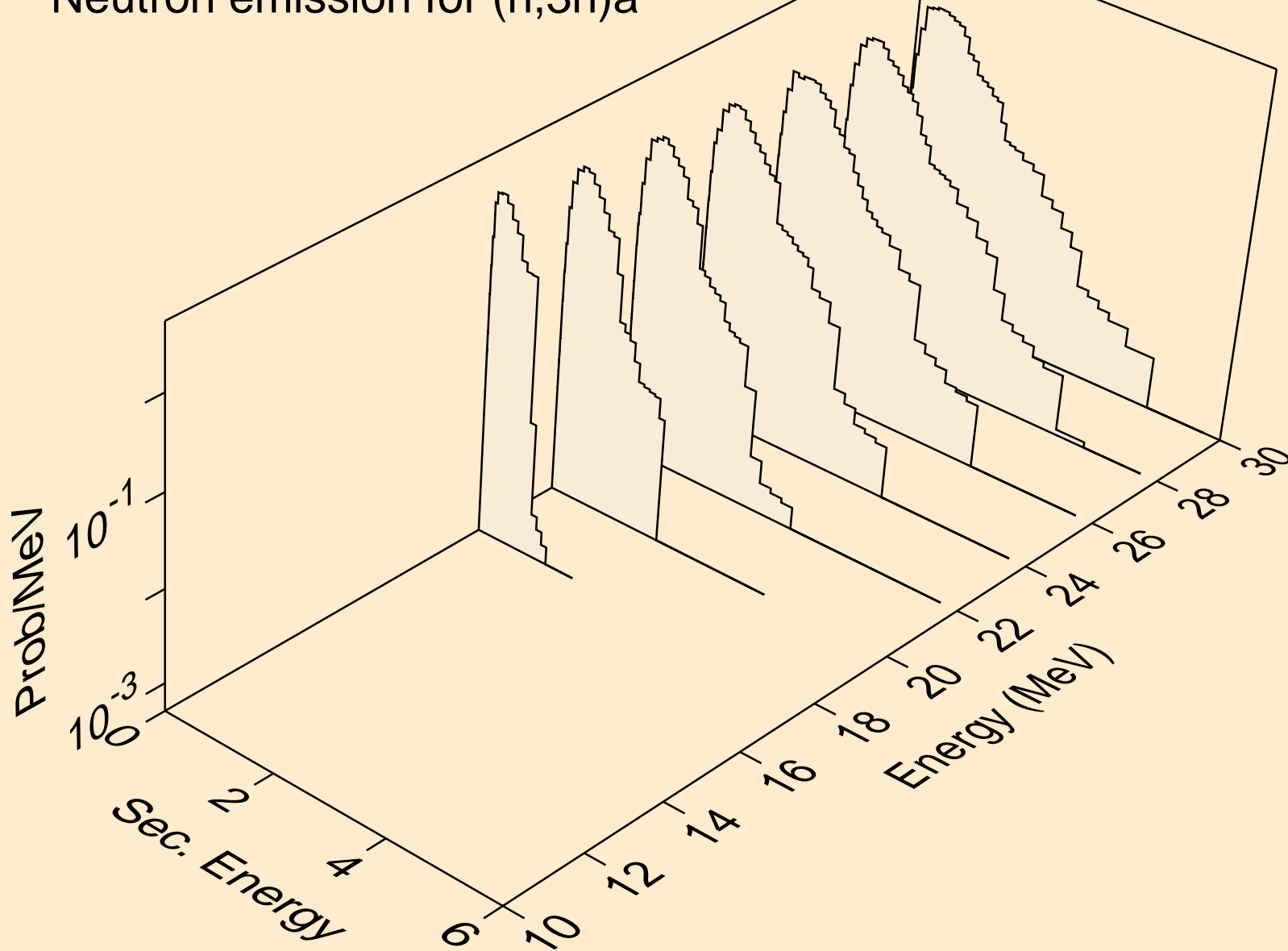

IR188 NEUTRON ACER TENDL-2019 LIBRARY; T=293.16K
Neutron emission for (n,n*)p

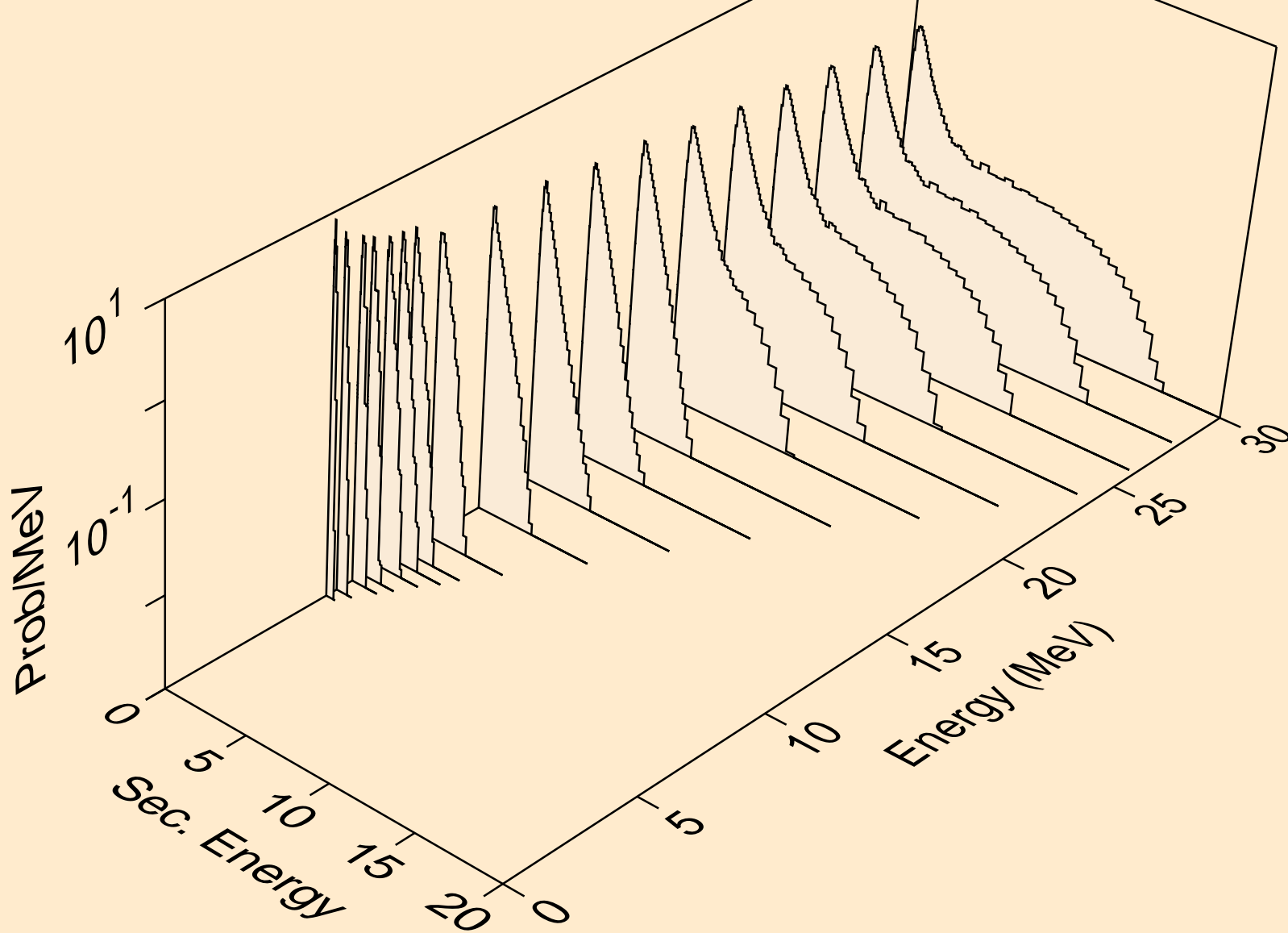

IR188 NEUTRON ACER TENDL-2019 LIBRARY; T=293.16K
Neutron emission for (n,n*)2a

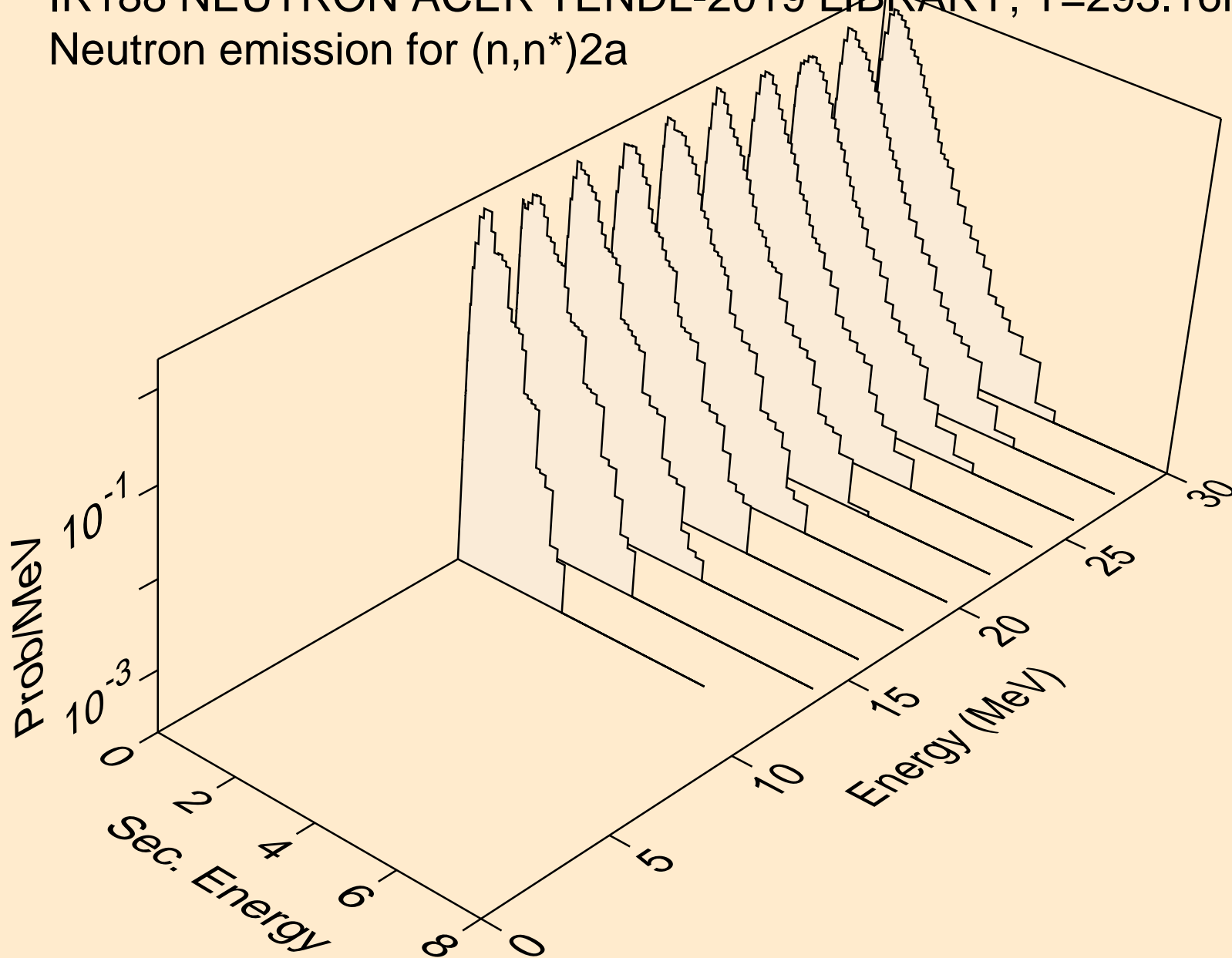

IR188 NEUTRON ACER TENDL-2019 LIBRARY; T=293.16K
Neutron emission for (n,n*)d

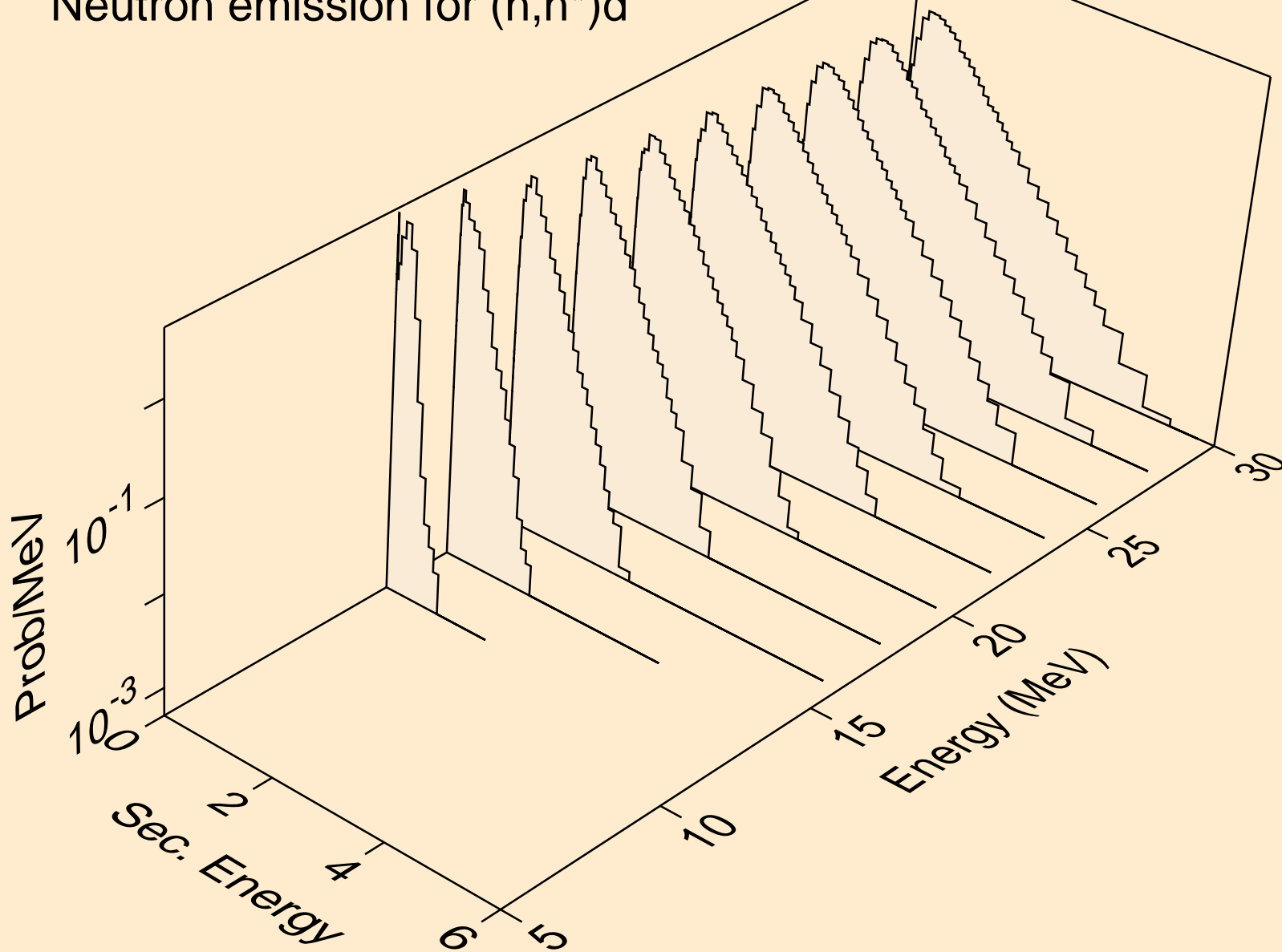

IR188 NEUTRON ACER TENDL-2019 LIBRARY; T=293.16K
Neutron emission for (n,n*)t

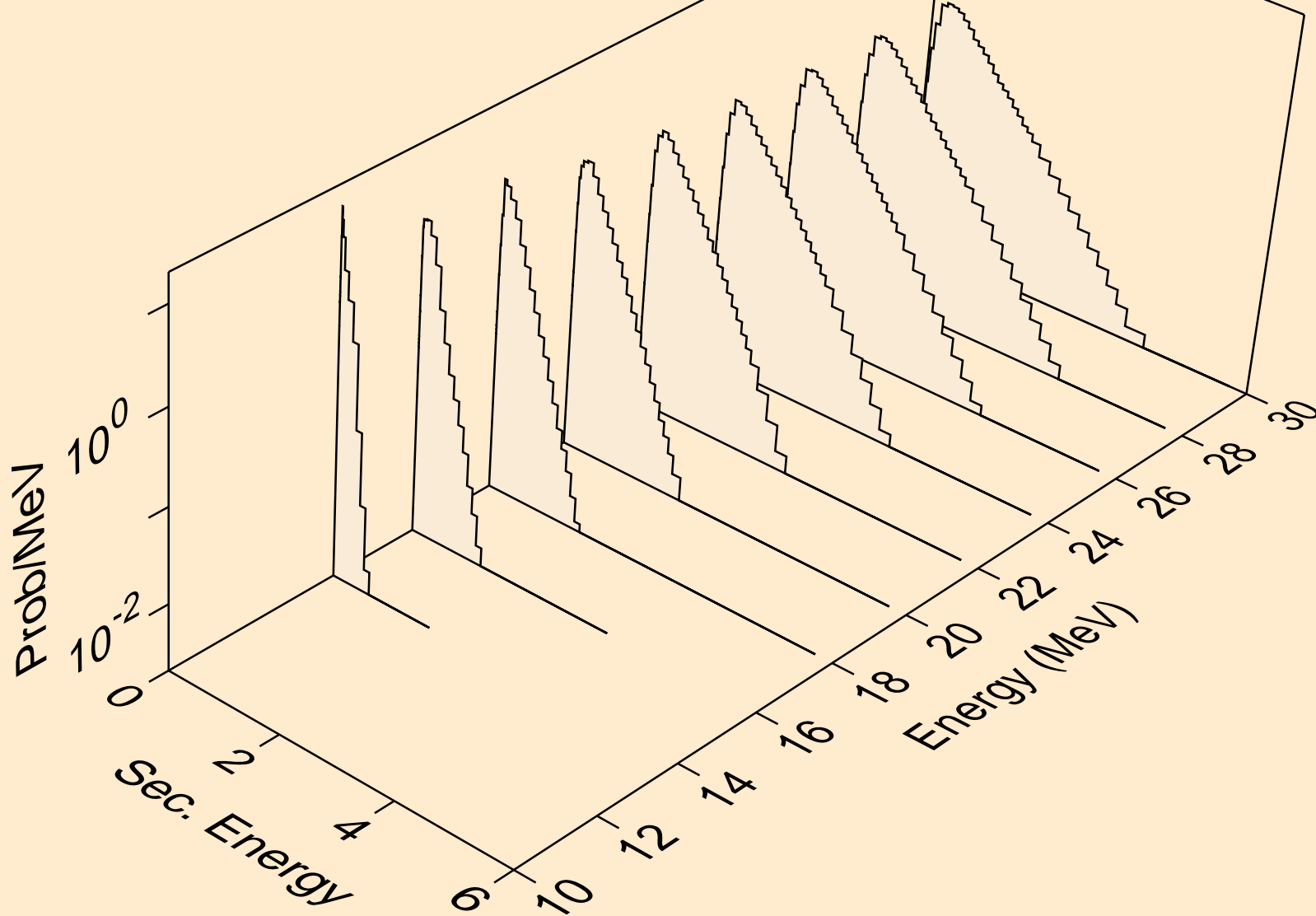

IR188 NEUTRON ACER TENDL-2019 LIBRARY; T=293.16K
Neutron emission for (n,n*)he3

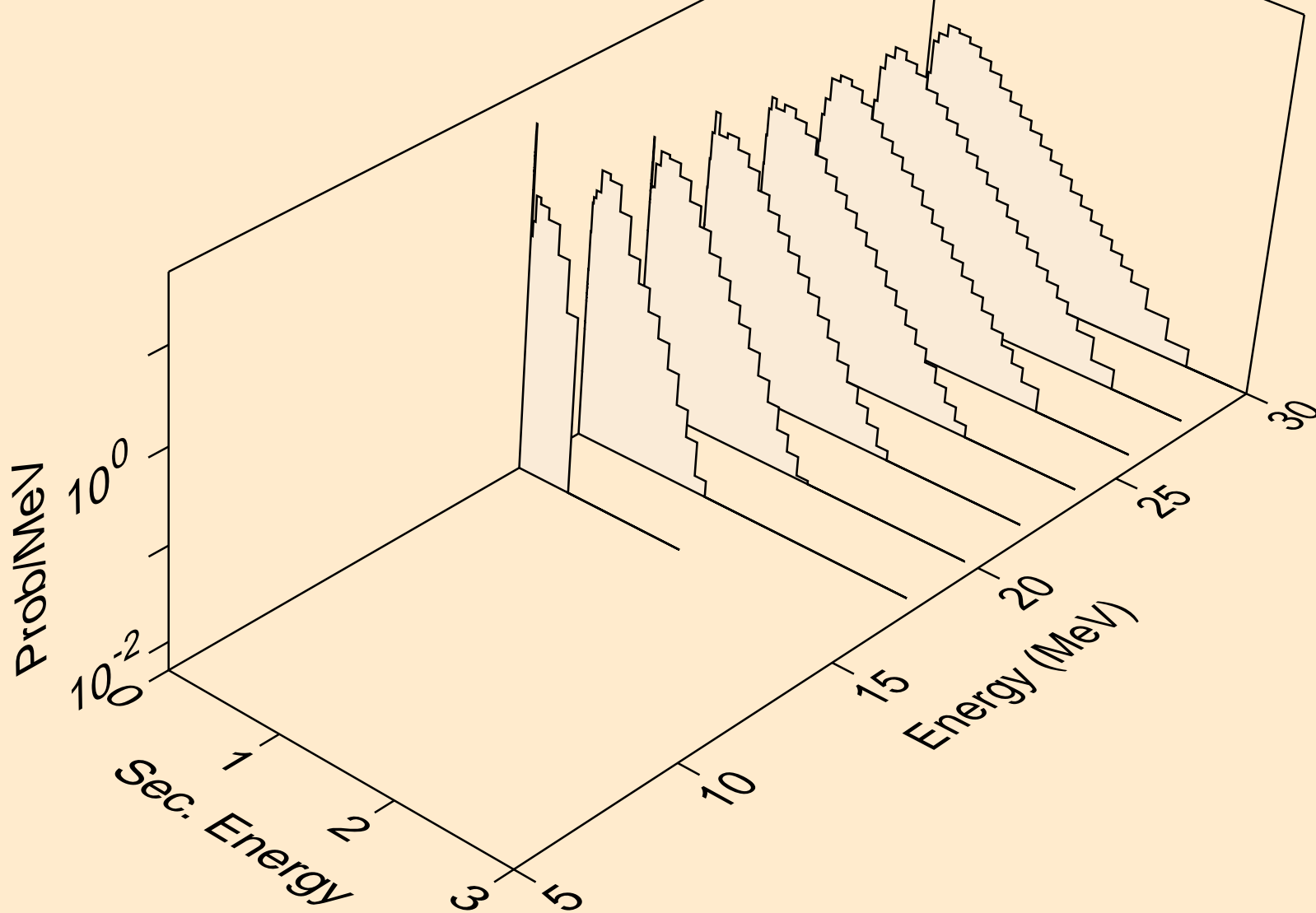

IR188 NEUTRON ACER TENDL-2019 LIBRARY; T=293.16K
Neutron emission for (n,4n)

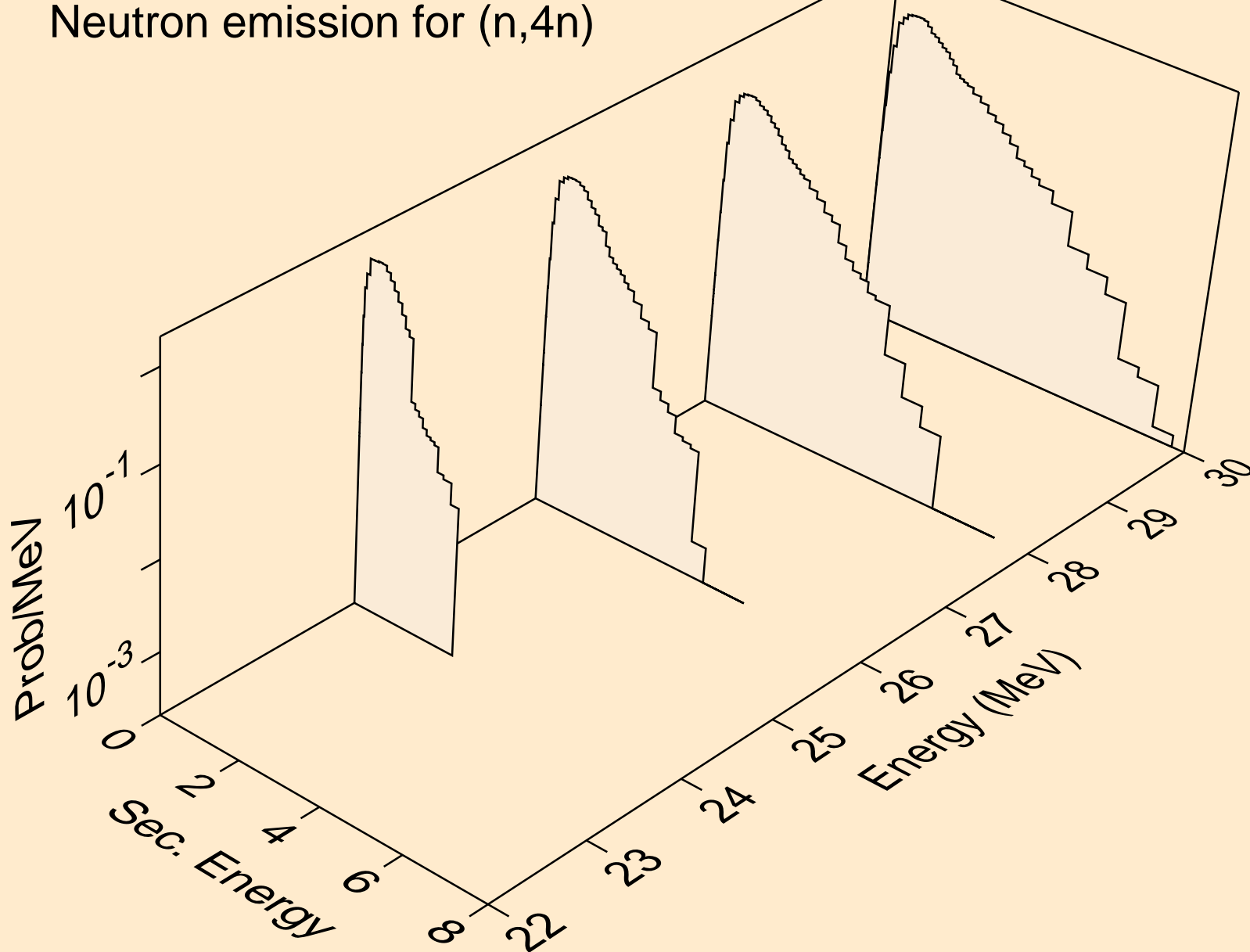

IR188 NEUTRON ACER TENDL-2019 LIBRARY; T=293.16K
Neutron emission for (n,2np)

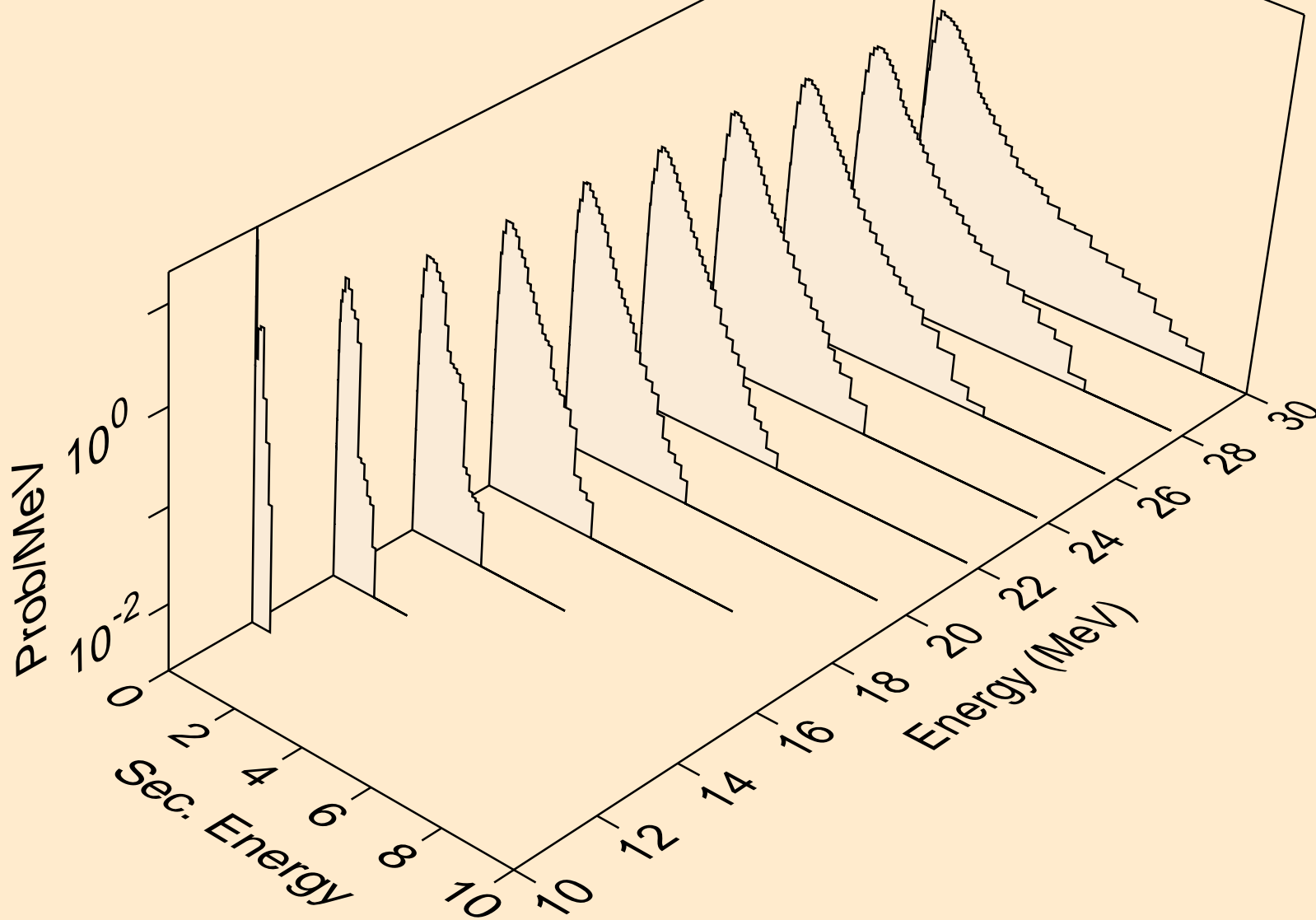

IR188 NEUTRON ACER TENDL-2019 LIBRARY; T=293.16K
Neutron emission for (n,3np)

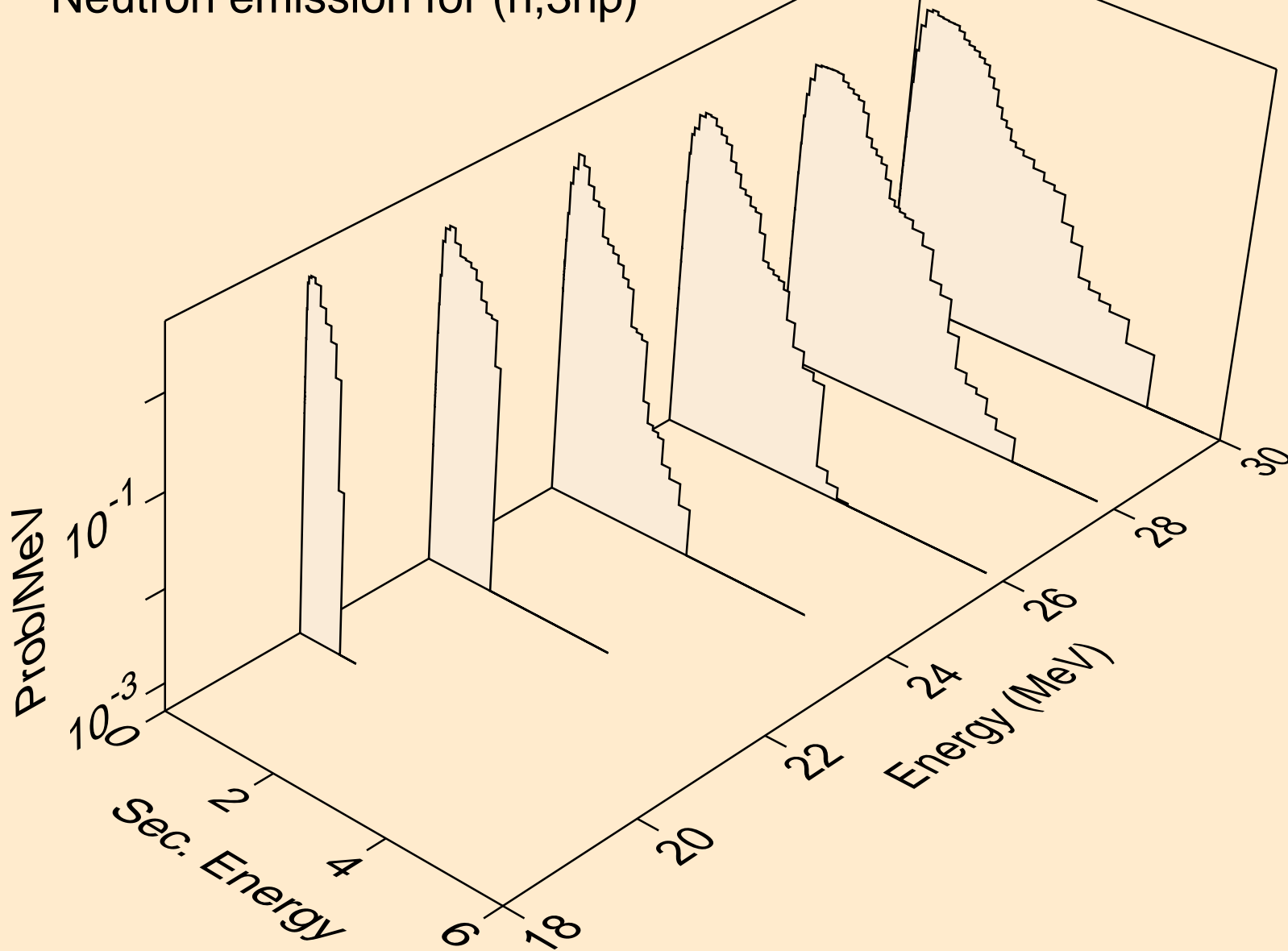

IR188 NEUTRON ACER TENDL-2019 LIBRARY; T=293.16K
Neutron emission for (n,2np)

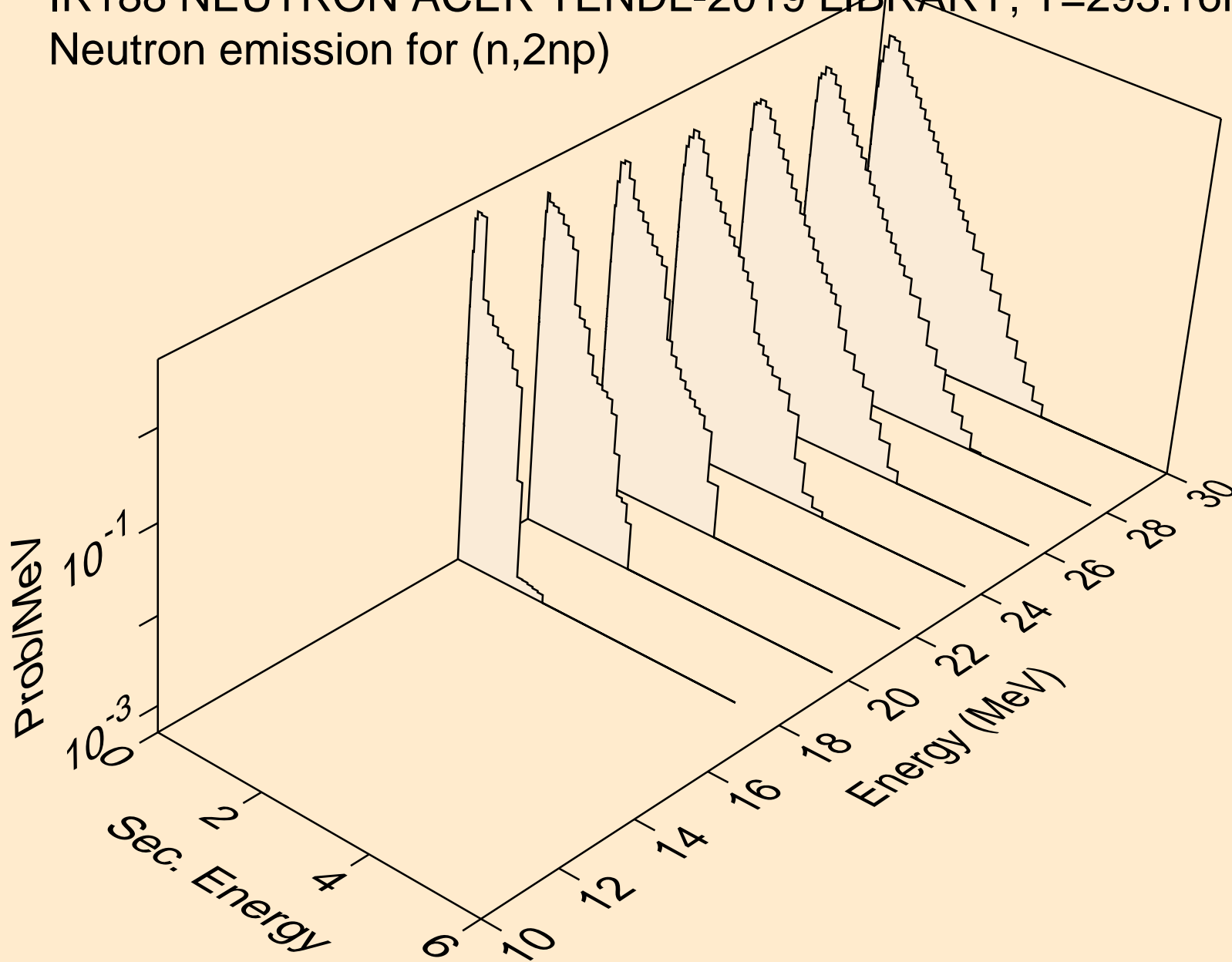

IR188 NEUTRON ACER TENDL-2019 LIBRARY; T=293.16K
Neutron emission for (n,npa)

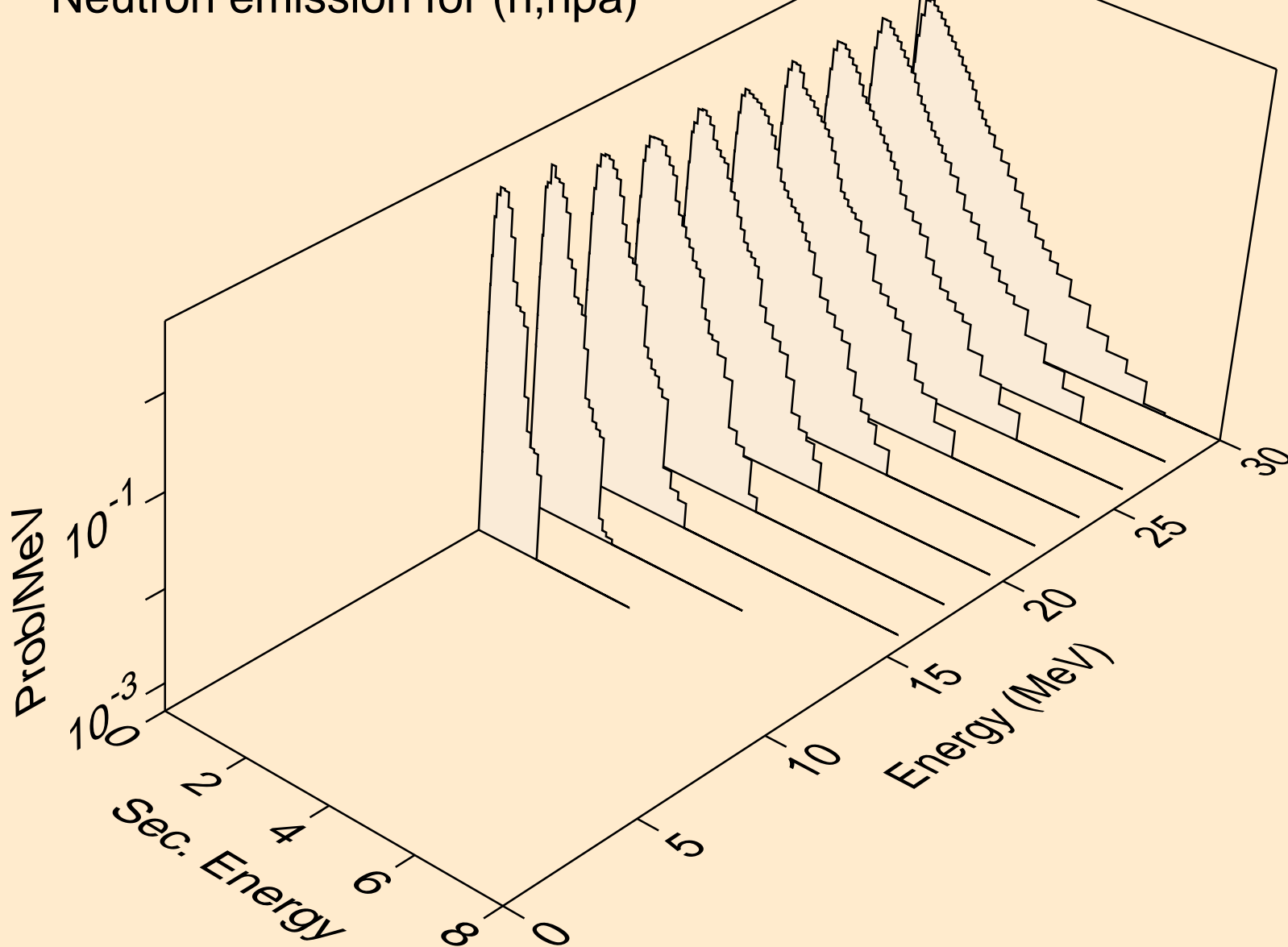

IR188 NEUTRON ACER TENDL-2019 LIBRARY; T=293.16K
Neutron emission for (n,n*c)

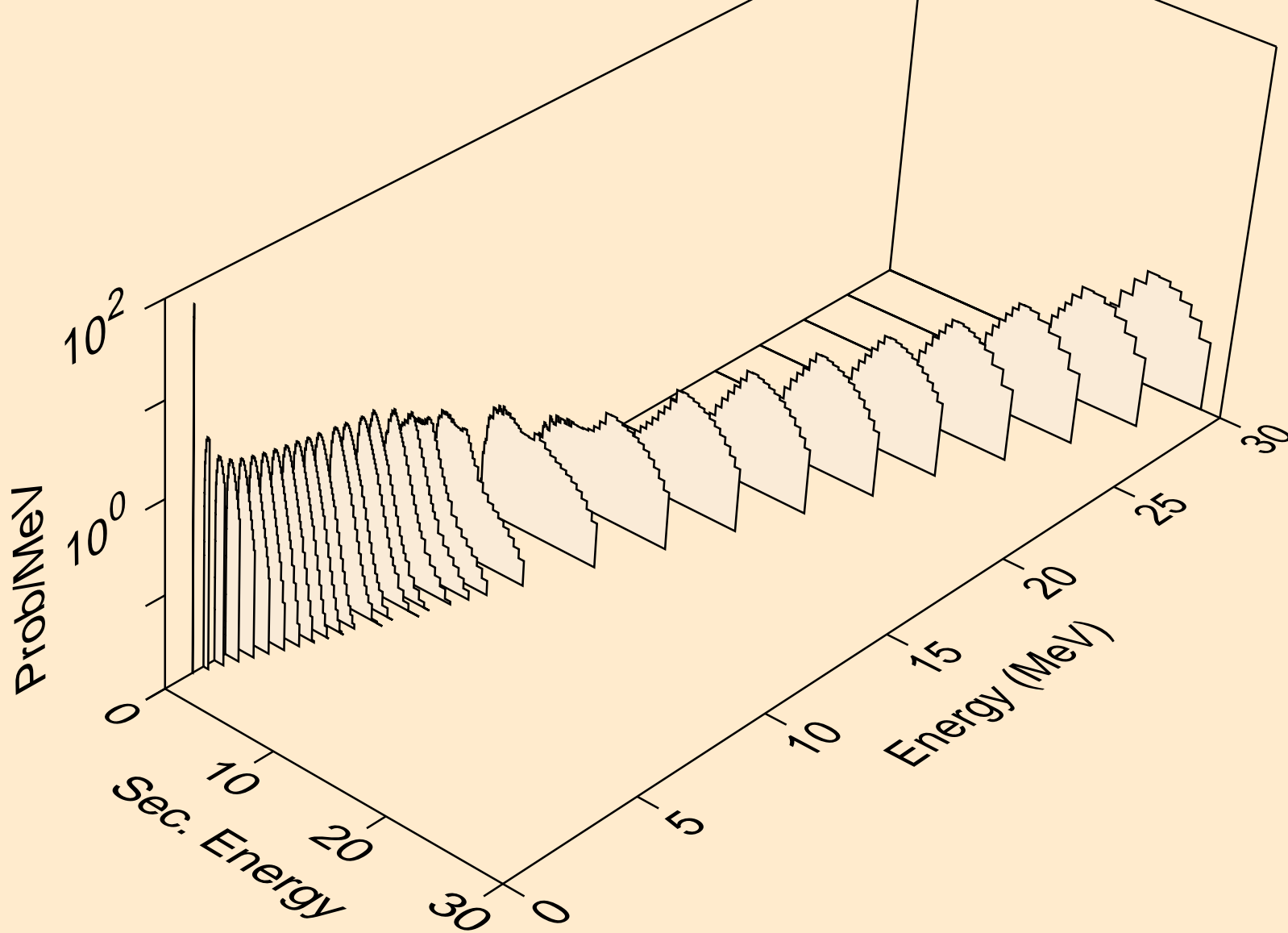

IR188 NEUTRON ACER TENDL-2019 LIBRARY; T=293.16K
Photon emission for (n,x)

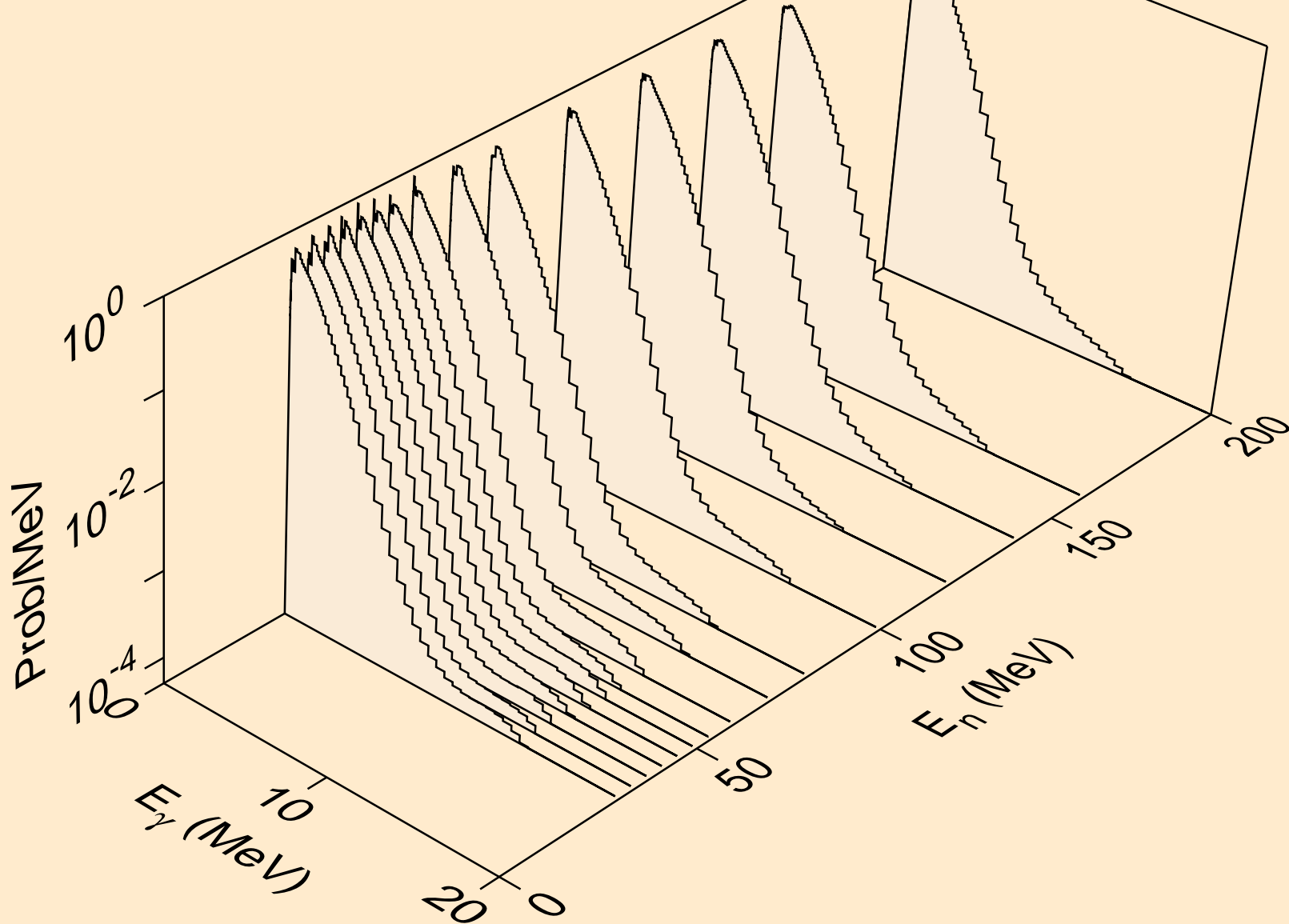

IR188 NEUTRON ACER TENDL-2019 LIBRARY; T=293.16K
Photon emission for (n,2nd)

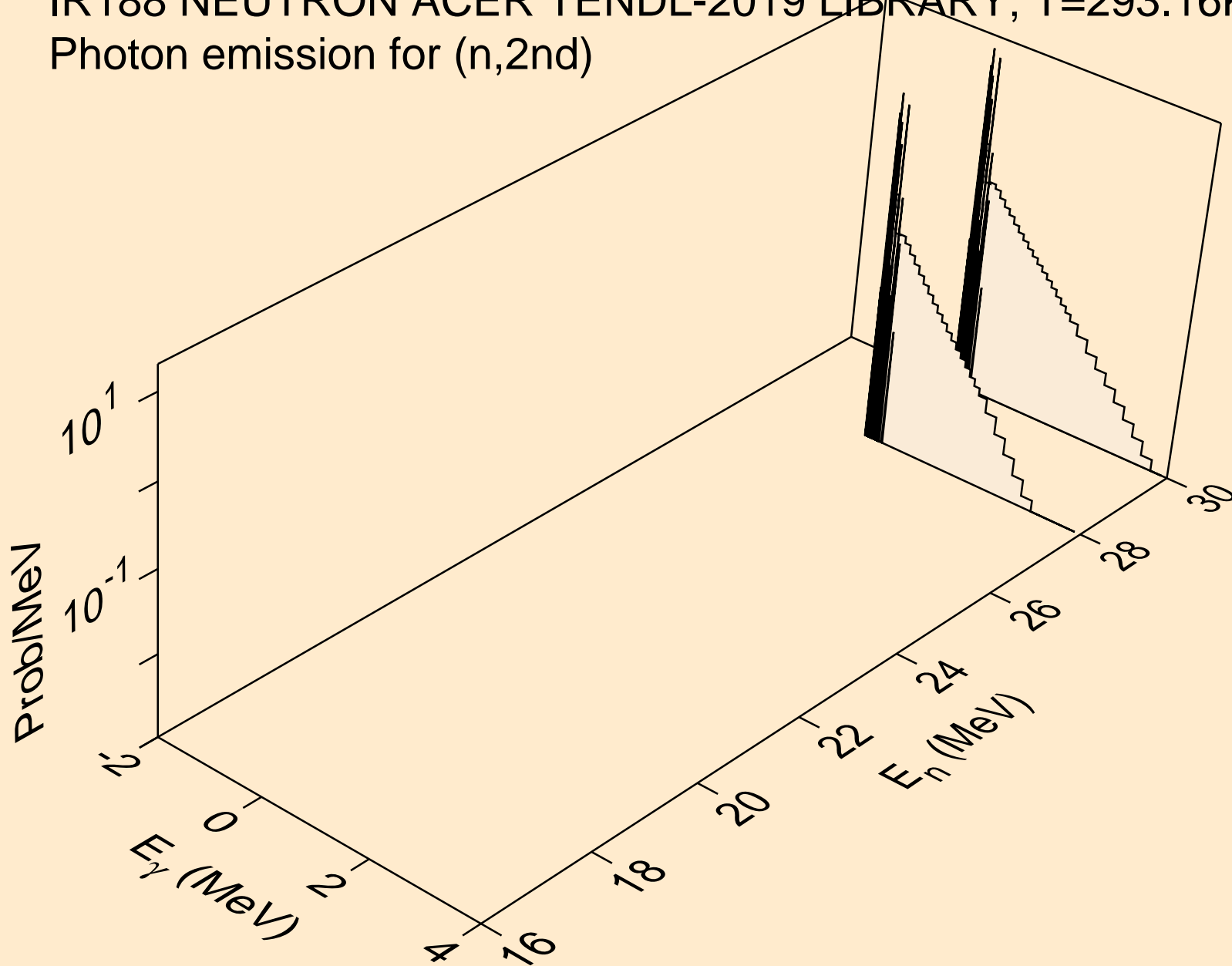

IR188 NEUTRON ACER TENDL-2019 LIBRARY; T=293.16K
Photon emission for (n,2n)

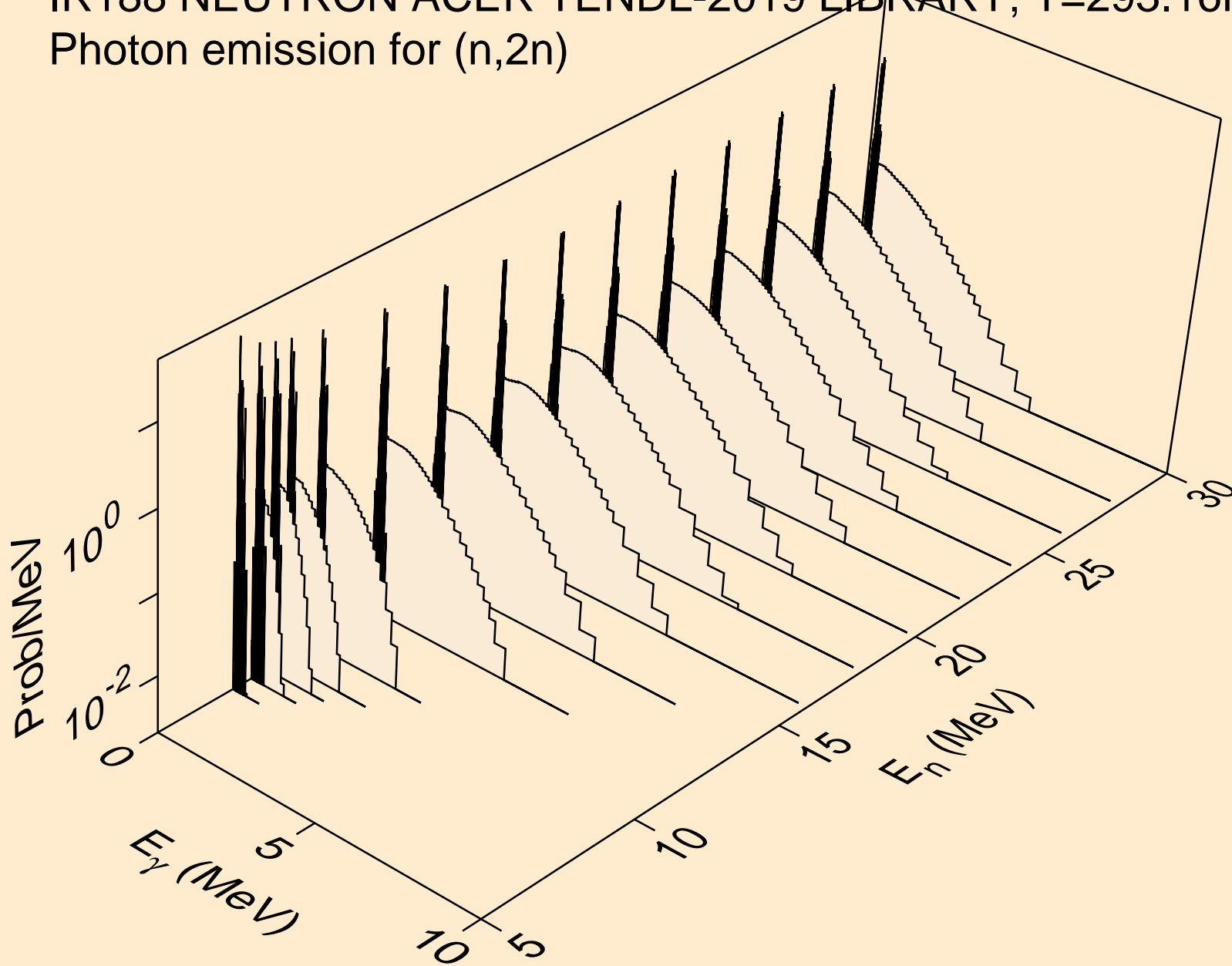

IR188 NEUTRON ACER TENDL-2019 LIBRARY; T=293.16K
Photon emission for (n,3n)

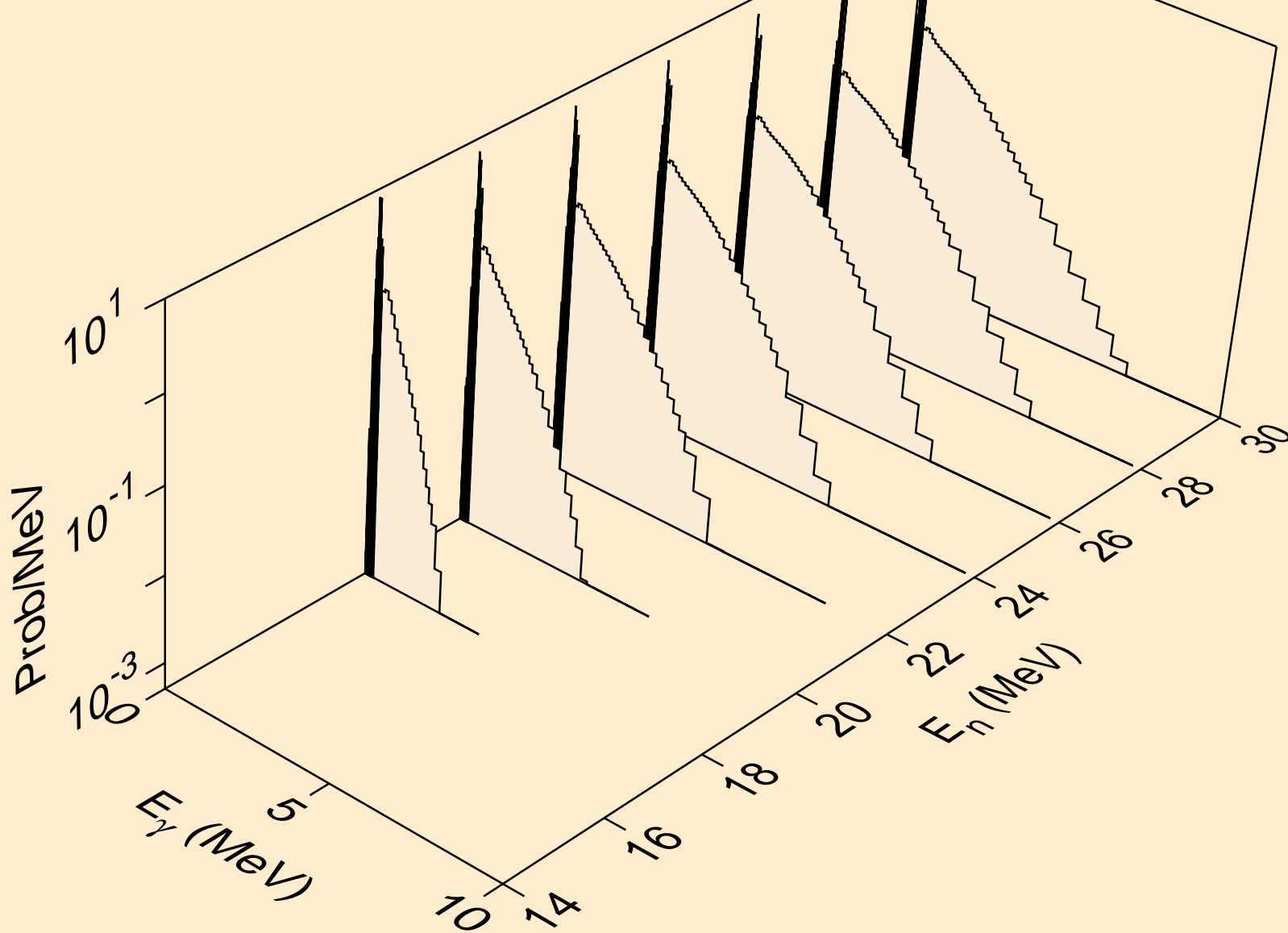

IR188 NEUTRON ACER TENDL-2019 LIBRARY; T=293.16K
Photon emission for (n,n*)a

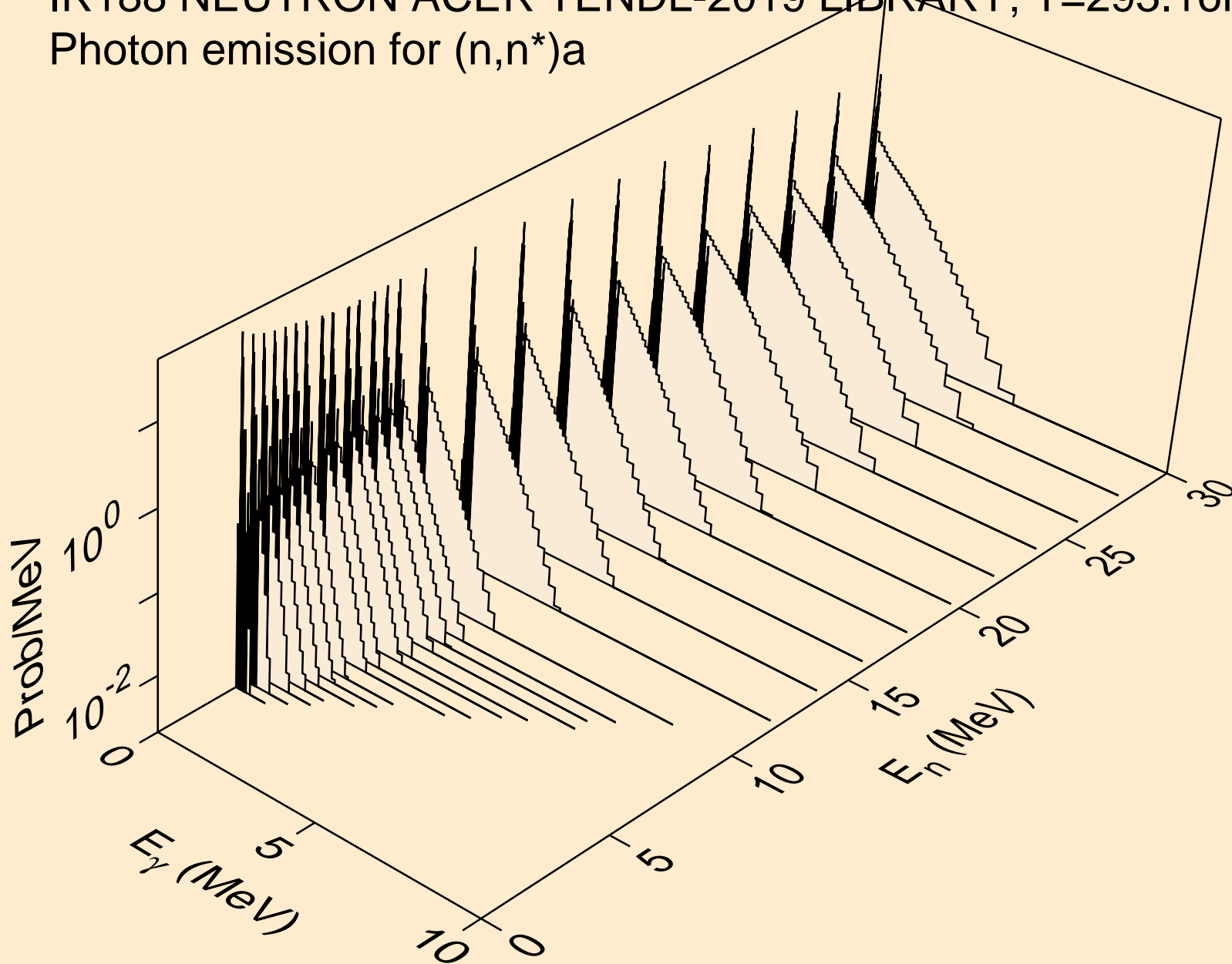

IR188 NEUTRON ACER TENDL-2019 LIBRARY; T=293.16K
Photon emission for (n,2n)a

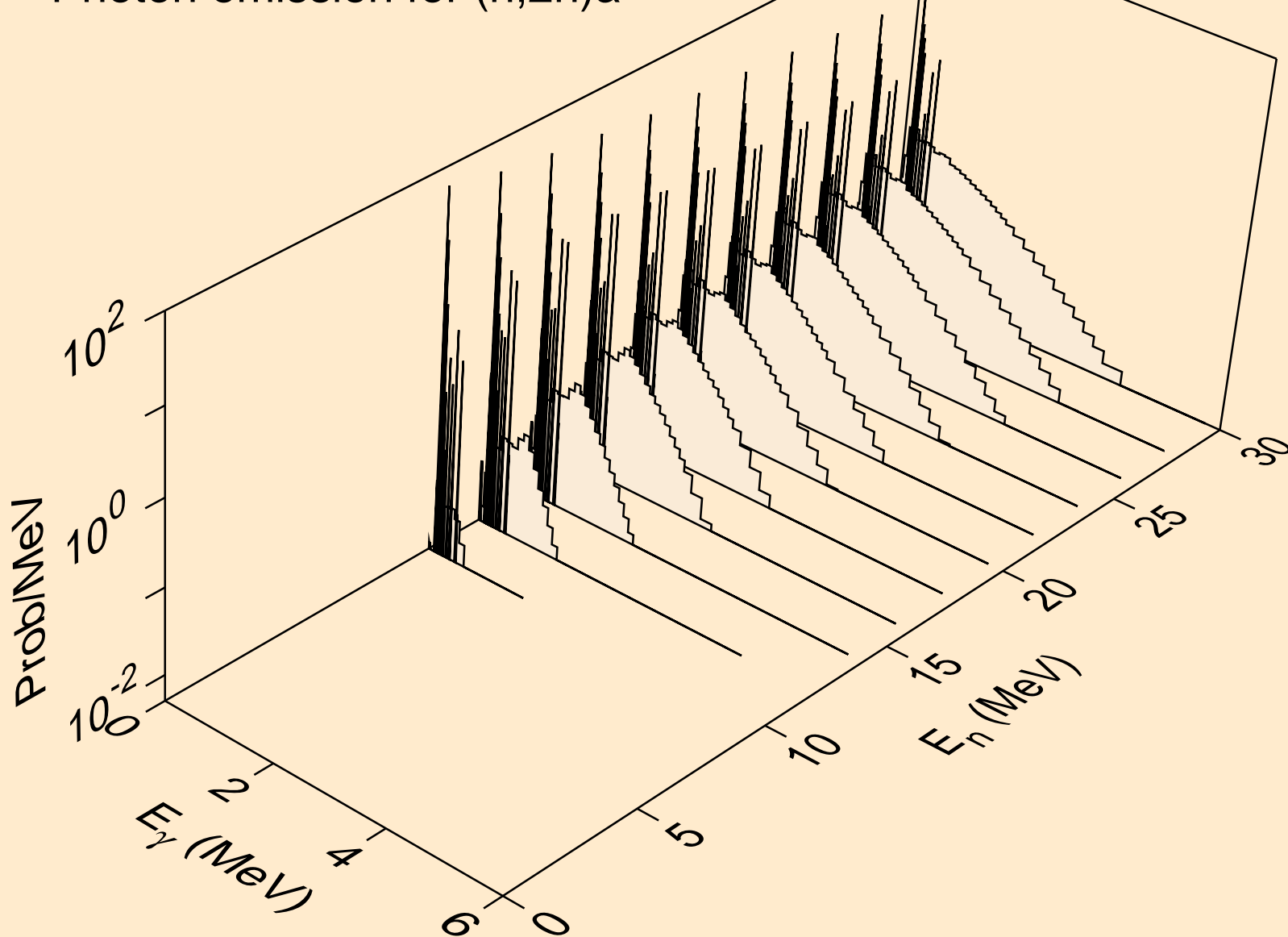

IR188 NEUTRON ACER TENDL-2019 LIBRARY; T=293.16K
Photon emission for (n,3n)a

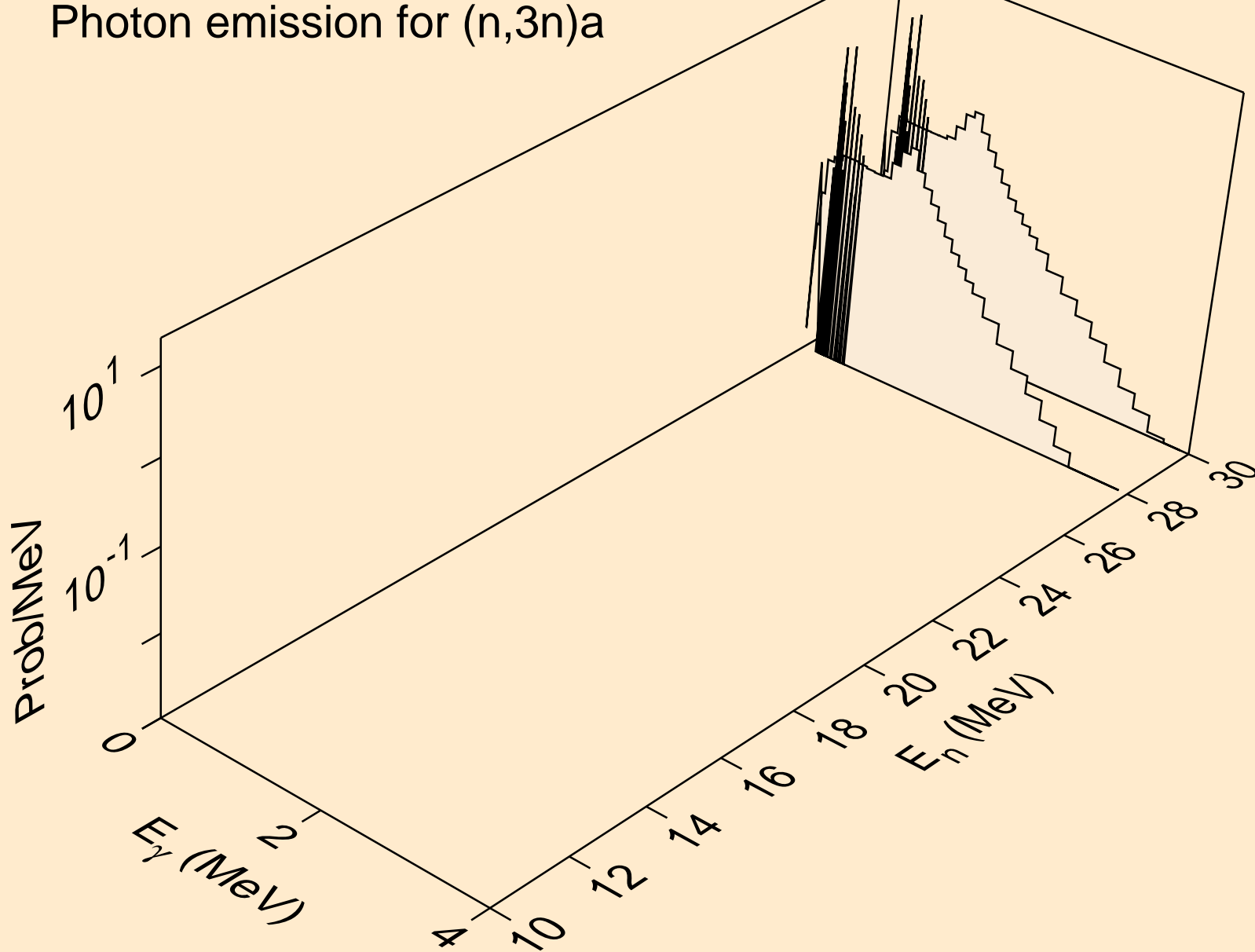

IR188 NEUTRON ACER TENDL-2019 LIBRARY; T=293.16K
Photon emission for (n,n*)p

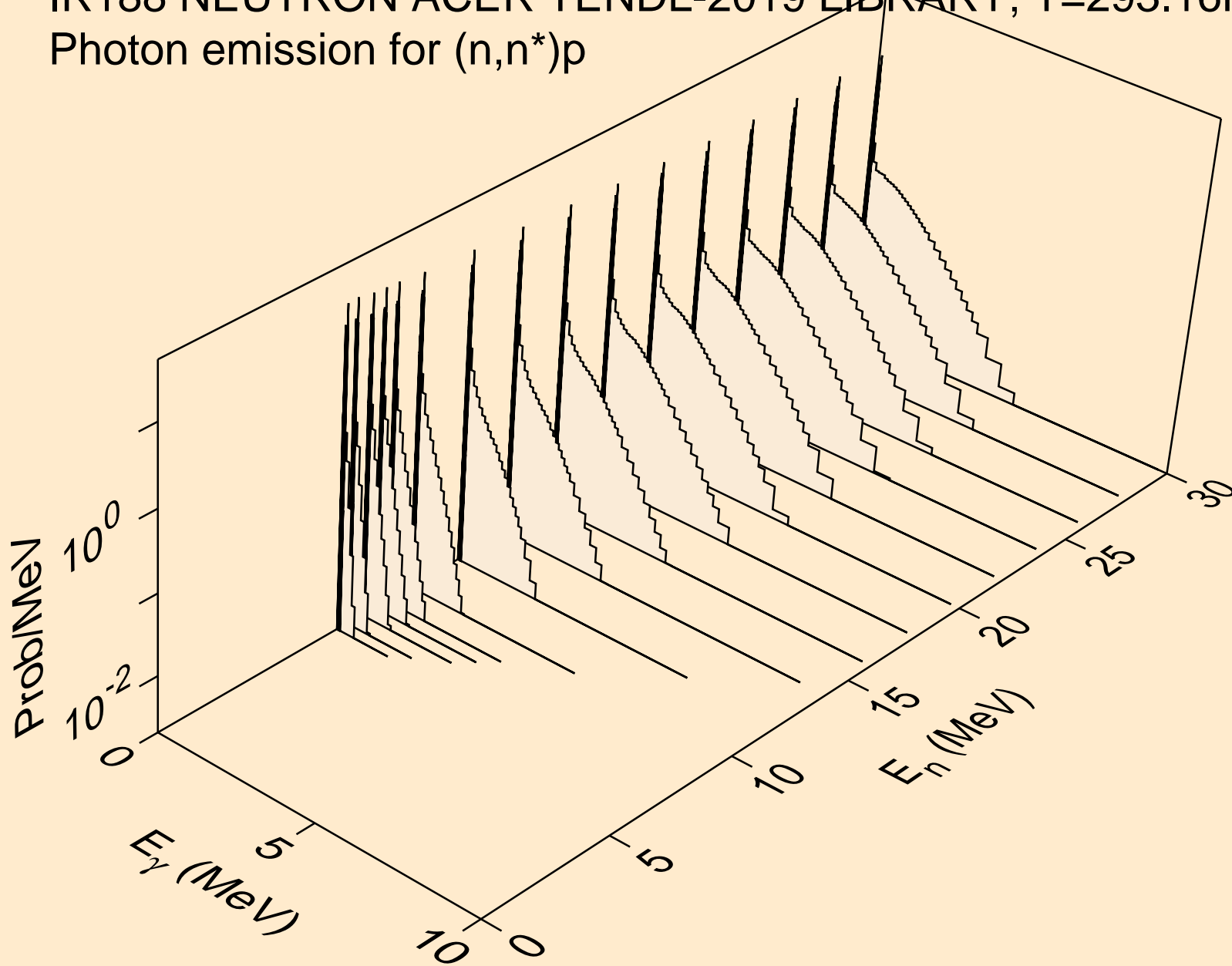

IR188 NEUTRON ACER TENDL-2019 LIBRARY; T=293.16K
Photon emission for (n,n*)2a

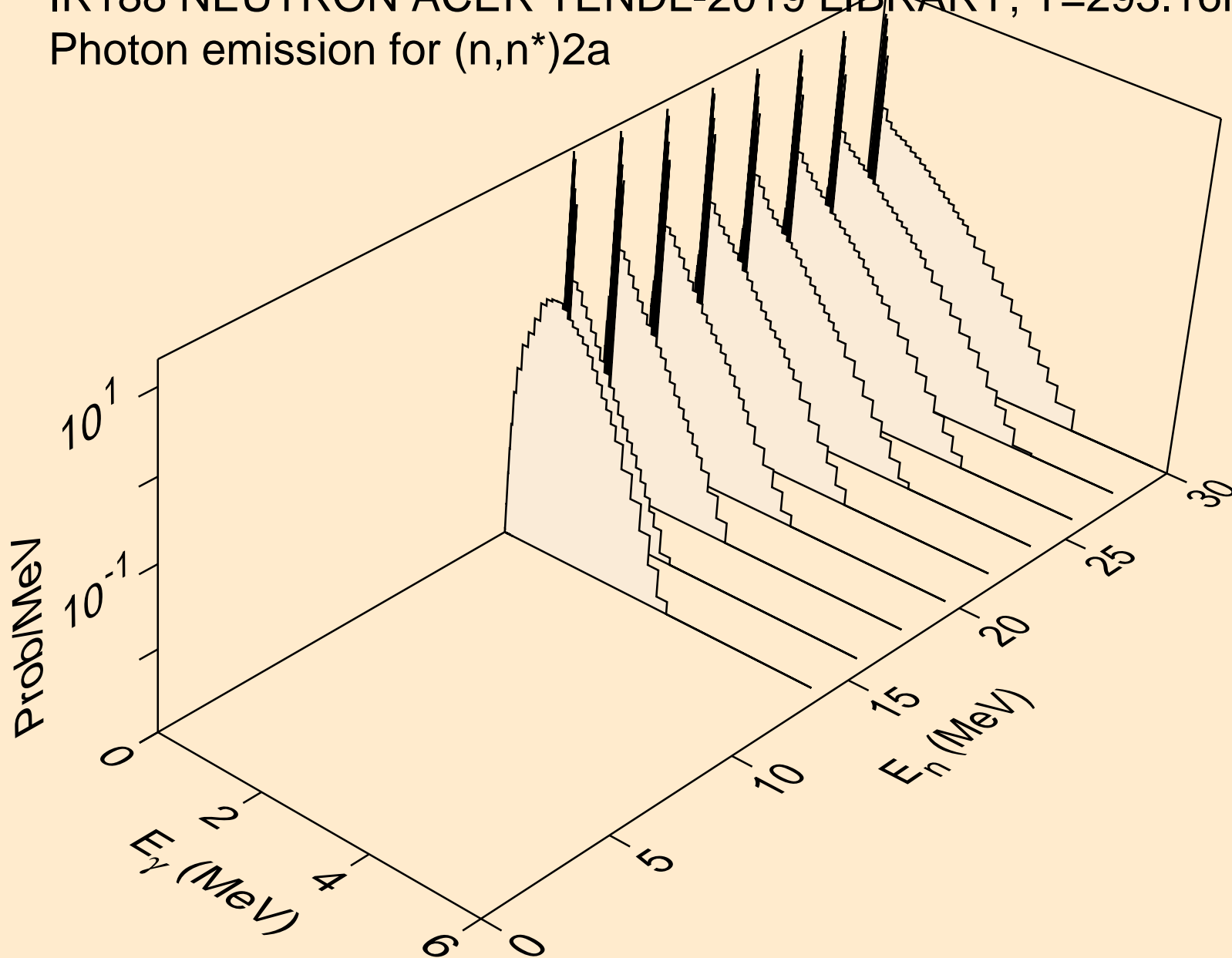

IR188 NEUTRON ACER TENDL-2019 LIBRARY; T=293.16K
Photon emission for (n,n*)d

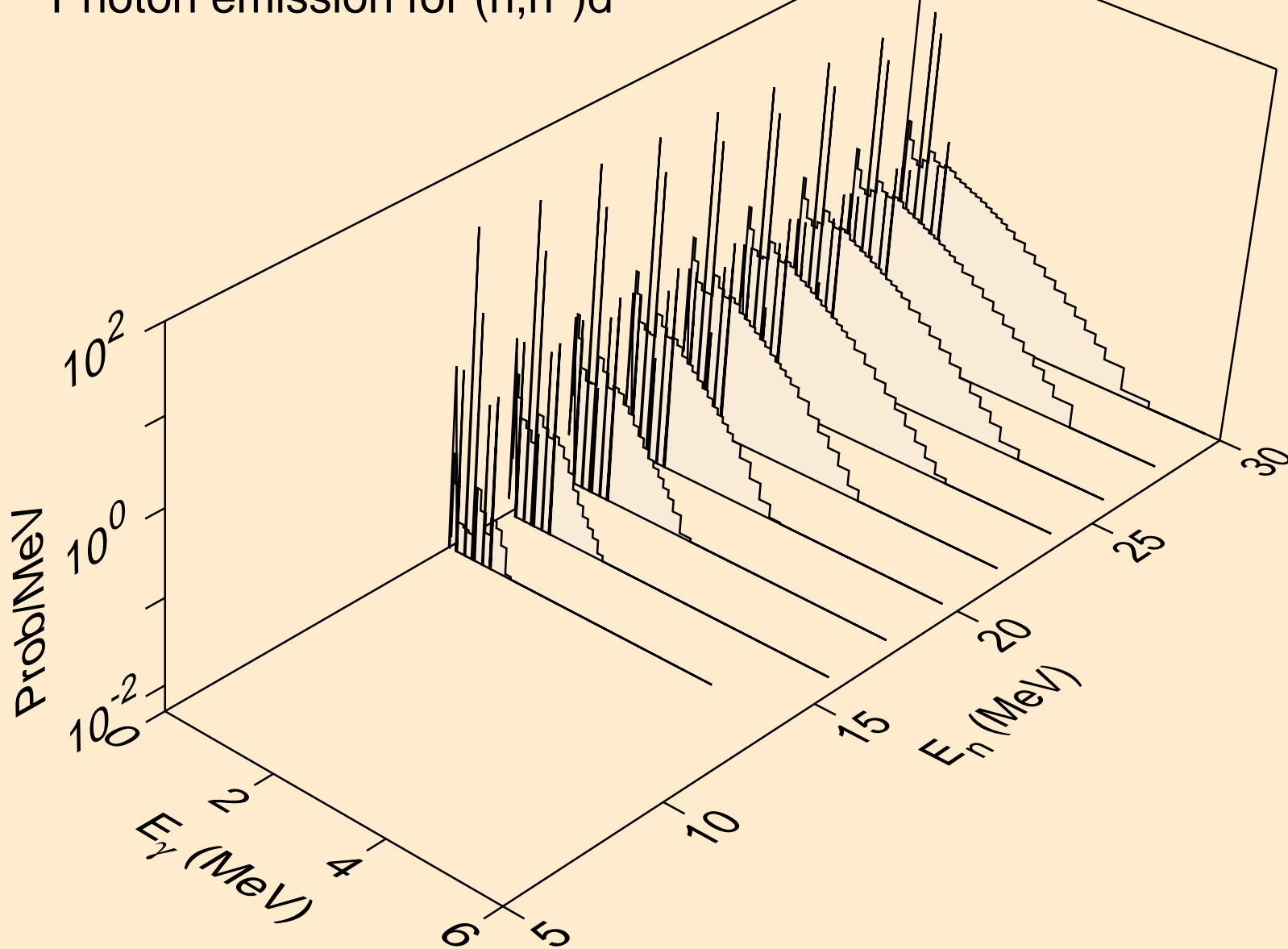

IR188 NEUTRON ACER TENDL-2019 LIBRARY; T=293.16K
Photon emission for (n,n*)t

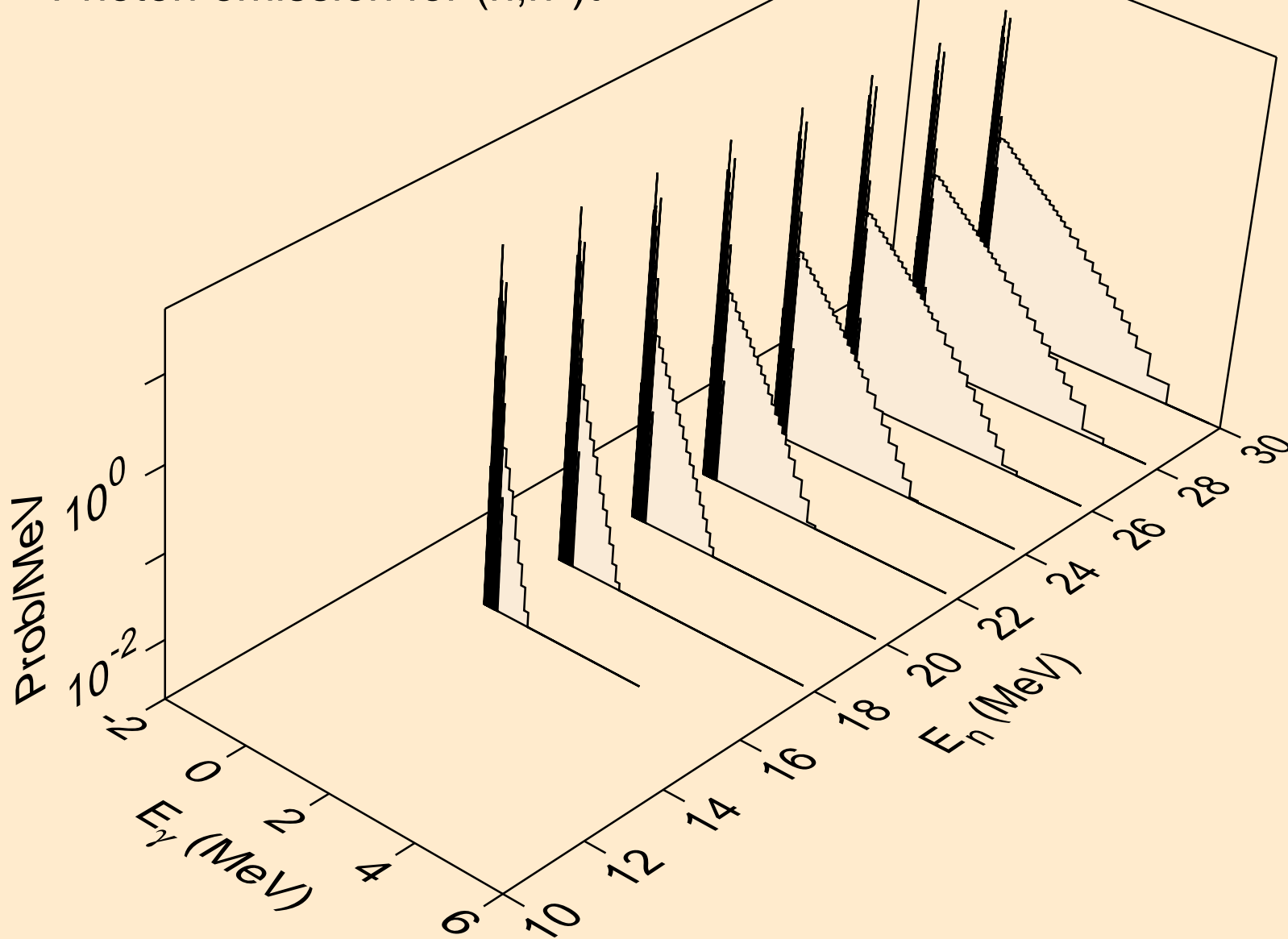

IR188 NEUTRON ACER TENDL-2019 LIBRARY; T=293.16K
Photon emission for (n,n*)he3

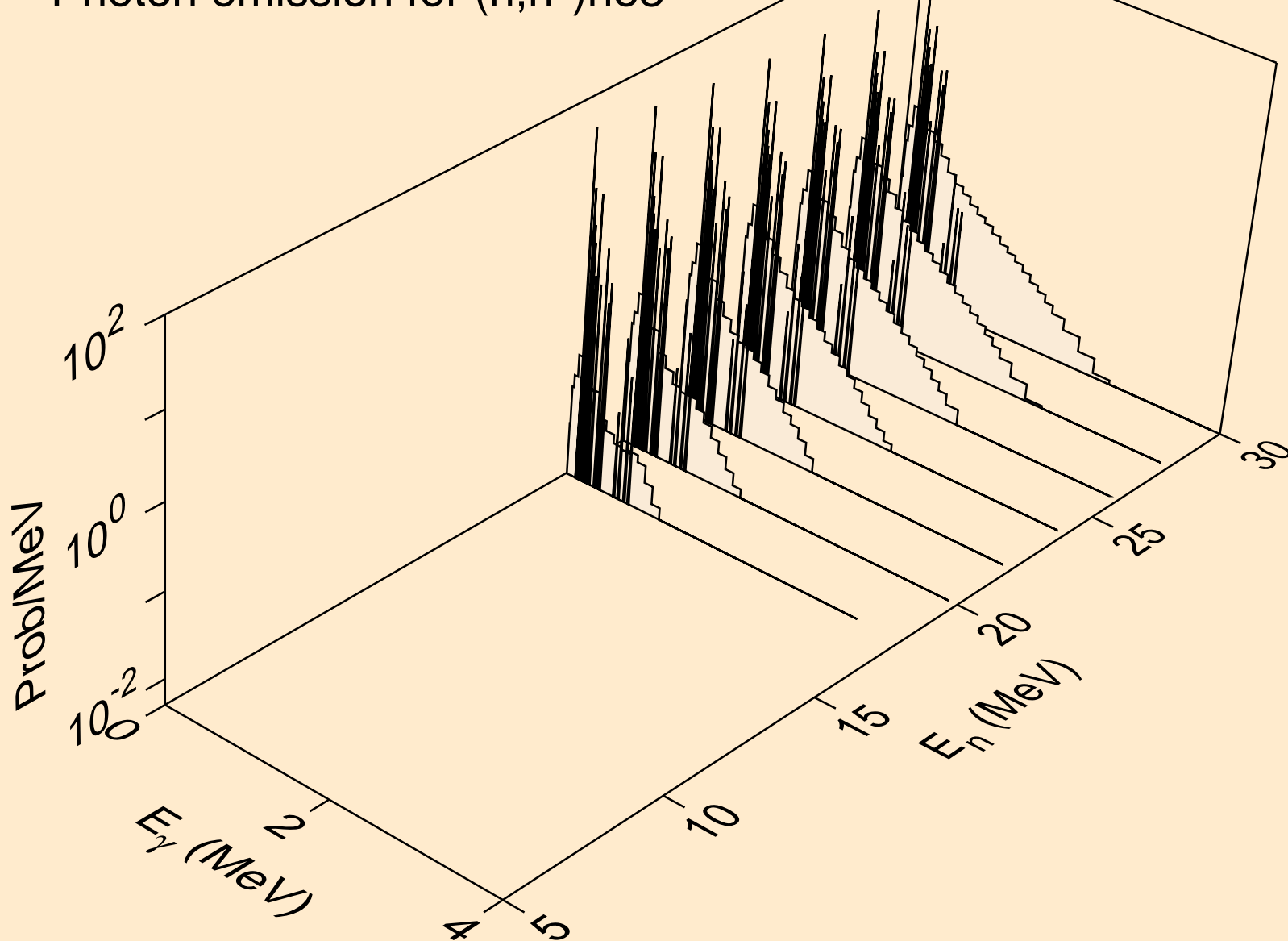

IR188 NEUTRON ACER TENDL-2019 LIBRARY; T=293.16K
Photon emission for (n,4n)

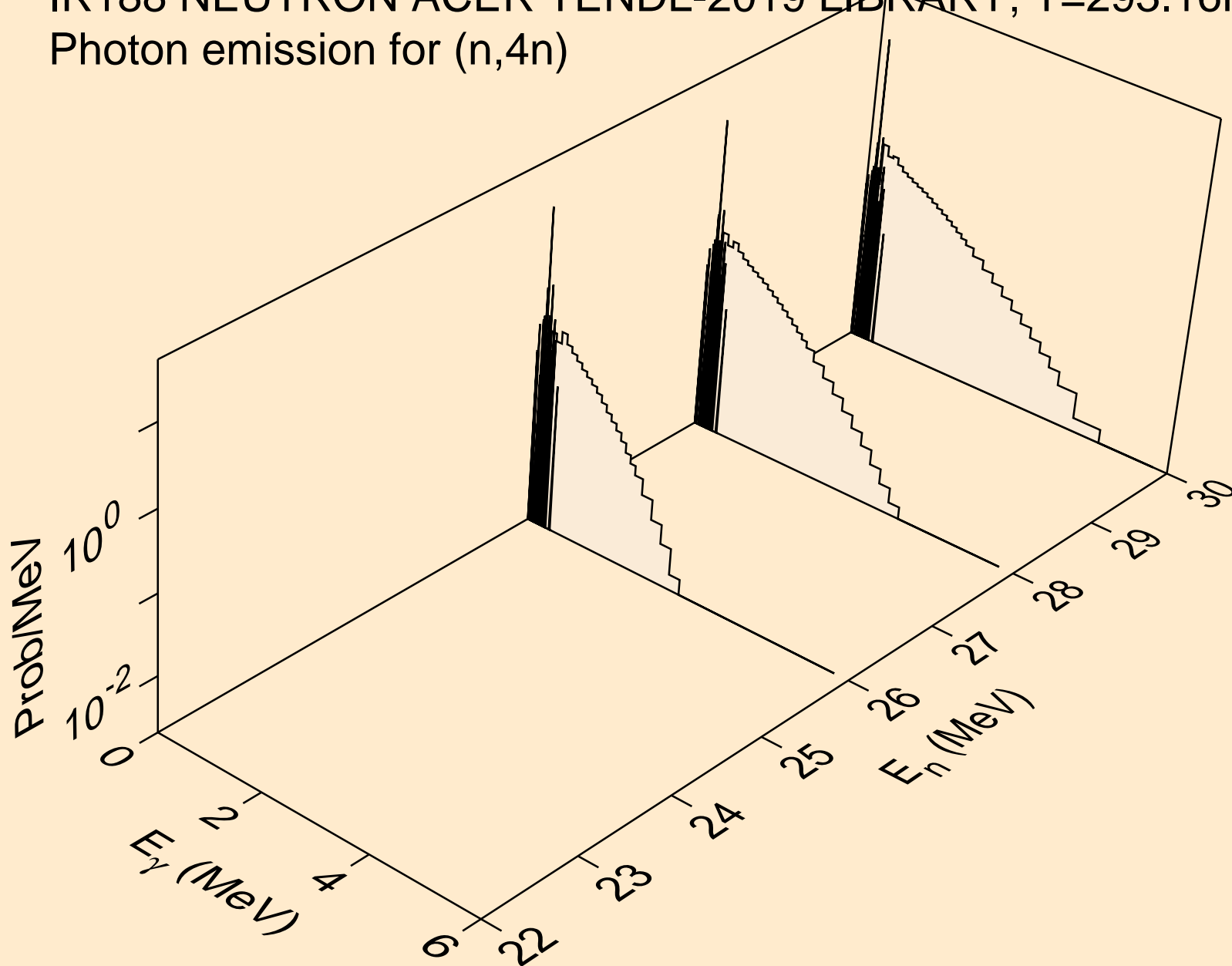

IR188 NEUTRON ACER TENDL-2019 LIBRARY; T=293.16K
Photon emission for (n,2np)

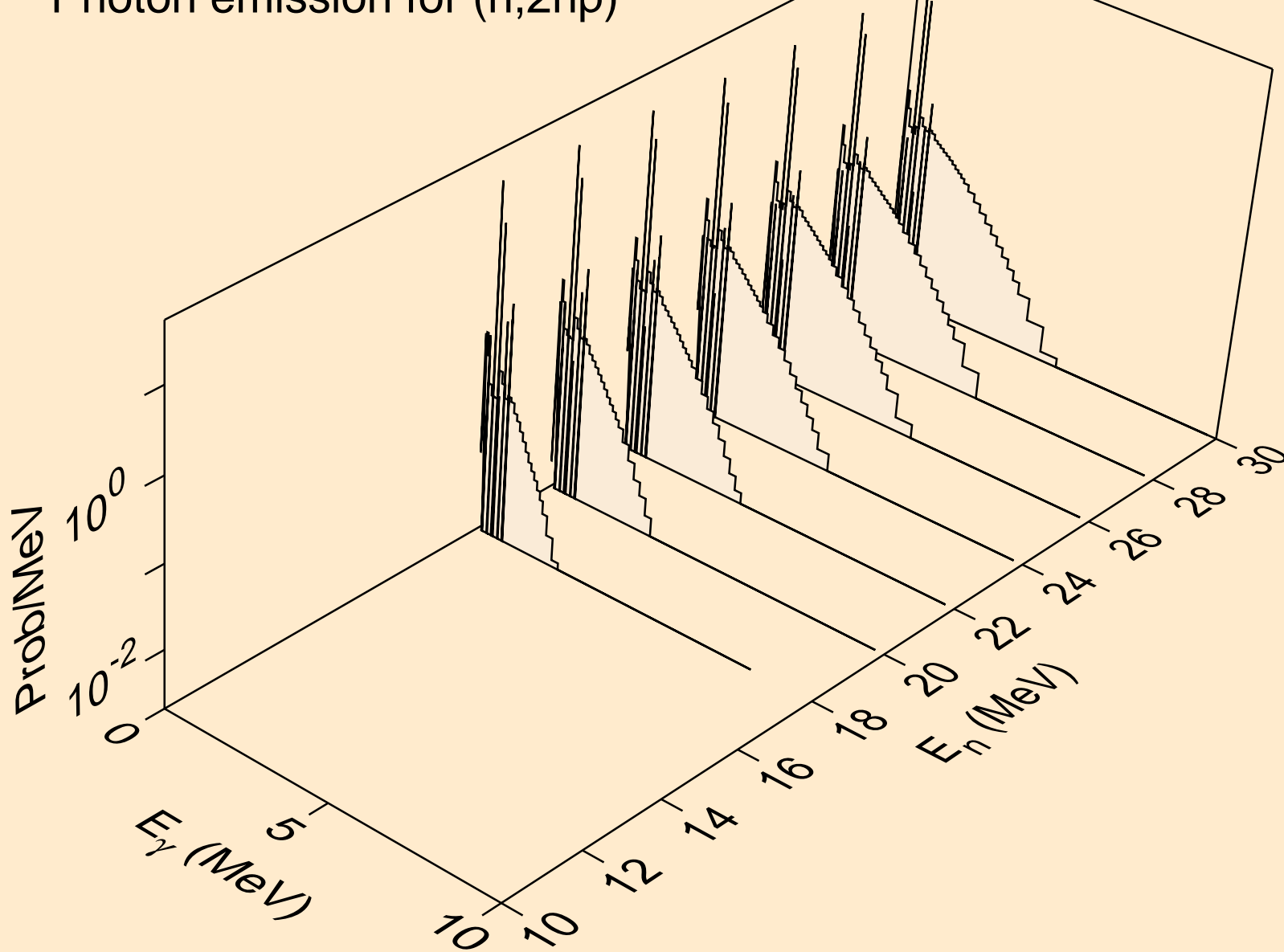

IR188 NEUTRON ACER TENDL-2019 LIBRARY; T=293.16K
Photon emission for (n,3np)

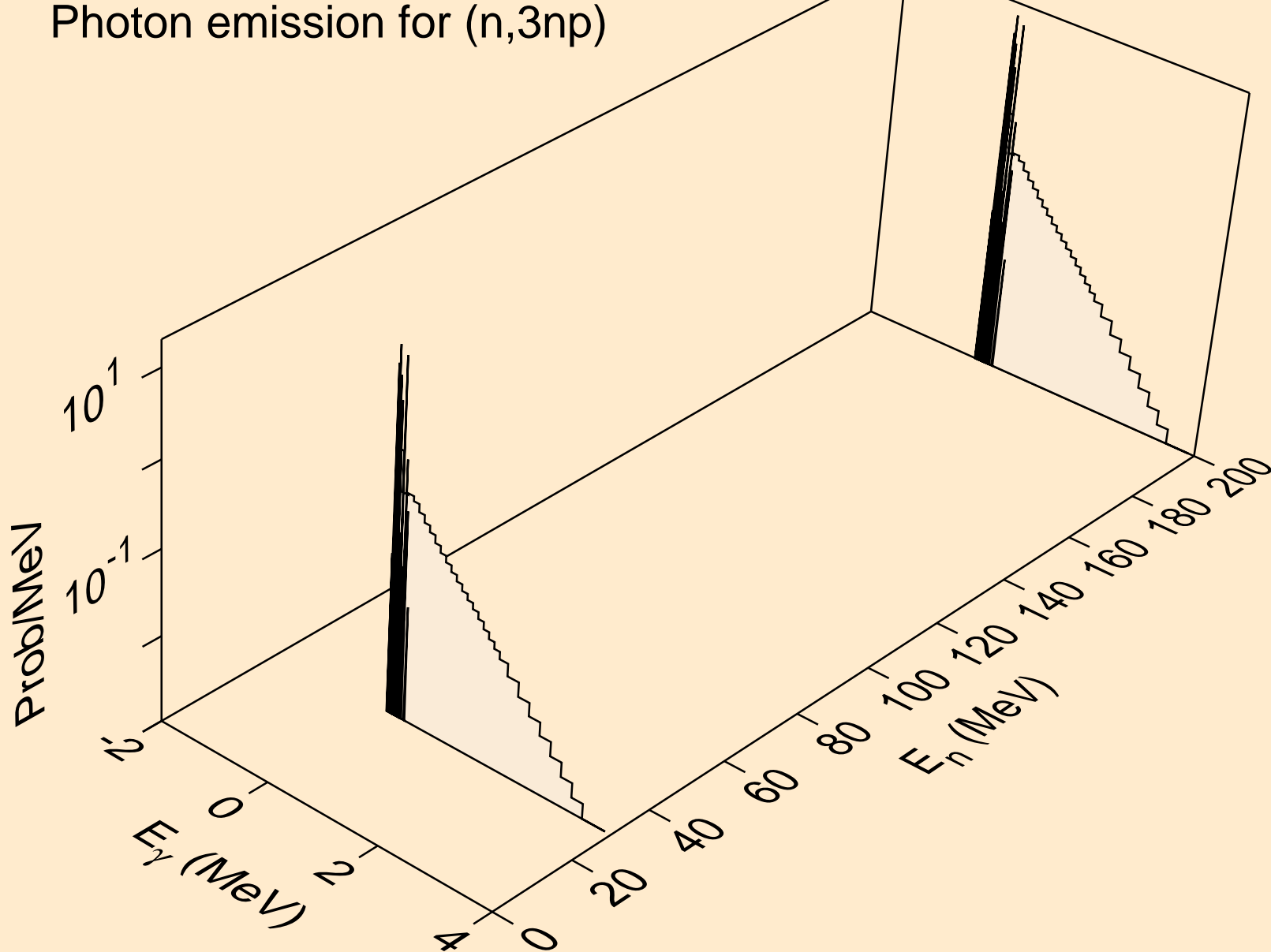

IR188 NEUTRON ACER TENDL-2019 LIBRARY; T=293.16K
Photon emission for (n,2np)

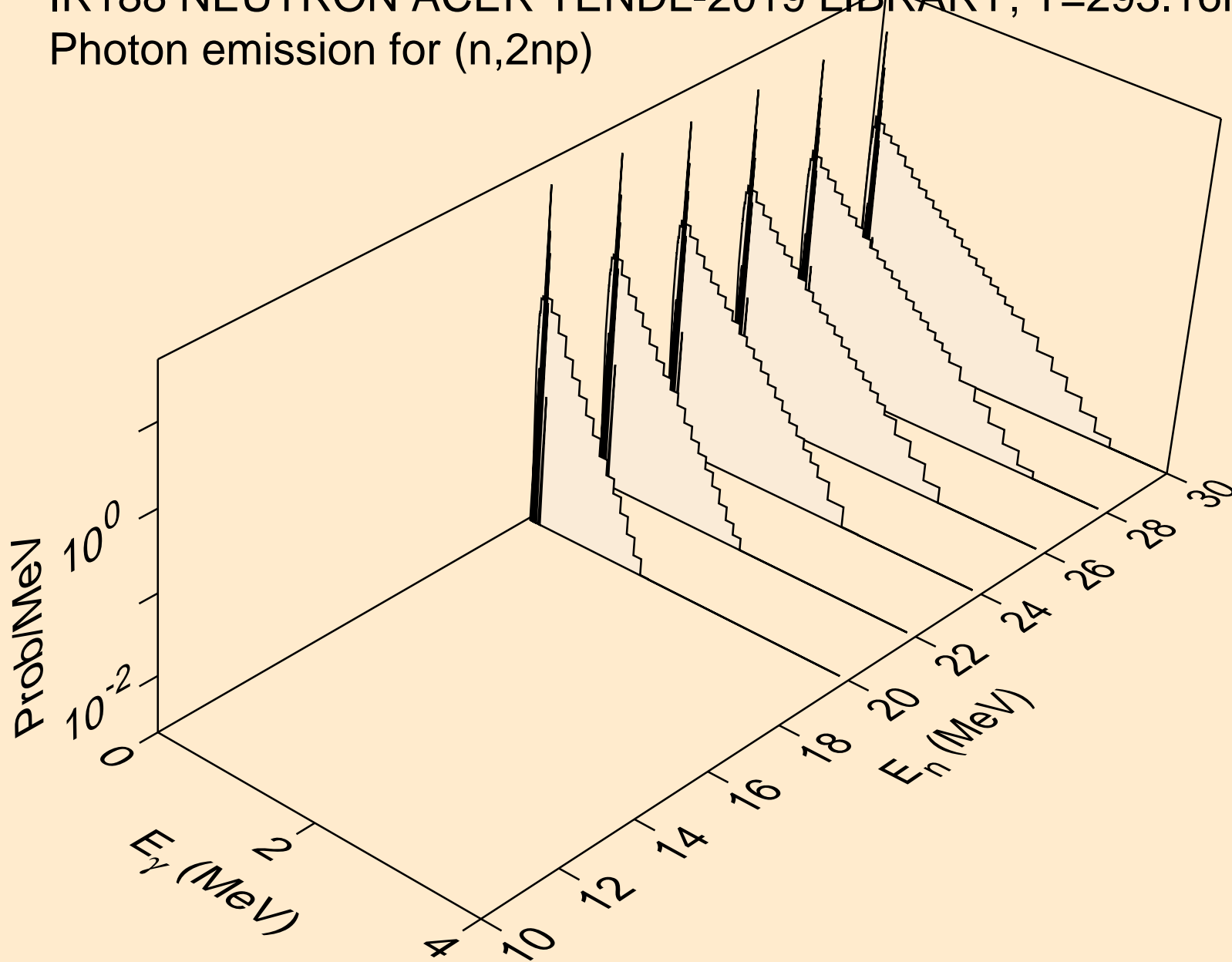

IR188 NEUTRON ACER TENDL-2019 LIBRARY; T=293.16K
Photon emission for (n,npa)

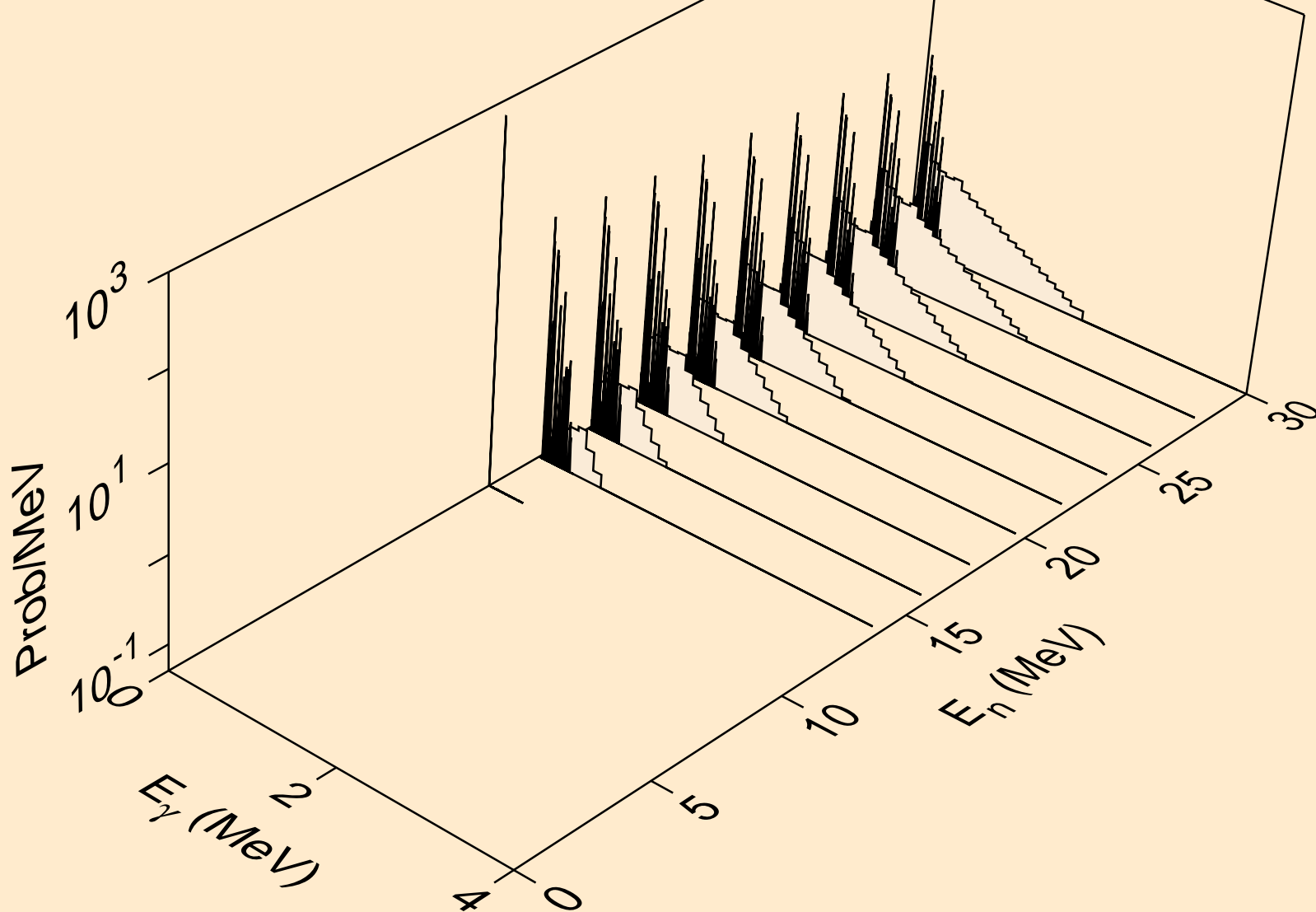

IR188 NEUTRON ACER TENDL-2019 LIBRARY; T=293.16K
Photon emission for (n,n*c)

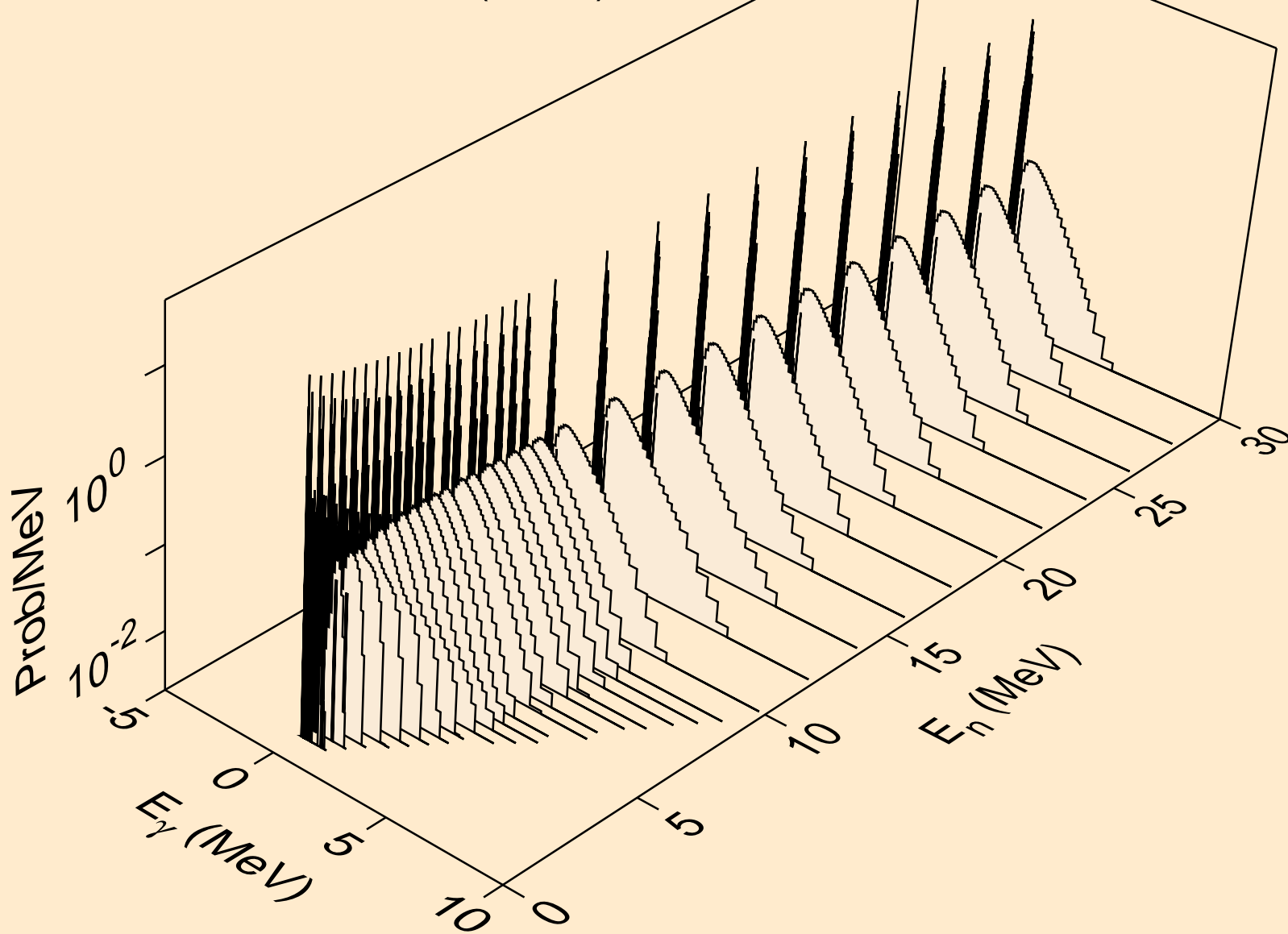

IR188 NEUTRON ACER TENDL-2019 LIBRARY; T=293.16K
Photon emission for (n,gma)

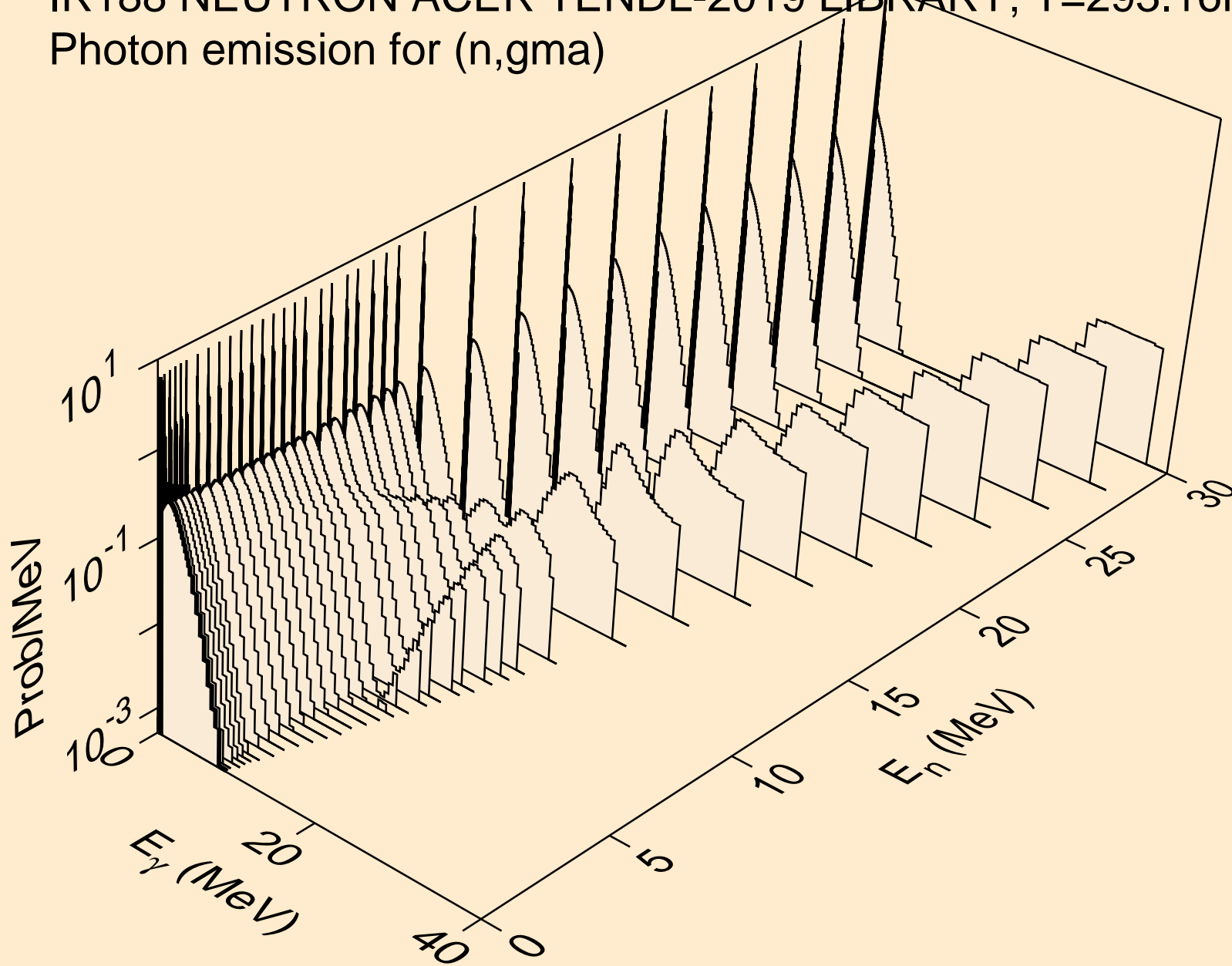

IR188 NEUTRON ACER TENDL-2019 LIBRARY; T=293.16K
Photon emission for (n,p)

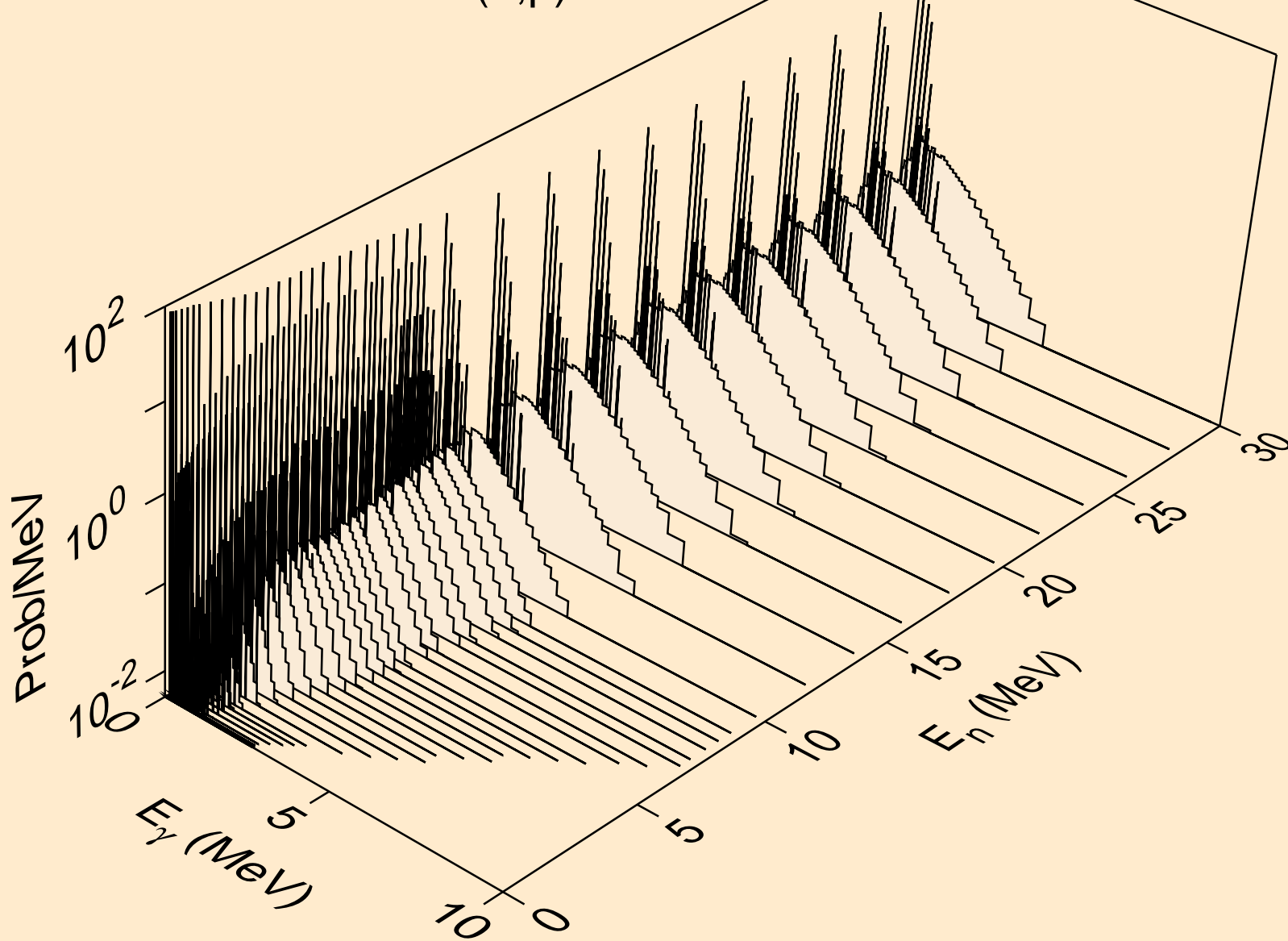

IR188 NEUTRON ACER TENDL-2019 LIBRARY; T=293.16K
Photon emission for (n,d)

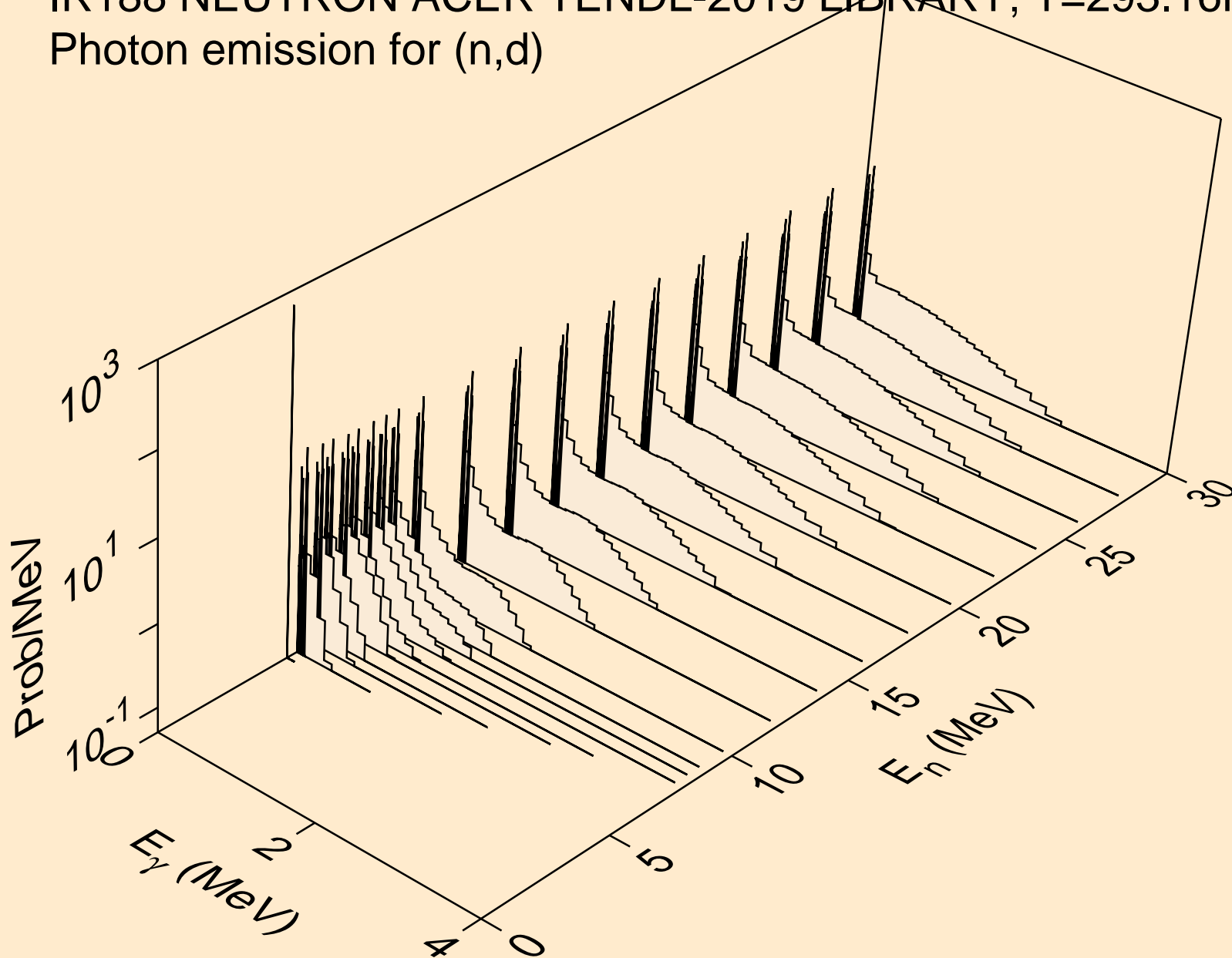

IR188 NEUTRON ACER TENDL-2019 LIBRARY; T=293.16K
Photon emission for (n,t)

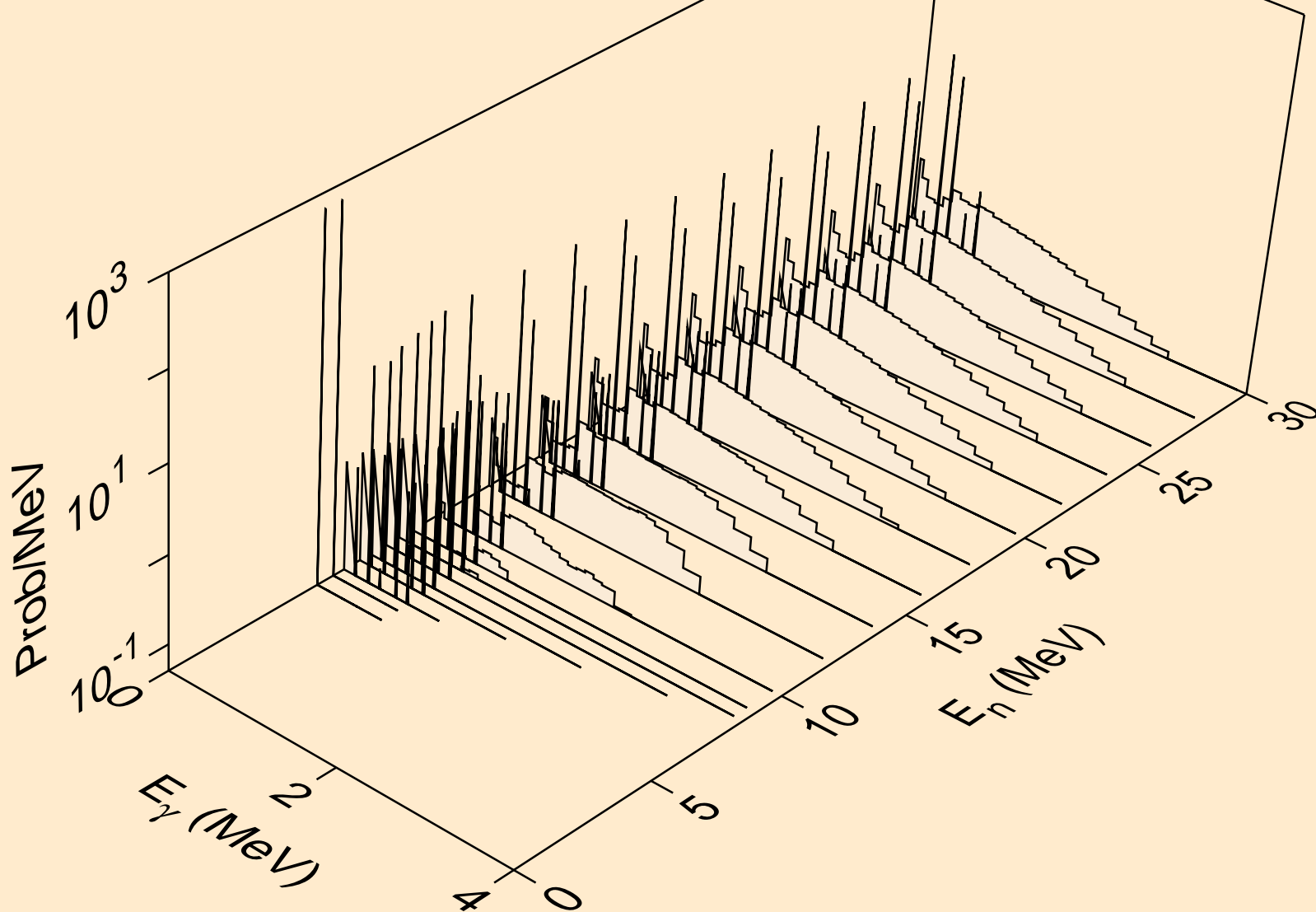

IR188 NEUTRON ACER TENDL-2019 LIBRARY; T=293.16K
Photon emission for (n,he3)

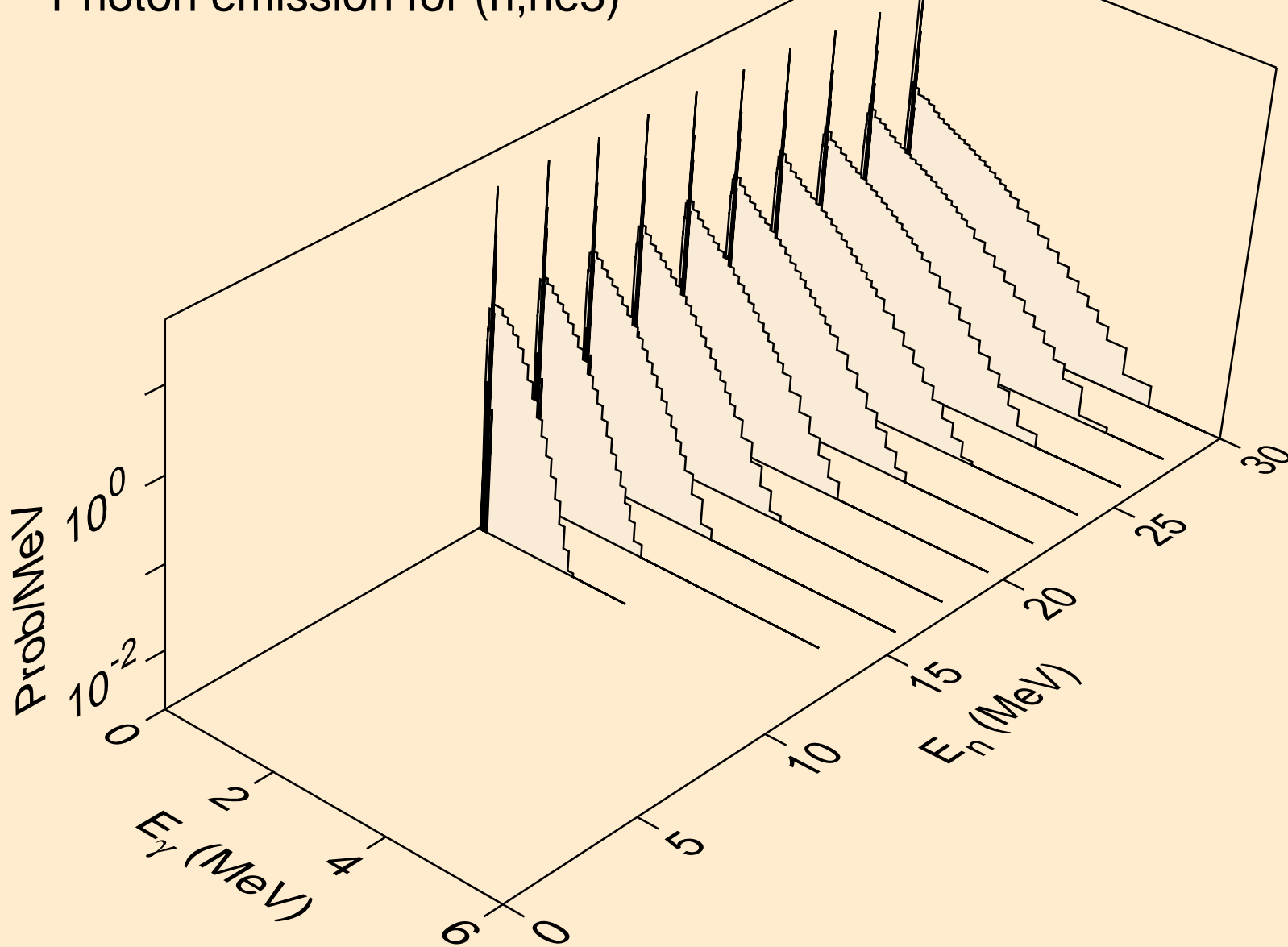

IR188 NEUTRON ACER TENDL-2019 LIBRARY; T=293.16K
Photon emission for (n,a)

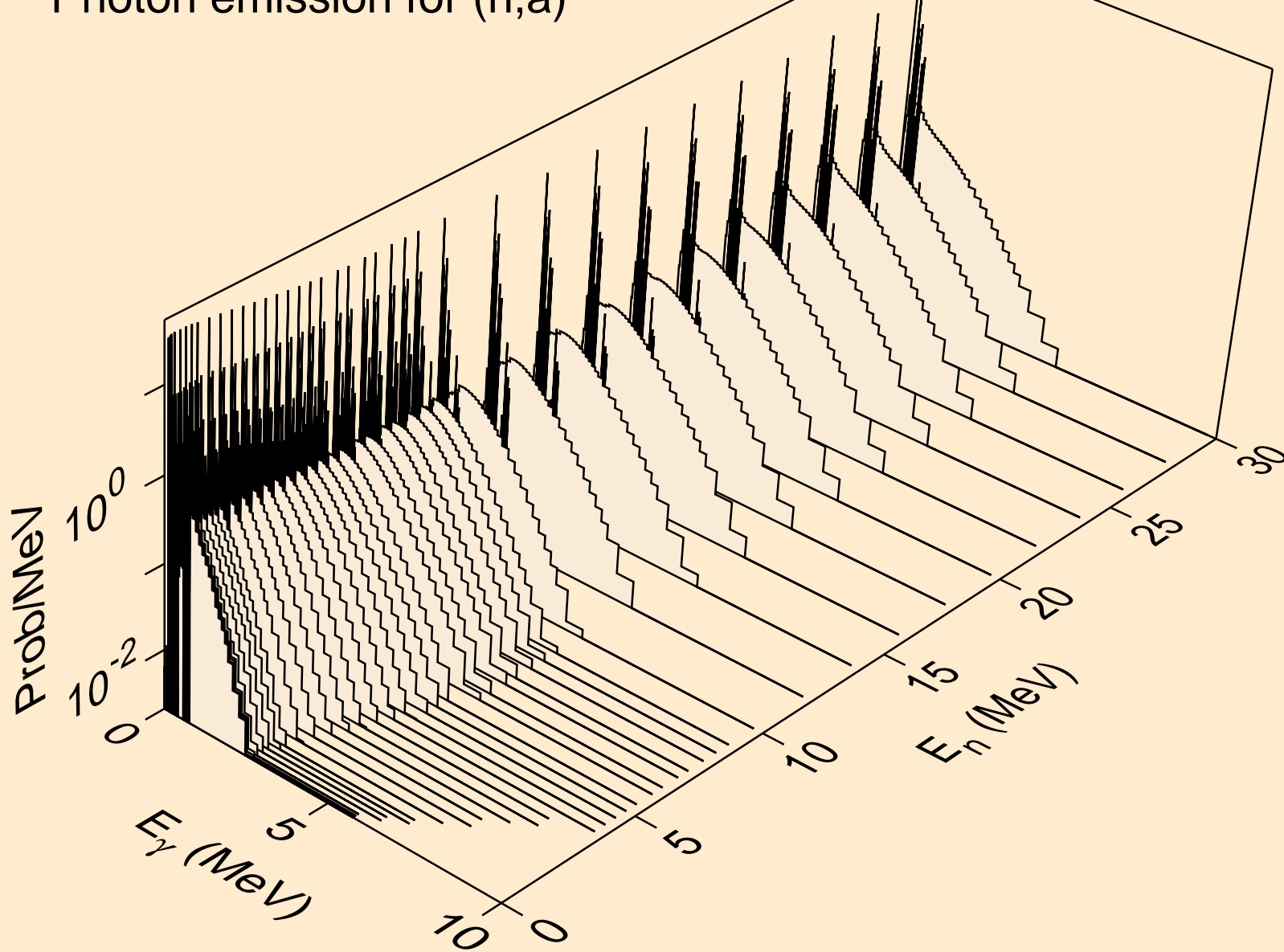

IR188 NEUTRON ACER TENDL-2019 LIBRARY; T=293.16K
Photon emission for (n,2a)

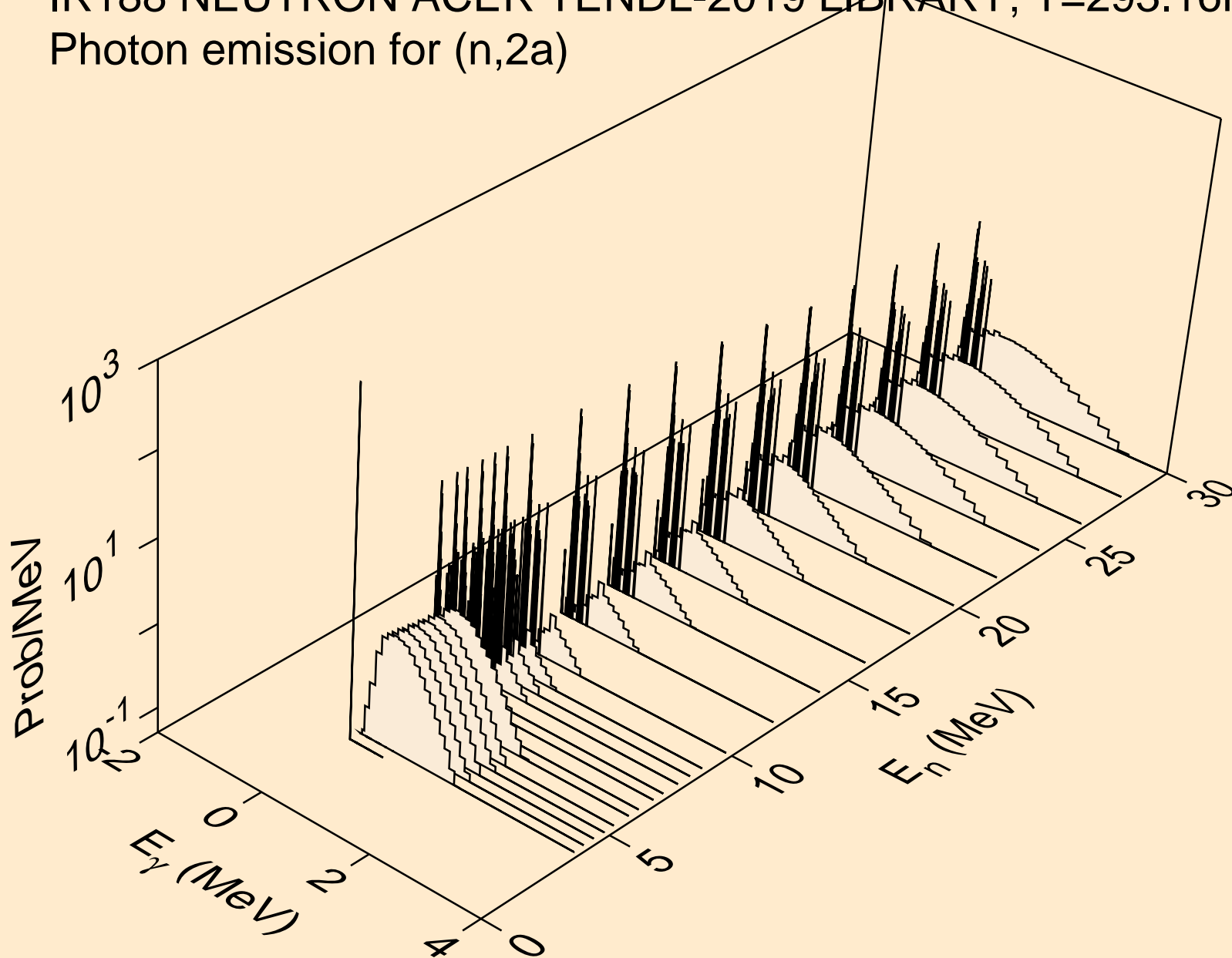

IR188 NEUTRON ACER TENDL-2019 LIBRARY; T=293.16K
Photon emission for (n,2p)

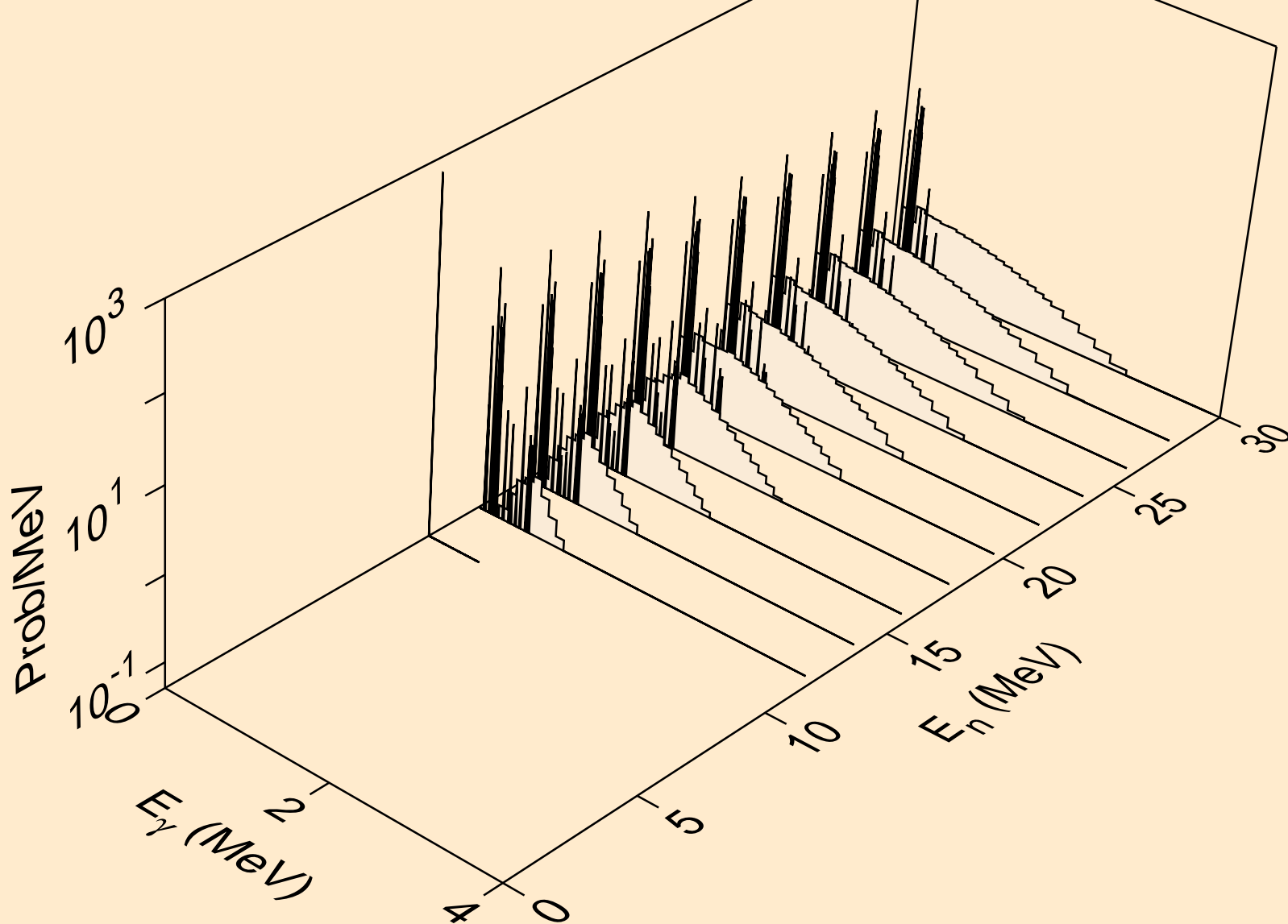

IR188 NEUTRON ACER TENDL-2019 LIBRARY; T=293.16K
Photon emission for (n,p α)

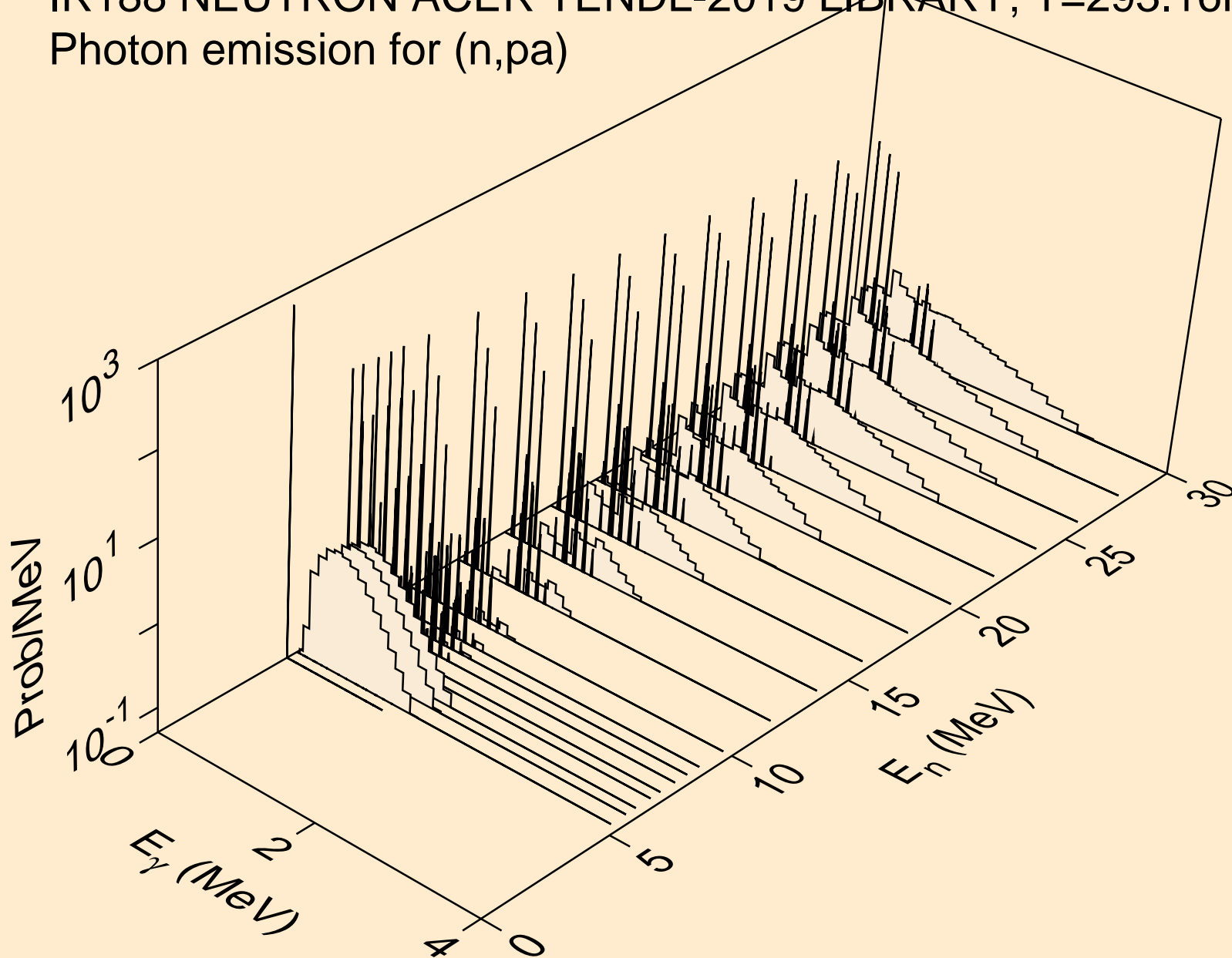

IR188 NEUTRON ACER TENDL-2019 LIBRARY; T=293.16K
Photon emission for (n,pd)

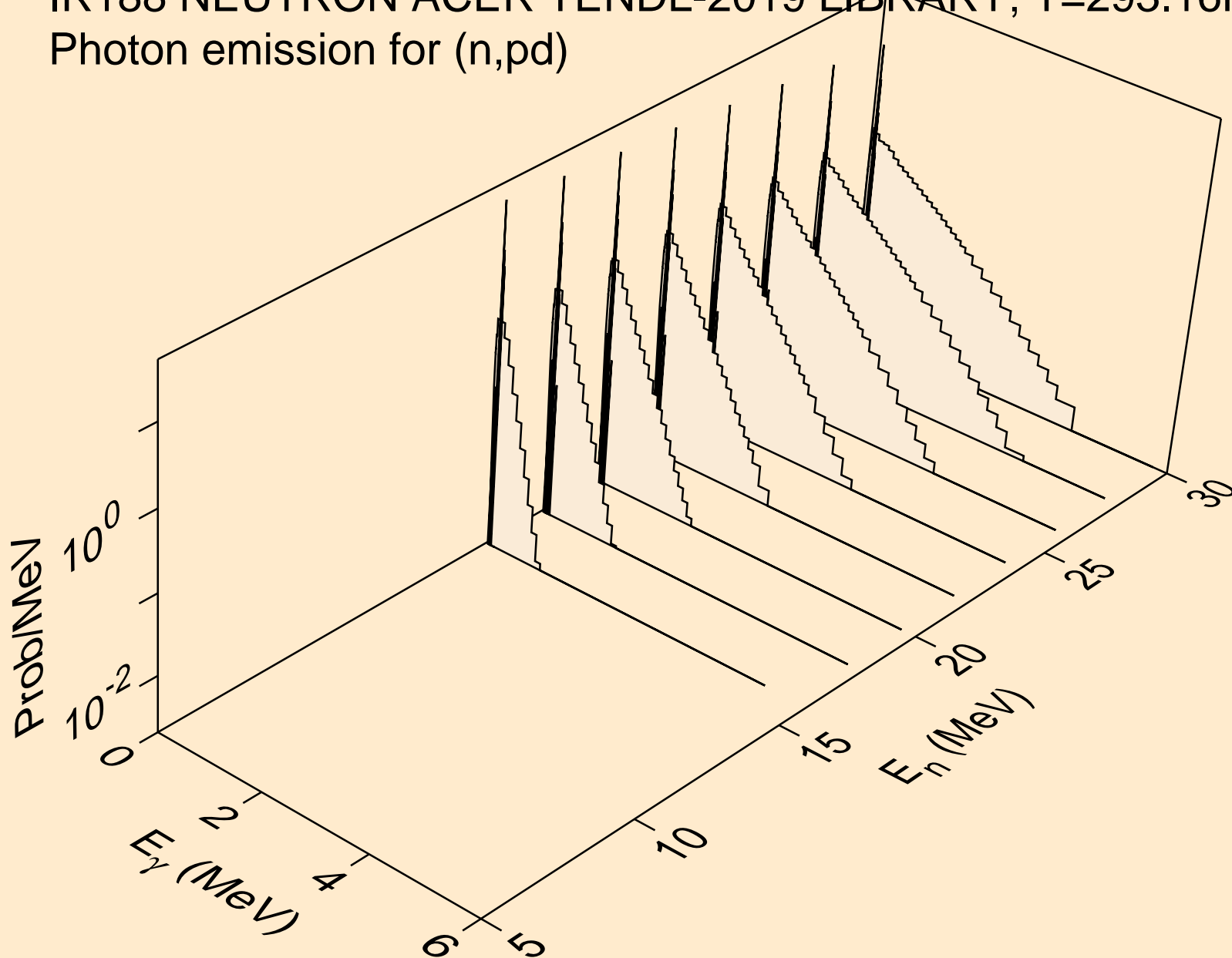

IR188 NEUTRON ACER TENDL-2019 LIBRARY; T=293.16K
Photon emission for (n,pt)

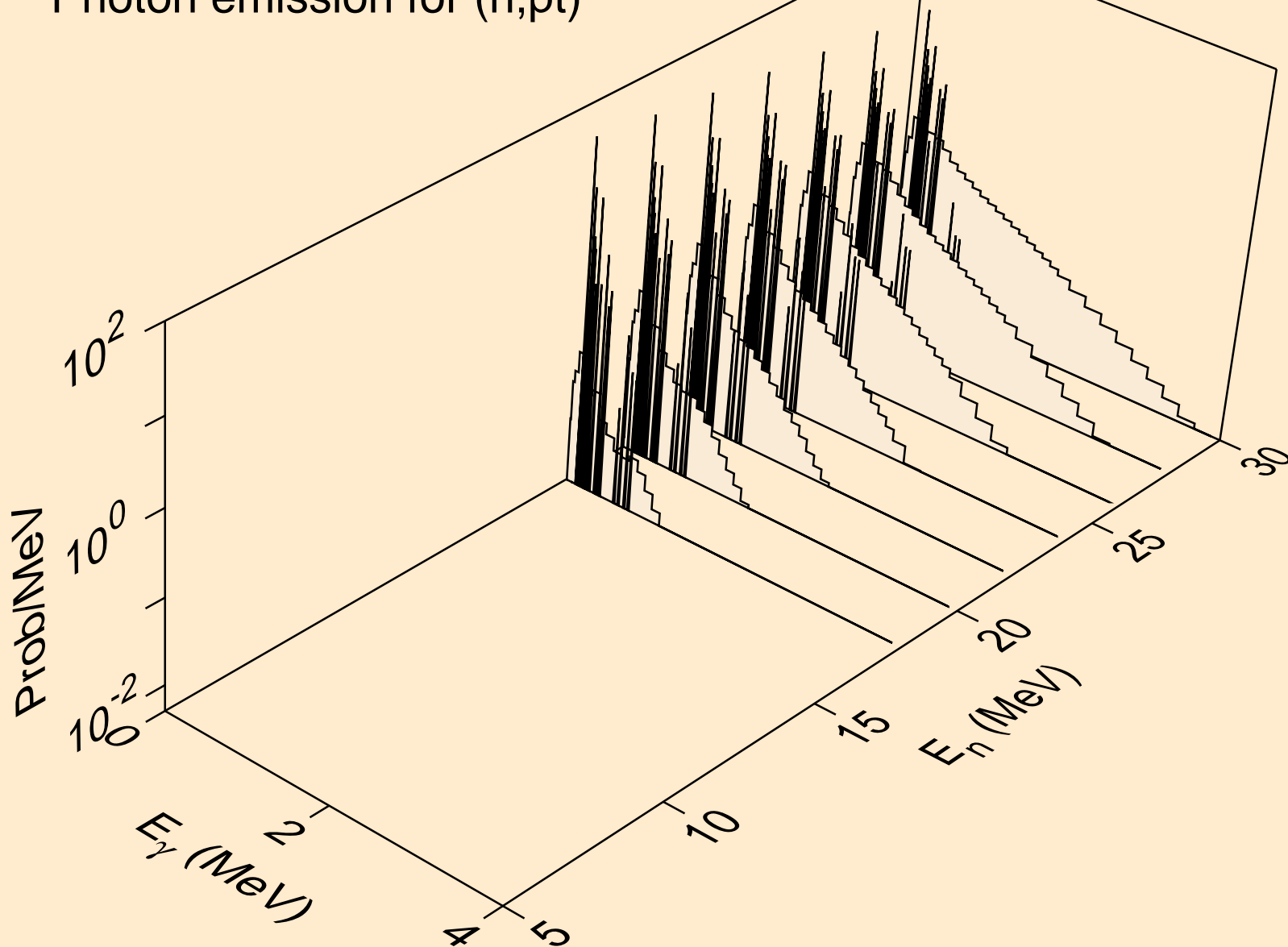

IR188 NEUTRON ACER TENDL-2019 LIBRARY; T=293.16K
Photon emission for (n,da)

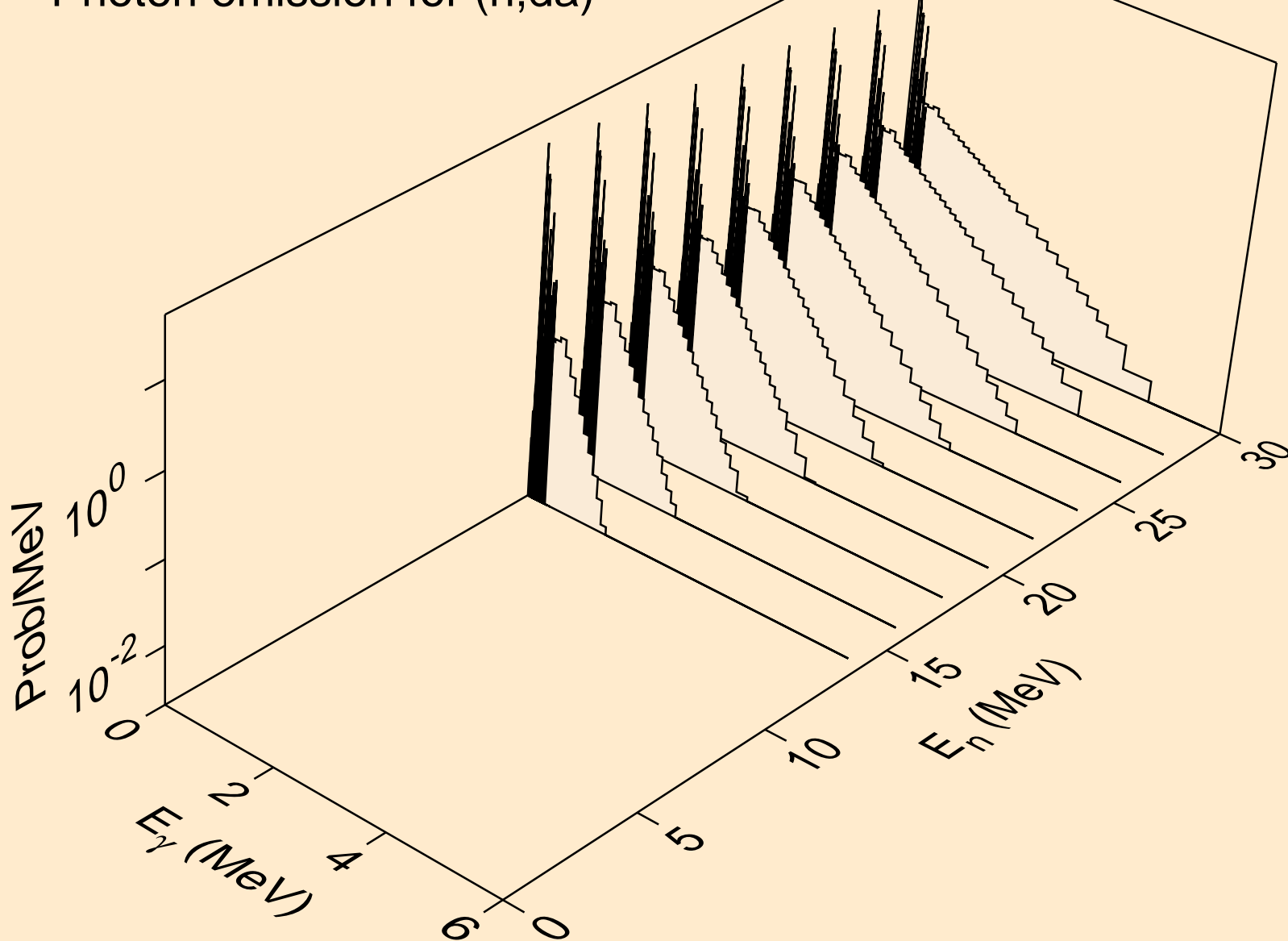

IR188 NEUTRON ACER TENDL-2019 LIBRARY; T=293.16K
thermal capture photon spectrum

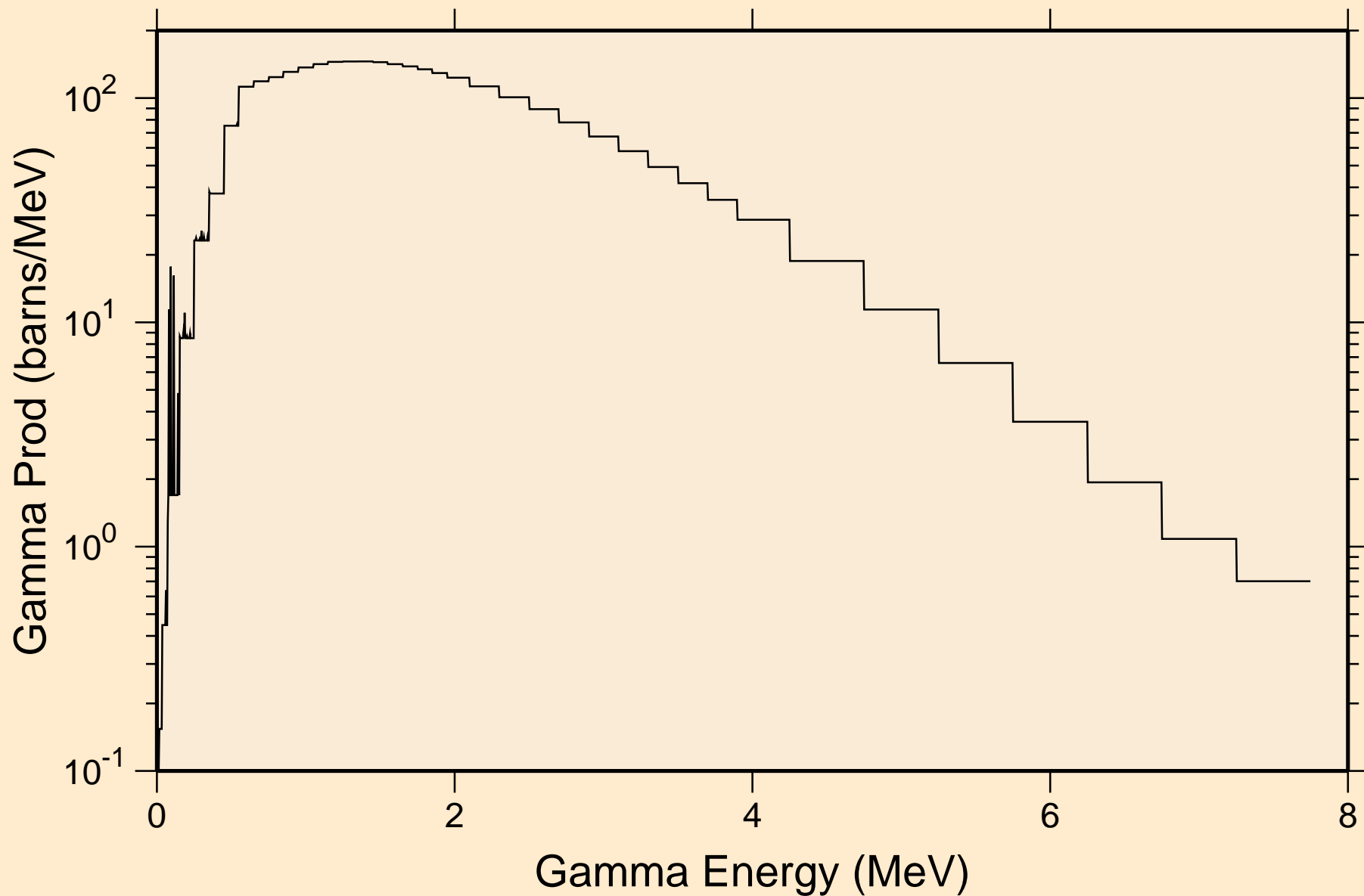

IR188 NEUTRON ACER TENDL-2019 LIBRARY; T=293.16K
14 MeV photon spectrum

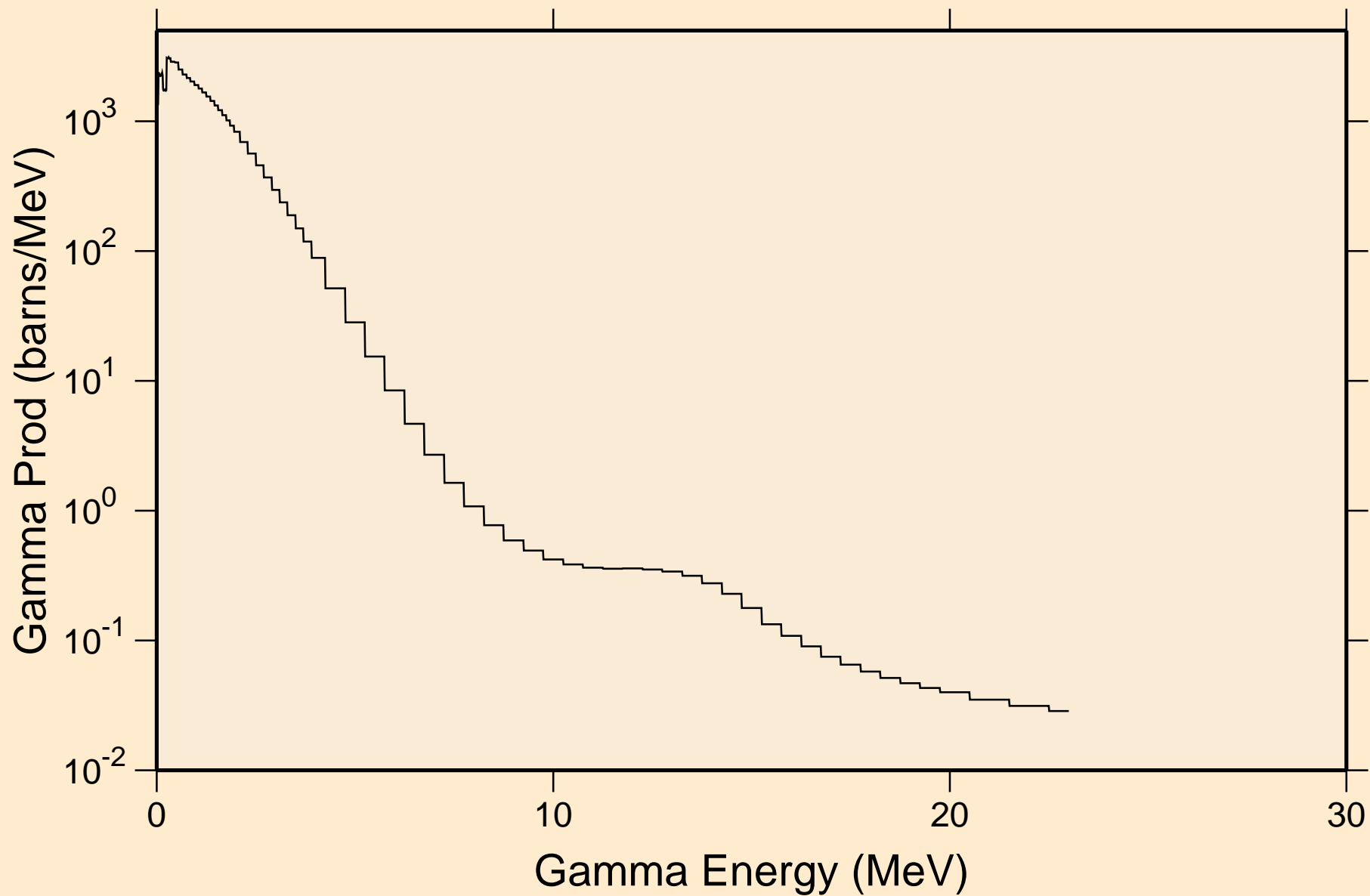

IR188 NEUTRON ACER TENDL-2019 LIBRARY; T=293.16K
Particle heating contributions

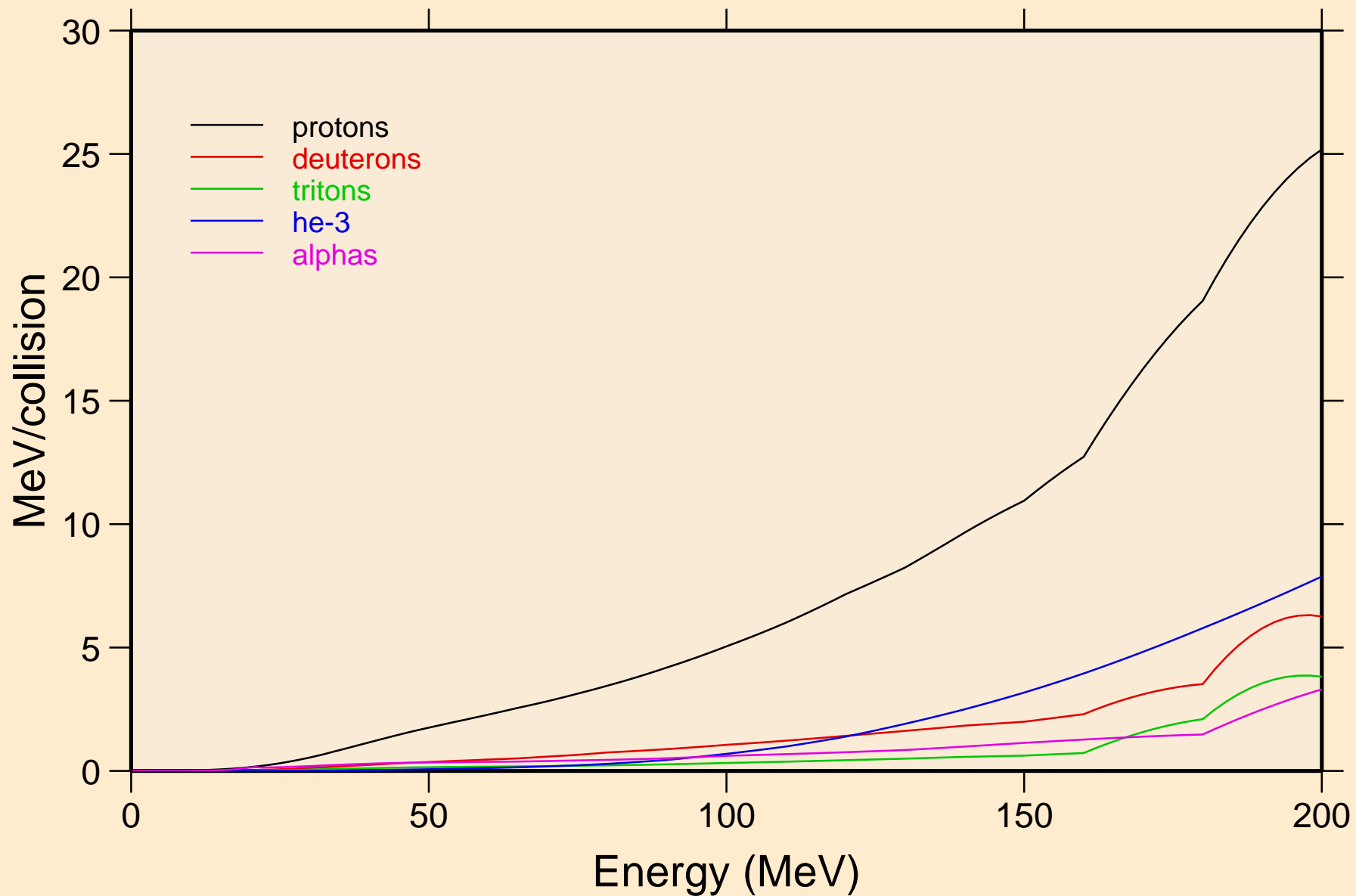

IR188 NEUTRON ACER TENDL-2019 LIBRARY; T=293.16K
Recoil Heating

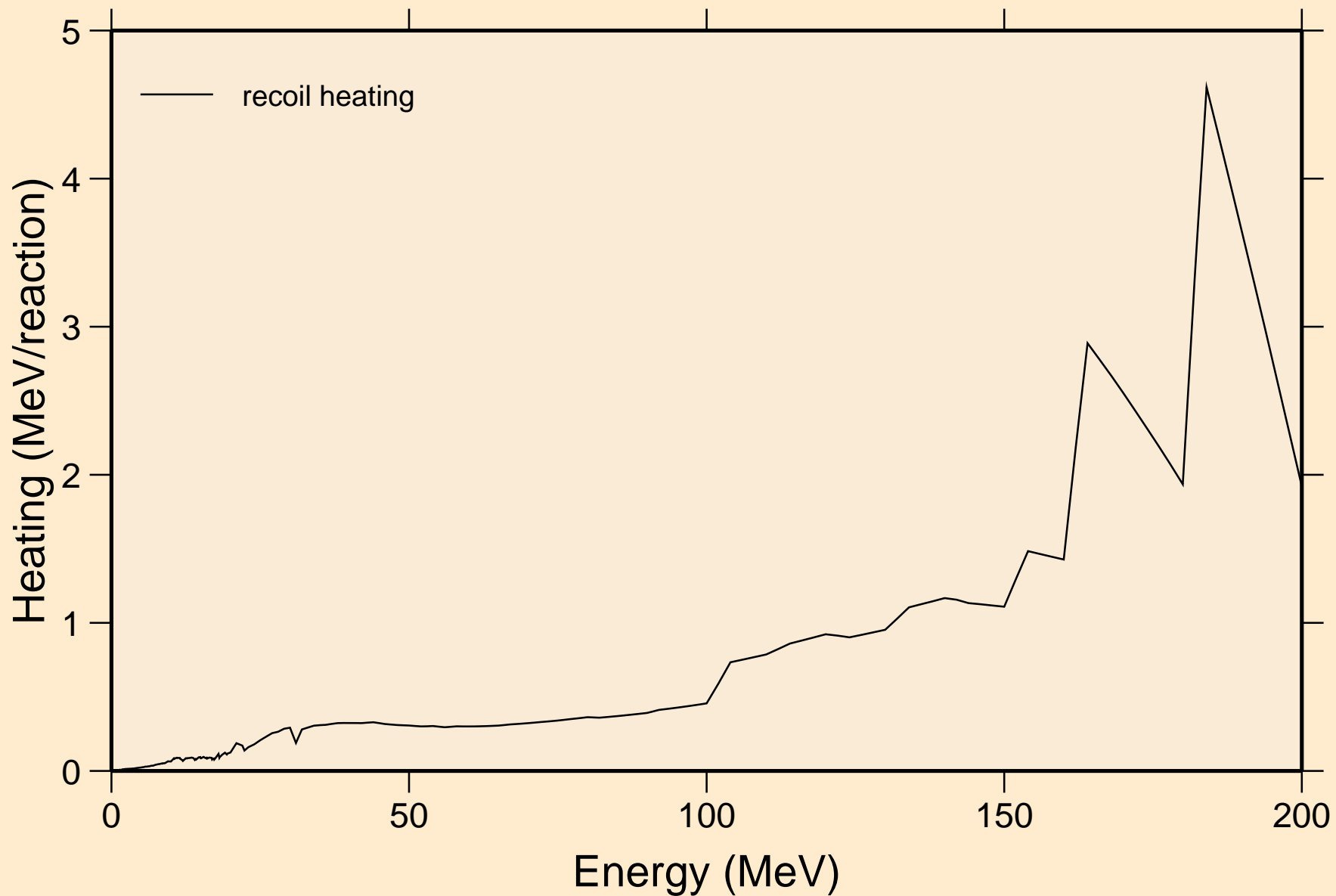

IR188 NEUTRON ACER TENDL-2019 LIBRARY; T=293.16K

Particle production cross sections

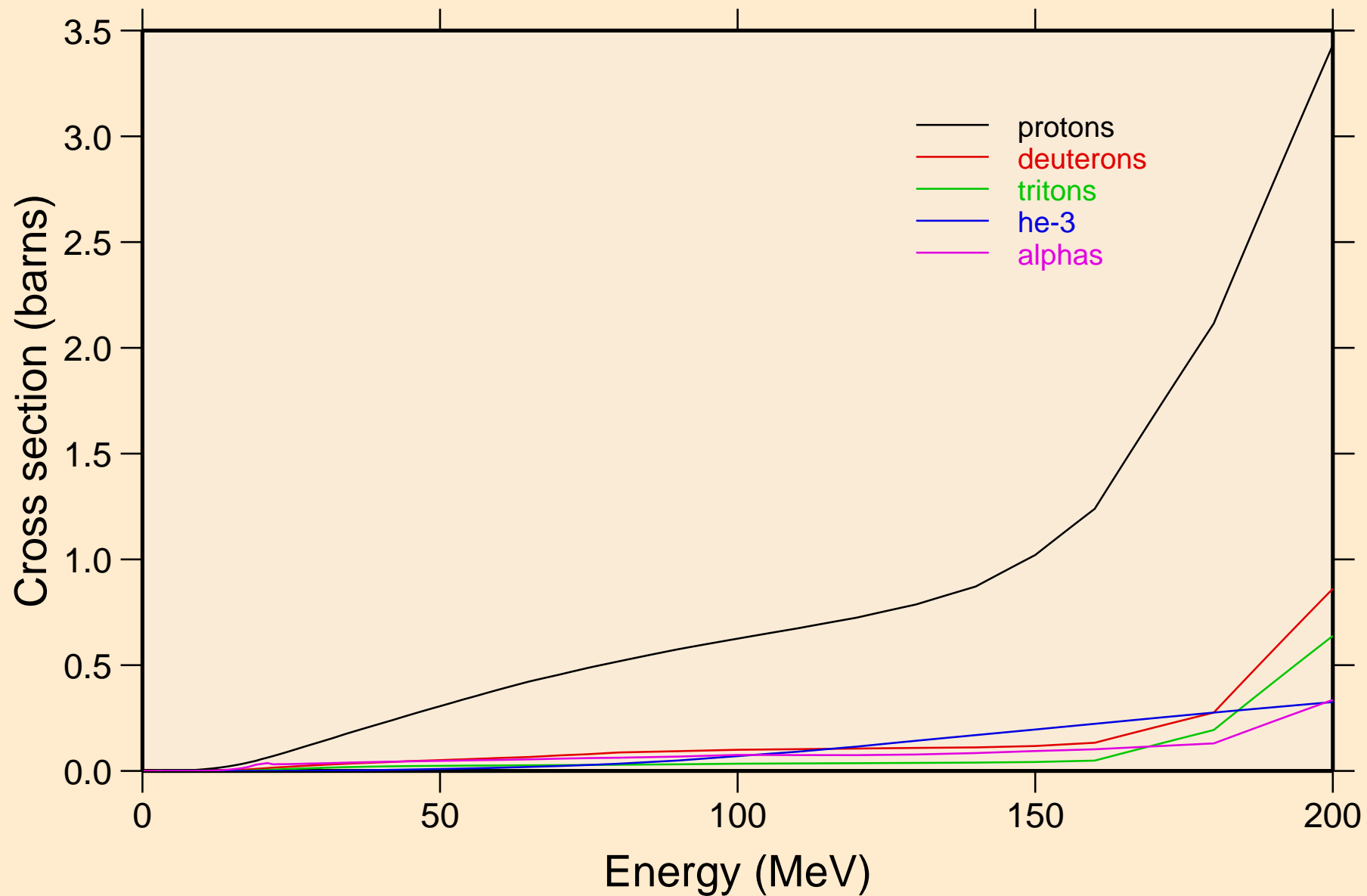

IR188 NEUTRON ACER TENDL-2019 LIBRARY; T=293.16K
protons from (n,x)

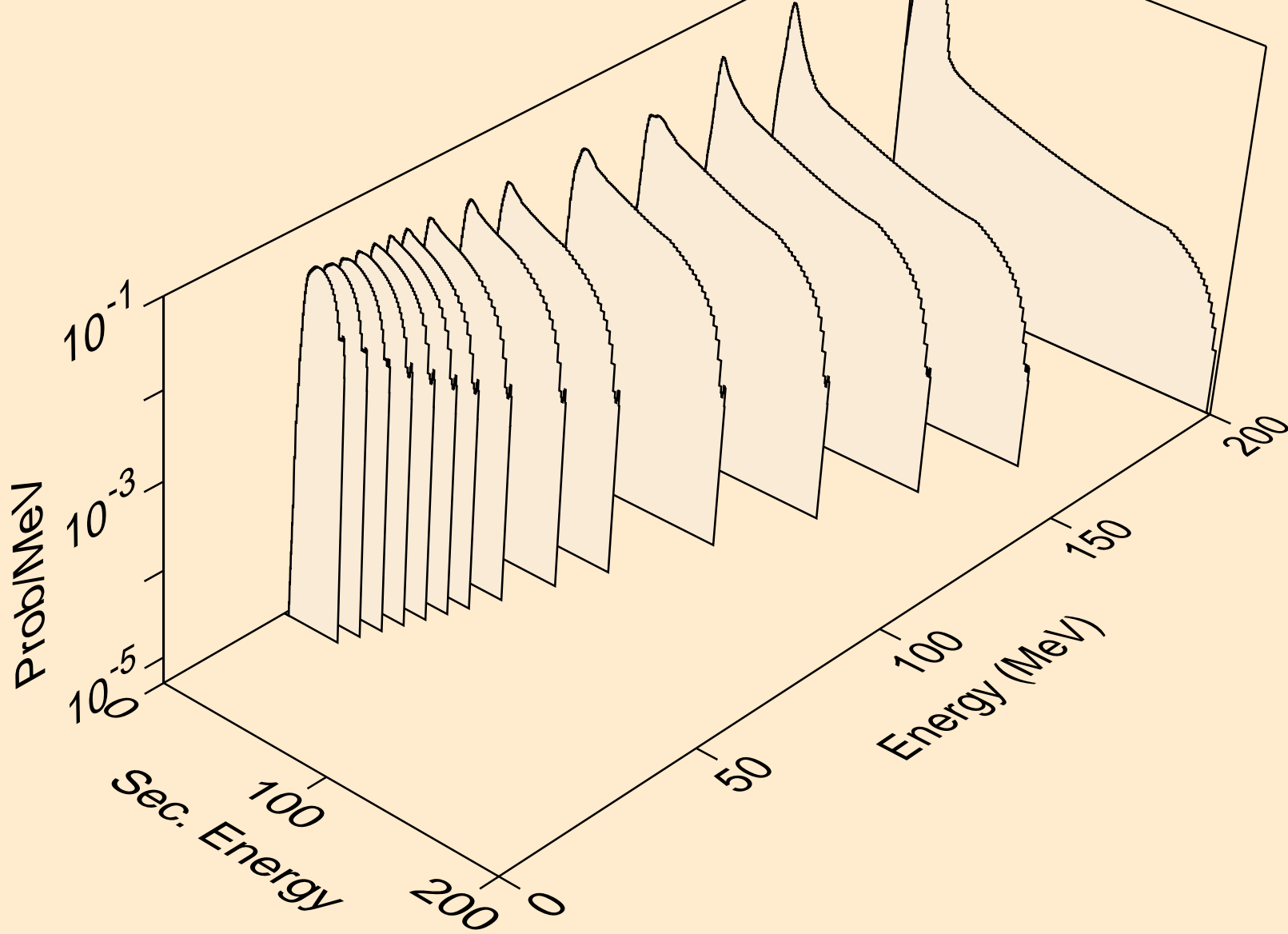

IR188 NEUTRON ACER TENDL-2019 LIBRARY; T=293.16K
protons from (n,n*)p

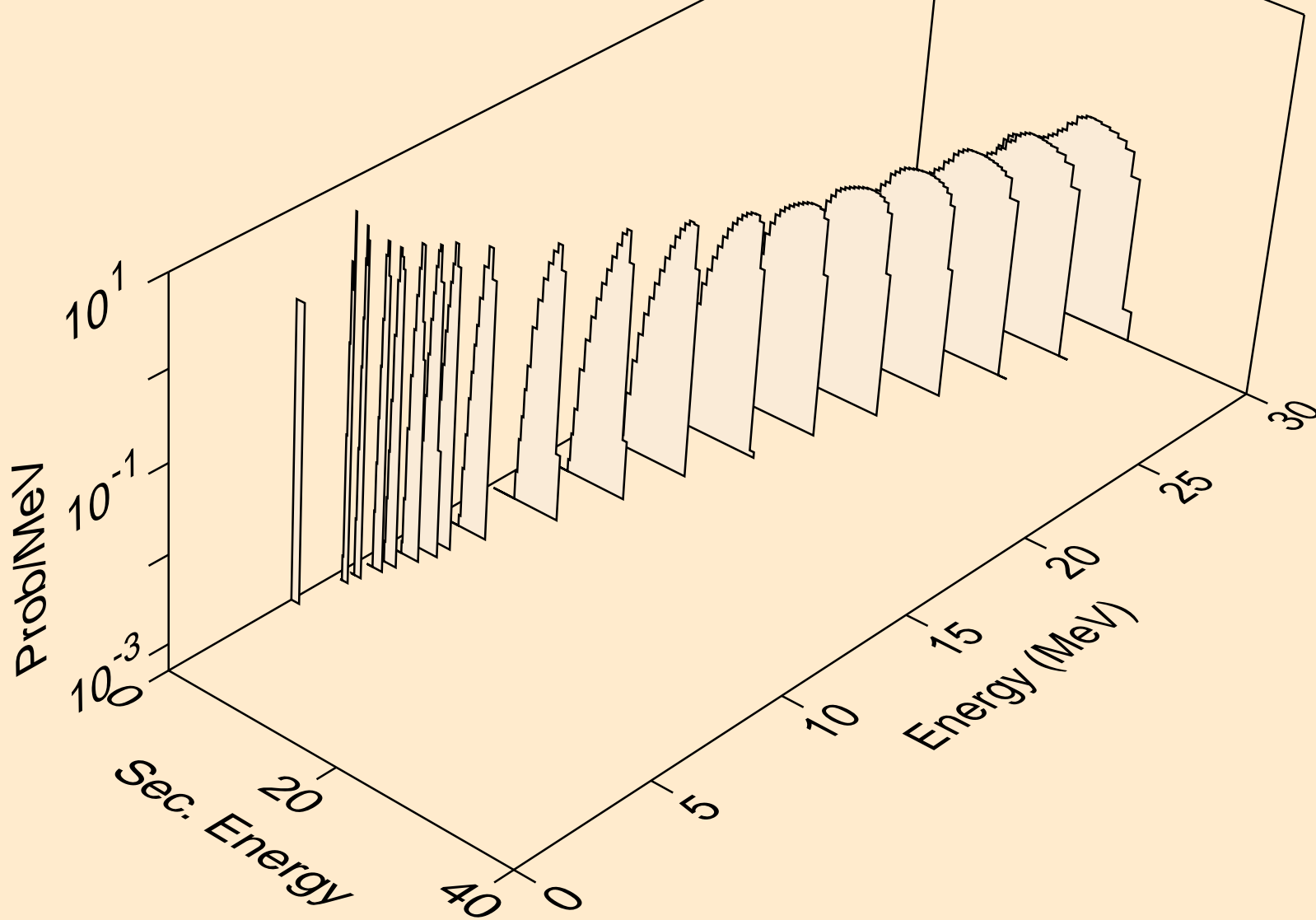

IR188 NEUTRON ACER TENDL-2019 LIBRARY; T=293.16K
protons from (n,2np)

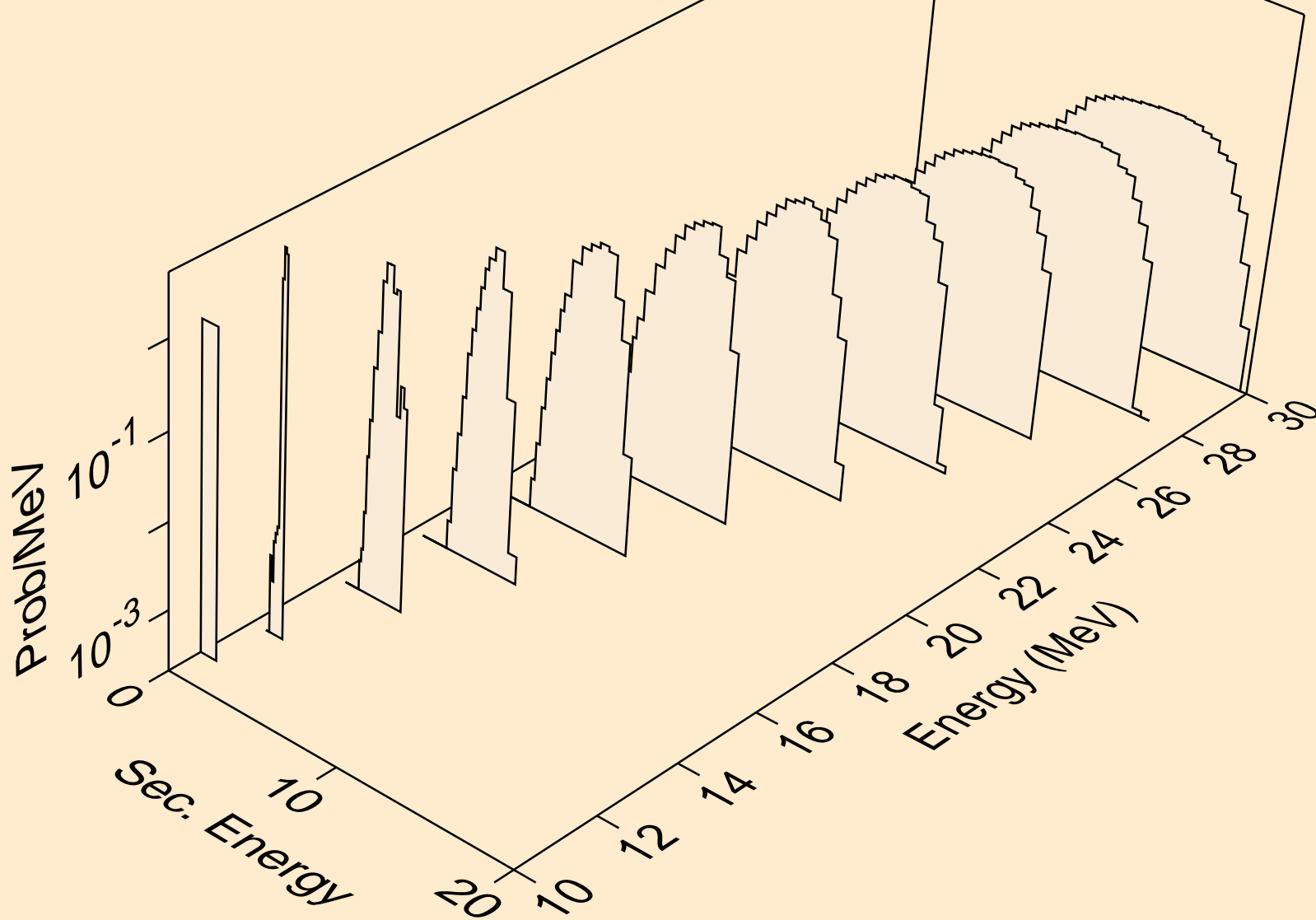

IR188 NEUTRON ACER TENDL-2019 LIBRARY; T=293.16K
protons from (n,3np)

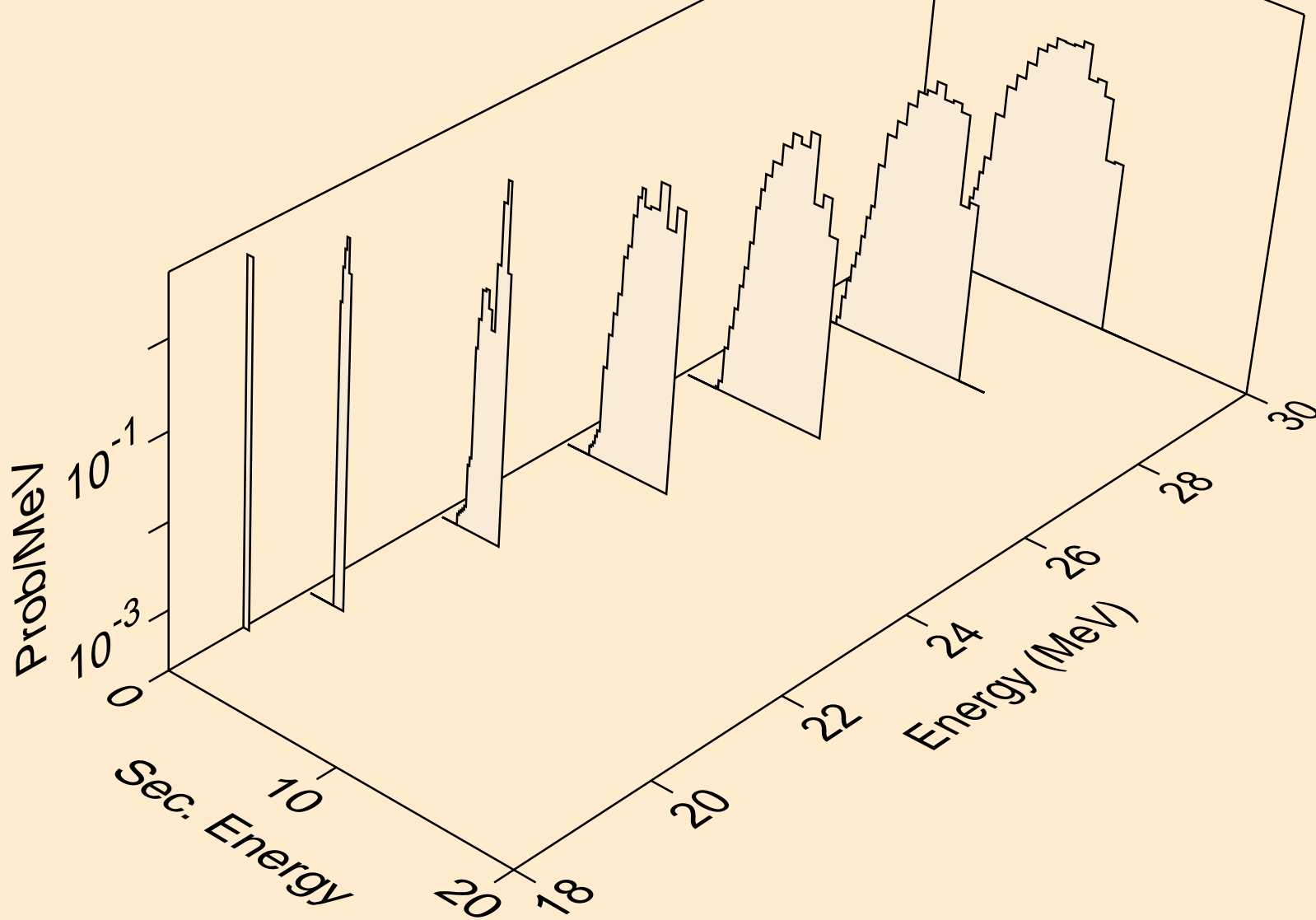

IR188 NEUTRON ACER TENDL-2019 LIBRARY; T=293.16K
protons from (n,2np)

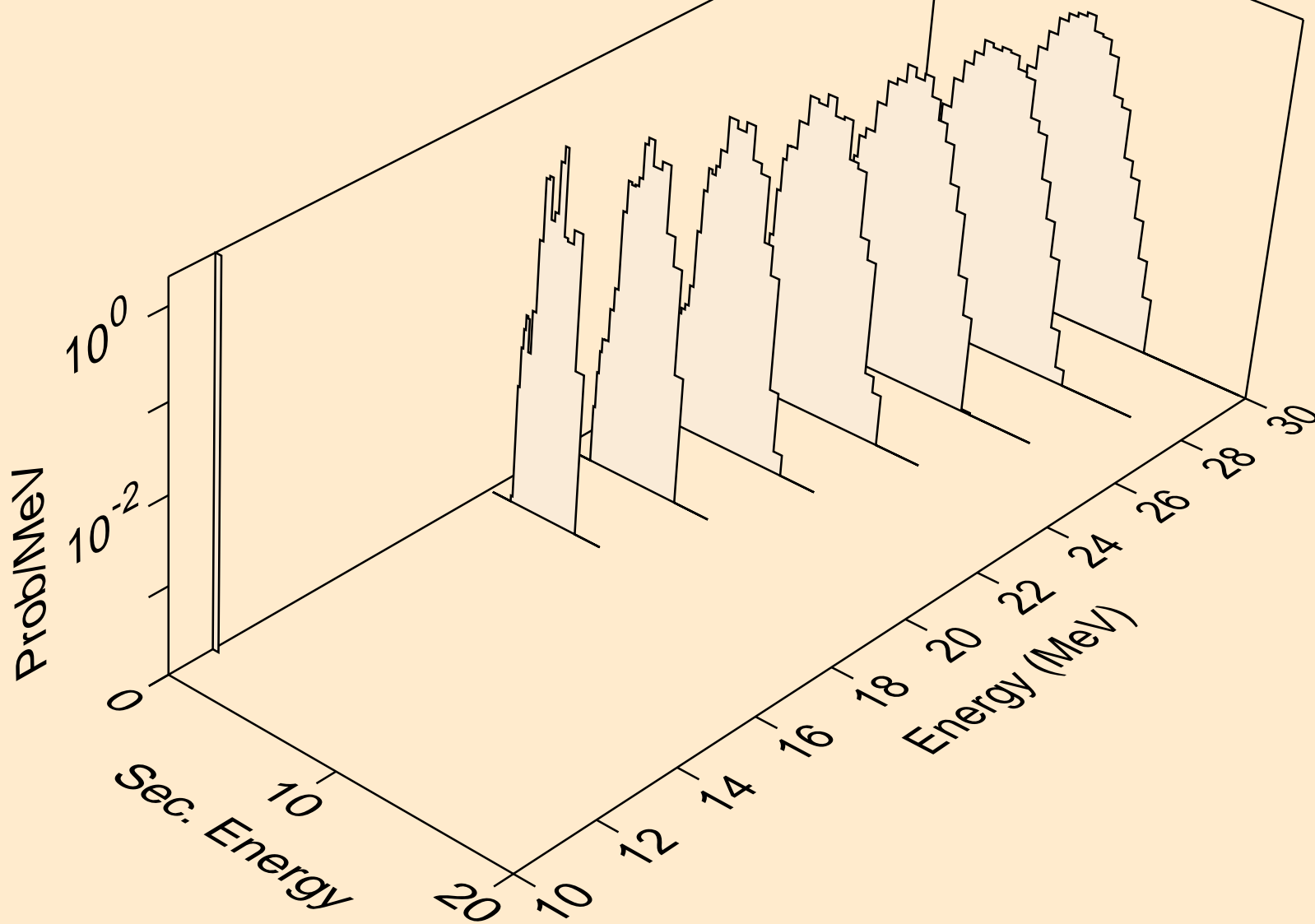

IR188 NEUTRON ACER TENDL-2019 LIBRARY; T=293.16K
protons from (n,npa)

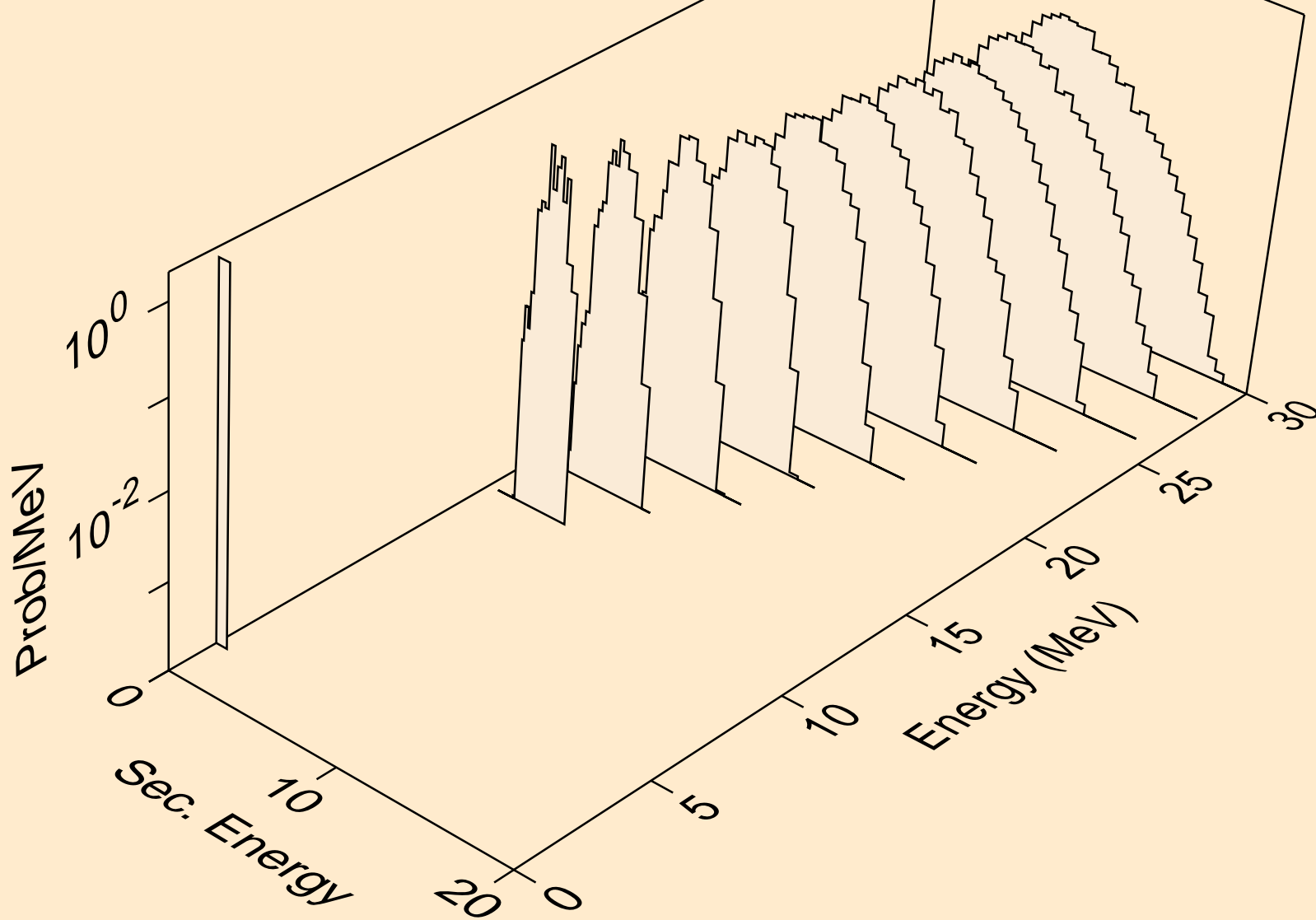

IR188 NEUTRON ACER TENDL-2019 LIBRARY; T=293.16K
protons from (n,p)

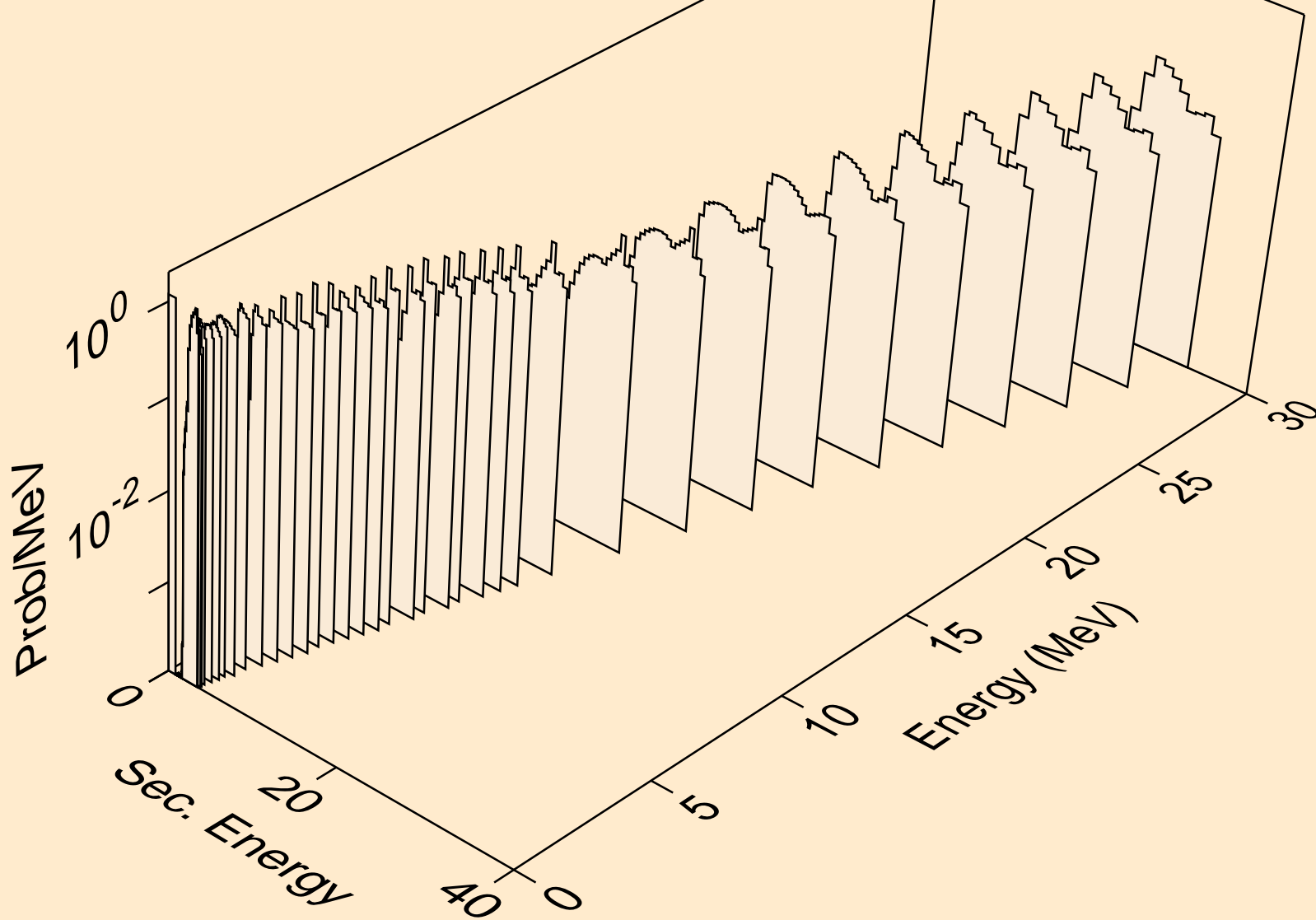

IR188 NEUTRON ACER TENDL-2019 LIBRARY; T=293.16K
protons from (n,2p)

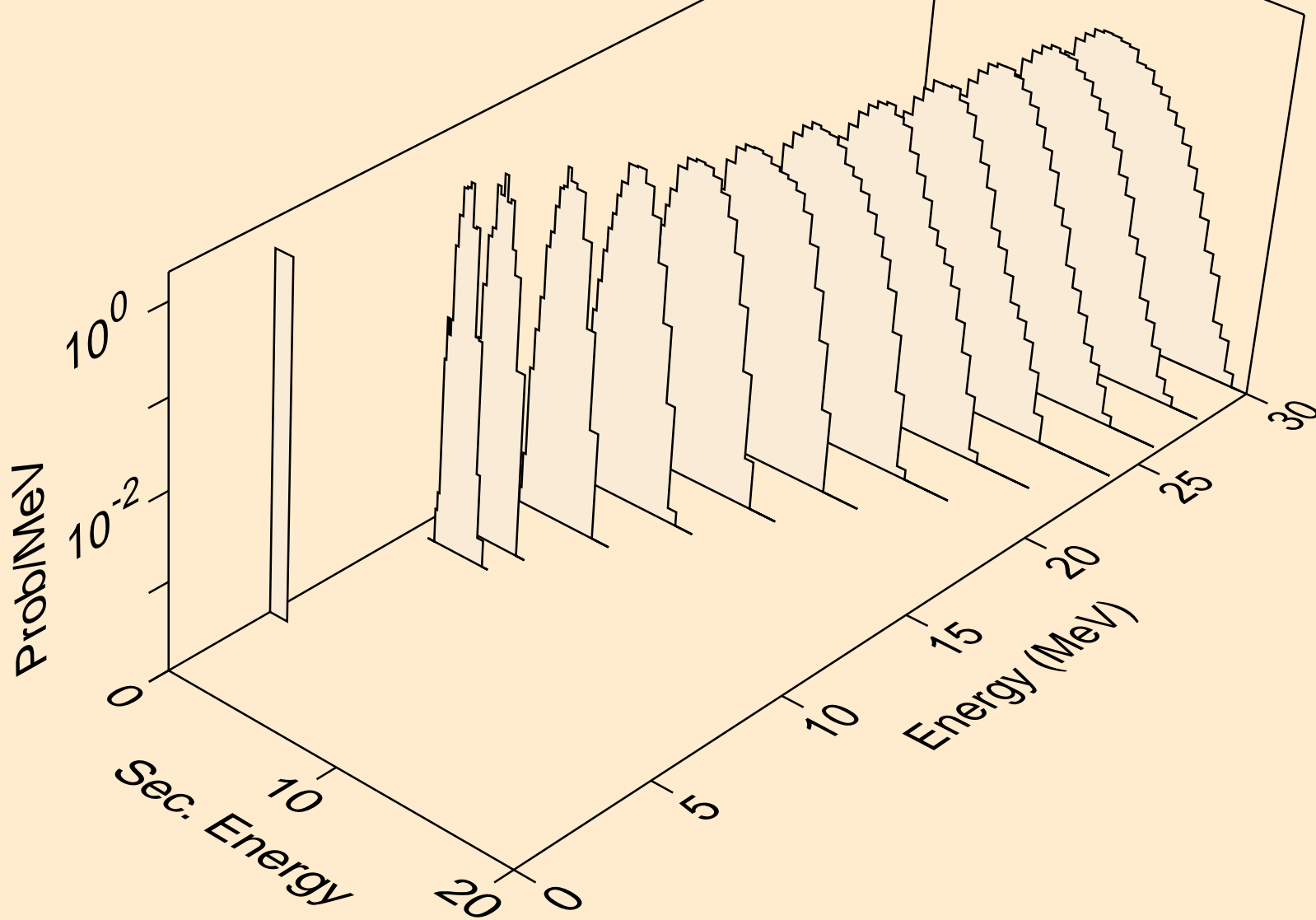

IR188 NEUTRON ACER TENDL-2019 LIBRARY; T=293.16K
protons from (n,p)

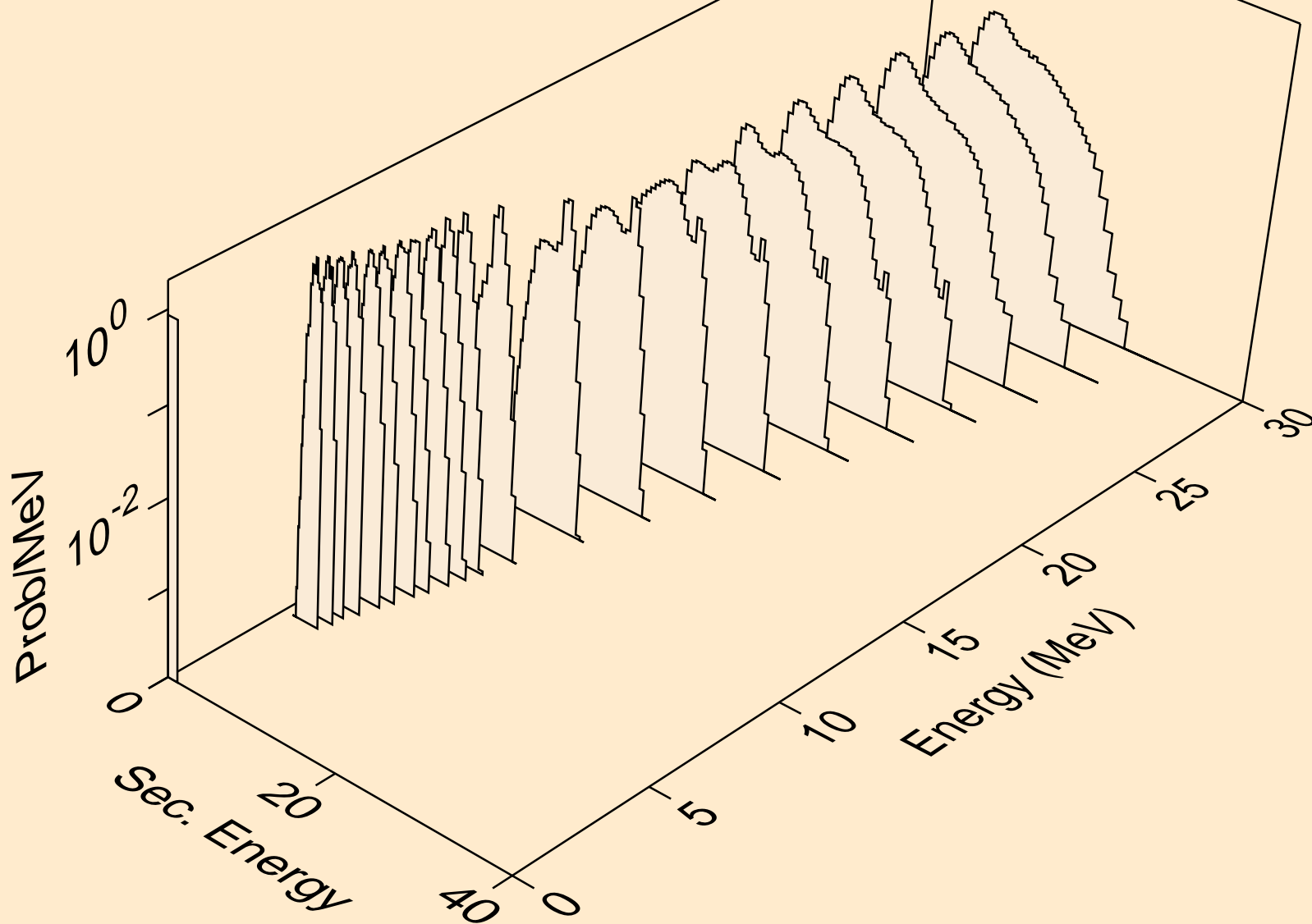

IR188 NEUTRON ACER TENDL-2019 LIBRARY; T=293.16K
protons from (n,pd)

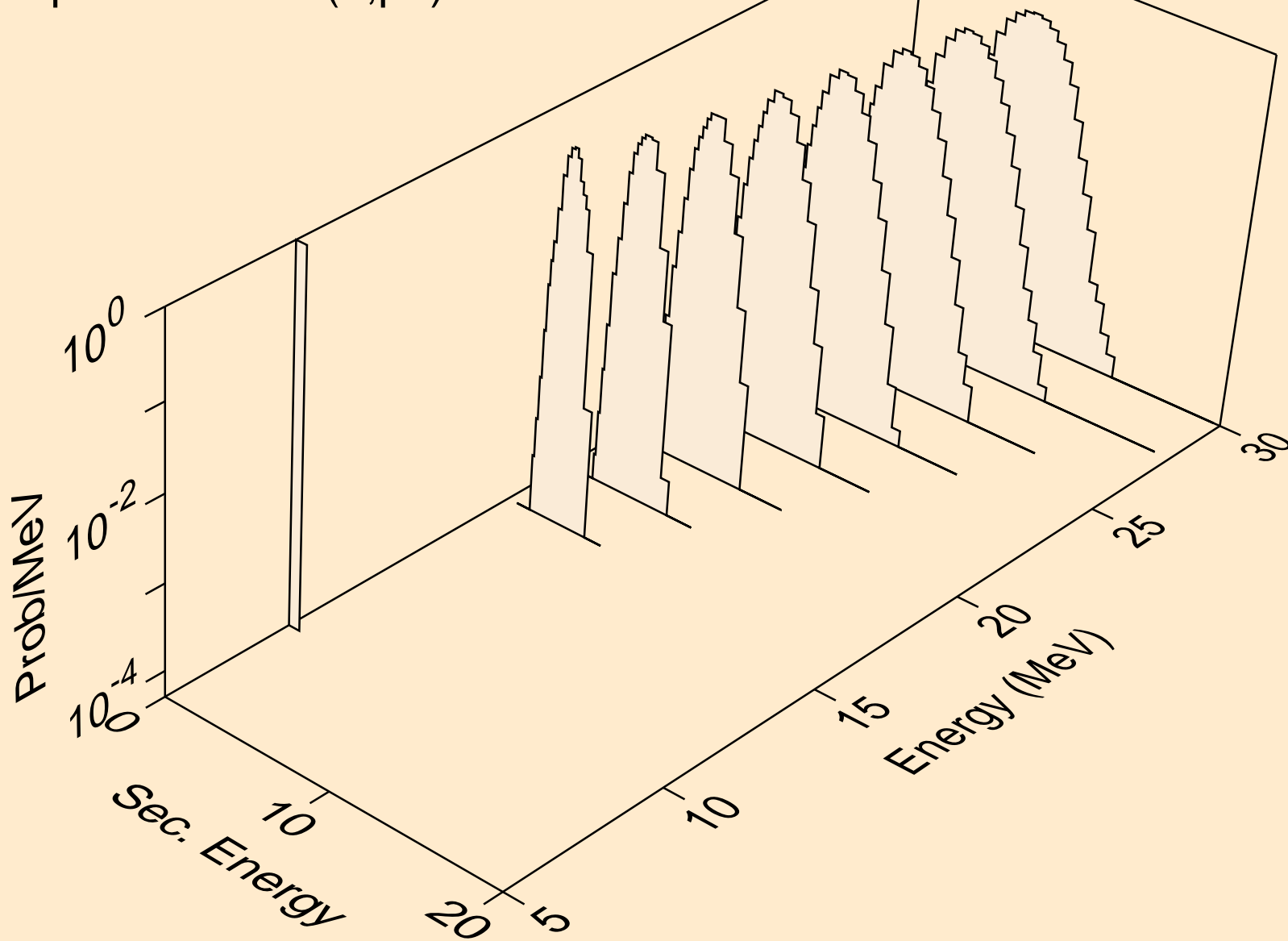

IR188 NEUTRON ACER TENDL-2019 LIBRARY; T=293.16K
protons from (n,pt)

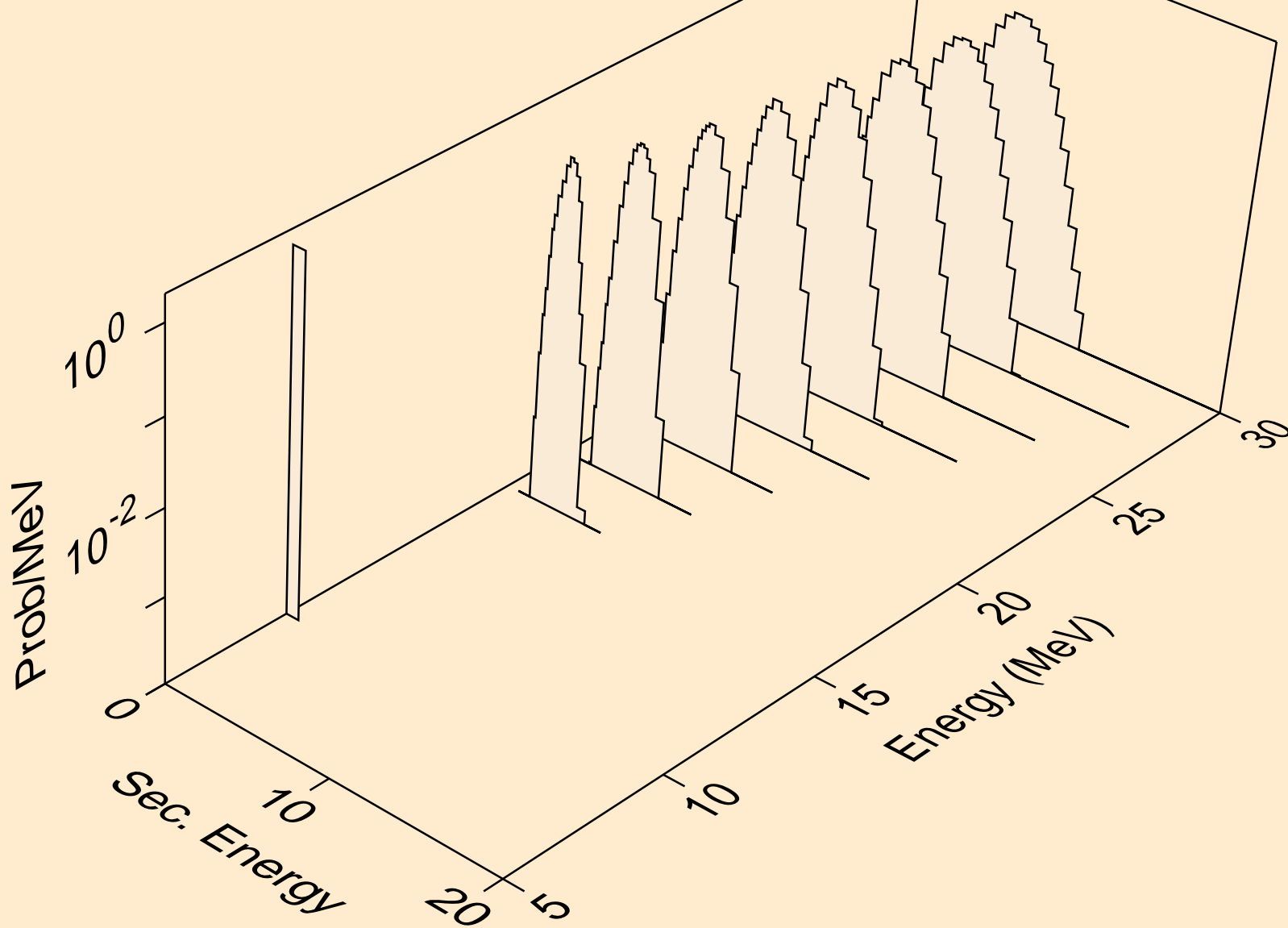

IR188 NEUTRON ACER TENDL-2019 LIBRARY; T=293.16K
deuterons from (n,x)

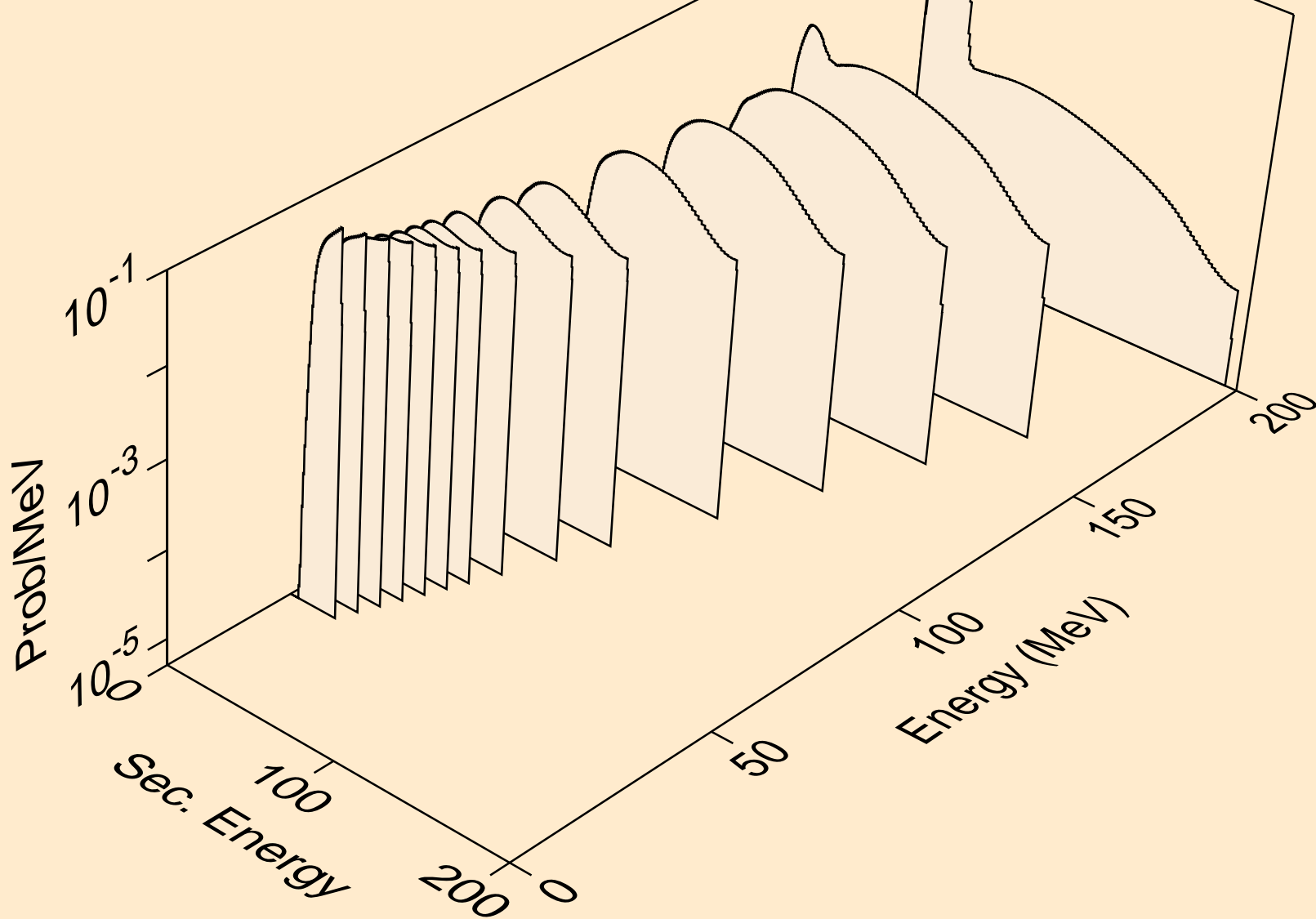

IR188 NEUTRON ACER TENDL-2019 LIBRARY; T=293.16K
deuterons from (n,2nd)

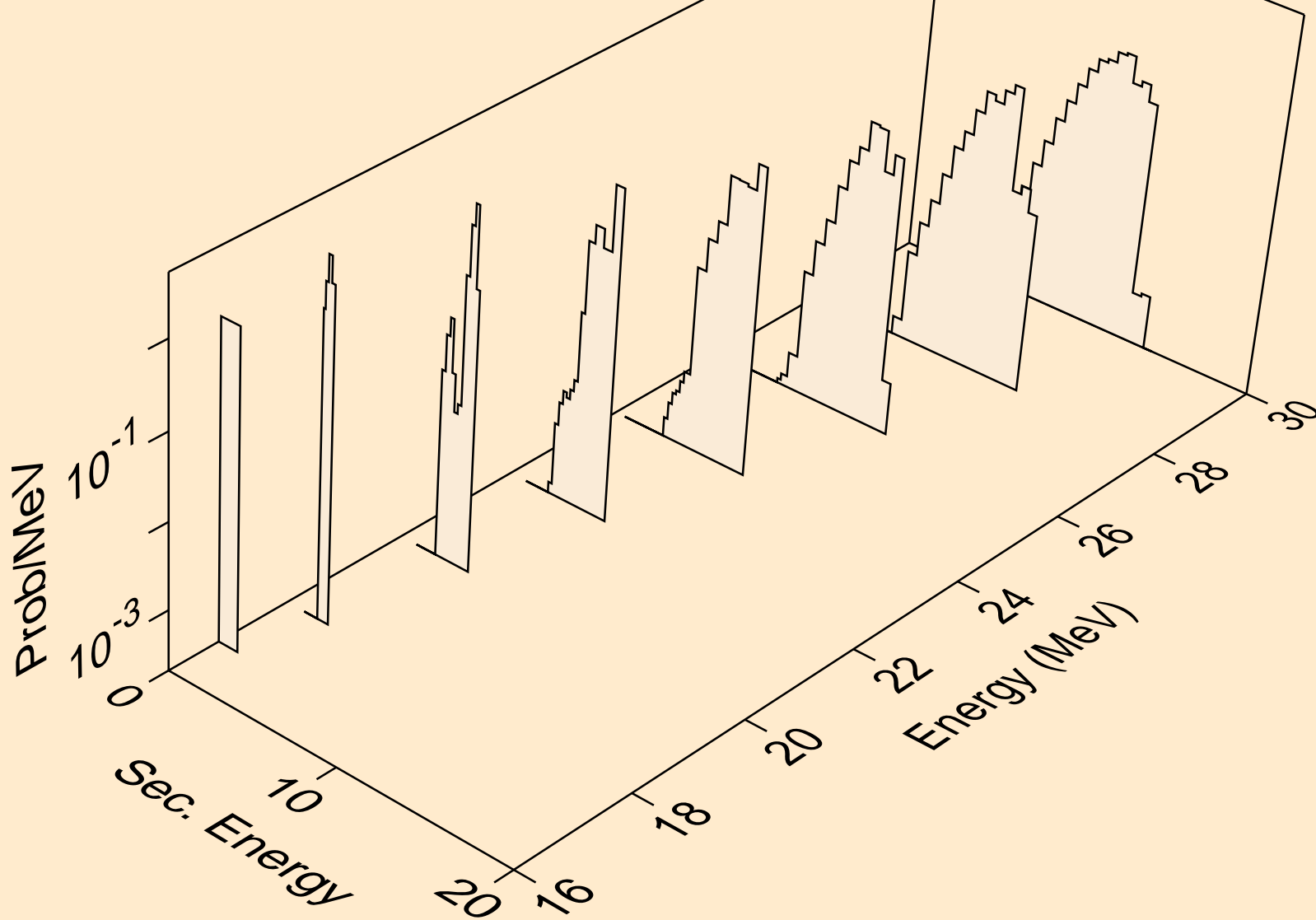

IR188 NEUTRON ACER TENDL-2019 LIBRARY; T=293.16K
deuterons from (n,n*)d

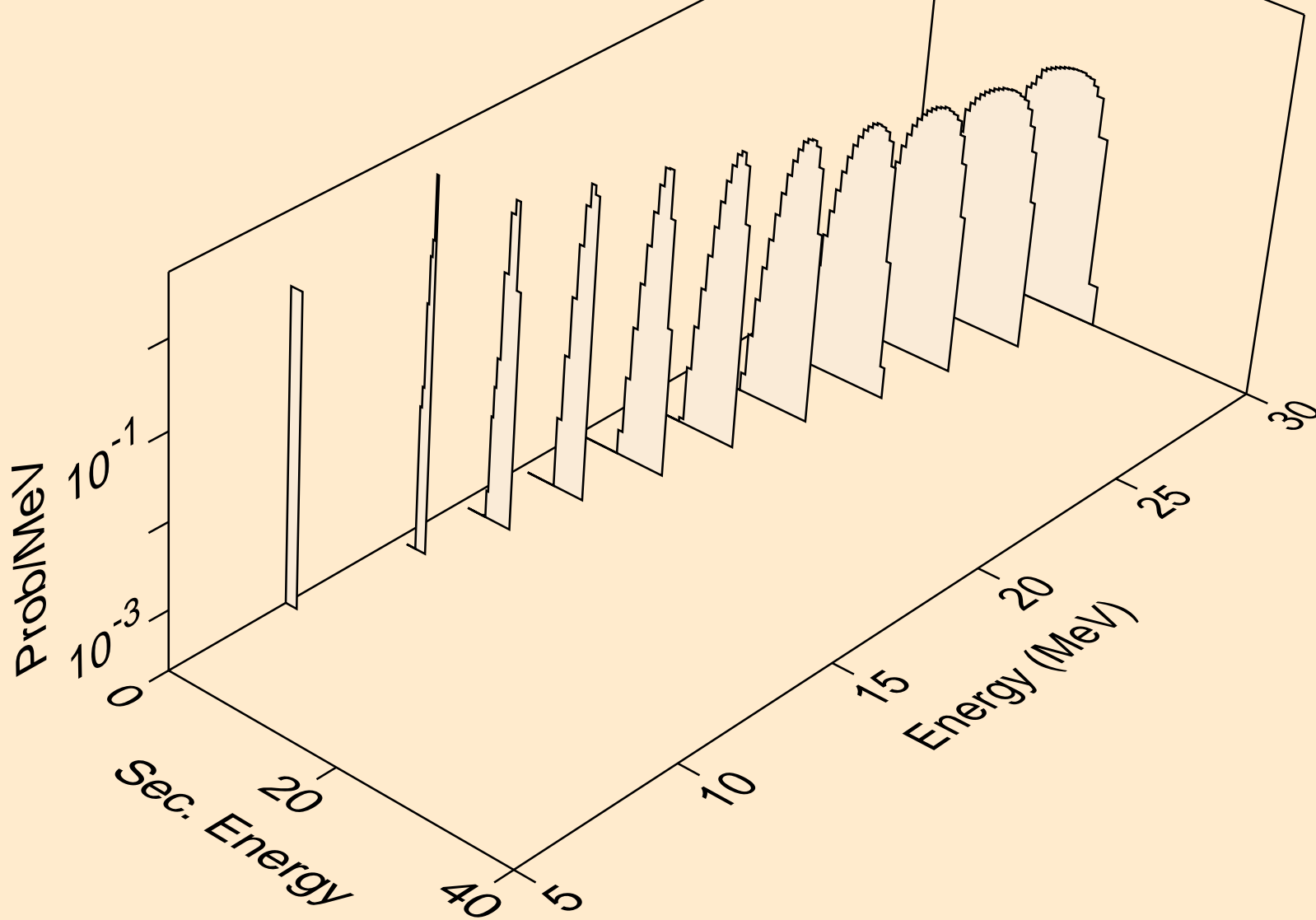

IR188 NEUTRON ACER TENDL-2019 LIBRARY; T=293.16K
deuterons from (n,d)

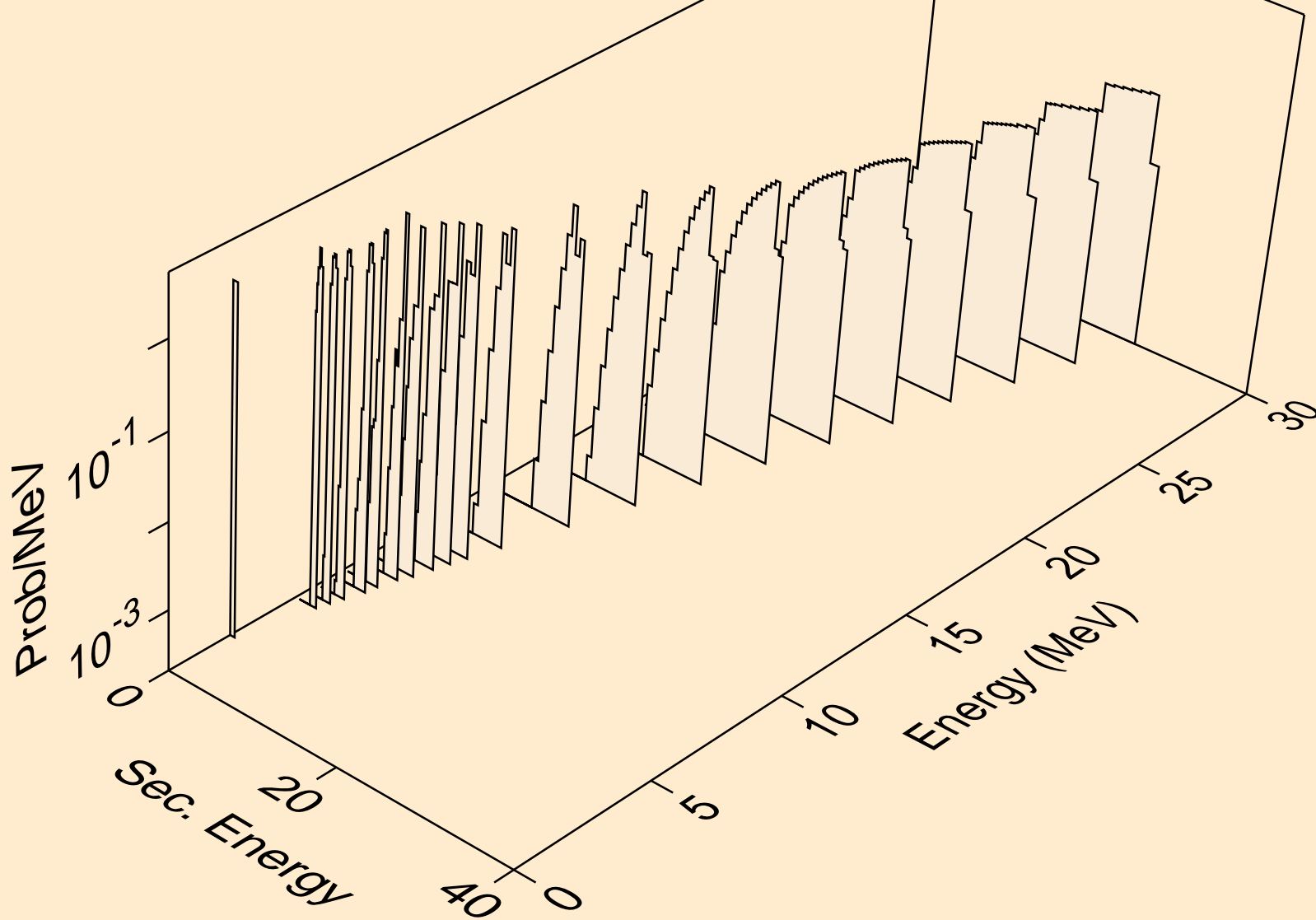

IR188 NEUTRON ACER TENDL-2019 LIBRARY; T=293.16K
deuterons from (n,pd)

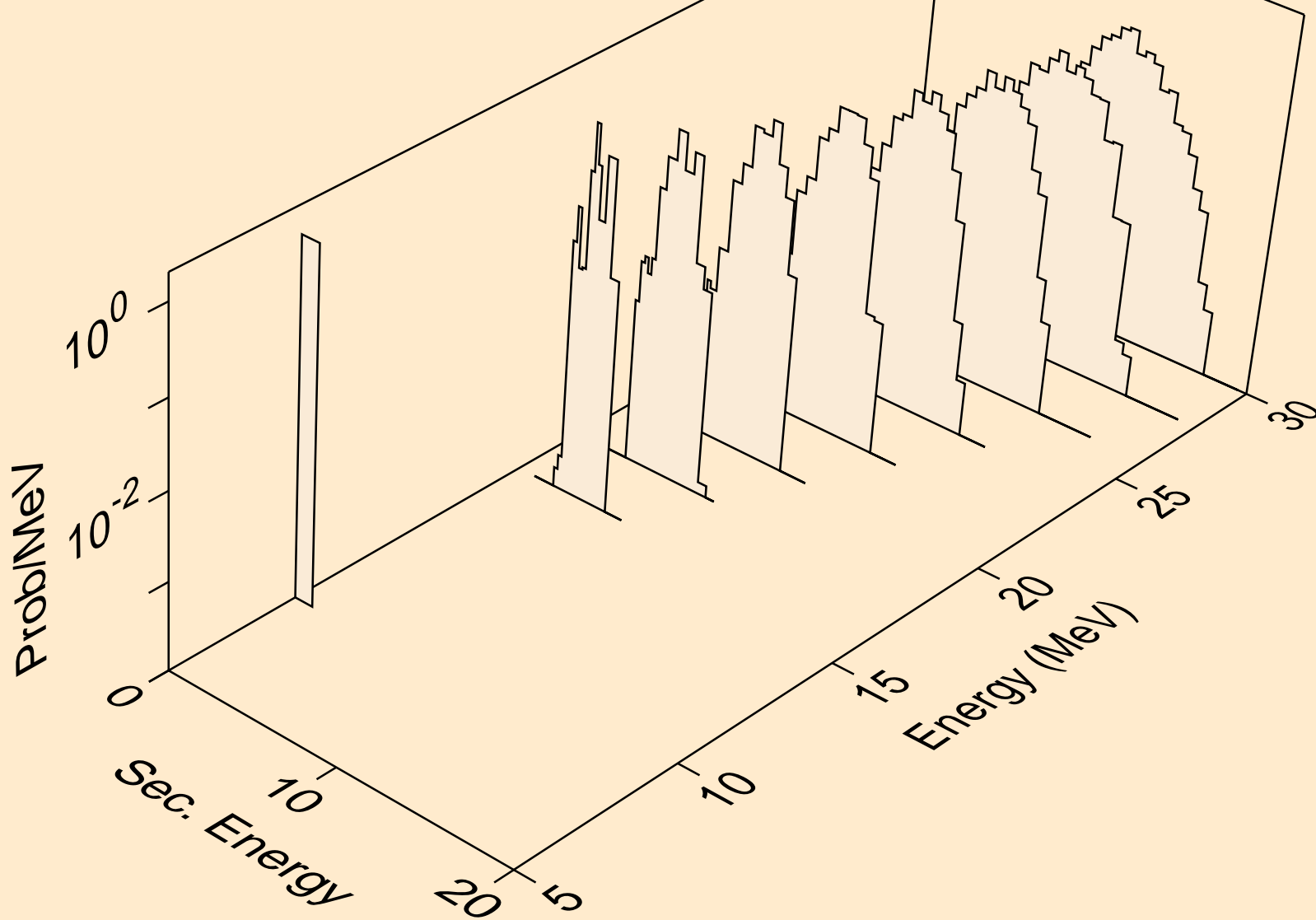

IR188 NEUTRON ACER TENDL-2019 LIBRARY; T=293.16K
deuterons from (n,da)

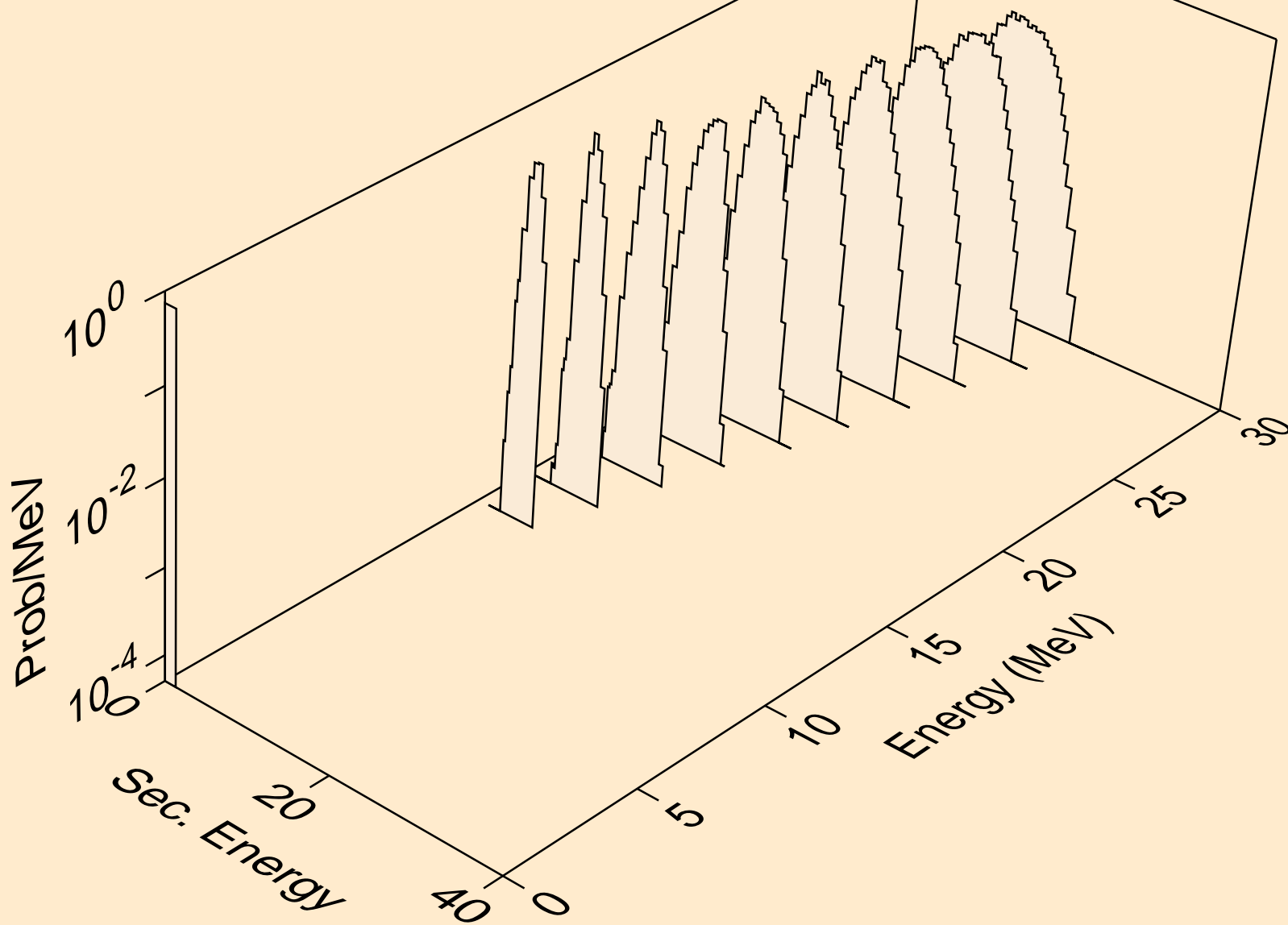

IR188 NEUTRON ACER TENDL-2019 LIBRARY; T=293.16K
tritons from (n,x)

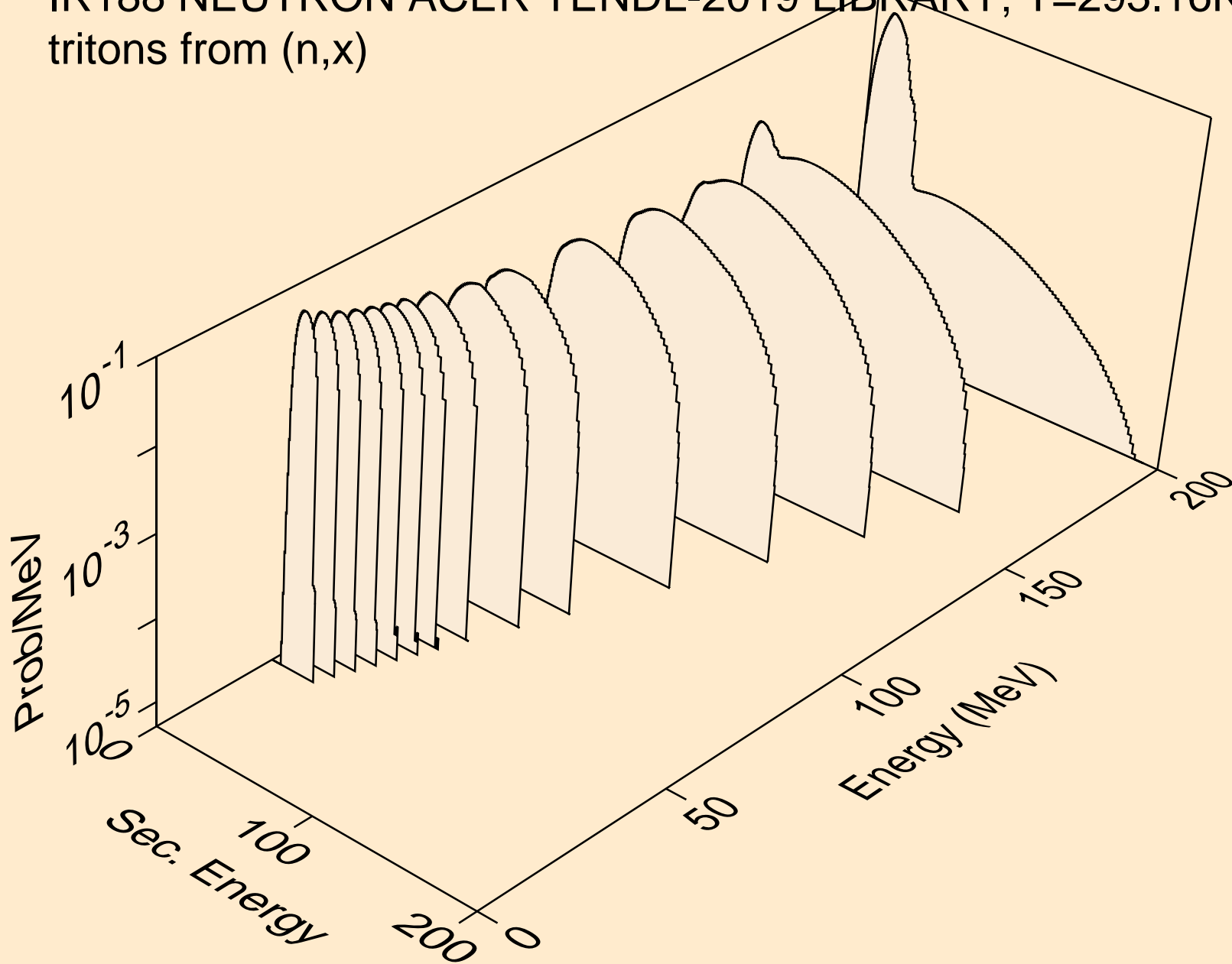

IR188 NEUTRON ACER TENDL-2019 LIBRARY; T=293.16K
tritons from (n,n*)t

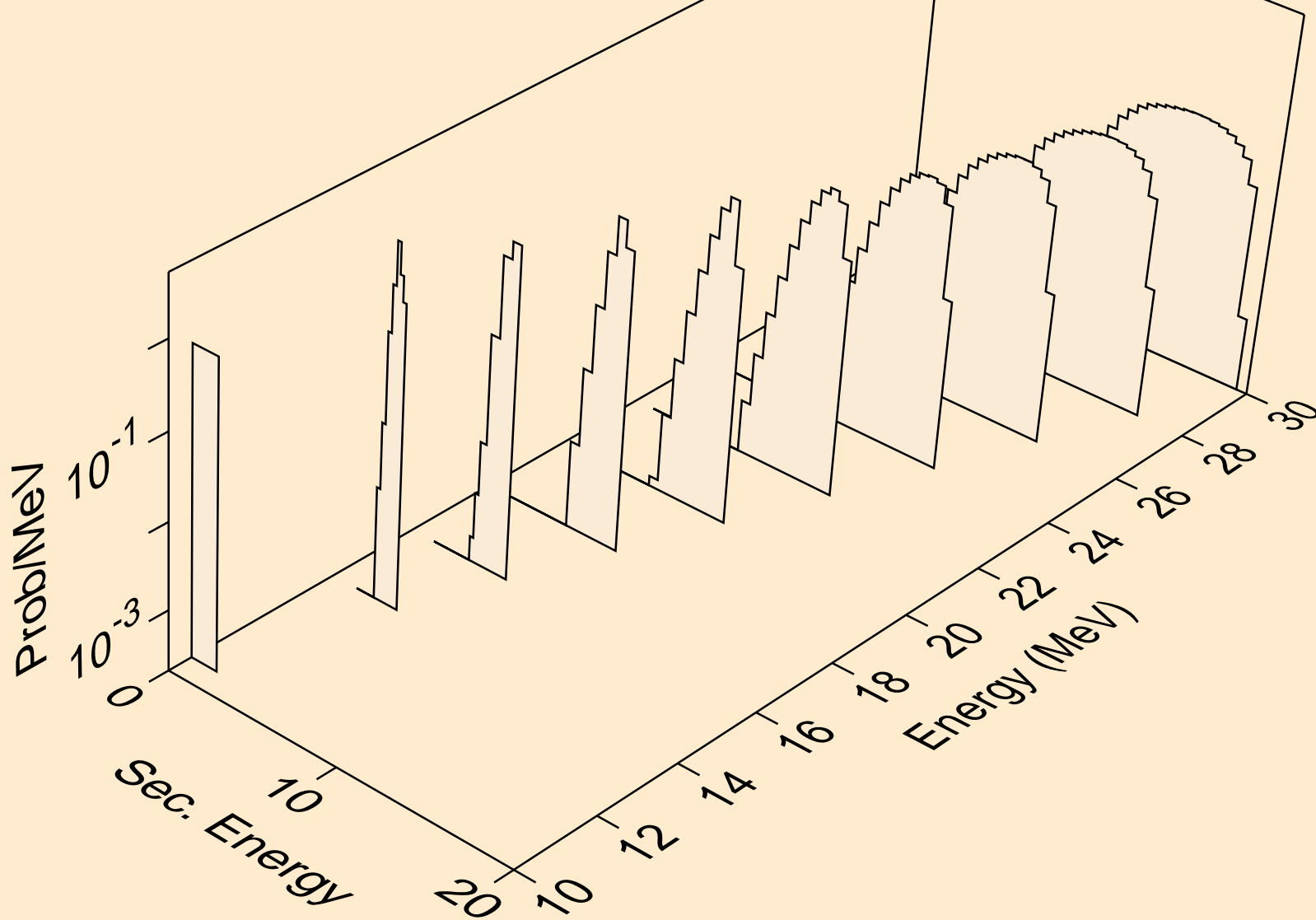

IR188 NEUTRON ACER TENDL-2019 LIBRARY; T=293.16K
tritons from (n,t)

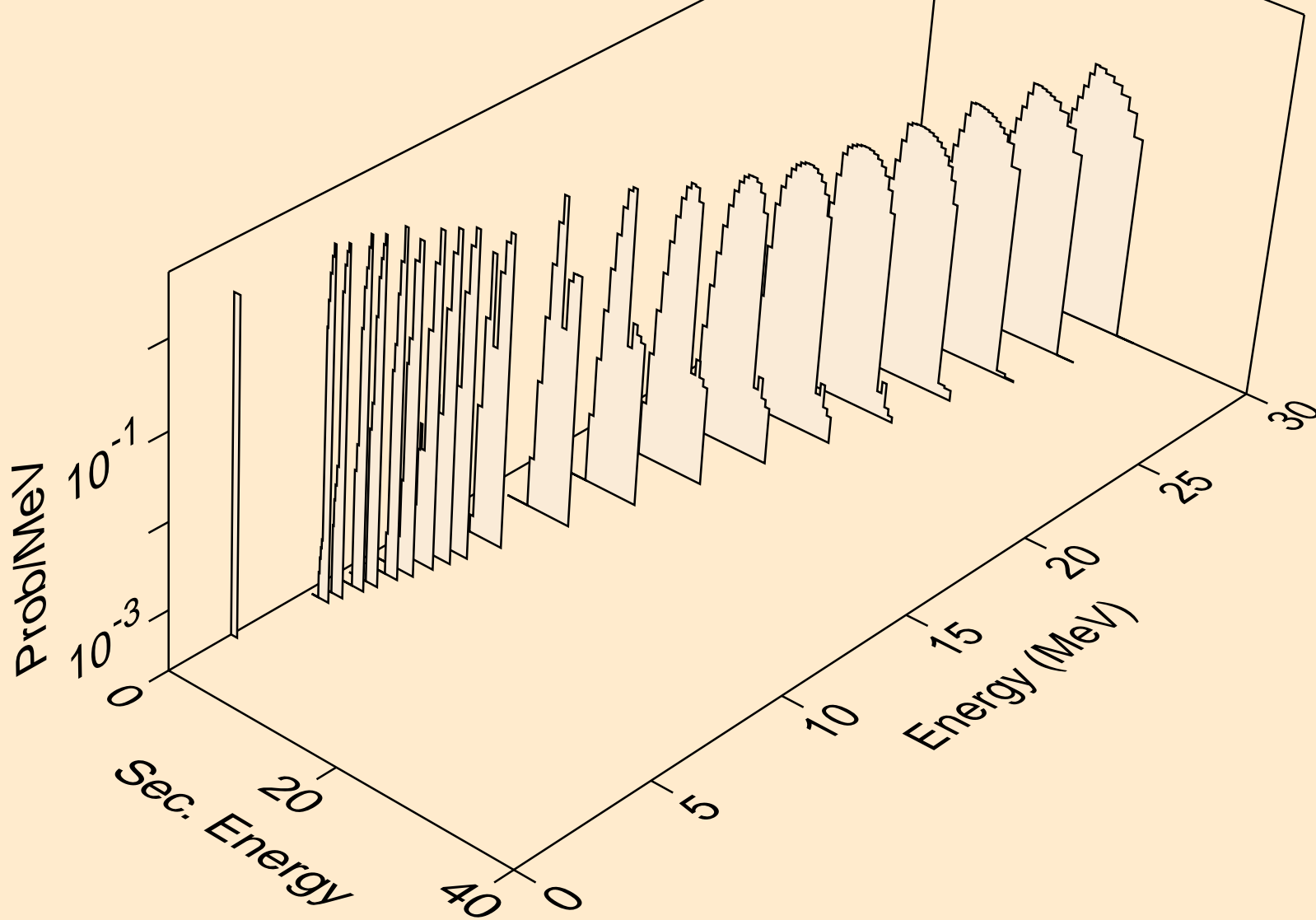

IR188 NEUTRON ACER TENDL-2019 LIBRARY; T=293.16K
tritons from (n,pt)

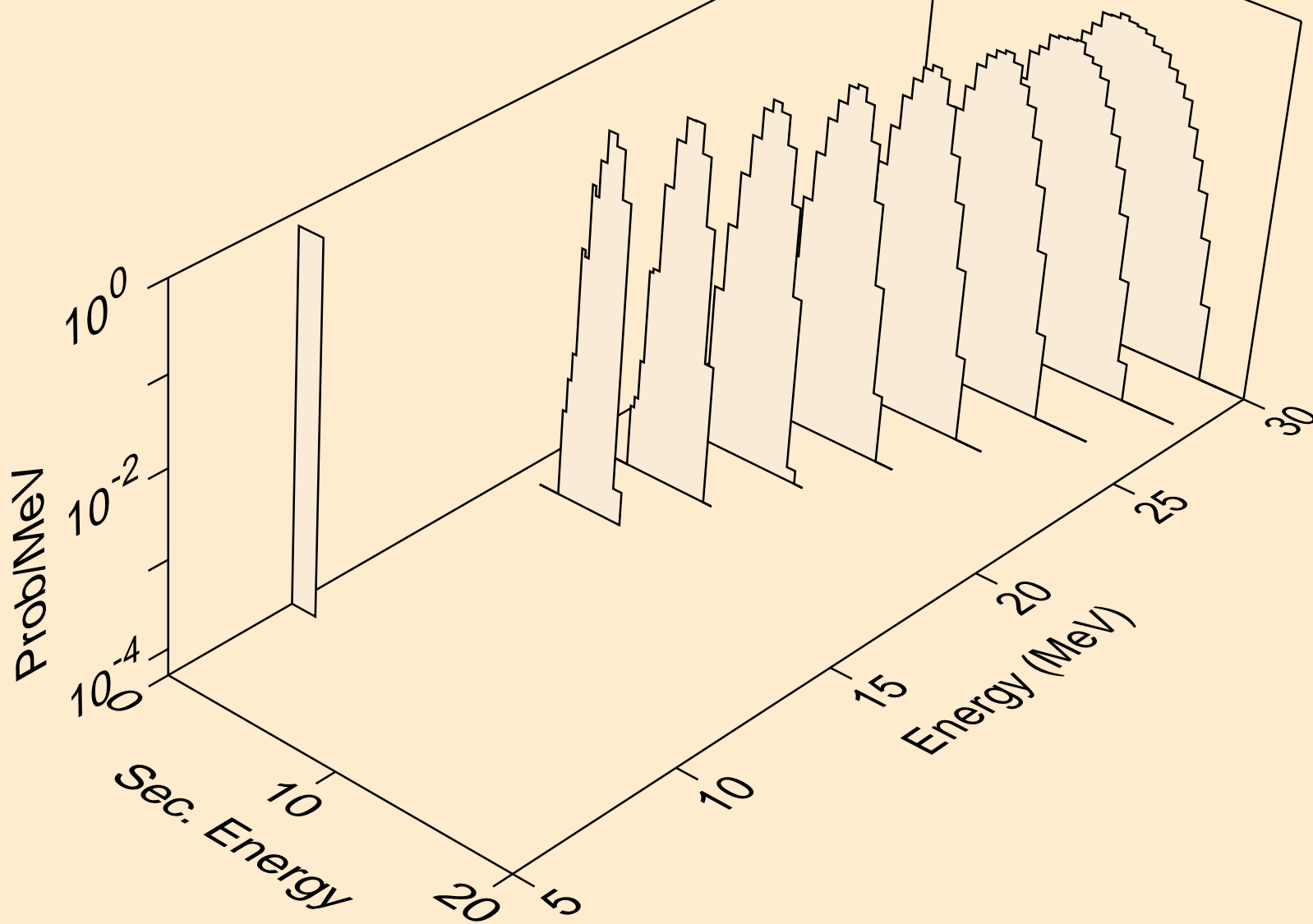

IR188 NEUTRON ACER TENDL-2019 LIBRARY; T=293.16K
he3s from (n,x)

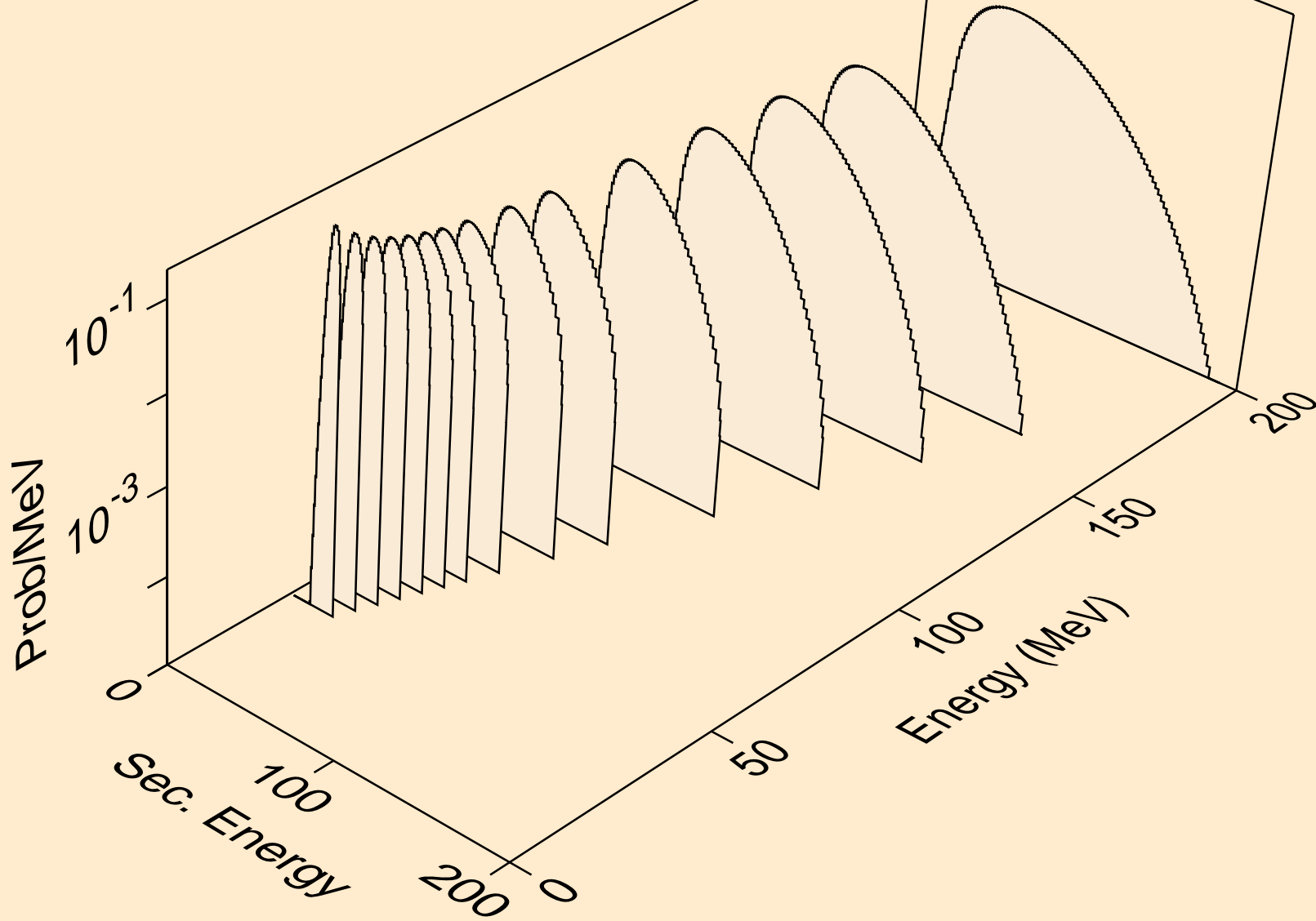

IR188 NEUTRON ACER TENDL-2019 LIBRARY; T=293.16K
he3s from (n,n*)he3

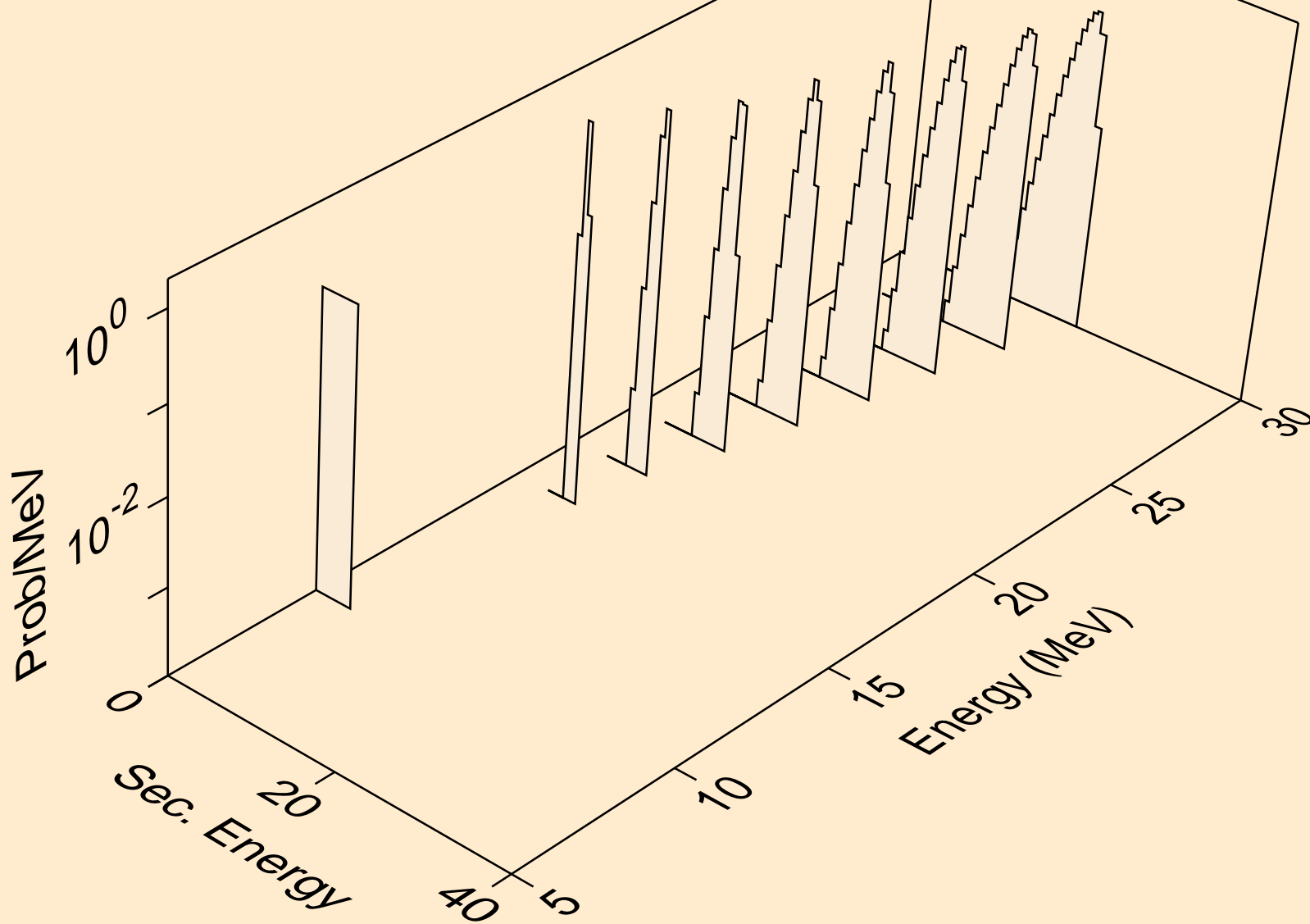

IR188 NEUTRON ACER TENDL-2019 LIBRARY; T=293.16K
he3s from (n,he3)

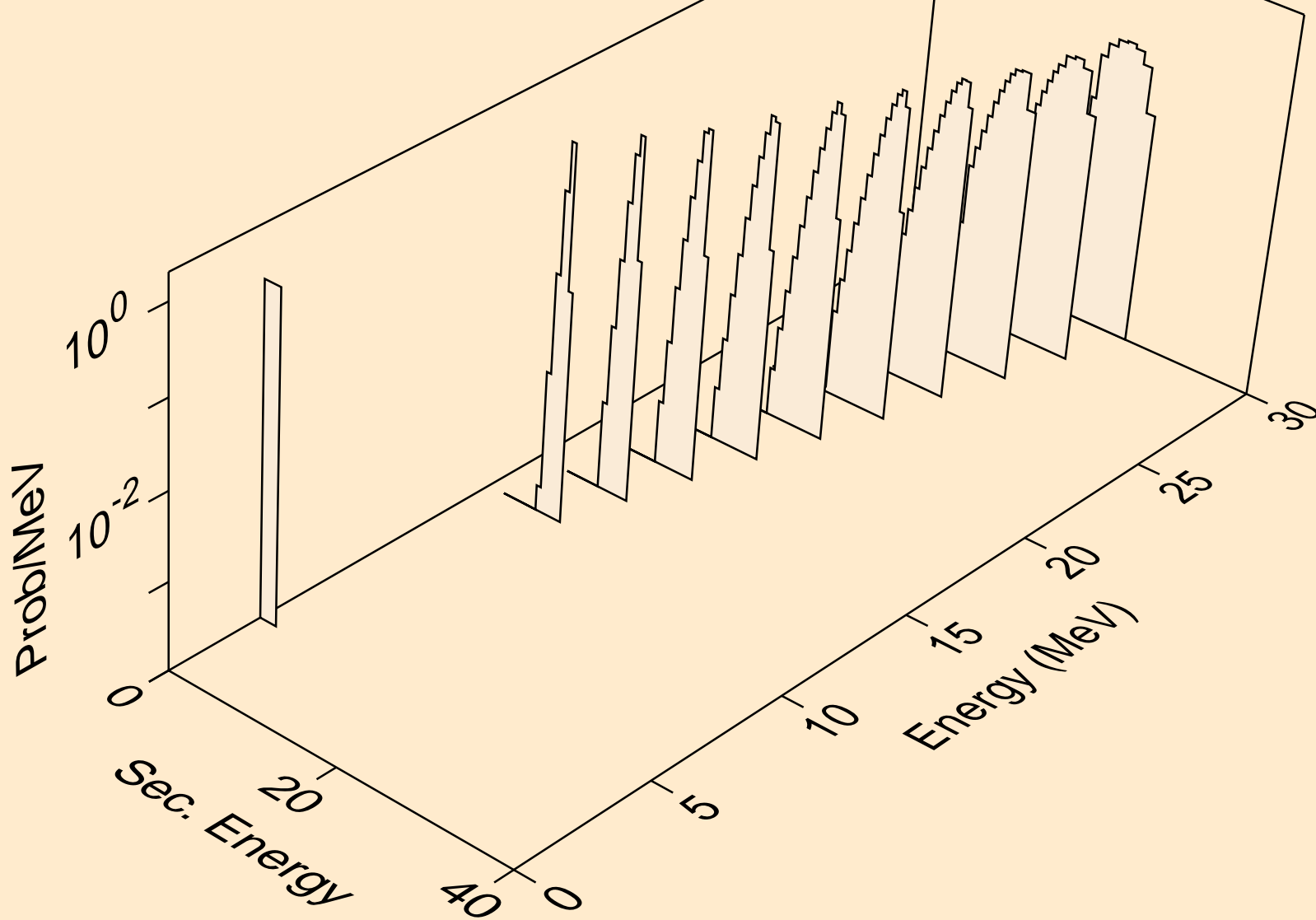

IR188 NEUTRON ACER TENDL-2019 LIBRARY; T=293.16K
alphas from (n,x)

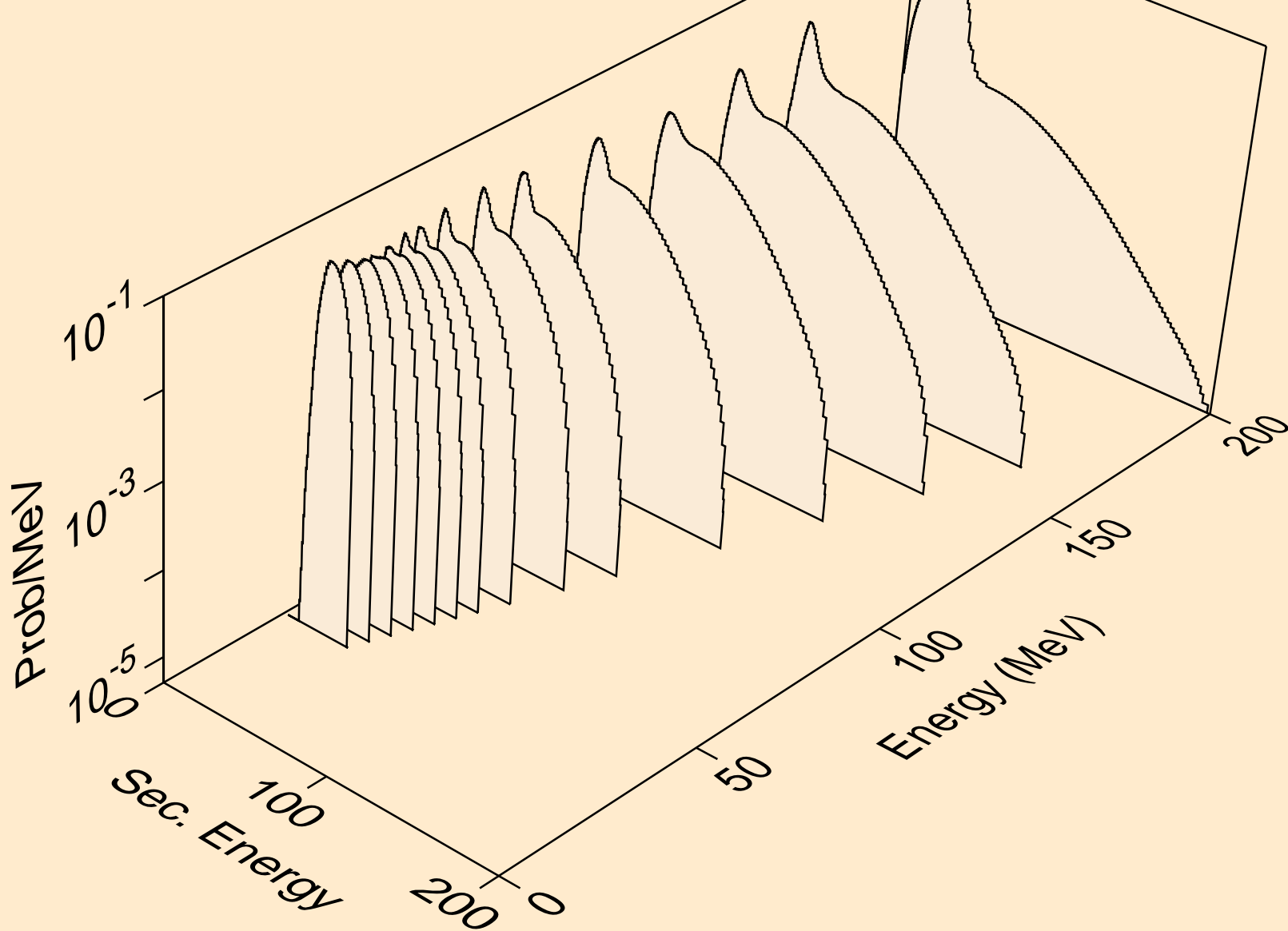

IR188 NEUTRON ACER TENDL-2019 LIBRARY; T=293.16K
alphas from (n,n*)a

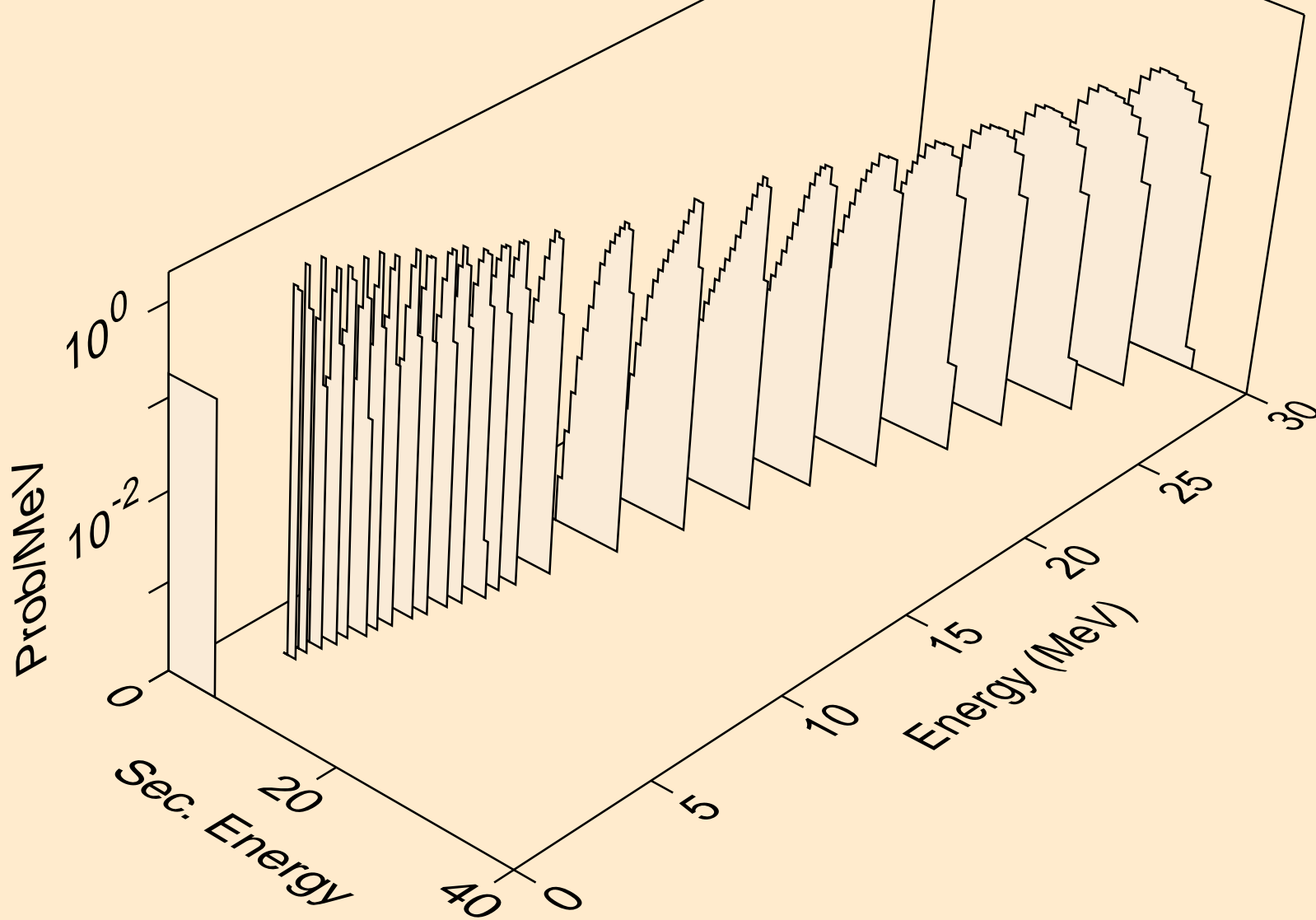

IR188 NEUTRON ACER TENDL-2019 LIBRARY; T=293.16K
alphas from (n,2n)a

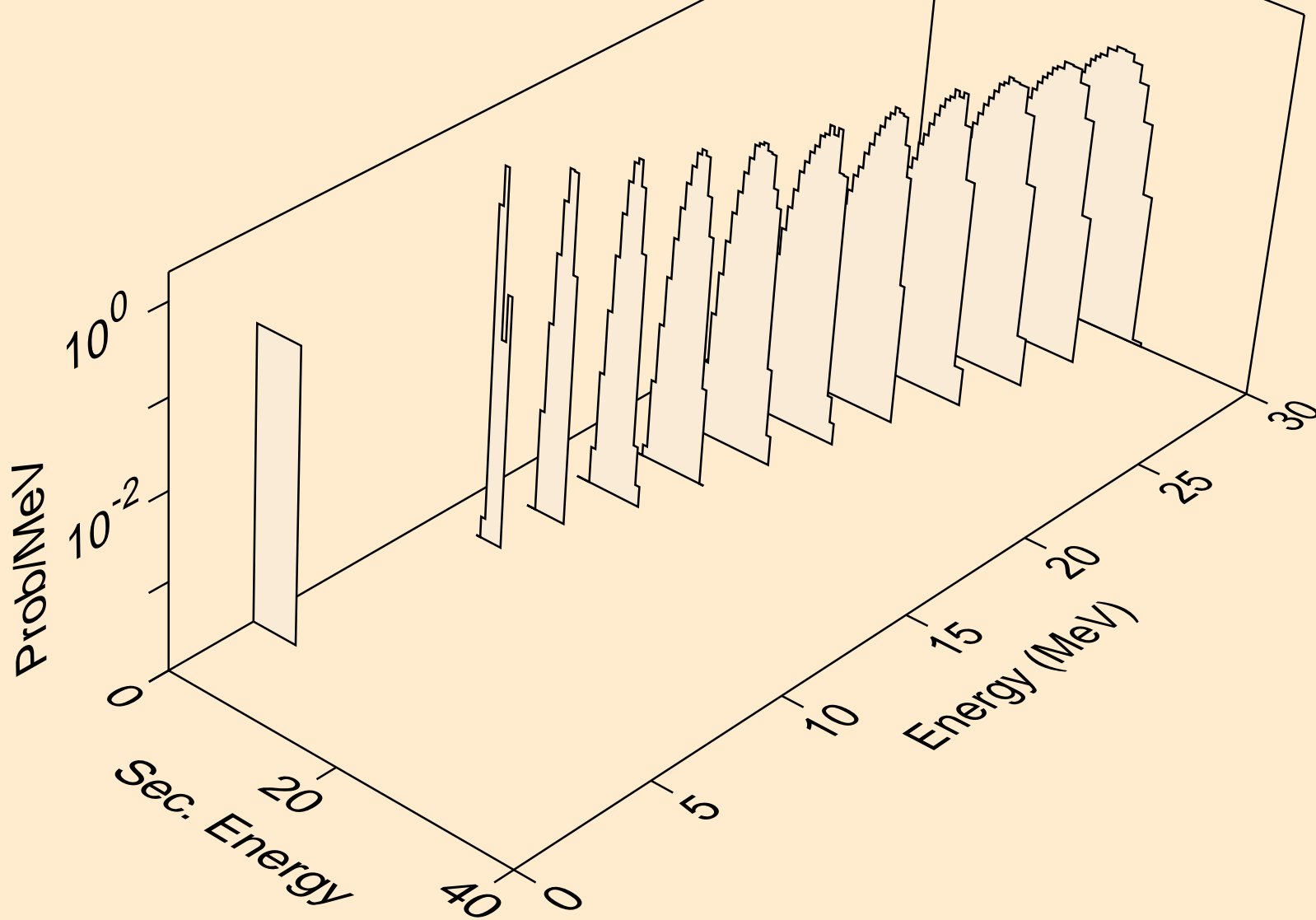

IR188 NEUTRON ACER TENDL-2019 LIBRARY; T=293.16K
alphas from (n,3n)a

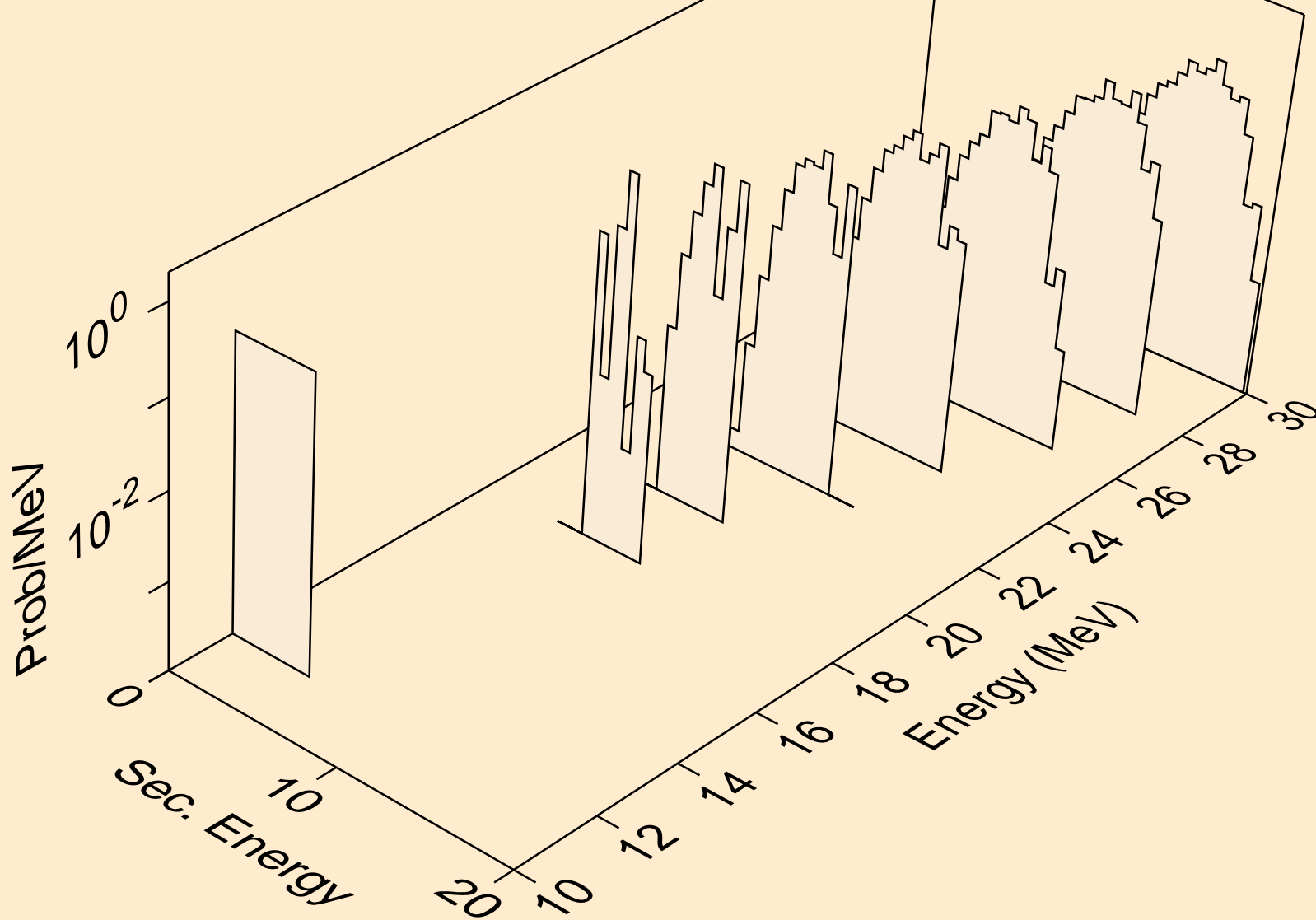

IR188 NEUTRON ACER TENDL-2019 LIBRARY; T=293.16K
alphas from (n,n*)2a

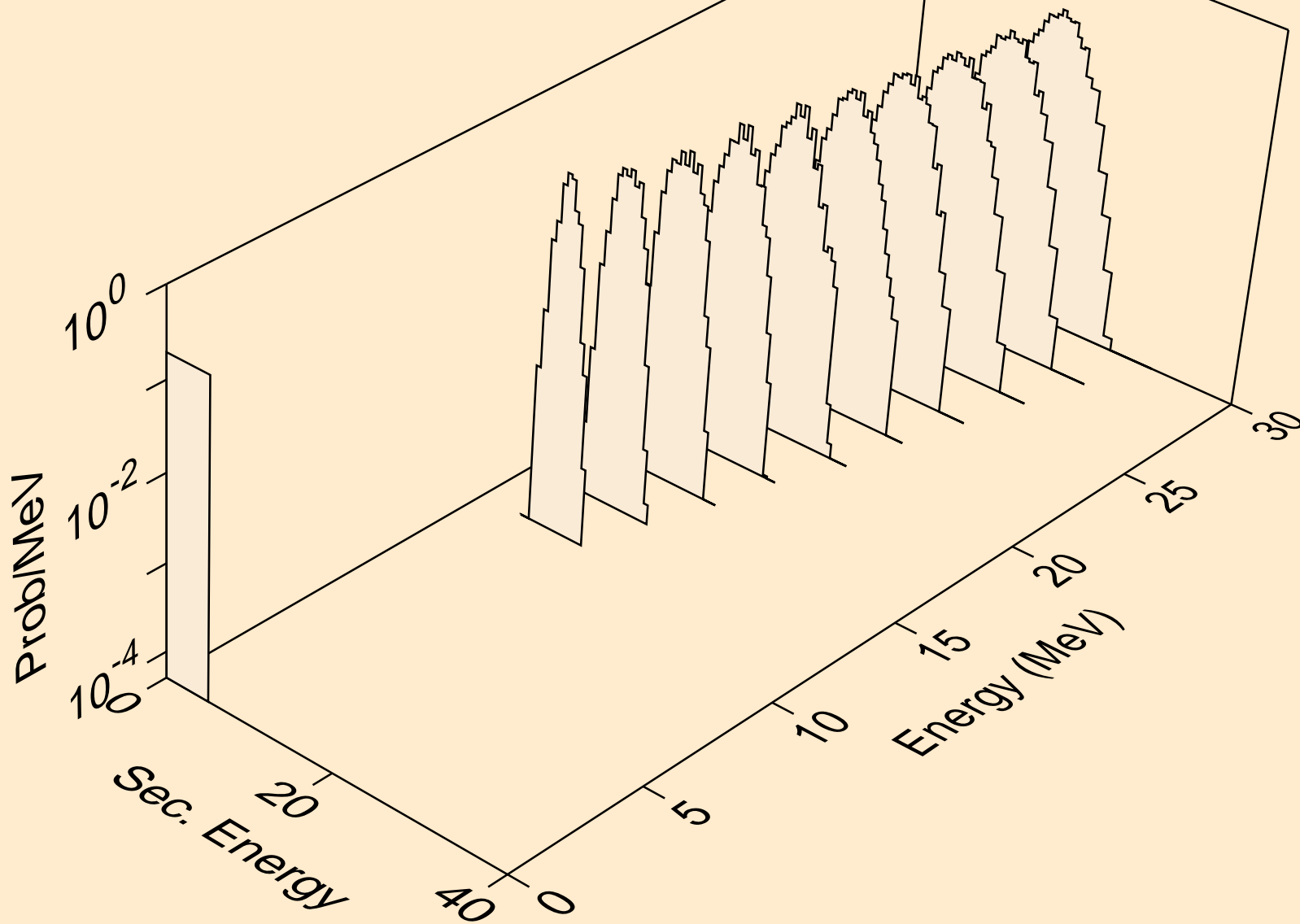

IR188 NEUTRON ACER TENDL-2019 LIBRARY; T=293.16K
alphas from (n,npa)

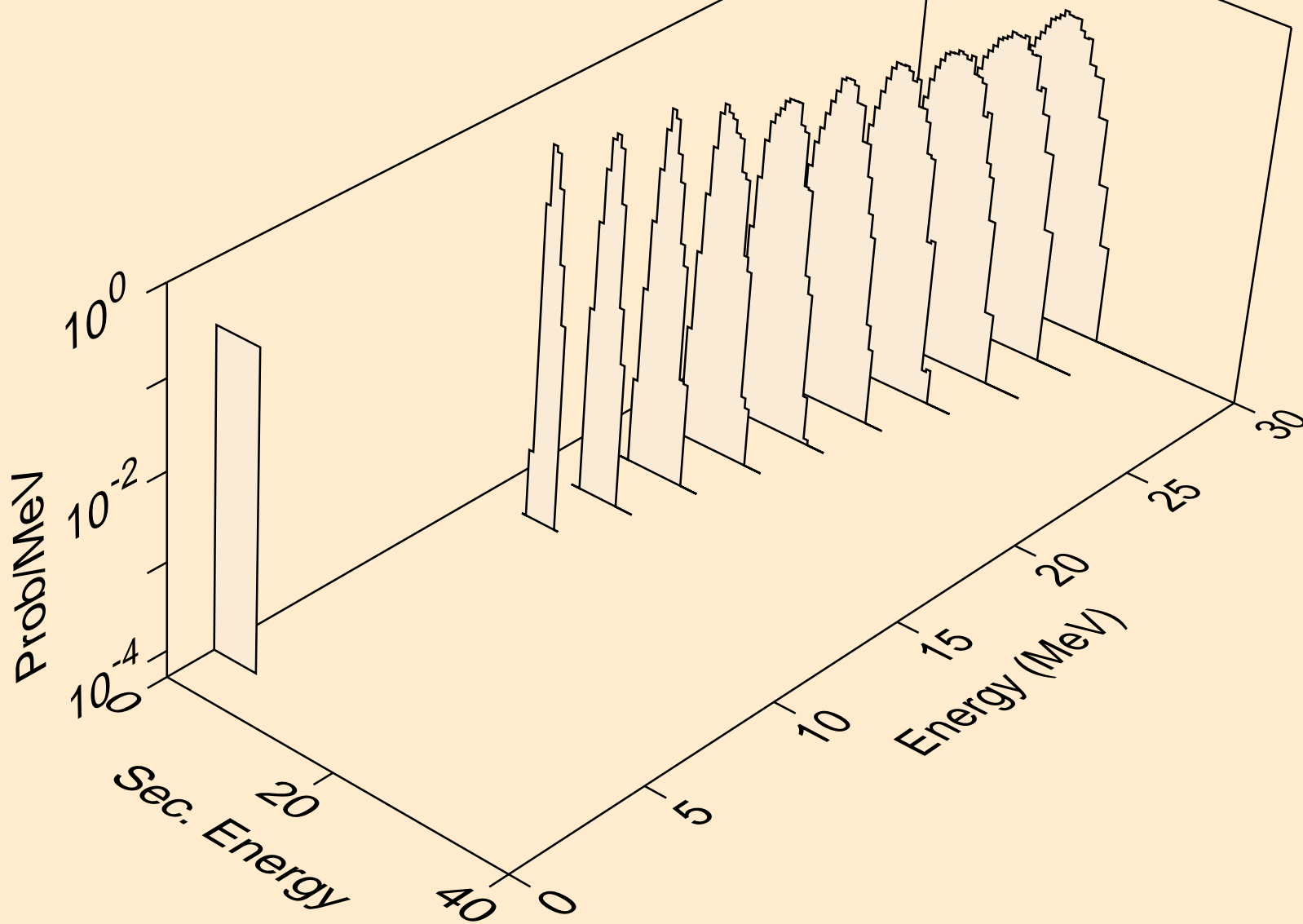

IR188 NEUTRON ACER TENDL-2019 LIBRARY; T=293.16K
alphas from (n,a)

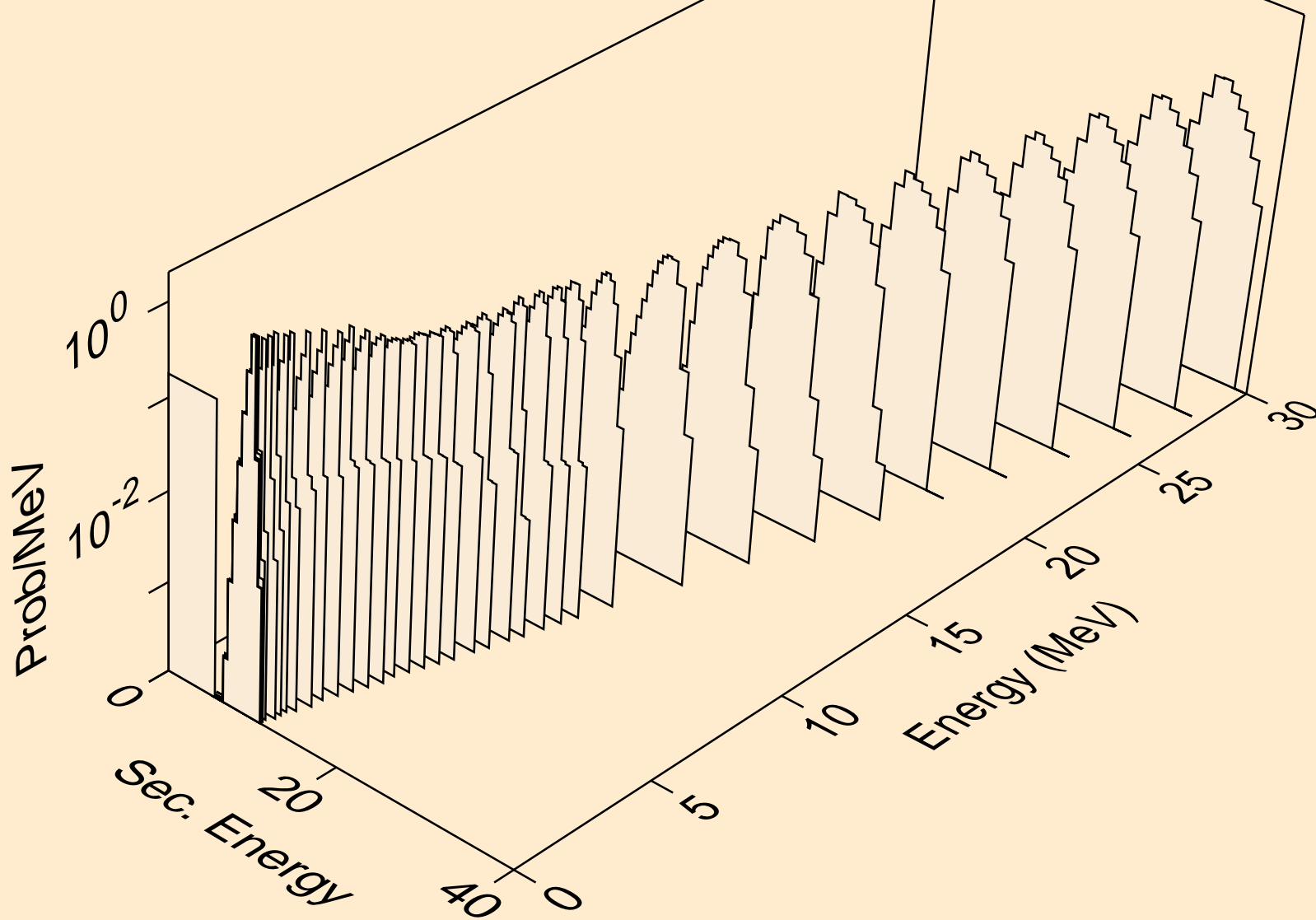

IR188 NEUTRON ACER TENDL-2019 LIBRARY; T=293.16K
alphas from (n,2a)

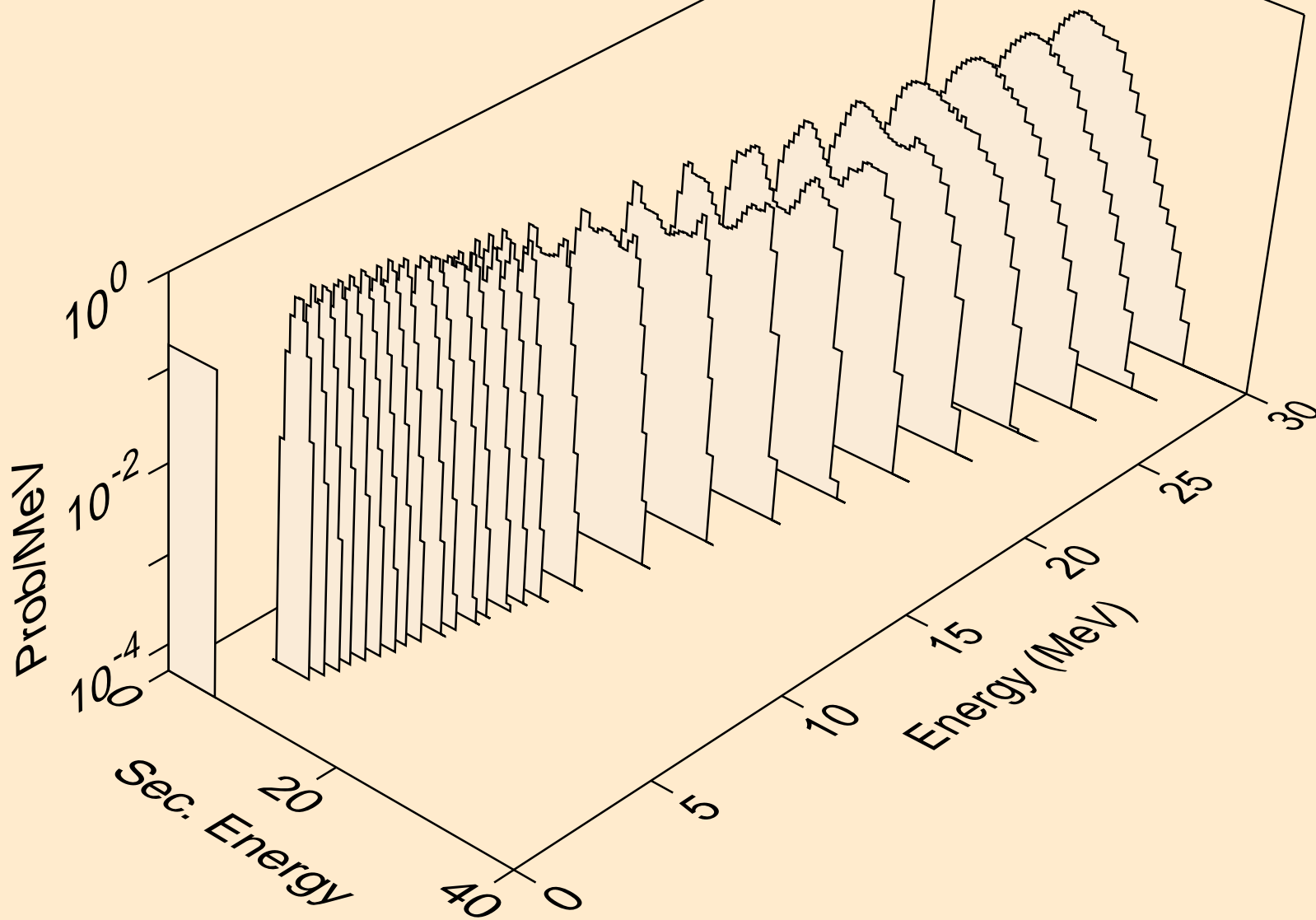

IR188 NEUTRON ACER TENDL-2019 LIBRARY; T=293.16K
alphas from (n,pa)

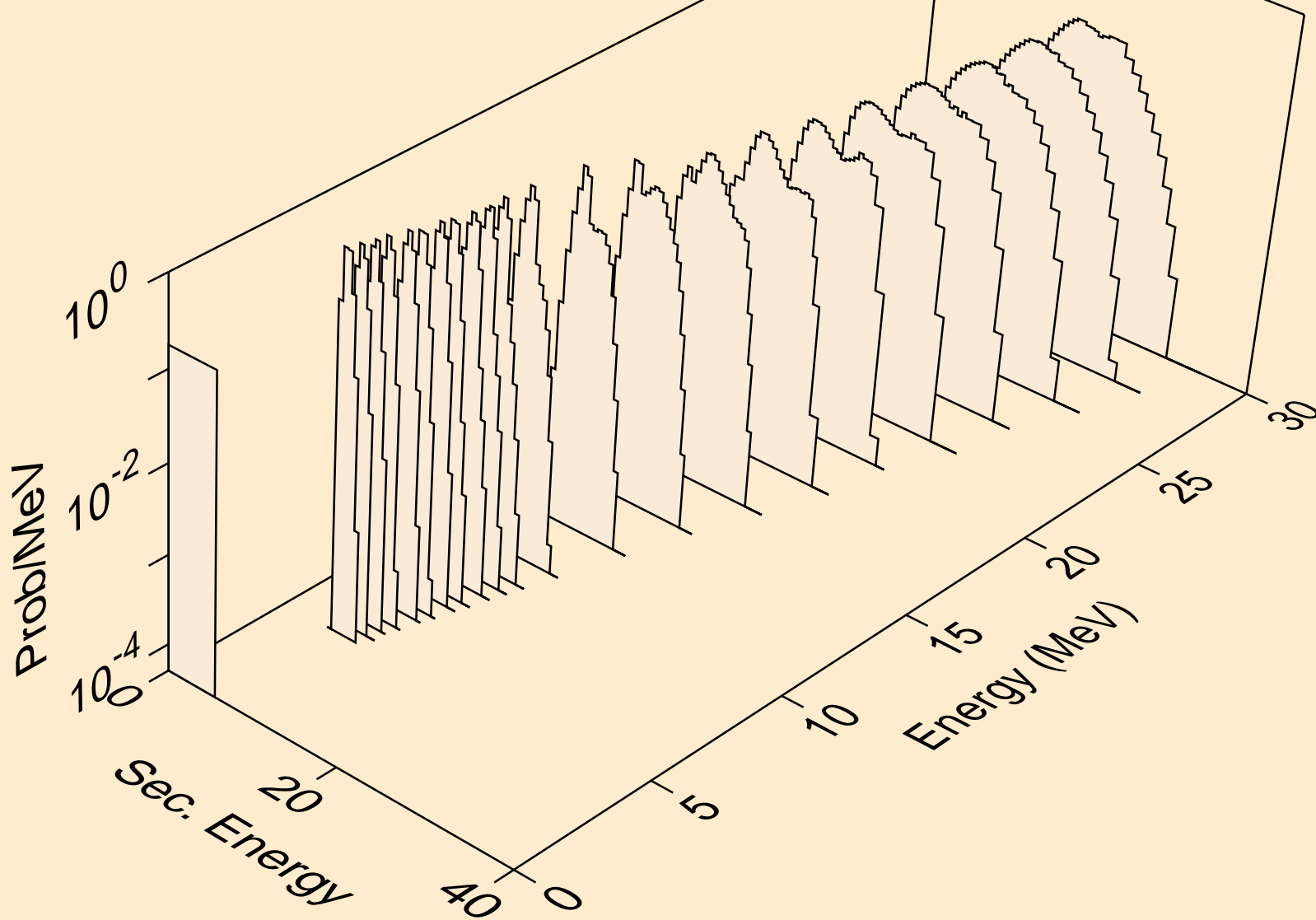

IR188 NEUTRON ACER TENDL-2019 LIBRARY; T=293.16K
alphas from (n,da)

