

IR189 NEUTRON ACER TENDL-2019 LIBRARY; T=293.16K  
Principal cross sections

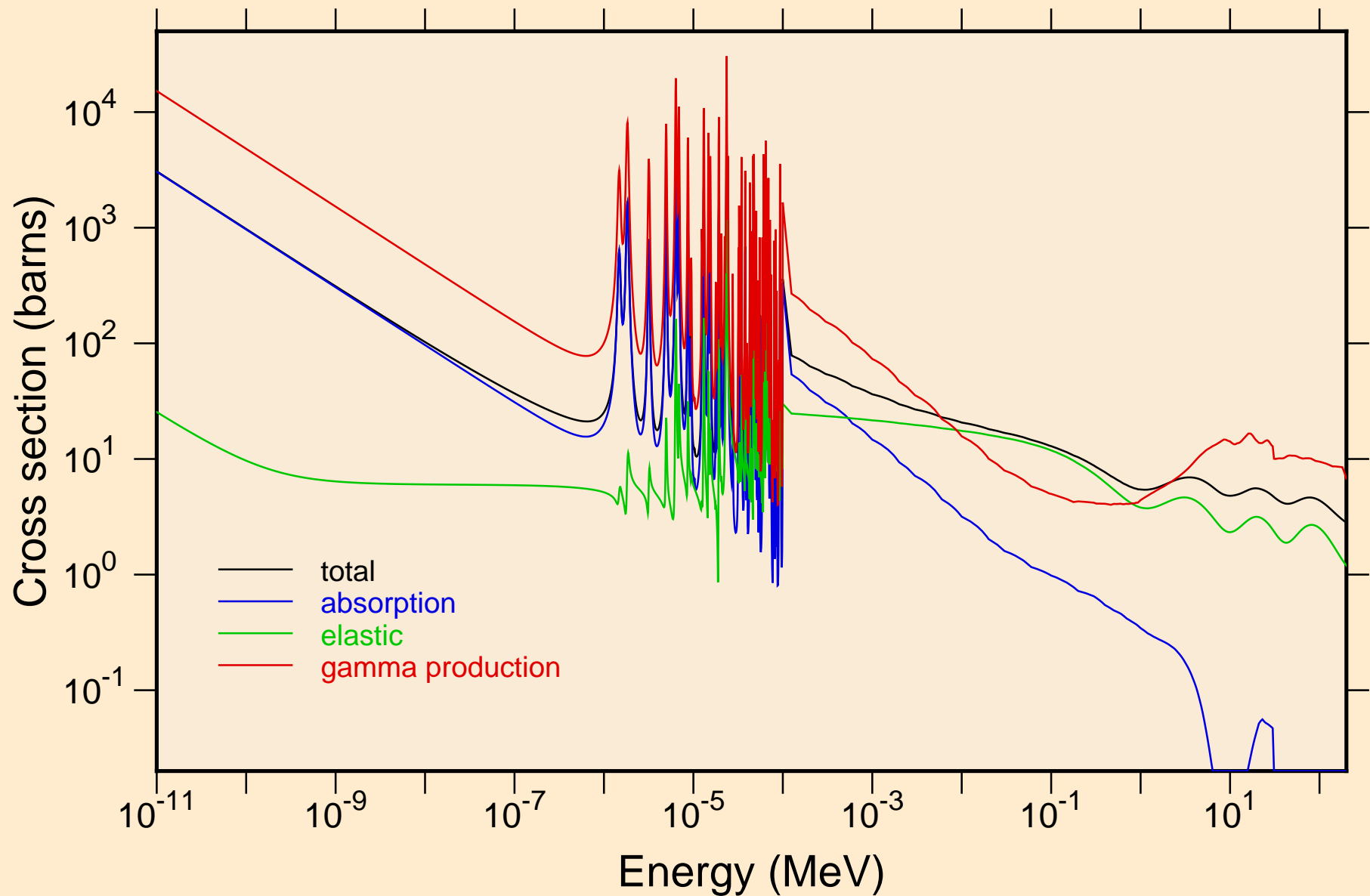

IR189 NEUTRON ACER TENDL-2019 LIBRARY; T=293.16K  
resonance total cross section

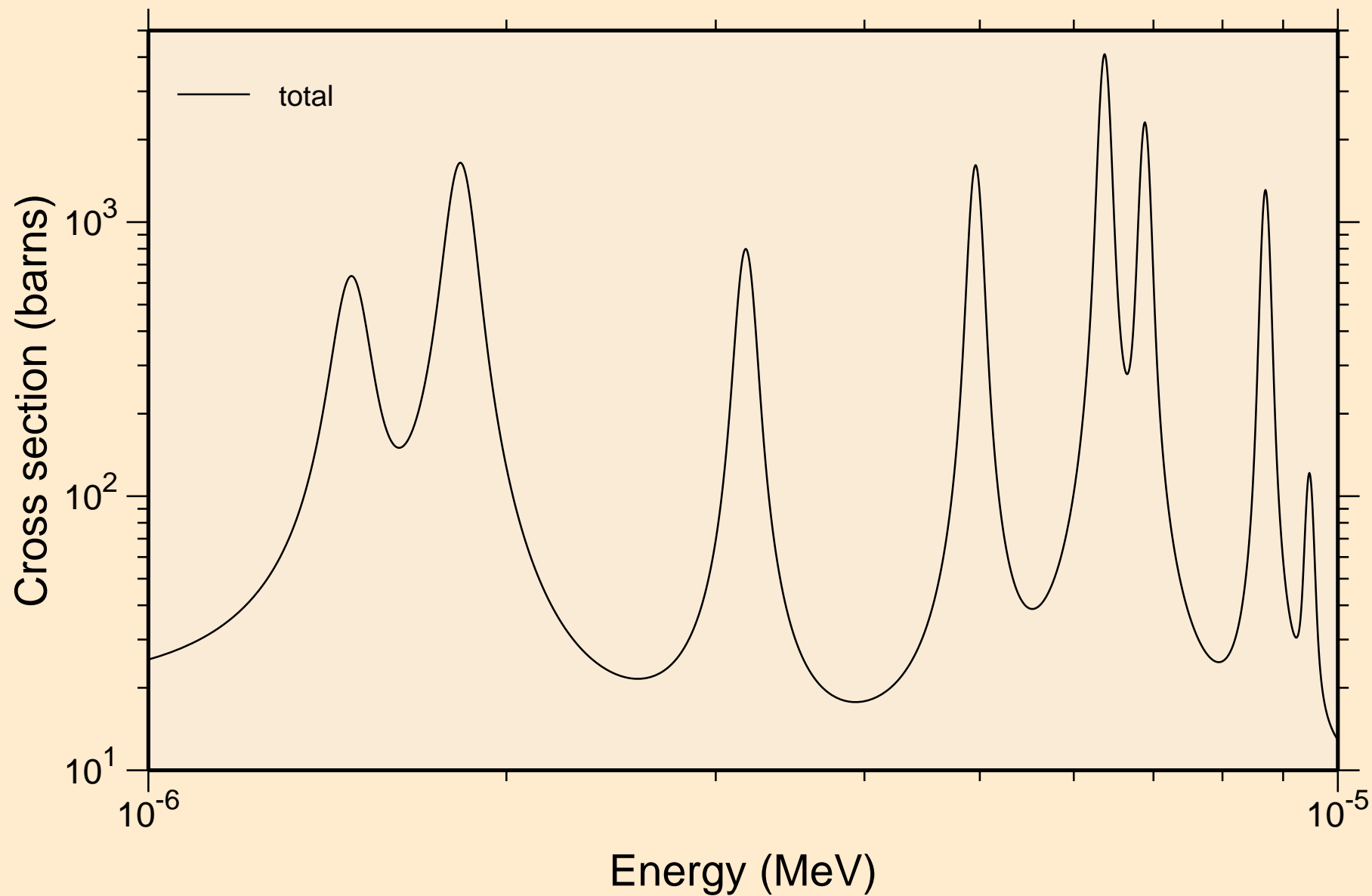

IR189 NEUTRON ACER TENDL-2019 LIBRARY; T=293.16K  
resonance total cross section

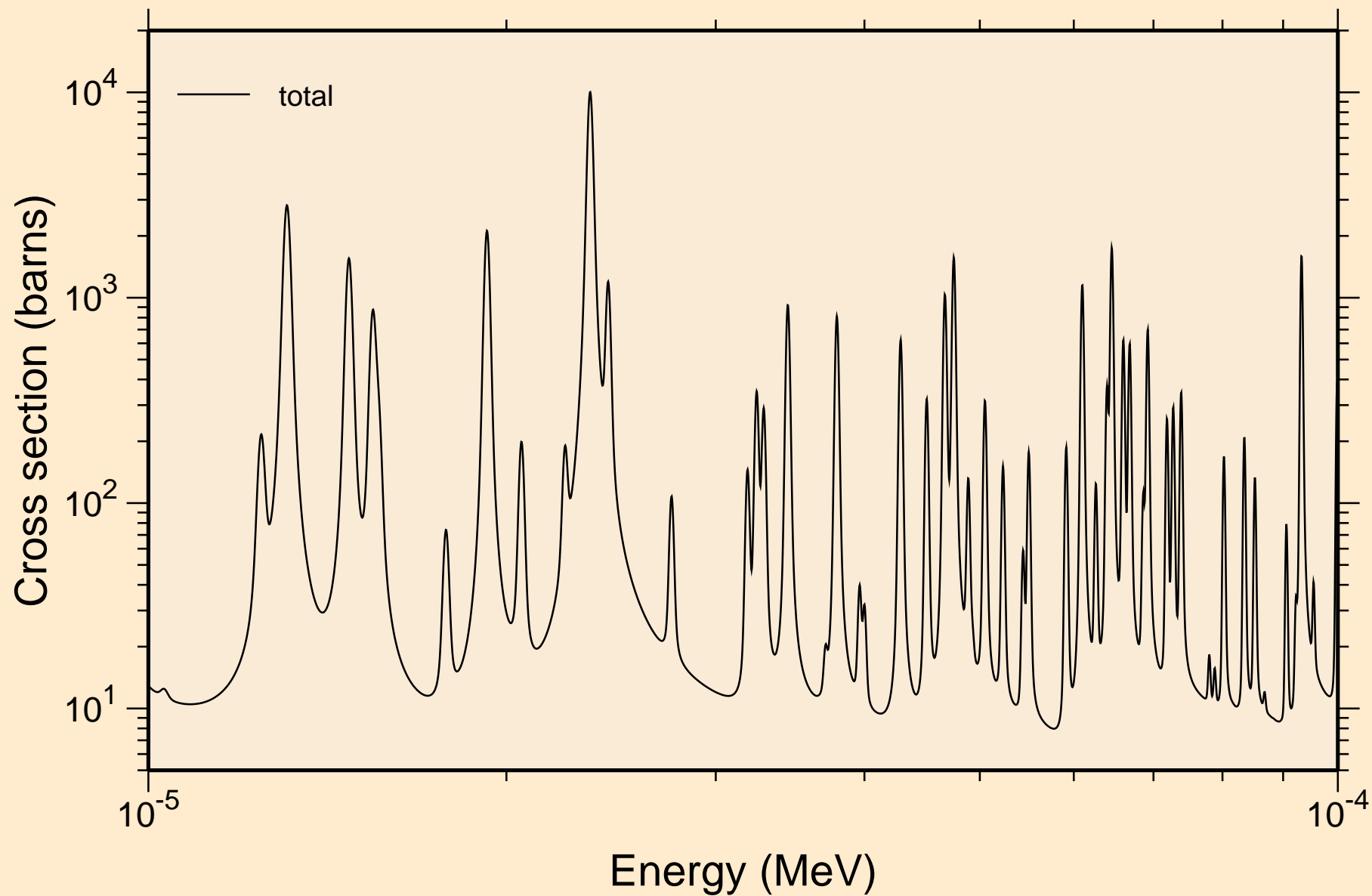

IR189 NEUTRON ACER TENDL-2019 LIBRARY; T=293.16K  
resonance total cross section

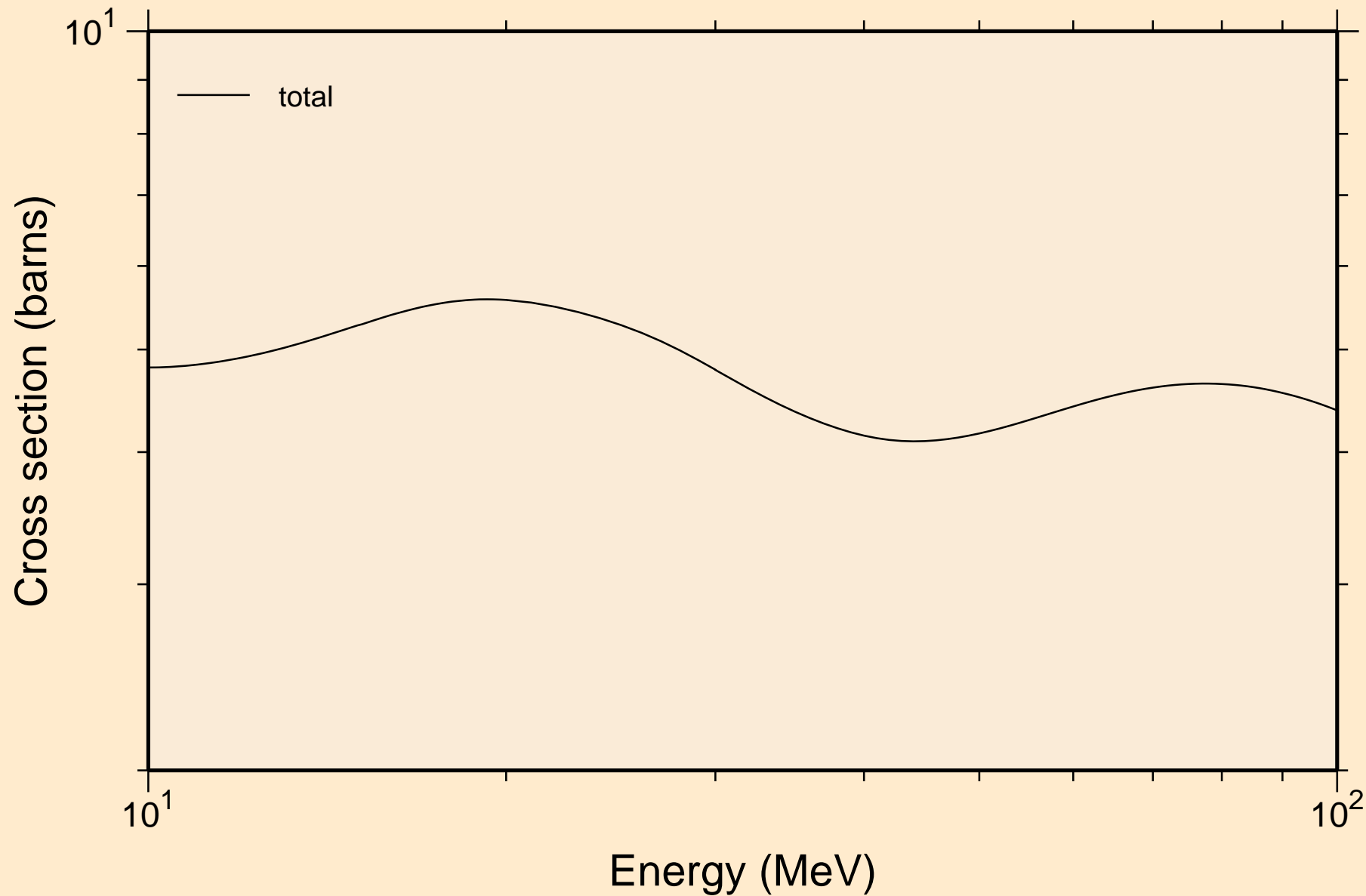

IR189 NEUTRON ACER TENDL-2019 LIBRARY; T=293.16K  
resonance absorption cross sections

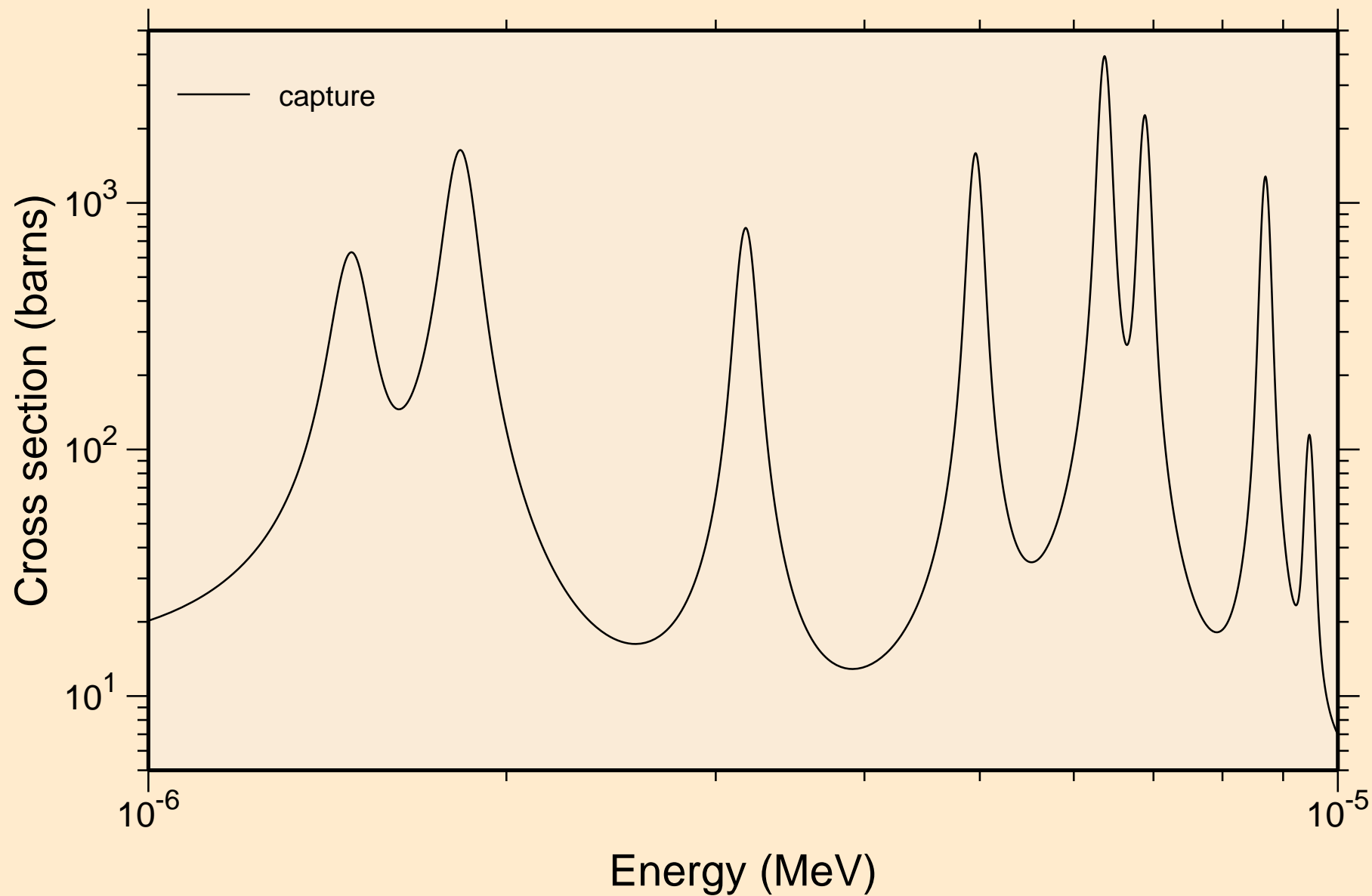

IR189 NEUTRON ACER TENDL-2019 LIBRARY; T=293.16K  
resonance absorption cross sections

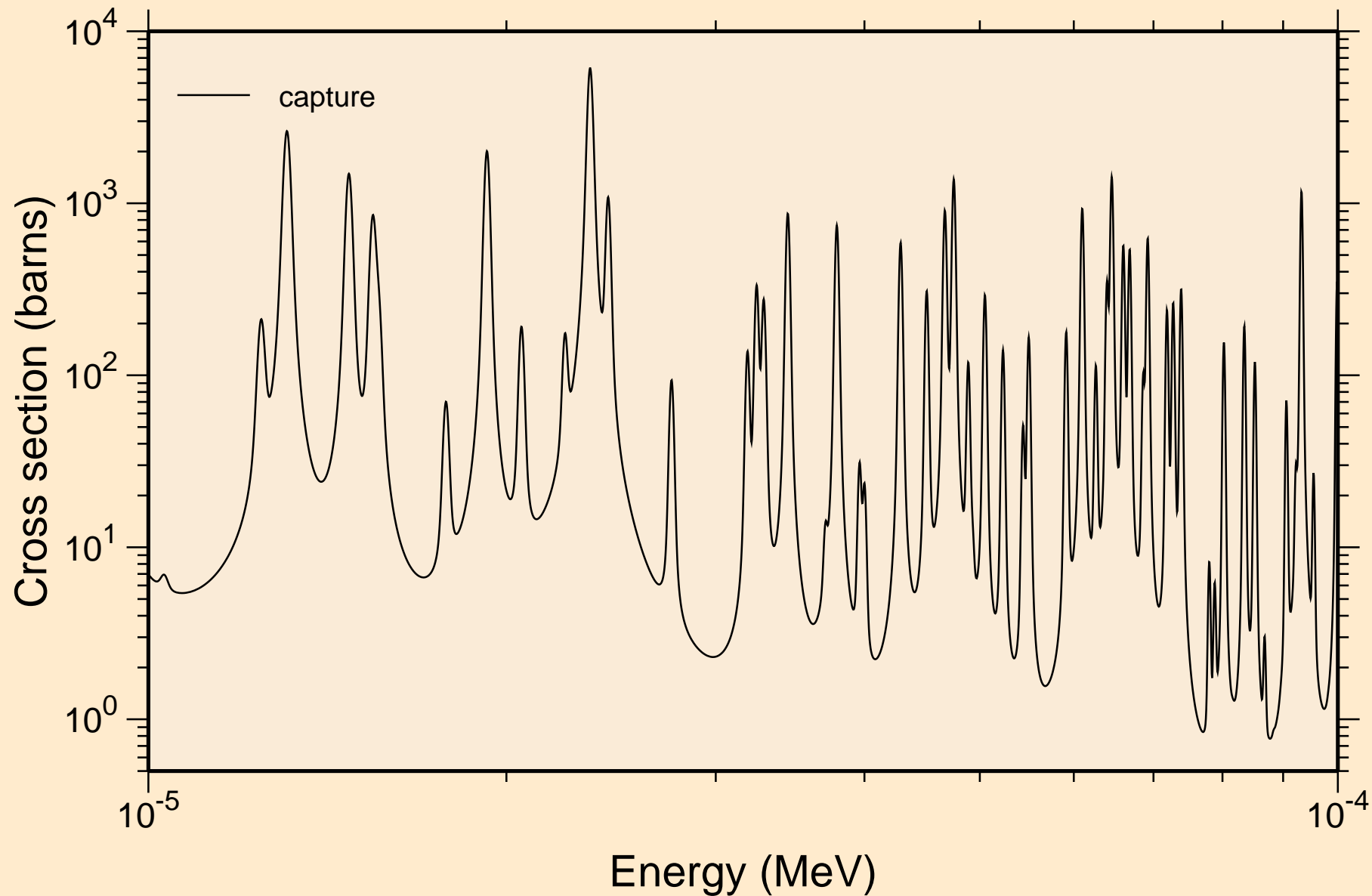

IR189 NEUTRON ACER TENDL-2019 LIBRARY; T=293.16K  
resonance absorption cross sections

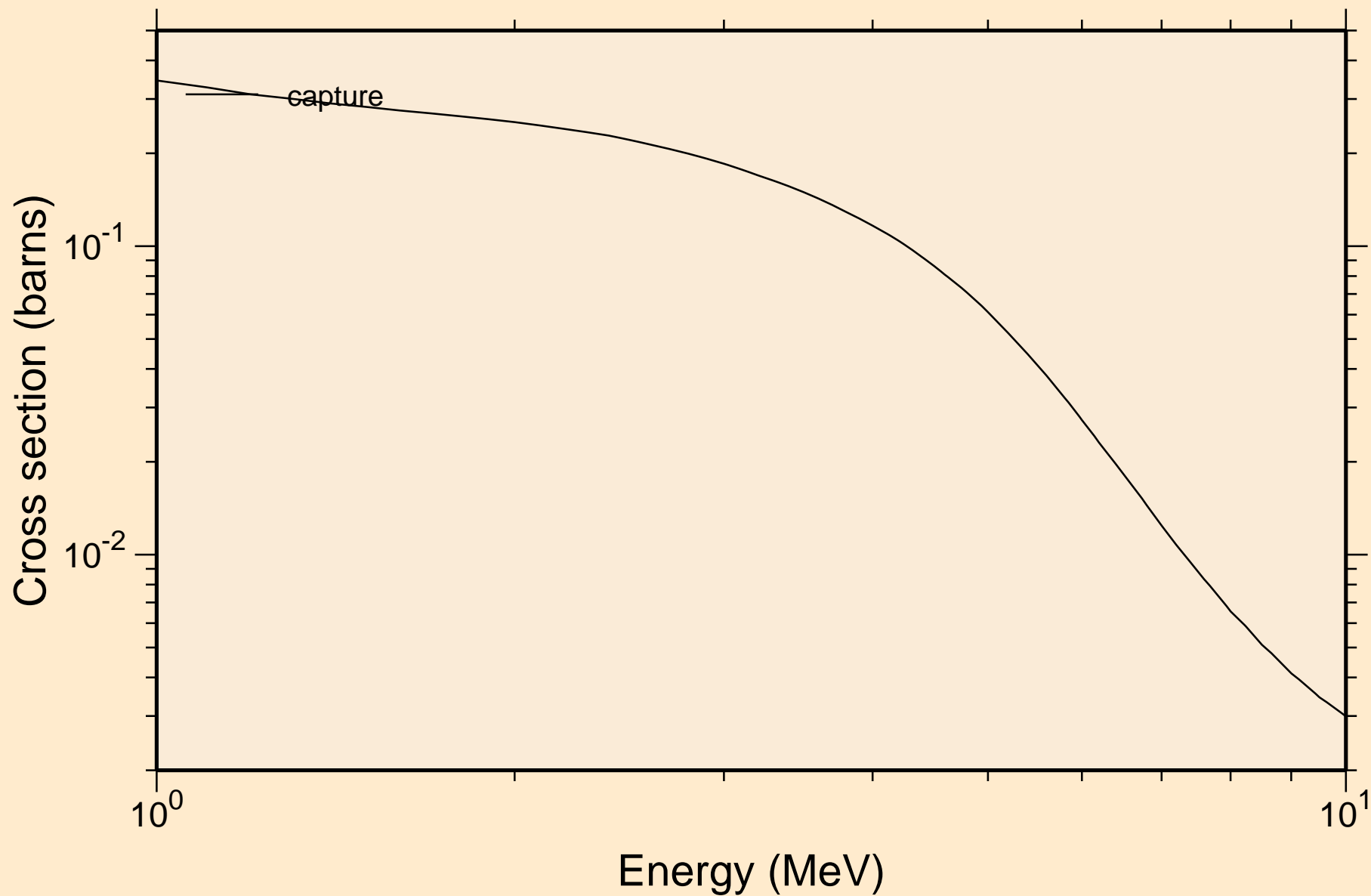

IR189 NEUTRON ACER TENDL-2019 LIBRARY; T=293.16K  
Heating

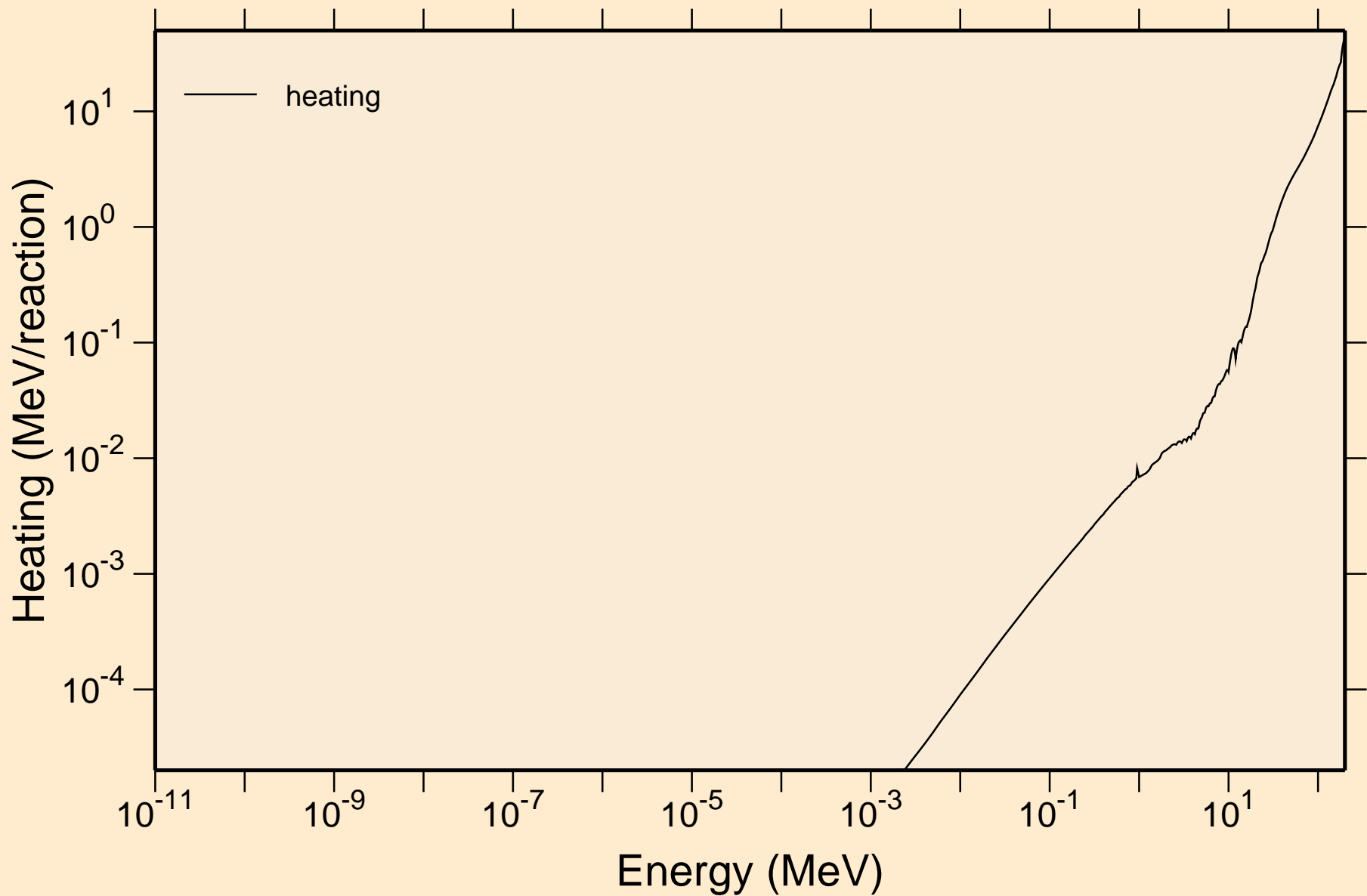



IR189 NEUTRON ACER TENDL-2019 LIBRARY; T=293.16K  
Damage

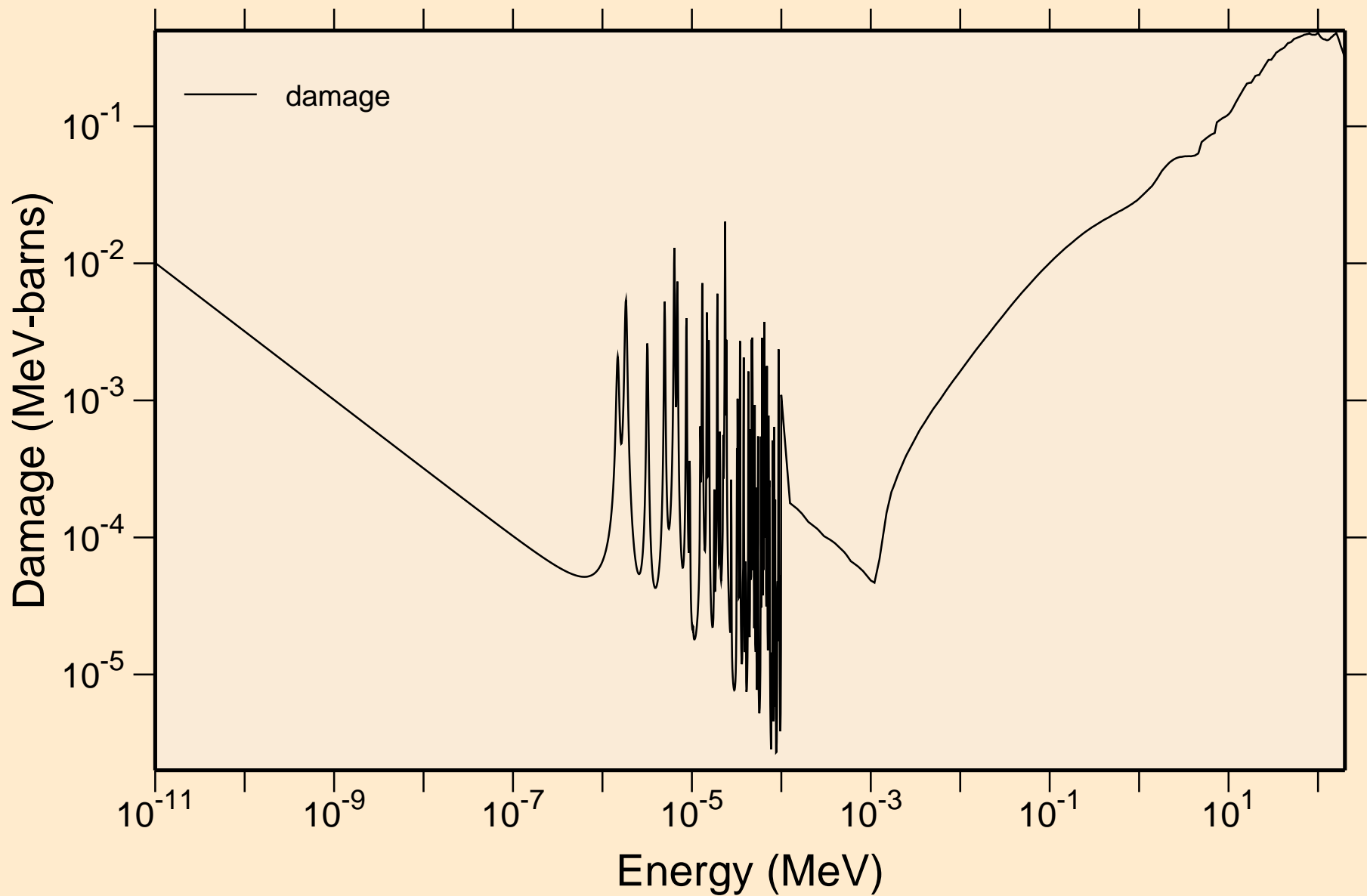

IR189 NEUTRON ACER TENDL-2019 LIBRARY; T=293.16K  
Non-threshold reactions

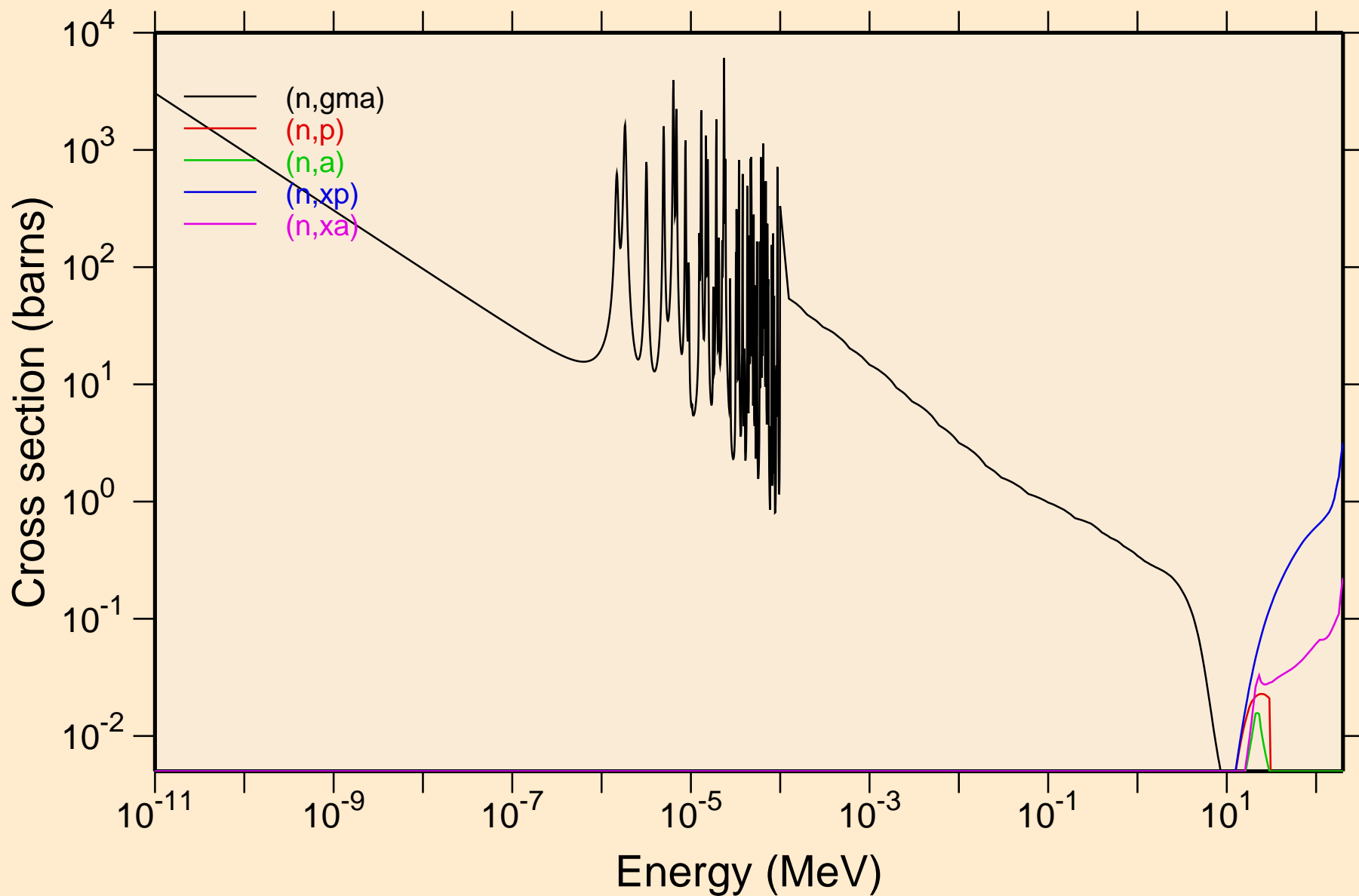

IR189 NEUTRON ACER TENDL-2019 LIBRARY; T=293.16K  
Principal cross sections

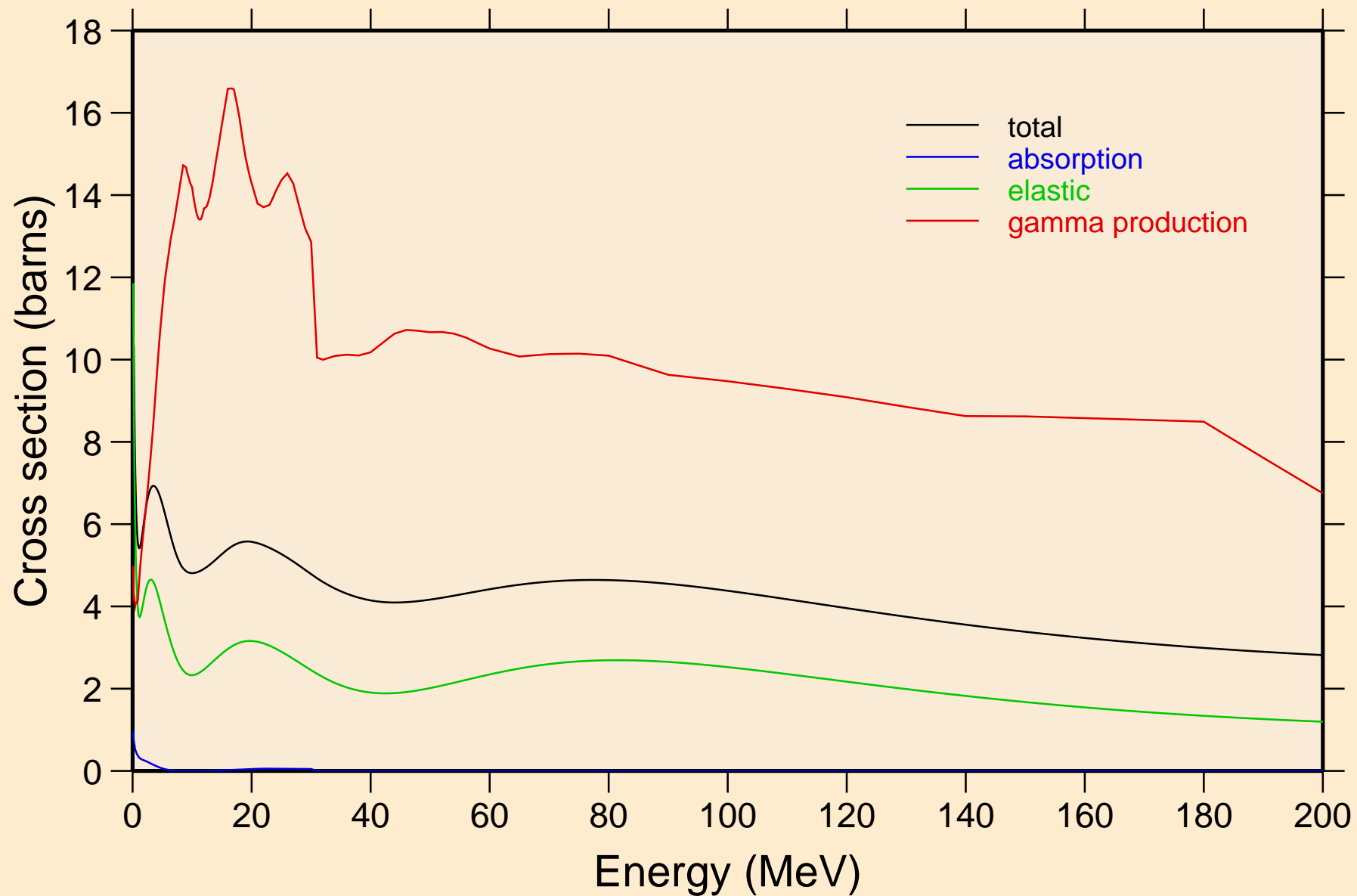

IR189 NEUTRON ACER TENDL-2019 LIBRARY; T=293.16K  
Heating

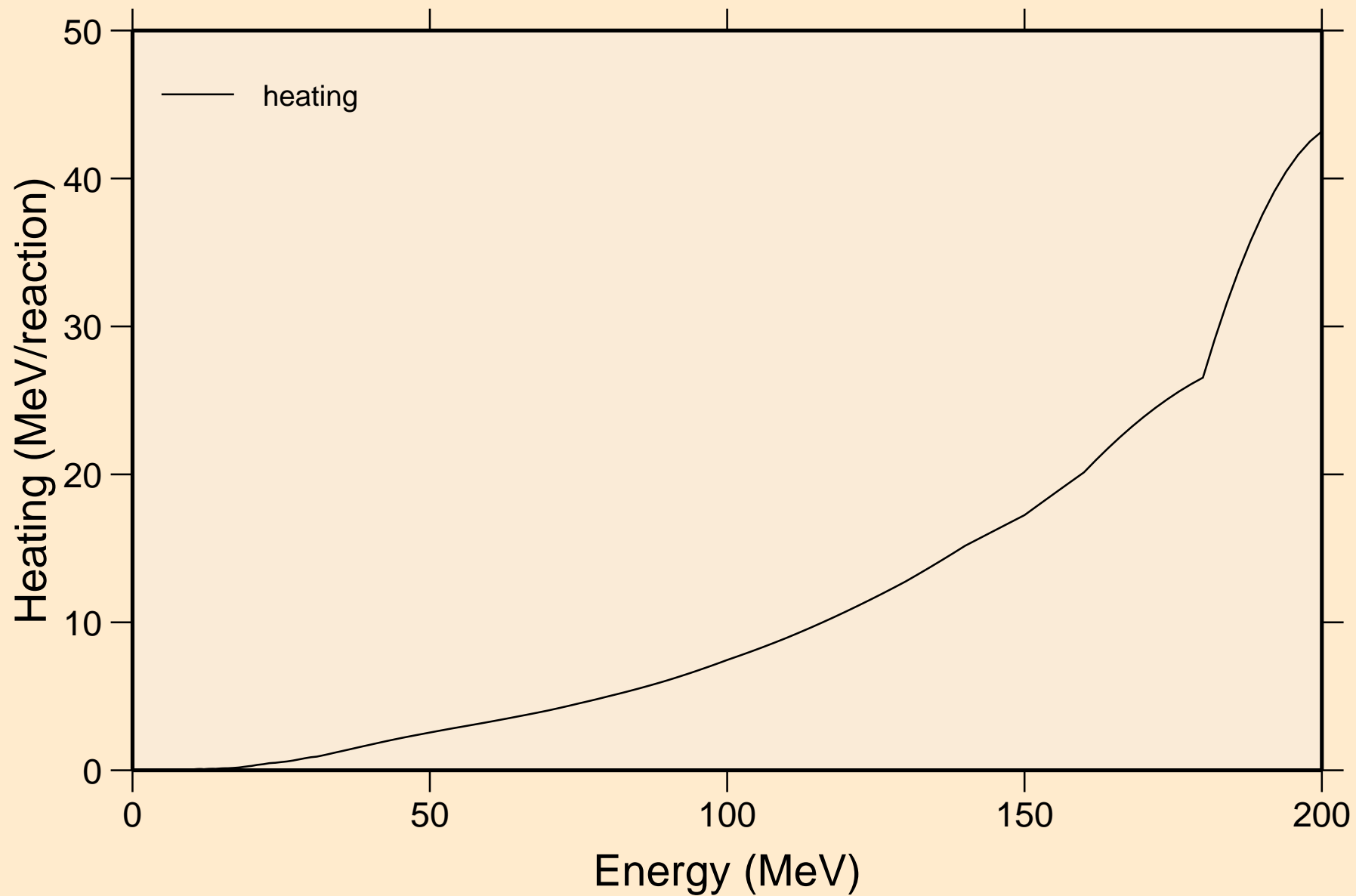

IR189 NEUTRON ACER TENDL-2019 LIBRARY; T=293.16K  
Damage

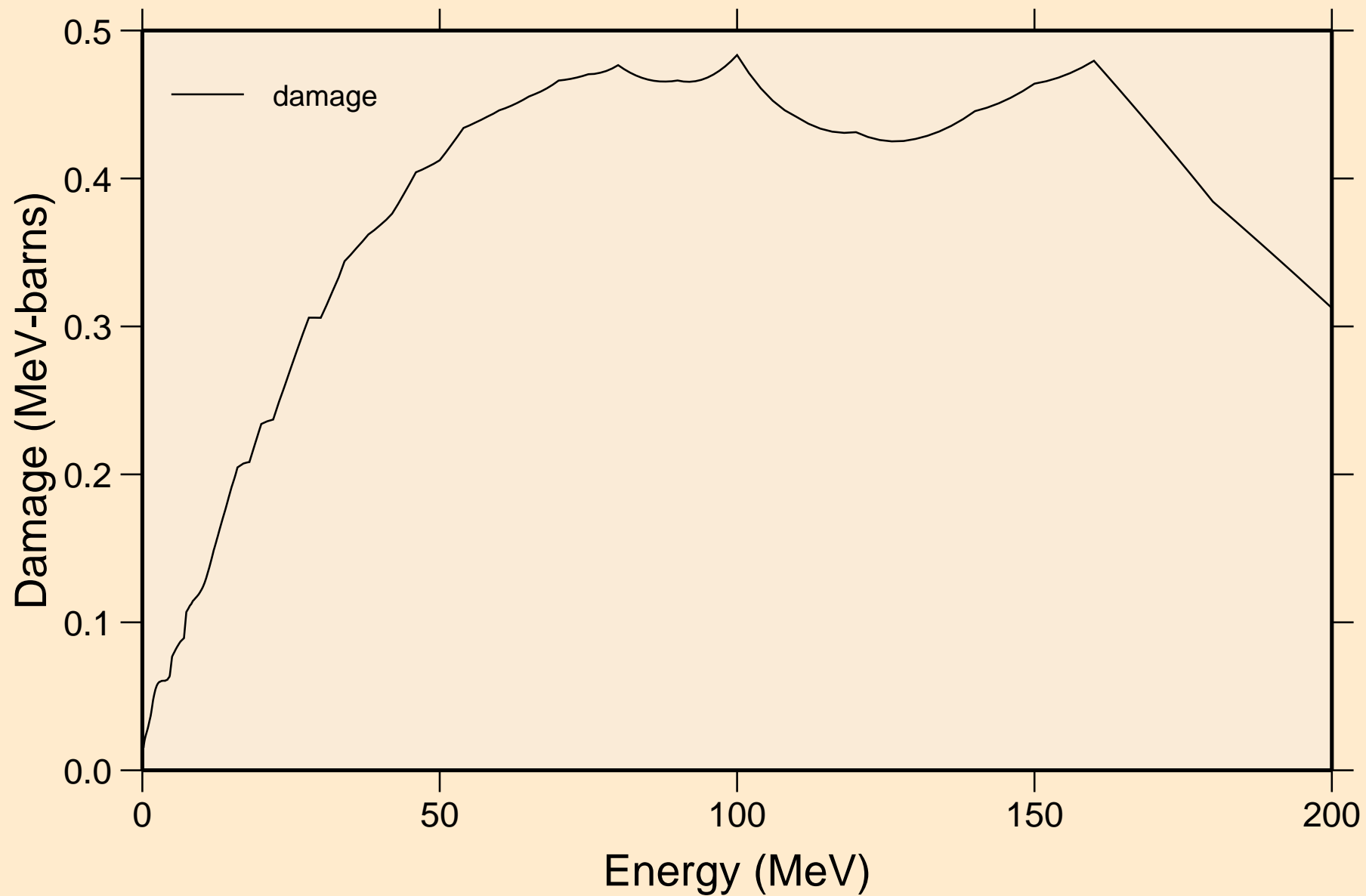

IR189 NEUTRON ACER TENDL-2019 LIBRARY; T=293.16K  
Non-threshold reactions

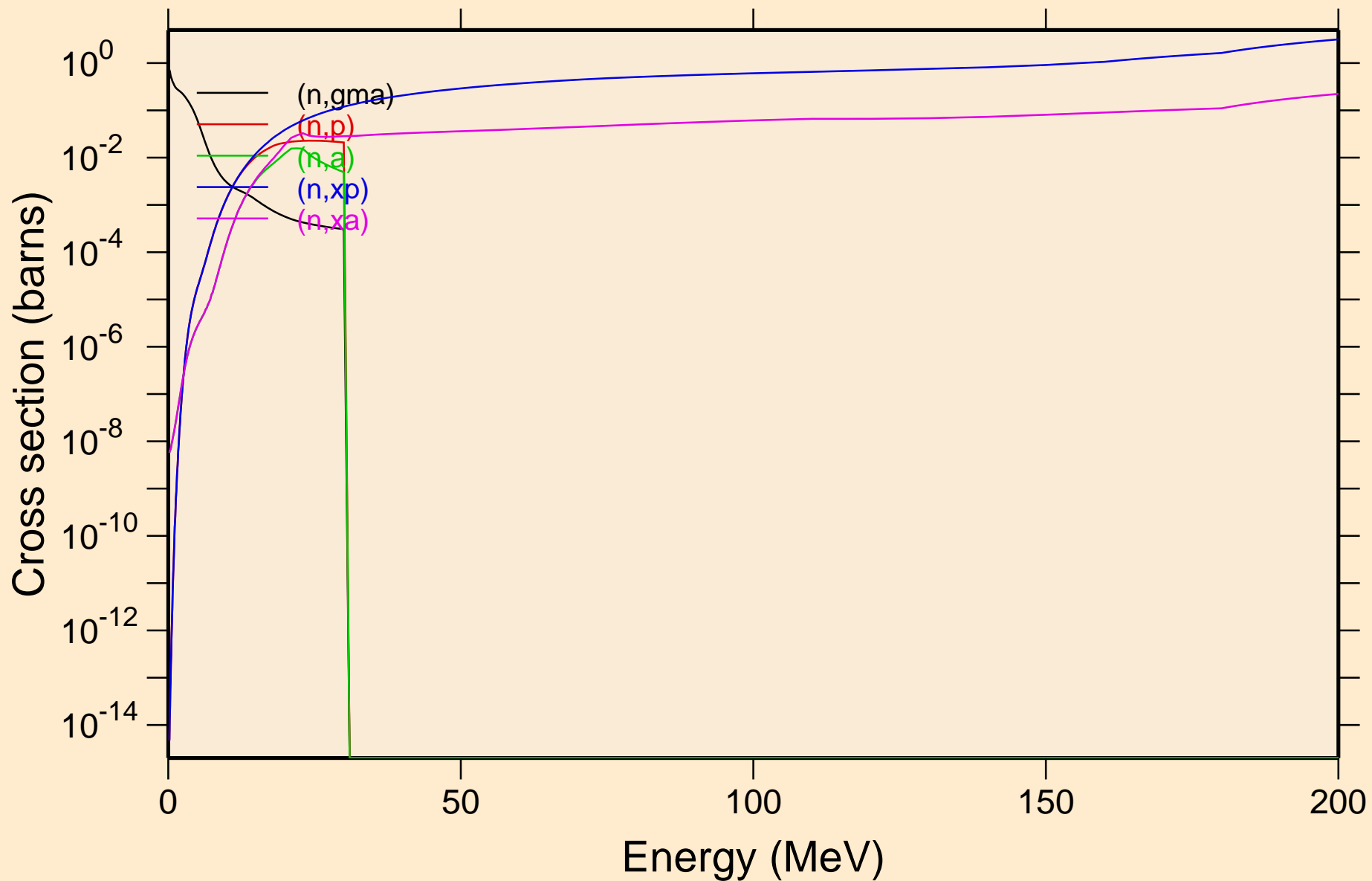

IR189 NEUTRON ACER TENDL-2019 LIBRARY; T=293.16K  
Inelastic levels

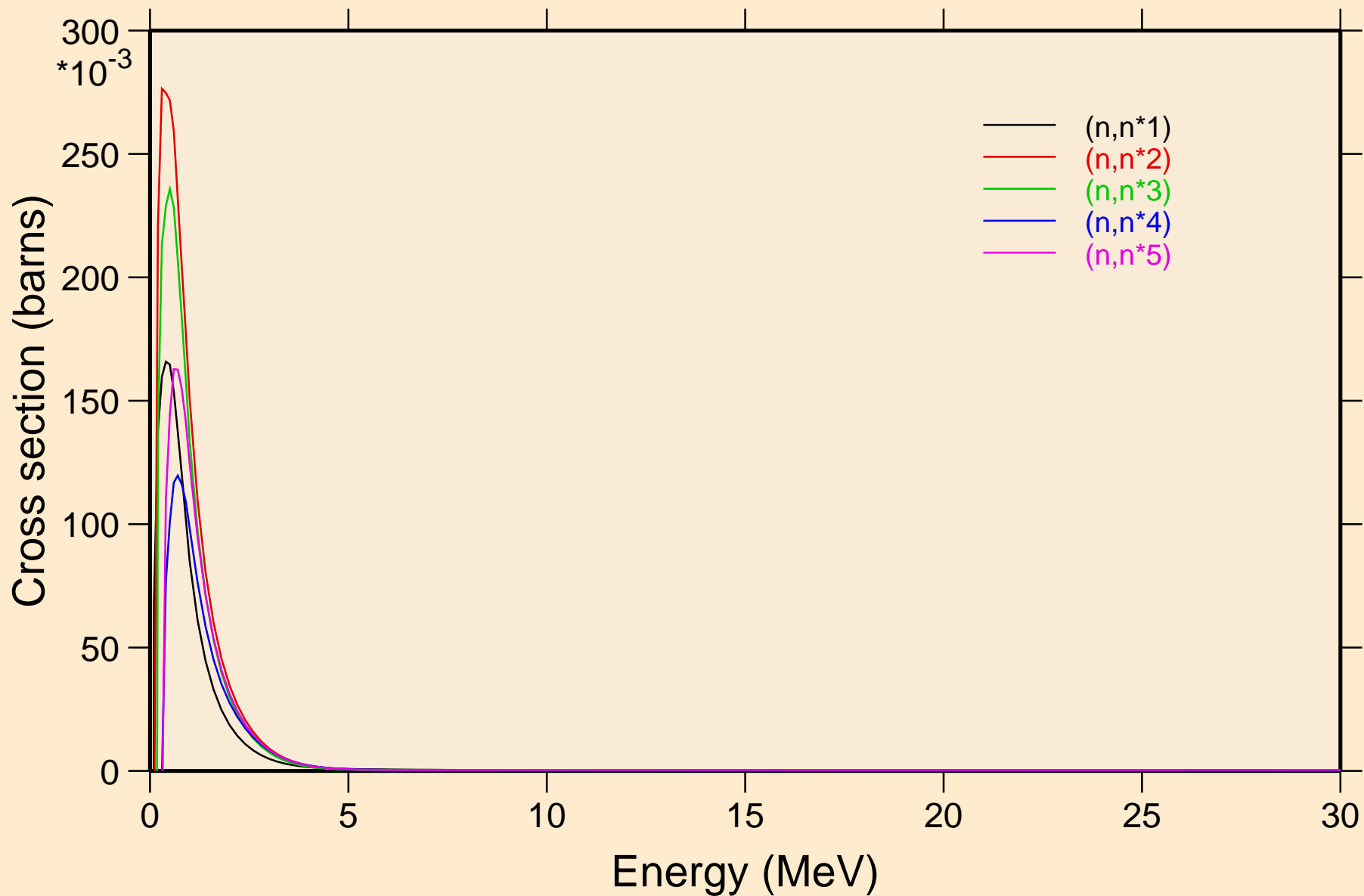

IR189 NEUTRON ACER TENDL-2019 LIBRARY; T=293.16K  
Inelastic levels

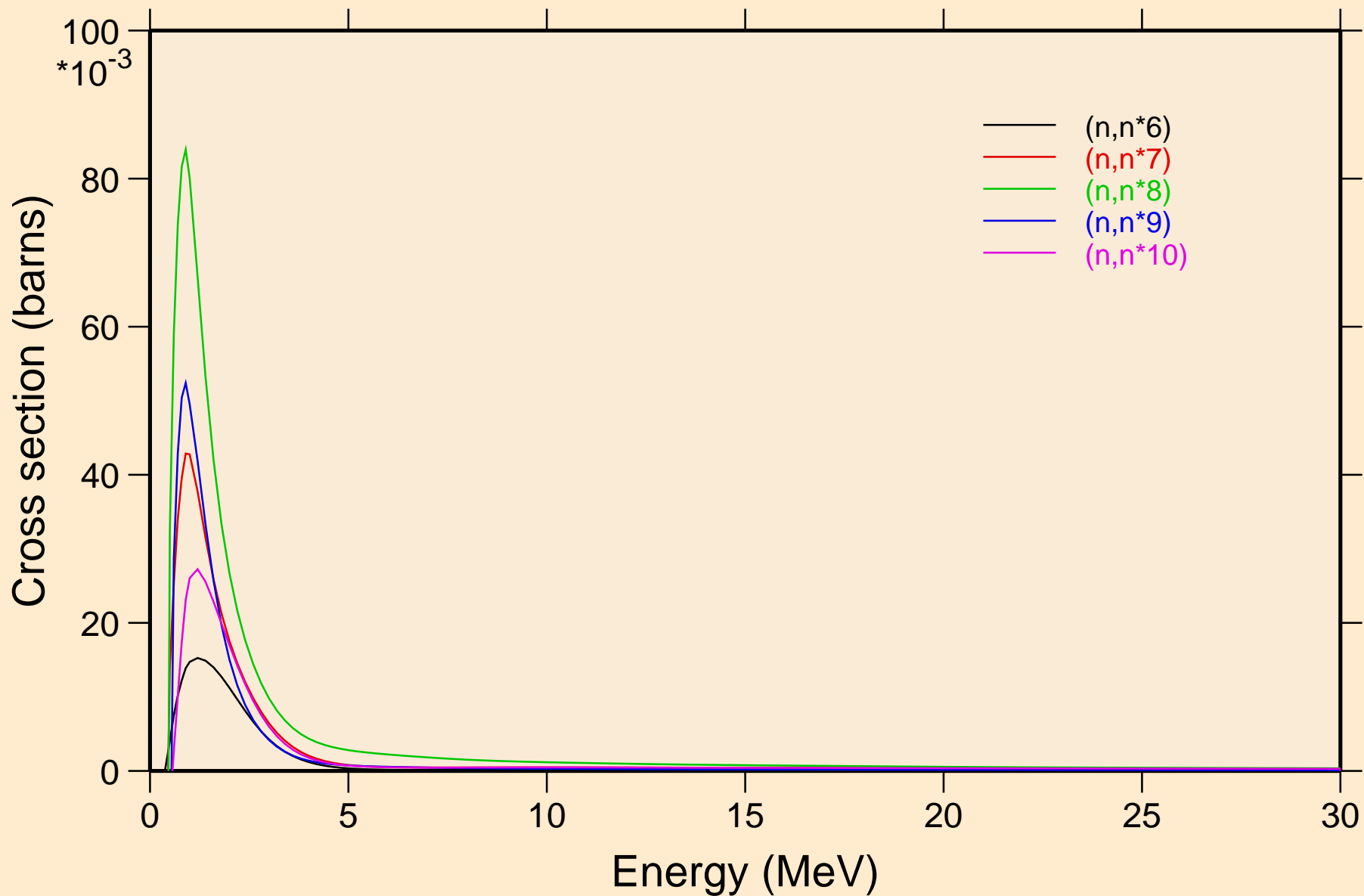



IR189 NEUTRON ACER TENDL-2019 LIBRARY; T=293.16K  
Inelastic levels

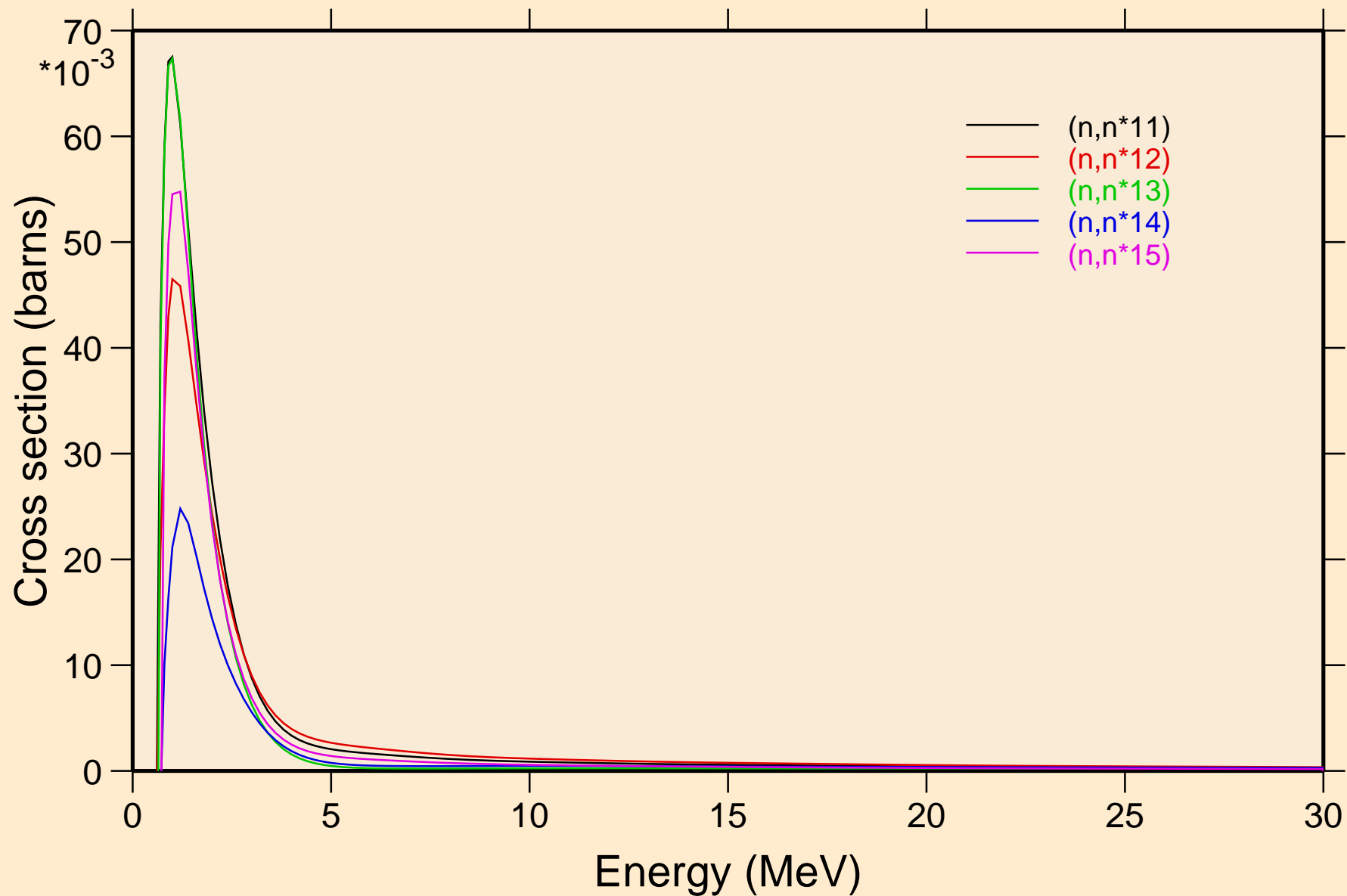

IR189 NEUTRON ACER TENDL-2019 LIBRARY; T=293.16K  
Inelastic levels

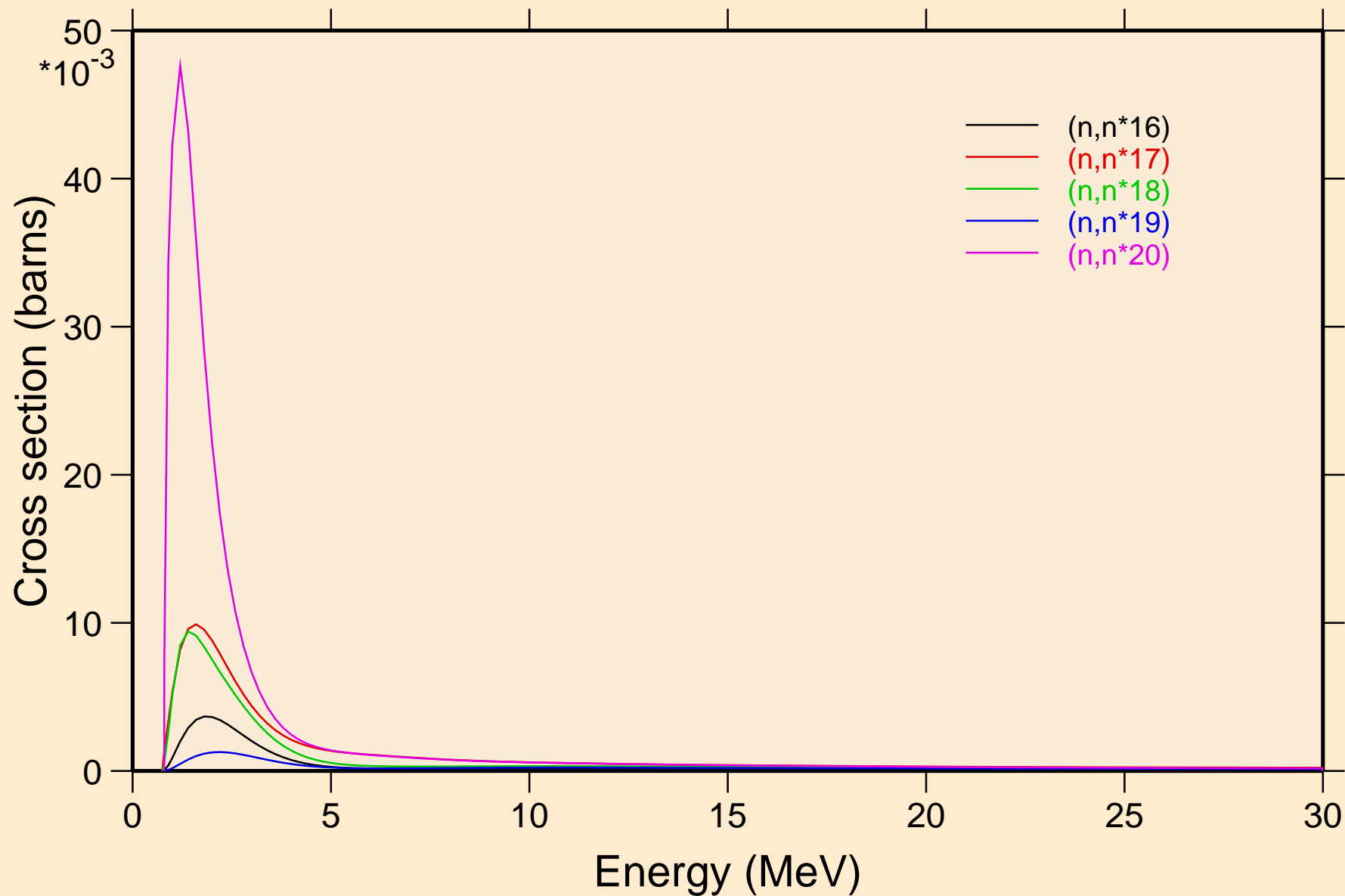

IR189 NEUTRON ACER TENDL-2019 LIBRARY; T=293.16K  
Inelastic levels

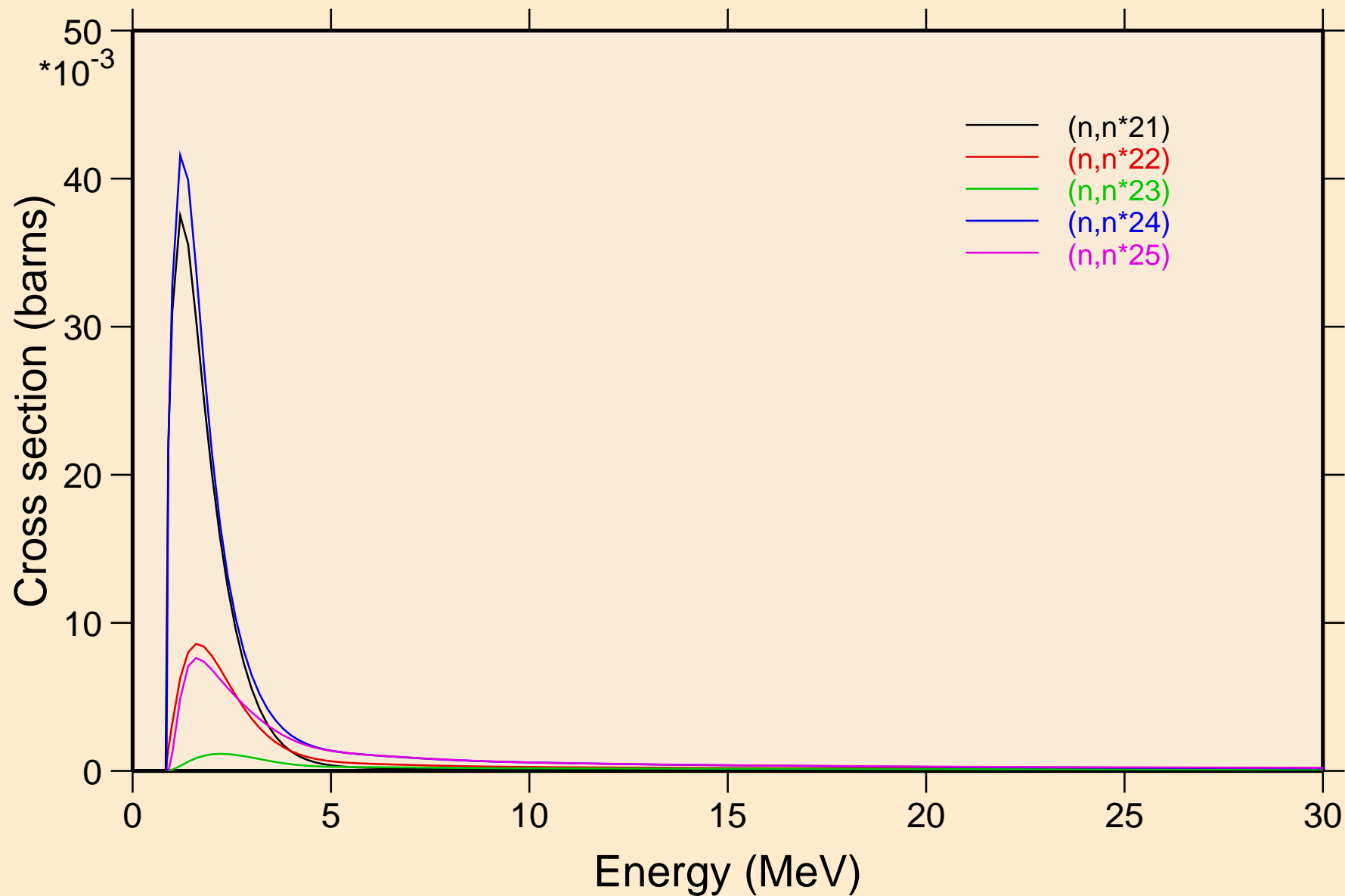

IR189 NEUTRON ACER TENDL-2019 LIBRARY; T=293.16K  
Inelastic levels

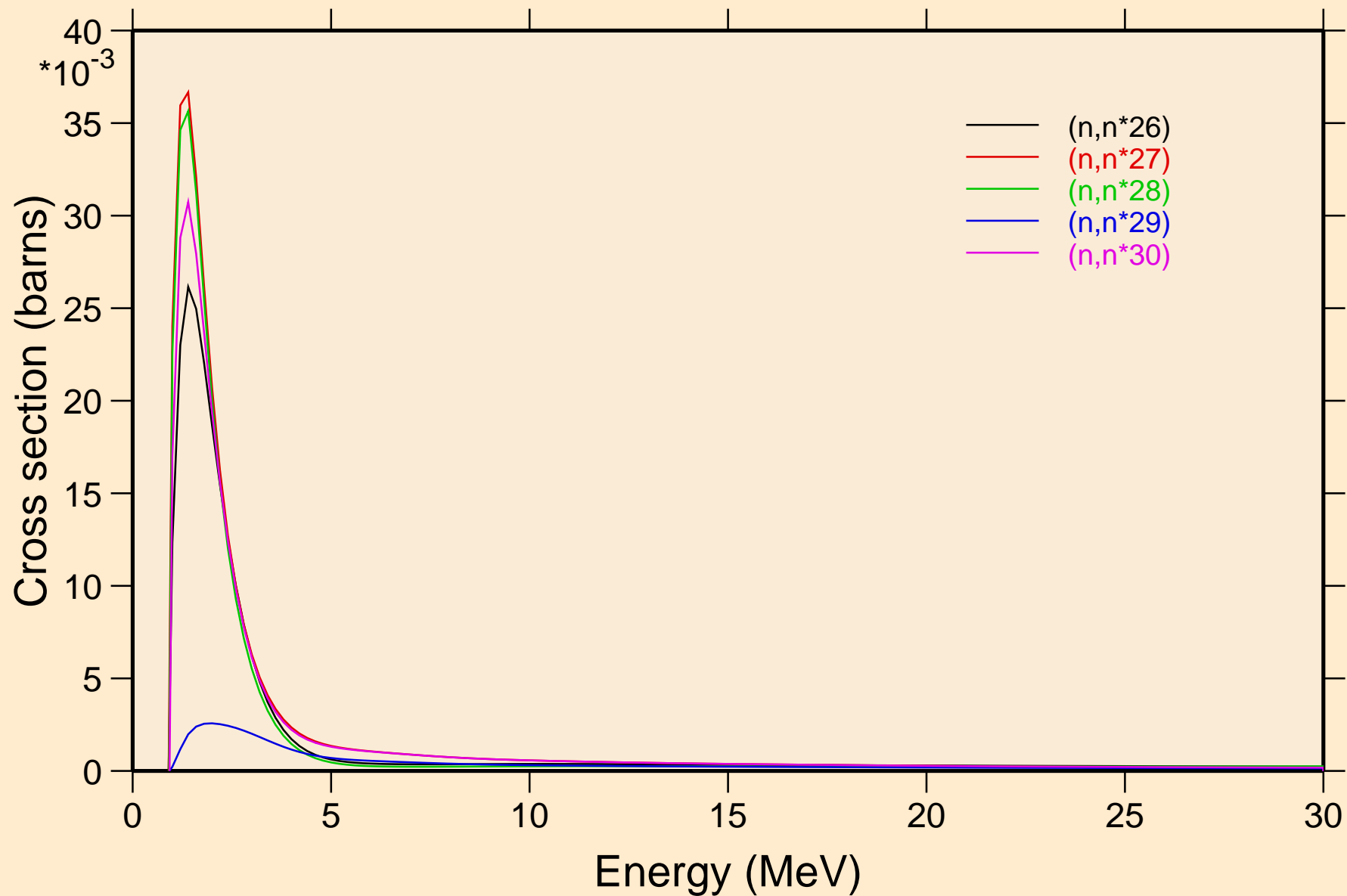

IR189 NEUTRON ACER TENDL-2019 LIBRARY; T=293.16K  
Threshold reactions

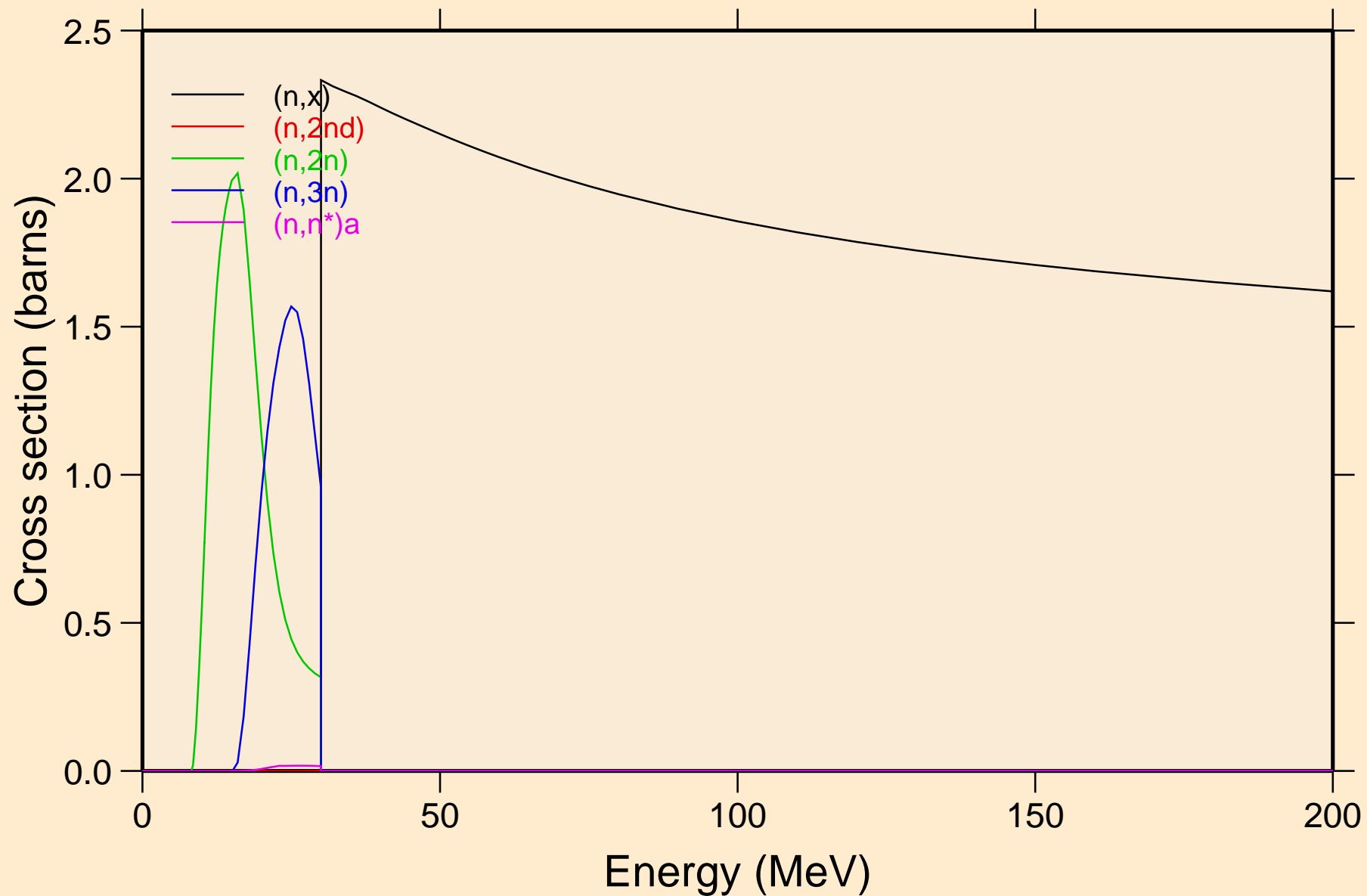

IR189 NEUTRON ACER TENDL-2019 LIBRARY; T=293.16K  
Threshold reactions

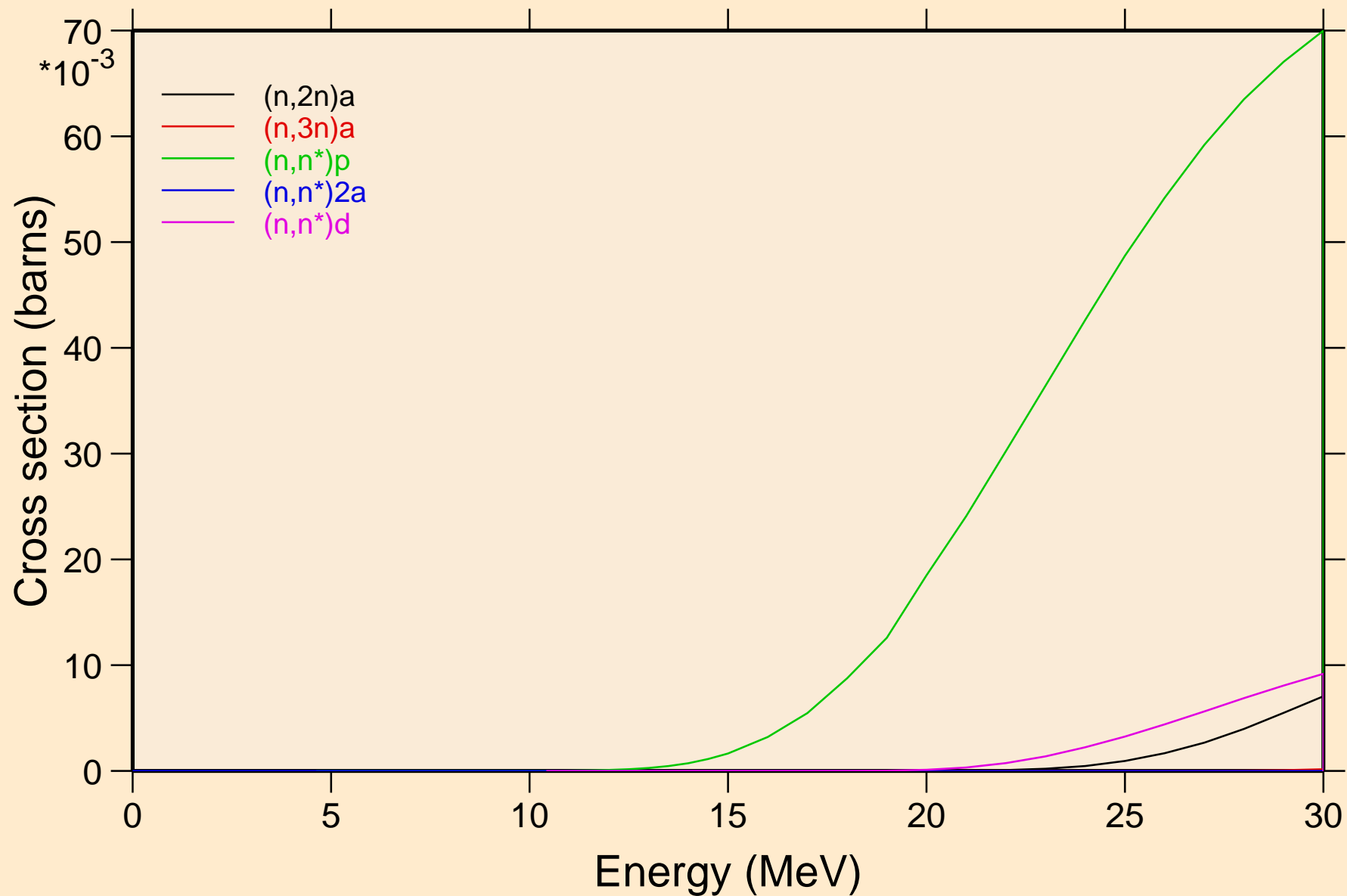

IR189 NEUTRON ACER TENDL-2019 LIBRARY; T=293.16K  
Threshold reactions

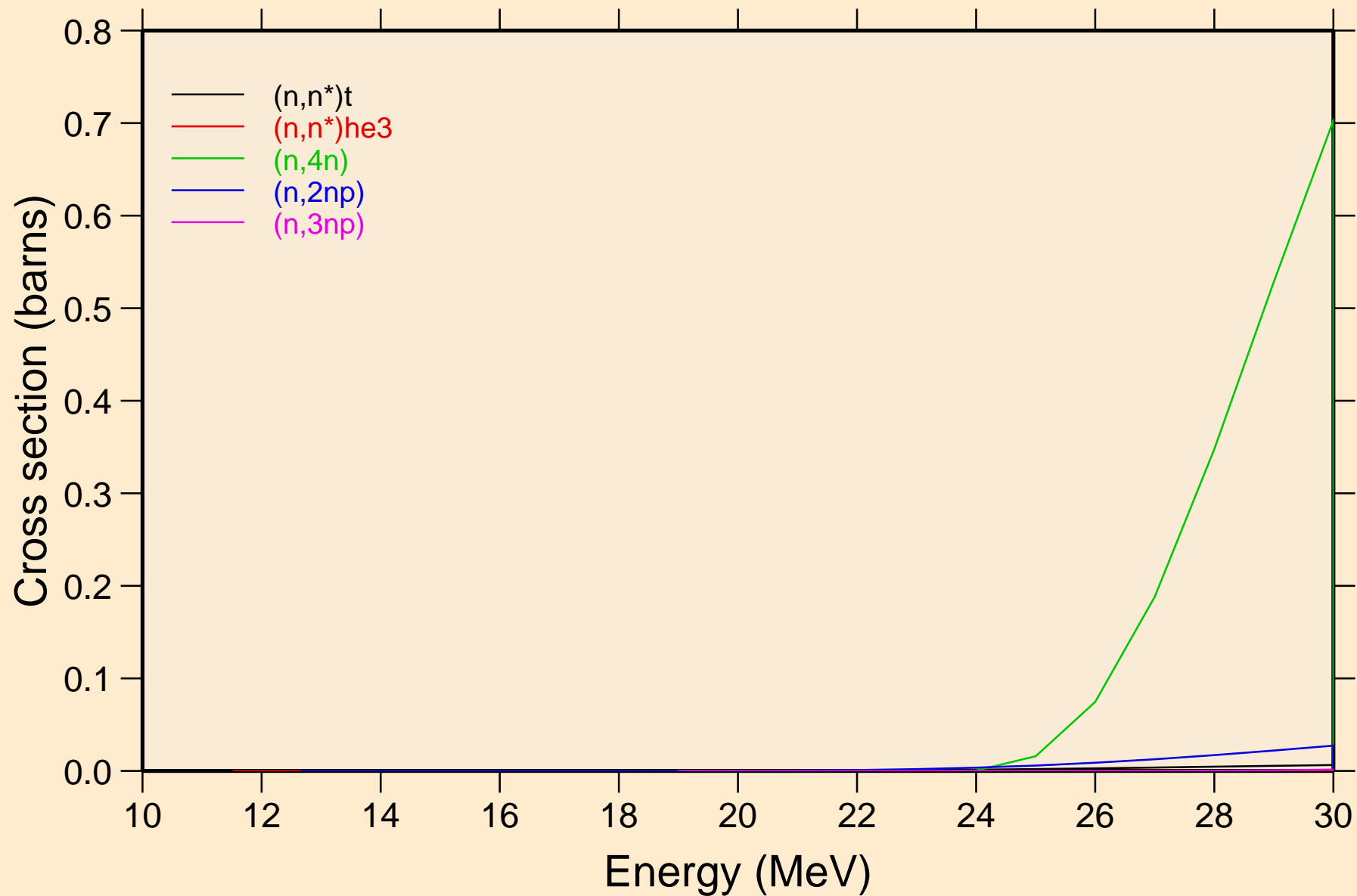

IR189 NEUTRON ACER TENDL-2019 LIBRARY; T=293.16K  
Threshold reactions

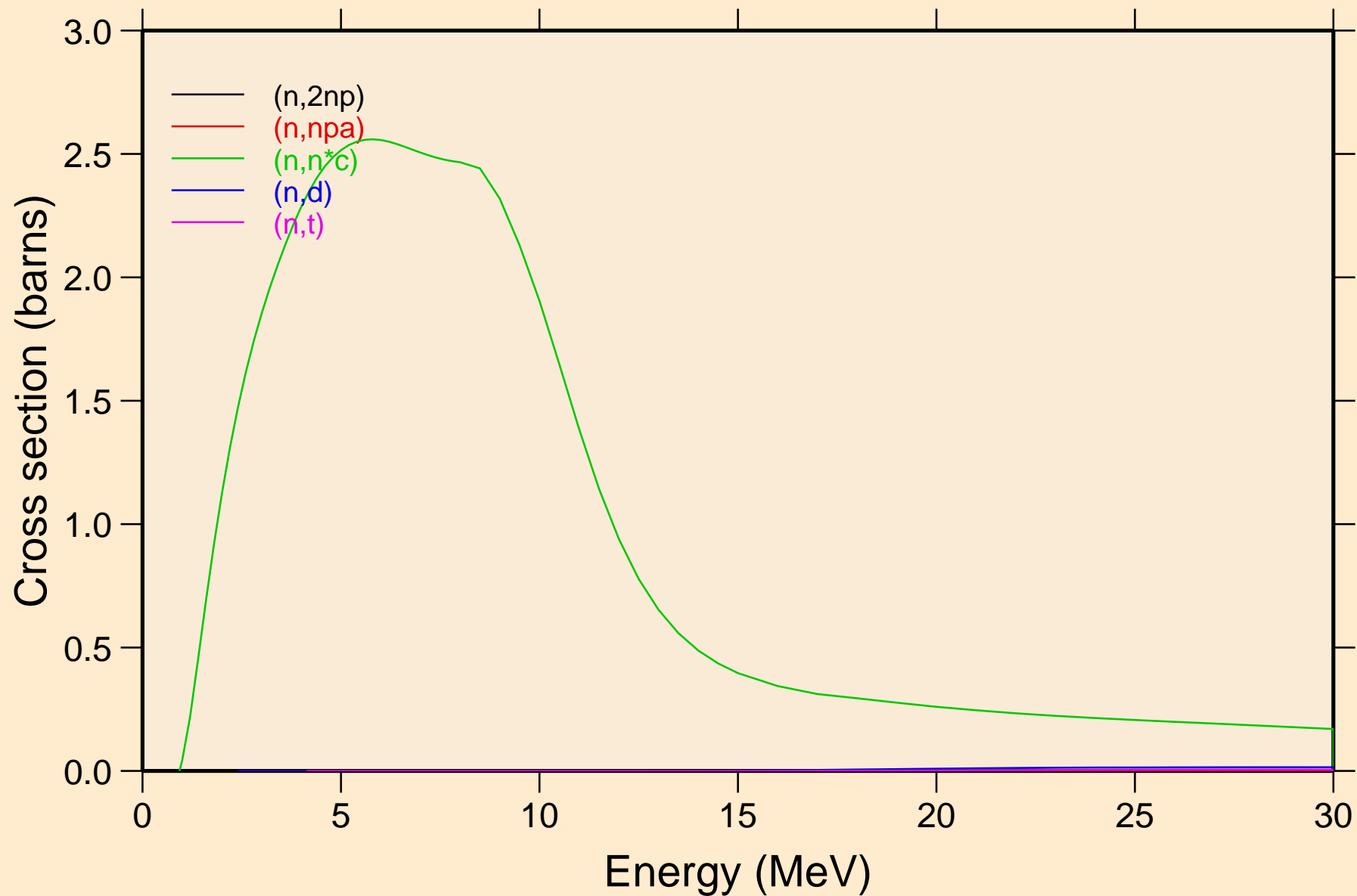



IR189 NEUTRON ACER TENDL-2019 LIBRARY; T=293.16K  
Threshold reactions

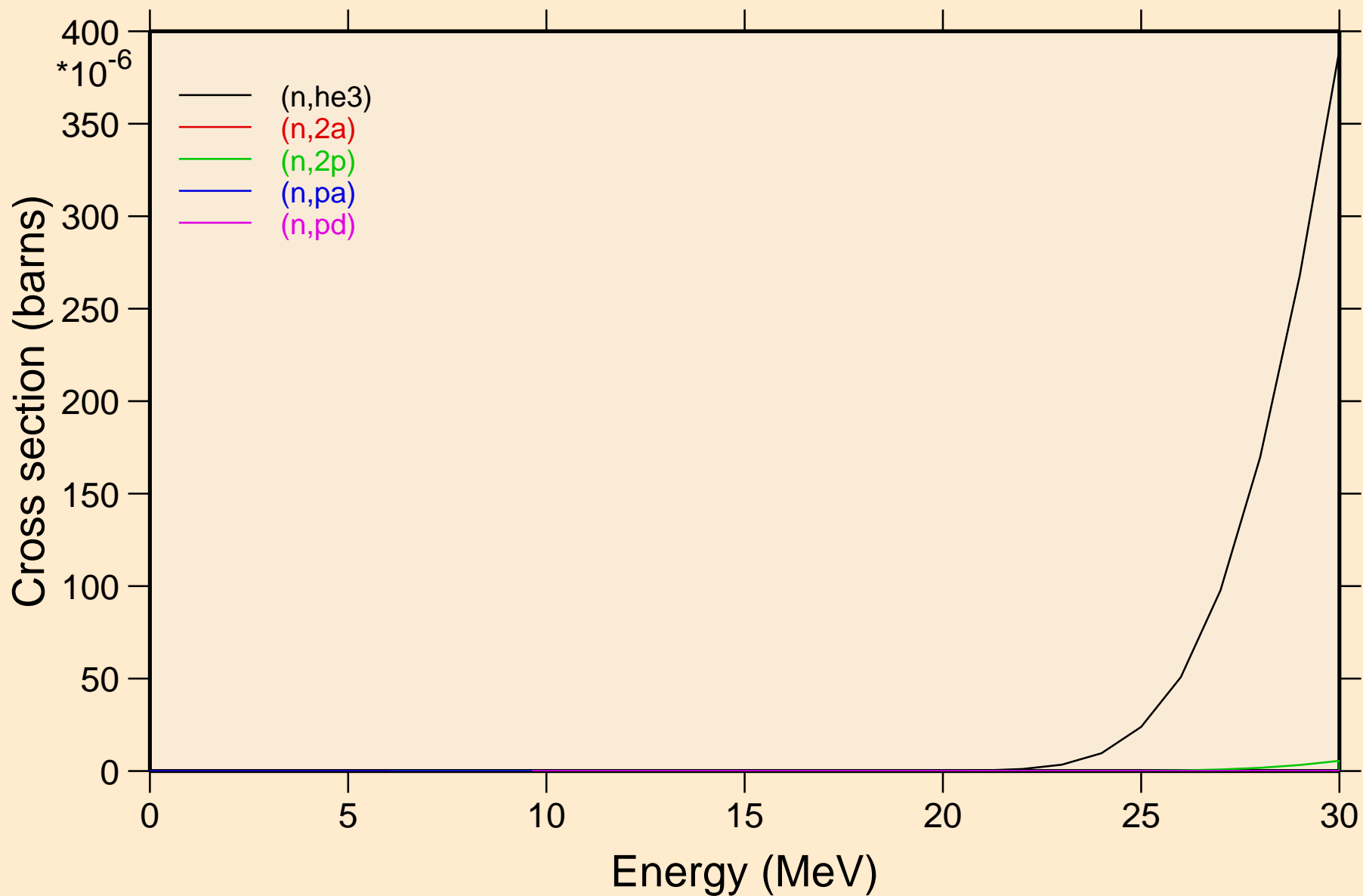

IR189 NEUTRON ACER TENDL-2019 LIBRARY; T=293.16K  
Threshold reactions

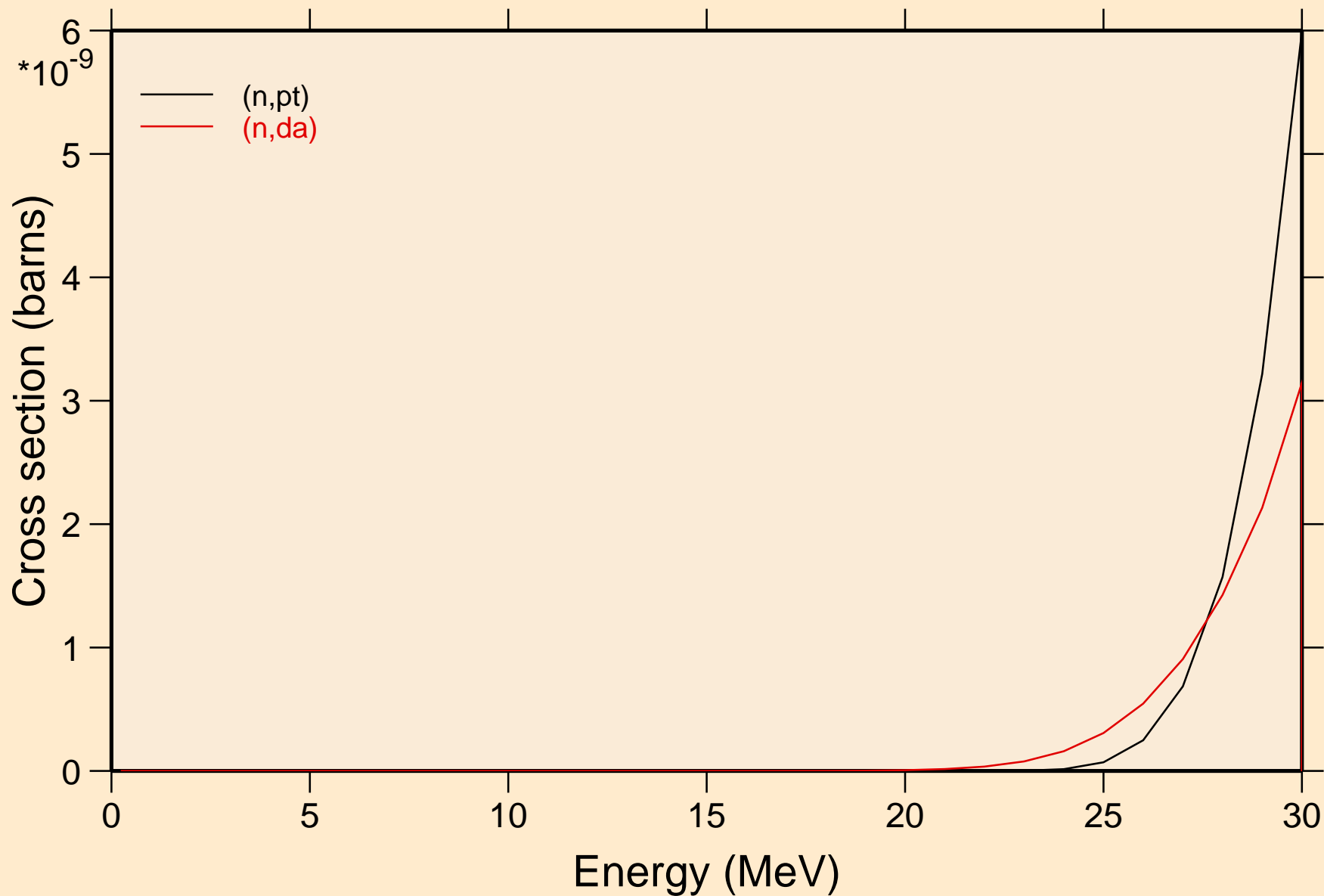

IR189 NEUTRON ACER TENDL-2019 LIBRARY; T=293.16K  
Threshold reactions

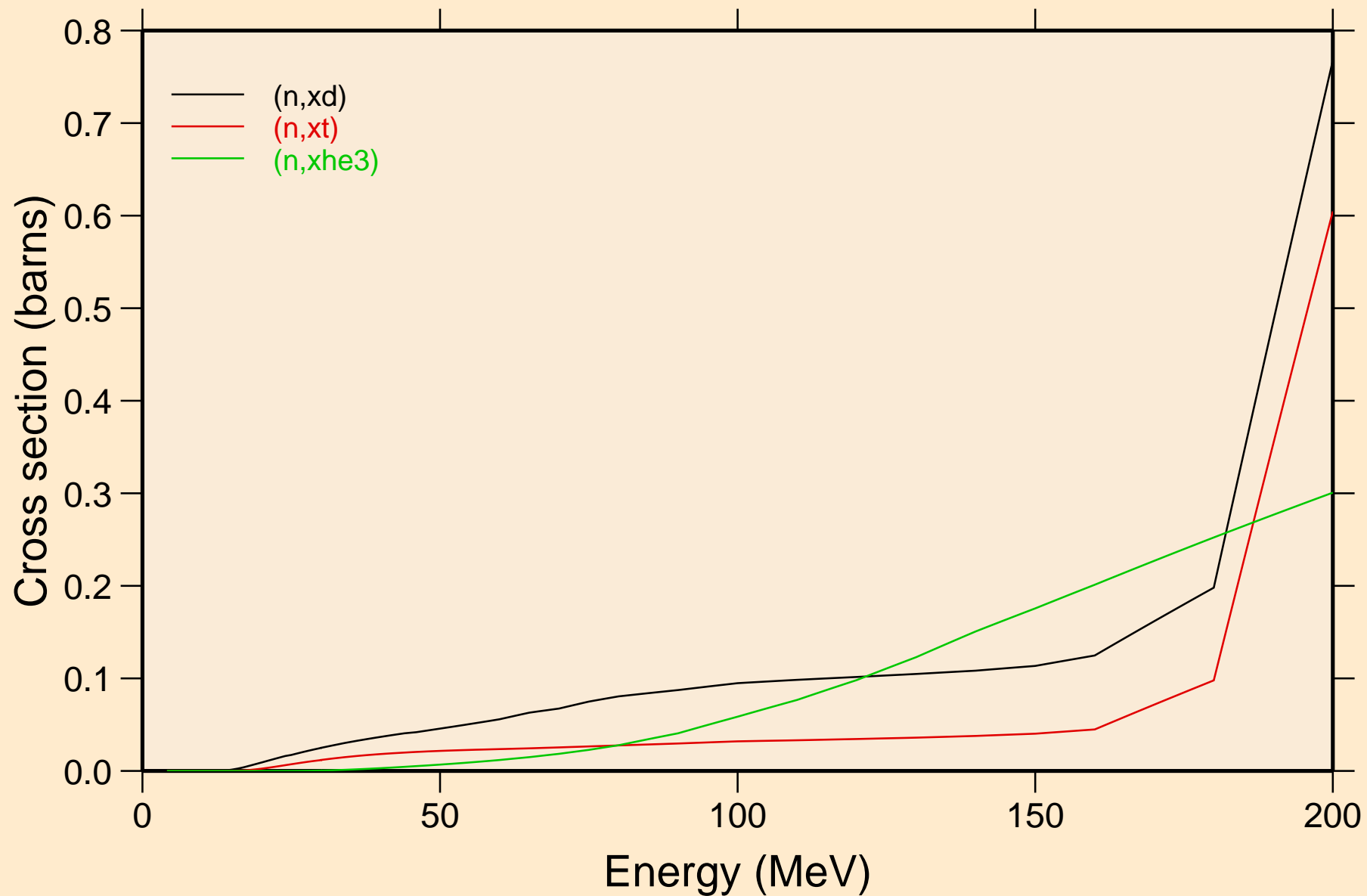

IR189 NEUTRON ACER TENDL-2019 LIBRARY; T=293.16K  
angular distribution for elastic

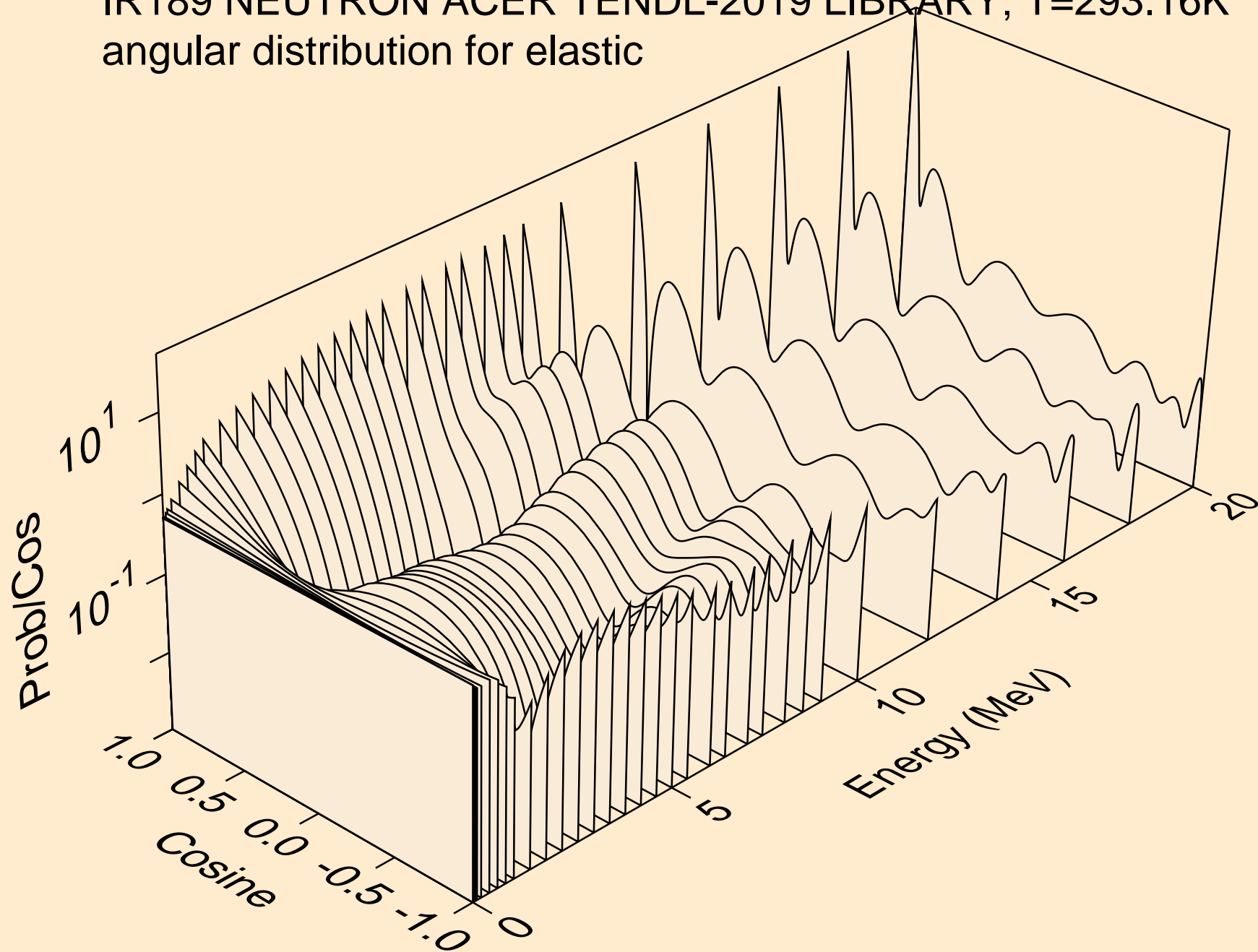

IR189 NEUTRON ACER TENDL-2019 LIBRARY; T=293.16K  
angular distribution for elastic

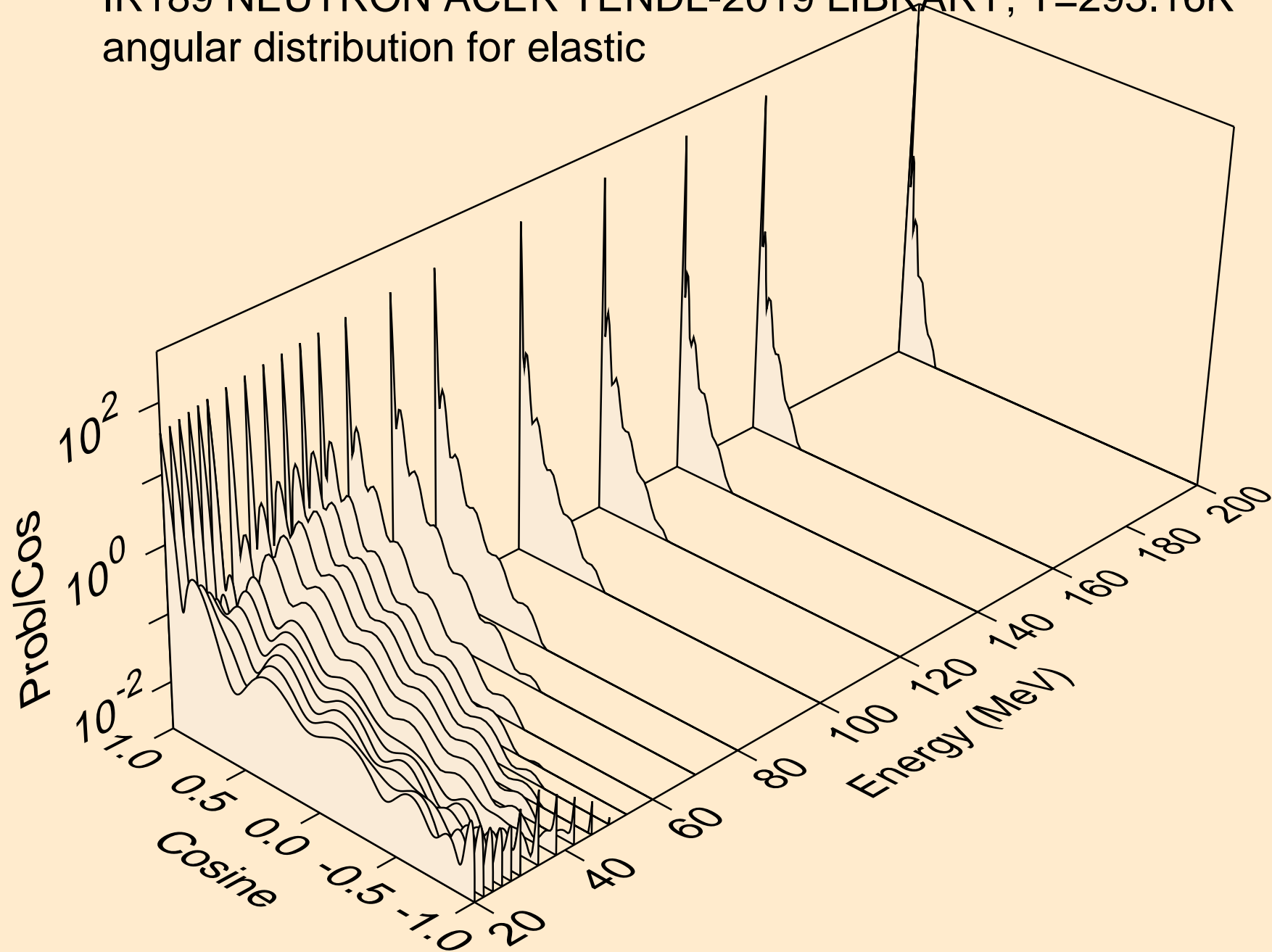

IR189 NEUTRON ACER TENDL-2019 LIBRARY; T=293.16K  
angular distribution for (n,n\*1)

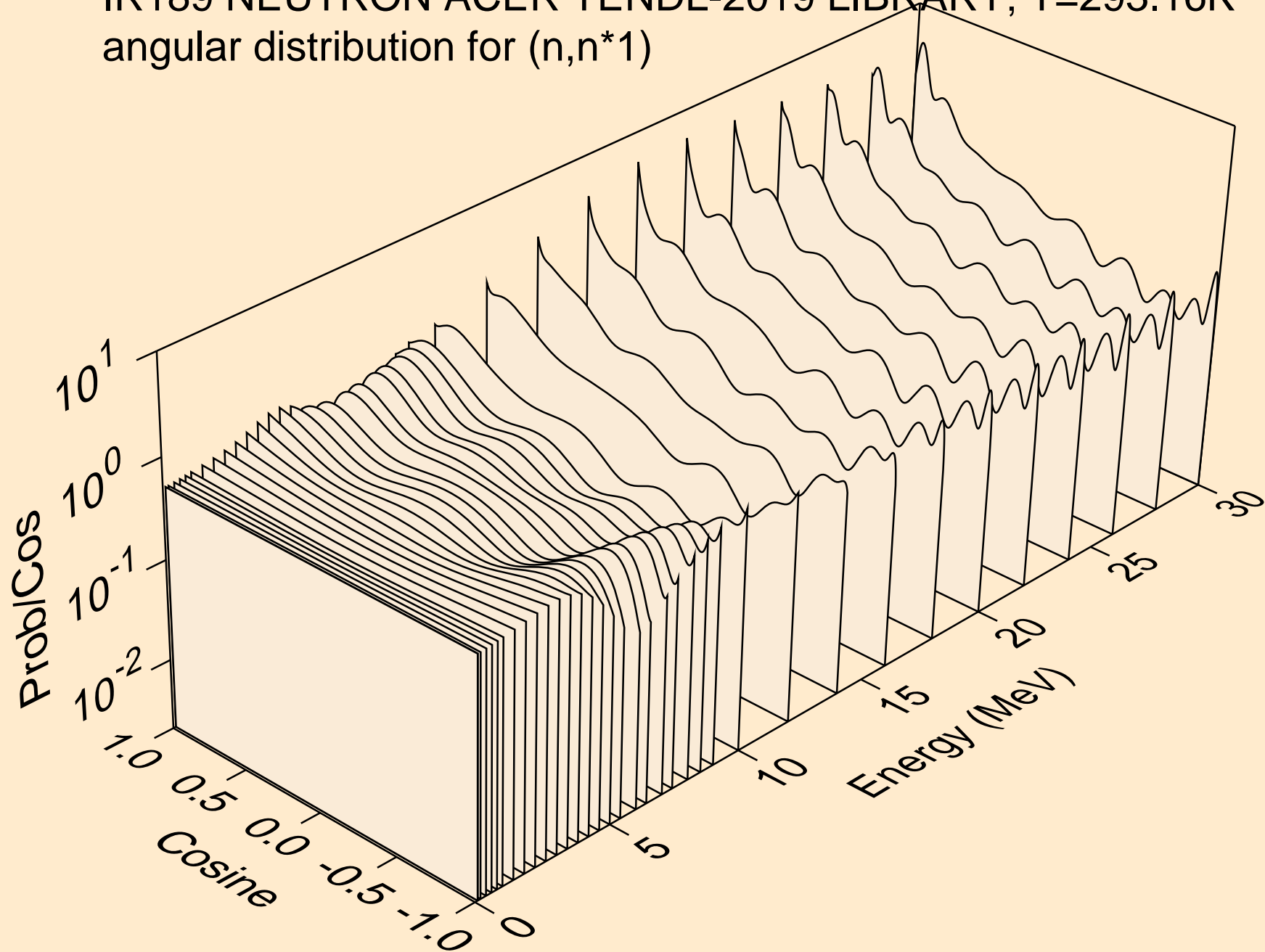

IR189 NEUTRON ACER TENDL-2019 LIBRARY; T=293.16K  
angular distribution for (n,n\*2)

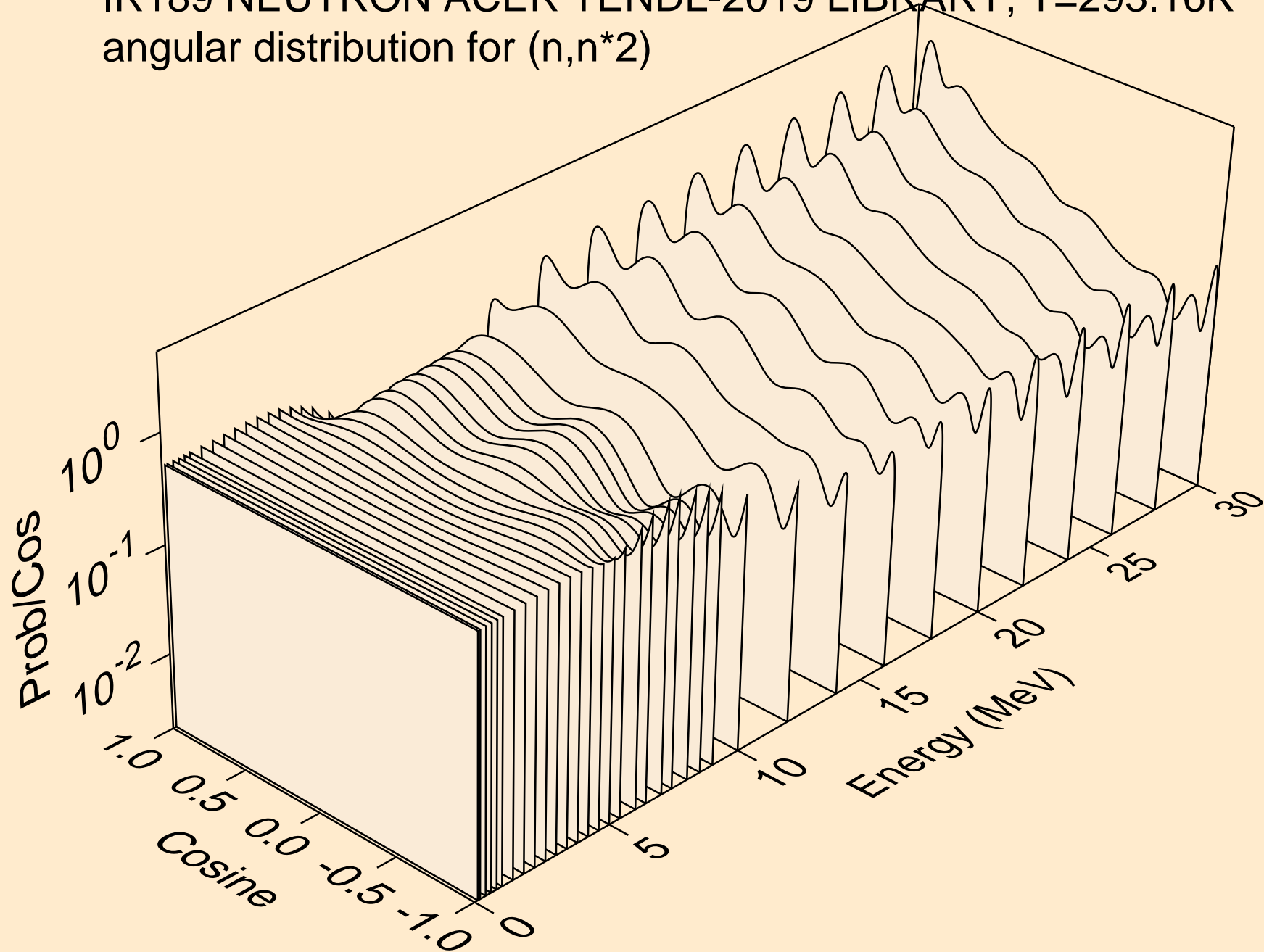

IR189 NEUTRON ACER TENDL-2019 LIBRARY; T=293.16K  
angular distribution for (n,n\*3)

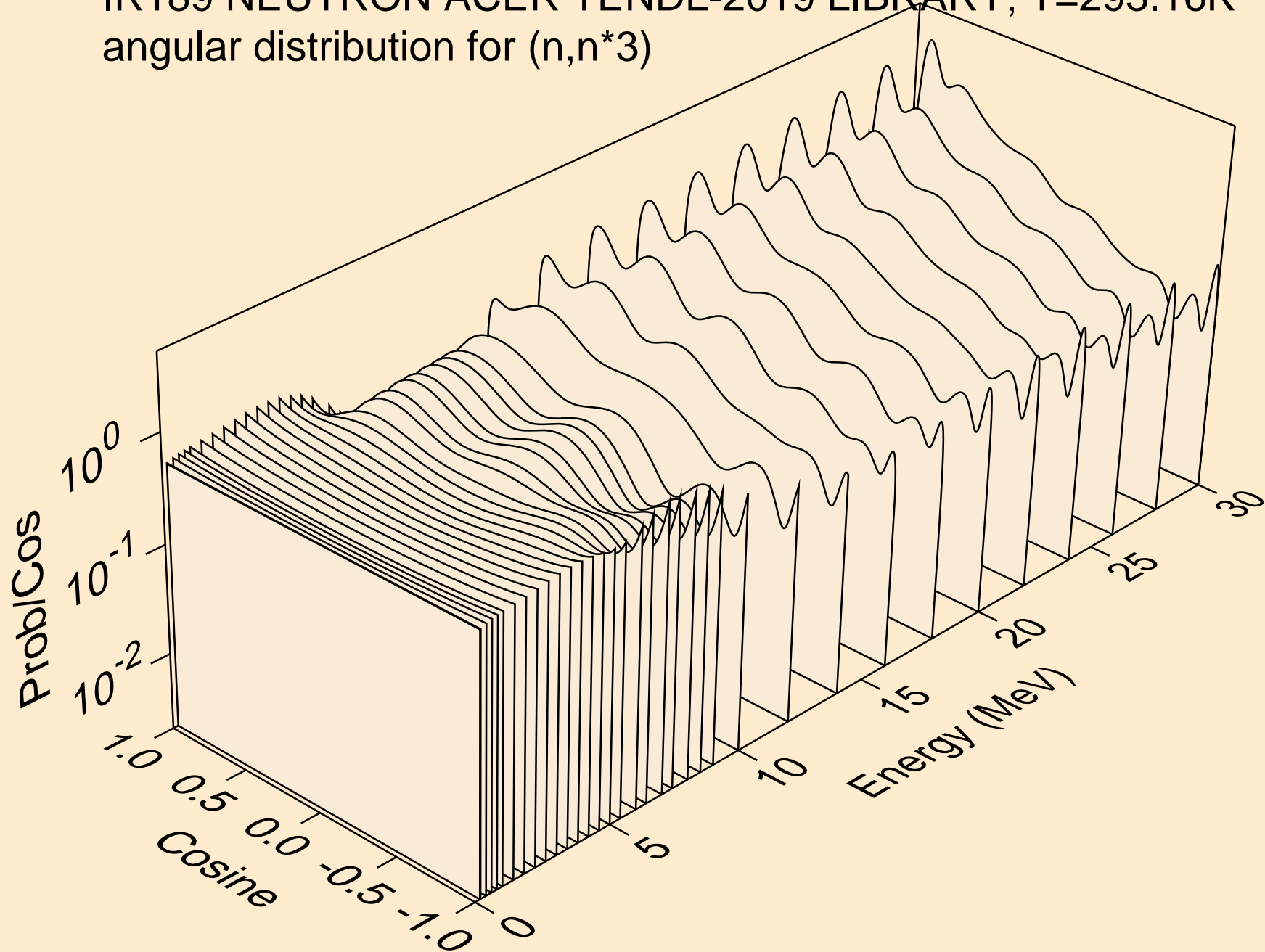



IR189 NEUTRON ACER TENDL-2019 LIBRARY; T=293.16K  
angular distribution for (n,n\*4)

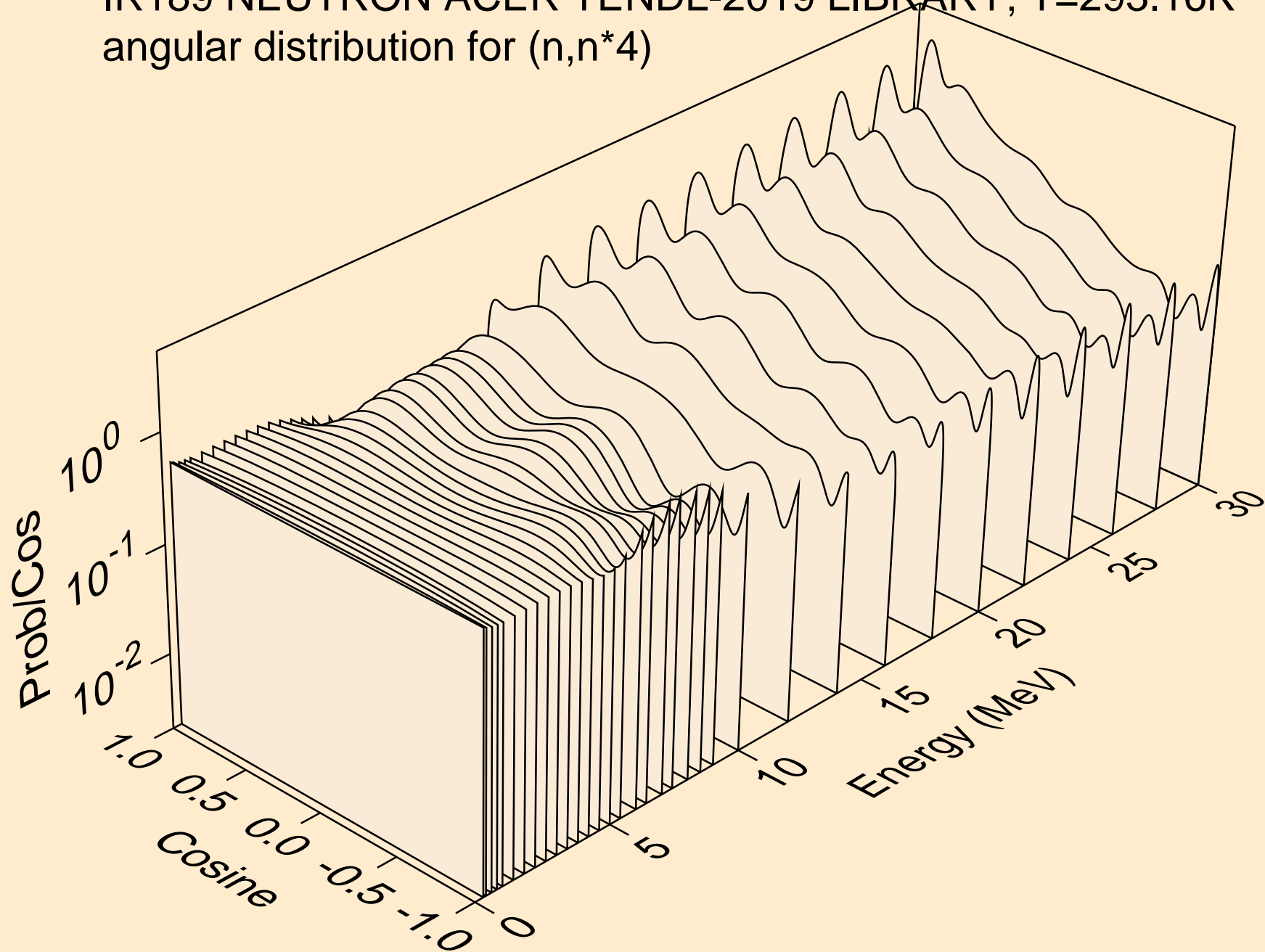

IR189 NEUTRON ACER TENDL-2019 LIBRARY; T=293.16K  
angular distribution for (n,n\*5)

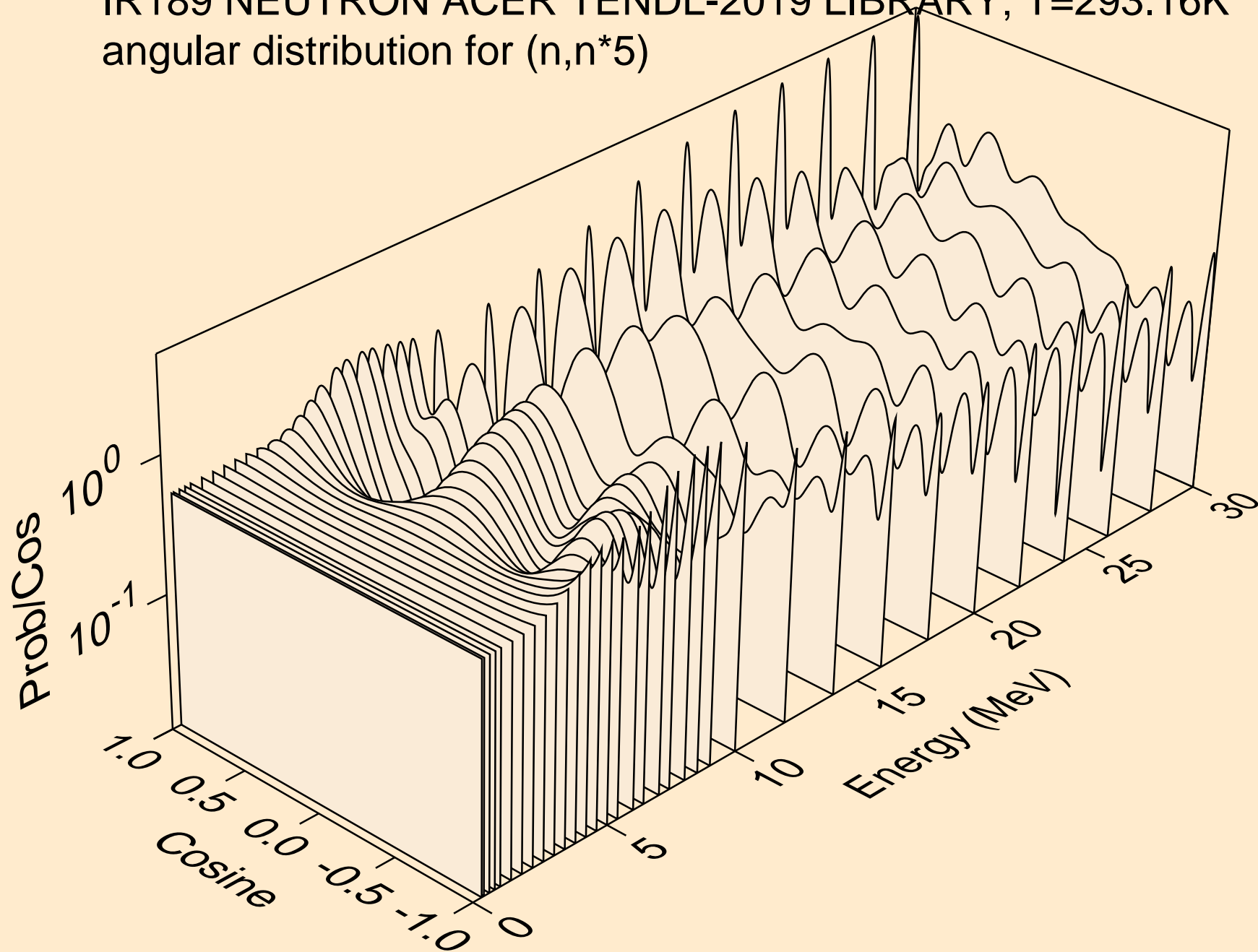

IR189 NEUTRON ACER TENDL-2019 LIBRARY; T=293.16K  
angular distribution for (n,n\*6)

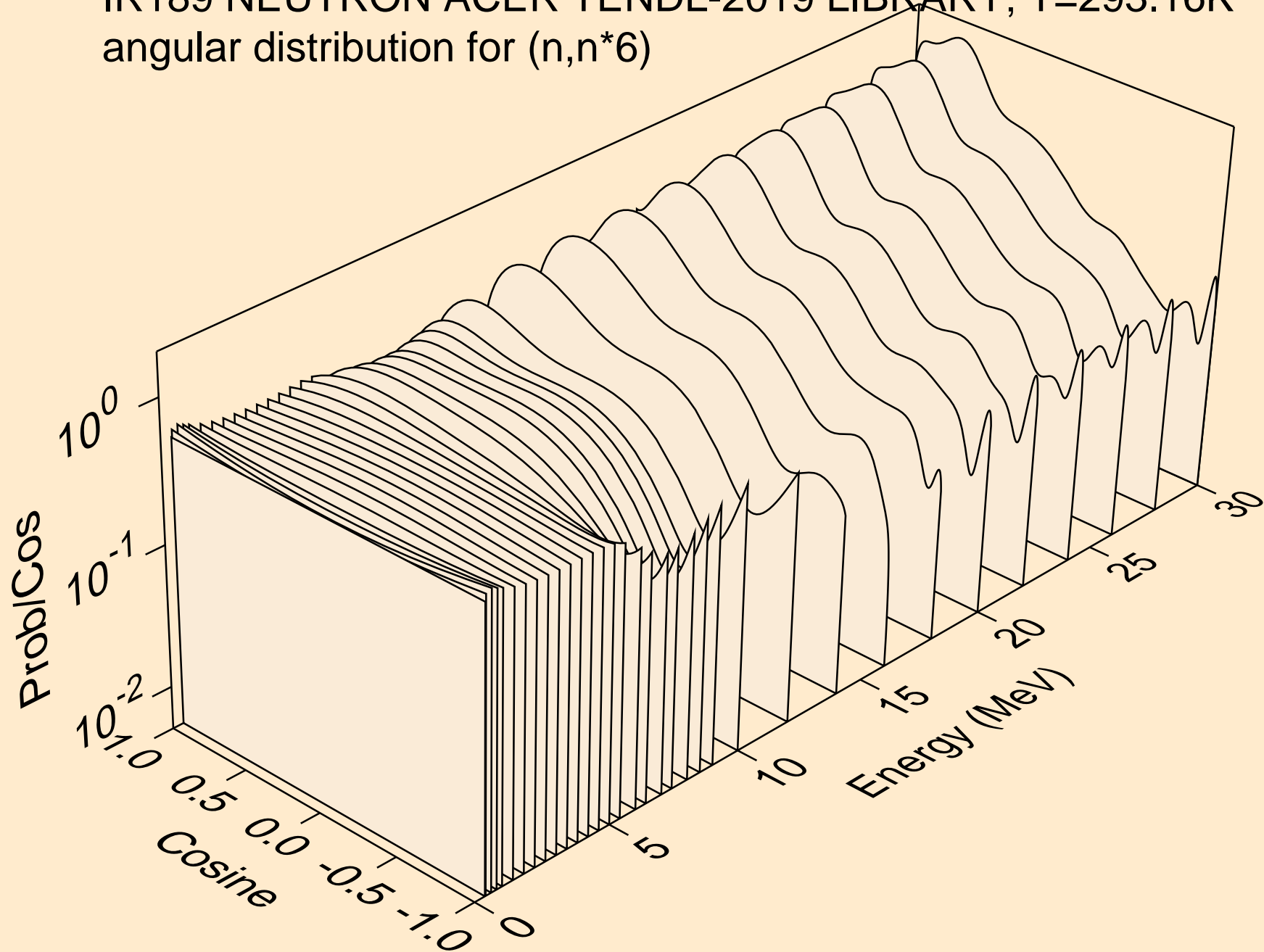

IR189 NEUTRON ACER TENDL-2019 LIBRARY; T=293.16K  
angular distribution for (n,n\*7)

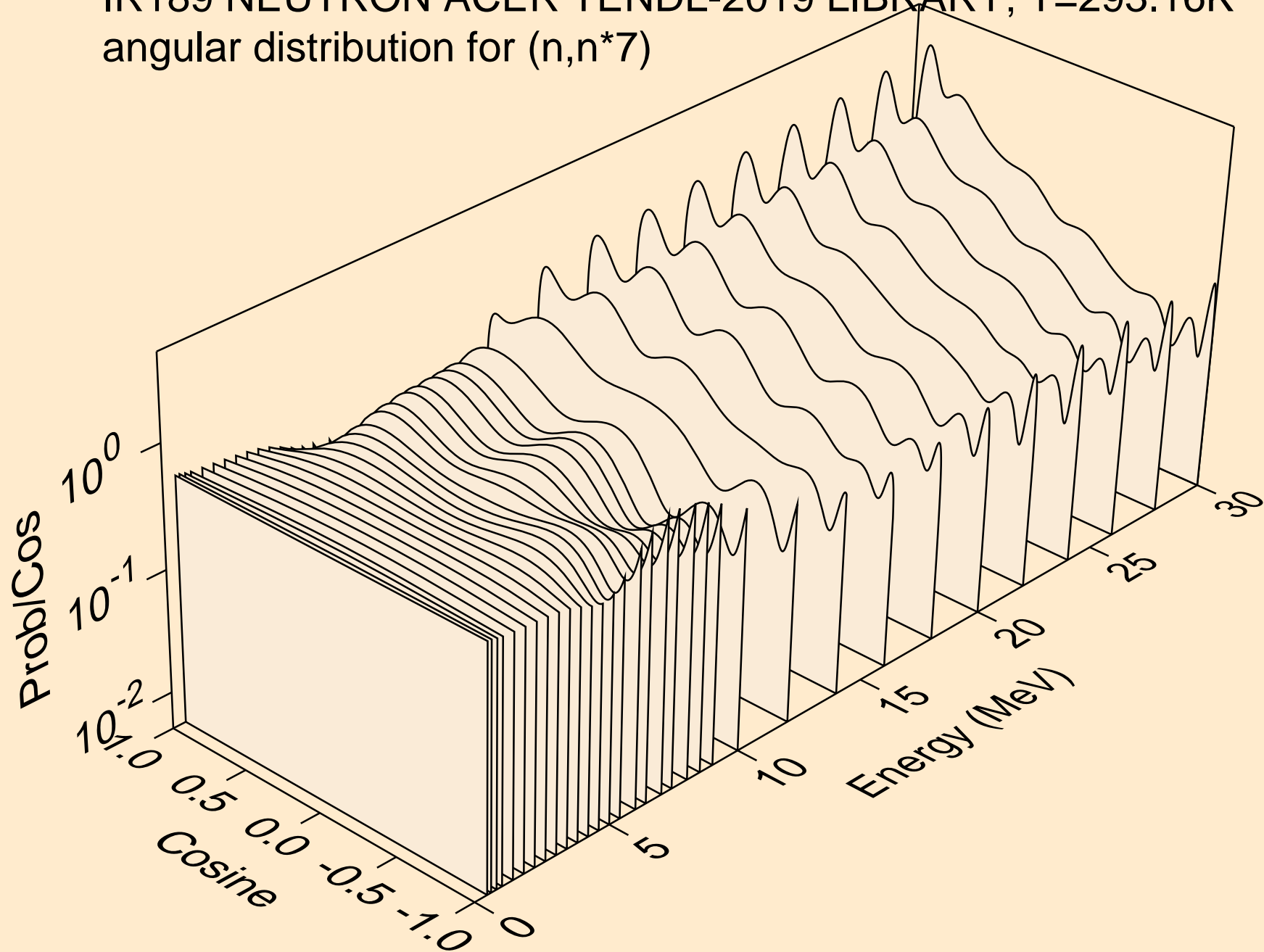

IR189 NEUTRON ACER TENDL-2019 LIBRARY; T=293.16K  
angular distribution for (n,n\*8)

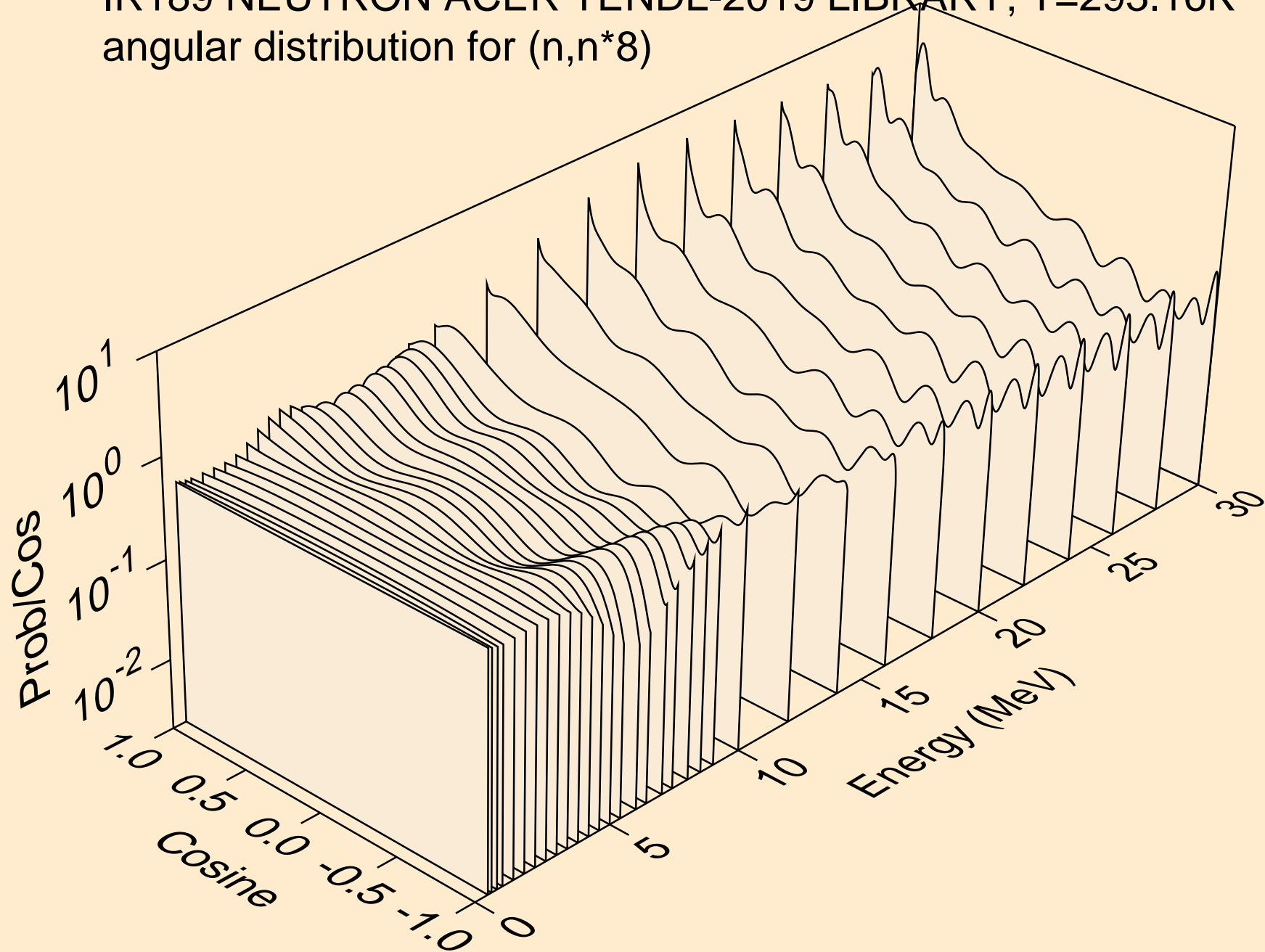

IR189 NEUTRON ACER TENDL-2019 LIBRARY; T=293.16K  
angular distribution for (n,n\*9)

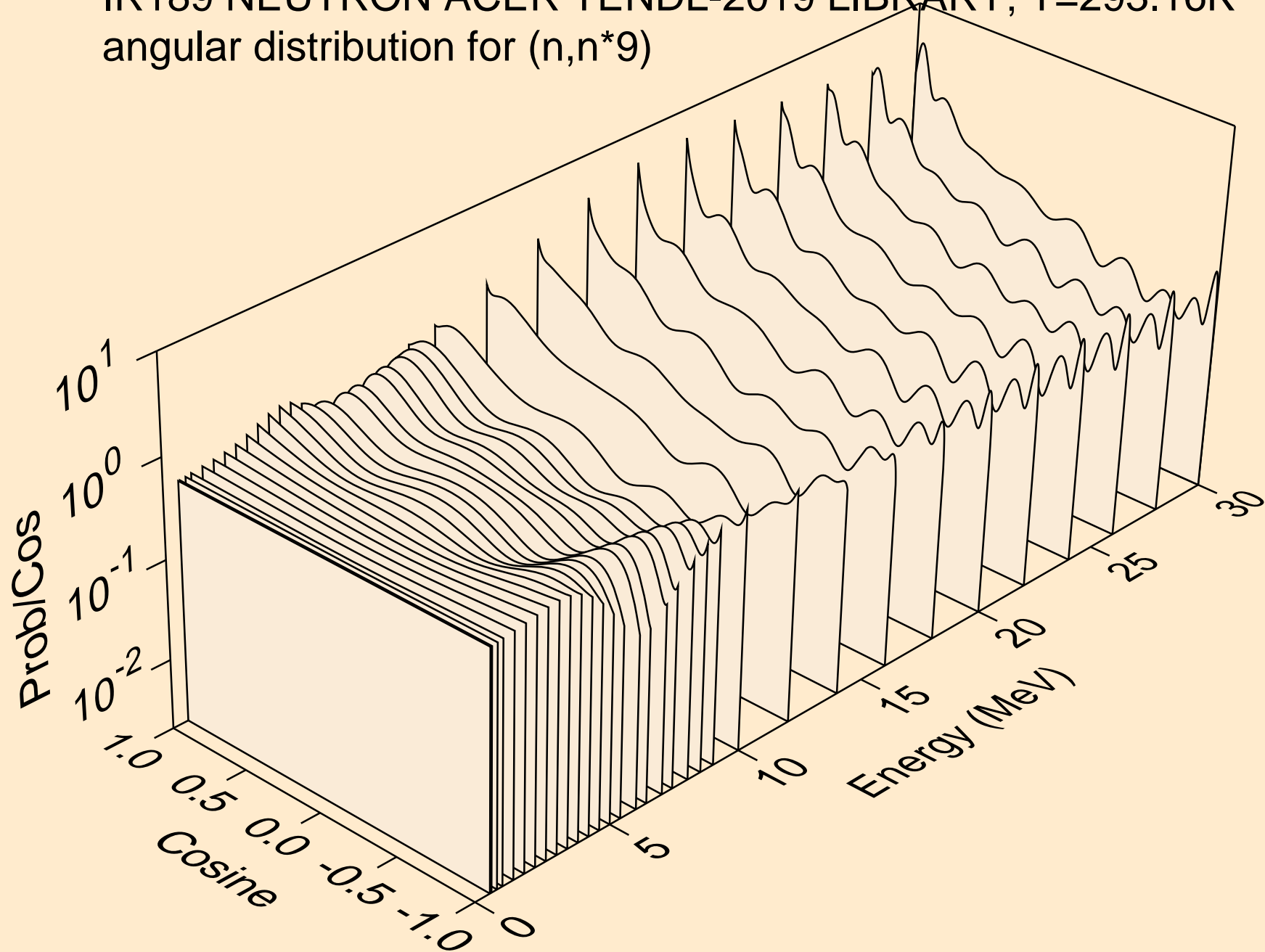

IR189 NEUTRON ACER TENDL-2019 LIBRARY; T=293.16K  
angular distribution for (n,n\*10)

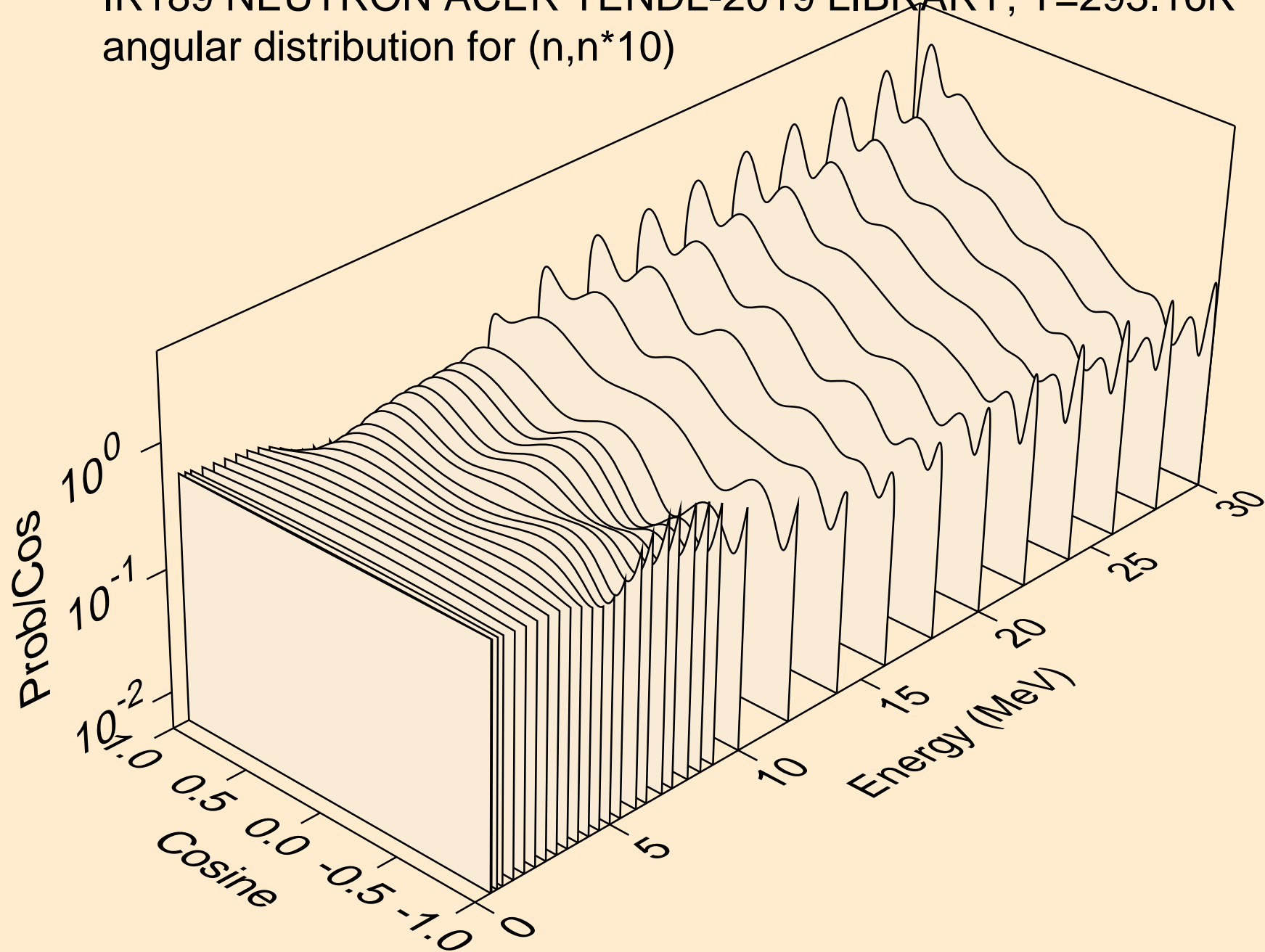

IR189 NEUTRON ACER TENDL-2019 LIBRARY; T=293.16K  
angular distribution for (n,n\*11)

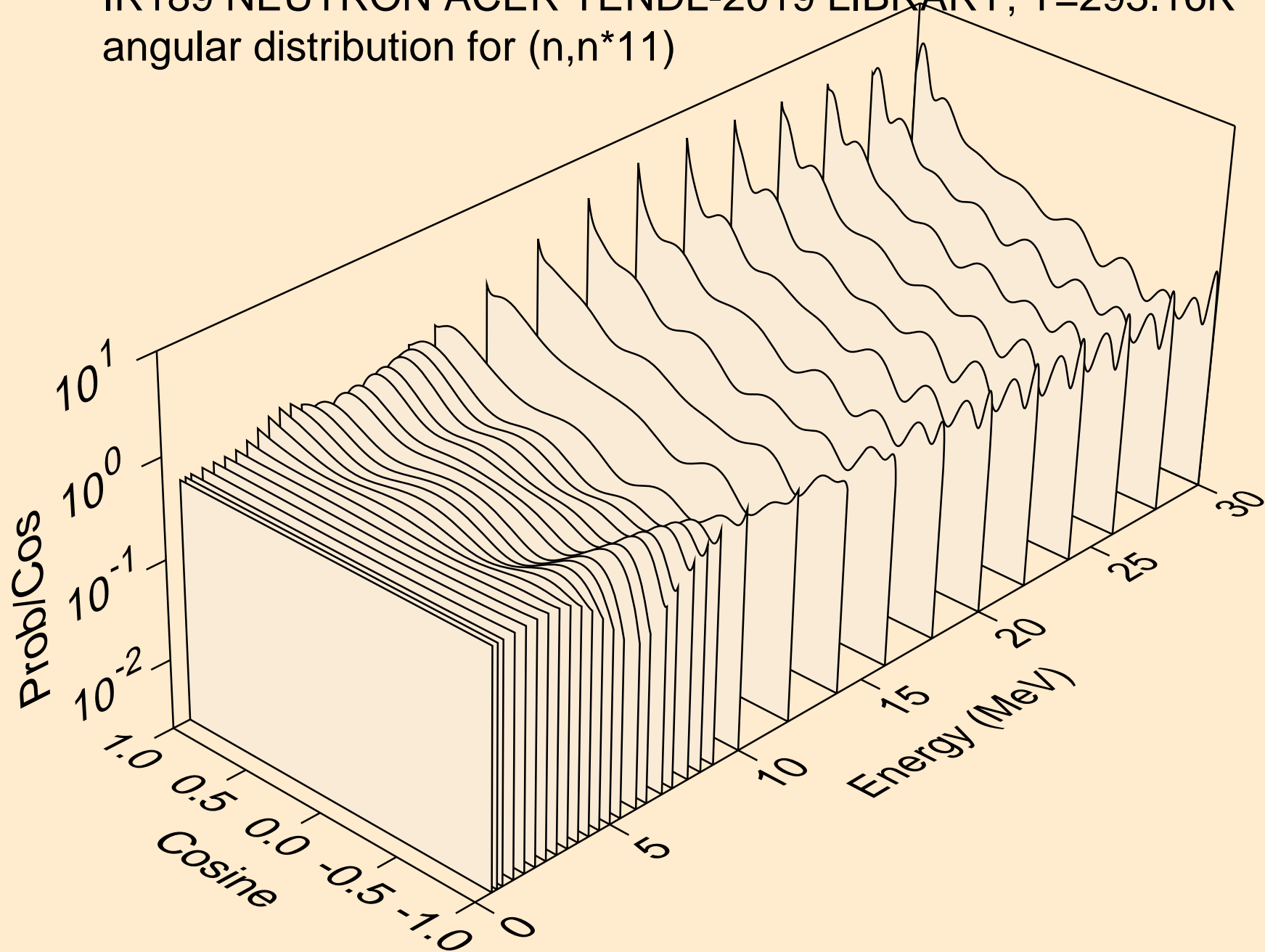



IR189 NEUTRON ACER TENDL-2019 LIBRARY; T=293.16K  
angular distribution for (n,n\*12)

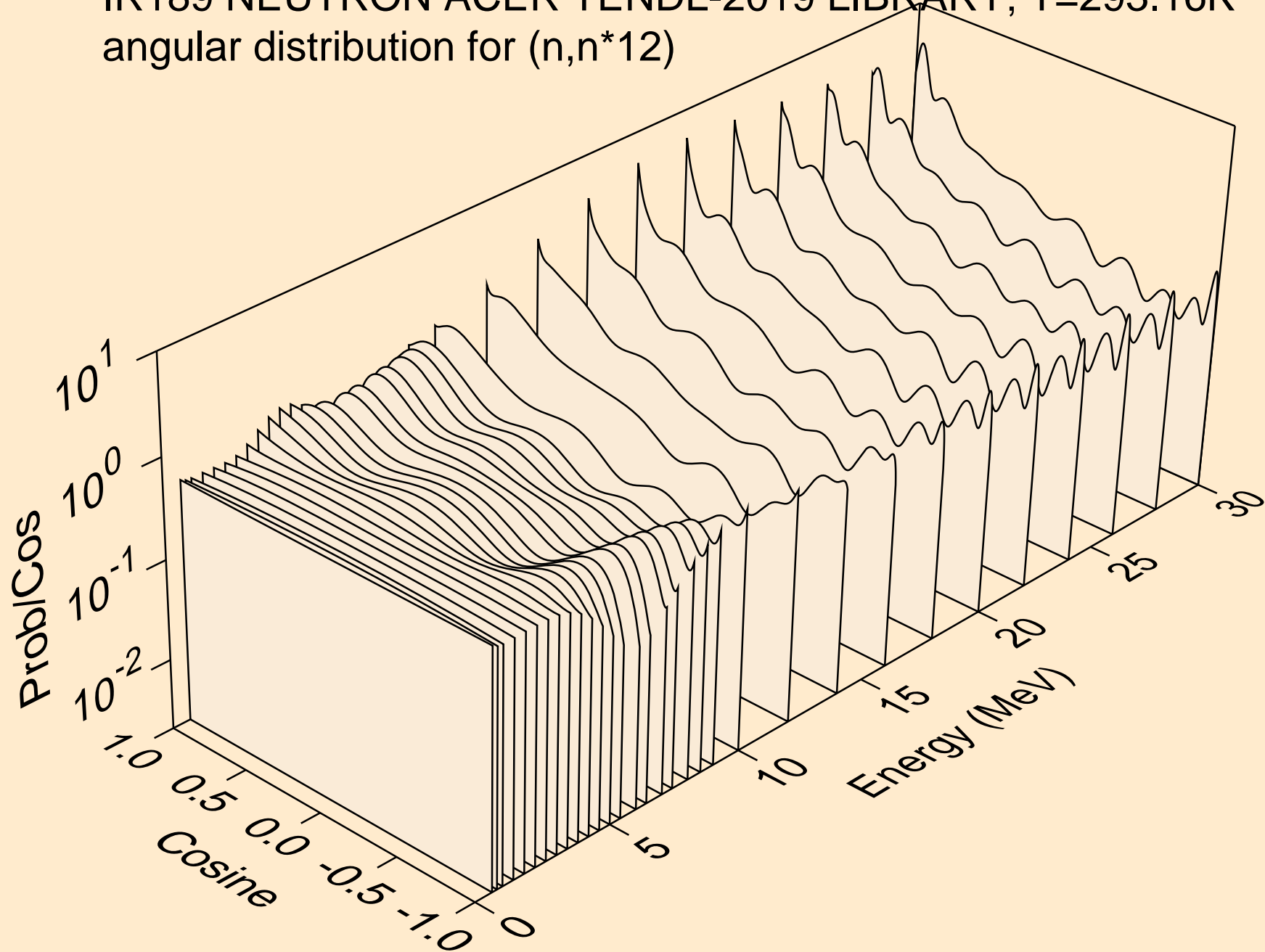

IR189 NEUTRON ACER TENDL-2019 LIBRARY; T=293.16K  
angular distribution for (n,n\*13)

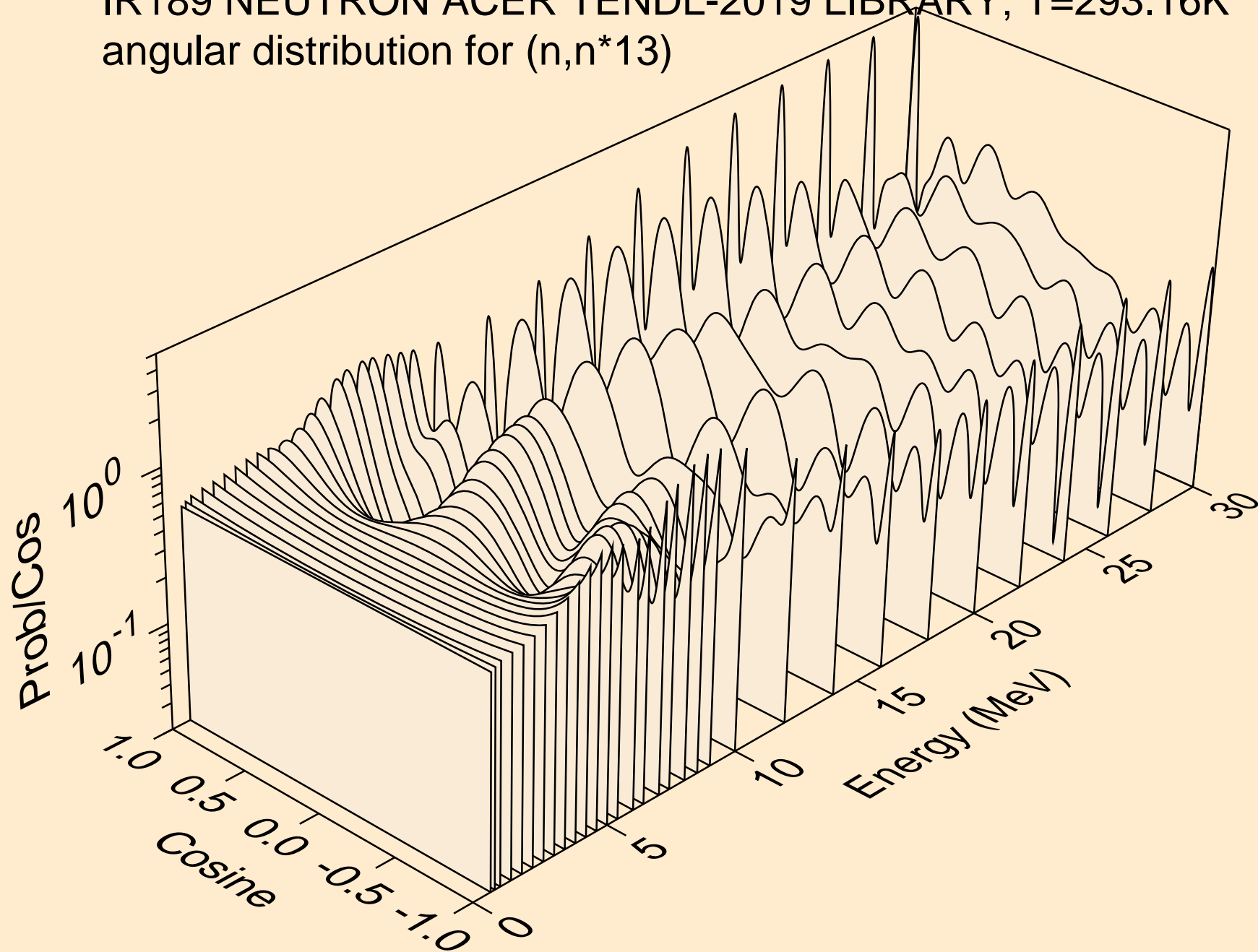

IR189 NEUTRON ACER TENDL-2019 LIBRARY; T=293.16K  
angular distribution for (n,n\*14)

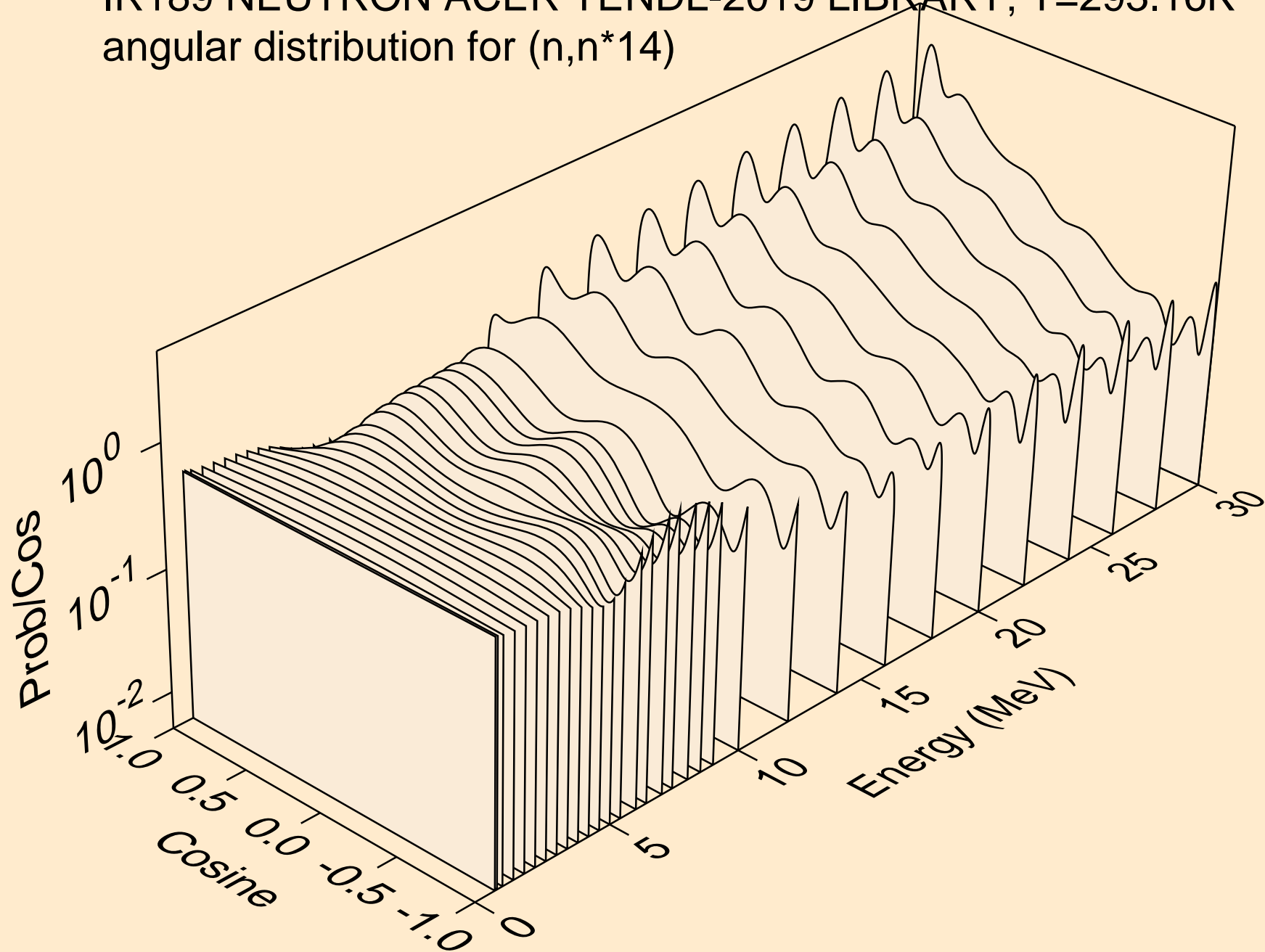

IR189 NEUTRON ACER TENDL-2019 LIBRARY; T=293.16K  
angular distribution for (n,n\*15)

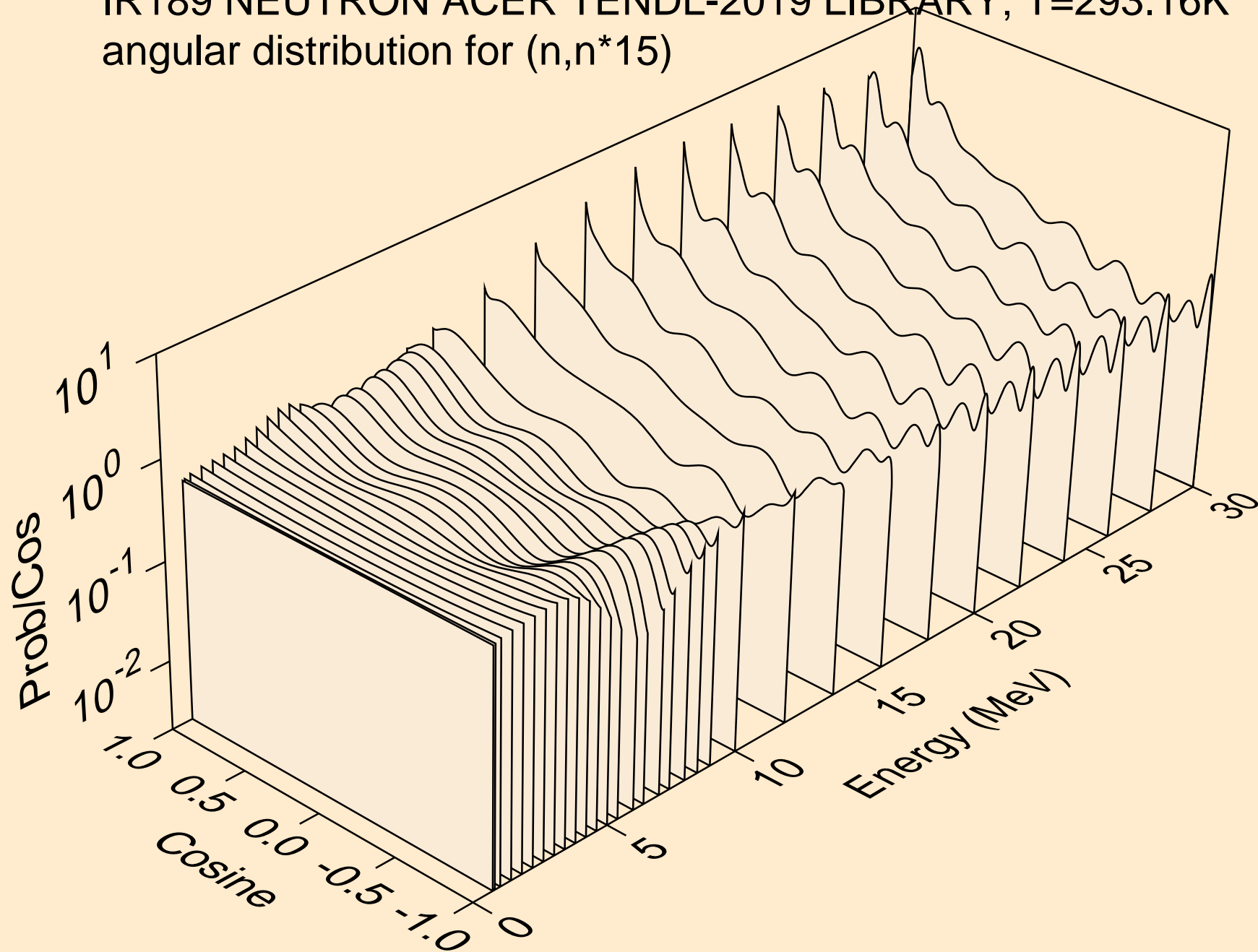

IR189 NEUTRON ACER TENDL-2019 LIBRARY; T=293.16K  
angular distribution for (n,n\*16)

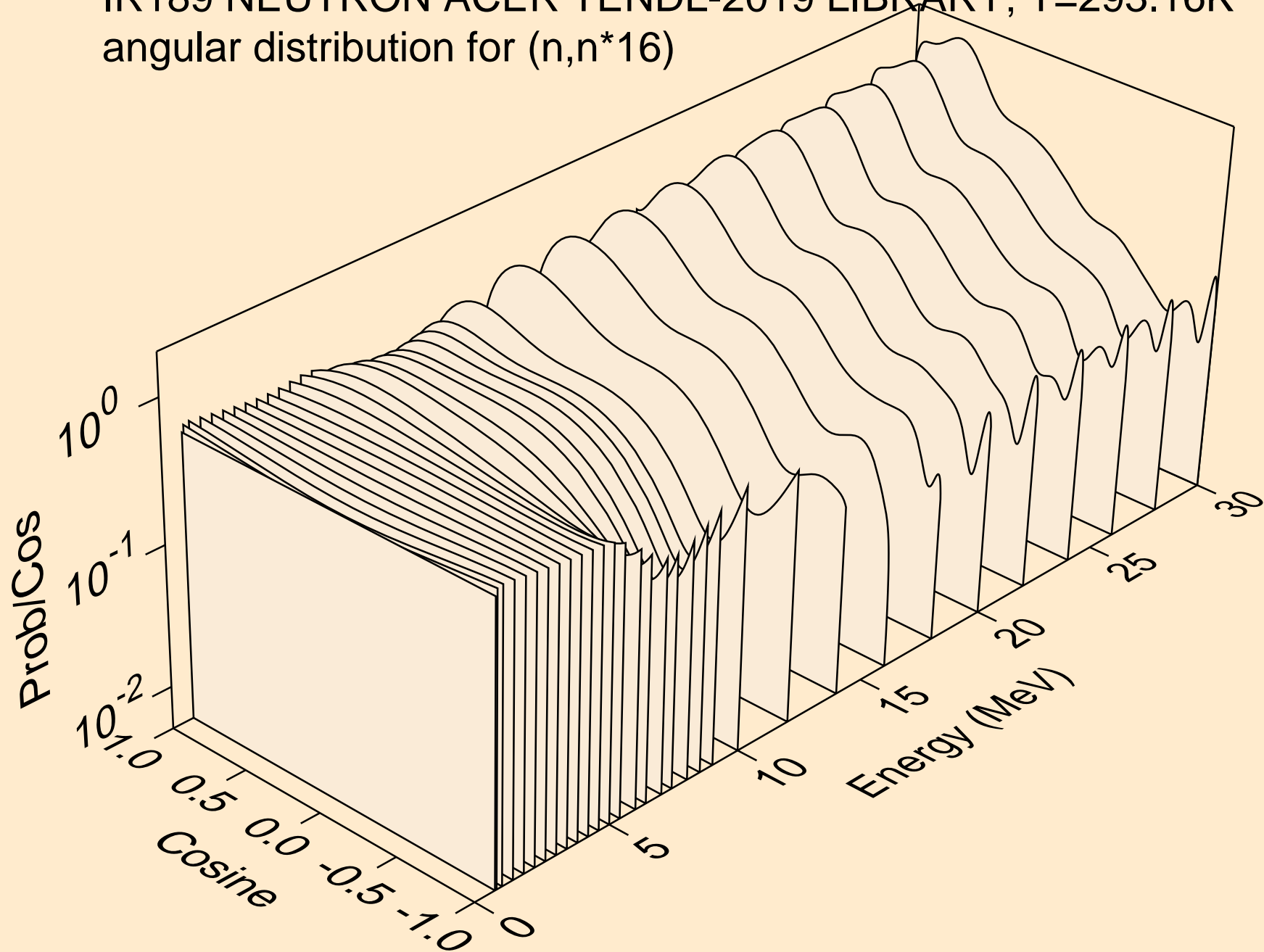

IR189 NEUTRON ACER TENDL-2019 LIBRARY; T=293.16K  
angular distribution for (n,n\*17)

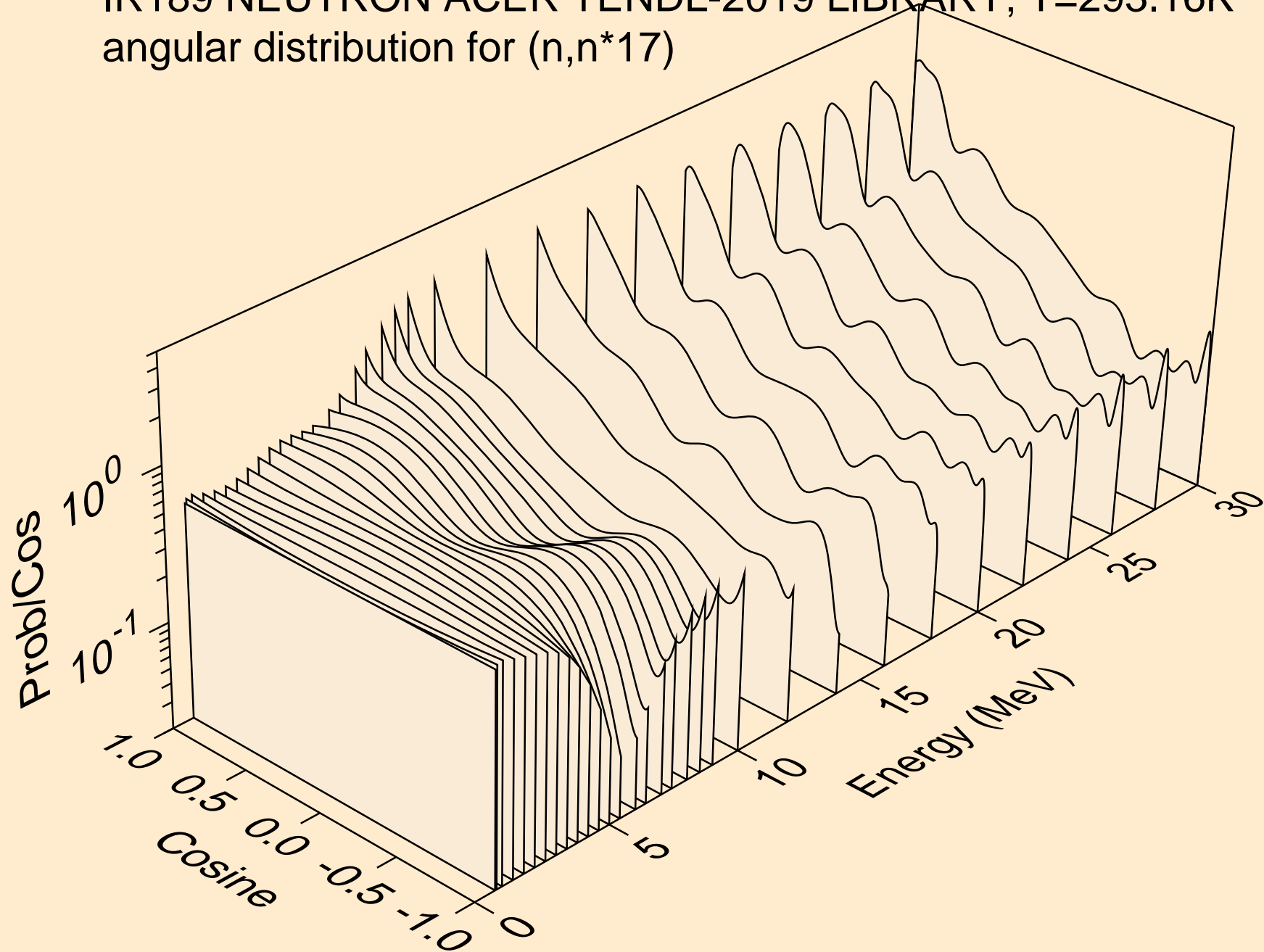

IR189 NEUTRON ACER TENDL-2019 LIBRARY; T=293.16K  
angular distribution for (n,n\*18)

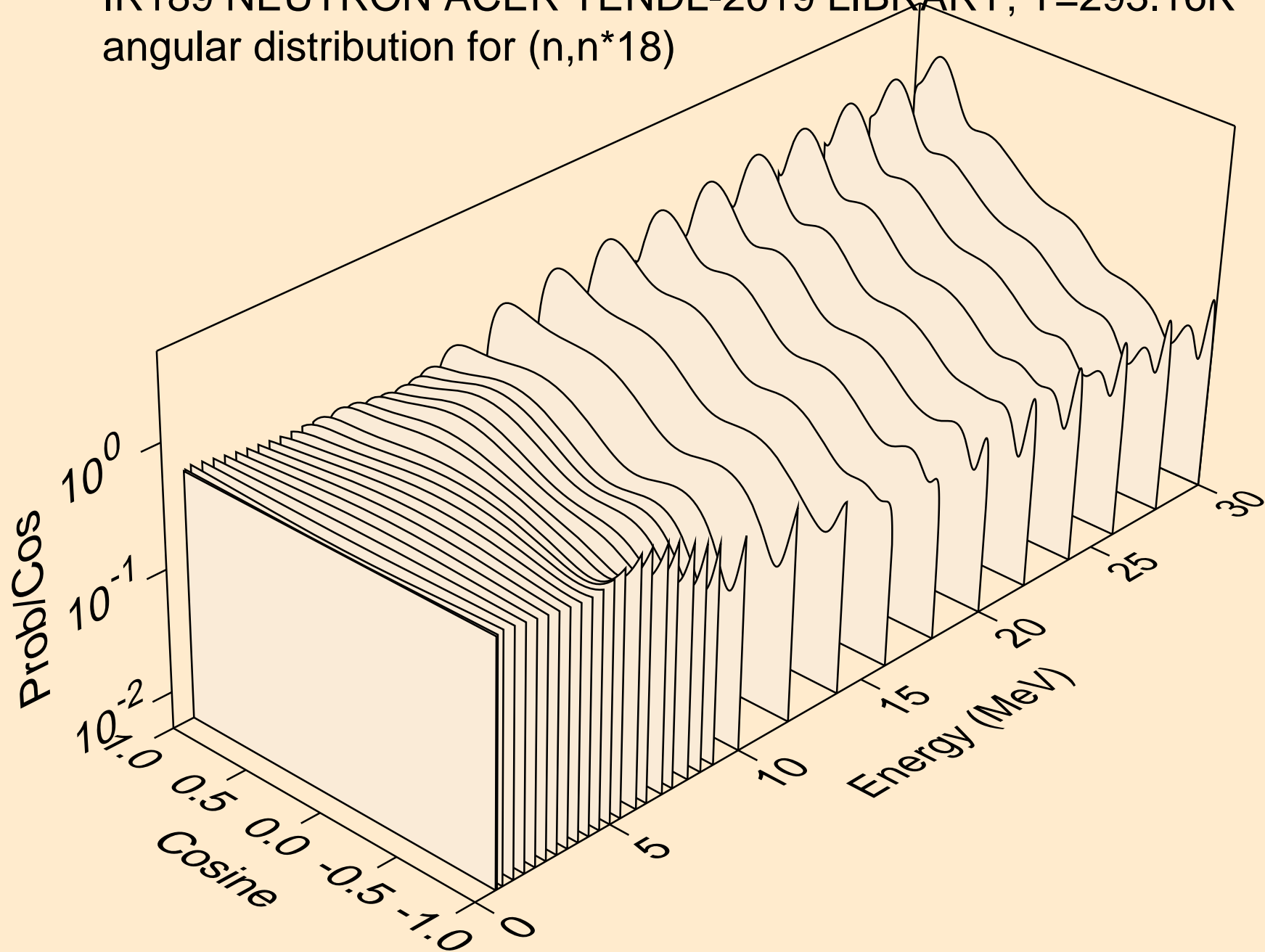

IR189 NEUTRON ACER TENDL-2019 LIBRARY; T=293.16K  
angular distribution for (n,n\*19)

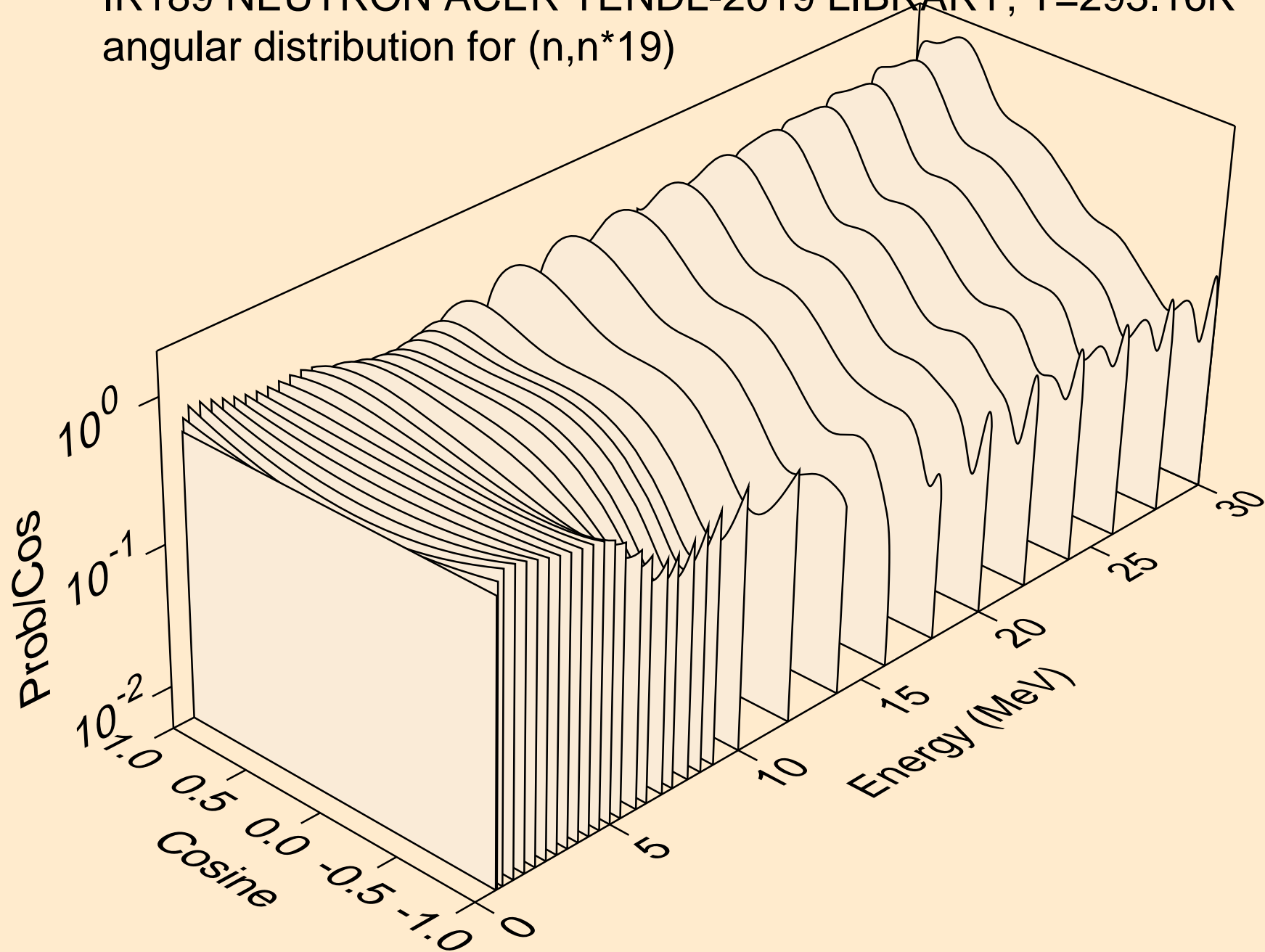



IR189 NEUTRON ACER TENDL-2019 LIBRARY; T=293.16K  
angular distribution for (n,n\*20)

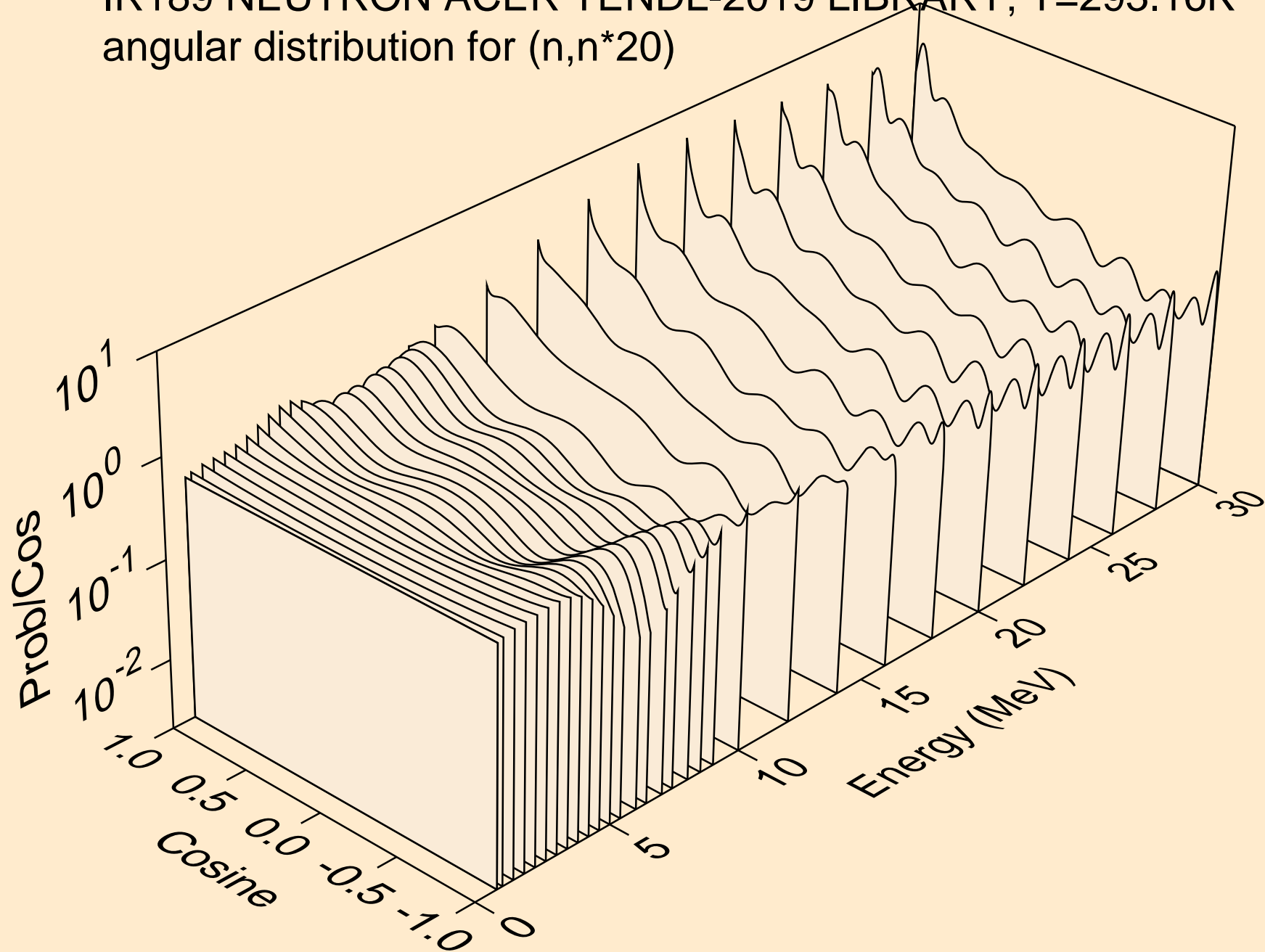

IR189 NEUTRON ACER TENDL-2019 LIBRARY; T=293.16K  
angular distribution for (n,n\*21)

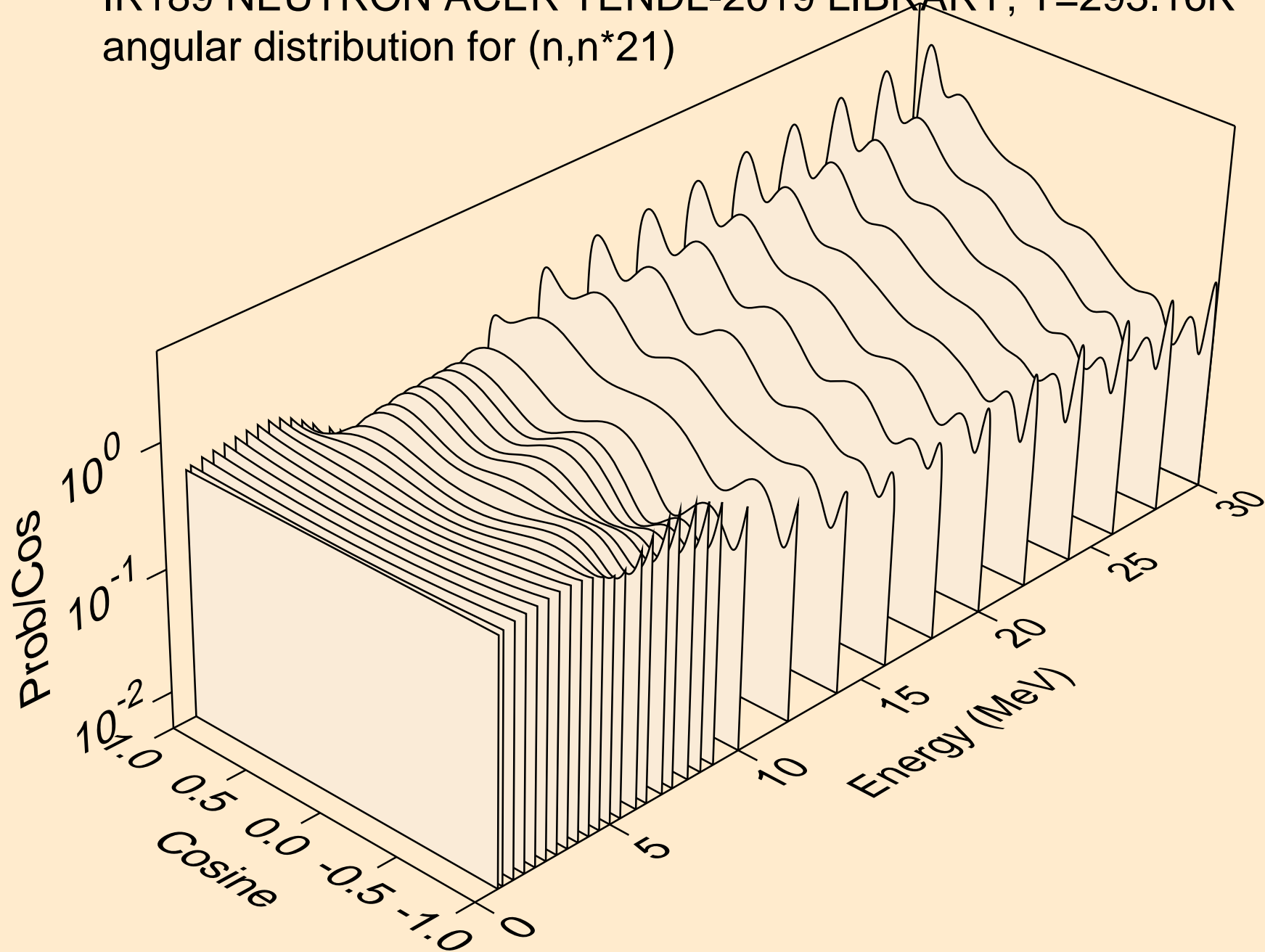

IR189 NEUTRON ACER TENDL-2019 LIBRARY; T=293.16K  
angular distribution for (n,n\*22)

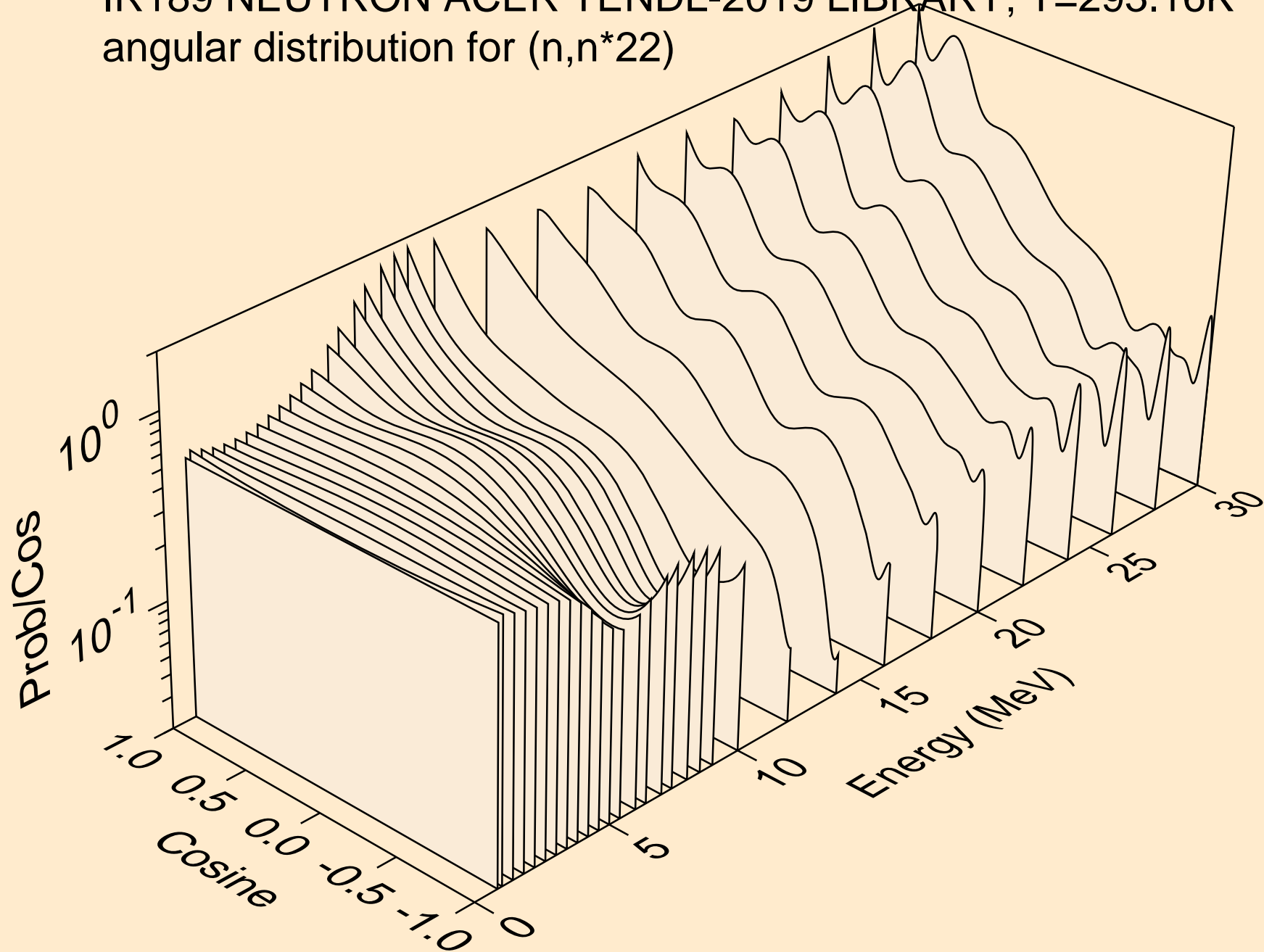

IR189 NEUTRON ACER TENDL-2019 LIBRARY; T=293.16K  
angular distribution for (n,n\*23)

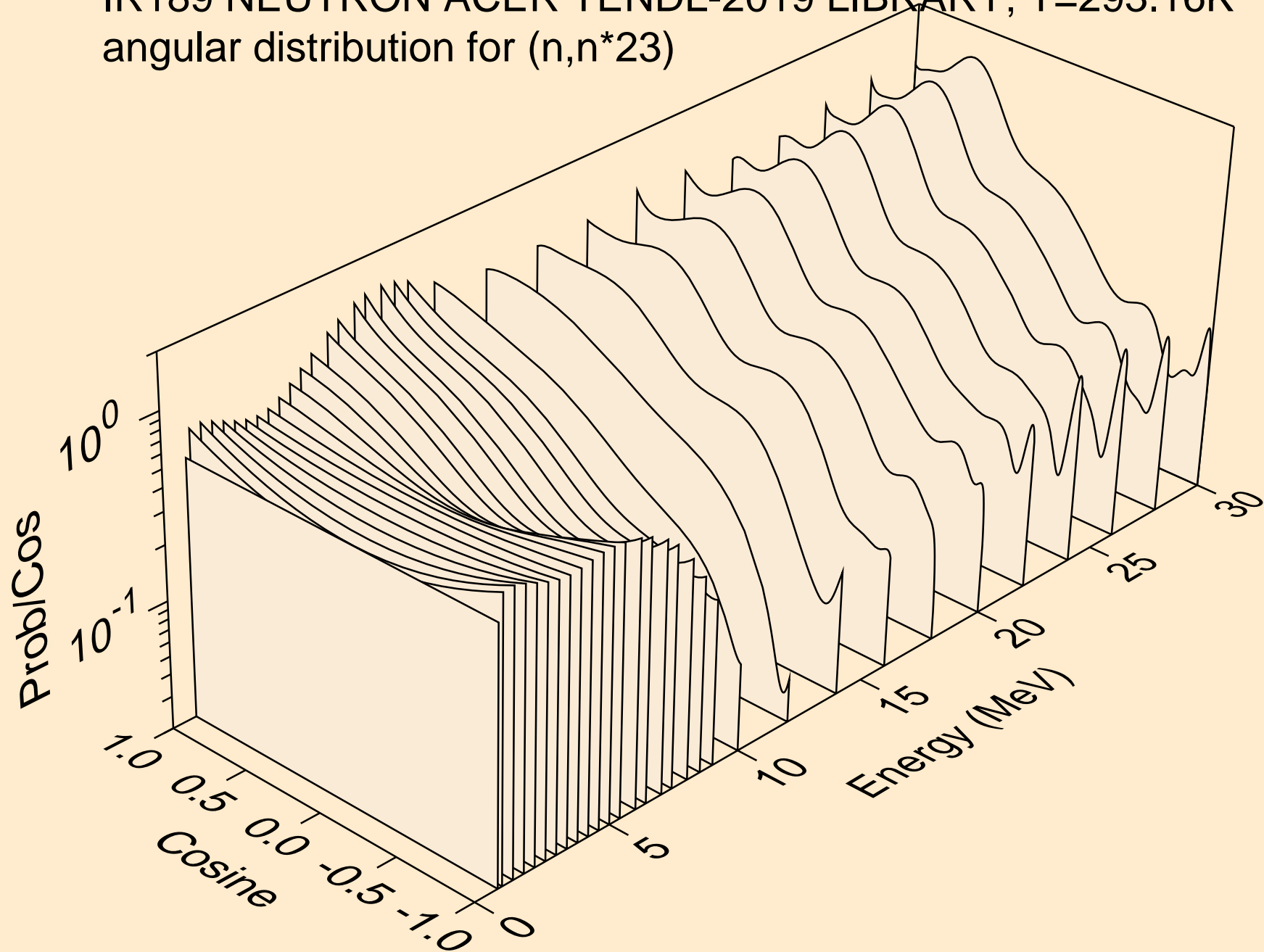

IR189 NEUTRON ACER TENDL-2019 LIBRARY; T=293.16K  
angular distribution for (n,n\*24)

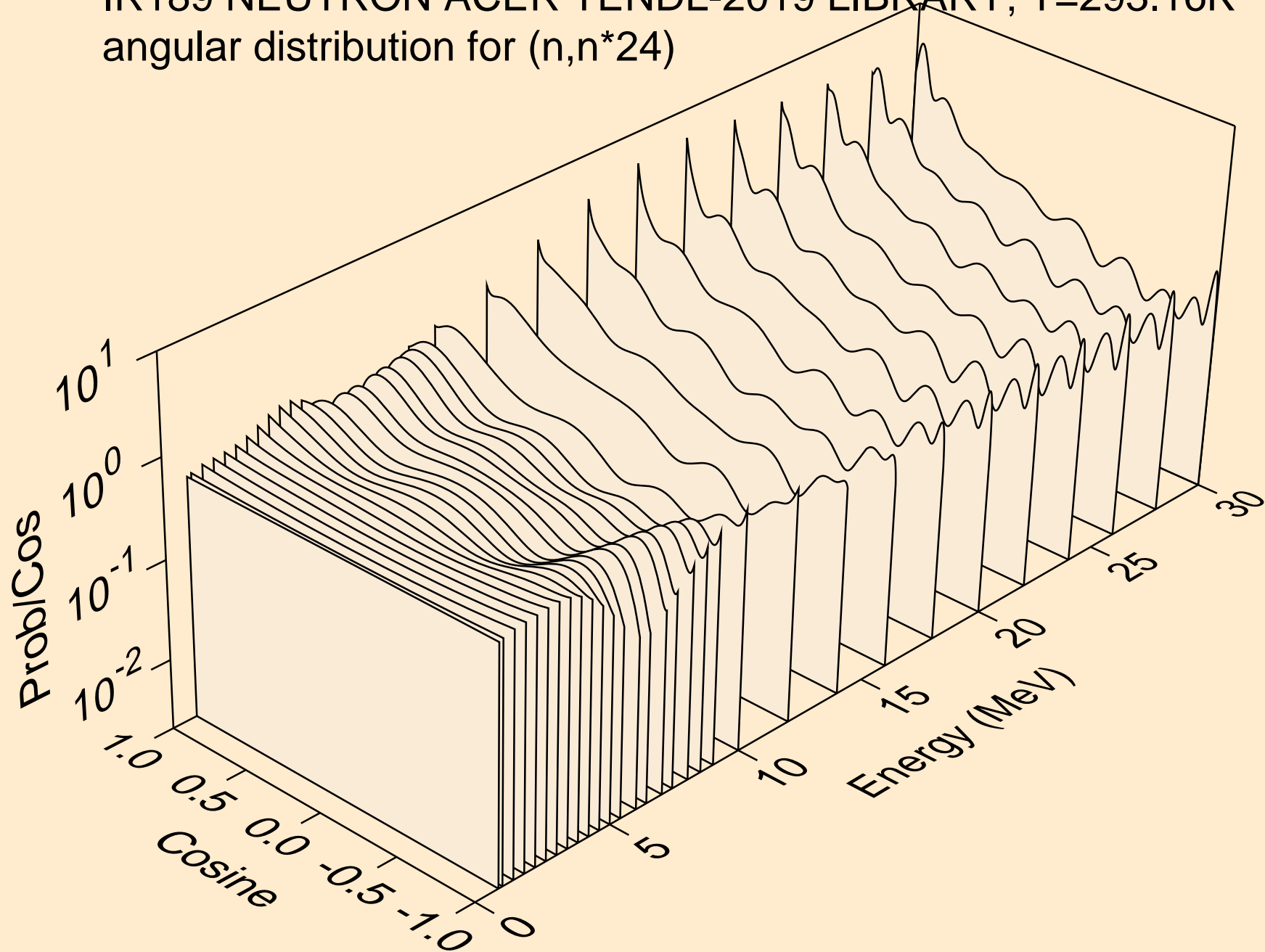

IR189 NEUTRON ACER TENDL-2019 LIBRARY; T=293.16K  
angular distribution for (n,n\*25)

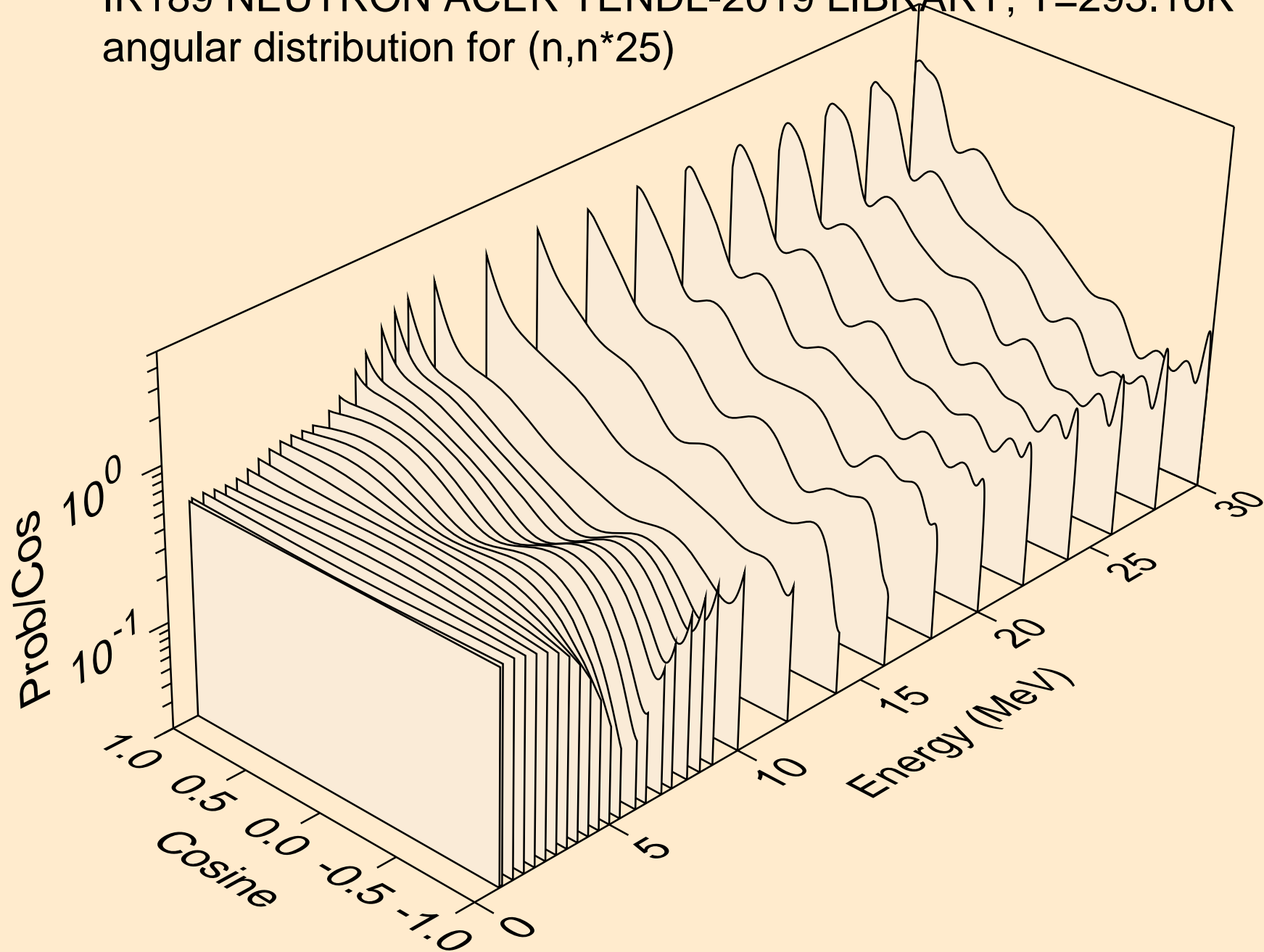

IR189 NEUTRON ACER TENDL-2019 LIBRARY; T=293.16K  
angular distribution for (n,n\*26)

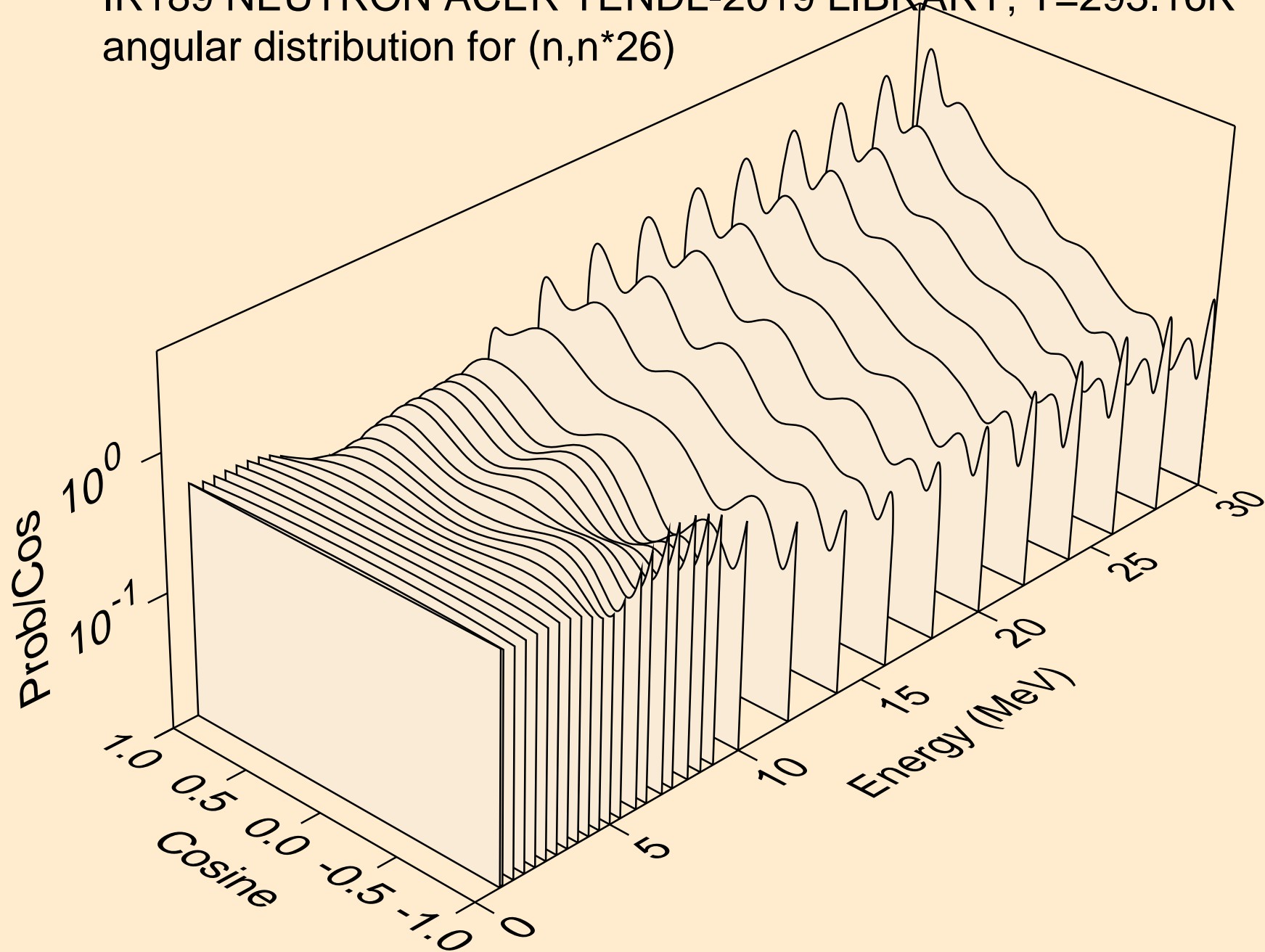

IR189 NEUTRON ACER TENDL-2019 LIBRARY; T=293.16K  
angular distribution for (n,n\*27)

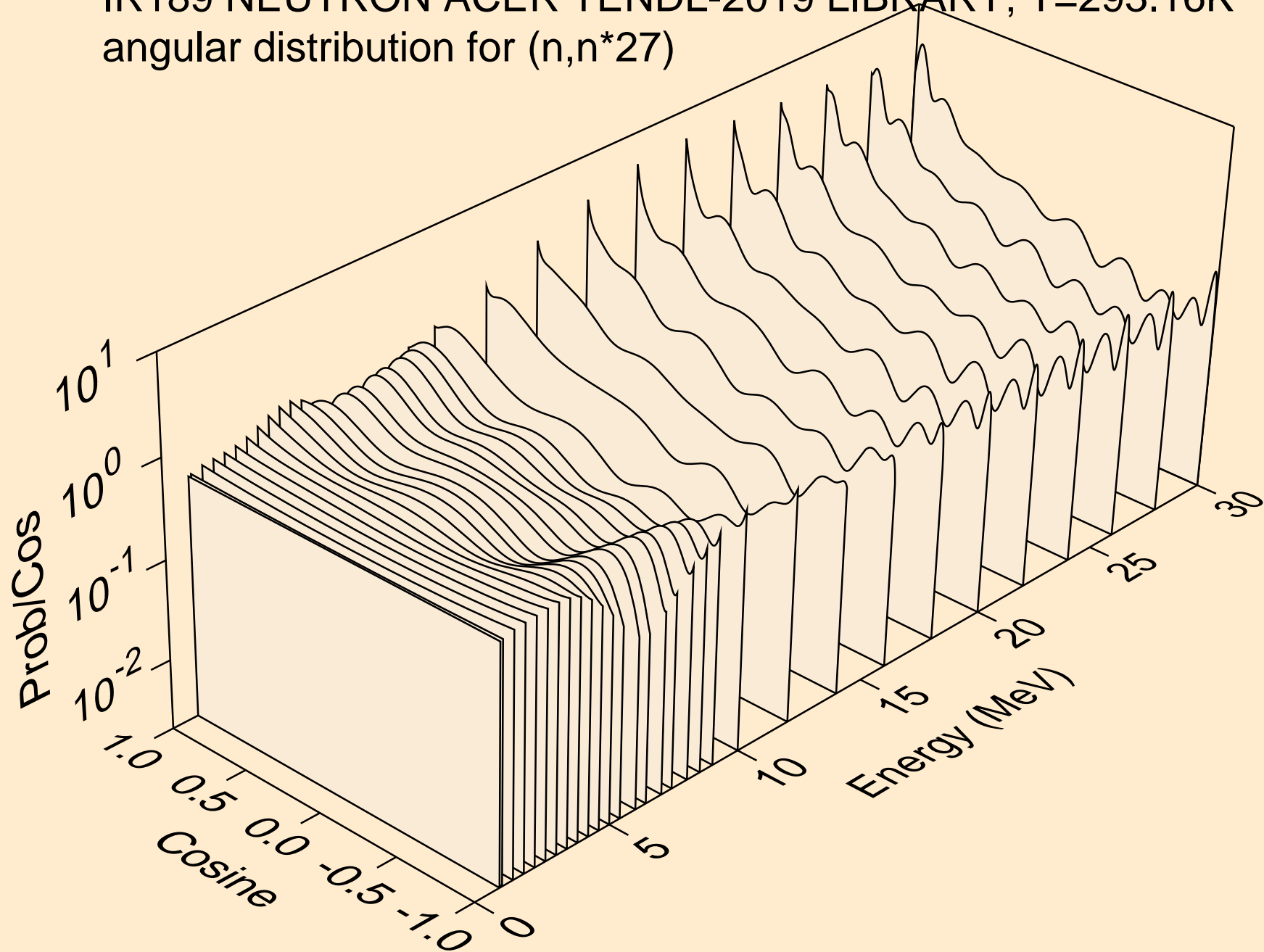



IR189 NEUTRON ACER TENDL-2019 LIBRARY; T=293.16K  
angular distribution for (n,n\*28)

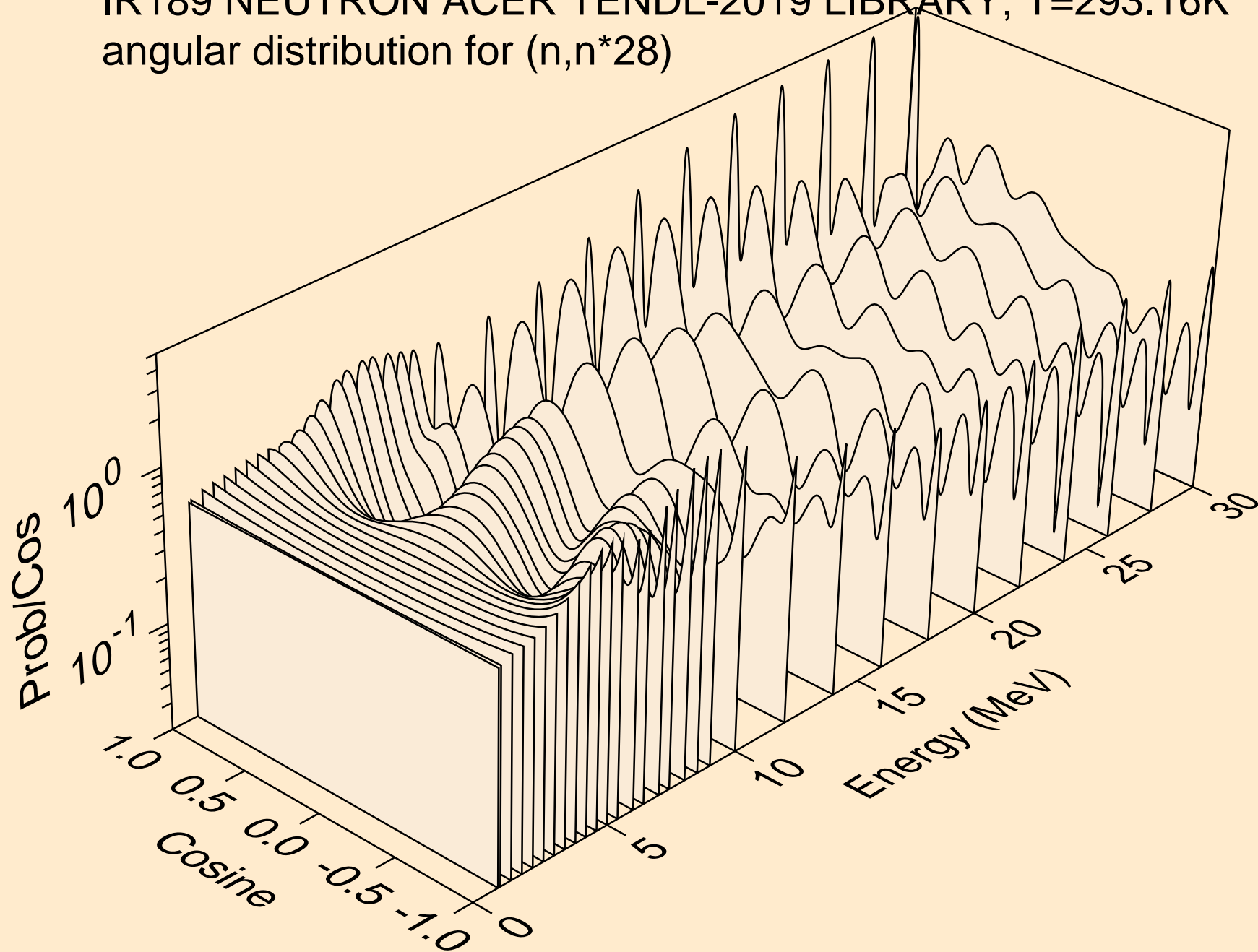

IR189 NEUTRON ACER TENDL-2019 LIBRARY; T=293.16K  
angular distribution for (n,n\*29)

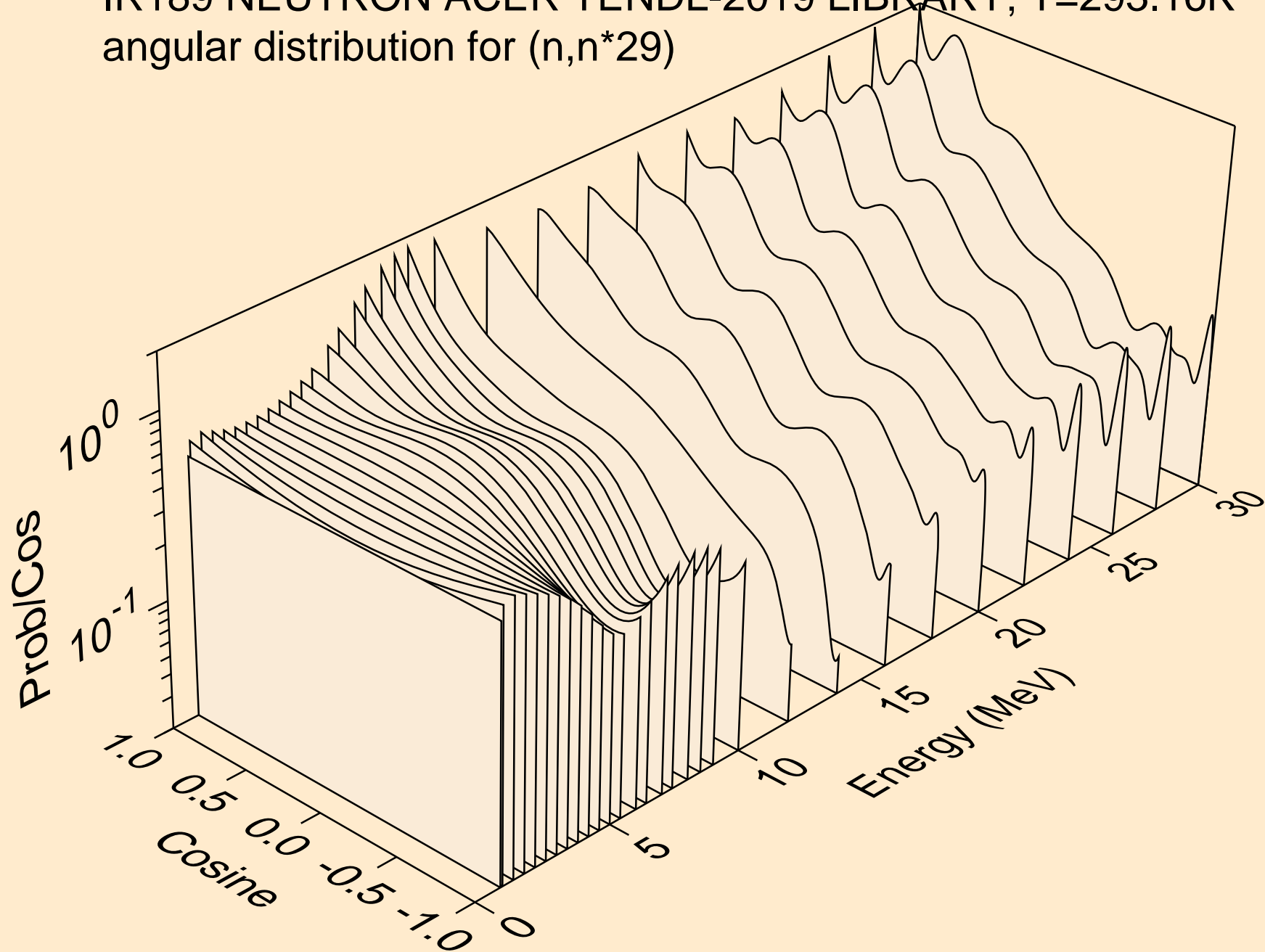

IR189 NEUTRON ACER TENDL-2019 LIBRARY; T=293.16K  
angular distribution for (n,n\*30)

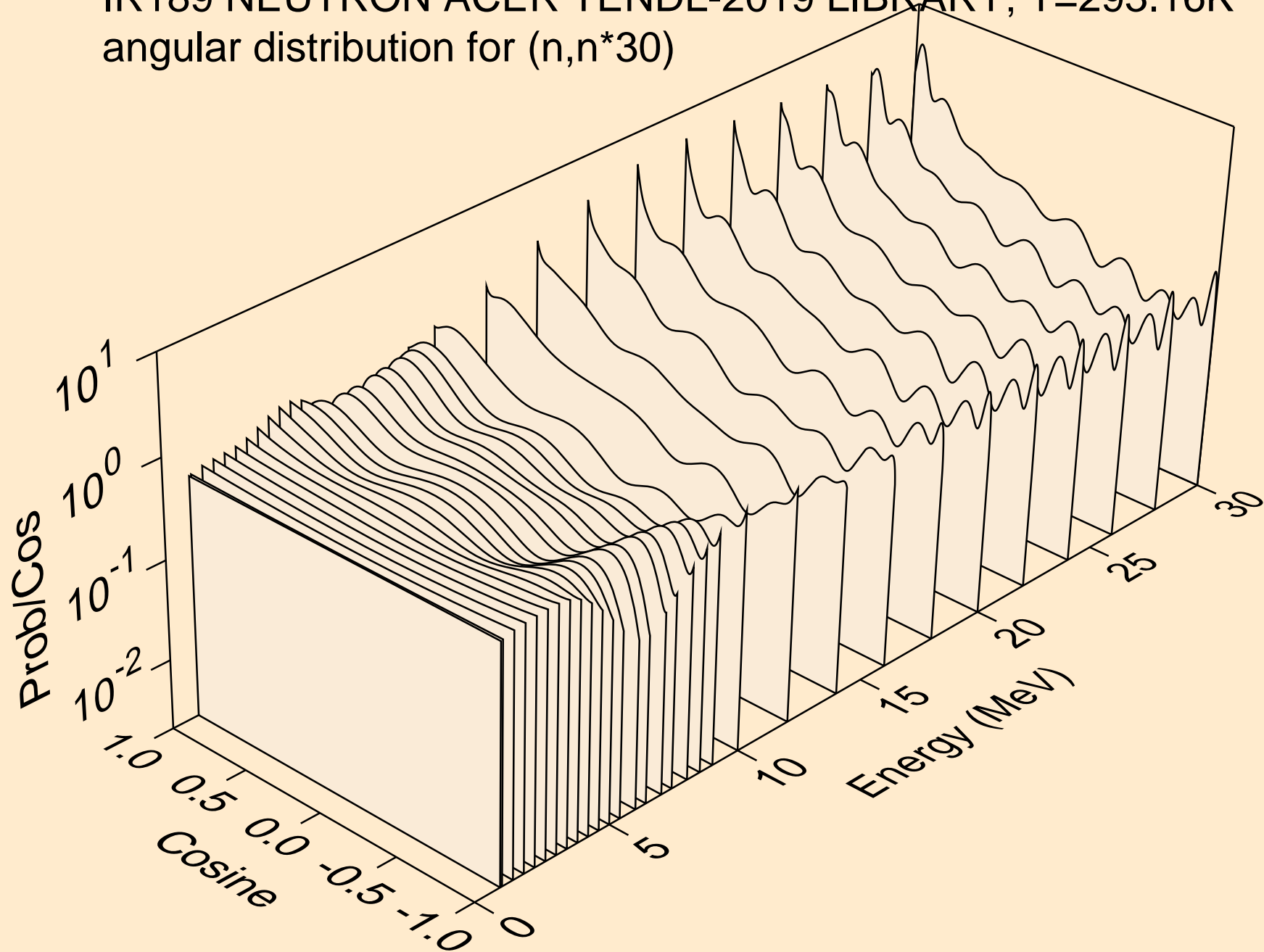

IR189 NEUTRON ACER TENDL-2019 LIBRARY; T=293.16K  
Neutron emission for (n,x)

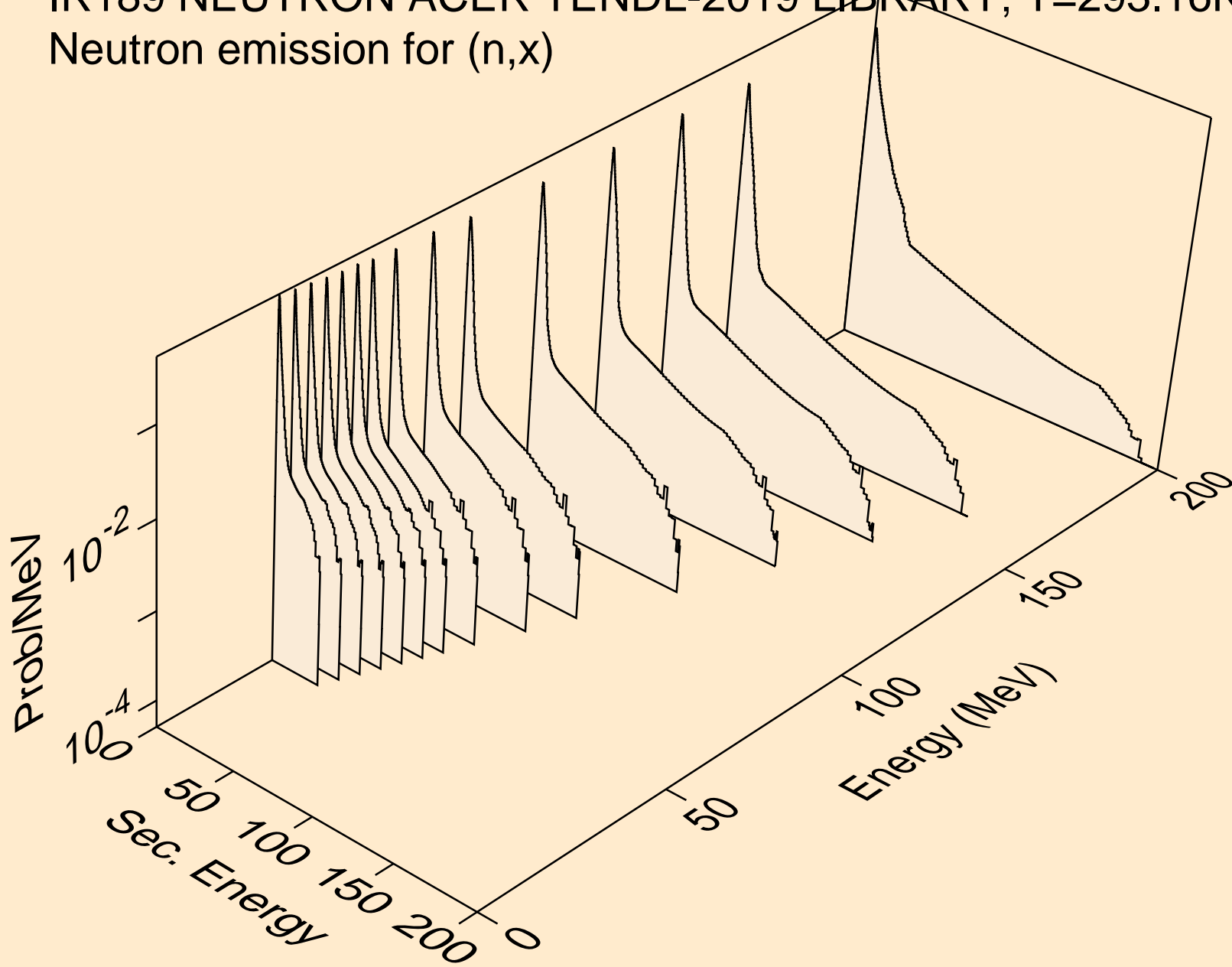

IR189 NEUTRON ACER TENDL-2019 LIBRARY; T=293.16K  
Neutron emission for (n,2nd)

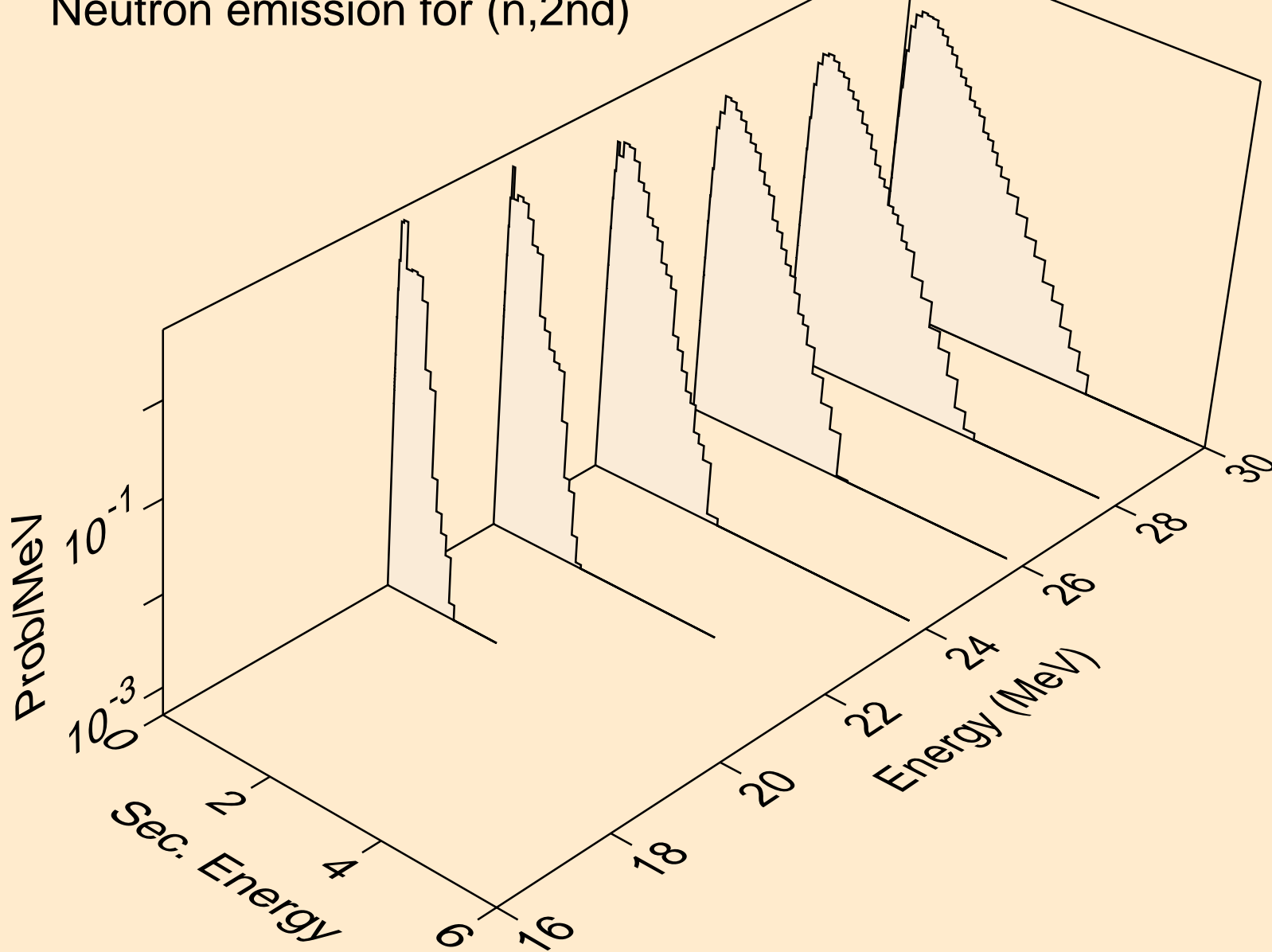

IR189 NEUTRON ACER TENDL-2019 LIBRARY; T=293.16K  
Neutron emission for (n,2n)

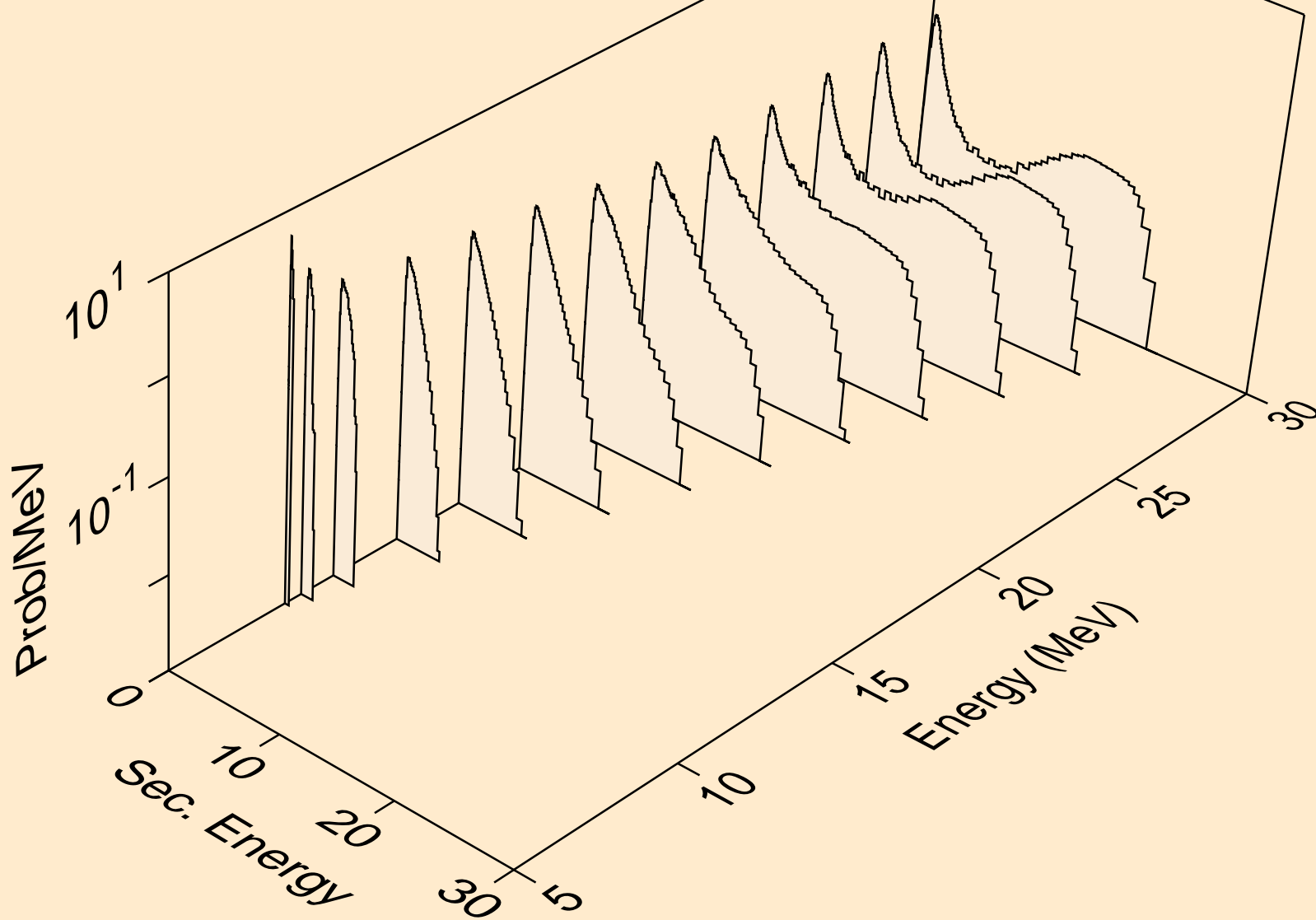

IR189 NEUTRON ACER TENDL-2019 LIBRARY; T=293.16K  
Neutron emission for (n,3n)

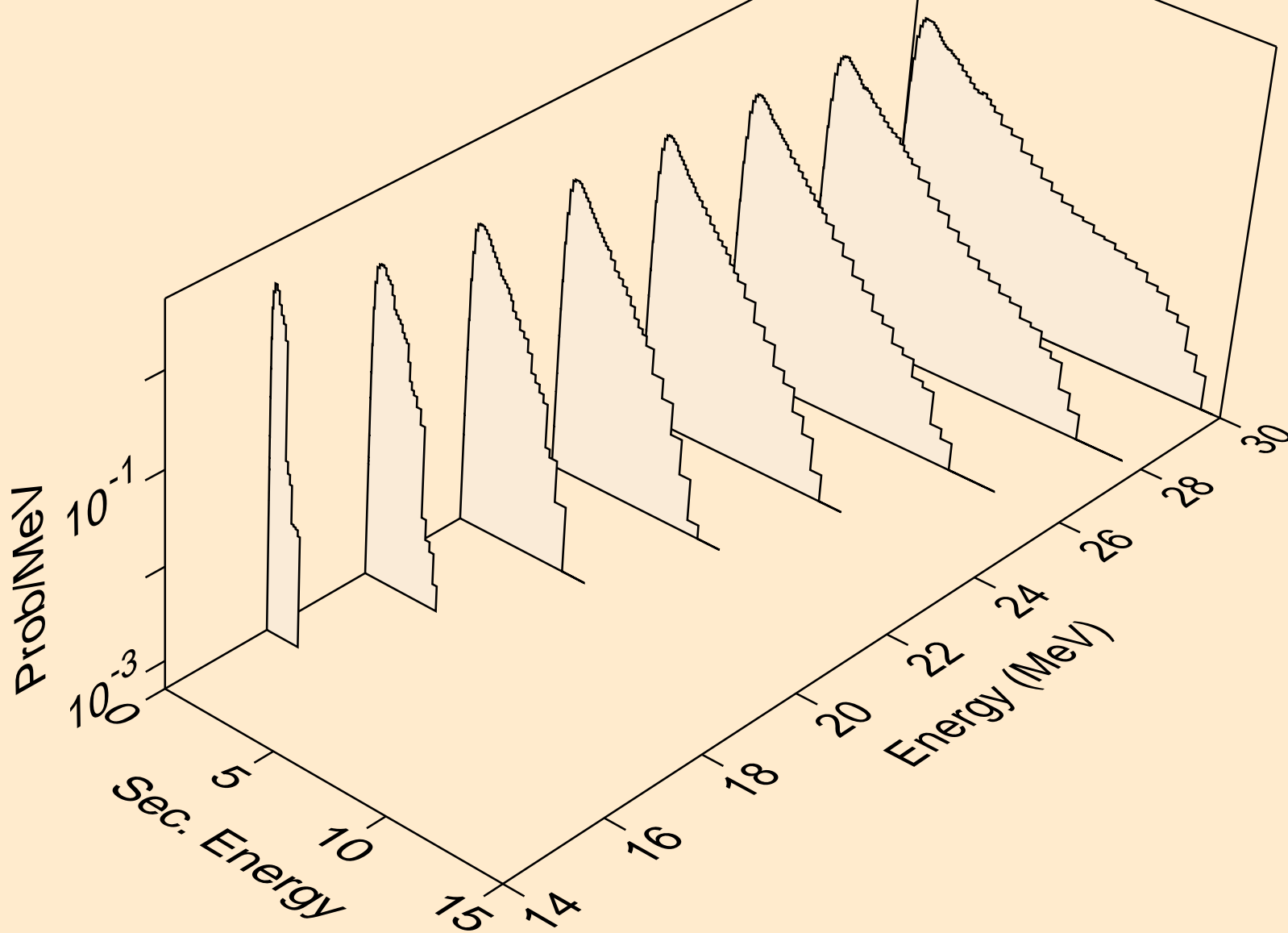

IR189 NEUTRON ACER TENDL-2019 LIBRARY; T=293.16K  
Neutron emission for (n,n\*)a

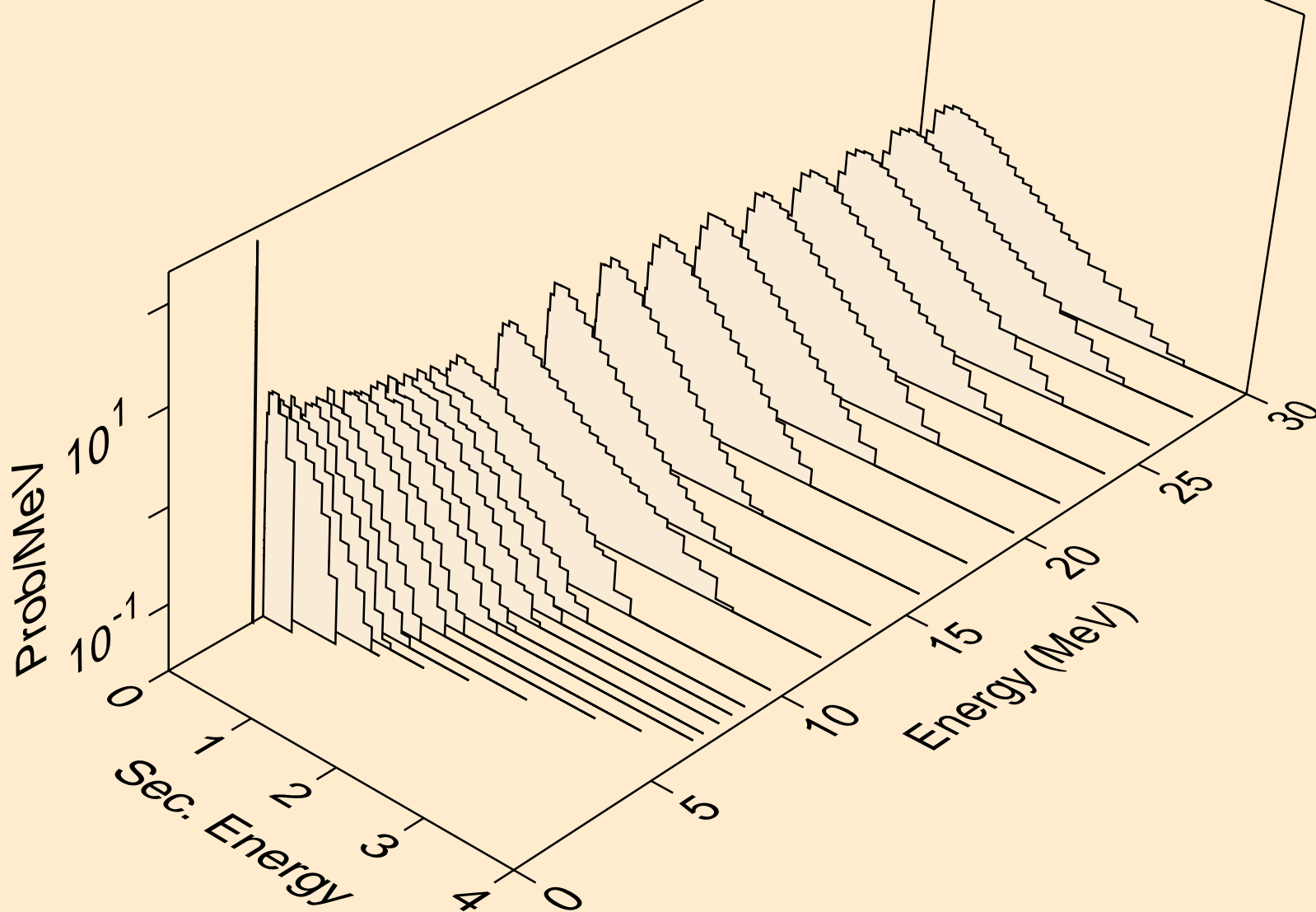



IR189 NEUTRON ACER TENDL-2019 LIBRARY; T=293.16K  
Neutron emission for (n,2n)a

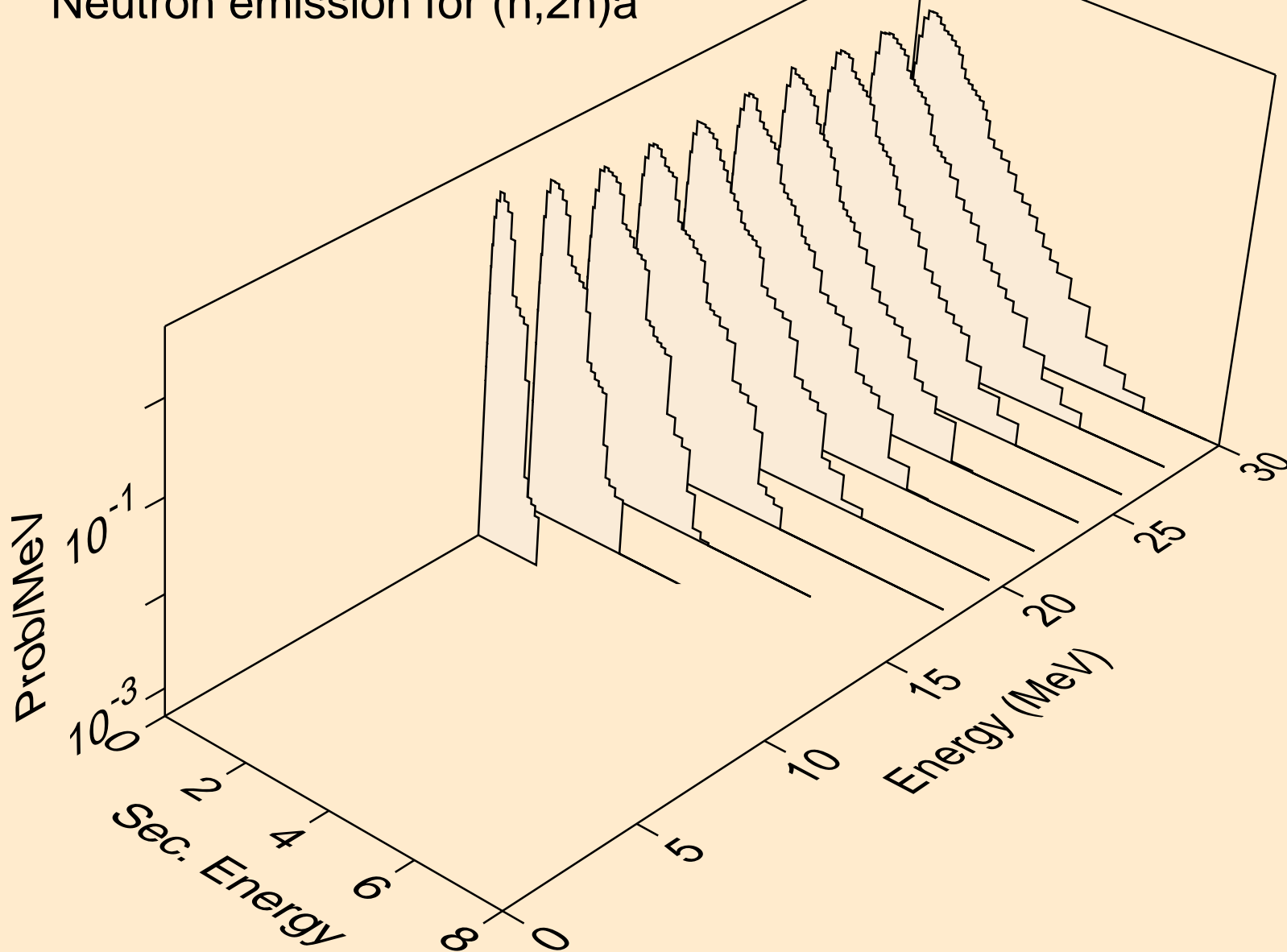

IR189 NEUTRON ACER TENDL-2019 LIBRARY; T=293.16K  
Neutron emission for (n,3n)a

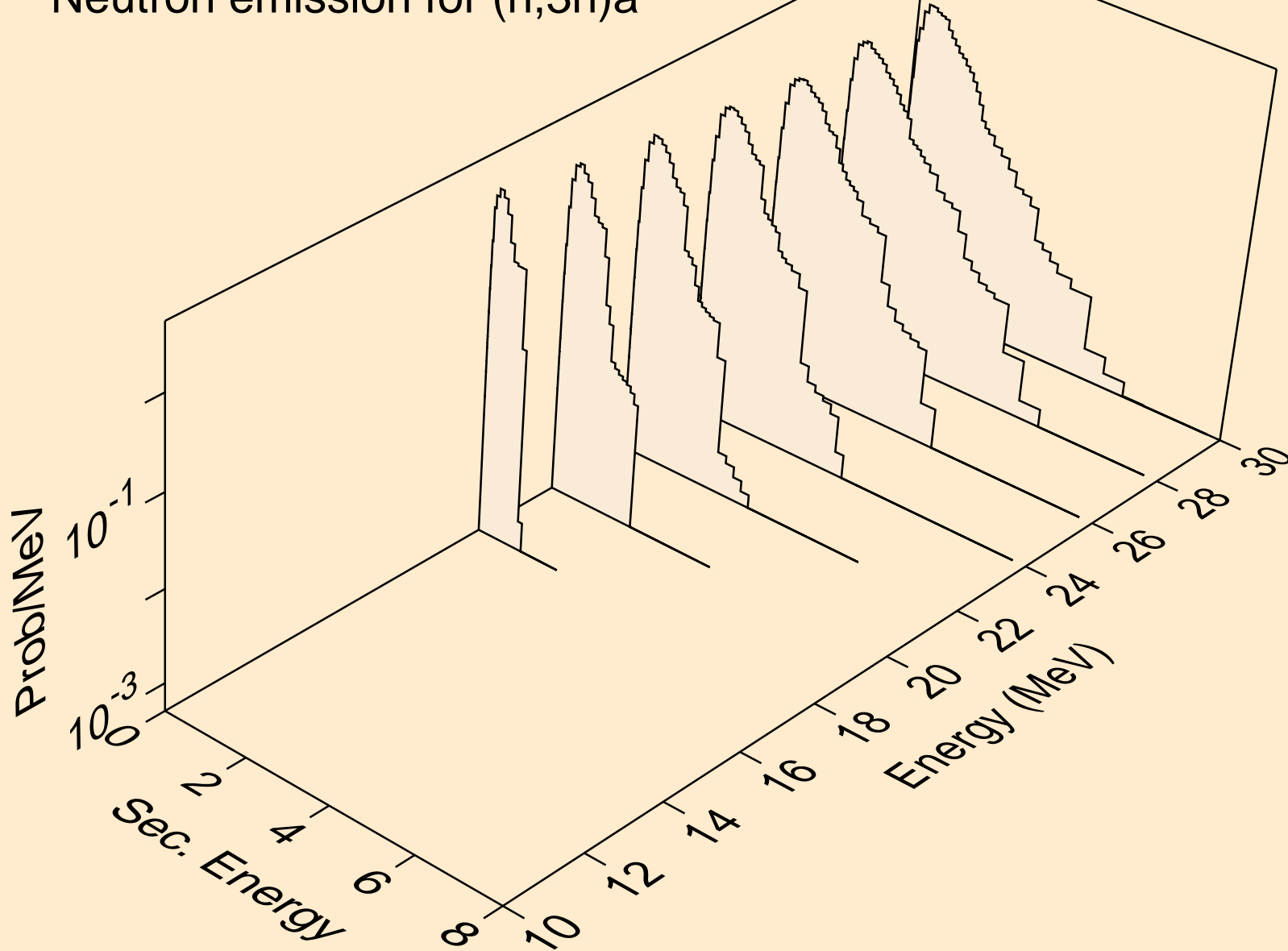

IR189 NEUTRON ACER TENDL-2019 LIBRARY; T=293.16K  
Neutron emission for (n,n\*)p

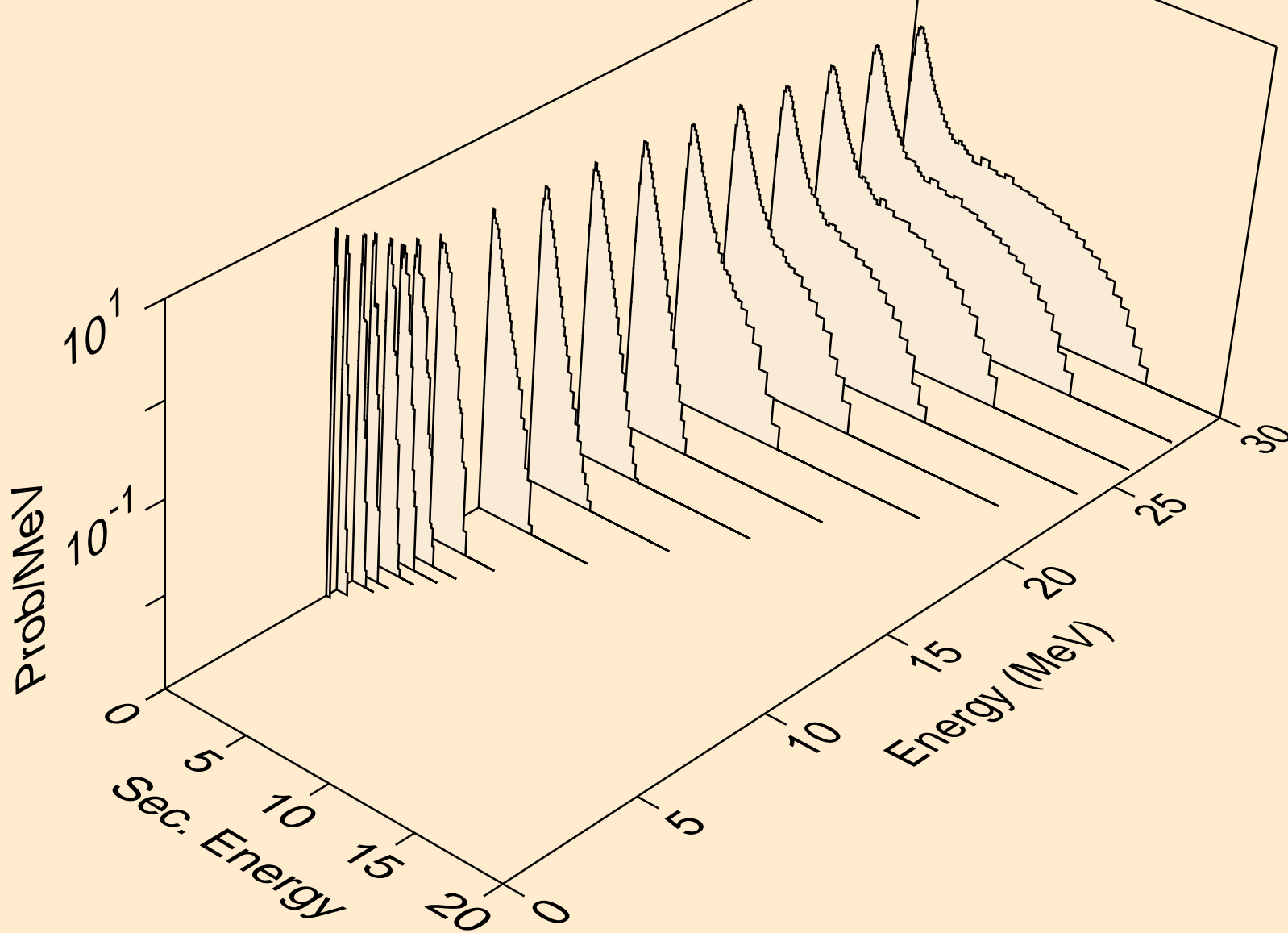

IR189 NEUTRON ACER TENDL-2019 LIBRARY; T=293.16K  
Neutron emission for (n,n\*)2a

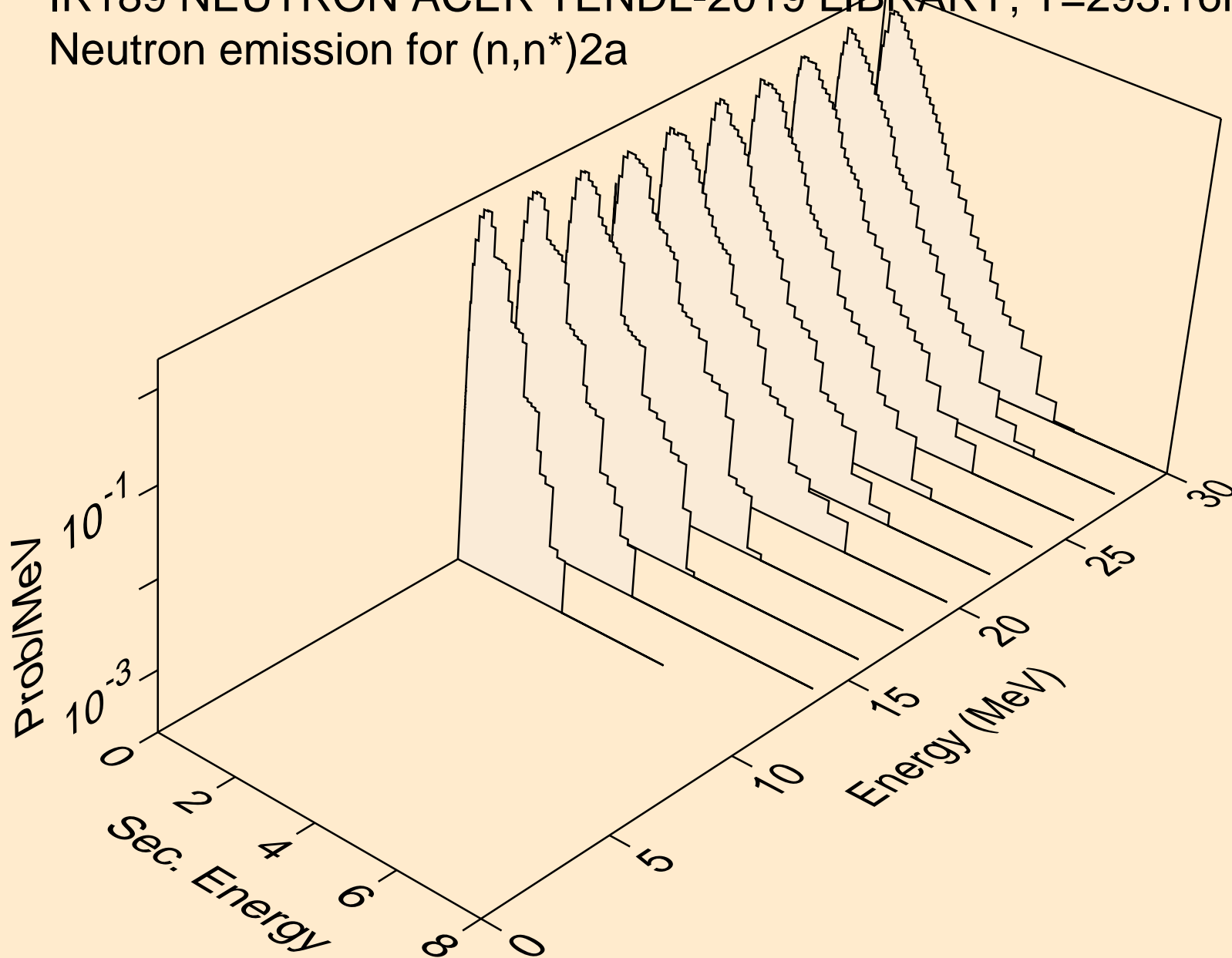

IR189 NEUTRON ACER TENDL-2019 LIBRARY; T=293.16K  
Neutron emission for (n,n\*)d

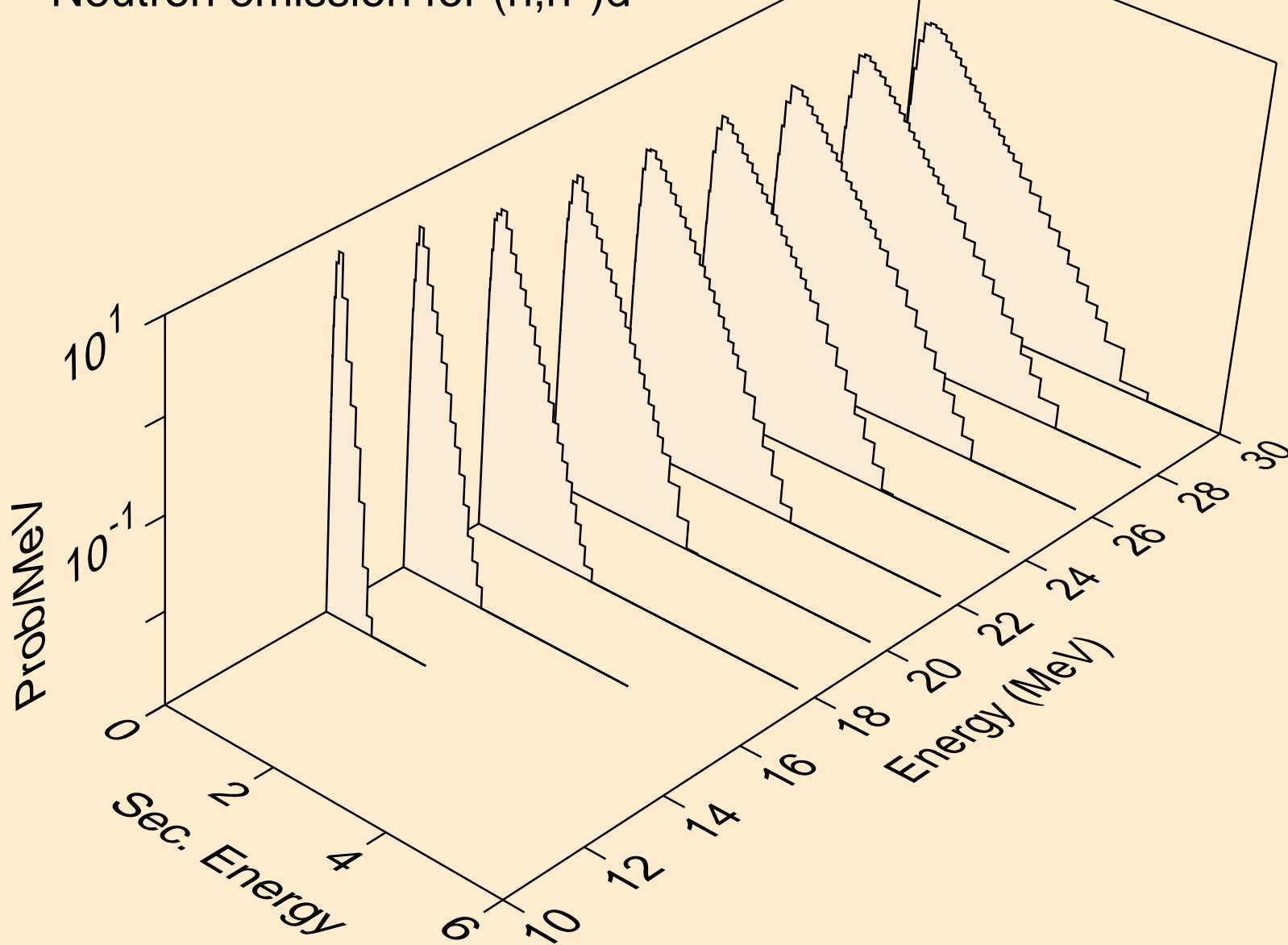

IR189 NEUTRON ACER TENDL-2019 LIBRARY; T=293.16K  
Neutron emission for (n,n\*)t

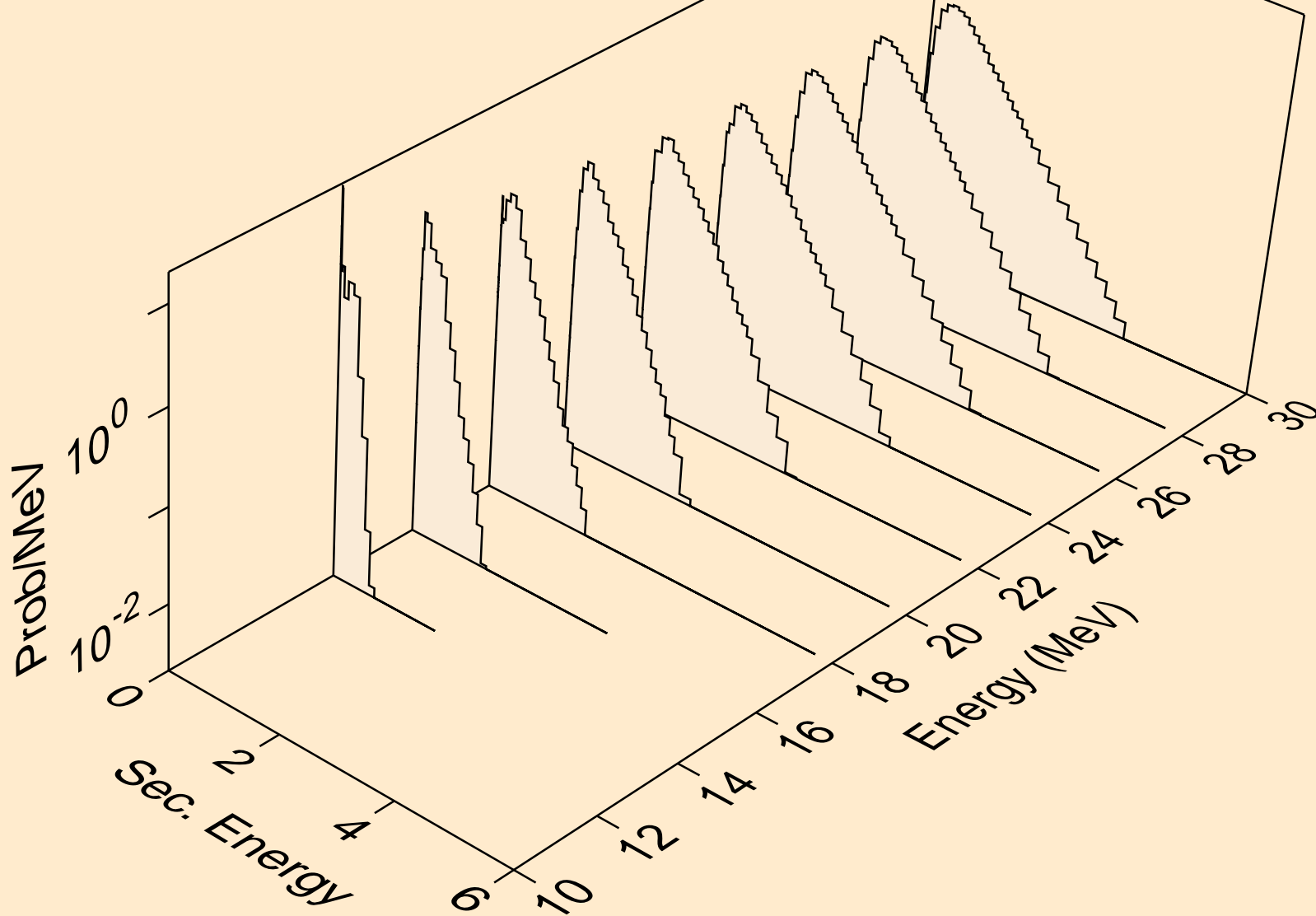

IR189 NEUTRON ACER TENDL-2019 LIBRARY; T=293.16K  
Neutron emission for (n,n\*)he3

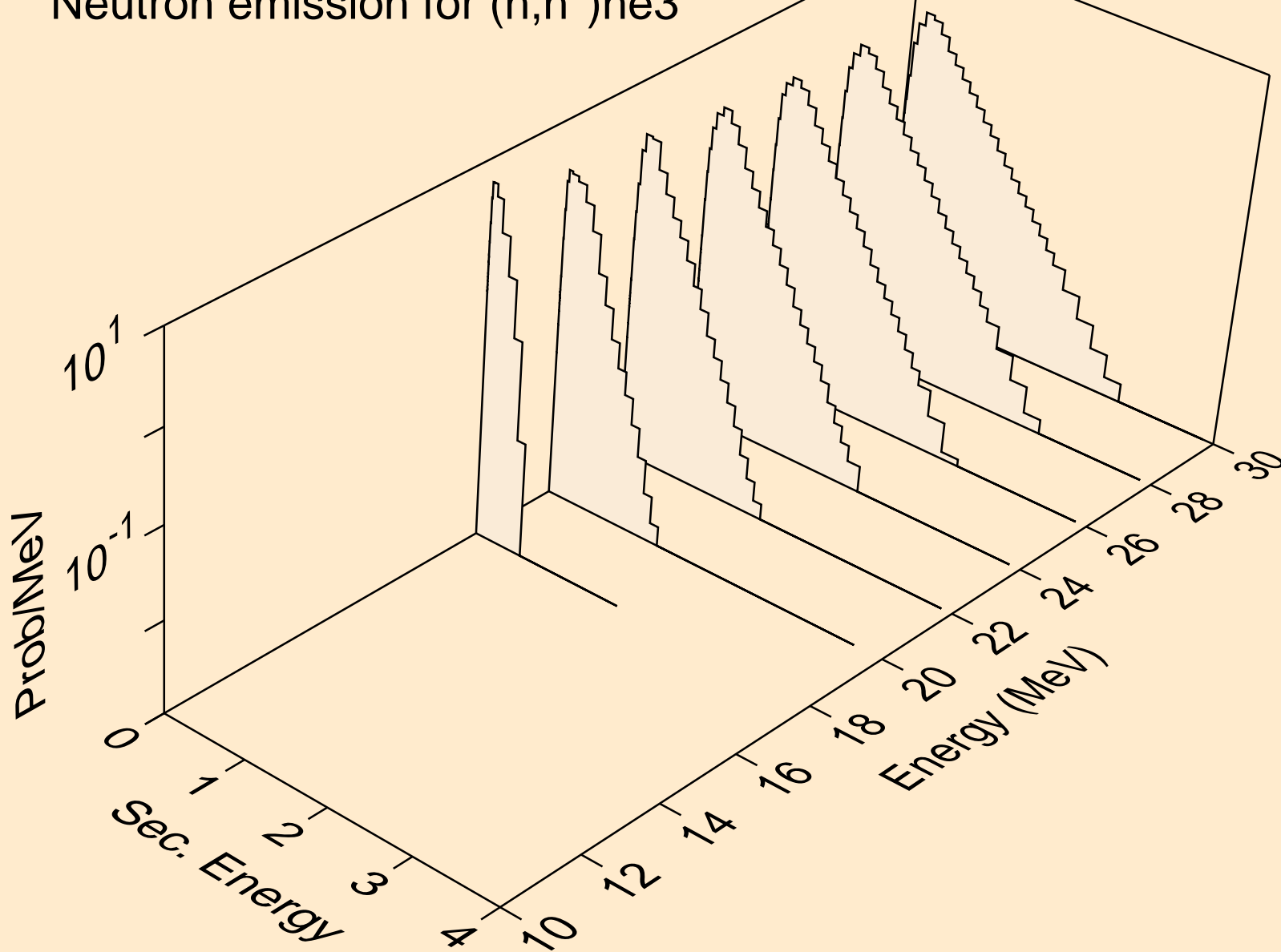

IR189 NEUTRON ACER TENDL-2019 LIBRARY; T=293.16K  
Neutron emission for (n,4n)

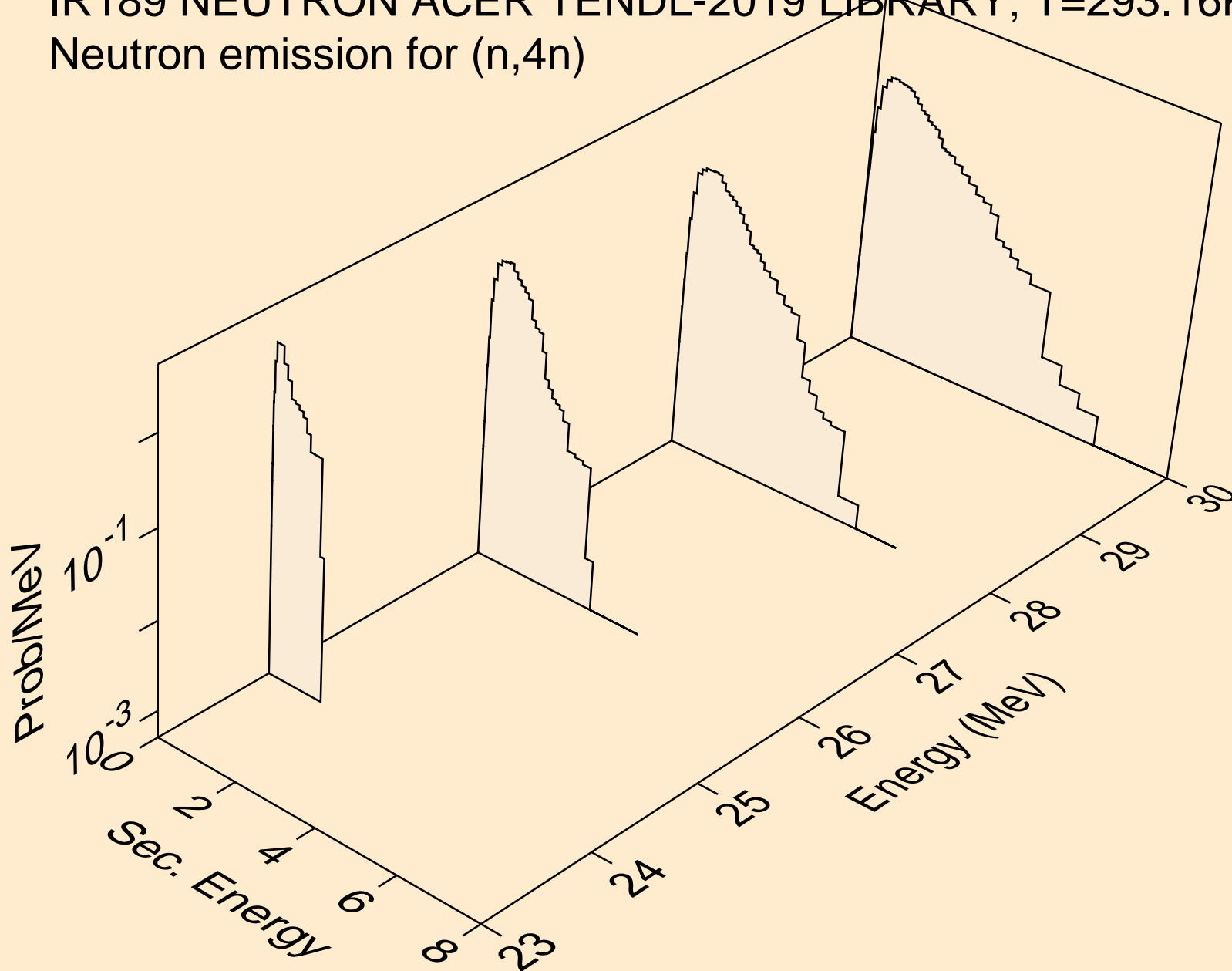



IR189 NEUTRON ACER TENDL-2019 LIBRARY; T=293.16K  
Neutron emission for (n,2np)

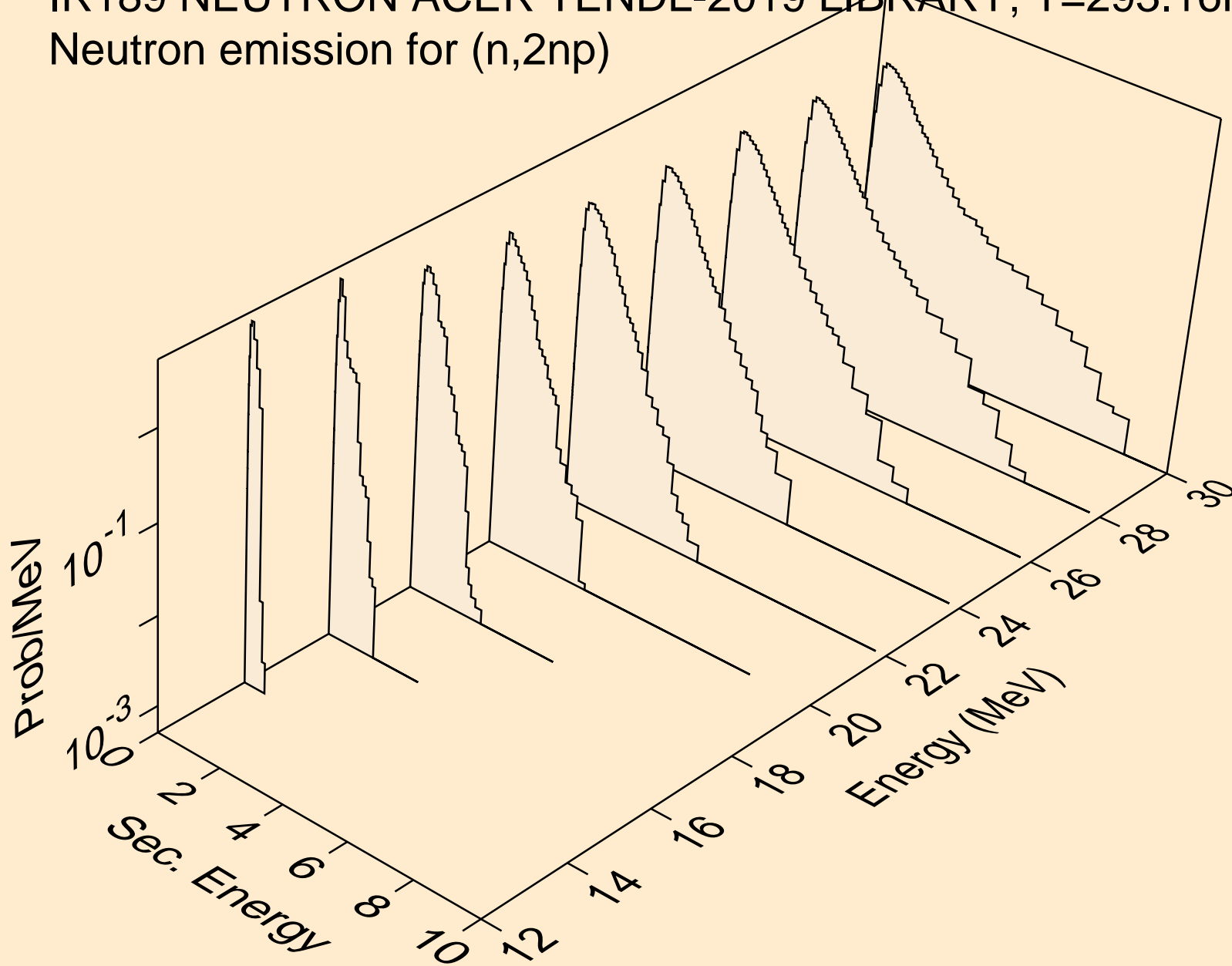

IR189 NEUTRON ACER TENDL-2019 LIBRARY; T=293.16K  
Neutron emission for (n,3np)

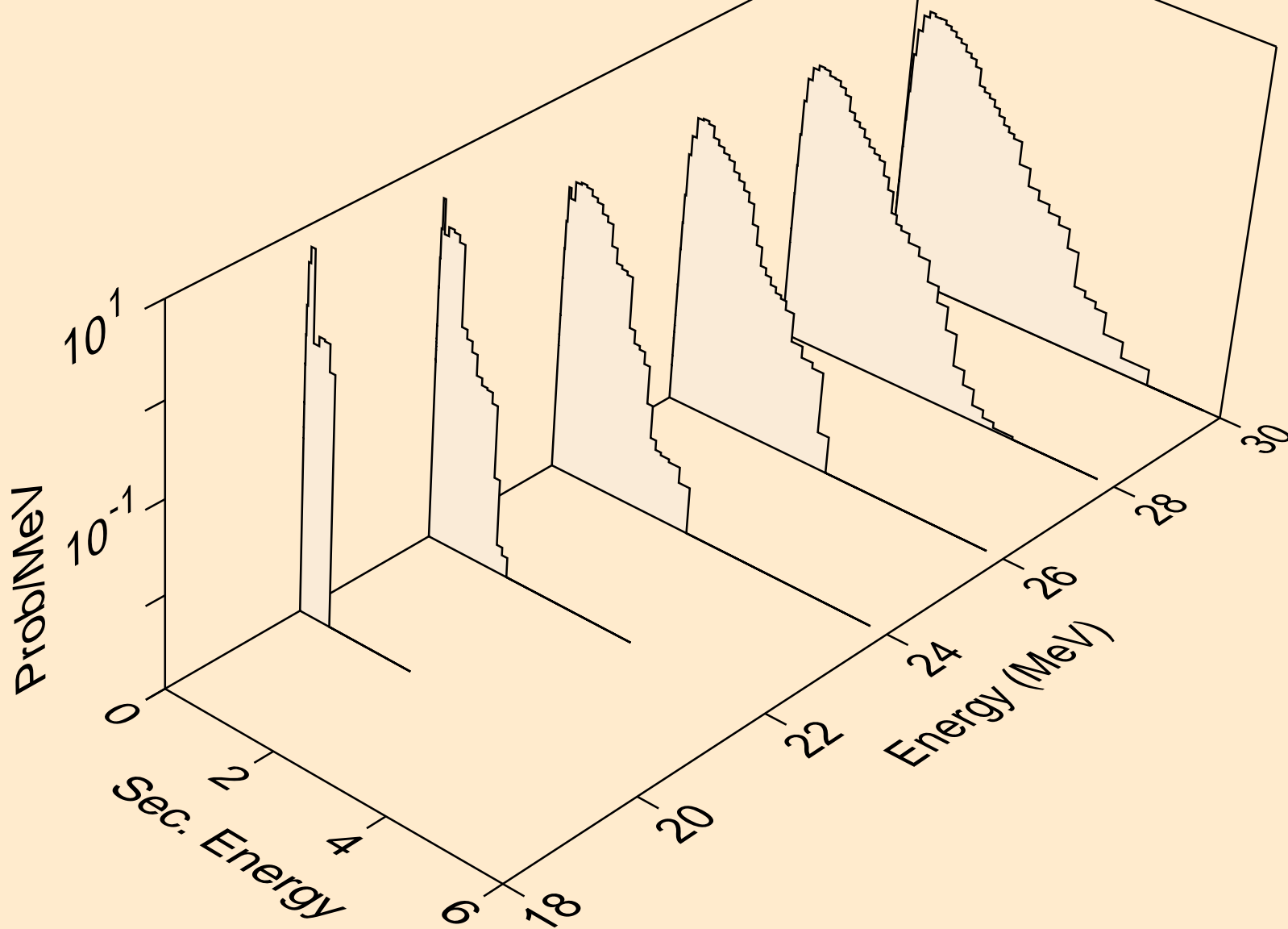

IR189 NEUTRON ACER TENDL-2019 LIBRARY; T=293.16K  
Neutron emission for (n,2np)

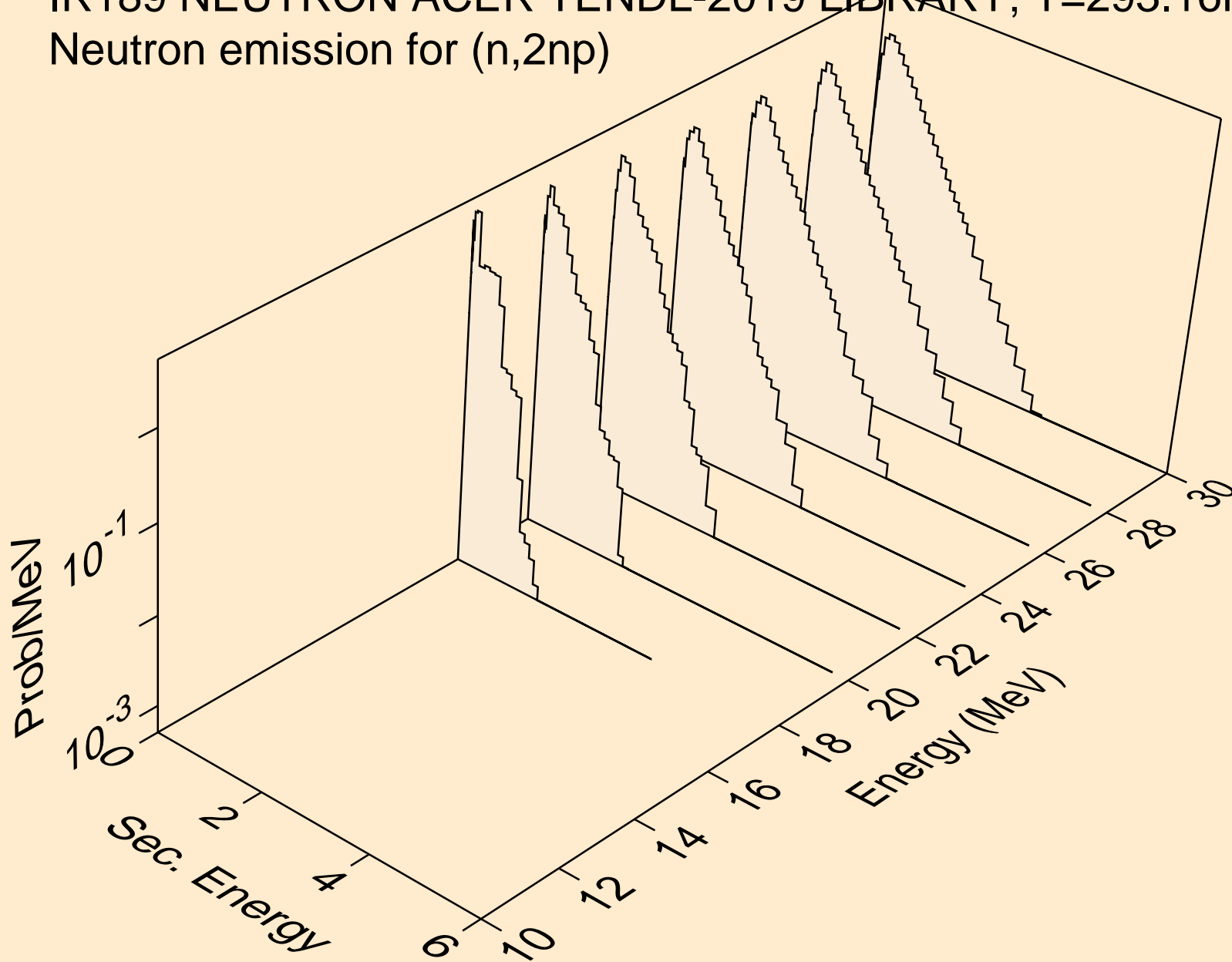

IR189 NEUTRON ACER TENDL-2019 LIBRARY; T=293.16K  
Neutron emission for (n,npa)

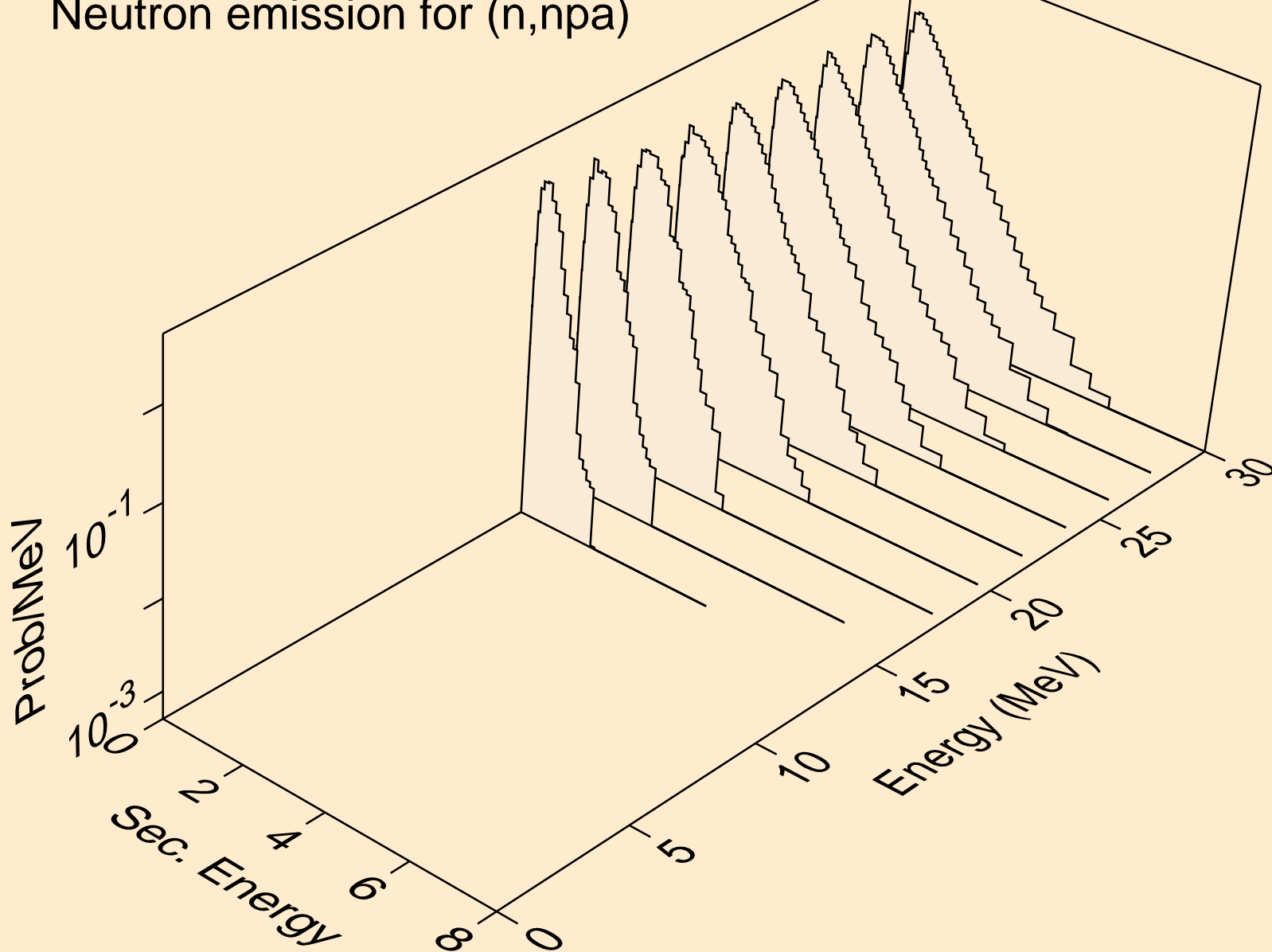

IR189 NEUTRON ACER TENDL-2019 LIBRARY; T=293.16K  
Neutron emission for (n,n\*c)

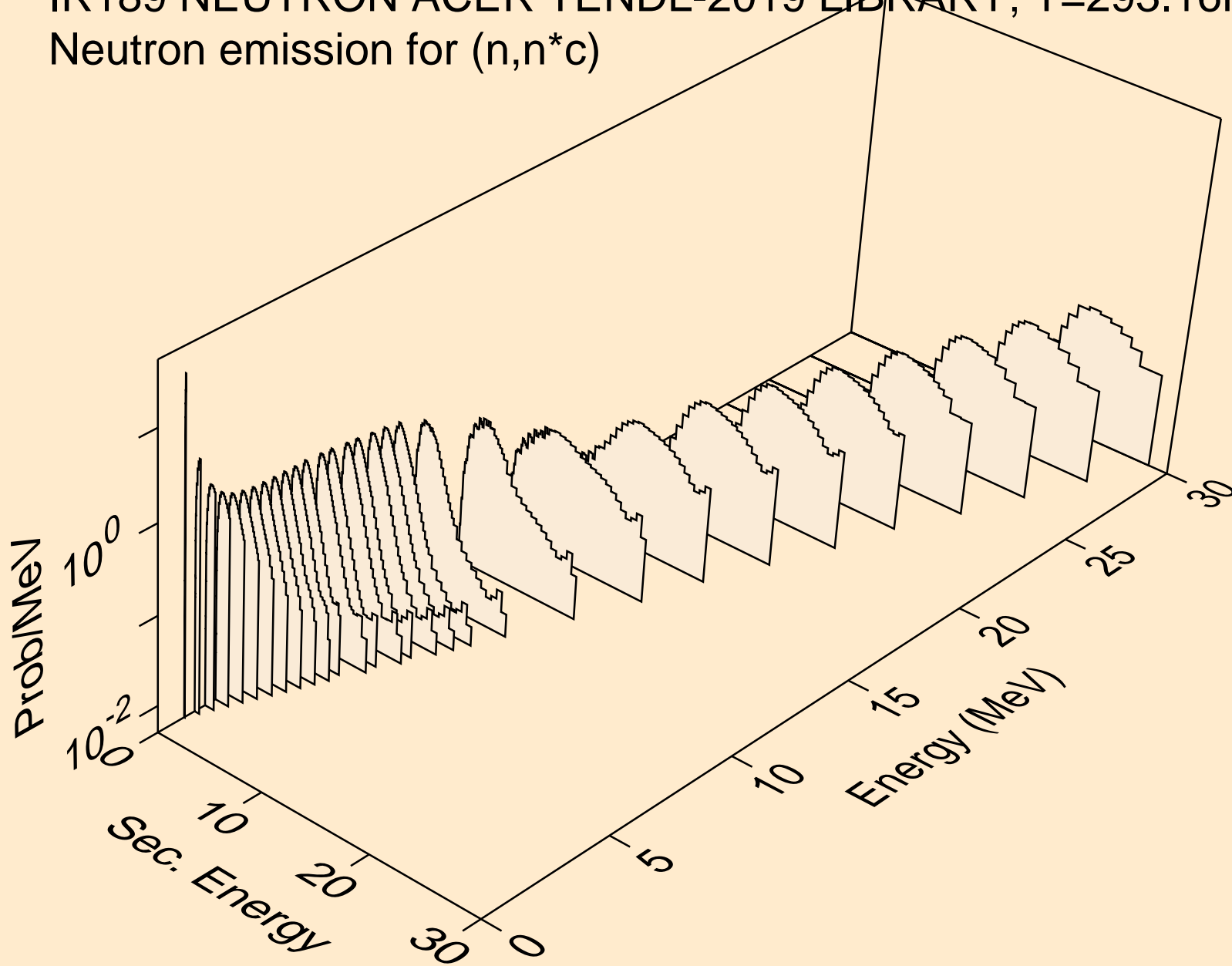

IR189 NEUTRON ACER TENDL-2019 LIBRARY; T=293.16K  
Photon emission for (n,x)

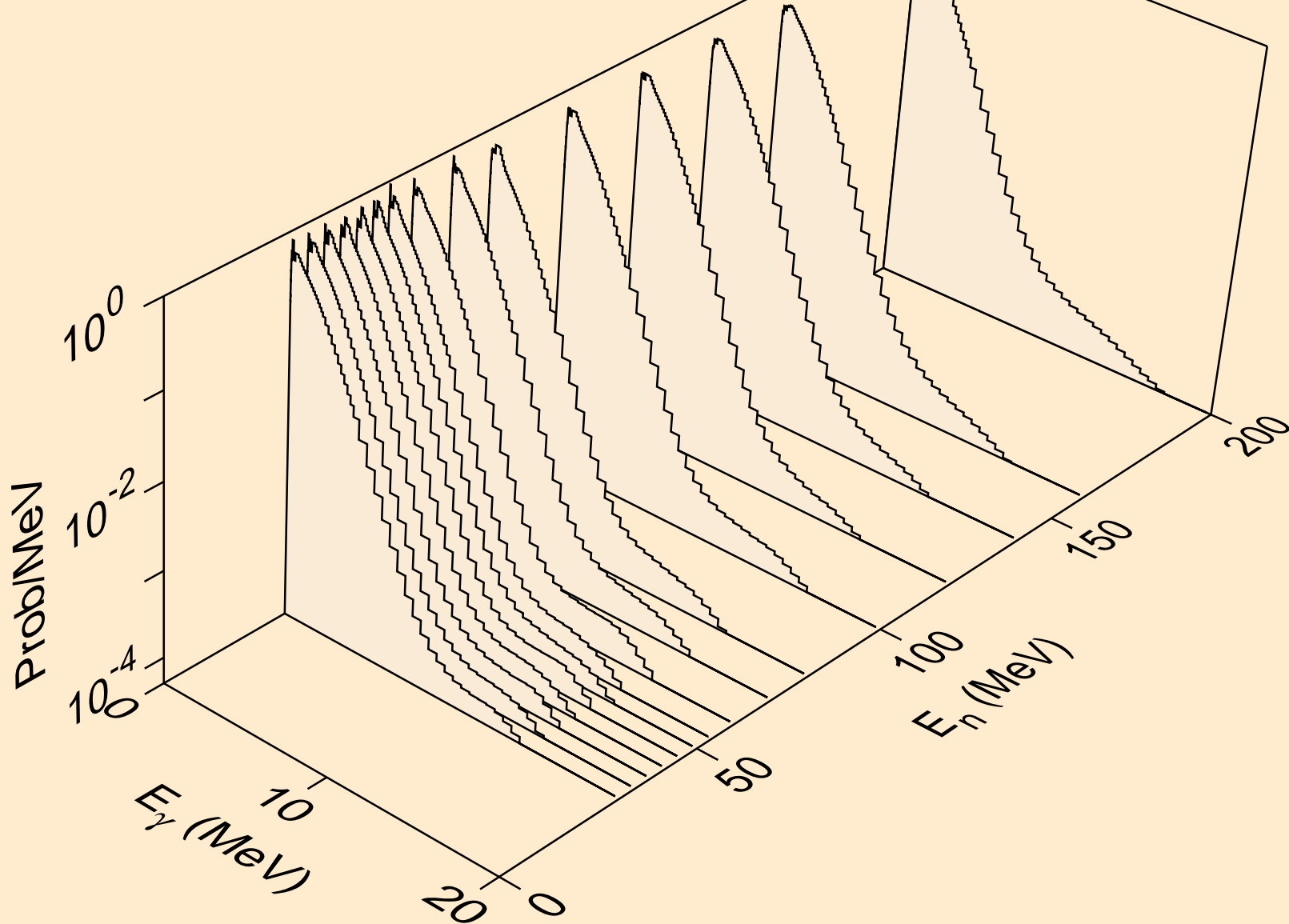

IR189 NEUTRON ACER TENDL-2019 LIBRARY; T=293.16K  
Photon emission for (n,2nd)

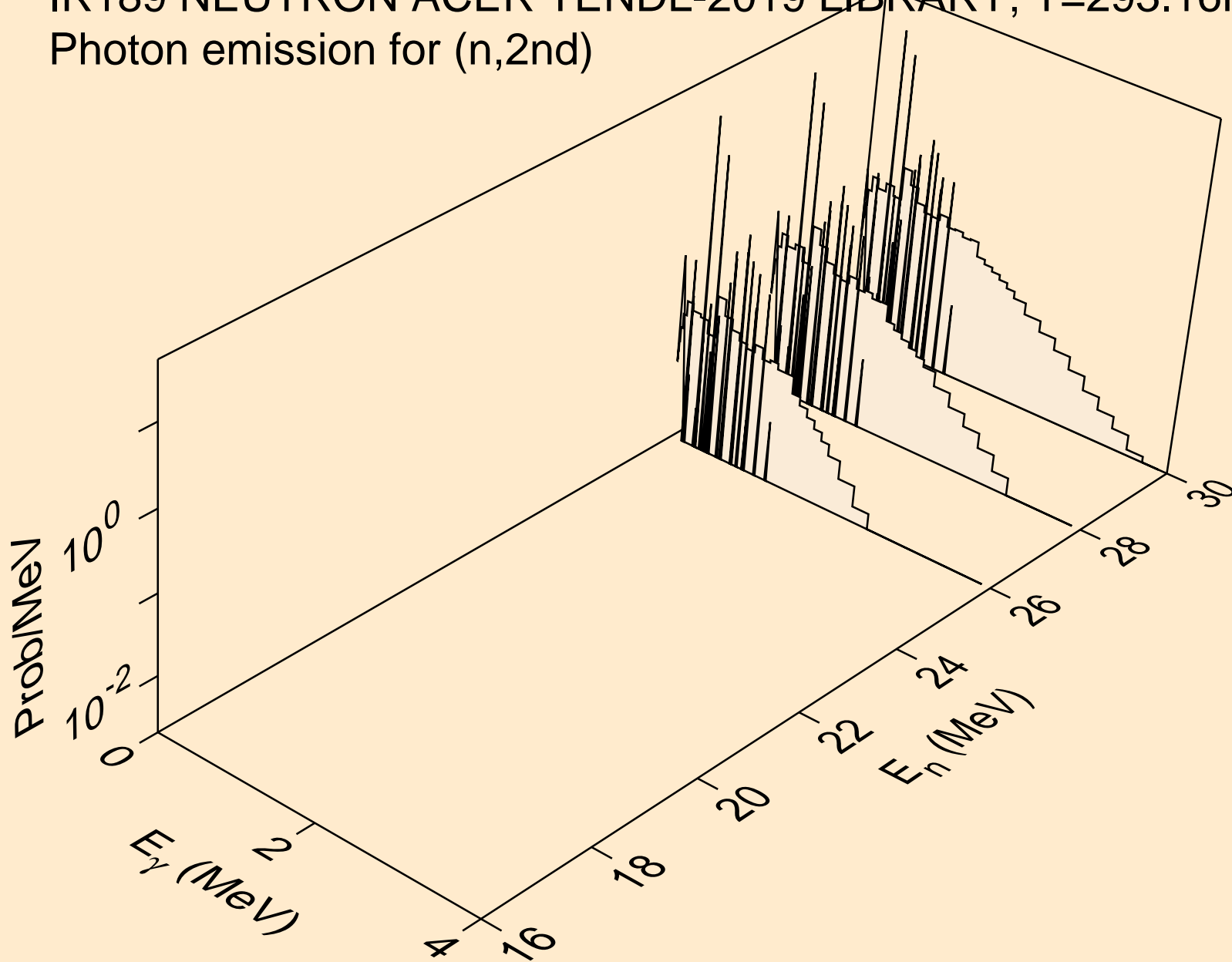

IR189 NEUTRON ACER TENDL-2019 LIBRARY; T=293.16K  
Photon emission for (n,2n)

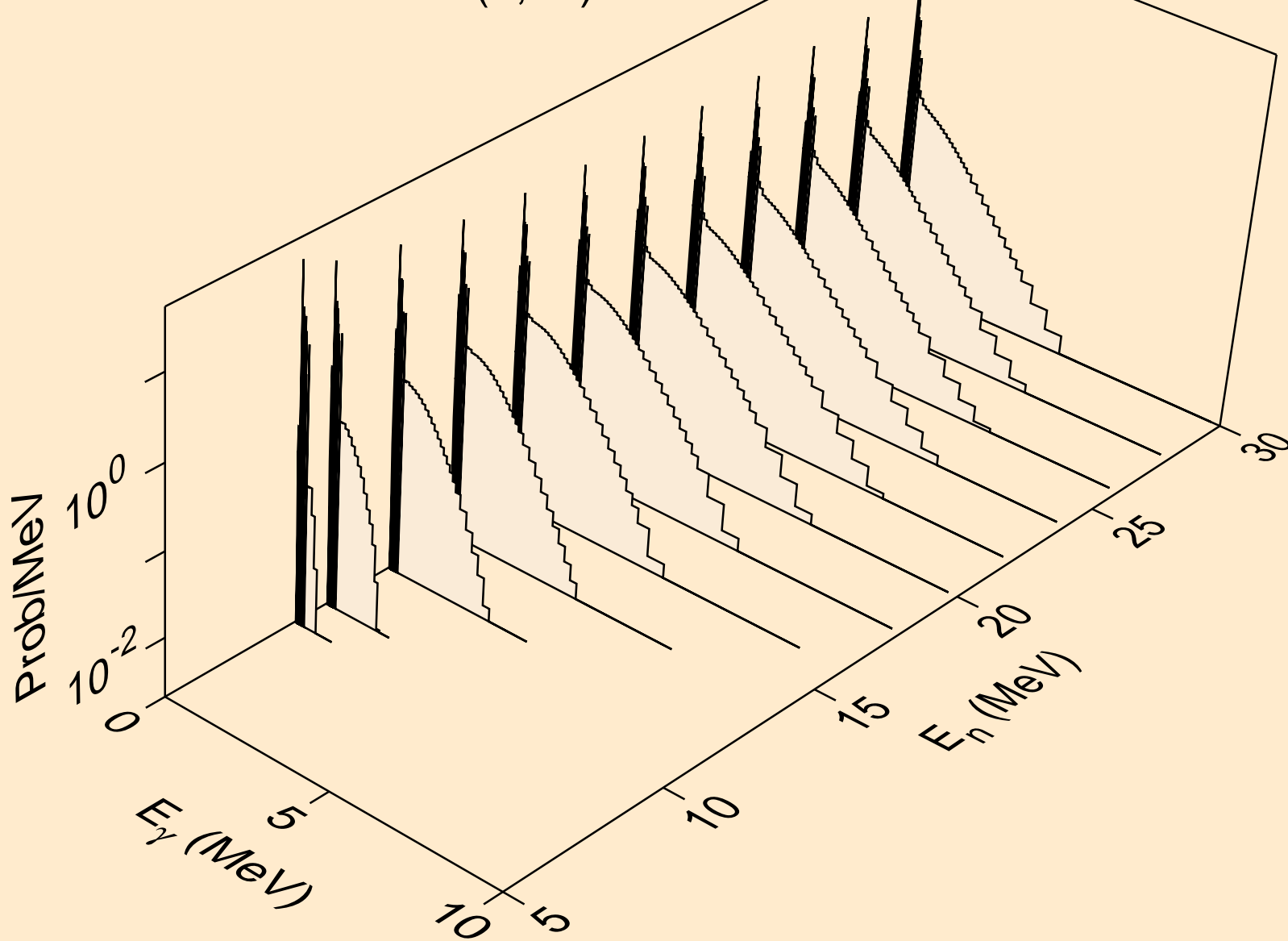



IR189 NEUTRON ACER TENDL-2019 LIBRARY; T=293.16K  
Photon emission for (n,3n)

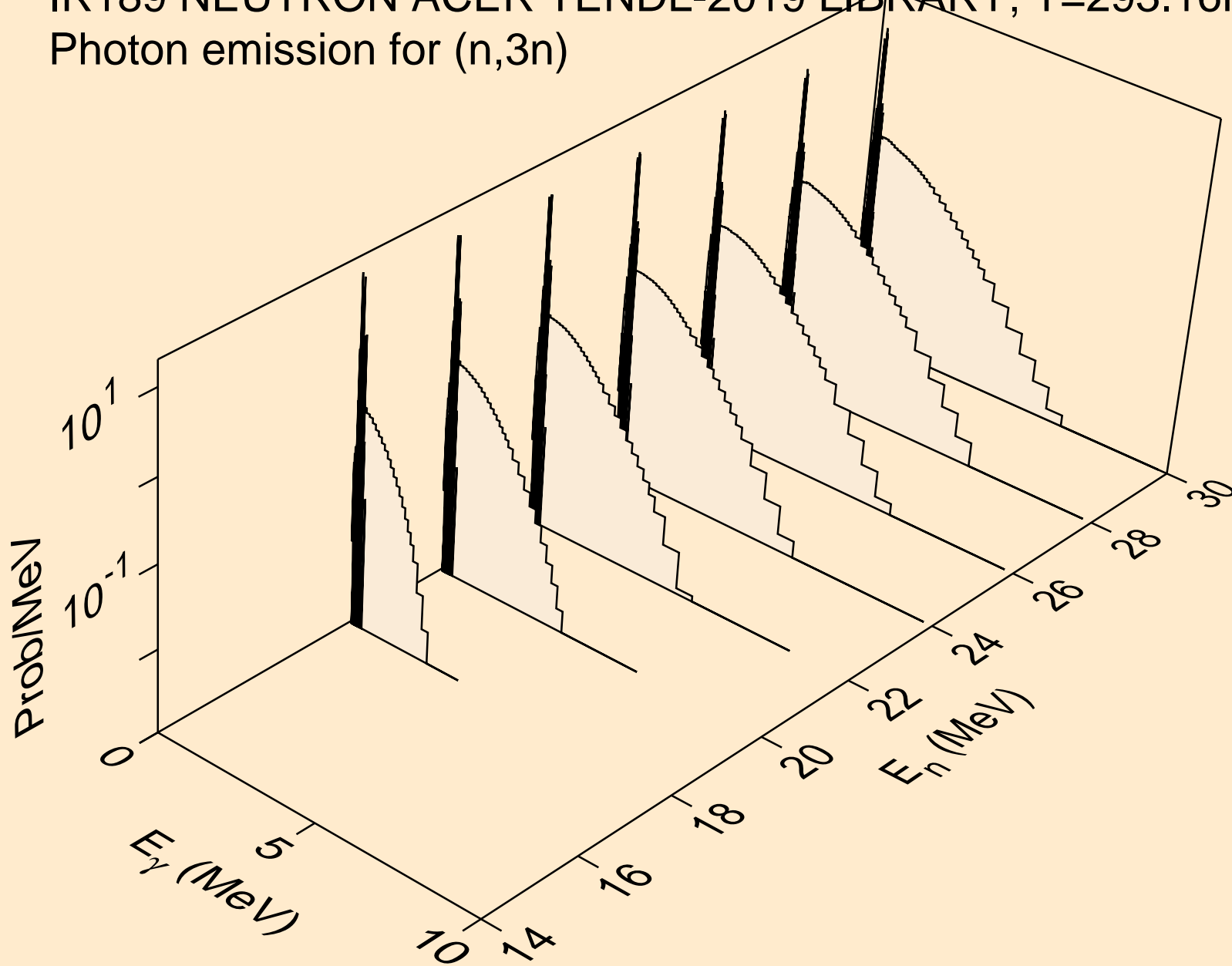

IR189 NEUTRON ACER TENDL-2019 LIBRARY; T=293.16K  
Photon emission for (n,n\*)a

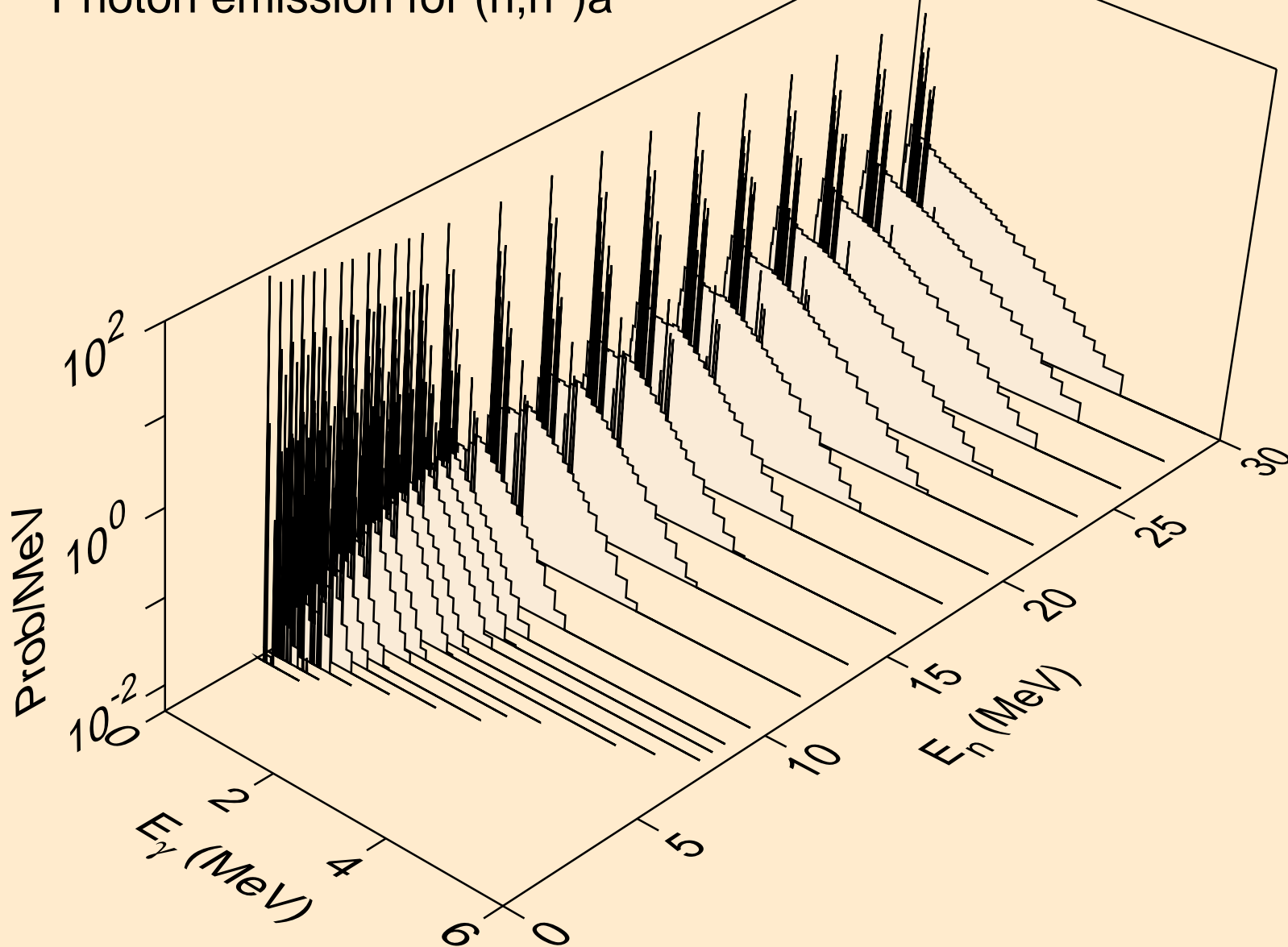

IR189 NEUTRON ACER TENDL-2019 LIBRARY; T=293.16K  
Photon emission for (n,2n)a

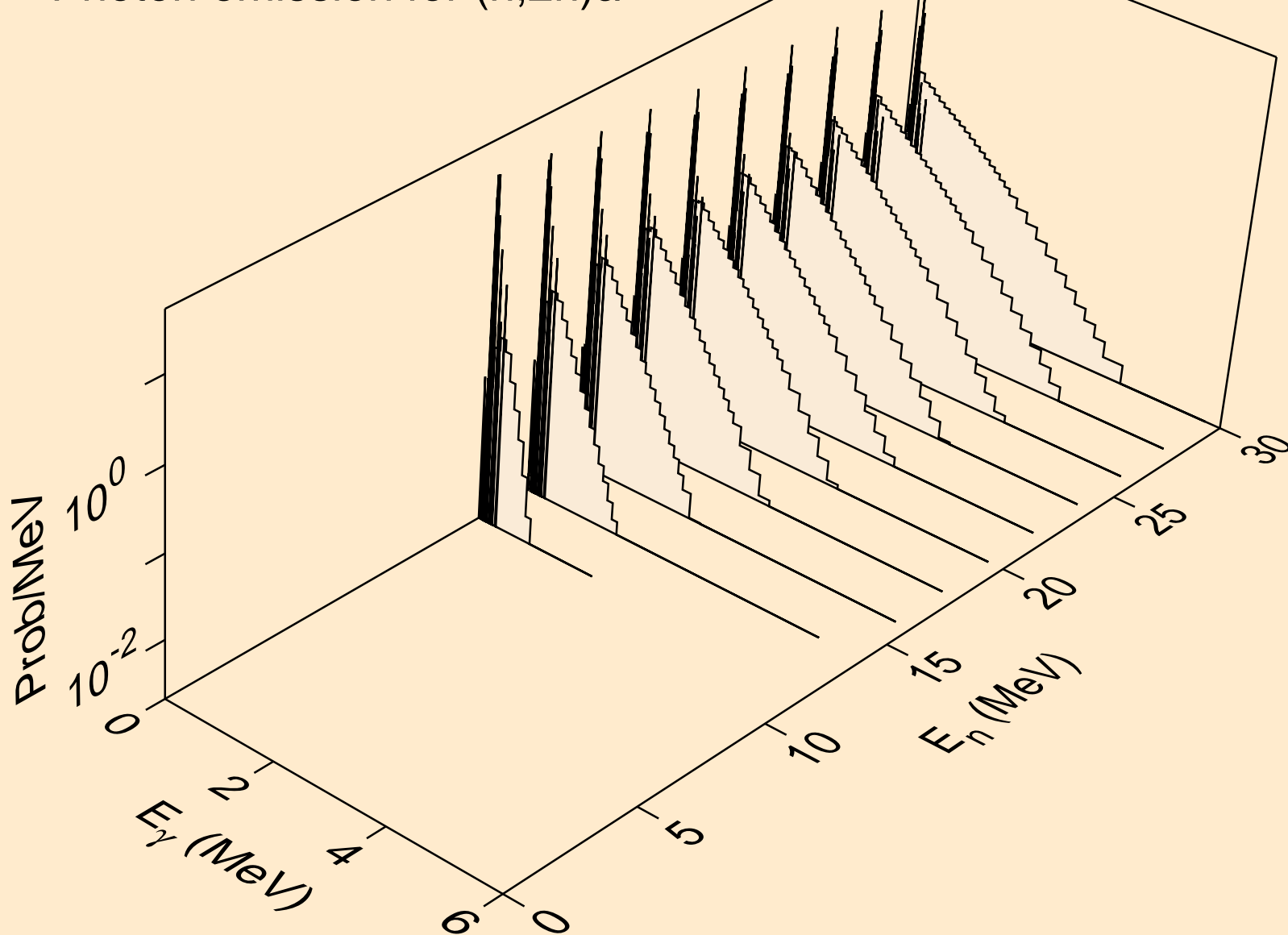

IR189 NEUTRON ACER TENDL-2019 LIBRARY; T=293.16K  
Photon emission for (n,3n)a

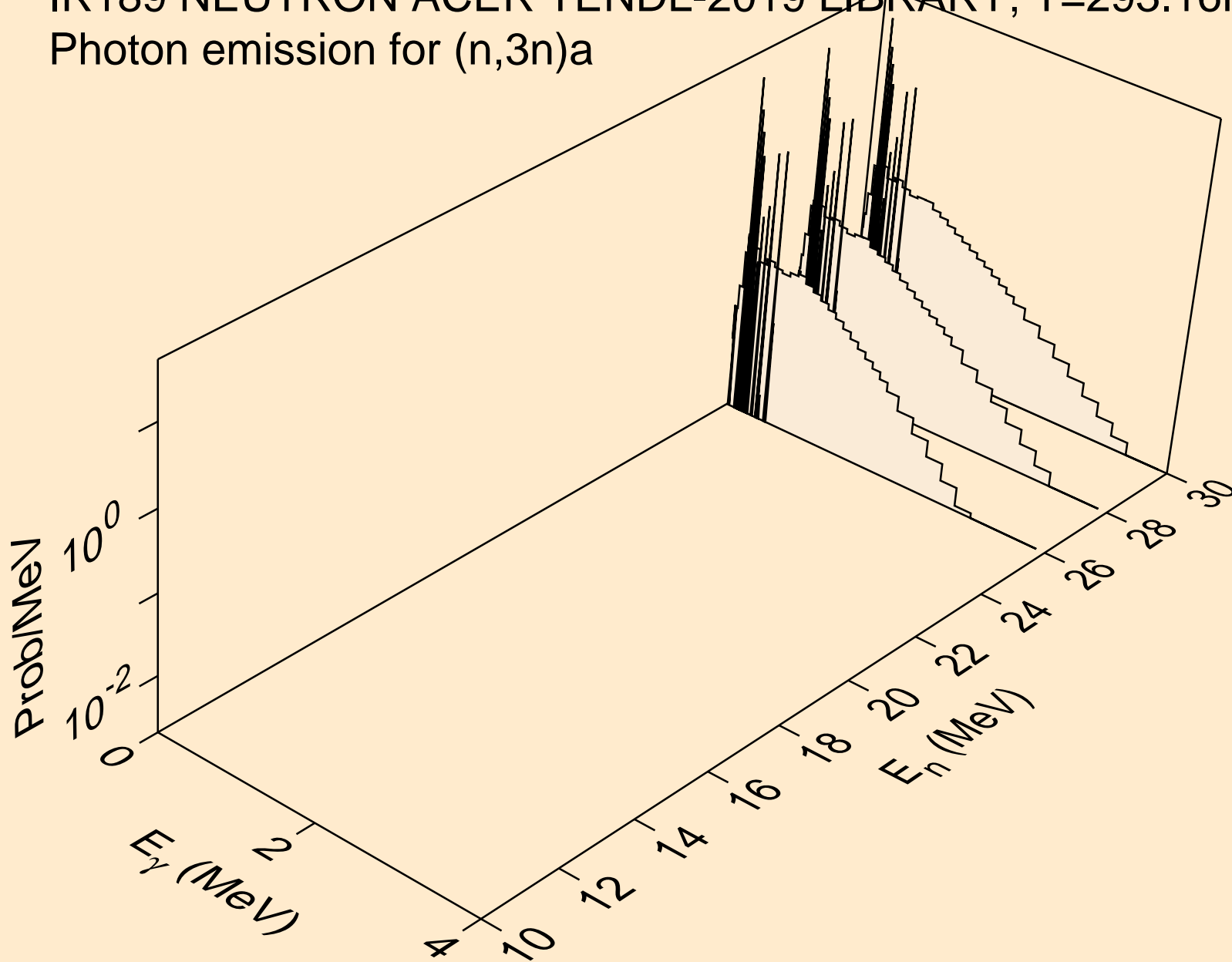

IR189 NEUTRON ACER TENDL-2019 LIBRARY; T=293.16K  
Photon emission for (n,n\*)p

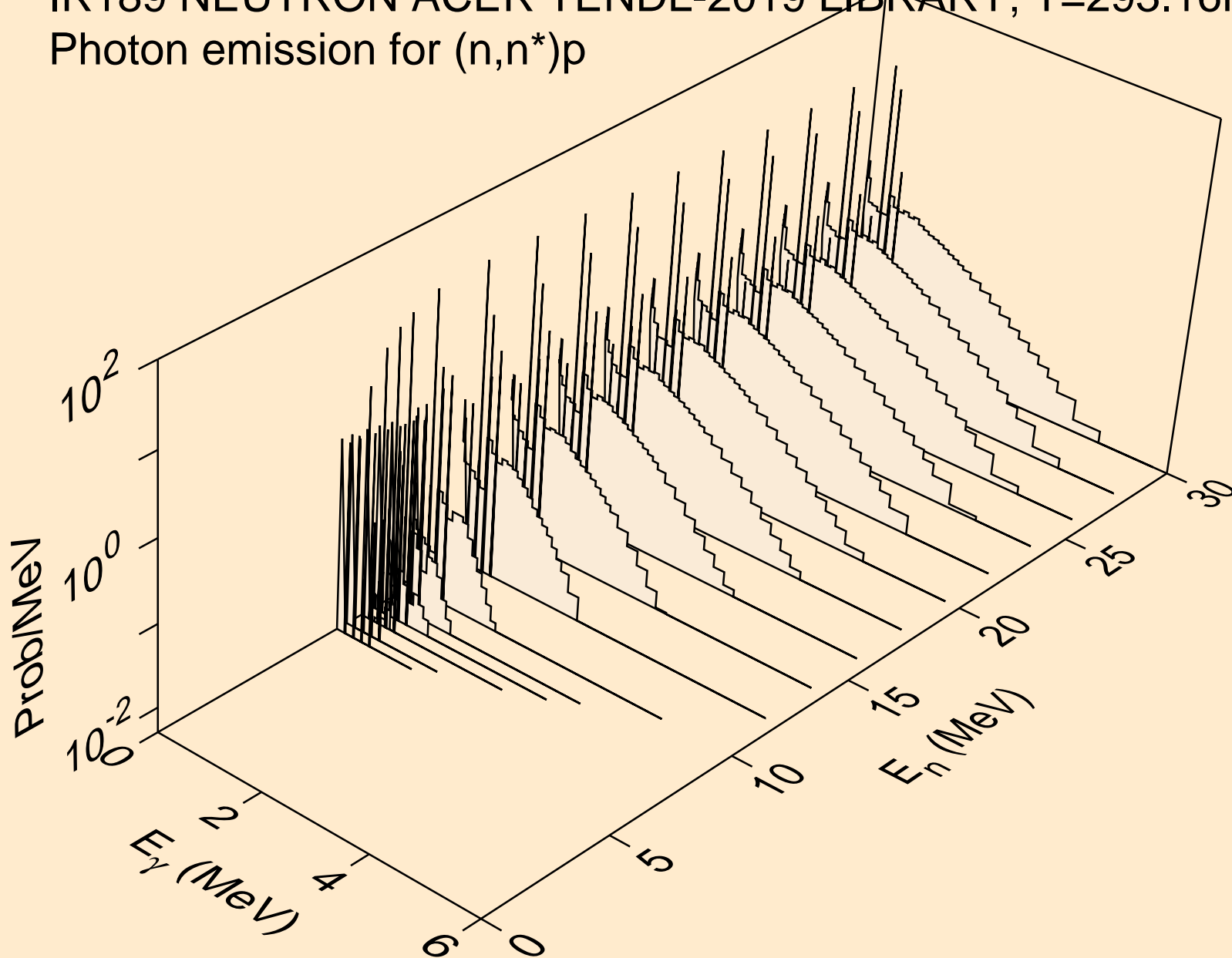

IR189 NEUTRON ACER TENDL-2019 LIBRARY; T=293.16K  
Photon emission for (n,n\*)2a

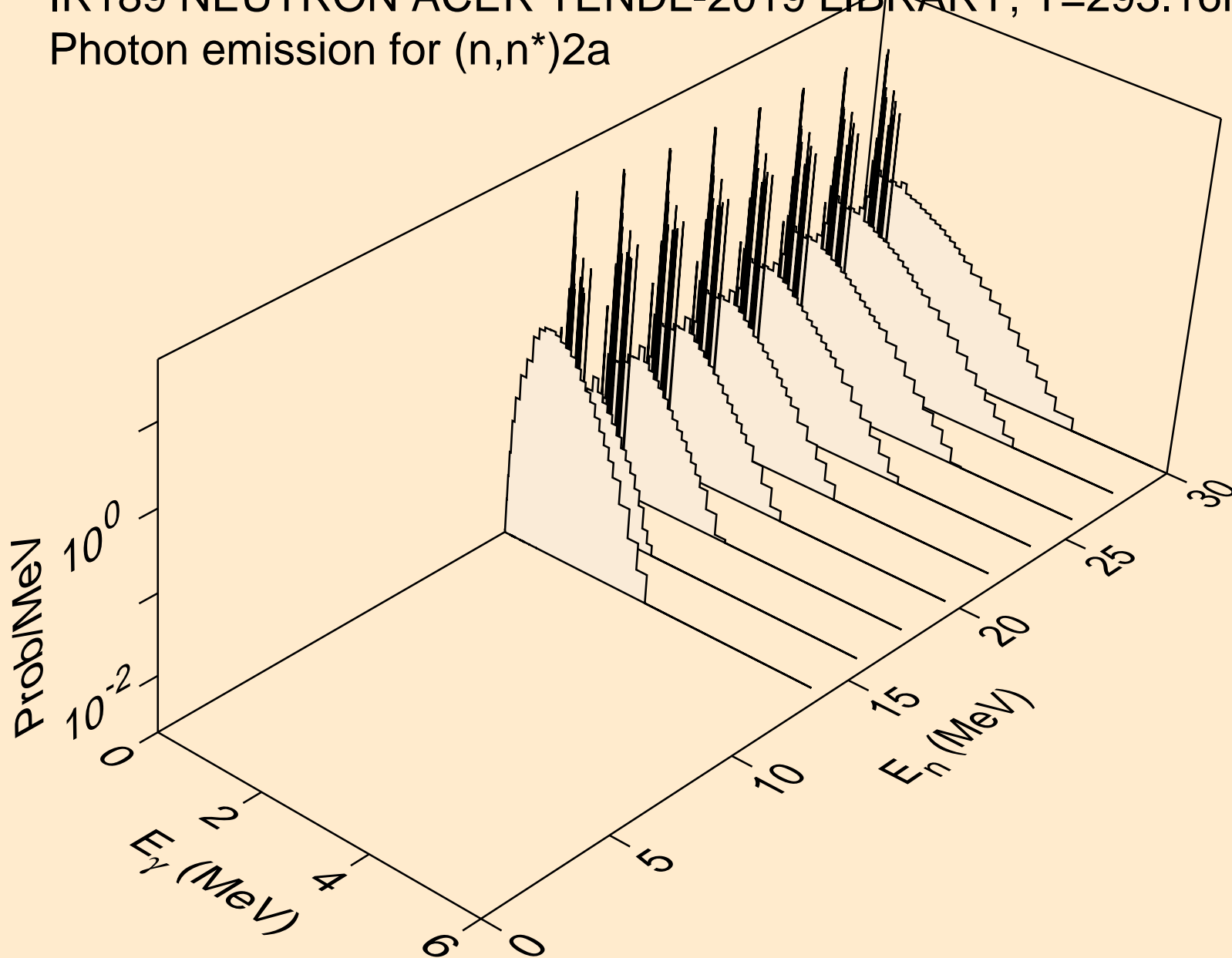

IR189 NEUTRON ACER TENDL-2019 LIBRARY; T=293.16K  
Photon emission for (n,n\*)d

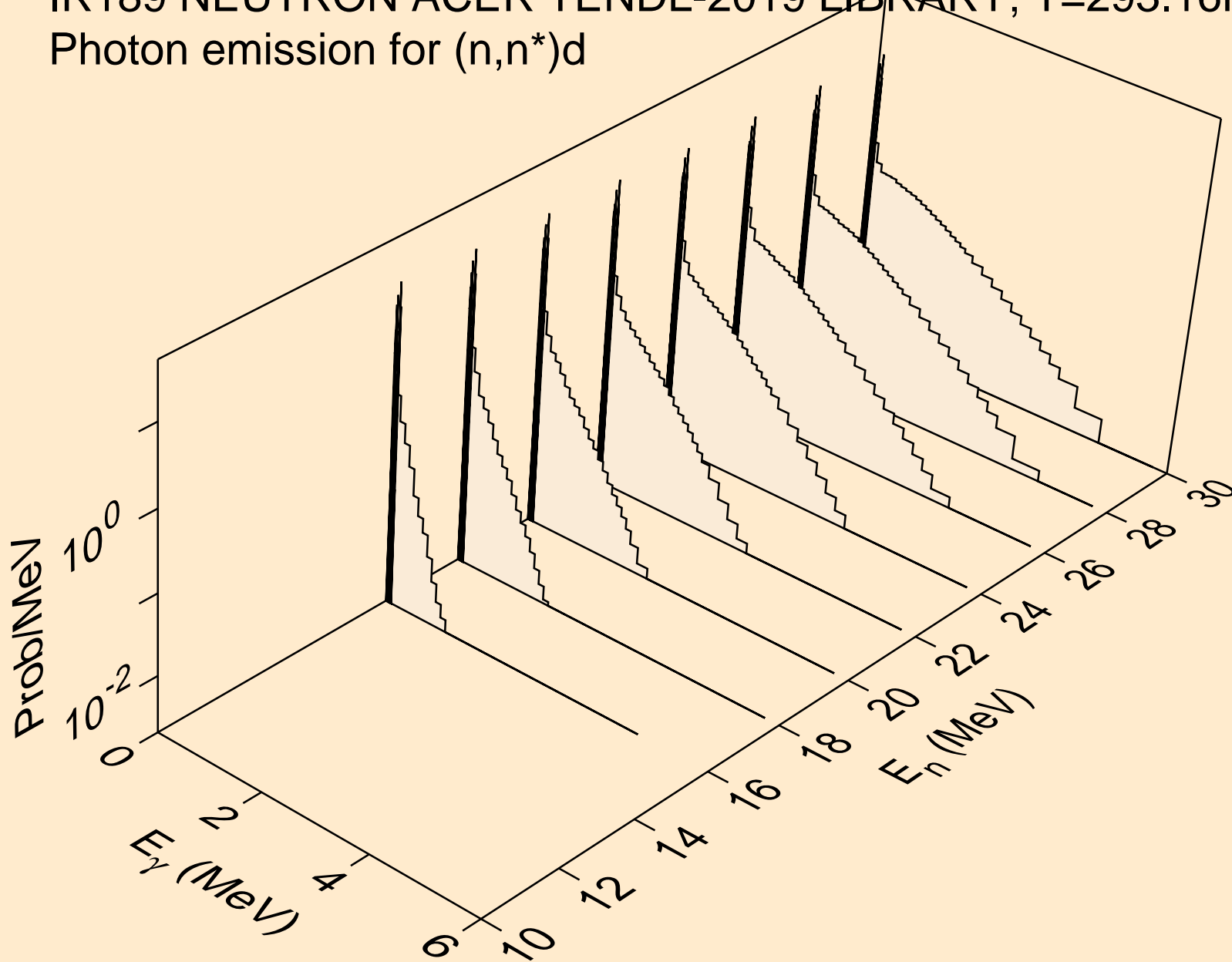

IR189 NEUTRON ACER TENDL-2019 LIBRARY; T=293.16K  
Photon emission for (n,n\*)t

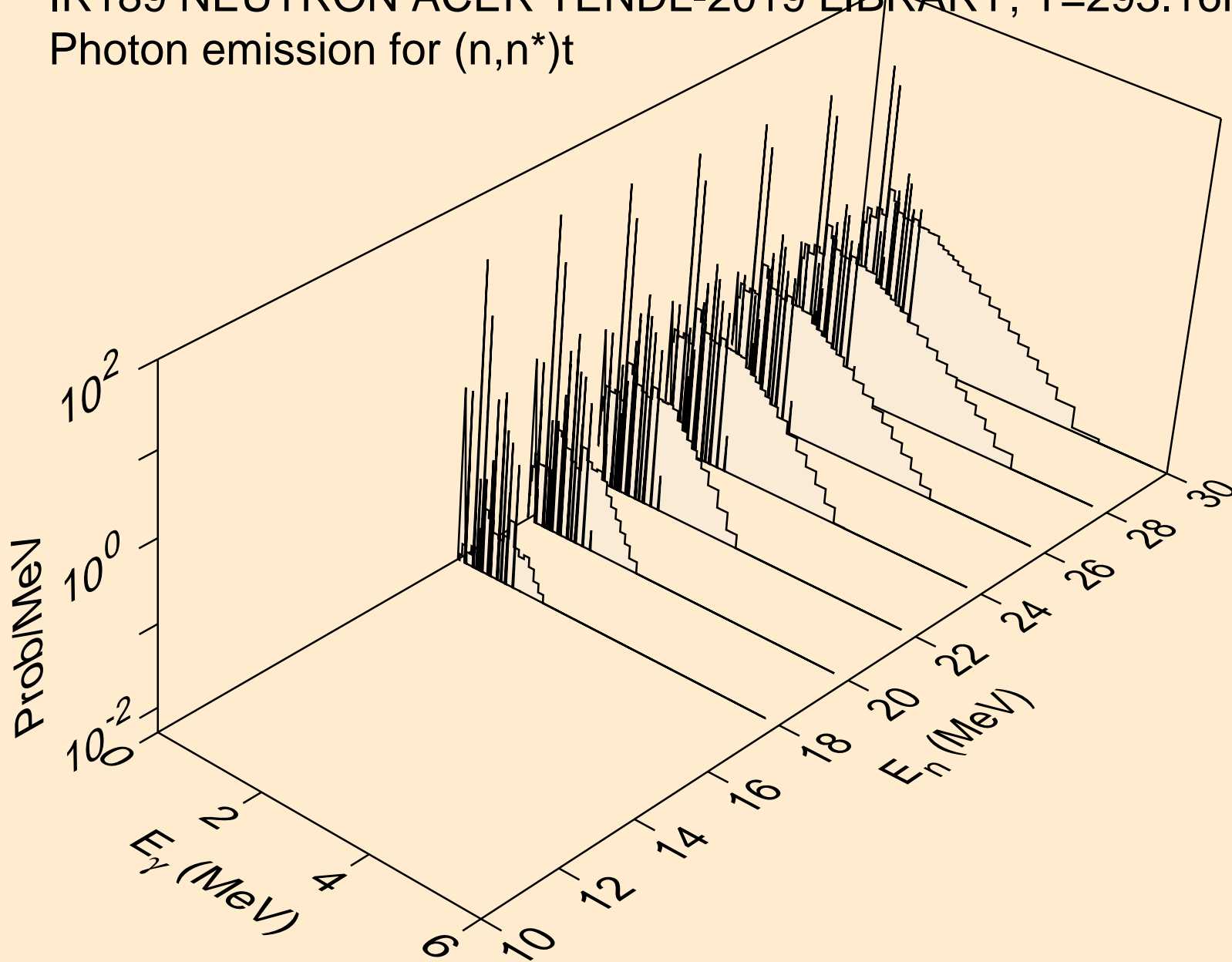



IR189 NEUTRON ACER TENDL-2019 LIBRARY; T=293.16K  
Photon emission for (n,n\*)he3

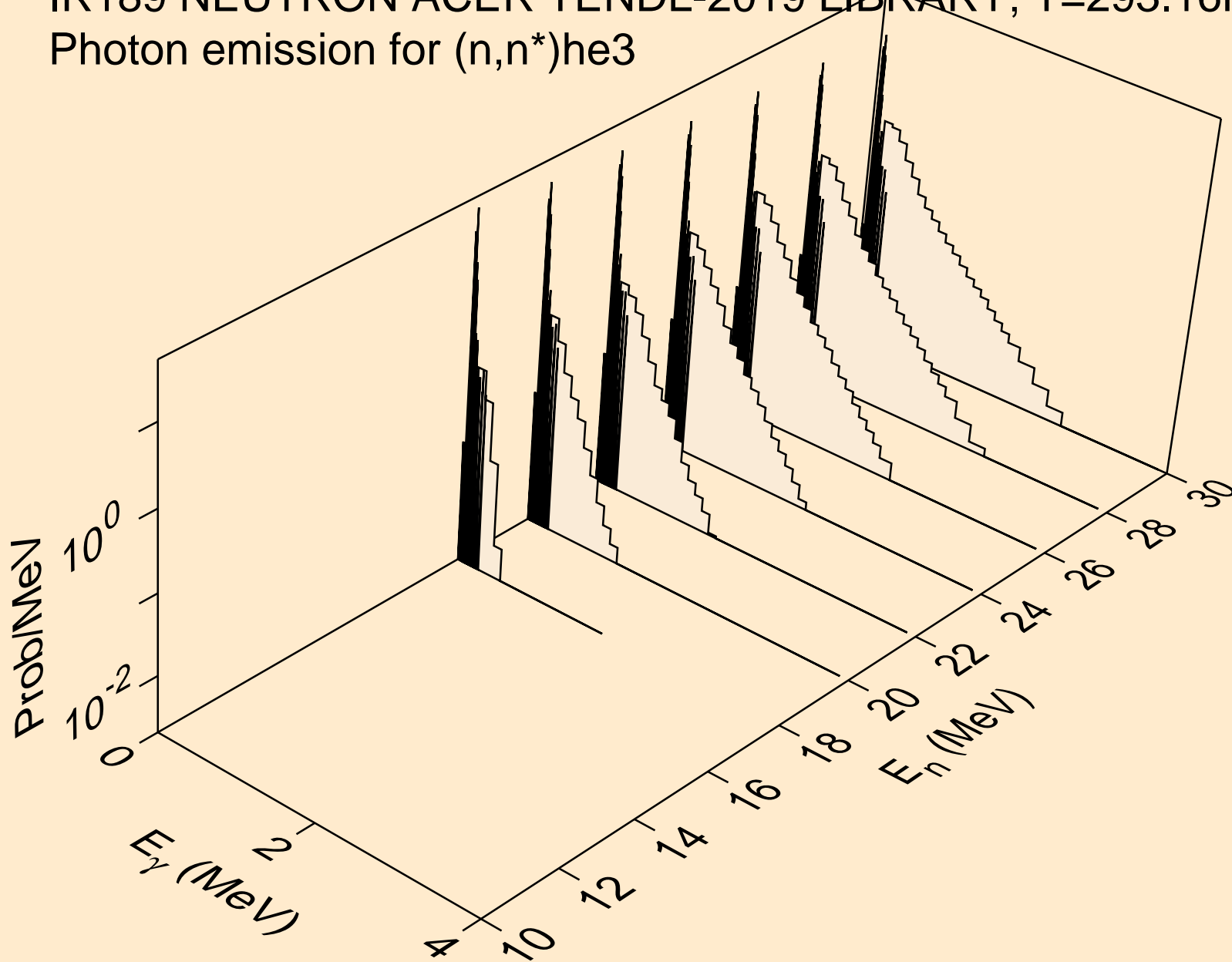

IR189 NEUTRON ACER TENDL-2019 LIBRARY; T=293.16K  
Photon emission for (n,4n)

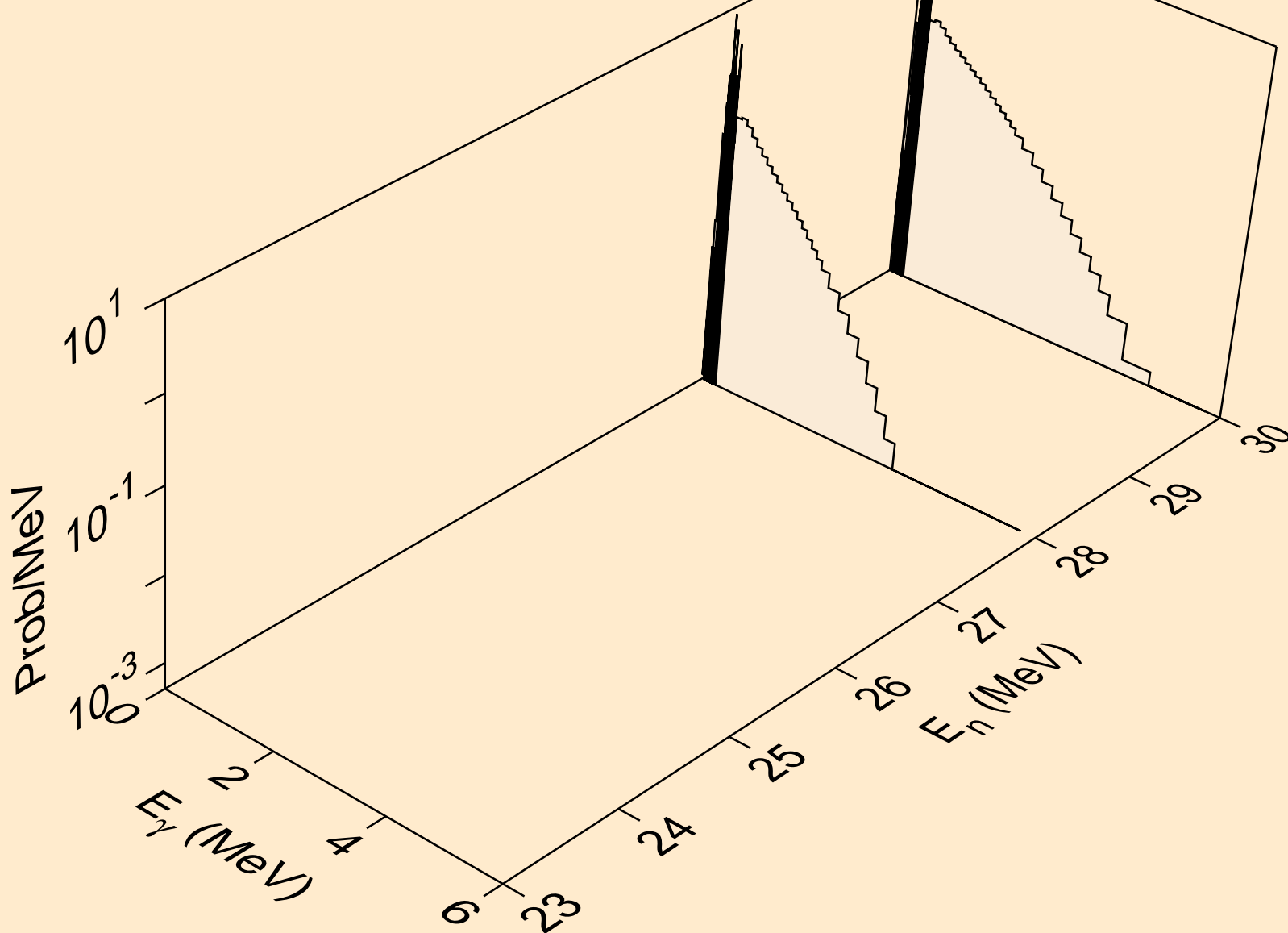

IR189 NEUTRON ACER TENDL-2019 LIBRARY; T=293.16K  
Photon emission for (n,2np)

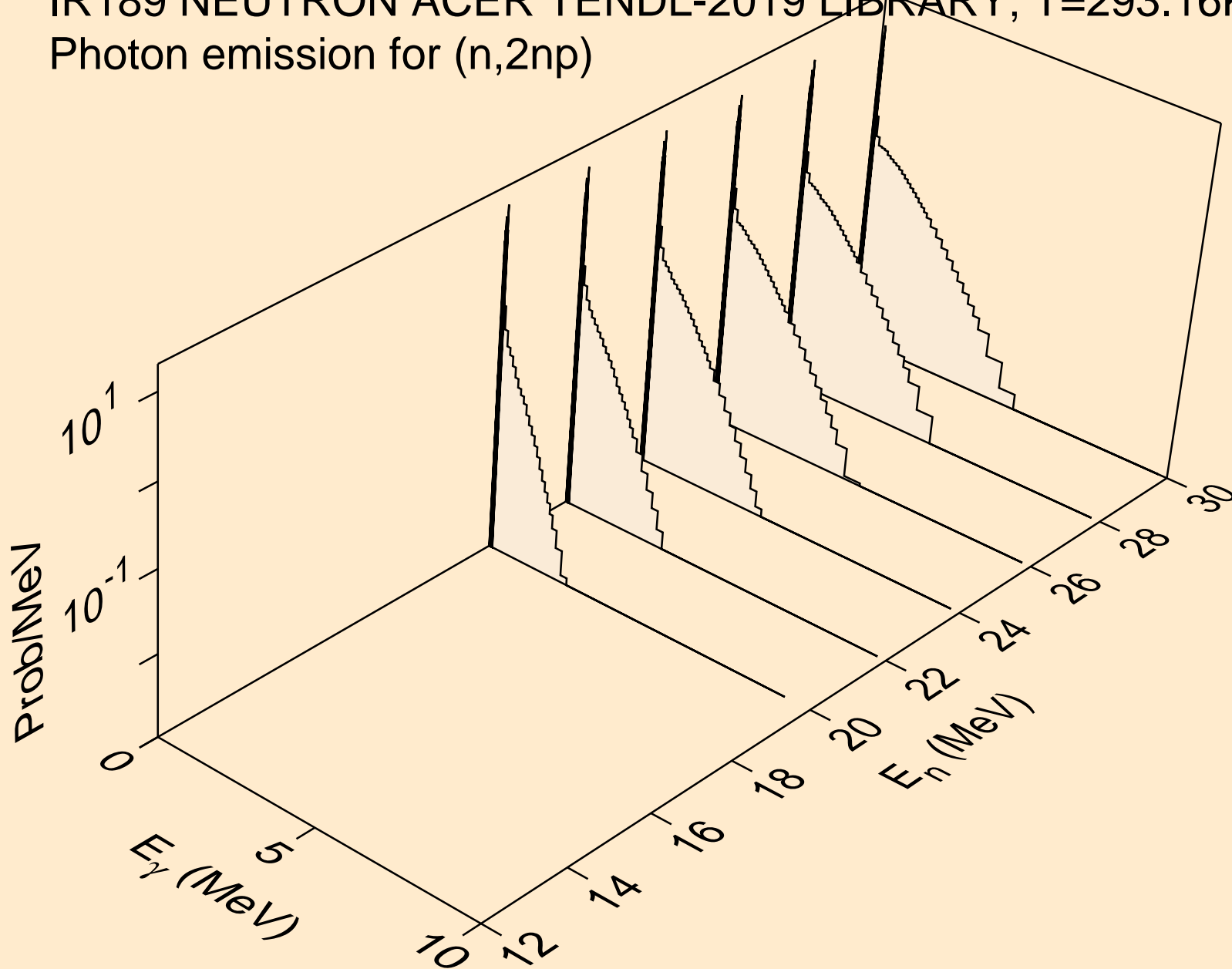

IR189 NEUTRON ACER TENDL-2019 LIBRARY; T=293.16K  
Photon emission for (n,3np)

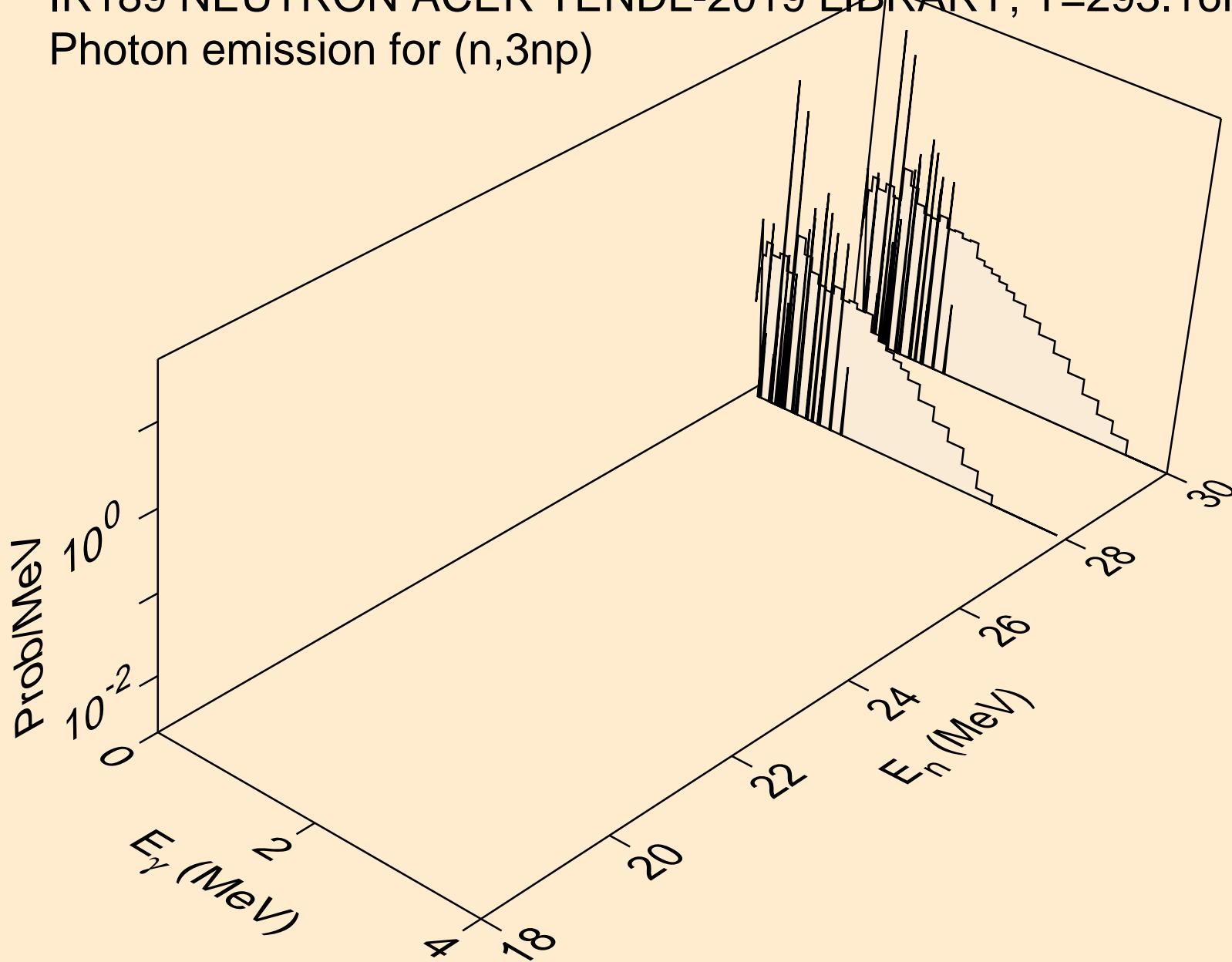

IR189 NEUTRON ACER TENDL-2019 LIBRARY; T=293.16K  
Photon emission for (n,2np)

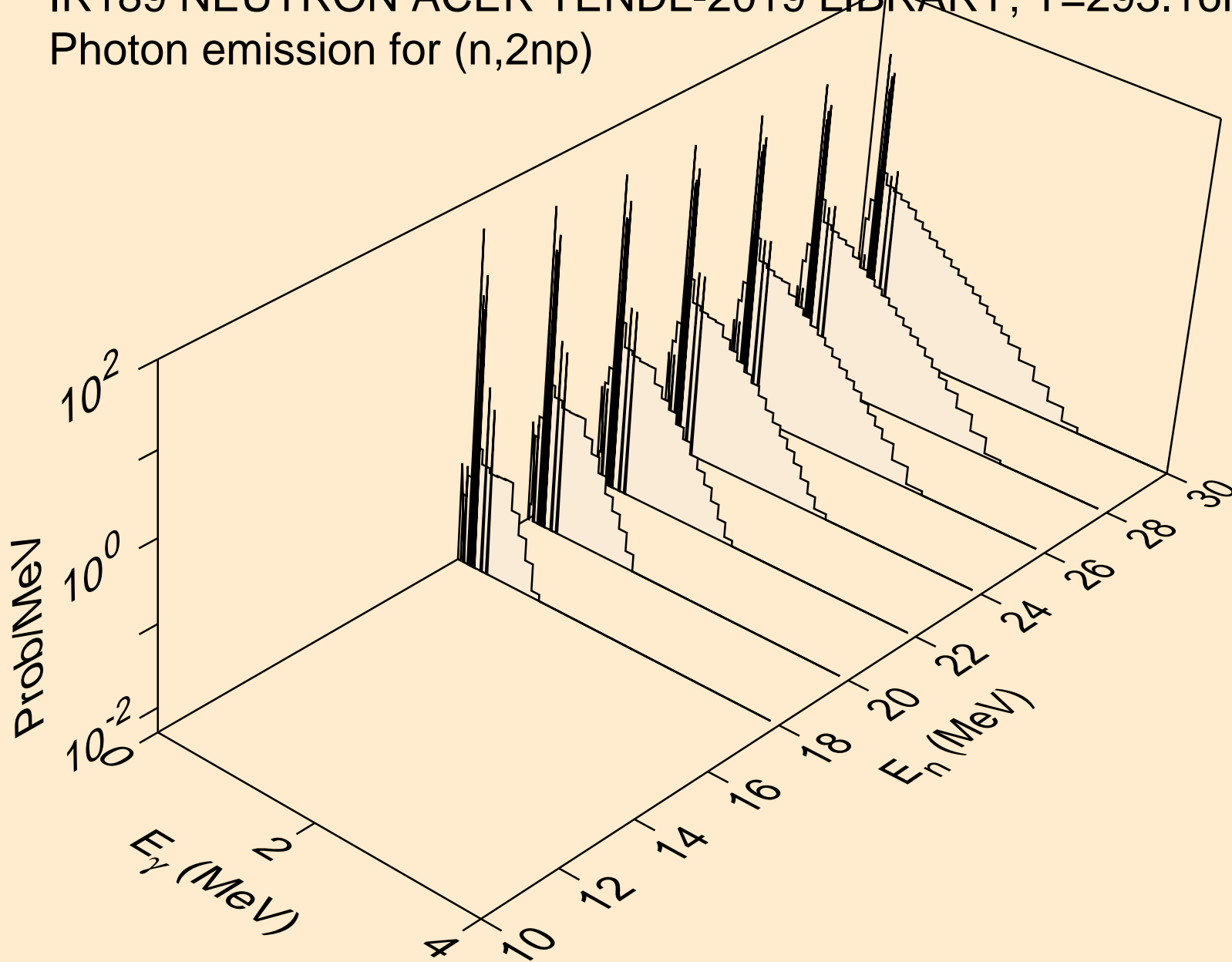

IR189 NEUTRON ACER TENDL-2019 LIBRARY; T=293.16K  
Photon emission for (n,npa)

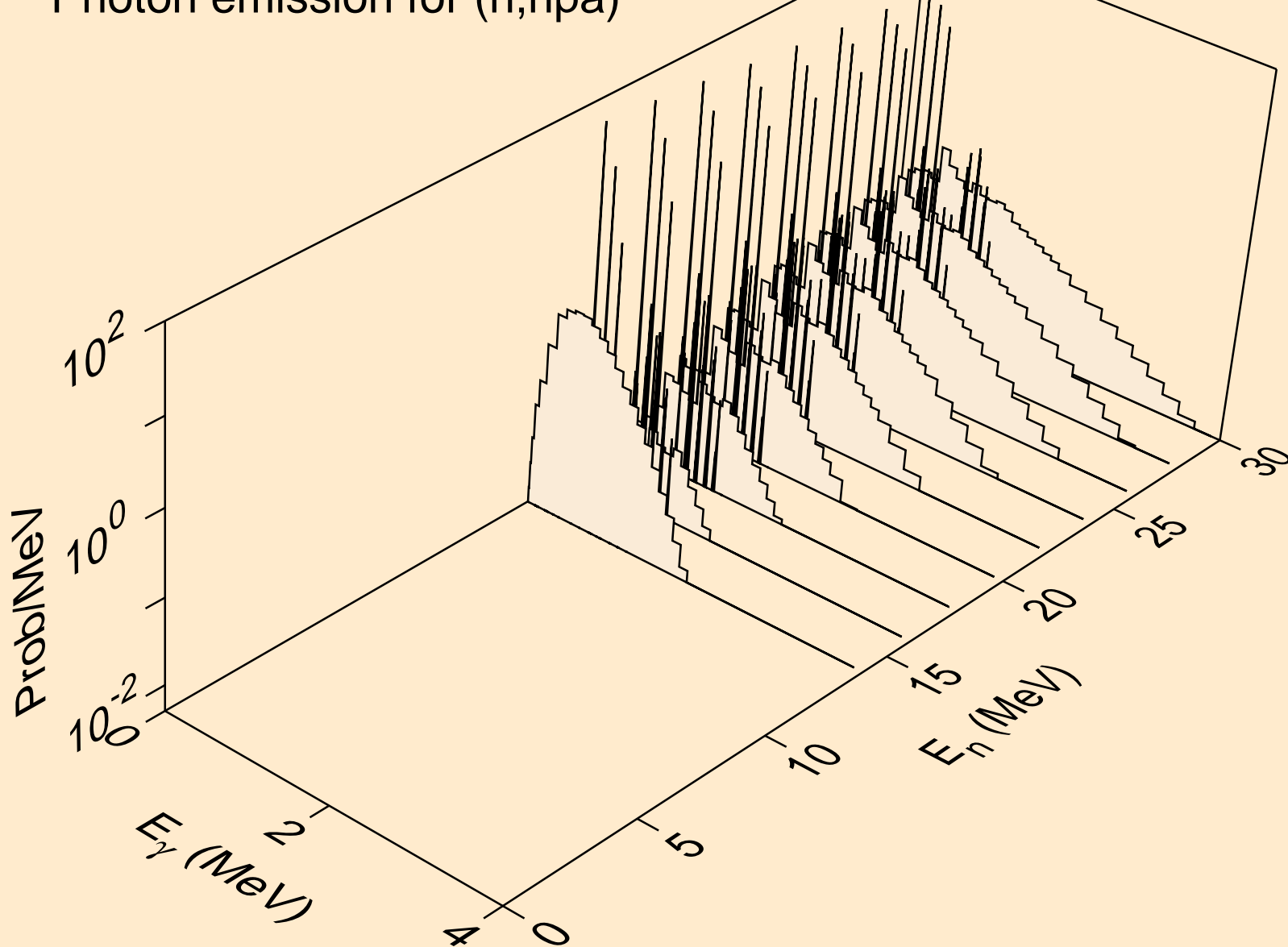

IR189 NEUTRON ACER TENDL-2019 LIBRARY; T=293.16K  
Photon emission for (n,n\*c)

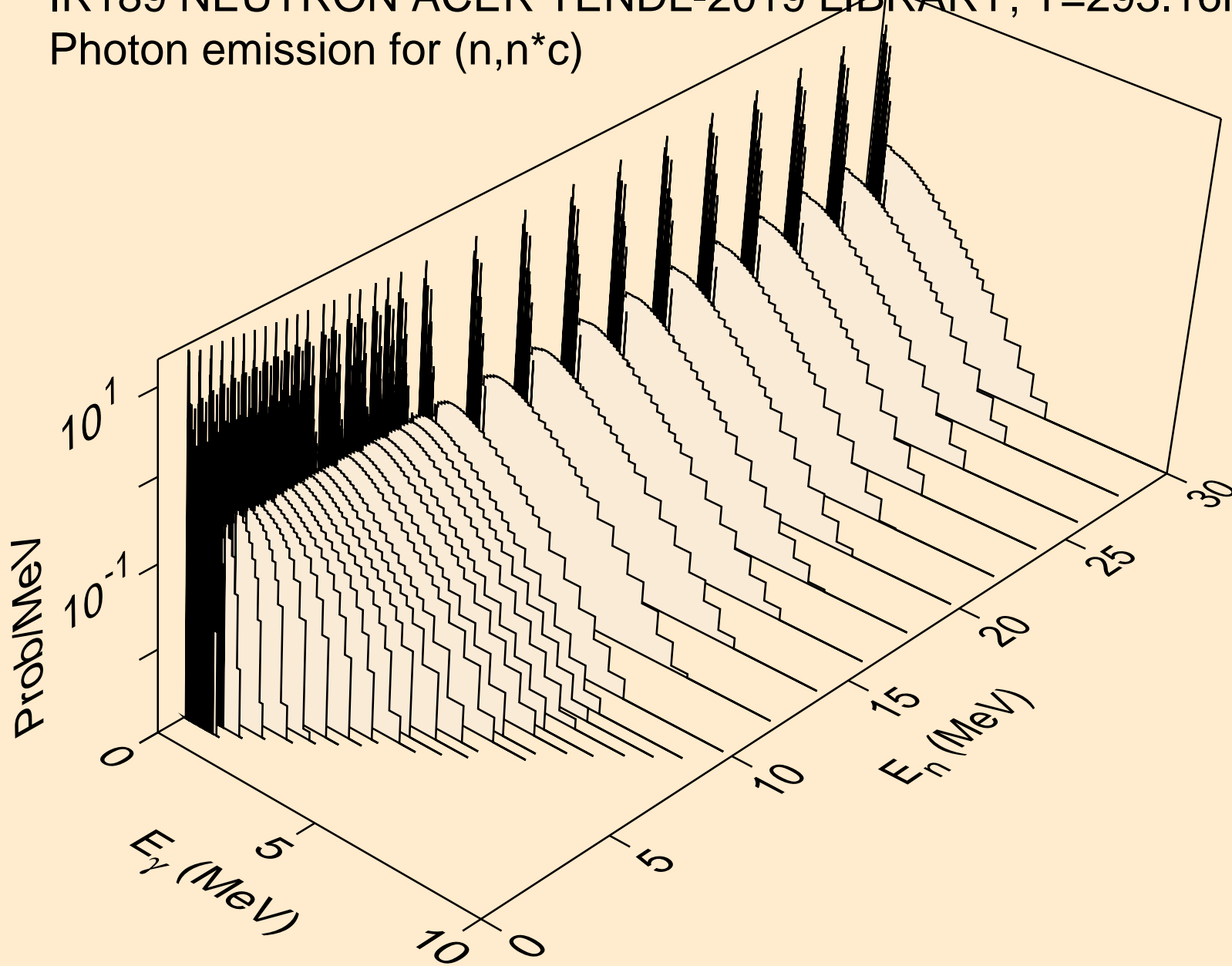

IR189 NEUTRON ACER TENDL-2019 LIBRARY; T=293.16K  
Photon emission for (n,gma)

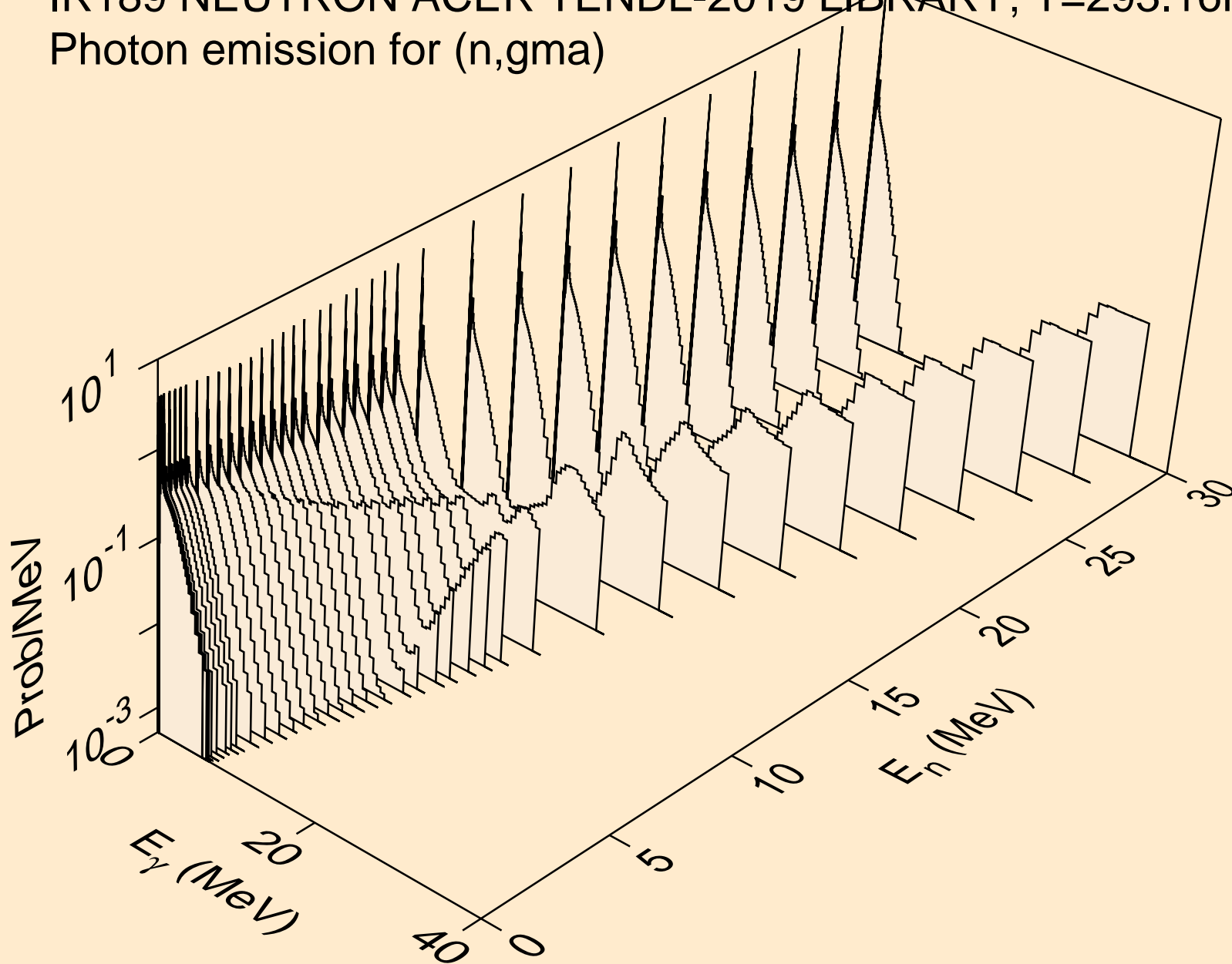



IR189 NEUTRON ACER TENDL-2019 LIBRARY; T=293.16K  
Photon emission for (n,p)

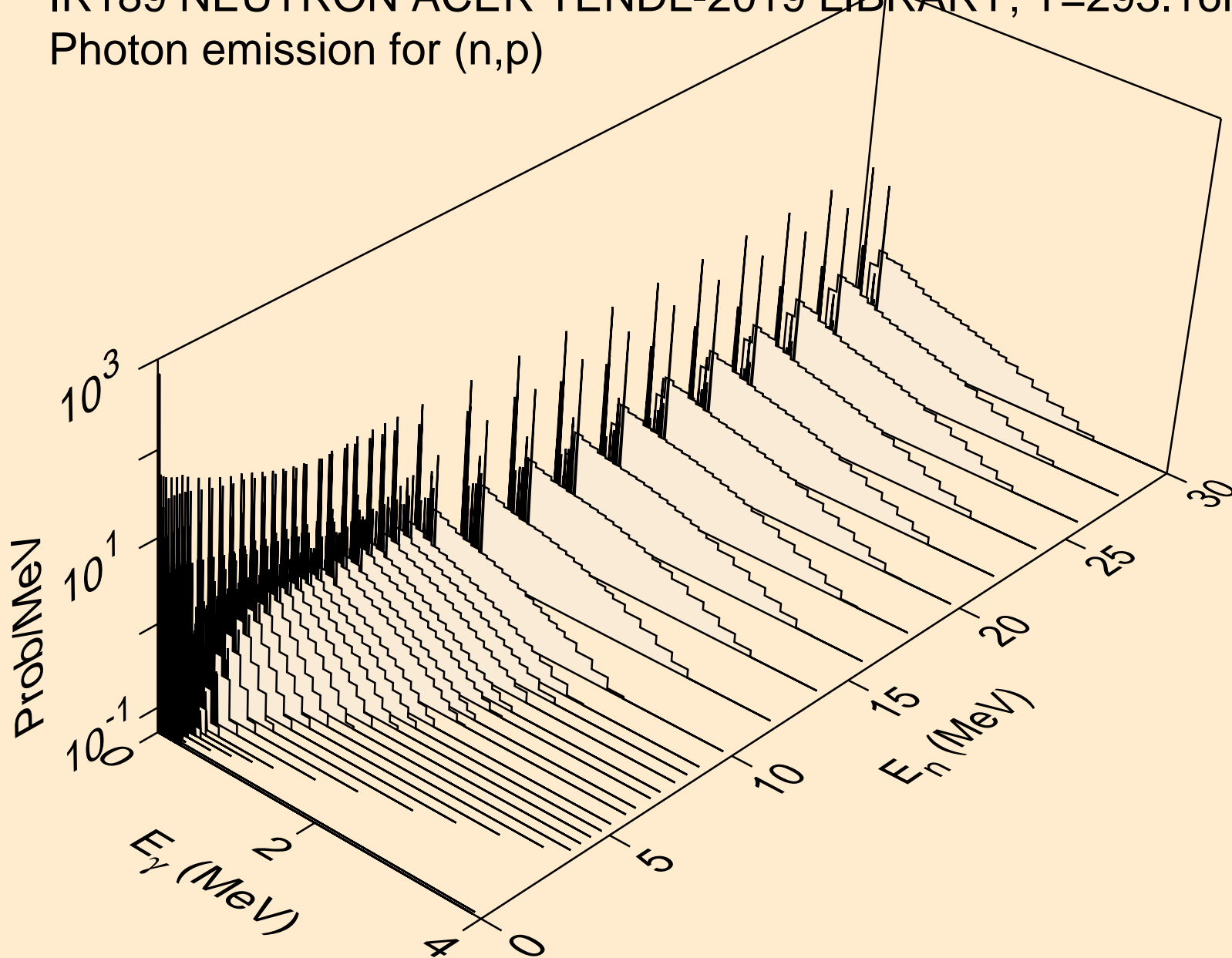

IR189 NEUTRON ACER TENDL-2019 LIBRARY; T=293.16K  
Photon emission for (n,d)

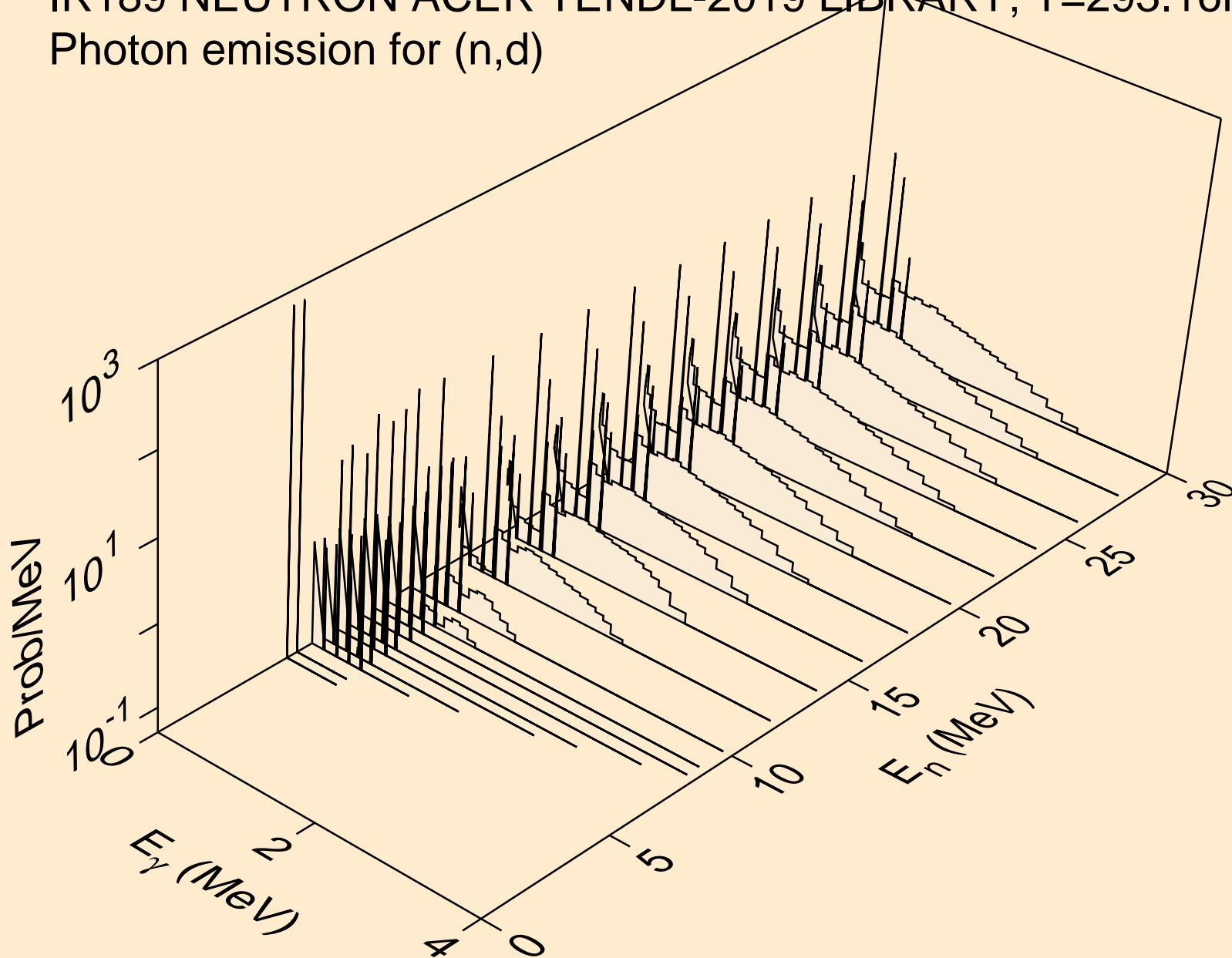

IR189 NEUTRON ACER TENDL-2019 LIBRARY; T=293.16K  
Photon emission for (n,t)

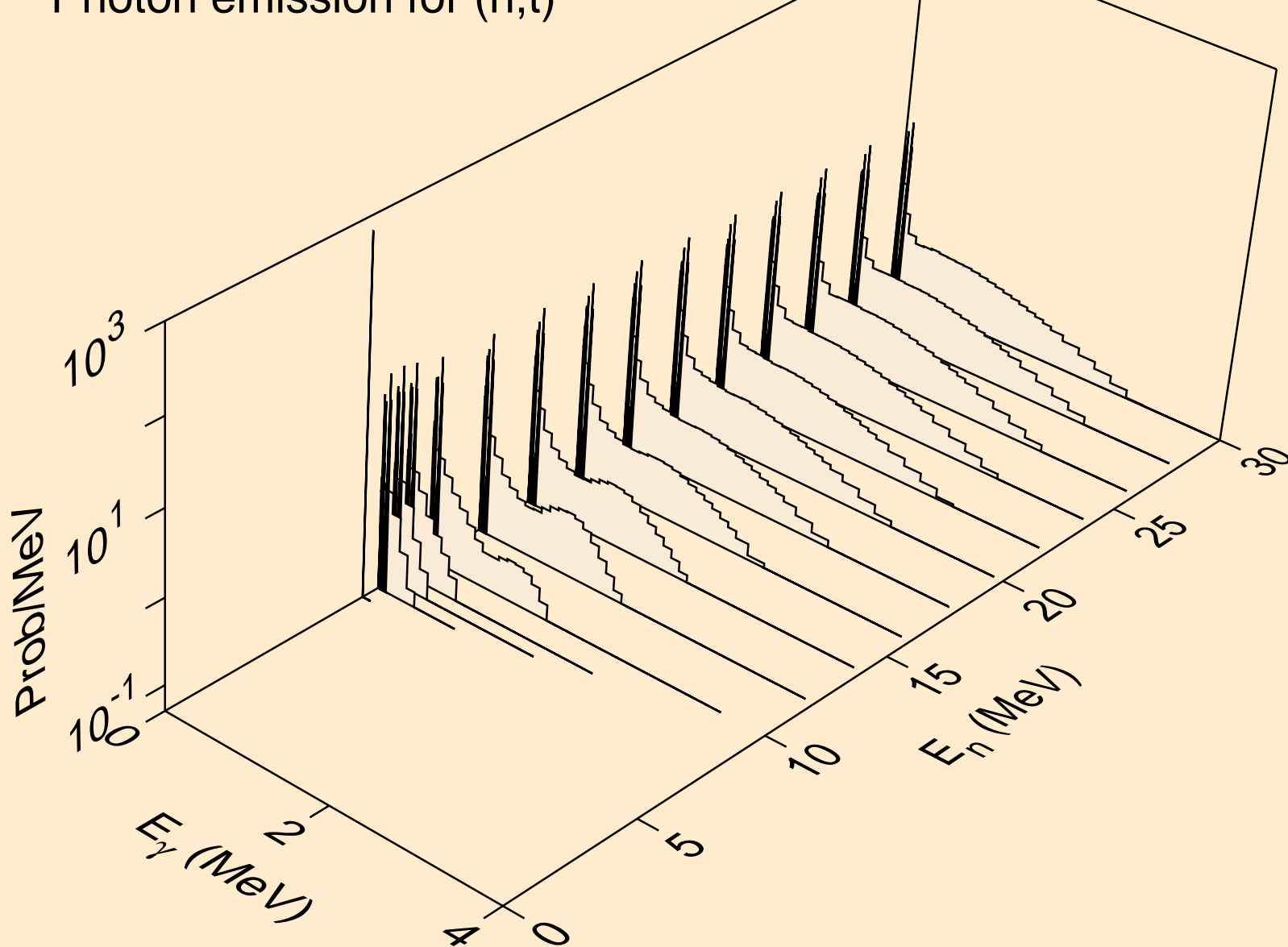

IR189 NEUTRON ACER TENDL-2019 LIBRARY; T=293.16K  
Photon emission for (n,he3)

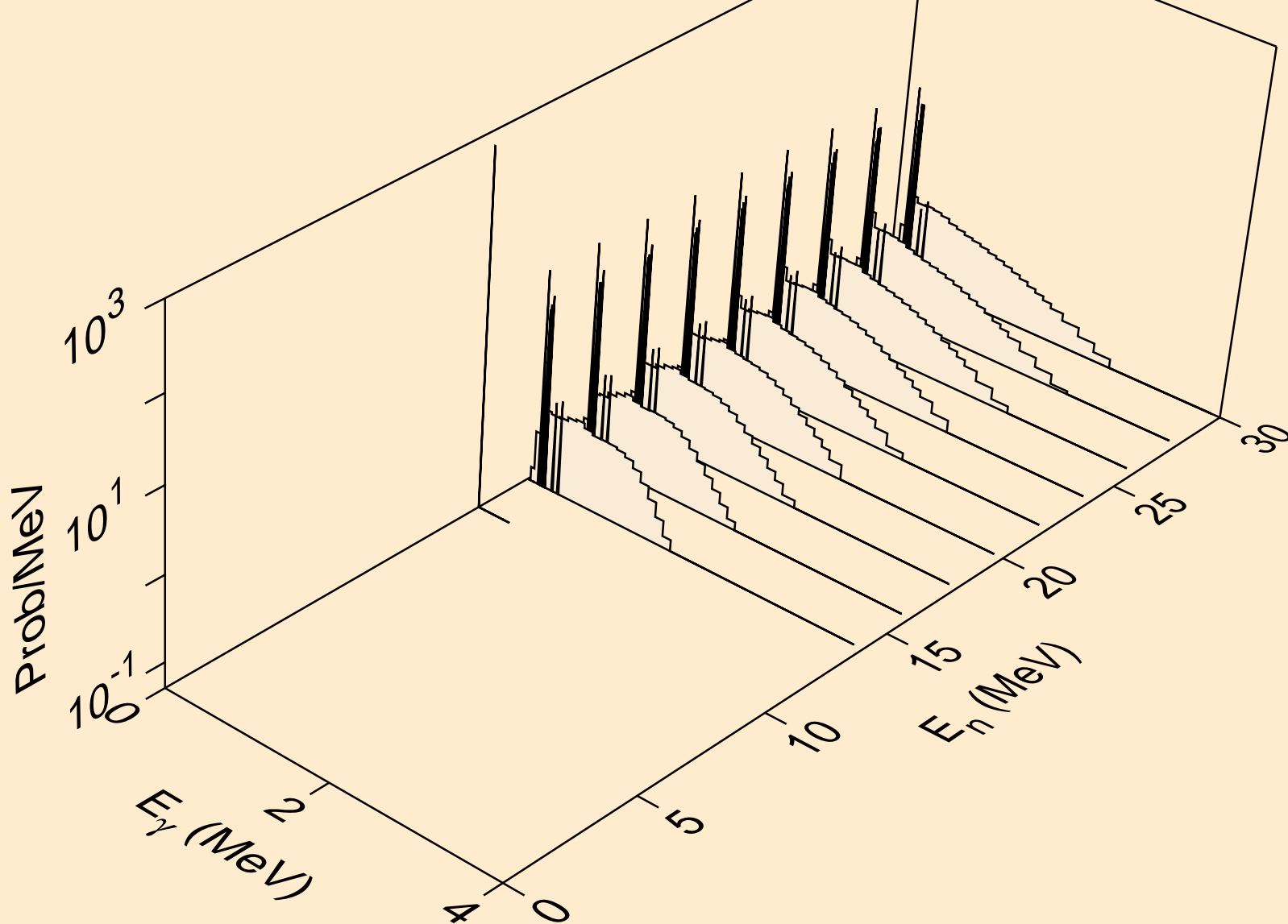

IR189 NEUTRON ACER TENDL-2019 LIBRARY; T=293.16K  
Photon emission for (n,a)

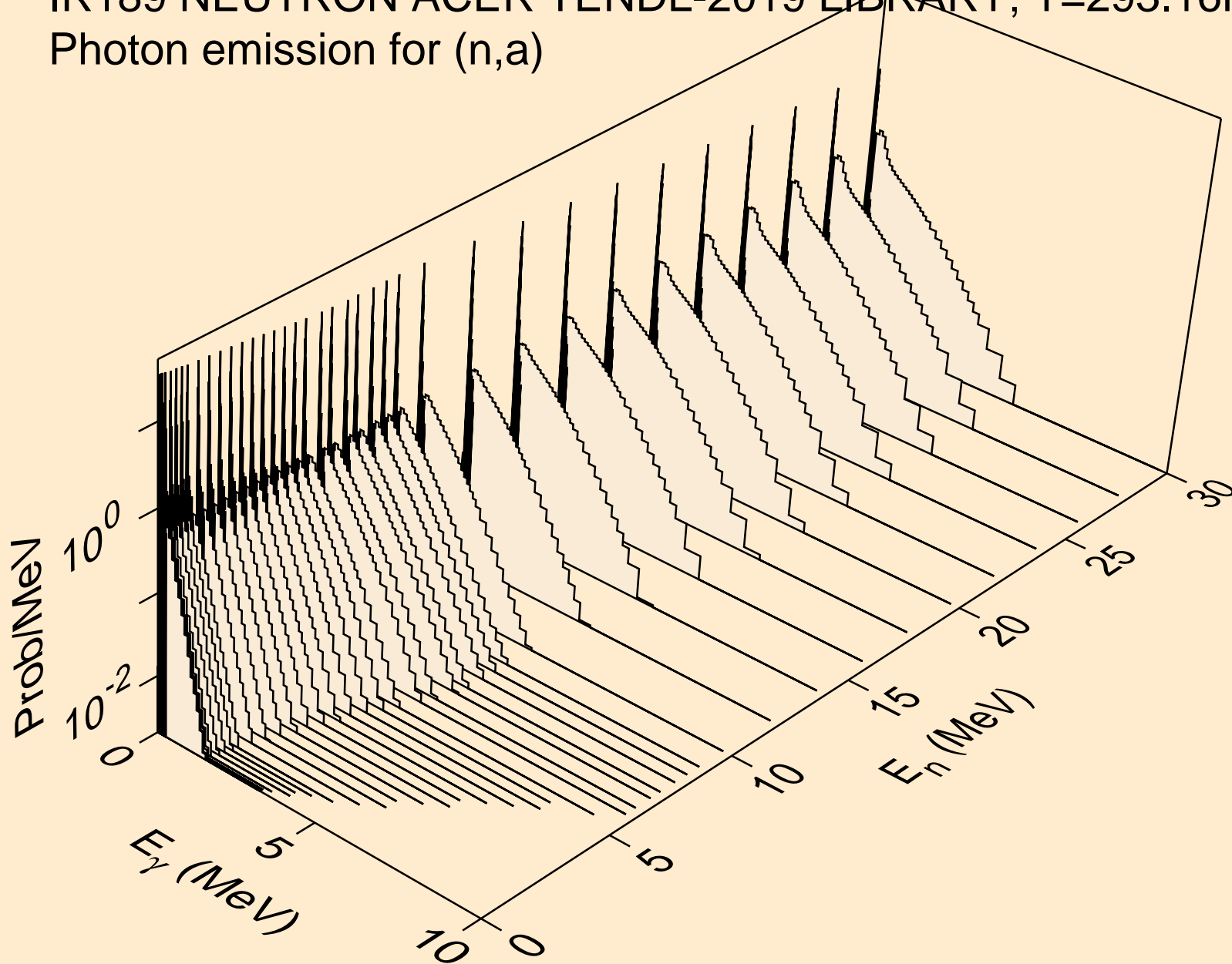

IR189 NEUTRON ACER TENDL-2019 LIBRARY; T=293.16K  
Photon emission for (n,2a)

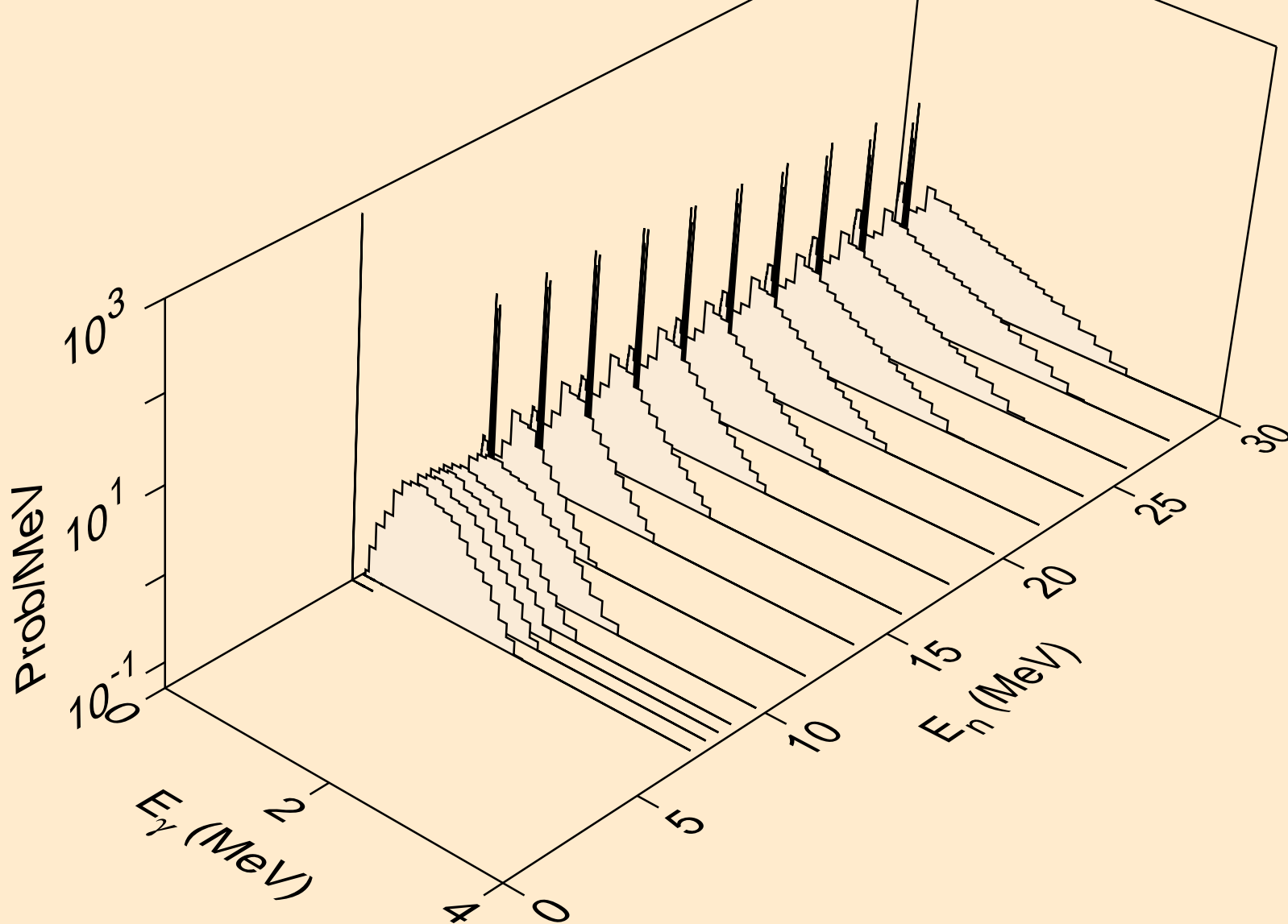

IR189 NEUTRON ACER TENDL-2019 LIBRARY; T=293.16K  
Photon emission for (n,2p)

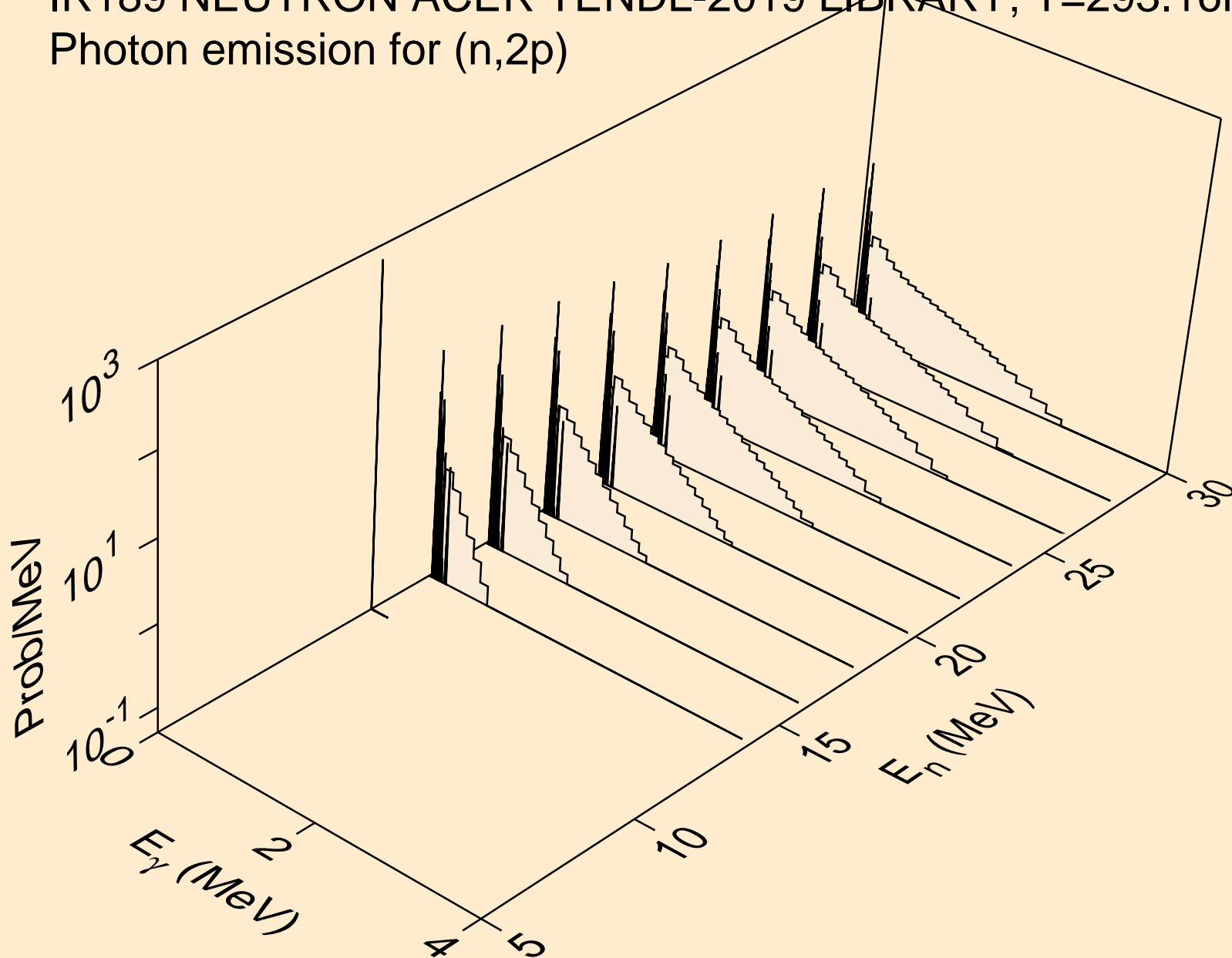

IR189 NEUTRON ACER TENDL-2019 LIBRARY; T=293.16K  
Photon emission for (n,p)

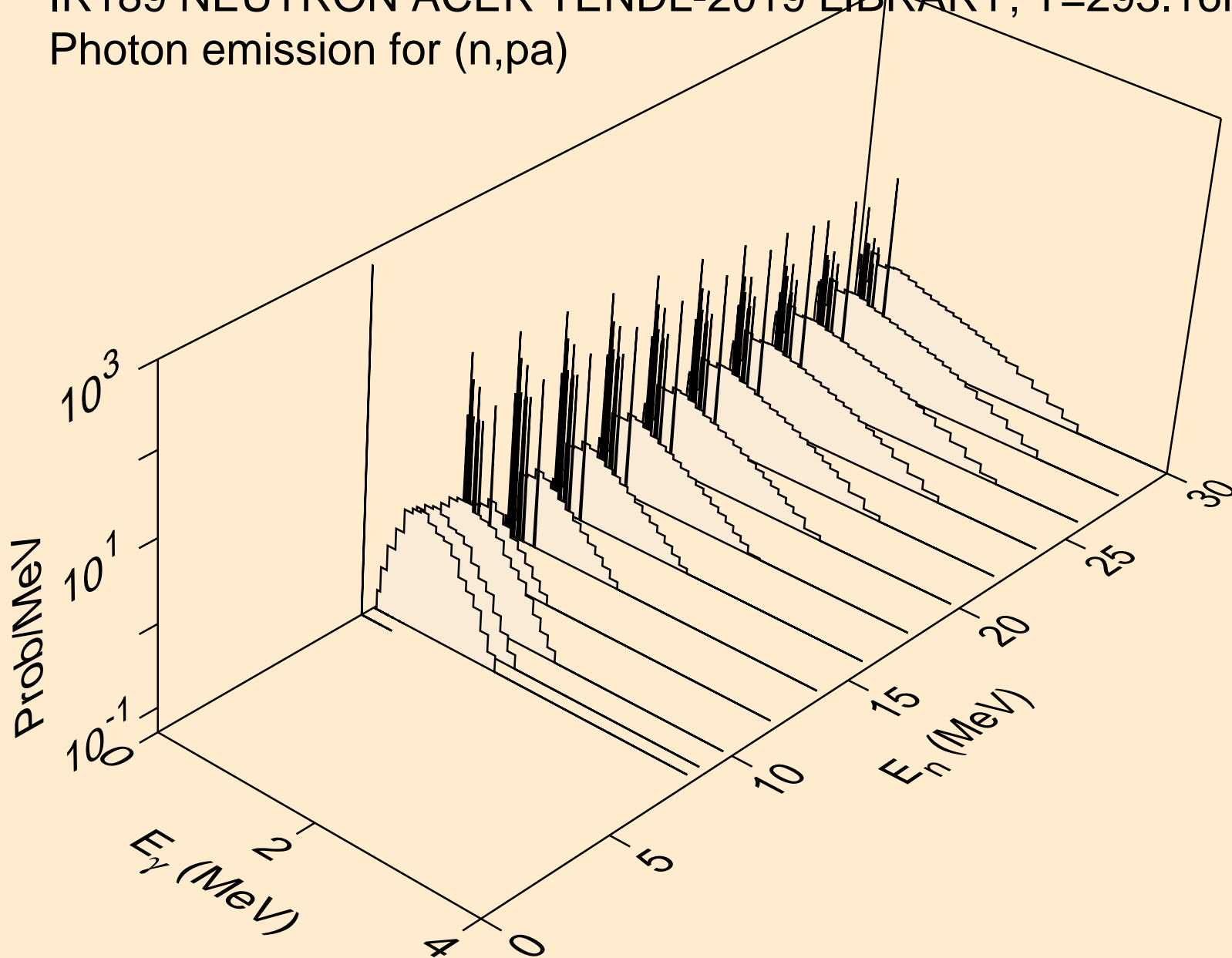



IR189 NEUTRON ACER TENDL-2019 LIBRARY; T=293.16K  
Photon emission for (n,pd)

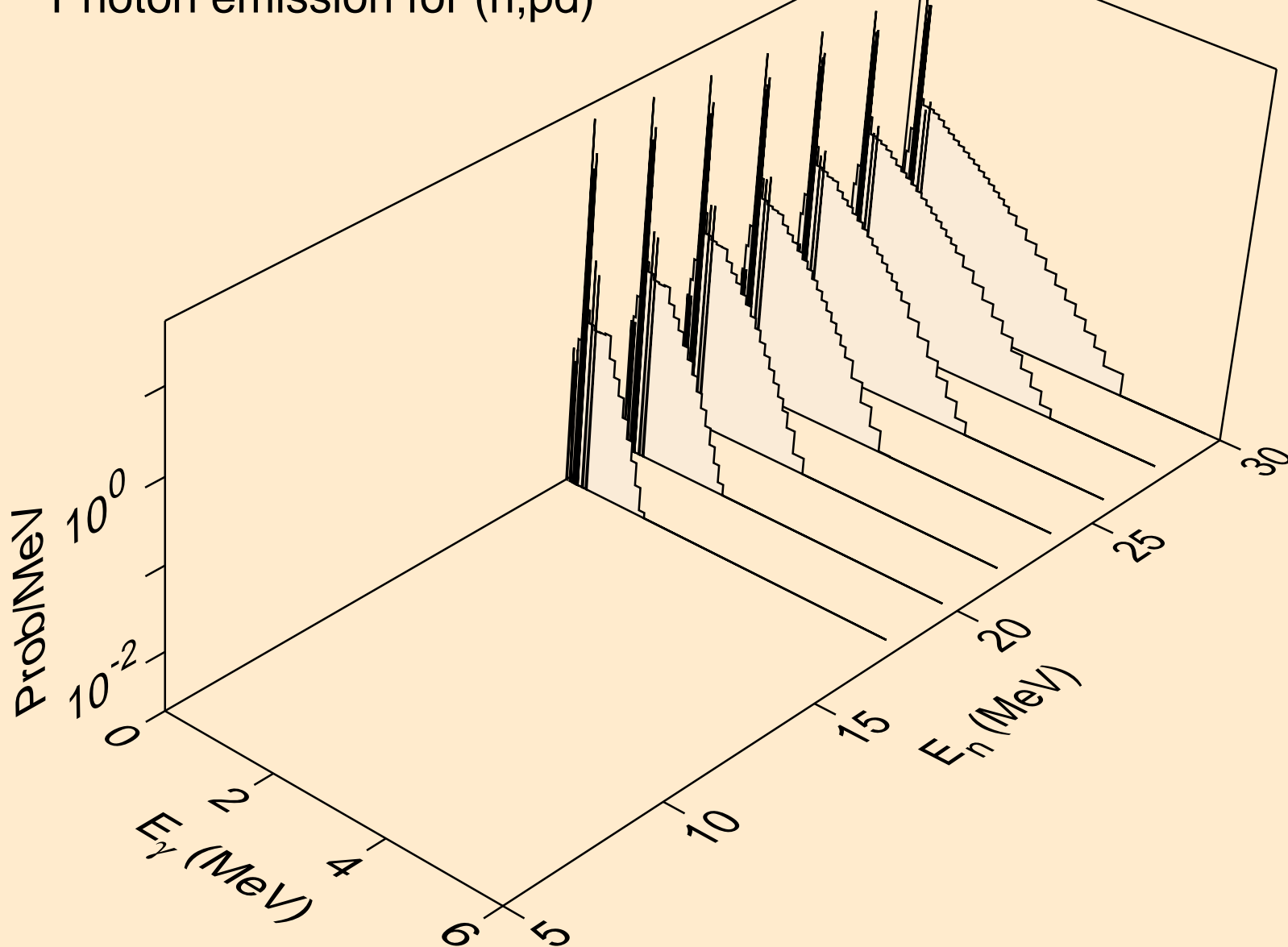

IR189 NEUTRON ACER TENDL-2019 LIBRARY; T=293.16K  
Photon emission for (n,pt)

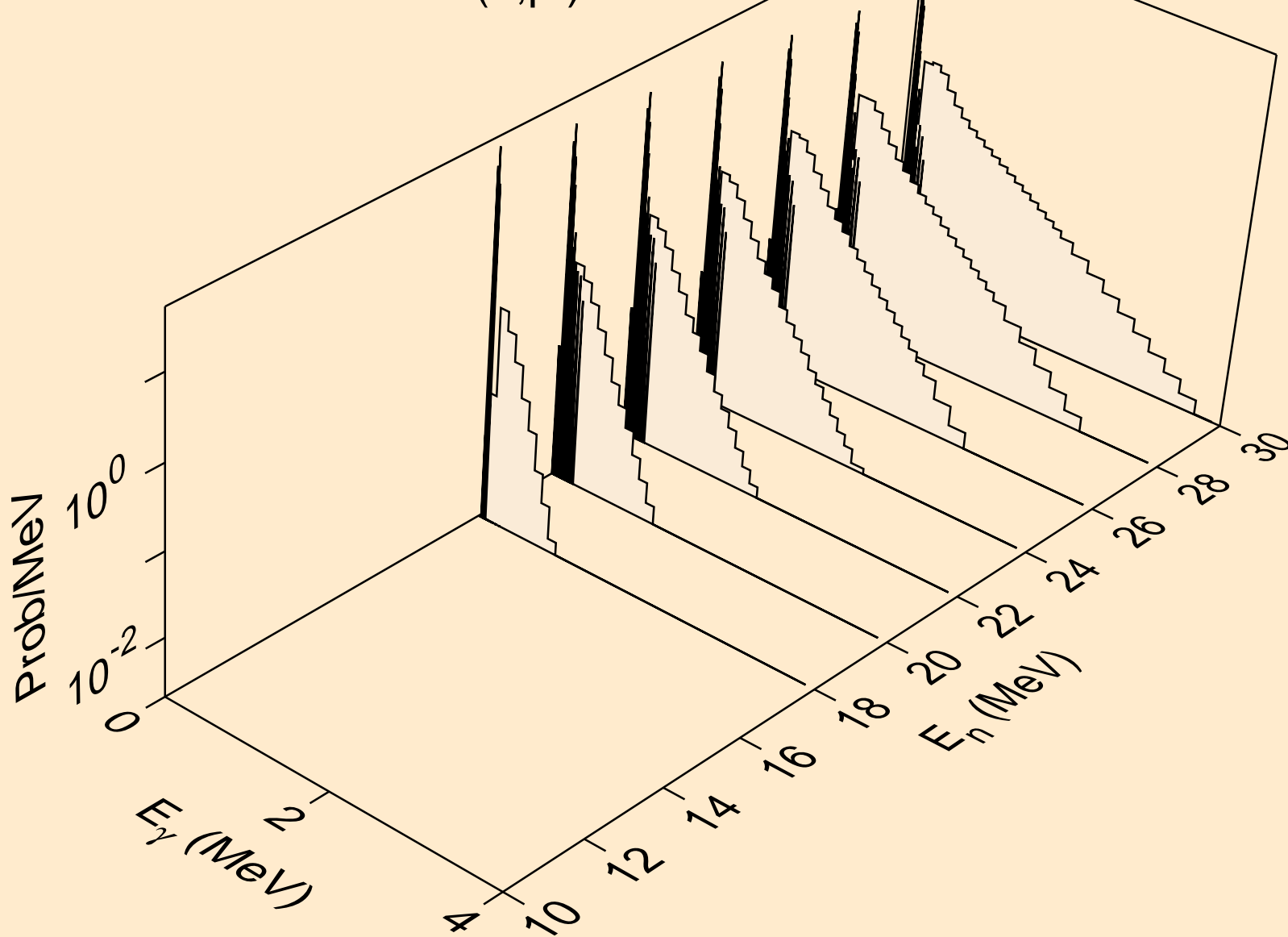

IR189 NEUTRON ACER TENDL-2019 LIBRARY; T=293.16K  
Photon emission for (n,da)

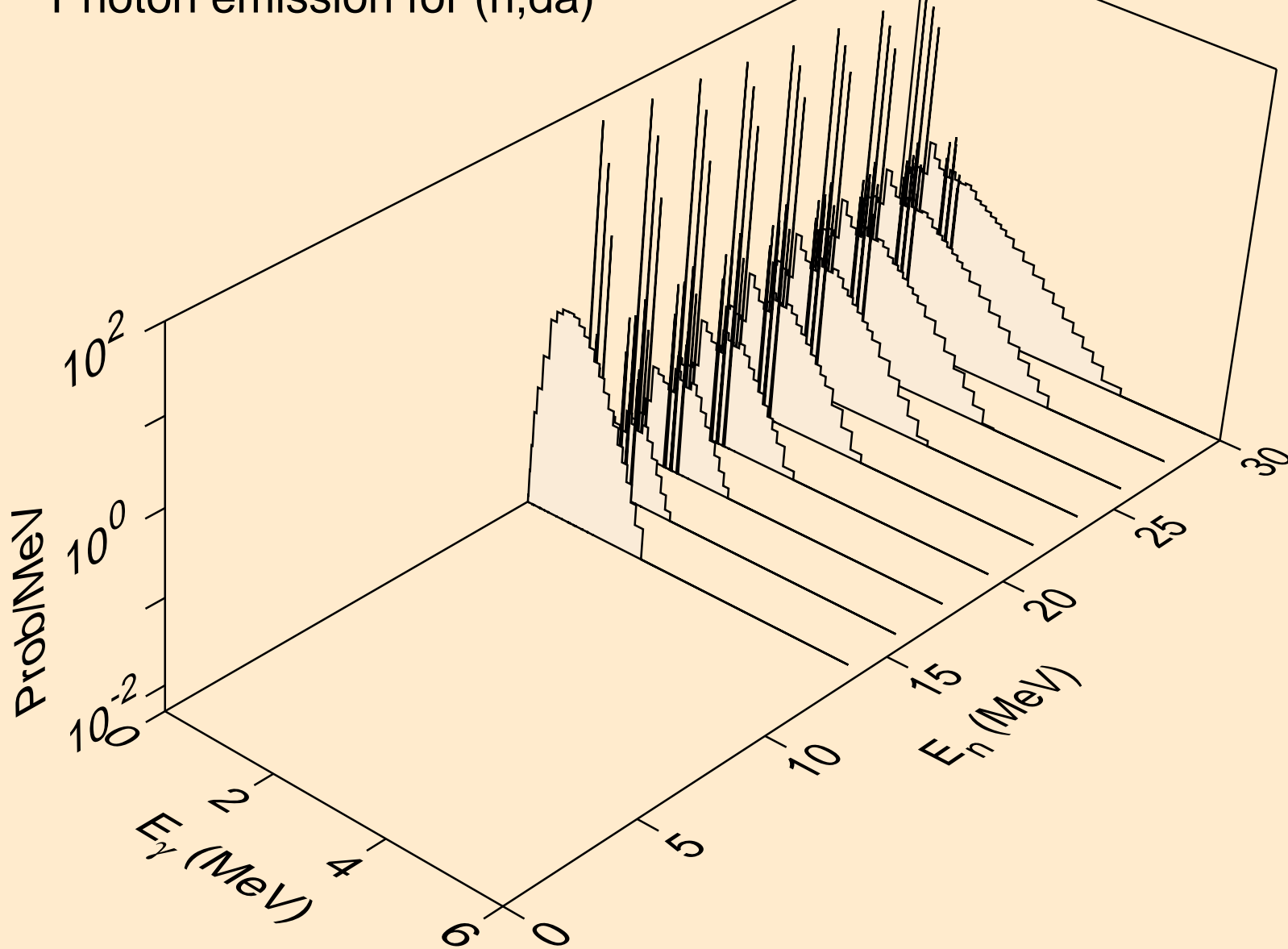

IR189 NEUTRON ACER TENDL-2019 LIBRARY; T=293.16K  
thermal capture photon spectrum

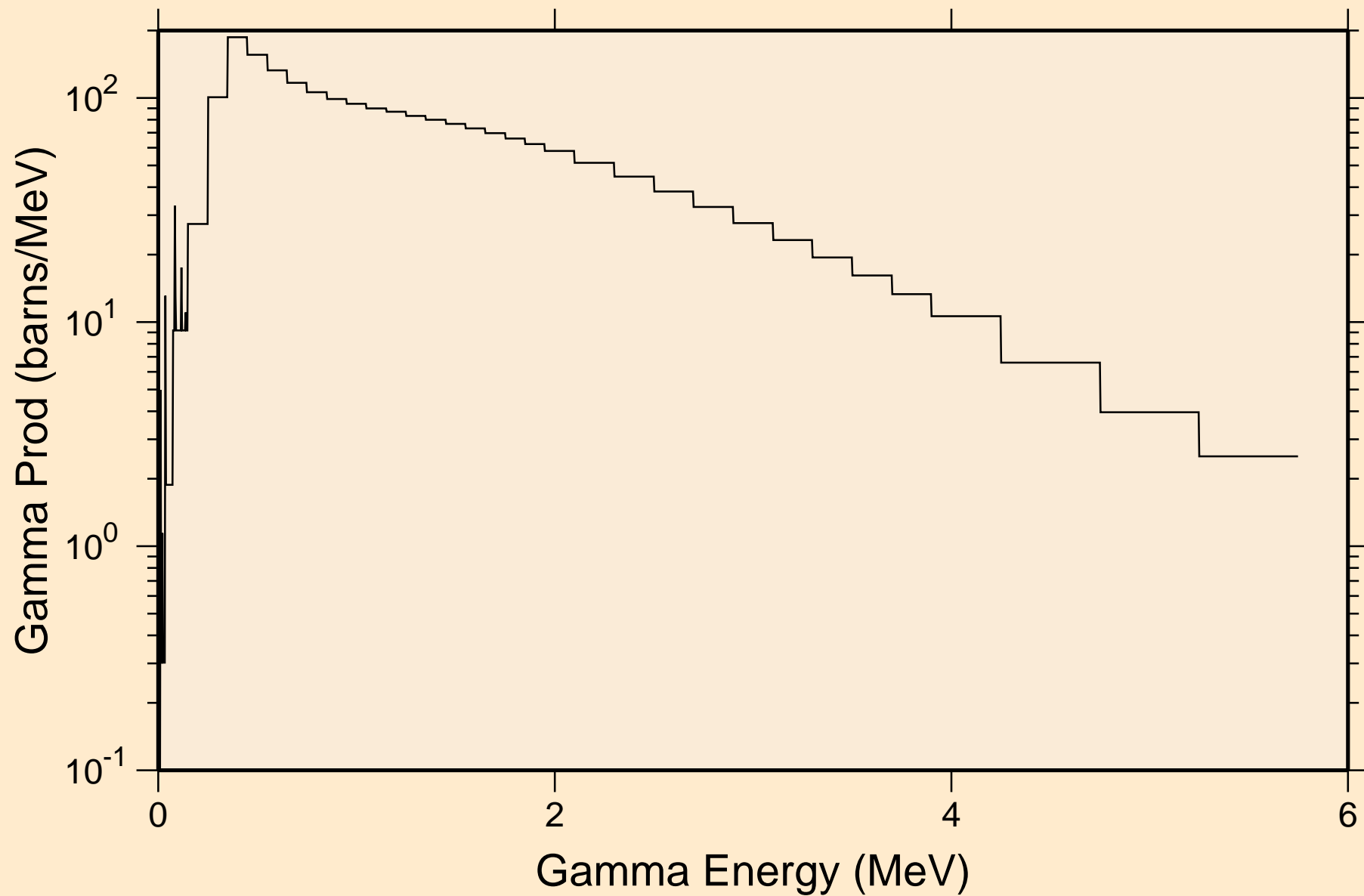

IR189 NEUTRON ACER TENDL-2019 LIBRARY; T=293.16K  
14 MeV photon spectrum

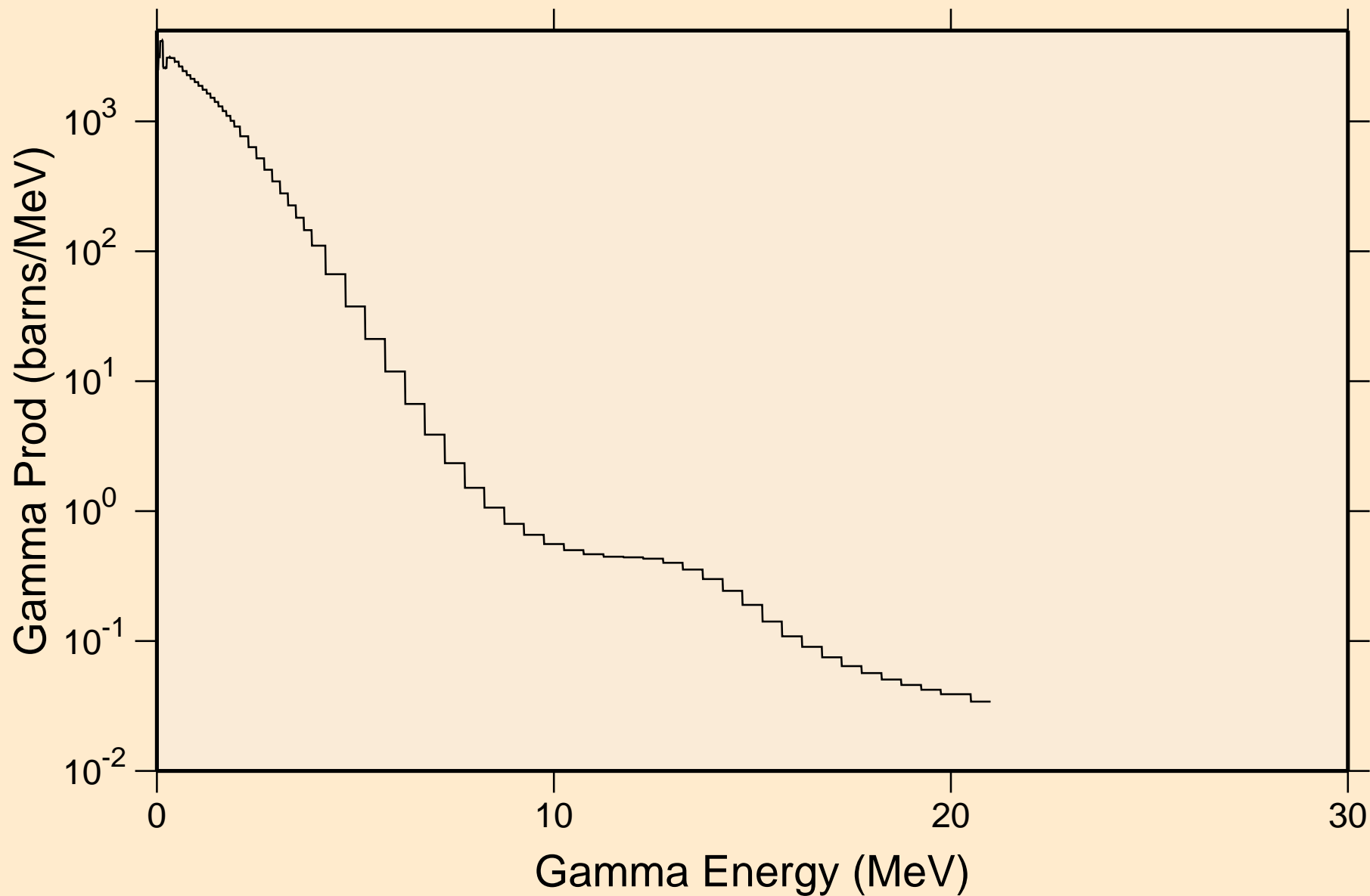

IR189 NEUTRON ACER TENDL-2019 LIBRARY; T=293.16K  
Particle heating contributions

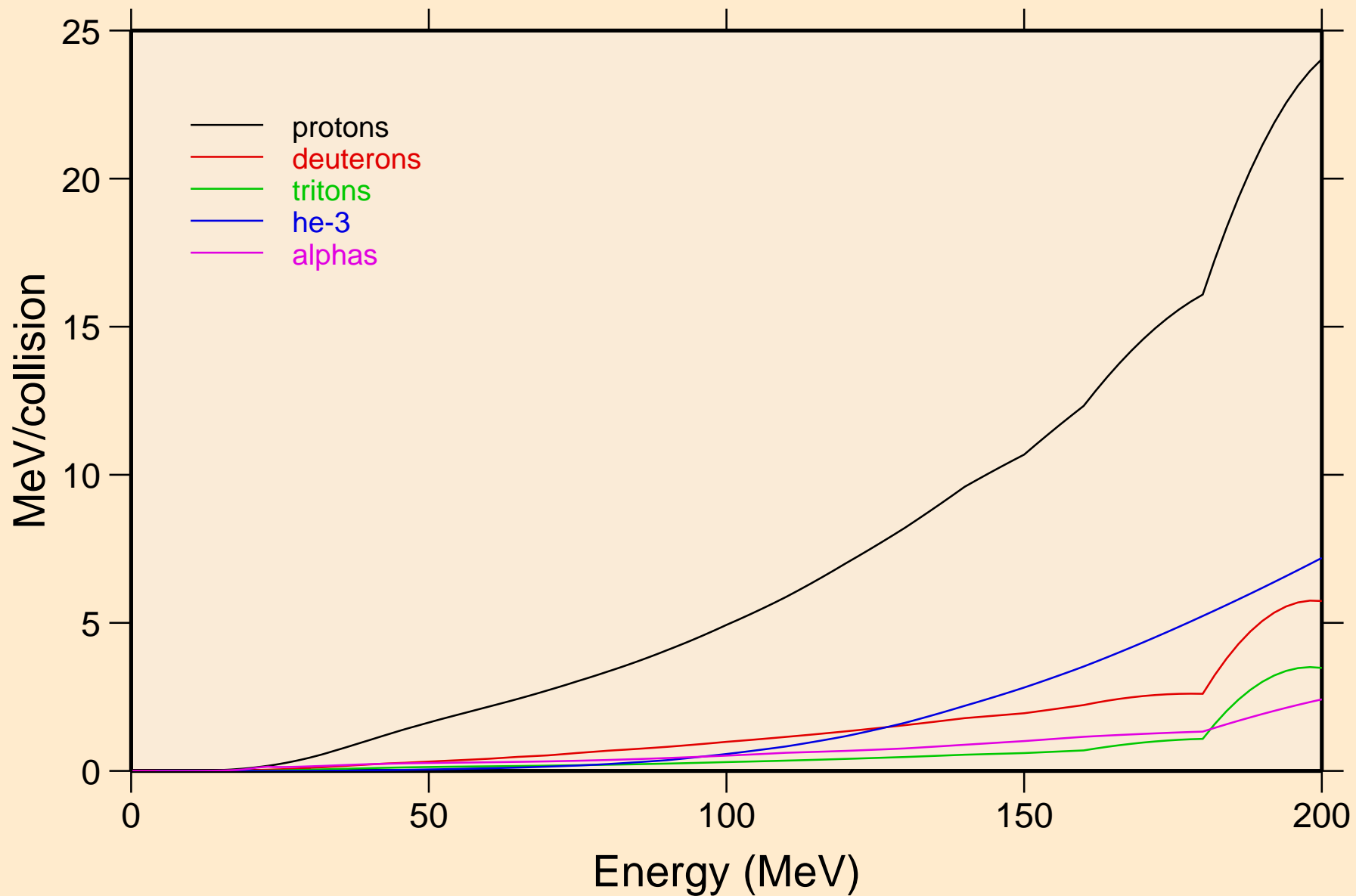

IR189 NEUTRON ACER TENDL-2019 LIBRARY; T=293.16K  
Recoil Heating

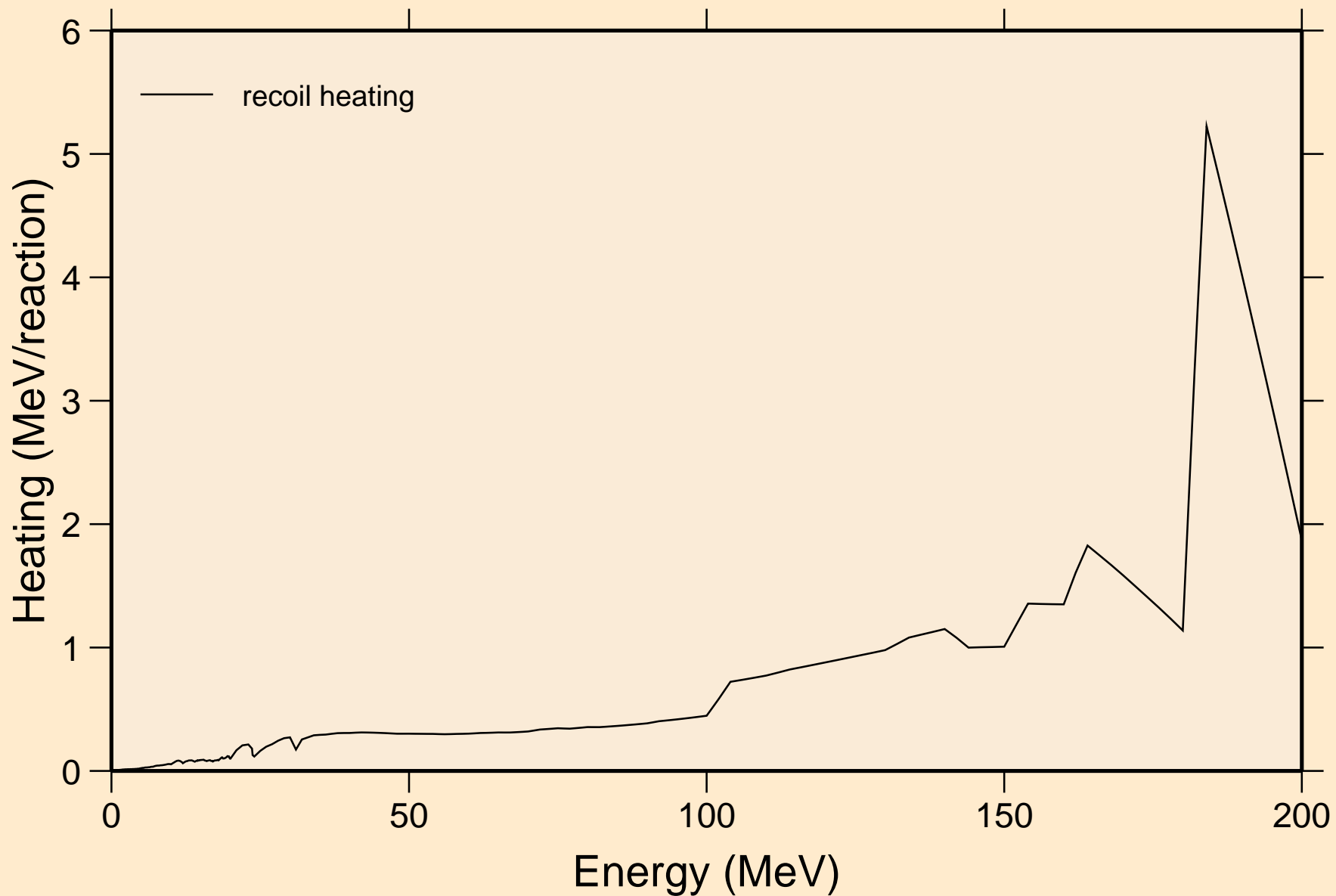

IR189 NEUTRON ACER TENDL-2019 LIBRARY; T=293.16K  
Particle production cross sections

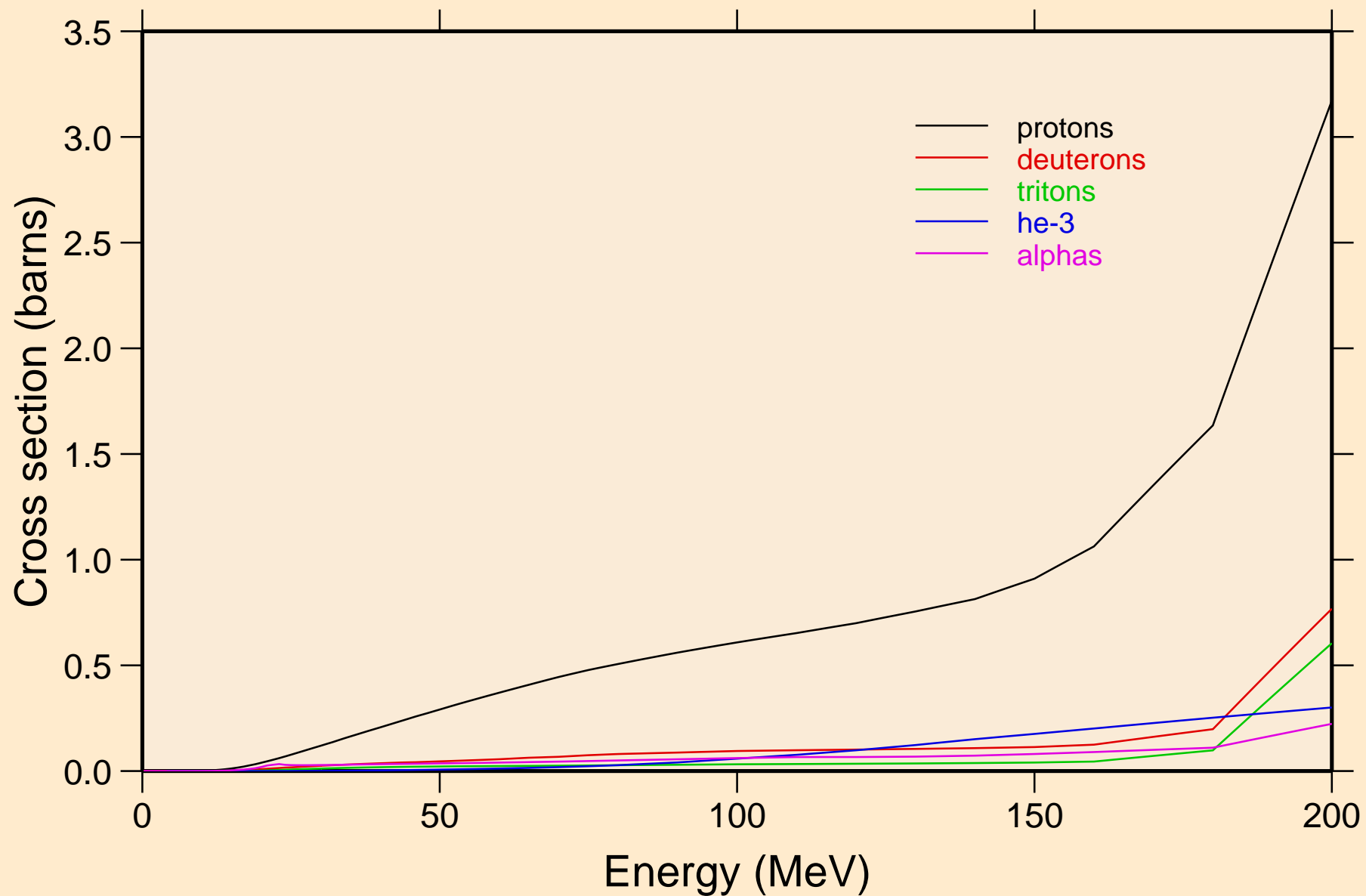



IR189 NEUTRON ACER TENDL-2019 LIBRARY; T=293.16K  
protons from (n,x)

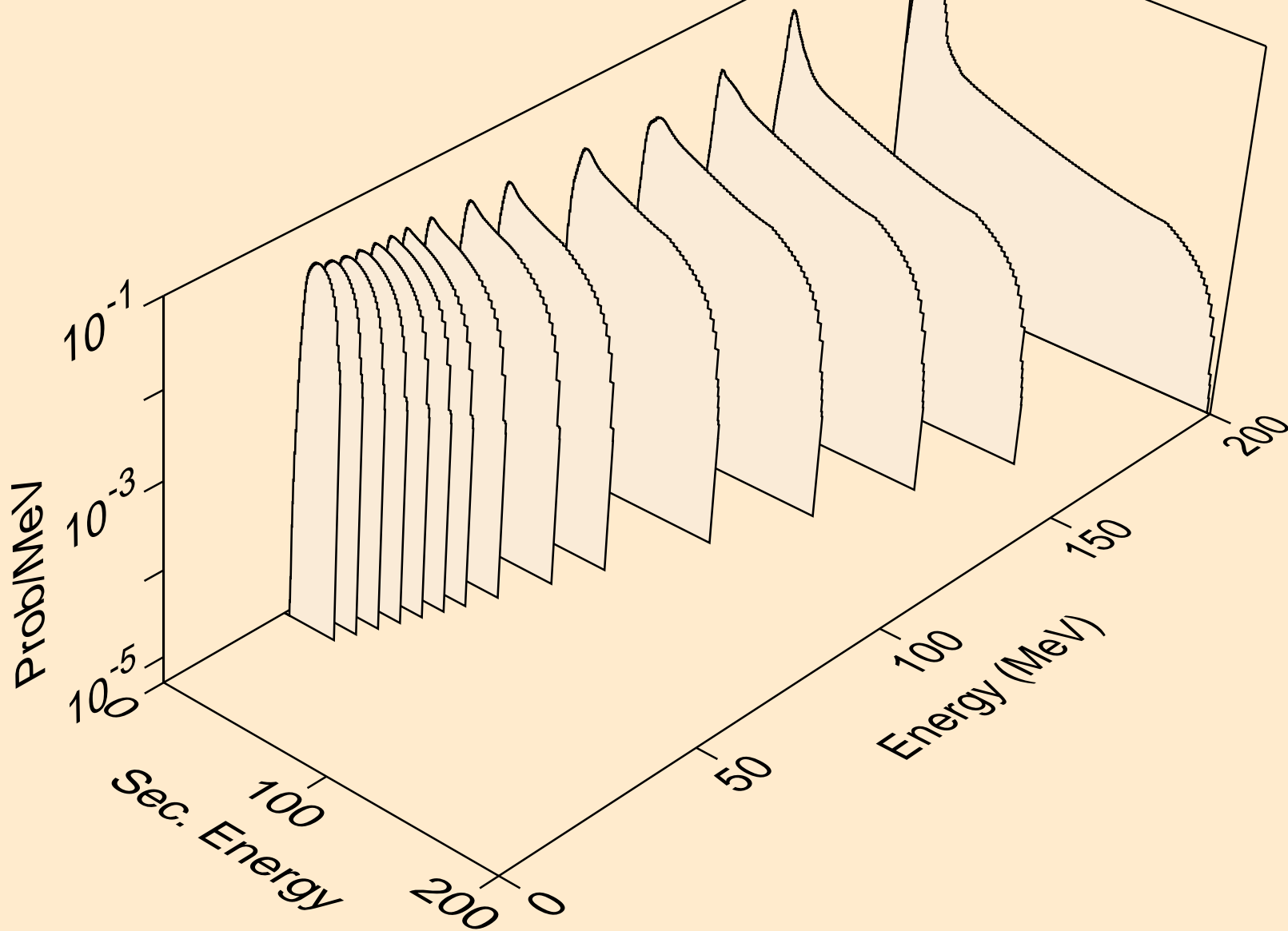

IR189 NEUTRON ACER TENDL-2019 LIBRARY; T=293.16K  
protons from (n,n\*)p

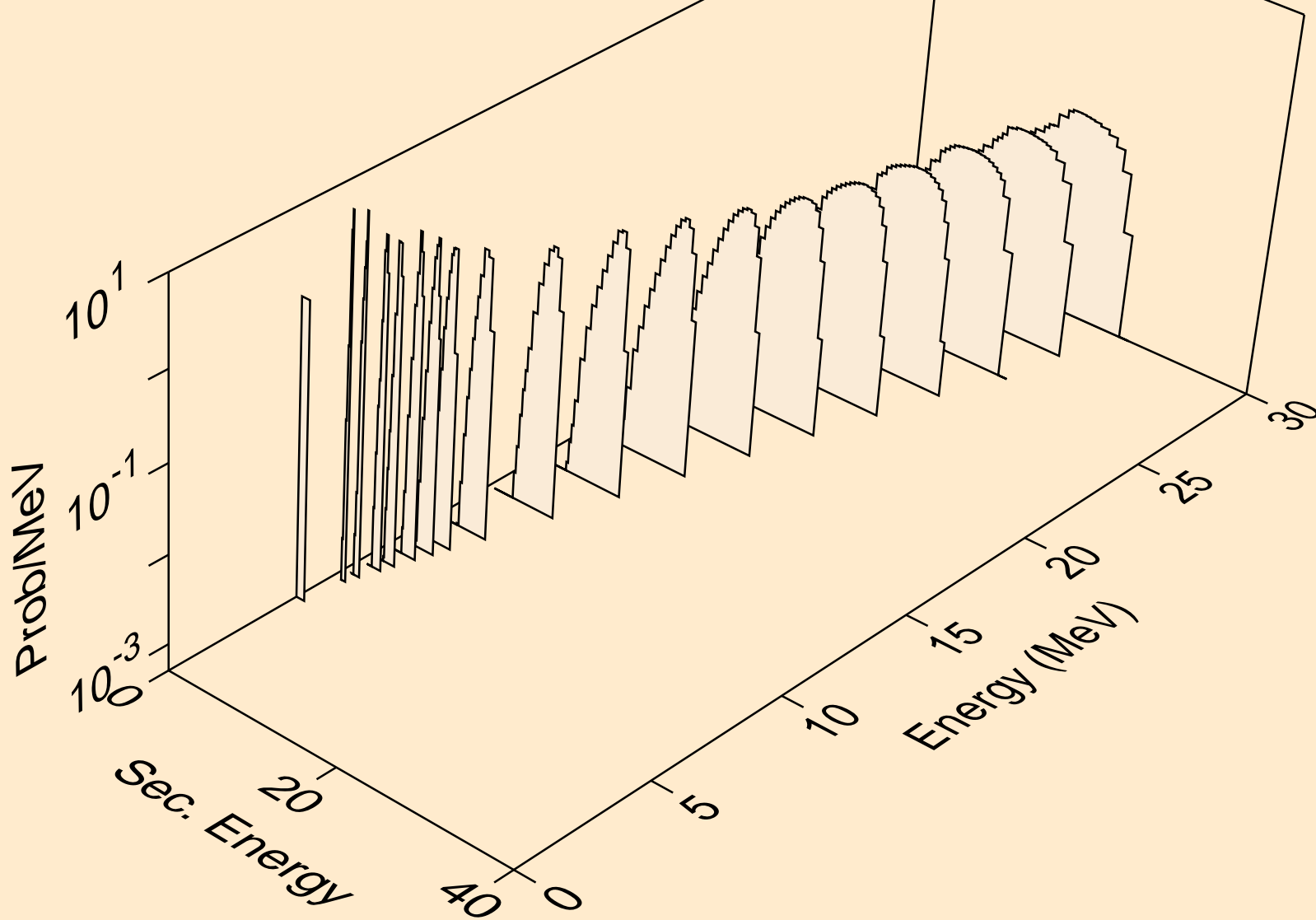

IR189 NEUTRON ACER TENDL-2019 LIBRARY; T=293.16K  
protons from (n,2np)

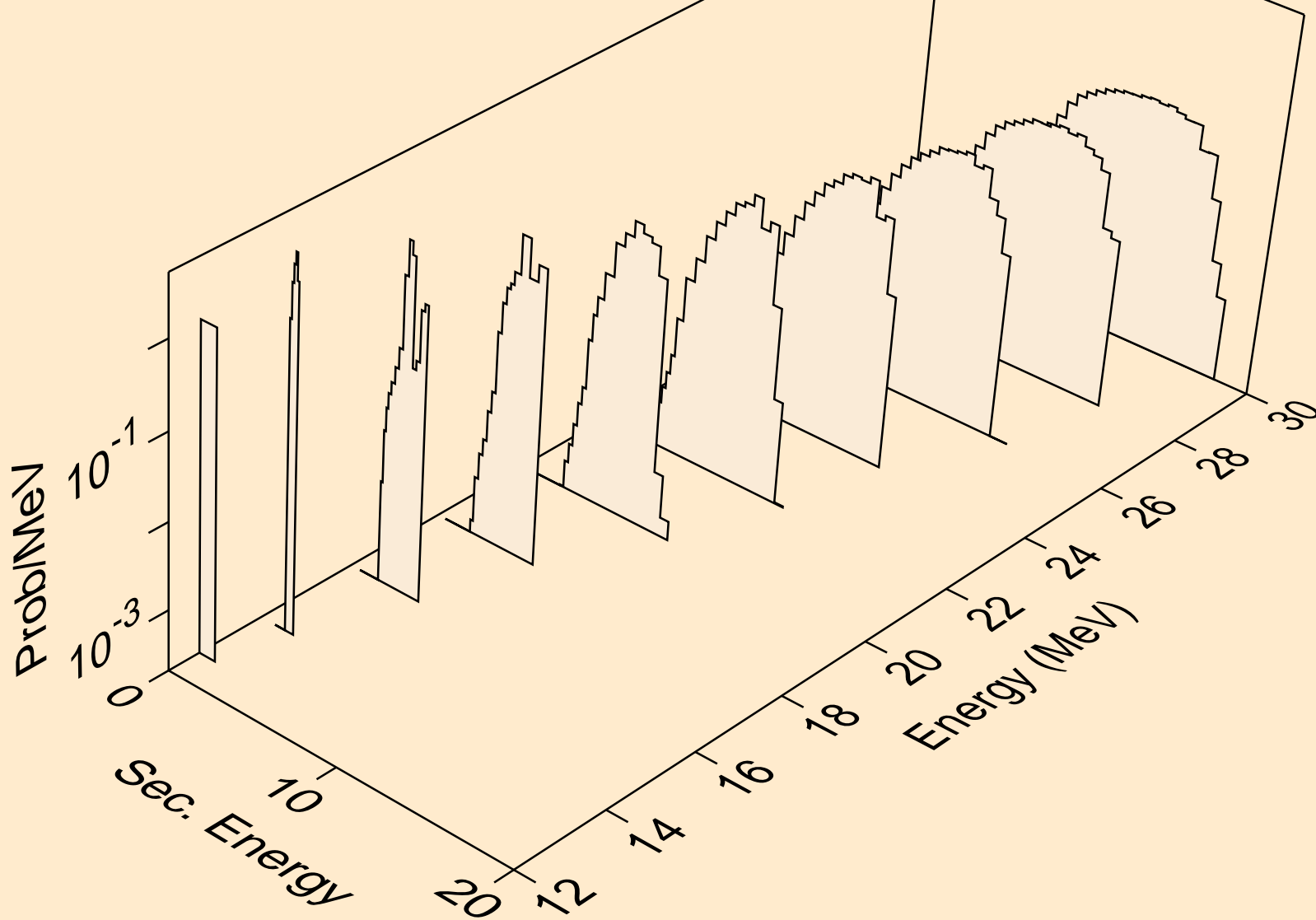

IR189 NEUTRON ACER TENDL-2019 LIBRARY; T=293.16K  
protons from (n,3np)

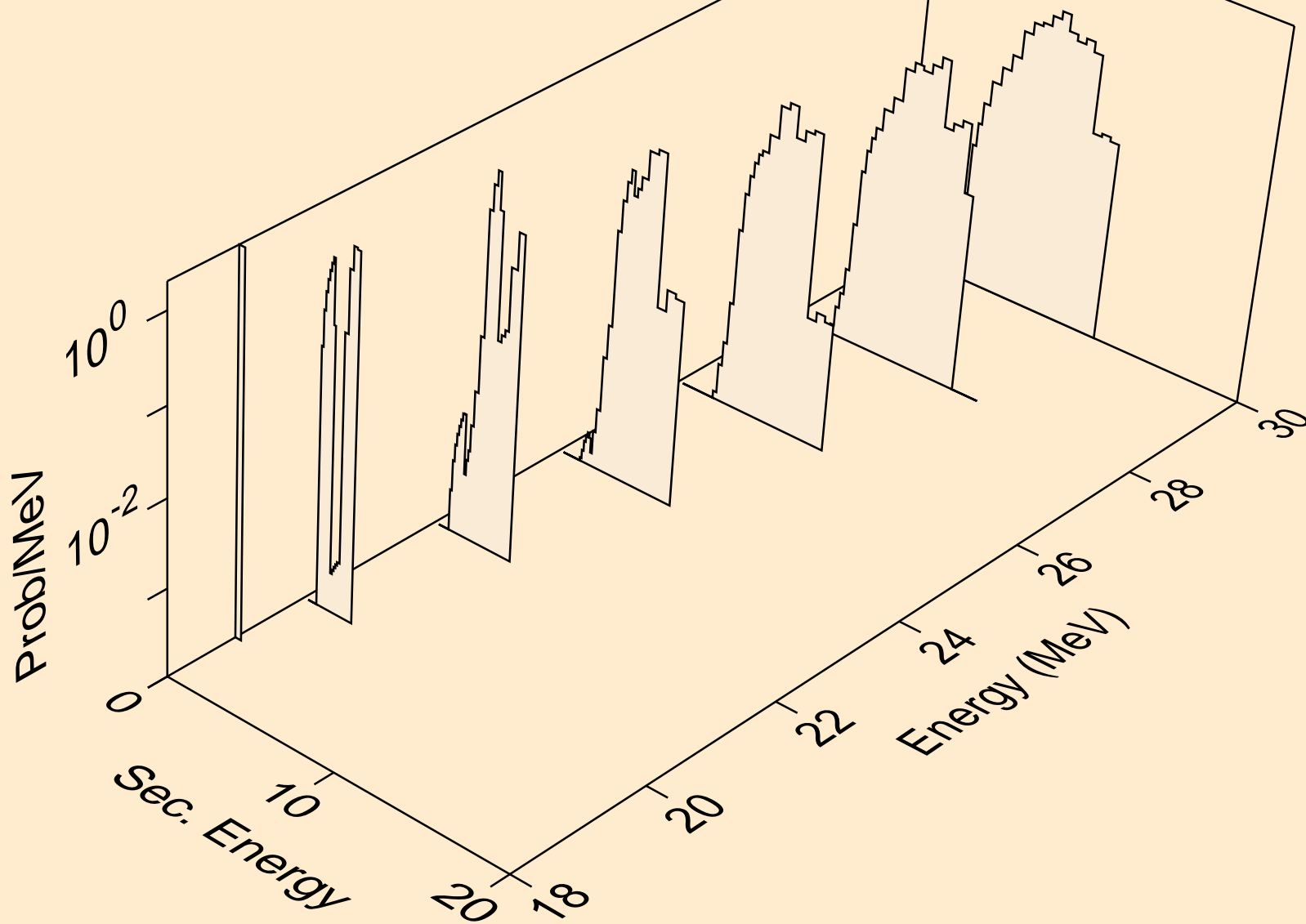

IR189 NEUTRON ACER TENDL-2019 LIBRARY; T=293.16K  
protons from (n,2np)

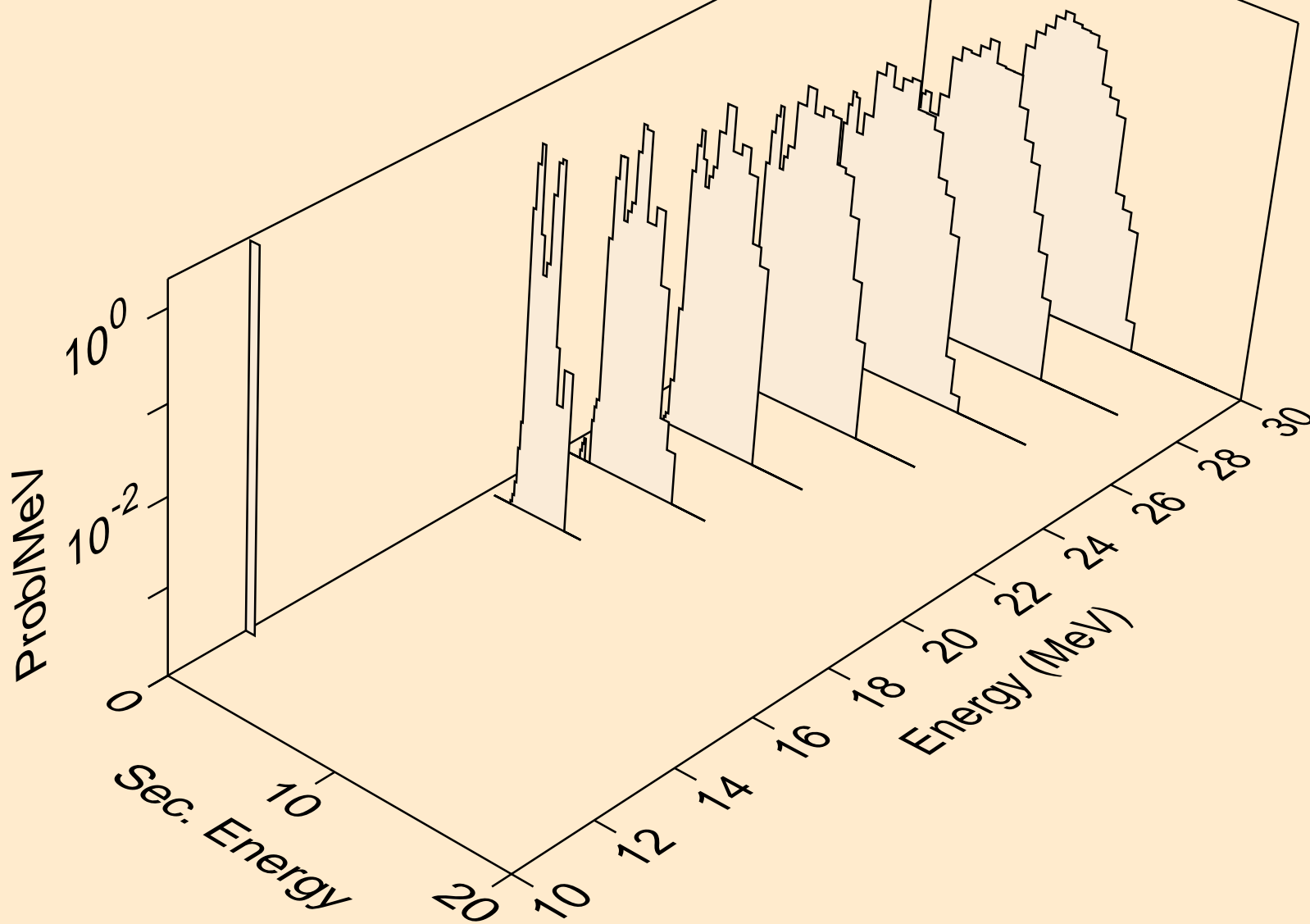

IR189 NEUTRON ACER TENDL-2019 LIBRARY; T=293.16K  
protons from (n,npa)

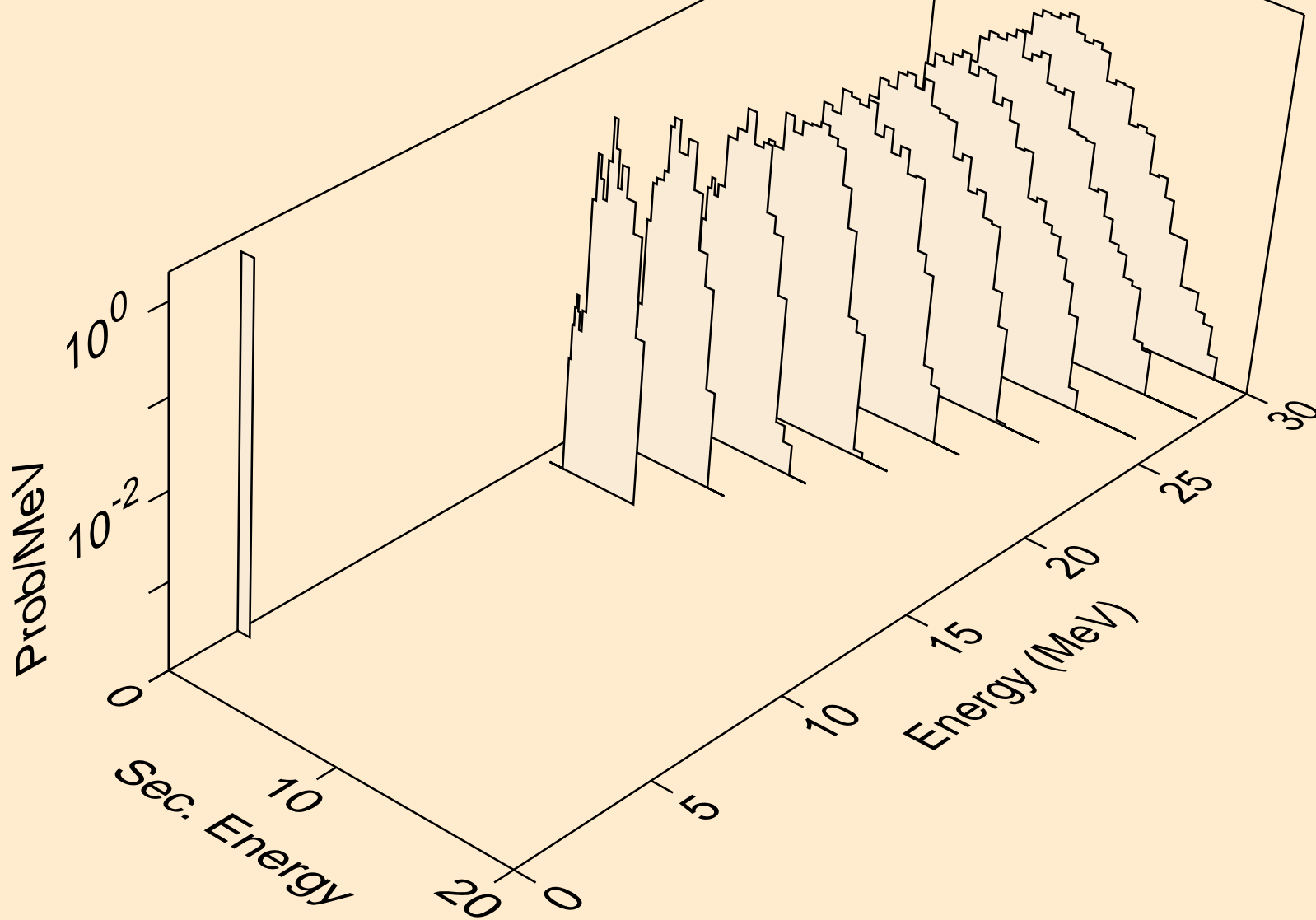

IR189 NEUTRON ACER TENDL-2019 LIBRARY; T=293.16K  
protons from (n,p)

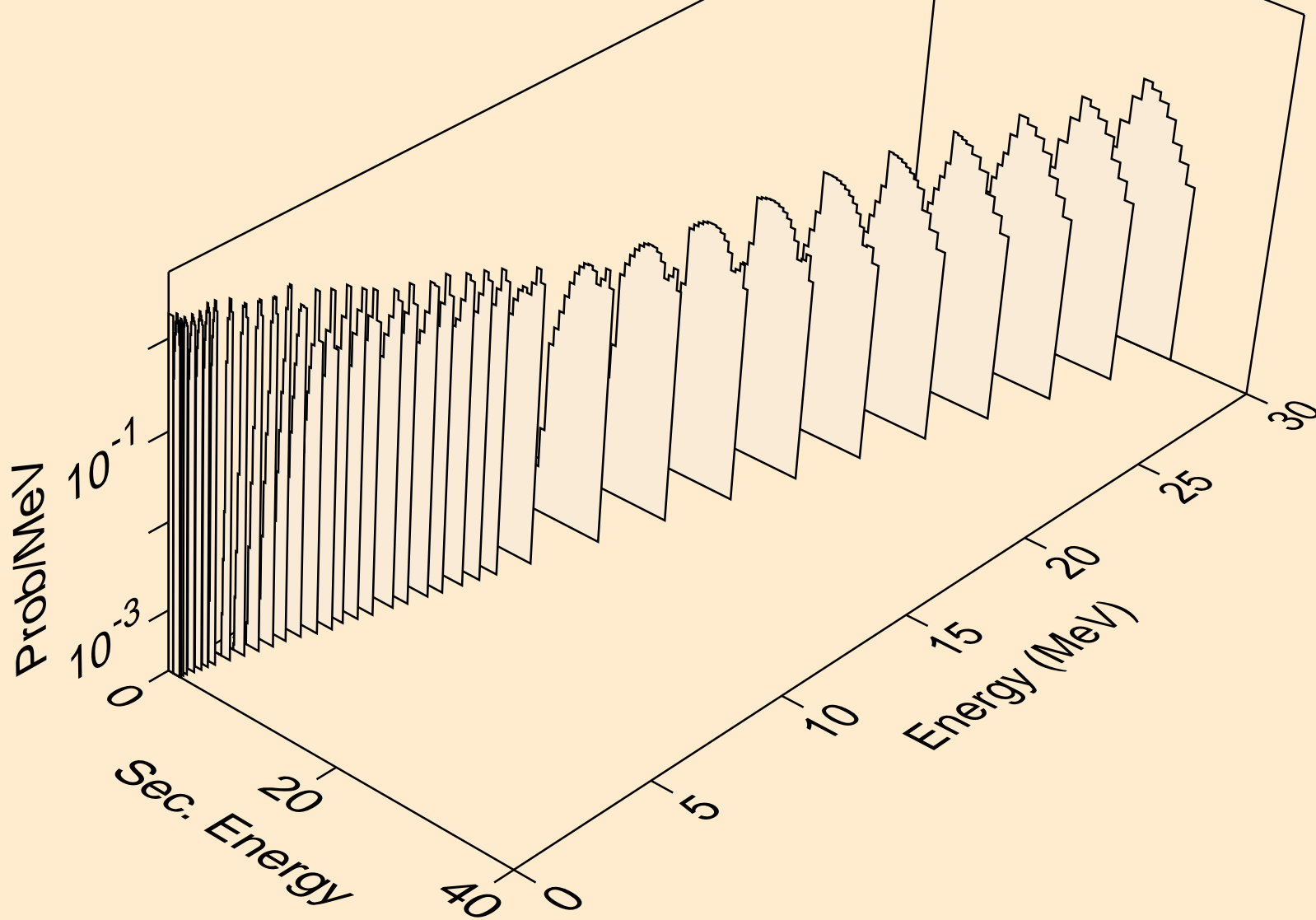

IR189 NEUTRON ACER TENDL-2019 LIBRARY; T=293.16K  
protons from (n,2p)

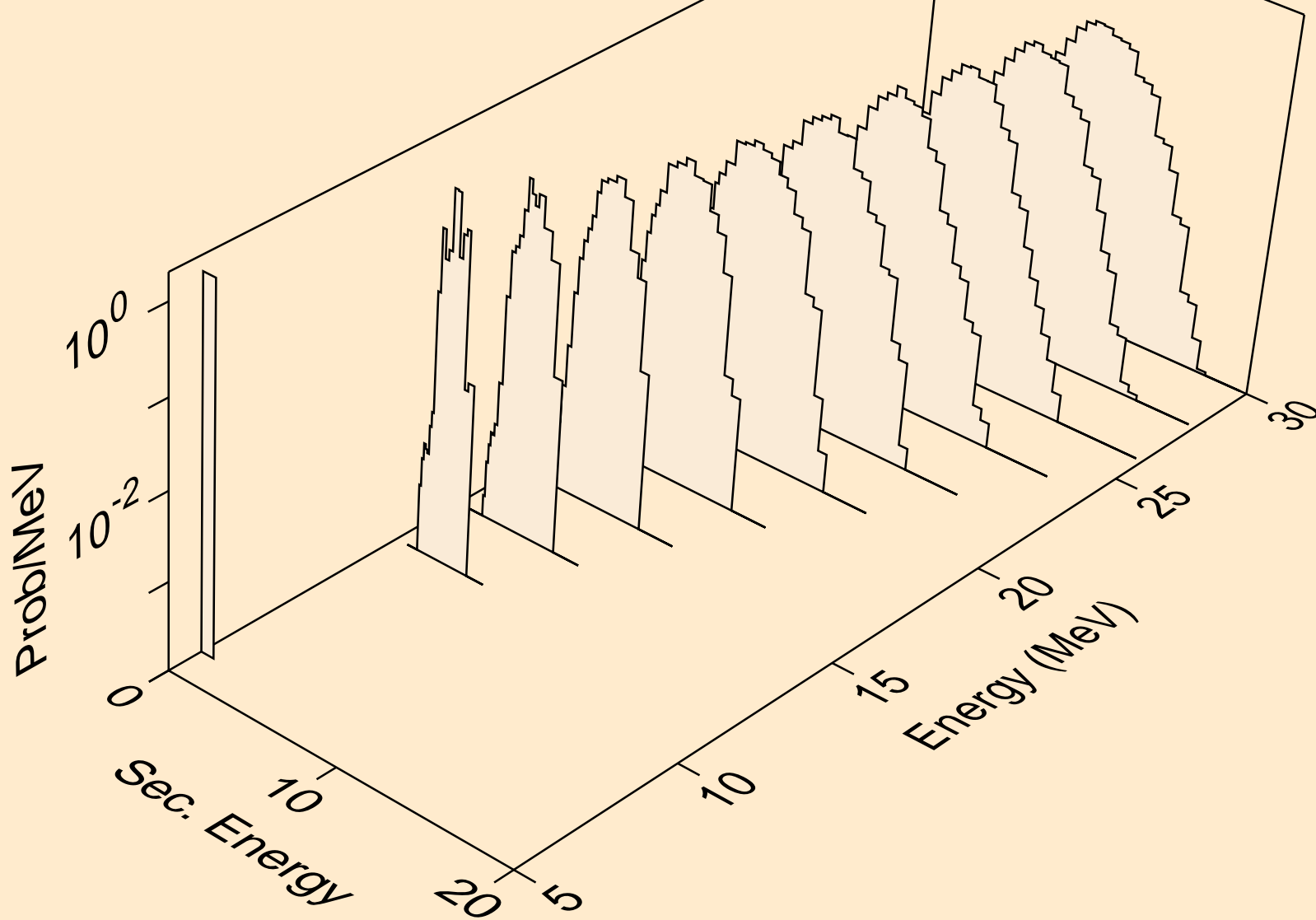



IR189 NEUTRON ACER TENDL-2019 LIBRARY; T=293.16K  
protons from (n,p)

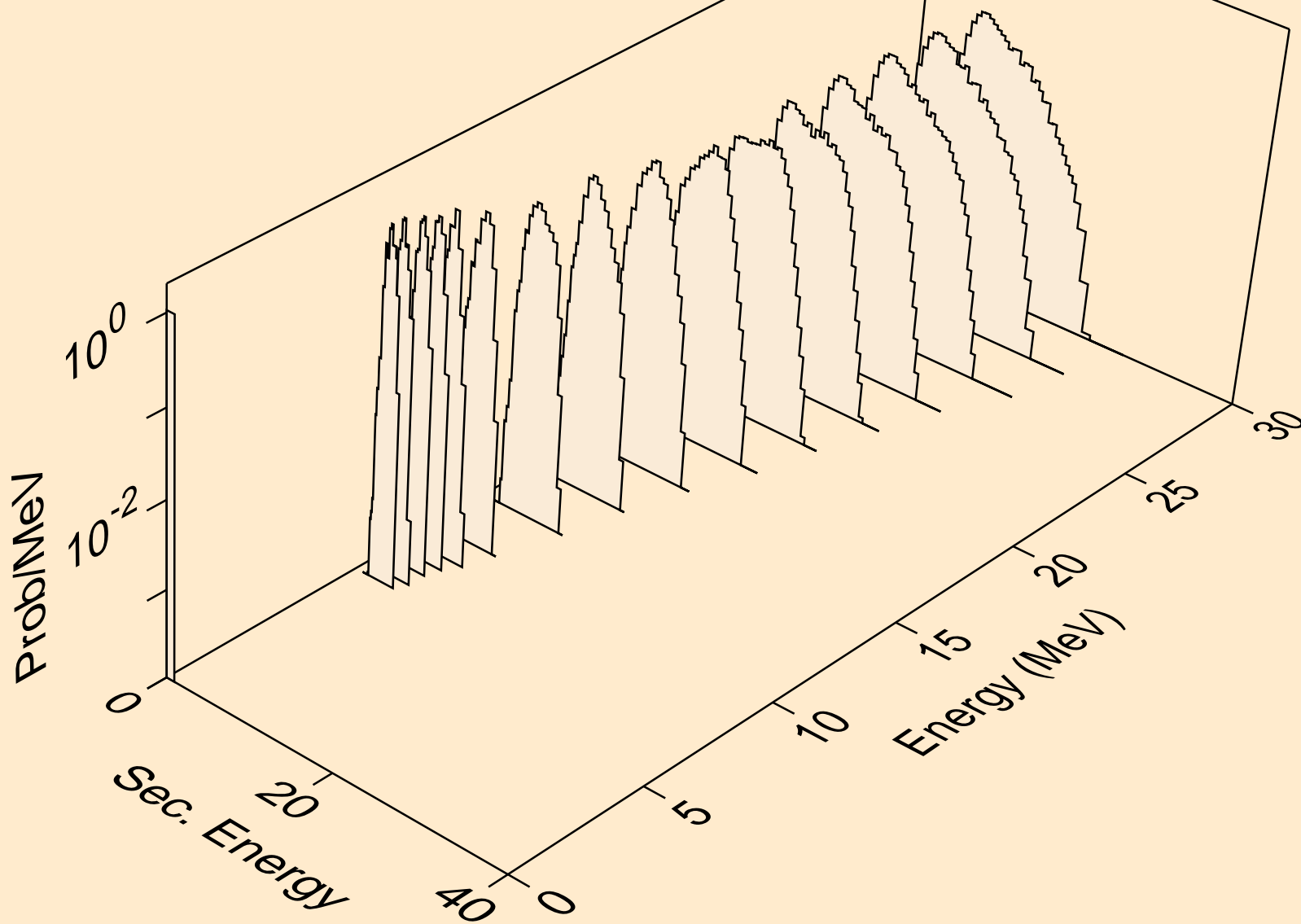

IR189 NEUTRON ACER TENDL-2019 LIBRARY; T=293.16K  
protons from (n,pd)

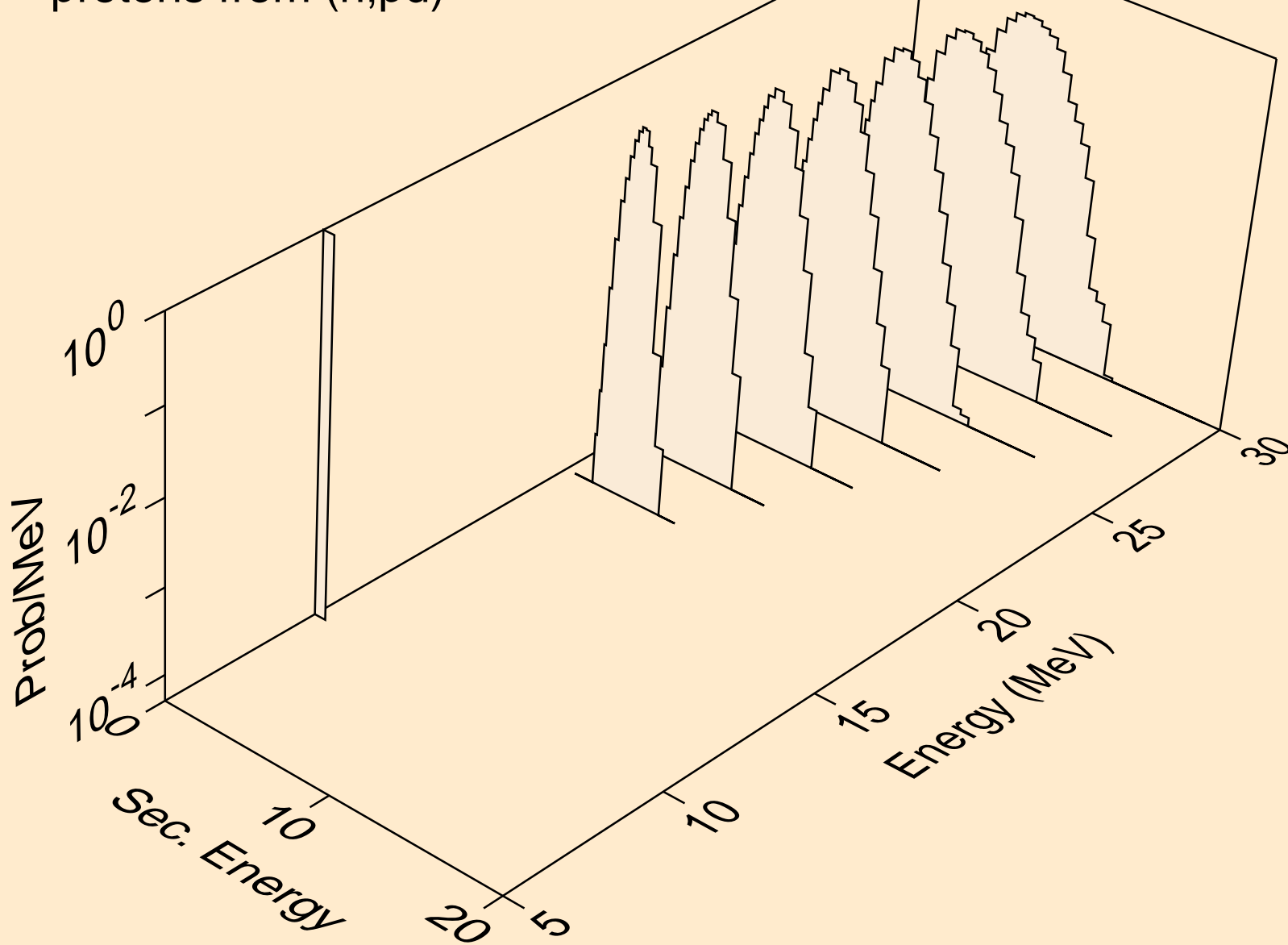

IR189 NEUTRON ACER TENDL-2019 LIBRARY; T=293.16K  
protons from (n,pt)

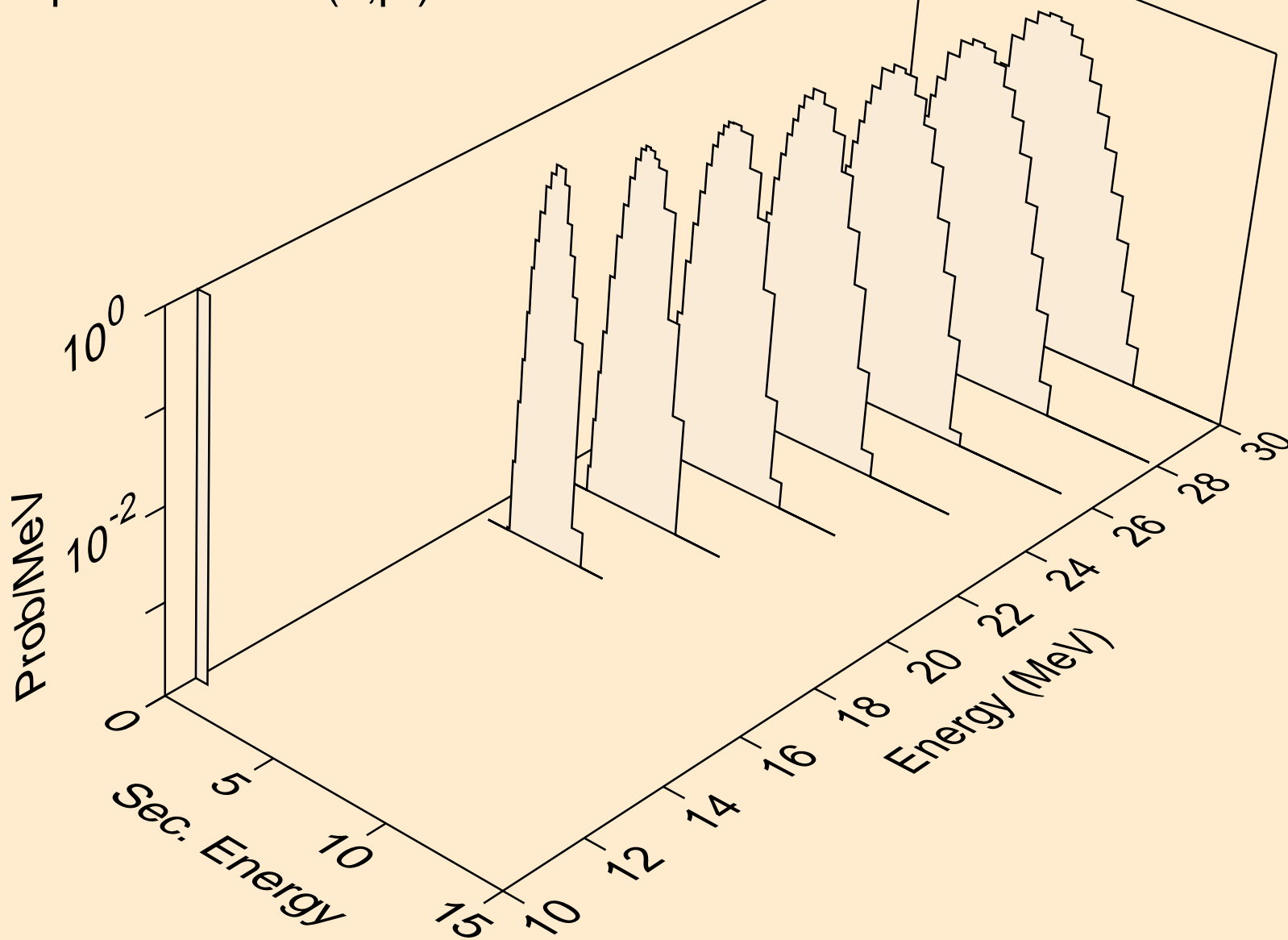

IR189 NEUTRON ACER TENDL-2019 LIBRARY; T=293.16K  
deuterons from (n,x)

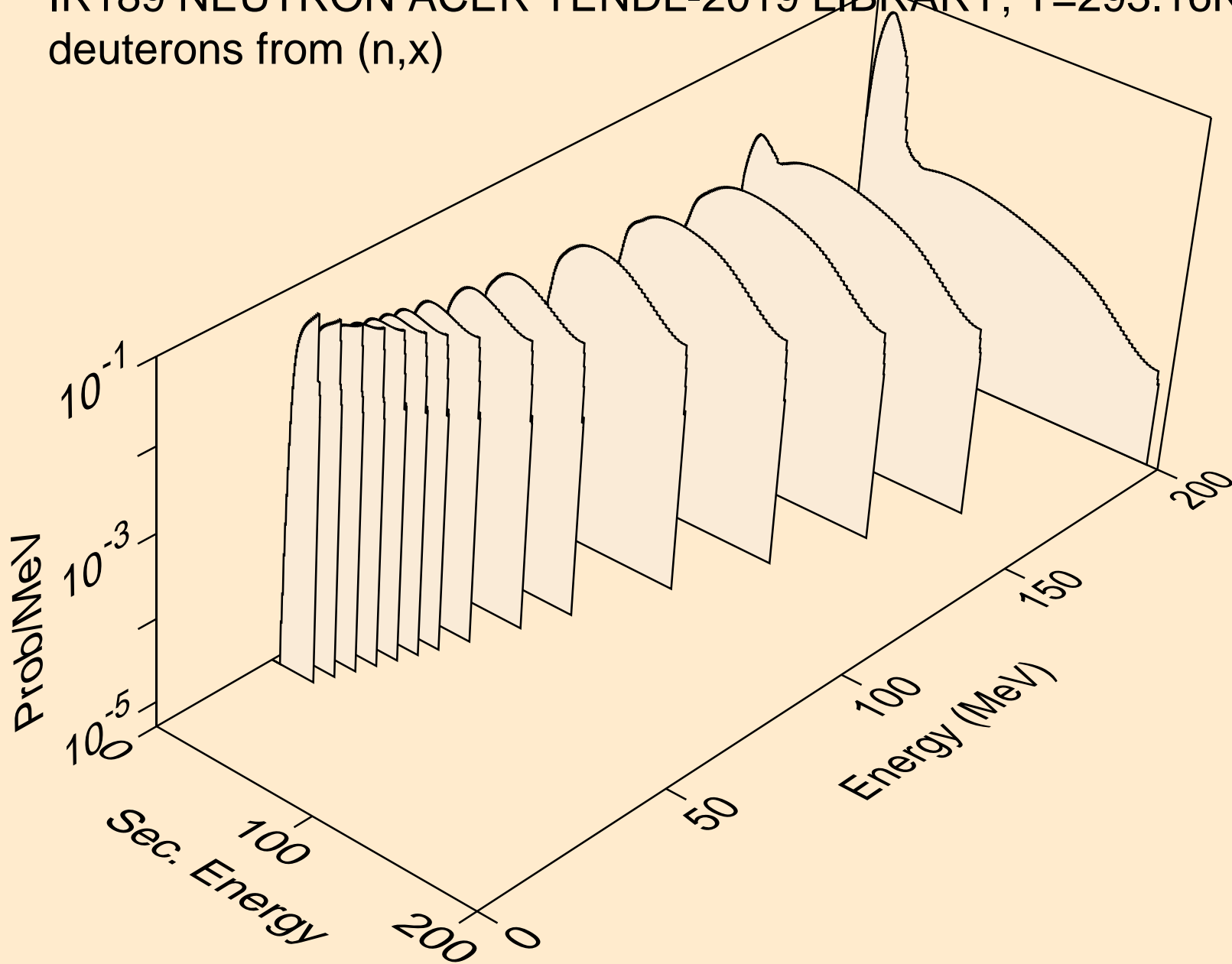

IR189 NEUTRON ACER TENDL-2019 LIBRARY; T=293.16K  
deuterons from (n,2nd)

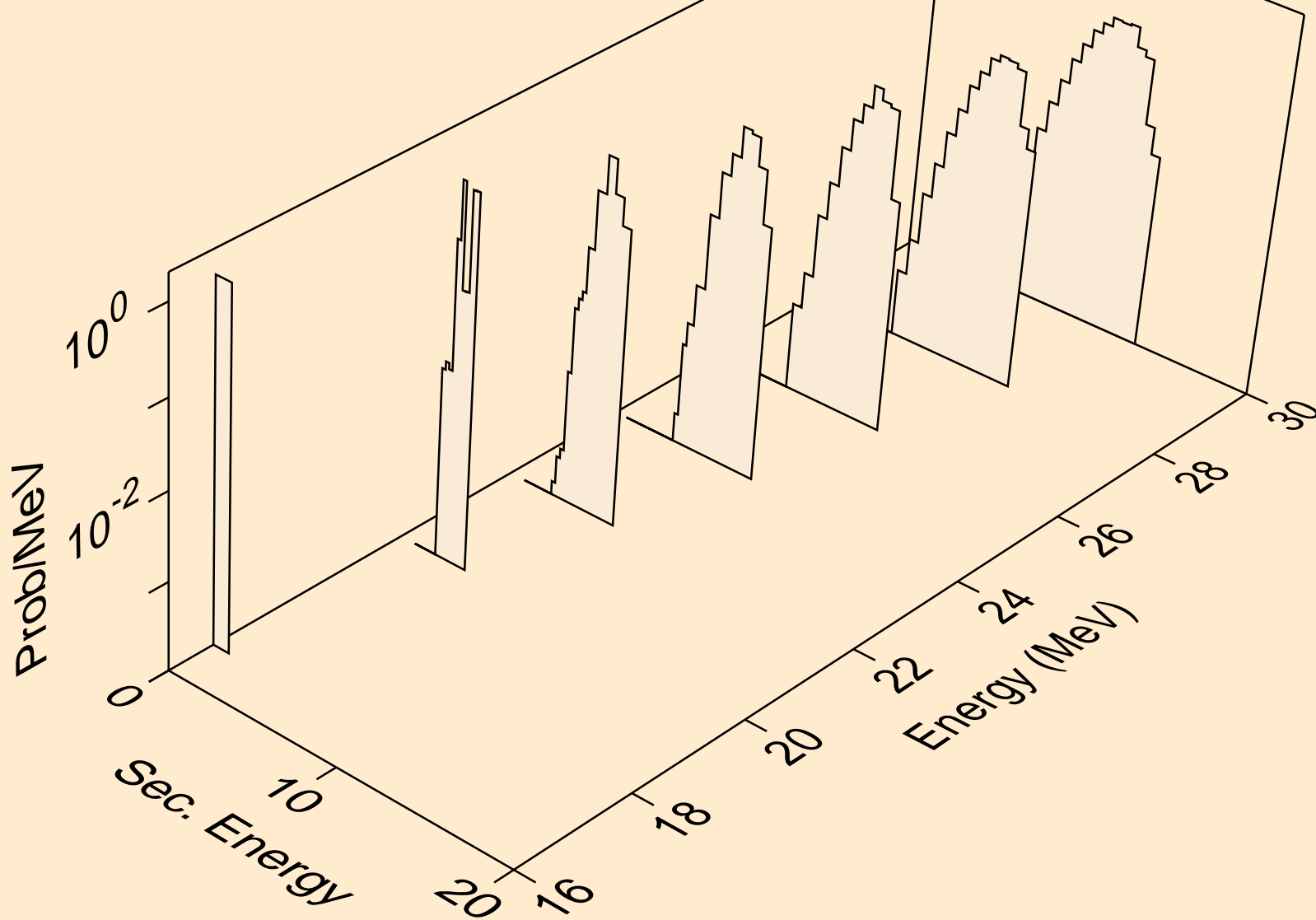

IR189 NEUTRON ACER TENDL-2019 LIBRARY; T=293.16K  
deuterons from (n,n\*)d

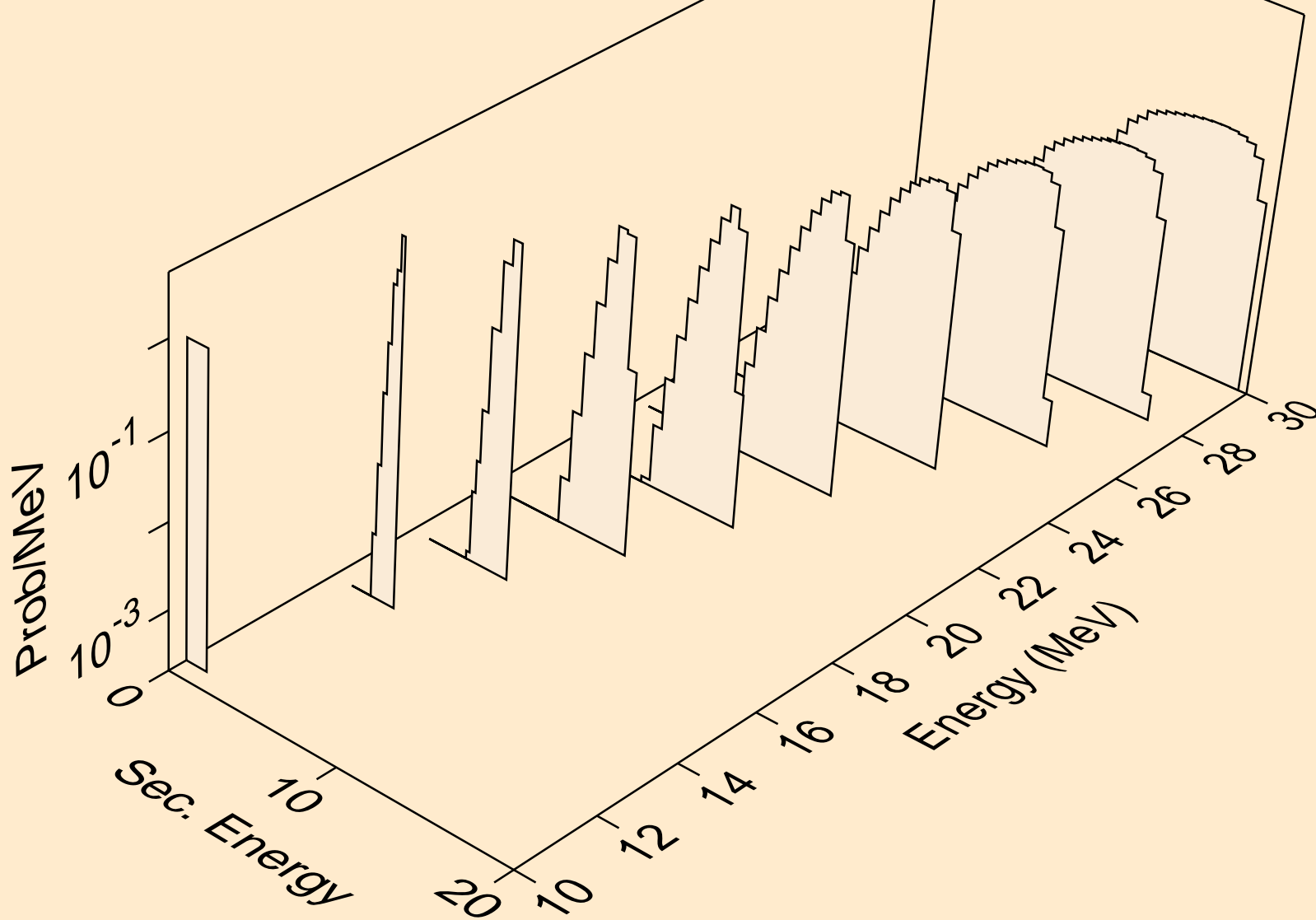

IR189 NEUTRON ACER TENDL-2019 LIBRARY; T=293.16K  
deuterons from (n,d)

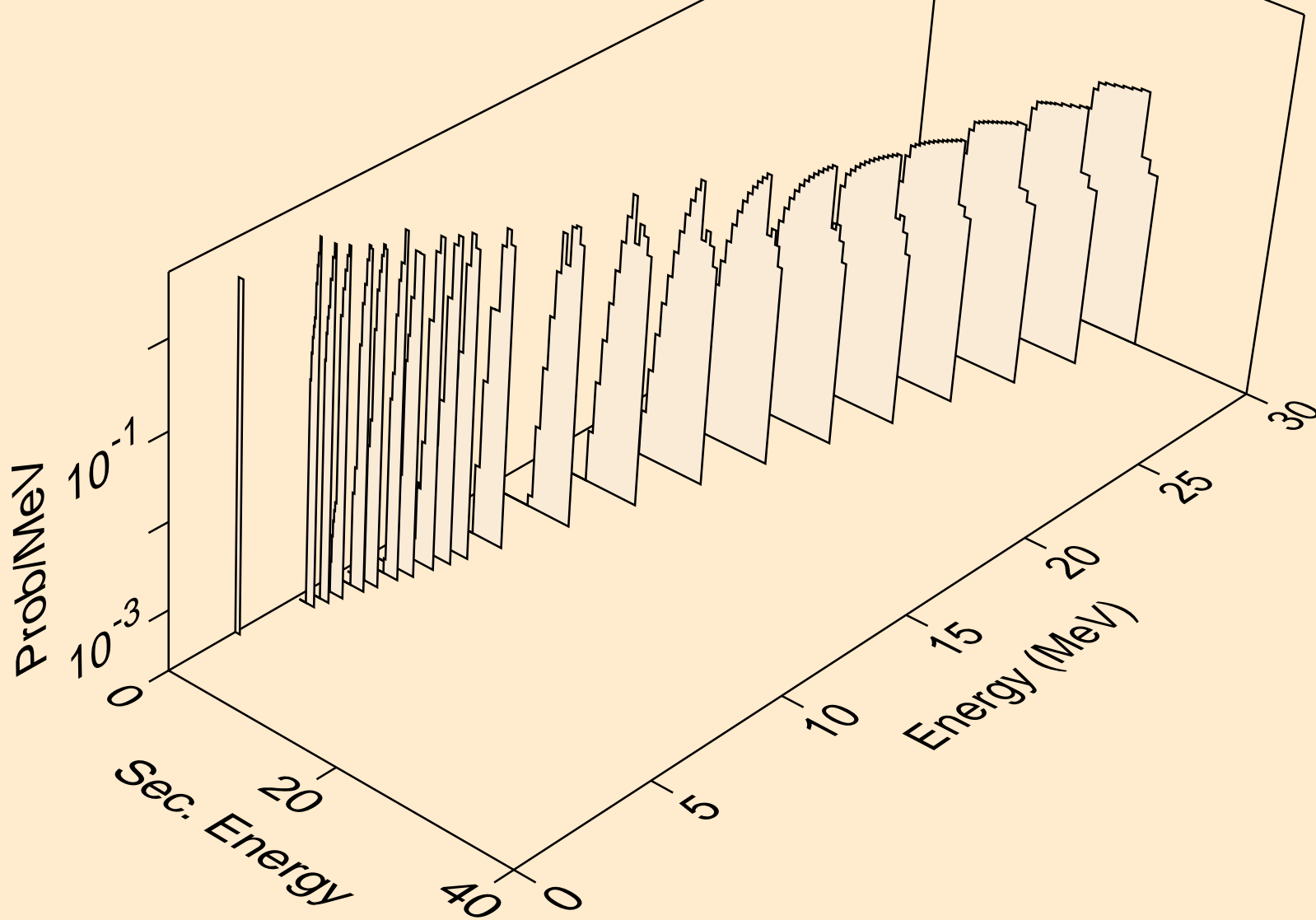

IR189 NEUTRON ACER TENDL-2019 LIBRARY; T=293.16K  
deuterons from (n,pd)

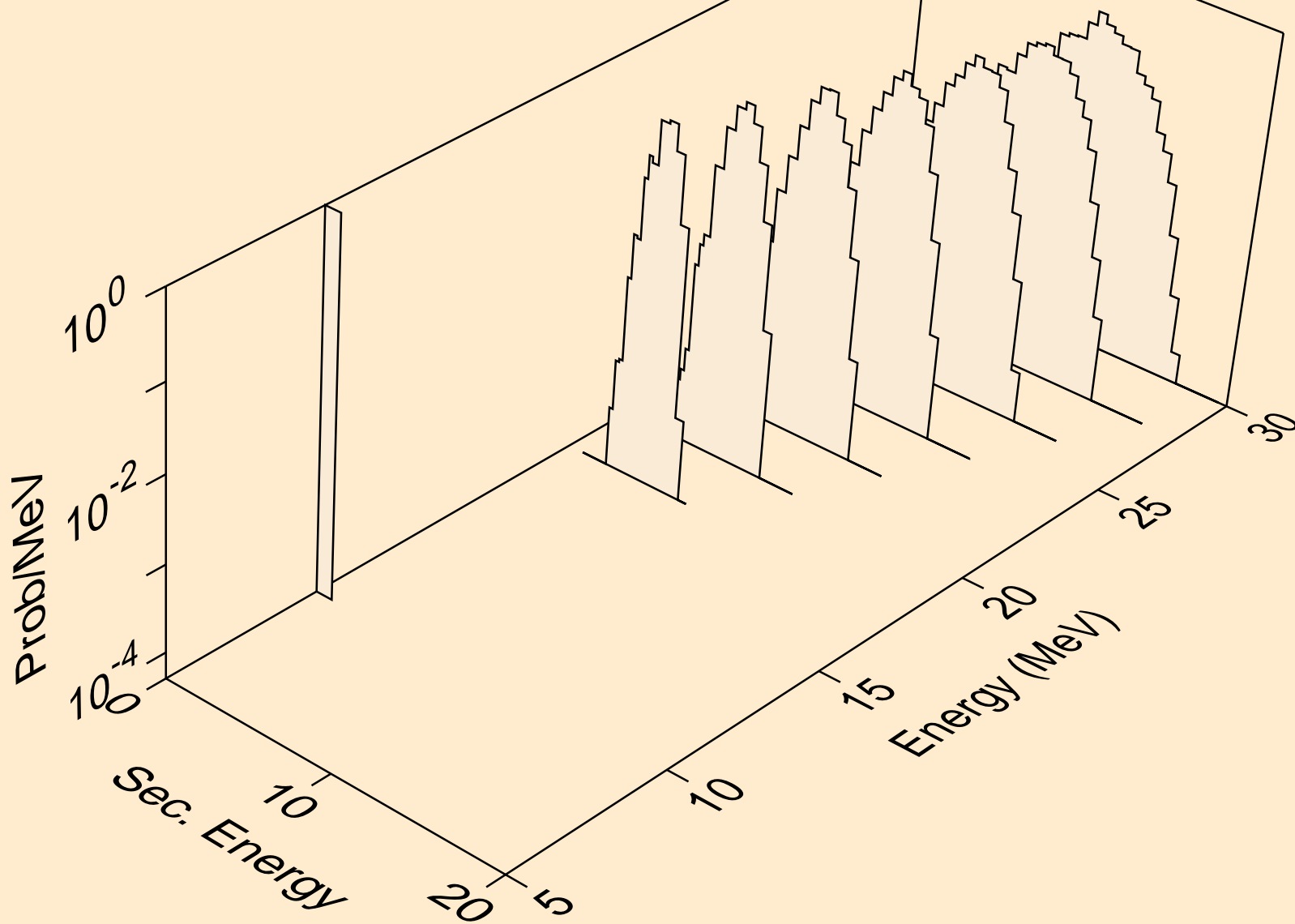



IR189 NEUTRON ACER TENDL-2019 LIBRARY; T=293.16K  
deuterons from (n,da)

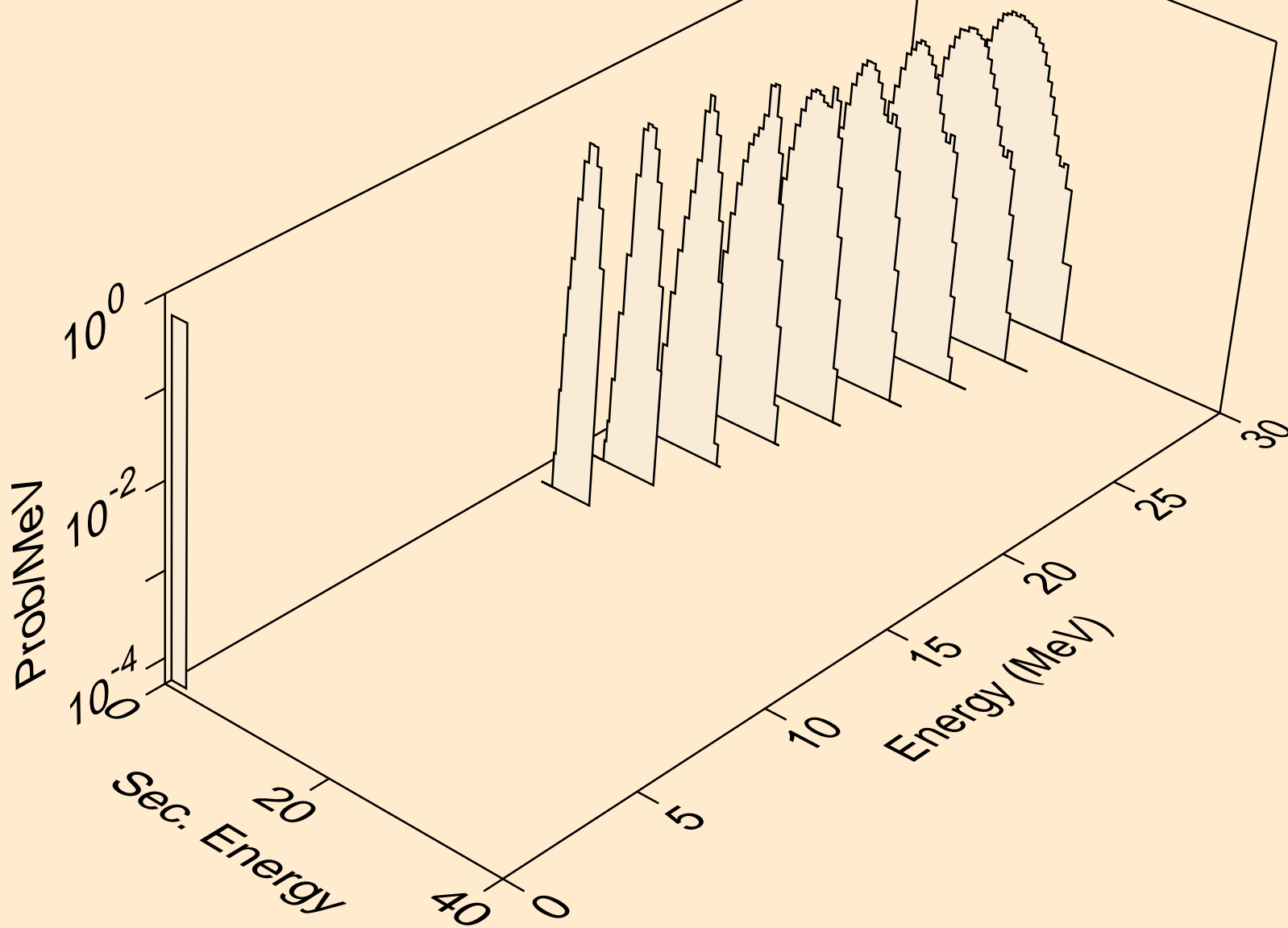

IR189 NEUTRON ACER TENDL-2019 LIBRARY; T=293.16K  
tritons from (n,x)

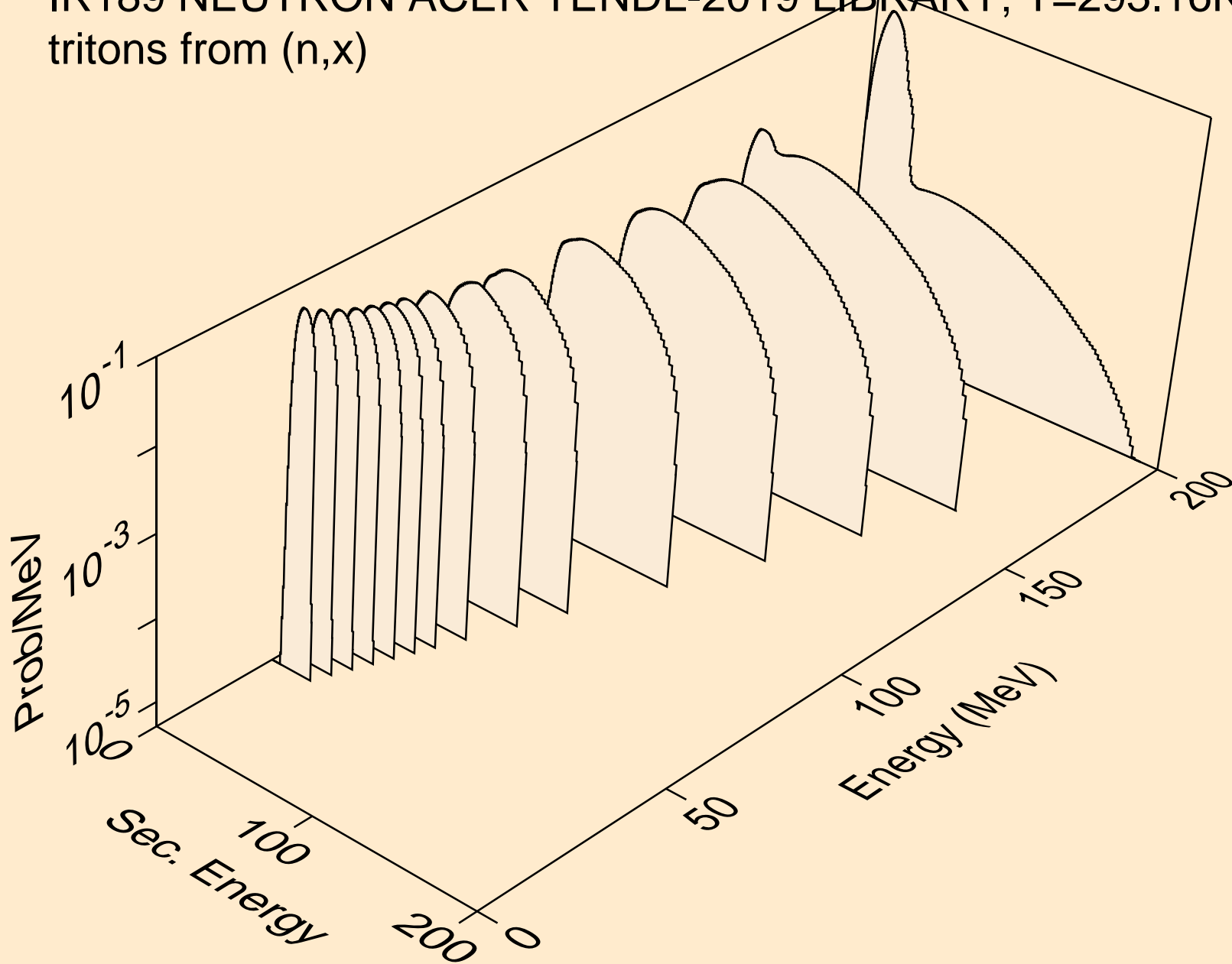

IR189 NEUTRON ACER TENDL-2019 LIBRARY; T=293.16K  
tritons from (n,n\*)t

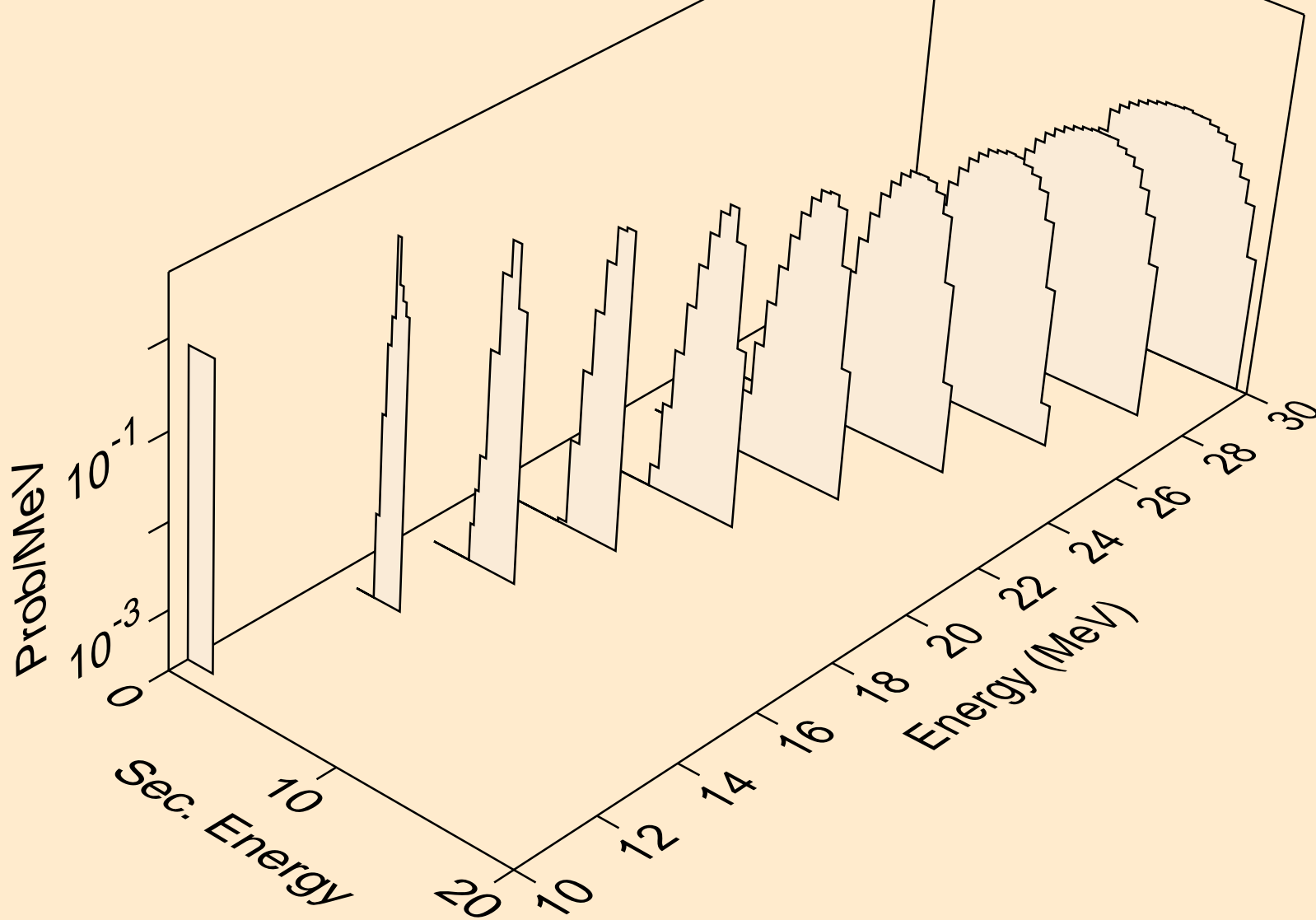

IR189 NEUTRON ACER TENDL-2019 LIBRARY; T=293.16K  
tritons from (n,t)

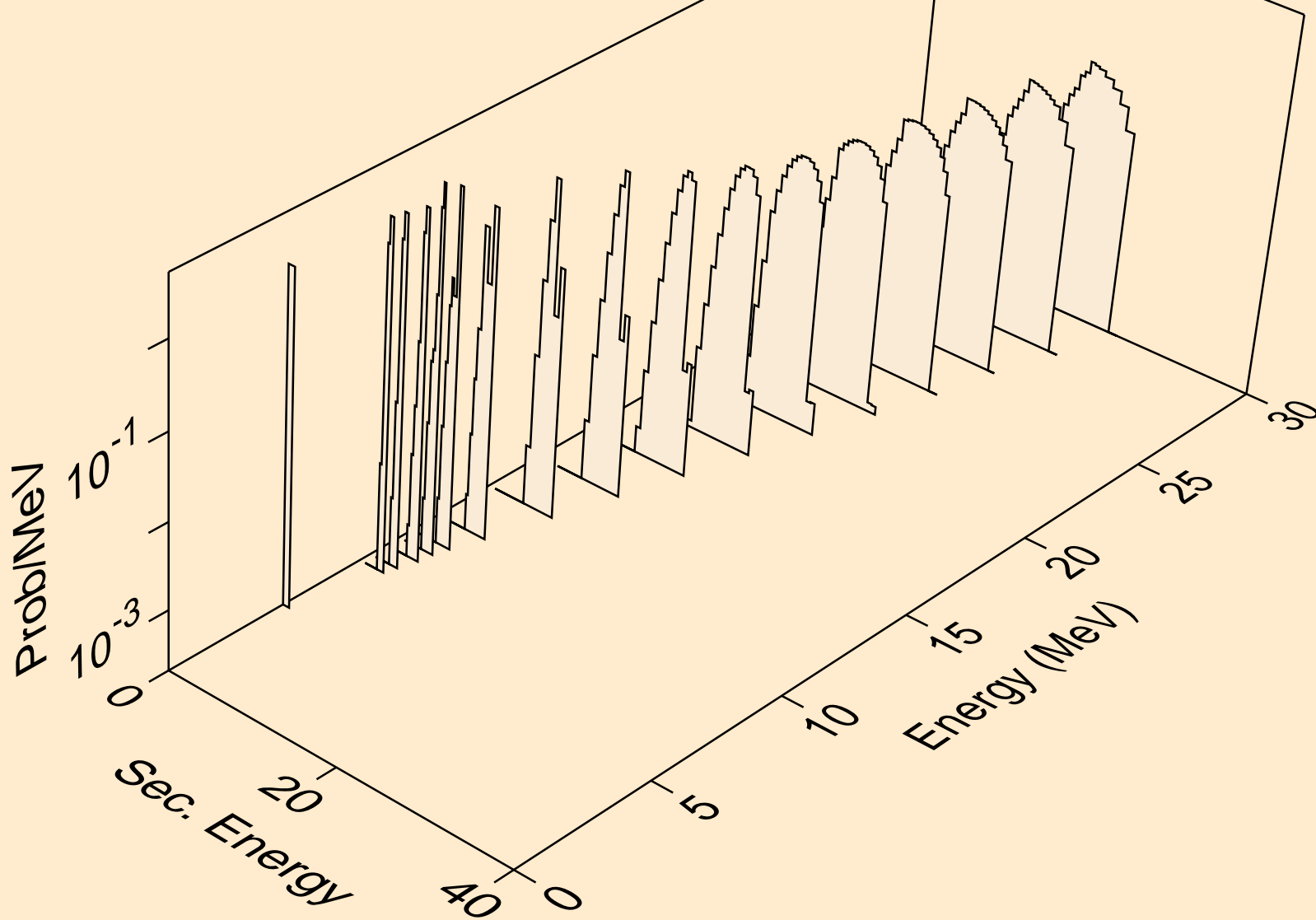

IR189 NEUTRON ACER TENDL-2019 LIBRARY; T=293.16K  
tritons from (n,pt)

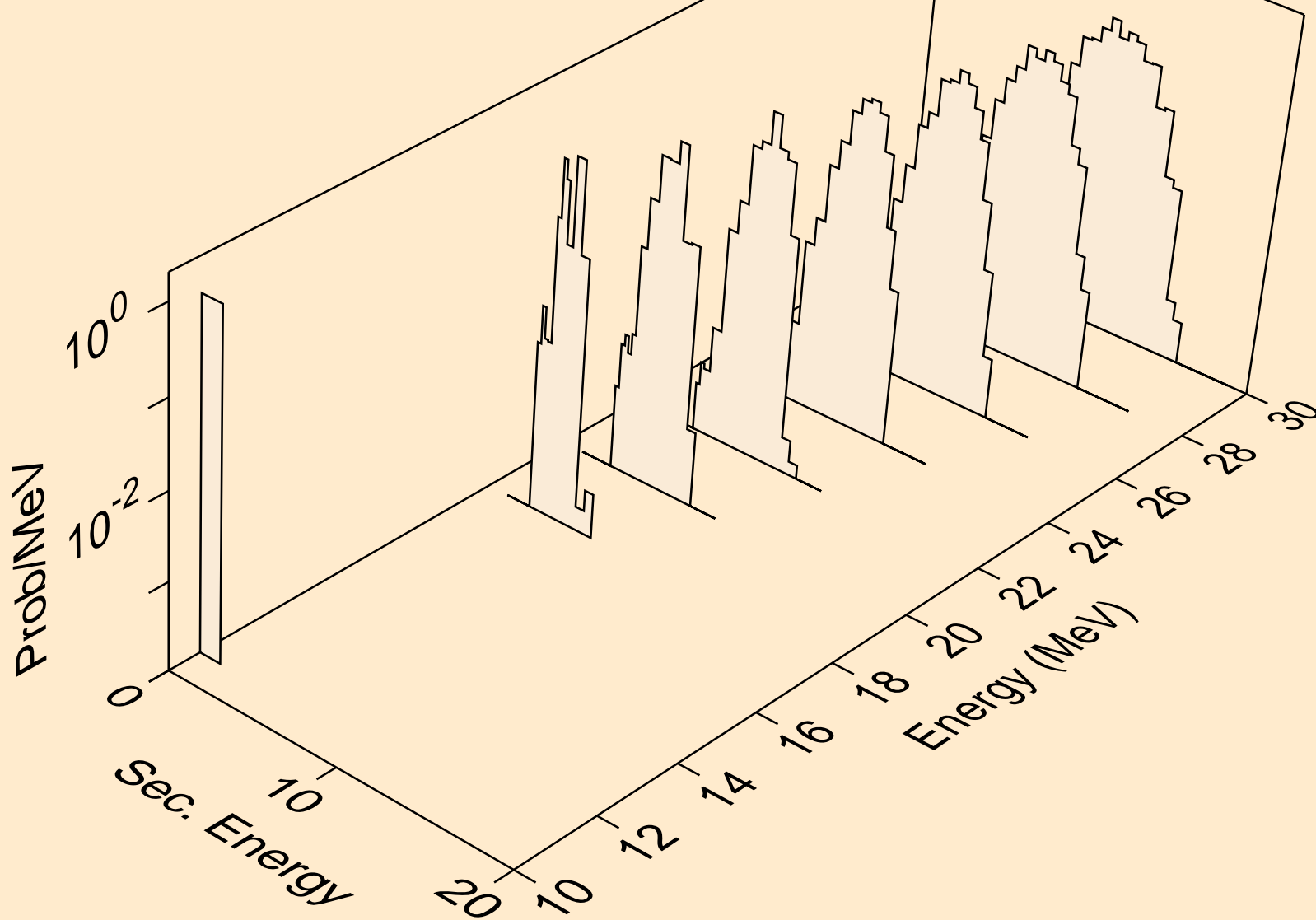

IR189 NEUTRON ACER TENDL-2019 LIBRARY; T=293.16K  
he3s from (n,x)

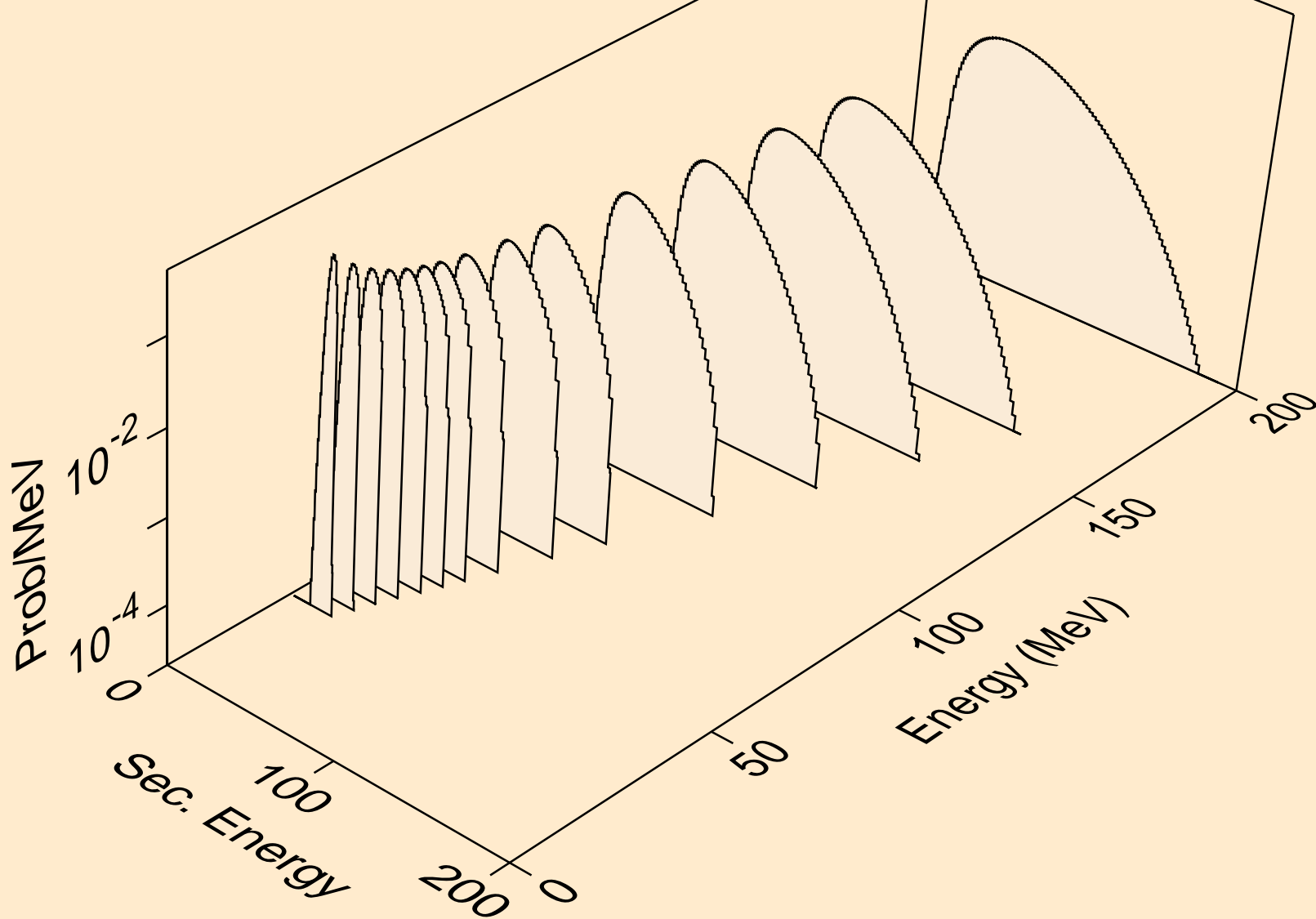

IR189 NEUTRON ACER TENDL-2019 LIBRARY; T=293.16K  
he3s from (n,n\*)he3

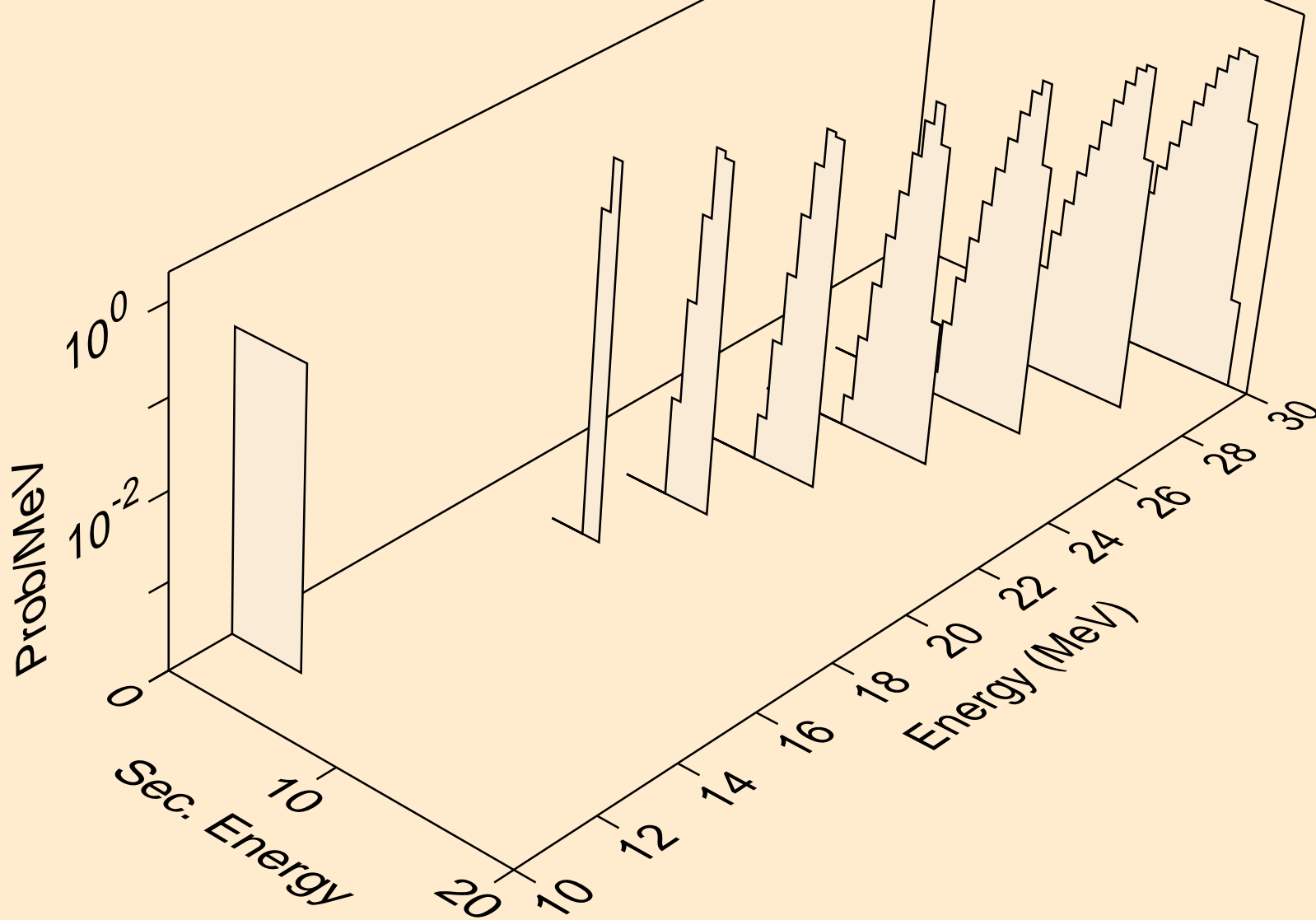

IR189 NEUTRON ACER TENDL-2019 LIBRARY; T=293.16K  
he3s from (n,he3)

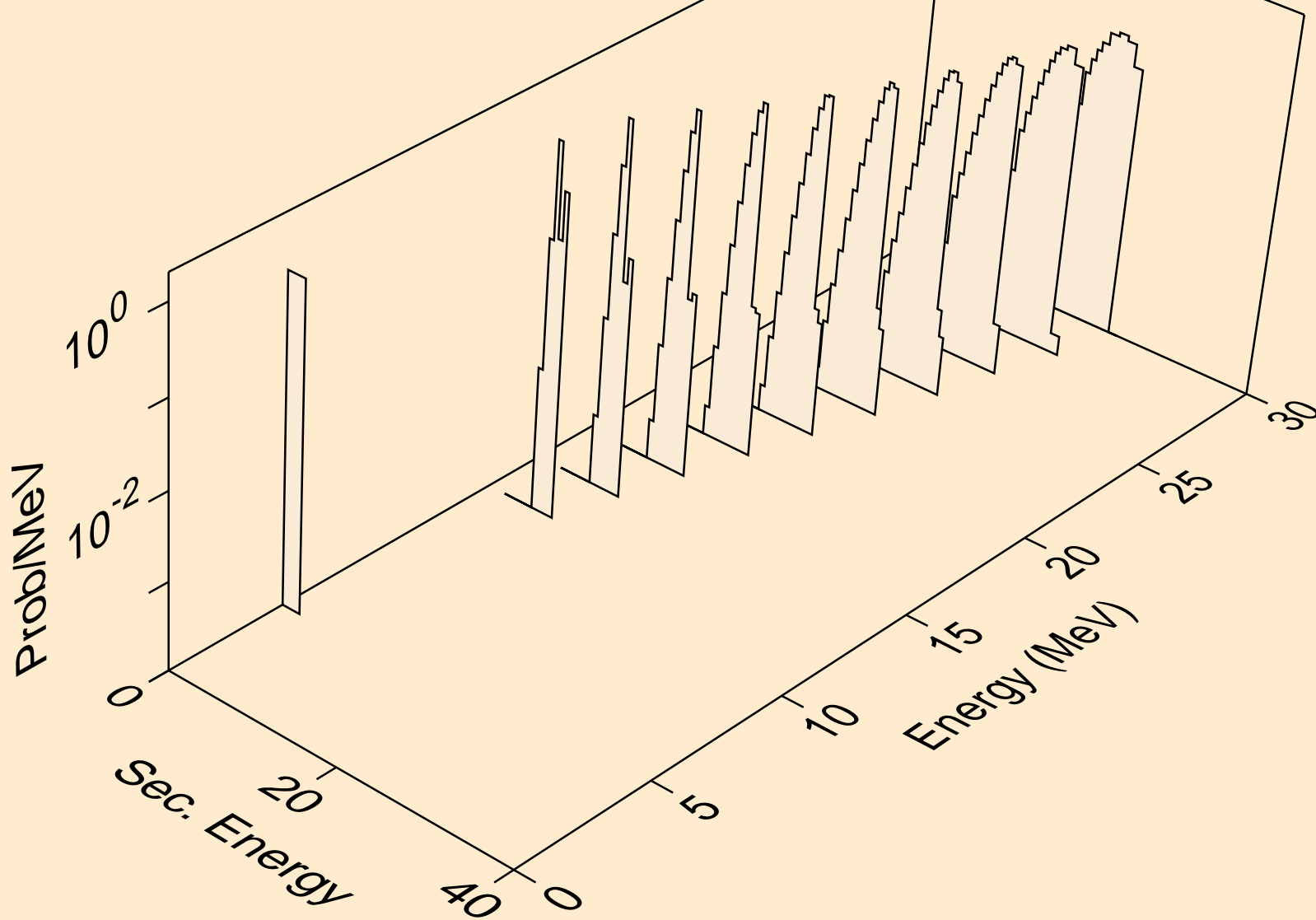



IR189 NEUTRON ACER TENDL-2019 LIBRARY; T=293.16K  
alphas from (n,x)

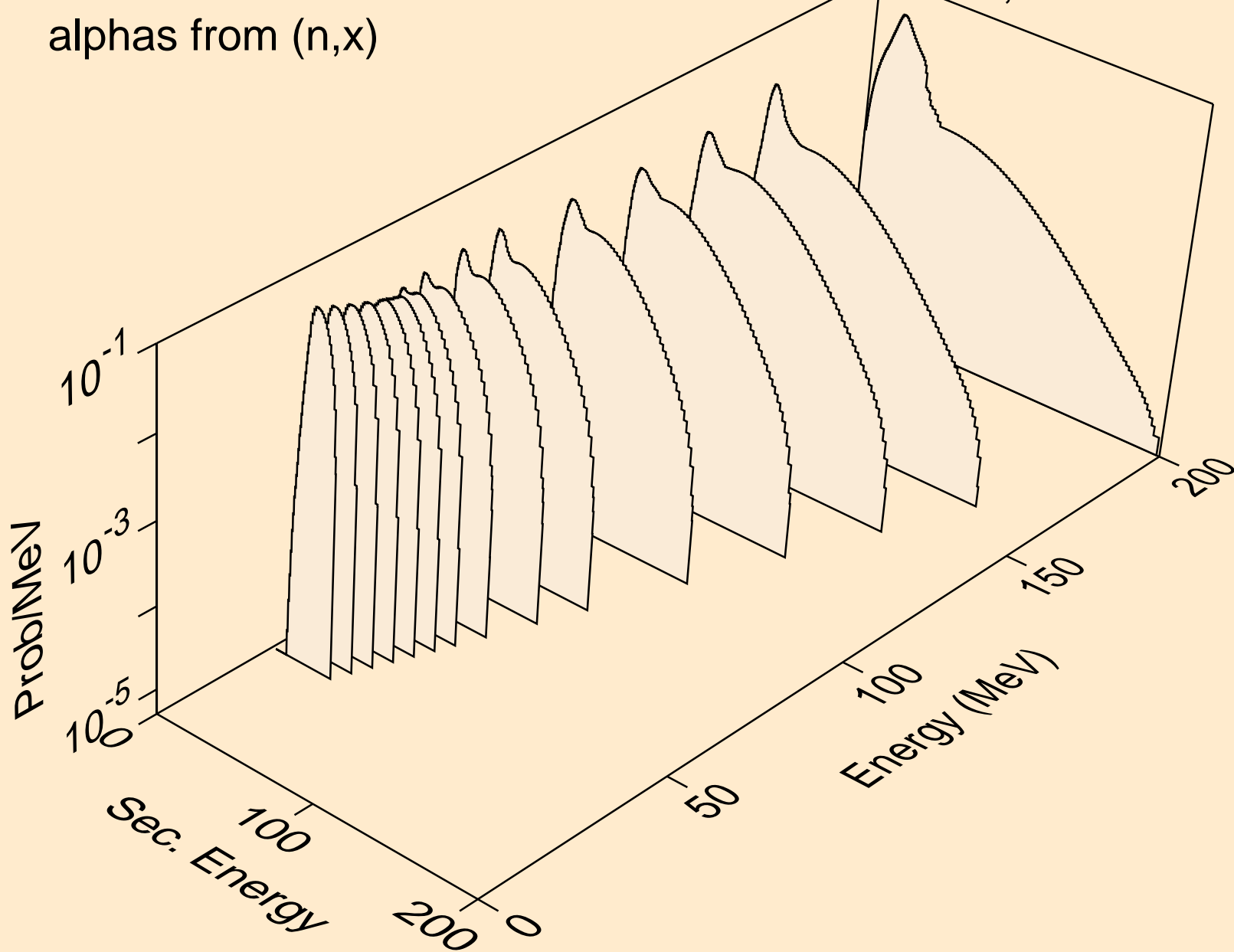

IR189 NEUTRON ACER TENDL-2019 LIBRARY; T=293.16K  
alphas from (n,n\*)a

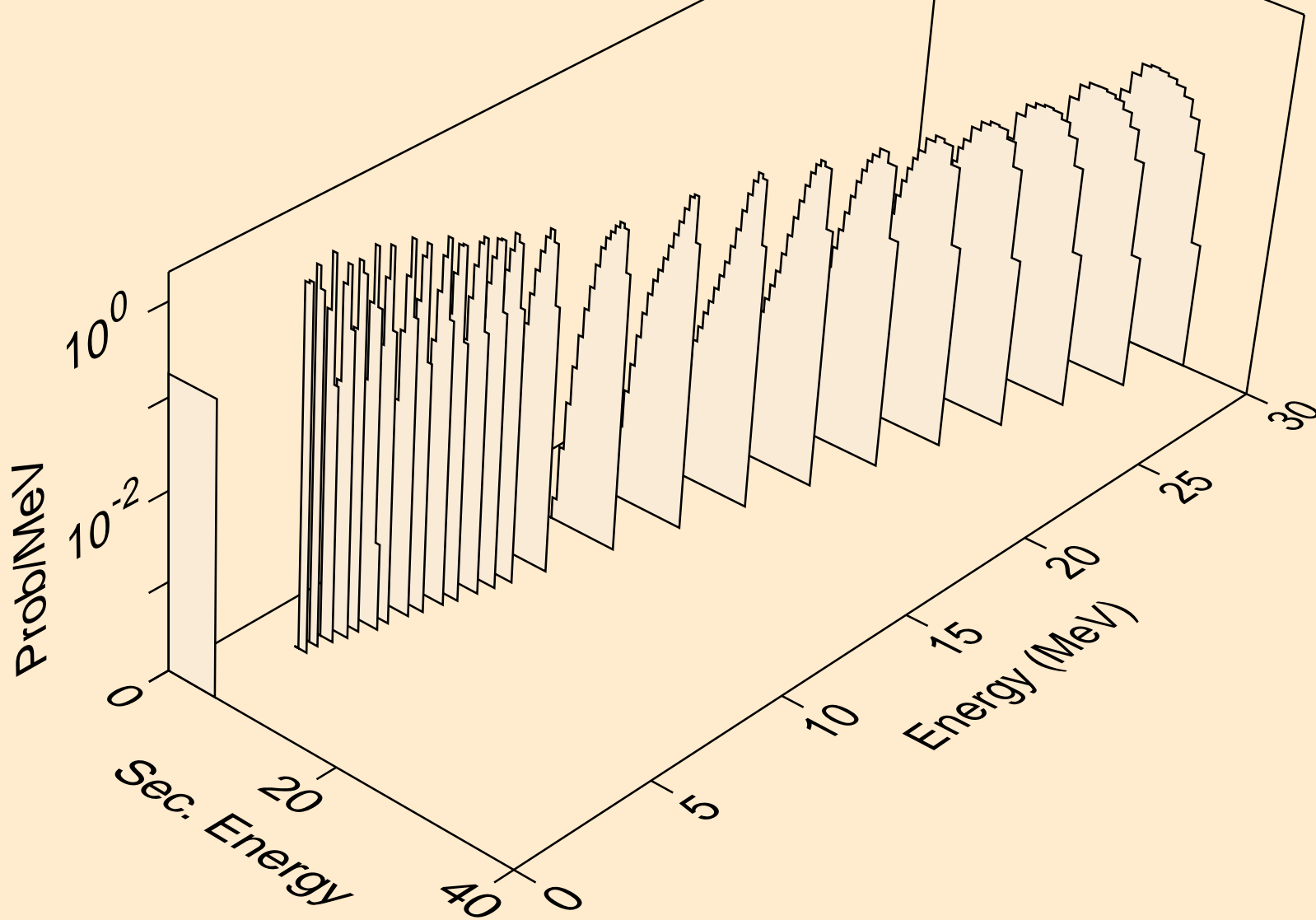

IR189 NEUTRON ACER TENDL-2019 LIBRARY; T=293.16K  
alphas from (n,2n)a

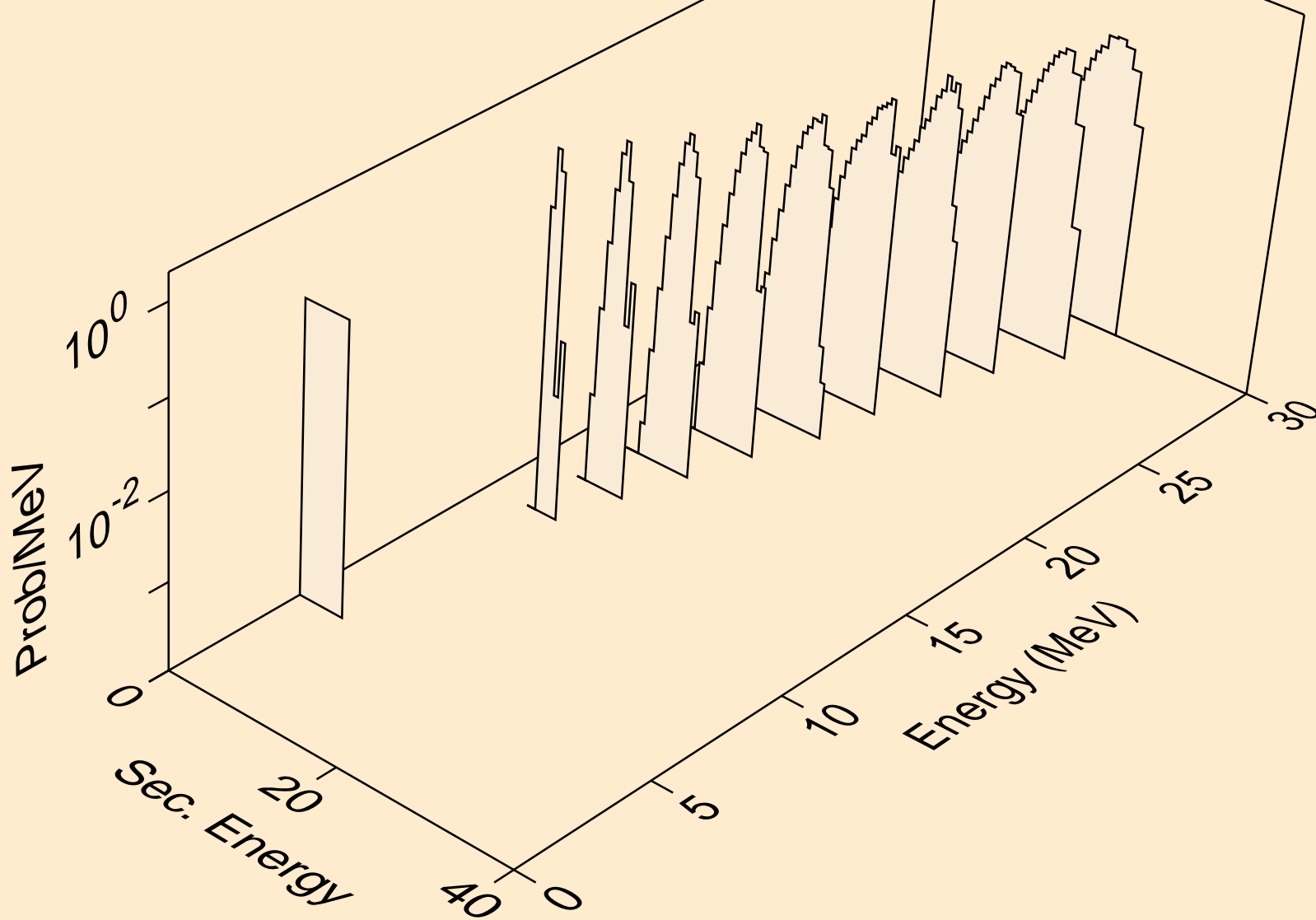

IR189 NEUTRON ACER TENDL-2019 LIBRARY; T=293.16K  
alphas from (n,3n)a

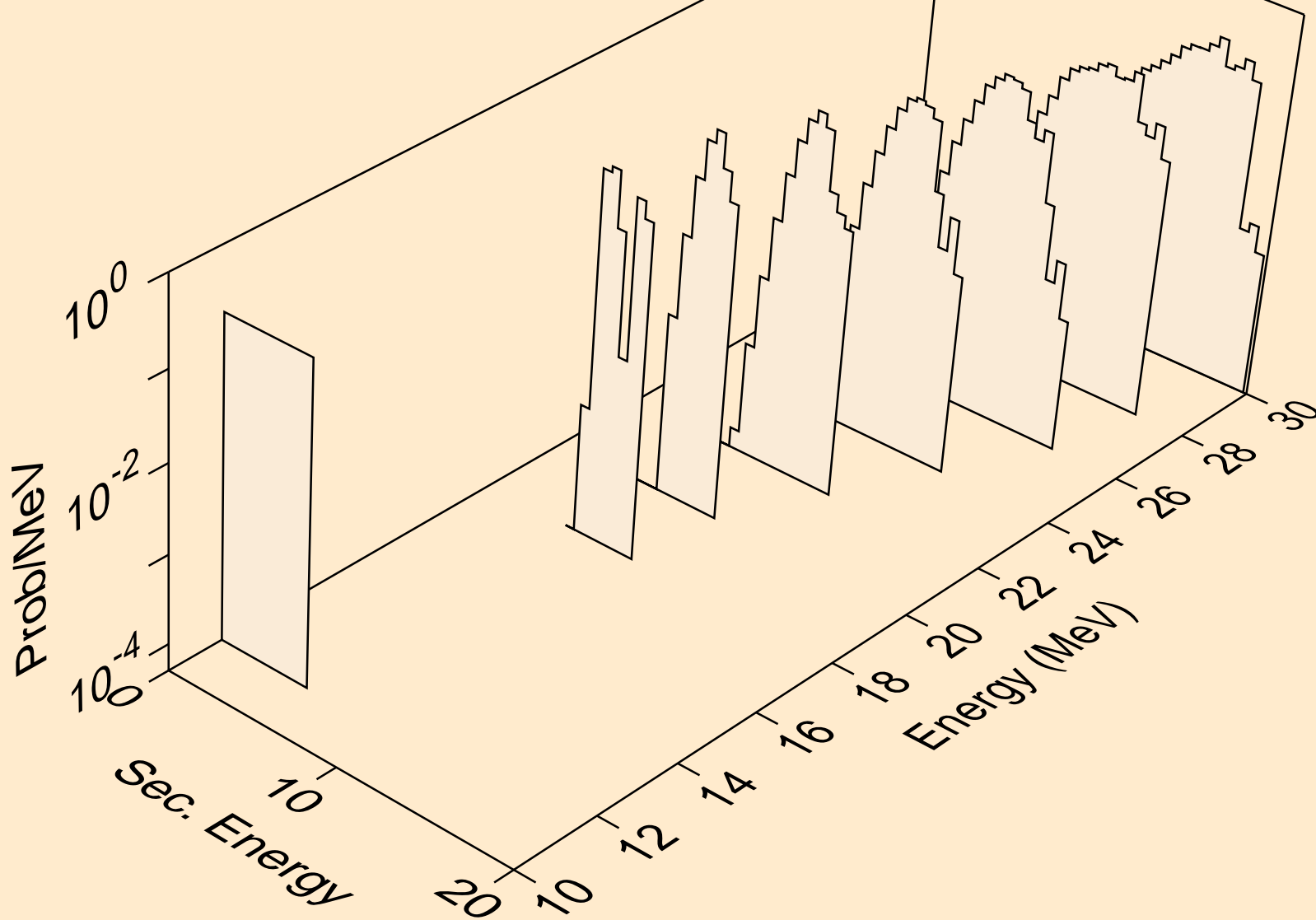

IR189 NEUTRON ACER TENDL-2019 LIBRARY; T=293.16K  
alphas from (n,n\*)2a

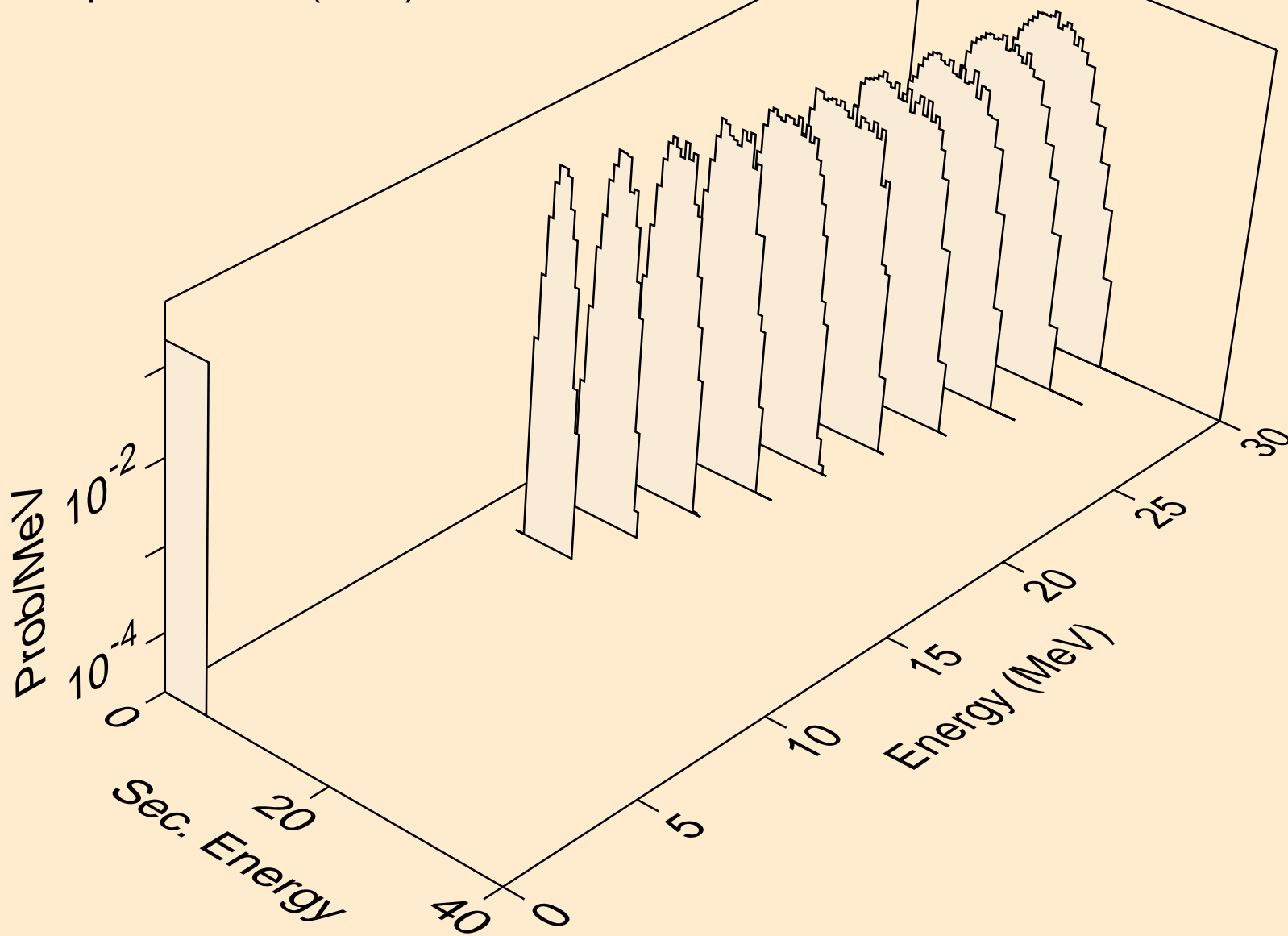

IR189 NEUTRON ACER TENDL-2019 LIBRARY; T=293.16K  
alphas from (n,npa)

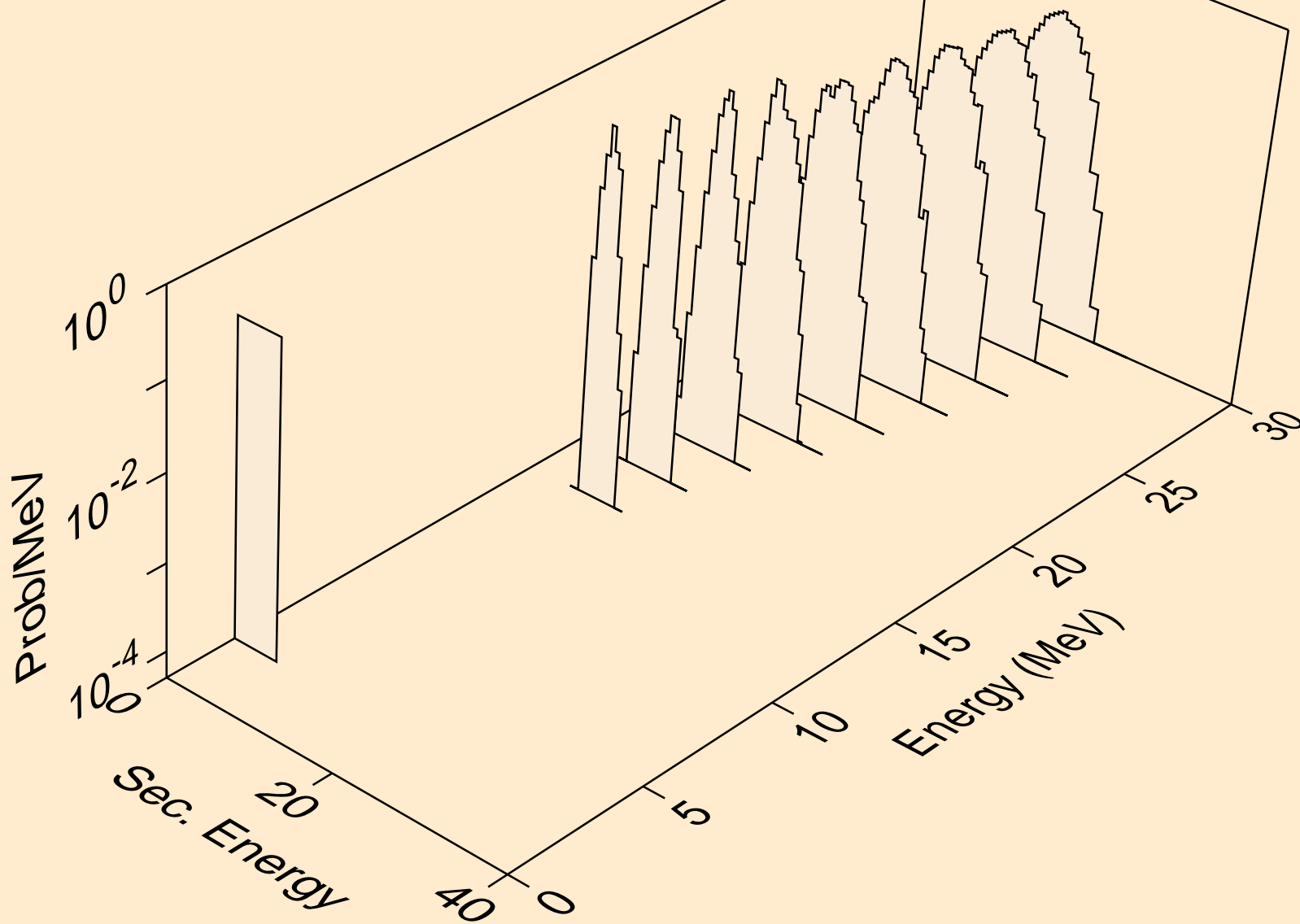

IR189 NEUTRON ACER TENDL-2019 LIBRARY; T=293.16K  
alphas from (n,a)

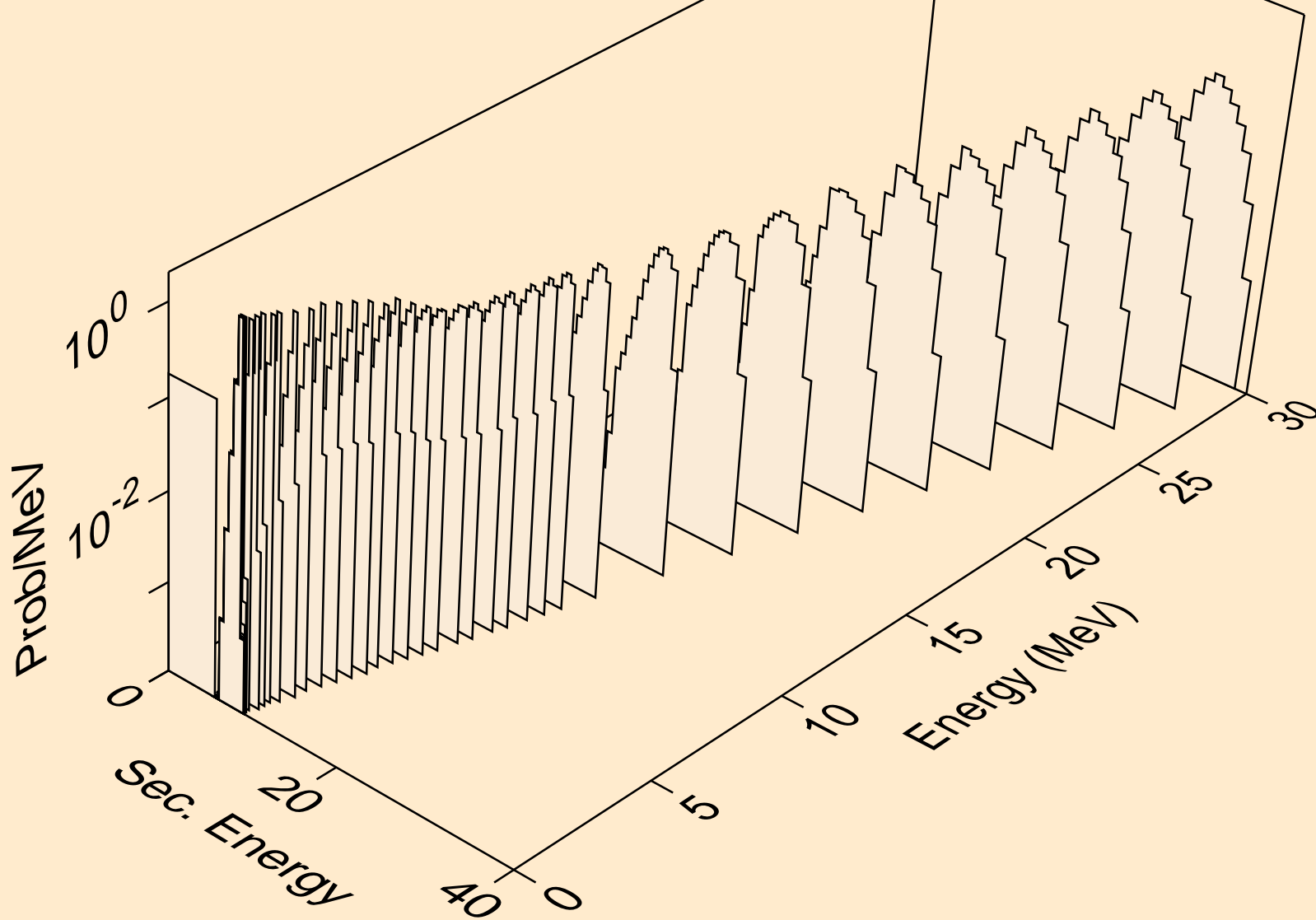

IR189 NEUTRON ACER TENDL-2019 LIBRARY; T=293.16K  
alphas from (n,2a)

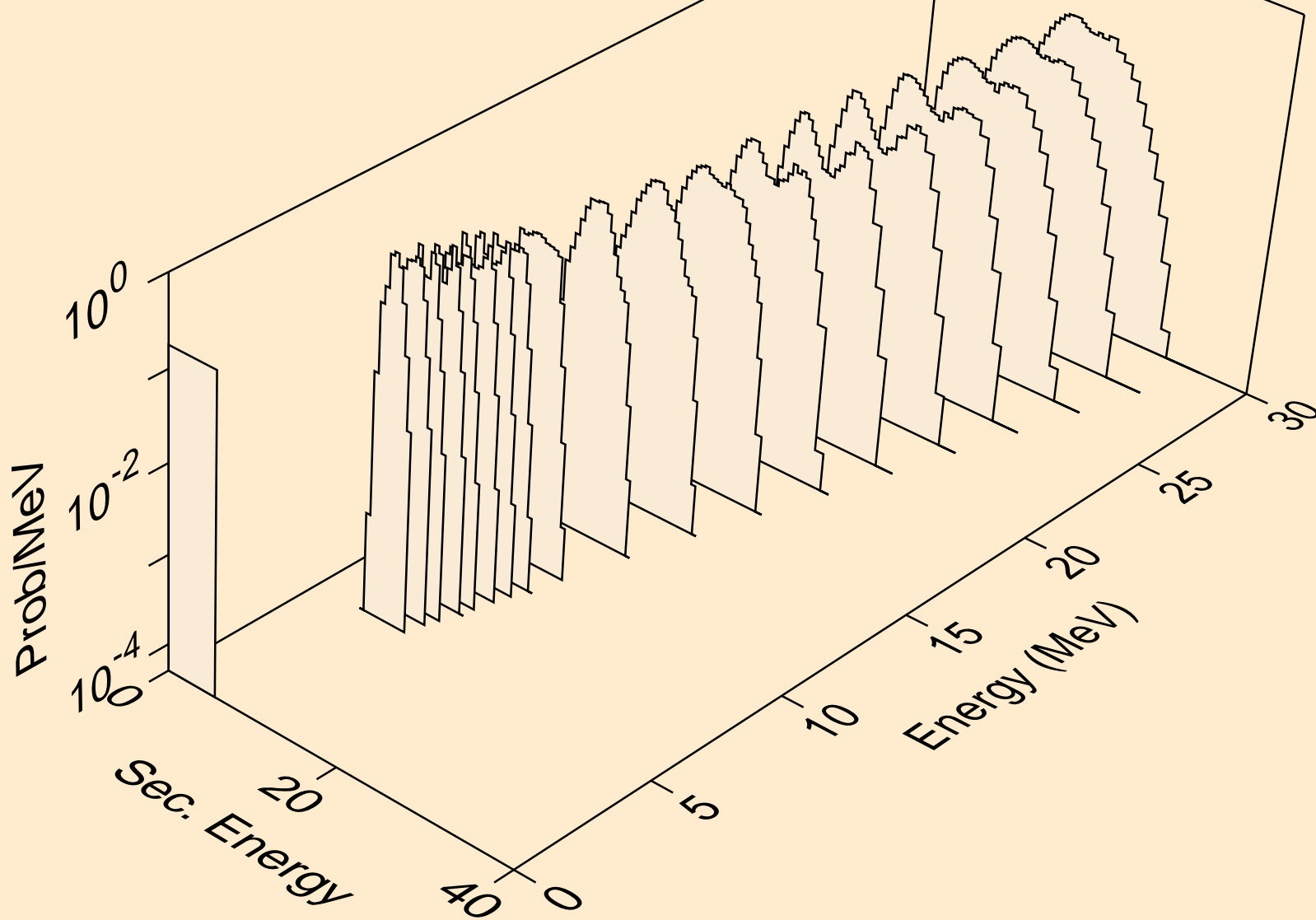



IR189 NEUTRON ACER TENDL-2019 LIBRARY; T=293.16K  
alphas from (n,pa)

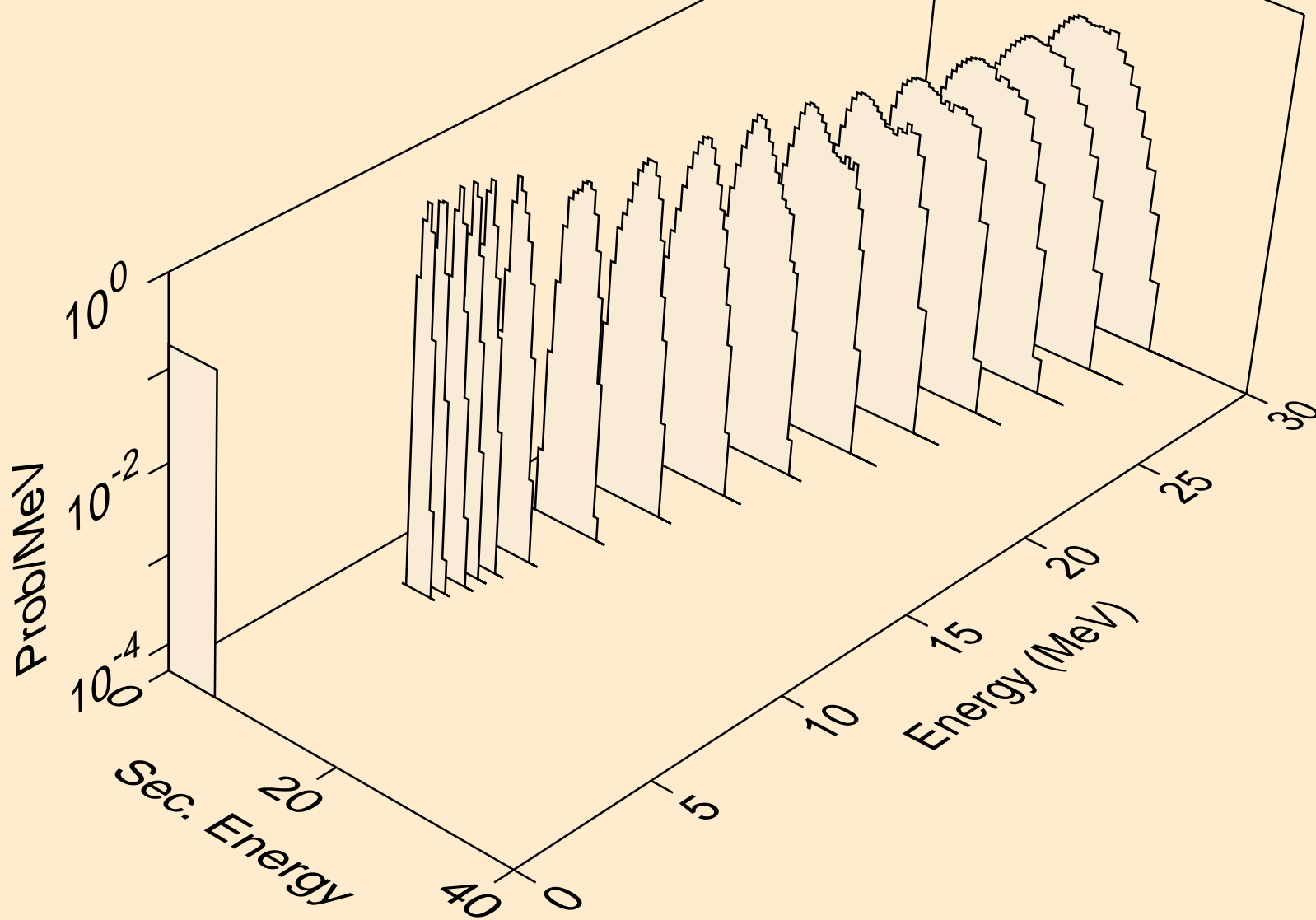

IR189 NEUTRON ACER TENDL-2019 LIBRARY; T=293.16K  
alphas from (n,da)

