

# IR191 NEUTRON ACER TENDL-2019 LIBRARY; T=293.16K

## Principal cross sections

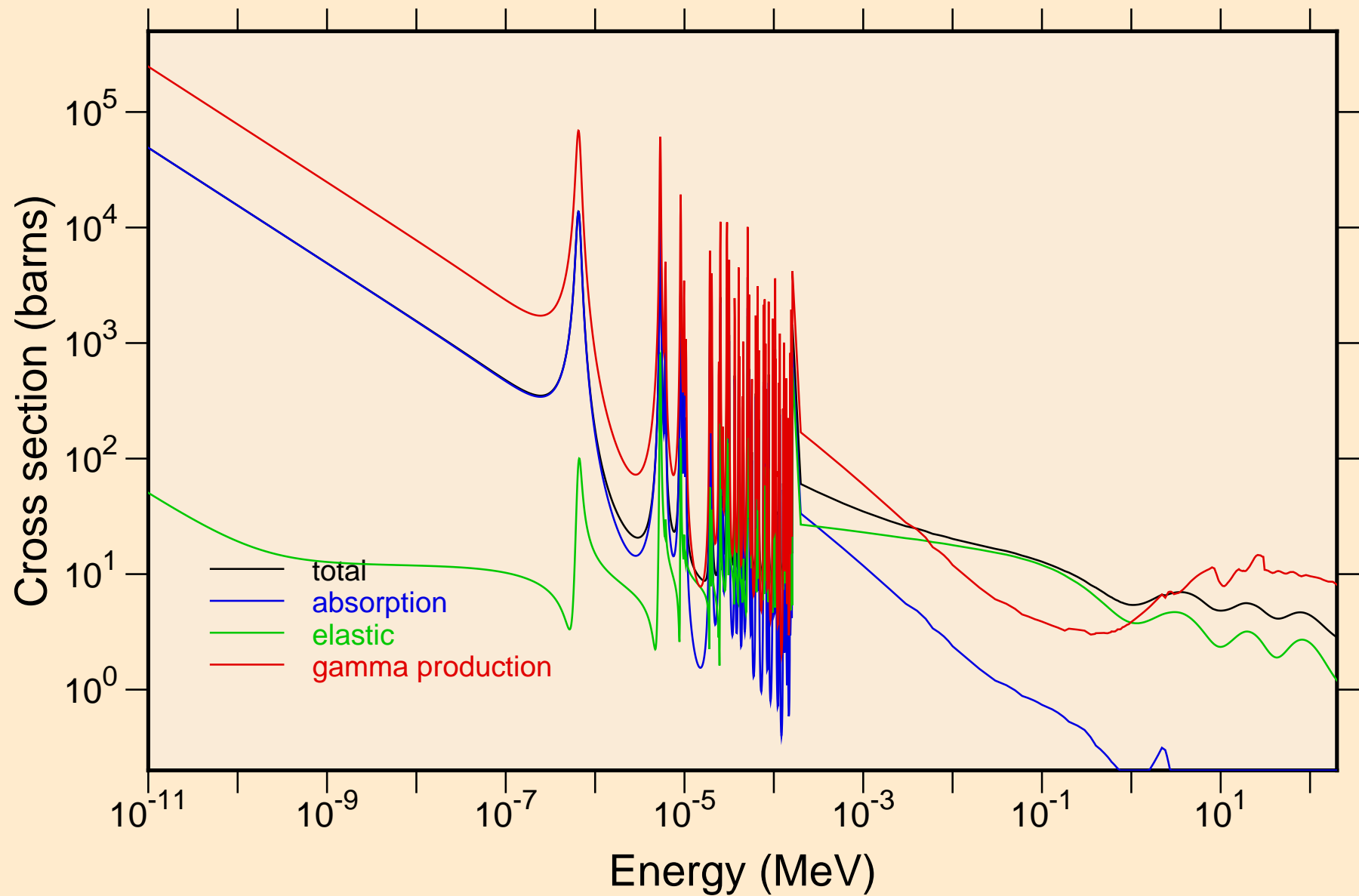

IR191 NEUTRON ACER TENDL-2019 LIBRARY; T=293.16K  
resonance total cross section

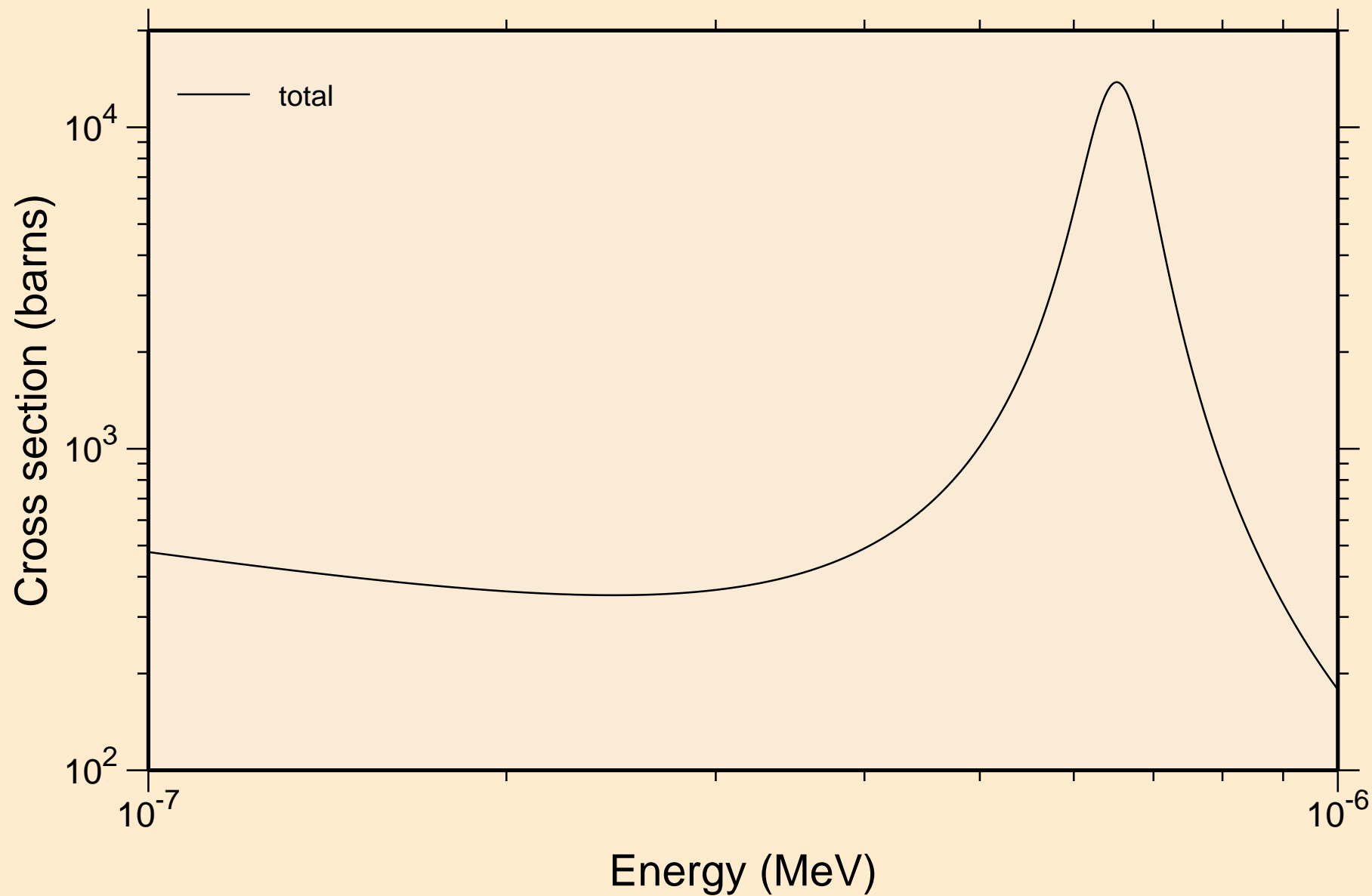

IR191 NEUTRON ACER TENDL-2019 LIBRARY; T=293.16K  
resonance total cross section

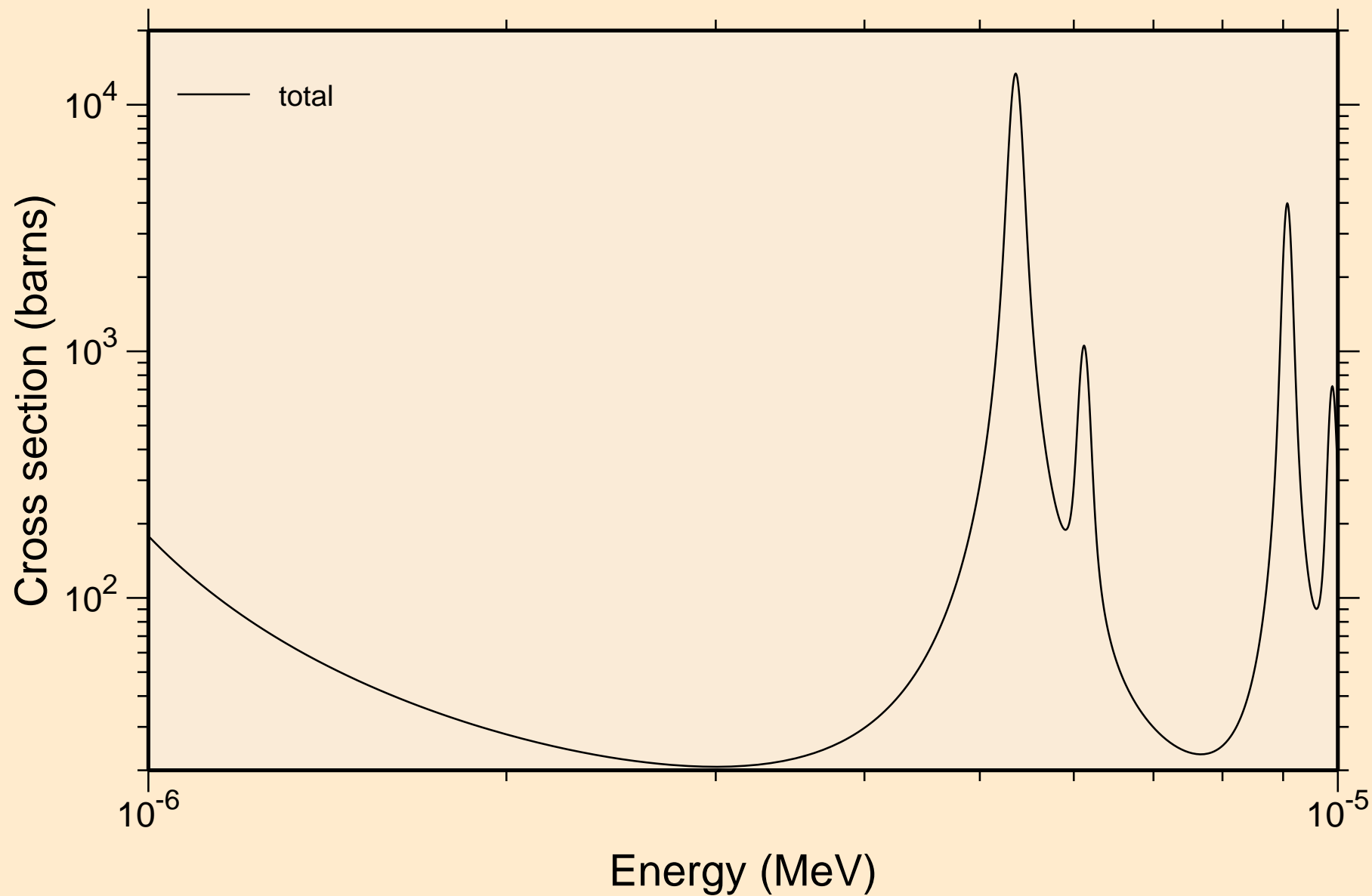

IR191 NEUTRON ACER TENDL-2019 LIBRARY; T=293.16K  
resonance total cross section

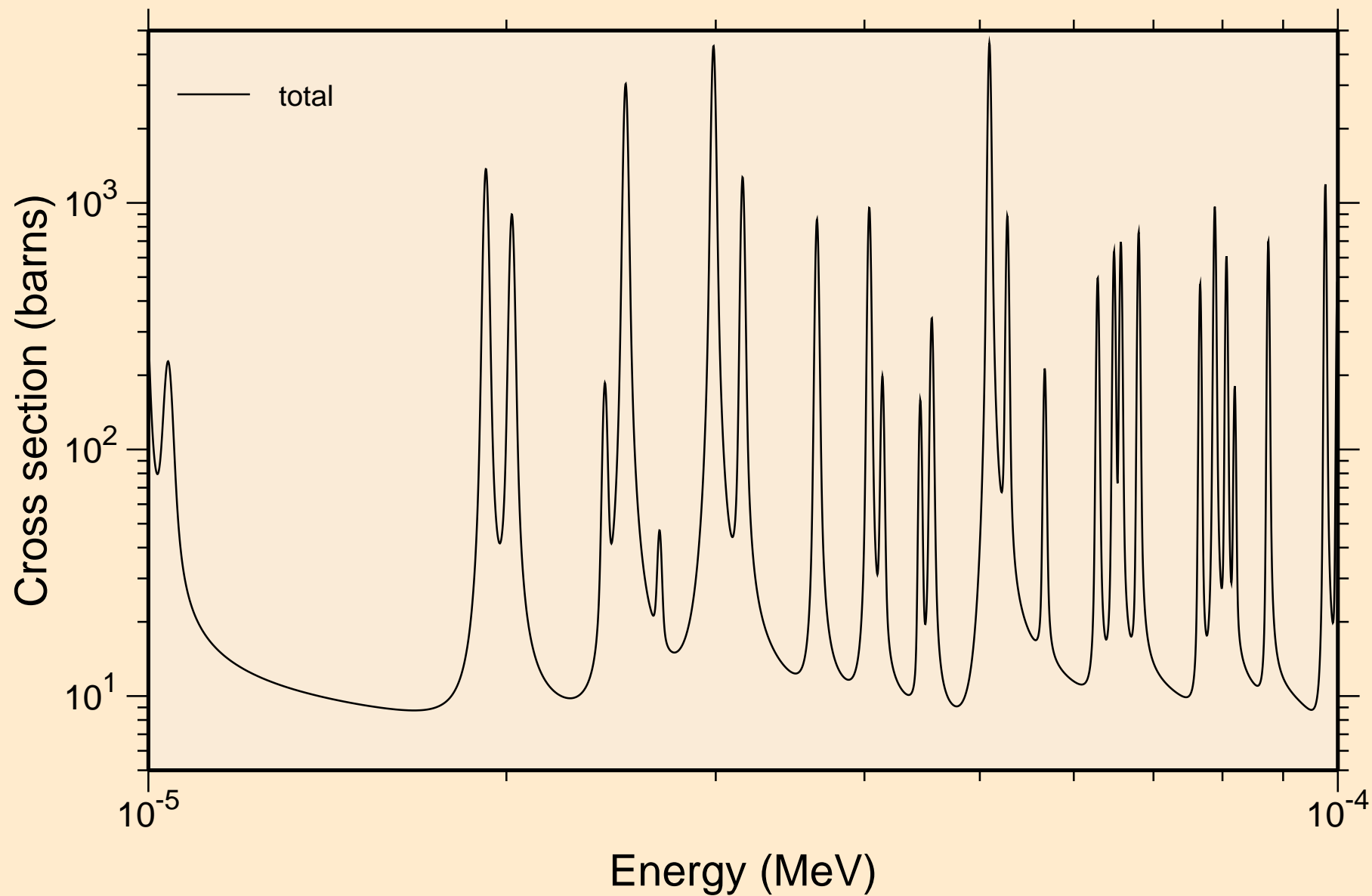

IR191 NEUTRON ACER TENDL-2019 LIBRARY; T=293.16K  
resonance total cross section

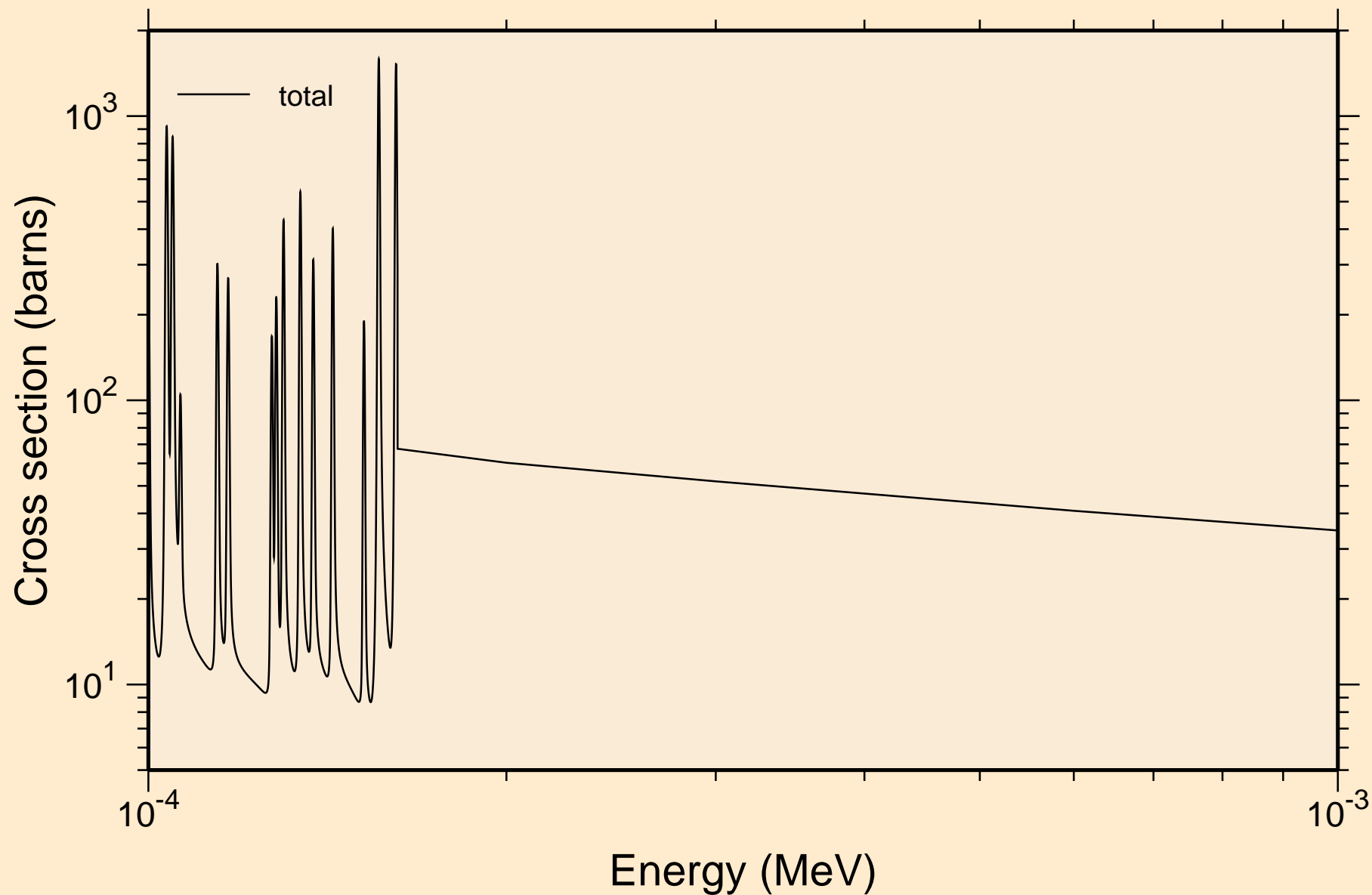

IR191 NEUTRON ACER TENDL-2019 LIBRARY; T=293.16K  
resonance total cross section

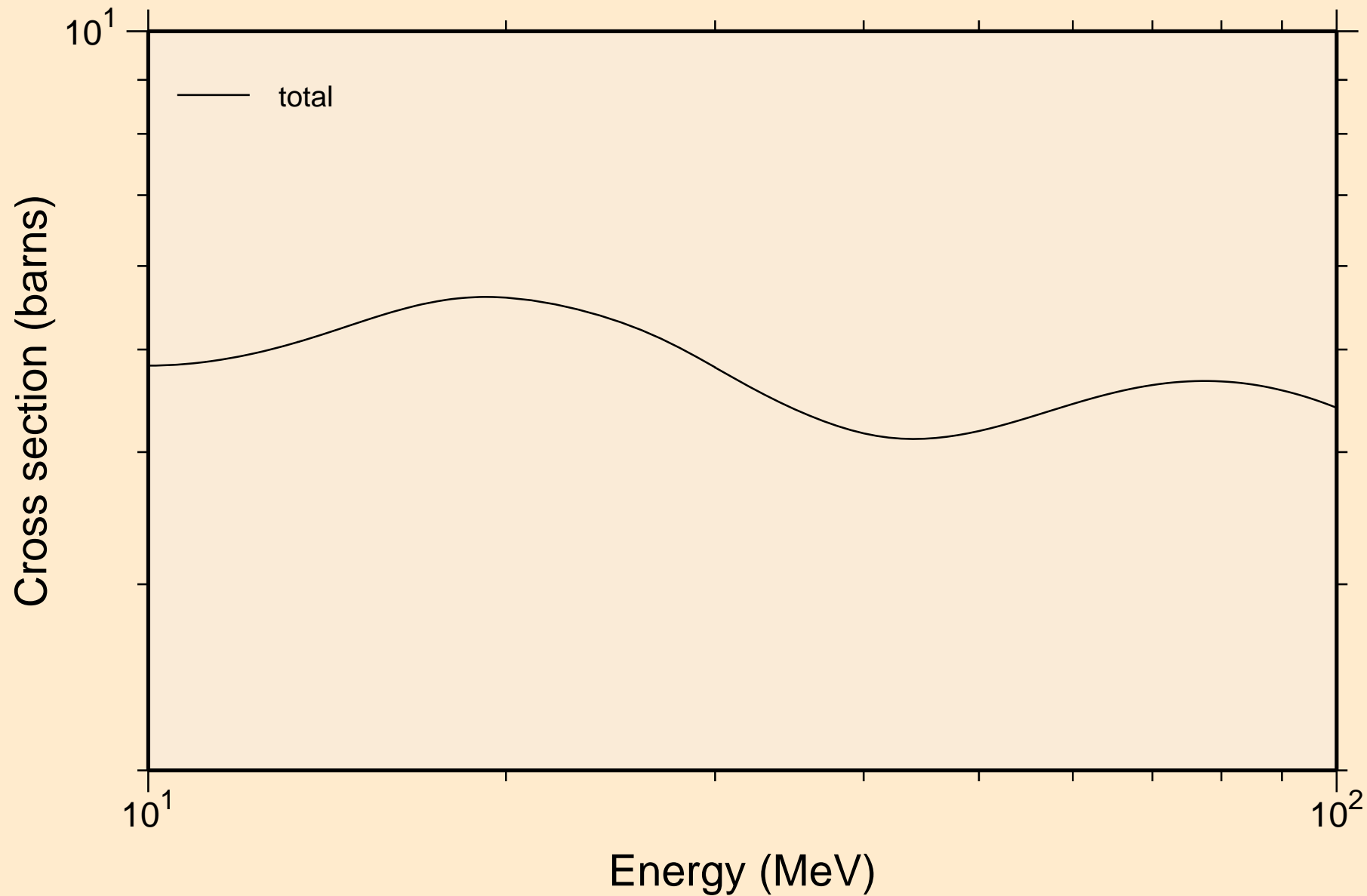

IR191 NEUTRON ACER TENDL-2019 LIBRARY; T=293.16K  
resonance absorption cross sections

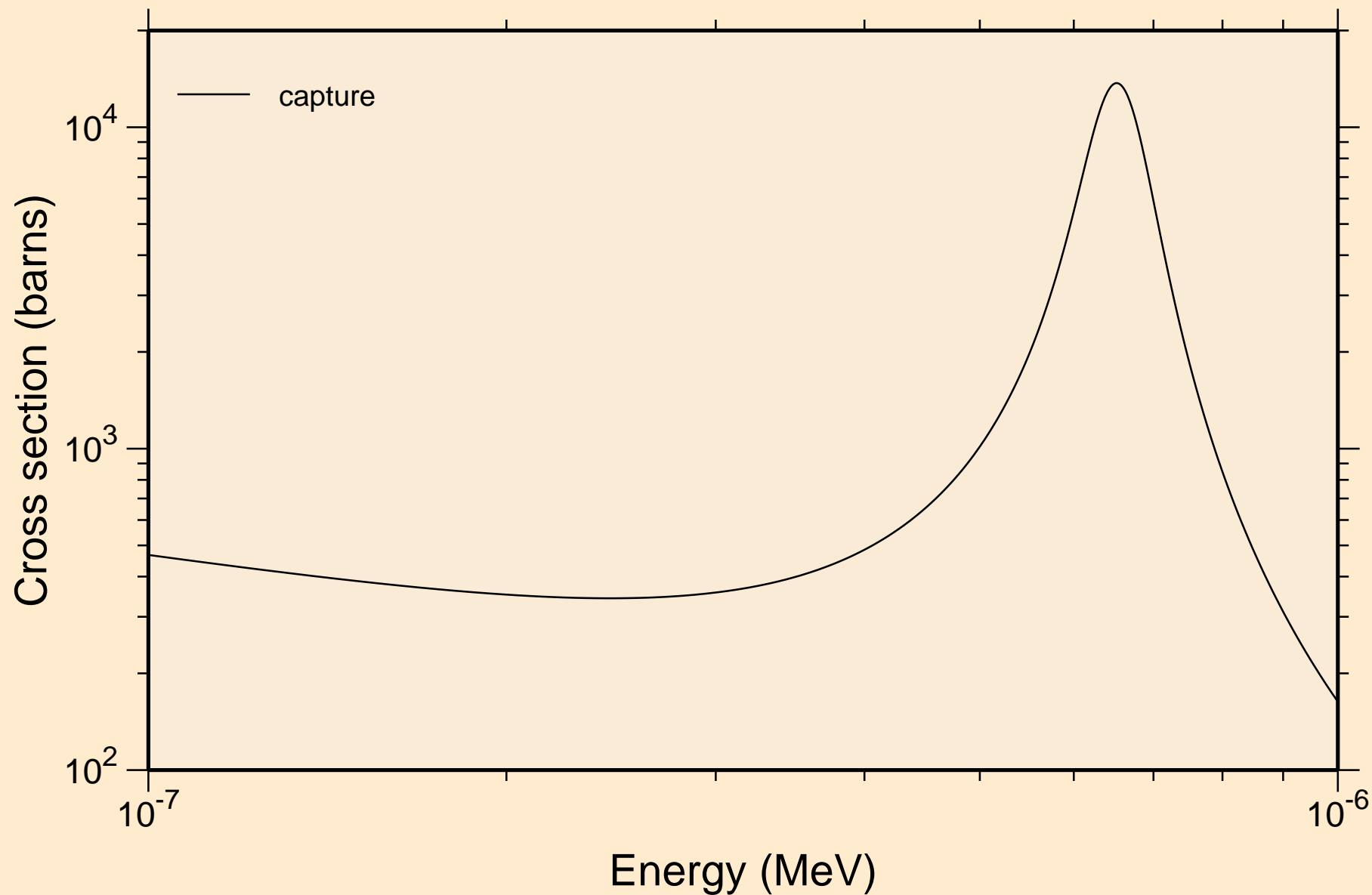

IR191 NEUTRON ACER TENDL-2019 LIBRARY; T=293.16K  
resonance absorption cross sections

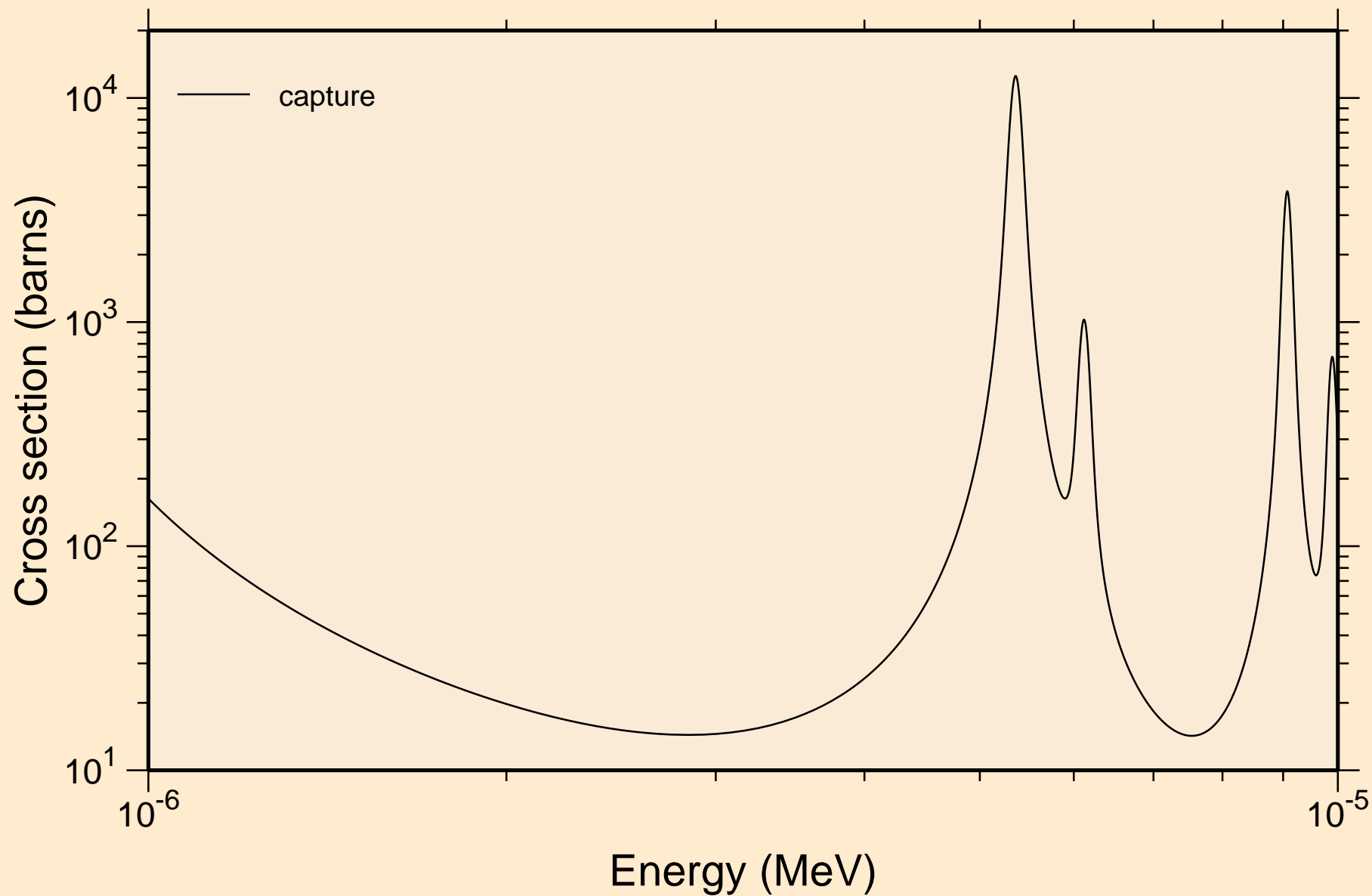



IR191 NEUTRON ACER TENDL-2019 LIBRARY; T=293.16K  
resonance absorption cross sections

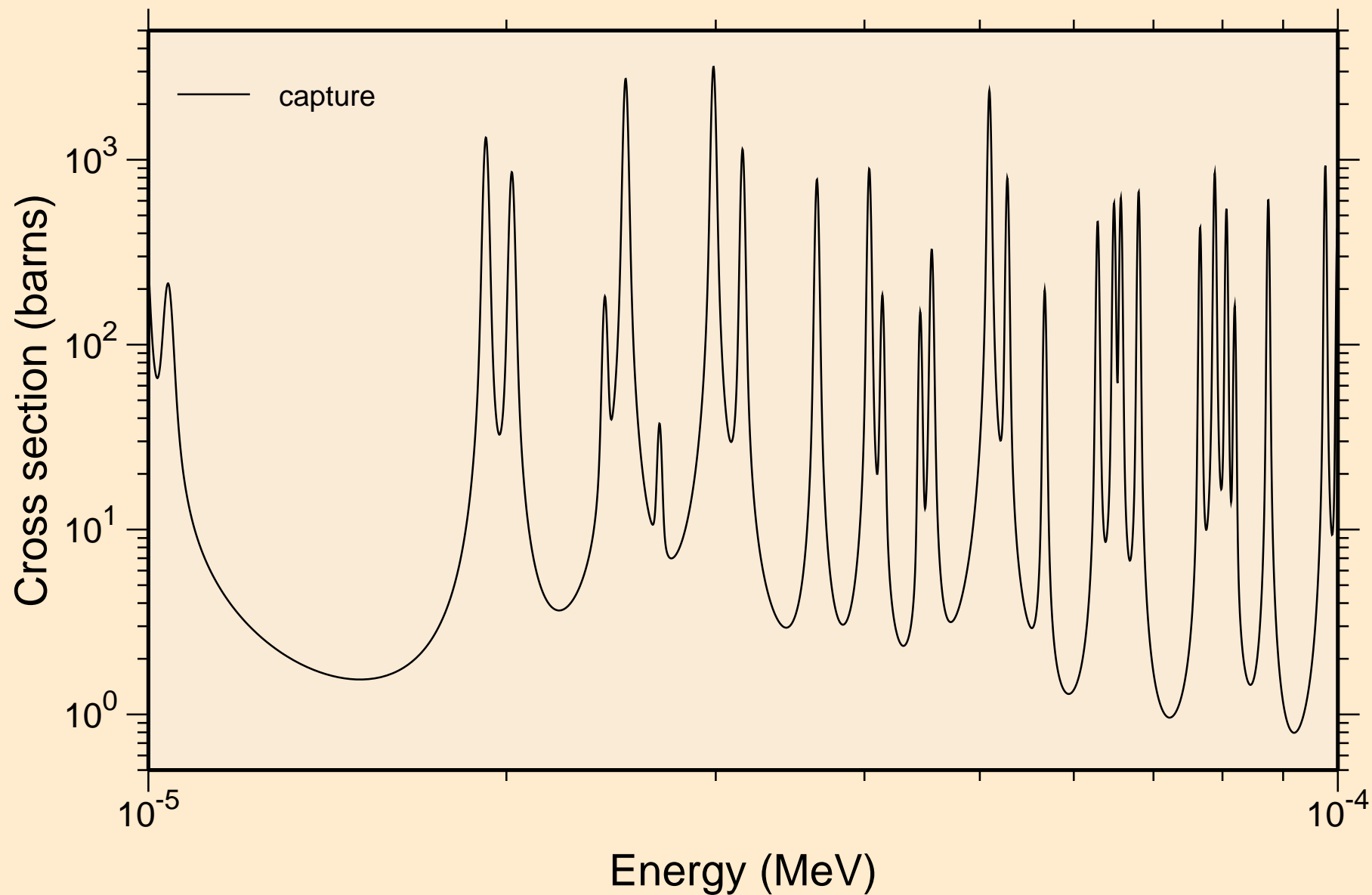

IR191 NEUTRON ACER TENDL-2019 LIBRARY; T=293.16K  
resonance absorption cross sections

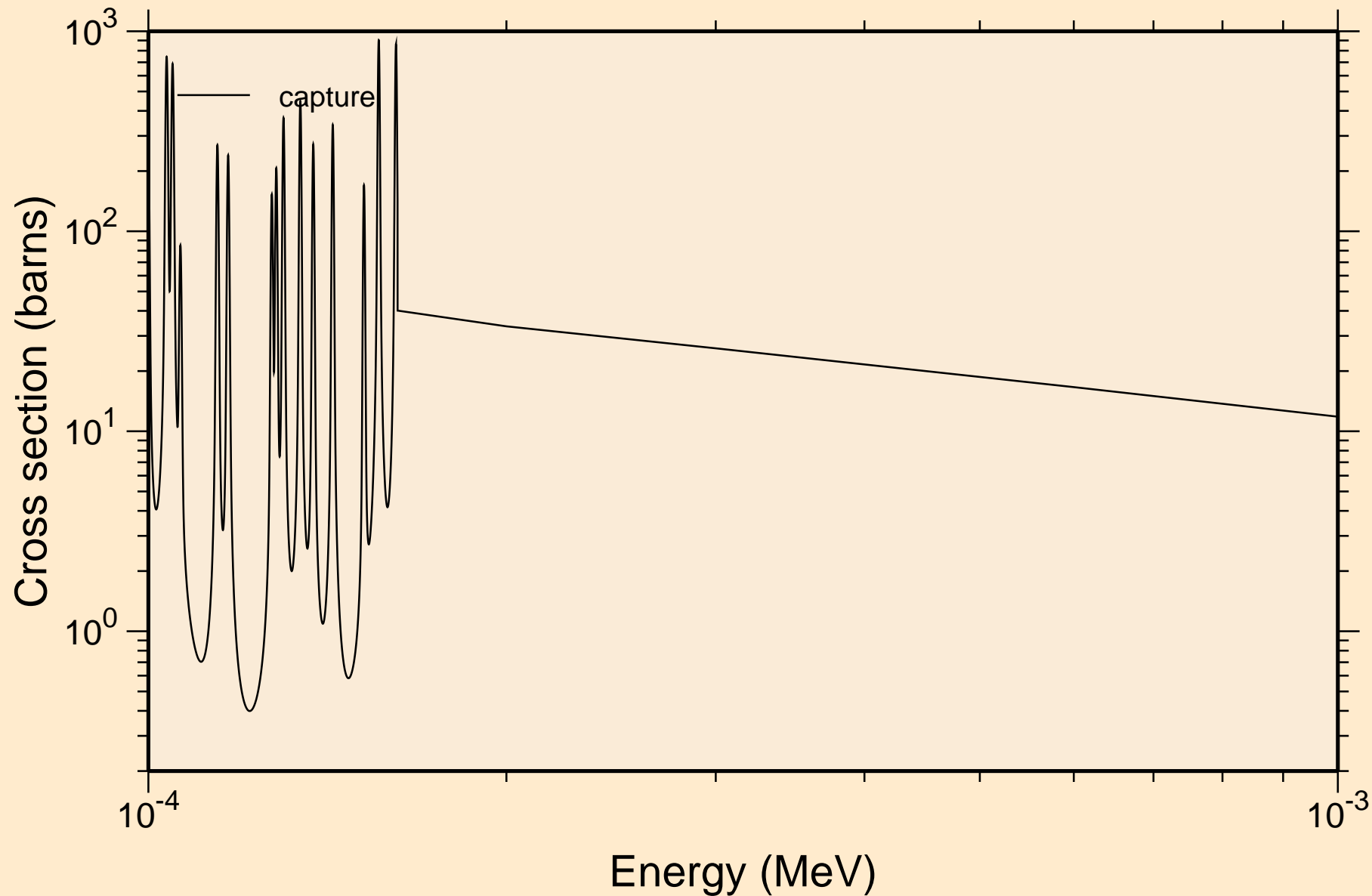

IR191 NEUTRON ACER TENDL-2019 LIBRARY; T=293.16K  
resonance absorption cross sections

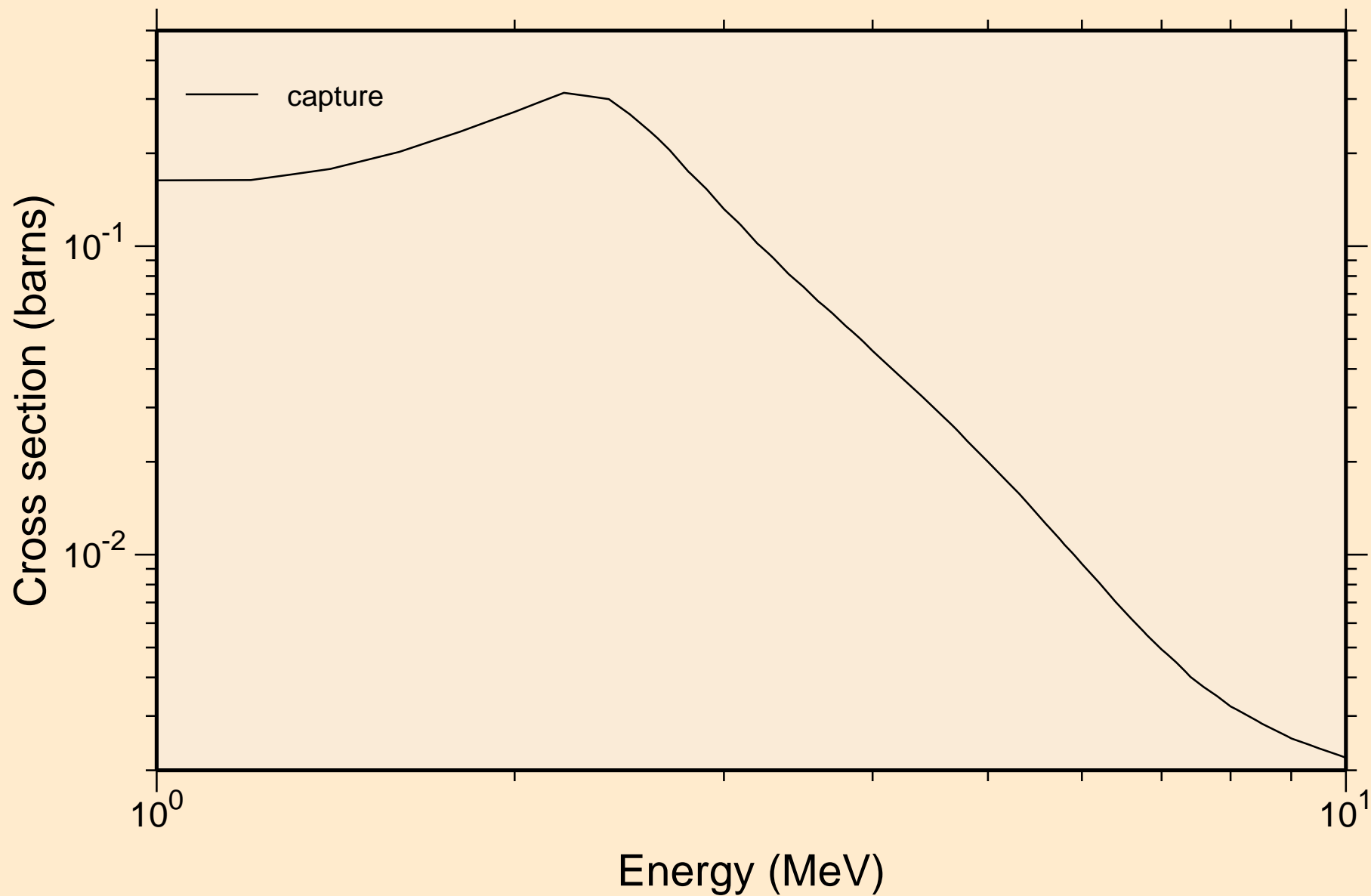

IR191 NEUTRON ACER TENDL-2019 LIBRARY; T=293.16K  
Heating

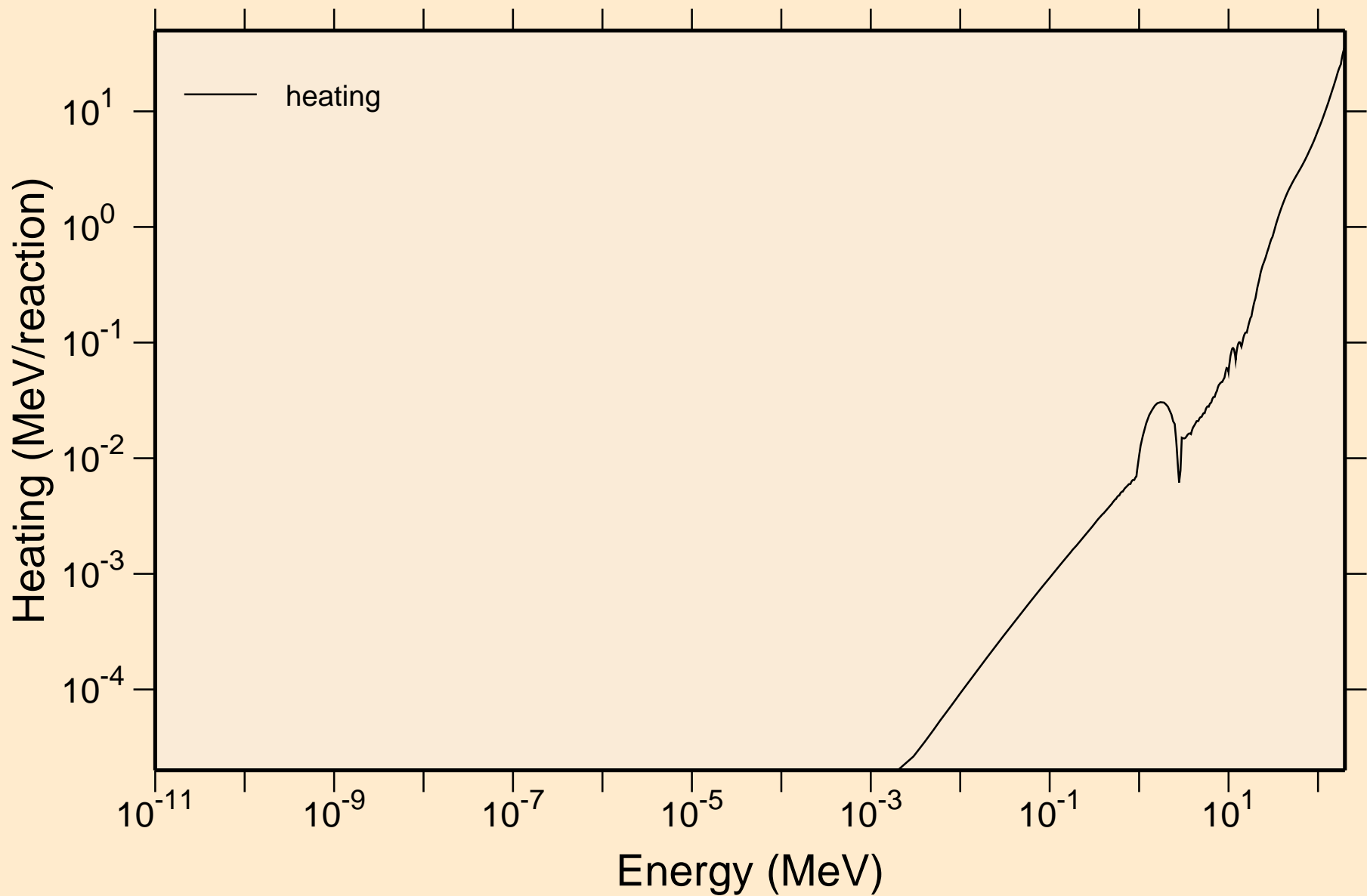

IR191 NEUTRON ACER TENDL-2019 LIBRARY; T=293.16K  
Damage

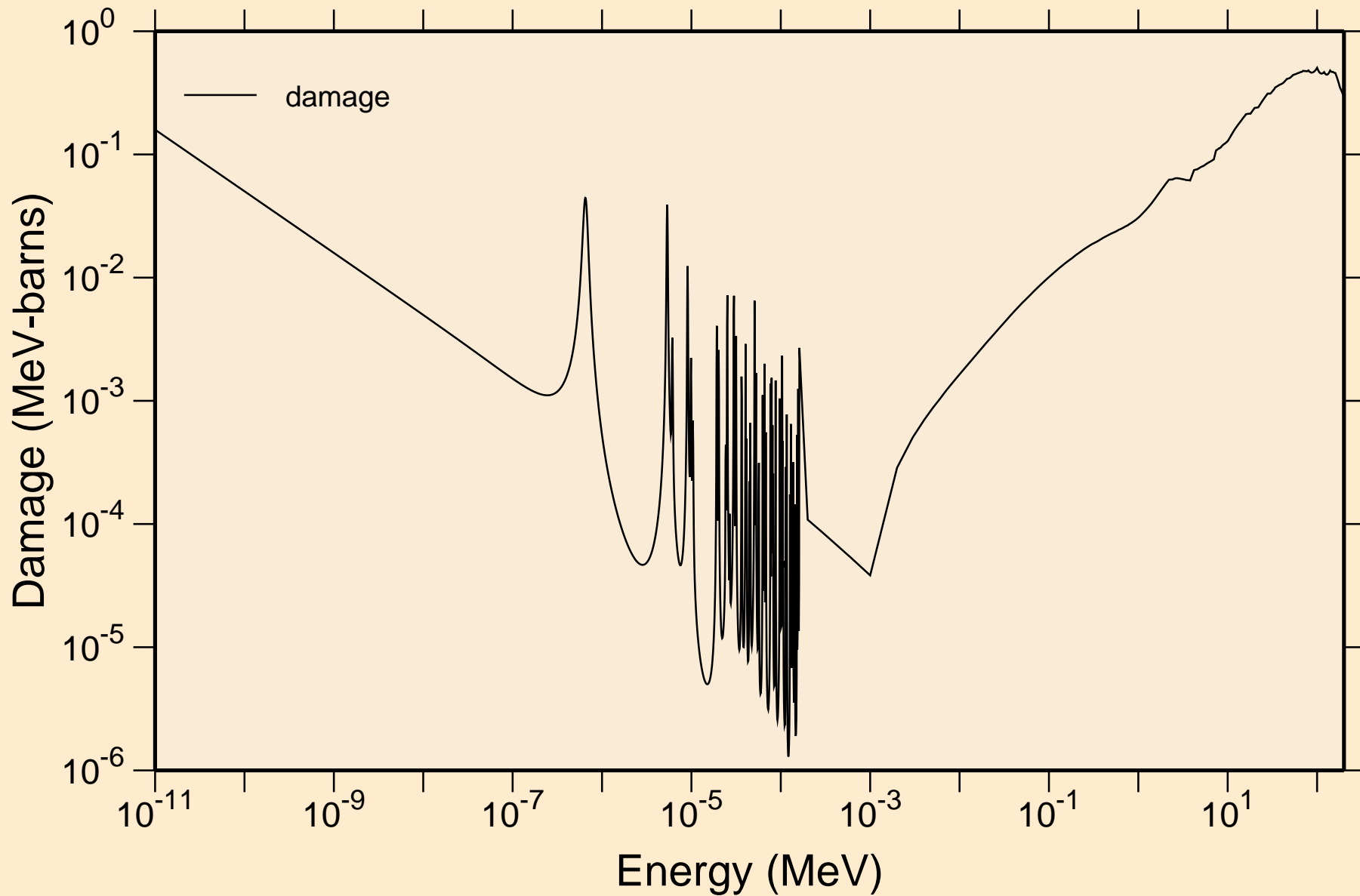

IR191 NEUTRON ACER TENDL-2019 LIBRARY; T=293.16K  
Non-threshold reactions

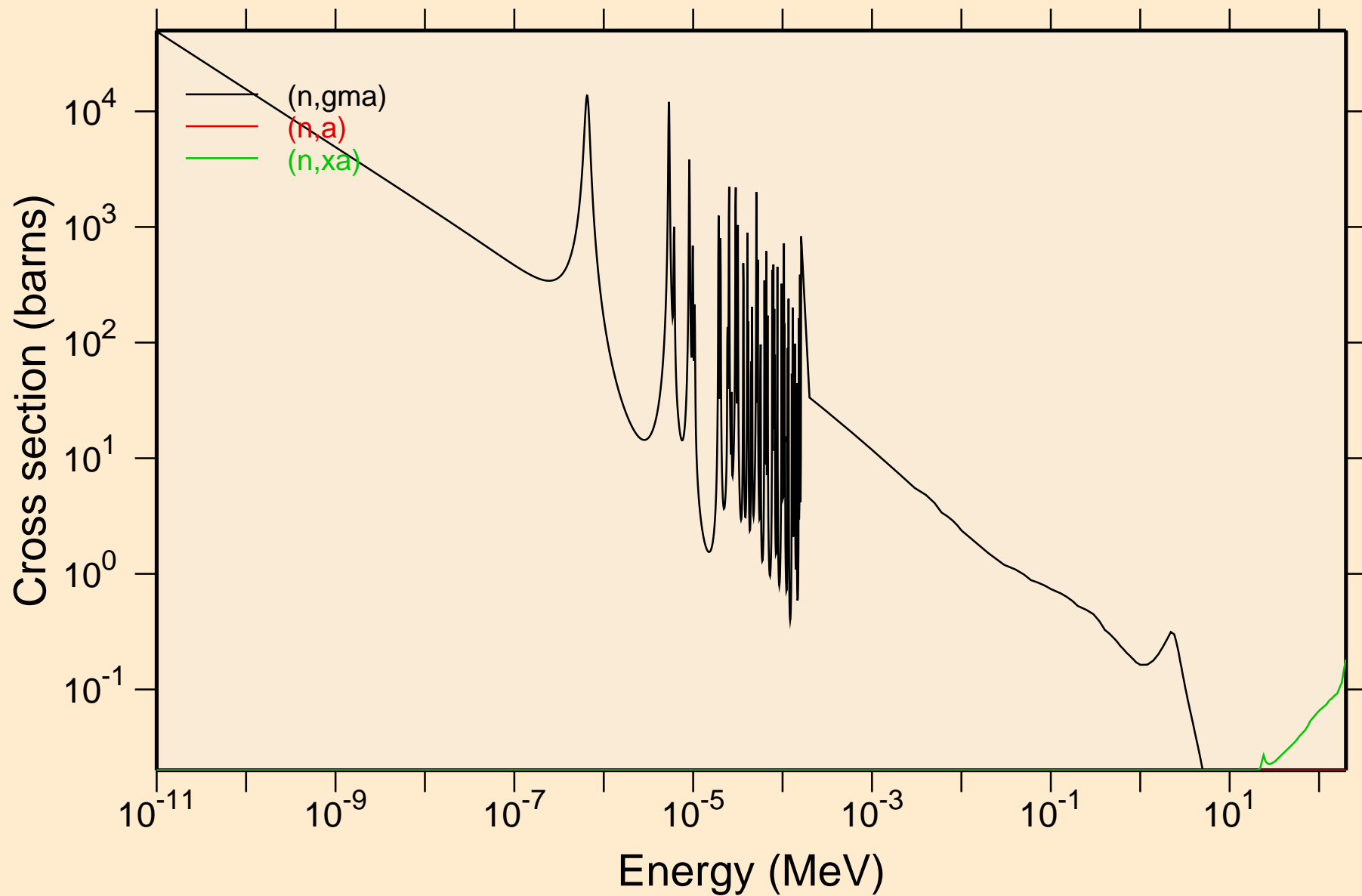

IR191 NEUTRON ACER TENDL-2019 LIBRARY; T=293.16K  
Principal cross sections

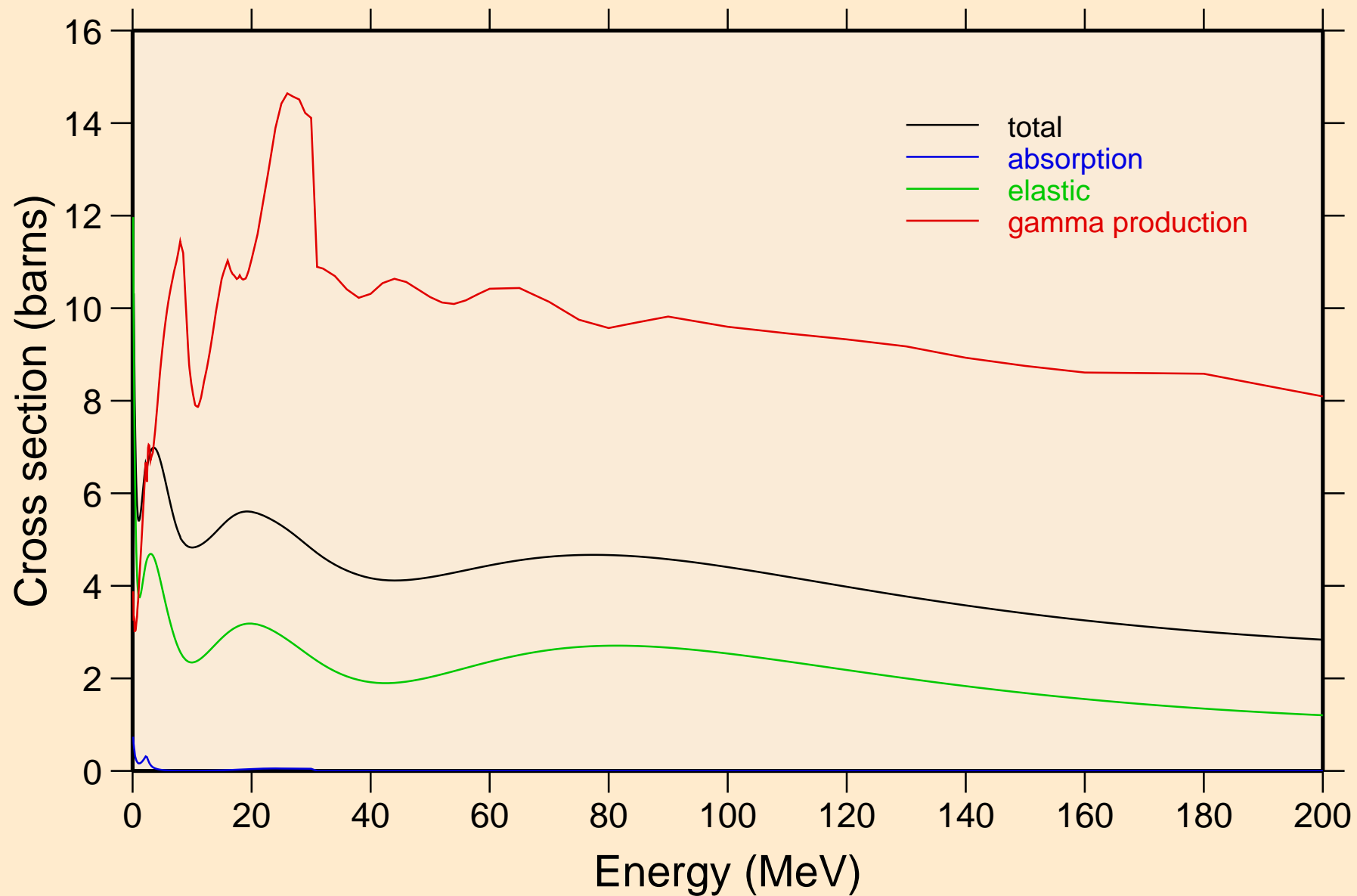

IR191 NEUTRON ACER TENDL-2019 LIBRARY; T=293.16K  
Heating

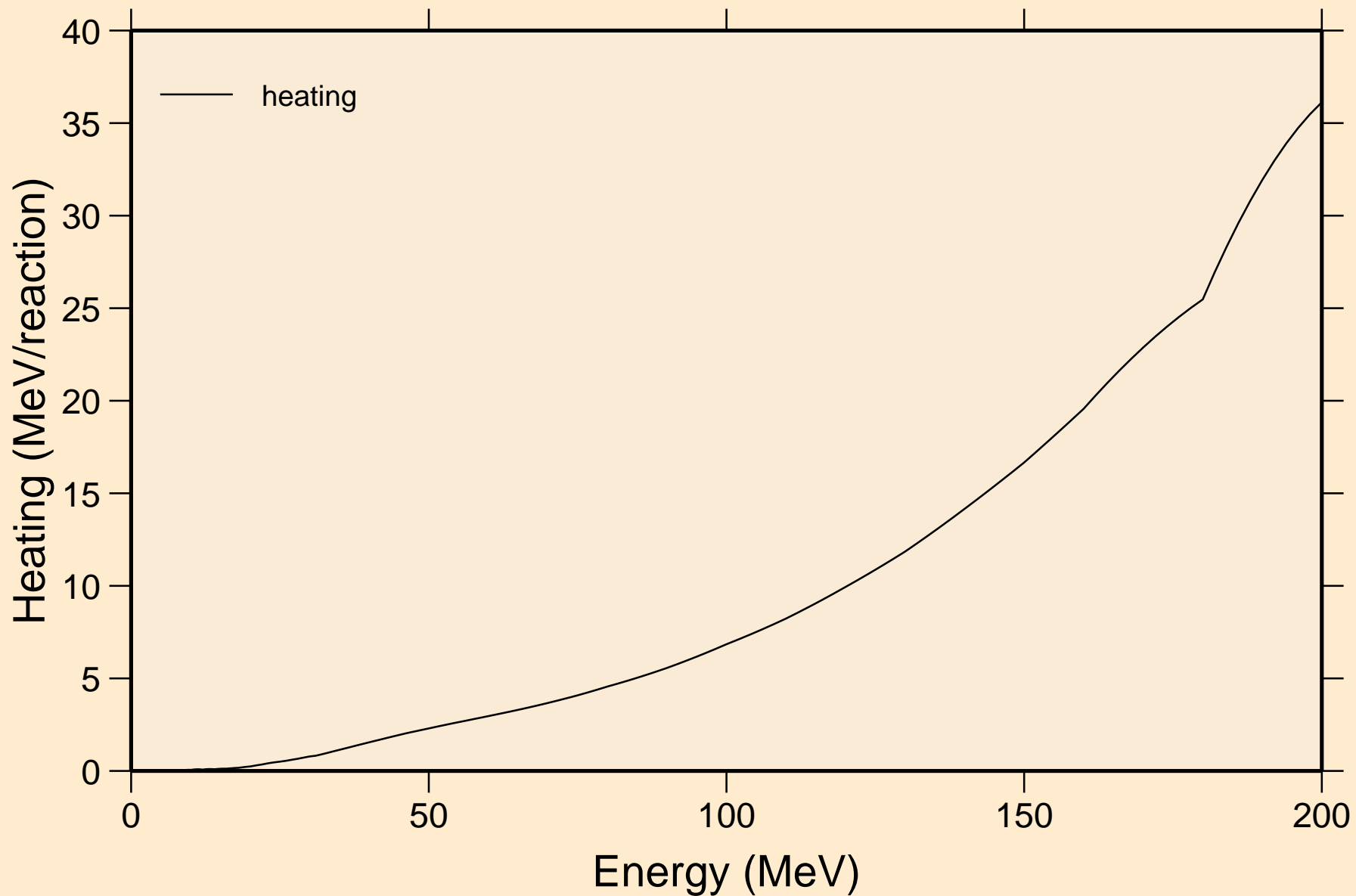



IR191 NEUTRON ACER TENDL-2019 LIBRARY; T=293.16K  
Damage

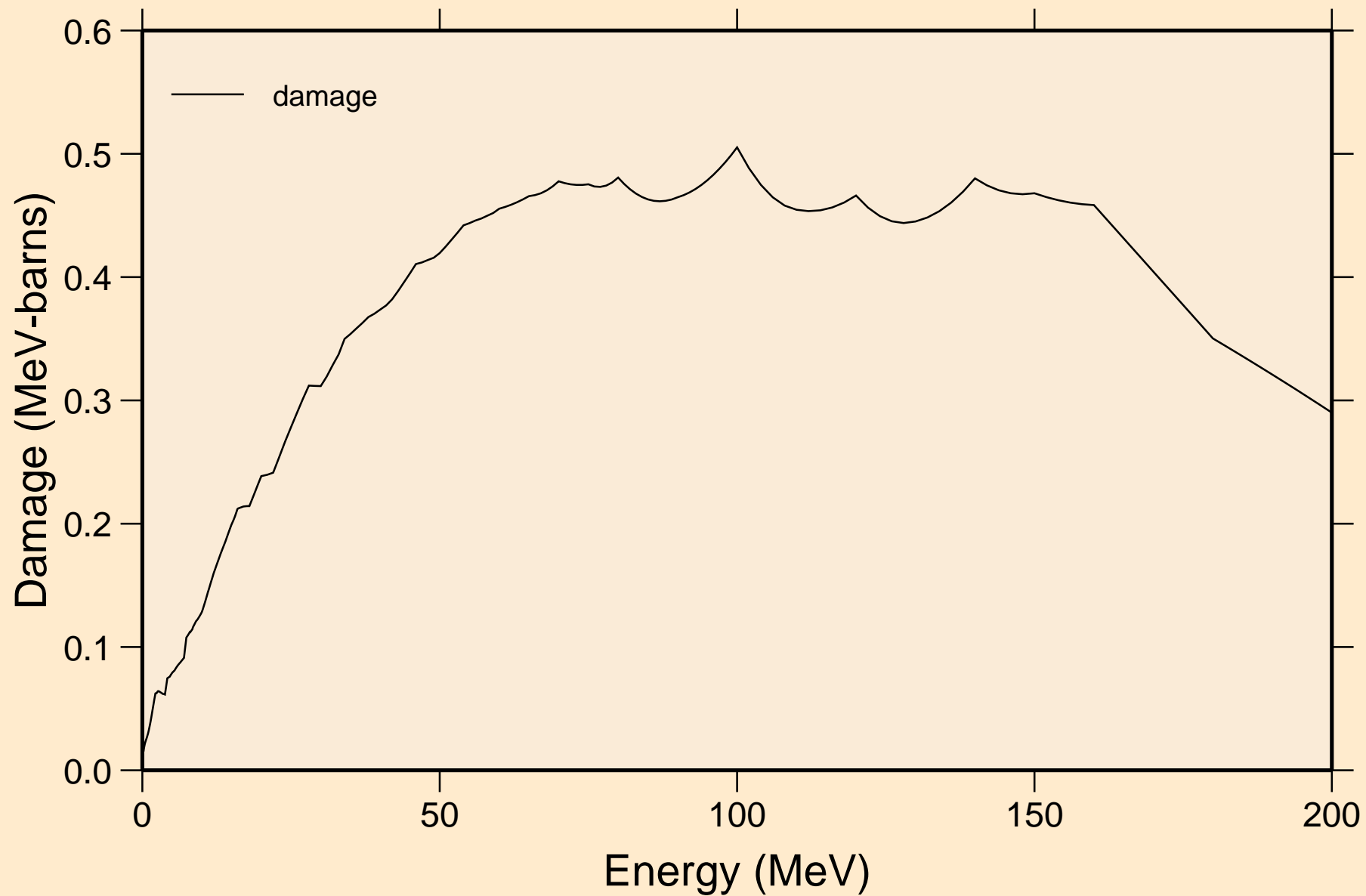

IR191 NEUTRON ACER TENDL-2019 LIBRARY; T=293.16K  
Non-threshold reactions

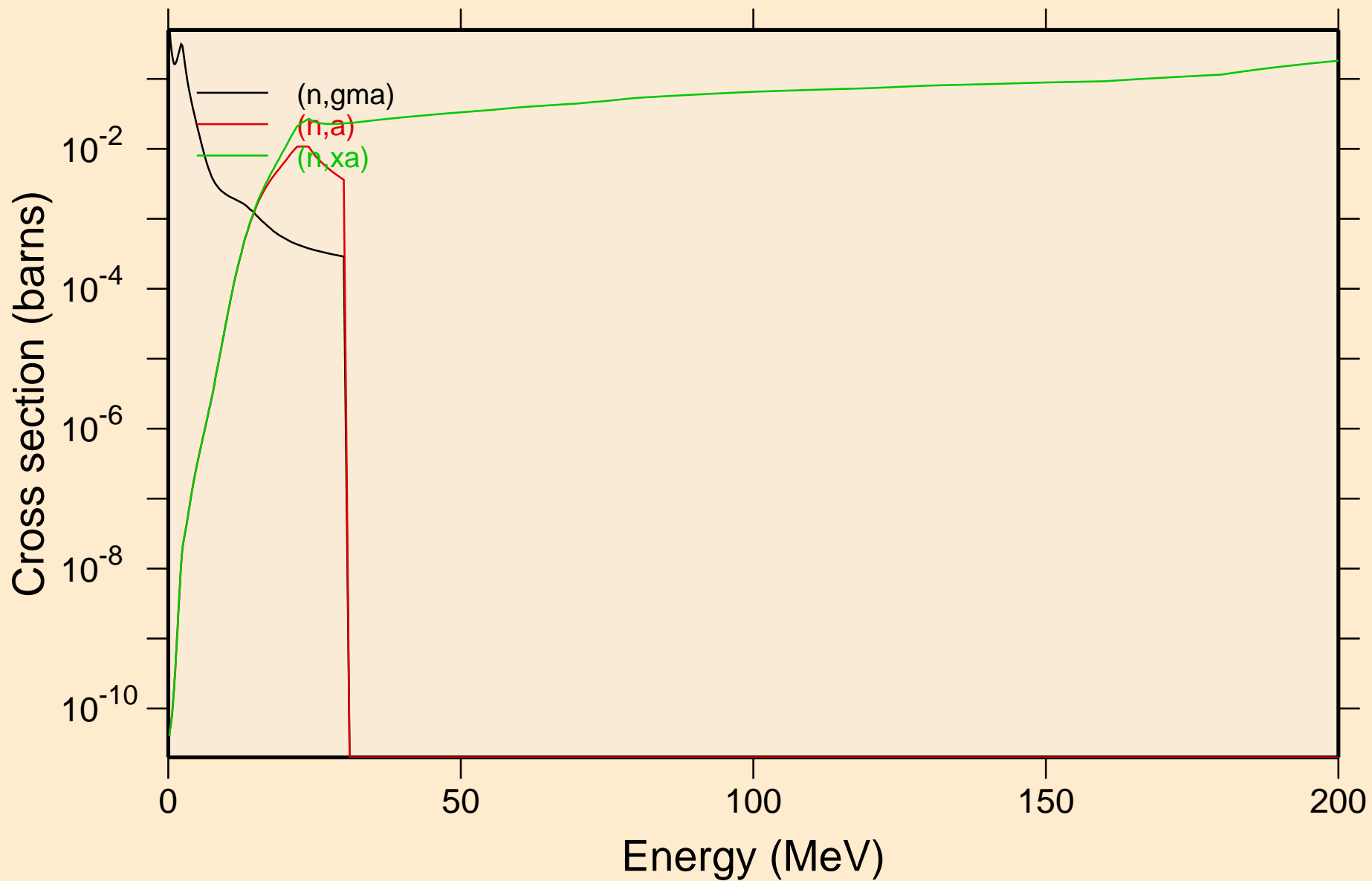

IR191 NEUTRON ACER TENDL-2019 LIBRARY; T=293.16K  
Inelastic levels

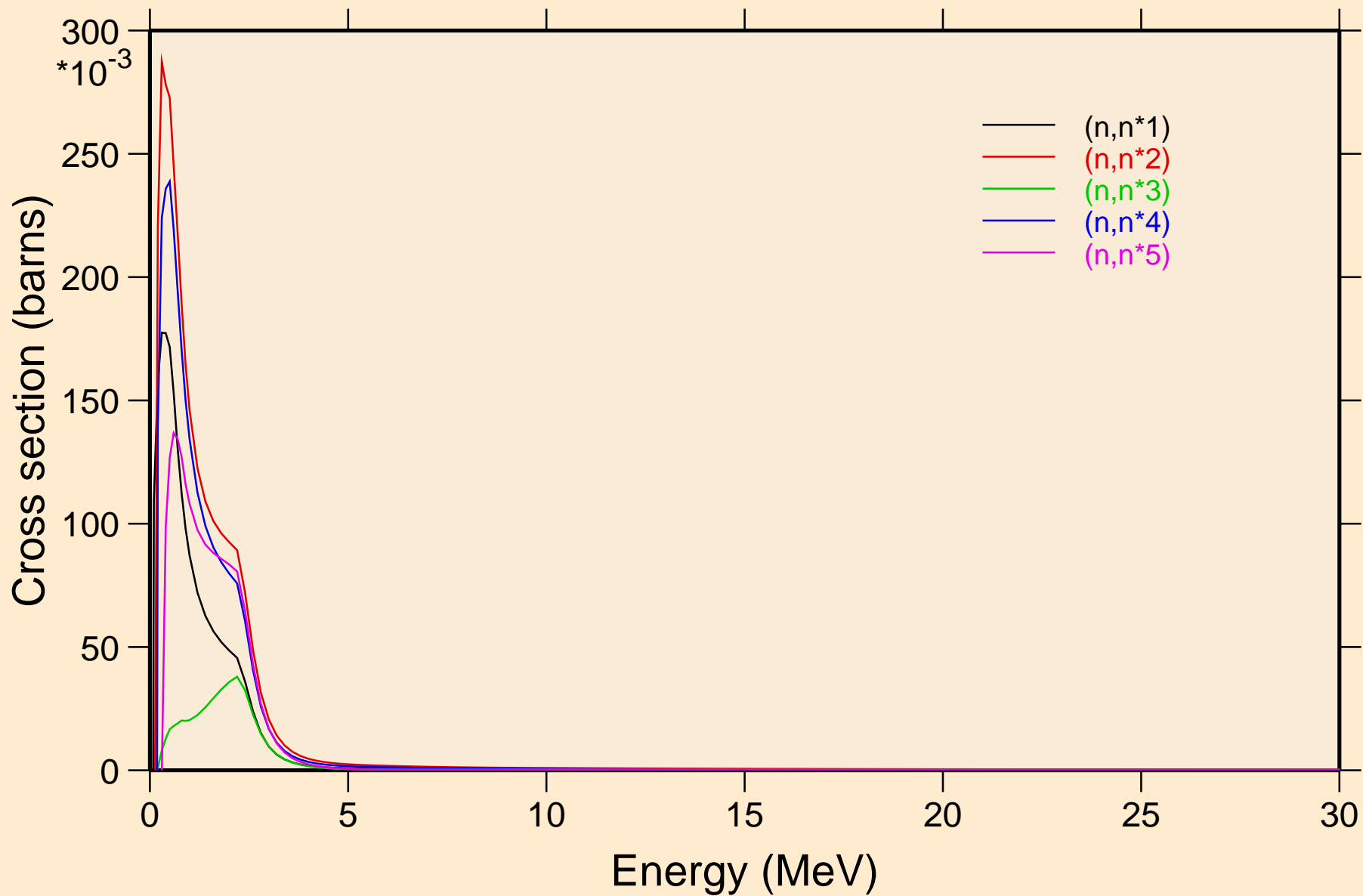

IR191 NEUTRON ACER TENDL-2019 LIBRARY; T=293.16K  
Inelastic levels

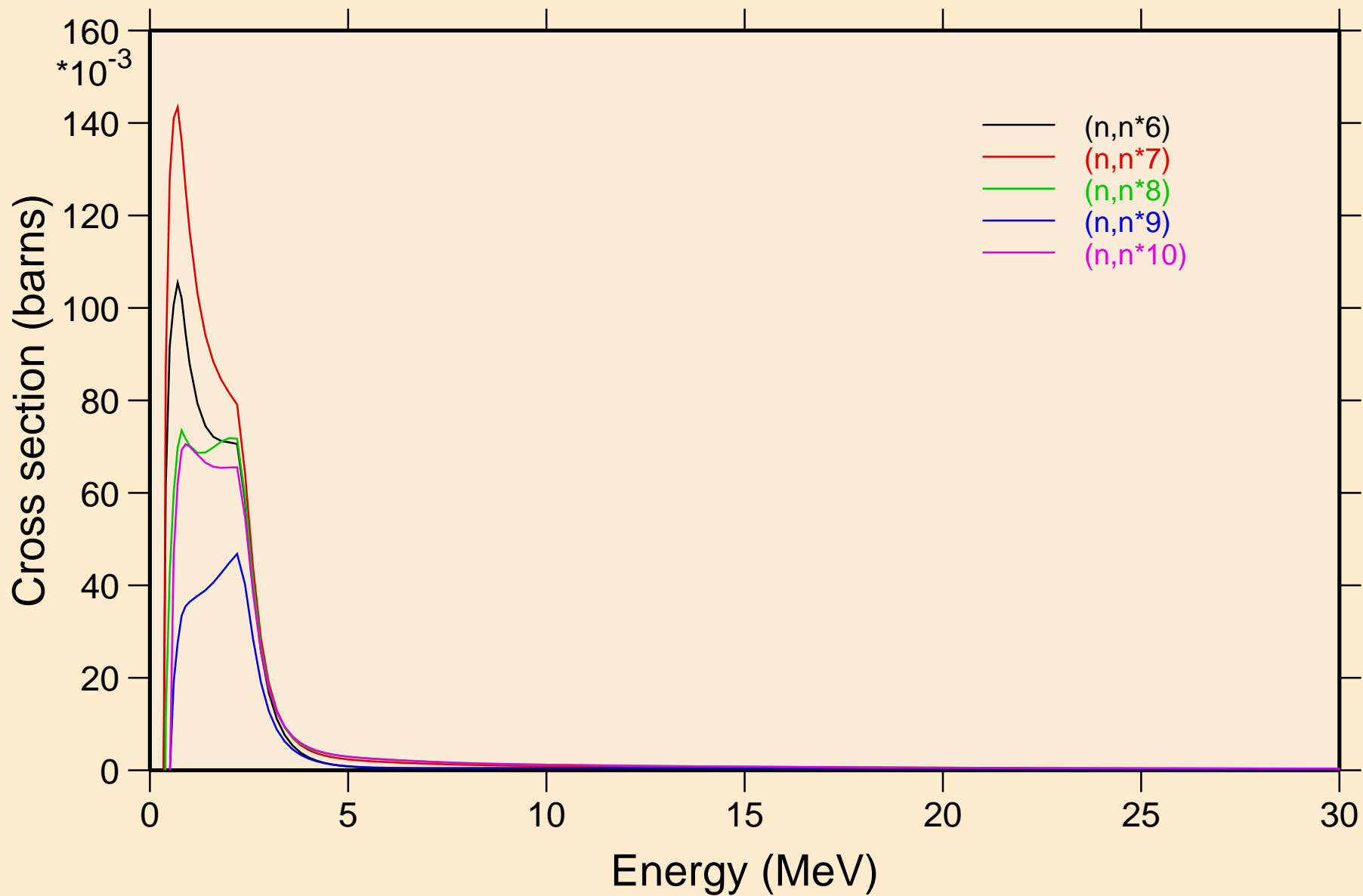

IR191 NEUTRON ACER TENDL-2019 LIBRARY; T=293.16K  
Inelastic levels

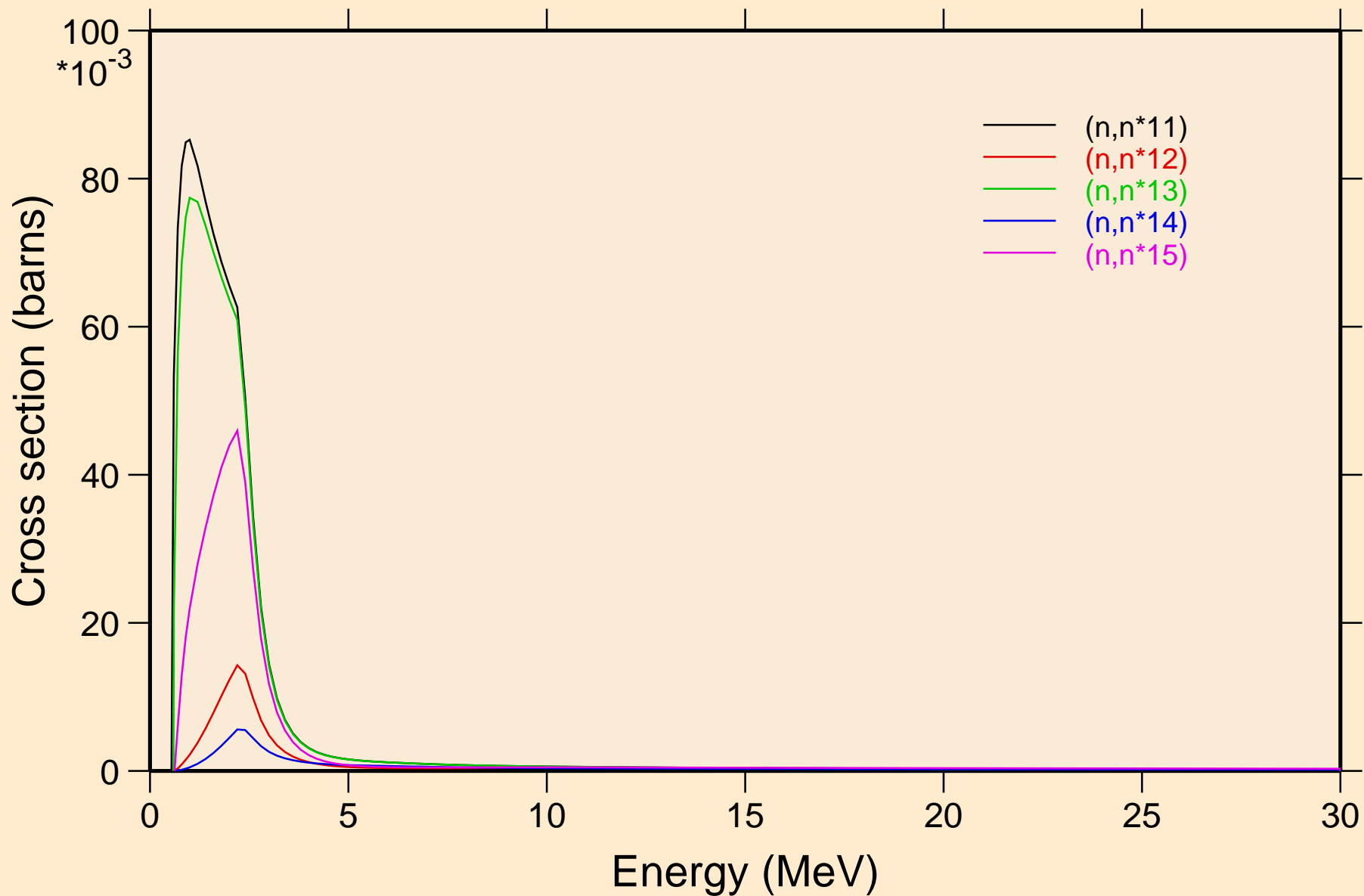

IR191 NEUTRON ACER TENDL-2019 LIBRARY; T=293.16K  
Inelastic levels

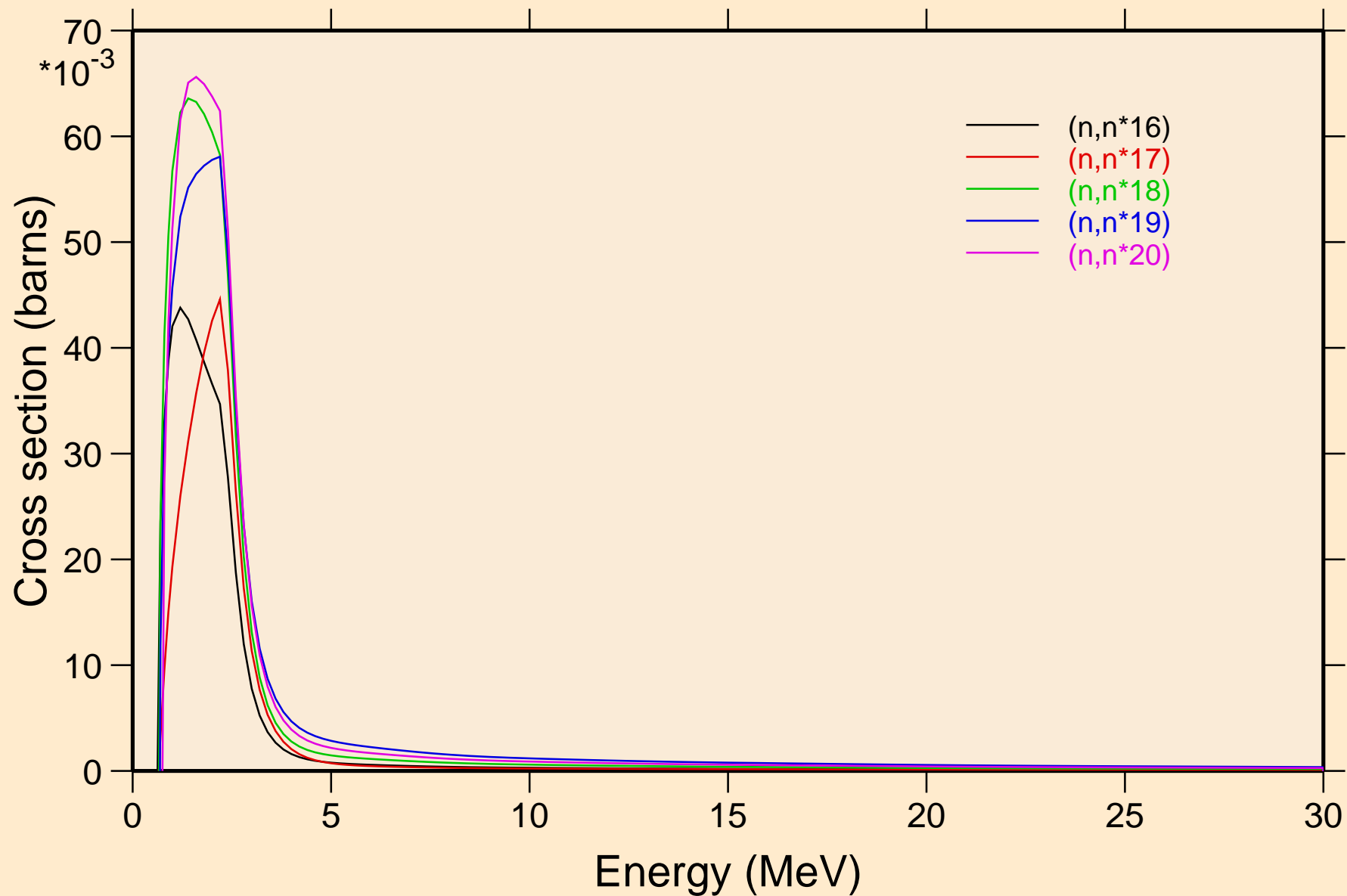

IR191 NEUTRON ACER TENDL-2019 LIBRARY; T=293.16K  
Inelastic levels

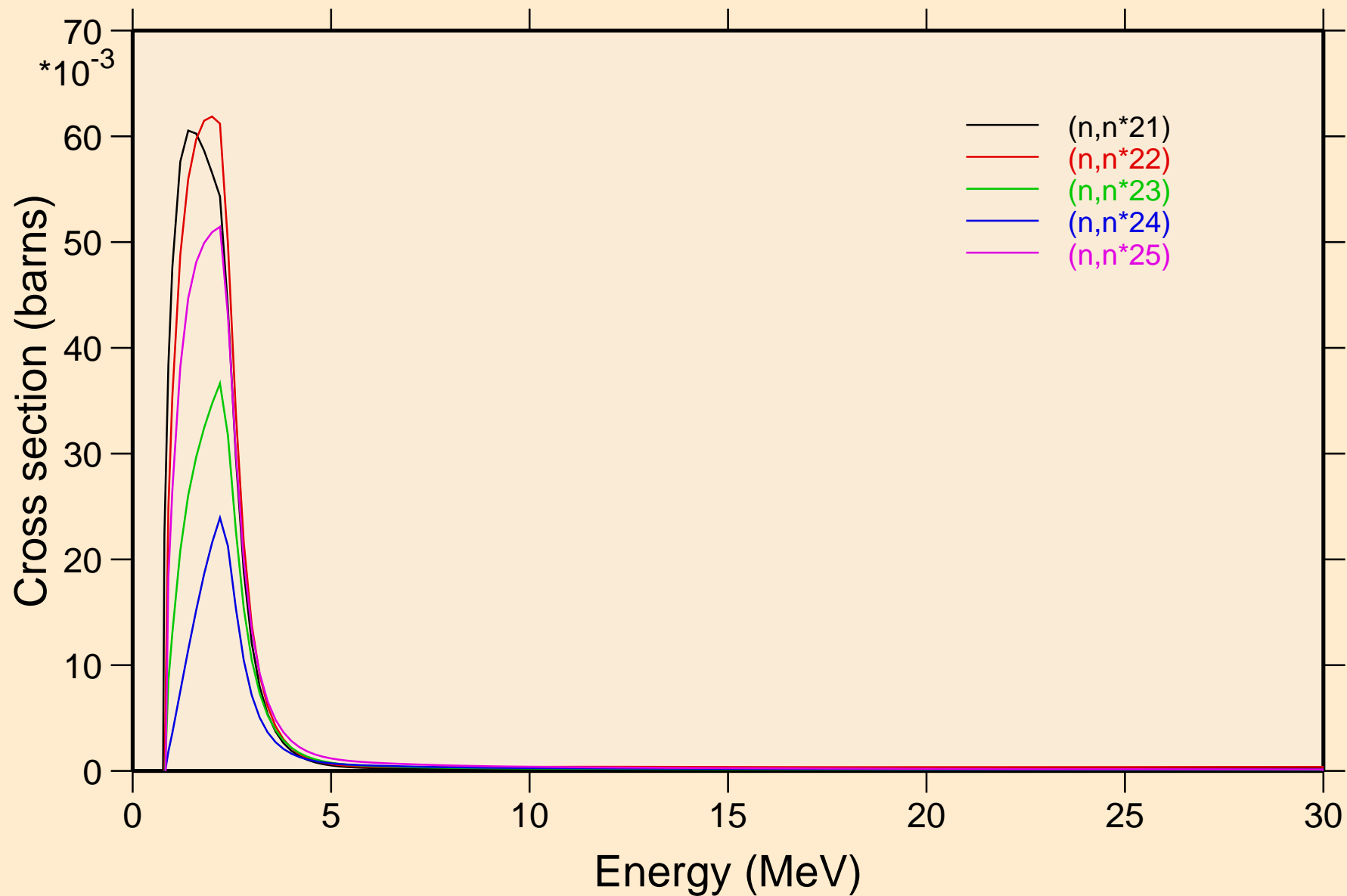

IR191 NEUTRON ACER TENDL-2019 LIBRARY; T=293.16K  
Inelastic levels

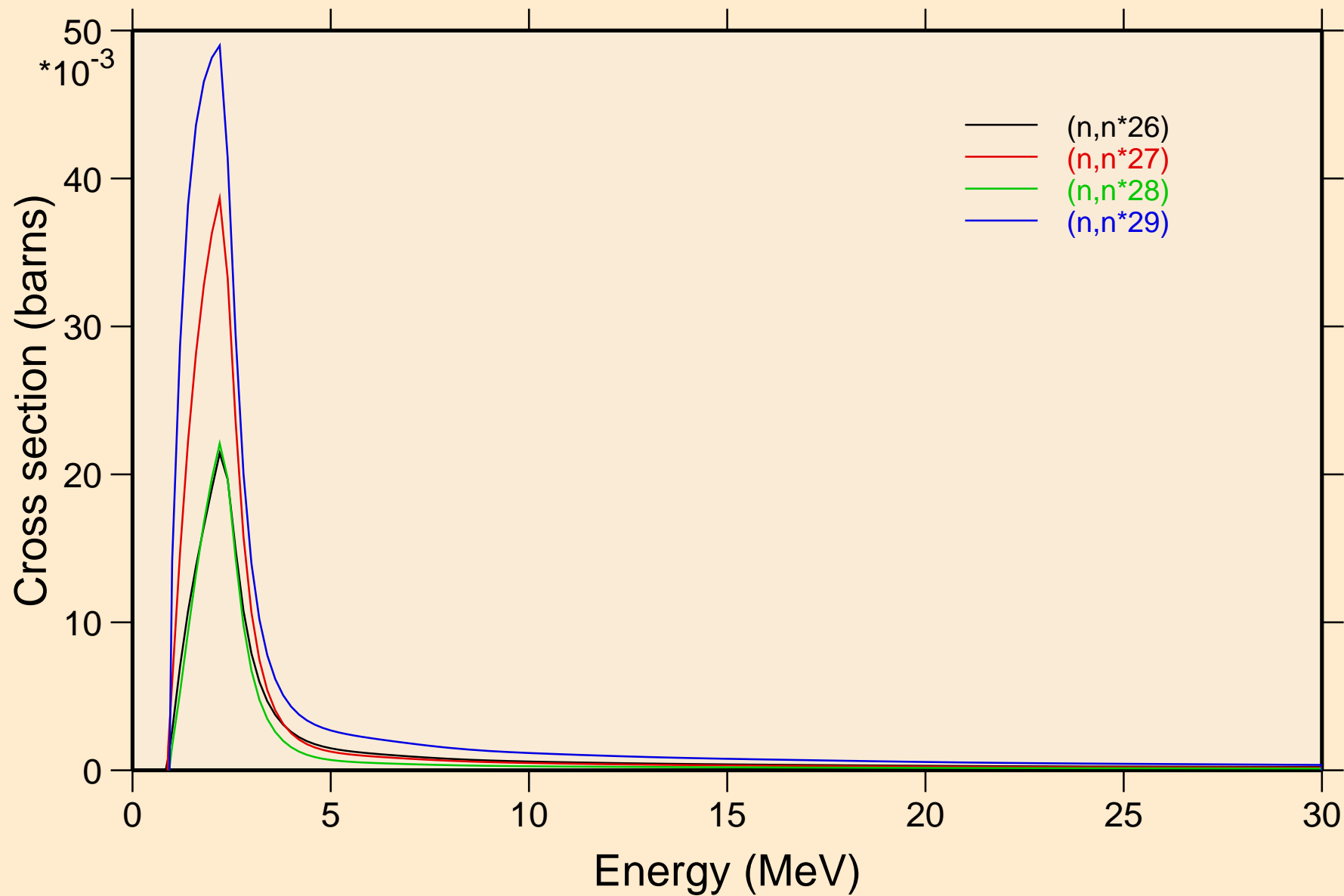



IR191 NEUTRON ACER TENDL-2019 LIBRARY; T=293.16K  
Threshold reactions

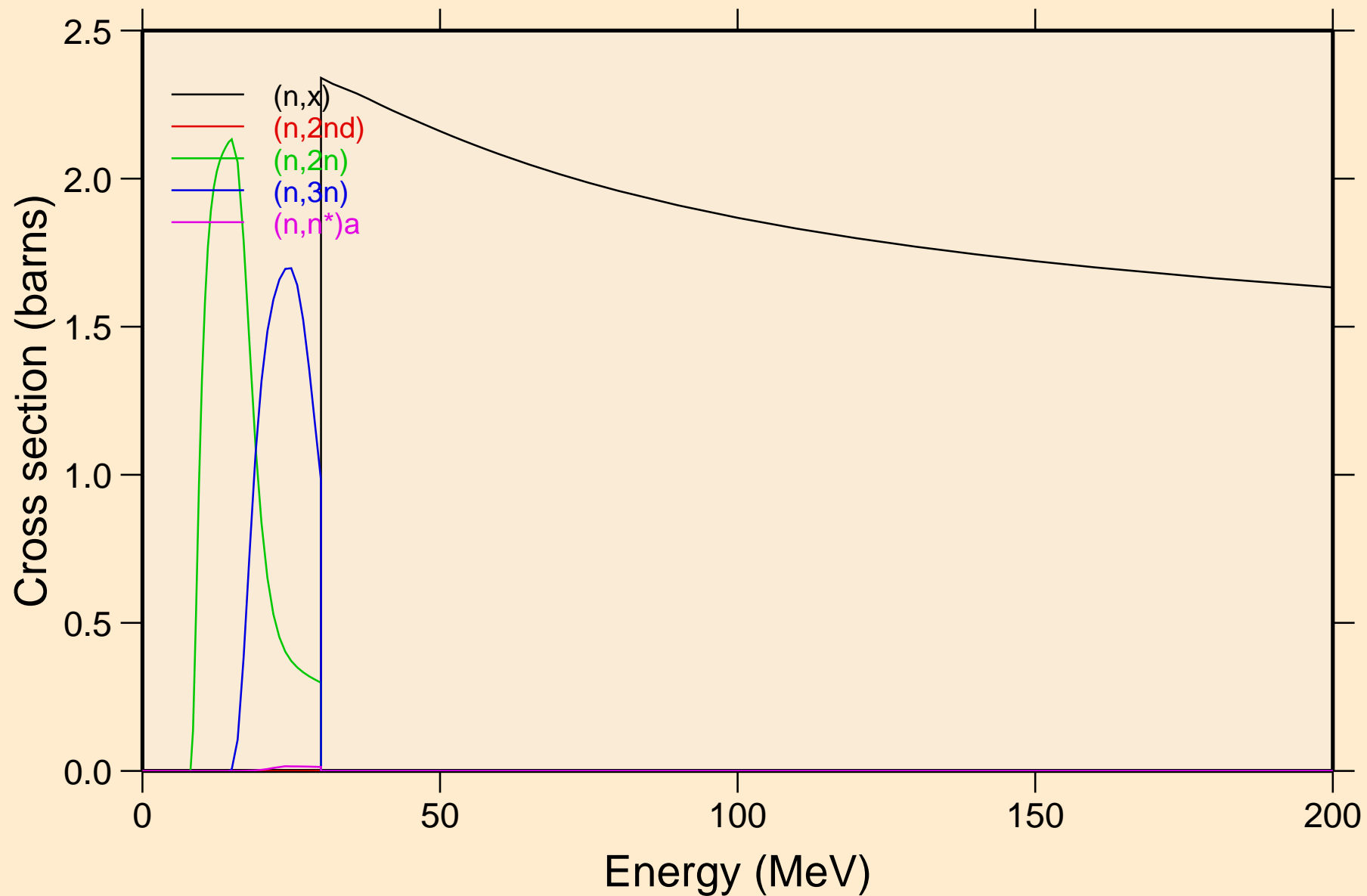

IR191 NEUTRON ACER TENDL-2019 LIBRARY; T=293.16K  
Threshold reactions

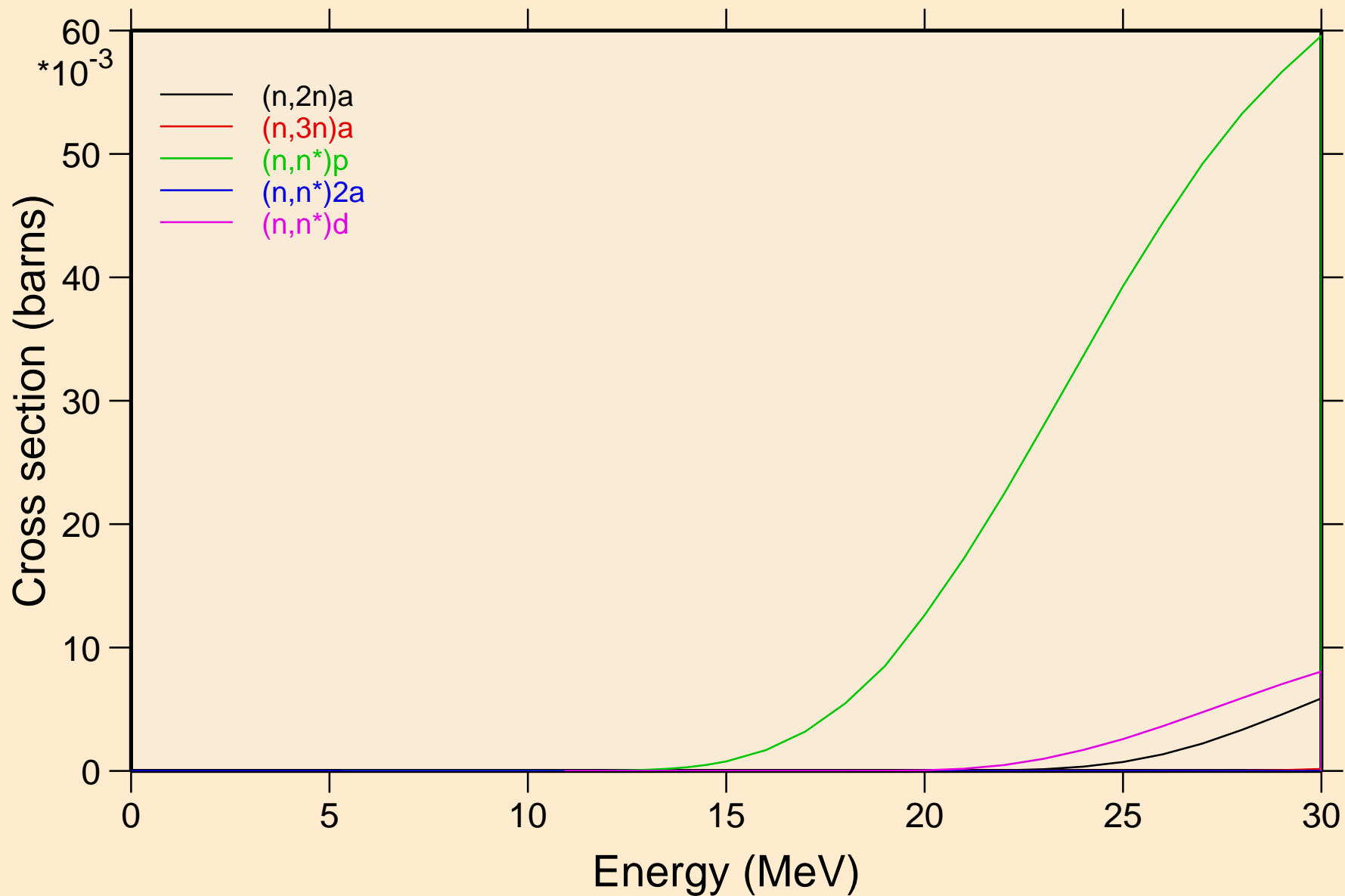

IR191 NEUTRON ACER TENDL-2019 LIBRARY; T=293.16K  
Threshold reactions

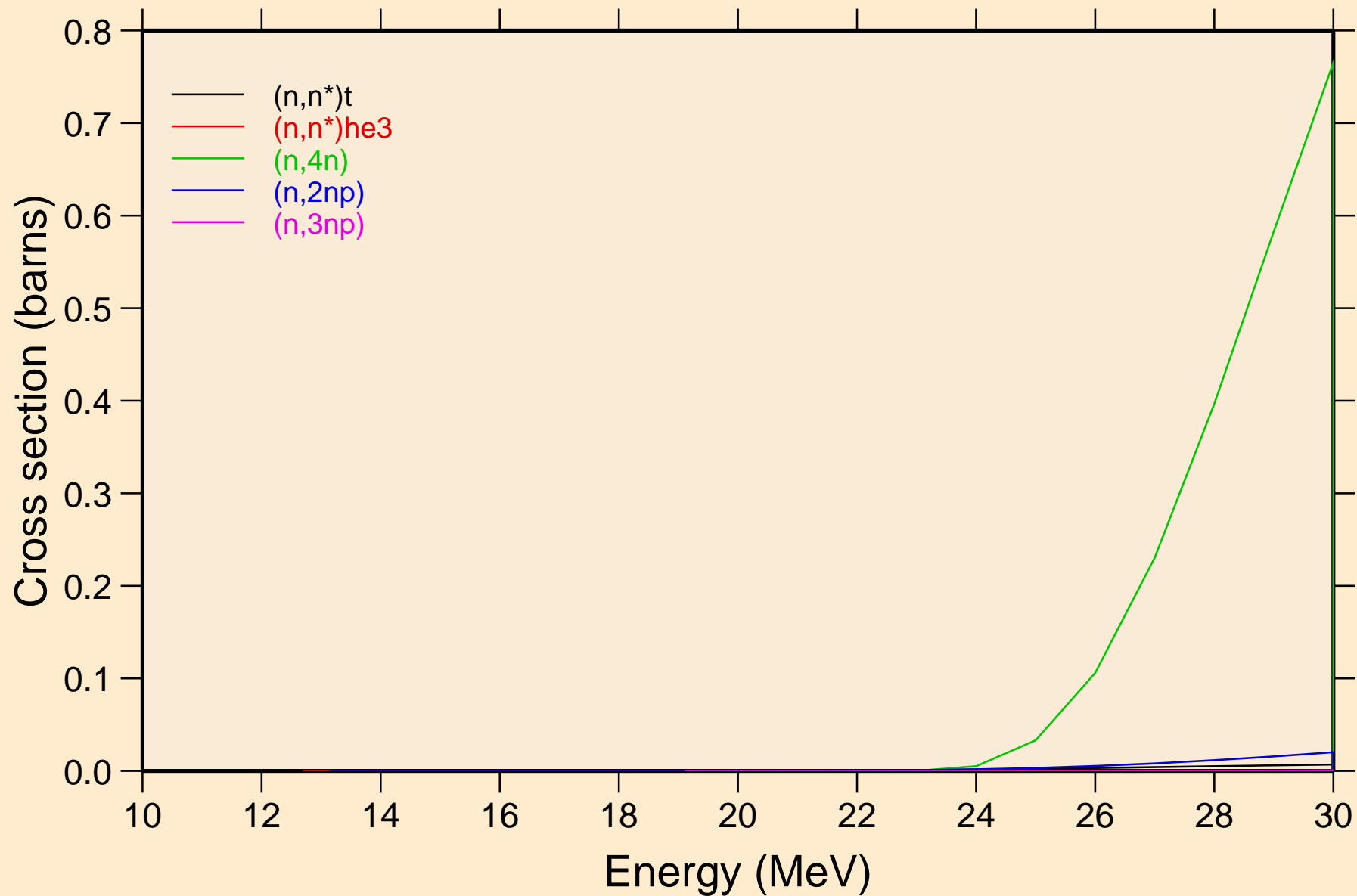

IR191 NEUTRON ACER TENDL-2019 LIBRARY; T=293.16K  
Threshold reactions

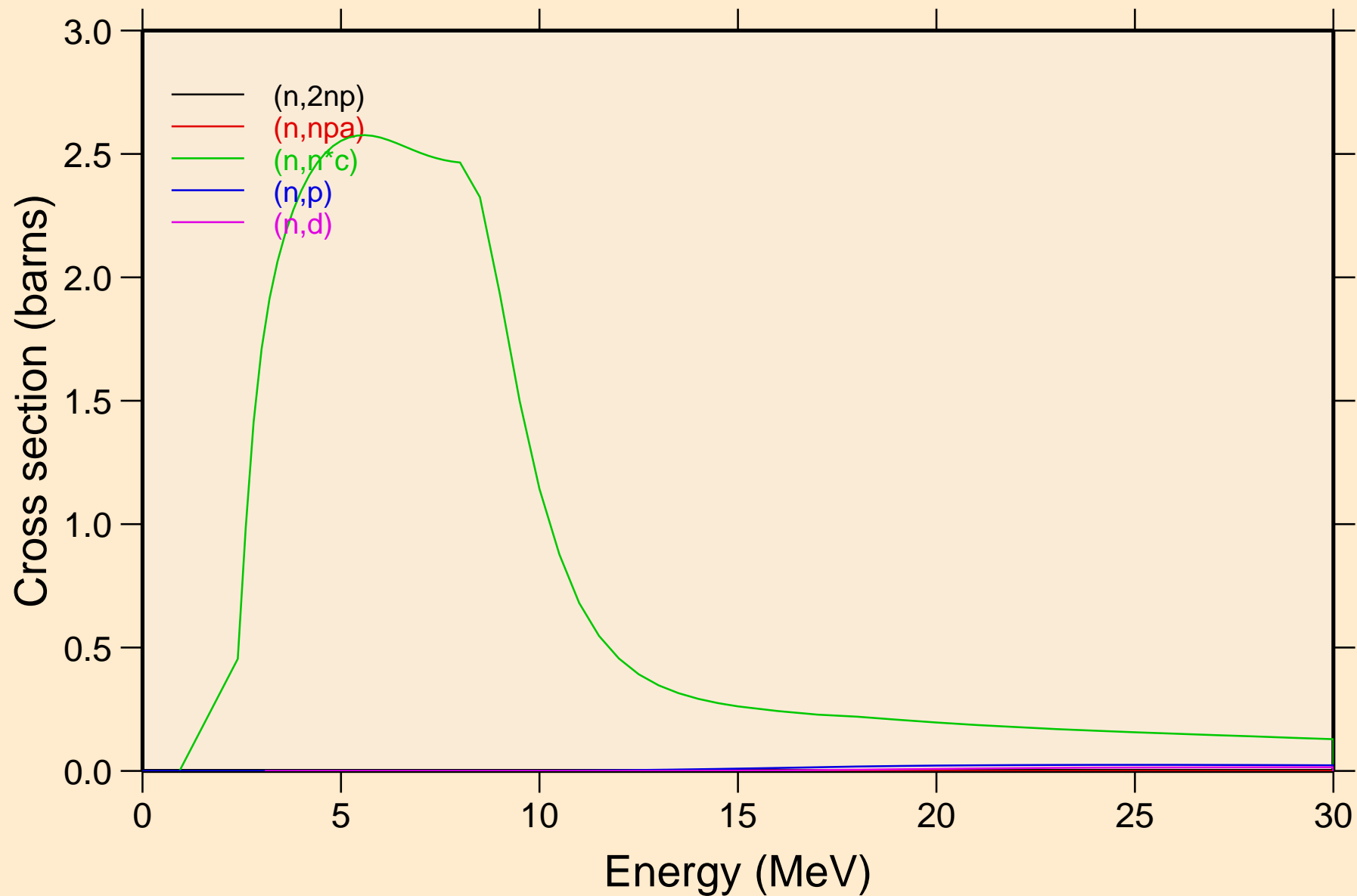

IR191 NEUTRON ACER TENDL-2019 LIBRARY; T=293.16K  
Threshold reactions

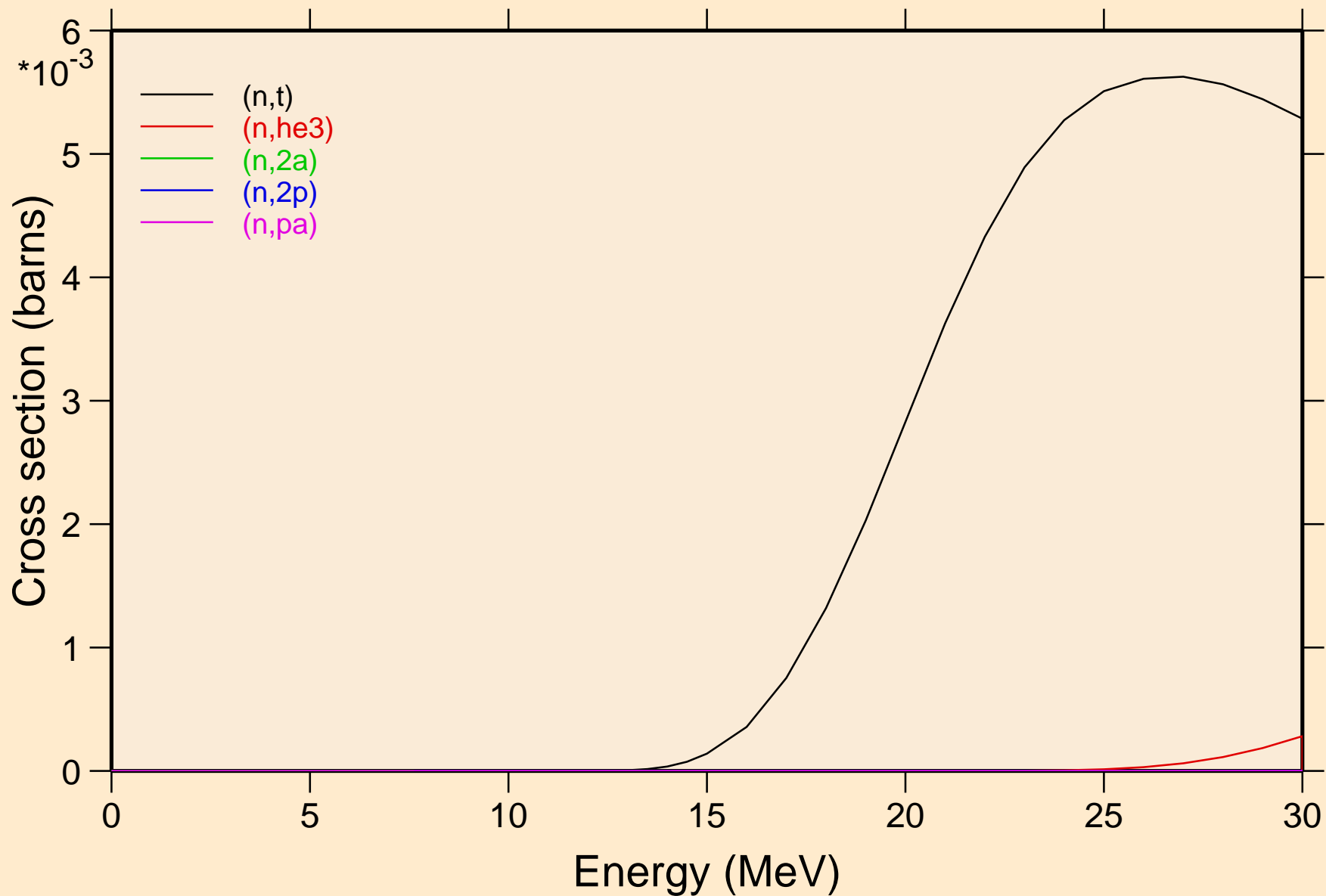

IR191 NEUTRON ACER TENDL-2019 LIBRARY; T=293.16K  
Threshold reactions

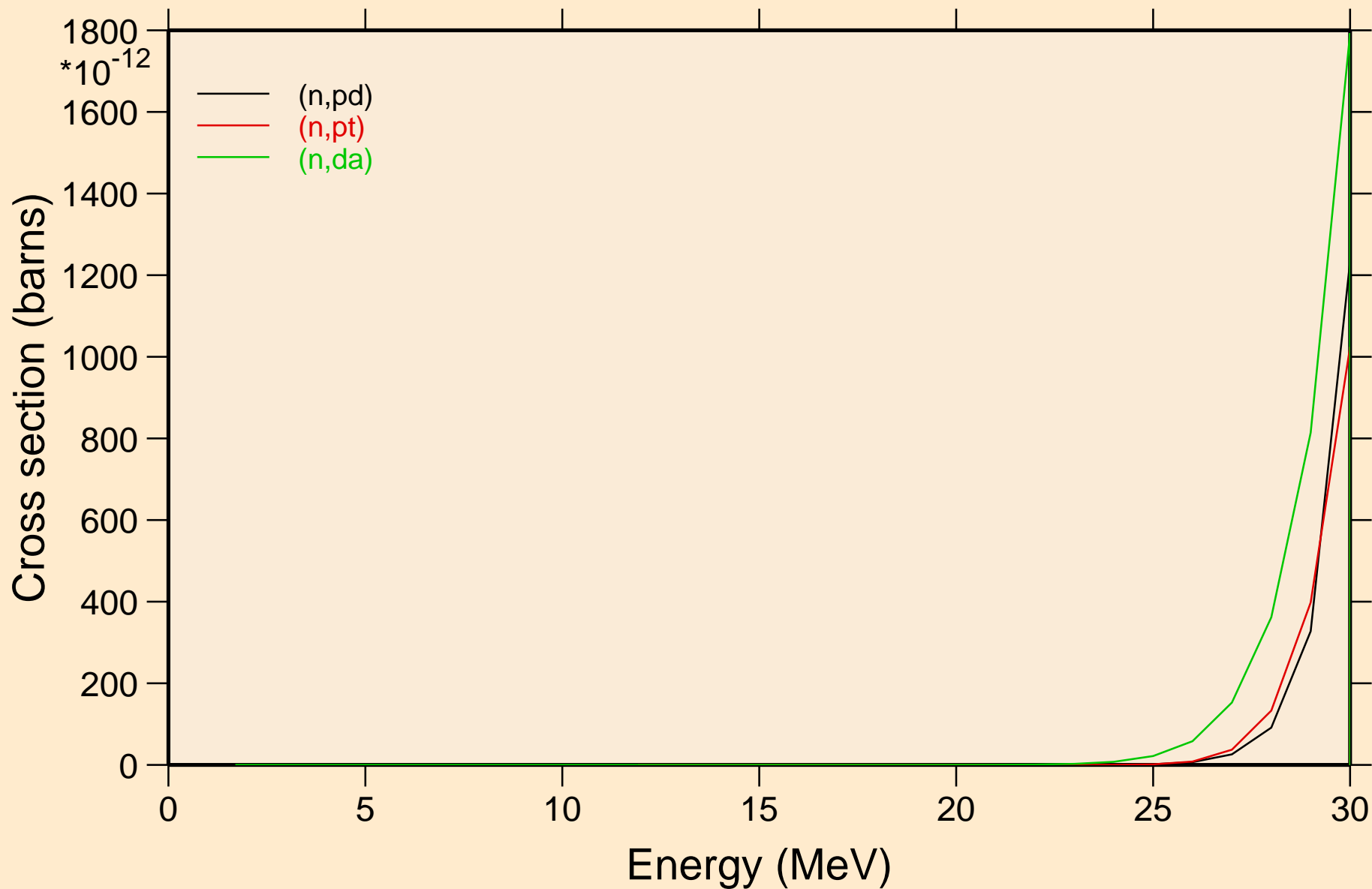

IR191 NEUTRON ACER TENDL-2019 LIBRARY; T=293.16K  
Threshold reactions

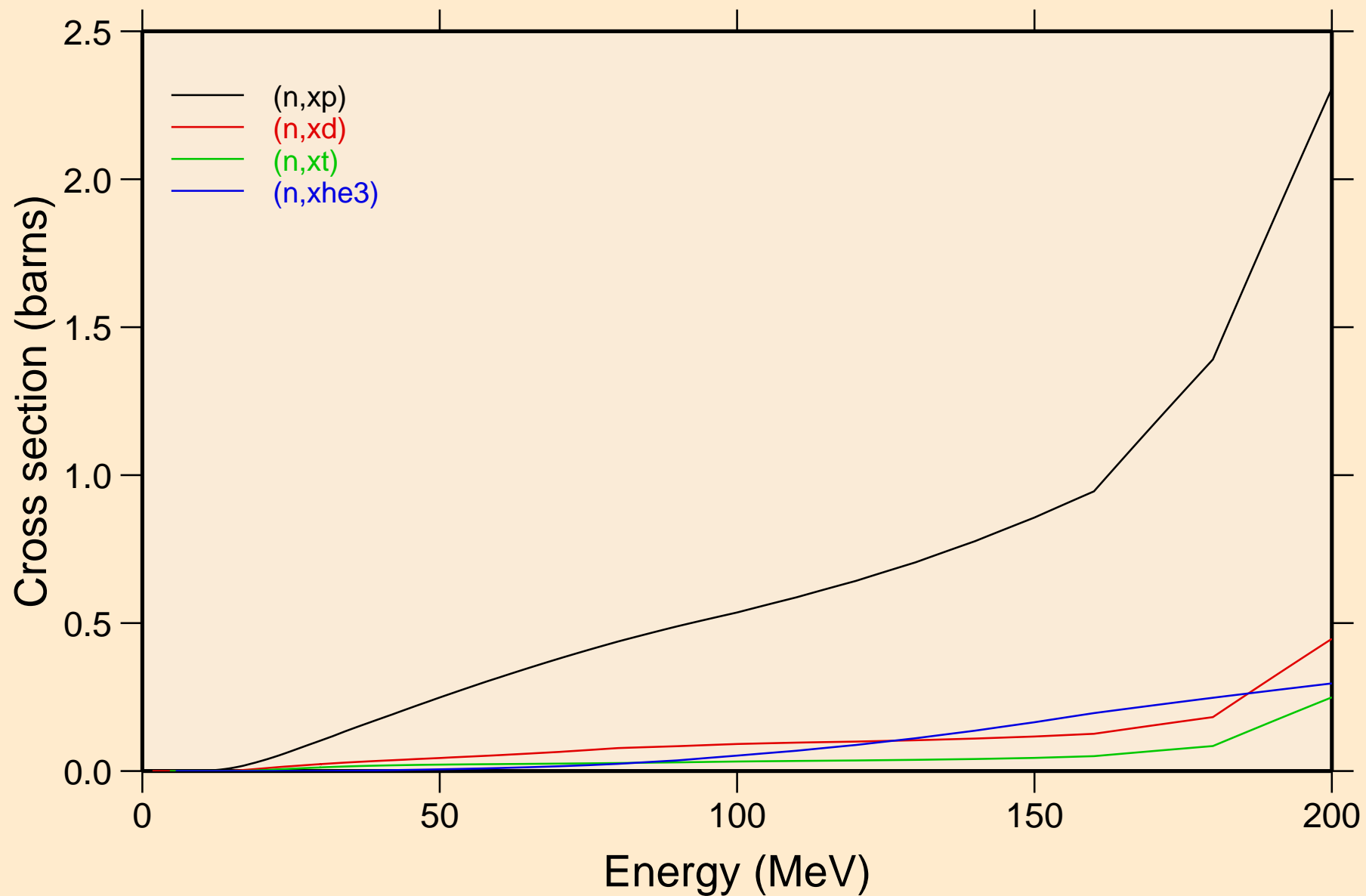

IR191 NEUTRON ACER TENDL-2019 LIBRARY; T=293.16K  
angular distribution for elastic

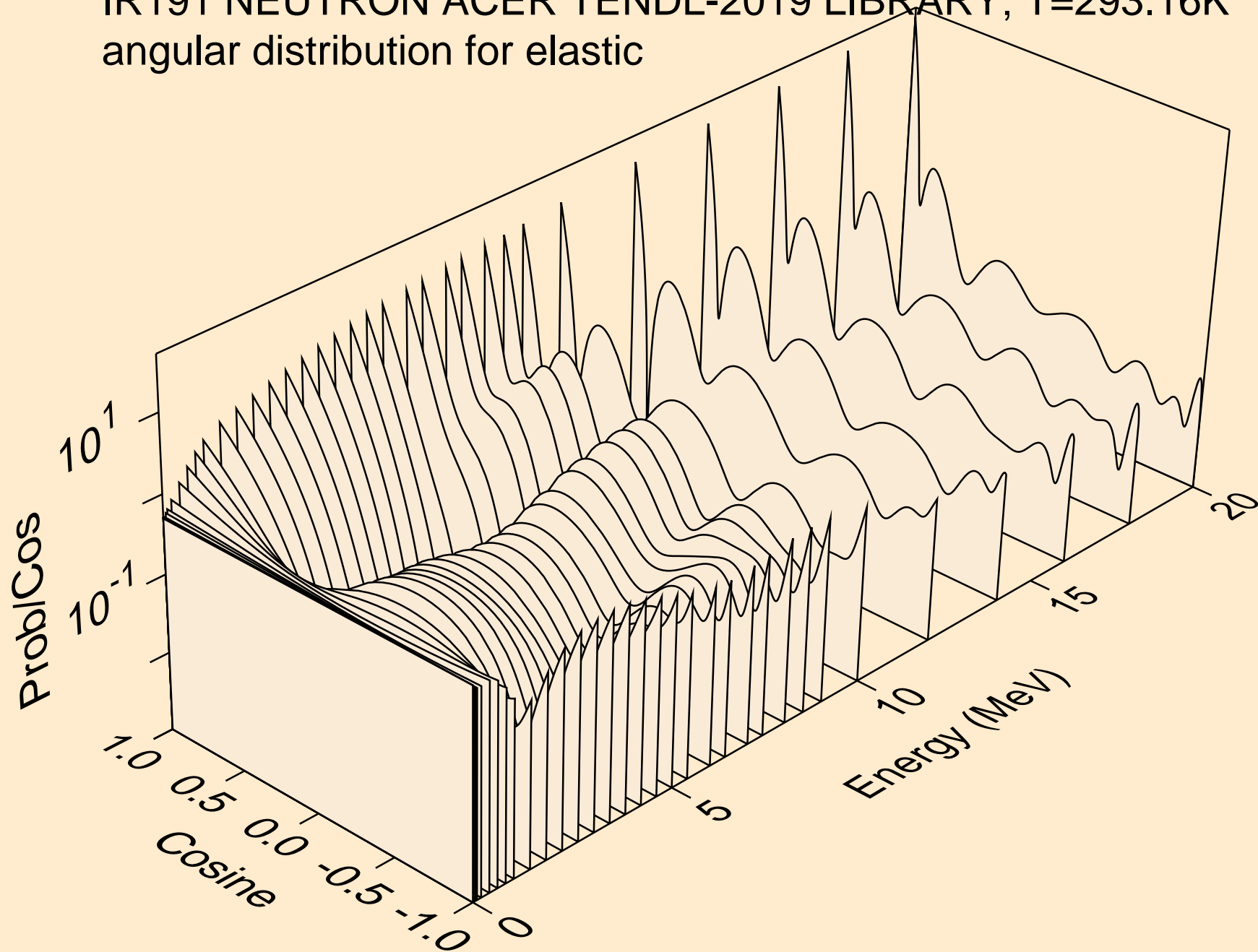



IR191 NEUTRON ACER TENDL-2019 LIBRARY; T=293.16K  
angular distribution for elastic

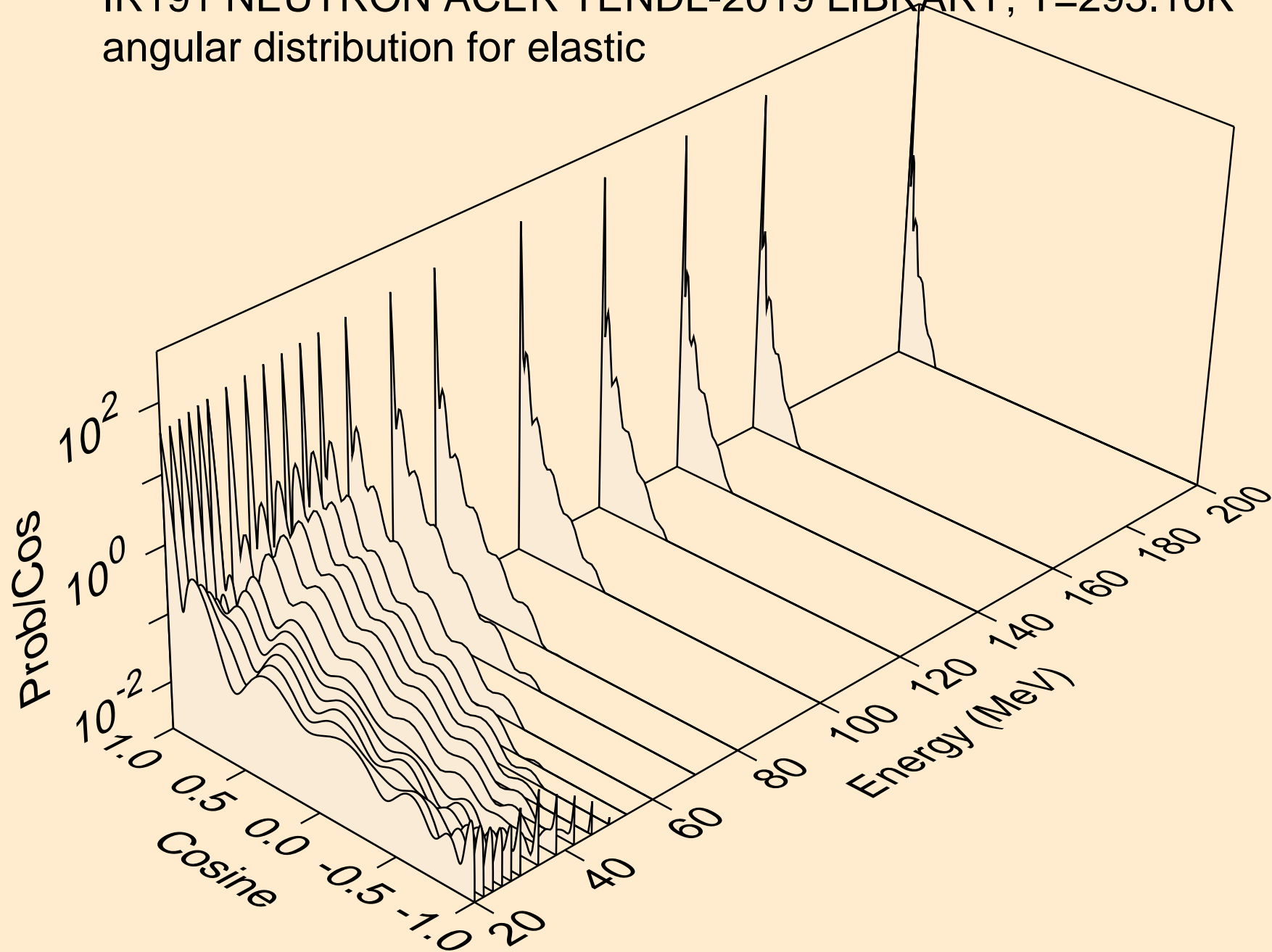

IR191 NEUTRON ACER TENDL-2019 LIBRARY; T=293.16K  
angular distribution for (n,n\*1)

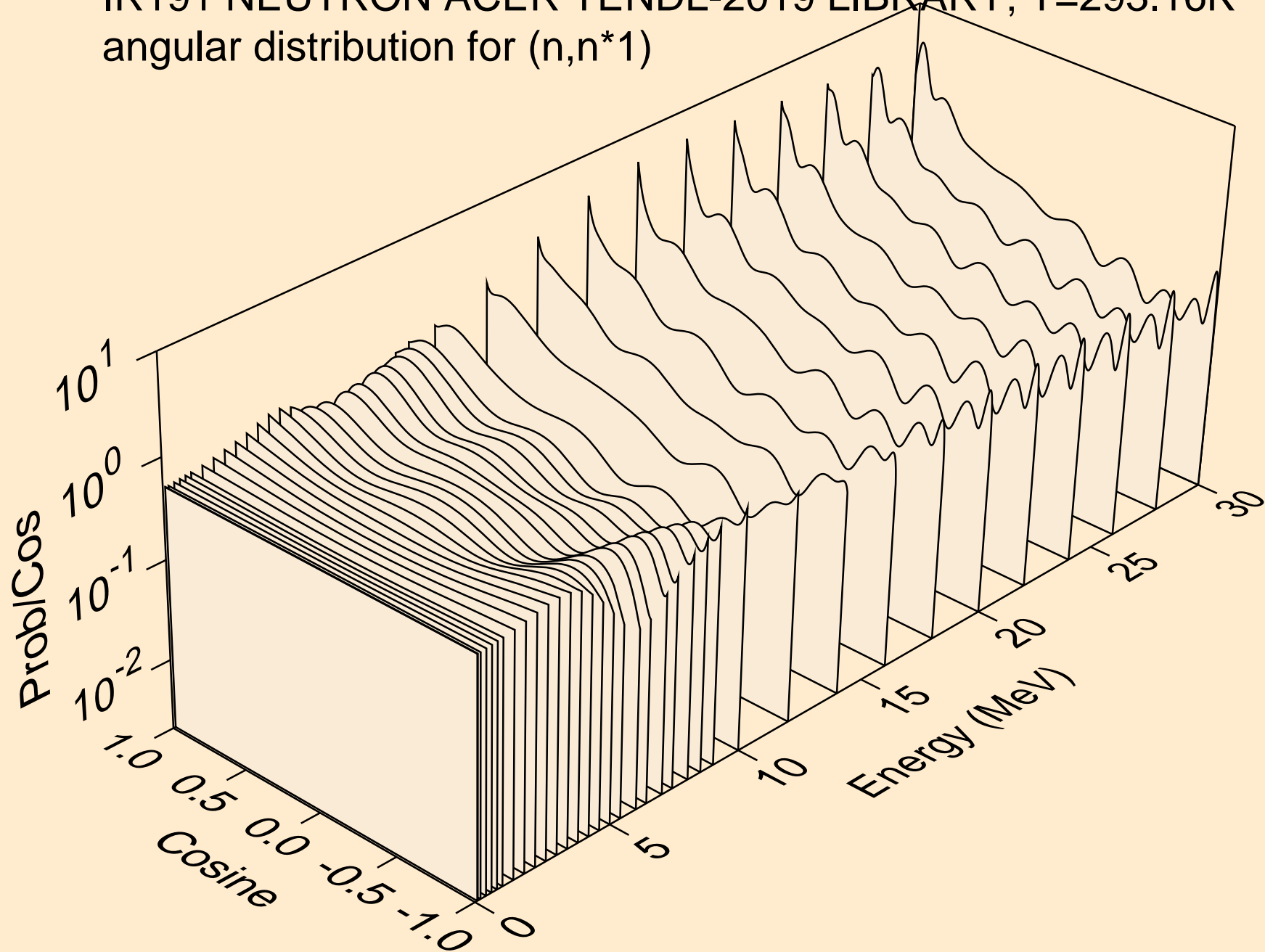

IR191 NEUTRON ACER TENDL-2019 LIBRARY; T=293.16K  
angular distribution for (n,n\*2)

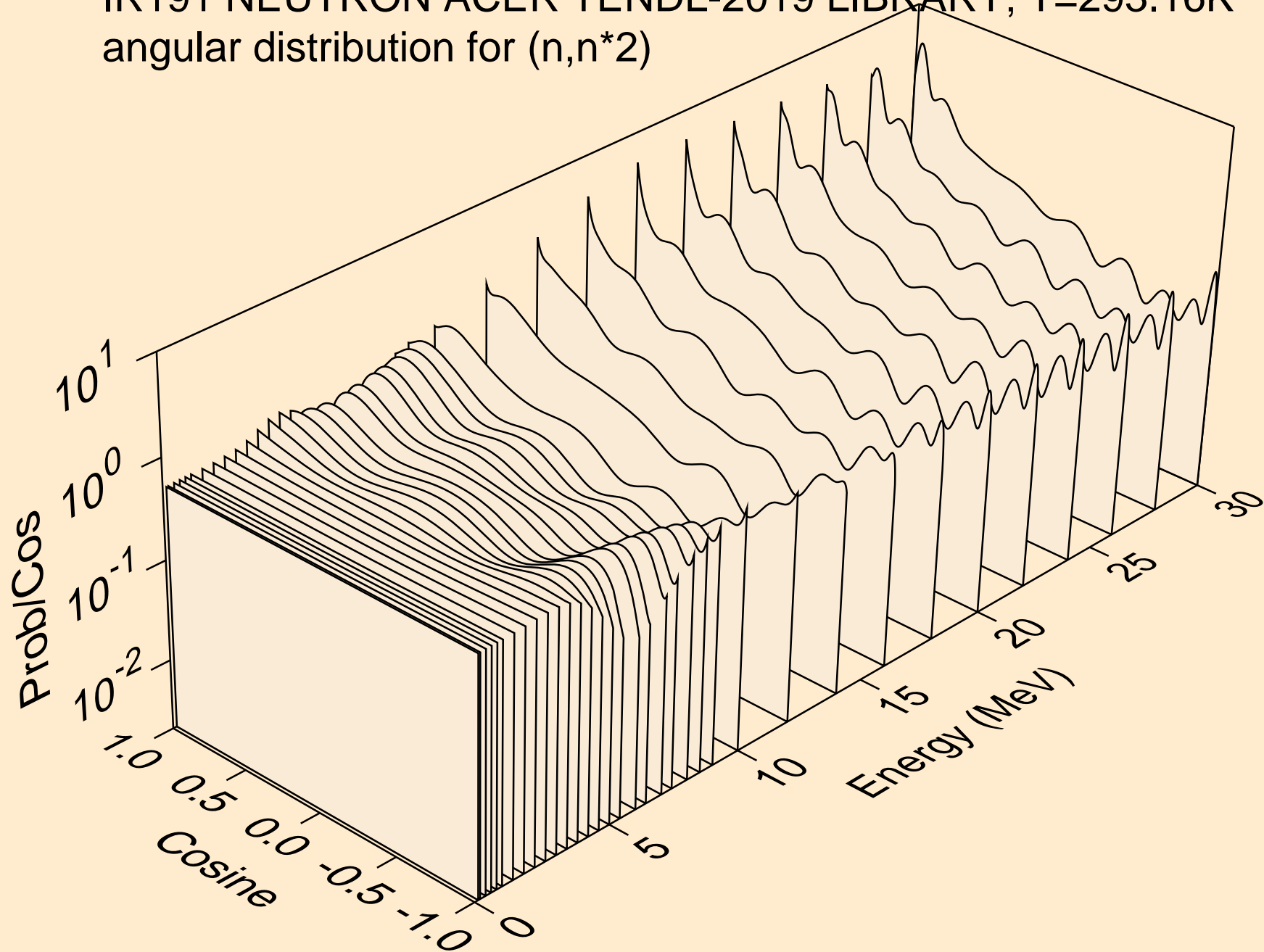

IR191 NEUTRON ACER TENDL-2019 LIBRARY; T=293.16K  
angular distribution for (n,n\*3)

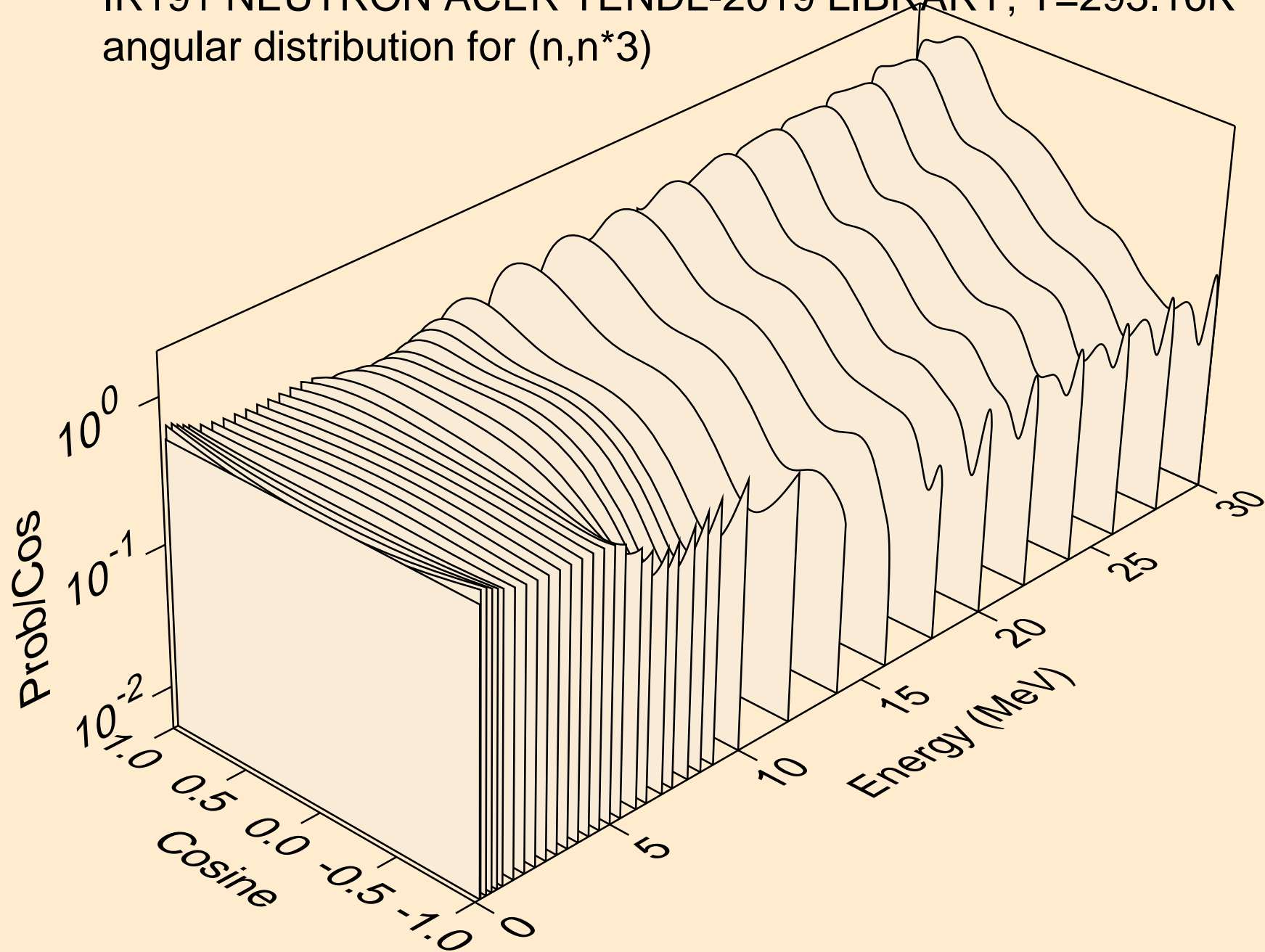

IR191 NEUTRON ACER TENDL-2019 LIBRARY; T=293.16K  
angular distribution for (n,n\*4)

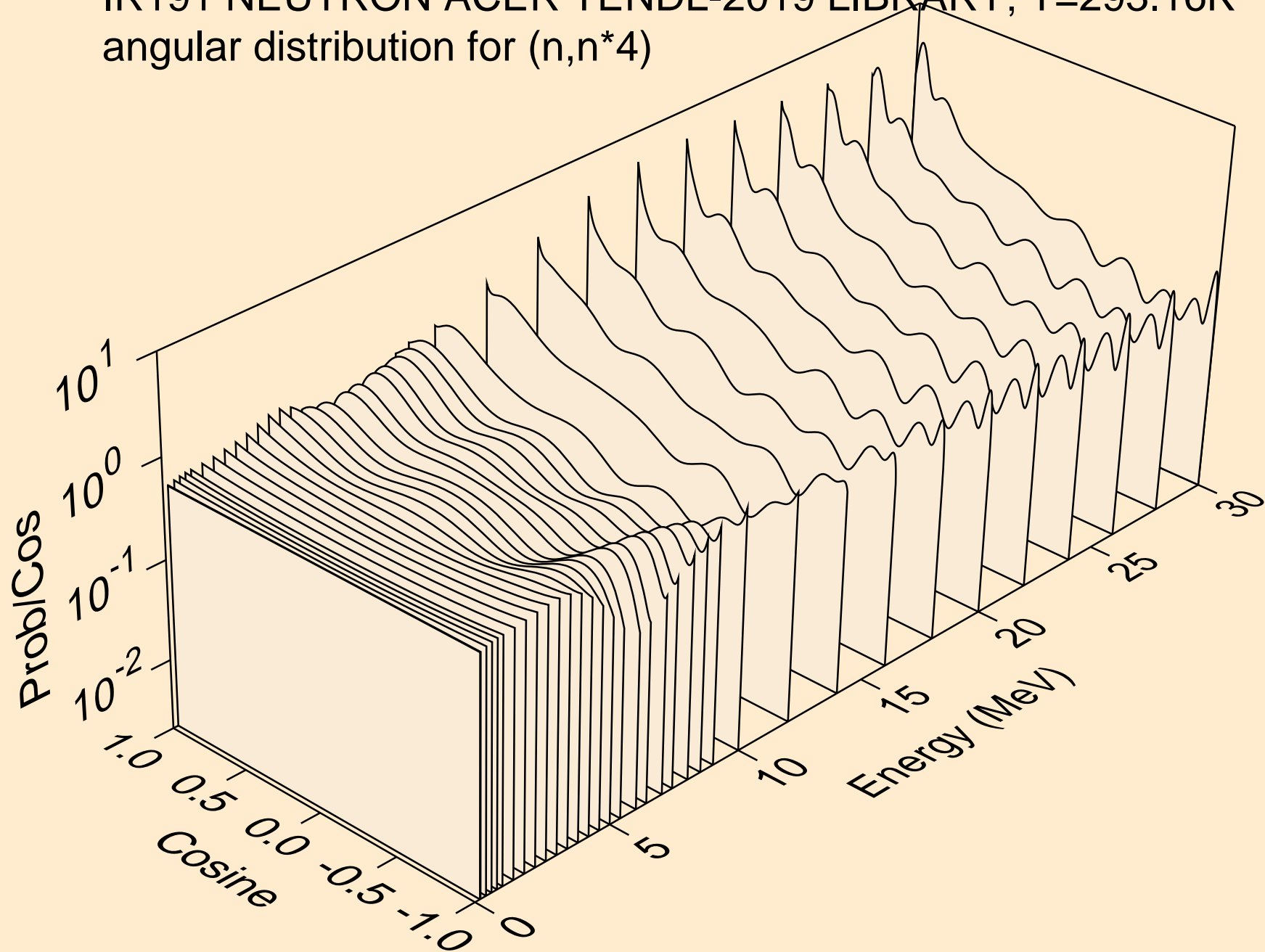

IR191 NEUTRON ACER TENDL-2019 LIBRARY; T=293.16K  
angular distribution for (n,n\*5)

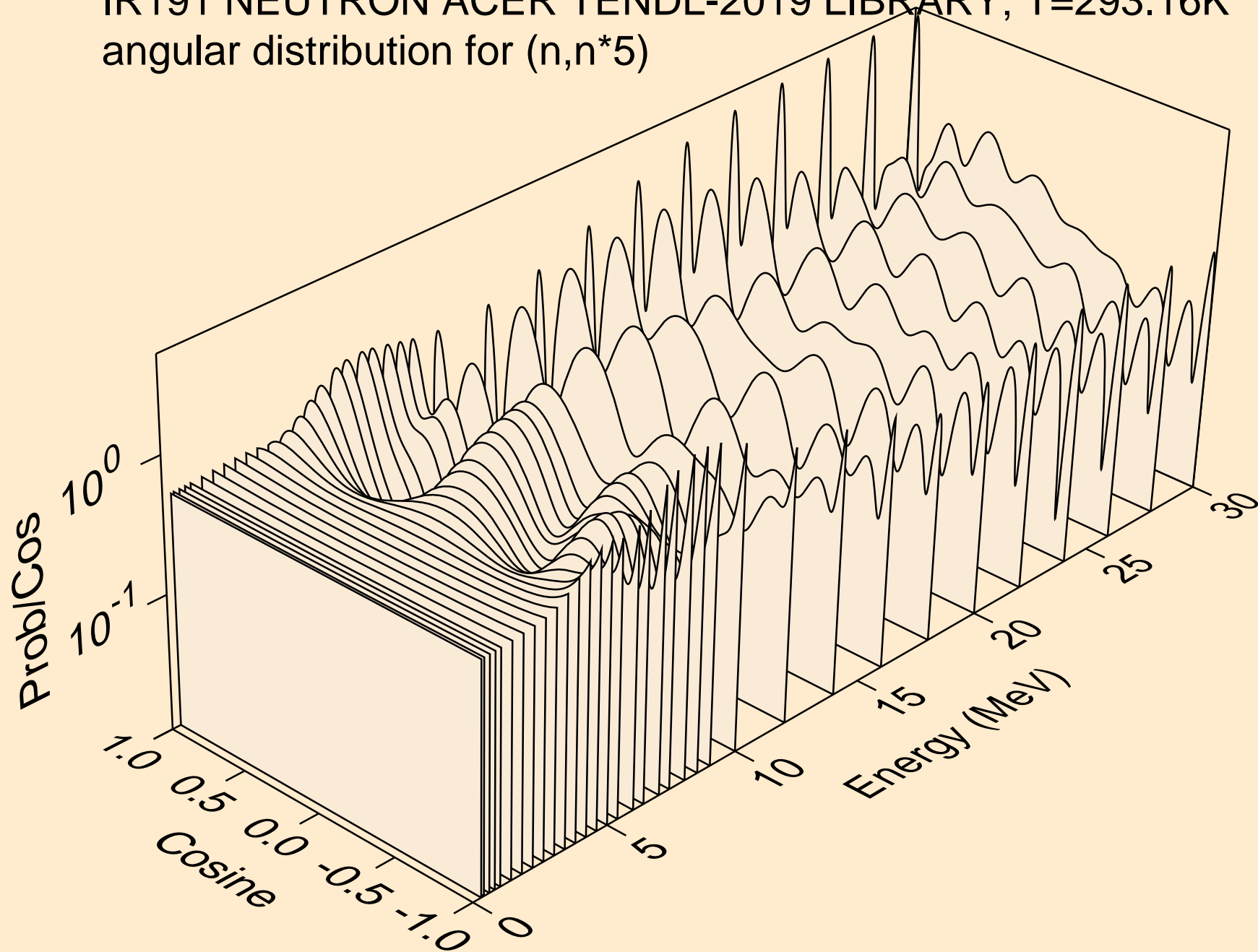

IR191 NEUTRON ACER TENDL-2019 LIBRARY; T=293.16K  
angular distribution for (n,n\*6)

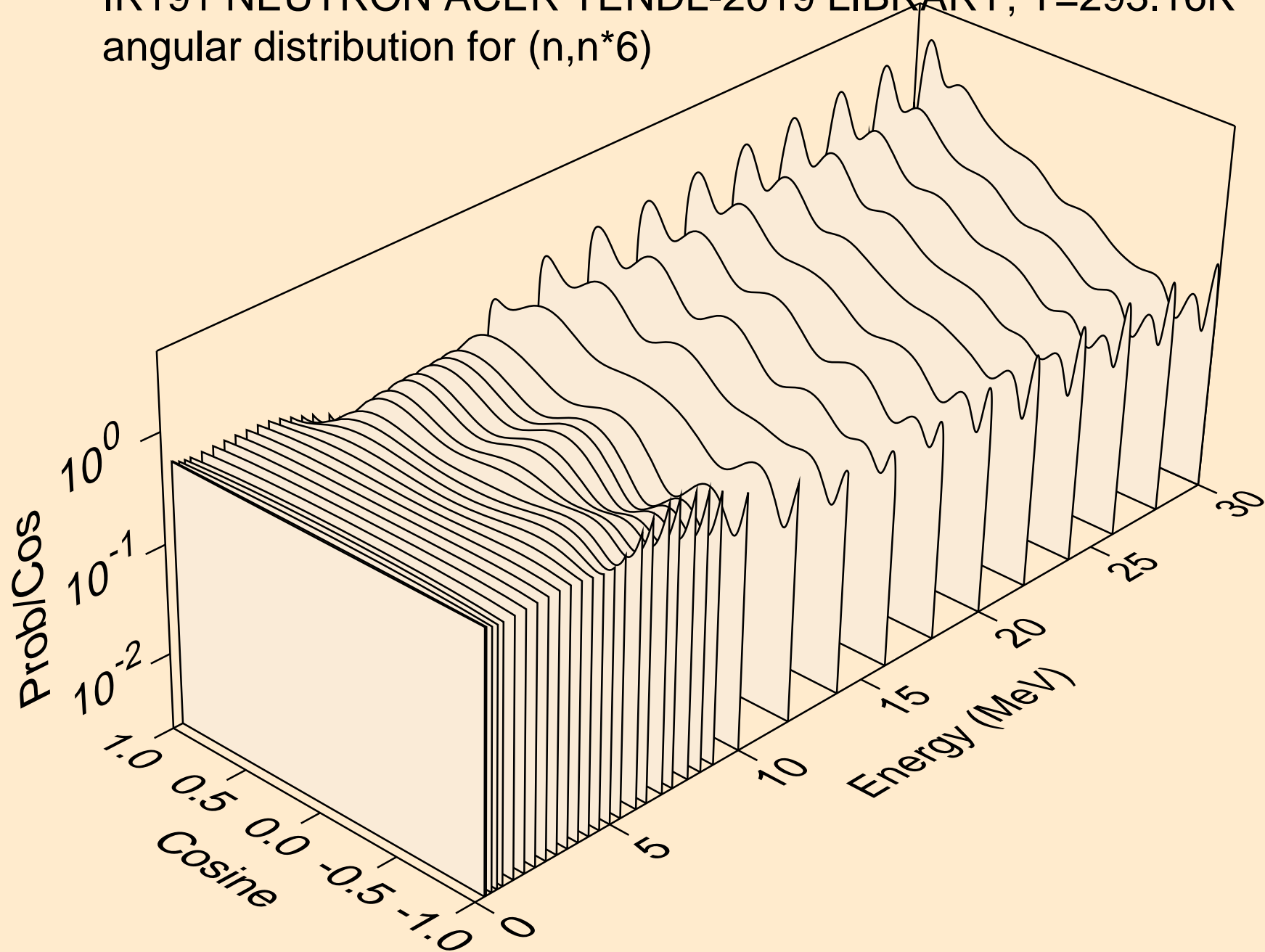

IR191 NEUTRON ACER TENDL-2019 LIBRARY; T=293.16K  
angular distribution for (n,n\*7)

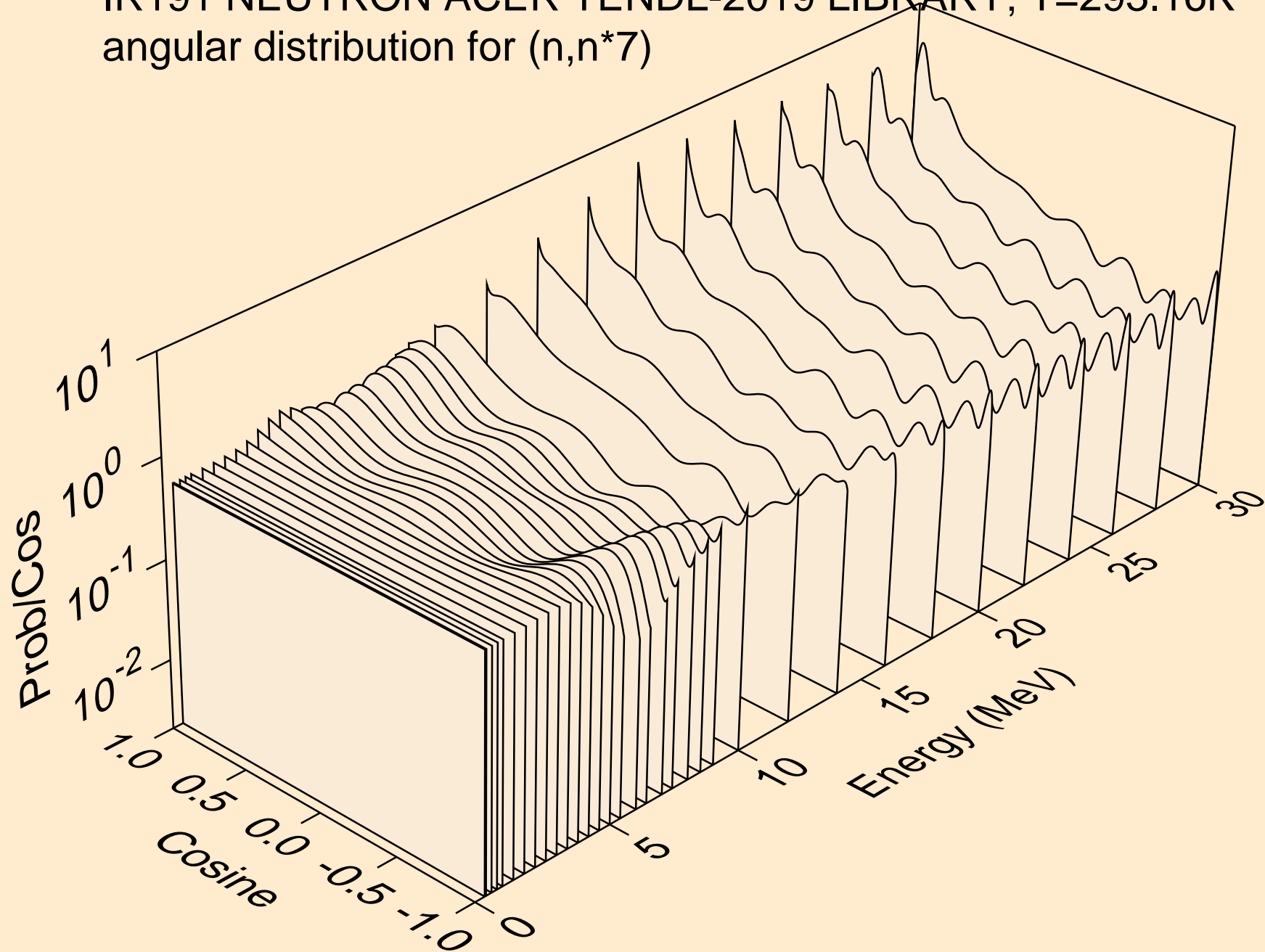



IR191 NEUTRON ACER TENDL-2019 LIBRARY; T=293.16K  
angular distribution for (n,n\*8)

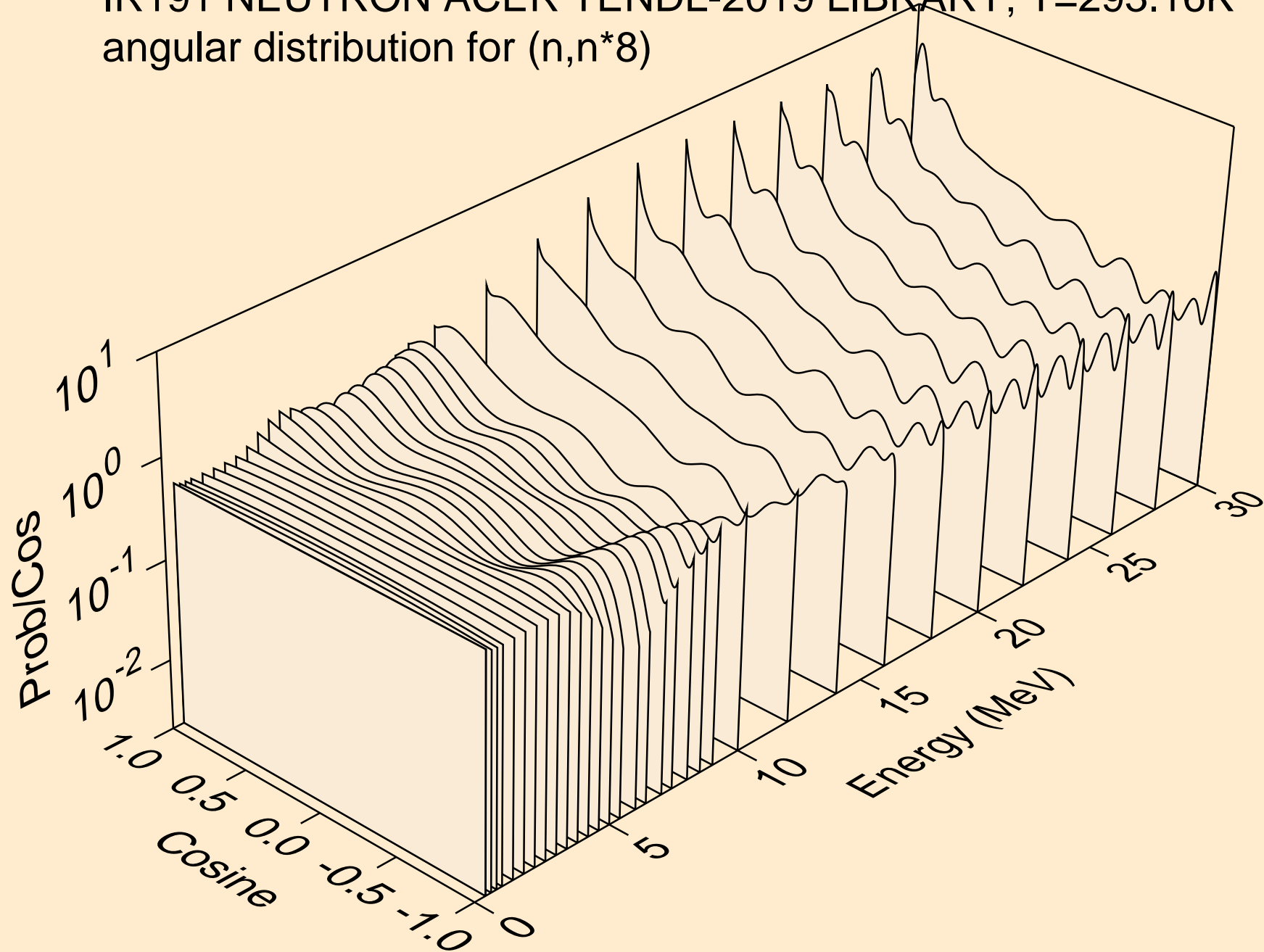

IR191 NEUTRON ACER TENDL-2019 LIBRARY; T=293.16K  
angular distribution for (n,n\*9)

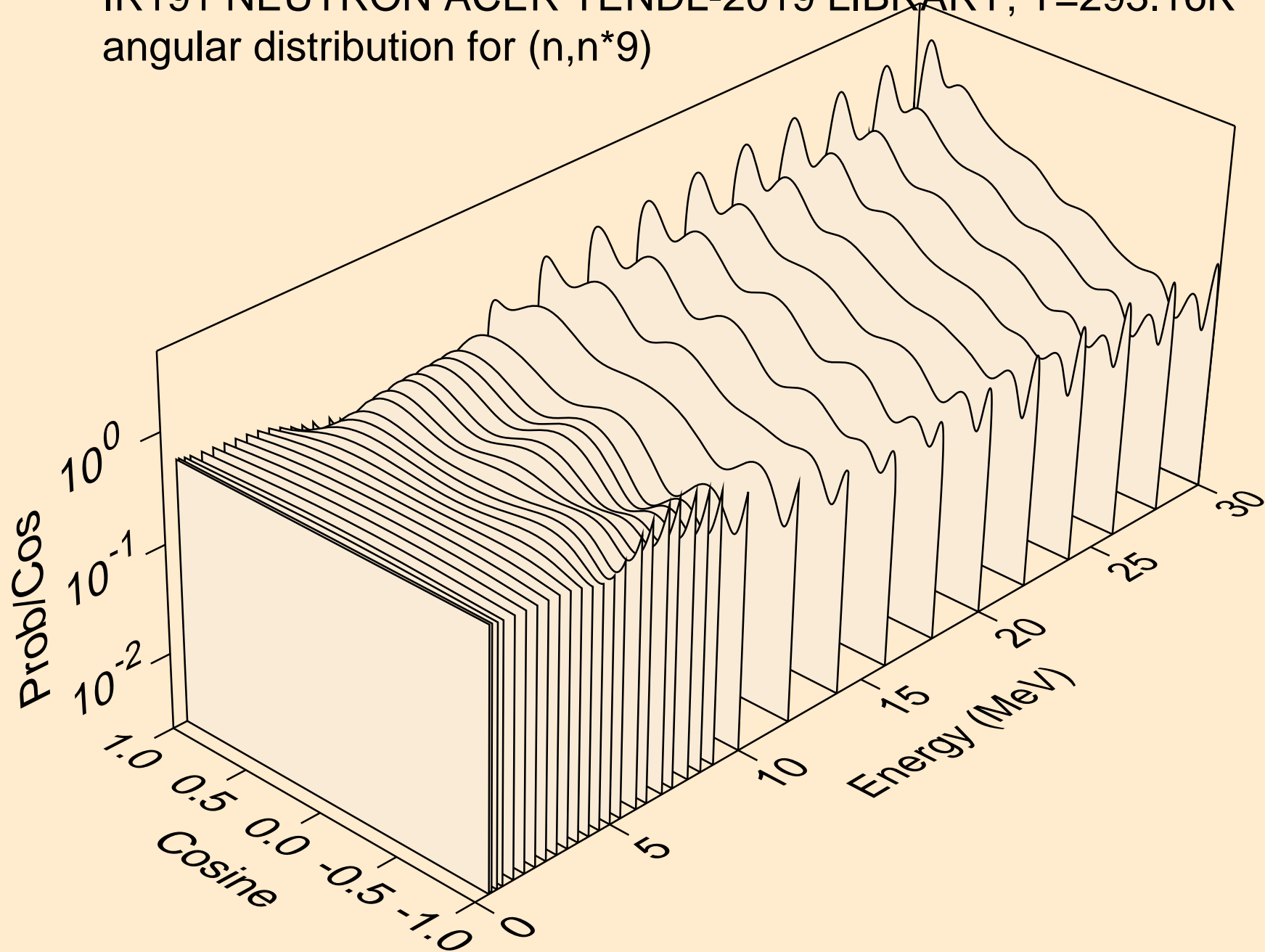

IR191 NEUTRON ACER TENDL-2019 LIBRARY; T=293.16K  
angular distribution for (n,n\*10)

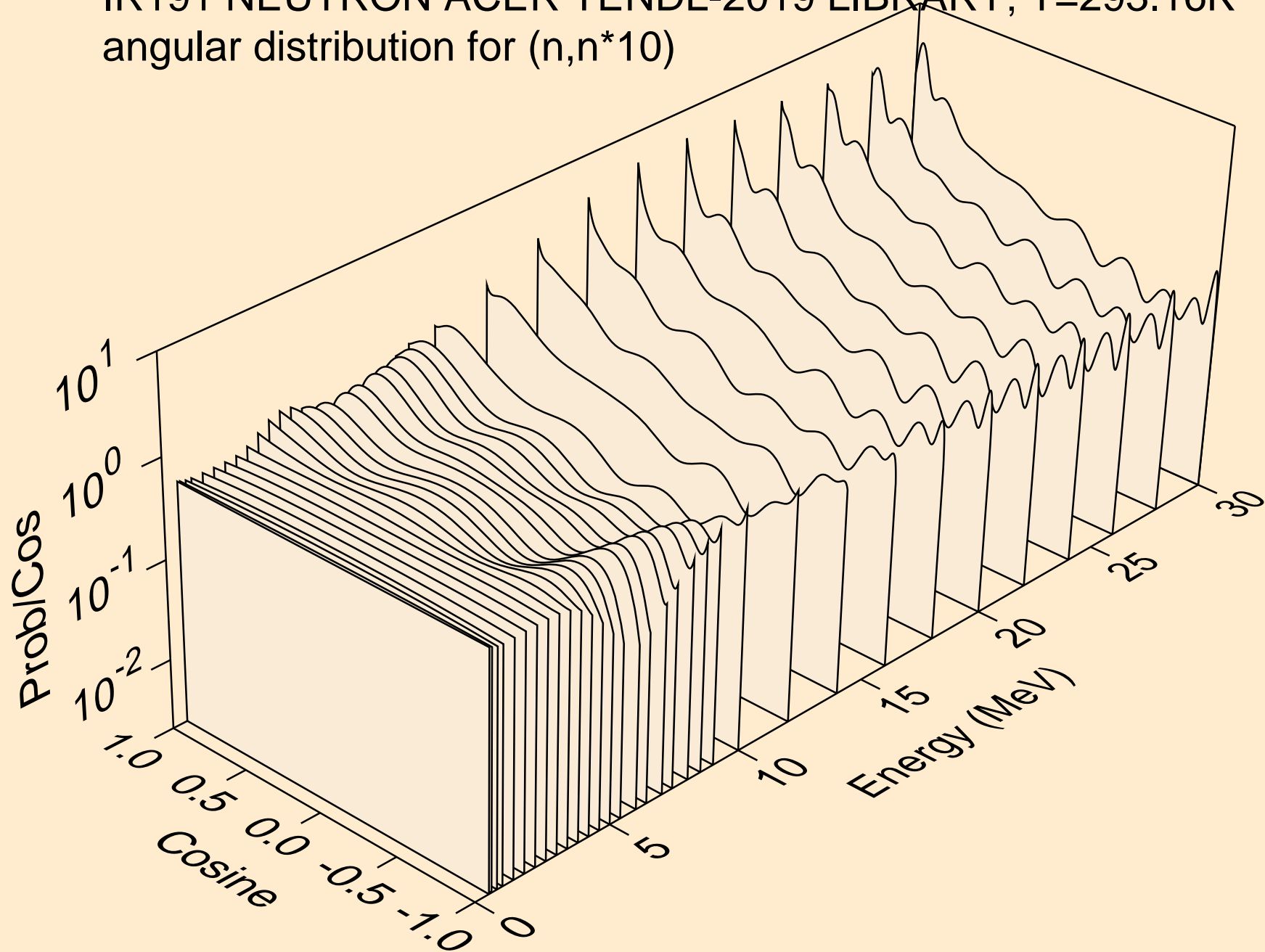

IR191 NEUTRON ACER TENDL-2019 LIBRARY; T=293.16K  
angular distribution for (n,n\*11)

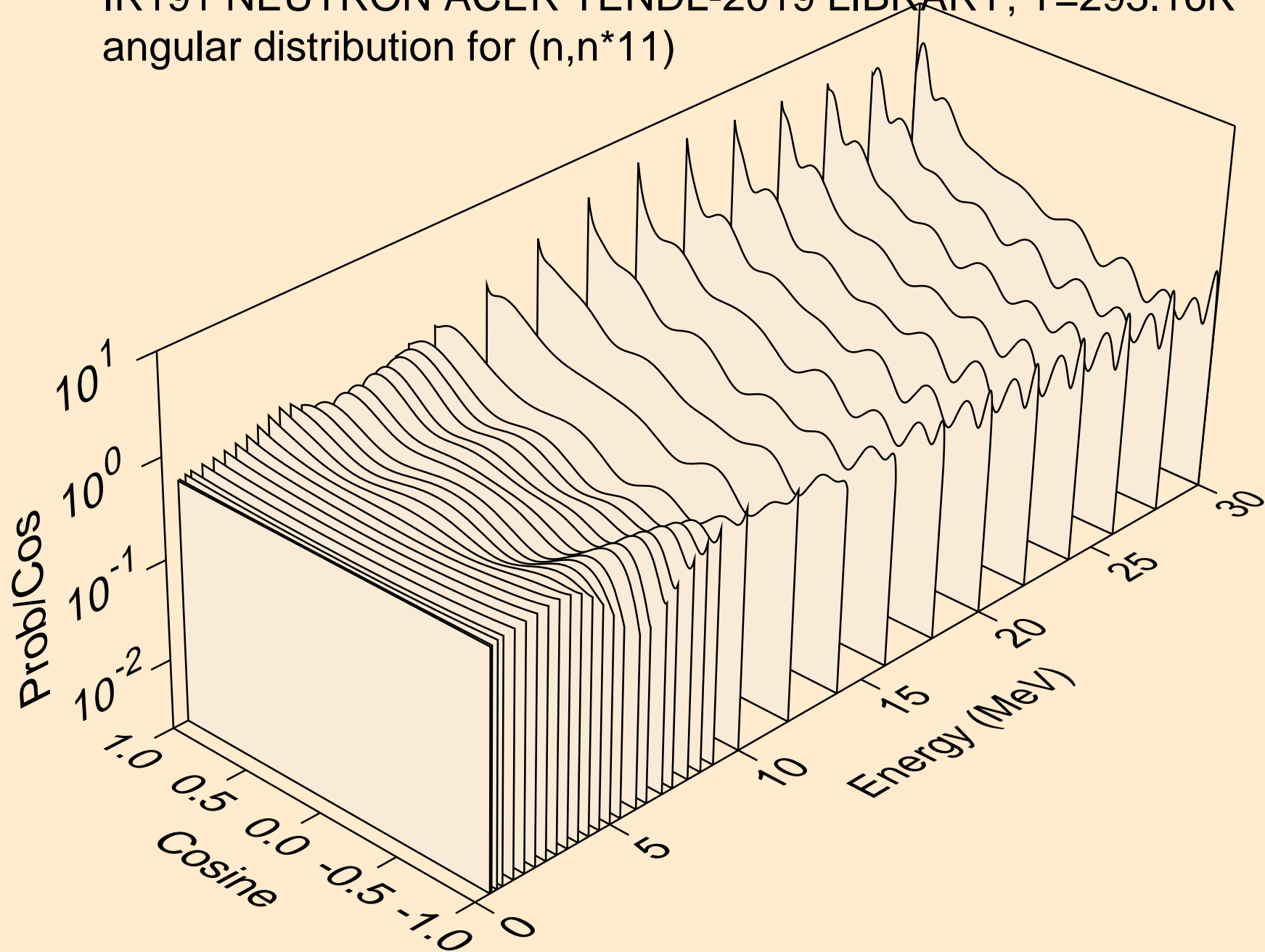

IR191 NEUTRON ACER TENDL-2019 LIBRARY; T=293.16K  
angular distribution for (n,n\*12)

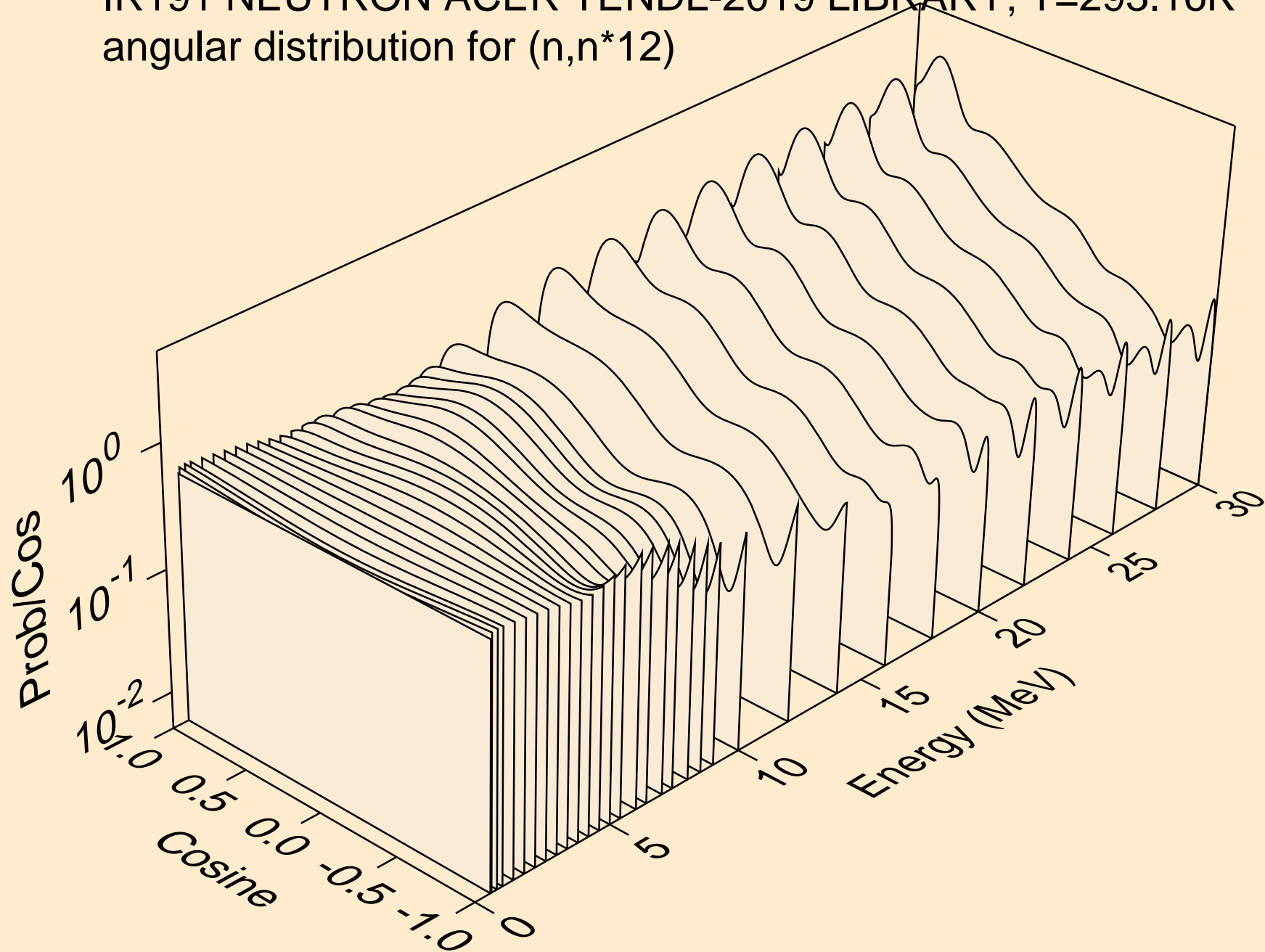

IR191 NEUTRON ACER TENDL-2019 LIBRARY; T=293.16K  
angular distribution for (n,n\*13)

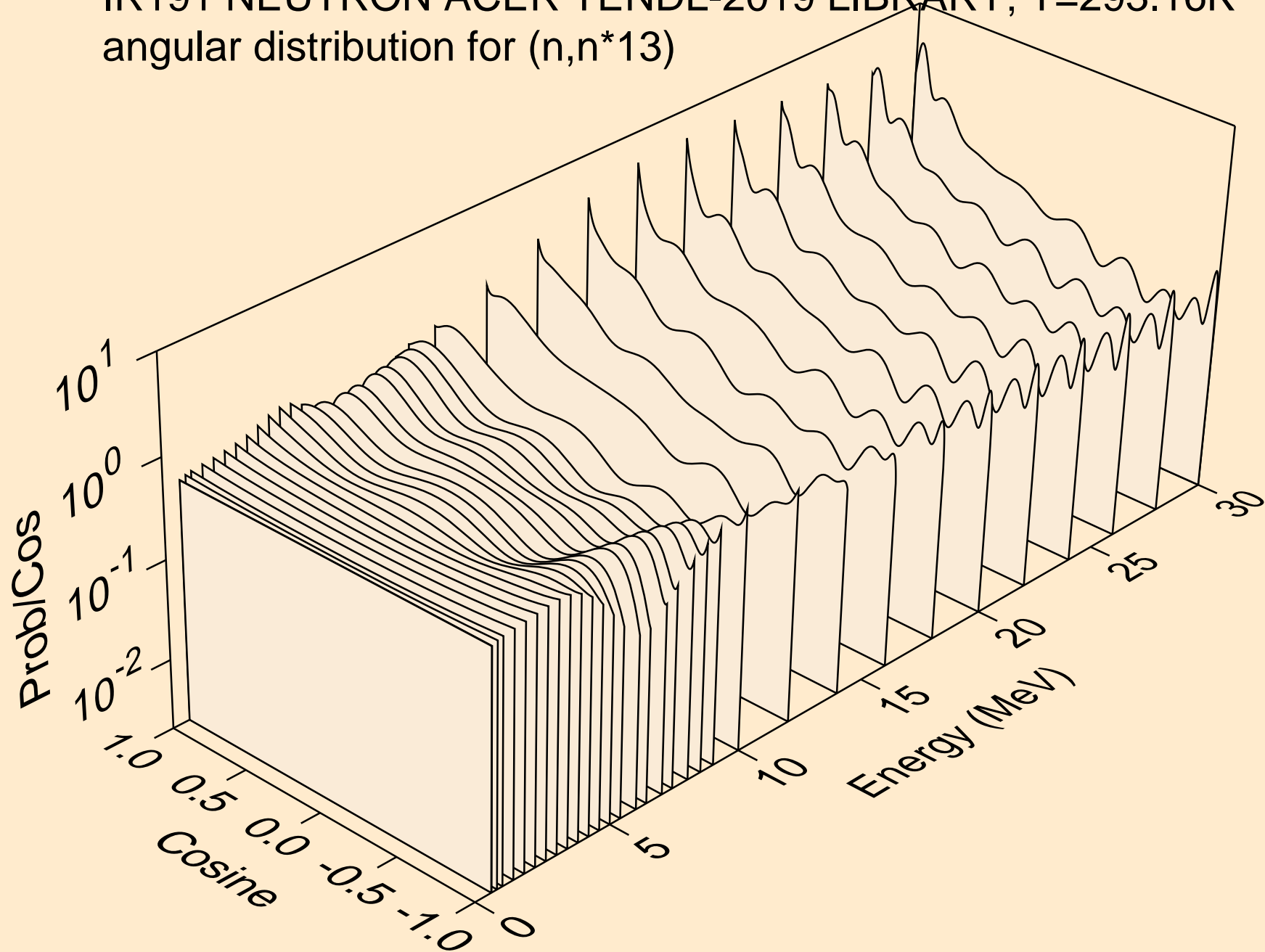

IR191 NEUTRON ACER TENDL-2019 LIBRARY; T=293.16K  
angular distribution for (n,n\*14)

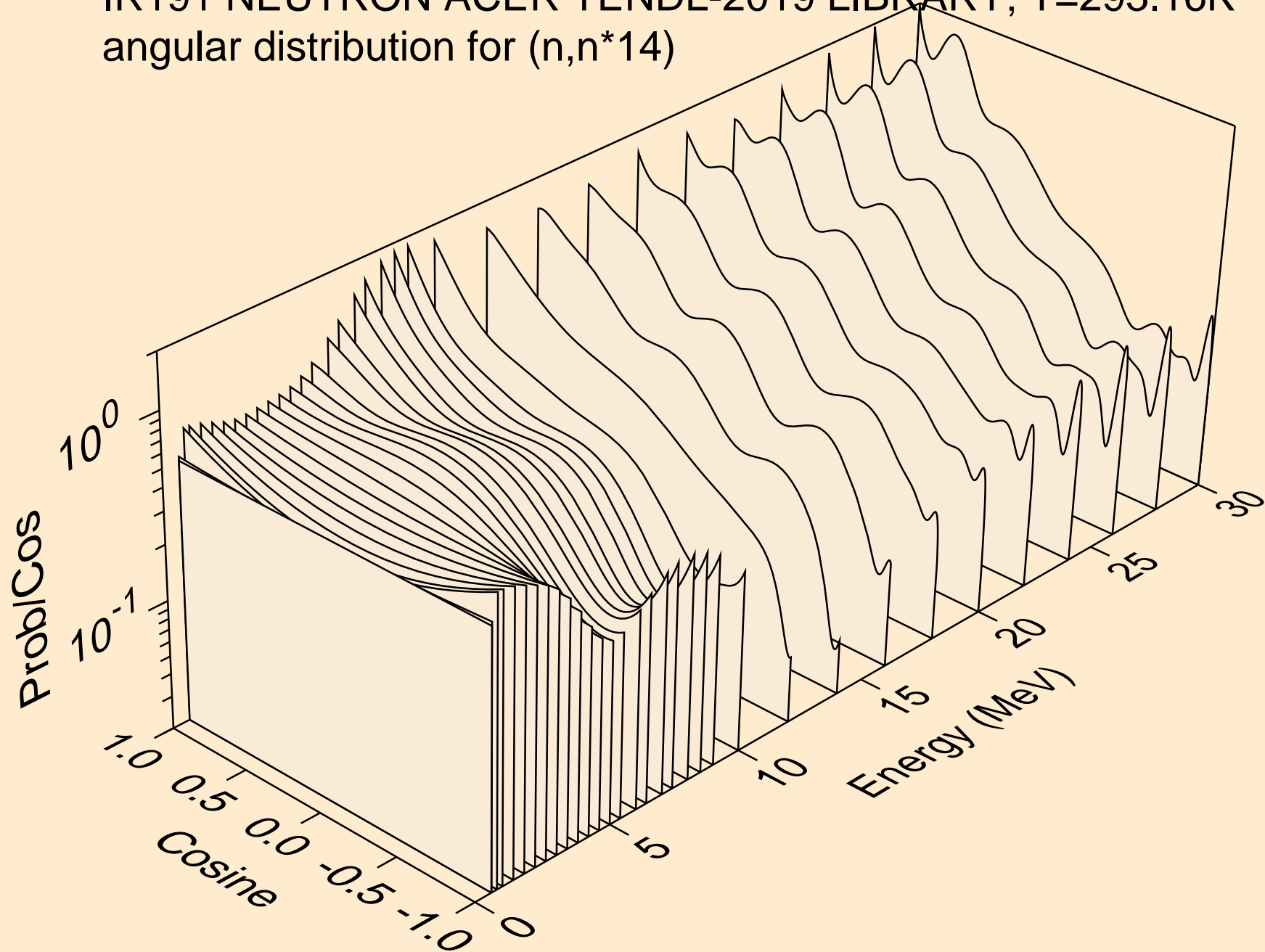

IR191 NEUTRON ACER TENDL-2019 LIBRARY; T=293.16K  
angular distribution for (n,n\*15)

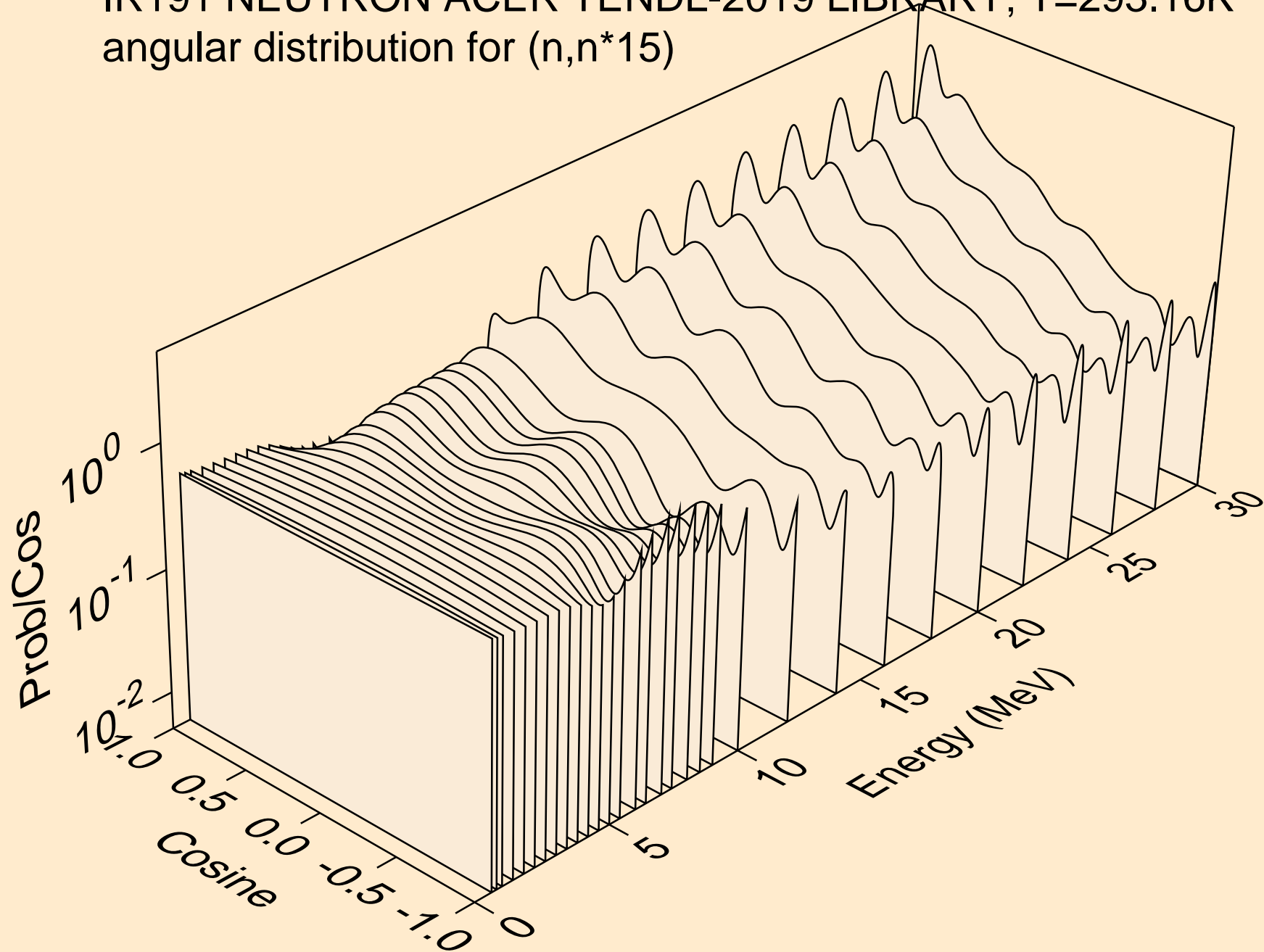



IR191 NEUTRON ACER TENDL-2019 LIBRARY; T=293.16K  
angular distribution for (n,n\*16)

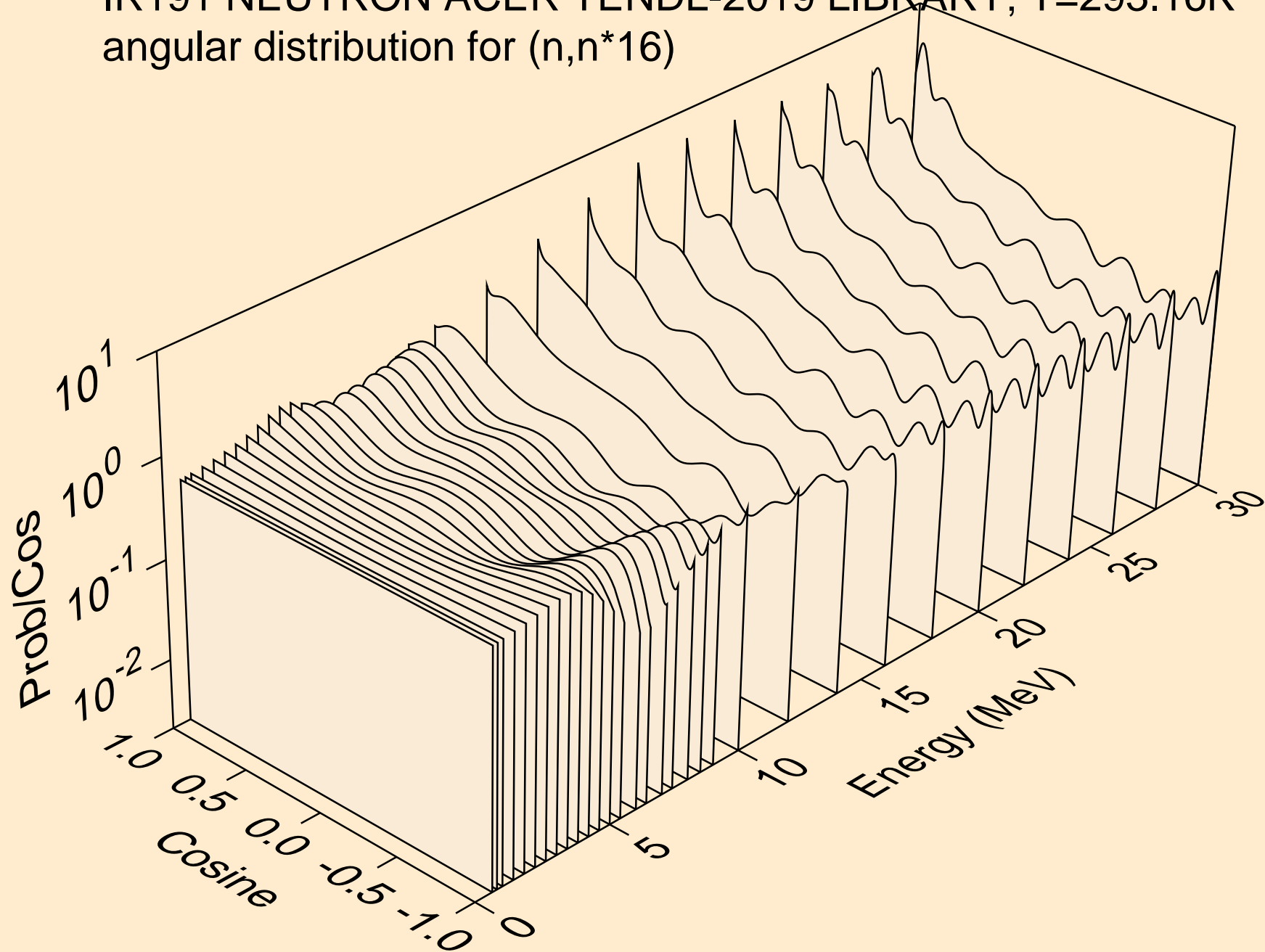

IR191 NEUTRON ACER TENDL-2019 LIBRARY; T=293.16K  
angular distribution for (n,n\*17)

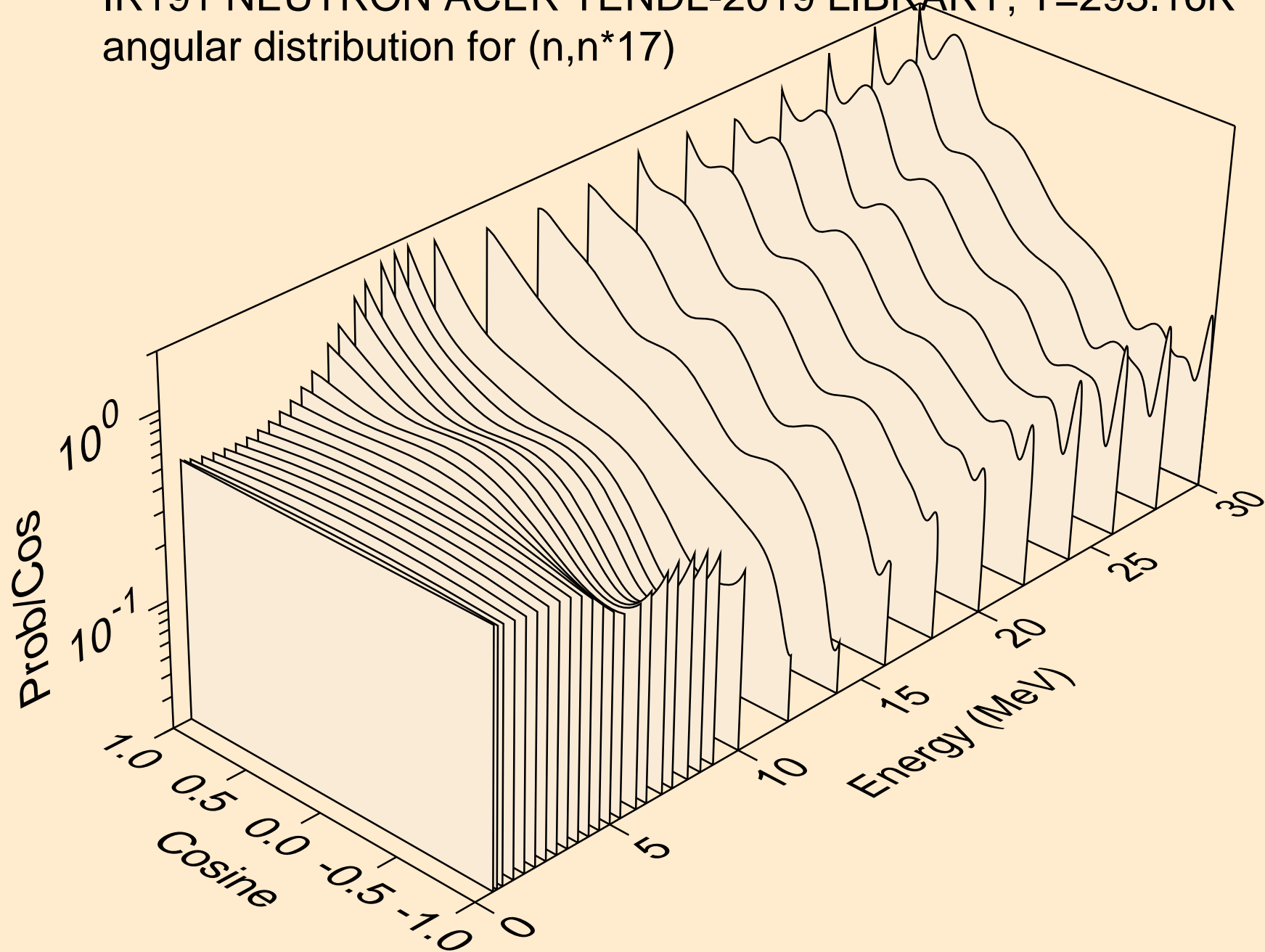

IR191 NEUTRON ACER TENDL-2019 LIBRARY; T=293.16K  
angular distribution for (n,n\*18)

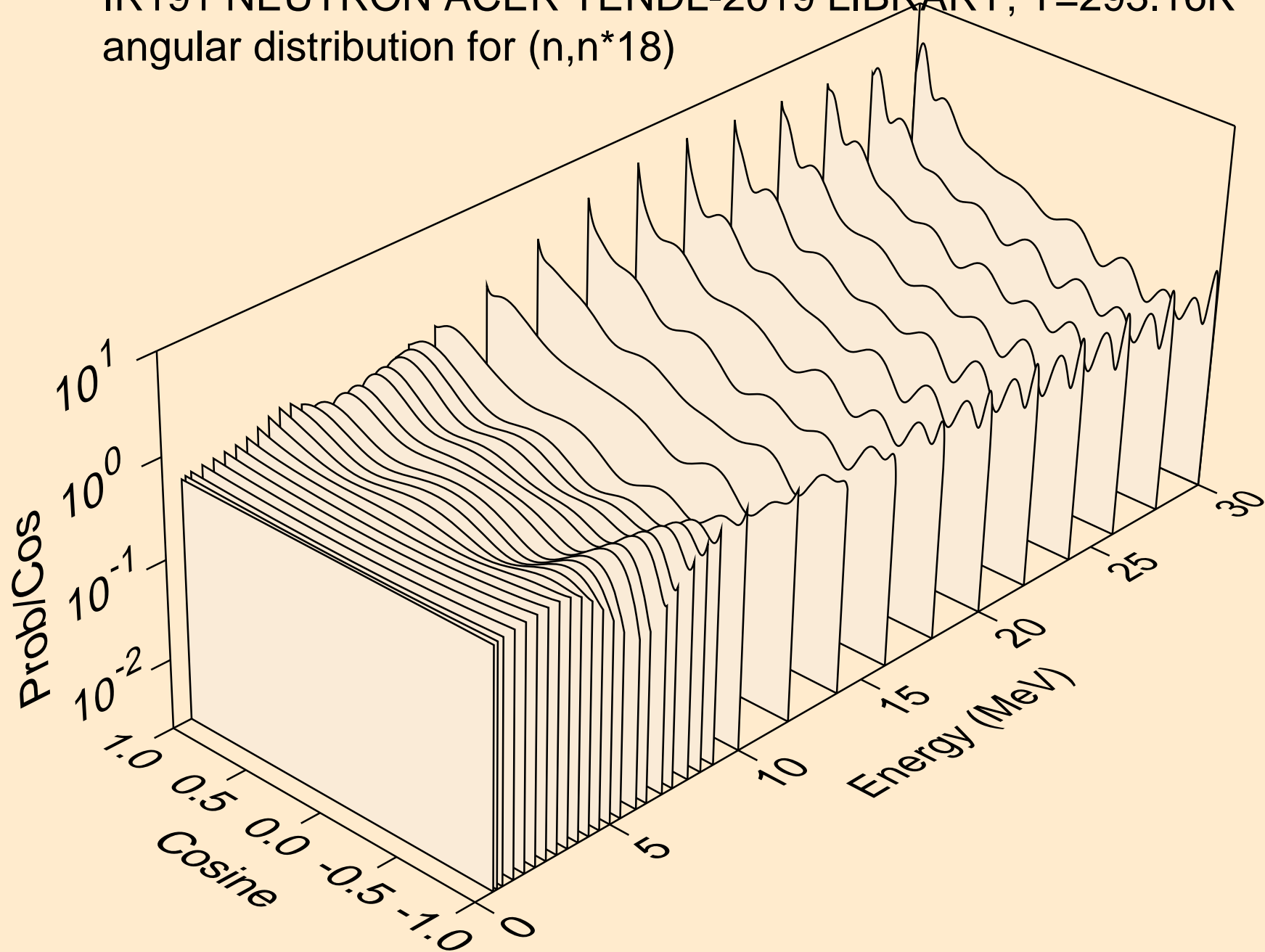

IR191 NEUTRON ACER TENDL-2019 LIBRARY; T=293.16K  
angular distribution for (n,n\*19)

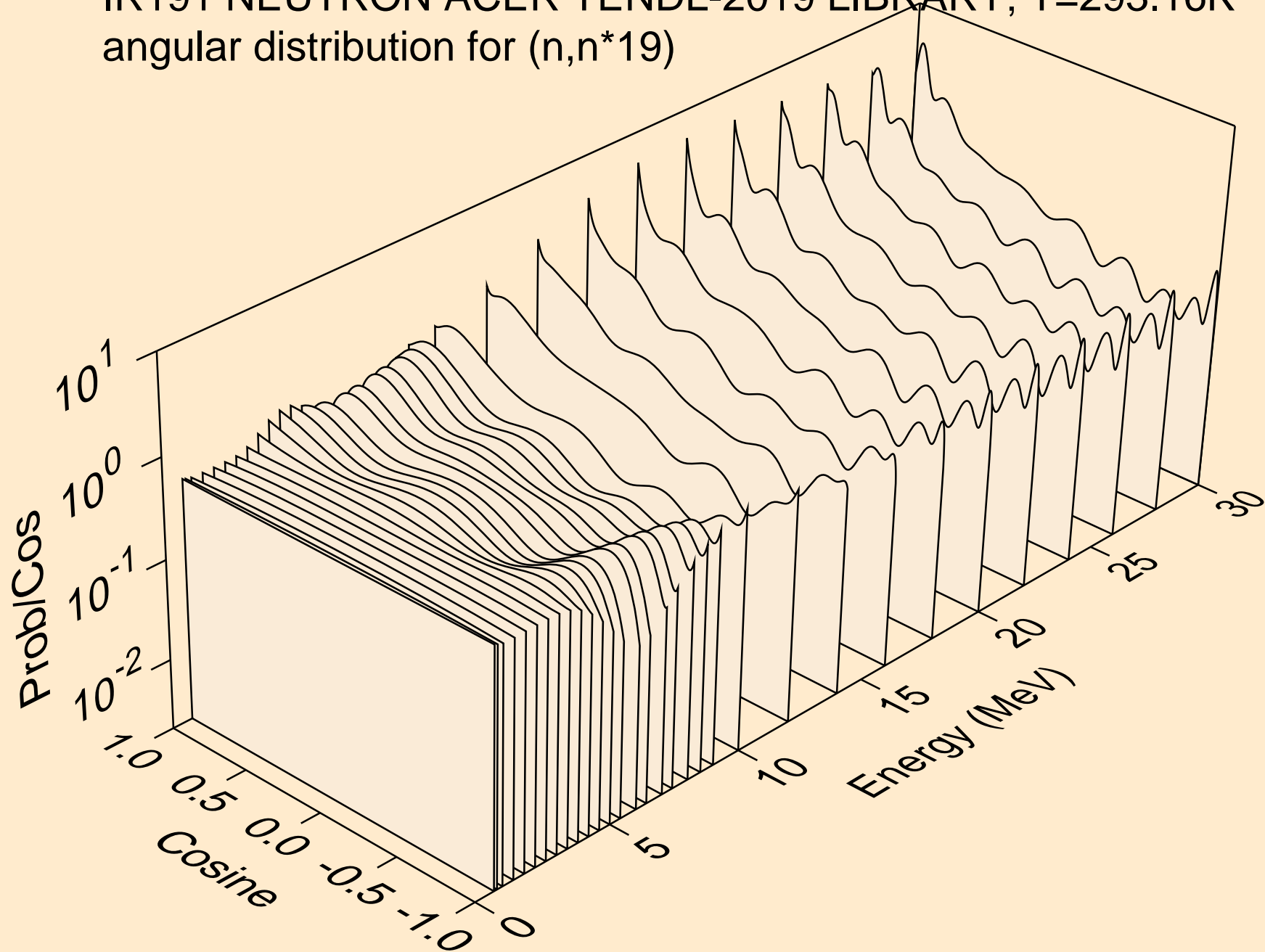

IR191 NEUTRON ACER TENDL-2019 LIBRARY; T=293.16K  
angular distribution for (n,n\*20)

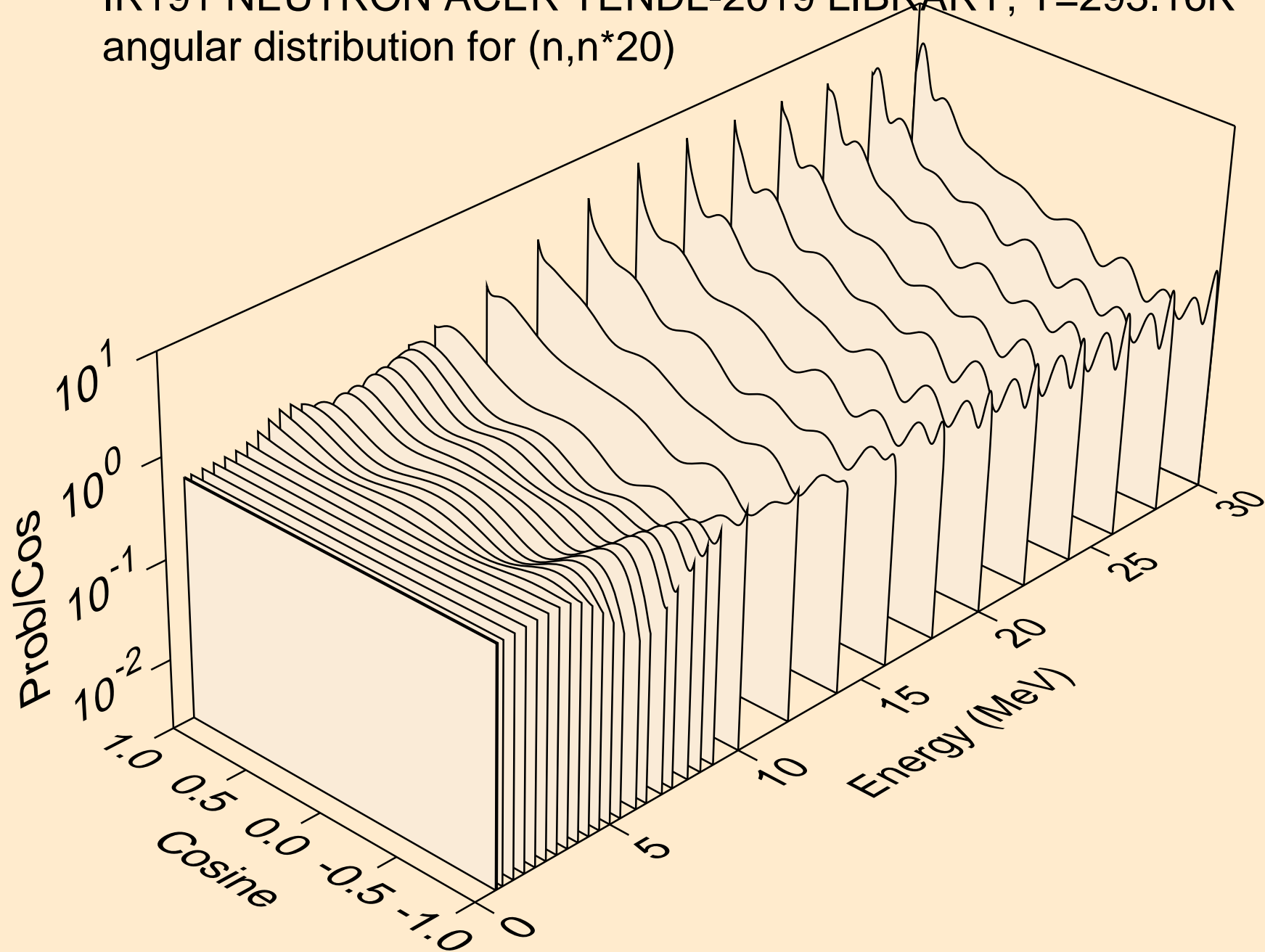

IR191 NEUTRON ACER TENDL-2019 LIBRARY; T=293.16K  
angular distribution for (n,n\*21)

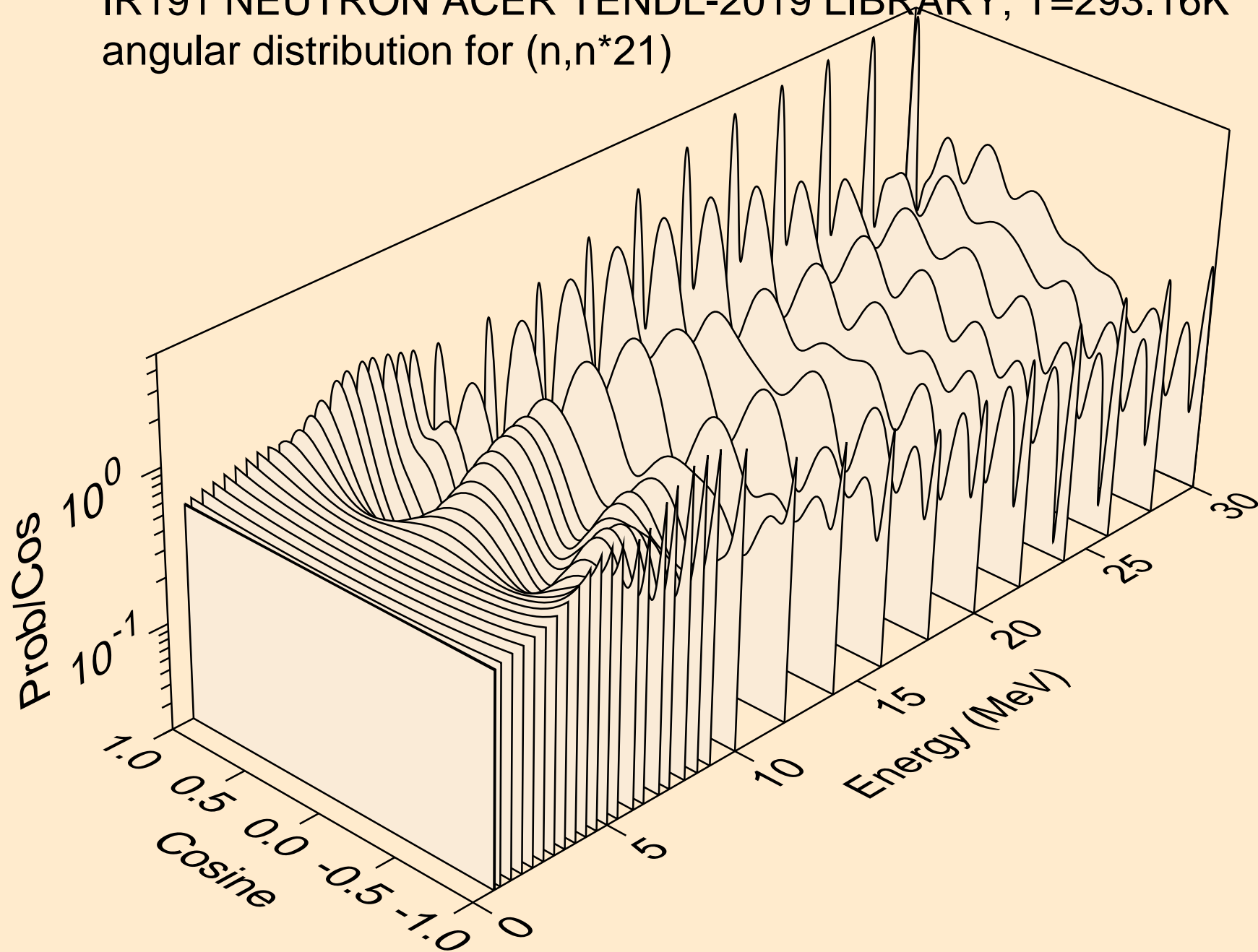

IR191 NEUTRON ACER TENDL-2019 LIBRARY; T=293.16K  
angular distribution for (n,n\*22)

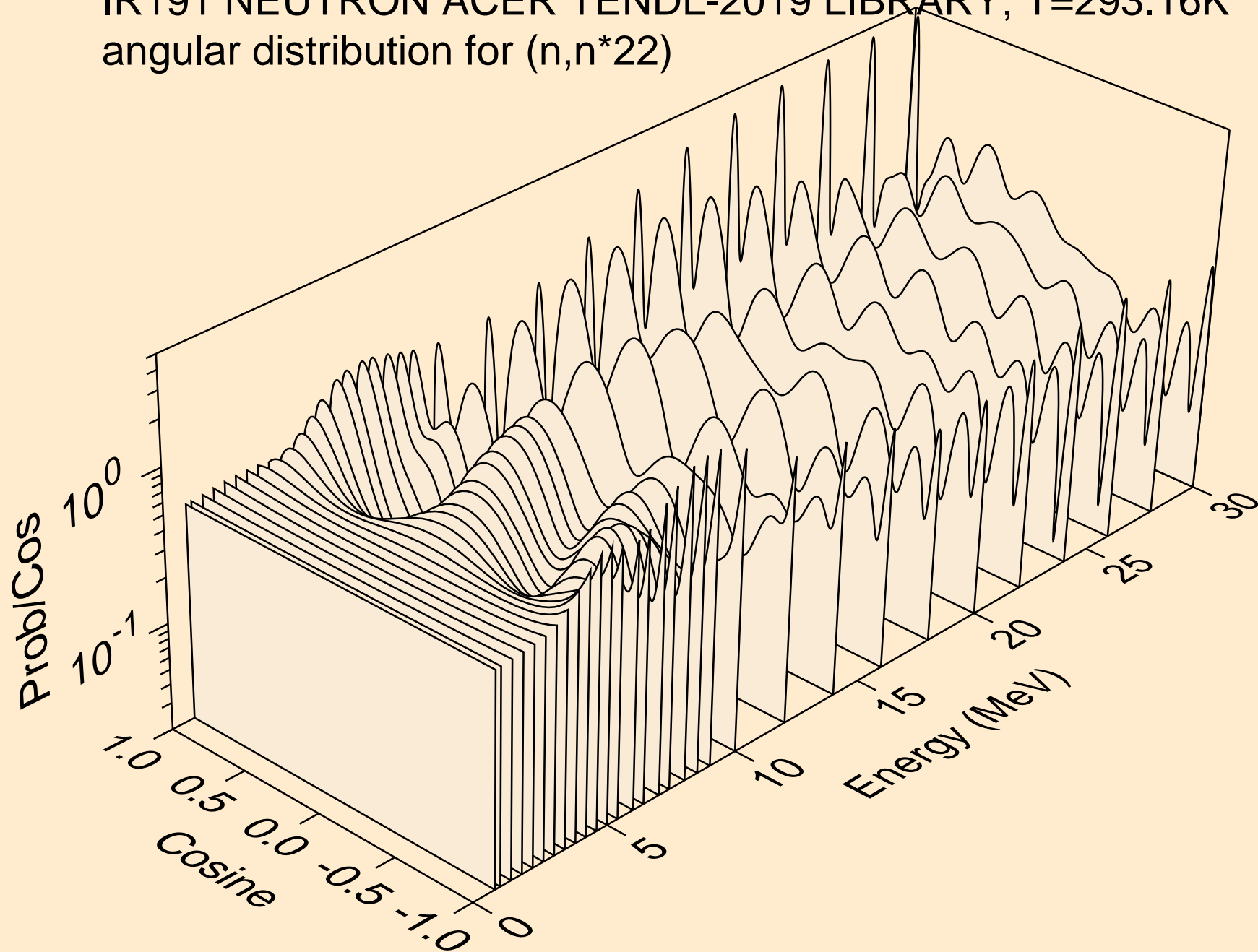

IR191 NEUTRON ACER TENDL-2019 LIBRARY; T=293.16K  
angular distribution for (n,n\*23)

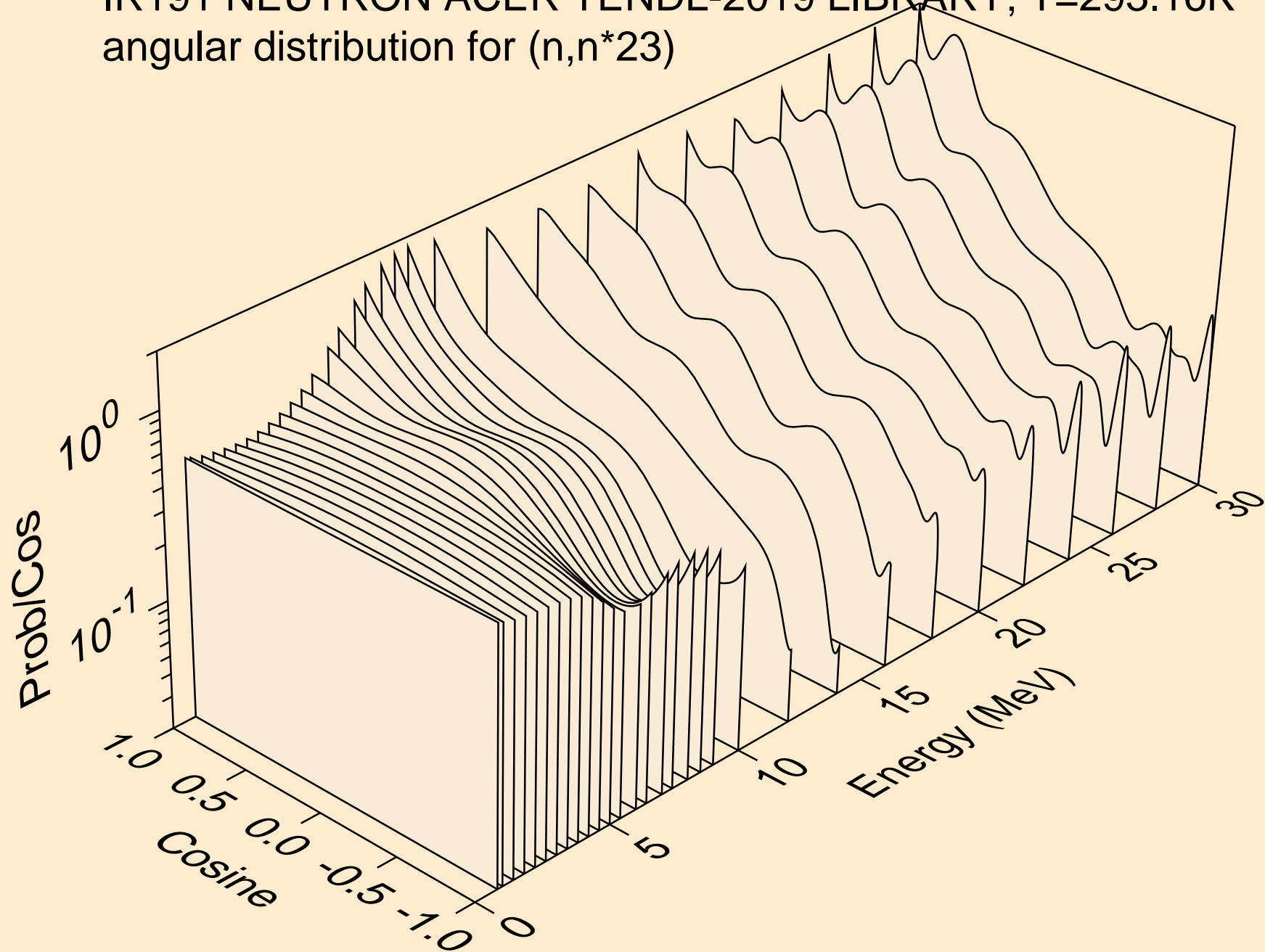



IR191 NEUTRON ACER TENDL-2019 LIBRARY; T=293.16K  
angular distribution for (n,n\*24)

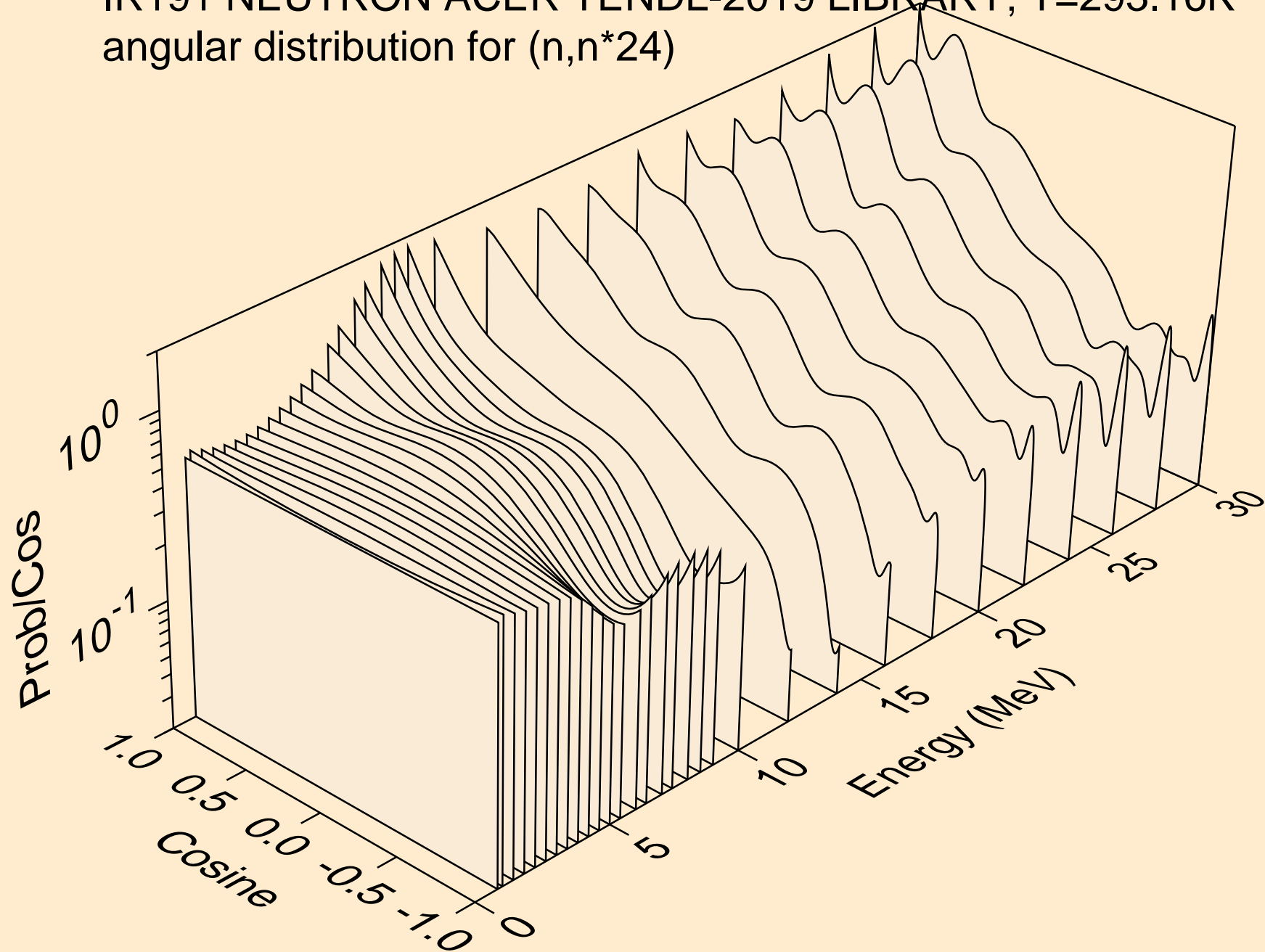

IR191 NEUTRON ACER TENDL-2019 LIBRARY; T=293.16K  
angular distribution for (n,n\*25)

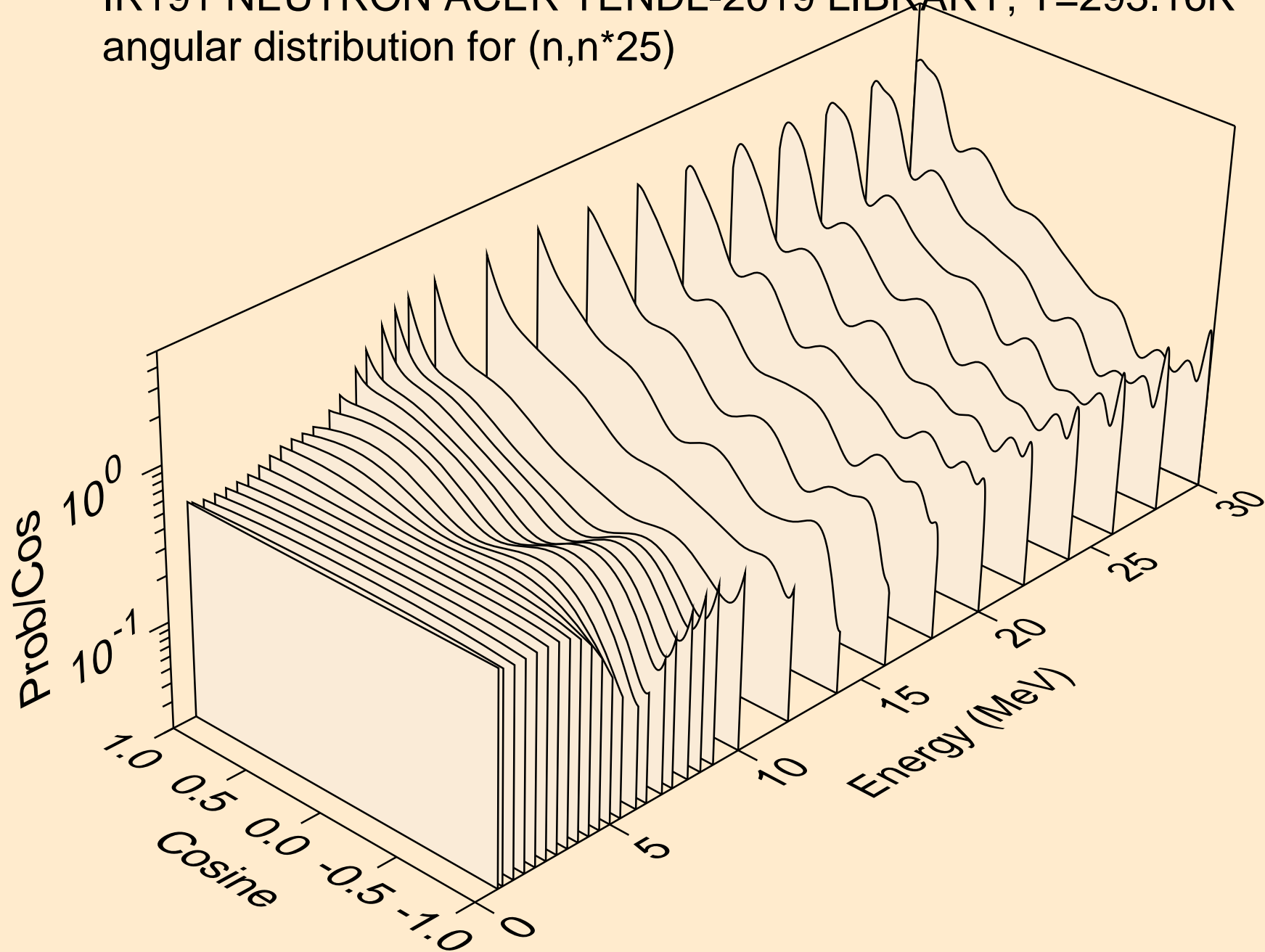

IR191 NEUTRON ACER TENDL-2019 LIBRARY; T=293.16K  
angular distribution for (n,n\*26)

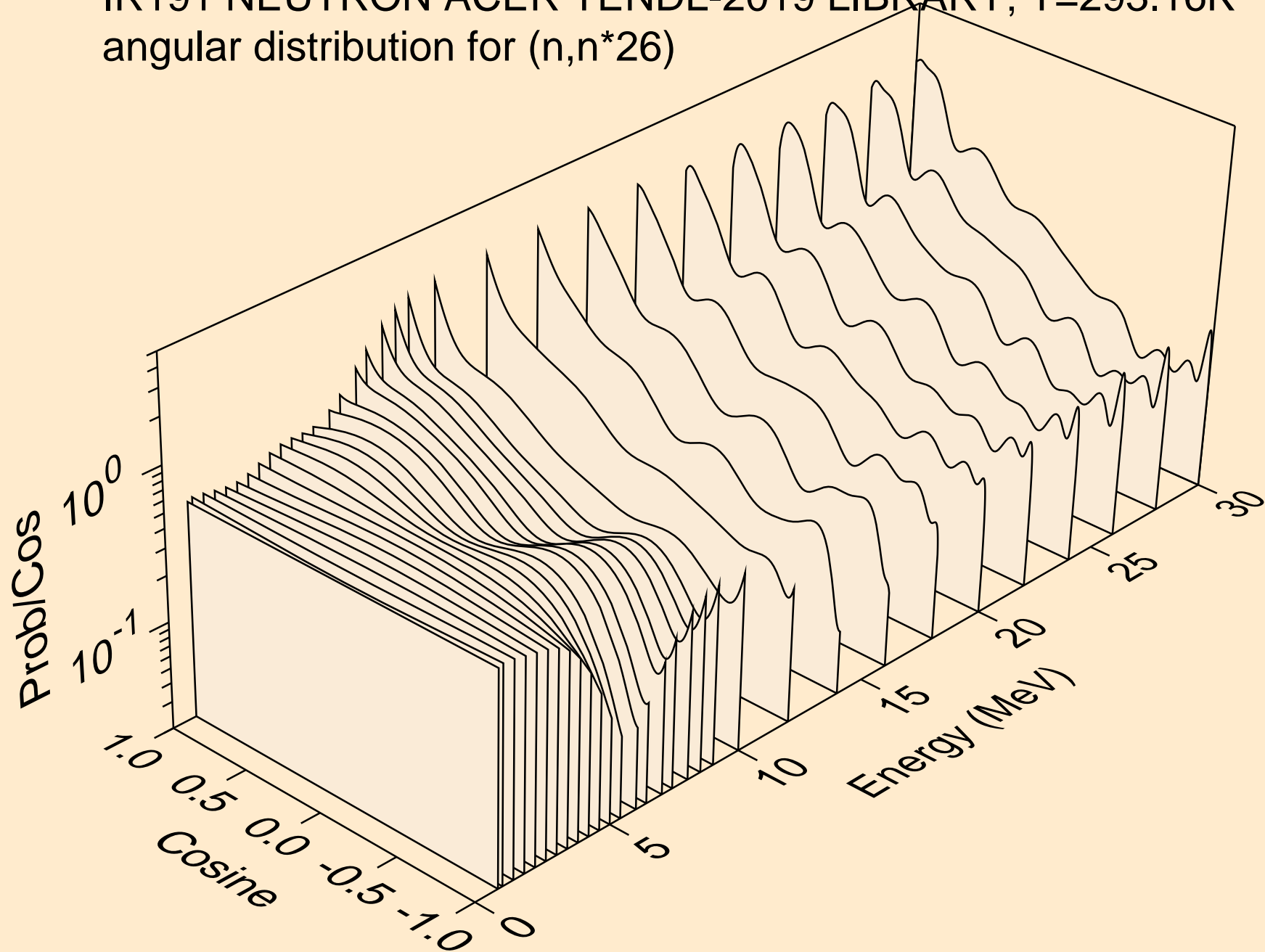

IR191 NEUTRON ACER TENDL-2019 LIBRARY; T=293.16K  
angular distribution for (n,n\*27)

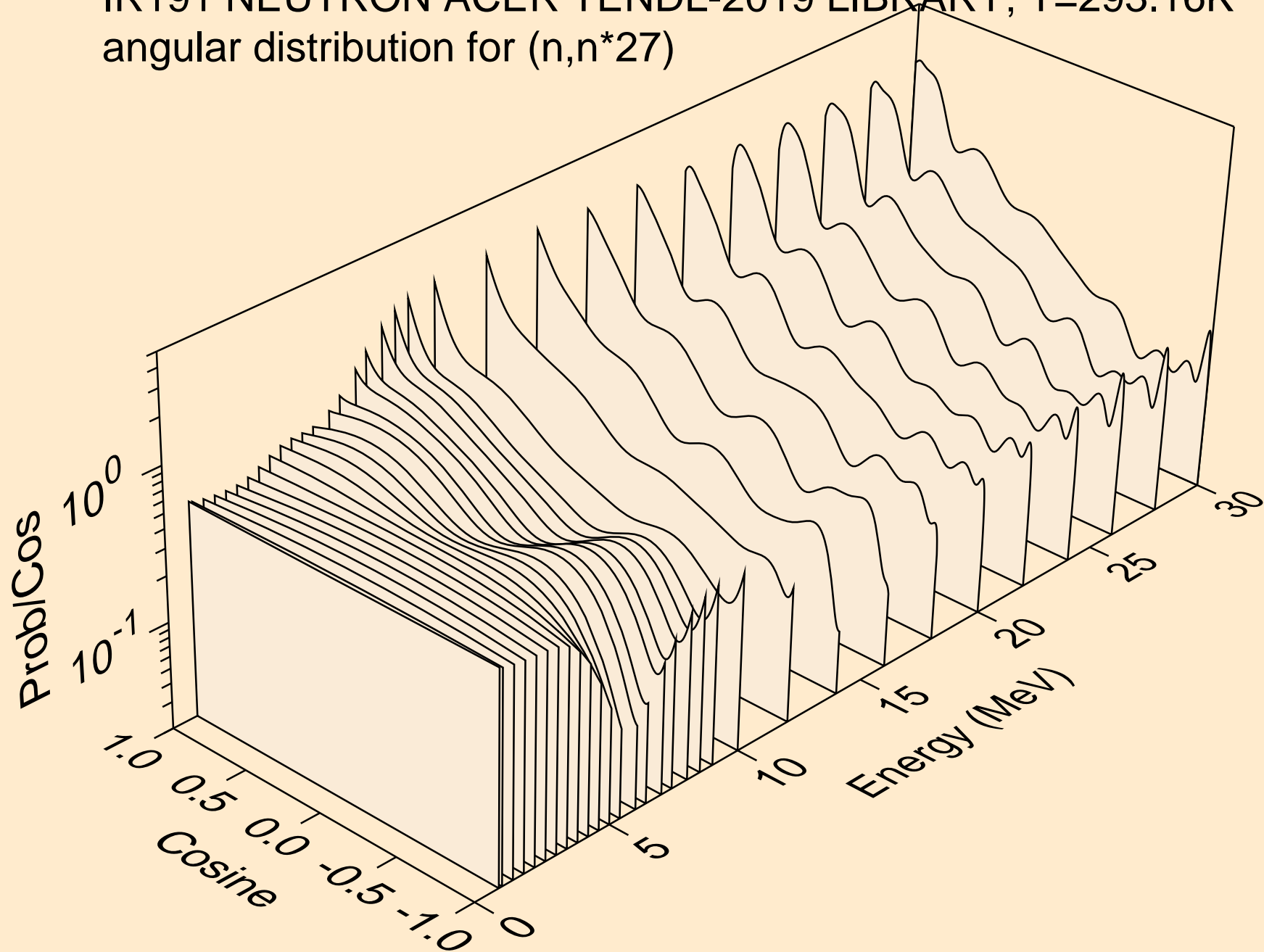

IR191 NEUTRON ACER TENDL-2019 LIBRARY; T=293.16K  
angular distribution for (n,n\*28)

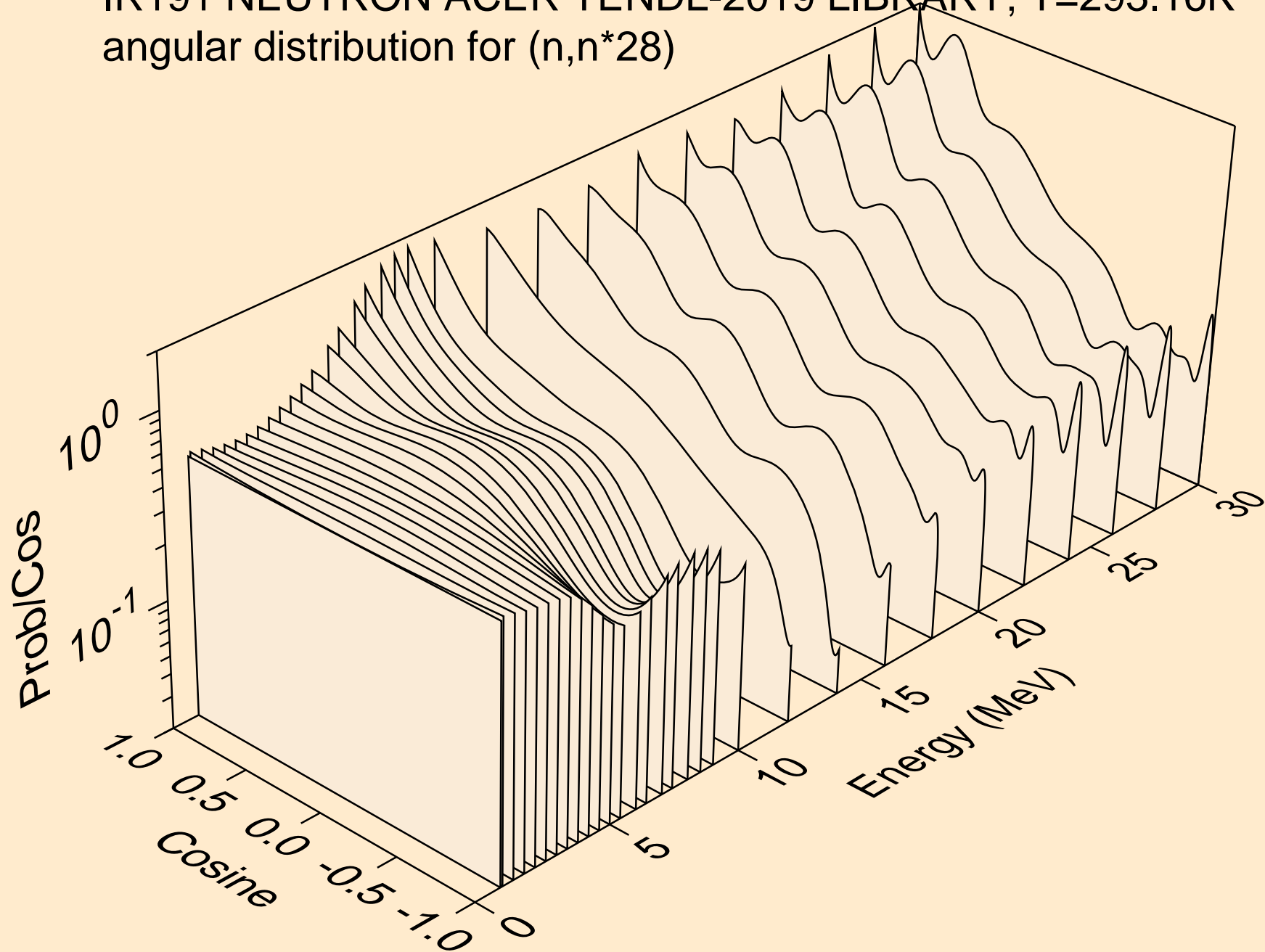

IR191 NEUTRON ACER TENDL-2019 LIBRARY; T=293.16K  
angular distribution for (n,n\*29)

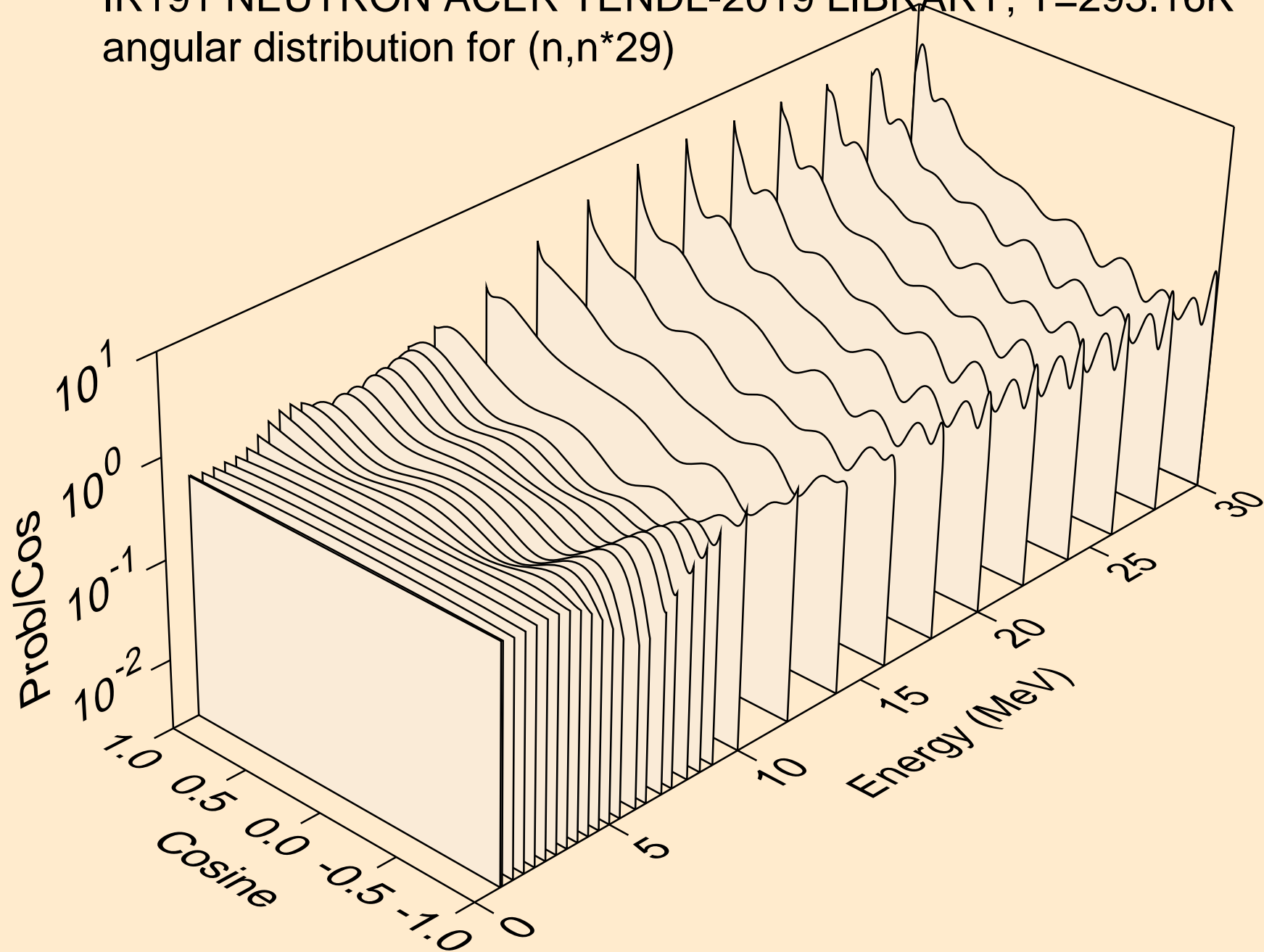

IR191 NEUTRON ACER TENDL-2019 LIBRARY; T=293.16K  
Neutron emission for (n,x)

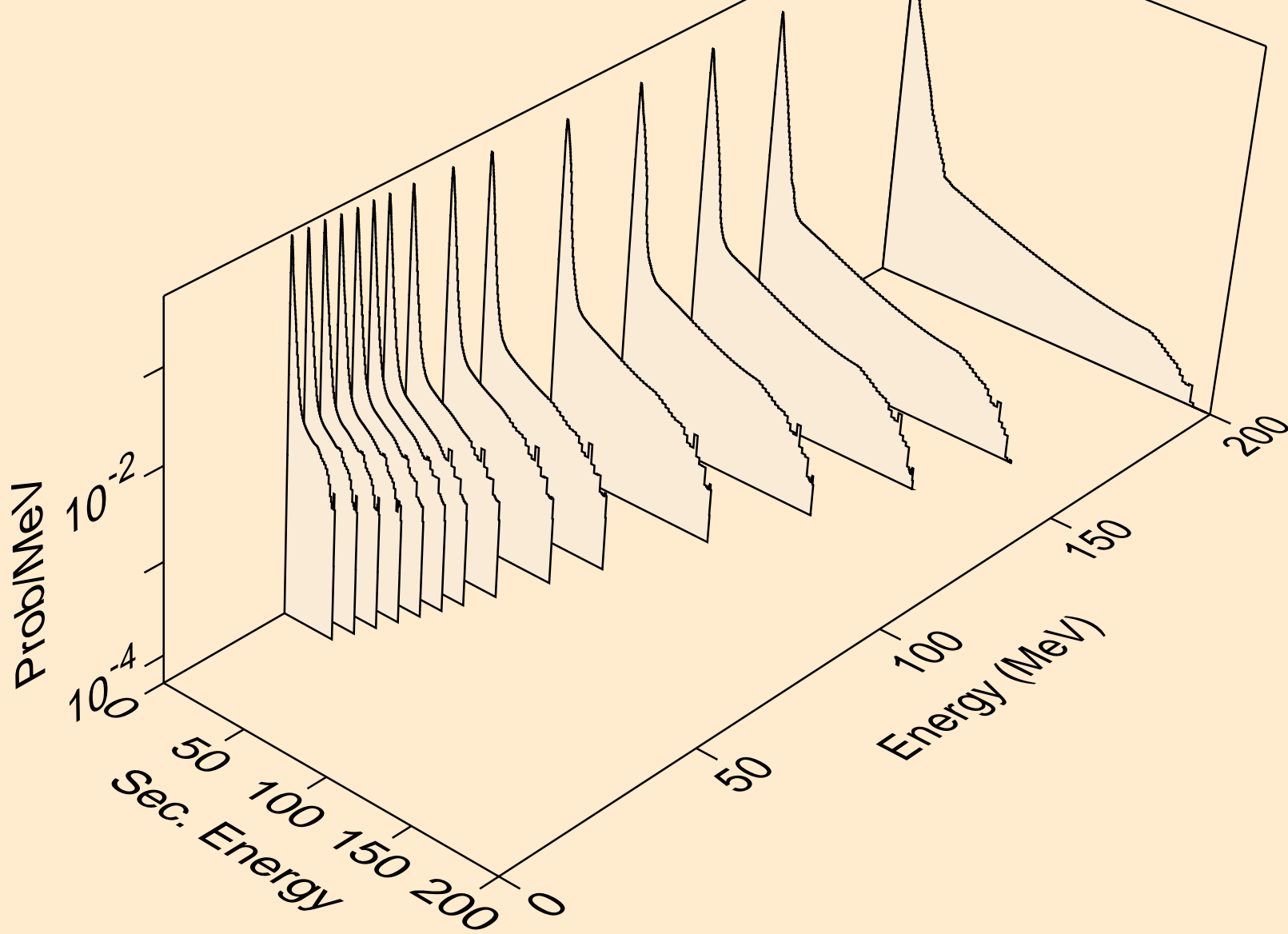

IR191 NEUTRON ACER TENDL-2019 LIBRARY; T=293.16K  
Neutron emission for (n,2nd)

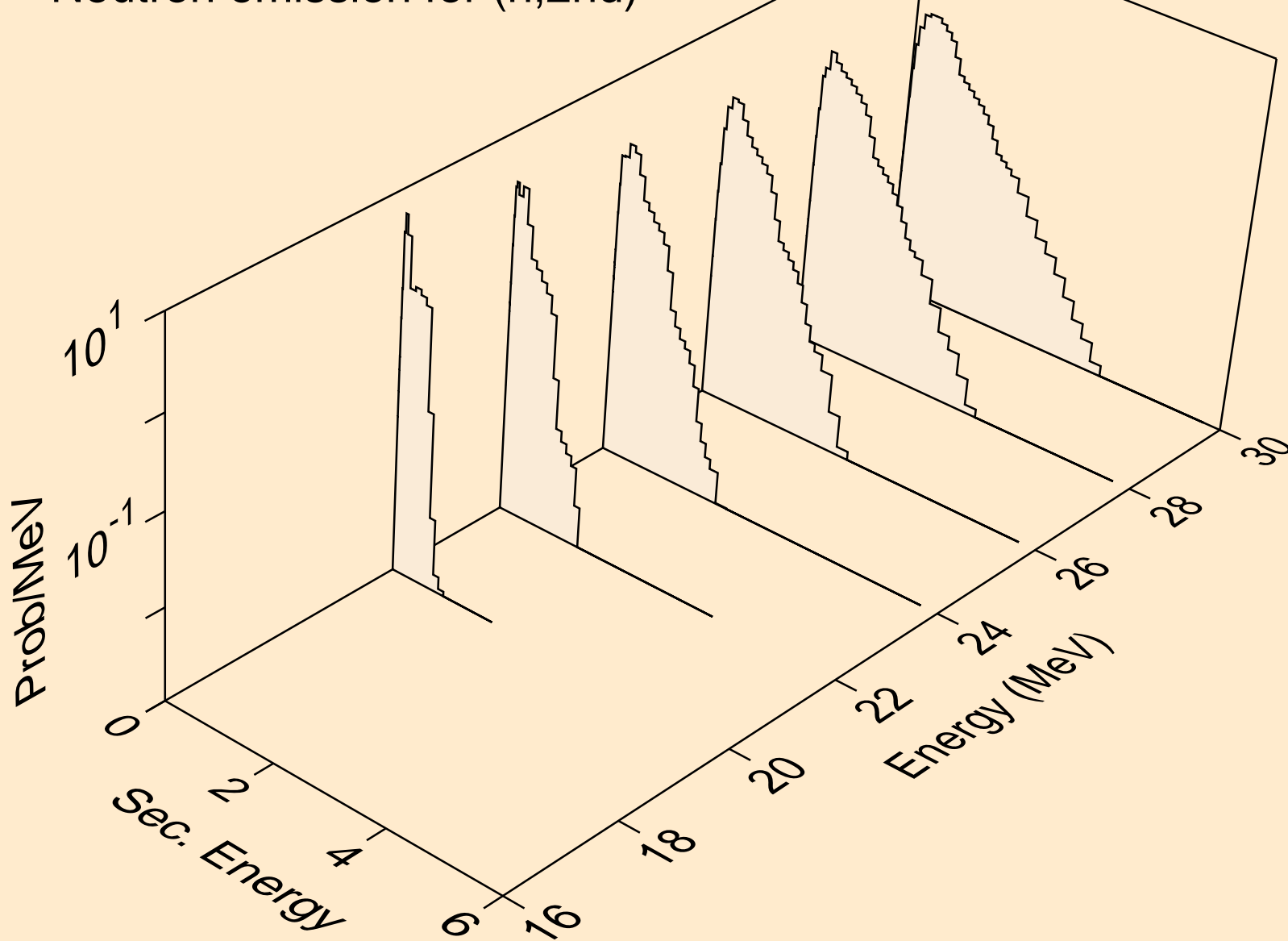



IR191 NEUTRON ACER TENDL-2019 LIBRARY; T=293.16K  
Neutron emission for (n,2n)

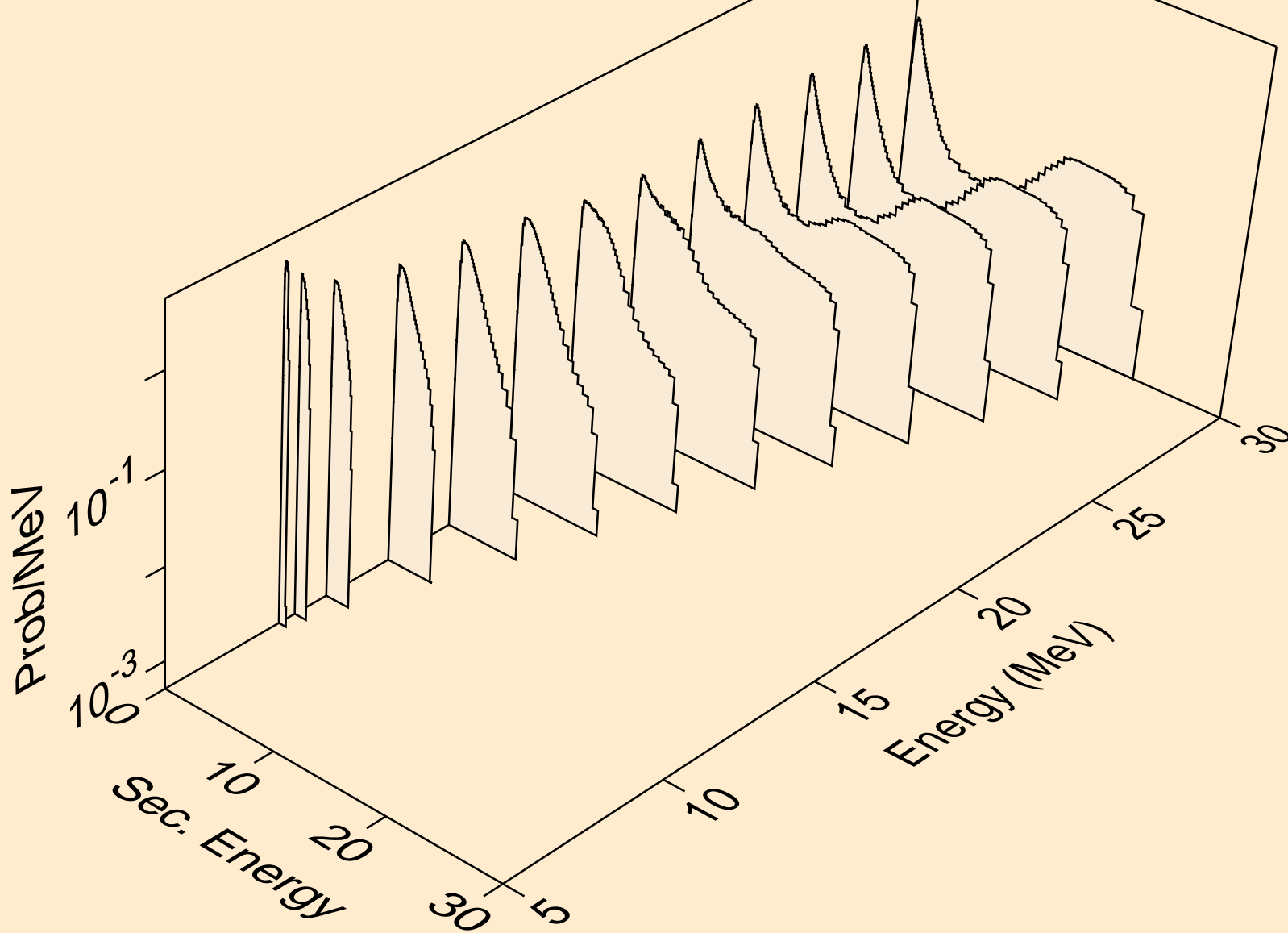

IR191 NEUTRON ACER TENDL-2019 LIBRARY; T=293.16K  
Neutron emission for (n,3n)

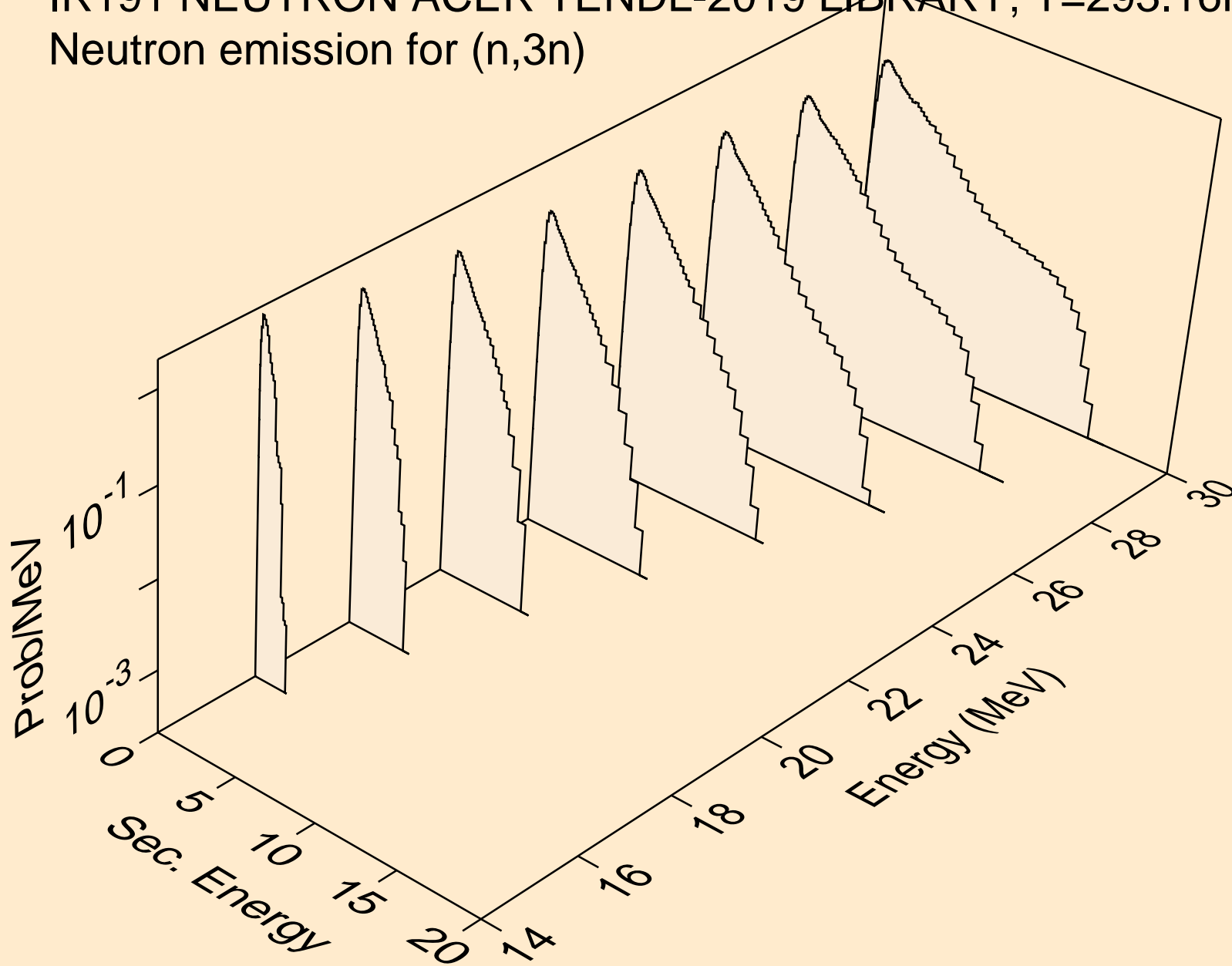

IR191 NEUTRON ACER TENDL-2019 LIBRARY; T=293.16K  
Neutron emission for (n,n\*)a

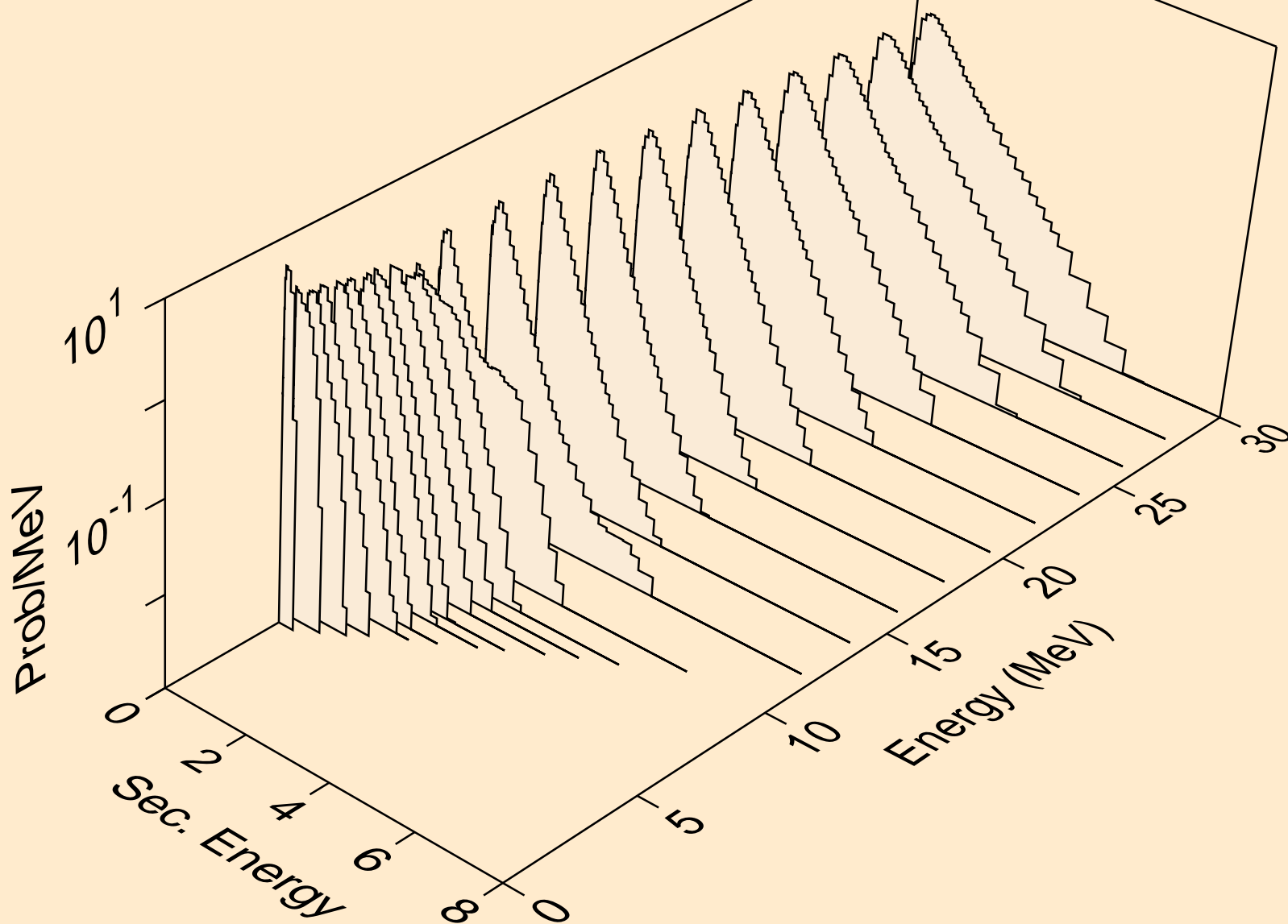

IR191 NEUTRON ACER TENDL-2019 LIBRARY; T=293.16K  
Neutron emission for (n,2n)a

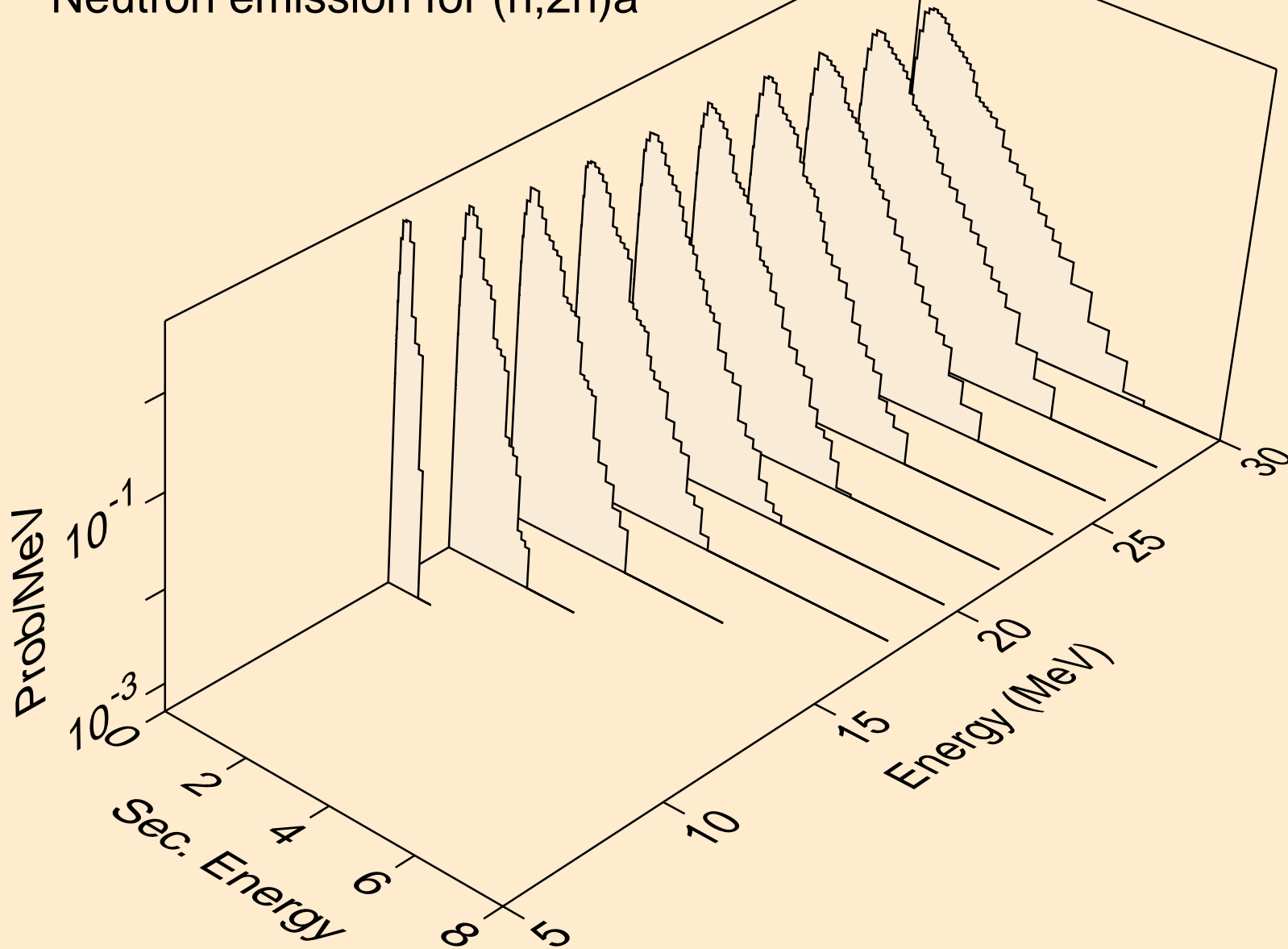

IR191 NEUTRON ACER TENDL-2019 LIBRARY; T=293.16K  
Neutron emission for (n,3n)a

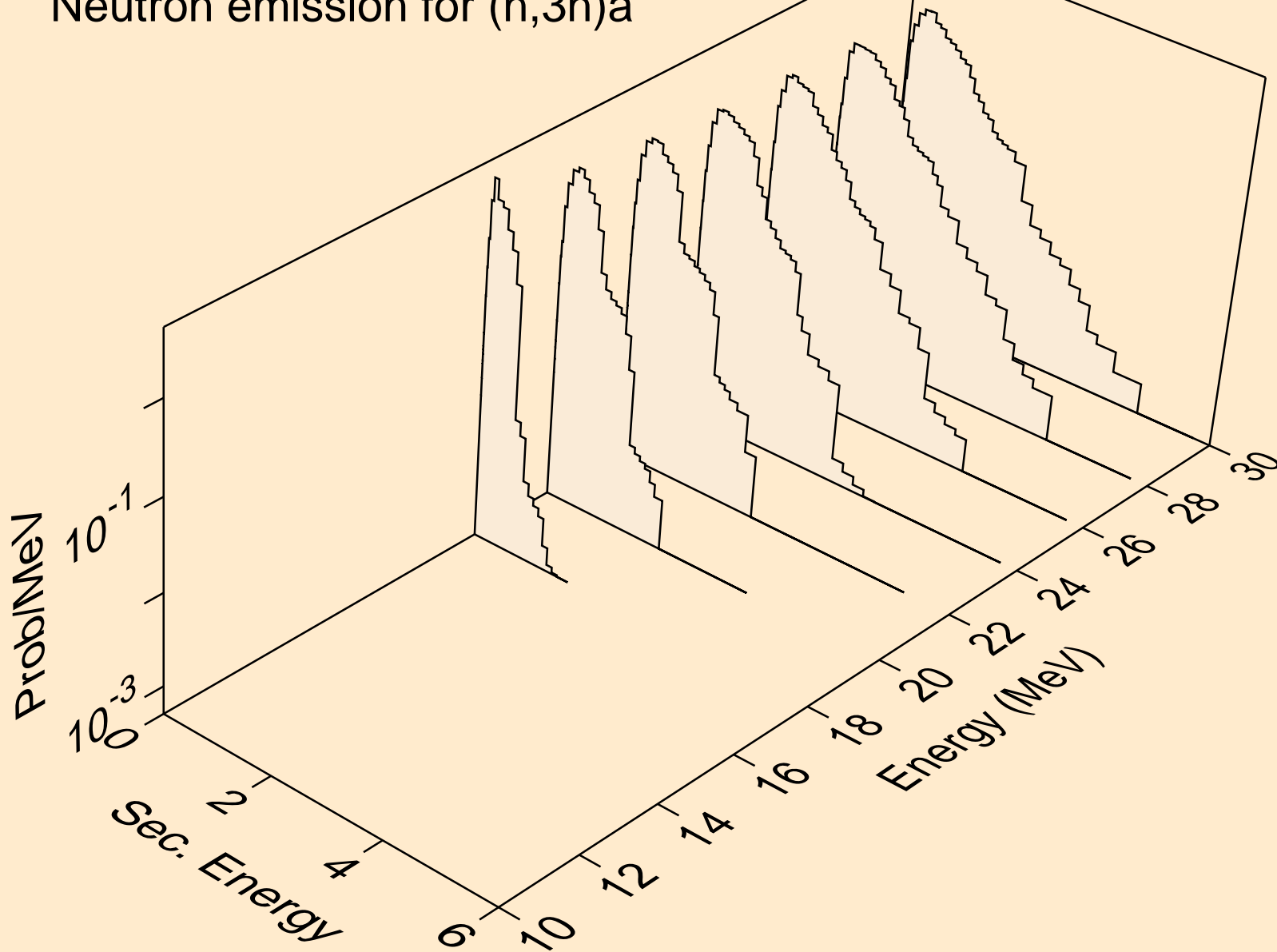

IR191 NEUTRON ACER TENDL-2019 LIBRARY; T=293.16K  
Neutron emission for (n,n\*)p

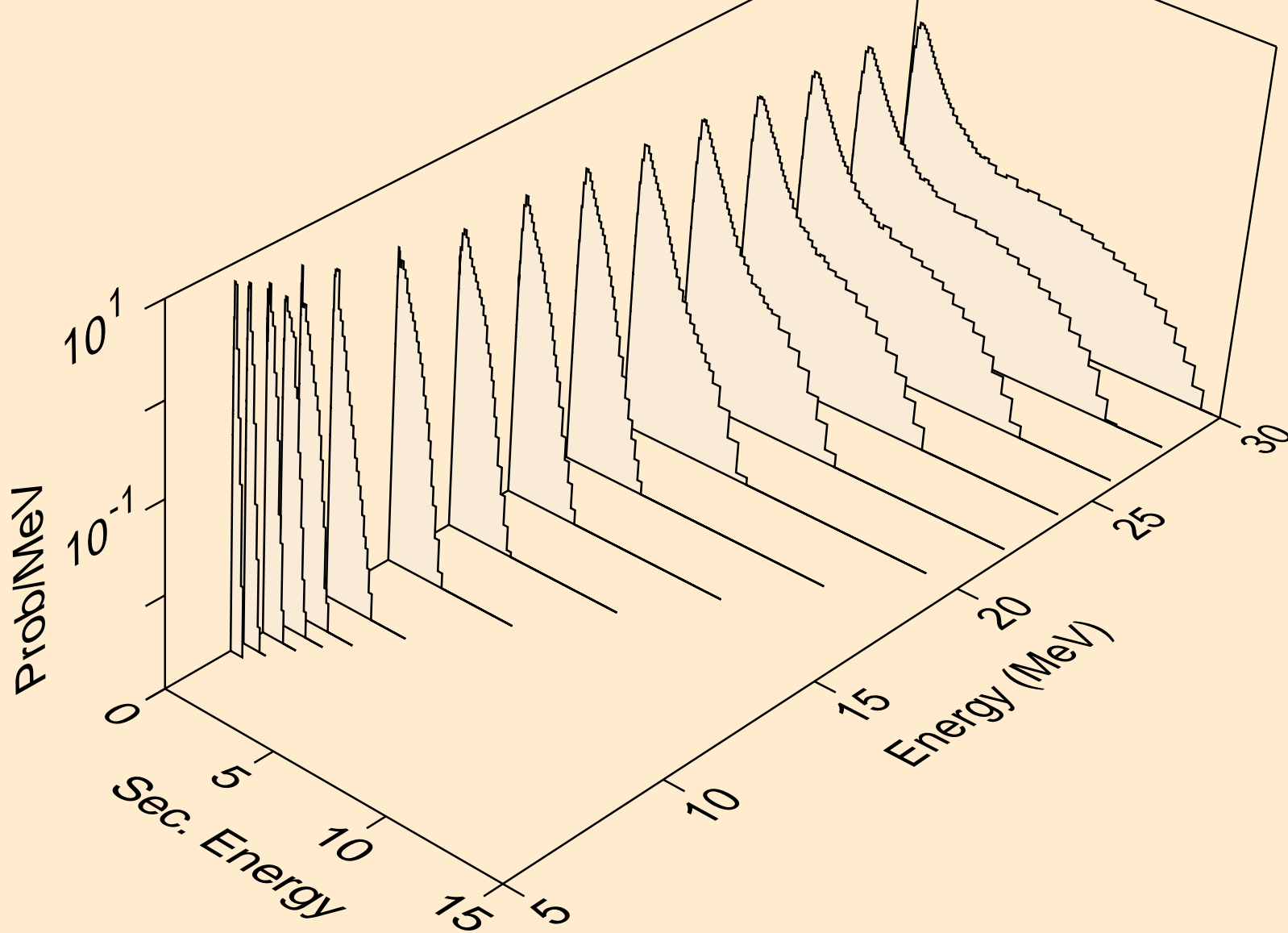

IR191 NEUTRON ACER TENDL-2019 LIBRARY; T=293.16K  
Neutron emission for (n,n\*)2a

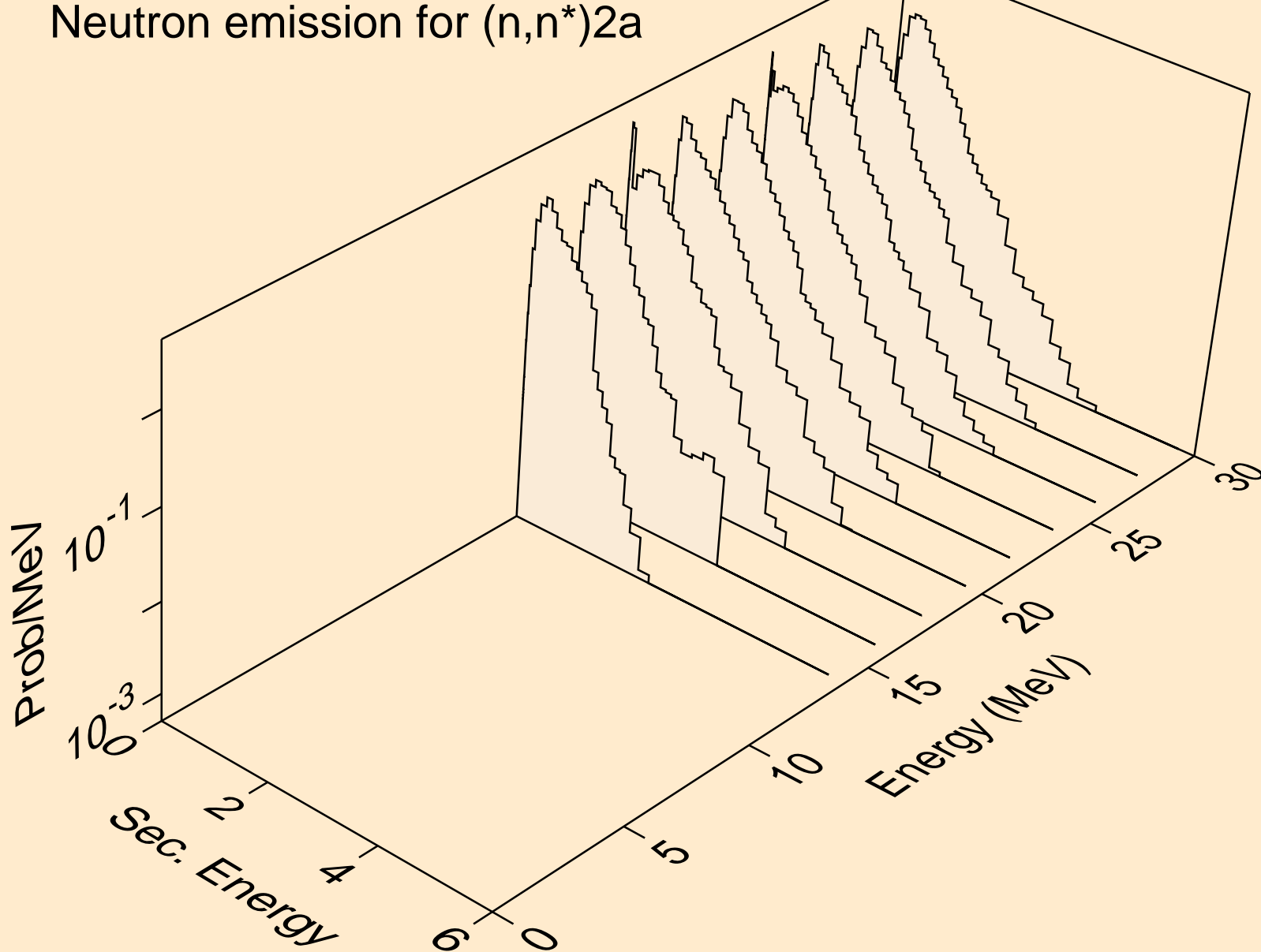

IR191 NEUTRON ACER TENDL-2019 LIBRARY; T=293.16K  
Neutron emission for (n,n\*)d

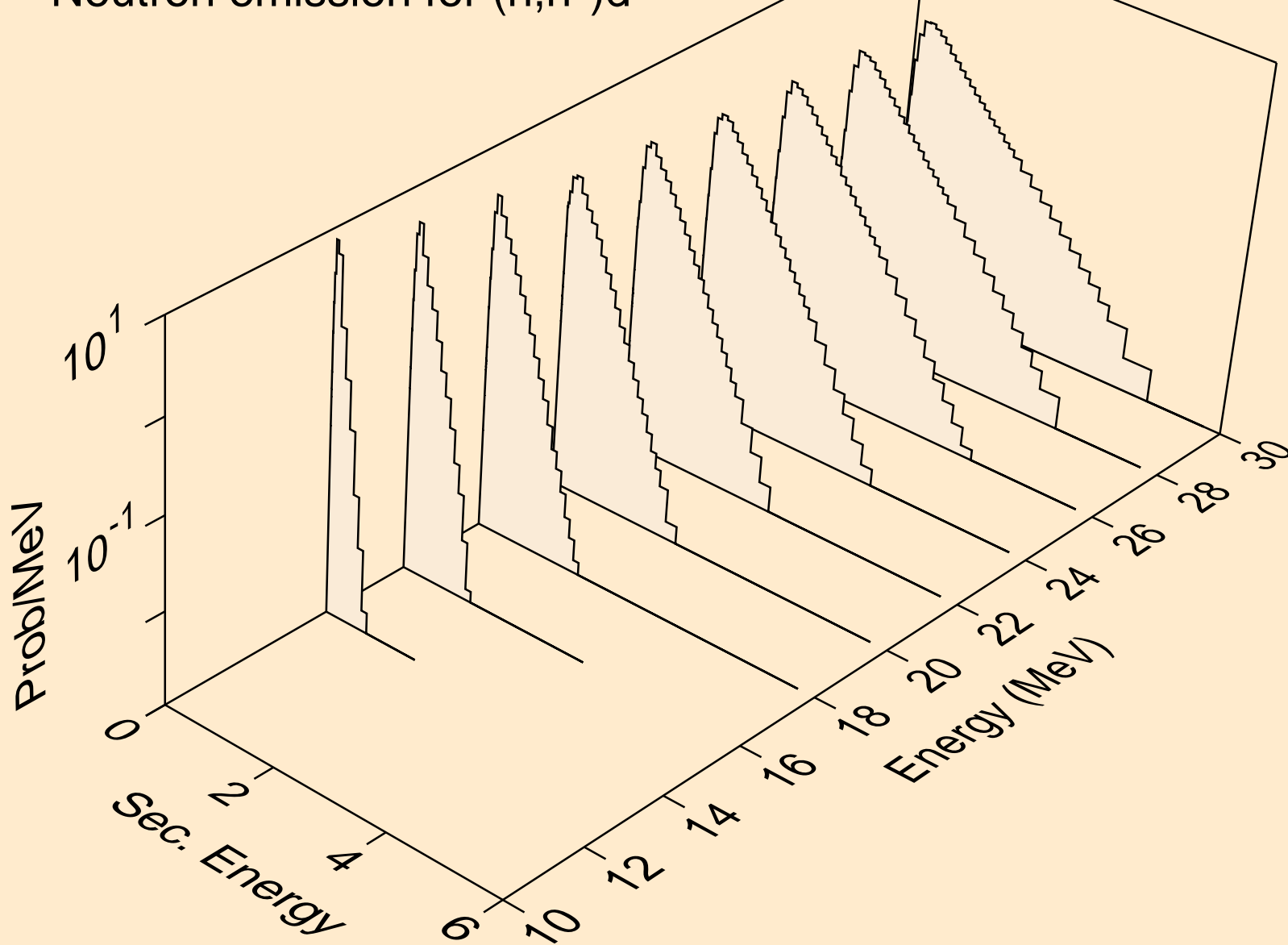



IR191 NEUTRON ACER TENDL-2019 LIBRARY; T=293.16K  
Neutron emission for (n,n\*)t

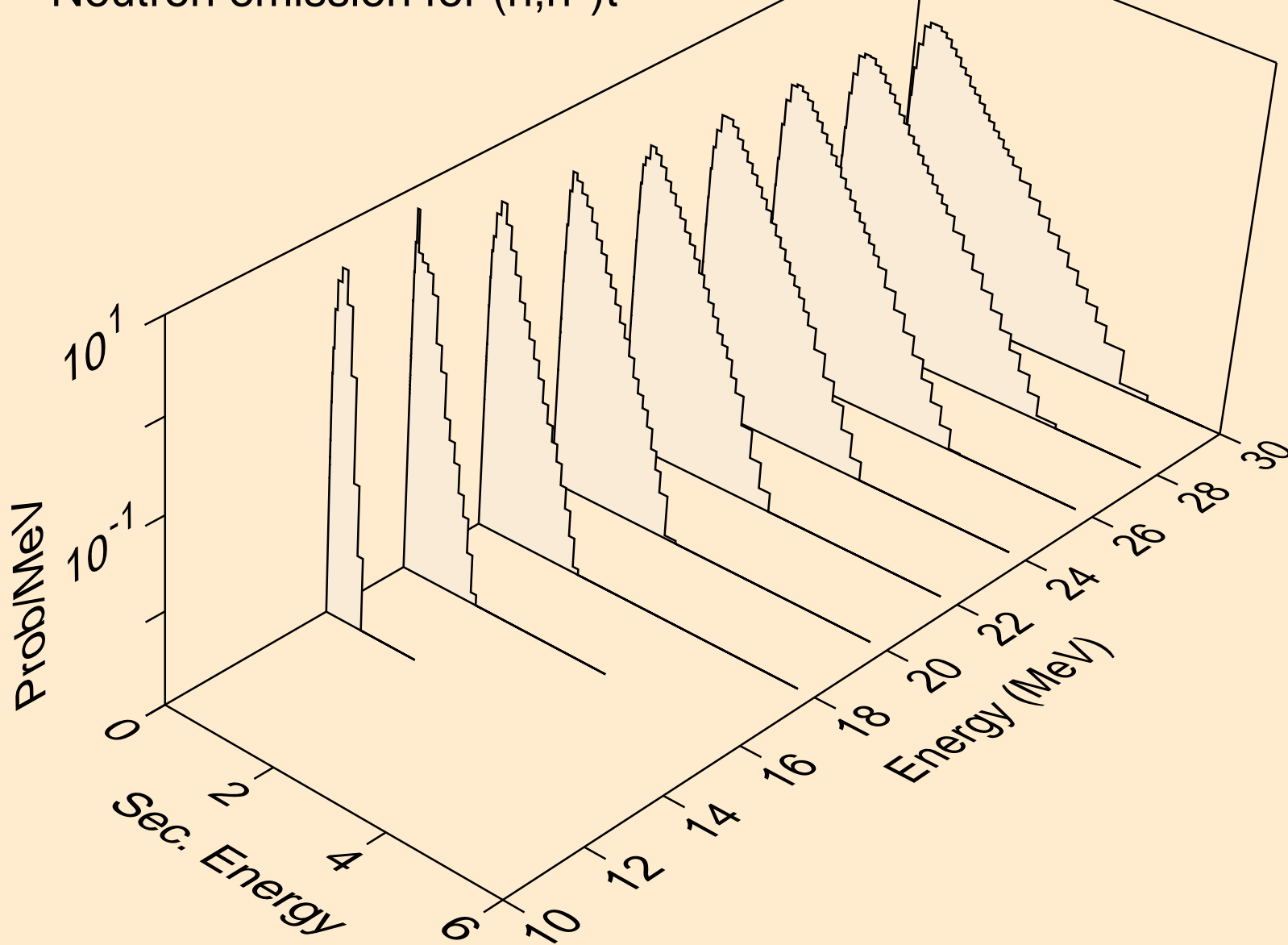

IR191 NEUTRON ACER TENDL-2019 LIBRARY; T=293.16K  
Neutron emission for (n,n\*)he3

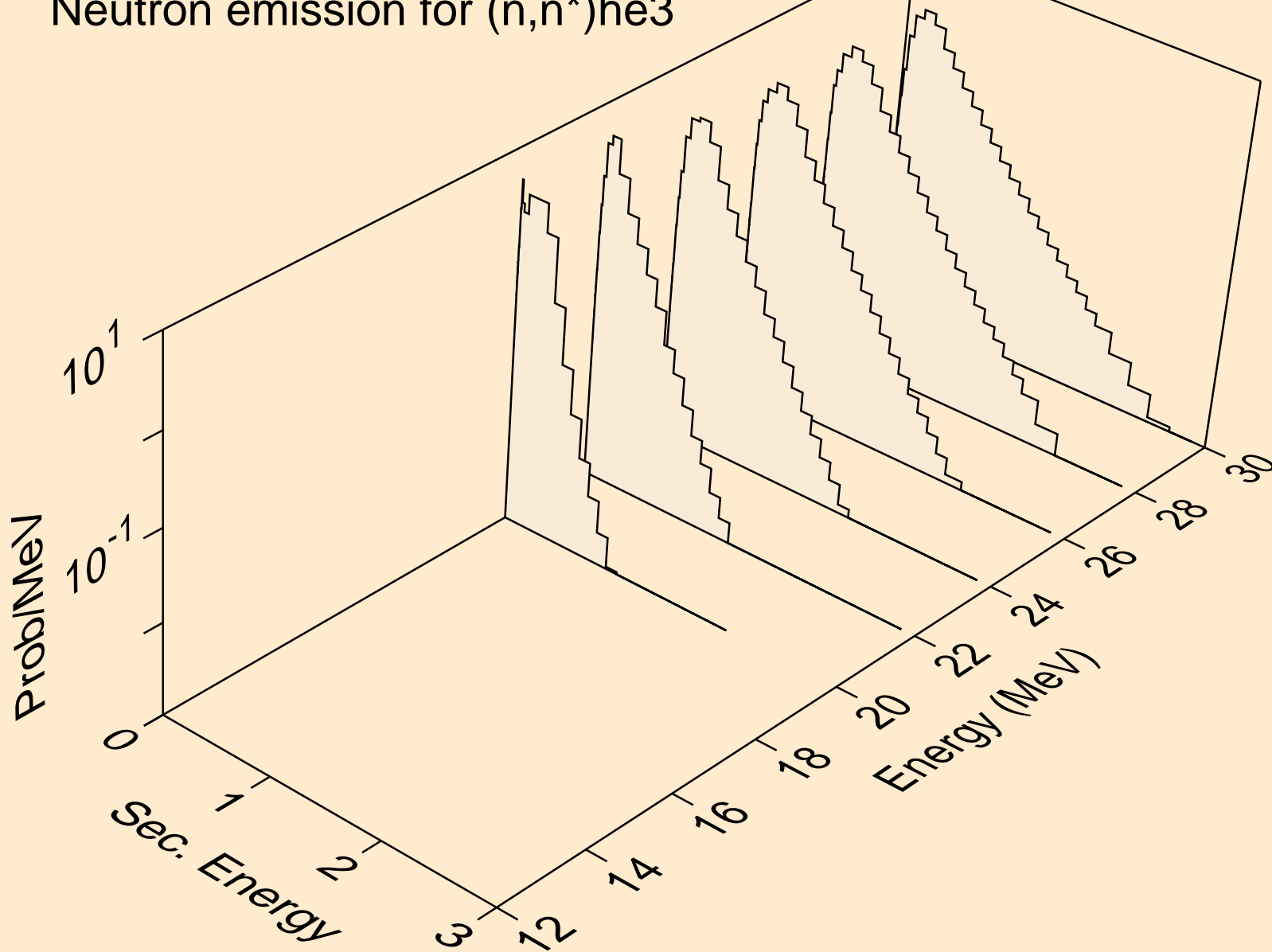

IR191 NEUTRON ACER TENDL-2019 LIBRARY; T=293.16K  
Neutron emission for (n,4n)

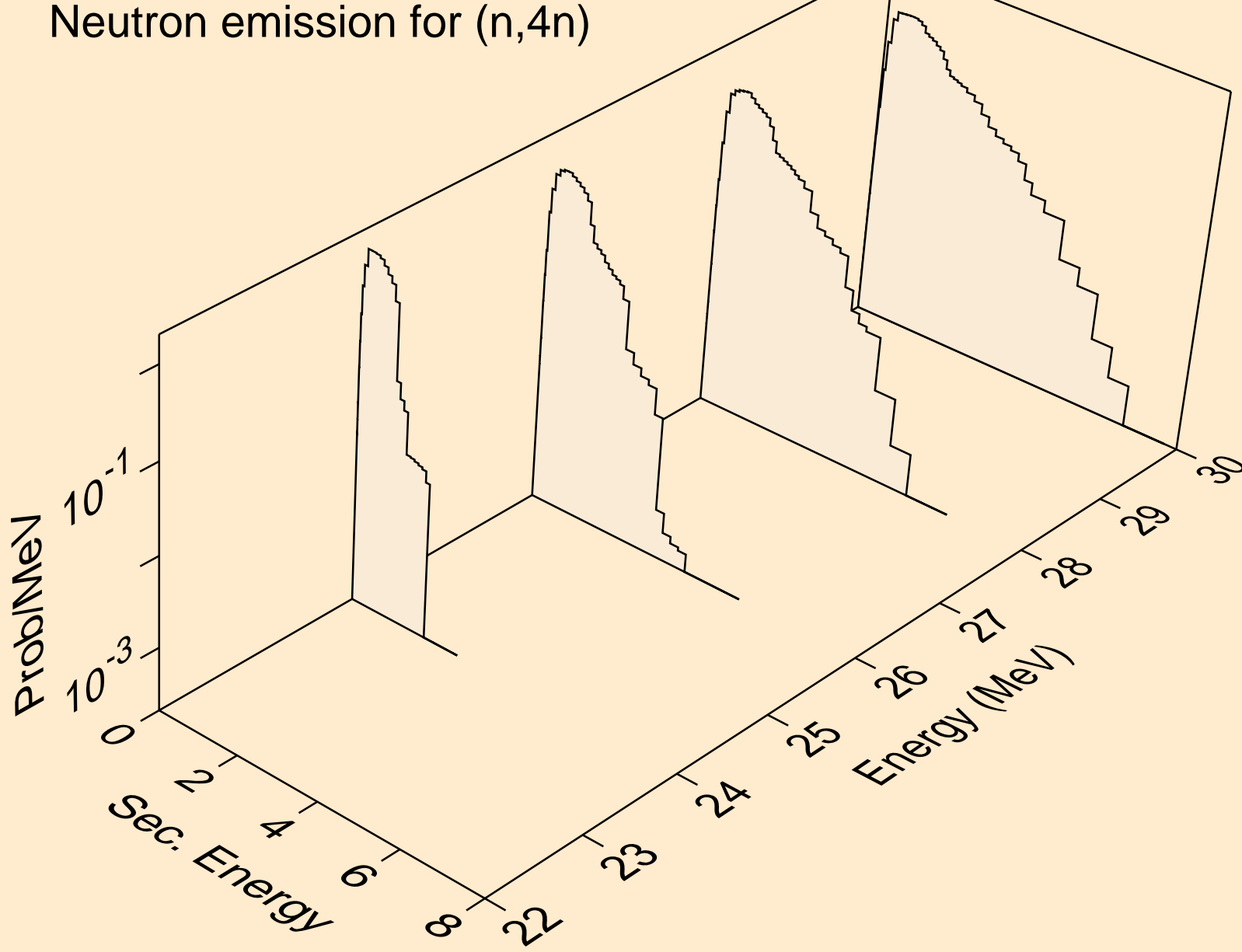

IR191 NEUTRON ACER TENDL-2019 LIBRARY; T=293.16K  
Neutron emission for (n,2np)

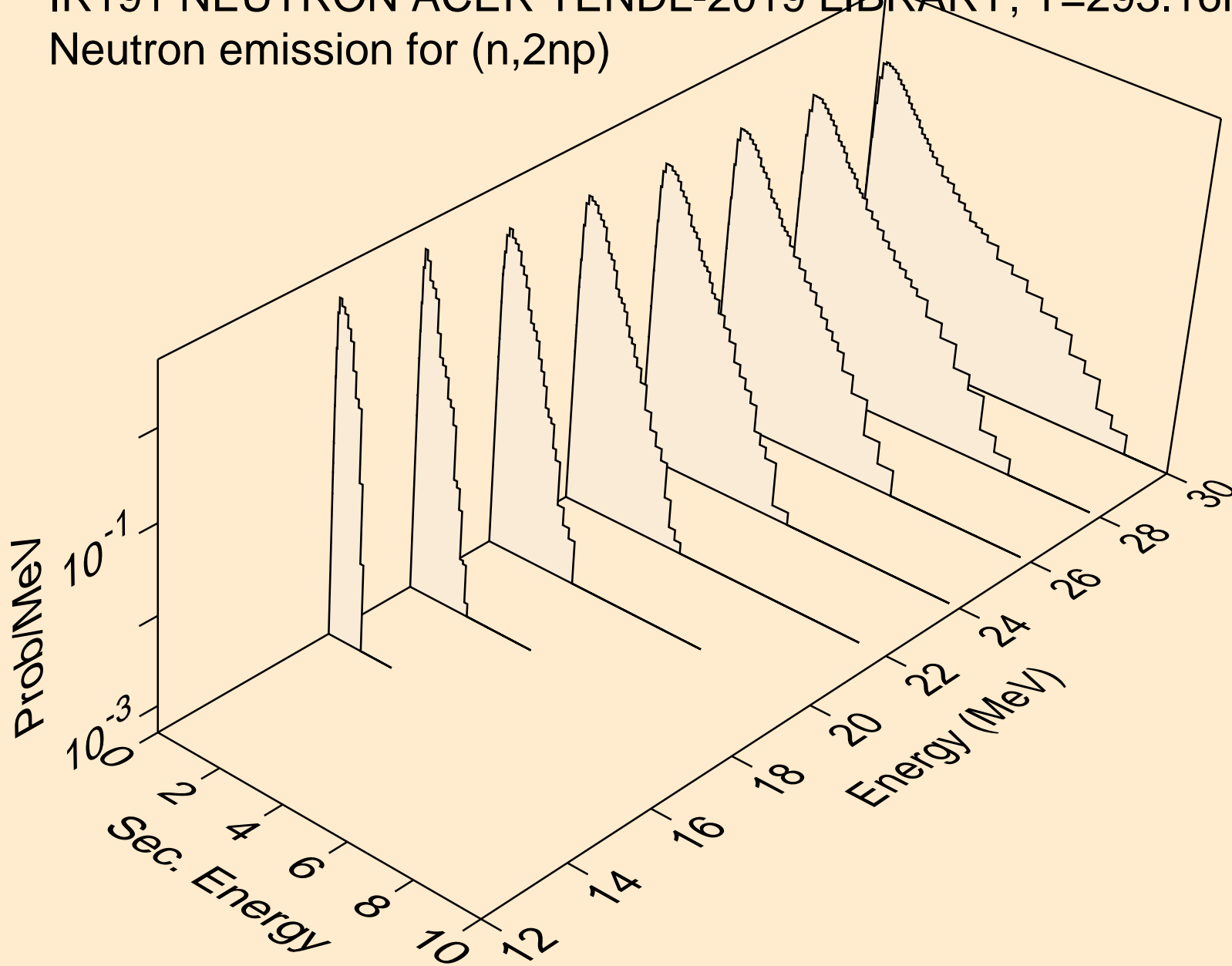

IR191 NEUTRON ACER TENDL-2019 LIBRARY; T=293.16K  
Neutron emission for (n,3np)

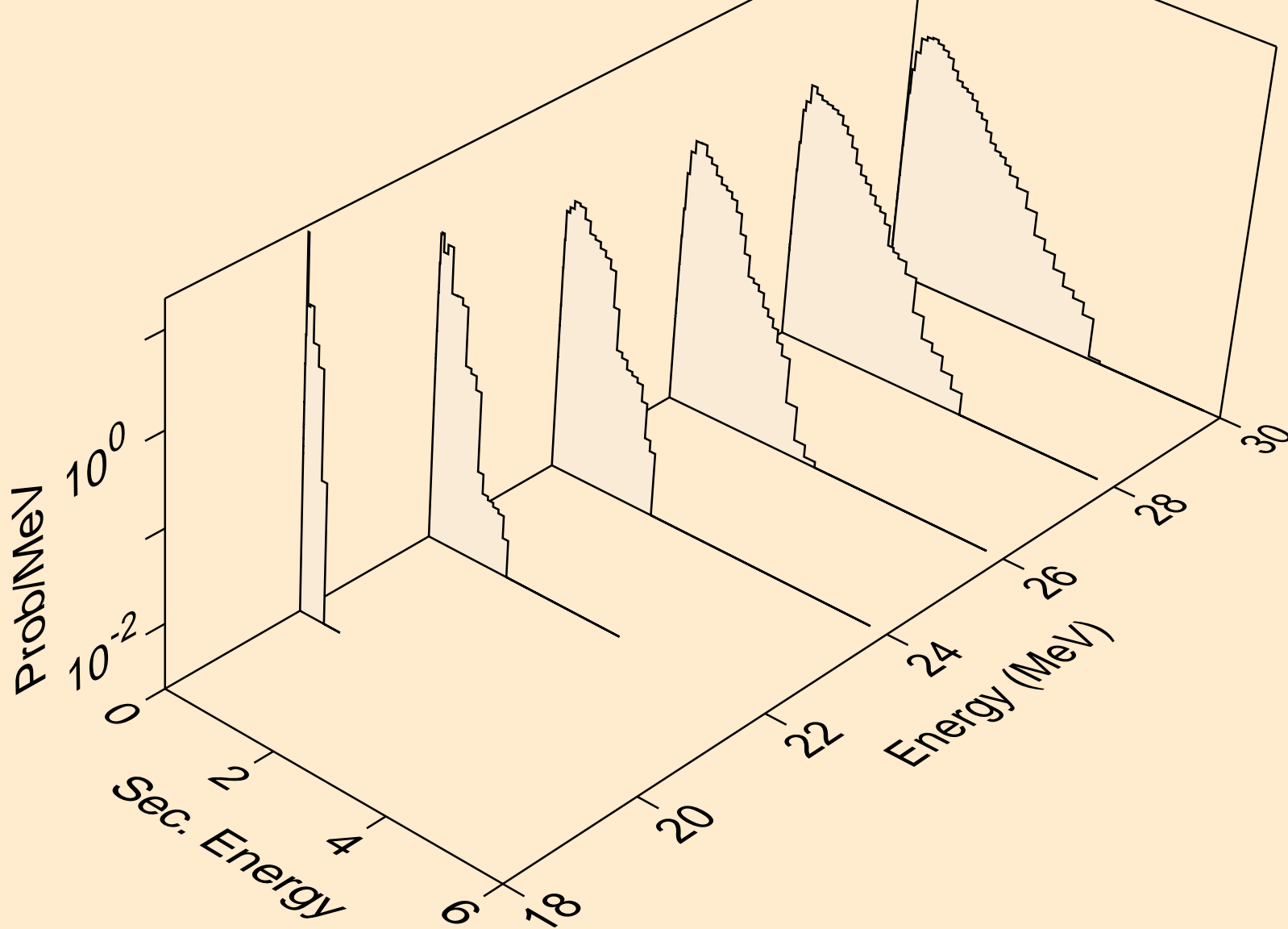

IR191 NEUTRON ACER TENDL-2019 LIBRARY; T=293.16K  
Neutron emission for (n,2np)

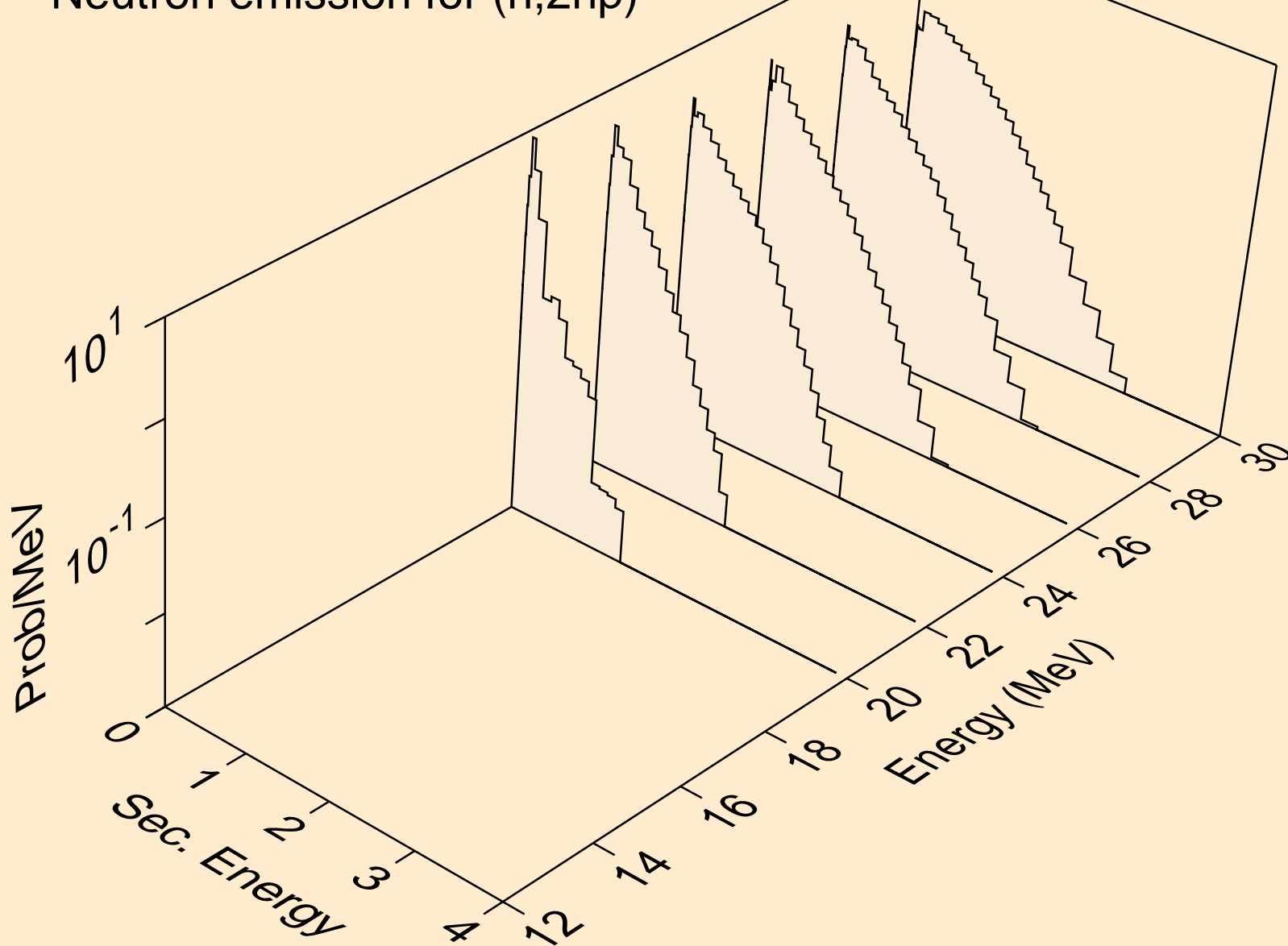

IR191 NEUTRON ACER TENDL-2019 LIBRARY; T=293.16K  
Neutron emission for (n,npa)

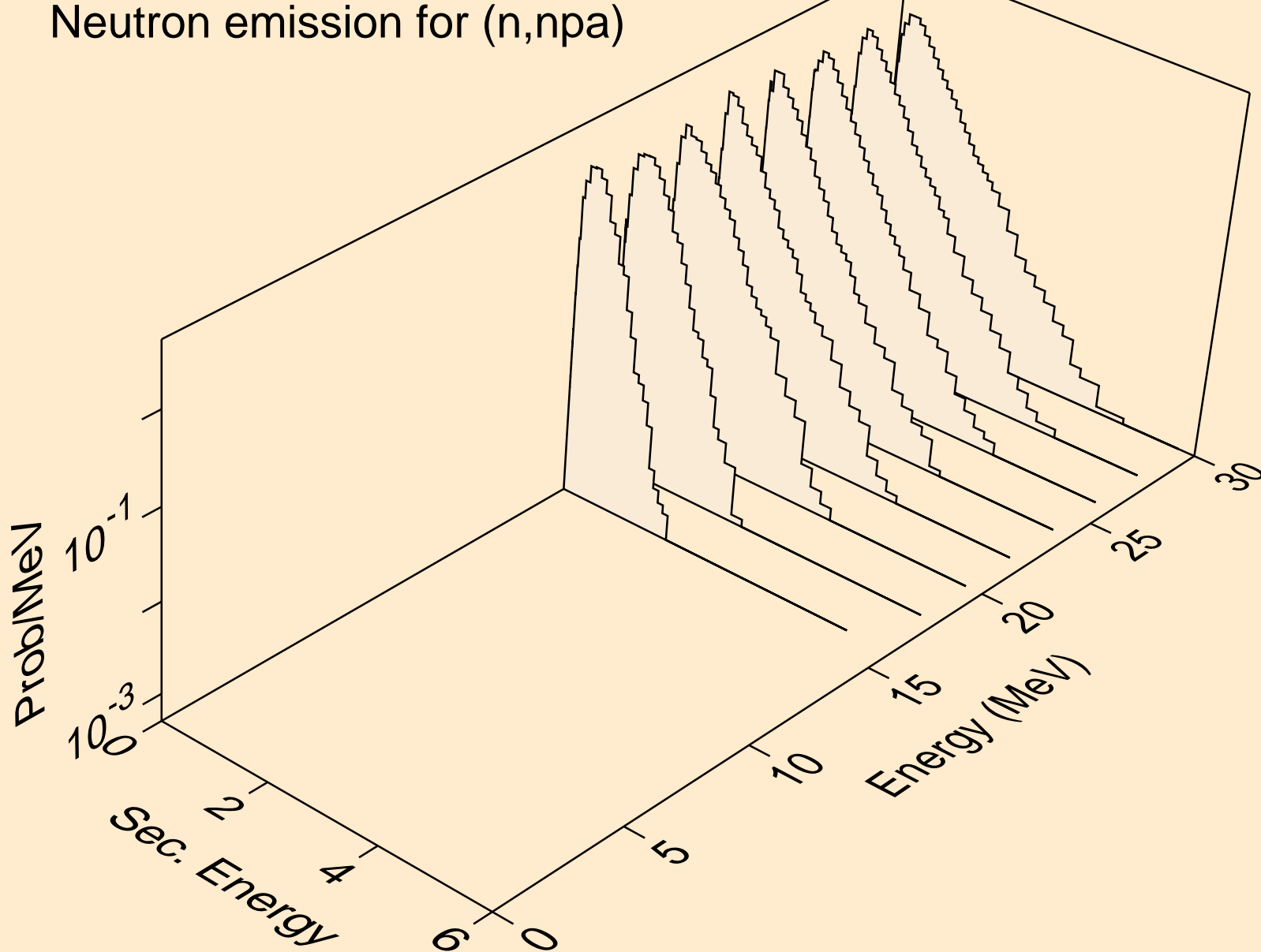

IR191 NEUTRON ACER TENDL-2019 LIBRARY; T=293.16K  
Neutron emission for (n,n\*c)

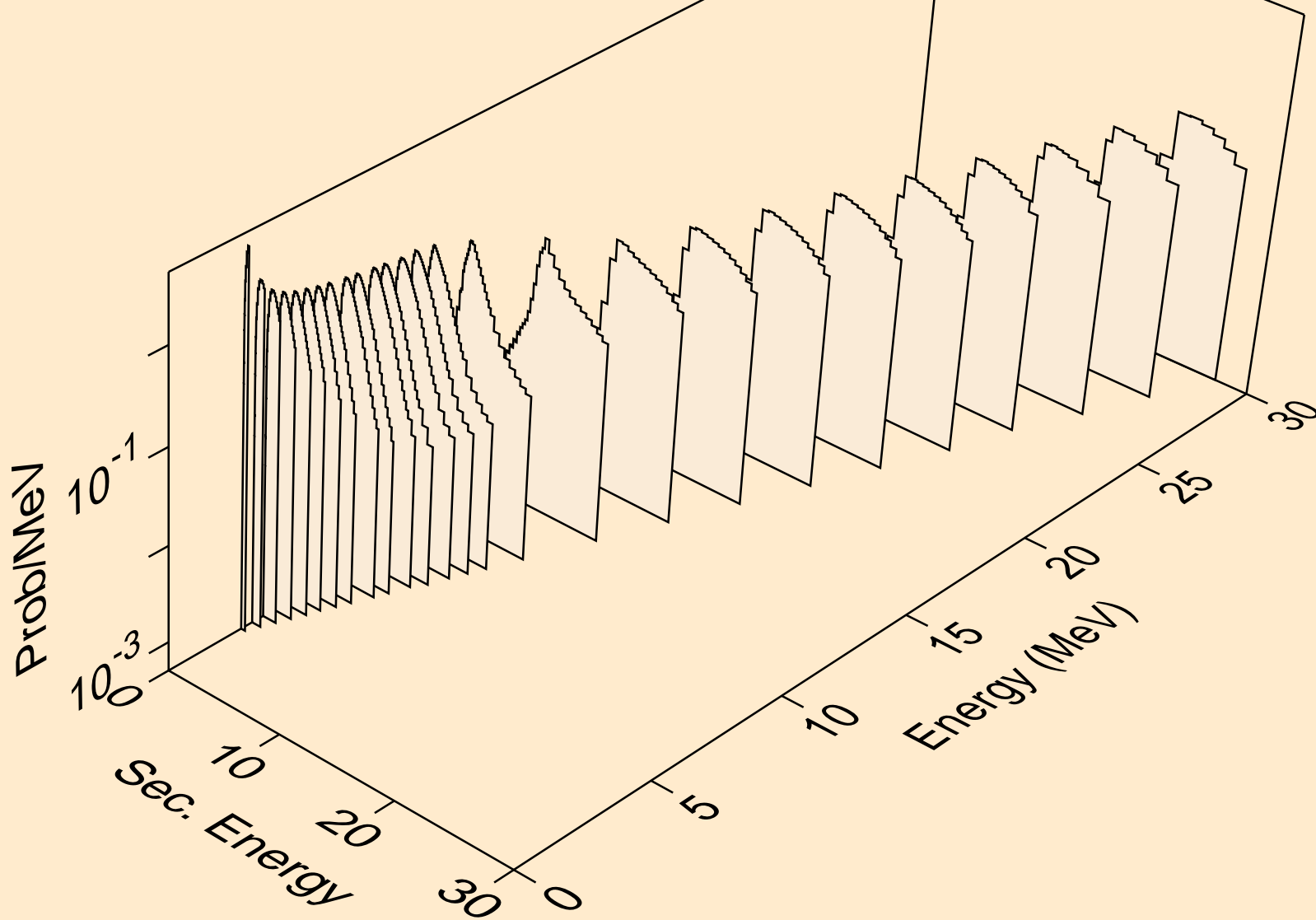



IR191 NEUTRON ACER TENDL-2019 LIBRARY; T=293.16K  
Photon emission for (n,x)

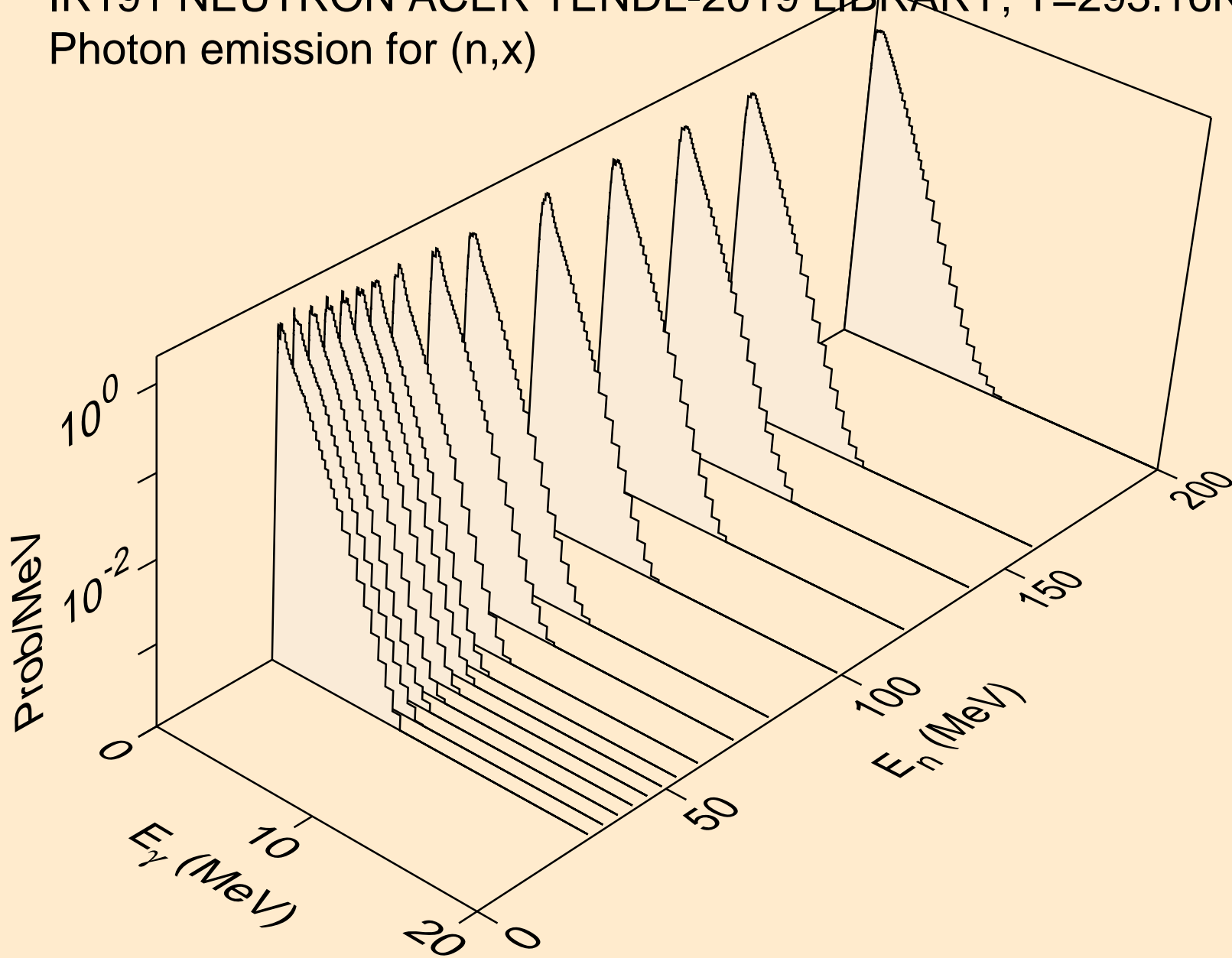

IR191 NEUTRON ACER TENDL-2019 LIBRARY; T=293.16K  
Photon emission for (n,2nd)

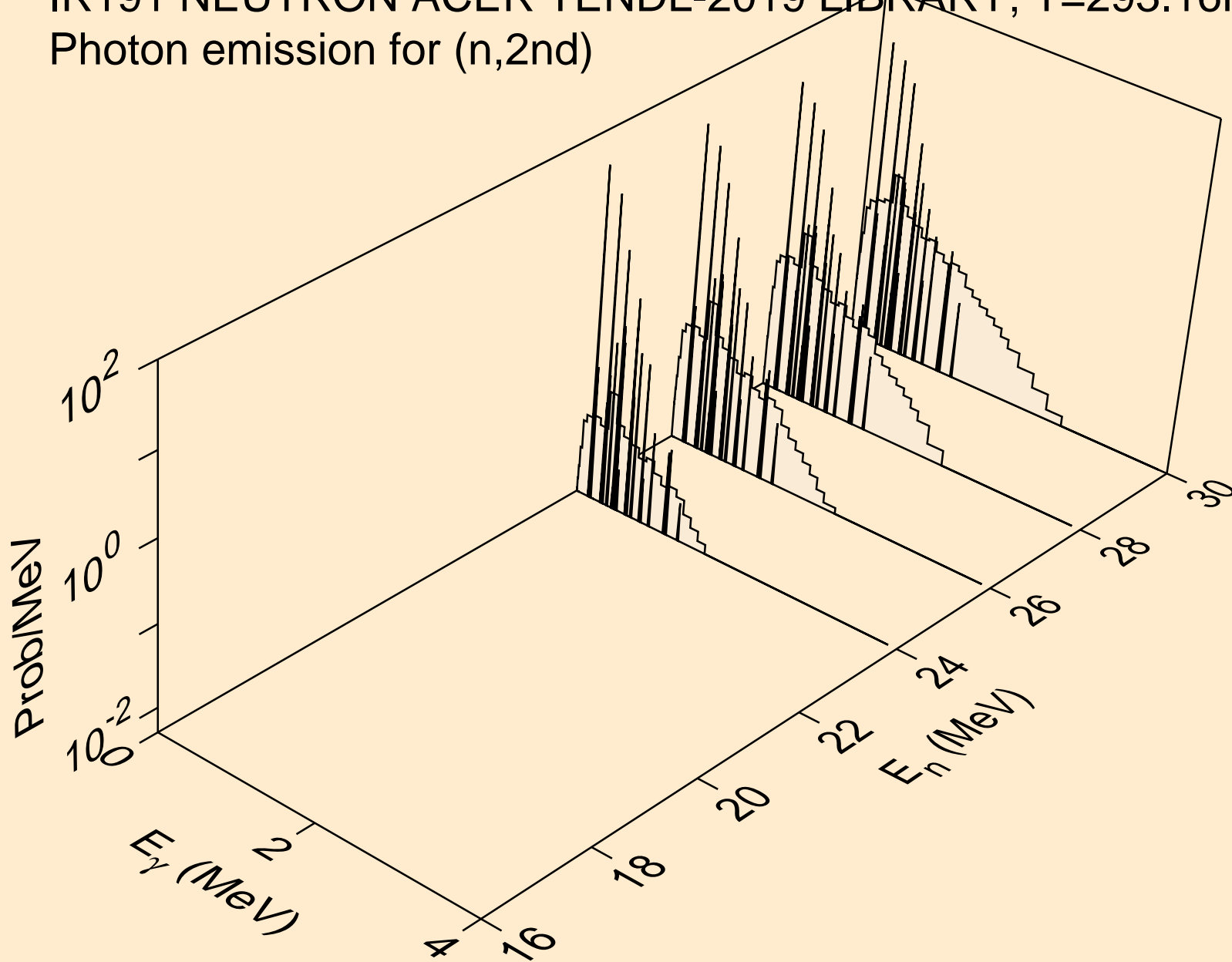

IR191 NEUTRON ACER TENDL-2019 LIBRARY; T=293.16K  
Photon emission for (n,2n)

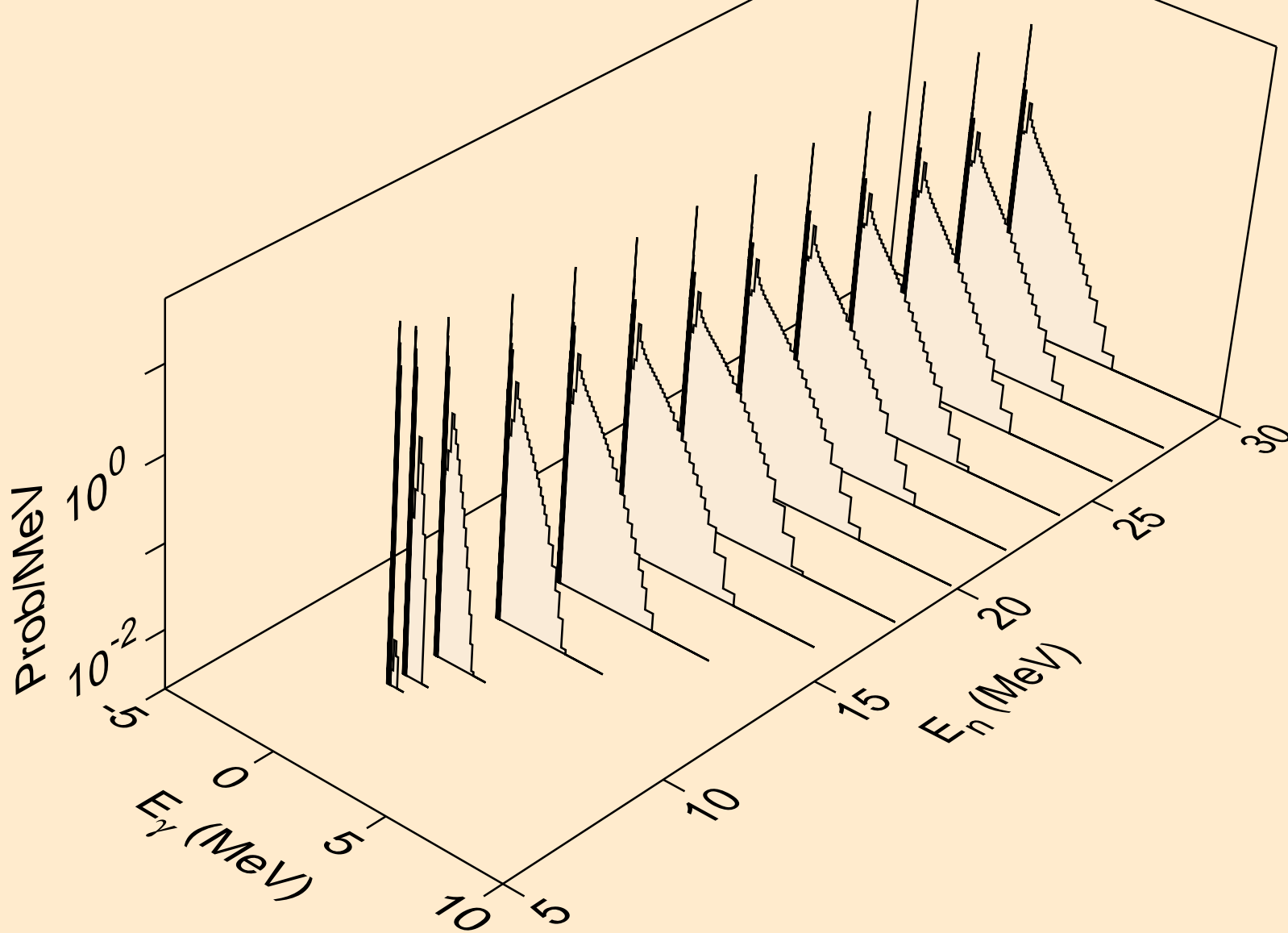

IR191 NEUTRON ACER TENDL-2019 LIBRARY; T=293.16K  
Photon emission for (n,3n)

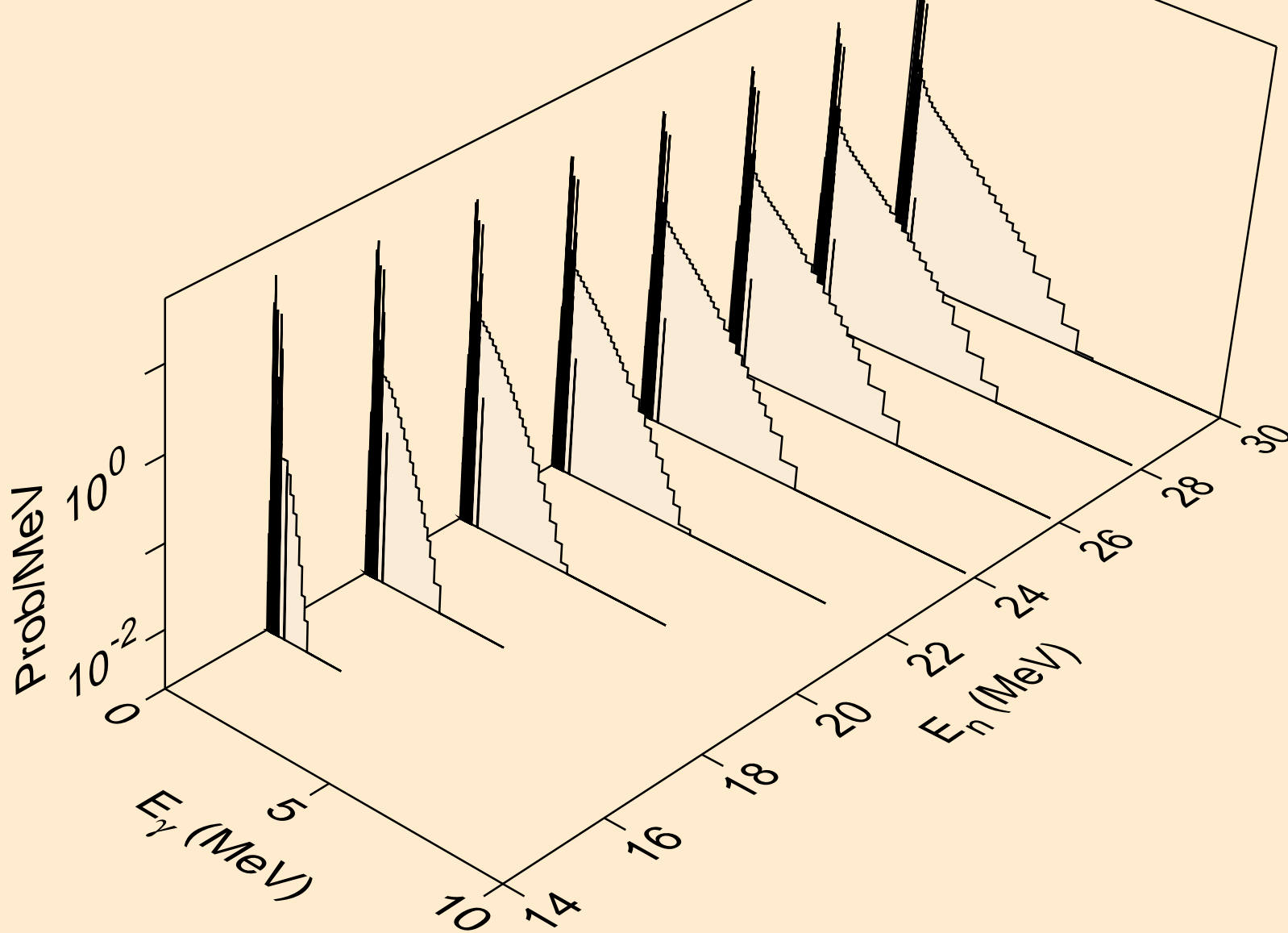

IR191 NEUTRON ACER TENDL-2019 LIBRARY; T=293.16K  
Photon emission for (n,n\*)a

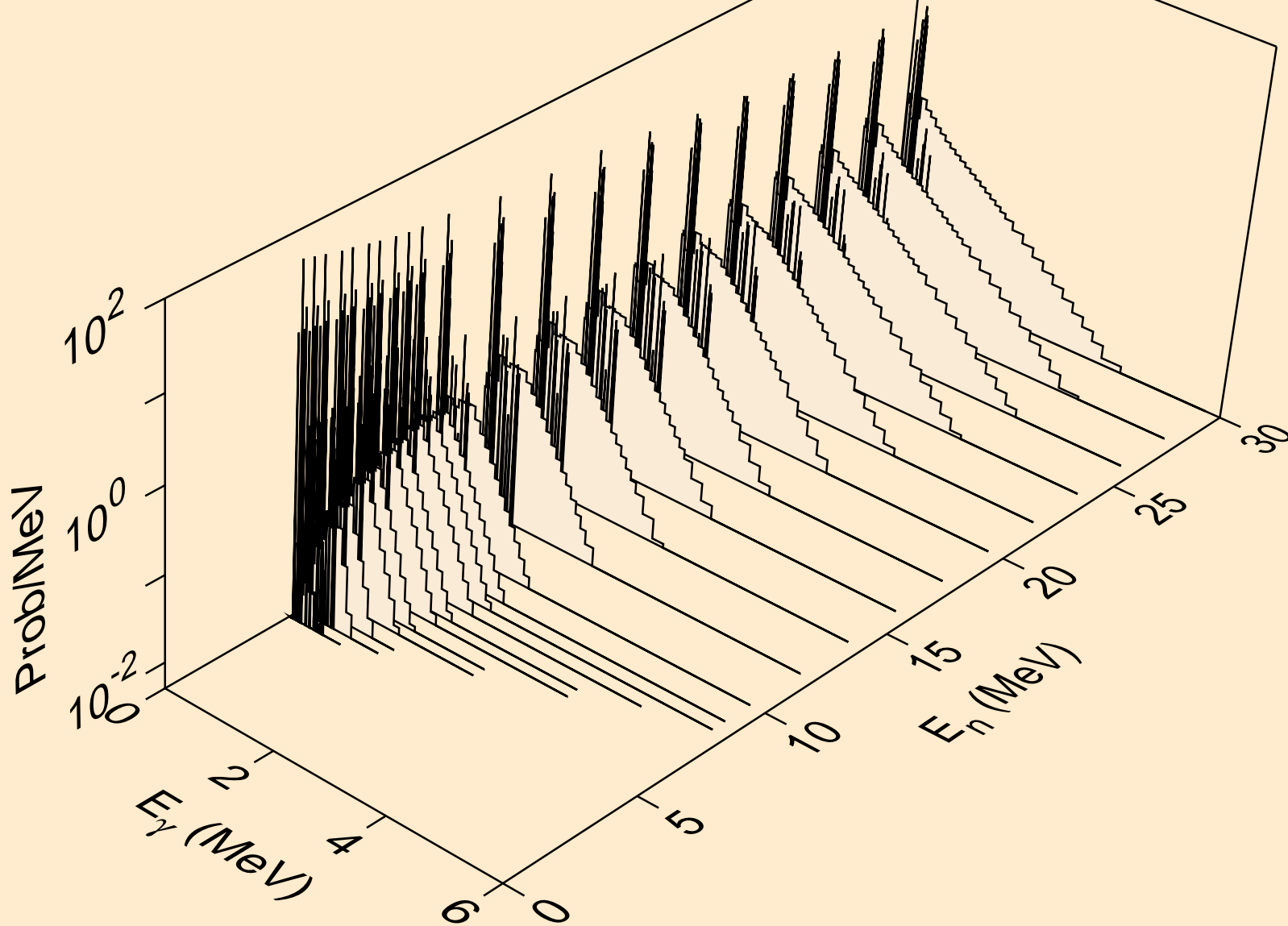

IR191 NEUTRON ACER TENDL-2019 LIBRARY; T=293.16K  
Photon emission for (n,2n)a

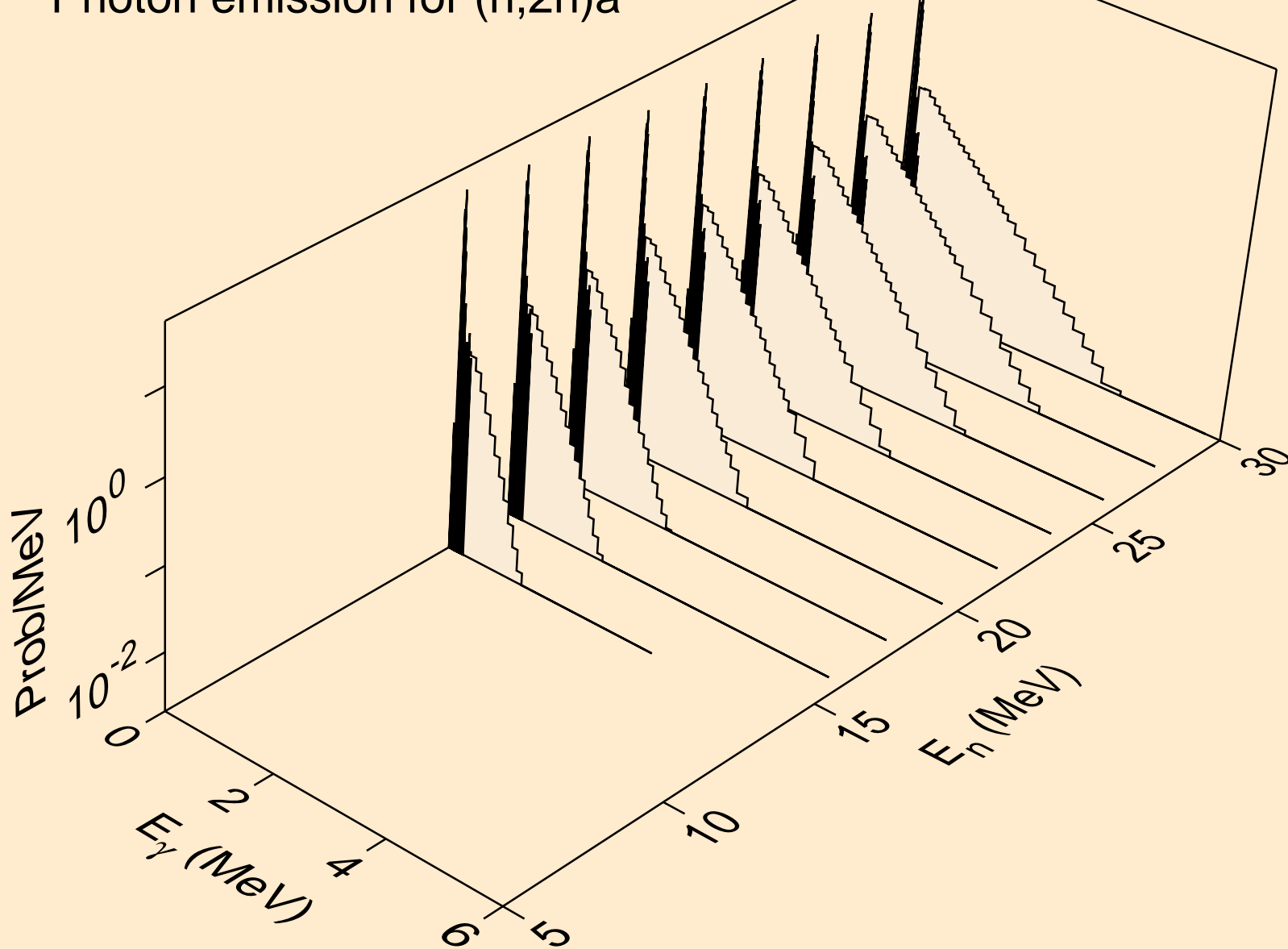

IR191 NEUTRON ACER TENDL-2019 LIBRARY; T=293.16K  
Photon emission for (n,3n)a

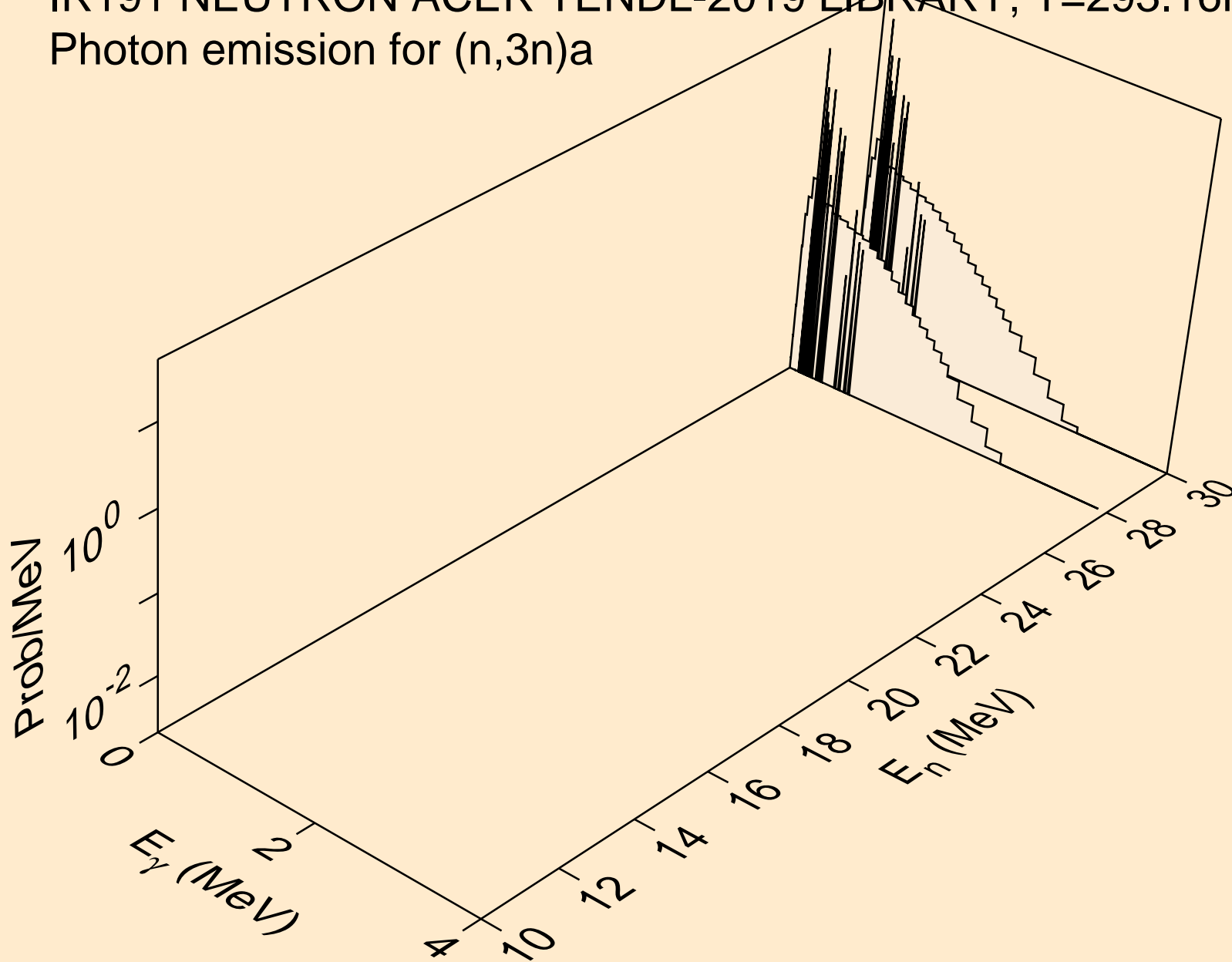

IR191 NEUTRON ACER TENDL-2019 LIBRARY; T=293.16K  
Photon emission for (n,n\*)p

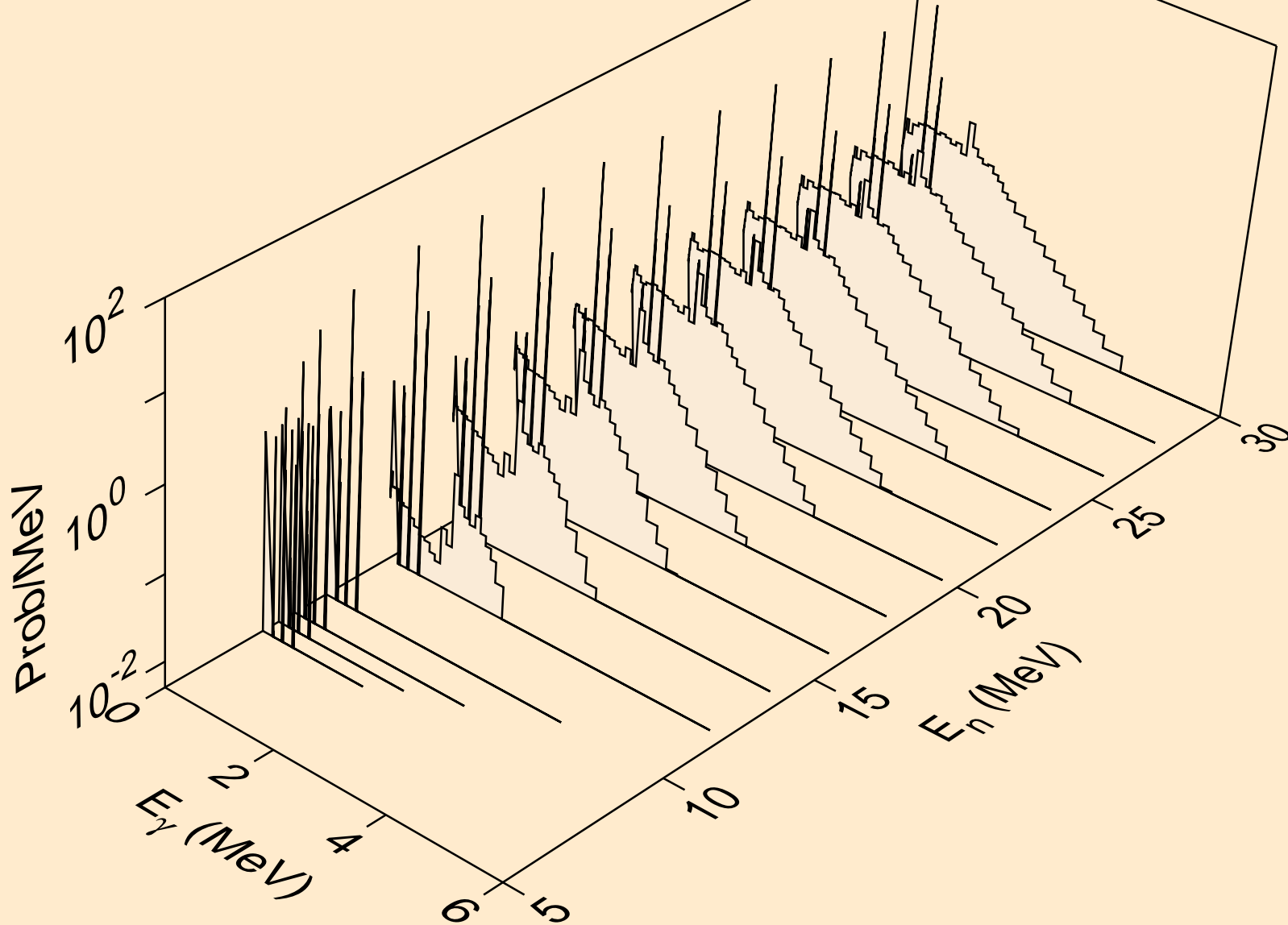



IR191 NEUTRON ACER TENDL-2019 LIBRARY; T=293.16K  
Photon emission for (n,n\*)2a

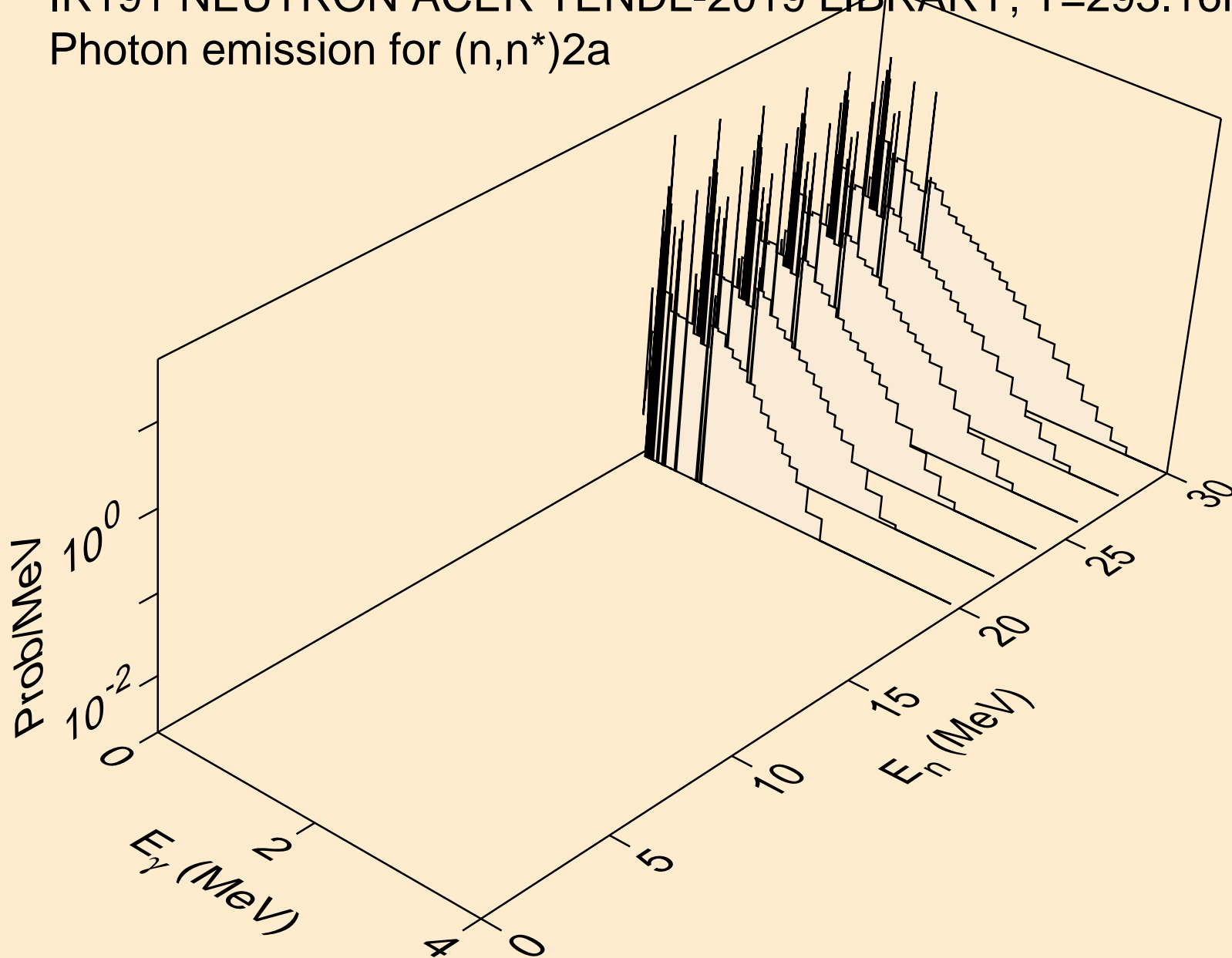

IR191 NEUTRON ACER TENDL-2019 LIBRARY; T=293.16K  
Photon emission for (n,n\*)d

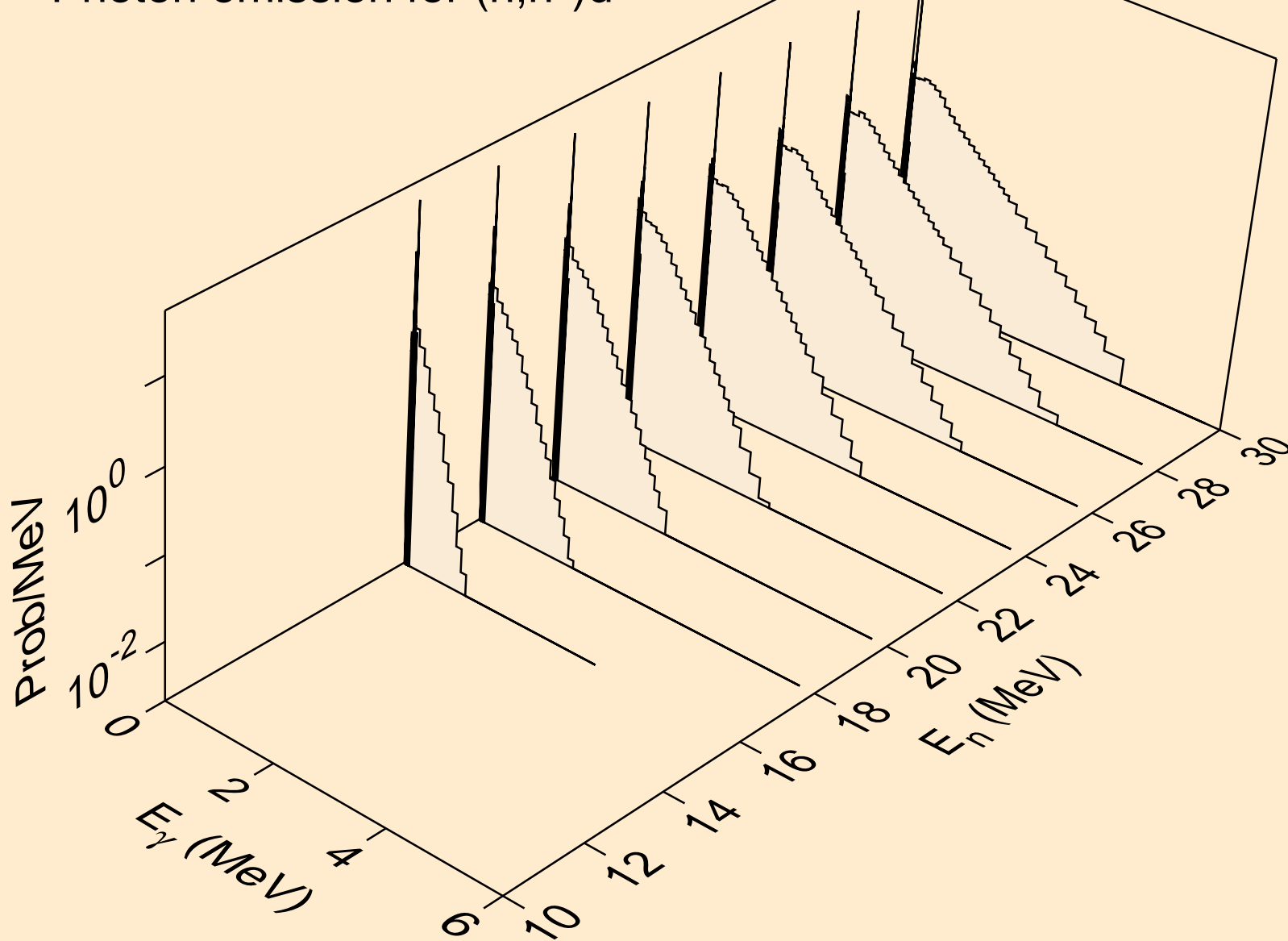

IR191 NEUTRON ACER TENDL-2019 LIBRARY; T=293.16K  
Photon emission for (n,n\*)t

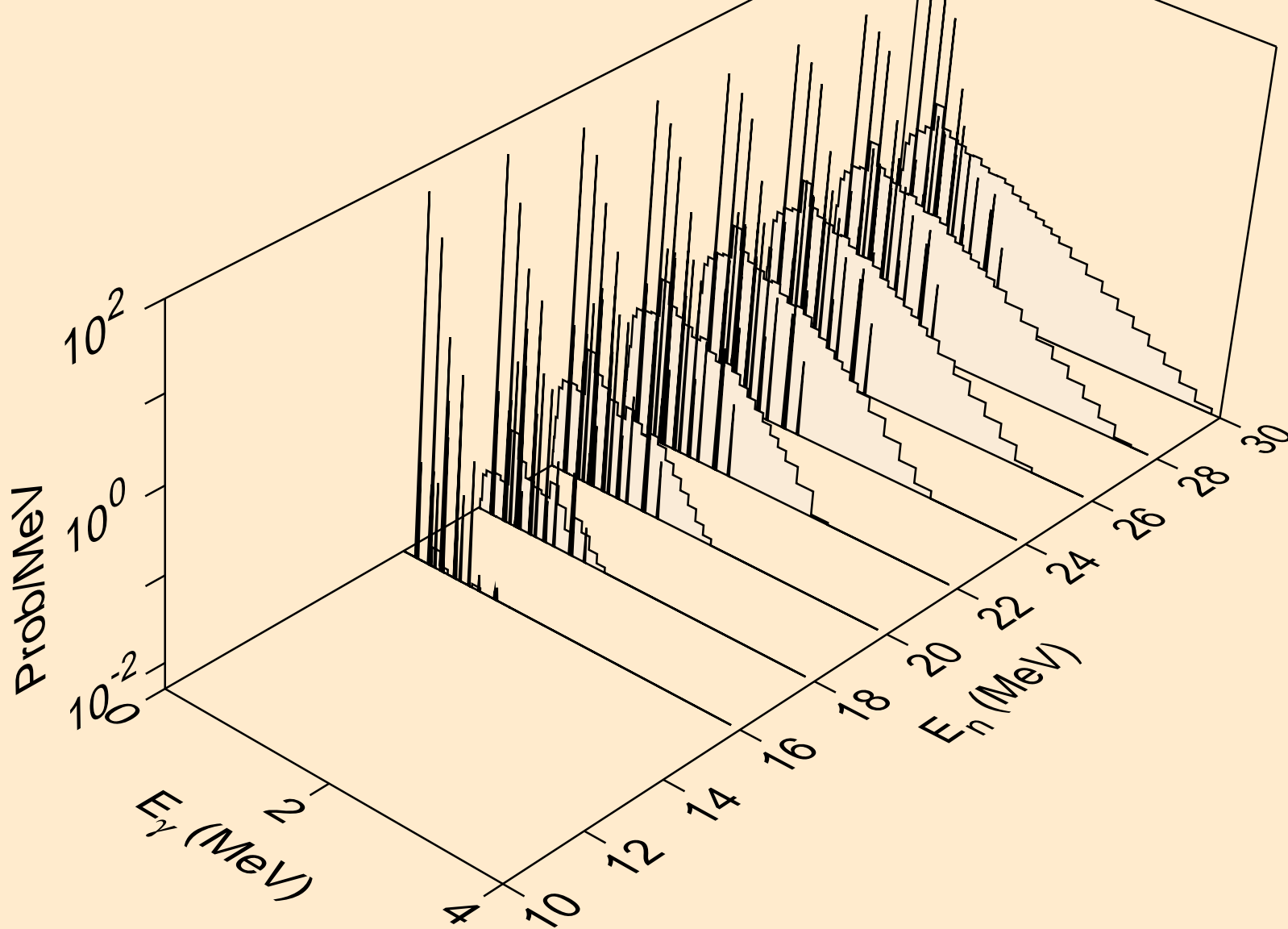

IR191 NEUTRON ACER TENDL-2019 LIBRARY; T=293.16K  
Photon emission for (n,n\*)he3

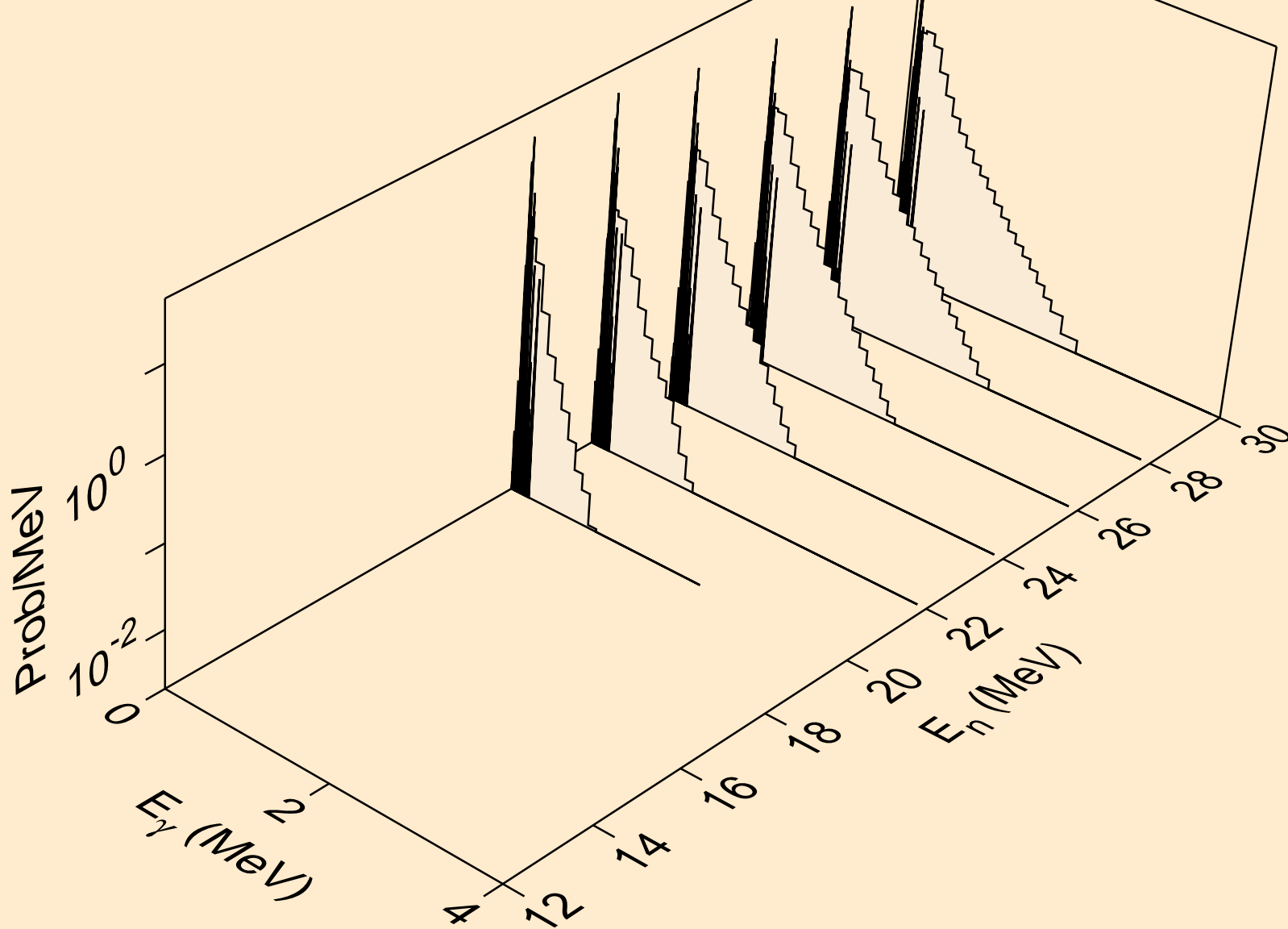

IR191 NEUTRON ACER TENDL-2019 LIBRARY; T=293.16K  
Photon emission for (n,4n)

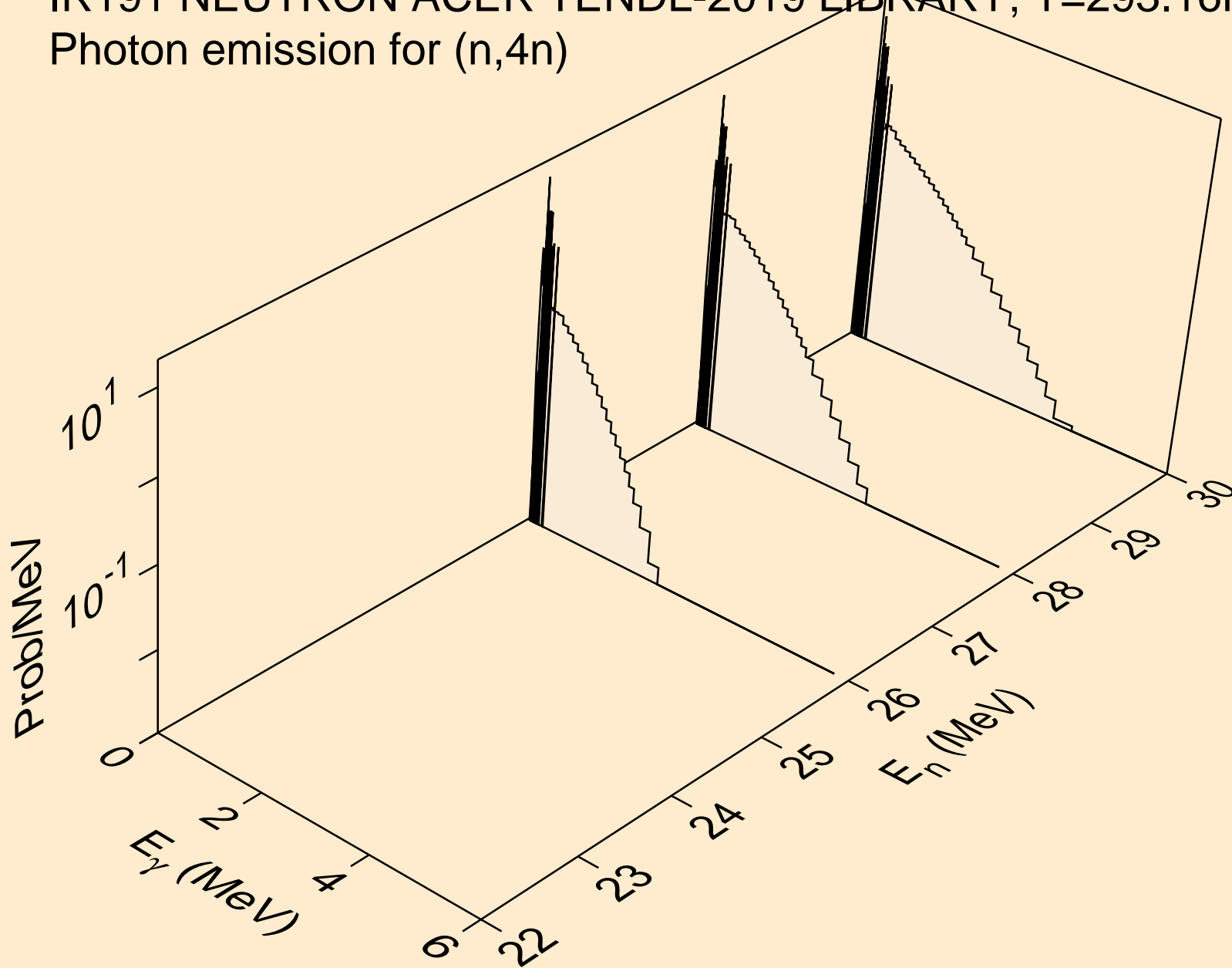

IR191 NEUTRON ACER TENDL-2019 LIBRARY; T=293.16K  
Photon emission for (n,2np)

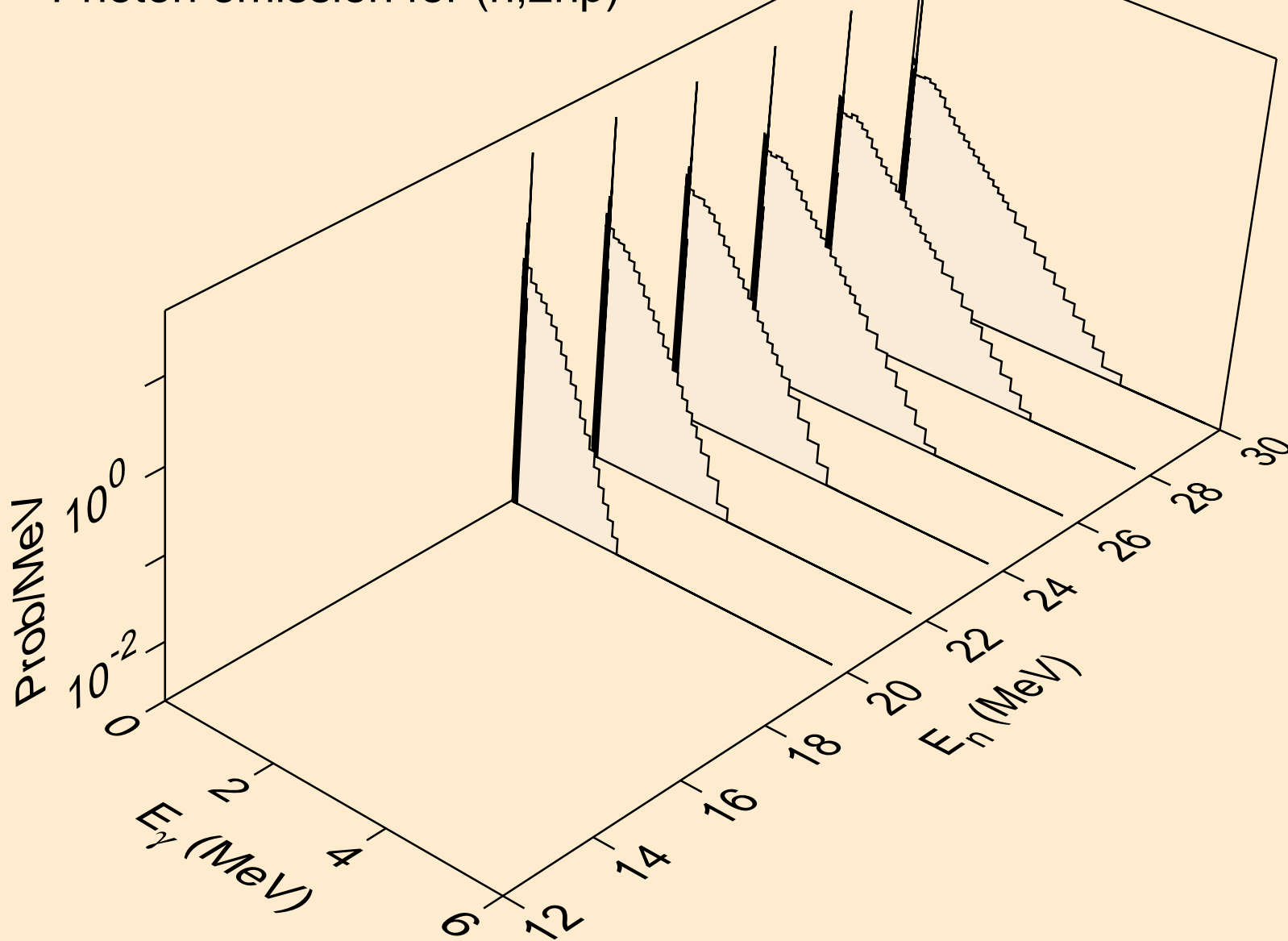

IR191 NEUTRON ACER TENDL-2019 LIBRARY; T=293.16K  
Photon emission for (n,3np)

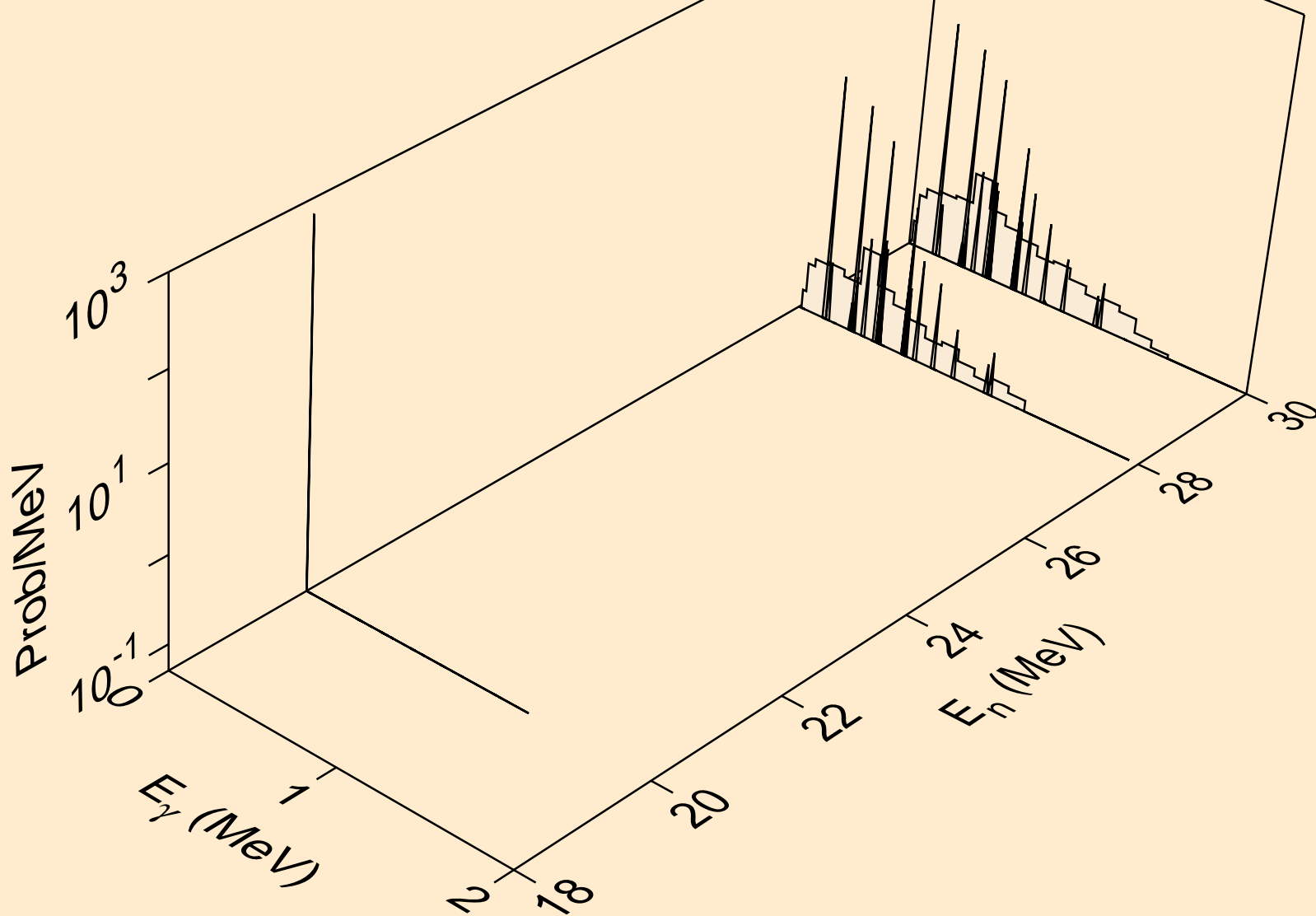

IR191 NEUTRON ACER TENDL-2019 LIBRARY; T=293.16K  
Photon emission for (n,2np)

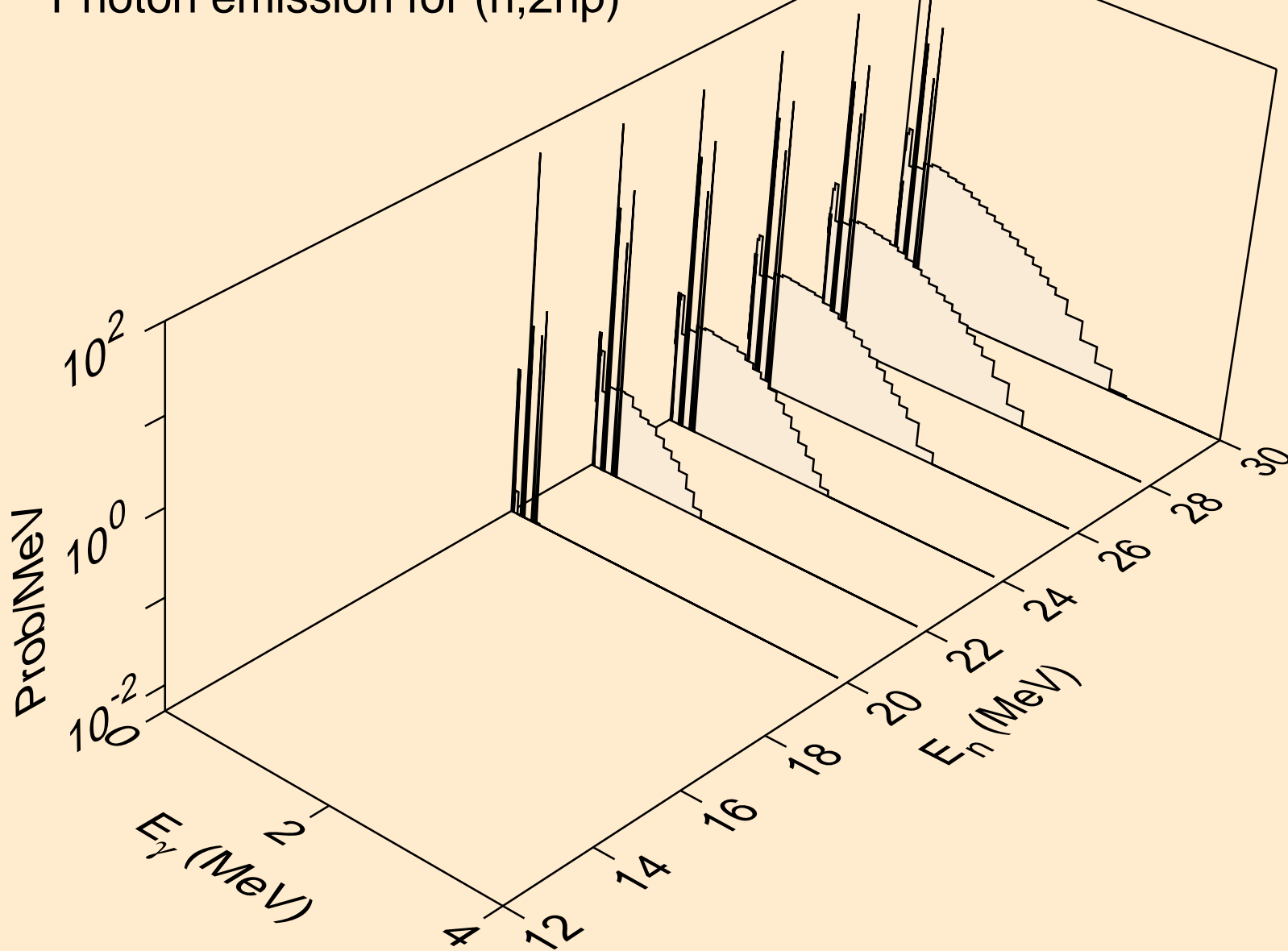



IR191 NEUTRON ACER TENDL-2019 LIBRARY; T=293.16K  
Photon emission for (n,npa)

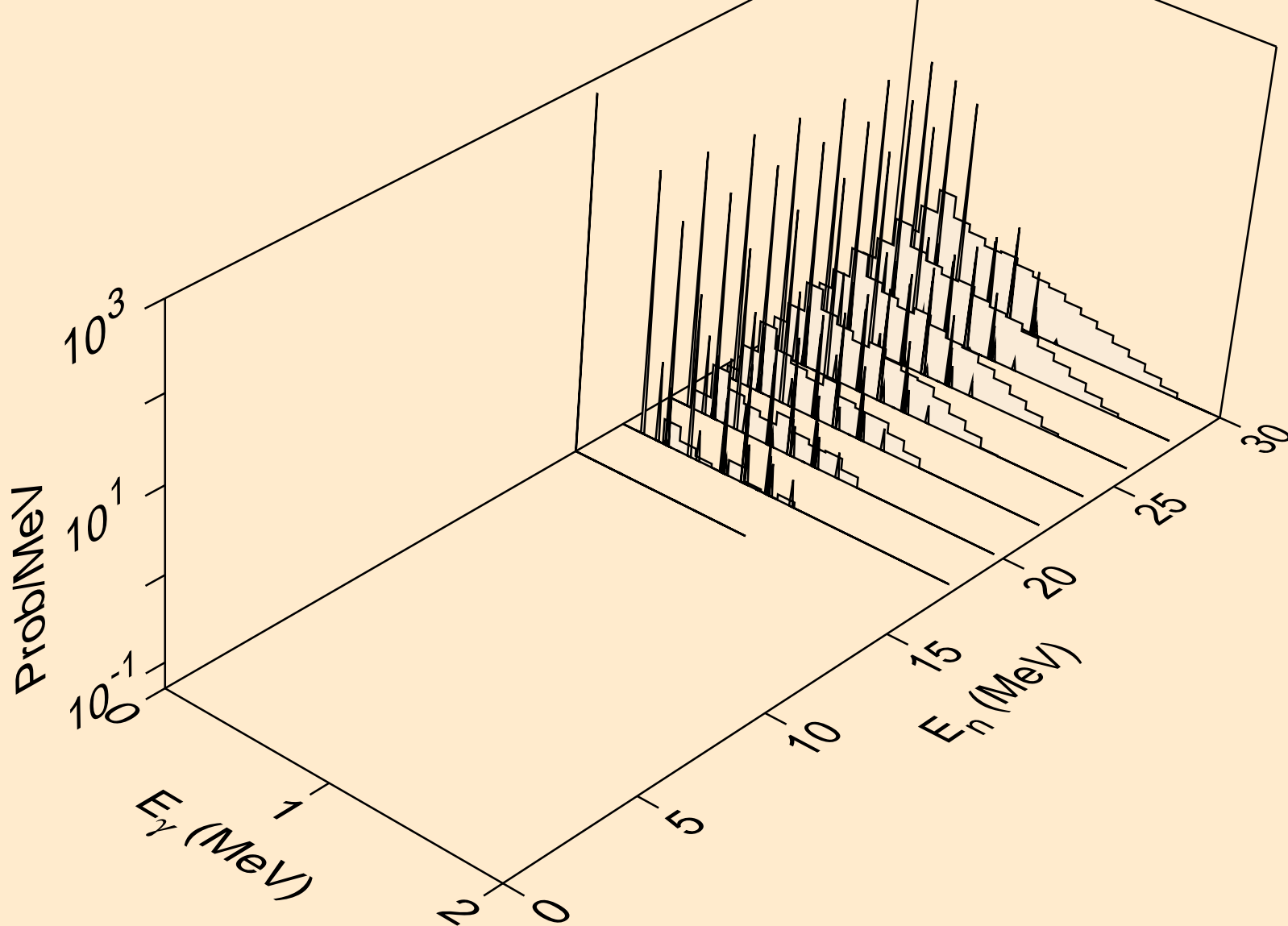

IR191 NEUTRON ACER TENDL-2019 LIBRARY; T=293.16K  
Photon emission for (n,n\*c)

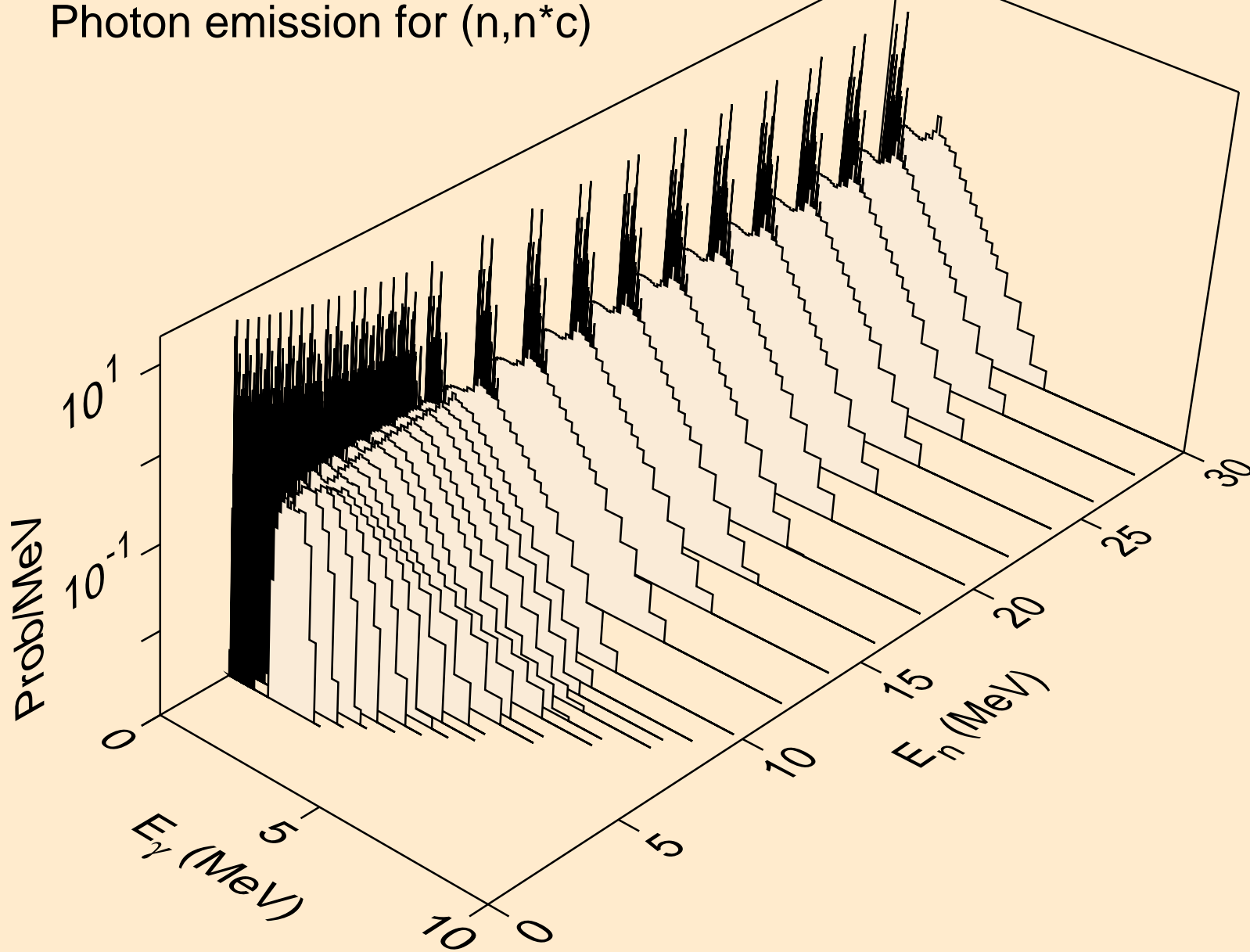

IR191 NEUTRON ACER TENDL-2019 LIBRARY; T=293.16K  
Photon emission for (n,gma)

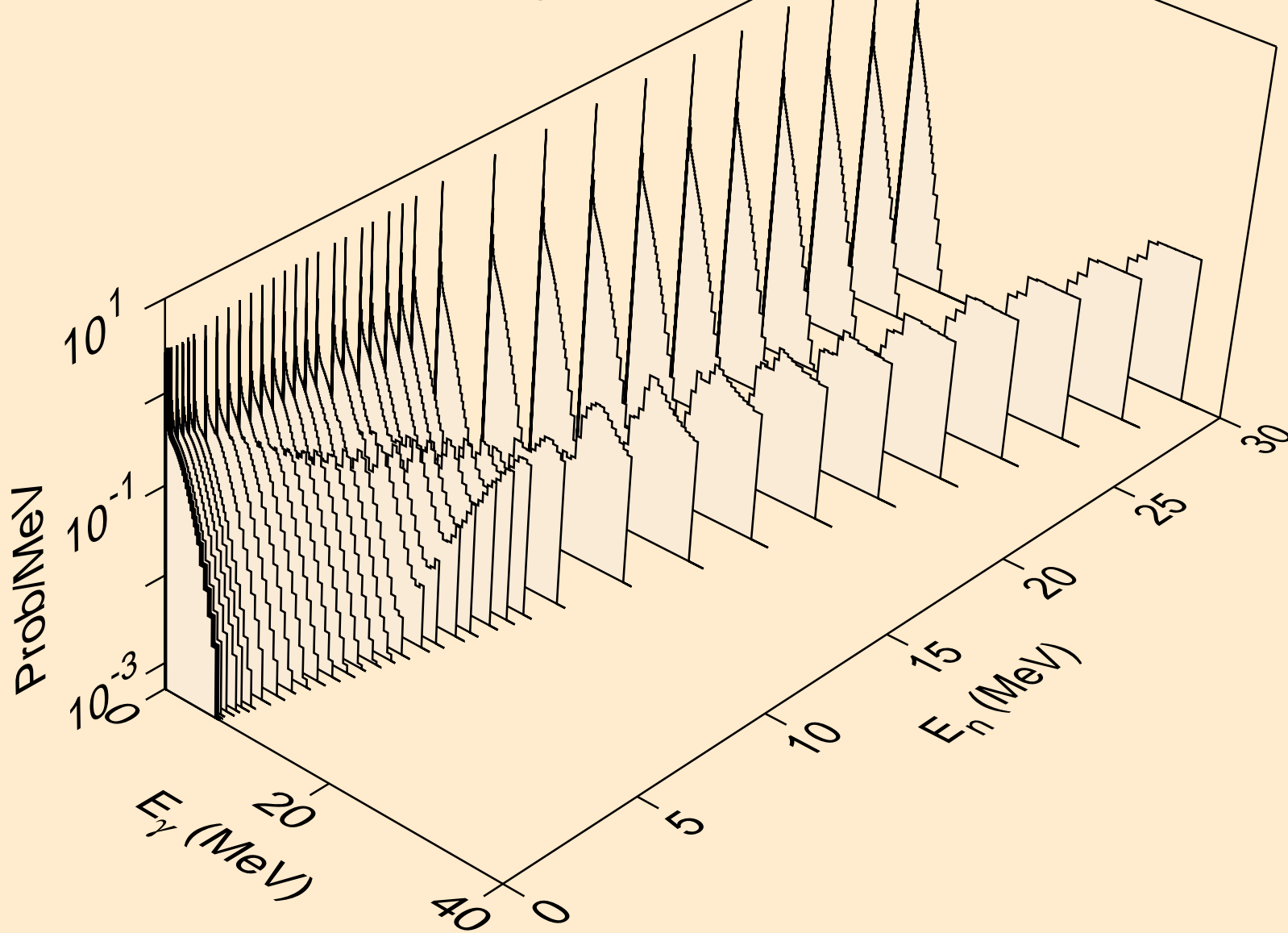

IR191 NEUTRON ACER TENDL-2019 LIBRARY; T=293.16K  
Photon emission for (n,p)

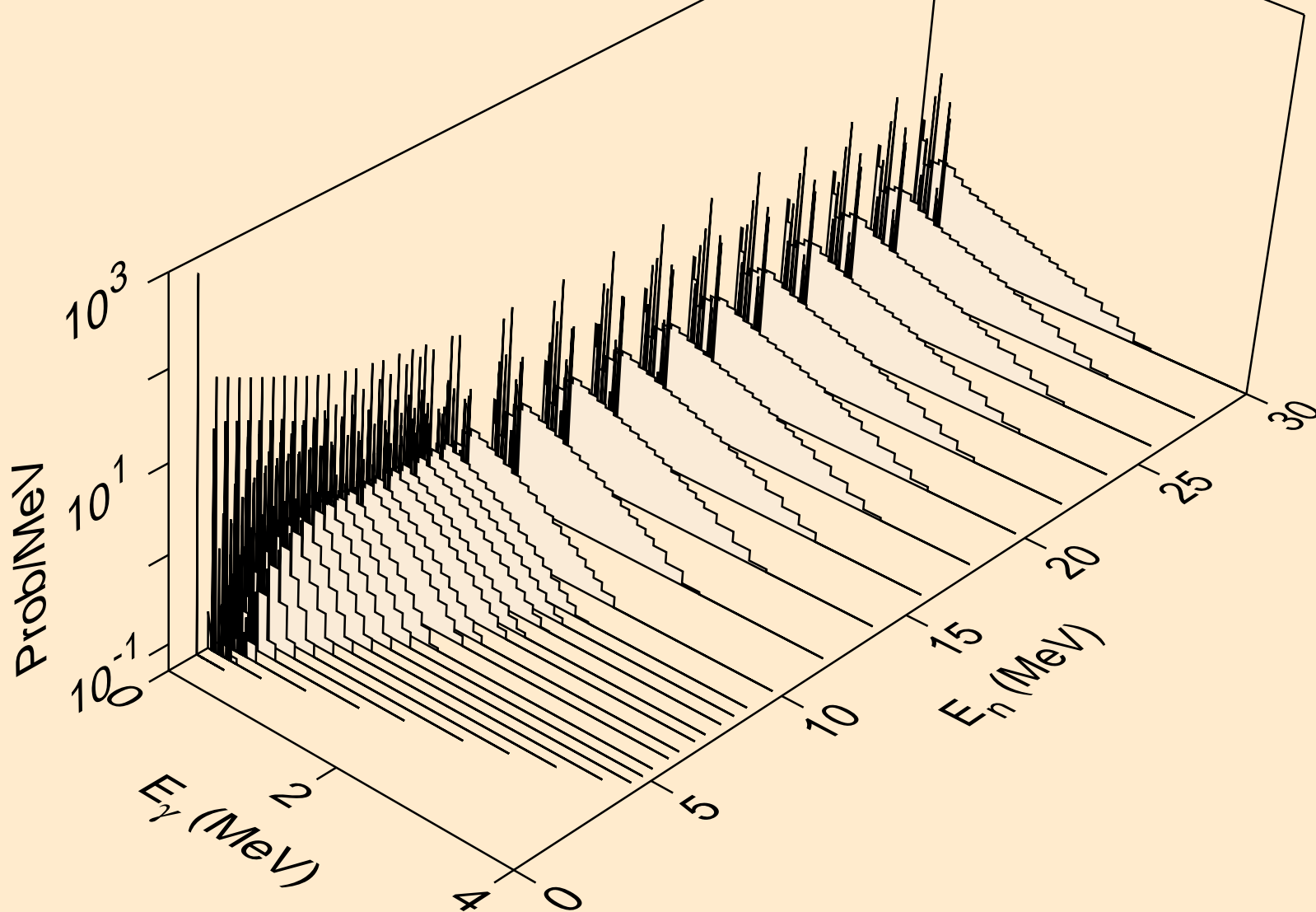

IR191 NEUTRON ACER TENDL-2019 LIBRARY; T=293.16K  
Photon emission for (n,d)

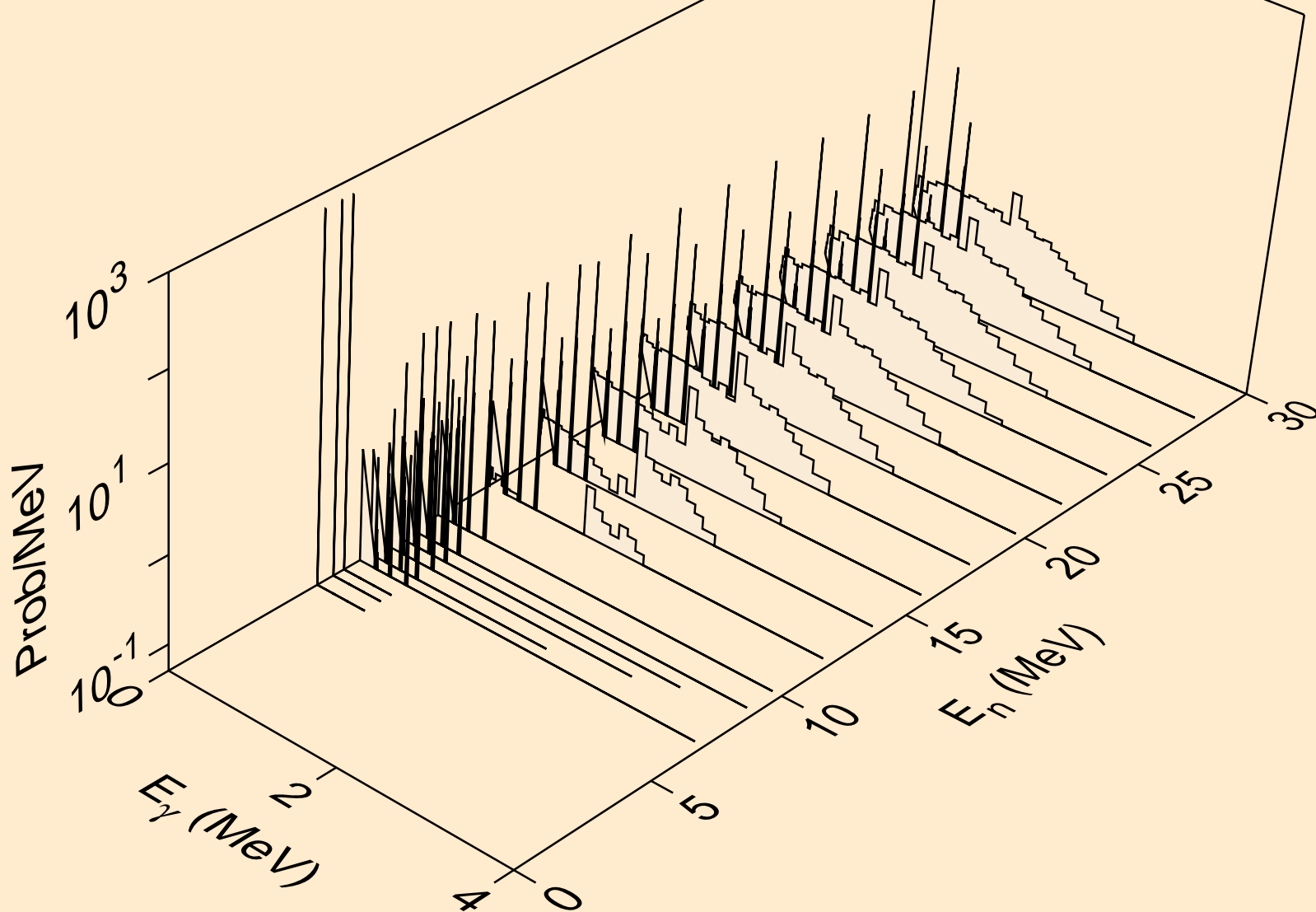

IR191 NEUTRON ACER TENDL-2019 LIBRARY; T=293.16K  
Photon emission for (n,t)

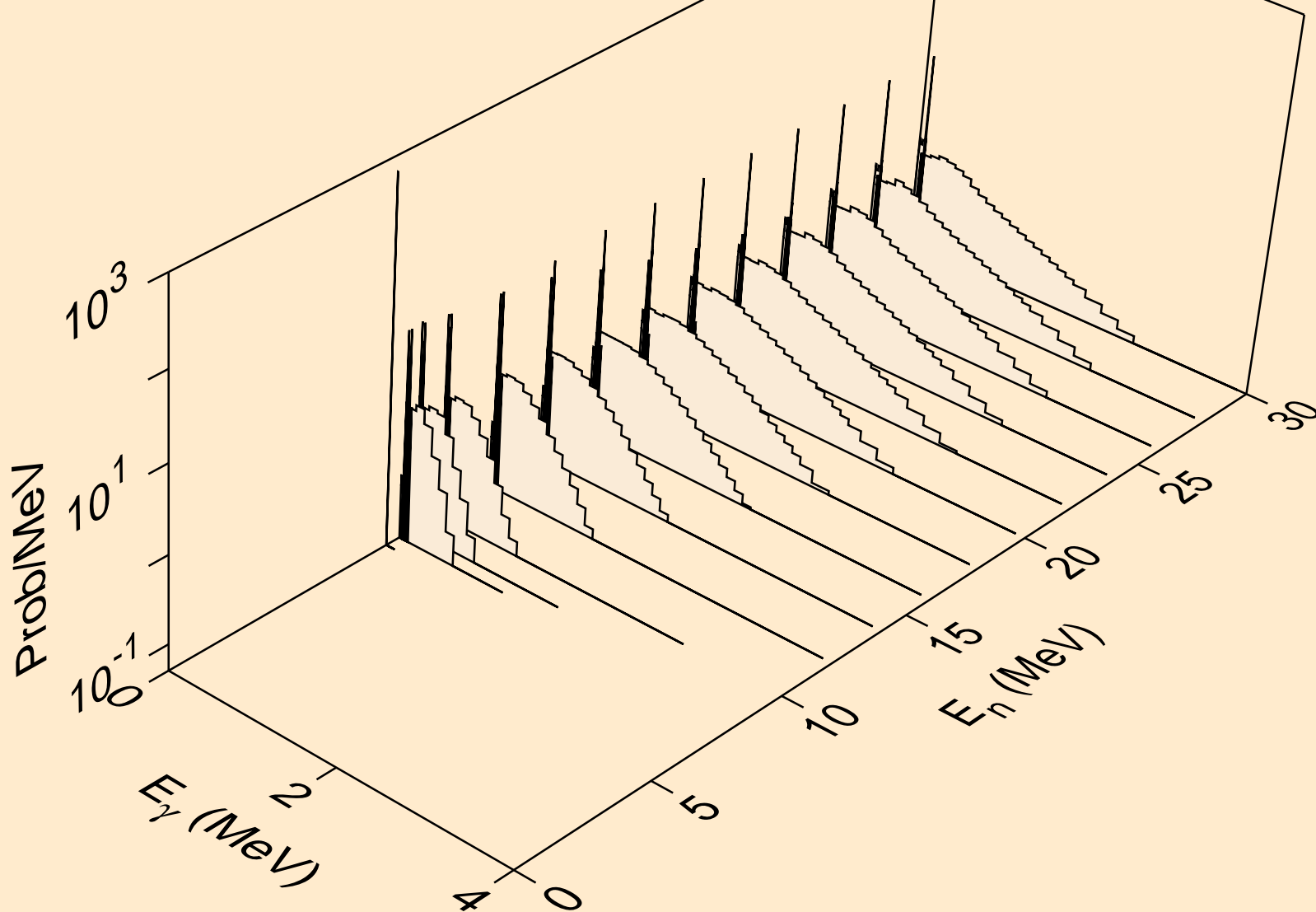

IR191 NEUTRON ACER TENDL-2019 LIBRARY; T=293.16K  
Photon emission for (n,he3)

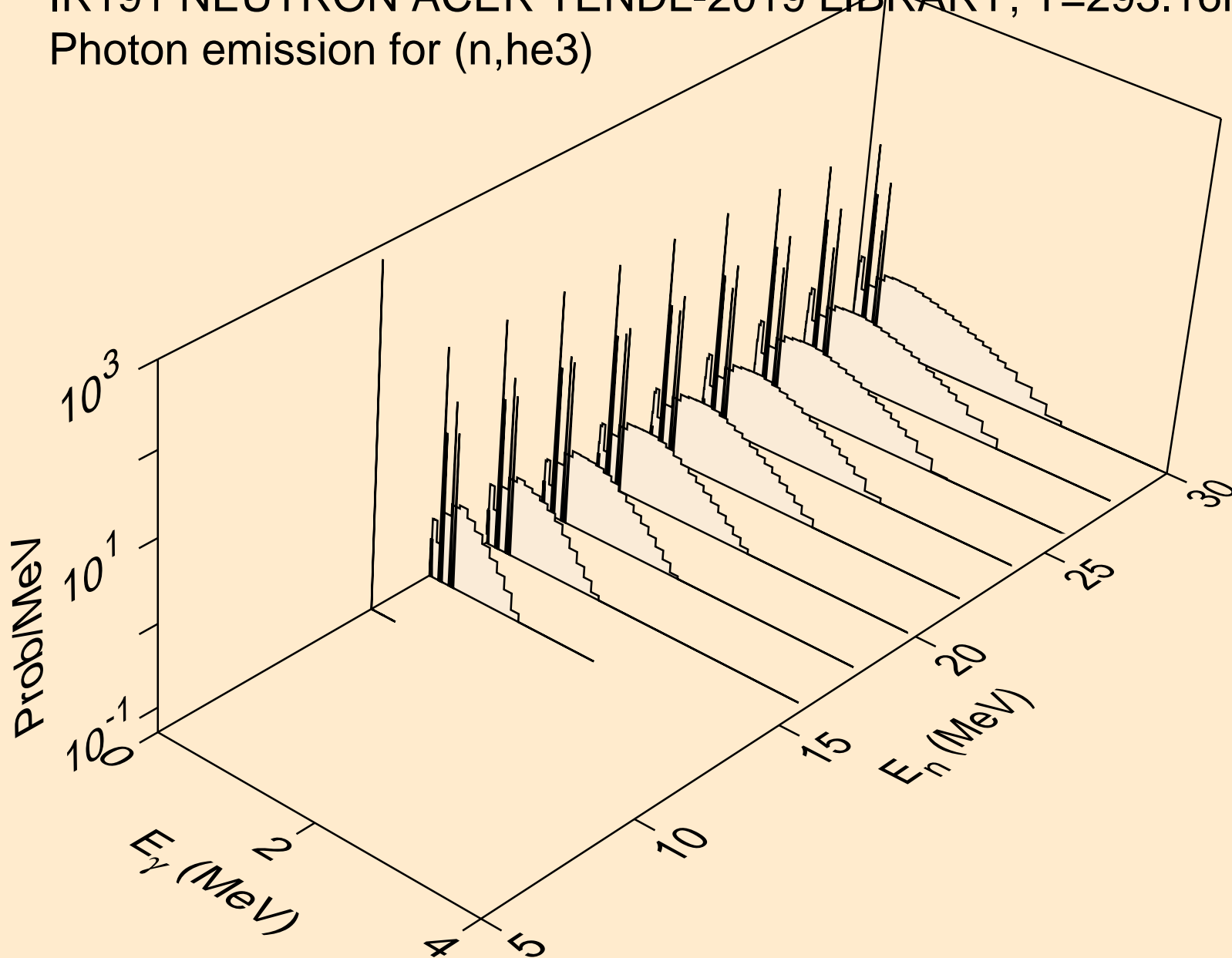

IR191 NEUTRON ACER TENDL-2019 LIBRARY; T=293.16K  
Photon emission for (n,a)

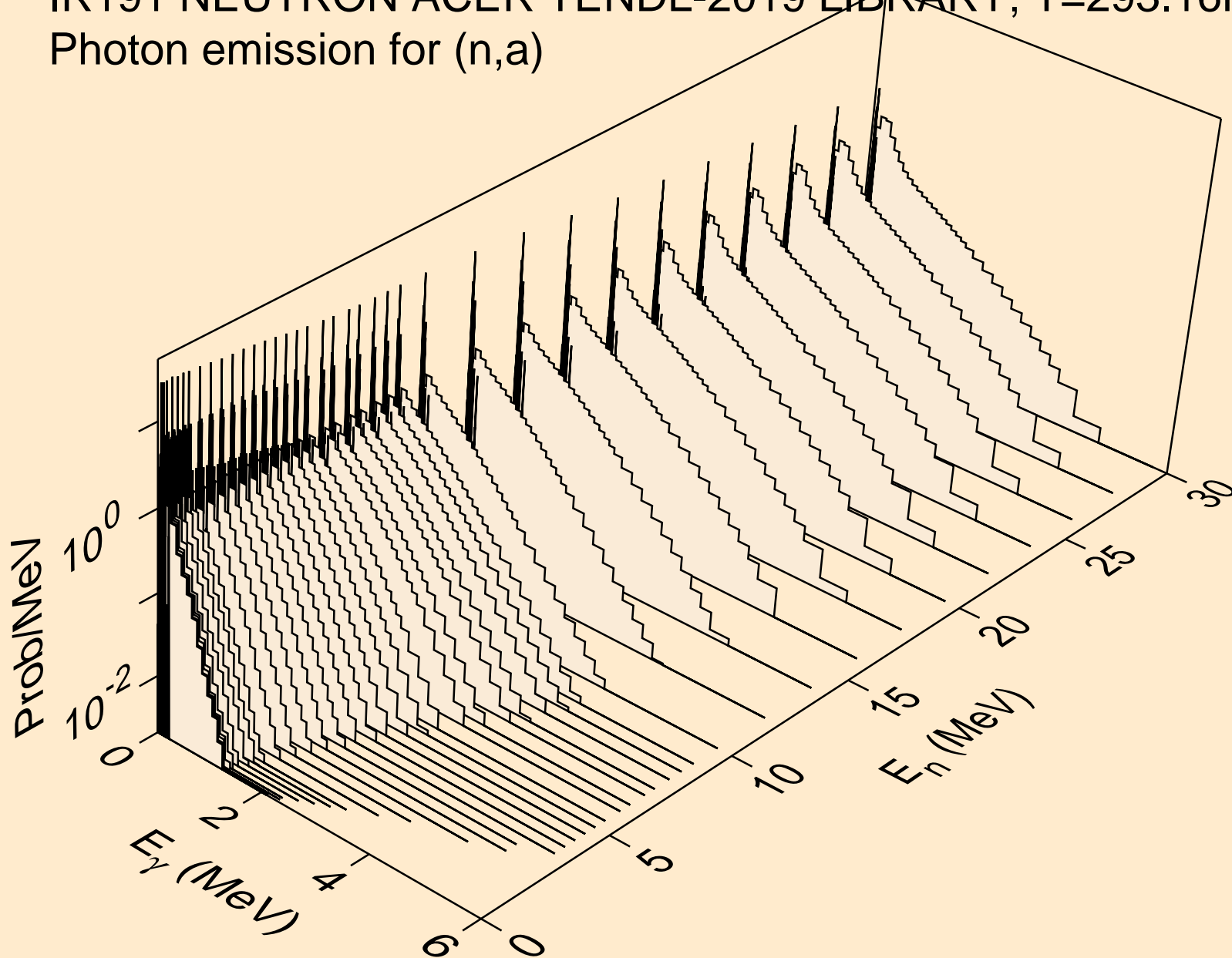



IR191 NEUTRON ACER TENDL-2019 LIBRARY; T=293.16K  
Photon emission for (n,2a)

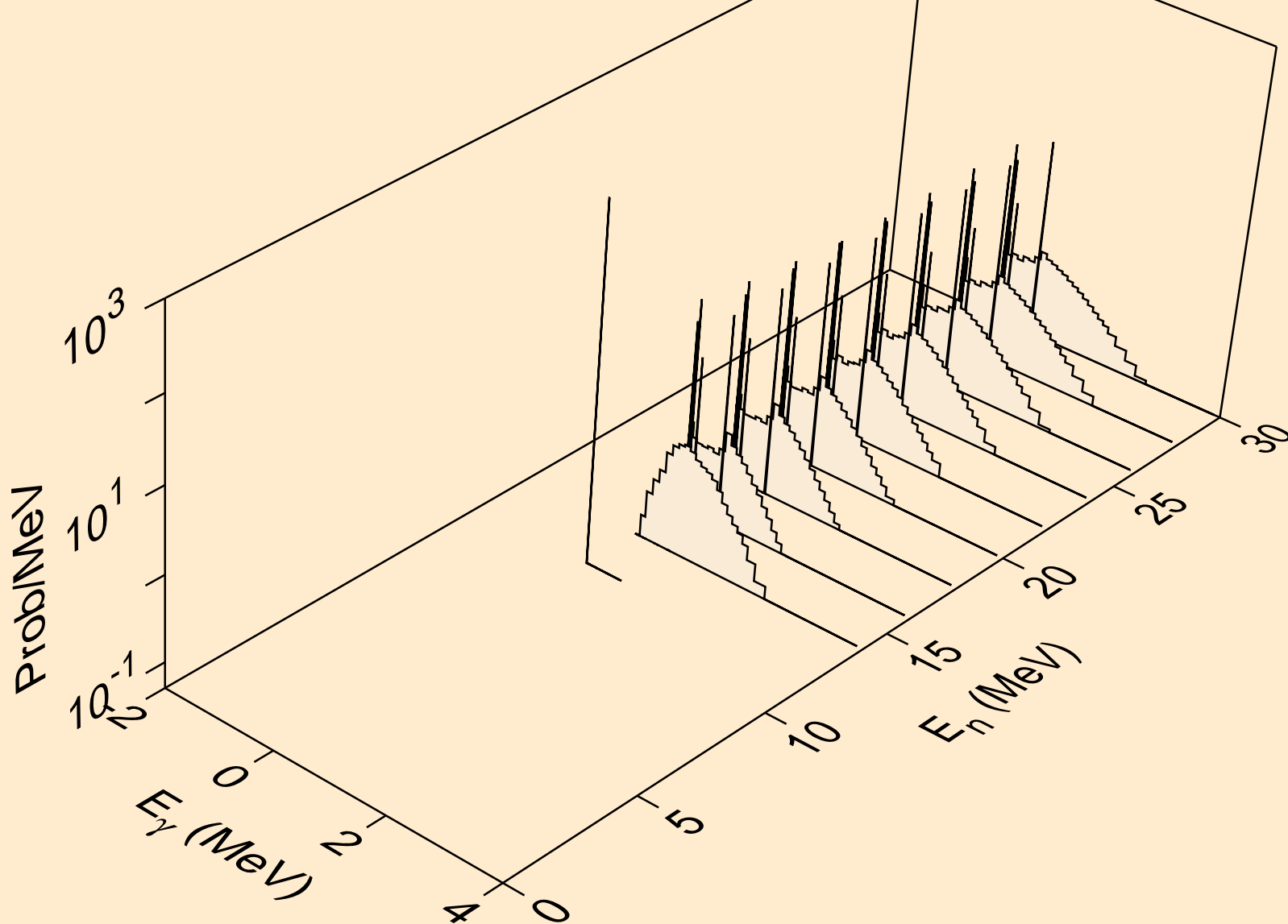

IR191 NEUTRON ACER TENDL-2019 LIBRARY; T=293.16K  
Photon emission for (n,2p)

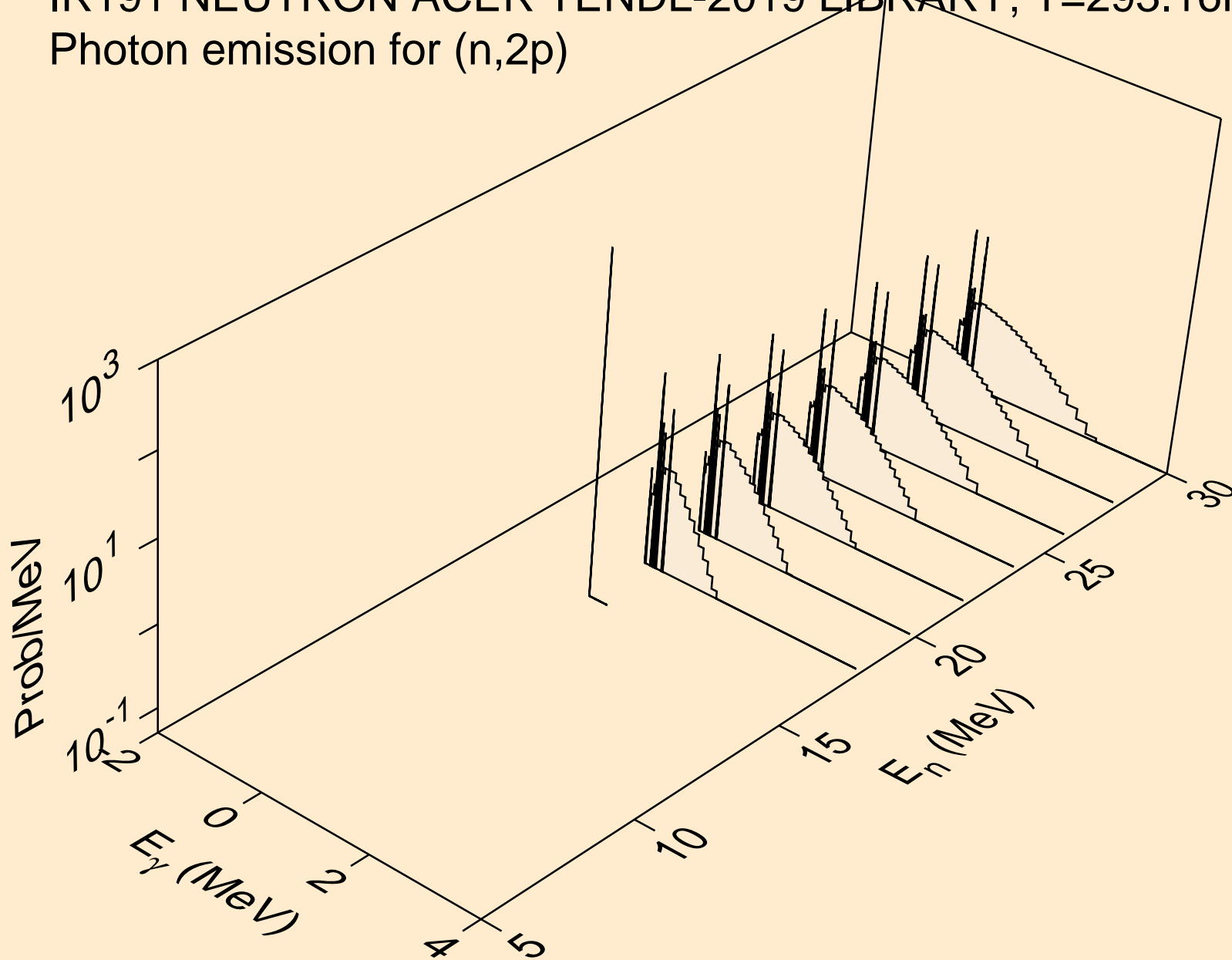

IR191 NEUTRON ACER TENDL-2019 LIBRARY; T=293.16K  
Photon emission for (n,p $\alpha$ )

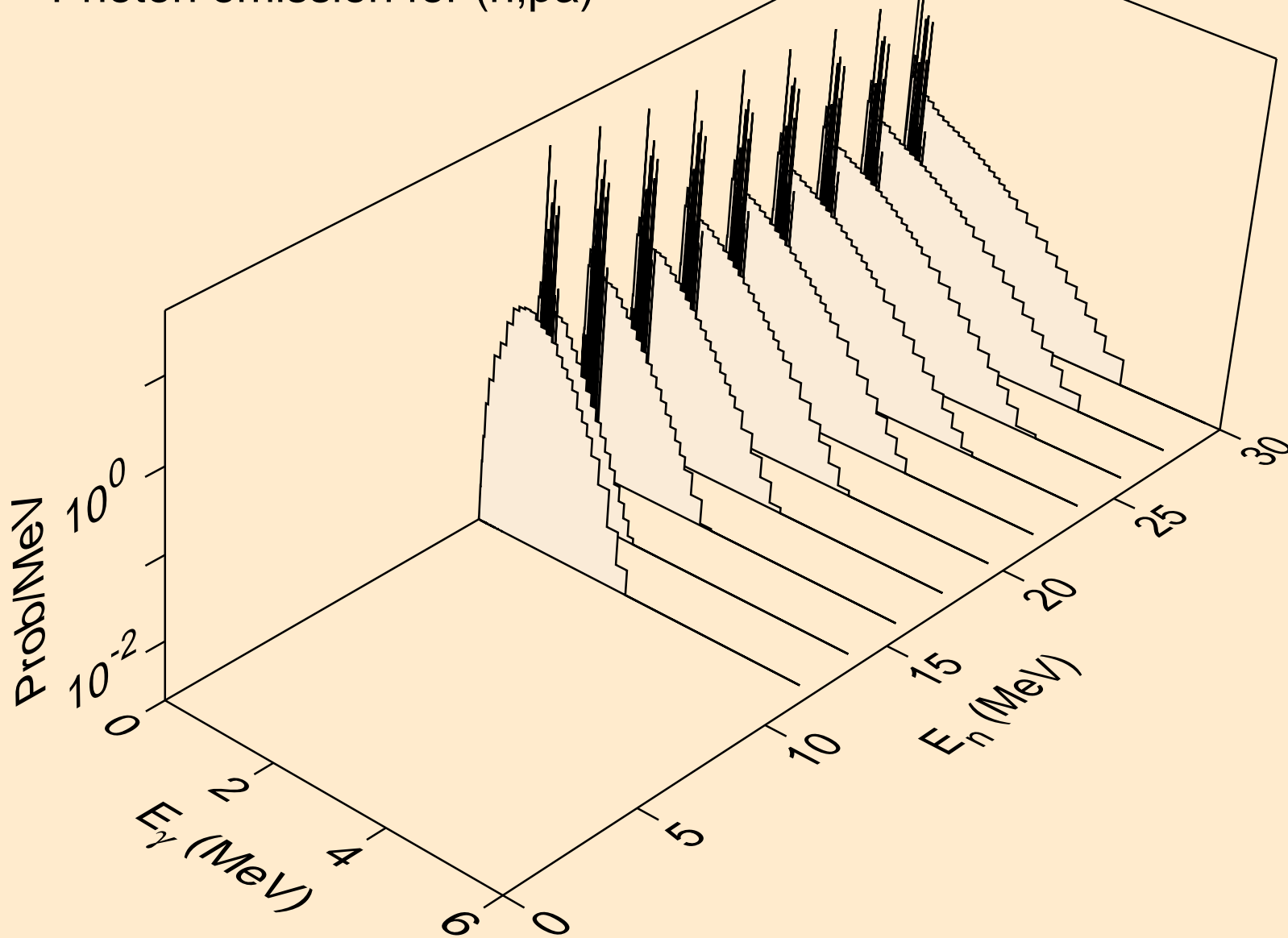

IR191 NEUTRON ACER TENDL-2019 LIBRARY; T=293.16K  
Photon emission for (n,pd)

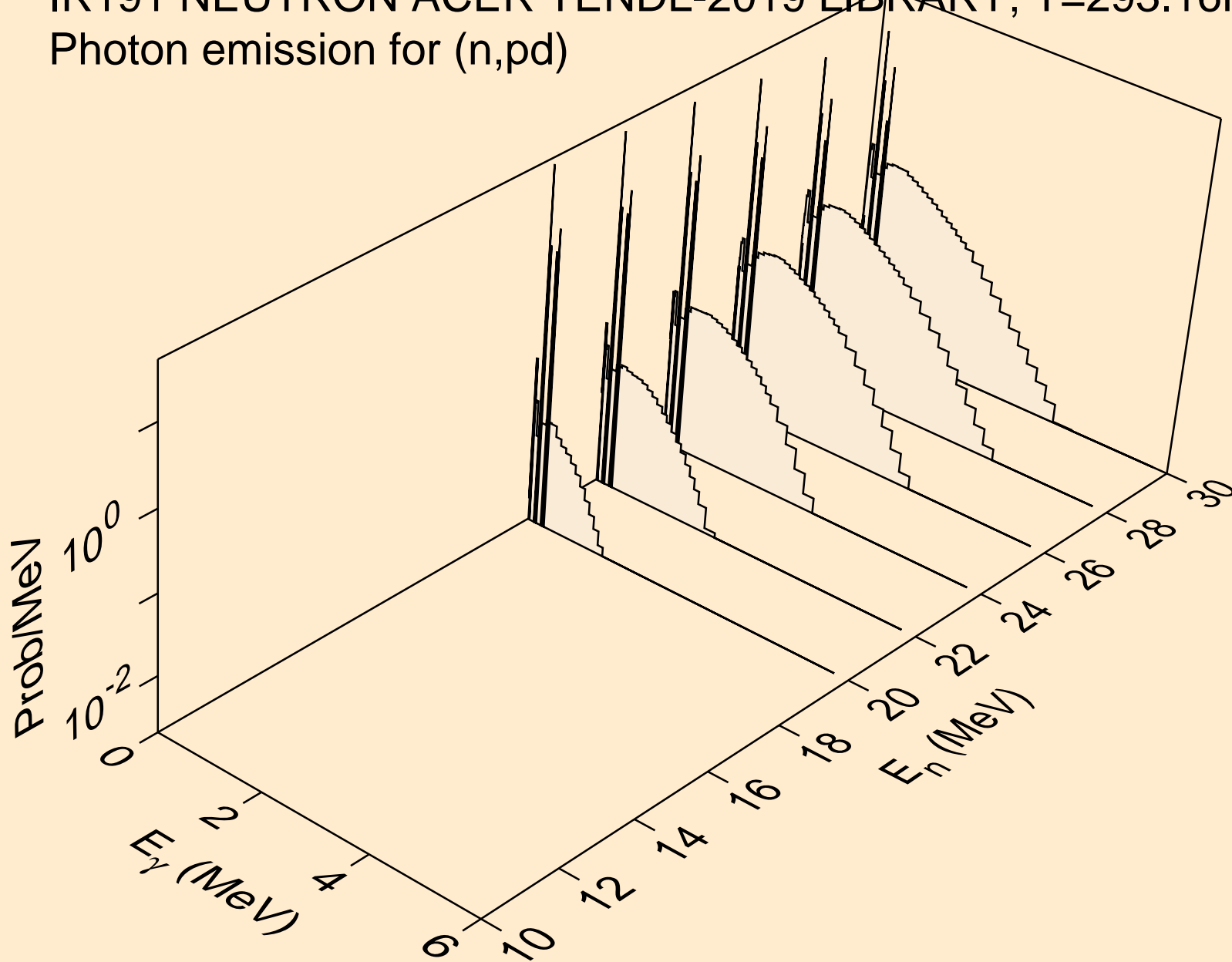

IR191 NEUTRON ACER TENDL-2019 LIBRARY; T=293.16K  
Photon emission for (n,pt)

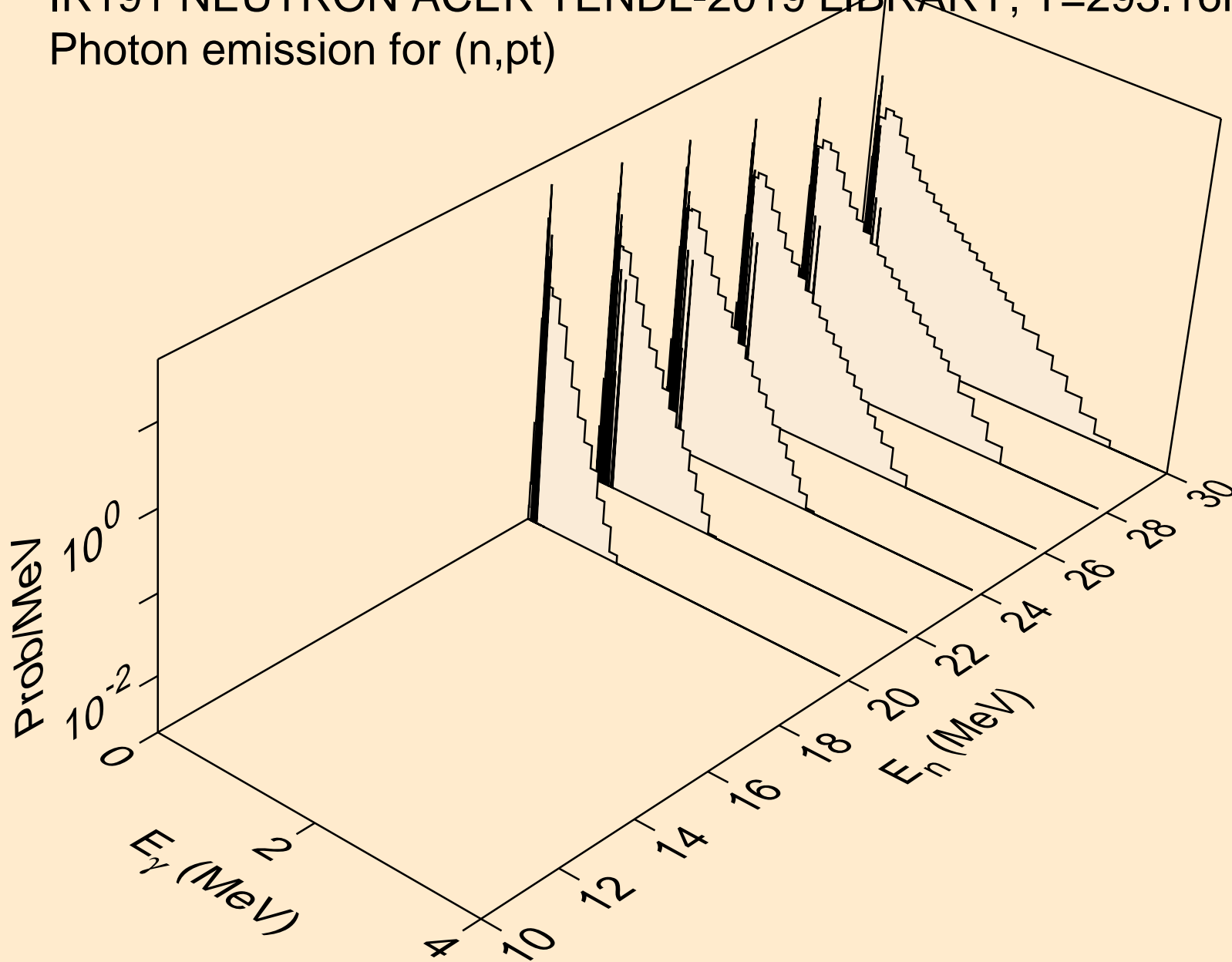

IR191 NEUTRON ACER TENDL-2019 LIBRARY; T=293.16K  
Photon emission for (n,da)

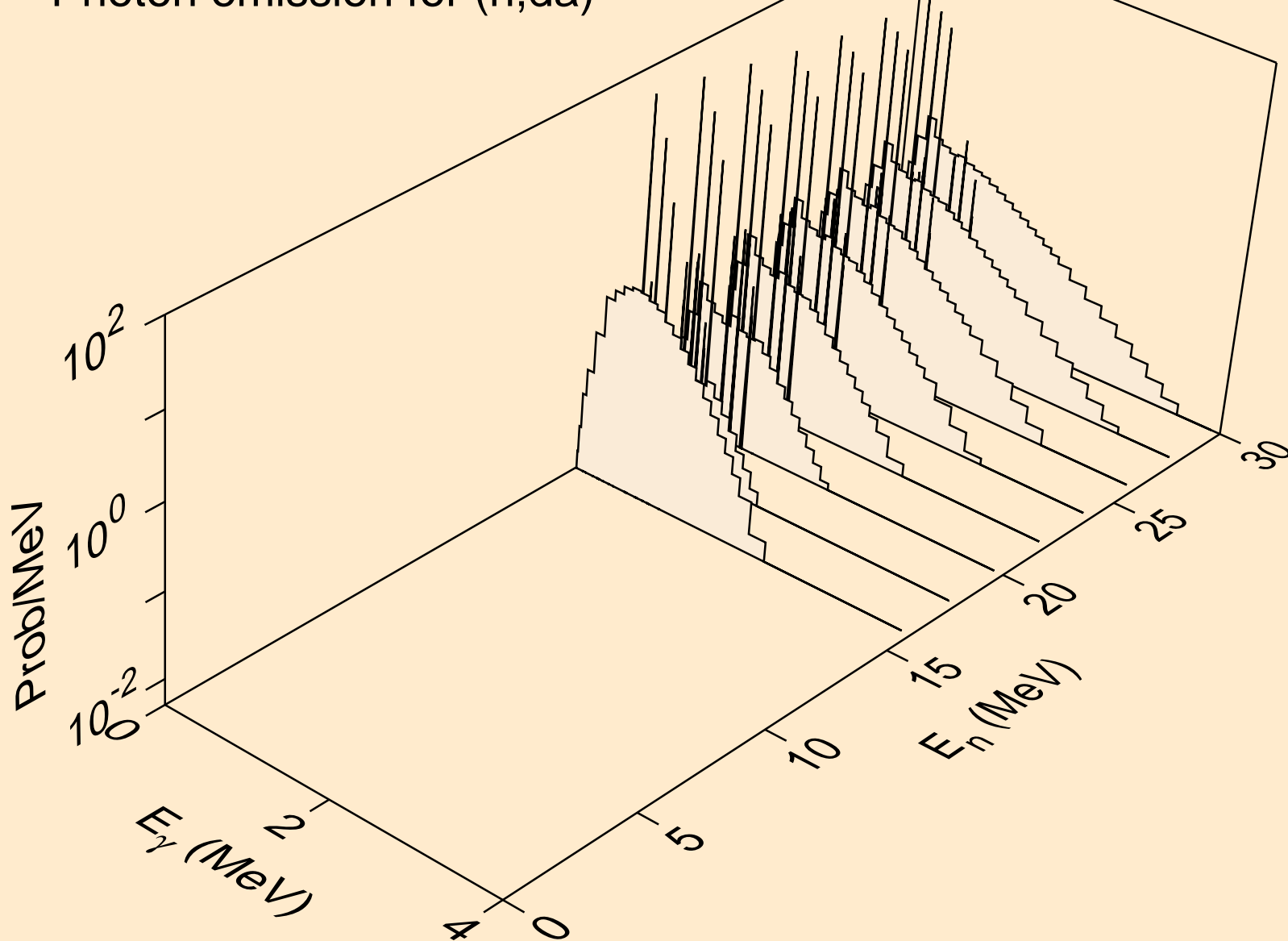

IR191 NEUTRON ACER TENDL-2019 LIBRARY; T=293.16K  
thermal capture photon spectrum

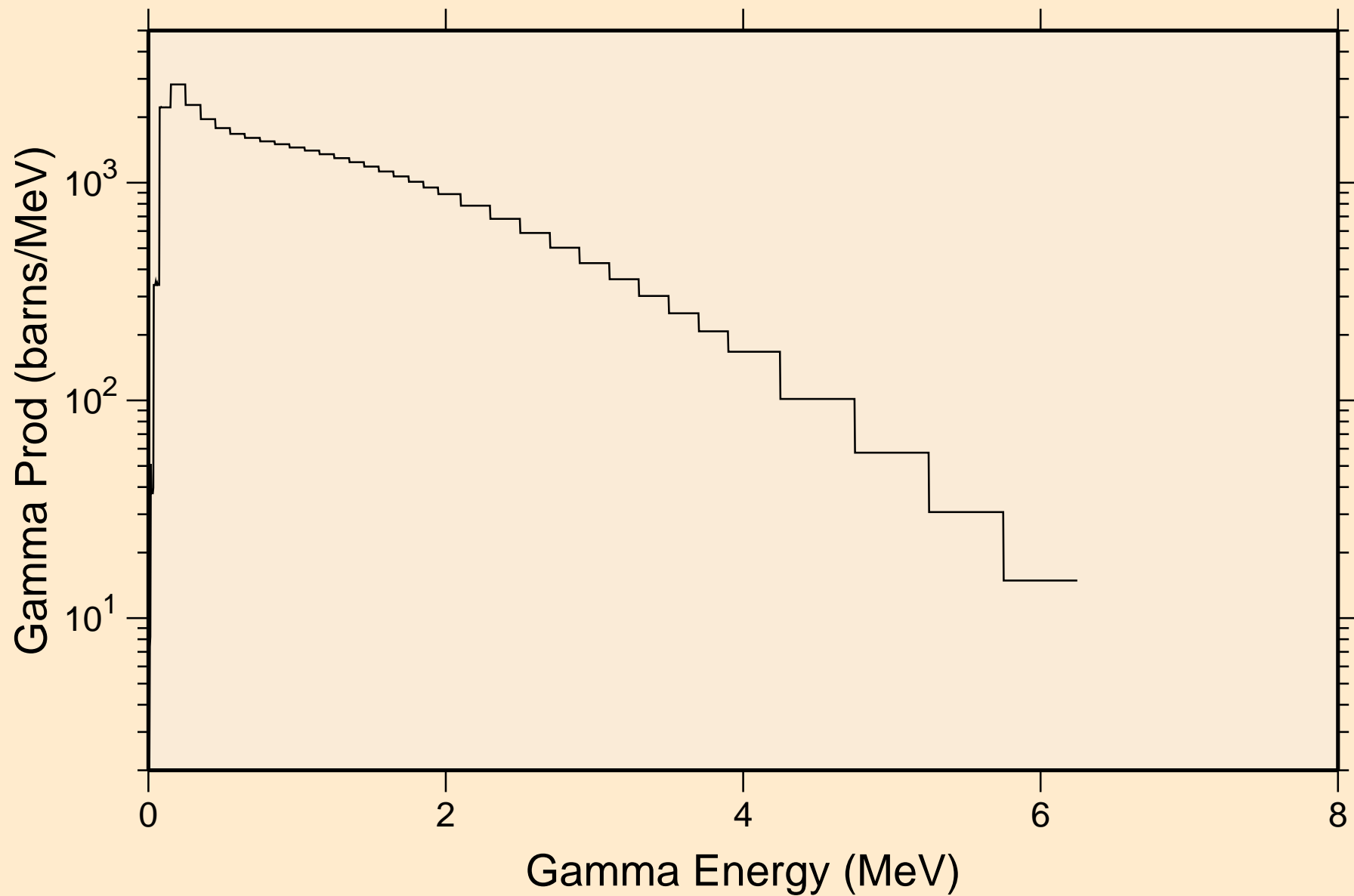

IR191 NEUTRON ACER TENDL-2019 LIBRARY; T=293.16K  
14 MeV photon spectrum

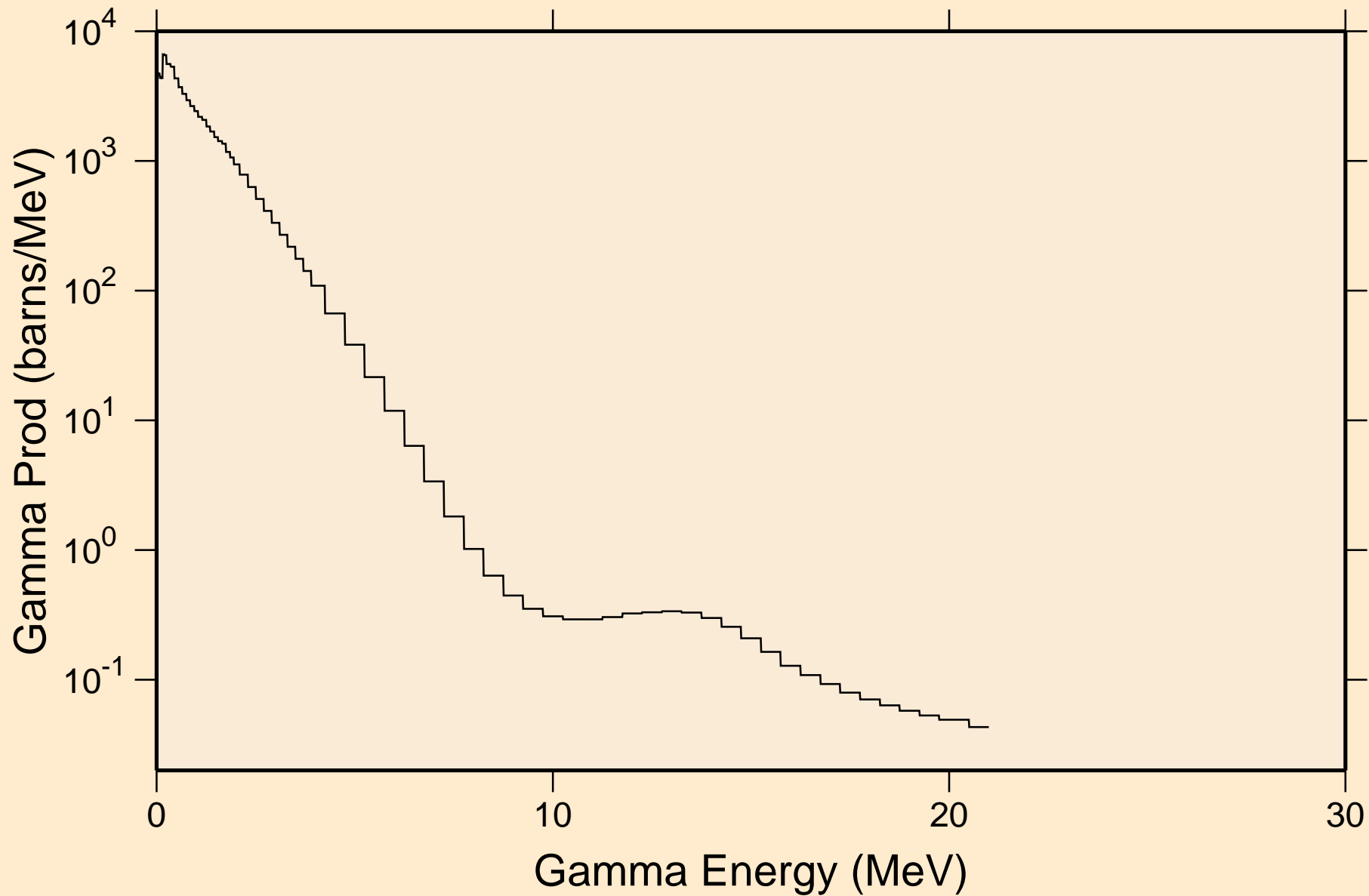



IR191 NEUTRON ACER TENDL-2019 LIBRARY; T=293.16K  
Particle heating contributions

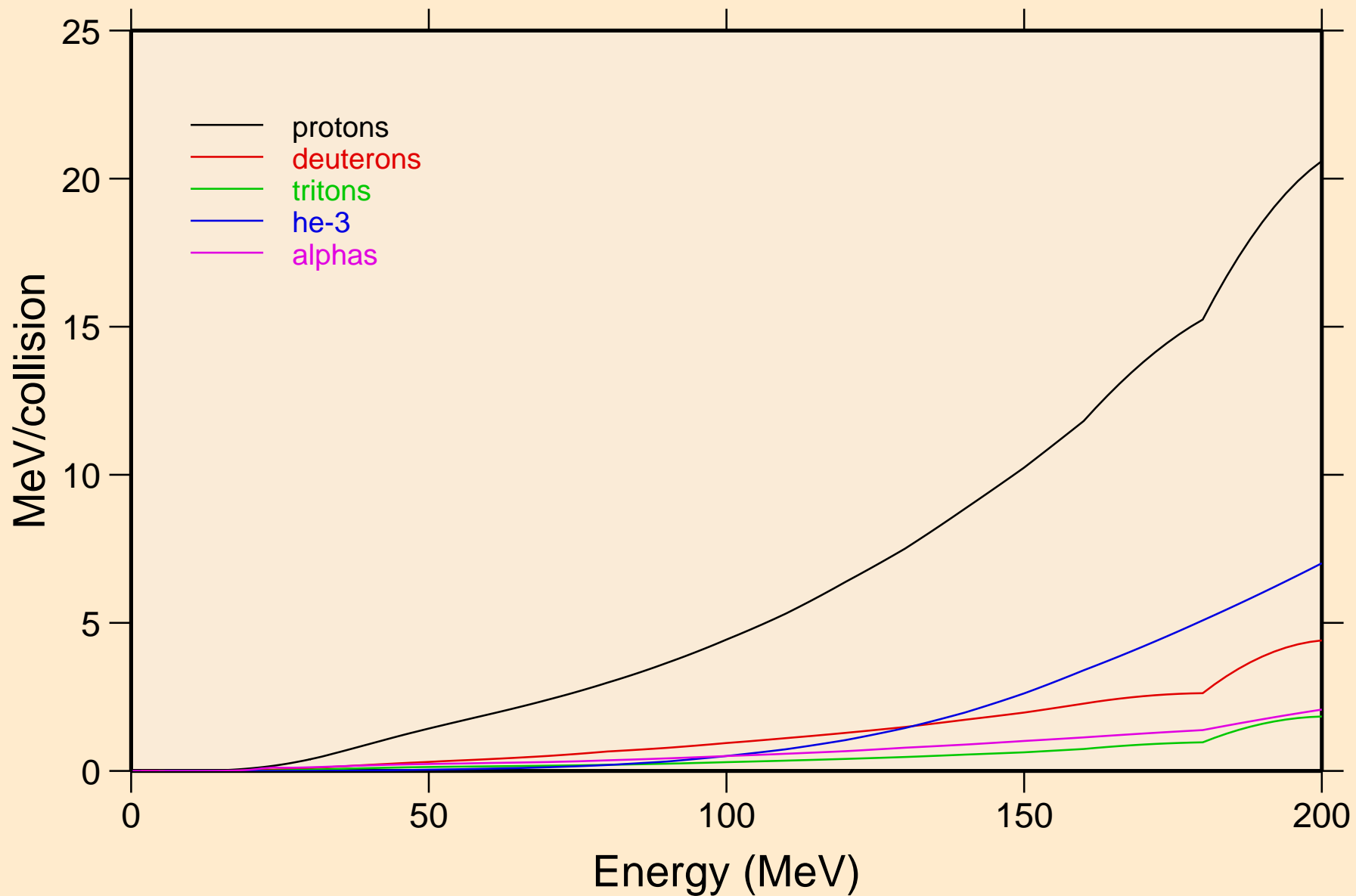

IR191 NEUTRON ACER TENDL-2019 LIBRARY; T=293.16K  
Recoil Heating

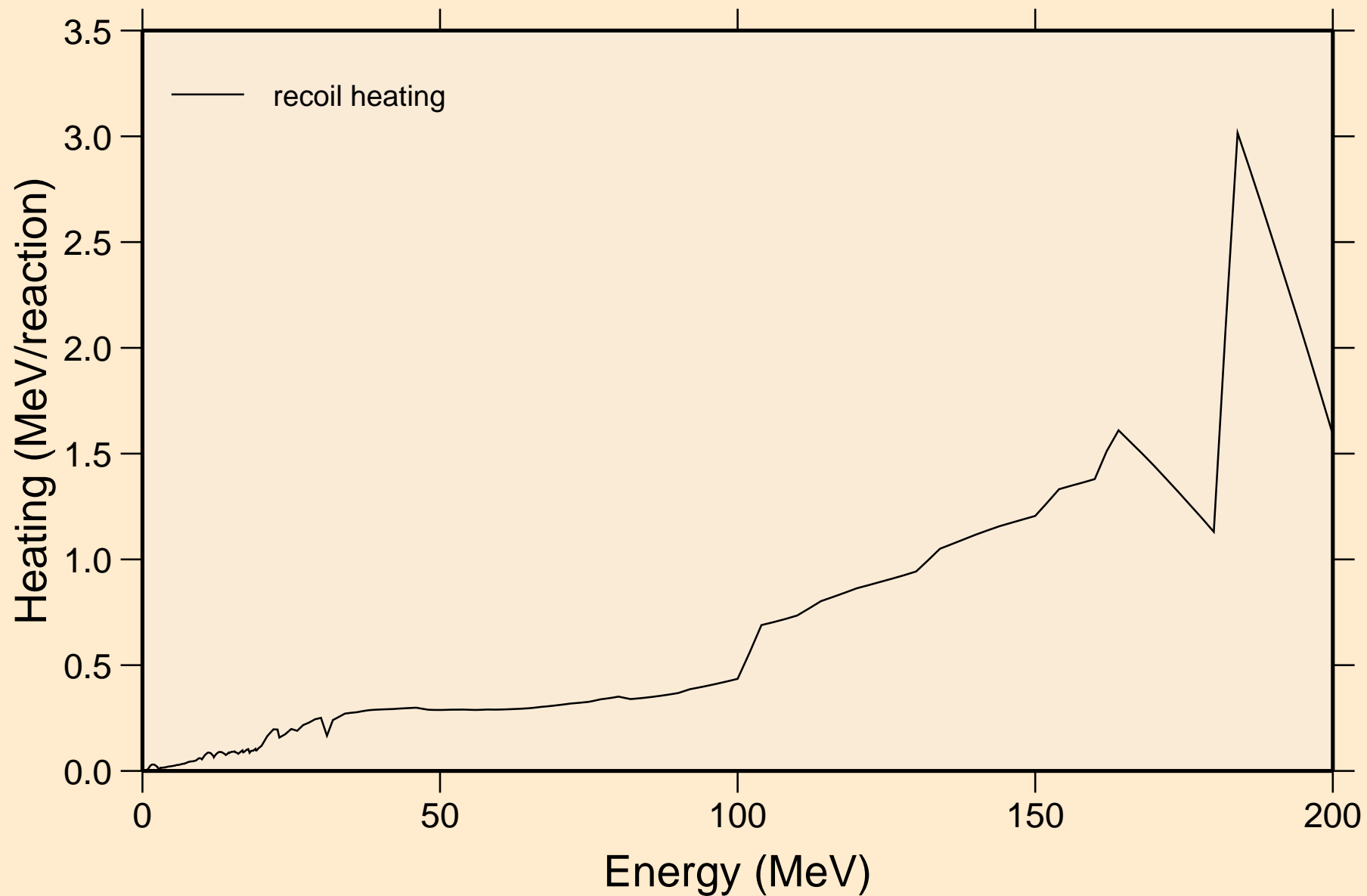

IR191 NEUTRON ACER TENDL-2019 LIBRARY; T=293.16K  
Particle production cross sections

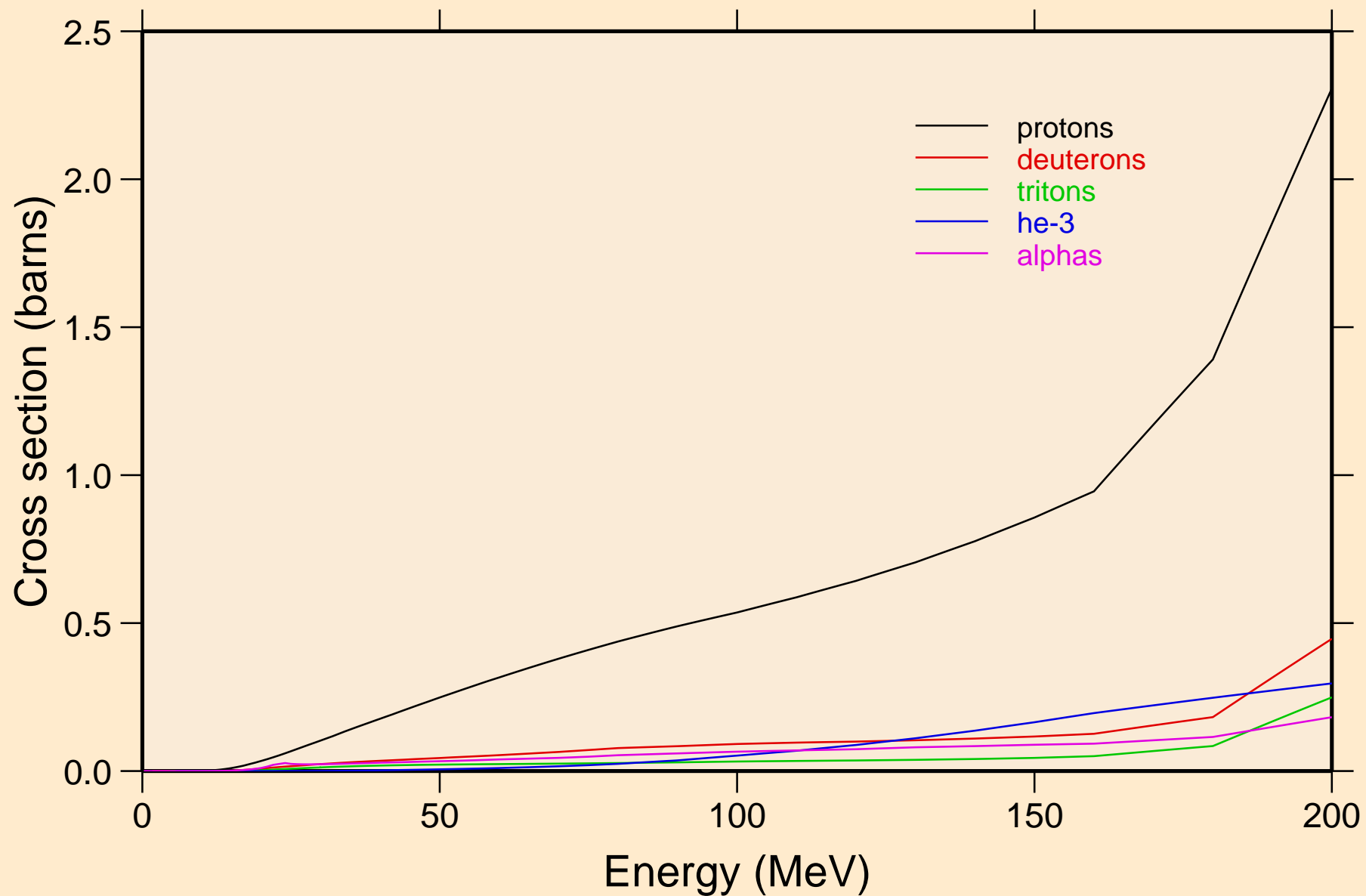

IR191 NEUTRON ACER TENDL-2019 LIBRARY; T=293.16K  
protons from (n,x)

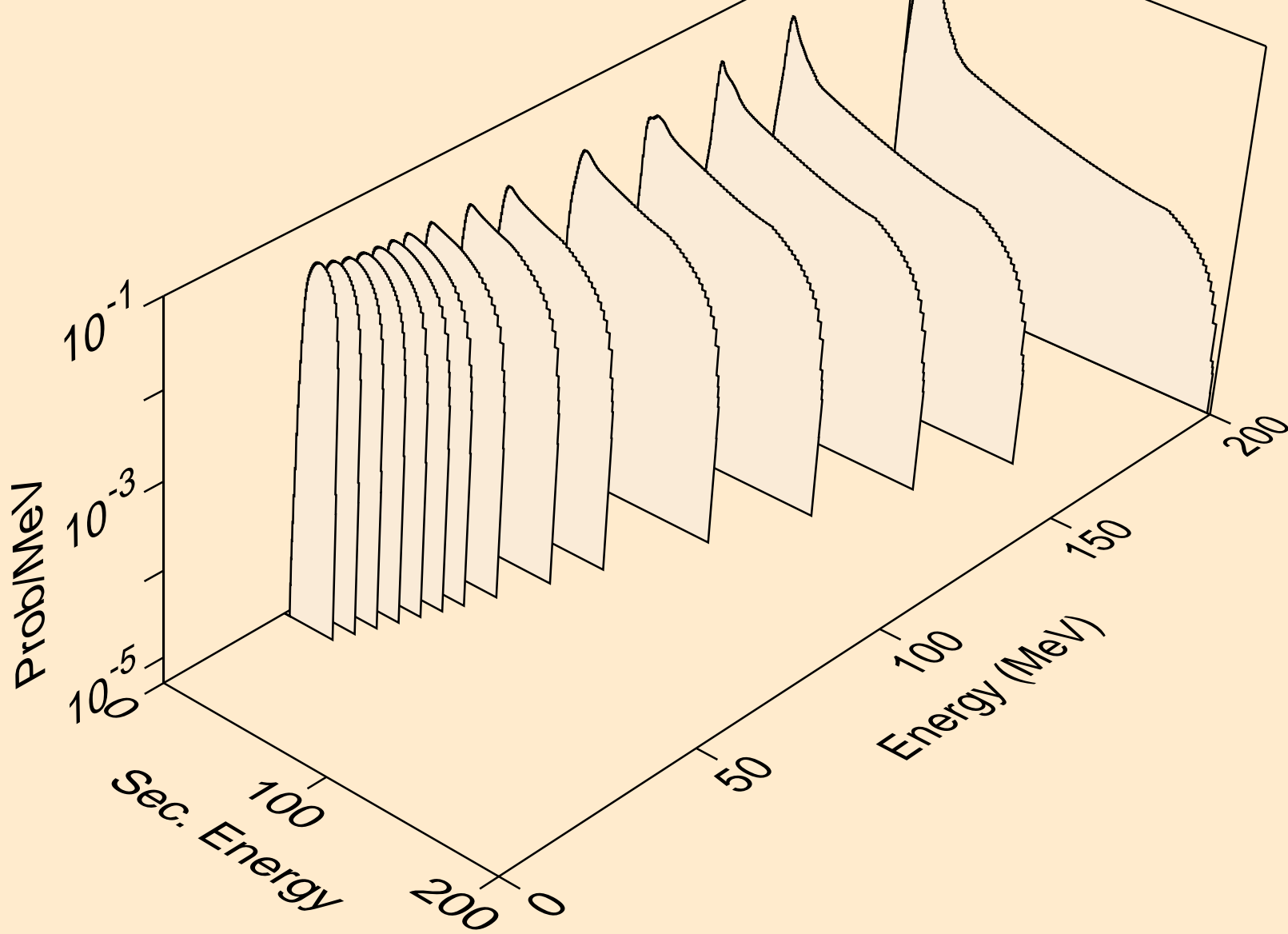

IR191 NEUTRON ACER TENDL-2019 LIBRARY; T=293.16K  
protons from (n,n\*)p

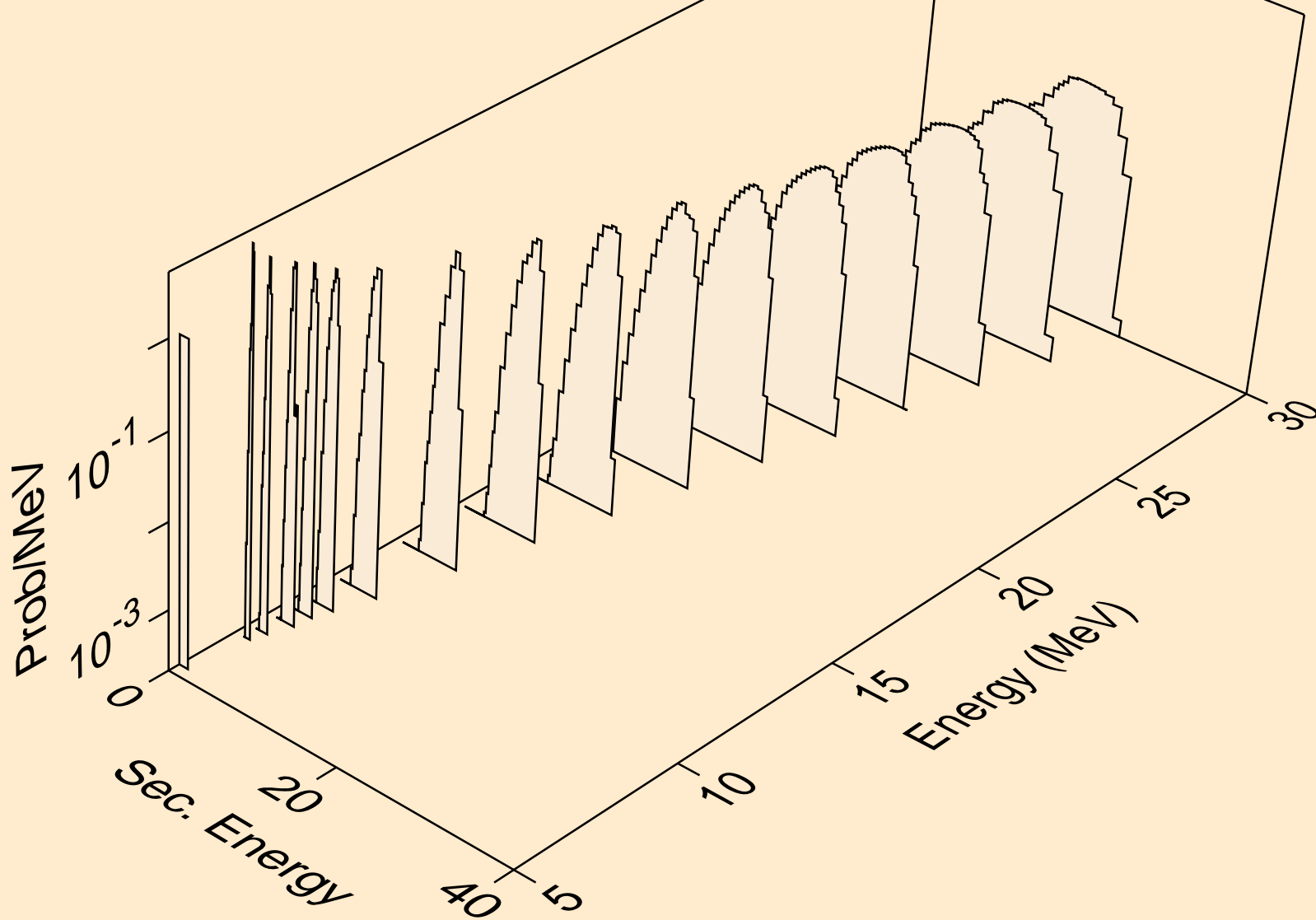

IR191 NEUTRON ACER TENDL-2019 LIBRARY; T=293.16K  
protons from (n,2np)

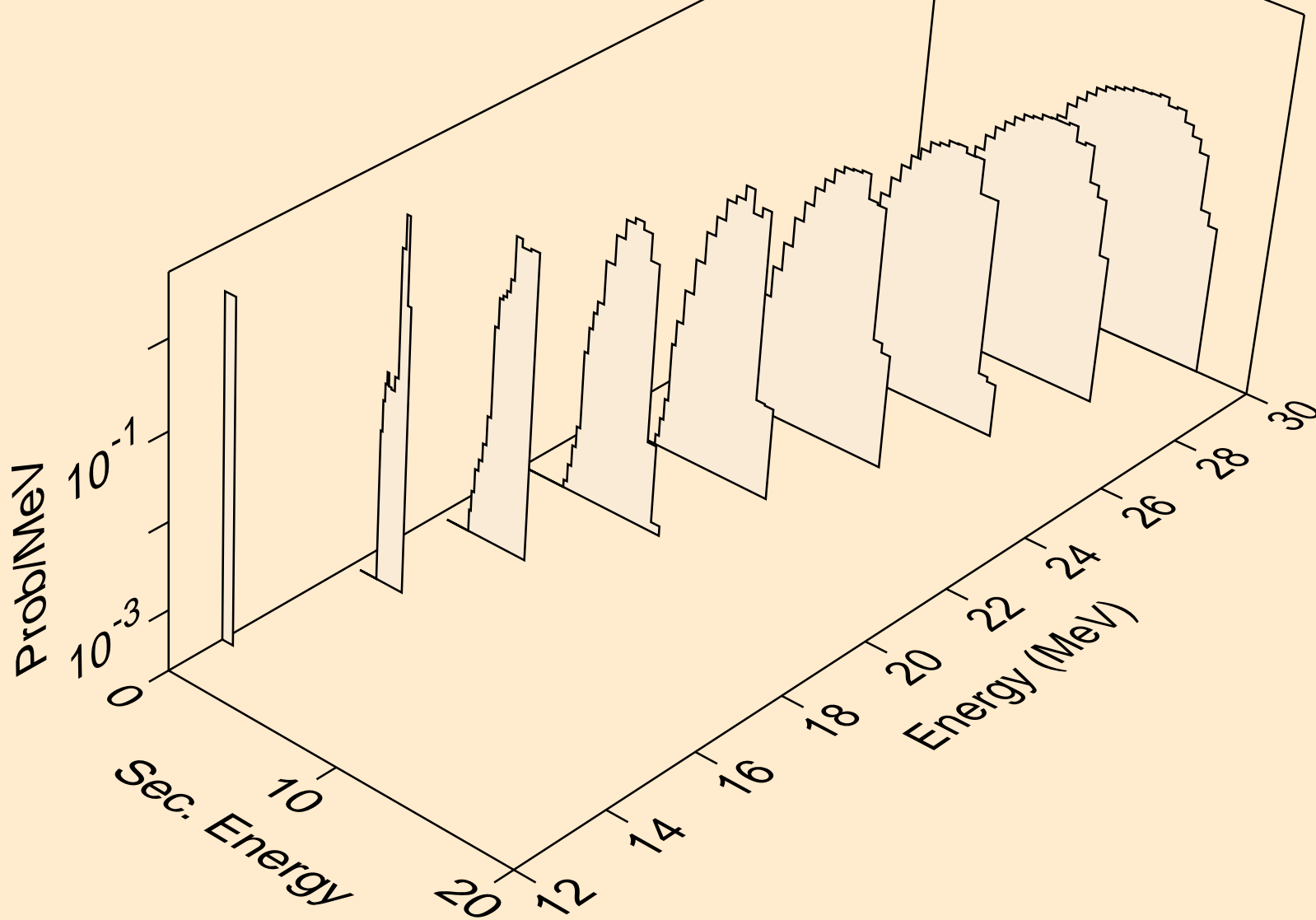

IR191 NEUTRON ACER TENDL-2019 LIBRARY; T=293.16K  
protons from (n,3np)

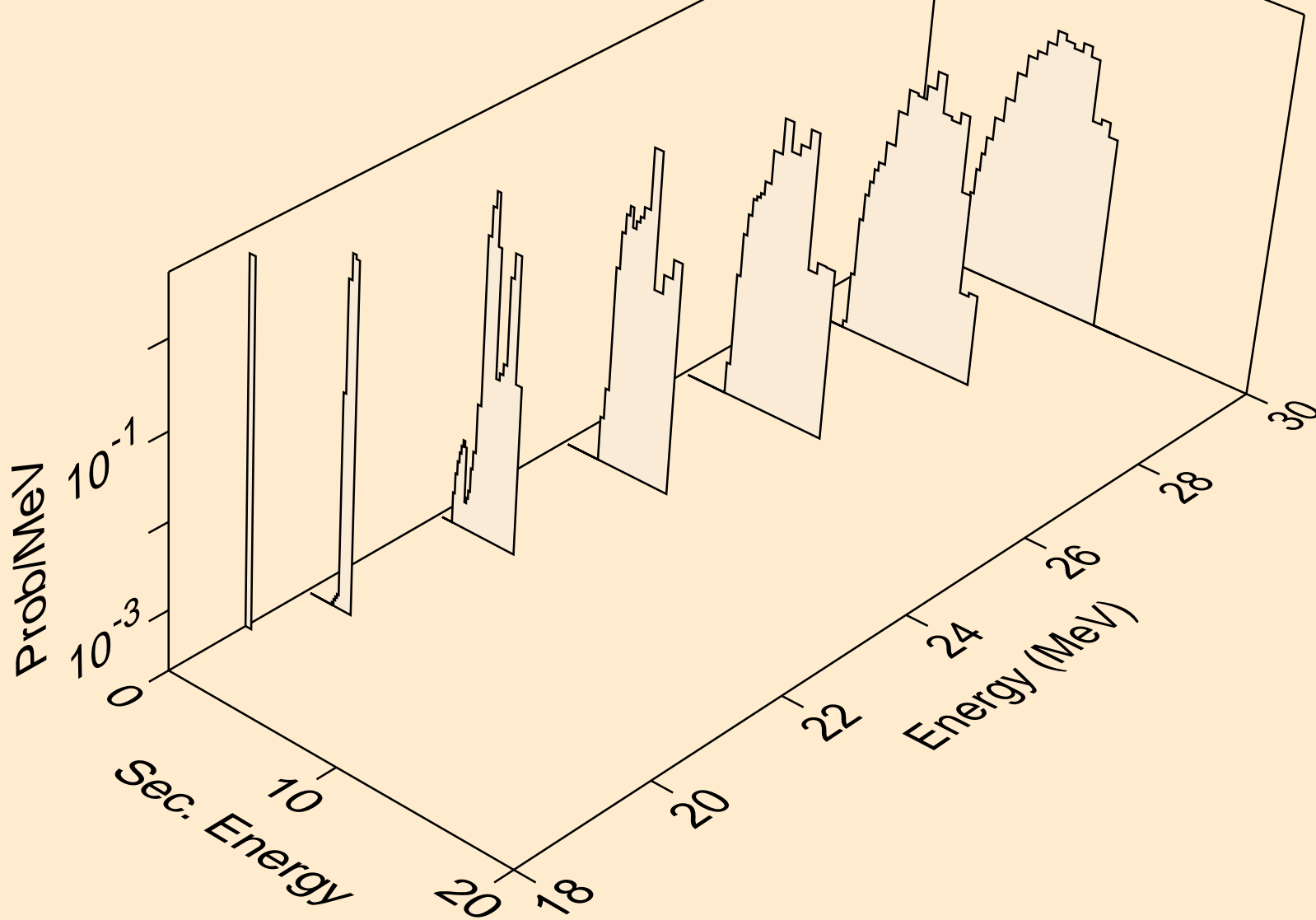

IR191 NEUTRON ACER TENDL-2019 LIBRARY; T=293.16K  
protons from (n,2np)

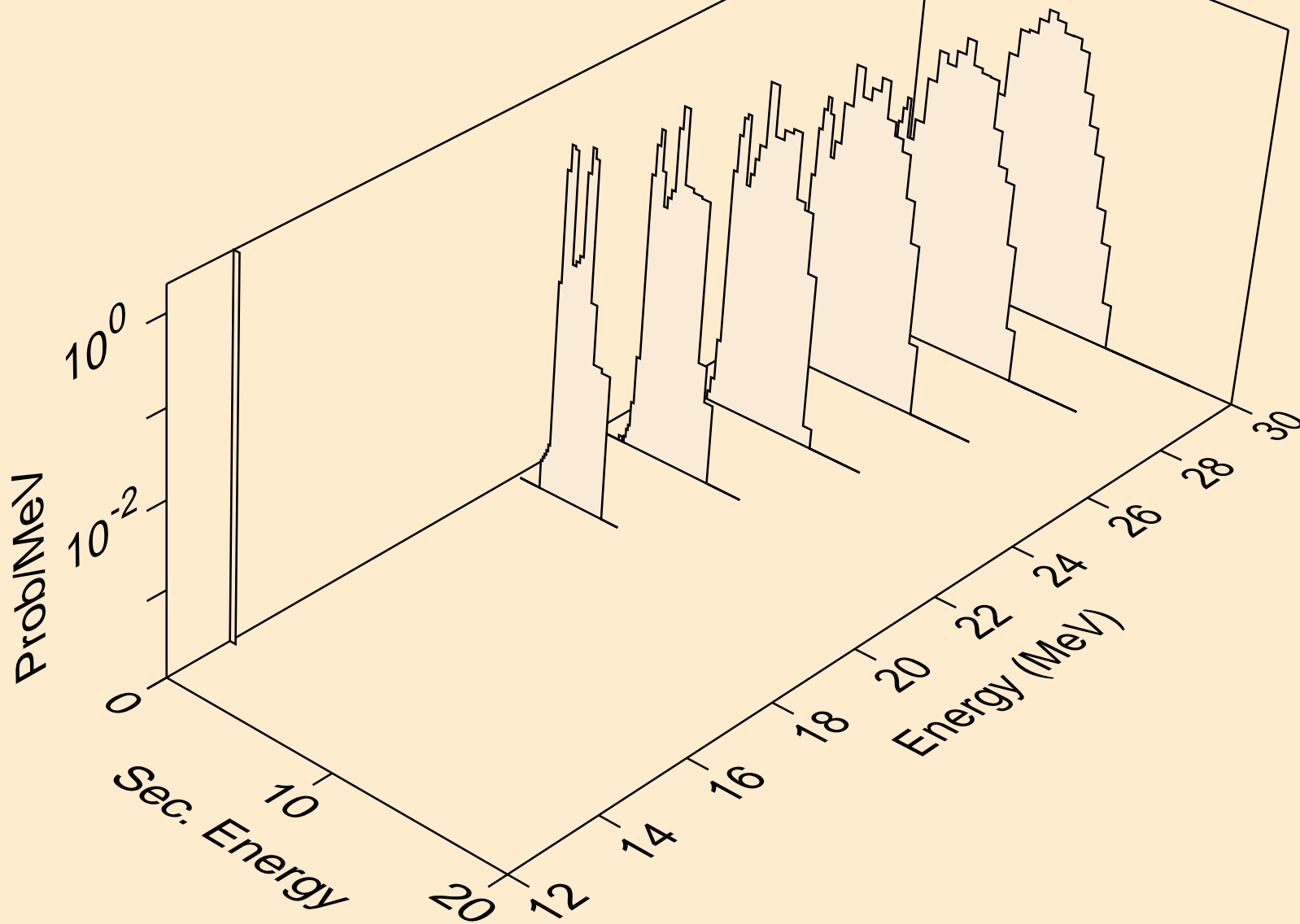



IR191 NEUTRON ACER TENDL-2019 LIBRARY; T=293.16K  
protons from (n,npa)

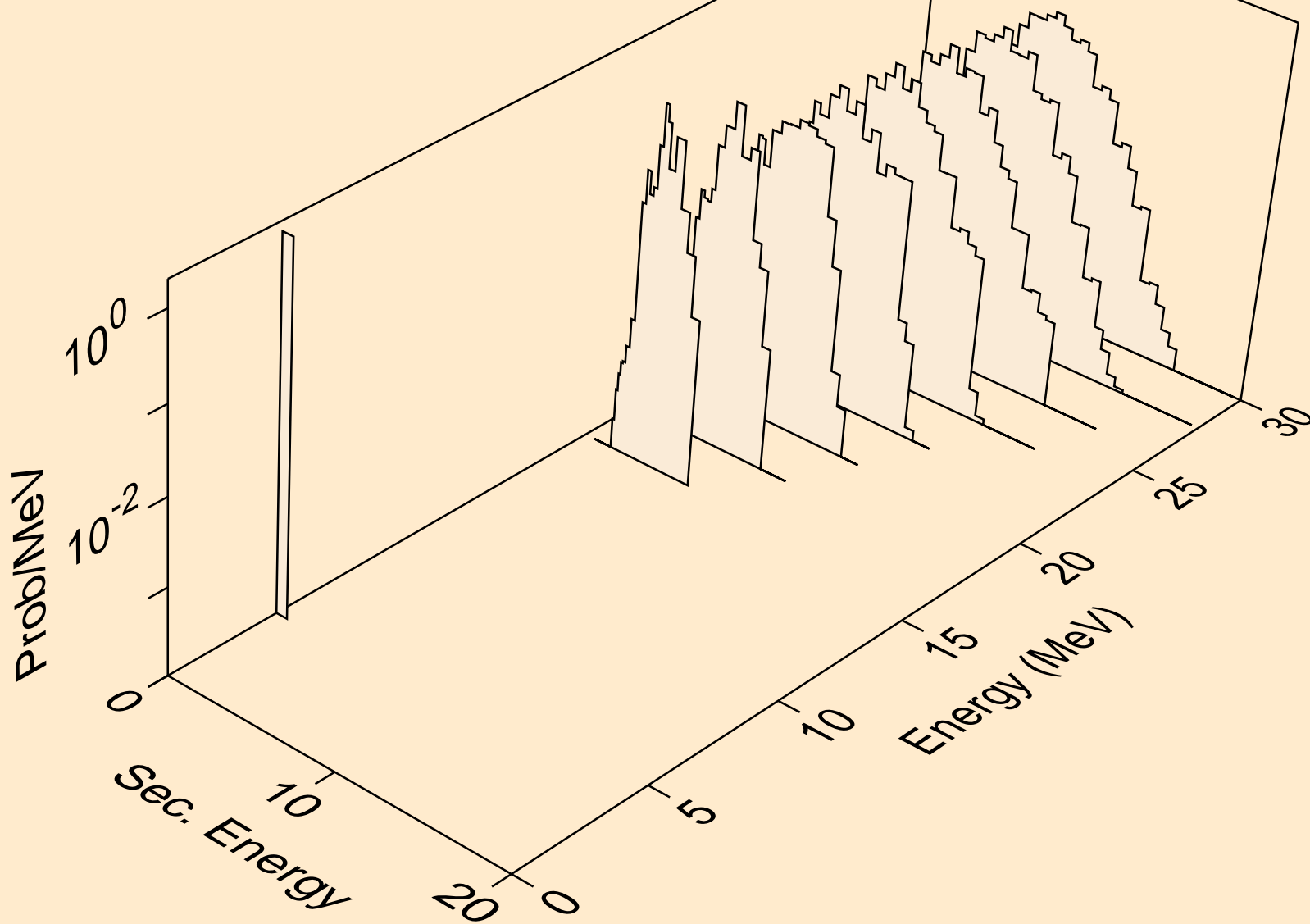

IR191 NEUTRON ACER TENDL-2019 LIBRARY; T=293.16K  
protons from (n,p)

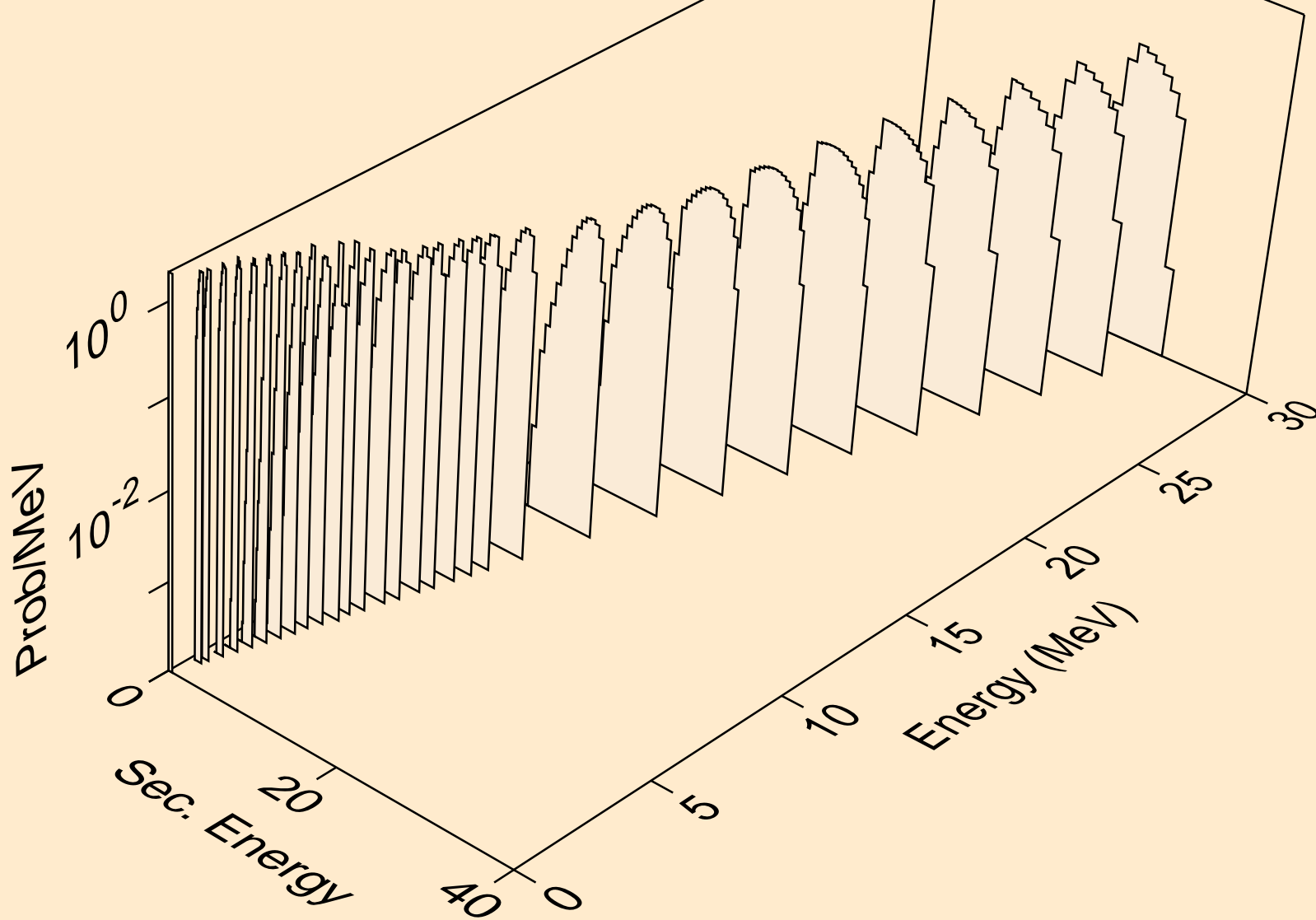

IR191 NEUTRON ACER TENDL-2019 LIBRARY; T=293.16K  
protons from (n,2p)

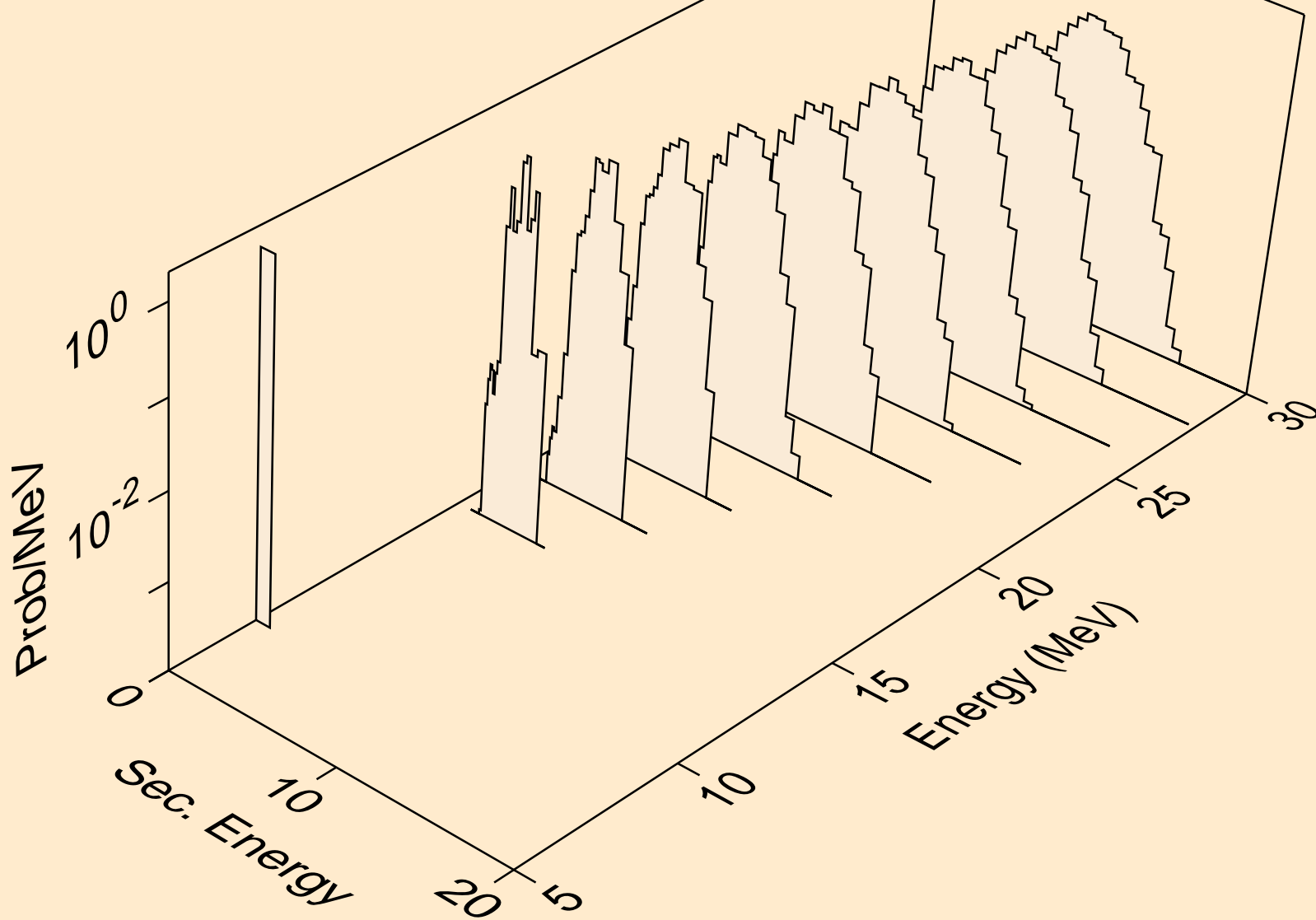

IR191 NEUTRON ACER TENDL-2019 LIBRARY; T=293.16K  
protons from (n,p)

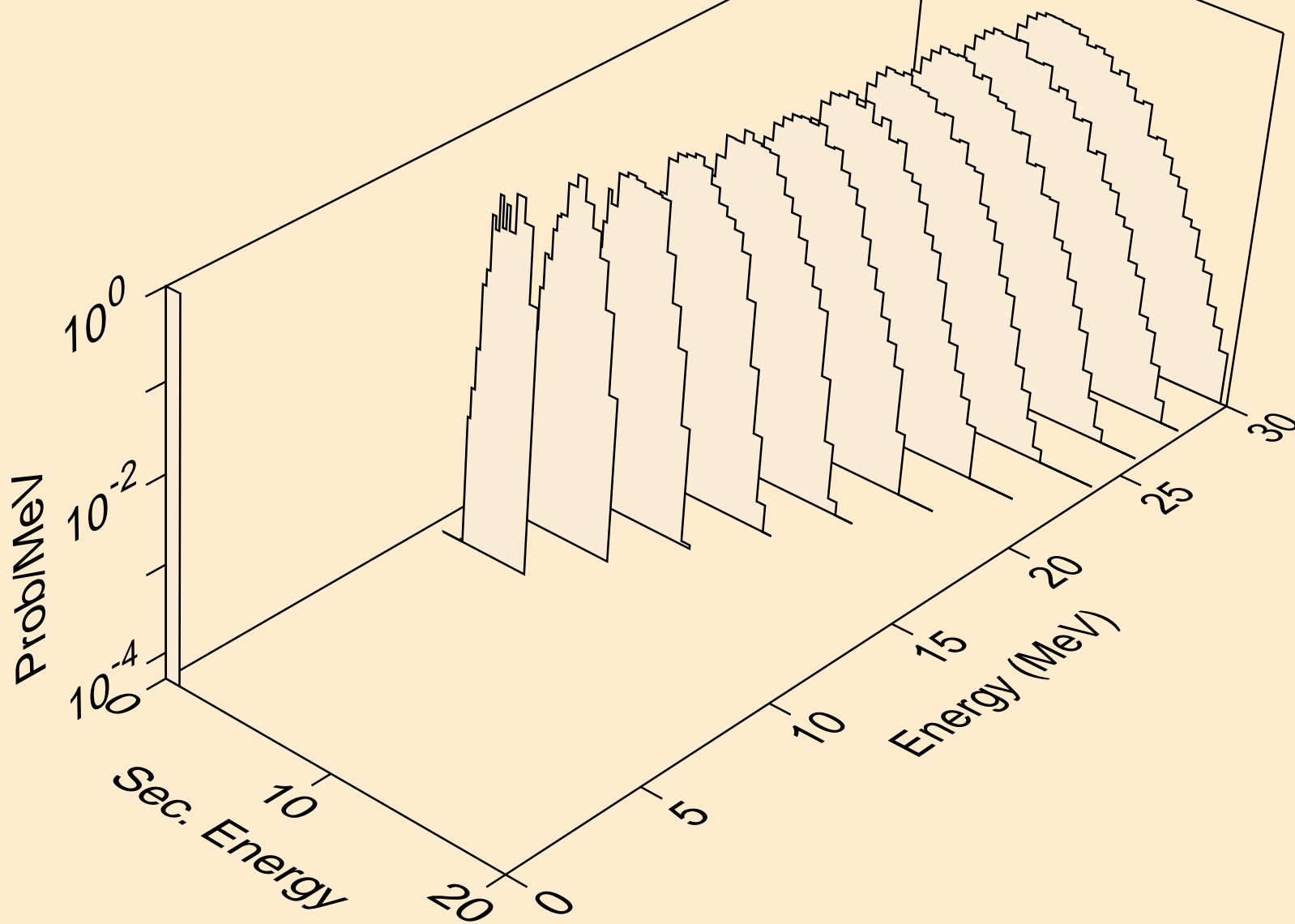

IR191 NEUTRON ACER TENDL-2019 LIBRARY; T=293.16K  
protons from (n,pd)

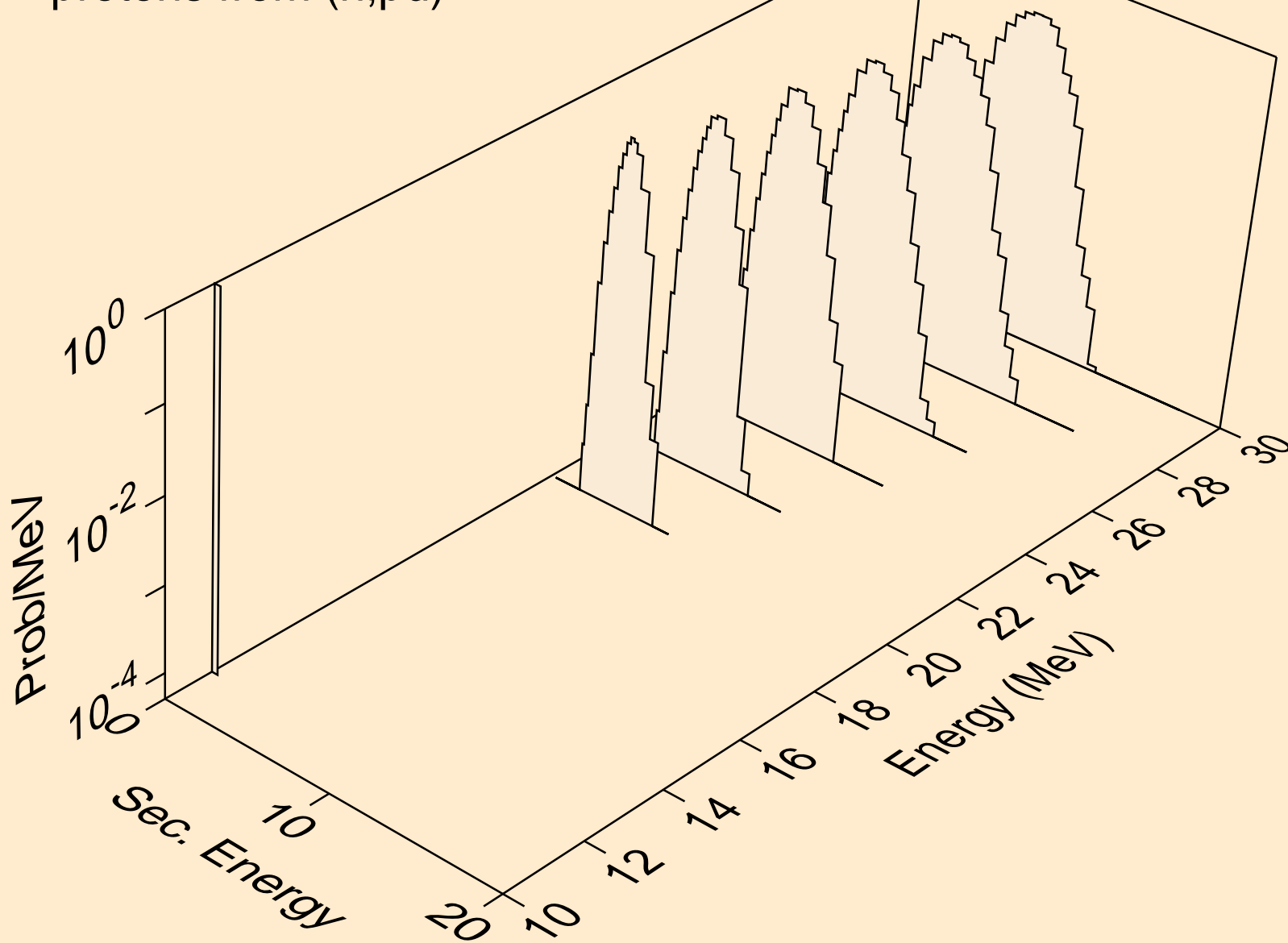

IR191 NEUTRON ACER TENDL-2019 LIBRARY; T=293.16K  
protons from (n,pt)

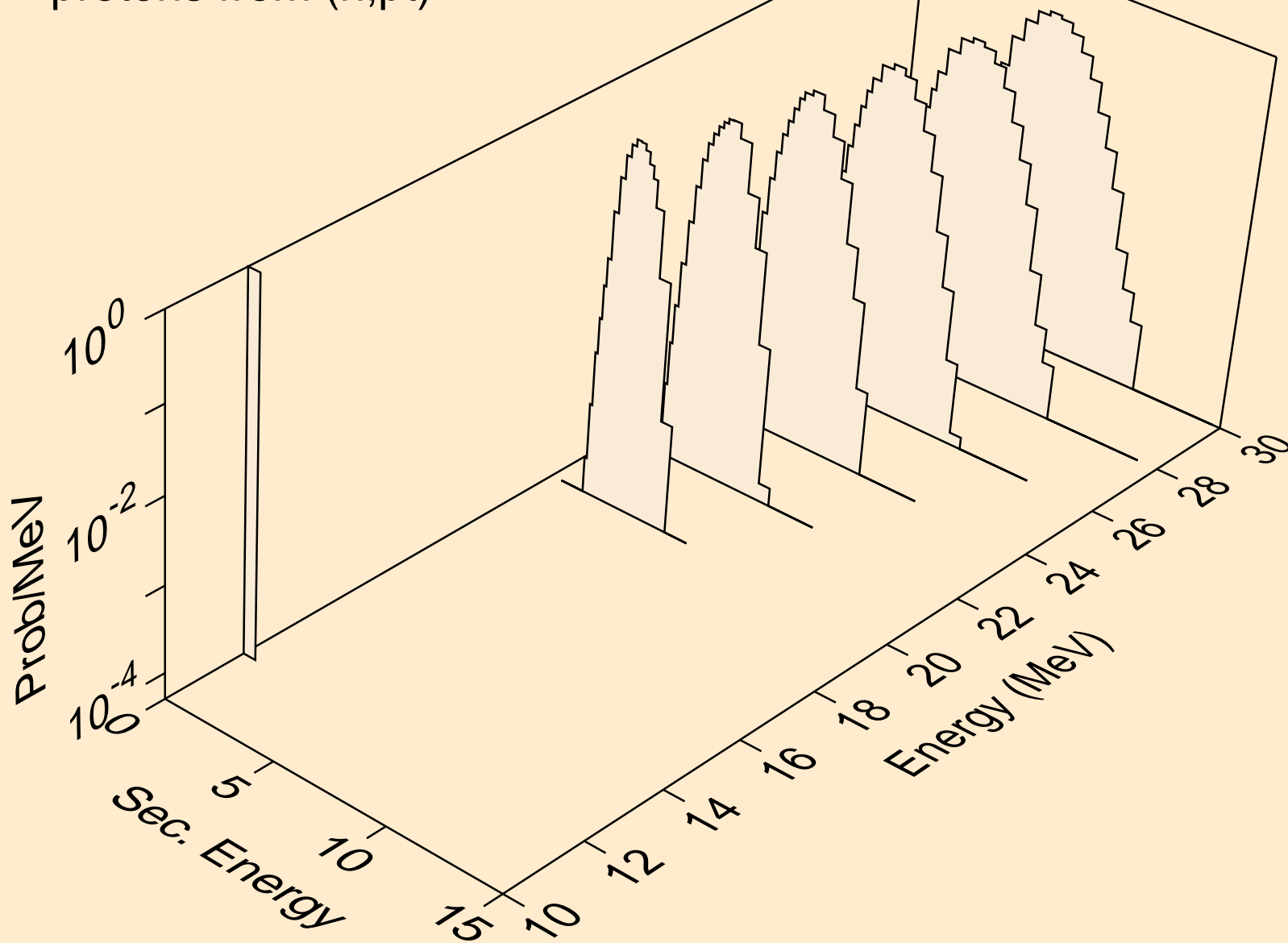

IR191 NEUTRON ACER TENDL-2019 LIBRARY; T=293.16K  
deuterons from (n,x)

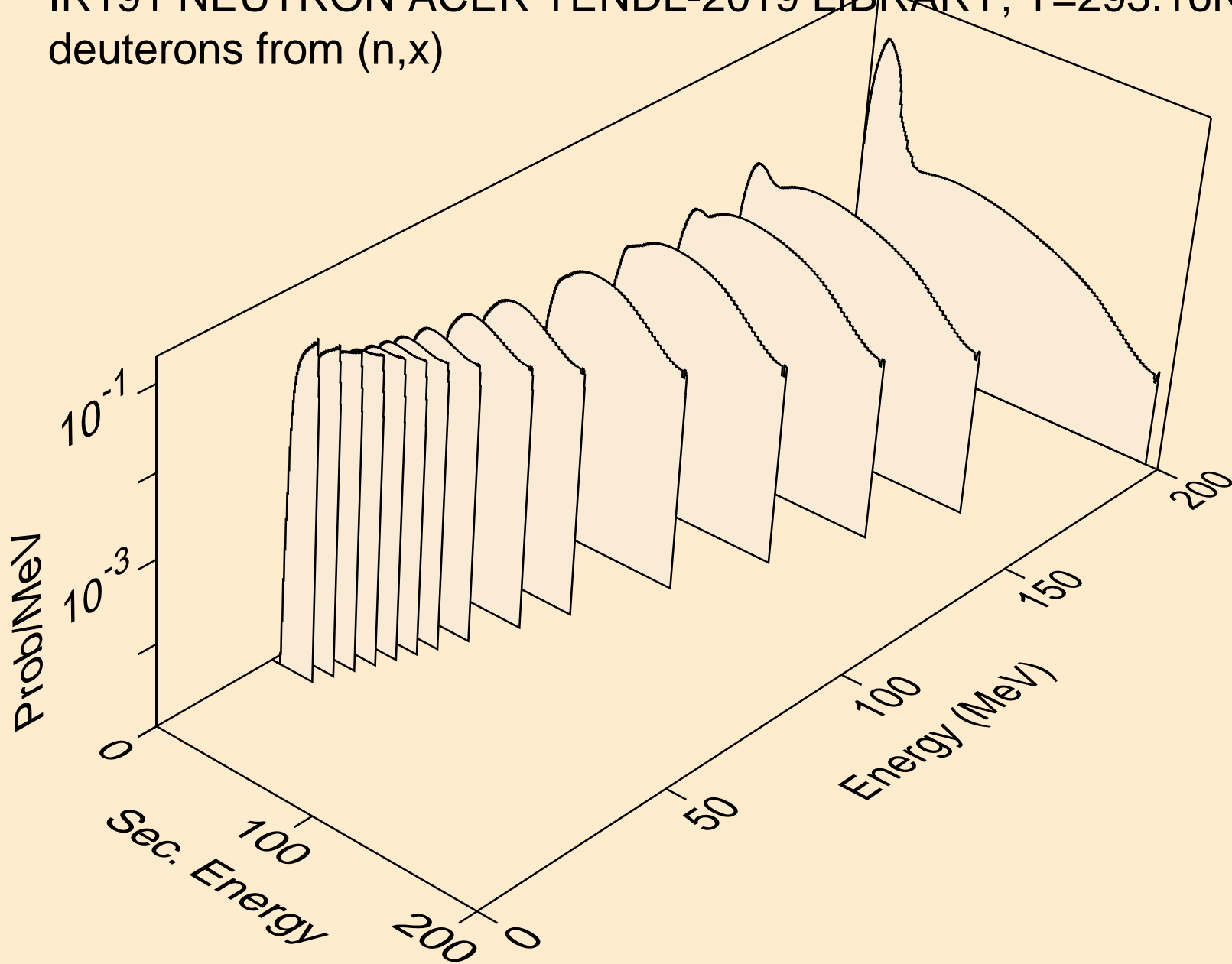

IR191 NEUTRON ACER TENDL-2019 LIBRARY; T=293.16K  
deuterons from (n,2nd)

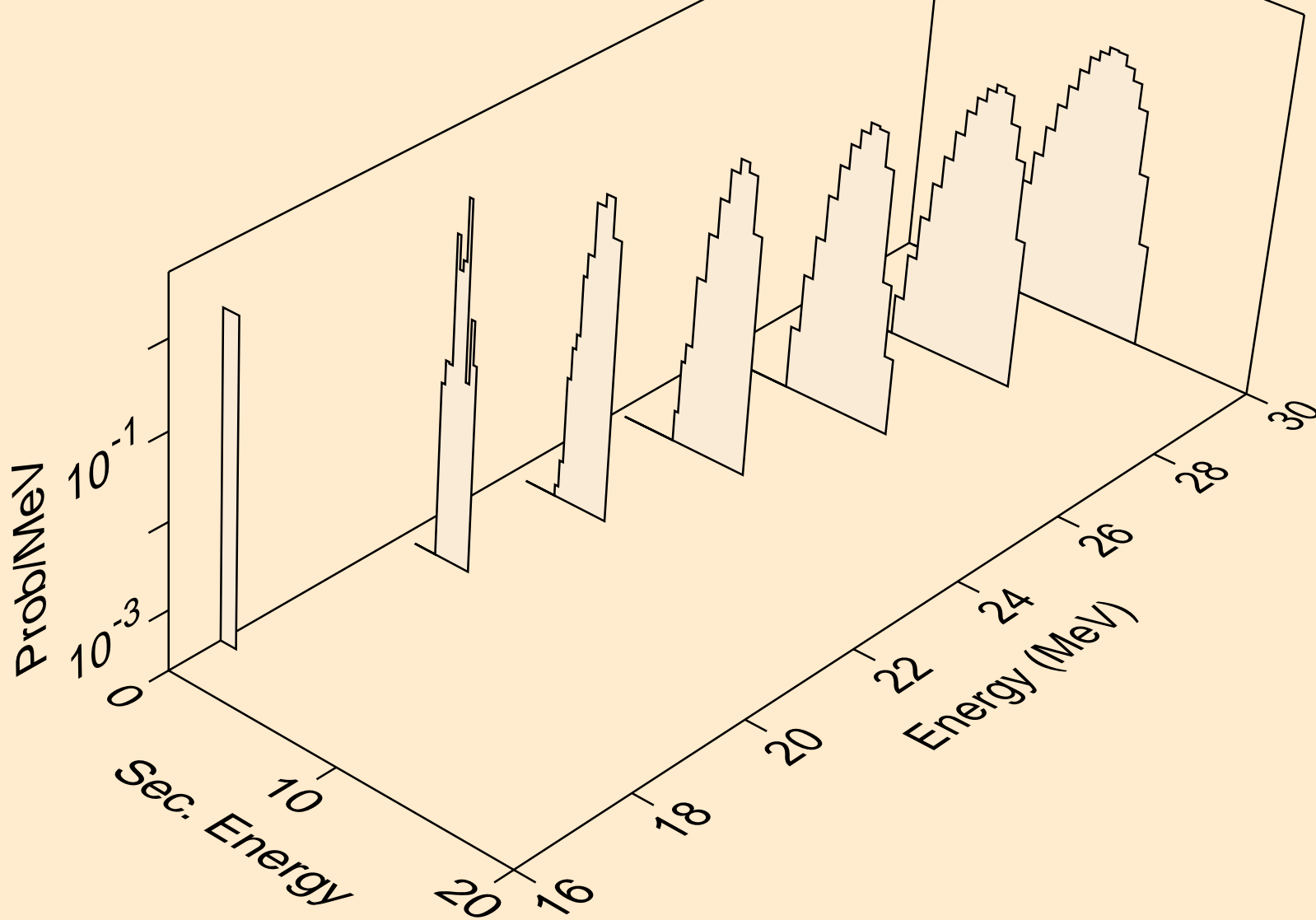



IR191 NEUTRON ACER TENDL-2019 LIBRARY; T=293.16K  
deuterons from (n,n\*)d

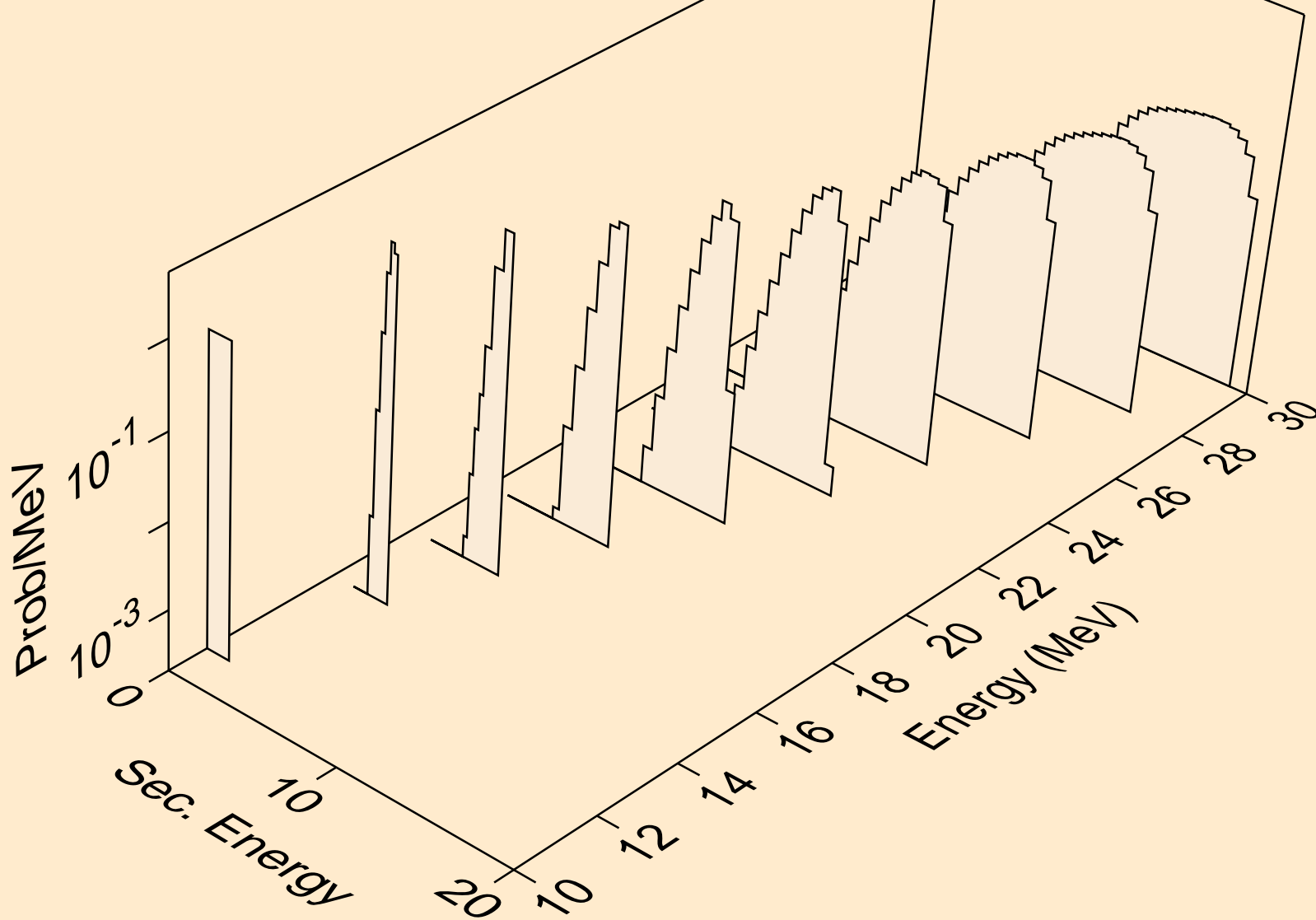

IR191 NEUTRON ACER TENDL-2019 LIBRARY; T=293.16K  
deuterons from (n,d)

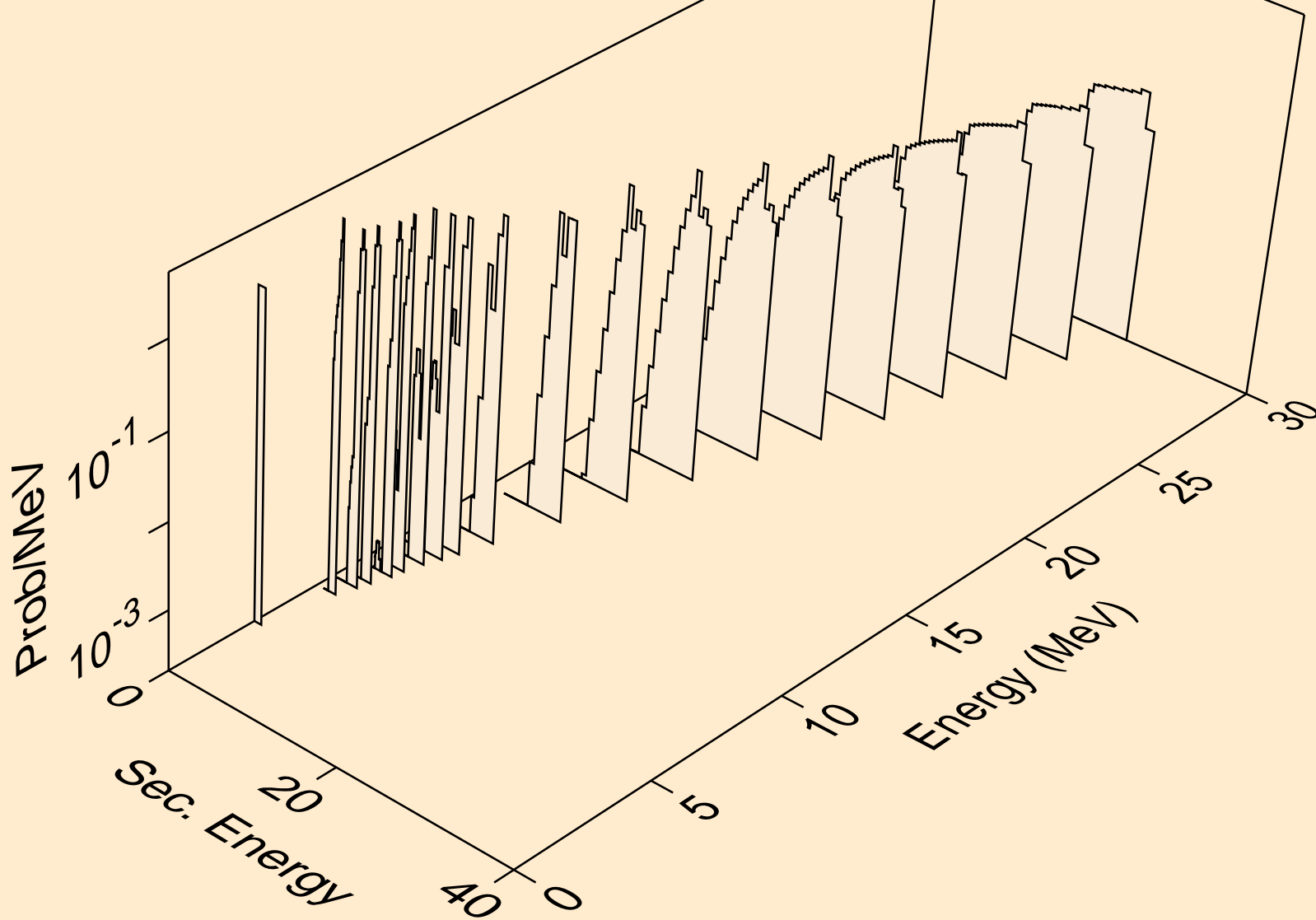

IR191 NEUTRON ACER TENDL-2019 LIBRARY; T=293.16K  
deuterons from (n,pd)

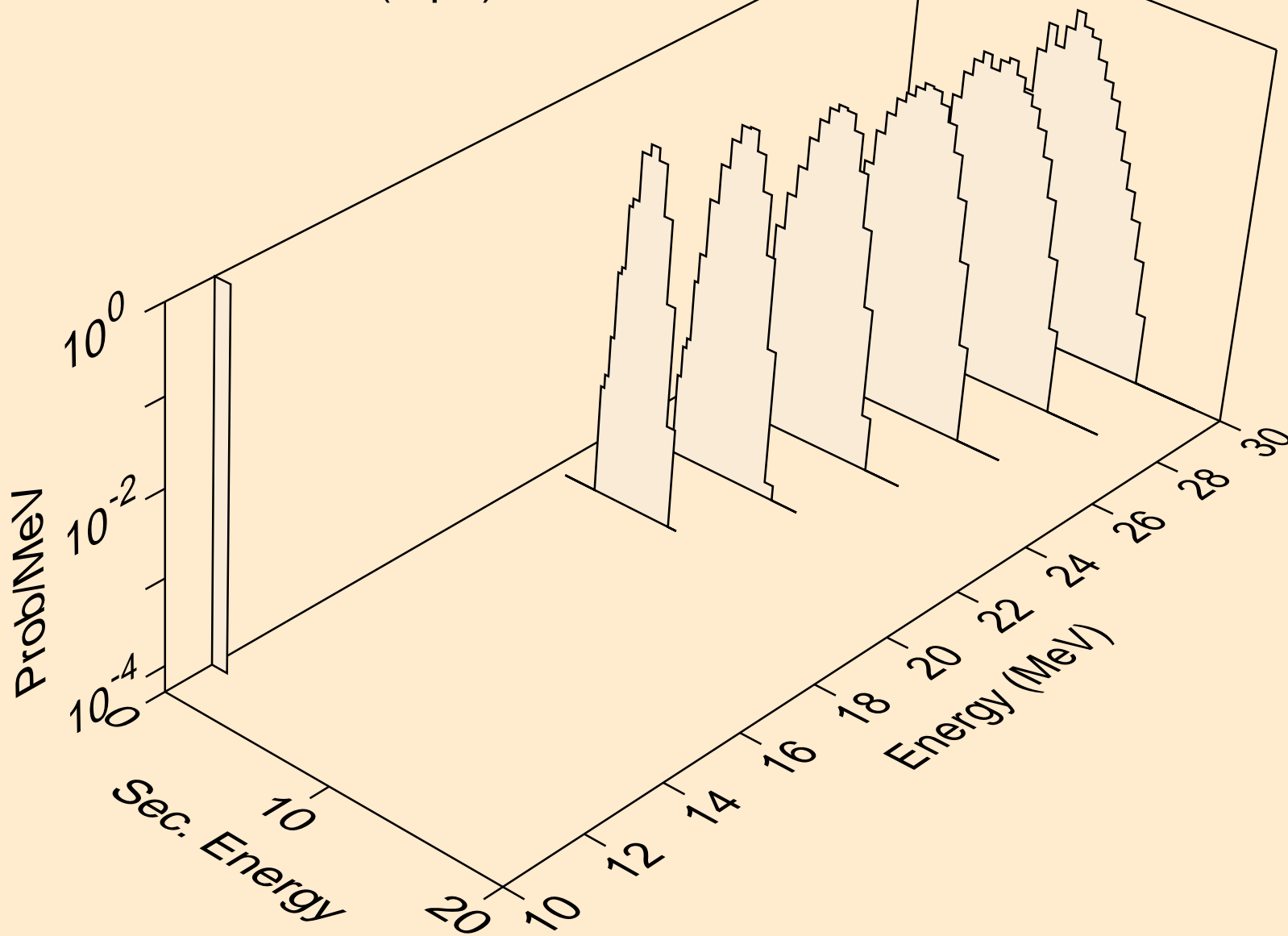

IR191 NEUTRON ACER TENDL-2019 LIBRARY; T=293.16K  
deuterons from (n,da)

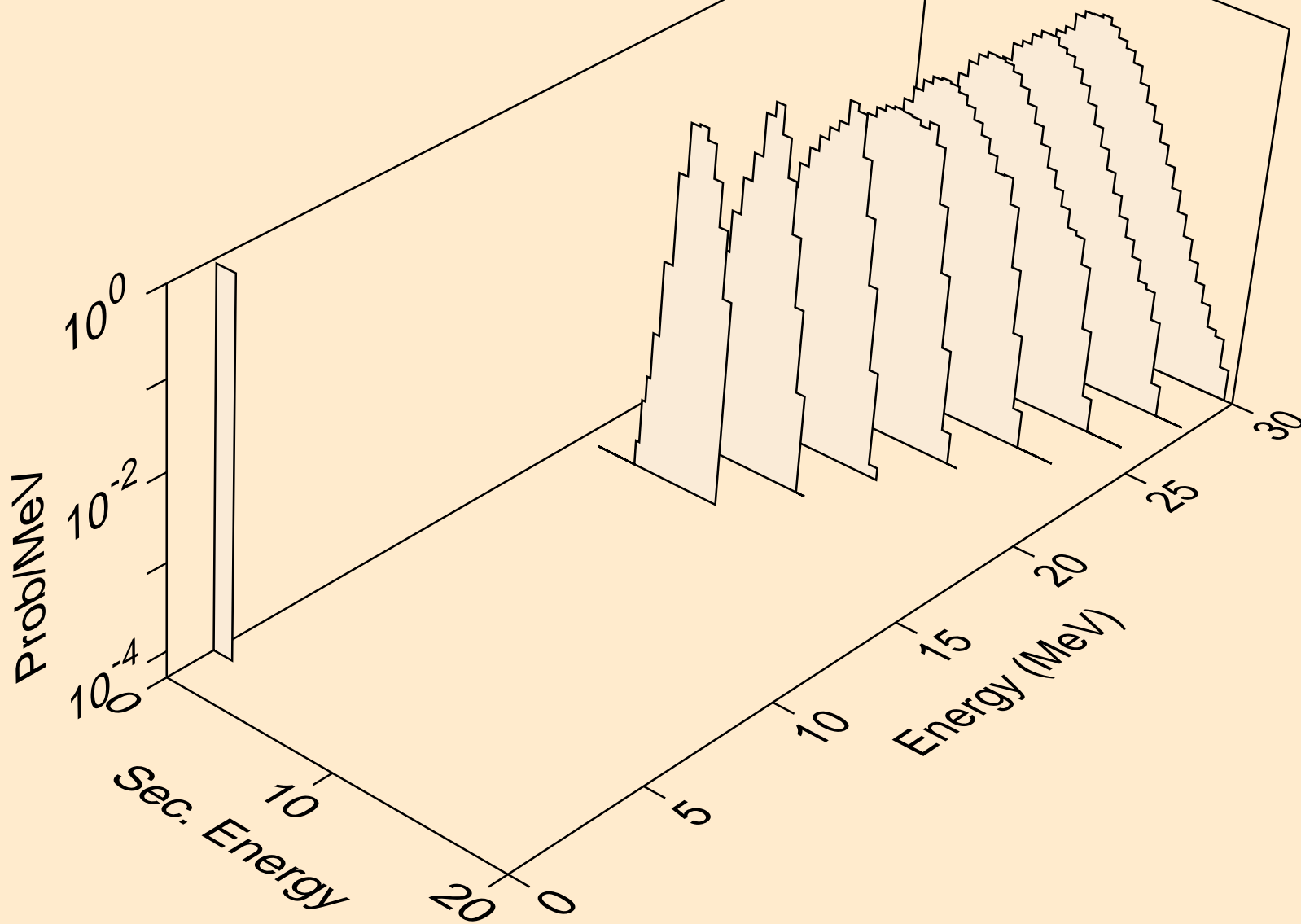

IR191 NEUTRON ACER TENDL-2019 LIBRARY; T=293.16K  
tritons from (n,x)

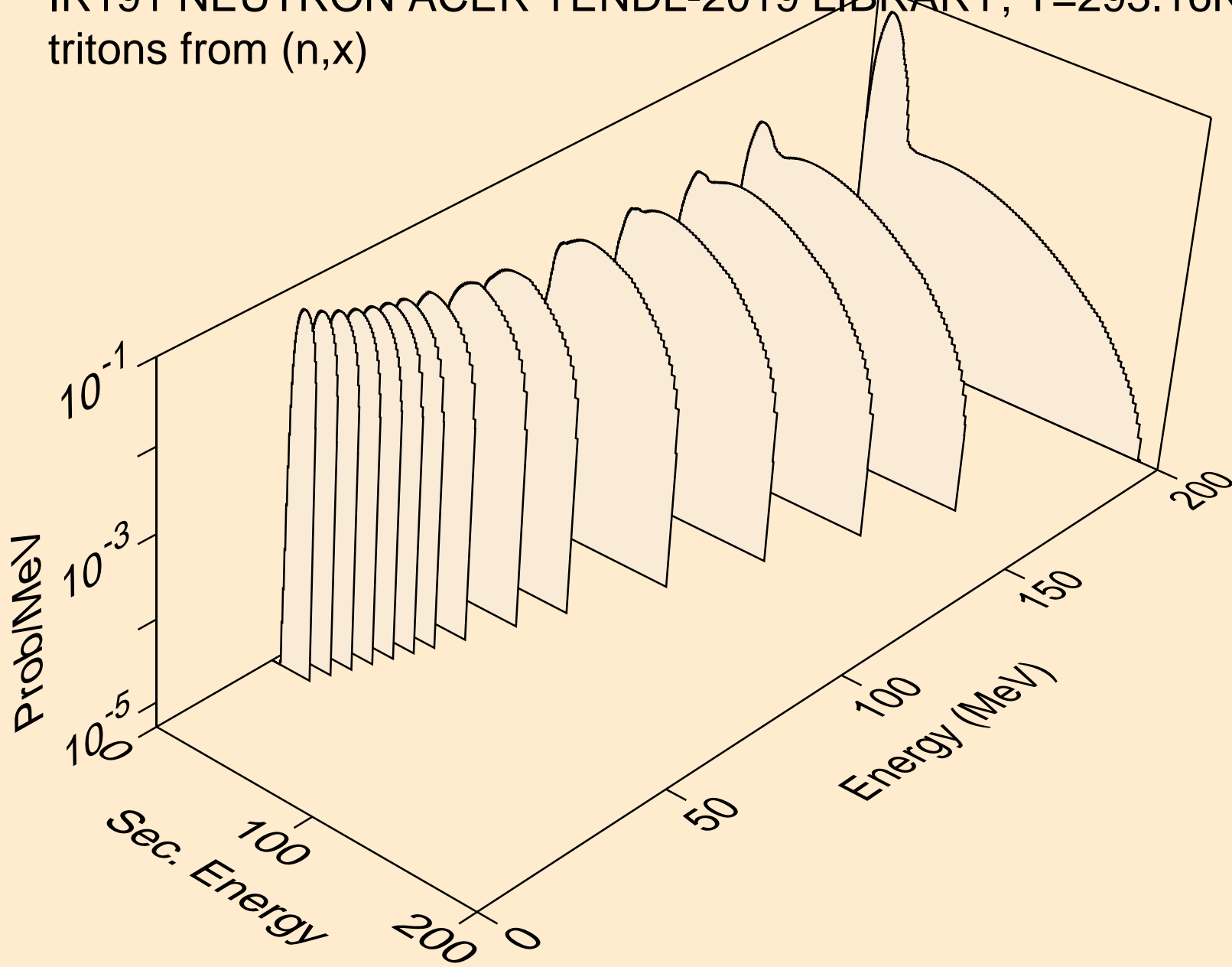

IR191 NEUTRON ACER TENDL-2019 LIBRARY; T=293.16K  
tritons from (n,n\*)t

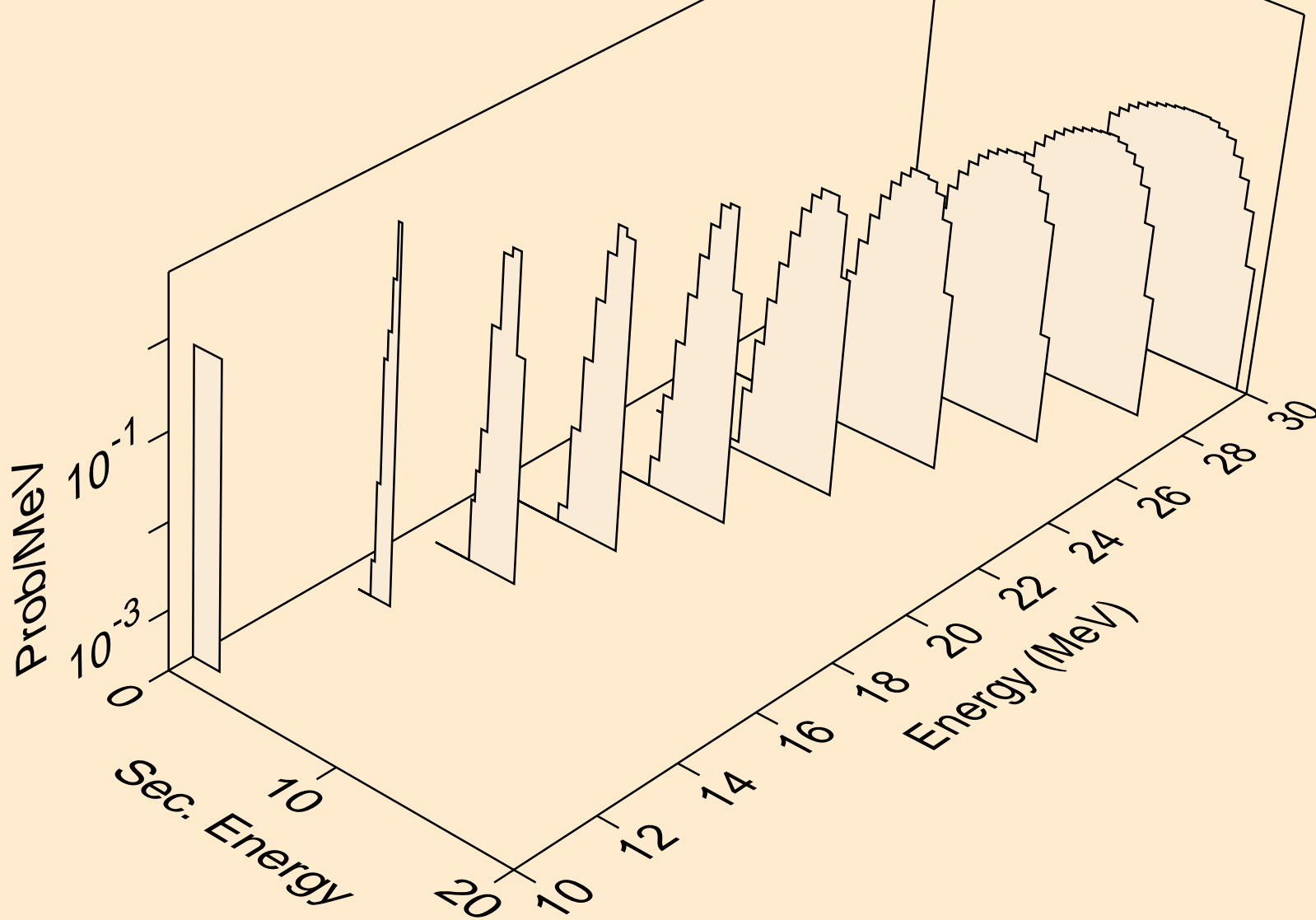

IR191 NEUTRON ACER TENDL-2019 LIBRARY; T=293.16K  
tritons from (n,t)

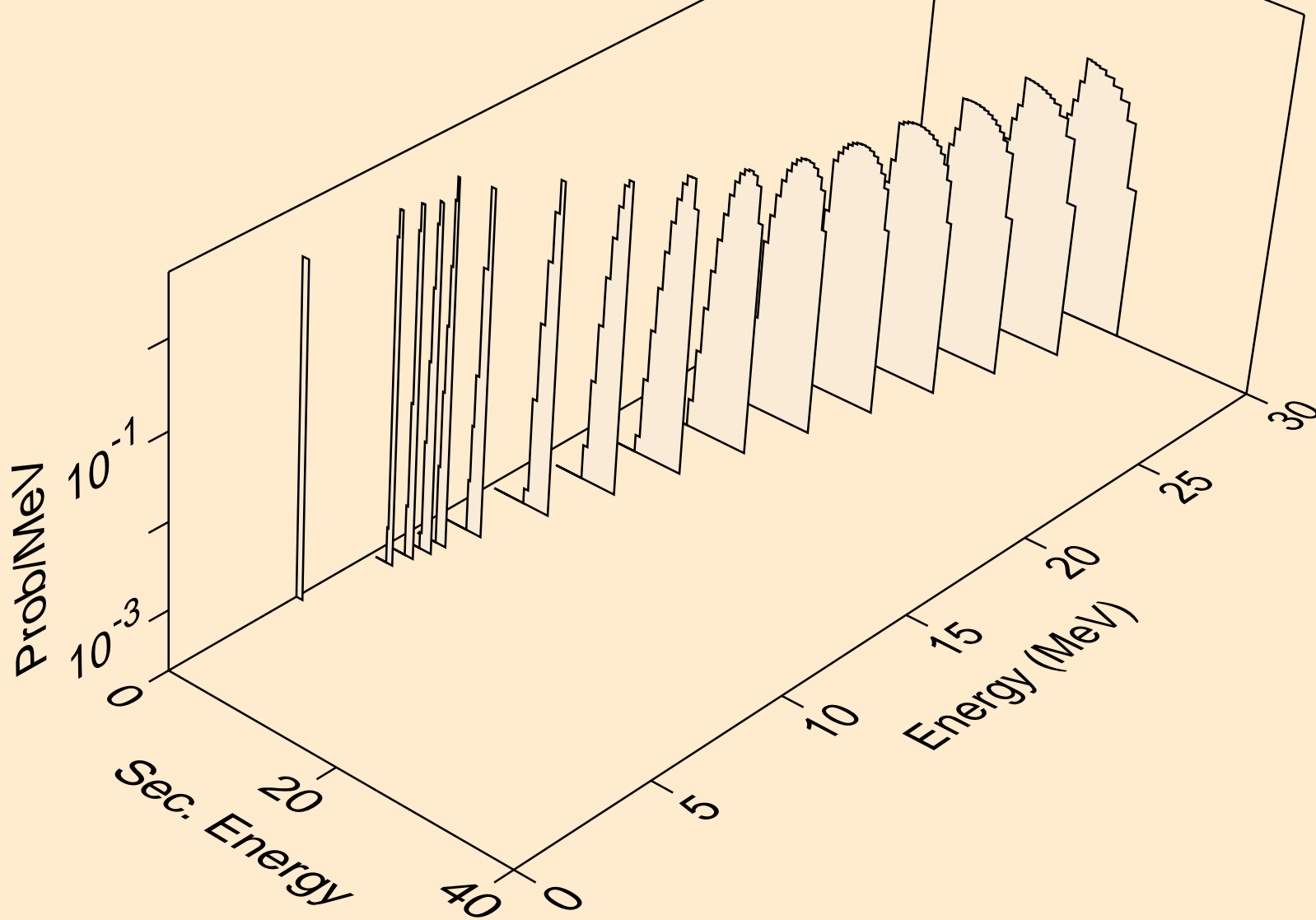

IR191 NEUTRON ACER TENDL-2019 LIBRARY; T=293.16K  
tritons from (n,pt)

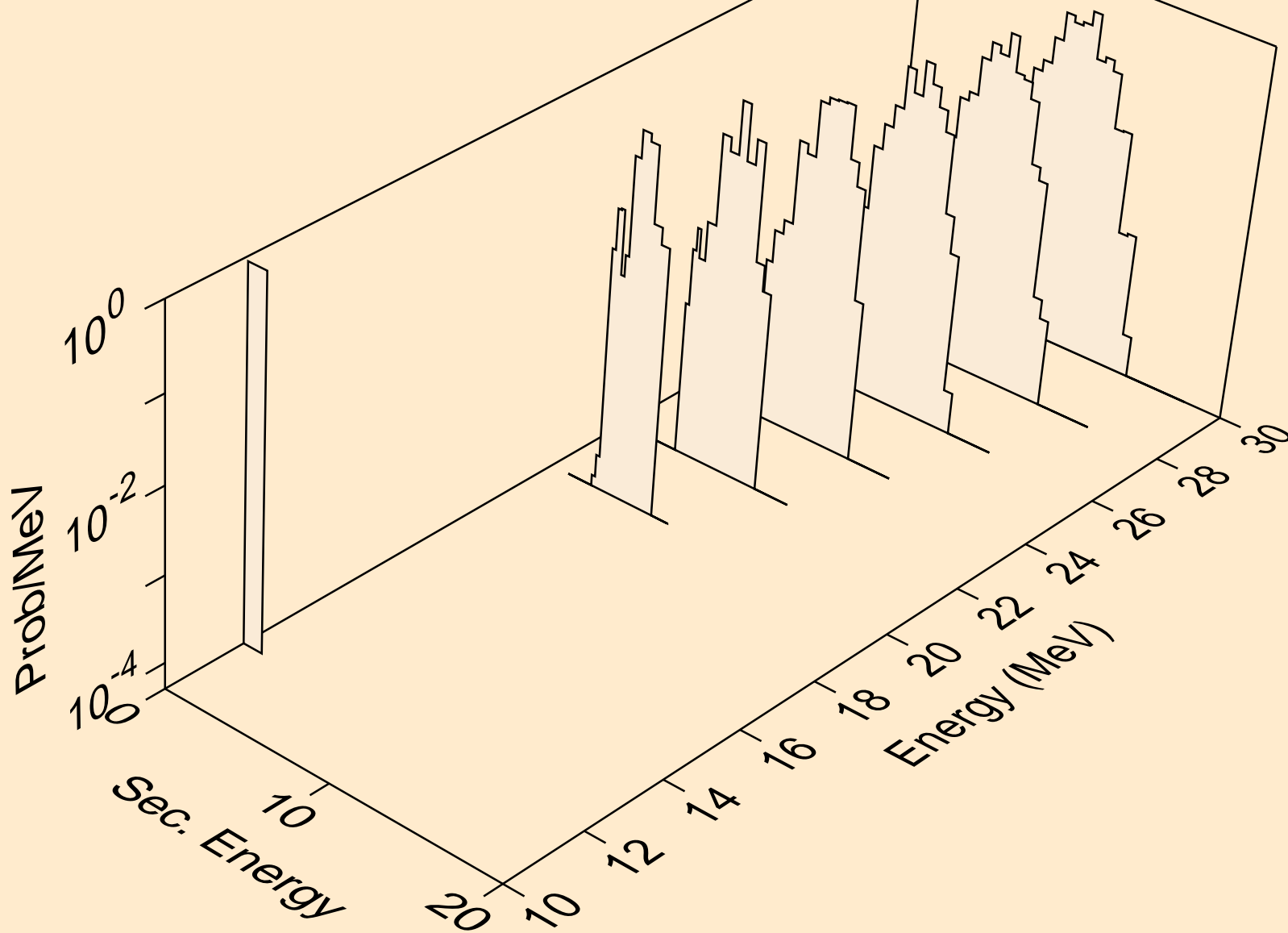



IR191 NEUTRON ACER TENDL-2019 LIBRARY; T=293.16K  
he3s from (n,x)

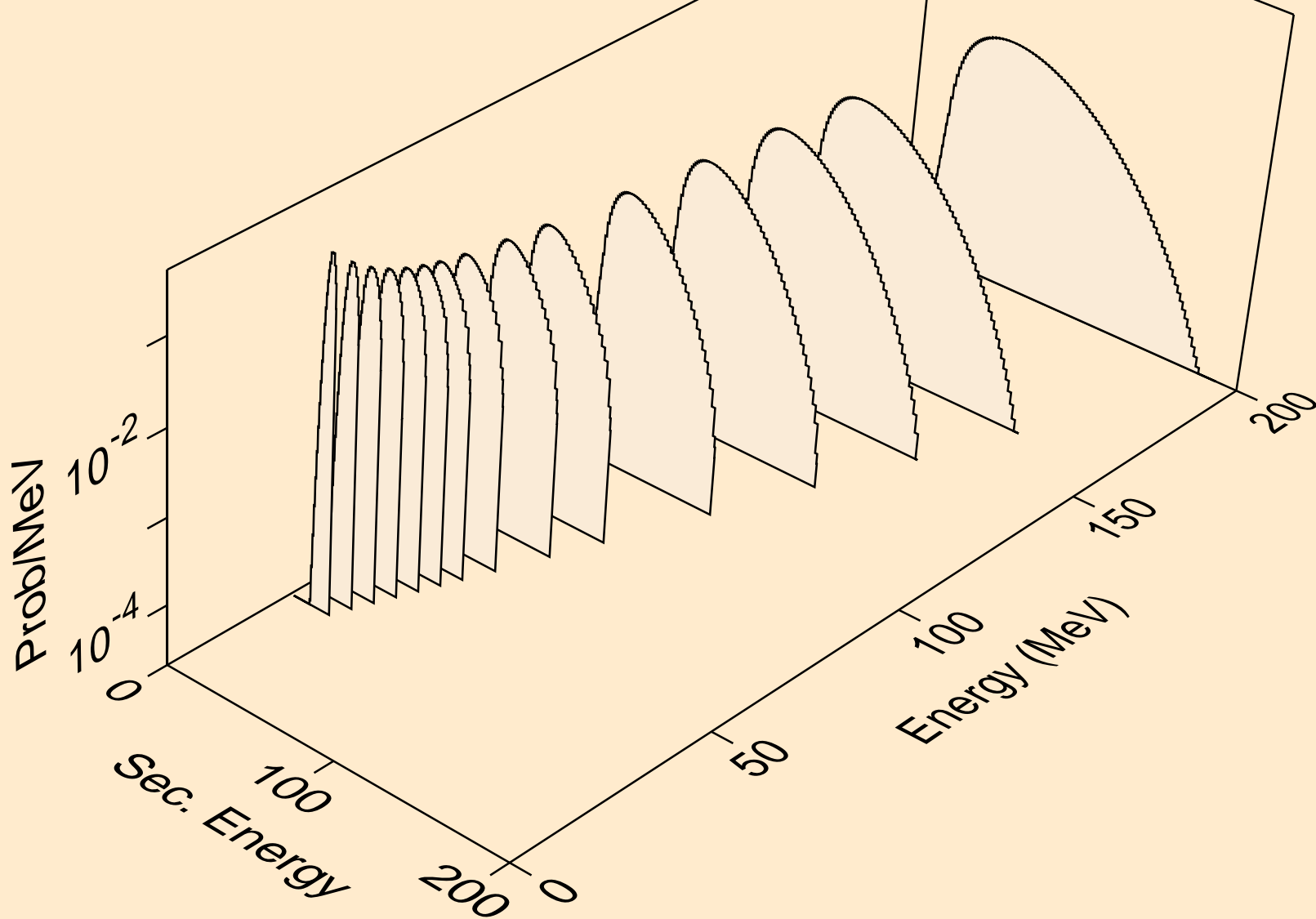

IR191 NEUTRON ACER TENDL-2019 LIBRARY; T=293.16K  
he3s from (n,n\*)he3

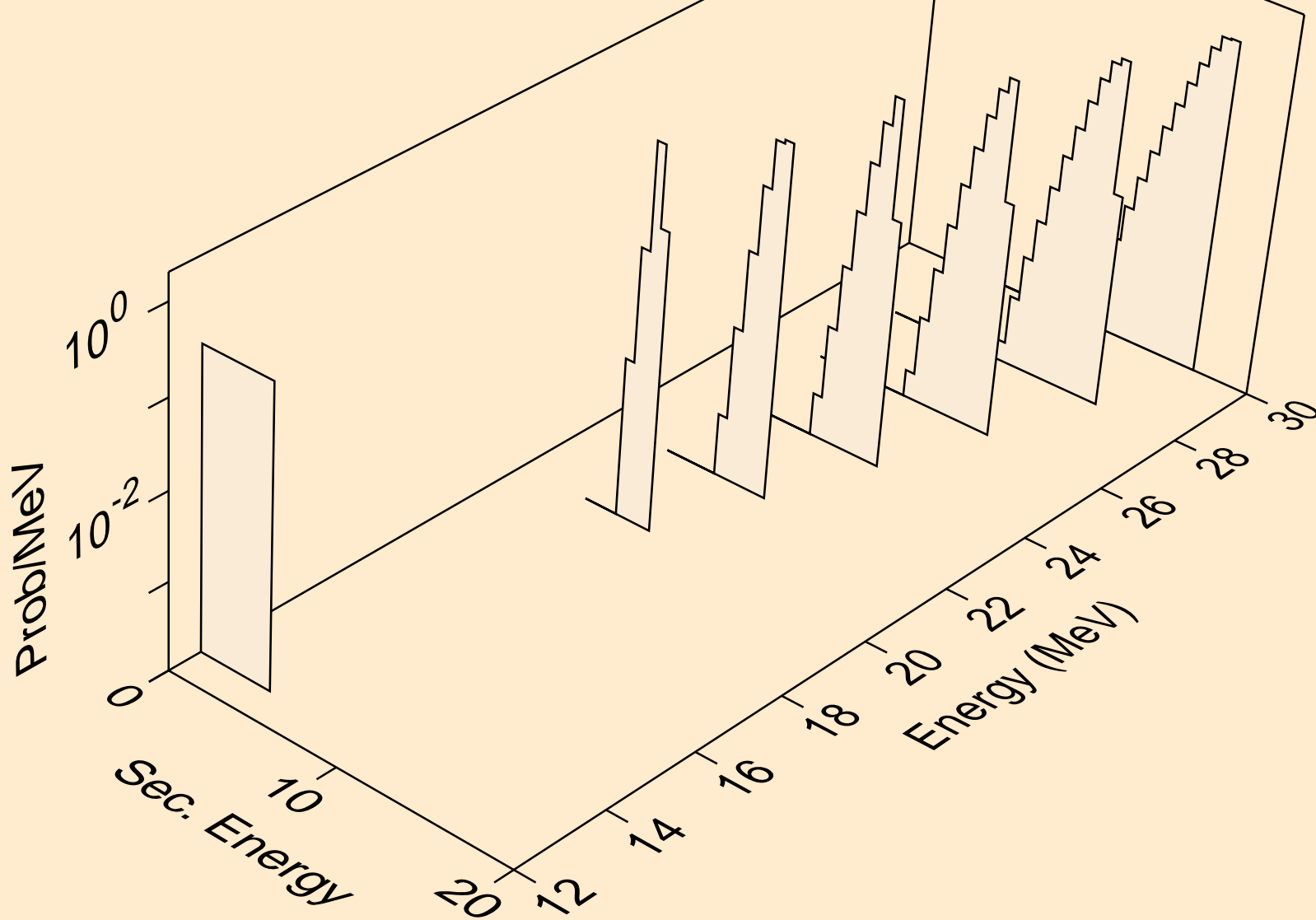

IR191 NEUTRON ACER TENDL-2019 LIBRARY; T=293.16K  
he3s from (n,he3)

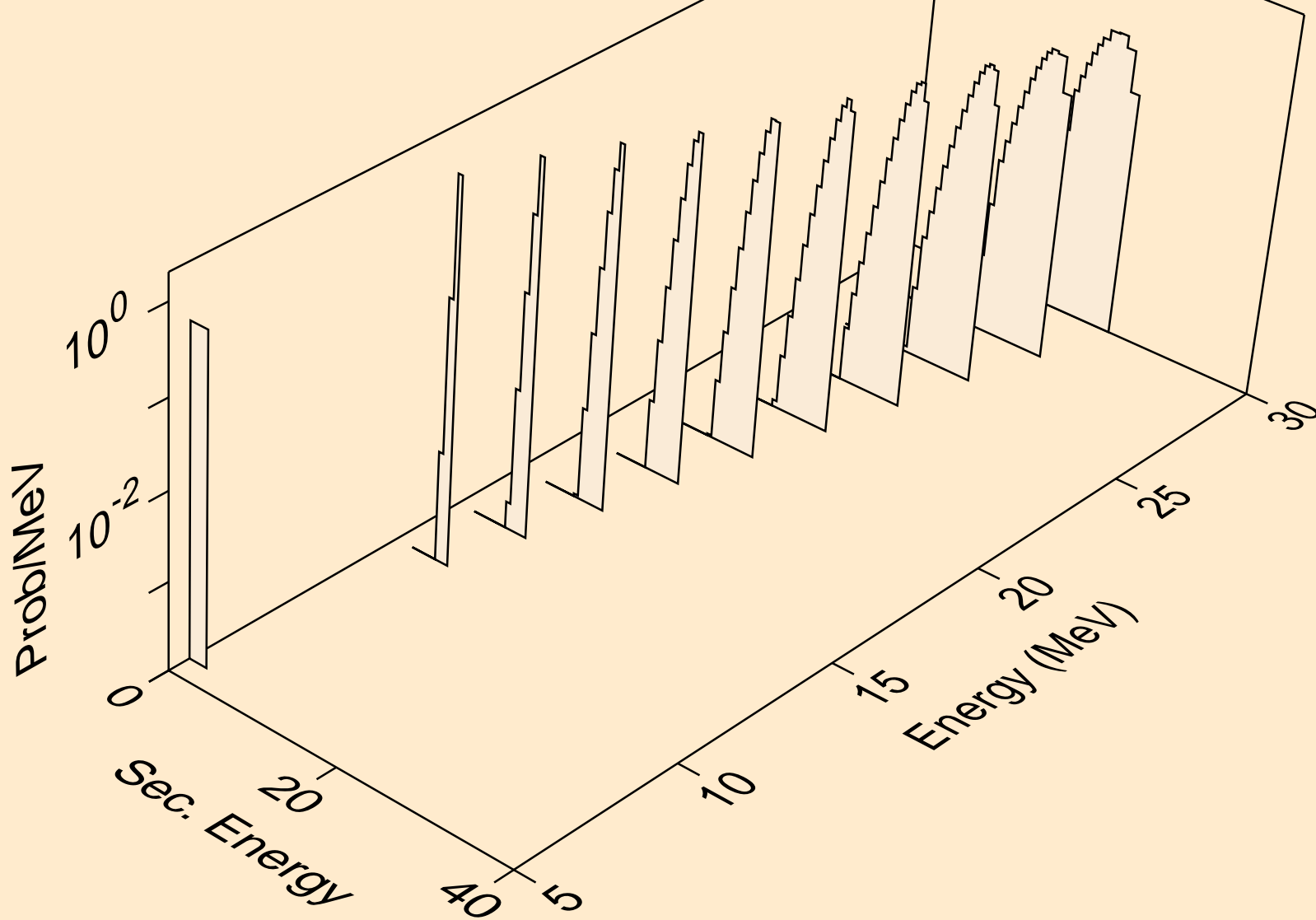

IR191 NEUTRON ACER TENDL-2019 LIBRARY; T=293.16K  
alphas from (n,x)

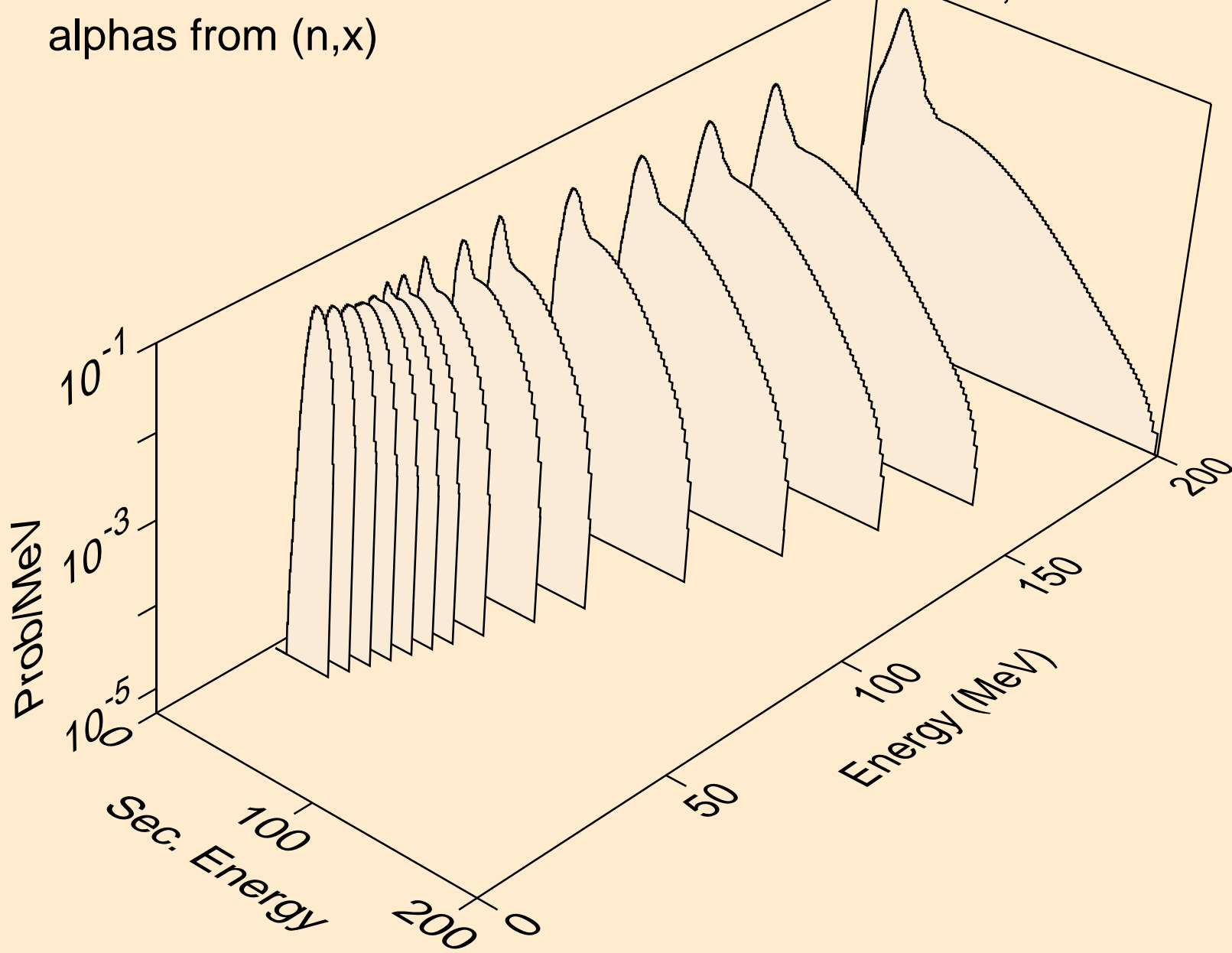

IR191 NEUTRON ACER TENDL-2019 LIBRARY; T=293.16K  
alphas from (n,n\*)a

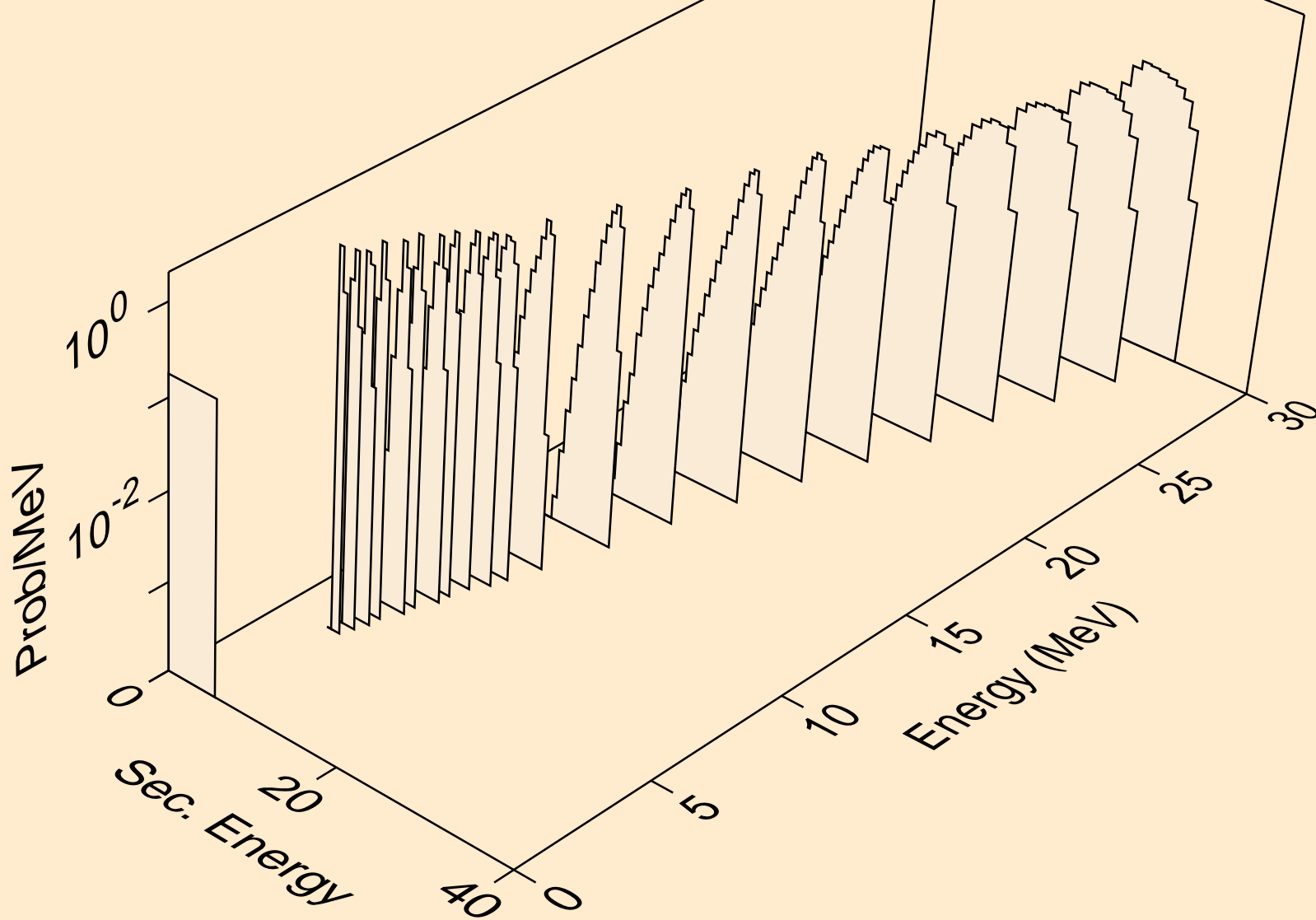

IR191 NEUTRON ACER TENDL-2019 LIBRARY; T=293.16K  
alphas from (n,2n)a

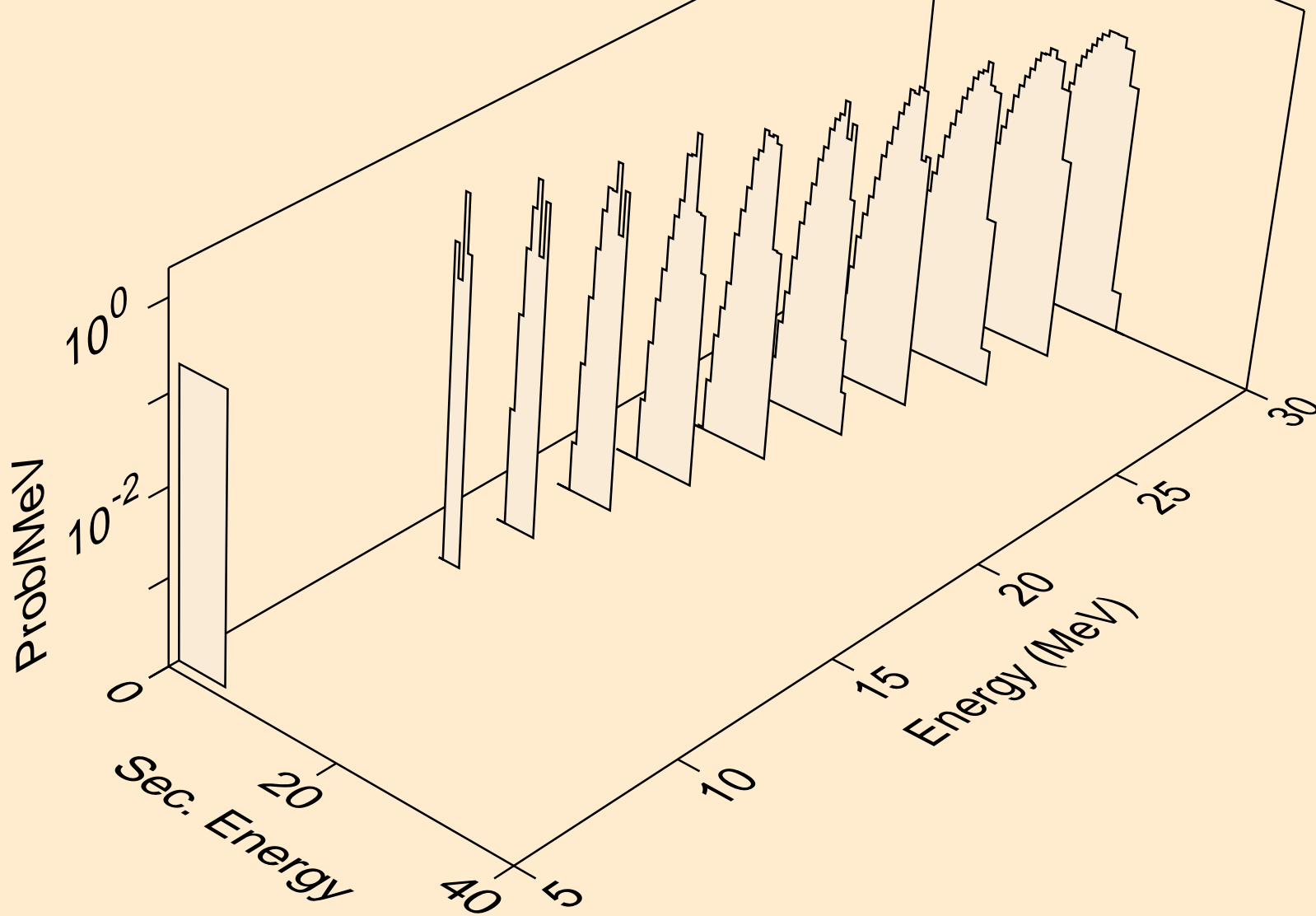

IR191 NEUTRON ACER TENDL-2019 LIBRARY; T=293.16K  
alphas from (n,3n)a

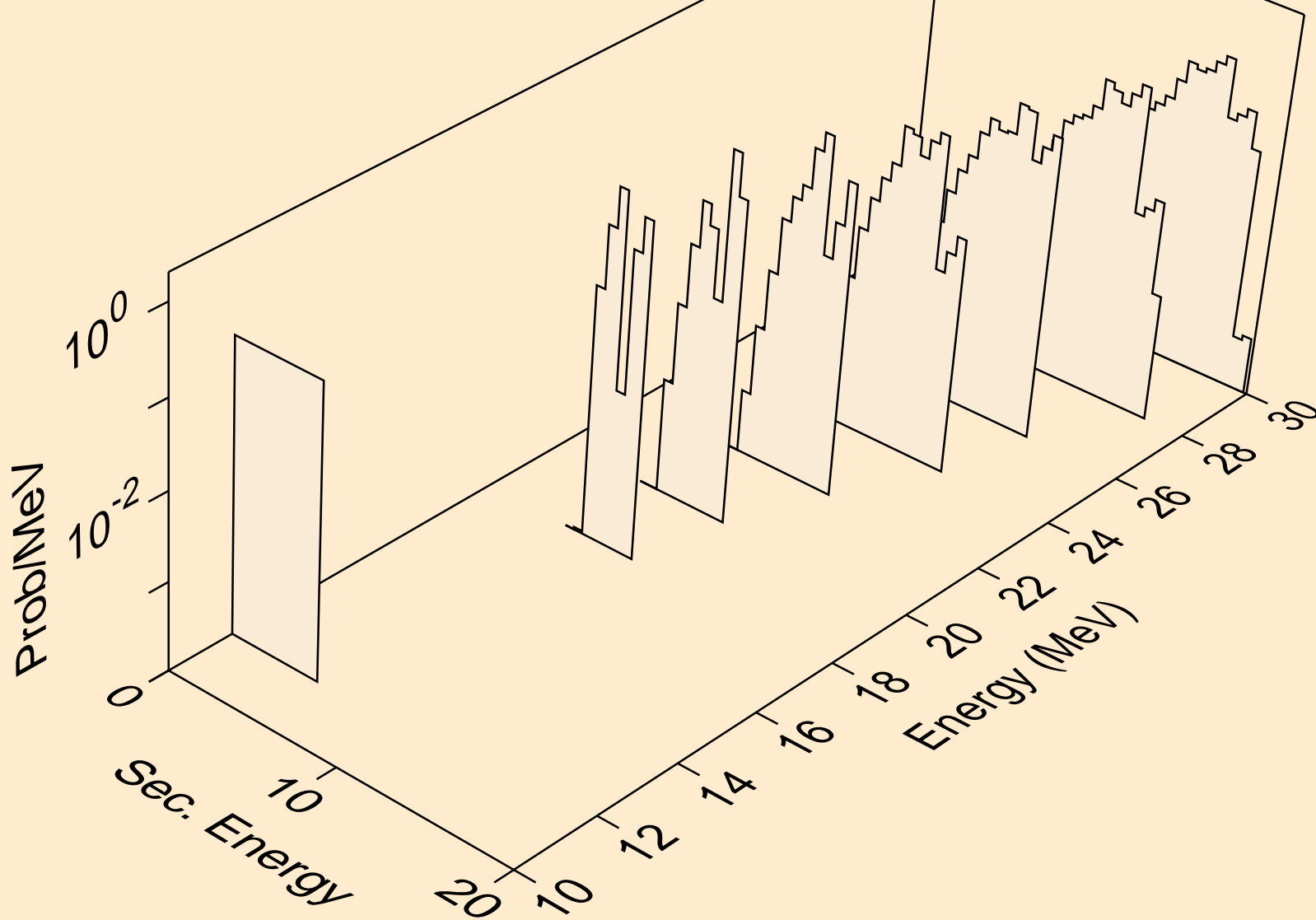

IR191 NEUTRON ACER TENDL-2019 LIBRARY; T=293.16K  
alphas from (n,n\*)2a

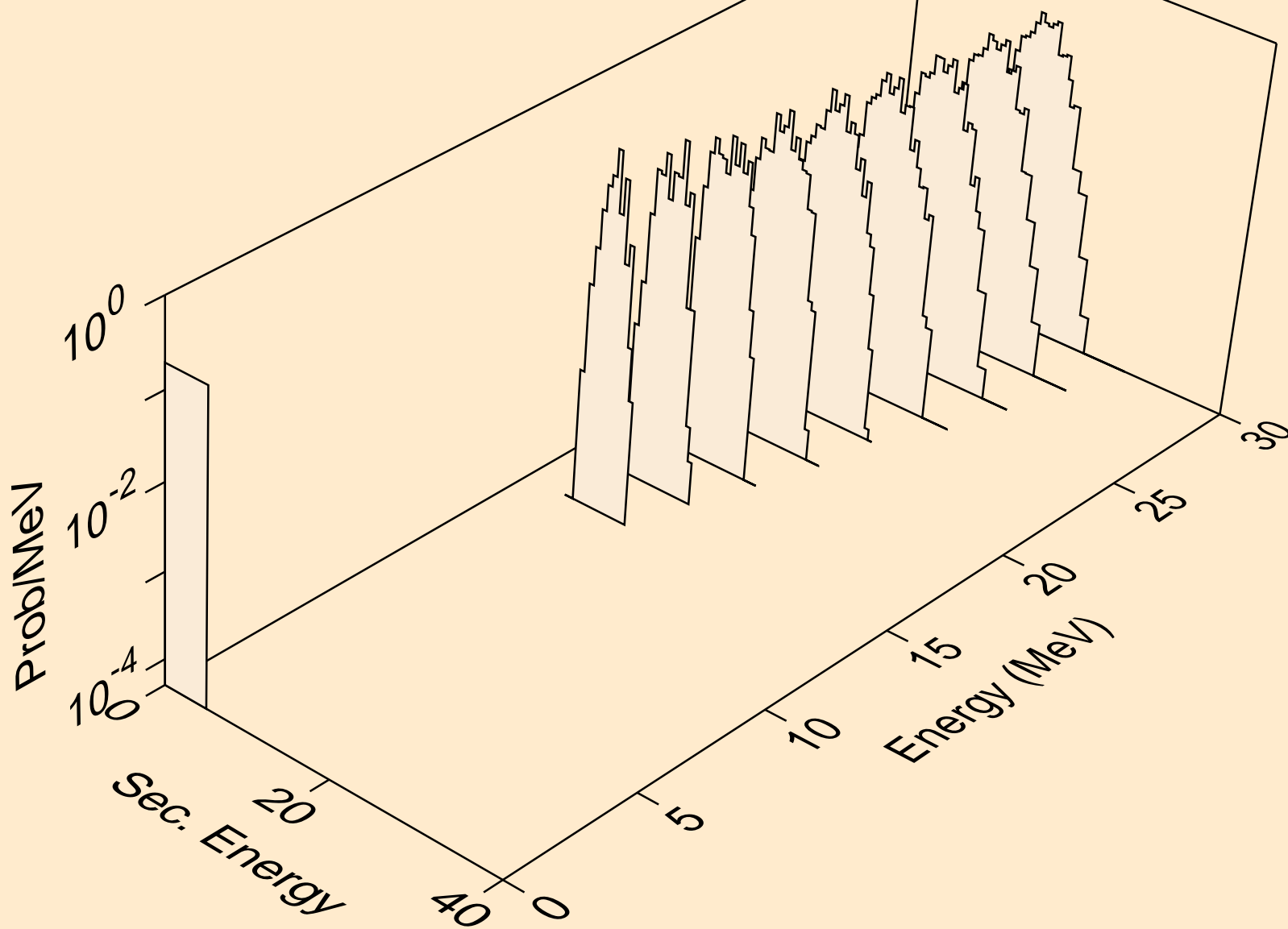



IR191 NEUTRON ACER TENDL-2019 LIBRARY; T=293.16K  
alphas from (n,npa)

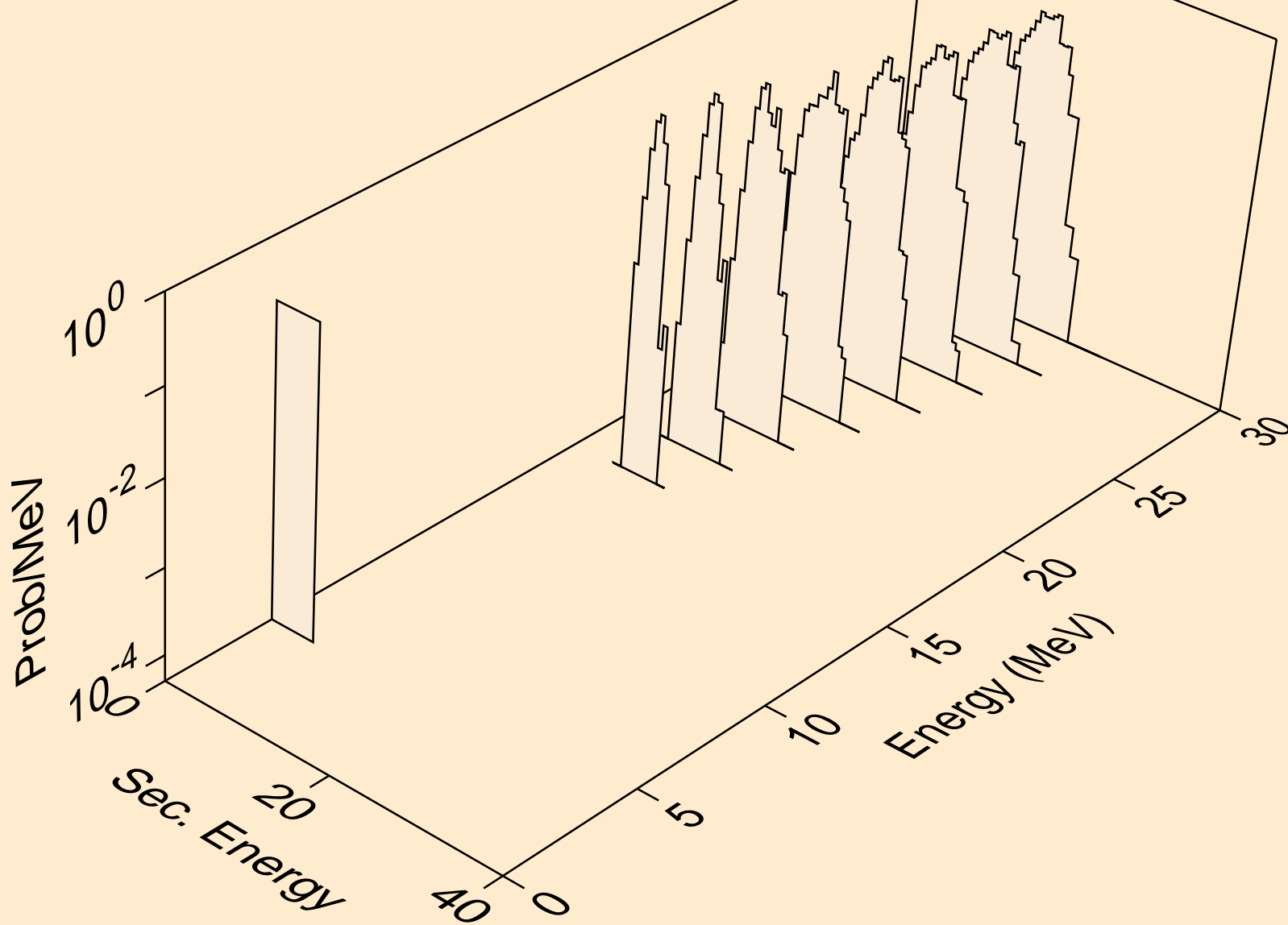

IR191 NEUTRON ACER TENDL-2019 LIBRARY; T=293.16K  
alphas from (n,a)

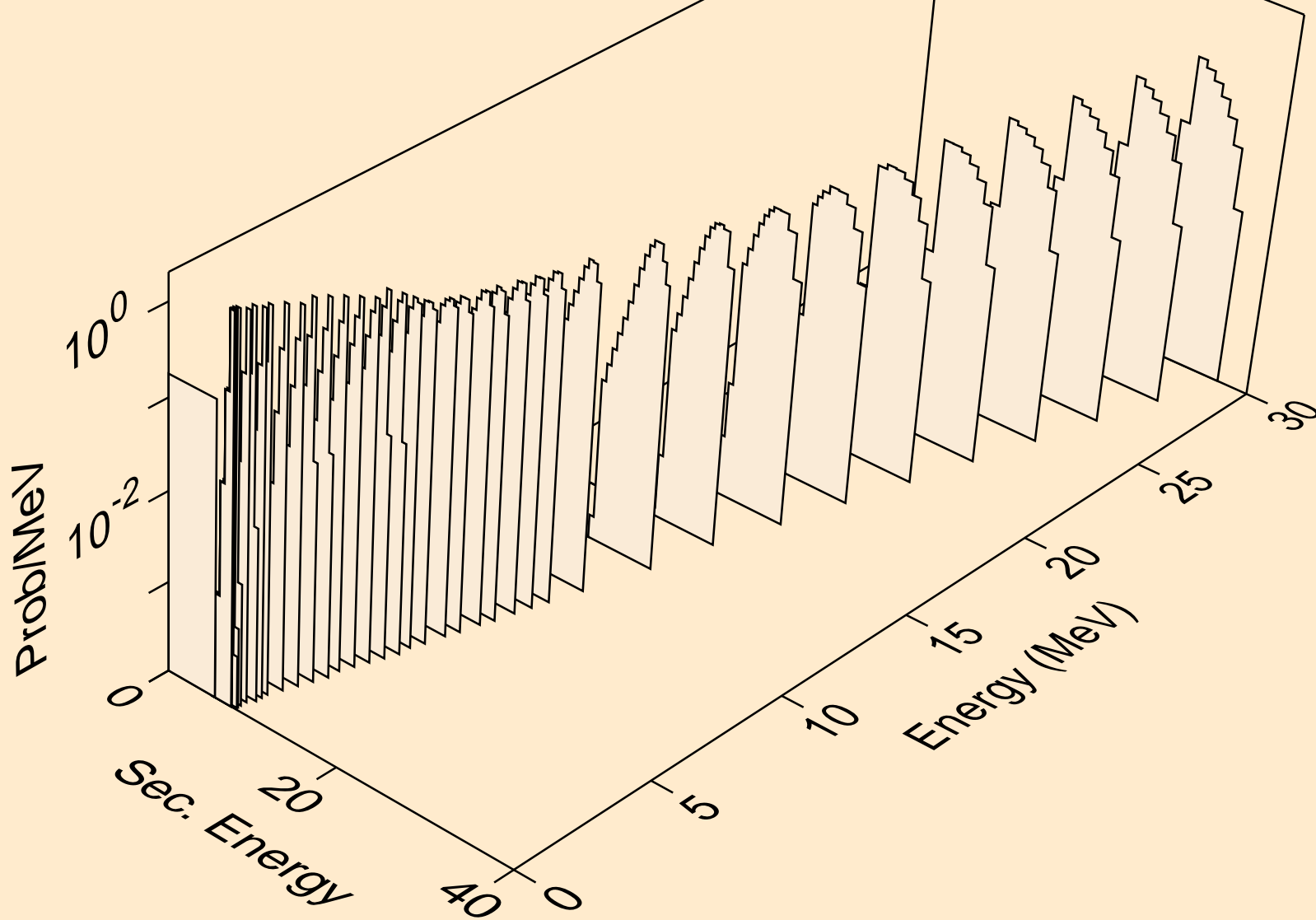

IR191 NEUTRON ACER TENDL-2019 LIBRARY; T=293.16K  
alphas from (n,2a)

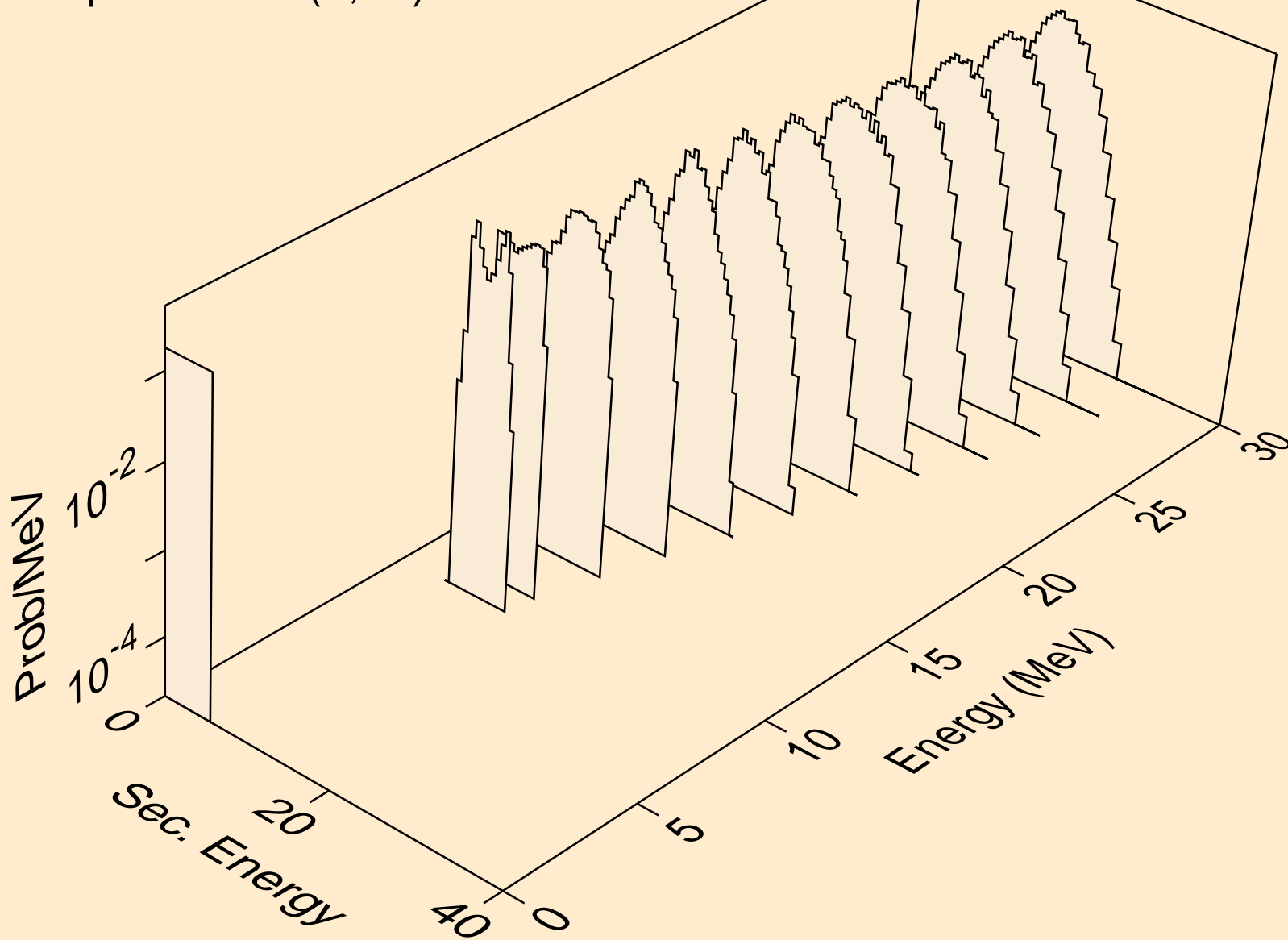

IR191 NEUTRON ACER TENDL-2019 LIBRARY; T=293.16K  
alphas from (n,pa)

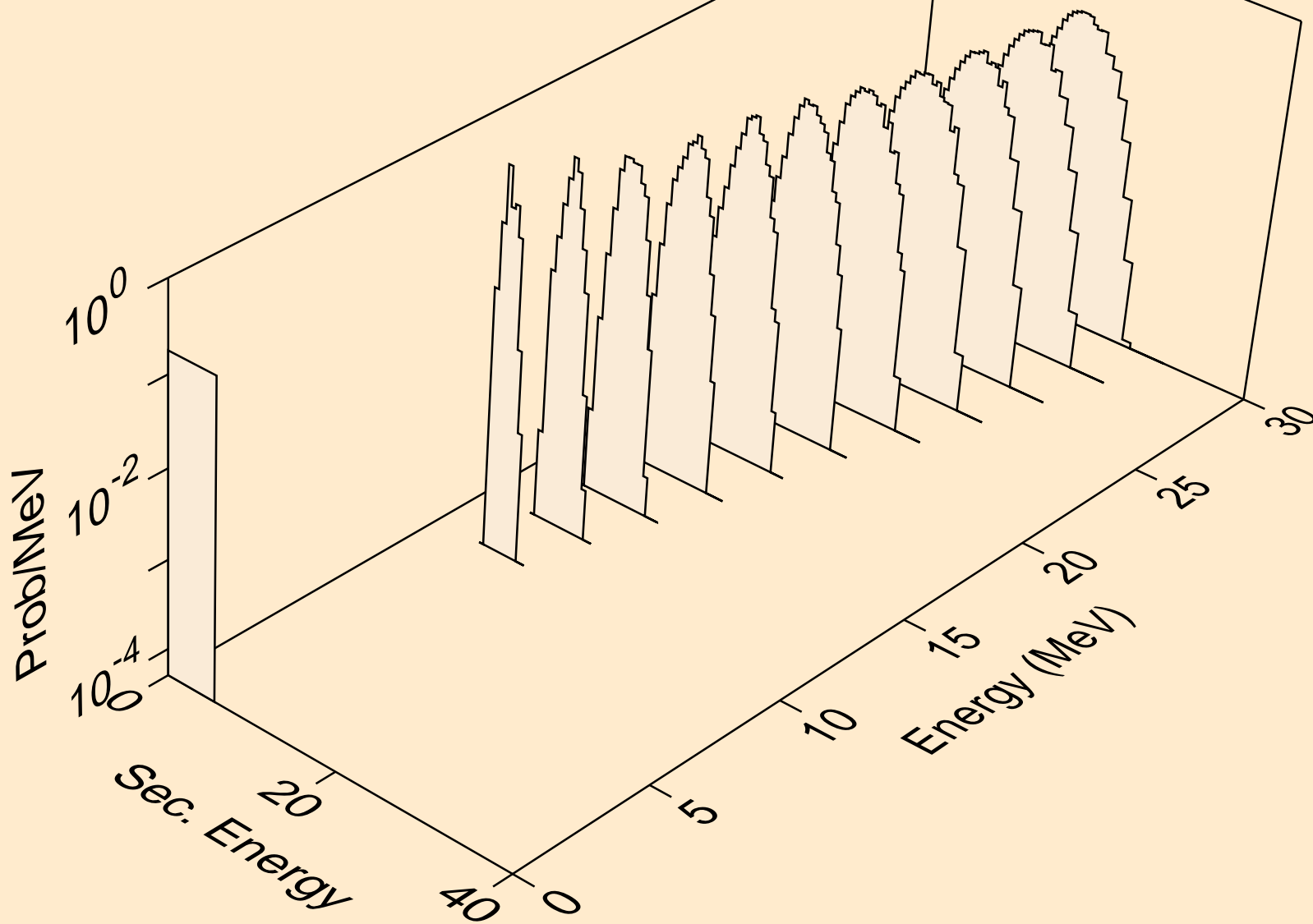

IR191 NEUTRON ACER TENDL-2019 LIBRARY; T=293.16K  
alphas from (n,da)

