

K045 NEUTRON ACER TENDL-2019 LIBRARY; T=293.16K

Principal cross sections

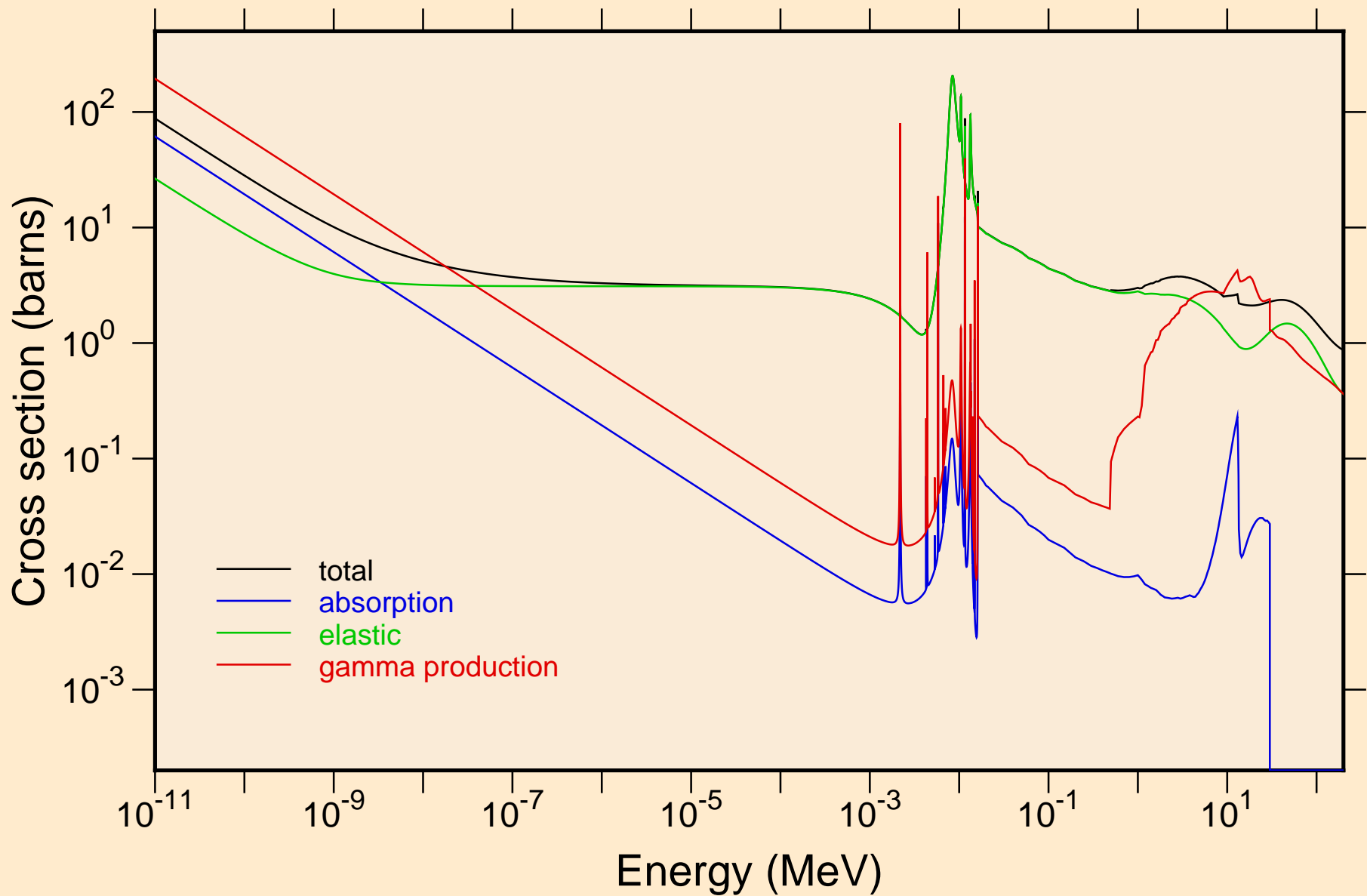

K045 NEUTRON ACER TENDL-2019 LIBRARY; T=293.16K
resonance total cross section

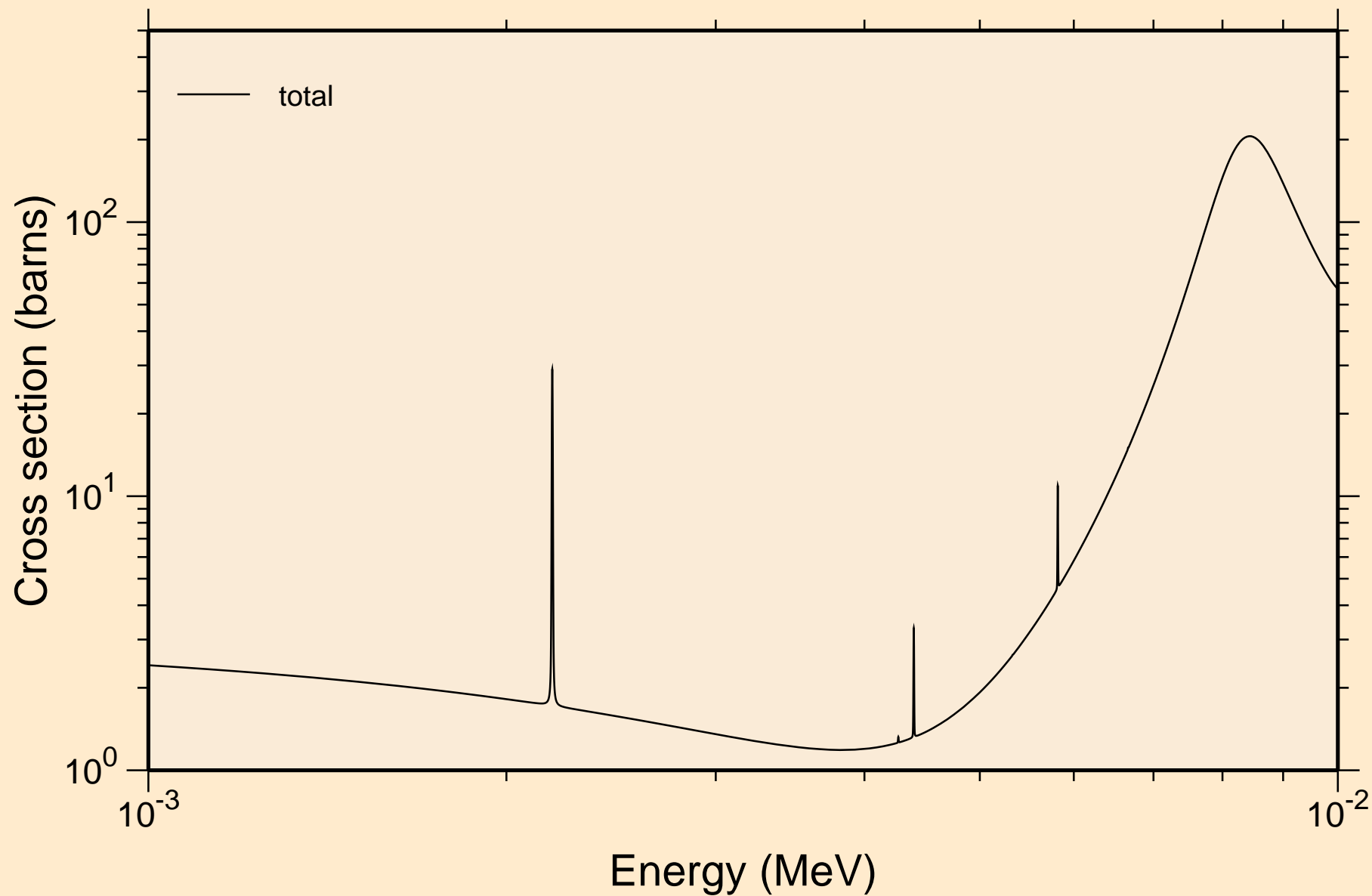

K045 NEUTRON ACER TENDL-2019 LIBRARY; T=293.16K
resonance total cross section

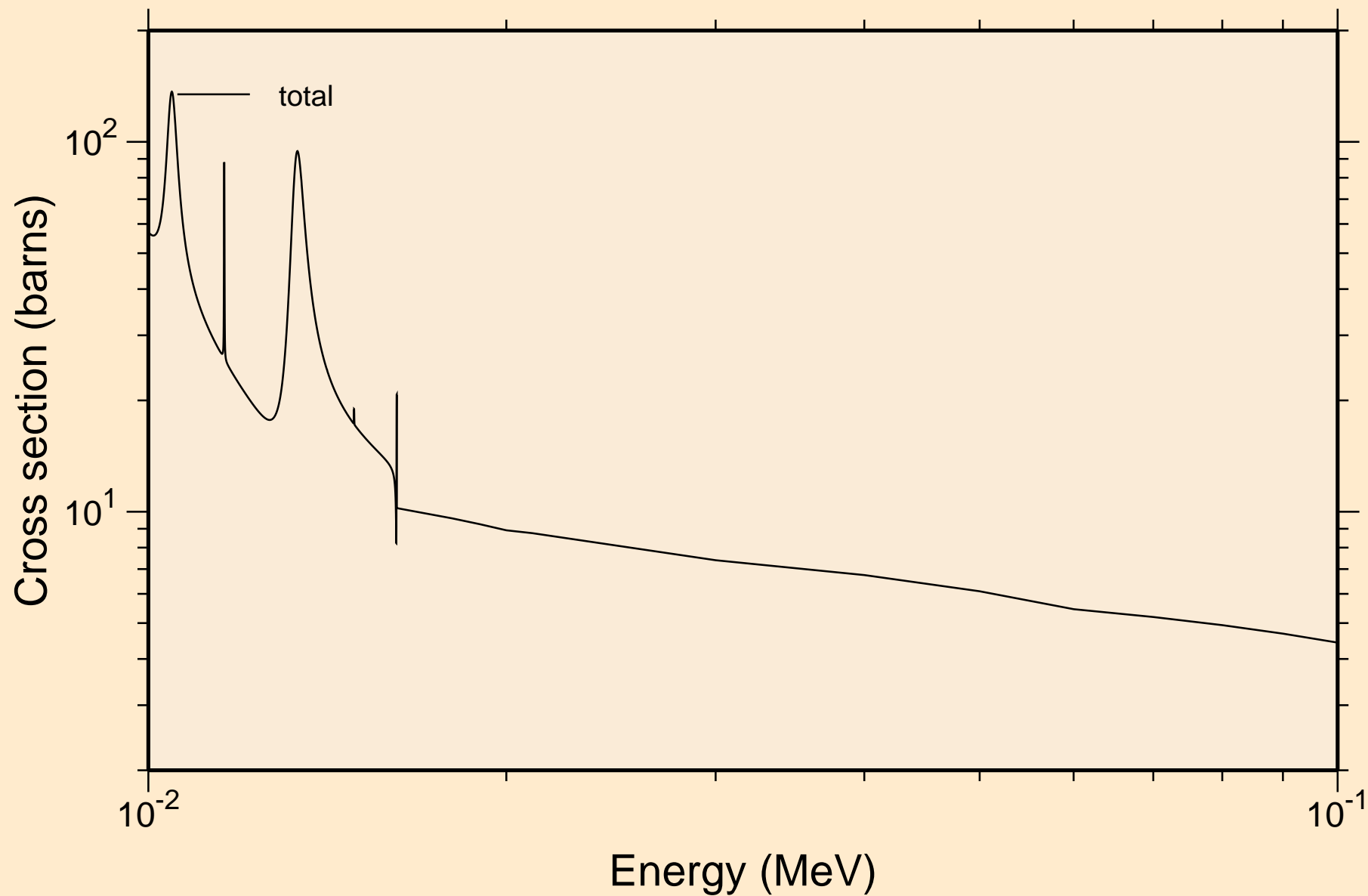

K045 NEUTRON ACER TENDL-2019 LIBRARY; T=293.16K
resonance total cross section

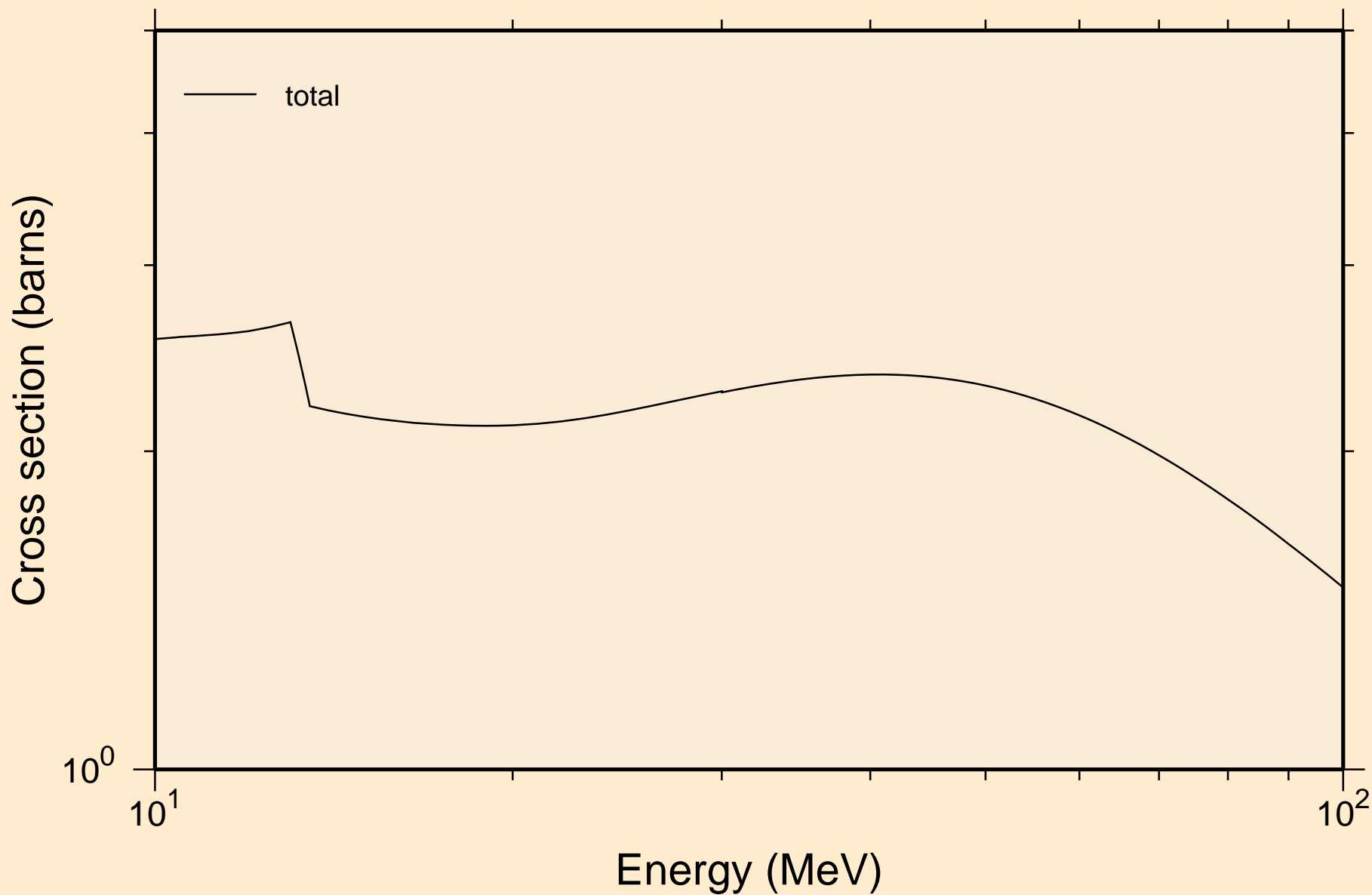

K045 NEUTRON ACER TENDL-2019 LIBRARY; T=293.16K
resonance absorption cross sections

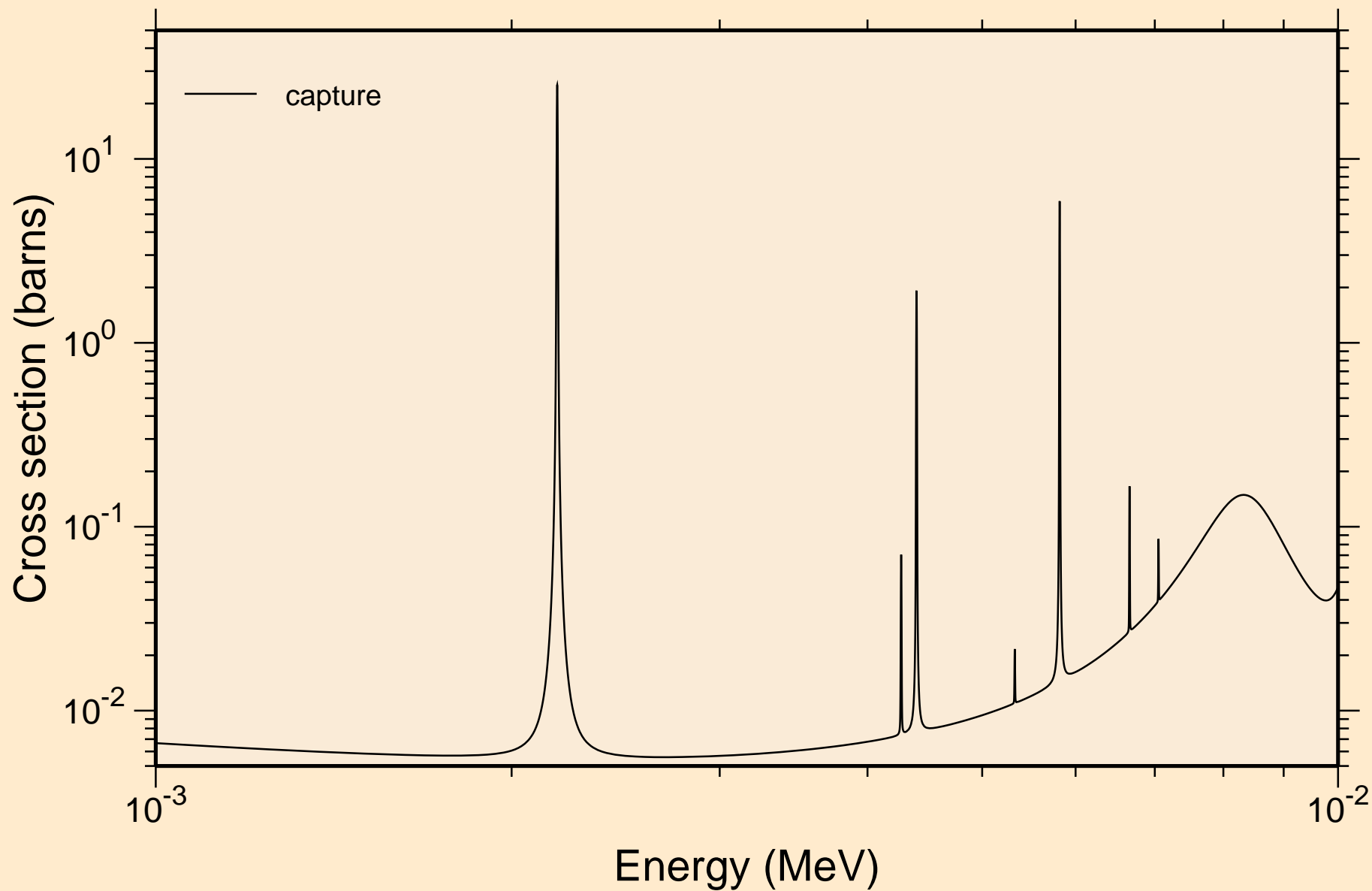

K045 NEUTRON ACER TENDL-2019 LIBRARY; T=293.16K
resonance absorption cross sections

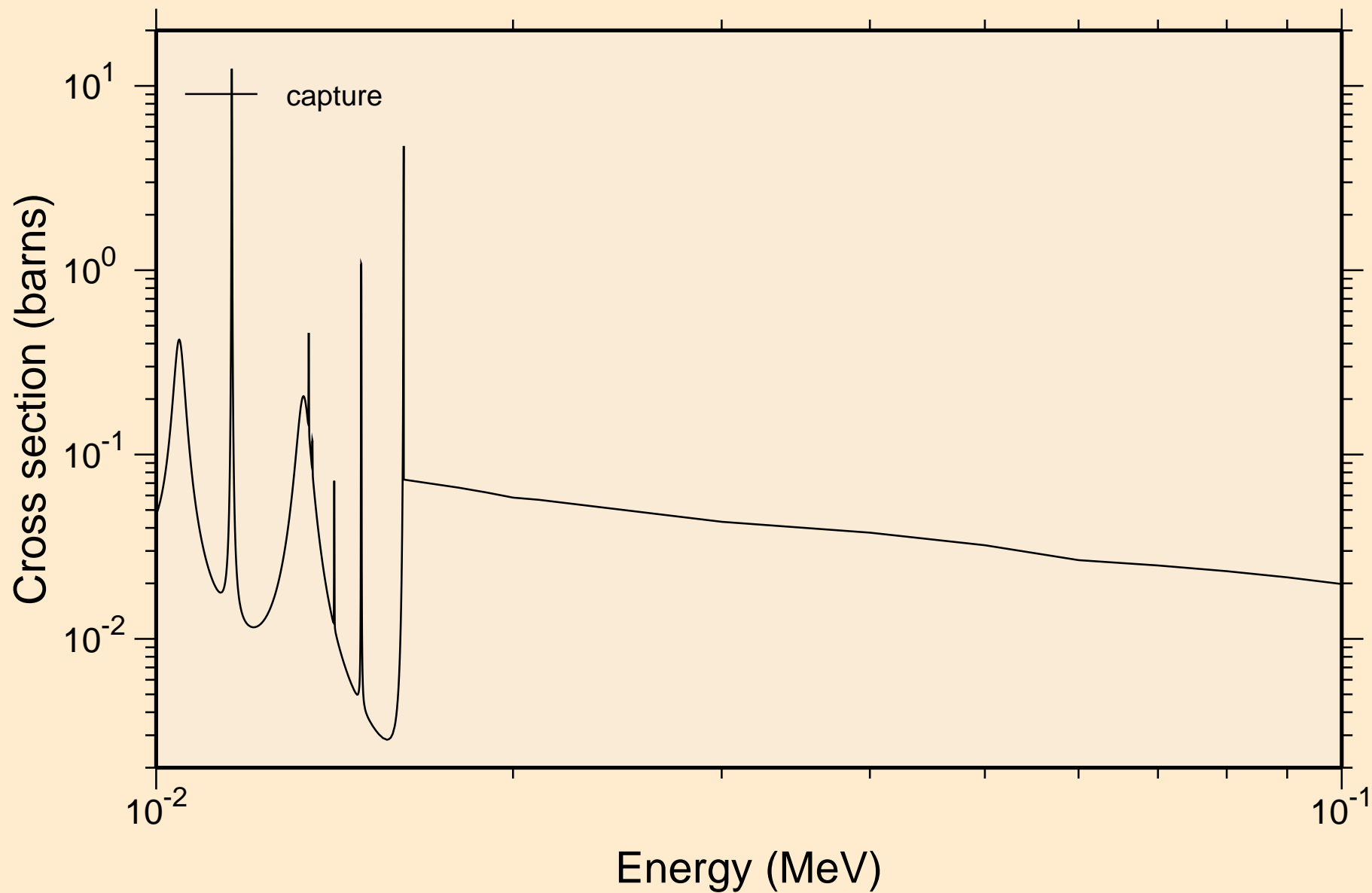

K045 NEUTRON ACER TENDL-2019 LIBRARY; T=293.16K
resonance absorption cross sections

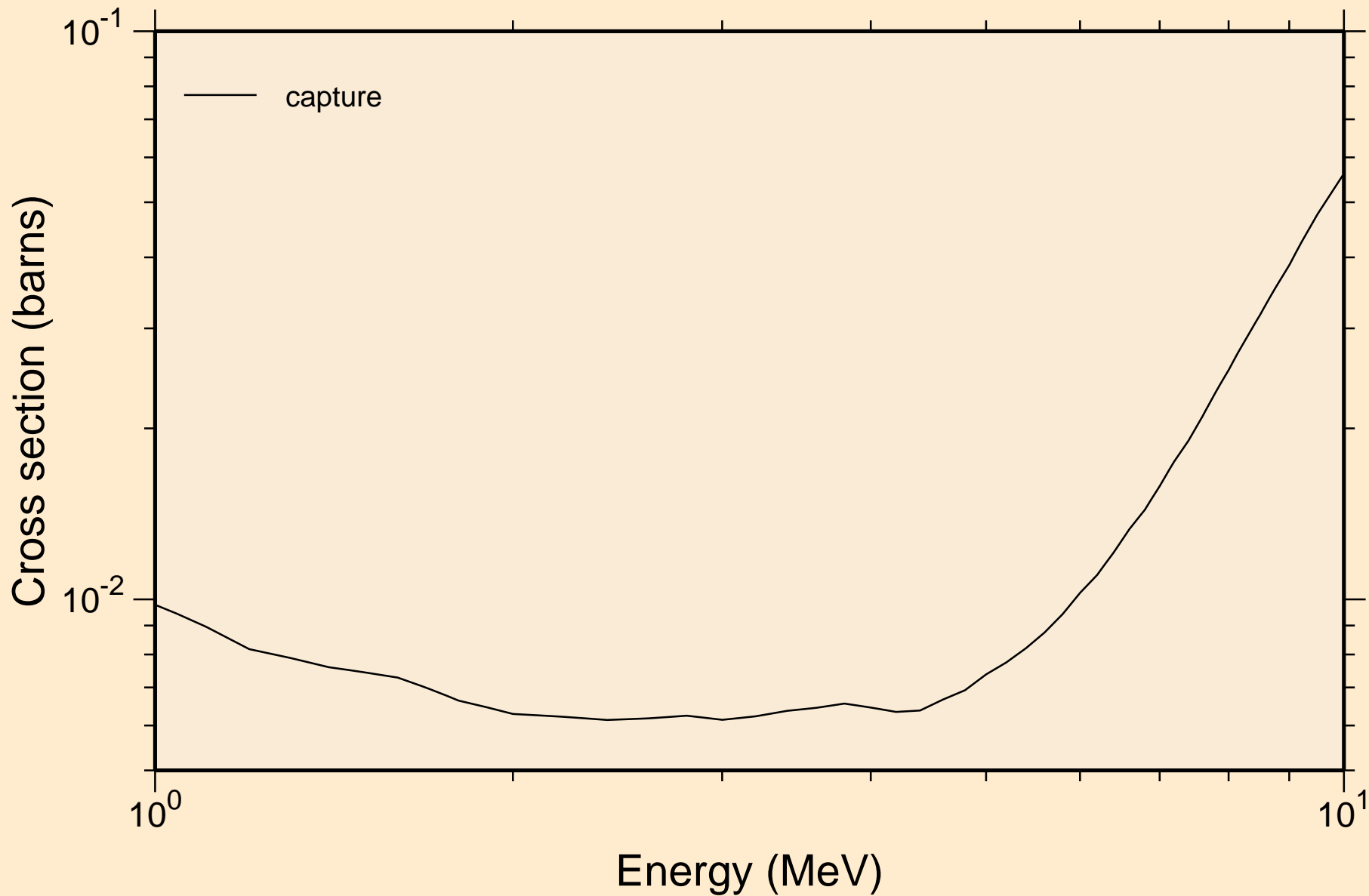

K045 NEUTRON ACER TENDL-2019 LIBRARY; T=293.16K
Heating

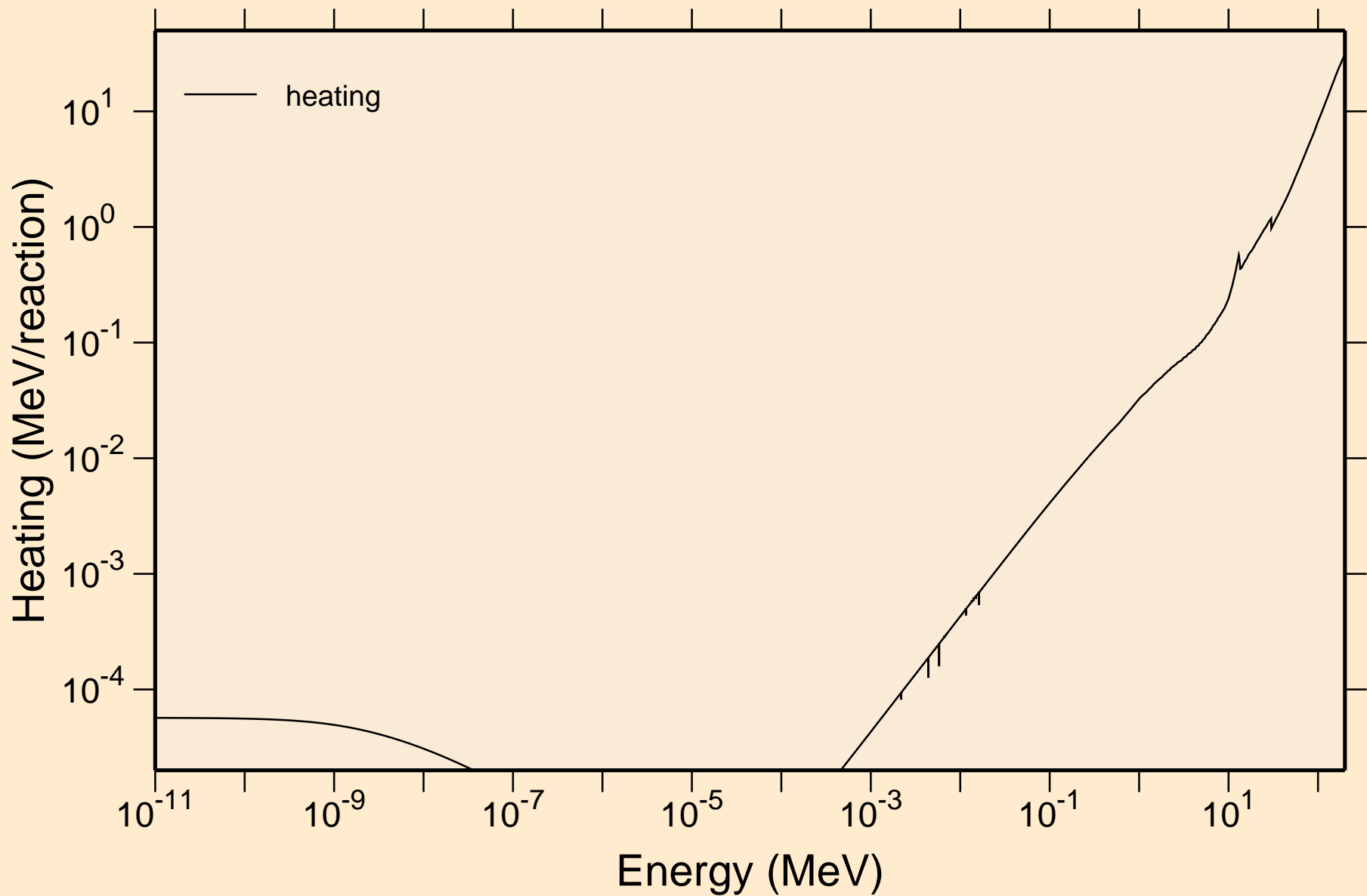

K045 NEUTRON ACER TENDL-2019 LIBRARY; T=293.16K
Damage

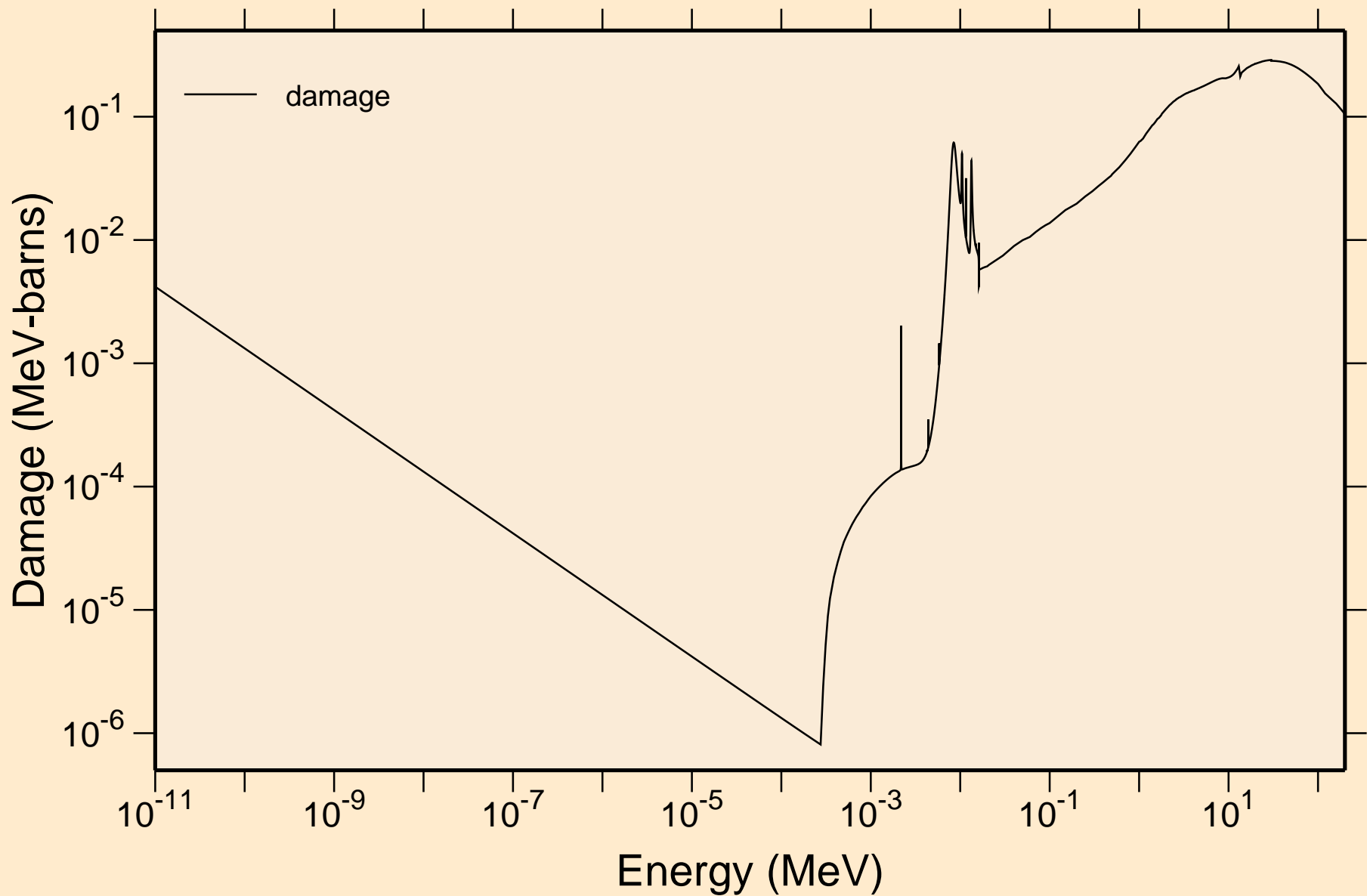

K045 NEUTRON ACER TENDL-2019 LIBRARY; T=293.16K
Non-threshold reactions

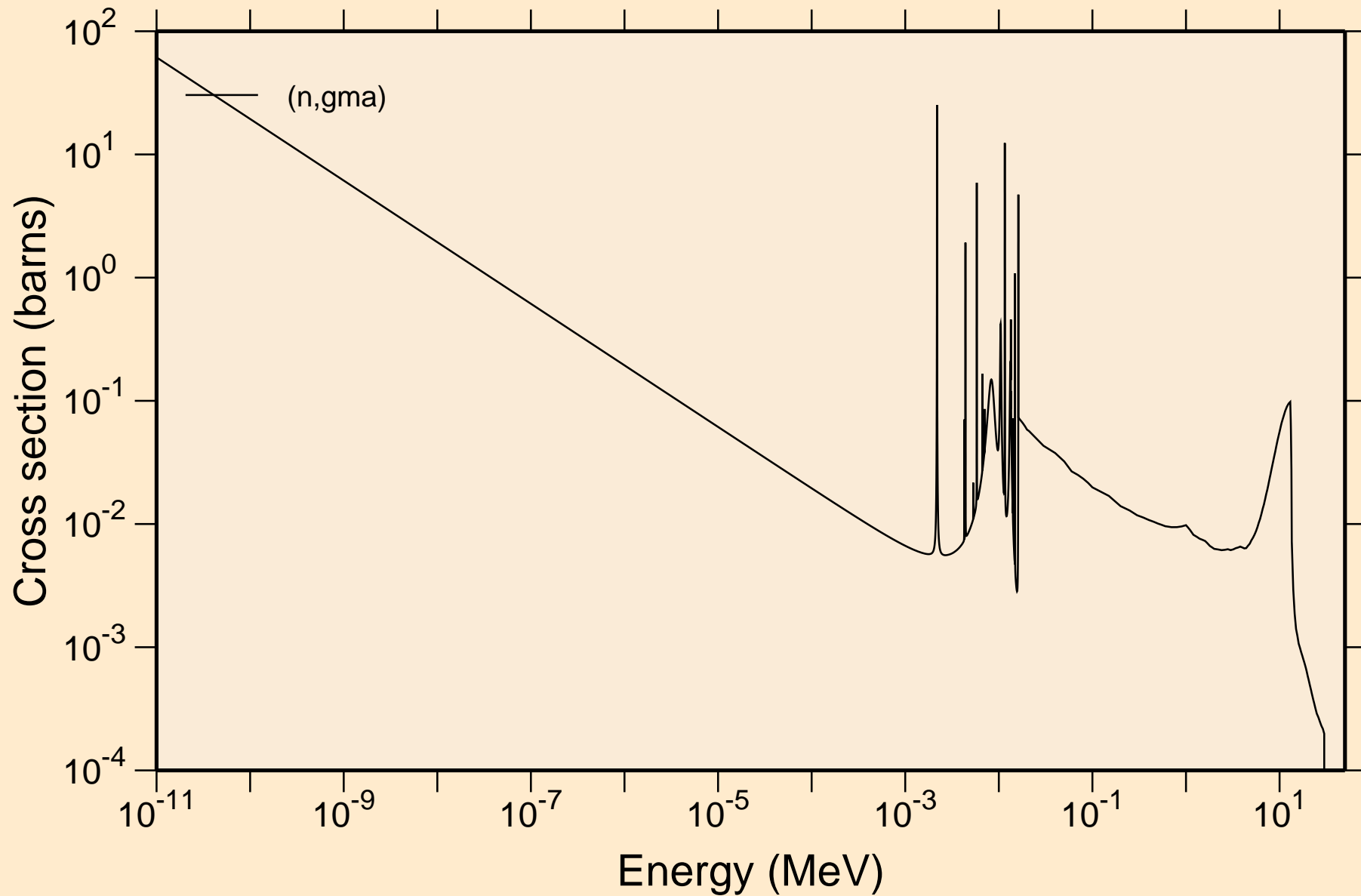

K045 NEUTRON ACER TENDL-2019 LIBRARY; T=293.16K
Principal cross sections

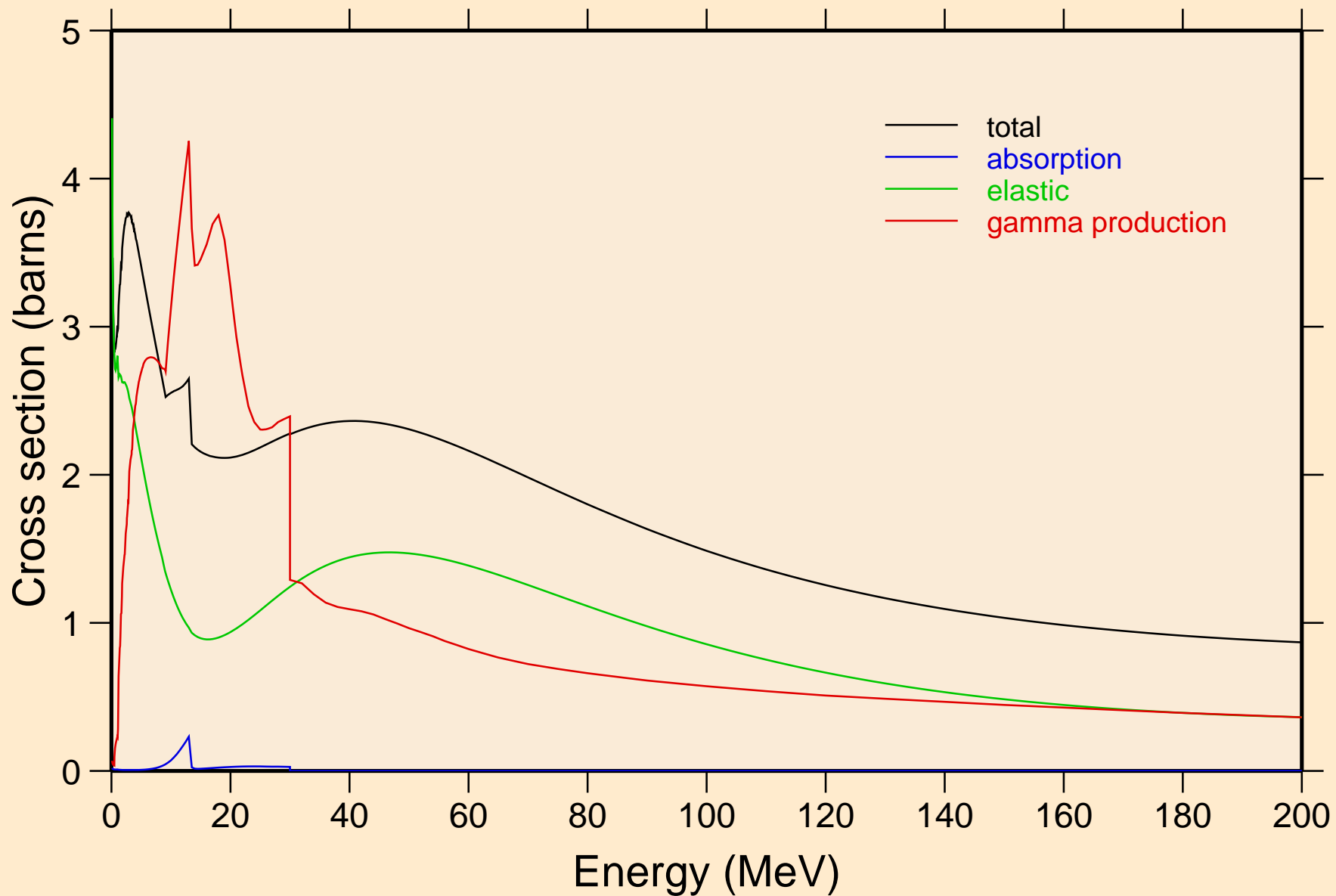

K045 NEUTRON ACER TENDL-2019 LIBRARY; T=293.16K
Heating

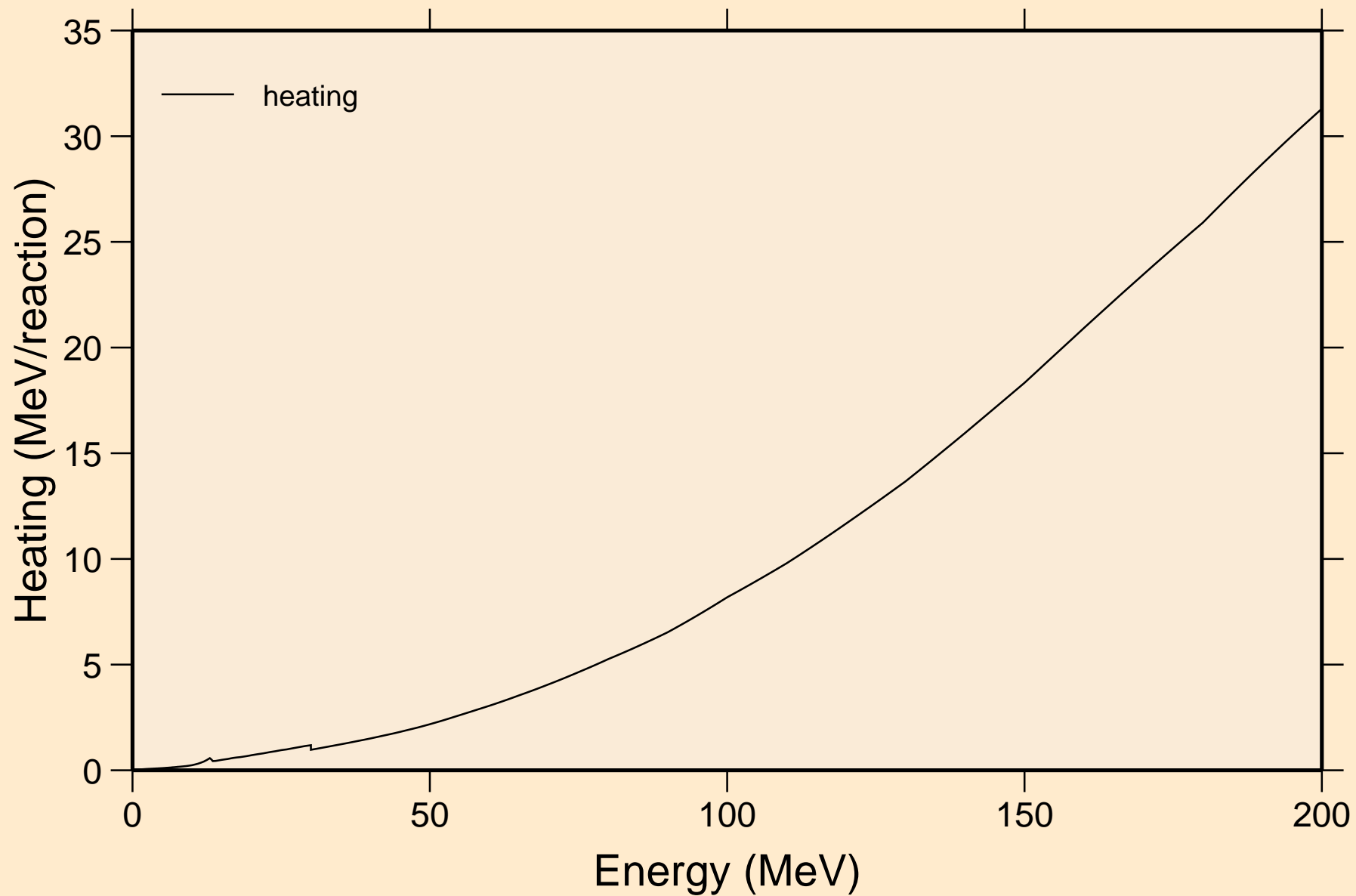

K045 NEUTRON ACER TENDL-2019 LIBRARY; T=293.16K
Damage

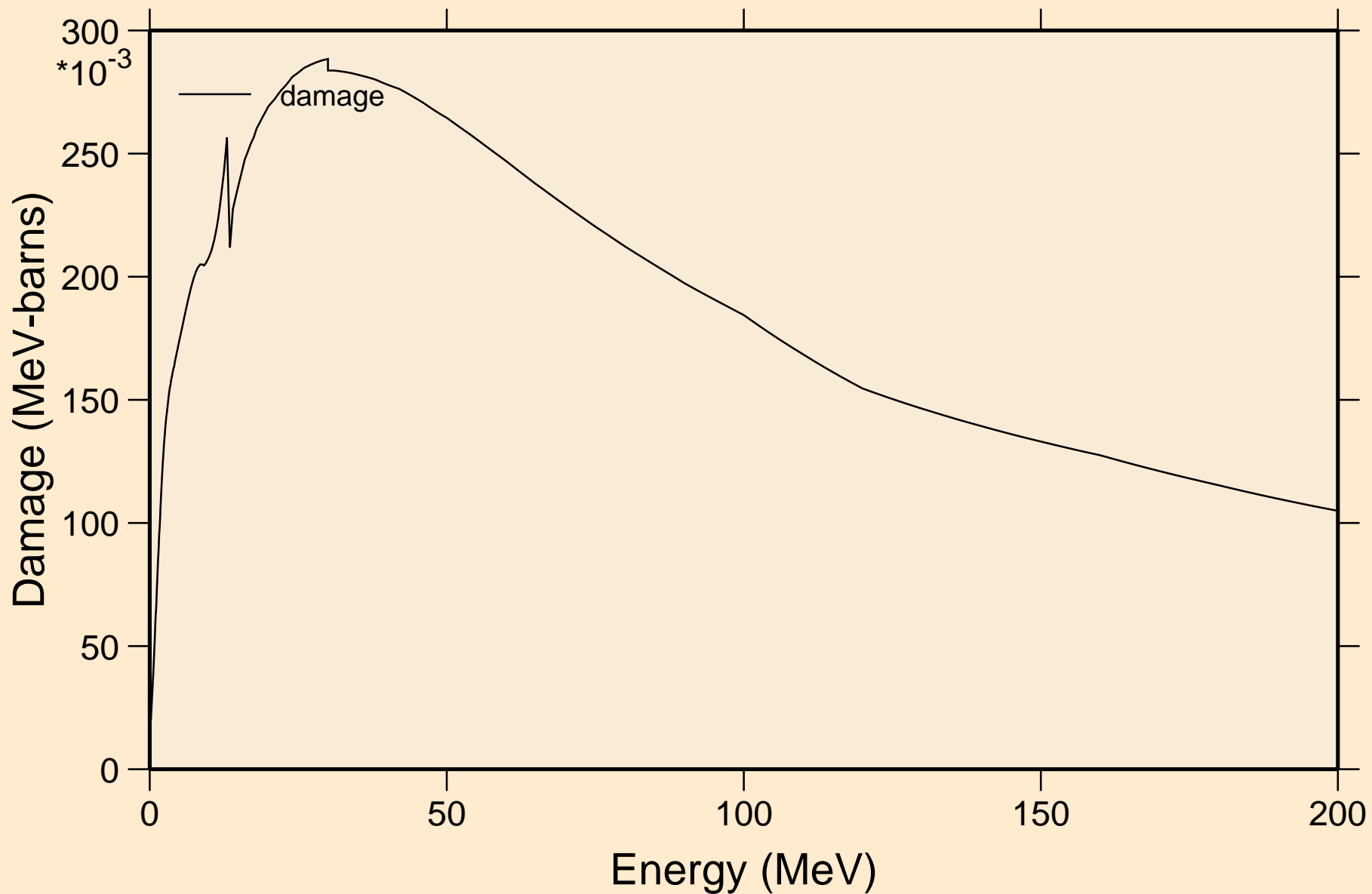

K045 NEUTRON ACER TENDL-2019 LIBRARY; T=293.16K
Non-threshold reactions

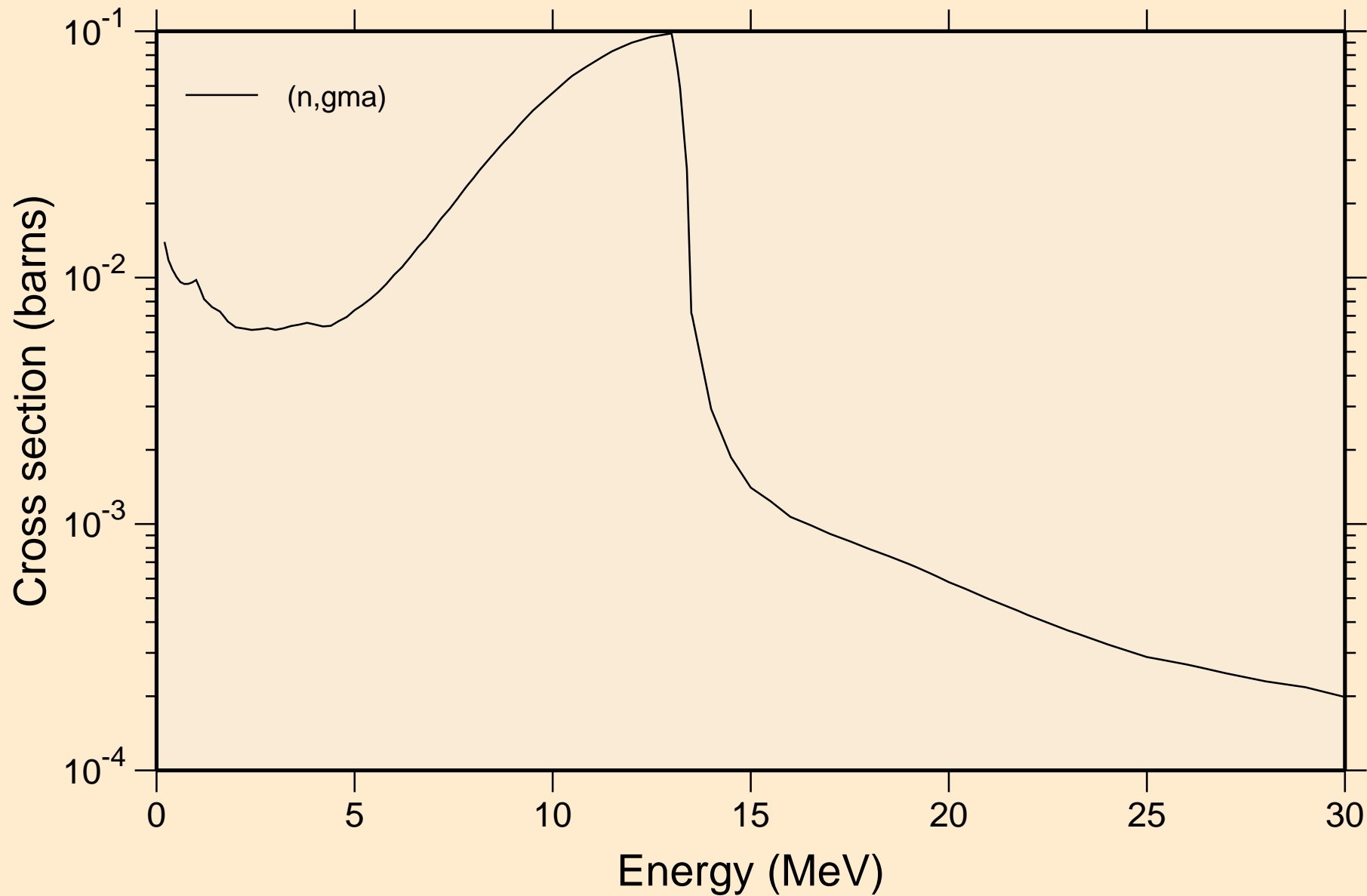

K045 NEUTRON ACER TENDL-2019 LIBRARY; T=293.16K
Inelastic levels

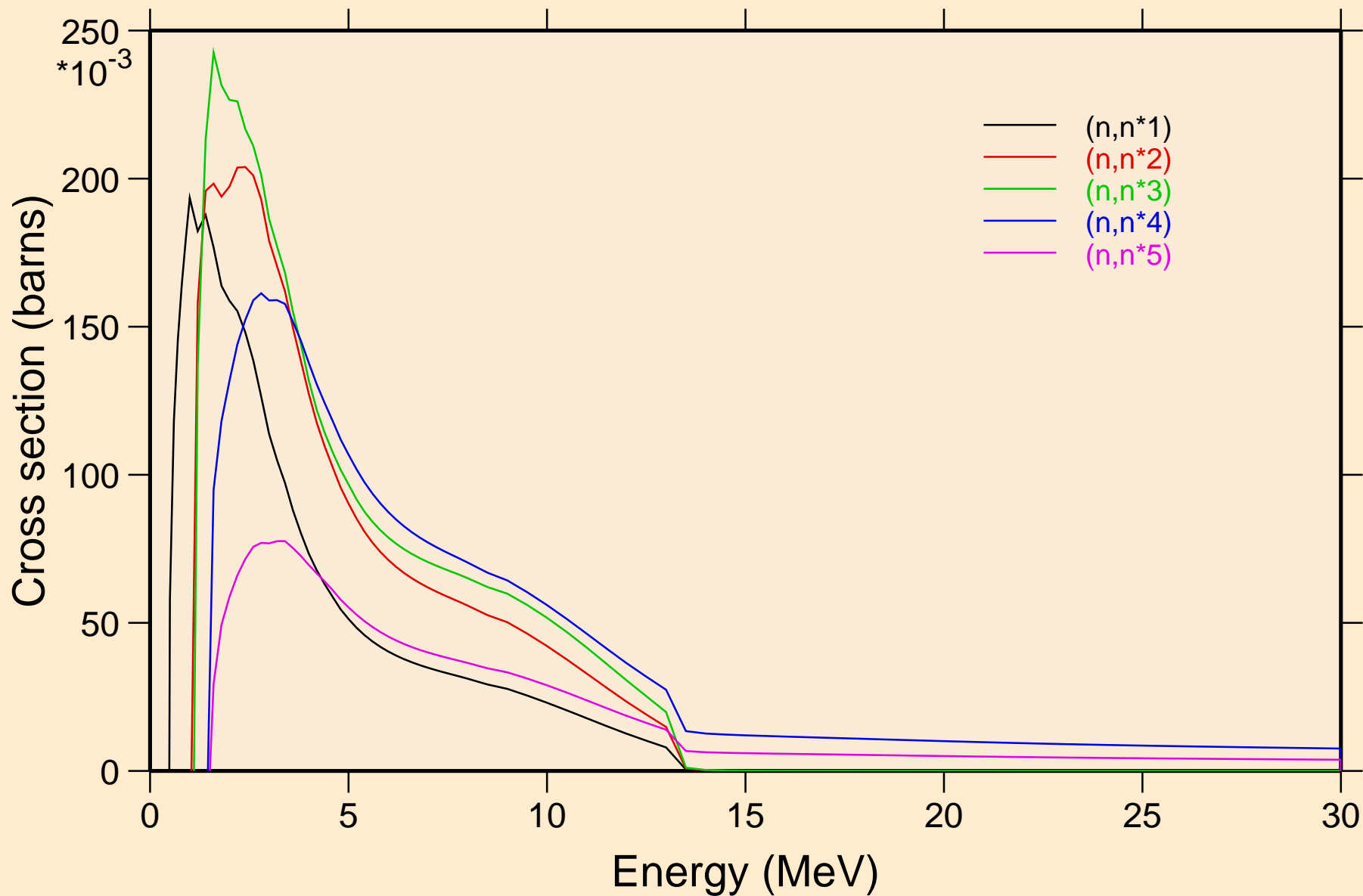

K045 NEUTRON ACER TENDL-2019 LIBRARY; T=293.16K
Inelastic levels

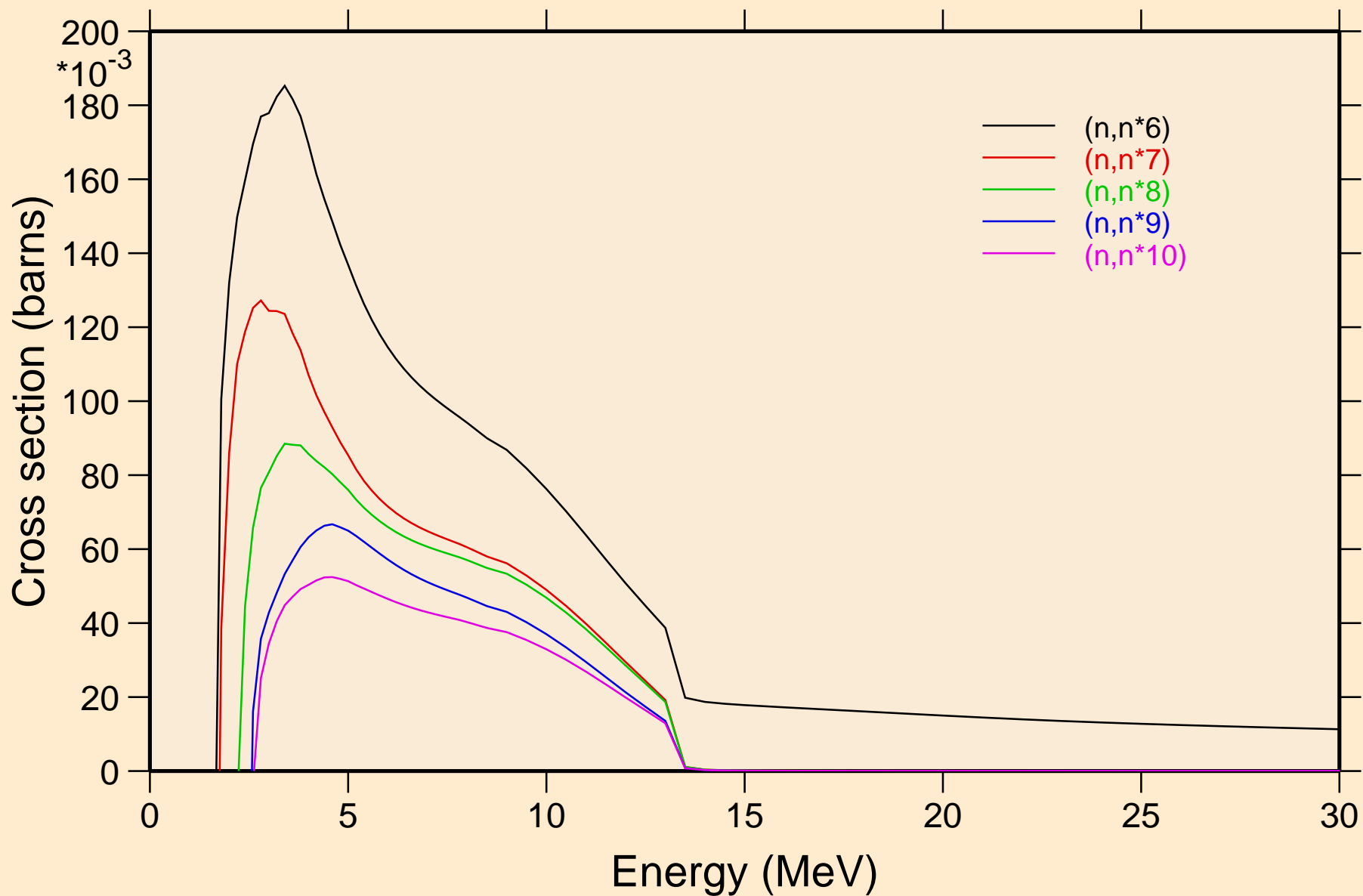

K045 NEUTRON ACER TENDL-2019 LIBRARY; T=293.16K
Inelastic levels

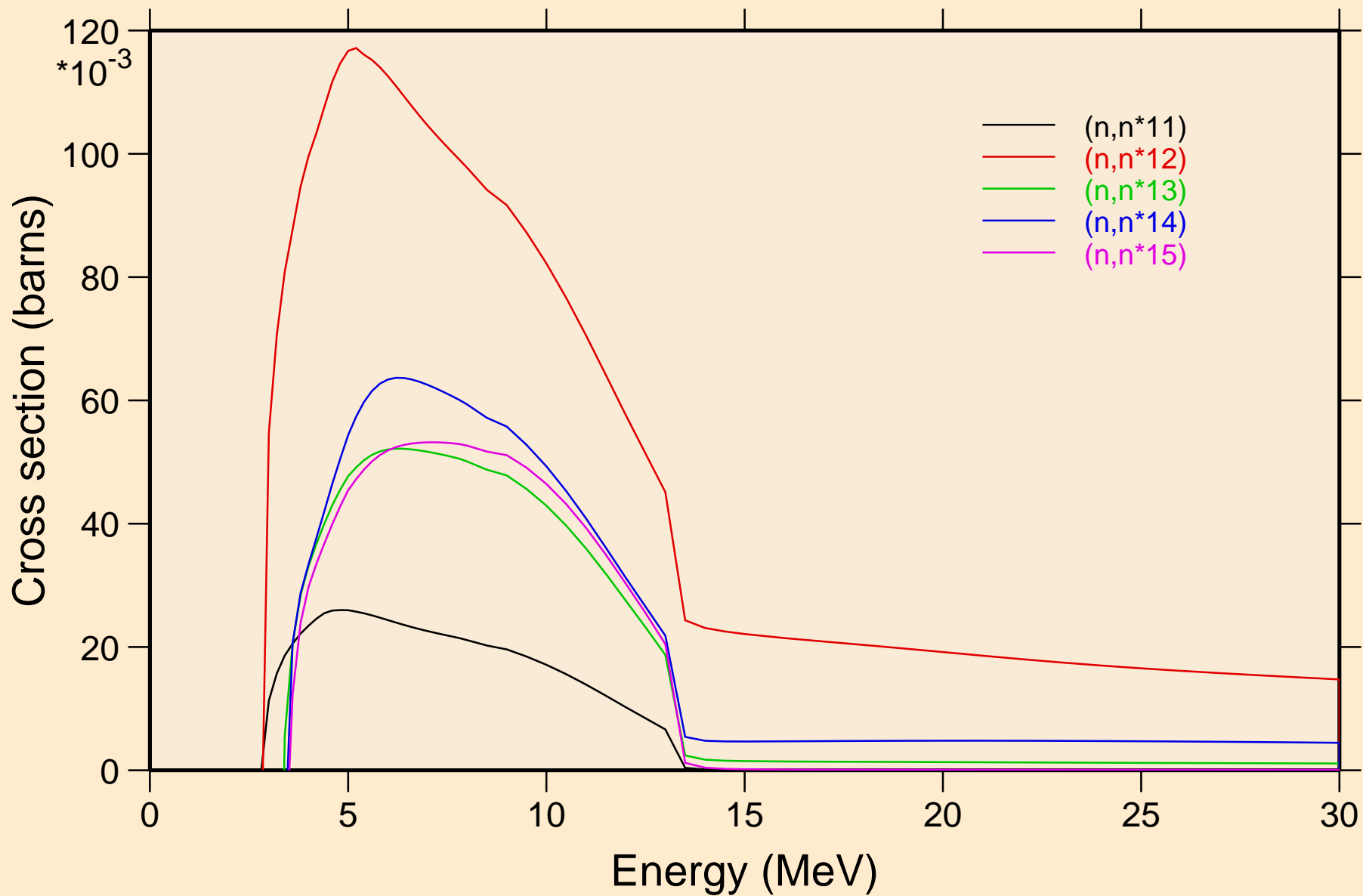

K045 NEUTRON ACER TENDL-2019 LIBRARY; T=293.16K
Inelastic levels

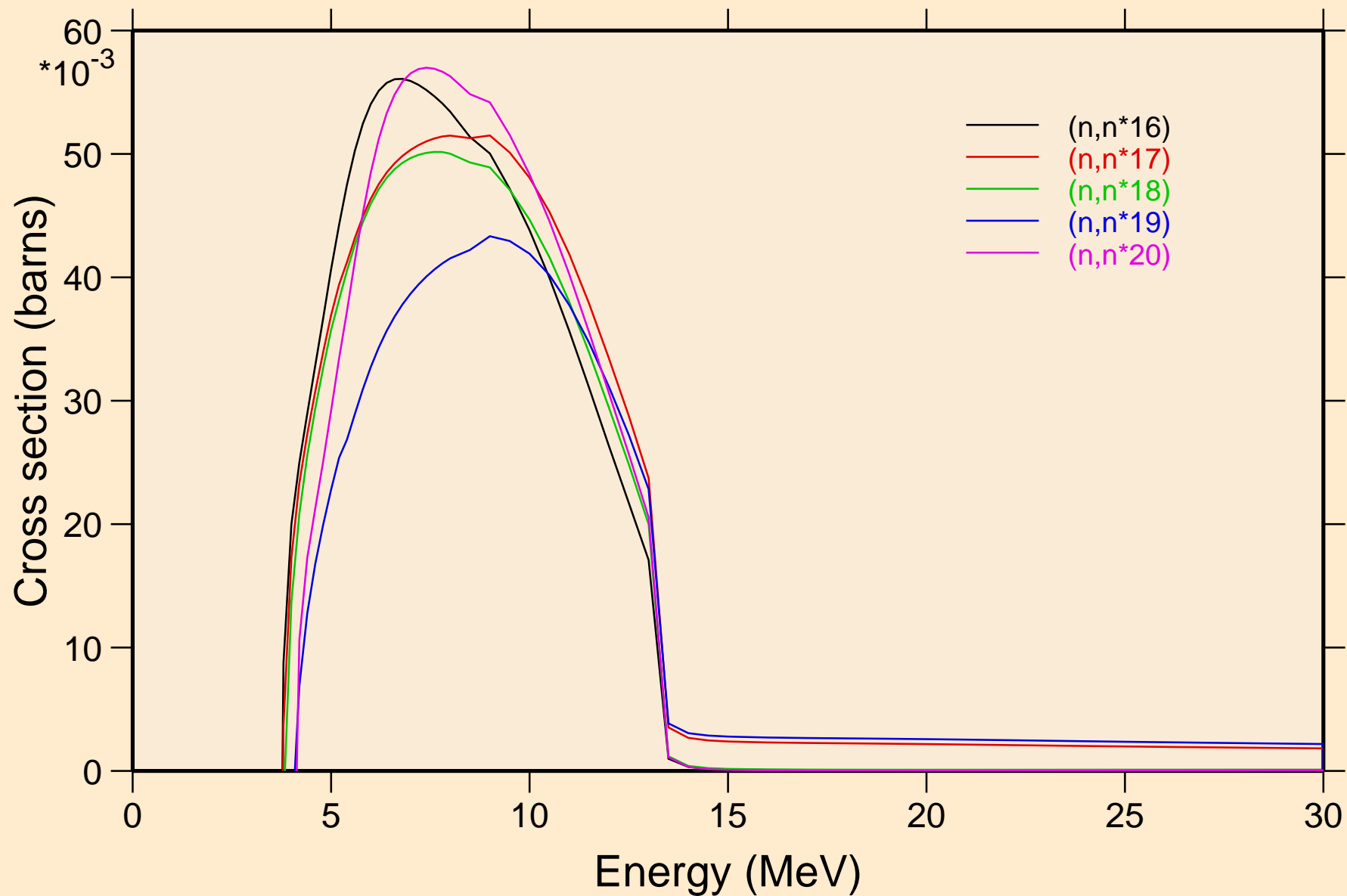

K045 NEUTRON ACER TENDL-2019 LIBRARY; T=293.16K
Inelastic levels

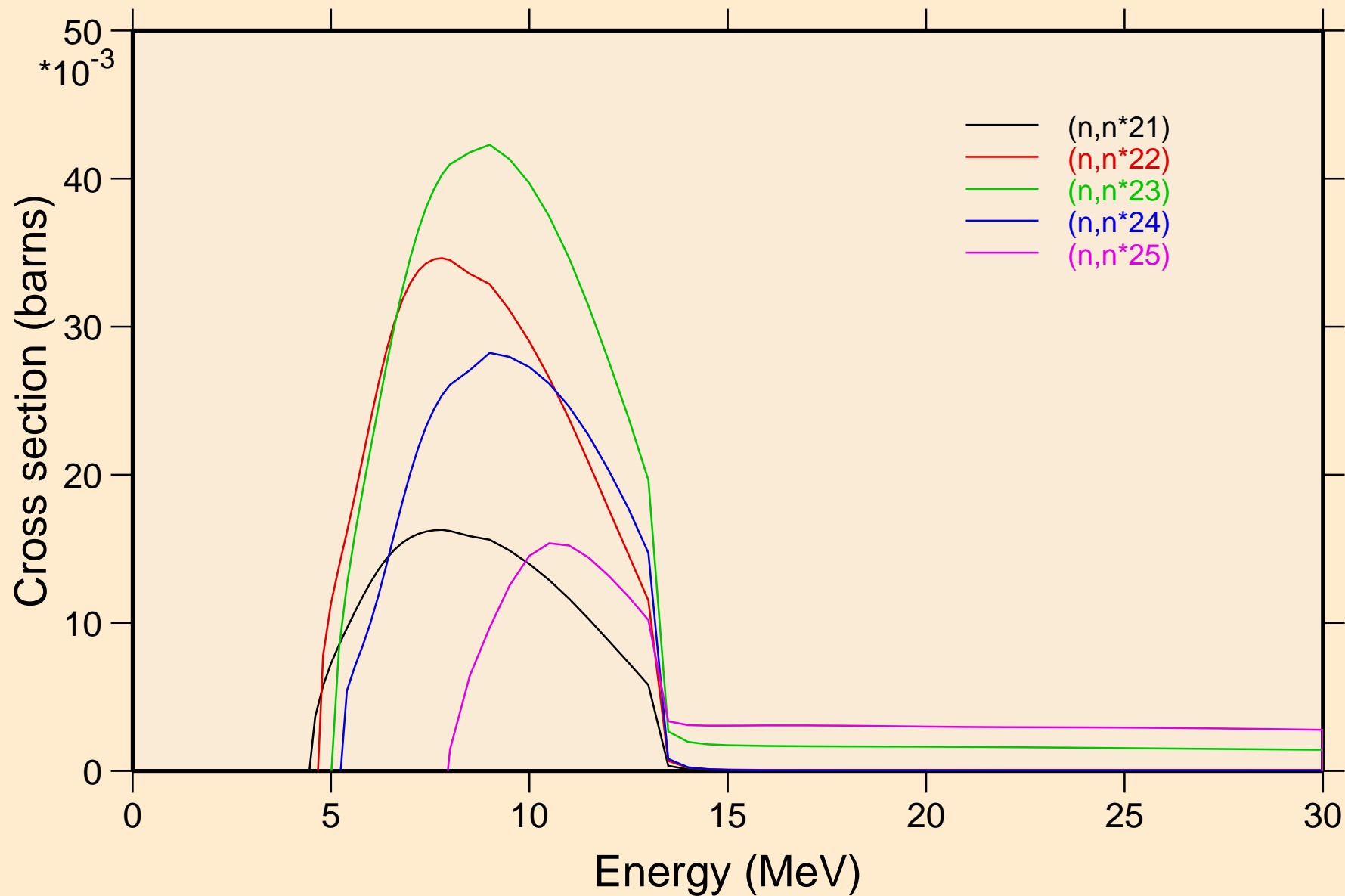

K045 NEUTRON ACER TENDL-2019 LIBRARY; T=293.16K
Threshold reactions

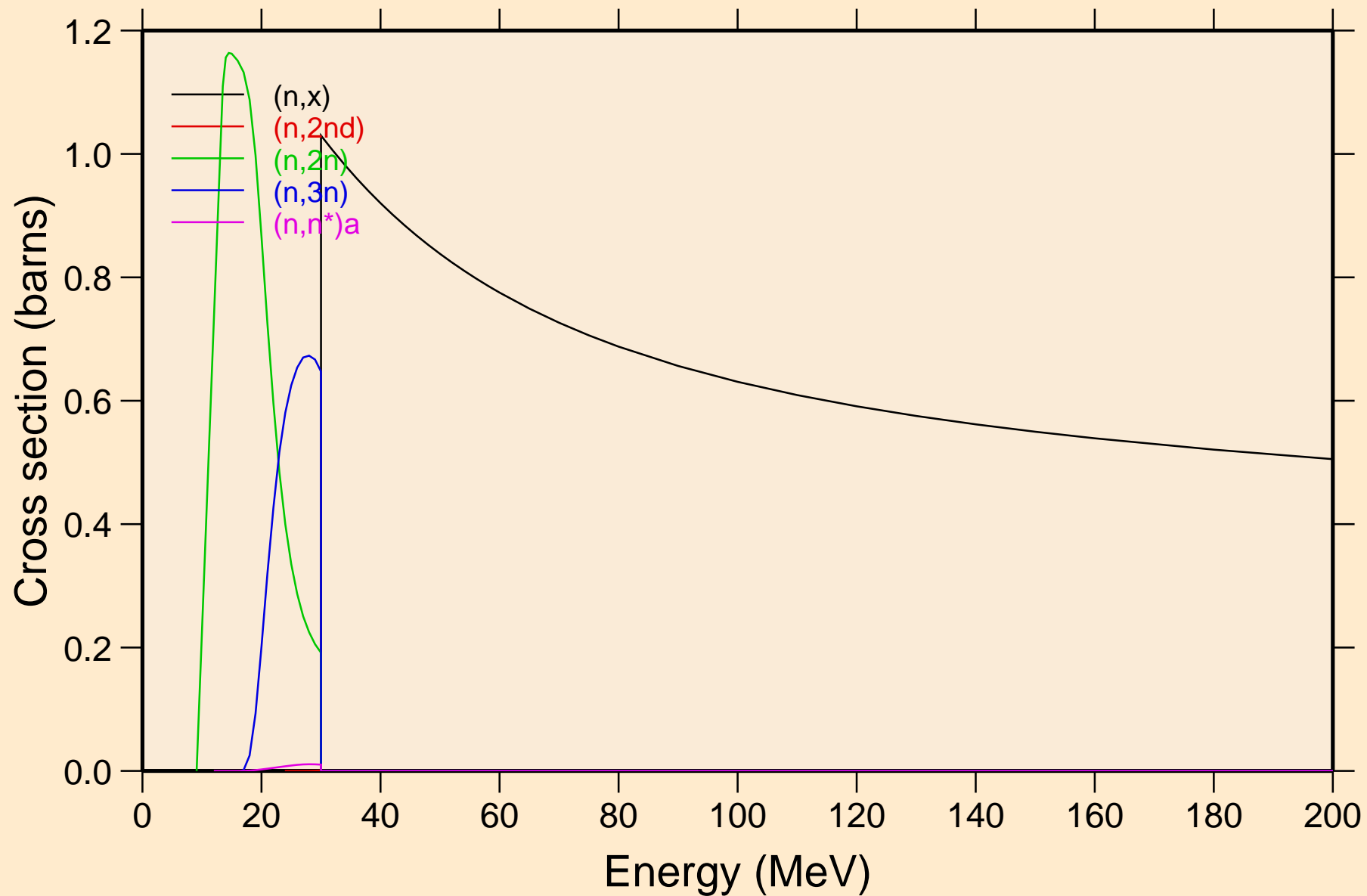

K045 NEUTRON ACER TENDL-2019 LIBRARY; T=293.16K
Threshold reactions

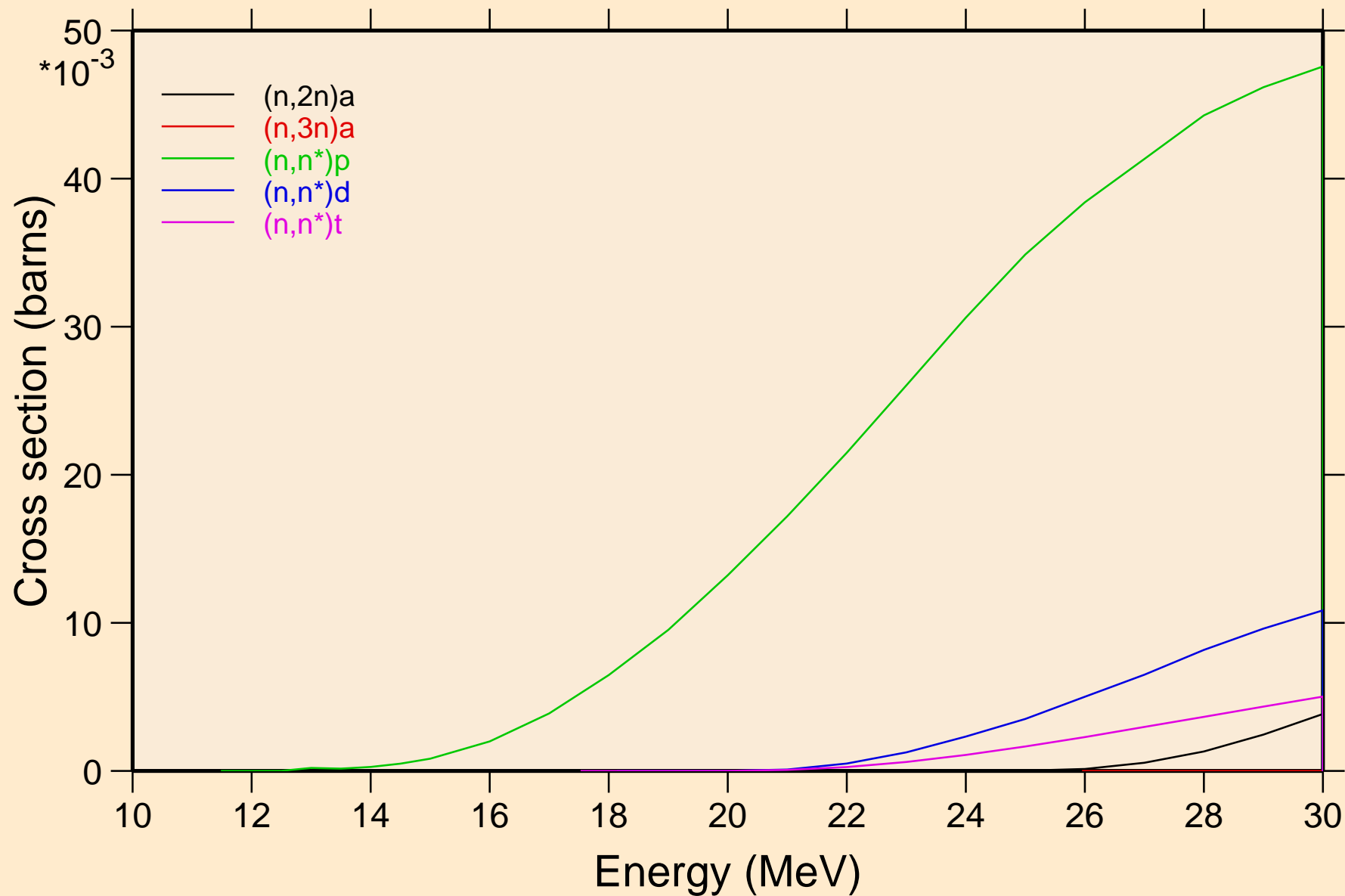

K045 NEUTRON ACER TENDL-2019 LIBRARY; T=293.16K
Threshold reactions

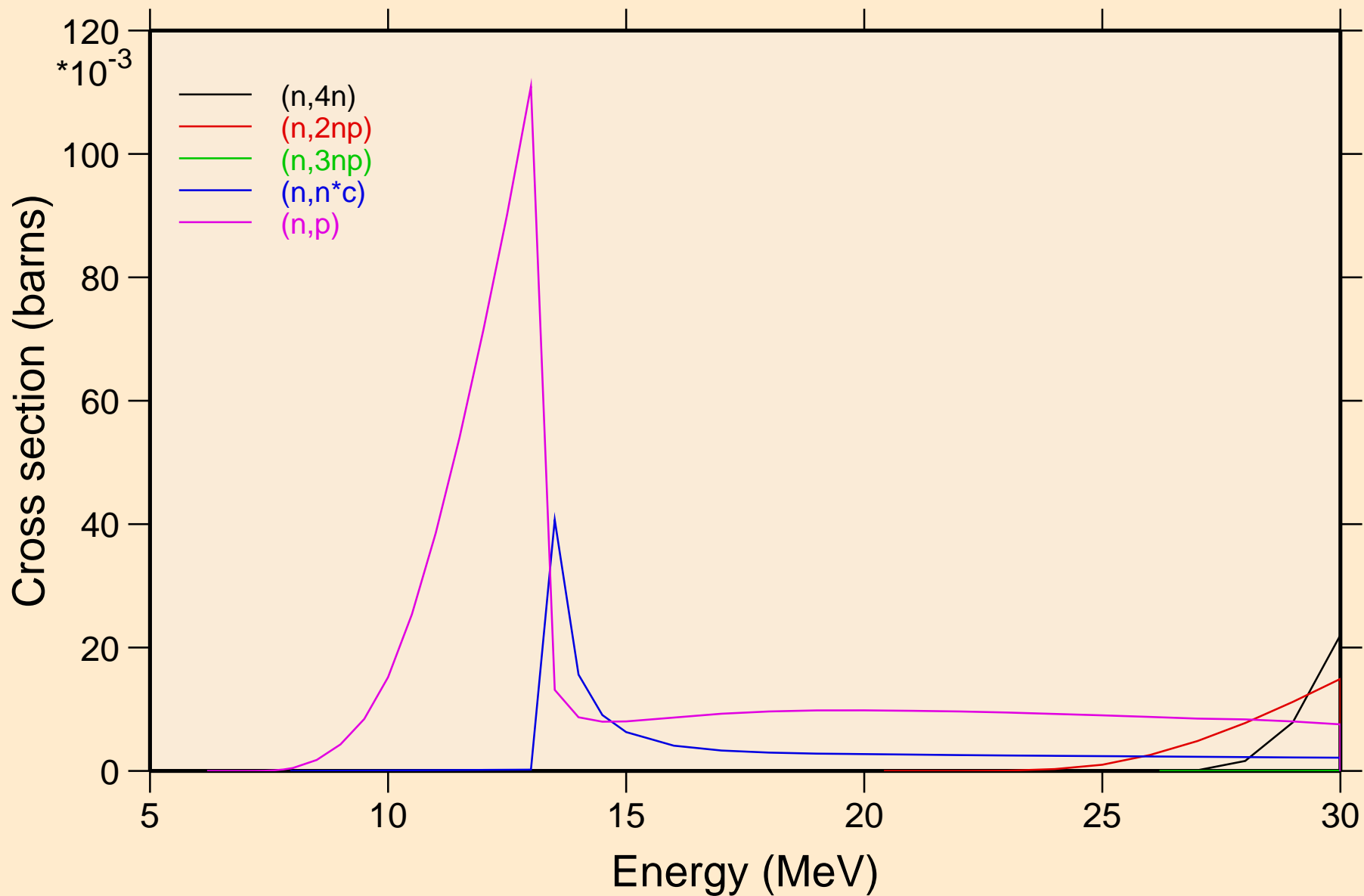

K045 NEUTRON ACER TENDL-2019 LIBRARY; T=293.16K
Threshold reactions

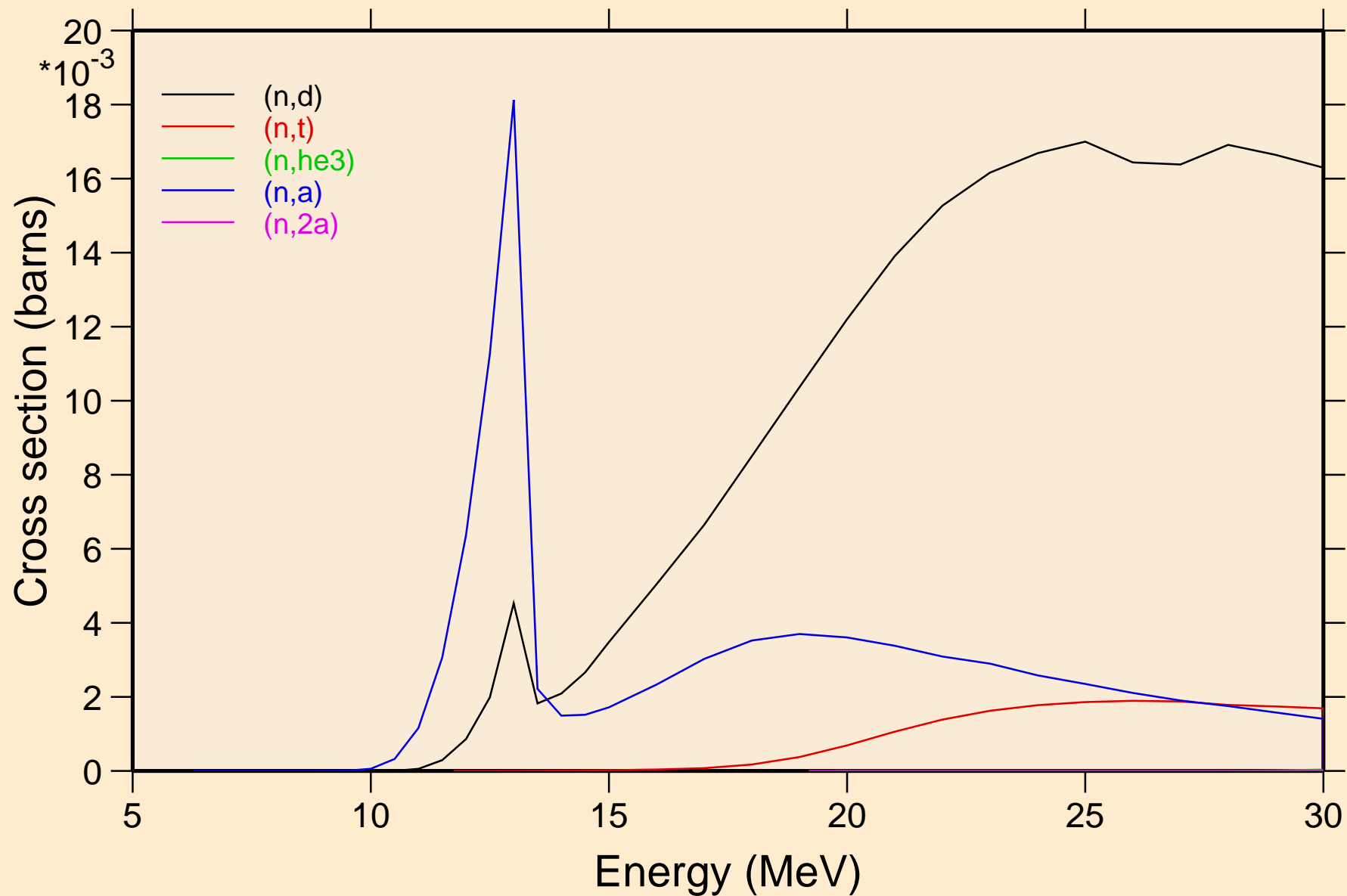

K045 NEUTRON ACER TENDL-2019 LIBRARY; T=293.16K
Threshold reactions

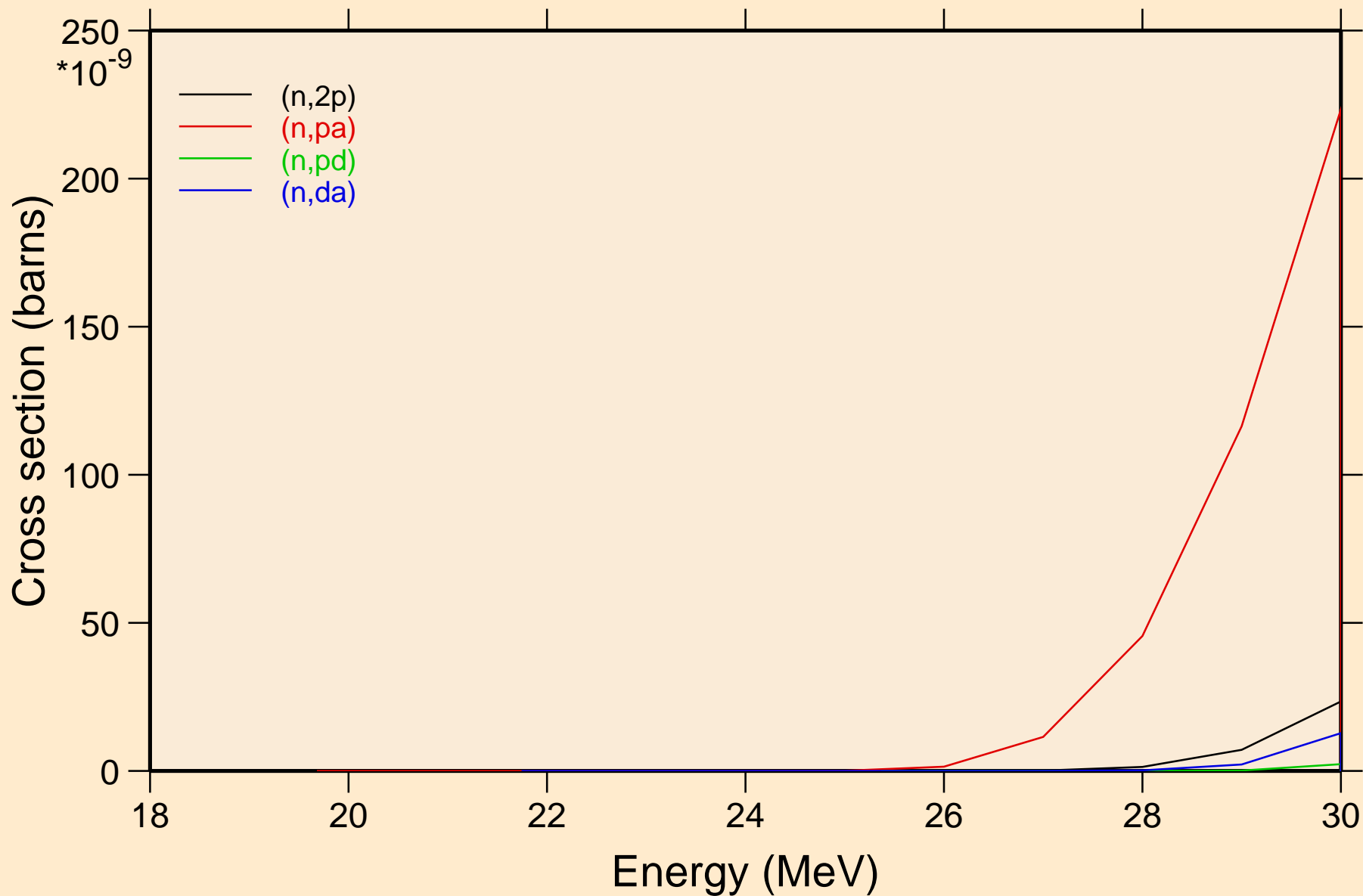

K045 NEUTRON ACER TENDL-2019 LIBRARY; T=293.16K
Threshold reactions

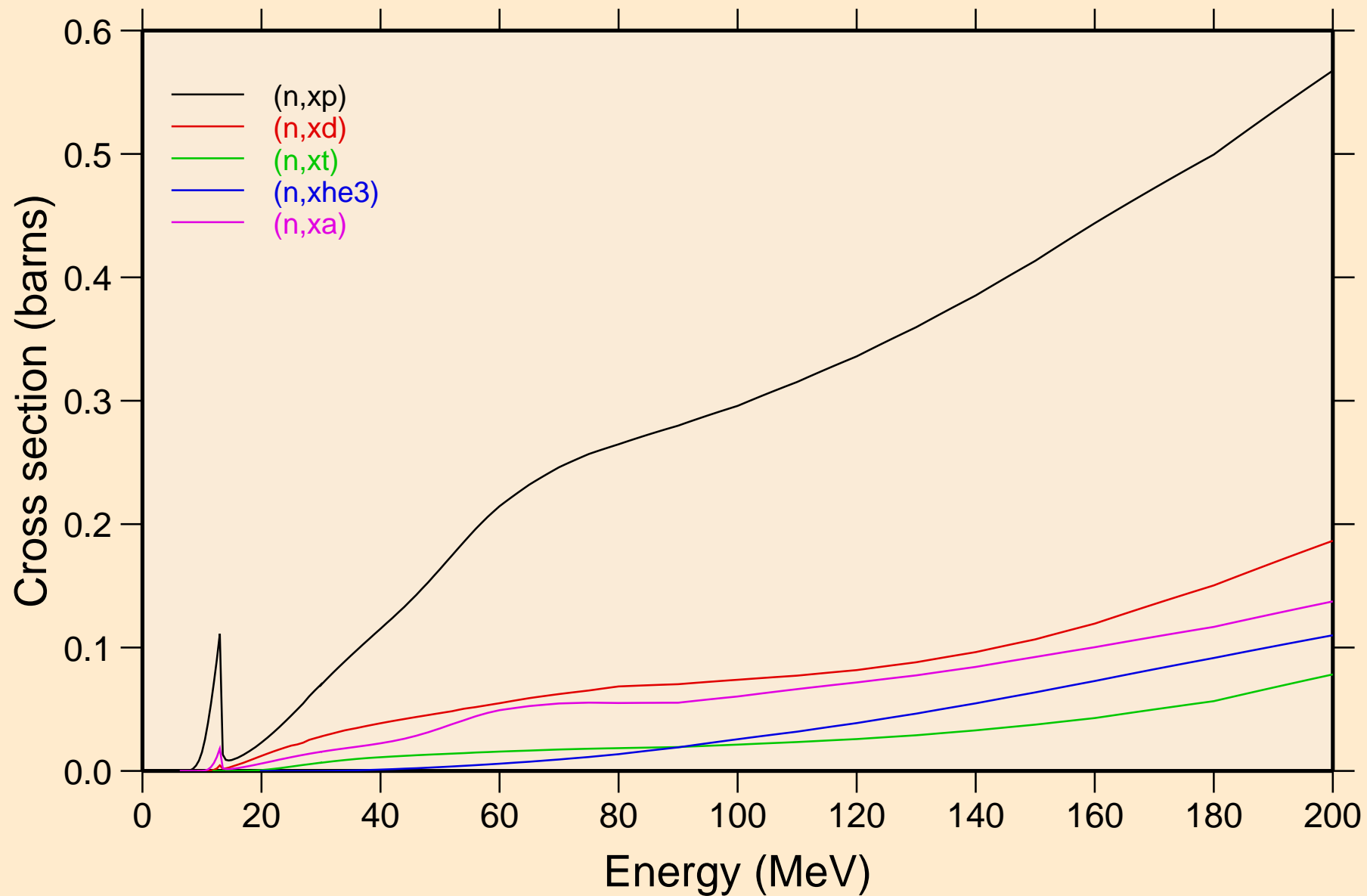

K045 NEUTRON ACER TENDL-2019 LIBRARY; T=293.16K
angular distribution for elastic

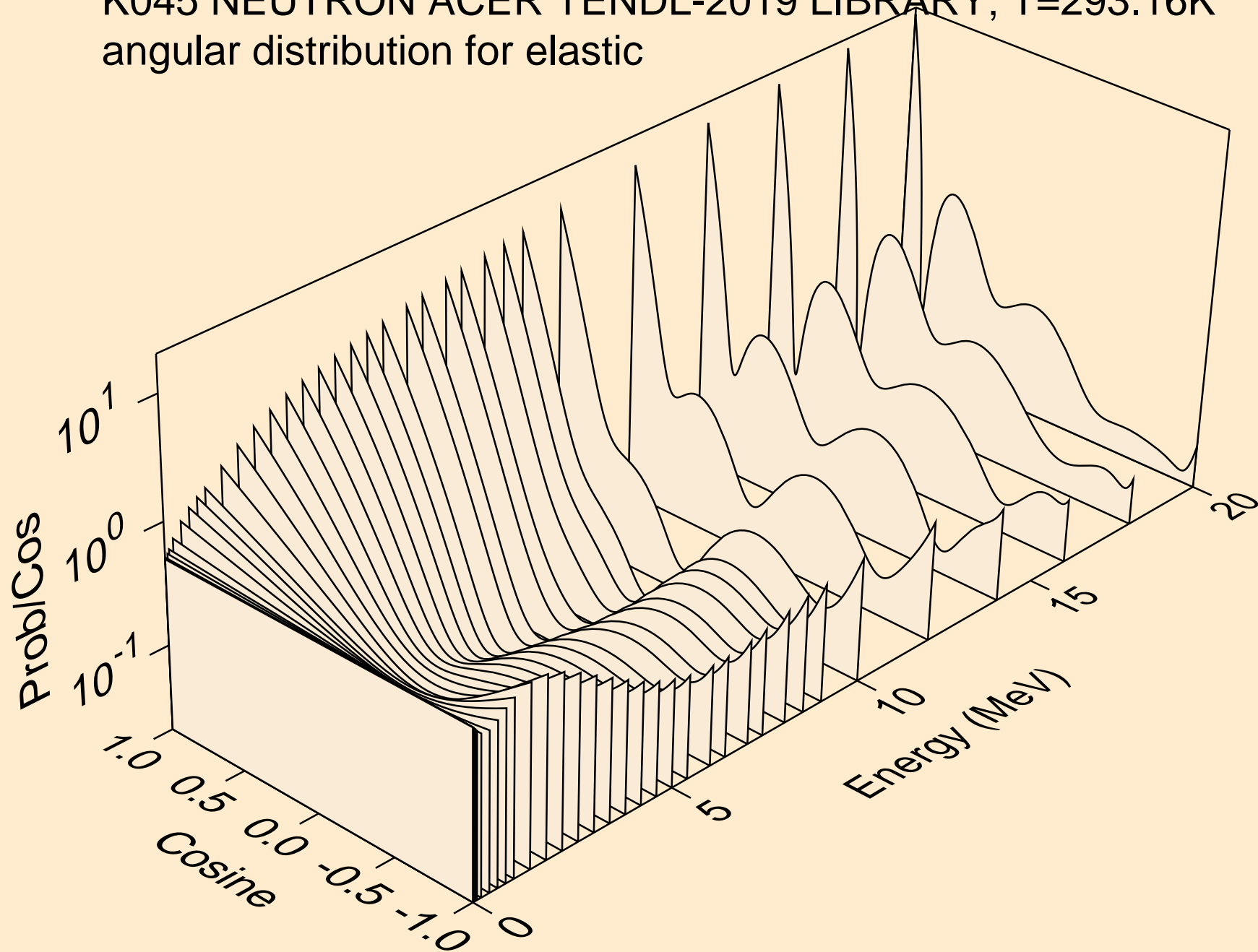

K045 NEUTRON ACER TENDL-2019 LIBRARY; T=293.16K
angular distribution for elastic

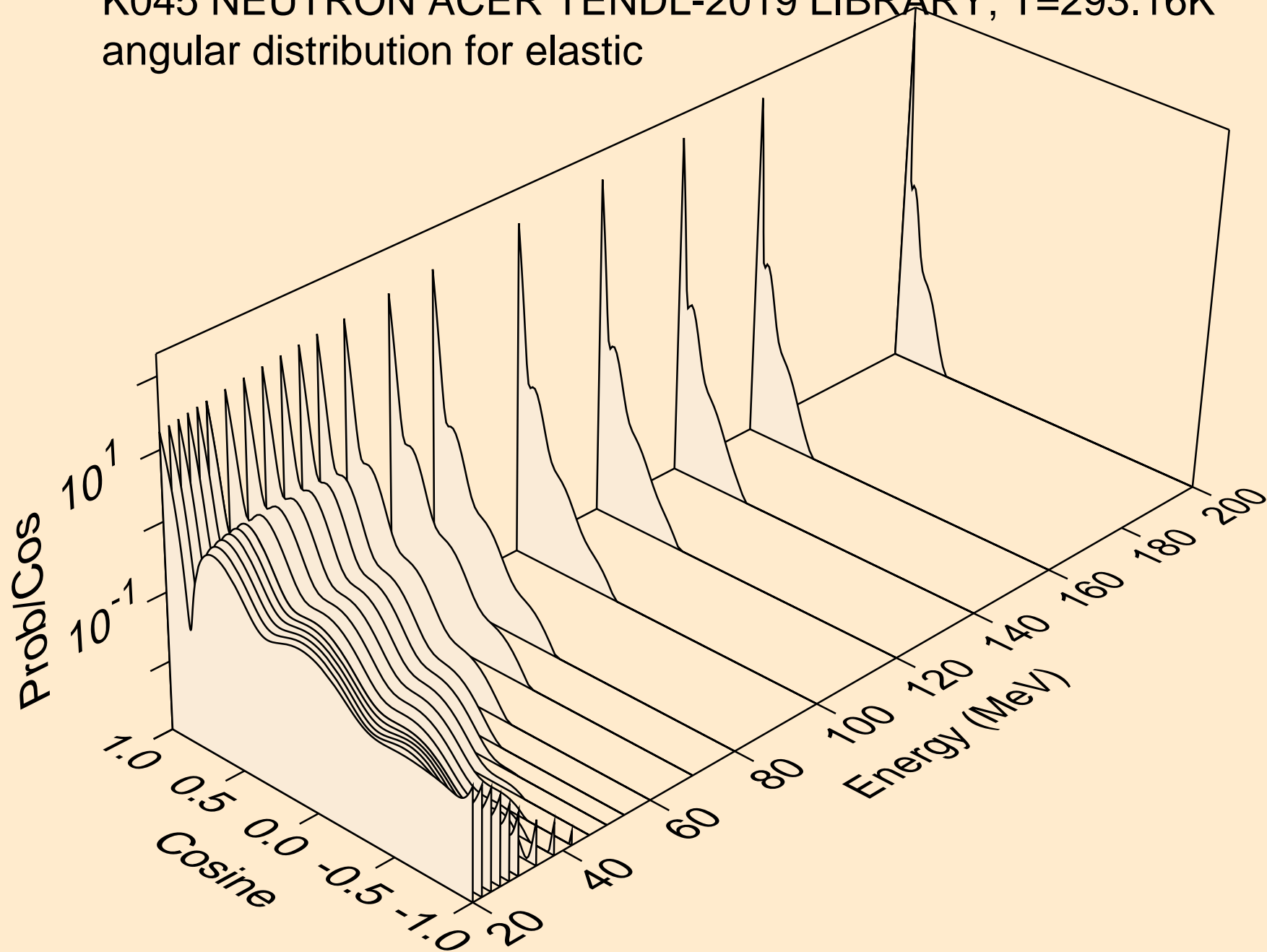

K045 NEUTRON ACER TENDL-2019 LIBRARY; T=293.16K
angular distribution for (n,n*1)

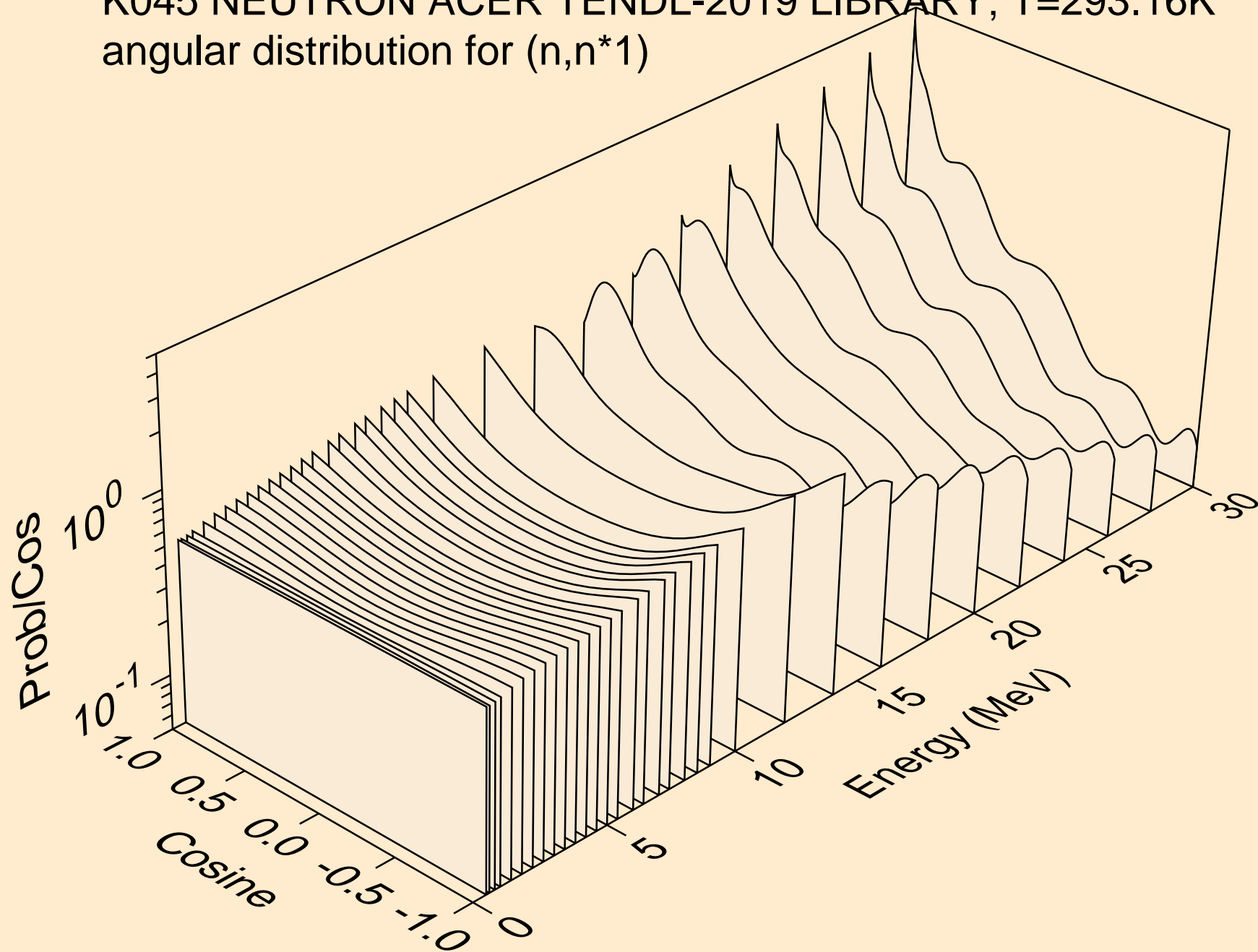

K045 NEUTRON ACER TENDL-2019 LIBRARY; T=293.16K
angular distribution for (n,n*2)

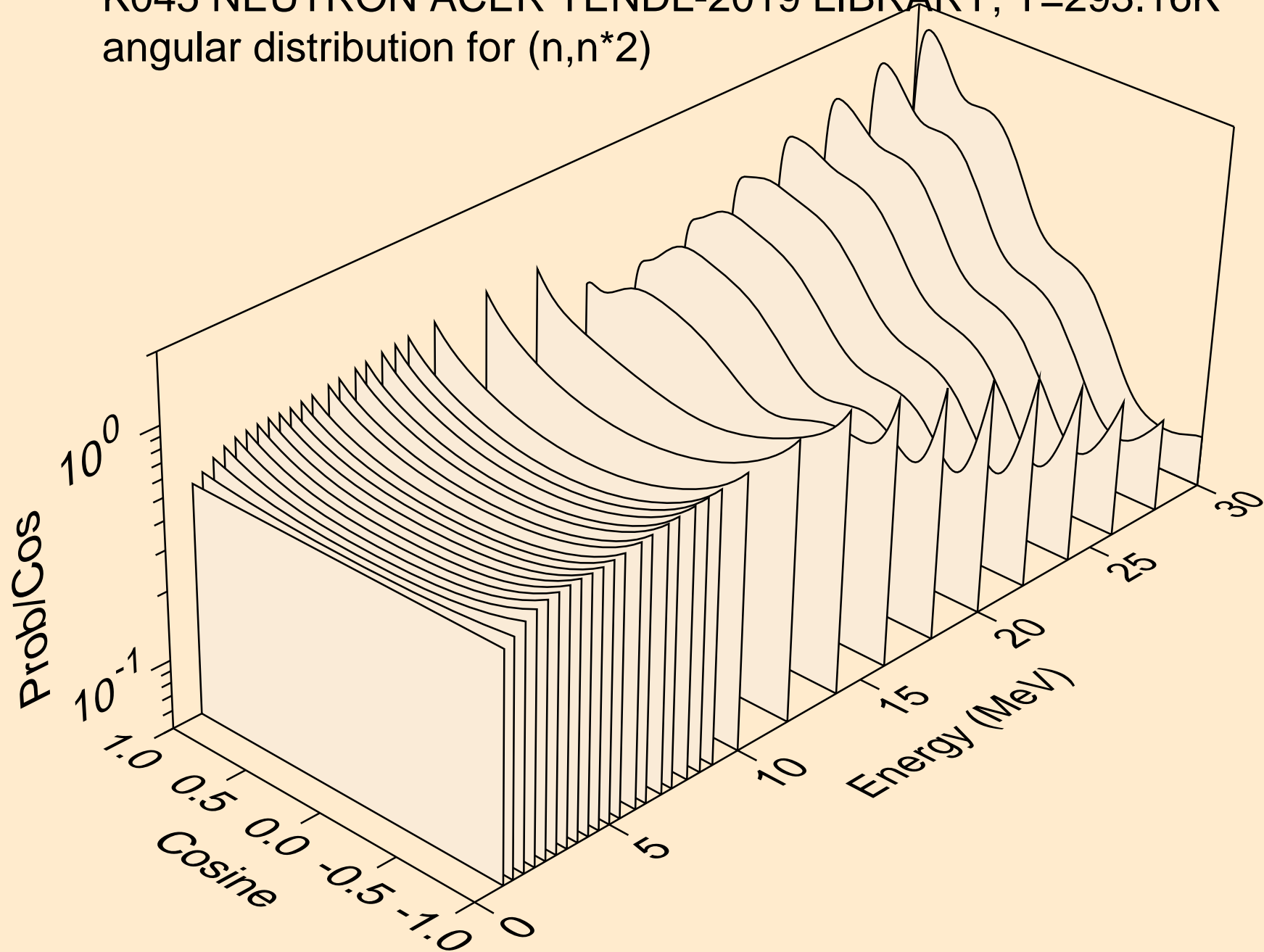

K045 NEUTRON ACER TENDL-2019 LIBRARY; T=293.16K
angular distribution for (n,n*3)

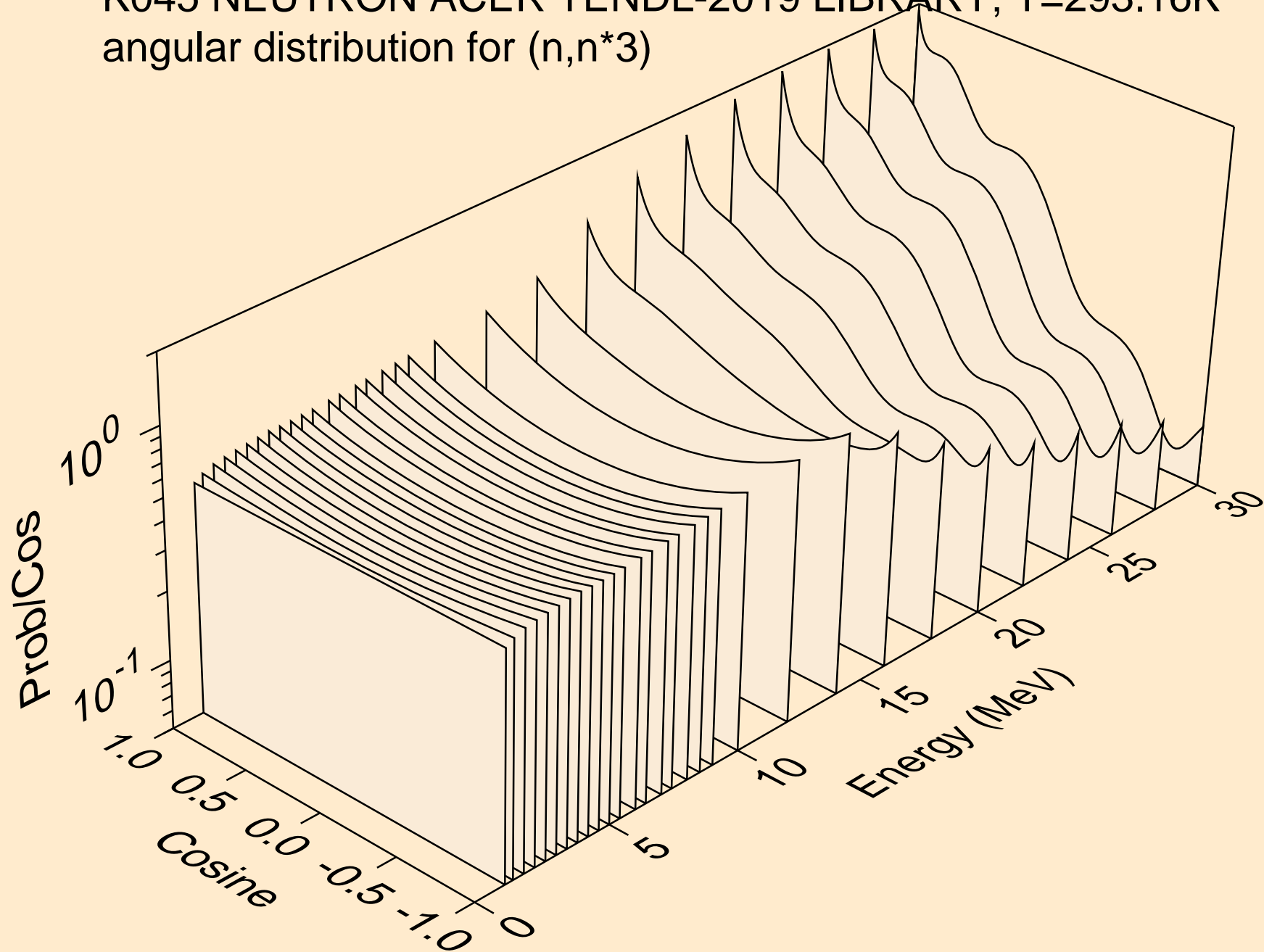

K045 NEUTRON ACER TENDL-2019 LIBRARY; T=293.16K
angular distribution for (n,n*4)

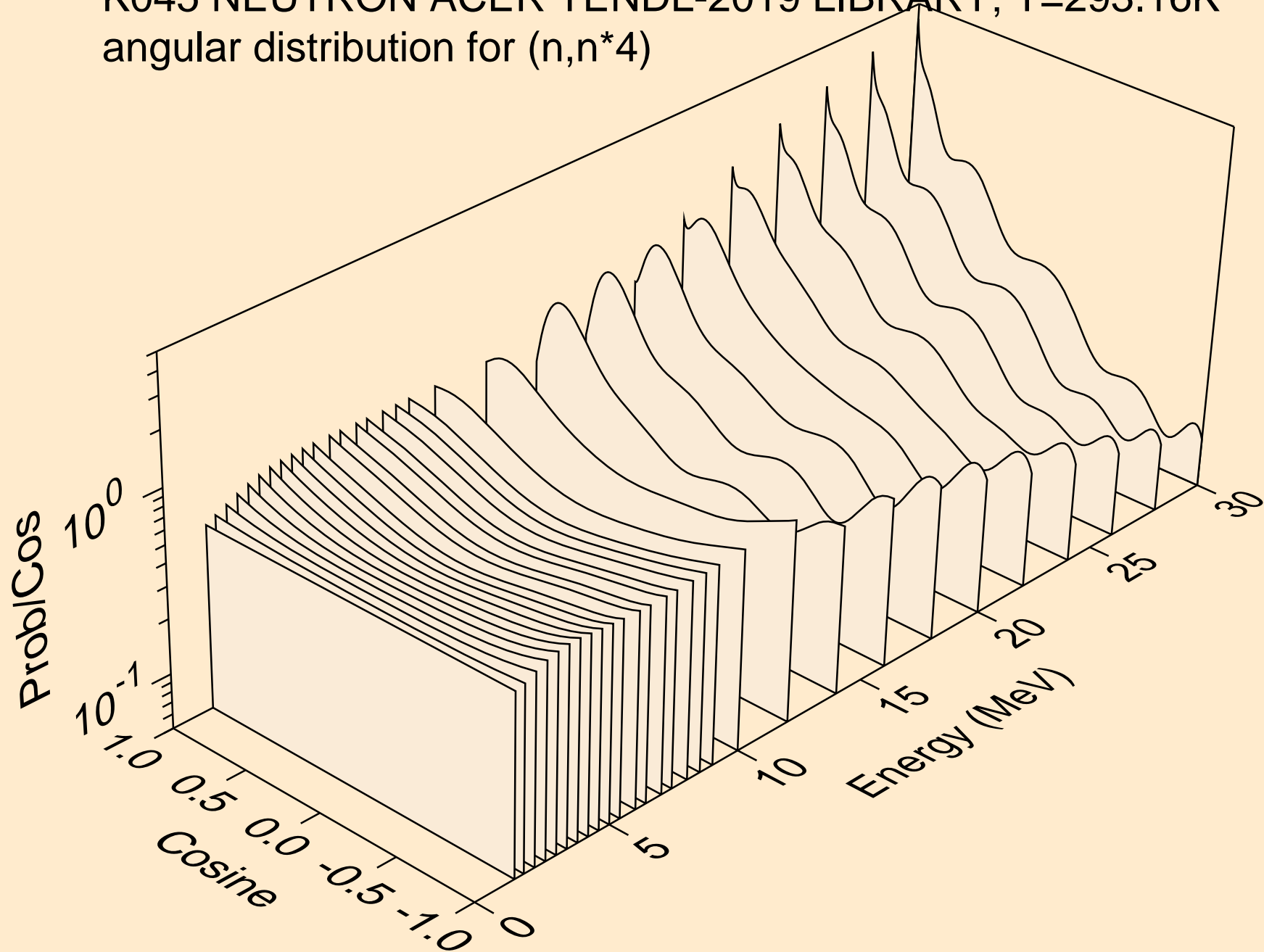

K045 NEUTRON ACER TENDL-2019 LIBRARY; T=293.16K
angular distribution for (n,n*5)

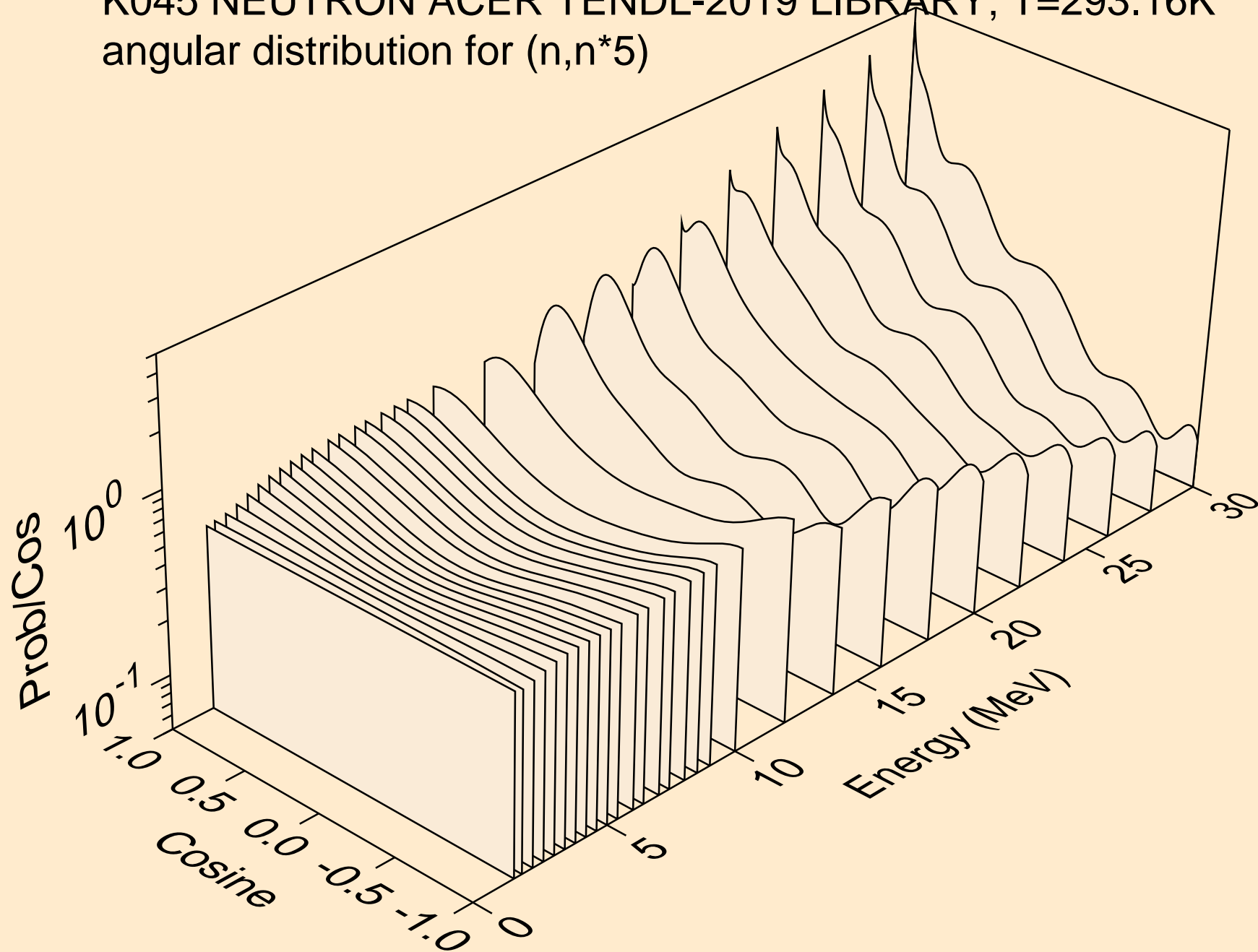

K045 NEUTRON ACER TENDL-2019 LIBRARY; T=293.16K
angular distribution for (n,n*6)

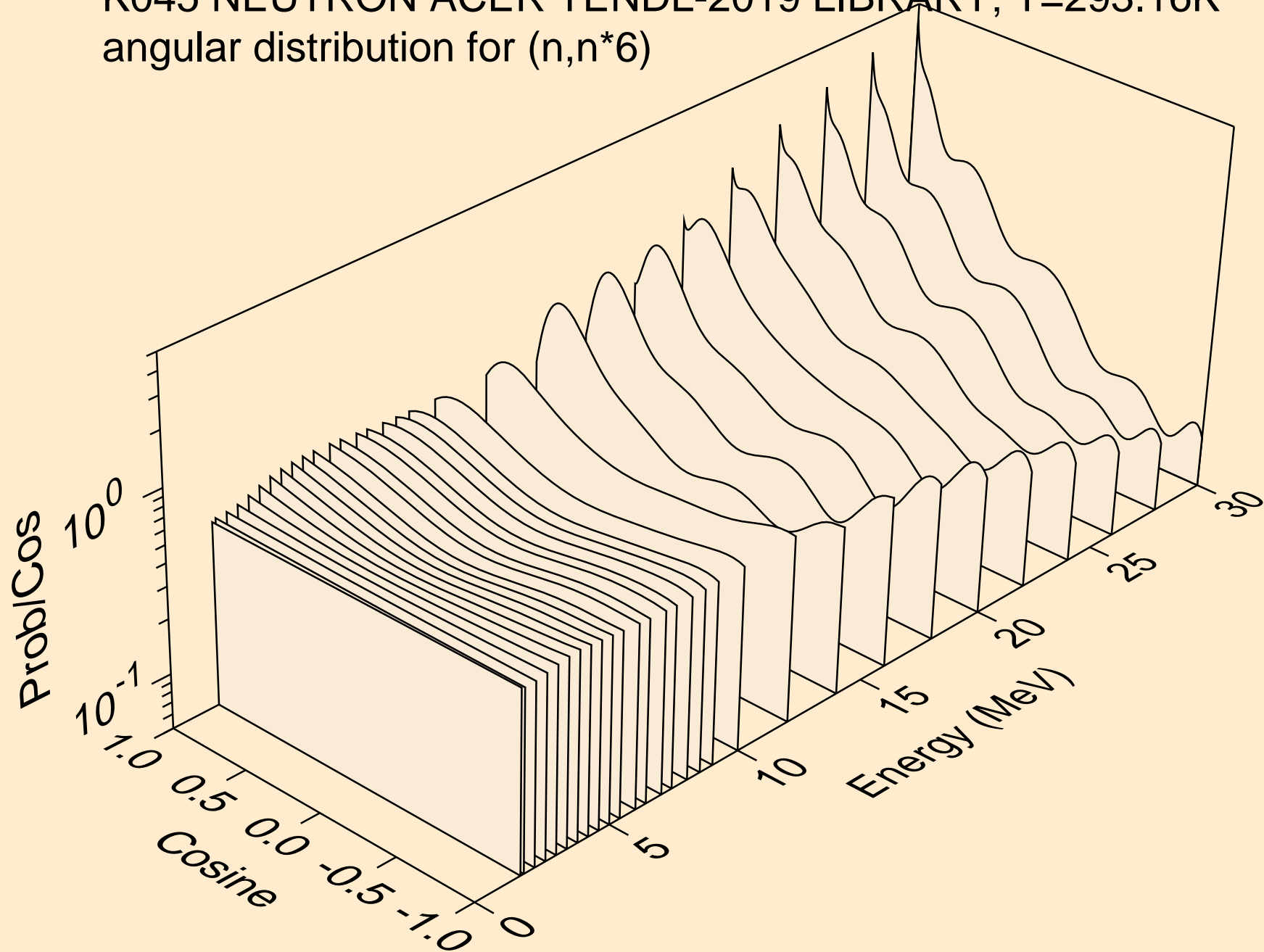

K045 NEUTRON ACER TENDL-2019 LIBRARY; T=293.16K
angular distribution for (n,n*7)

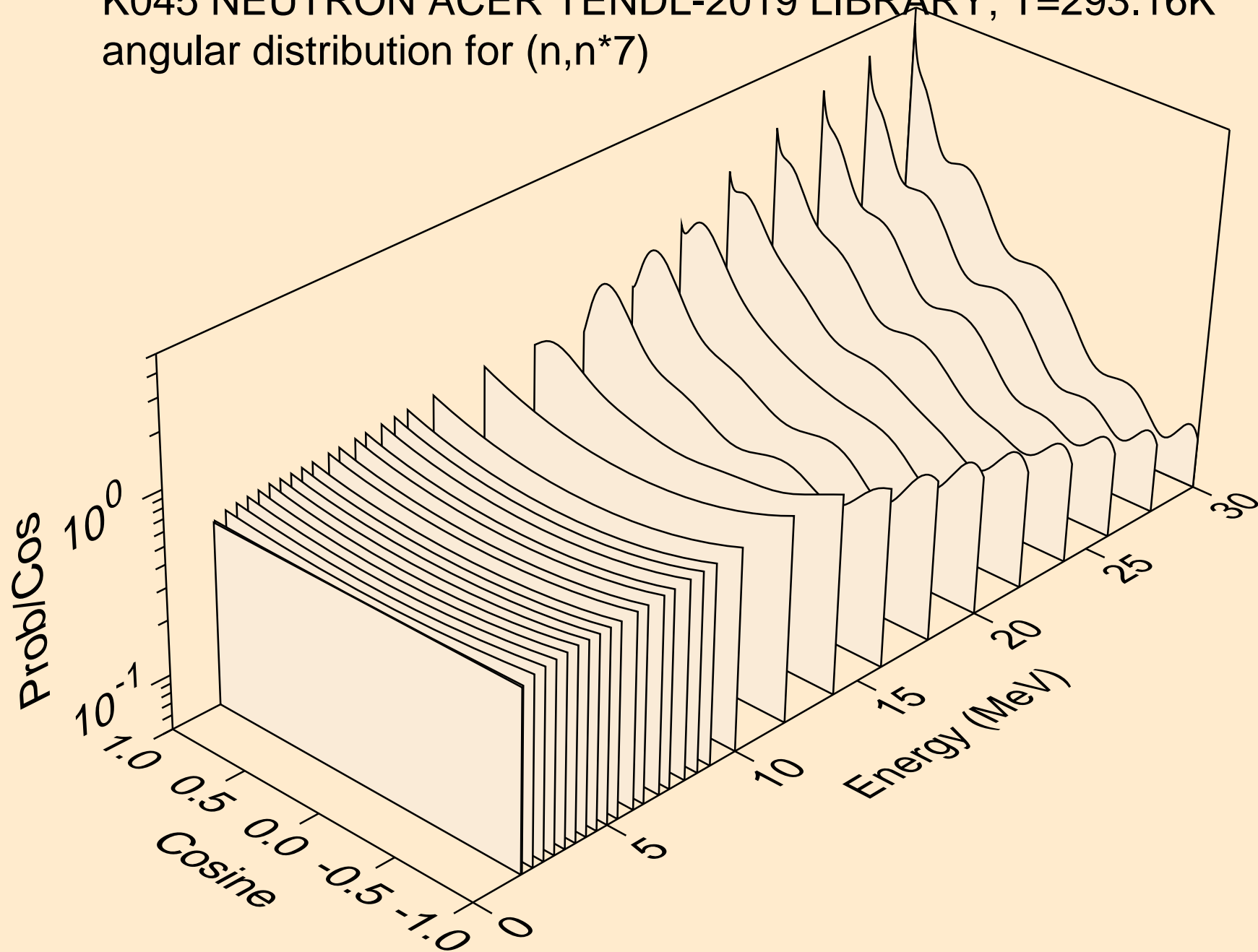

K045 NEUTRON ACER TENDL-2019 LIBRARY; T=293.16K
angular distribution for (n,n*8)

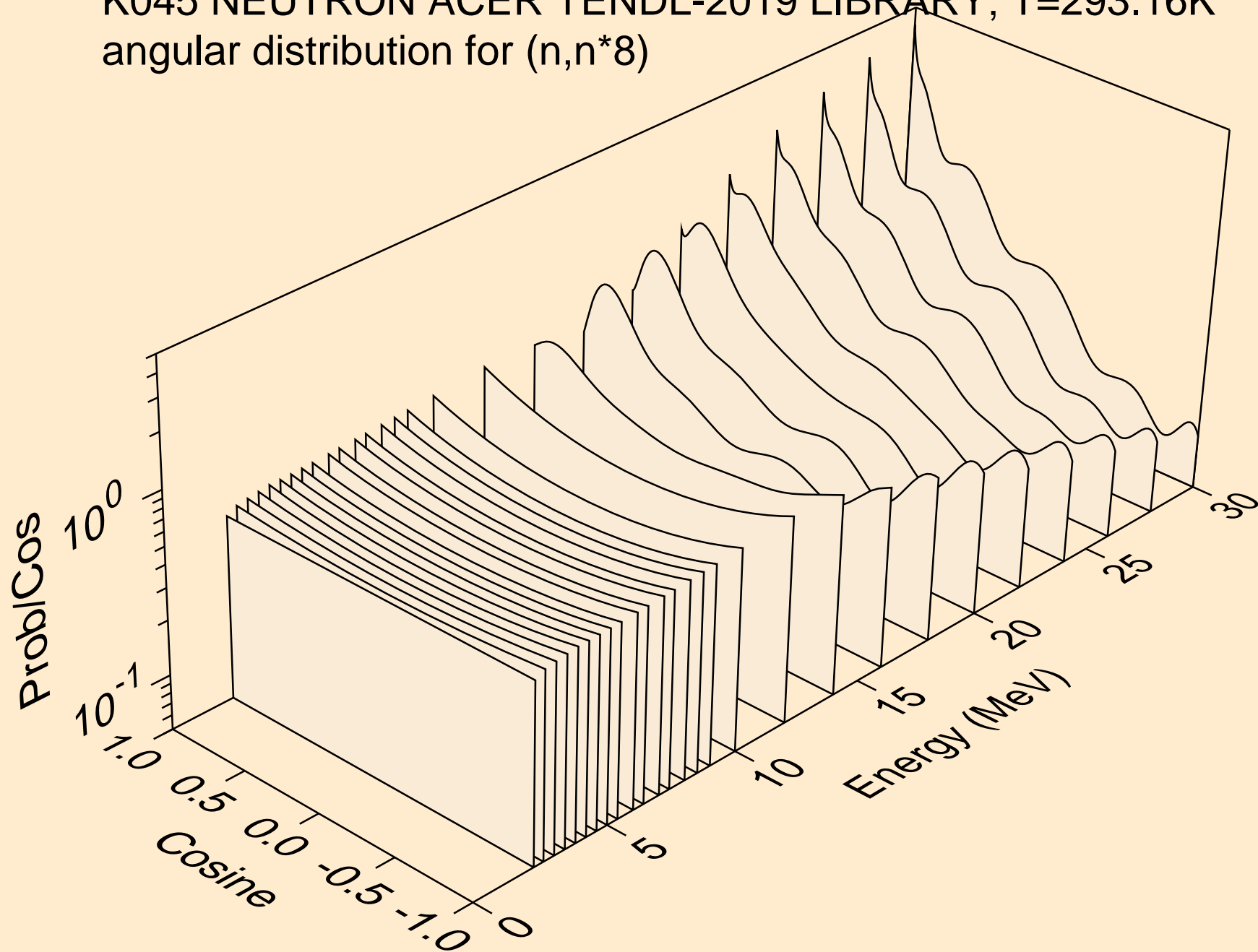

K045 NEUTRON ACER TENDL-2019 LIBRARY; T=293.16K
angular distribution for (n,n*9)

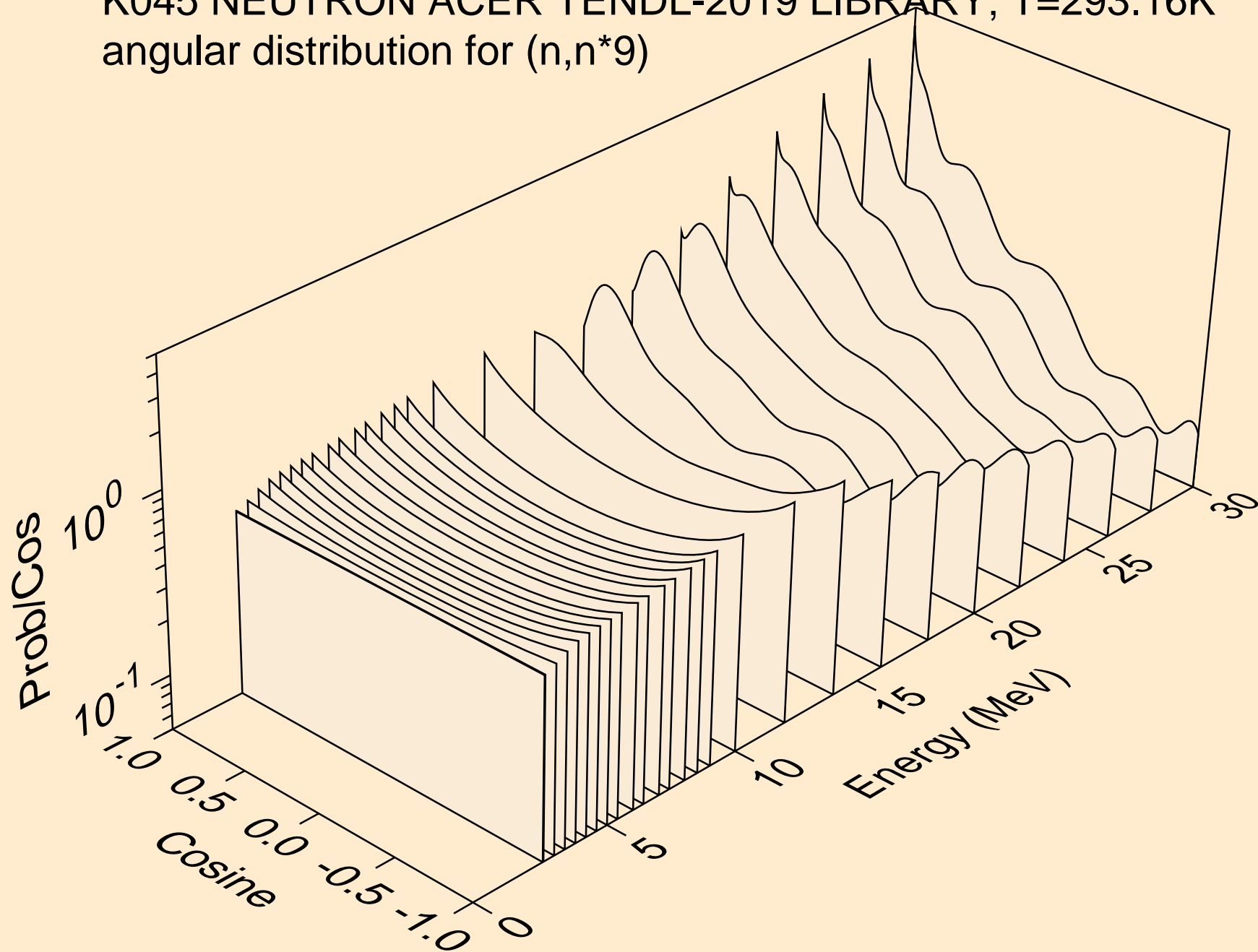

K045 NEUTRON ACER TENDL-2019 LIBRARY; T=293.16K
angular distribution for (n,n*10)

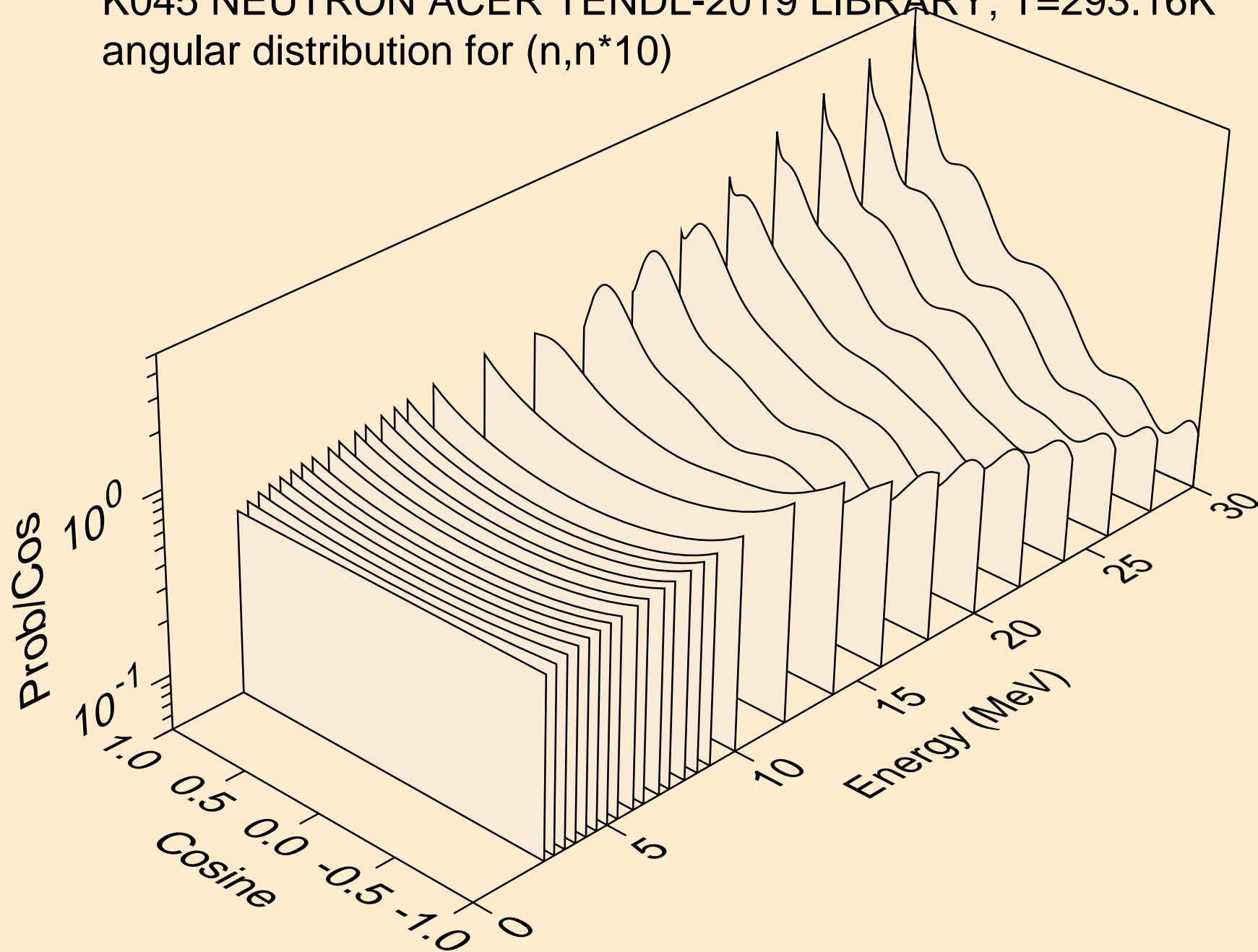

K045 NEUTRON ACER TENDL-2019 LIBRARY; T=293.16K
angular distribution for (n,n*11)

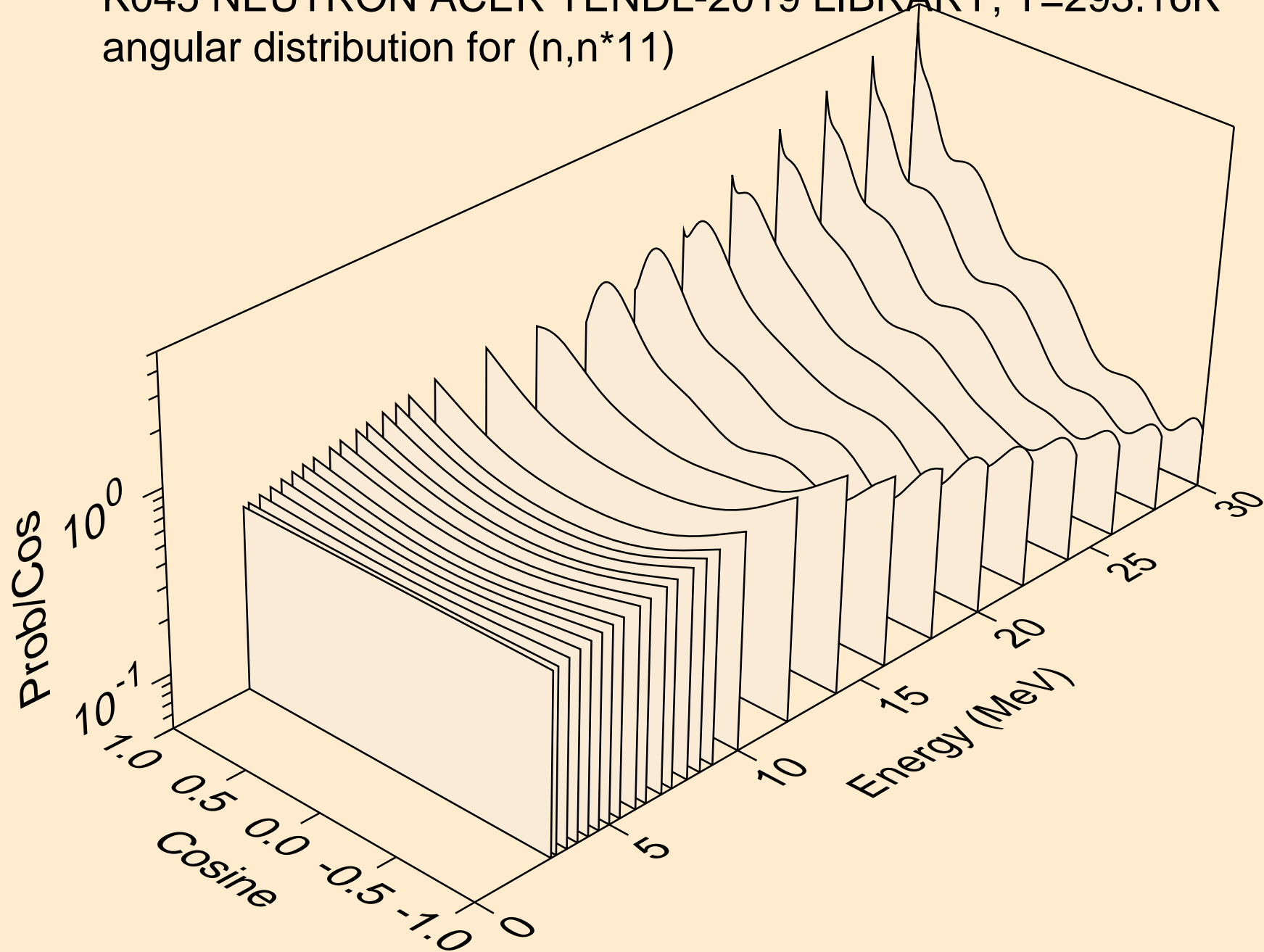

K045 NEUTRON ACER TENDL-2019 LIBRARY; T=293.16K
angular distribution for (n,n*12)

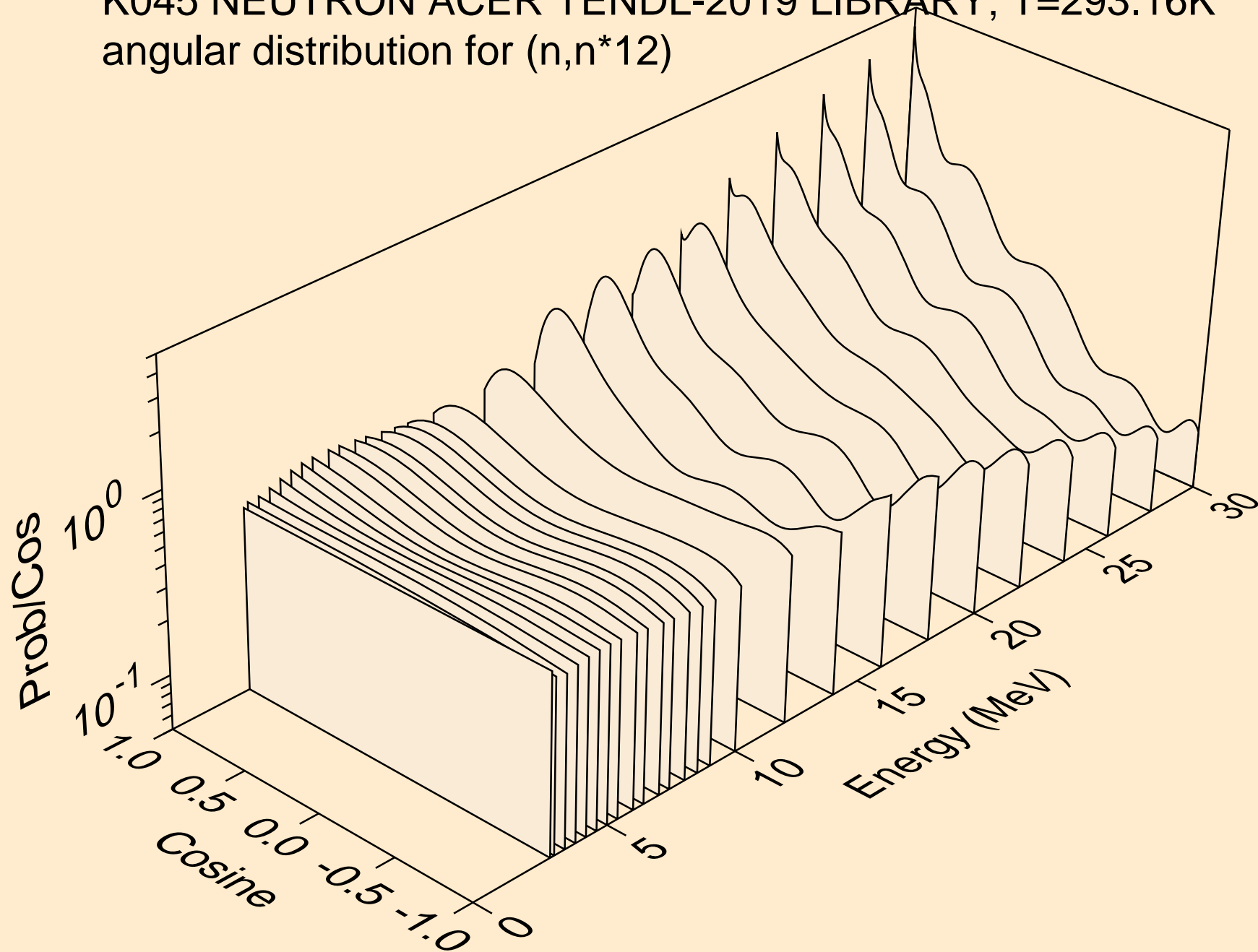

K045 NEUTRON ACER TENDL-2019 LIBRARY; T=293.16K
angular distribution for (n,n*13)

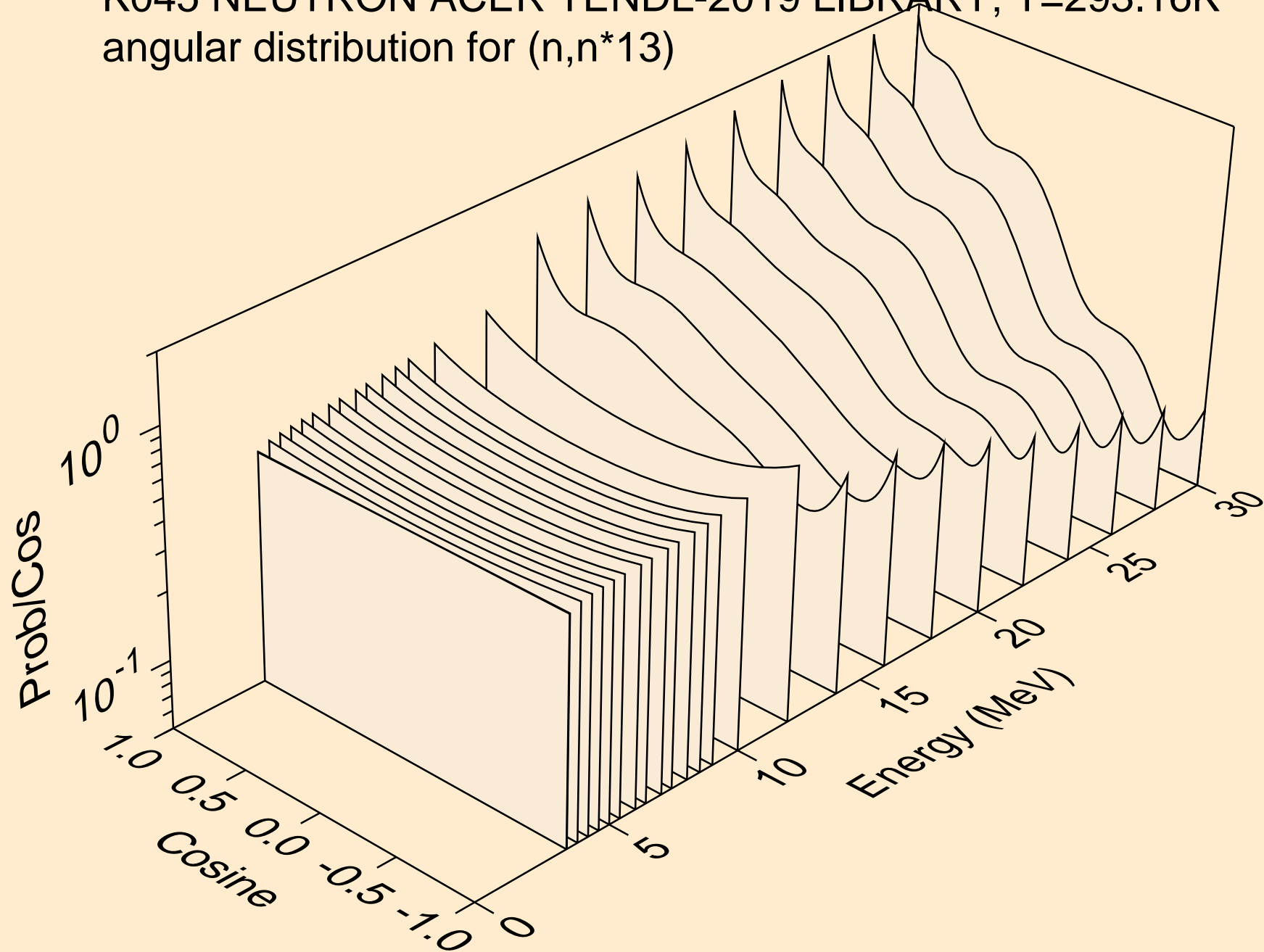

K045 NEUTRON ACER TENDL-2019 LIBRARY; T=293.16K
angular distribution for (n,n*14)

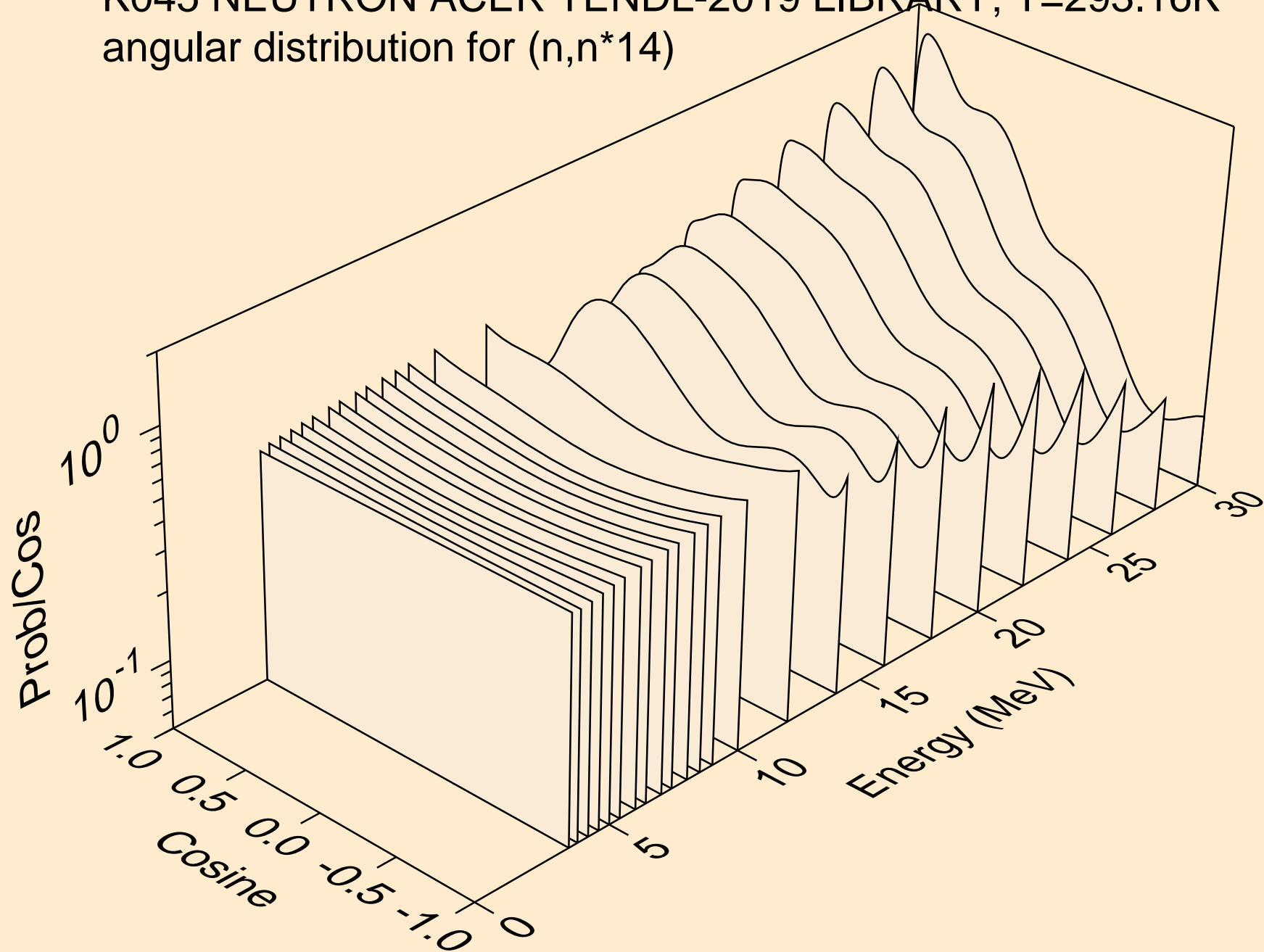

K045 NEUTRON ACER TENDL-2019 LIBRARY; T=293.16K
angular distribution for (n,n*15)

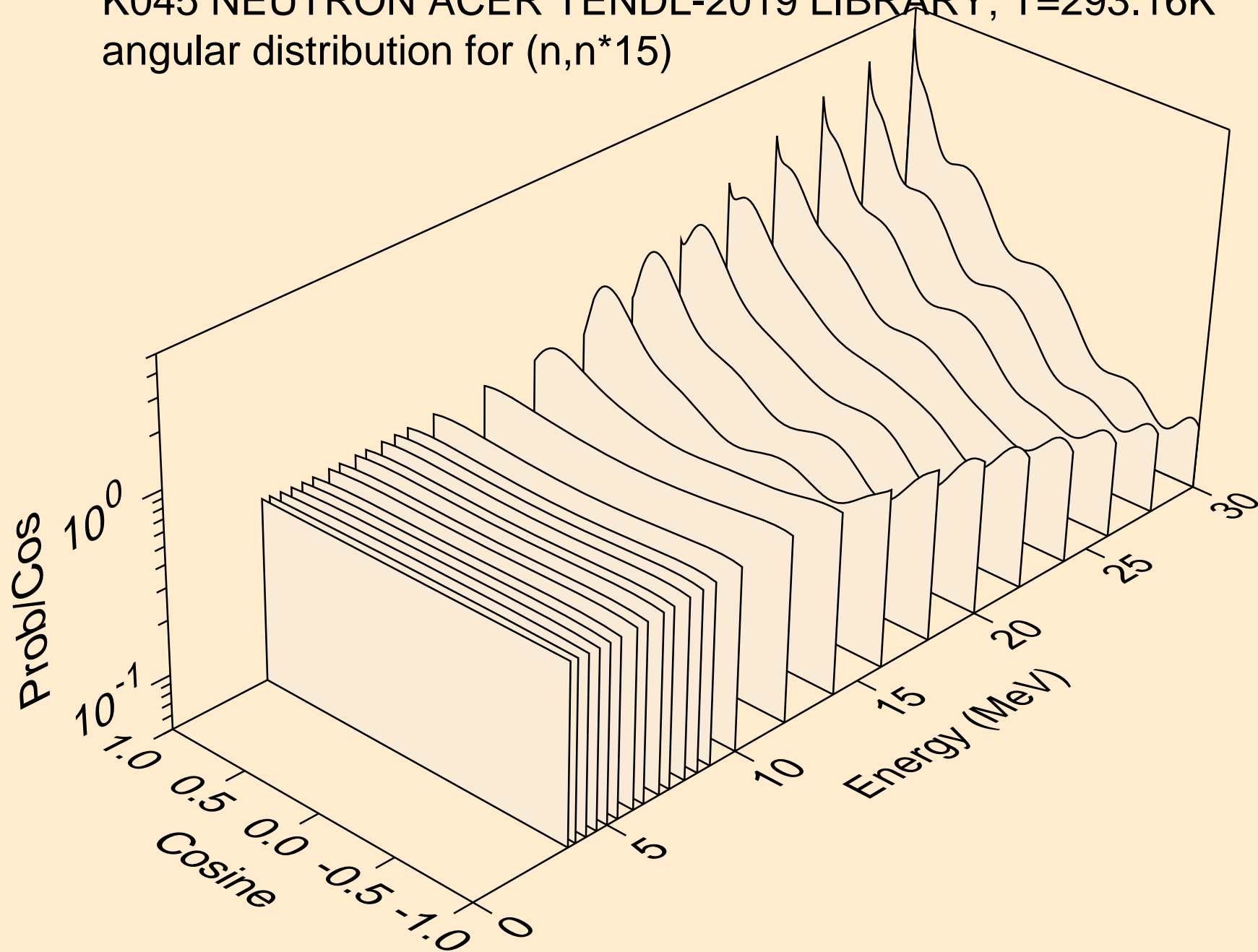

K045 NEUTRON ACER TENDL-2019 LIBRARY; T=293.16K
angular distribution for (n,n*16)

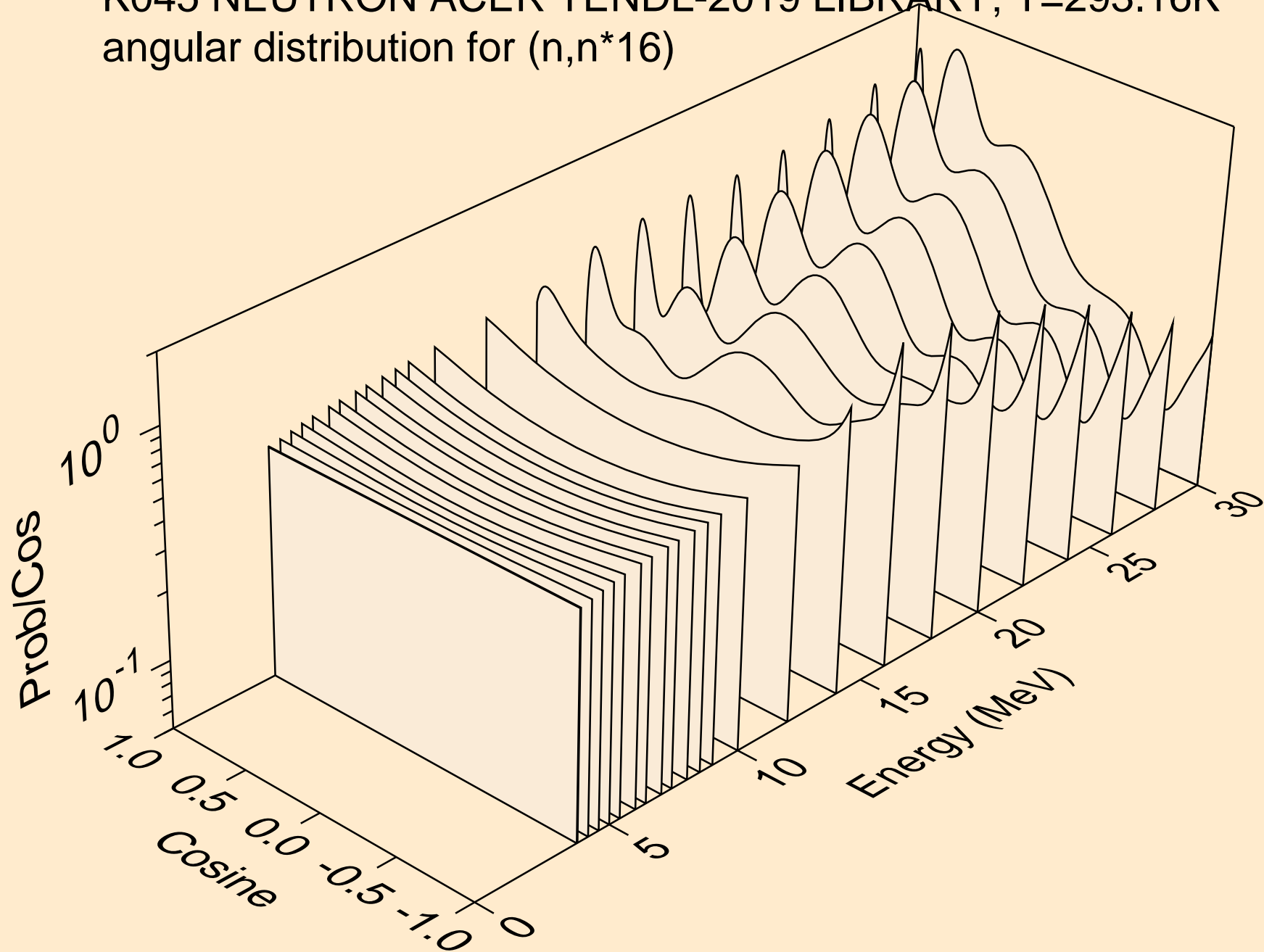

K045 NEUTRON ACER TENDL-2019 LIBRARY; T=293.16K
angular distribution for (n,n*17)

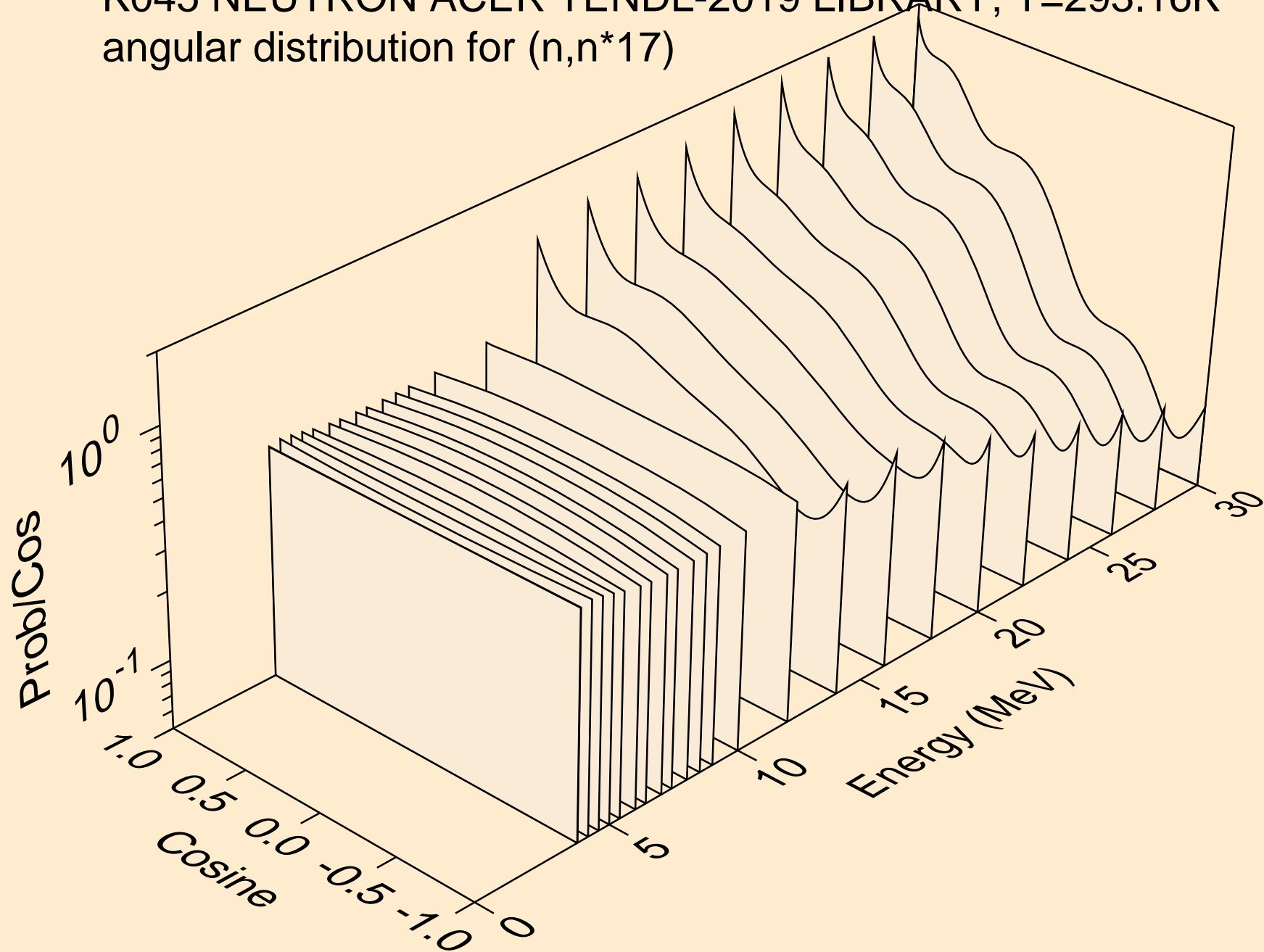

K045 NEUTRON ACER TENDL-2019 LIBRARY; T=293.16K
angular distribution for (n,n*18)

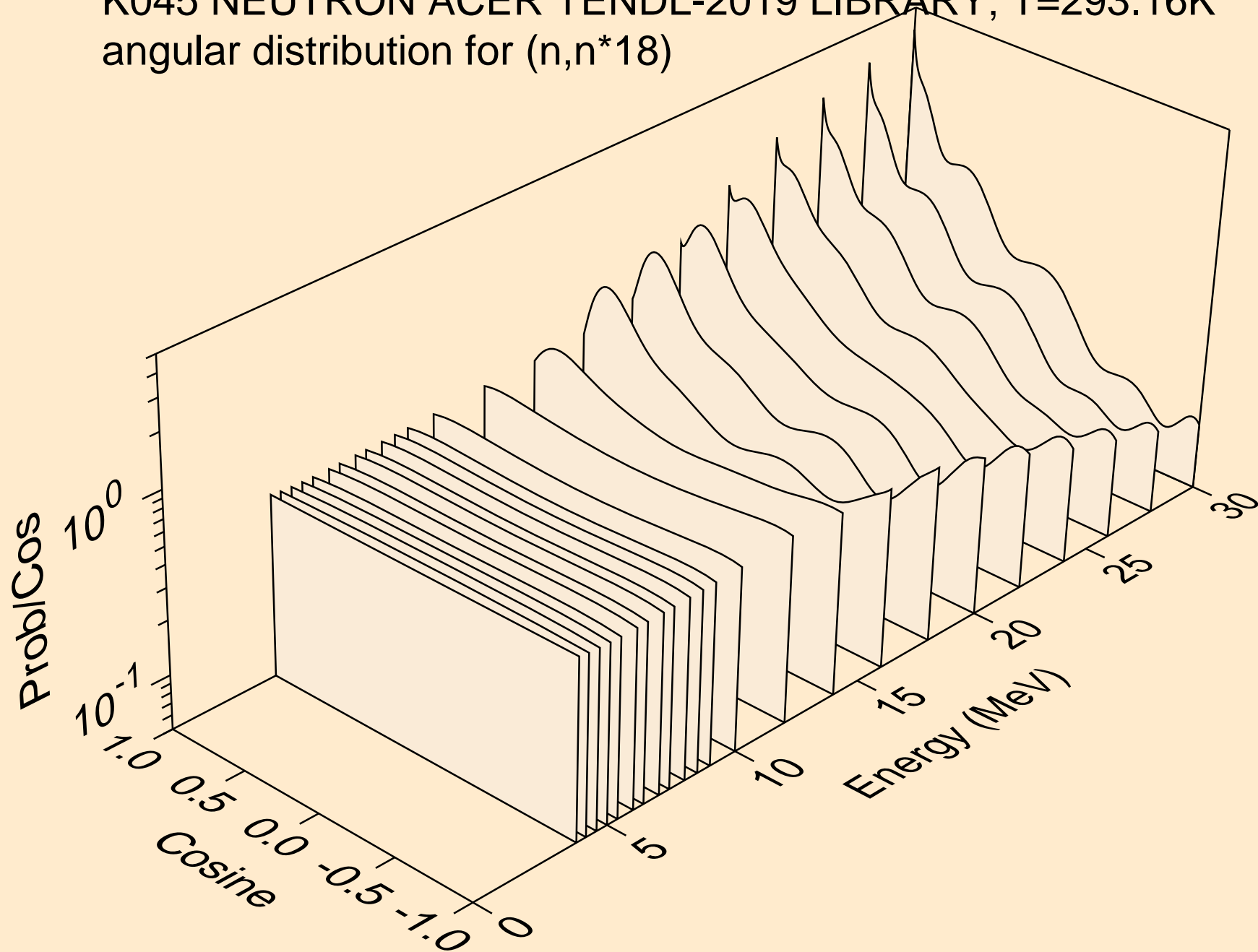

K045 NEUTRON ACER TENDL-2019 LIBRARY; T=293.16K
angular distribution for (n,n*19)

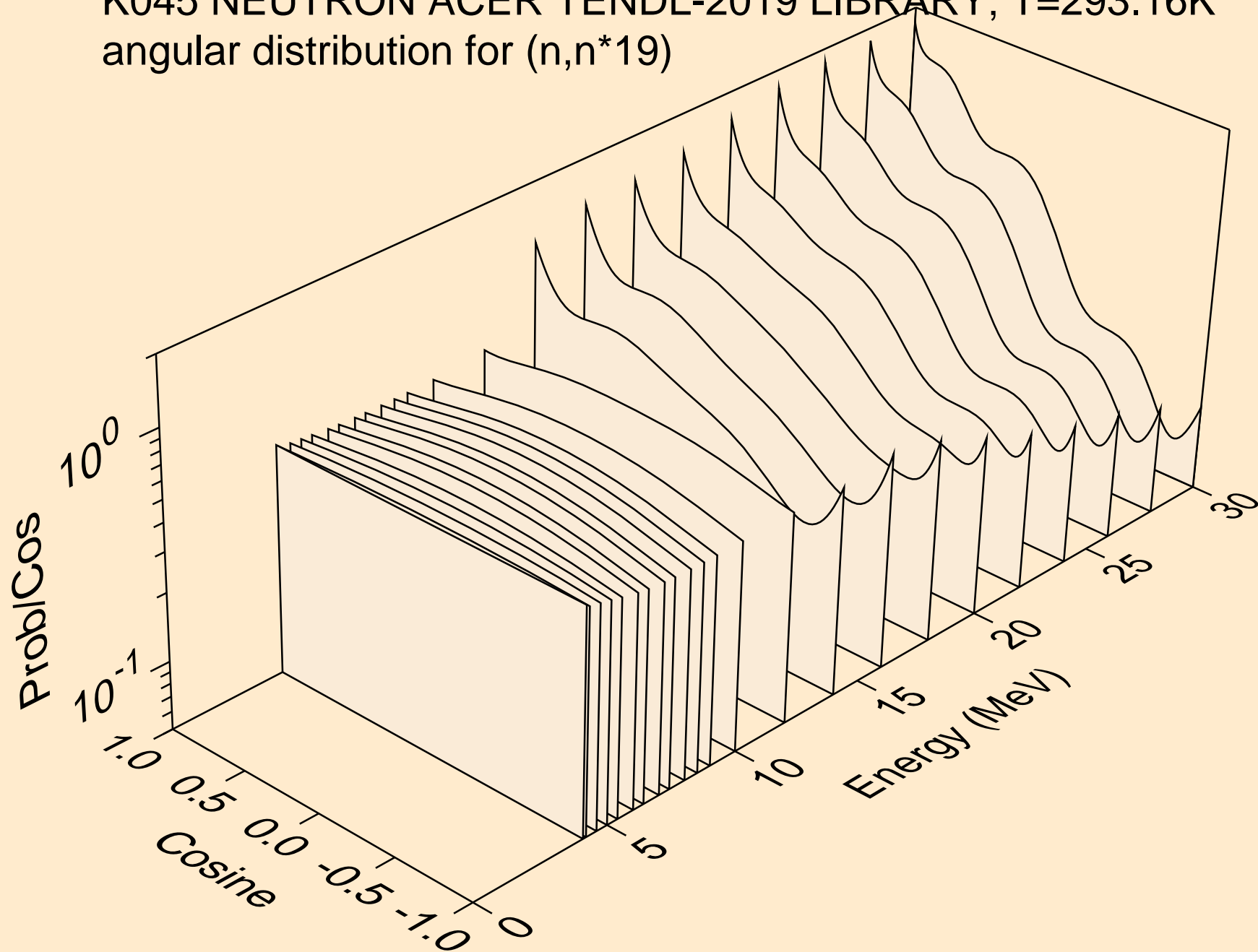

K045 NEUTRON ACER TENDL-2019 LIBRARY; T=293.16K
angular distribution for (n,n*20)

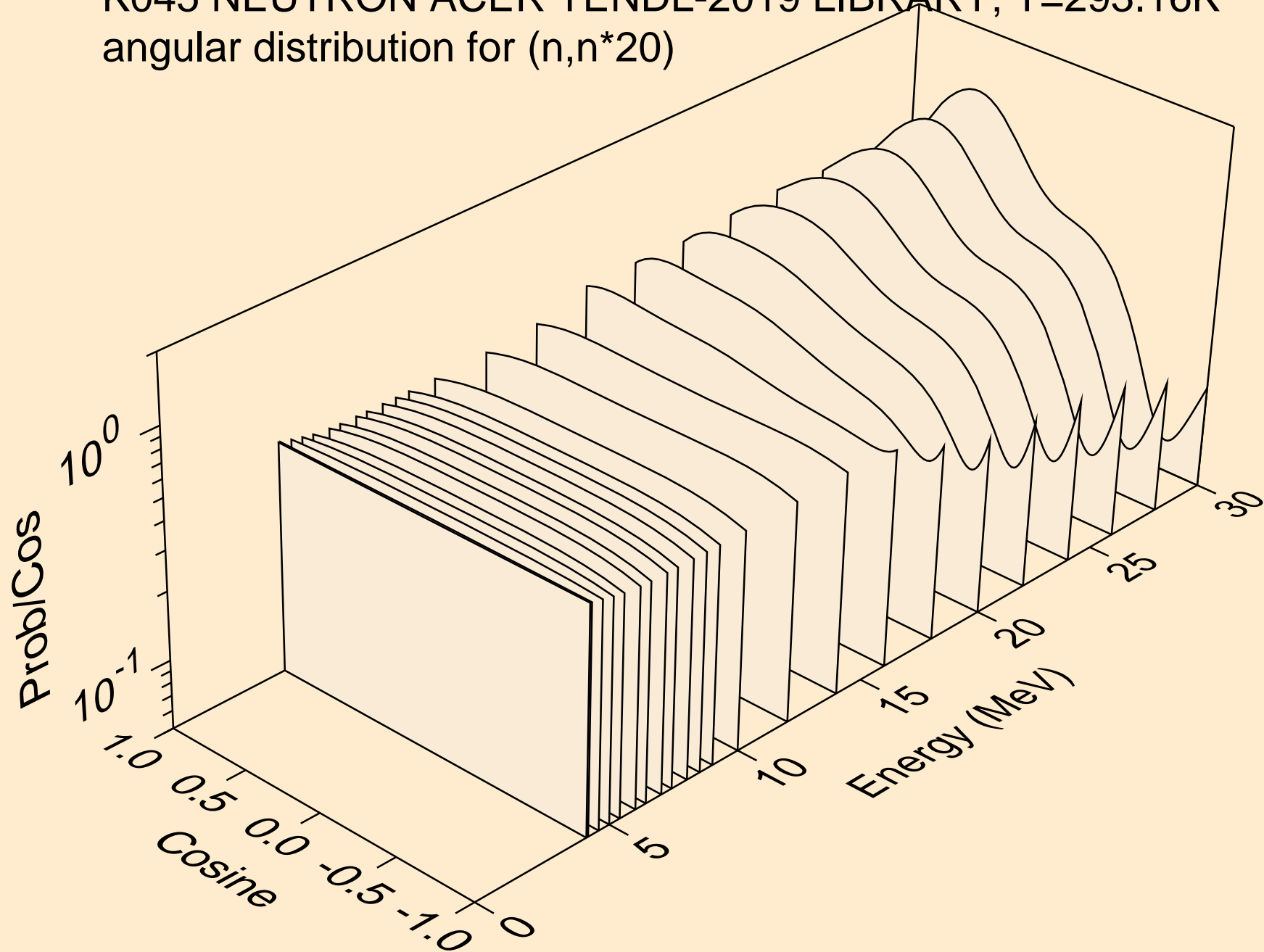

K045 NEUTRON ACER TENDL-2019 LIBRARY; T=293.16K
angular distribution for (n,n*21)

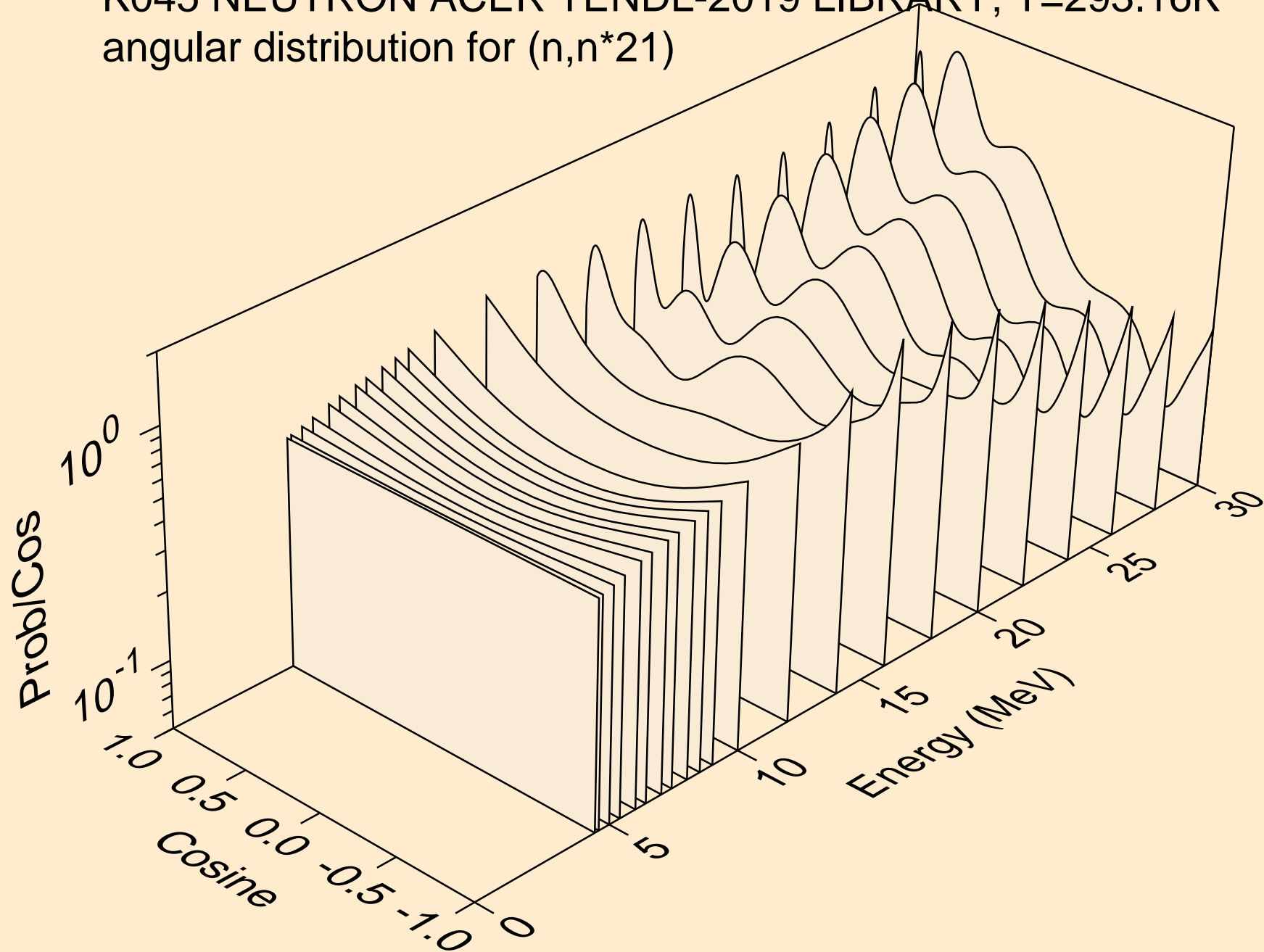

K045 NEUTRON ACER TENDL-2019 LIBRARY; T=293.16K
angular distribution for (n,n*22)

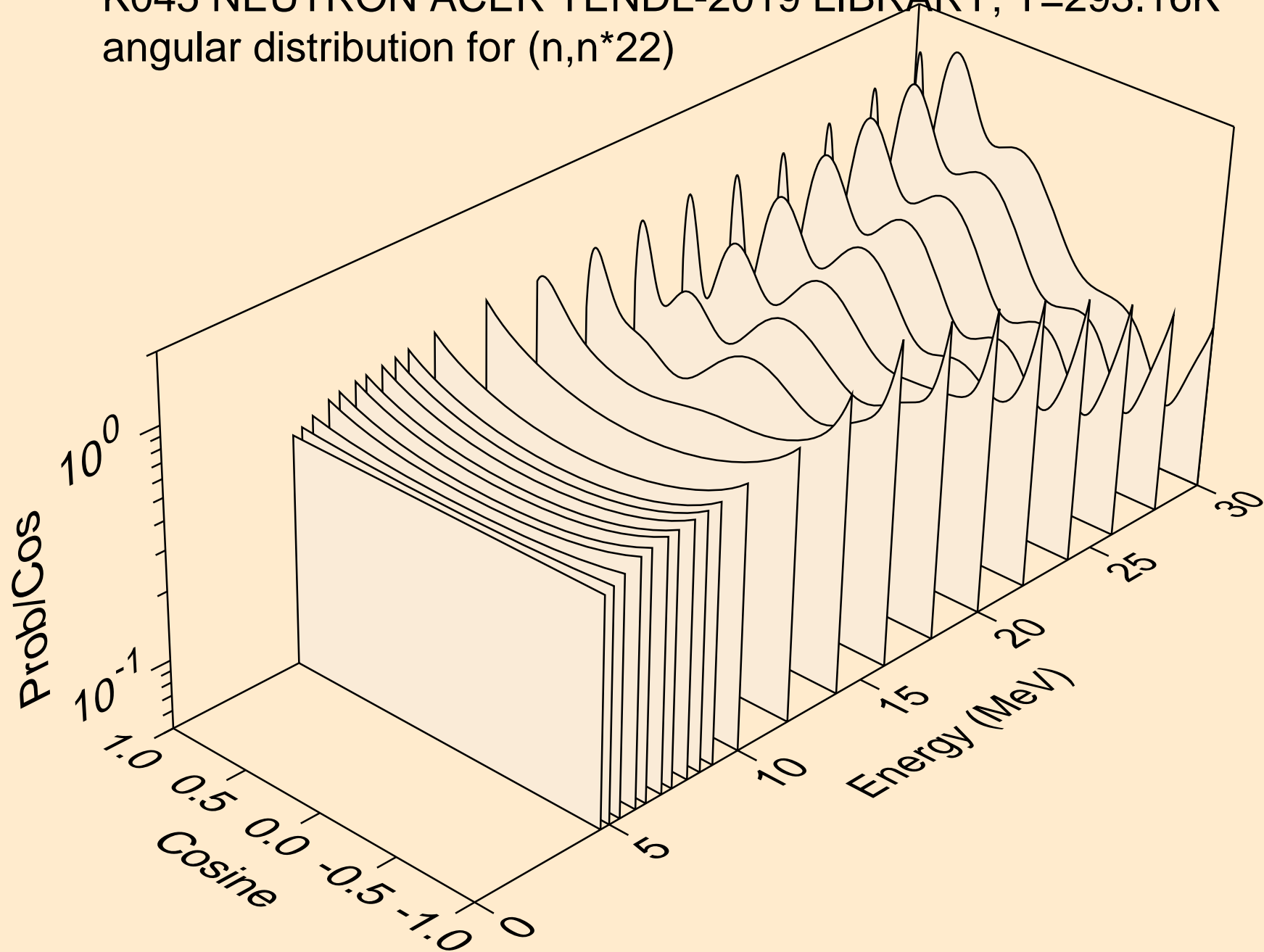

K045 NEUTRON ACER TENDL-2019 LIBRARY; T=293.16K
angular distribution for (n,n*23)

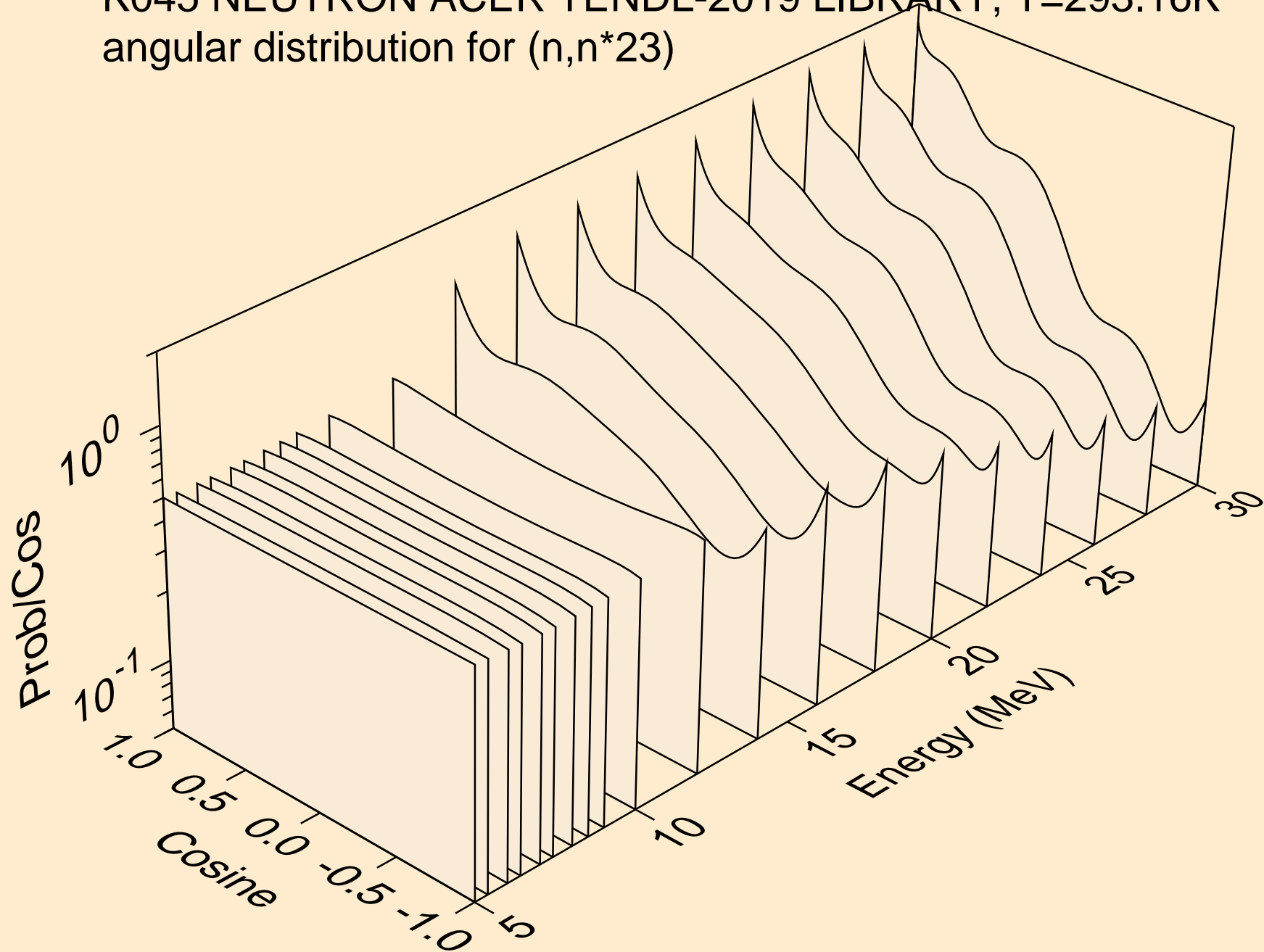

K045 NEUTRON ACER TENDL-2019 LIBRARY; T=293.16K
angular distribution for (n,n*24)

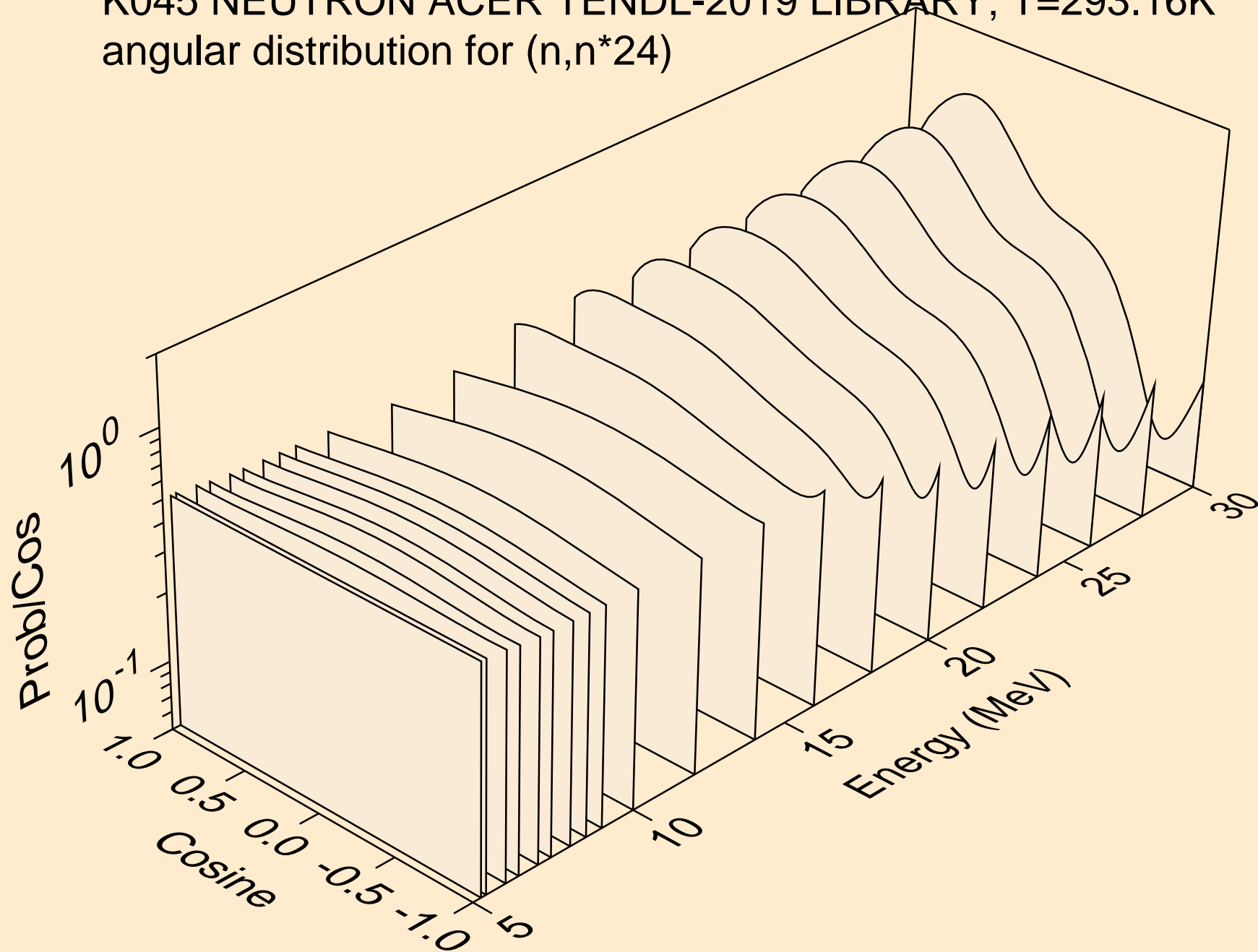

K045 NEUTRON ACER TENDL-2019 LIBRARY; T=293.16K
angular distribution for (n,n*25)

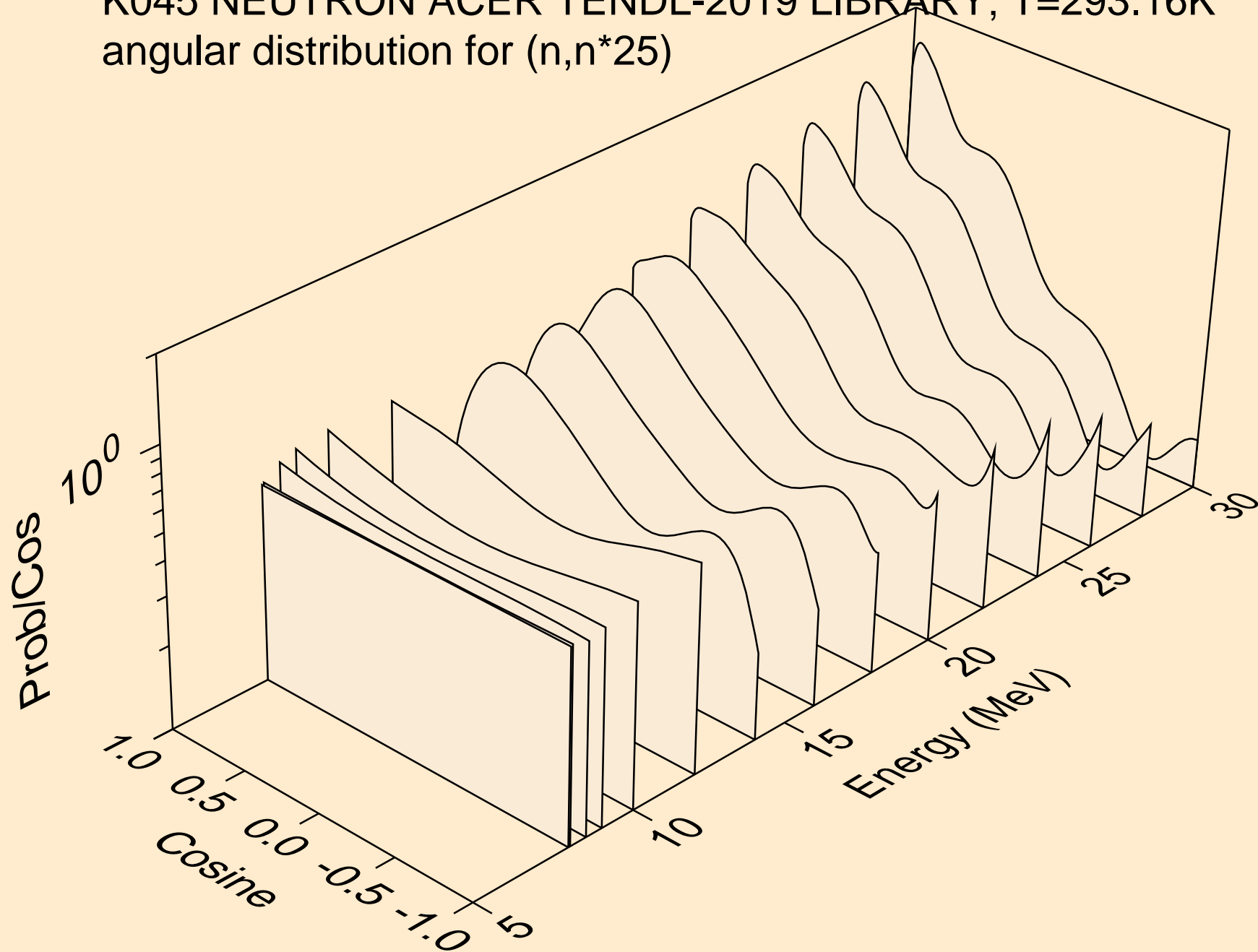

K045 NEUTRON ACER TENDL-2019 LIBRARY; T=293.16K
Neutron emission for (n,x)

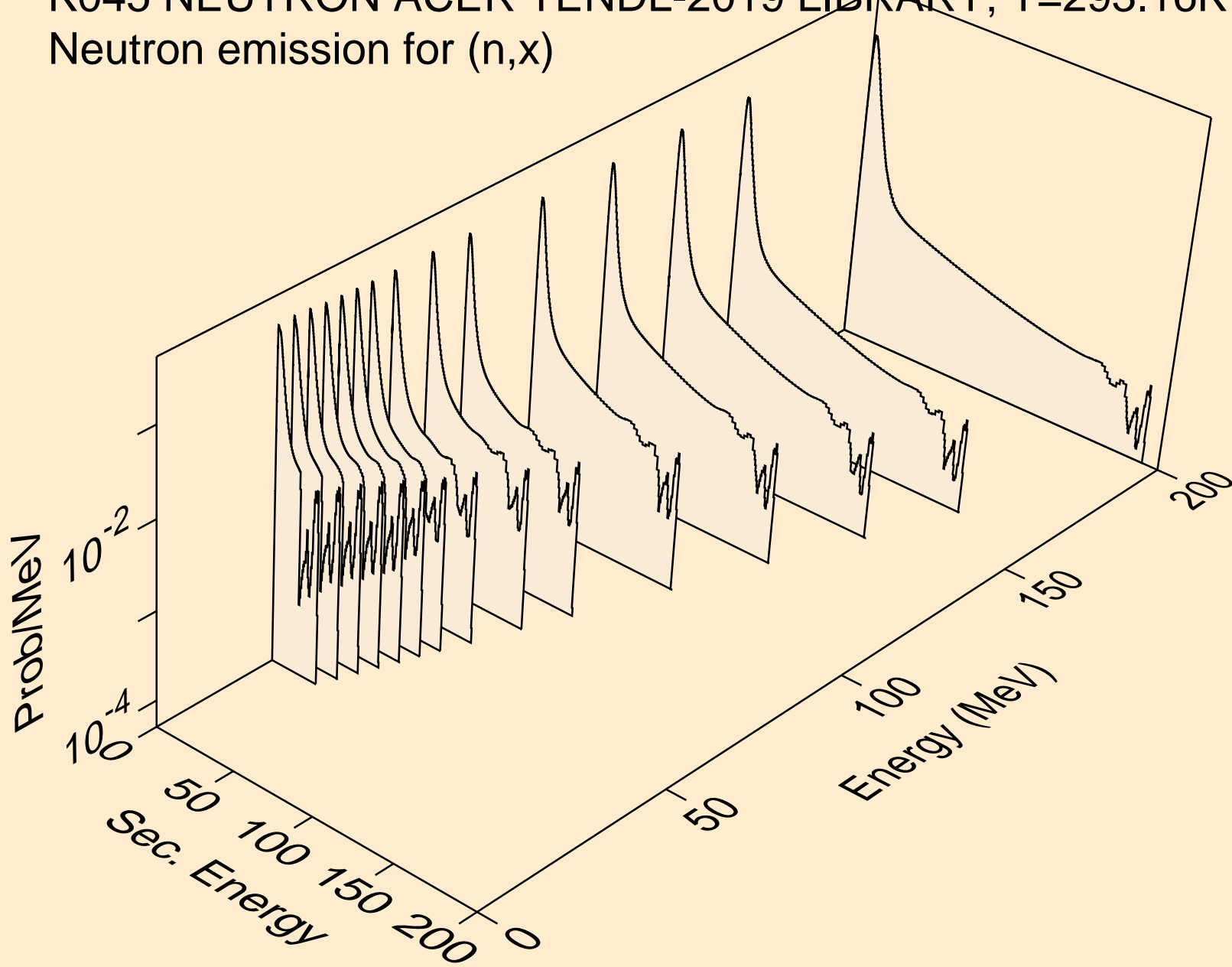

K045 NEUTRON ACER TENDL-2019 LIBRARY; T=293.16K
Neutron emission for (n,2nd)

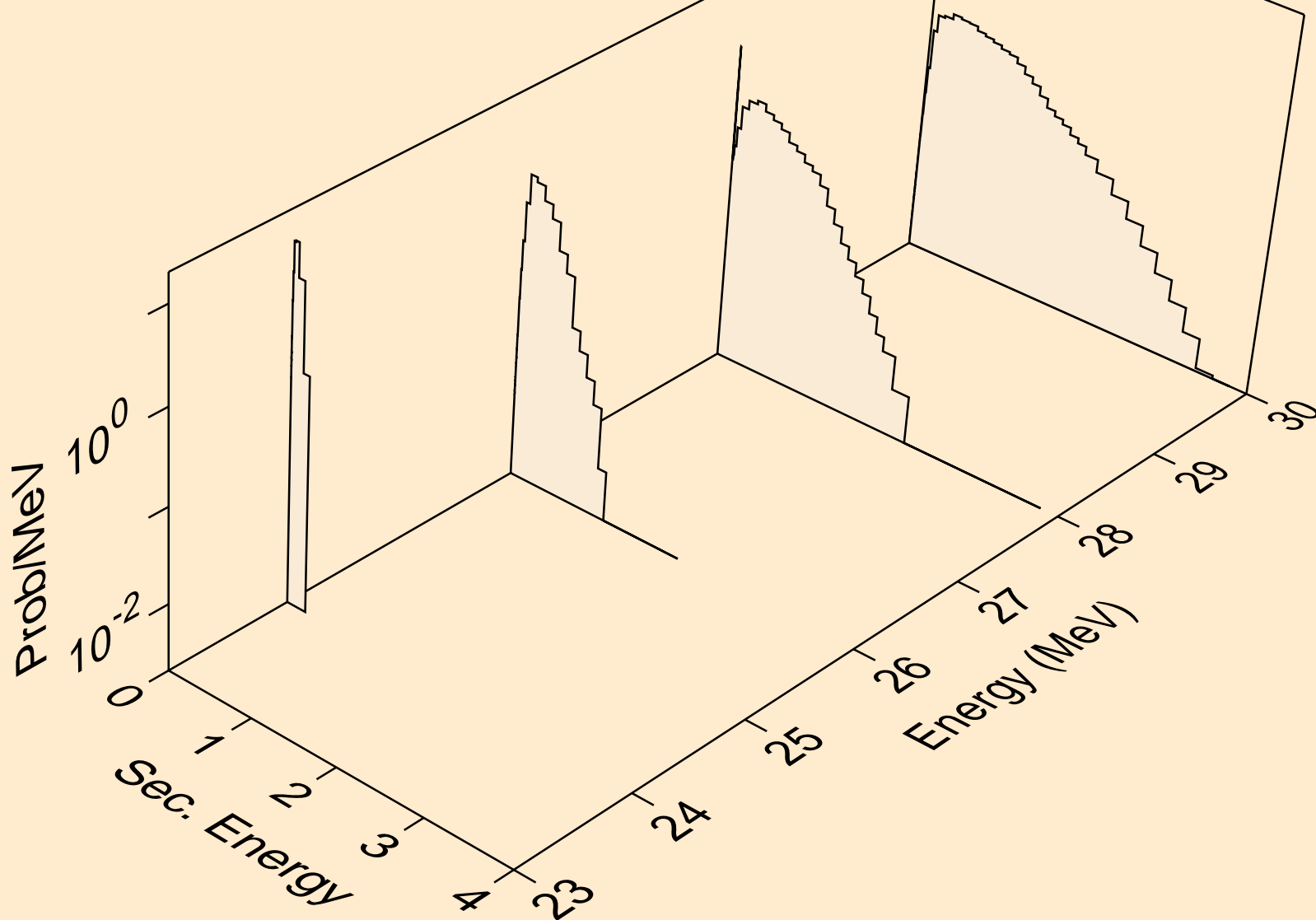

K045 NEUTRON ACER TENDL-2019 LIBRARY; T=293.16K
Neutron emission for (n,2n)

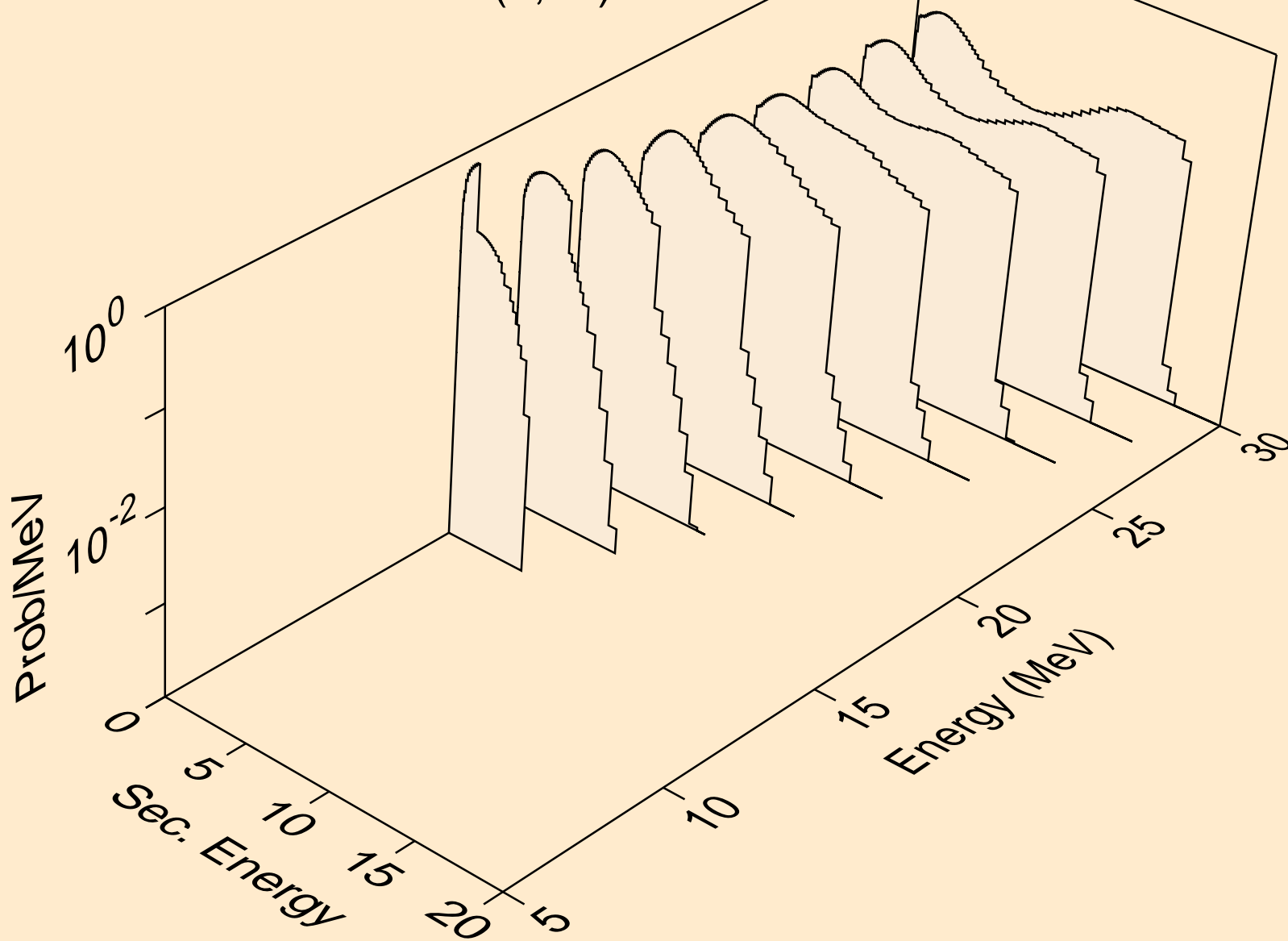

K045 NEUTRON ACER TENDL-2019 LIBRARY; T=293.16K
Neutron emission for (n,3n)

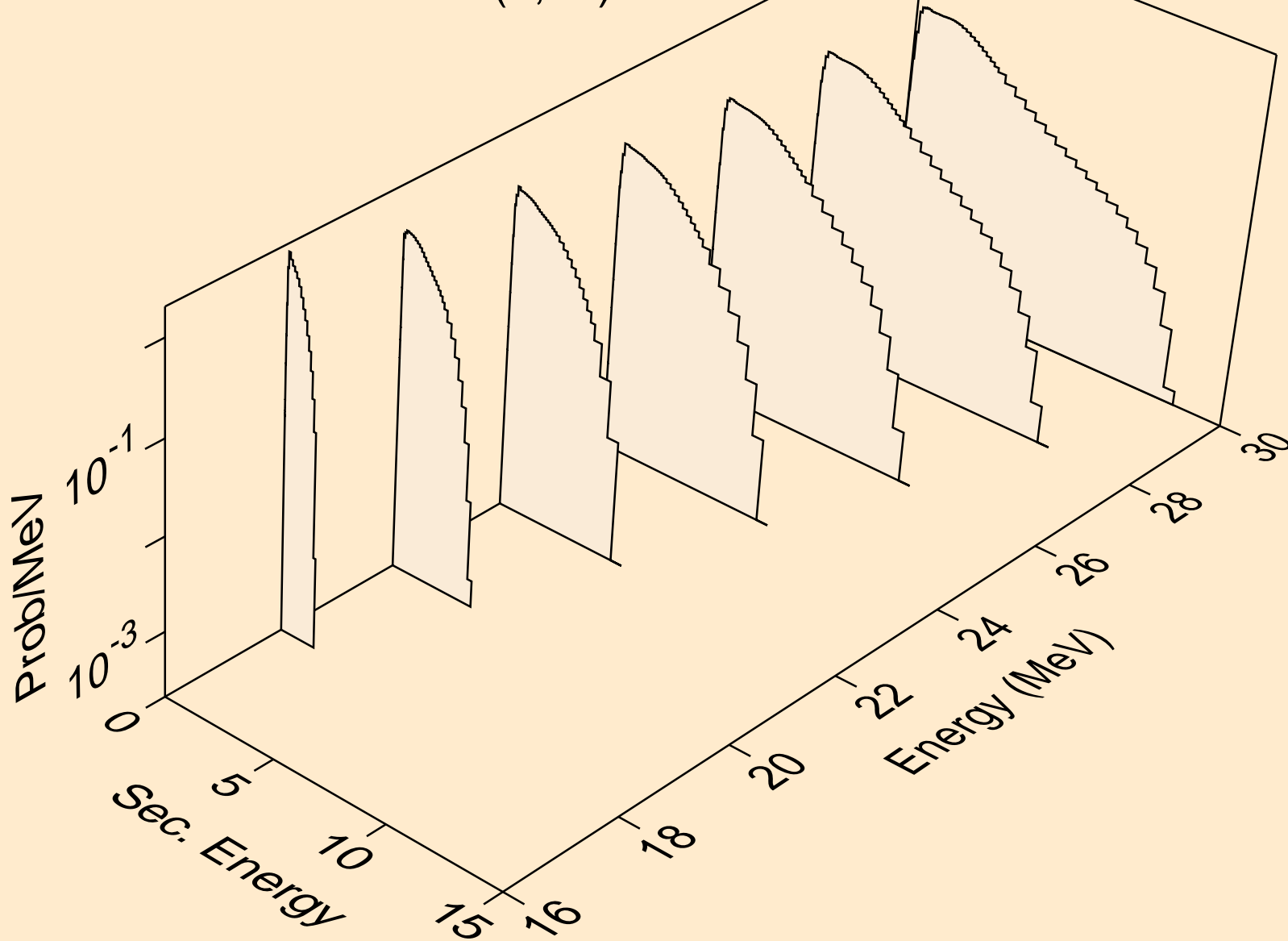

K045 NEUTRON ACER TENDL-2019 LIBRARY; T=293.16K
Neutron emission for (n,n*)a

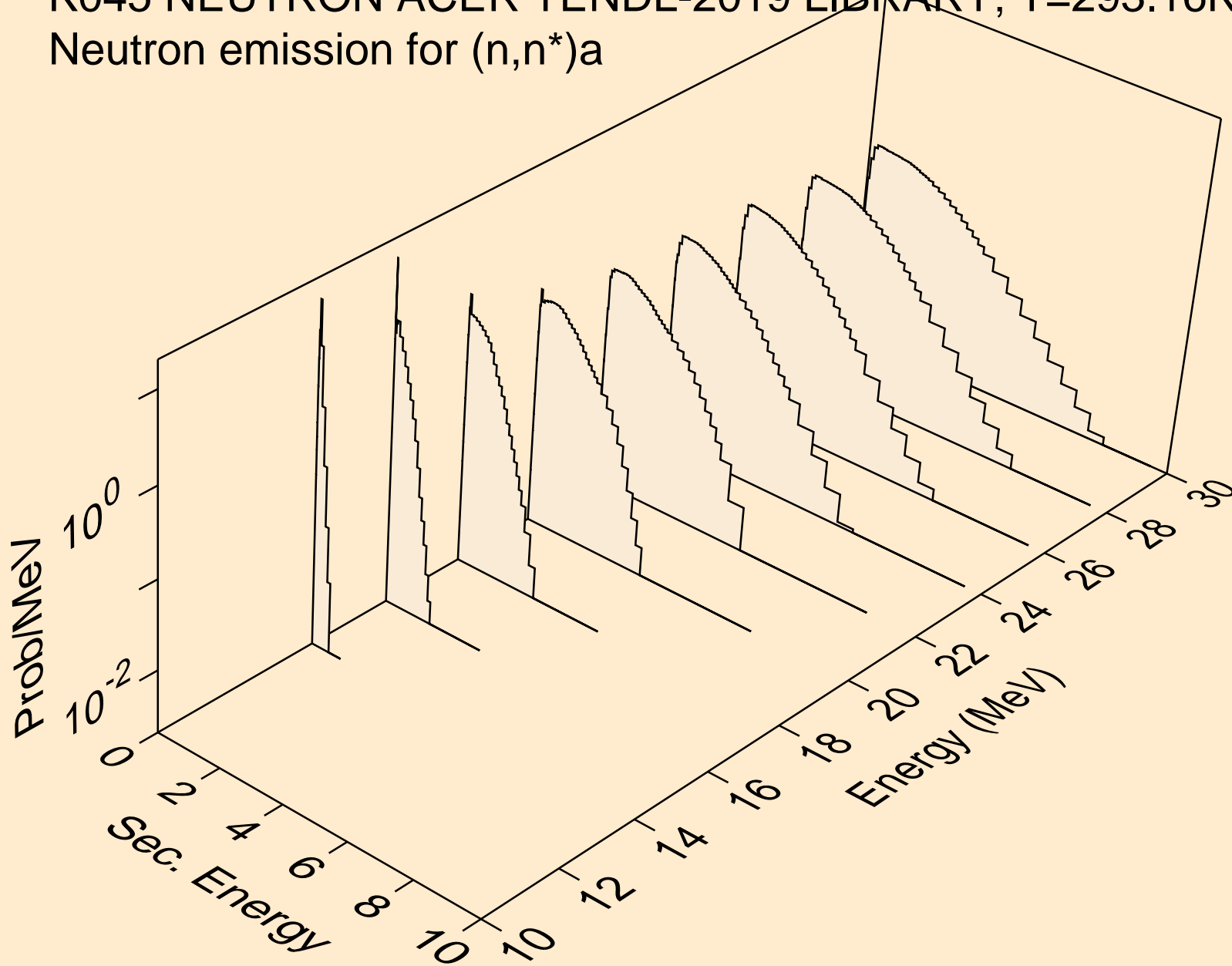

K045 NEUTRON ACER TENDL-2019 LIBRARY; T=293.16K
Neutron emission for (n,2n)a

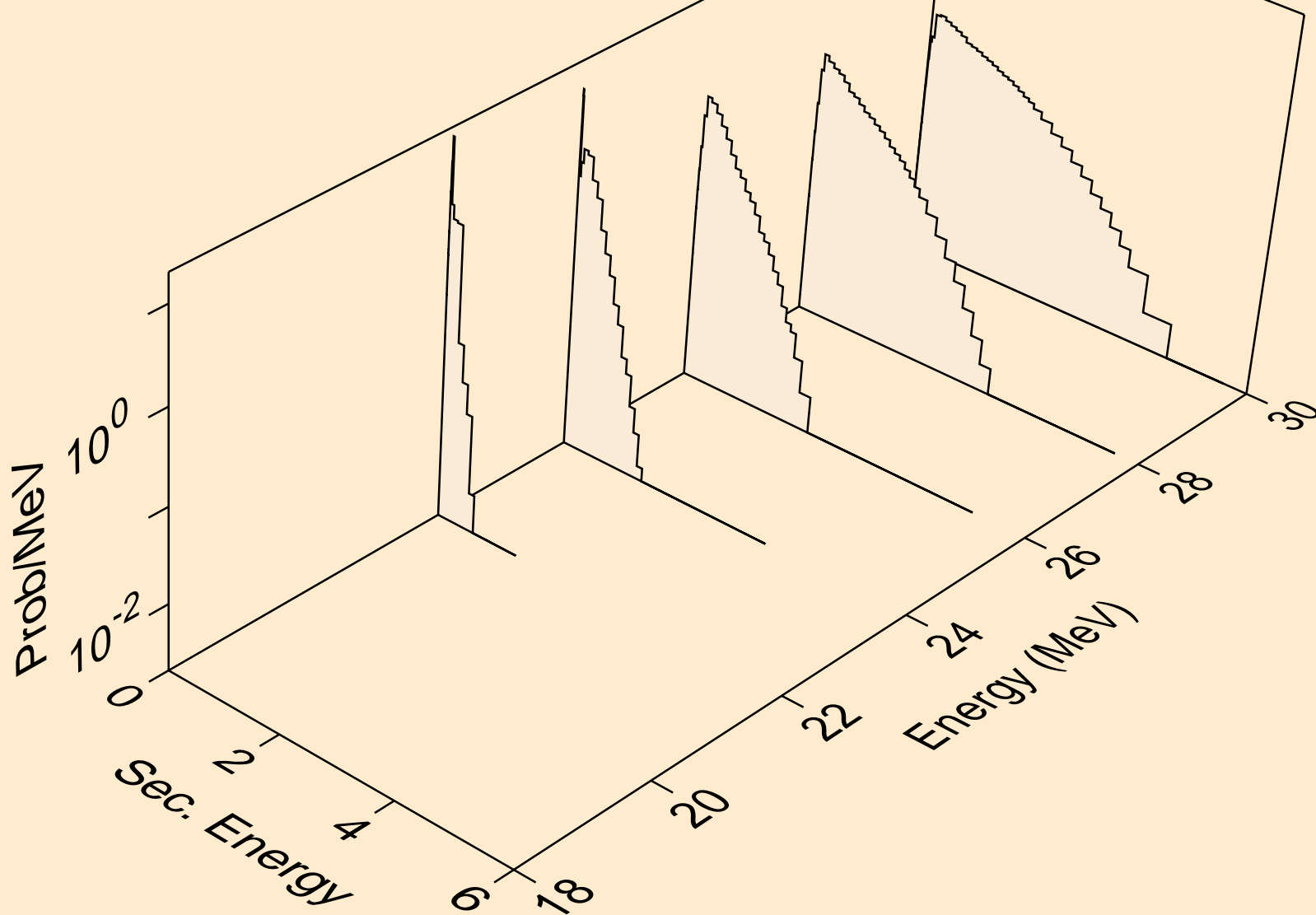

K045 NEUTRON ACER TENDL-2019 LIBRARY; T=293.16K
Neutron emission for (n,3n)a

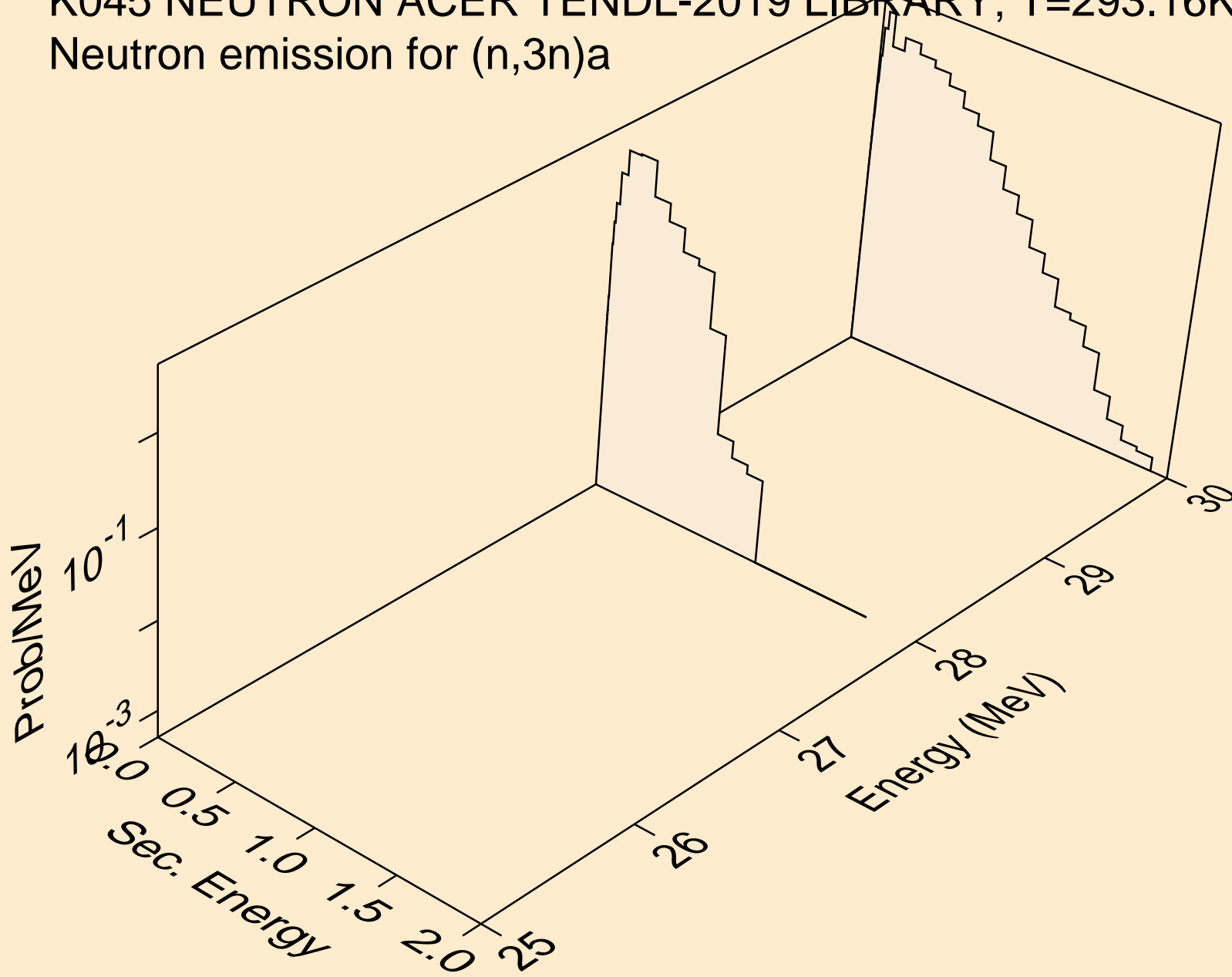

K045 NEUTRON ACER TENDL-2019 LIBRARY; T=293.16K
Neutron emission for (n,n*)p

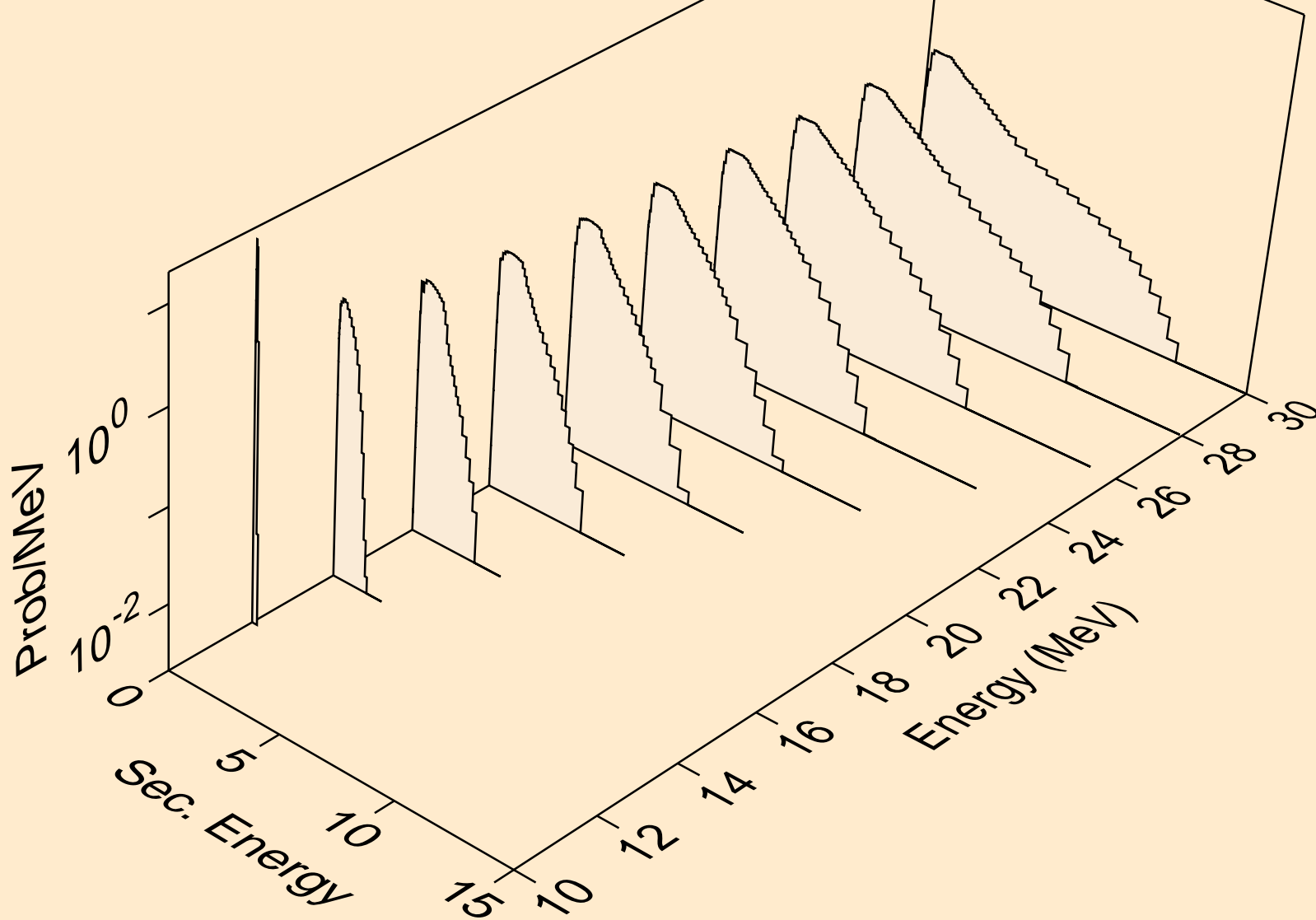

K045 NEUTRON ACER TENDL-2019 LIBRARY; T=293.16K
Neutron emission for (n,n*)d

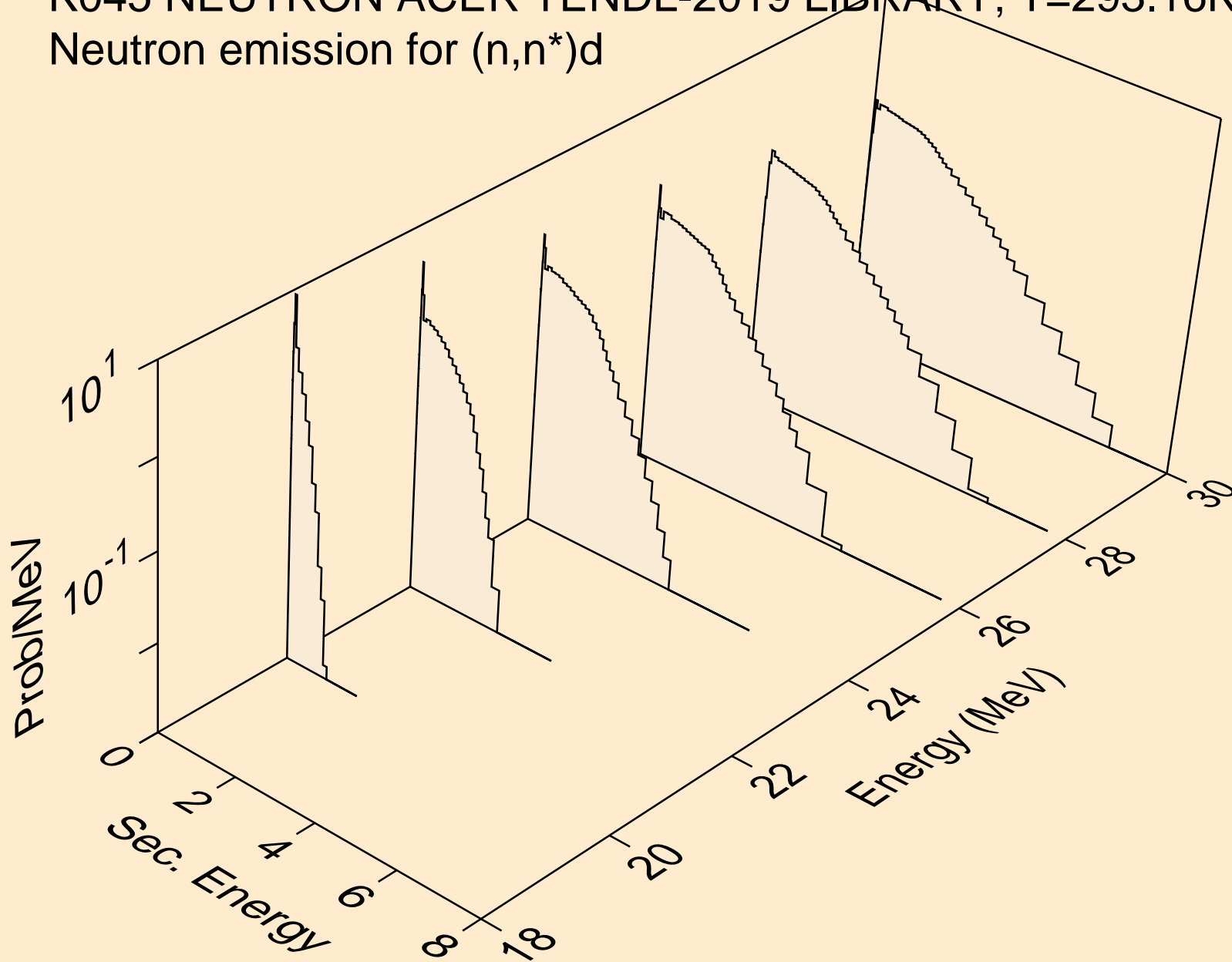

K045 NEUTRON ACER TENDL-2019 LIBRARY; T=293.16K
Neutron emission for (n,n*)t

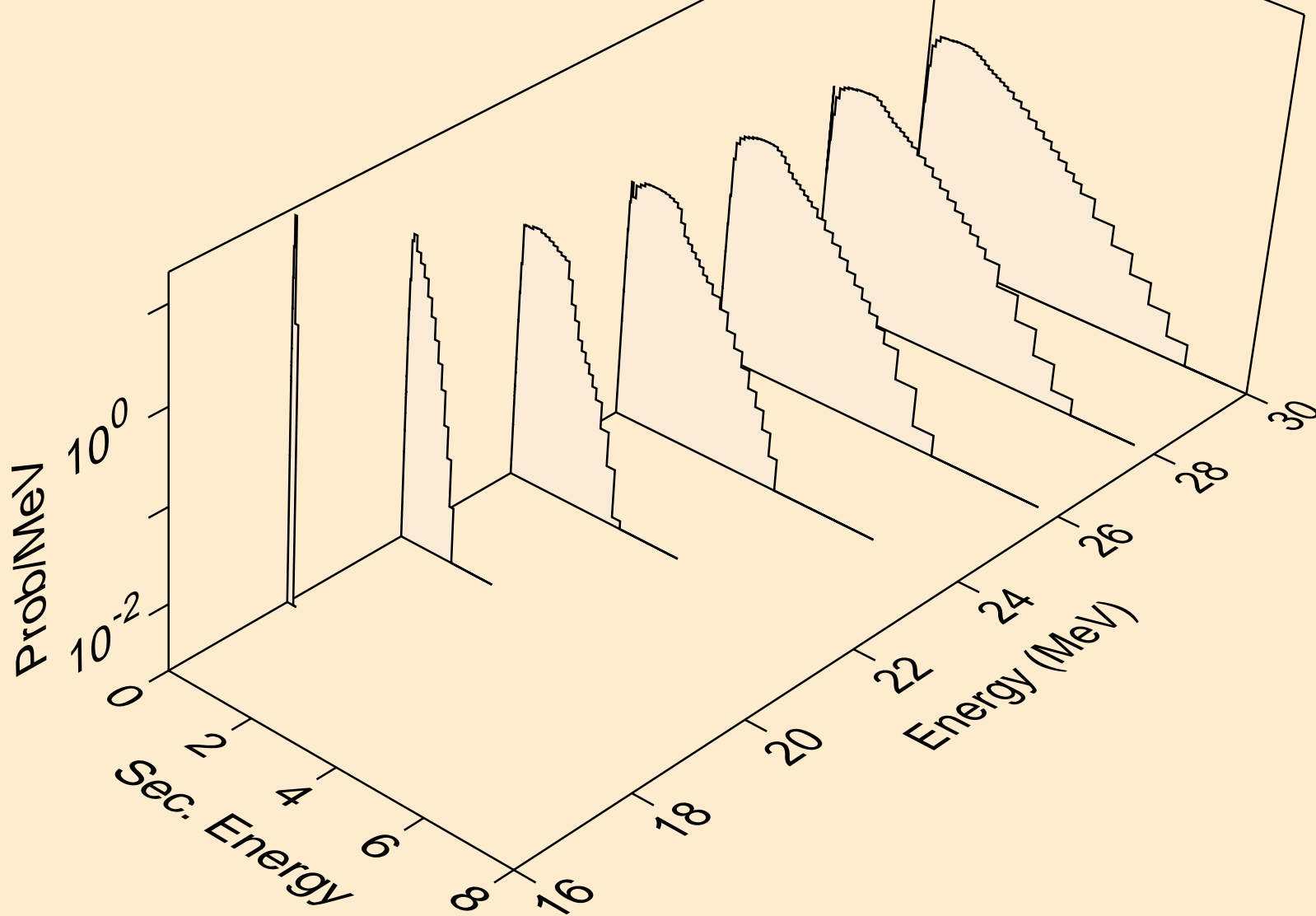

K045 NEUTRON ACER TENDL-2019 LIBRARY; T=293.16K
Neutron emission for (n,4n)

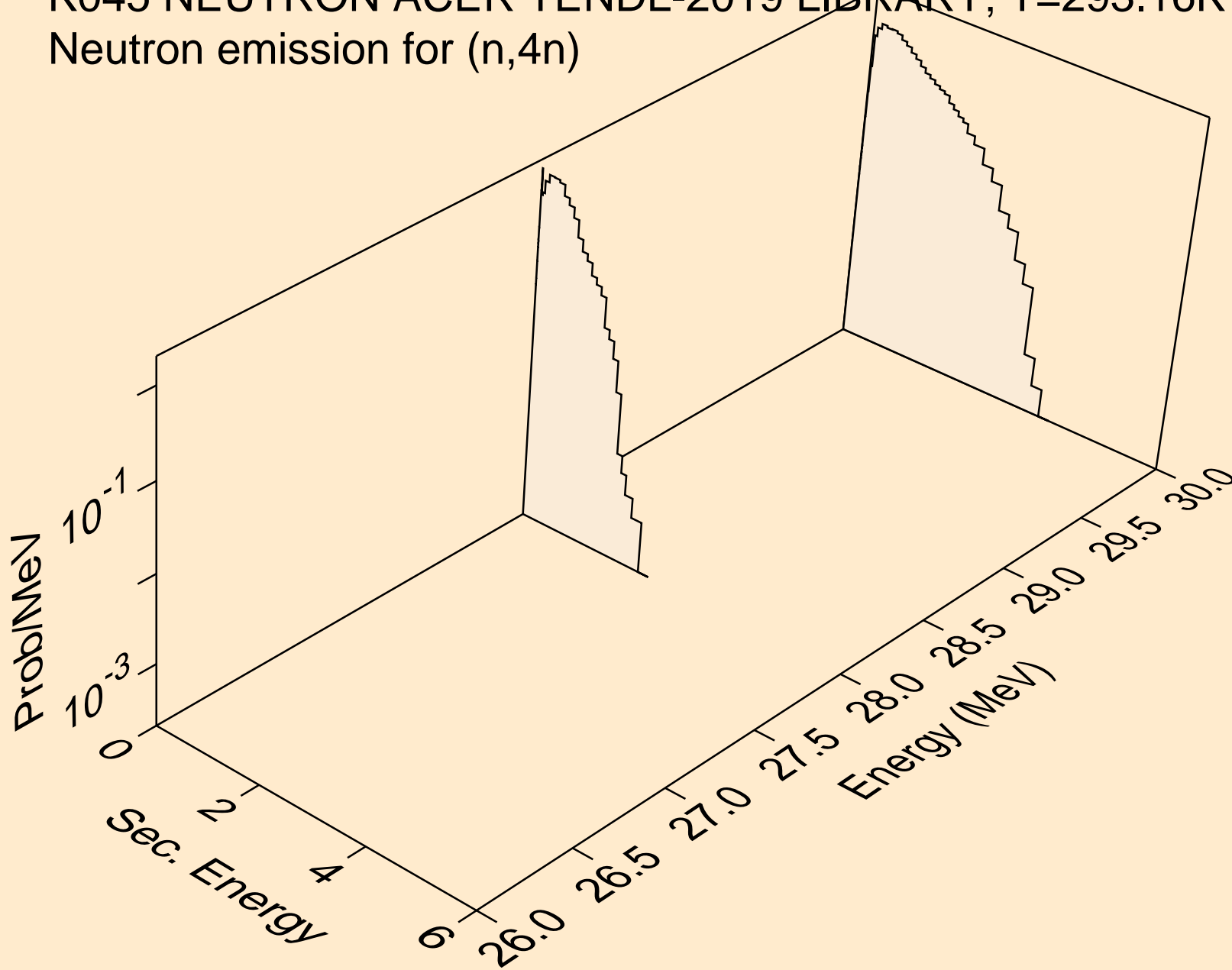

K045 NEUTRON ACER TENDL-2019 LIBRARY; T=293.16K
Neutron emission for (n,2np)

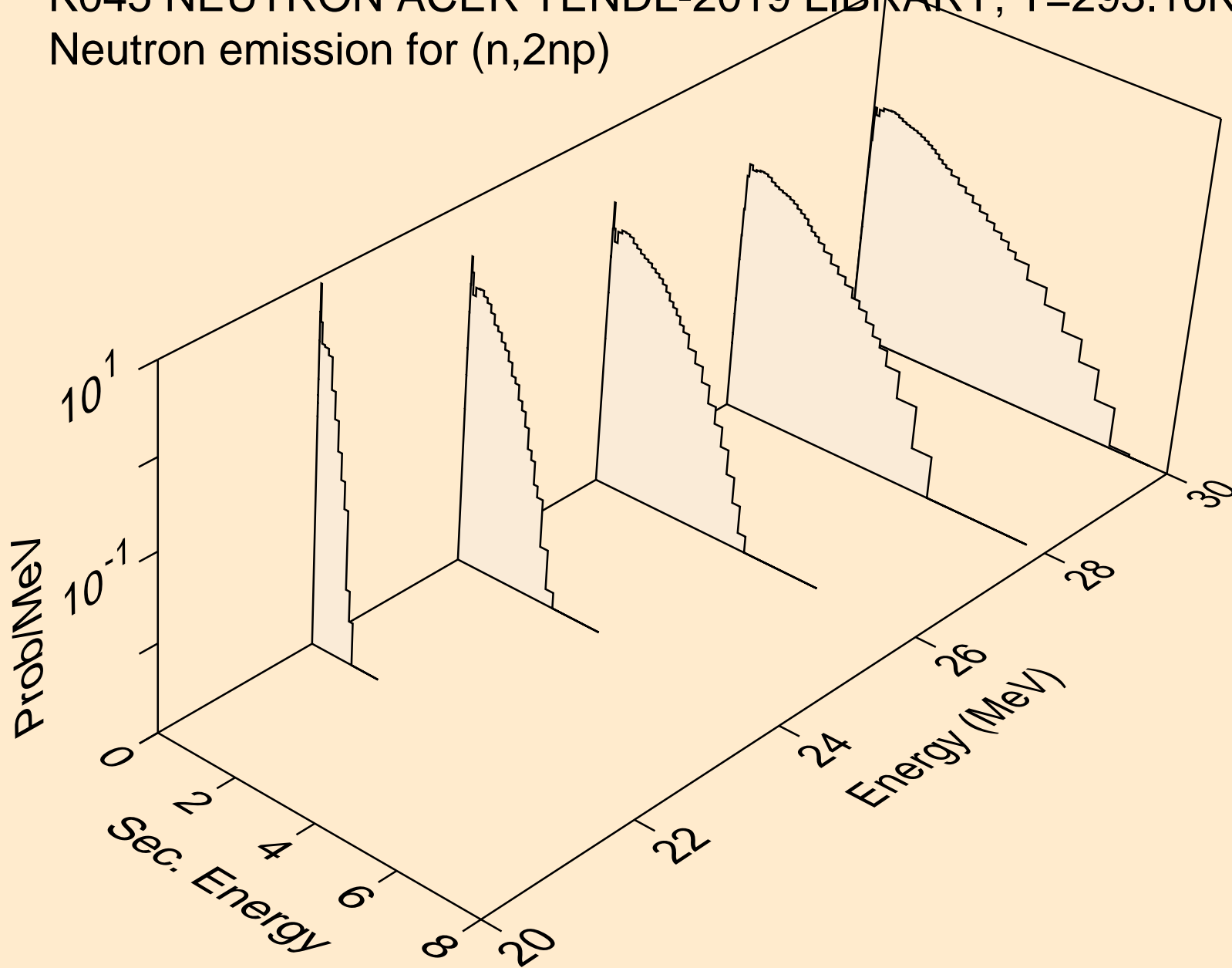

K045 NEUTRON ACER TENDL-2019 LIBRARY; T=293.16K
Neutron emission for (n,3np)

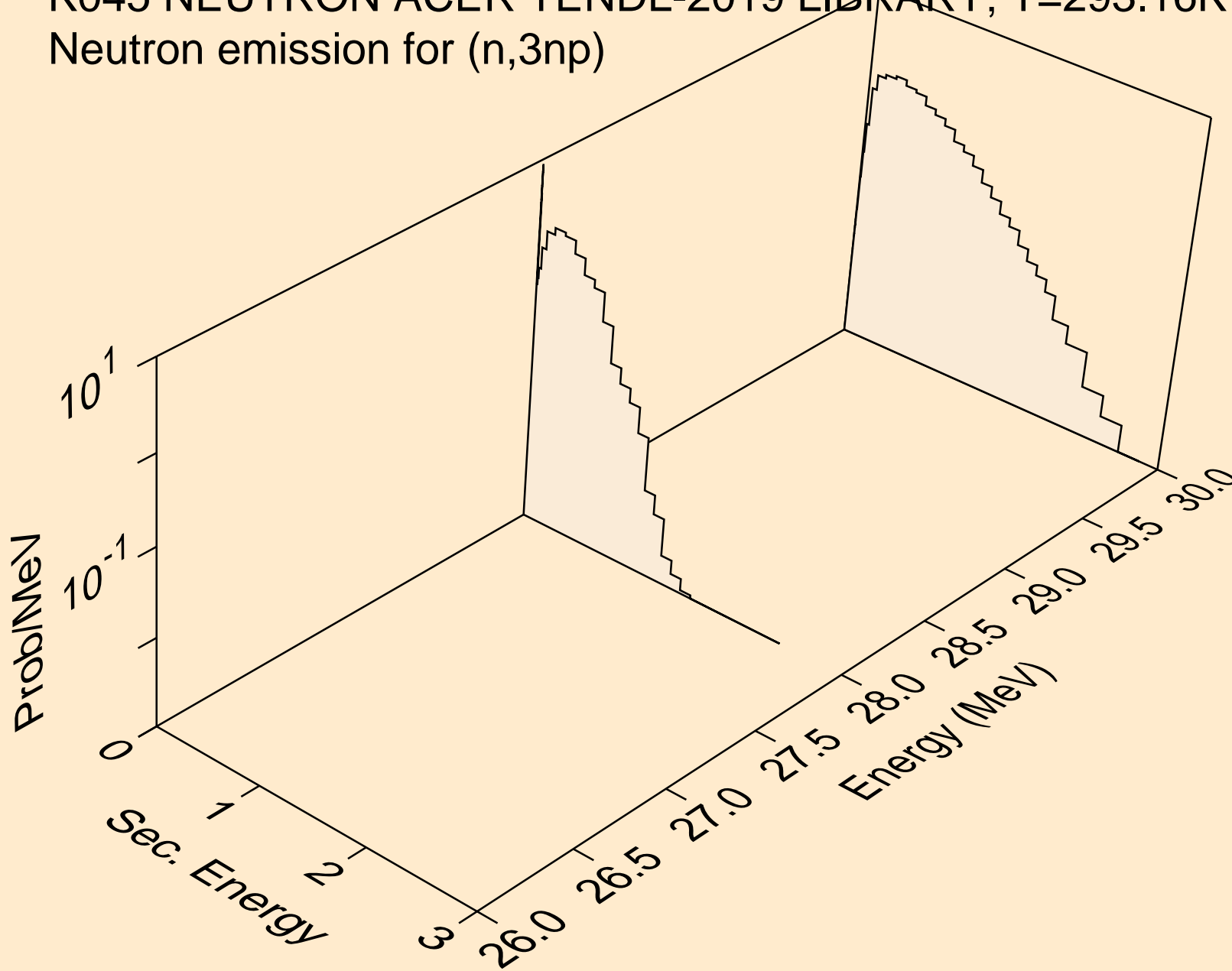

K045 NEUTRON ACER TENDL-2019 LIBRARY; T=293.16K
Neutron emission for (n,n*c)

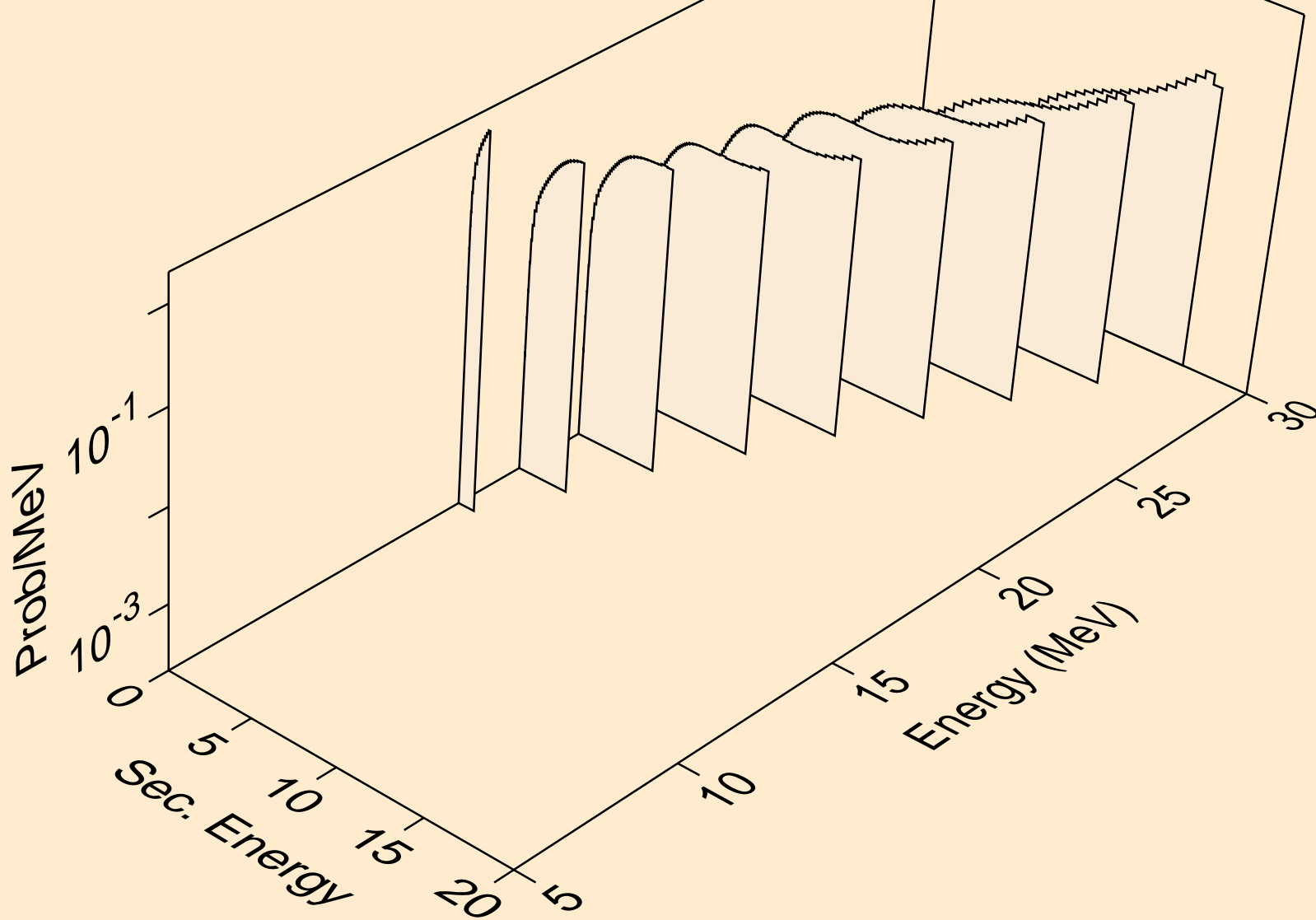

K045 NEUTRON ACER TENDL-2019 LIBRARY; T=293.16K
Photon emission for (n,x)

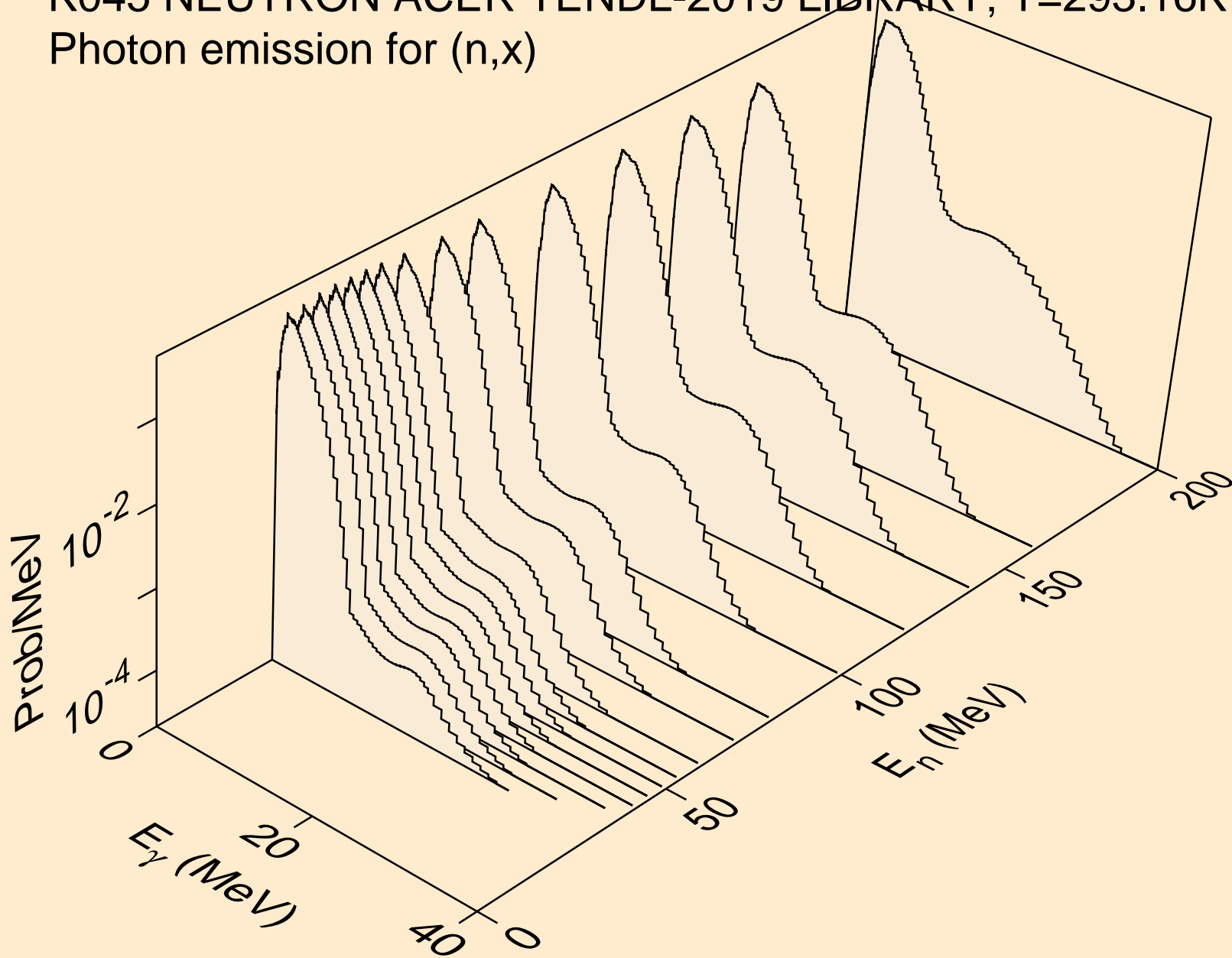

K045 NEUTRON ACER TENDL-2019 LIBRARY; T=293.16K
Photon emission for (n,2nd)

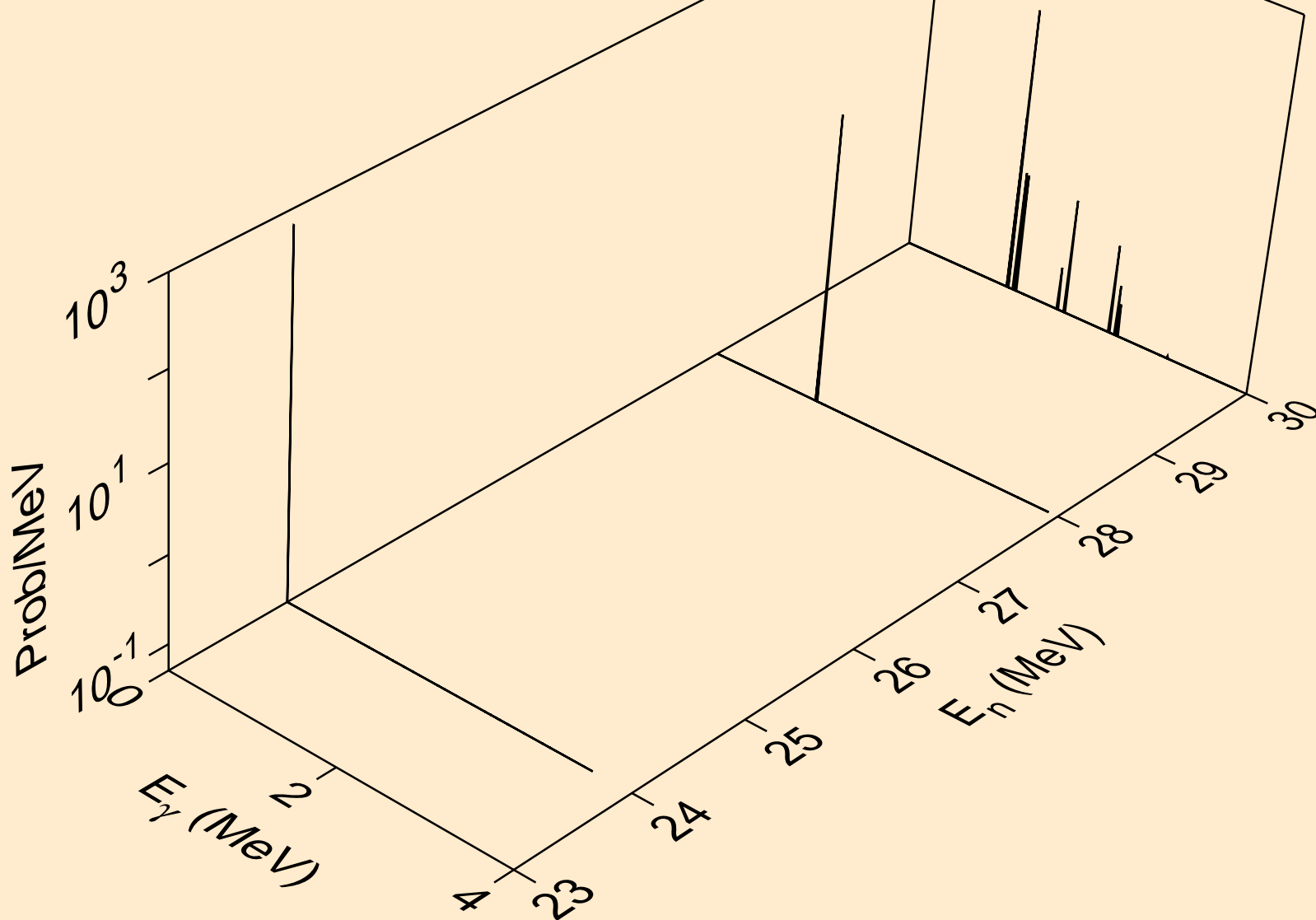

K045 NEUTRON ACER TENDL-2019 LIBRARY; T=293.16K
Photon emission for (n,2n)

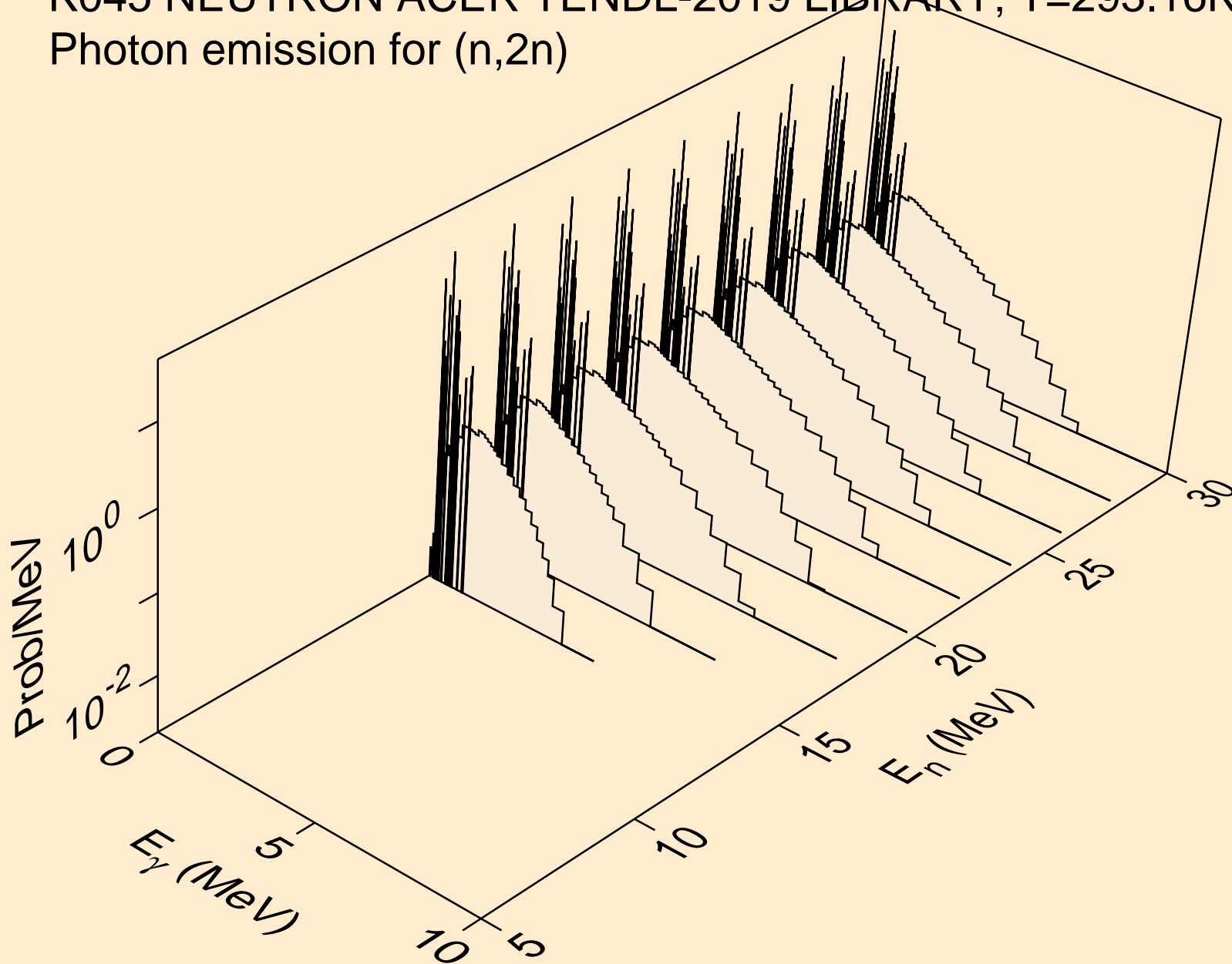

K045 NEUTRON ACER TENDL-2019 LIBRARY; T=293.16K
Photon emission for (n,3n)

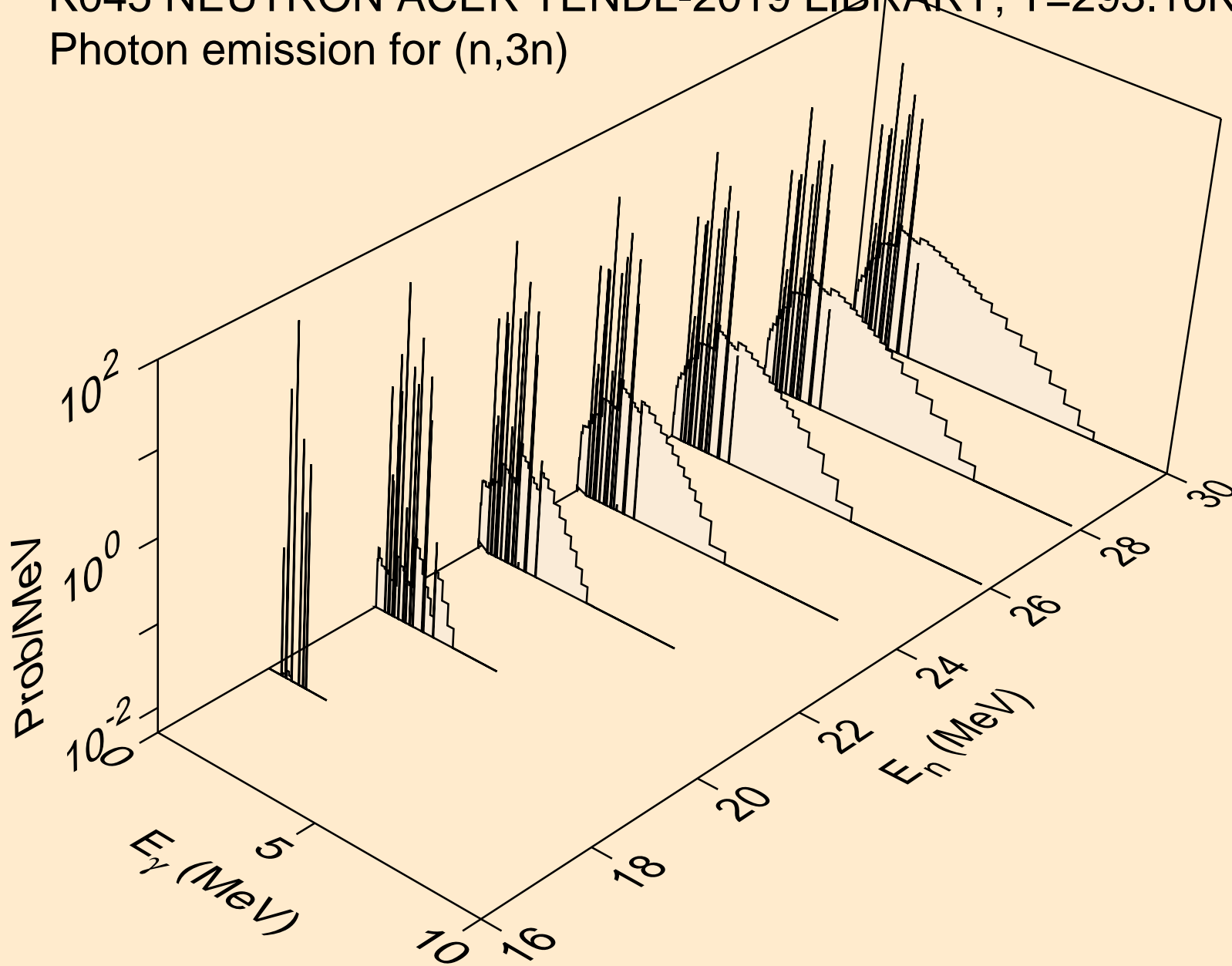

K045 NEUTRON ACER TENDL-2019 LIBRARY; T=293.16K
Photon emission for (n,n*)a

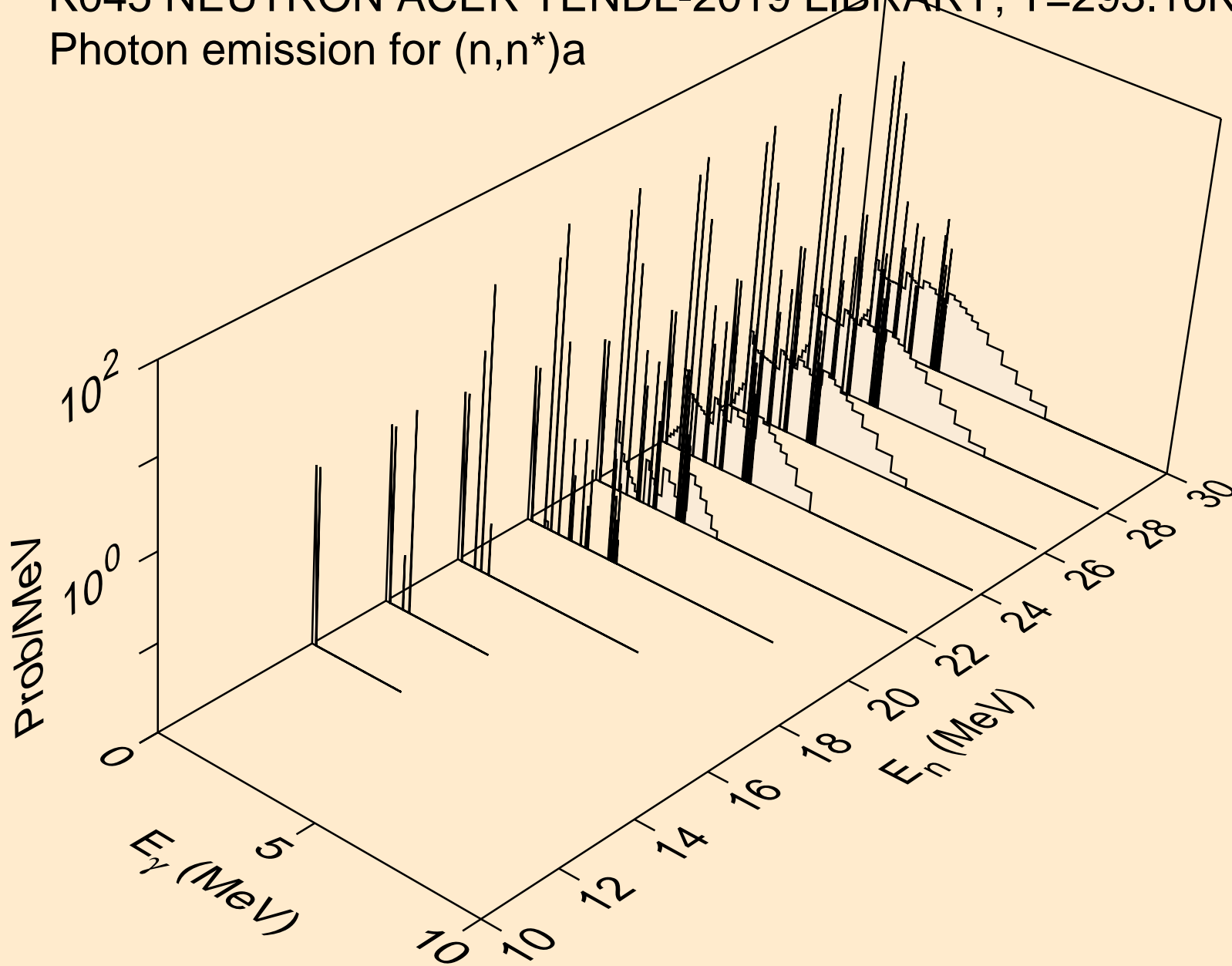

K045 NEUTRON ACER TENDL-2019 LIBRARY; T=293.16K
Photon emission for (n,2n)a

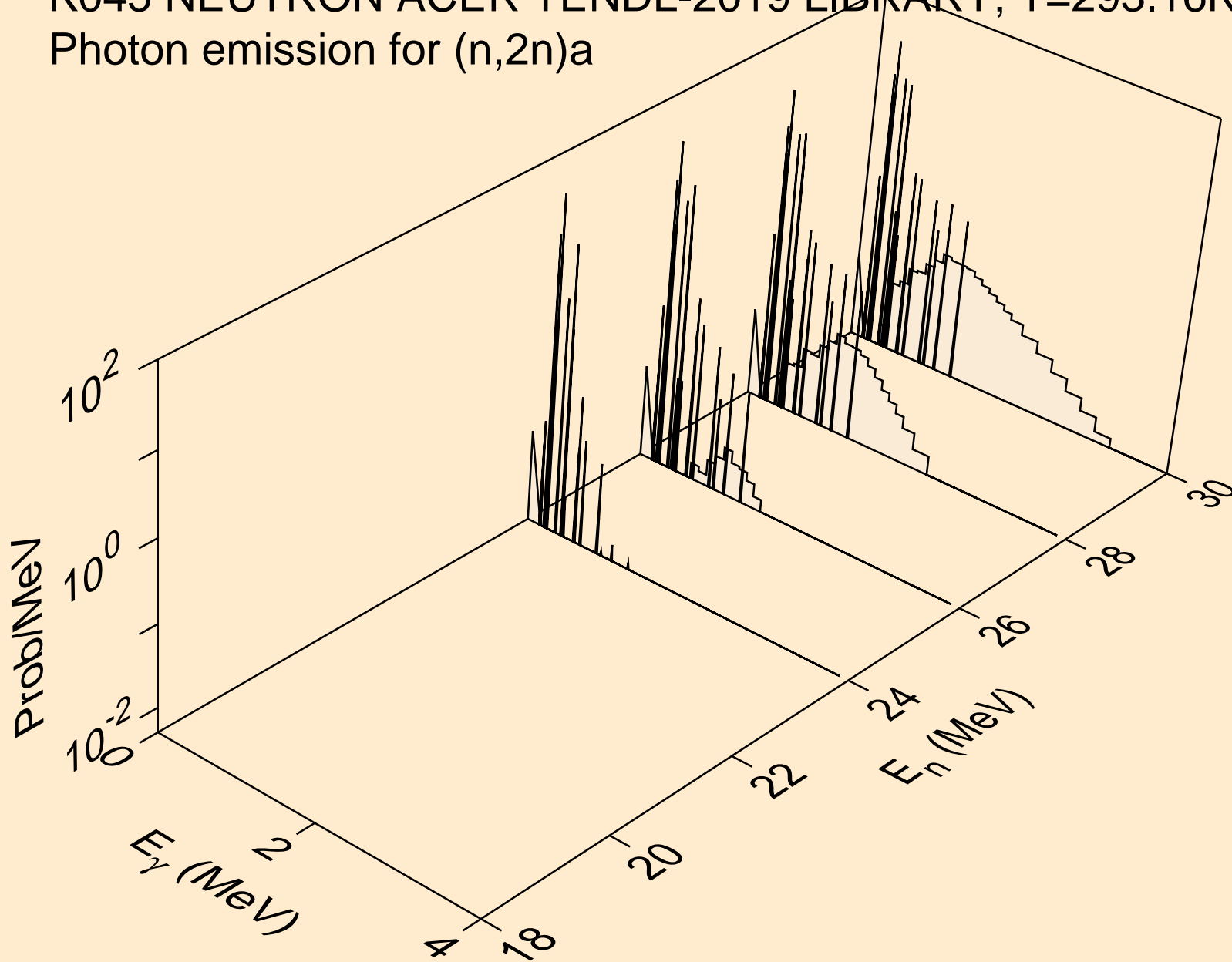

K045 NEUTRON ACER TENDL-2019 LIBRARY; T=293.16K
Photon emission for (n,3n)a

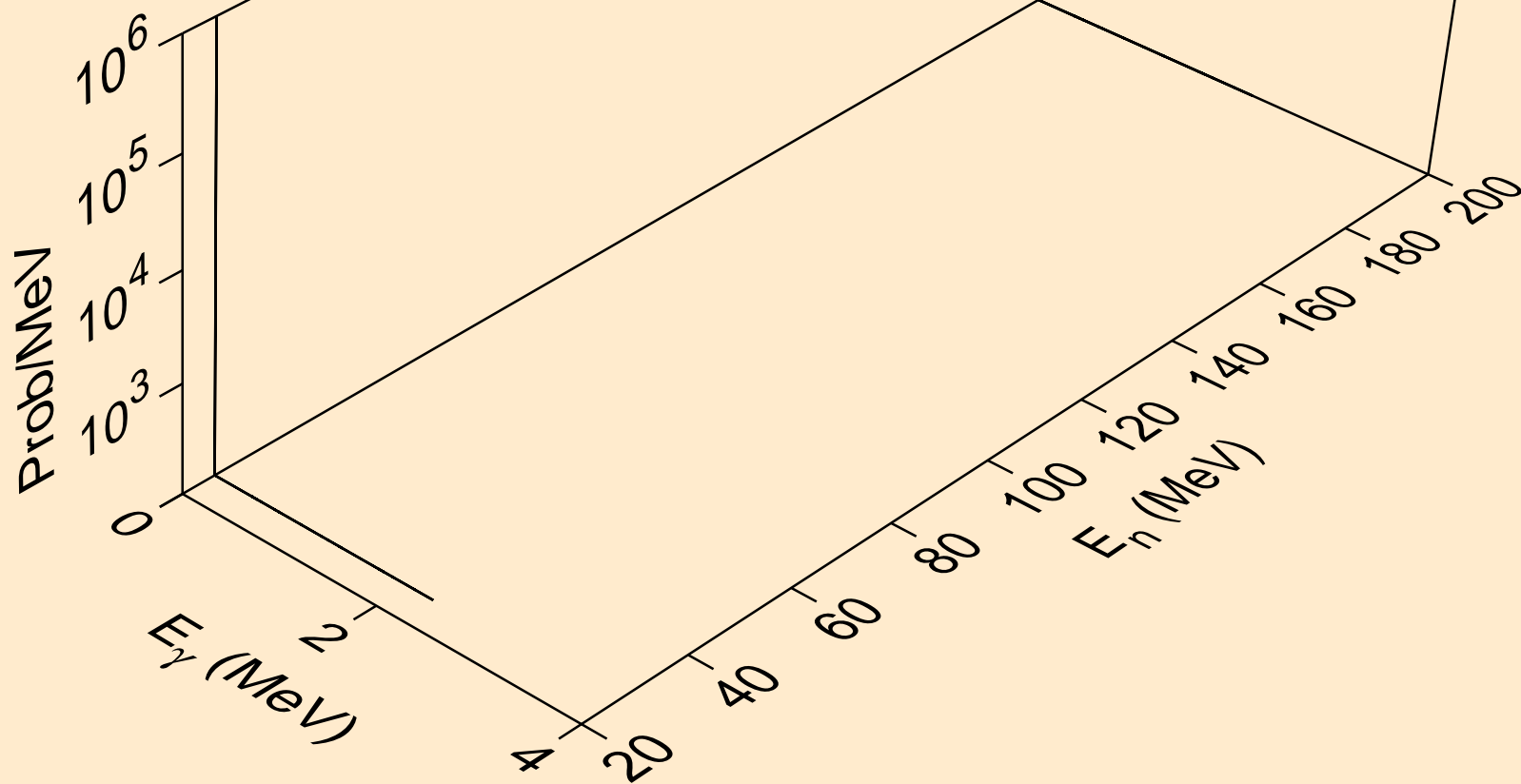

K045 NEUTRON ACER TENDL-2019 LIBRARY; T=293.16K
Photon emission for (n,n*)p

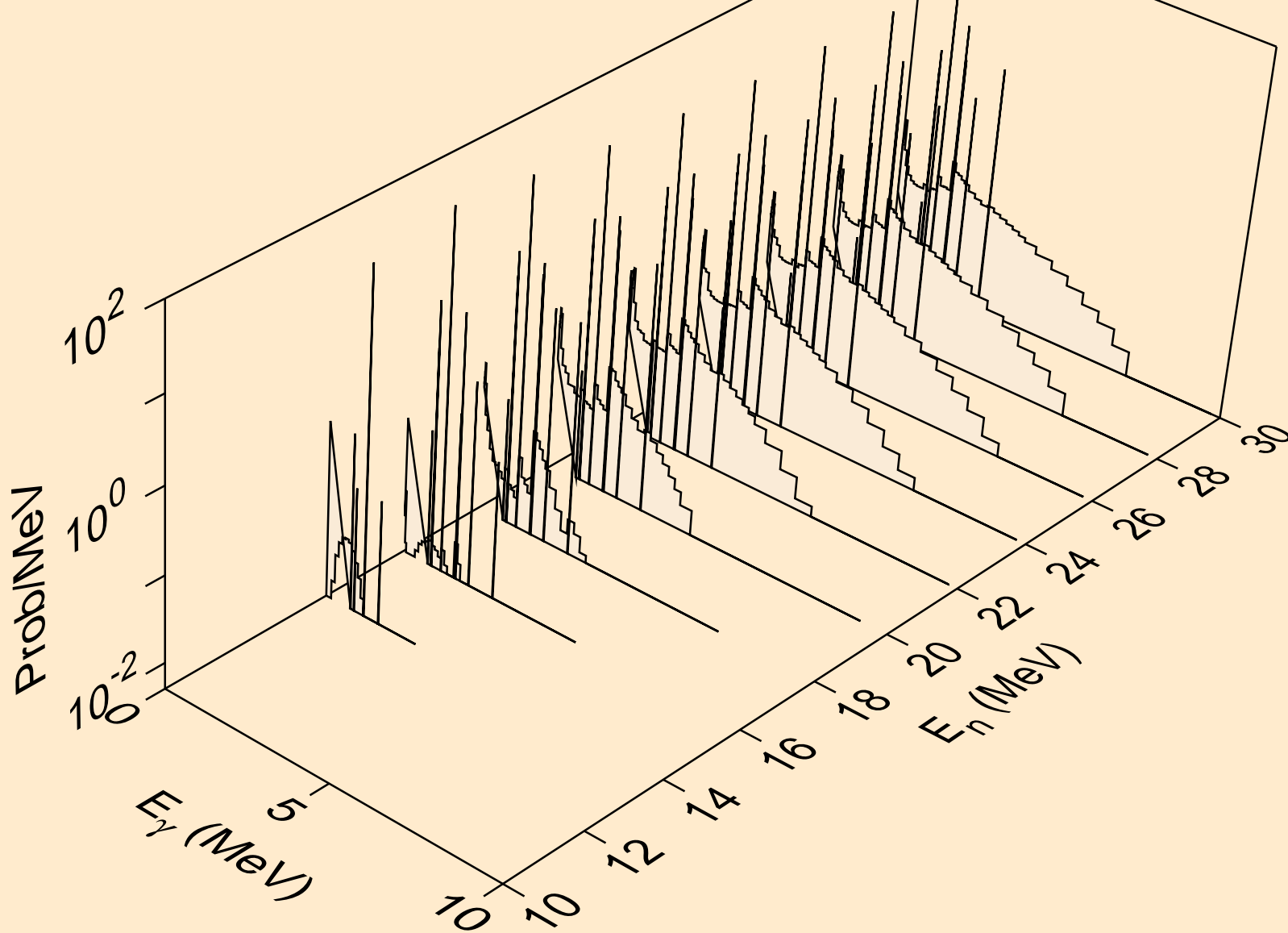

K045 NEUTRON ACER TENDL-2019 LIBRARY; T=293.16K
Photon emission for (n,n*)d

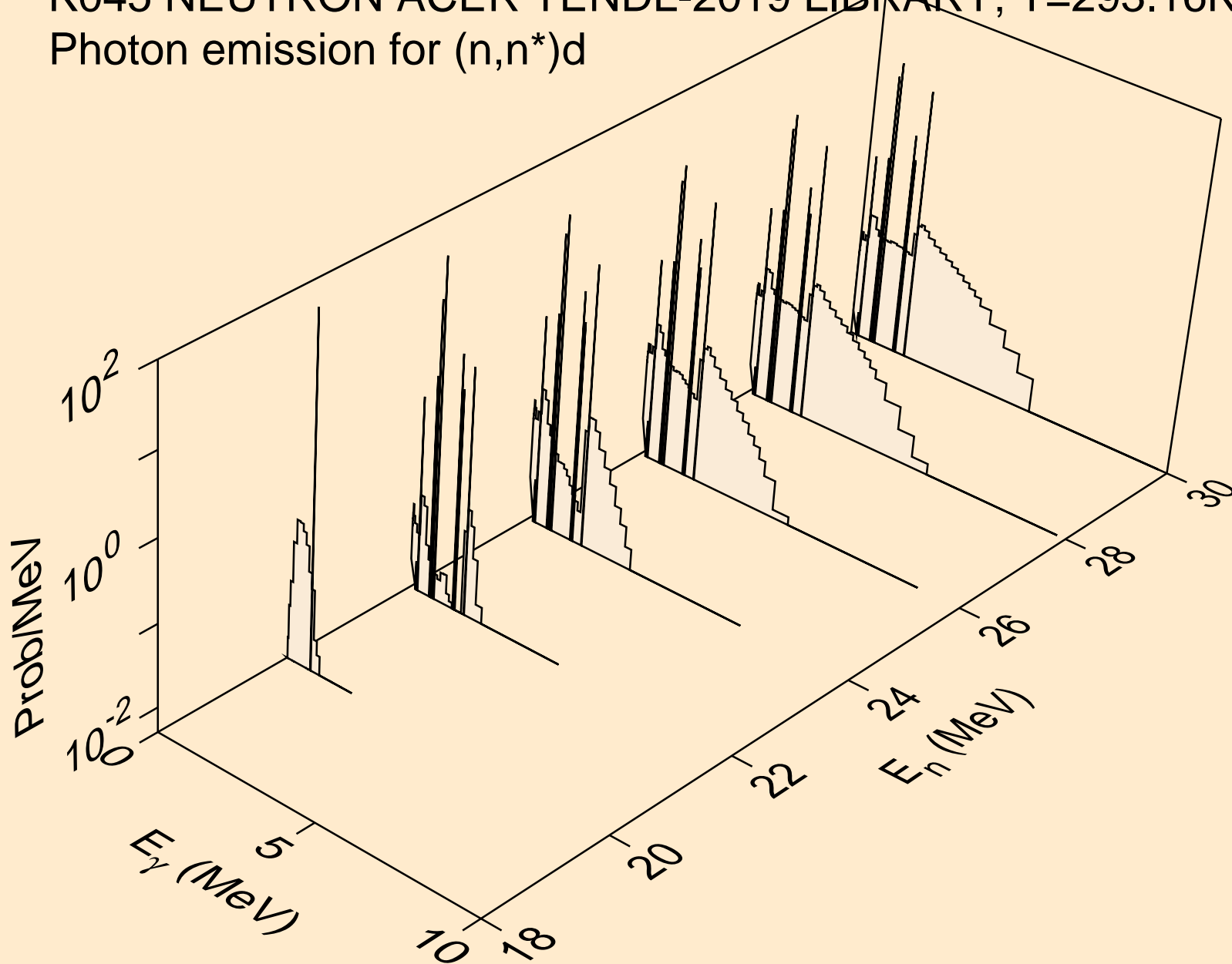

K045 NEUTRON ACER TENDL-2019 LIBRARY; T=293.16K
Photon emission for (n,n*)t

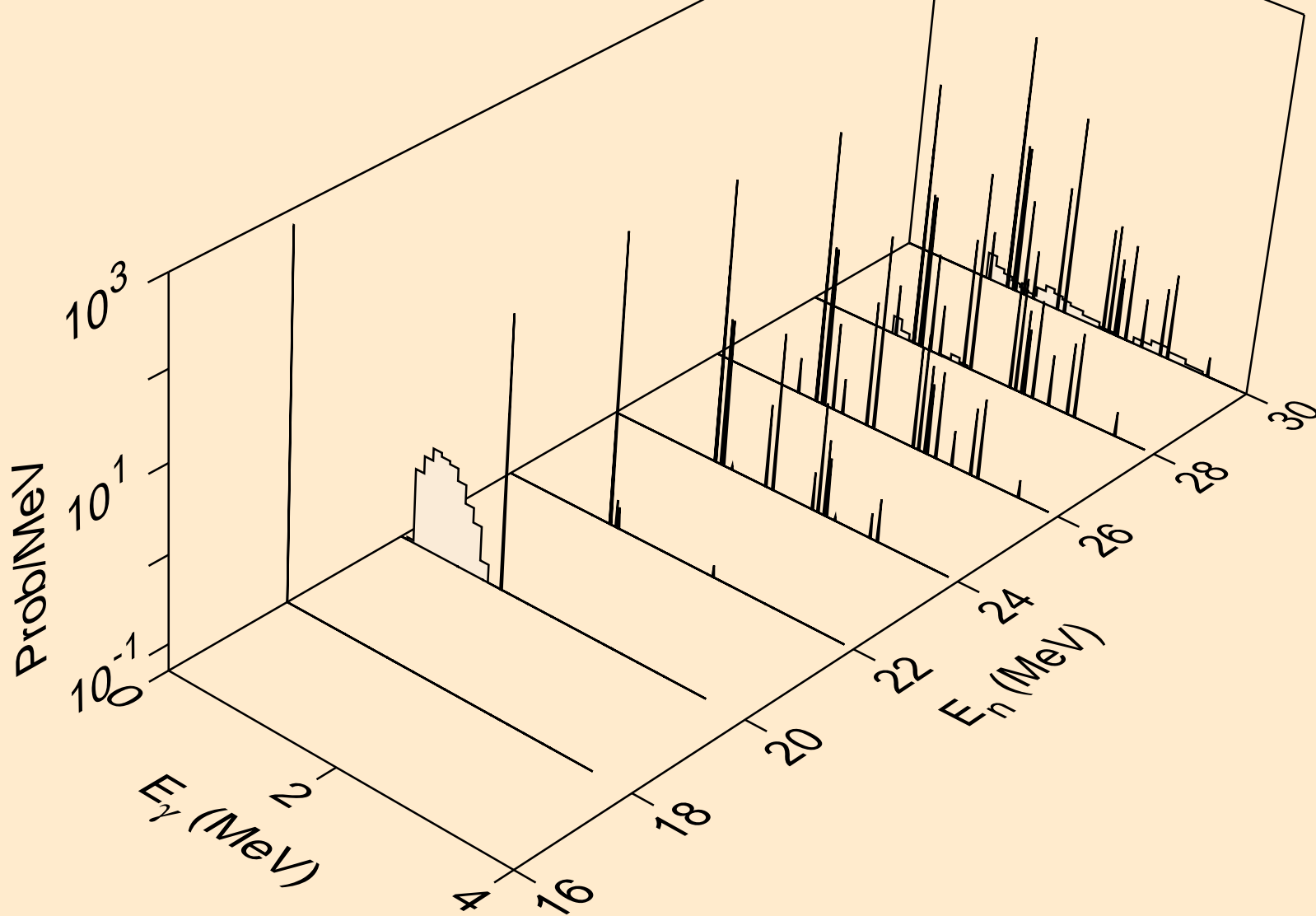

K045 NEUTRON ACER TENDL-2019 LIBRARY; T=293.16K
Photon emission for (n,4n)

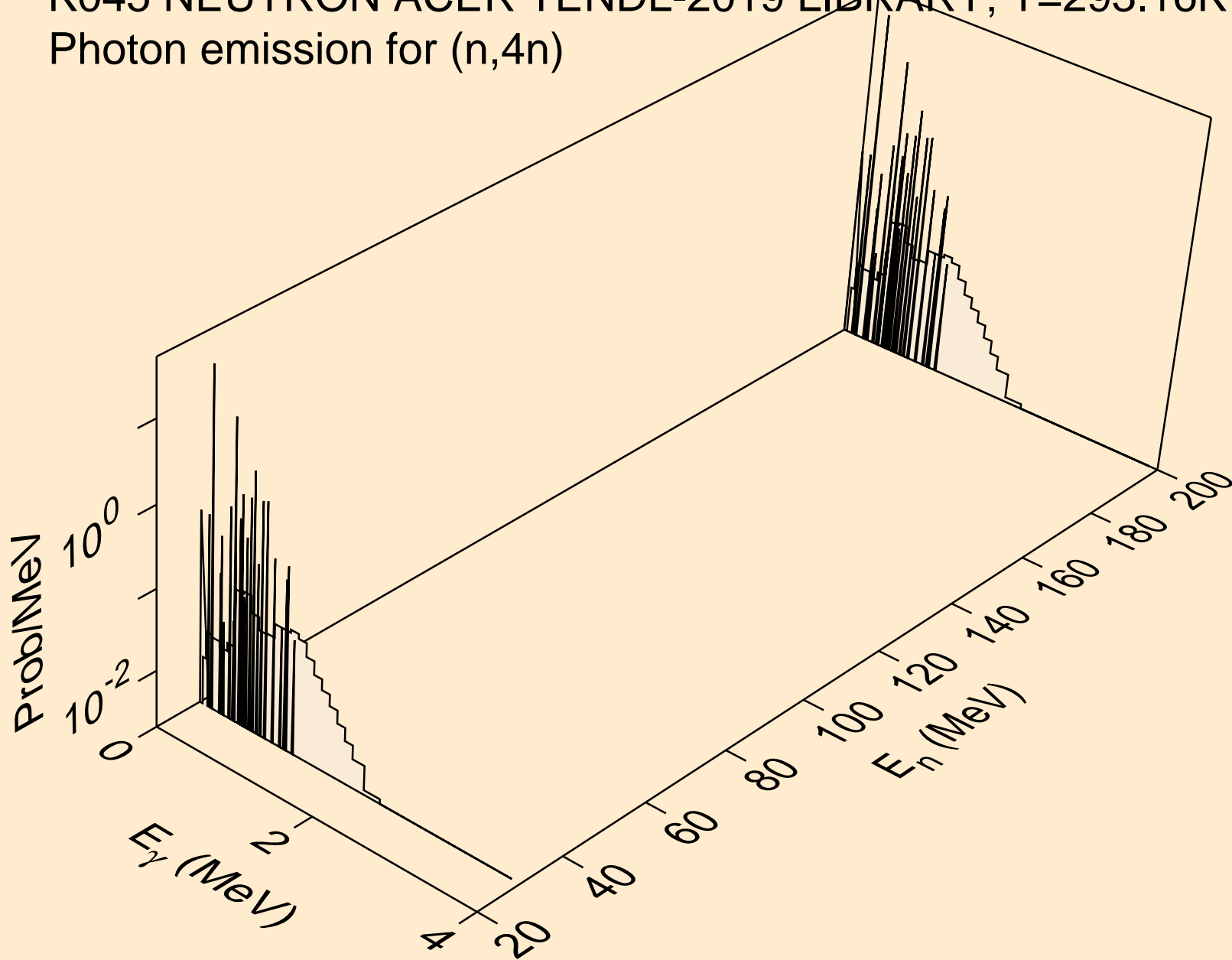

K045 NEUTRON ACER TENDL-2019 LIBRARY; T=293.16K
Photon emission for (n,2np)

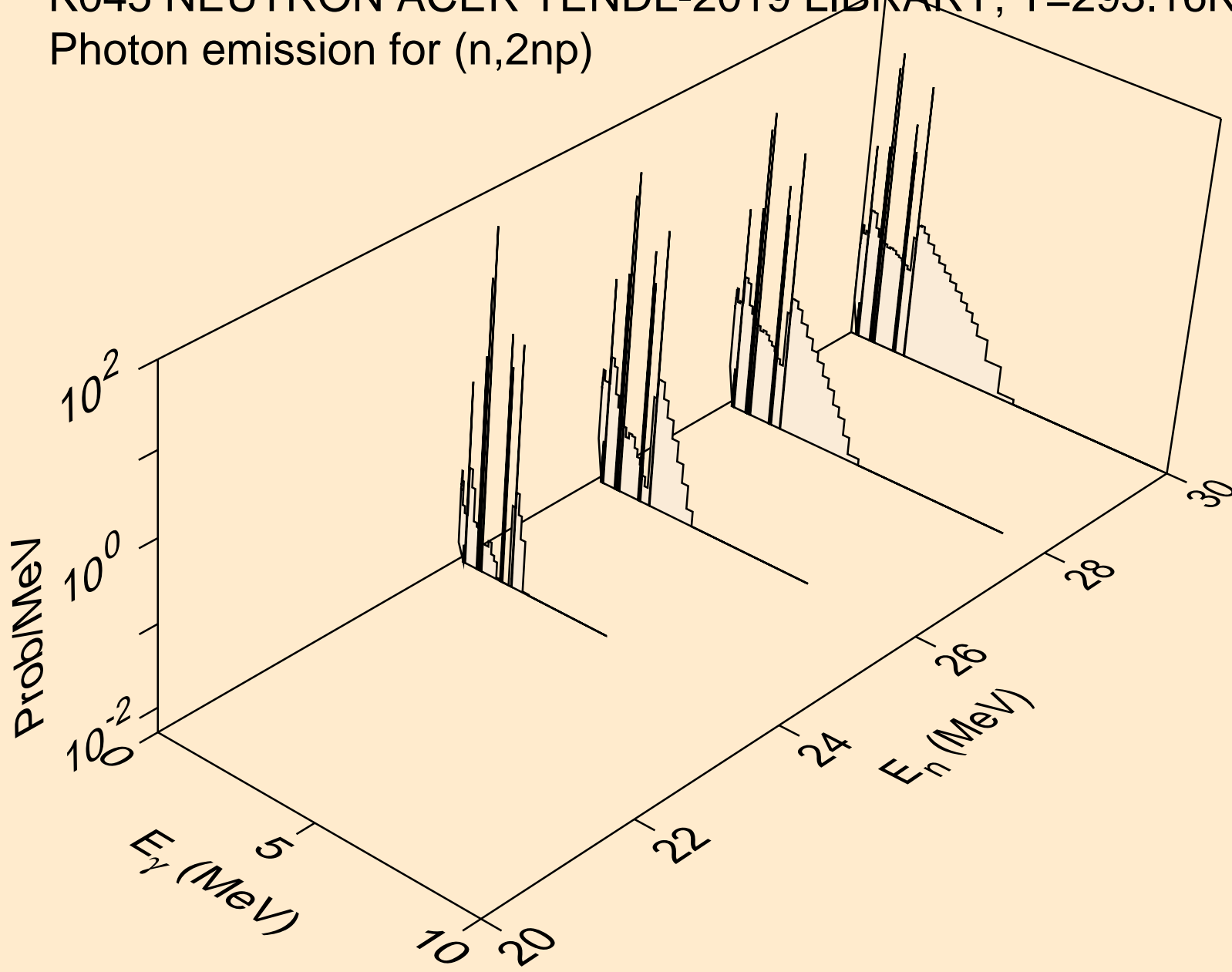

K045 NEUTRON ACER TENDL-2019 LIBRARY; T=293.16K
Photon emission for (n,3np)

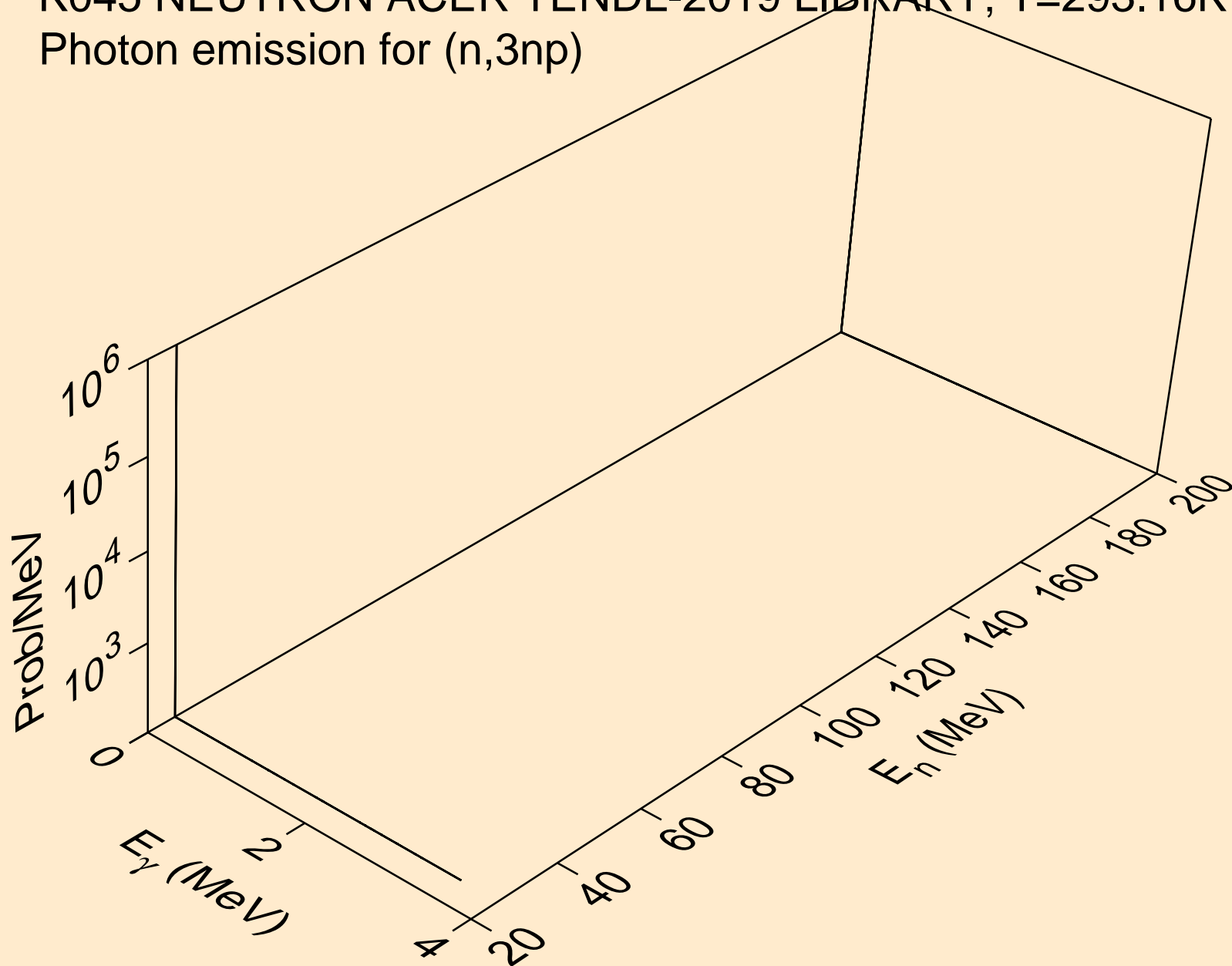

K045 NEUTRON ACER TENDL-2019 LIBRARY; T=293.16K
Photon emission for (n,n*c)

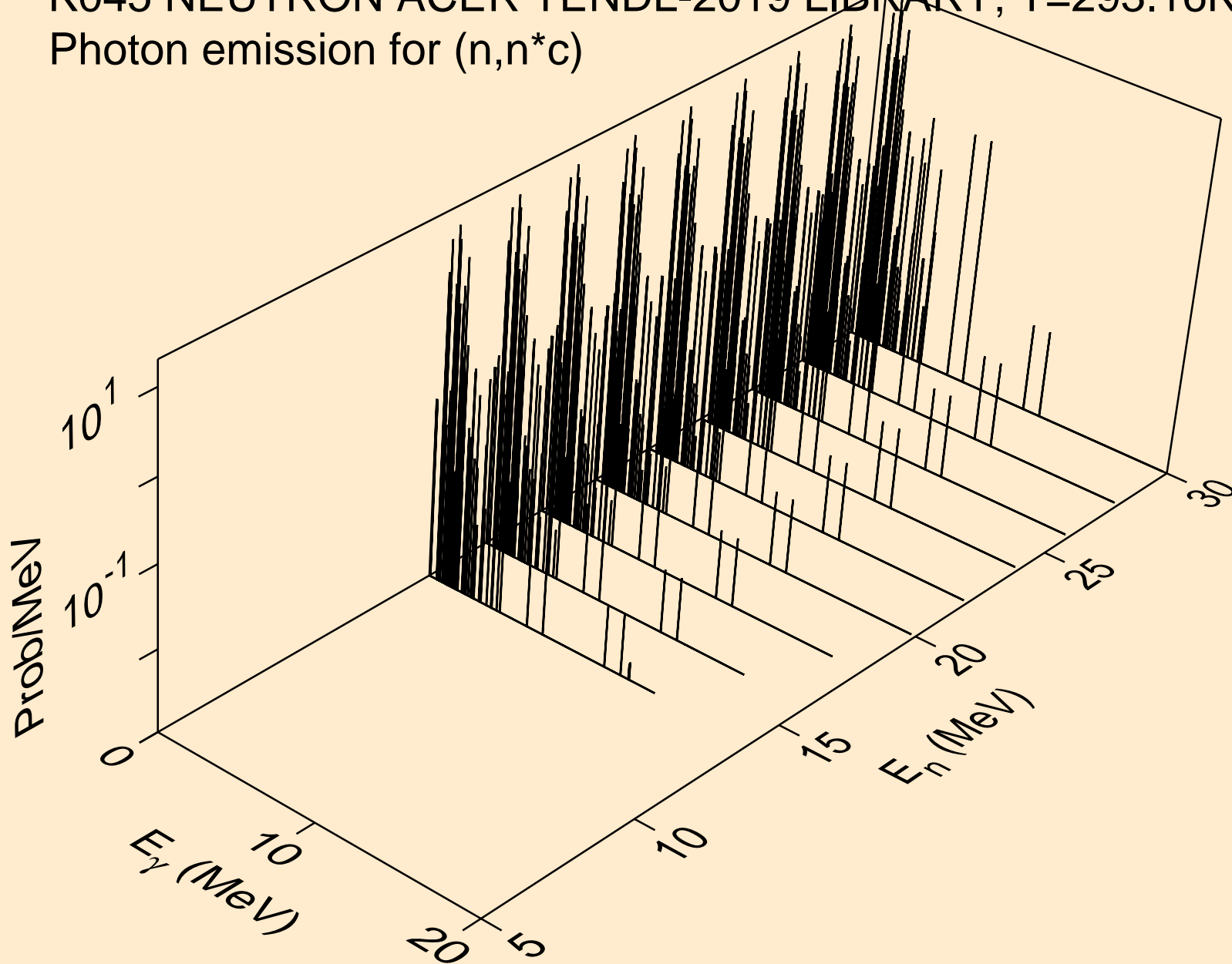

K045 NEUTRON ACER TENDL-2019 LIBRARY; T=293.16K
Photon emission for (n,gma)

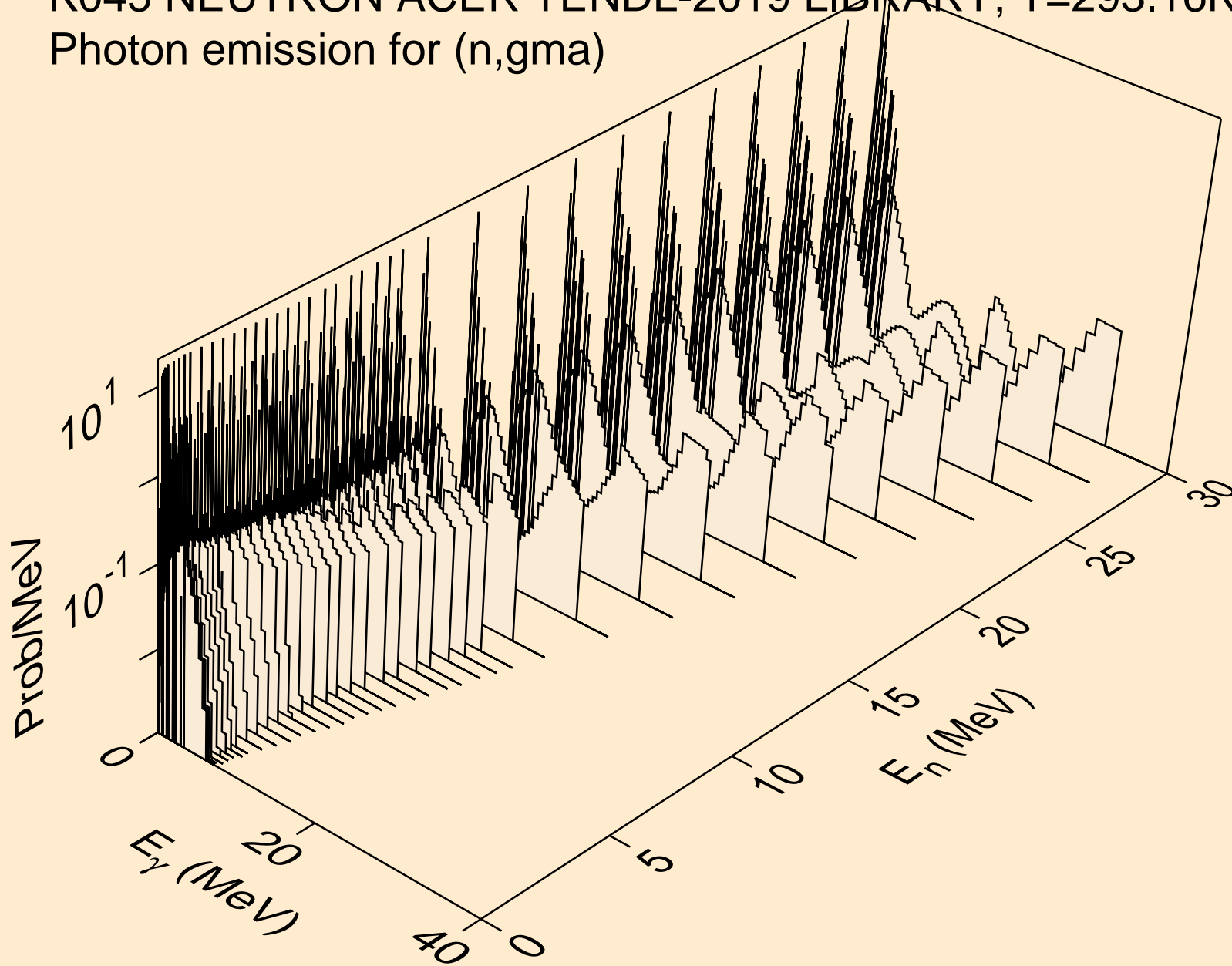

K045 NEUTRON ACER TENDL-2019 LIBRARY; T=293.16K
Photon emission for (n,p)

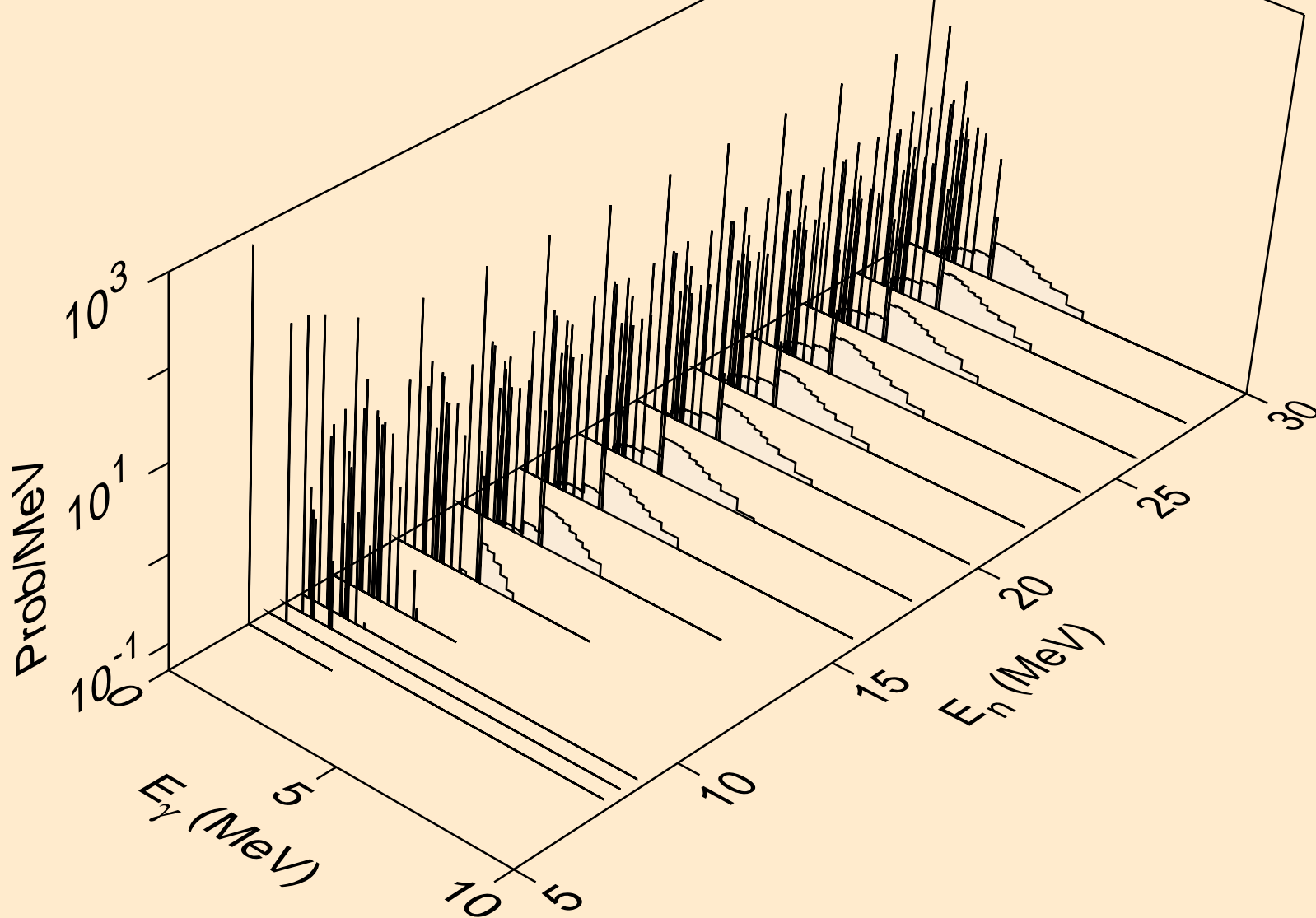

K045 NEUTRON ACER TENDL-2019 LIBRARY; T=293.16K
Photon emission for (n,d)

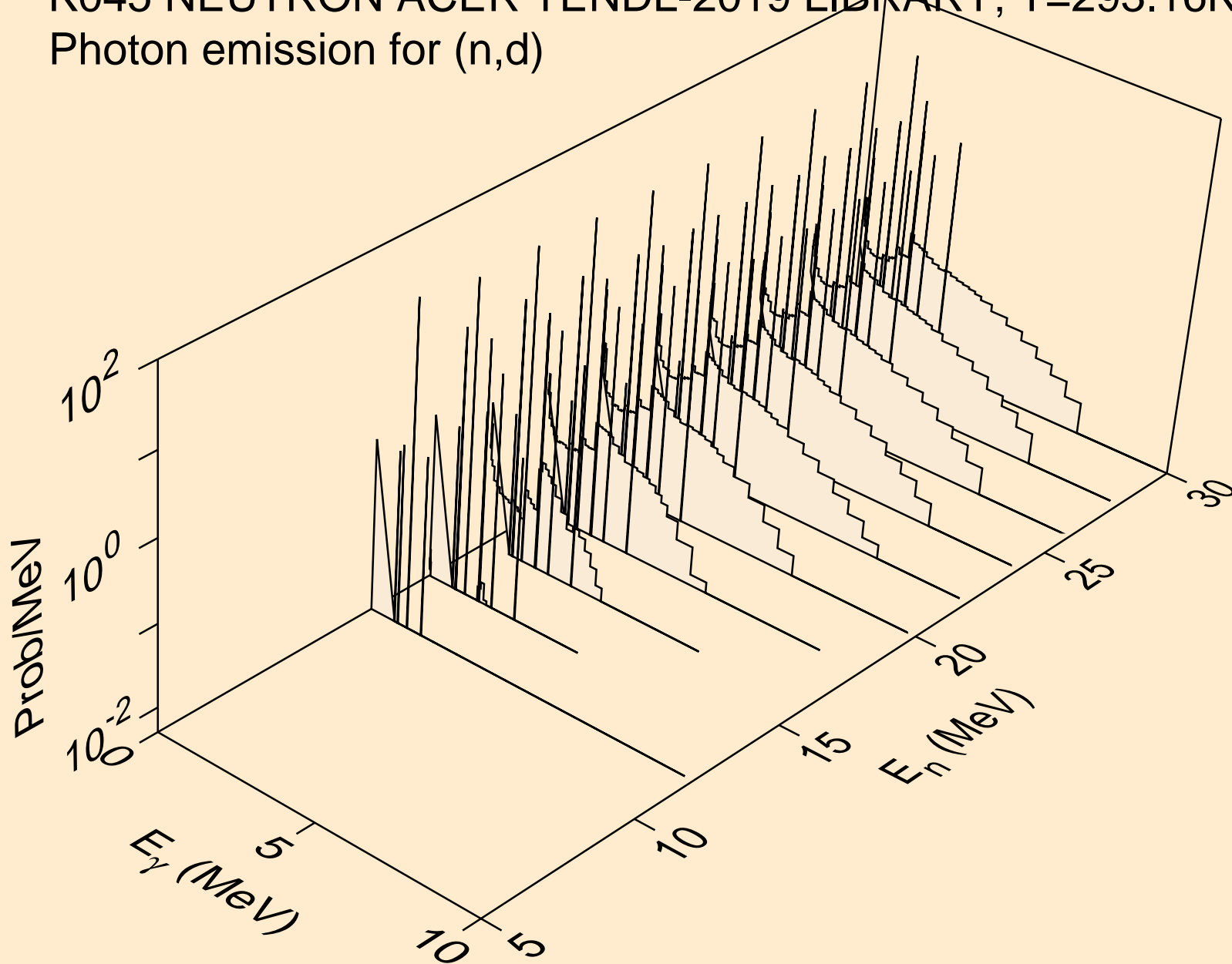

K045 NEUTRON ACER TENDL-2019 LIBRARY; T=293.16K
Photon emission for (n,t)

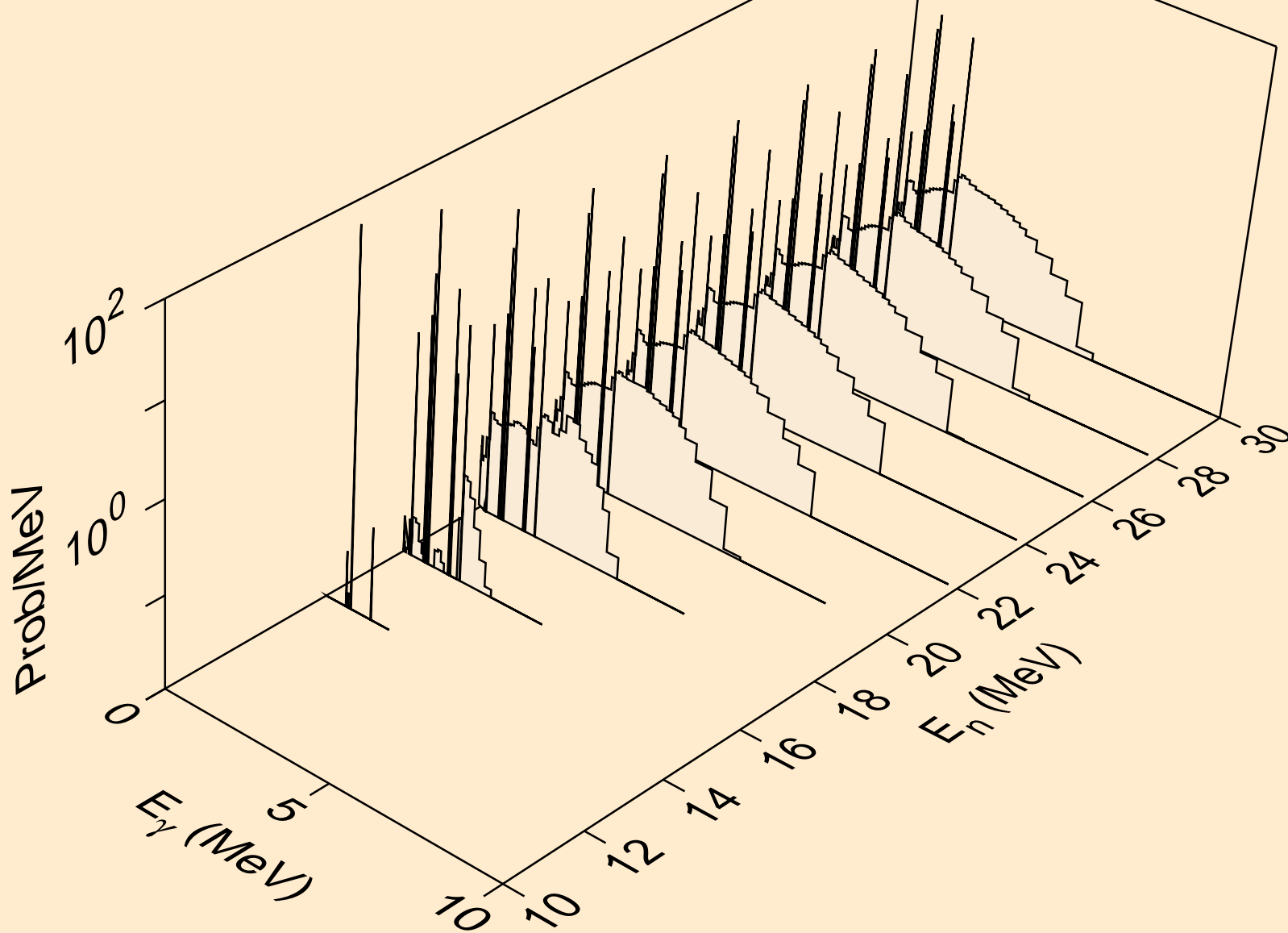

K045 NEUTRON ACER TENDL-2019 LIBRARY; T=293.16K
Photon emission for (n,he3)

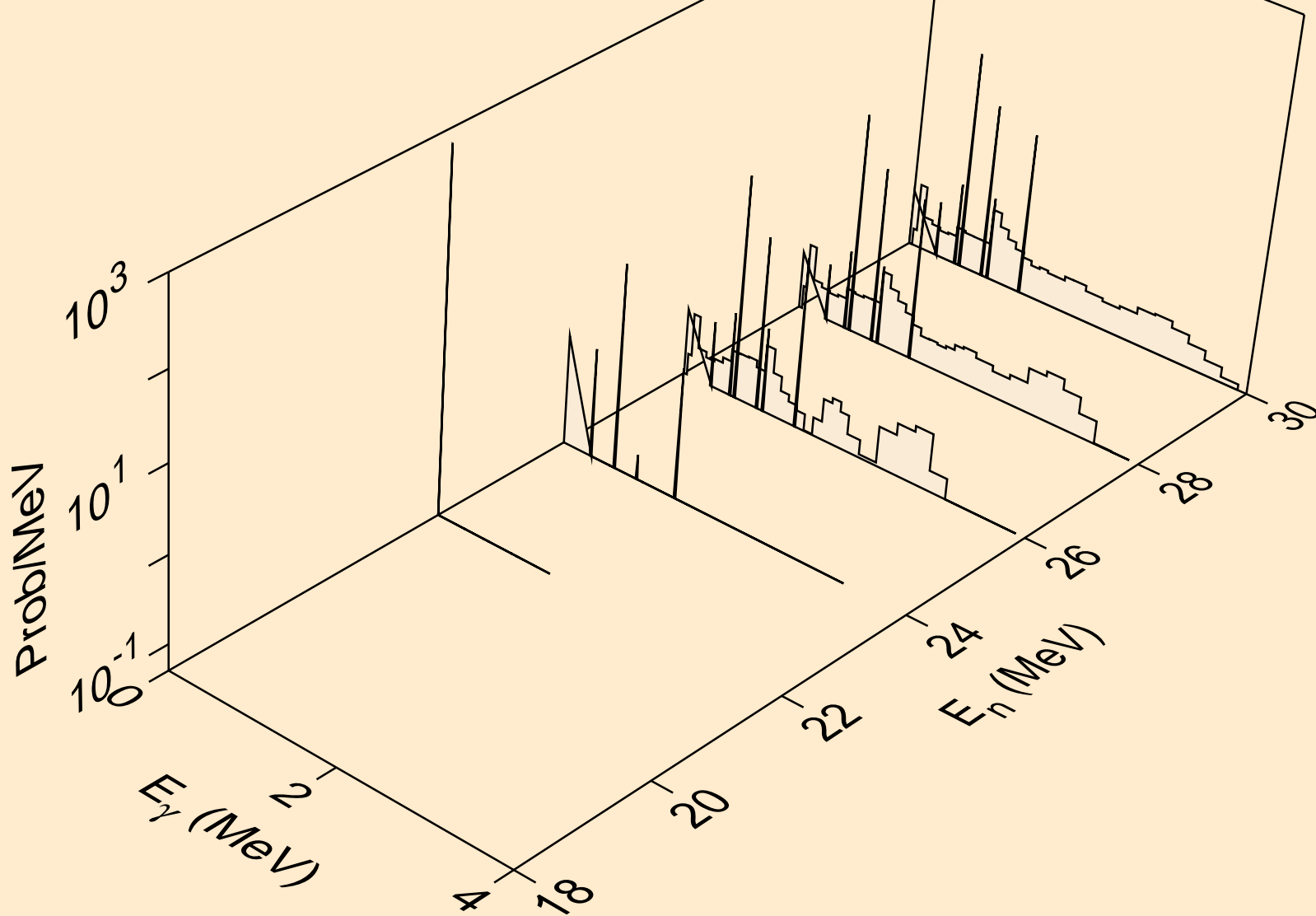

K045 NEUTRON ACER TENDL-2019 LIBRARY; T=293.16K
Photon emission for (n,a)

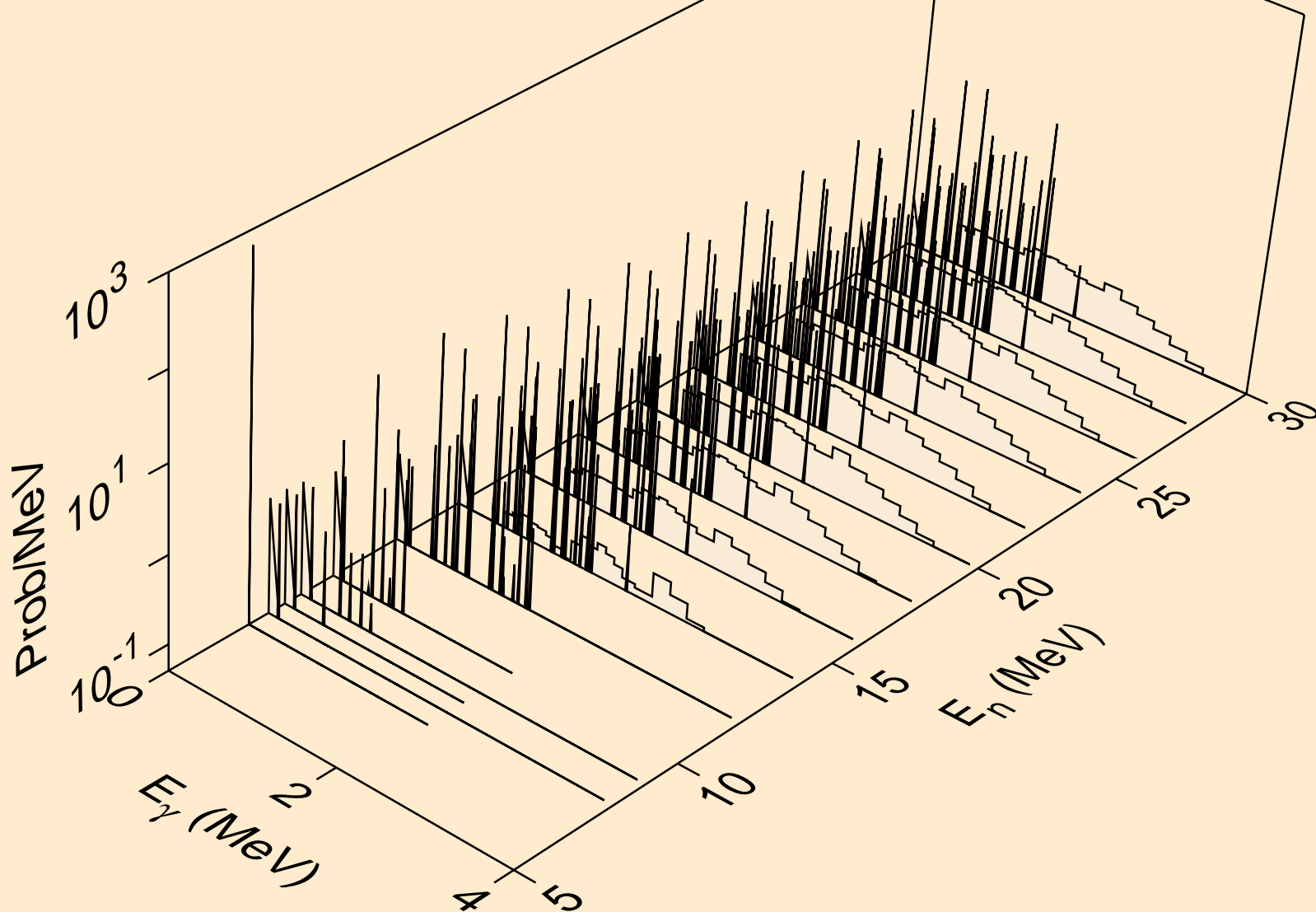

K045 NEUTRON ACER TENDL-2019 LIBRARY; T=293.16K
Photon emission for (n,2a)

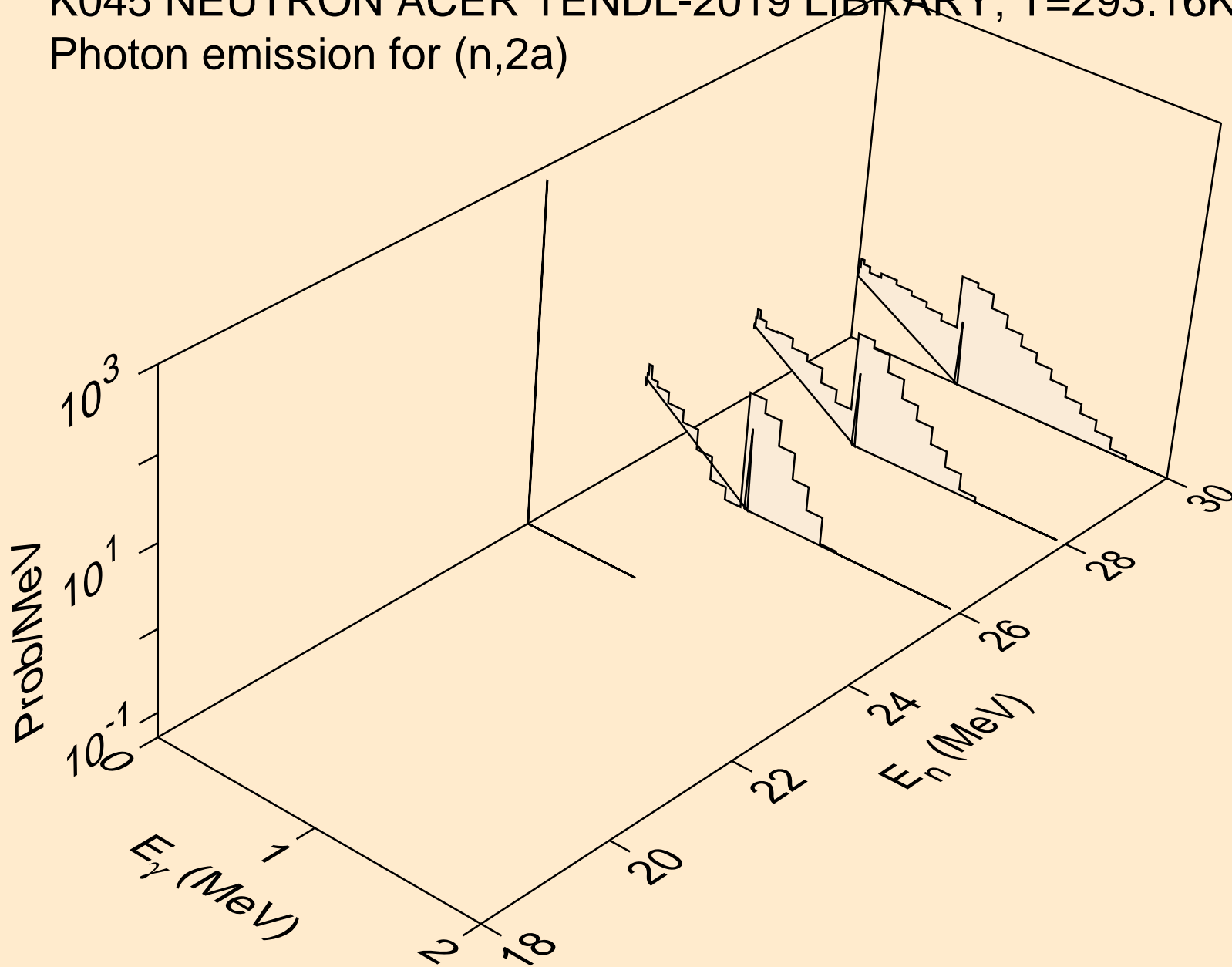

K045 NEUTRON ACER TENDL-2019 LIBRARY; T=293.16K
Photon emission for (n,2p)

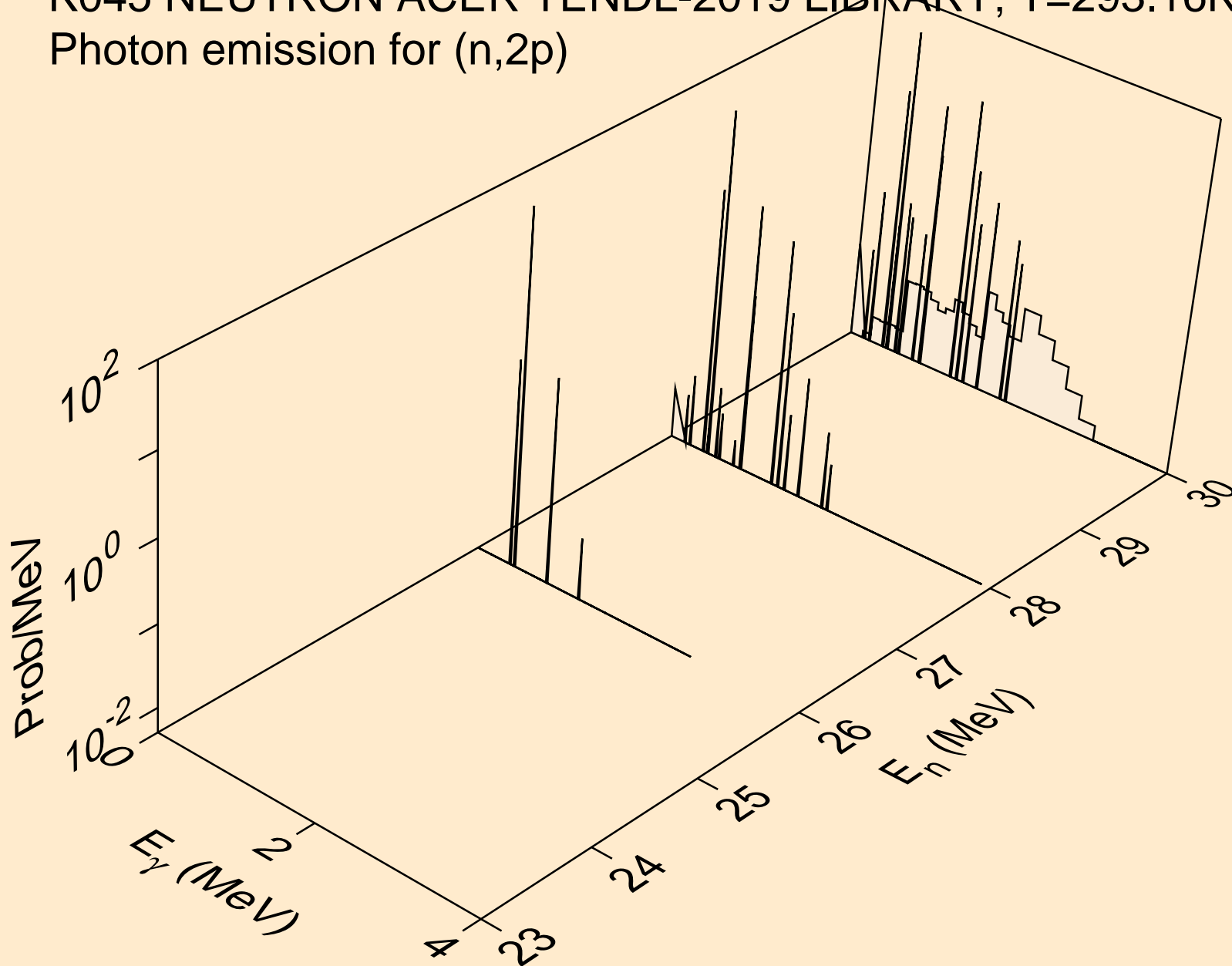

K045 NEUTRON ACER TENDL-2019 LIBRARY; T=293.16K
Photon emission for (n,p α)

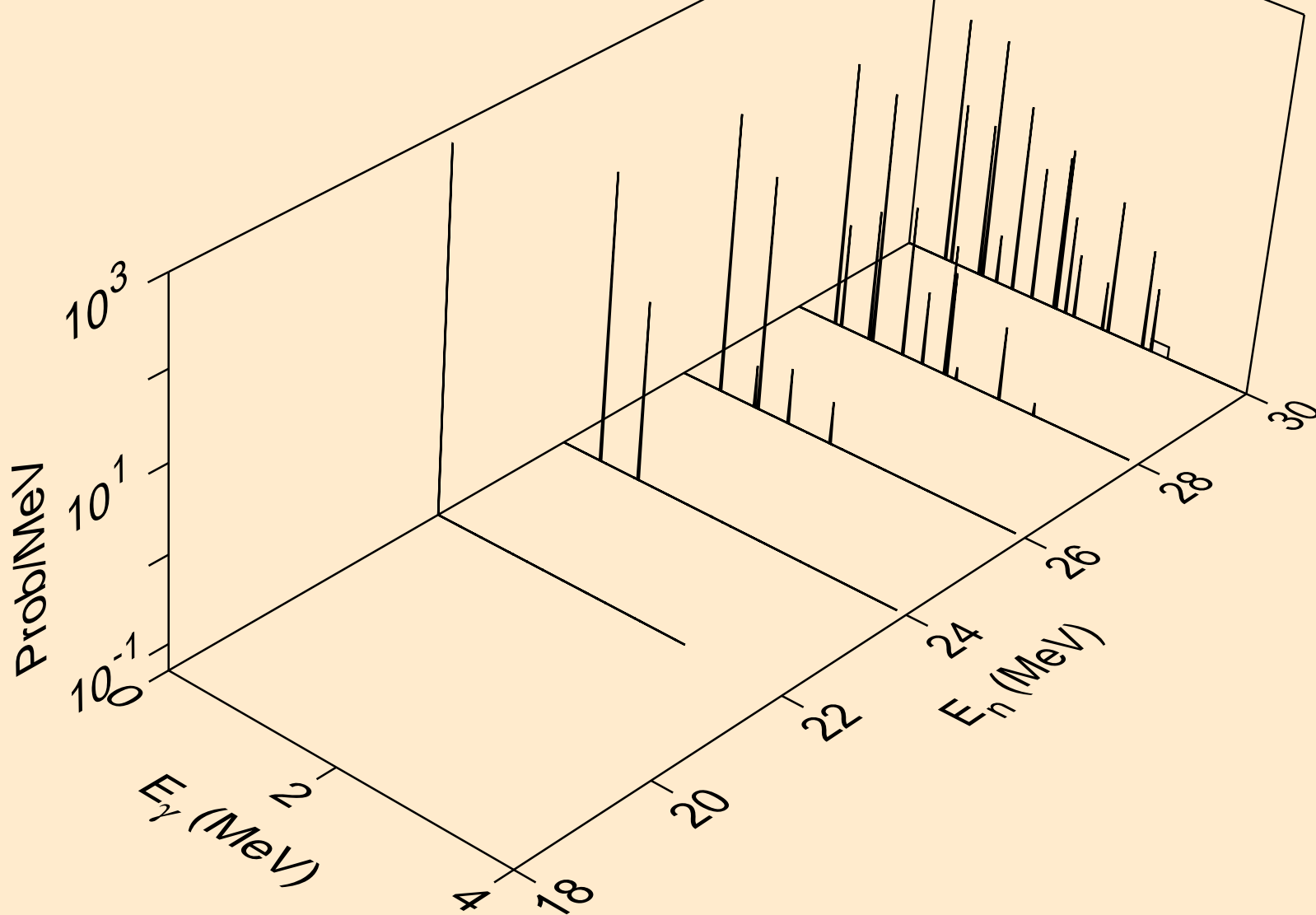

K045 NEUTRON ACER TENDL-2019 LIBRARY; T=293.16K
Photon emission for (n,pd)

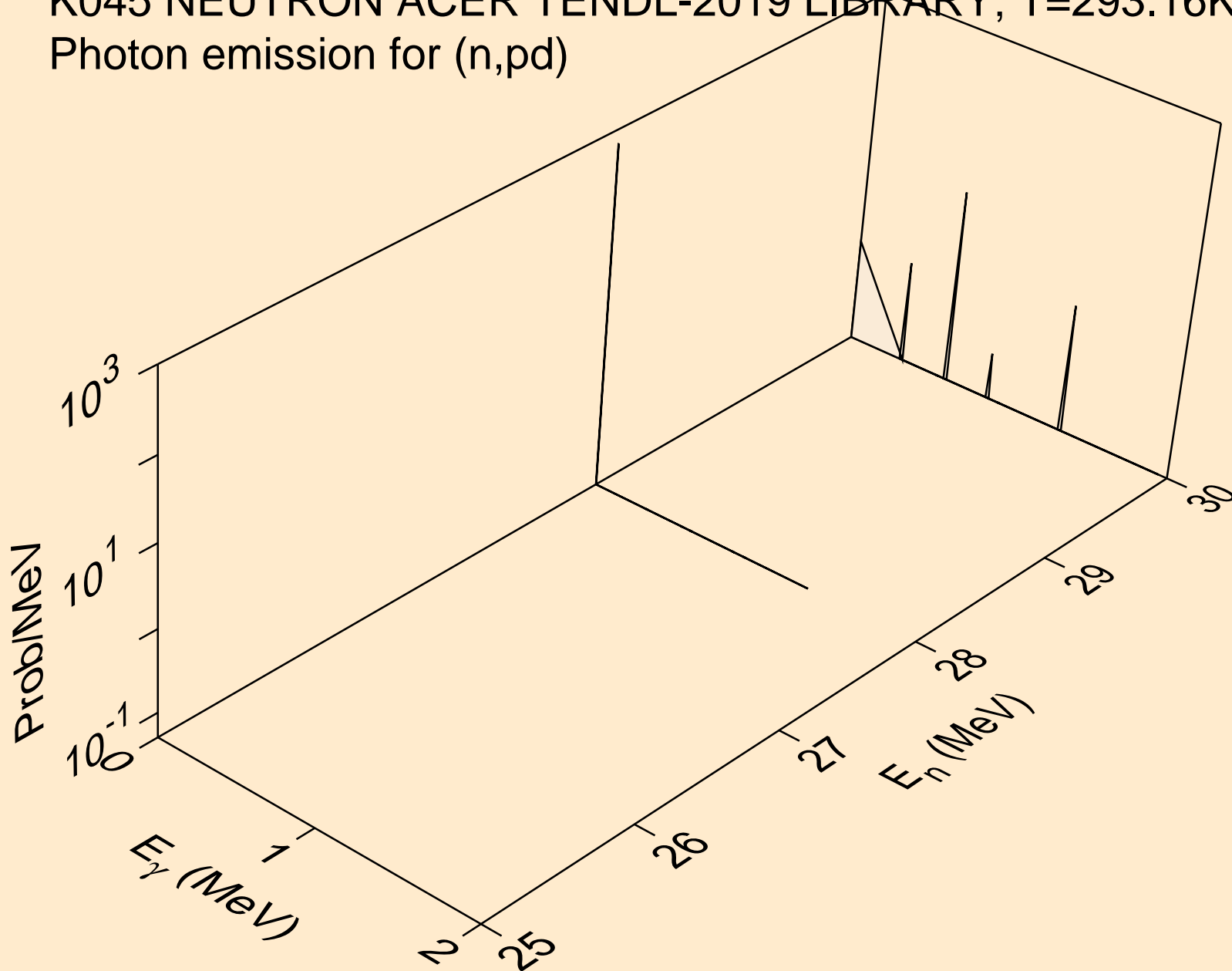

K045 NEUTRON ACER TENDL-2019 LIBRARY; T=293.16K
Photon emission for (n,da)

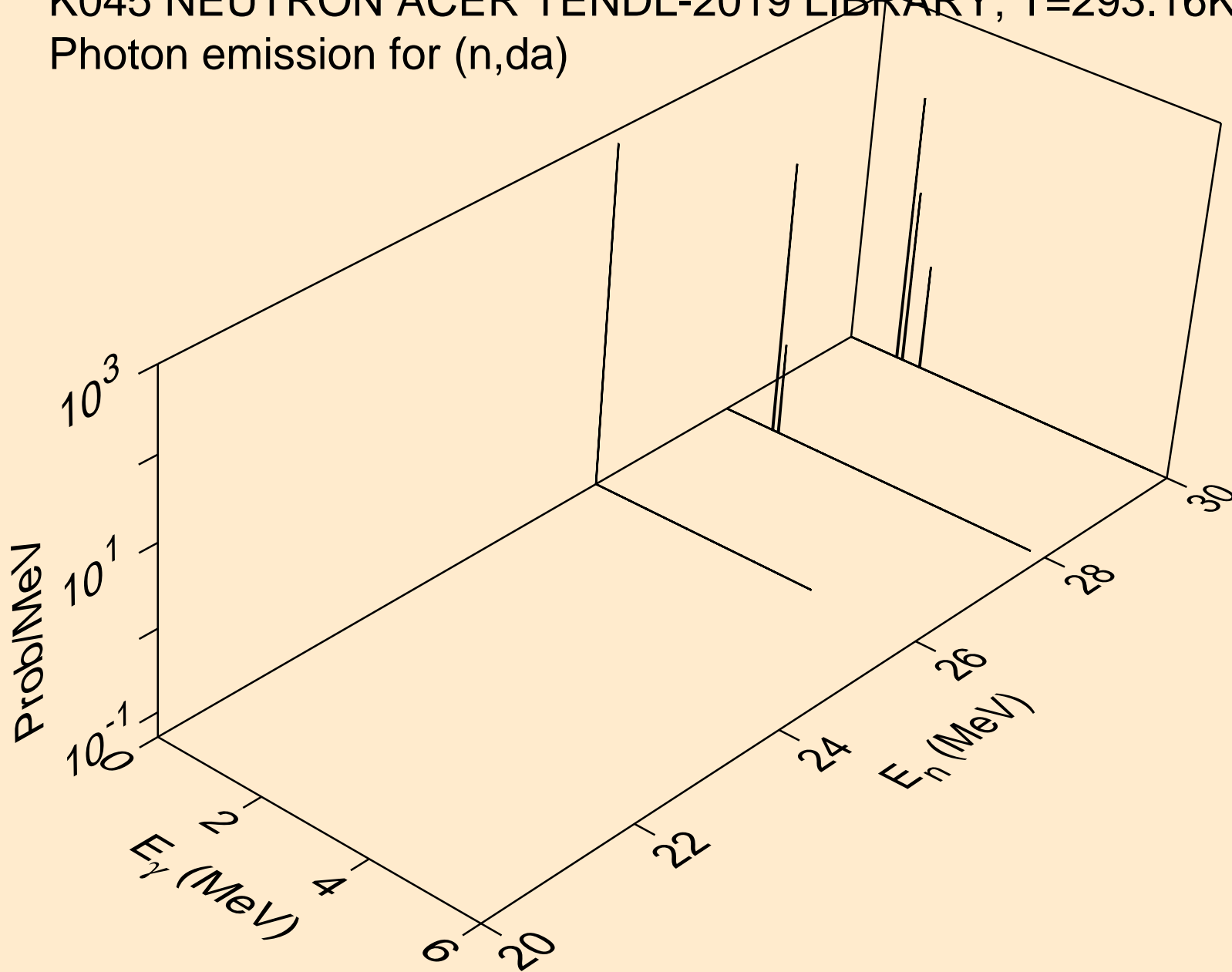

K045 NEUTRON ACER TENDL-2019 LIBRARY; T=293.16K
thermal capture photon spectrum

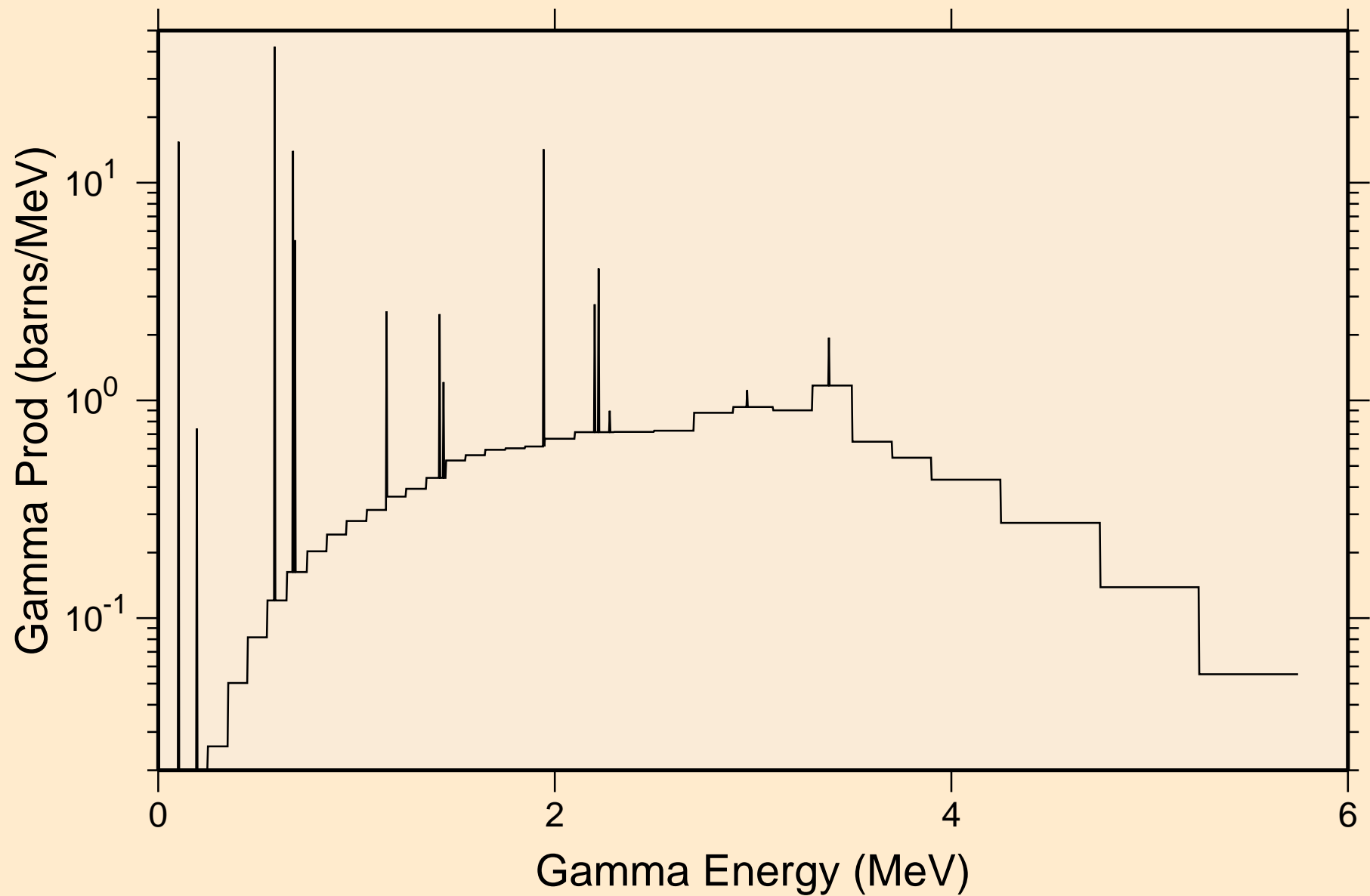

K045 NEUTRON ACER TENDL-2019 LIBRARY; T=293.16K
14 MeV photon spectrum

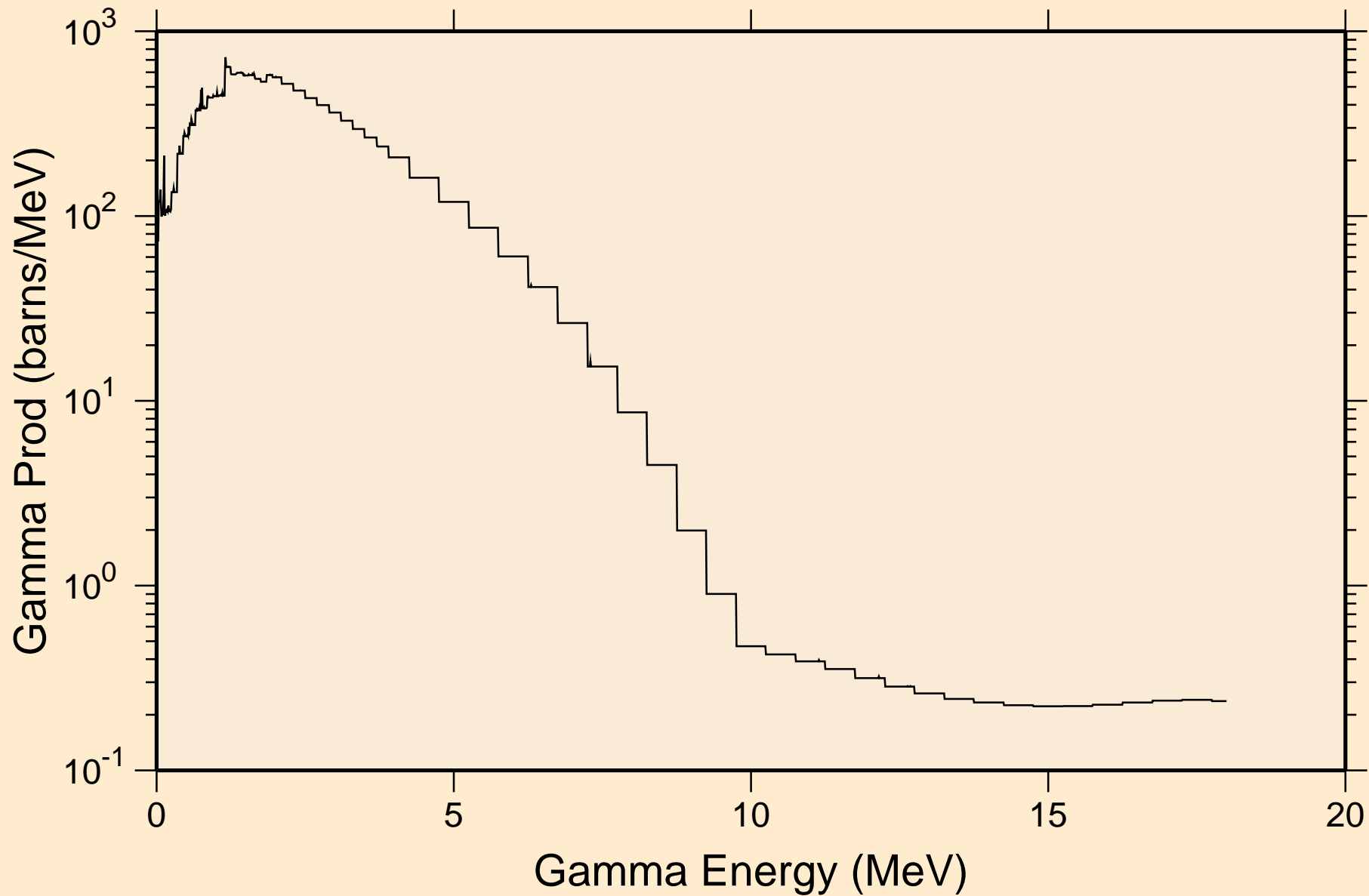

K045 NEUTRON ACER TENDL-2019 LIBRARY; T=293.16K

Particle heating contributions

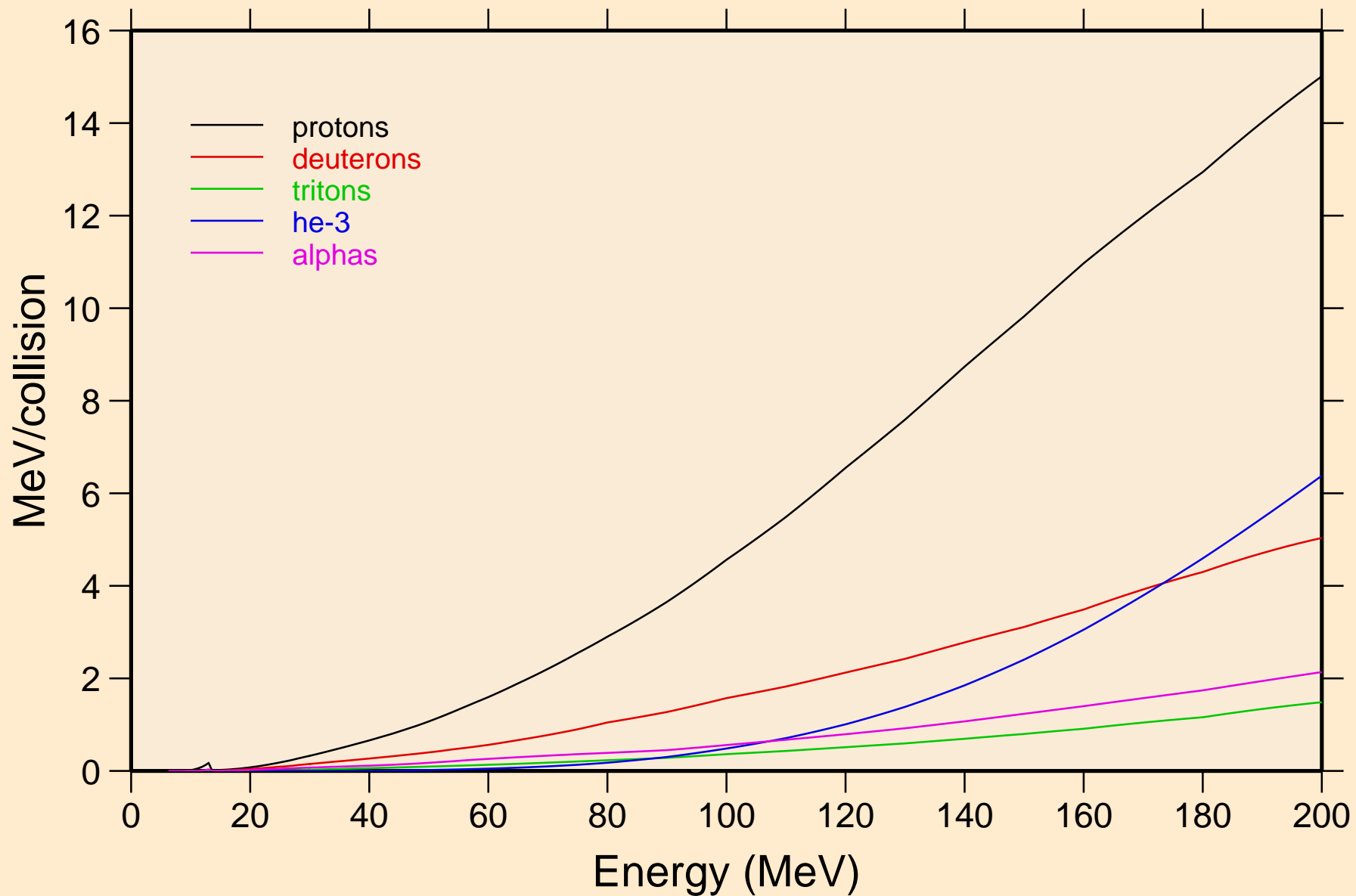

K045 NEUTRON ACER TENDL-2019 LIBRARY; T=293.16K
Recoil Heating

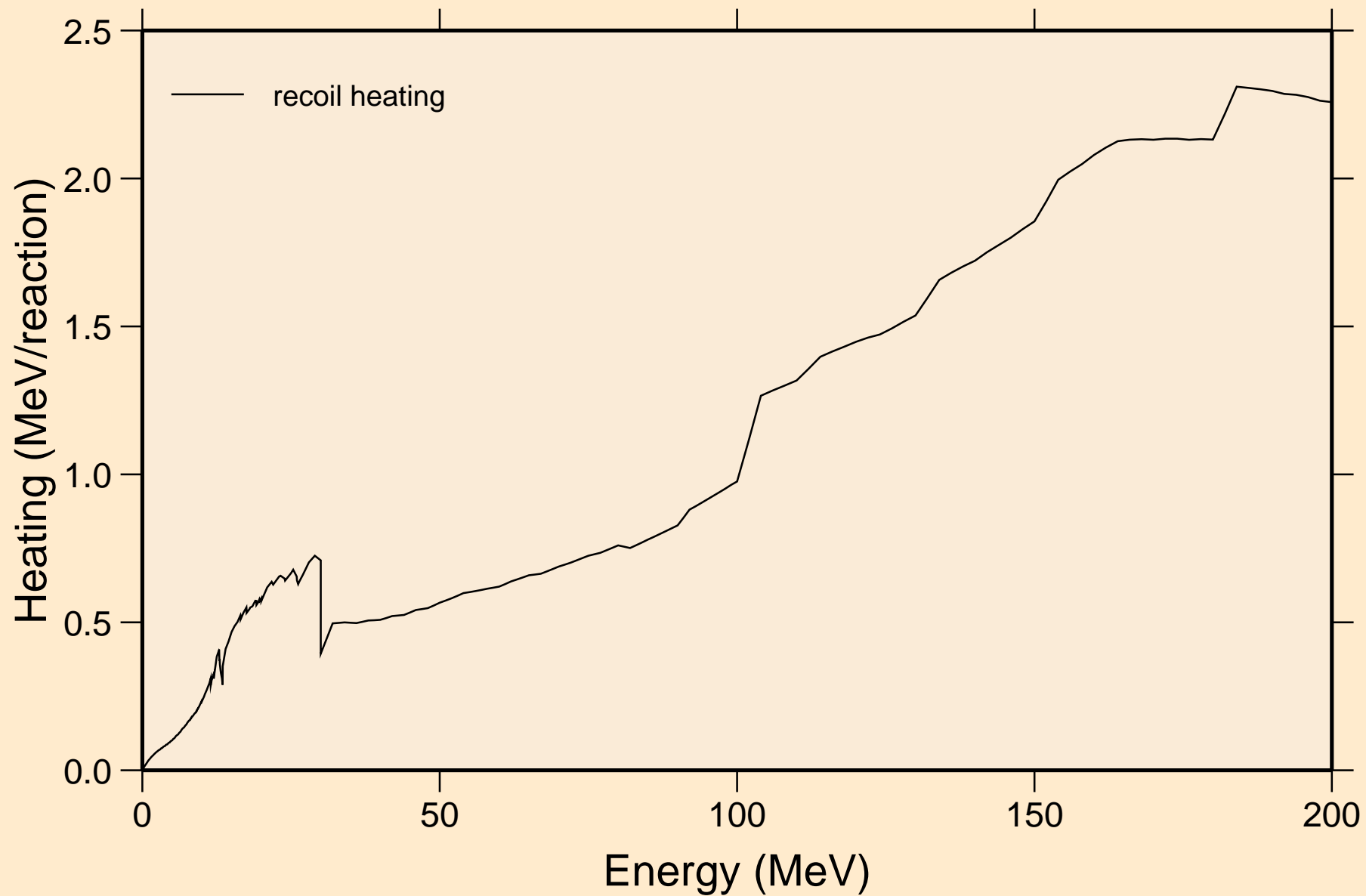

K045 NEUTRON ACER TENDL-2019 LIBRARY; T=293.16K

Particle production cross sections

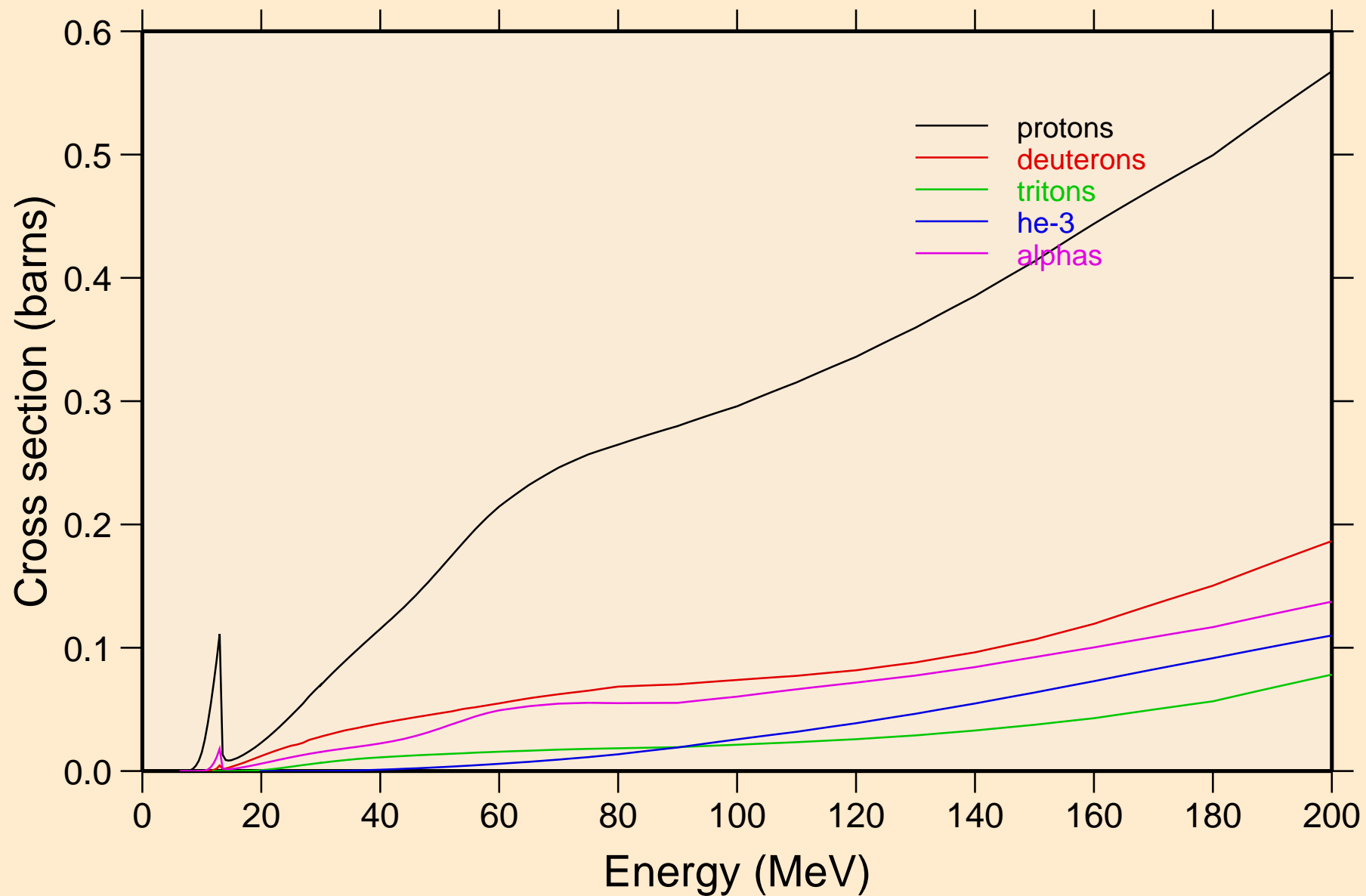

K045 NEUTRON ACER TENDL-2019 LIBRARY; T=293.16K
protons from (n,x)

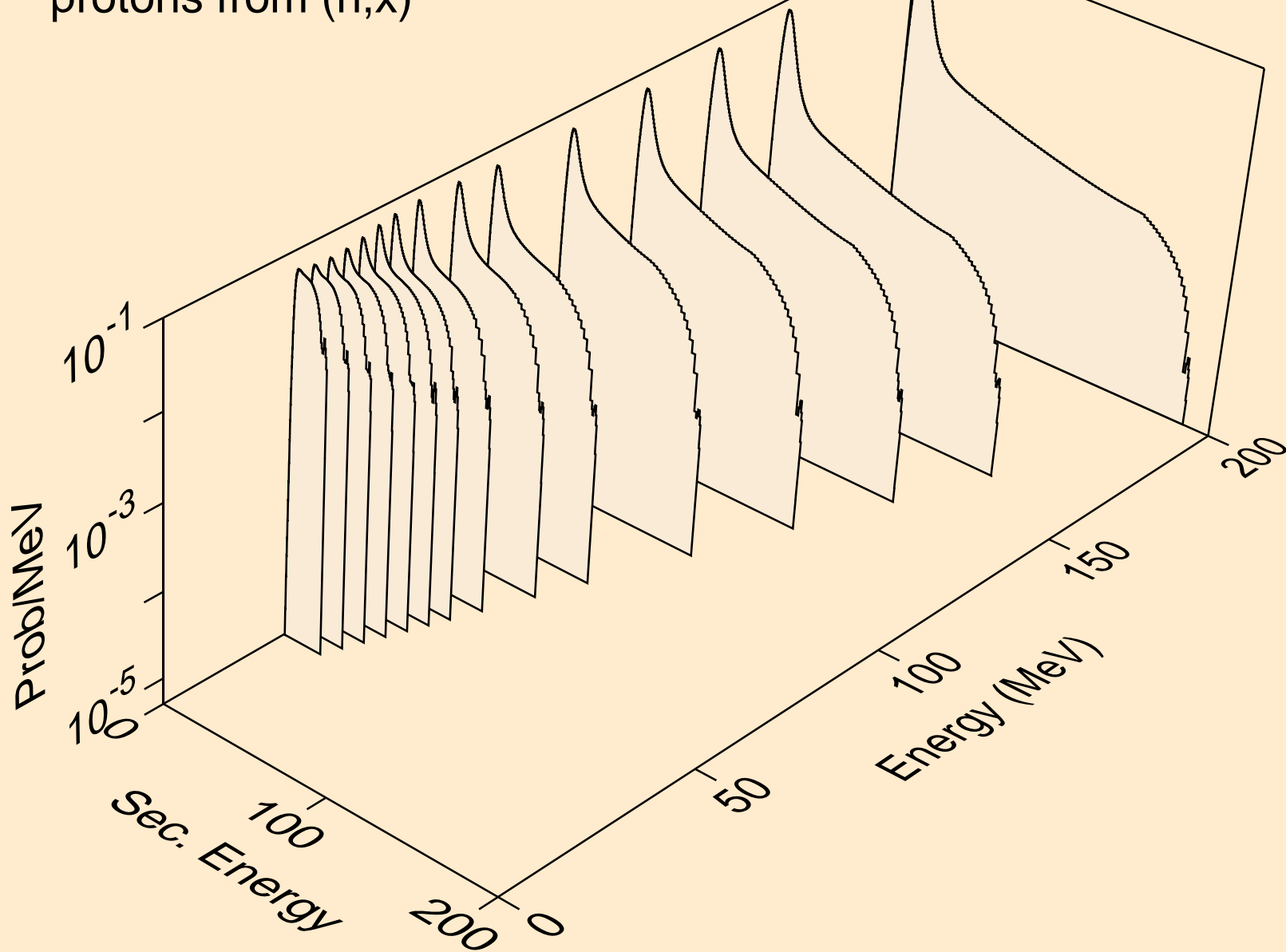

K045 NEUTRON ACER TENDL-2019 LIBRARY; T=293.16K
protons from (n,n*)p

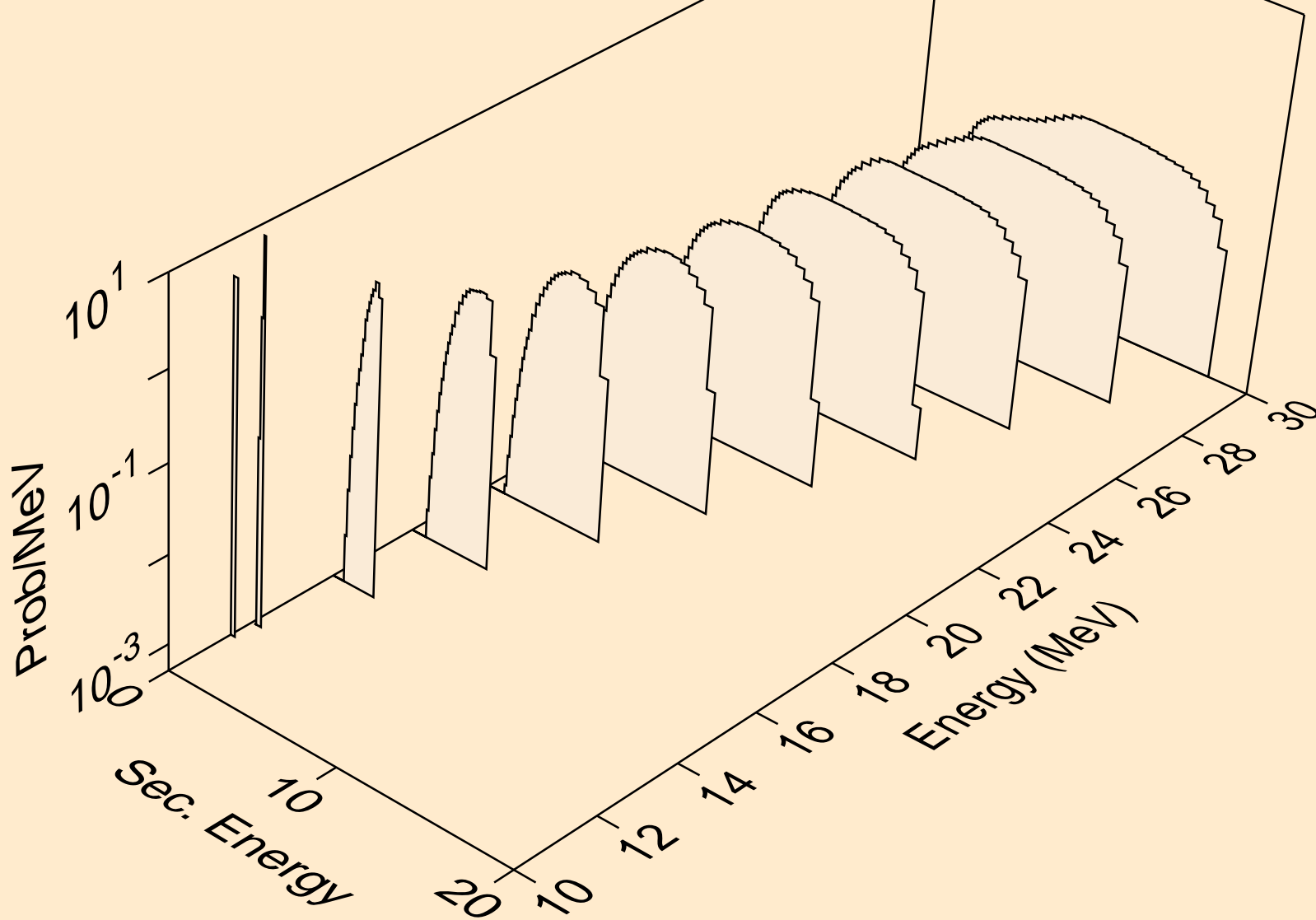

K045 NEUTRON ACER TENDL-2019 LIBRARY; T=293.16K
protons from (n,2np)

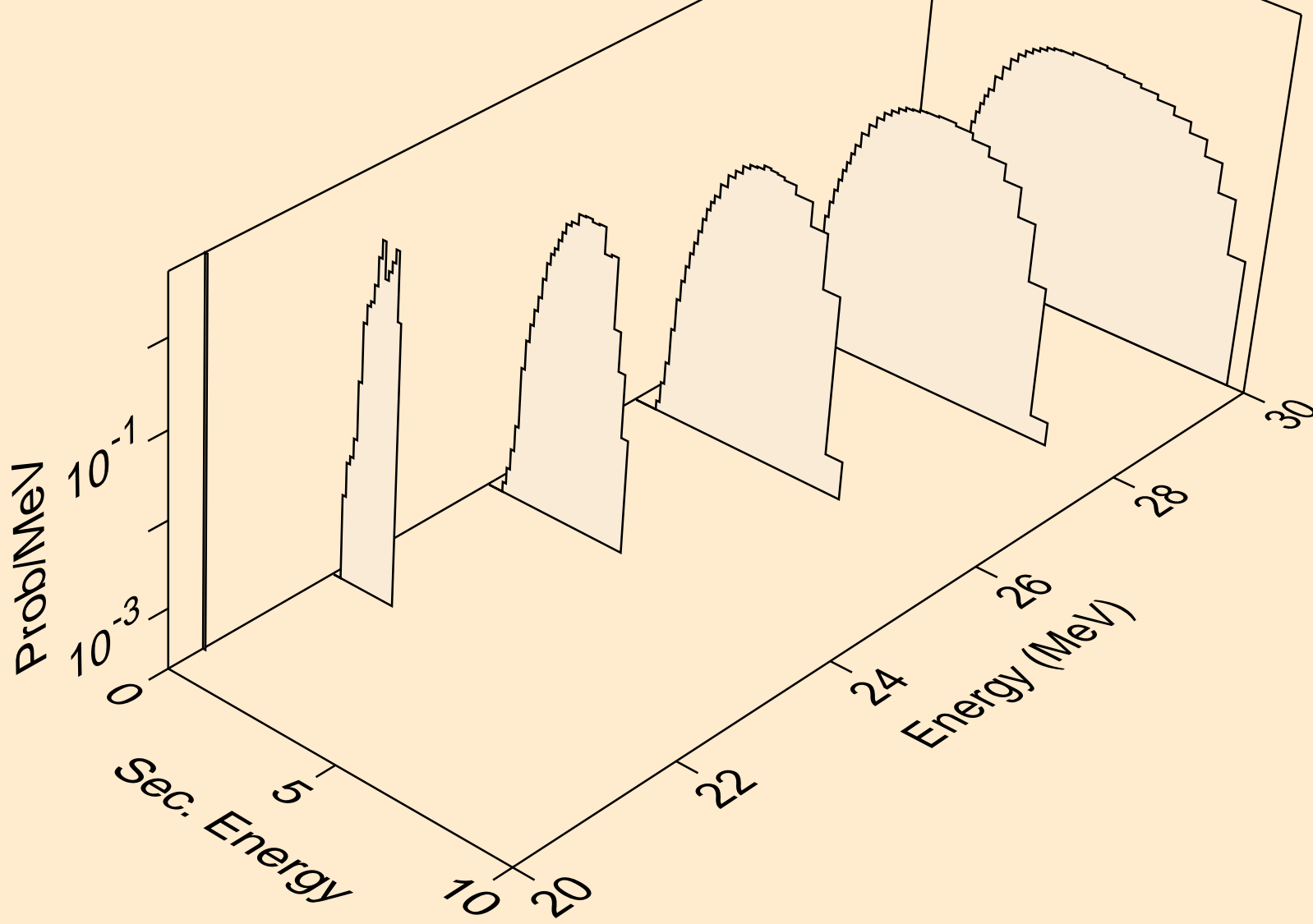

K045 NEUTRON ACER TENDL-2019 LIBRARY; T=293.16K
protons from (n,3np)

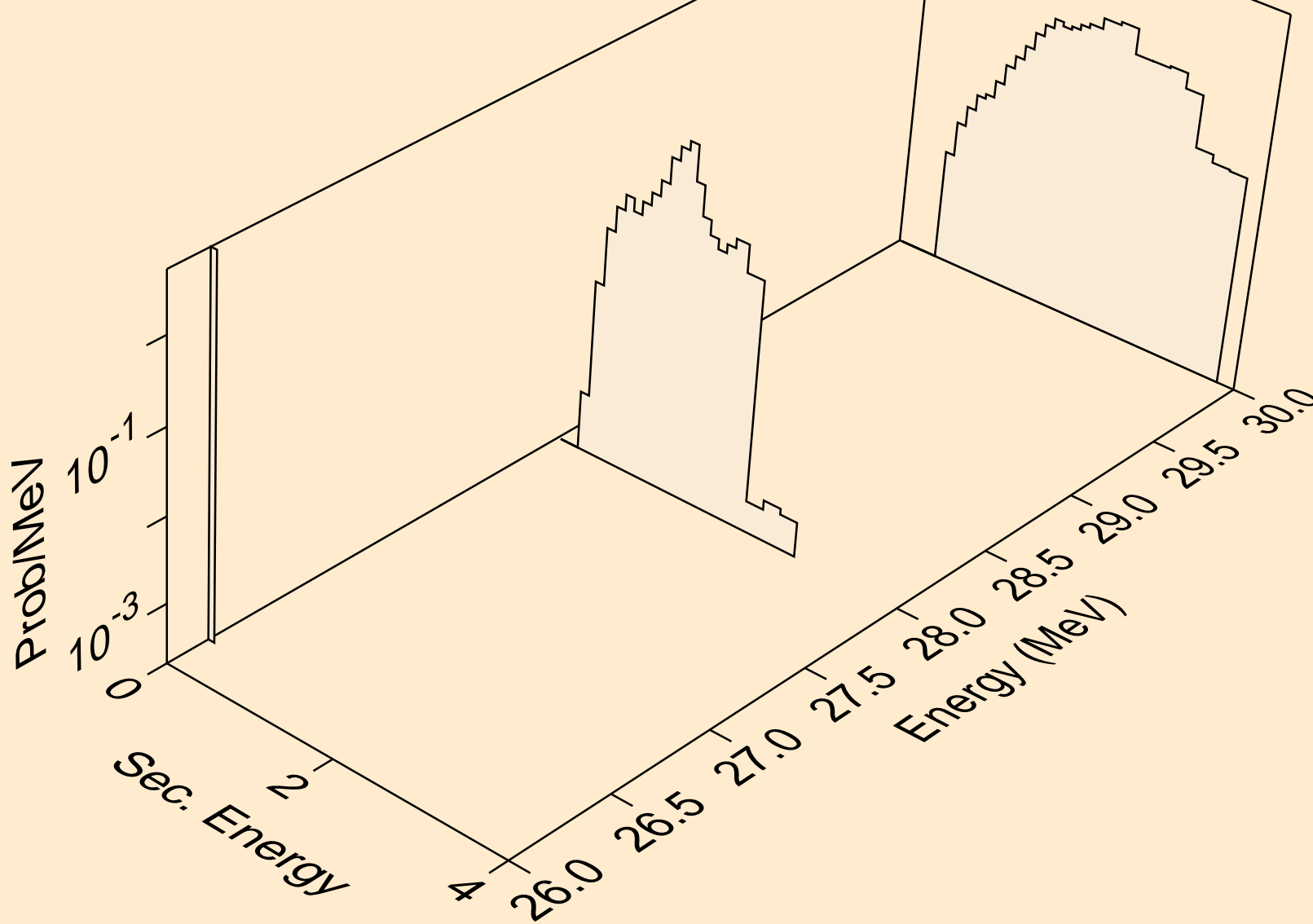

K045 NEUTRON ACER TENDL-2019 LIBRARY; T=293.16K
protons from (n,p)

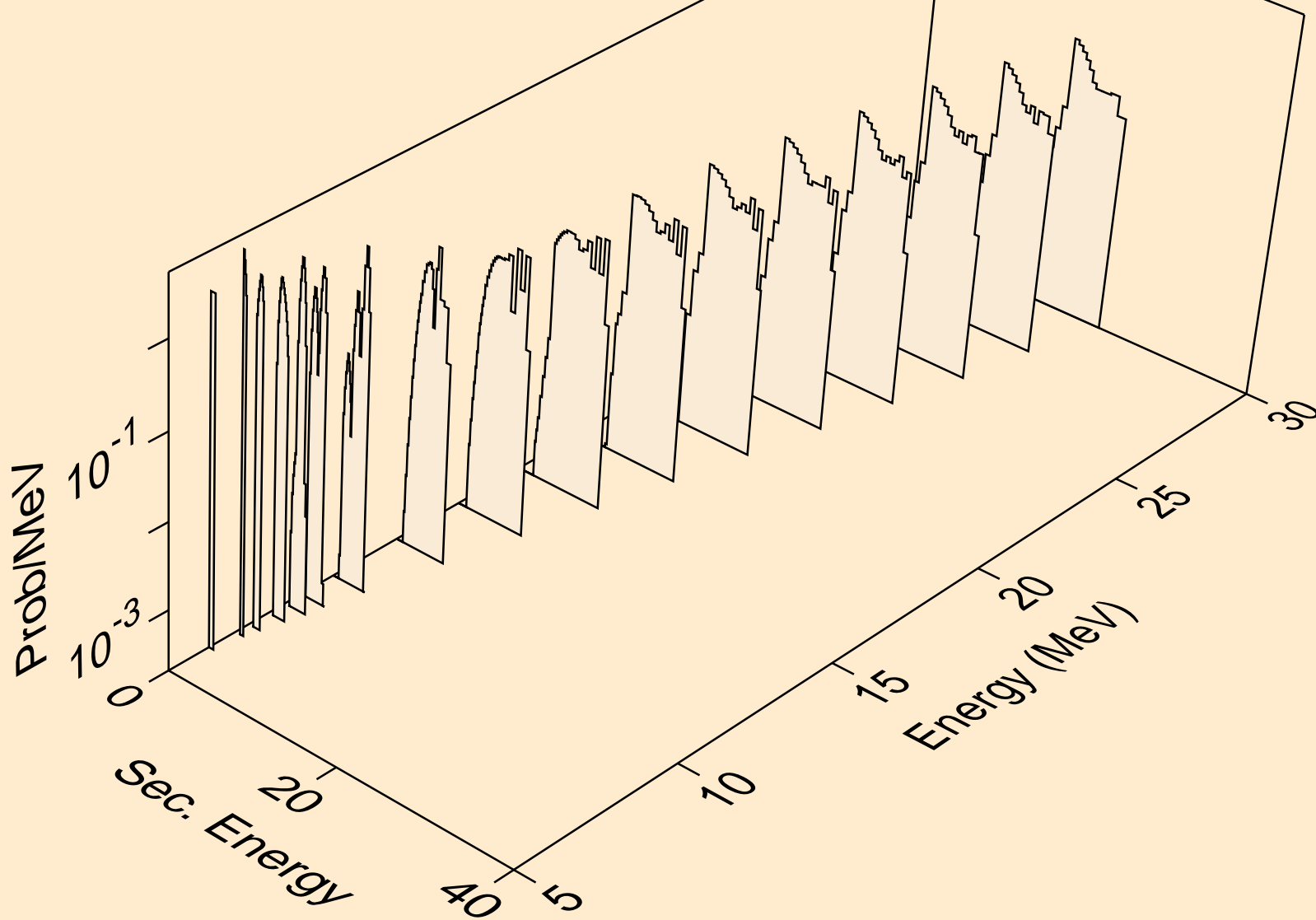

K045 NEUTRON ACER TENDL-2019 LIBRARY; T=293.16K
protons from (n,2p)

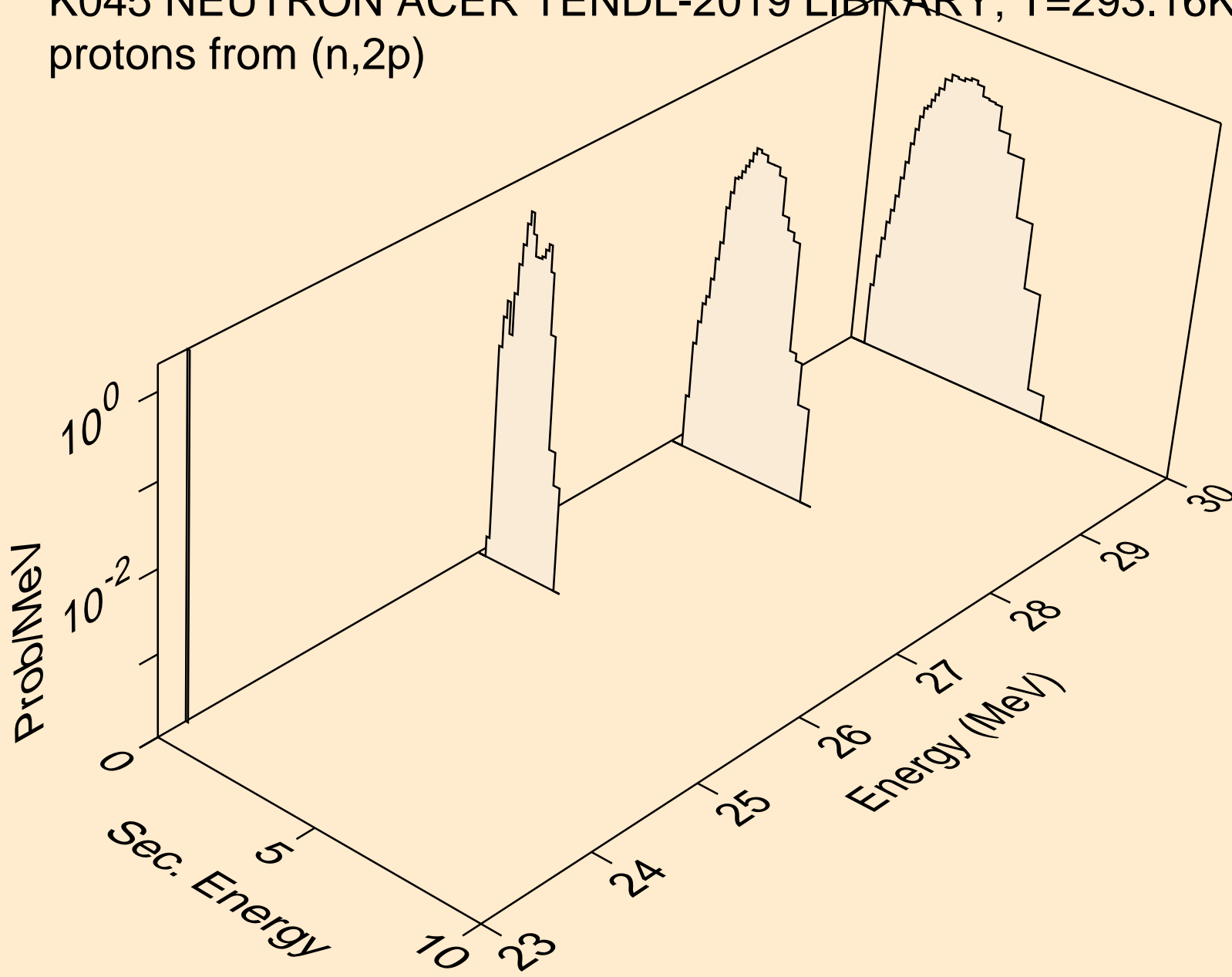

K045 NEUTRON ACER TENDL-2019 LIBRARY; T=293.16K
protons from (n,p)

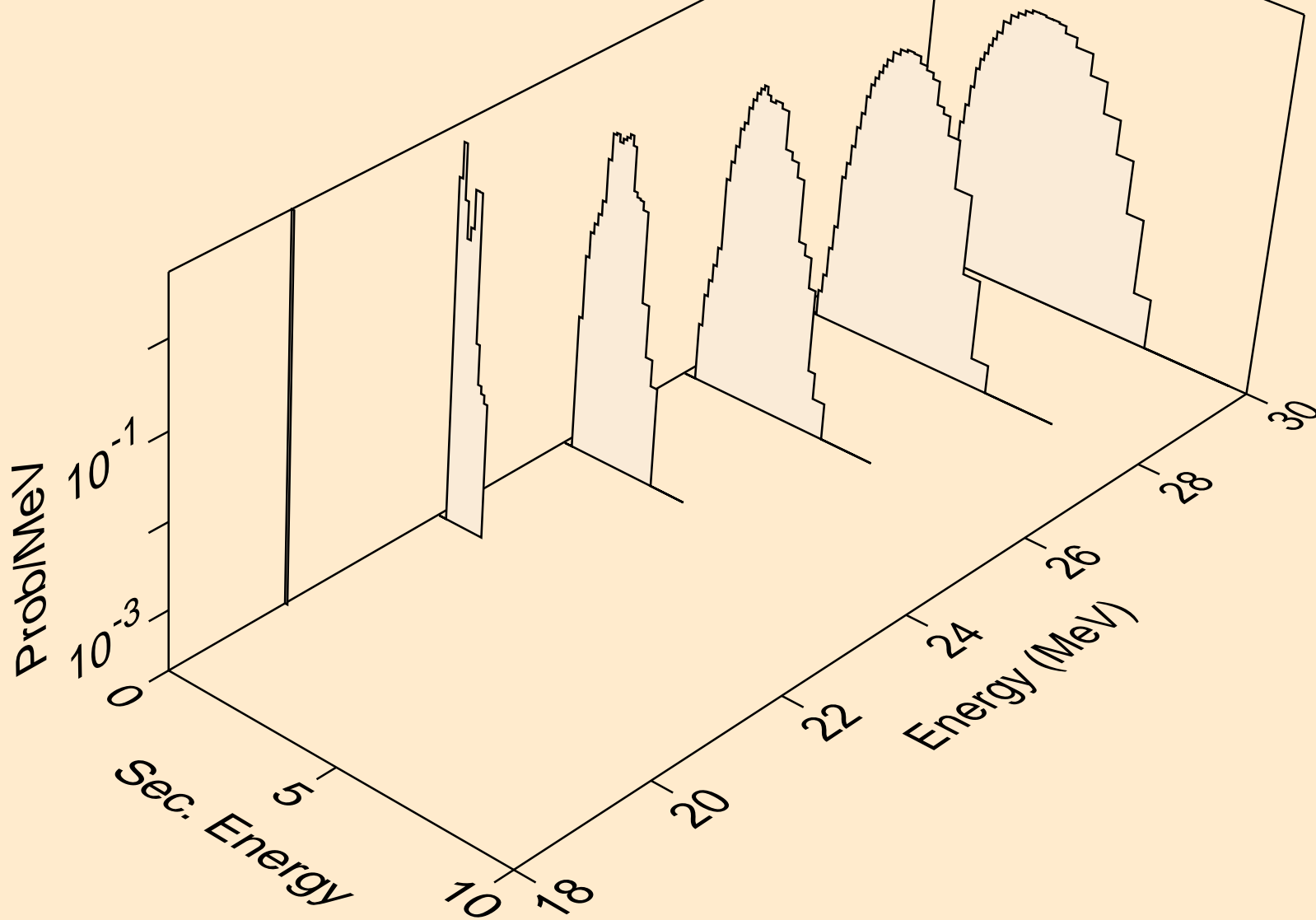

K045 NEUTRON ACER TENDL-2019 LIBRARY; T=293.16K
protons from (n,pd)

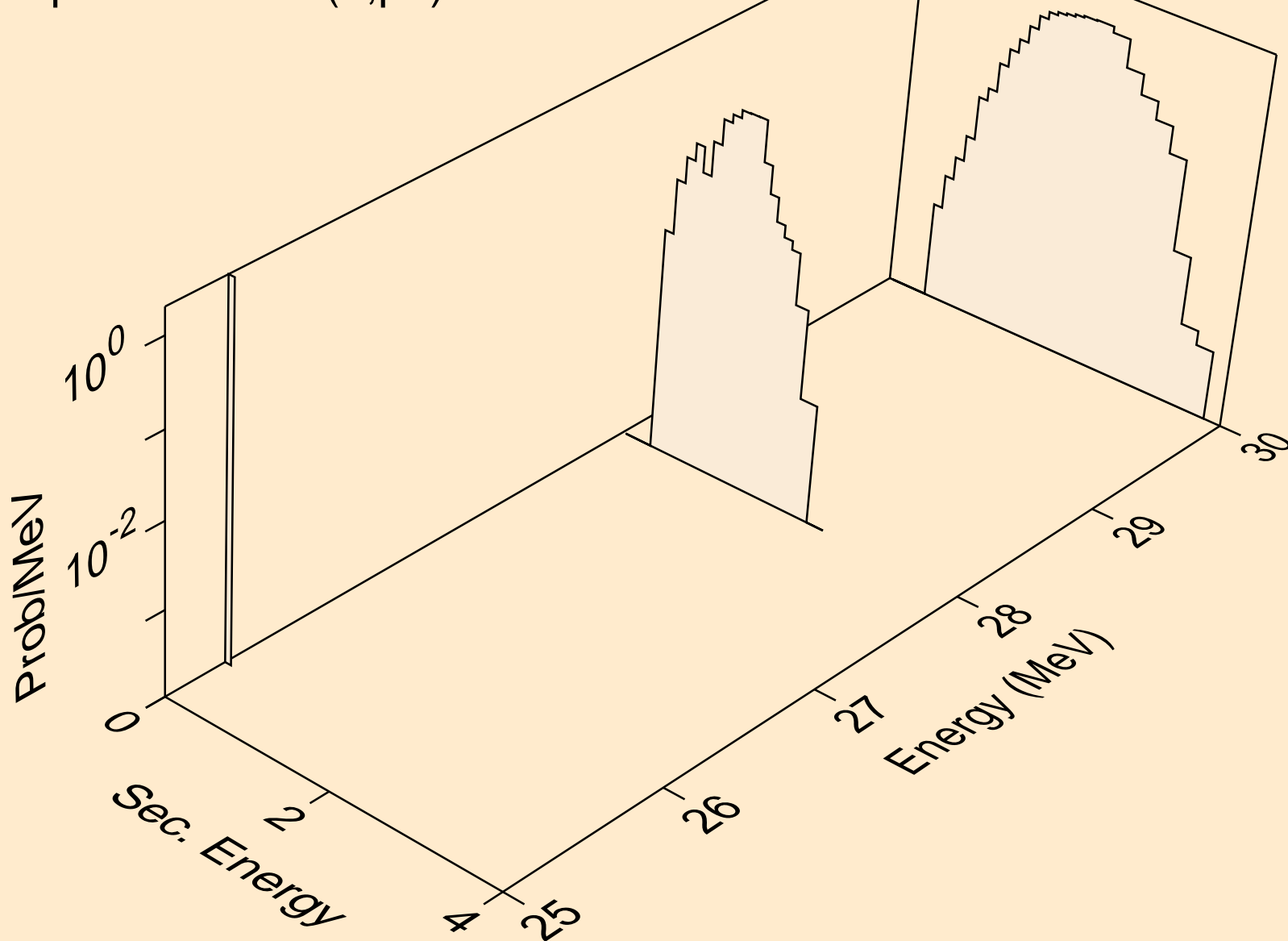

K045 NEUTRON ACER TENDL-2019 LIBRARY; T=293.16K
deuterons from (n,x)

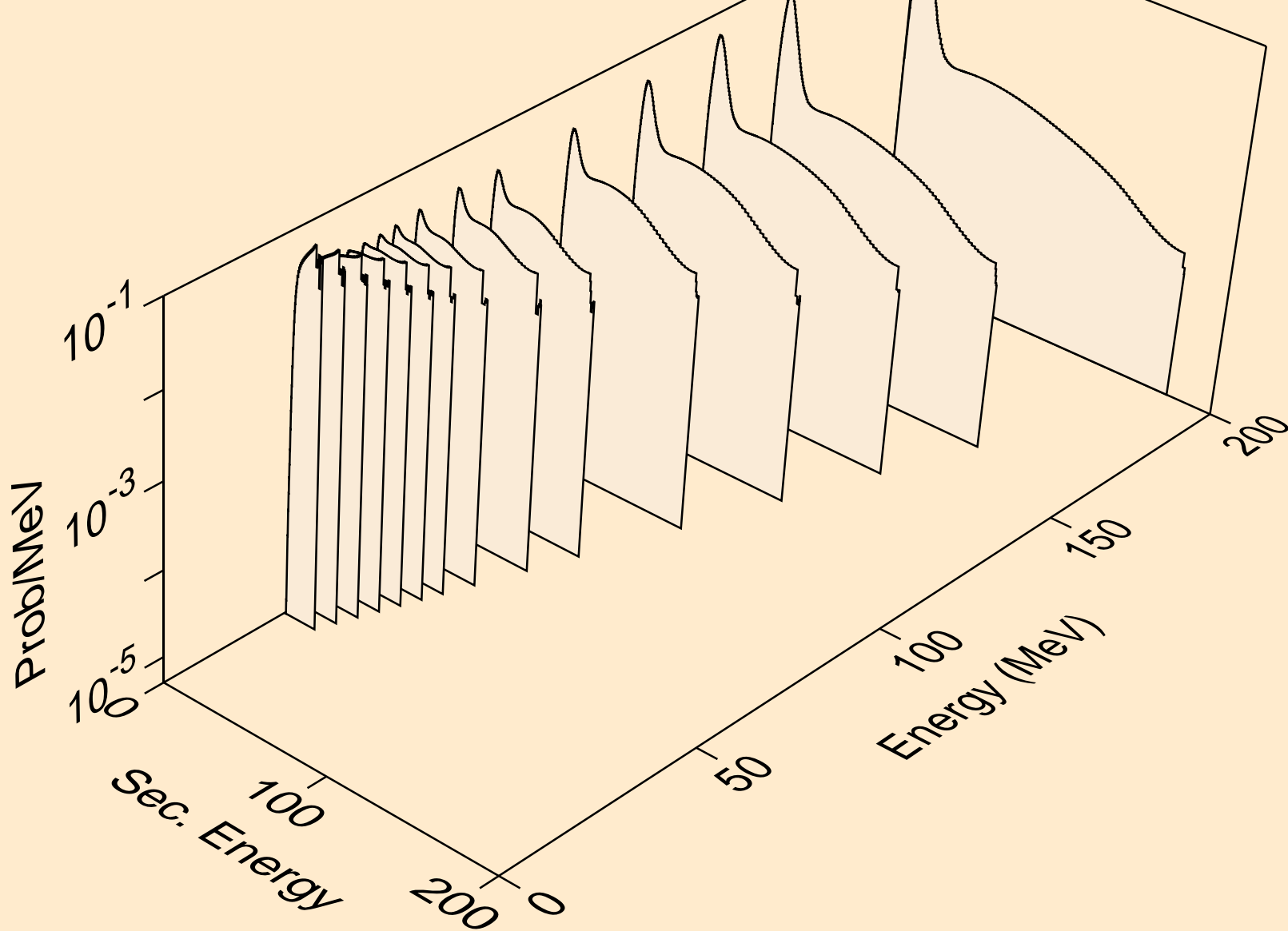

K045 NEUTRON ACER TENDL-2019 LIBRARY; T=293.16K
deuterons from (n,2nd)

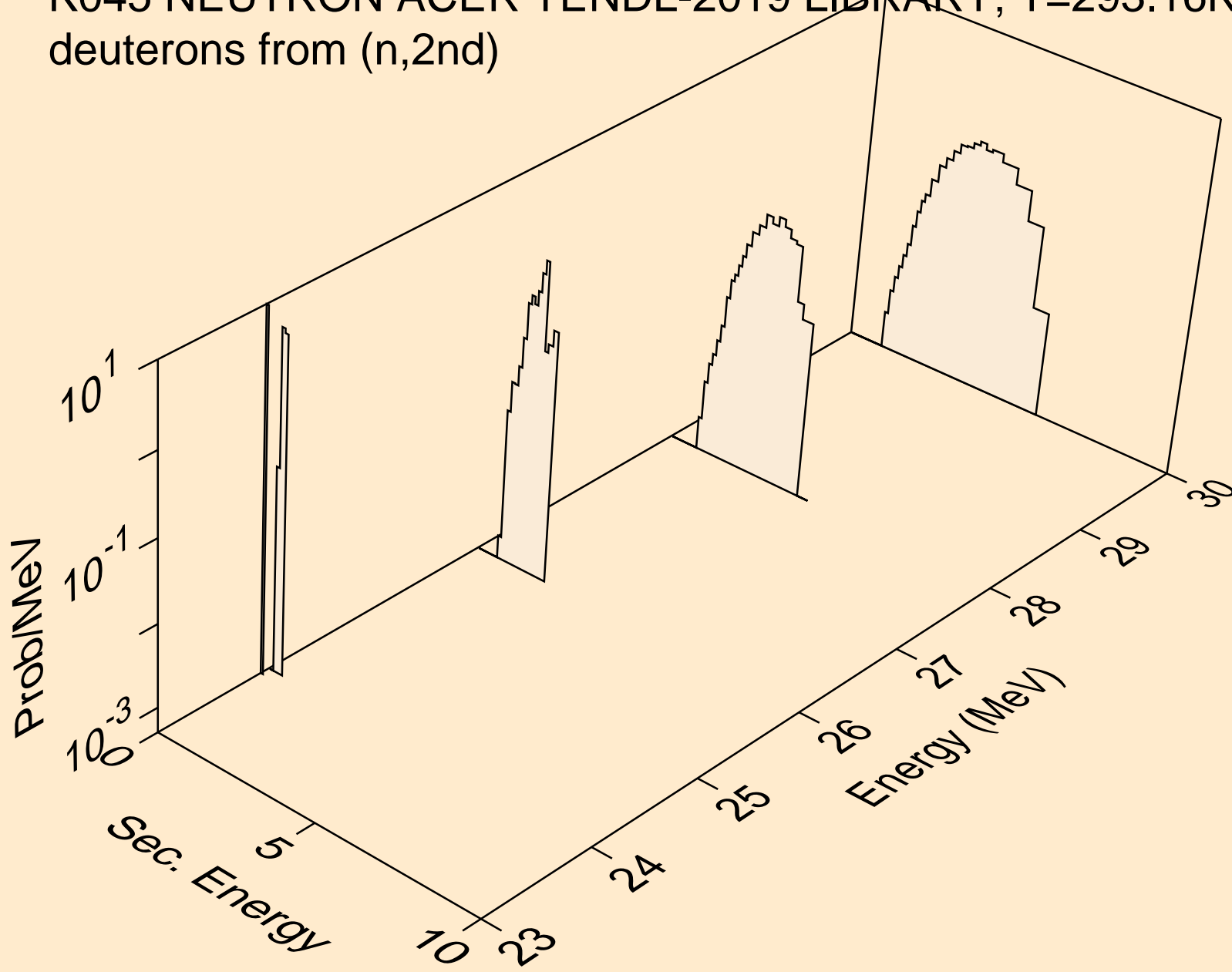

K045 NEUTRON ACER TENDL-2019 LIBRARY; T=293.16K
deuterons from (n,n*)d

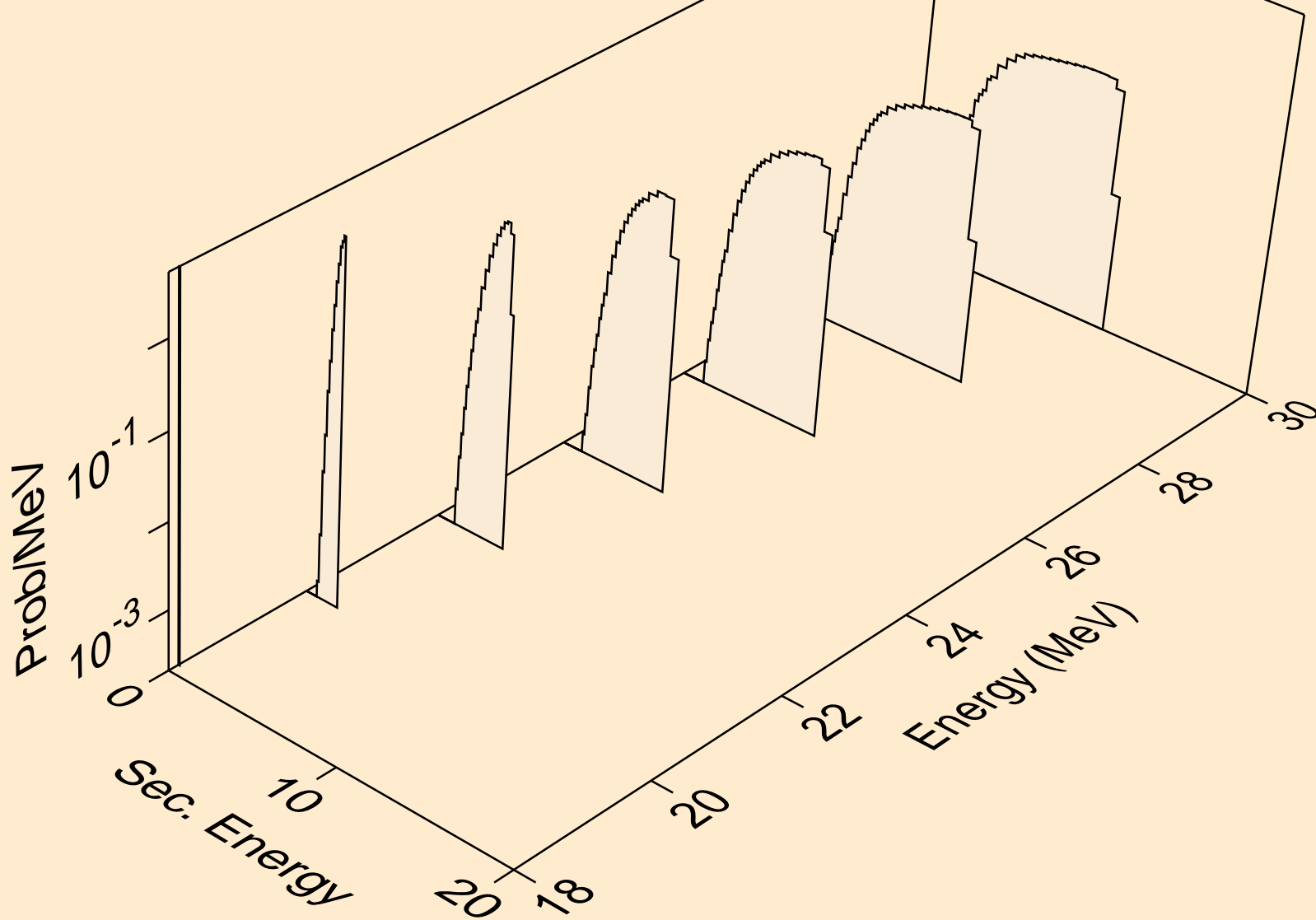

K045 NEUTRON ACER TENDL-2019 LIBRARY; T=293.16K
deuterons from (n,d)

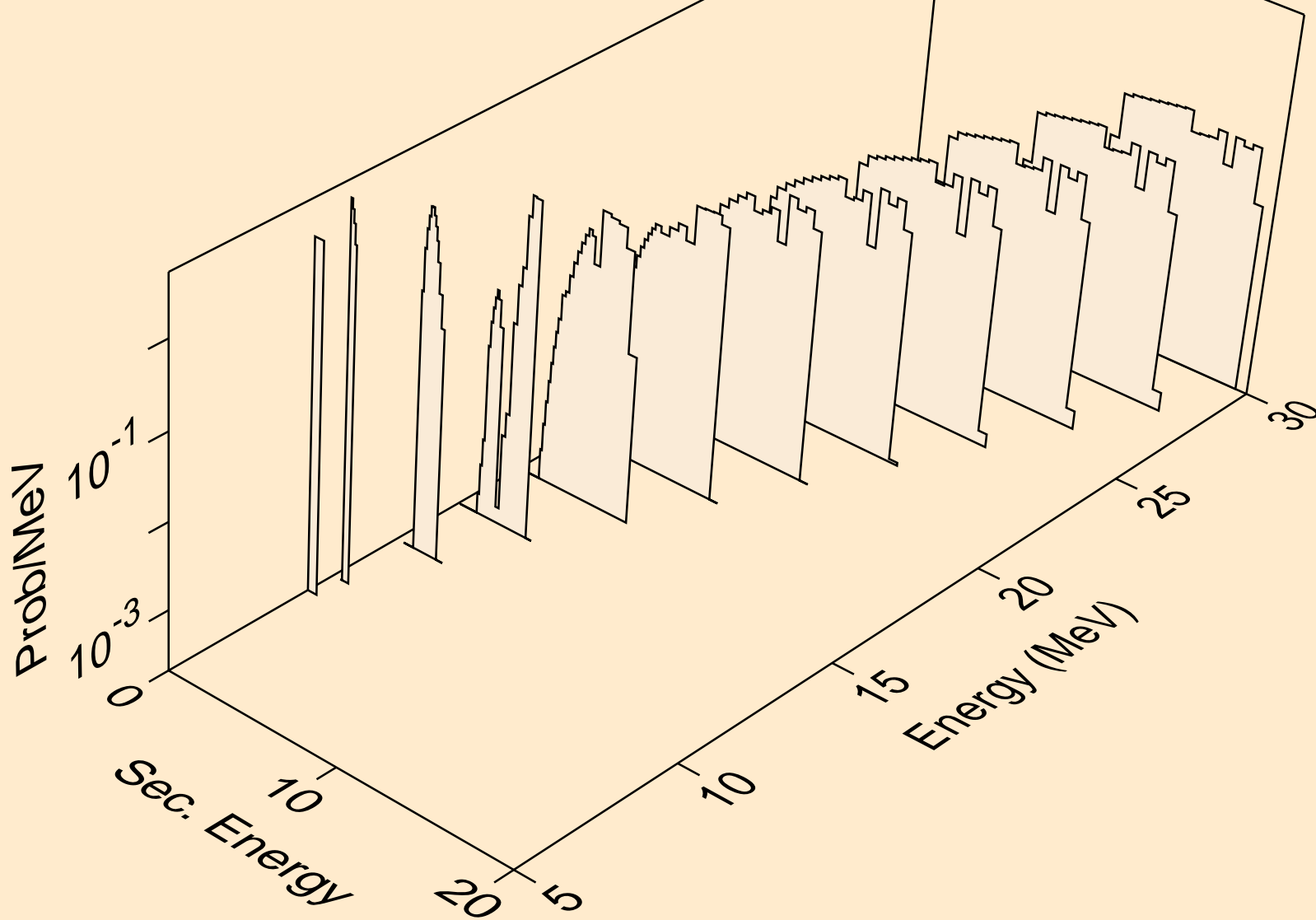

K045 NEUTRON ACER TENDL-2019 LIBRARY; T=293.16K
deuterons from (n,pd)

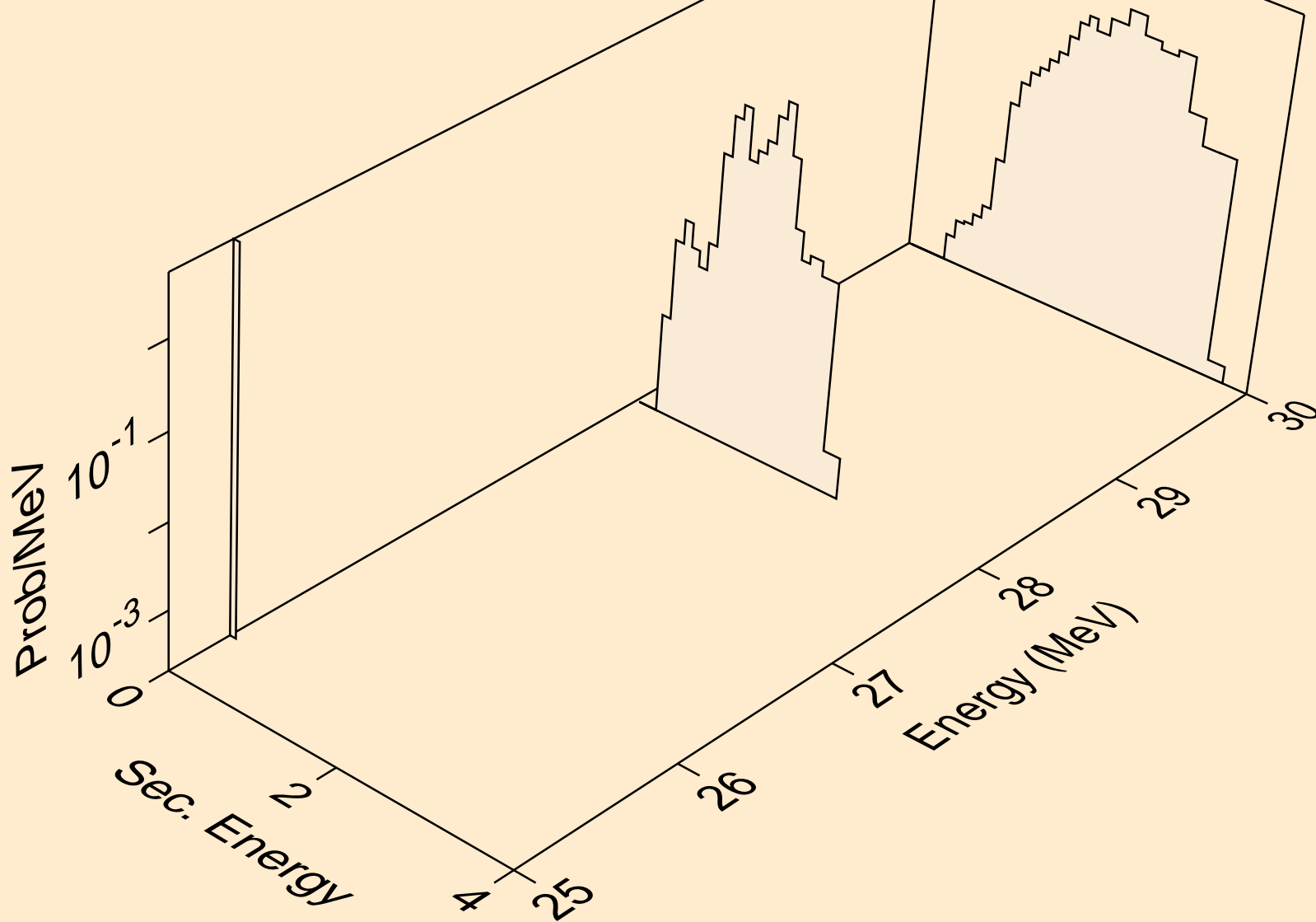

K045 NEUTRON ACER TENDL-2019 LIBRARY; T=293.16K
deuterons from (n,da)

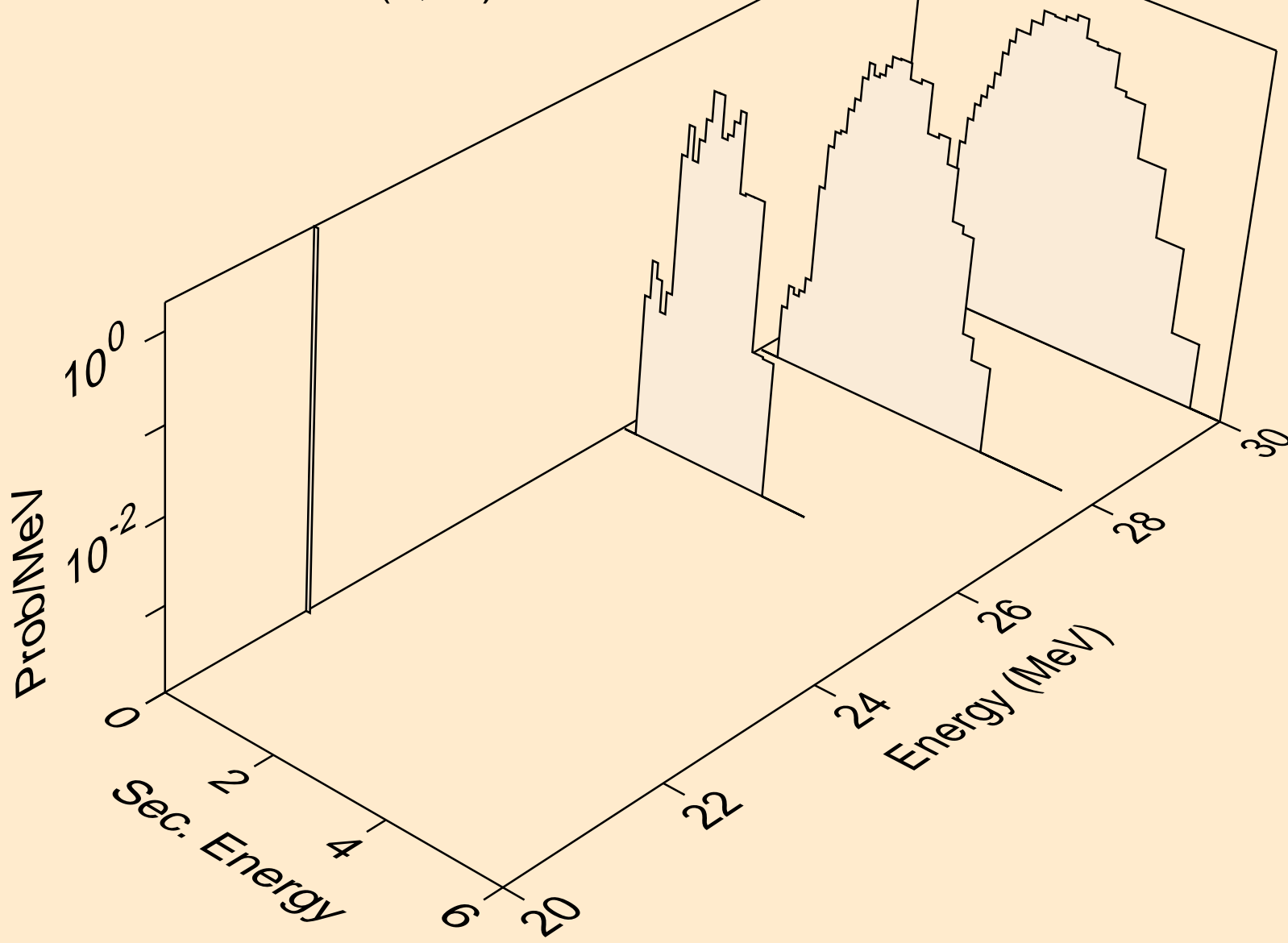

K045 NEUTRON ACER TENDL-2019 LIBRARY; T=293.16K
tritons from (n,x)

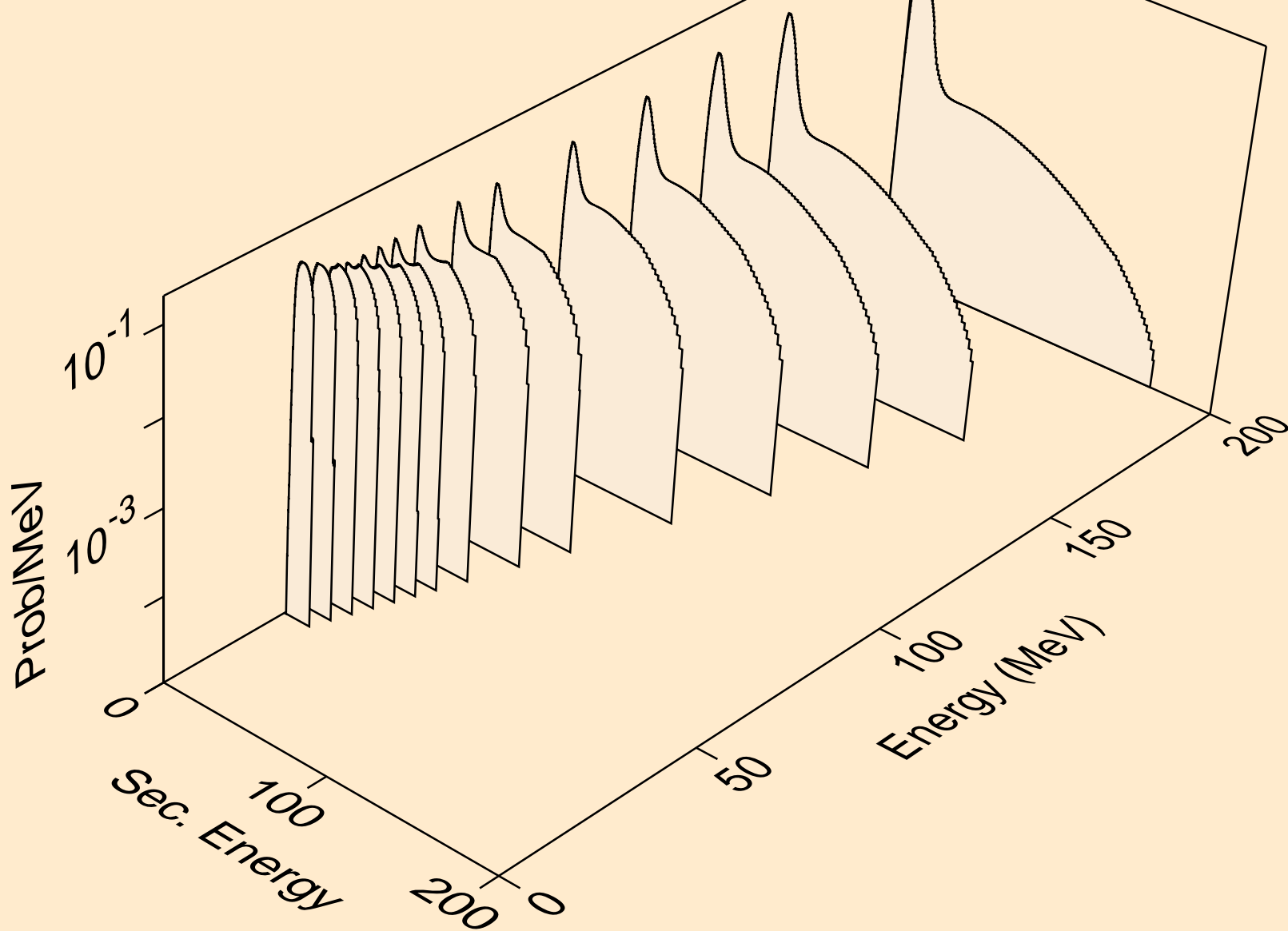

K045 NEUTRON ACER TENDL-2019 LIBRARY; T=293.16K
tritons from (n,n*)t

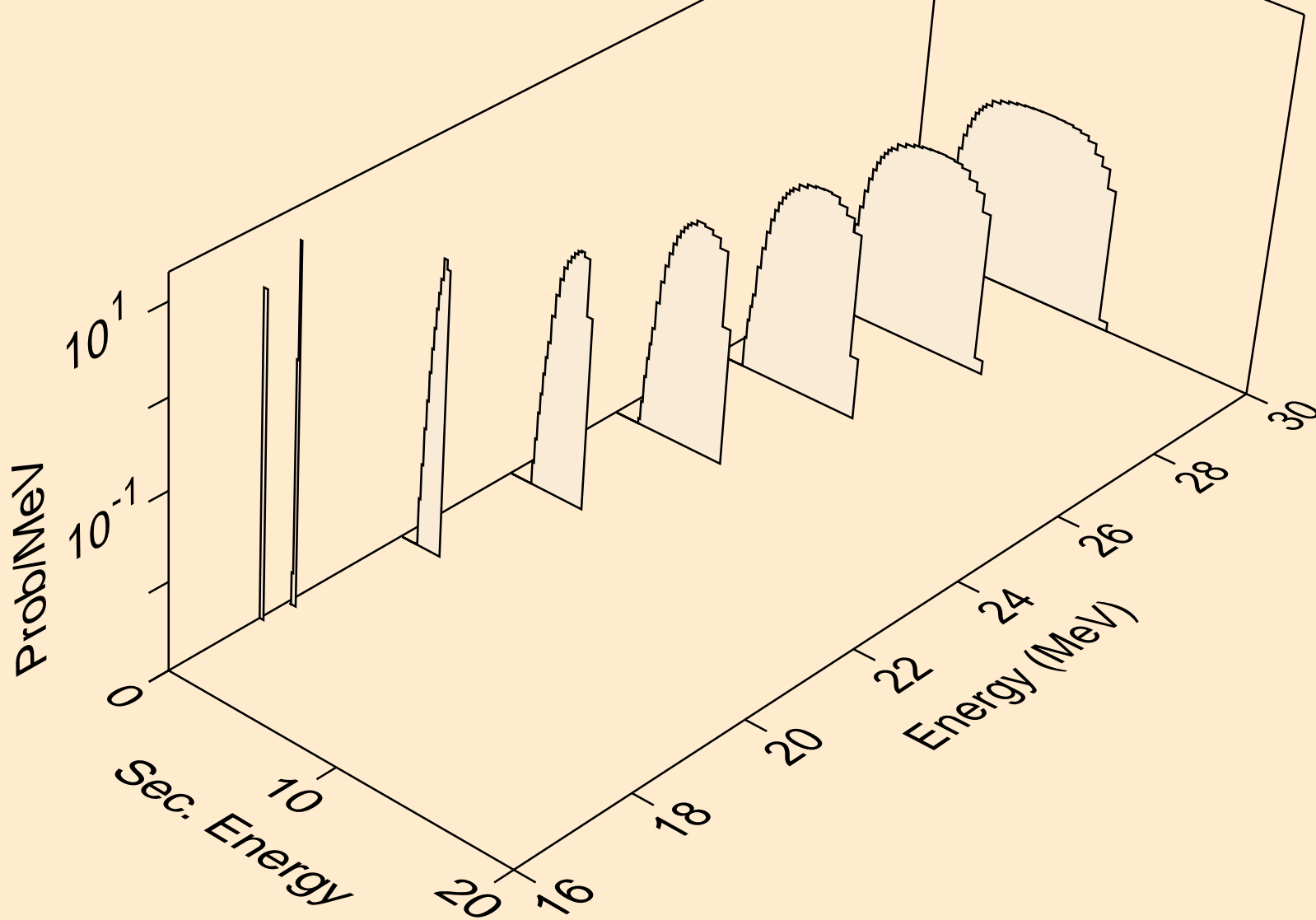

K045 NEUTRON ACER TENDL-2019 LIBRARY; T=293.16K
tritons from (n,t)

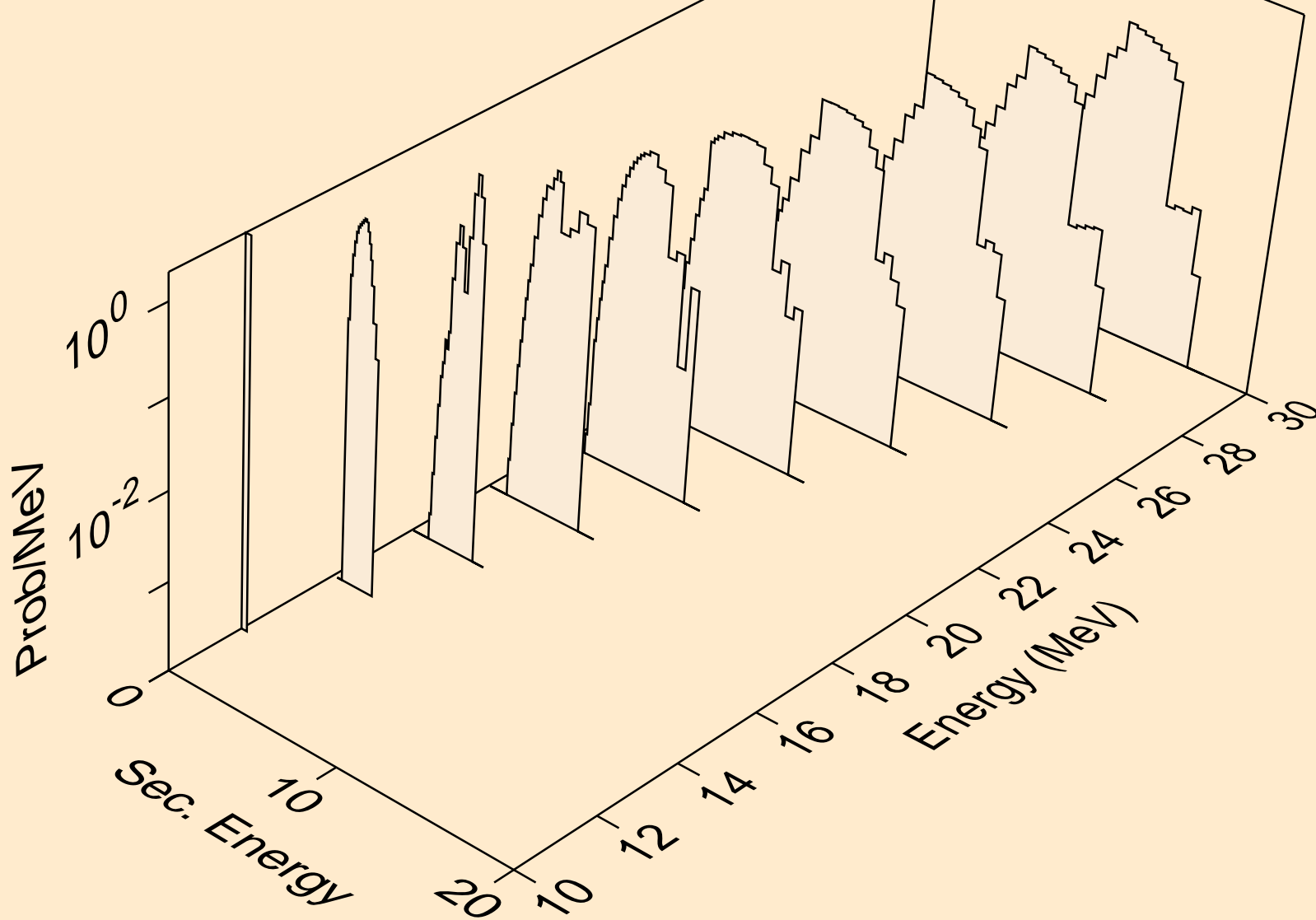

K045 NEUTRON ACER TENDL-2019 LIBRARY; T=293.16K
he3s from (n,x)

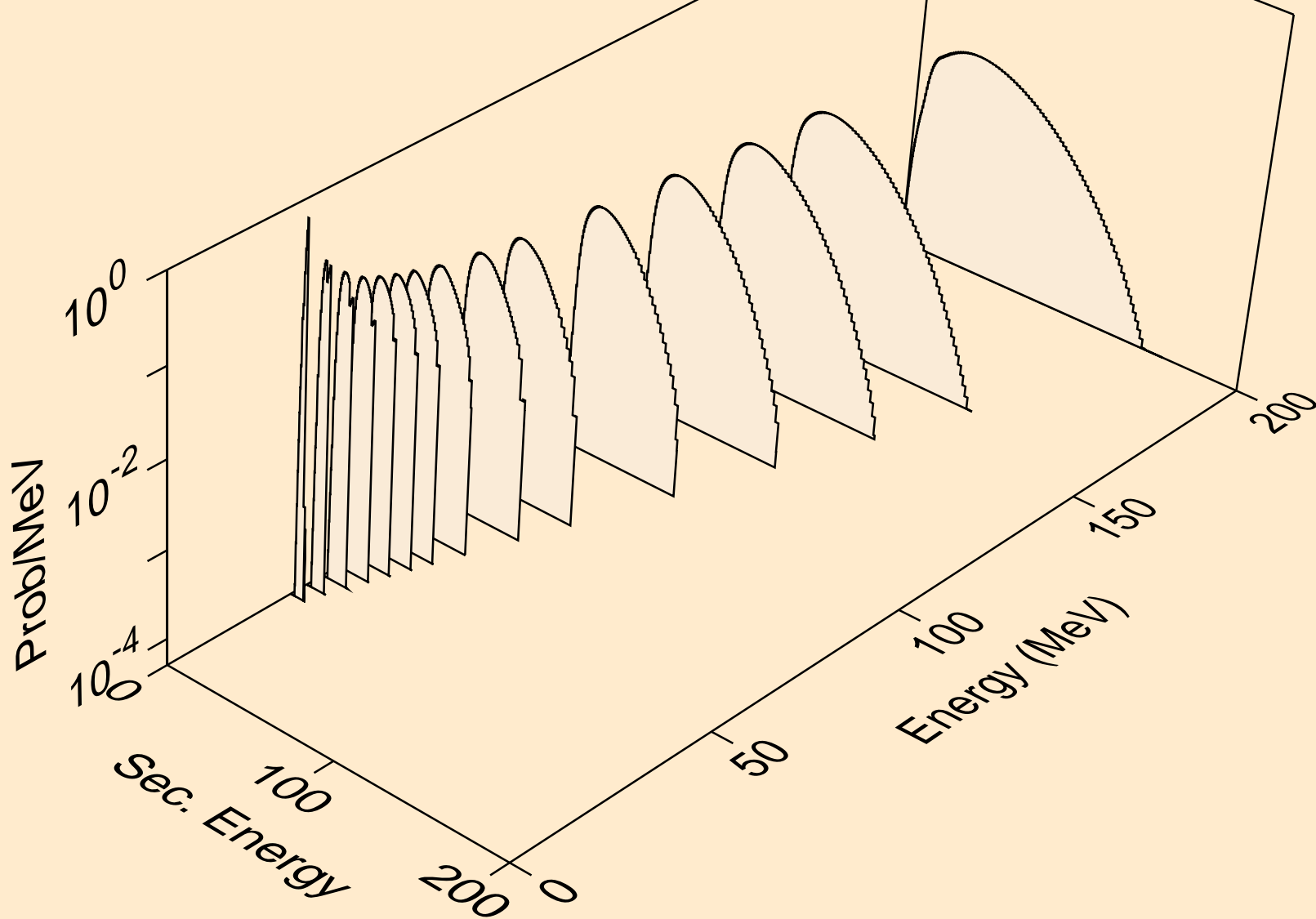

K045 NEUTRON ACER TENDL-2019 LIBRARY; T=293.16K
he3s from (n,he3)

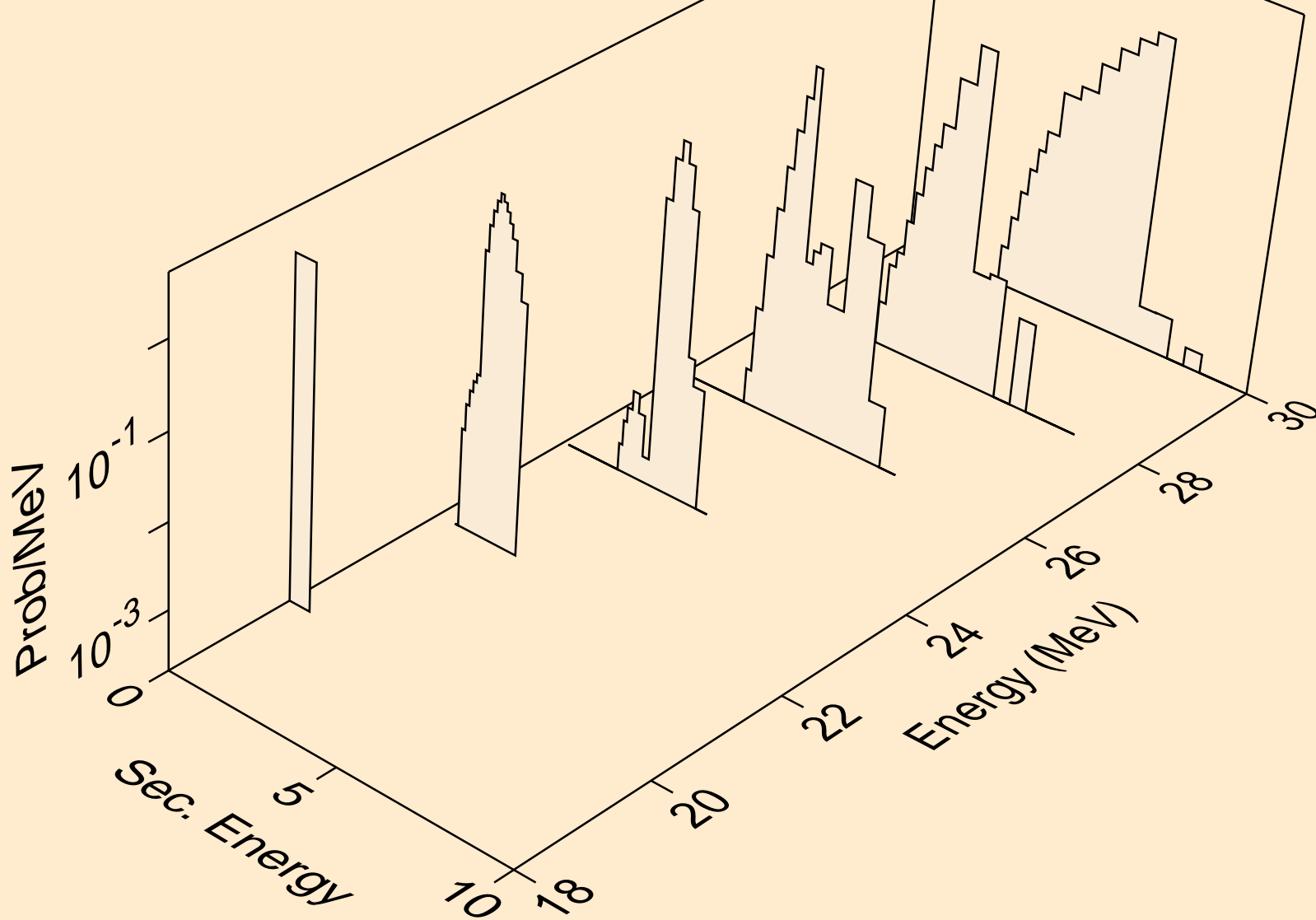

K045 NEUTRON ACER TENDL-2019 LIBRARY; T=293.16K
alphas from (n,x)

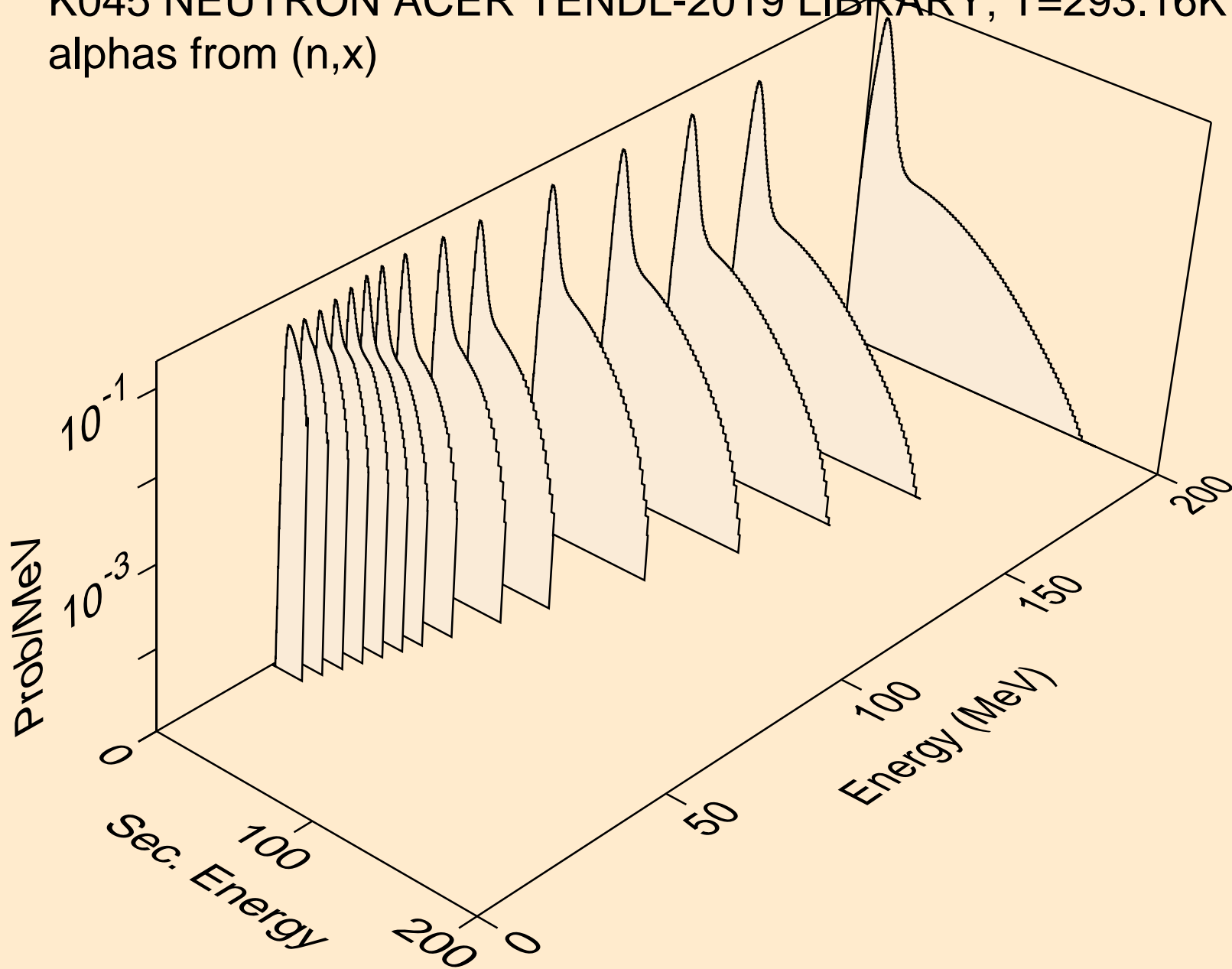

K045 NEUTRON ACER TENDL-2019 LIBRARY; T=293.16K
alphas from (n,n*)a

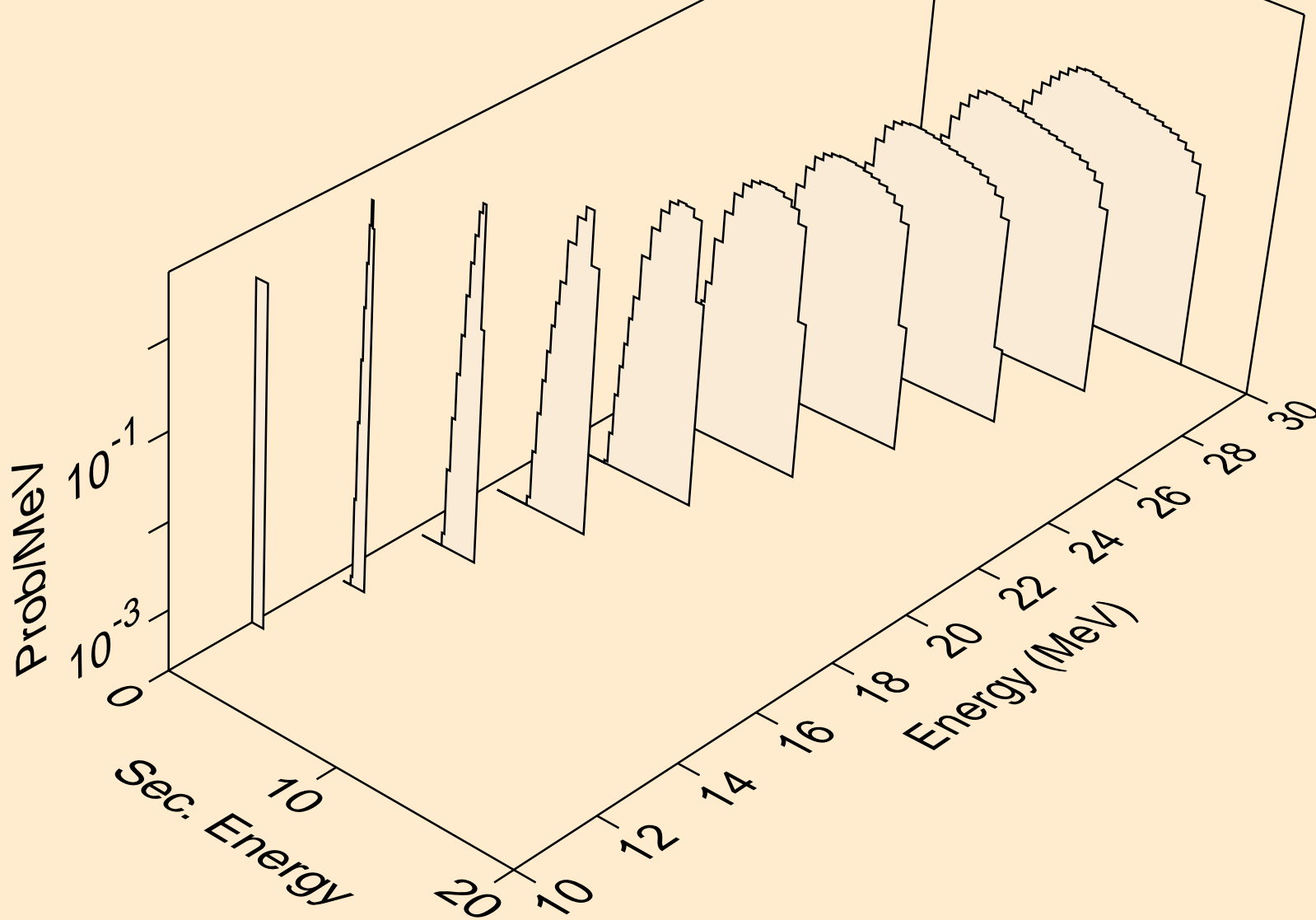

K045 NEUTRON ACER TENDL-2019 LIBRARY; T=293.16K
alphas from (n,2n)a

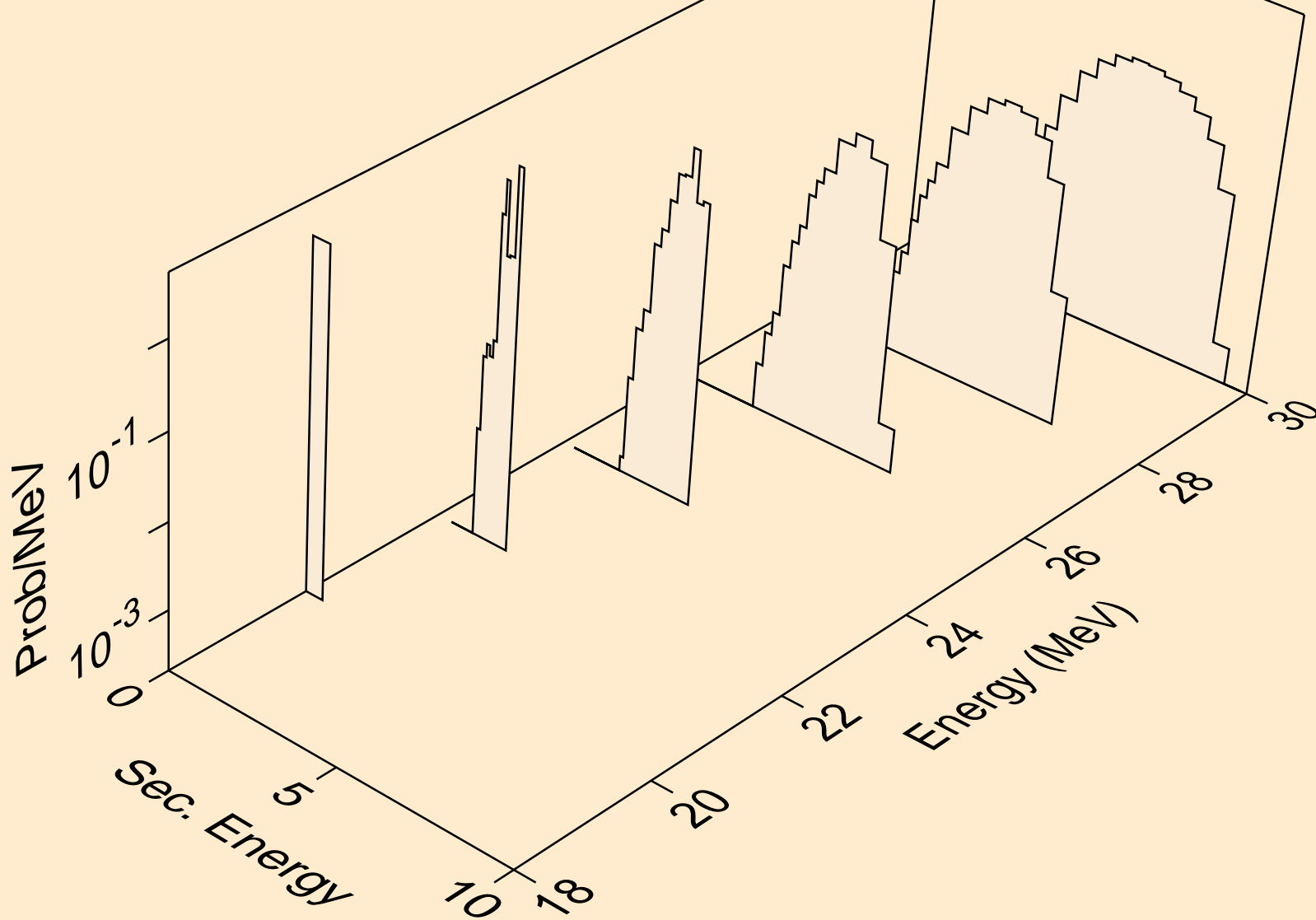

K045 NEUTRON ACER TENDL-2019 LIBRARY; T=293.16K
alphas from (n,3n)a

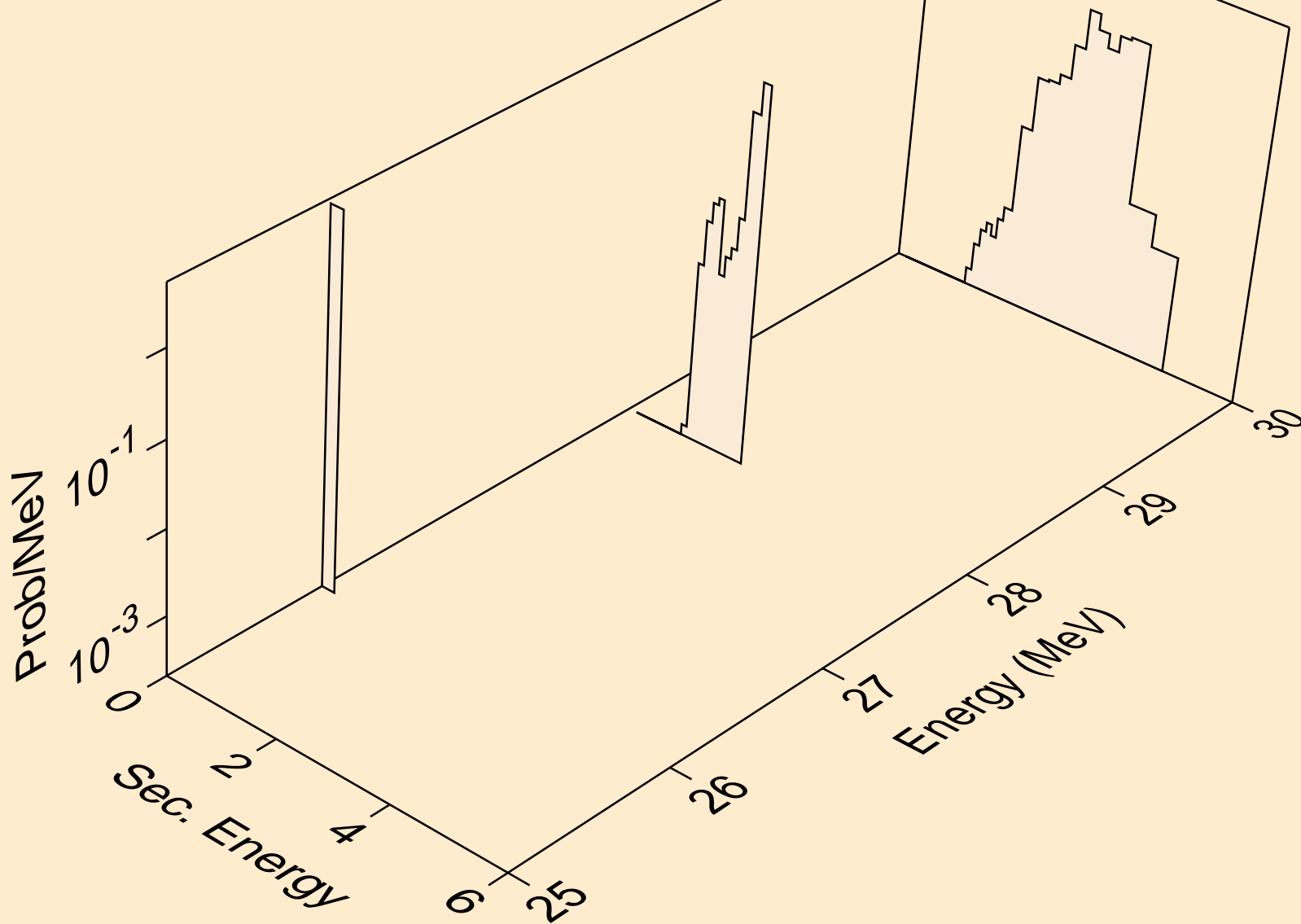

K045 NEUTRON ACER TENDL-2019 LIBRARY; T=293.16K
alphas from (n,a)

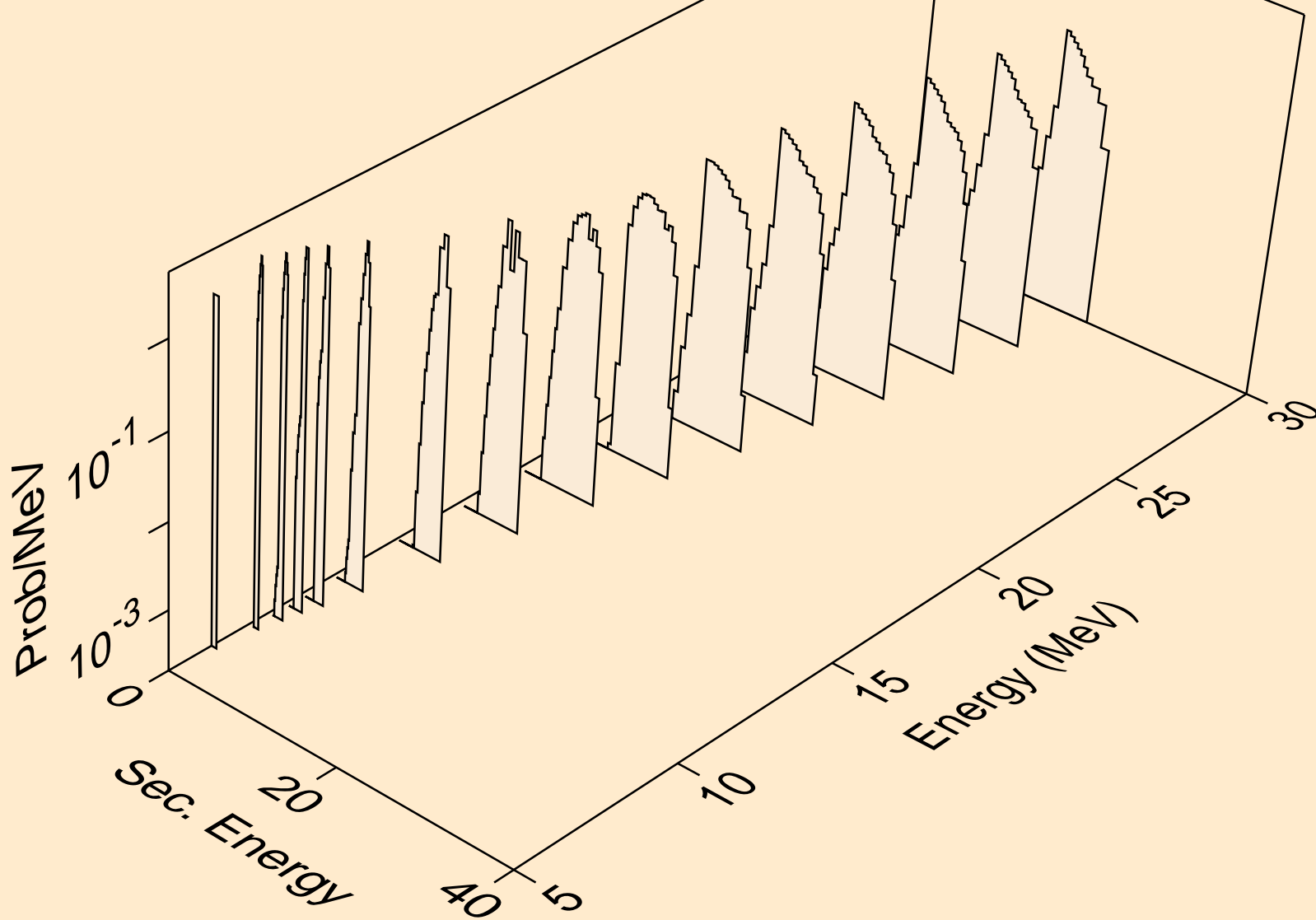

K045 NEUTRON ACER TENDL-2019 LIBRARY; T=293.16K
alphas from (n,2a)

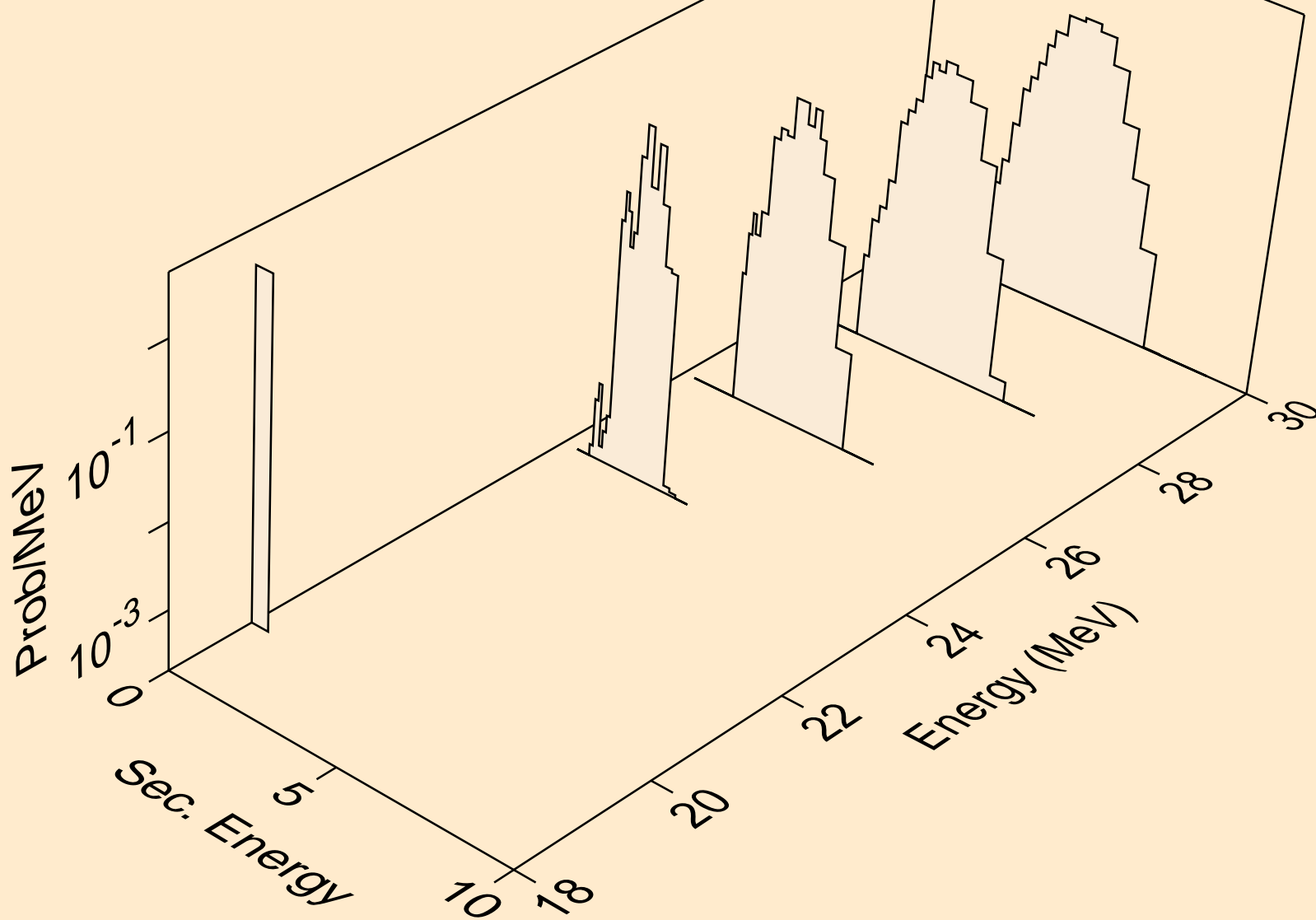

K045 NEUTRON ACER TENDL-2019 LIBRARY; T=293.16K
alphas from (n,pa)

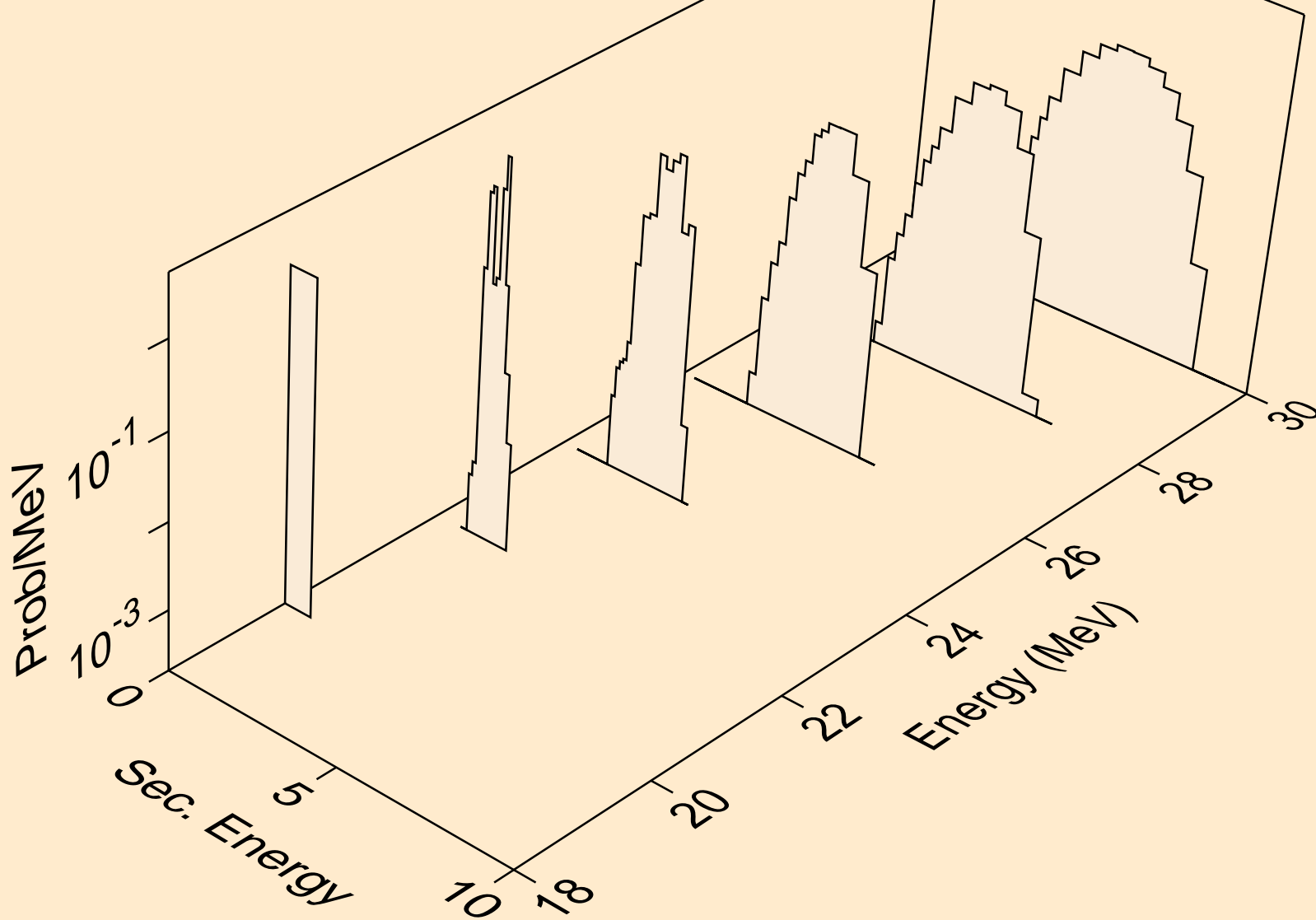

K045 NEUTRON ACER TENDL-2019 LIBRARY; T=293.16K
alphas from (n,da)

