

# K047 NEUTRON ACER TENDL-2019 LIBRARY; T=293.16K

## Principal cross sections

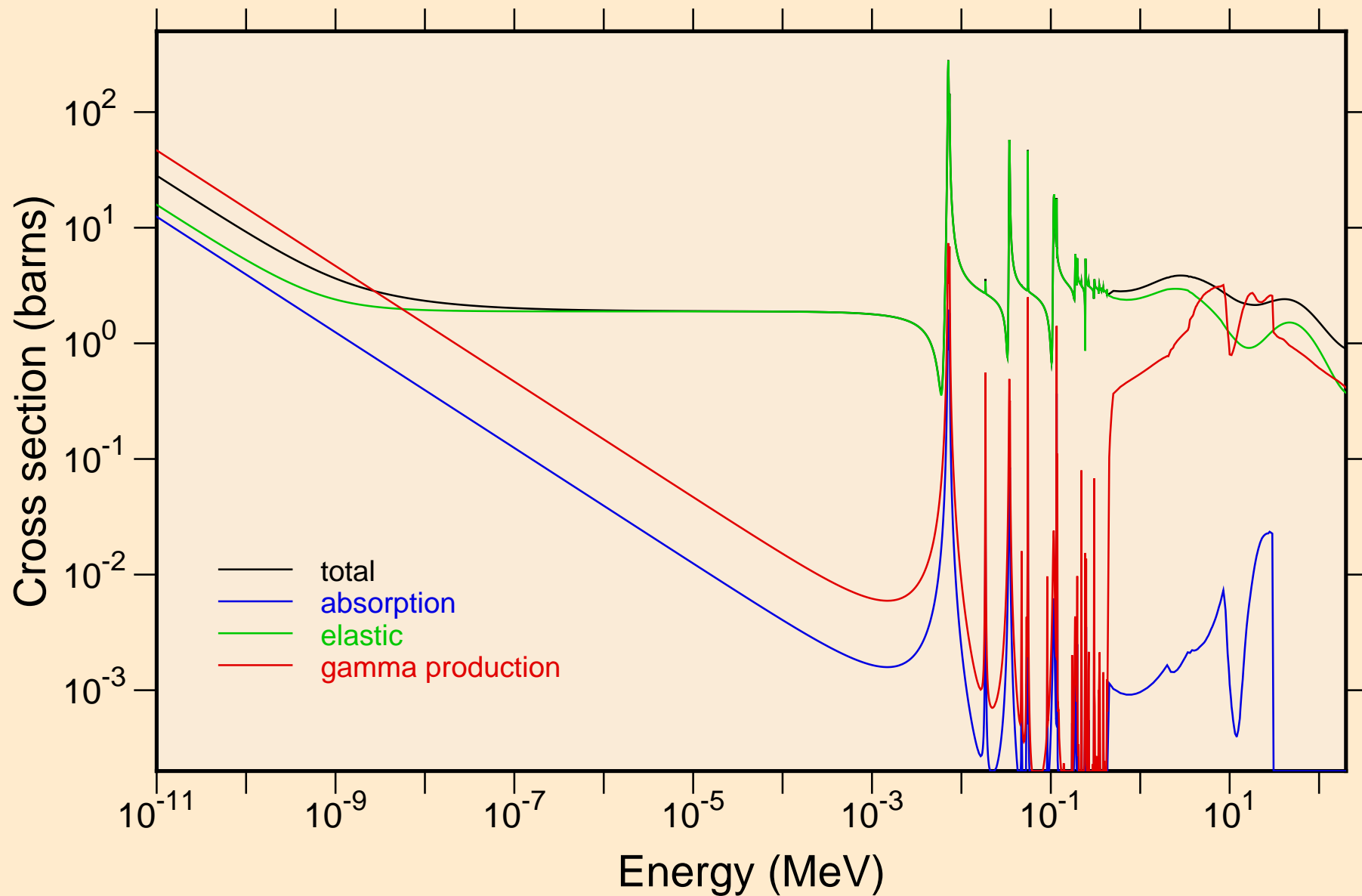

K047 NEUTRON ACER TENDL-2019 LIBRARY; T=293.16K  
resonance total cross section

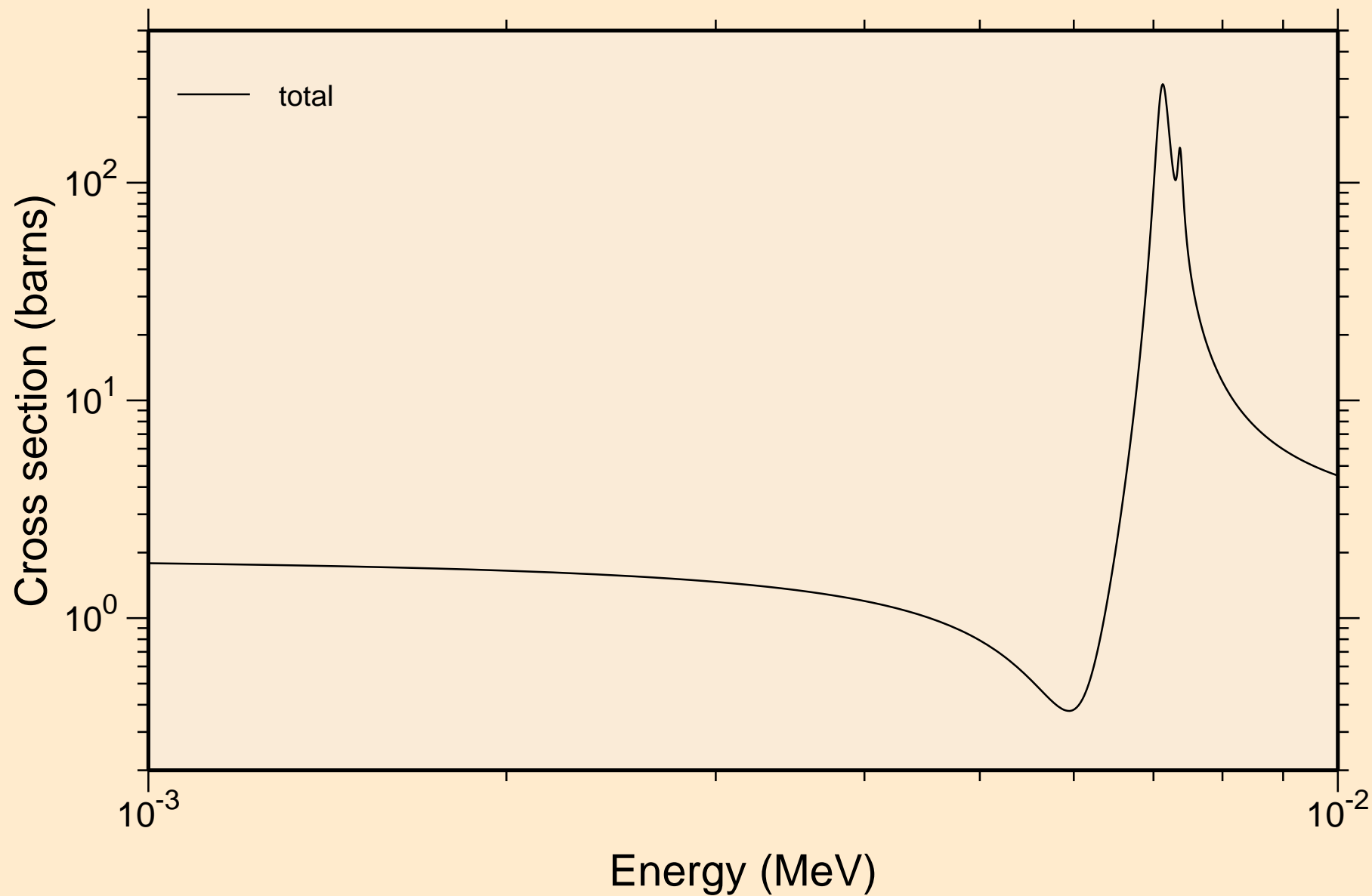

K047 NEUTRON ACER TENDL-2019 LIBRARY; T=293.16K  
resonance total cross section

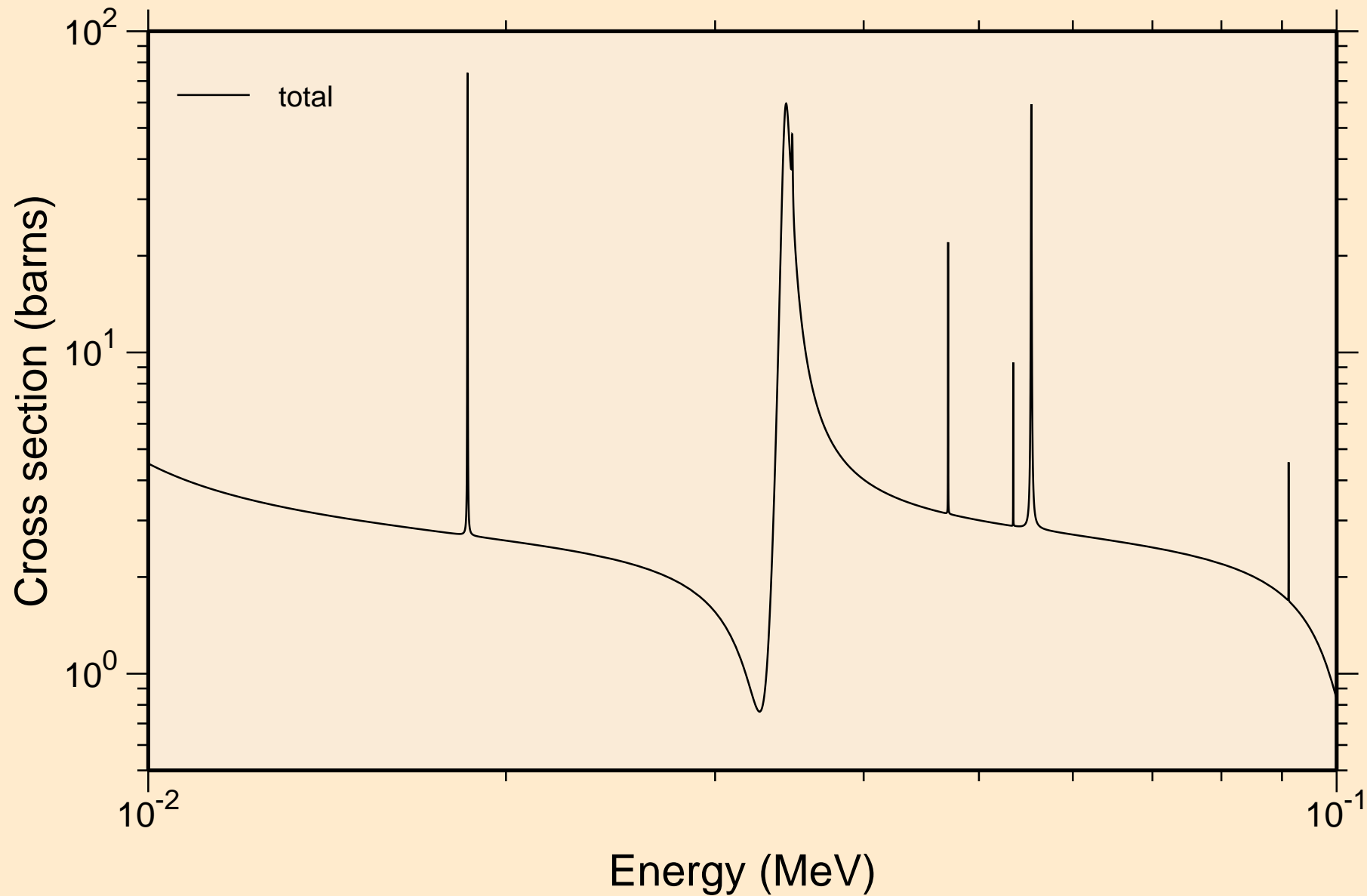

K047 NEUTRON ACER TENDL-2019 LIBRARY; T=293.16K  
resonance total cross section

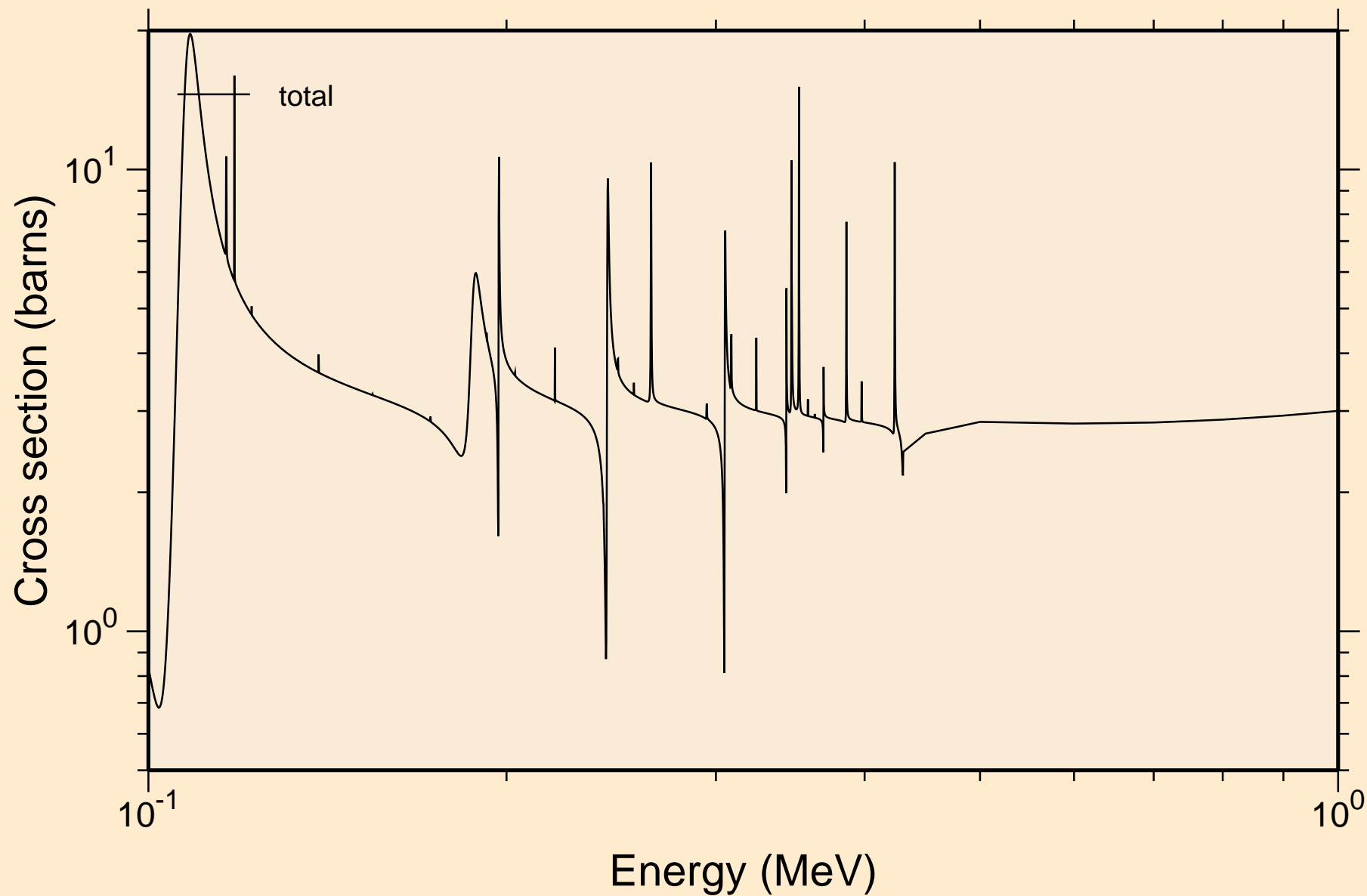

K047 NEUTRON ACER TENDL-2019 LIBRARY; T=293.16K  
resonance total cross section

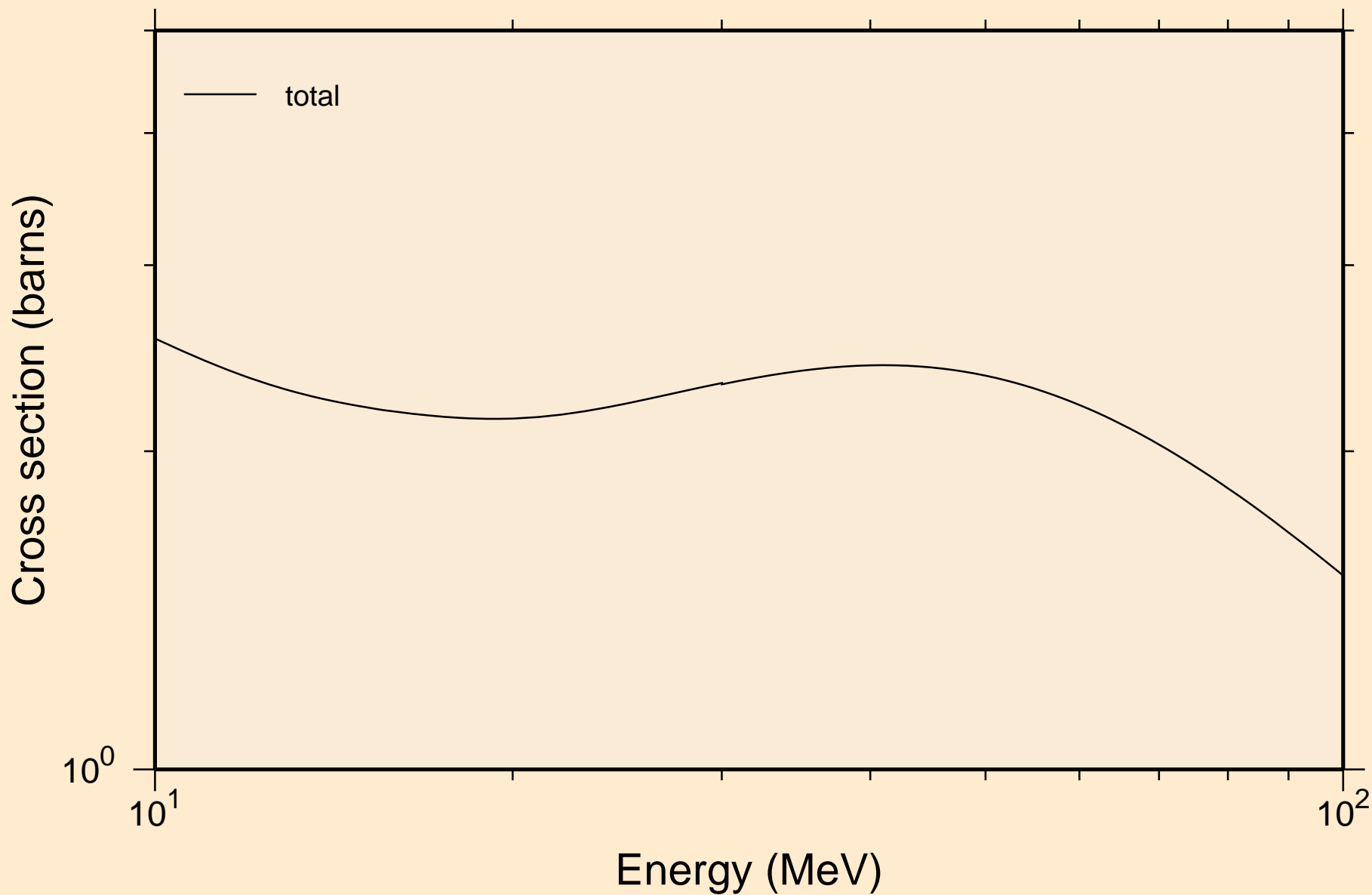

K047 NEUTRON ACER TENDL-2019 LIBRARY; T=293.16K  
resonance absorption cross sections

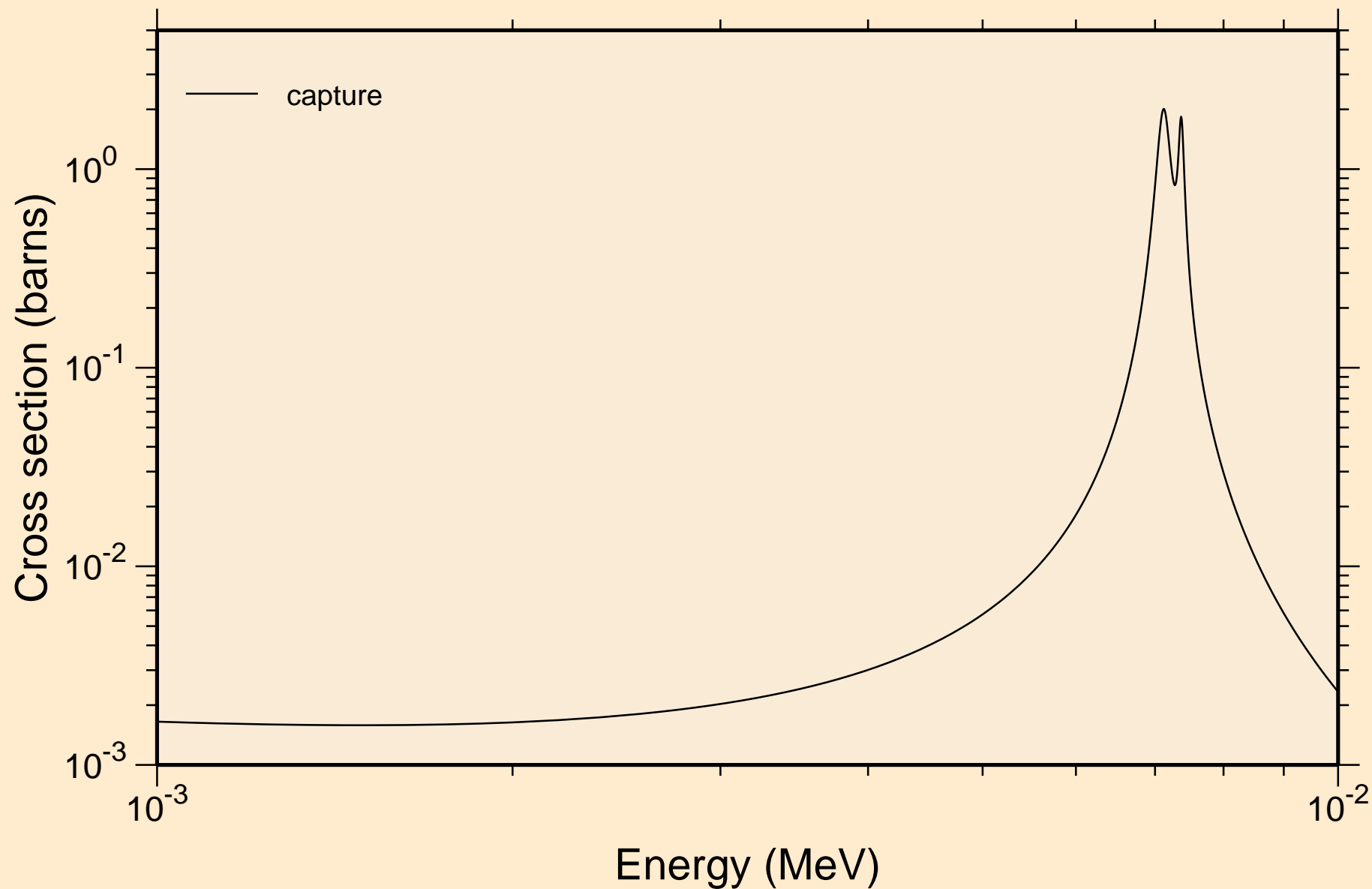

K047 NEUTRON ACER TENDL-2019 LIBRARY; T=293.16K  
resonance absorption cross sections

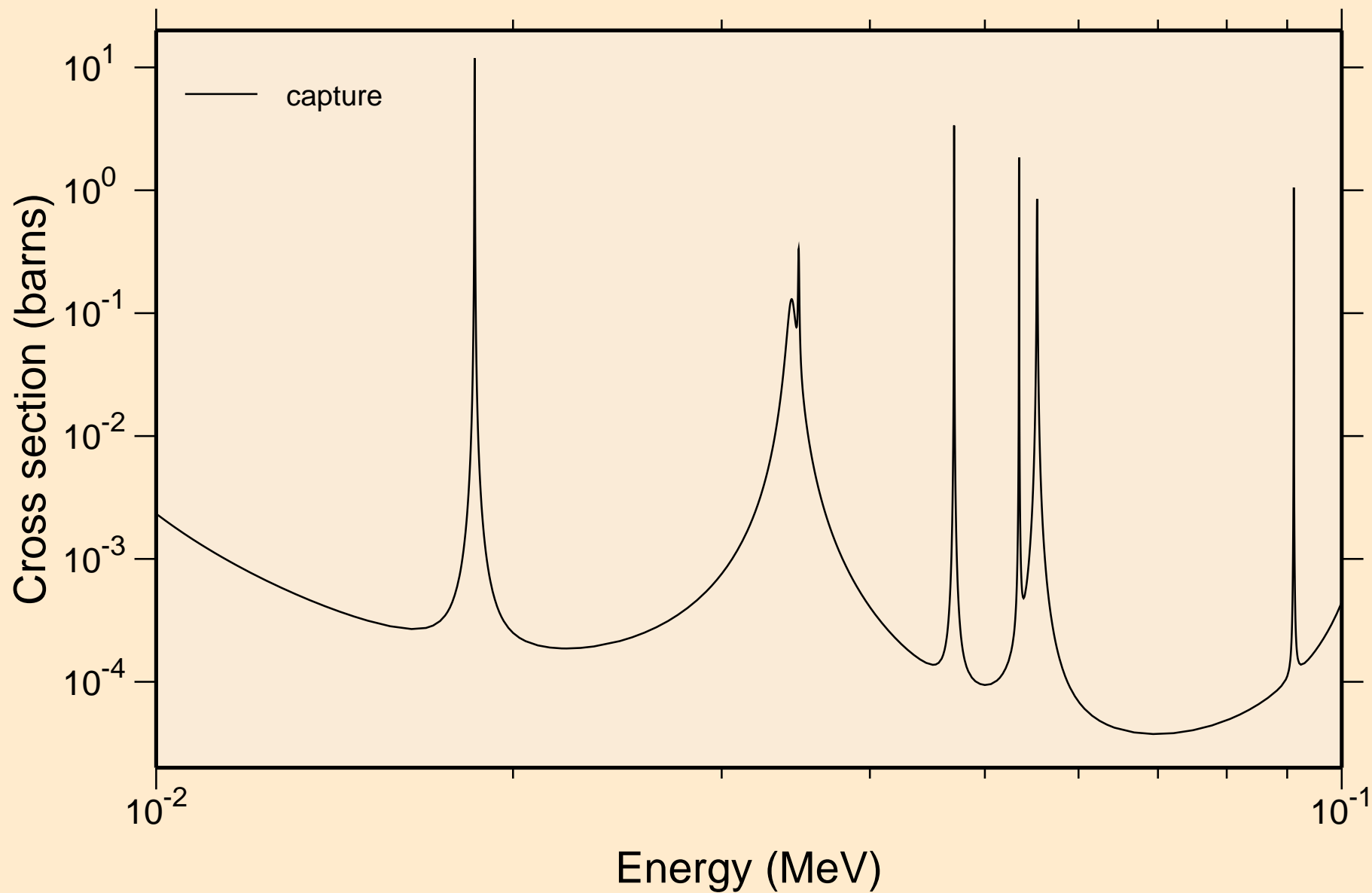

K047 NEUTRON ACER TENDL-2019 LIBRARY; T=293.16K  
resonance absorption cross sections

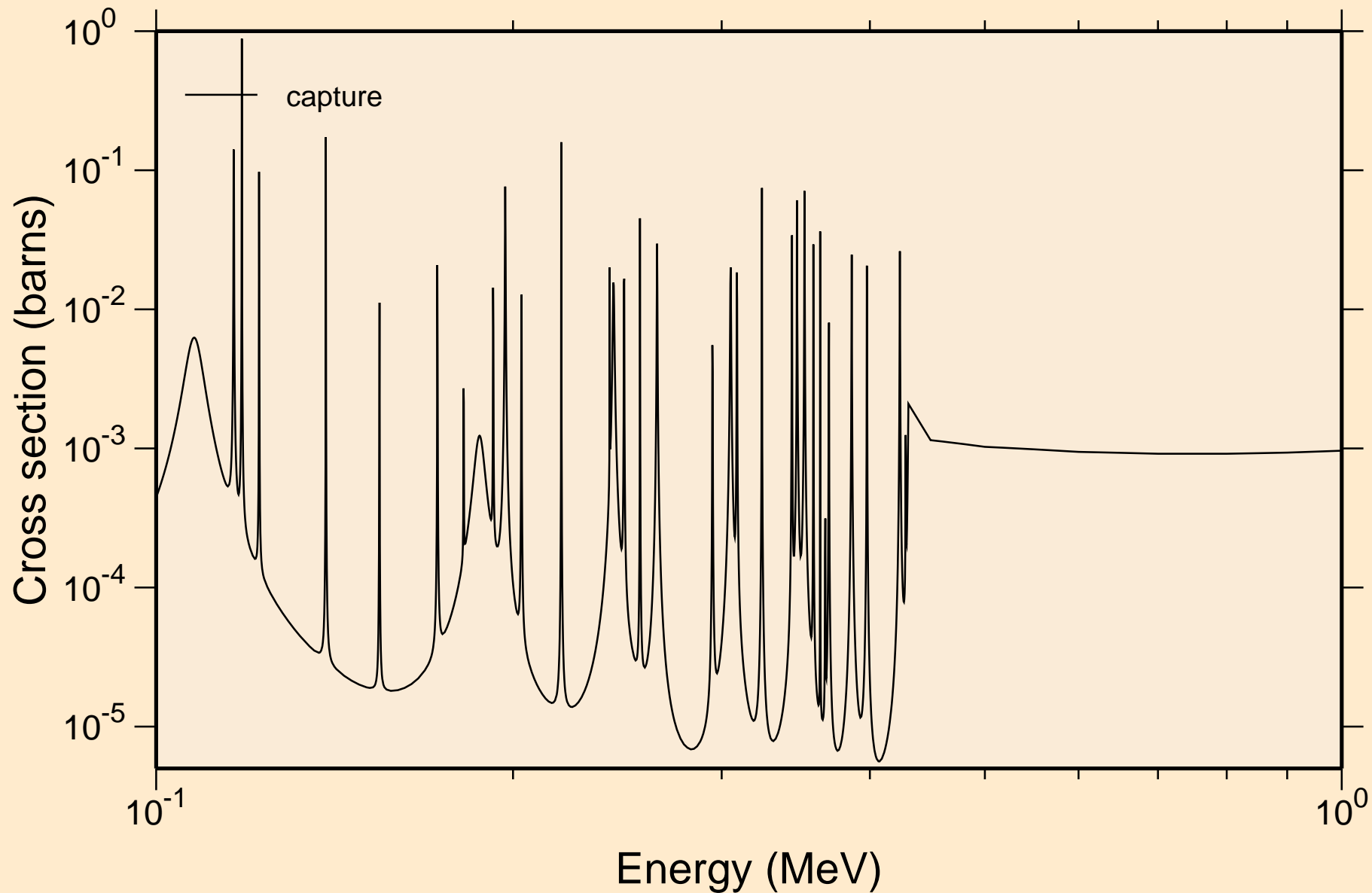



K047 NEUTRON ACER TENDL-2019 LIBRARY; T=293.16K  
resonance absorption cross sections

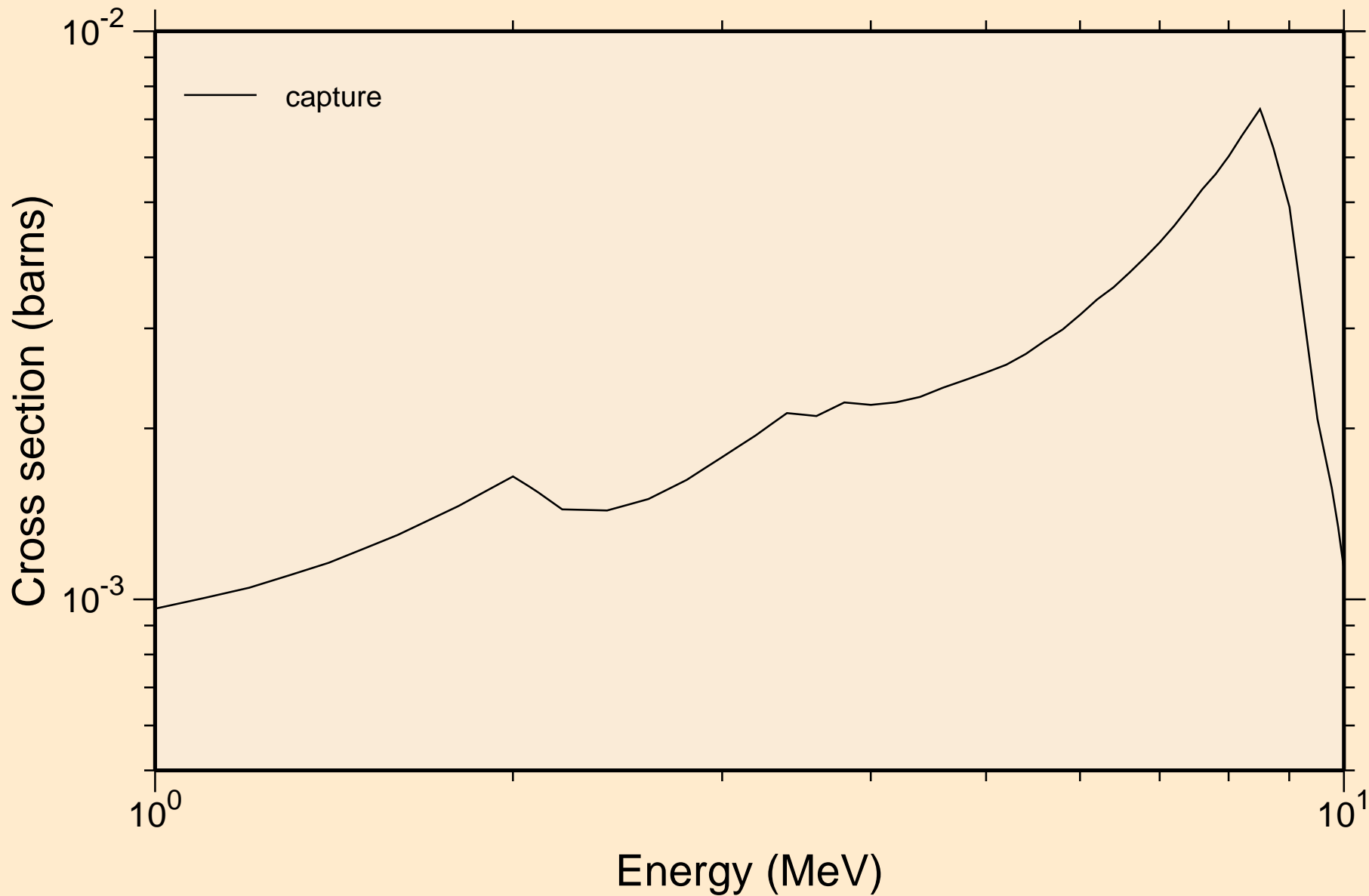

K047 NEUTRON ACER TENDL-2019 LIBRARY; T=293.16K  
Heating

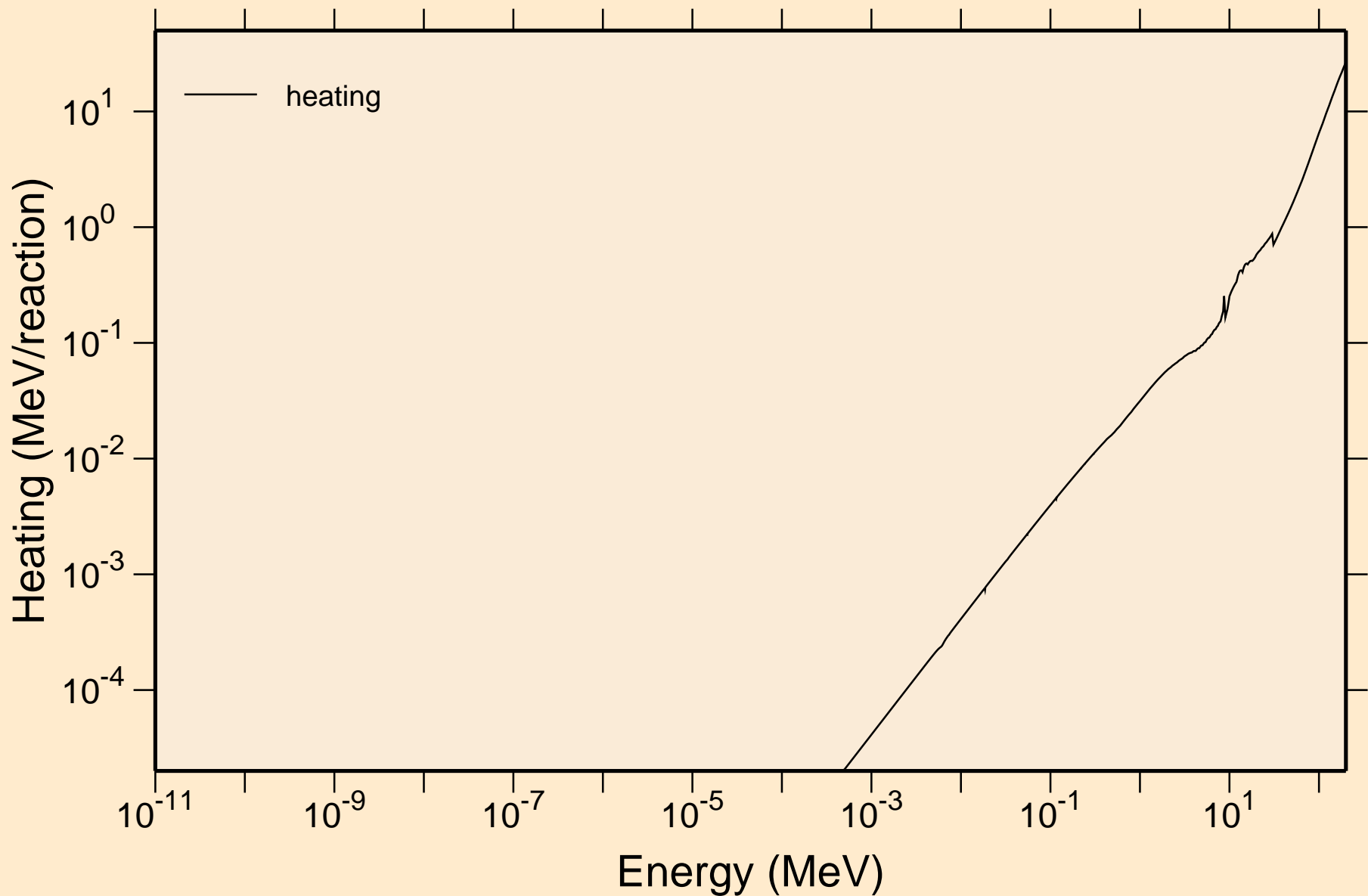

K047 NEUTRON ACER TENDL-2019 LIBRARY; T=293.16K  
Damage

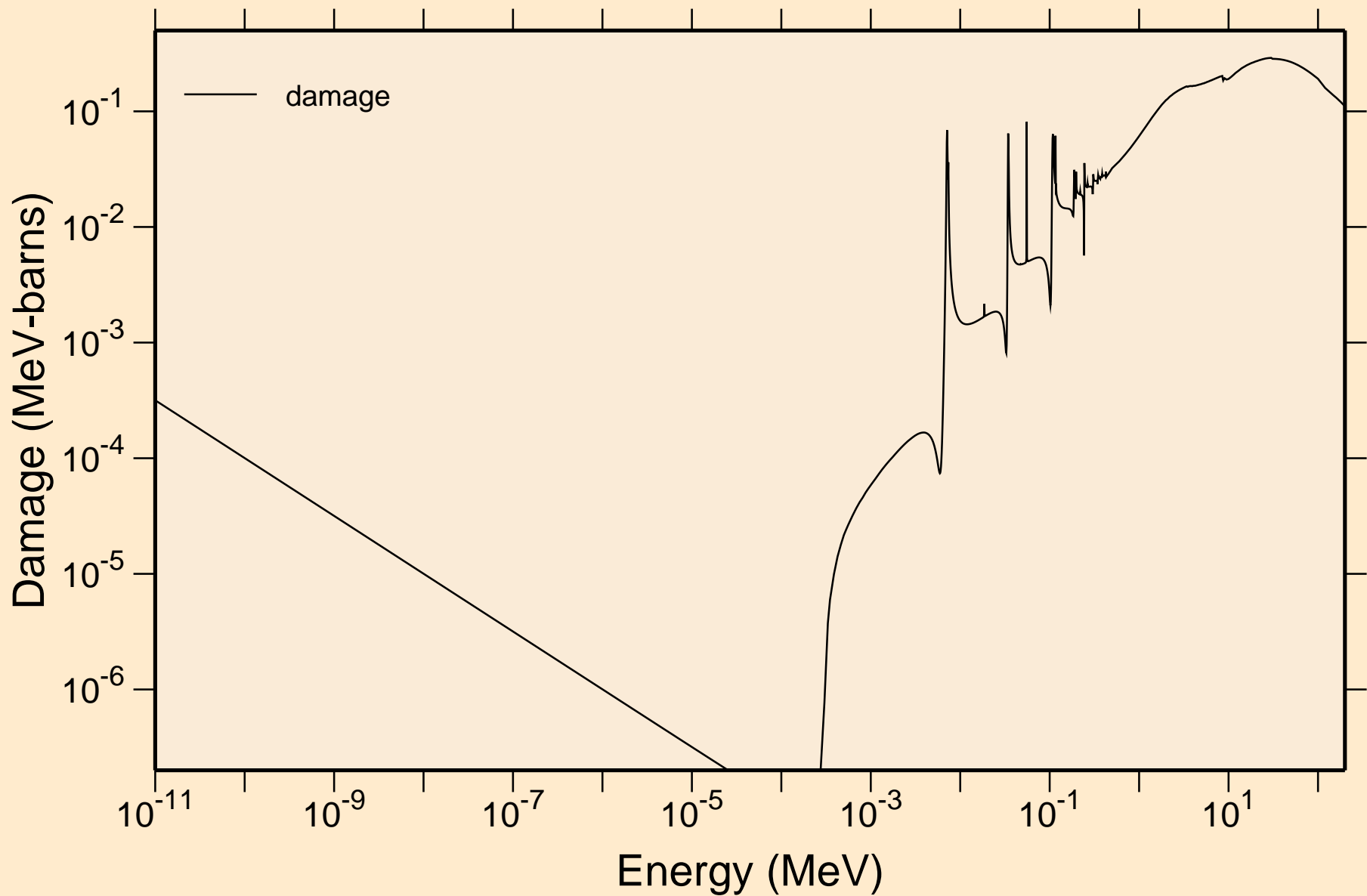

K047 NEUTRON ACER TENDL-2019 LIBRARY; T=293.16K  
Non-threshold reactions

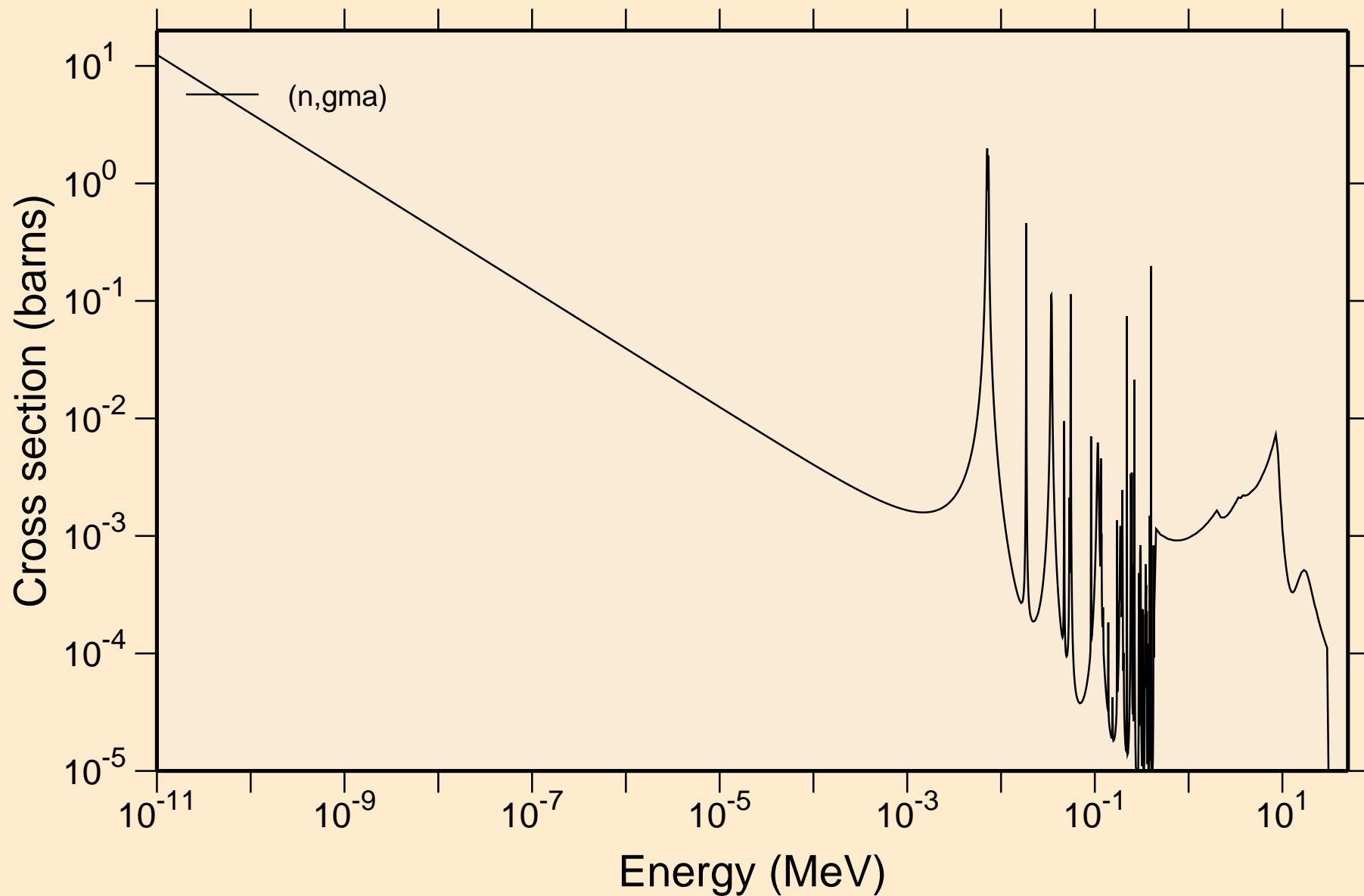

# K047 NEUTRON ACER TENDL-2019 LIBRARY; T=293.16K

## Principal cross sections

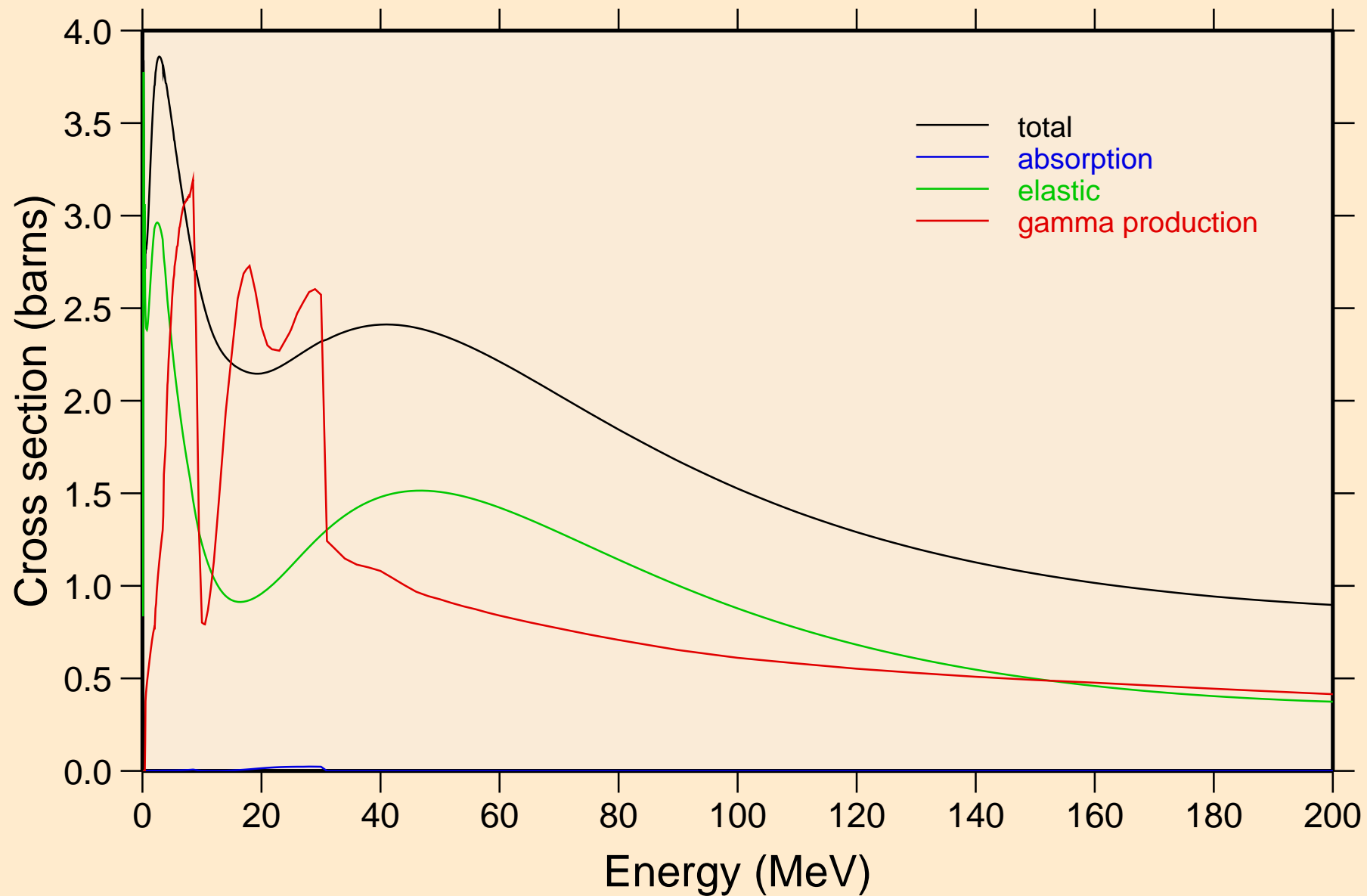

K047 NEUTRON ACER TENDL-2019 LIBRARY; T=293.16K  
Heating

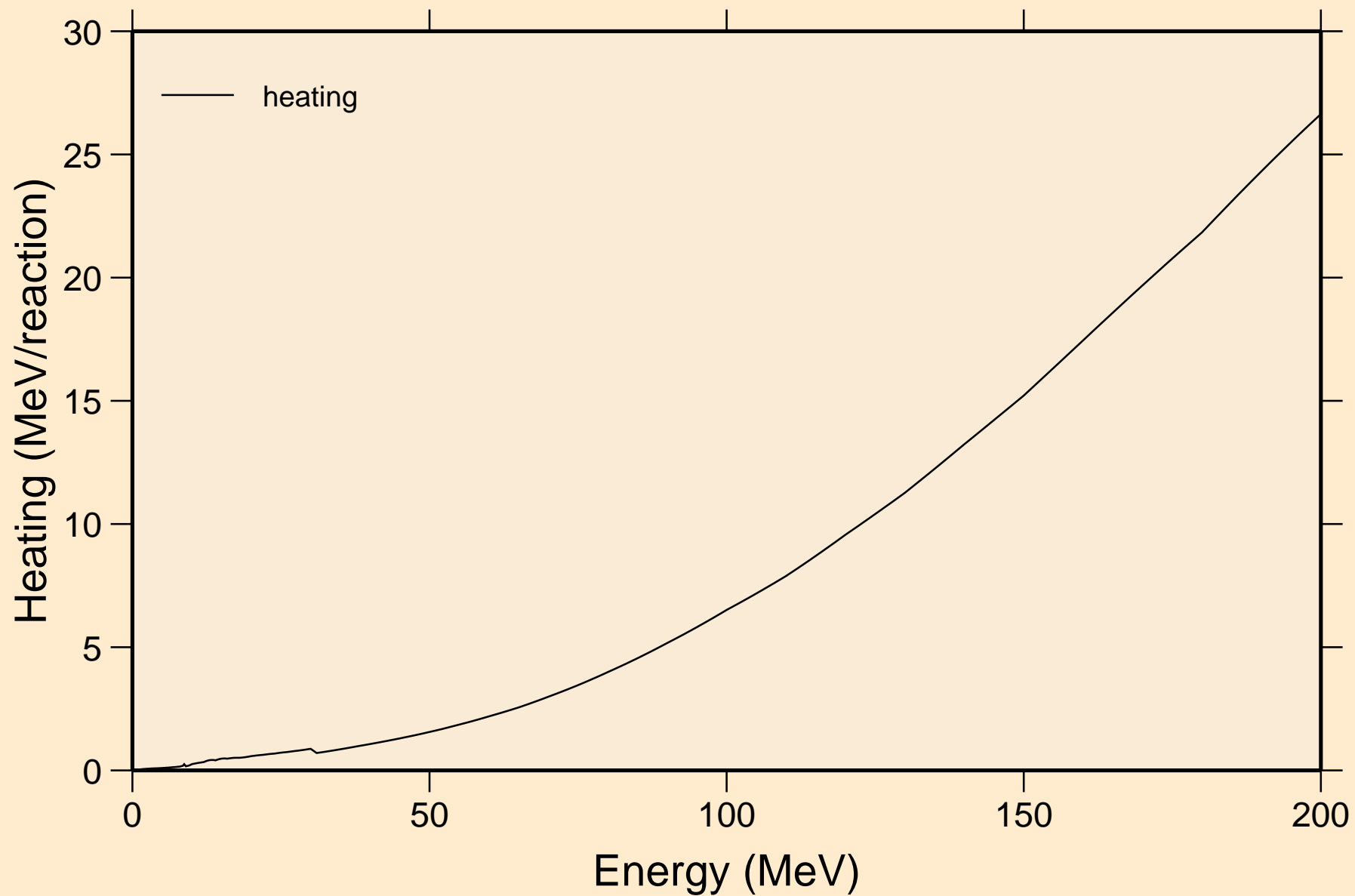

K047 NEUTRON ACER TENDL-2019 LIBRARY; T=293.16K  
Damage

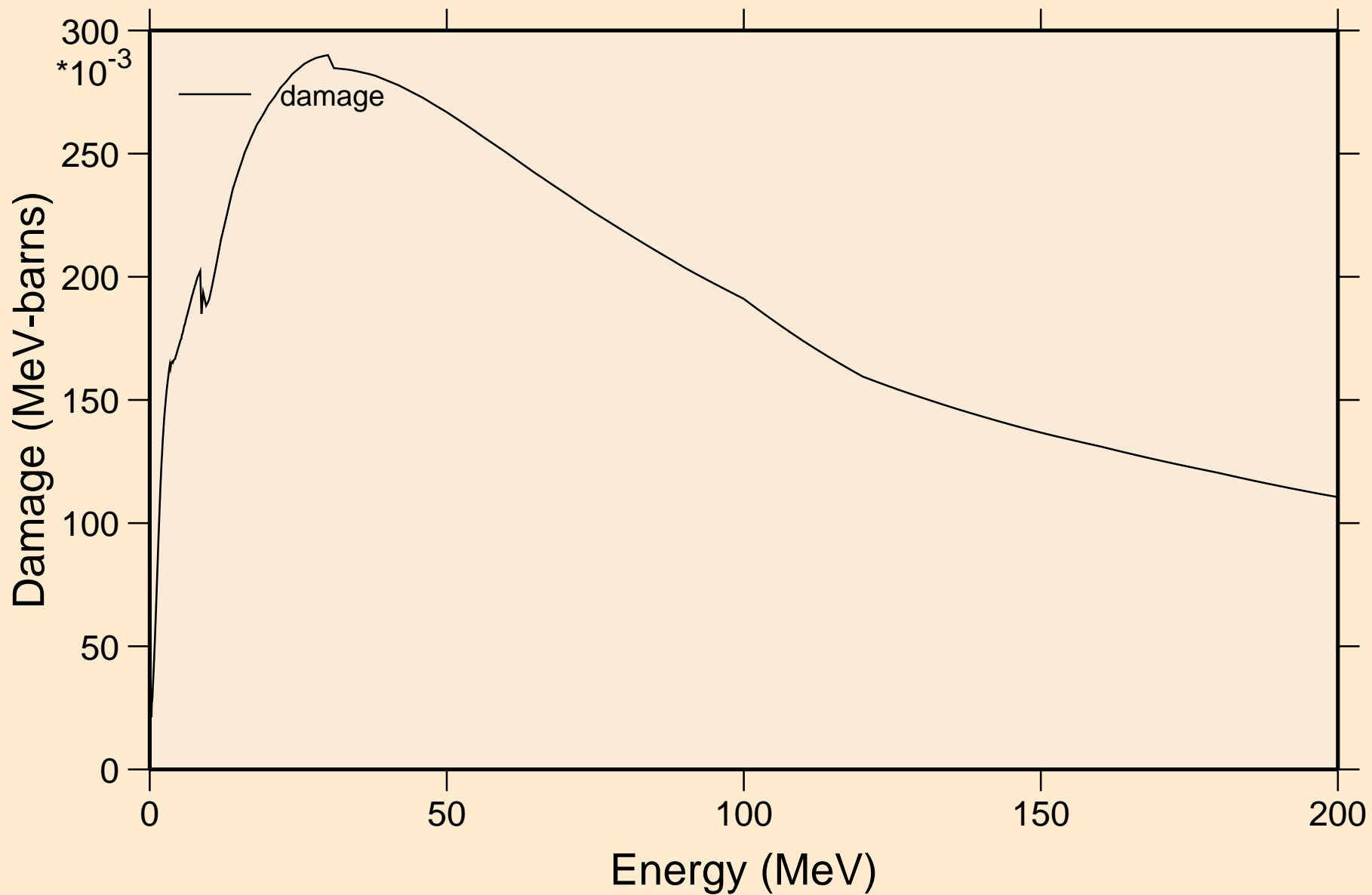

K047 NEUTRON ACER TENDL-2019 LIBRARY; T=293.16K  
Non-threshold reactions

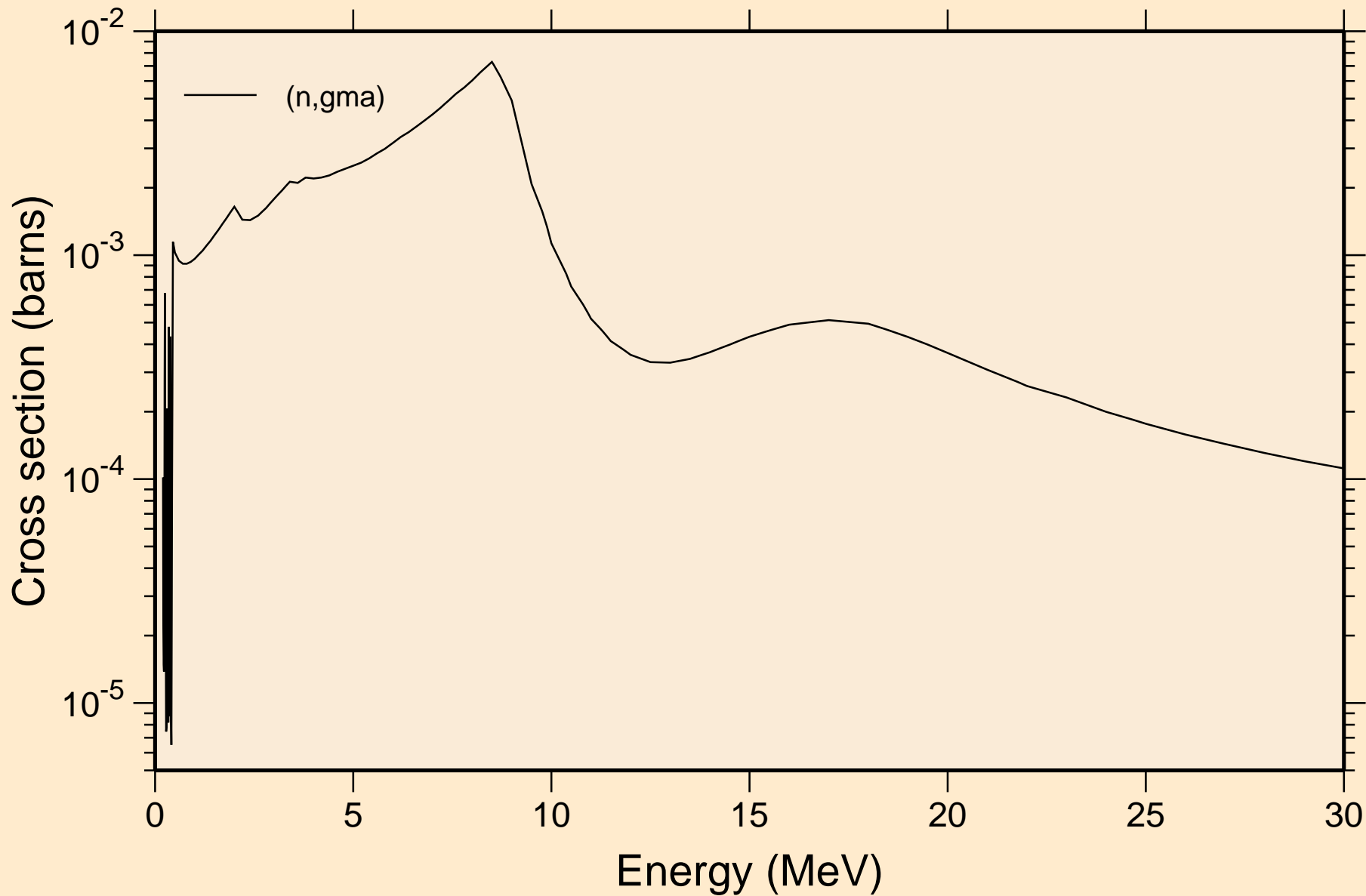



K047 NEUTRON ACER TENDL-2019 LIBRARY; T=293.16K  
Inelastic levels

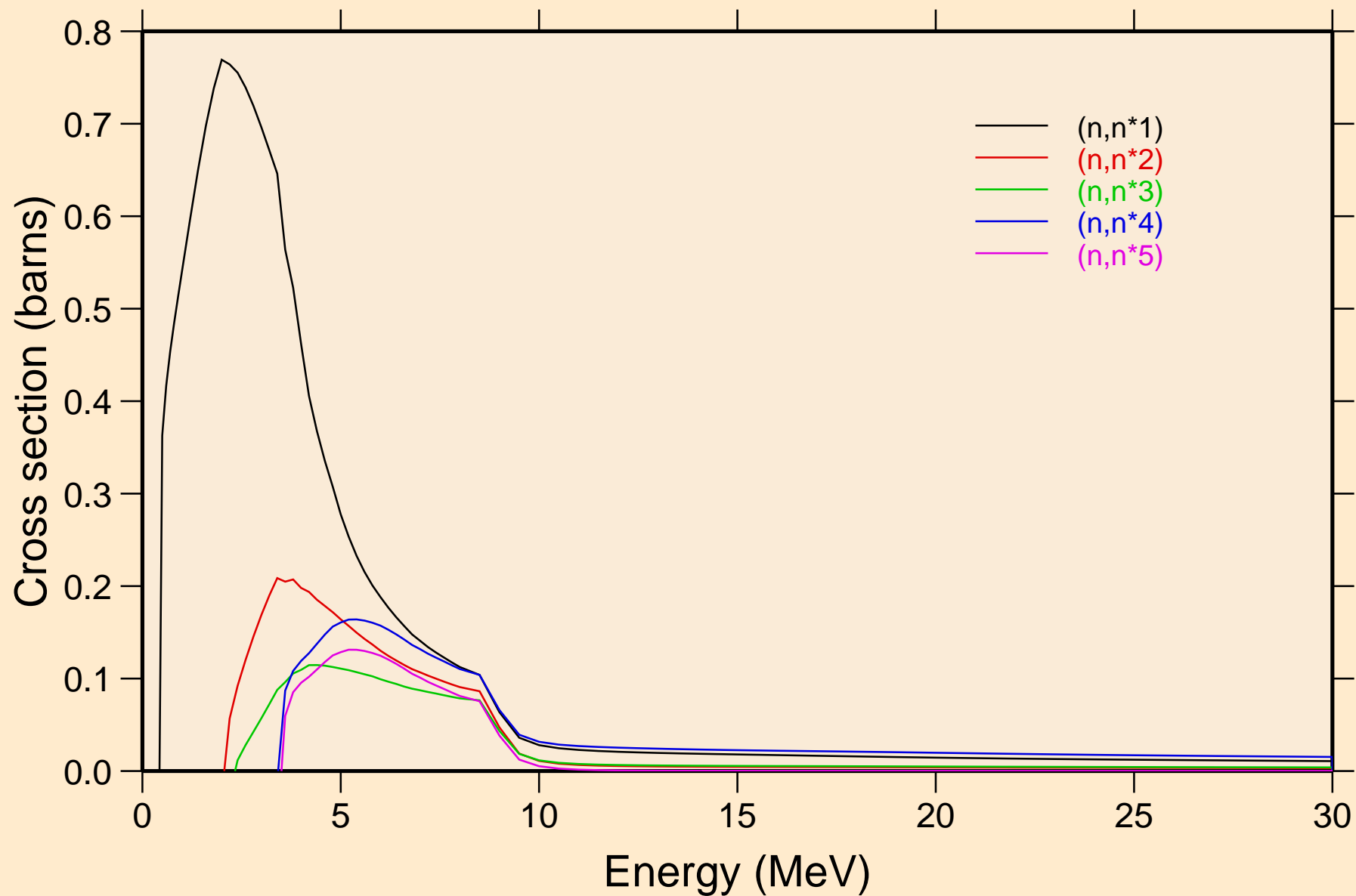

K047 NEUTRON ACER TENDL-2019 LIBRARY; T=293.16K  
Inelastic levels

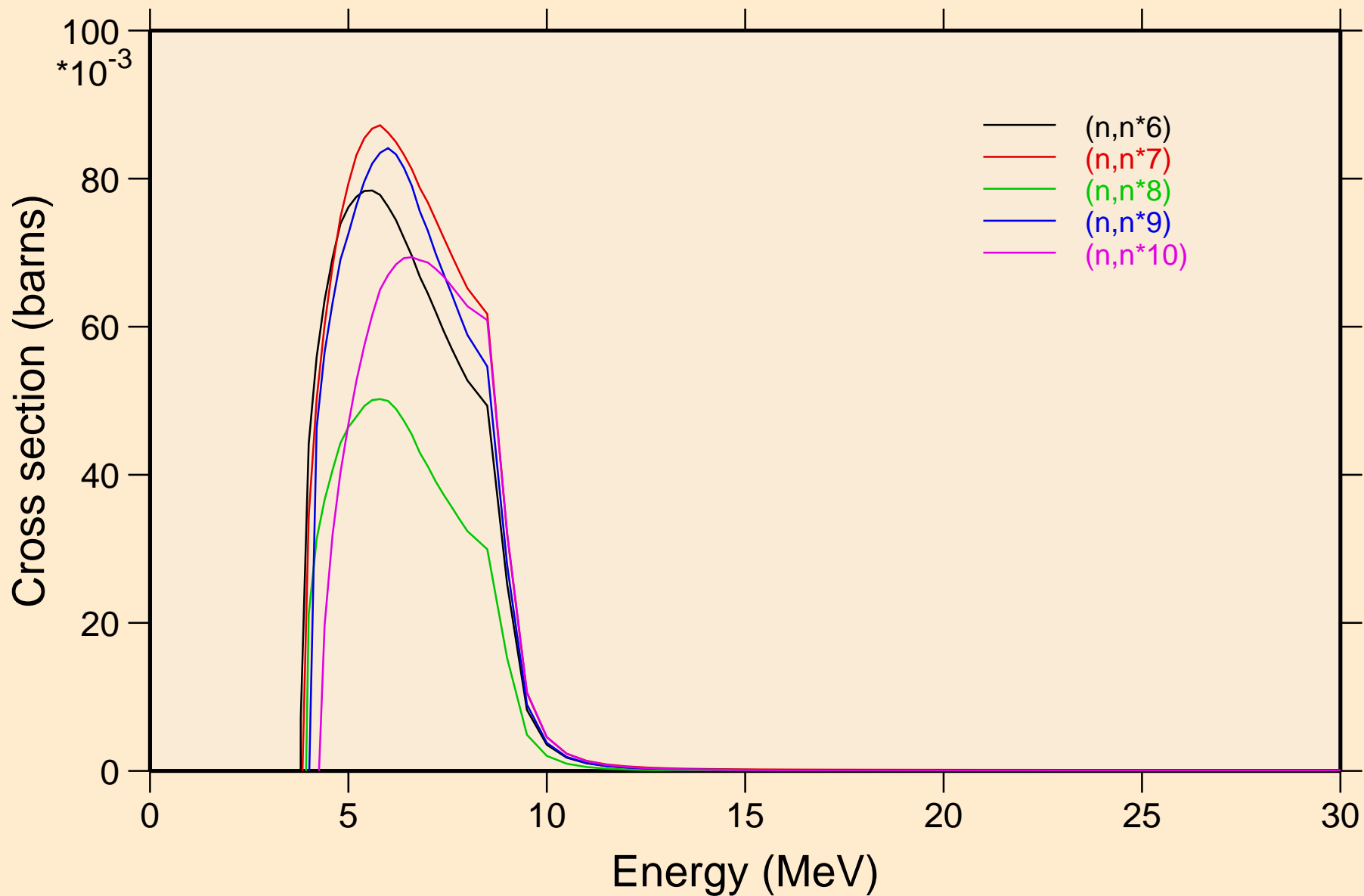

K047 NEUTRON ACER TENDL-2019 LIBRARY; T=293.16K  
Inelastic levels

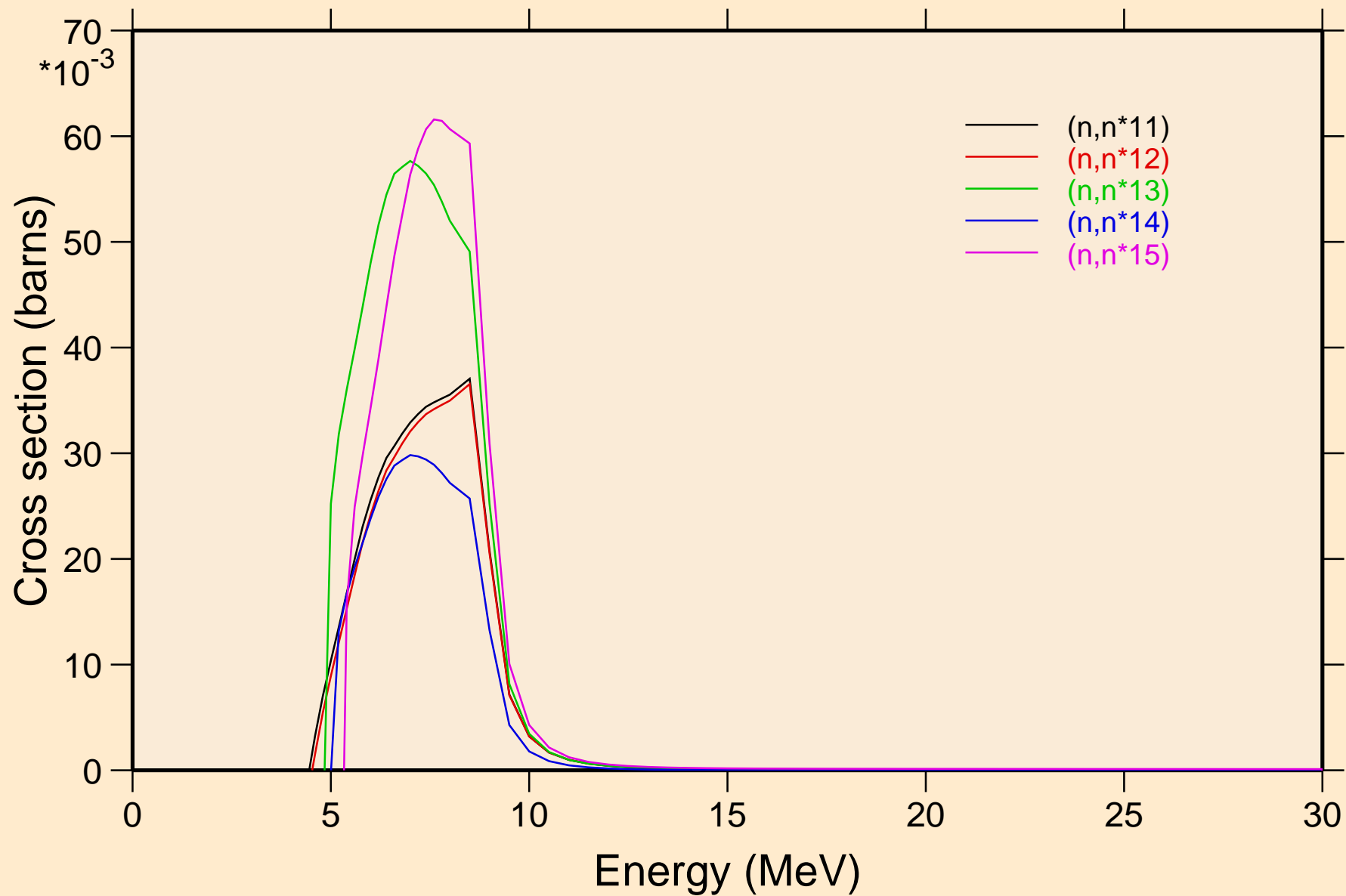

K047 NEUTRON ACER TENDL-2019 LIBRARY; T=293.16K  
Inelastic levels

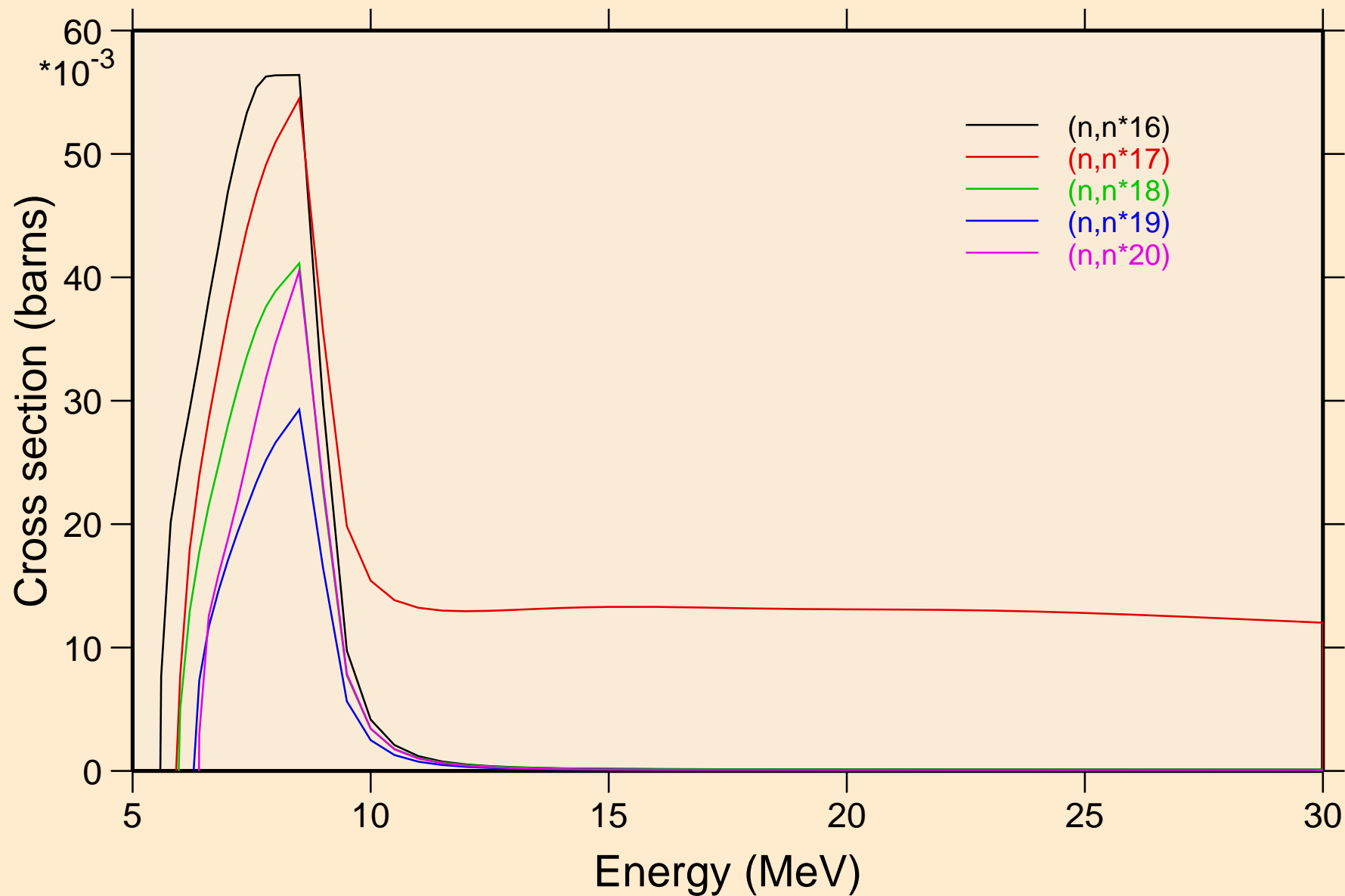

K047 NEUTRON ACER TENDL-2019 LIBRARY; T=293.16K  
Inelastic levels

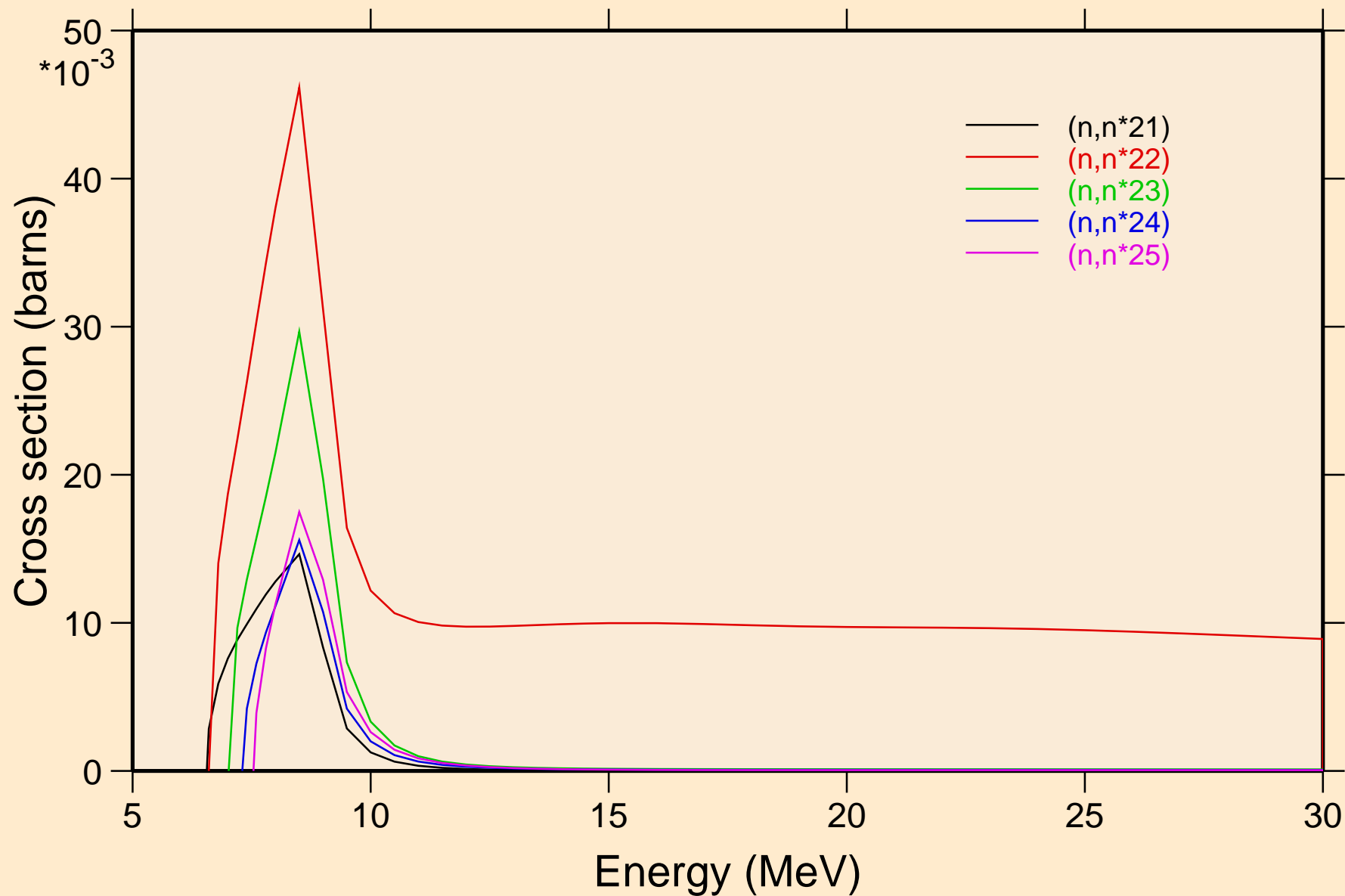

K047 NEUTRON ACER TENDL-2019 LIBRARY; T=293.16K  
Inelastic levels

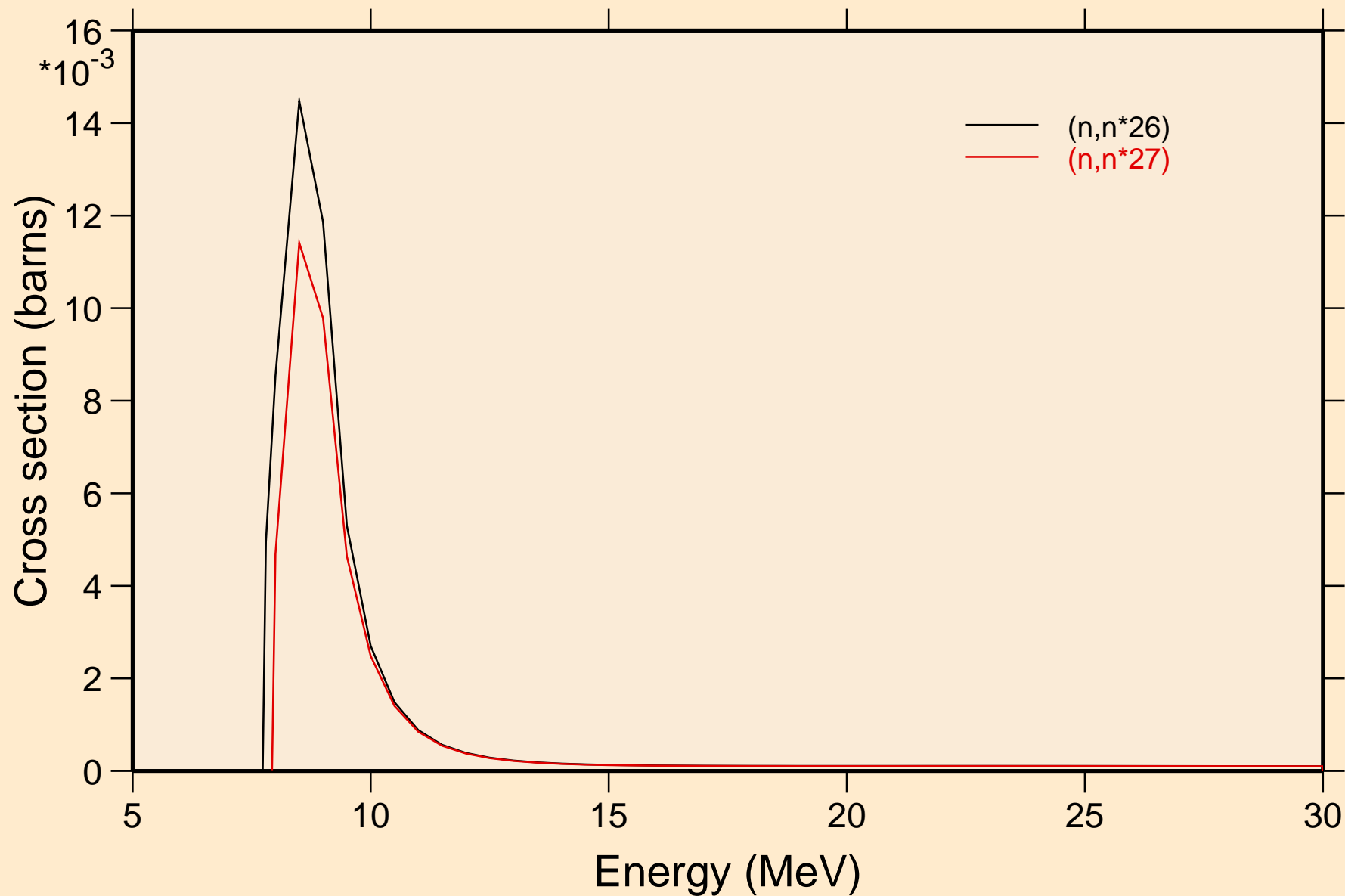

K047 NEUTRON ACER TENDL-2019 LIBRARY; T=293.16K  
Threshold reactions

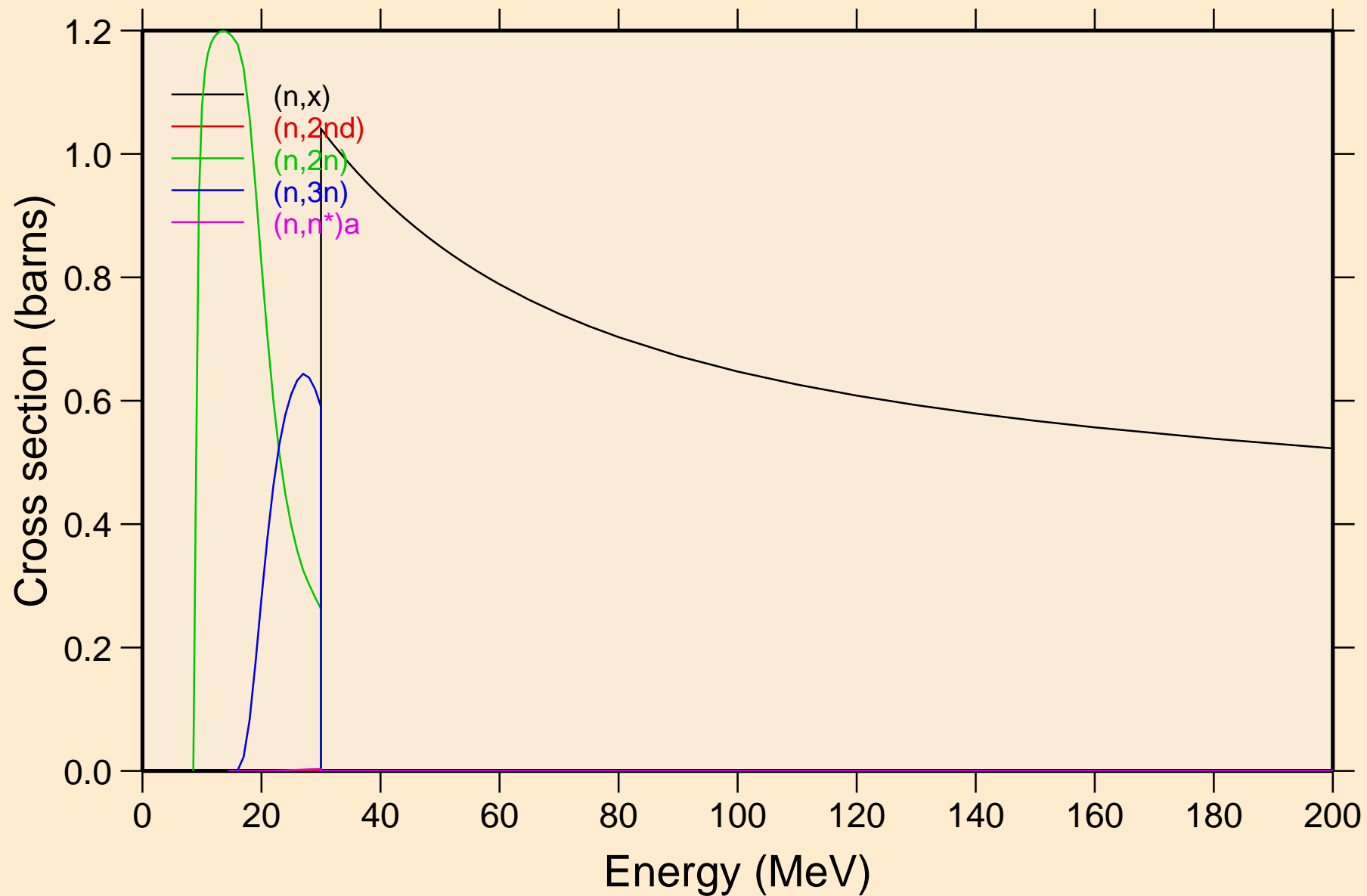

K047 NEUTRON ACER TENDL-2019 LIBRARY; T=293.16K  
Threshold reactions

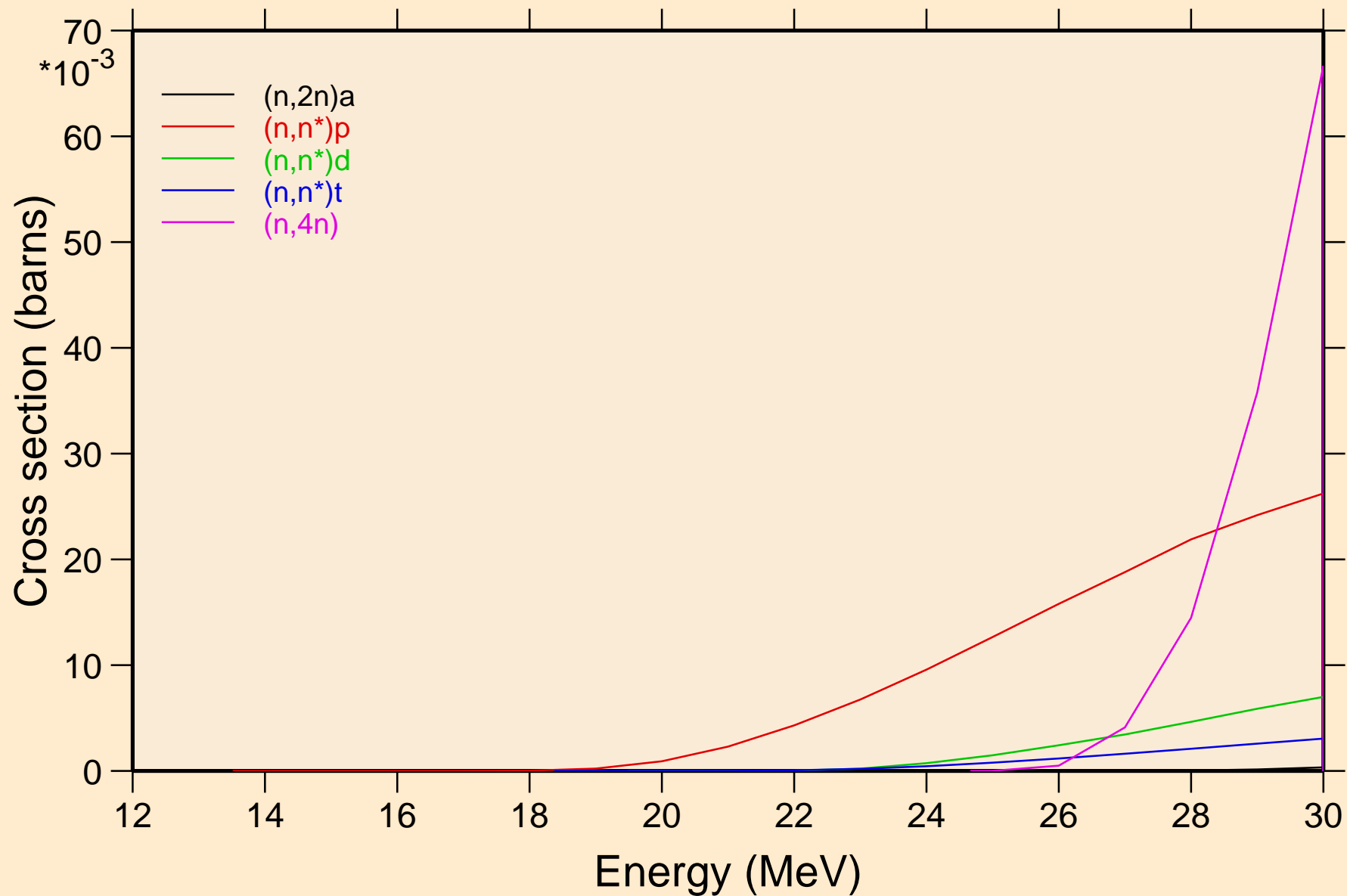



# K047 NEUTRON ACER TENDL-2019 LIBRARY; T=293.16K

## Threshold reactions

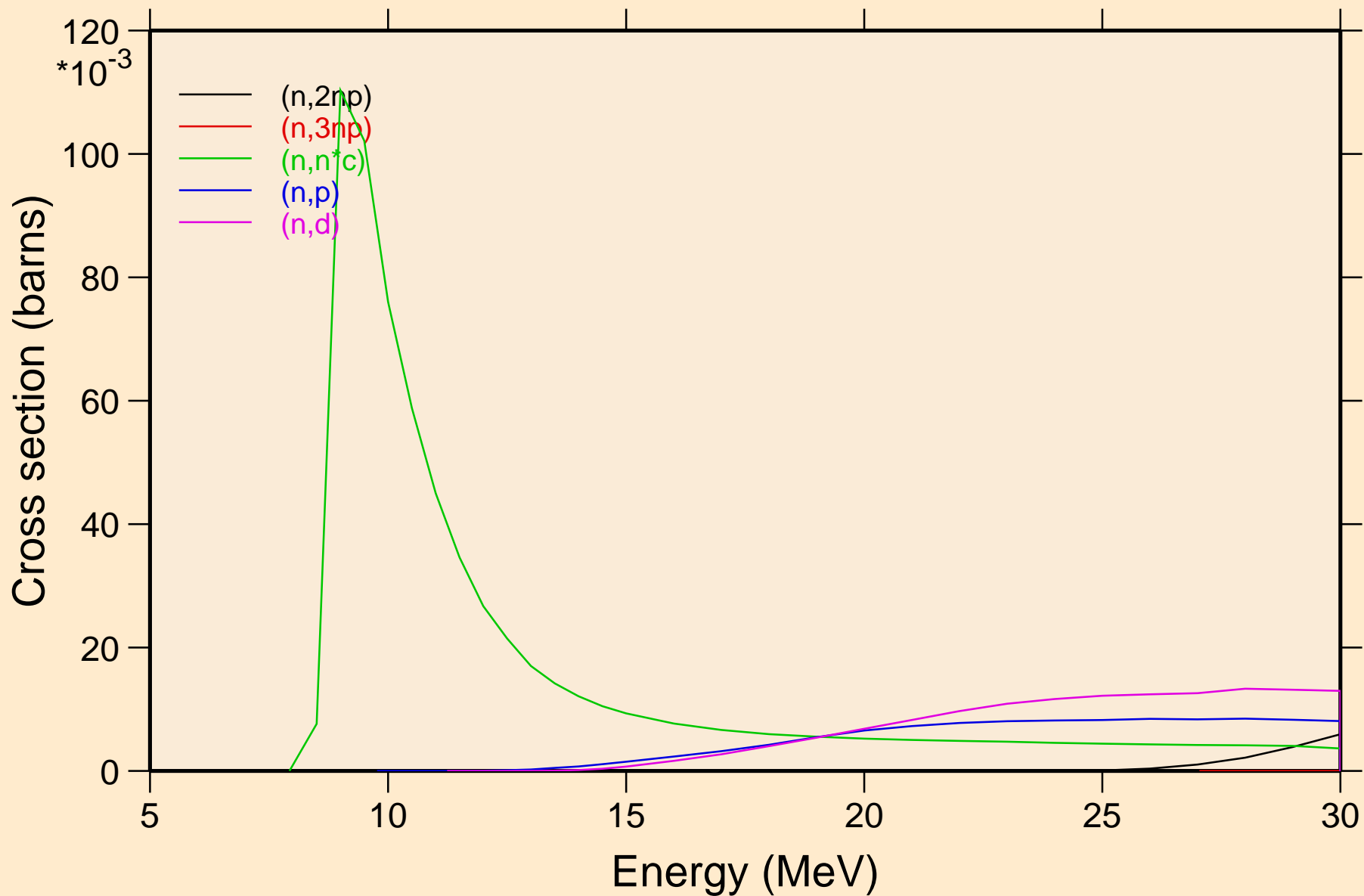

K047 NEUTRON ACER TENDL-2019 LIBRARY; T=293.16K  
Threshold reactions

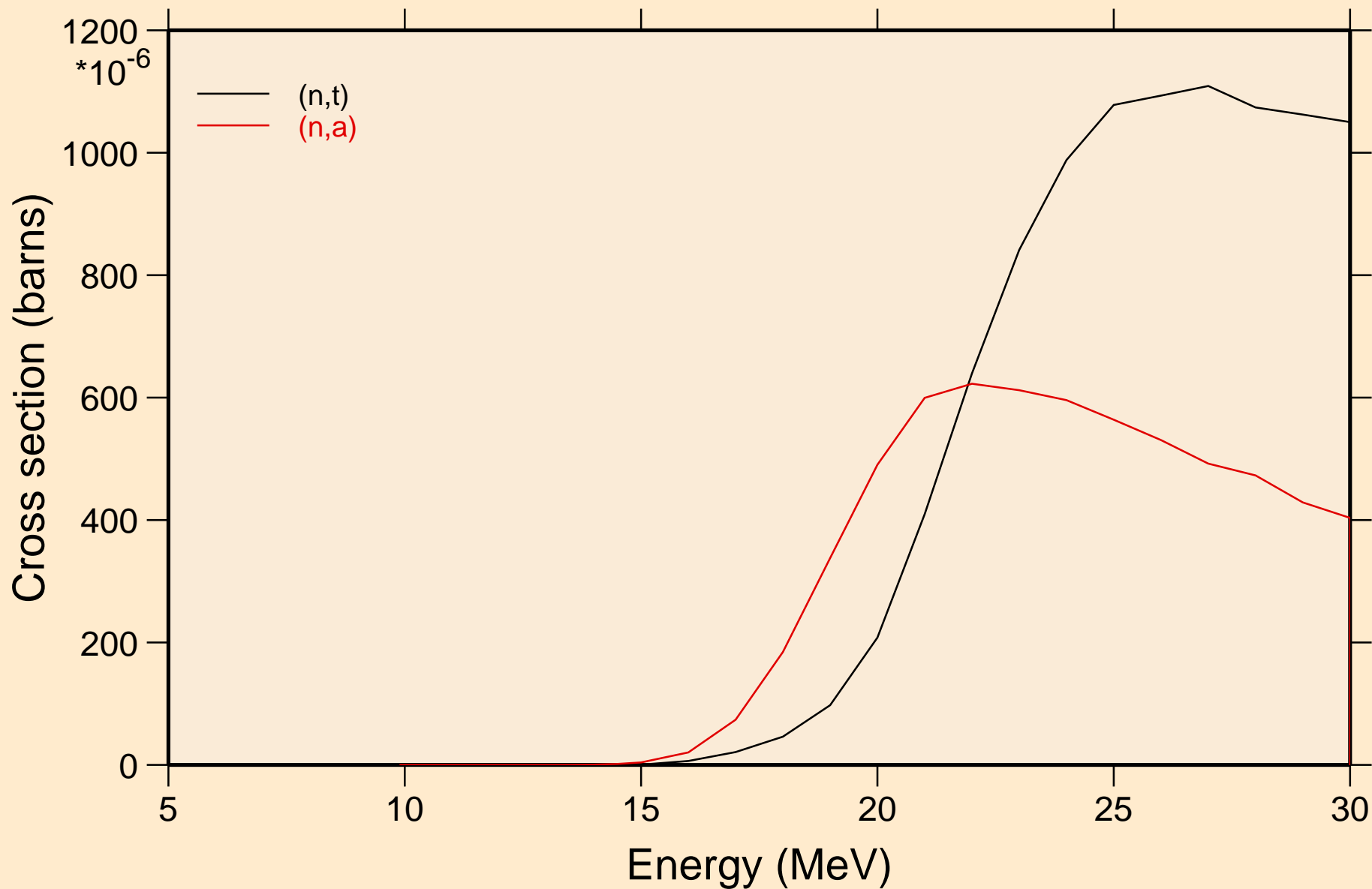

K047 NEUTRON ACER TENDL-2019 LIBRARY; T=293.16K  
Threshold reactions

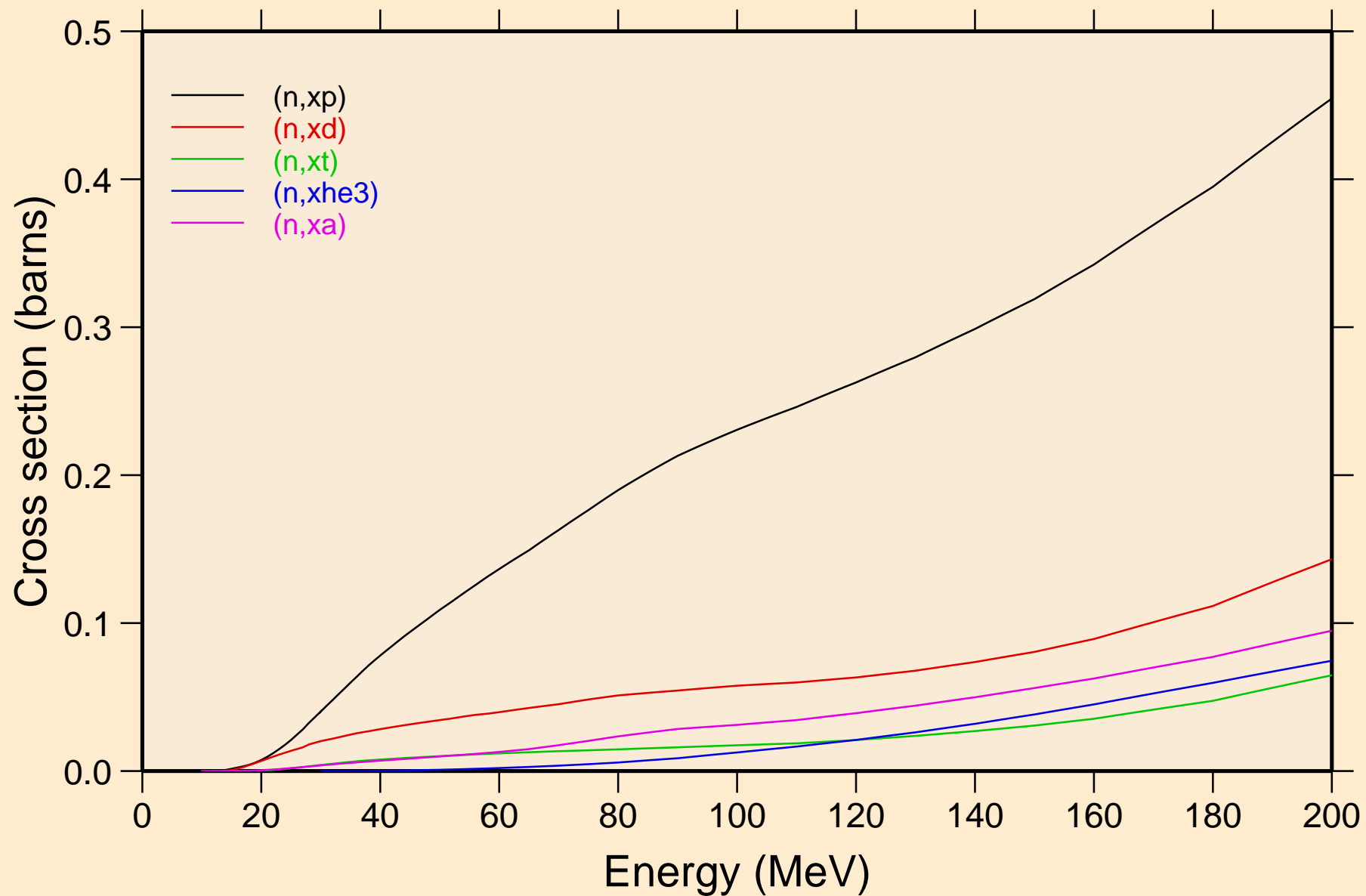

K047 NEUTRON ACER TENDL-2019 LIBRARY; T=293.16K  
angular distribution for elastic

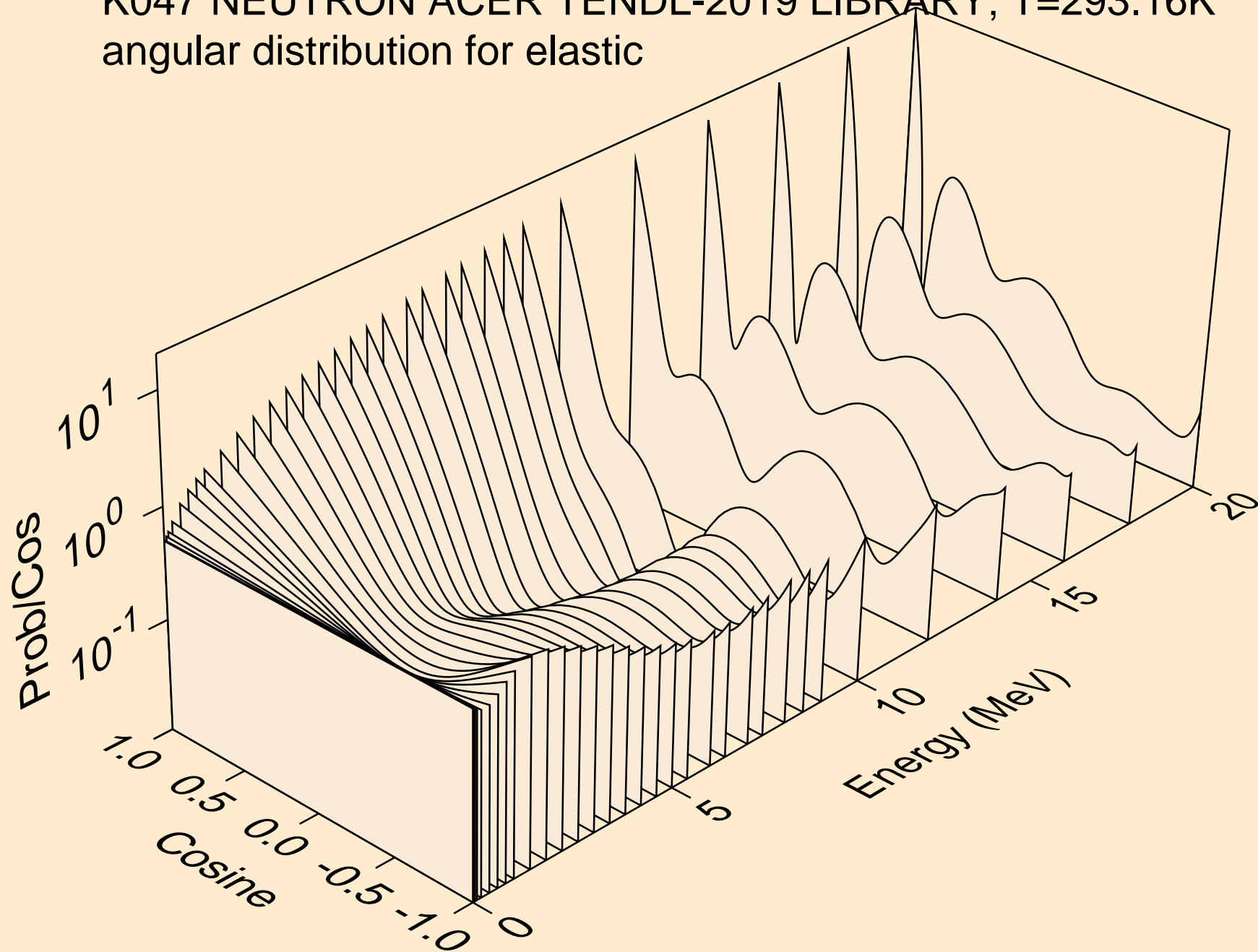

K047 NEUTRON ACER TENDL-2019 LIBRARY; T=293.16K  
angular distribution for elastic

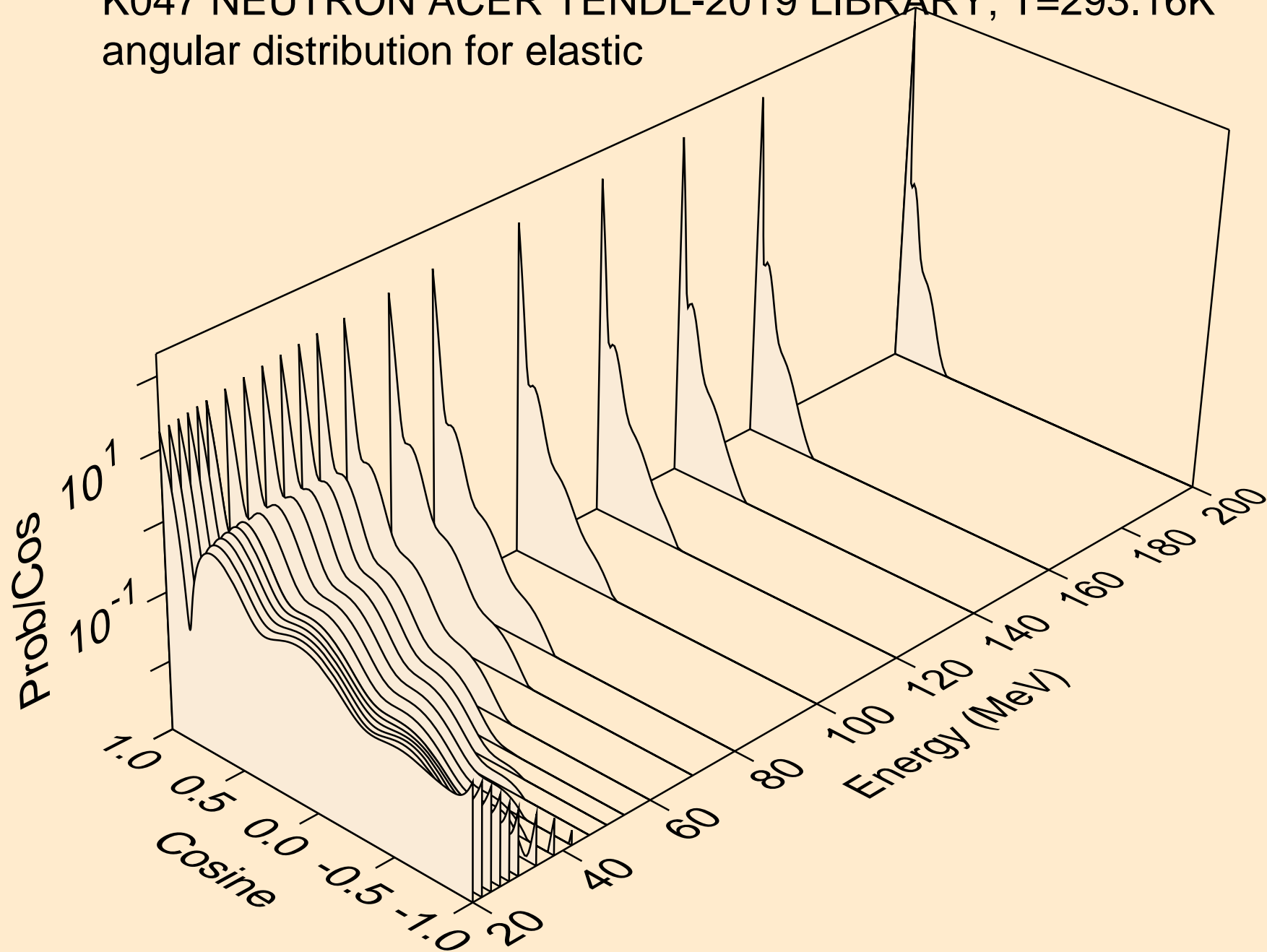

K047 NEUTRON ACER TENDL-2019 LIBRARY; T=293.16K  
angular distribution for (n,n\*1)

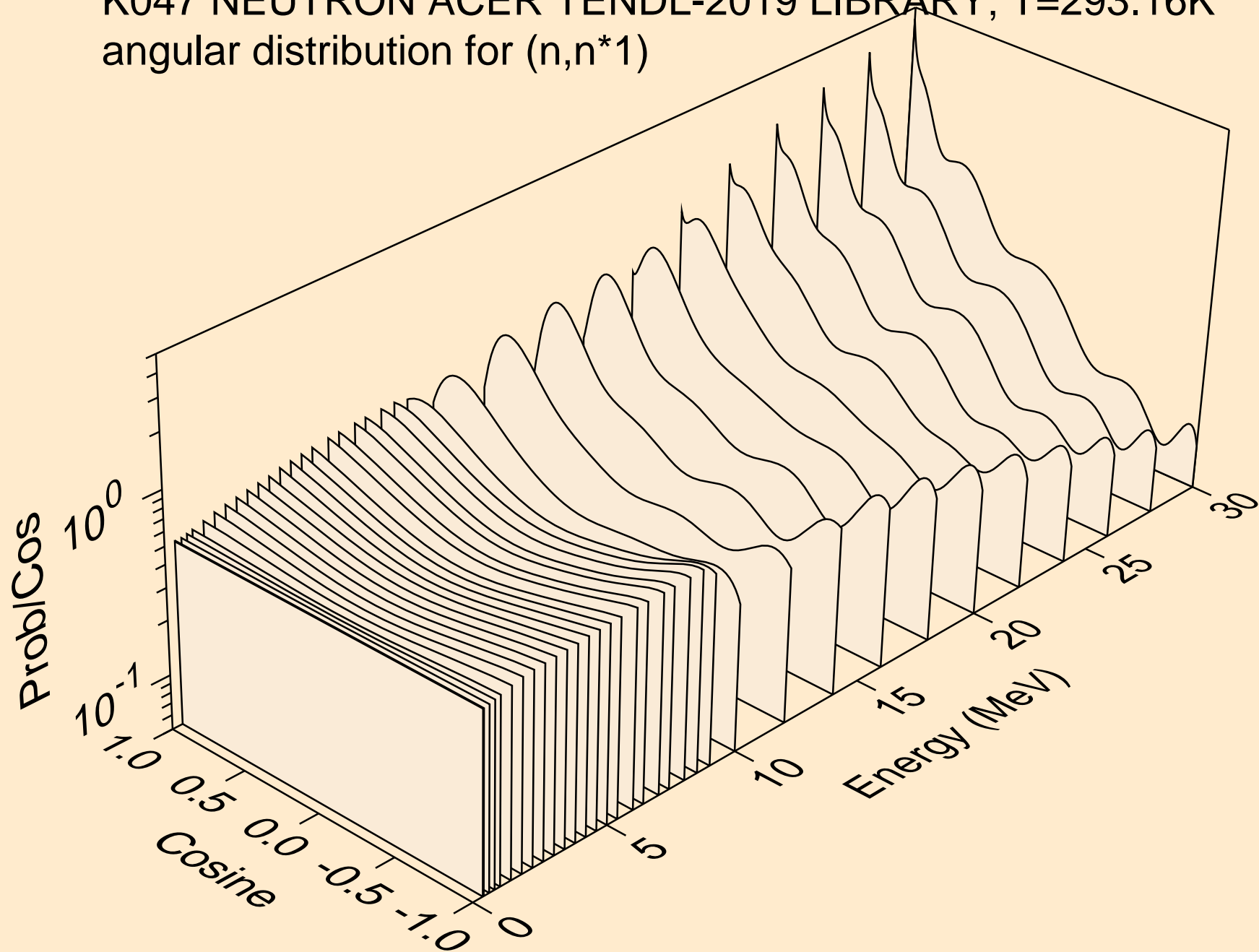

K047 NEUTRON ACER TENDL-2019 LIBRARY; T=293.16K  
angular distribution for (n,n\*2)

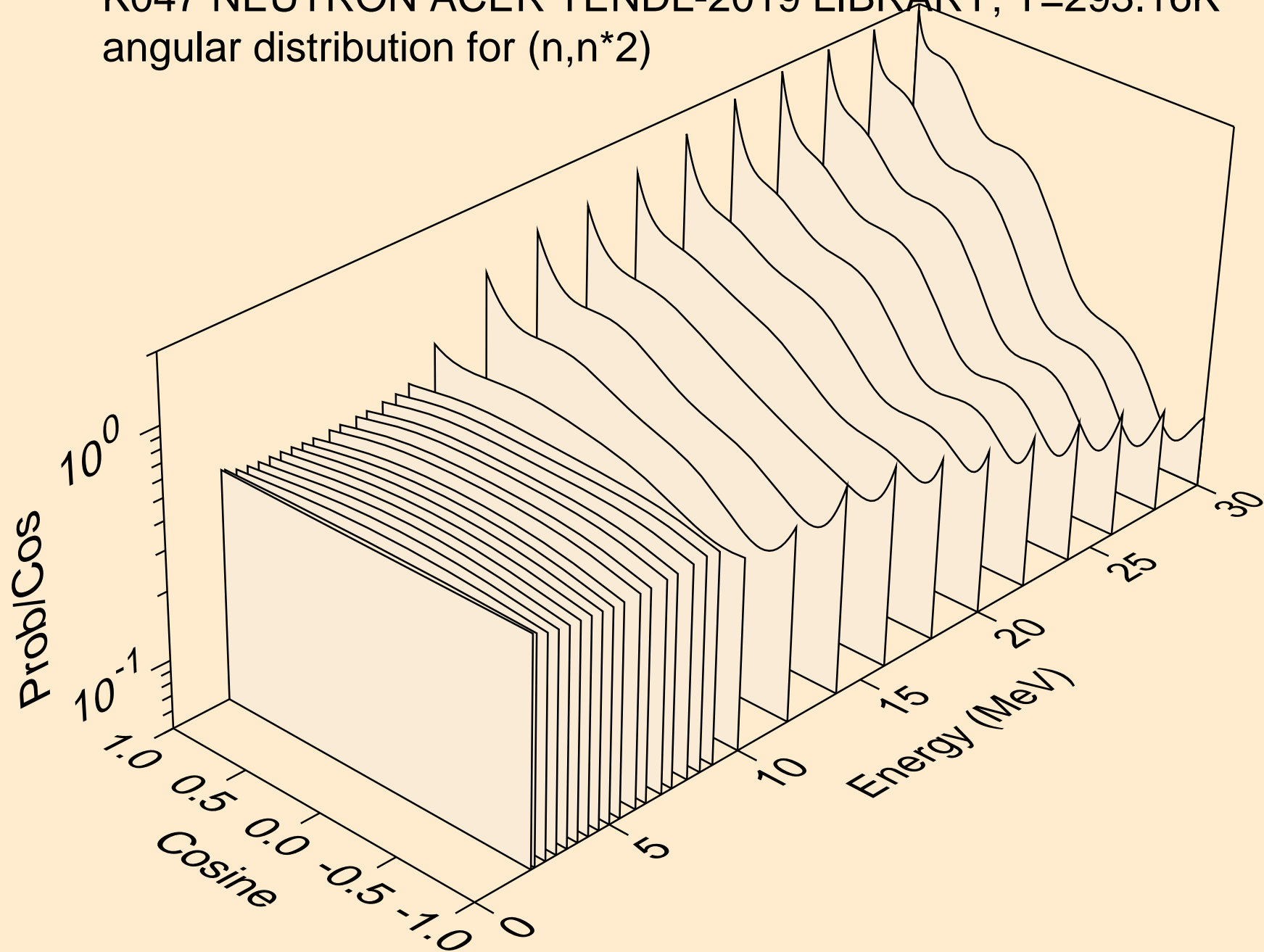

K047 NEUTRON ACER TENDL-2019 LIBRARY; T=293.16K  
angular distribution for (n,n\*3)

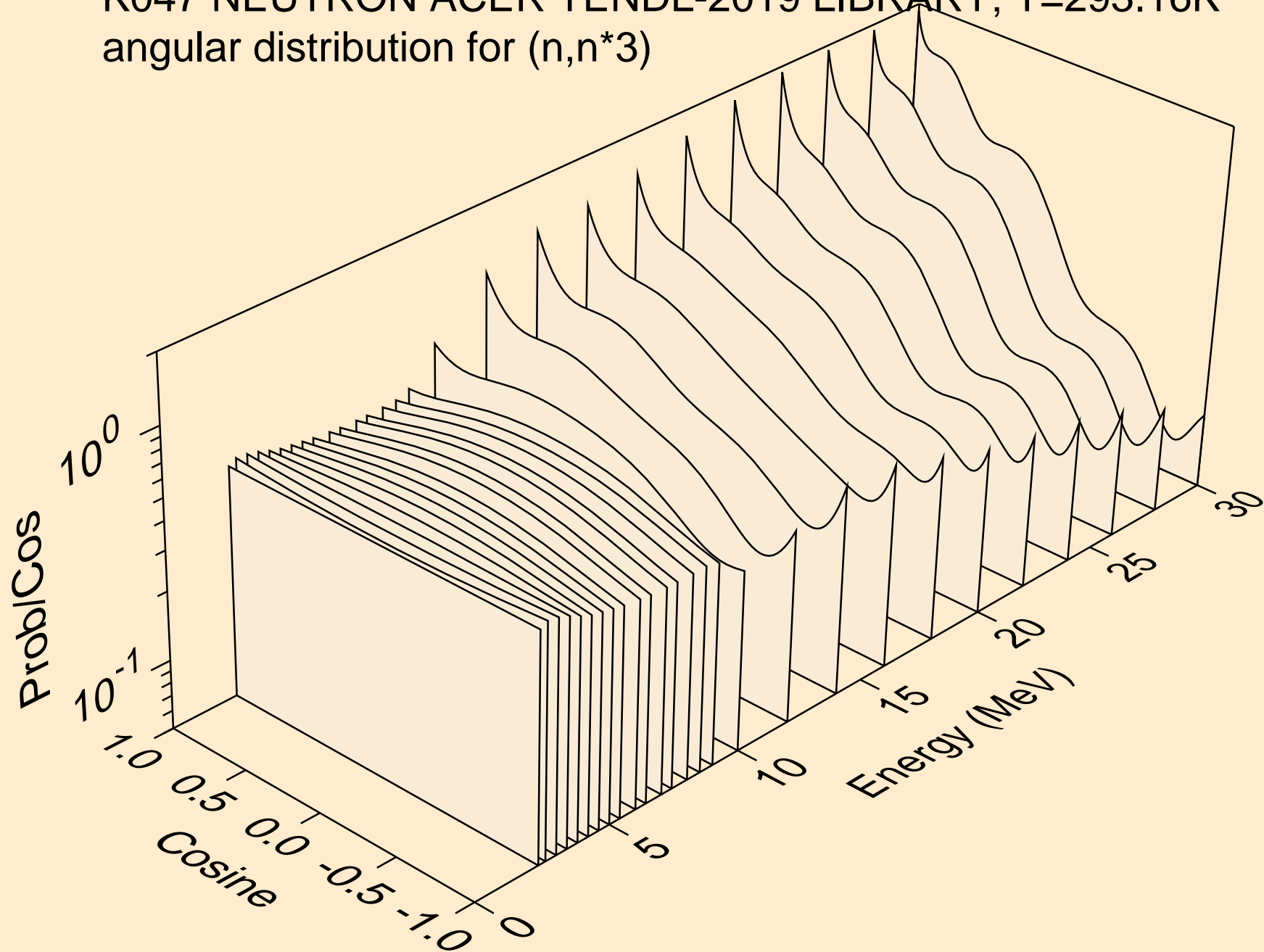



K047 NEUTRON ACER TENDL-2019 LIBRARY; T=293.16K  
angular distribution for (n,n\*4)

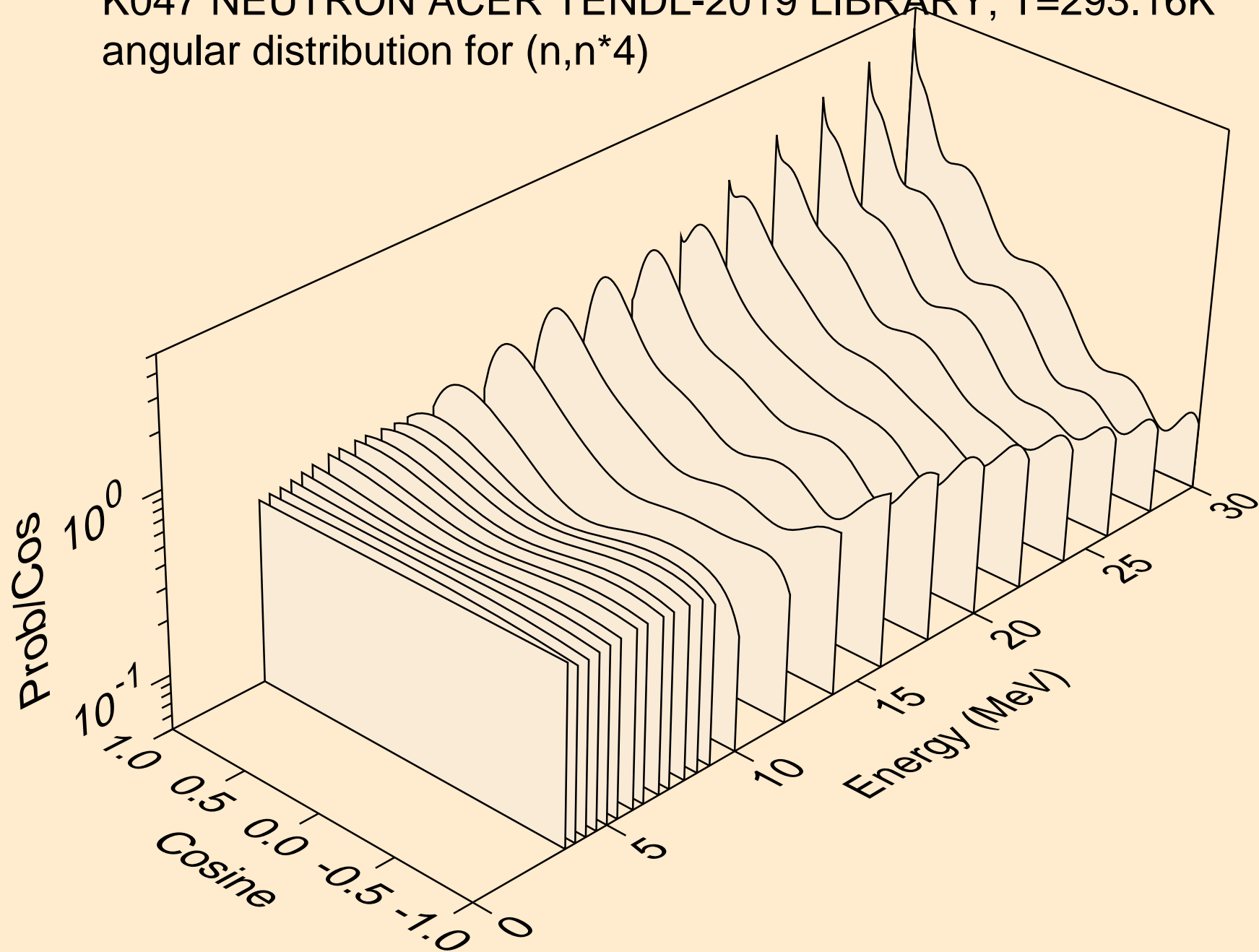

K047 NEUTRON ACER TENDL-2019 LIBRARY; T=293.16K  
angular distribution for (n,n\*5)

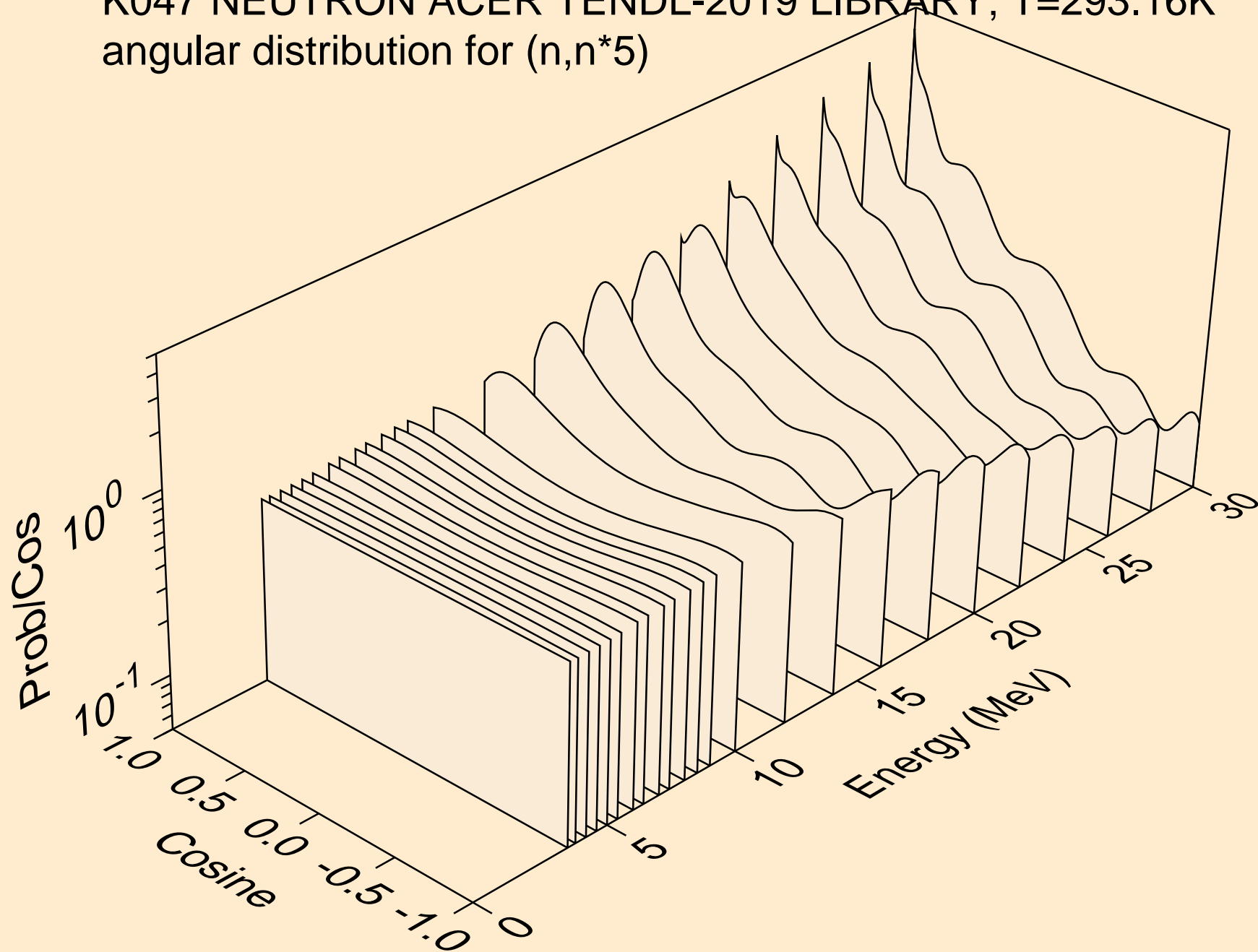

K047 NEUTRON ACER TENDL-2019 LIBRARY; T=293.16K  
angular distribution for (n,n\*6)

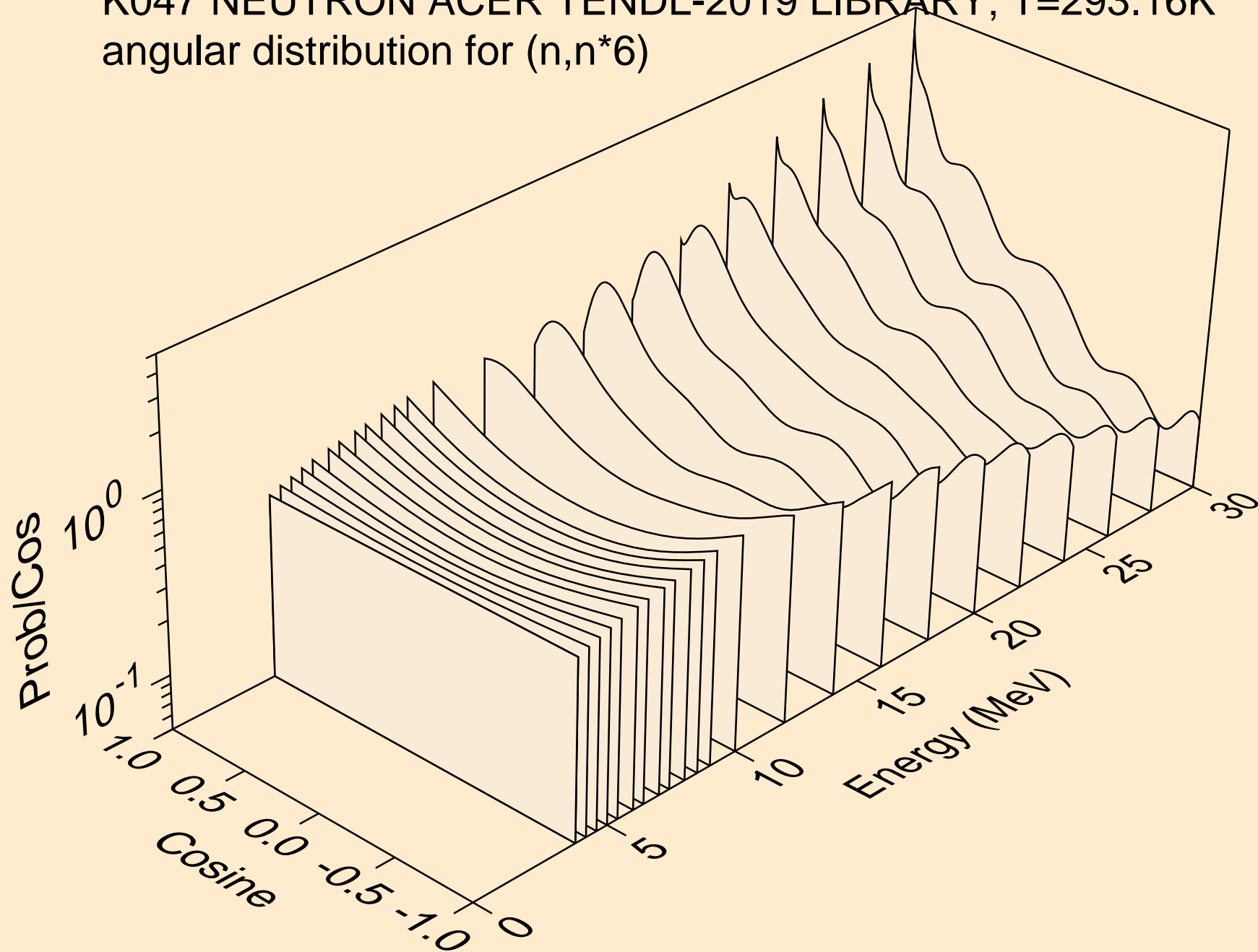

K047 NEUTRON ACER TENDL-2019 LIBRARY; T=293.16K  
angular distribution for (n,n\*7)

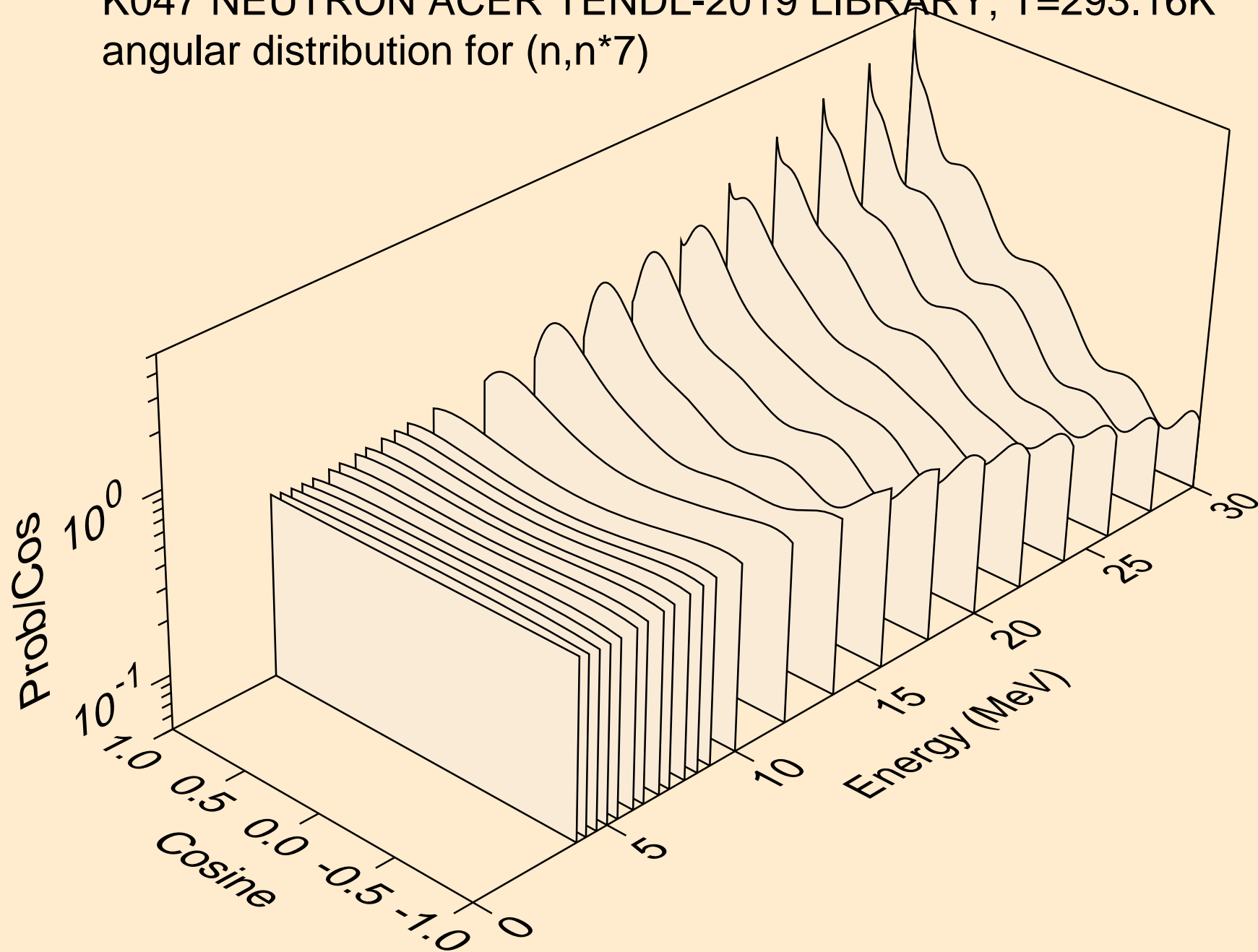

K047 NEUTRON ACER TENDL-2019 LIBRARY; T=293.16K  
angular distribution for (n,n\*8)

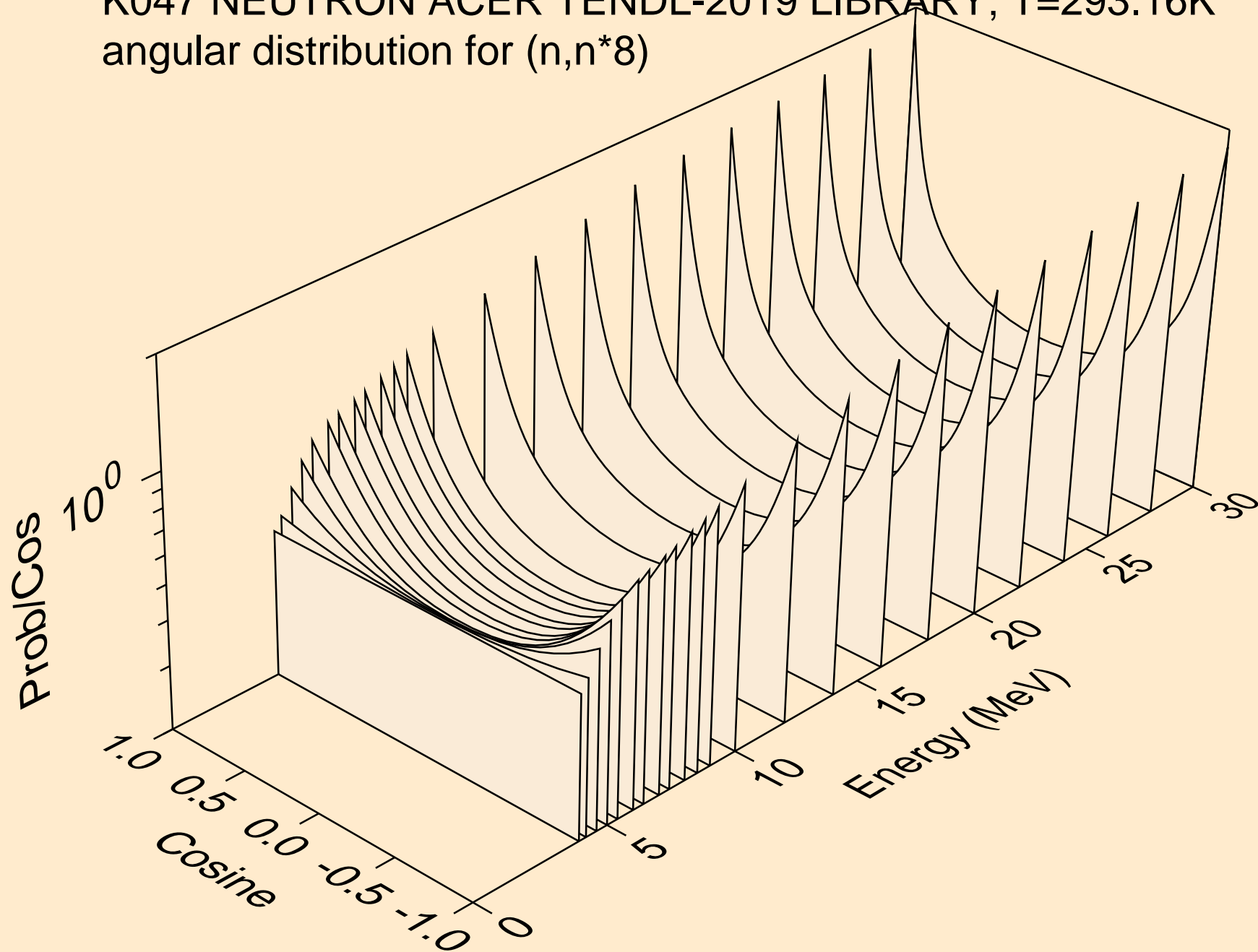

K047 NEUTRON ACER TENDL-2019 LIBRARY; T=293.16K  
angular distribution for (n,n\*9)

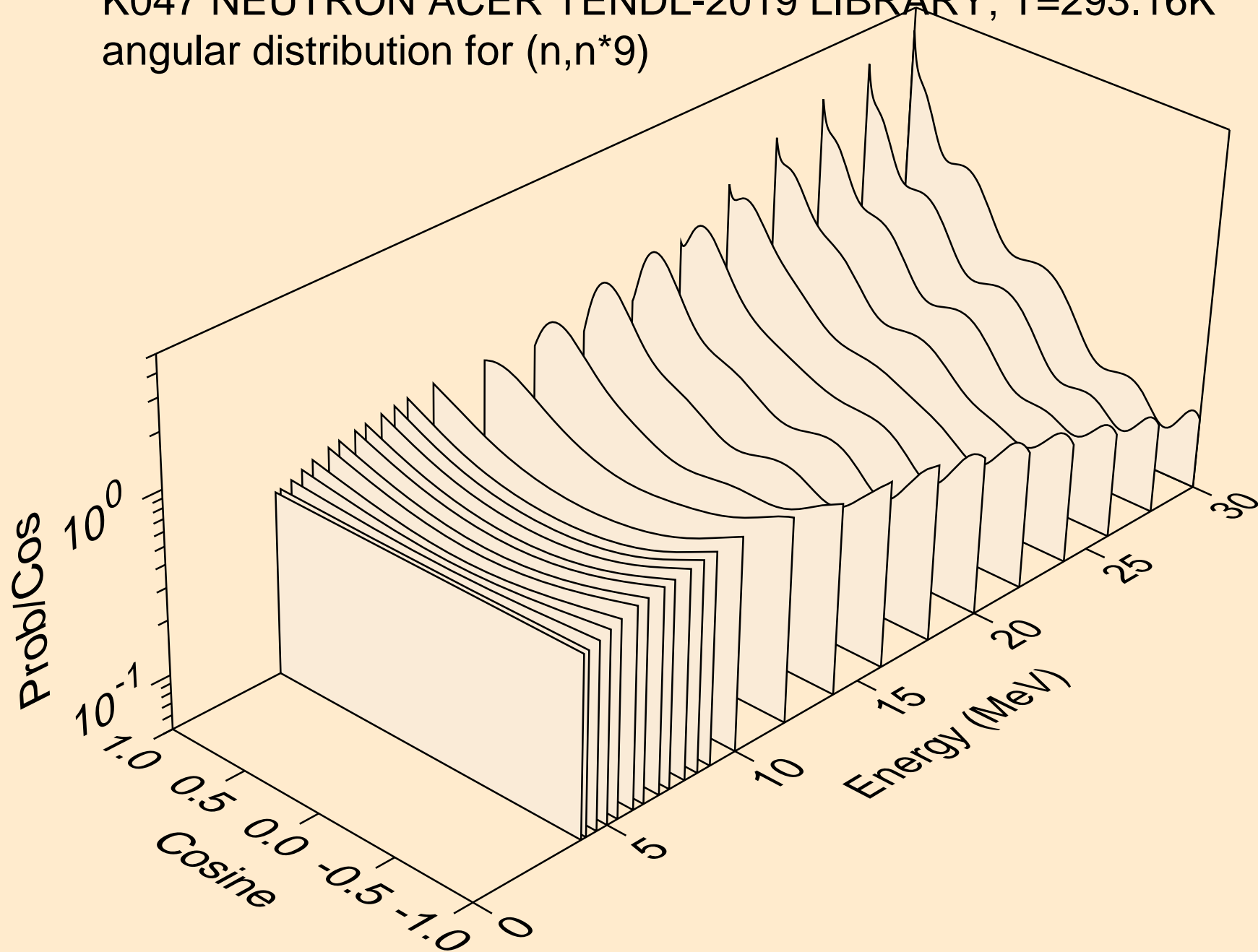

K047 NEUTRON ACER TENDL-2019 LIBRARY; T=293.16K  
angular distribution for (n,n\*10)

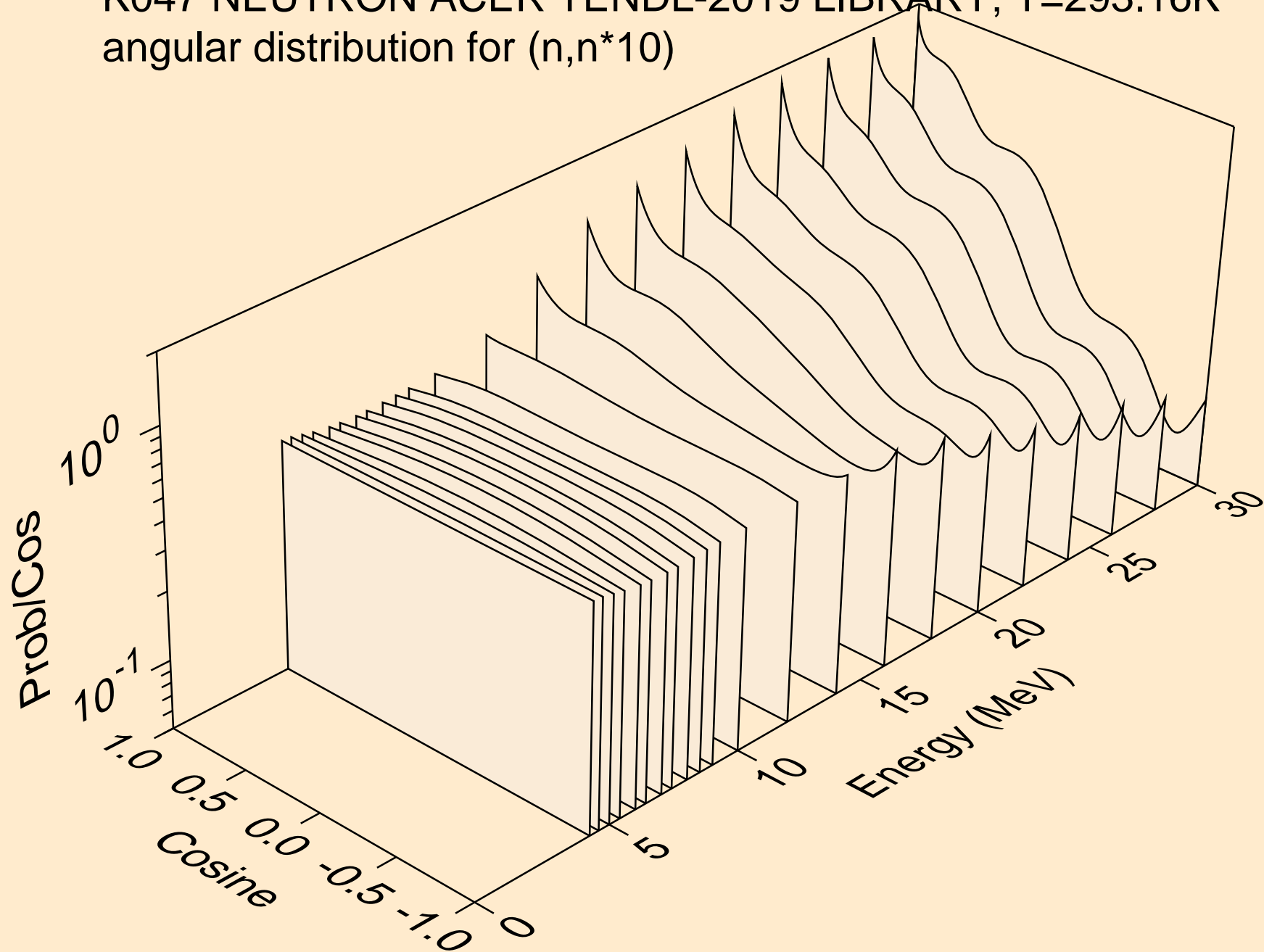

K047 NEUTRON ACER TENDL-2019 LIBRARY; T=293.16K  
angular distribution for (n,n\*11)

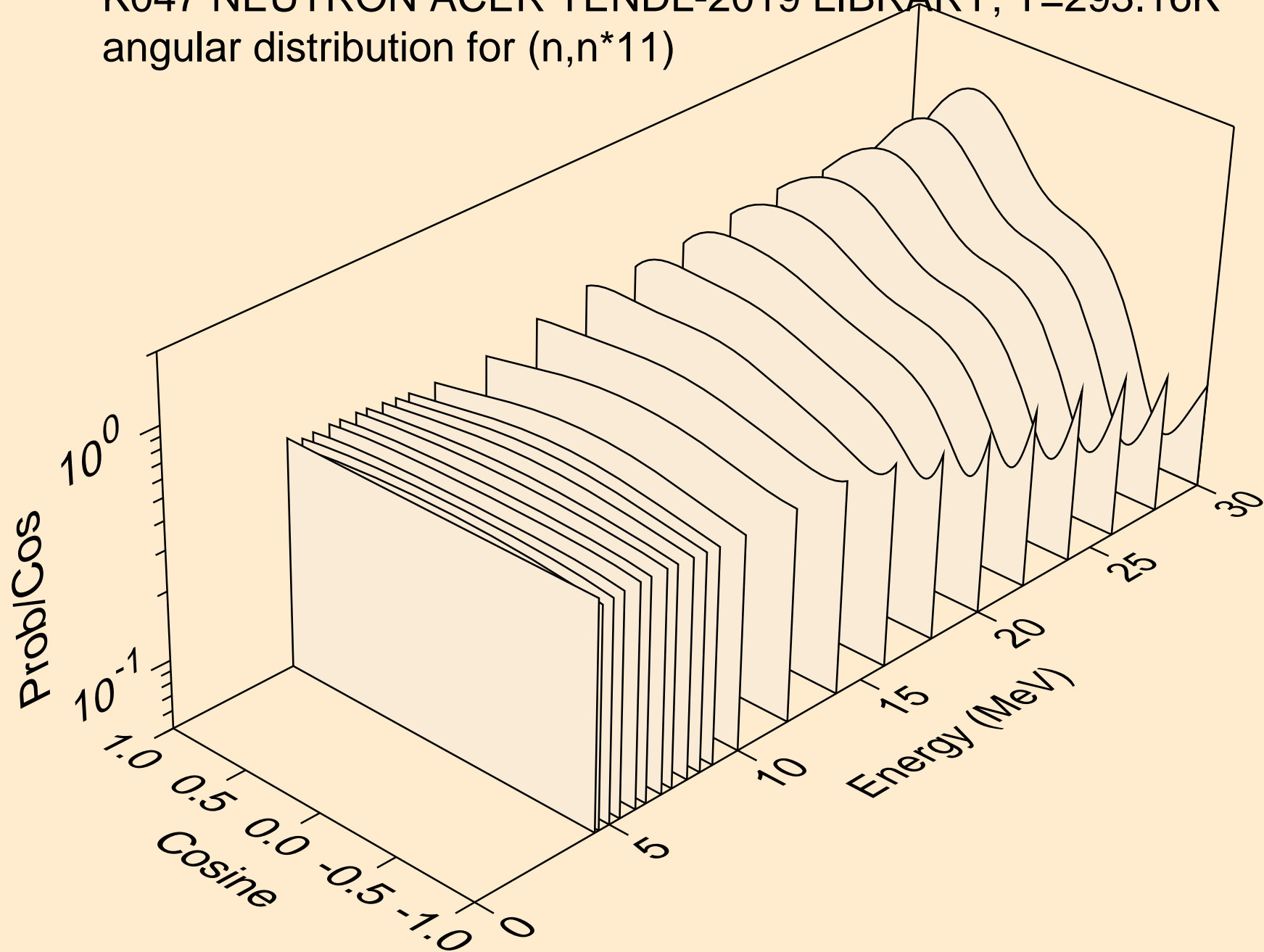



K047 NEUTRON ACER TENDL-2019 LIBRARY; T=293.16K  
angular distribution for (n,n\*12)

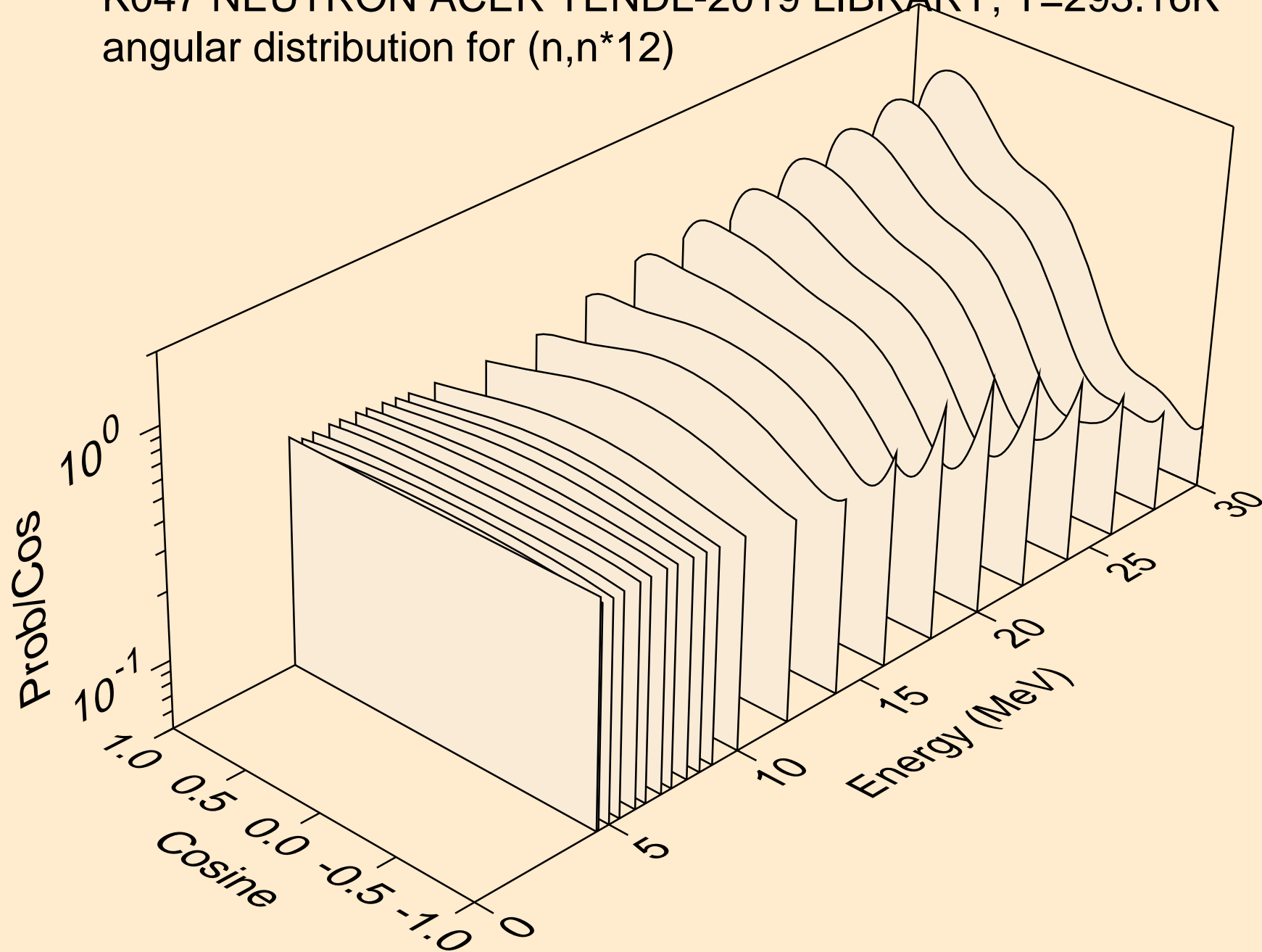

K047 NEUTRON ACER TENDL-2019 LIBRARY; T=293.16K  
angular distribution for (n,n\*13)

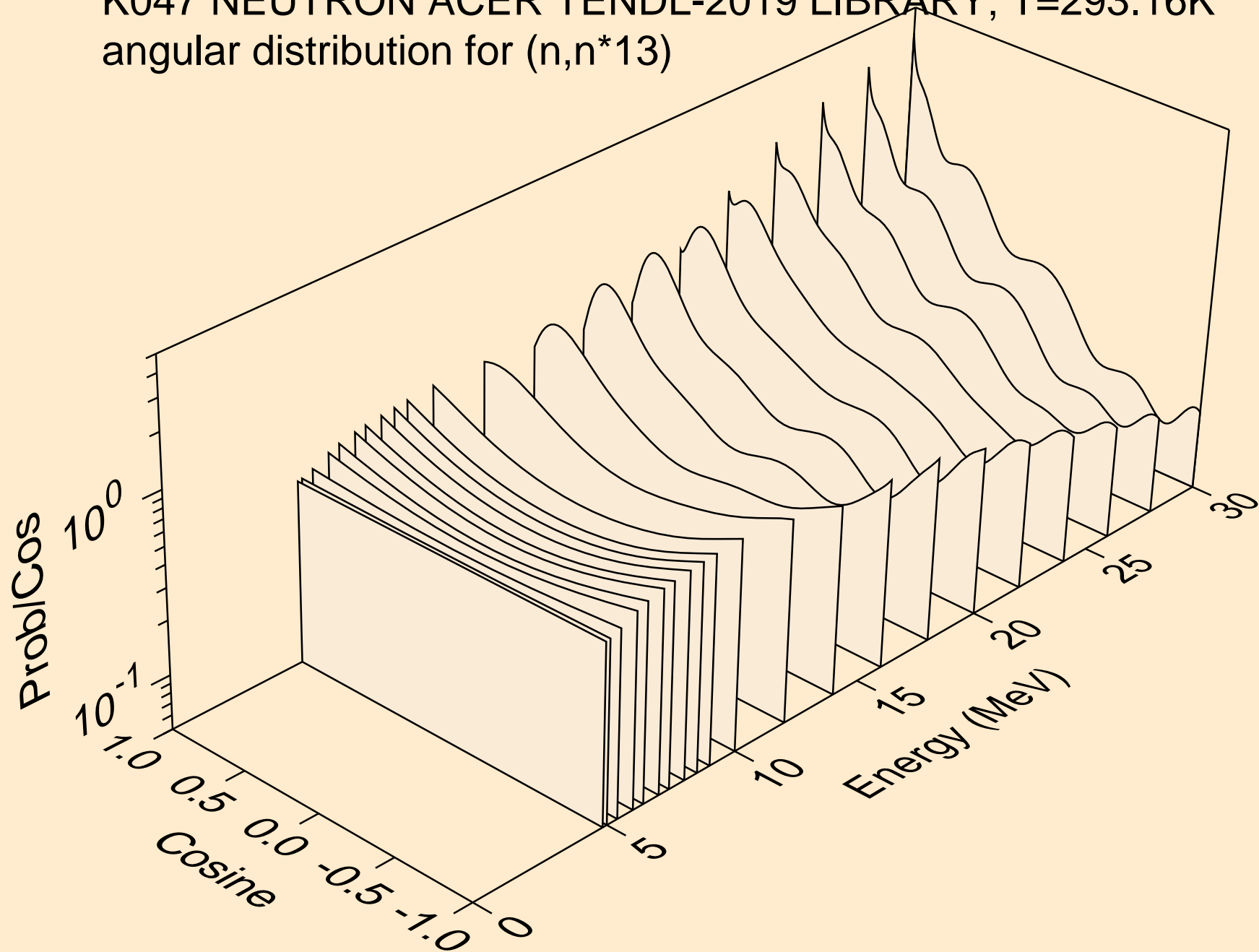

K047 NEUTRON ACER TENDL-2019 LIBRARY; T=293.16K  
angular distribution for (n,n\*14)

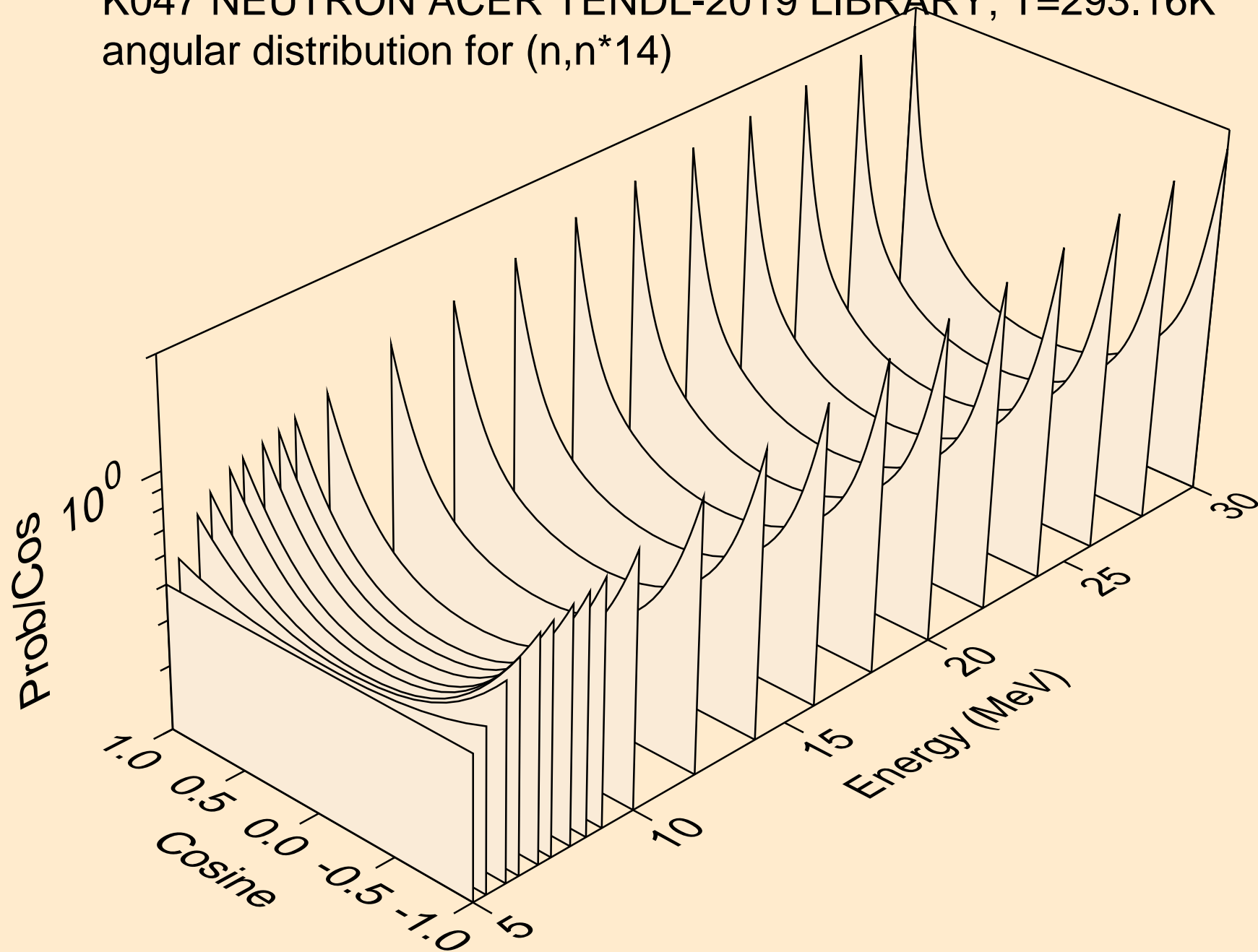

K047 NEUTRON ACER TENDL-2019 LIBRARY; T=293.16K  
angular distribution for (n,n\*15)

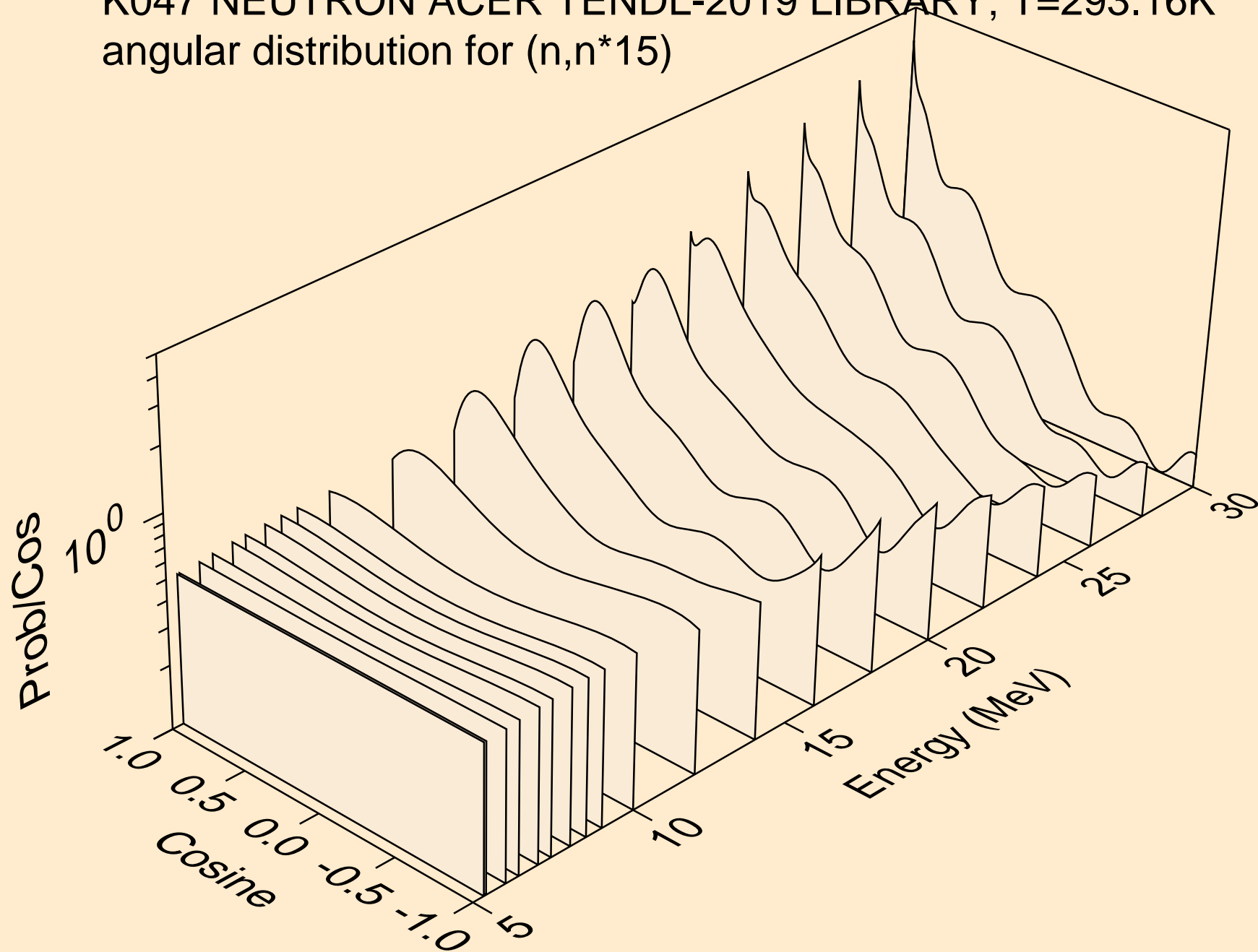

K047 NEUTRON ACER TENDL-2019 LIBRARY; T=293.16K  
angular distribution for (n,n\*16)

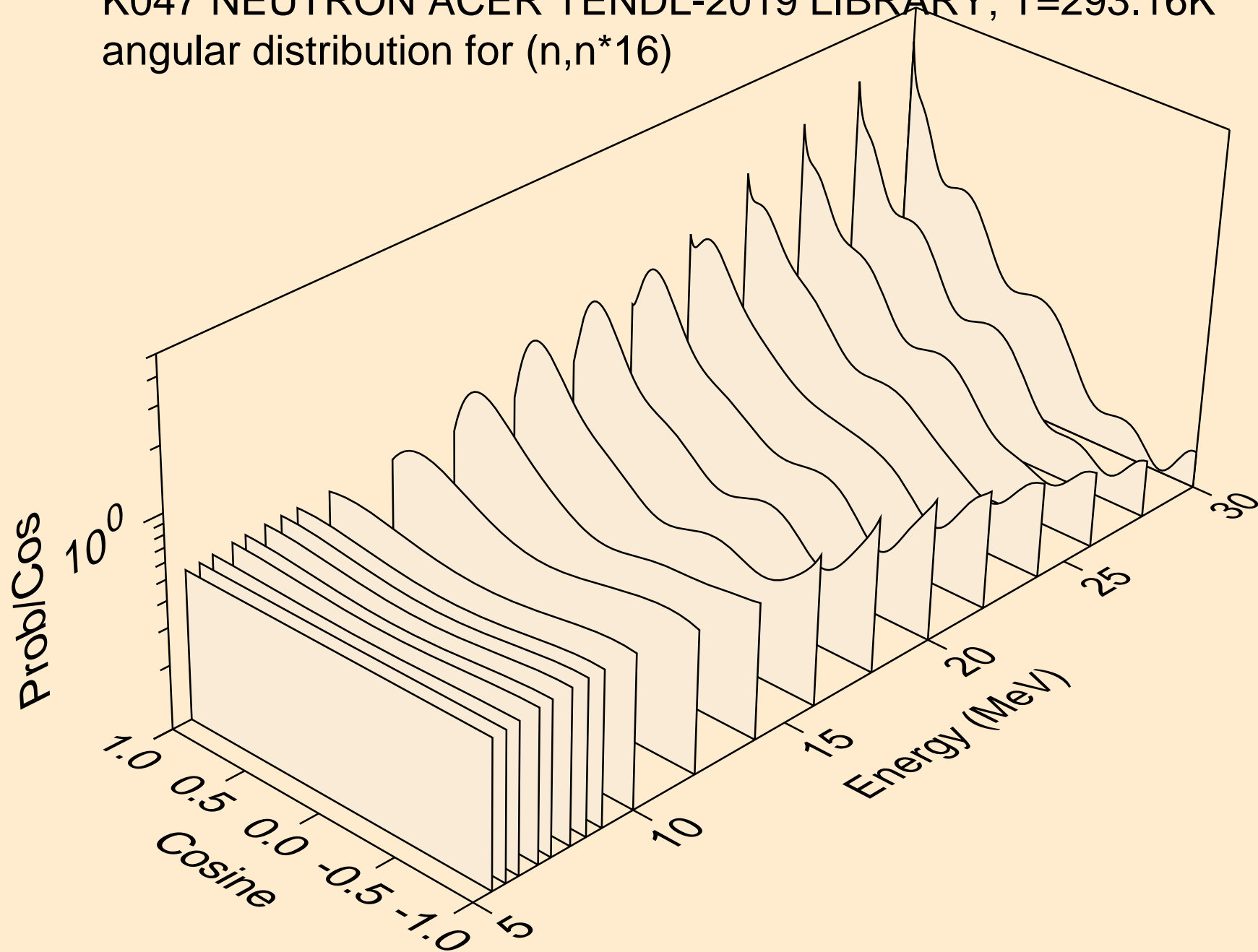

K047 NEUTRON ACER TENDL-2019 LIBRARY; T=293.16K  
angular distribution for (n,n\*17)

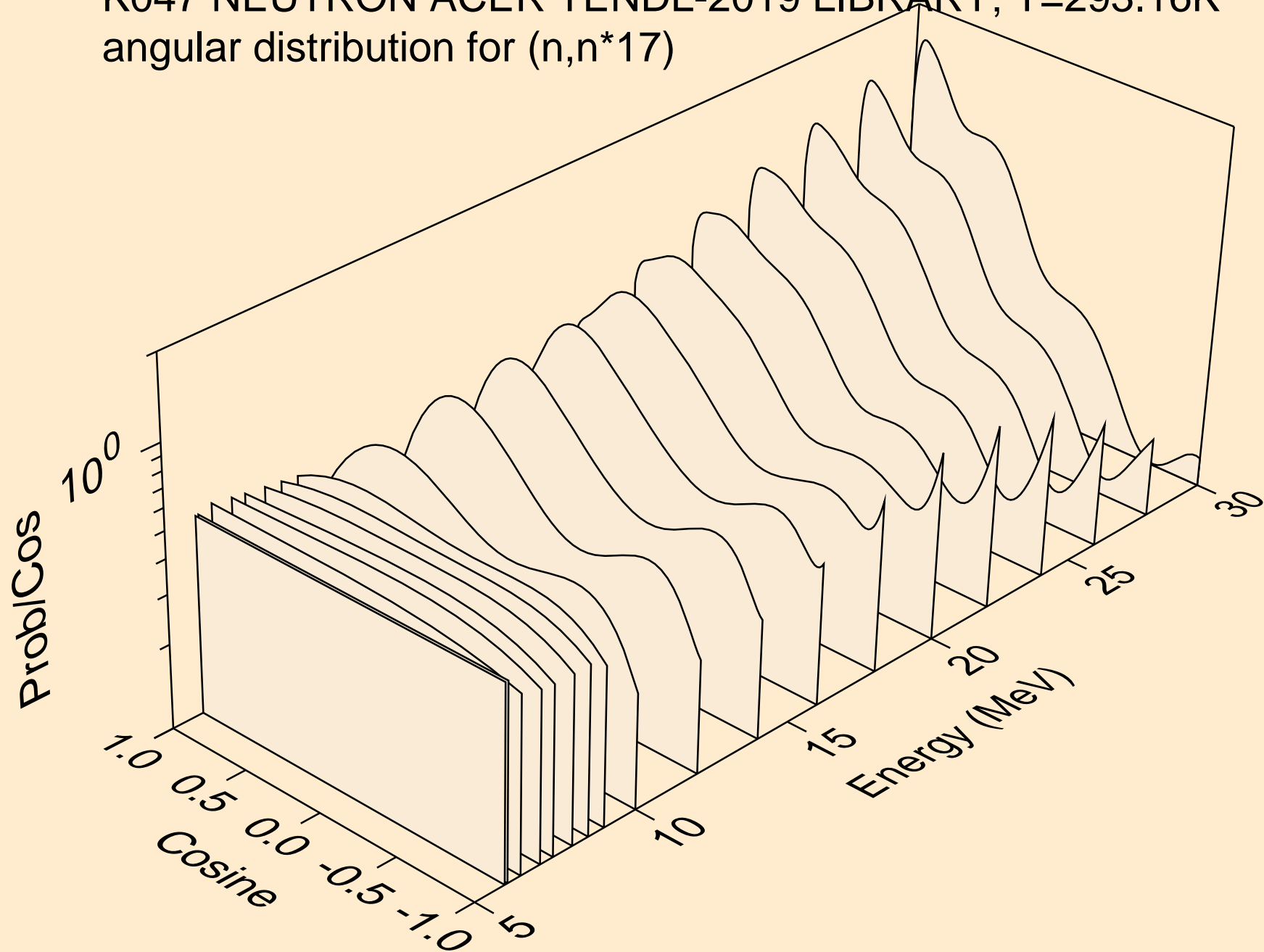

K047 NEUTRON ACER TENDL-2019 LIBRARY; T=293.16K  
angular distribution for (n,n\*18)

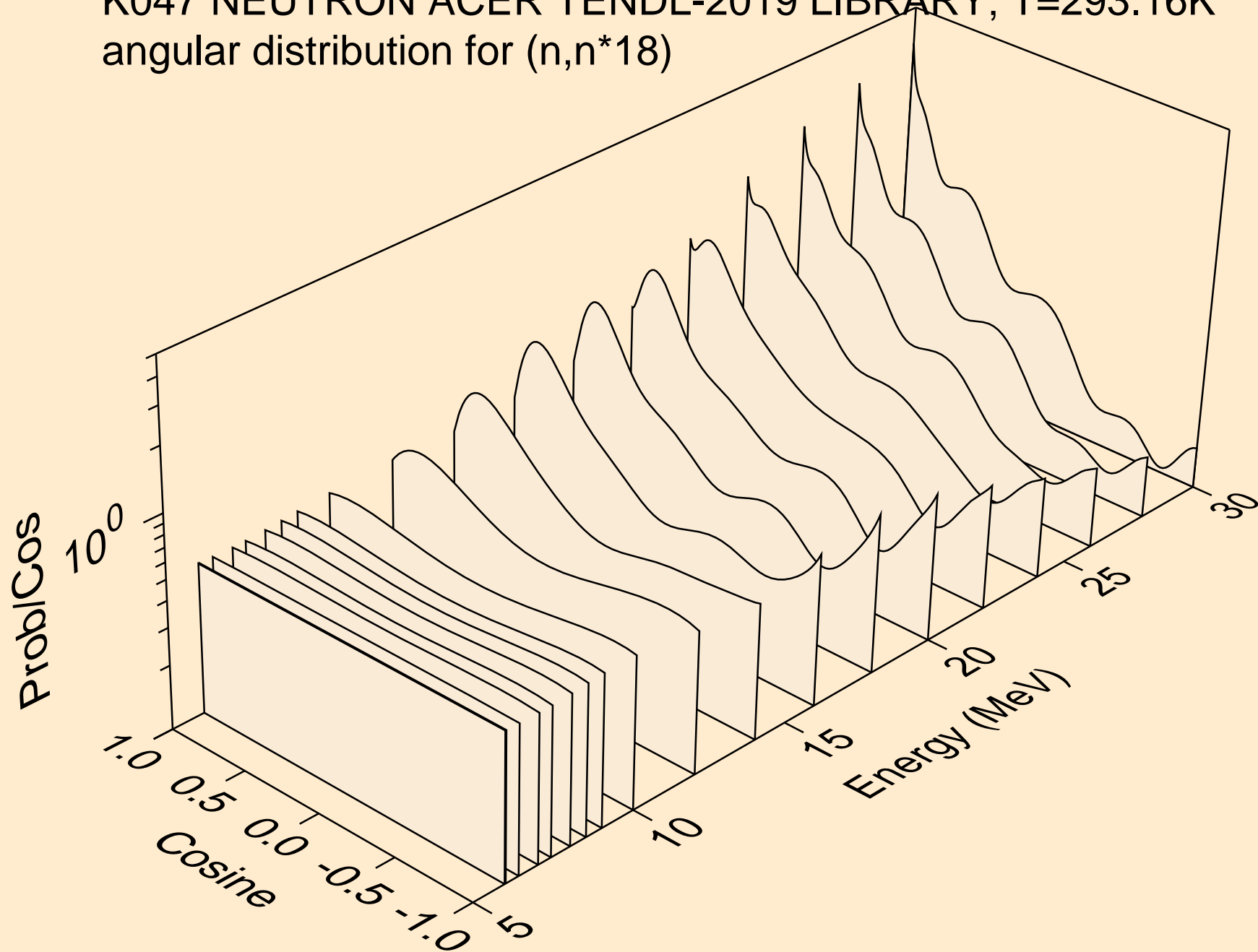

K047 NEUTRON ACER TENDL-2019 LIBRARY; T=293.16K  
angular distribution for (n,n\*19)

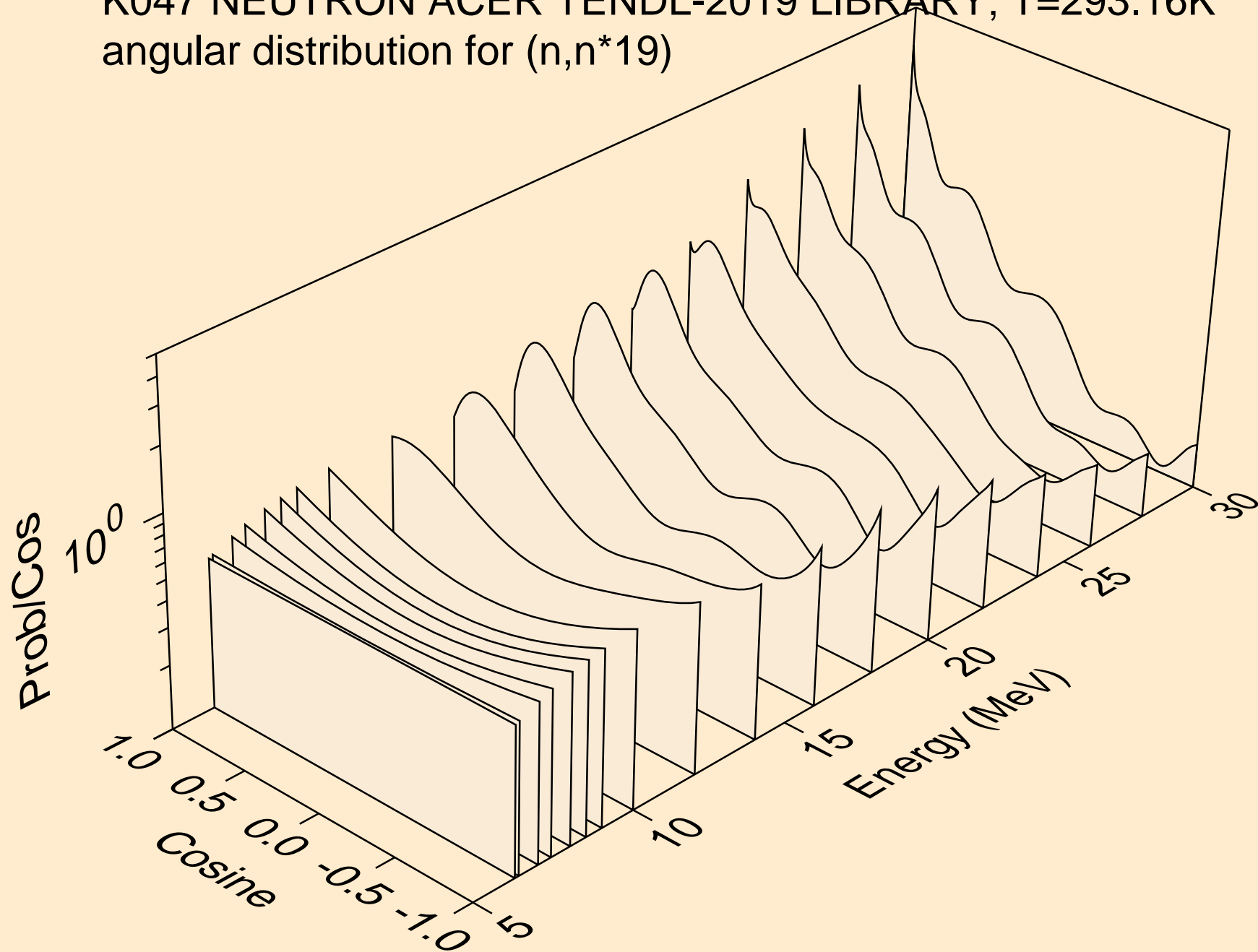



K047 NEUTRON ACER TENDL-2019 LIBRARY; T=293.16K  
angular distribution for (n,n\*20)

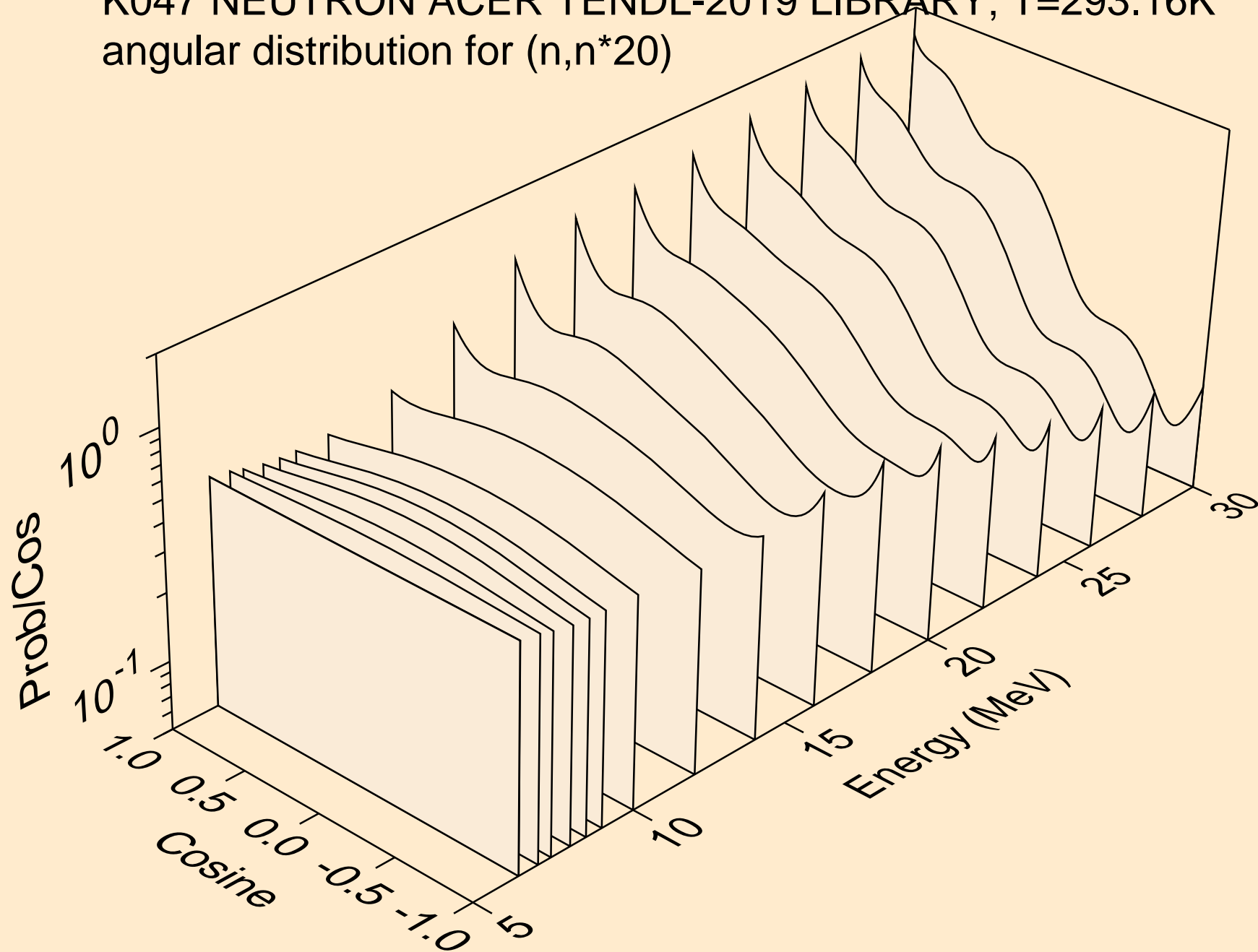

K047 NEUTRON ACER TENDL-2019 LIBRARY; T=293.16K  
angular distribution for (n,n\*21)

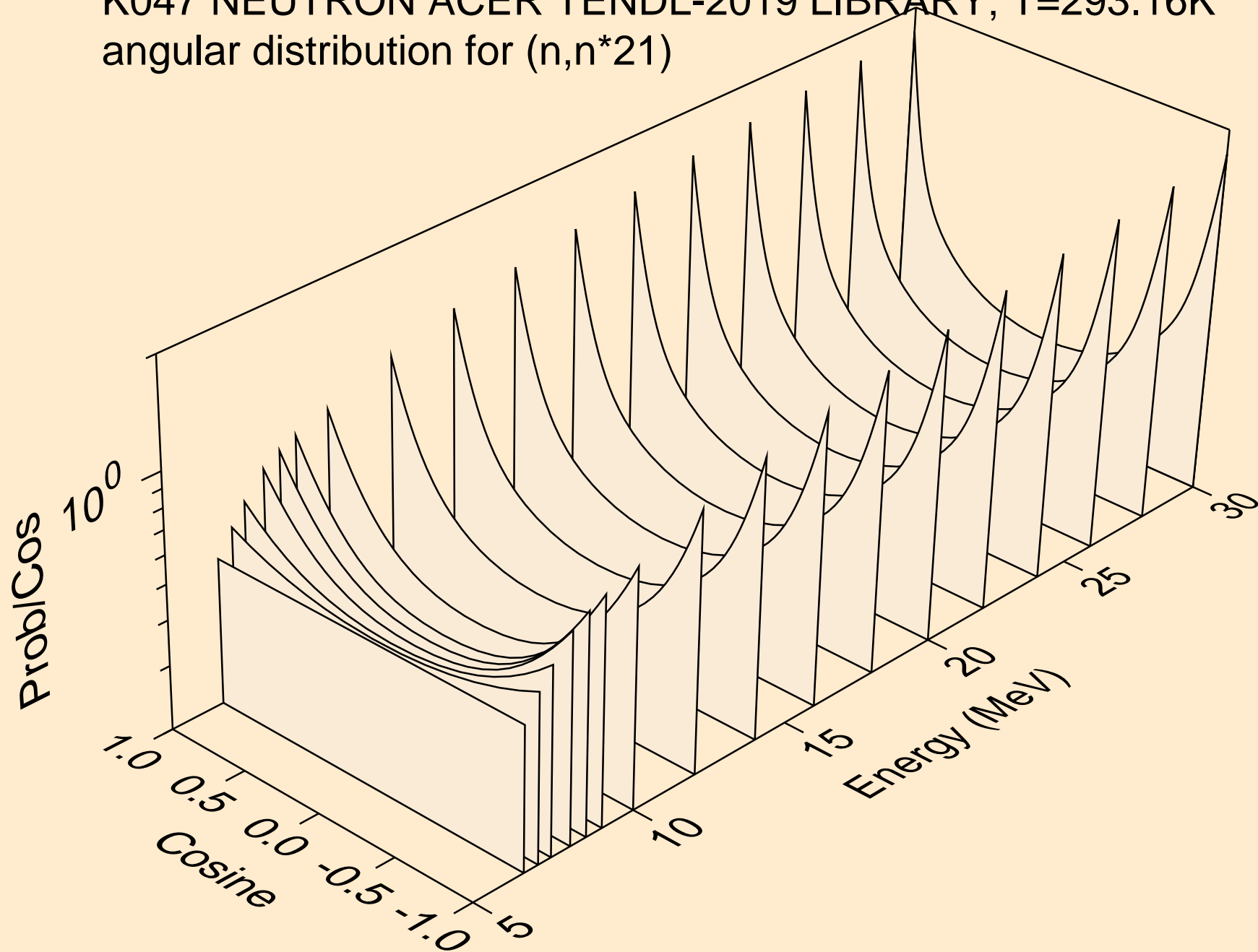

K047 NEUTRON ACER TENDL-2019 LIBRARY; T=293.16K  
angular distribution for (n,n\*22)

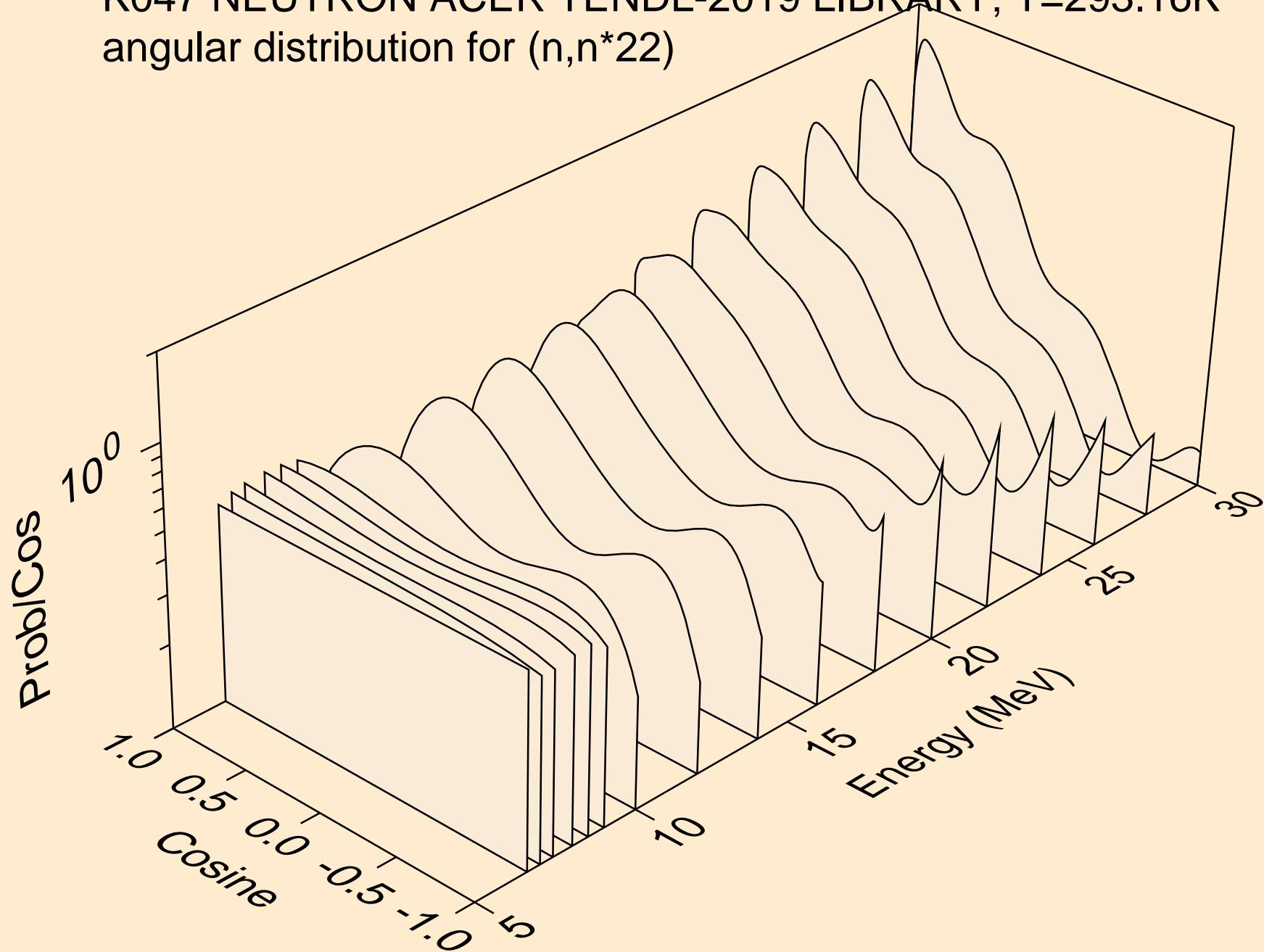

K047 NEUTRON ACER TENDL-2019 LIBRARY; T=293.16K  
angular distribution for (n,n\*23)

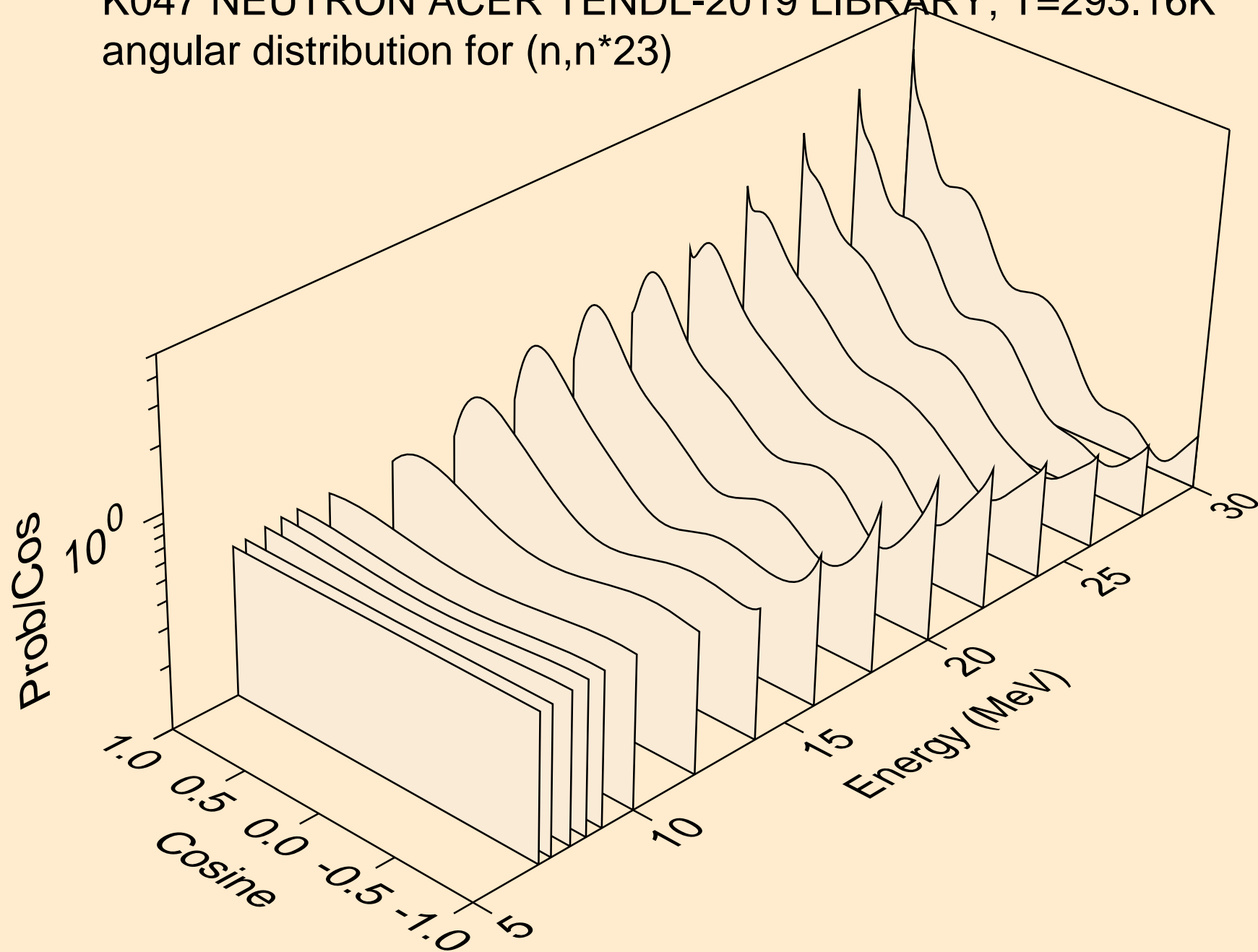

K047 NEUTRON ACER TENDL-2019 LIBRARY; T=293.16K  
angular distribution for (n,n\*24)

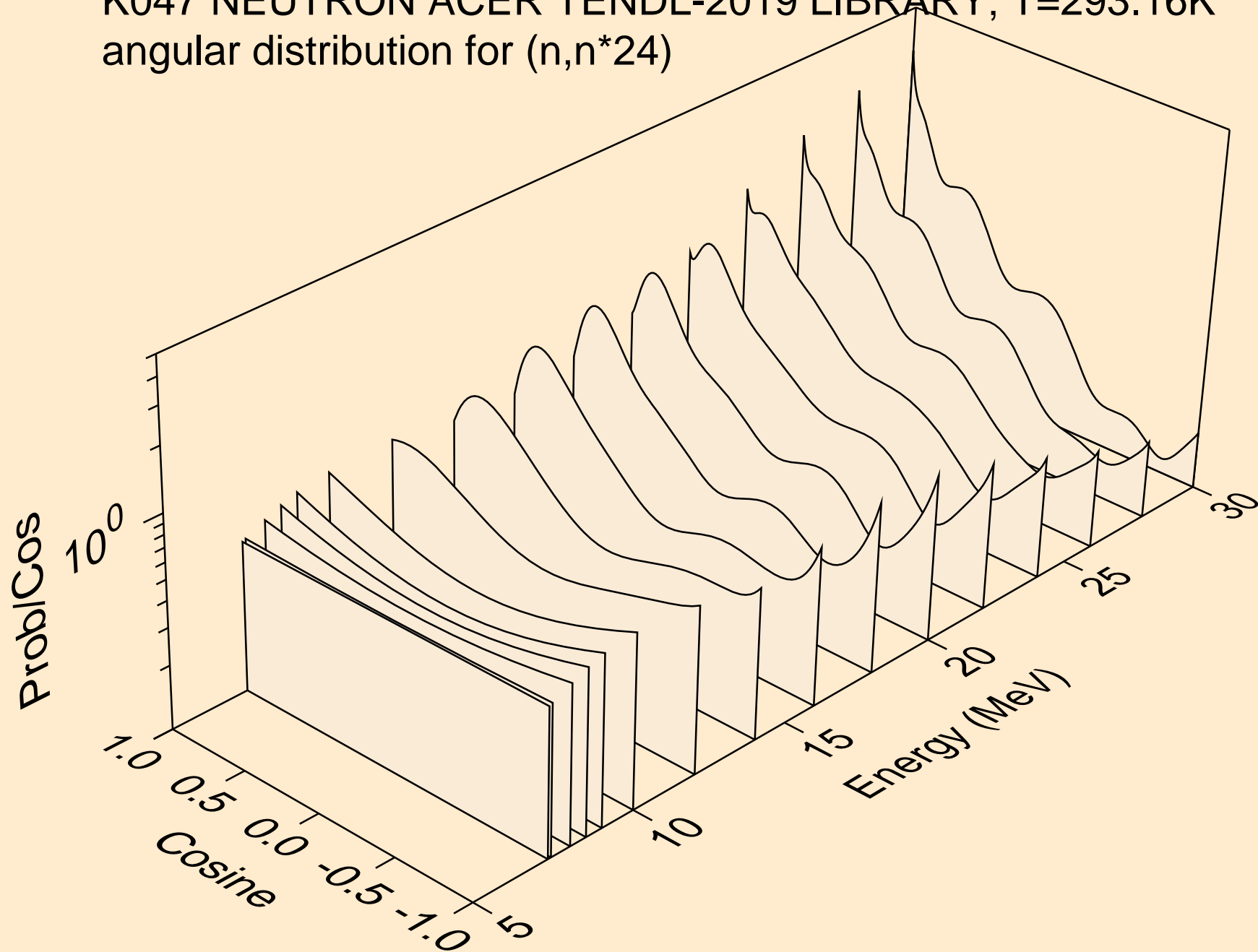

K047 NEUTRON ACER TENDL-2019 LIBRARY; T=293.16K  
angular distribution for (n,n\*25)

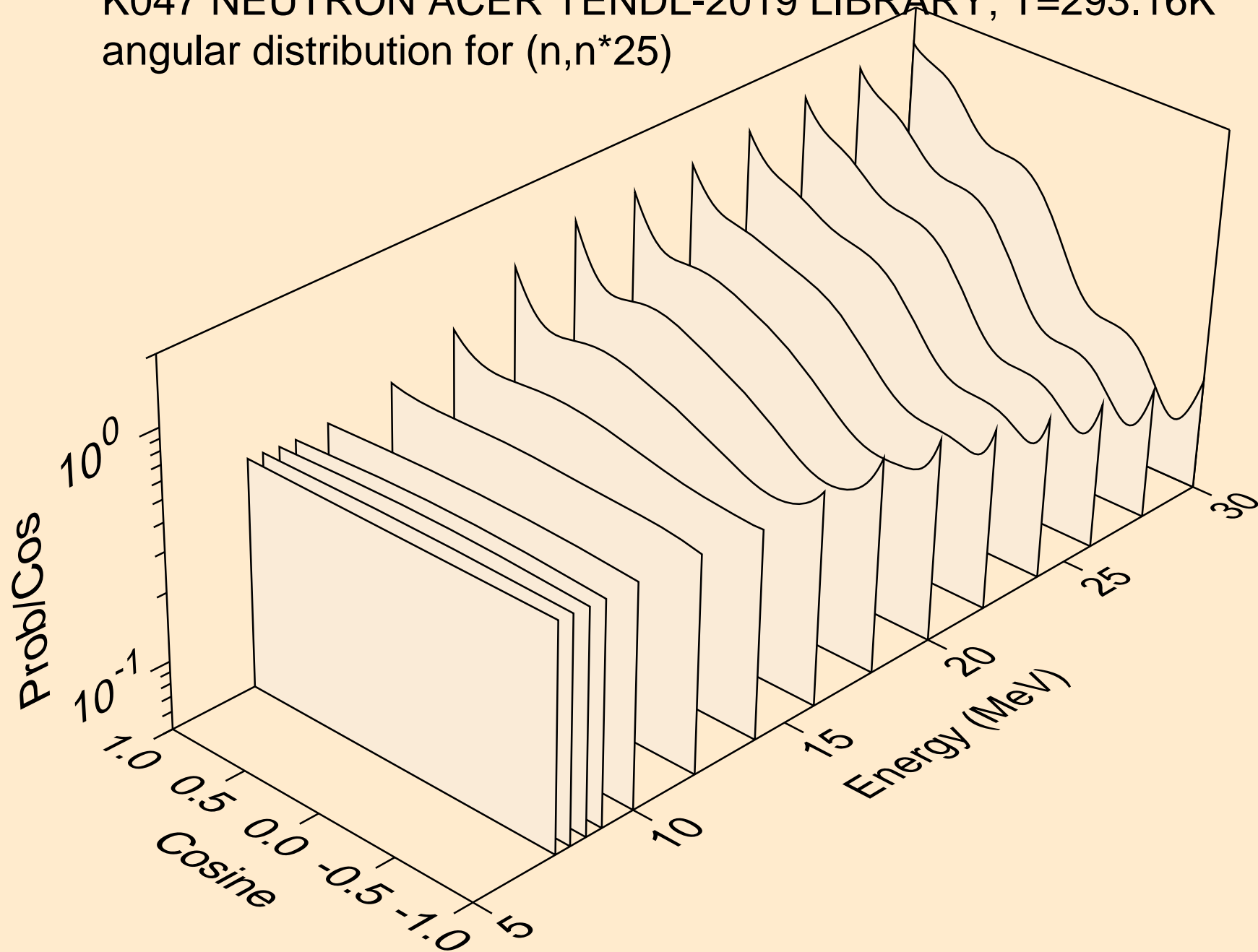

K047 NEUTRON ACER TENDL-2019 LIBRARY; T=293.16K  
angular distribution for (n,n\*26)

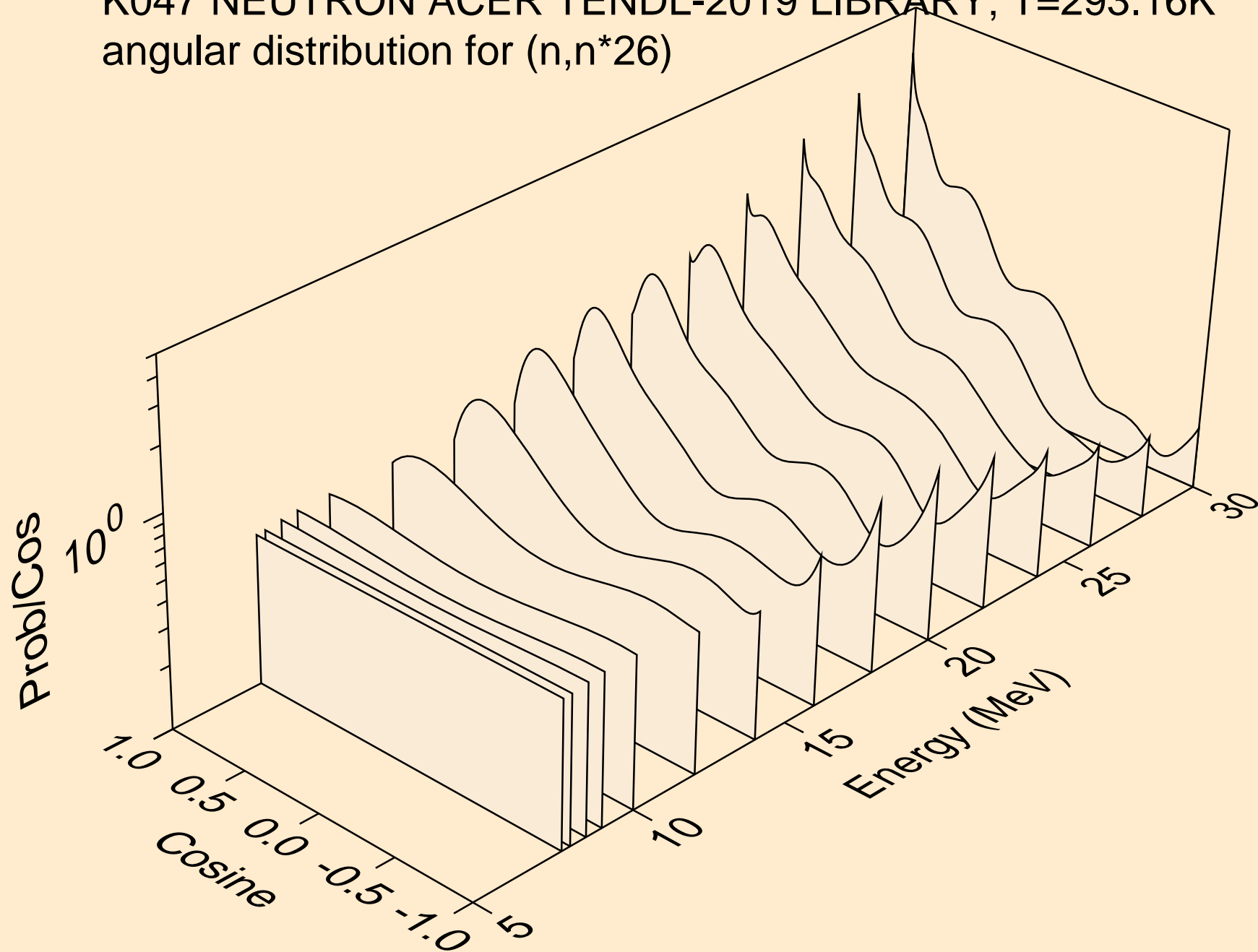

K047 NEUTRON ACER TENDL-2019 LIBRARY; T=293.16K  
angular distribution for (n,n\*27)

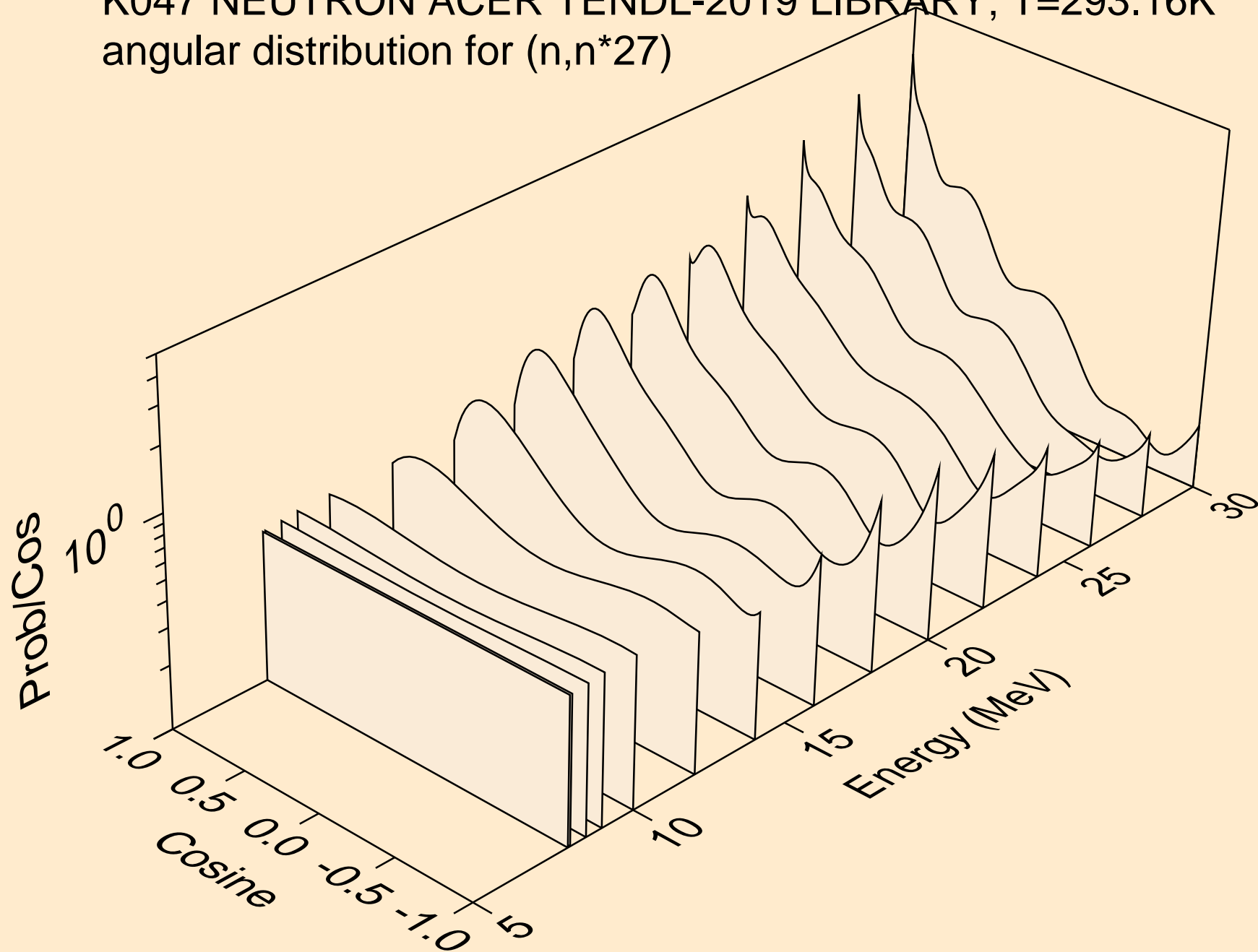



K047 NEUTRON ACER TENDL-2019 LIBRARY; T=293.16K  
Neutron emission for (n,x)

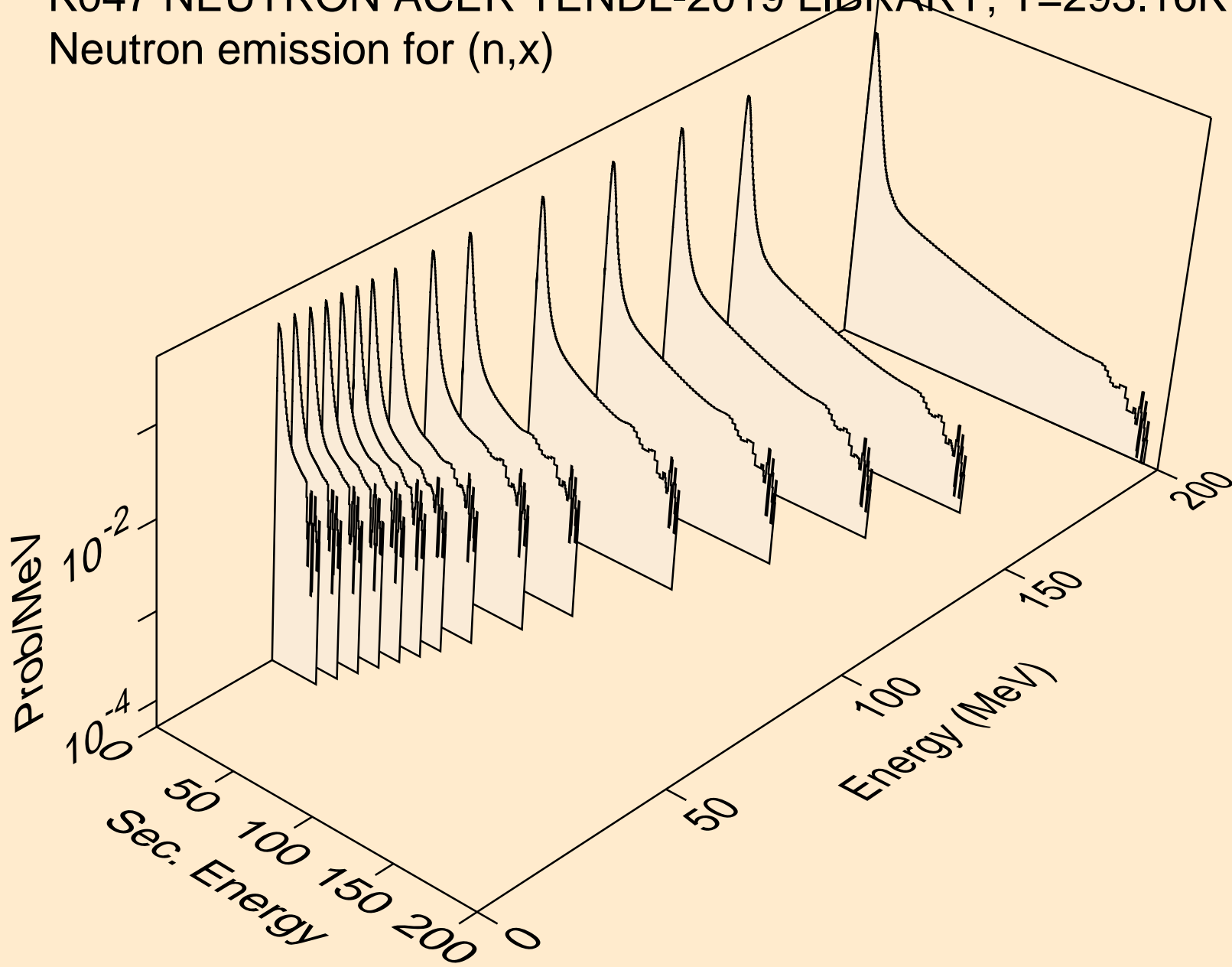

K047 NEUTRON ACER TENDL-2019 LIBRARY; T=293.16K  
Neutron emission for (n,2nd)

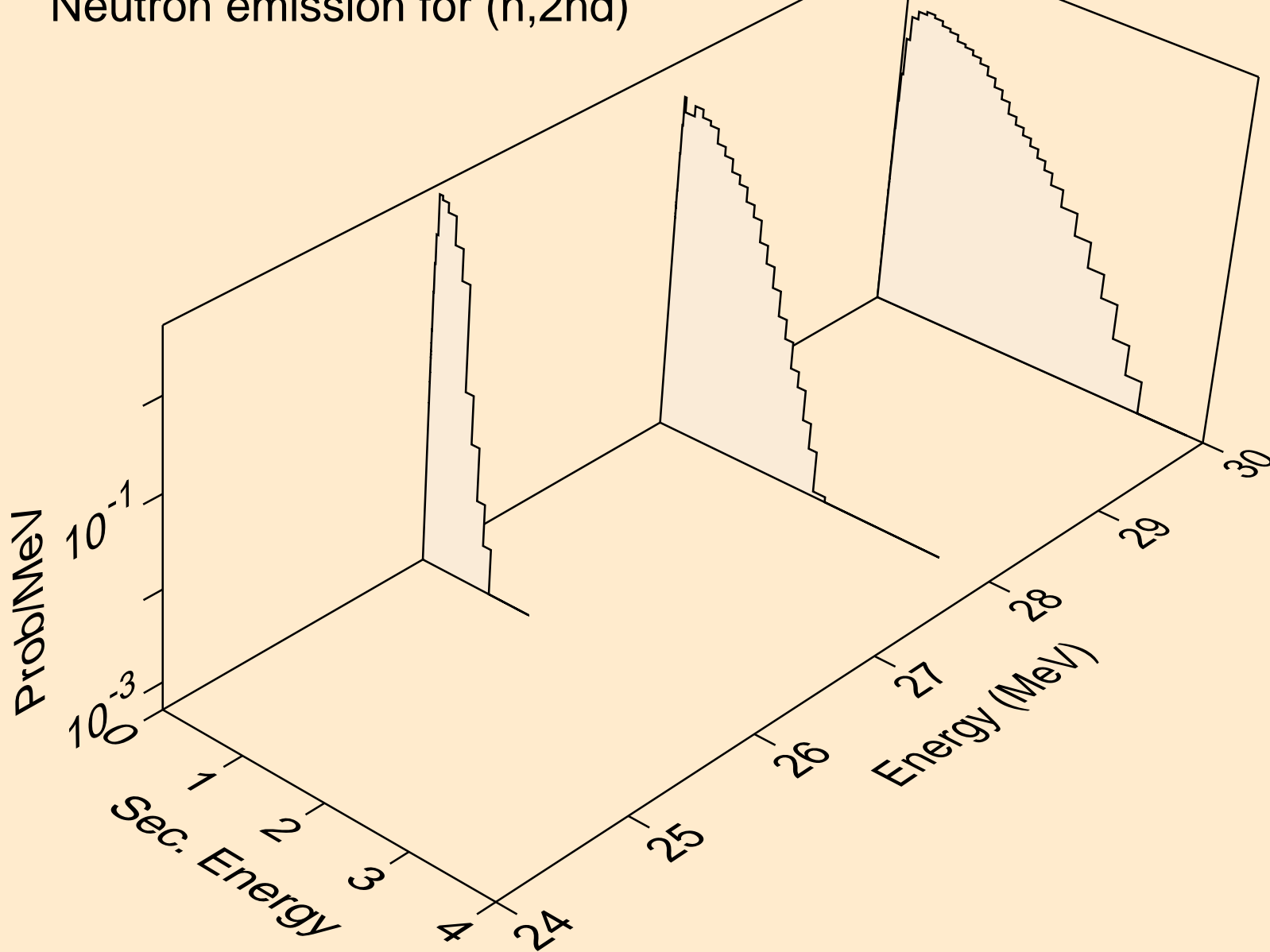

K047 NEUTRON ACER TENDL-2019 LIBRARY; T=293.16K  
Neutron emission for (n,2n)

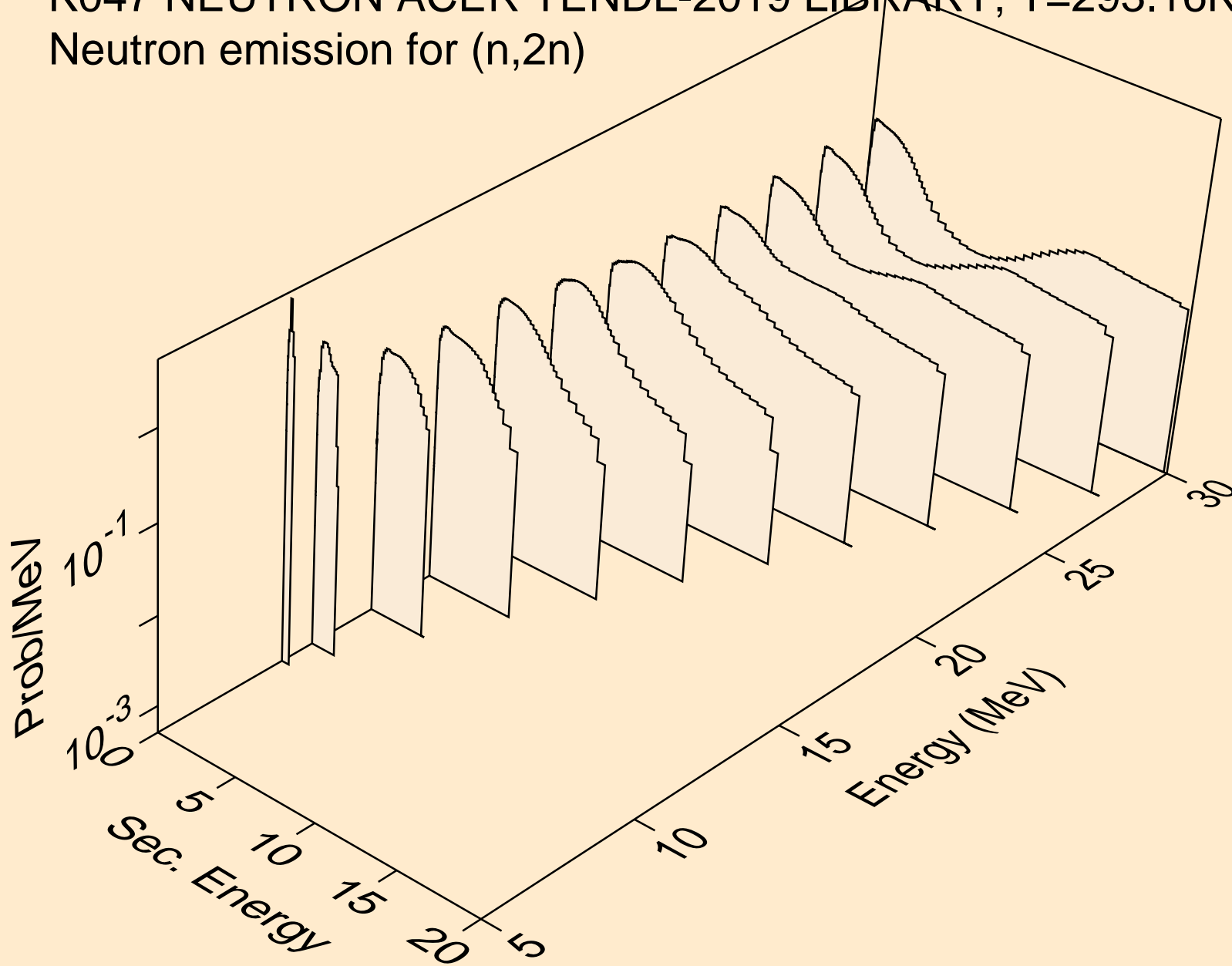

K047 NEUTRON ACER TENDL-2019 LIBRARY; T=293.16K  
Neutron emission for (n,3n)

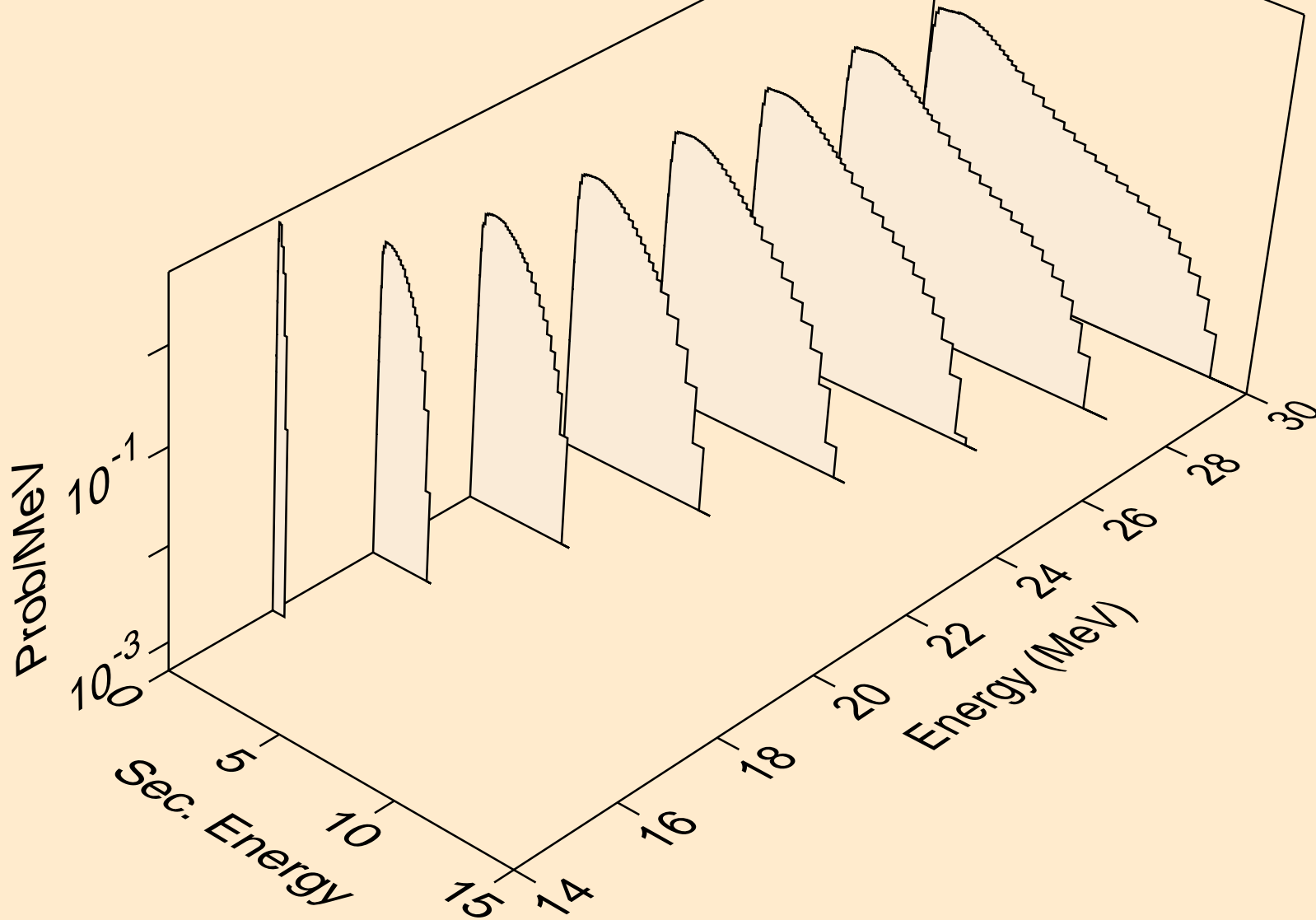

K047 NEUTRON ACER TENDL-2019 LIBRARY; T=293.16K  
Neutron emission for (n,n\*)a

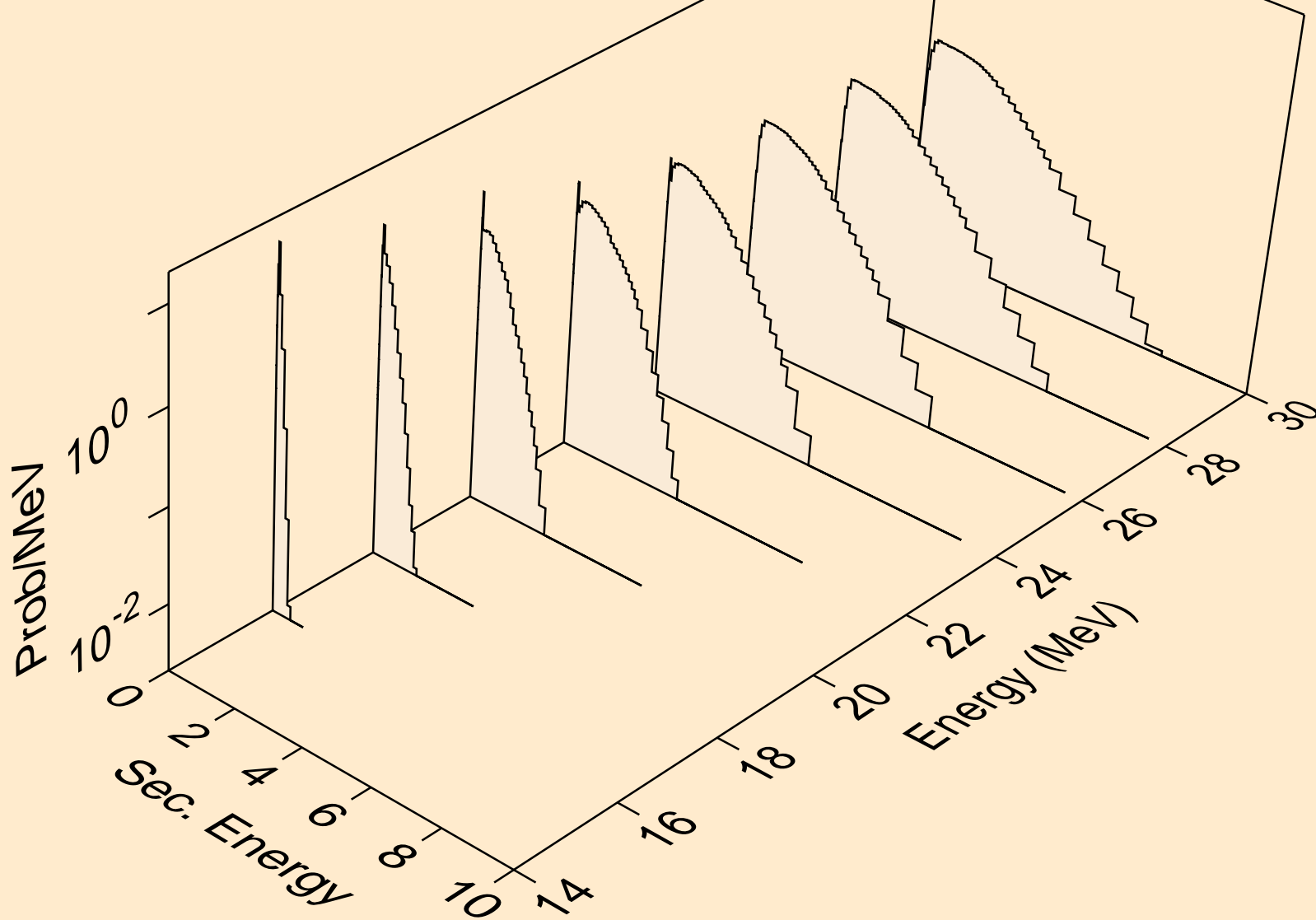

K047 NEUTRON ACER TENDL-2019 LIBRARY; T=293.16K  
Neutron emission for (n,2n)a

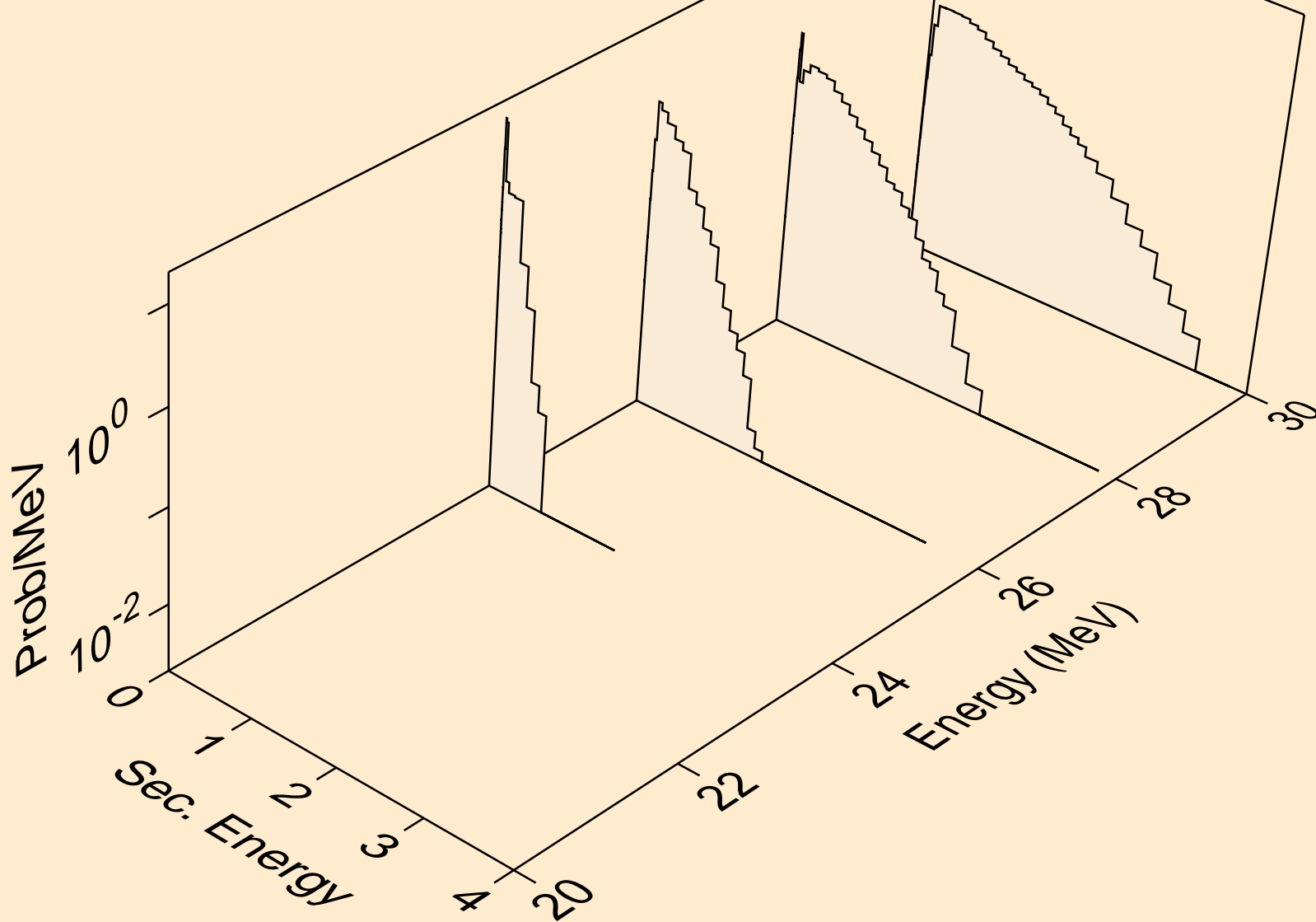

K047 NEUTRON ACER TENDL-2019 LIBRARY; T=293.16K  
Neutron emission for (n,n\*)p

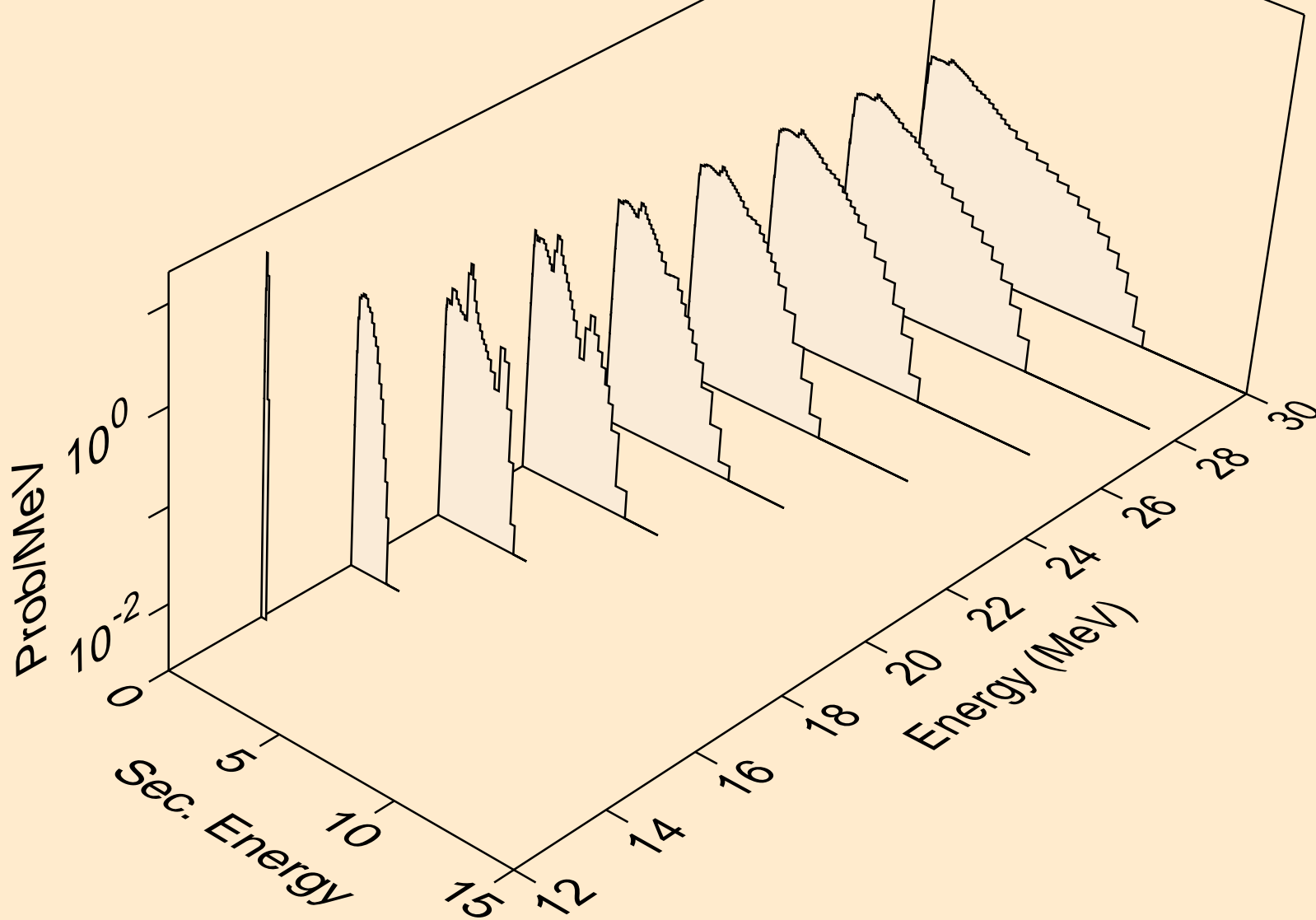

K047 NEUTRON ACER TENDL-2019 LIBRARY; T=293.16K  
Neutron emission for (n,n\*)d

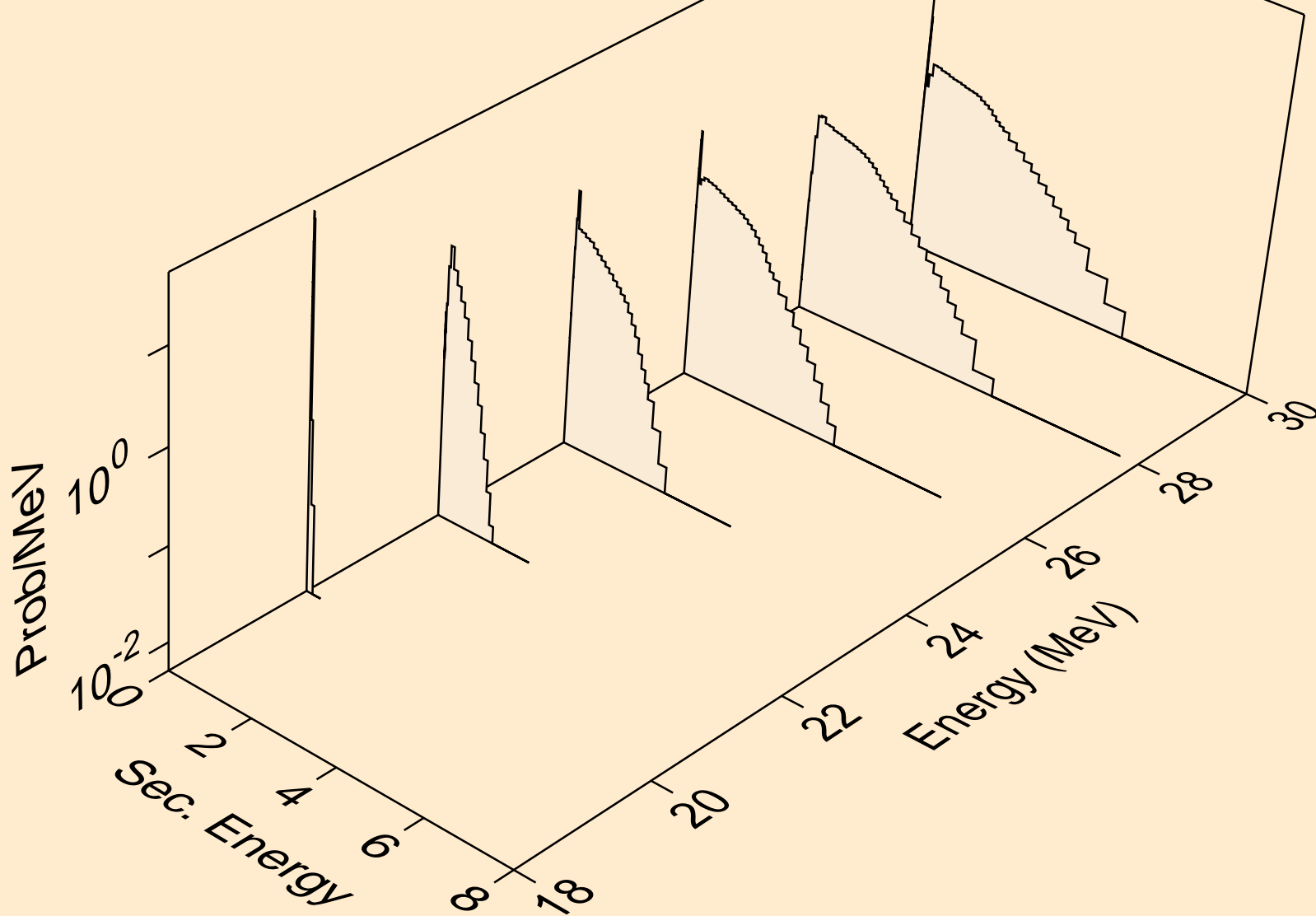



K047 NEUTRON ACER TENDL-2019 LIBRARY; T=293.16K  
Neutron emission for (n,n\*)t

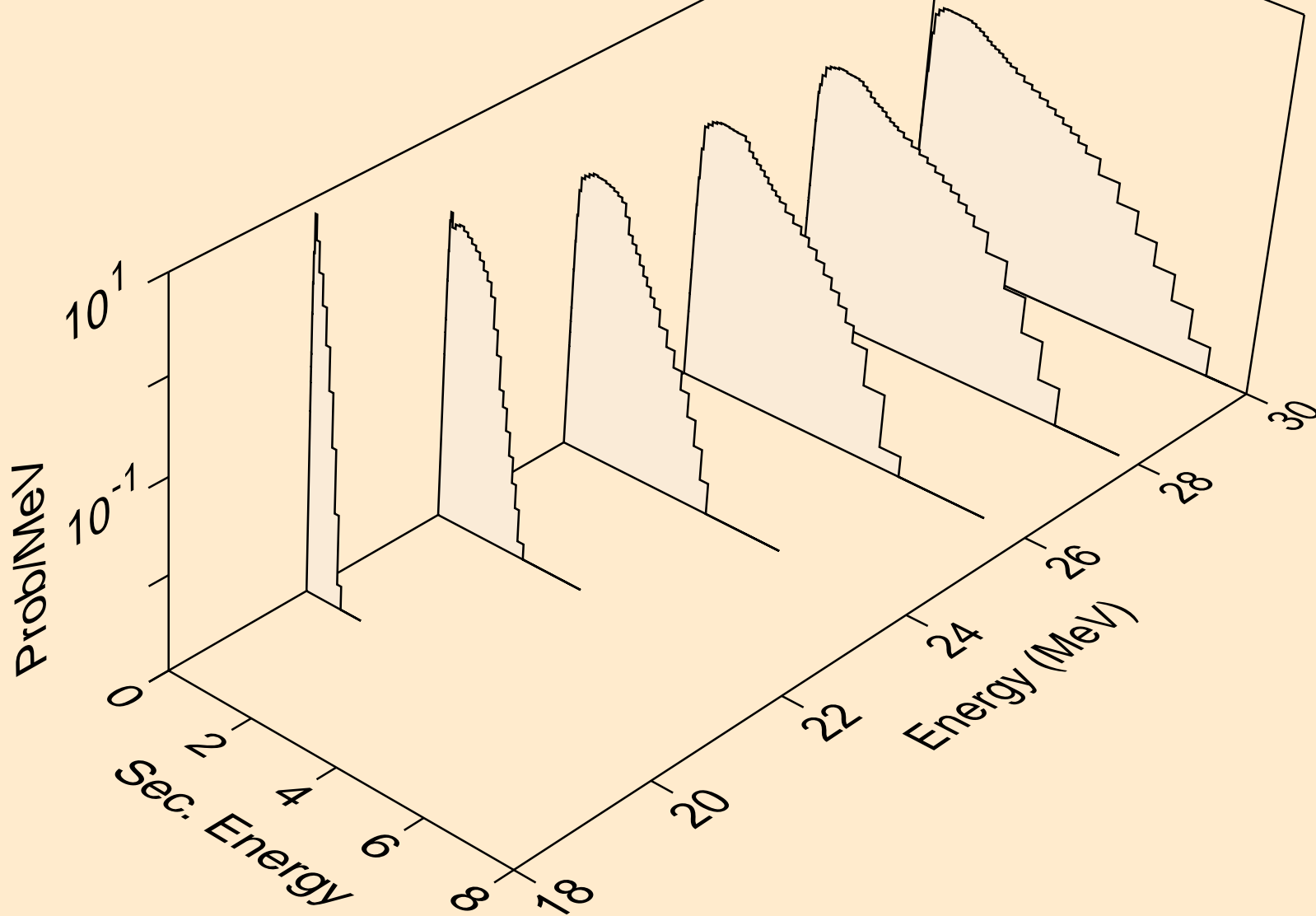

K047 NEUTRON ACER TENDL-2019 LIBRARY; T=293.16K  
Neutron emission for (n,4n)

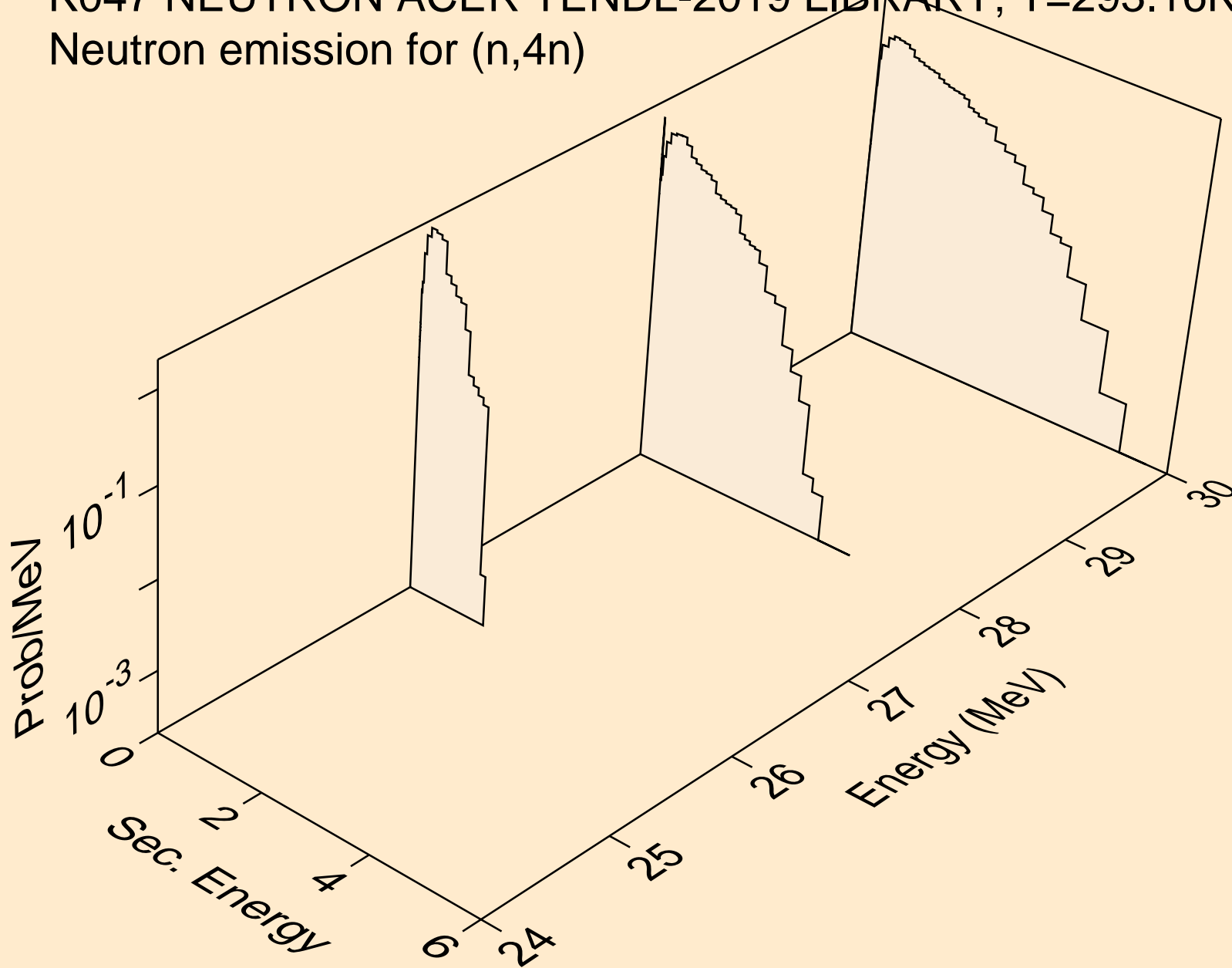

K047 NEUTRON ACER TENDL-2019 LIBRARY; T=293.16K  
Neutron emission for (n,2np)

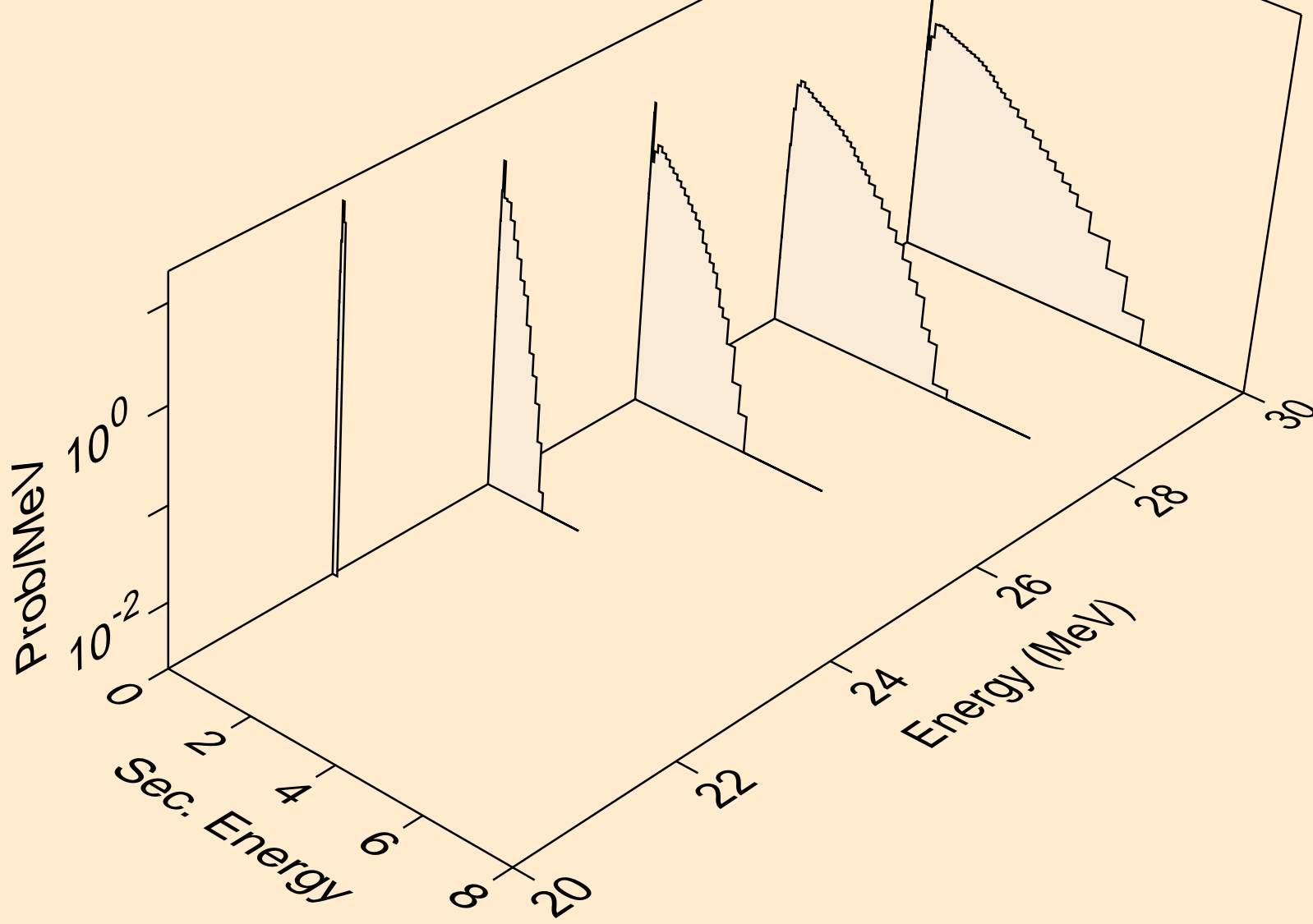

K047 NEUTRON ACER TENDL-2019 LIBRARY; T=293.16K  
Neutron emission for (n,3np)

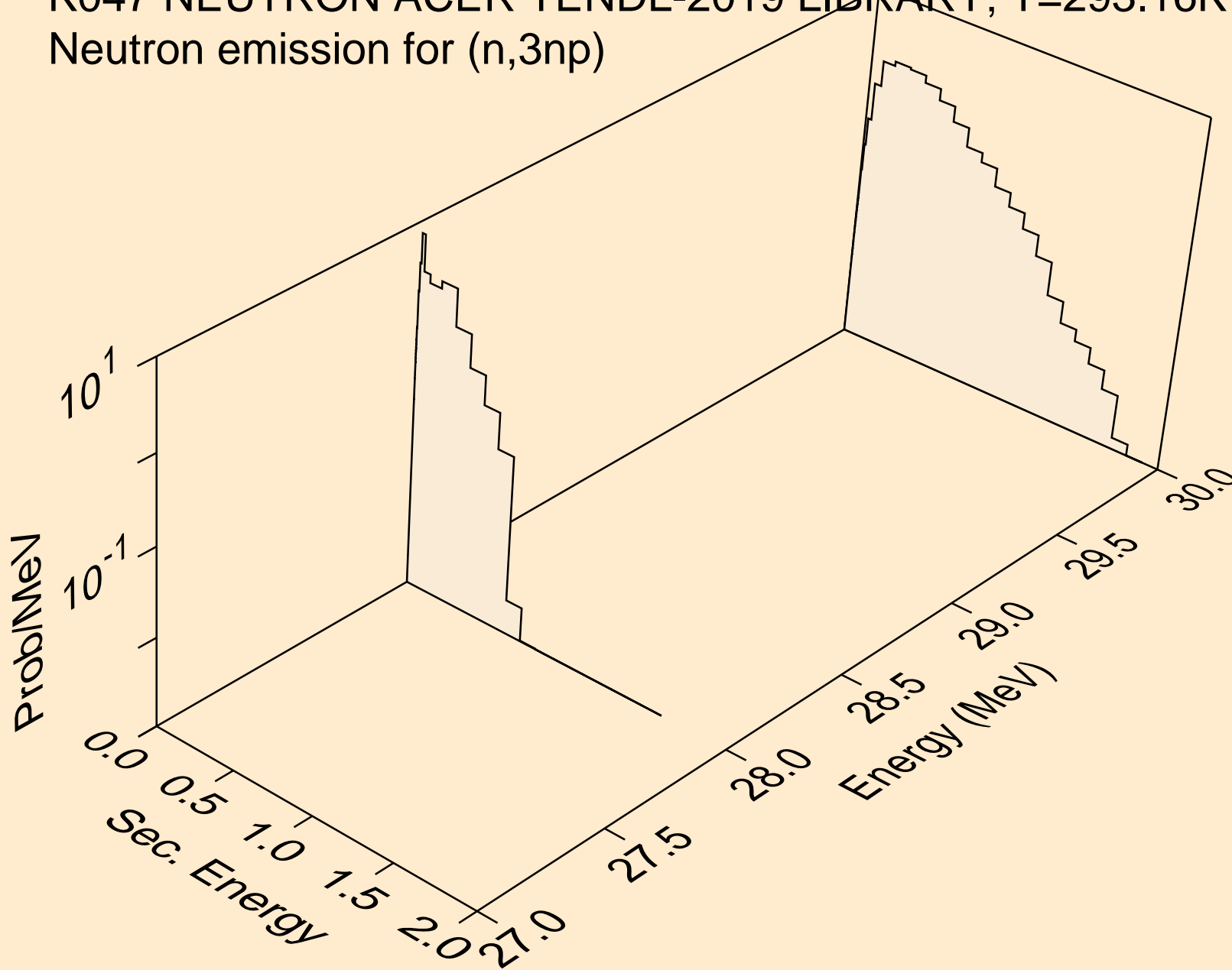

K047 NEUTRON ACER TENDL-2019 LIBRARY; T=293.16K  
Neutron emission for (n,n\*c)

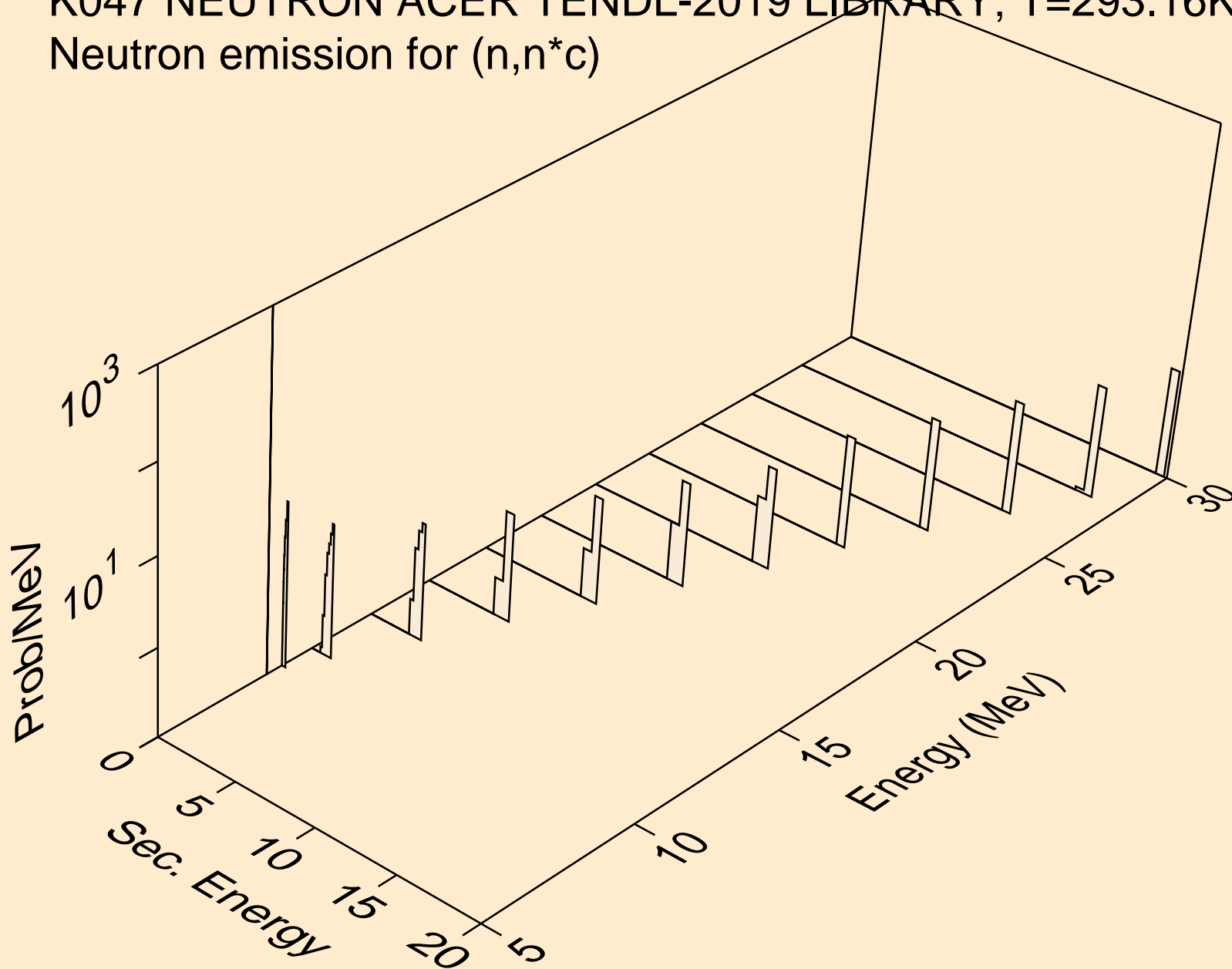

K047 NEUTRON ACER TENDL-2019 LIBRARY; T=293.16K  
Photon emission for (n,x)

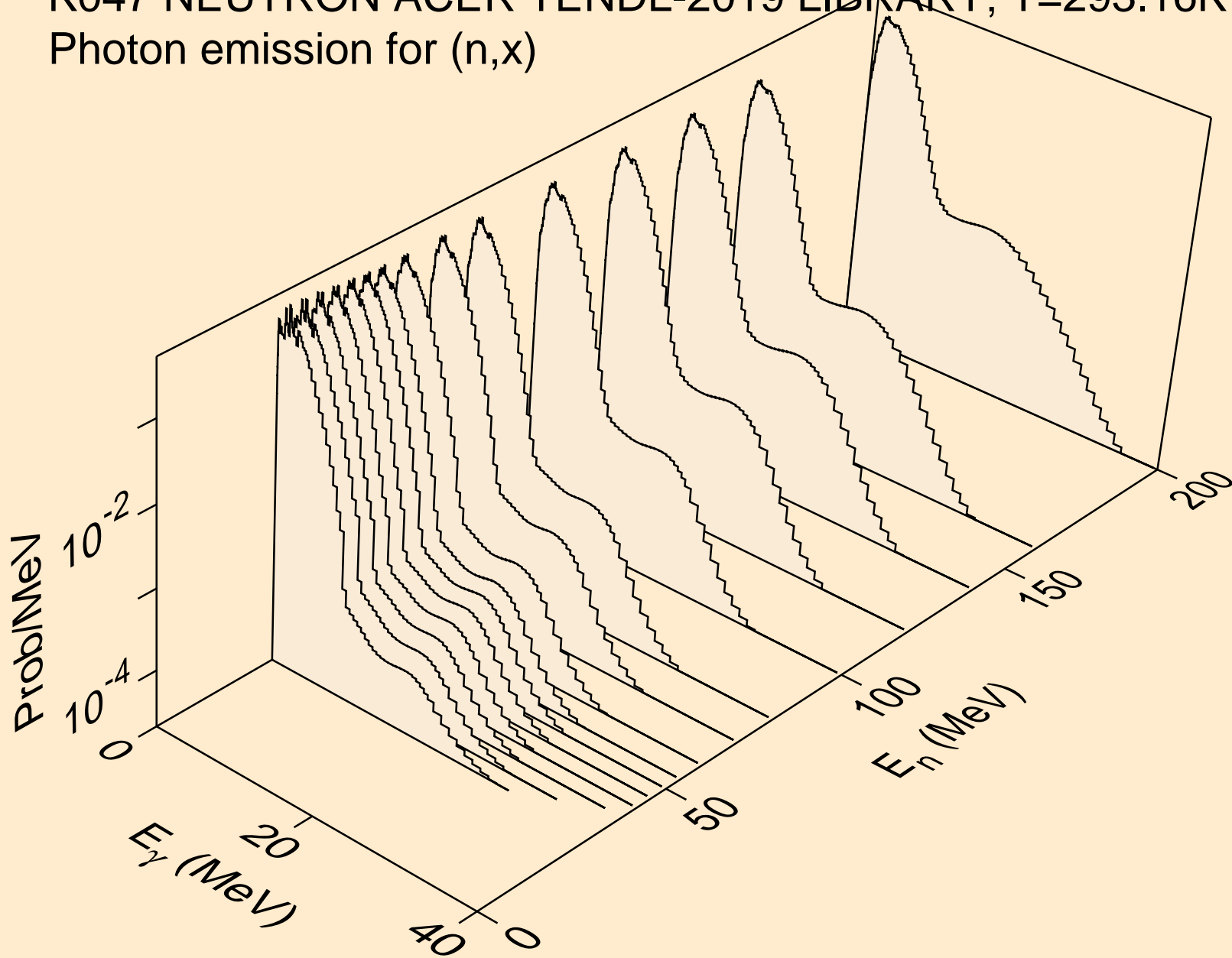

K047 NEUTRON ACER TENDL-2019 LIBRARY; T=293.16K  
Photon emission for (n,2nd)

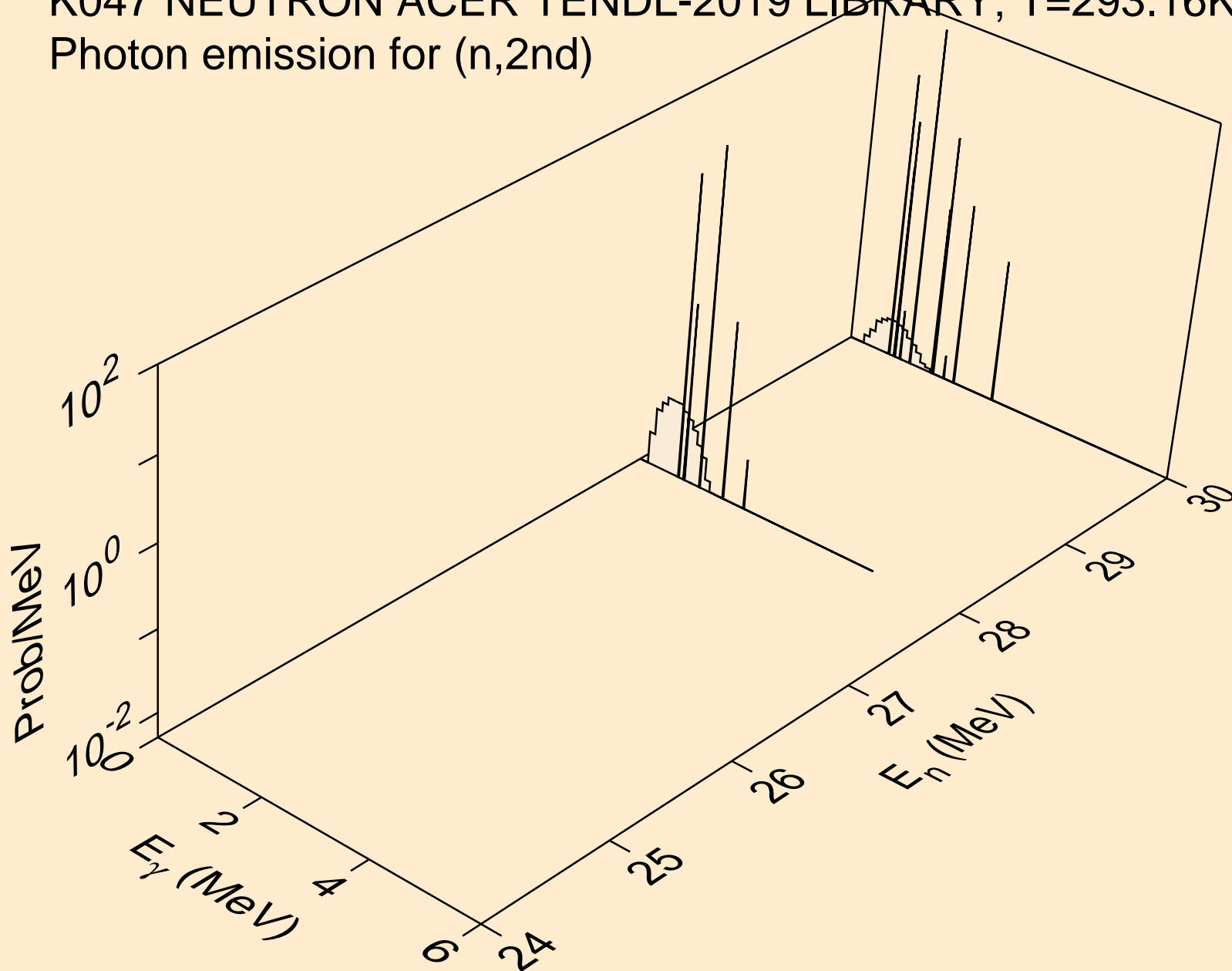

K047 NEUTRON ACER TENDL-2019 LIBRARY; T=293.16K  
Photon emission for (n,2n)

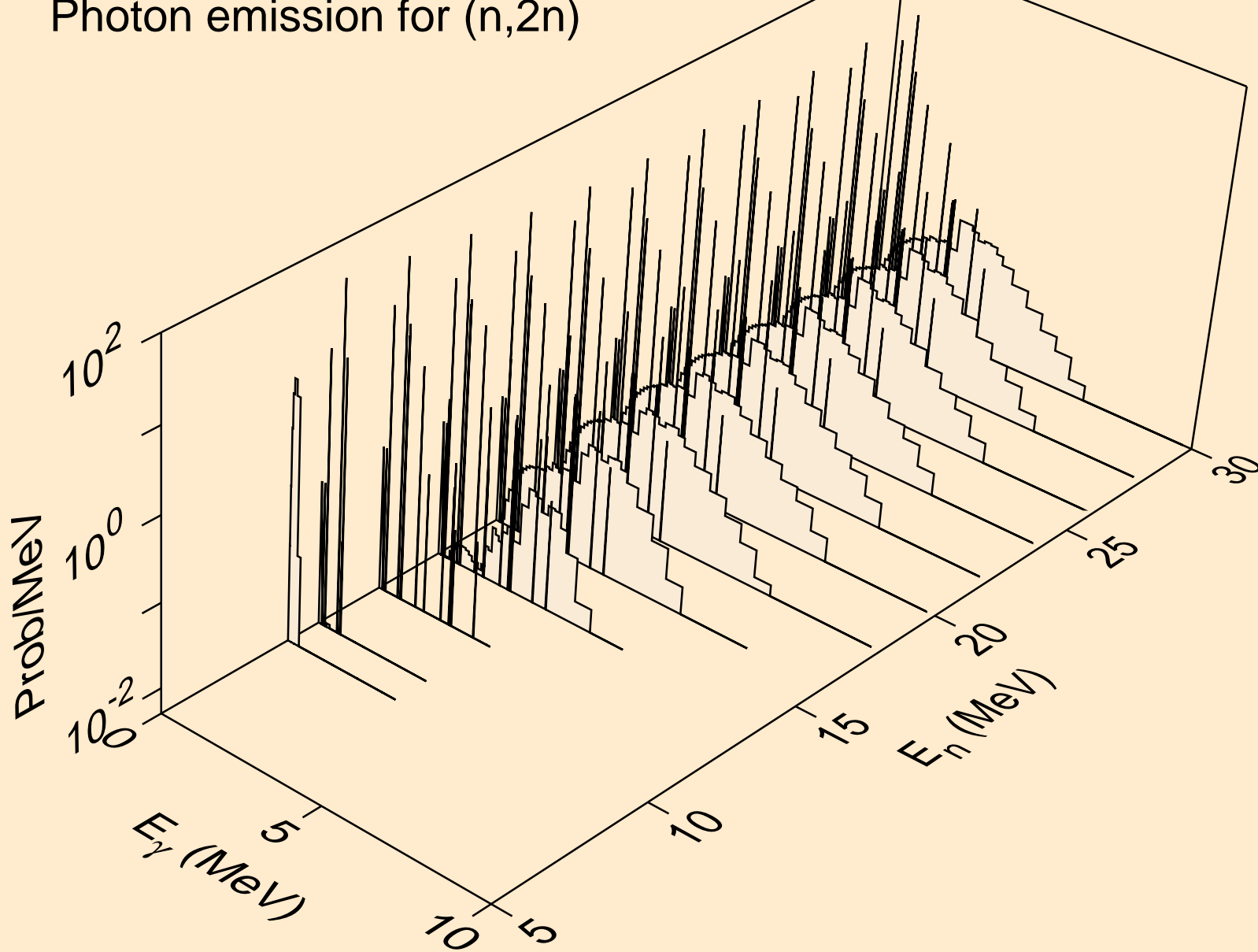



K047 NEUTRON ACER TENDL-2019 LIBRARY; T=293.16K  
Photon emission for (n,3n)

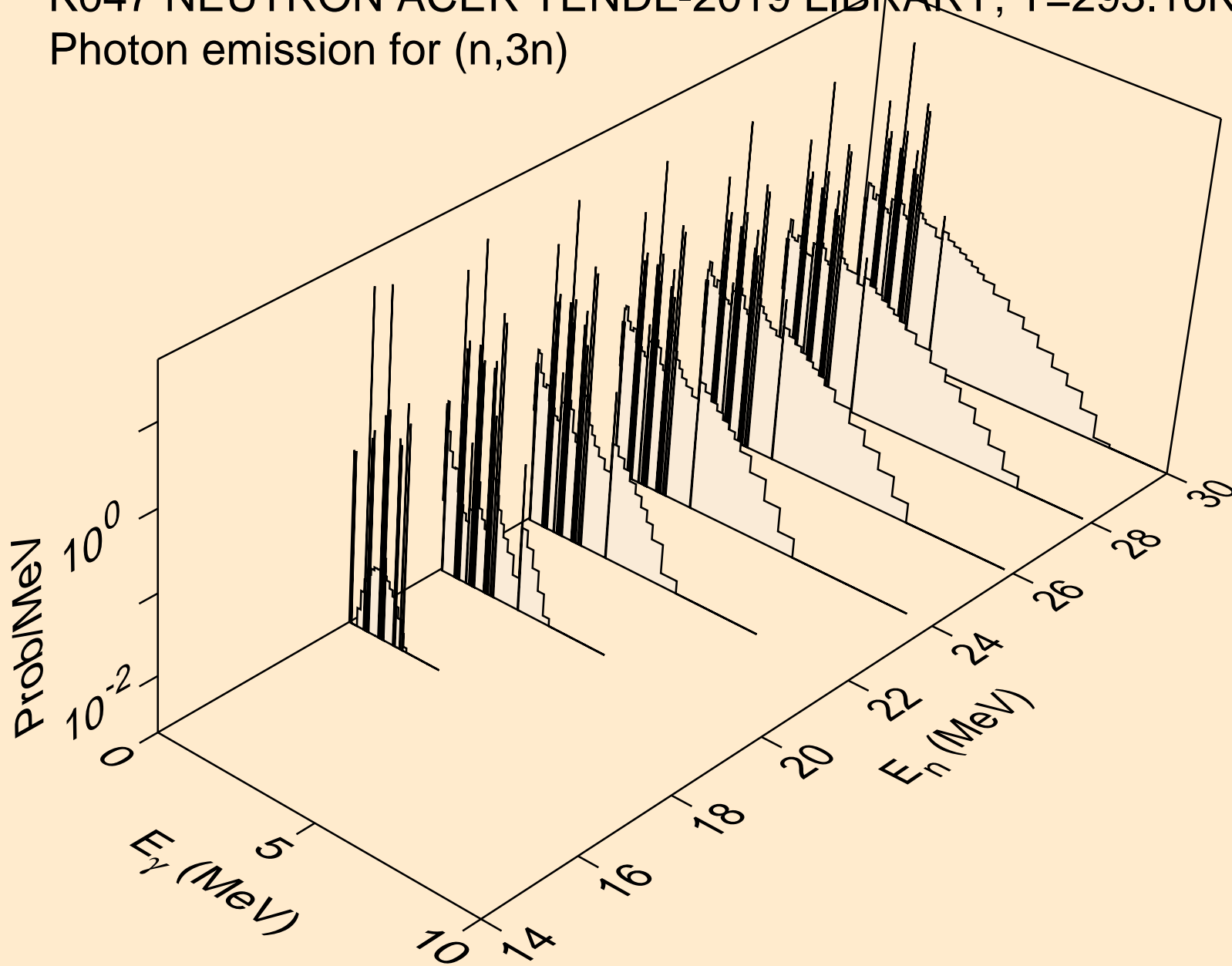

K047 NEUTRON ACER TENDL-2019 LIBRARY; T=293.16K  
Photon emission for (n,n\*)a

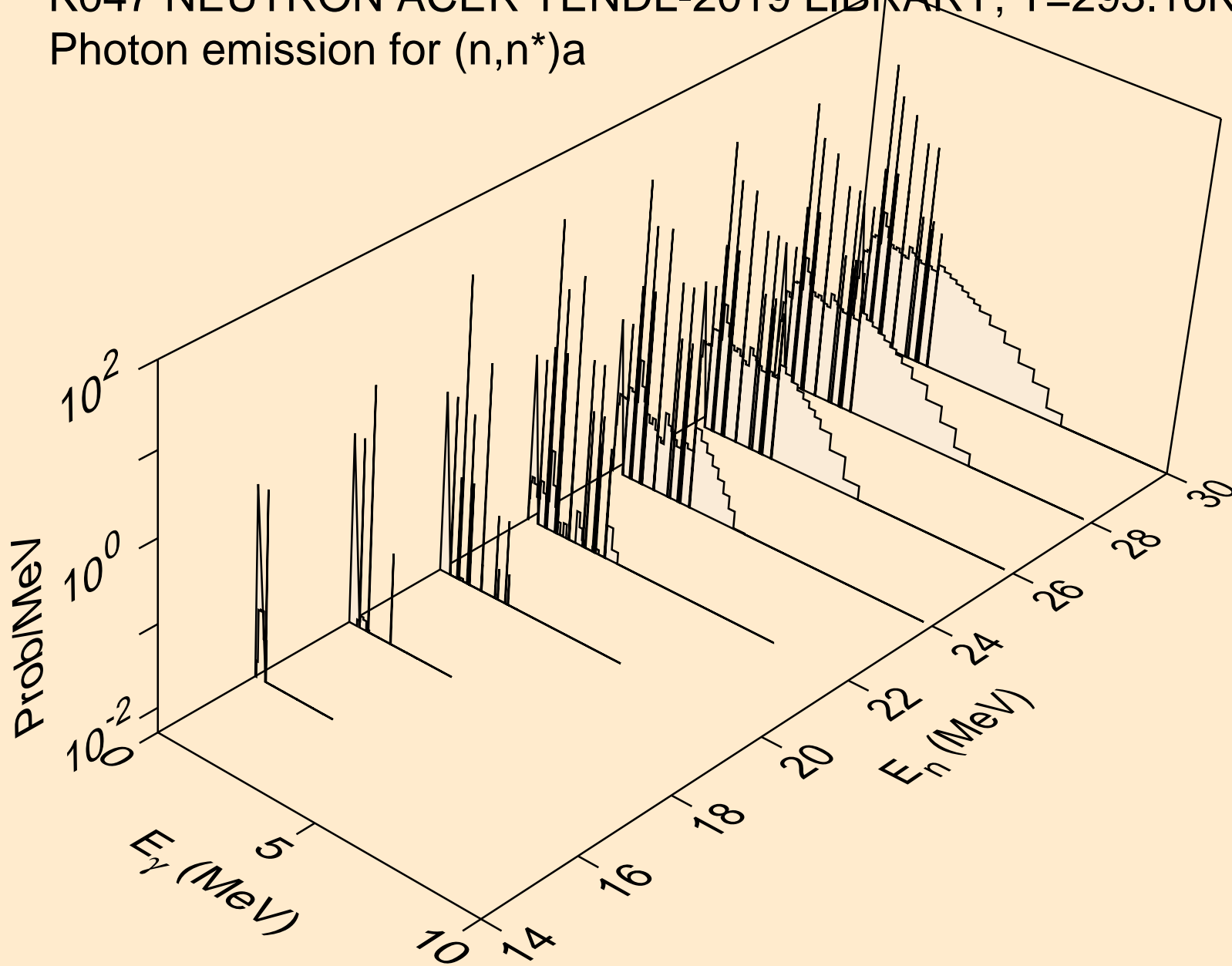

K047 NEUTRON ACER TENDL-2019 LIBRARY; T=293.16K  
Photon emission for (n,2n)a

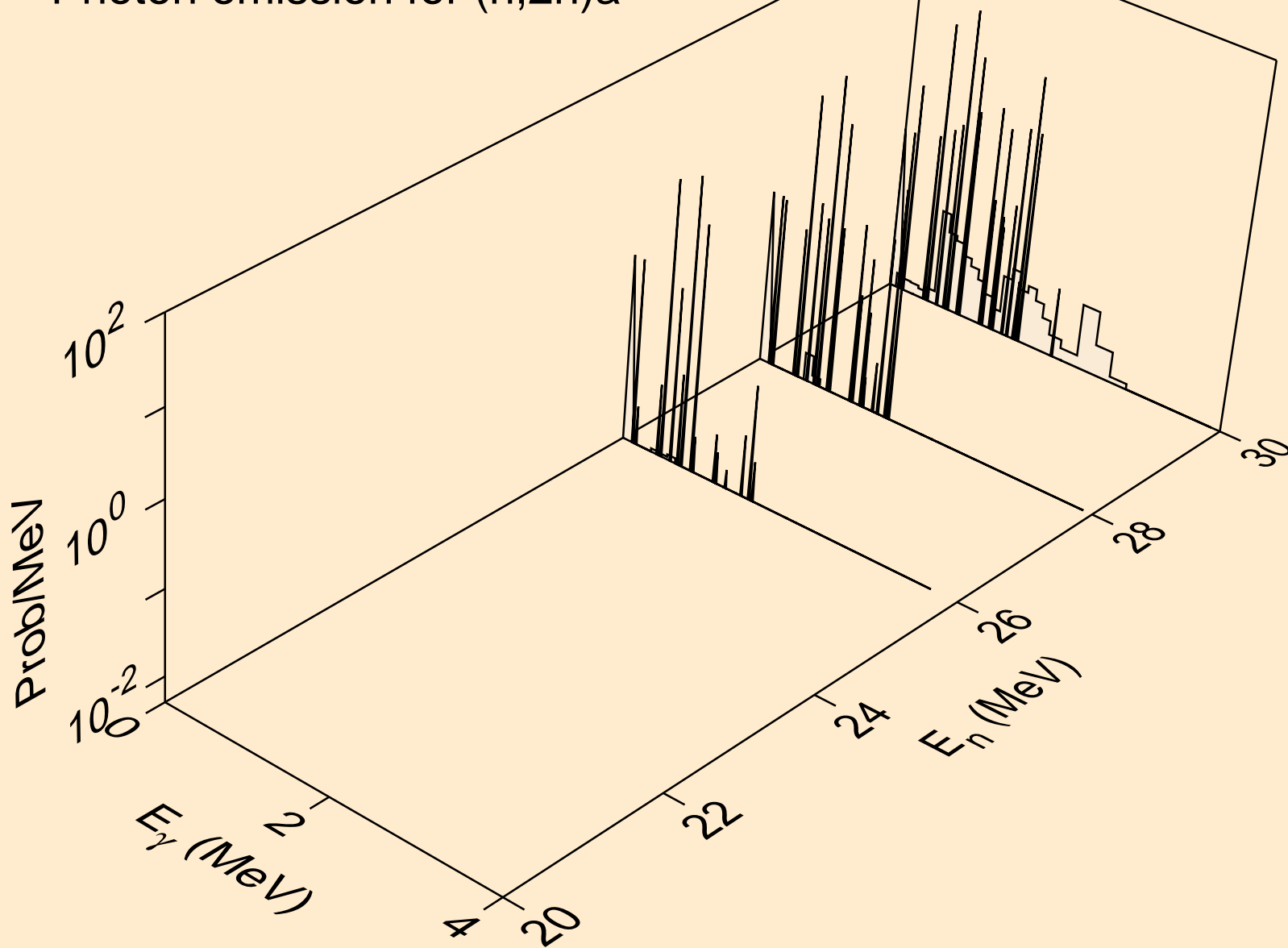

K047 NEUTRON ACER TENDL-2019 LIBRARY; T=293.16K  
Photon emission for (n,n\*)p

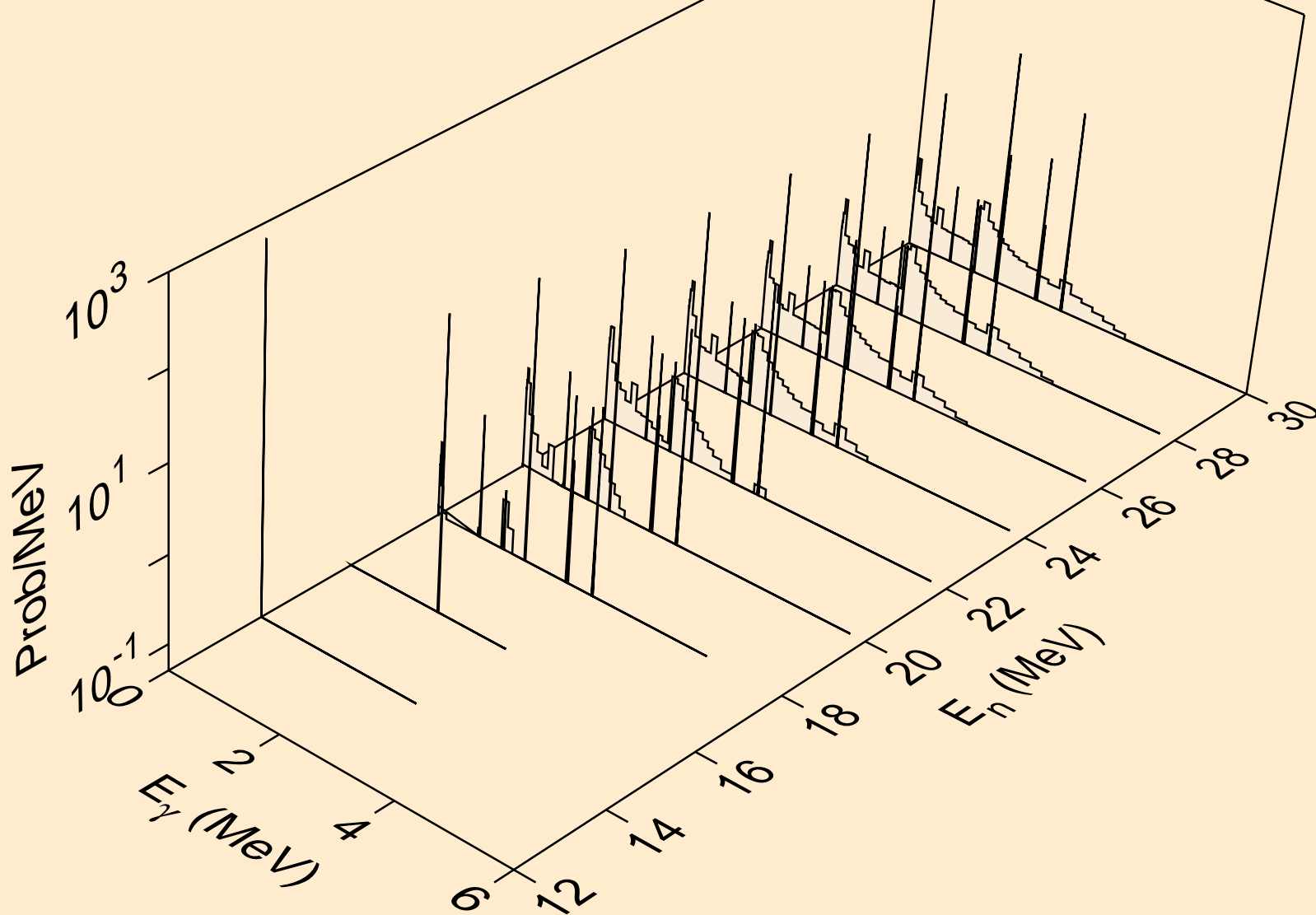

K047 NEUTRON ACER TENDL-2019 LIBRARY; T=293.16K  
Photon emission for (n,n\*)d

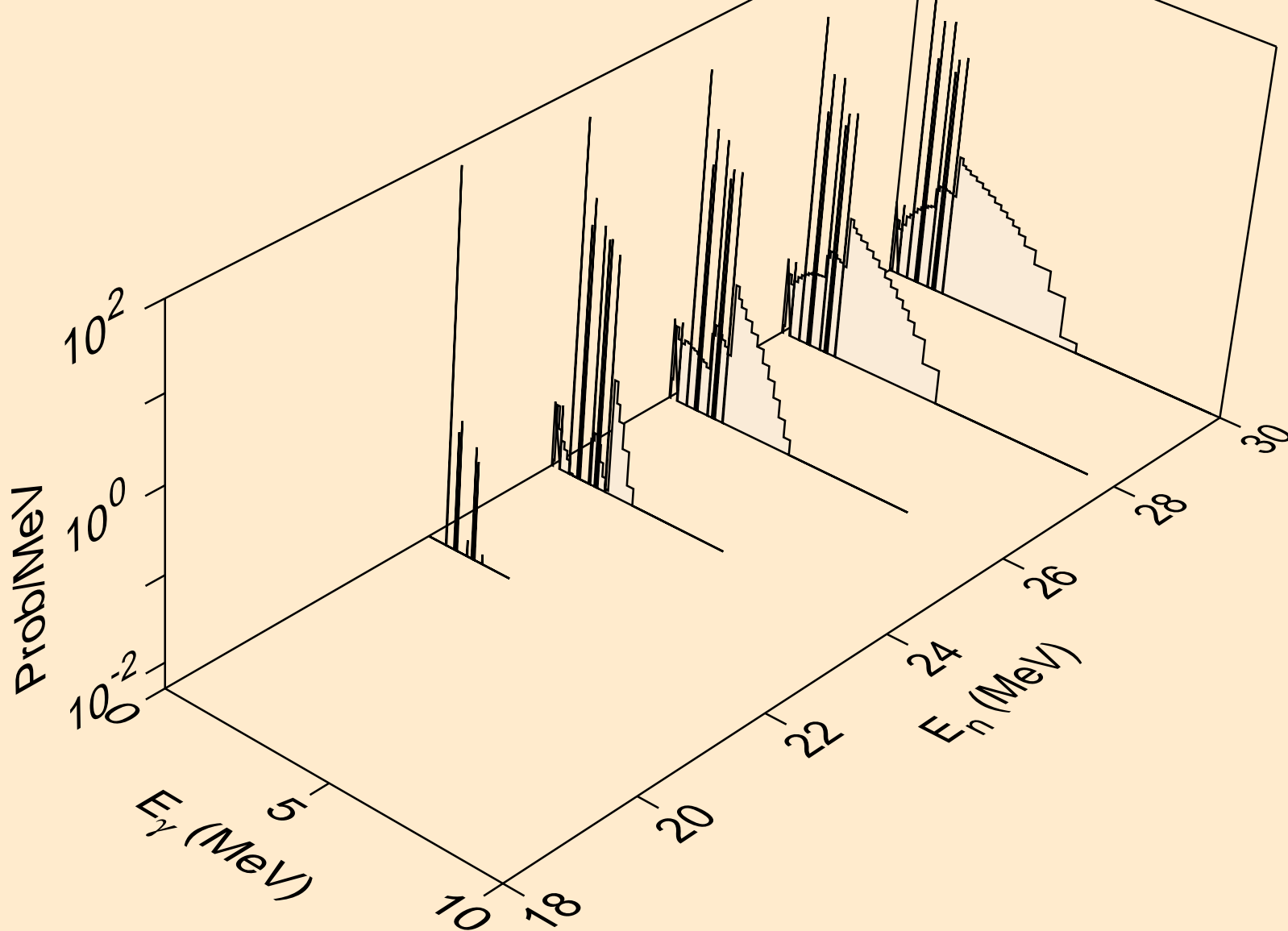

K047 NEUTRON ACER TENDL-2019 LIBRARY; T=293.16K  
Photon emission for (n,n\*)t

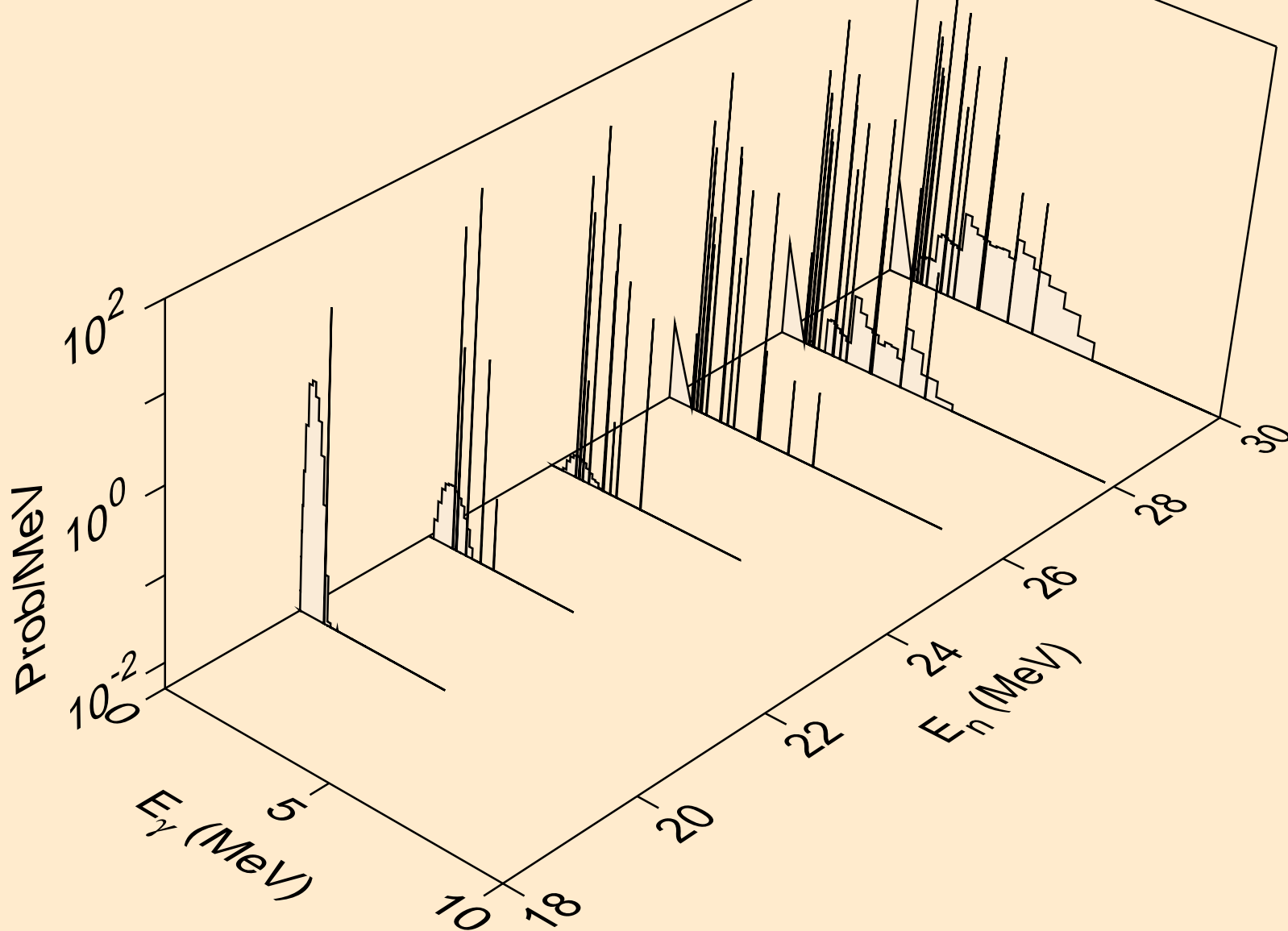

K047 NEUTRON ACER TENDL-2019 LIBRARY; T=293.16K  
Photon emission for (n,4n)

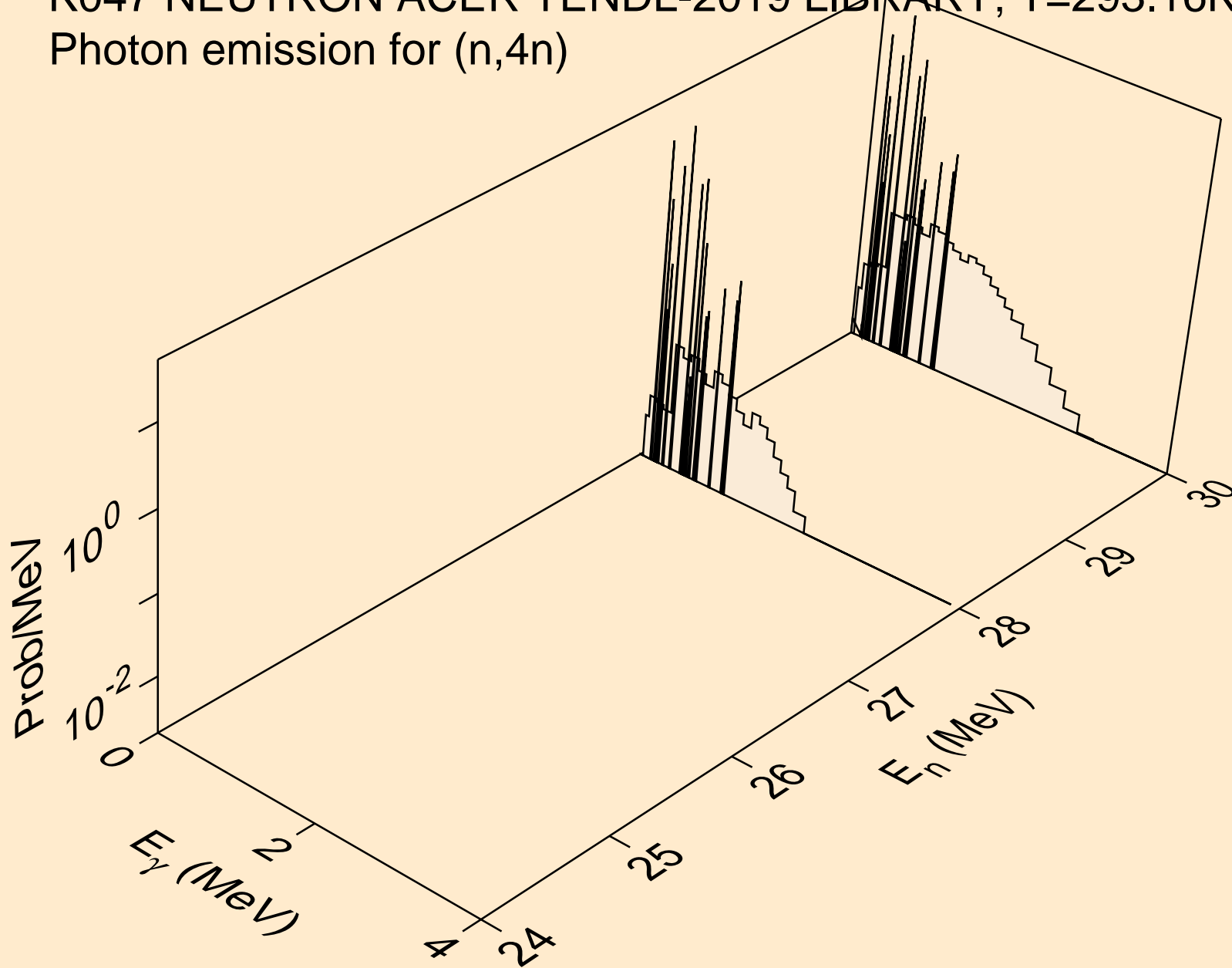

K047 NEUTRON ACER TENDL-2019 LIBRARY; T=293.16K  
Photon emission for (n,2np)

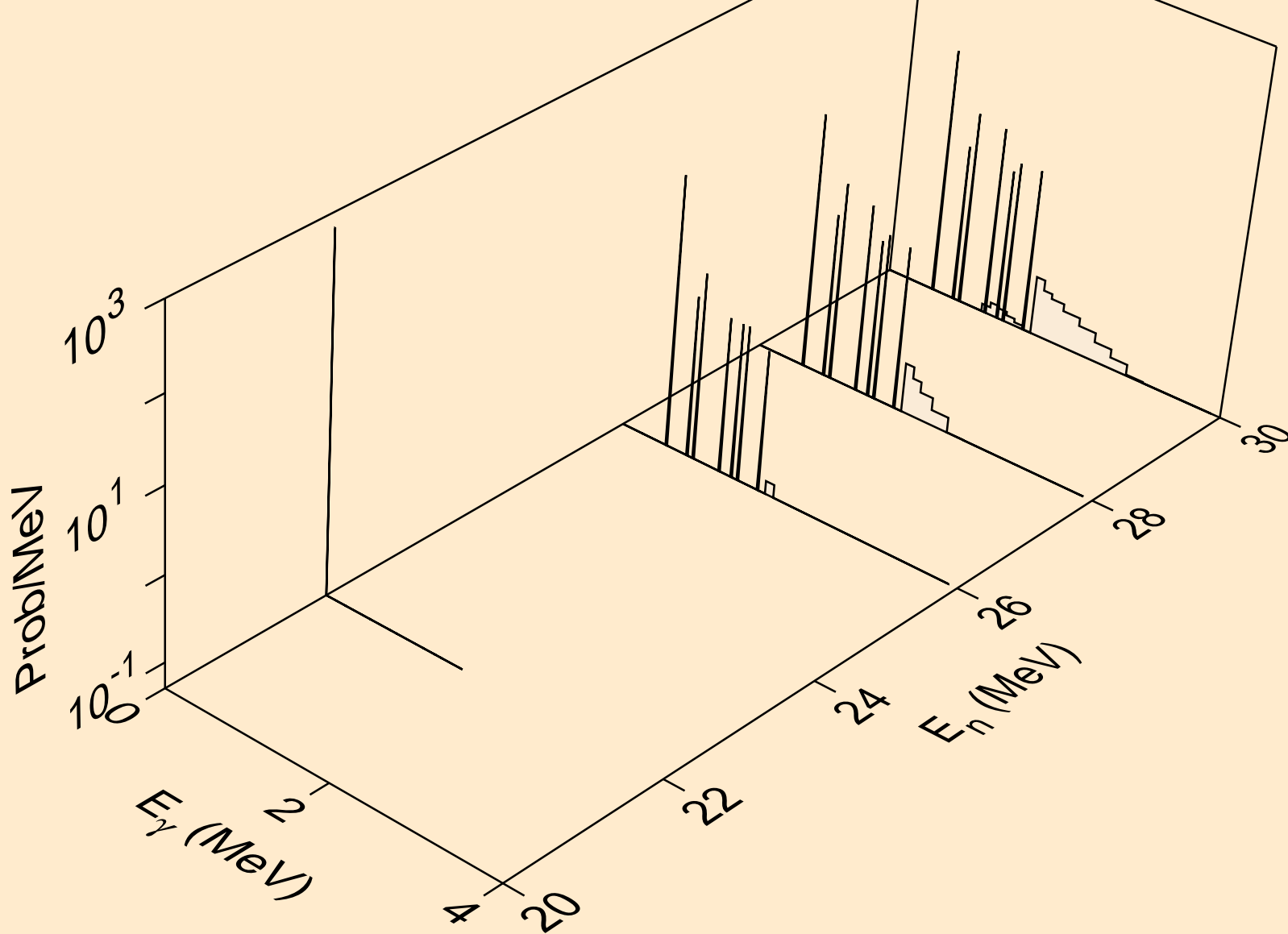



K047 NEUTRON ACER TENDL-2019 LIBRARY; T=293.16K  
Photon emission for (n,3np)

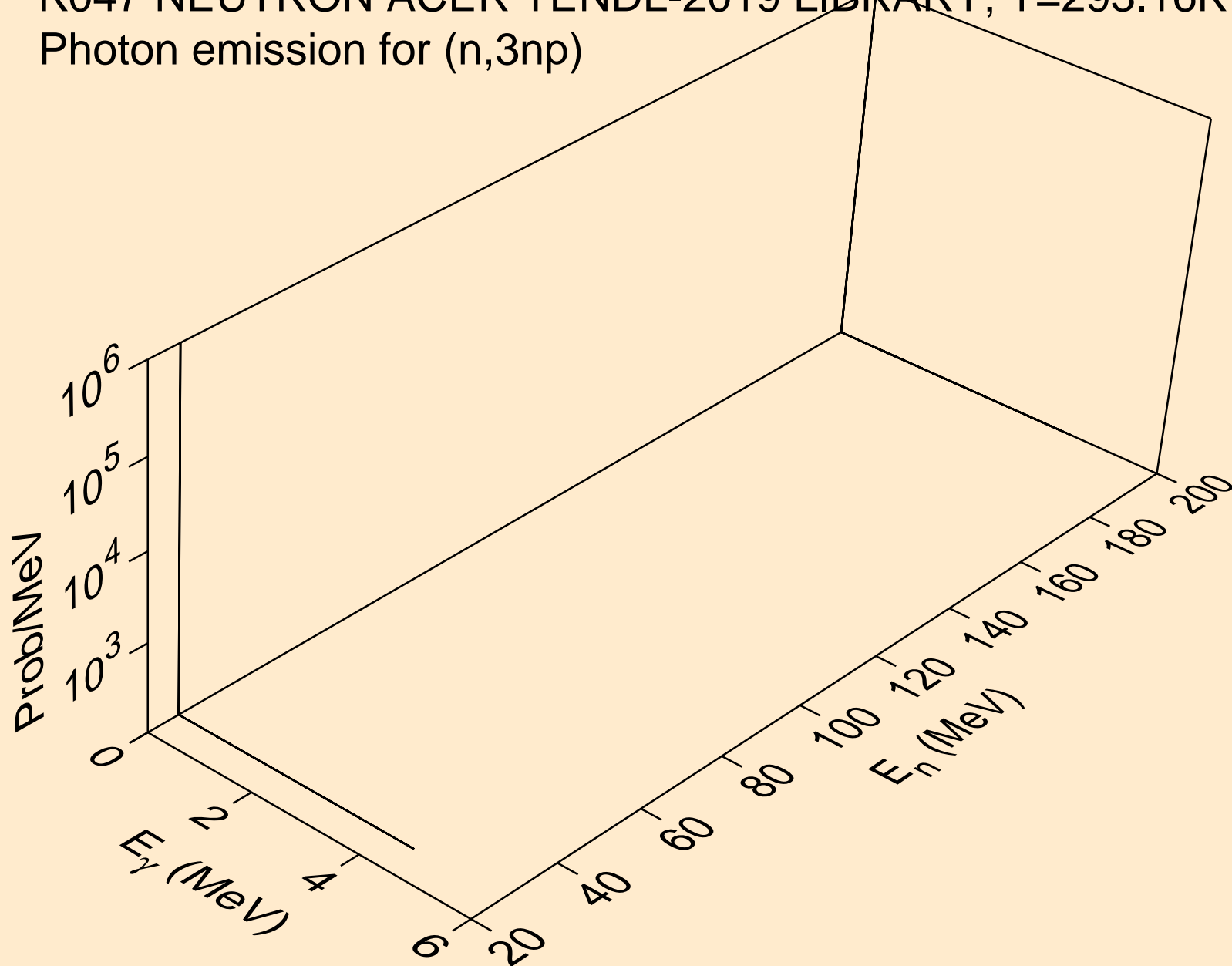

K047 NEUTRON ACER TENDL-2019 LIBRARY; T=293.16K  
Photon emission for (n,n\*c)

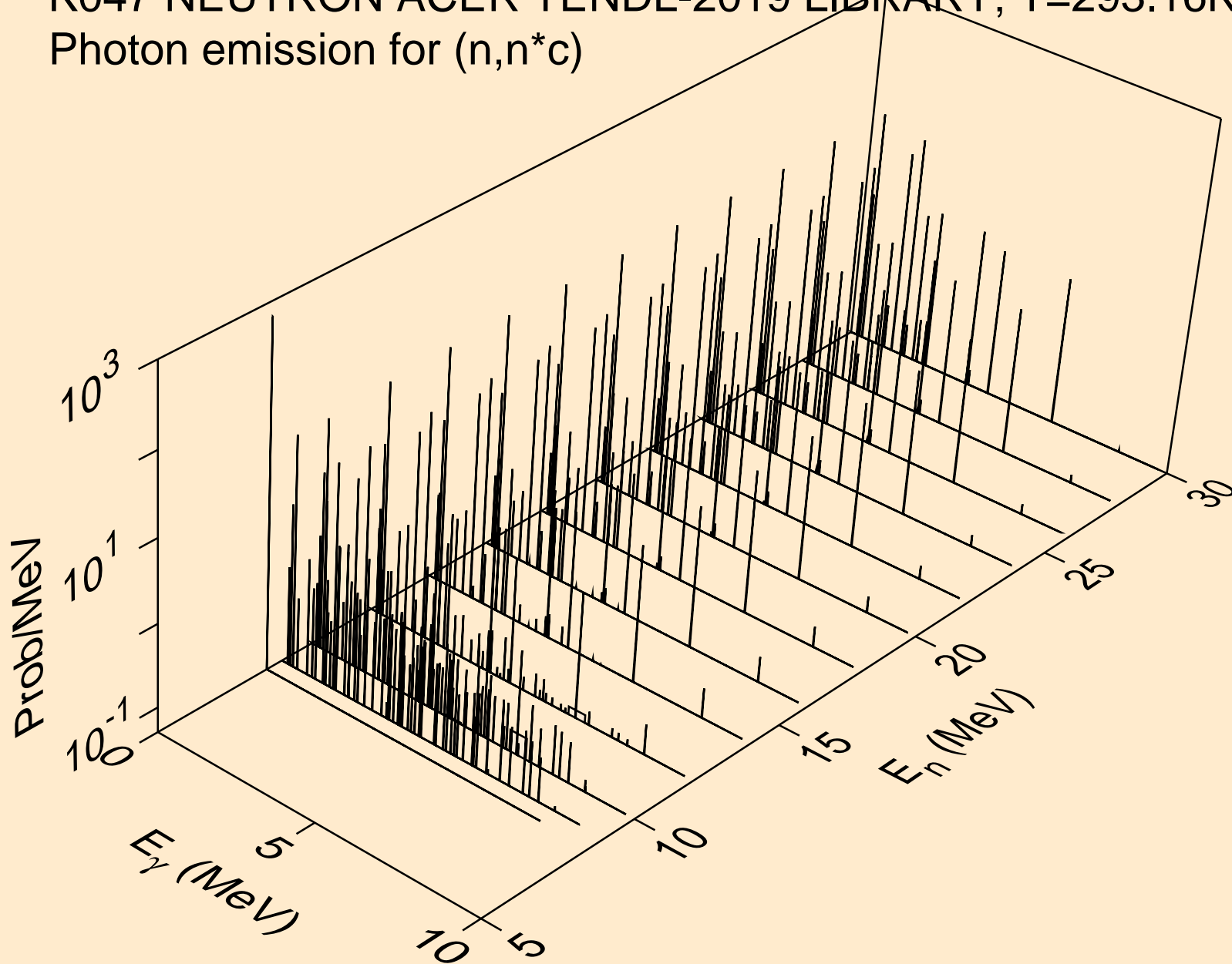

K047 NEUTRON ACER TENDL-2019 LIBRARY; T=293.16K  
Photon emission for (n,gma)

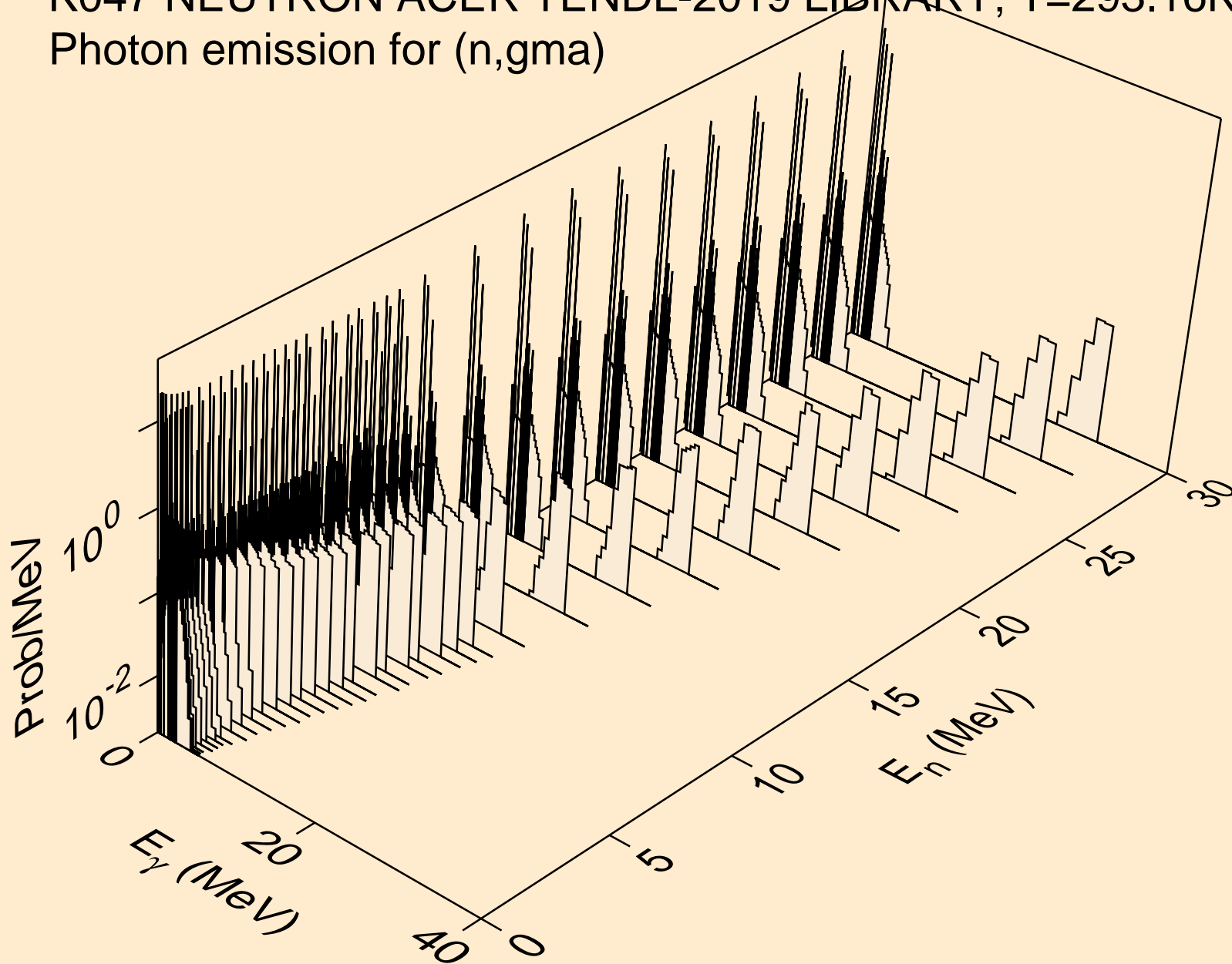

K047 NEUTRON ACER TENDL-2019 LIBRARY; T=293.16K  
Photon emission for (n,p)

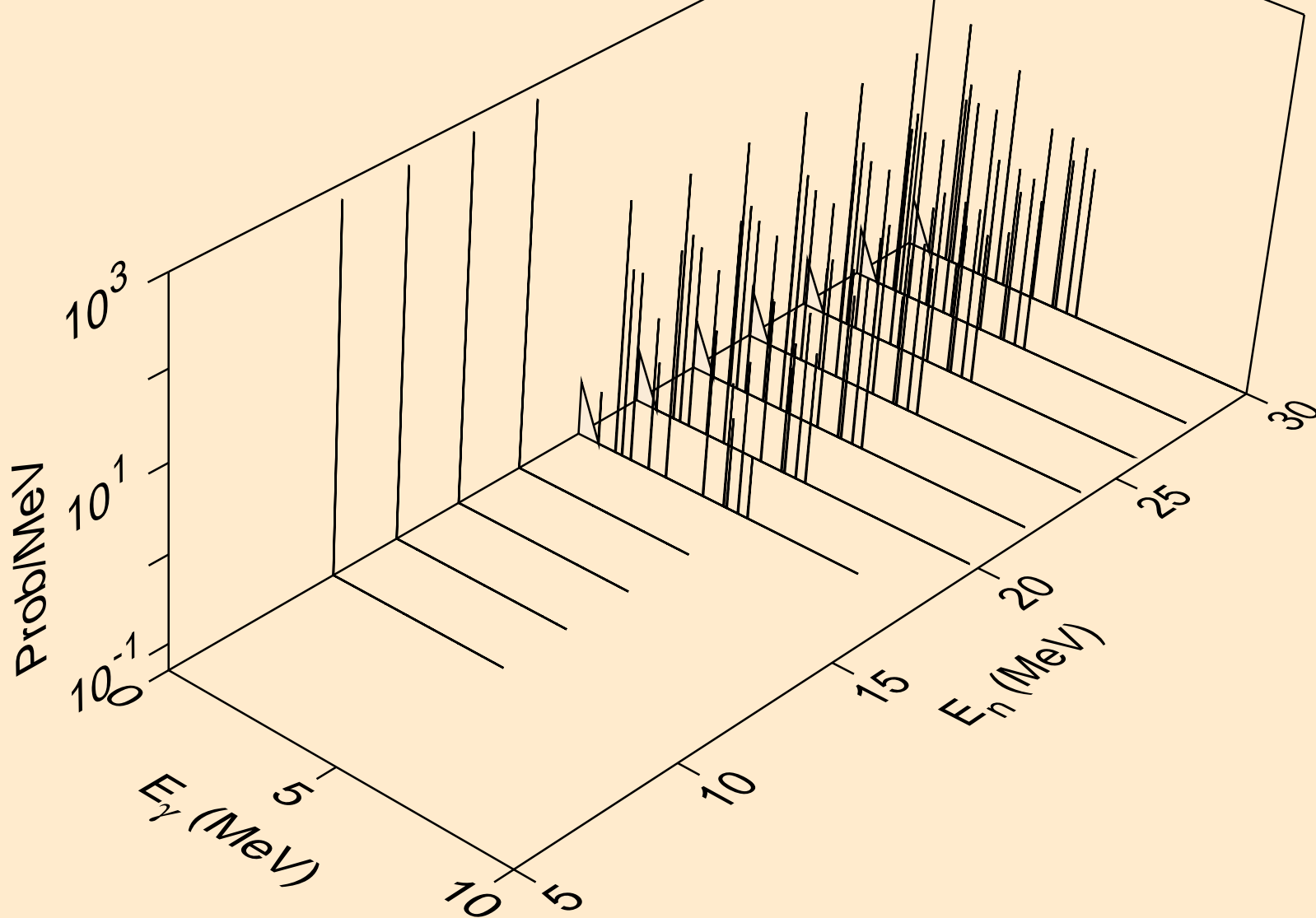

K047 NEUTRON ACER TENDL-2019 LIBRARY; T=293.16K  
Photon emission for (n,d)

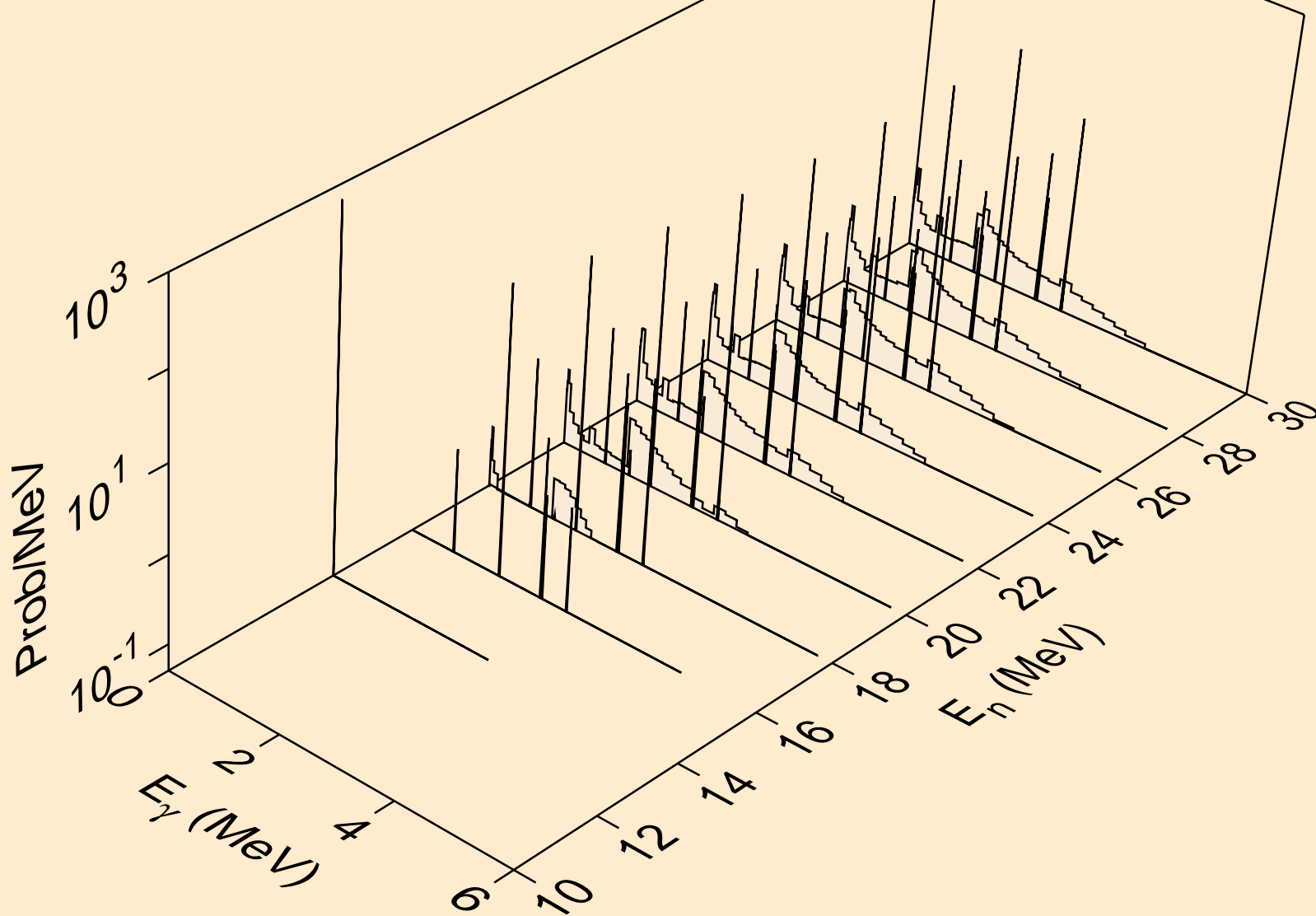

K047 NEUTRON ACER TENDL-2019 LIBRARY; T=293.16K  
Photon emission for (n,t)

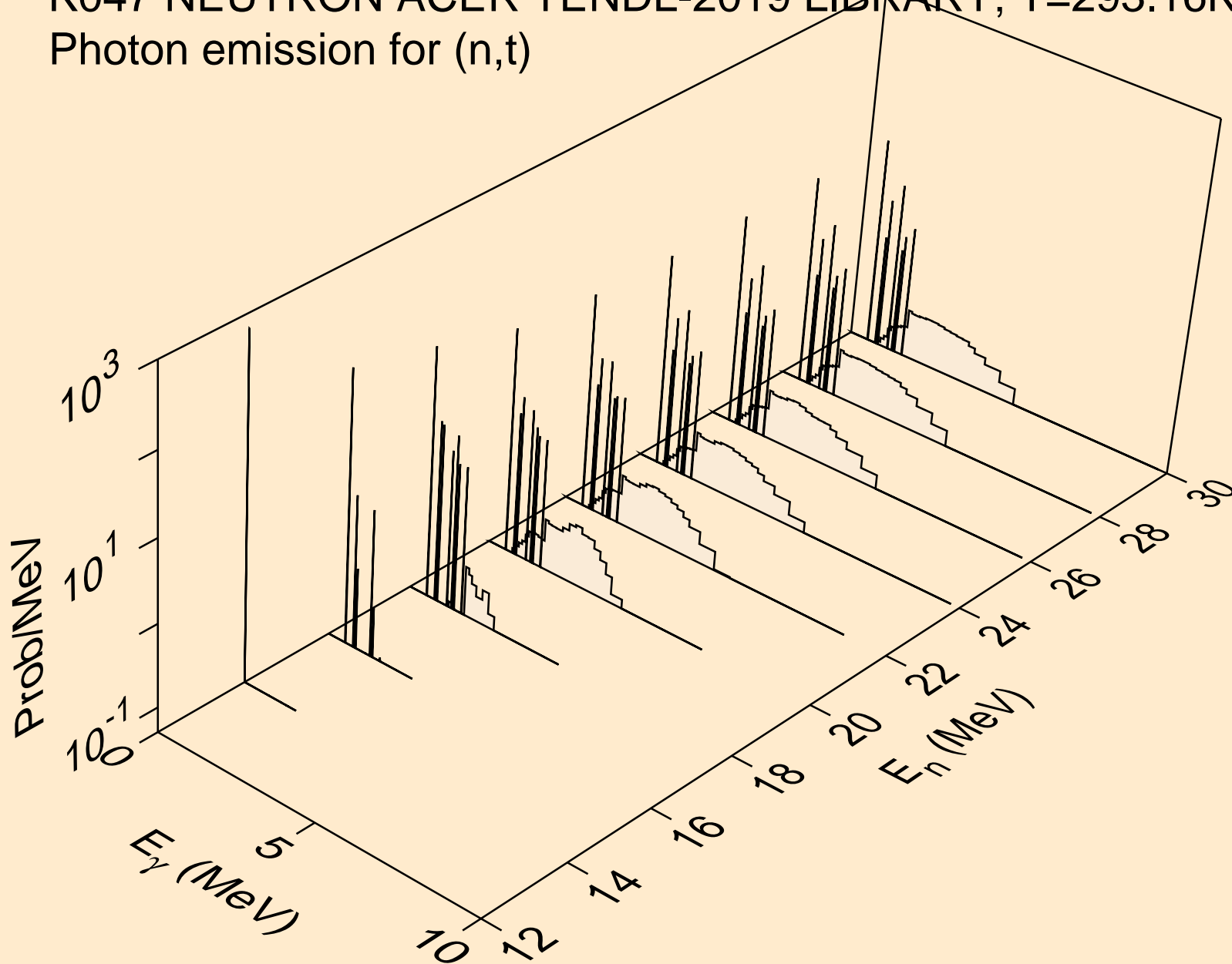

K047 NEUTRON ACER TENDL-2019 LIBRARY; T=293.16K  
Photon emission for (n,a)

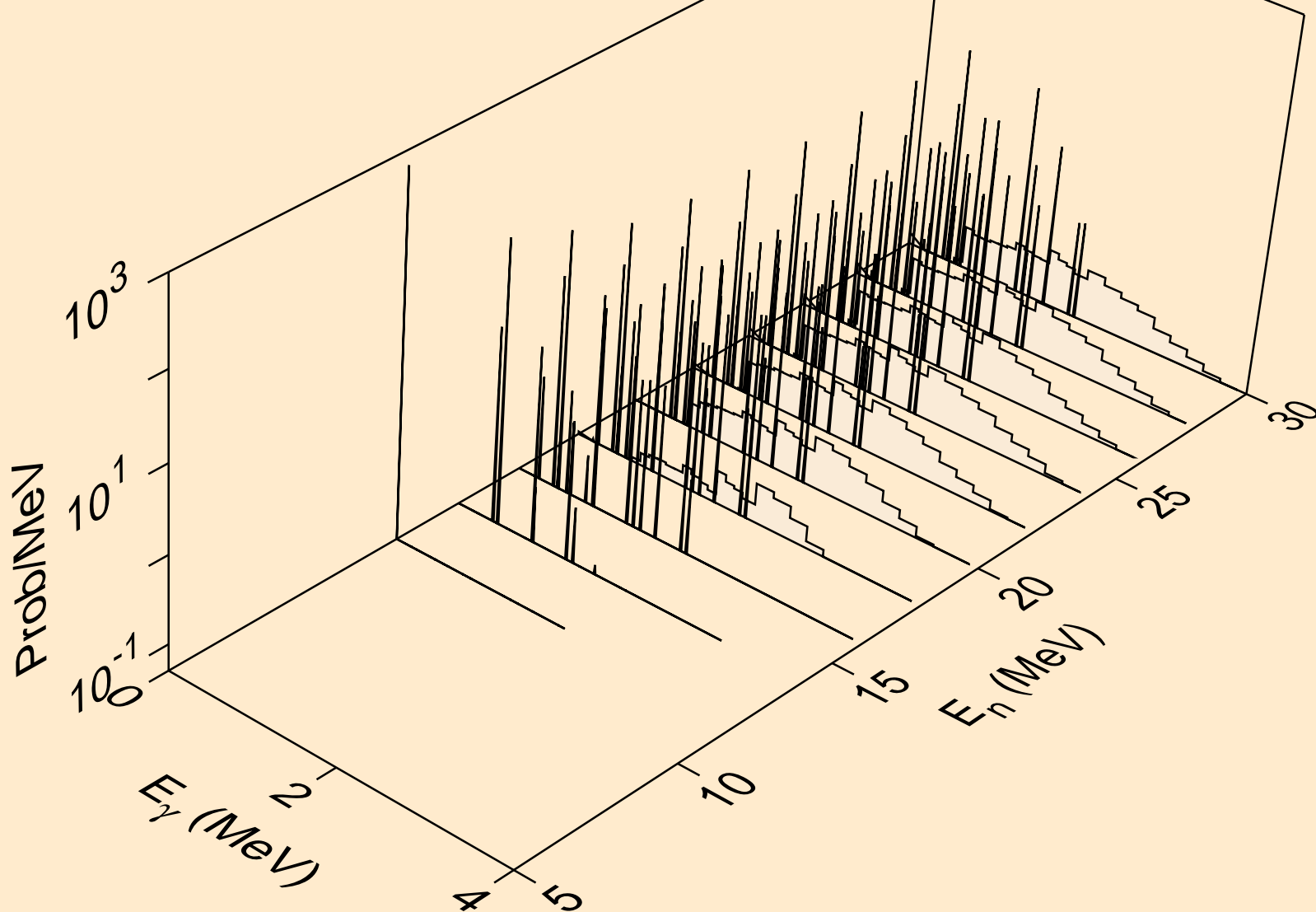





K047 NEUTRON ACER TENDL-2019 LIBRARY; T=293.16K  
14 MeV photon spectrum

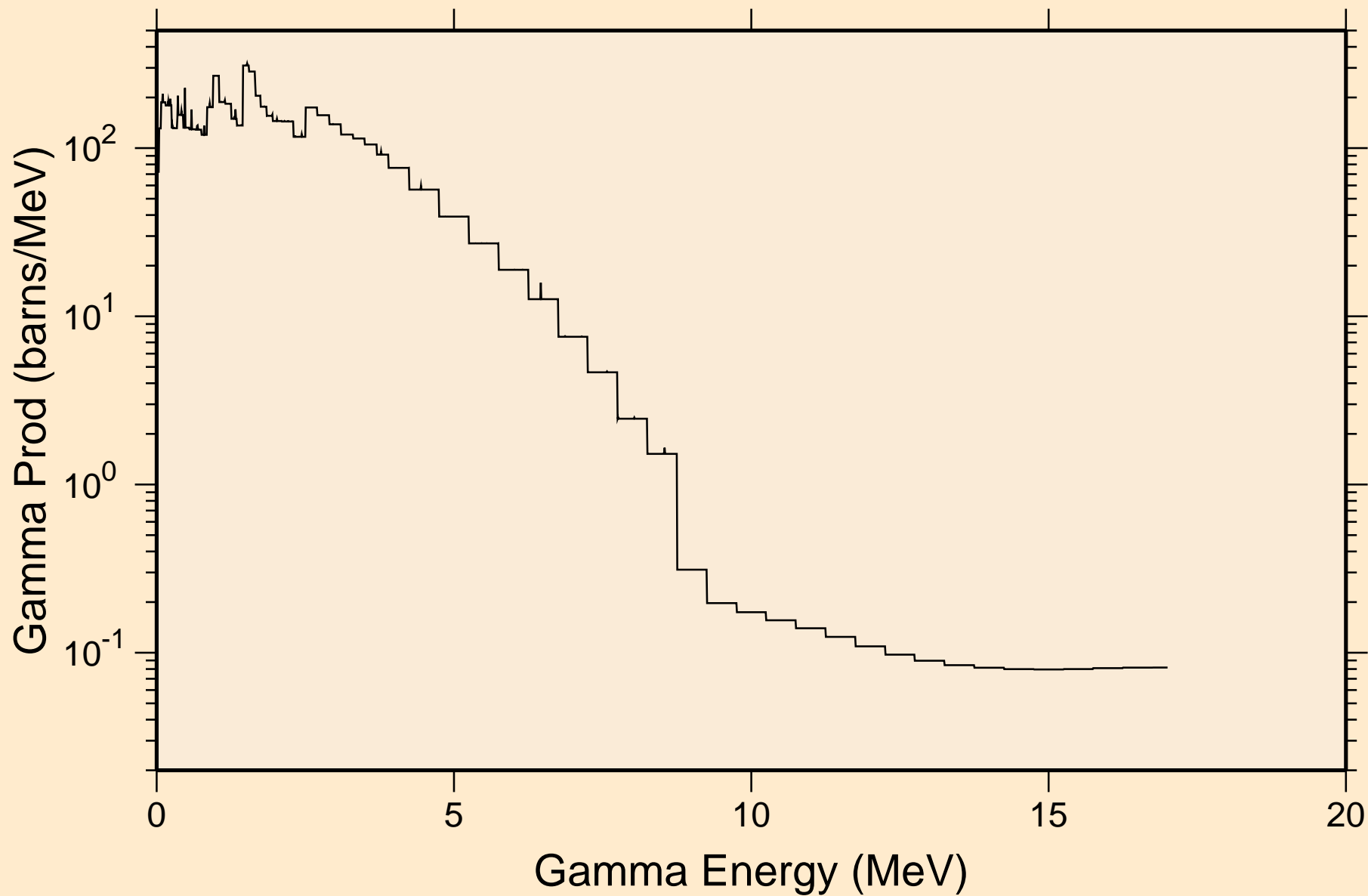

# K047 NEUTRON ACER TENDL-2019 LIBRARY; T=293.16K

## Particle heating contributions

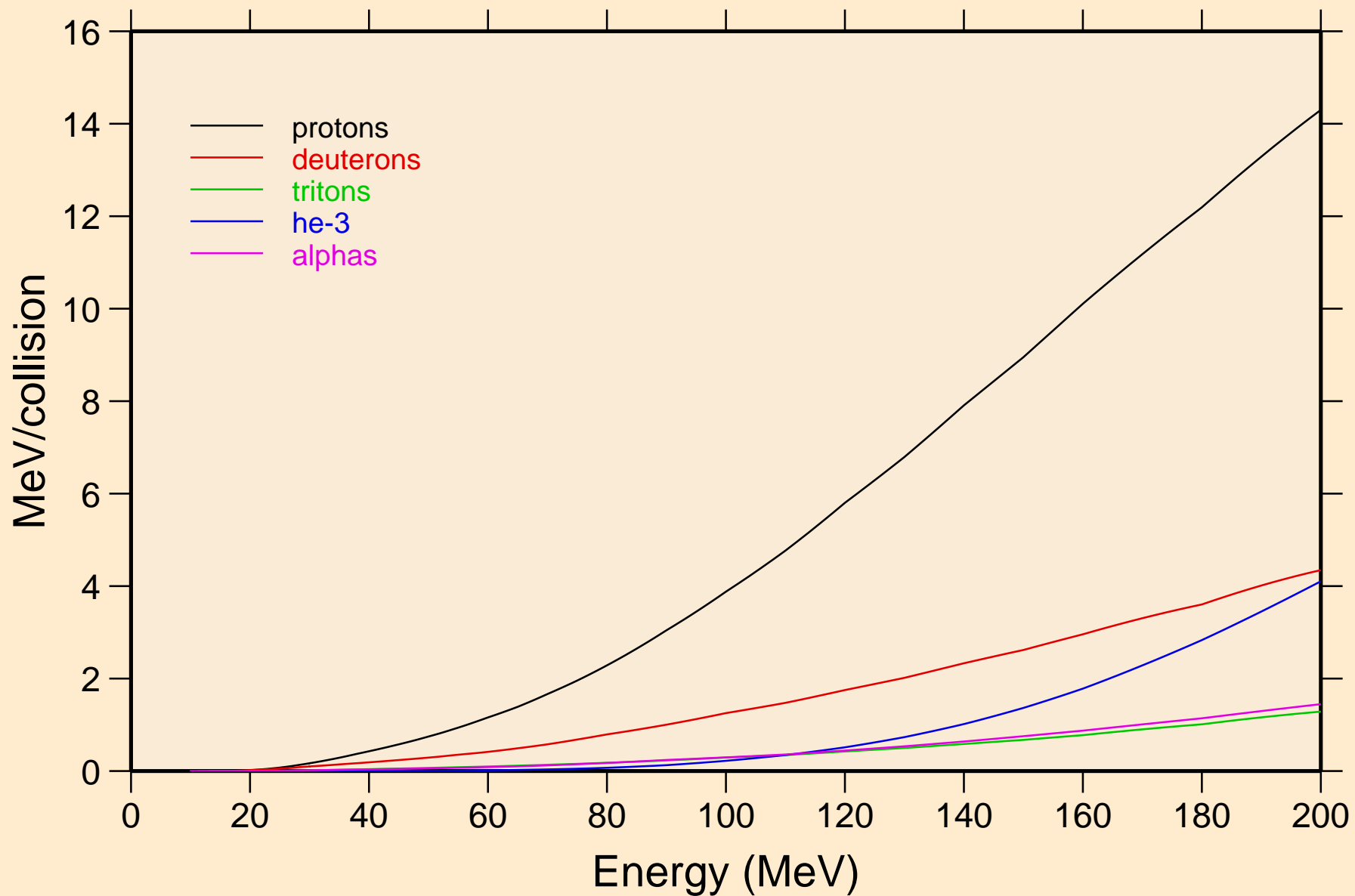

K047 NEUTRON ACER TENDL-2019 LIBRARY; T=293.16K  
Recoil Heating

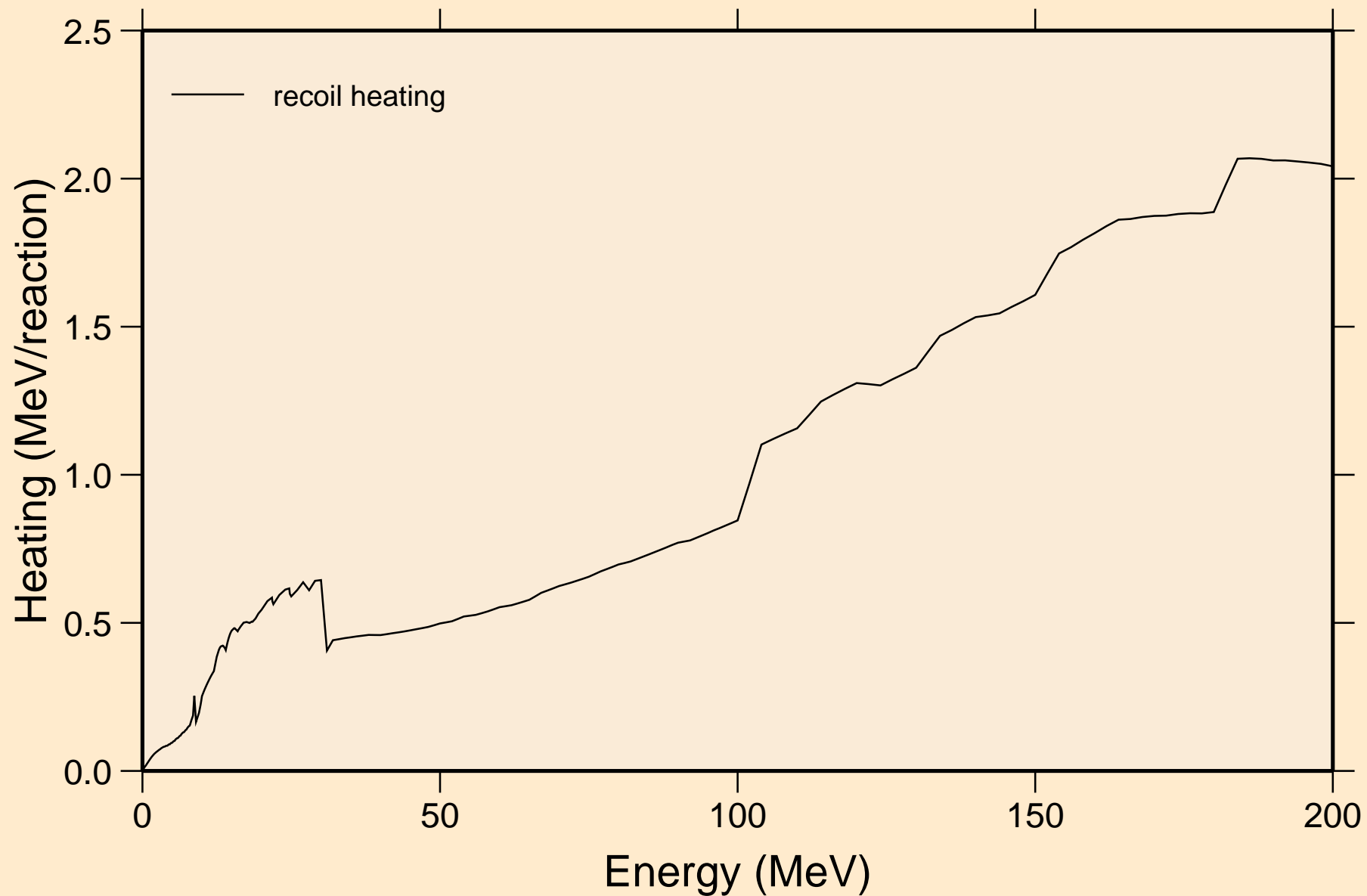

K047 NEUTRON ACER TENDL-2019 LIBRARY; T=293.16K  
Particle production cross sections

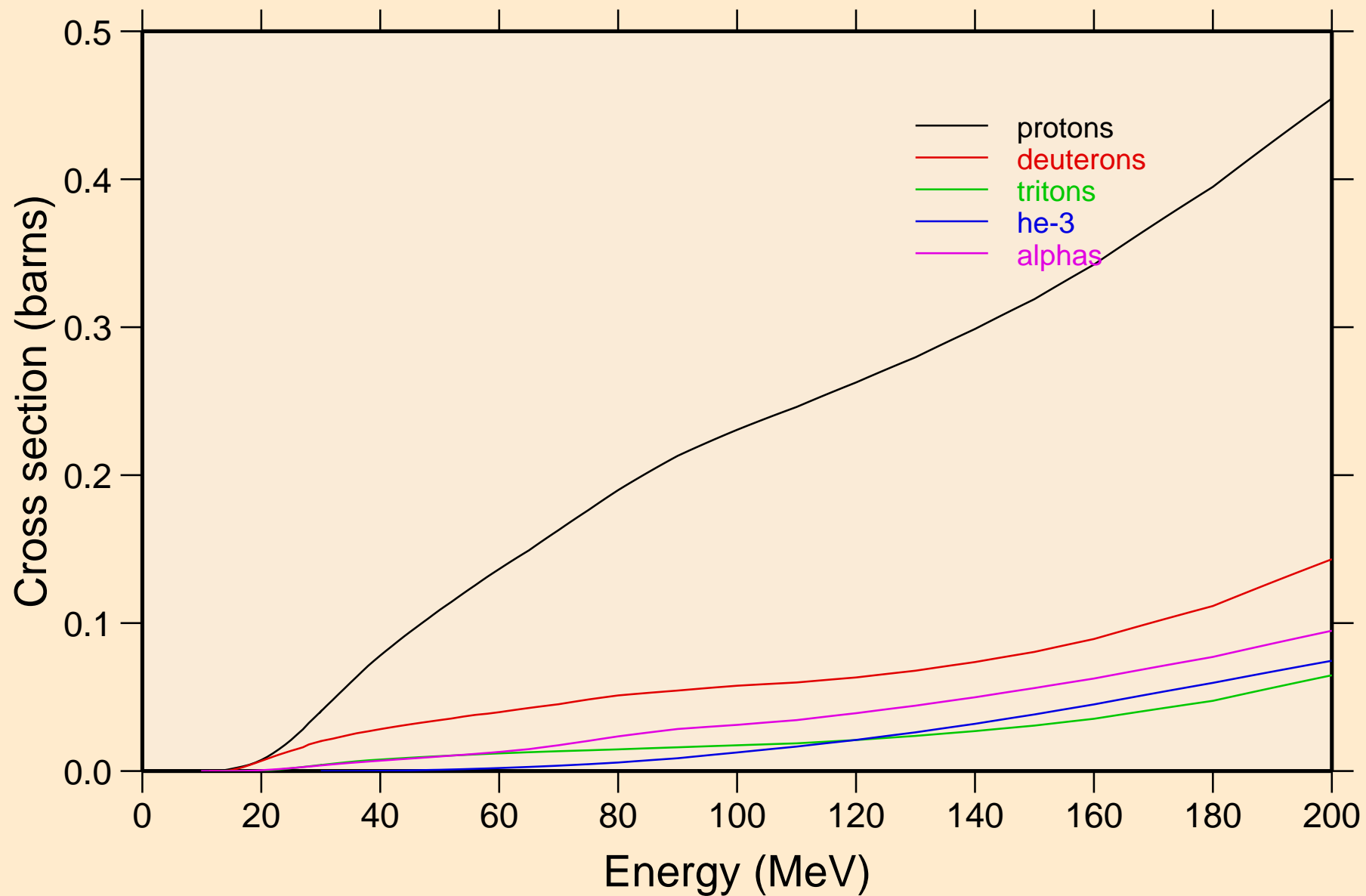

K047 NEUTRON ACER TENDL-2019 LIBRARY; T=293.16K  
protons from (n,x)

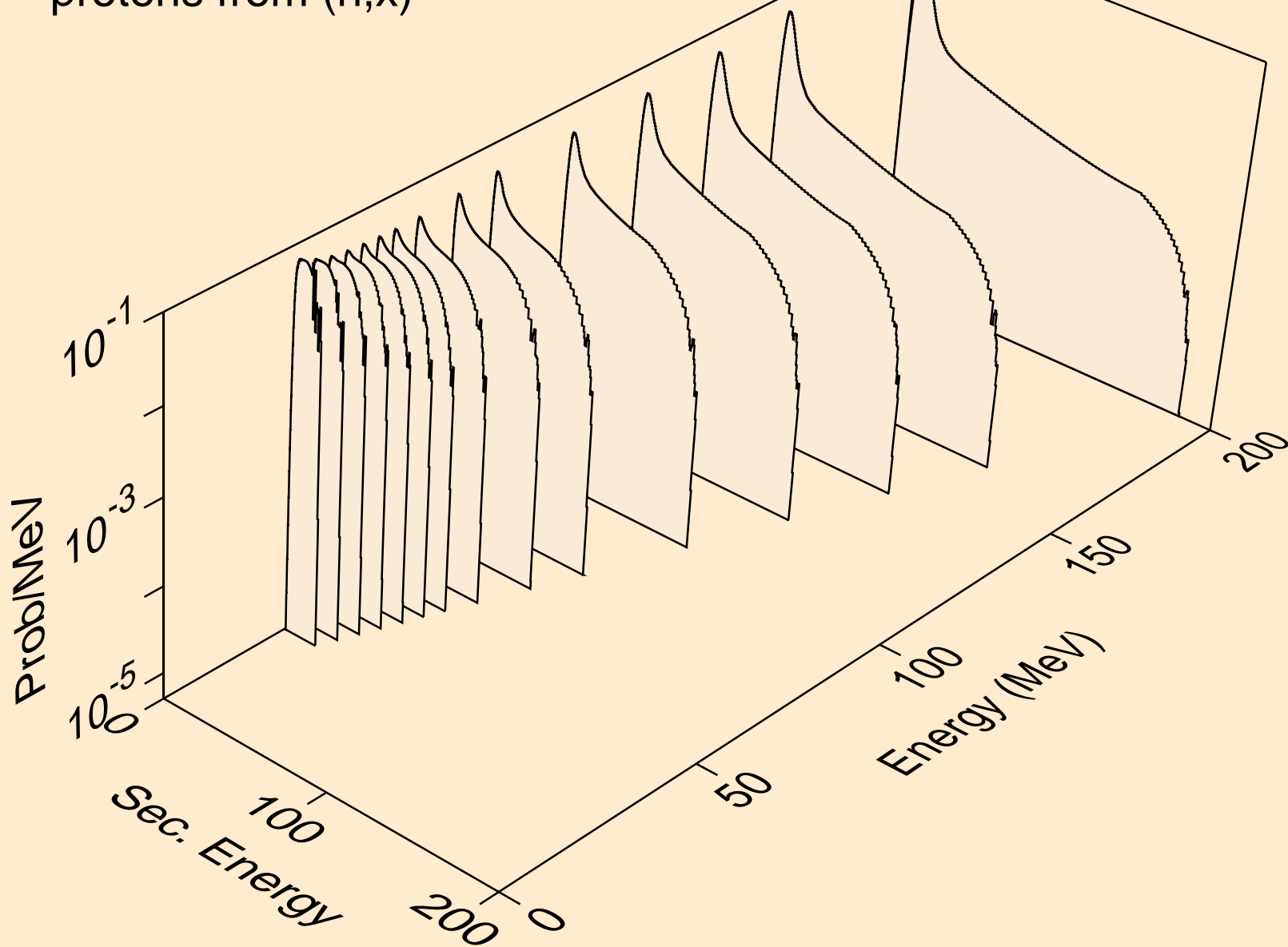

K047 NEUTRON ACER TENDL-2019 LIBRARY; T=293.16K  
protons from (n,n\*)p

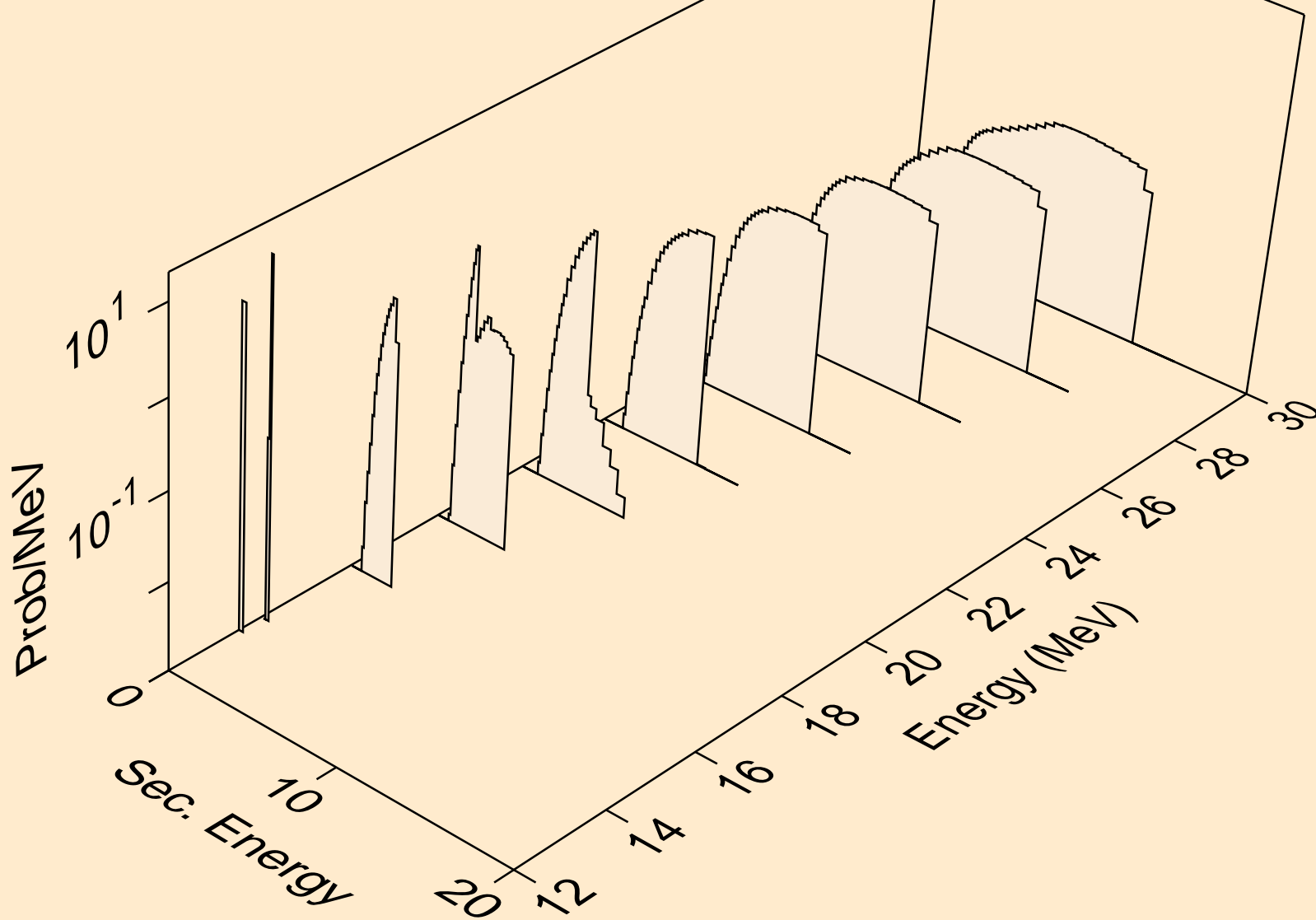

K047 NEUTRON ACER TENDL-2019 LIBRARY; T=293.16K  
protons from (n,2np)

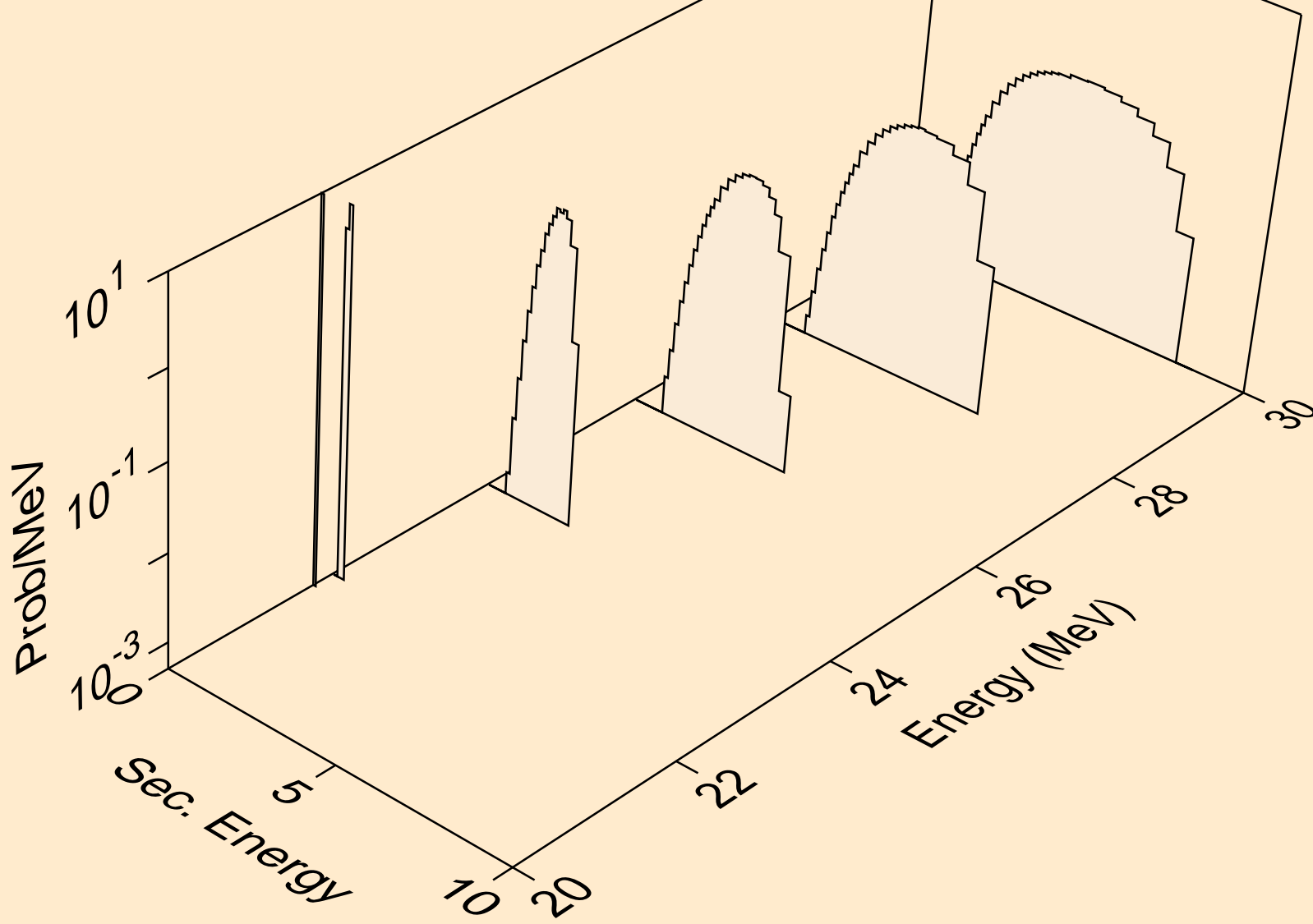

K047 NEUTRON ACER TENDL-2019 LIBRARY; T=293.16K  
protons from (n,3np)

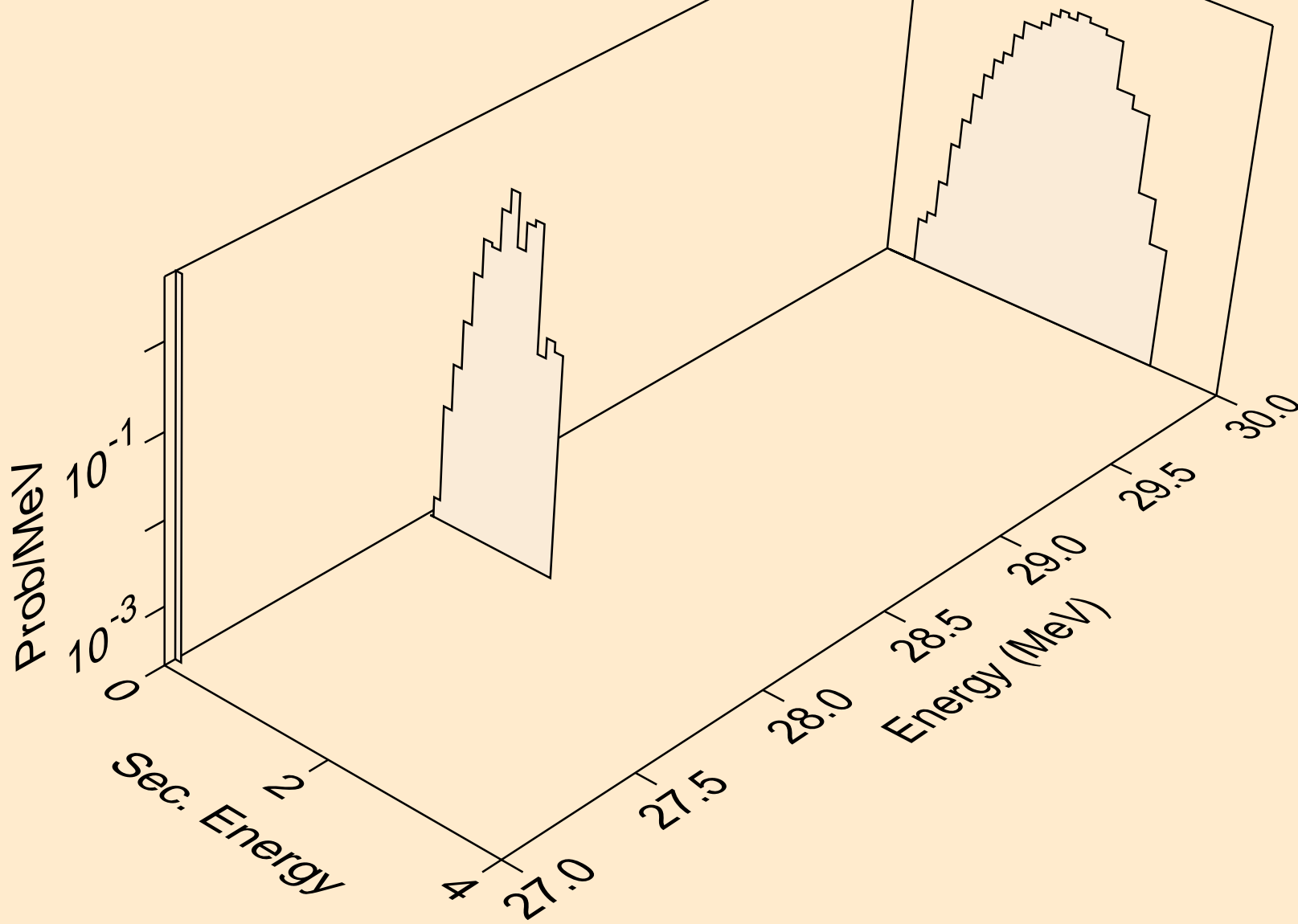



K047 NEUTRON ACER TENDL-2019 LIBRARY; T=293.16K  
protons from (n,p)

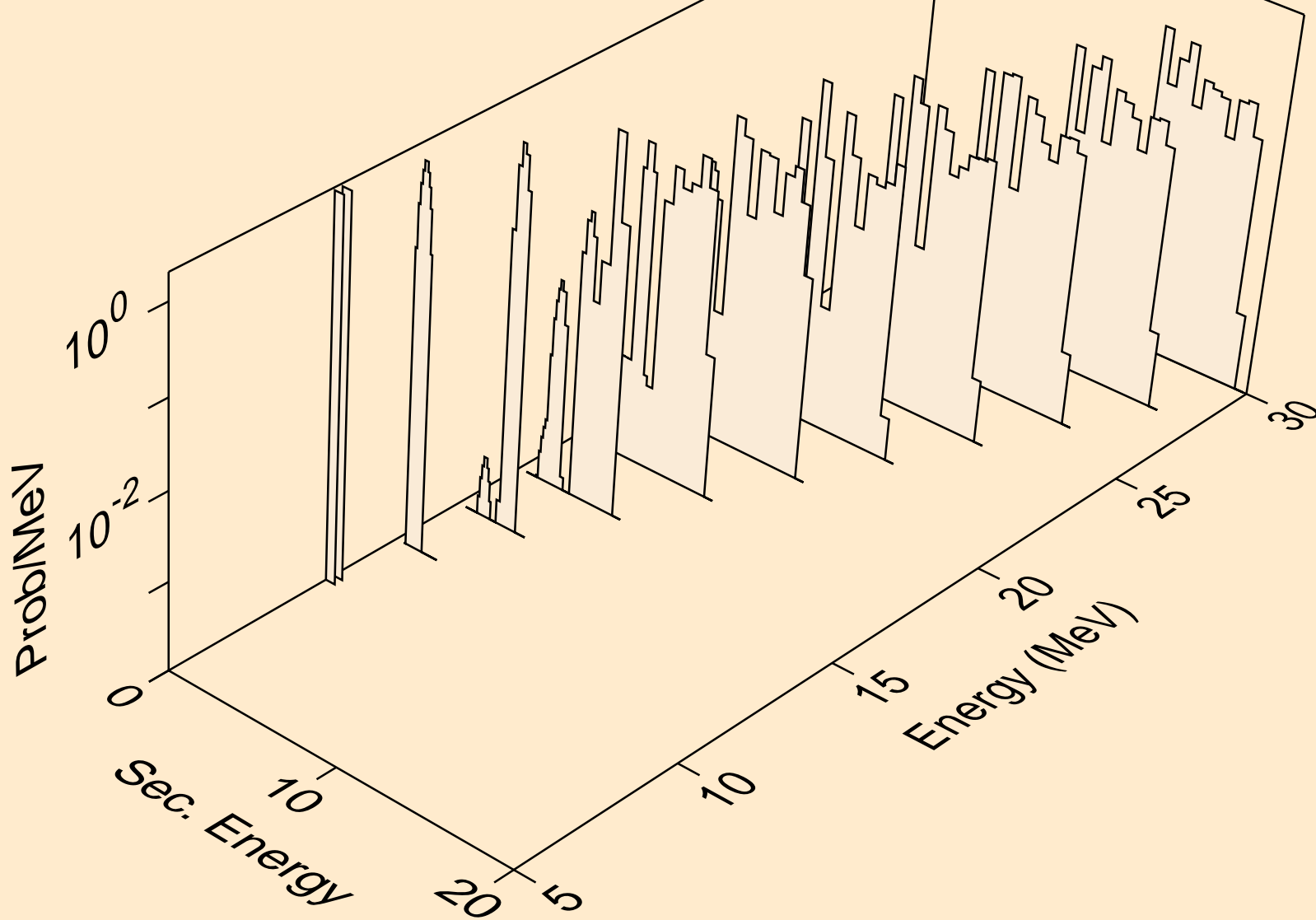

K047 NEUTRON ACER TENDL-2019 LIBRARY; T=293.16K  
deuterons from (n,x)

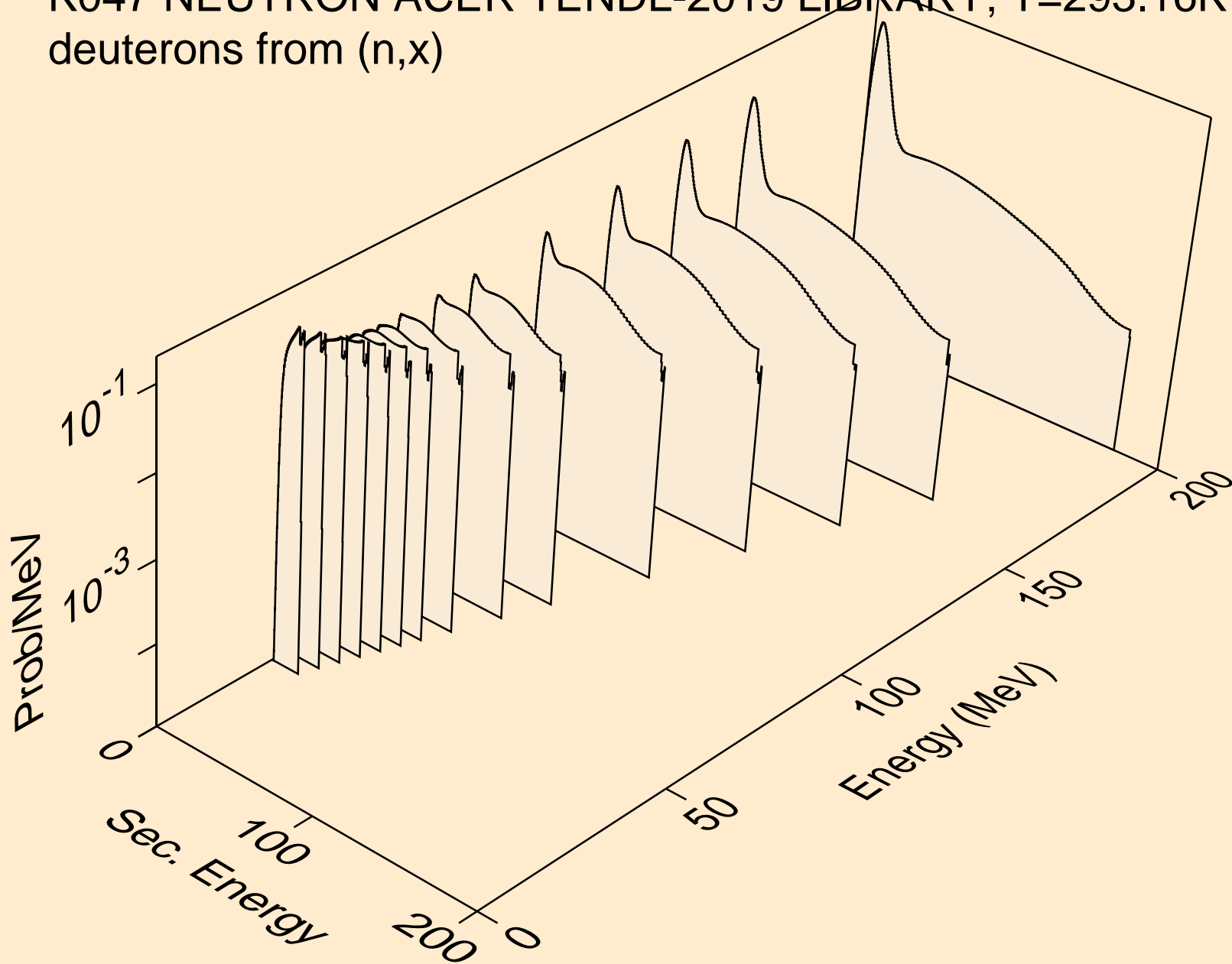

K047 NEUTRON ACER TENDL-2019 LIBRARY; T=293.16K  
deuterons from (n,2nd)

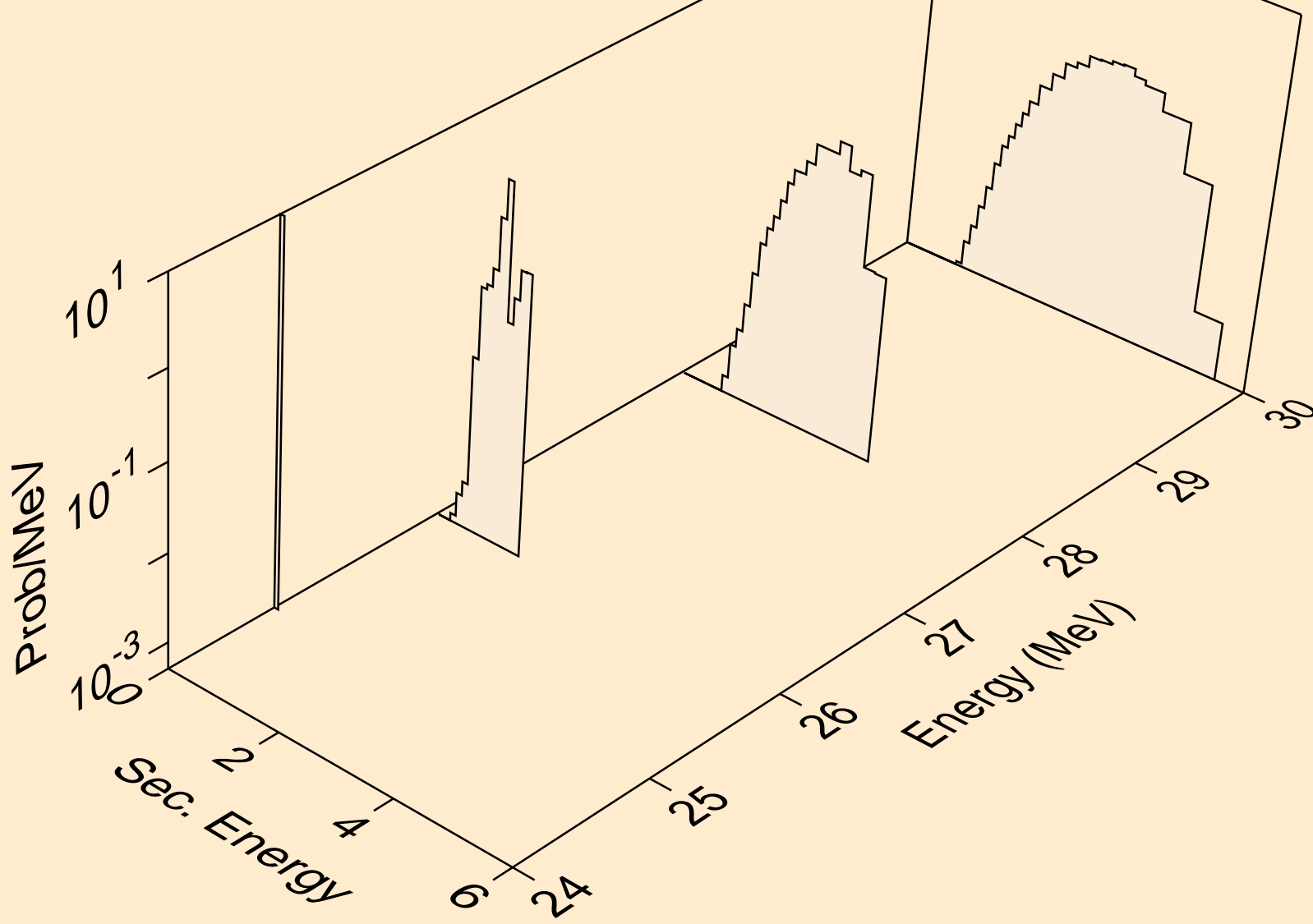

K047 NEUTRON ACER TENDL-2019 LIBRARY; T=293.16K  
deuterons from (n,n\*)d

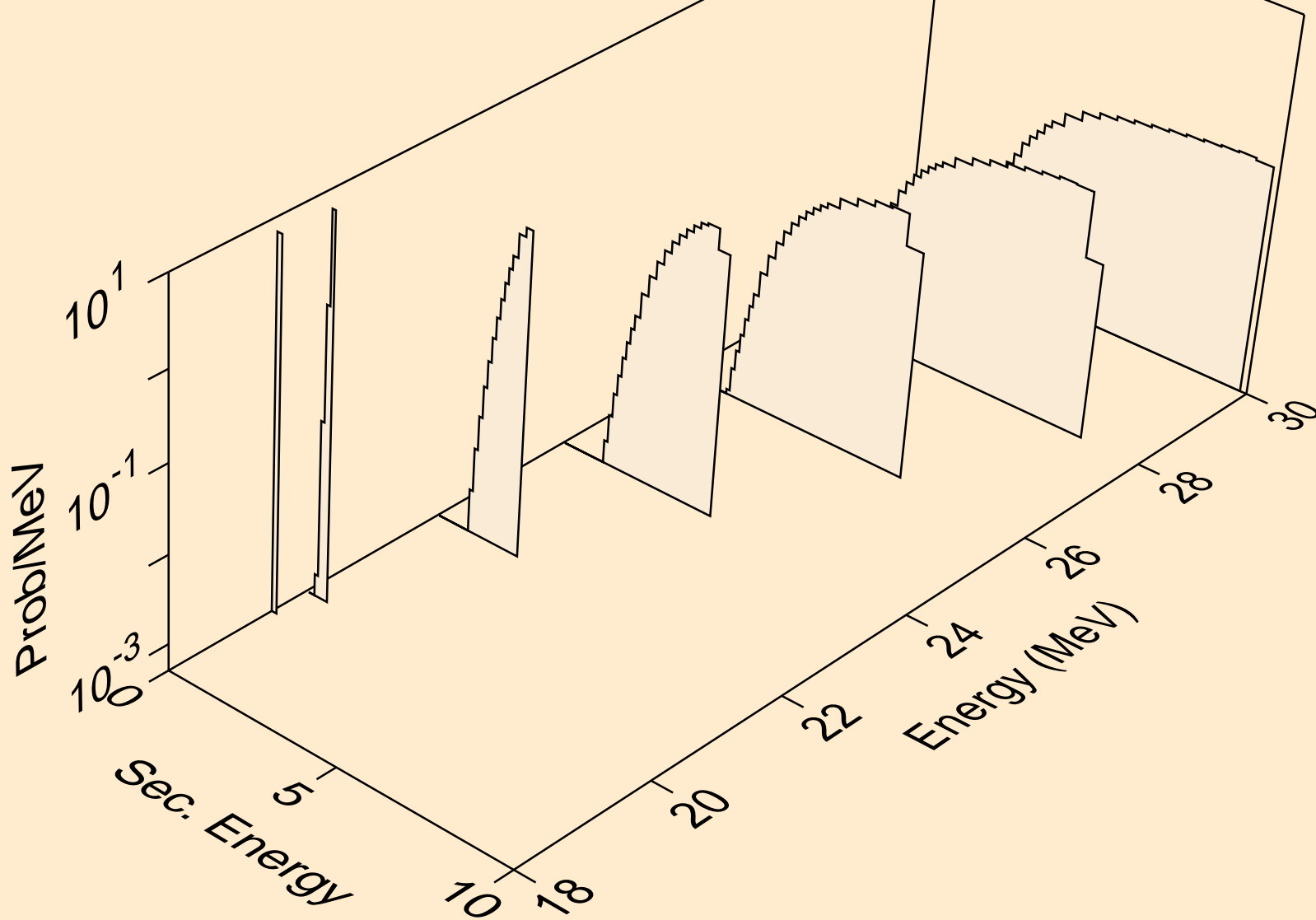

K047 NEUTRON ACER TENDL-2019 LIBRARY; T=293.16K  
deuterons from (n,d)

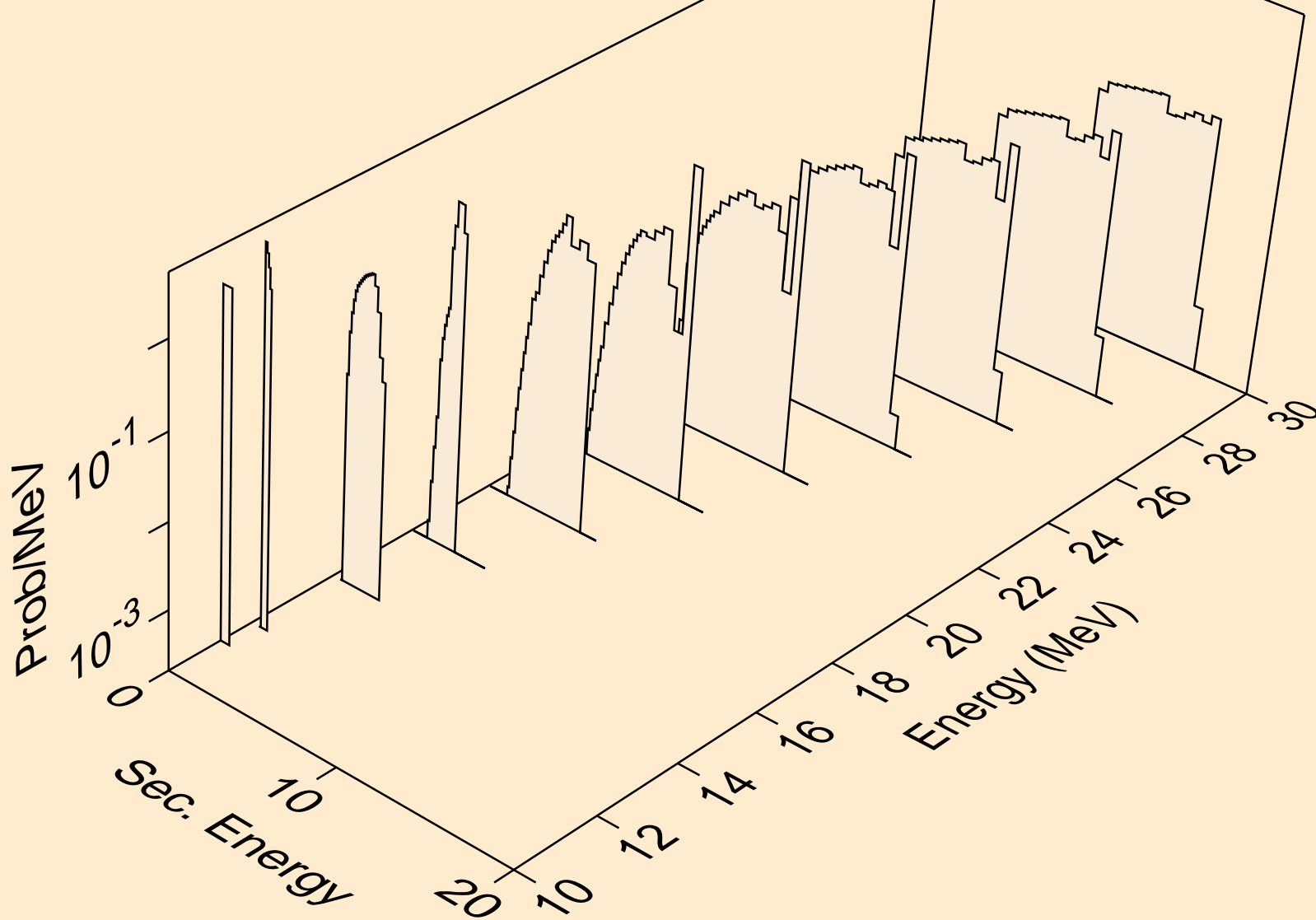

K047 NEUTRON ACER TENDL-2019 LIBRARY; T=293.16K  
tritons from (n,x)

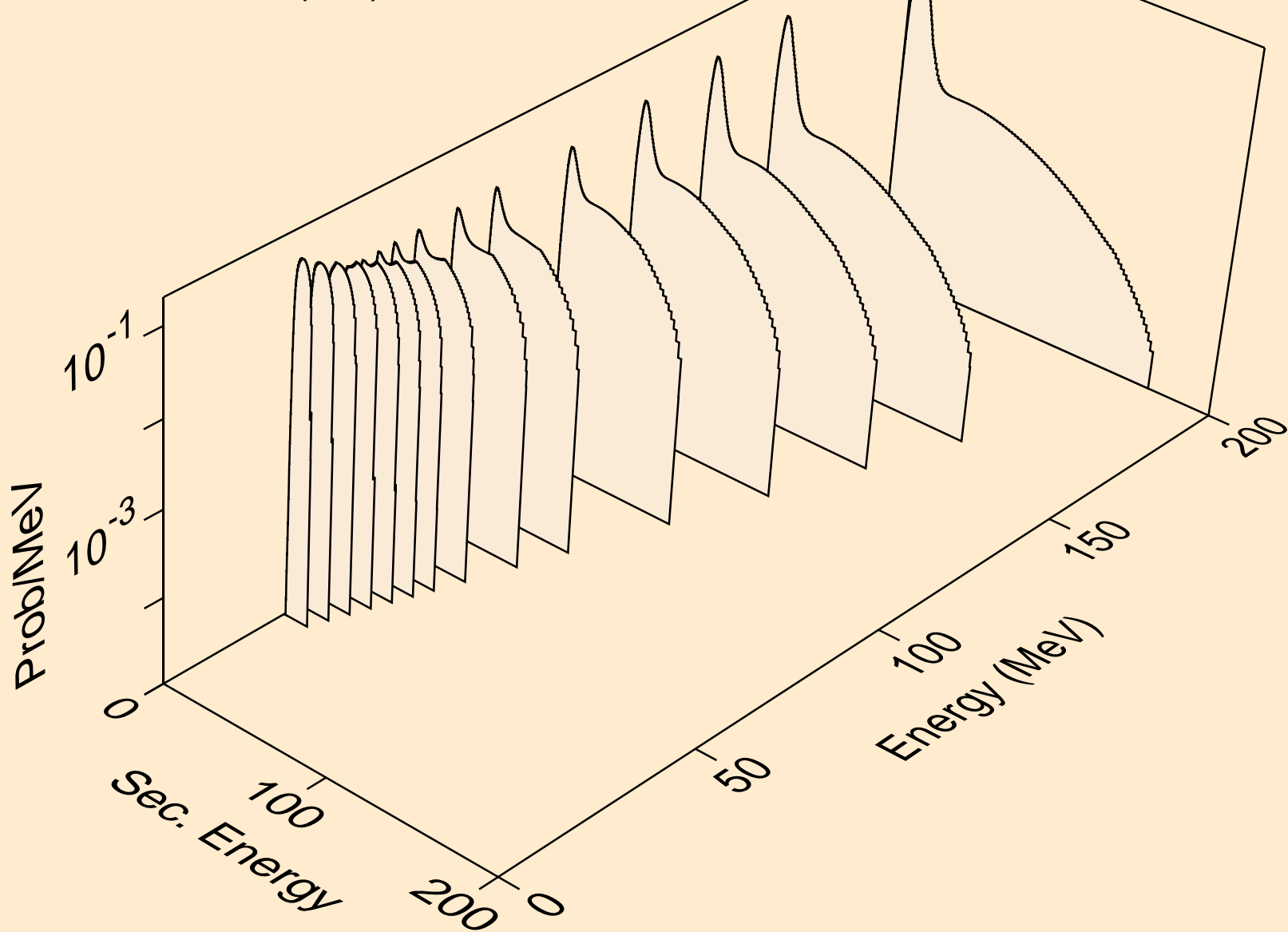

K047 NEUTRON ACER TENDL-2019 LIBRARY; T=293.16K  
tritons from (n,n\*)t

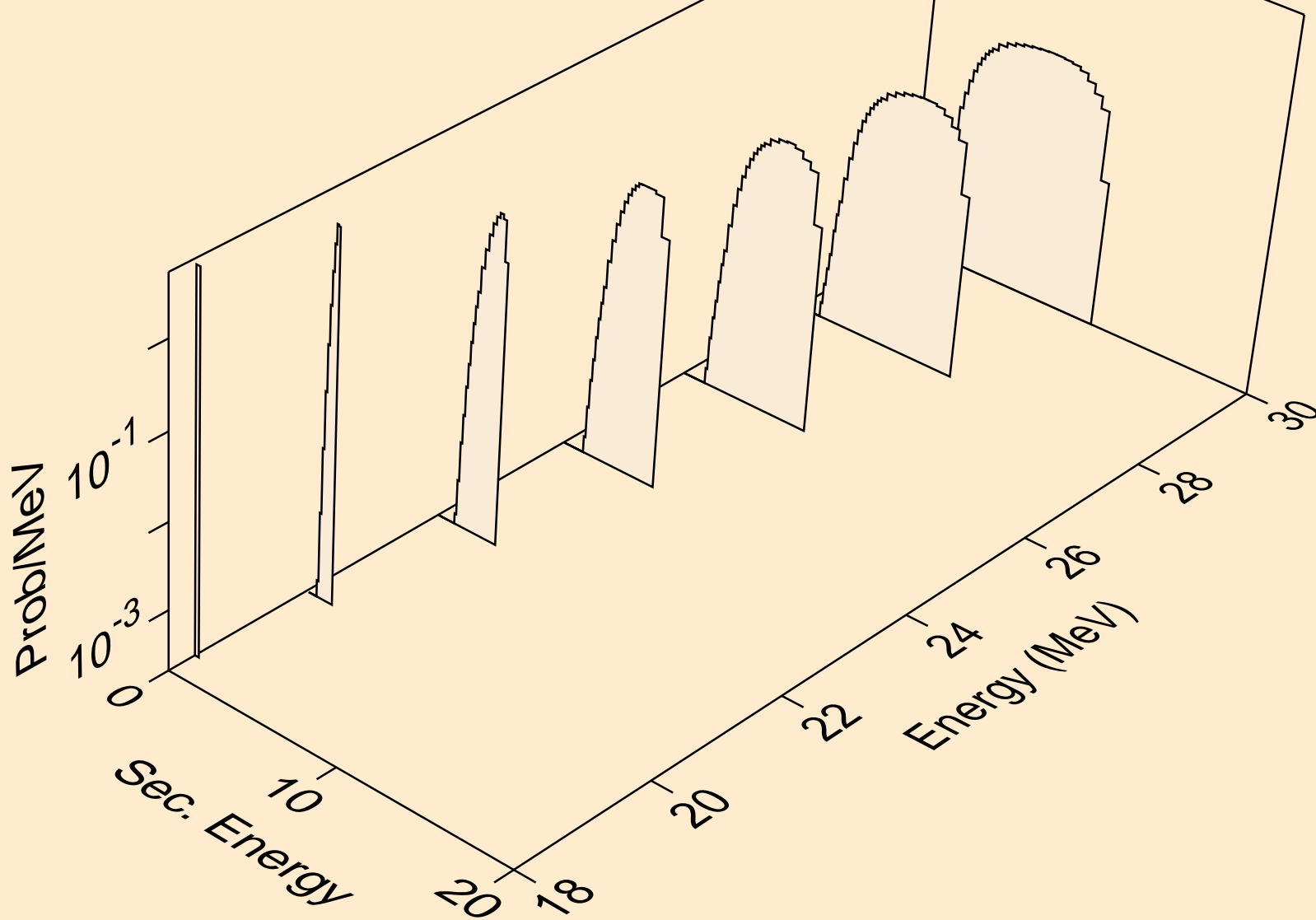

K047 NEUTRON ACER TENDL-2019 LIBRARY; T=293.16K  
tritons from (n,t)

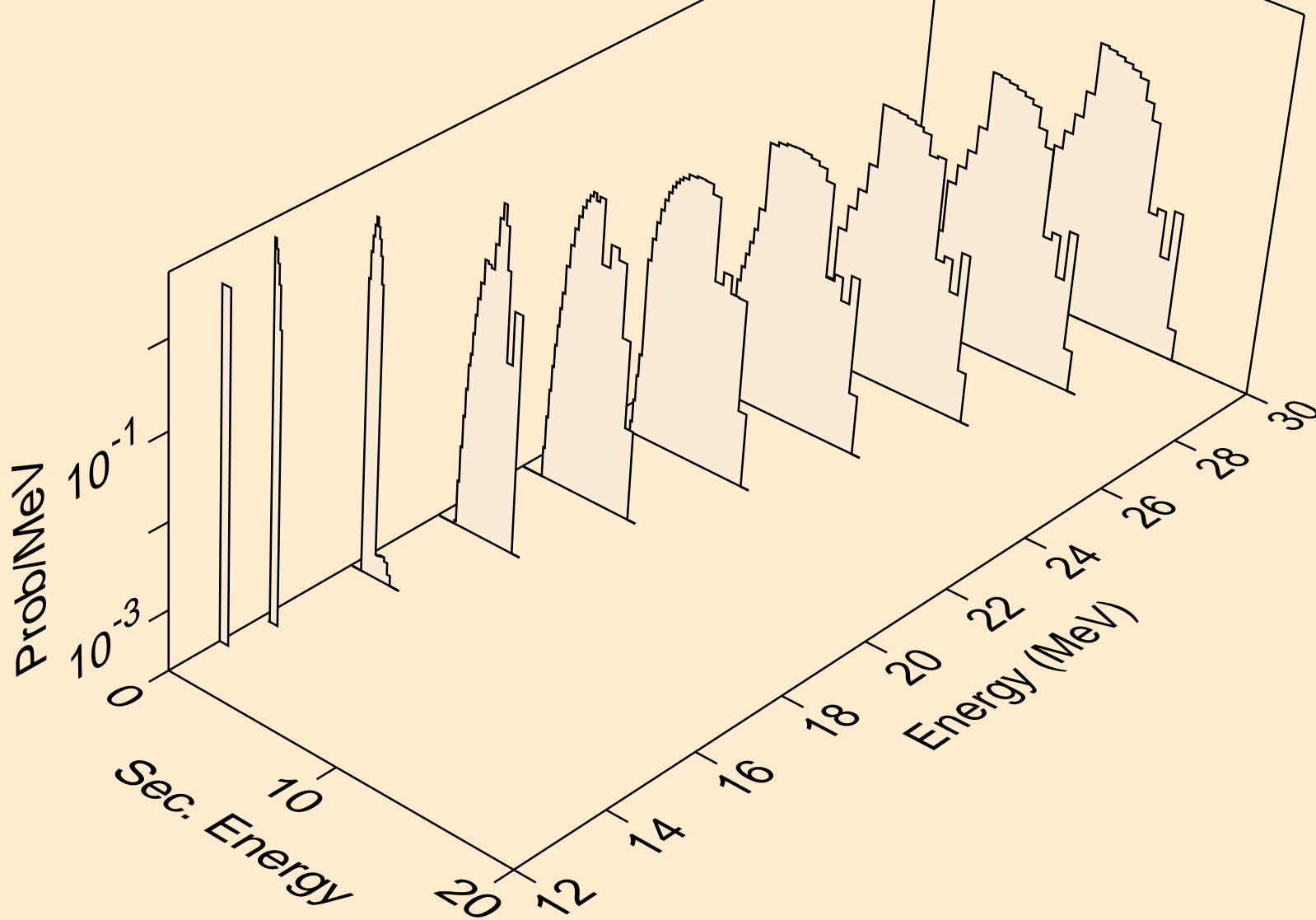



K047 NEUTRON ACER TENDL-2019 LIBRARY; T=293.16K  
he3s from (n,x)

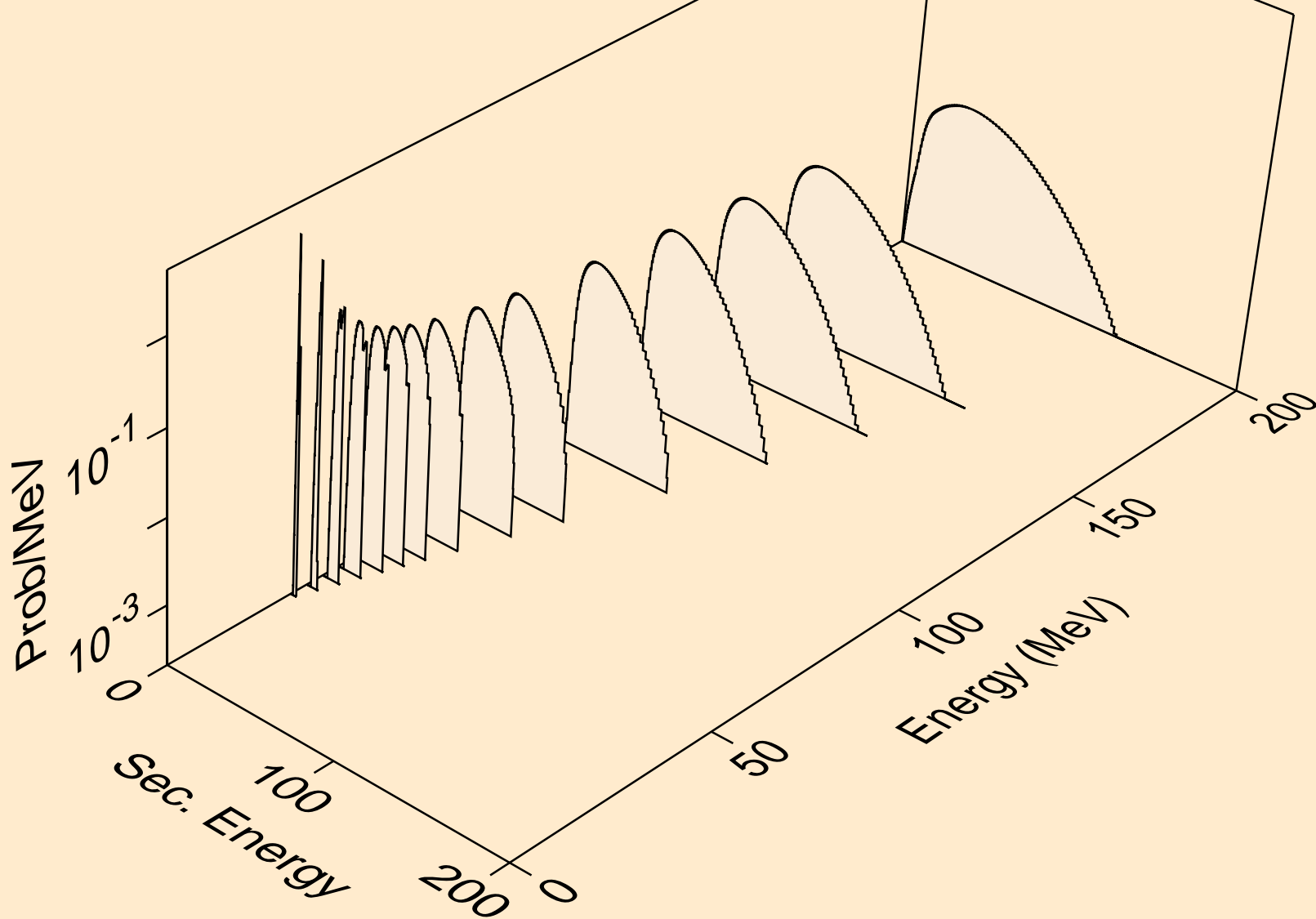

K047 NEUTRON ACER TENDL-2019 LIBRARY; T=293.16K  
alphas from (n,x)

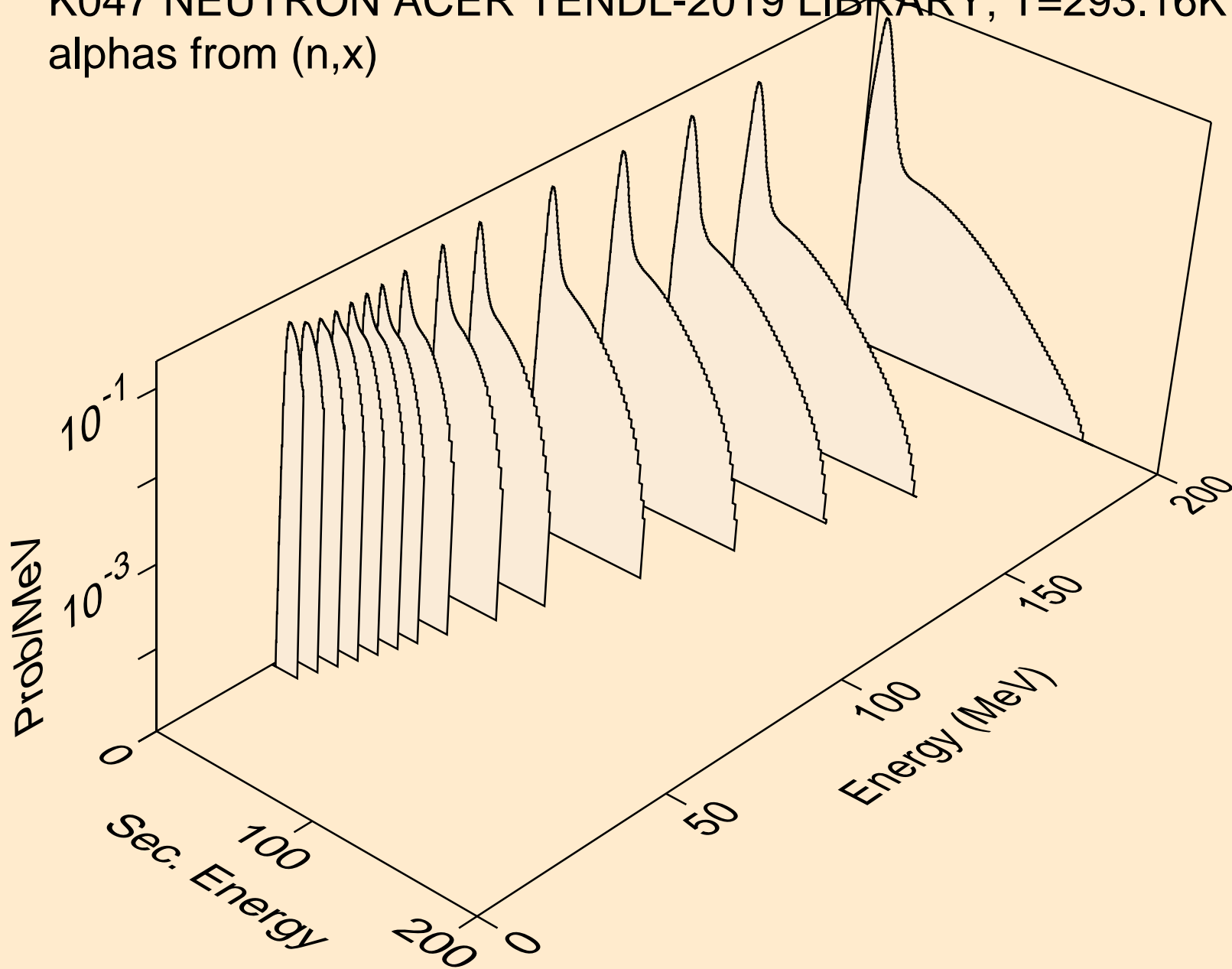

K047 NEUTRON ACER TENDL-2019 LIBRARY; T=293.16K  
alphas from (n,n\*)a

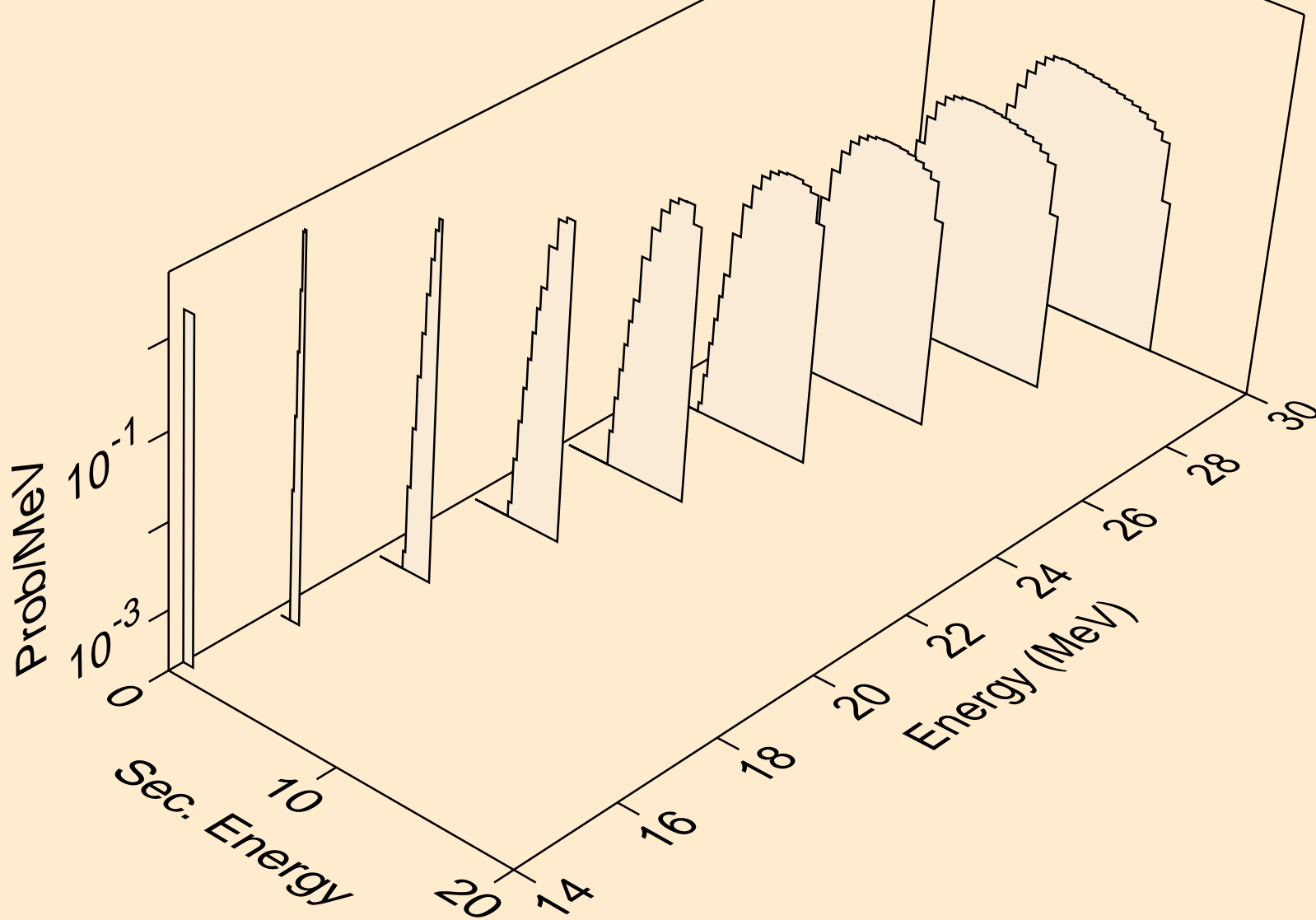

K047 NEUTRON ACER TENDL-2019 LIBRARY; T=293.16K  
alphas from (n,2n)a

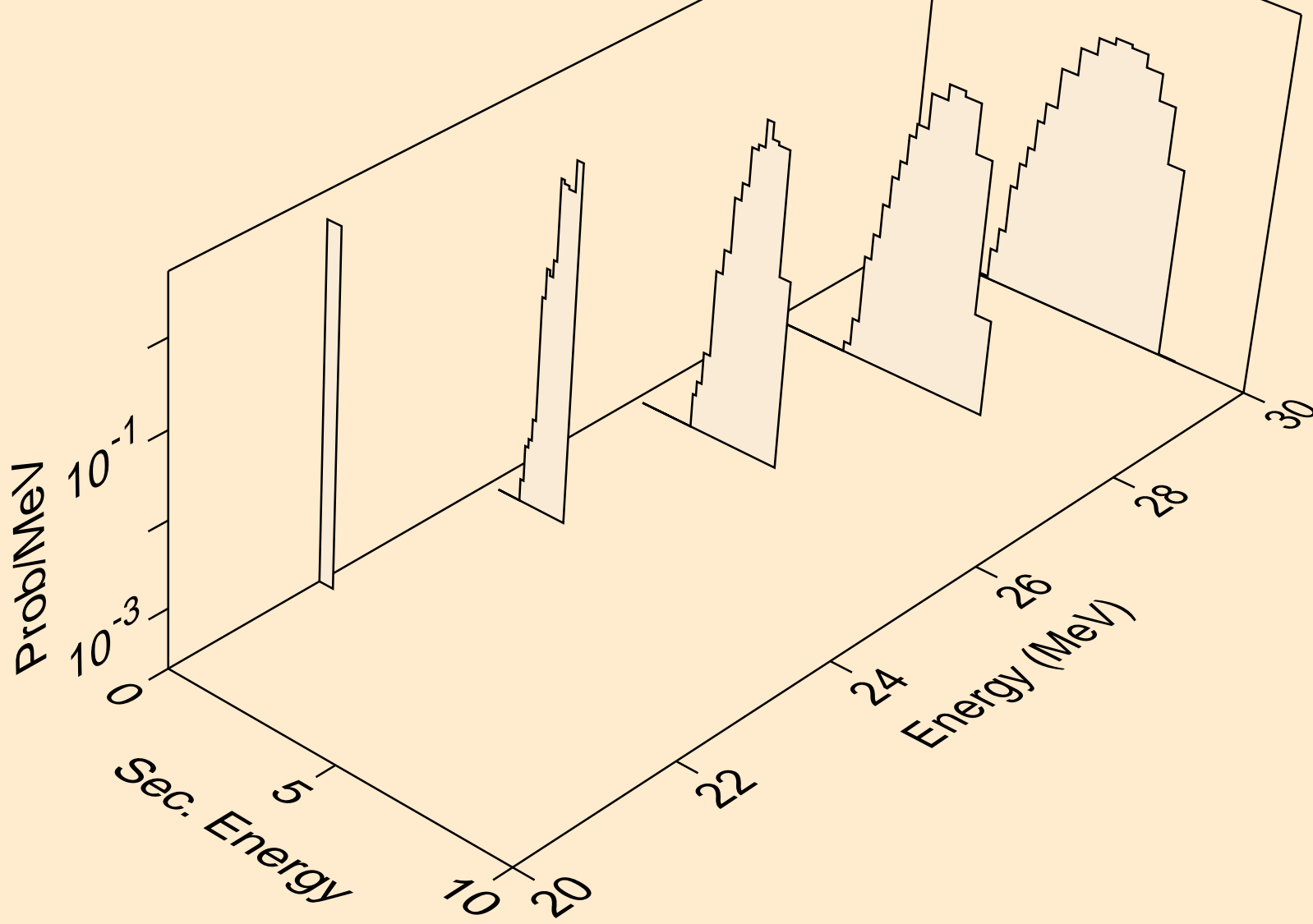

K047 NEUTRON ACER TENDL-2019 LIBRARY; T=293.16K  
alphas from (n,a)

