

KR079 NEUTRON ACER TENDL-2019 LIBRARY; T=293.16K  
Principal cross sections

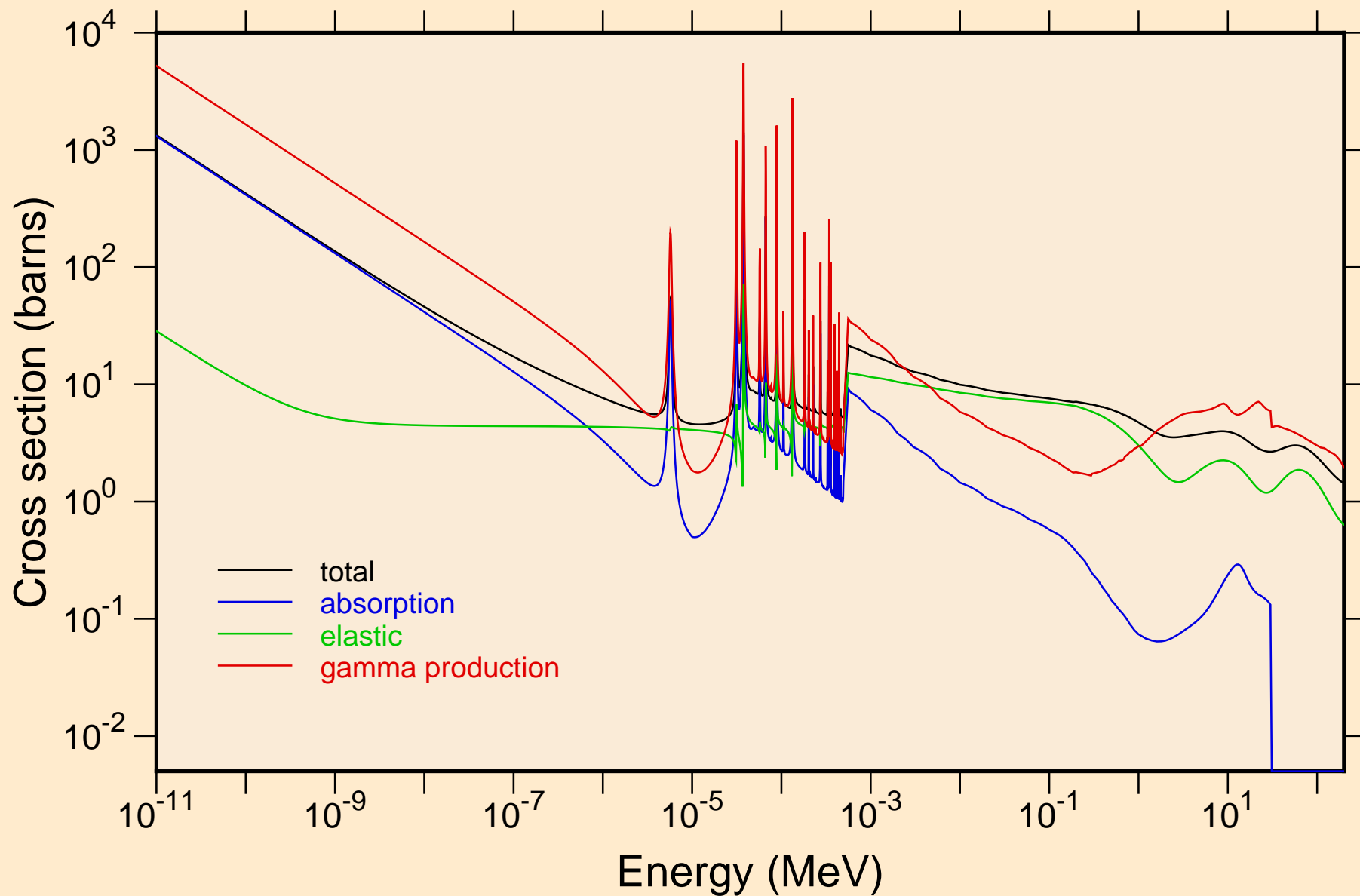

KR079 NEUTRON ACER TENDL-2019 LIBRARY; T=293.16K  
resonance total cross section

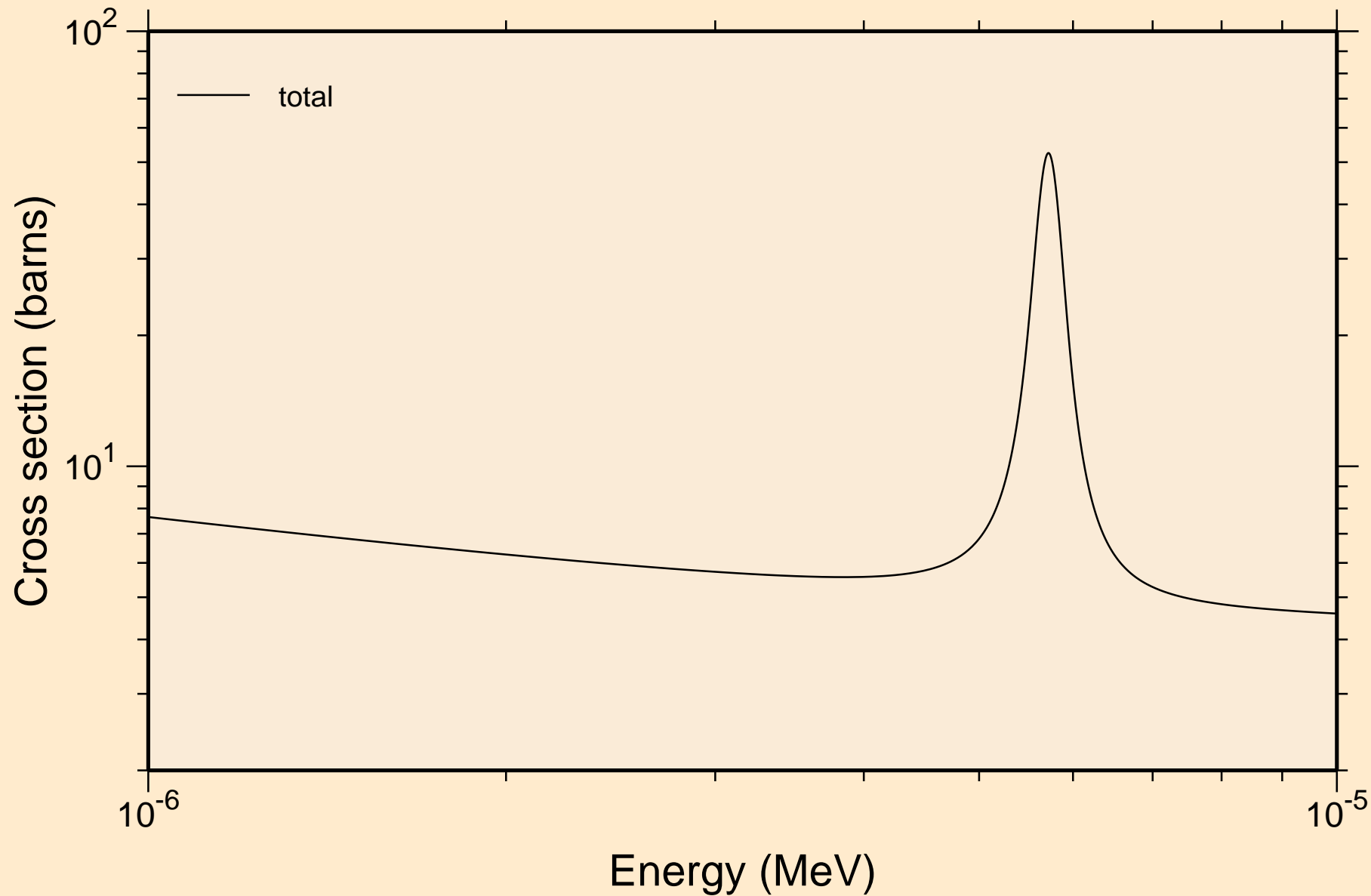

KR079 NEUTRON ACER TENDL-2019 LIBRARY; T=293.16K  
resonance total cross section

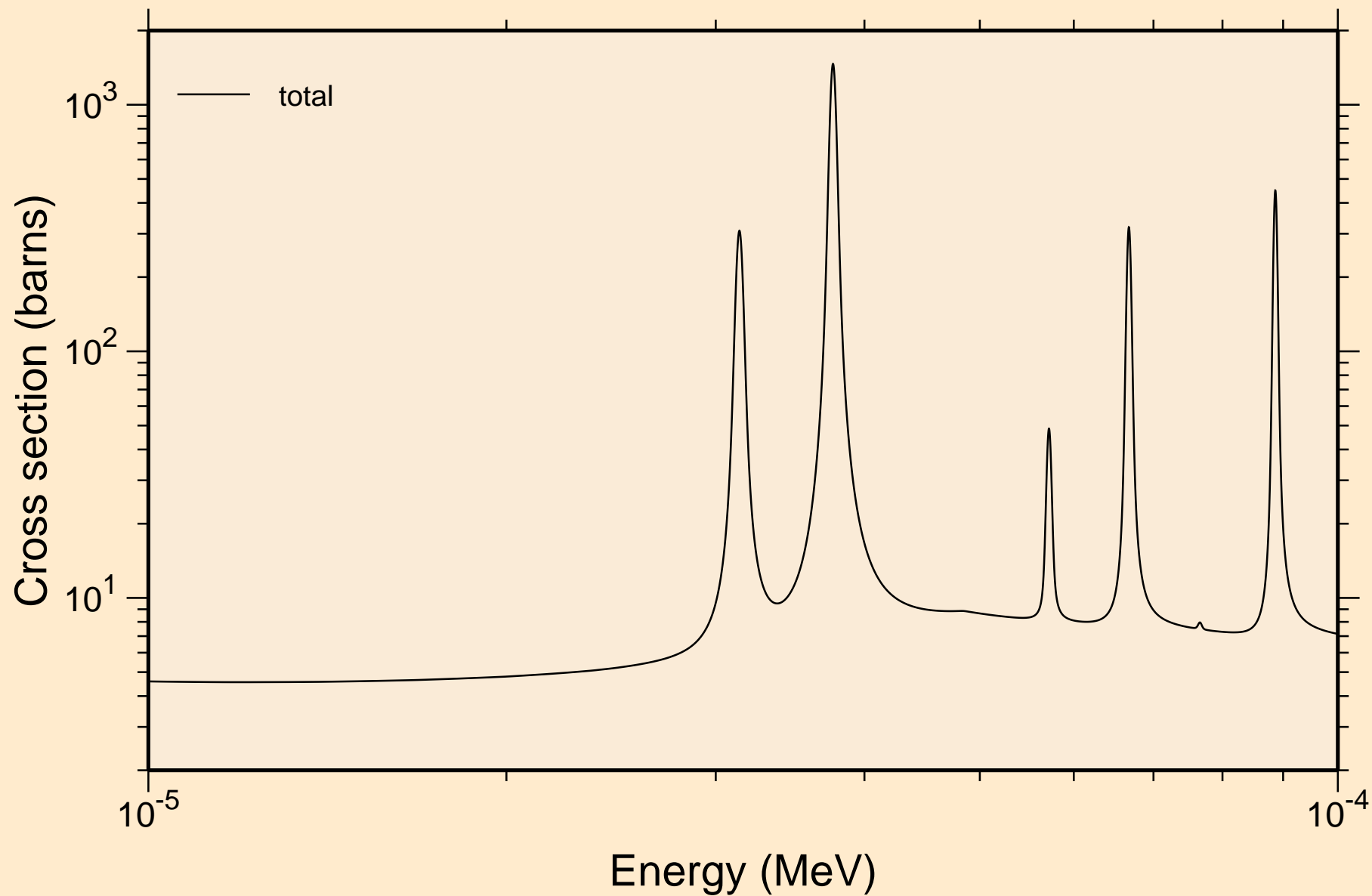

KR079 NEUTRON ACER TENDL-2019 LIBRARY; T=293.16K  
resonance total cross section

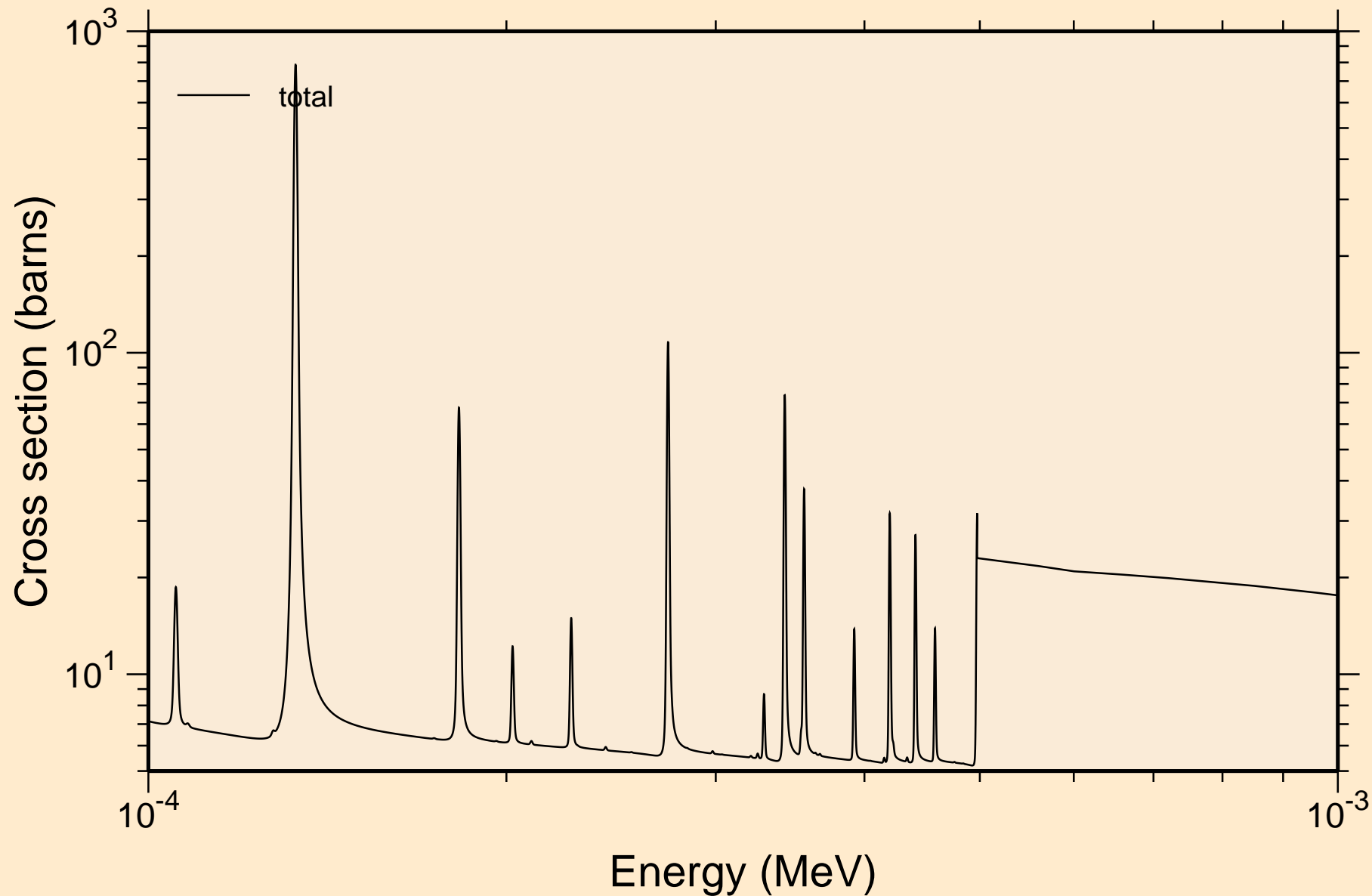

KR079 NEUTRON ACER TENDL-2019 LIBRARY; T=293.16K  
resonance total cross section

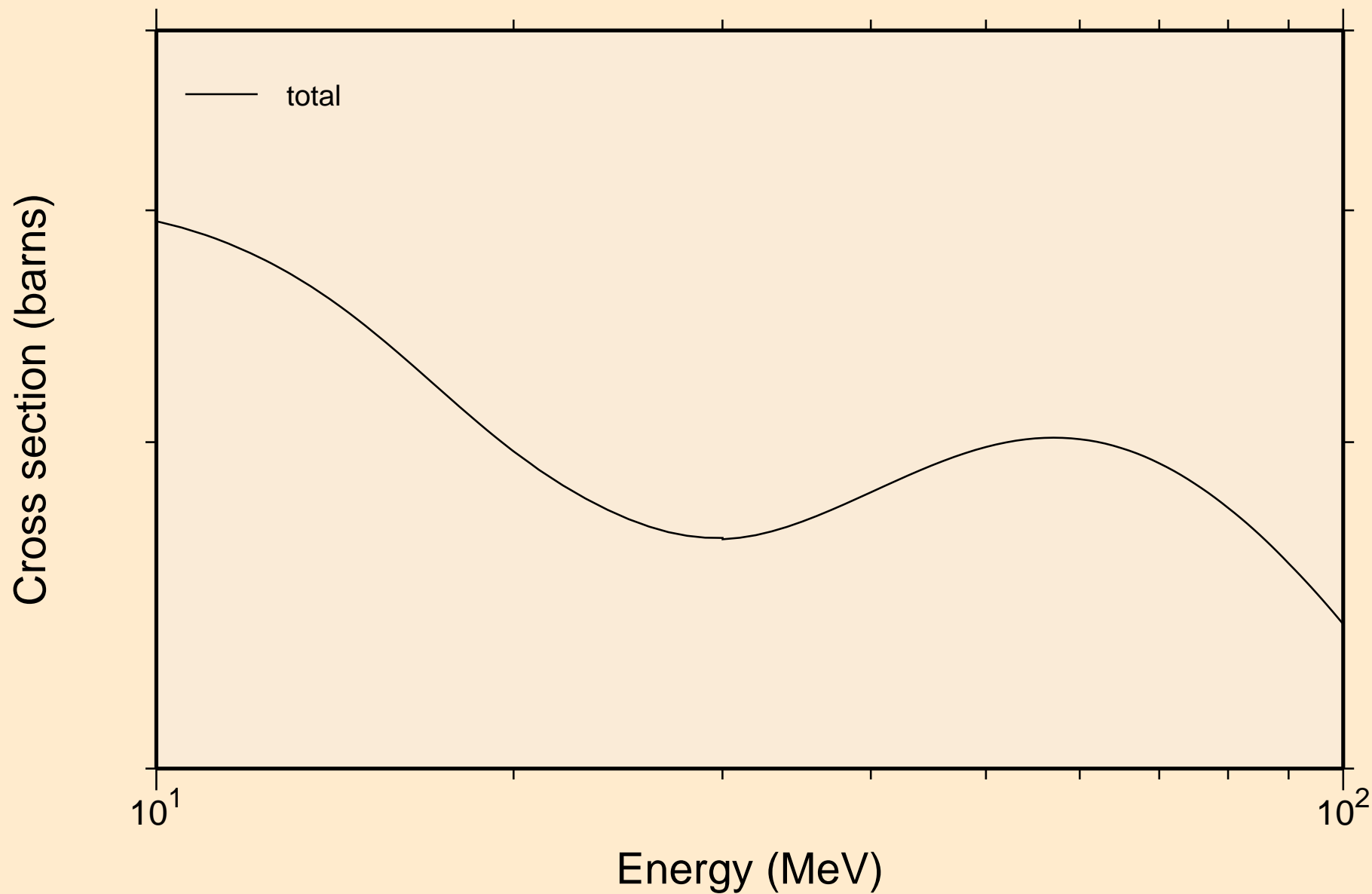

KR079 NEUTRON ACER TENDL-2019 LIBRARY; T=293.16K  
resonance absorption cross sections

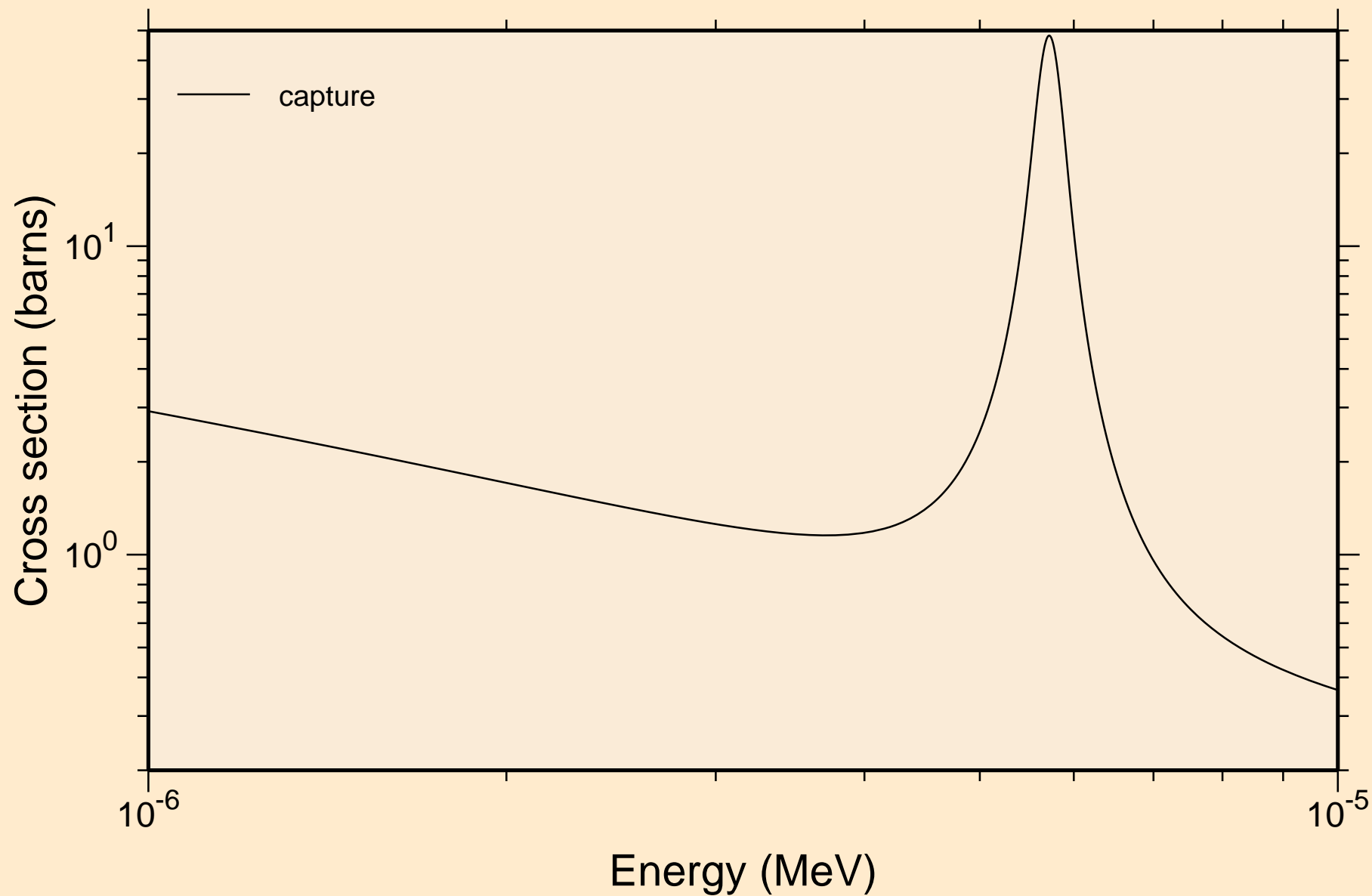

KR079 NEUTRON ACER TENDL-2019 LIBRARY; T=293.16K  
resonance absorption cross sections

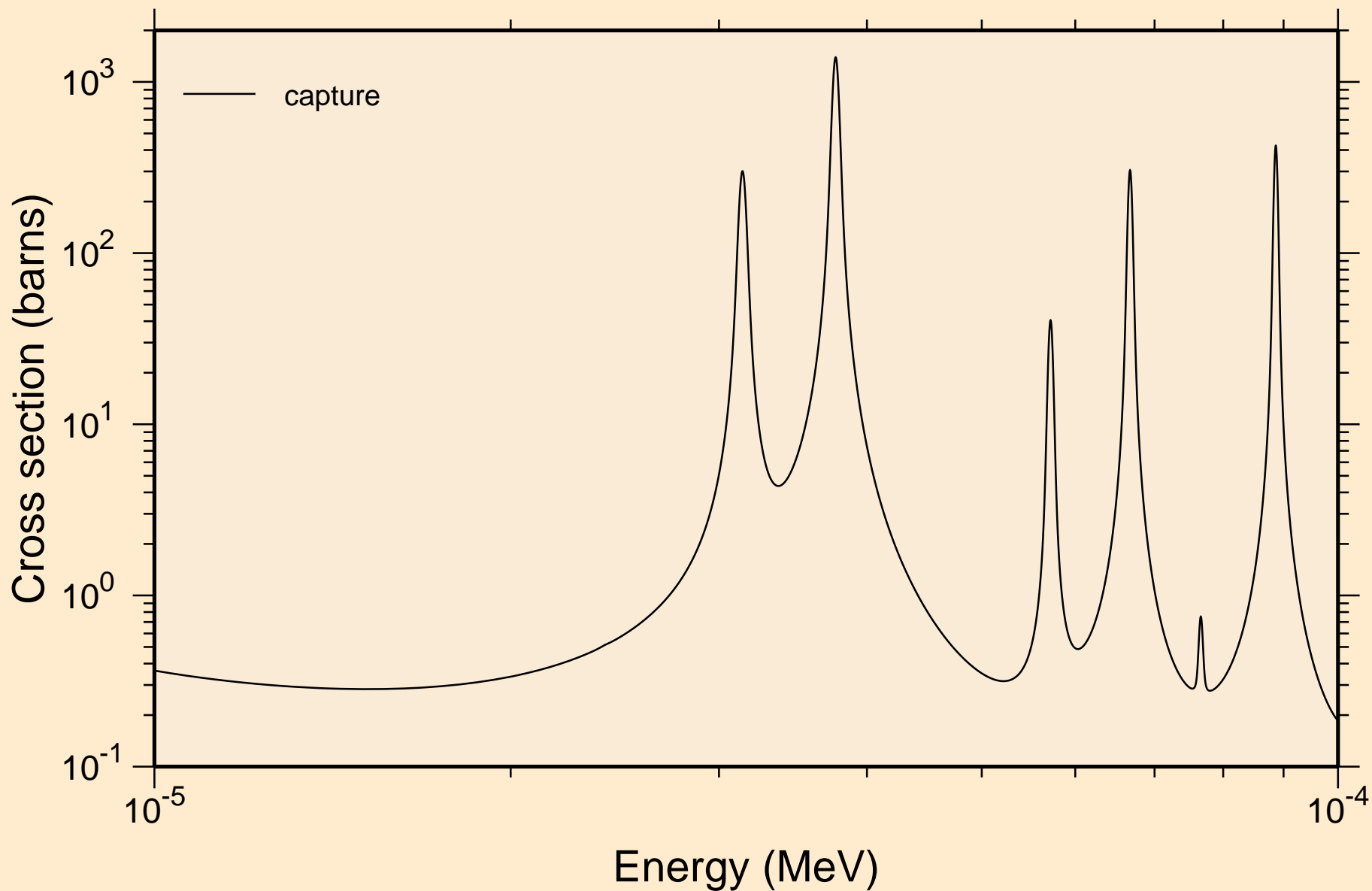

KR079 NEUTRON ACER TENDL-2019 LIBRARY; T=293.16K  
resonance absorption cross sections

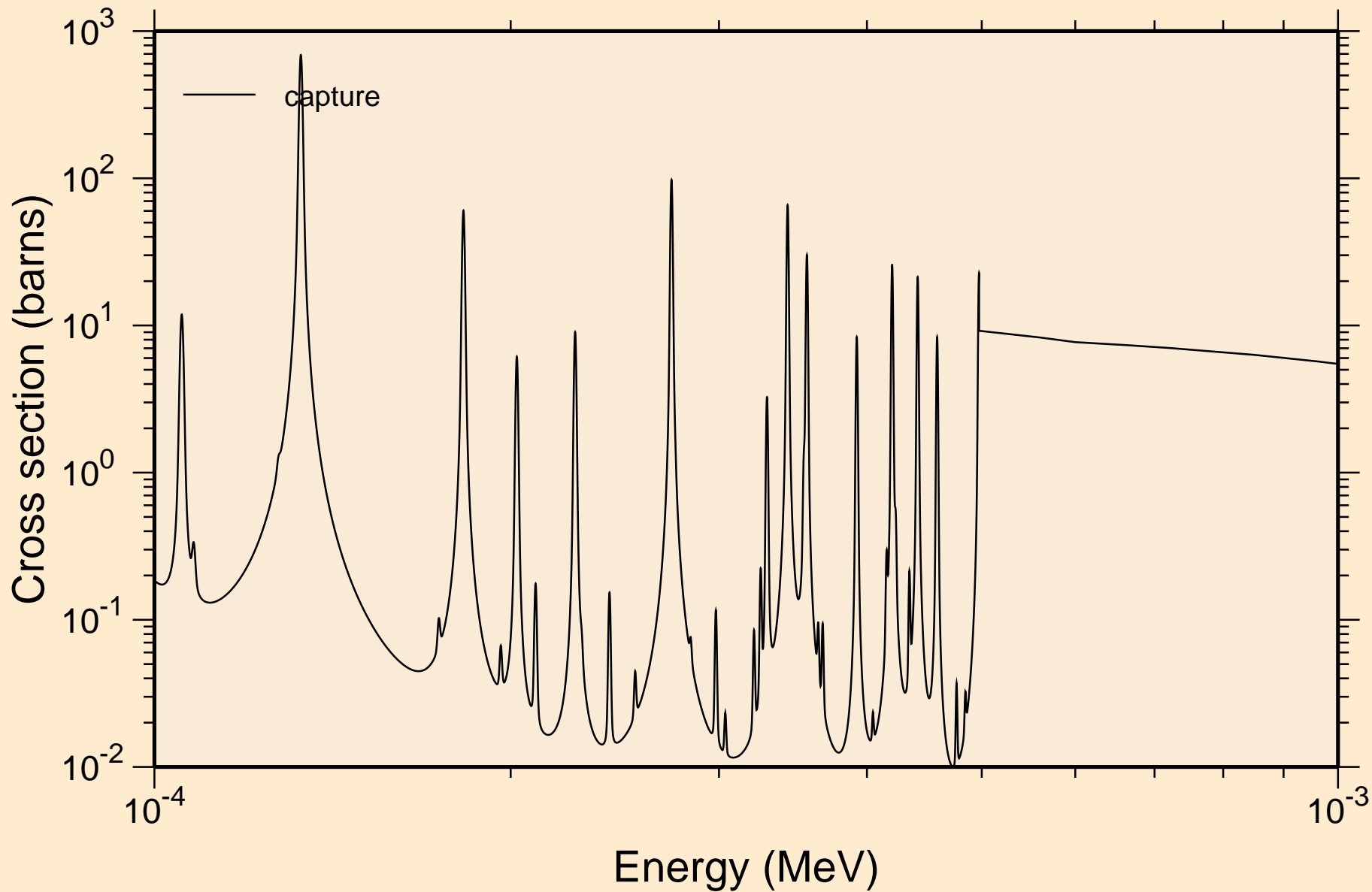



KR079 NEUTRON ACER TENDL-2019 LIBRARY; T=293.16K  
resonance absorption cross sections

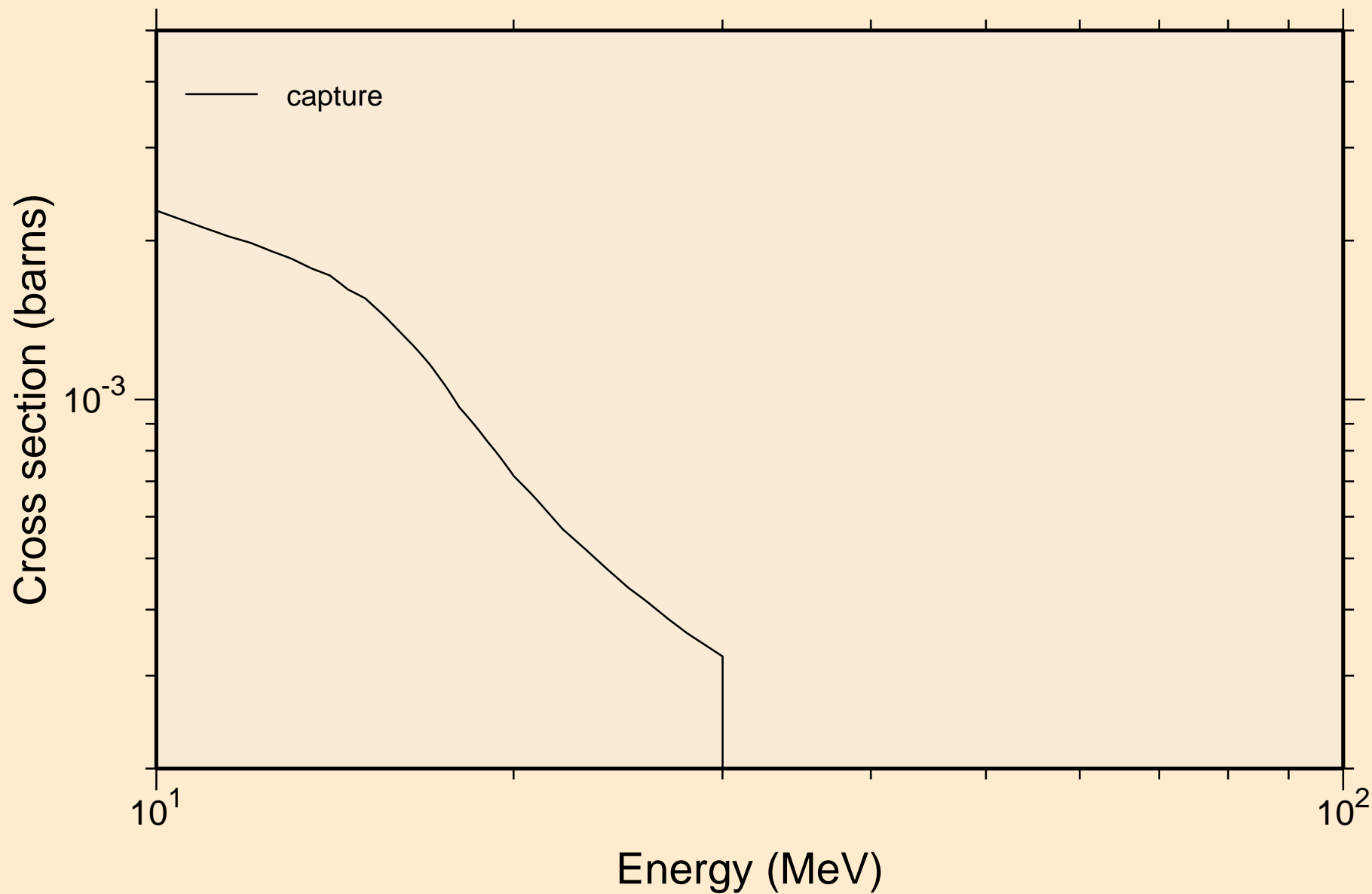

KR079 NEUTRON ACER TENDL-2019 LIBRARY; T=293.16K  
Heating

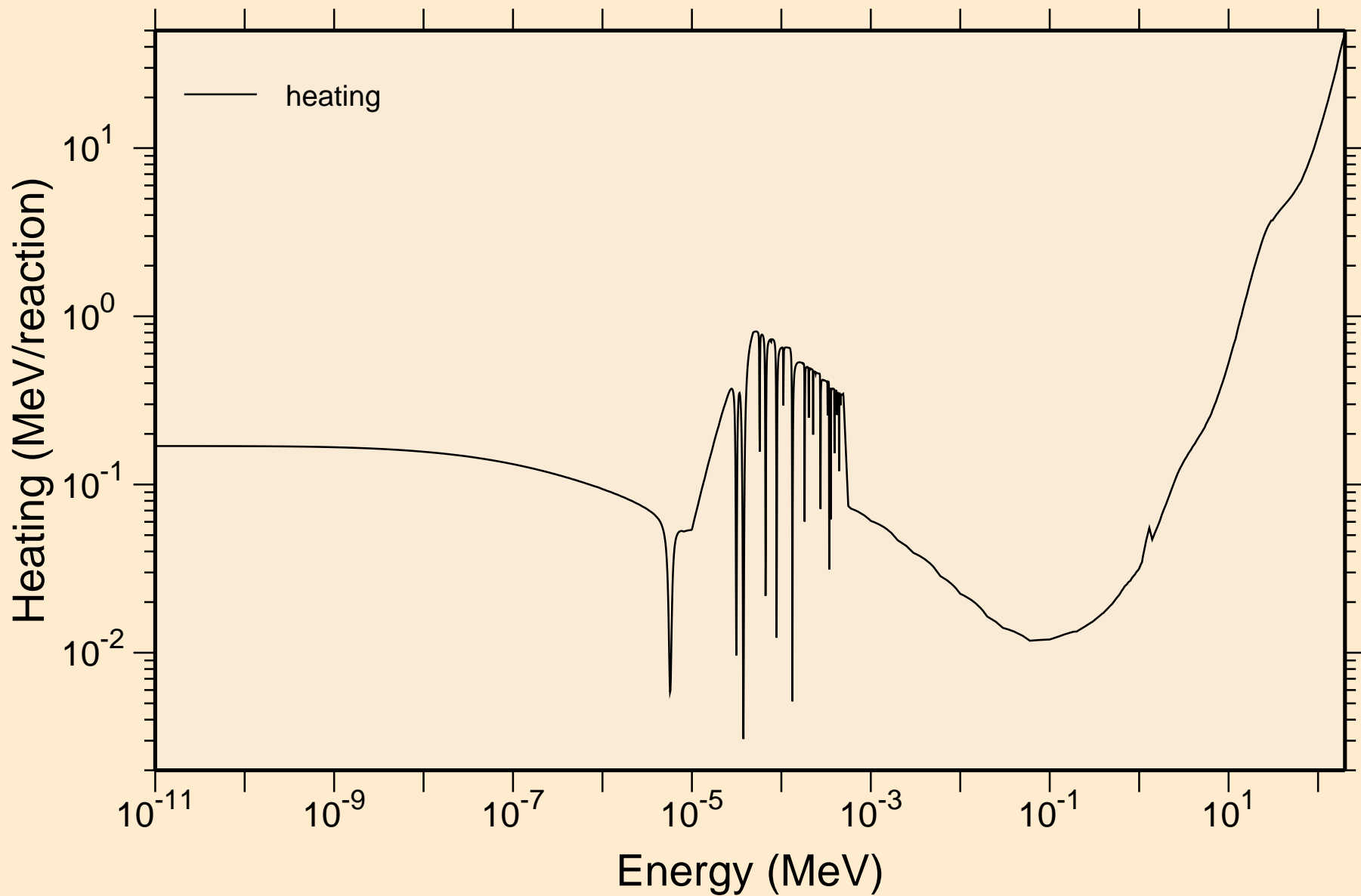

KR079 NEUTRON ACER TENDL-2019 LIBRARY; T=293.16K  
Damage

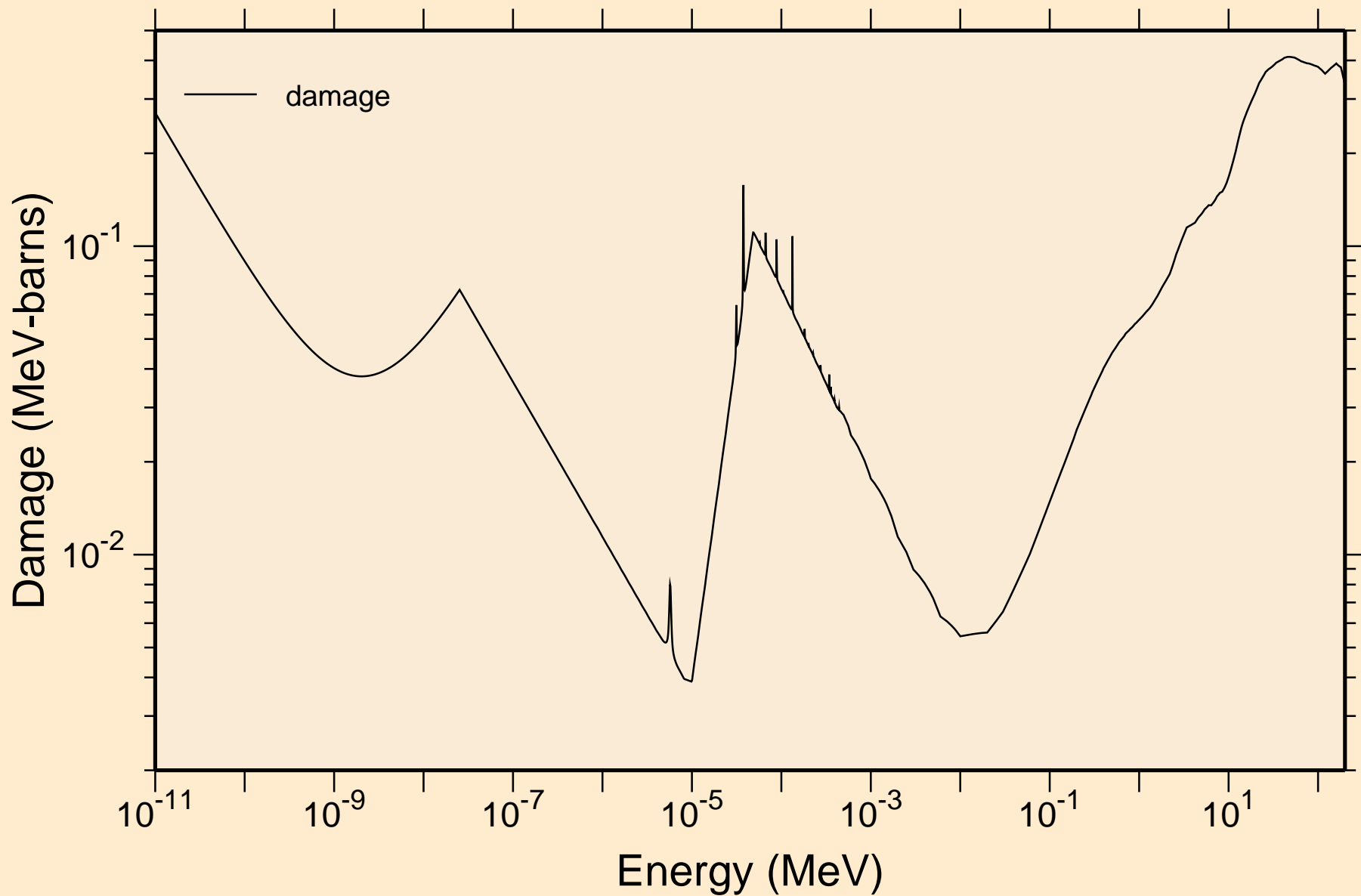

KR079 NEUTRON ACER TENDL-2019 LIBRARY; T=293.16K  
Non-threshold reactions

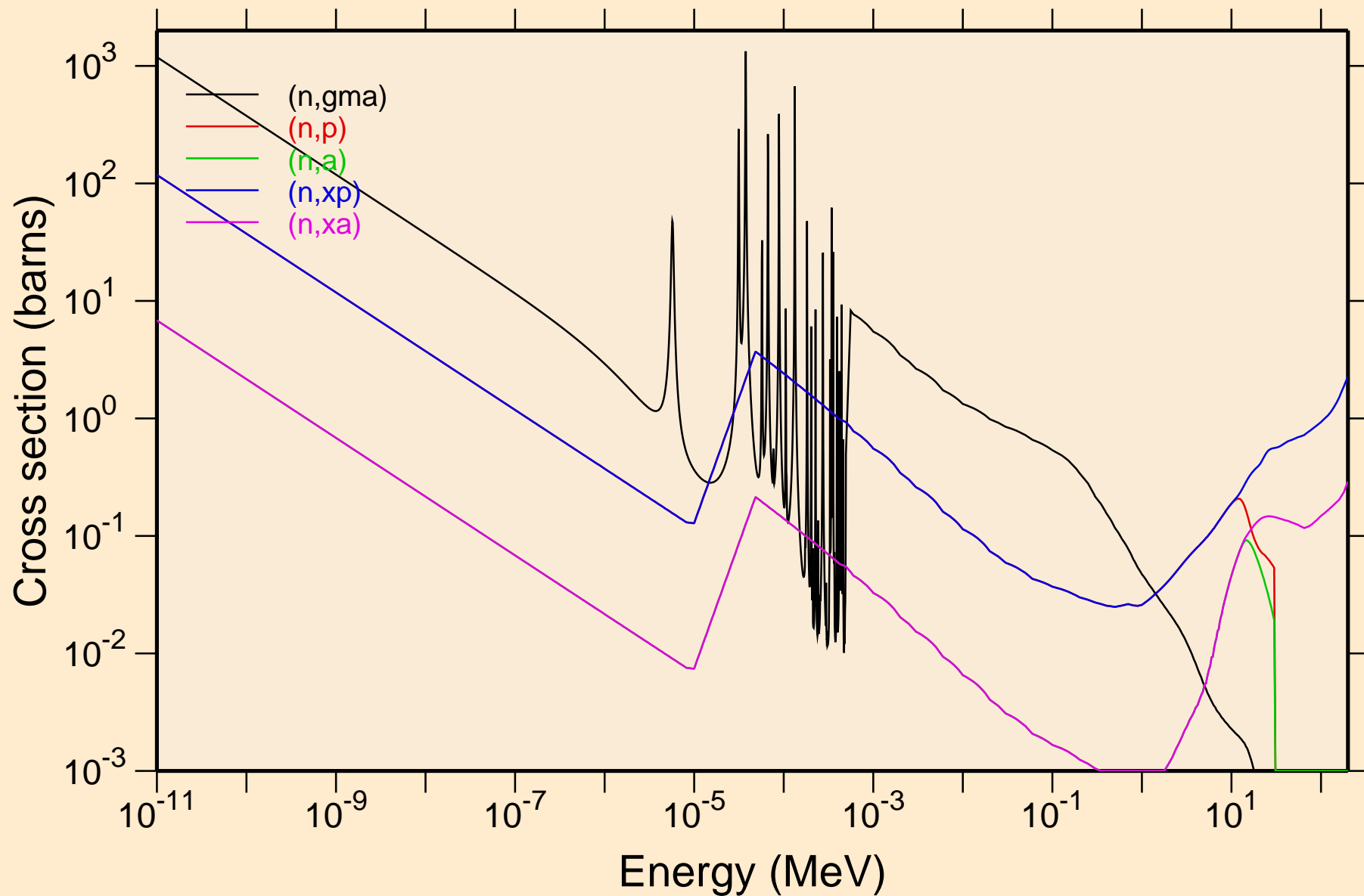

KR079 NEUTRON ACER TENDL-2019 LIBRARY; T=293.16K  
Principal cross sections

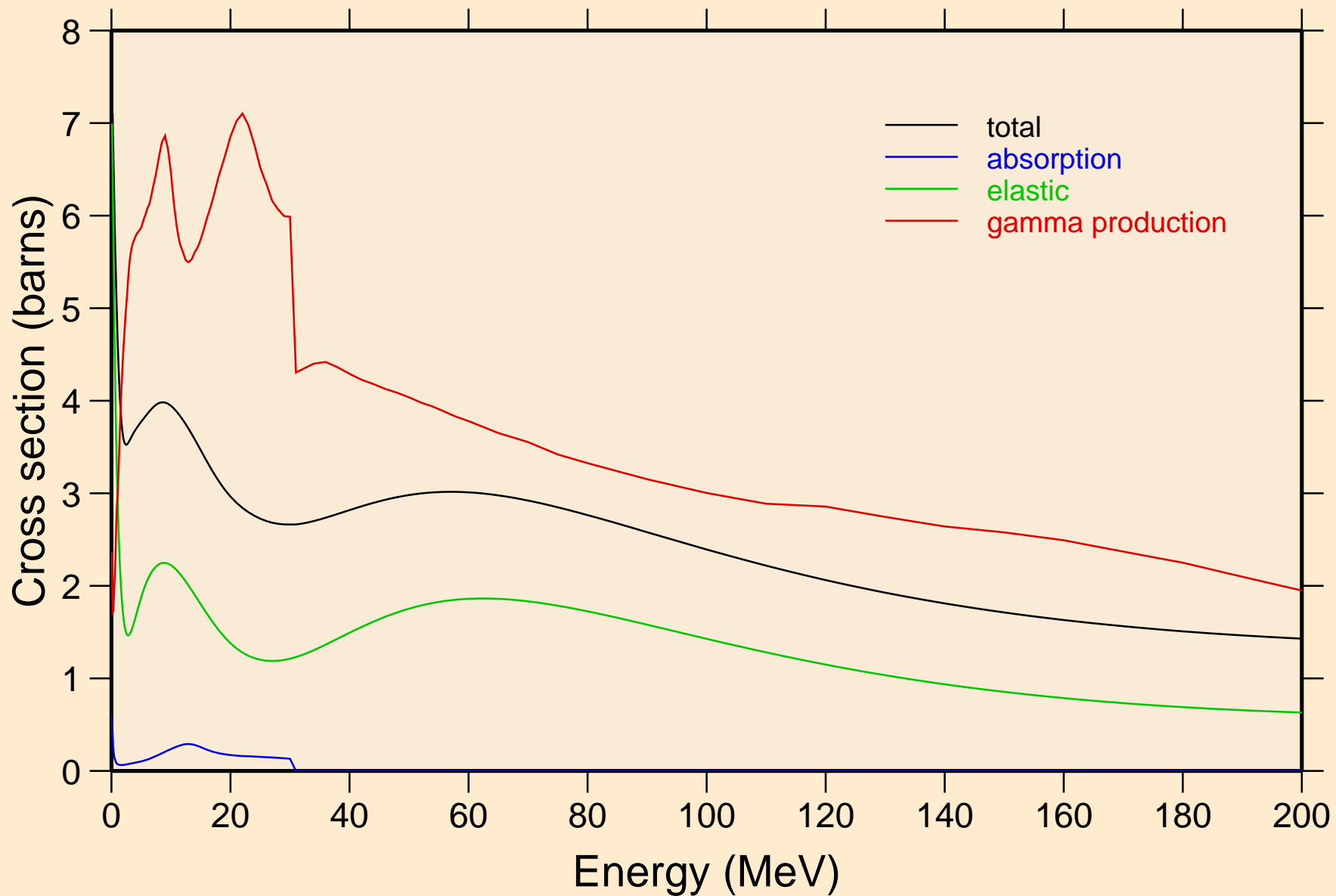

KR079 NEUTRON ACER TENDL-2019 LIBRARY; T=293.16K  
Heating

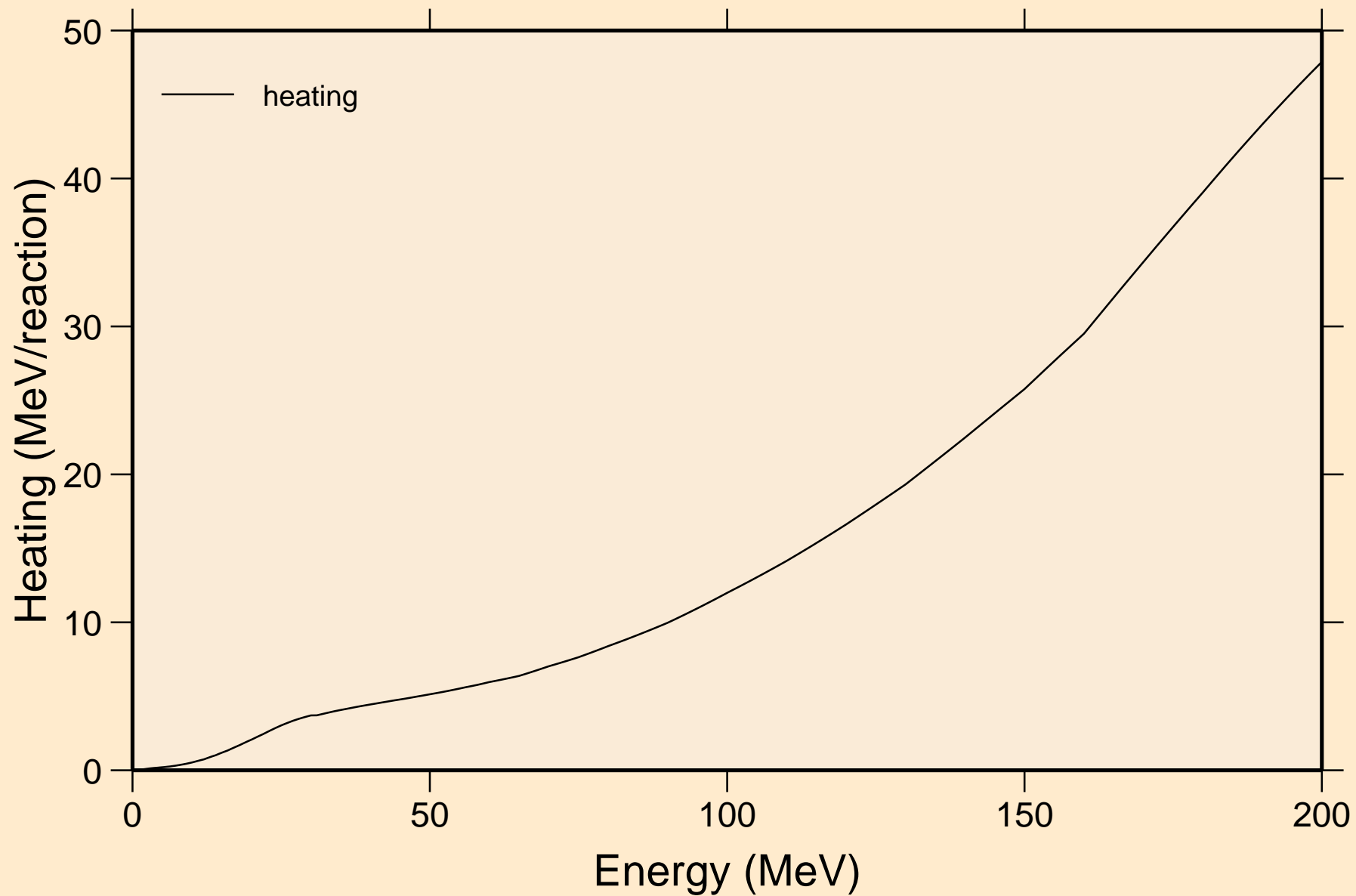

KR079 NEUTRON ACER TENDL-2019 LIBRARY; T=293.16K  
Damage

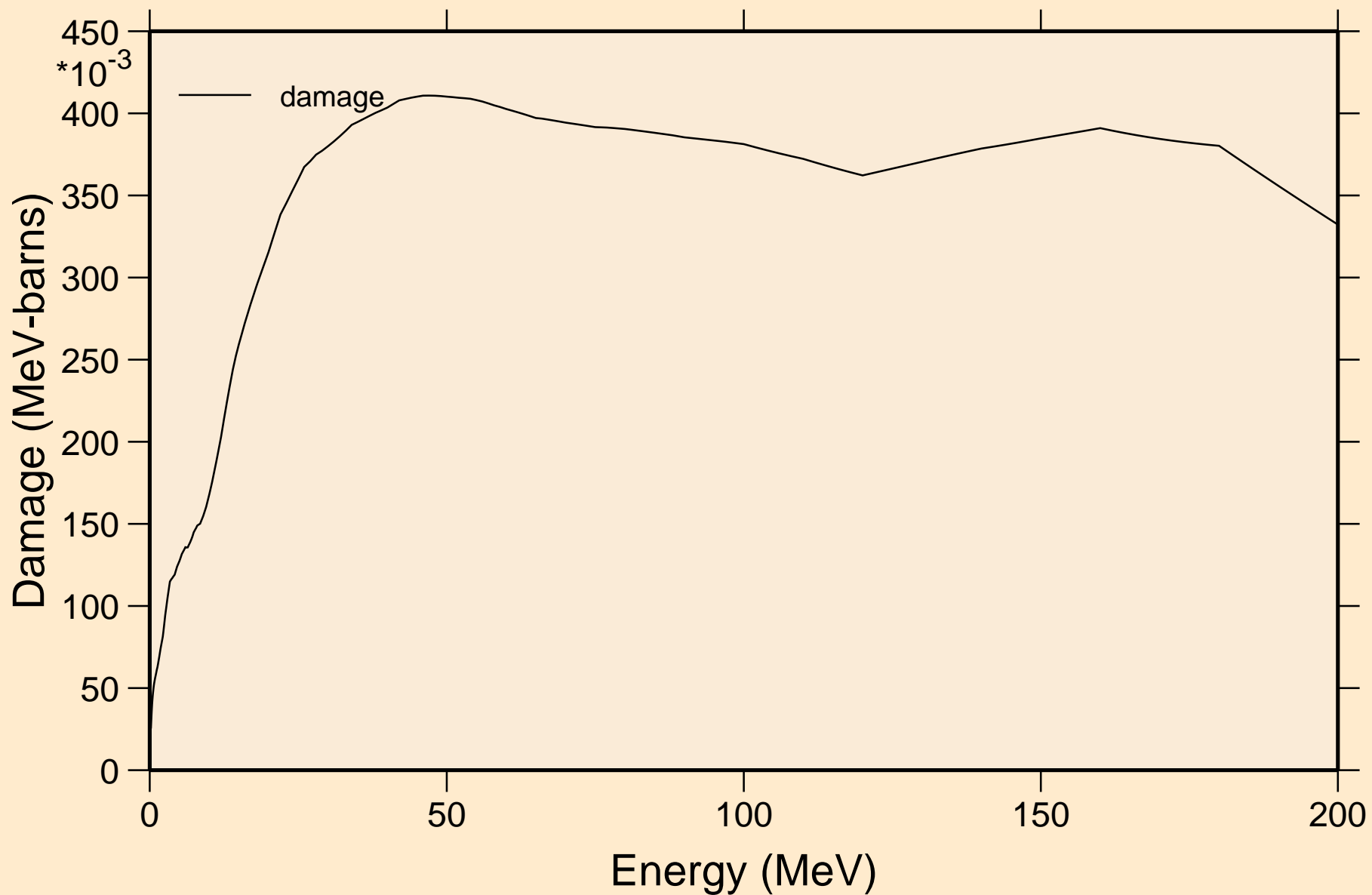

KR079 NEUTRON ACER TENDL-2019 LIBRARY; T=293.16K  
Non-threshold reactions

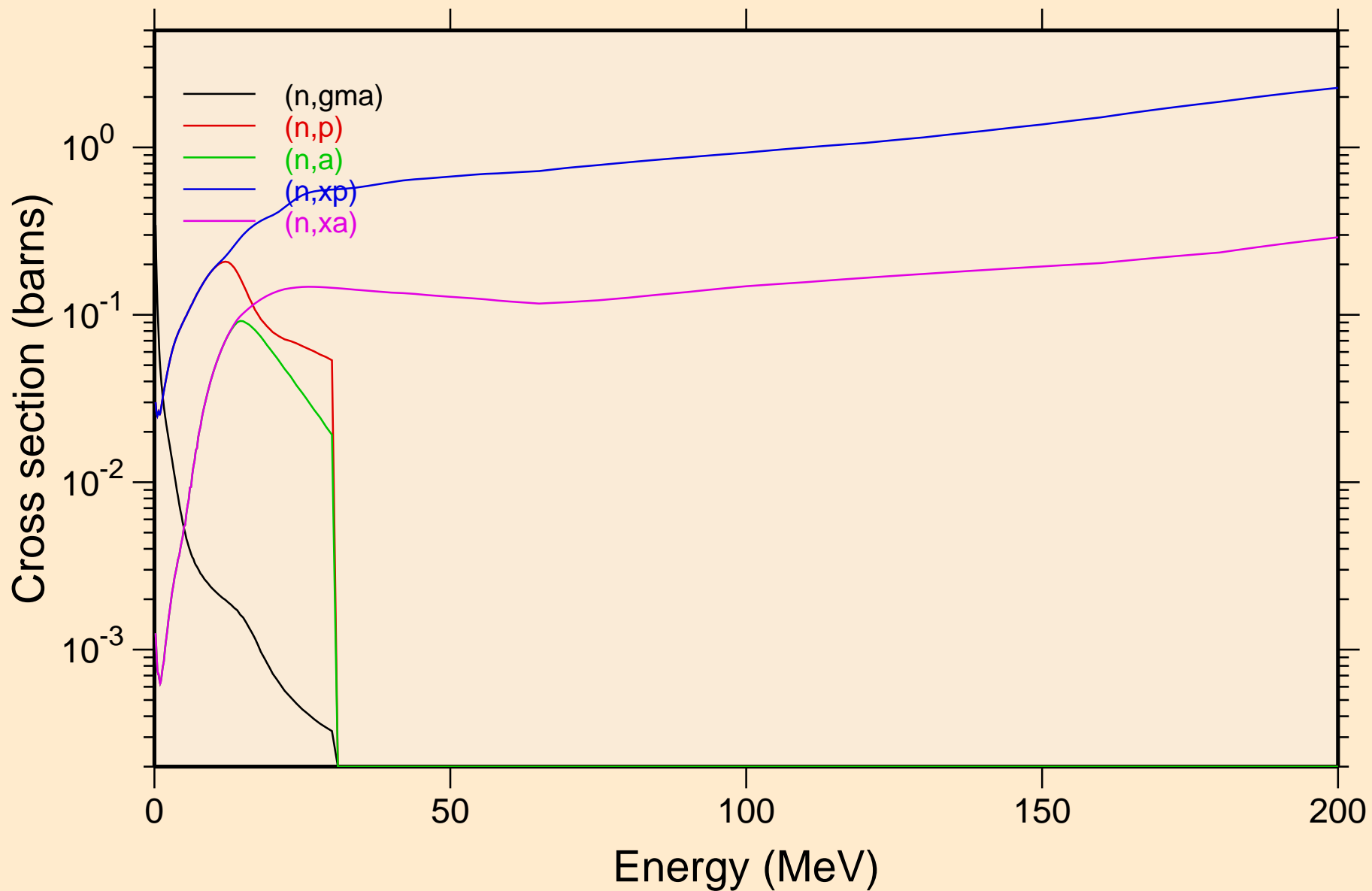



KR079 NEUTRON ACER TENDL-2019 LIBRARY; T=293.16K  
Inelastic levels

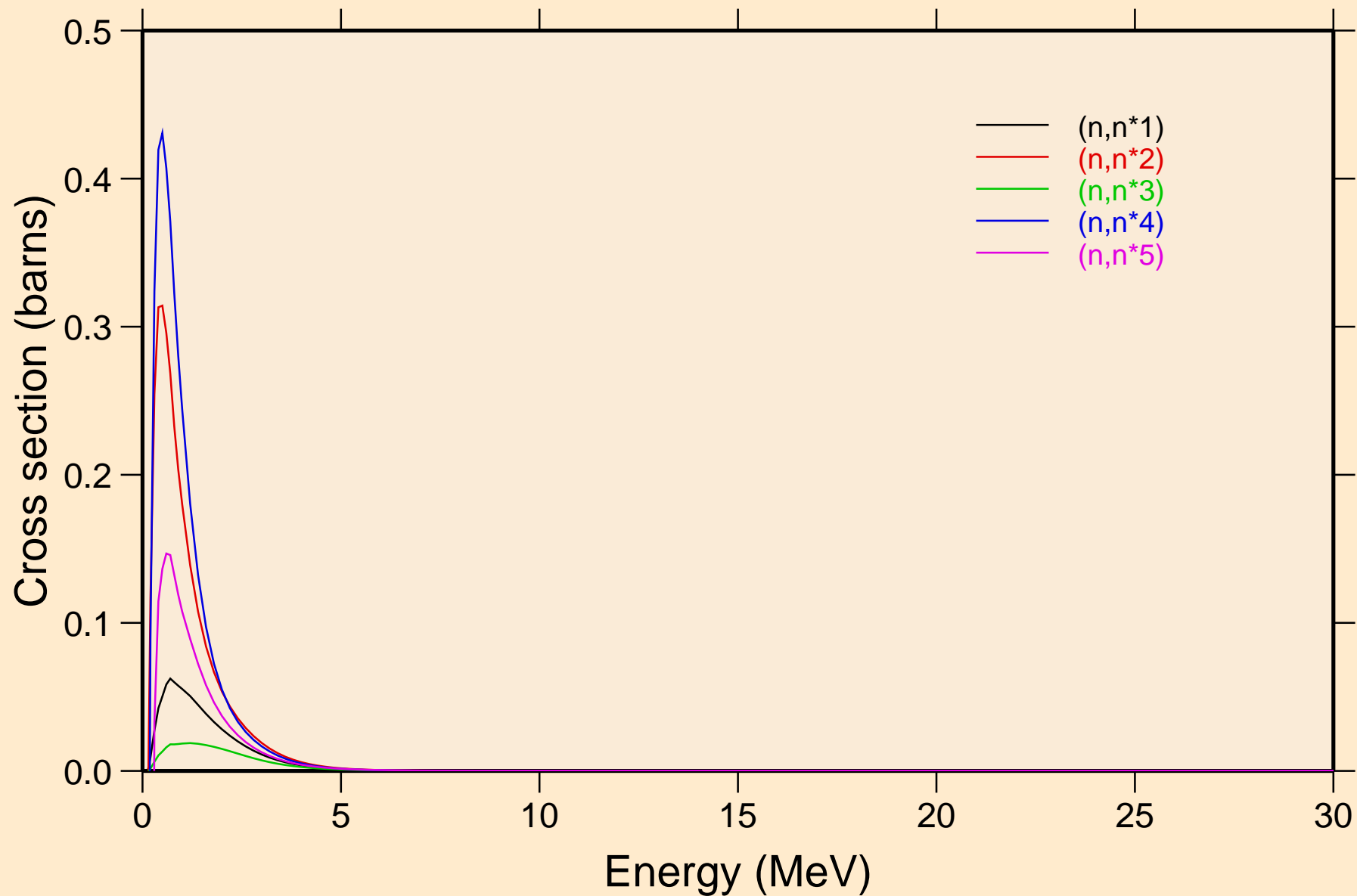

KR079 NEUTRON ACER TENDL-2019 LIBRARY; T=293.16K  
Inelastic levels

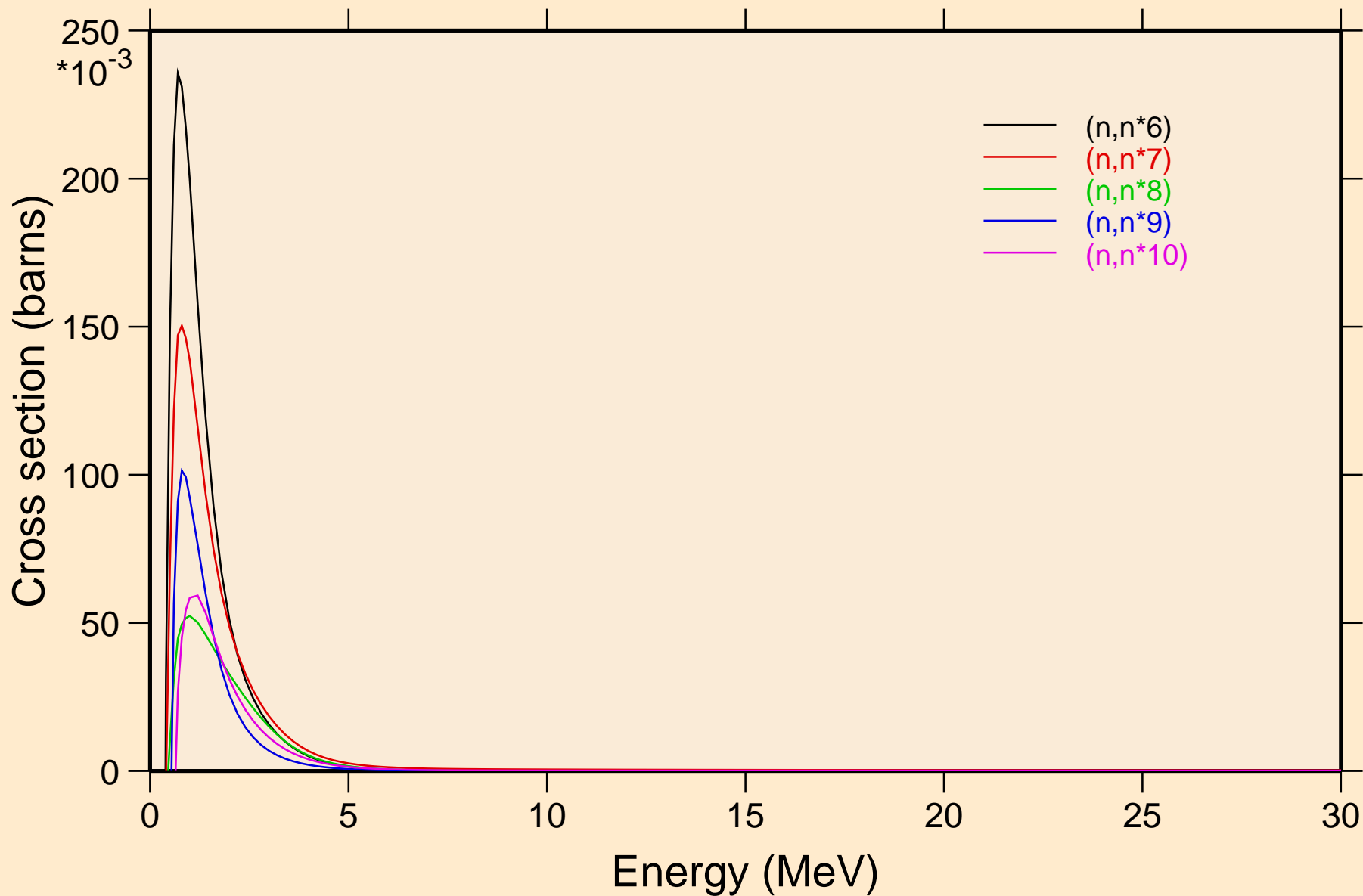

KR079 NEUTRON ACER TENDL-2019 LIBRARY; T=293.16K  
Inelastic levels

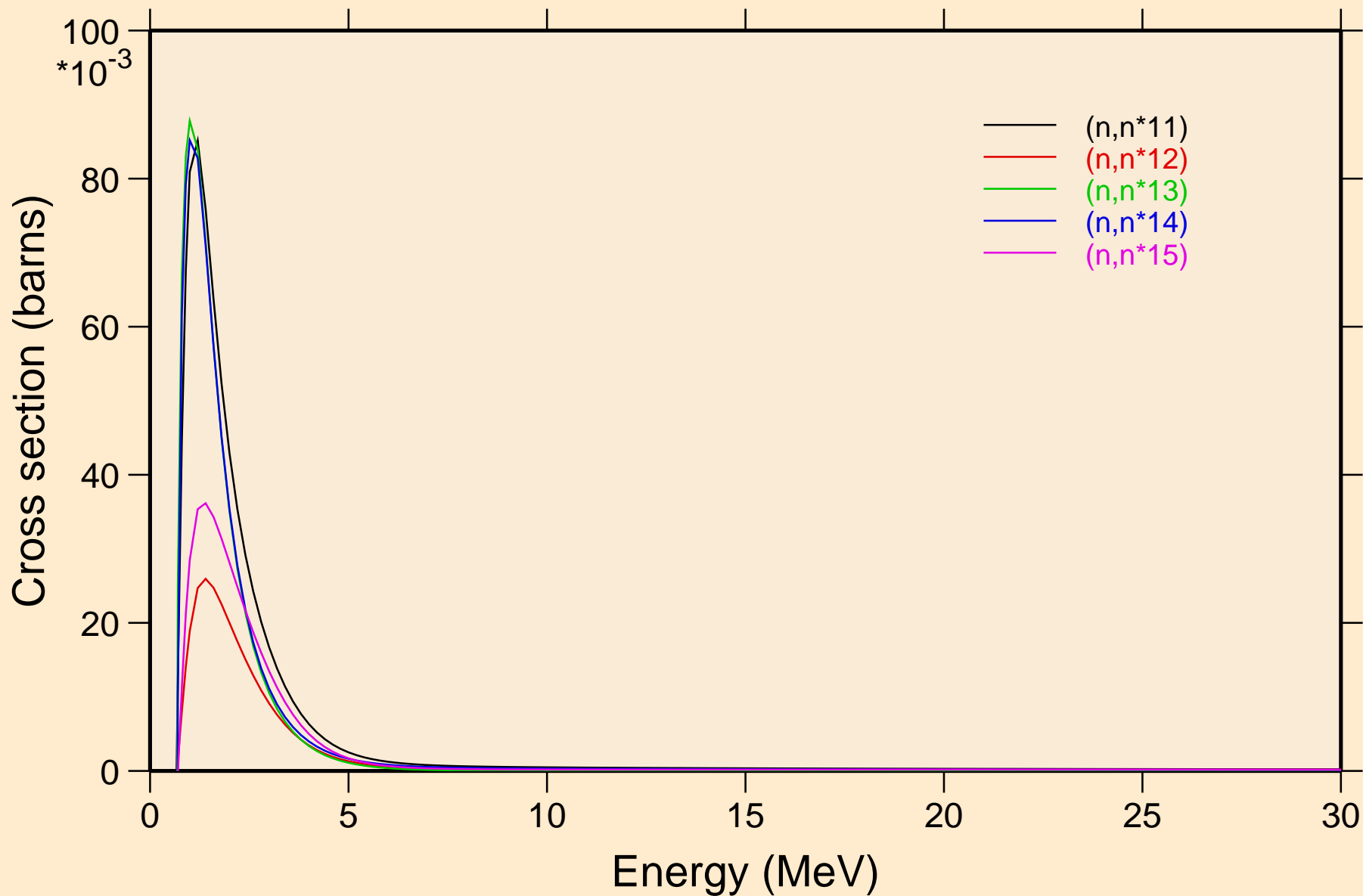

KR079 NEUTRON ACER TENDL-2019 LIBRARY; T=293.16K  
Inelastic levels

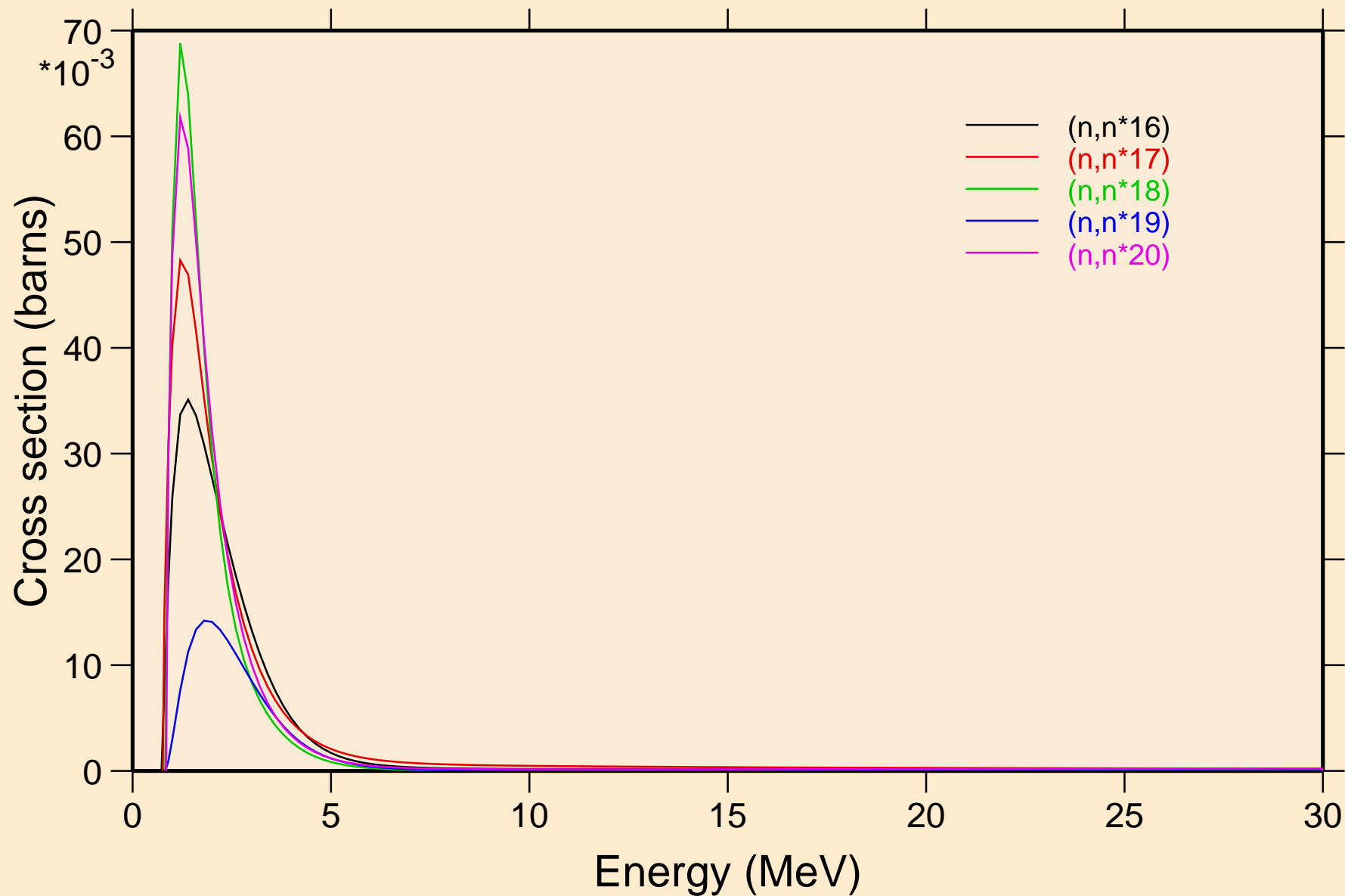

KR079 NEUTRON ACER TENDL-2019 LIBRARY; T=293.16K  
Inelastic levels

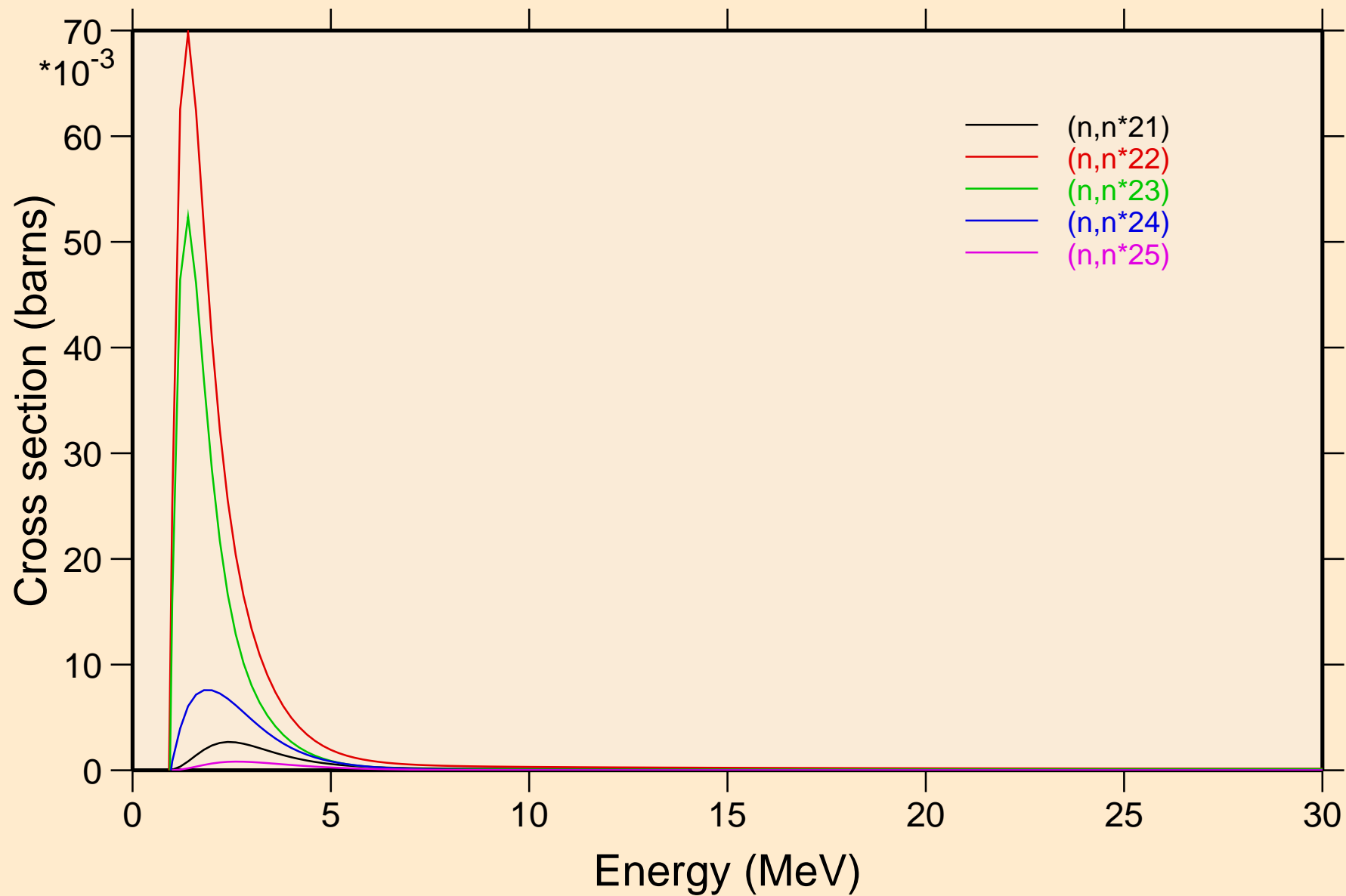

KR079 NEUTRON ACER TENDL-2019 LIBRARY; T=293.16K  
Inelastic levels

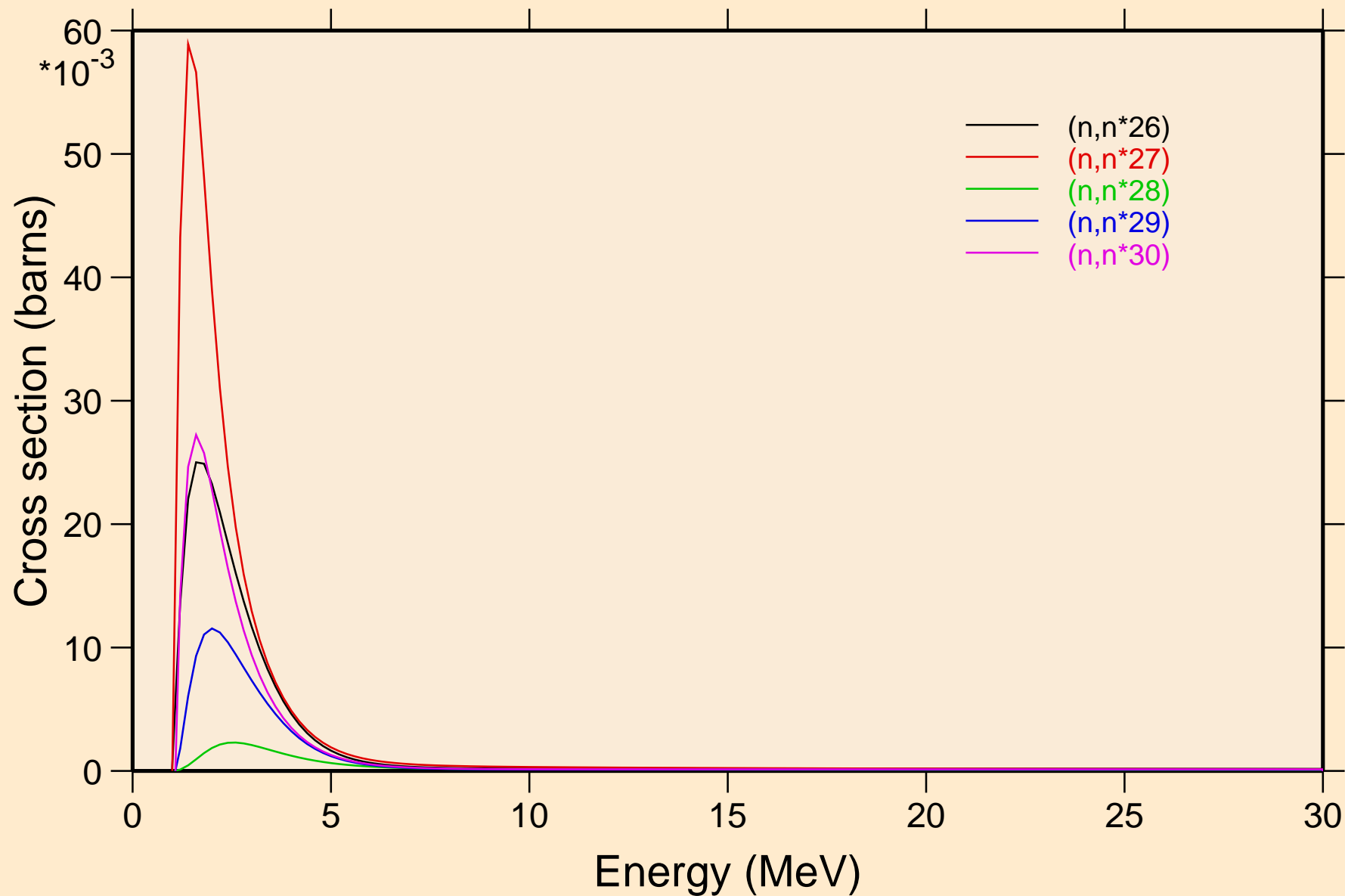

KR079 NEUTRON ACER TENDL-2019 LIBRARY; T=293.16K  
Threshold reactions

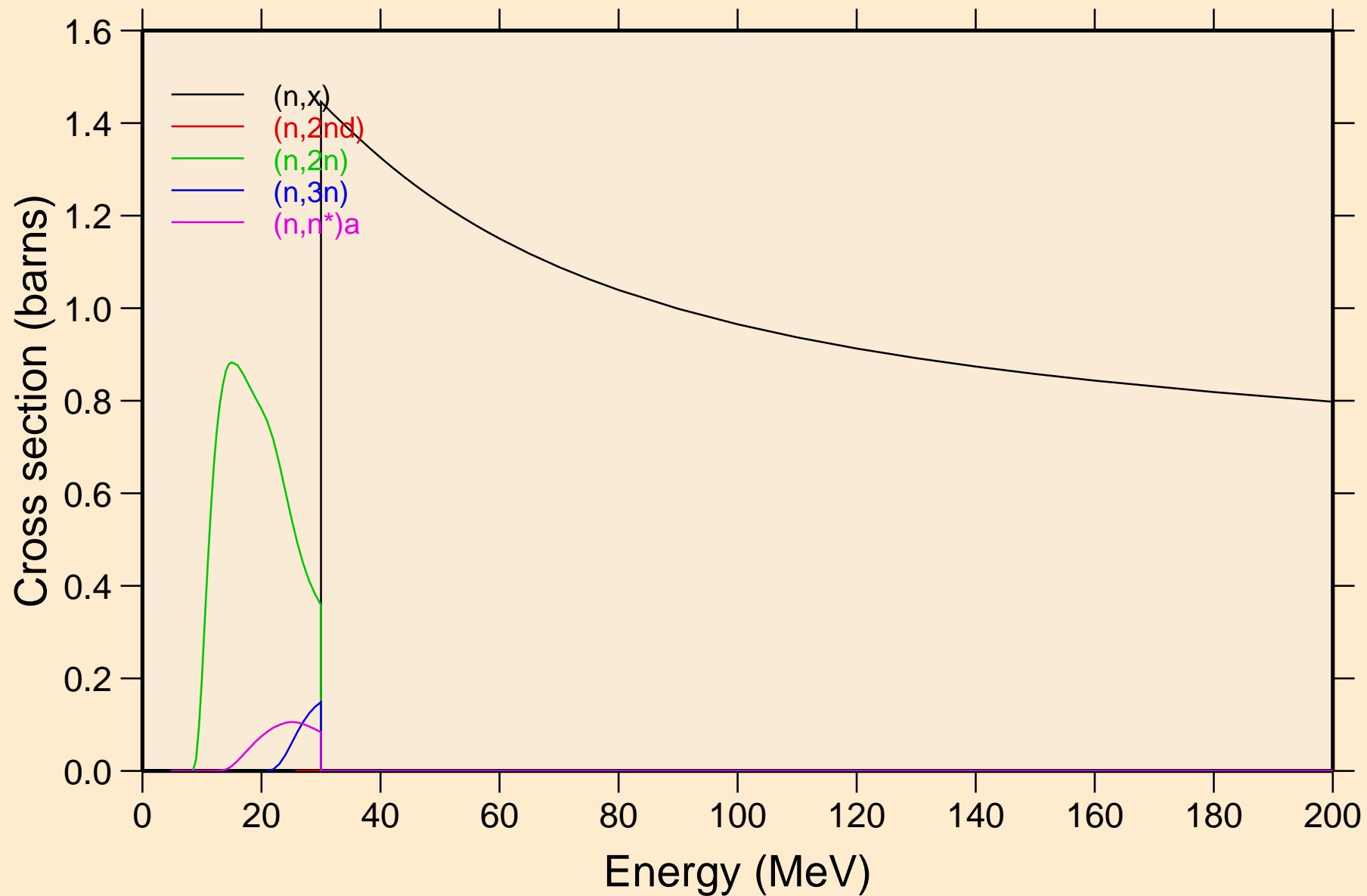

KR079 NEUTRON ACER TENDL-2019 LIBRARY; T=293.16K  
Threshold reactions

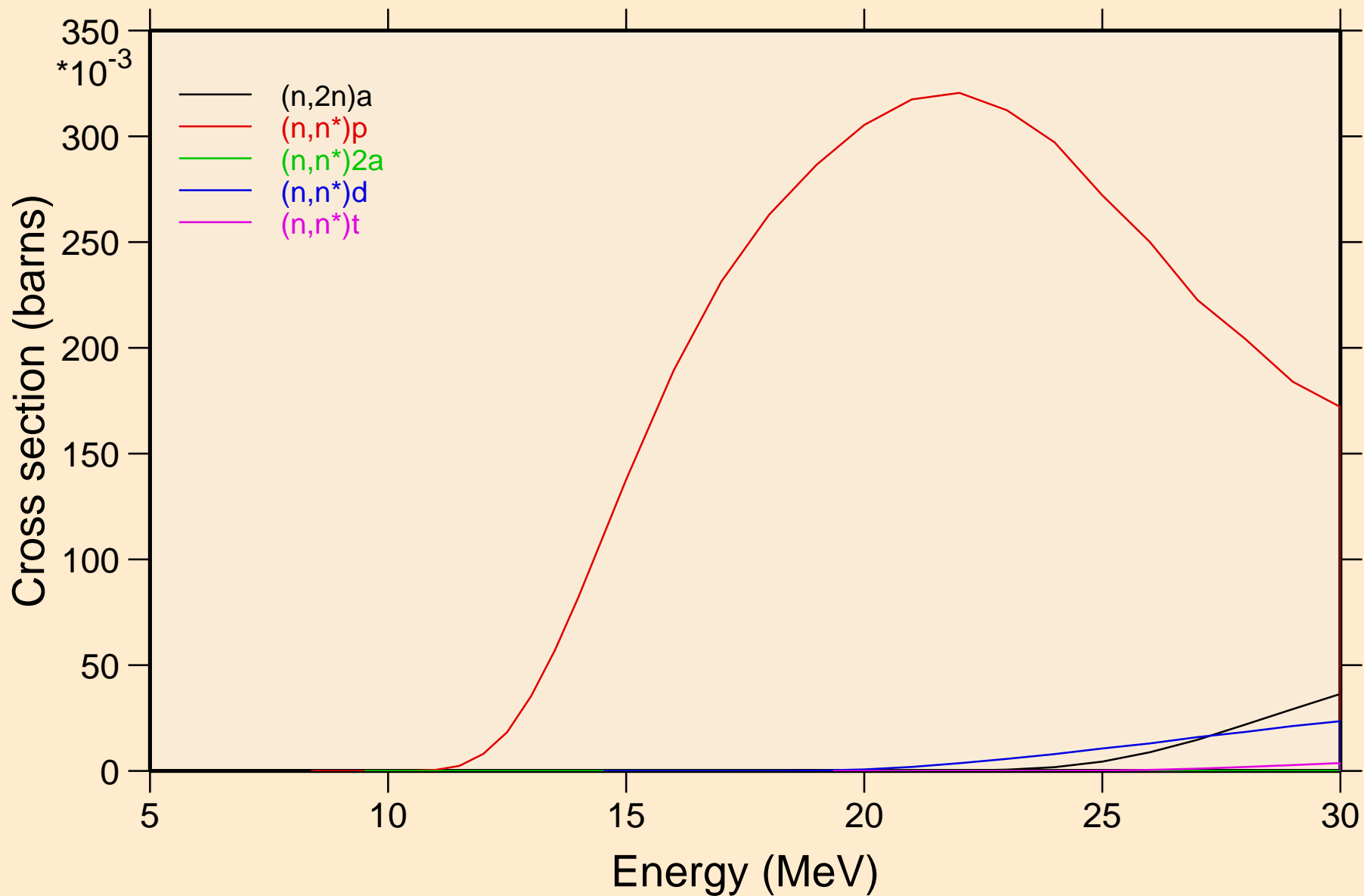



KR079 NEUTRON ACER TENDL-2019 LIBRARY; T=293.16K  
Threshold reactions

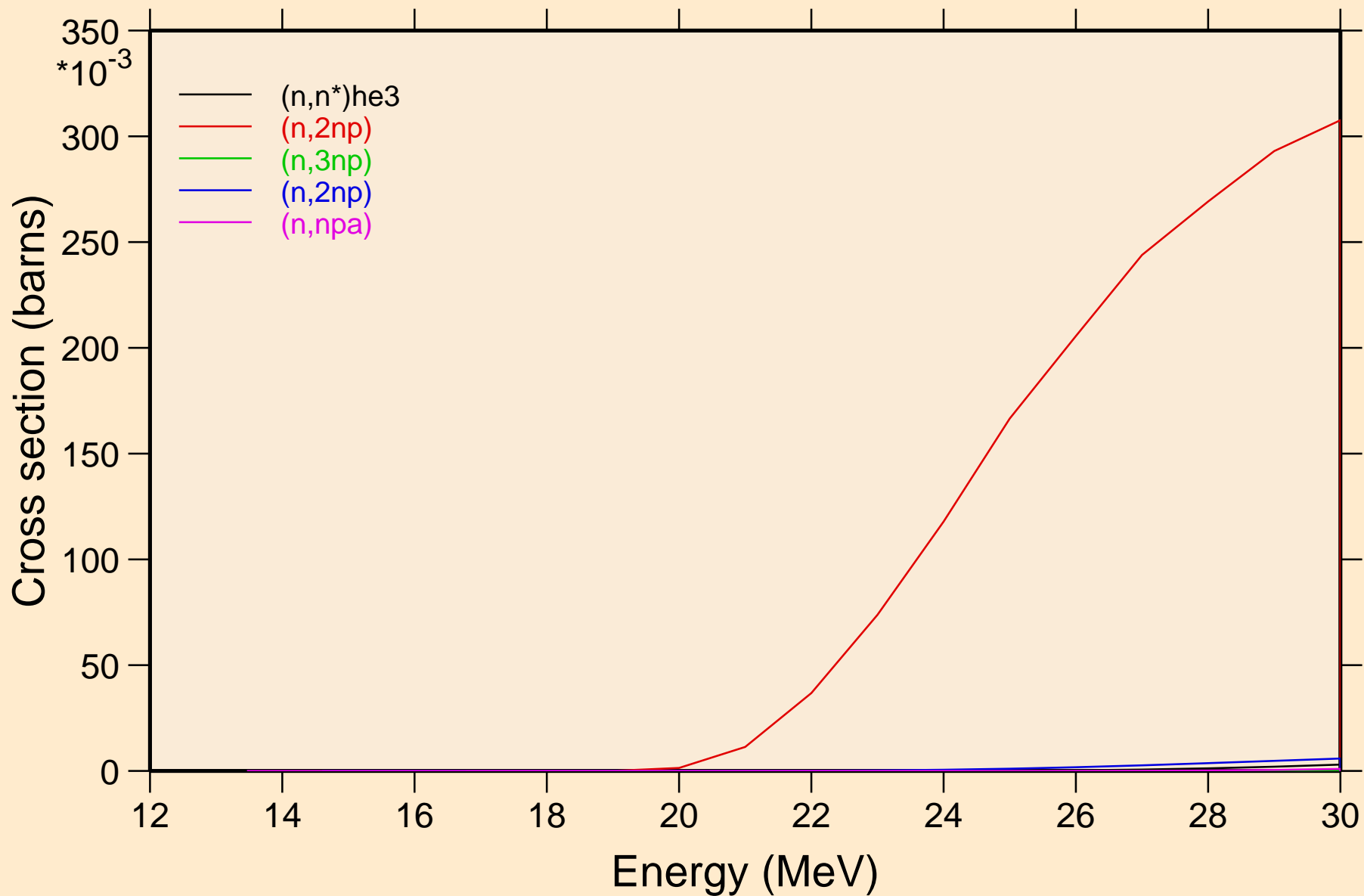

KR079 NEUTRON ACER TENDL-2019 LIBRARY; T=293.16K  
Threshold reactions

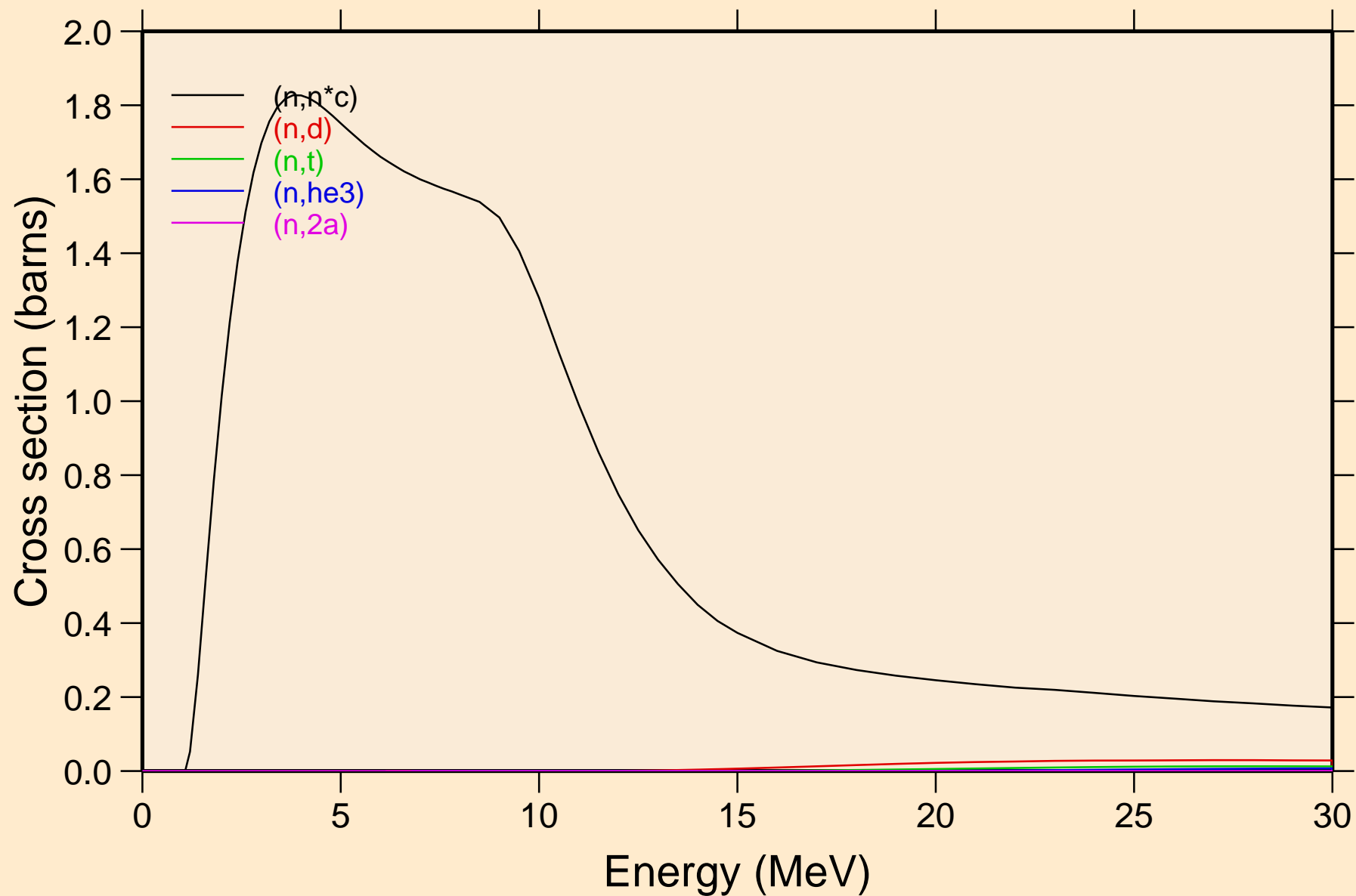

KR079 NEUTRON ACER TENDL-2019 LIBRARY; T=293.16K  
Threshold reactions

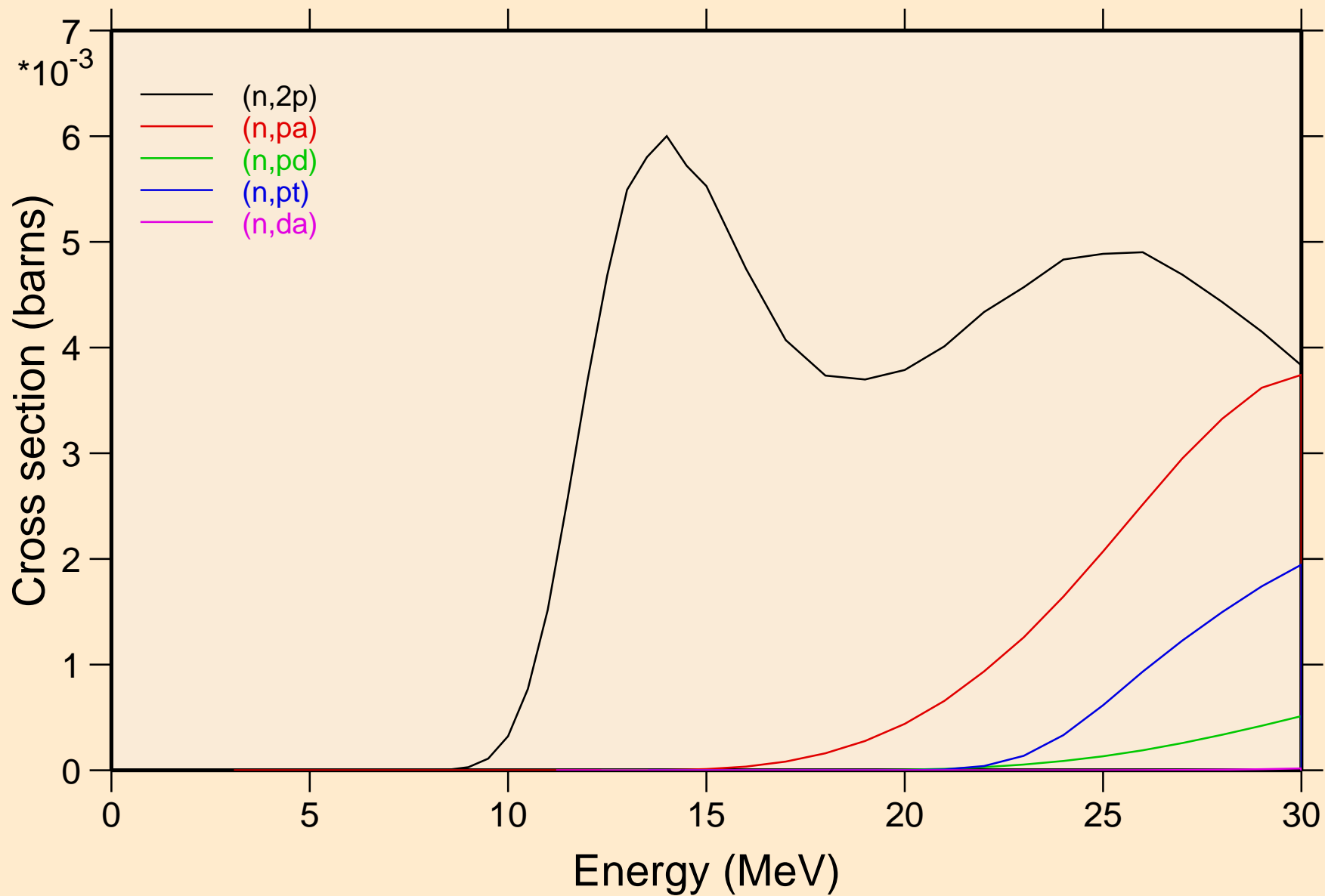

KR079 NEUTRON ACER TENDL-2019 LIBRARY; T=293.16K  
Threshold reactions

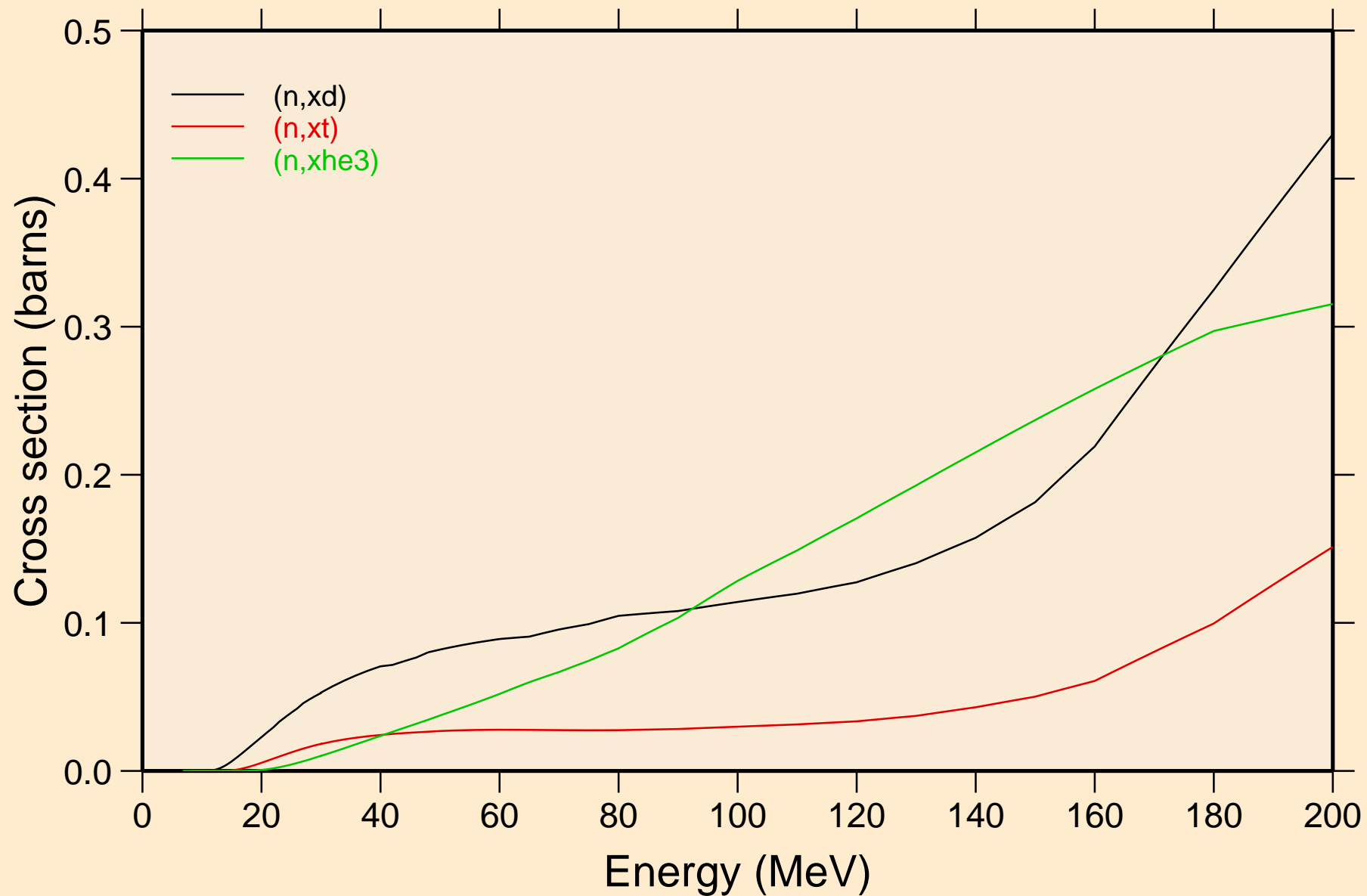

KR079 NEUTRON ACER TENDL-2019 LIBRARY; T=293.16K  
angular distribution for elastic

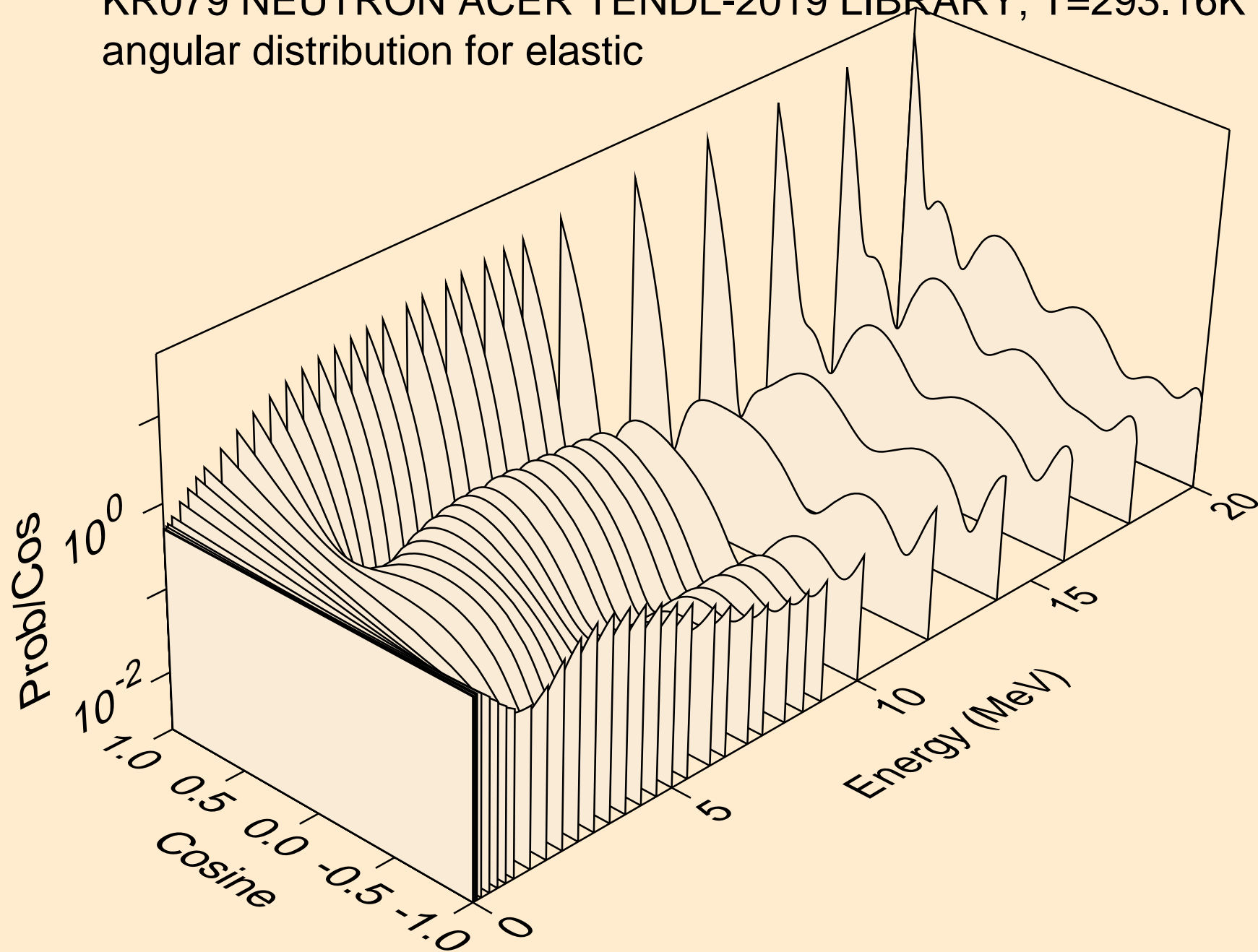

KR079 NEUTRON ACER TENDL-2019 LIBRARY; T=293.16K  
angular distribution for elastic

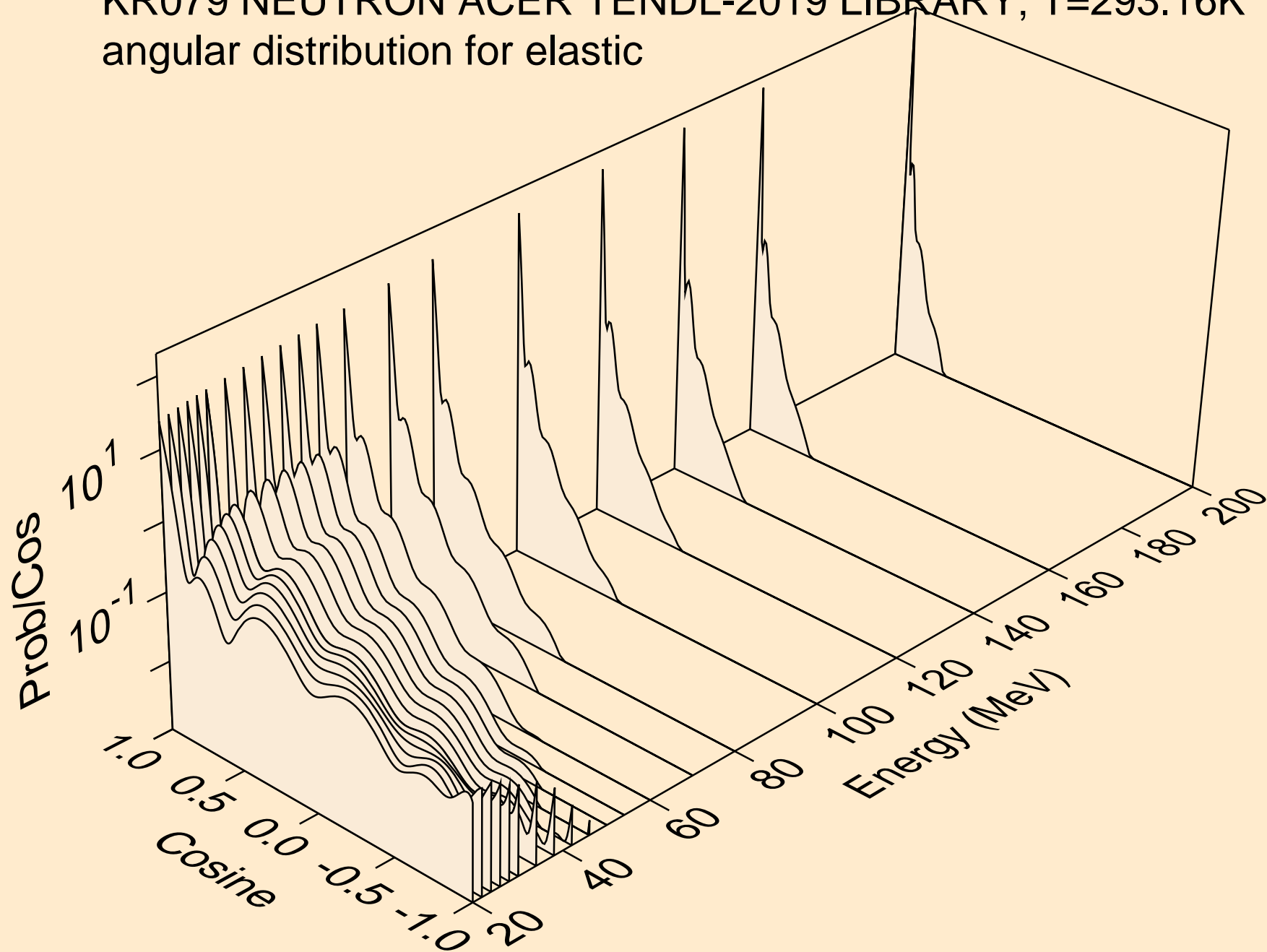

KR079 NEUTRON ACER TENDL-2019 LIBRARY; T=293.16K  
angular distribution for (n,n\*1)

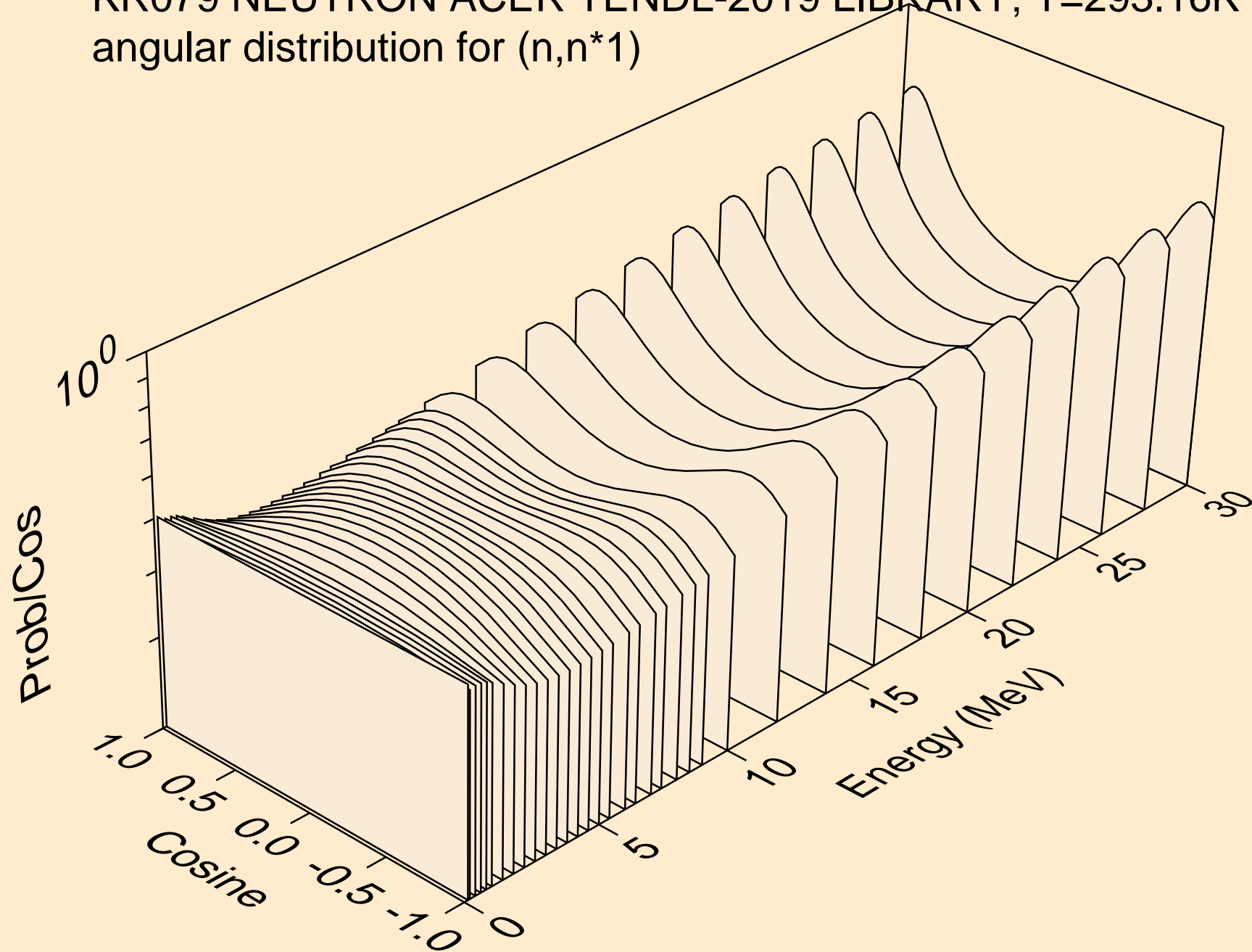

KR079 NEUTRON ACER TENDL-2019 LIBRARY; T=293.16K  
angular distribution for (n,n\*2)

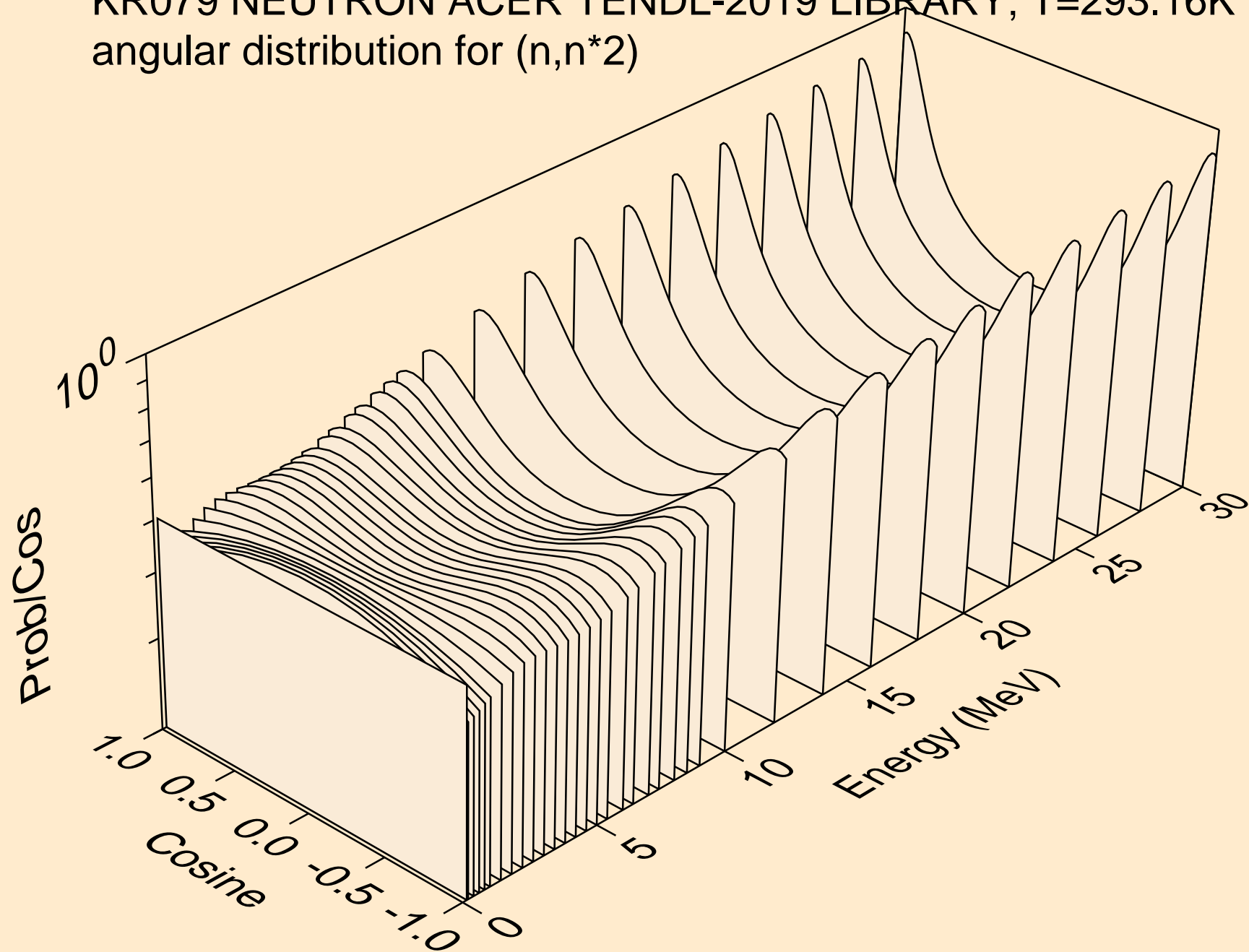



KR079 NEUTRON ACER TENDL-2019 LIBRARY; T=293.16K  
angular distribution for (n,n\*3)

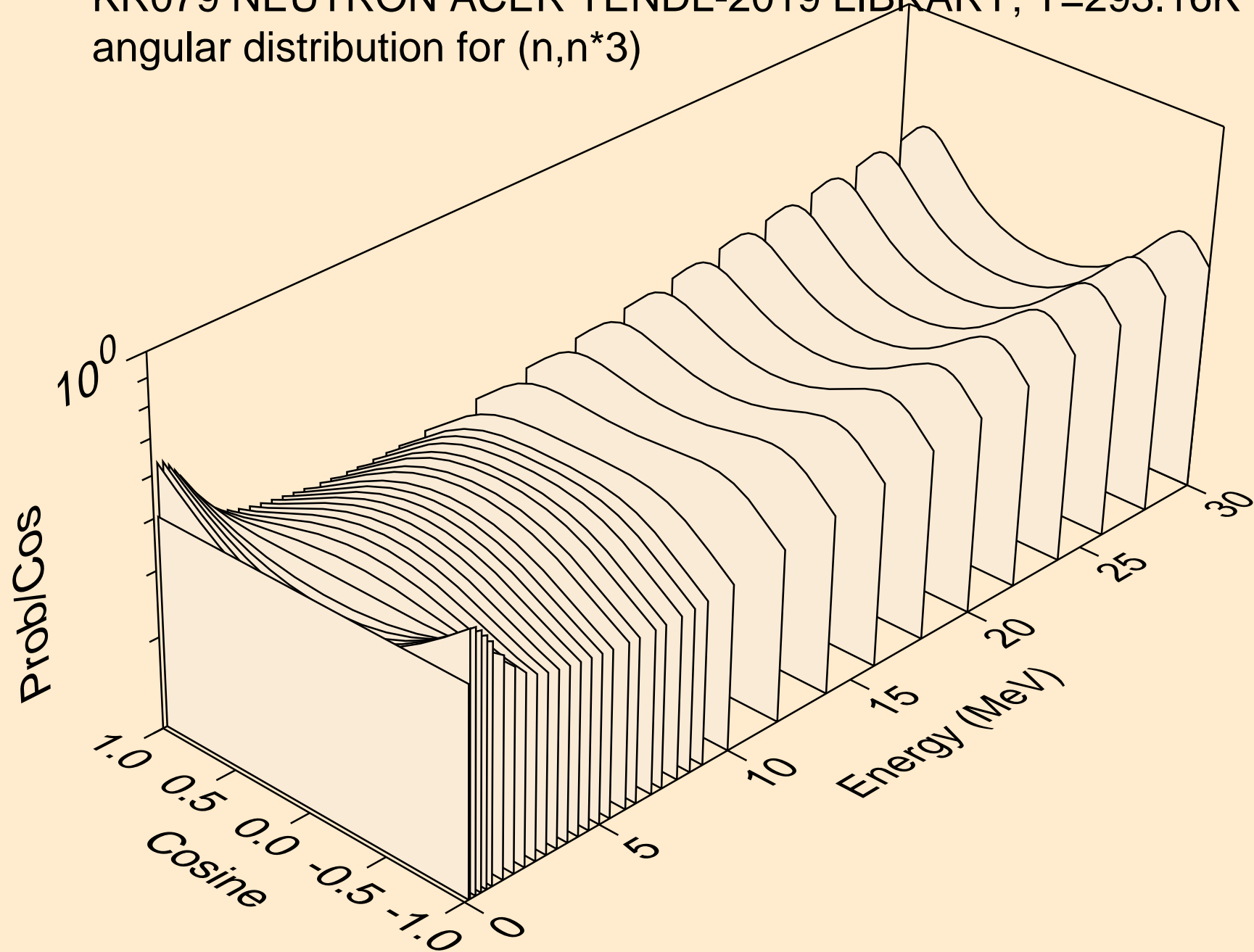

KR079 NEUTRON ACER TENDL-2019 LIBRARY; T=293.16K  
angular distribution for (n,n\*4)

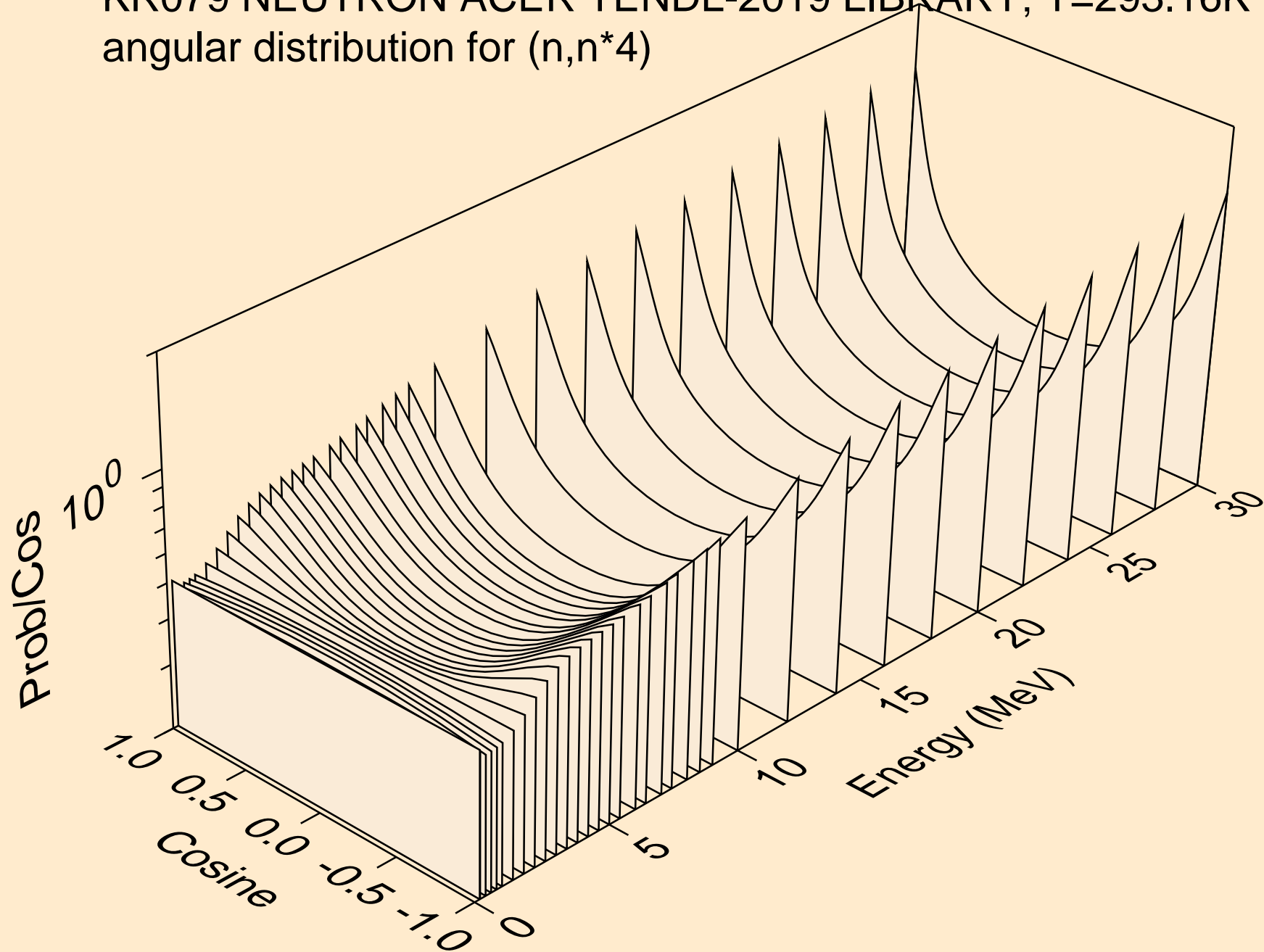

KR079 NEUTRON ACER TENDL-2019 LIBRARY; T=293.16K  
angular distribution for (n,n\*5)

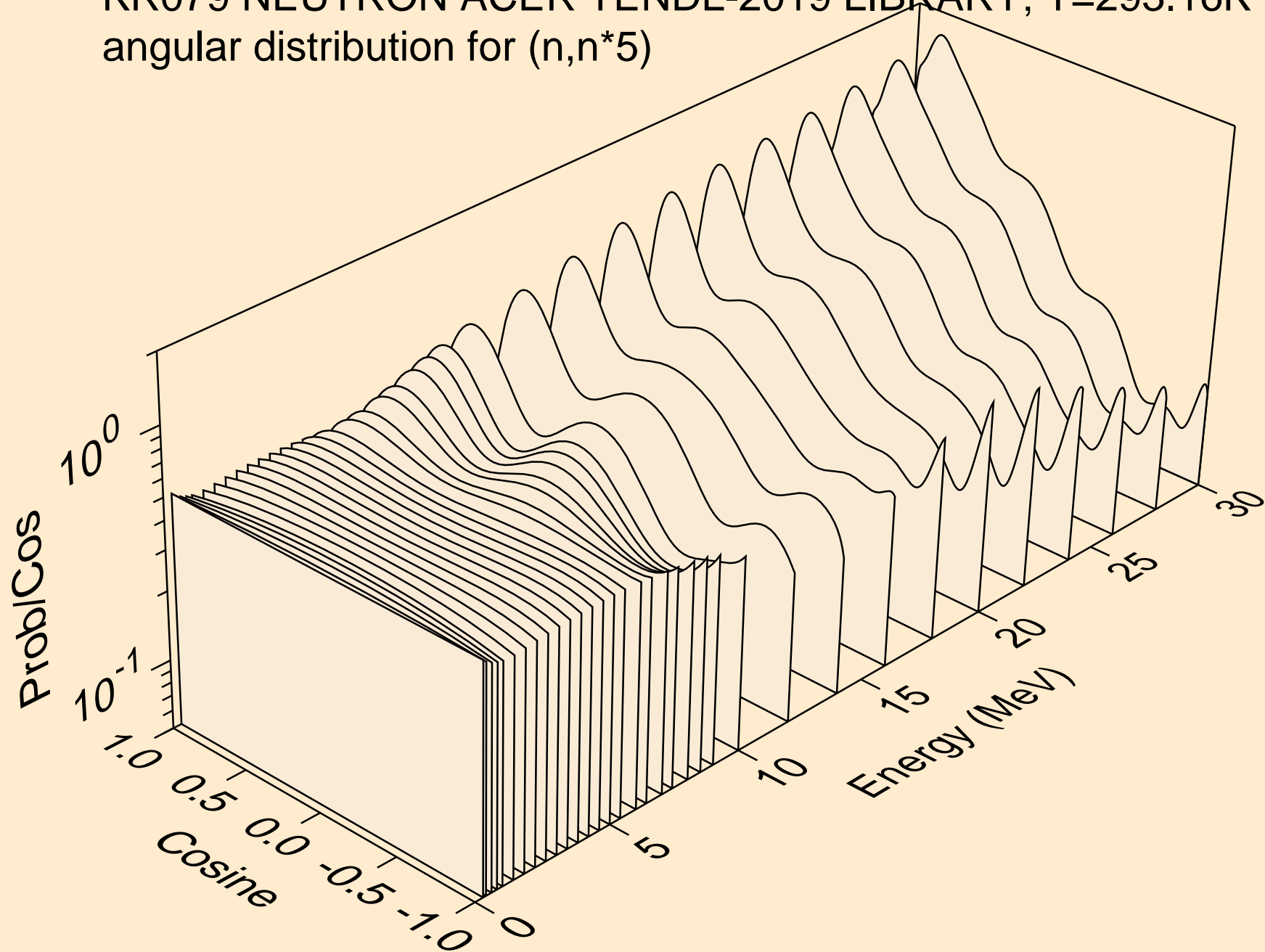

KR079 NEUTRON ACER TENDL-2019 LIBRARY; T=293.16K  
angular distribution for (n,n\*6)

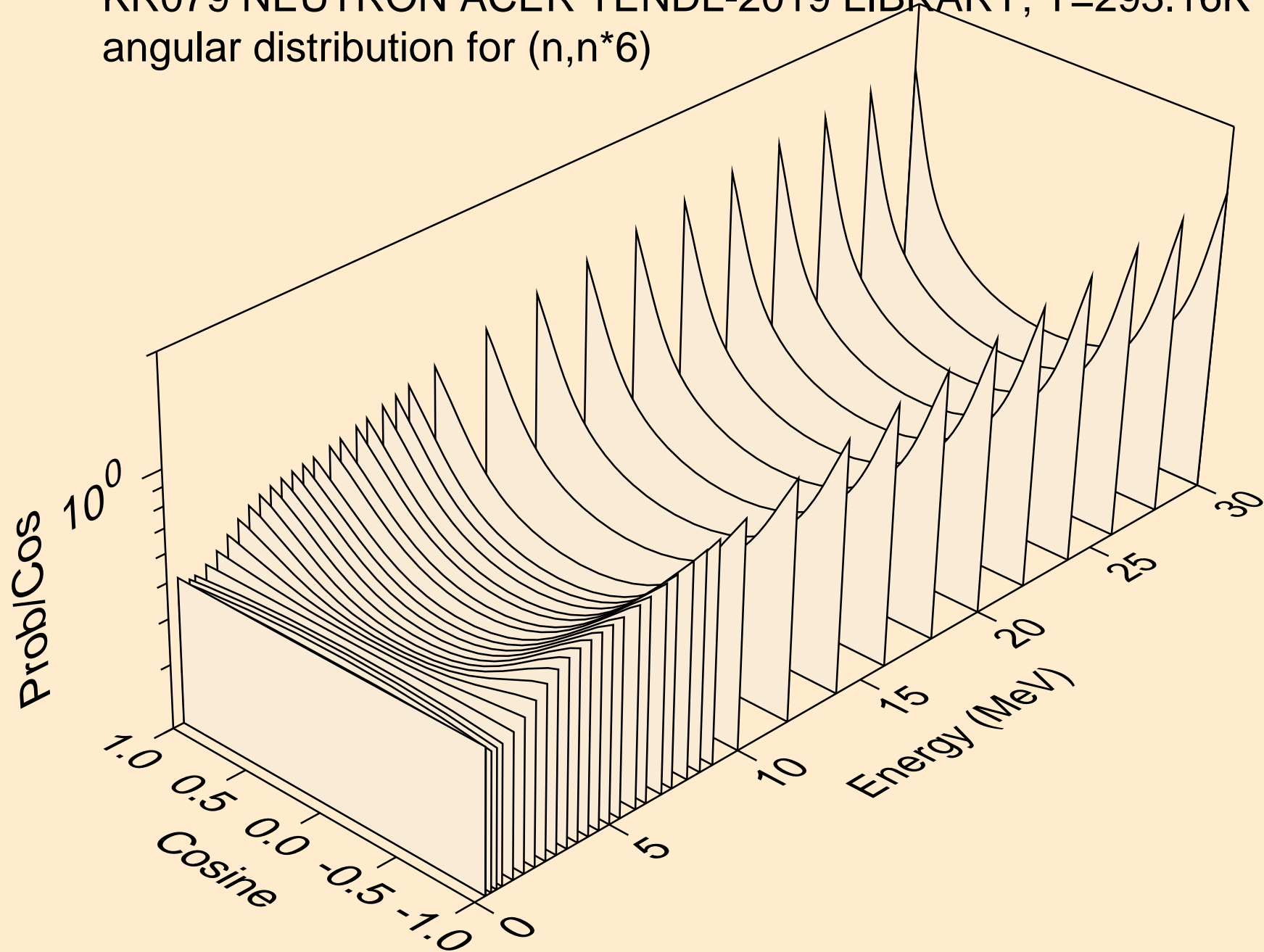

KR079 NEUTRON ACER TENDL-2019 LIBRARY; T=293.16K  
angular distribution for (n,n\*7)

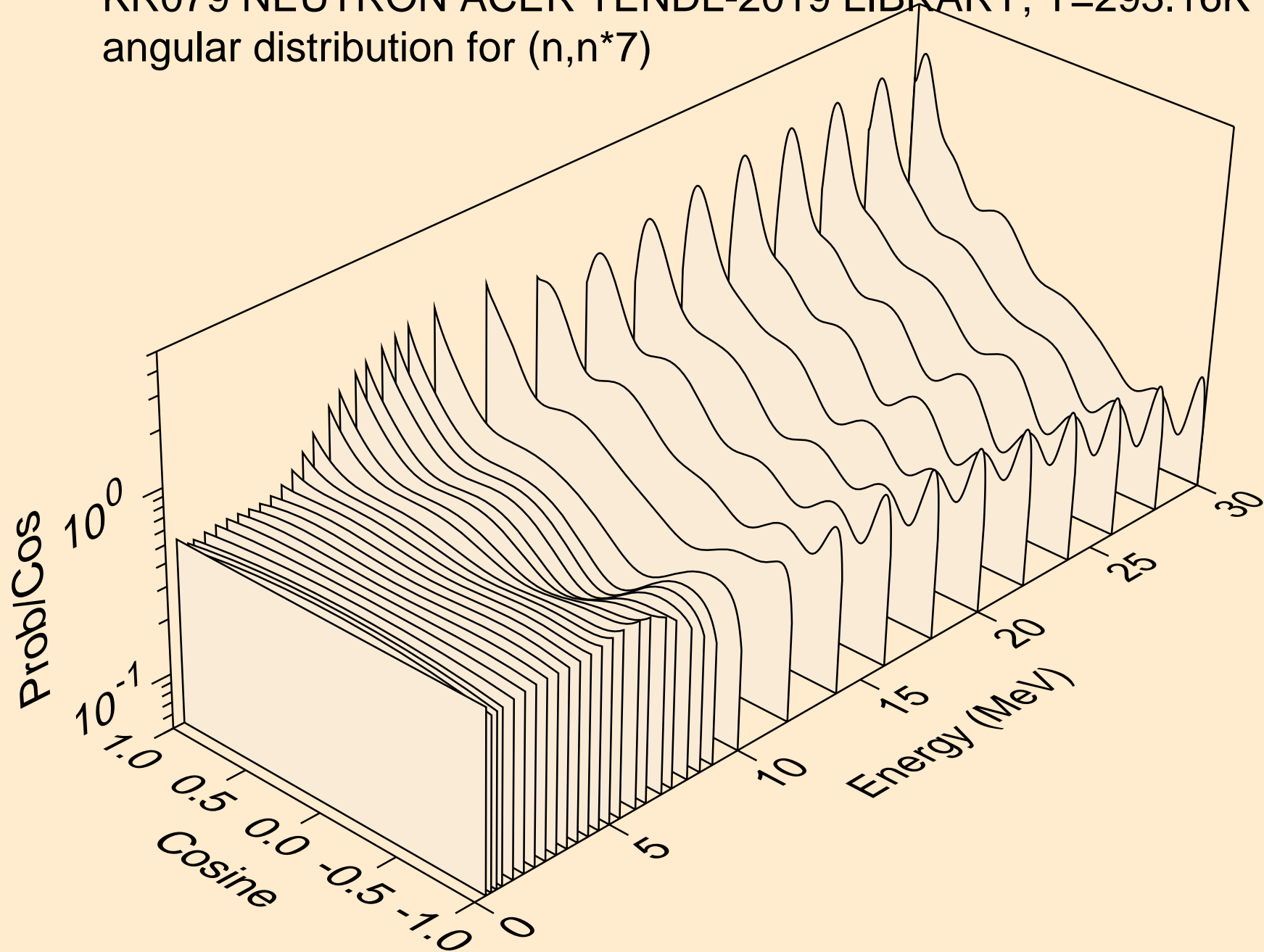

KR079 NEUTRON ACER TENDL-2019 LIBRARY; T=293.16K  
angular distribution for (n,n\*8)

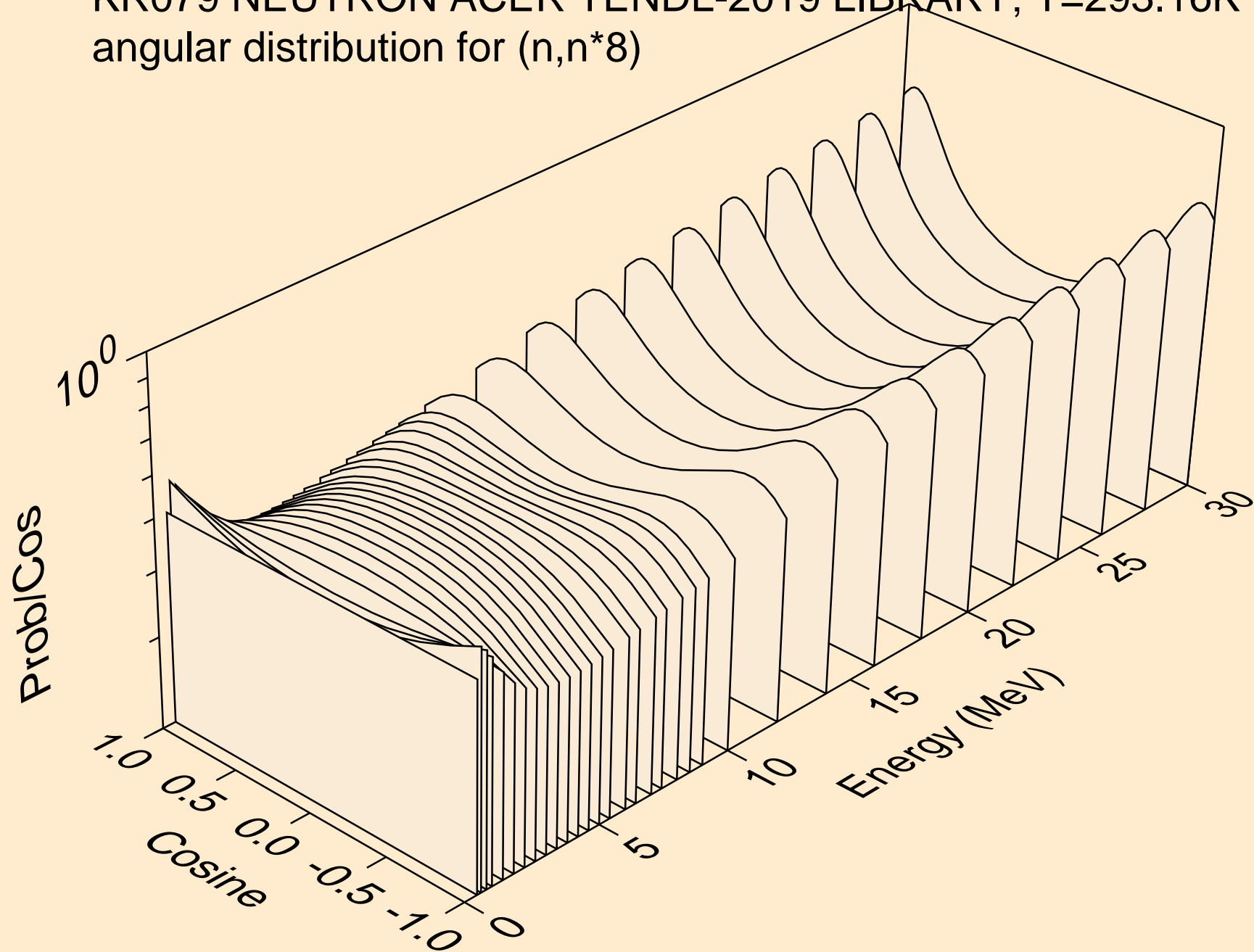

KR079 NEUTRON ACER TENDL-2019 LIBRARY; T=293.16K  
angular distribution for (n,n\*9)

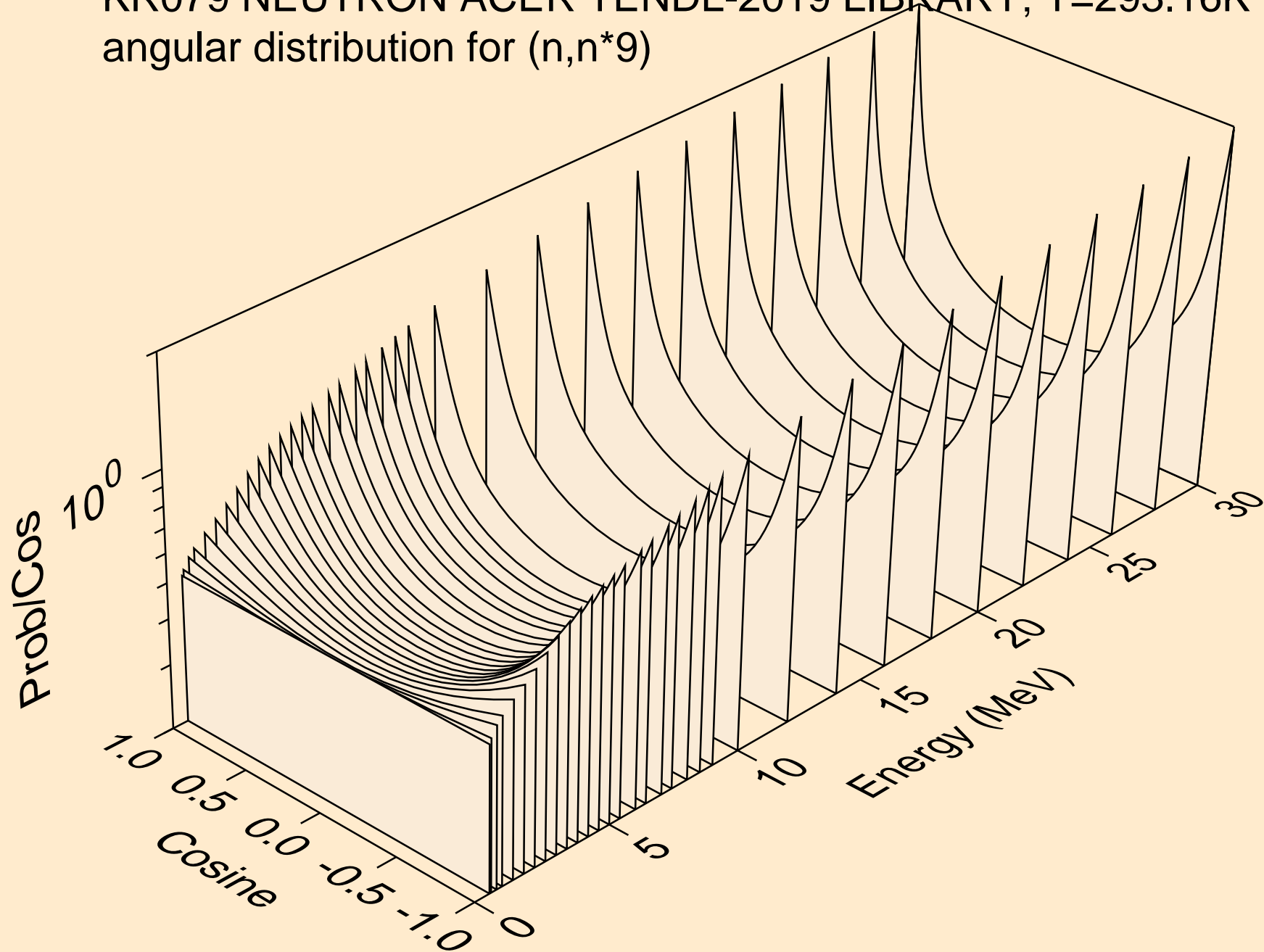

KR079 NEUTRON ACER TENDL-2019 LIBRARY; T=293.16K  
angular distribution for (n,n\*10)

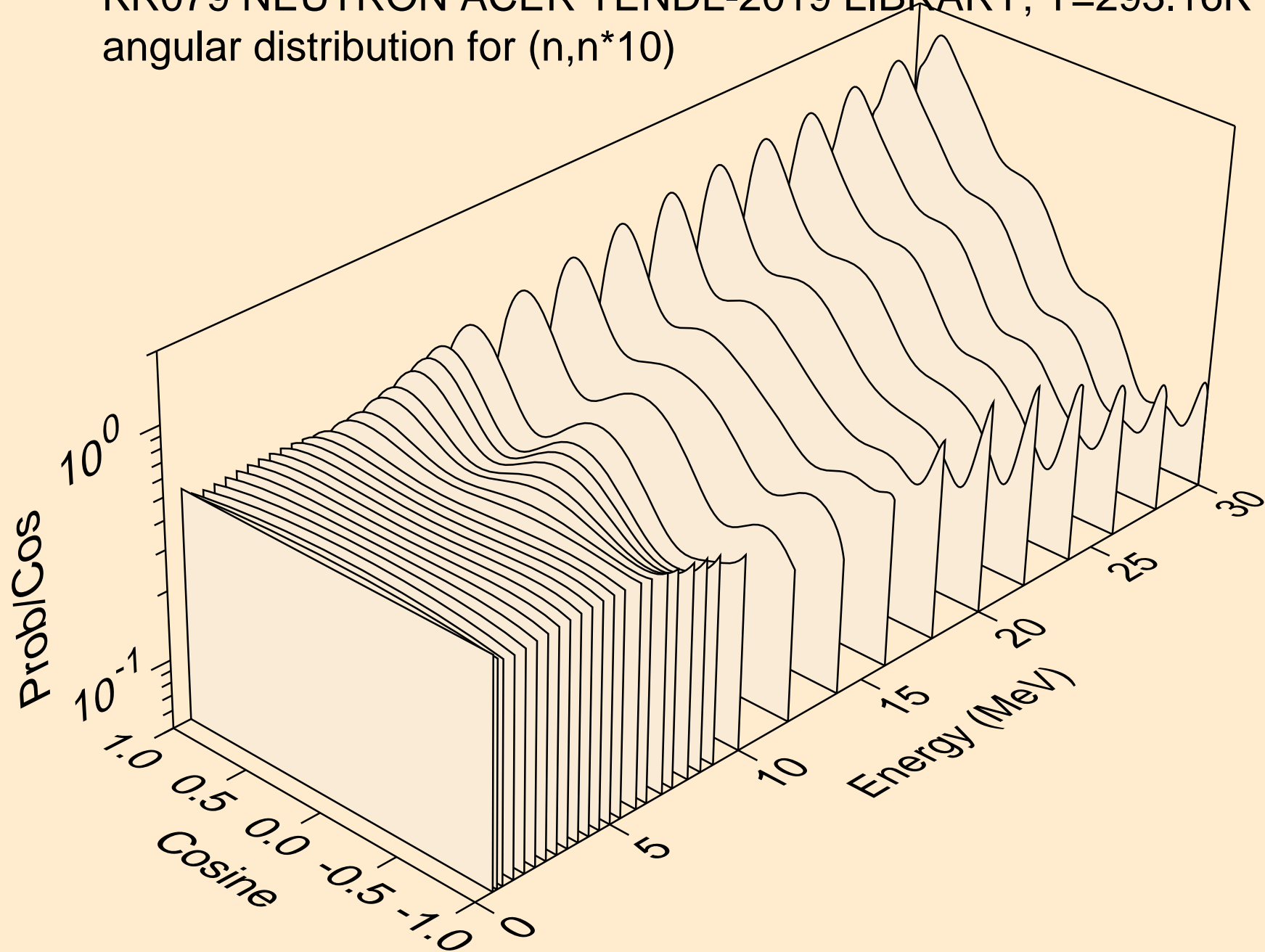



KR079 NEUTRON ACER TENDL-2019 LIBRARY; T=293.16K  
angular distribution for (n,n\*11)

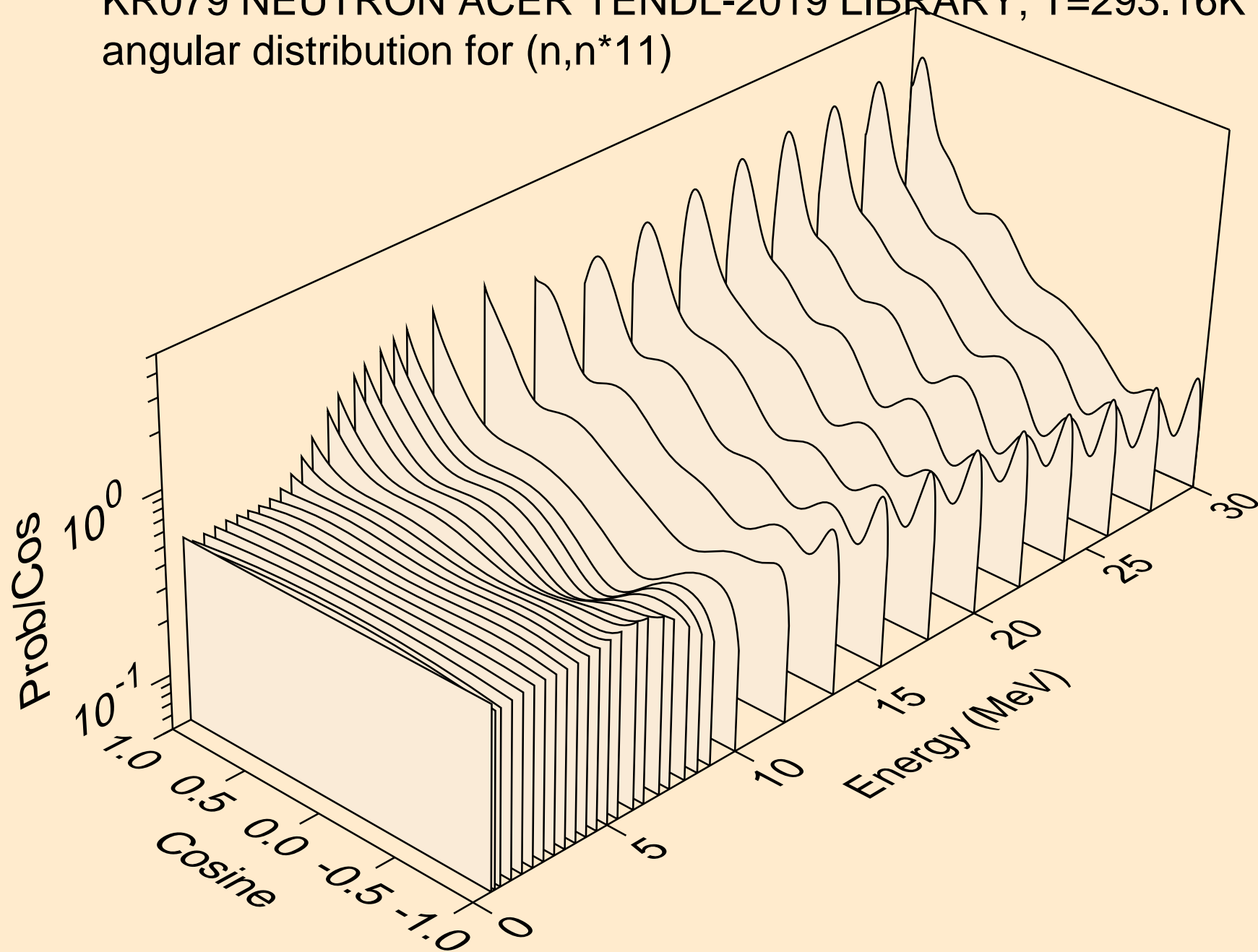

KR079 NEUTRON ACER TENDL-2019 LIBRARY; T=293.16K  
angular distribution for (n,n\*12)

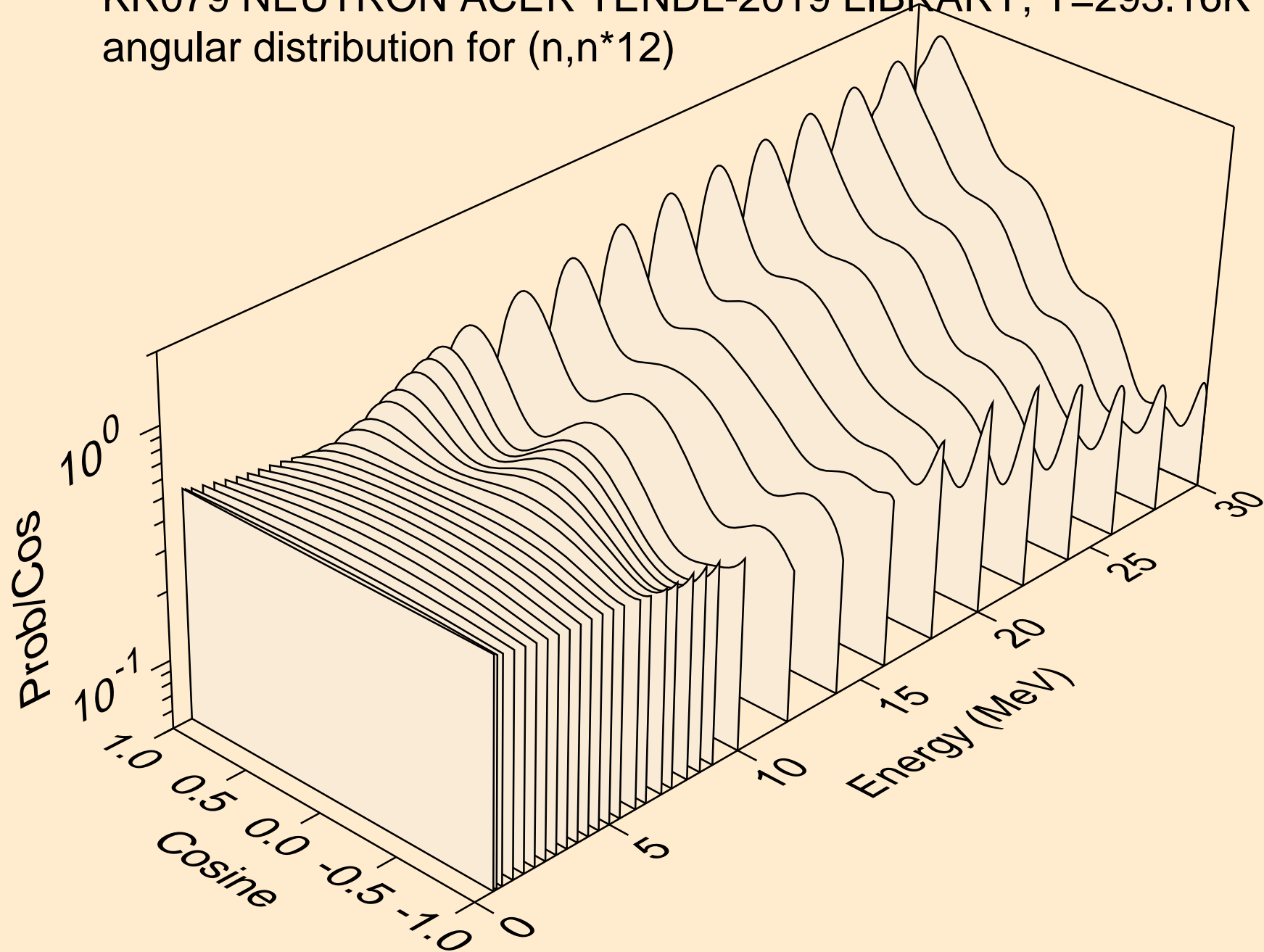

KR079 NEUTRON ACER TENDL-2019 LIBRARY; T=293.16K  
angular distribution for (n,n\*13)

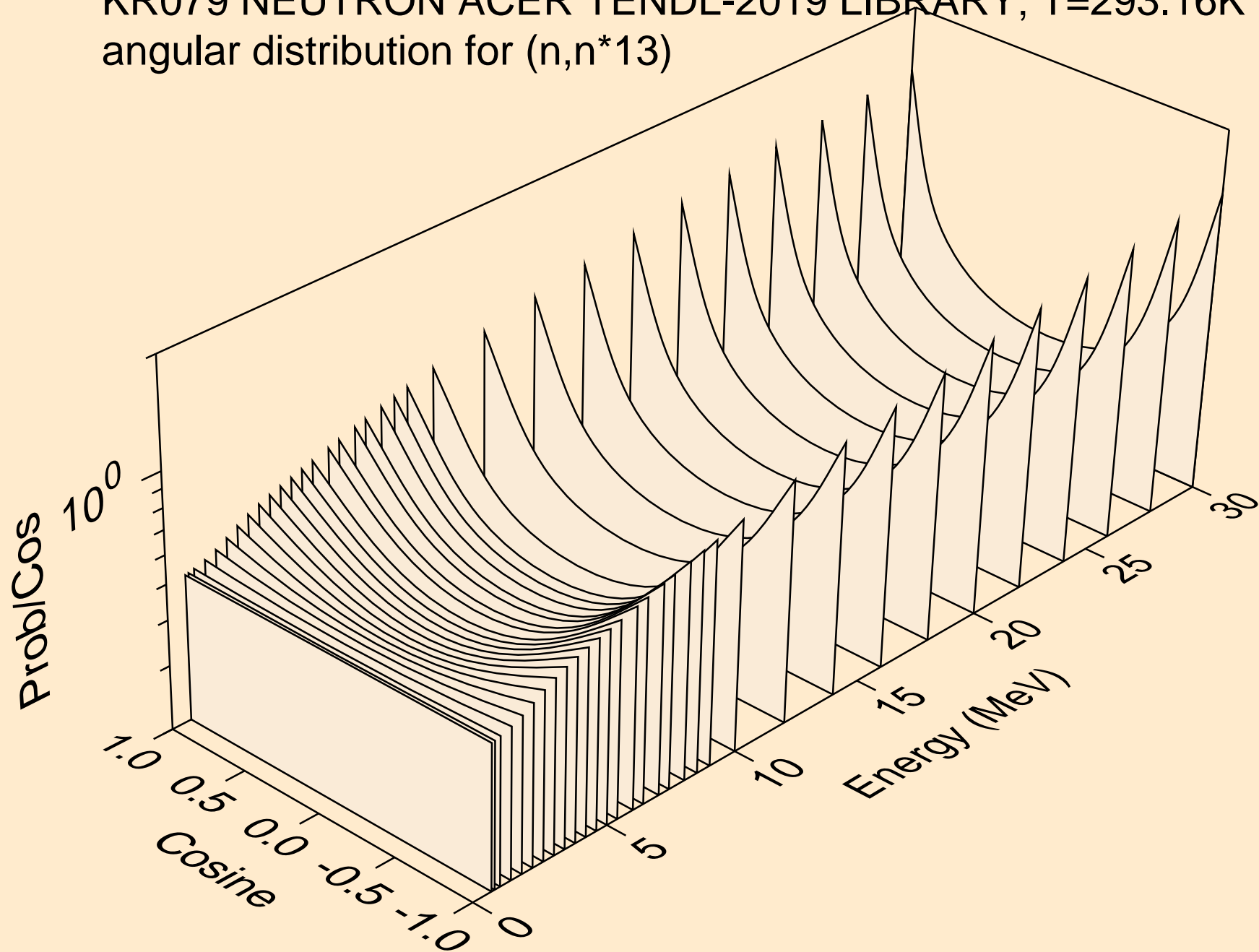

KR079 NEUTRON ACER TENDL-2019 LIBRARY; T=293.16K  
angular distribution for (n,n\*14)

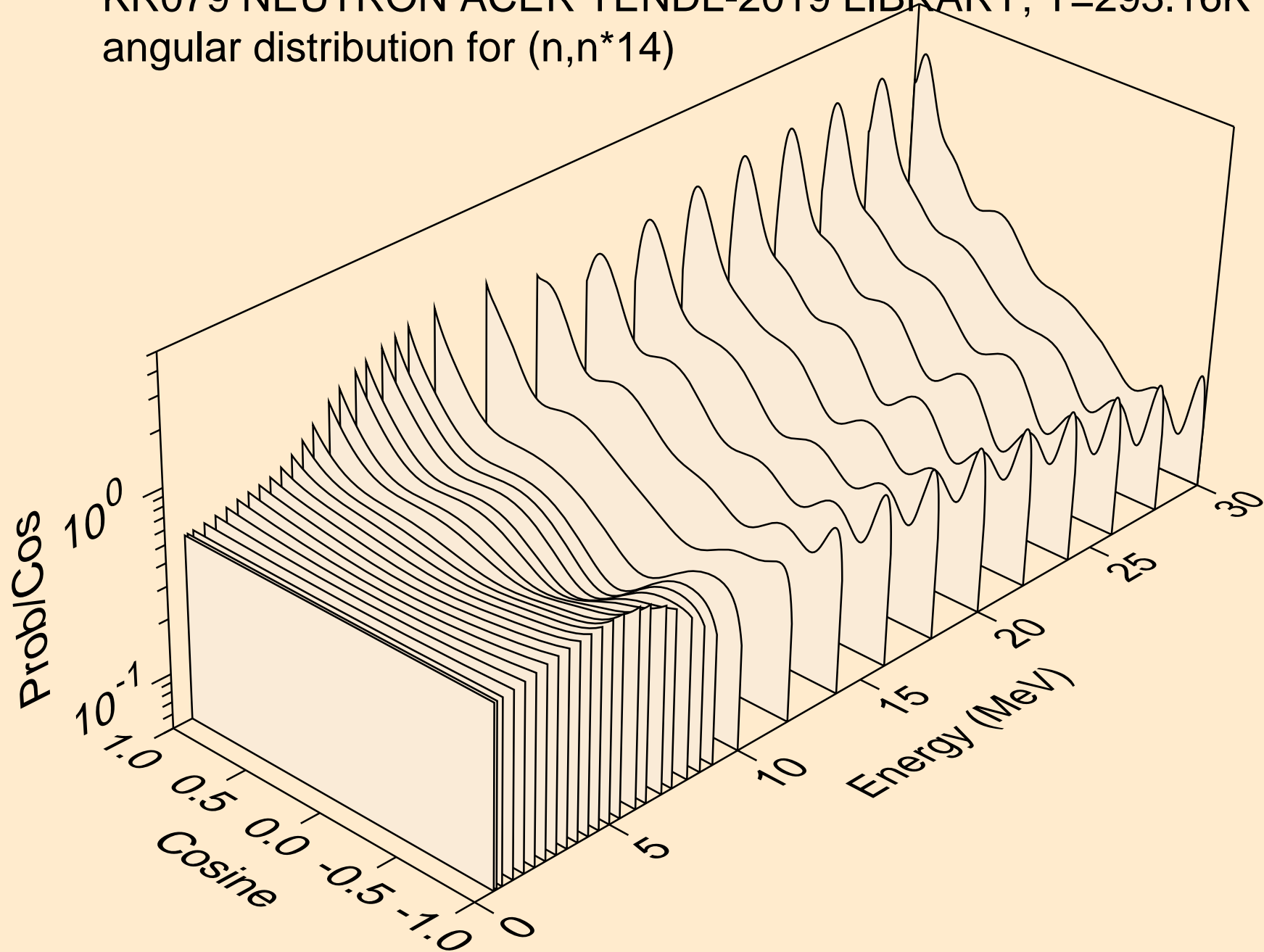

KR079 NEUTRON ACER TENDL-2019 LIBRARY; T=293.16K  
angular distribution for (n,n\*15)

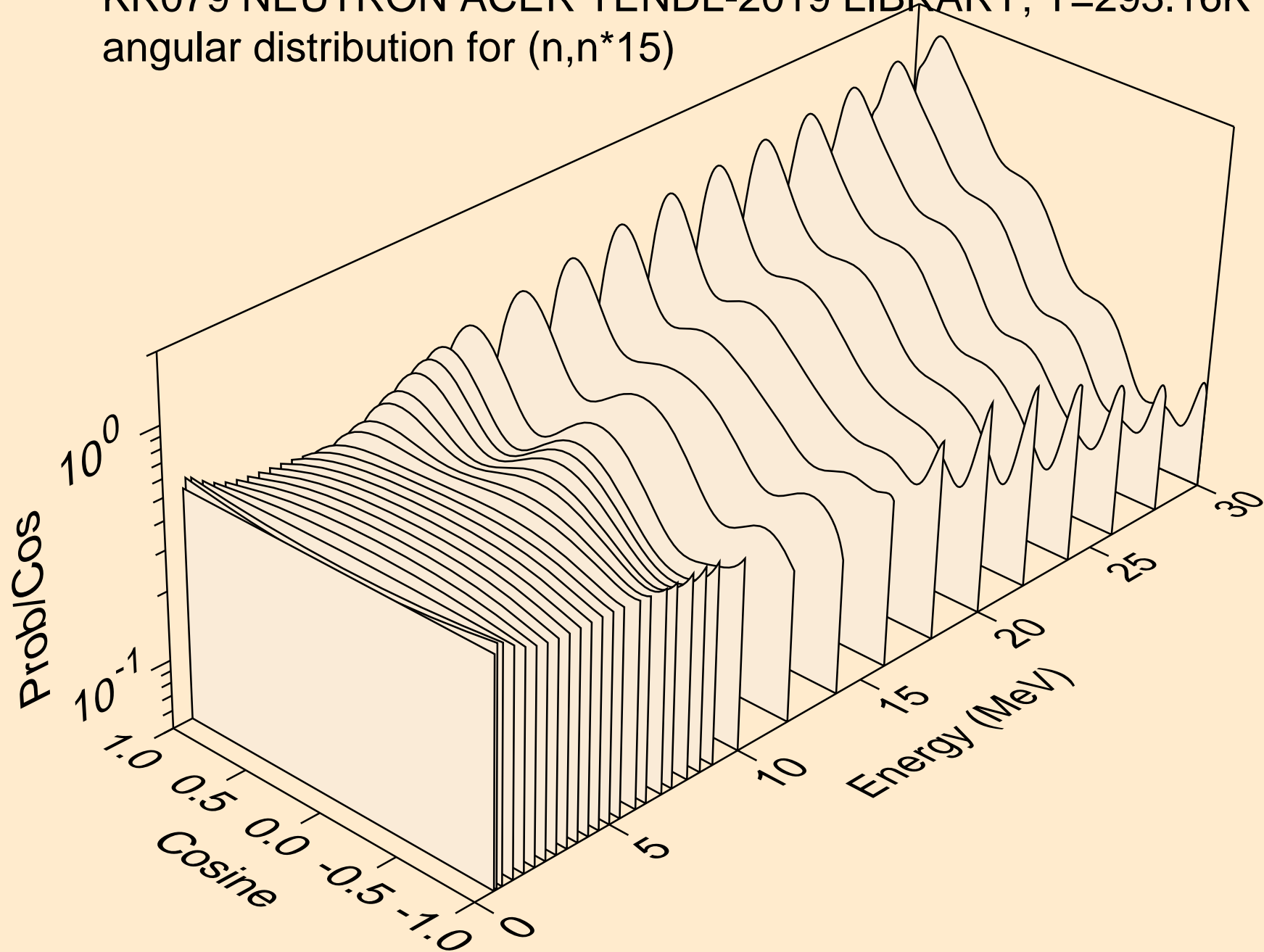

KR079 NEUTRON ACER TENDL-2019 LIBRARY; T=293.16K  
angular distribution for (n,n\*16)

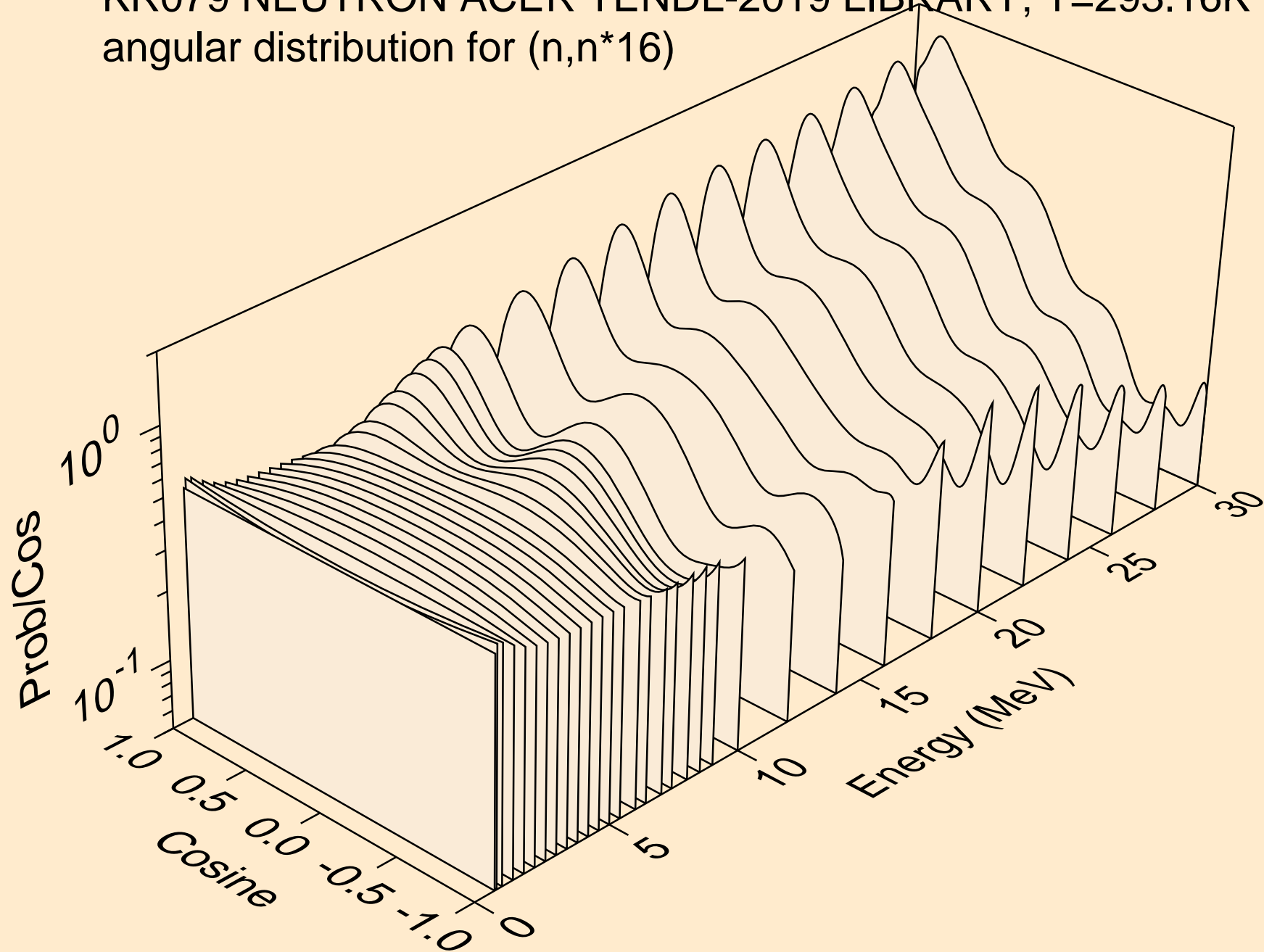

KR079 NEUTRON ACER TENDL-2019 LIBRARY; T=293.16K  
angular distribution for (n,n\*17)

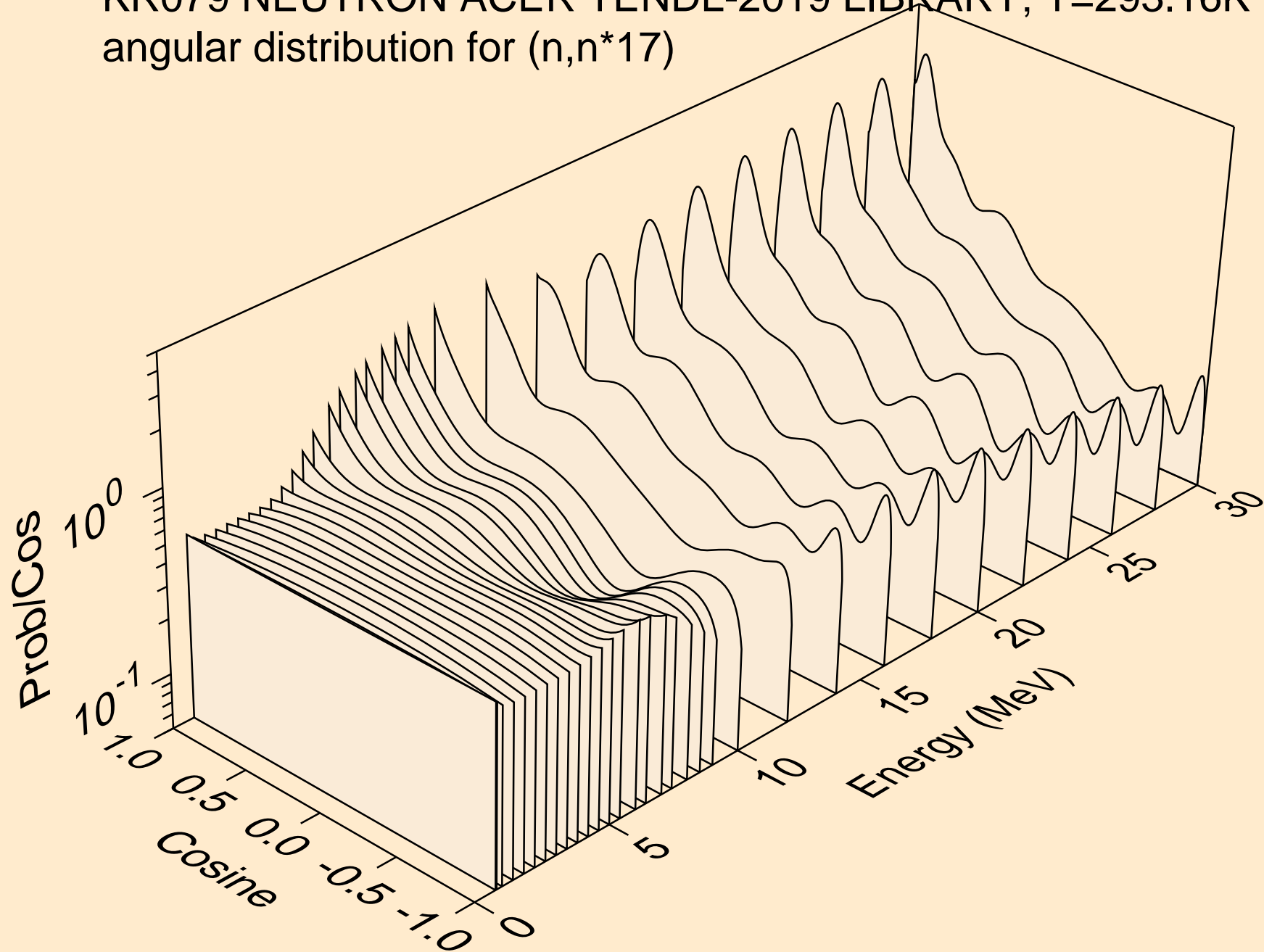

KR079 NEUTRON ACER TENDL-2019 LIBRARY; T=293.16K  
angular distribution for (n,n\*18)

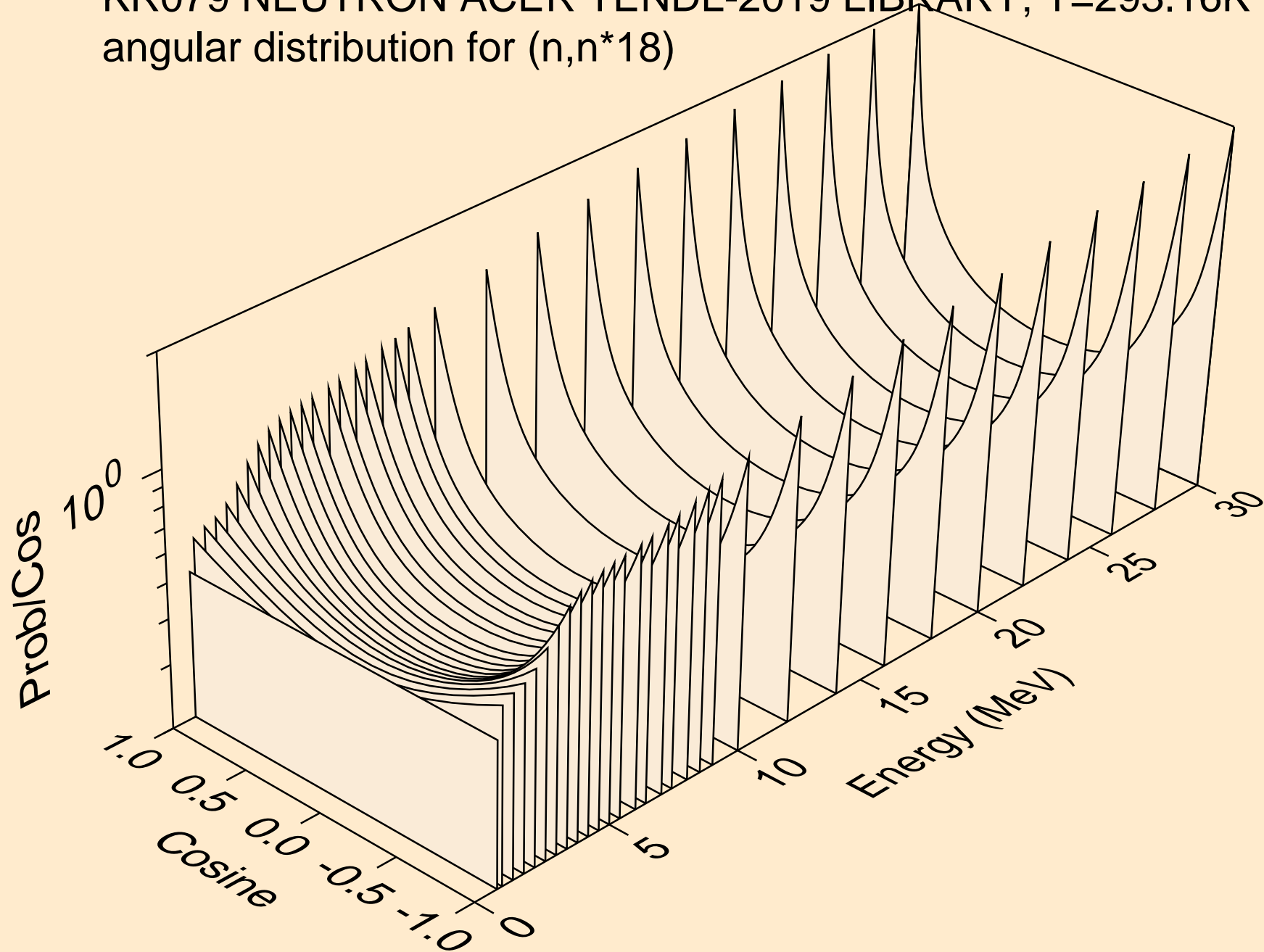



KR079 NEUTRON ACER TENDL-2019 LIBRARY; T=293.16K  
angular distribution for (n,n\*19)

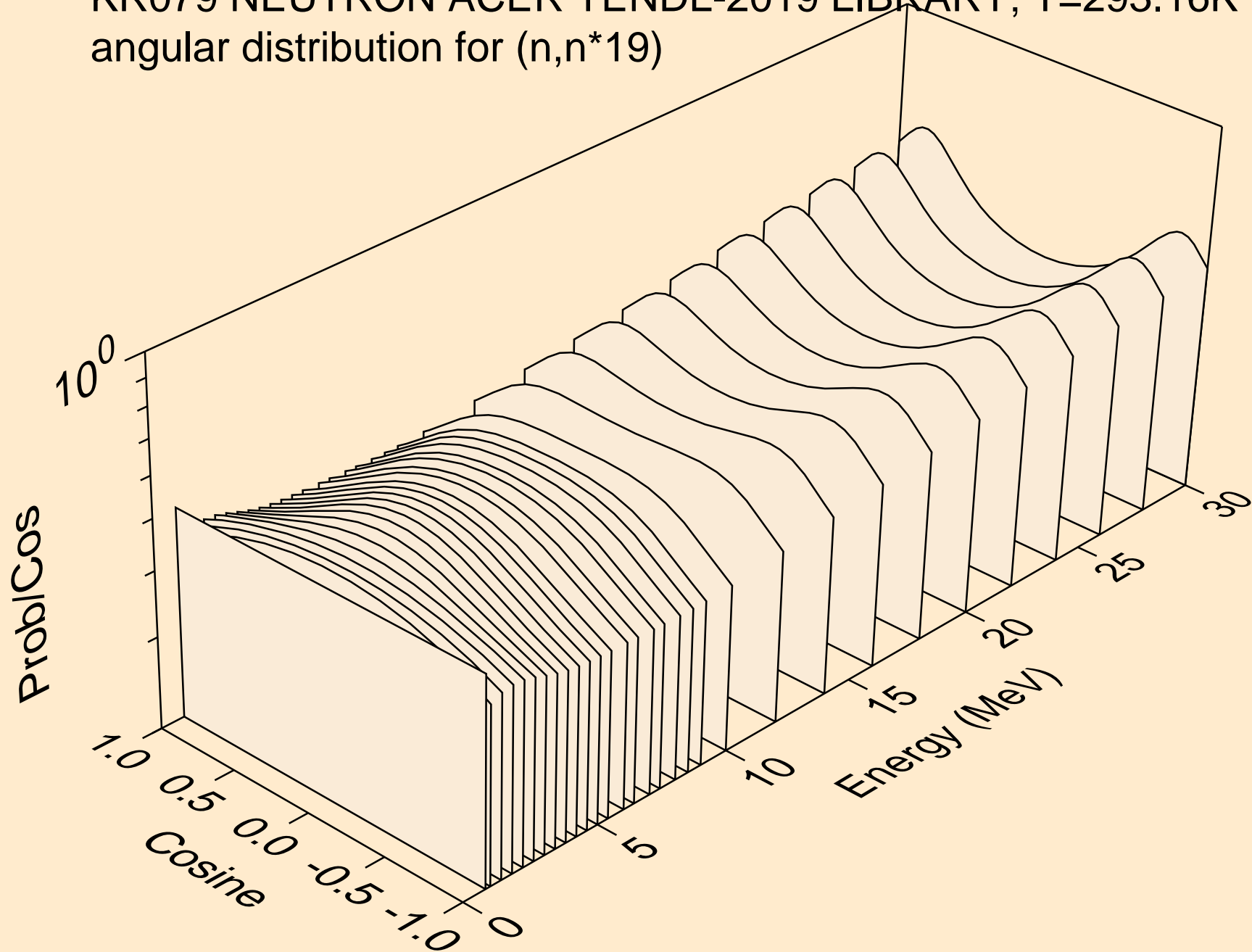

KR079 NEUTRON ACER TENDL-2019 LIBRARY; T=293.16K  
angular distribution for (n,n\*20)

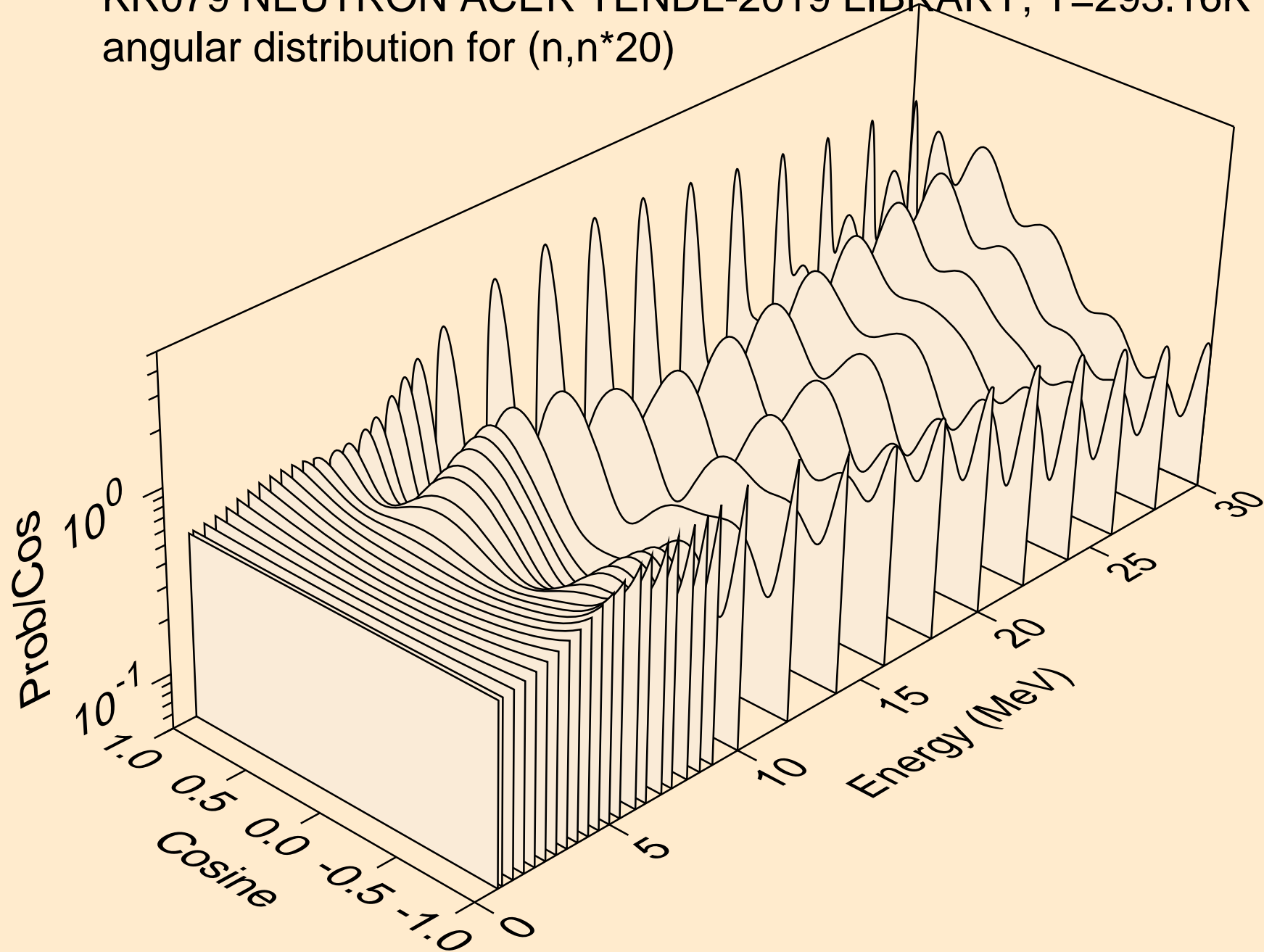

KR079 NEUTRON ACER TENDL-2019 LIBRARY; T=293.16K  
angular distribution for (n,n\*21)

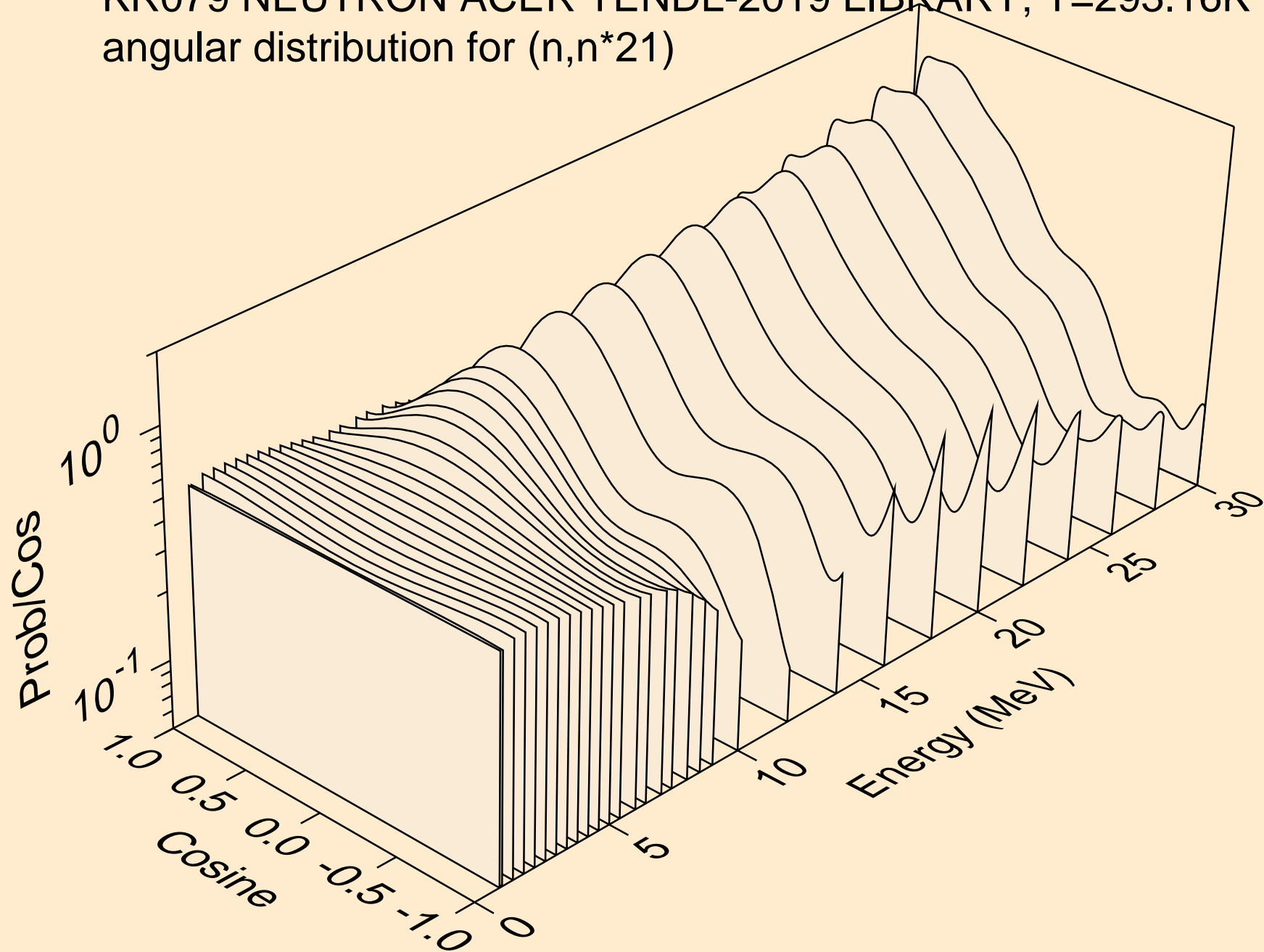

KR079 NEUTRON ACER TENDL-2019 LIBRARY; T=293.16K  
angular distribution for (n,n\*22)

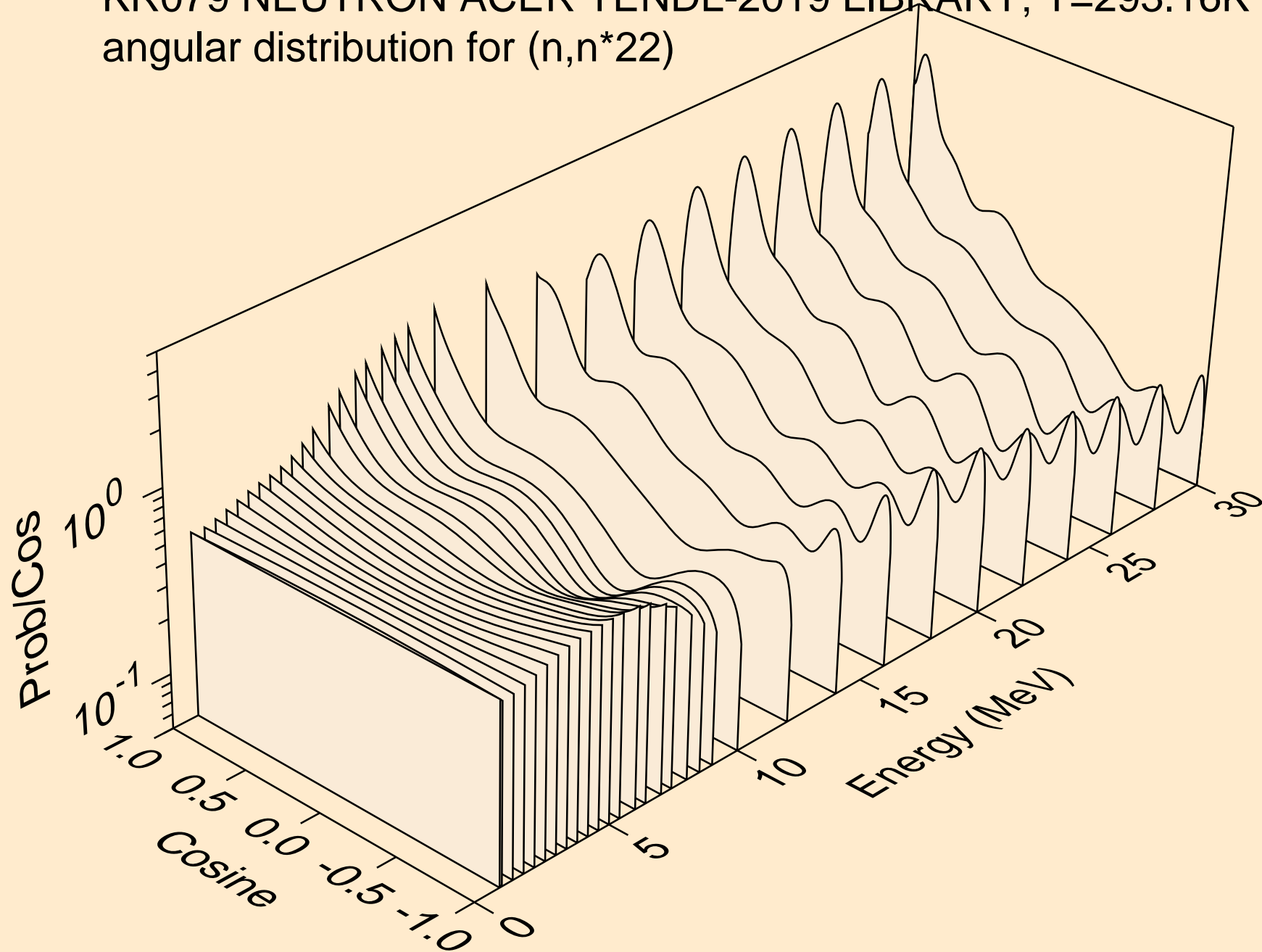

KR079 NEUTRON ACER TENDL-2019 LIBRARY; T=293.16K  
angular distribution for (n,n\*23)

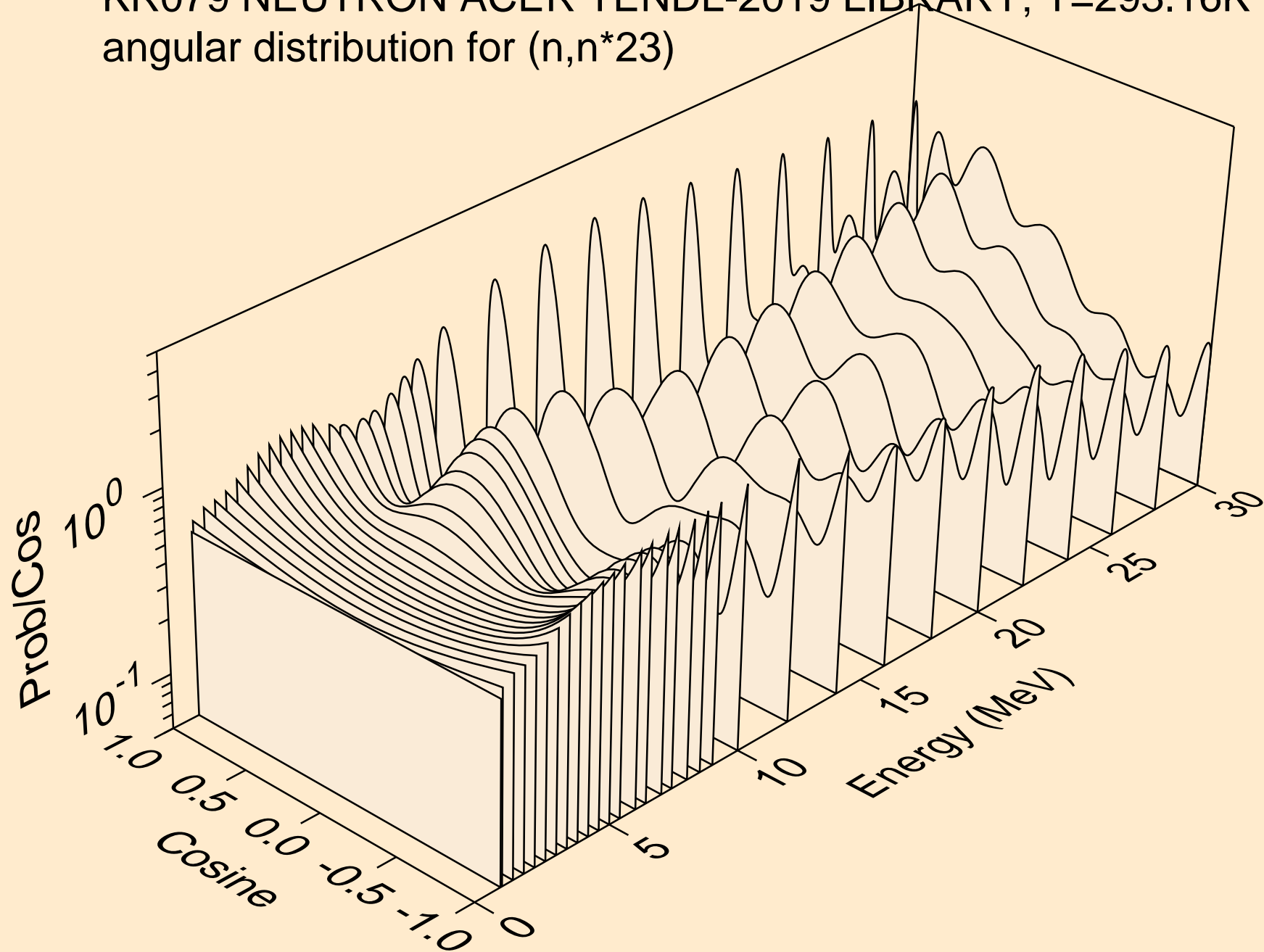

KR079 NEUTRON ACER TENDL-2019 LIBRARY; T=293.16K  
angular distribution for (n,n\*24)

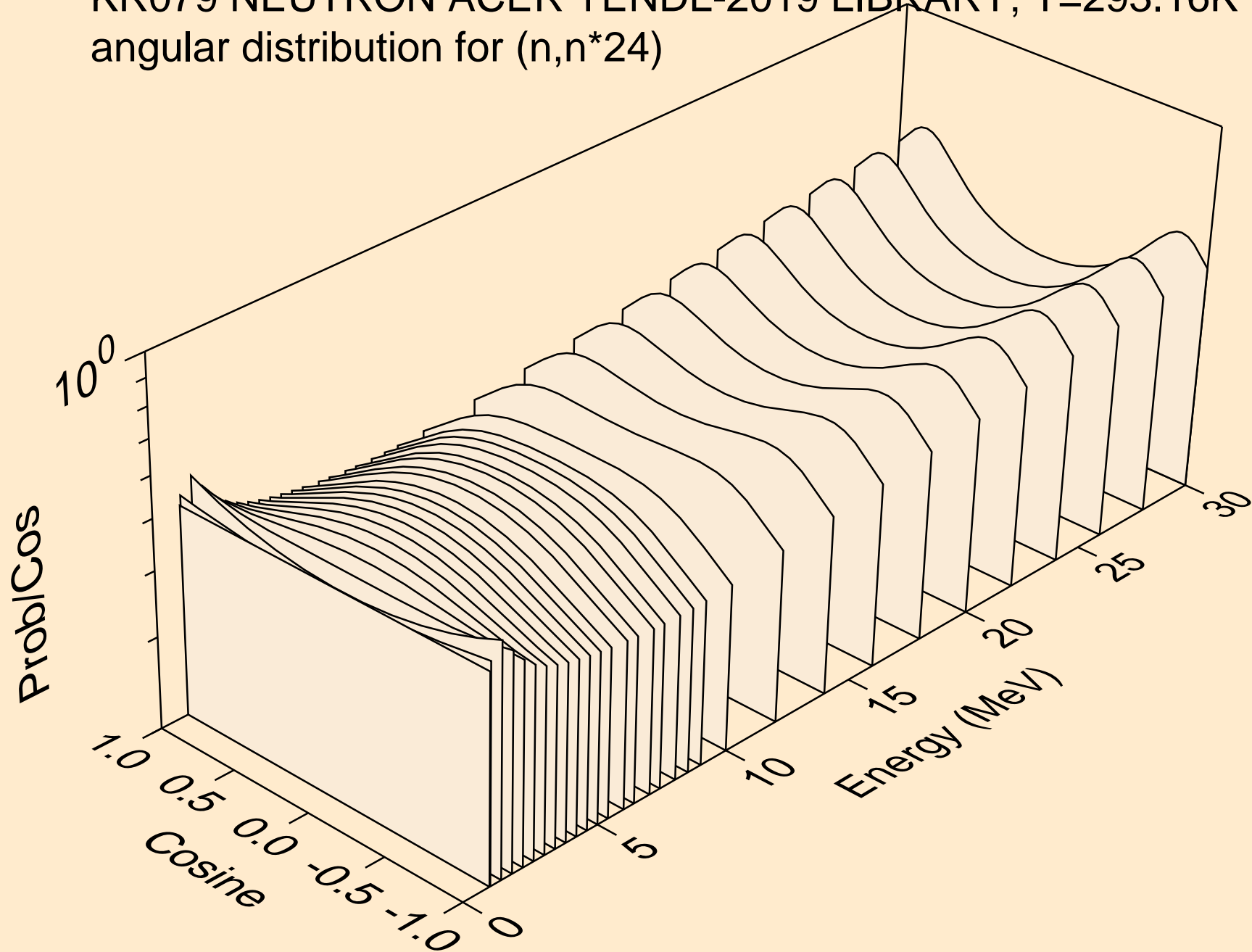

KR079 NEUTRON ACER TENDL-2019 LIBRARY; T=293.16K  
angular distribution for (n,n\*25)

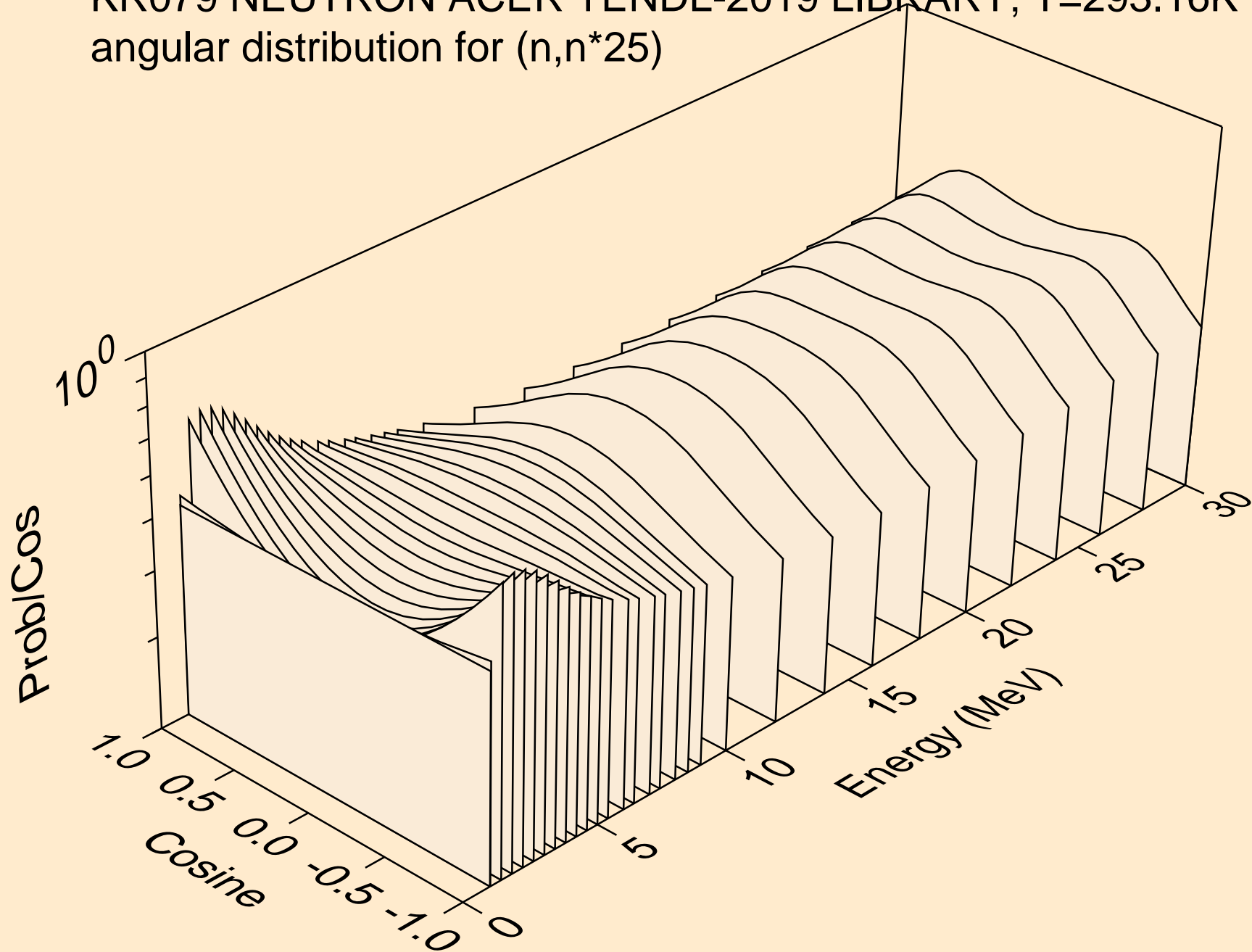

KR079 NEUTRON ACER TENDL-2019 LIBRARY; T=293.16K  
angular distribution for (n,n\*26)

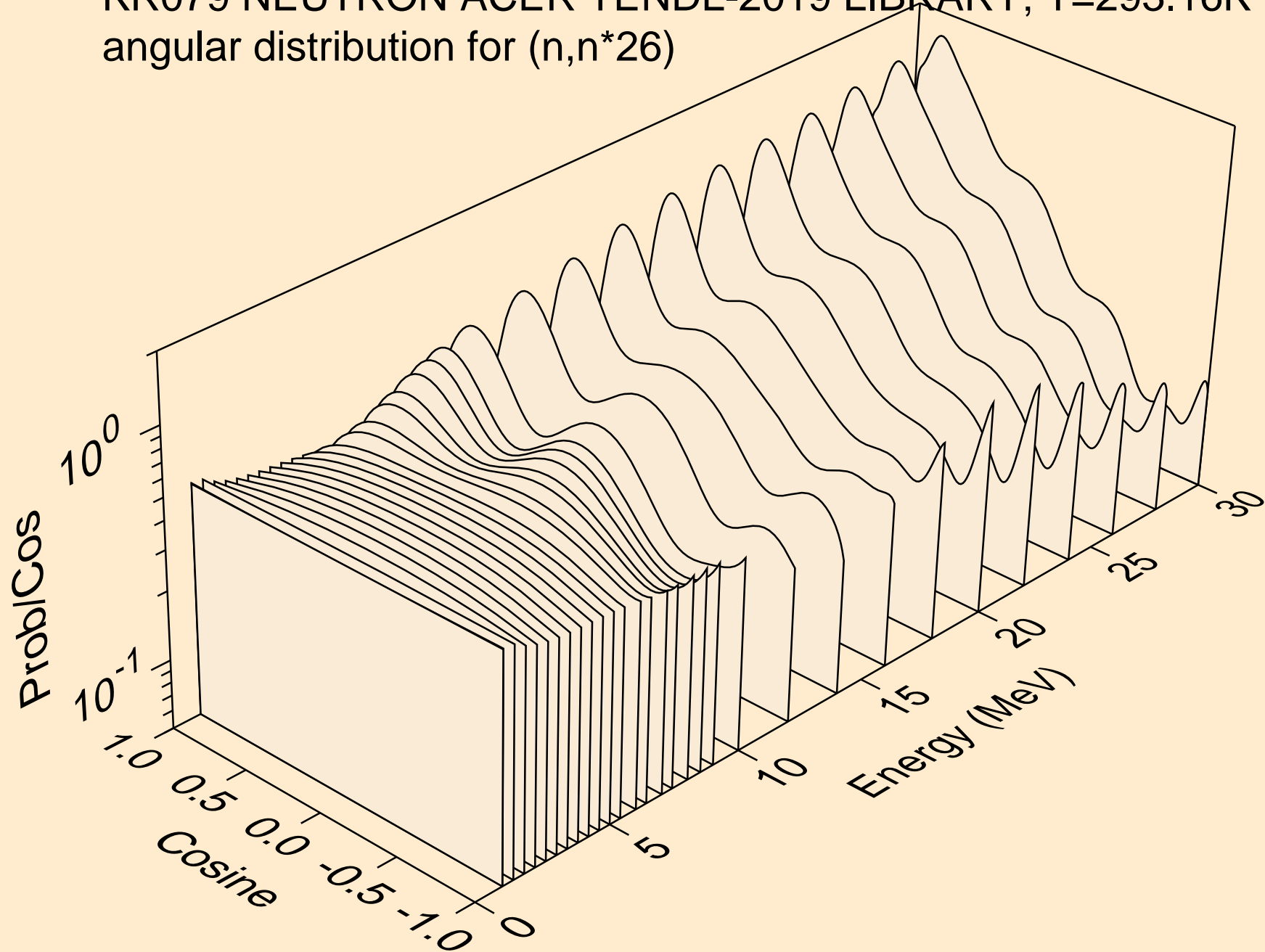



KR079 NEUTRON ACER TENDL-2019 LIBRARY; T=293.16K  
angular distribution for (n,n\*27)

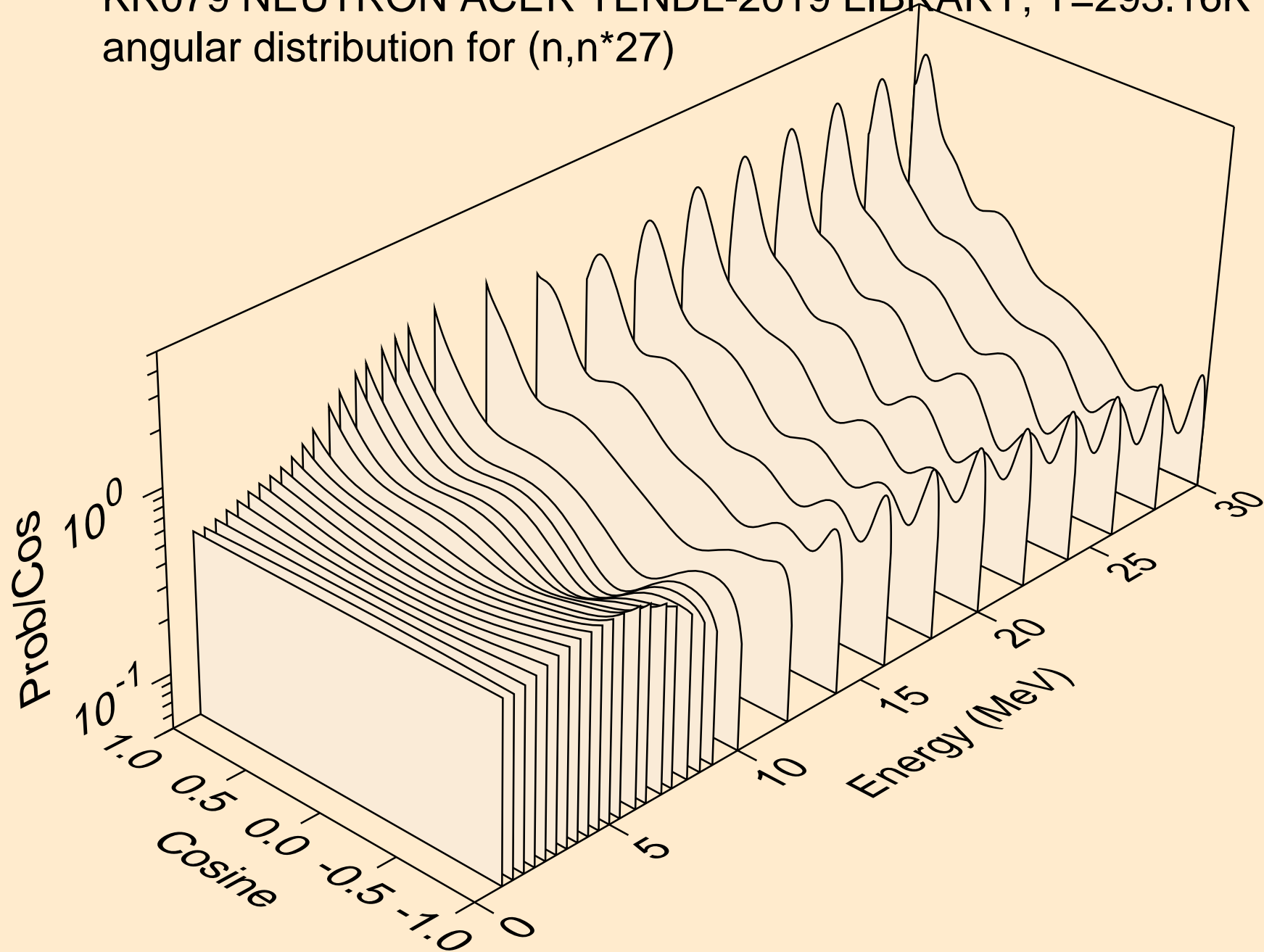

KR079 NEUTRON ACER TENDL-2019 LIBRARY; T=293.16K  
angular distribution for (n,n\*28)

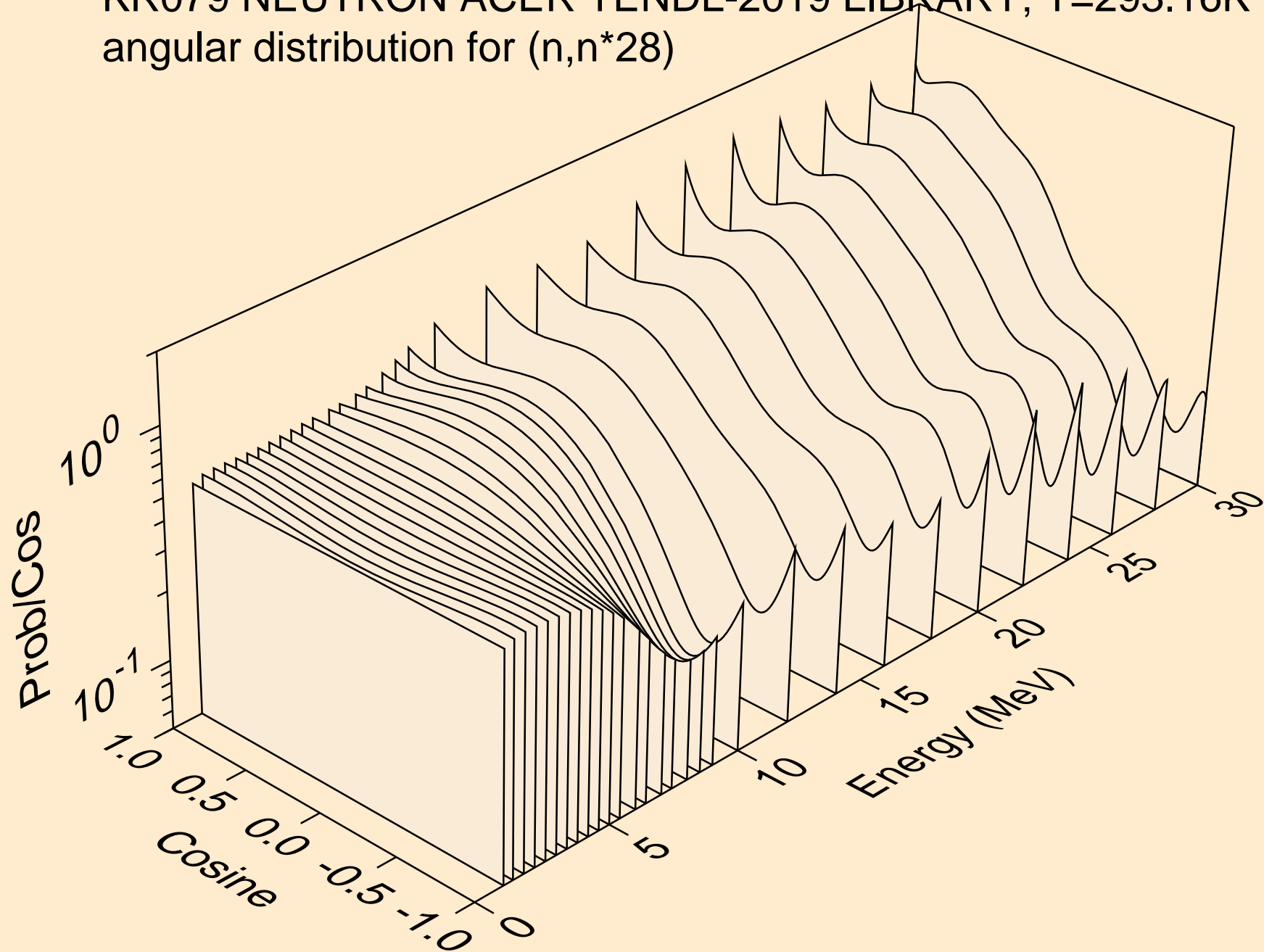

KR079 NEUTRON ACER TENDL-2019 LIBRARY; T=293.16K  
angular distribution for (n,n\*29)

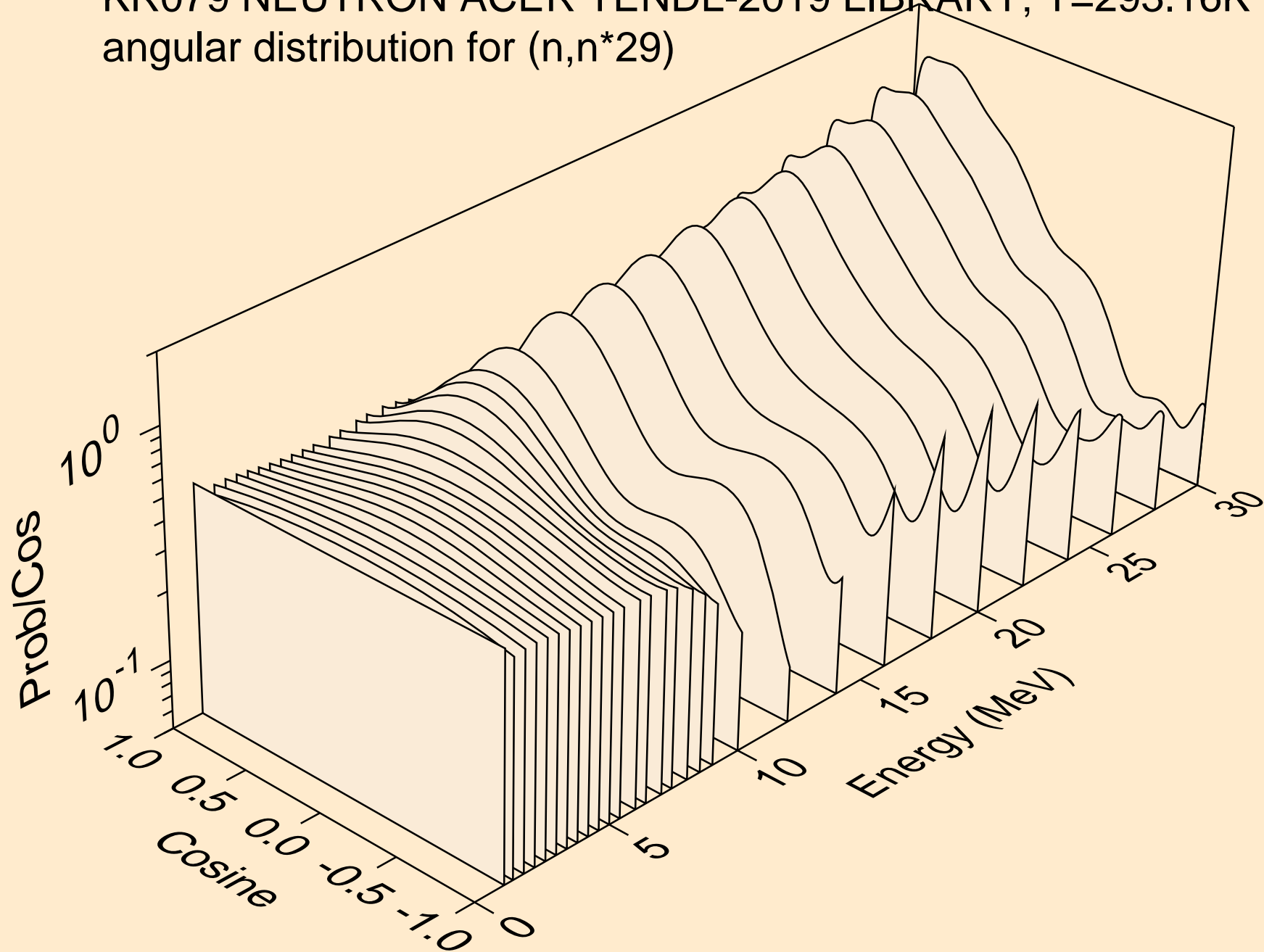

KR079 NEUTRON ACER TENDL-2019 LIBRARY; T=293.16K  
angular distribution for (n,n\*30)

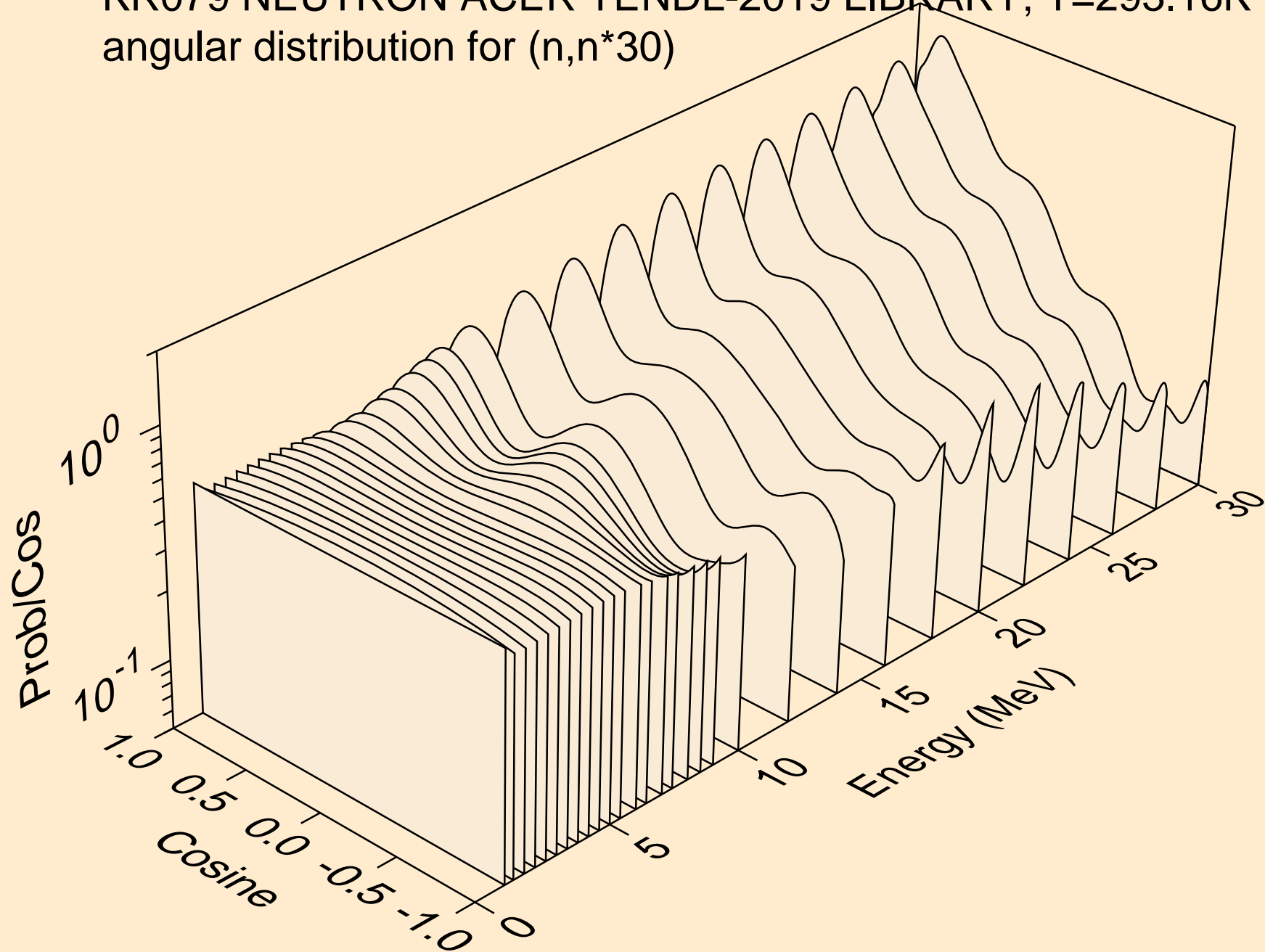

KR079 NEUTRON ACER TENDL-2019 LIBRARY; T=293.16K  
Neutron emission for (n,x)

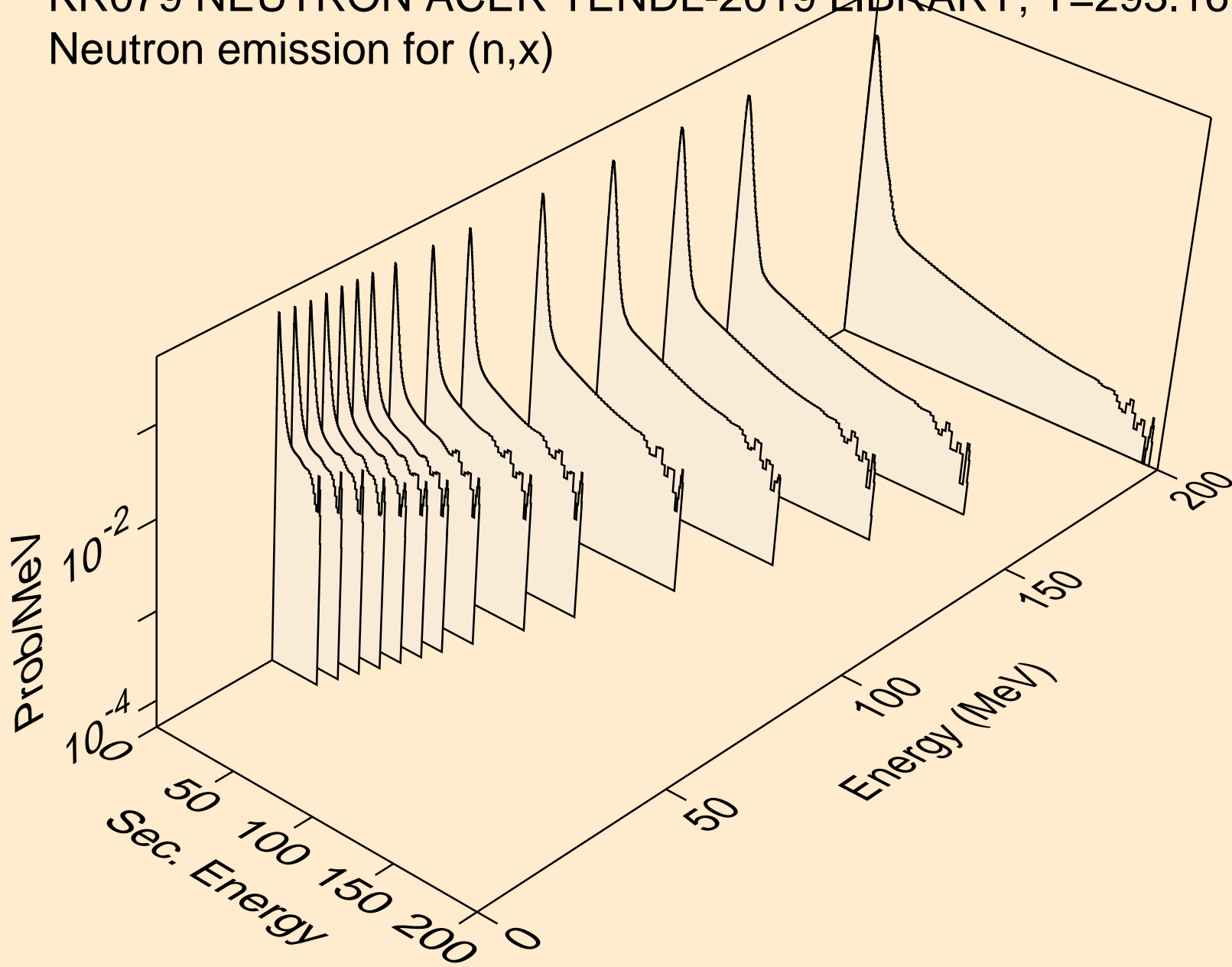

KR079 NEUTRON ACER TENDL-2019 LIBRARY; T=293.16K  
Neutron emission for (n,2nd)

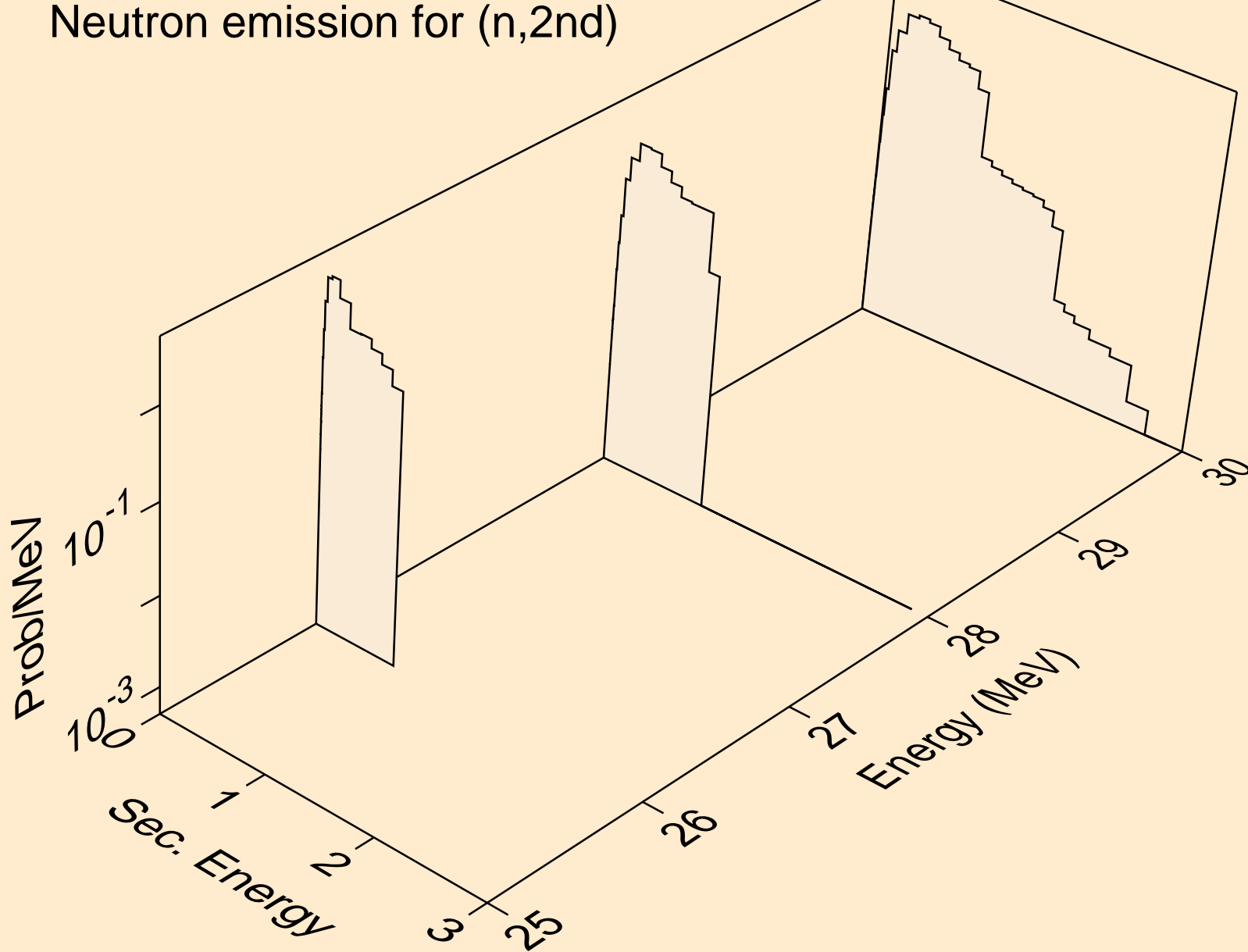

KR079 NEUTRON ACER TENDL-2019 LIBRARY; T=293.16K  
Neutron emission for (n,2n)

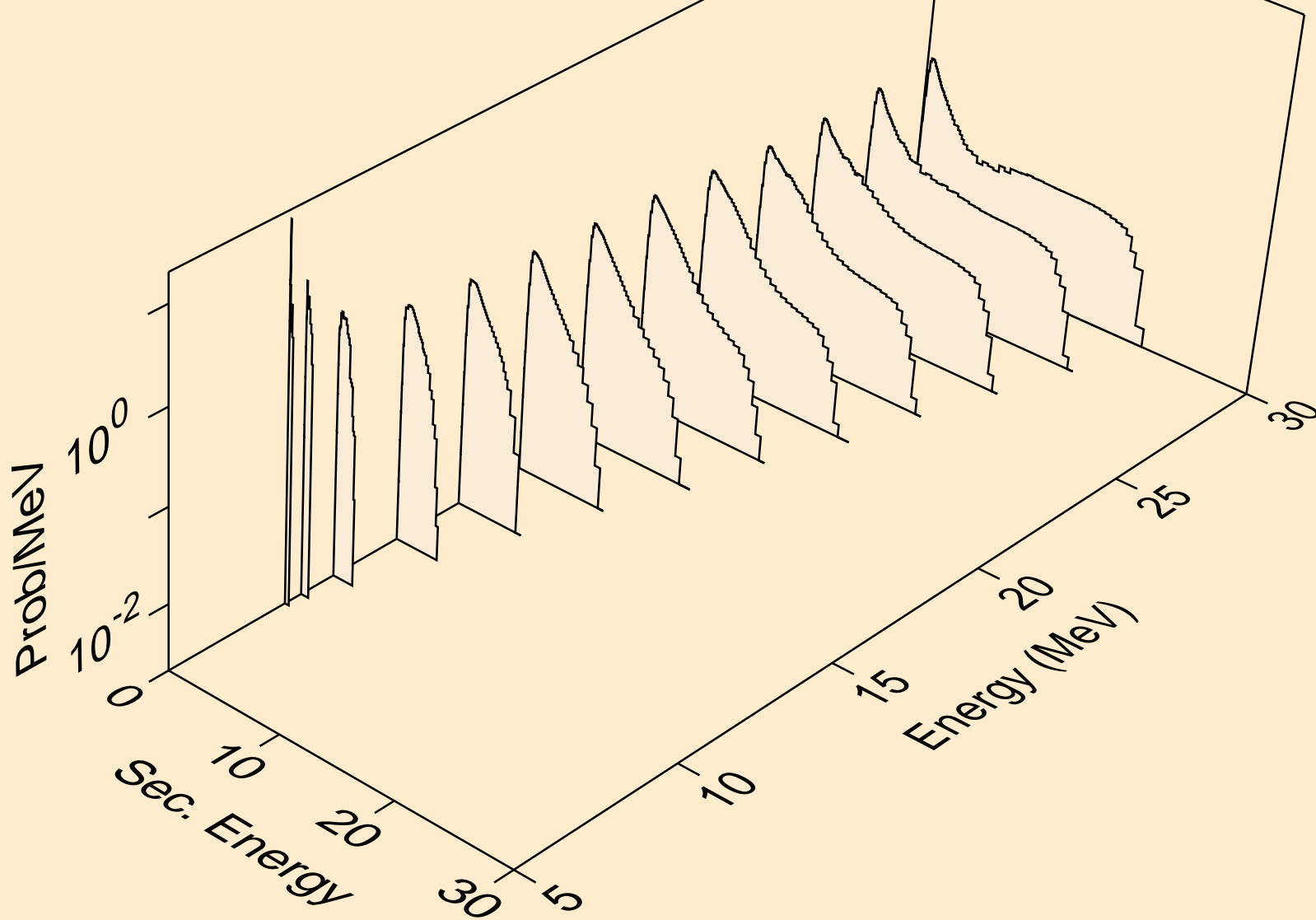

KR079 NEUTRON ACER TENDL-2019 LIBRARY; T=293.16K  
Neutron emission for (n,3n)

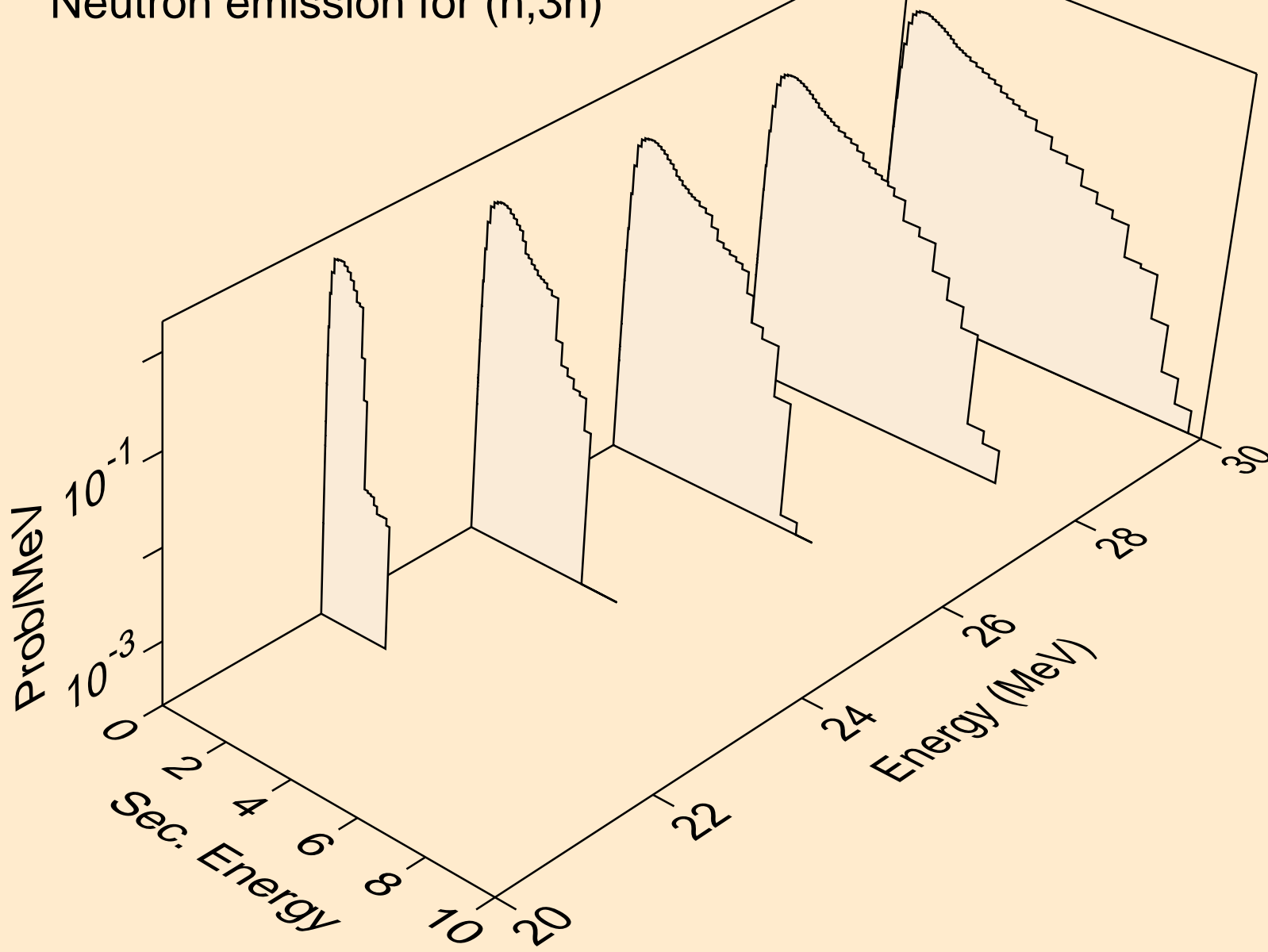



KR079 NEUTRON ACER TENDL-2019 LIBRARY; T=293.16K  
Neutron emission for (n,n\*)a

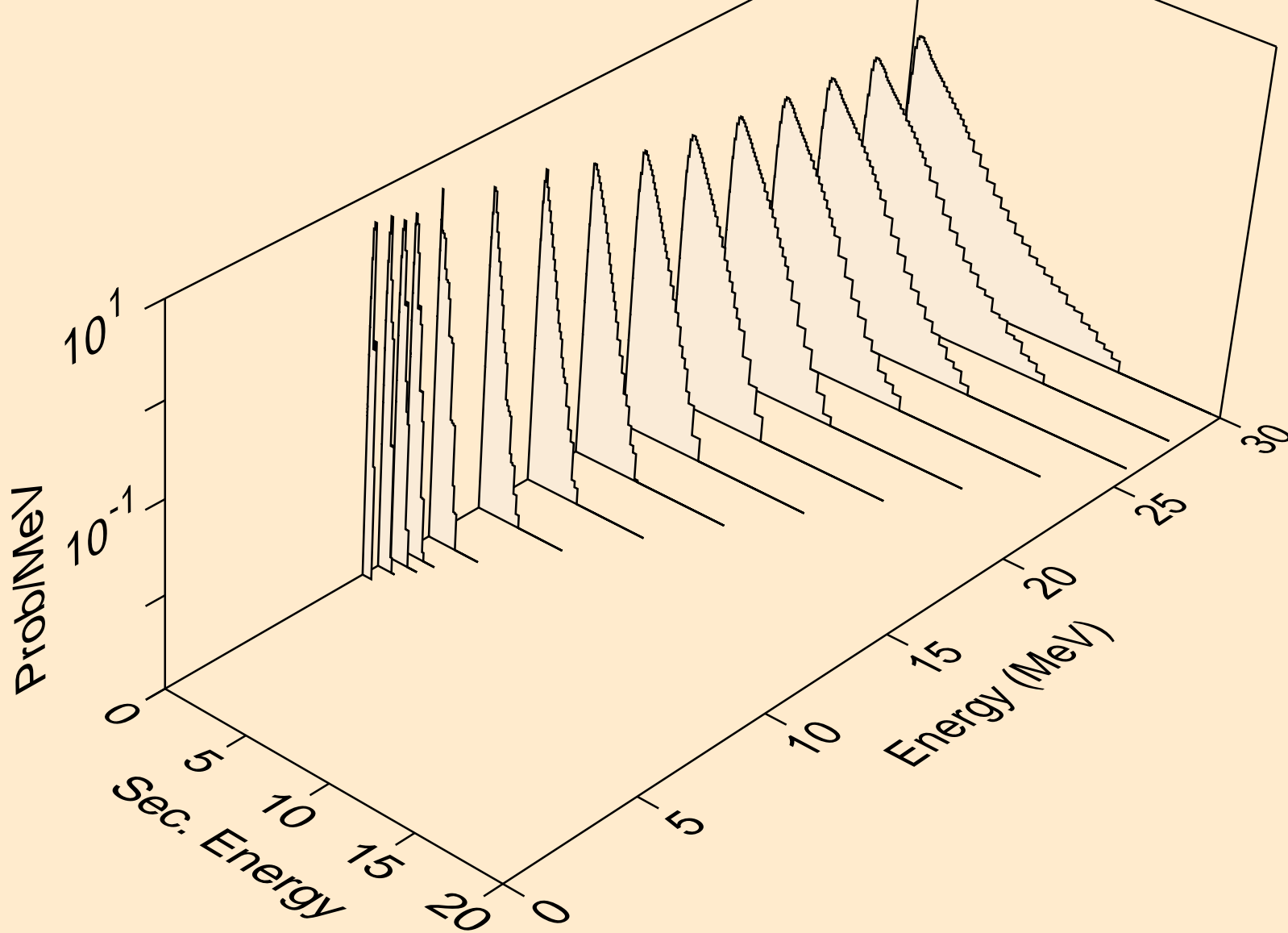

KR079 NEUTRON ACER TENDL-2019 LIBRARY; T=293.16K  
Neutron emission for (n,2n)a

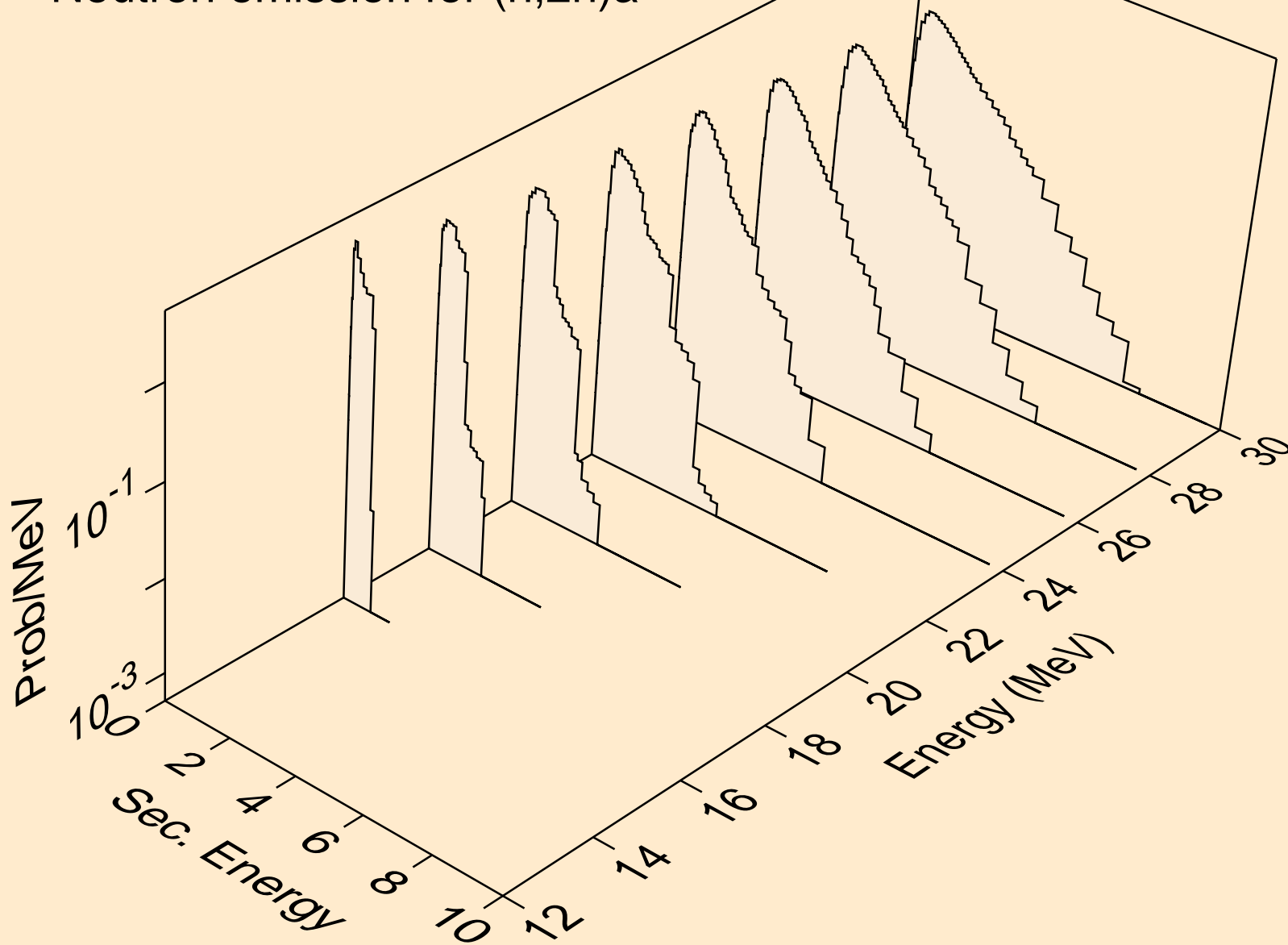

KR079 NEUTRON ACER TENDL-2019 LIBRARY; T=293.16K  
Neutron emission for (n,n\*)p

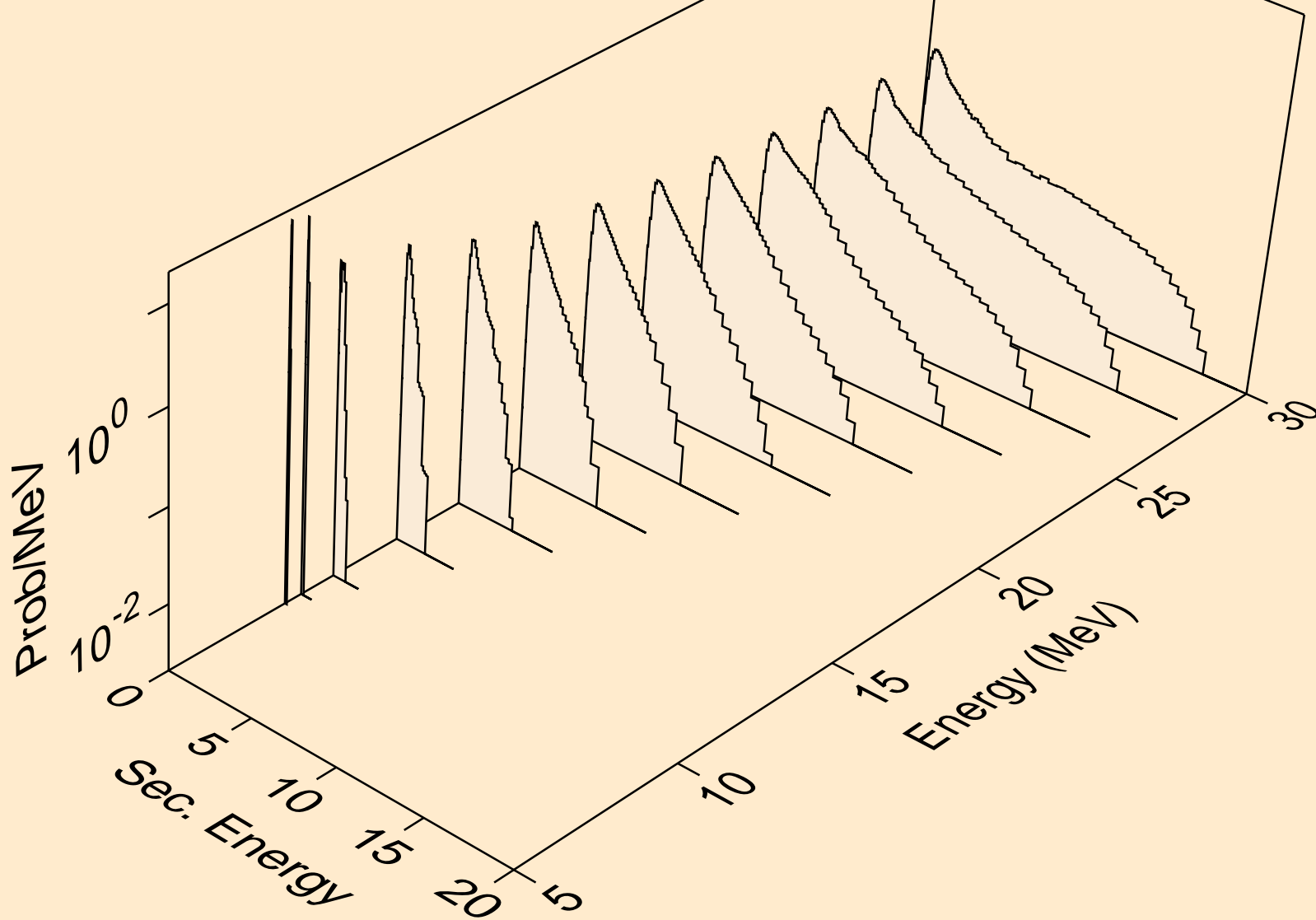

KR079 NEUTRON ACER TENDL-2019 LIBRARY; T=293.16K  
Neutron emission for (n,n\*)2a

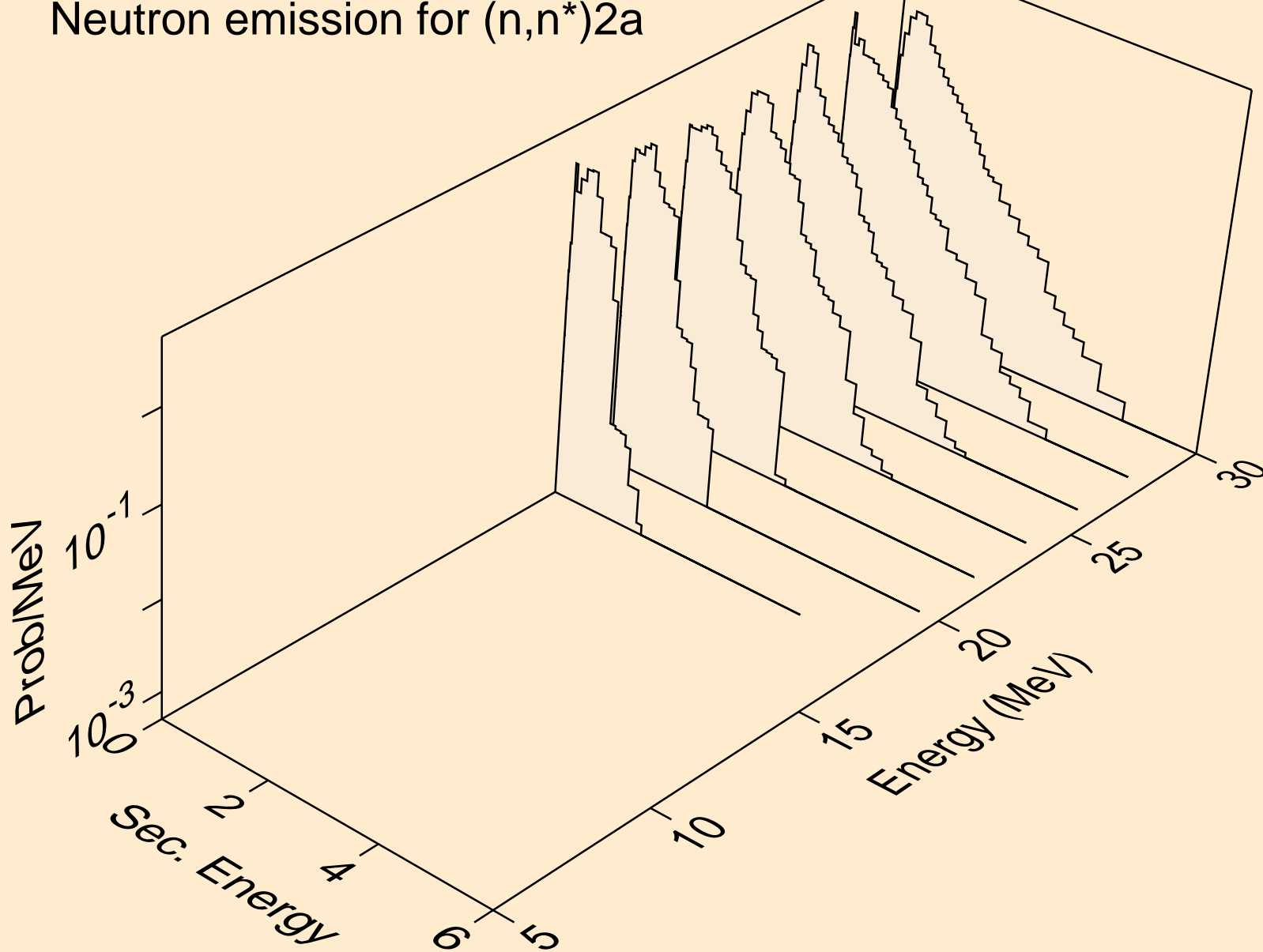

KR079 NEUTRON ACER TENDL-2019 LIBRARY; T=293.16K  
Neutron emission for (n,n\*)d

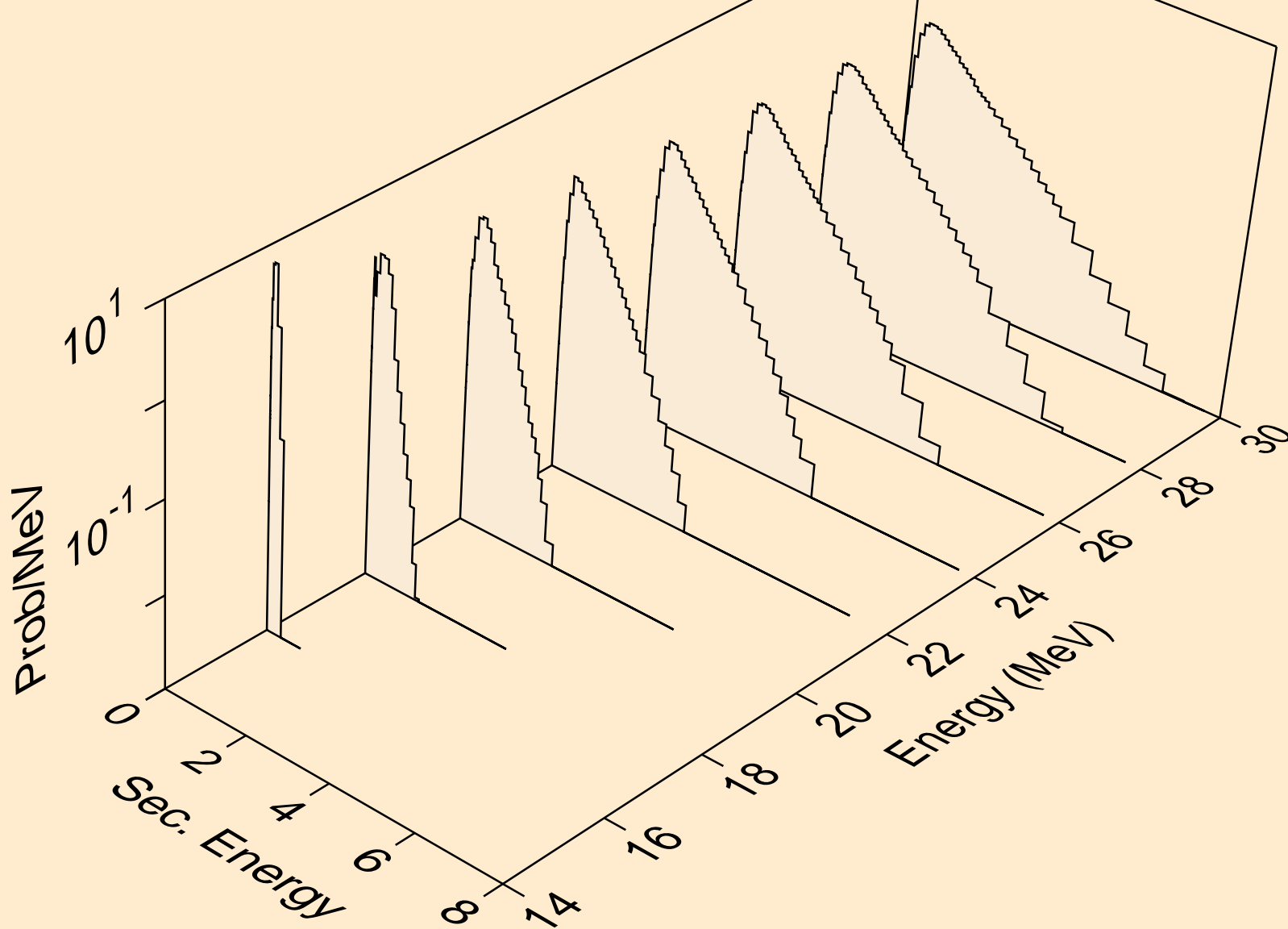

KR079 NEUTRON ACER TENDL-2019 LIBRARY; T=293.16K  
Neutron emission for (n,n\*)t

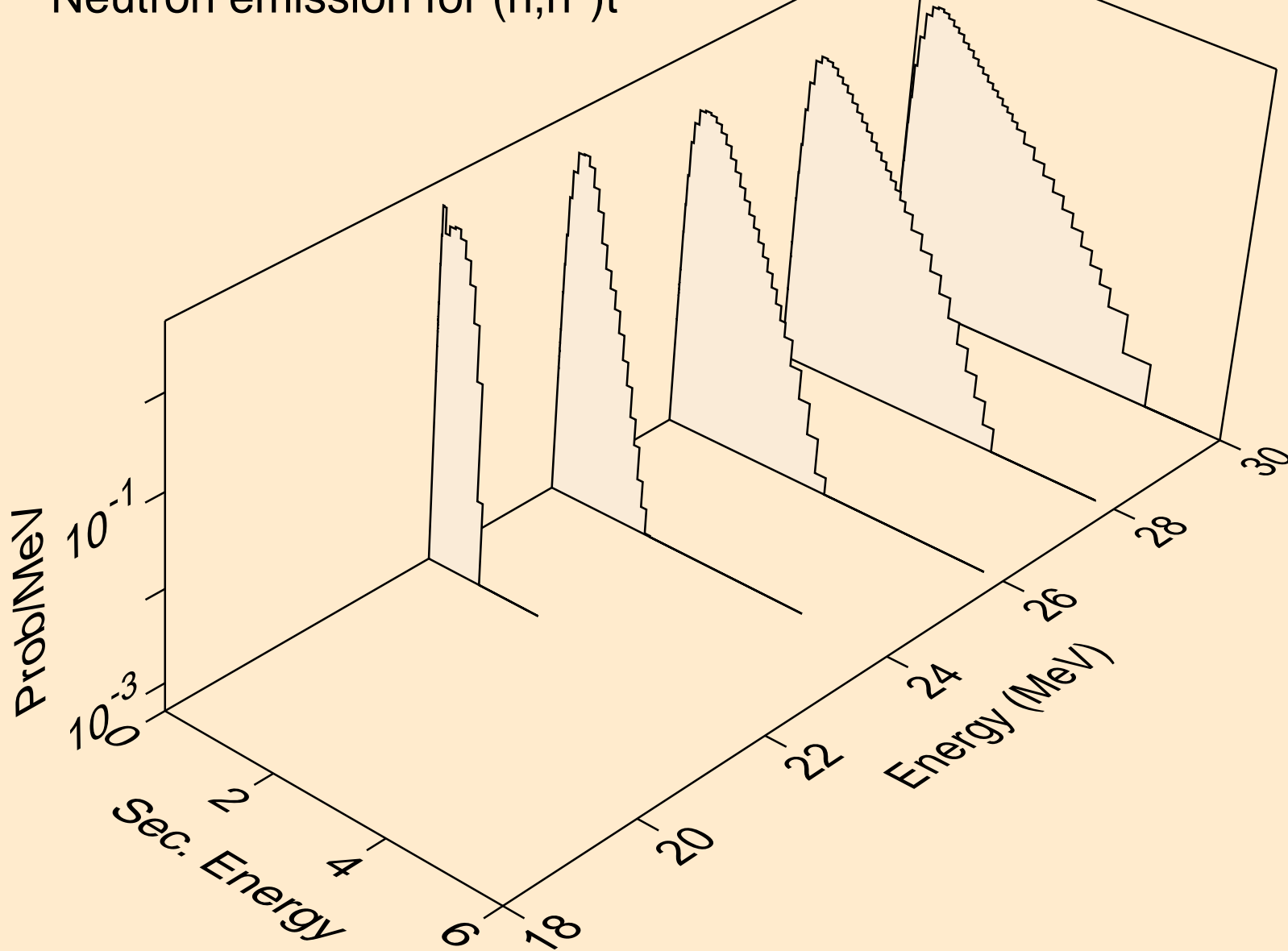

KR079 NEUTRON ACER TENDL-2019 LIBRARY; T=293.16K  
Neutron emission for (n,n\*)he3

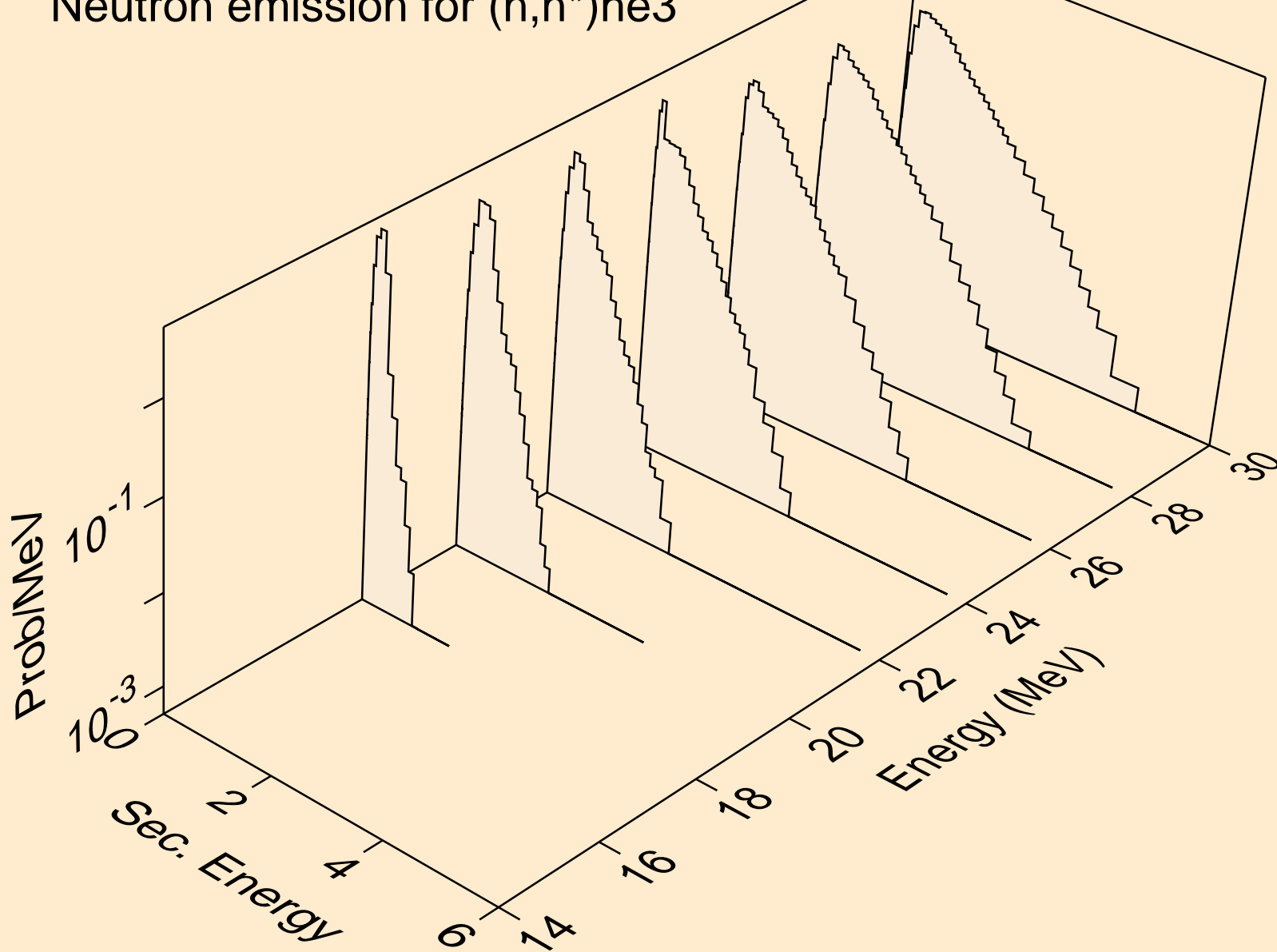

KR079 NEUTRON ACER TENDL-2019 LIBRARY; T=293.16K  
Neutron emission for (n,2np)

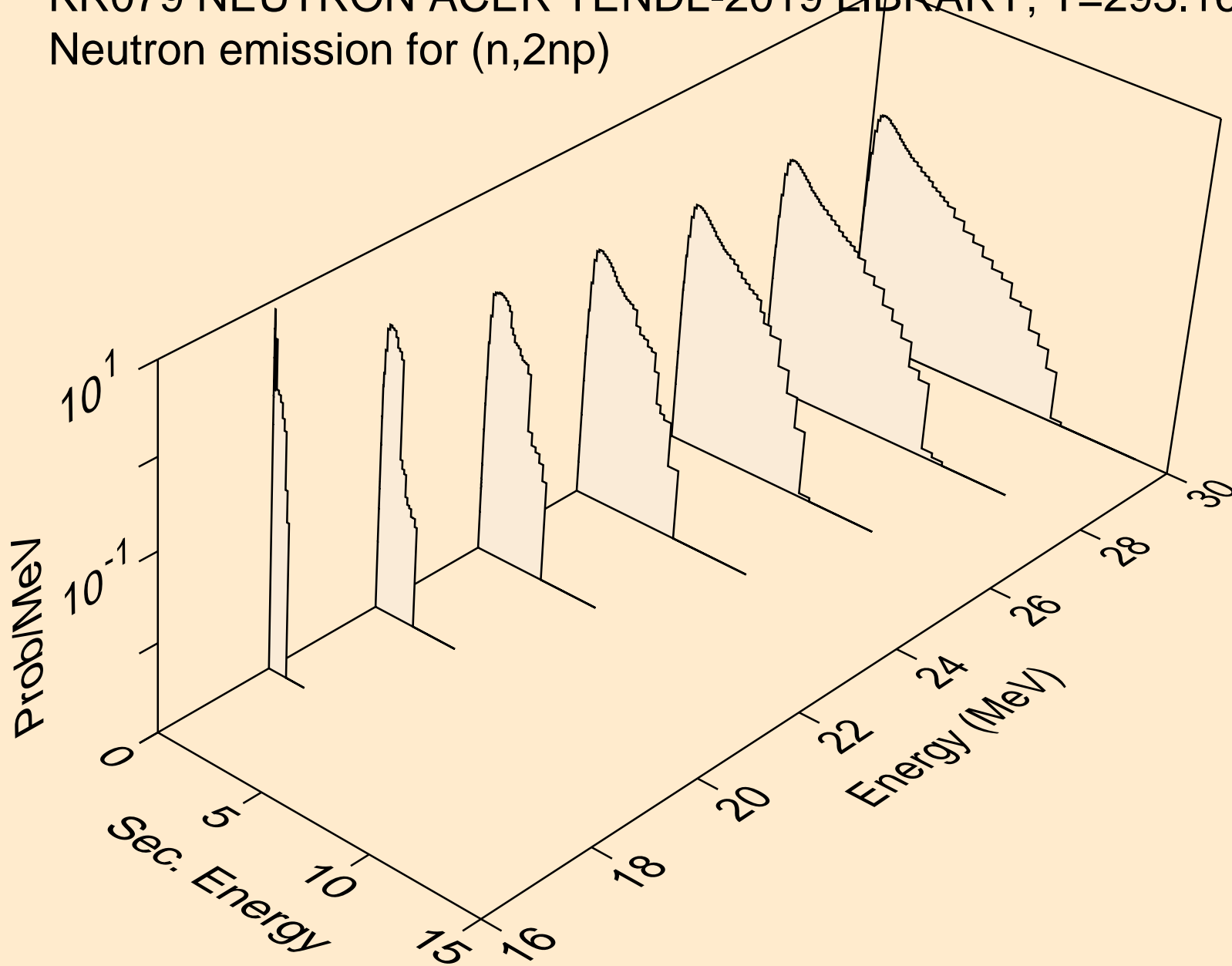



KR079 NEUTRON ACER TENDL-2019 LIBRARY; T=293.16K  
Neutron emission for (n,3np)

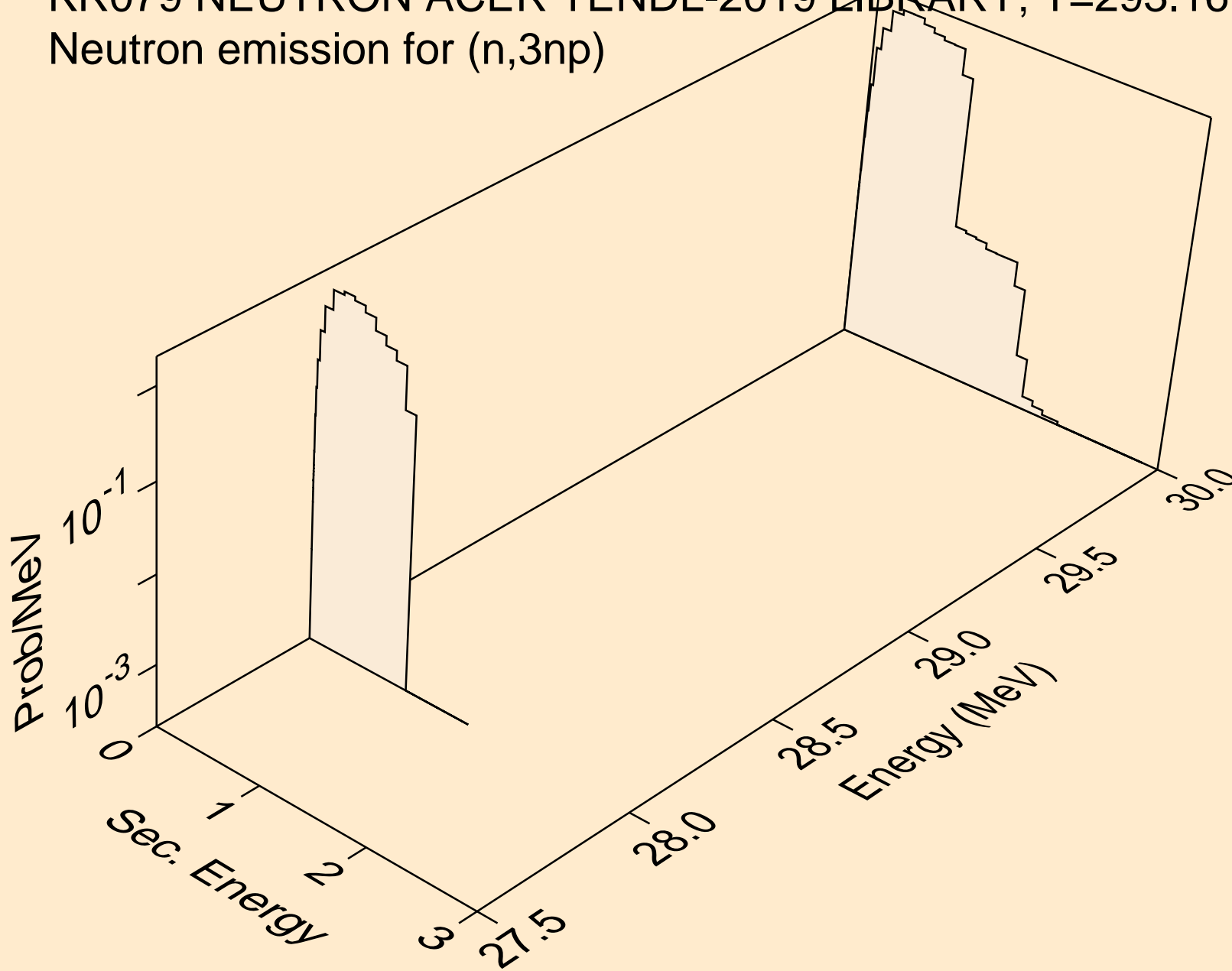

KR079 NEUTRON ACER TENDL-2019 LIBRARY; T=293.16K  
Neutron emission for (n,2np)

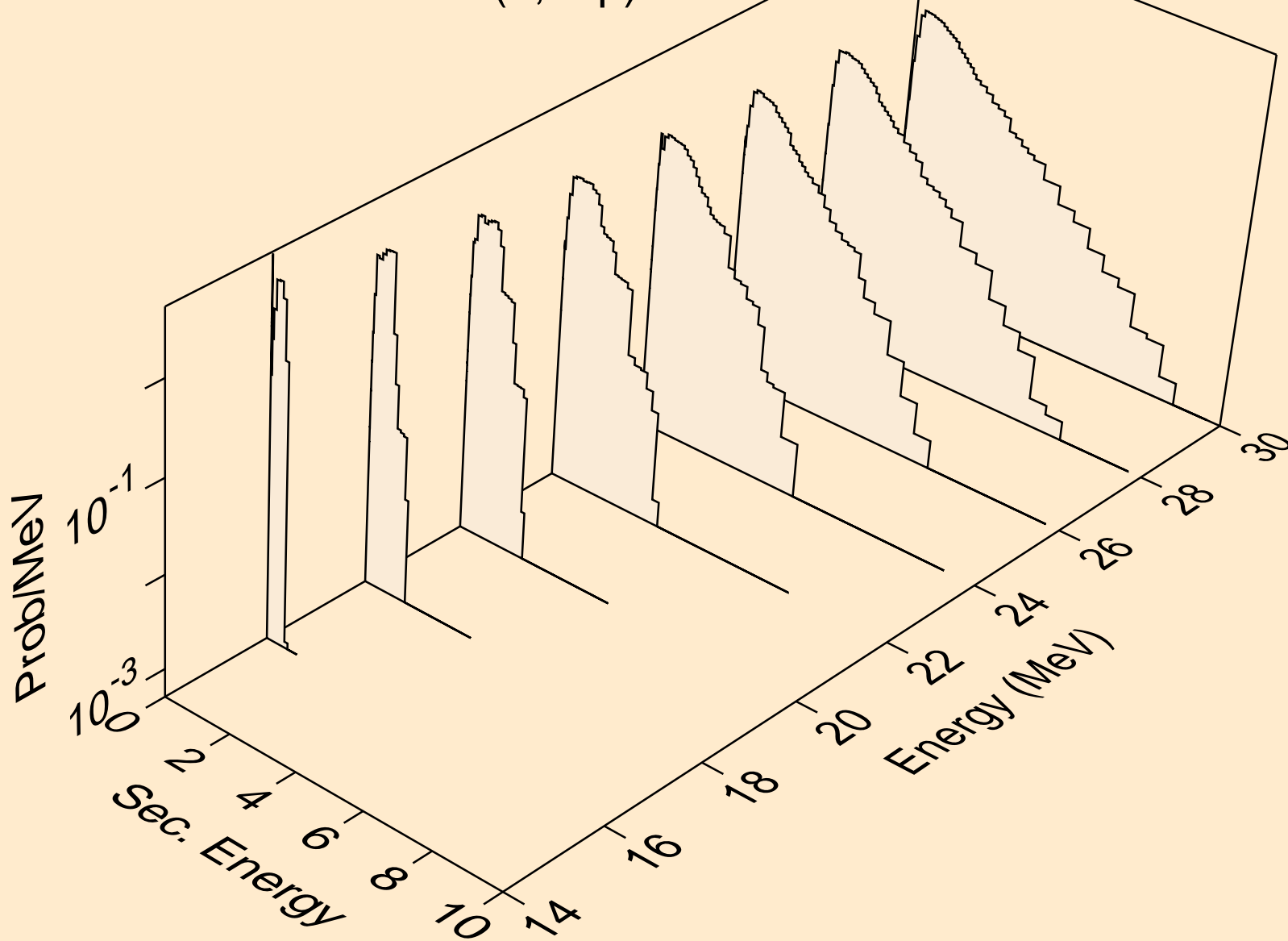

KR079 NEUTRON ACER TENDL-2019 LIBRARY; T=293.16K  
Neutron emission for (n,npa)

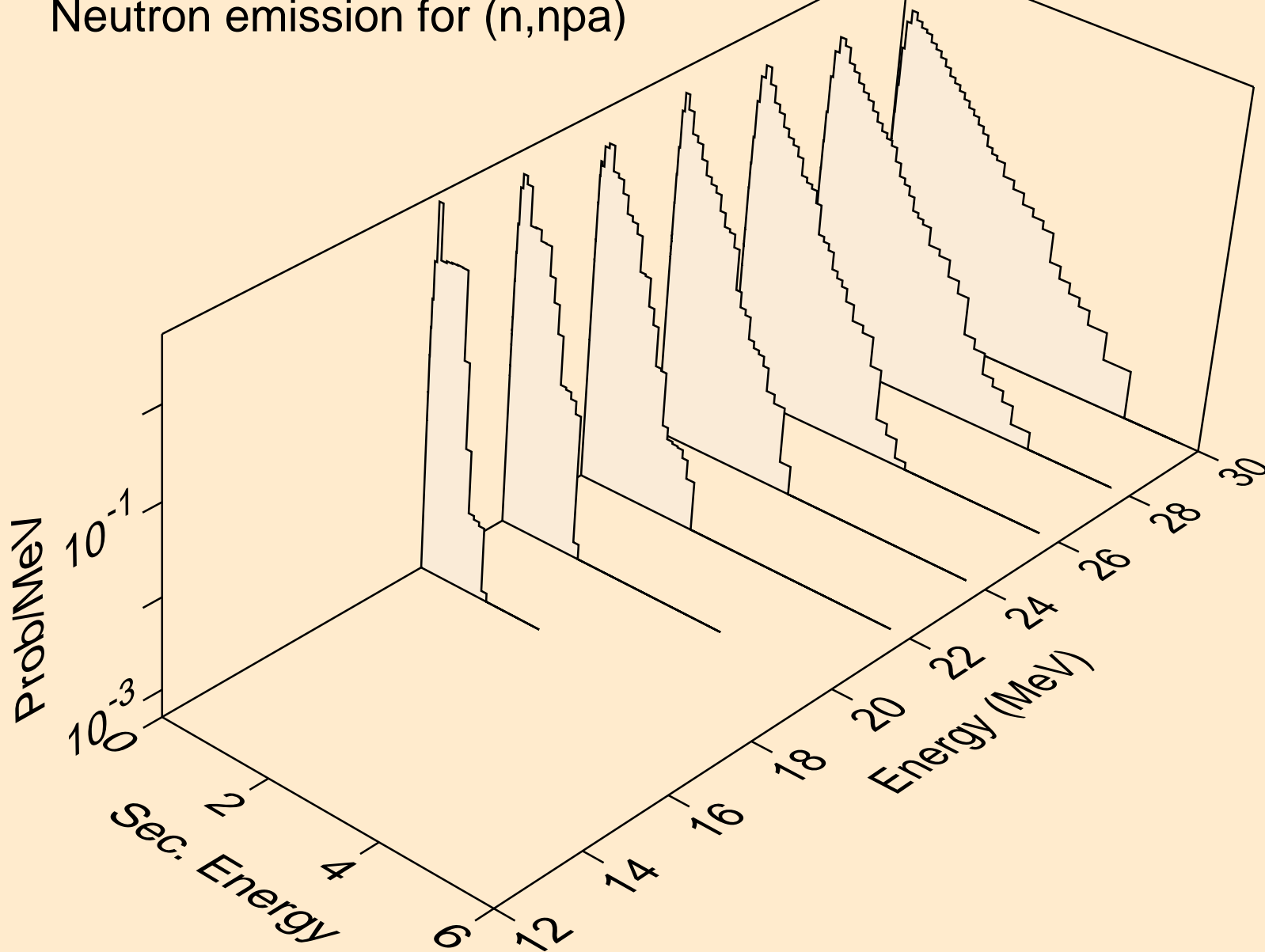

KR079 NEUTRON ACER TENDL-2019 LIBRARY; T=293.16K  
Neutron emission for (n,n\*c)

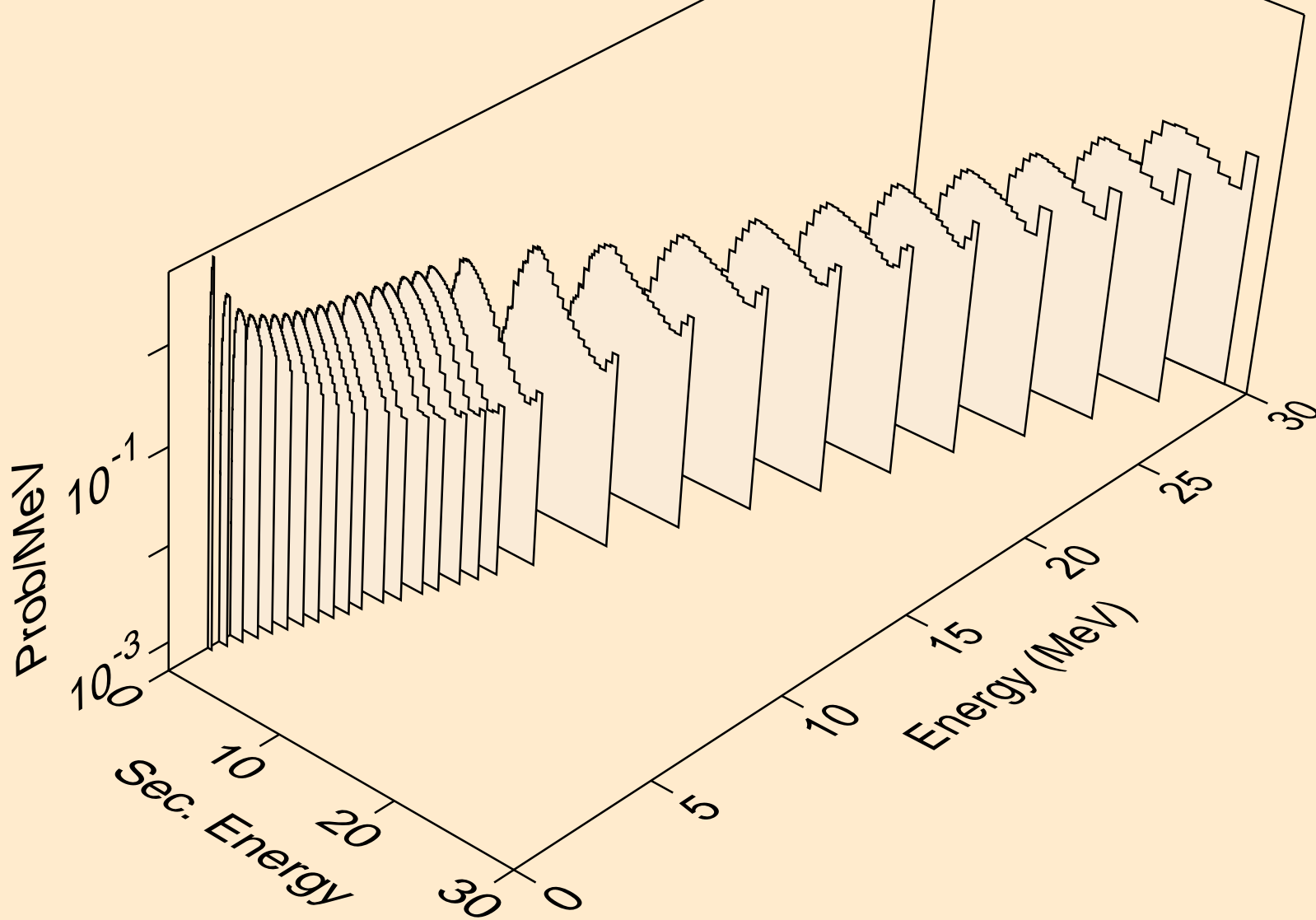

KR079 NEUTRON ACER TENDL-2019 LIBRARY; T=293.16K  
Photon emission for (n,x)

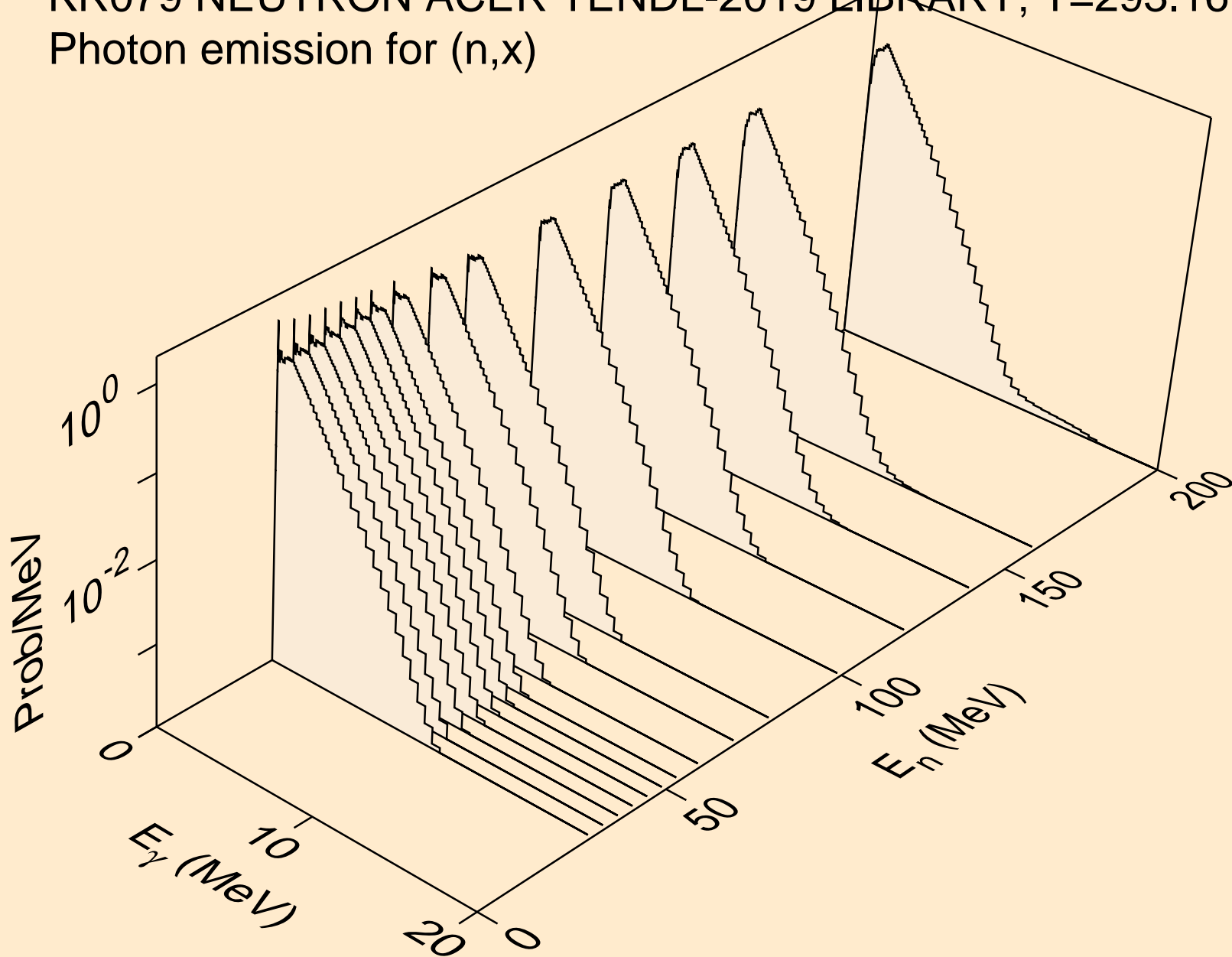

KR079 NEUTRON ACER TENDL-2019 LIBRARY; T=293.16K  
Photon emission for (n,2nd)

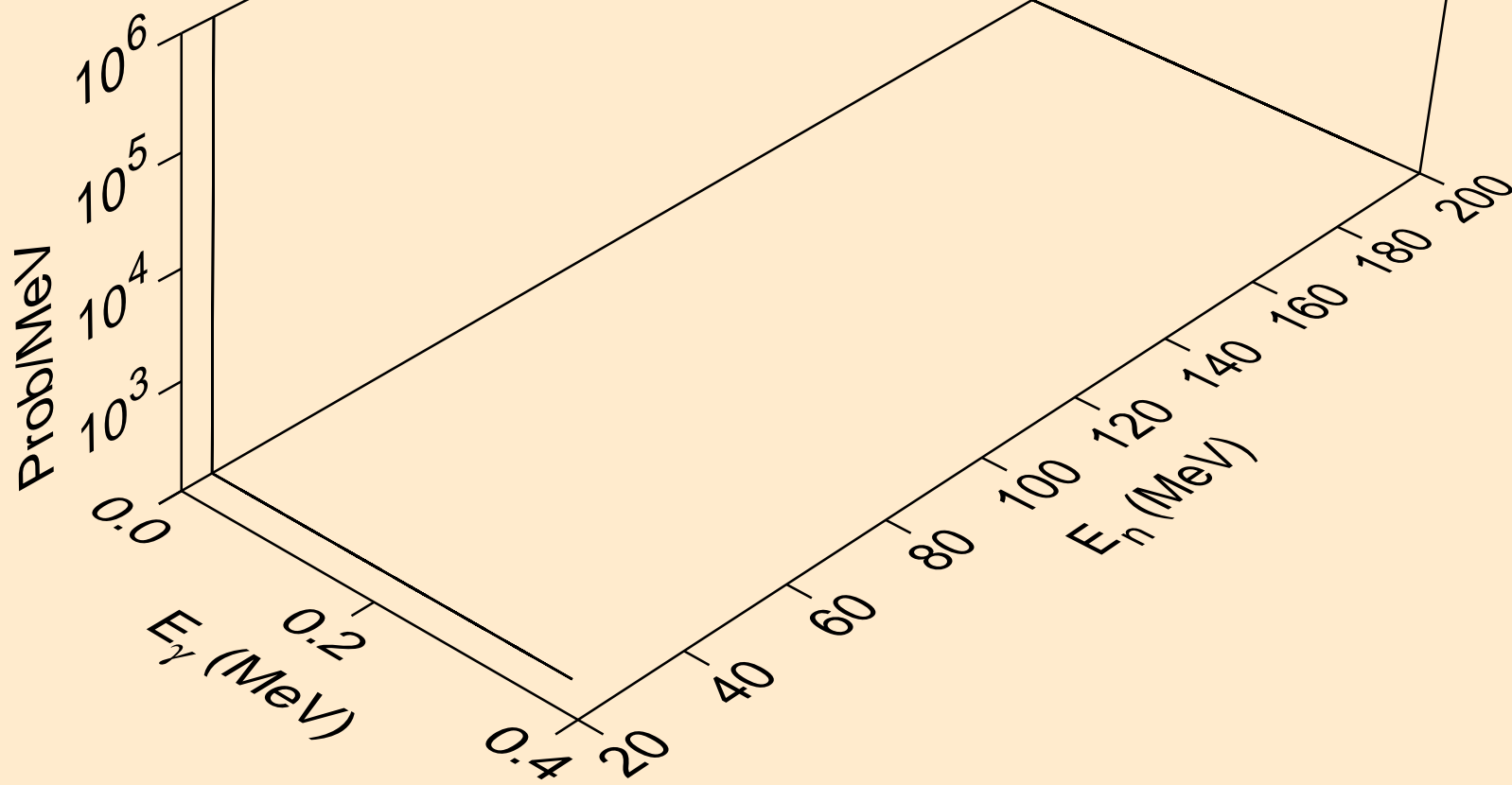

KR079 NEUTRON ACER TENDL-2019 LIBRARY; T=293.16K  
Photon emission for (n,2n)

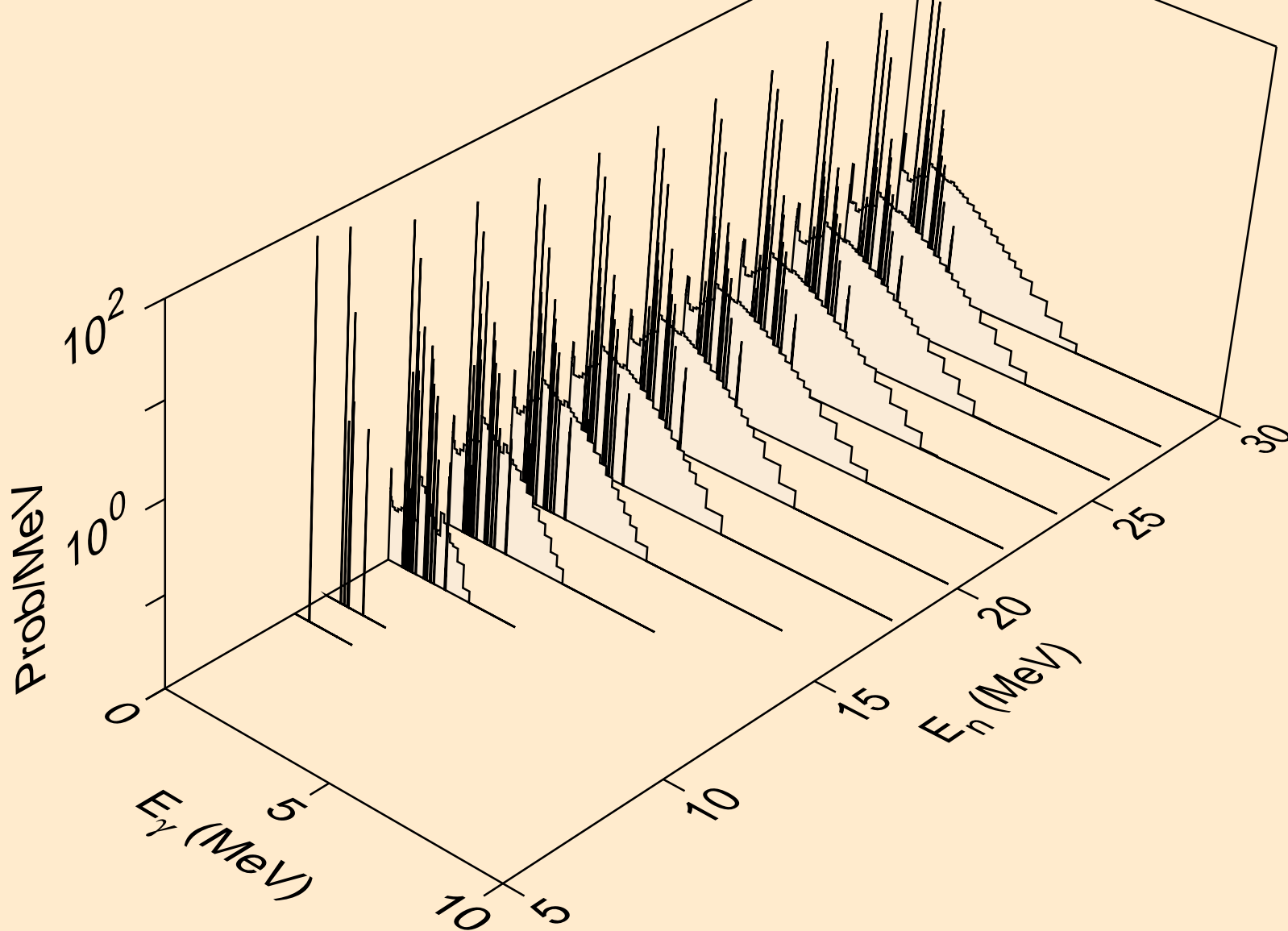

KR079 NEUTRON ACER TENDL-2019 LIBRARY; T=293.16K  
Photon emission for (n,3n)

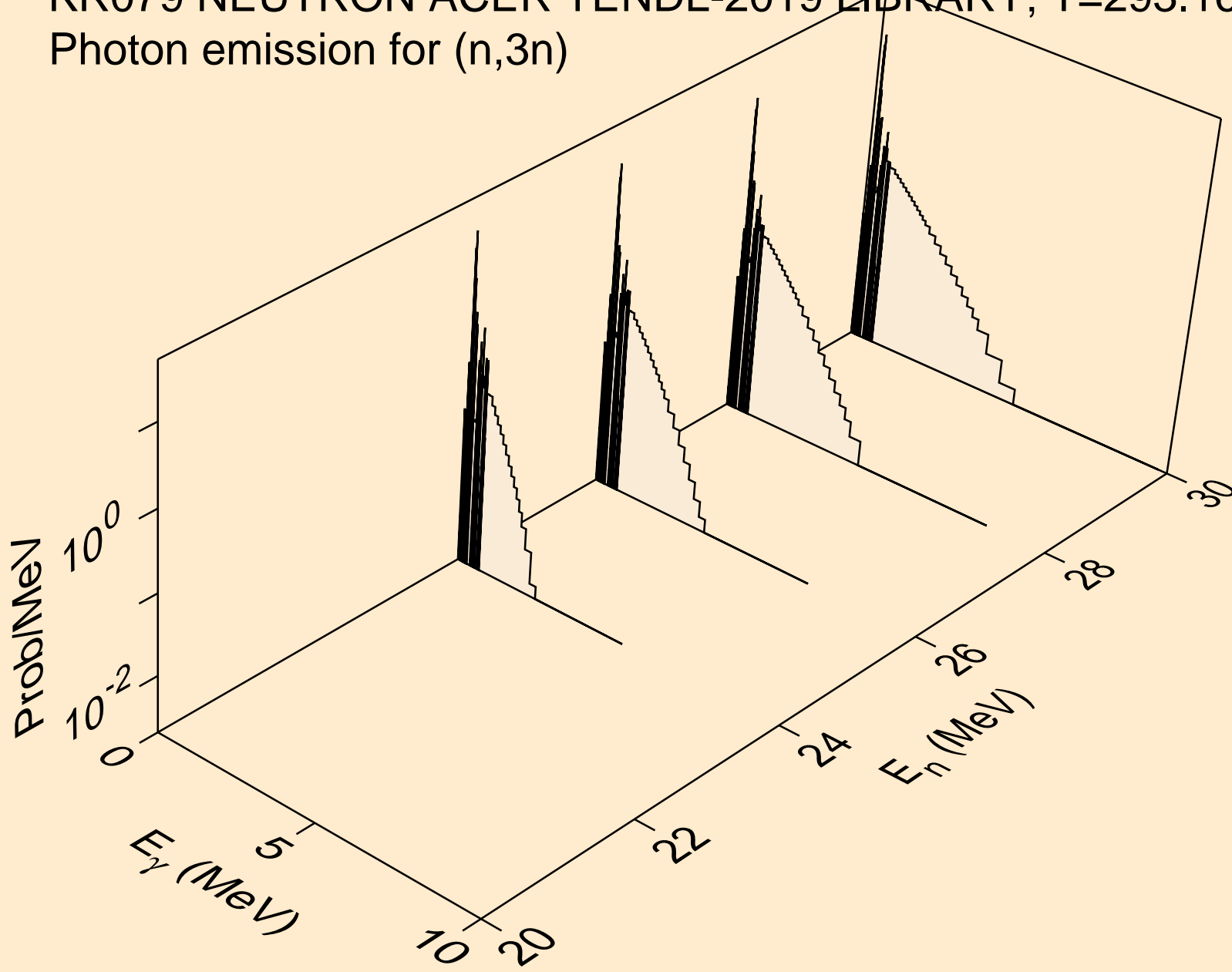



KR079 NEUTRON ACER TENDL-2019 LIBRARY; T=293.16K  
Photon emission for (n,n\*)a

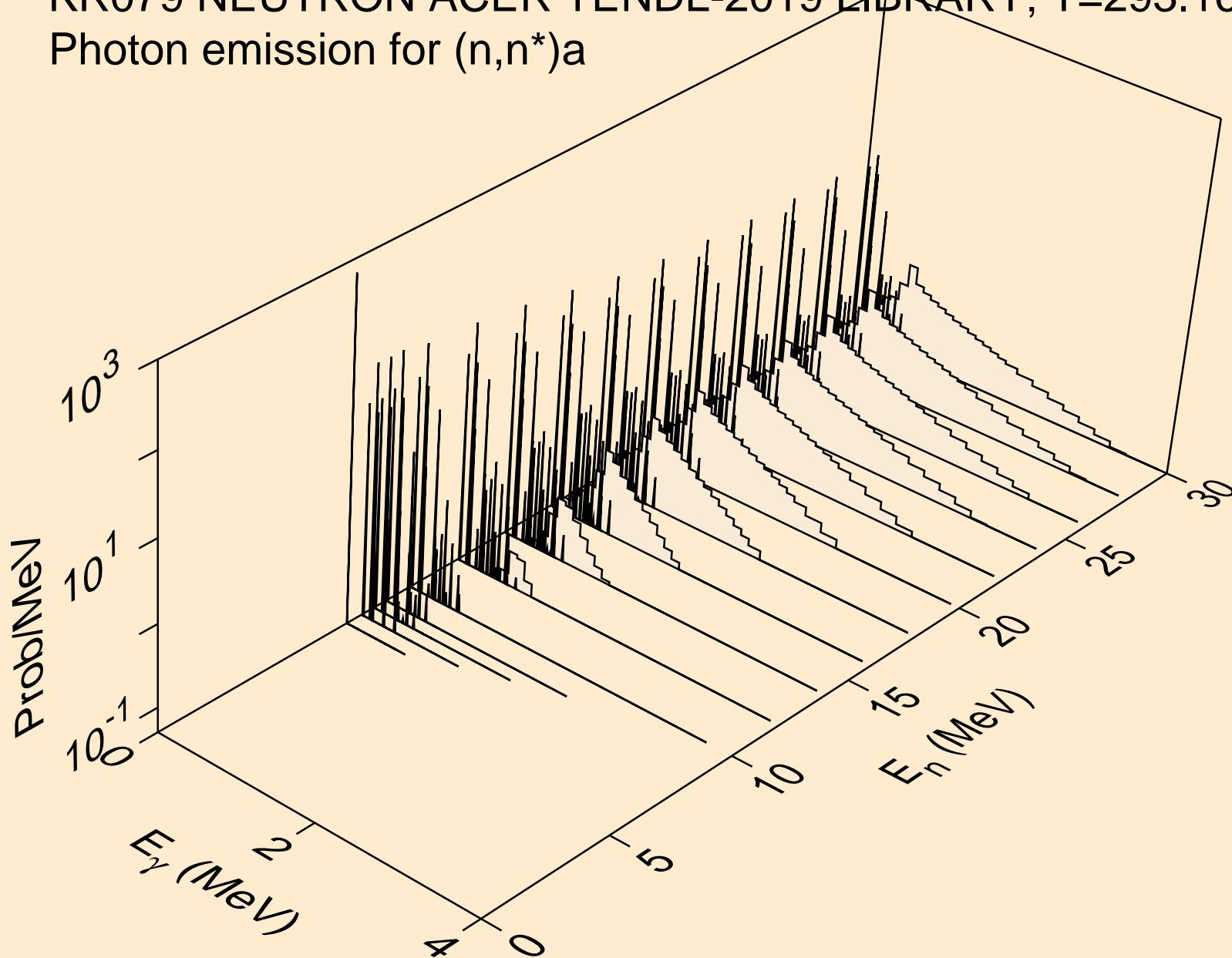

KR079 NEUTRON ACER TENDL-2019 LIBRARY; T=293.16K  
Photon emission for (n,2n)a

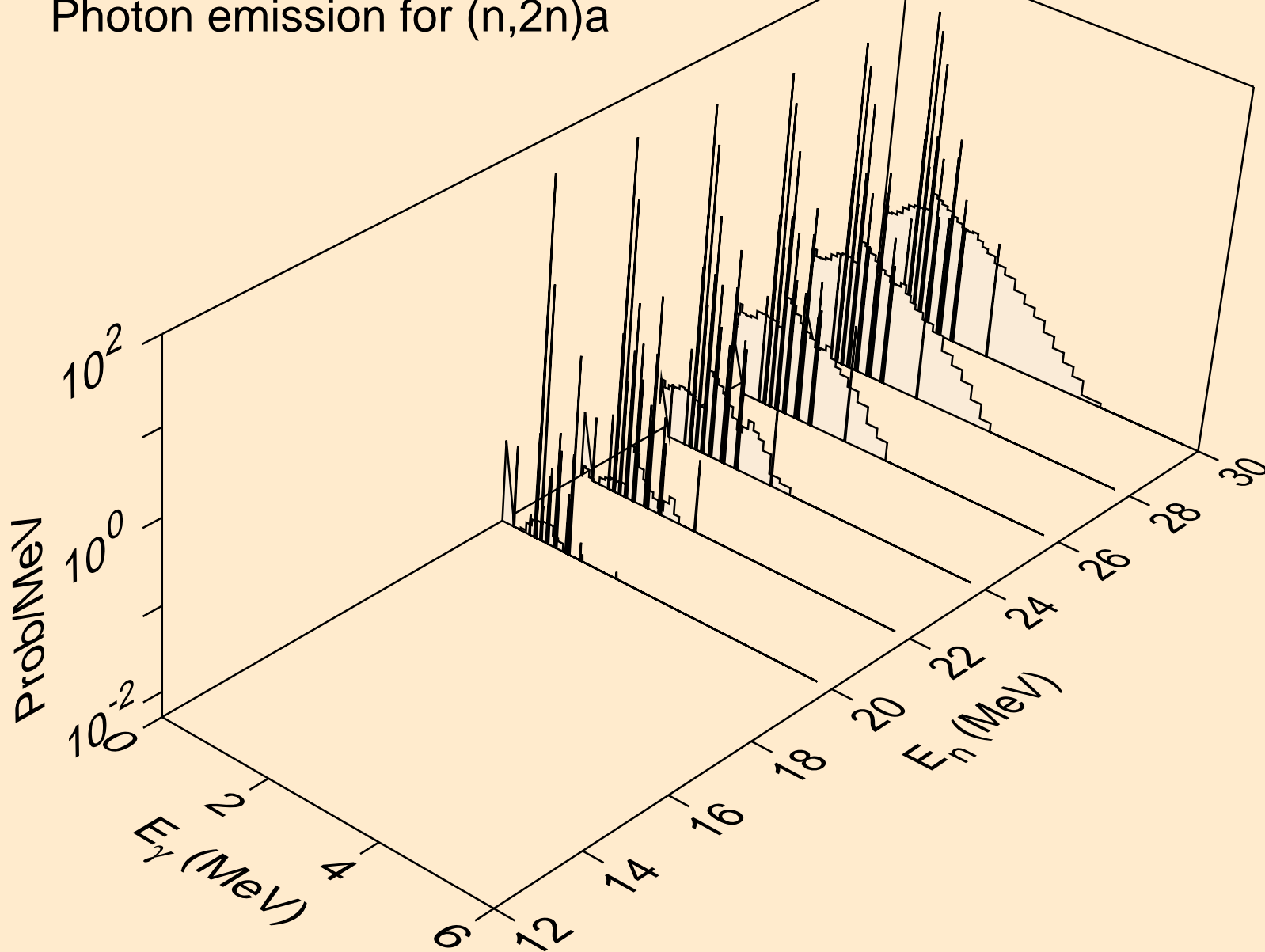

KR079 NEUTRON ACER TENDL-2019 LIBRARY; T=293.16K  
Photon emission for (n,n\*)p

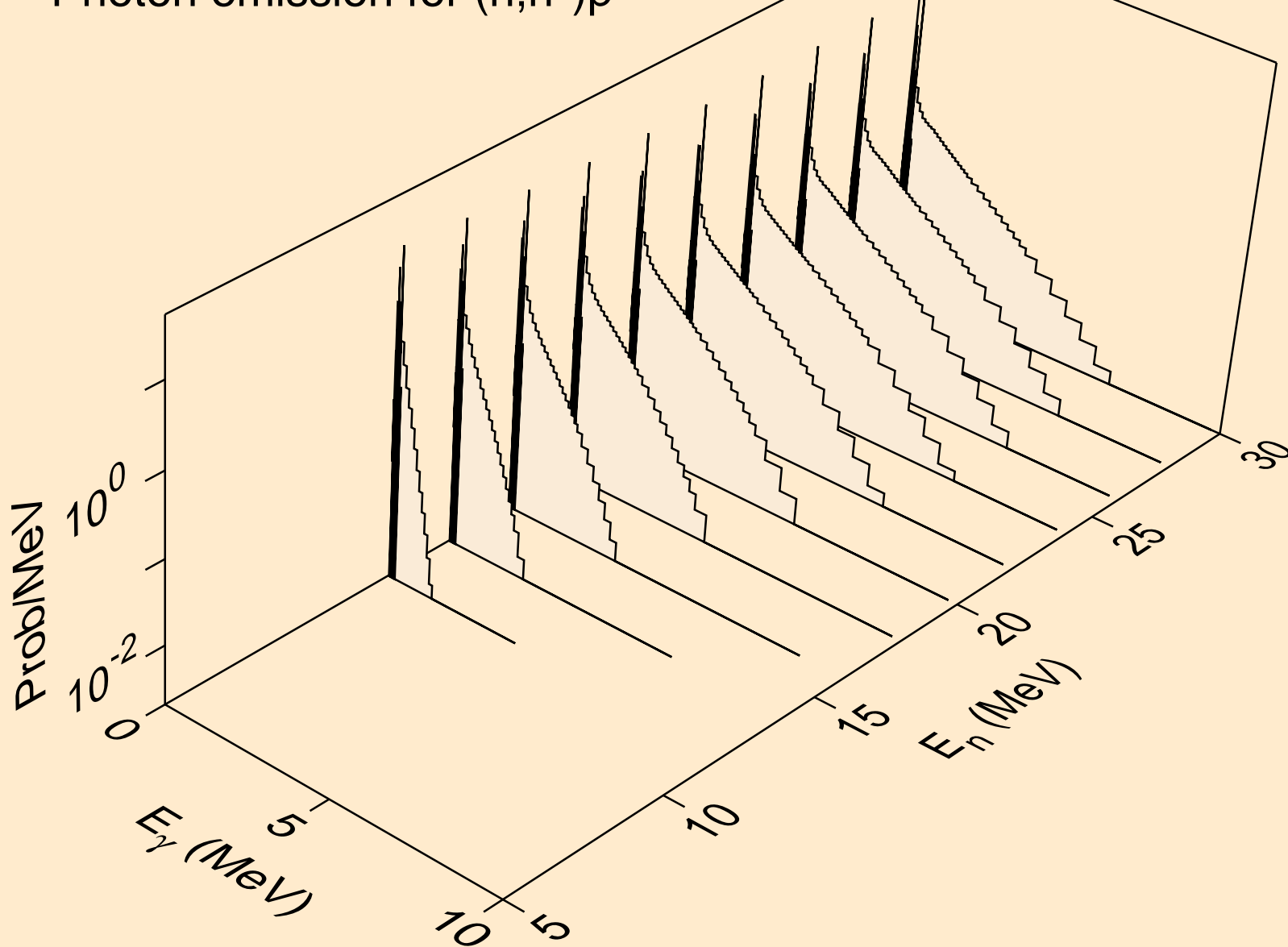

KR079 NEUTRON ACER TENDL-2019 LIBRARY; T=293.16K  
Photon emission for (n,n\*)2a

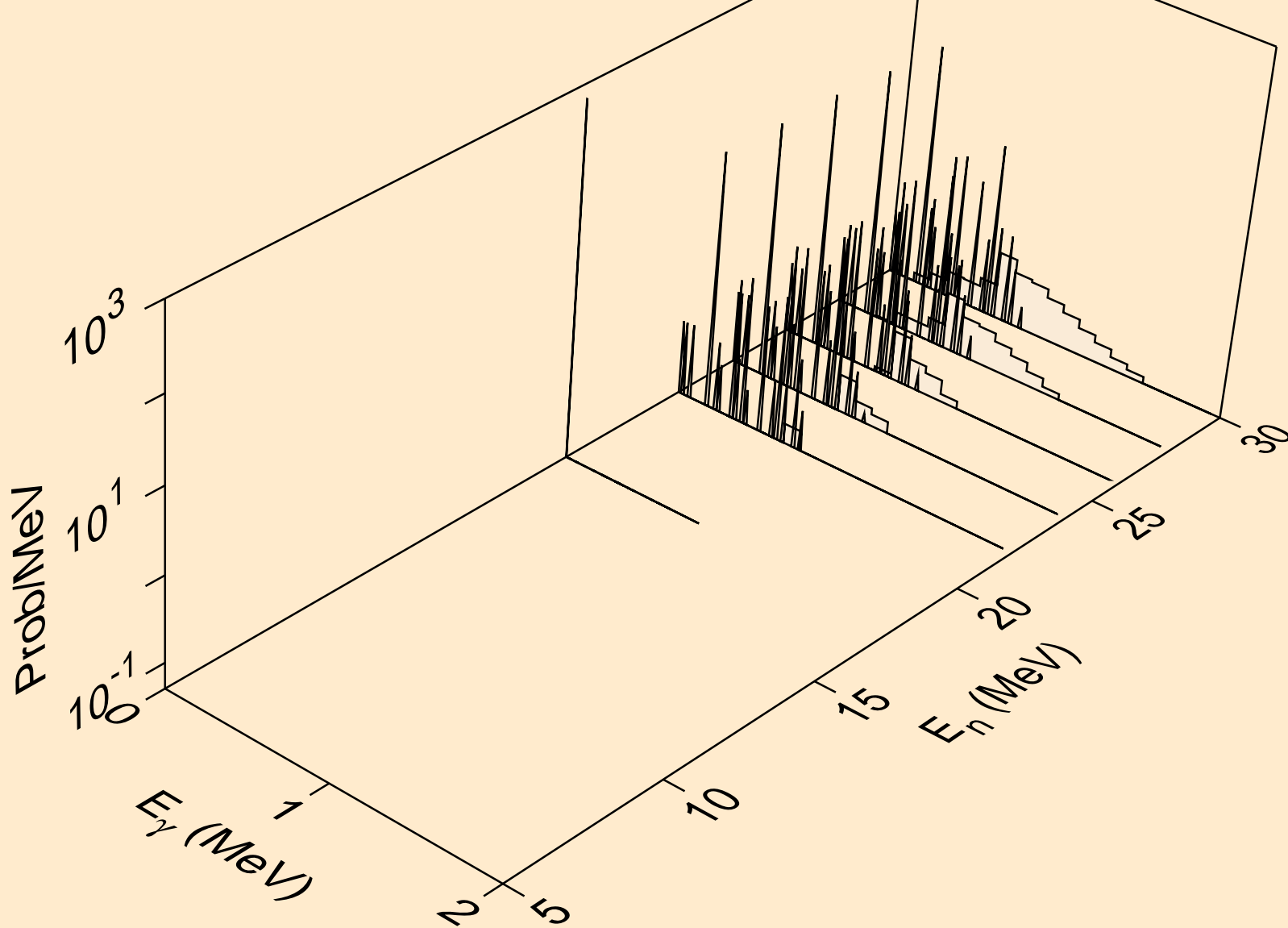

KR079 NEUTRON ACER TENDL-2019 LIBRARY; T=293.16K  
Photon emission for (n,n\*)d

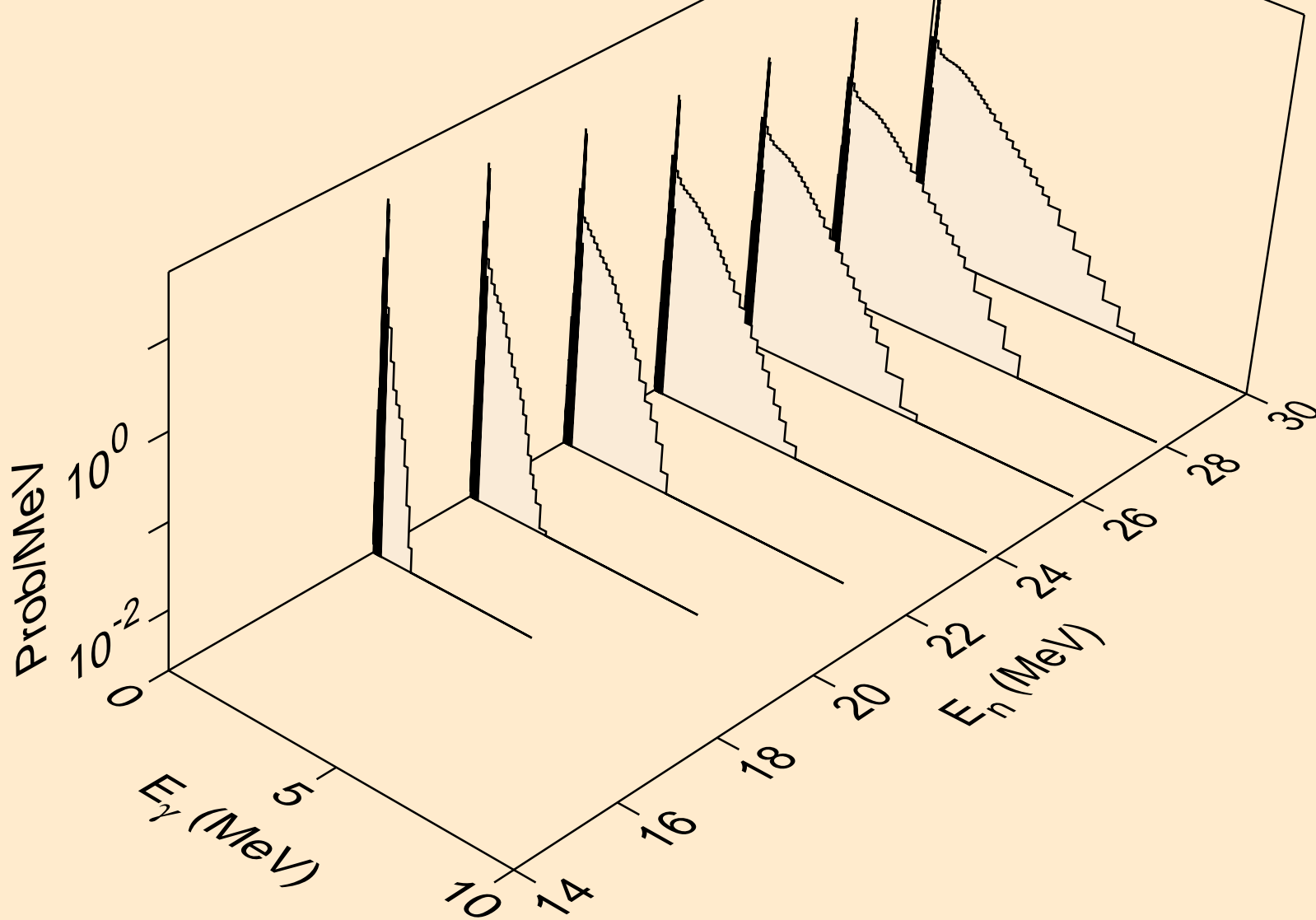

KR079 NEUTRON ACER TENDL-2019 LIBRARY; T=293.16K  
Photon emission for (n,n\*)t

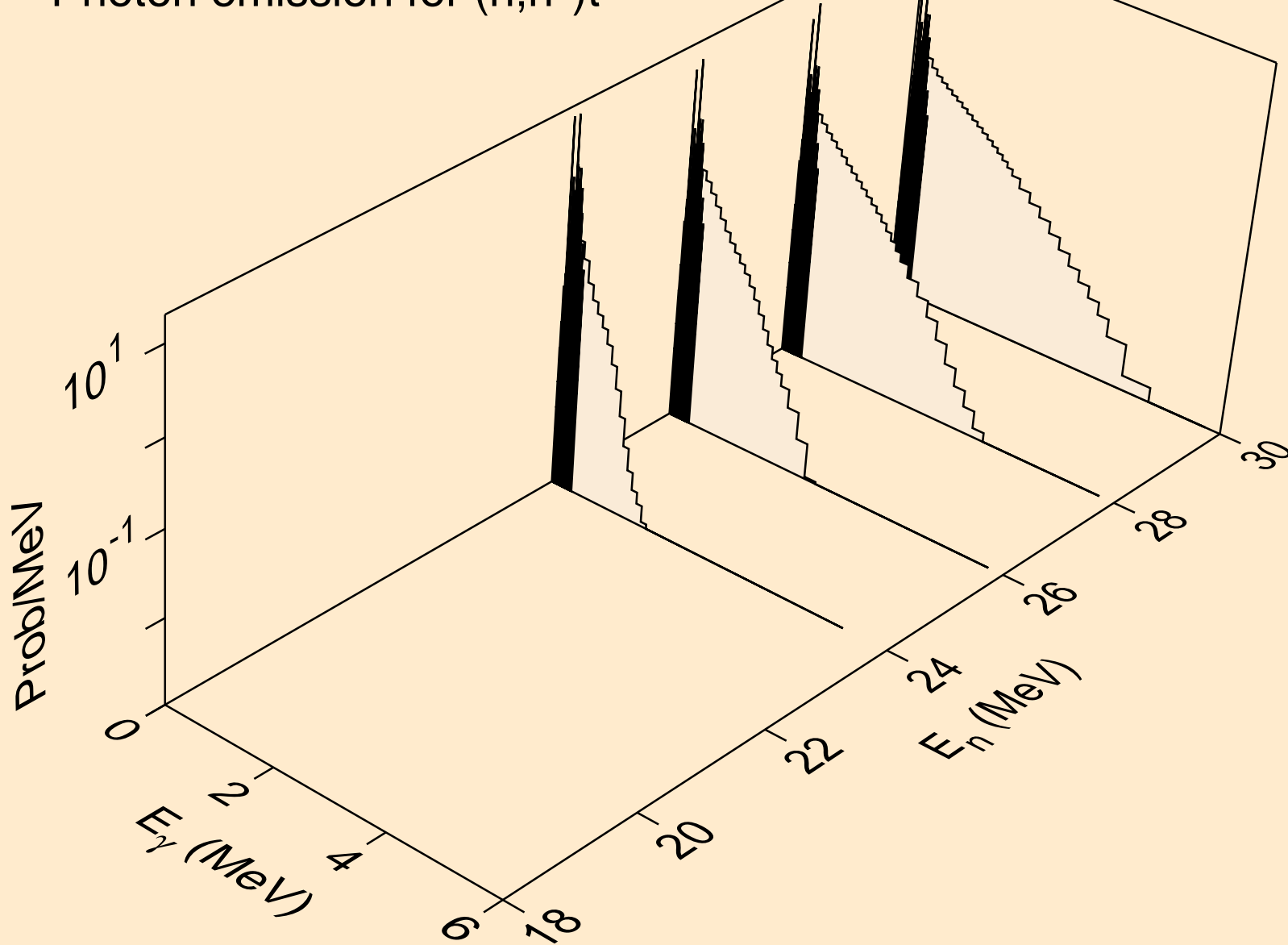

KR079 NEUTRON ACER TENDL-2019 LIBRARY; T=293.16K  
Photon emission for (n,n\*)he3

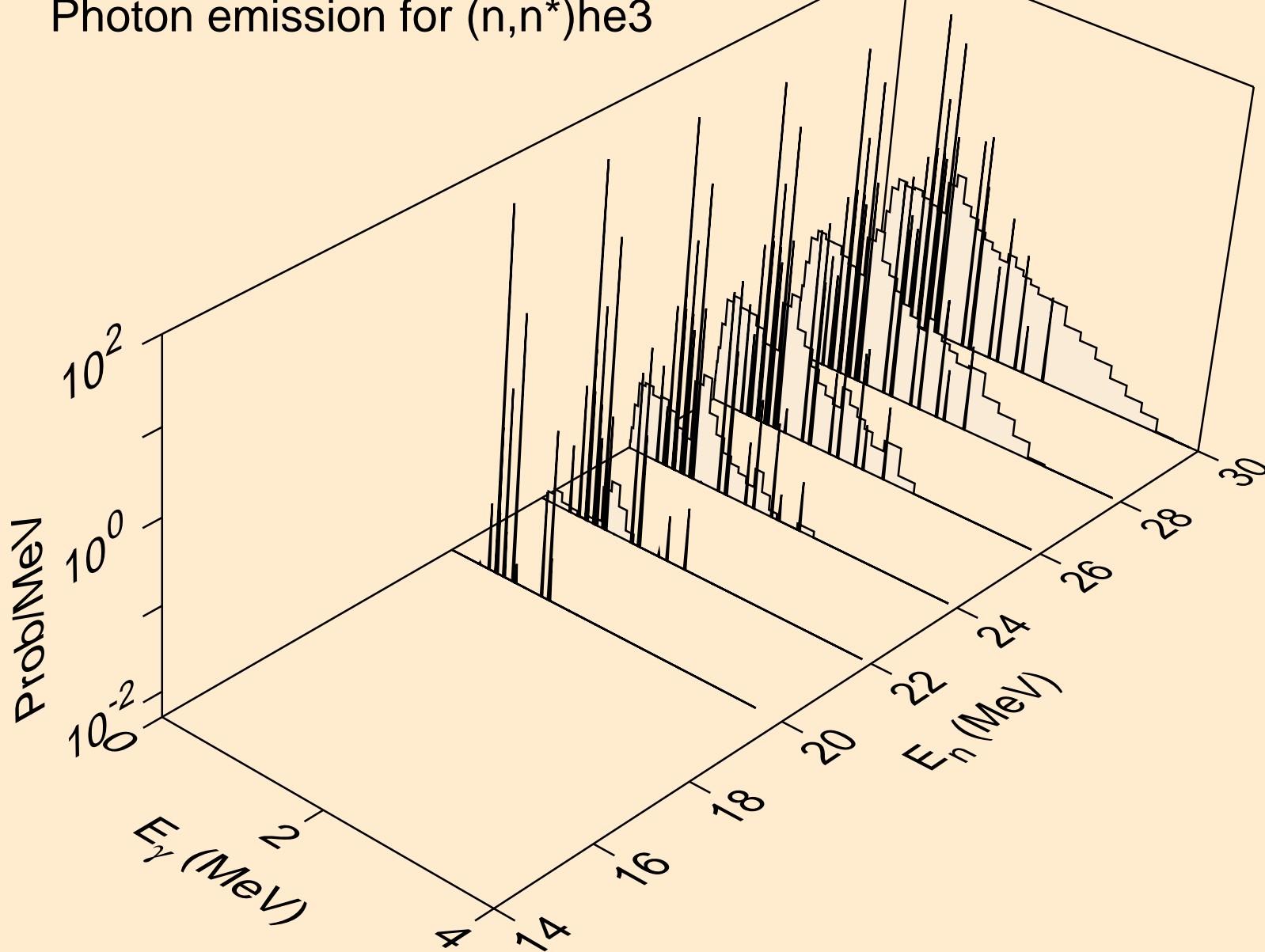

KR079 NEUTRON ACER TENDL-2019 LIBRARY; T=293.16K  
Photon emission for (n,2np)

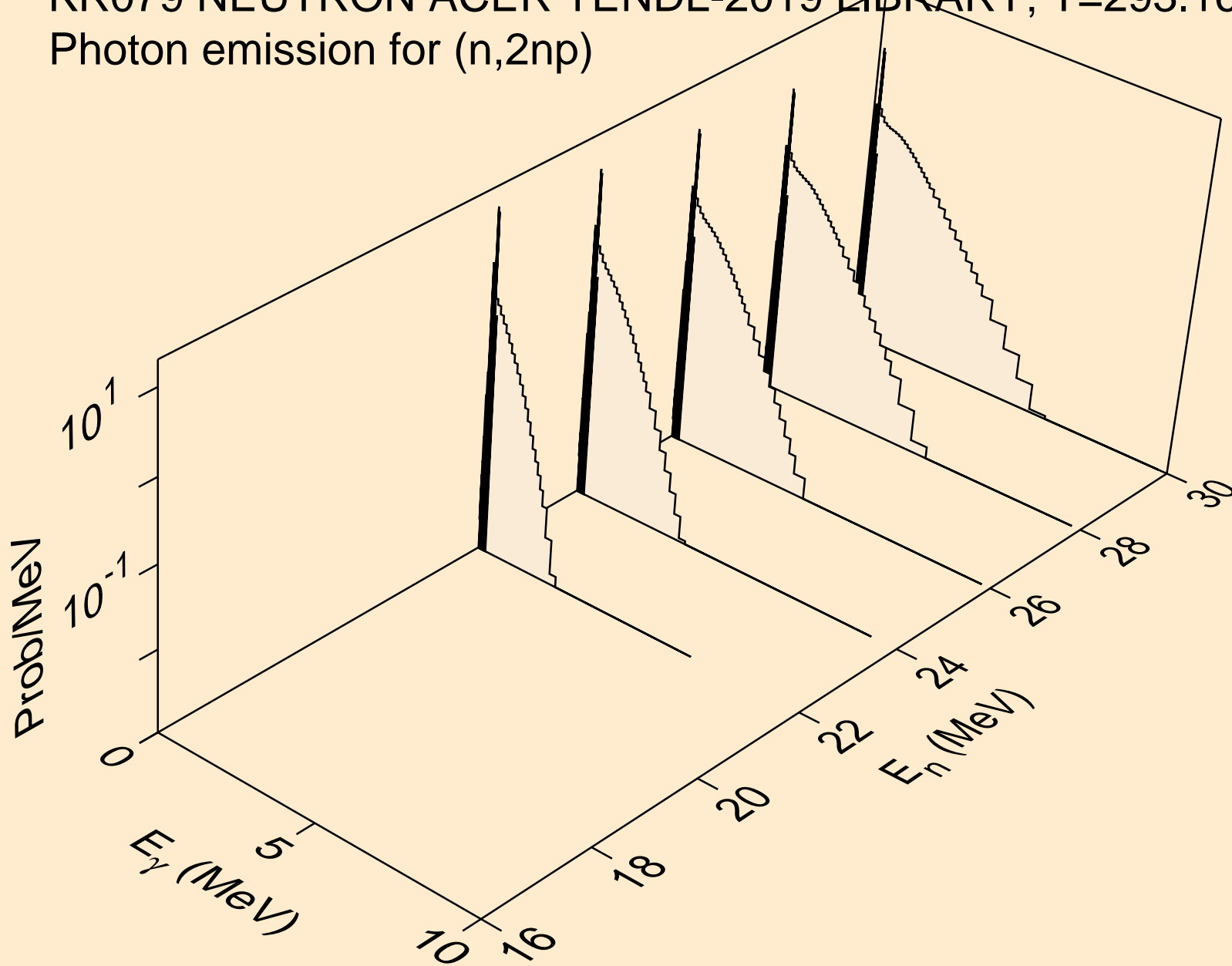



KR079 NEUTRON ACER TENDL-2019 LIBRARY; T=293.16K  
Photon emission for (n,3np)

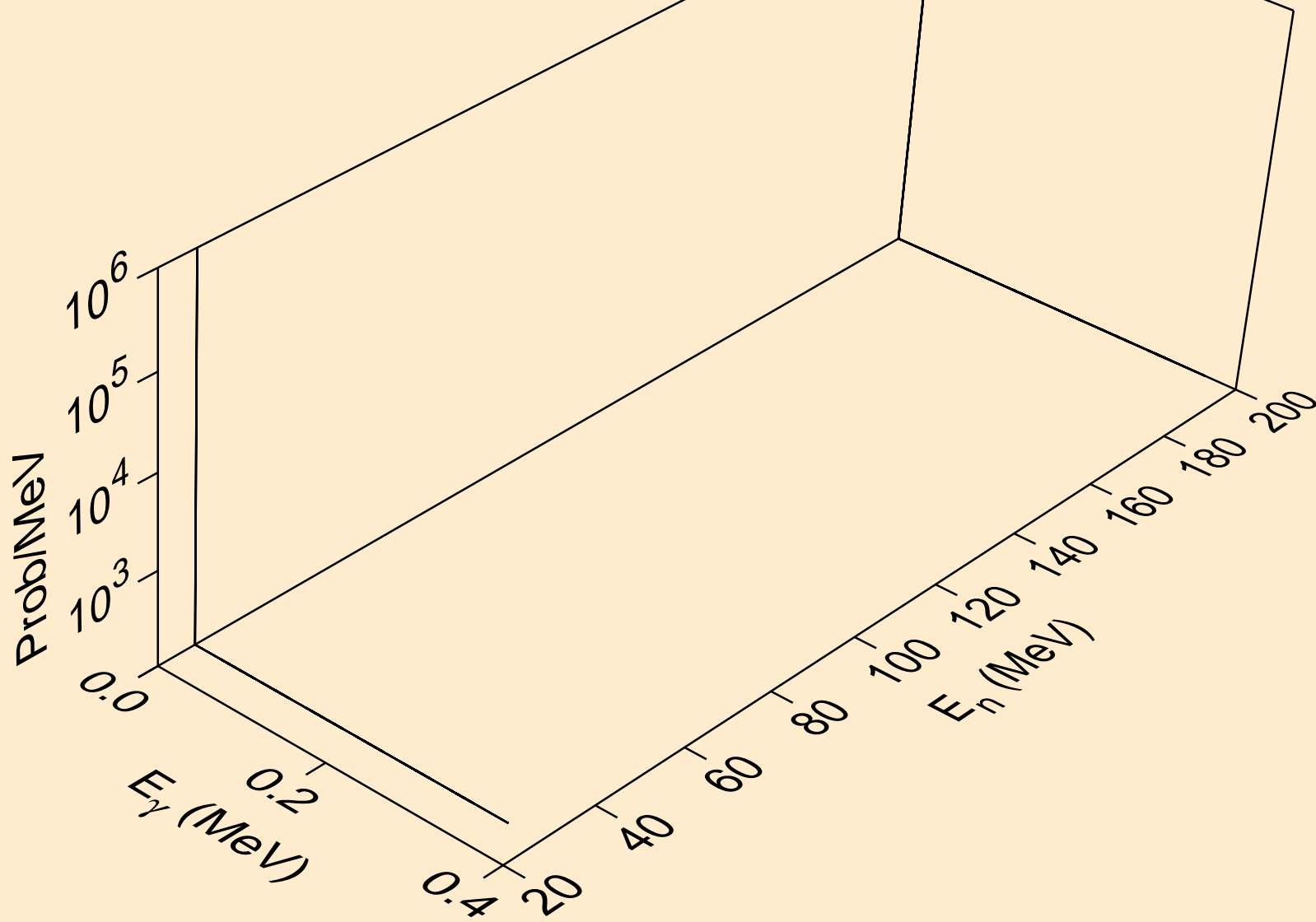

KR079 NEUTRON ACER TENDL-2019 LIBRARY; T=293.16K  
Photon emission for (n,2np)

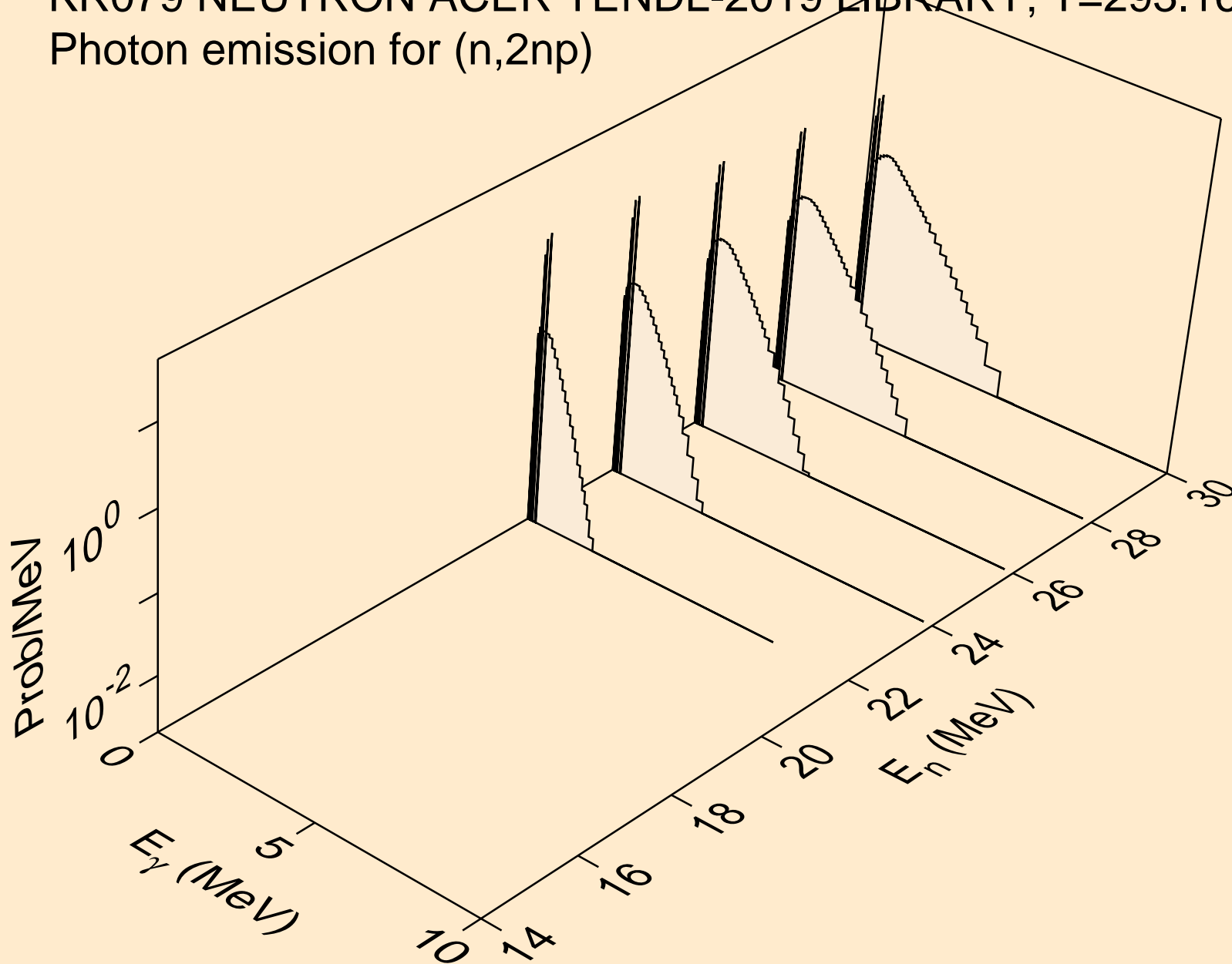

KR079 NEUTRON ACER TENDL-2019 LIBRARY; T=293.16K  
Photon emission for (n,npa)

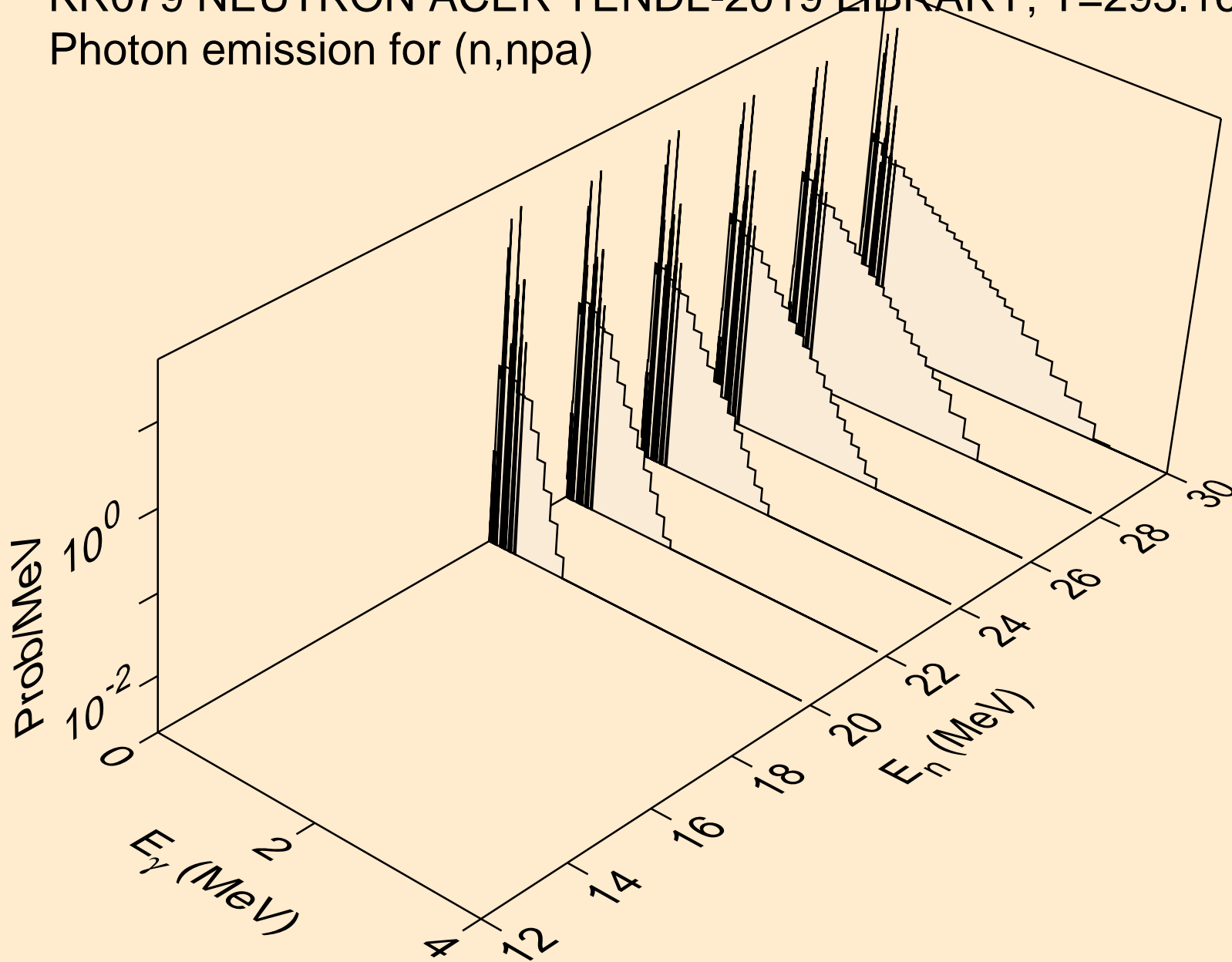

KR079 NEUTRON ACER TENDL-2019 LIBRARY; T=293.16K  
Photon emission for (n,n\*c)

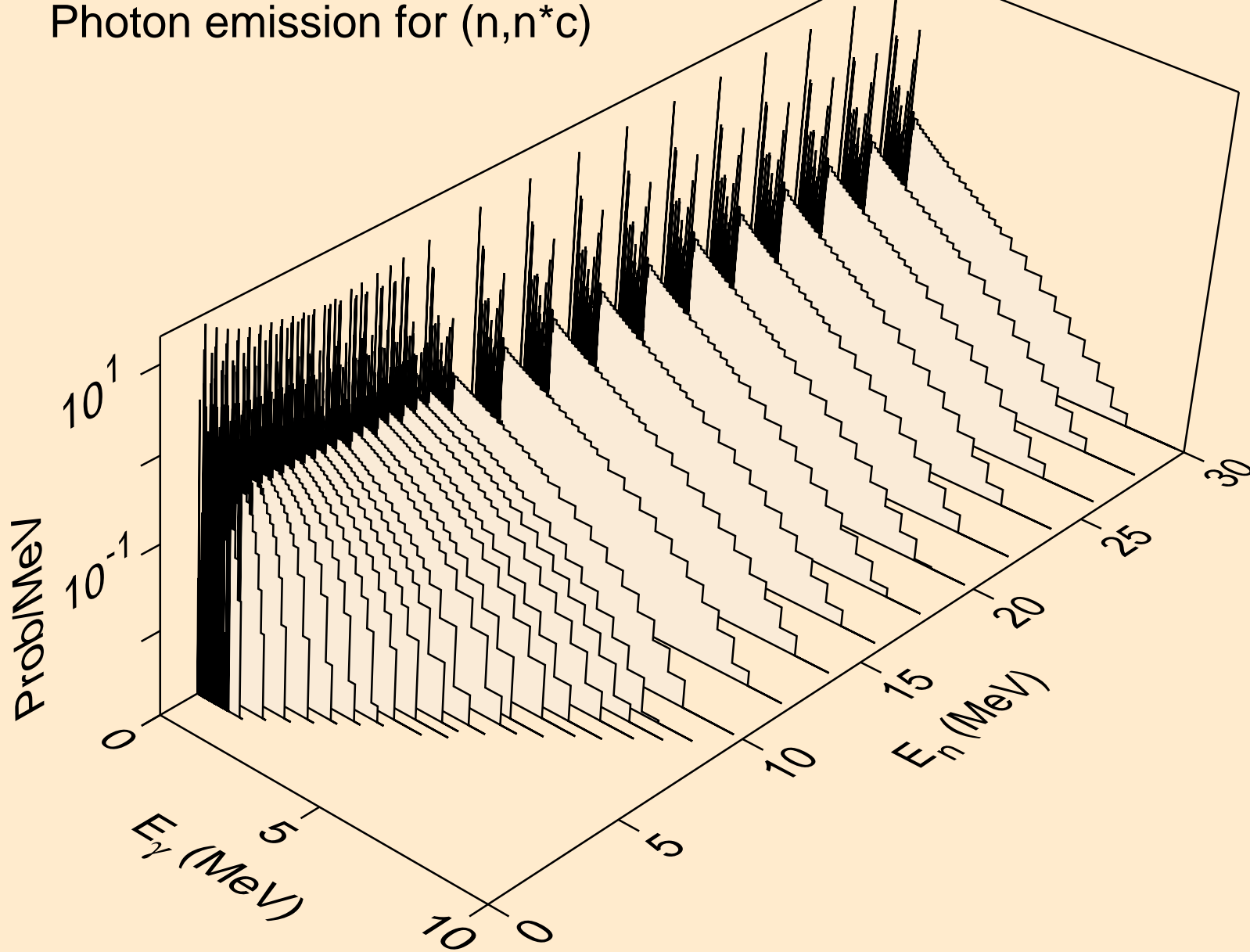

KR079 NEUTRON ACER TENDL-2019 LIBRARY; T=293.16K  
Photon emission for (n,gma)

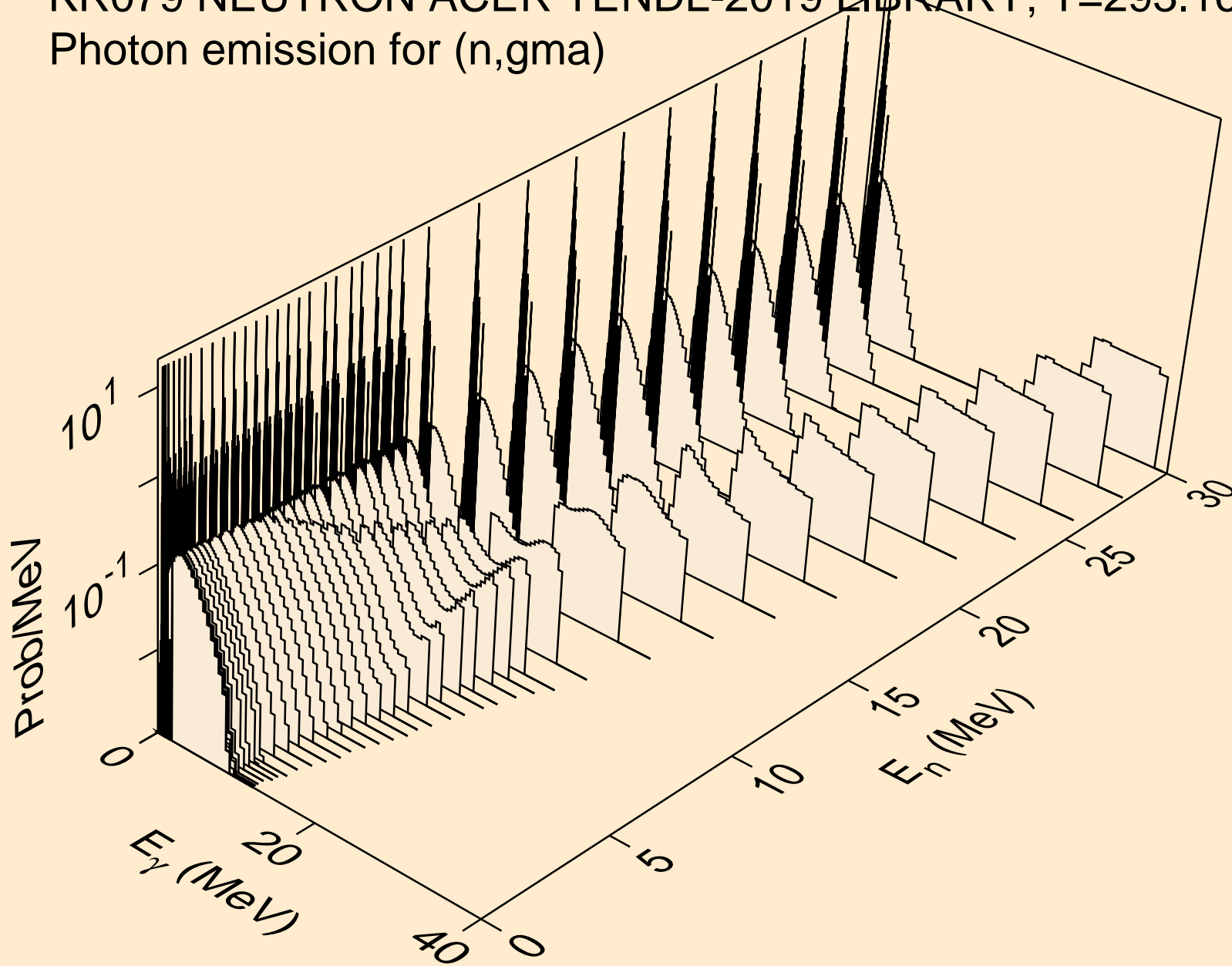

KR079 NEUTRON ACER TENDL-2019 LIBRARY; T=293.16K  
Photon emission for (n,p)

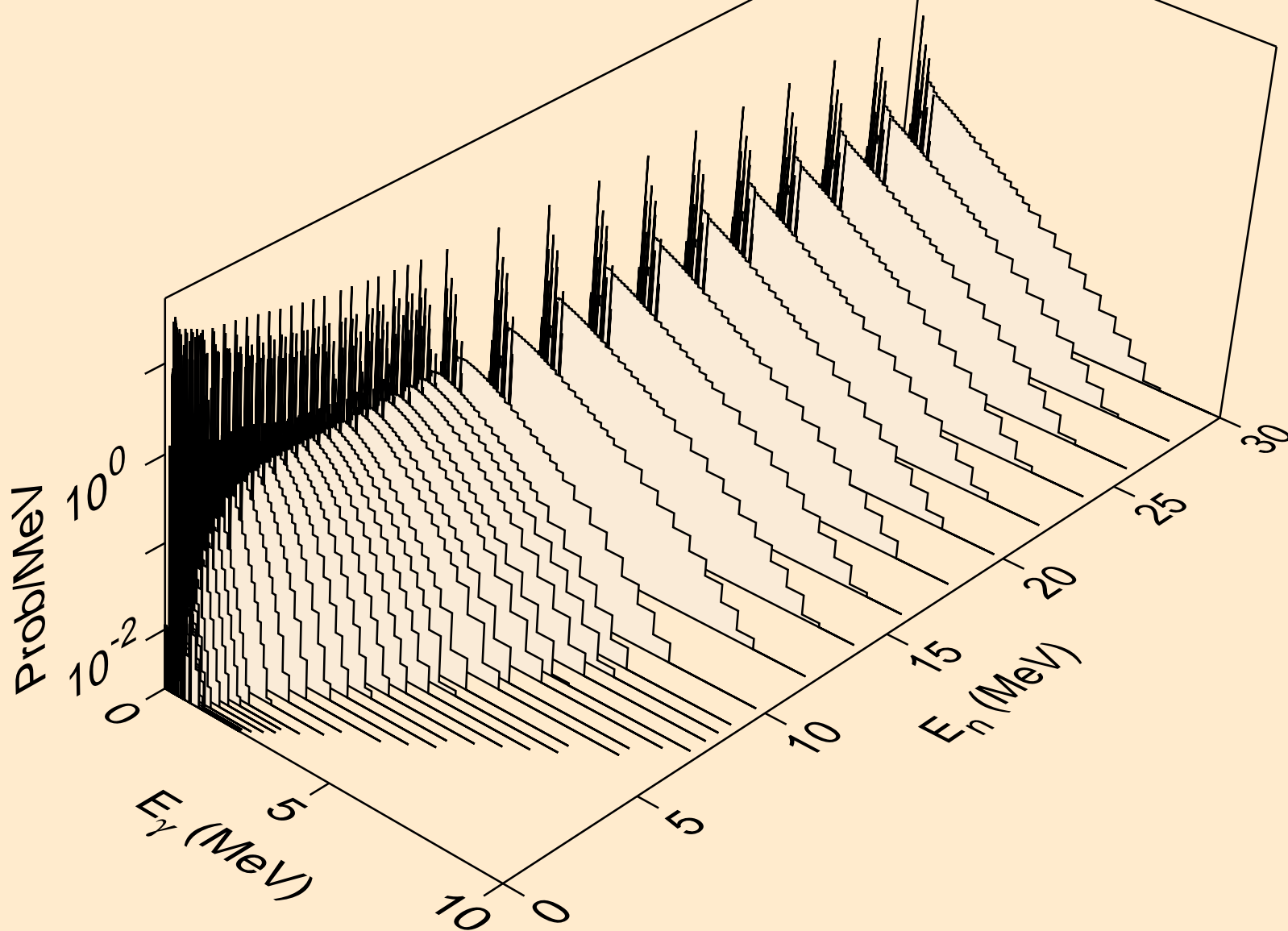

KR079 NEUTRON ACER TENDL-2019 LIBRARY; T=293.16K  
Photon emission for (n,d)

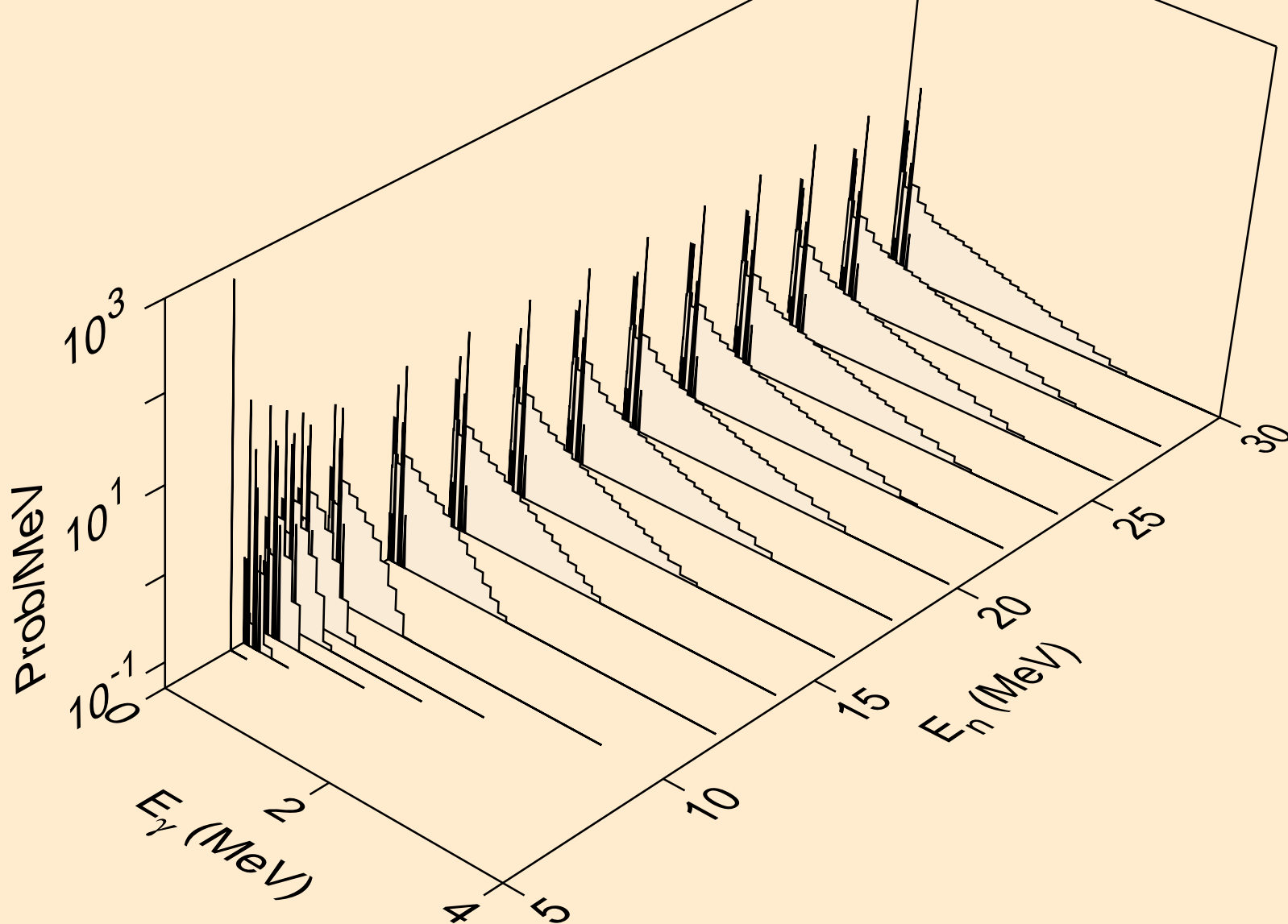

KR079 NEUTRON ACER TENDL-2019 LIBRARY; T=293.16K  
Photon emission for (n,t)

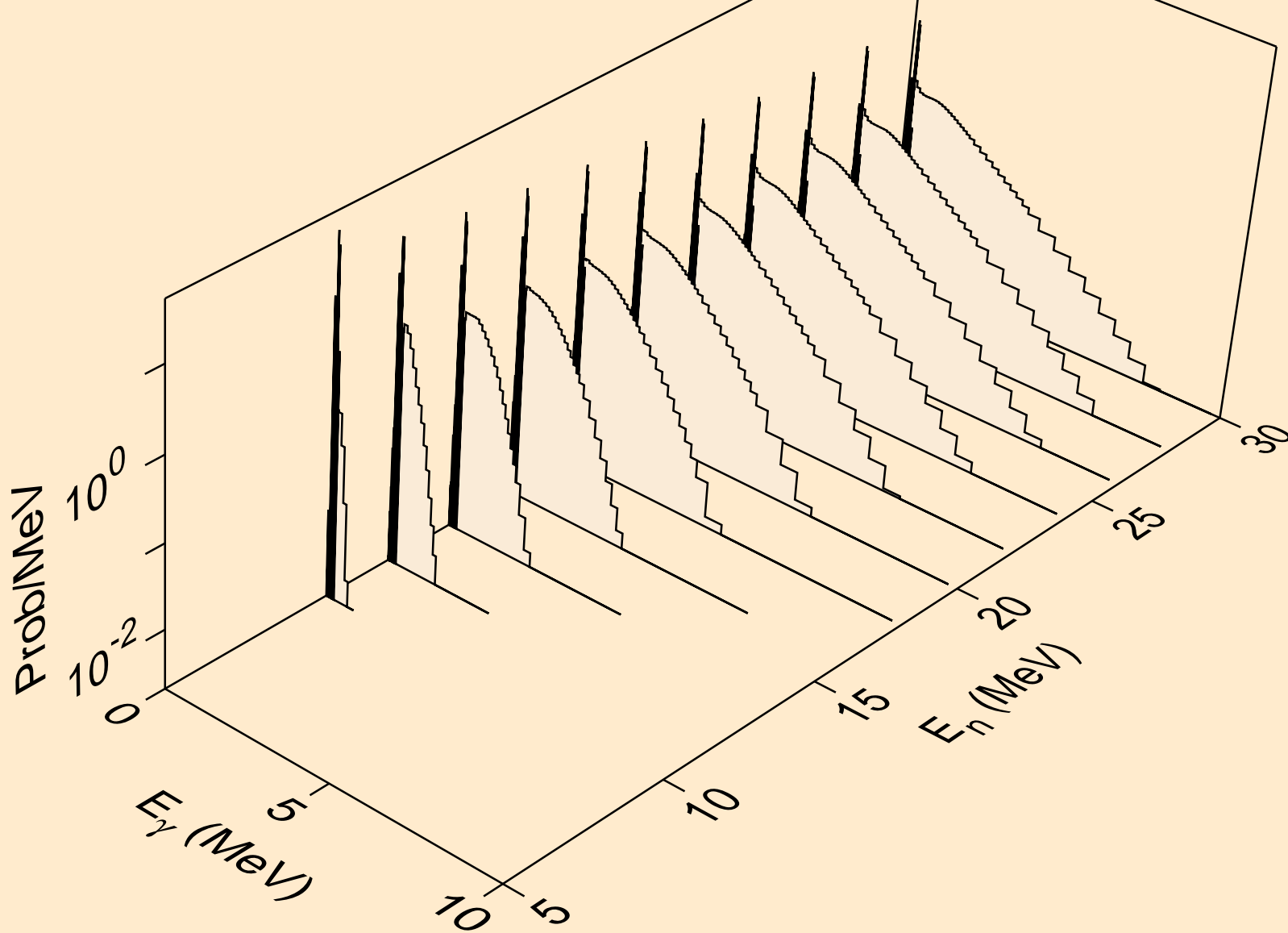



KR079 NEUTRON ACER TENDL-2019 LIBRARY; T=293.16K  
Photon emission for (n,he3)

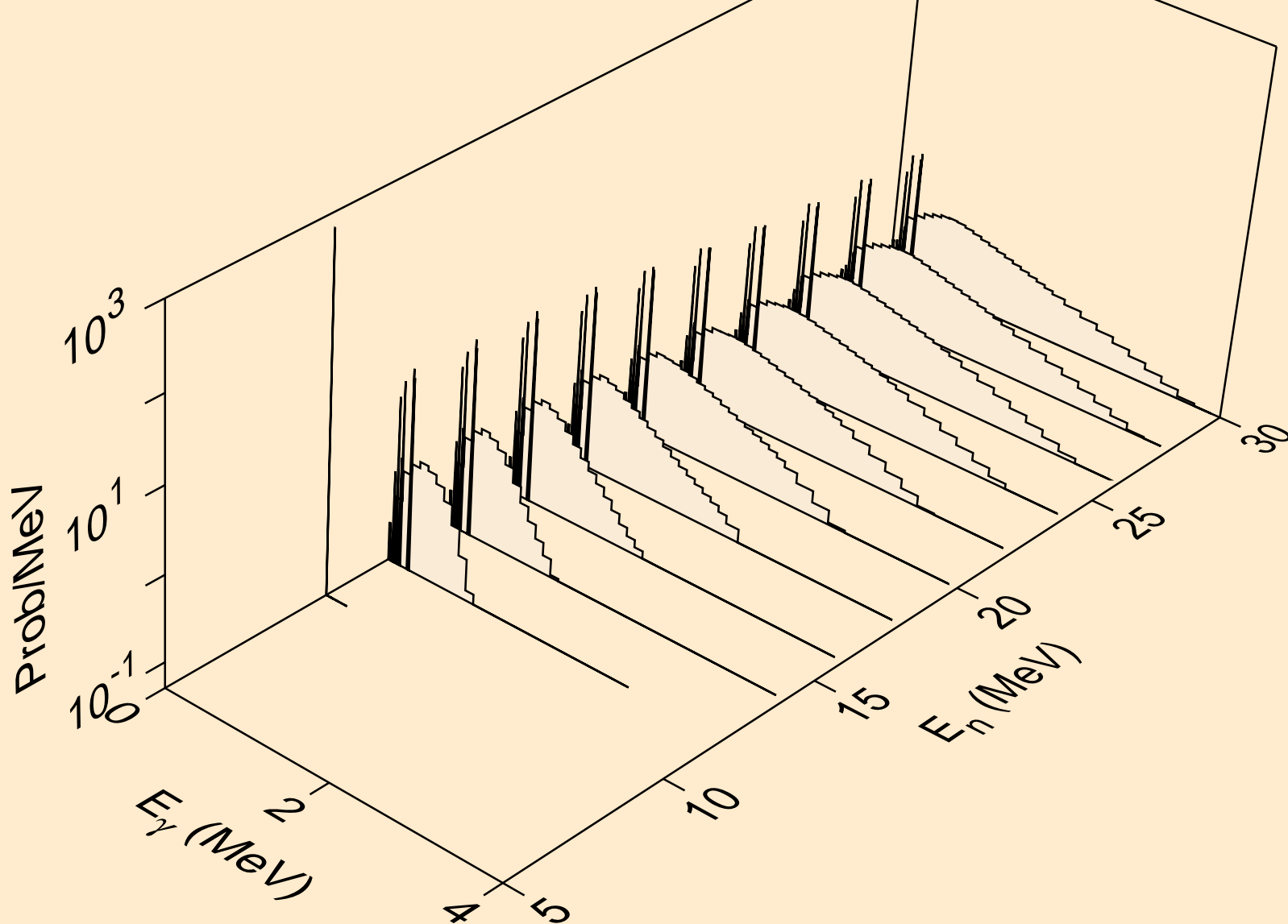

KR079 NEUTRON ACER TENDL-2019 LIBRARY; T=293.16K  
Photon emission for (n,a)

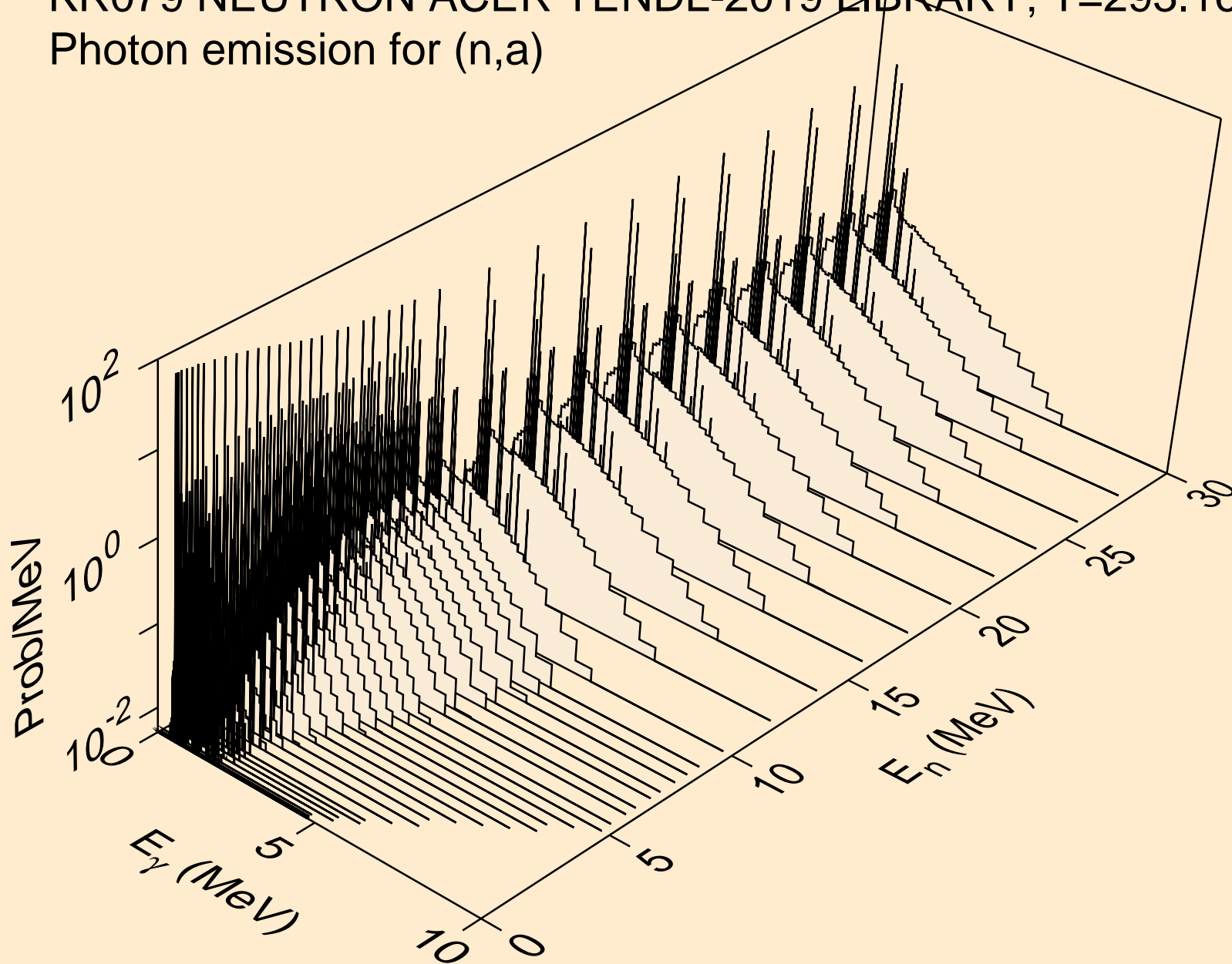

KR079 NEUTRON ACER TENDL-2019 LIBRARY; T=293.16K  
Photon emission for (n,2a)

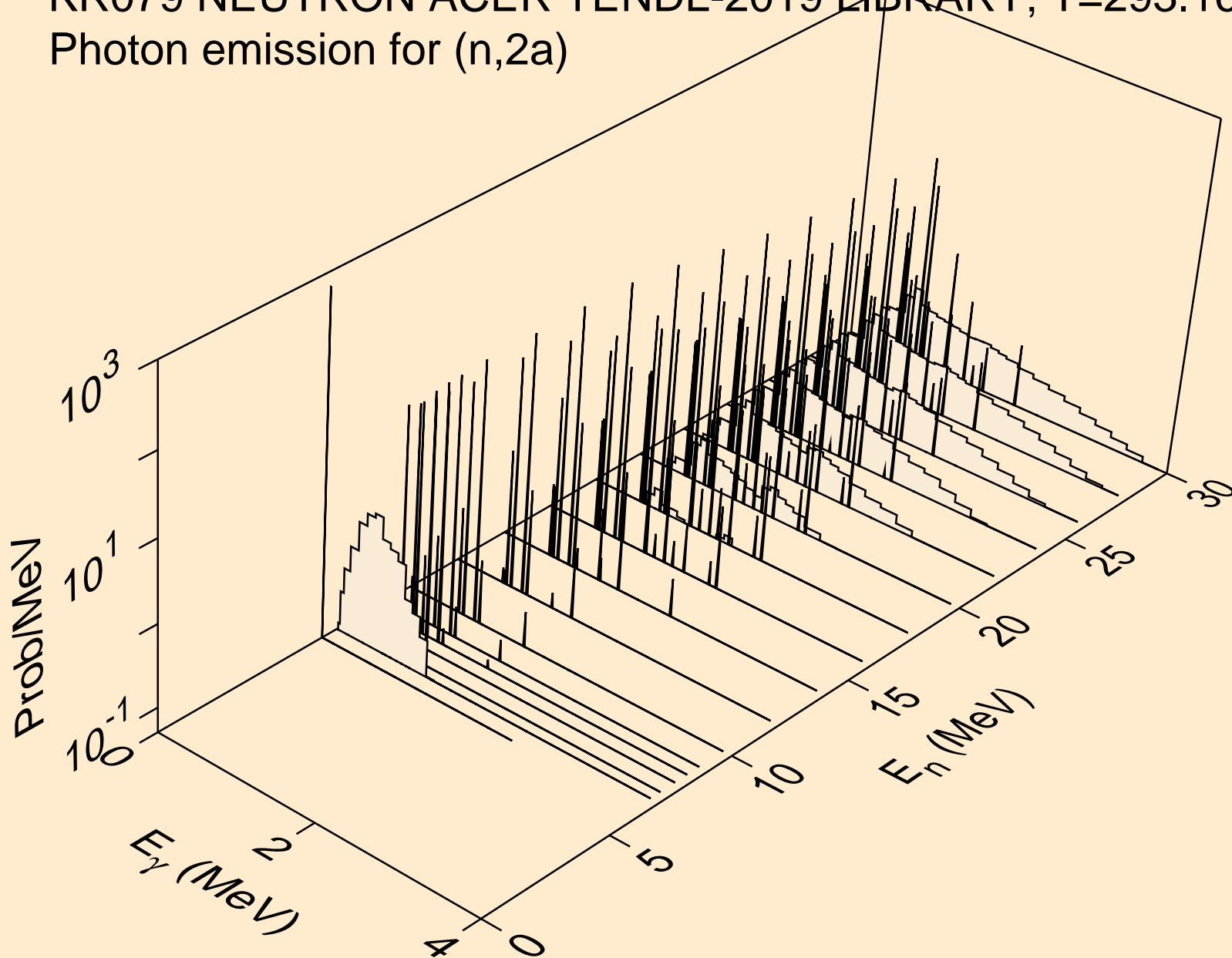

KR079 NEUTRON ACER TENDL-2019 LIBRARY; T=293.16K  
Photon emission for (n,2p)

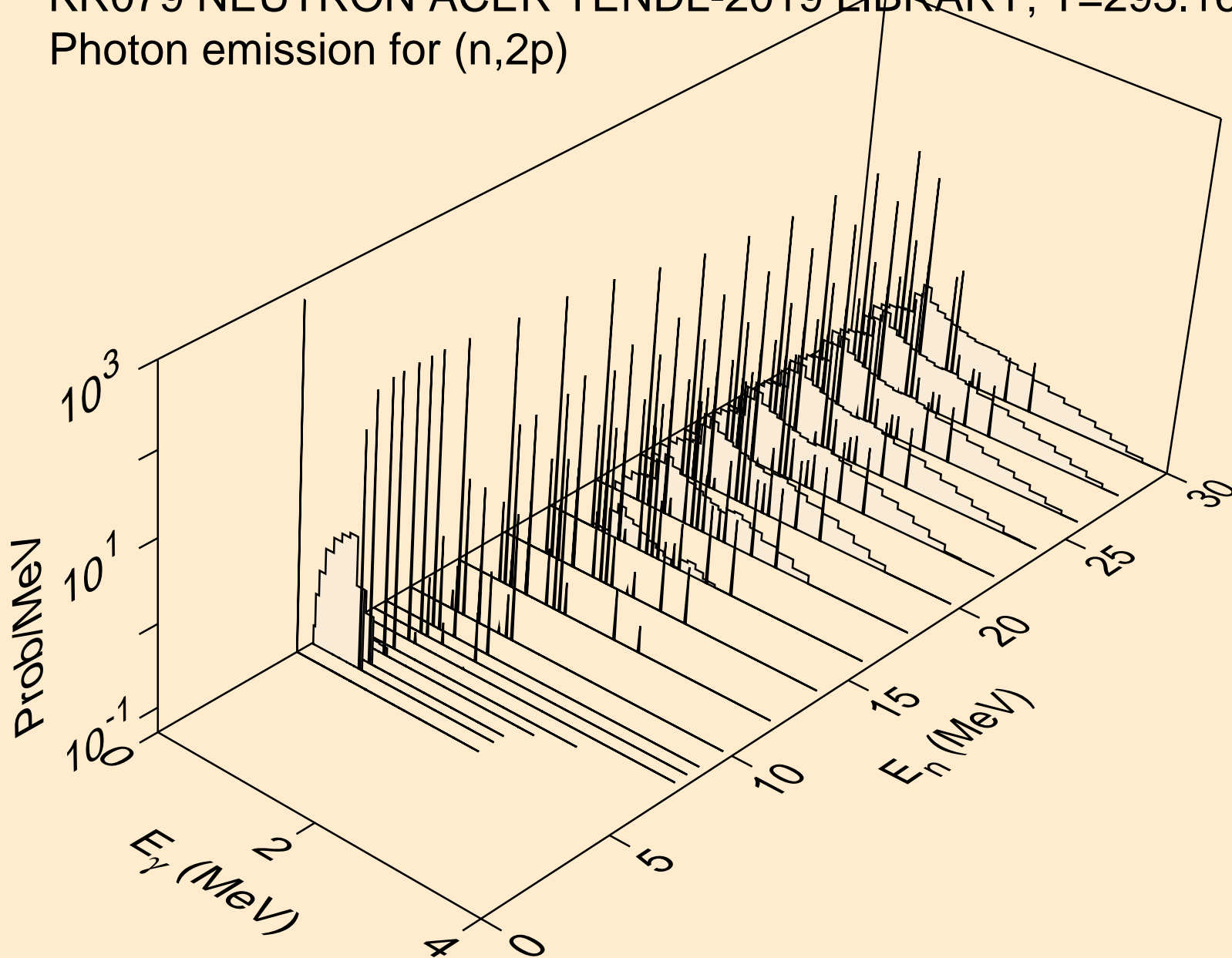

KR079 NEUTRON ACER TENDL-2019 LIBRARY; T=293.16K  
Photon emission for (n,p $\alpha$ )

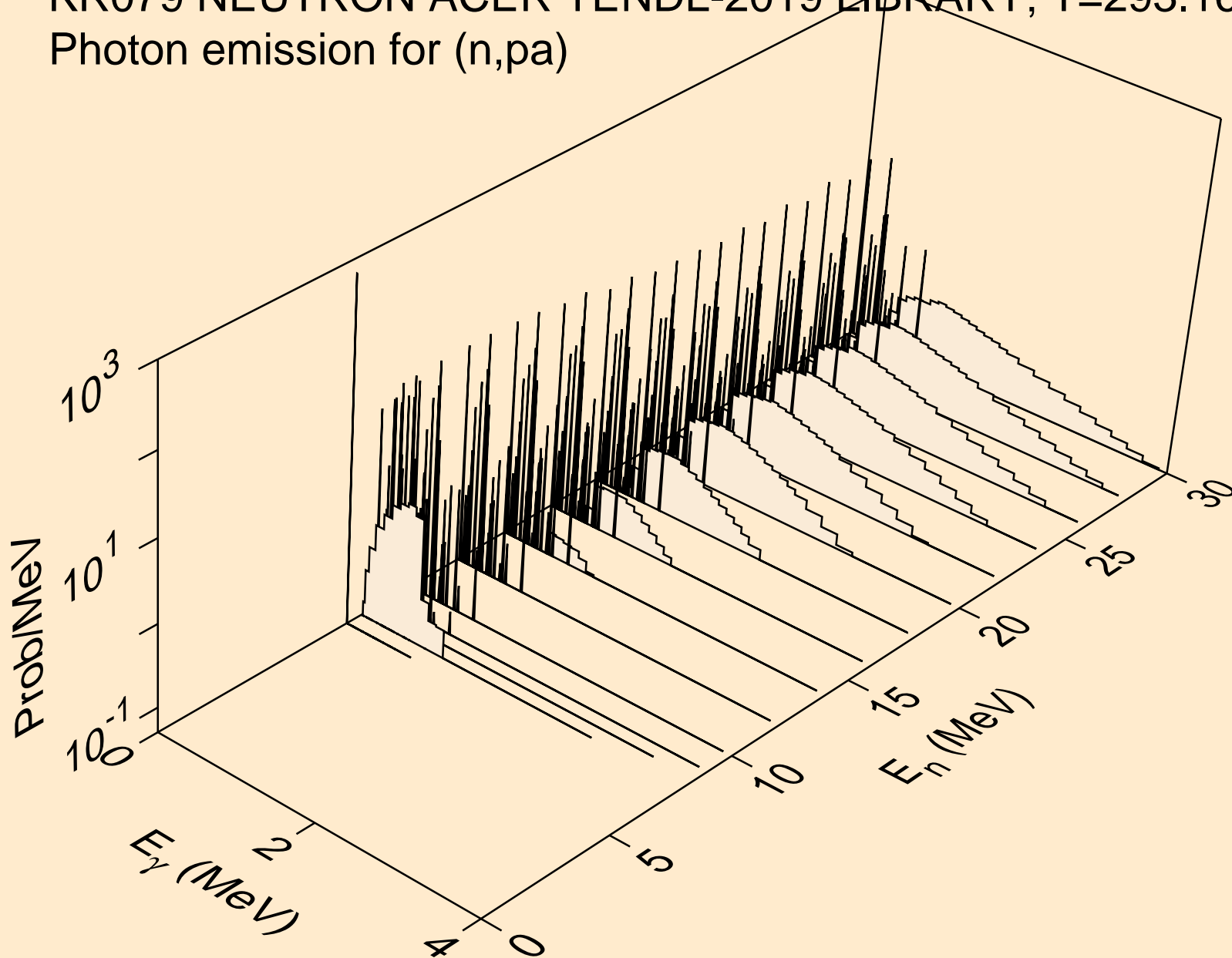

KR079 NEUTRON ACER TENDL-2019 LIBRARY; T=293.16K  
Photon emission for (n,pd)

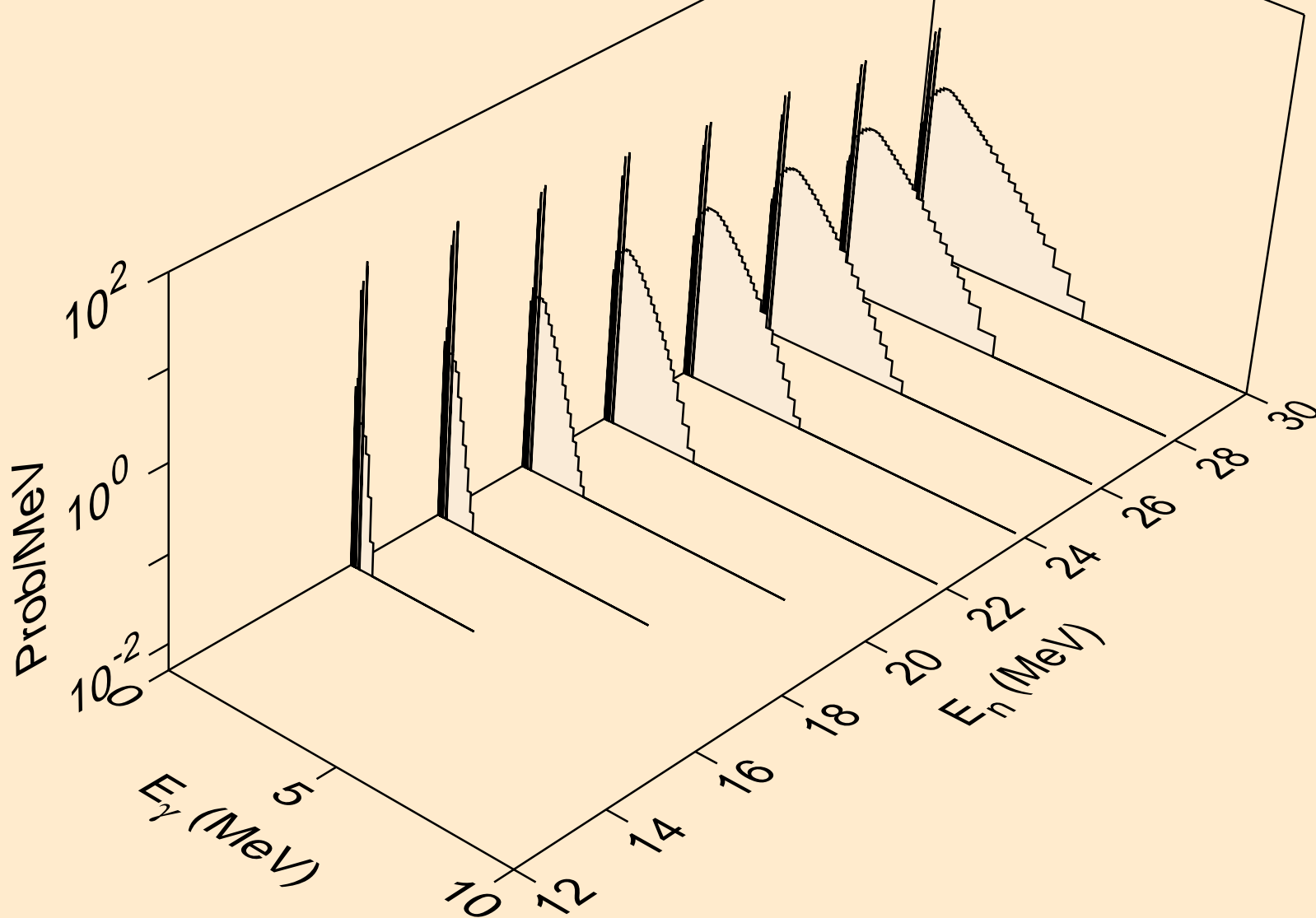

KR079 NEUTRON ACER TENDL-2019 LIBRARY; T=293.16K  
Photon emission for (n,pt)

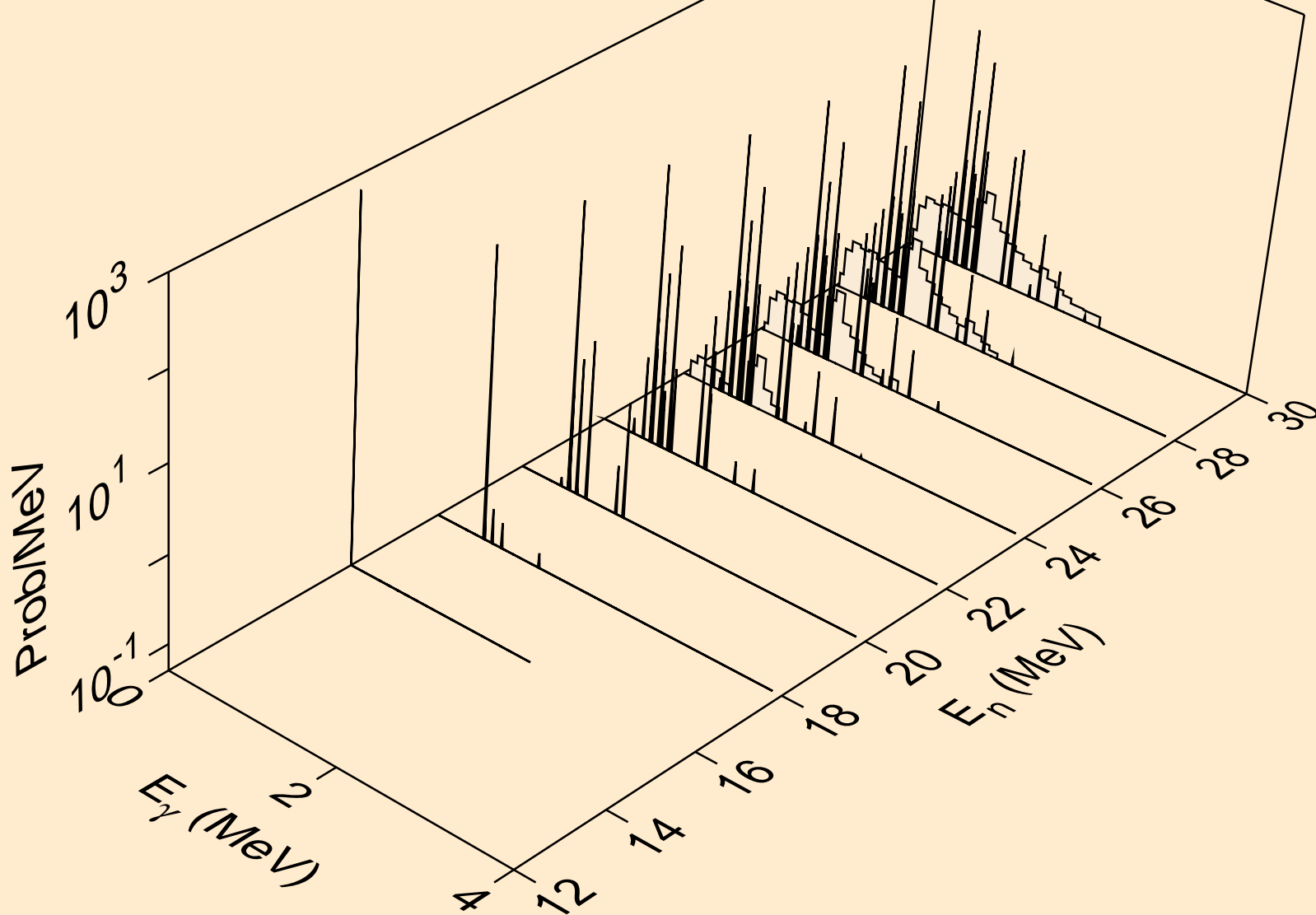

KR079 NEUTRON ACER TENDL-2019 LIBRARY; T=293.16K  
Photon emission for (n,da)

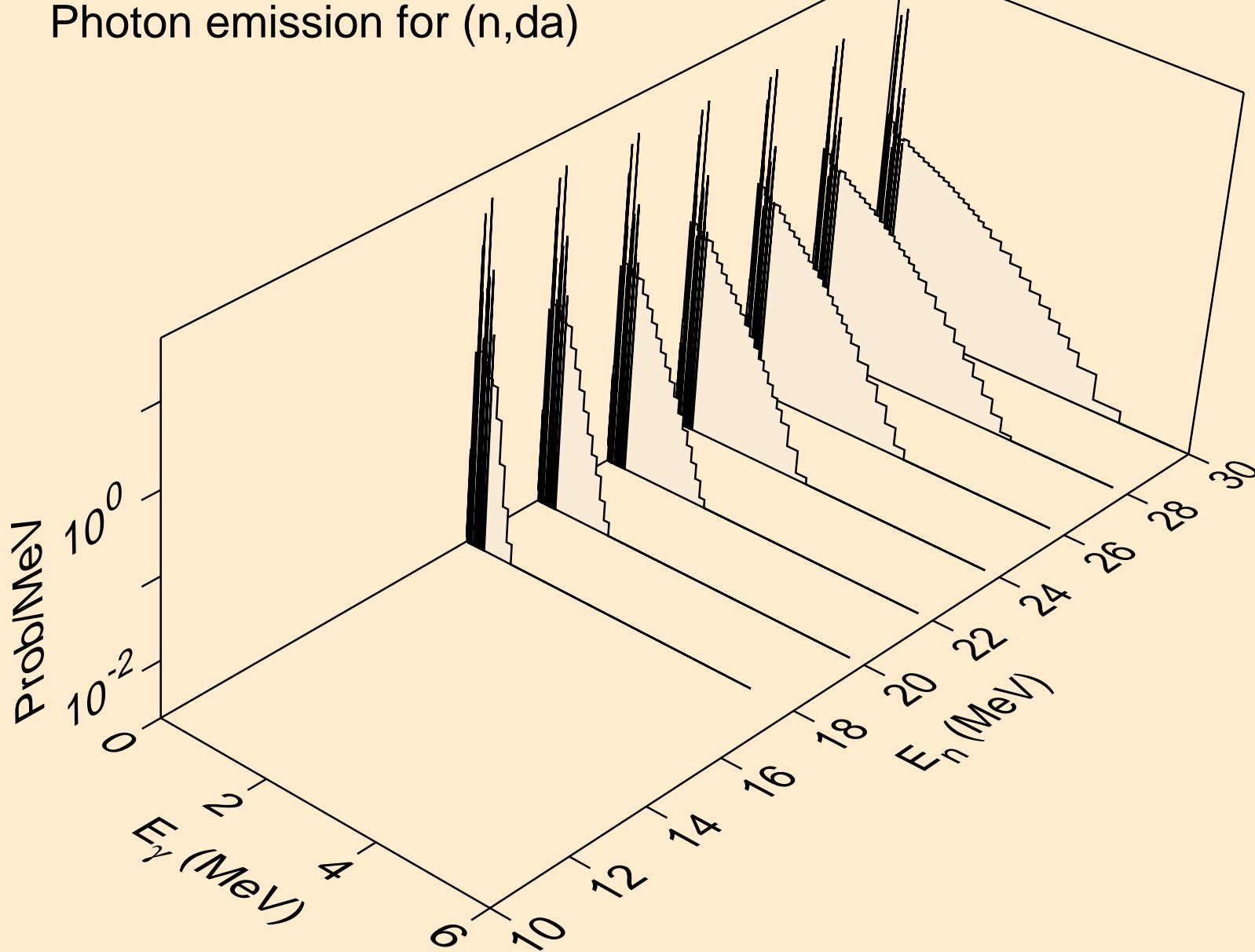



KR079 NEUTRON ACER TENDL-2019 LIBRARY; T=293.16K  
thermal capture photon spectrum

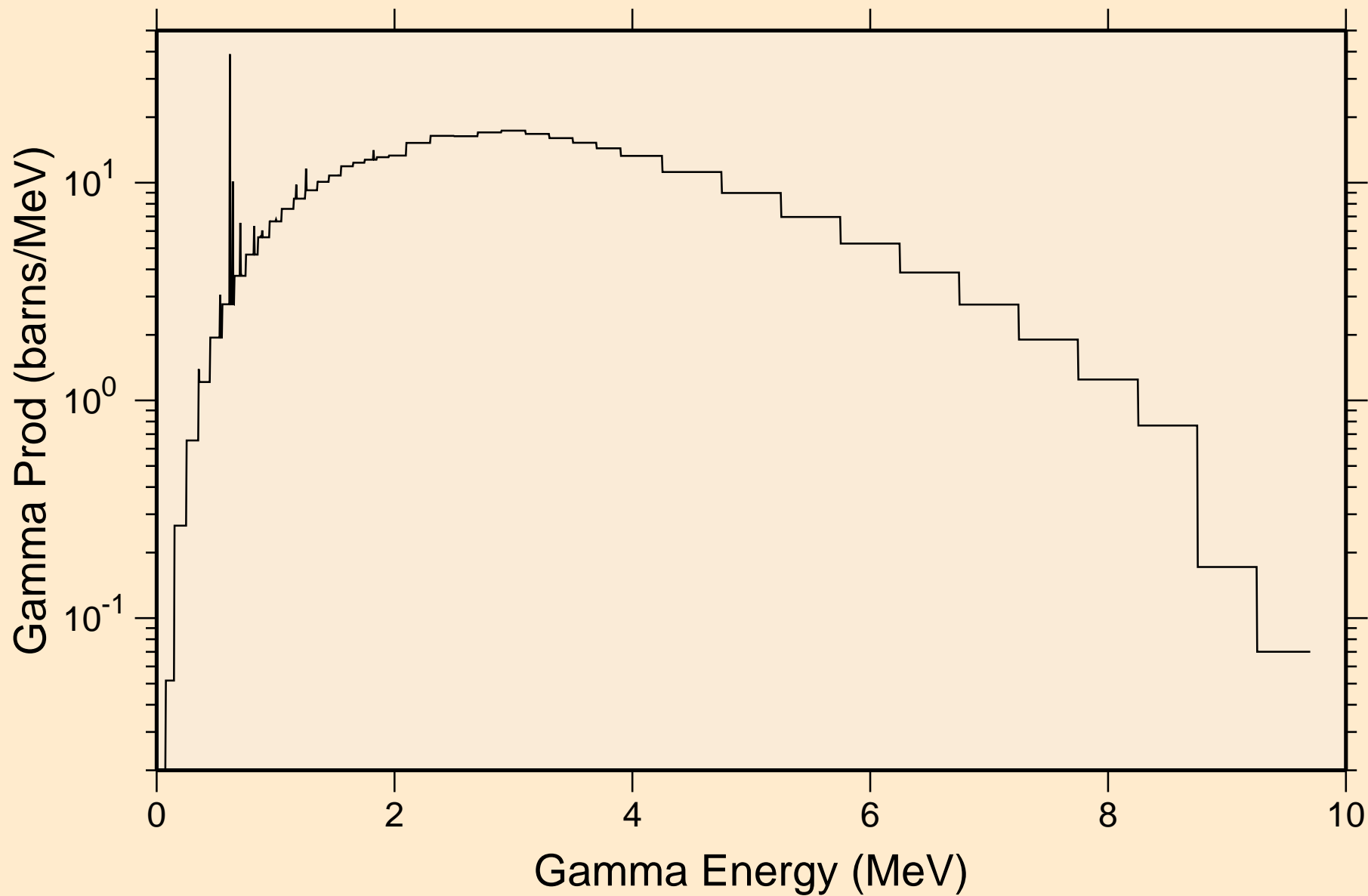

KR079 NEUTRON ACER TENDL-2019 LIBRARY; T=293.16K  
14 MeV photon spectrum

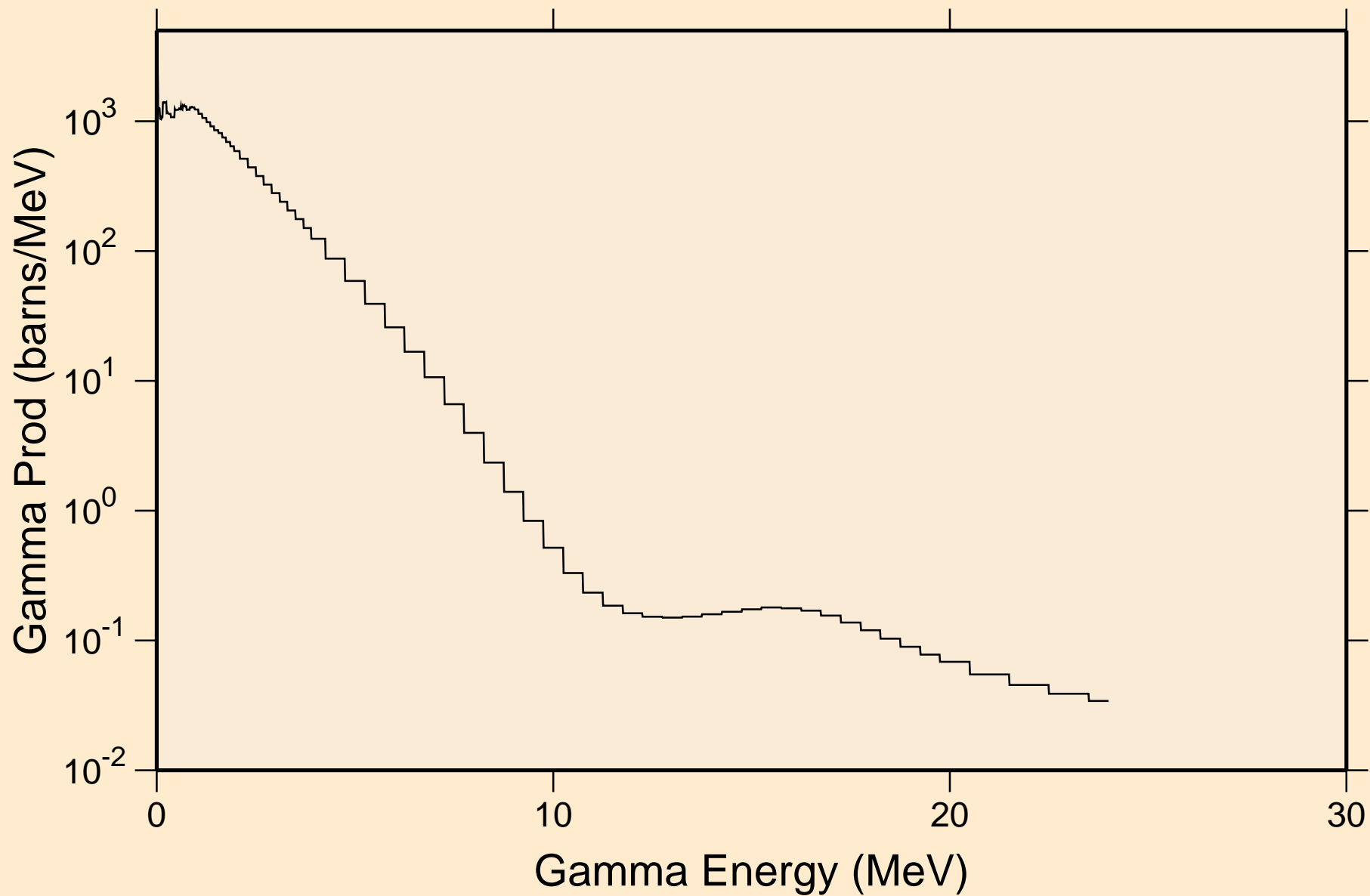

# KR079 NEUTRON ACER TENDL-2019 LIBRARY; T=293.16K

## Particle heating contributions

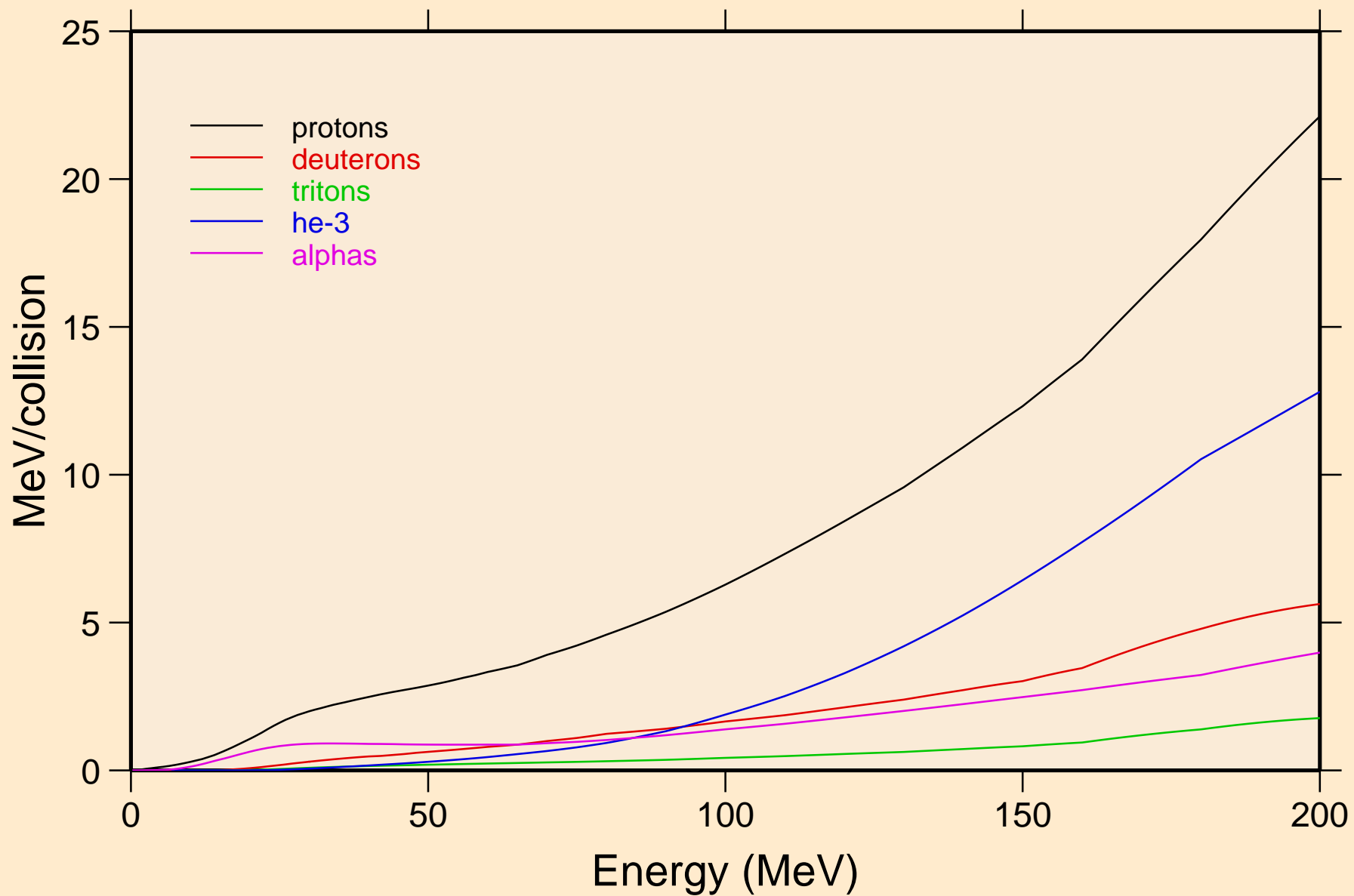

KR079 NEUTRON ACER TENDL-2019 LIBRARY; T=293.16K  
Recoil Heating

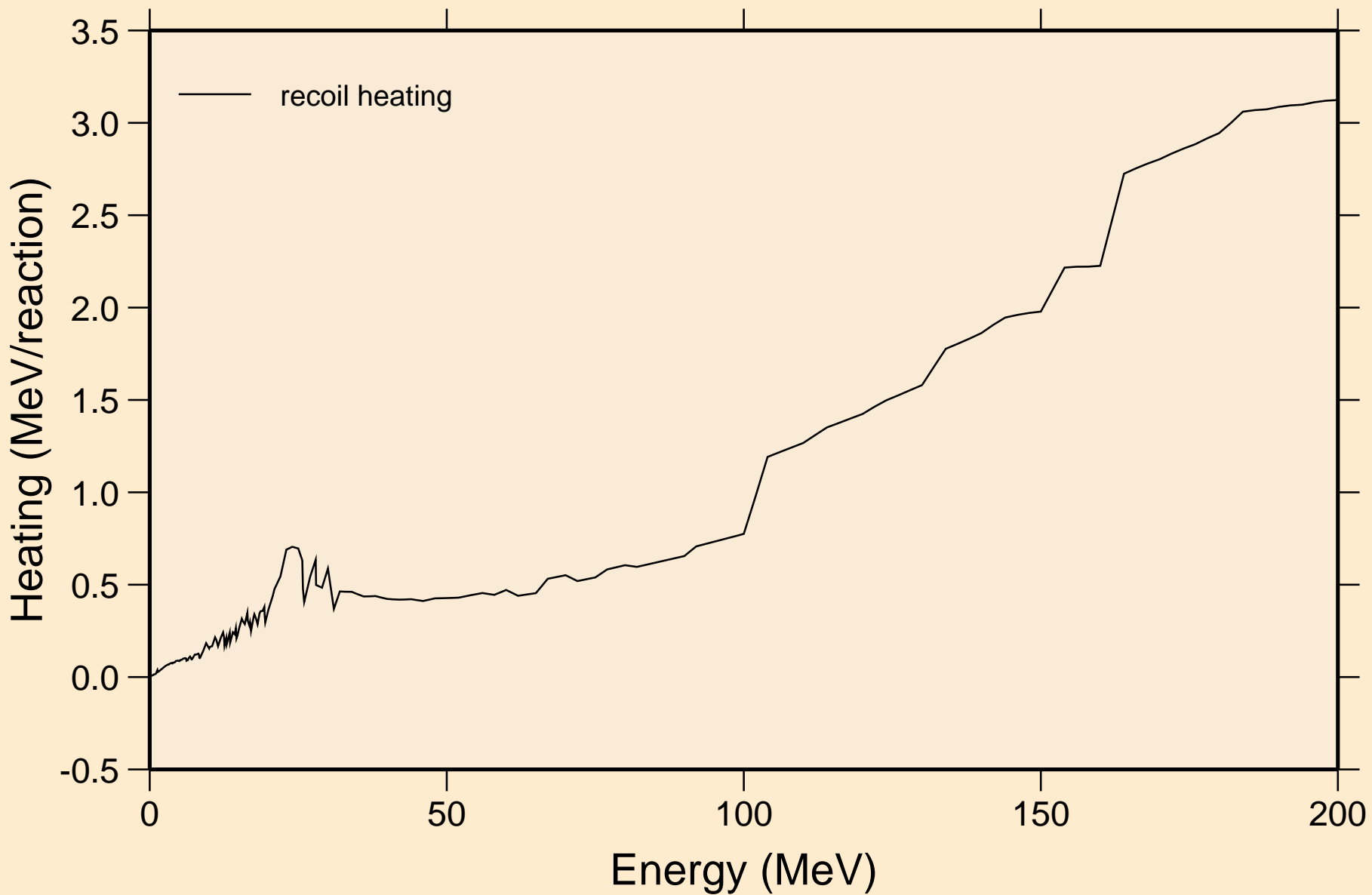

KR079 NEUTRON ACER TENDL-2019 LIBRARY; T=293.16K  
Particle production cross sections

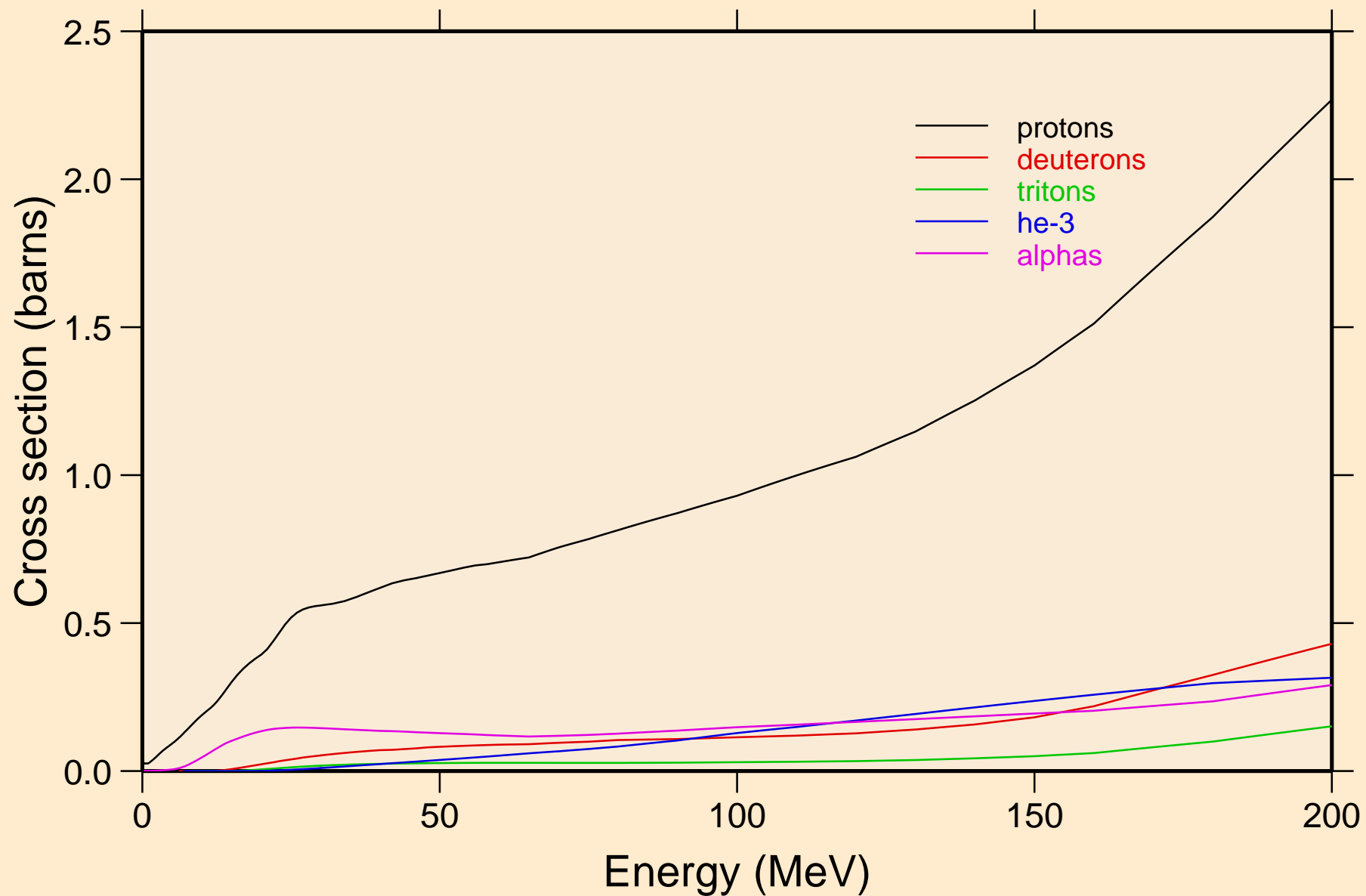

KR079 NEUTRON ACER TENDL-2019 LIBRARY; T=293.16K  
protons from (n,x)

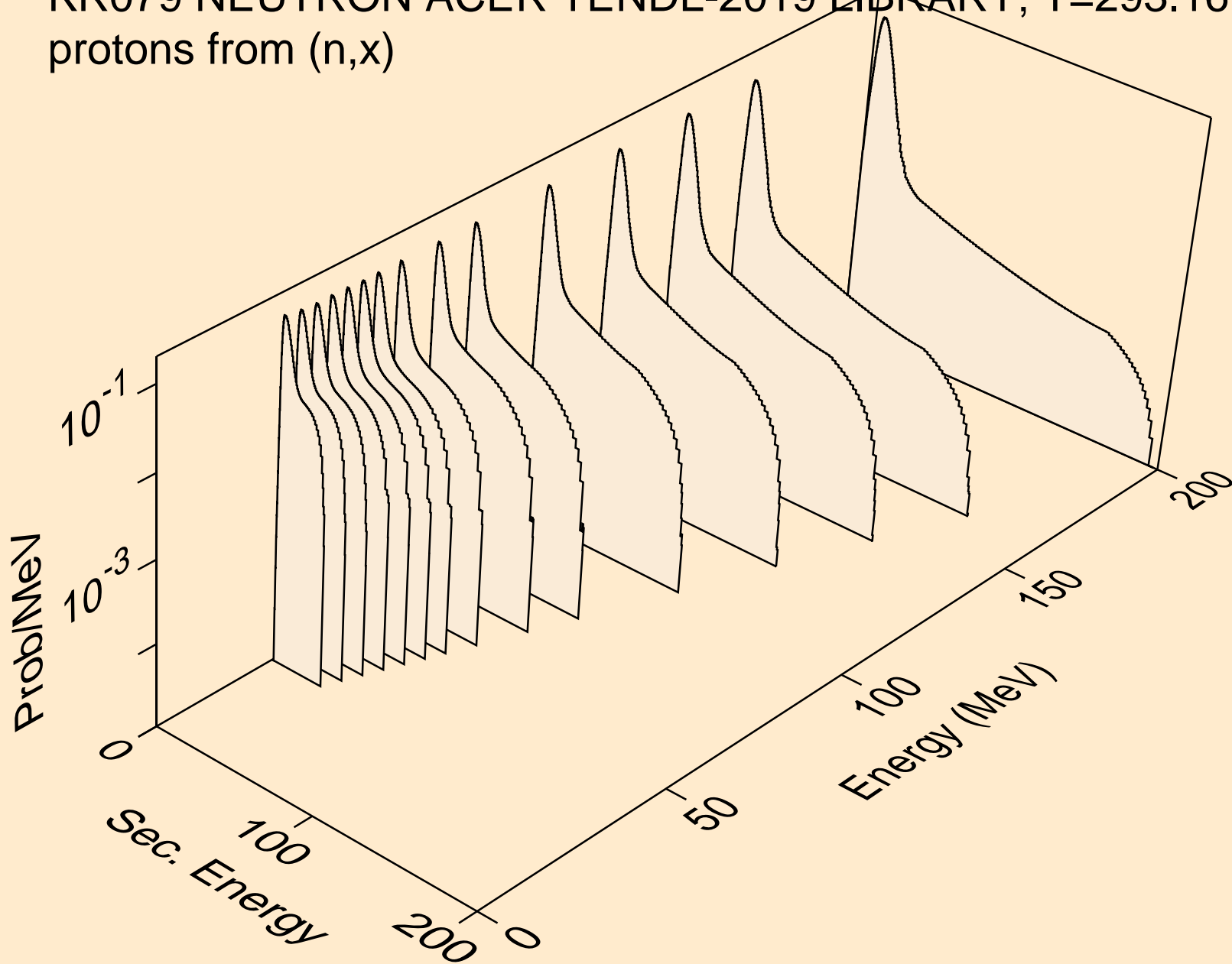

KR079 NEUTRON ACER TENDL-2019 LIBRARY; T=293.16K  
protons from (n,n\*)p

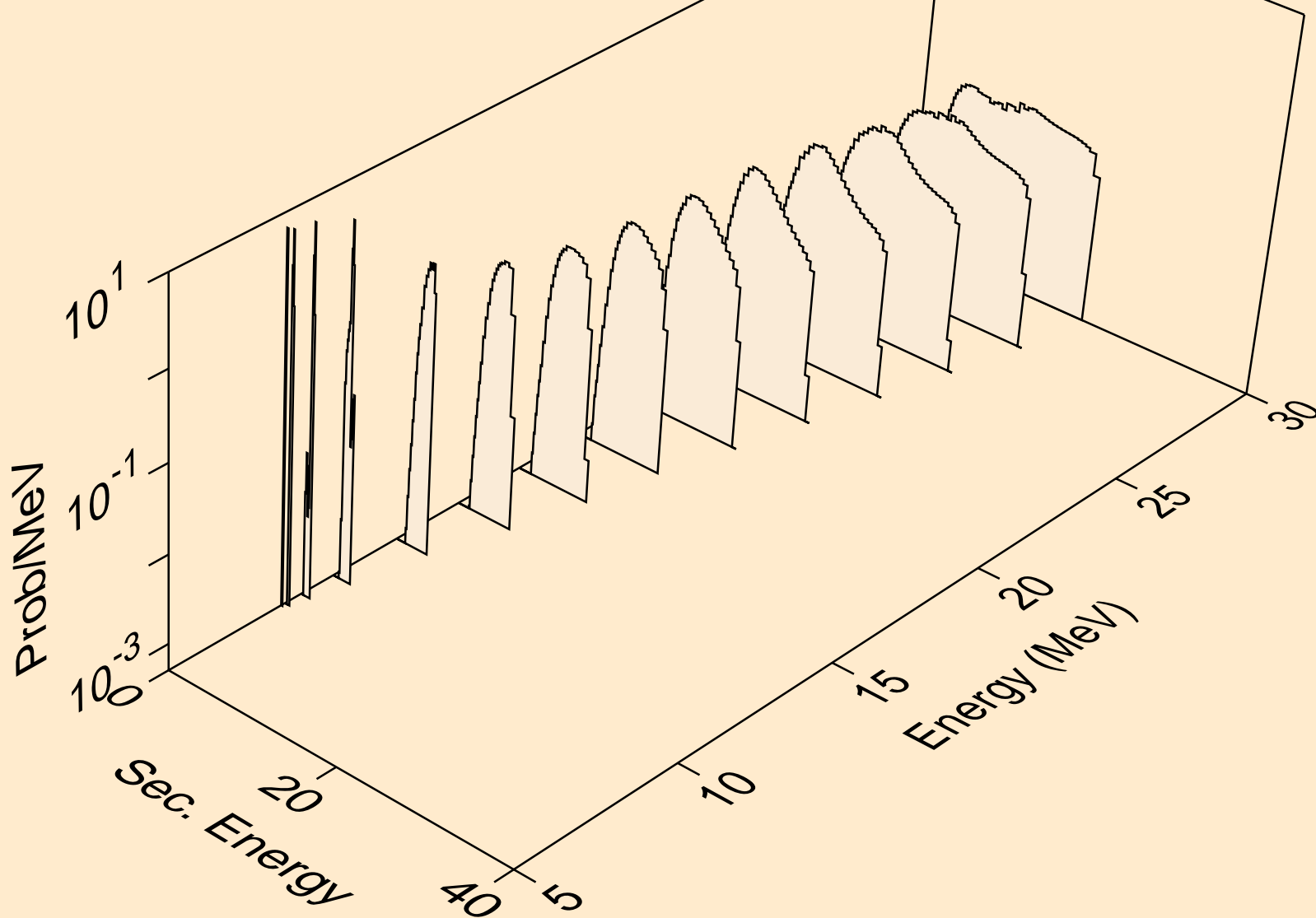

KR079 NEUTRON ACER TENDL-2019 LIBRARY; T=293.16K  
protons from (n,2np)

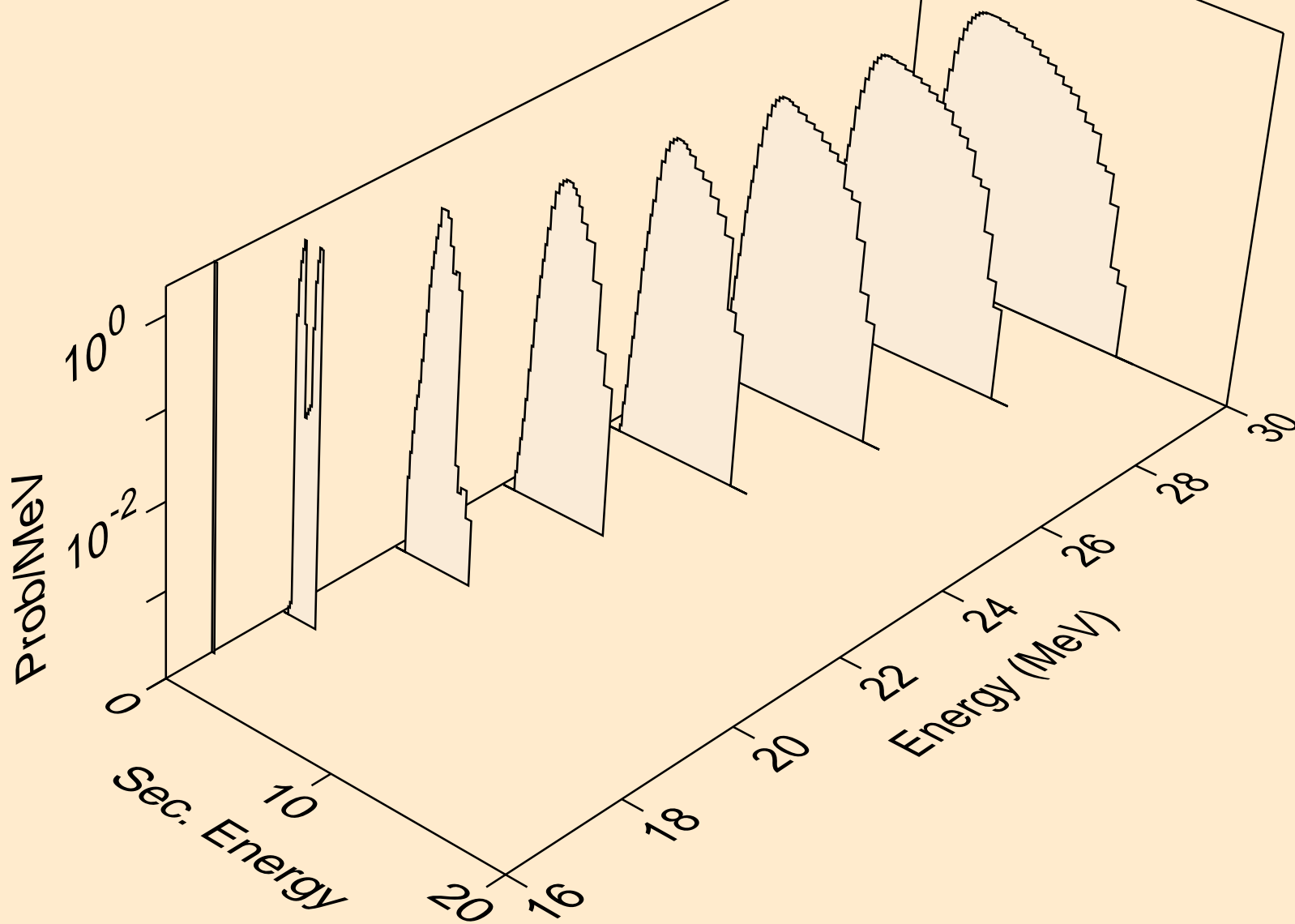



KR079 NEUTRON ACER TENDL-2019 LIBRARY; T=293.16K  
protons from (n,3np)

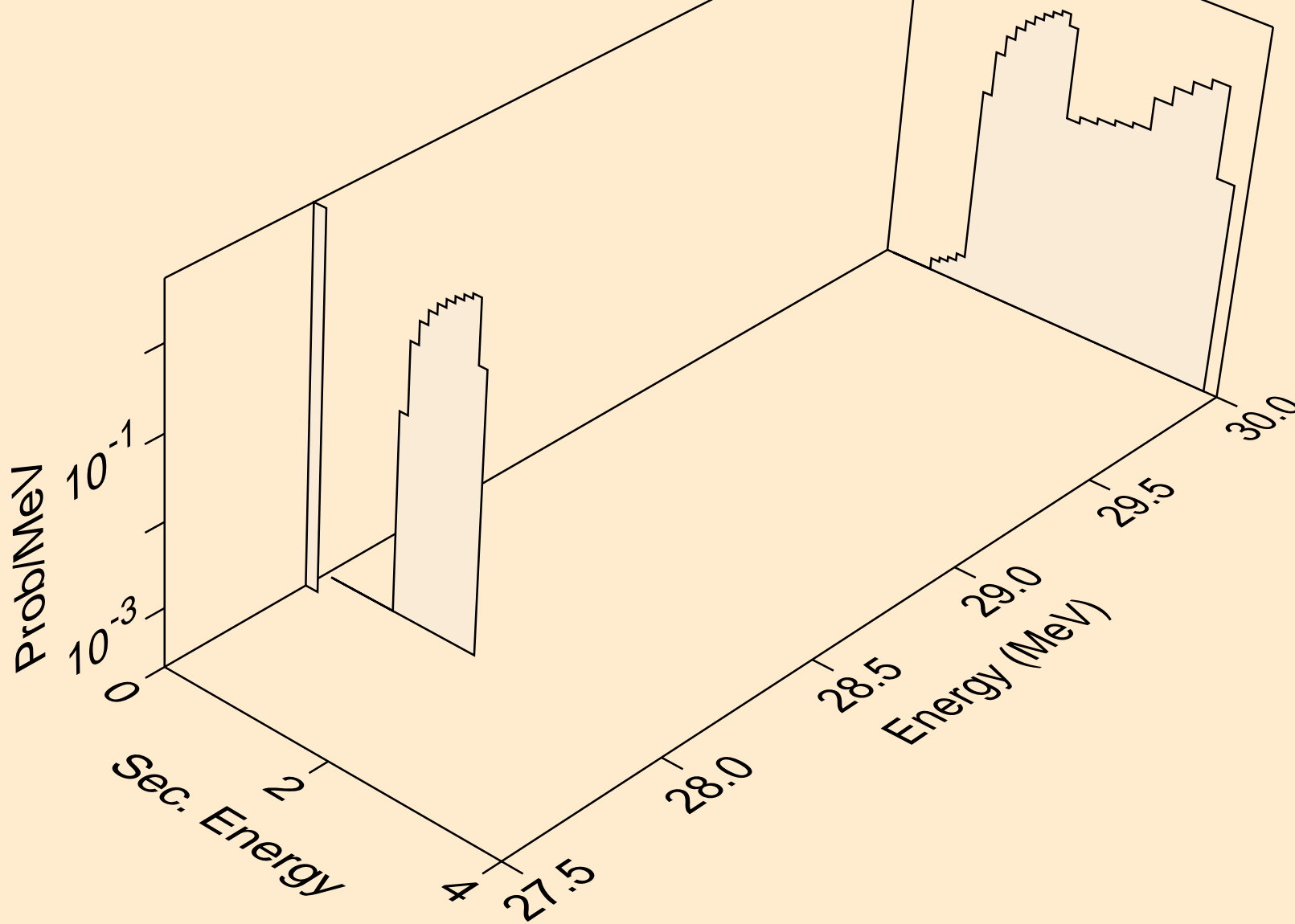

KR079 NEUTRON ACER TENDL-2019 LIBRARY; T=293.16K  
protons from (n,2np)

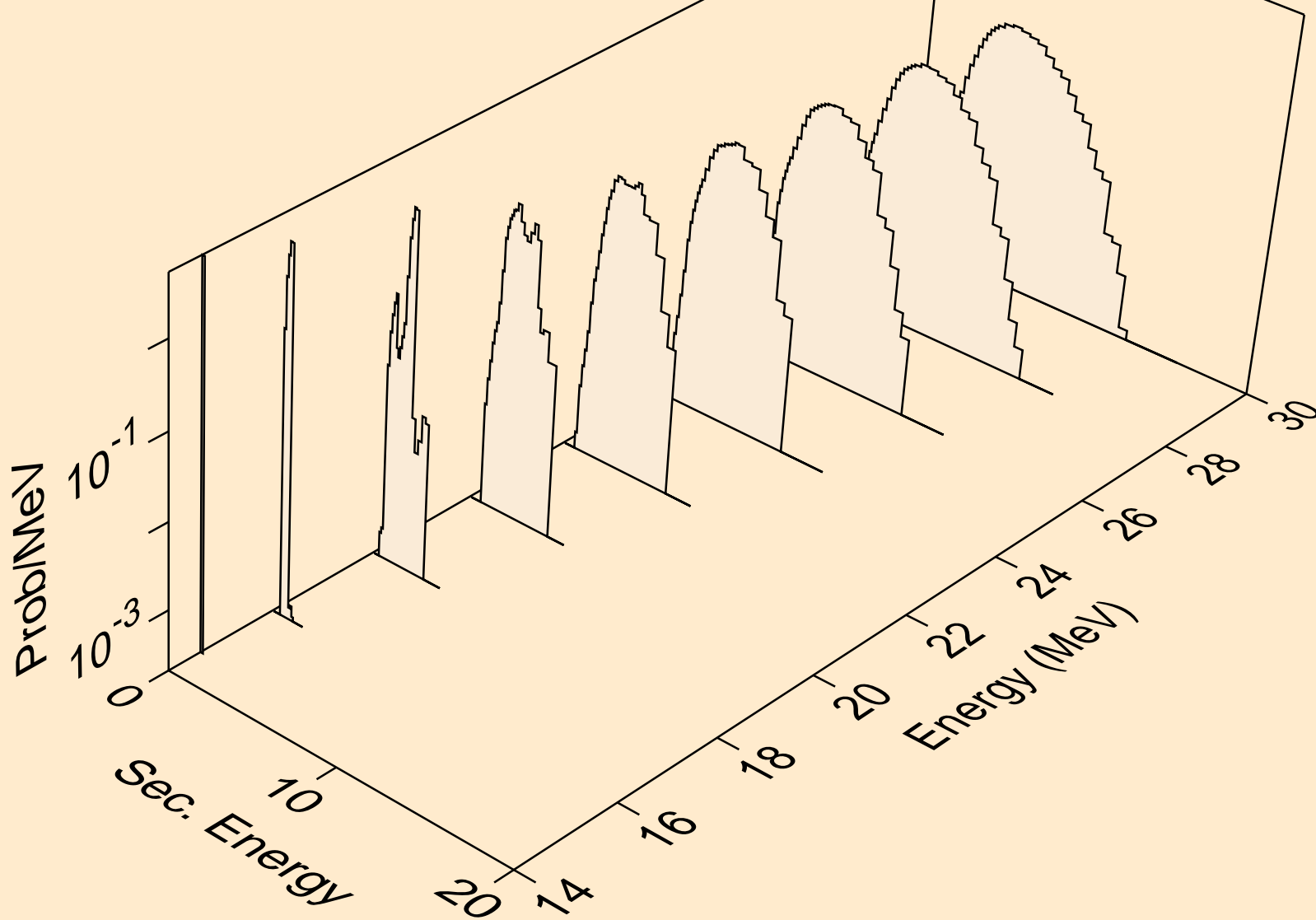

KR079 NEUTRON ACER TENDL-2019 LIBRARY; T=293.16K  
protons from (n,npa)

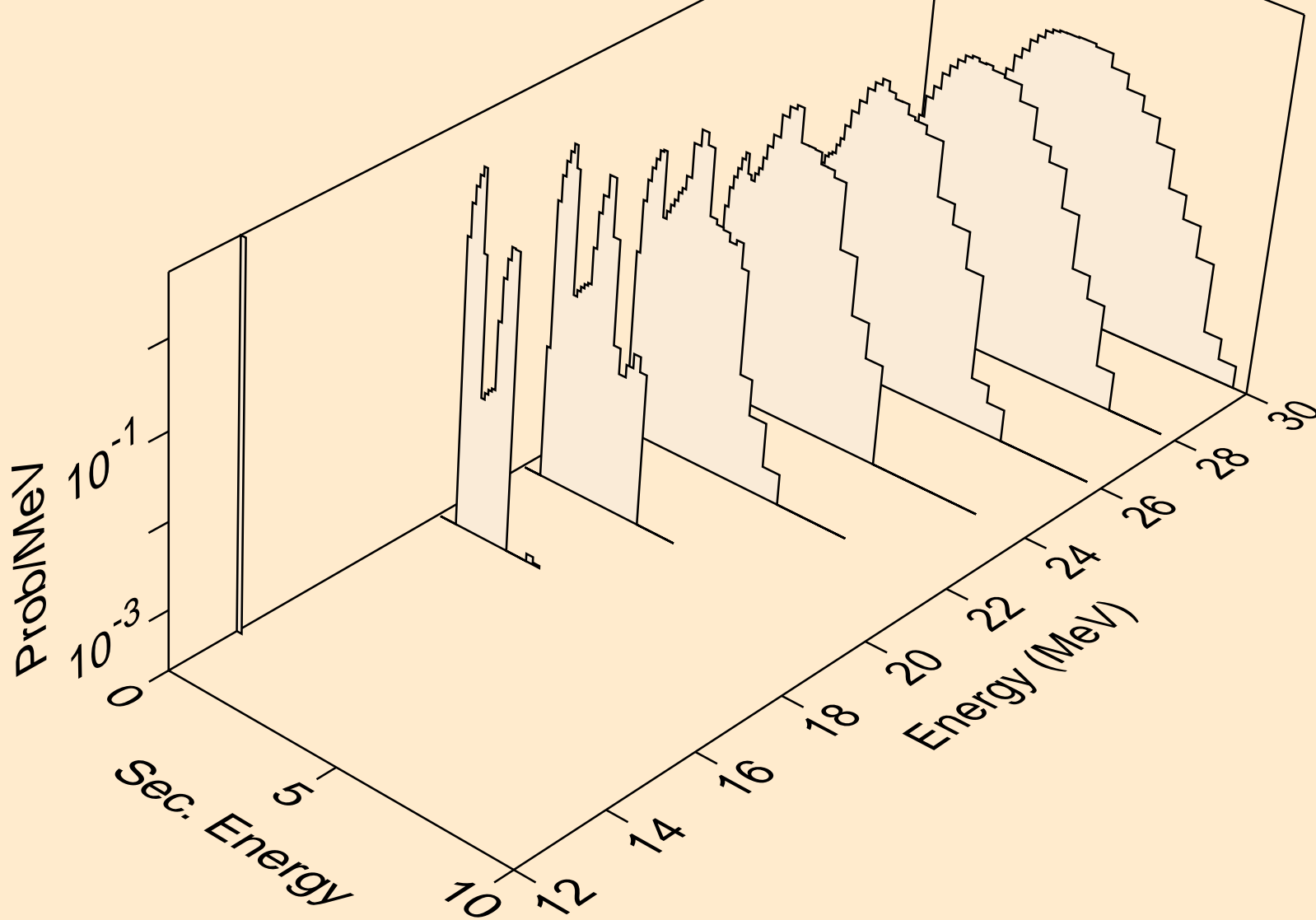

KR079 NEUTRON ACER TENDL-2019 LIBRARY; T=293.16K  
protons from (n,p)

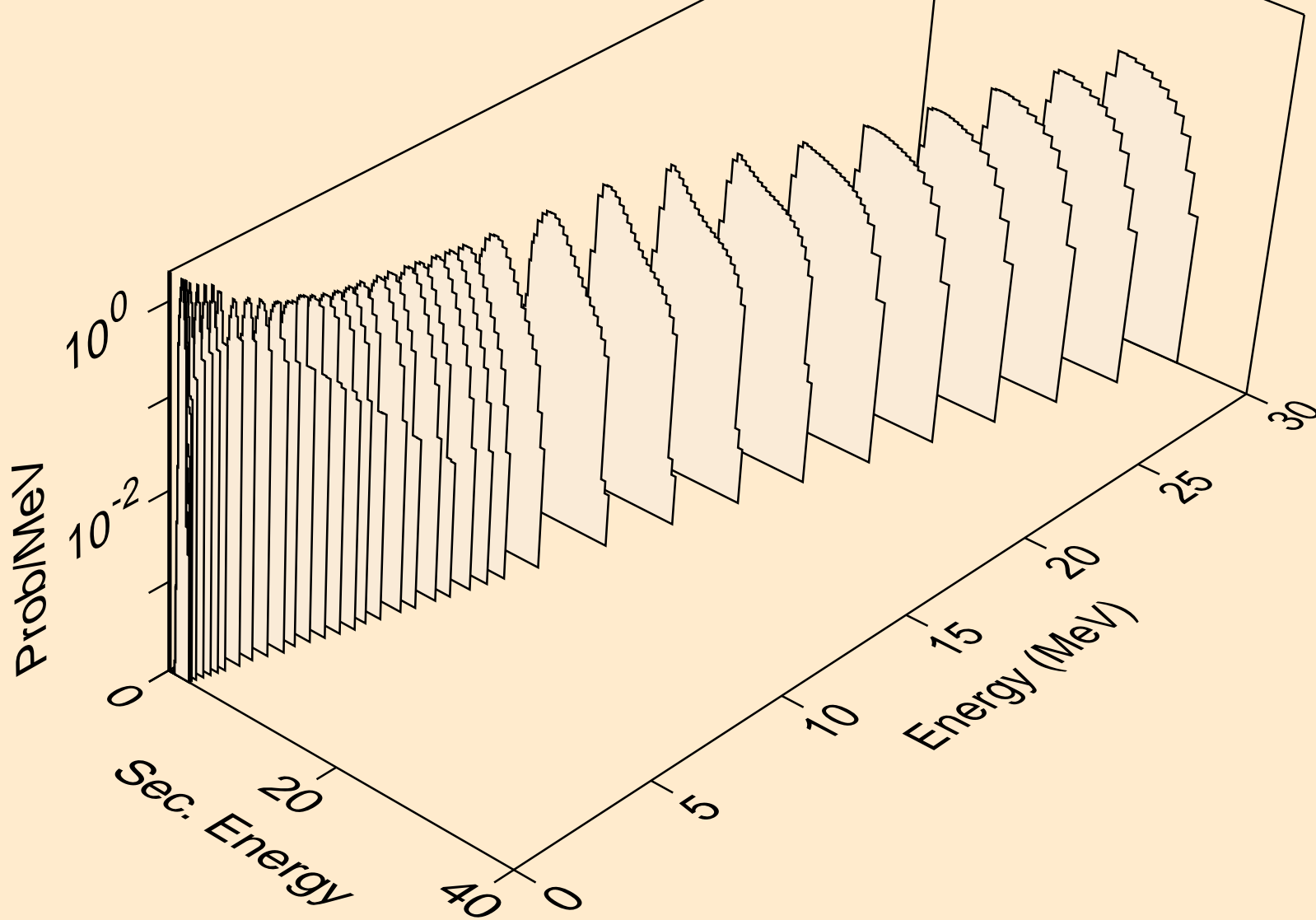

KR079 NEUTRON ACER TENDL-2019 LIBRARY; T=293.16K  
protons from (n,2p)

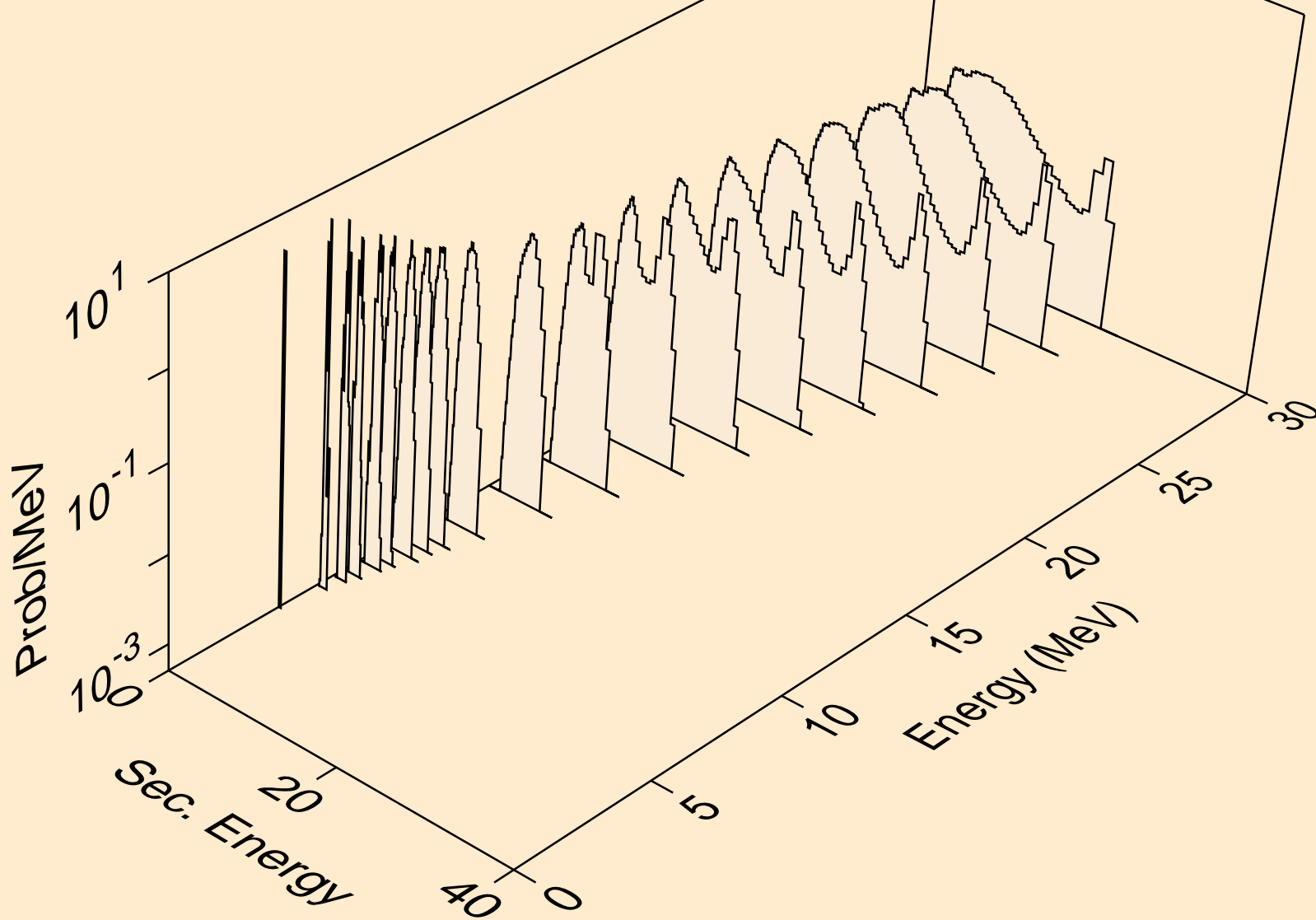

KR079 NEUTRON ACER TENDL-2019 LIBRARY; T=293.16K  
protons from (n,p)

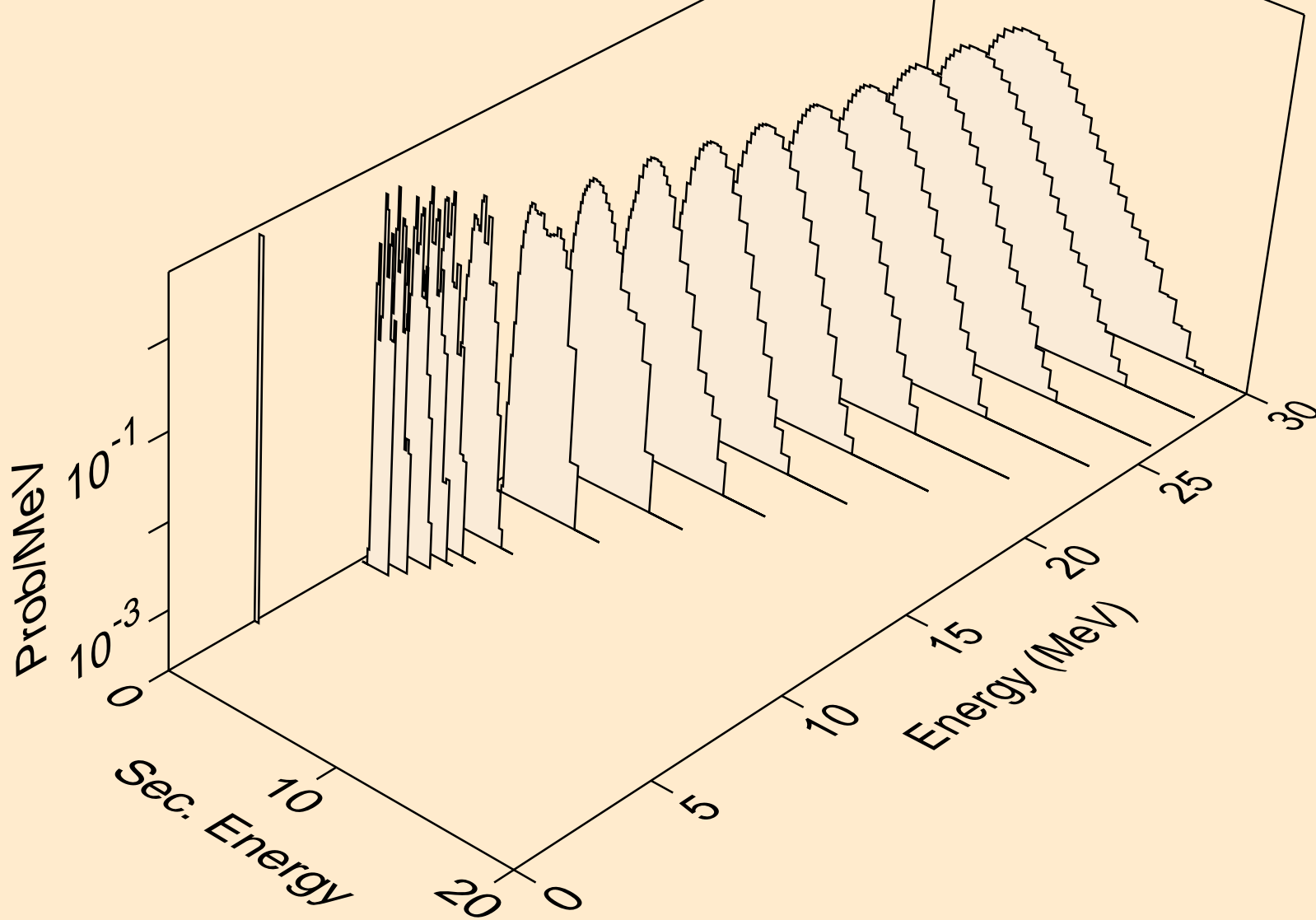

KR079 NEUTRON ACER TENDL-2019 LIBRARY; T=293.16K  
protons from (n,pd)

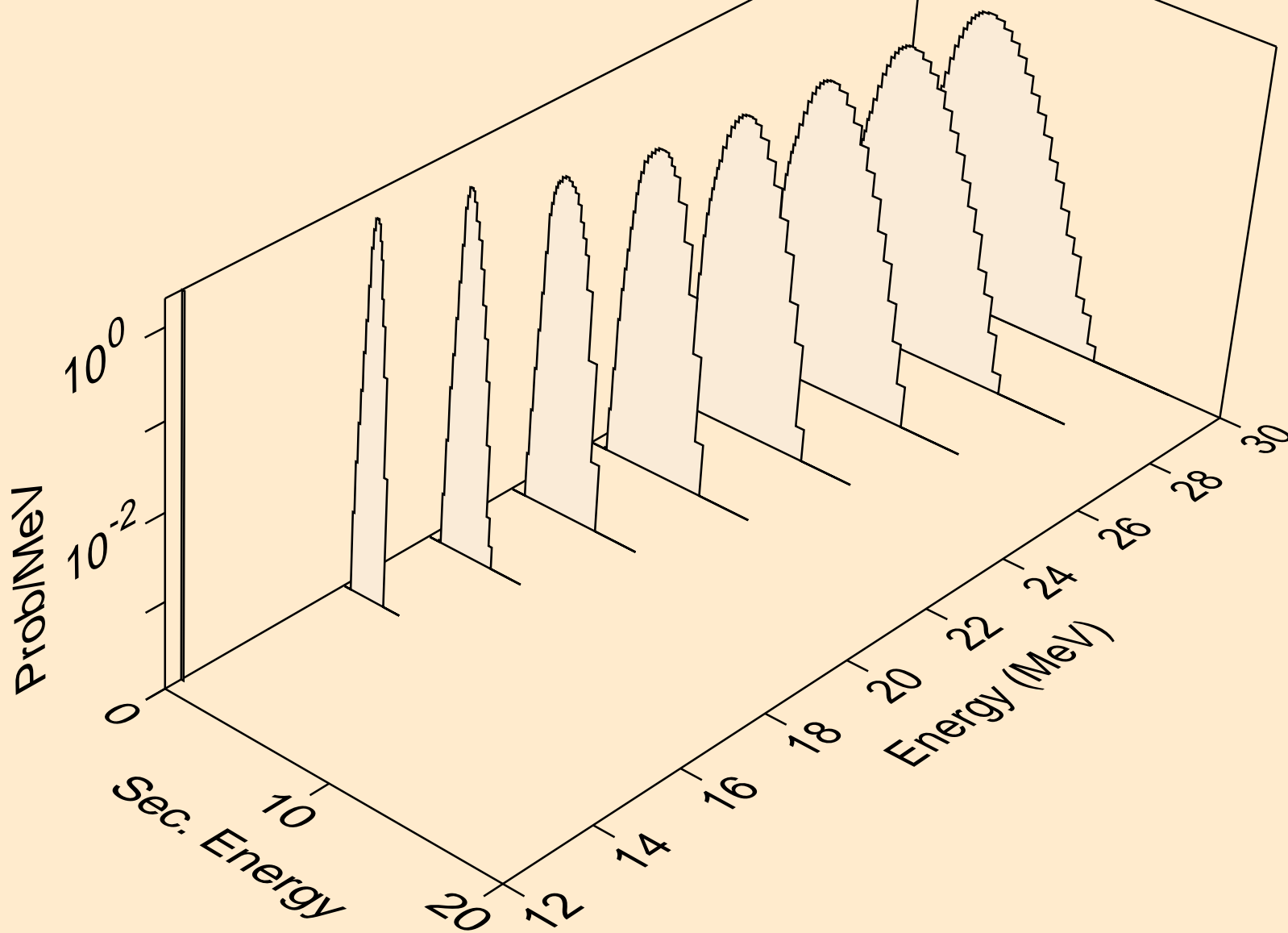

KR079 NEUTRON ACER TENDL-2019 LIBRARY; T=293.16K  
protons from (n,pt)

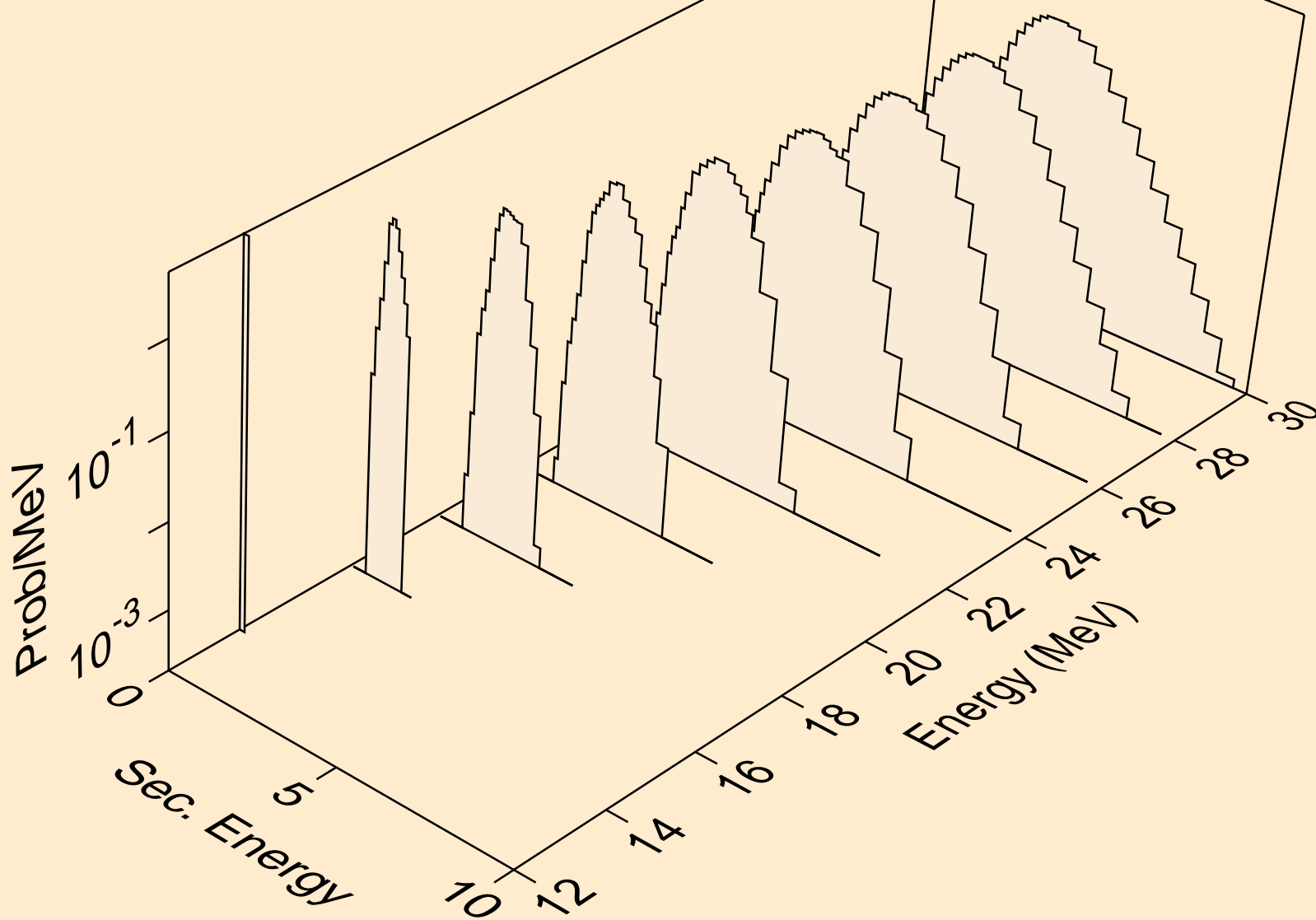



KR079 NEUTRON ACER TENDL-2019 LIBRARY; T=293.16K  
deuterons from (n,x)

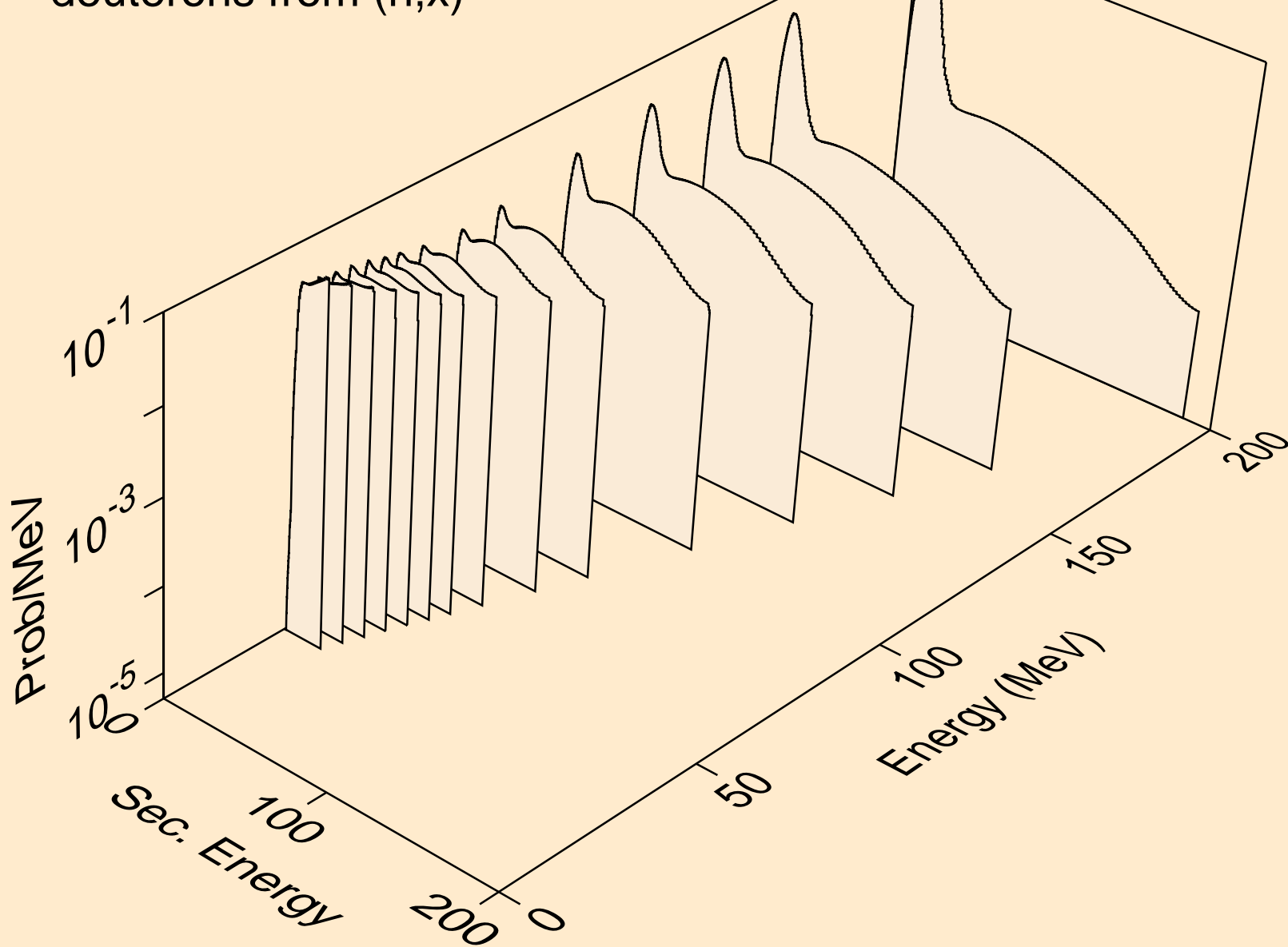

KR079 NEUTRON ACER TENDL-2019 LIBRARY; T=293.16K  
deuterons from (n,2nd)

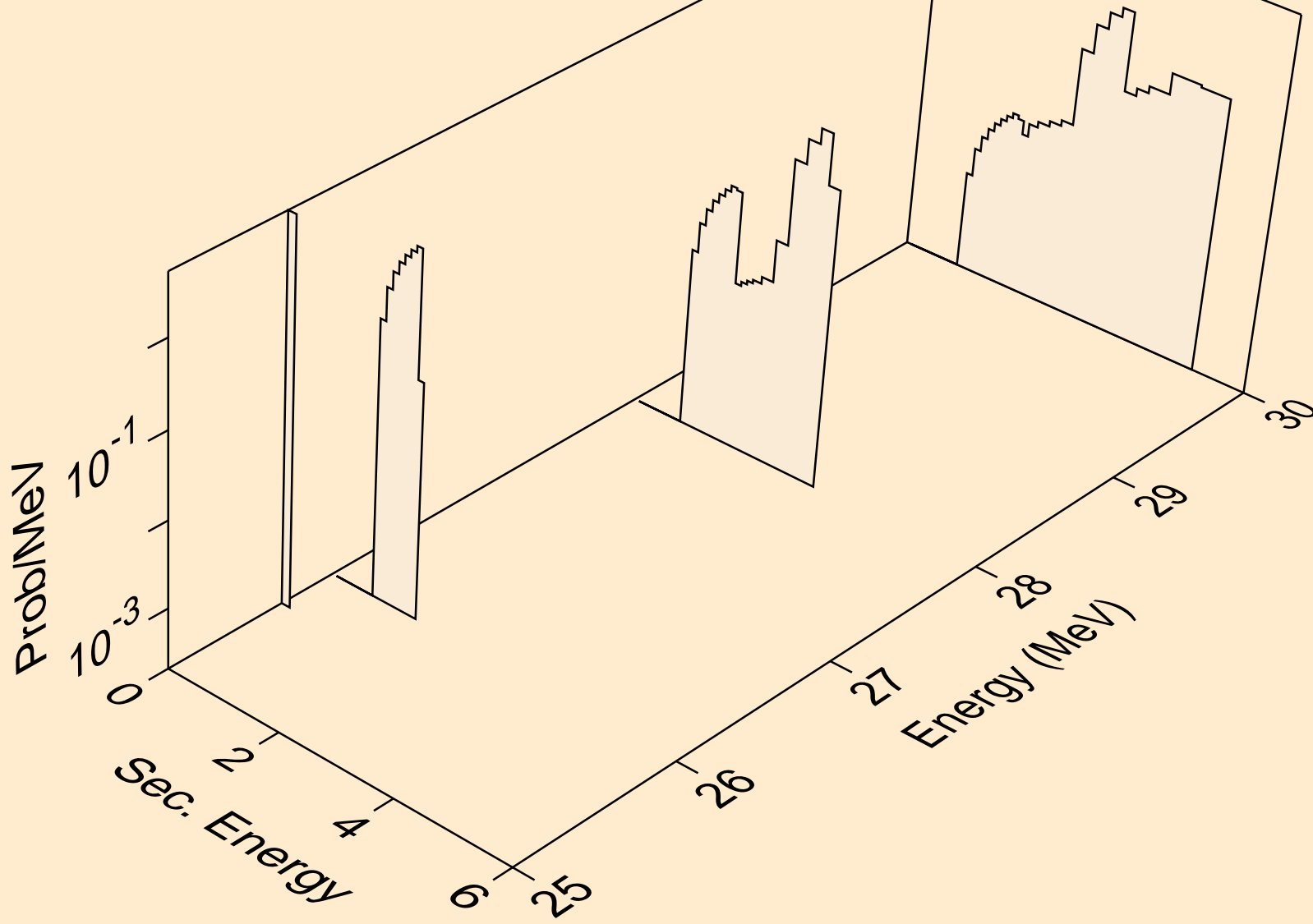

KR079 NEUTRON ACER TENDL-2019 LIBRARY; T=293.16K  
deuterons from (n,n\*)d

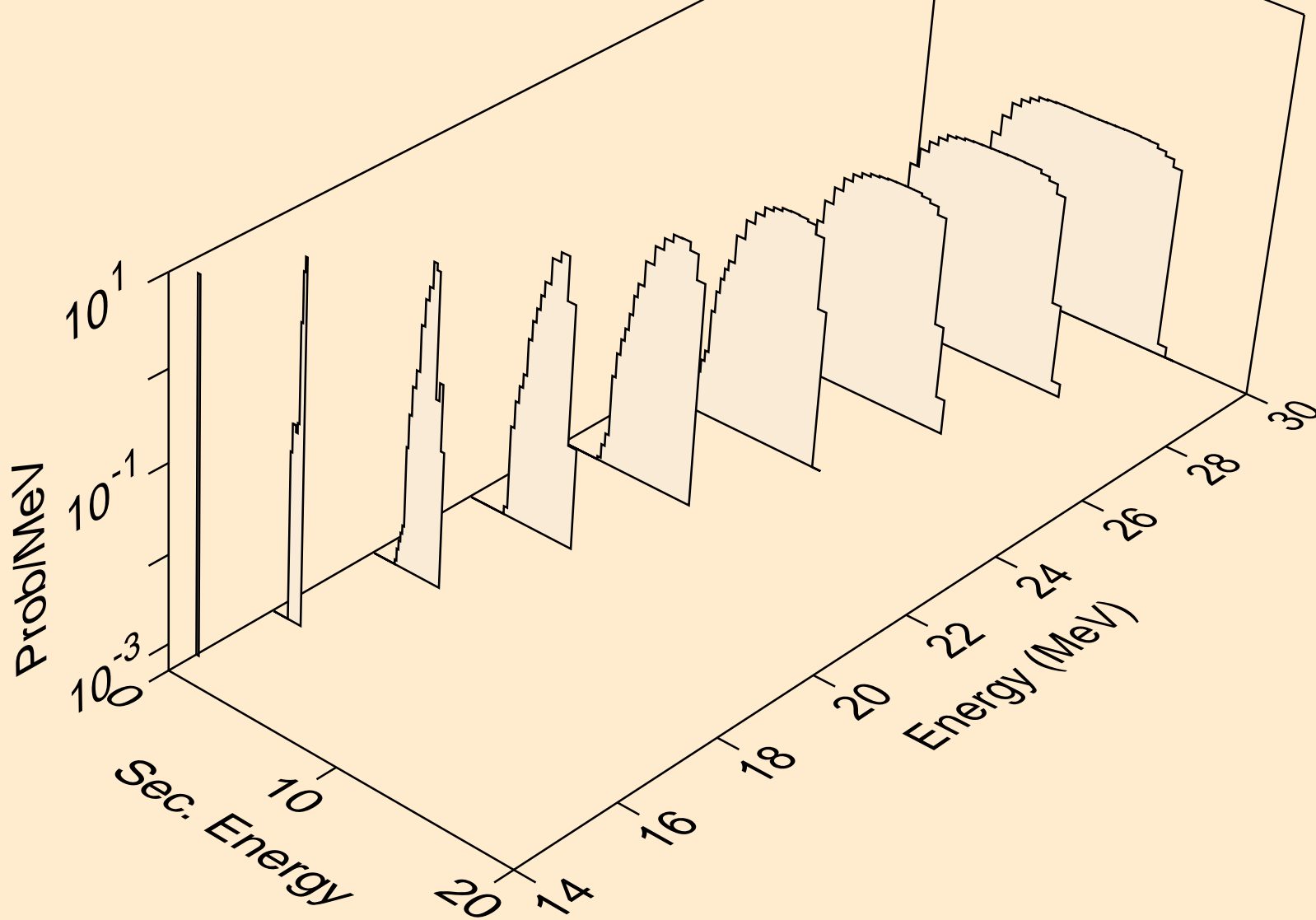

KR079 NEUTRON ACER TENDL-2019 LIBRARY; T=293.16K  
deuterons from (n,d)

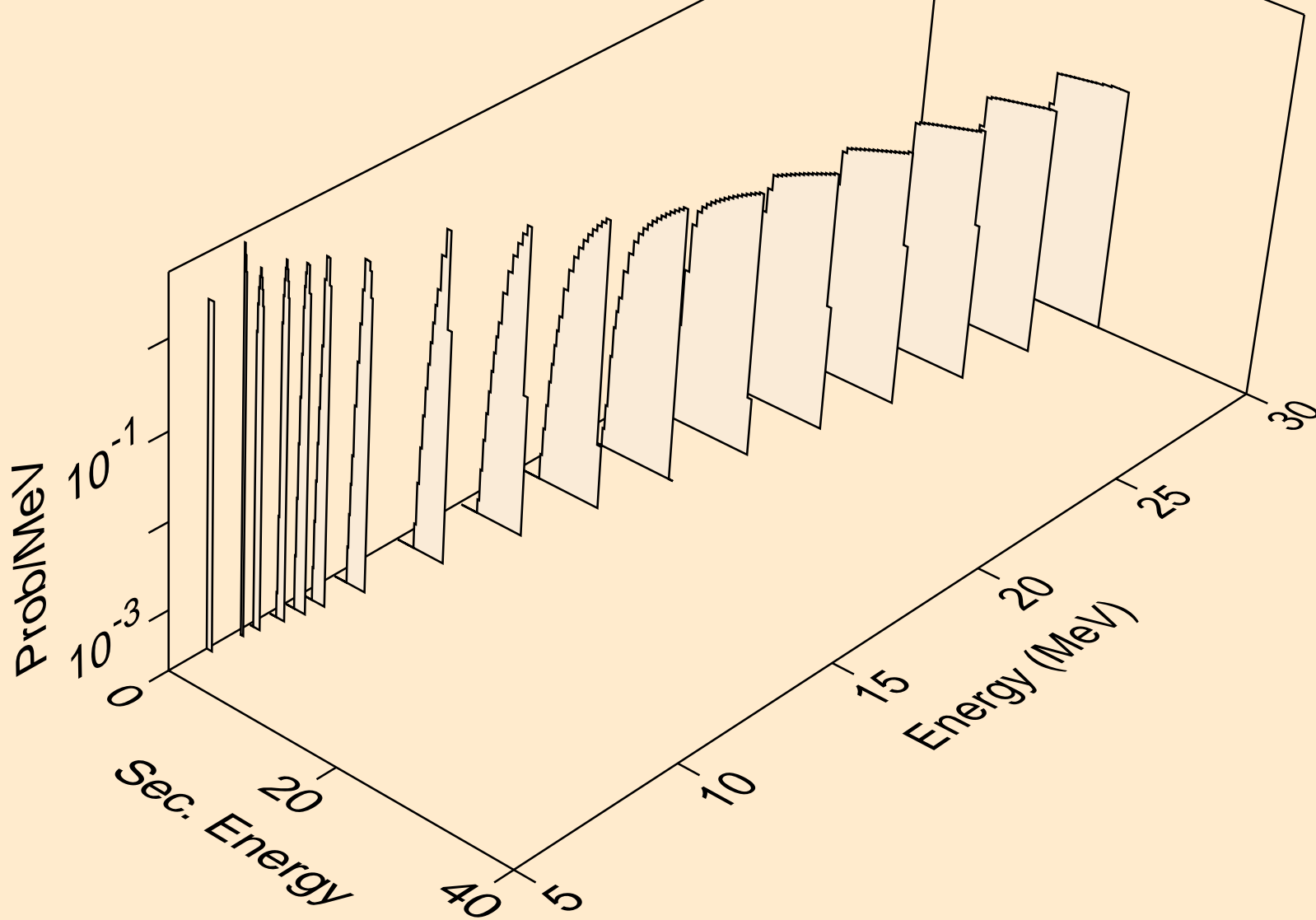

KR079 NEUTRON ACER TENDL-2019 LIBRARY; T=293.16K  
deuterons from (n,pd)

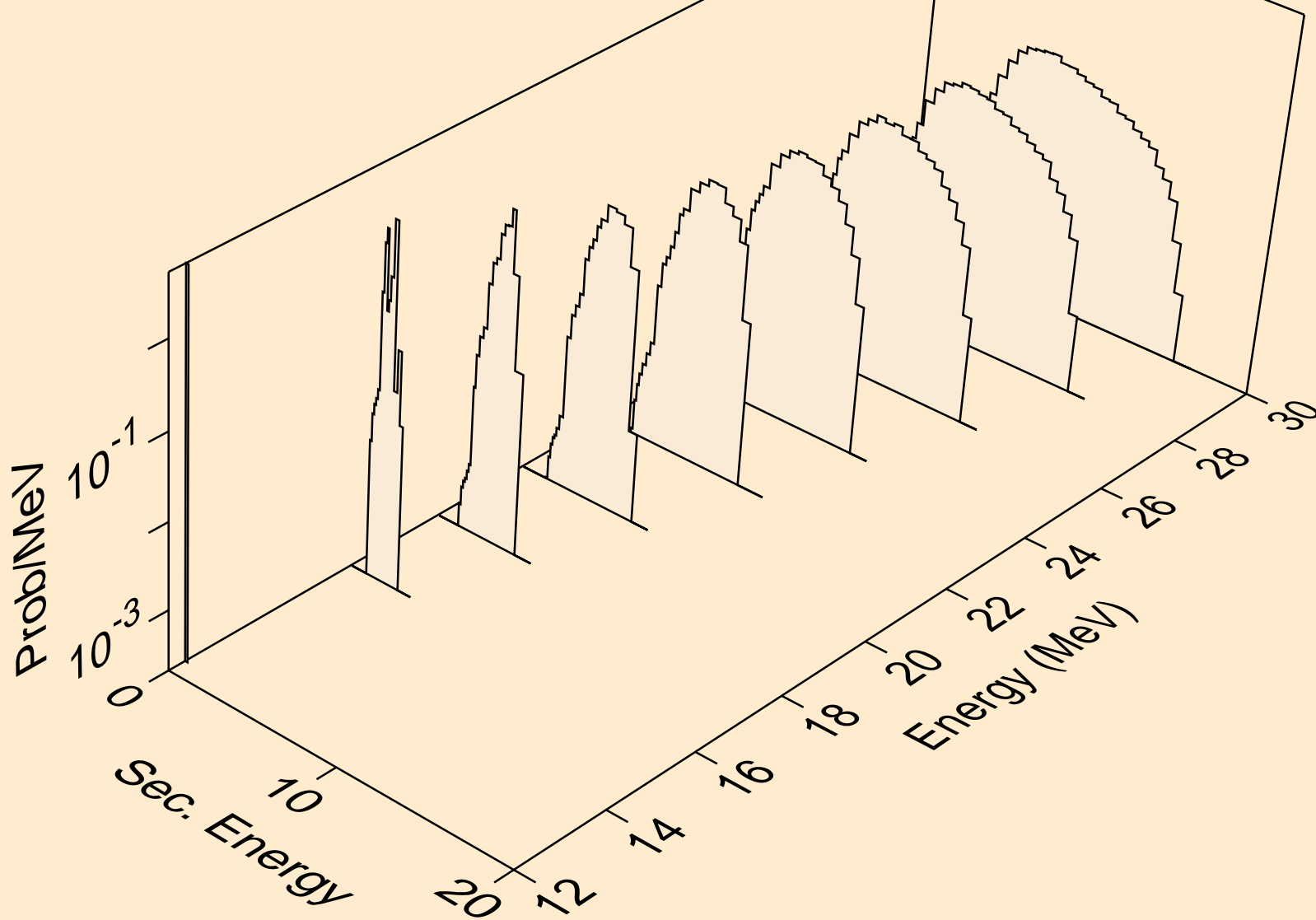

KR079 NEUTRON ACER TENDL-2019 LIBRARY; T=293.16K  
deuterons from (n,da)

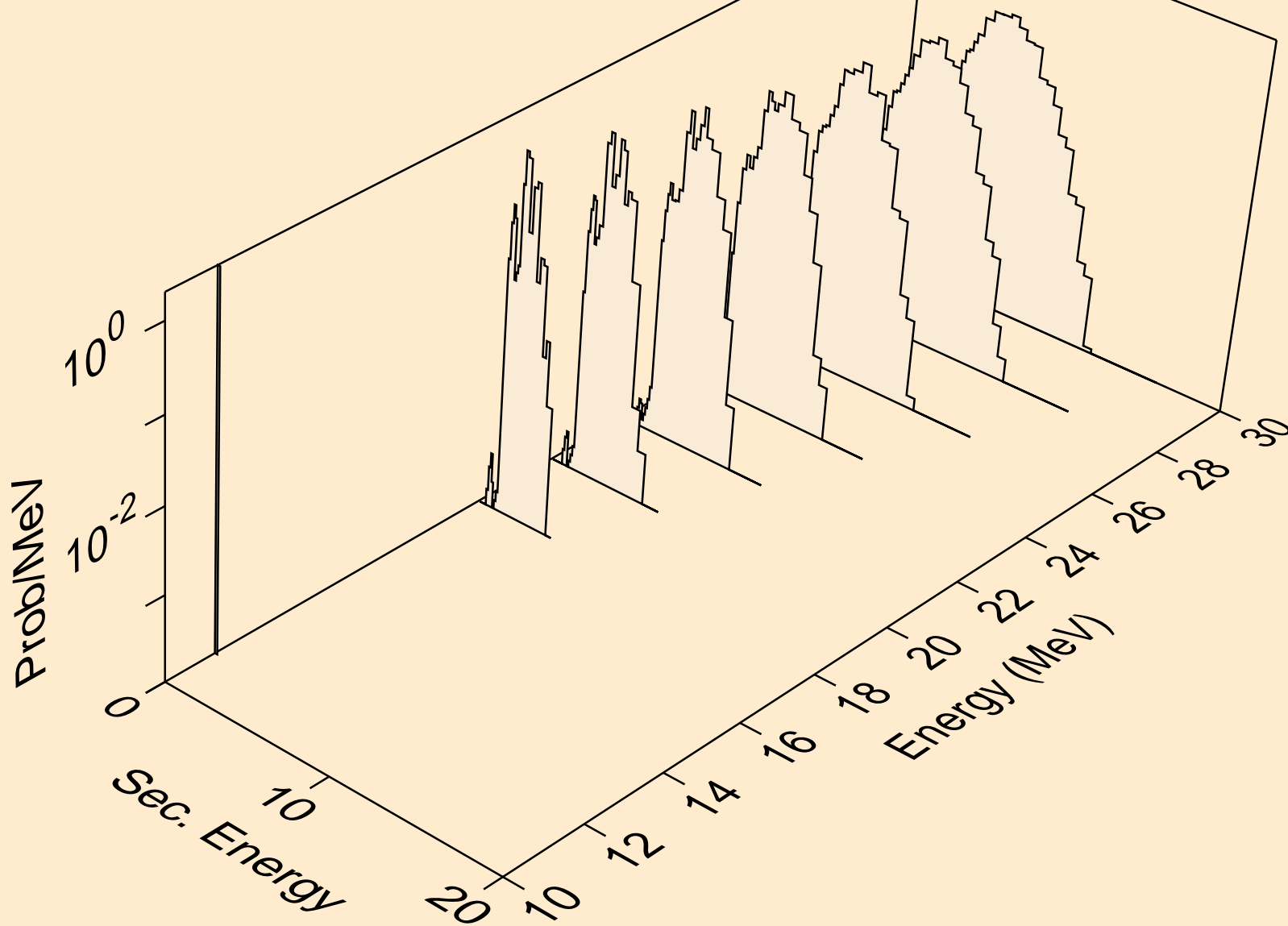

KR079 NEUTRON ACER TENDL-2019 LIBRARY; T=293.16K  
tritons from (n,x)

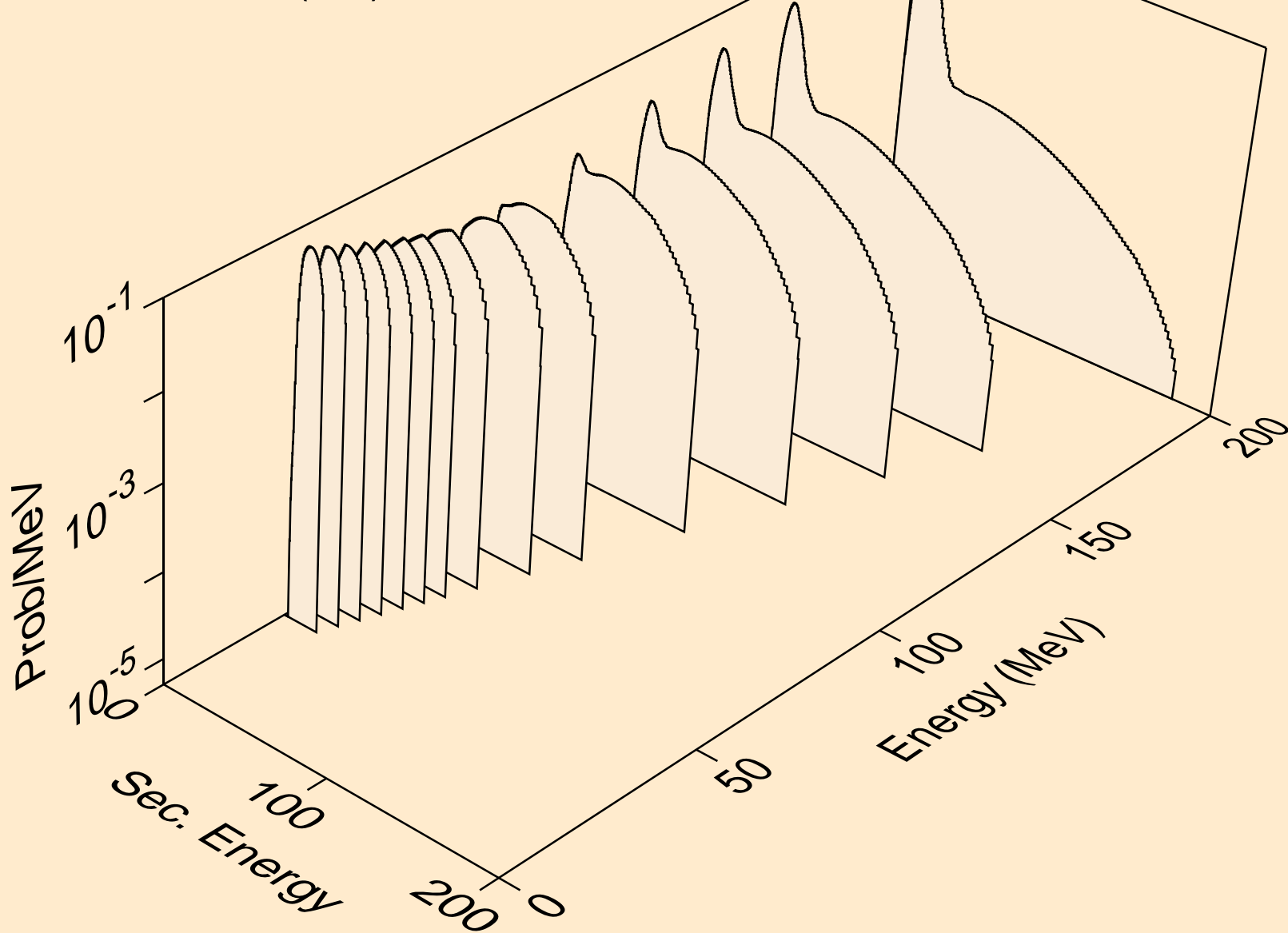

KR079 NEUTRON ACER TENDL-2019 LIBRARY; T=293.16K  
tritons from (n,n\*)t

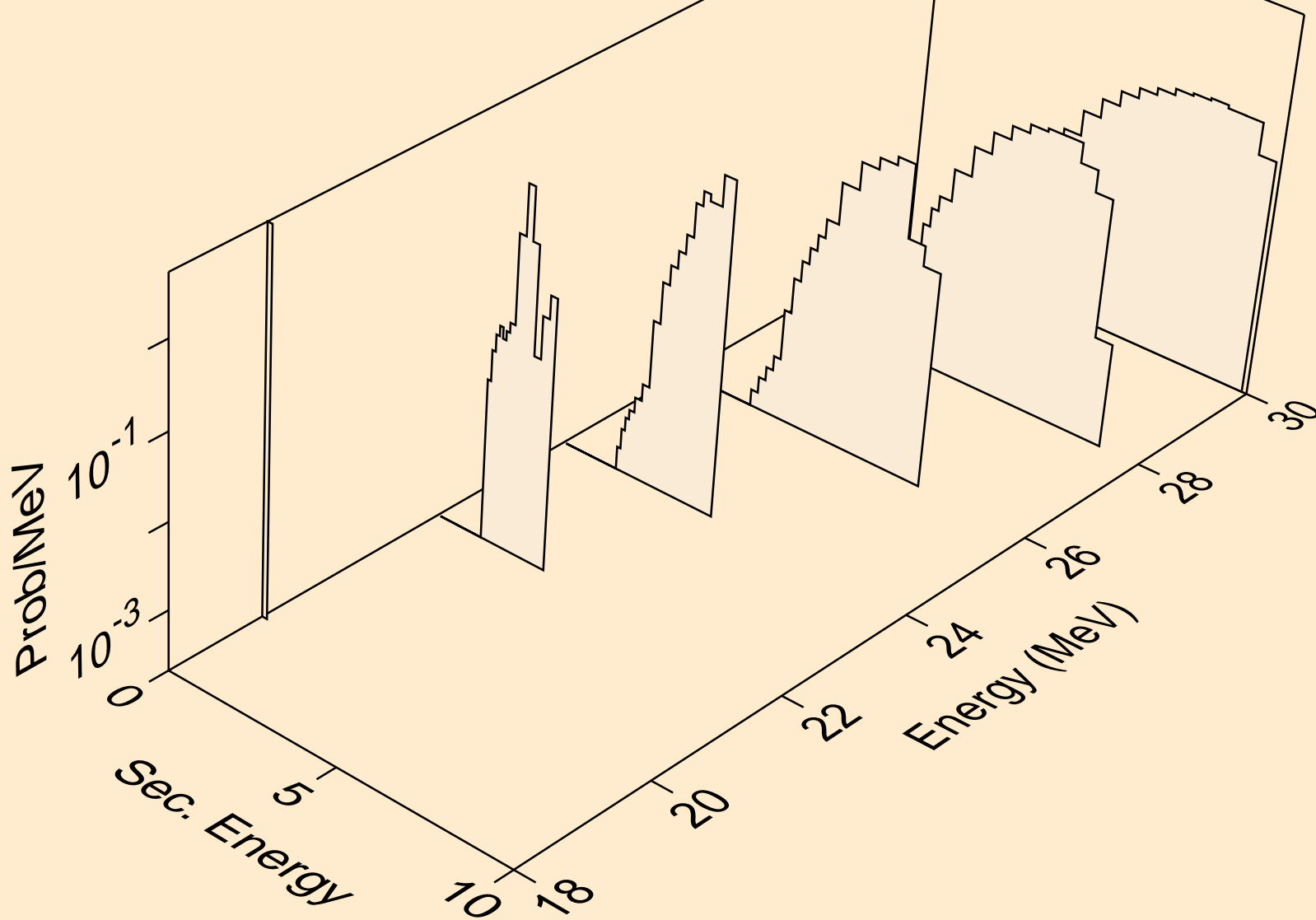



KR079 NEUTRON ACER TENDL-2019 LIBRARY; T=293.16K  
tritons from (n,t)

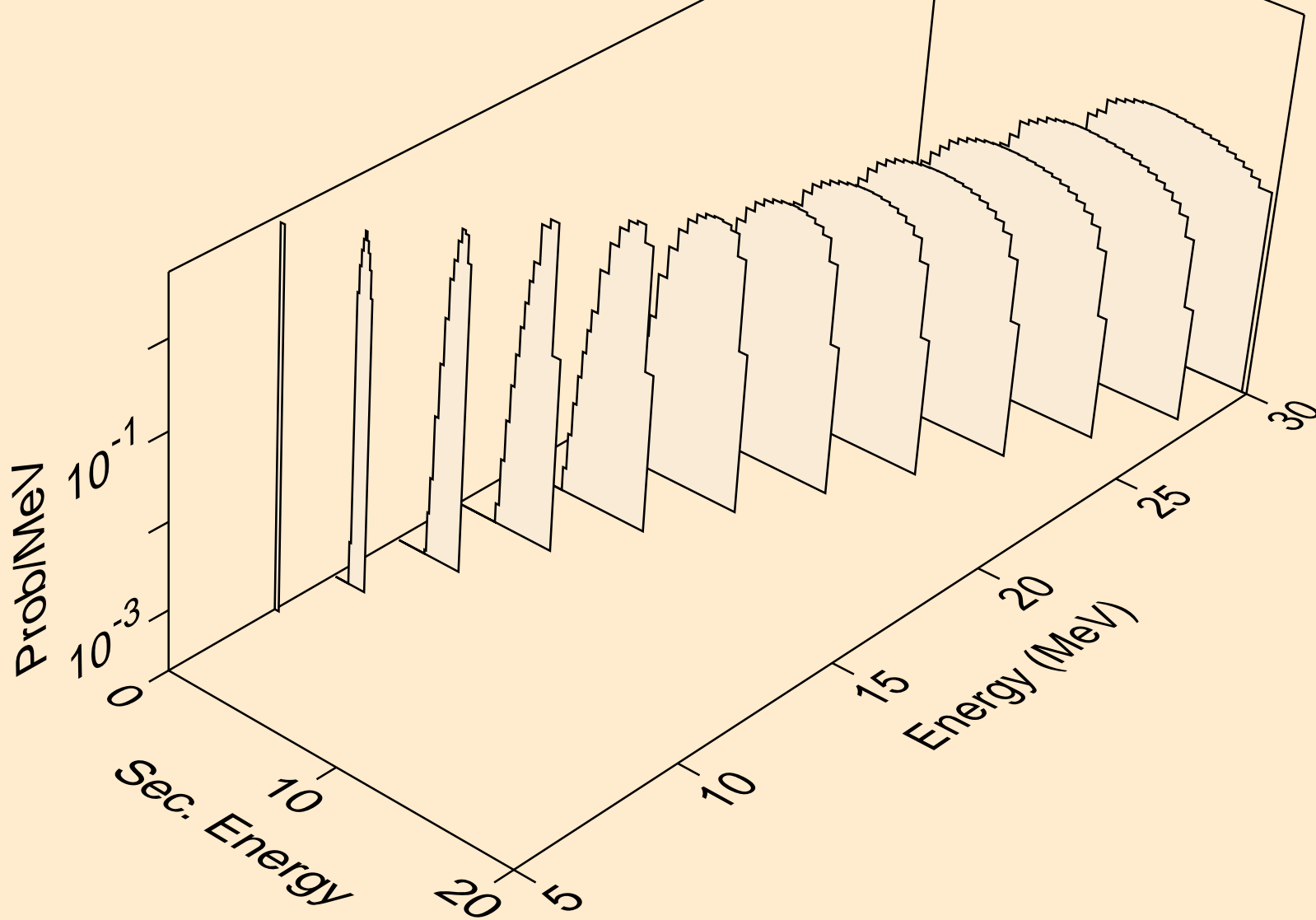

KR079 NEUTRON ACER TENDL-2019 LIBRARY; T=293.16K  
tritons from (n,pt)

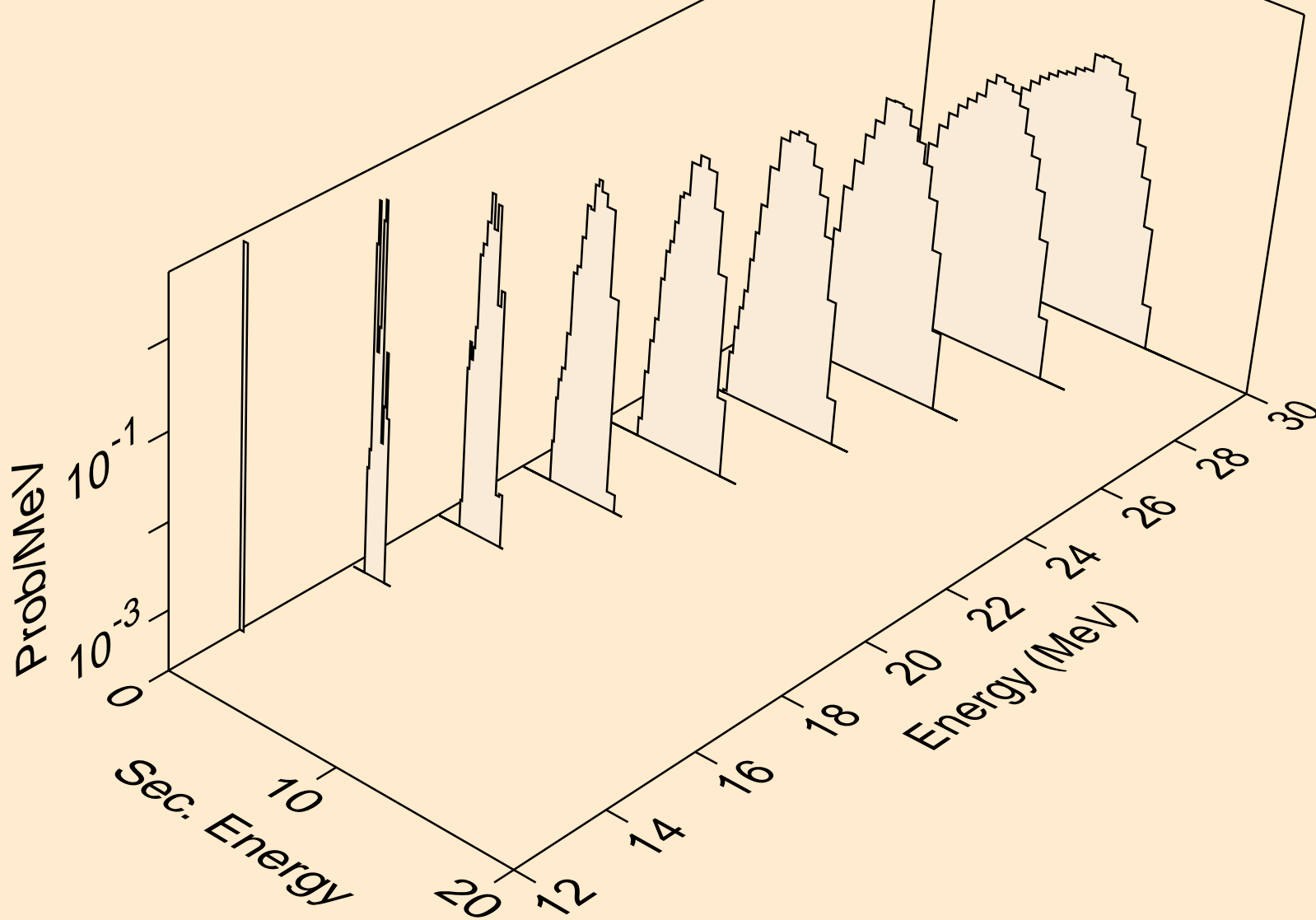

KR079 NEUTRON ACER TENDL-2019 LIBRARY; T=293.16K  
he3s from (n,x)

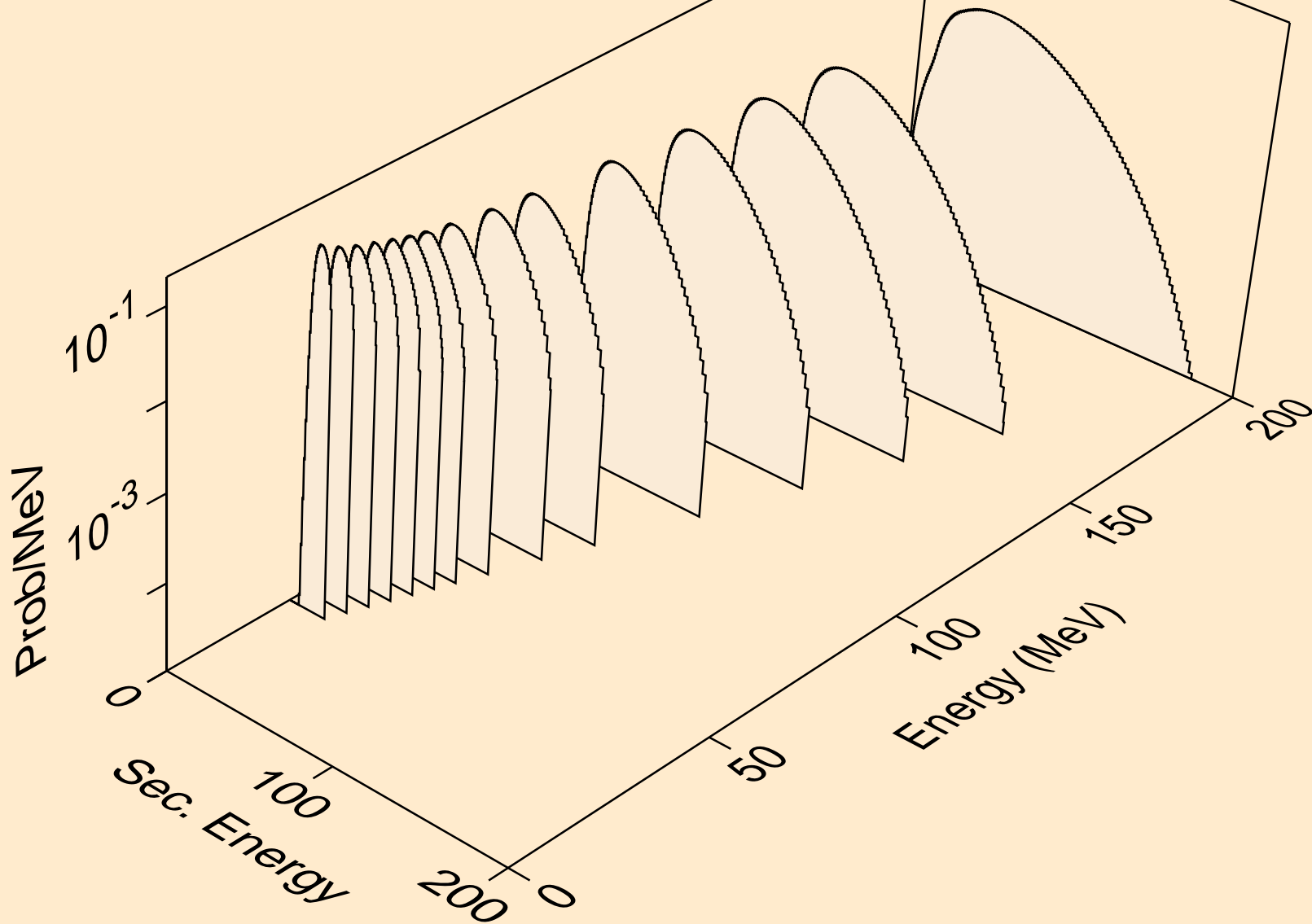

KR079 NEUTRON ACER TENDL-2019 LIBRARY; T=293.16K  
he3s from (n,n\*)he3

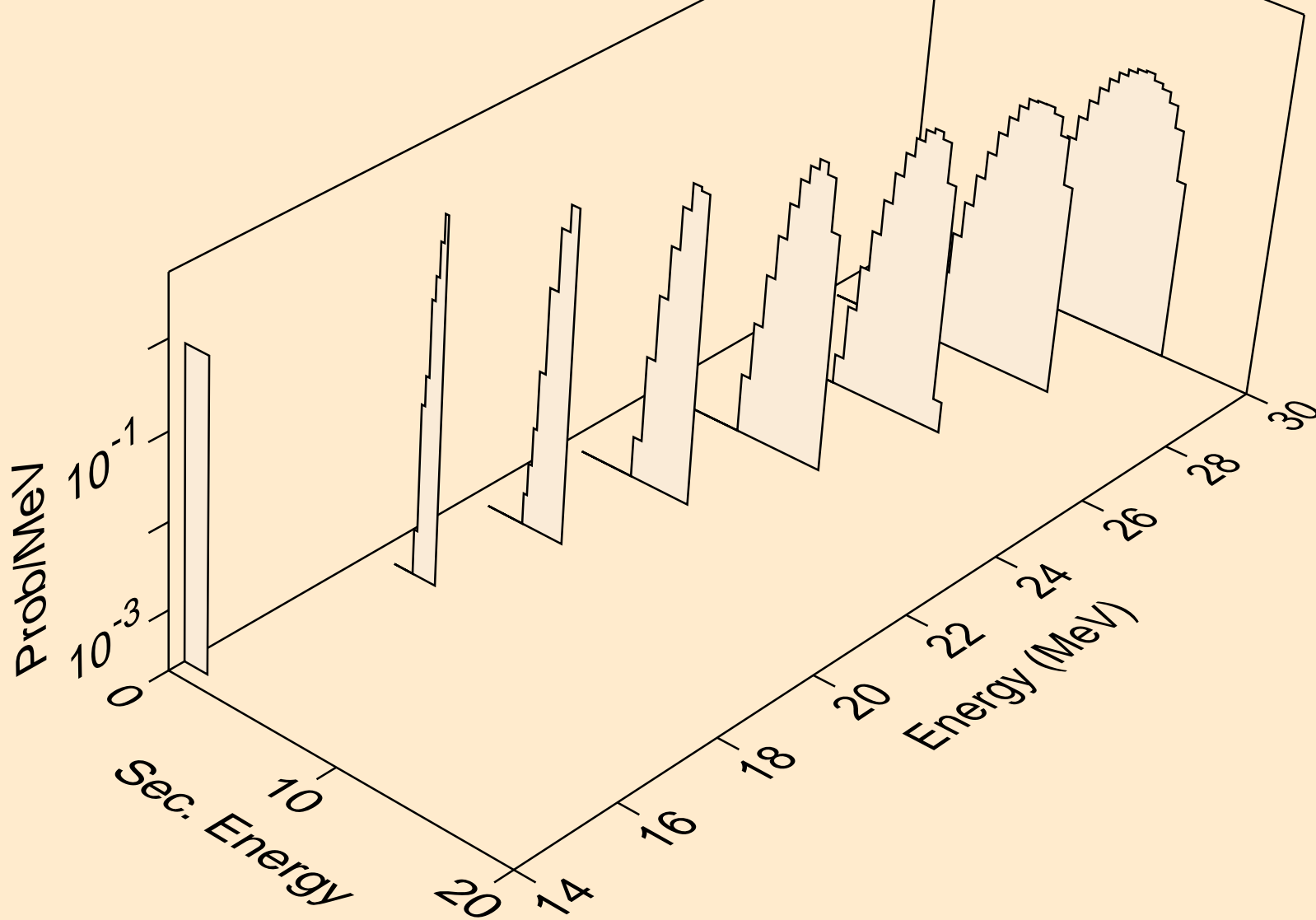

KR079 NEUTRON ACER TENDL-2019 LIBRARY; T=293.16K  
he3s from (n,he3)

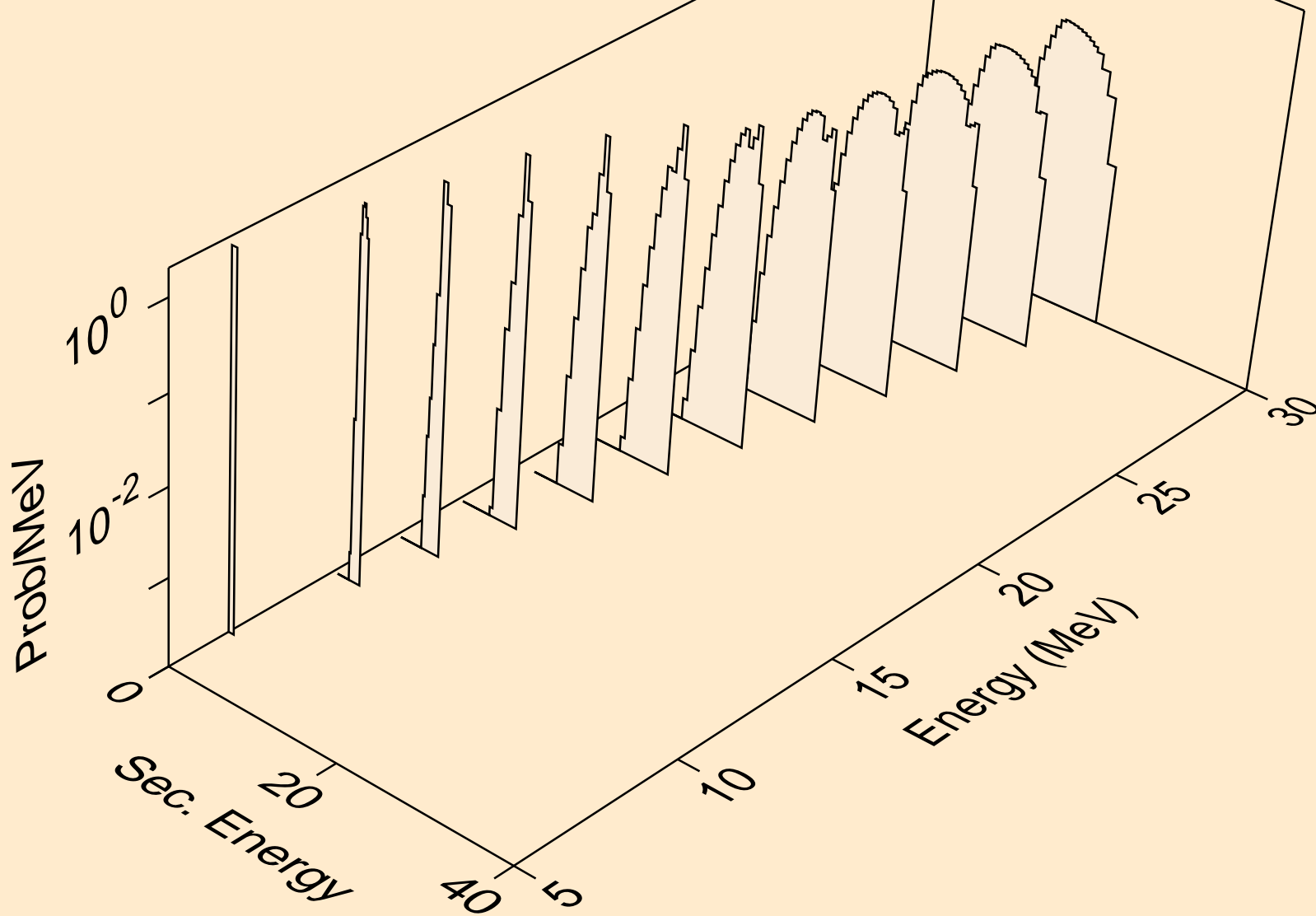

KR079 NEUTRON ACER TENDL-2019 LIBRARY; T=293.16K  
alphas from (n,x)

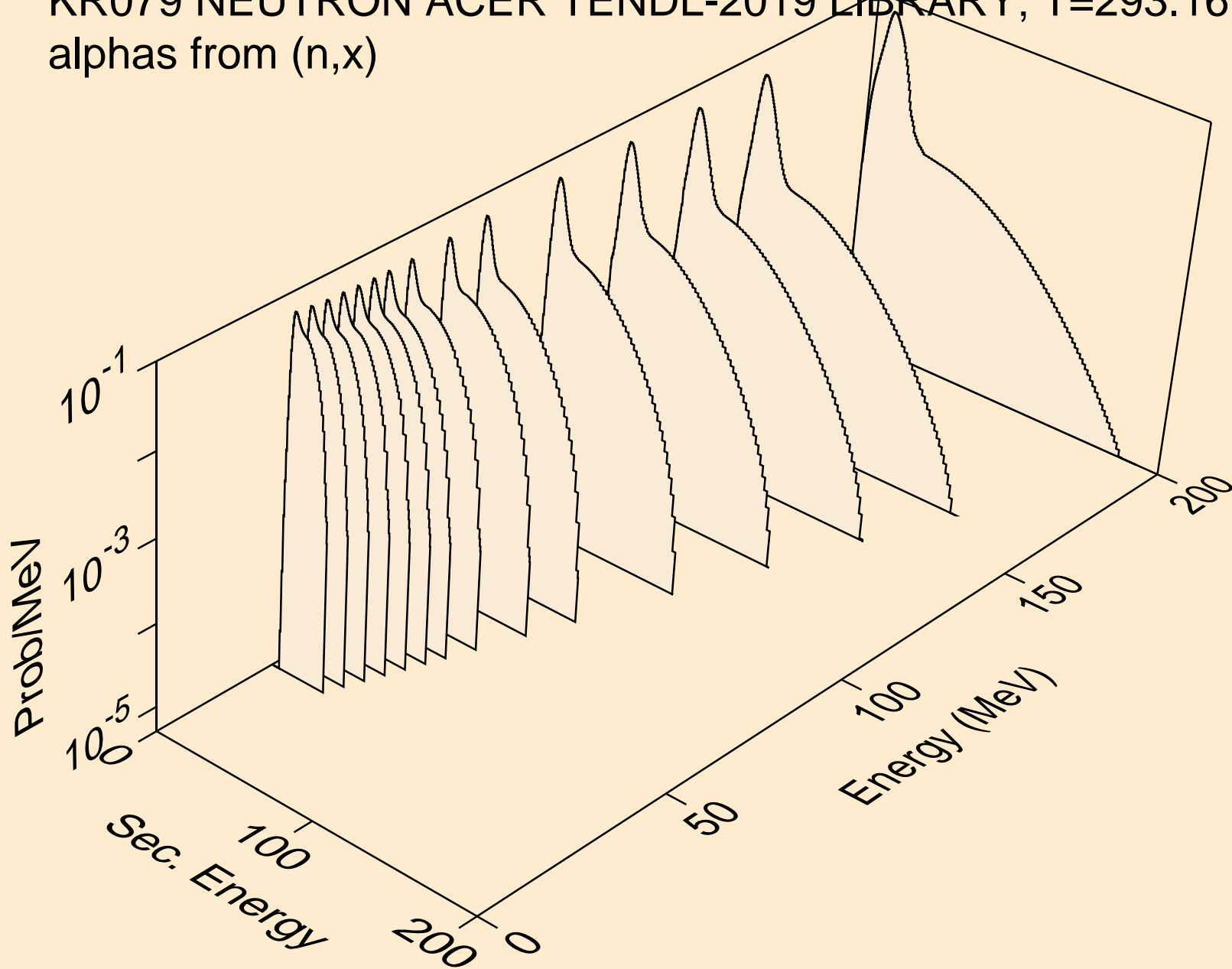

KR079 NEUTRON ACER TENDL-2019 LIBRARY; T=293.16K  
alphas from (n,n\*)a

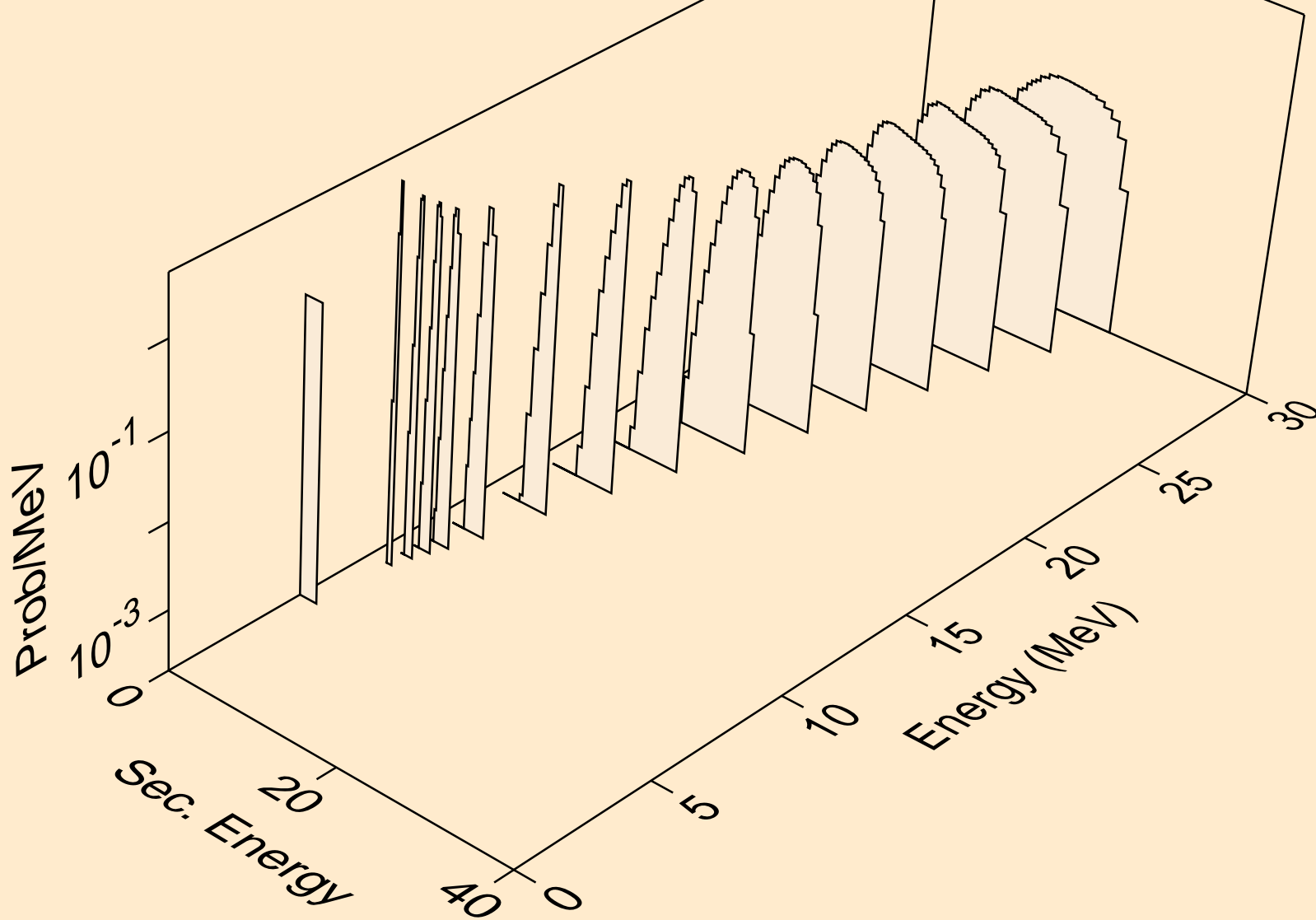

KR079 NEUTRON ACER TENDL-2019 LIBRARY; T=293.16K  
alphas from (n,2n)a

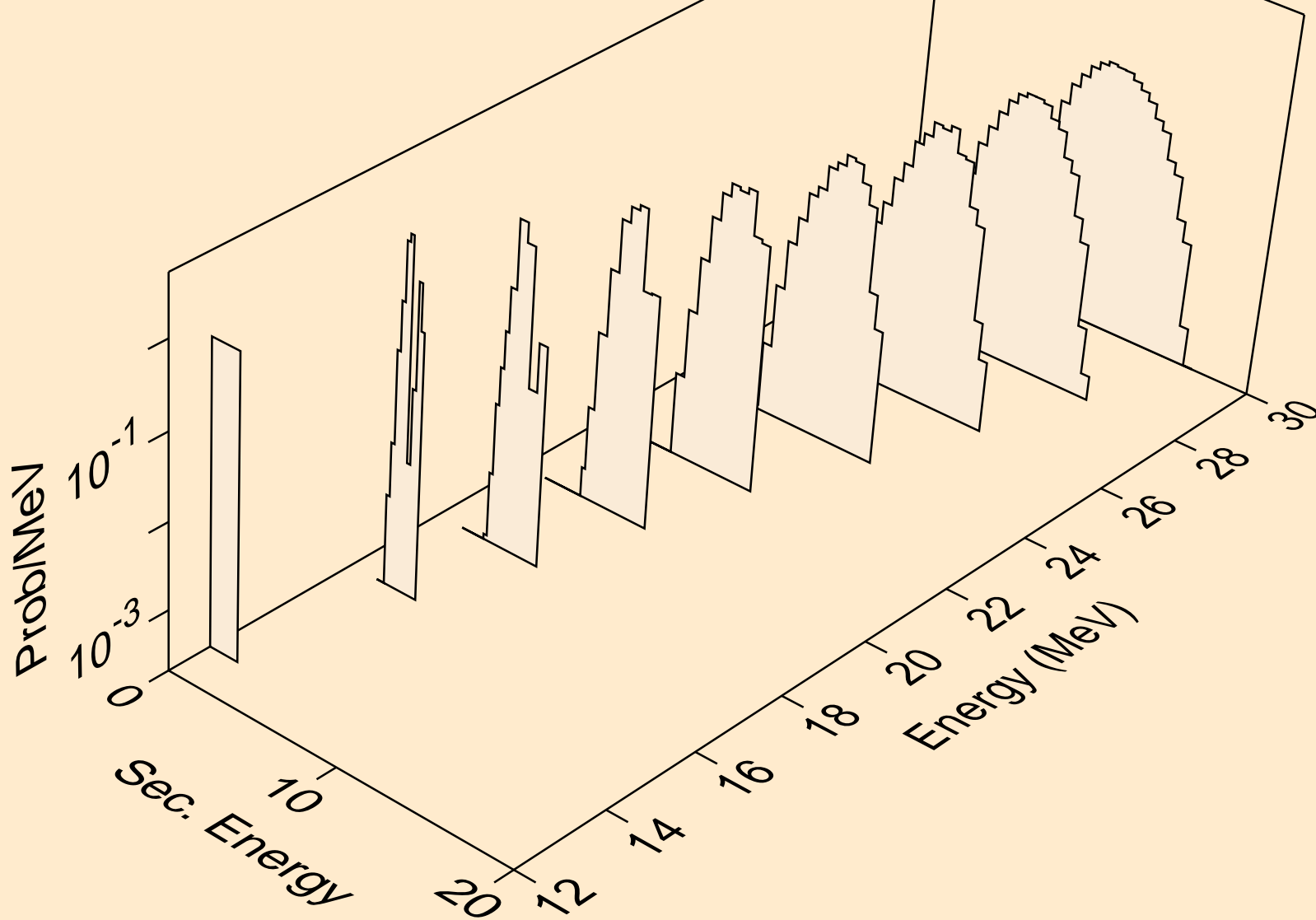



KR079 NEUTRON ACER TENDL-2019 LIBRARY; T=293.16K  
alphas from (n,n\*)2a

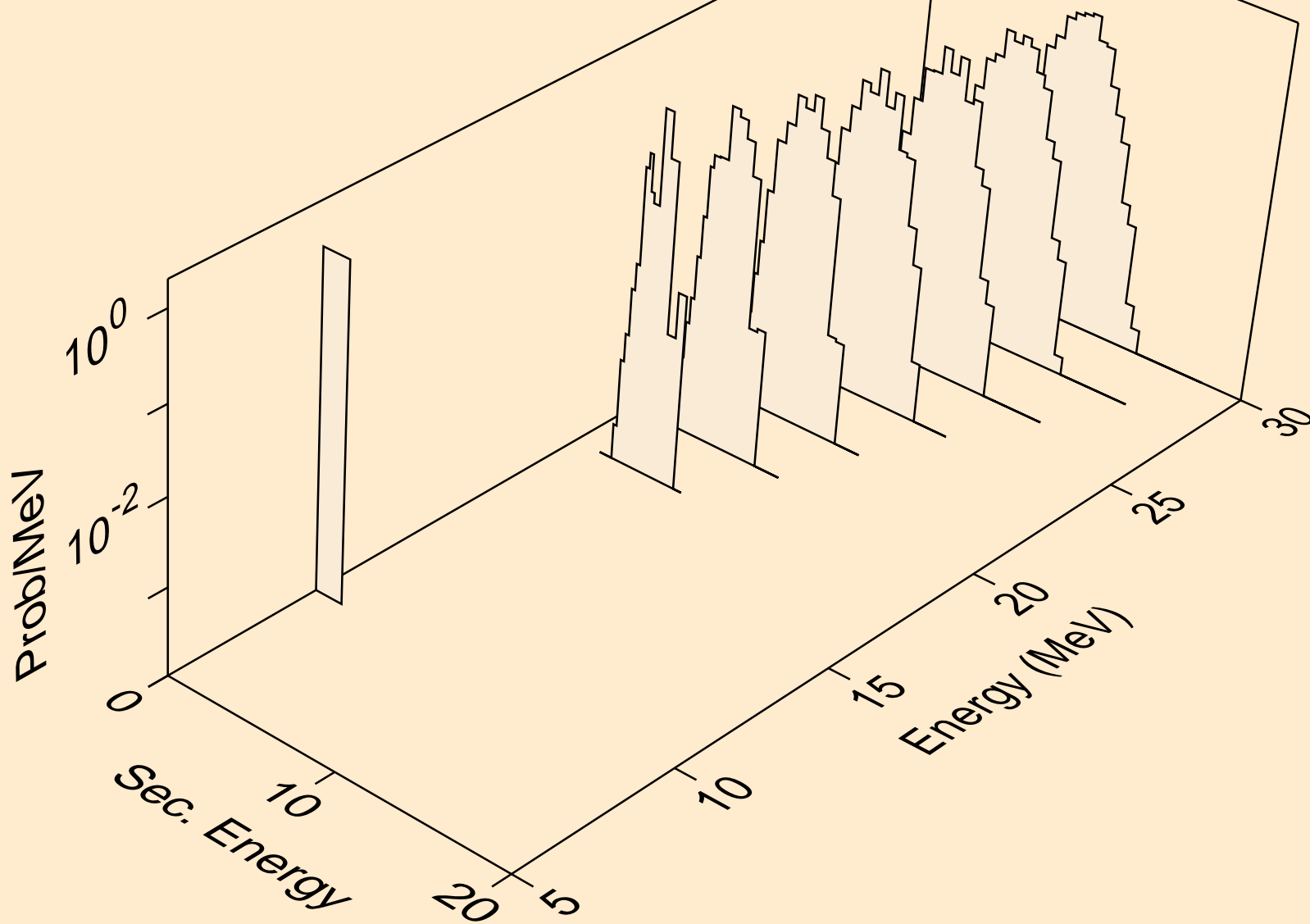

KR079 NEUTRON ACER TENDL-2019 LIBRARY; T=293.16K  
alphas from (n,npa)

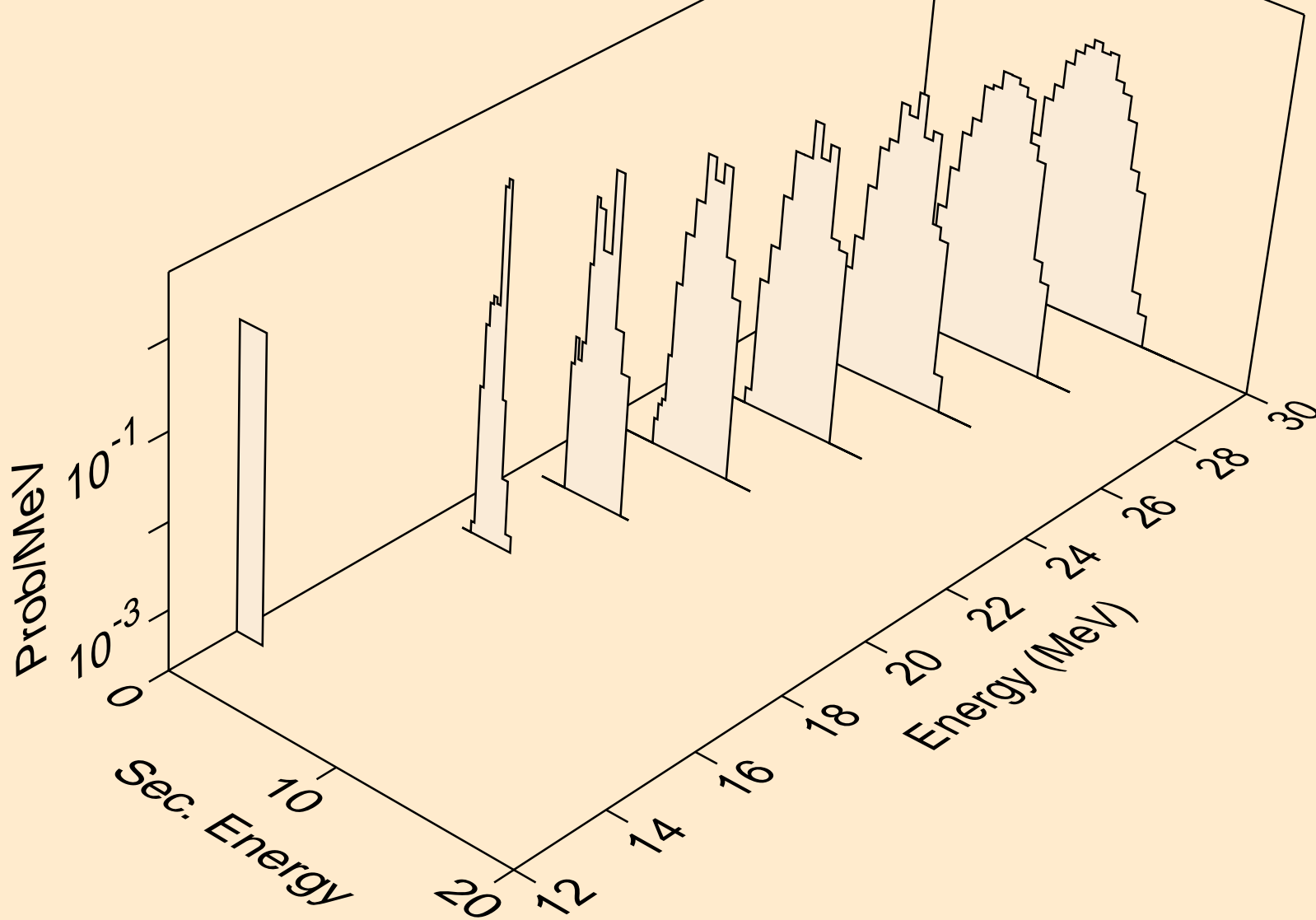

KR079 NEUTRON ACER TENDL-2019 LIBRARY; T=293.16K  
alphas from (n,a)

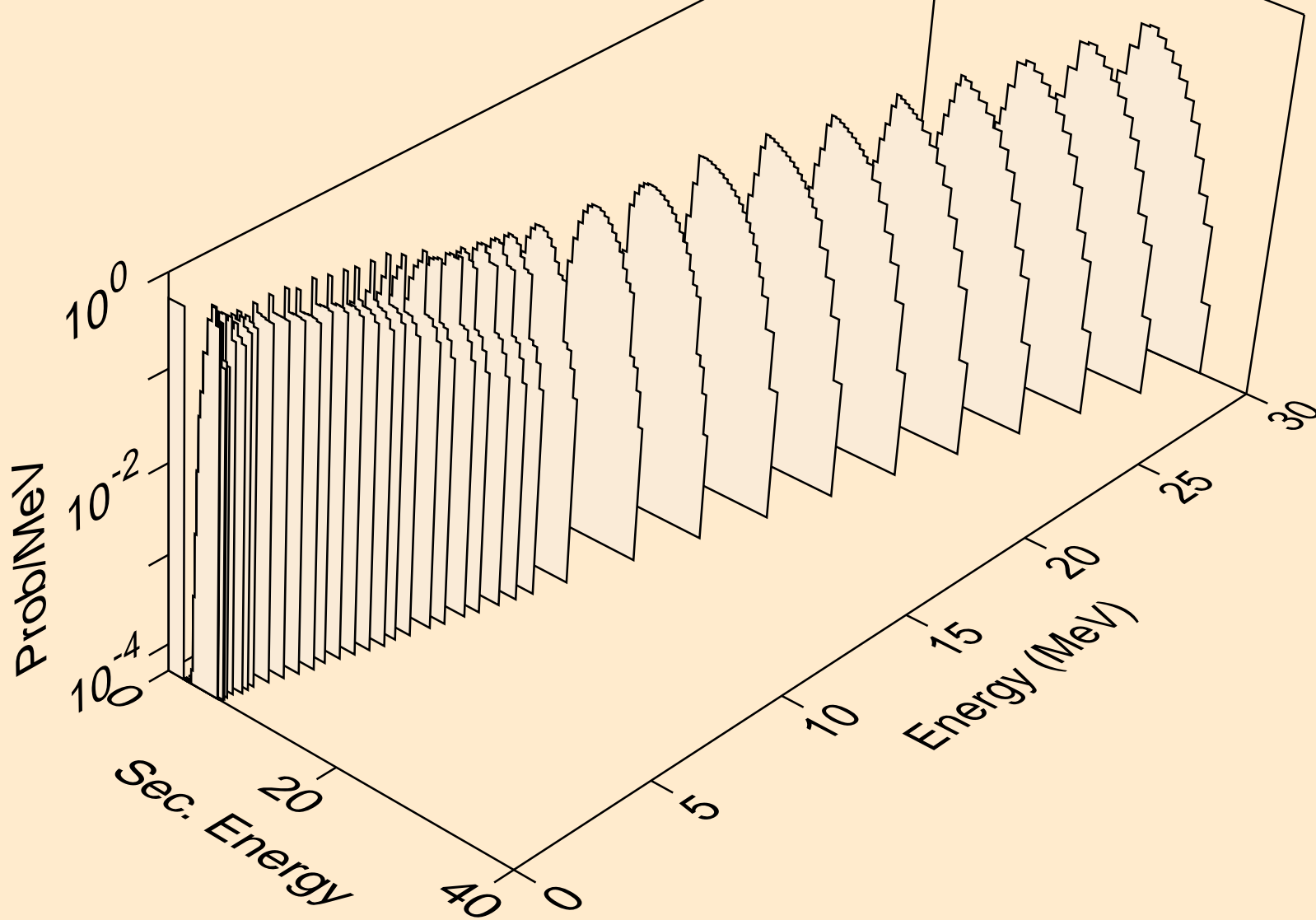

KR079 NEUTRON ACER TENDL-2019 LIBRARY; T=293.16K  
alphas from (n,2a)

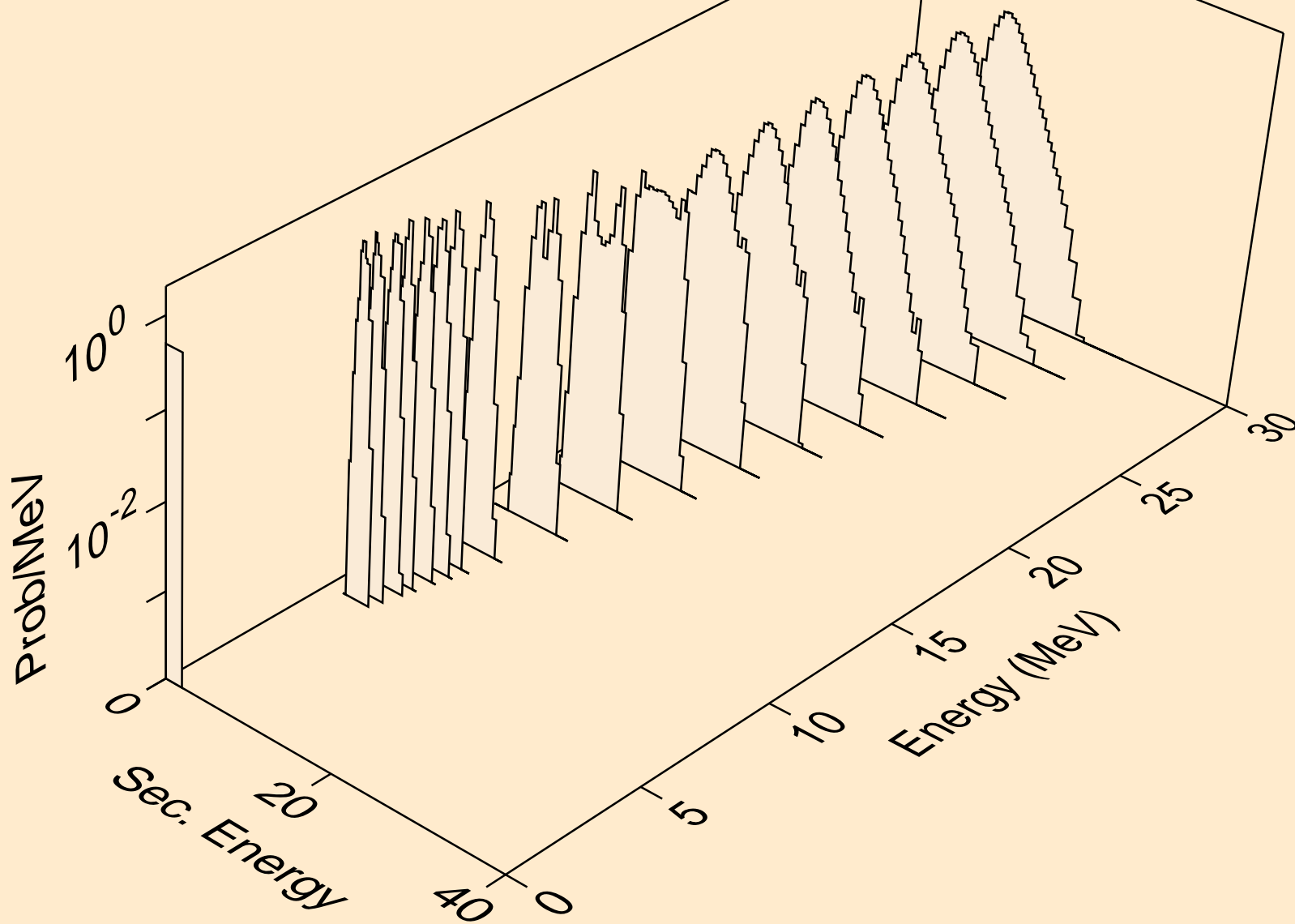

KR079 NEUTRON ACER TENDL-2019 LIBRARY; T=293.16K  
alphas from (n,pa)

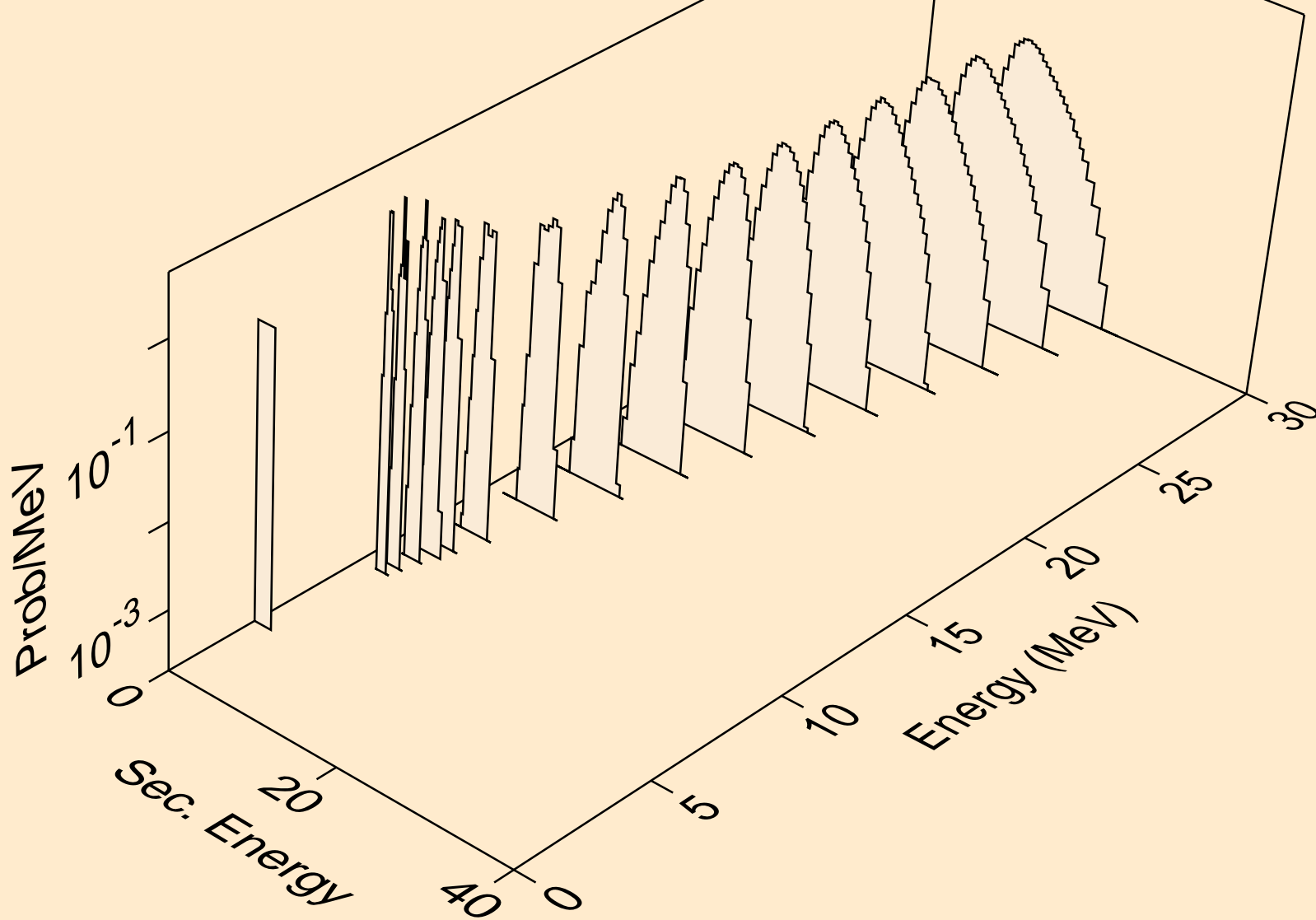

KR079 NEUTRON ACER TENDL-2019 LIBRARY; T=293.16K  
alphas from (n,da)

