

KR082 NEUTRON ACER TENDL-2019 LIBRARY; T=293.16K  
Principal cross sections

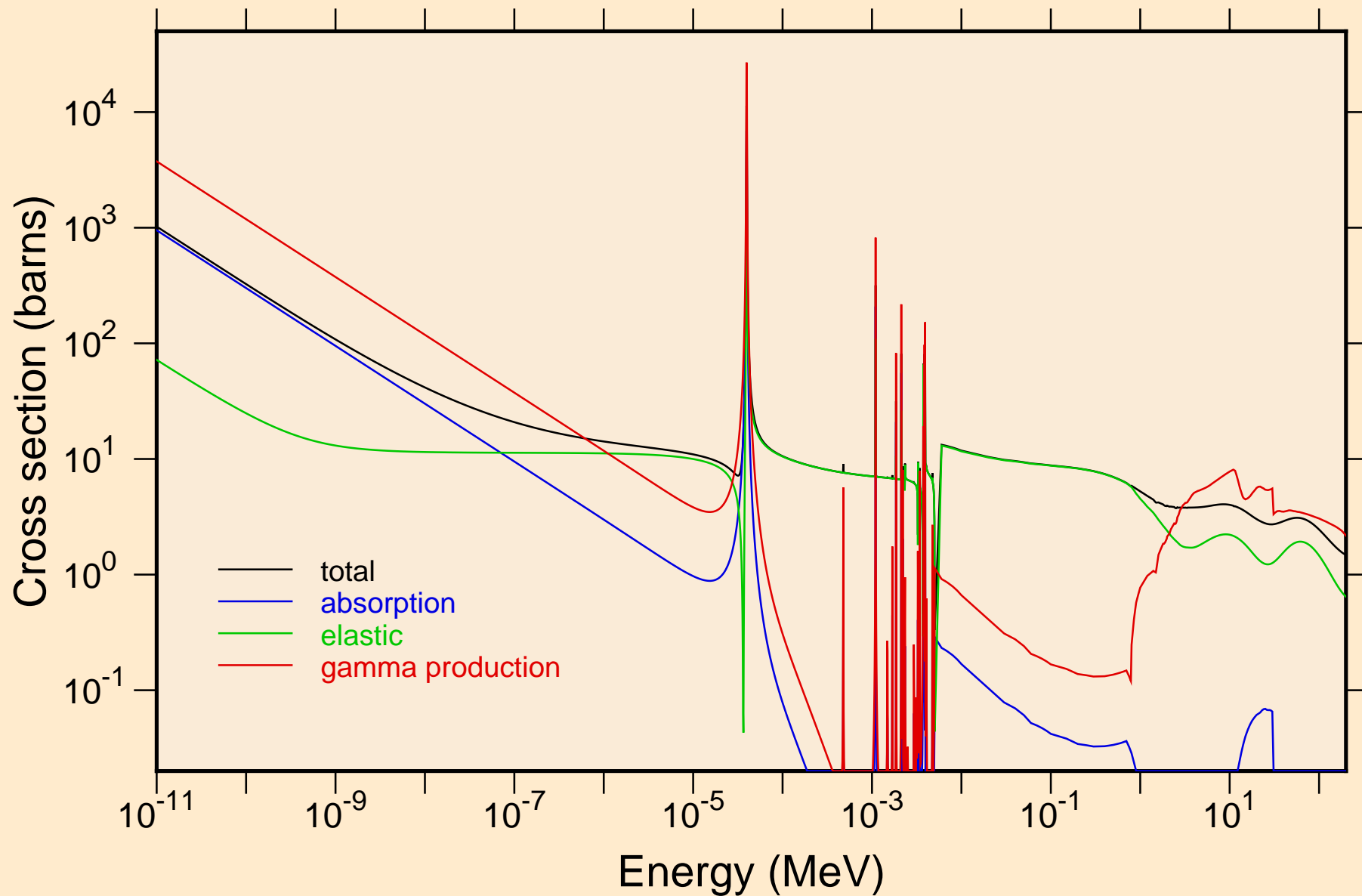

KR082 NEUTRON ACER TENDL-2019 LIBRARY; T=293.16K  
resonance total cross section

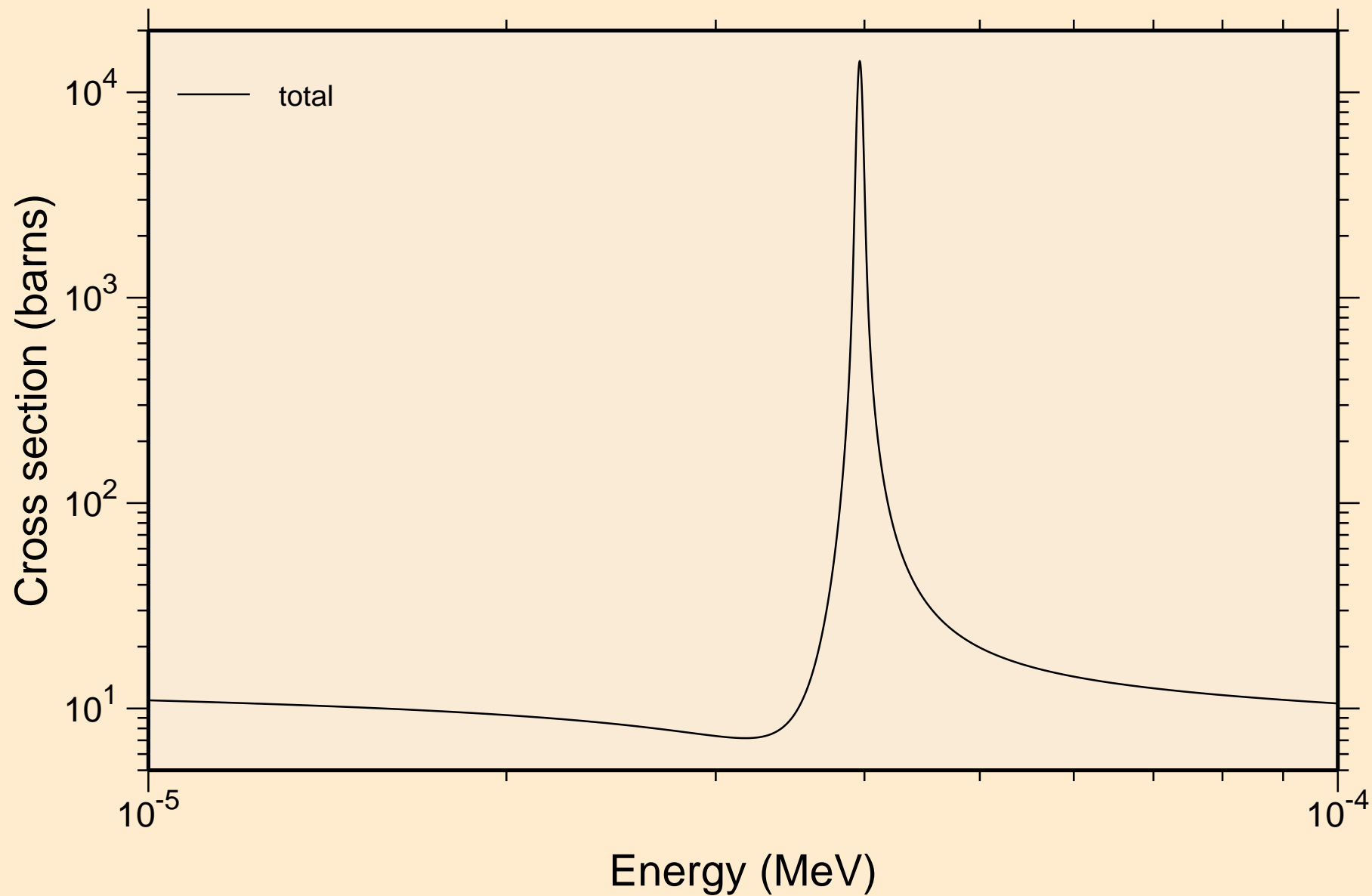

KR082 NEUTRON ACER TENDL-2019 LIBRARY; T=293.16K  
resonance total cross section

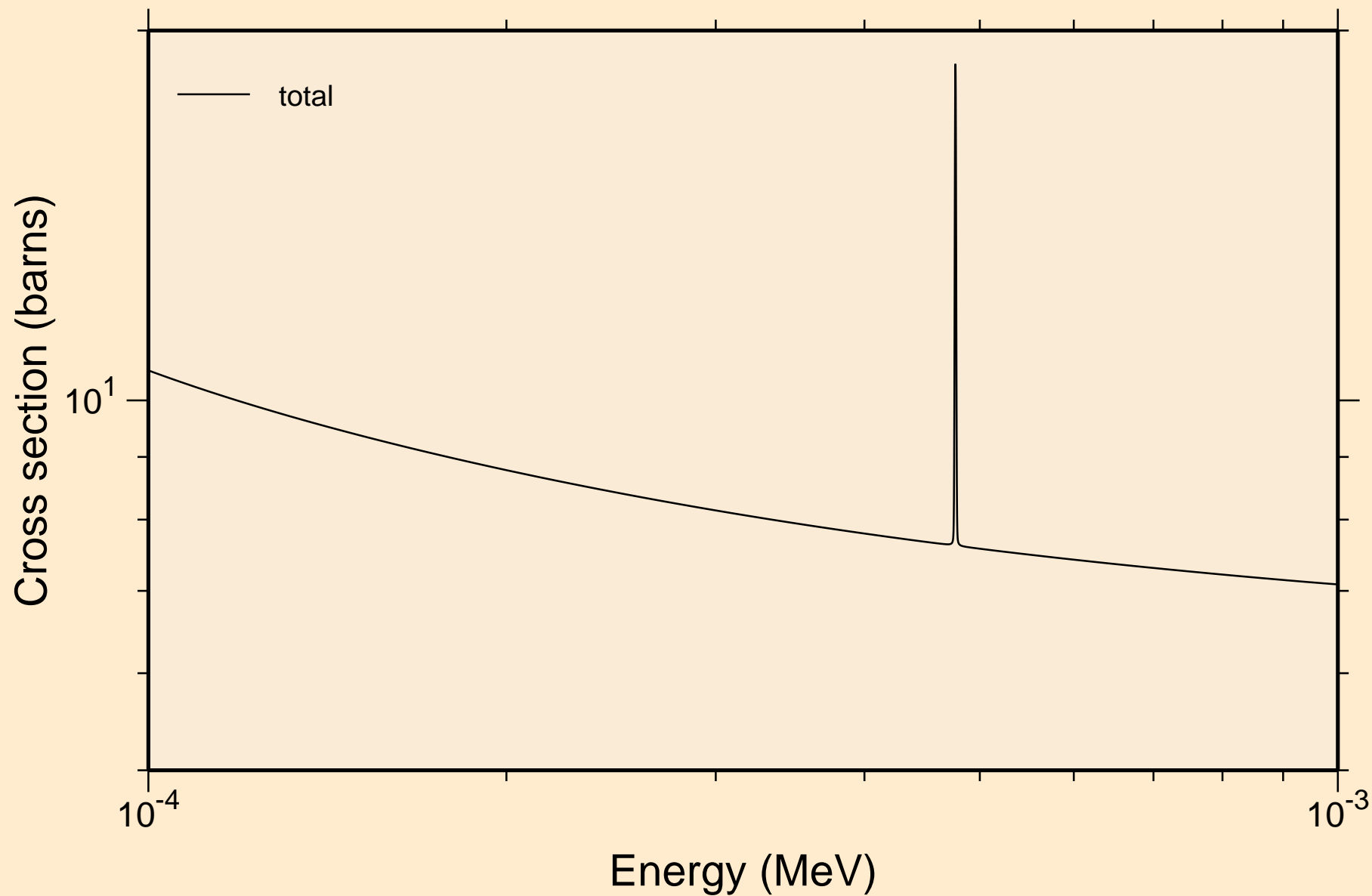

KR082 NEUTRON ACER TENDL-2019 LIBRARY; T=293.16K  
resonance total cross section

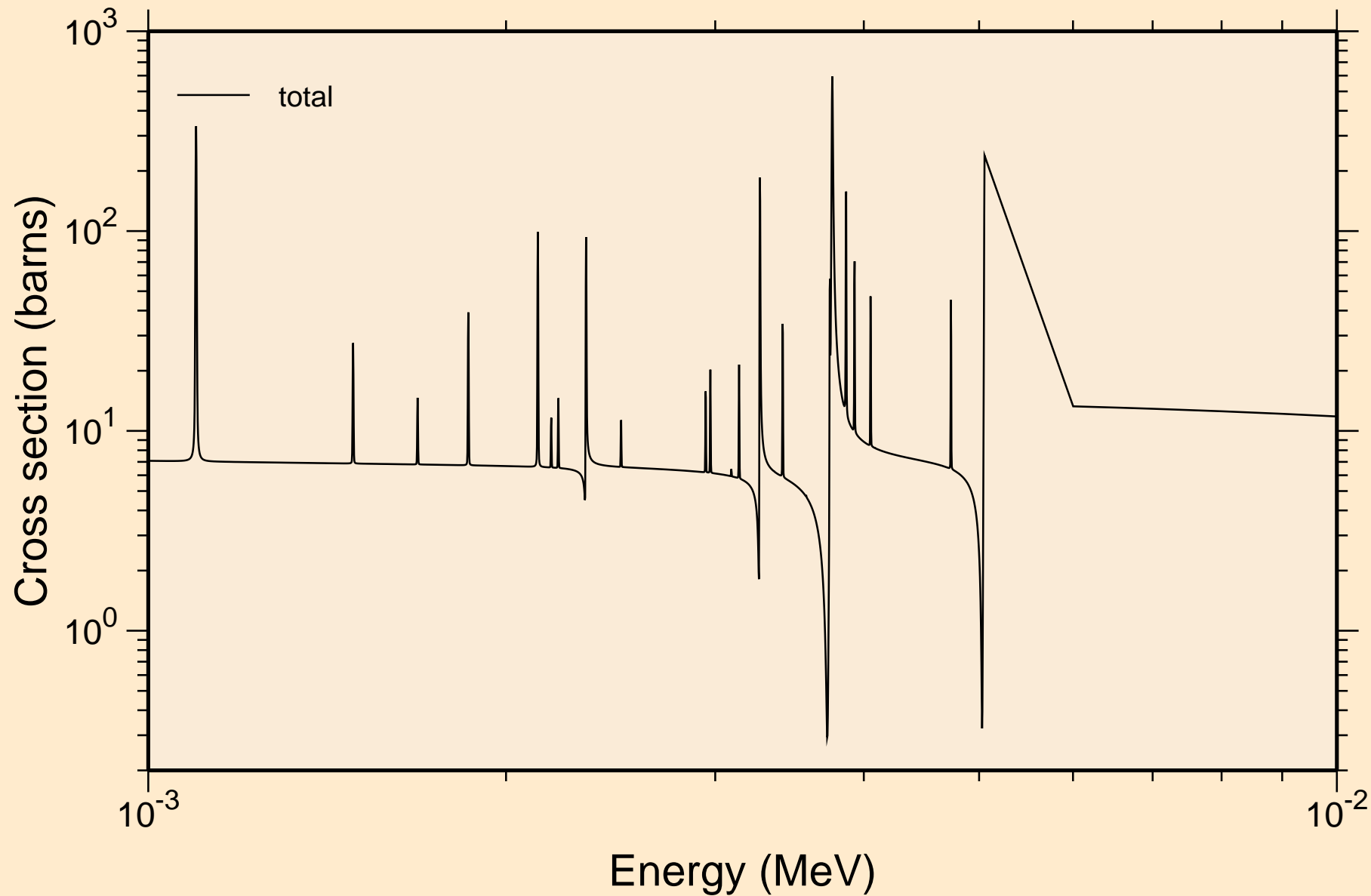

KR082 NEUTRON ACER TENDL-2019 LIBRARY; T=293.16K  
resonance total cross section

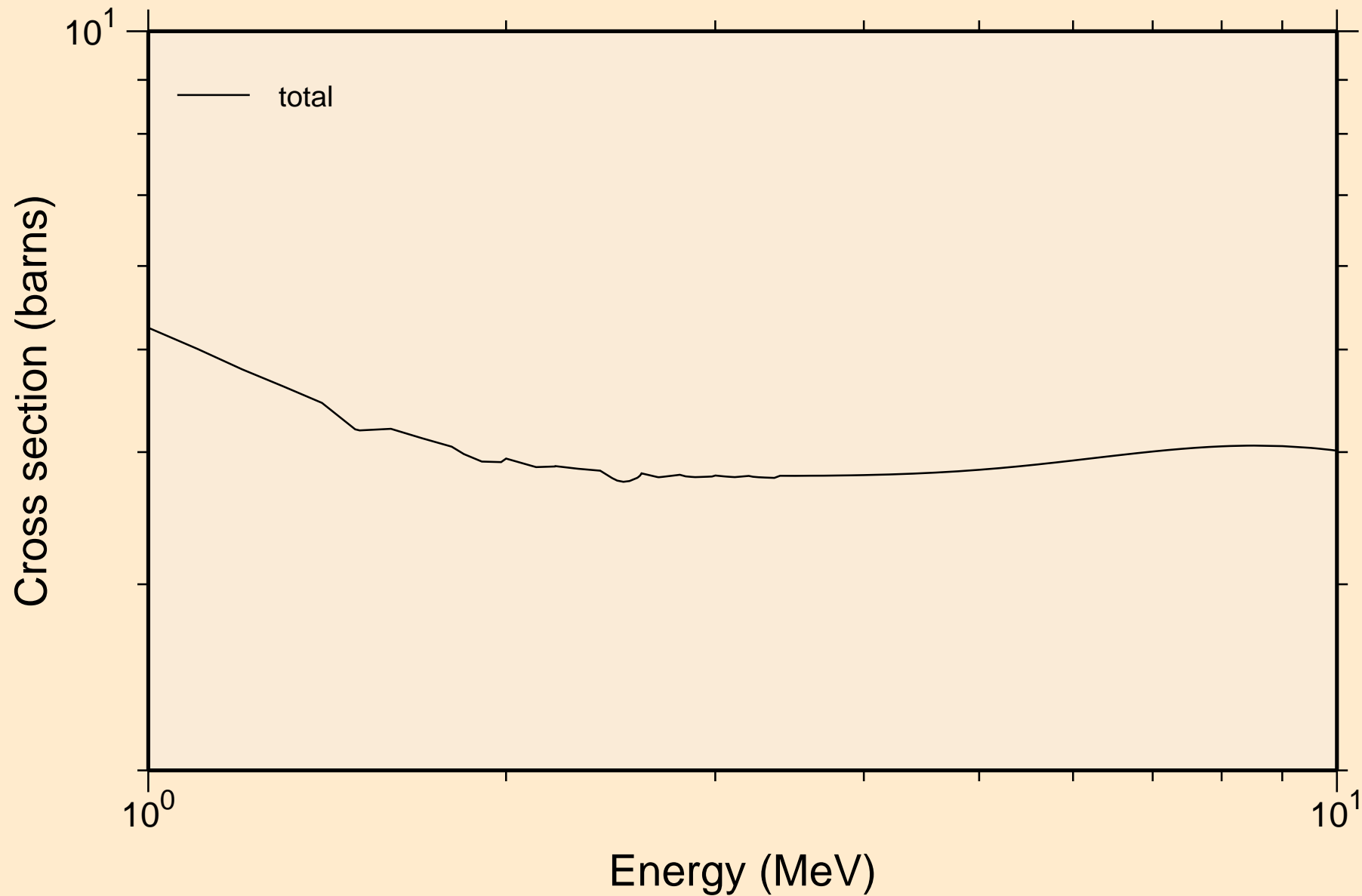

KR082 NEUTRON ACER TENDL-2019 LIBRARY; T=293.16K  
resonance absorption cross sections

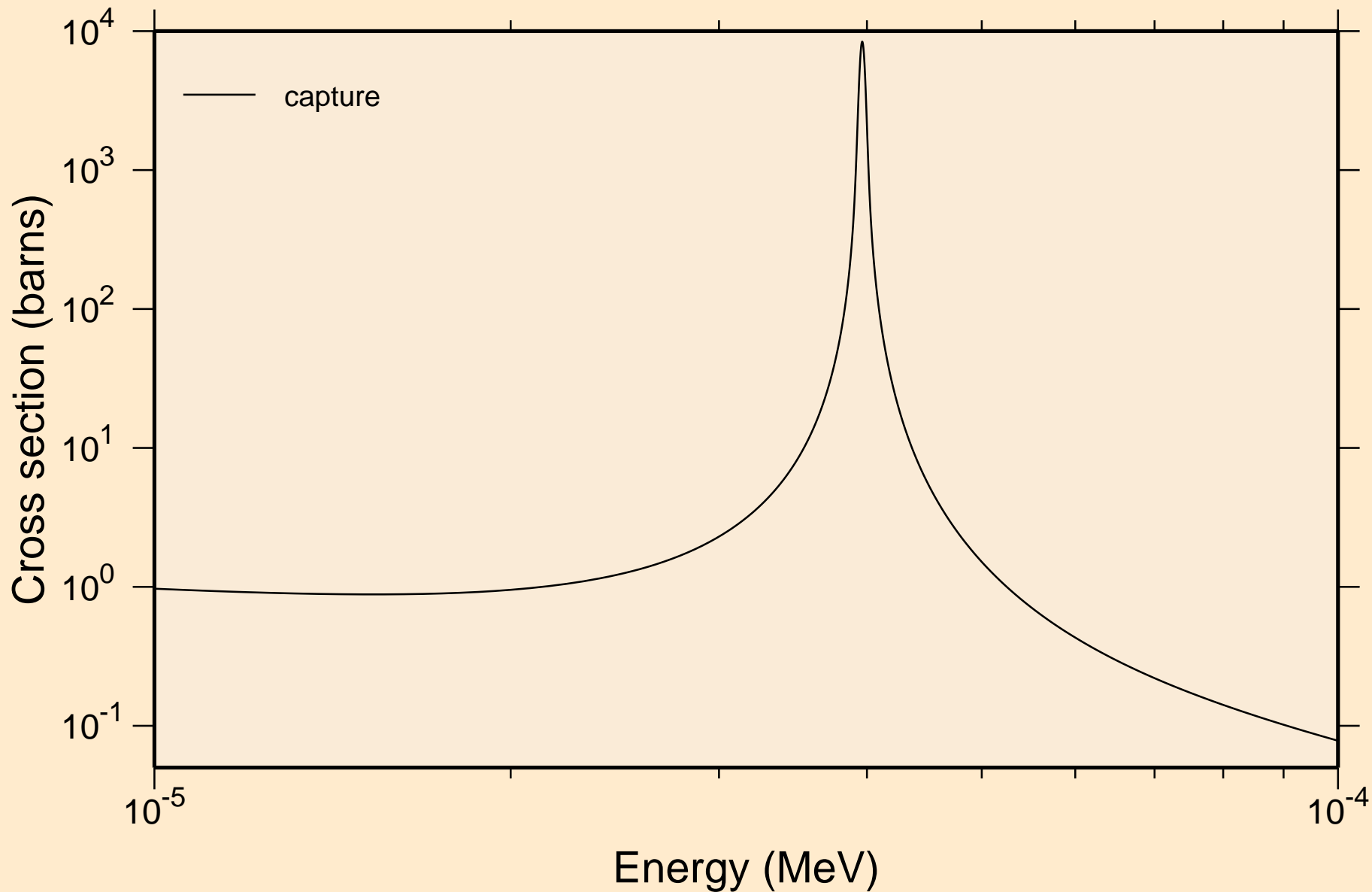

KR082 NEUTRON ACER TENDL-2019 LIBRARY; T=293.16K  
resonance absorption cross sections

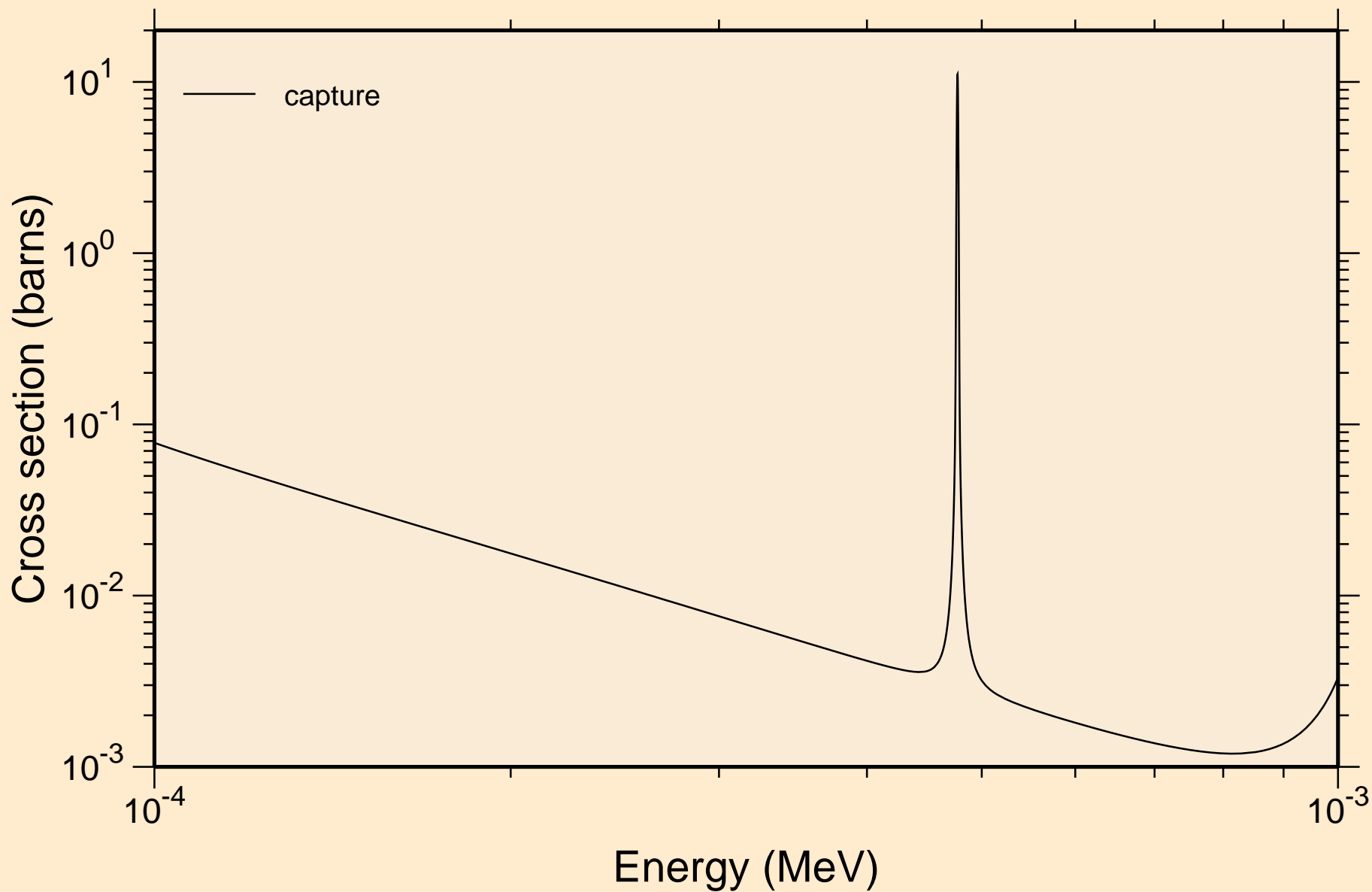

KR082 NEUTRON ACER TENDL-2019 LIBRARY; T=293.16K  
resonance absorption cross sections

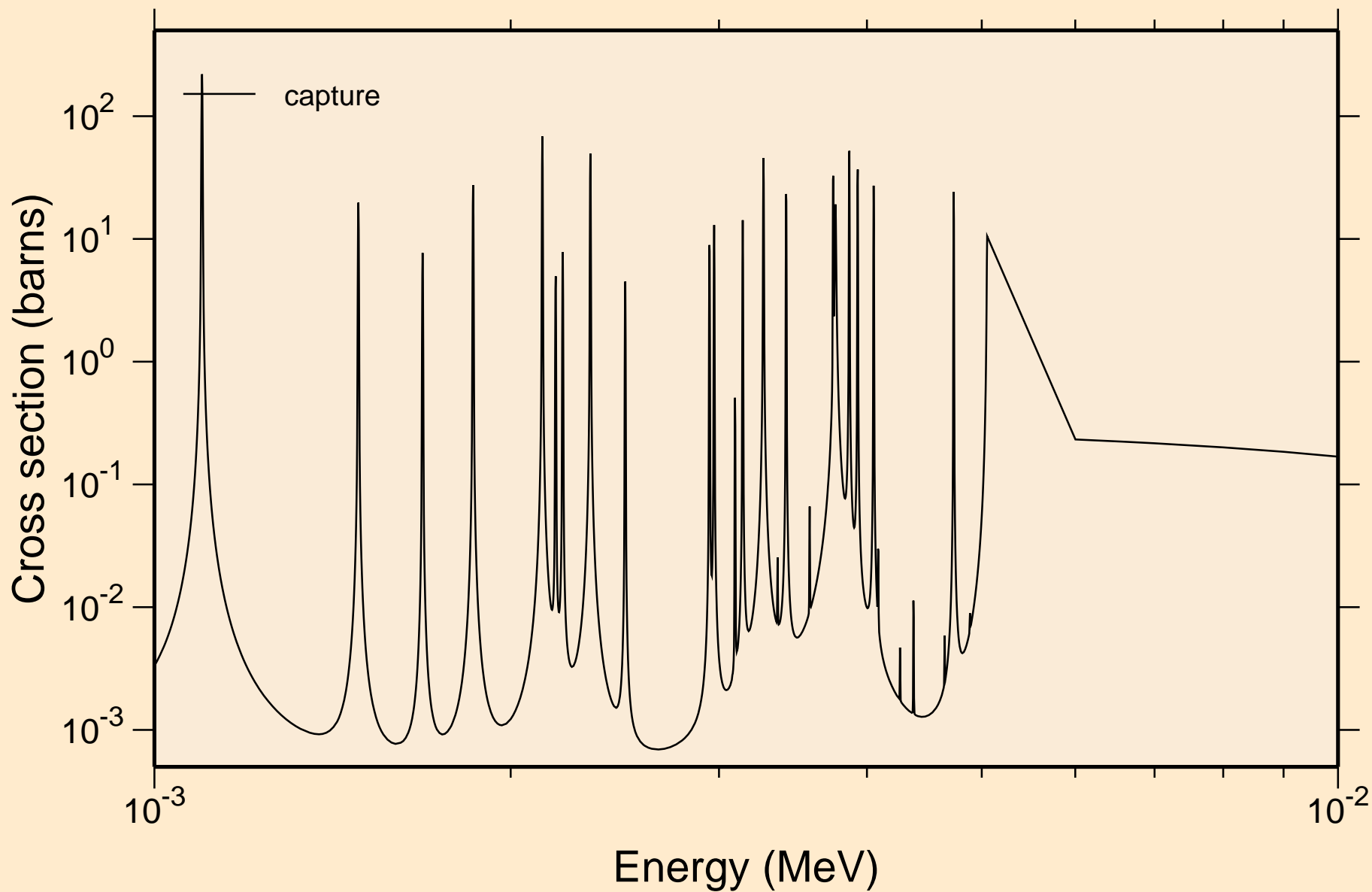



KR082 NEUTRON ACER TENDL-2019 LIBRARY; T=293.16K  
resonance absorption cross sections

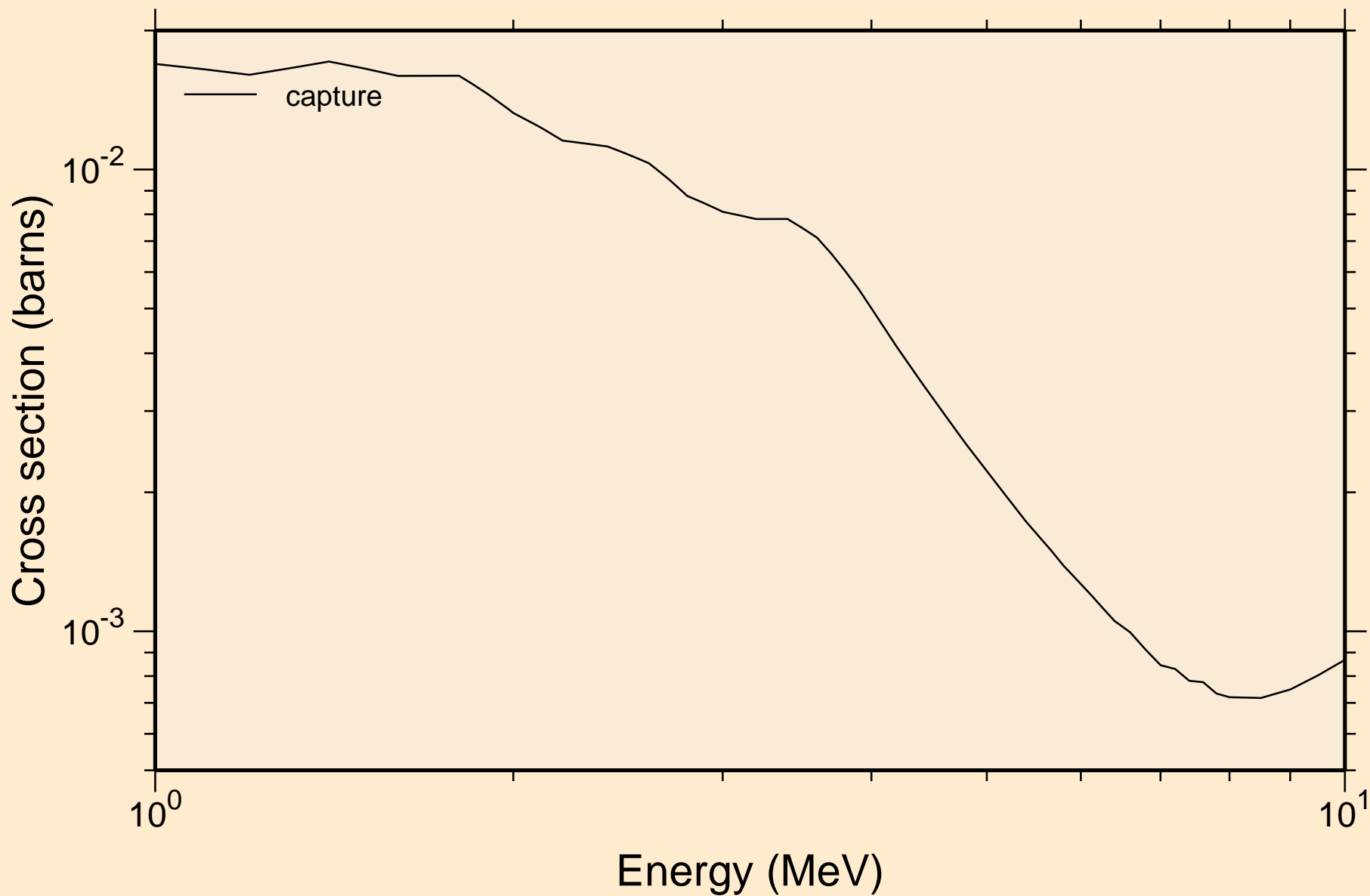

KR082 NEUTRON ACER TENDL-2019 LIBRARY; T=293.16K  
Heating

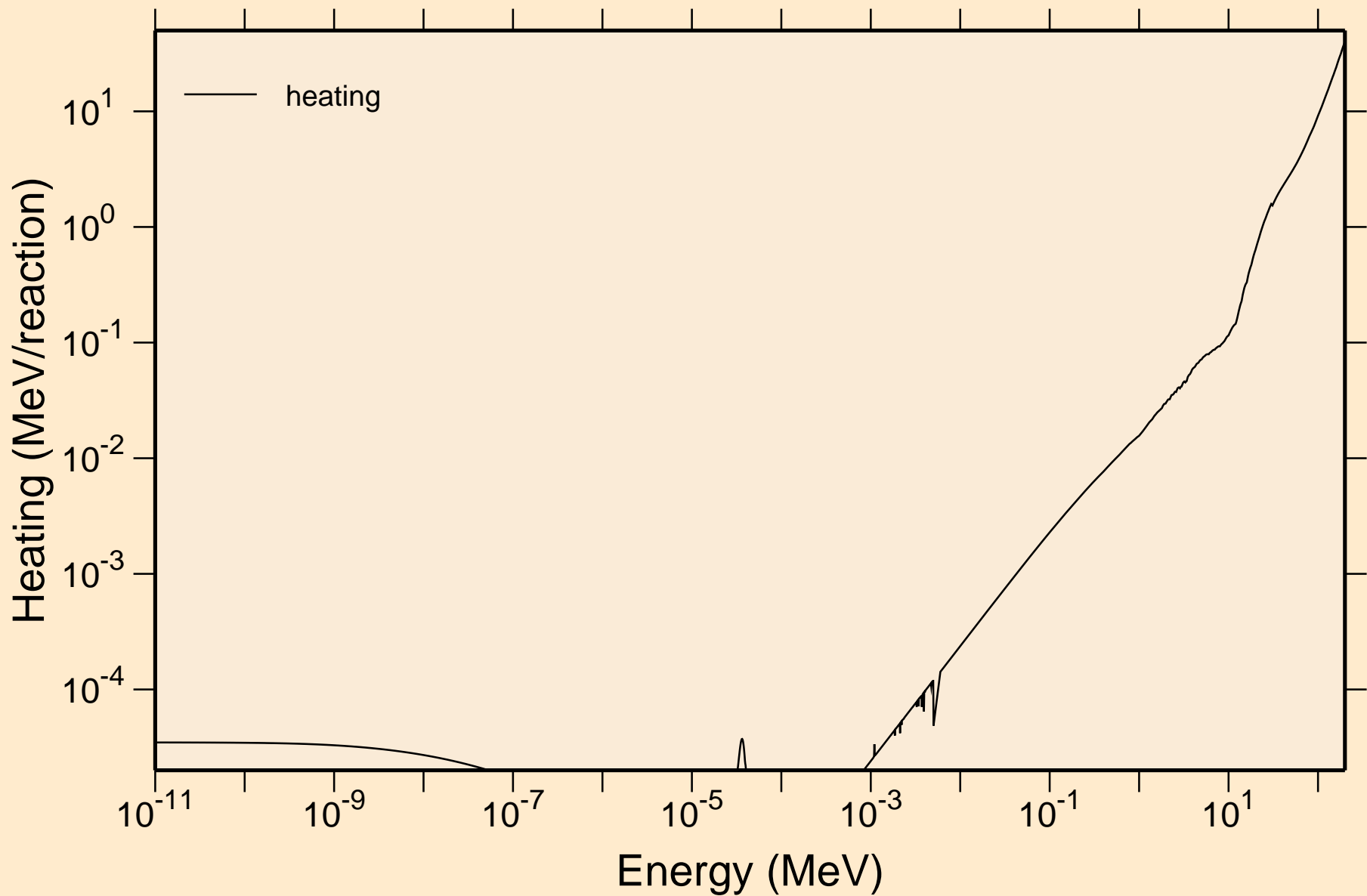

# KR082 NEUTRON ACER TENDL-2019 LIBRARY; T=293.16K Damage

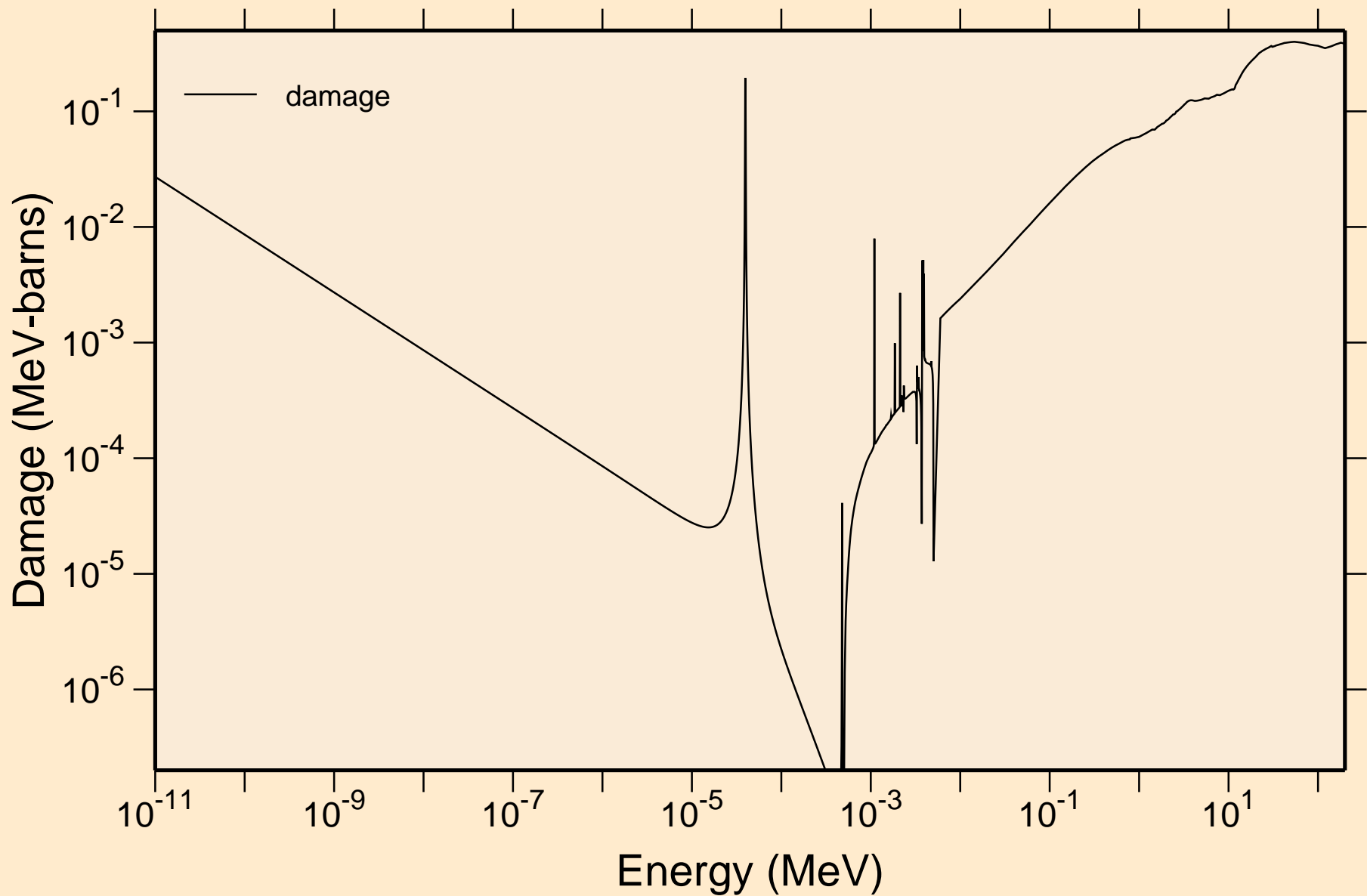

KR082 NEUTRON ACER TENDL-2019 LIBRARY; T=293.16K  
Non-threshold reactions

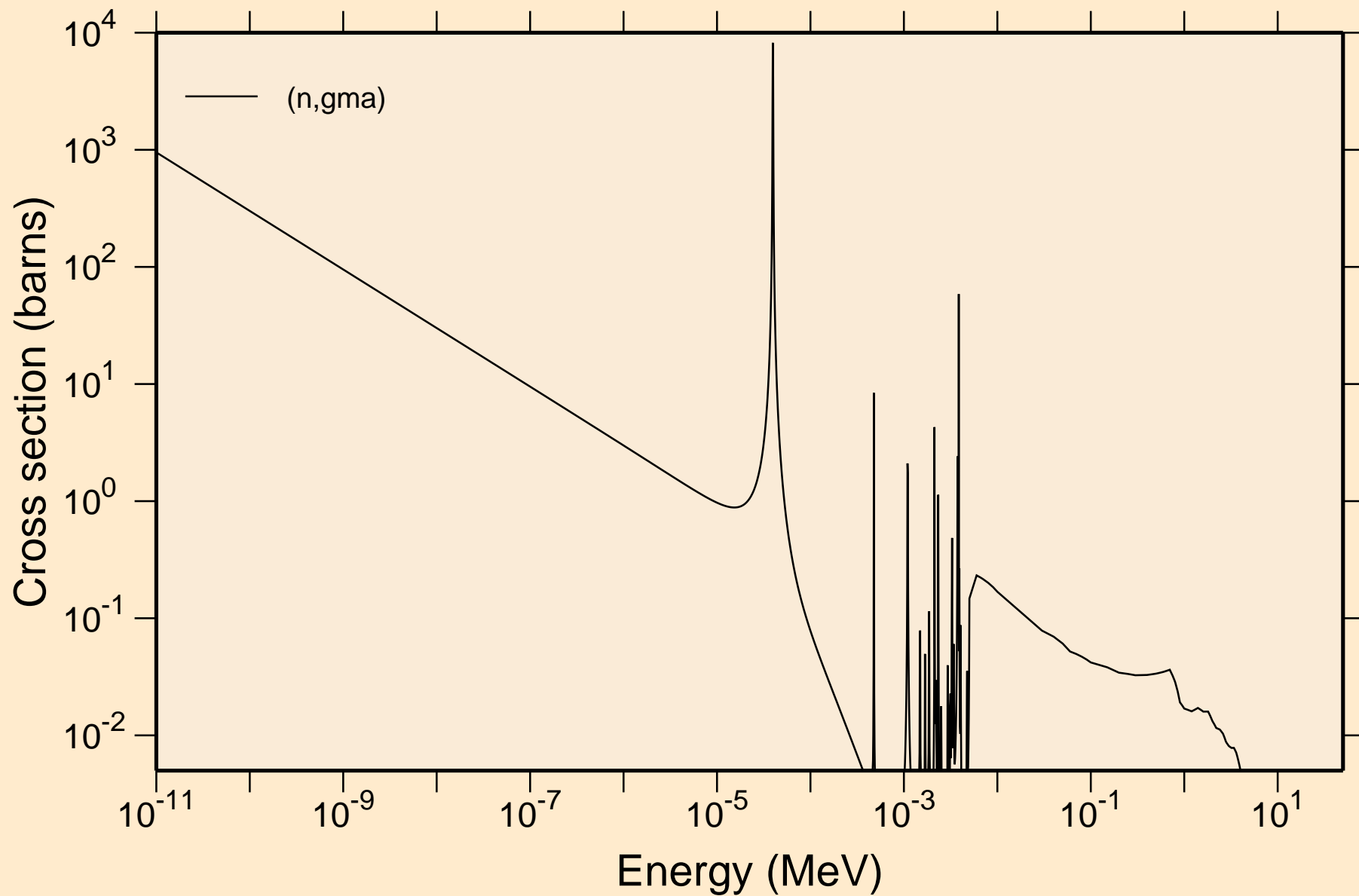

KR082 NEUTRON ACER TENDL-2019 LIBRARY; T=293.16K  
Principal cross sections

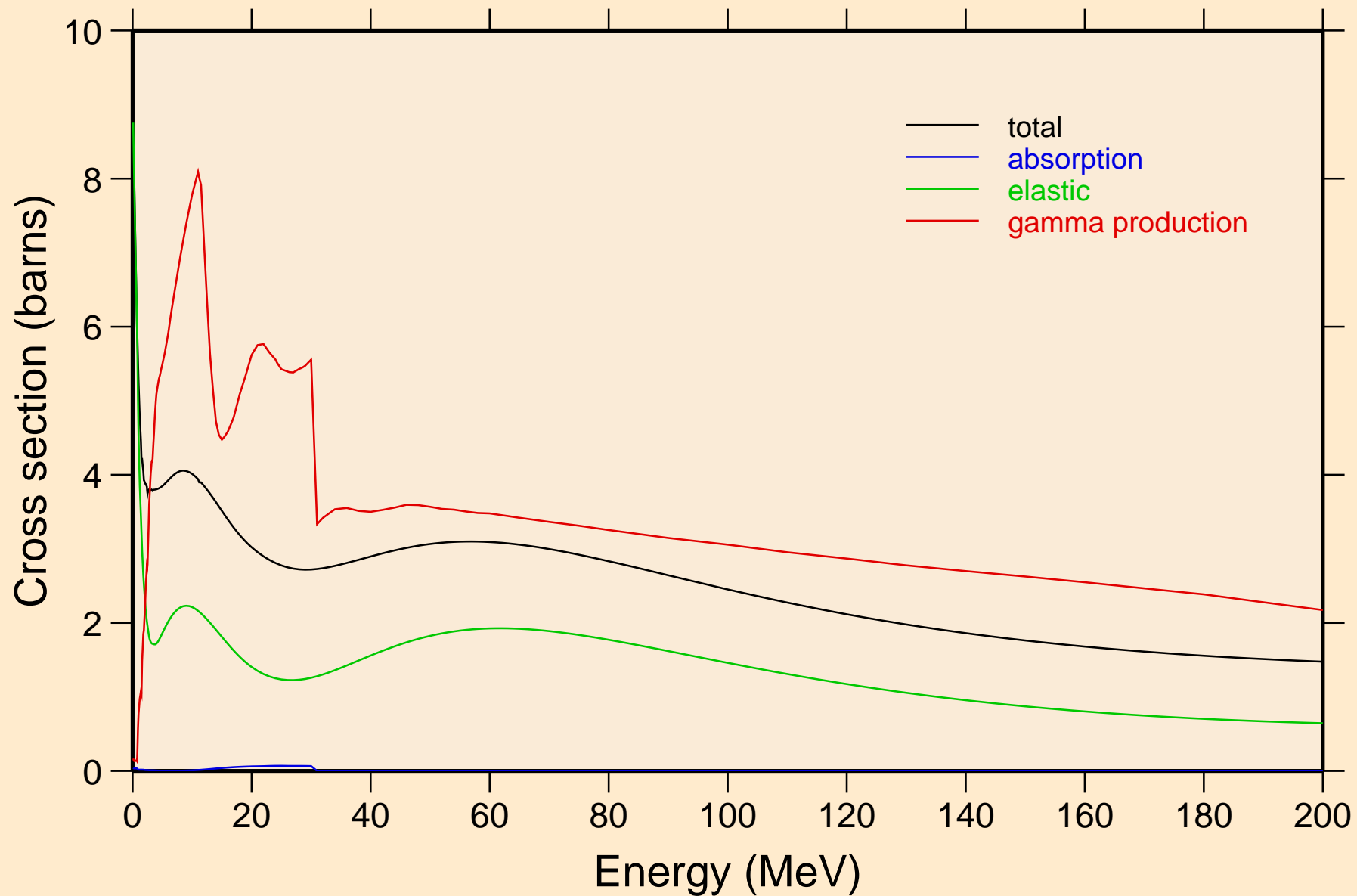

KR082 NEUTRON ACER TENDL-2019 LIBRARY; T=293.16K  
Heating

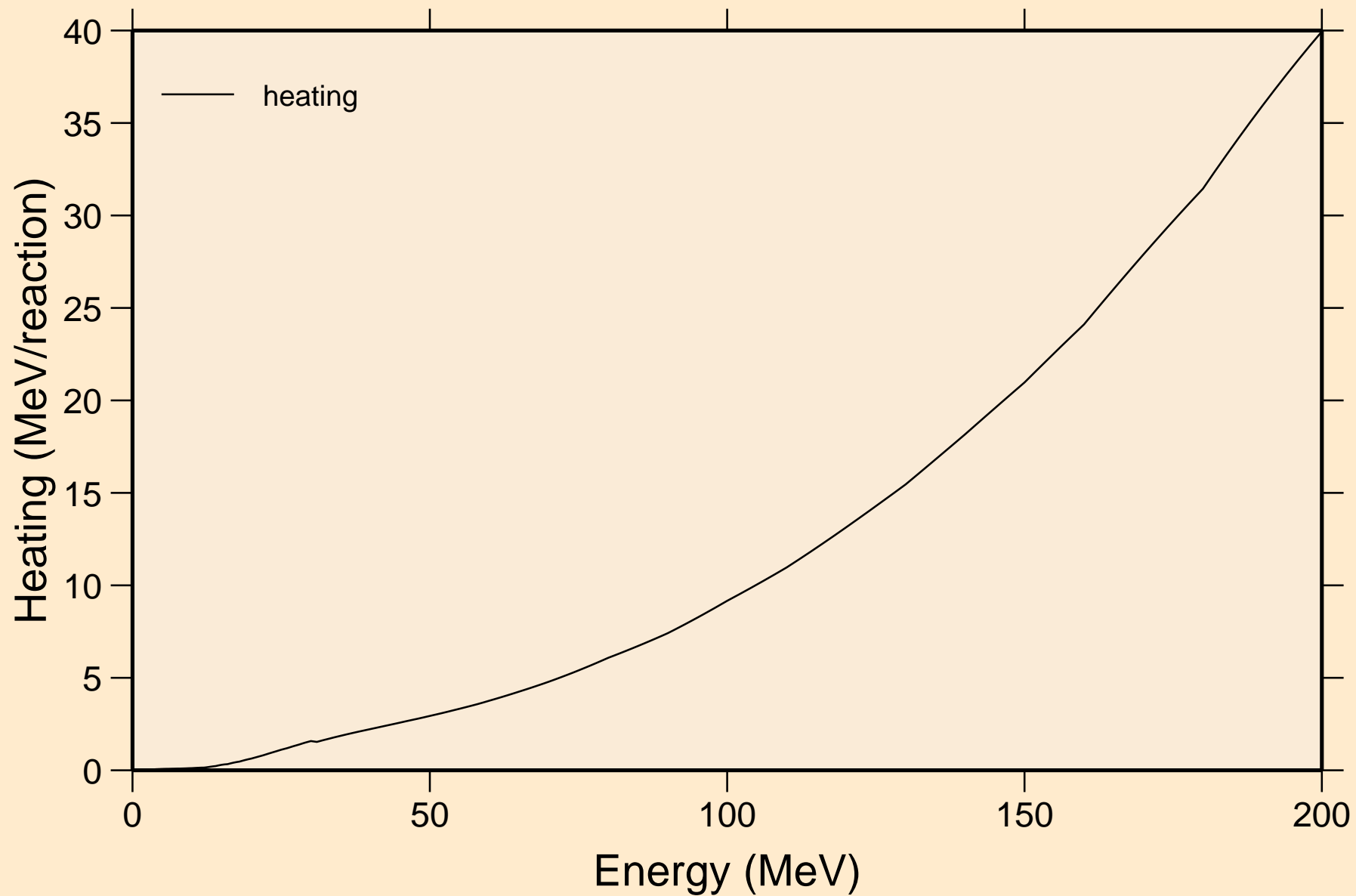

KR082 NEUTRON ACER TENDL-2019 LIBRARY; T=293.16K  
Damage

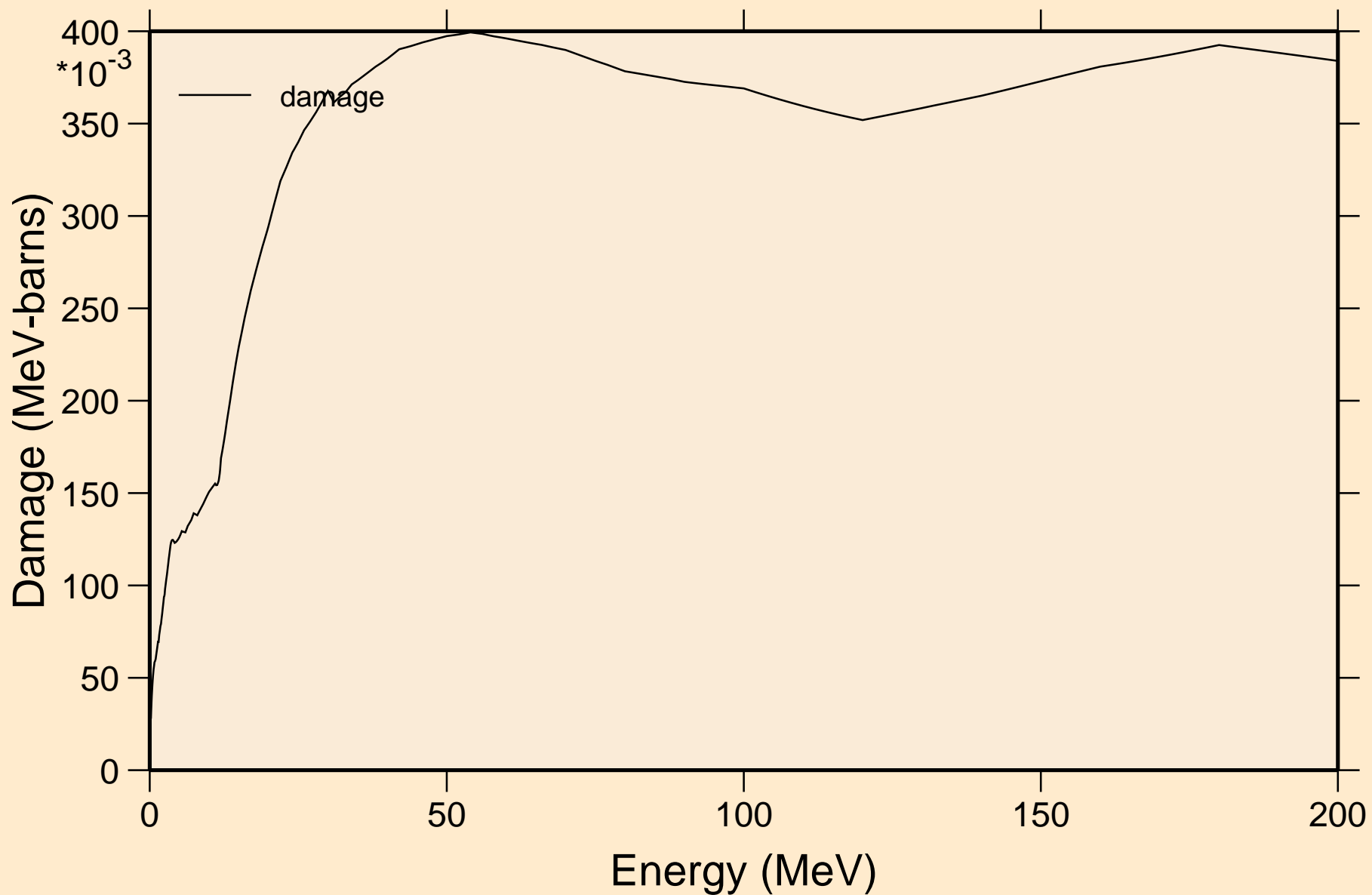

KR082 NEUTRON ACER TENDL-2019 LIBRARY; T=293.16K  
Non-threshold reactions

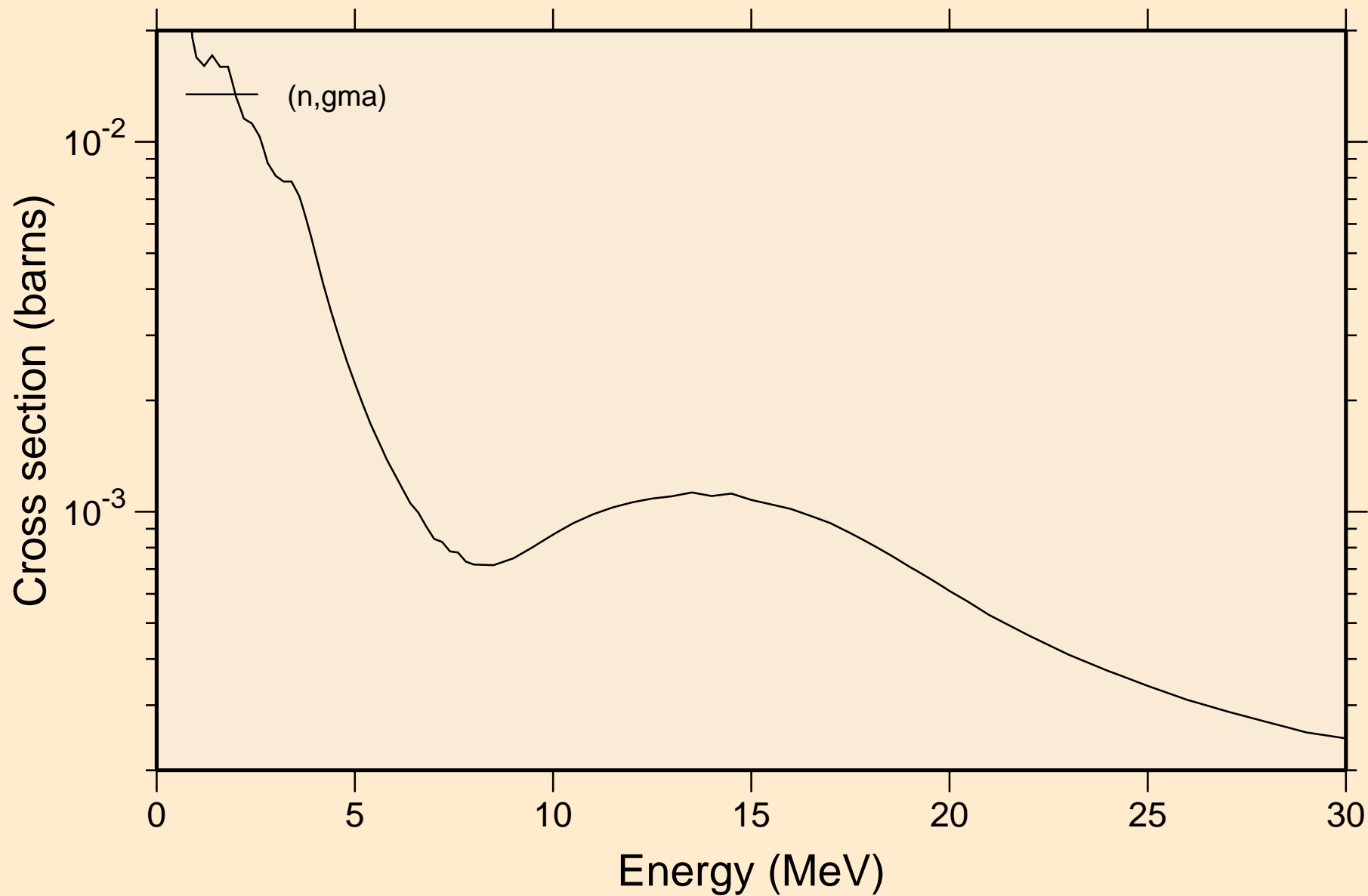



KR082 NEUTRON ACER TENDL-2019 LIBRARY; T=293.16K  
Inelastic levels

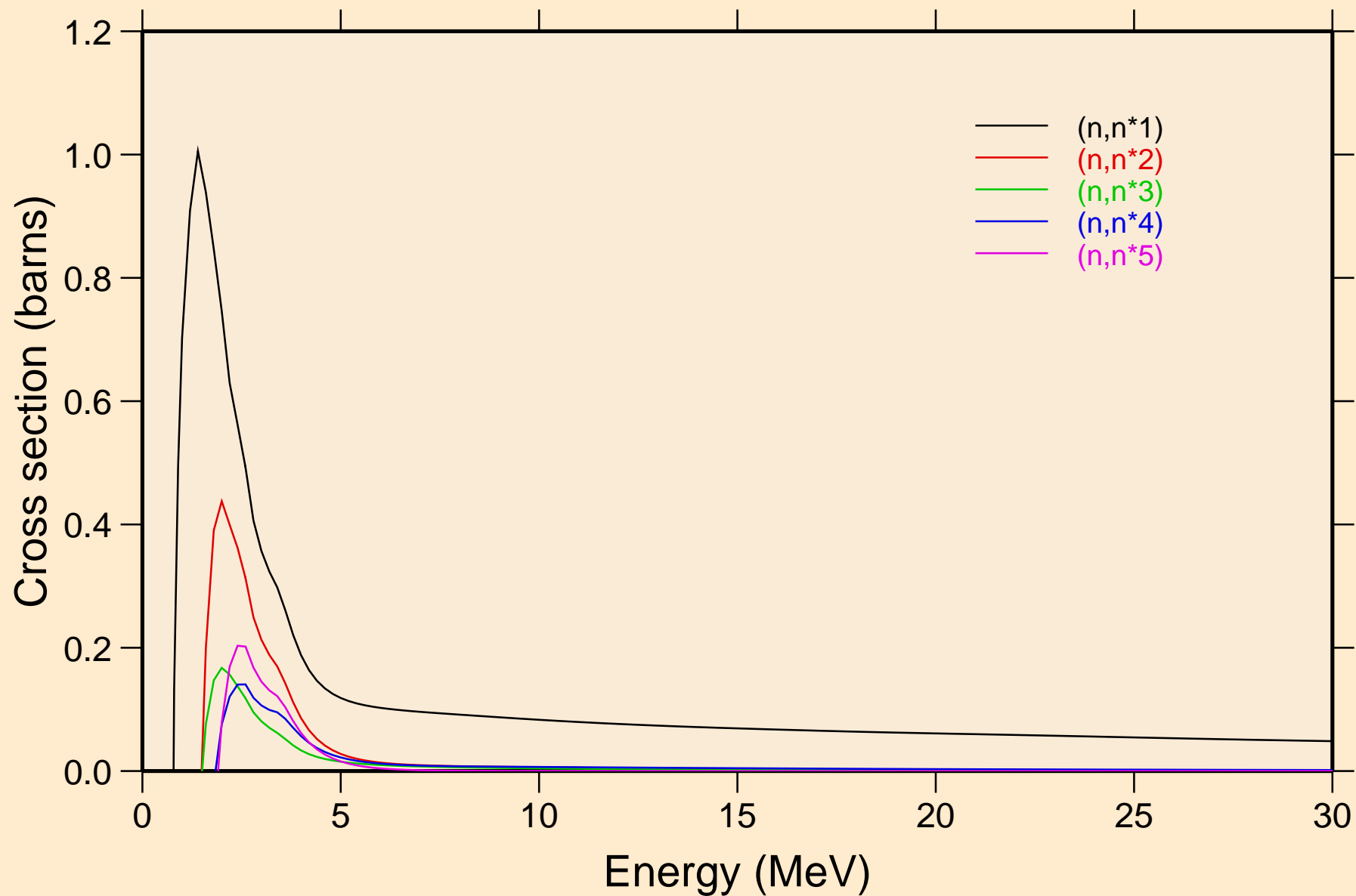

KR082 NEUTRON ACER TENDL-2019 LIBRARY; T=293.16K  
Inelastic levels

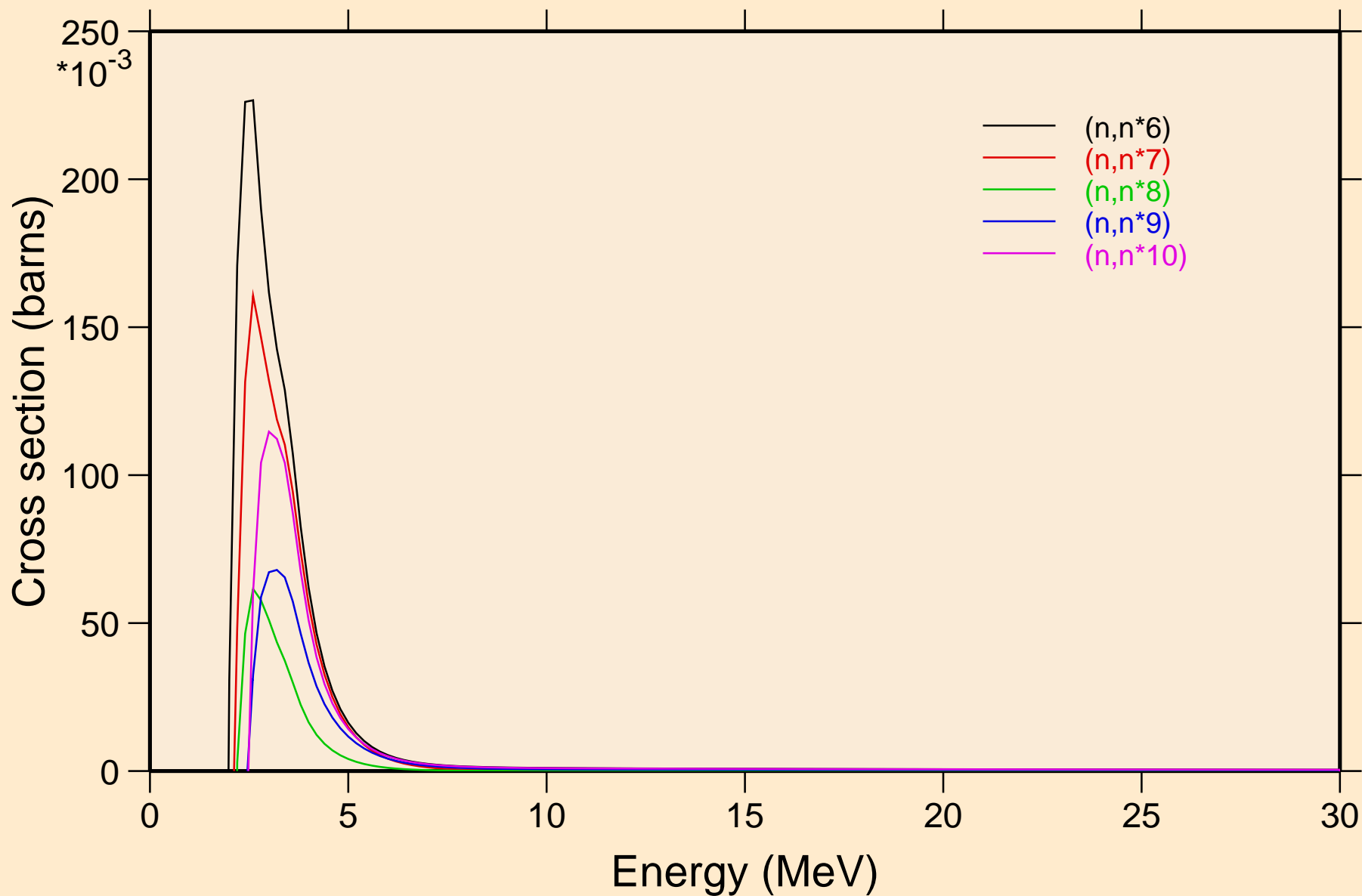

KR082 NEUTRON ACER TENDL-2019 LIBRARY; T=293.16K  
Inelastic levels

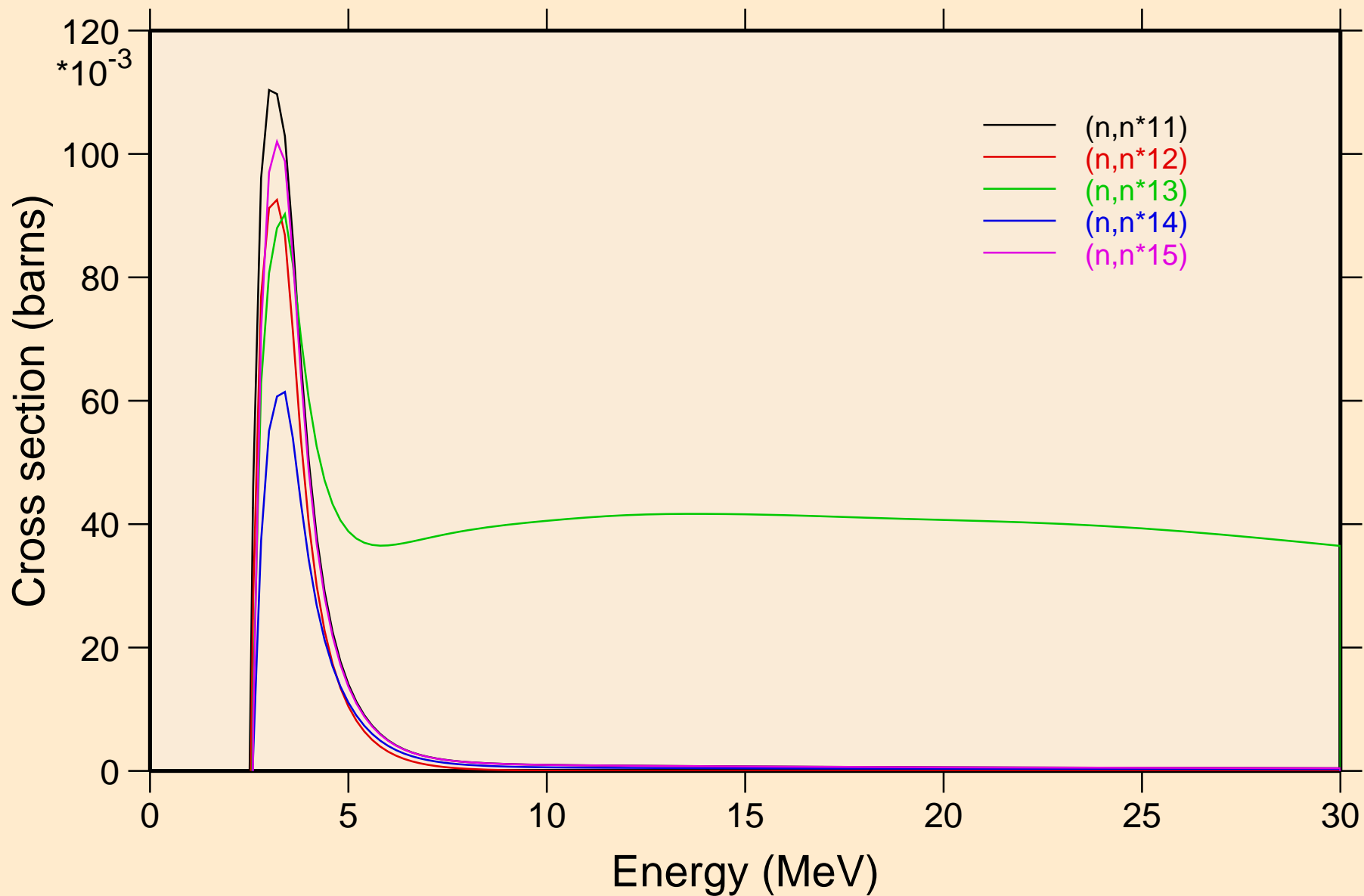

KR082 NEUTRON ACER TENDL-2019 LIBRARY; T=293.16K  
Inelastic levels

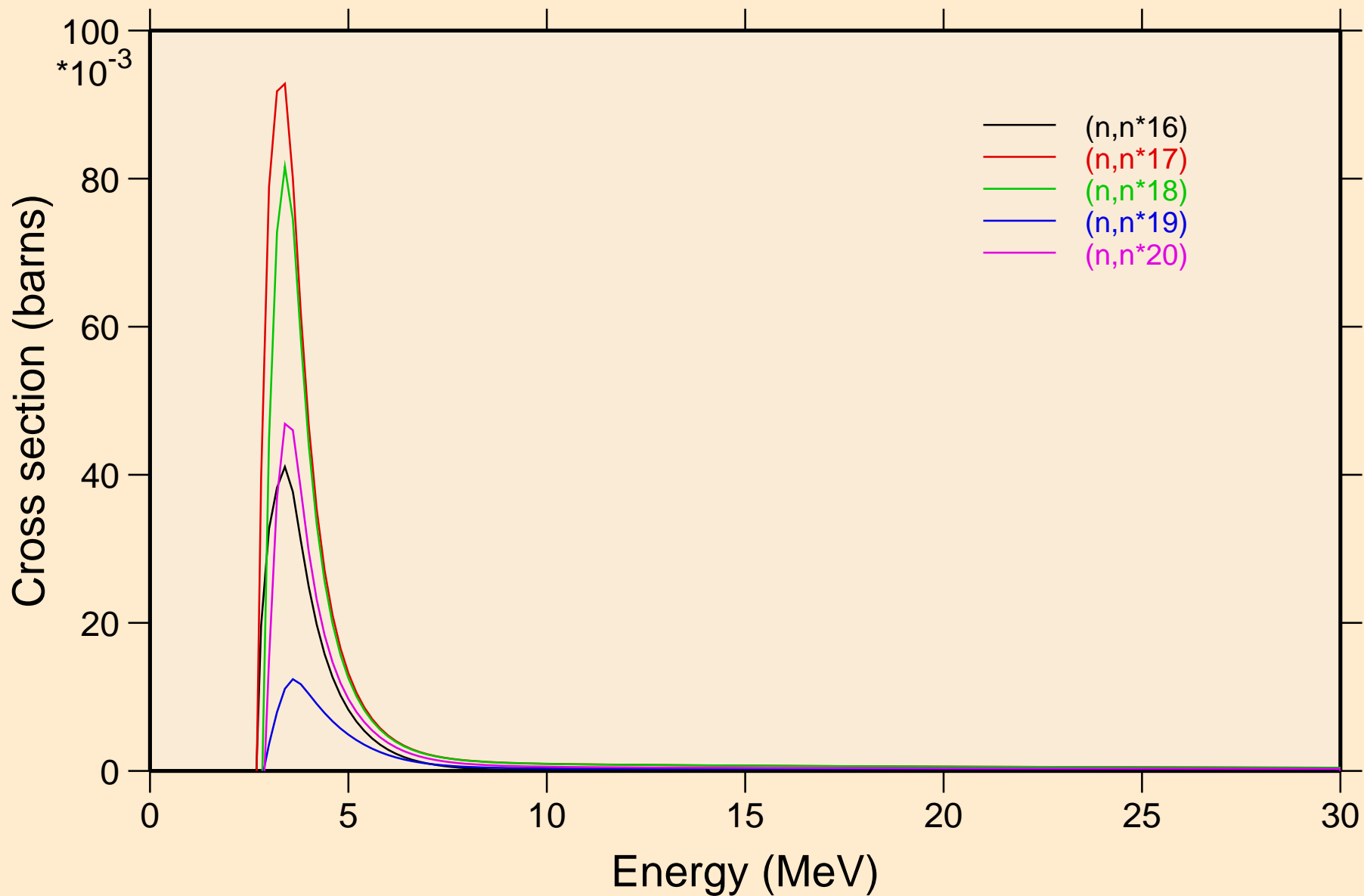

KR082 NEUTRON ACER TENDL-2019 LIBRARY; T=293.16K  
Inelastic levels

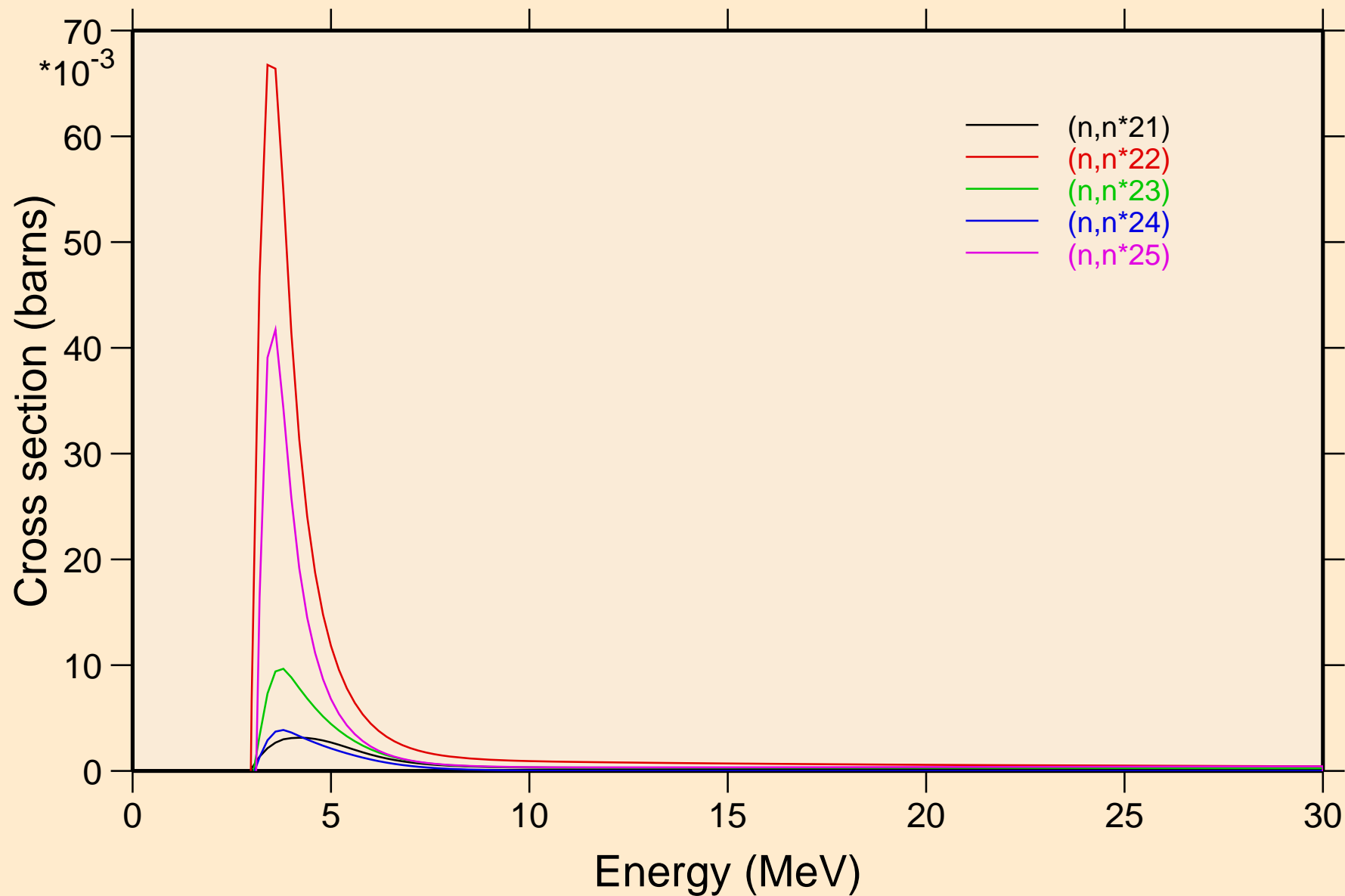

KR082 NEUTRON ACER TENDL-2019 LIBRARY; T=293.16K  
Inelastic levels

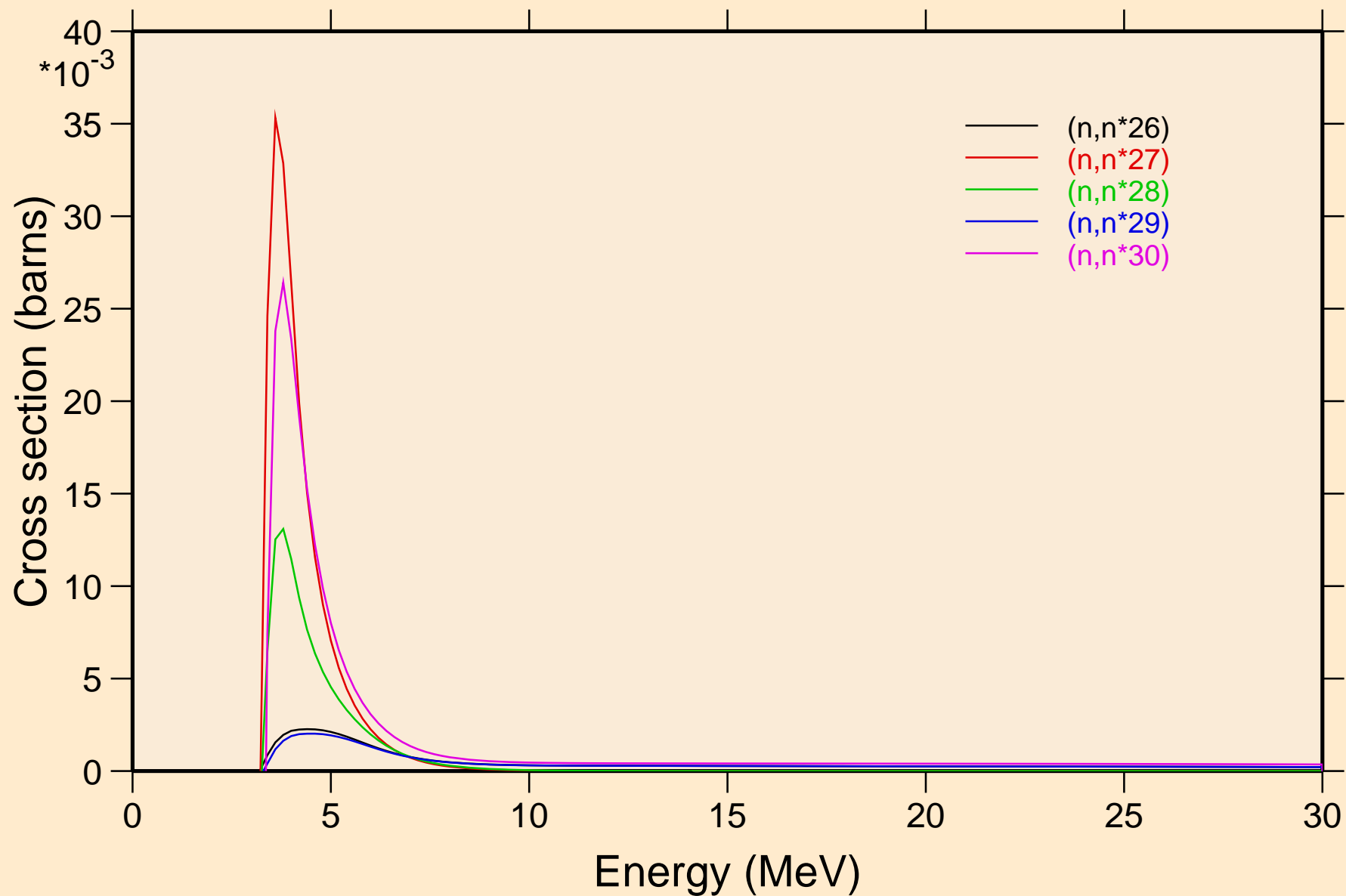

KR082 NEUTRON ACER TENDL-2019 LIBRARY; T=293.16K  
Threshold reactions

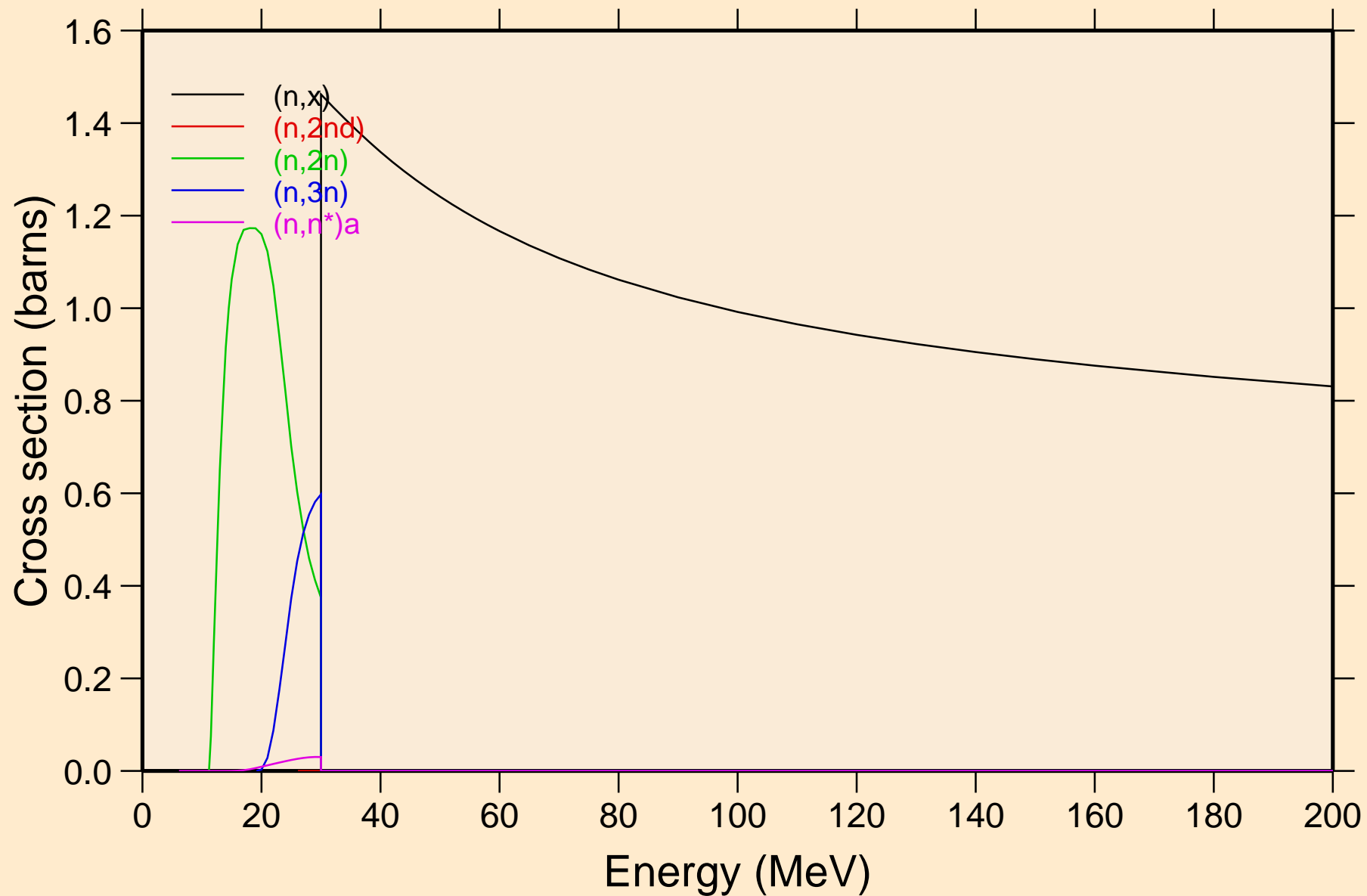

KR082 NEUTRON ACER TENDL-2019 LIBRARY; T=293.16K  
Threshold reactions

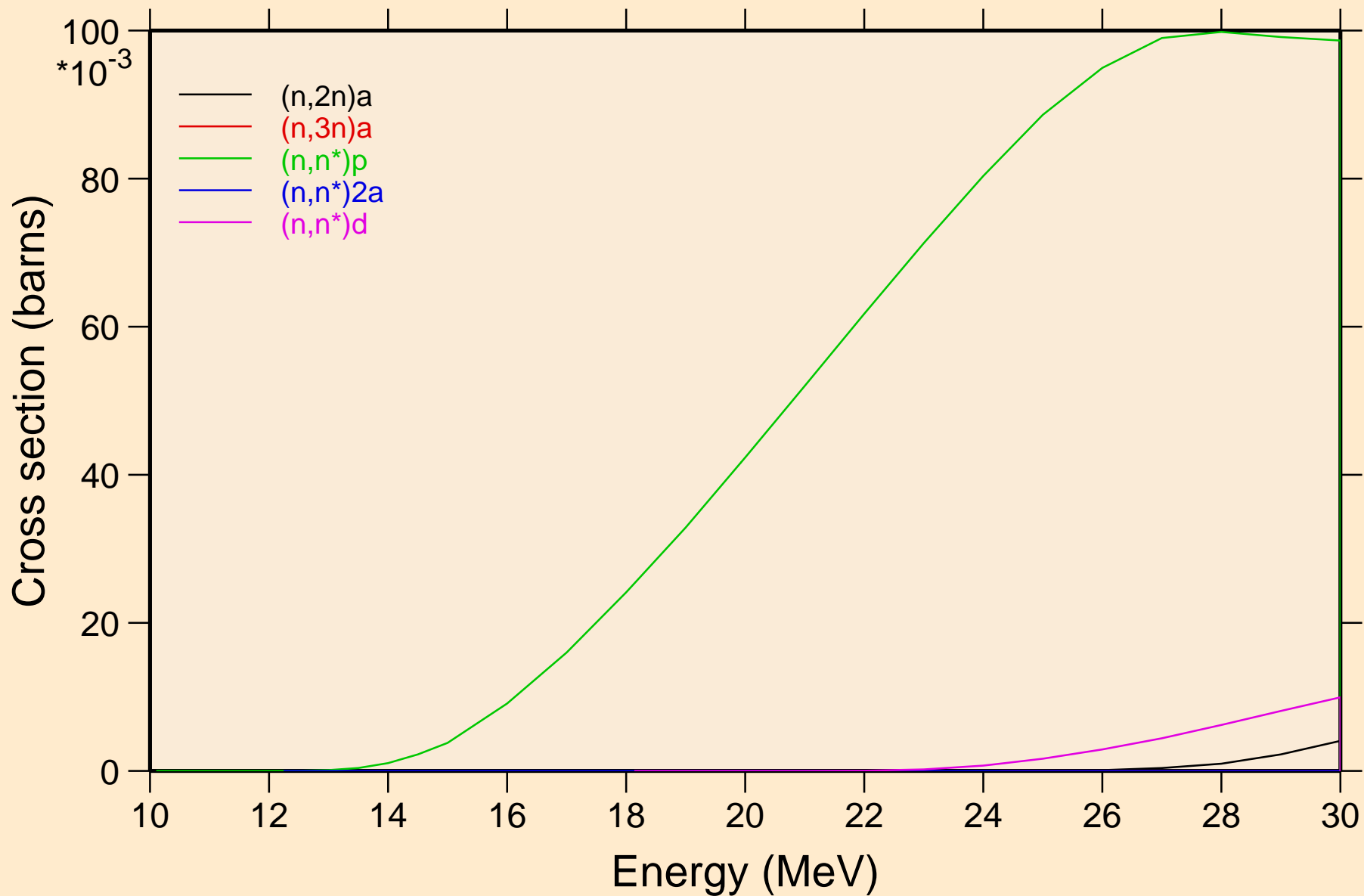



KR082 NEUTRON ACER TENDL-2019 LIBRARY; T=293.16K  
Threshold reactions

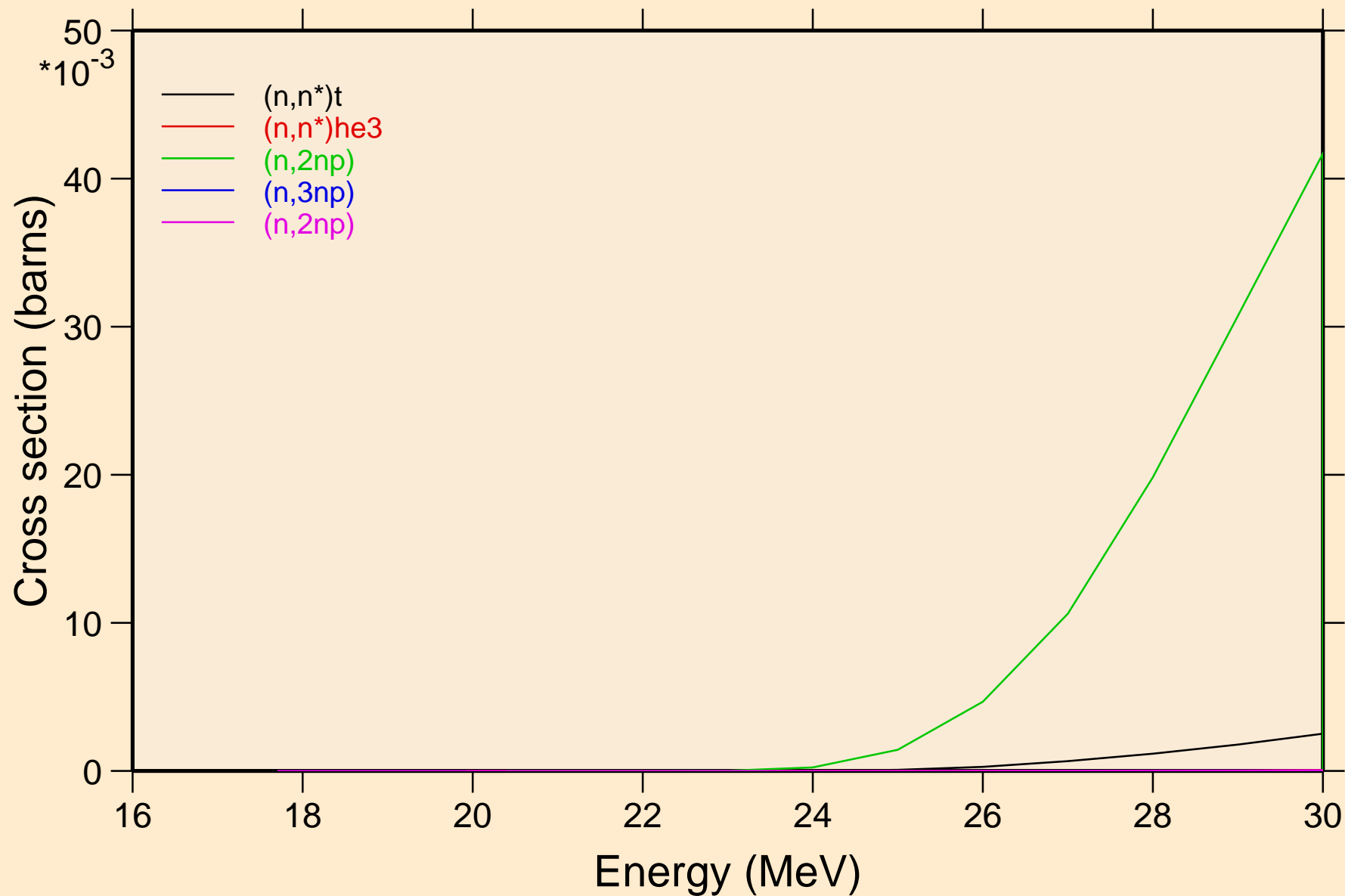

KR082 NEUTRON ACER TENDL-2019 LIBRARY; T=293.16K  
Threshold reactions

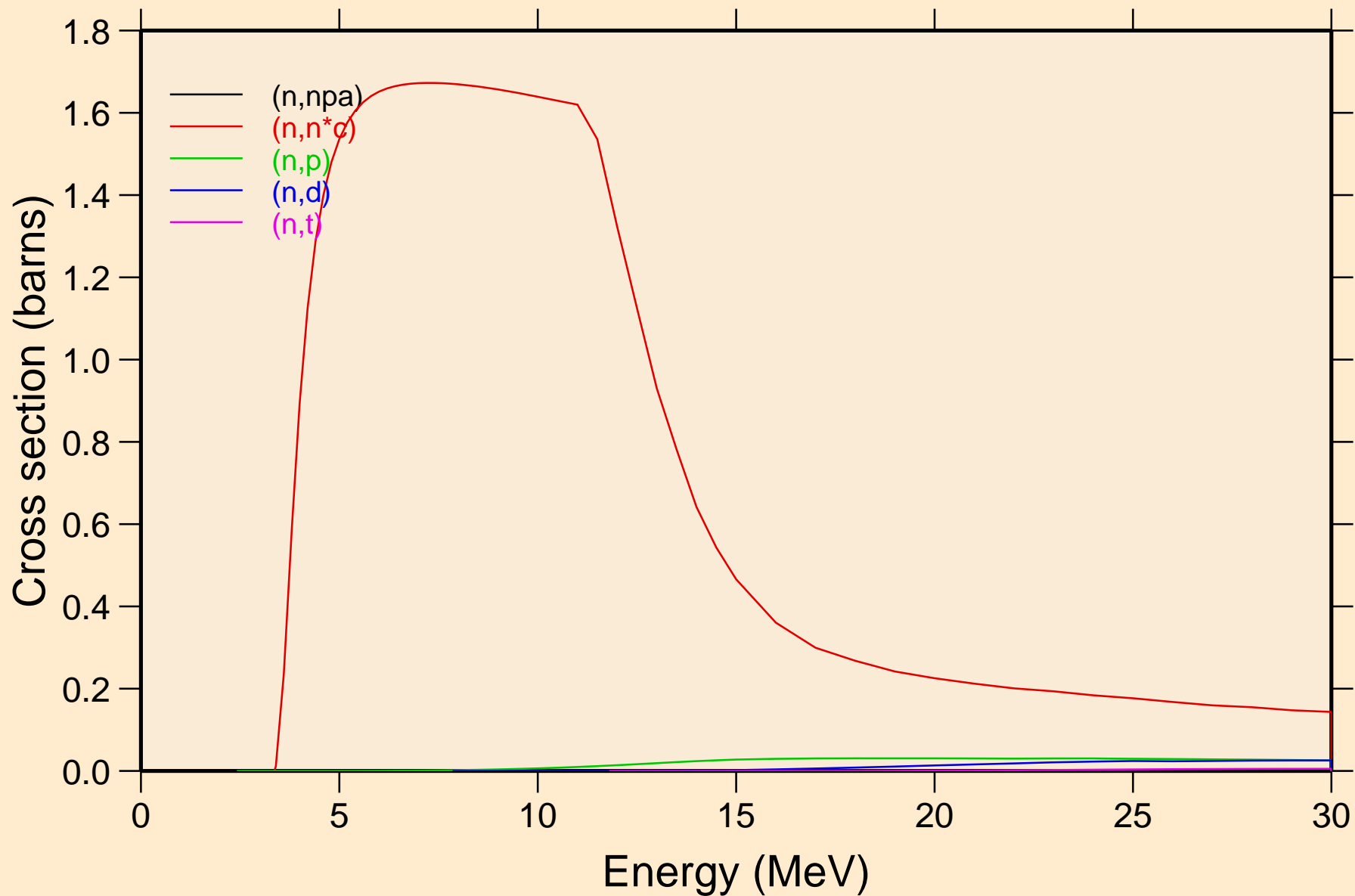

KR082 NEUTRON ACER TENDL-2019 LIBRARY; T=293.16K  
Threshold reactions

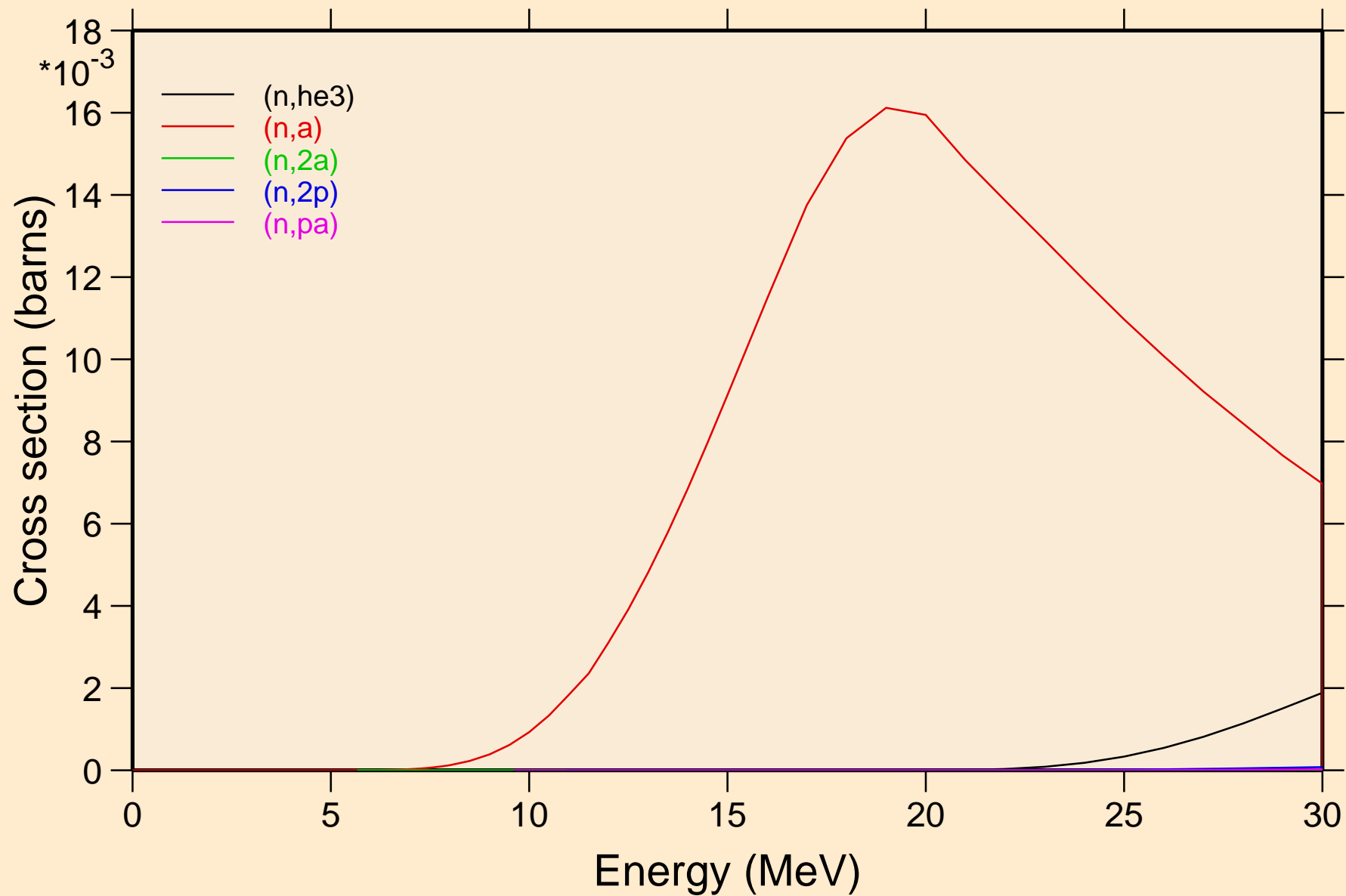

KR082 NEUTRON ACER TENDL-2019 LIBRARY; T=293.16K  
Threshold reactions

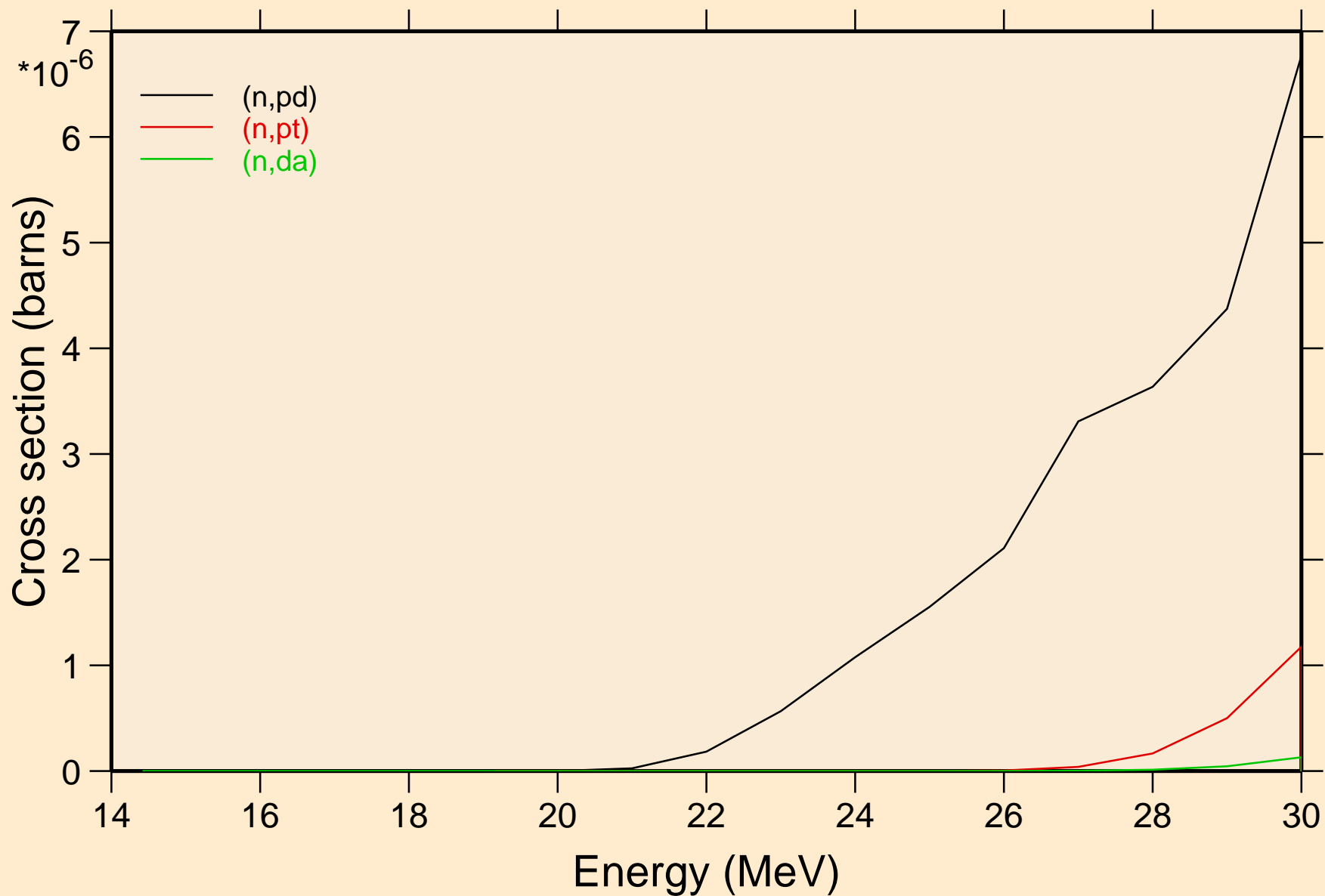

KR082 NEUTRON ACER TENDL-2019 LIBRARY; T=293.16K  
Threshold reactions

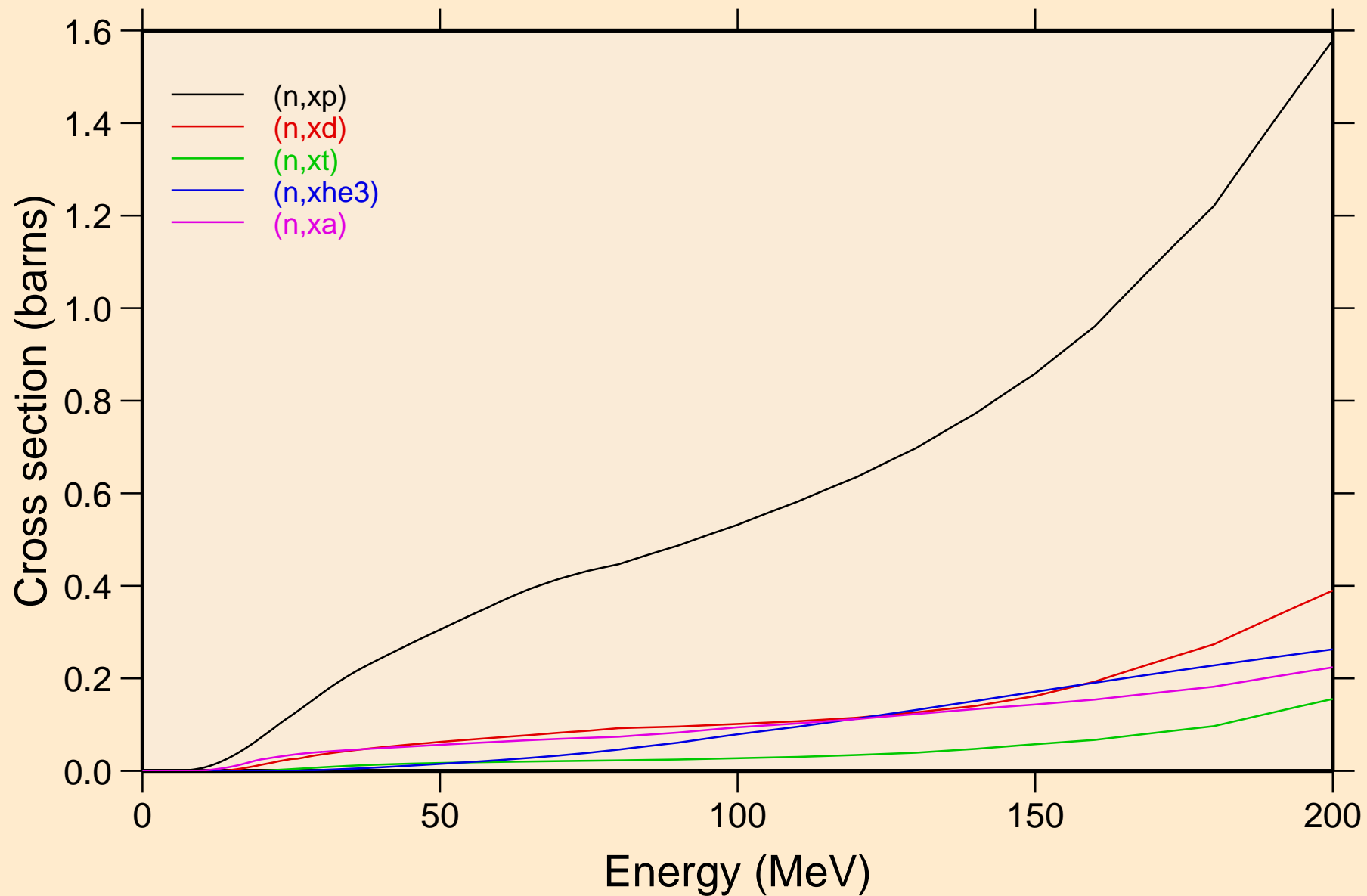

KR082 NEUTRON ACER TENDL-2019 LIBRARY; T=293.16K  
angular distribution for elastic

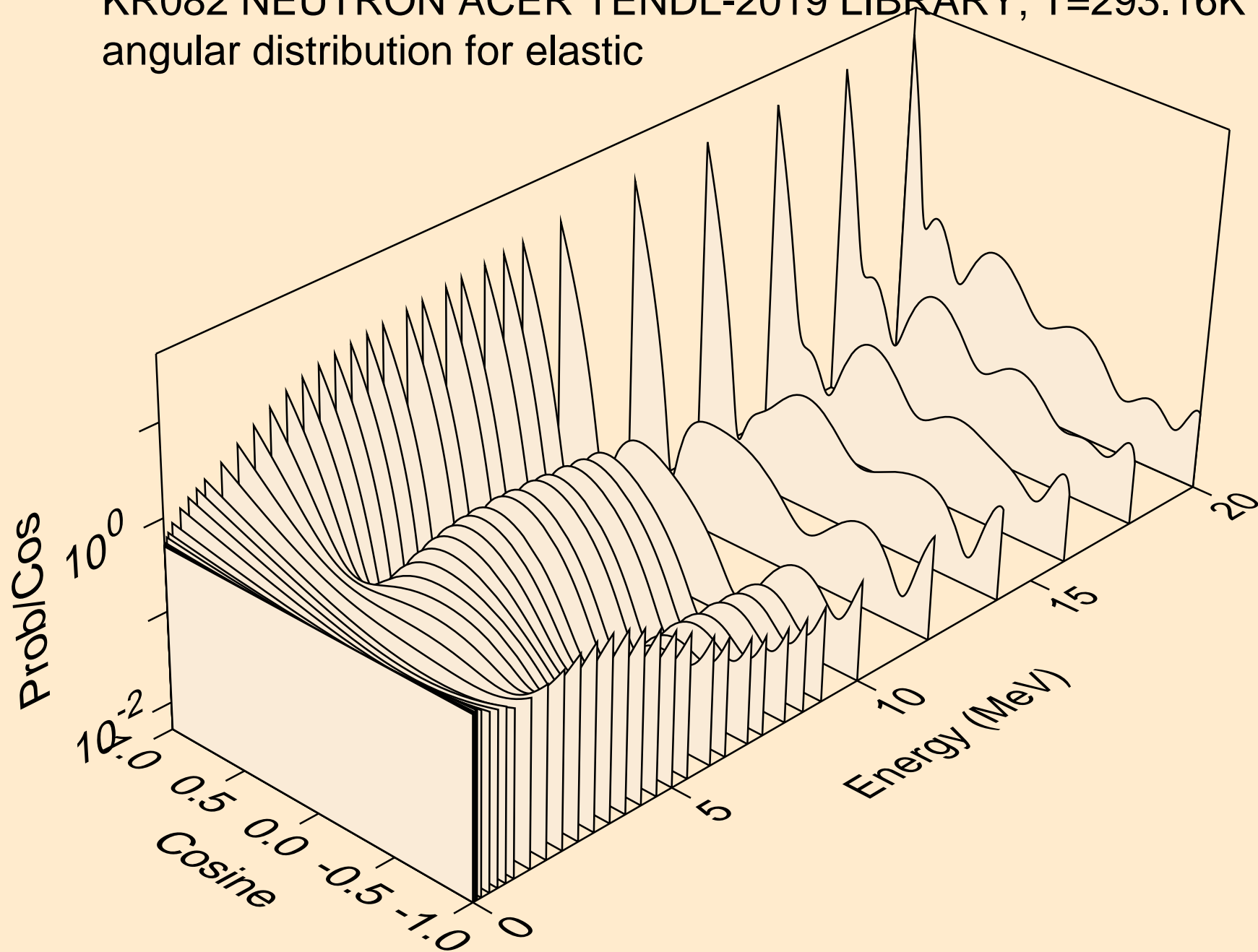

KR082 NEUTRON ACER TENDL-2019 LIBRARY; T=293.16K  
angular distribution for elastic

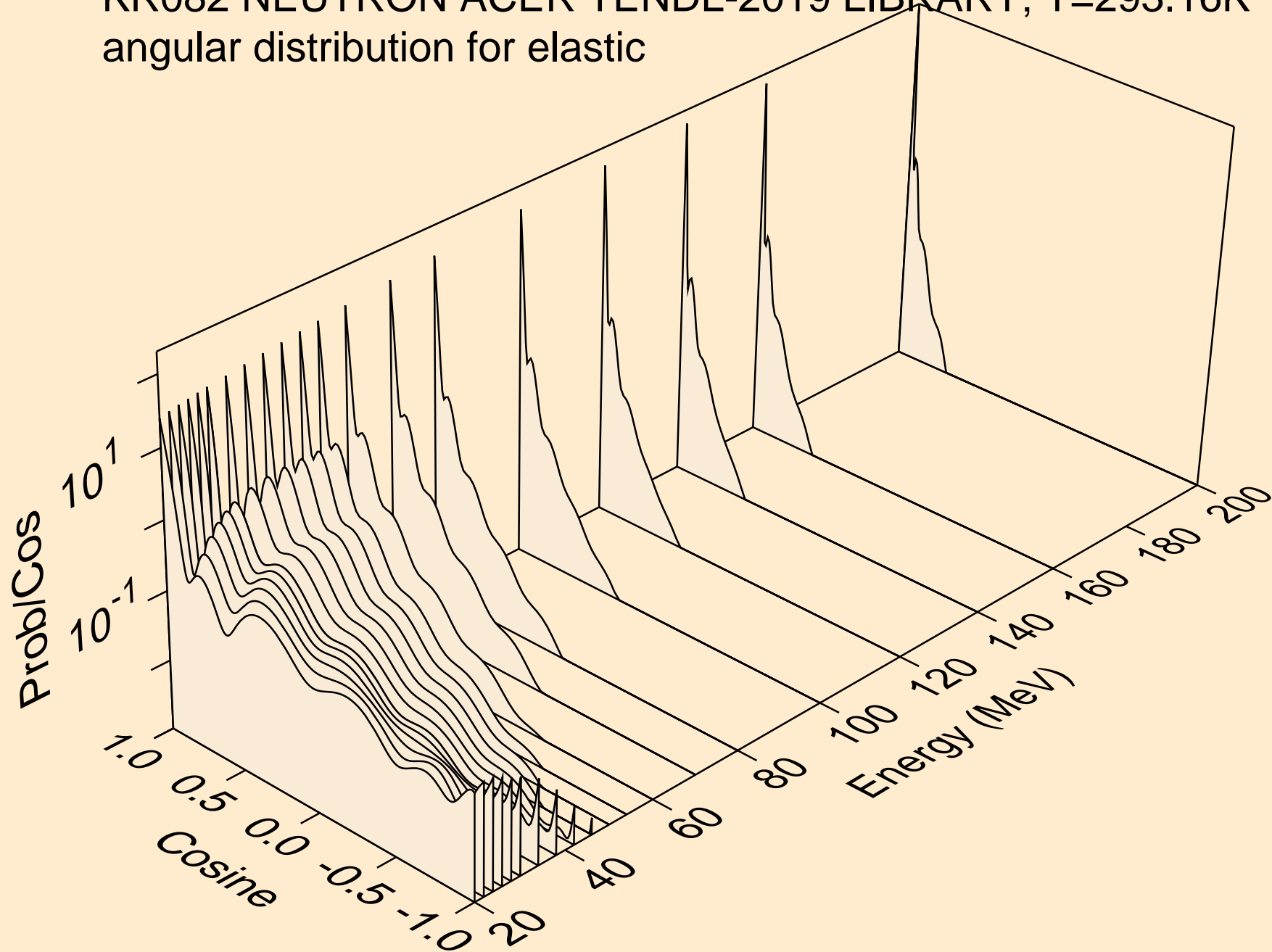

KR082 NEUTRON ACER TENDL-2019 LIBRARY; T=293.16K  
angular distribution for (n,n\*1)

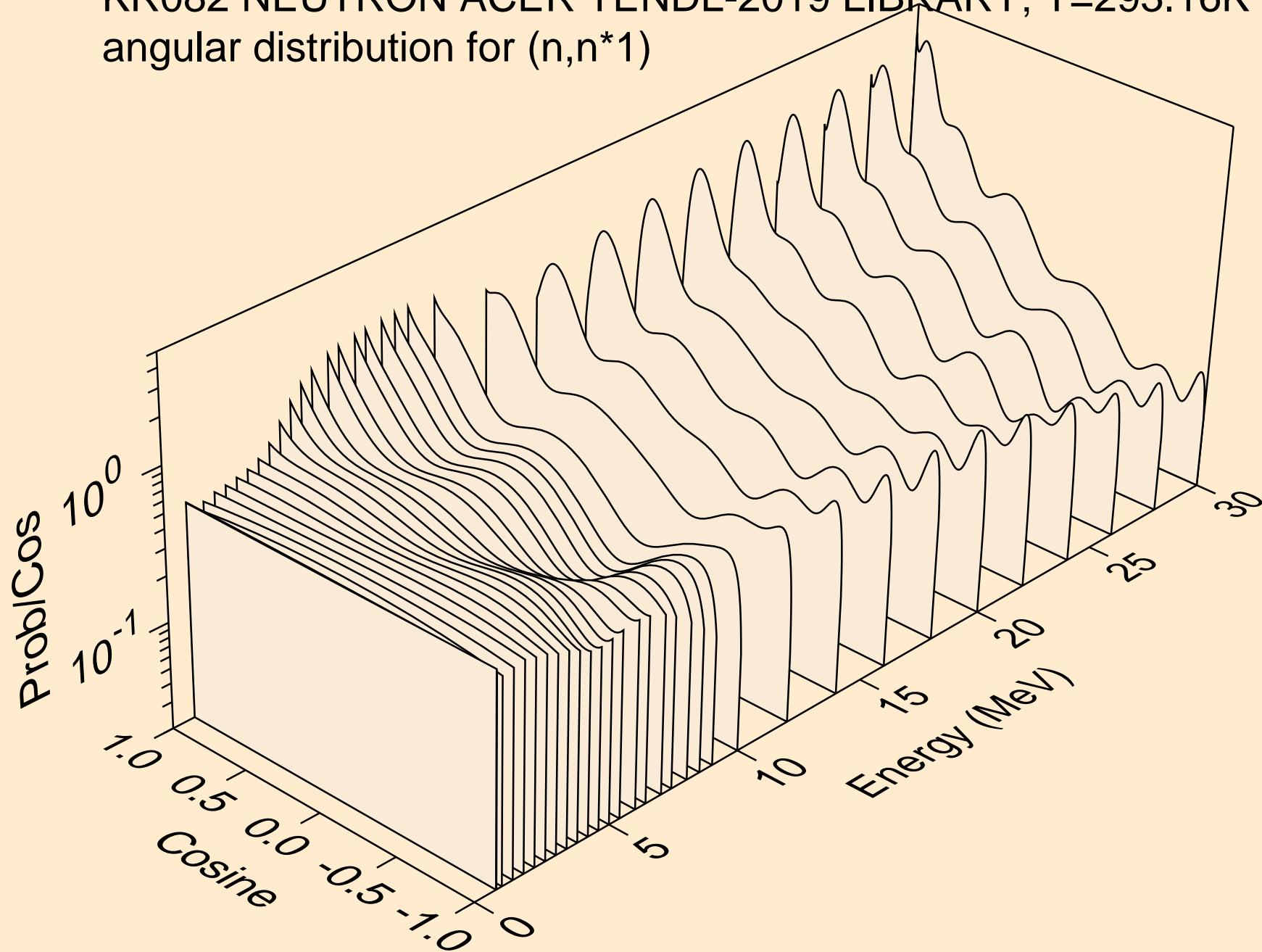



KR082 NEUTRON ACER TENDL-2019 LIBRARY; T=293.16K  
angular distribution for (n,n\*2)

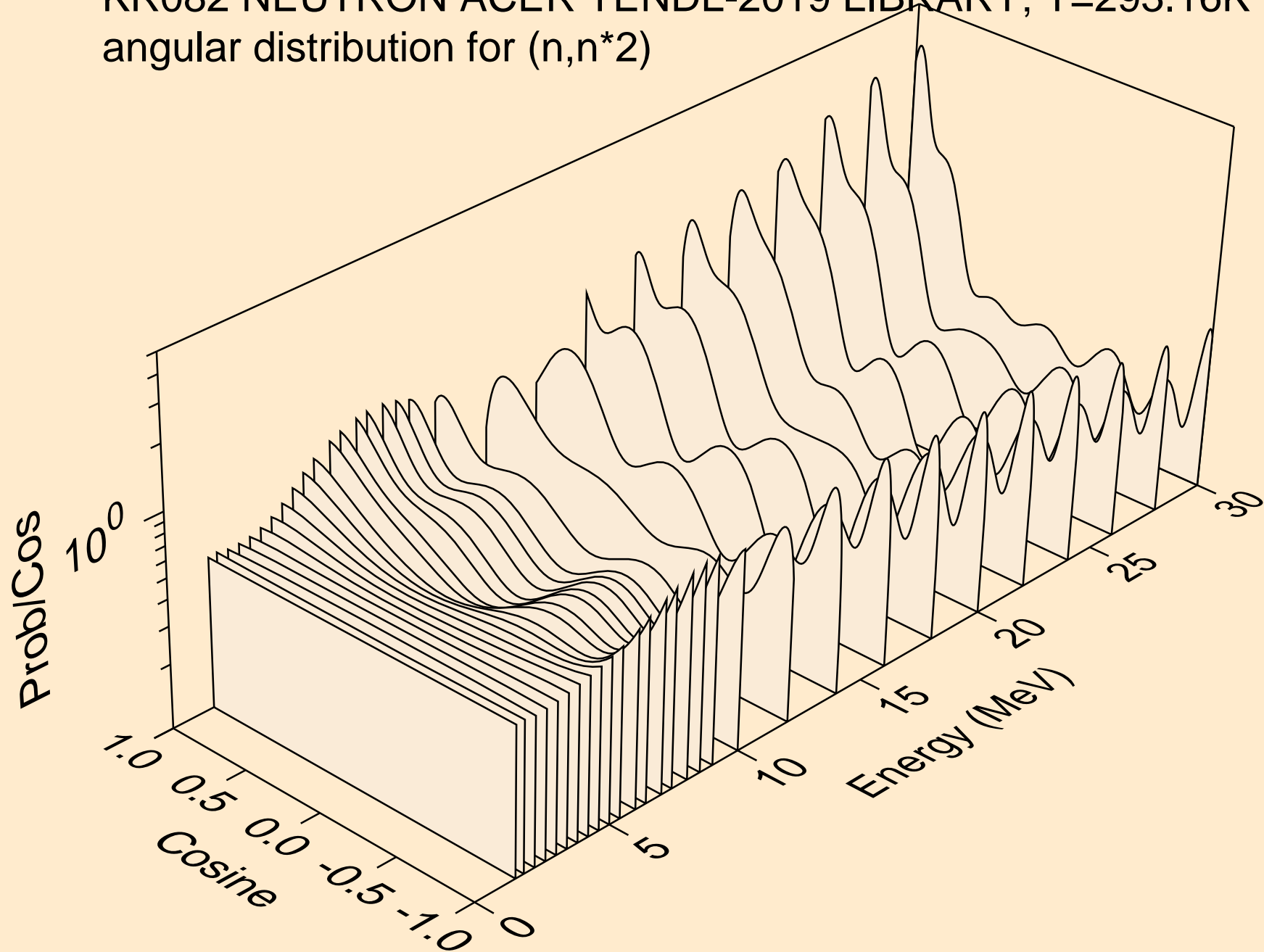

KR082 NEUTRON ACER TENDL-2019 LIBRARY; T=293.16K  
angular distribution for (n,n\*3)

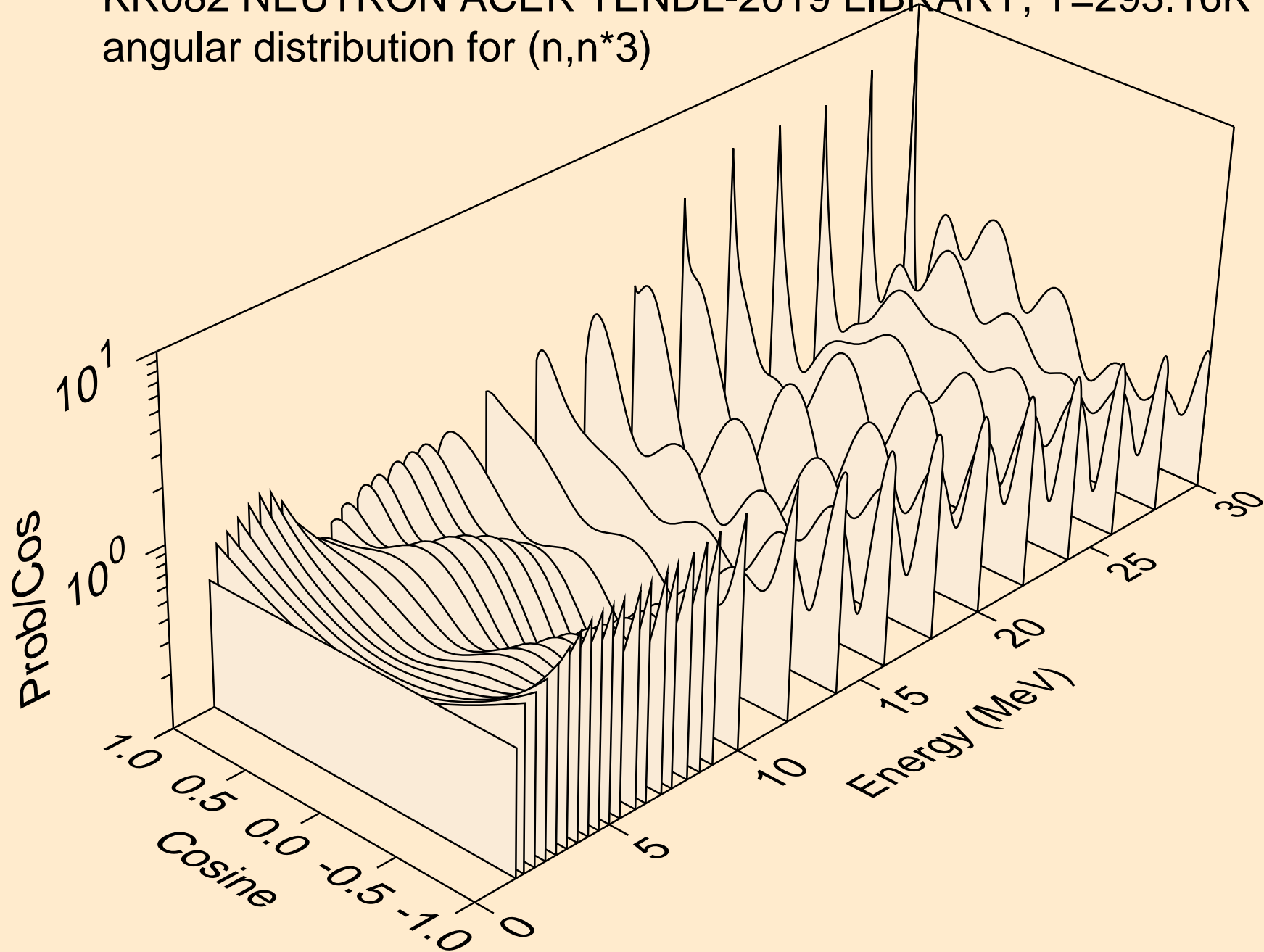

KR082 NEUTRON ACER TENDL-2019 LIBRARY; T=293.16K  
angular distribution for (n,n\*4)

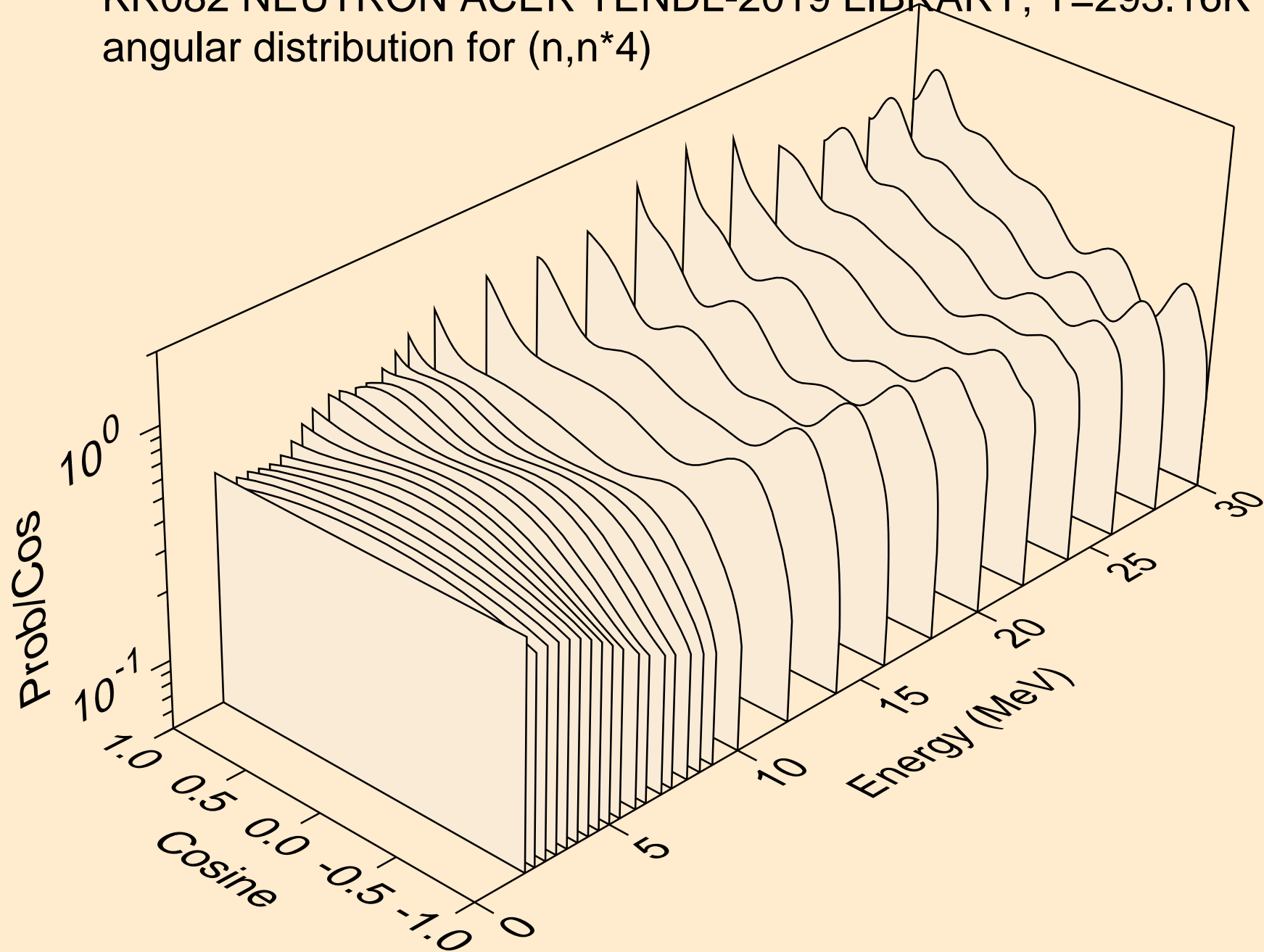

KR082 NEUTRON ACER TENDL-2019 LIBRARY; T=293.16K  
angular distribution for (n,n\*5)

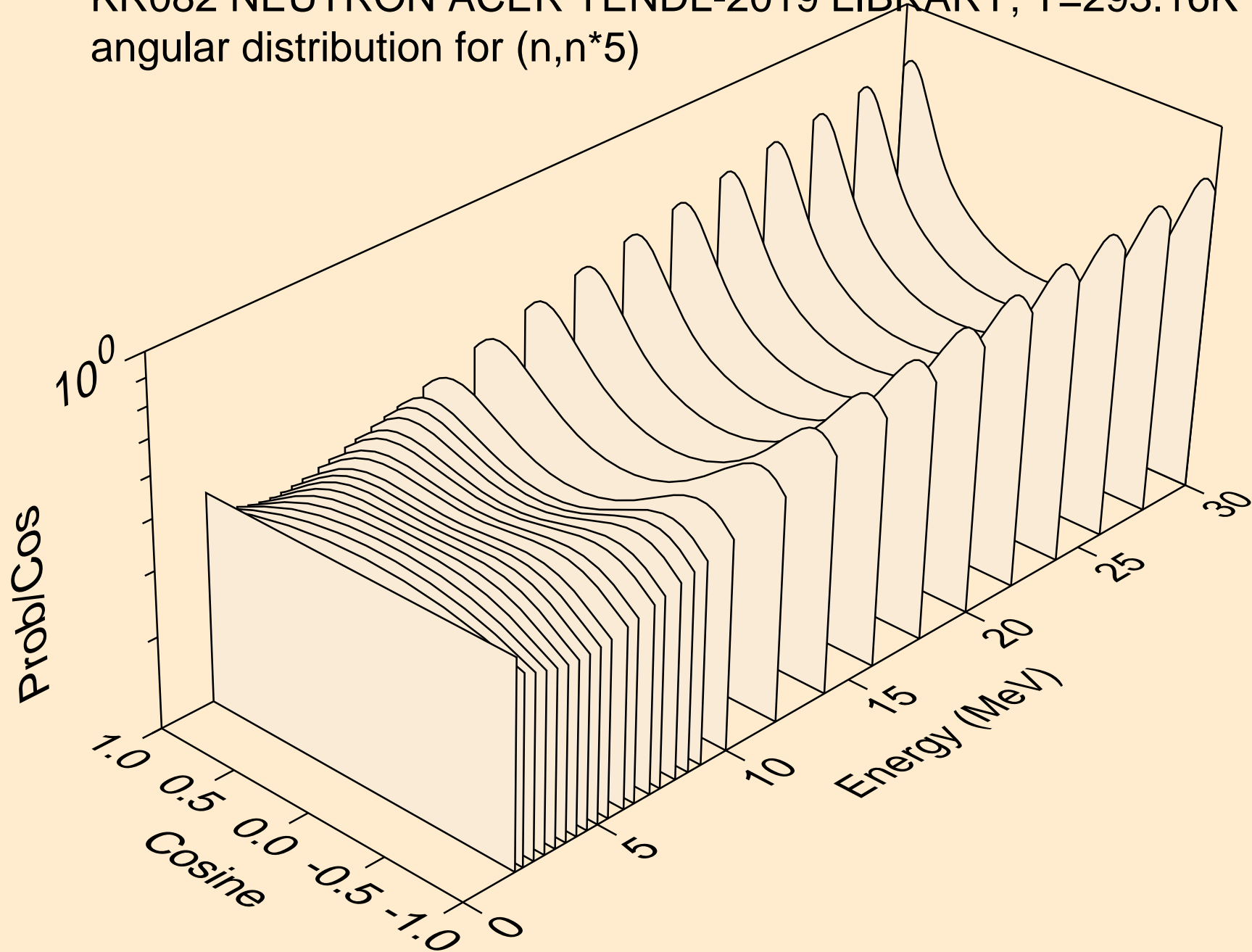

KR082 NEUTRON ACER TENDL-2019 LIBRARY; T=293.16K  
angular distribution for (n,n\*6)

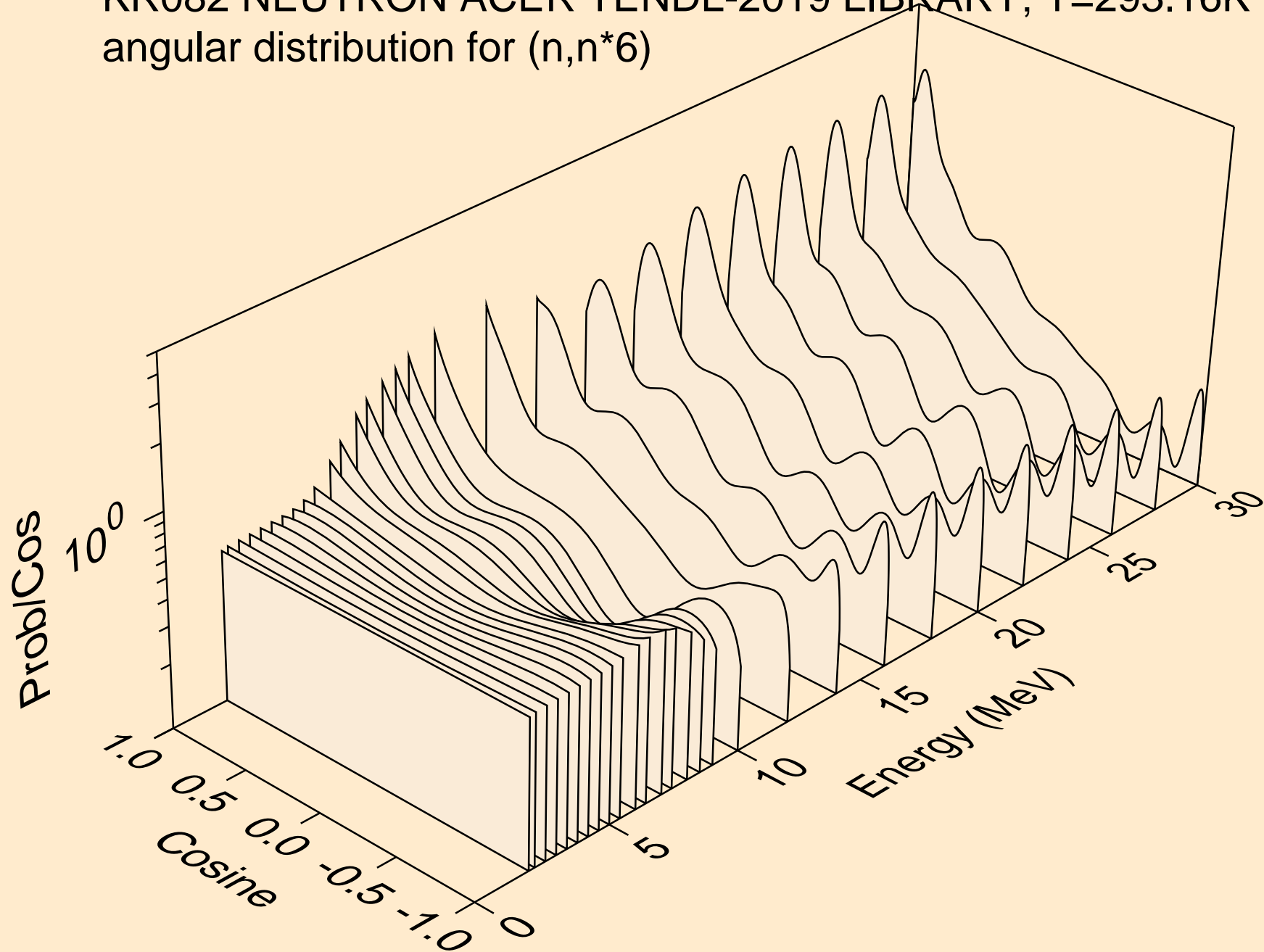

KR082 NEUTRON ACER TENDL-2019 LIBRARY; T=293.16K  
angular distribution for (n,n\*7)

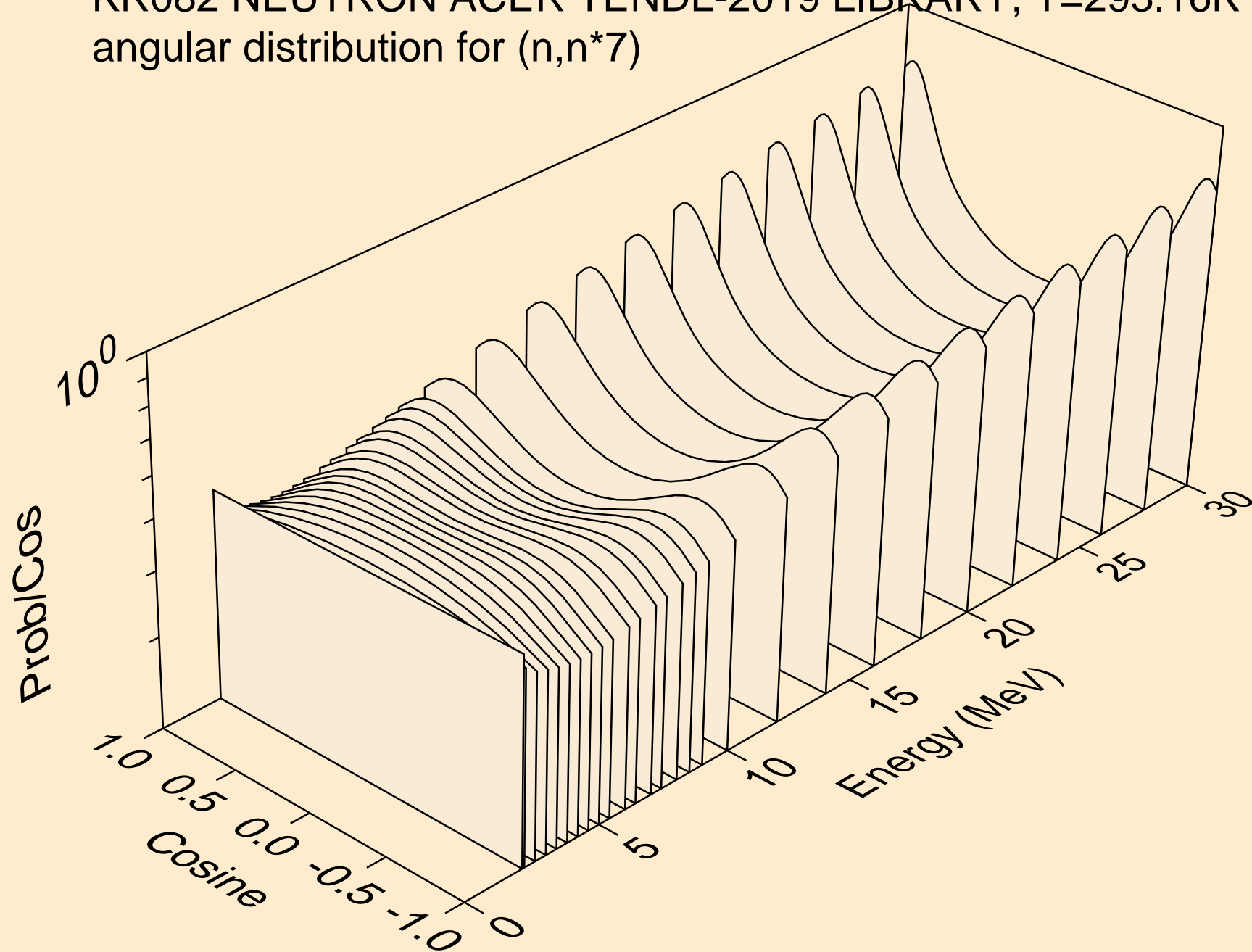

KR082 NEUTRON ACER TENDL-2019 LIBRARY; T=293.16K  
angular distribution for (n,n\*8)

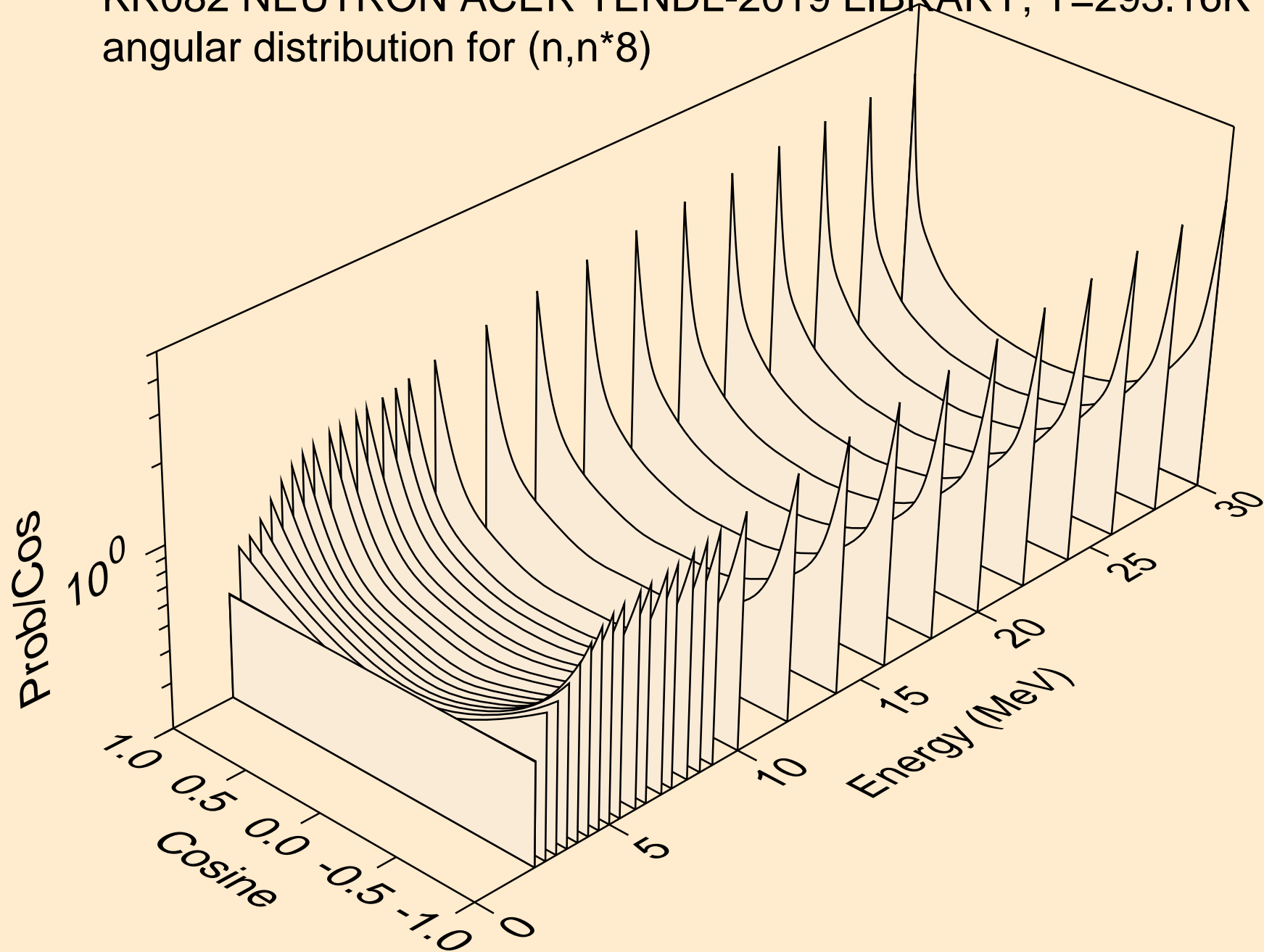

KR082 NEUTRON ACER TENDL-2019 LIBRARY; T=293.16K  
angular distribution for (n,n\*9)

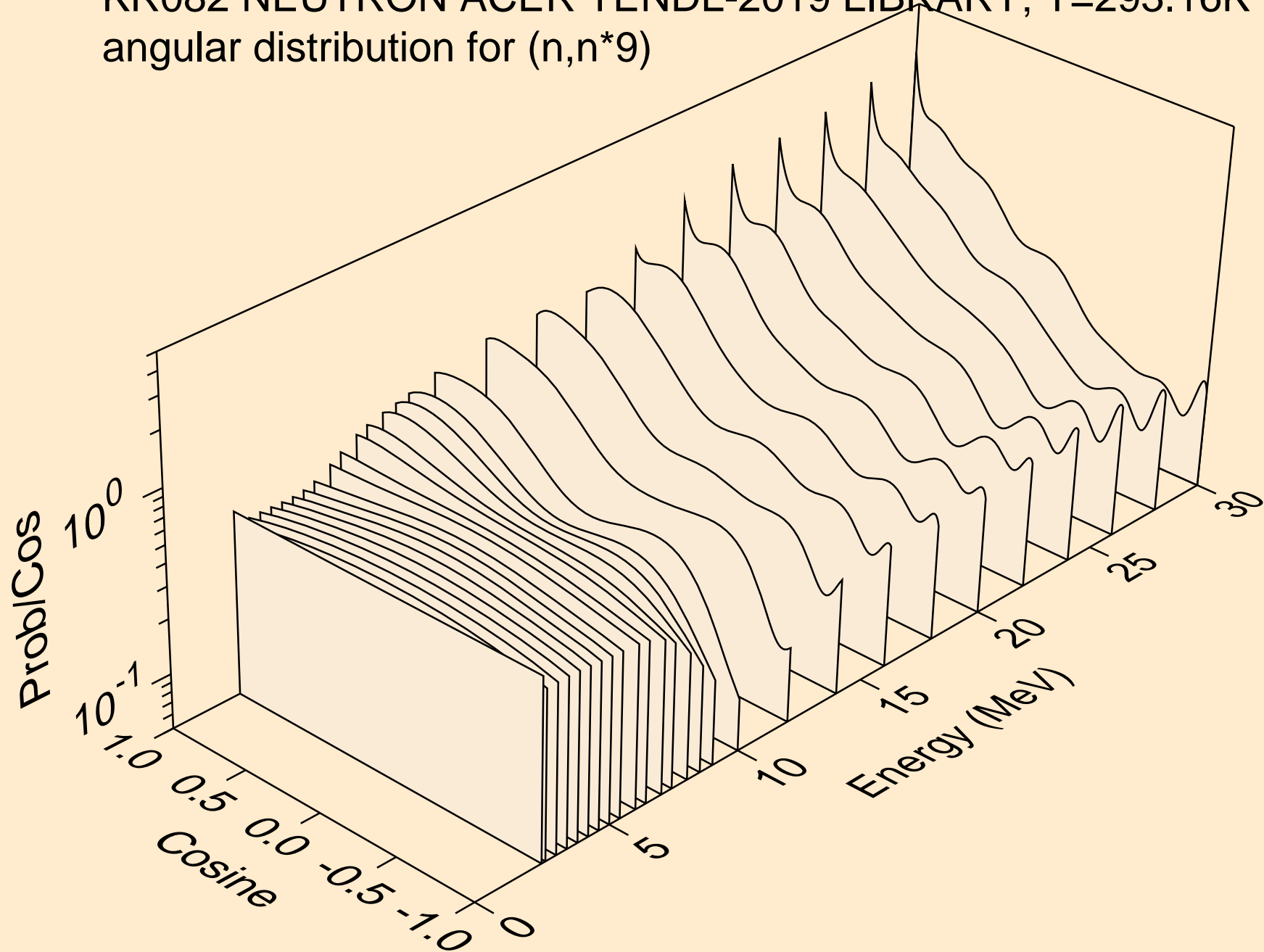



KR082 NEUTRON ACER TENDL-2019 LIBRARY; T=293.16K  
angular distribution for (n,n\*10)

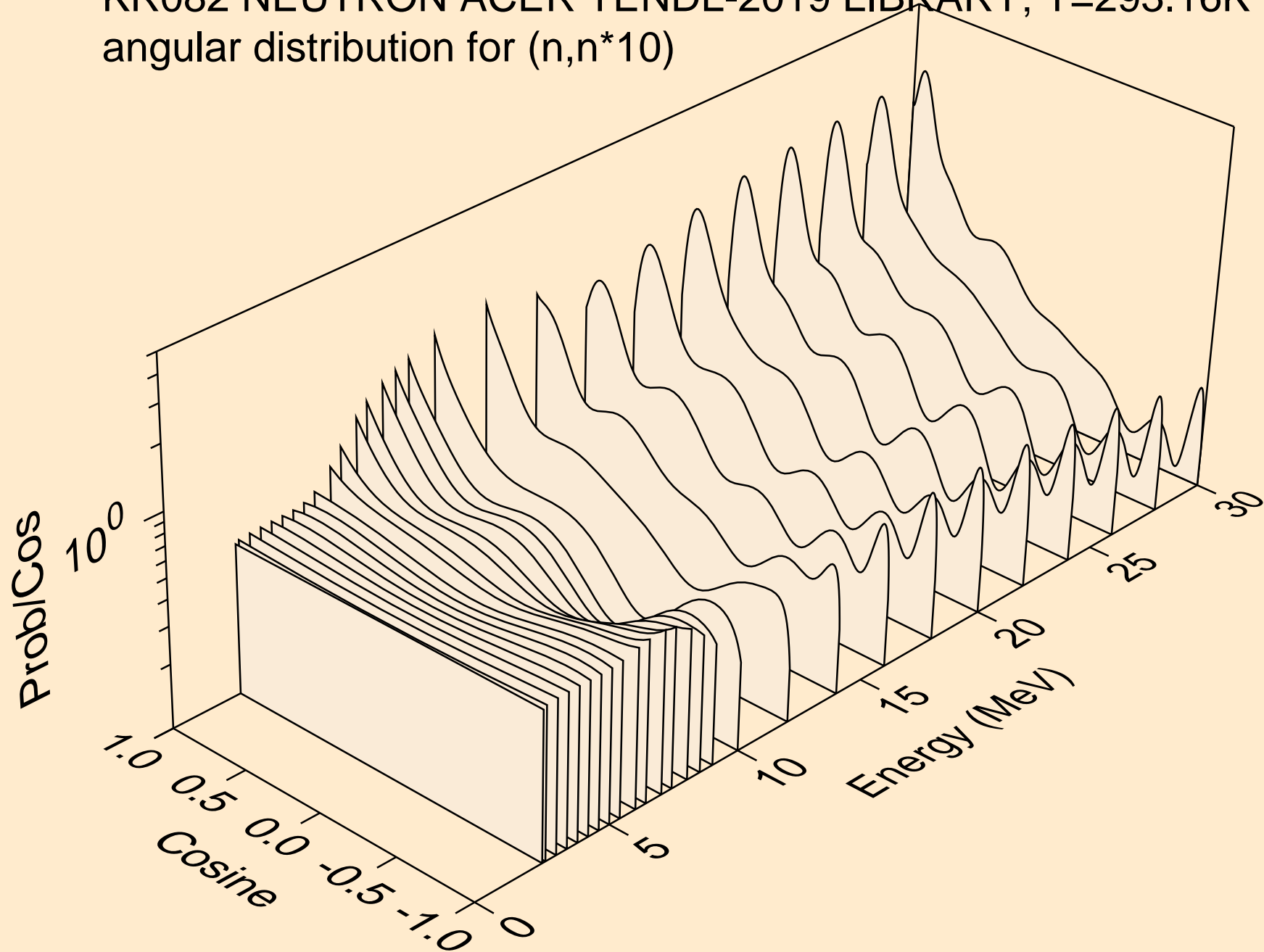

KR082 NEUTRON ACER TENDL-2019 LIBRARY; T=293.16K  
angular distribution for (n,n\*11)

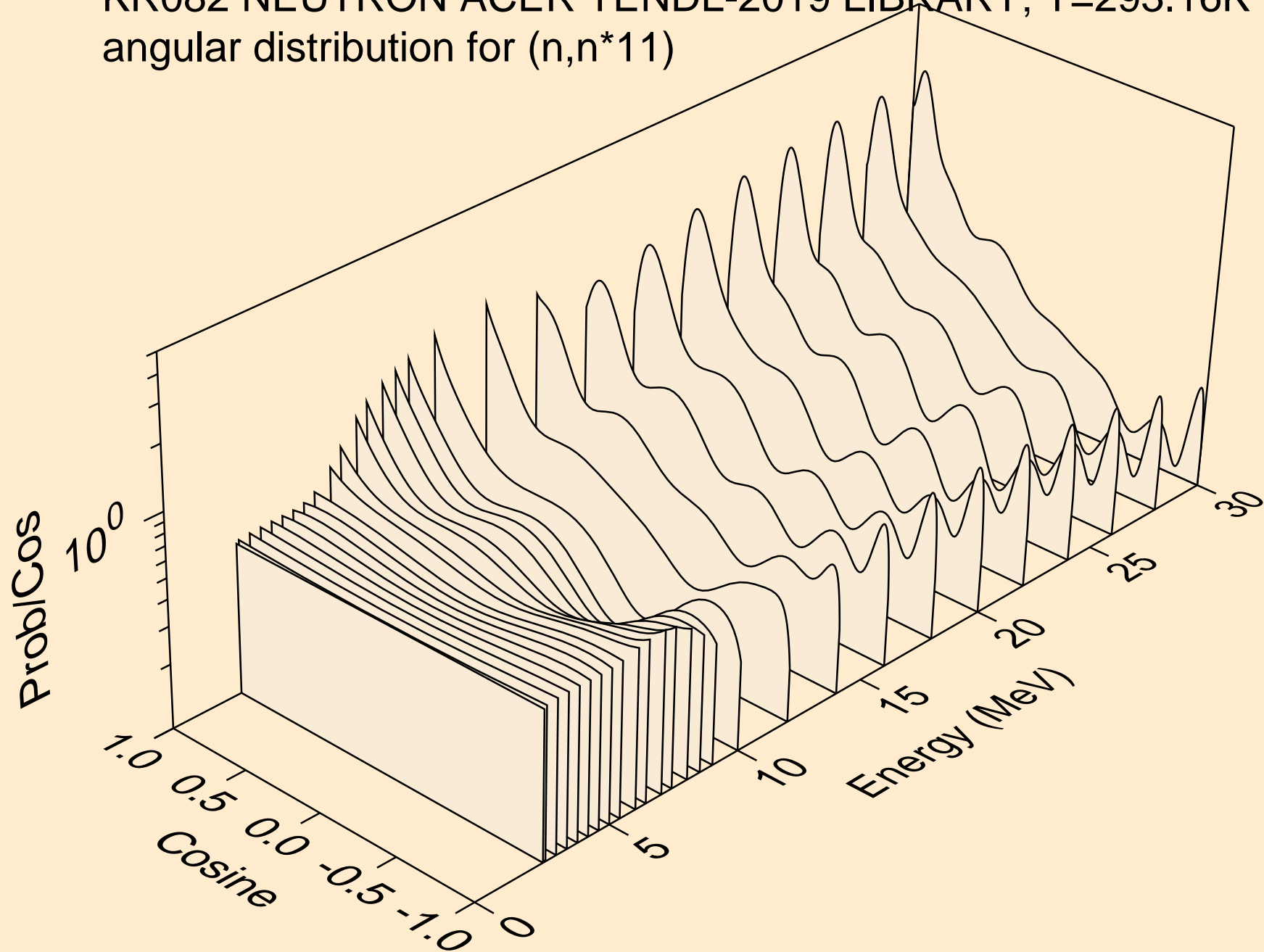

KR082 NEUTRON ACER TENDL-2019 LIBRARY; T=293.16K  
angular distribution for (n,n\*12)

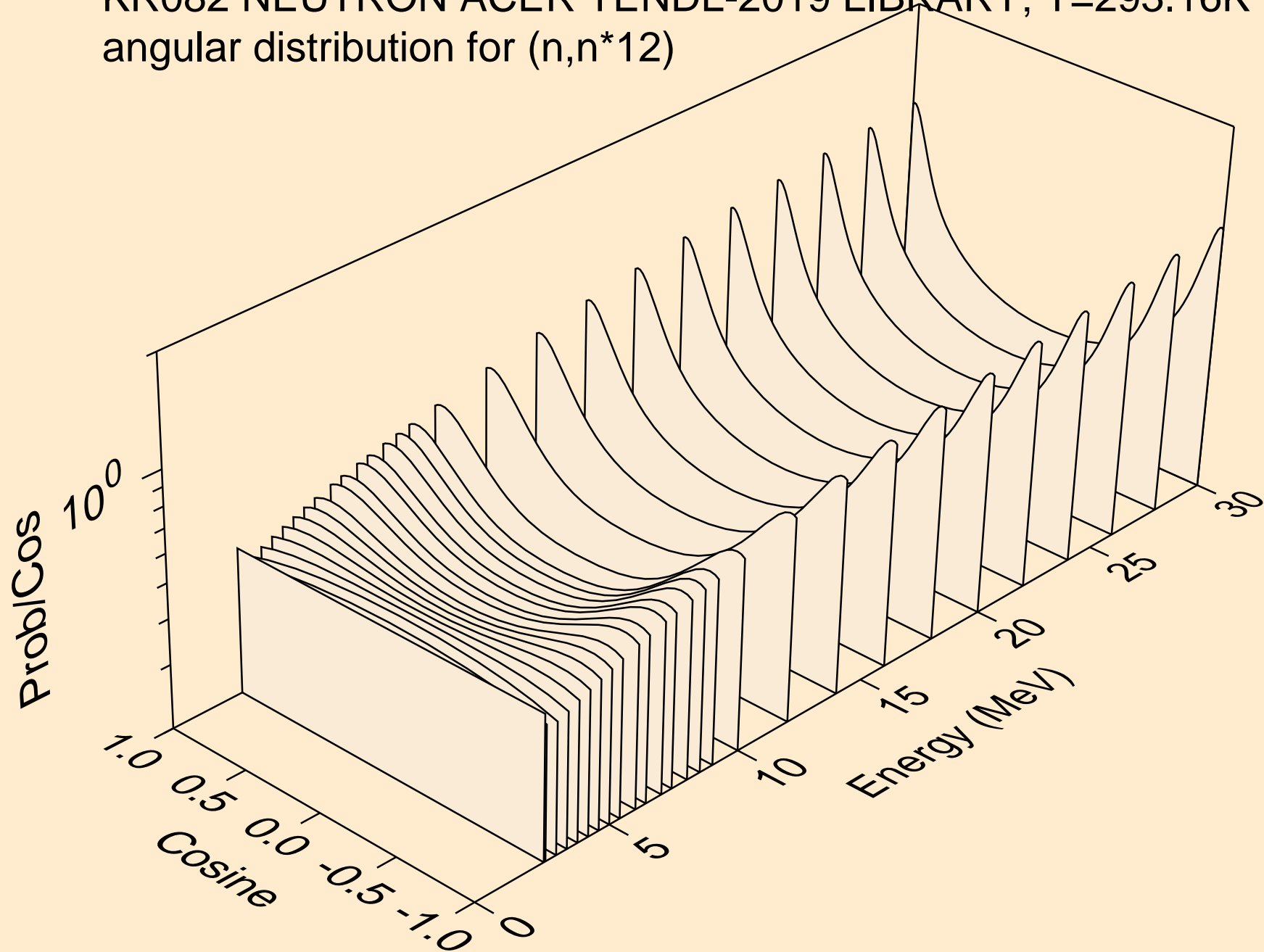

KR082 NEUTRON ACER TENDL-2019 LIBRARY; T=293.16K  
angular distribution for (n,n\*13)

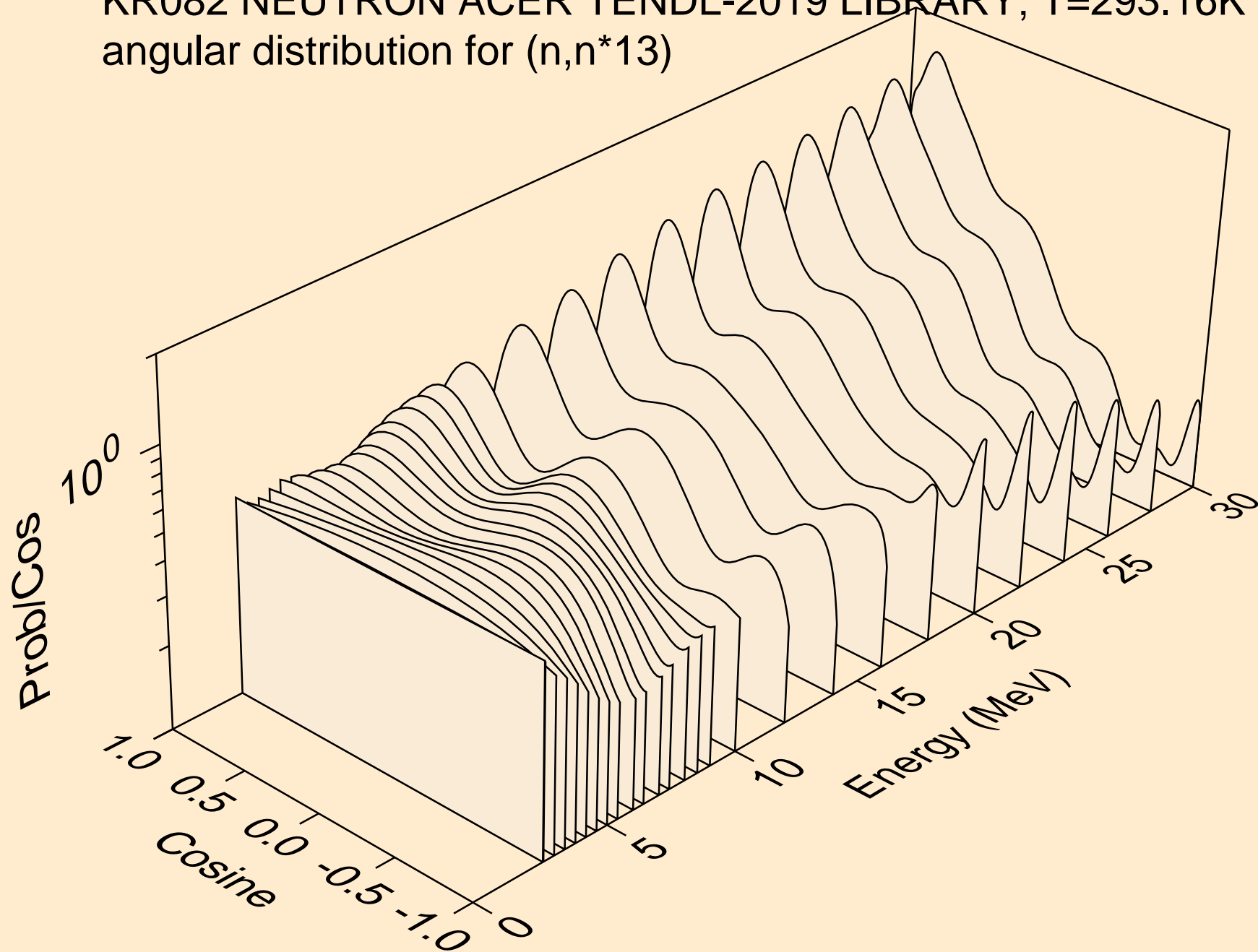

KR082 NEUTRON ACER TENDL-2019 LIBRARY; T=293.16K  
angular distribution for (n,n\*14)

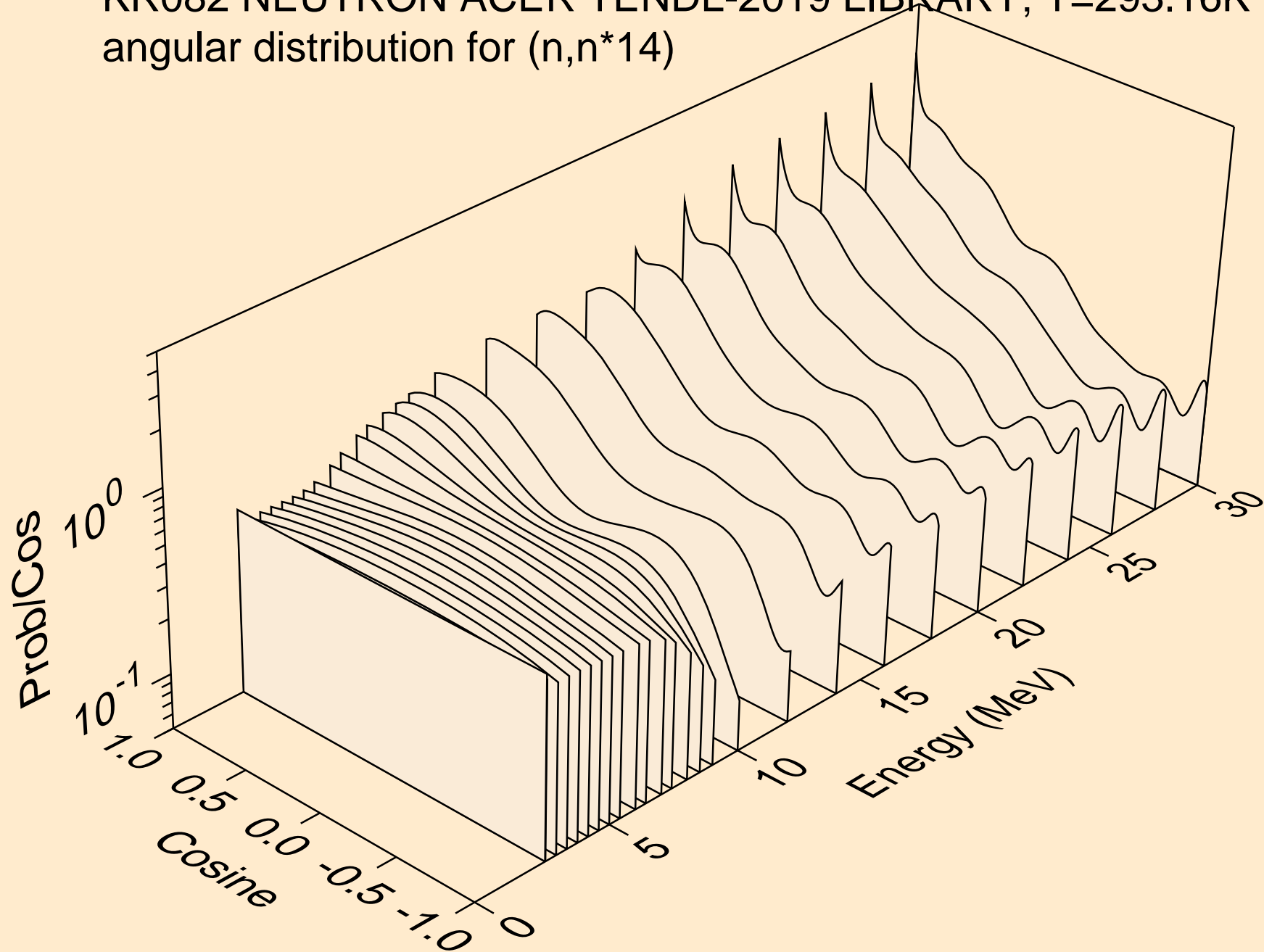

KR082 NEUTRON ACER TENDL-2019 LIBRARY; T=293.16K  
angular distribution for (n,n\*15)

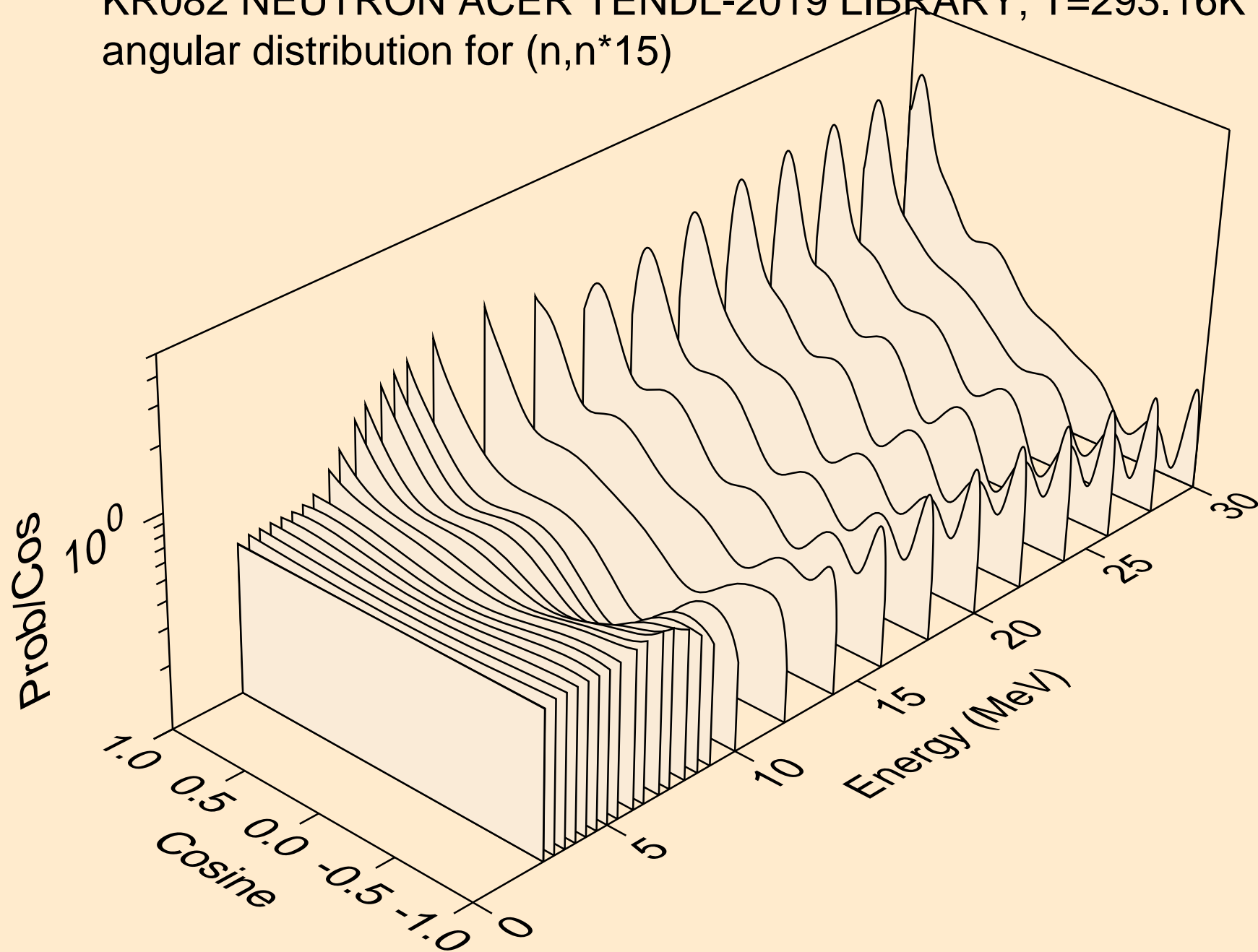

KR082 NEUTRON ACER TENDL-2019 LIBRARY; T=293.16K  
angular distribution for (n,n\*16)

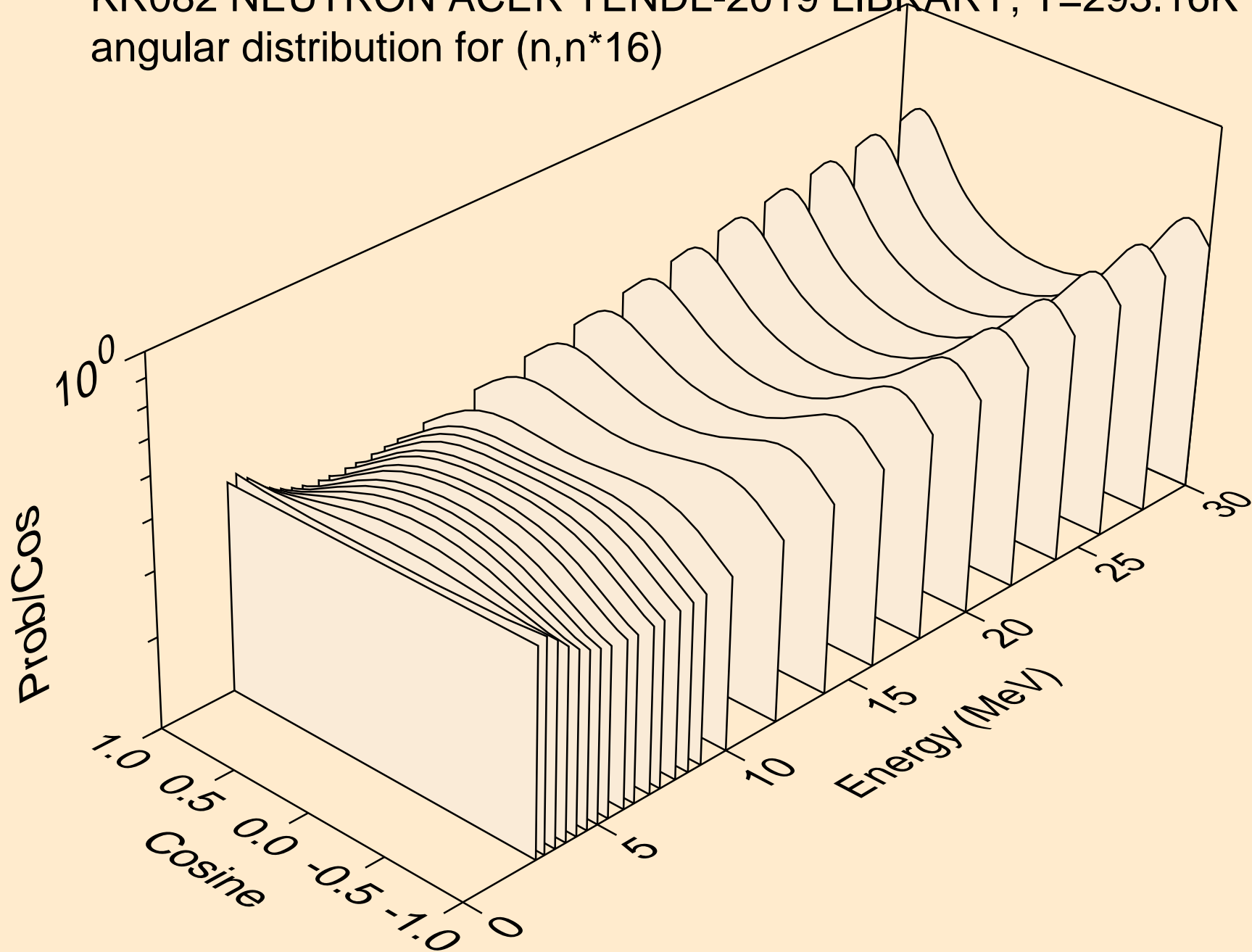

KR082 NEUTRON ACER TENDL-2019 LIBRARY; T=293.16K  
angular distribution for (n,n\*17)

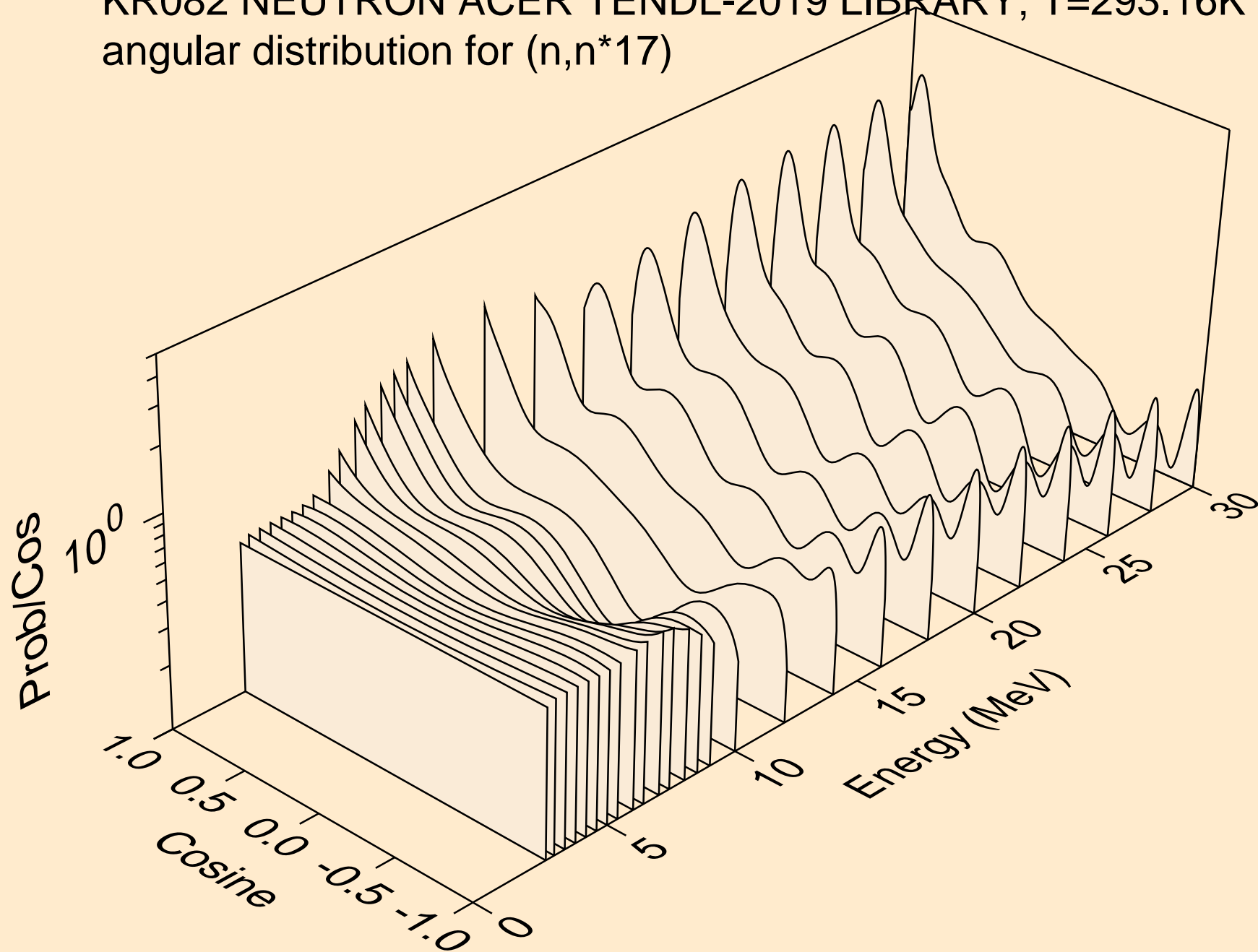



KR082 NEUTRON ACER TENDL-2019 LIBRARY; T=293.16K  
angular distribution for (n,n\*18)

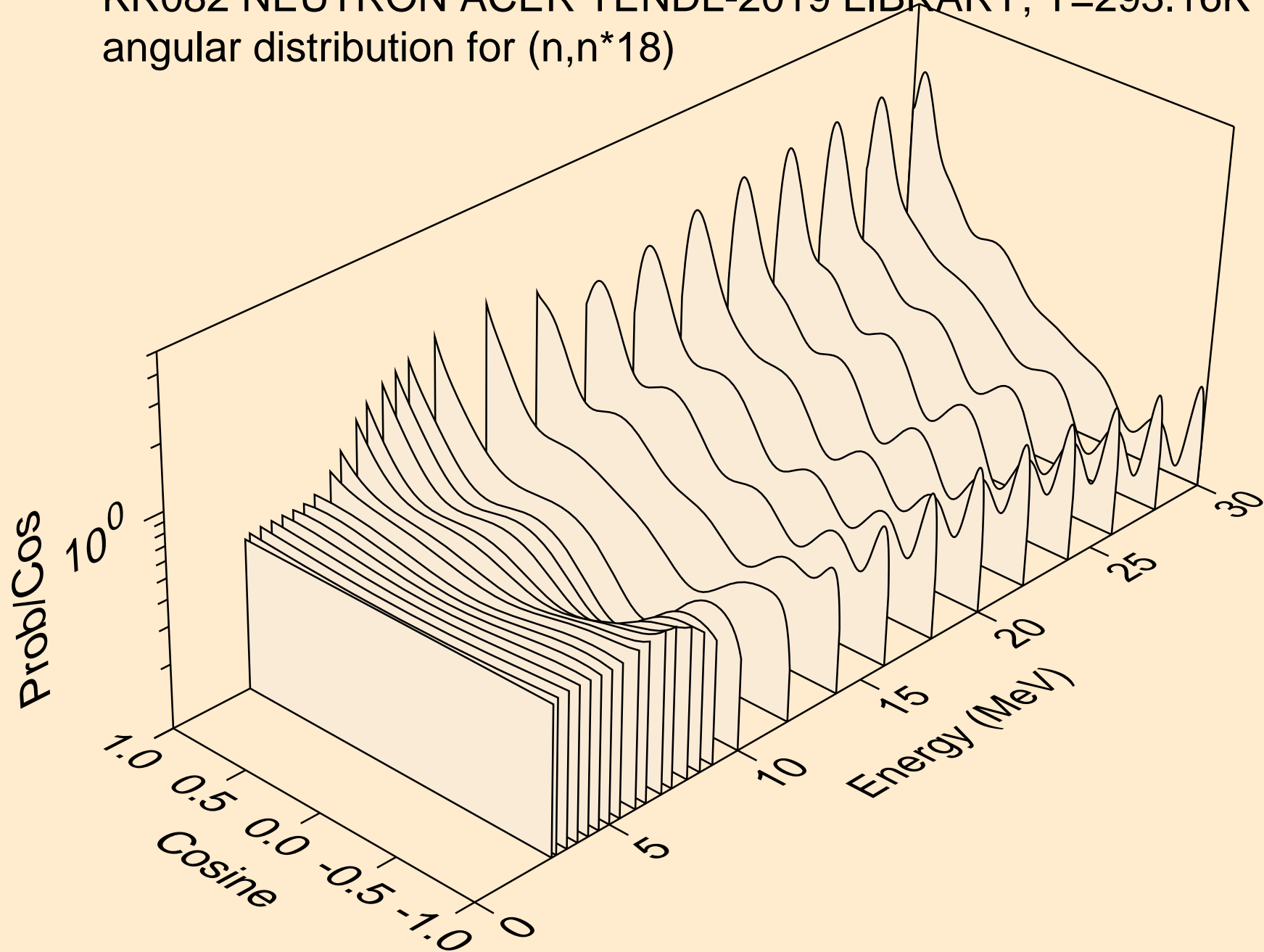

KR082 NEUTRON ACER TENDL-2019 LIBRARY; T=293.16K  
angular distribution for (n,n\*19)

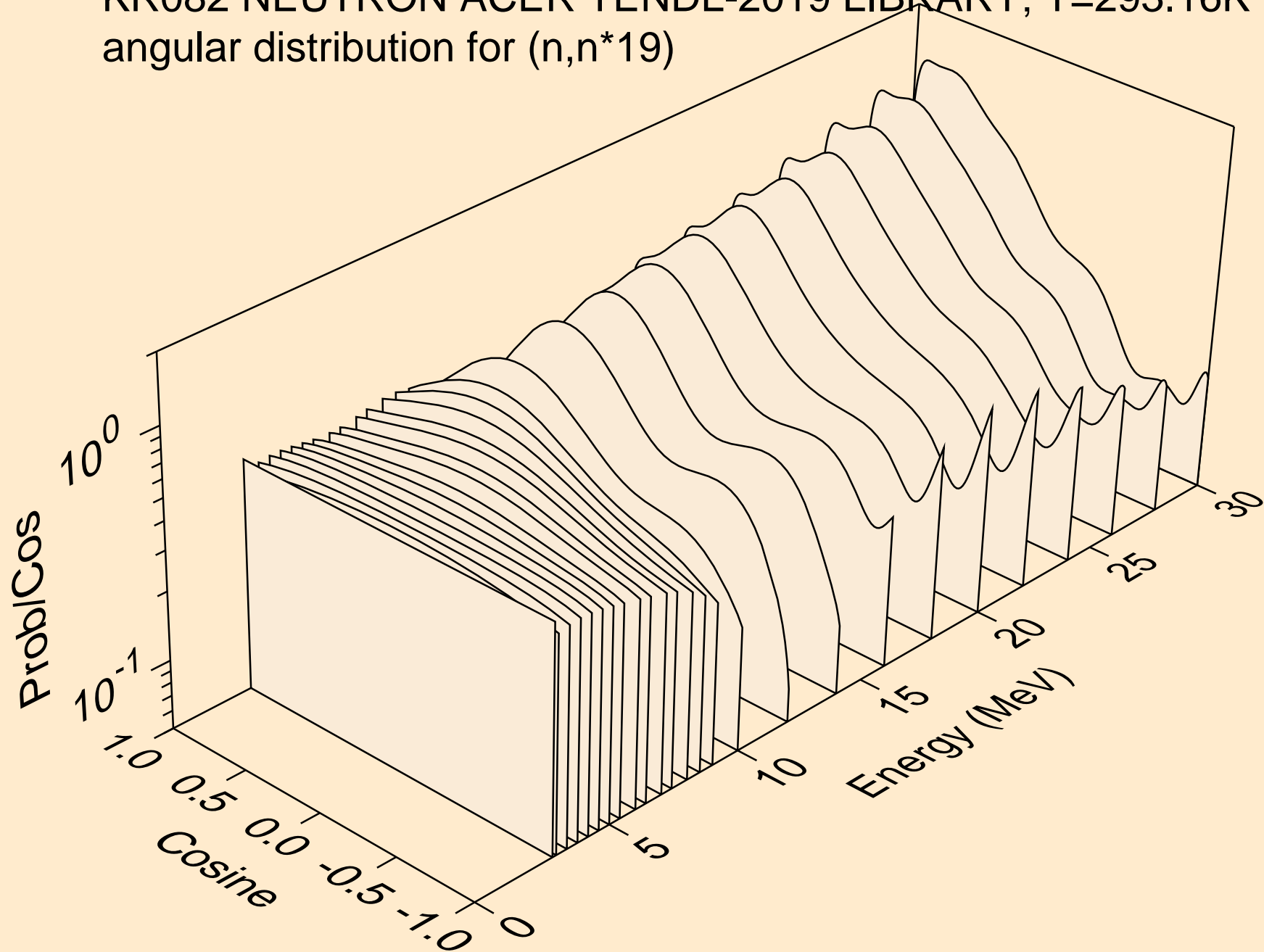

KR082 NEUTRON ACER TENDL-2019 LIBRARY; T=293.16K  
angular distribution for (n,n\*20)

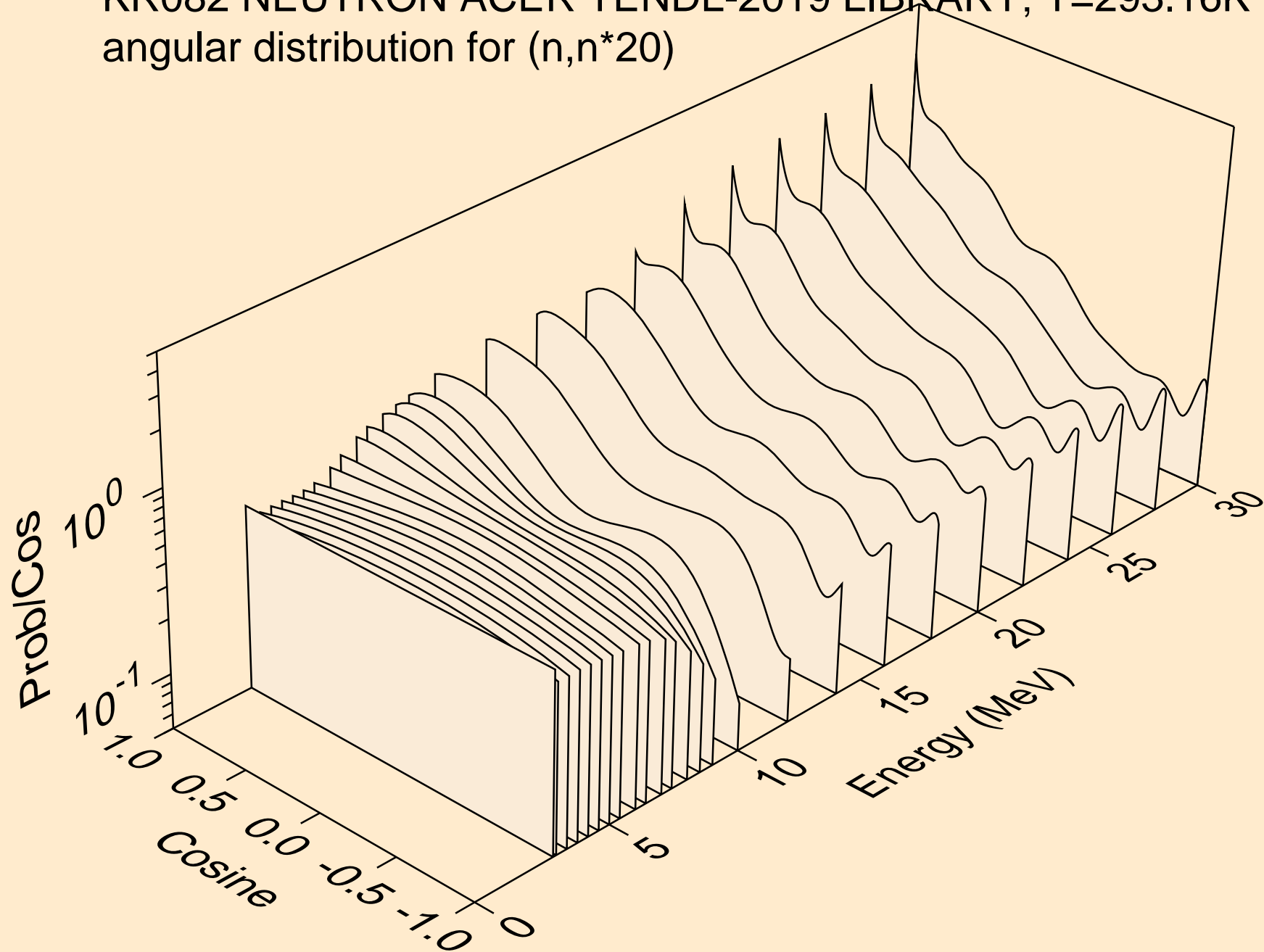

KR082 NEUTRON ACER TENDL-2019 LIBRARY; T=293.16K  
angular distribution for (n,n\*21)

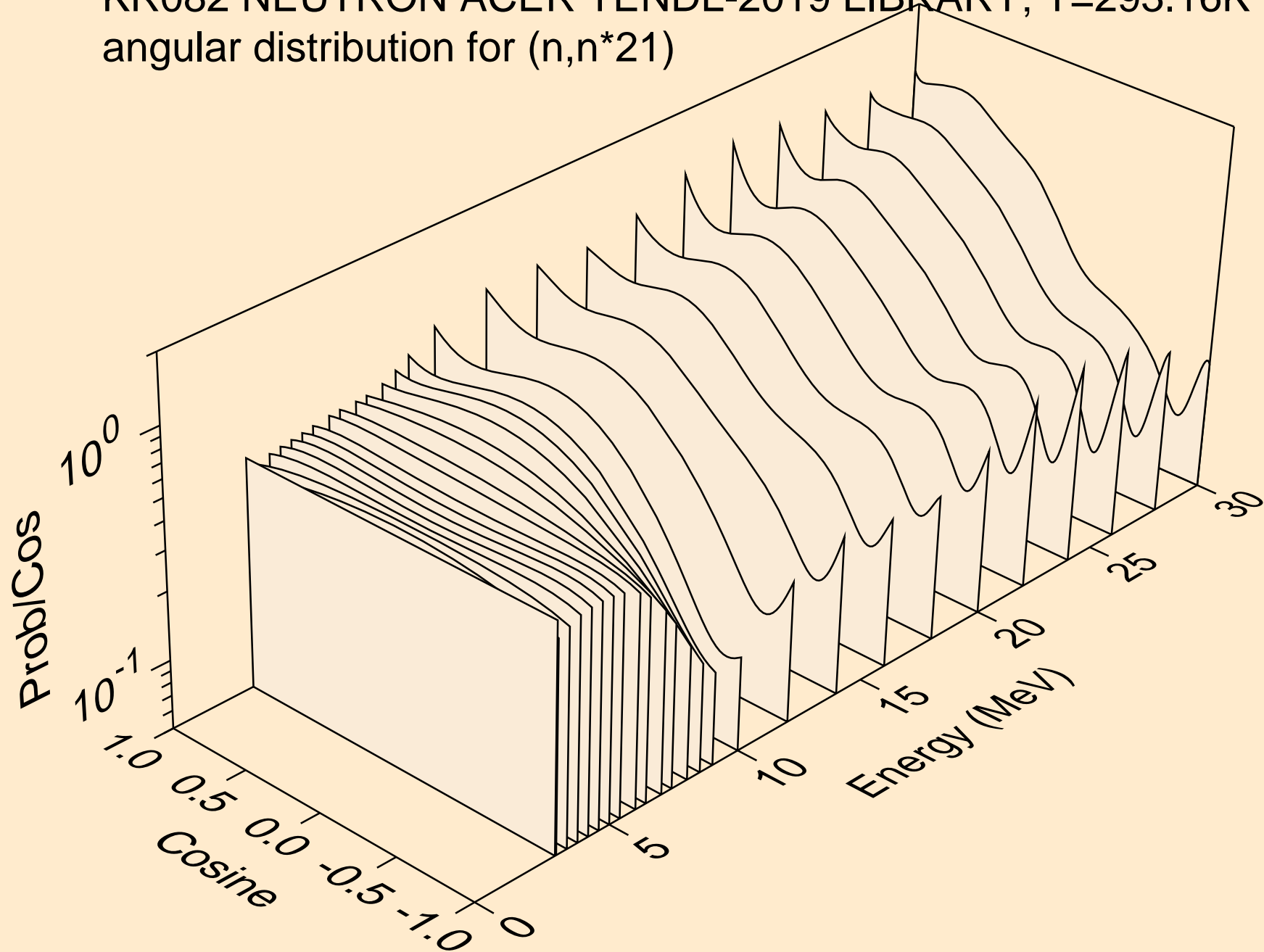

KR082 NEUTRON ACER TENDL-2019 LIBRARY; T=293.16K  
angular distribution for (n,n\*22)

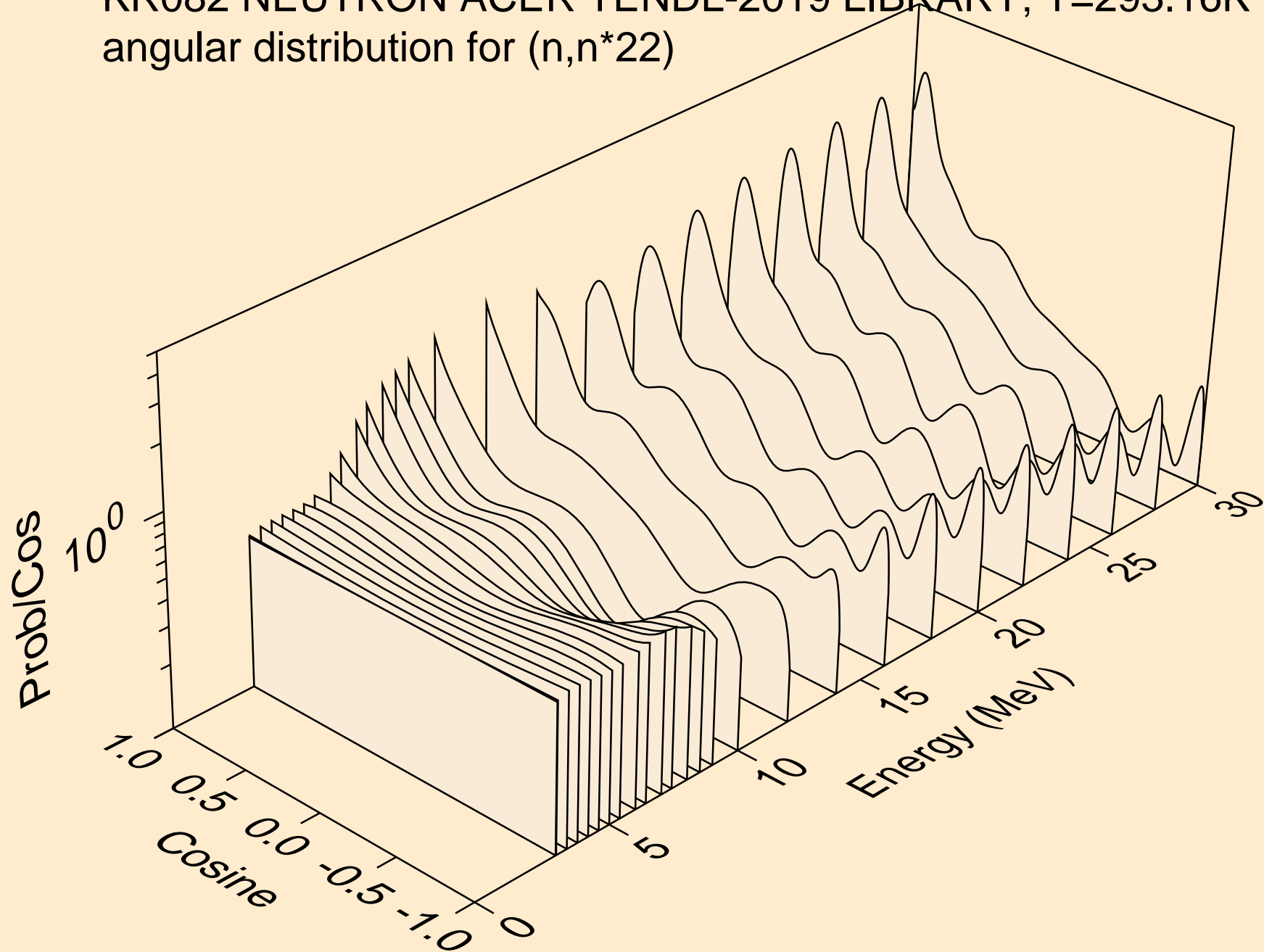

KR082 NEUTRON ACER TENDL-2019 LIBRARY; T=293.16K  
angular distribution for (n,n\*23)

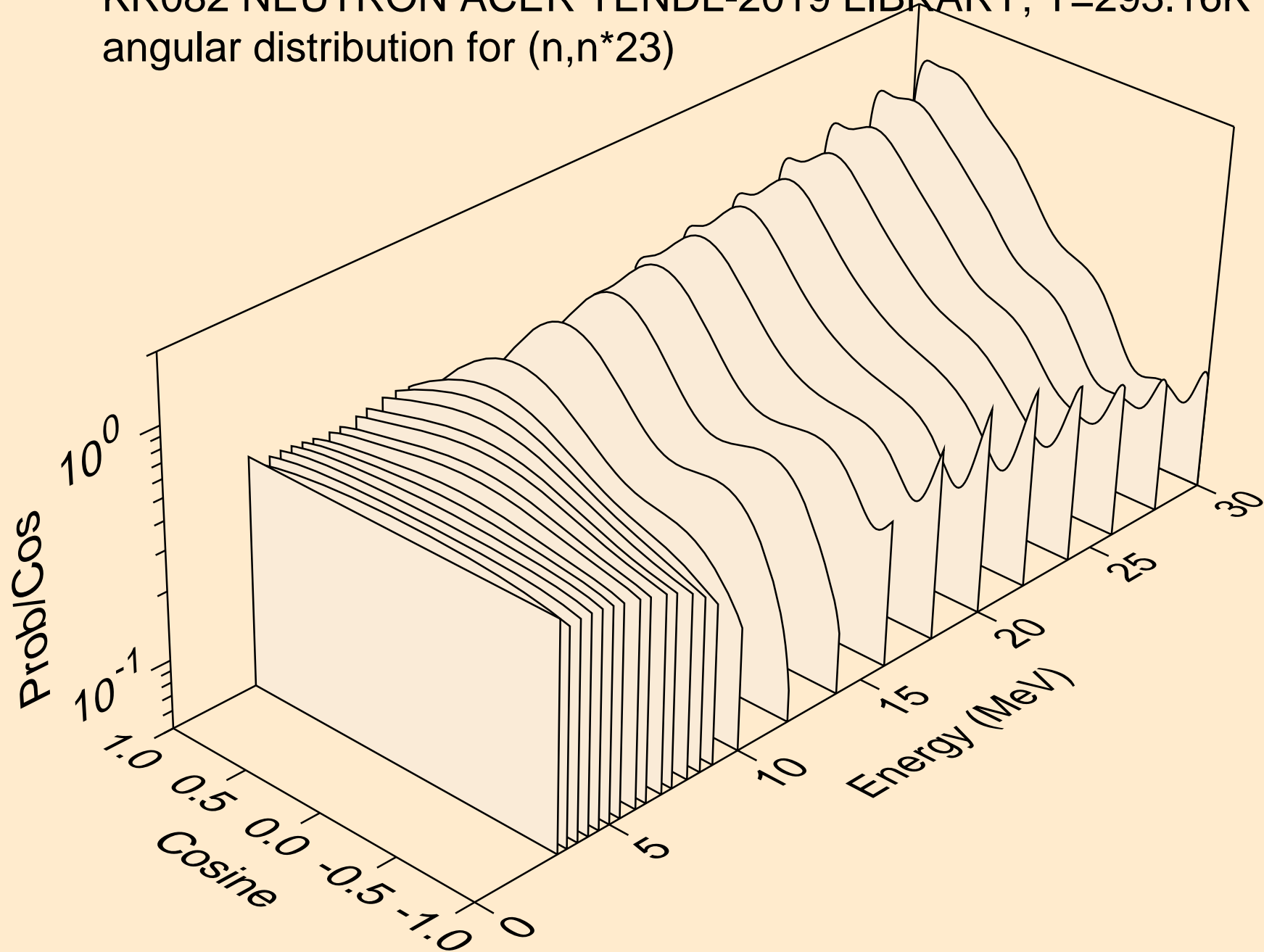

KR082 NEUTRON ACER TENDL-2019 LIBRARY; T=293.16K  
angular distribution for (n,n\*24)

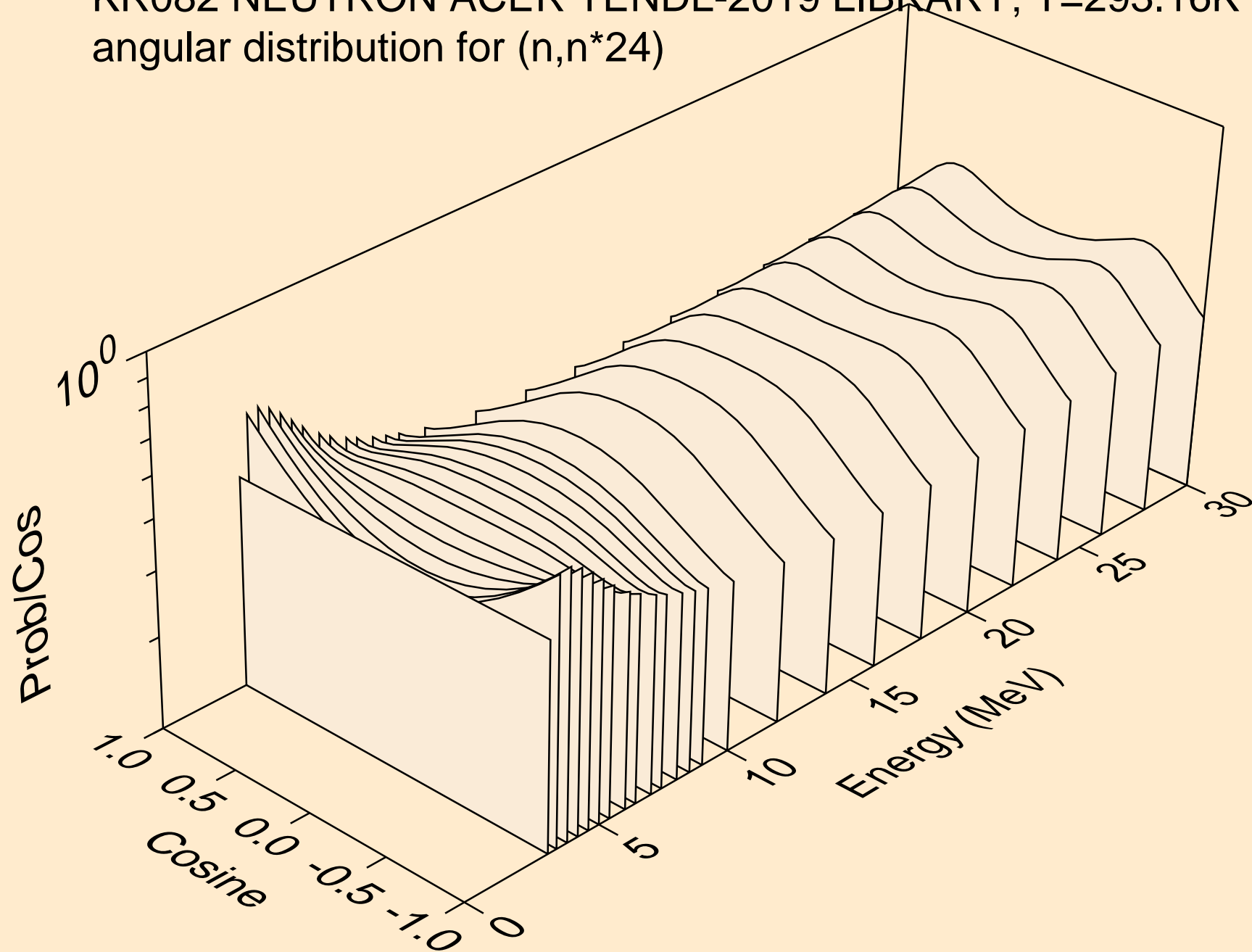

KR082 NEUTRON ACER TENDL-2019 LIBRARY; T=293.16K  
angular distribution for (n,n\*25)

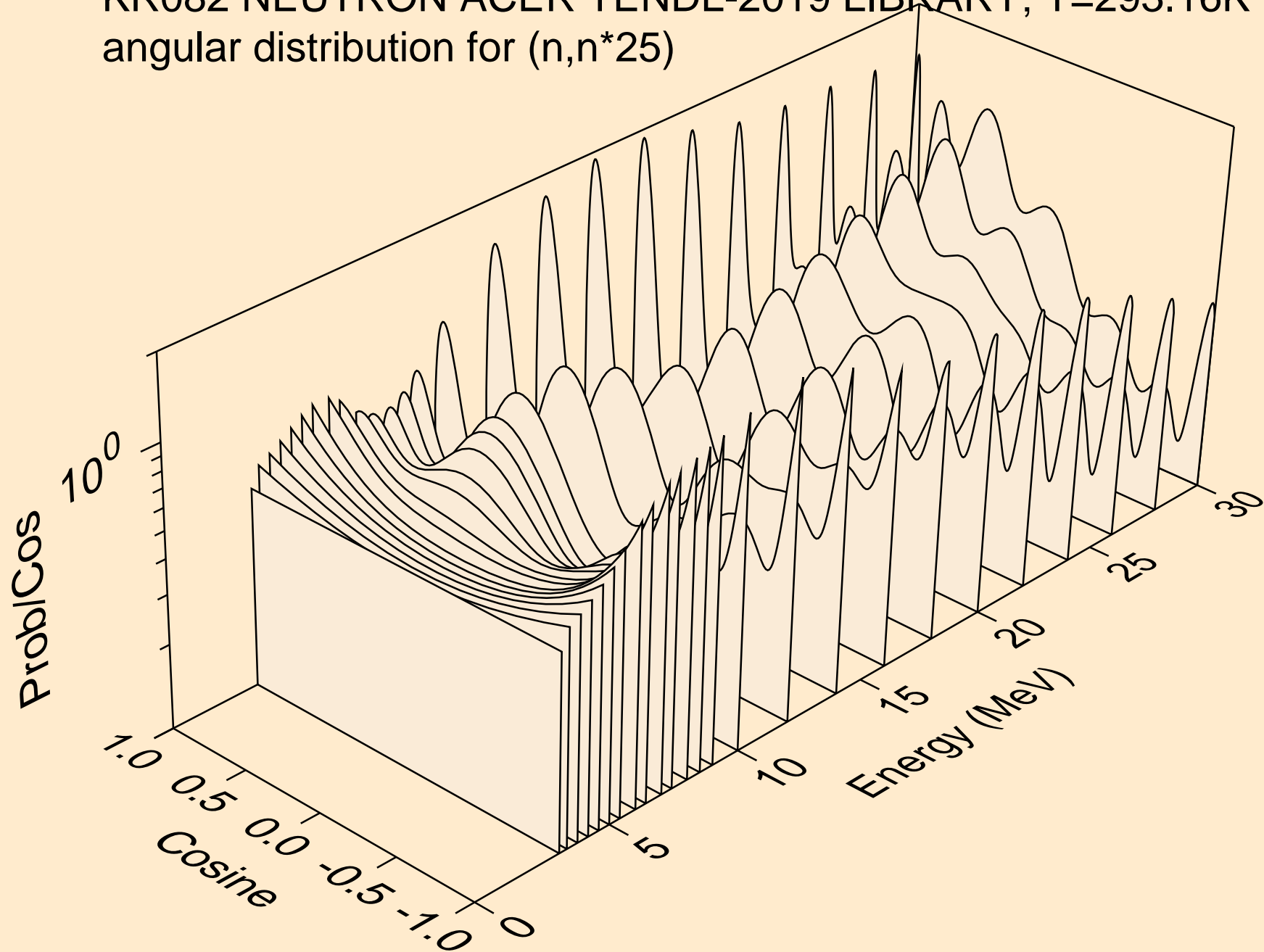



KR082 NEUTRON ACER TENDL-2019 LIBRARY; T=293.16K  
angular distribution for (n,n\*26)

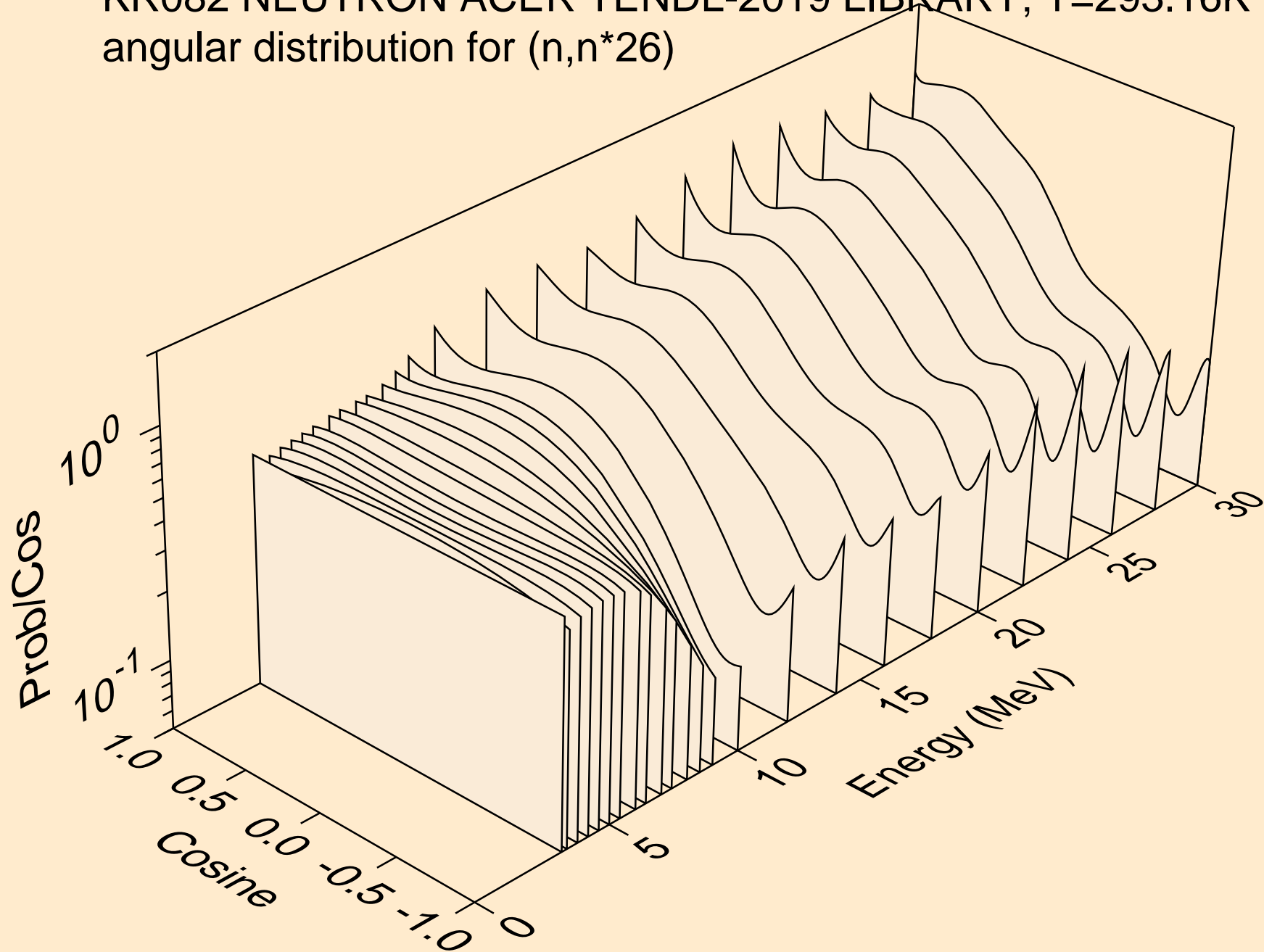

KR082 NEUTRON ACER TENDL-2019 LIBRARY; T=293.16K  
angular distribution for (n,n\*27)

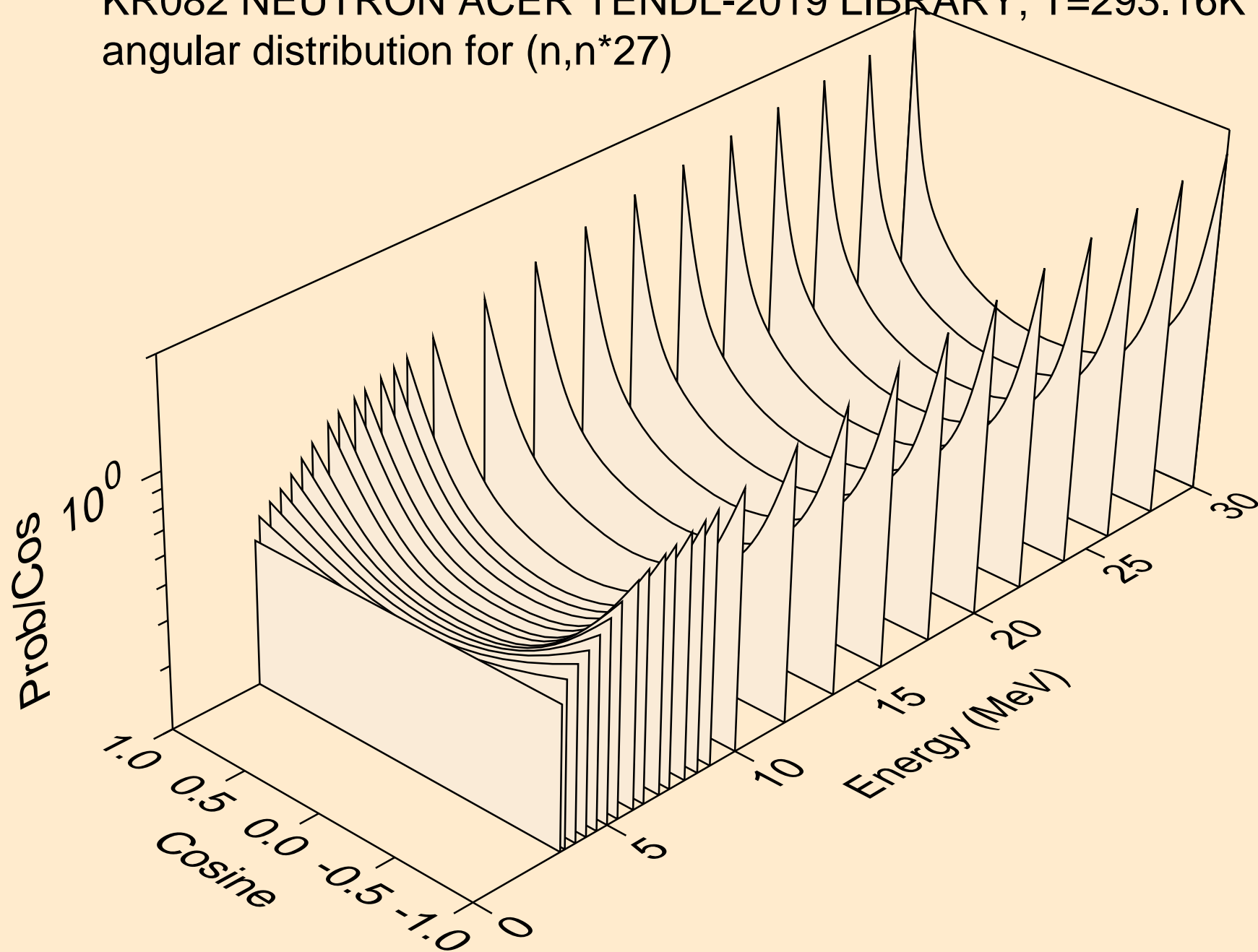

KR082 NEUTRON ACER TENDL-2019 LIBRARY; T=293.16K  
angular distribution for (n,n\*28)

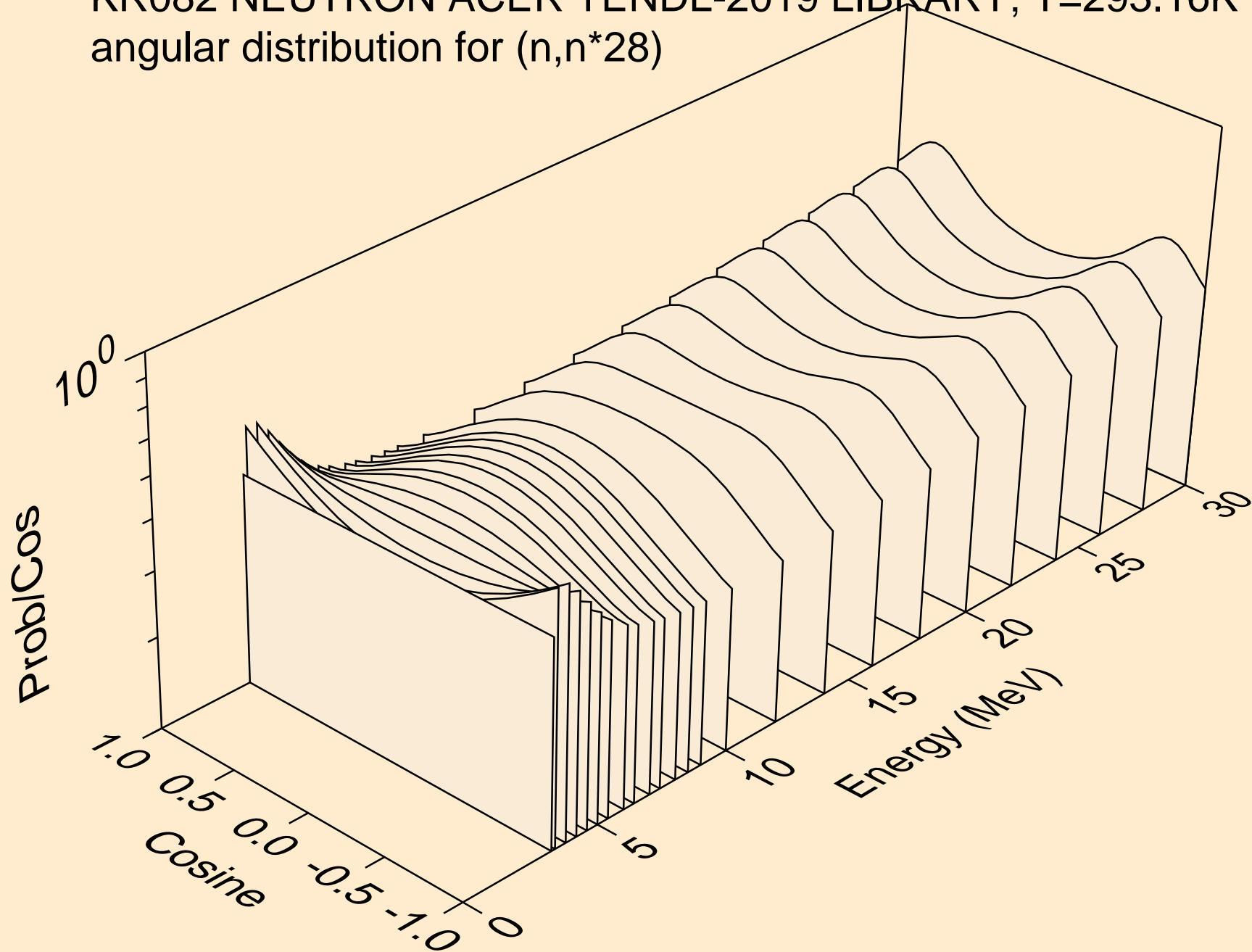

KR082 NEUTRON ACER TENDL-2019 LIBRARY; T=293.16K  
angular distribution for (n,n\*29)

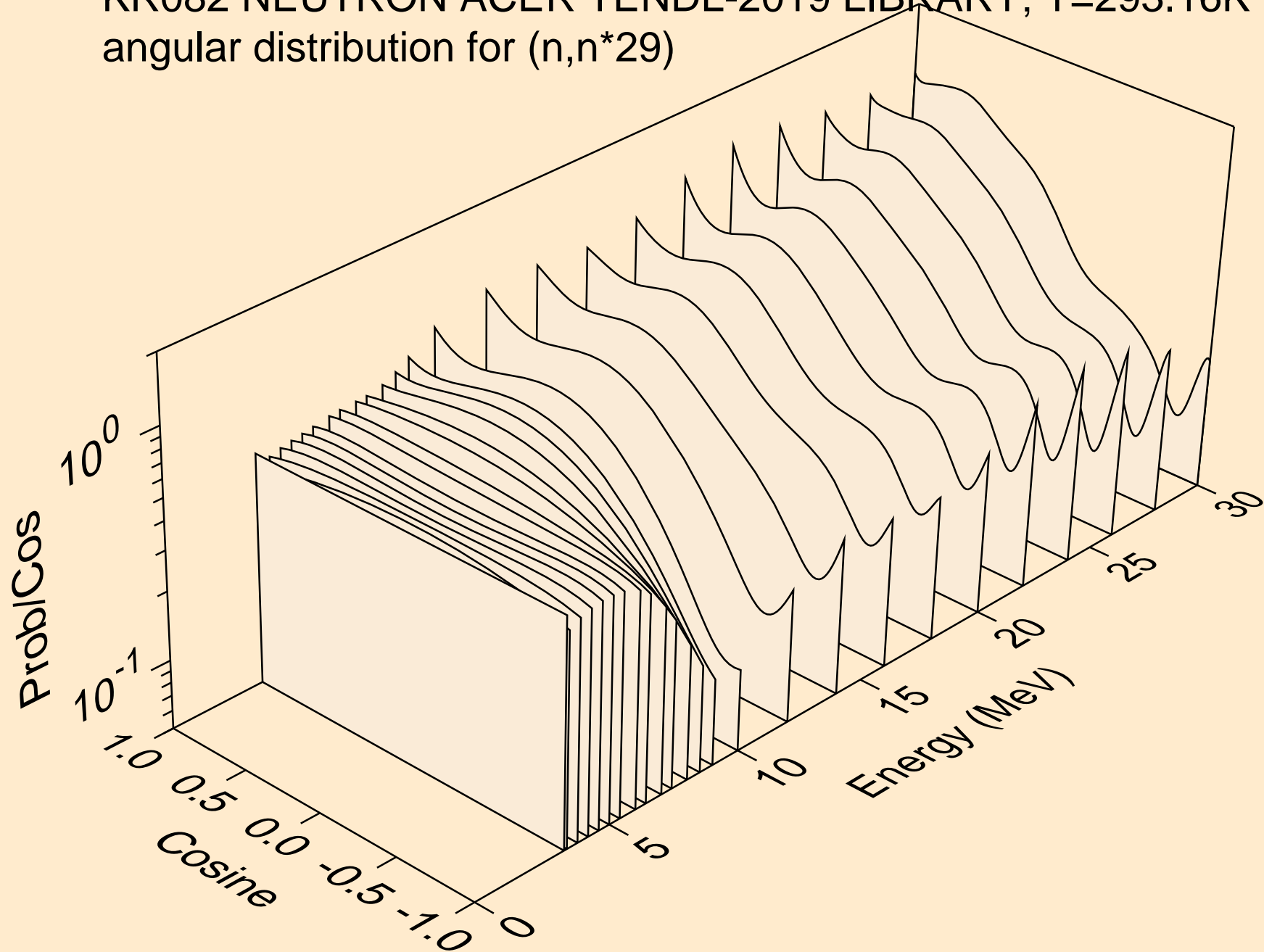

KR082 NEUTRON ACER TENDL-2019 LIBRARY; T=293.16K  
angular distribution for (n,n\*30)

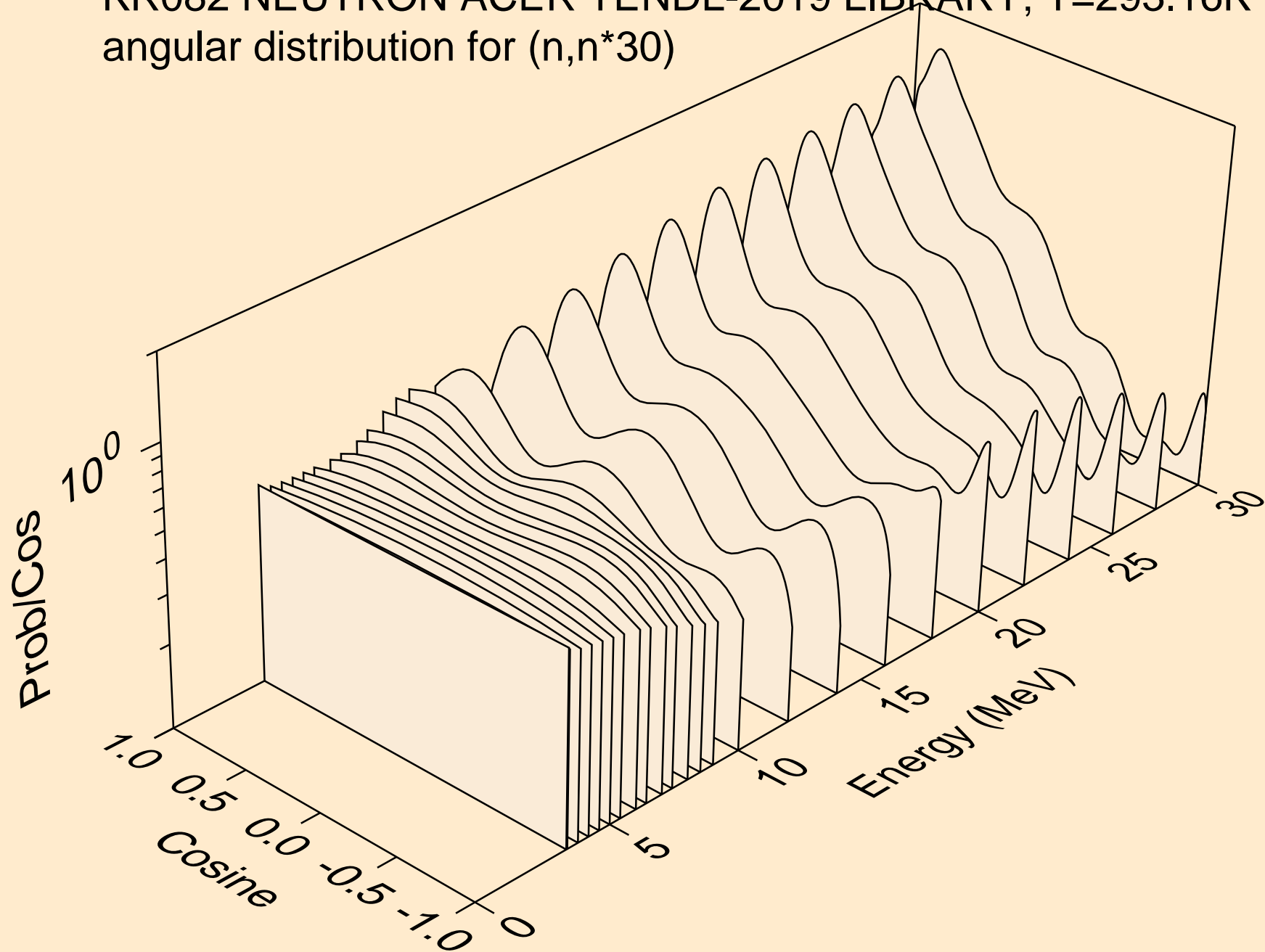

KR082 NEUTRON ACER TENDL-2019 LIBRARY; T=293.16K  
Neutron emission for (n,x)

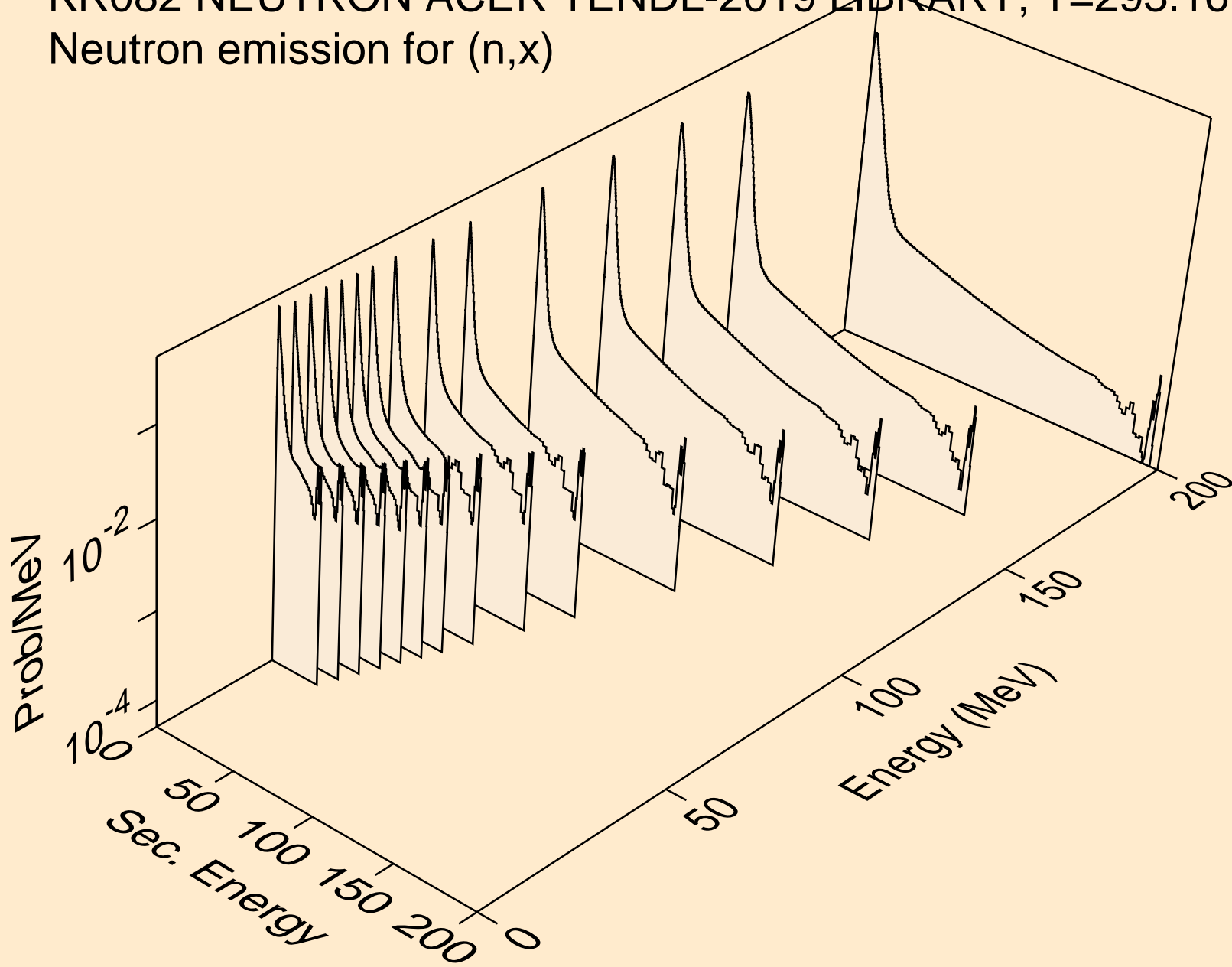

KR082 NEUTRON ACER TENDL-2019 LIBRARY; T=293.16K  
Neutron emission for (n,2nd)

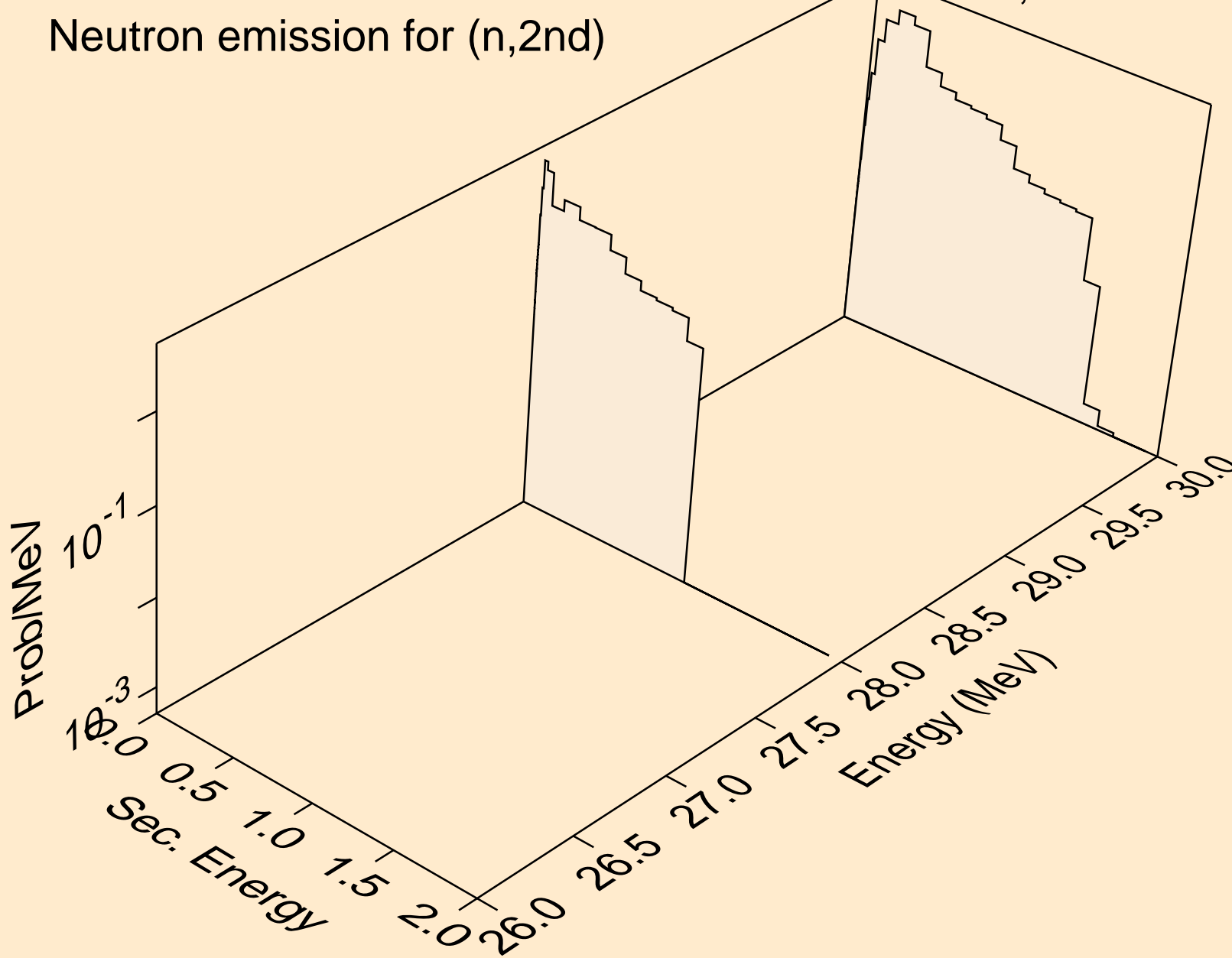

KR082 NEUTRON ACER TENDL-2019 LIBRARY; T=293.16K  
Neutron emission for (n,2n)

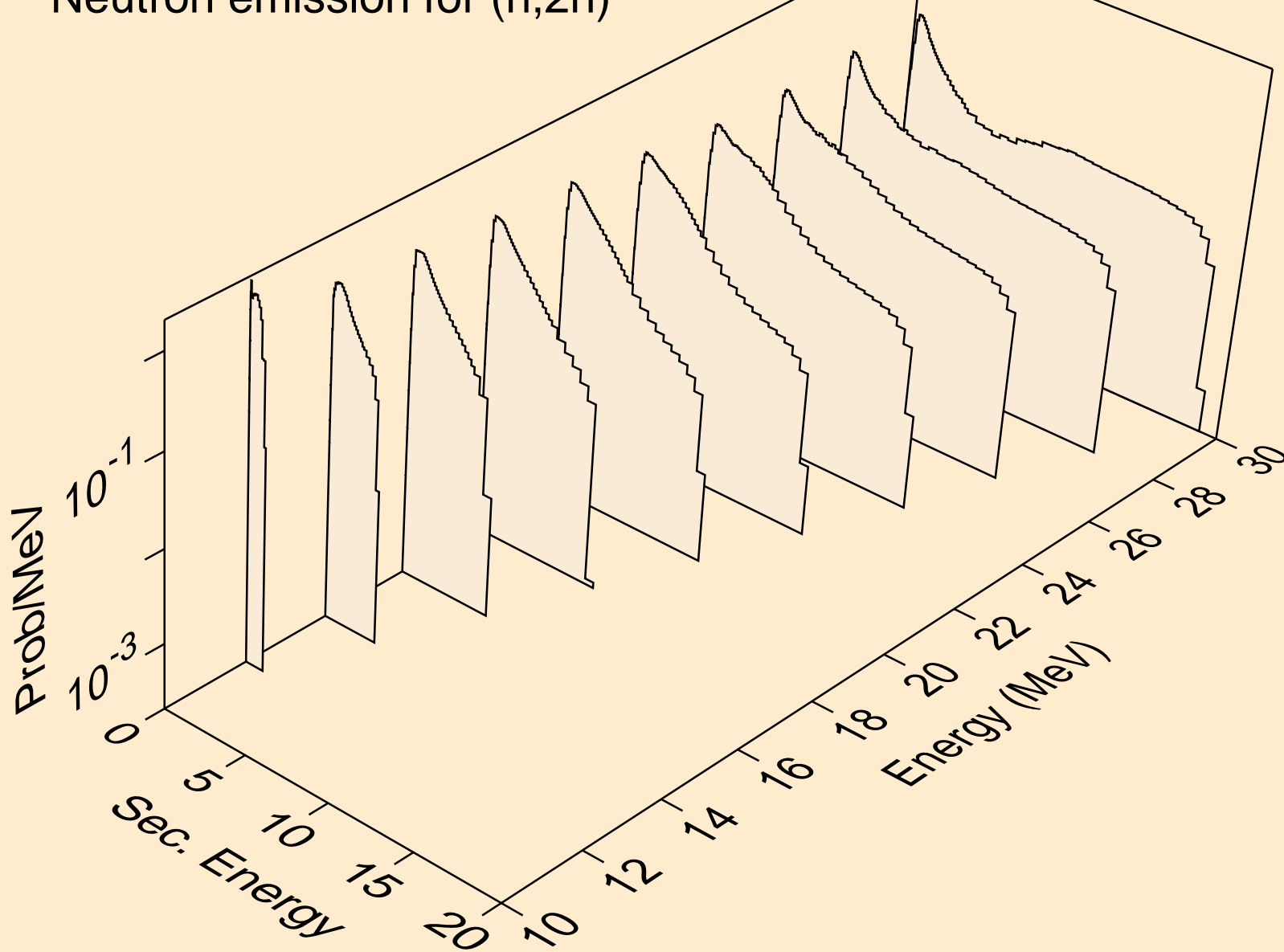



KR082 NEUTRON ACER TENDL-2019 LIBRARY; T=293.16K  
Neutron emission for (n,3n)

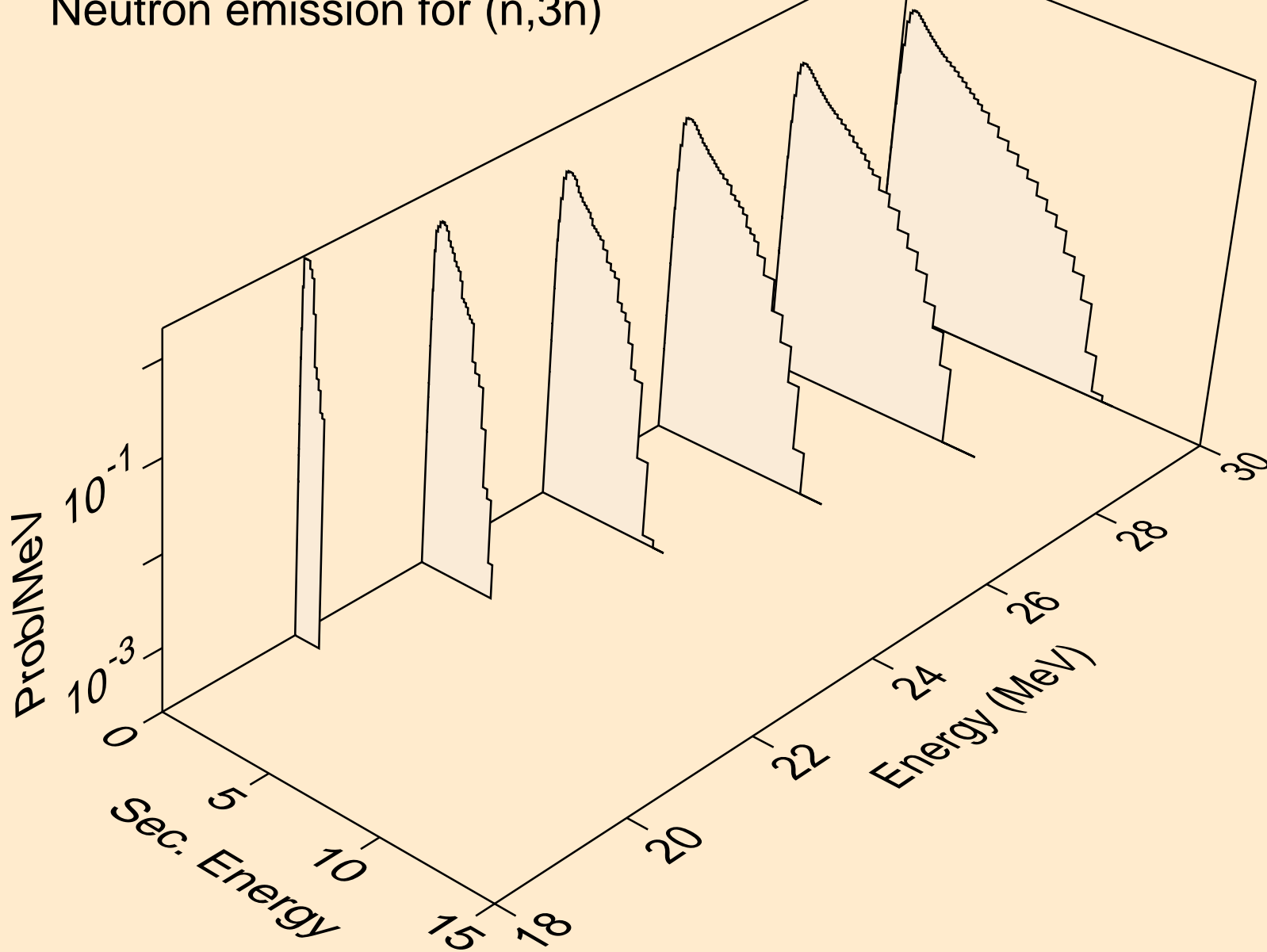

KR082 NEUTRON ACER TENDL-2019 LIBRARY; T=293.16K  
Neutron emission for (n,n\*)a

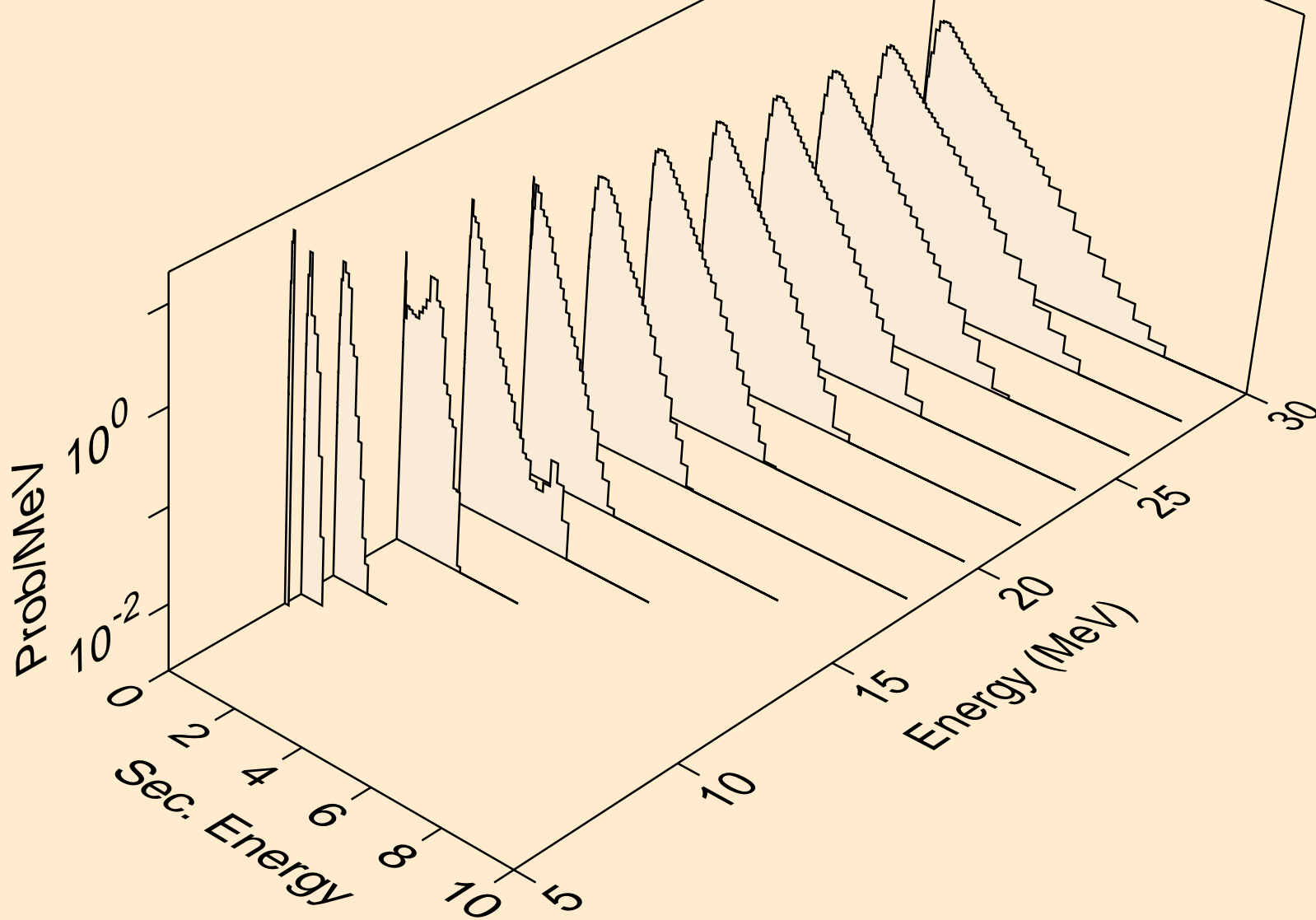

KR082 NEUTRON ACER TENDL-2019 LIBRARY; T=293.16K  
Neutron emission for (n,2n)a

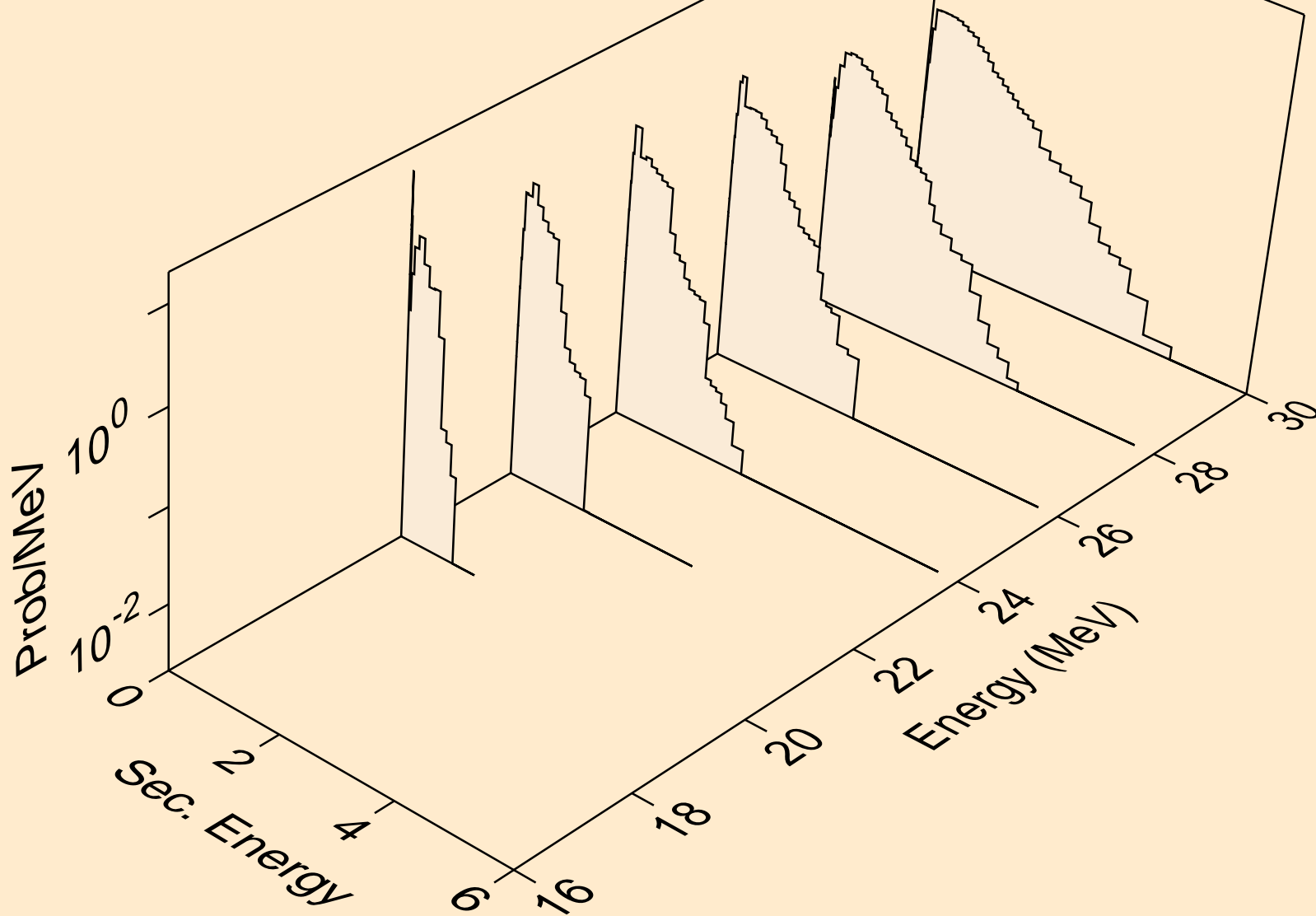

KR082 NEUTRON ACER TENDL-2019 LIBRARY; T=293.16K  
Neutron emission for (n,3n)a

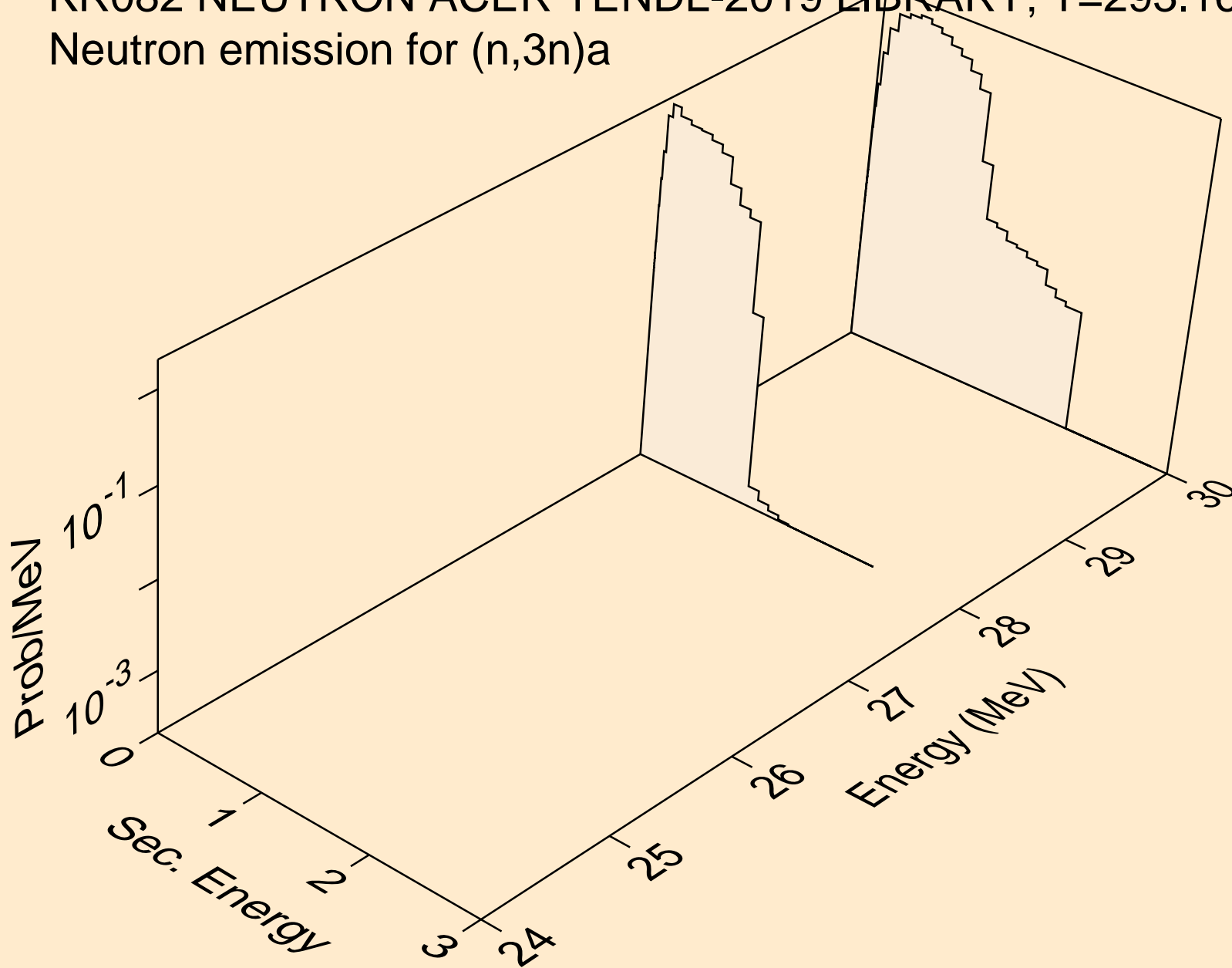

KR082 NEUTRON ACER TENDL-2019 LIBRARY; T=293.16K  
Neutron emission for (n,n\*)p

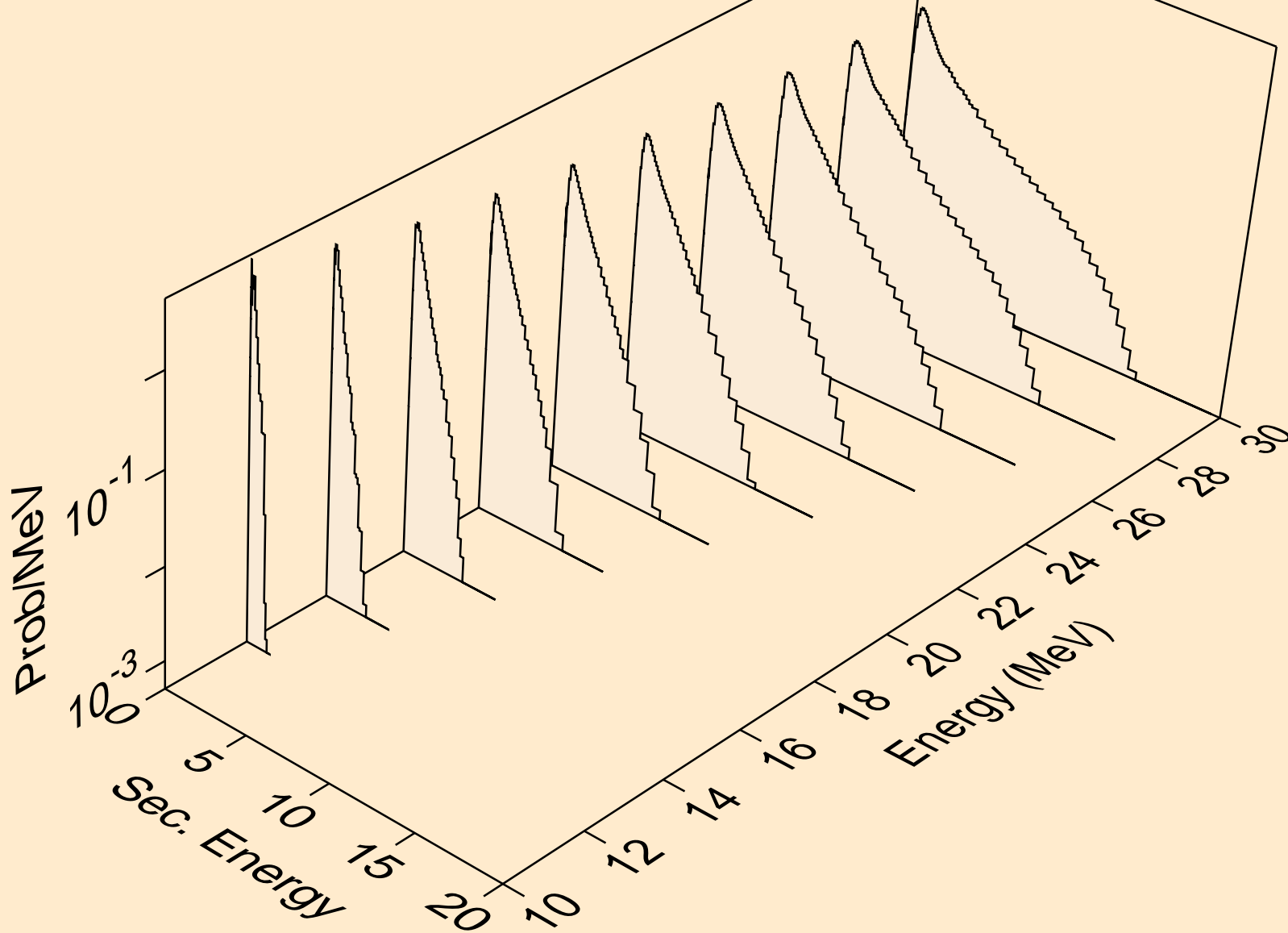

KR082 NEUTRON ACER TENDL-2019 LIBRARY; T=293.16K  
Neutron emission for (n,n\*)2a

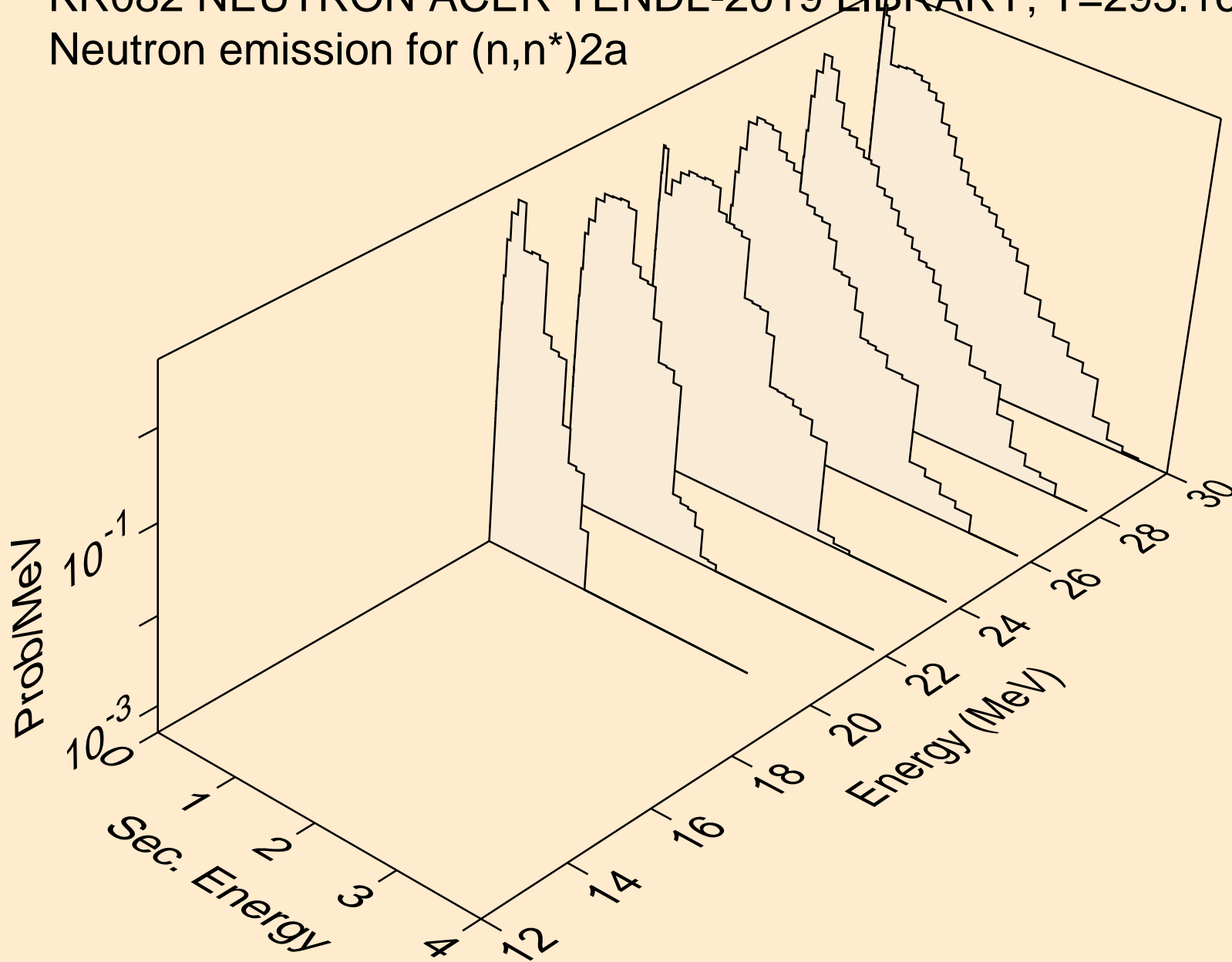

KR082 NEUTRON ACER TENDL-2019 LIBRARY; T=293.16K  
Neutron emission for (n,n\*)d

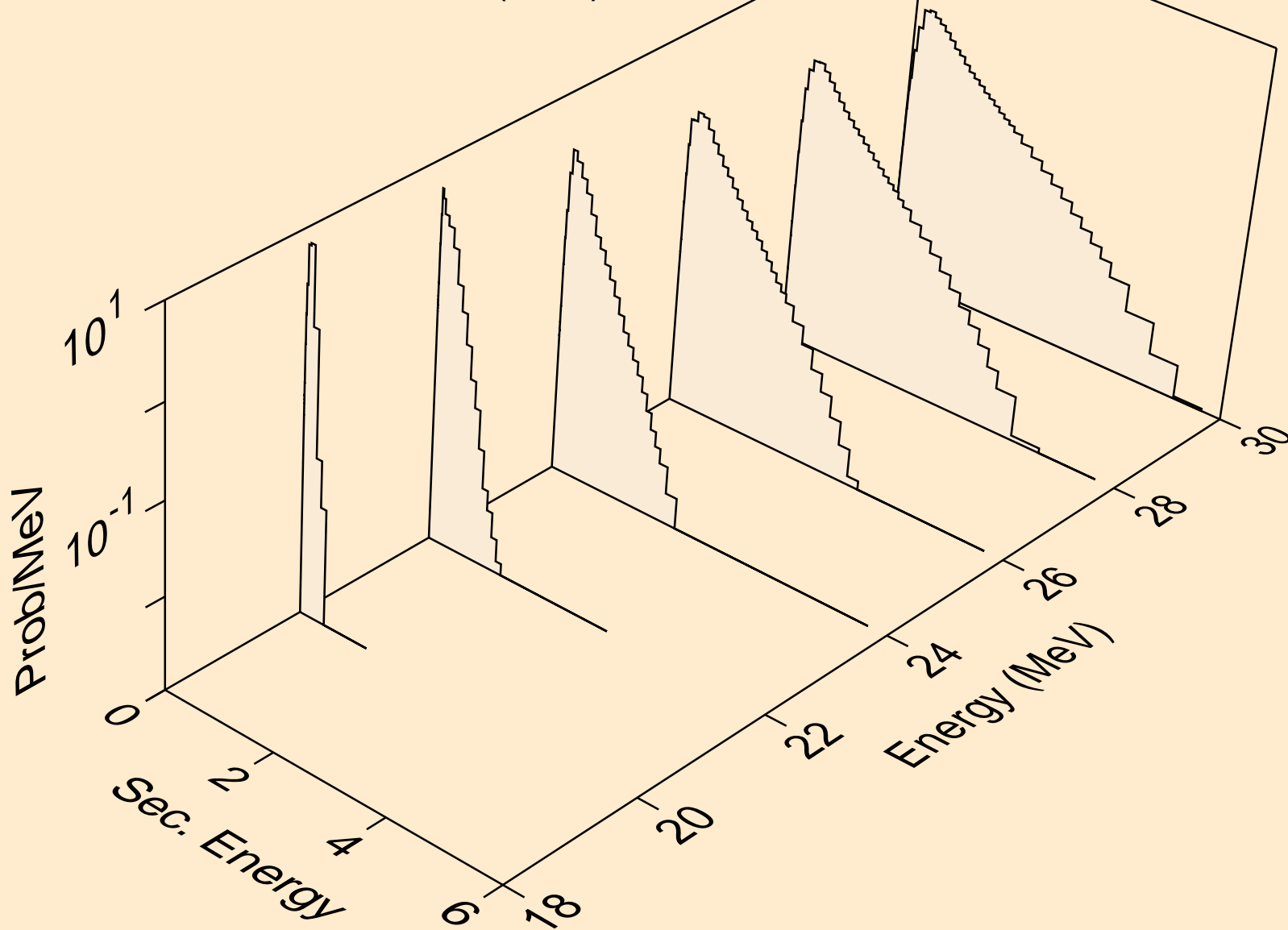

KR082 NEUTRON ACER TENDL-2019 LIBRARY; T=293.16K  
Neutron emission for (n,n\*)t

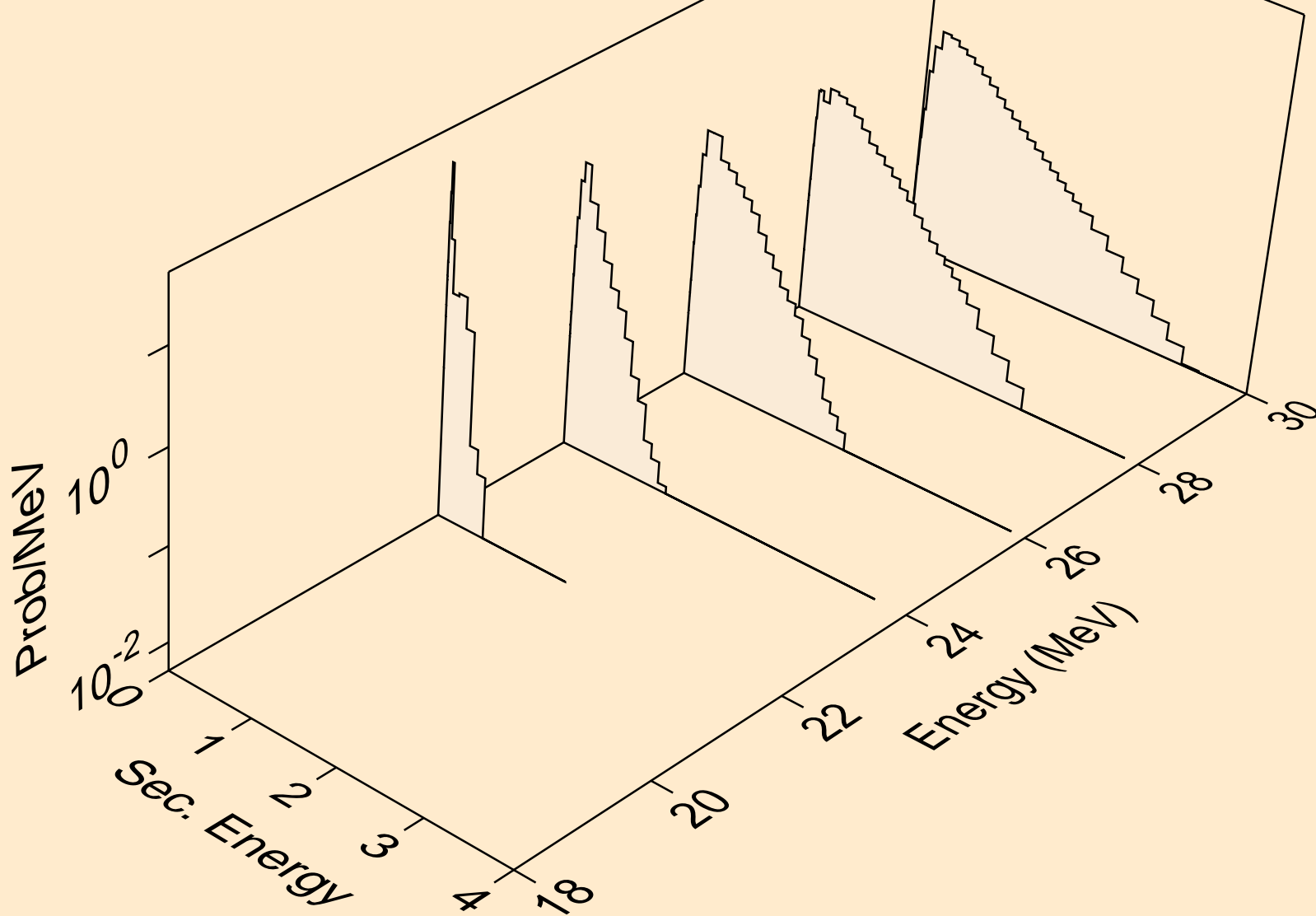



KR082 NEUTRON ACER TENDL-2019 LIBRARY; T=293.16K  
Neutron emission for (n,n\*)he3

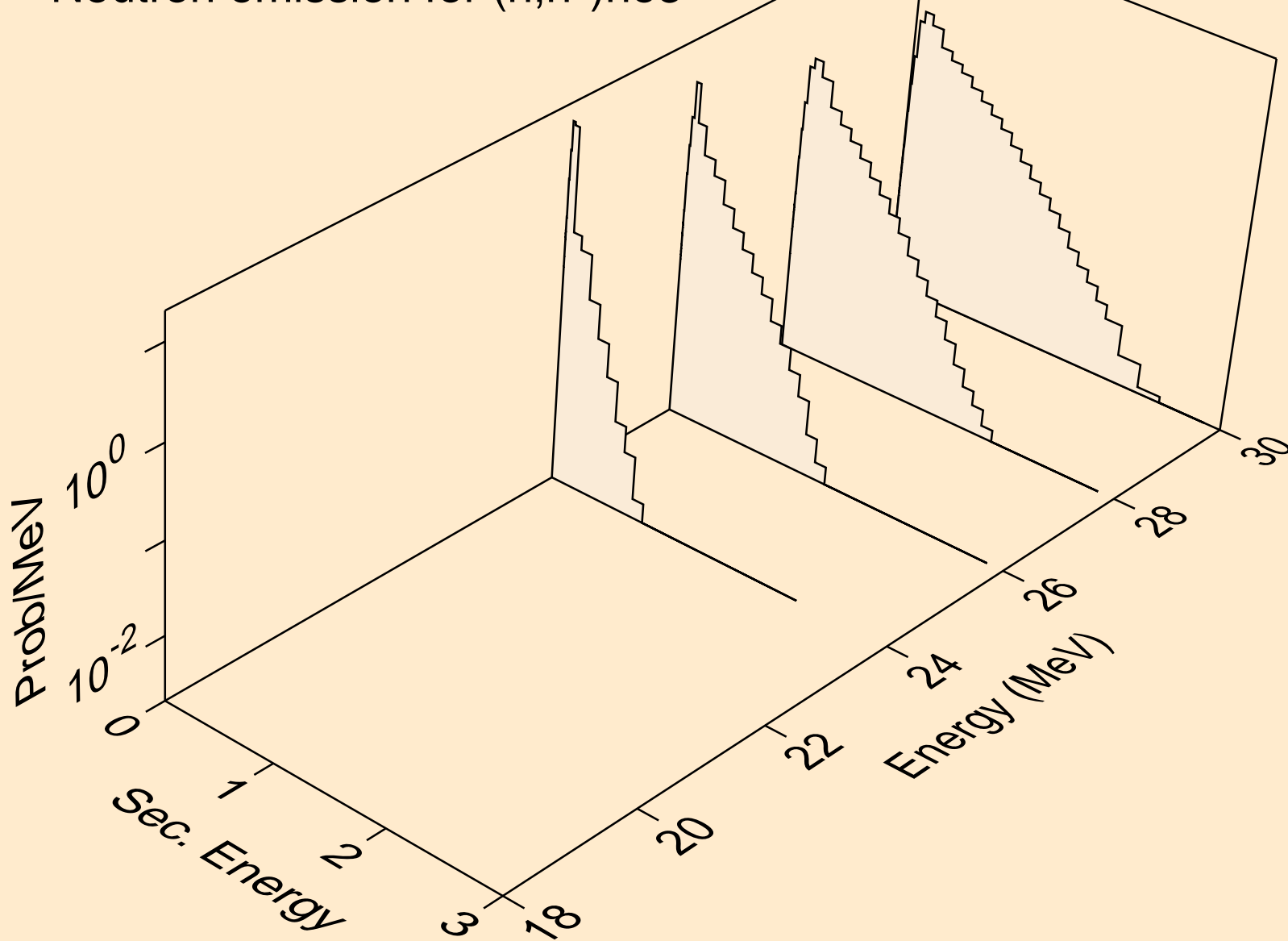

KR082 NEUTRON ACER TENDL-2019 LIBRARY; T=293.16K  
Neutron emission for (n,2np)

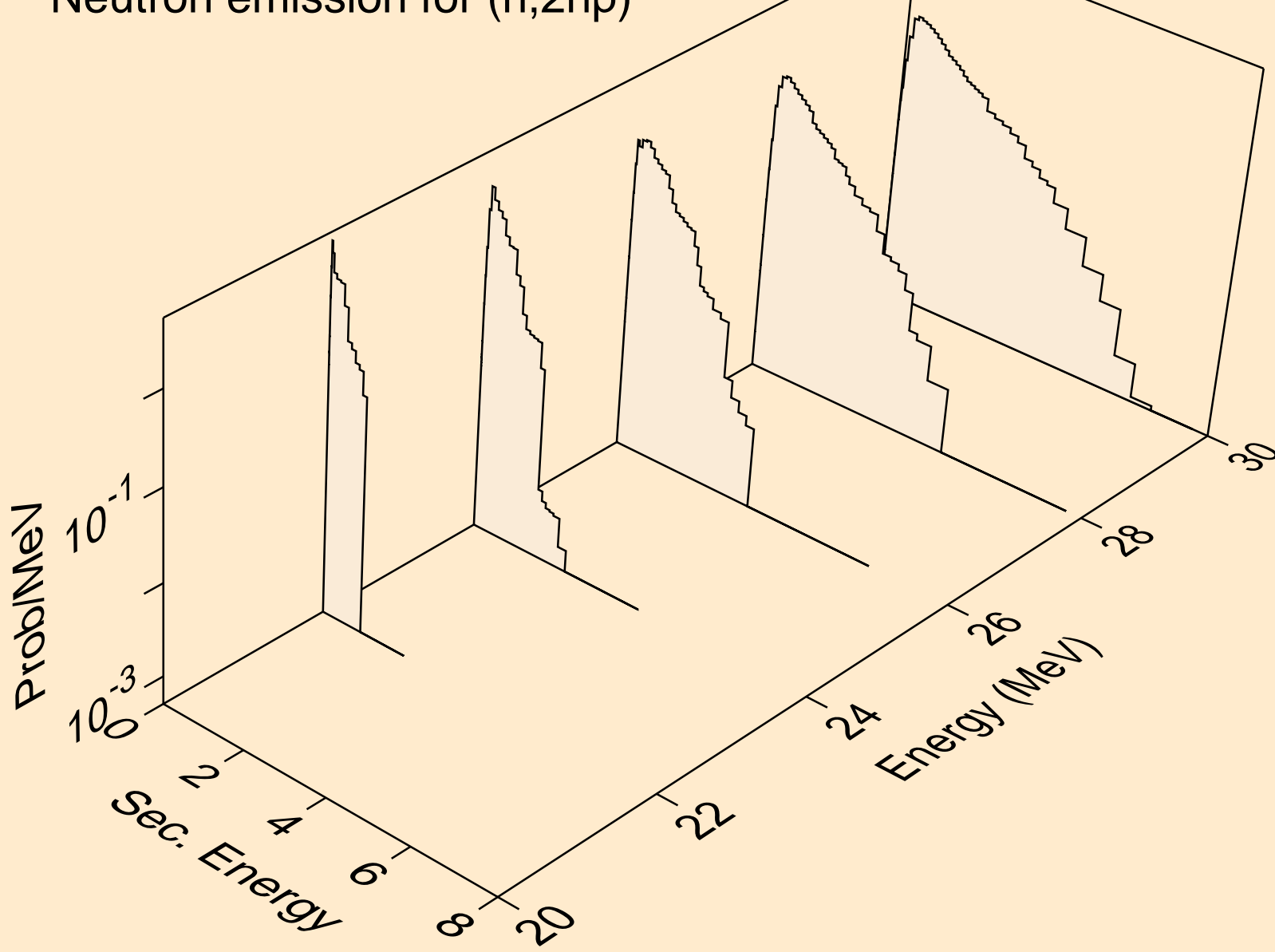

KR082 NEUTRON ACER TENDL-2019 LIBRARY; T=293.16K  
Neutron emission for (n,3np)

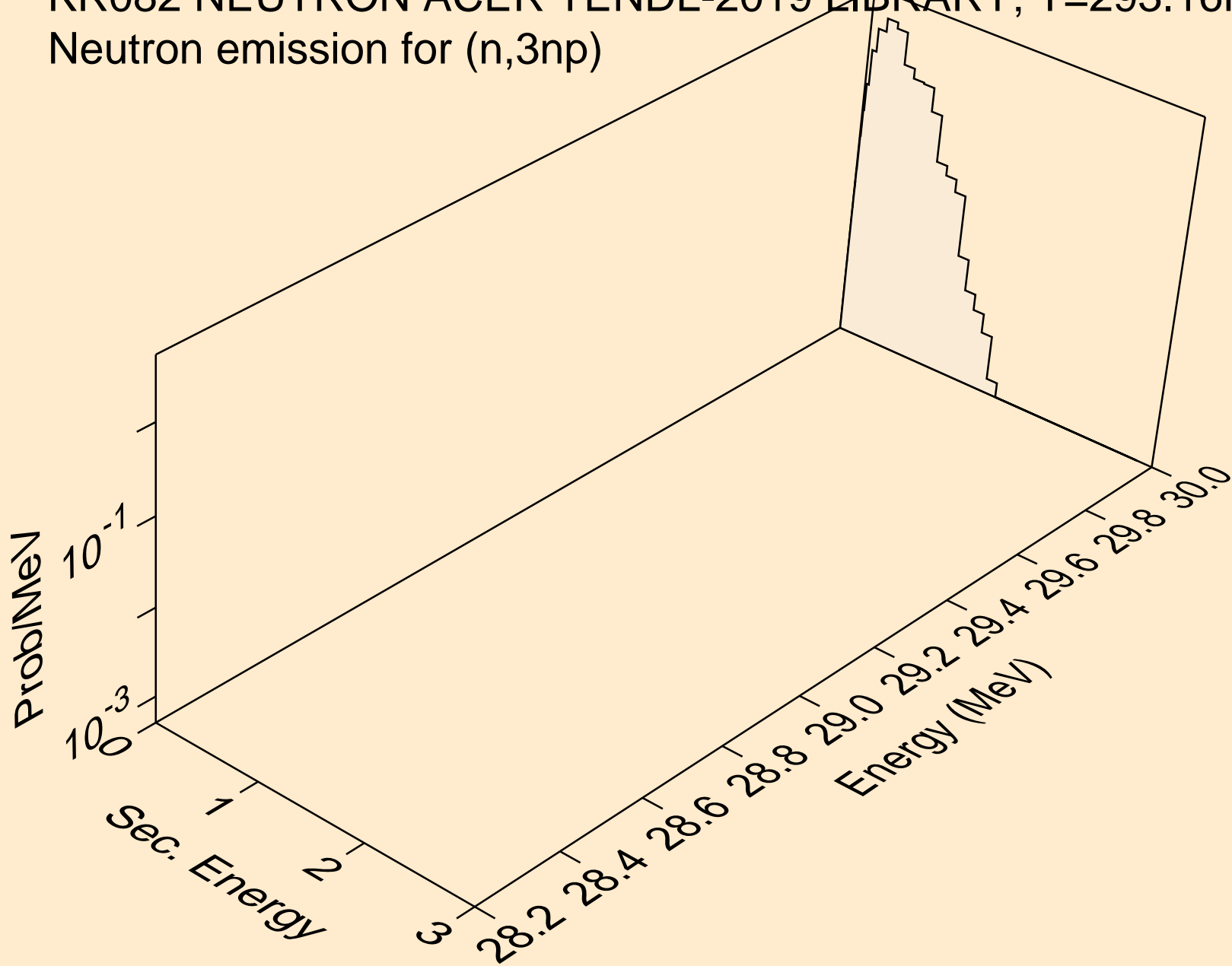

KR082 NEUTRON ACER TENDL-2019 LIBRARY; T=293.16K  
Neutron emission for (n,2np)

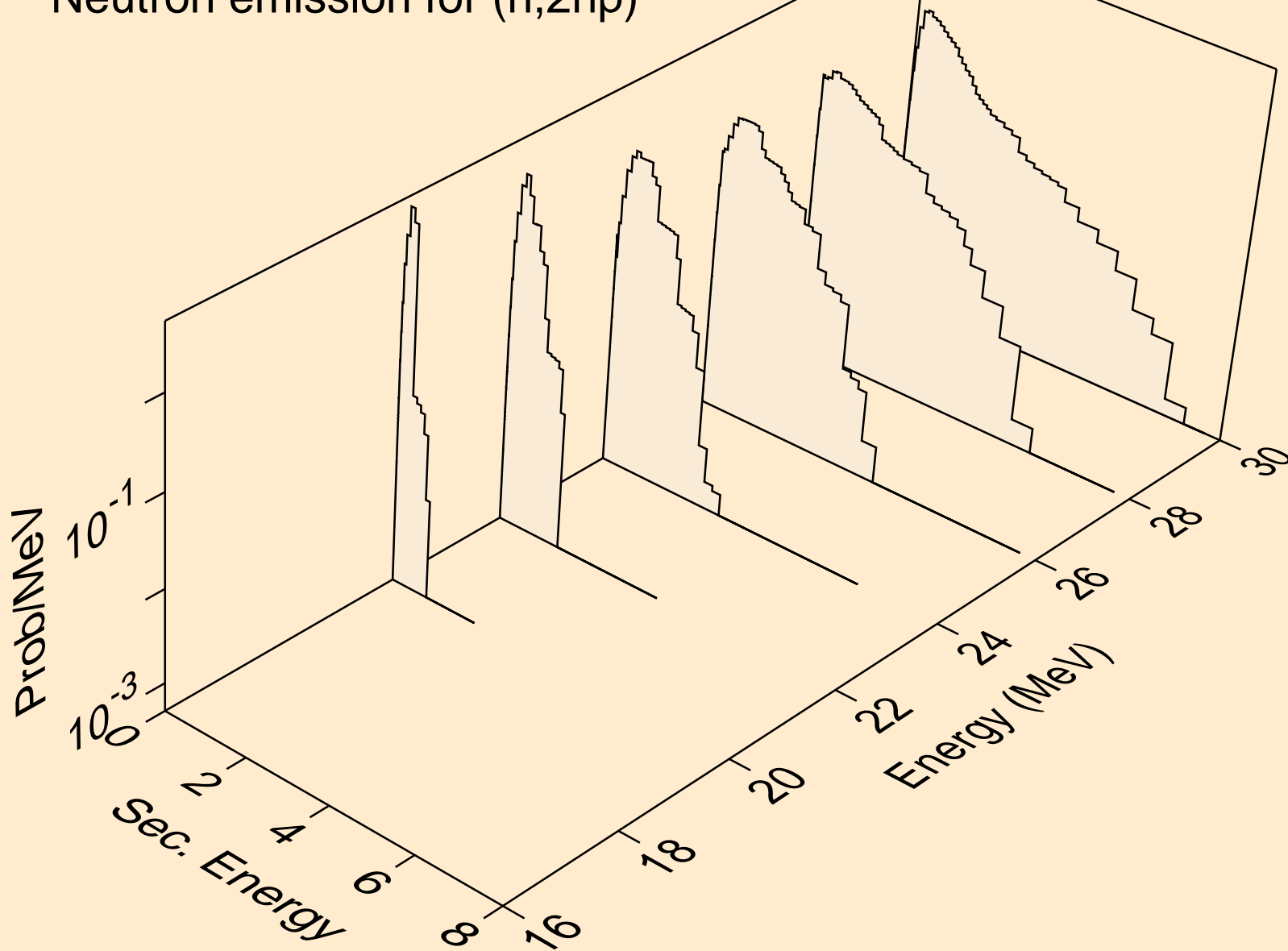

KR082 NEUTRON ACER TENDL-2019 LIBRARY; T=293.16K  
Neutron emission for (n,npa)

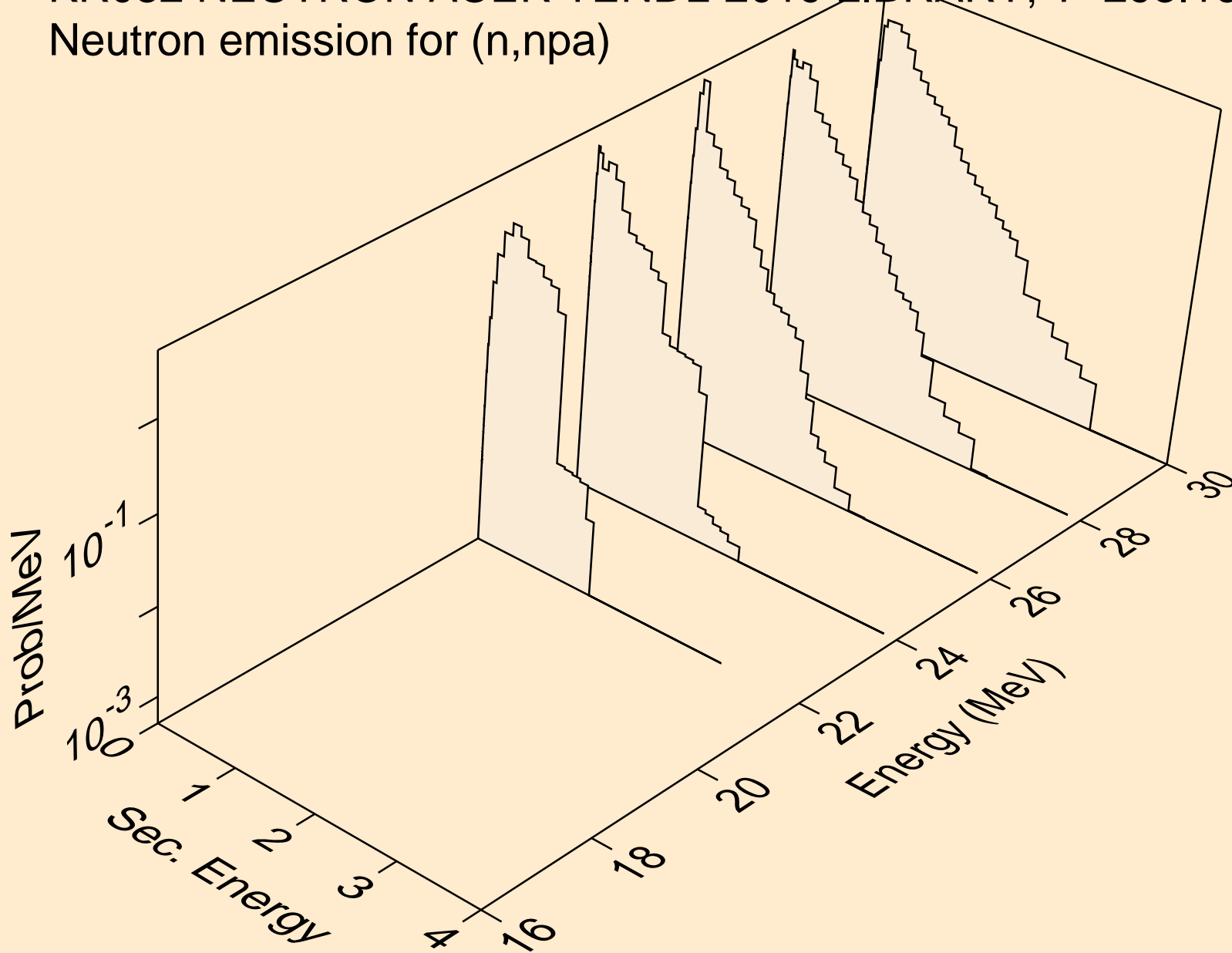

KR082 NEUTRON ACER TENDL-2019 LIBRARY; T=293.16K  
Neutron emission for (n,n\*c)

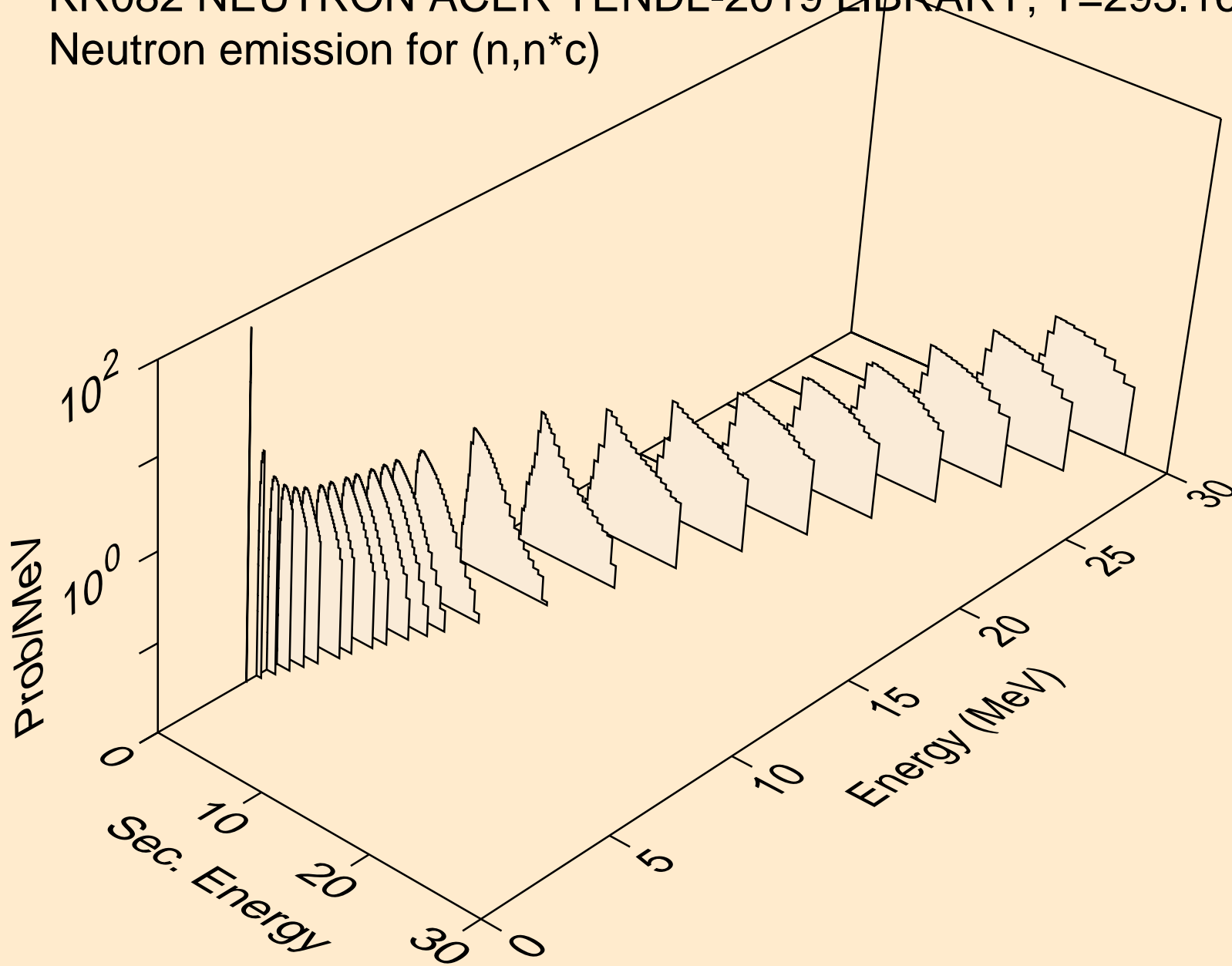

KR082 NEUTRON ACER TENDL-2019 LIBRARY; T=293.16K  
Photon emission for (n,x)

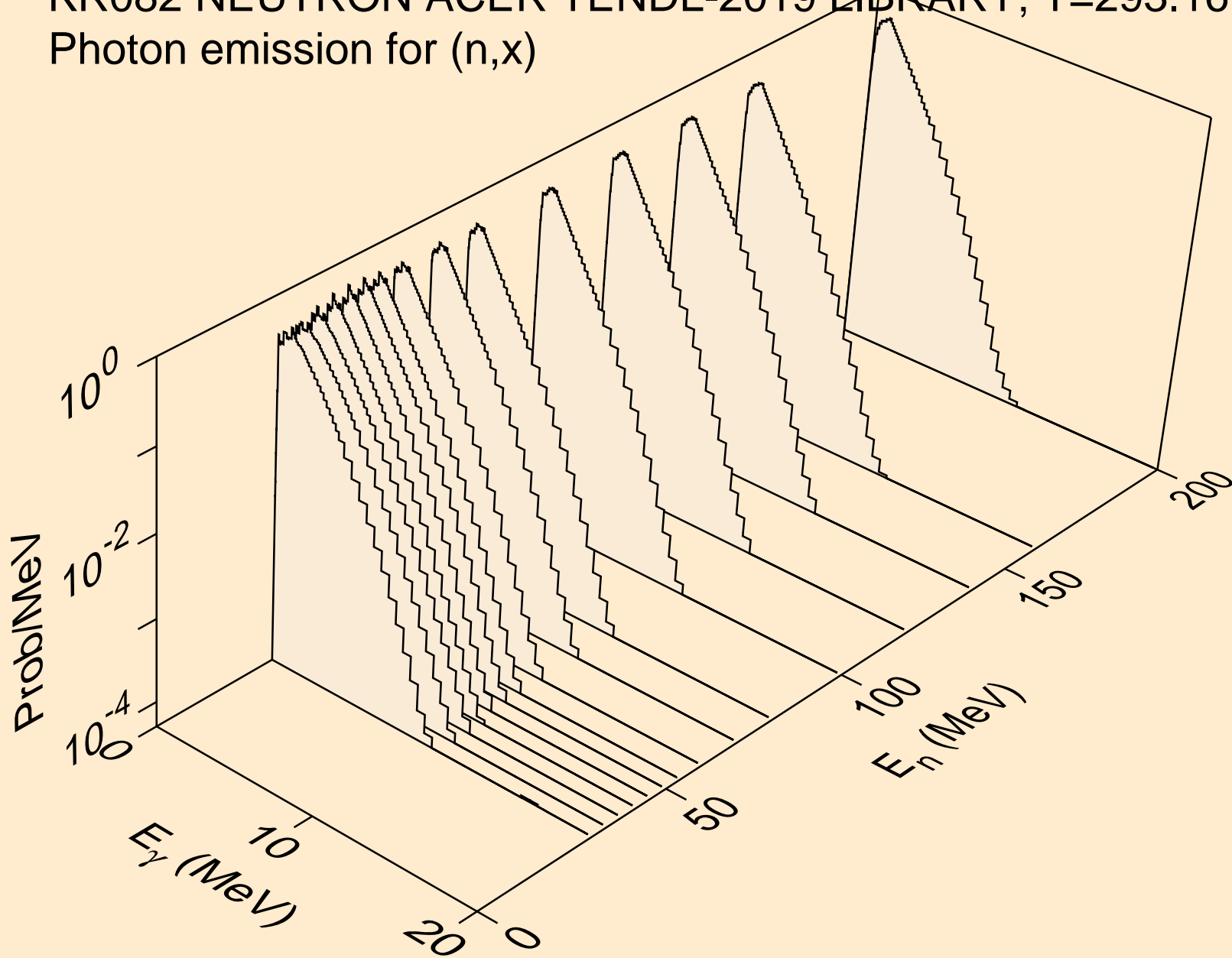

KR082 NEUTRON ACER TENDL-2019 LIBRARY; T=293.16K  
Photon emission for (n,2nd)

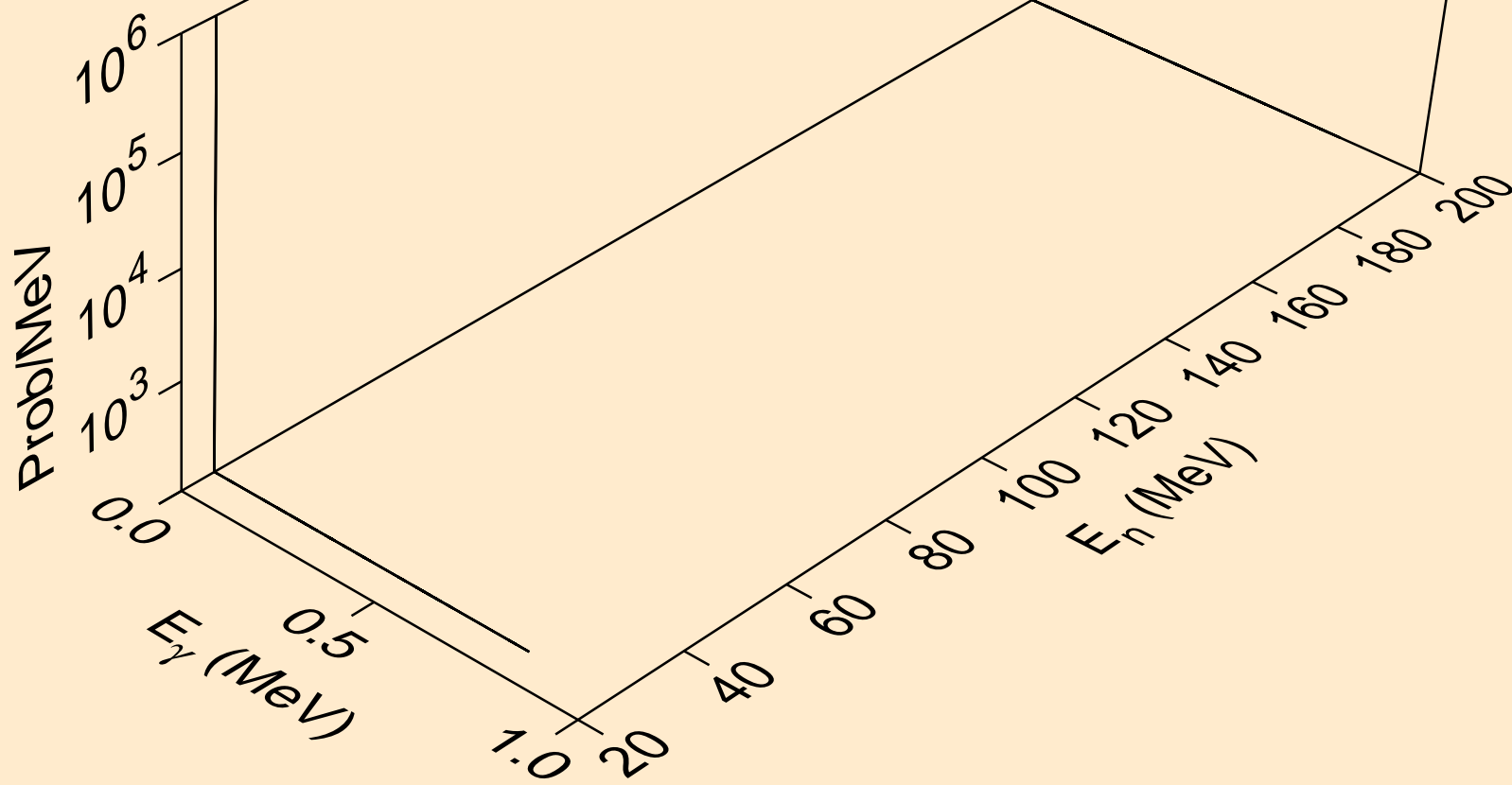



KR082 NEUTRON ACER TENDL-2019 LIBRARY; T=293.16K  
Photon emission for (n,2n)

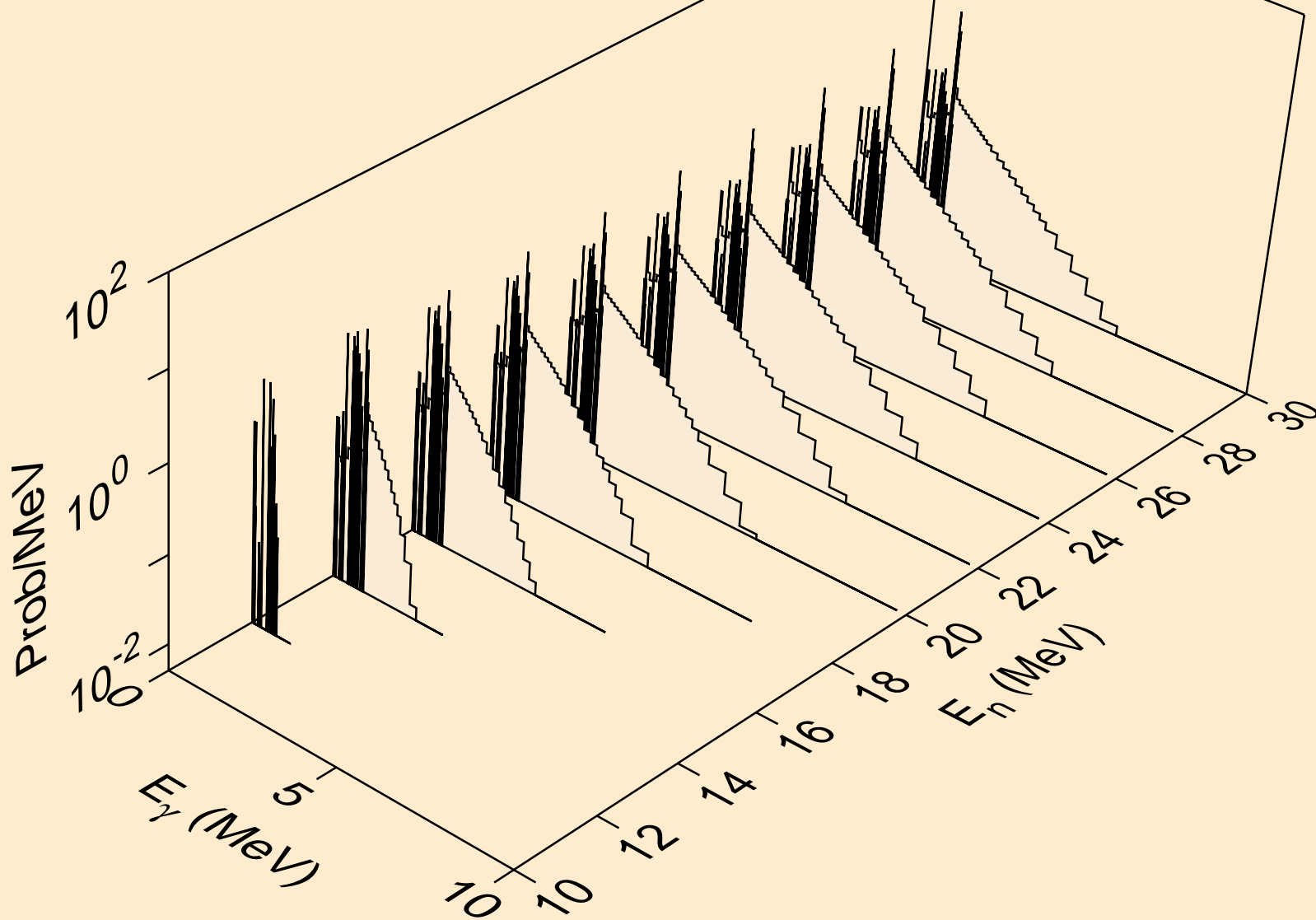

KR082 NEUTRON ACER TENDL-2019 LIBRARY; T=293.16K  
Photon emission for (n,3n)

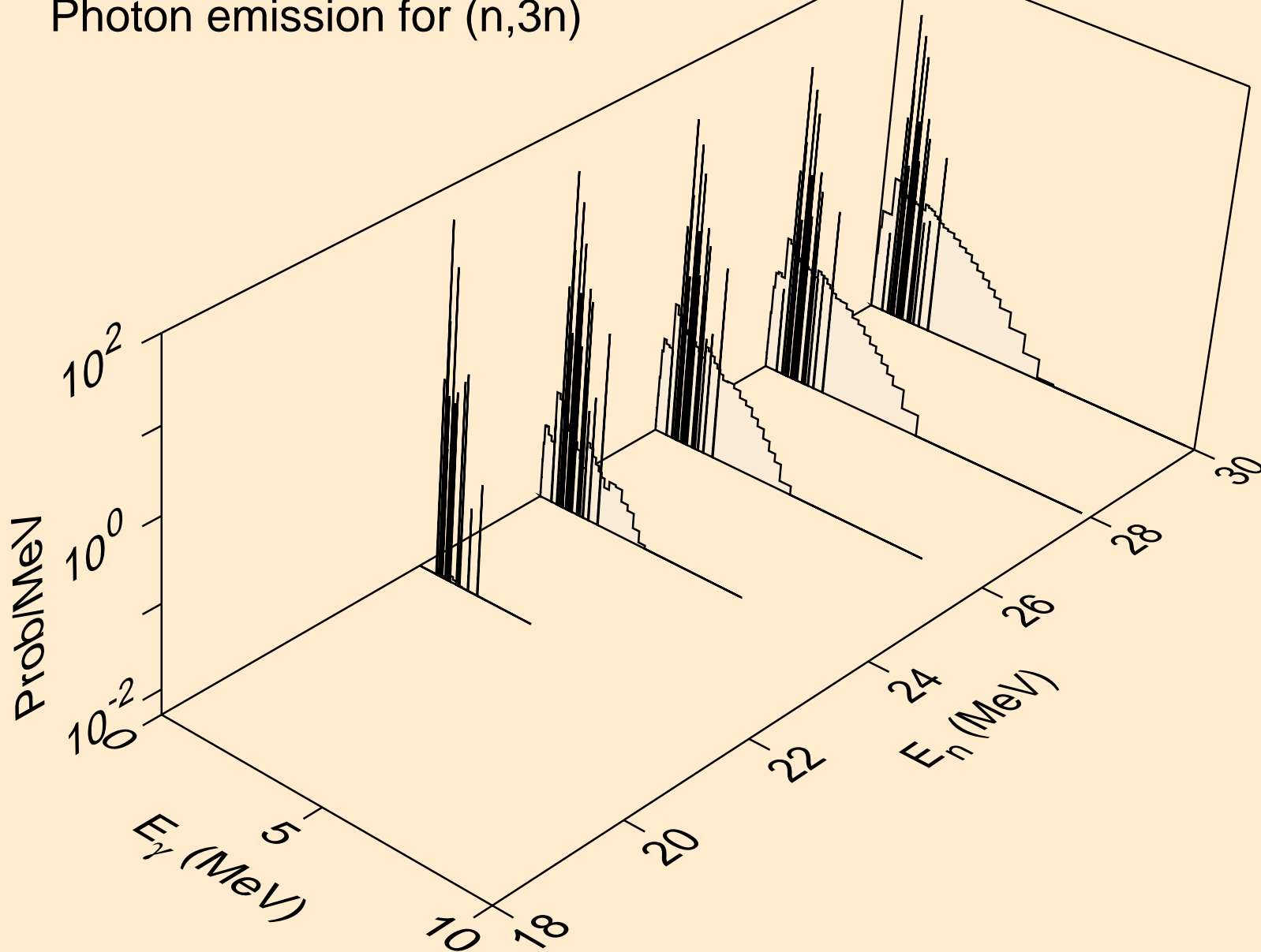

KR082 NEUTRON ACER TENDL-2019 LIBRARY; T=293.16K  
Photon emission for (n,n\*)a

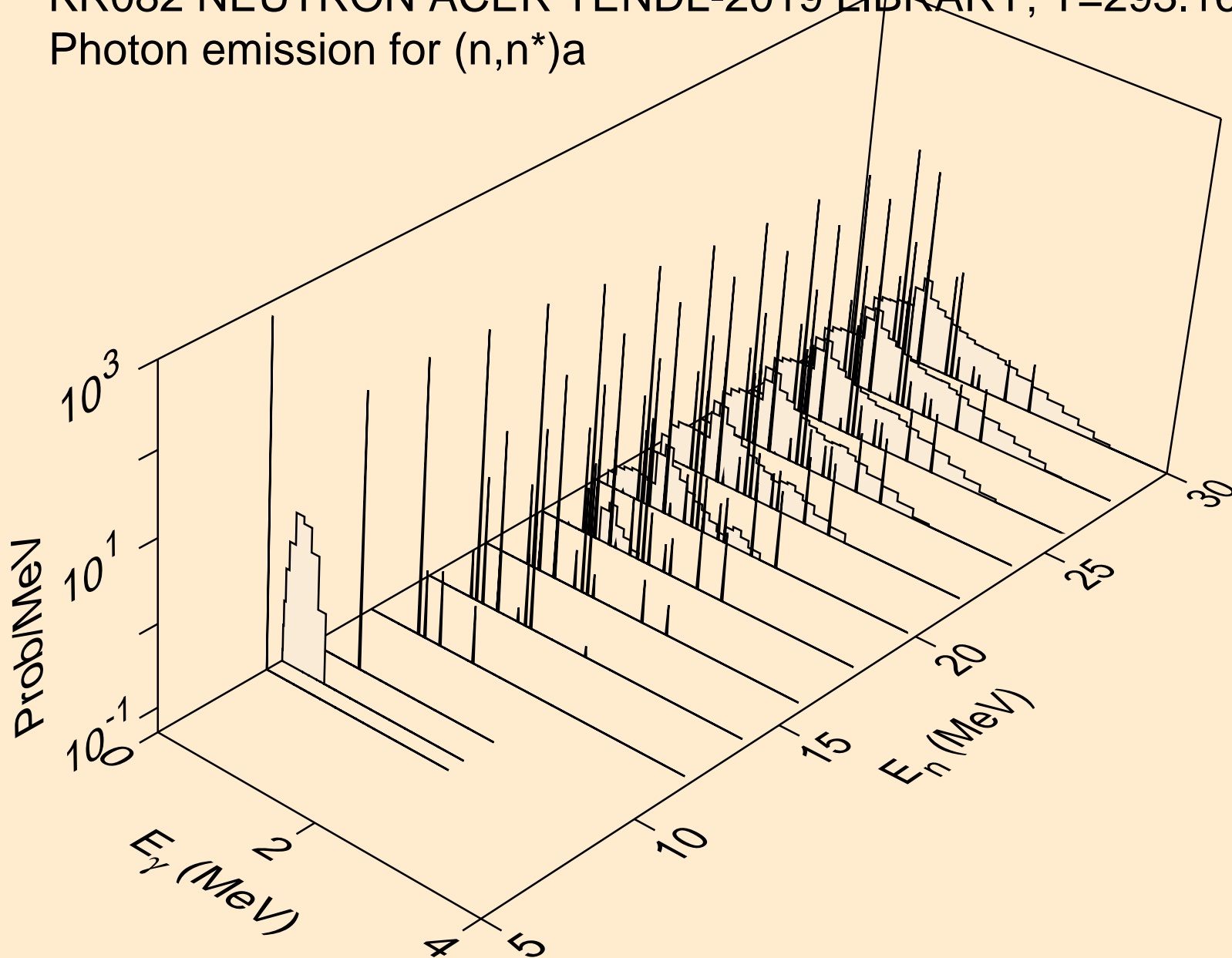

KR082 NEUTRON ACER TENDL-2019 LIBRARY; T=293.16K  
Photon emission for (n,2n)a

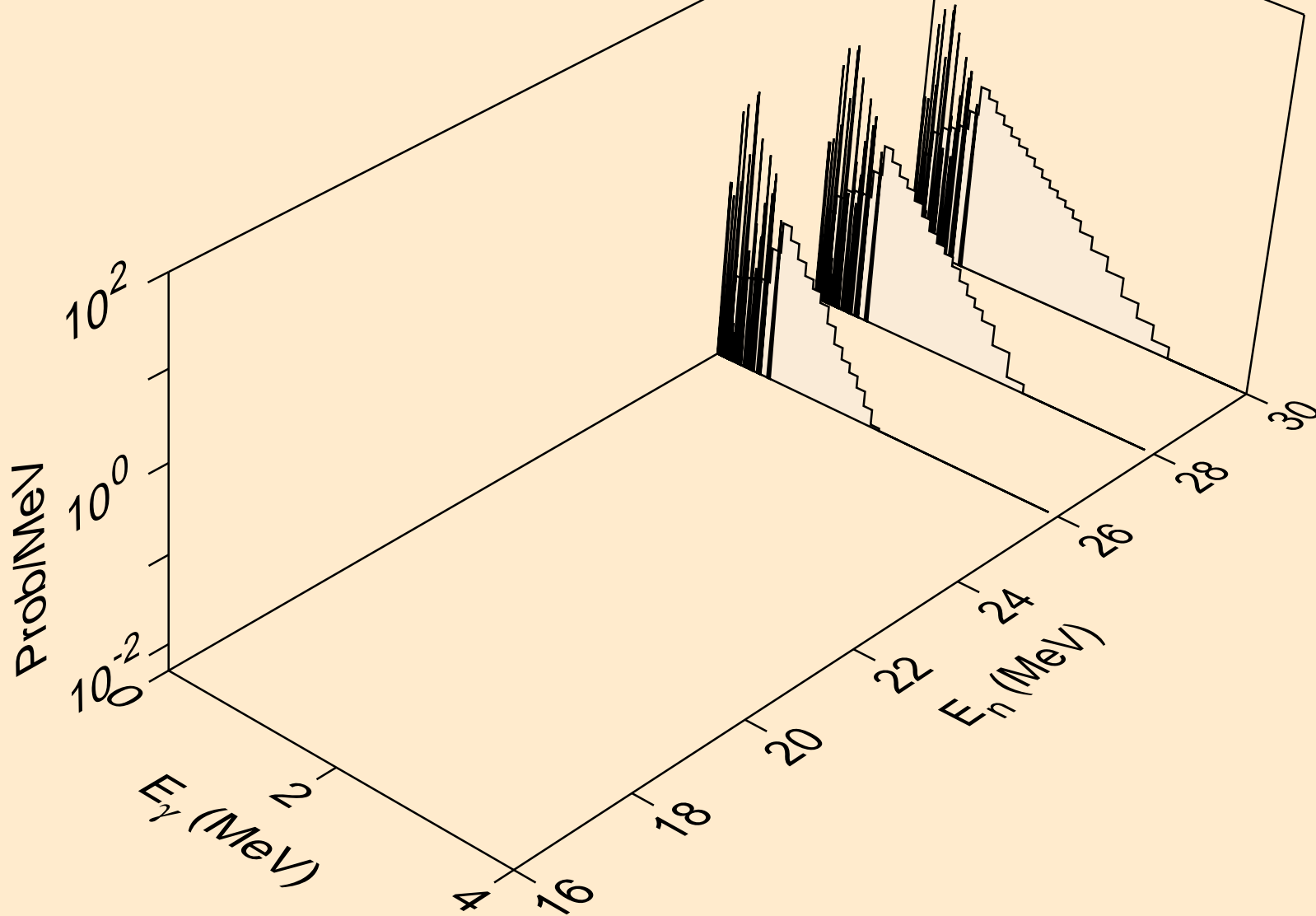

KR082 NEUTRON ACER TENDL-2019 LIBRARY; T=293.16K  
Photon emission for (n,3n)a

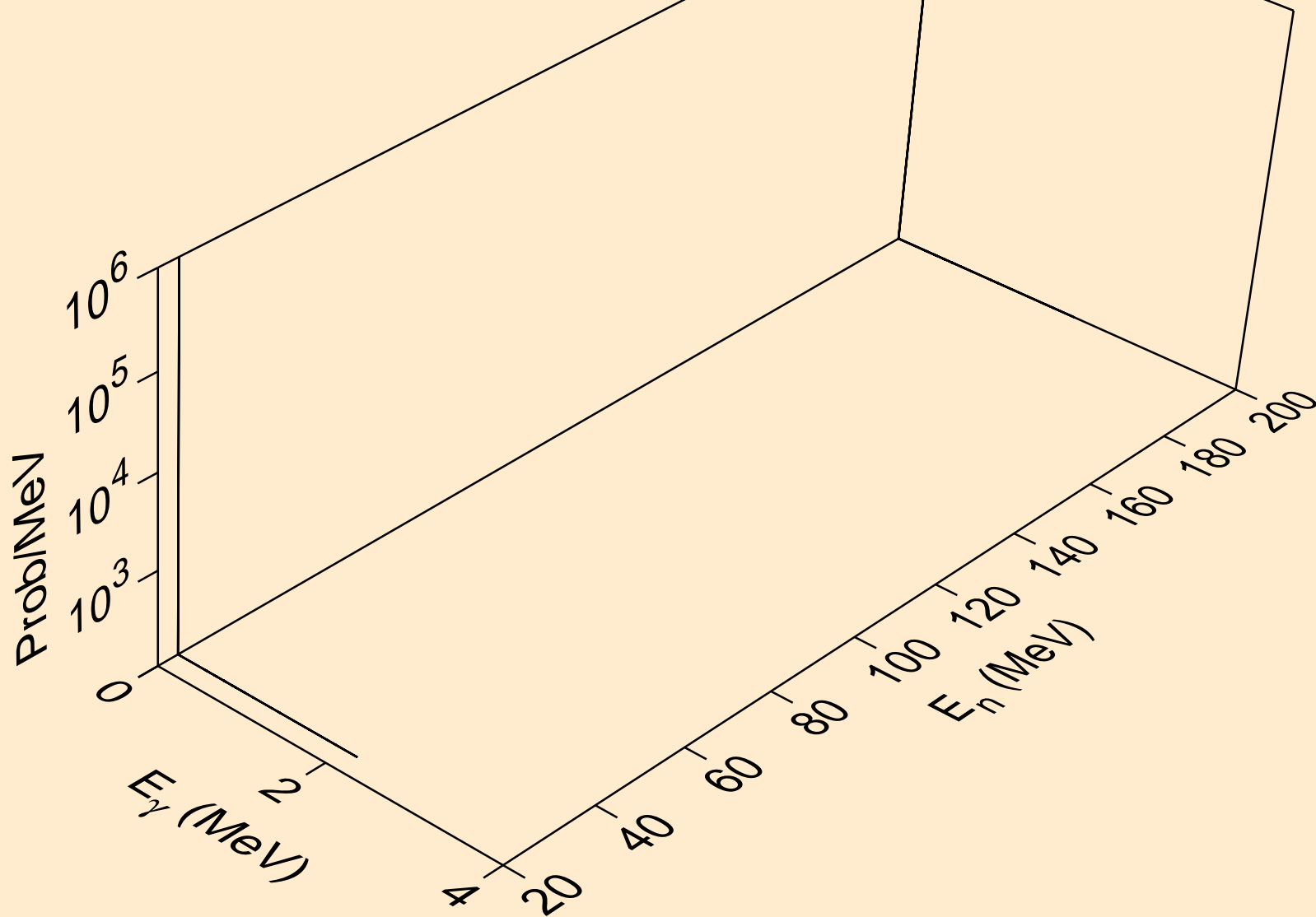

KR082 NEUTRON ACER TENDL-2019 LIBRARY; T=293.16K  
Photon emission for (n,n\*)p

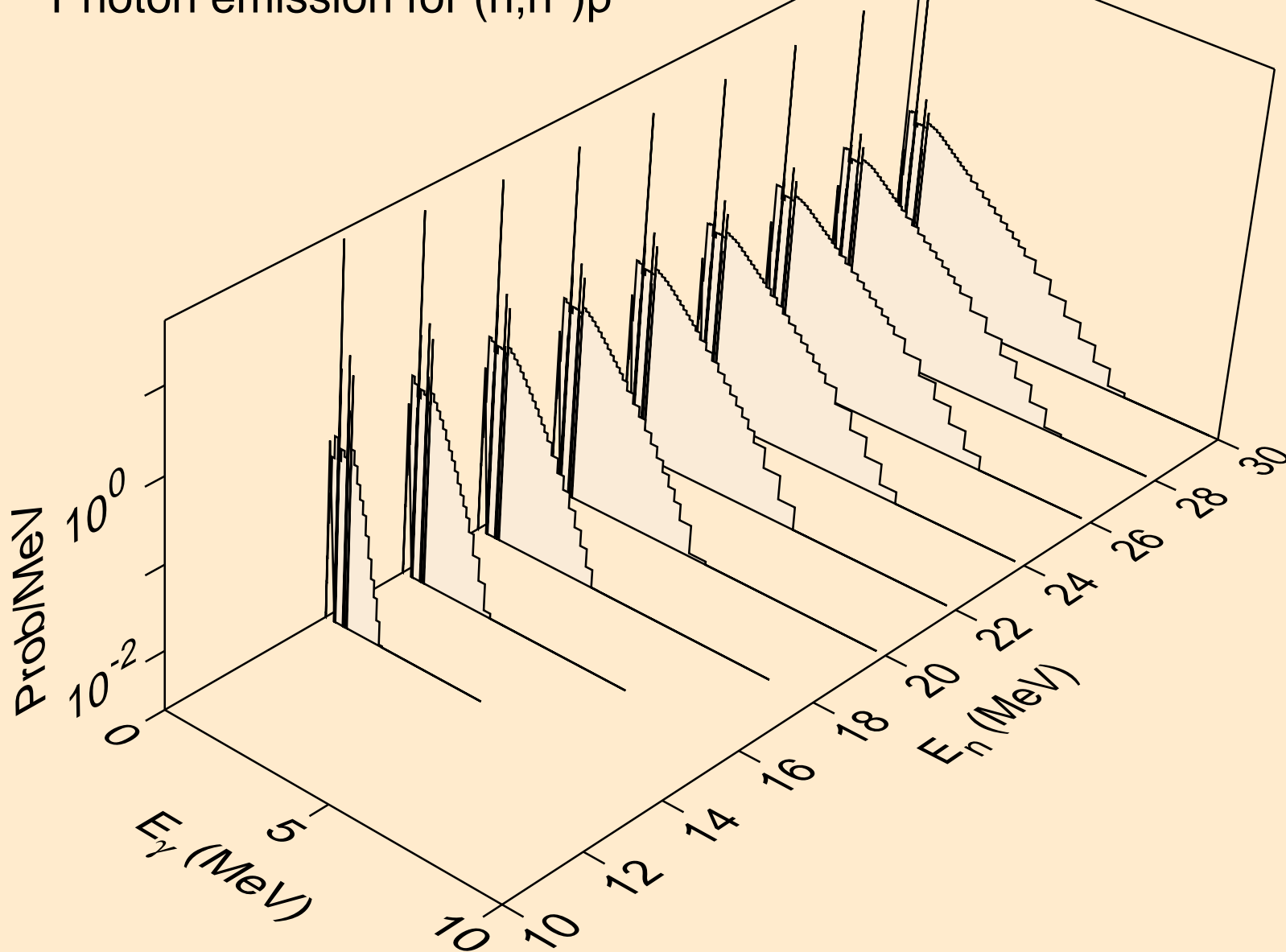

KR082 NEUTRON ACER TENDL-2019 LIBRARY; T=293.16K  
Photon emission for (n,n\*)2a

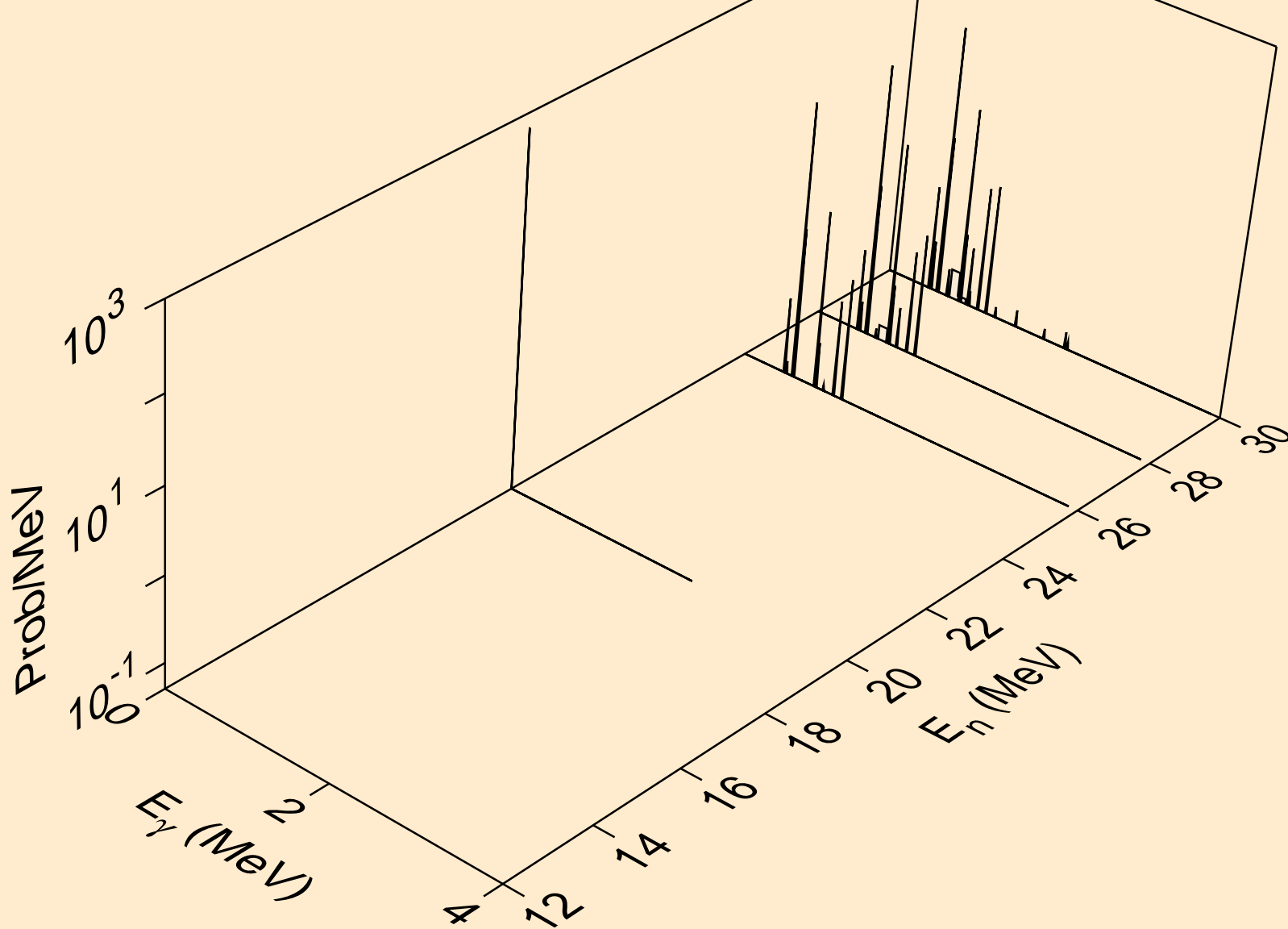

KR082 NEUTRON ACER TENDL-2019 LIBRARY; T=293.16K  
Photon emission for (n,n\*)d

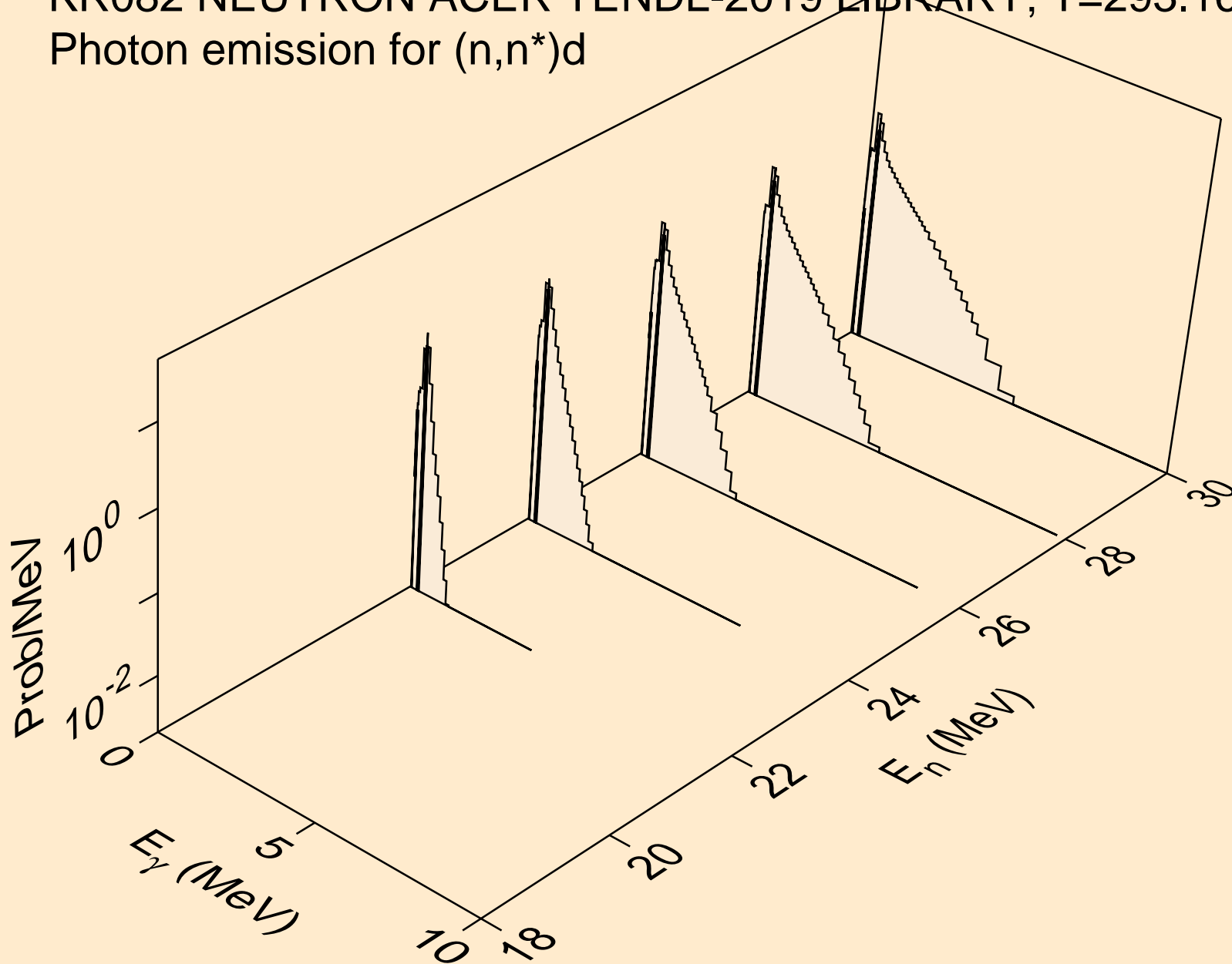



KR082 NEUTRON ACER TENDL-2019 LIBRARY; T=293.16K  
Photon emission for (n,n\*)t

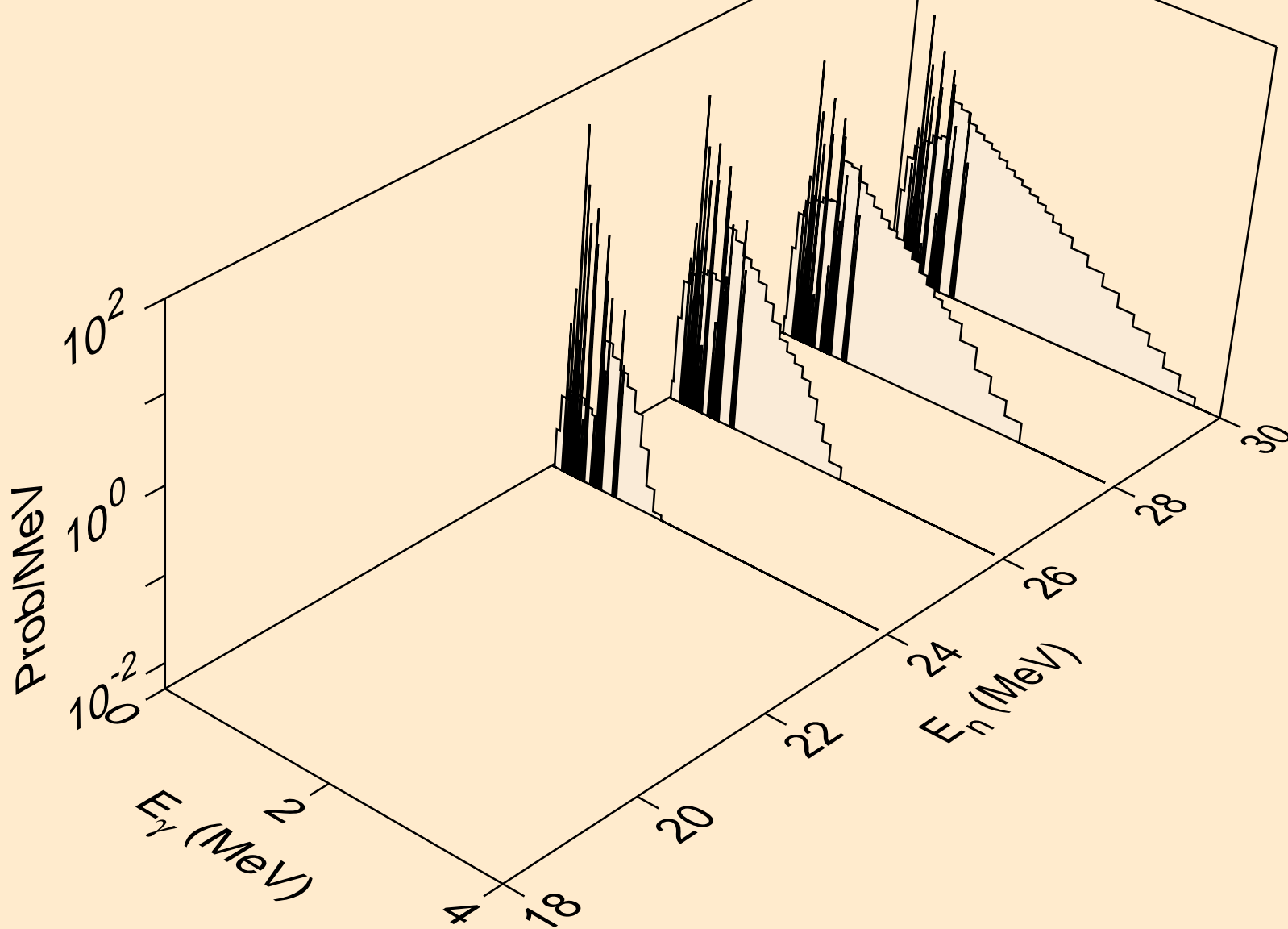

KR082 NEUTRON ACER TENDL-2019 LIBRARY; T=293.16K  
Photon emission for (n,n\*)he3

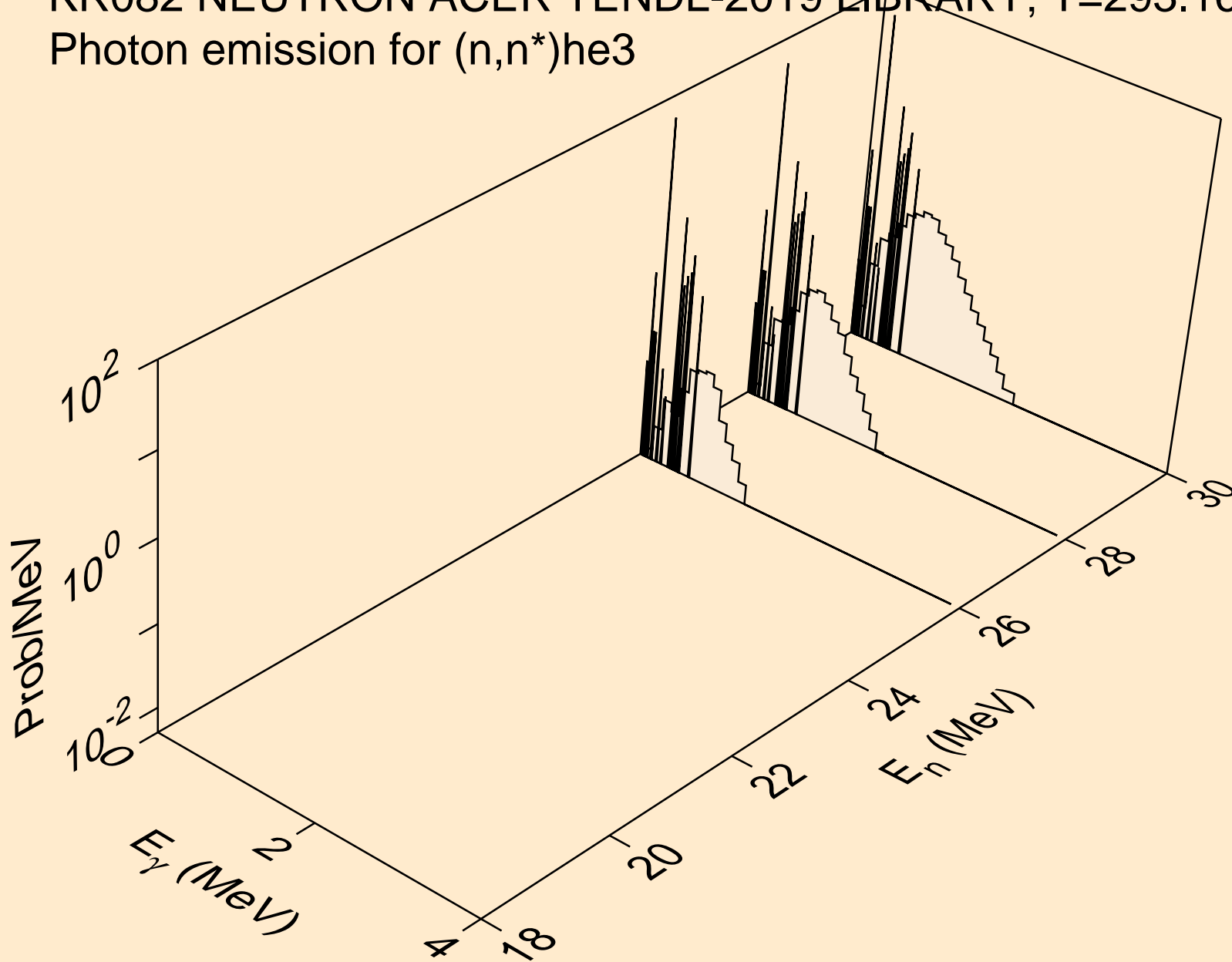

KR082 NEUTRON ACER TENDL-2019 LIBRARY; T=293.16K  
Photon emission for (n,2np)

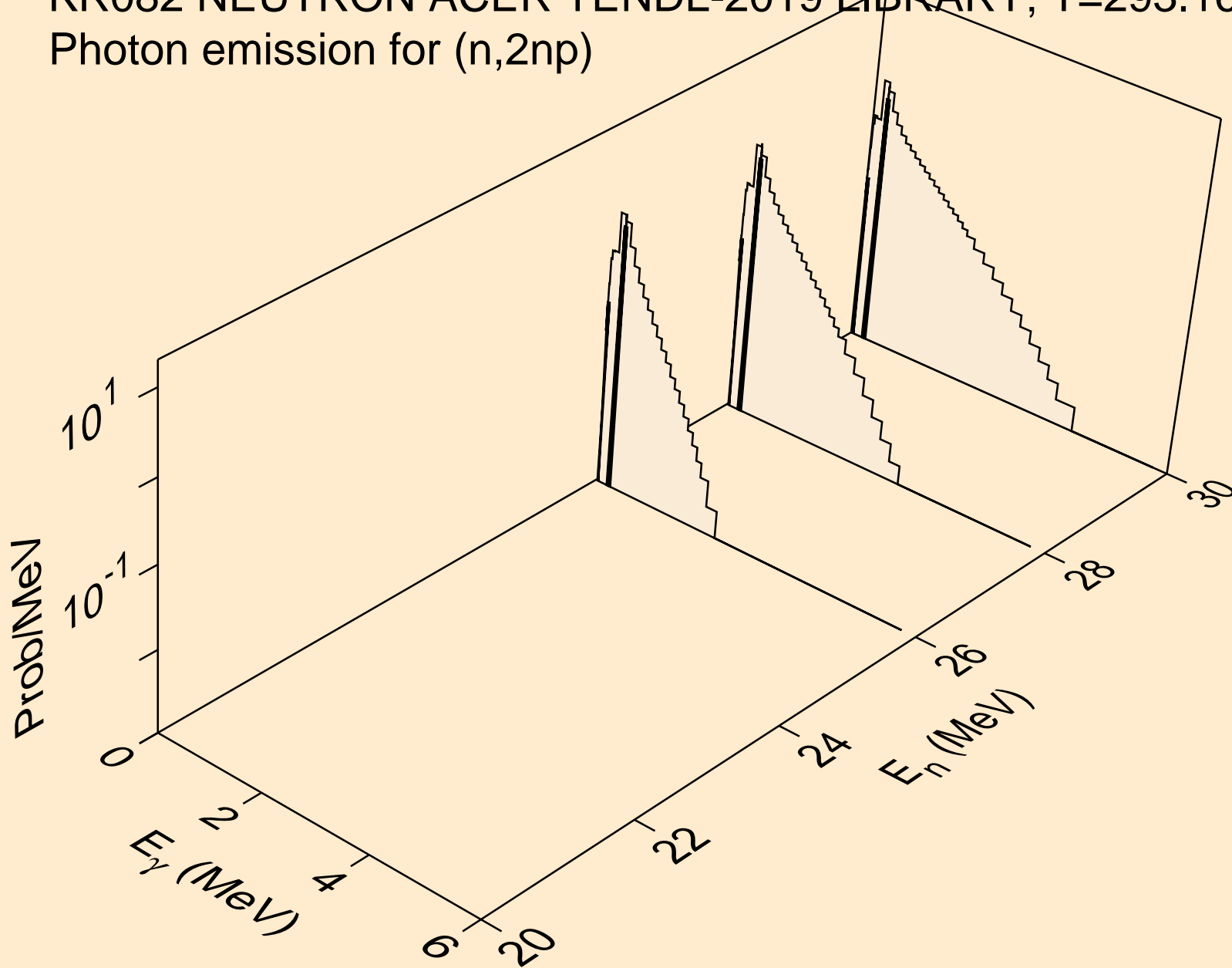

KR082 NEUTRON ACER TENDL-2019 LIBRARY; T=293.16K  
Photon emission for (n,3np)

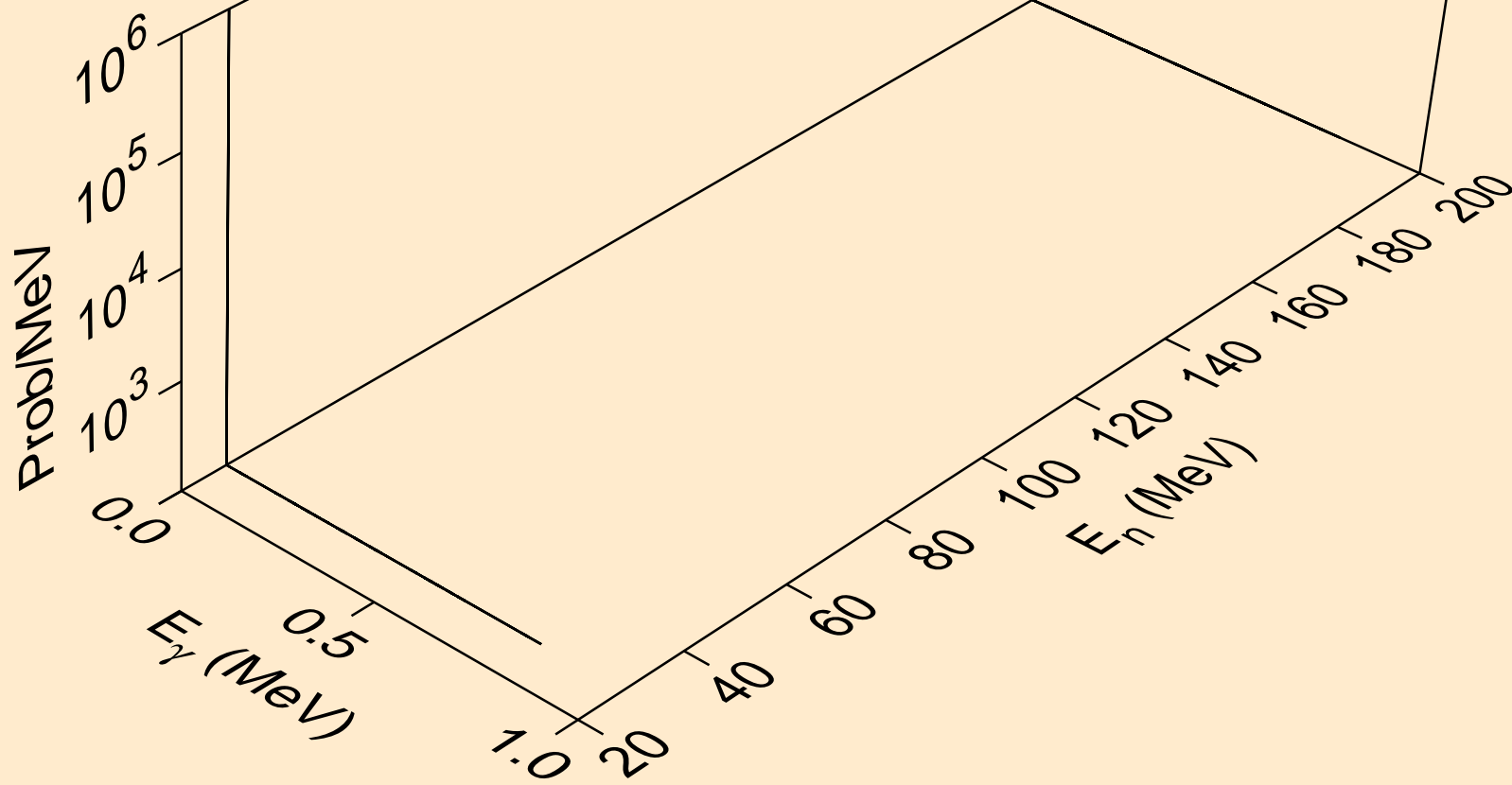

KR082 NEUTRON ACER TENDL-2019 LIBRARY; T=293.16K  
Photon emission for (n,2np)

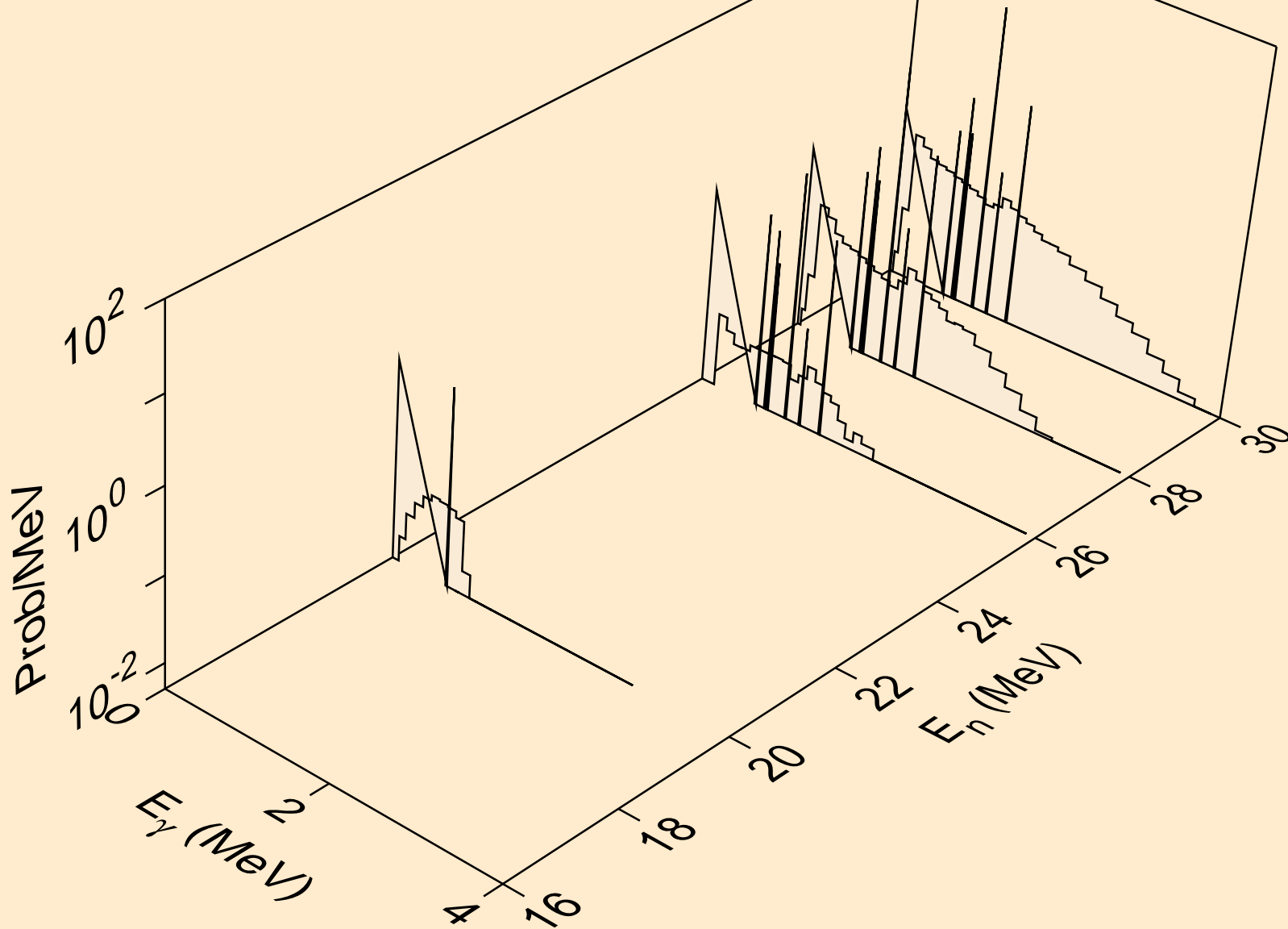

KR082 NEUTRON ACER TENDL-2019 LIBRARY; T=293.16K  
Photon emission for (n,npa)

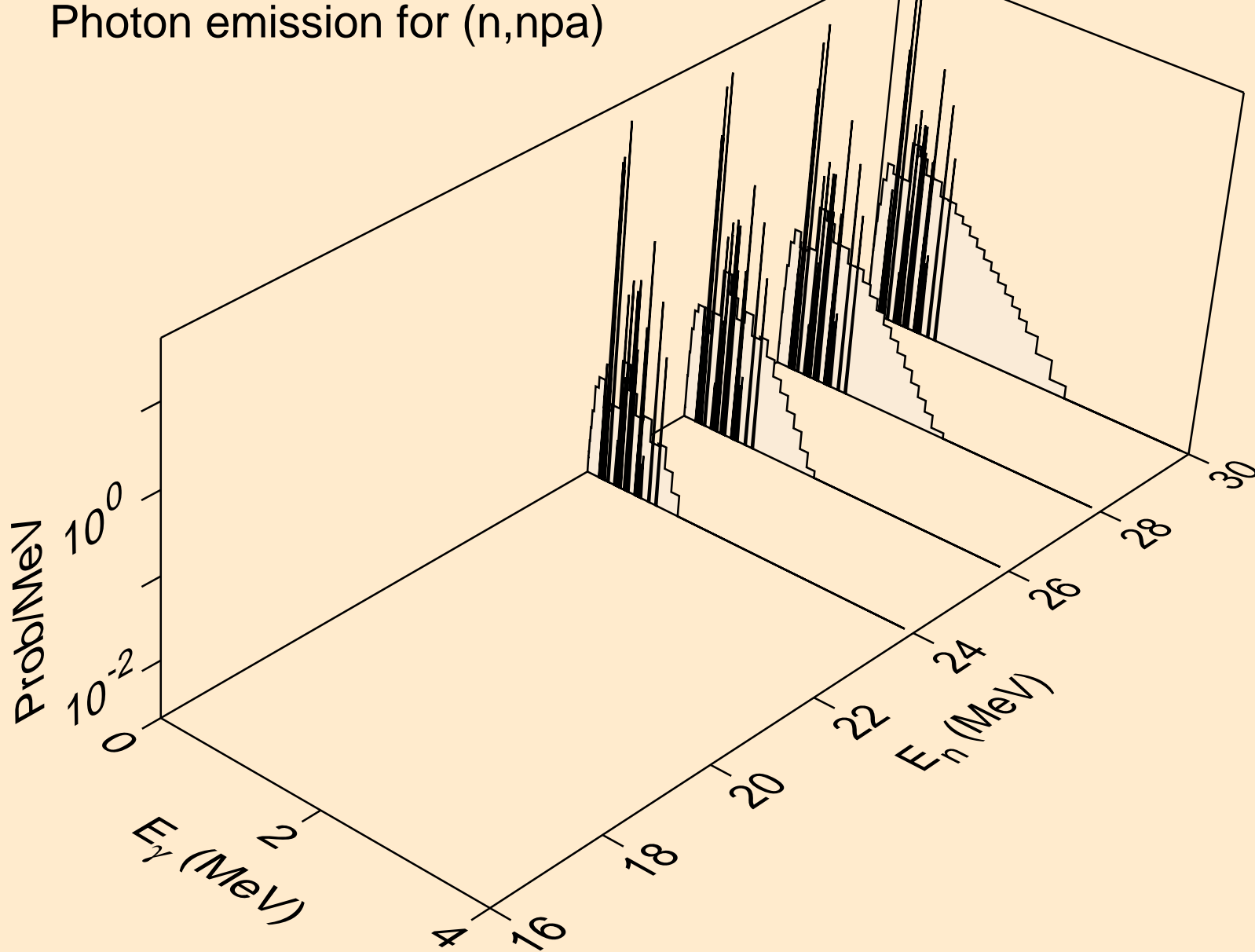

KR082 NEUTRON ACER TENDL-2019 LIBRARY; T=293.16K  
Photon emission for (n,n\*c)

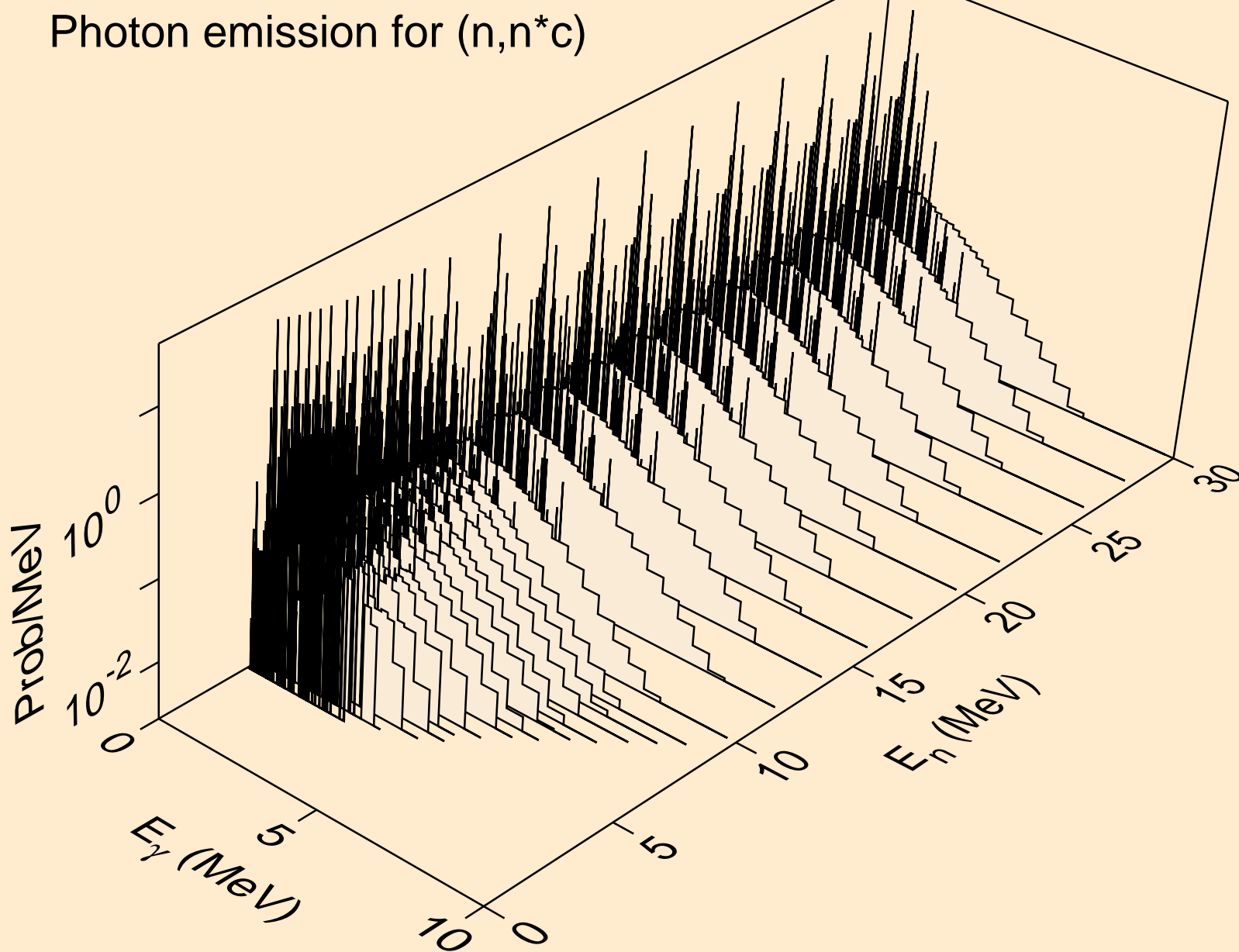

KR082 NEUTRON ACER TENDL-2019 LIBRARY; T=293.16K  
Photon emission for (n,gma)

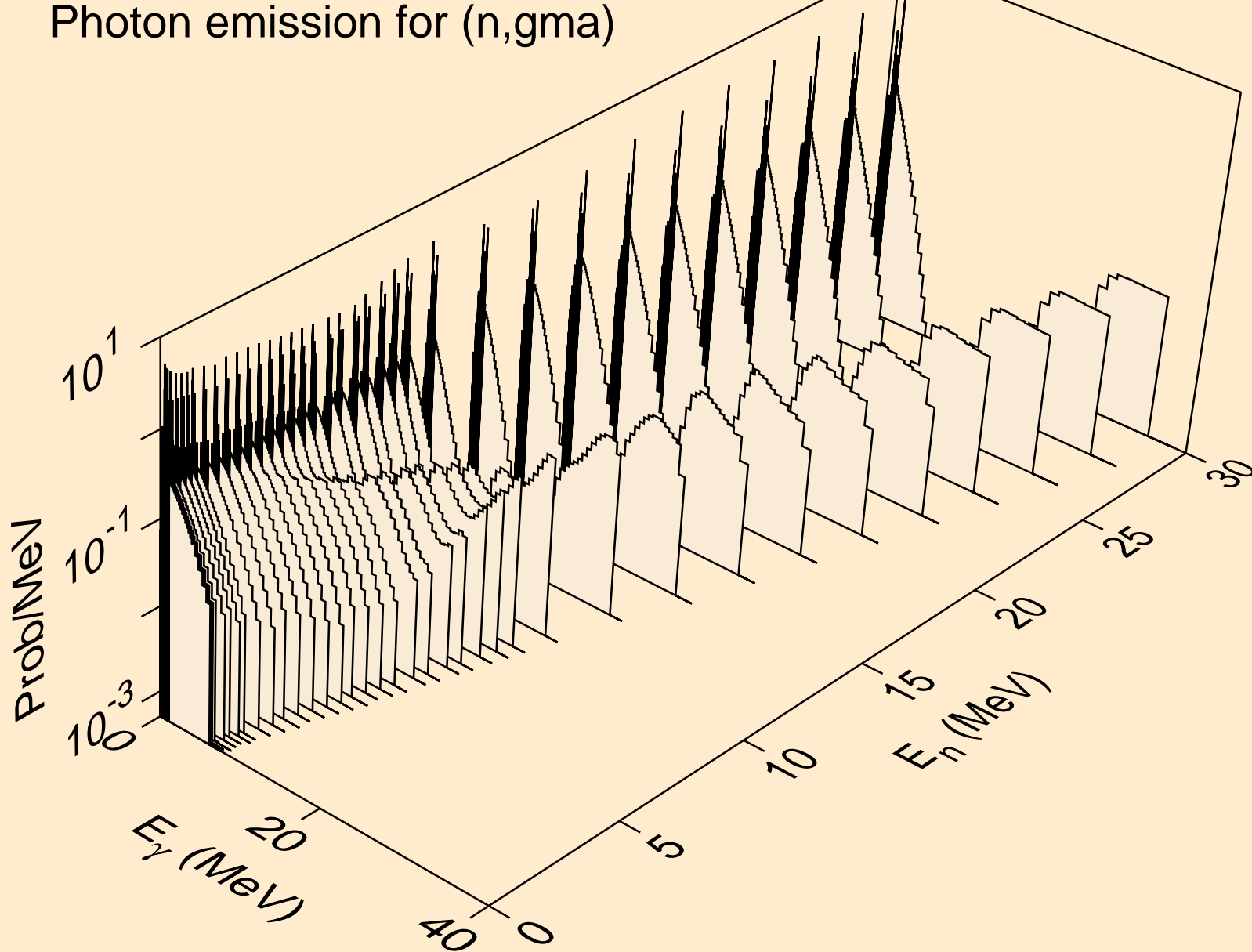



KR082 NEUTRON ACER TENDL-2019 LIBRARY; T=293.16K  
Photon emission for (n,p)

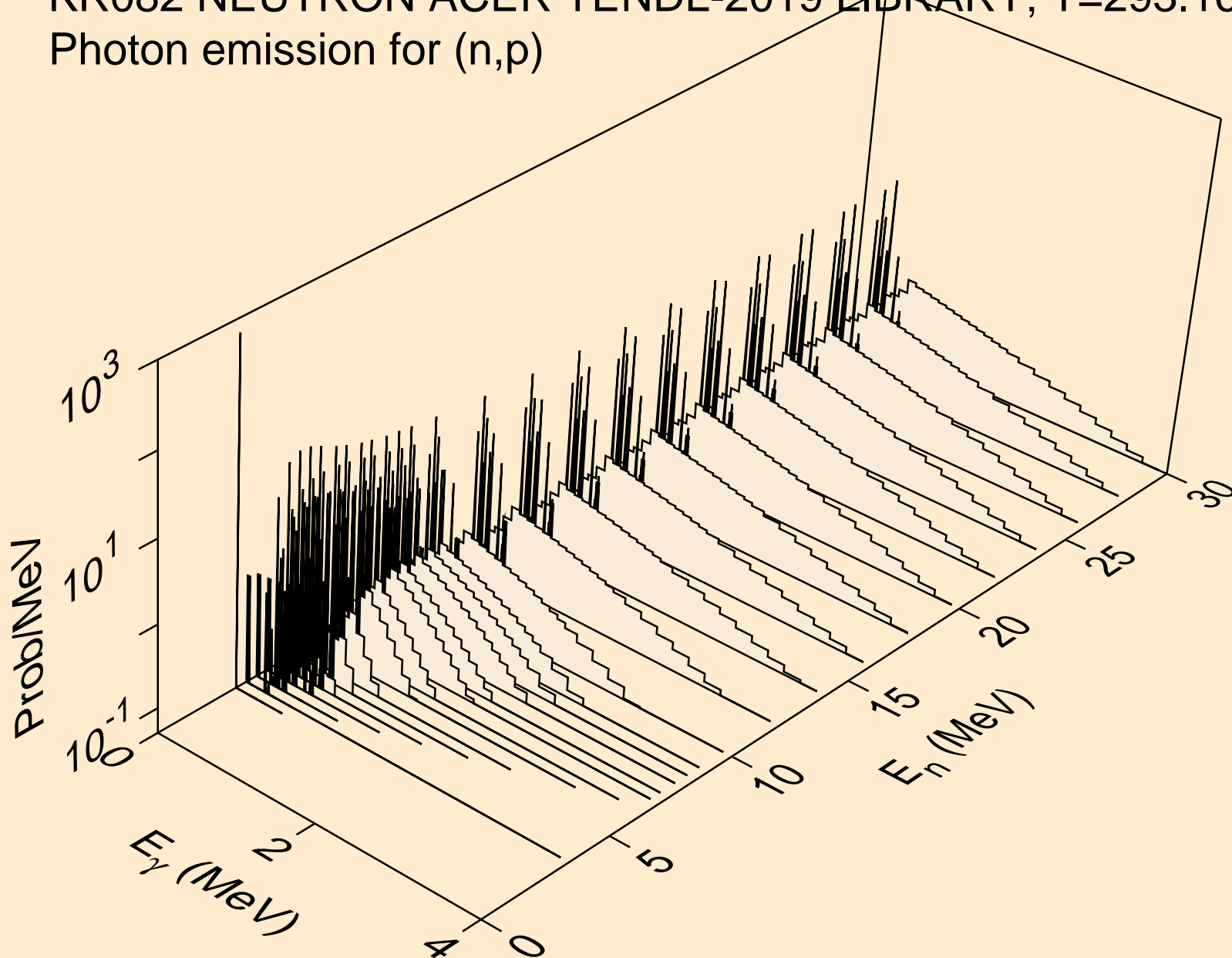

KR082 NEUTRON ACER TENDL-2019 LIBRARY; T=293.16K  
Photon emission for (n,d)

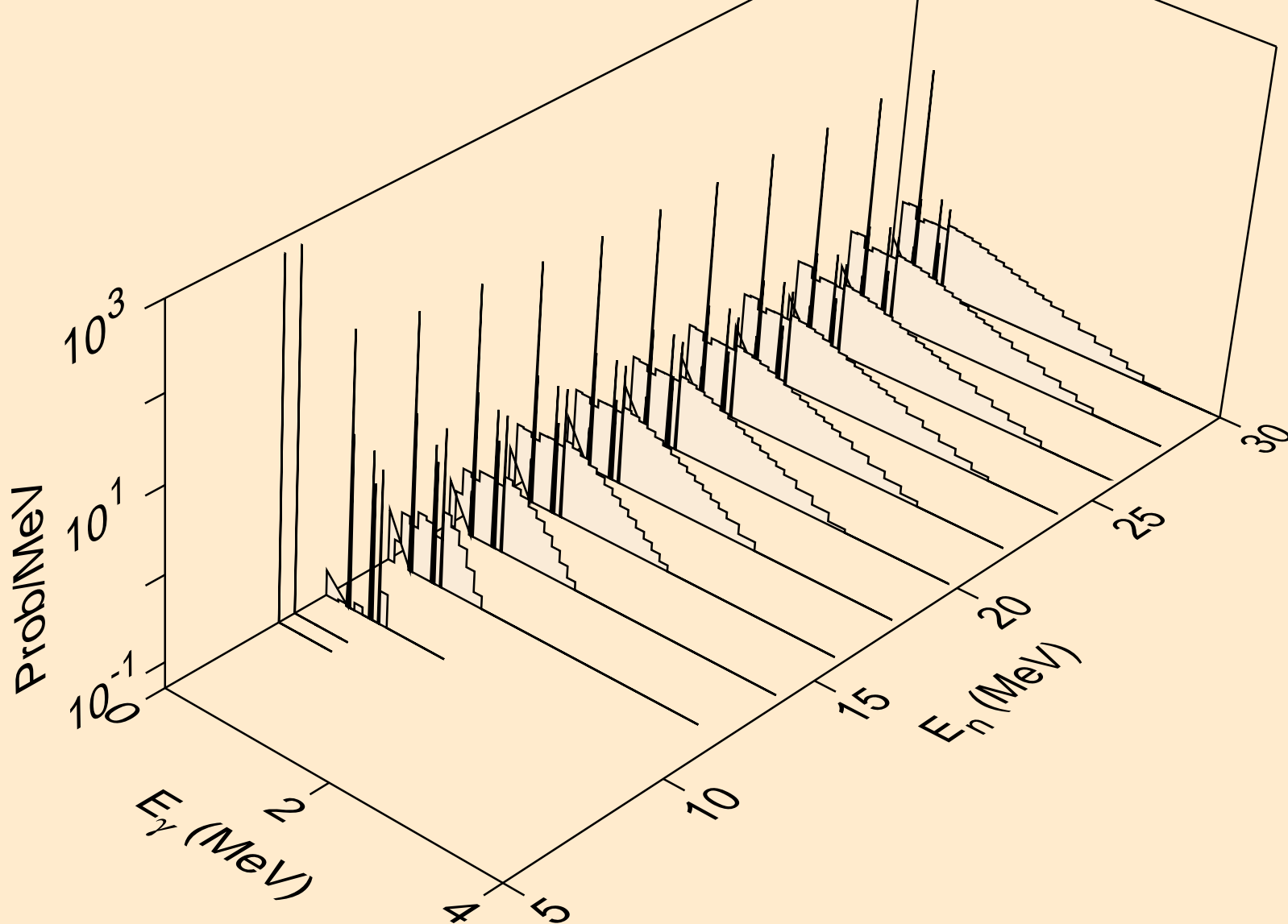

KR082 NEUTRON ACER TENDL-2019 LIBRARY; T=293.16K  
Photon emission for (n,t)

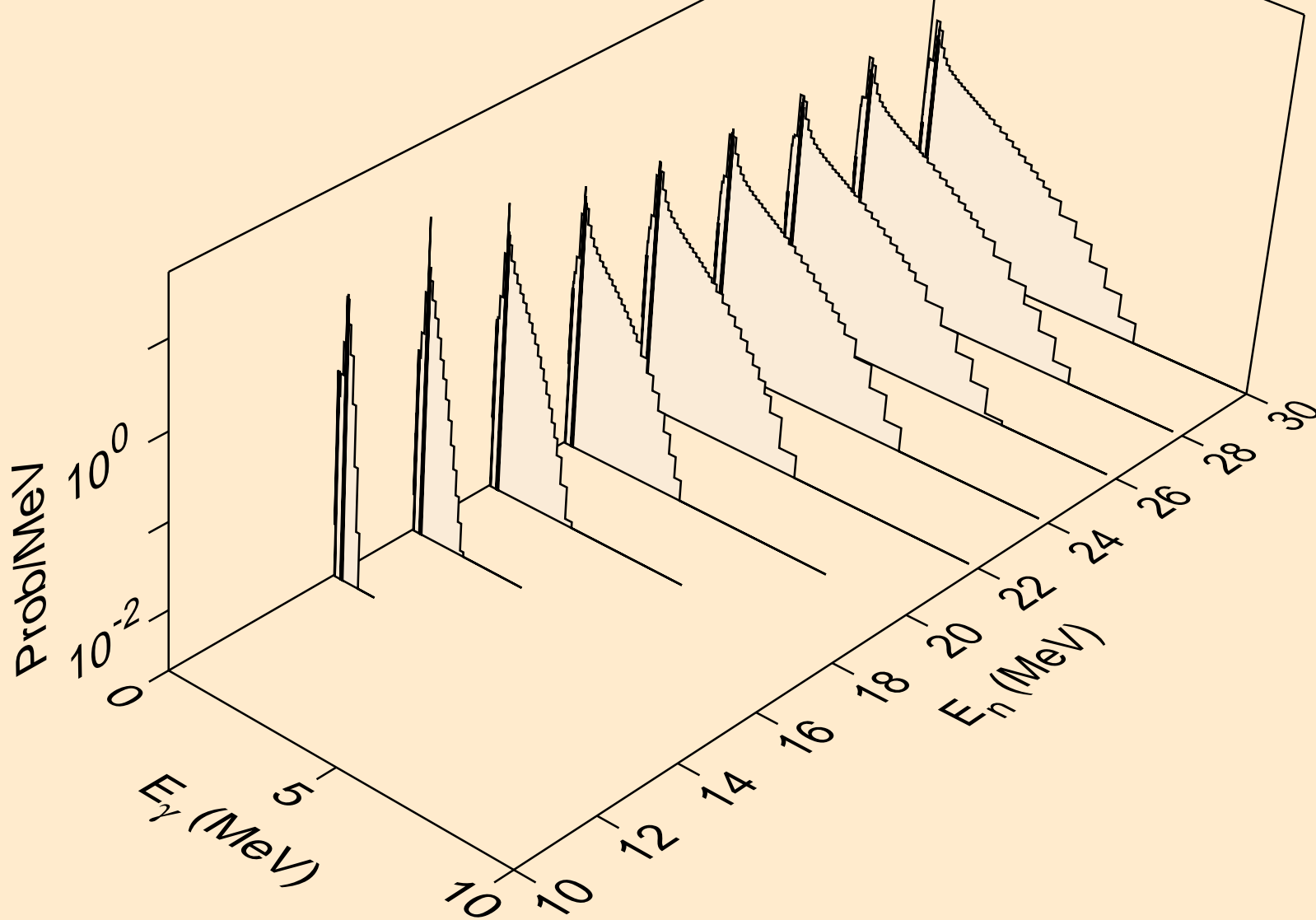

KR082 NEUTRON ACER TENDL-2019 LIBRARY; T=293.16K  
Photon emission for (n,he3)

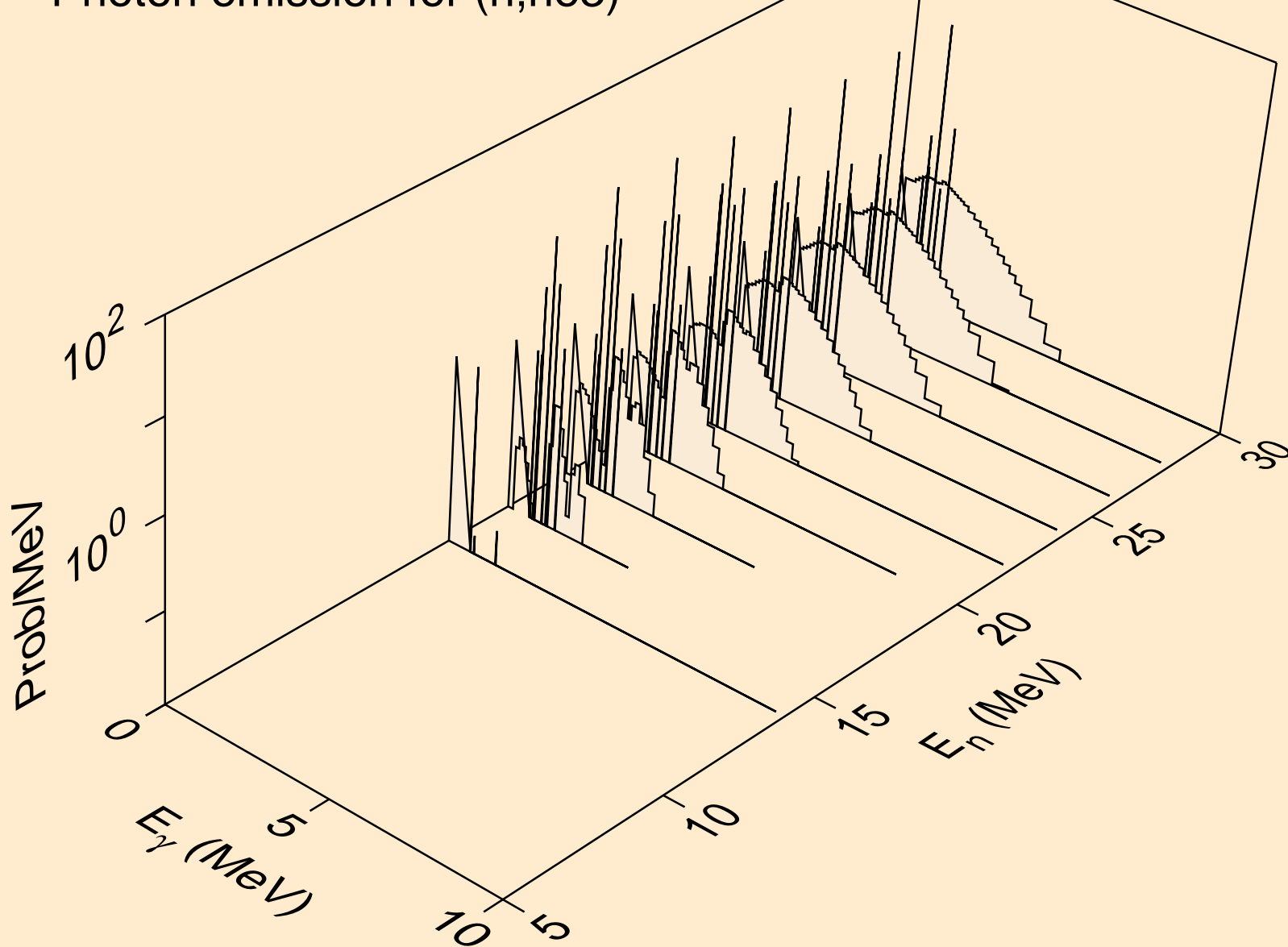

KR082 NEUTRON ACER TENDL-2019 LIBRARY; T=293.16K  
Photon emission for (n,a)

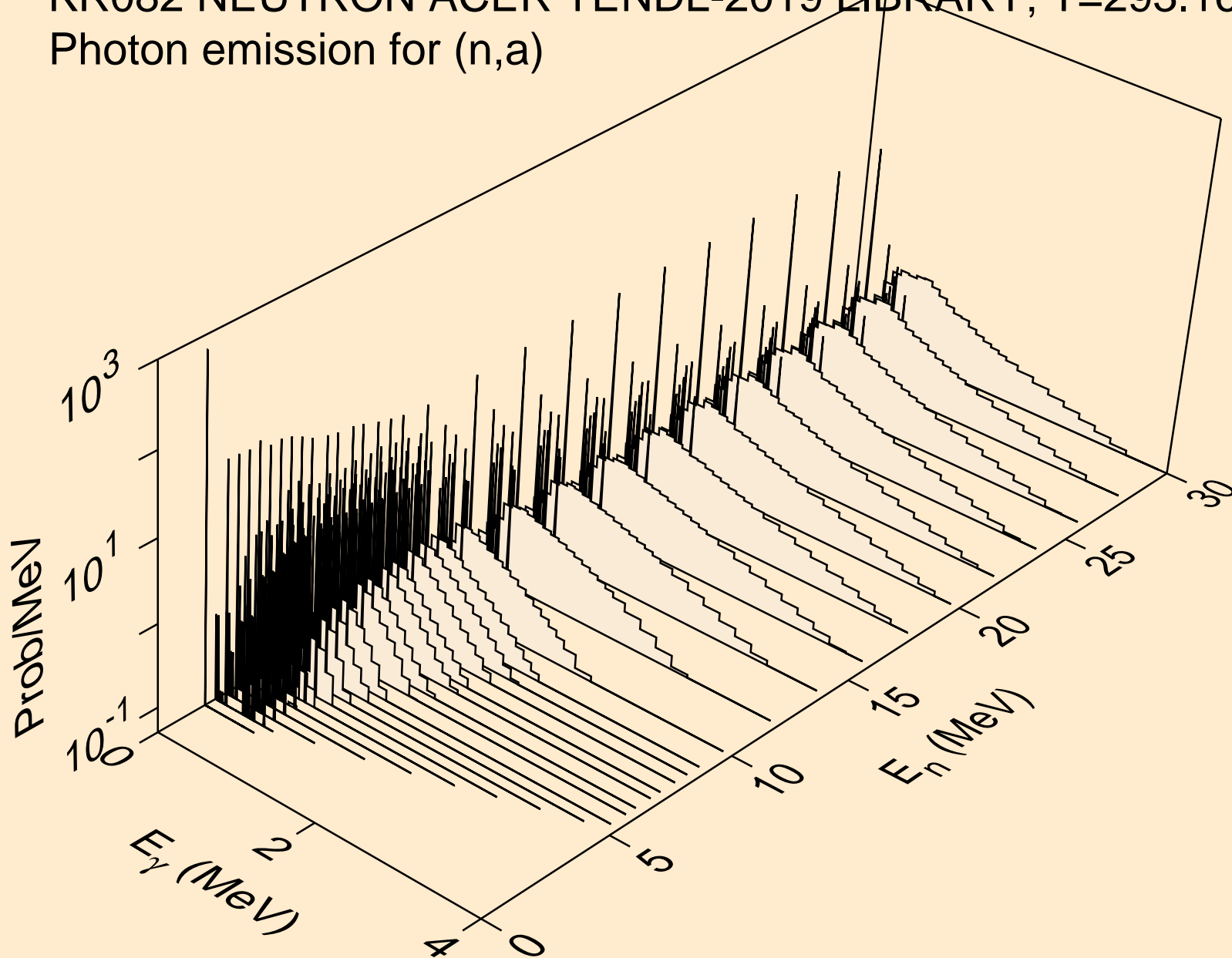

KR082 NEUTRON ACER TENDL-2019 LIBRARY; T=293.16K  
Photon emission for (n,2a)

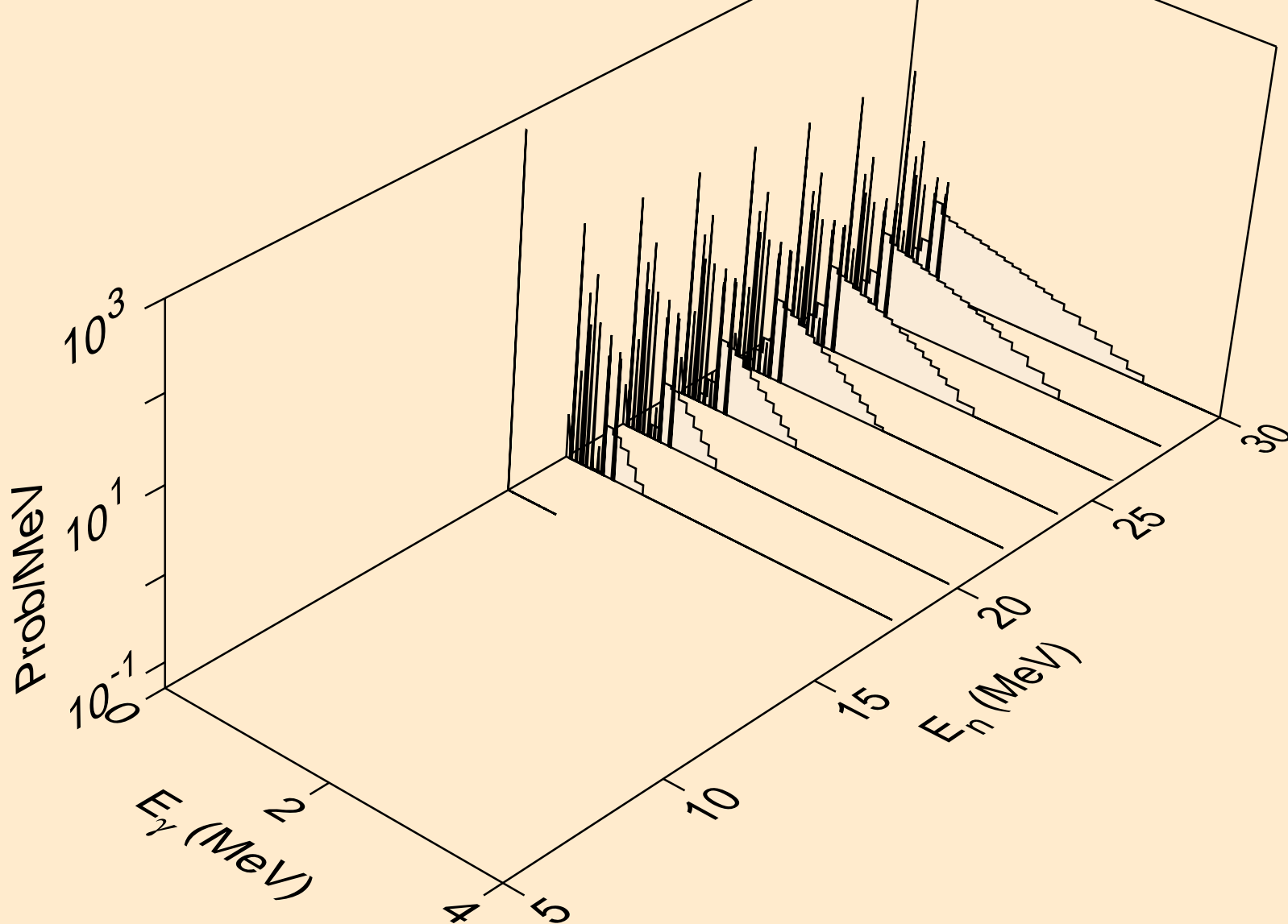

KR082 NEUTRON ACER TENDL-2019 LIBRARY; T=293.16K  
Photon emission for (n,2p)

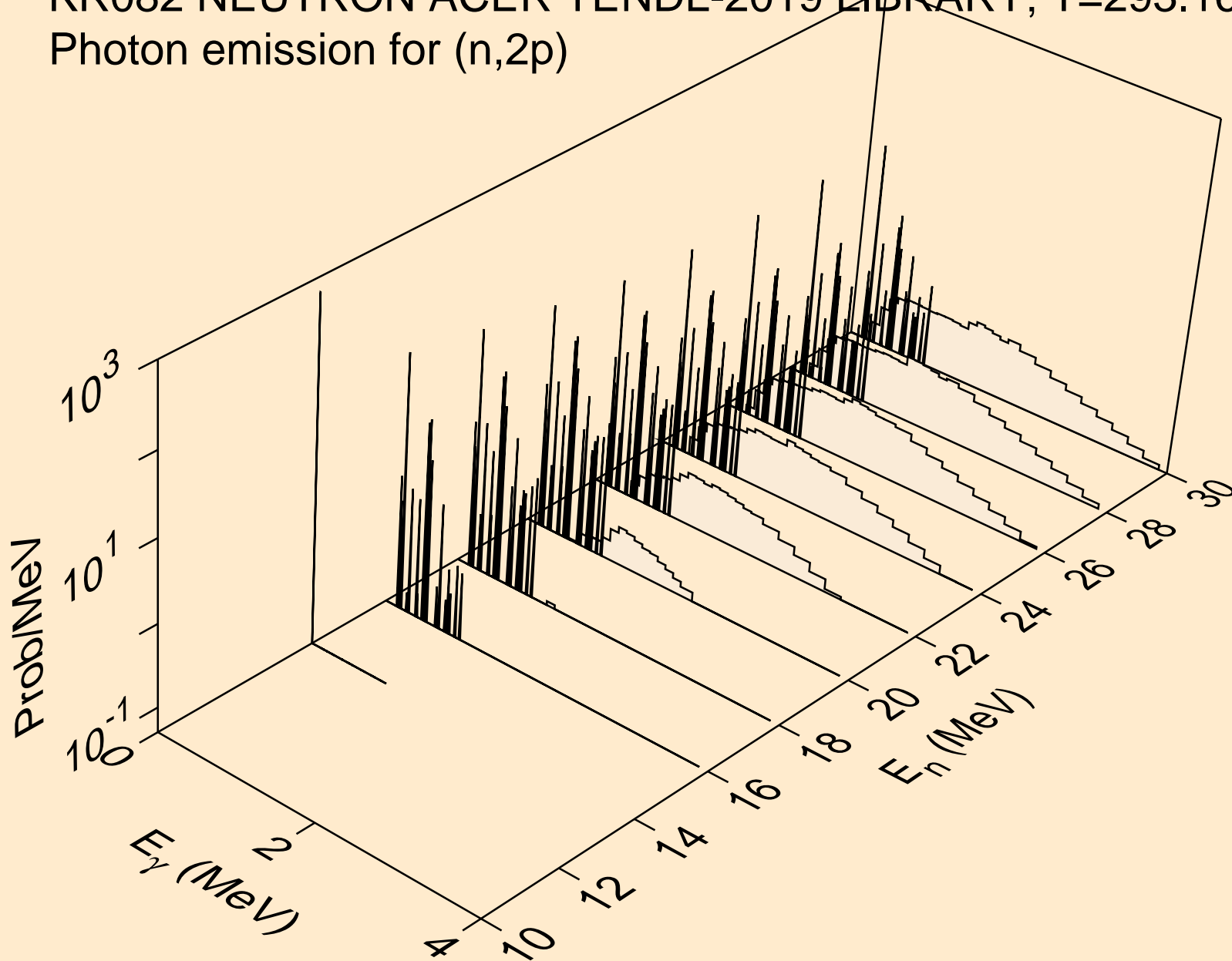

KR082 NEUTRON ACER TENDL-2019 LIBRARY; T=293.16K  
Photon emission for (n,p $\alpha$ )

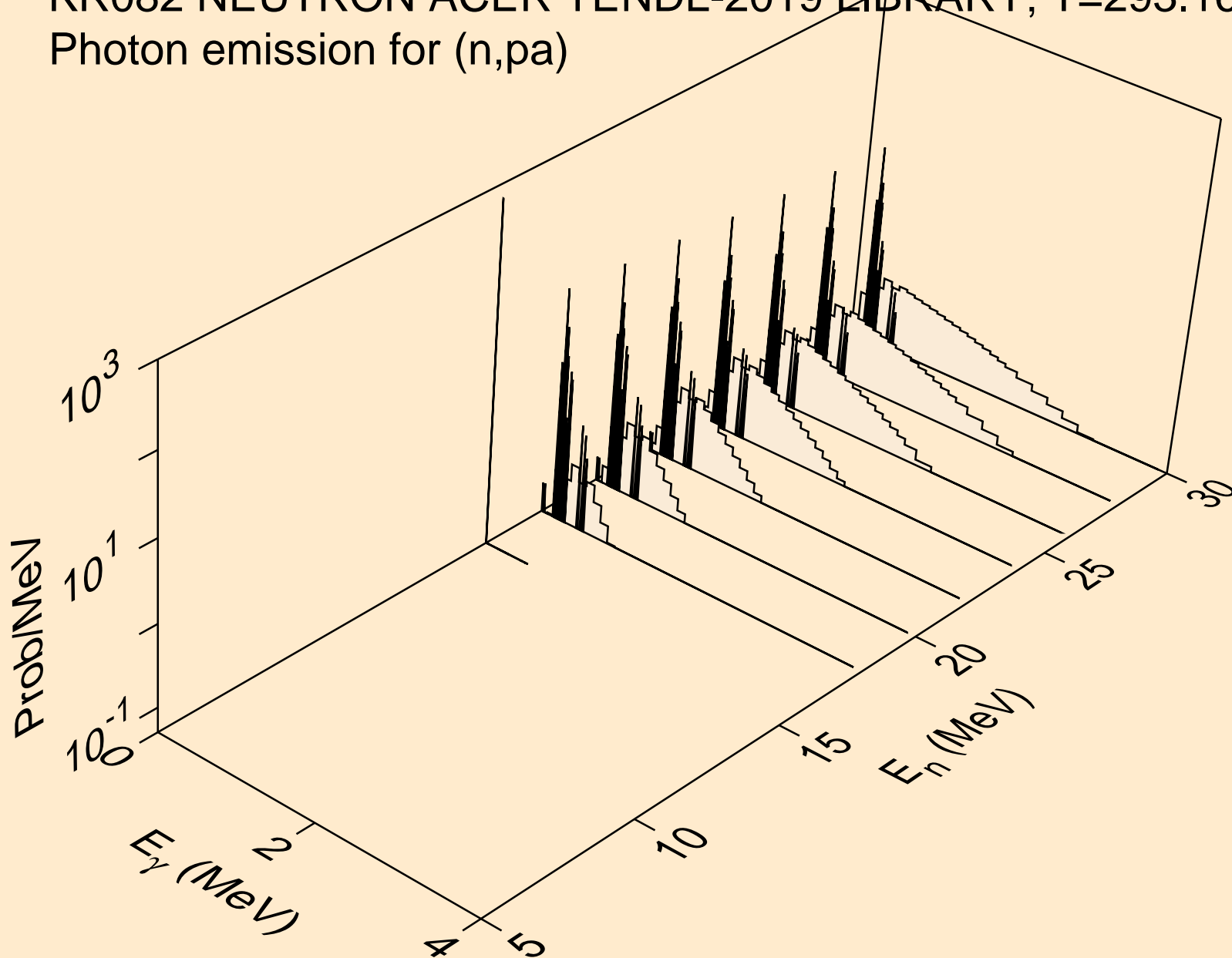



KR082 NEUTRON ACER TENDL-2019 LIBRARY; T=293.16K  
Photon emission for (n,pd)

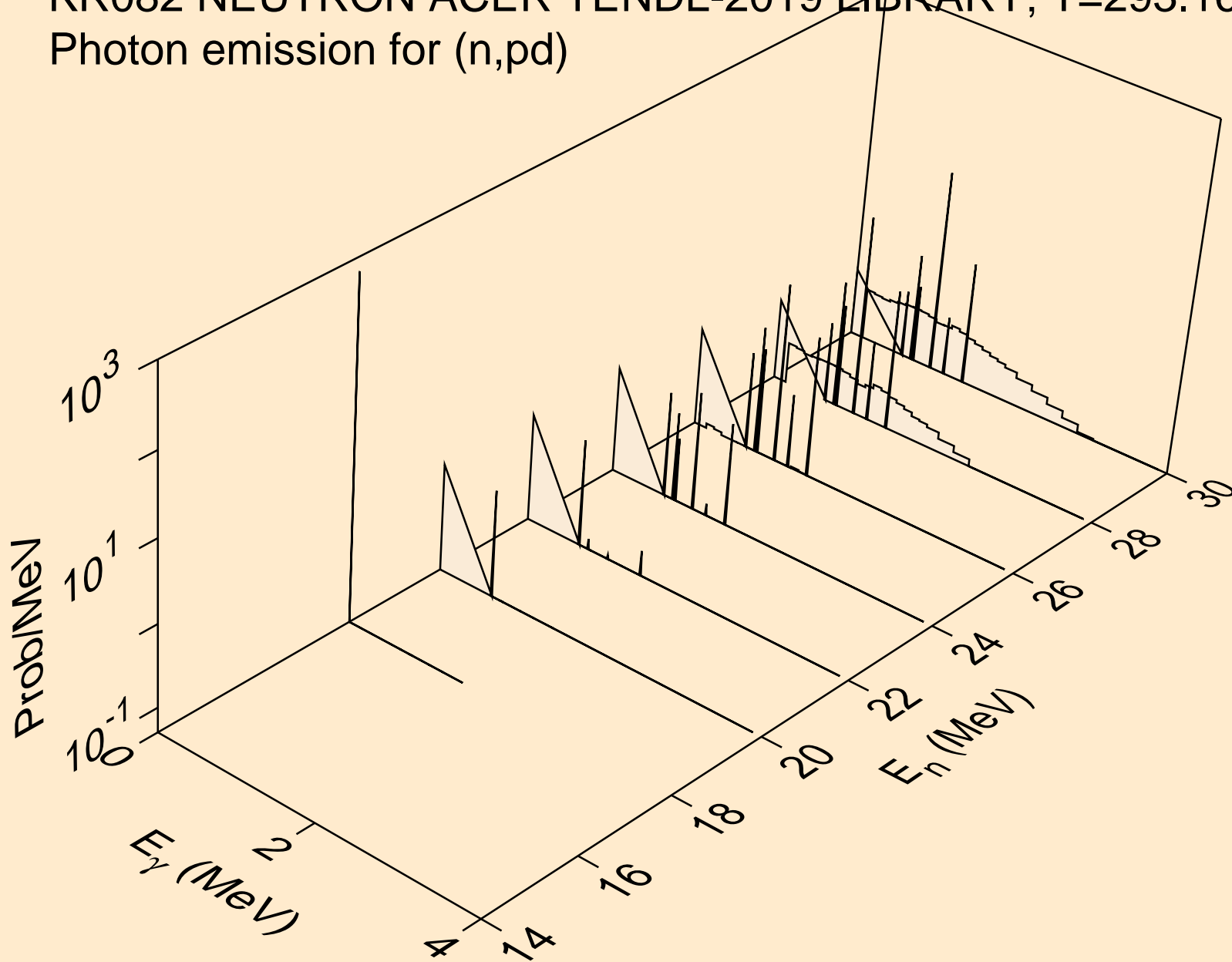

KR082 NEUTRON ACER TENDL-2019 LIBRARY; T=293.16K  
Photon emission for (n,pt)

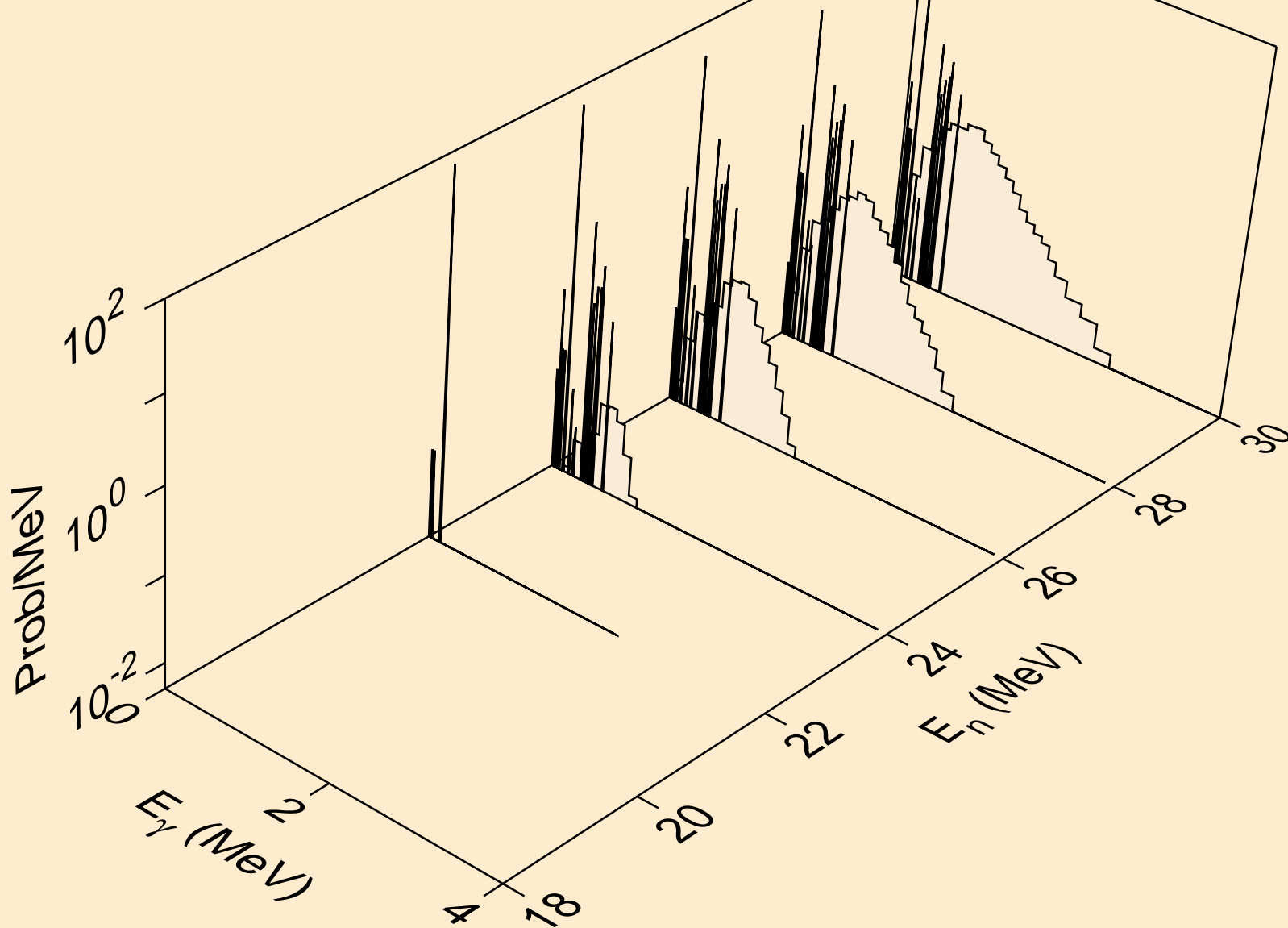

KR082 NEUTRON ACER TENDL-2019 LIBRARY; T=293.16K  
Photon emission for (n,da)

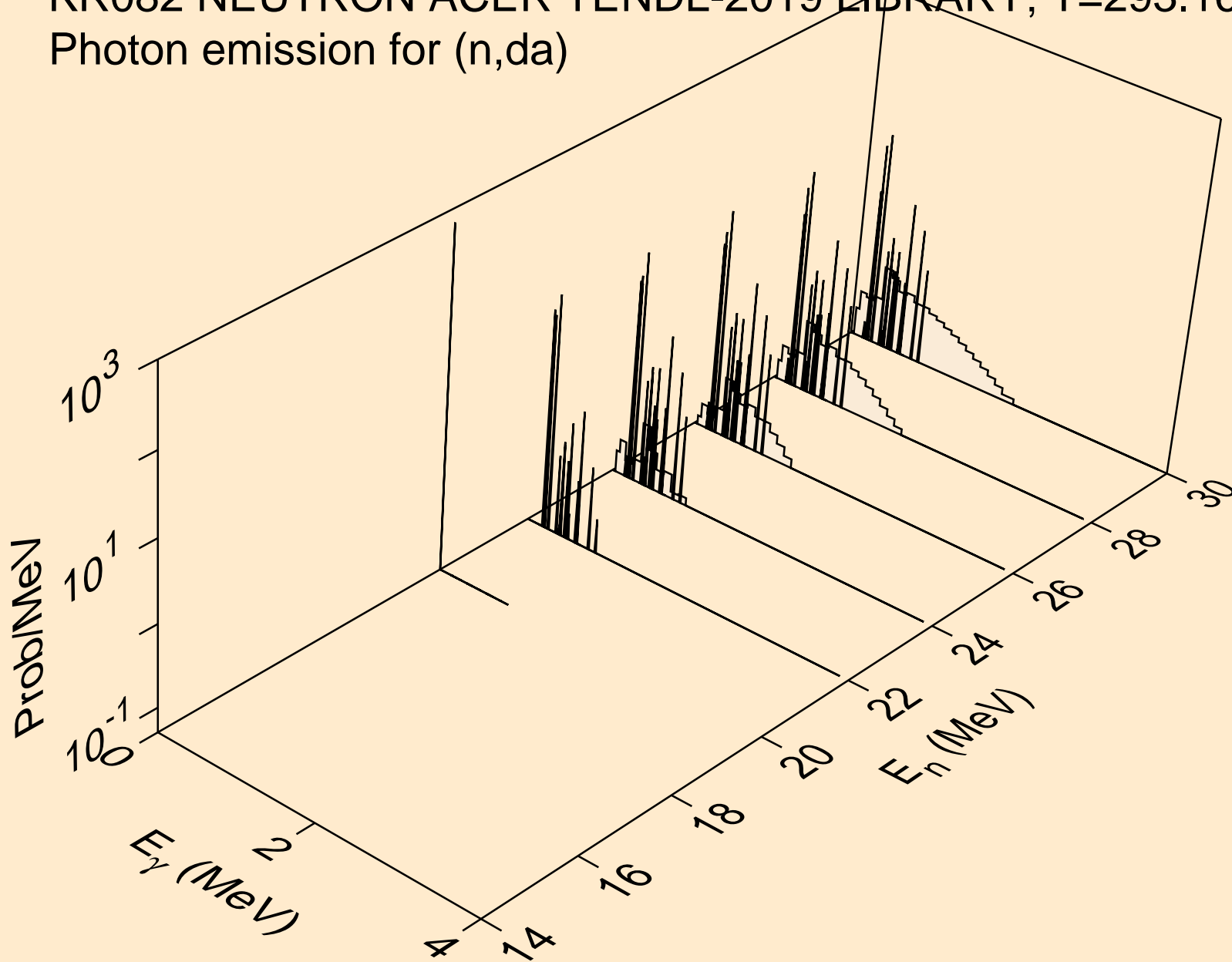

KR082 NEUTRON ACER TENDL-2019 LIBRARY; T=293.16K  
thermal capture photon spectrum

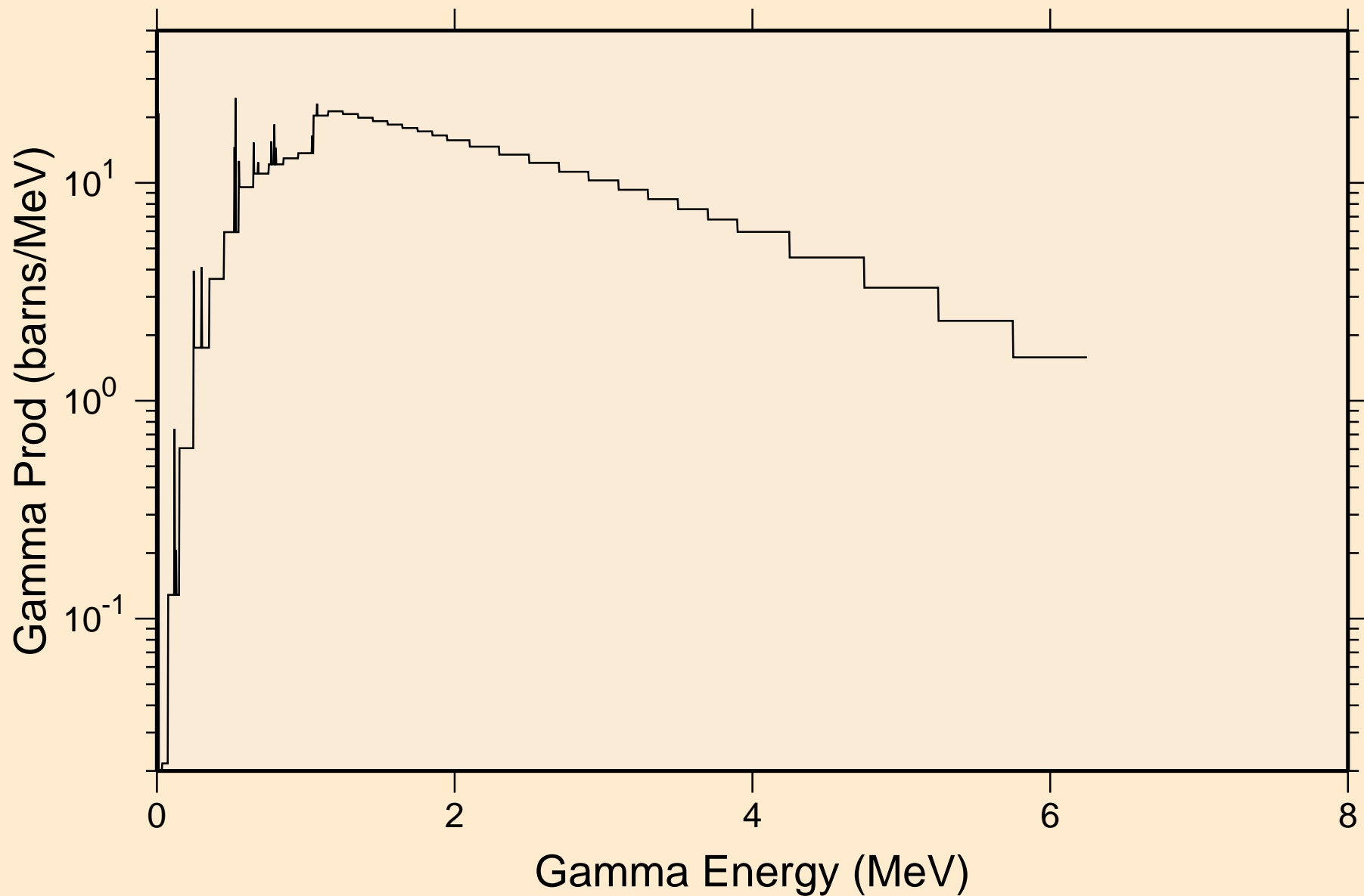

KR082 NEUTRON ACER TENDL-2019 LIBRARY; T=293.16K  
14 MeV photon spectrum

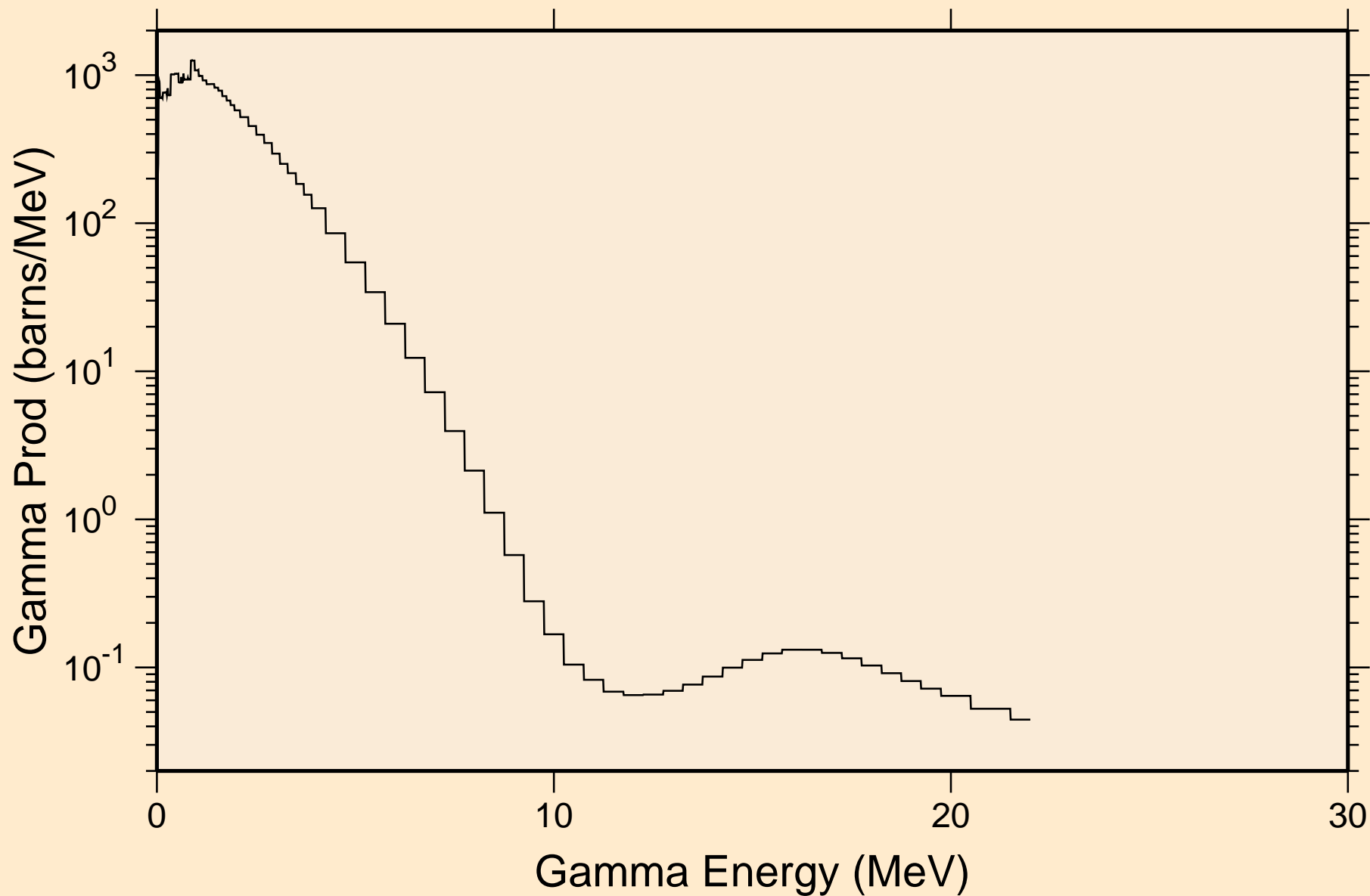

# KR082 NEUTRON ACER TENDL-2019 LIBRARY; T=293.16K

## Particle heating contributions

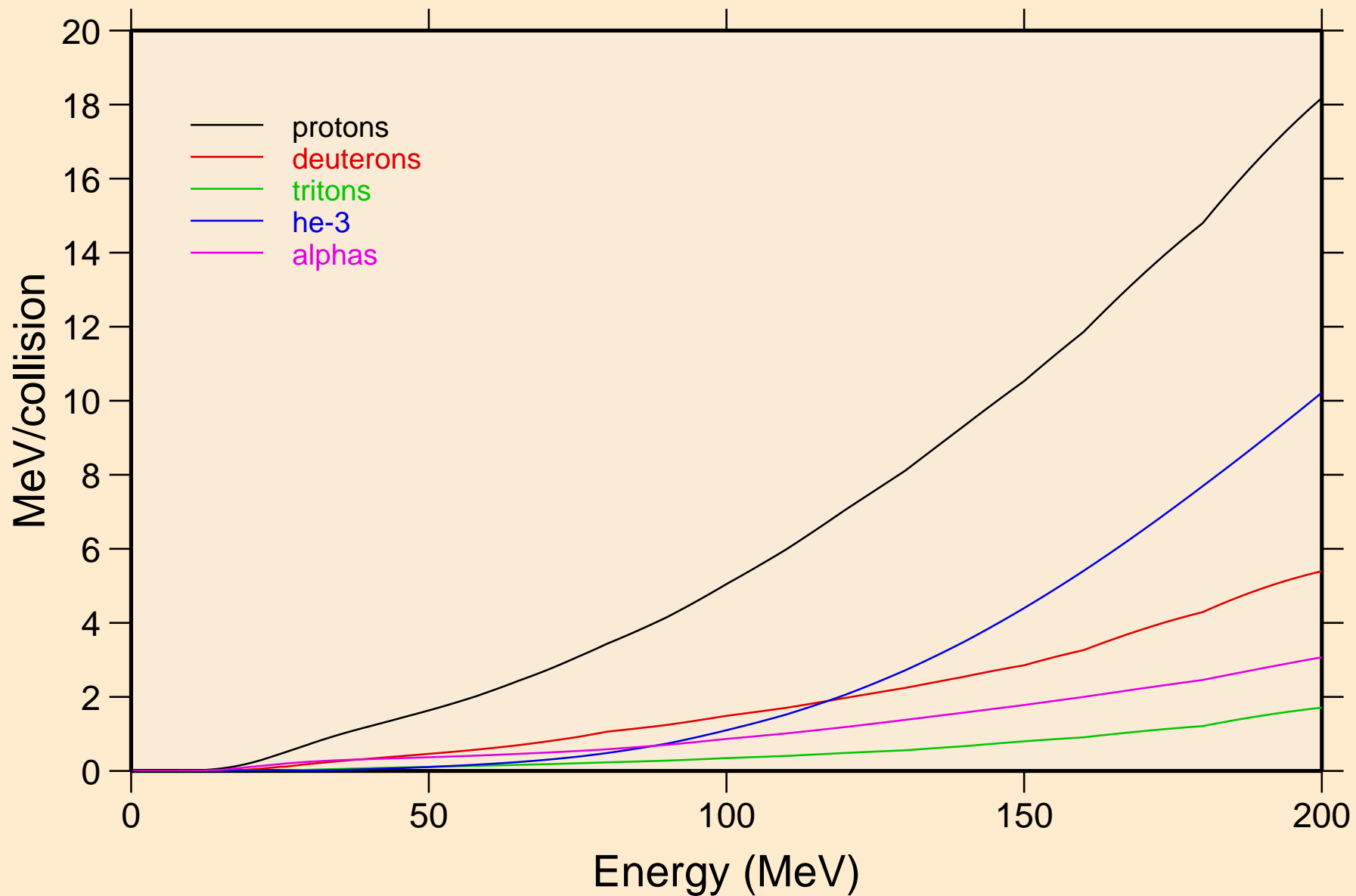

KR082 NEUTRON ACER TENDL-2019 LIBRARY; T=293.16K  
Recoil Heating

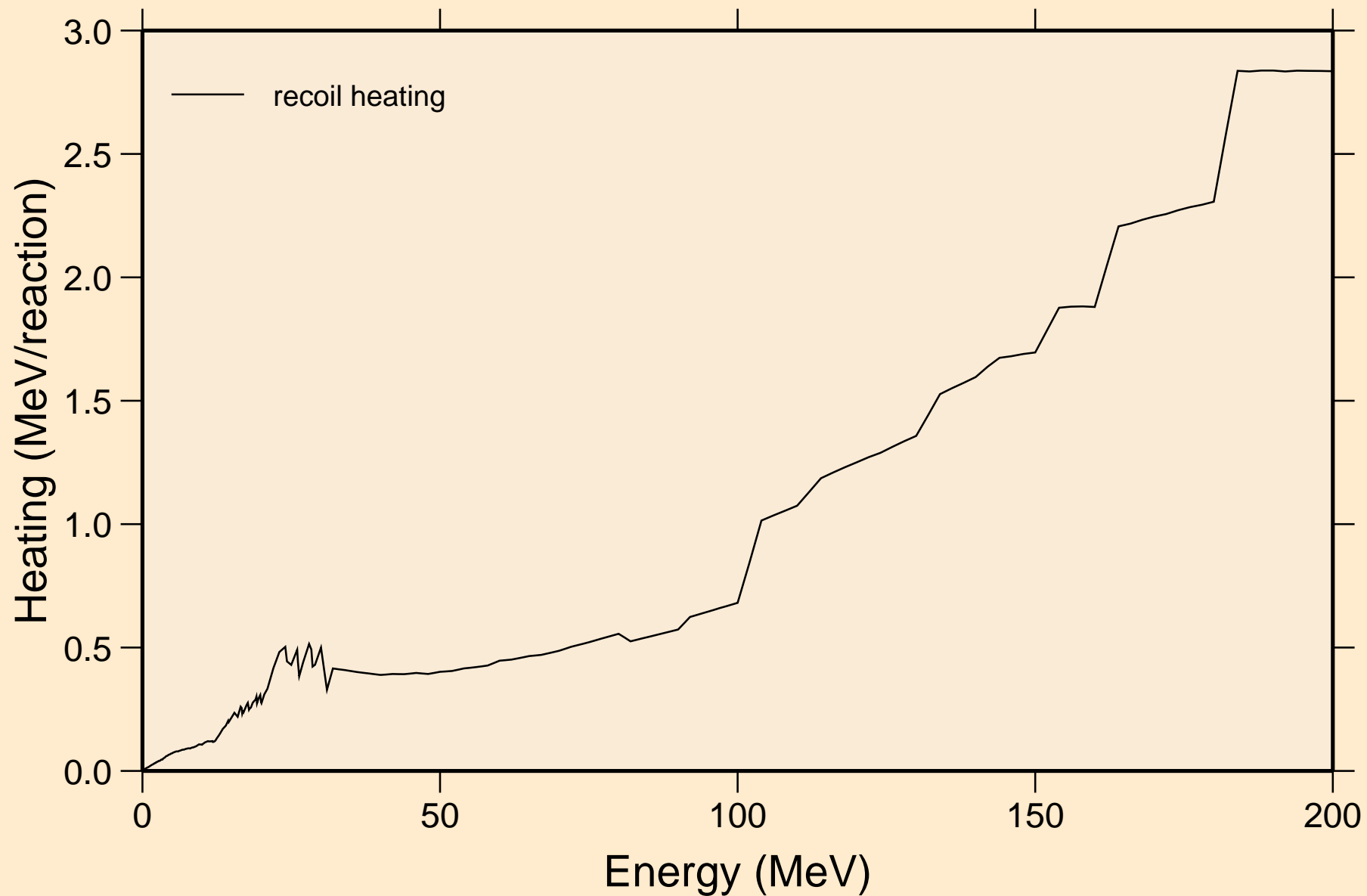

KR082 NEUTRON ACER TENDL-2019 LIBRARY; T=293.16K  
Particle production cross sections

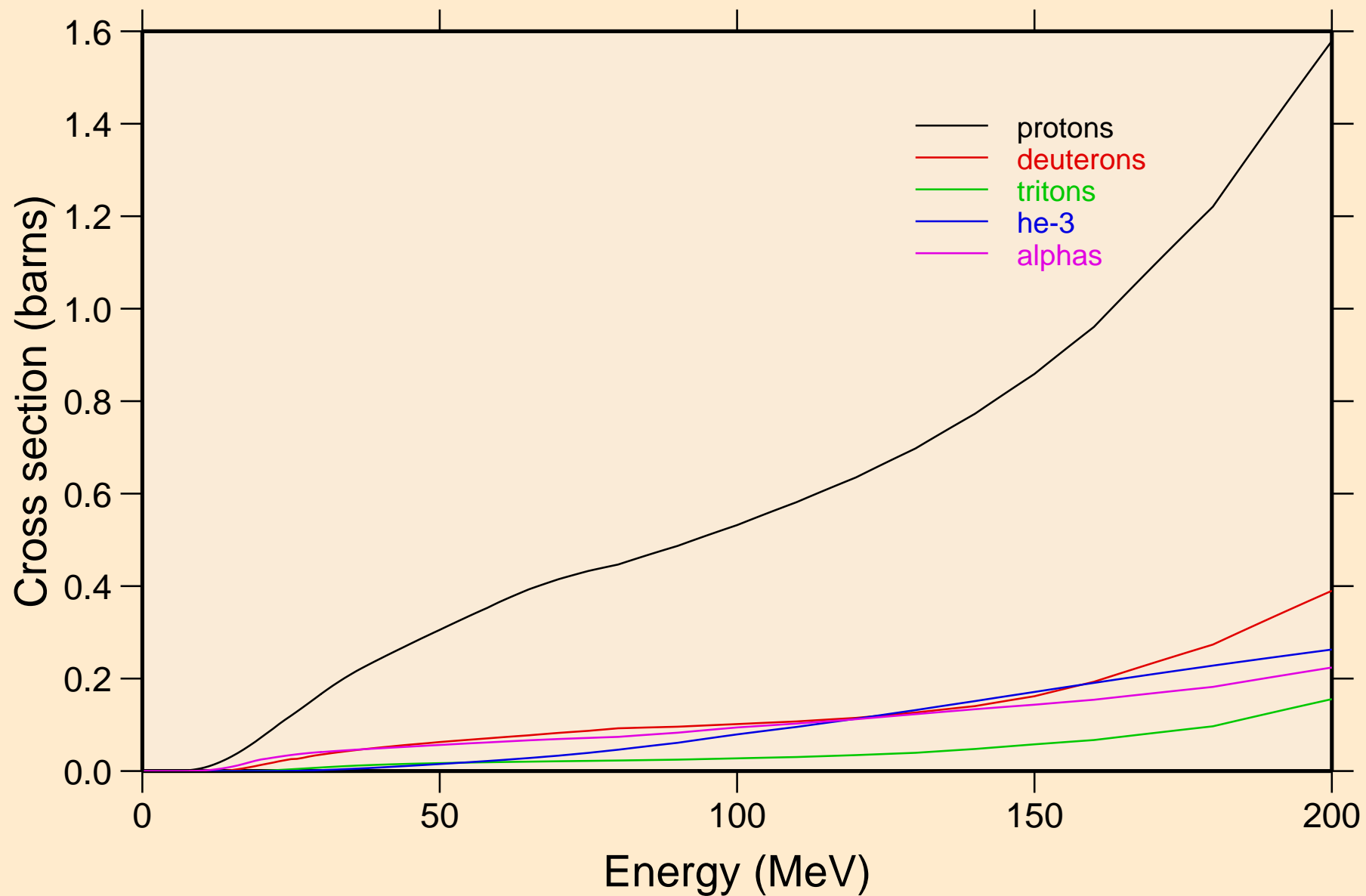



KR082 NEUTRON ACER TENDL-2019 LIBRARY; T=293.16K  
protons from (n,x)

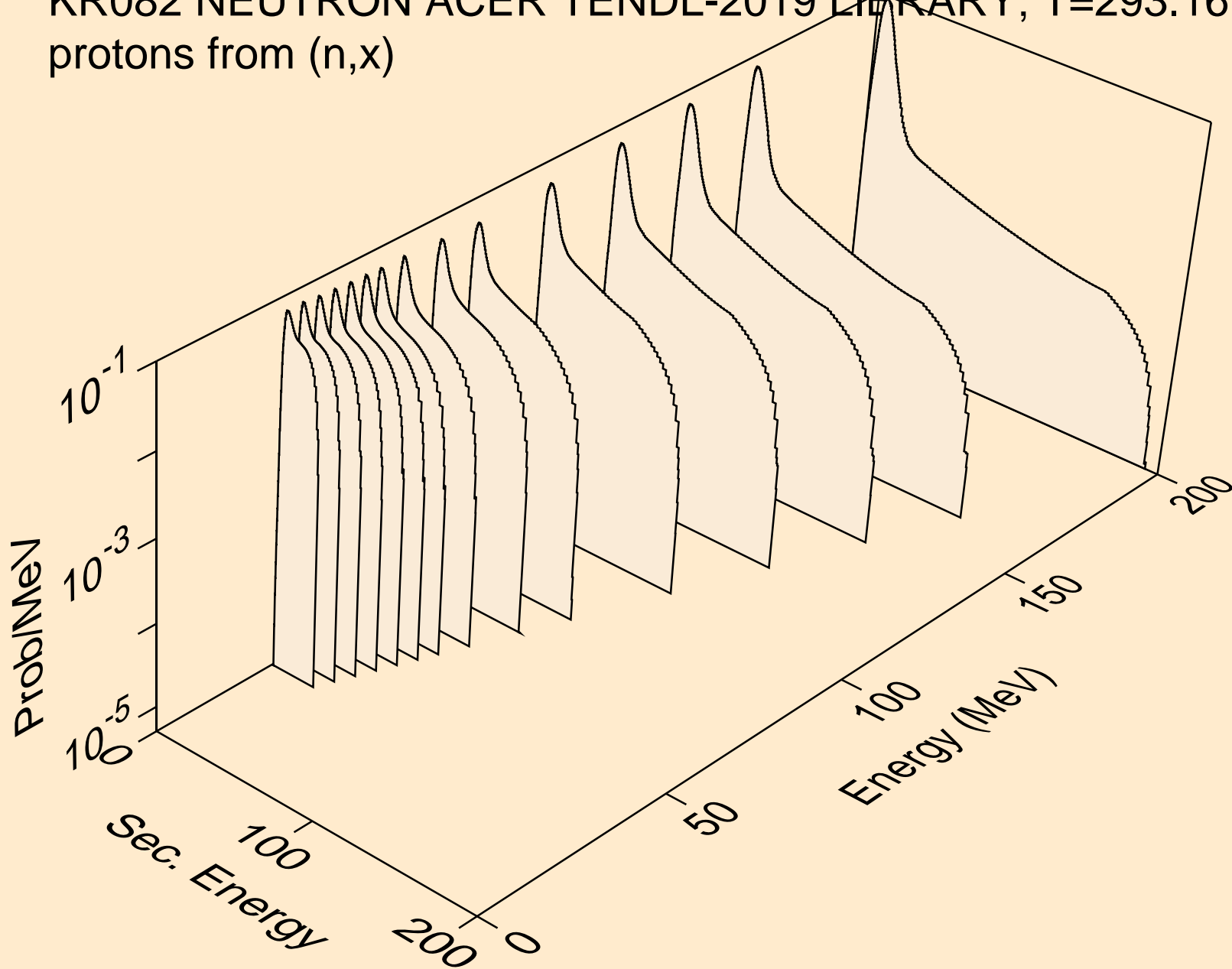

KR082 NEUTRON ACER TENDL-2019 LIBRARY; T=293.16K  
protons from (n,n\*)p

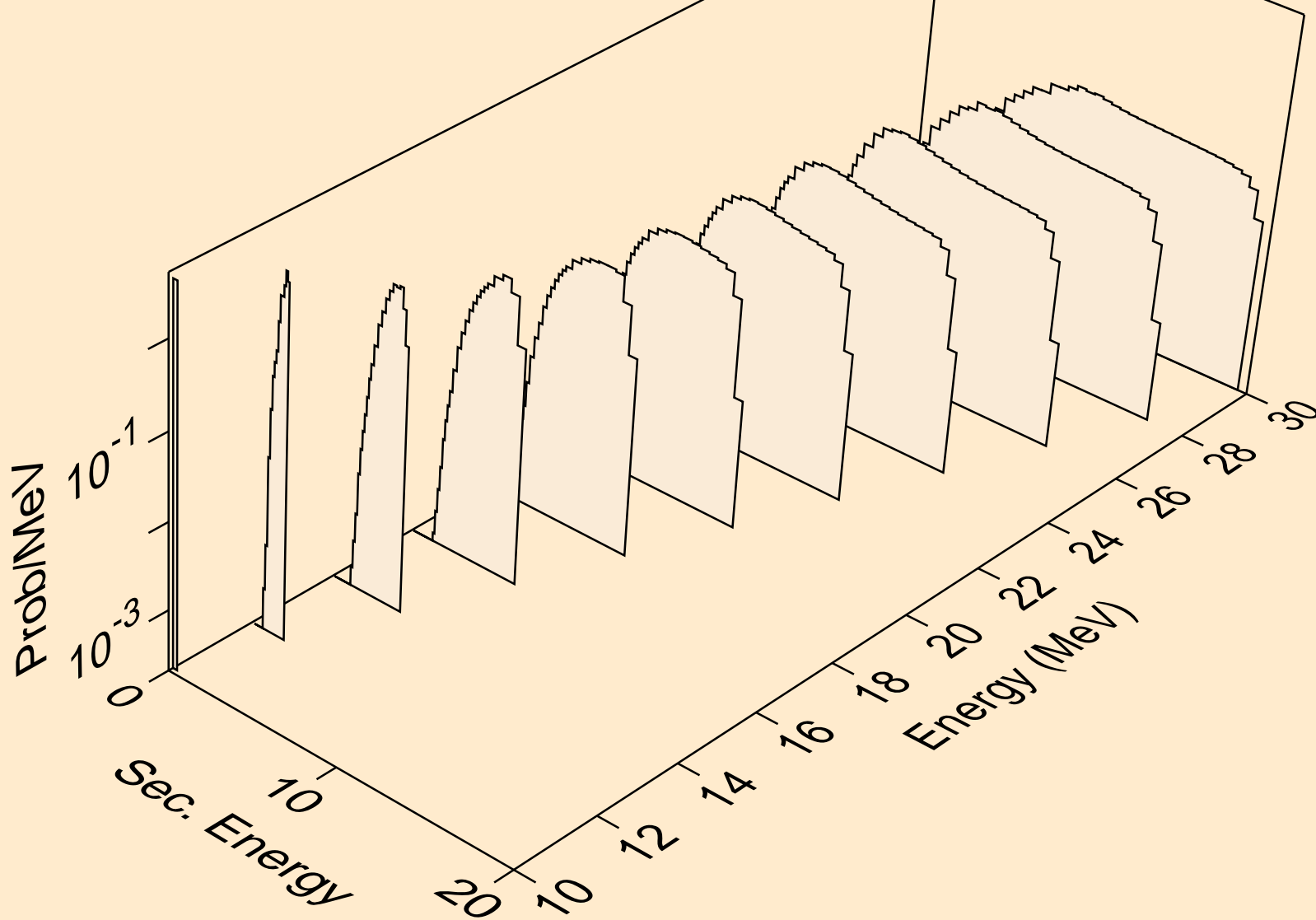

KR082 NEUTRON ACER TENDL-2019 LIBRARY; T=293.16K  
protons from (n,2np)

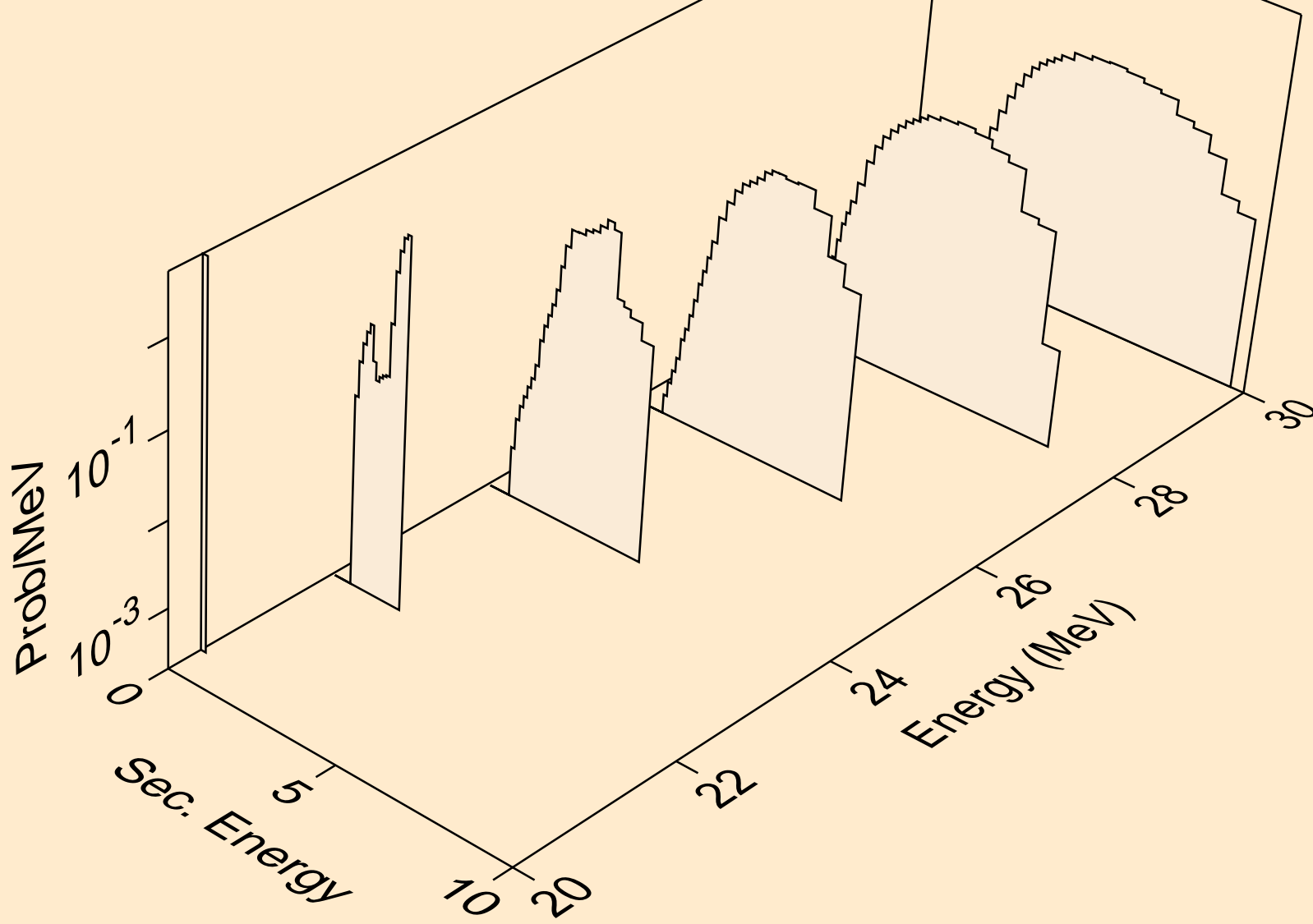

KR082 NEUTRON ACER TENDL-2019 LIBRARY; T=293.16K  
protons from (n,3np)

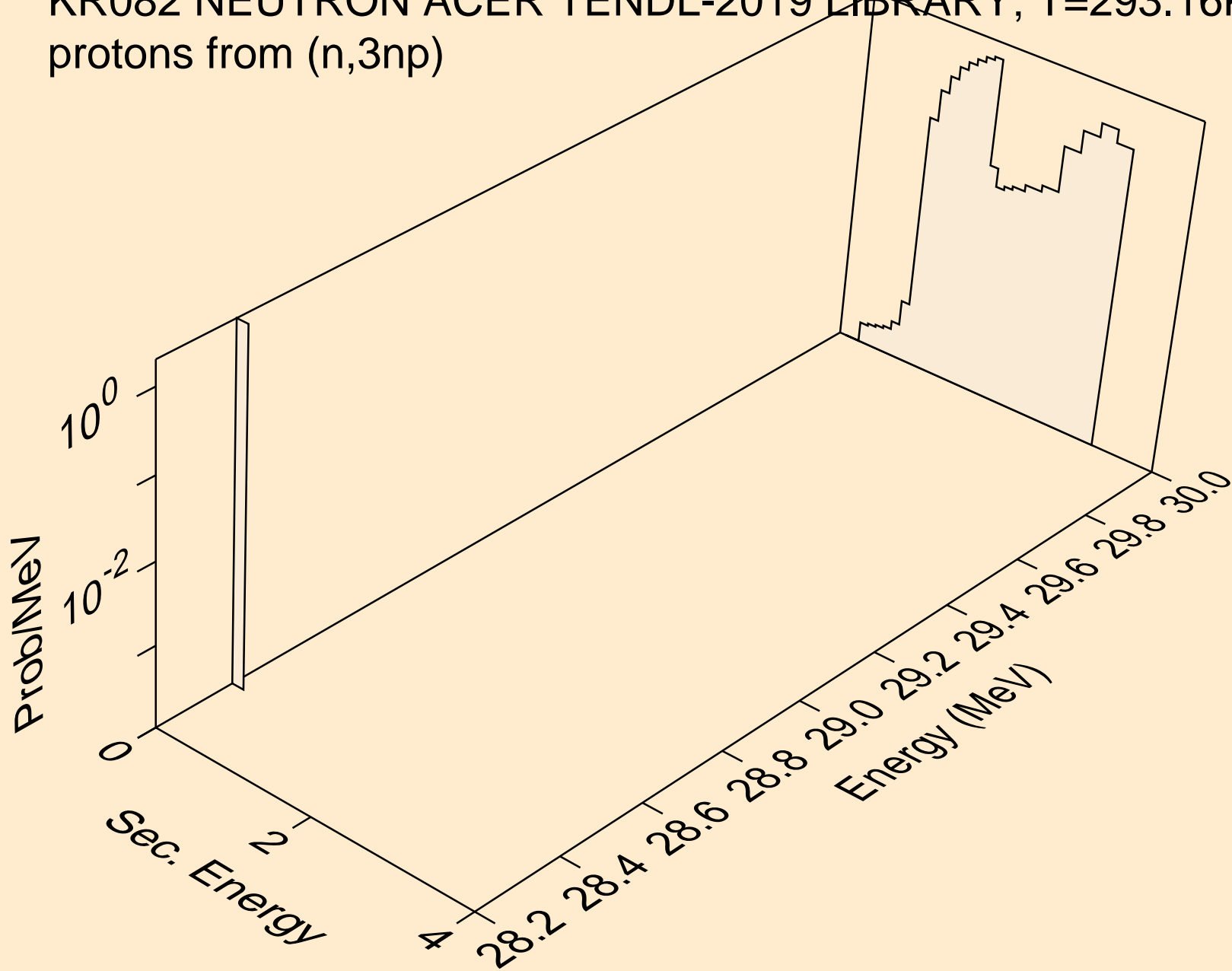

KR082 NEUTRON ACER TENDL-2019 LIBRARY; T=293.16K  
protons from (n,2np)

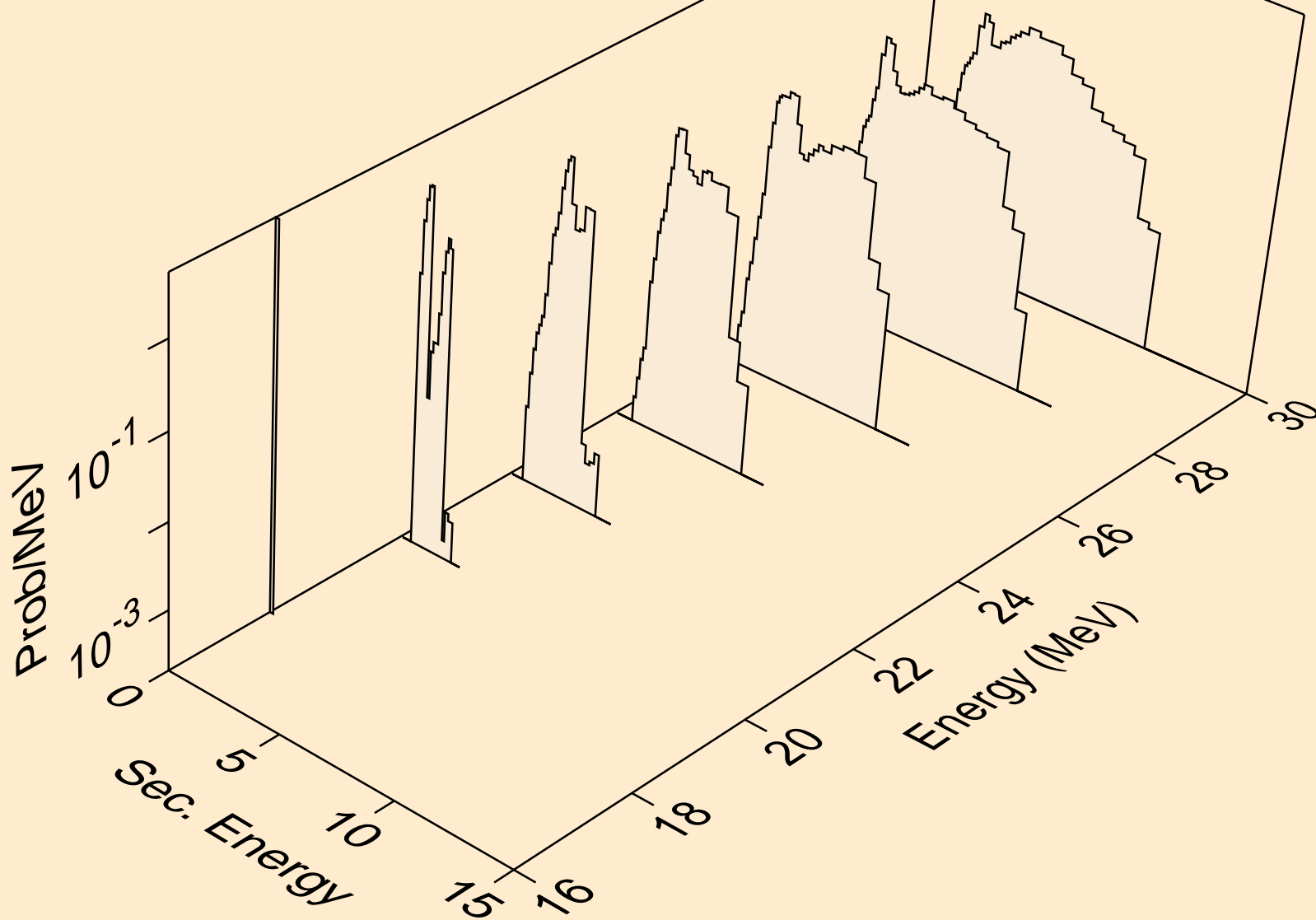

KR082 NEUTRON ACER TENDL-2019 LIBRARY; T=293.16K  
protons from (n,npa)

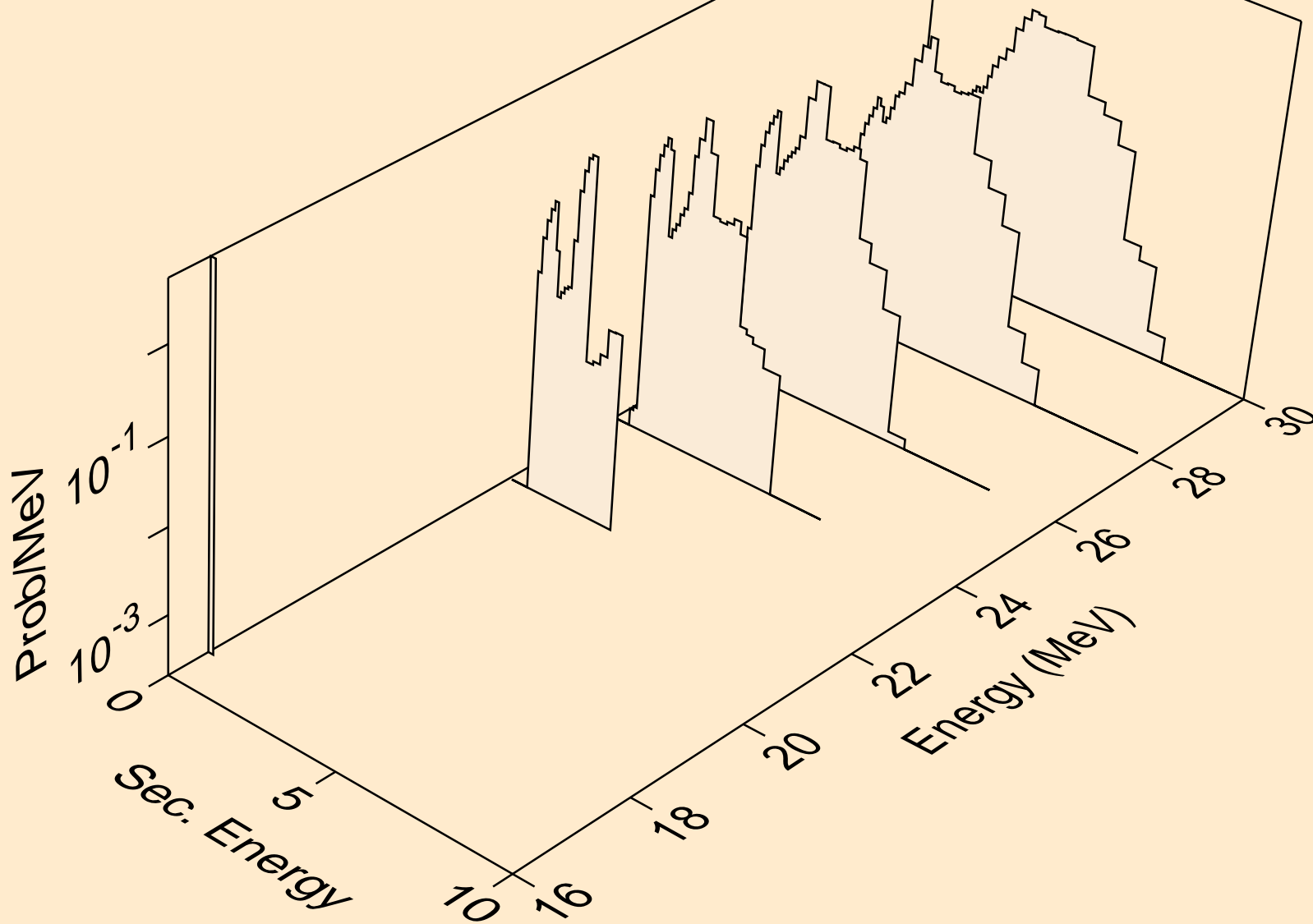

KR082 NEUTRON ACER TENDL-2019 LIBRARY; T=293.16K  
protons from (n,p)

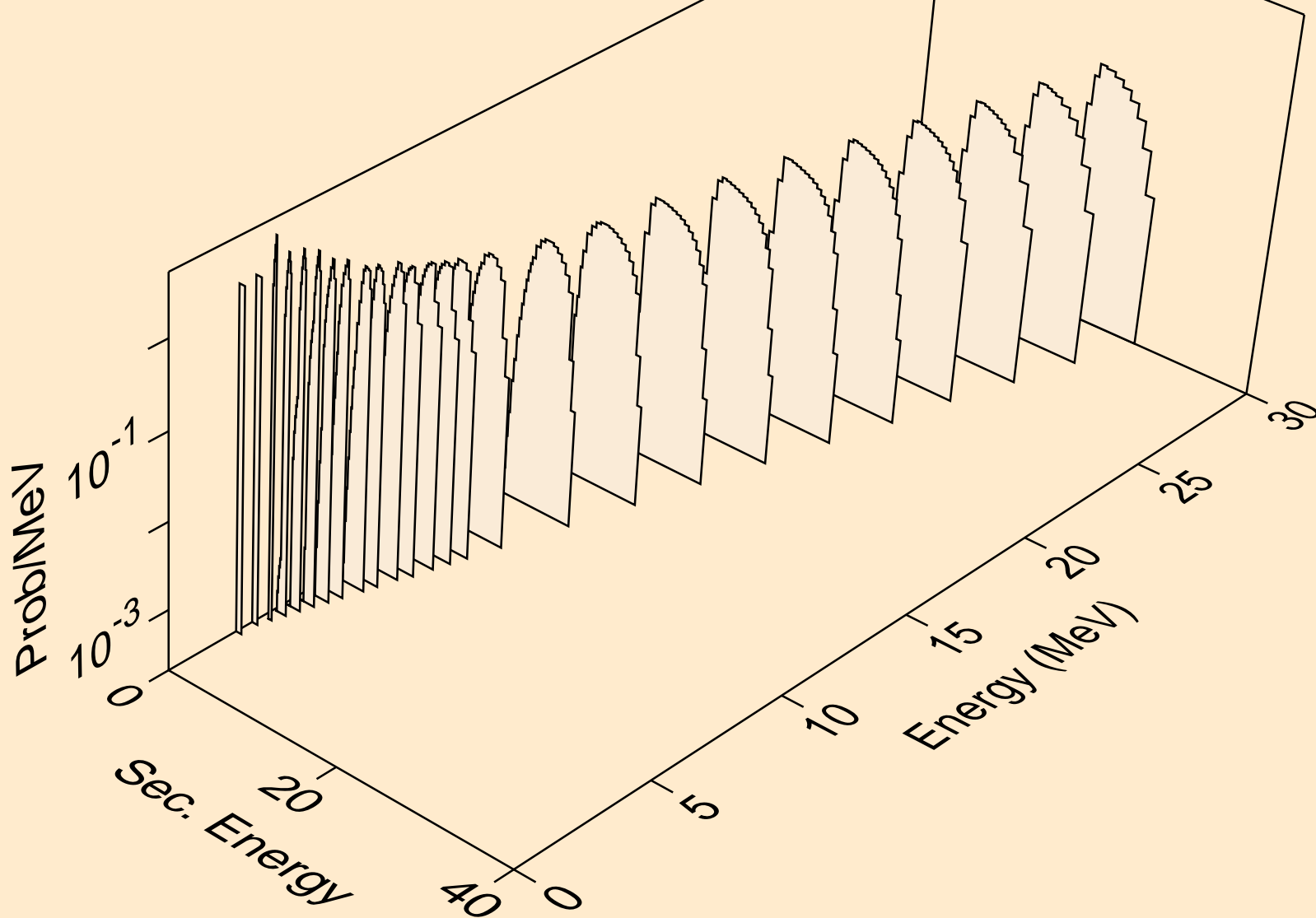

KR082 NEUTRON ACER TENDL-2019 LIBRARY; T=293.16K  
protons from (n,2p)

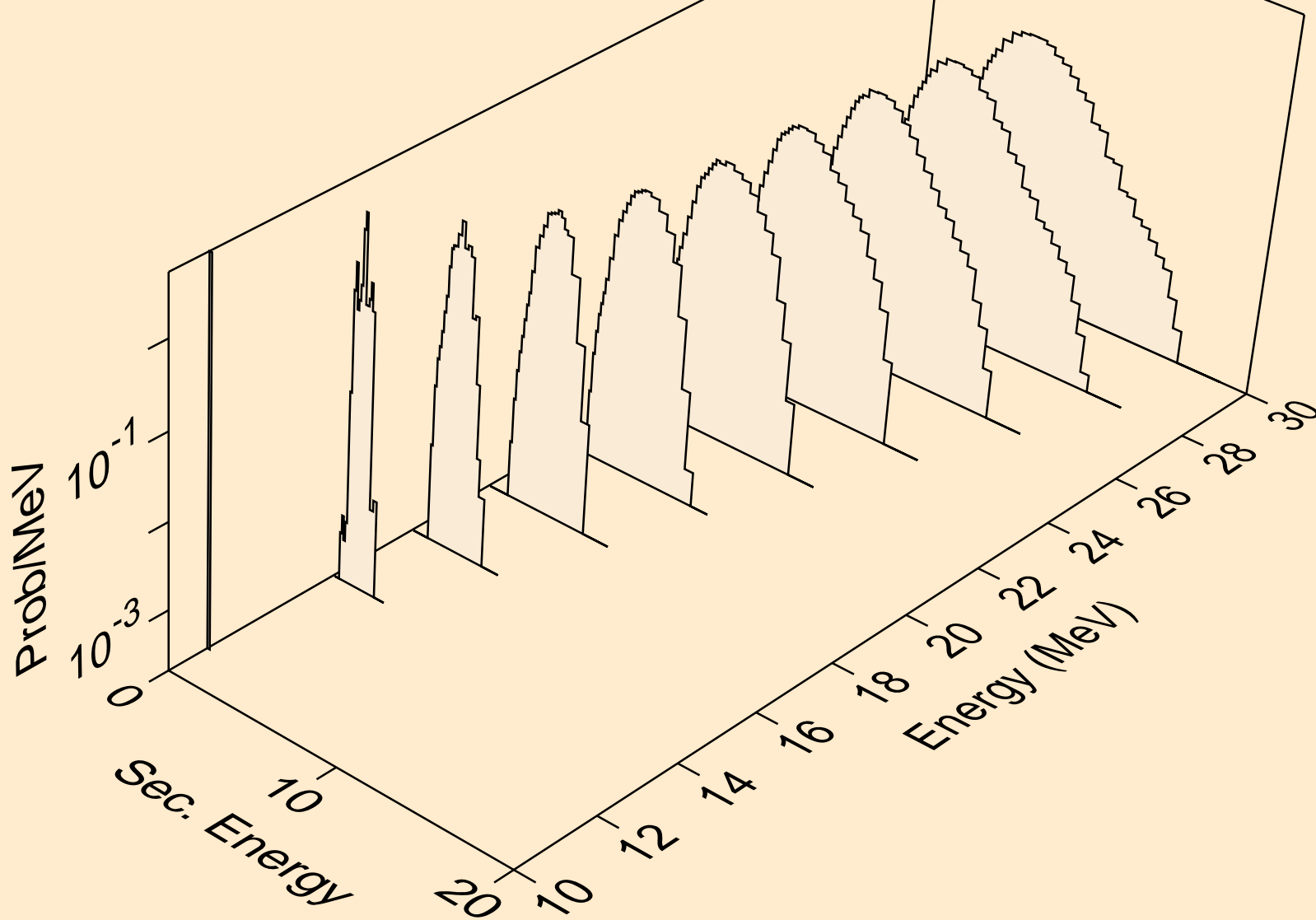



KR082 NEUTRON ACER TENDL-2019 LIBRARY; T=293.16K  
protons from (n,p)

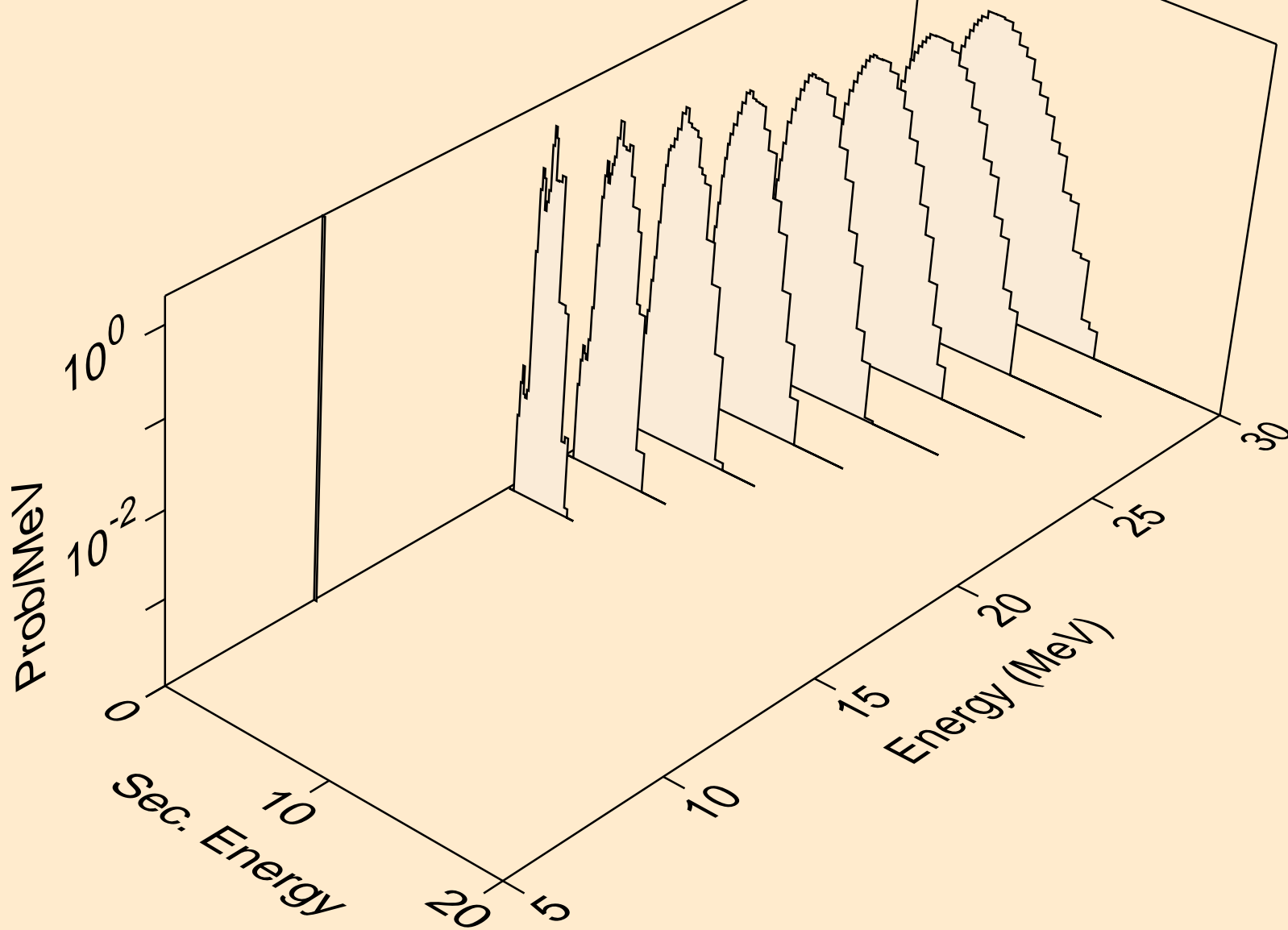

KR082 NEUTRON ACER TENDL-2019 LIBRARY; T=293.16K  
protons from (n,pd)

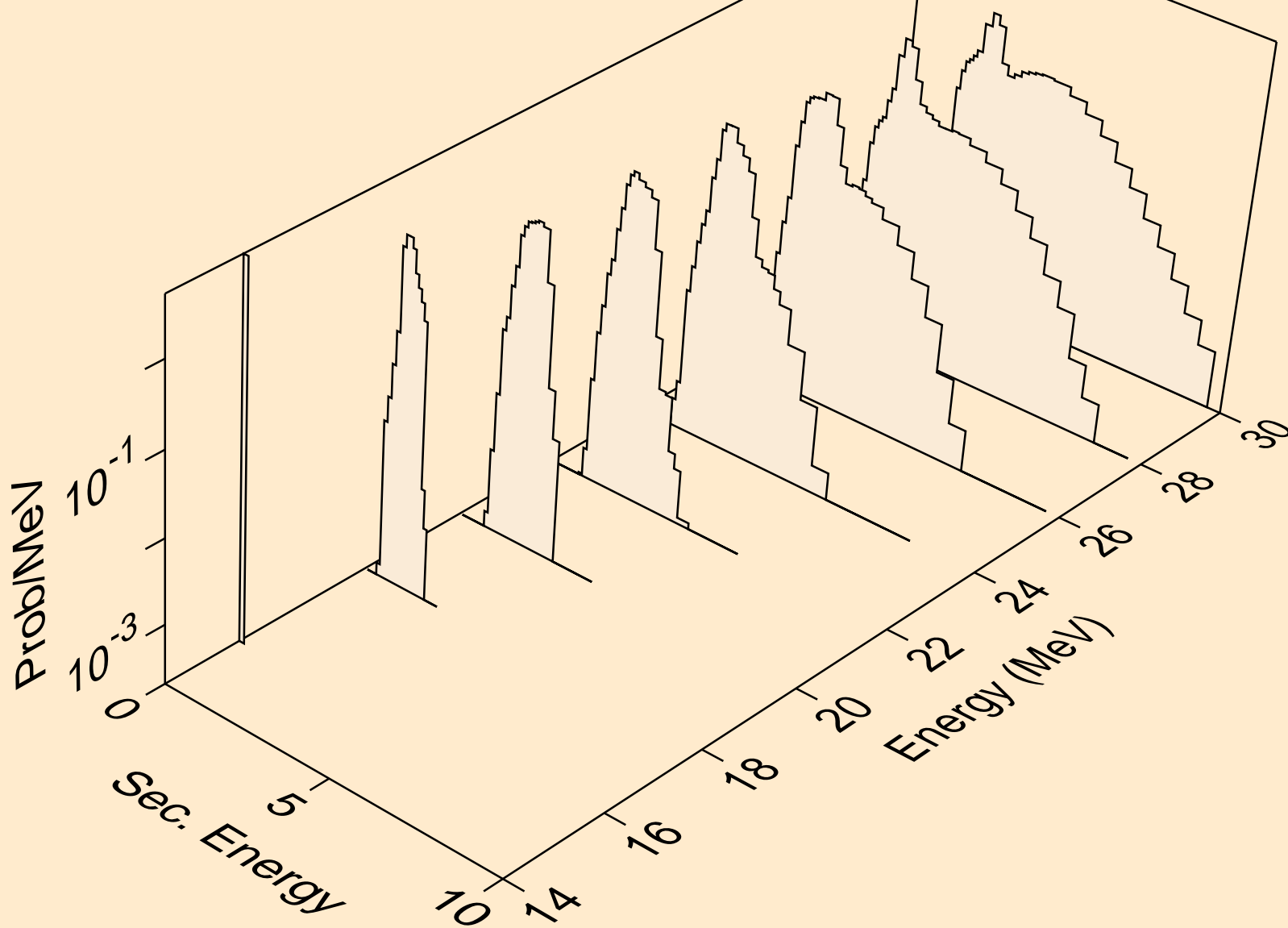

KR082 NEUTRON ACER TENDL-2019 LIBRARY; T=293.16K  
protons from (n,pt)

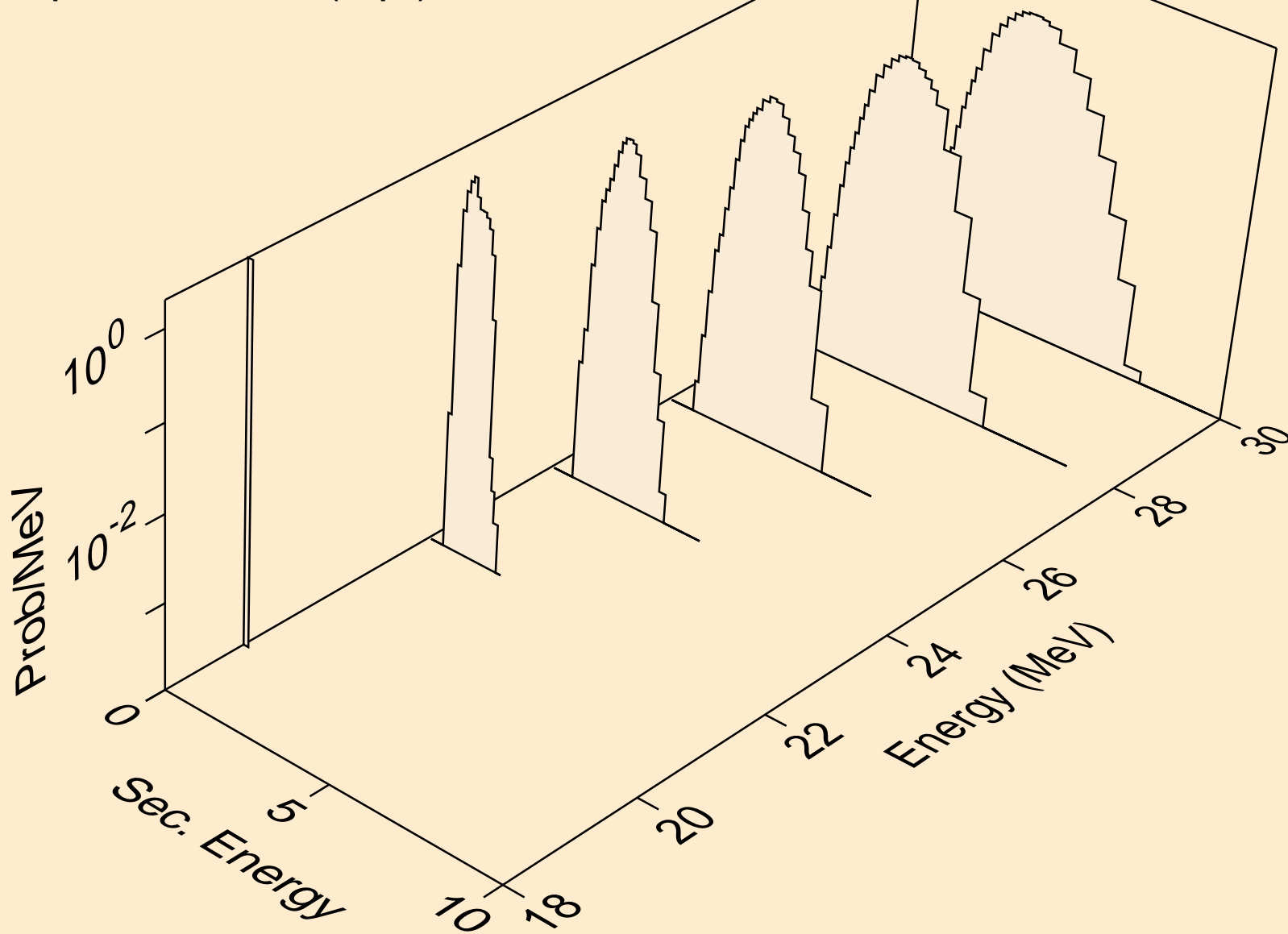

KR082 NEUTRON ACER TENDL-2019 LIBRARY; T=293.16K  
deuterons from (n,x)

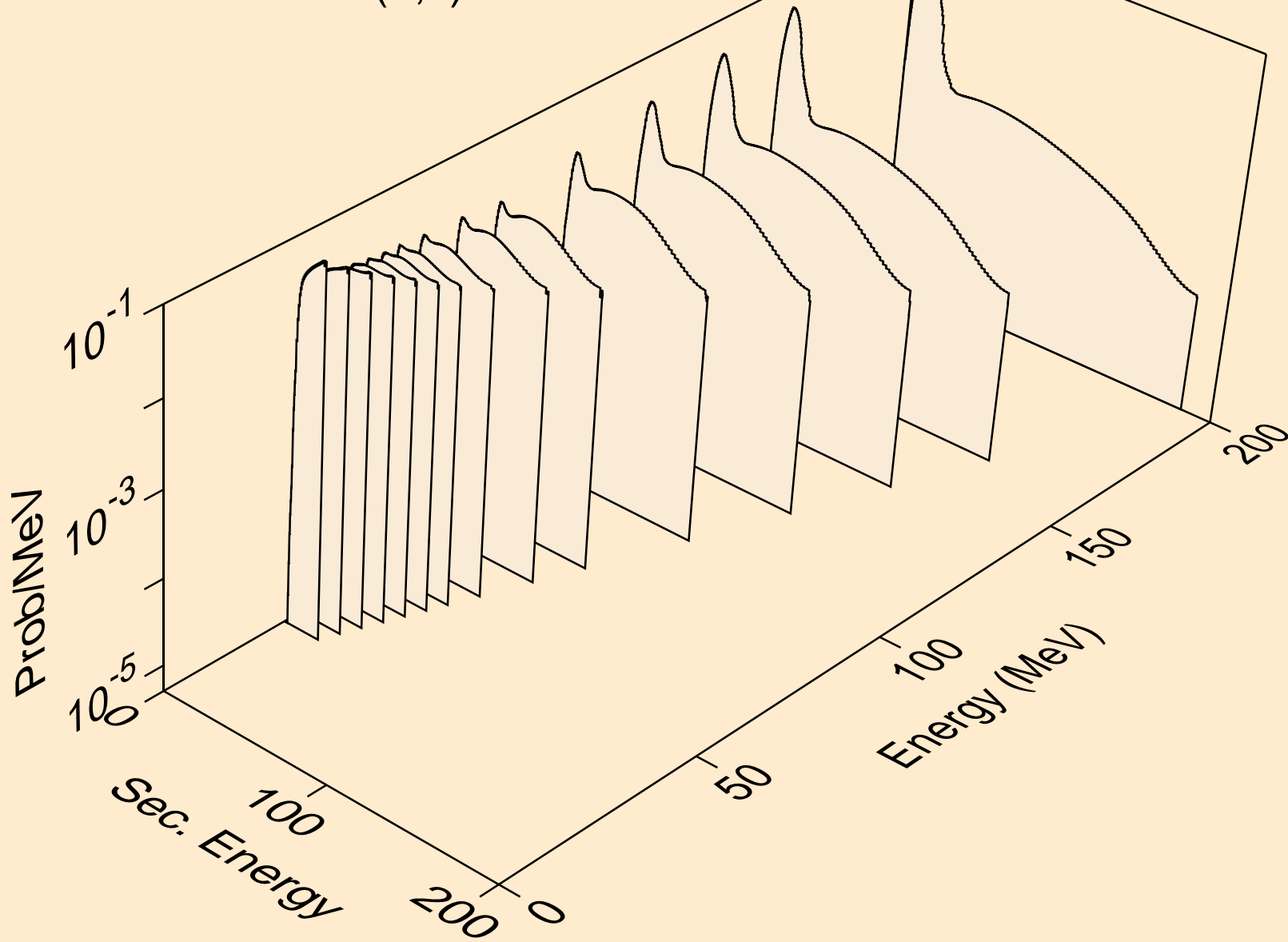

KR082 NEUTRON ACER TENDL-2019 LIBRARY; T=293.16K  
deuterons from (n,2nd)

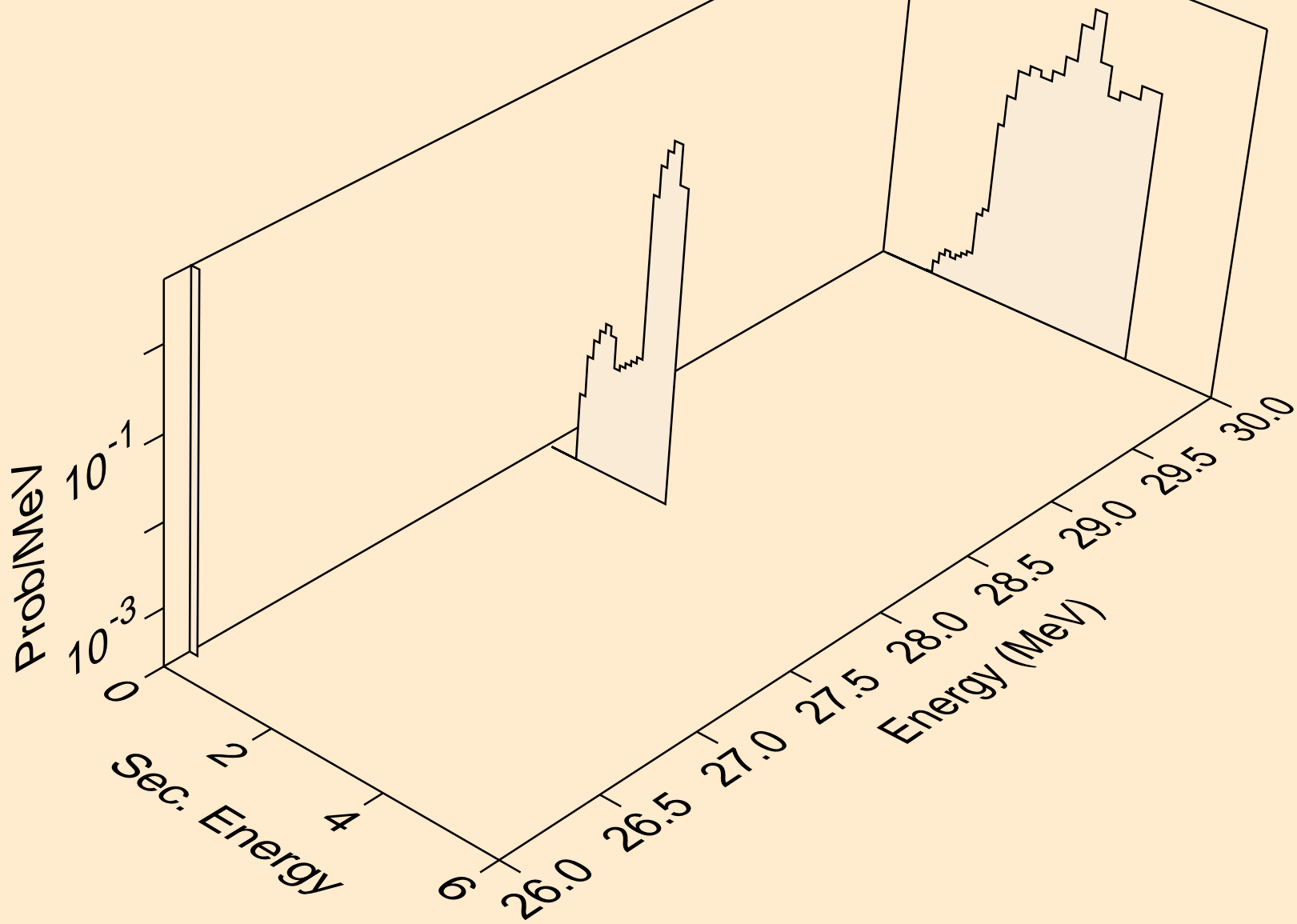

KR082 NEUTRON ACER TENDL-2019 LIBRARY; T=293.16K  
deuterons from (n,n\*)d

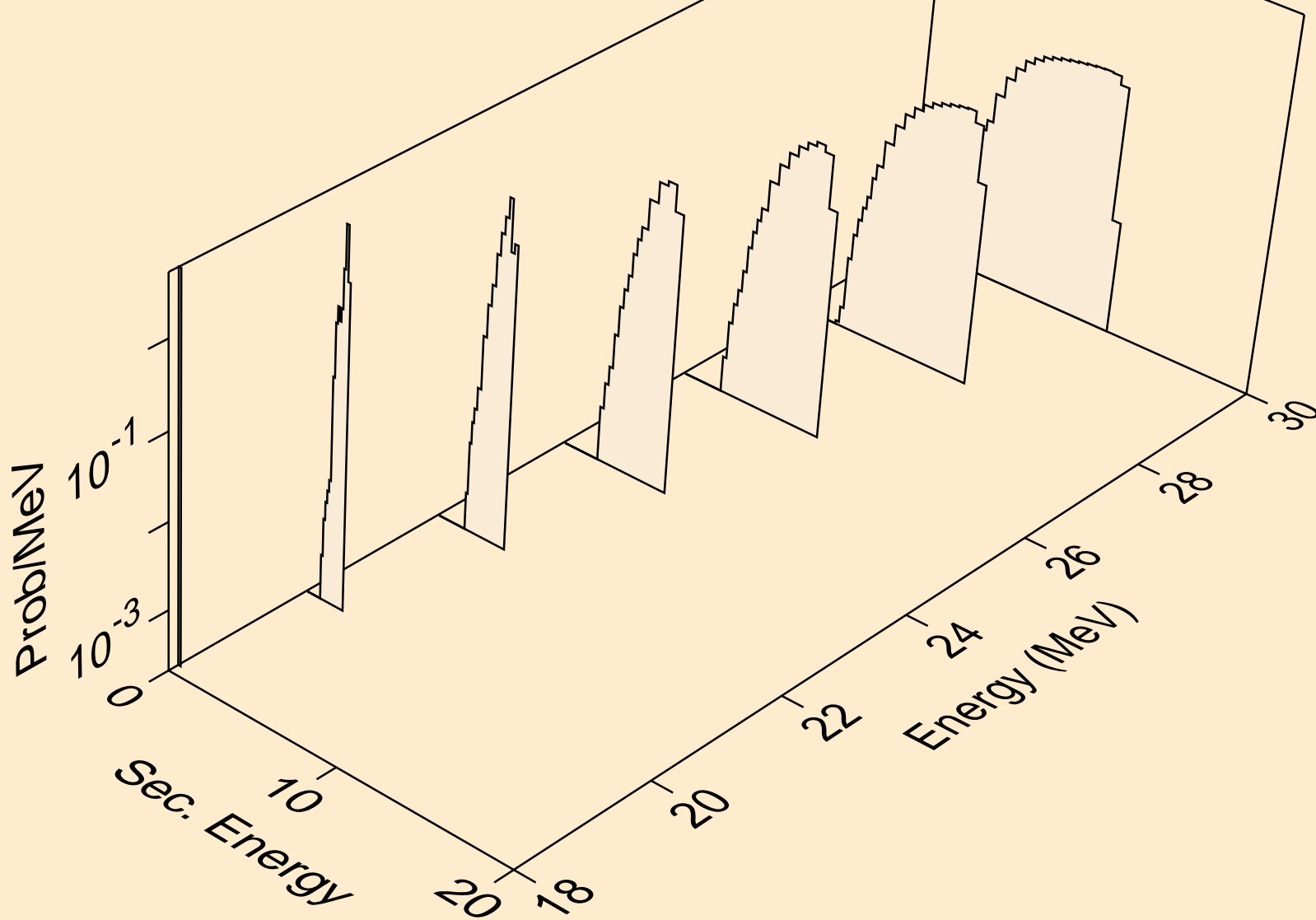

KR082 NEUTRON ACER TENDL-2019 LIBRARY; T=293.16K  
deuterons from (n,d)

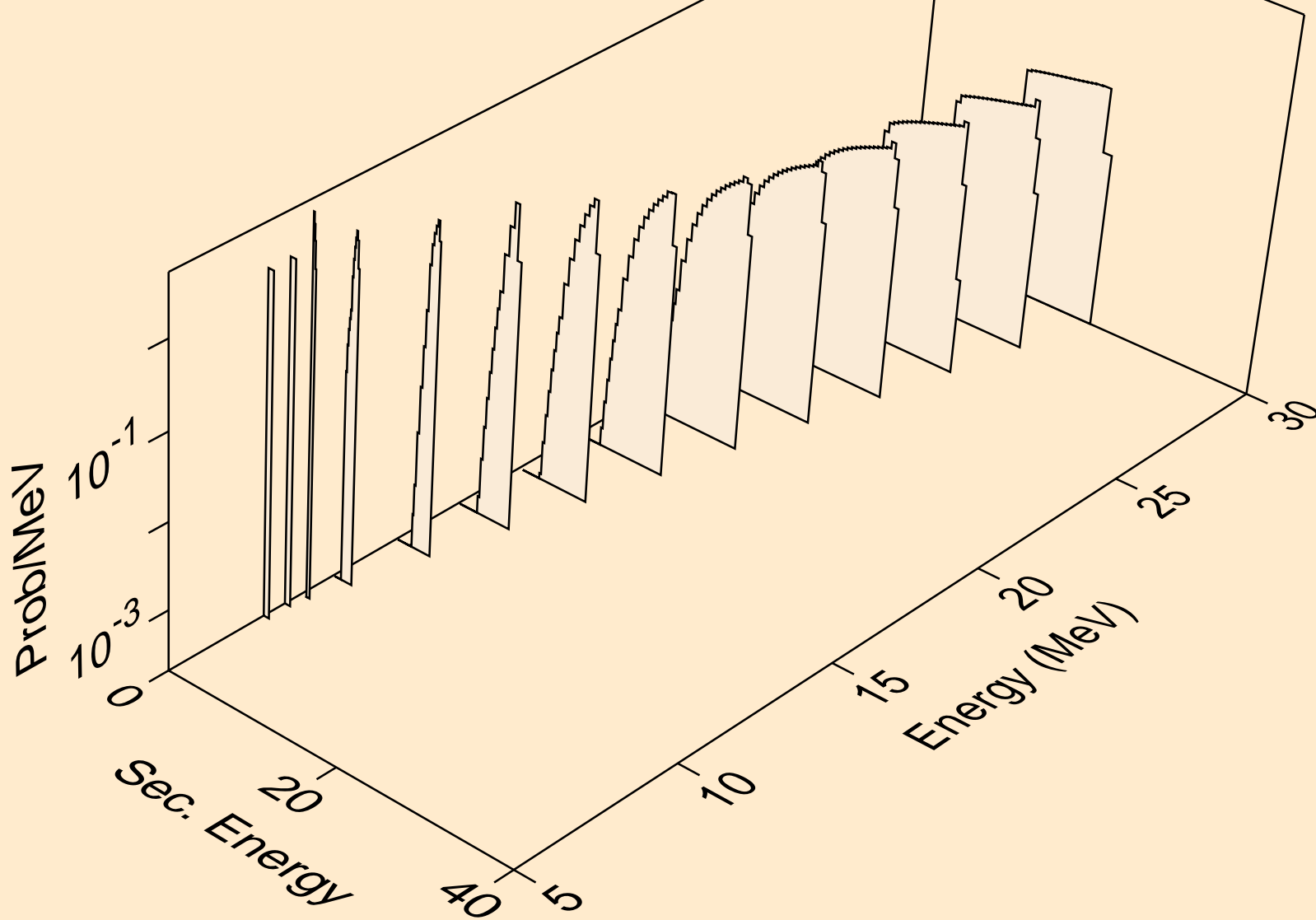

KR082 NEUTRON ACER TENDL-2019 LIBRARY; T=293.16K  
deuterons from (n,pd)

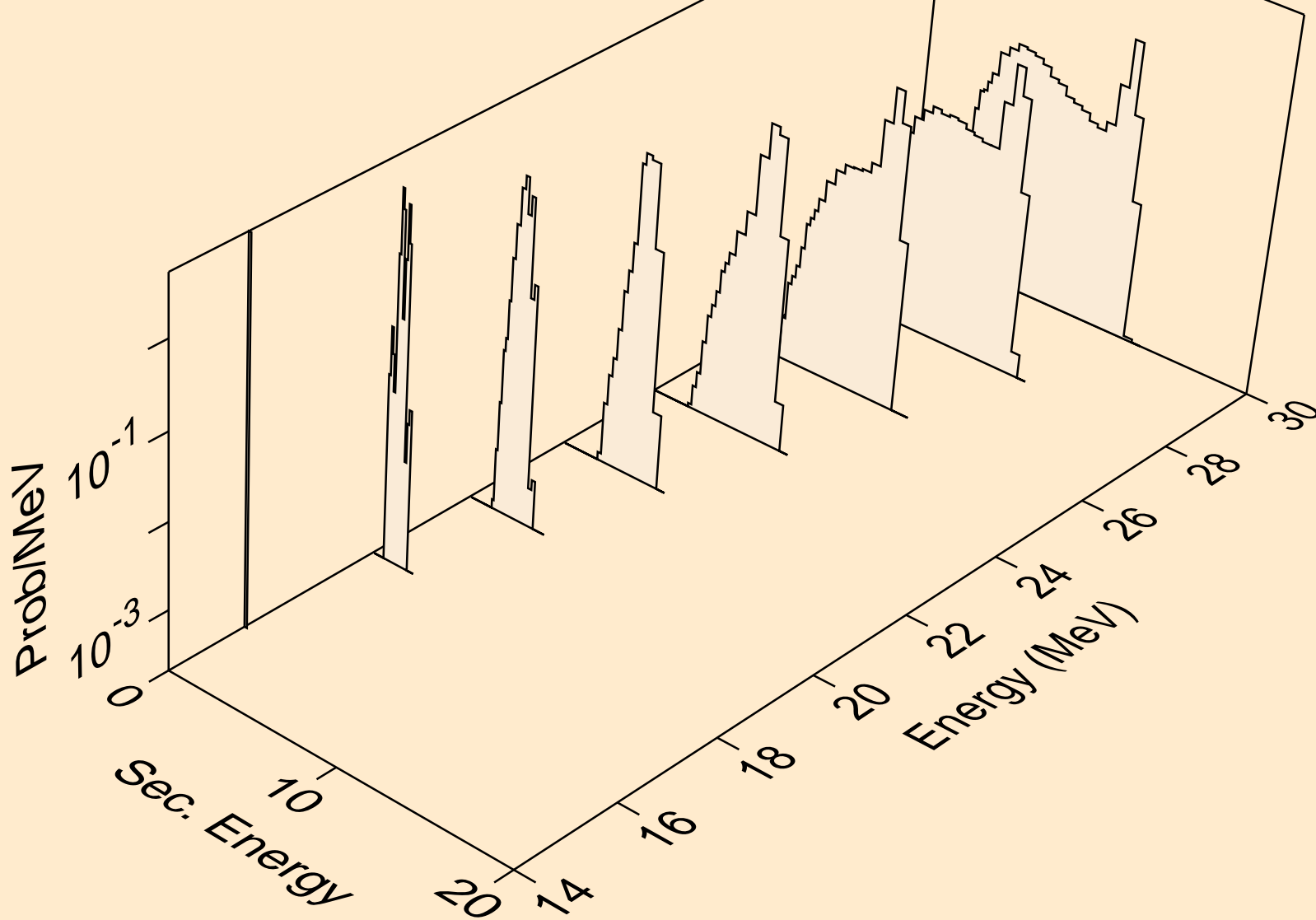



KR082 NEUTRON ACER TENDL-2019 LIBRARY; T=293.16K  
deuterons from (n,da)

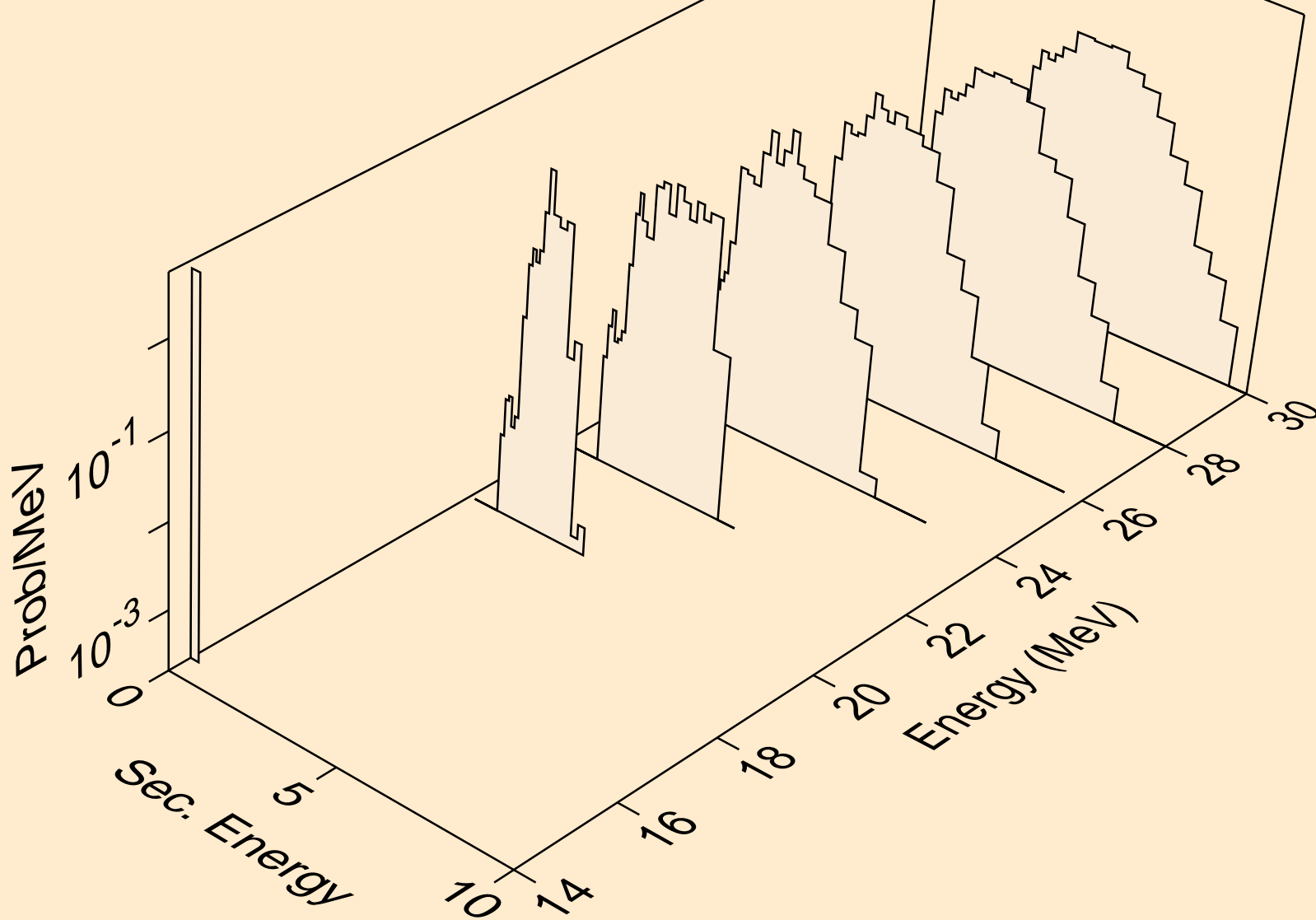

KR082 NEUTRON ACER TENDL-2019 LIBRARY; T=293.16K  
tritons from (n,x)

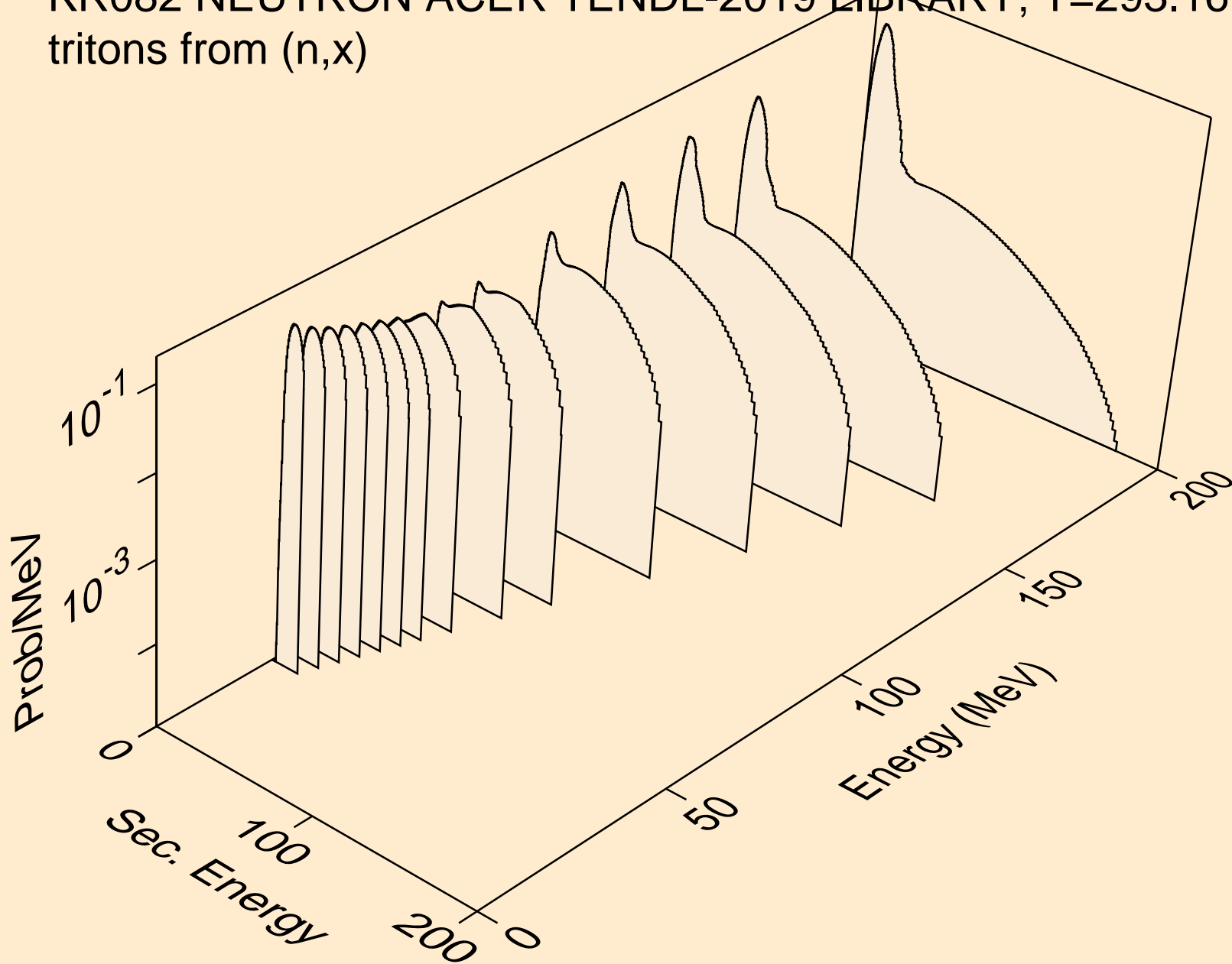

KR082 NEUTRON ACER TENDL-2019 LIBRARY; T=293.16K  
tritons from (n,n\*)t

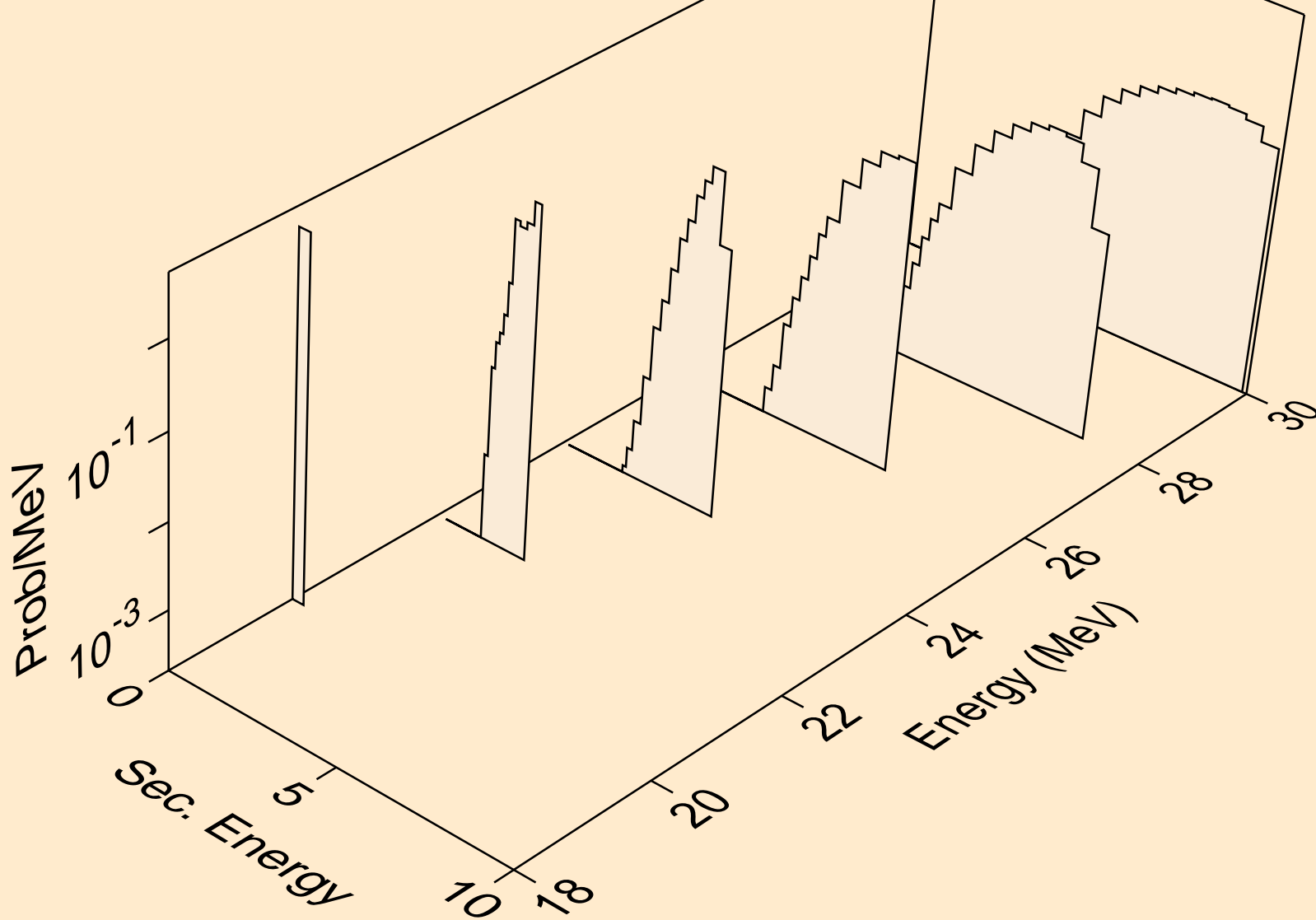

KR082 NEUTRON ACER TENDL-2019 LIBRARY; T=293.16K  
tritons from (n,t)

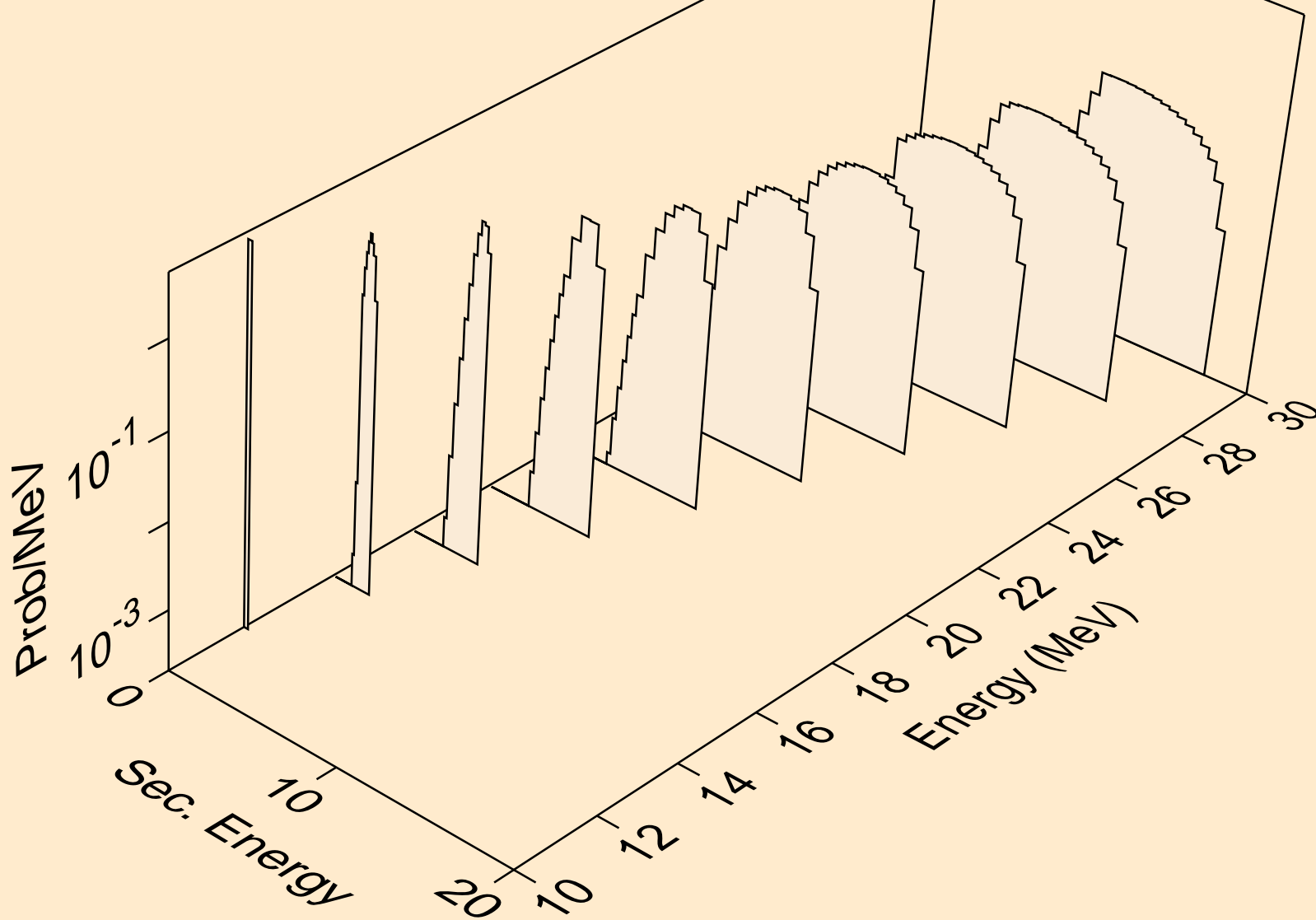

KR082 NEUTRON ACER TENDL-2019 LIBRARY; T=293.16K  
tritons from (n,pt)

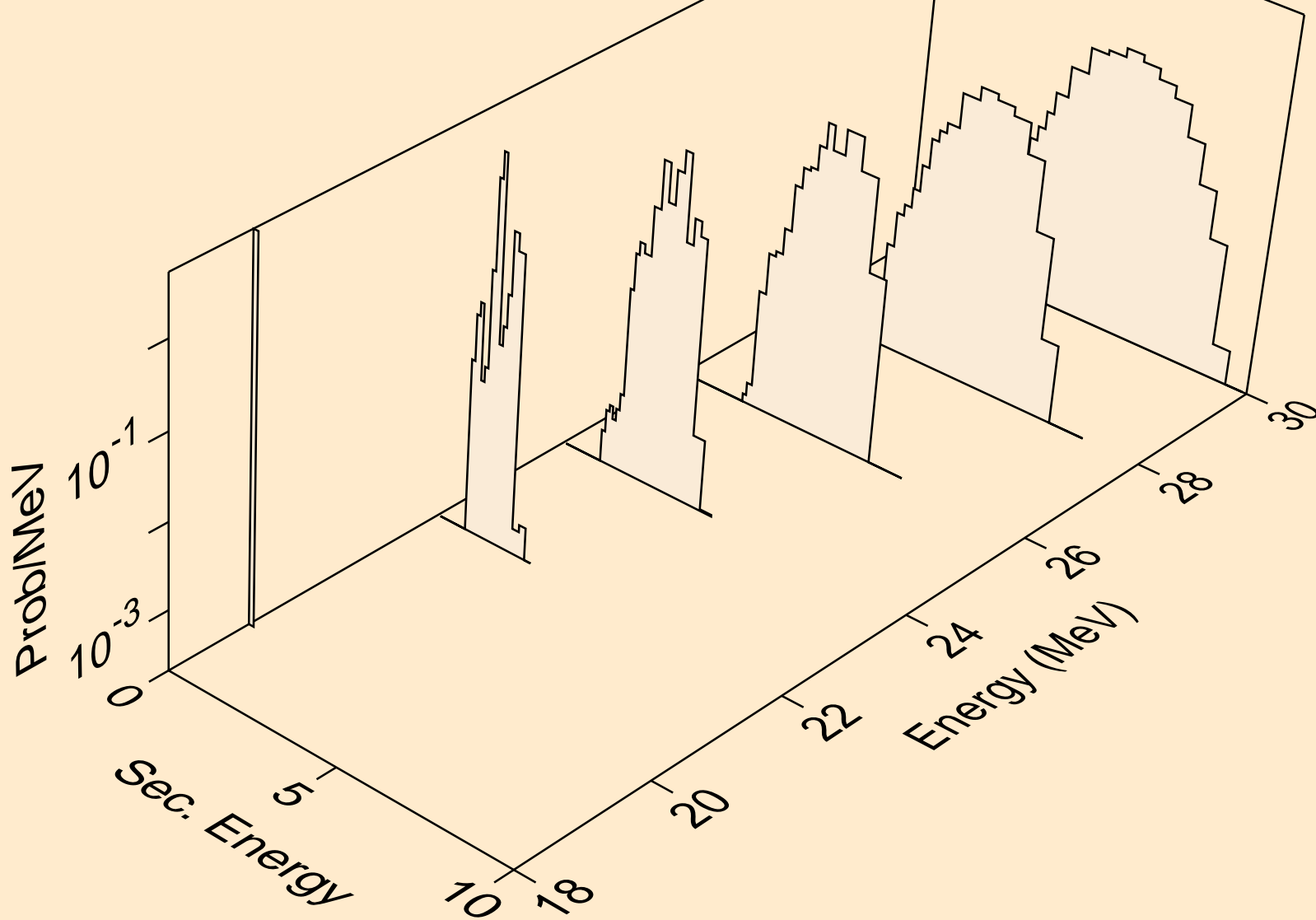

KR082 NEUTRON ACER TENDL-2019 LIBRARY; T=293.16K  
he3s from (n,x)

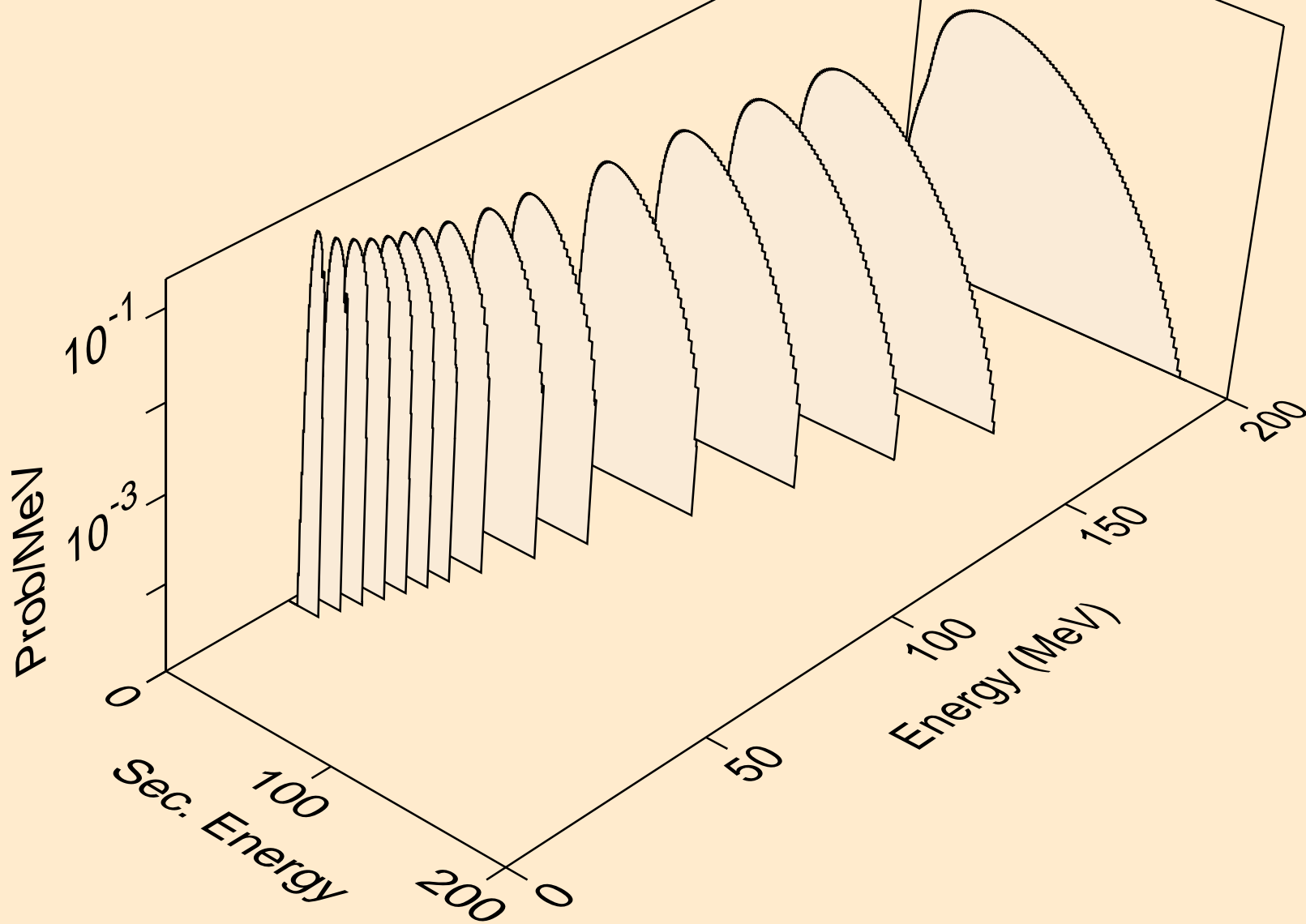

KR082 NEUTRON ACER TENDL-2019 LIBRARY; T=293.16K  
he3s from (n,n\*)he3

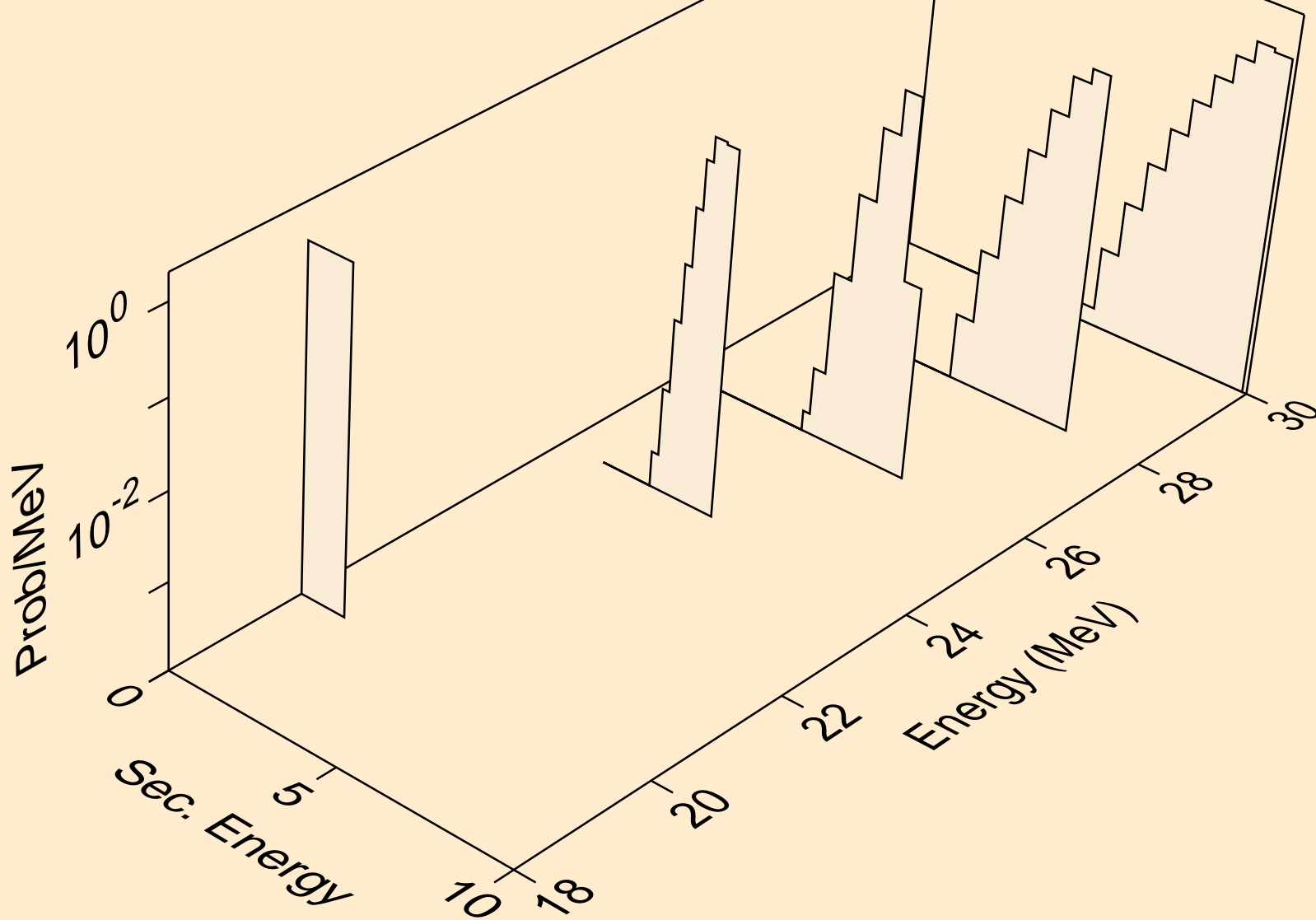

KR082 NEUTRON ACER TENDL-2019 LIBRARY; T=293.16K  
he3s from (n,he3)

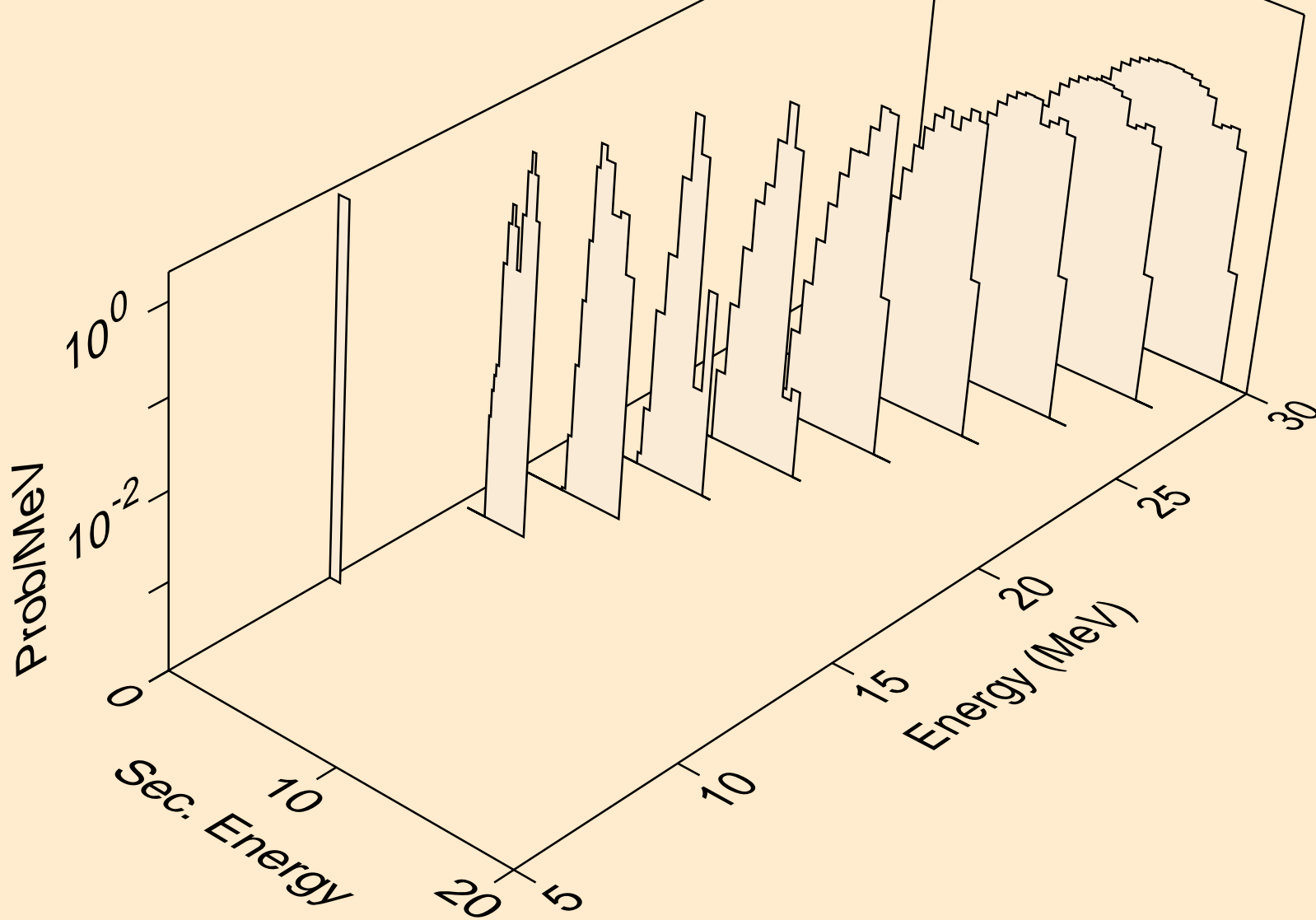



KR082 NEUTRON ACER TENDL-2019 LIBRARY; T=293.16K  
alphas from (n,x)

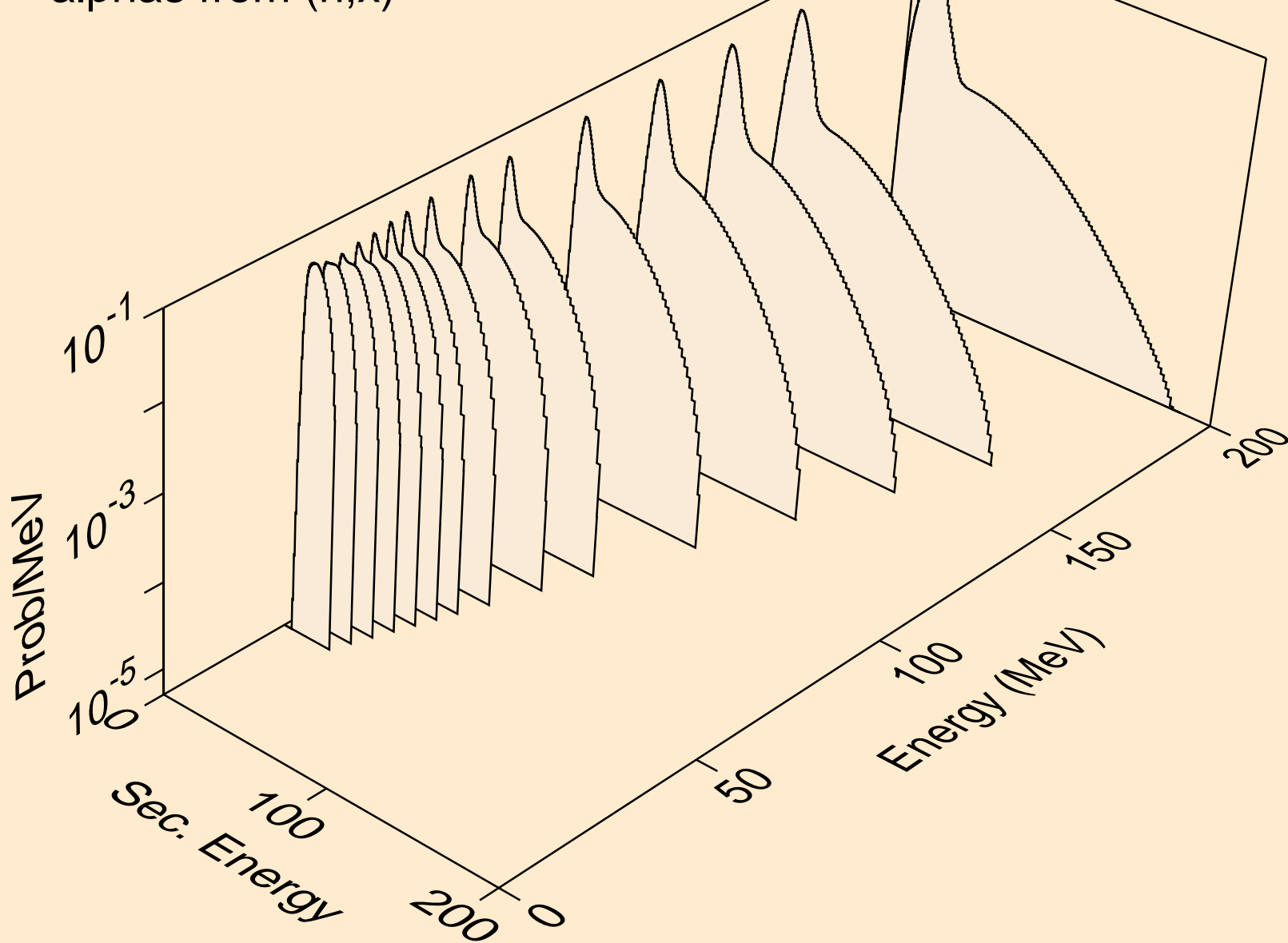

KR082 NEUTRON ACER TENDL-2019 LIBRARY; T=293.16K  
alphas from (n,n\*)a

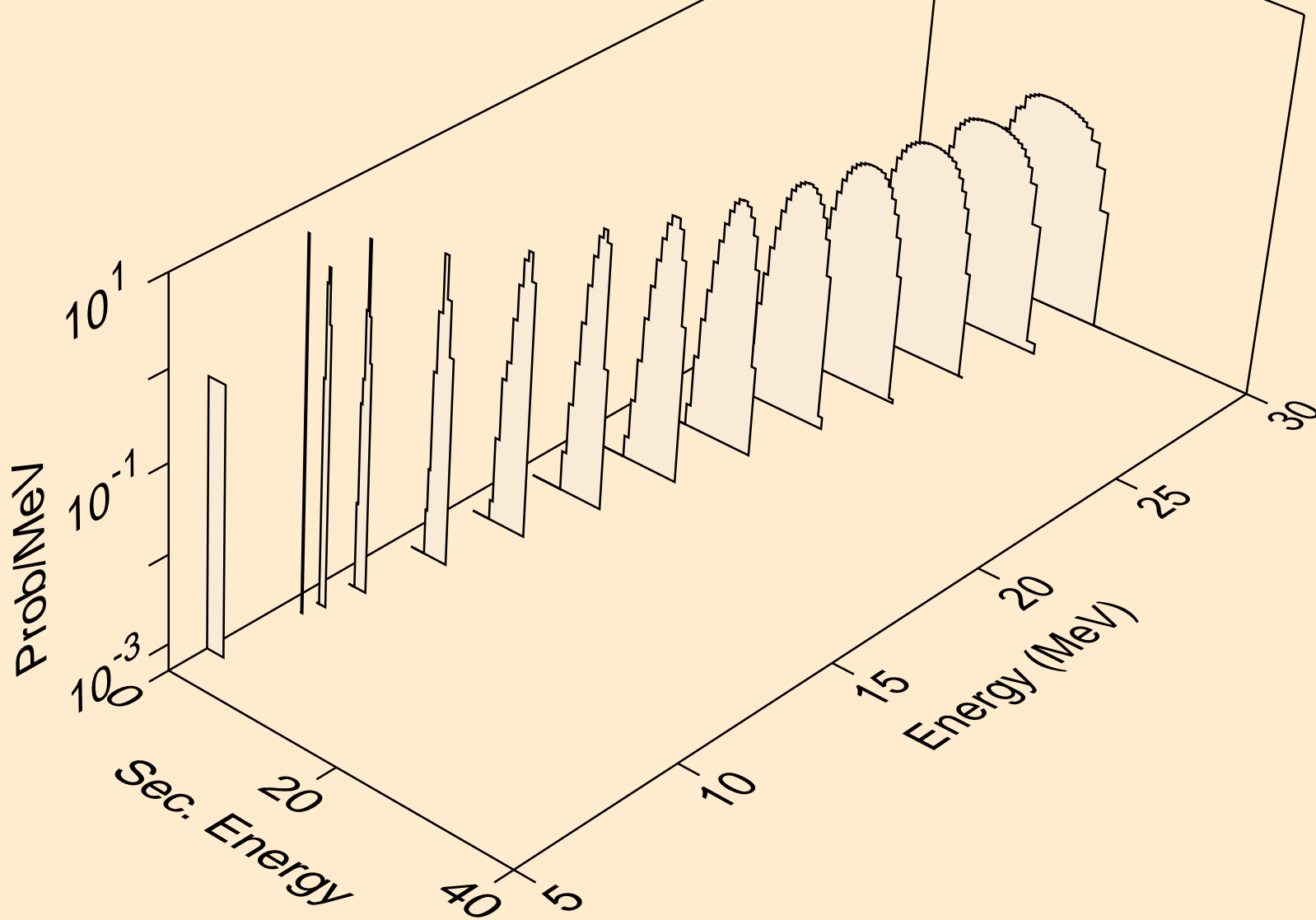

KR082 NEUTRON ACER TENDL-2019 LIBRARY; T=293.16K  
alphas from (n,2n)a

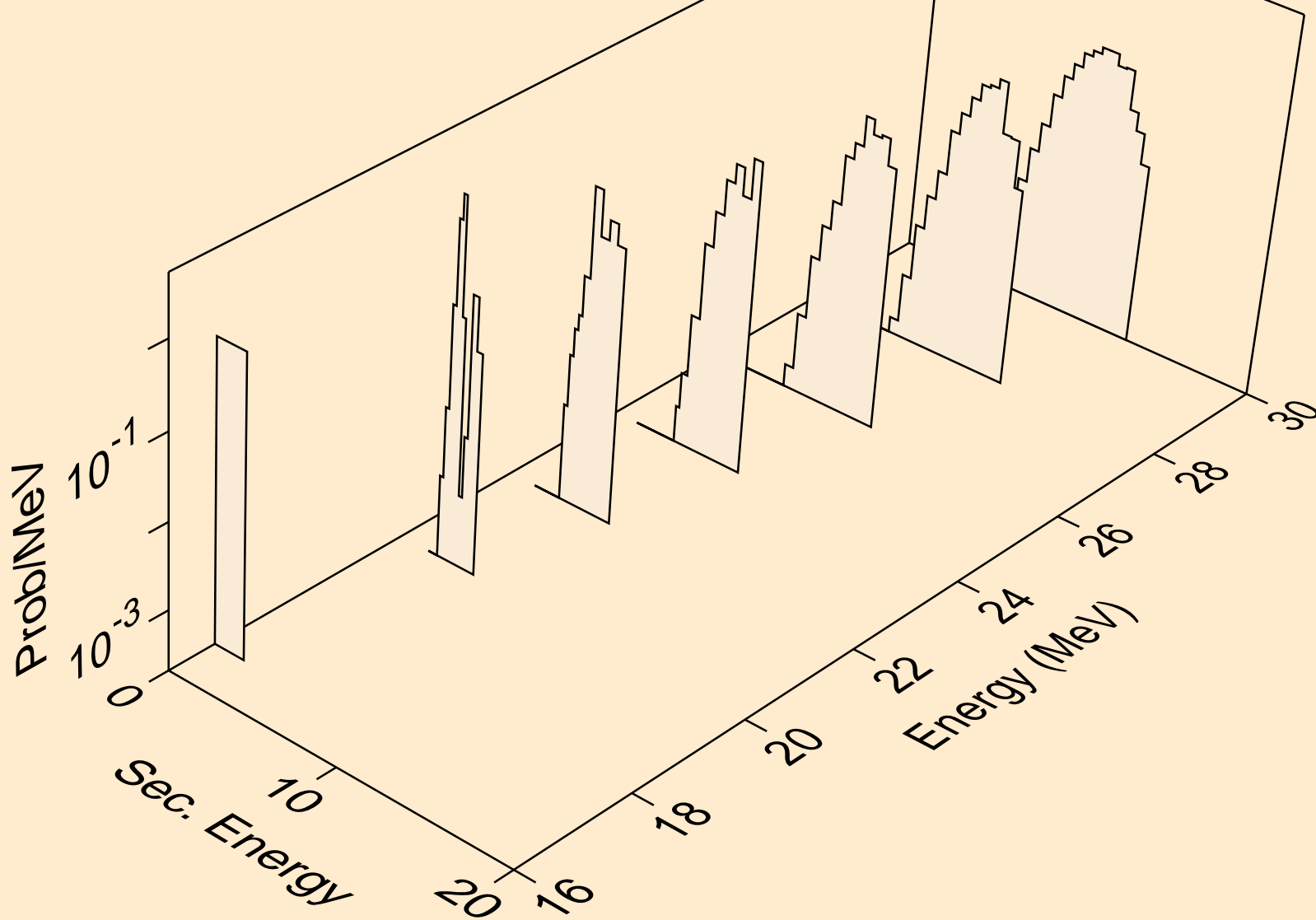

KR082 NEUTRON ACER TENDL-2019 LIBRARY; T=293.16K  
alphas from (n,3n)a

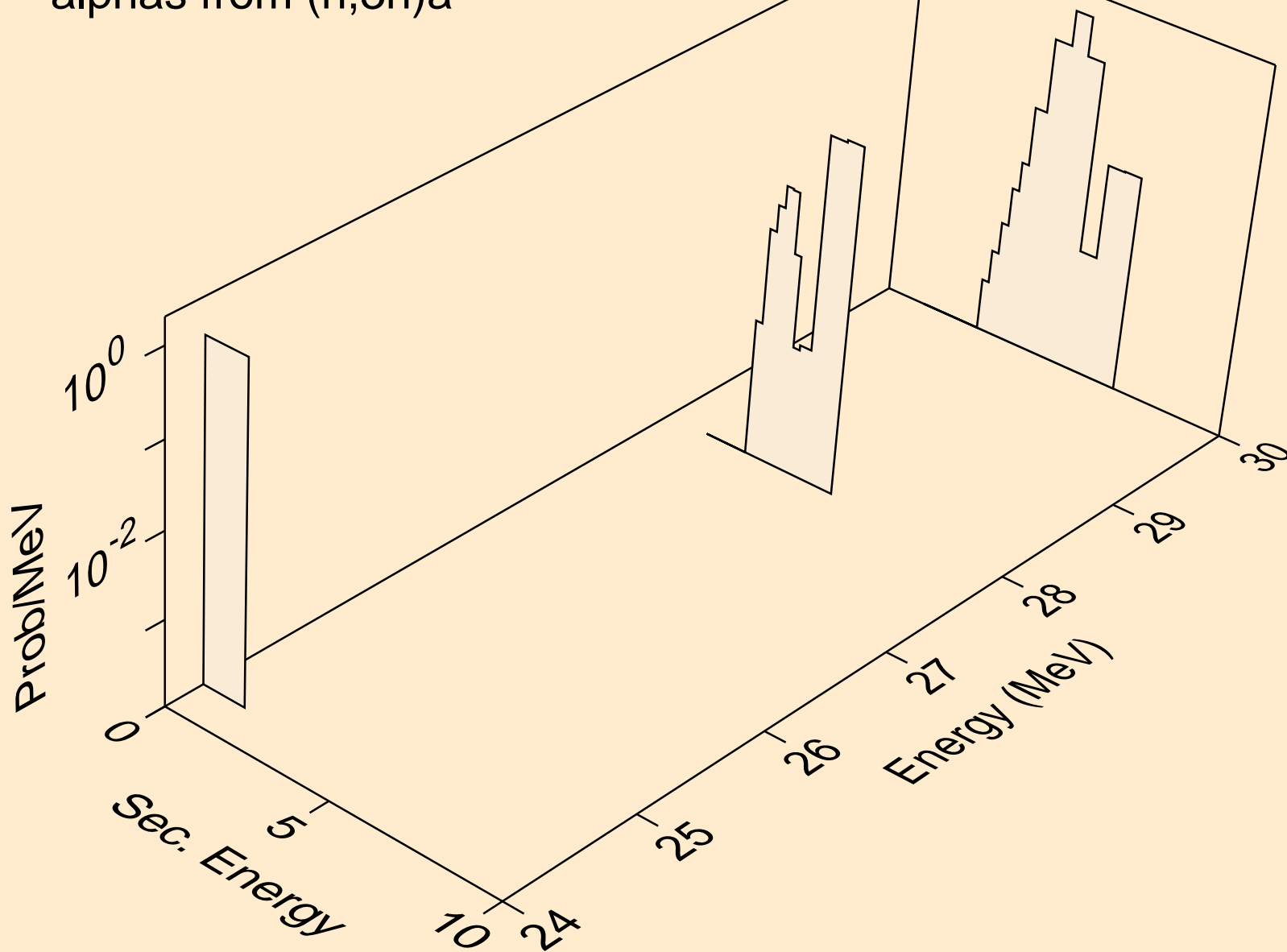

KR082 NEUTRON ACER TENDL-2019 LIBRARY; T=293.16K  
alphas from (n,n\*)2a

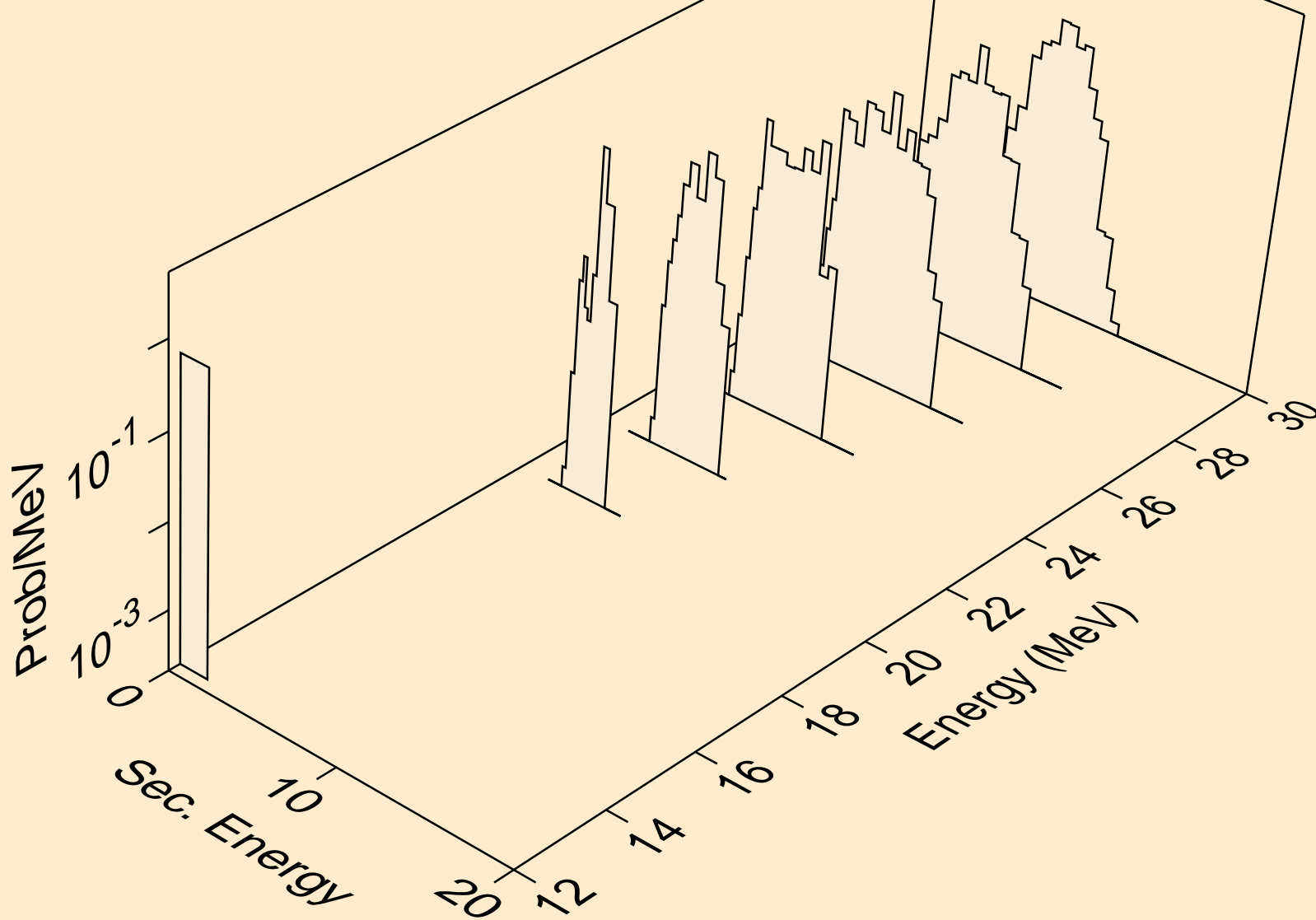

KR082 NEUTRON ACER TENDL-2019 LIBRARY; T=293.16K  
alphas from (n,npa)

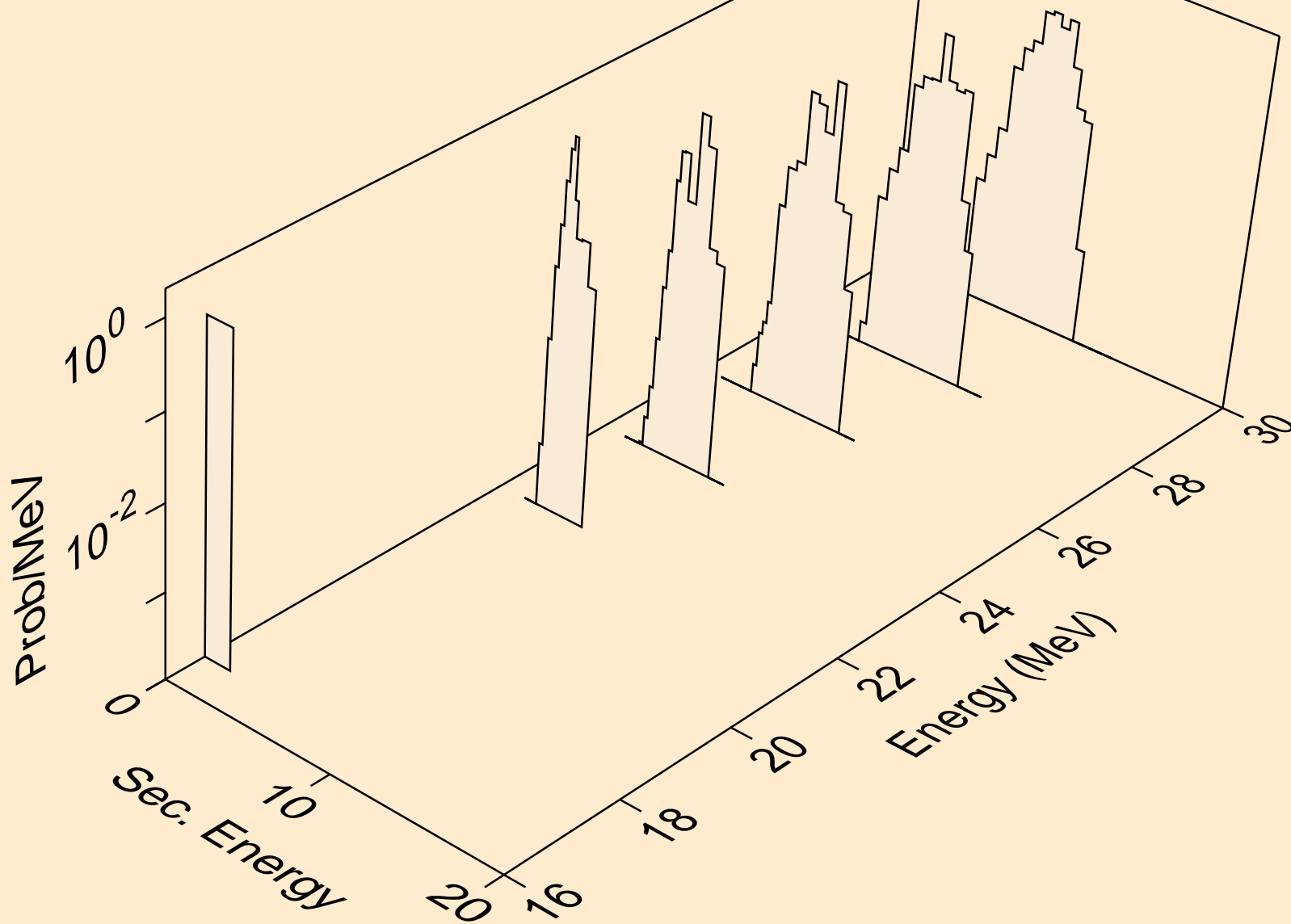

KR082 NEUTRON ACER TENDL-2019 LIBRARY; T=293.16K  
alphas from (n,a)

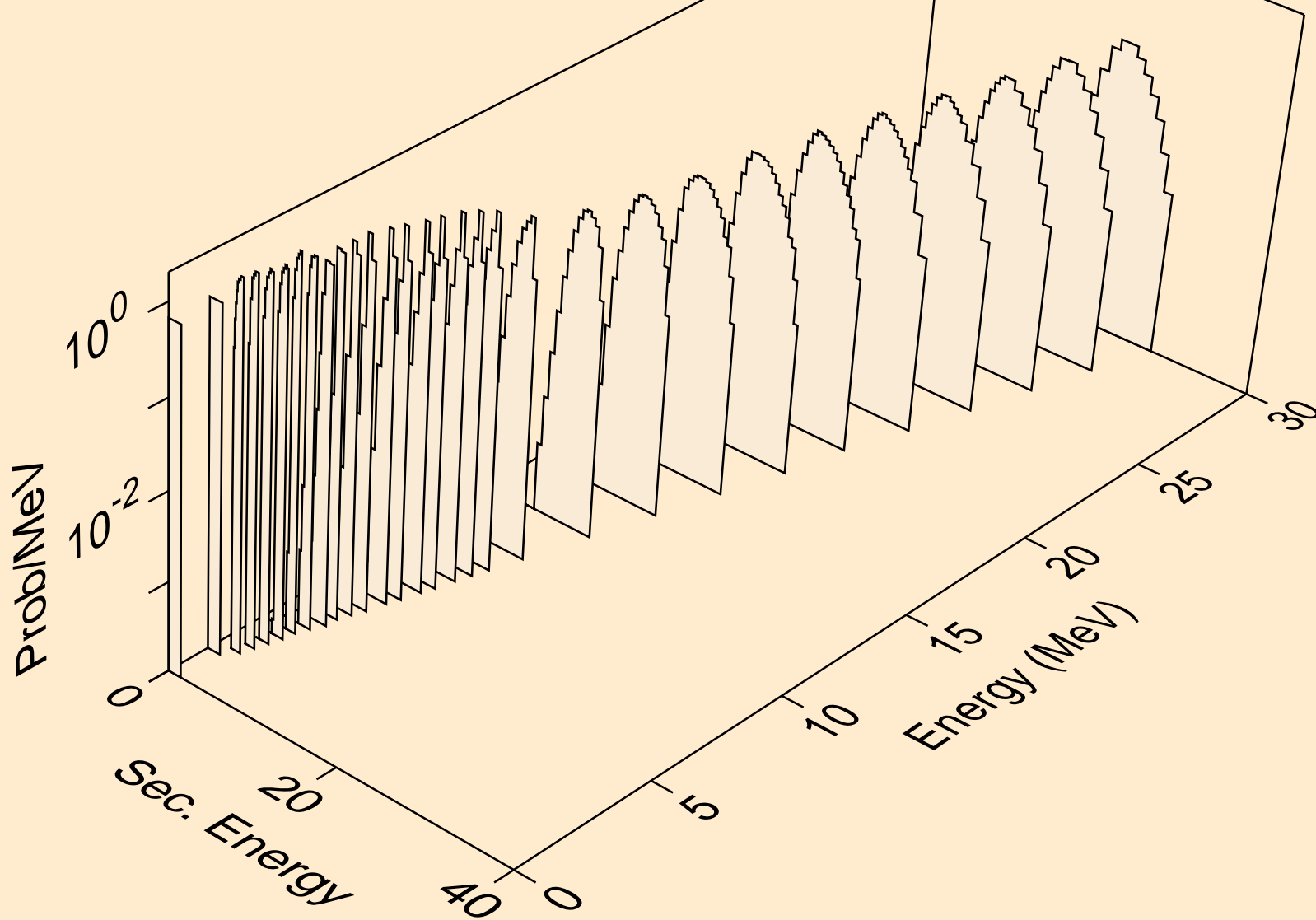

KR082 NEUTRON ACER TENDL-2019 LIBRARY; T=293.16K  
alphas from (n,2a)

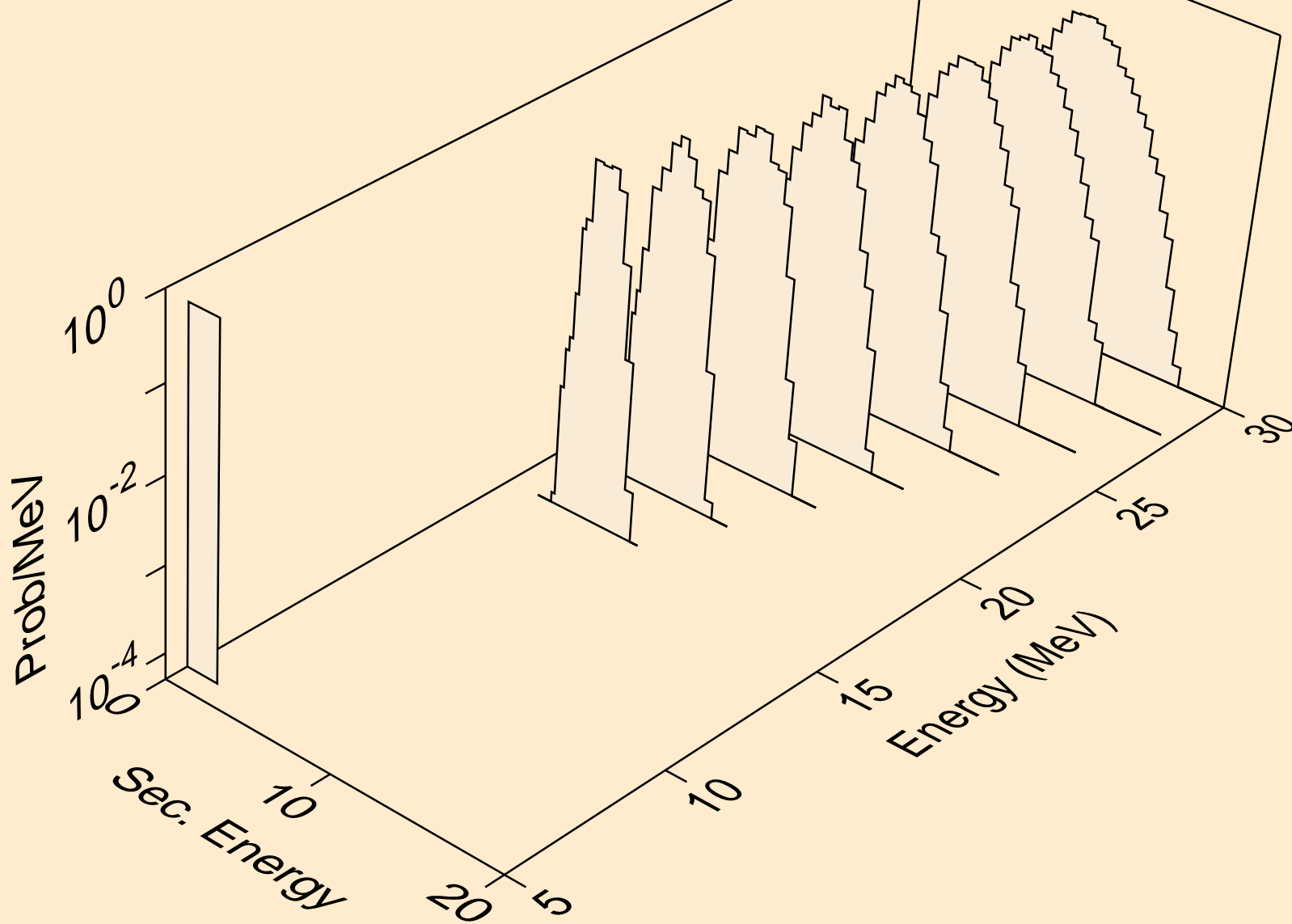



KR082 NEUTRON ACER TENDL-2019 LIBRARY; T=293.16K  
alphas from (n,pa)

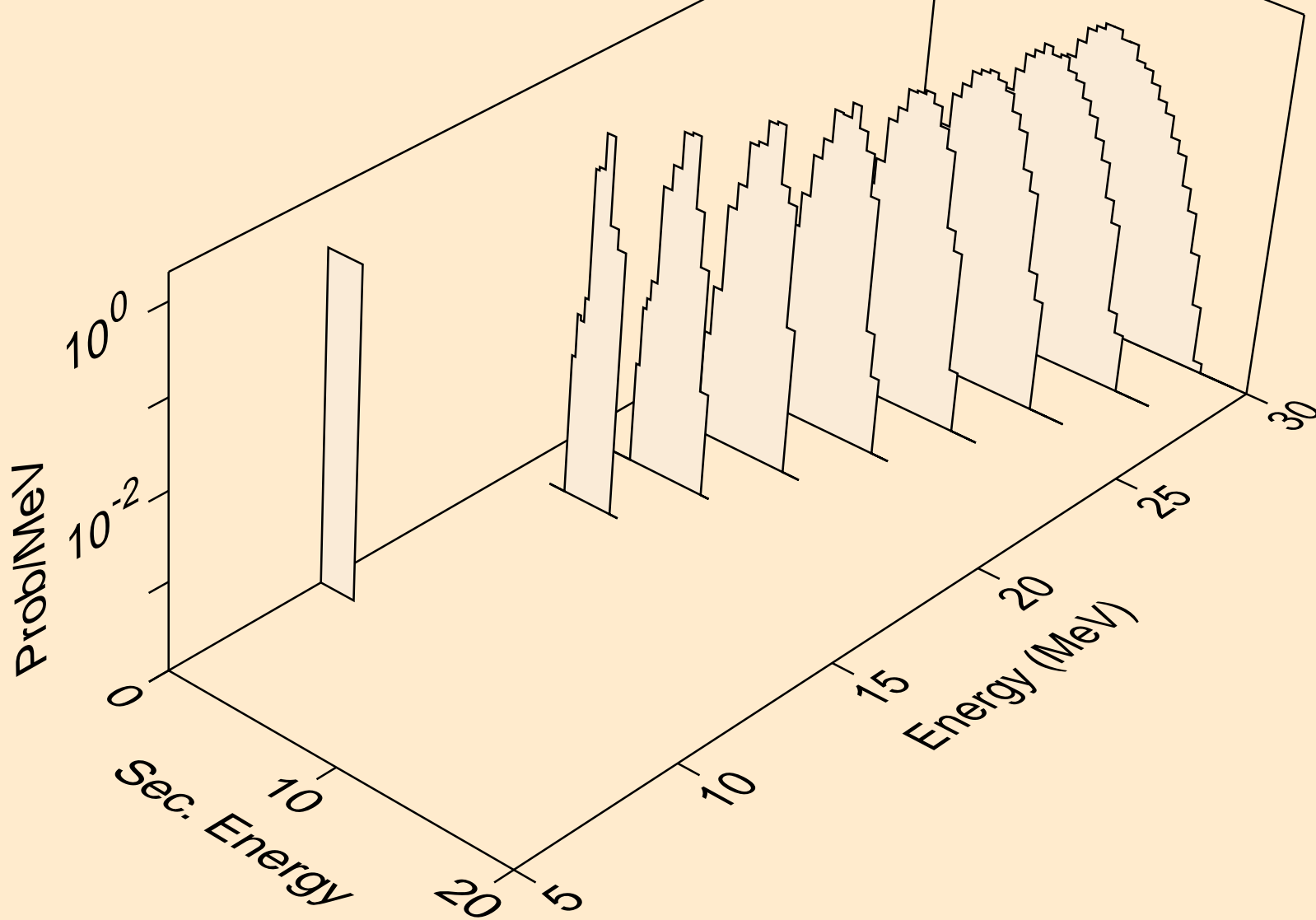

KR082 NEUTRON ACER TENDL-2019 LIBRARY; T=293.16K  
alphas from (n,da)

