

KR088 NEUTRON ACER TENDL-2019 LIBRARY; T=293.16K
Principal cross sections

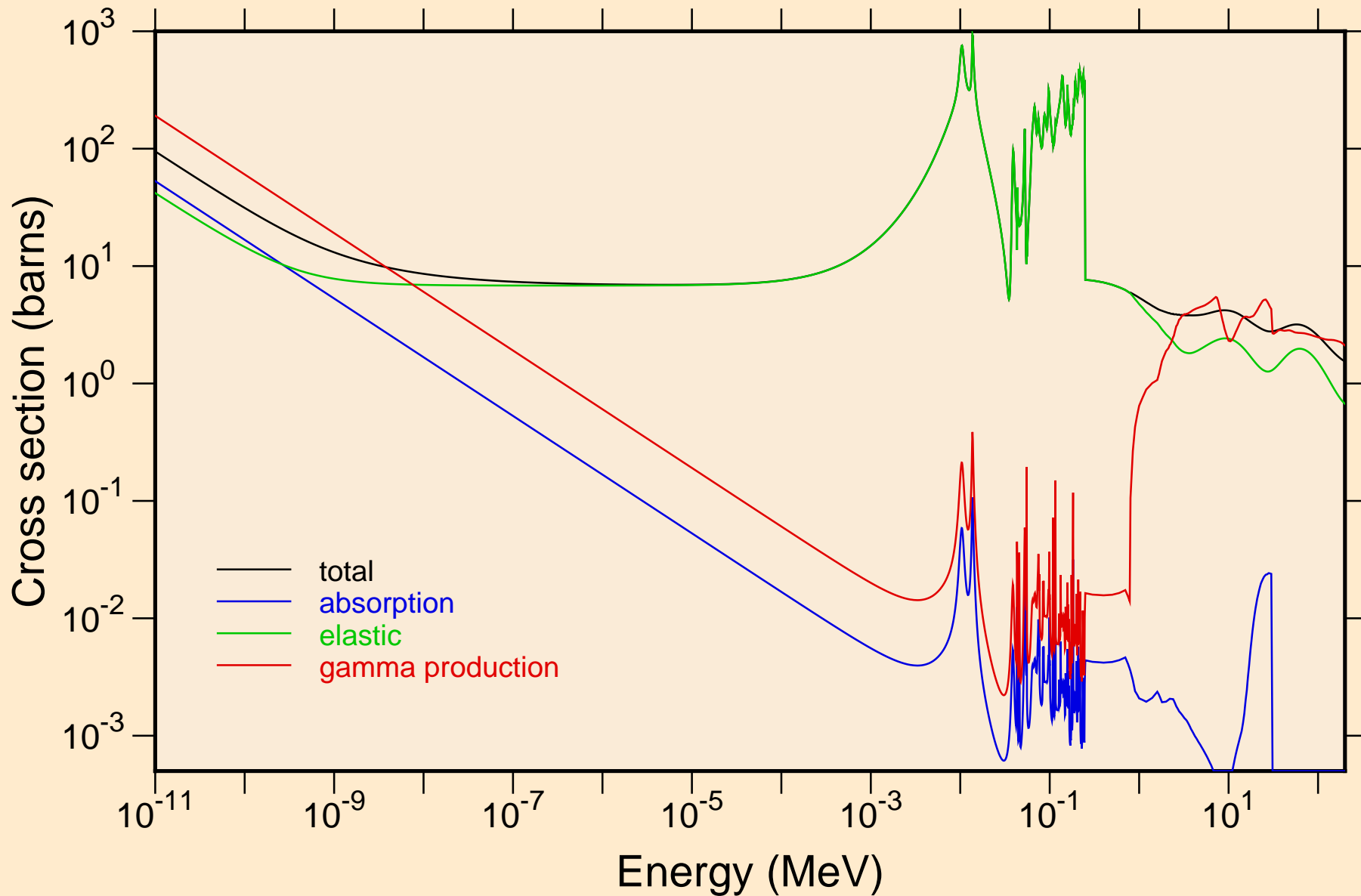

KR088 NEUTRON ACER TENDL-2019 LIBRARY; T=293.16K
resonance total cross section

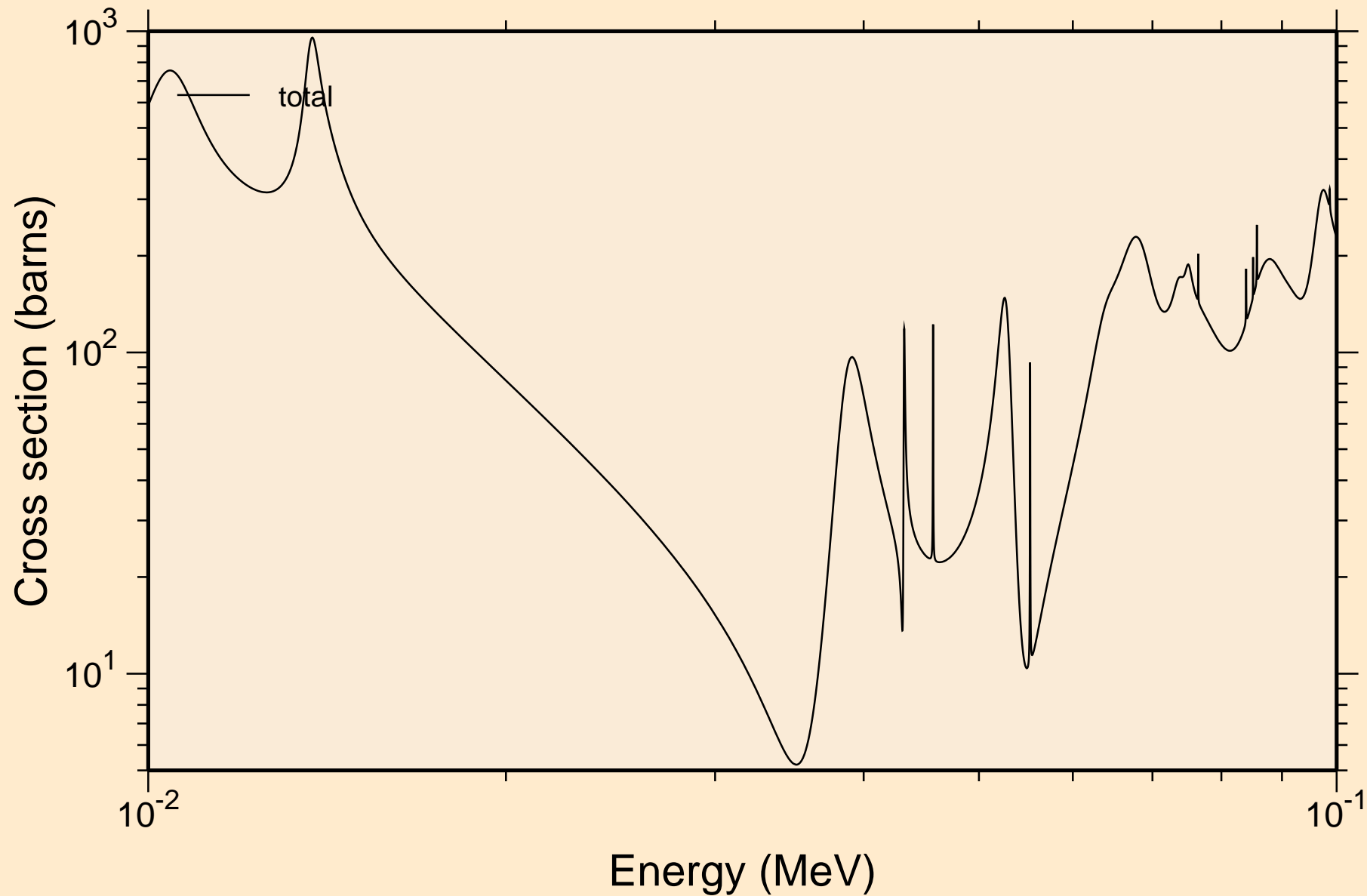

KR088 NEUTRON ACER TENDL-2019 LIBRARY; T=293.16K
resonance total cross section

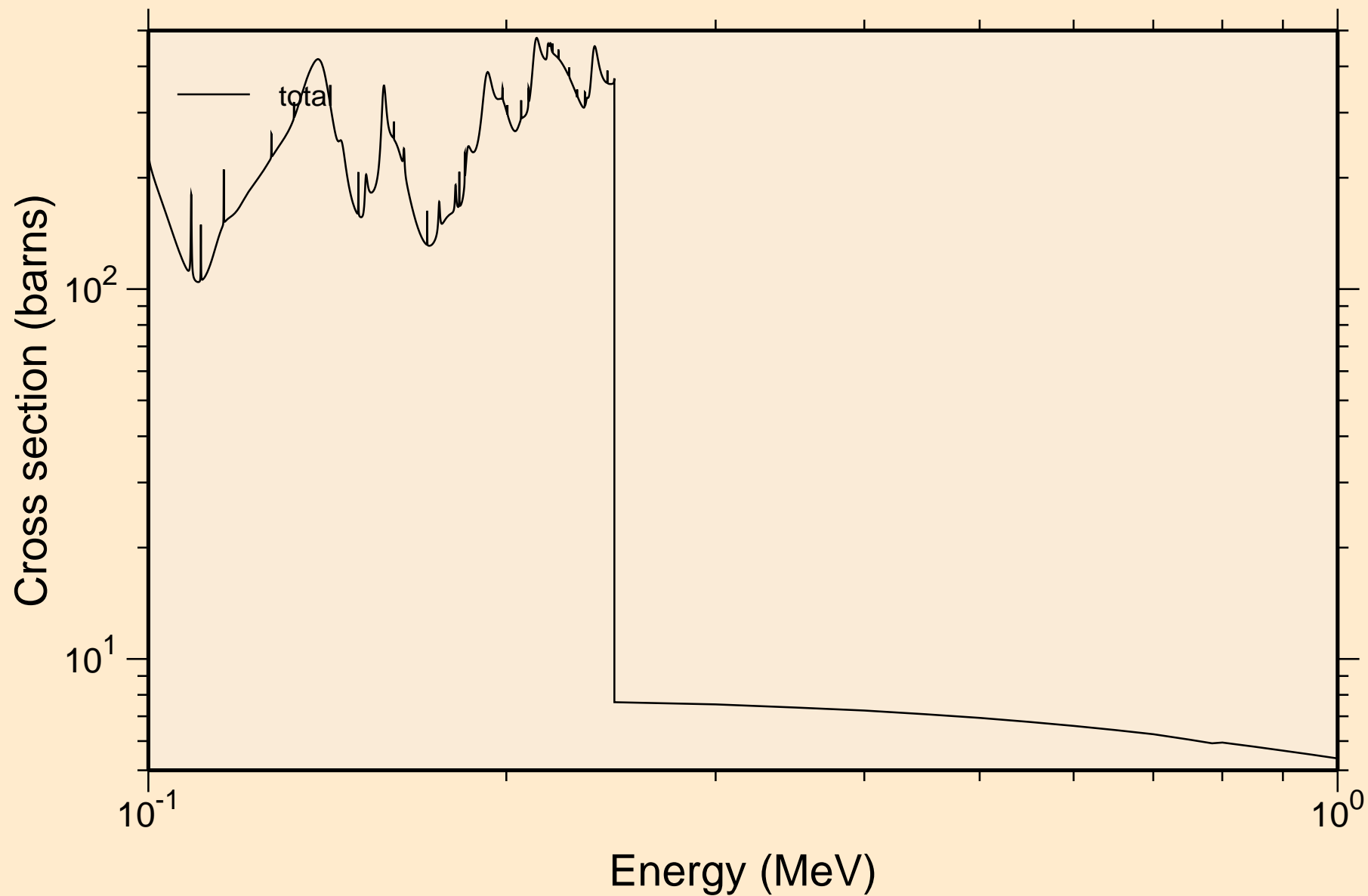

KR088 NEUTRON ACER TENDL-2019 LIBRARY; T=293.16K
resonance total cross section

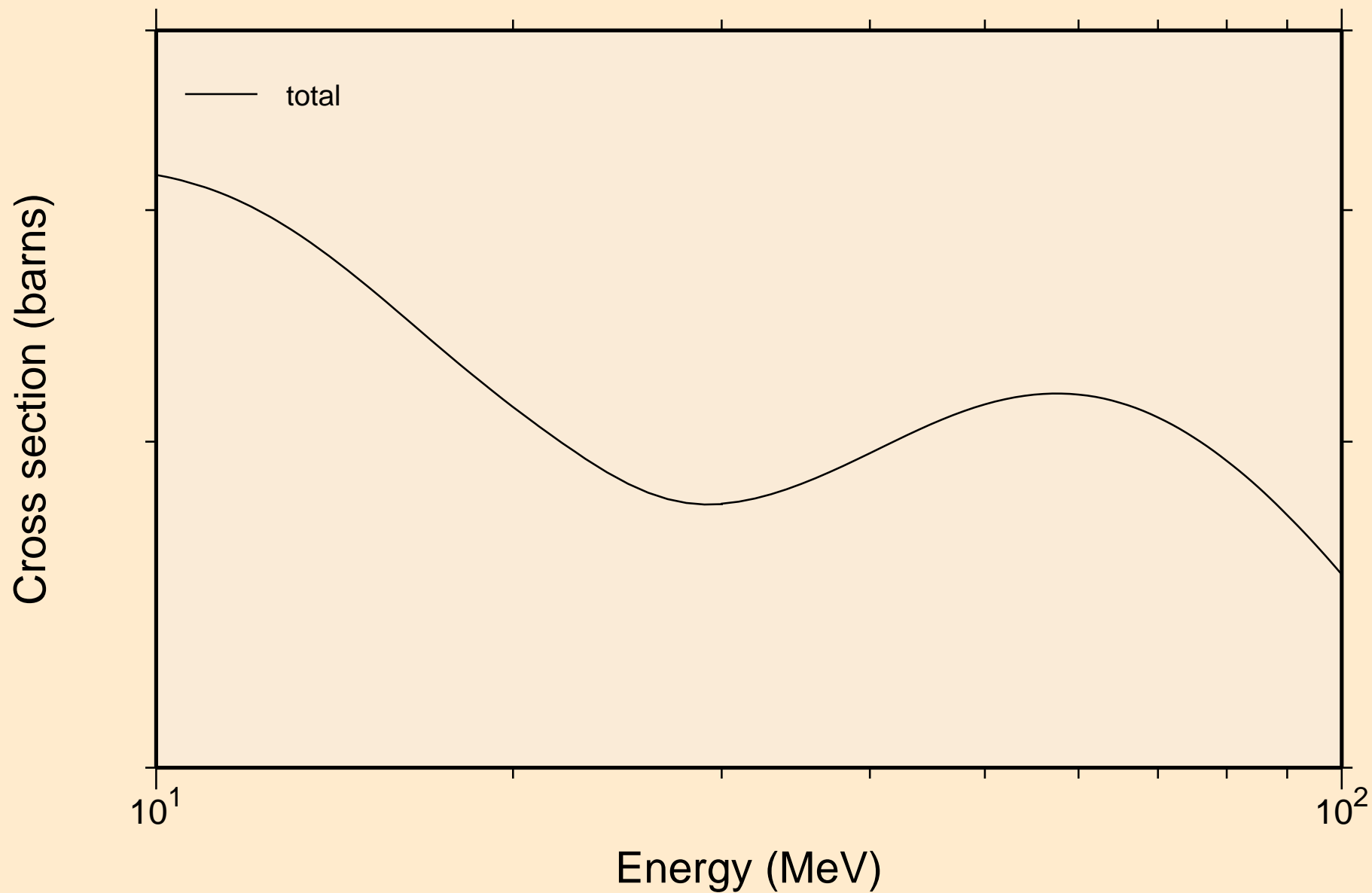

KR088 NEUTRON ACER TENDL-2019 LIBRARY; T=293.16K
resonance absorption cross sections

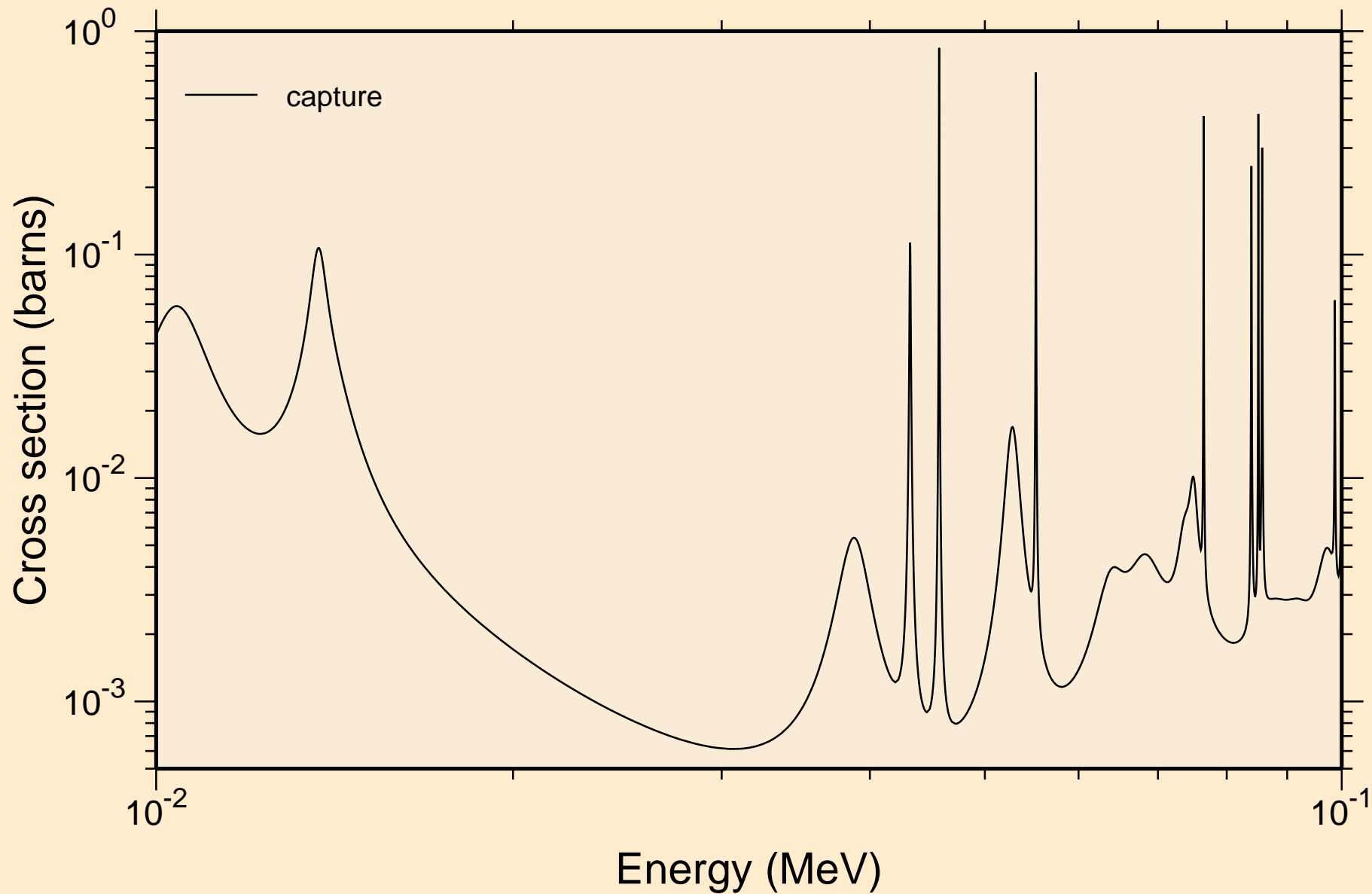

KR088 NEUTRON ACER TENDL-2019 LIBRARY; T=293.16K
resonance absorption cross sections

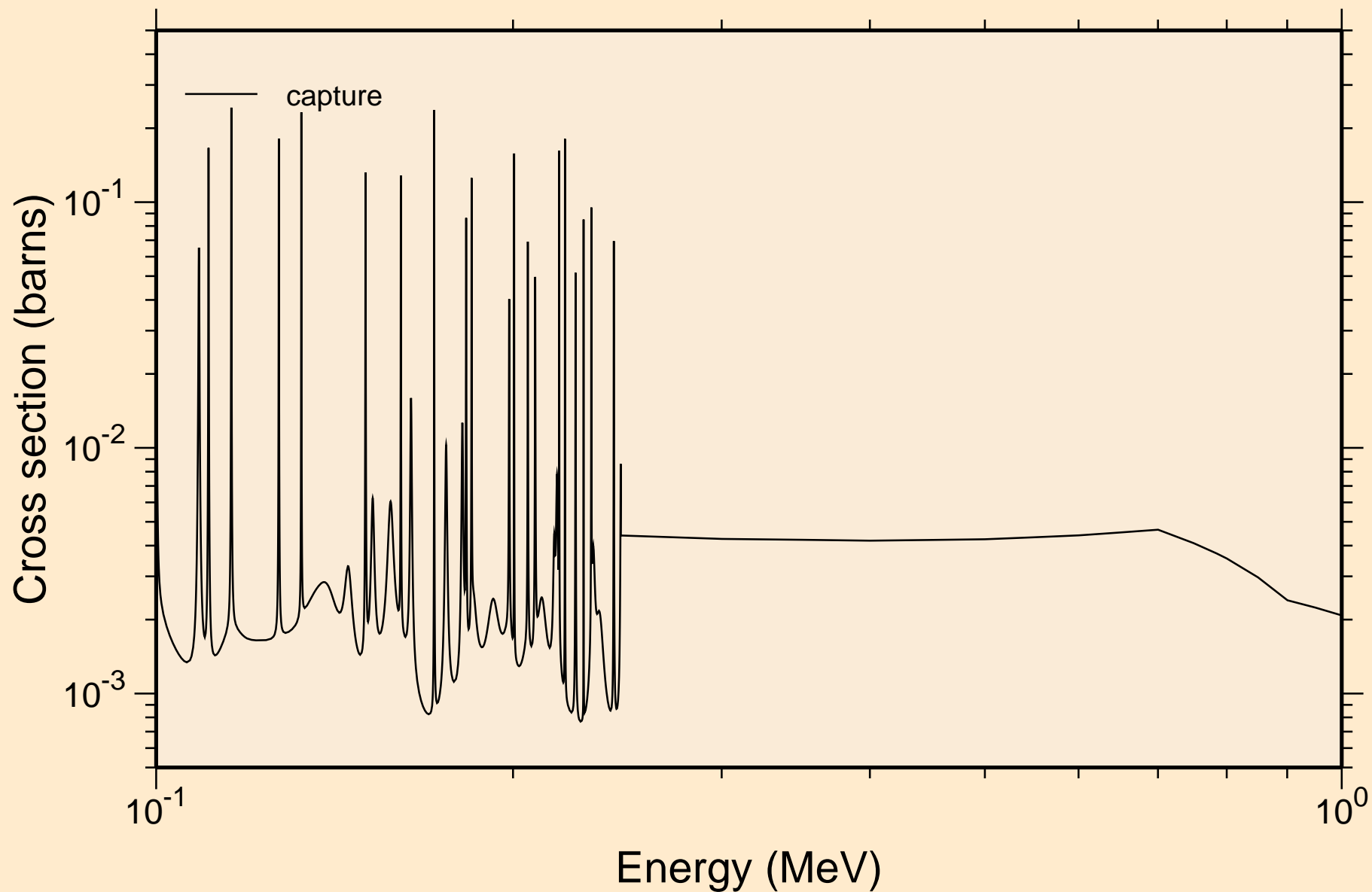

KR088 NEUTRON ACER TENDL-2019 LIBRARY; T=293.16K
resonance absorption cross sections

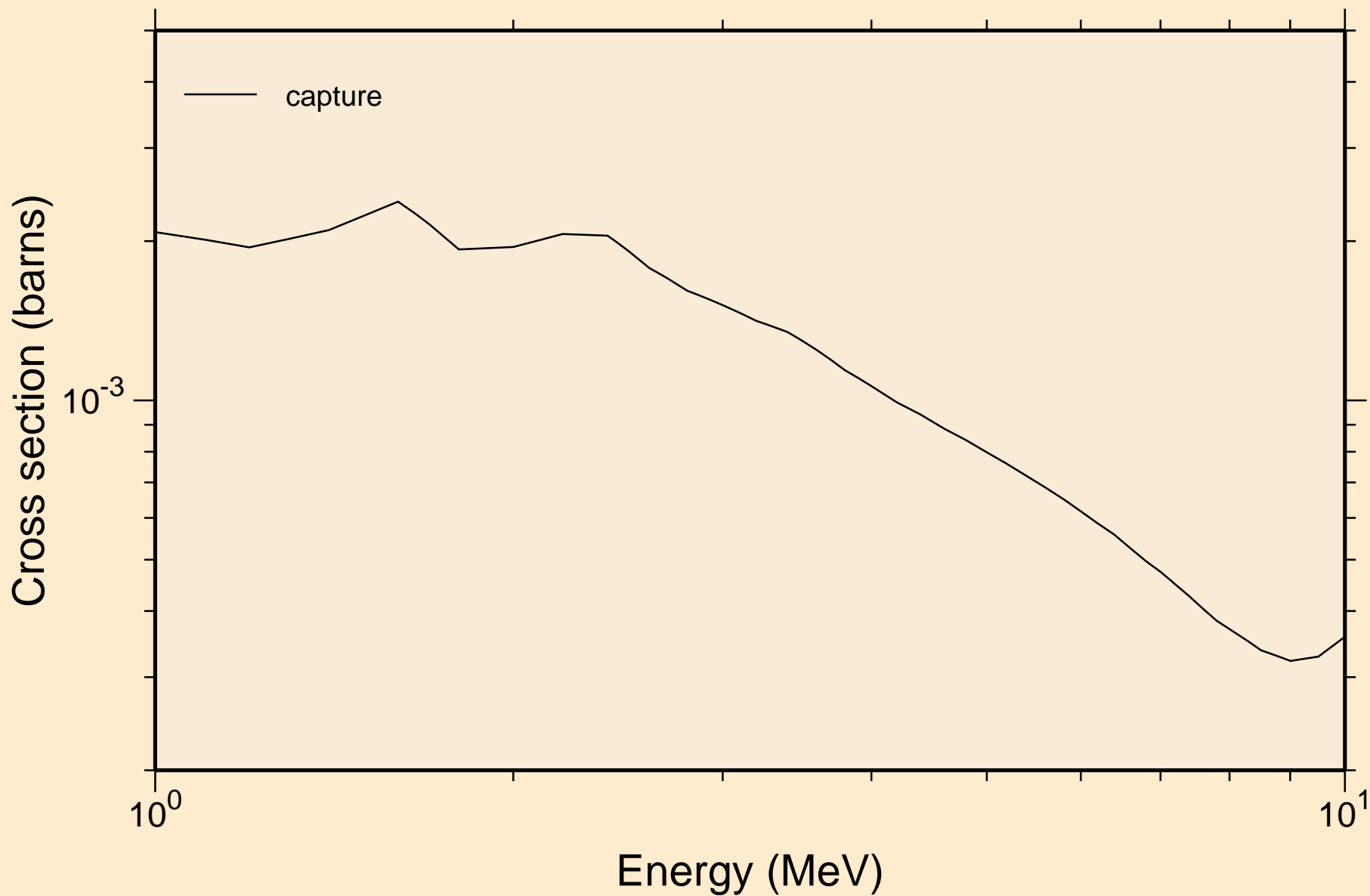

KR088 NEUTRON ACER TENDL-2019 LIBRARY; T=293.16K
Heating

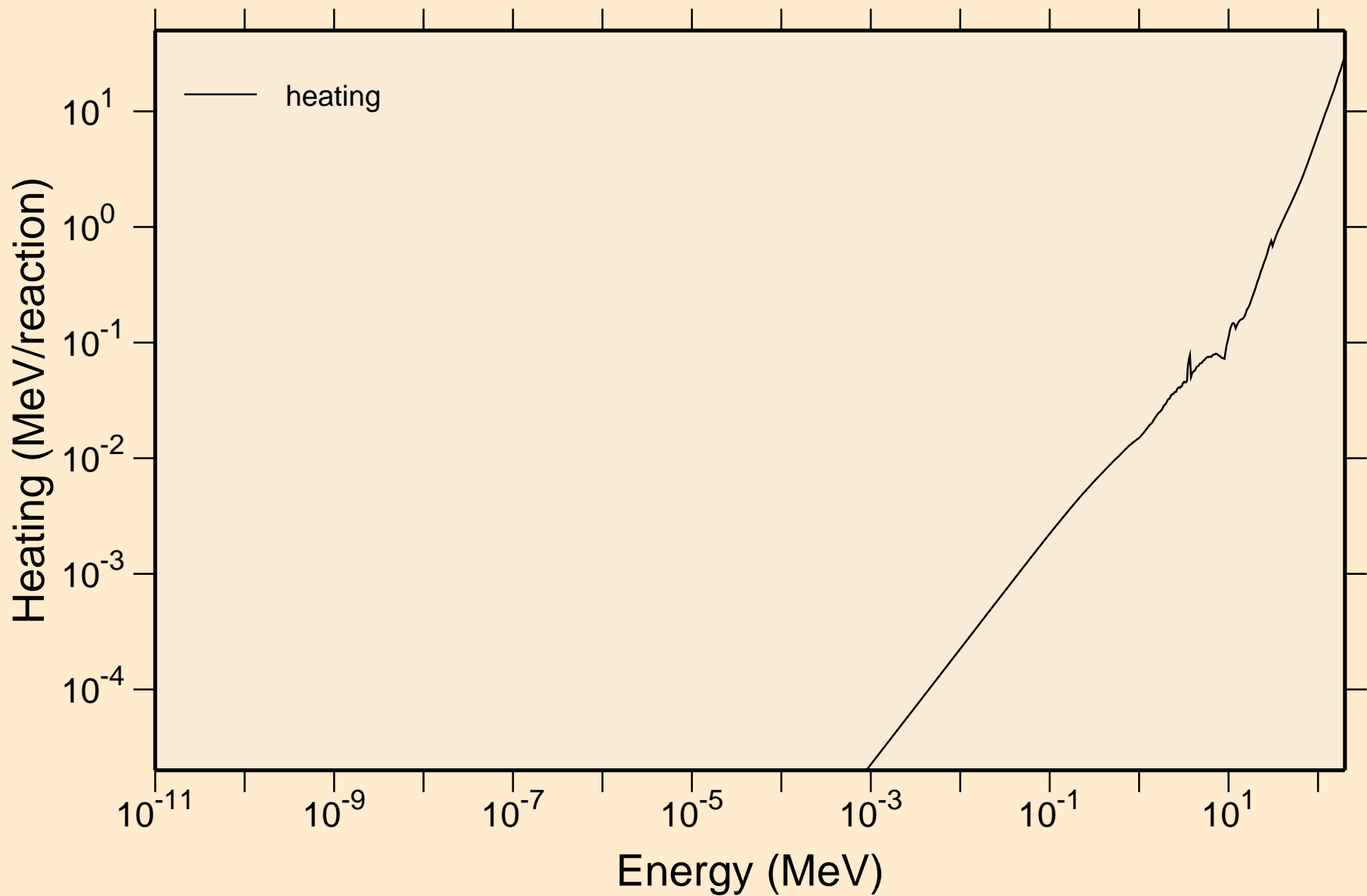

KR088 NEUTRON ACER TENDL-2019 LIBRARY; T=293.16K
Damage

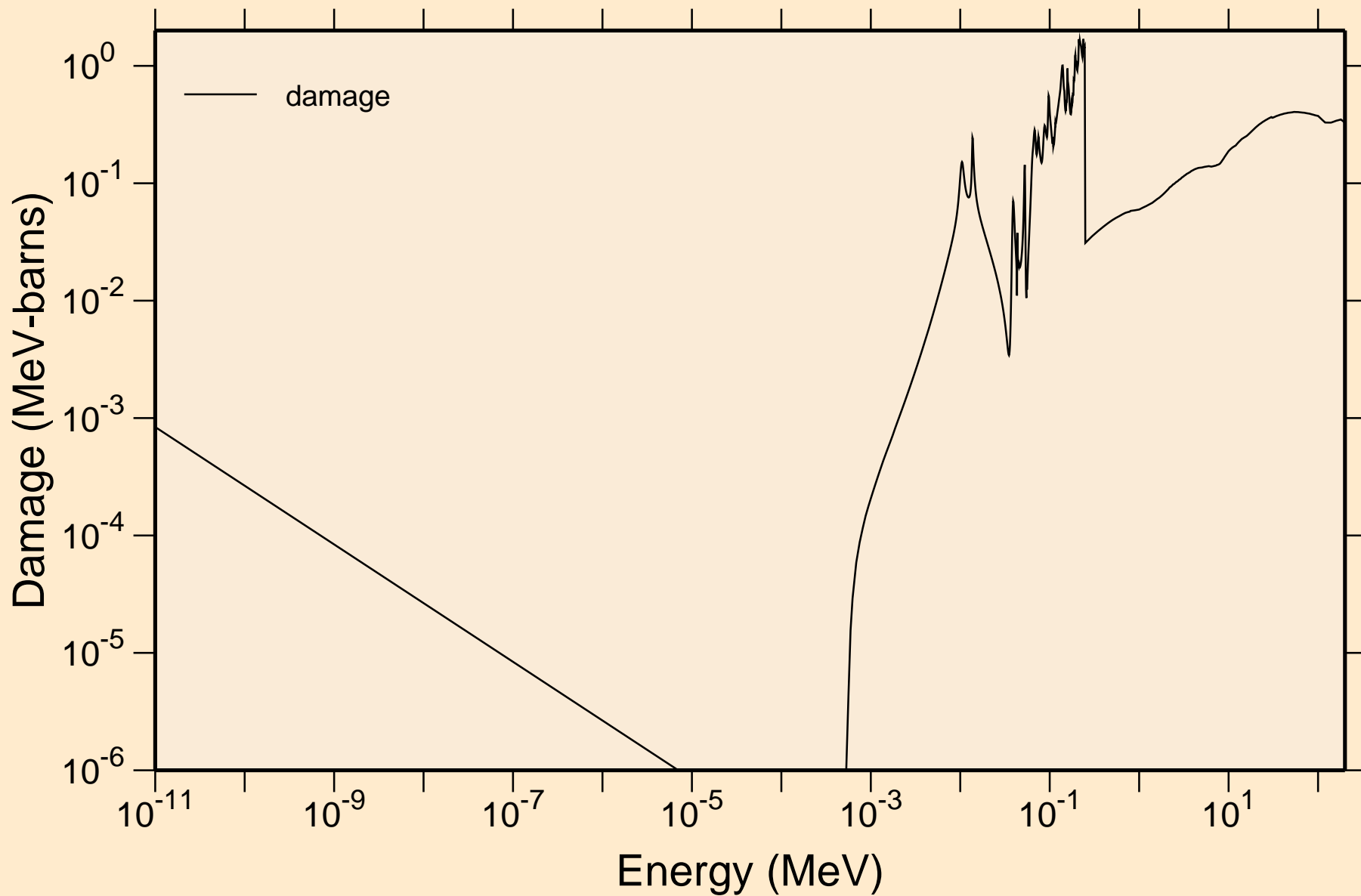

KR088 NEUTRON ACER TENDL-2019 LIBRARY; T=293.16K
Non-threshold reactions

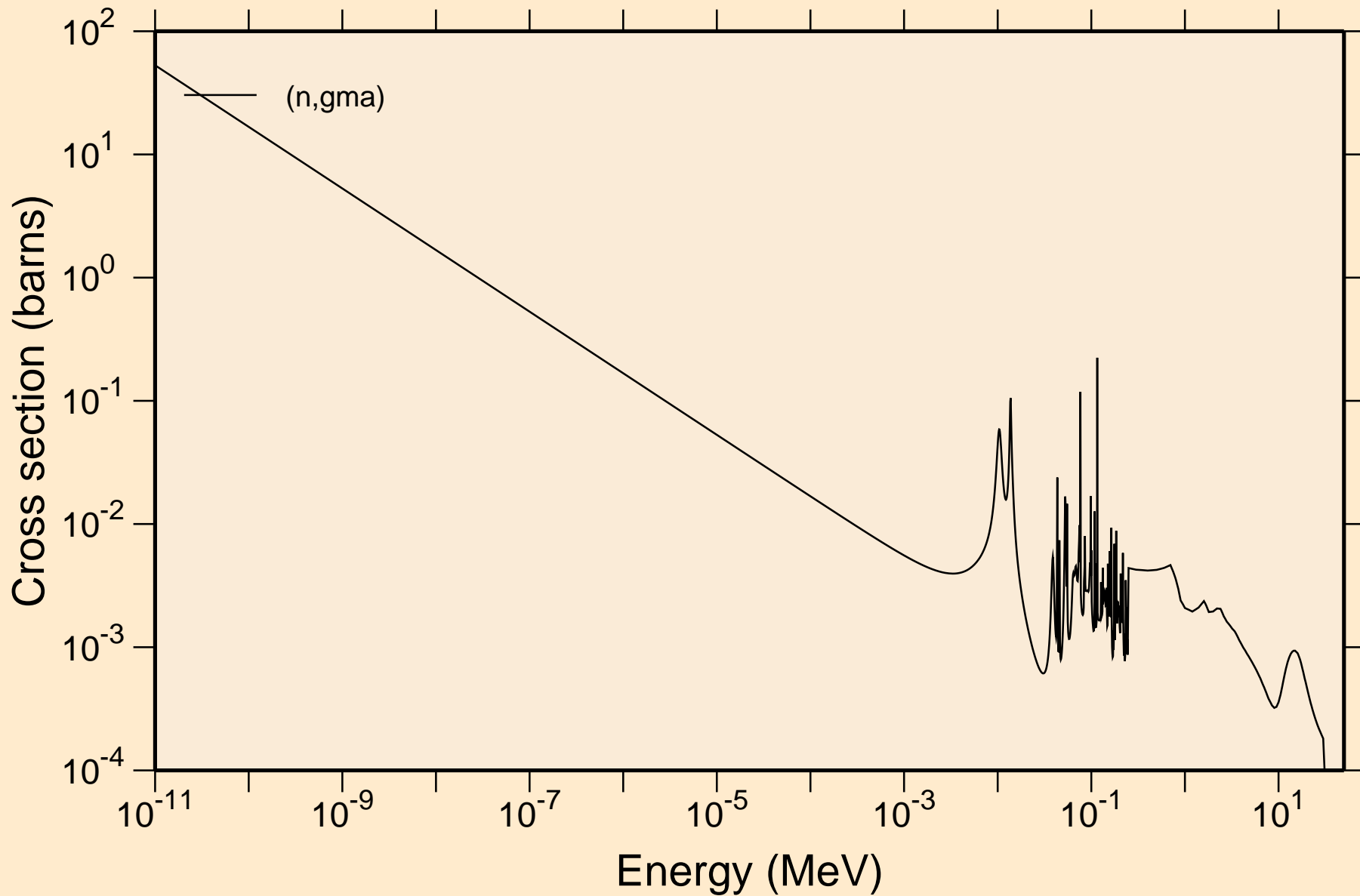

KR088 NEUTRON ACER TENDL-2019 LIBRARY; T=293.16K
Principal cross sections

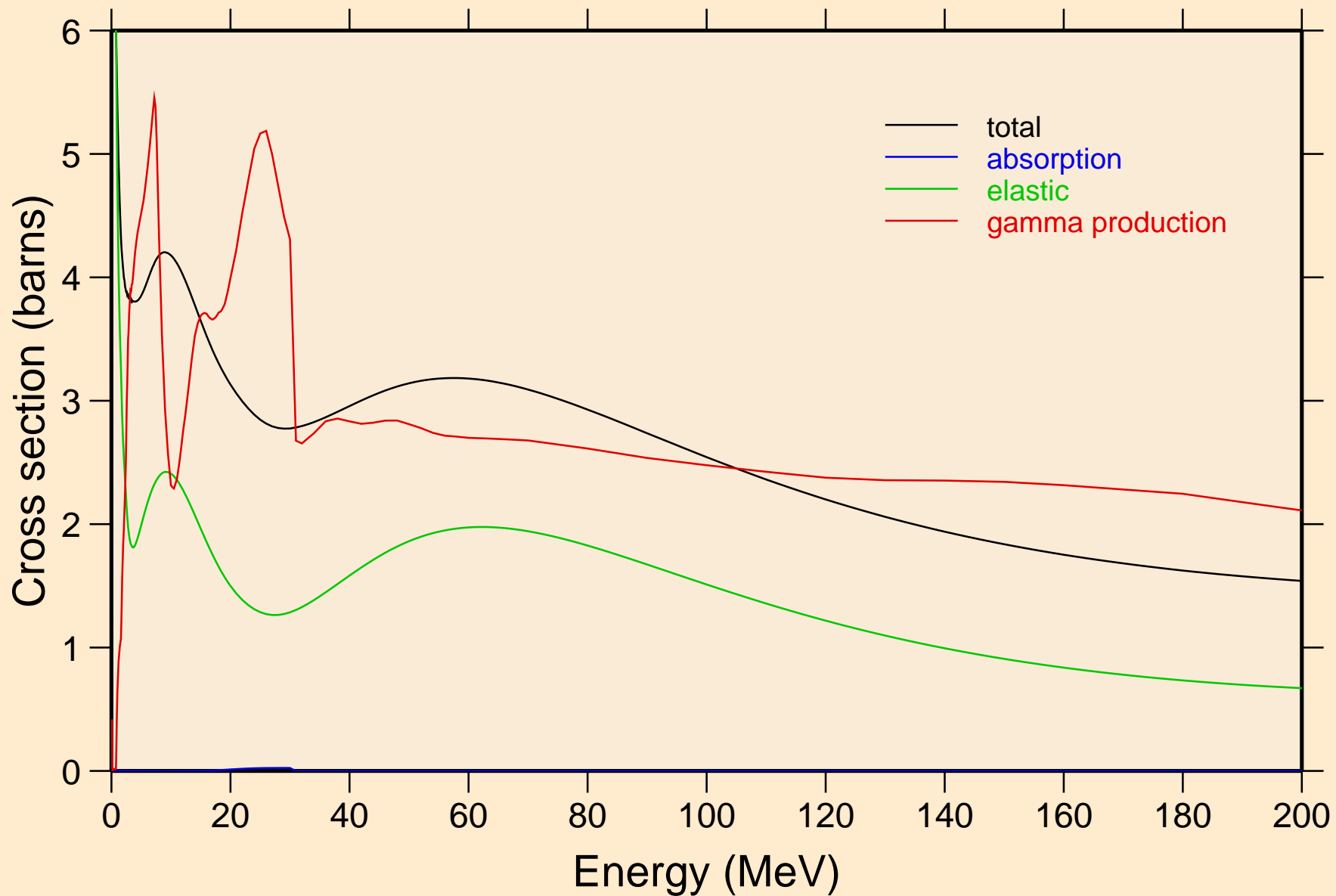

KR088 NEUTRON ACER TENDL-2019 LIBRARY; T=293.16K
Heating

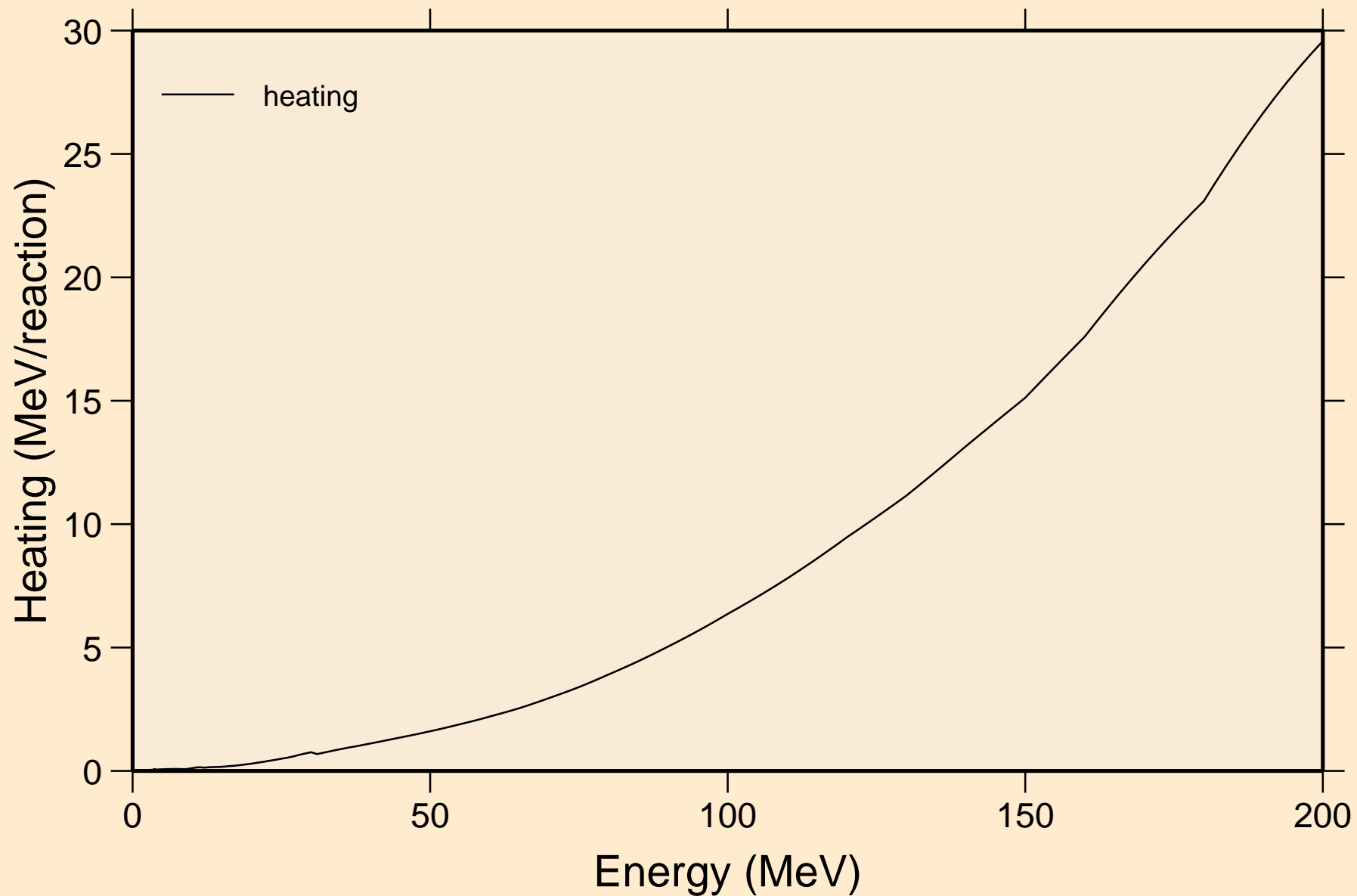

KR088 NEUTRON ACER TENDL-2019 LIBRARY; T=293.16K
Damage

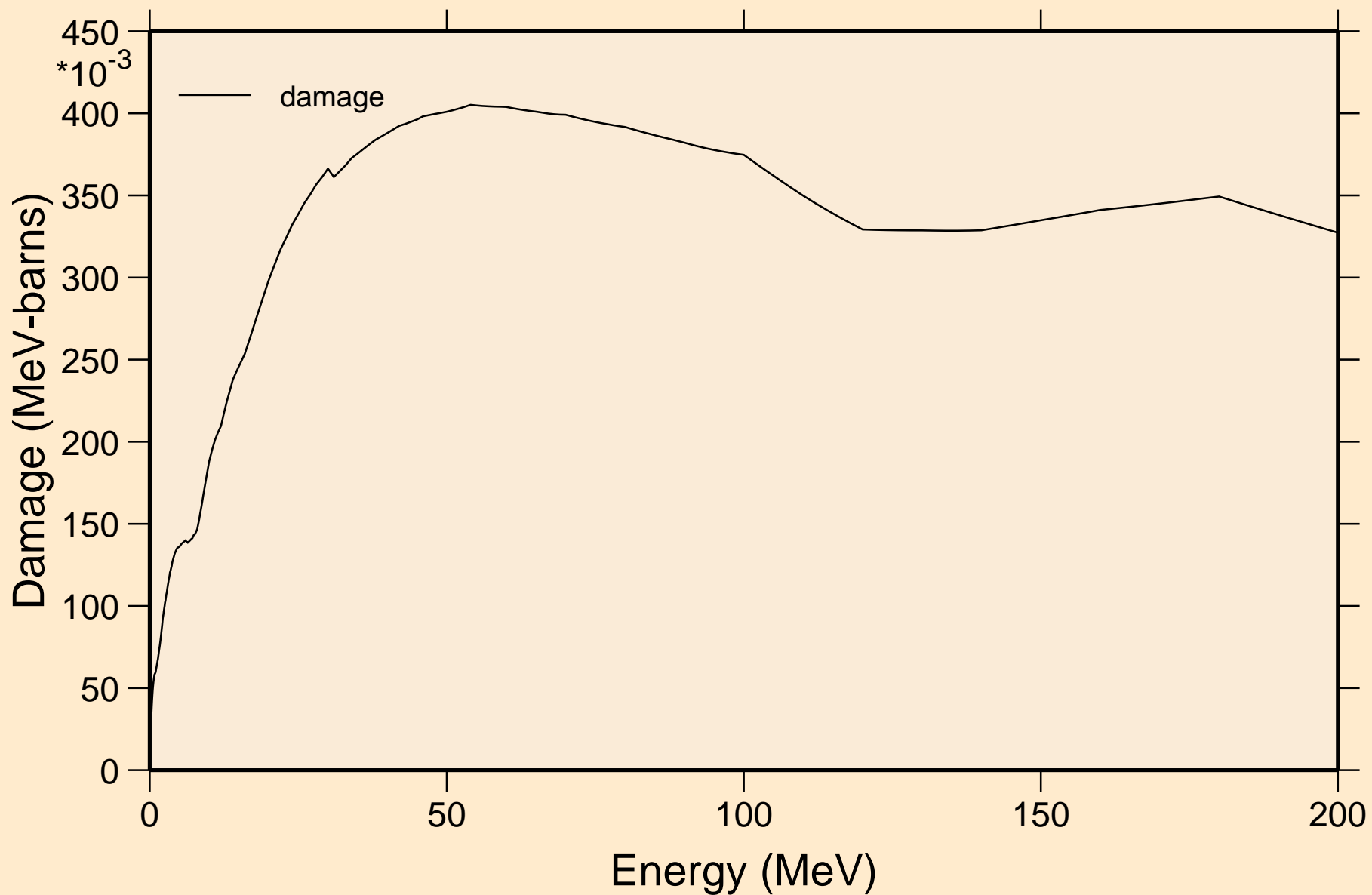

KR088 NEUTRON ACER TENDL-2019 LIBRARY; T=293.16K
Non-threshold reactions

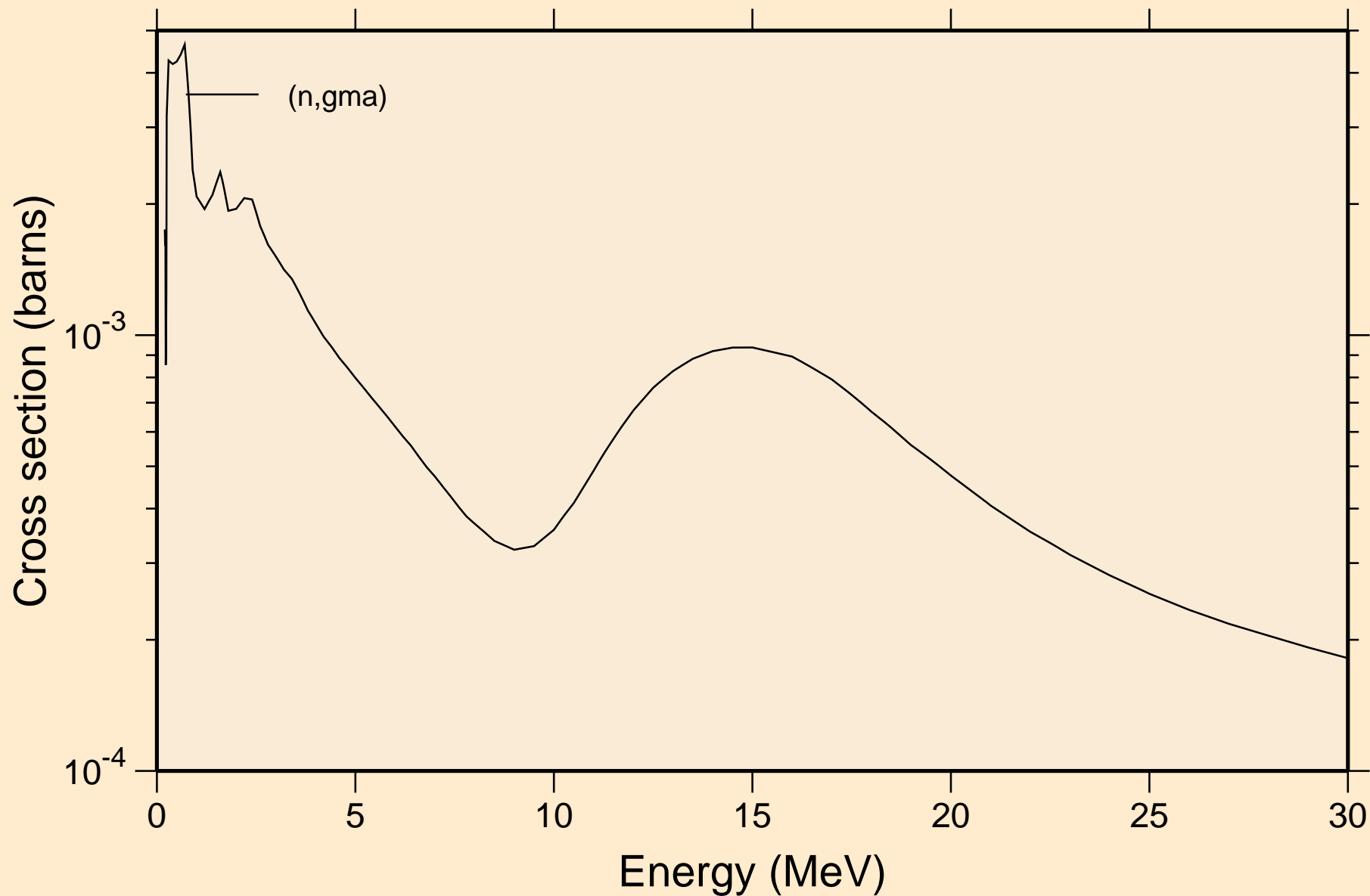

KR088 NEUTRON ACER TENDL-2019 LIBRARY; T=293.16K
Inelastic levels

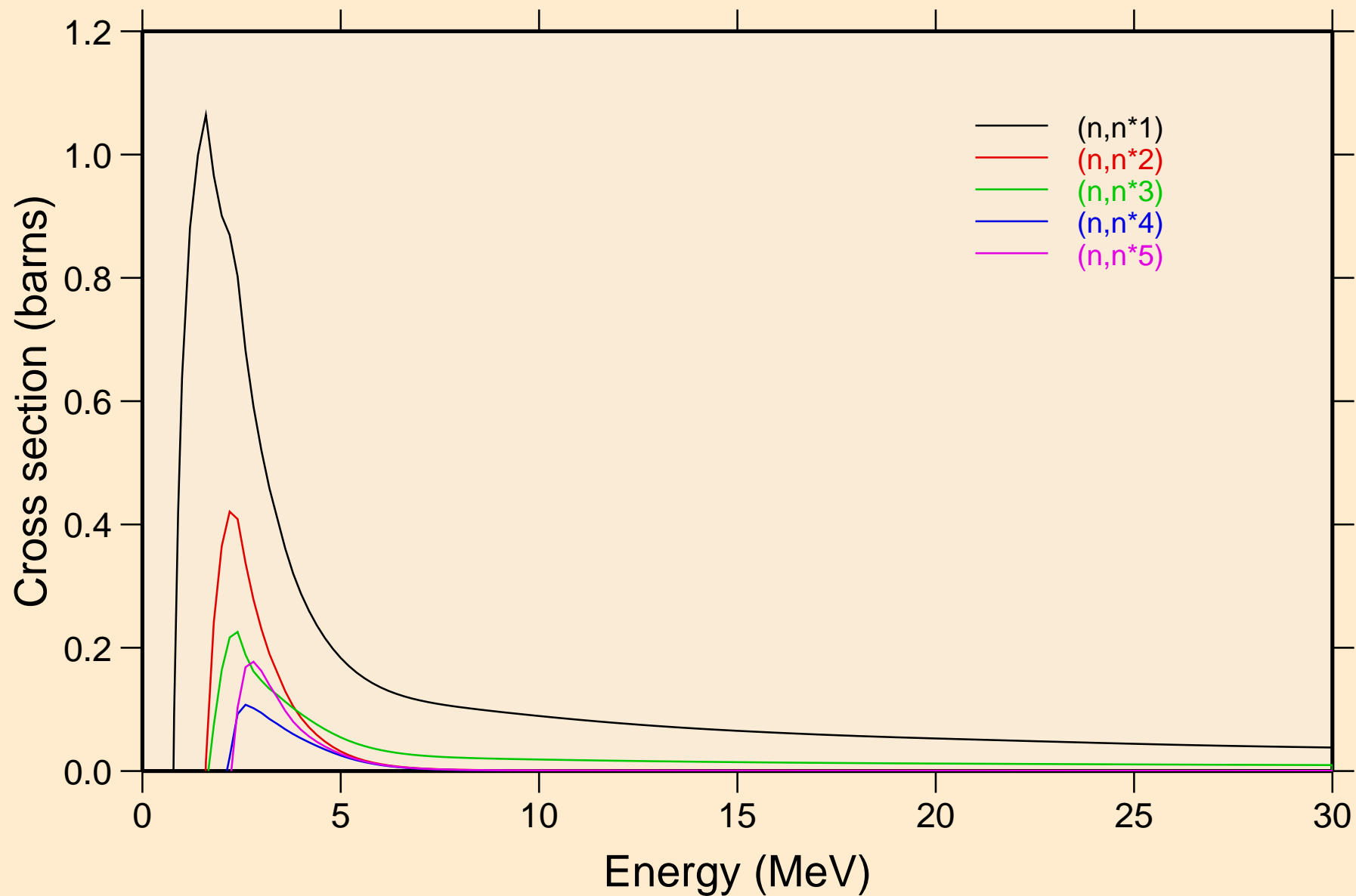

KR088 NEUTRON ACER TENDL-2019 LIBRARY; T=293.16K
Inelastic levels

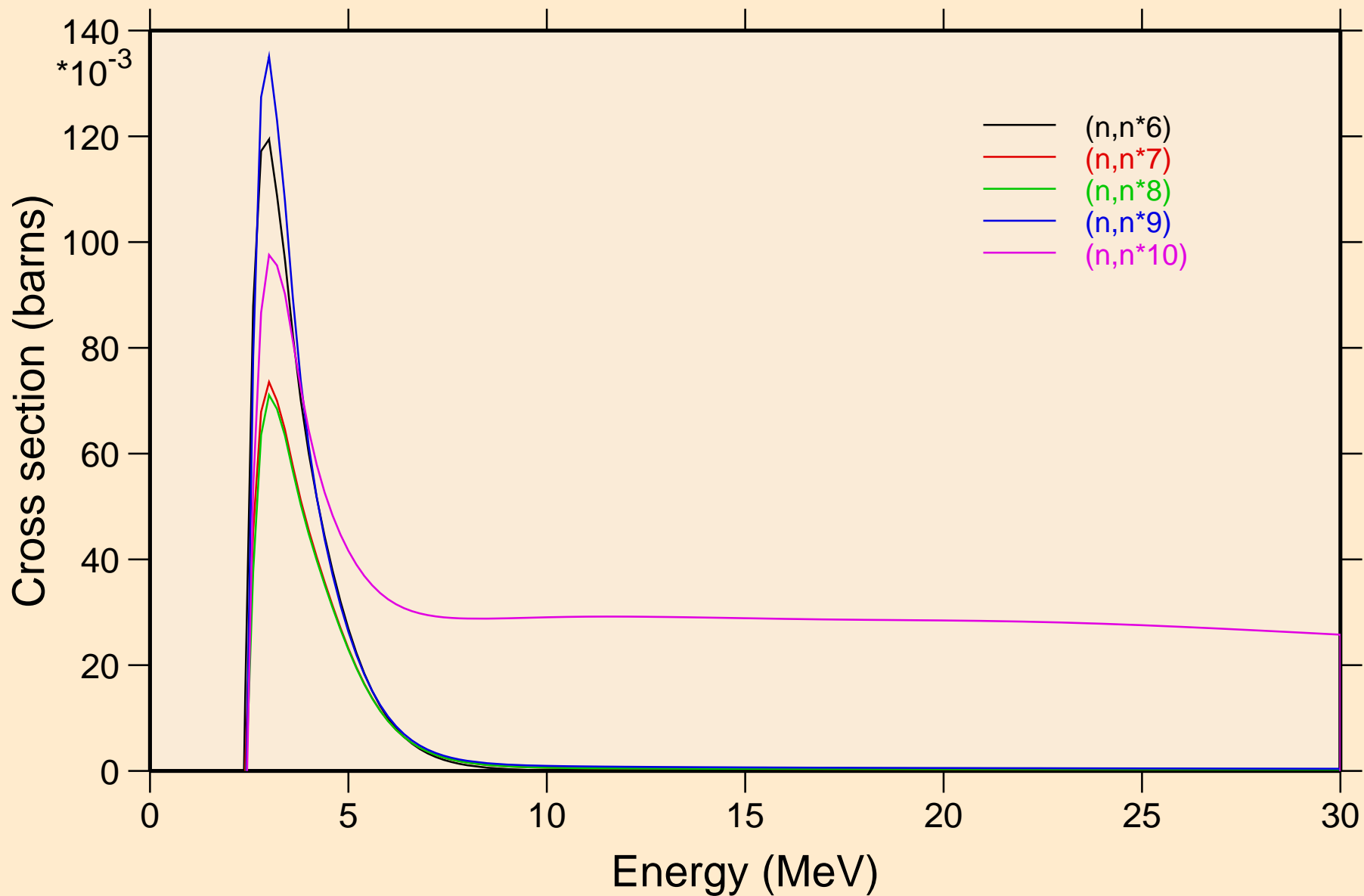

KR088 NEUTRON ACER TENDL-2019 LIBRARY; T=293.16K
Inelastic levels

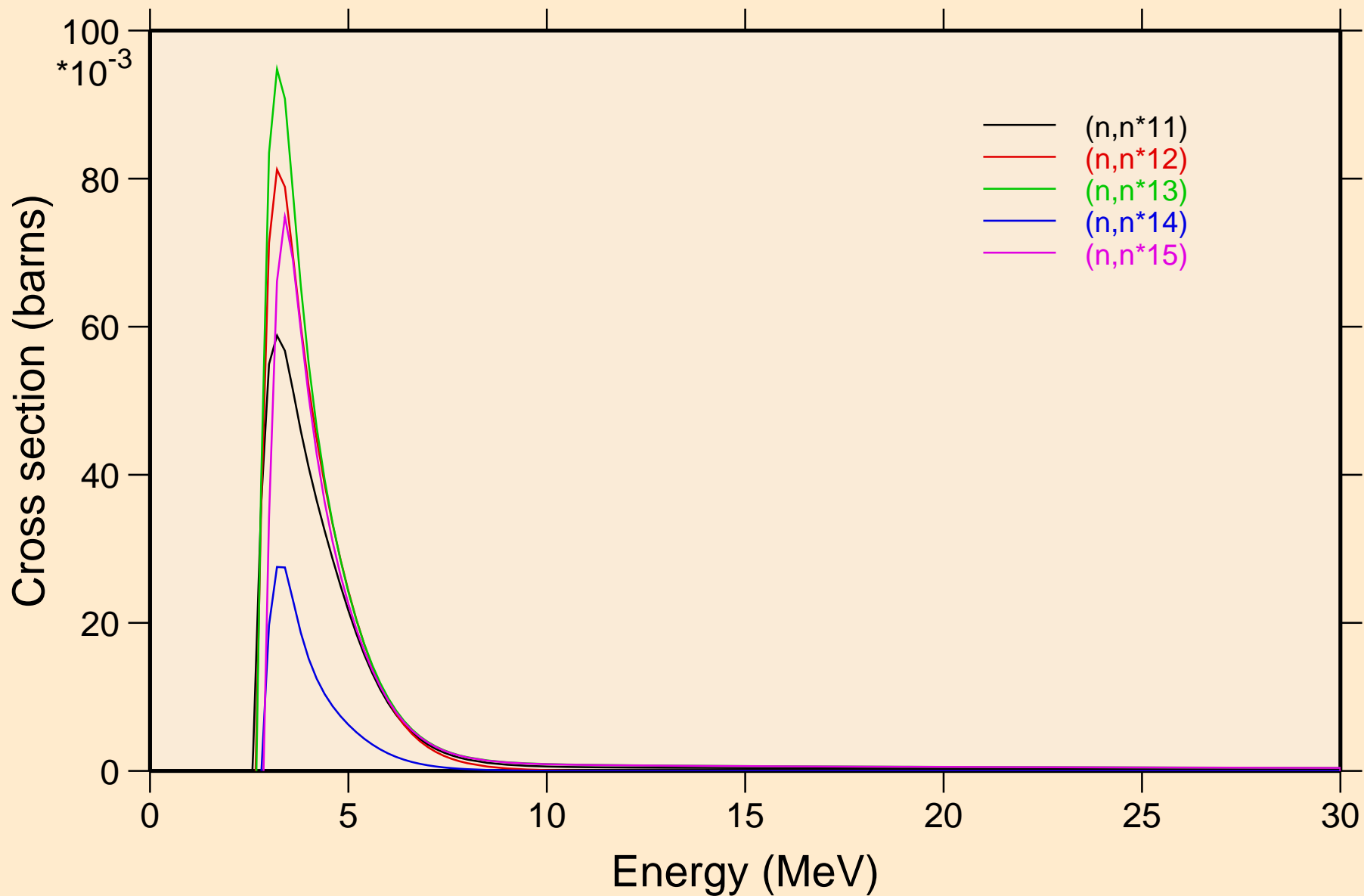

KR088 NEUTRON ACER TENDL-2019 LIBRARY; T=293.16K
Inelastic levels

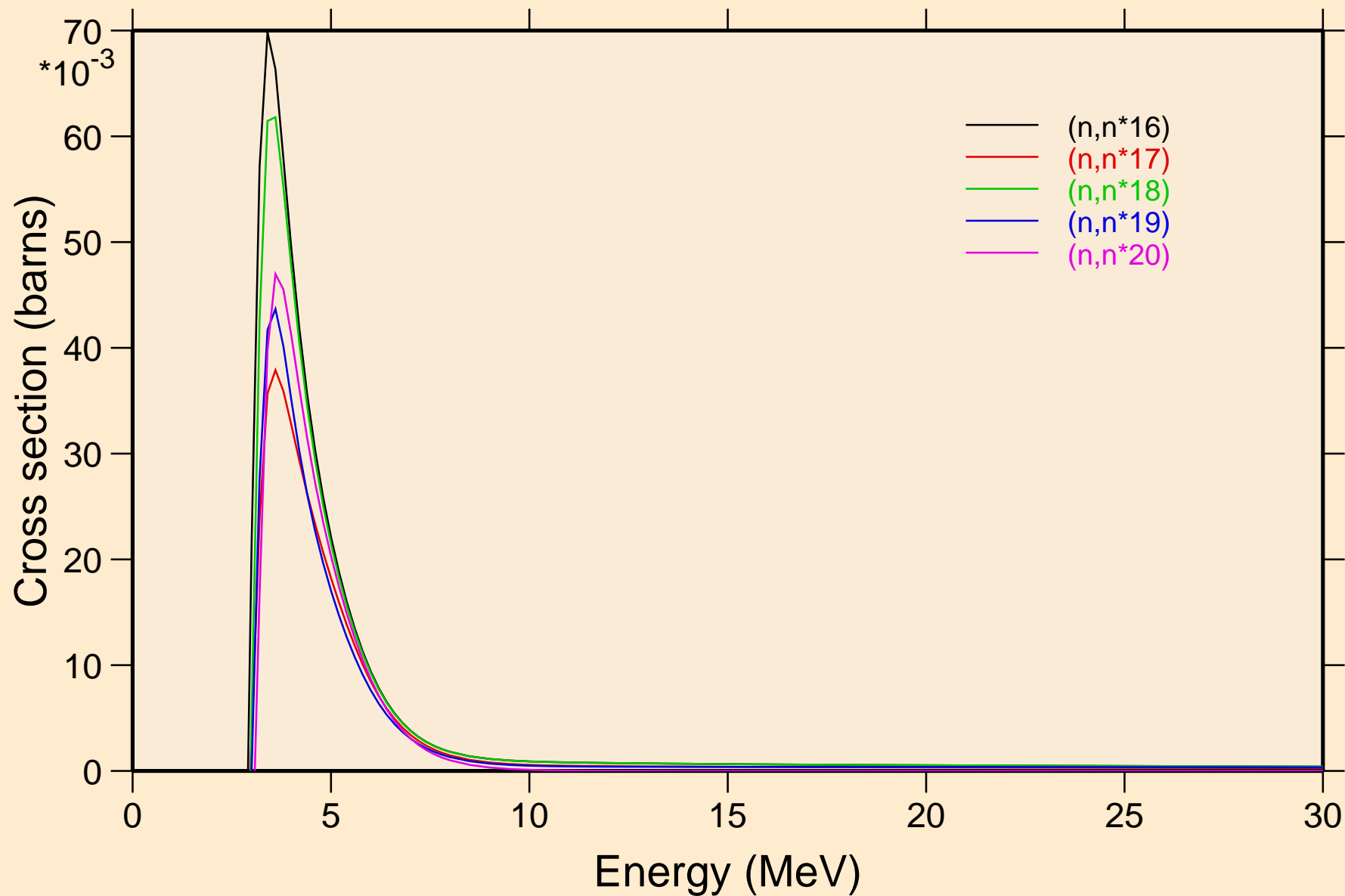

KR088 NEUTRON ACER TENDL-2019 LIBRARY; T=293.16K
Inelastic levels

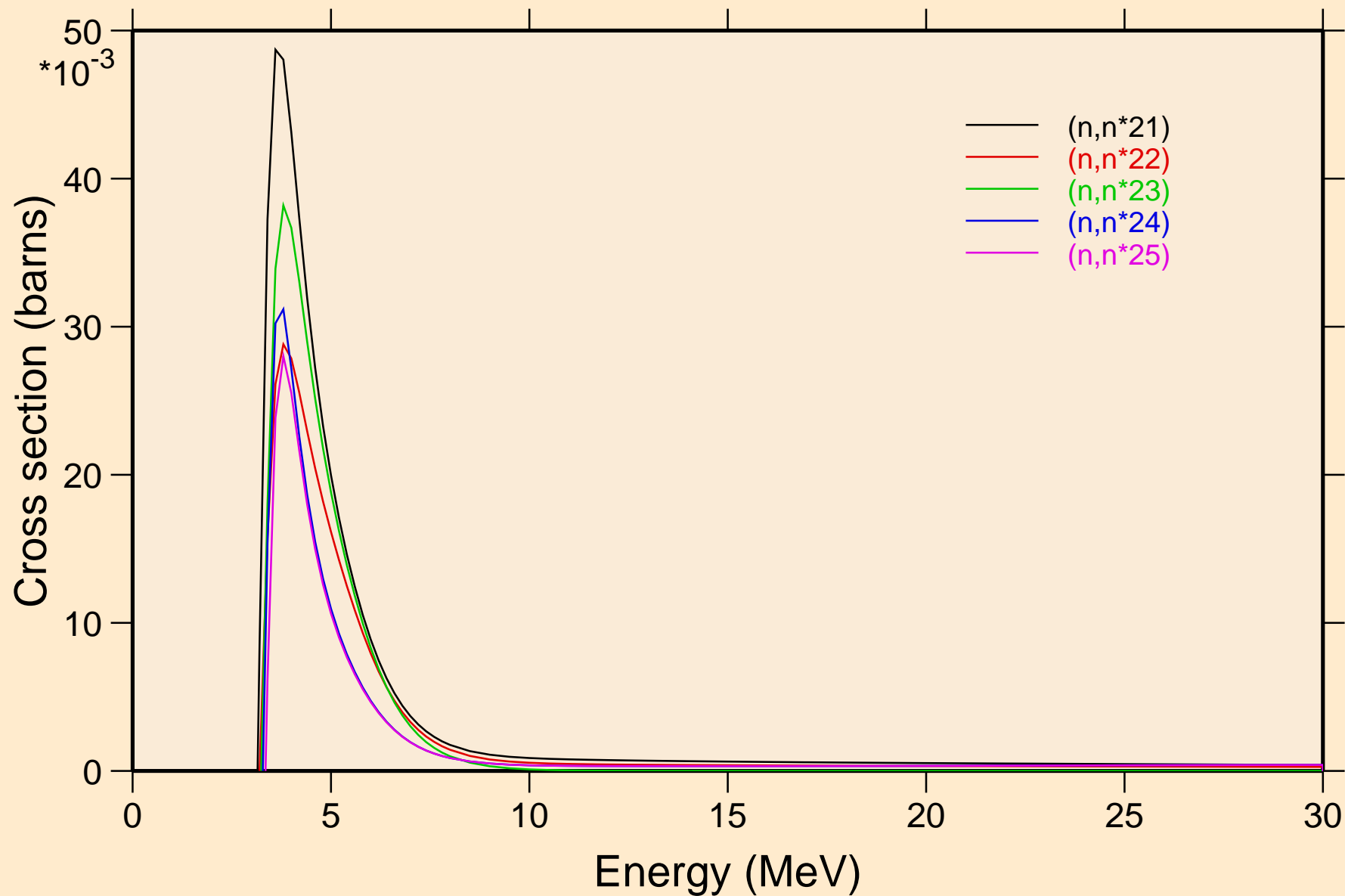

KR088 NEUTRON ACER TENDL-2019 LIBRARY; T=293.16K
Inelastic levels

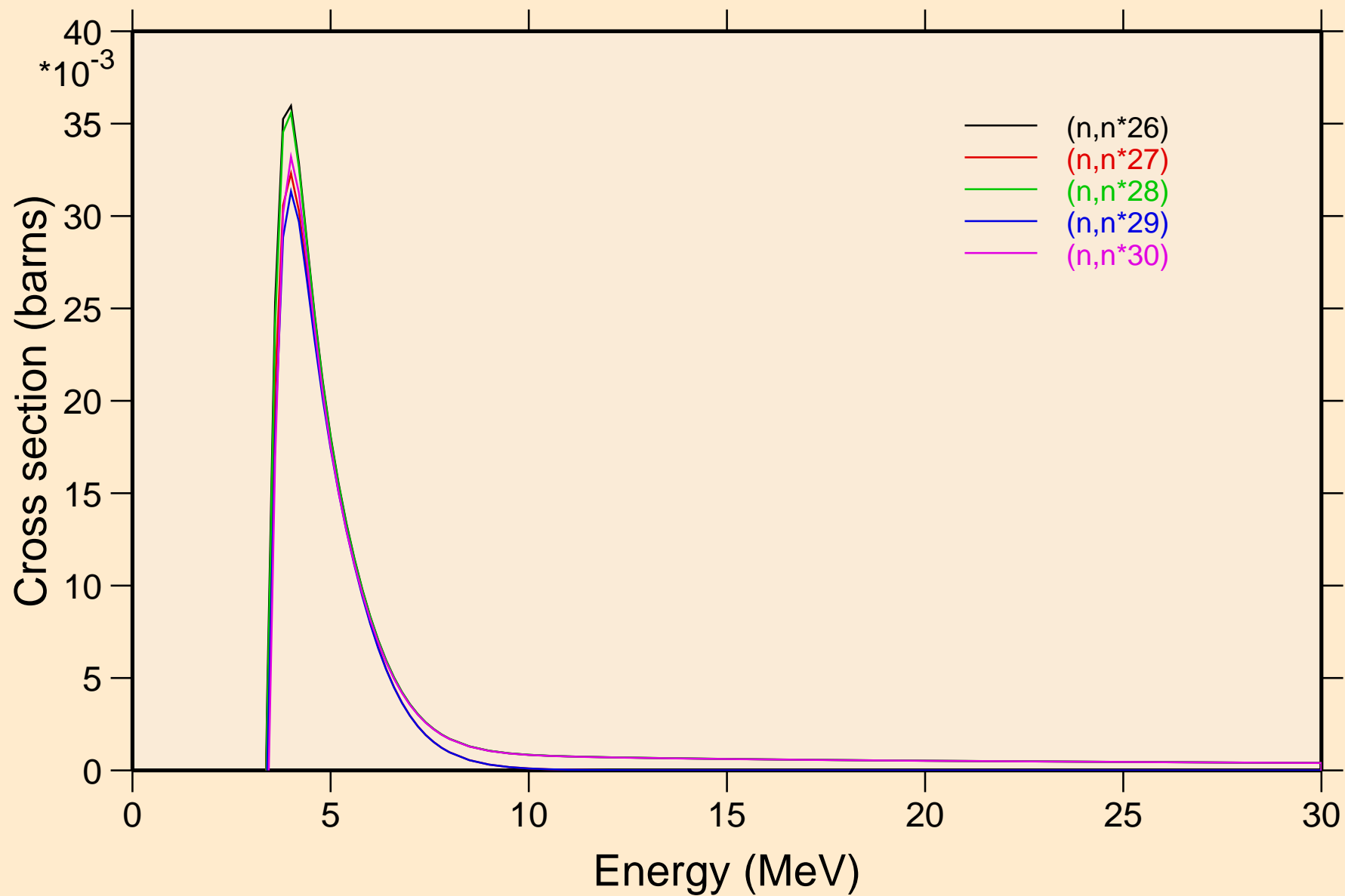

KR088 NEUTRON ACER TENDL-2019 LIBRARY; T=293.16K
Threshold reactions

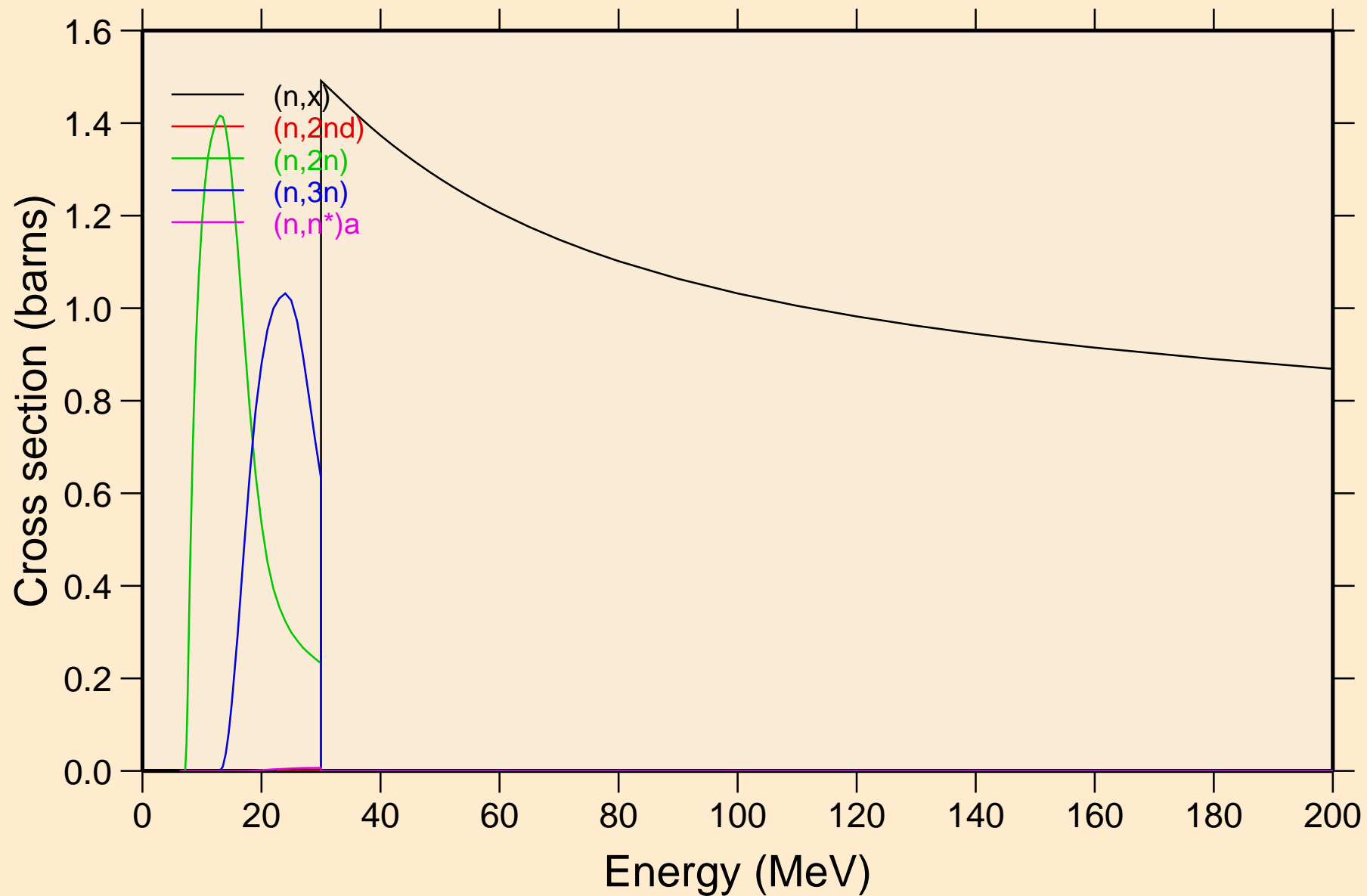

KR088 NEUTRON ACER TENDL-2019 LIBRARY; T=293.16K
Threshold reactions

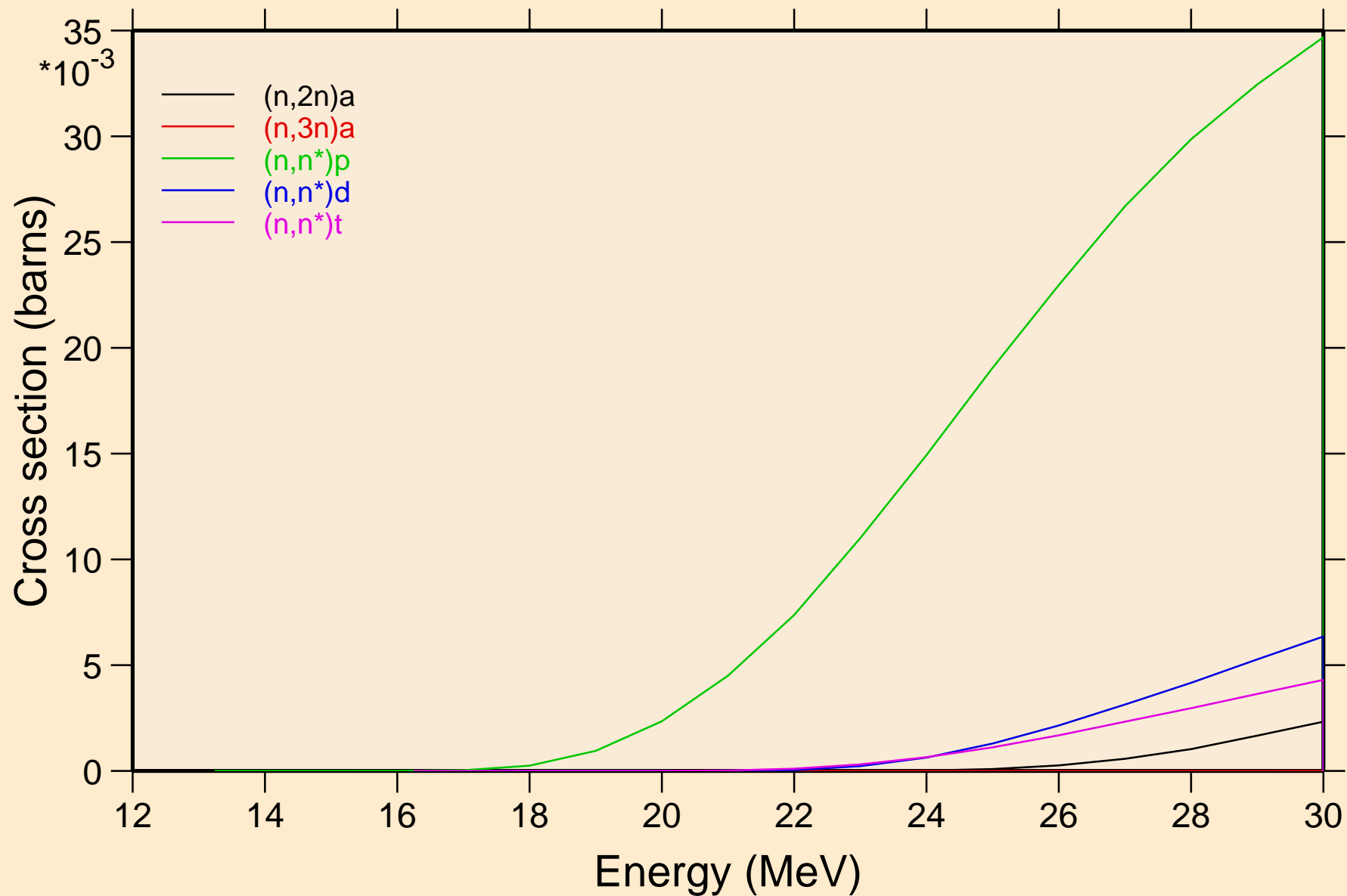

KR088 NEUTRON ACER TENDL-2019 LIBRARY; T=293.16K
Threshold reactions

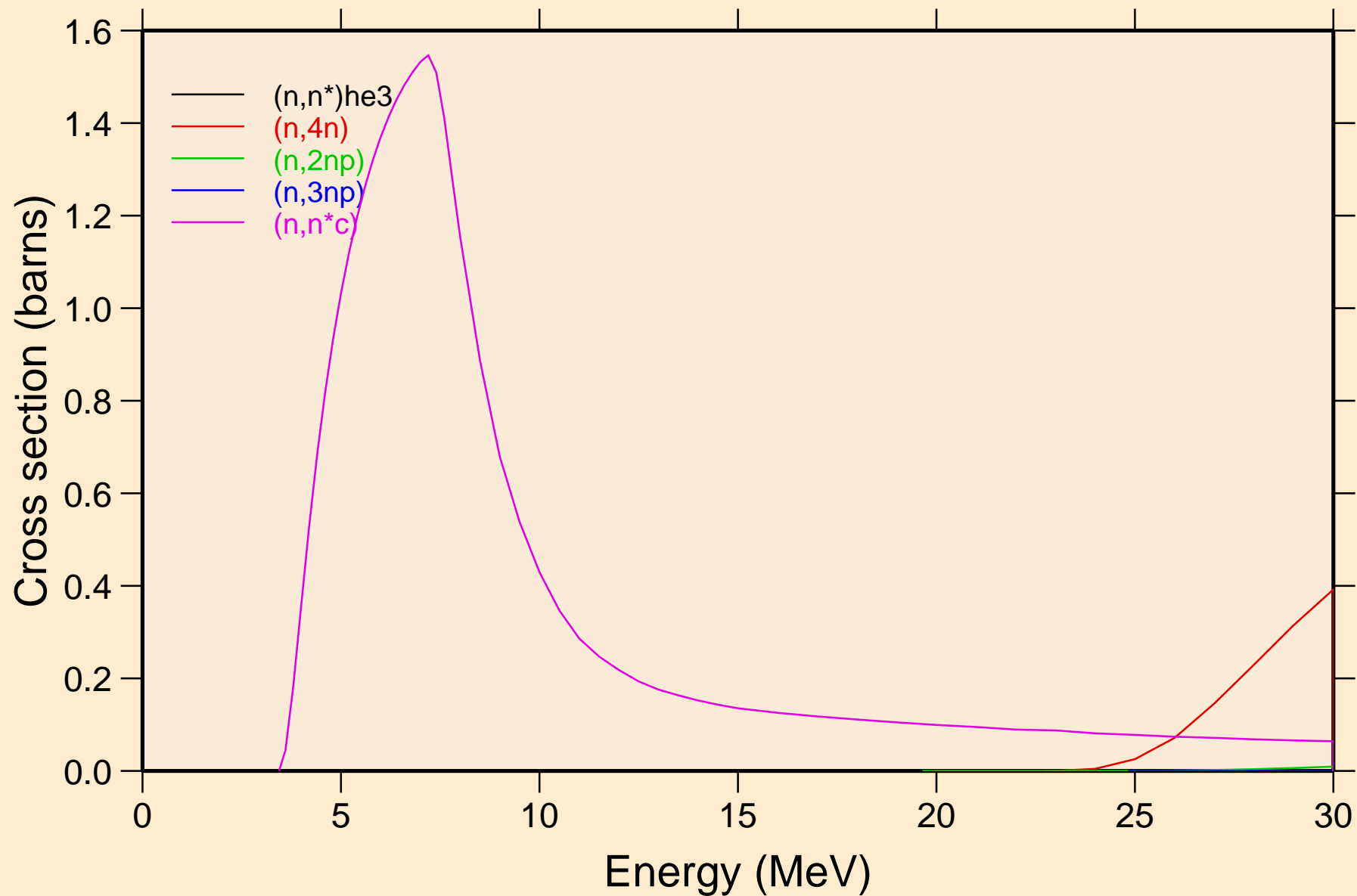

KR088 NEUTRON ACER TENDL-2019 LIBRARY; T=293.16K
Threshold reactions

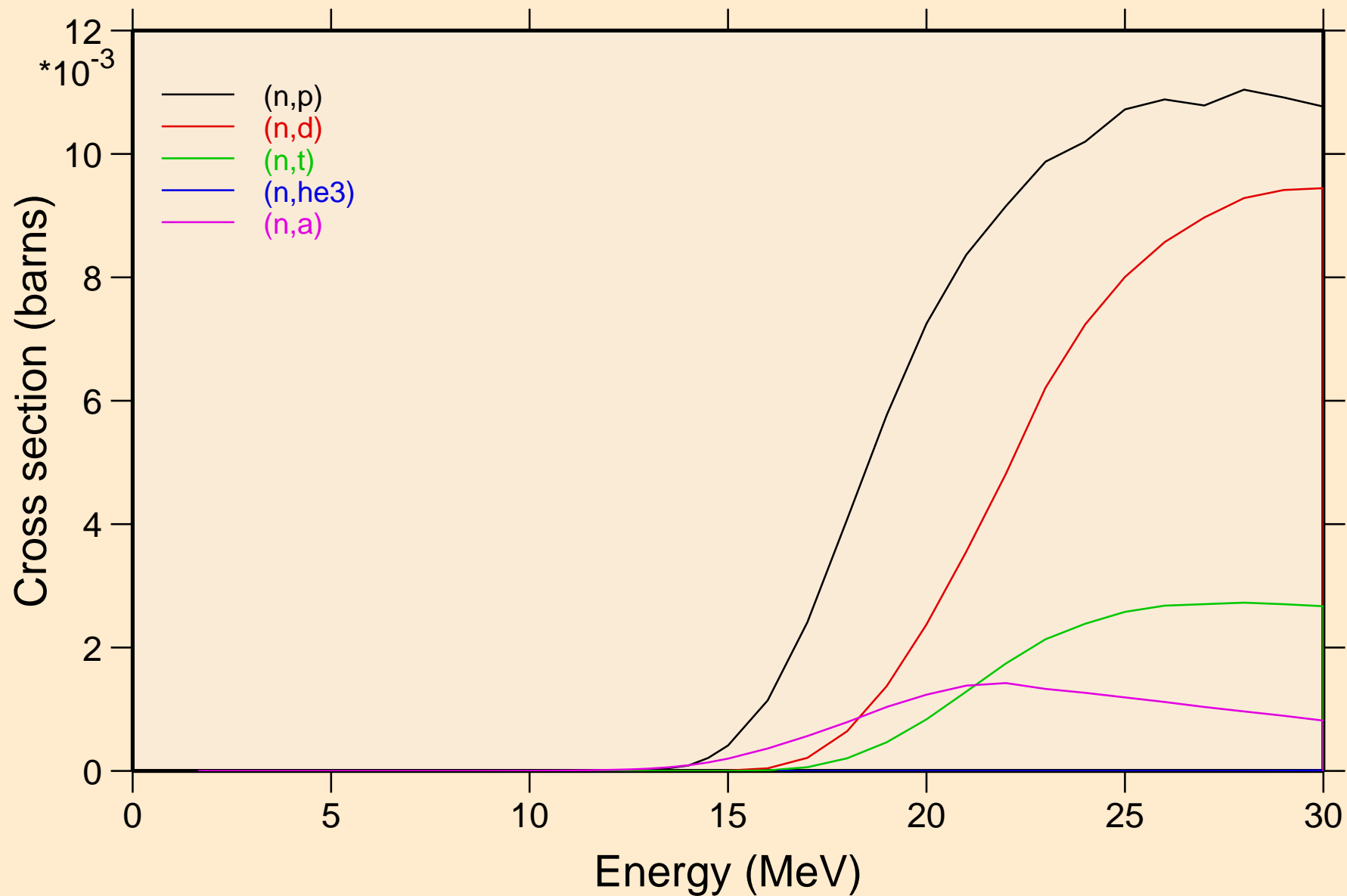

KR088 NEUTRON ACER TENDL-2019 LIBRARY; T=293.16K
Threshold reactions

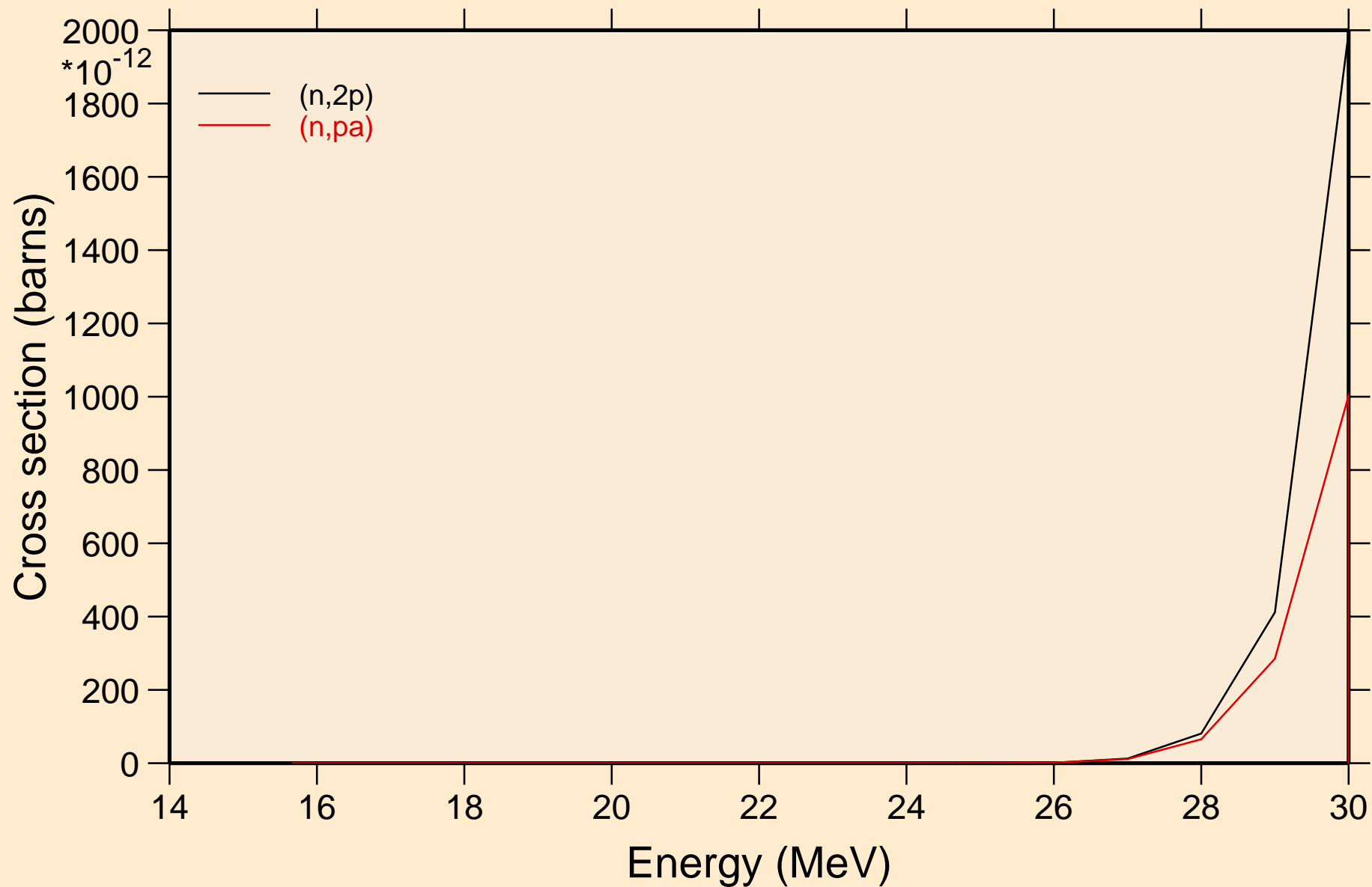

KR088 NEUTRON ACER TENDL-2019 LIBRARY; T=293.16K
Threshold reactions

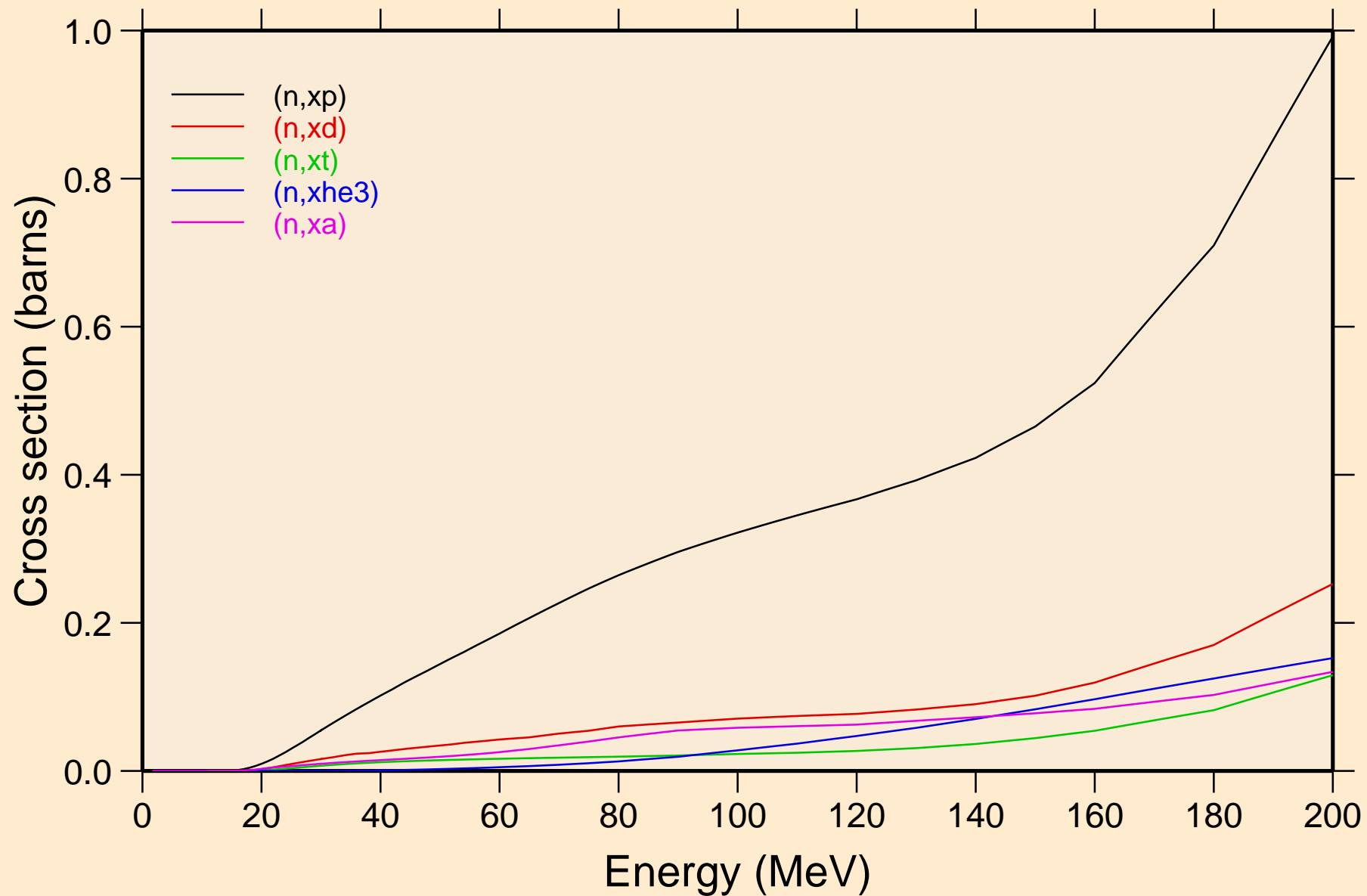

KR088 NEUTRON ACER TENDL-2019 LIBRARY; T=293.16K
angular distribution for elastic

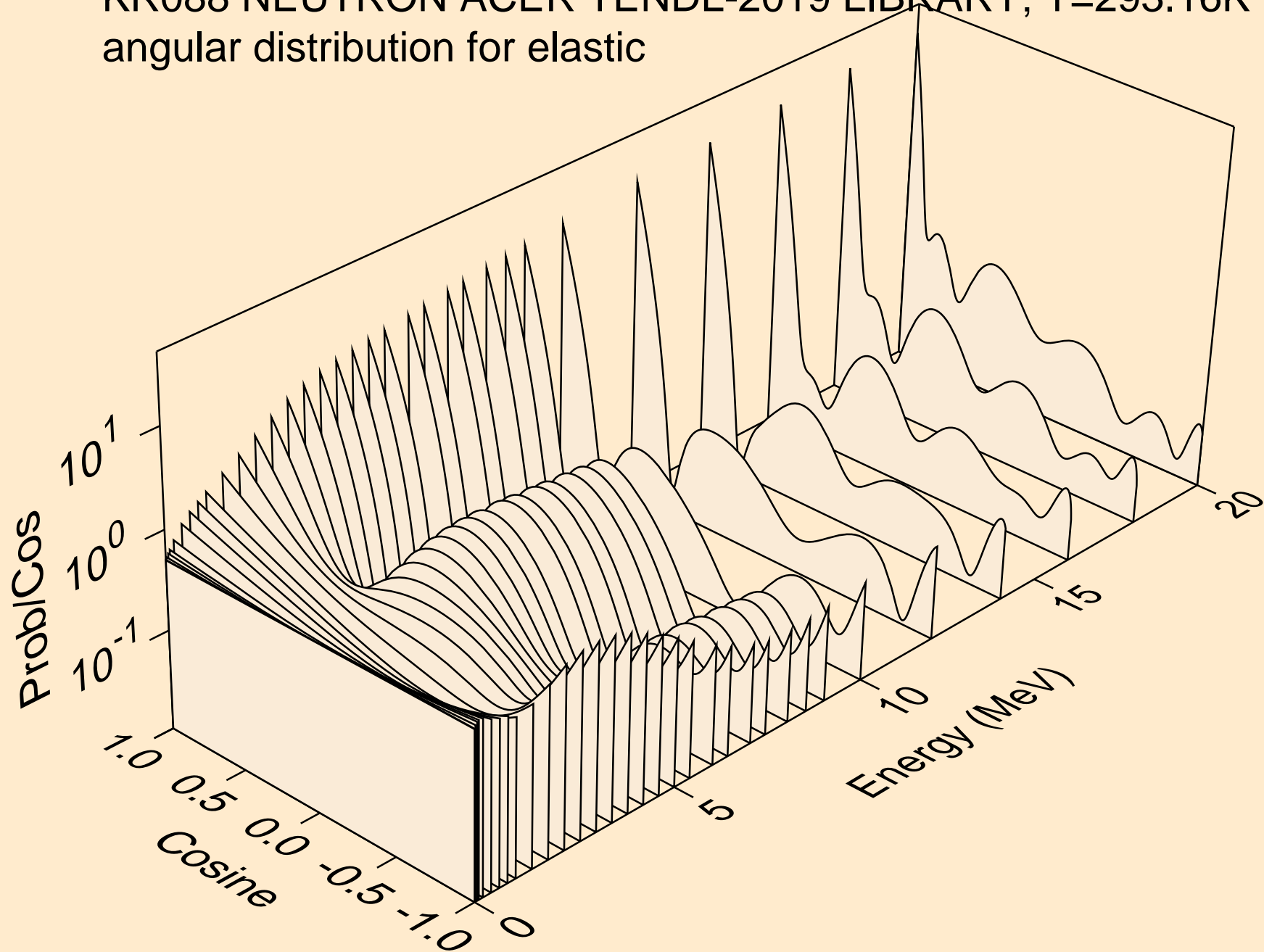

KR088 NEUTRON ACER TENDL-2019 LIBRARY; T=293.16K
angular distribution for elastic

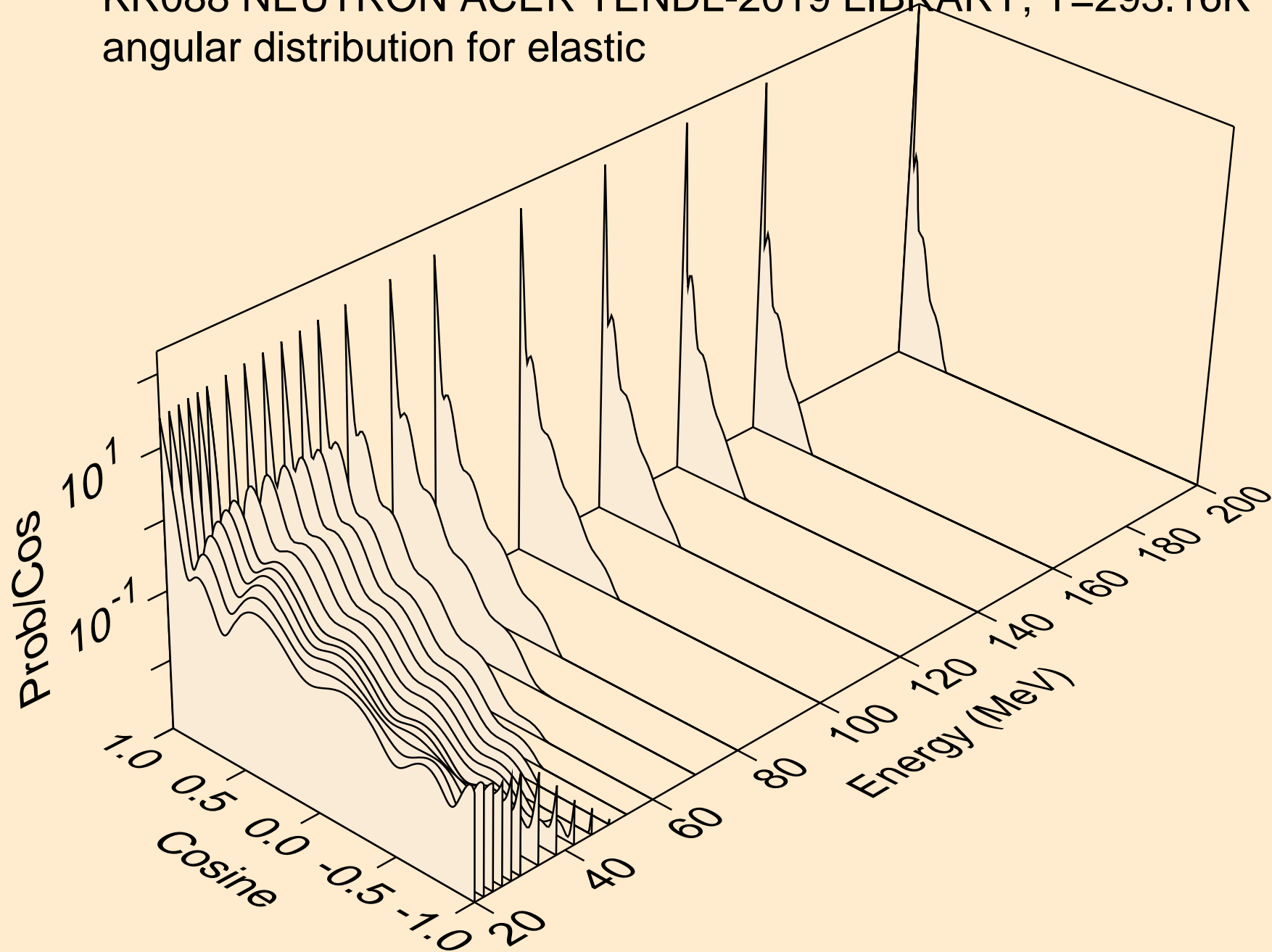

KR088 NEUTRON ACER TENDL-2019 LIBRARY; T=293.16K
angular distribution for (n,n*1)

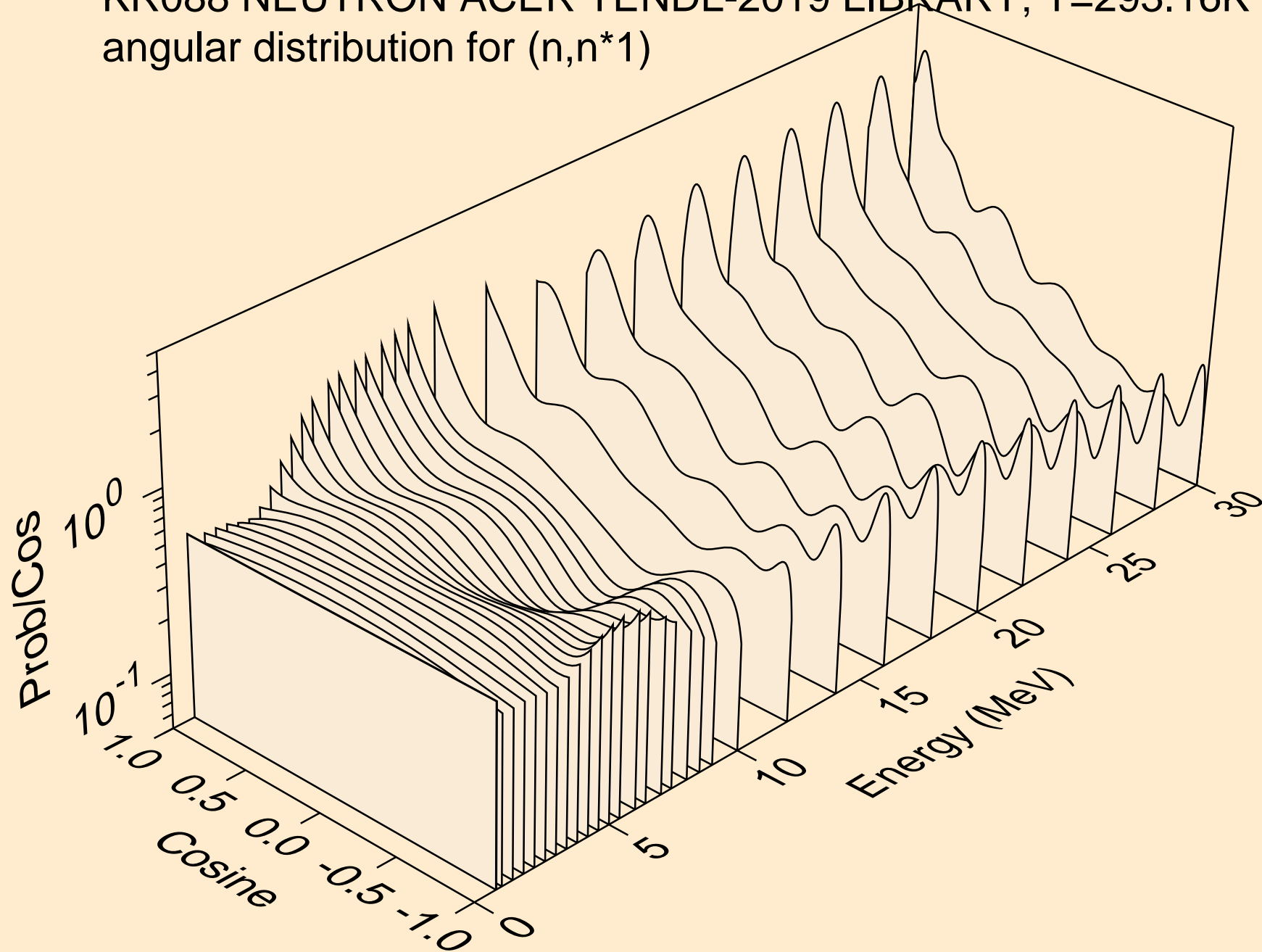

KR088 NEUTRON ACER TENDL-2019 LIBRARY; T=293.16K
angular distribution for (n,n*2)

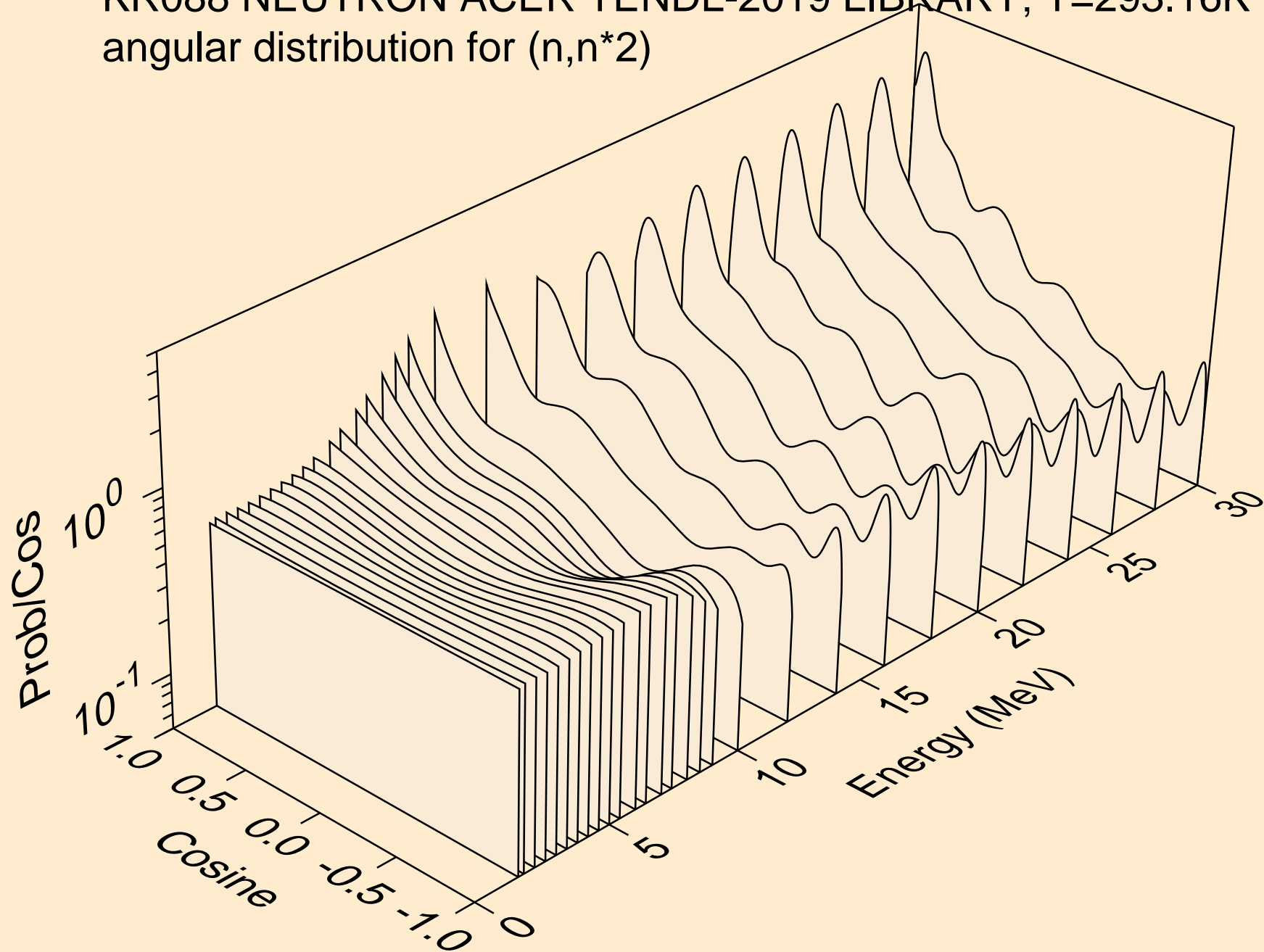

KR088 NEUTRON ACER TENDL-2019 LIBRARY; T=293.16K
angular distribution for (n,n*3)

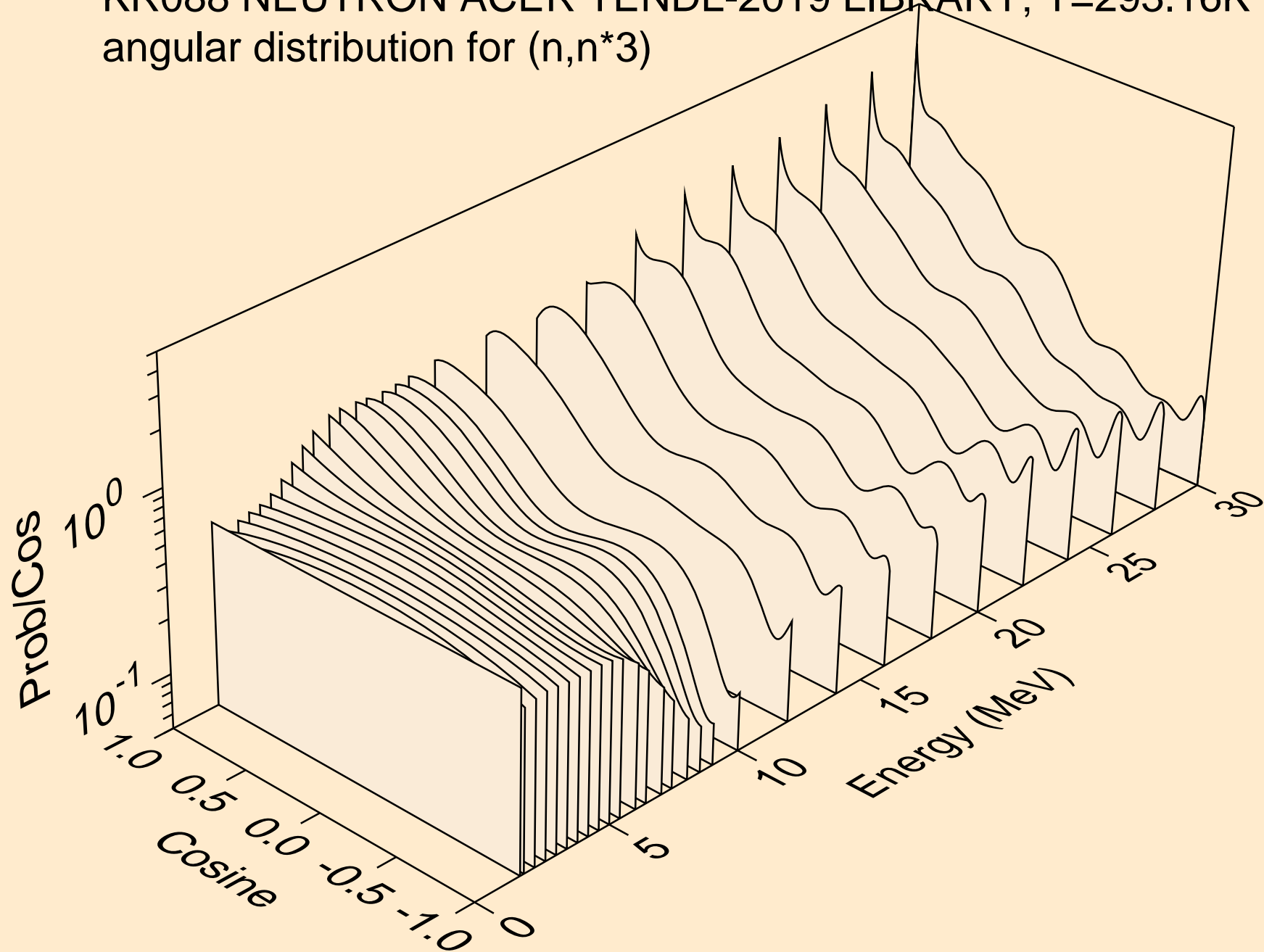

KR088 NEUTRON ACER TENDL-2019 LIBRARY; T=293.16K
angular distribution for (n,n*4)

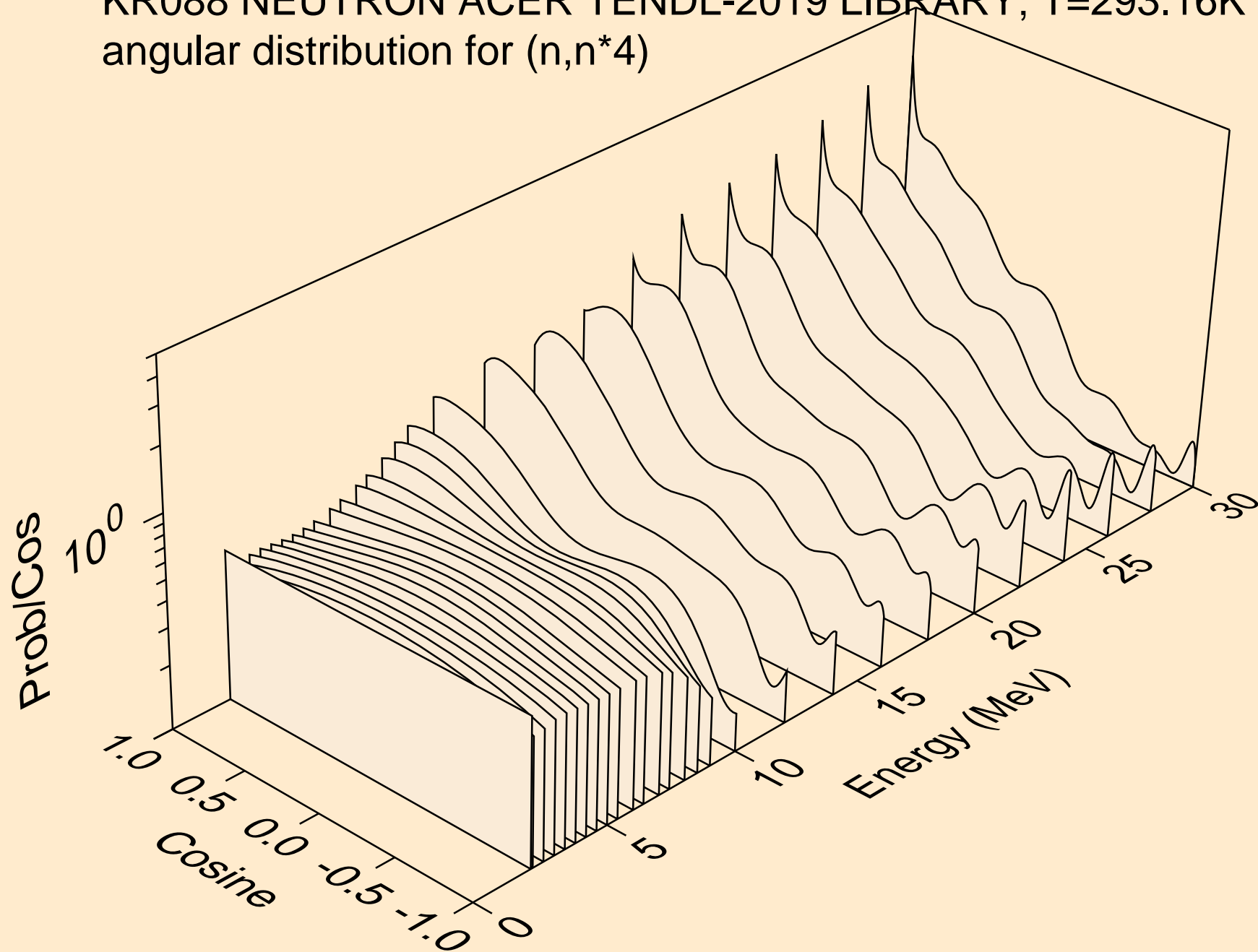

KR088 NEUTRON ACER TENDL-2019 LIBRARY; T=293.16K
angular distribution for (n,n*5)

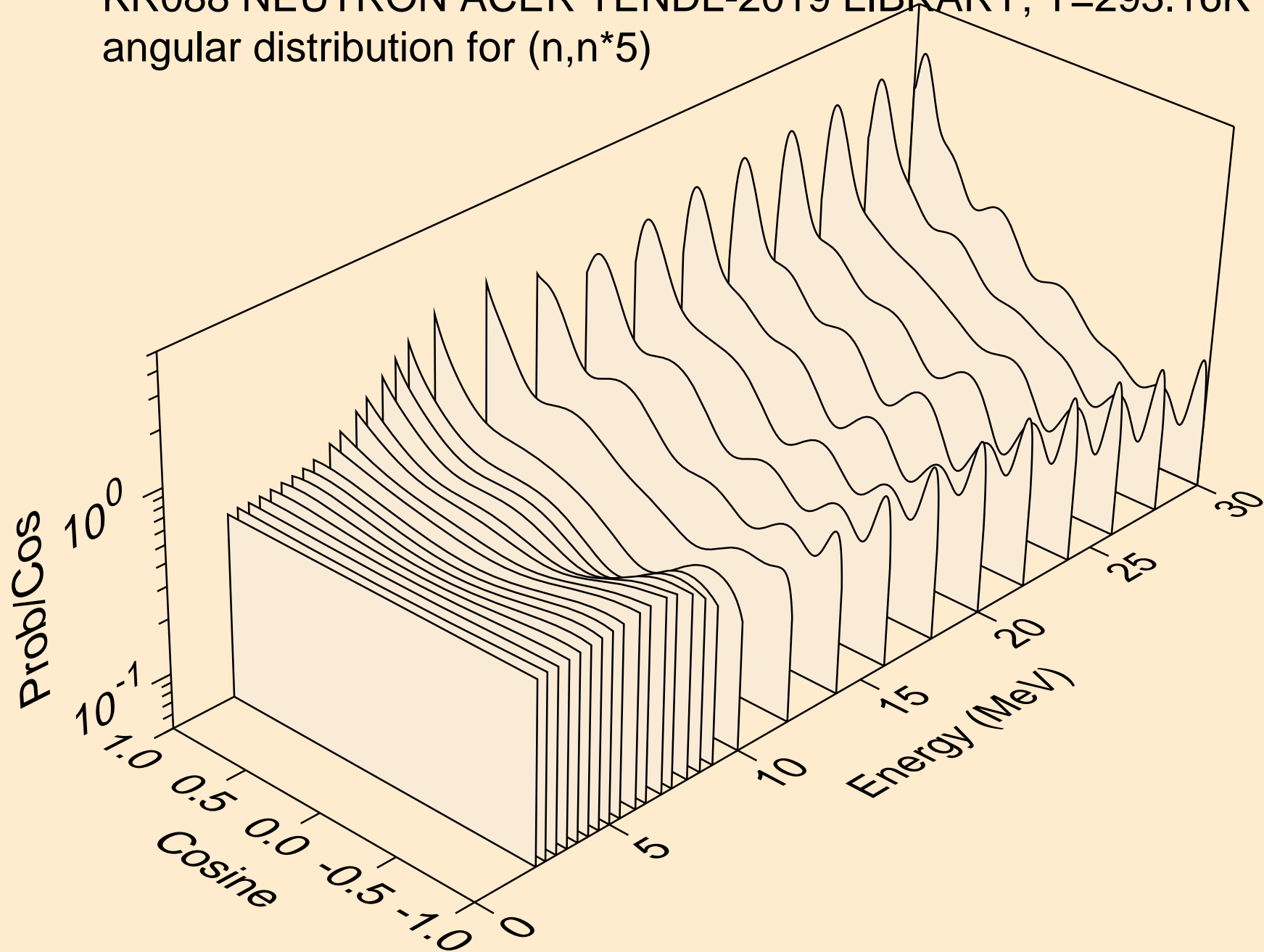

KR088 NEUTRON ACER TENDL-2019 LIBRARY; T=293.16K
angular distribution for (n,n*6)

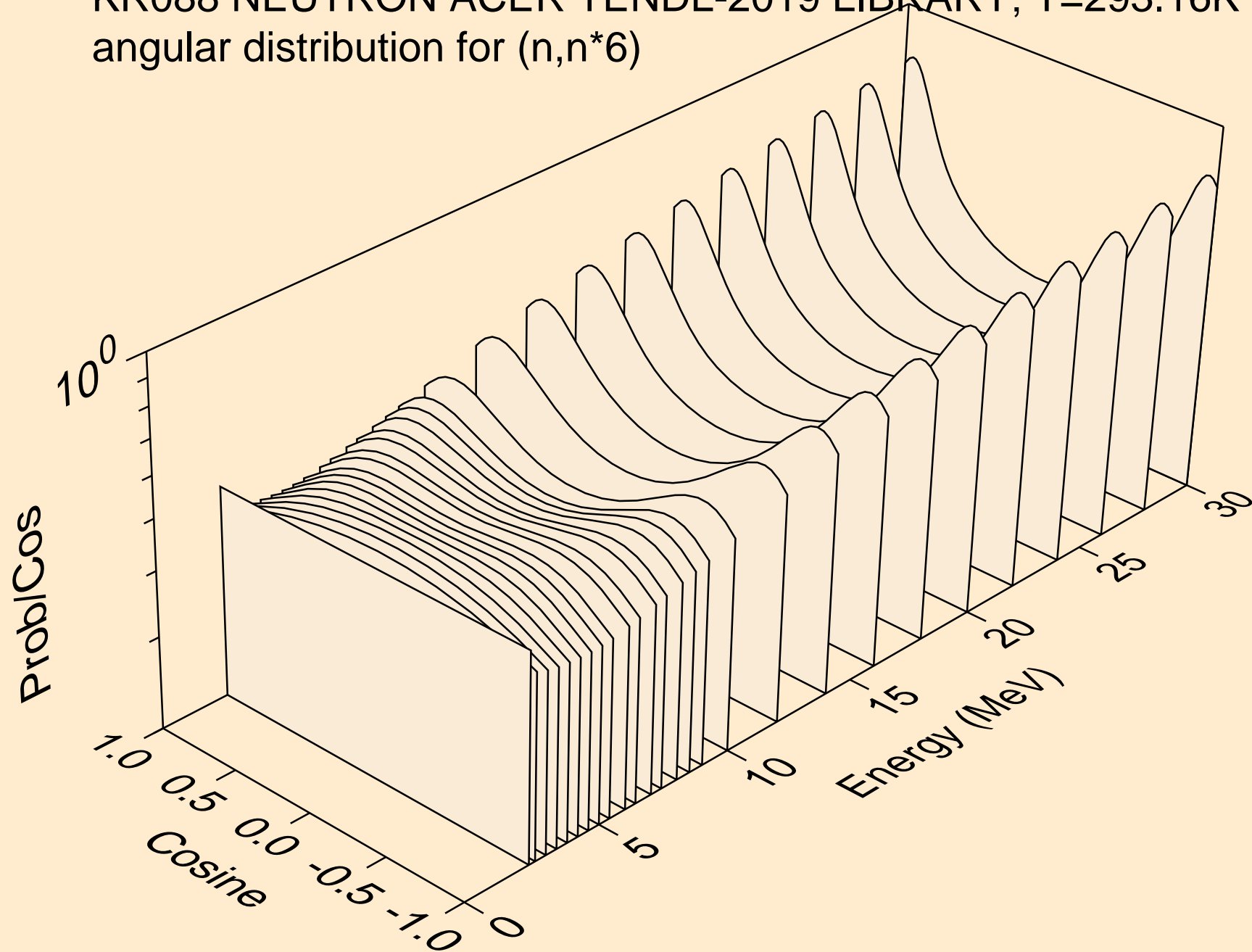

KR088 NEUTRON ACER TENDL-2019 LIBRARY; T=293.16K
angular distribution for (n,n*7)

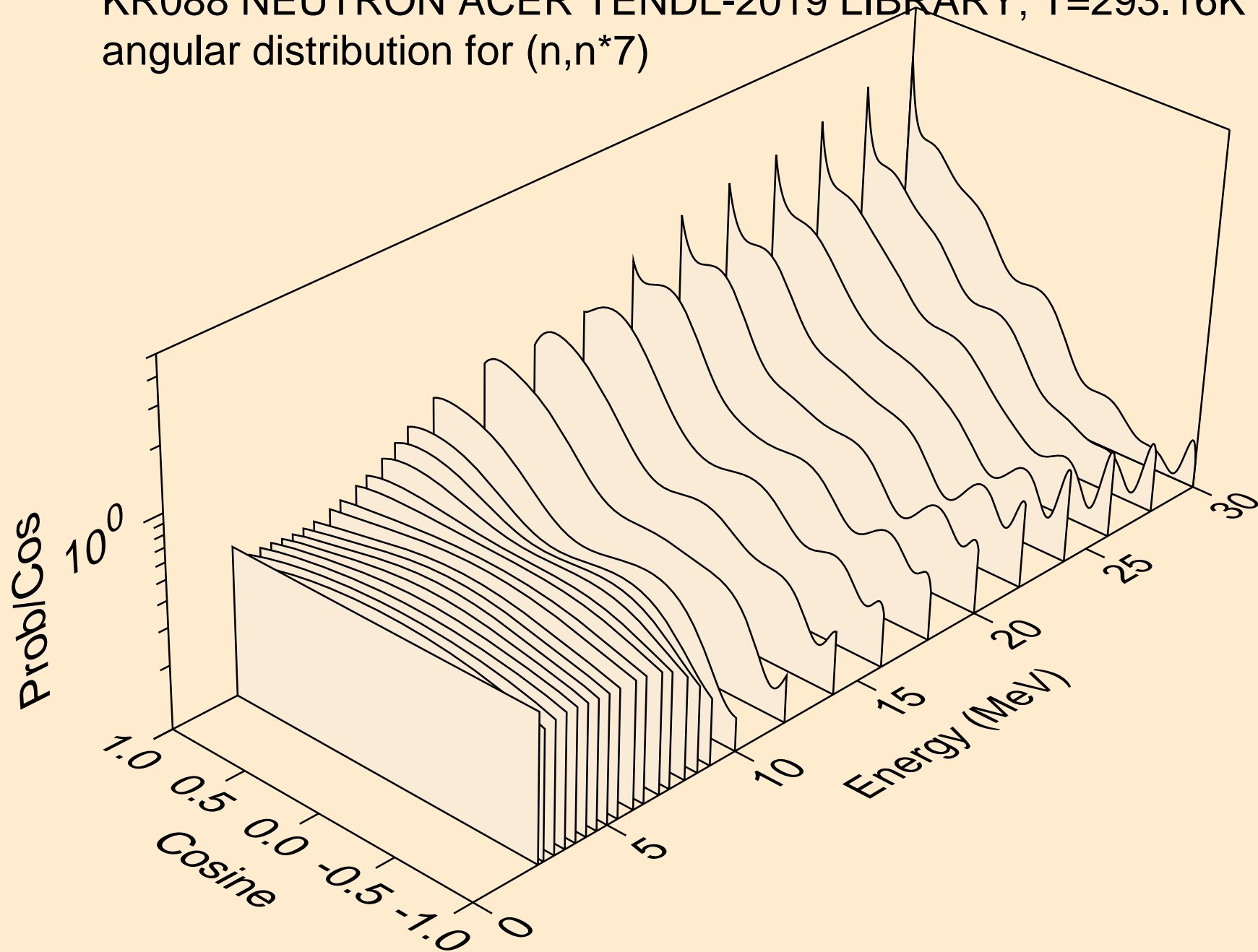

KR088 NEUTRON ACER TENDL-2019 LIBRARY; T=293.16K
angular distribution for (n,n*8)

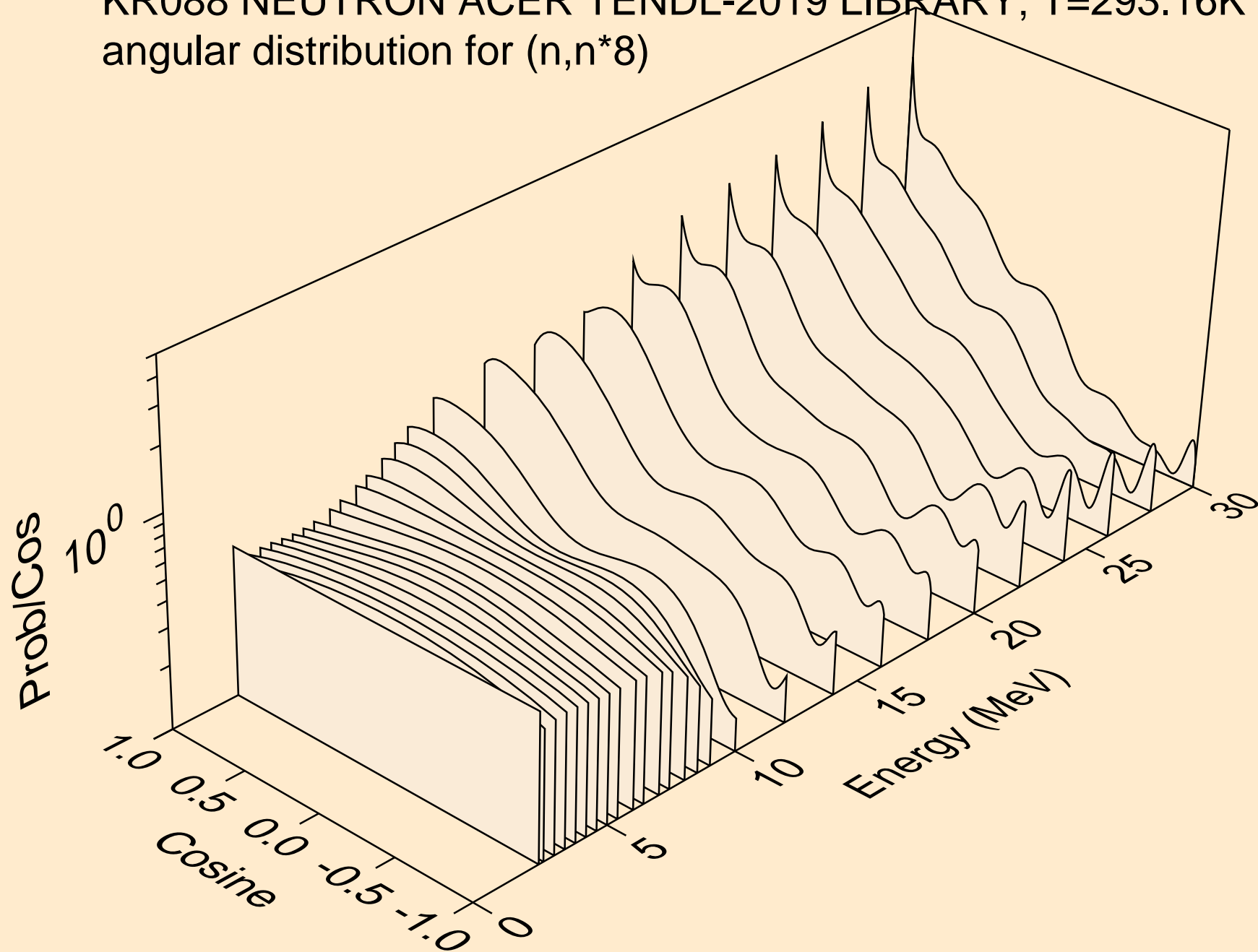

KR088 NEUTRON ACER TENDL-2019 LIBRARY; T=293.16K
angular distribution for (n,n*9)

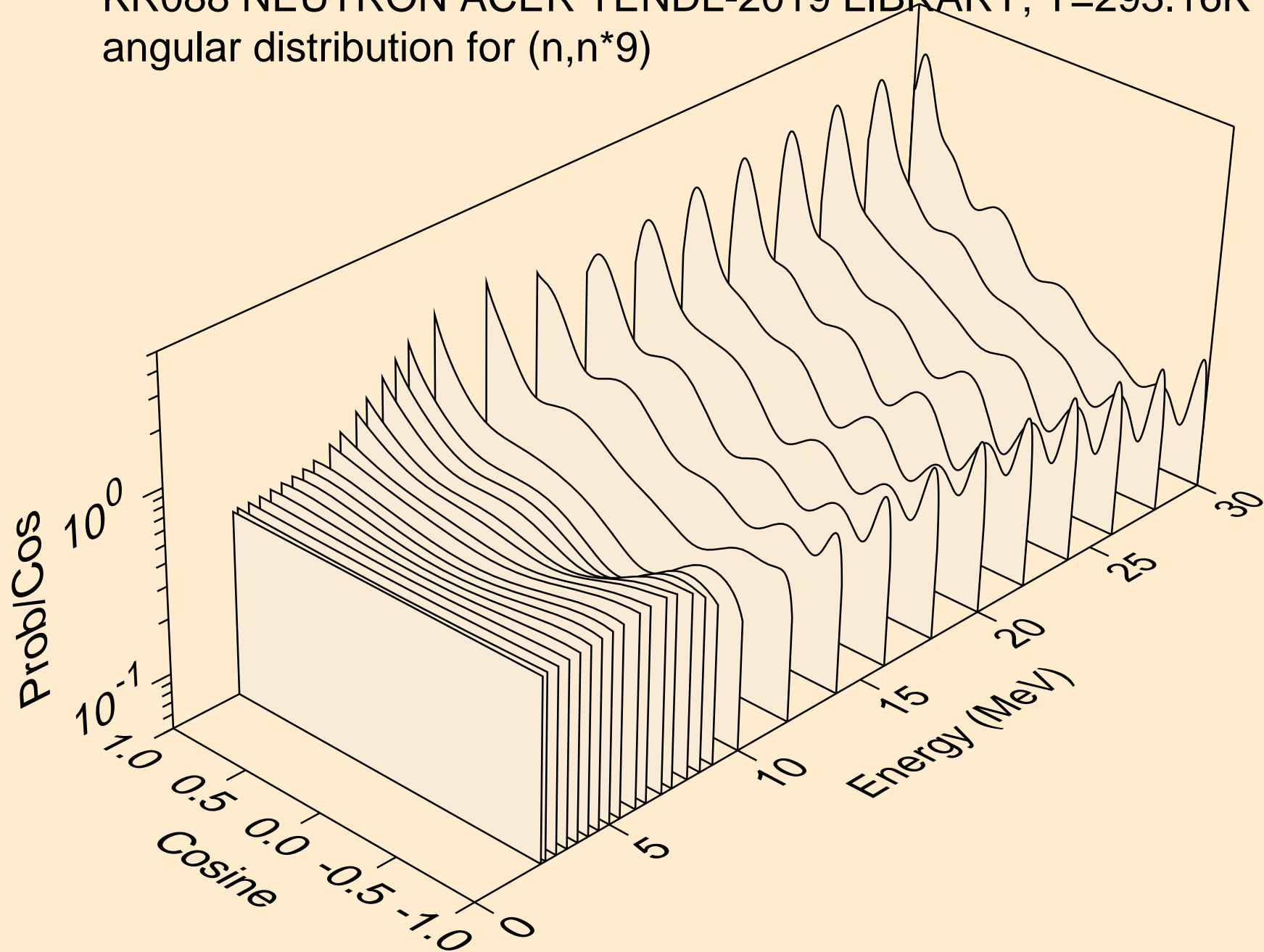

KR088 NEUTRON ACER TENDL-2019 LIBRARY; T=293.16K
angular distribution for (n,n*10)

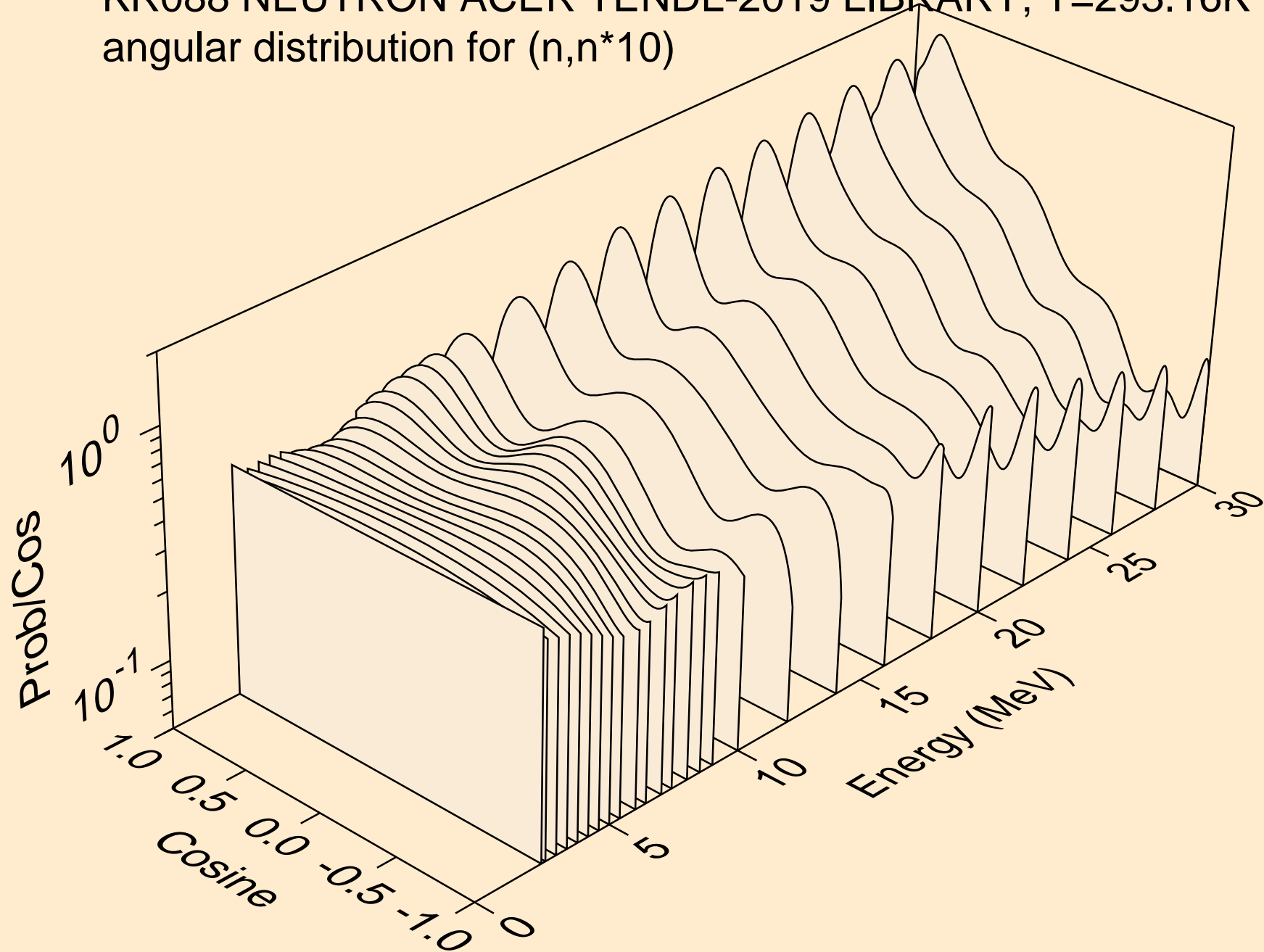

KR088 NEUTRON ACER TENDL-2019 LIBRARY; T=293.16K
angular distribution for (n,n*11)

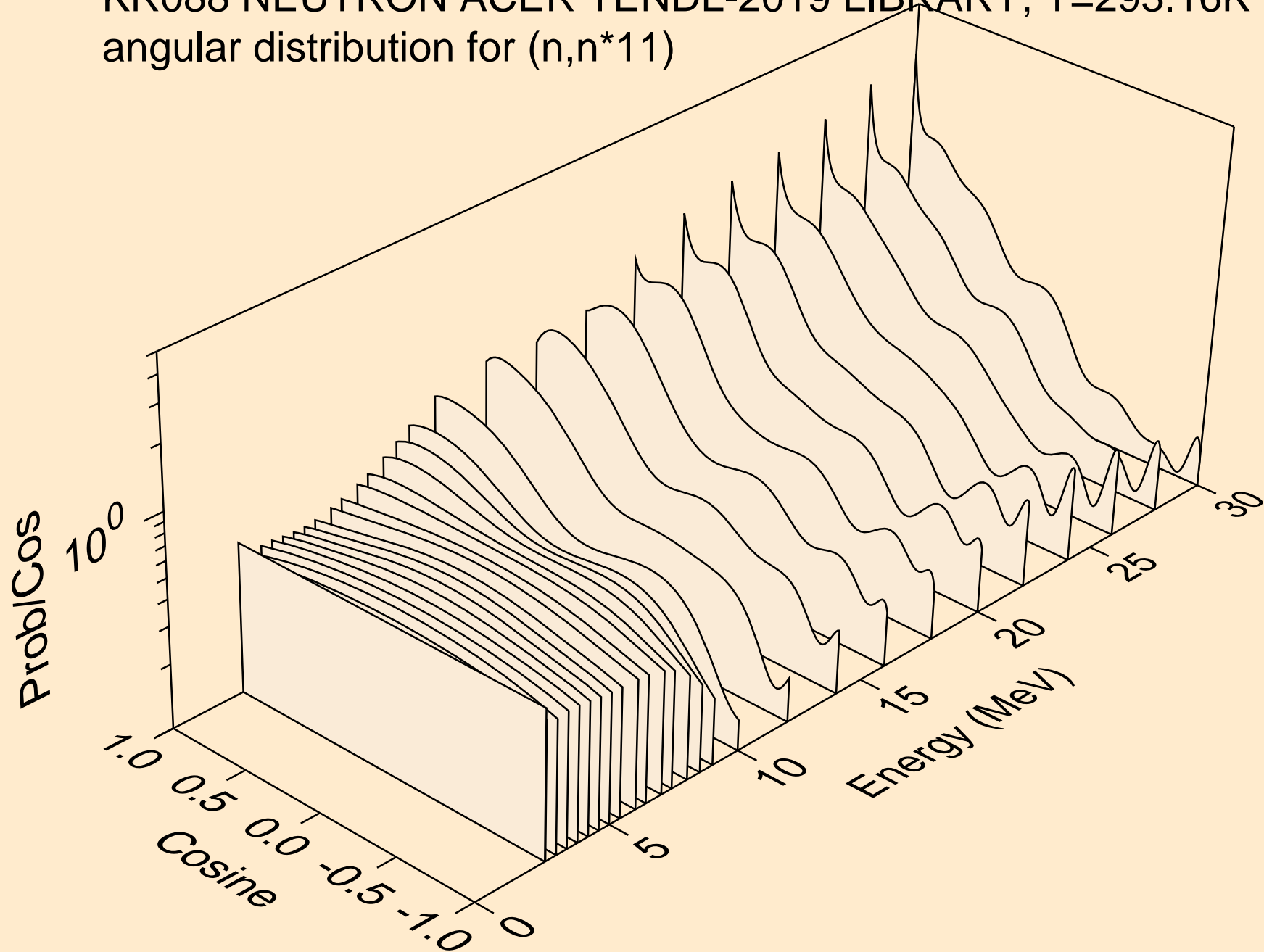

KR088 NEUTRON ACER TENDL-2019 LIBRARY; T=293.16K
angular distribution for (n,n*12)

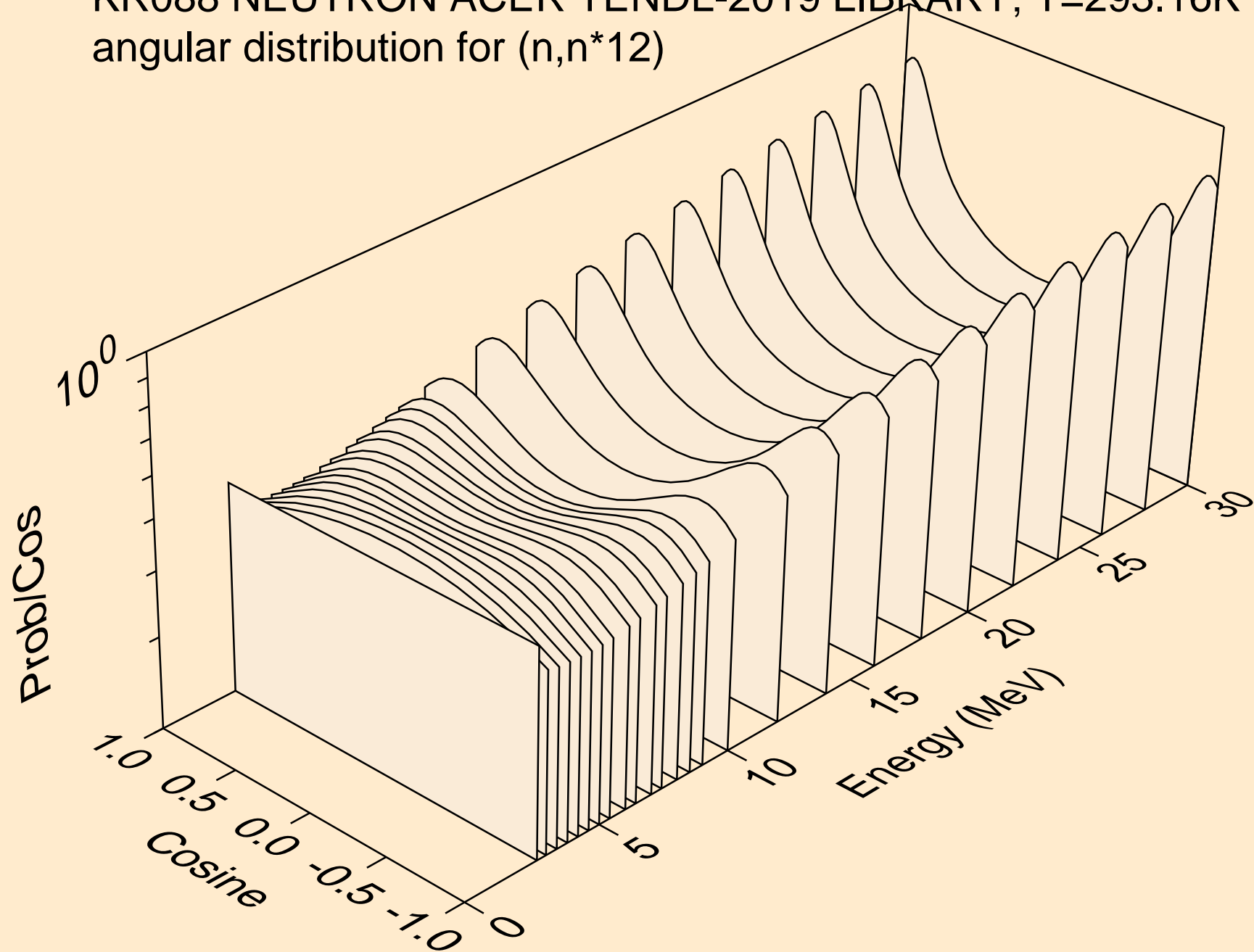

KR088 NEUTRON ACER TENDL-2019 LIBRARY; T=293.16K
angular distribution for (n,n*13)

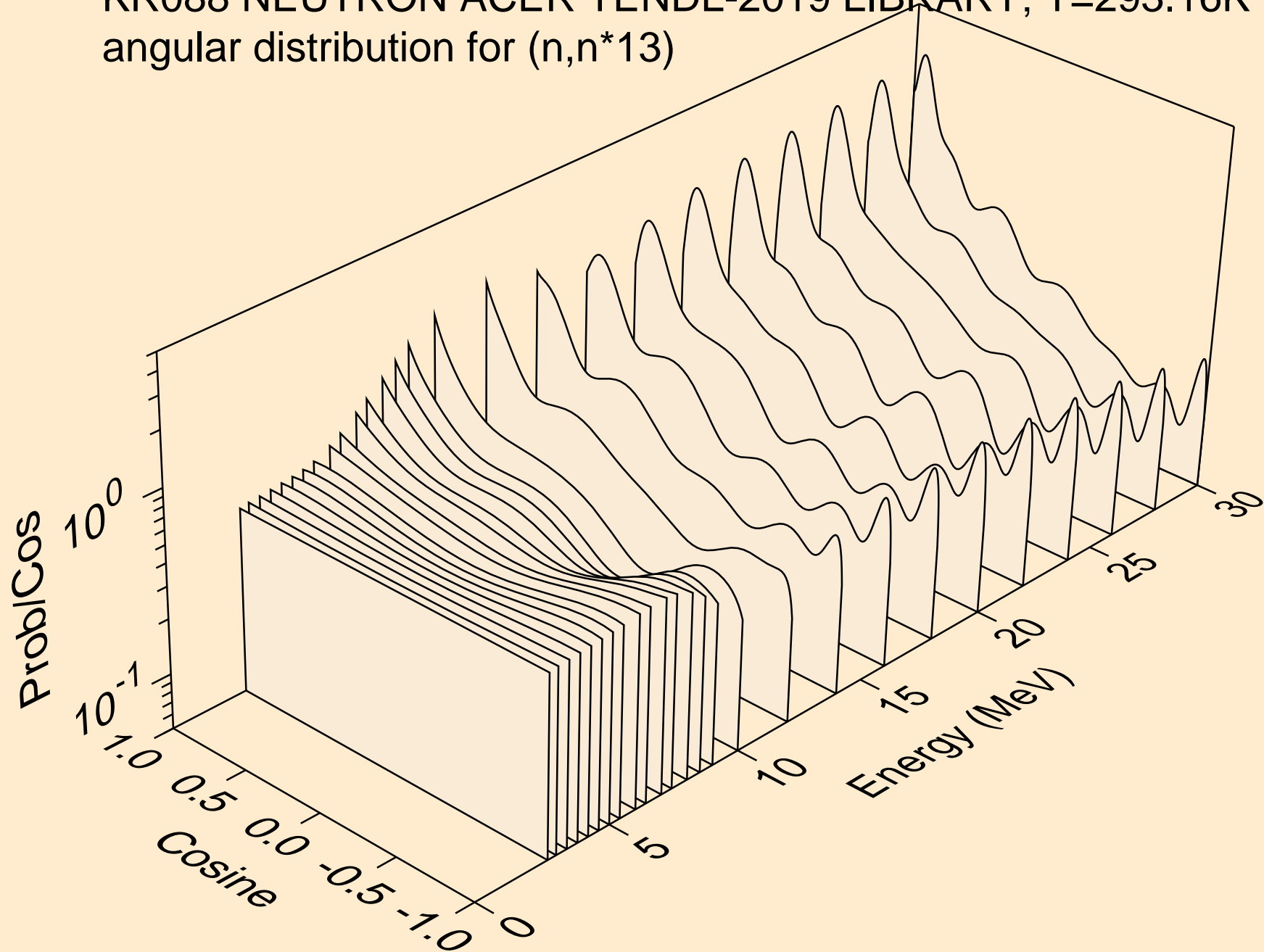

KR088 NEUTRON ACER TENDL-2019 LIBRARY; T=293.16K
angular distribution for (n,n*14)

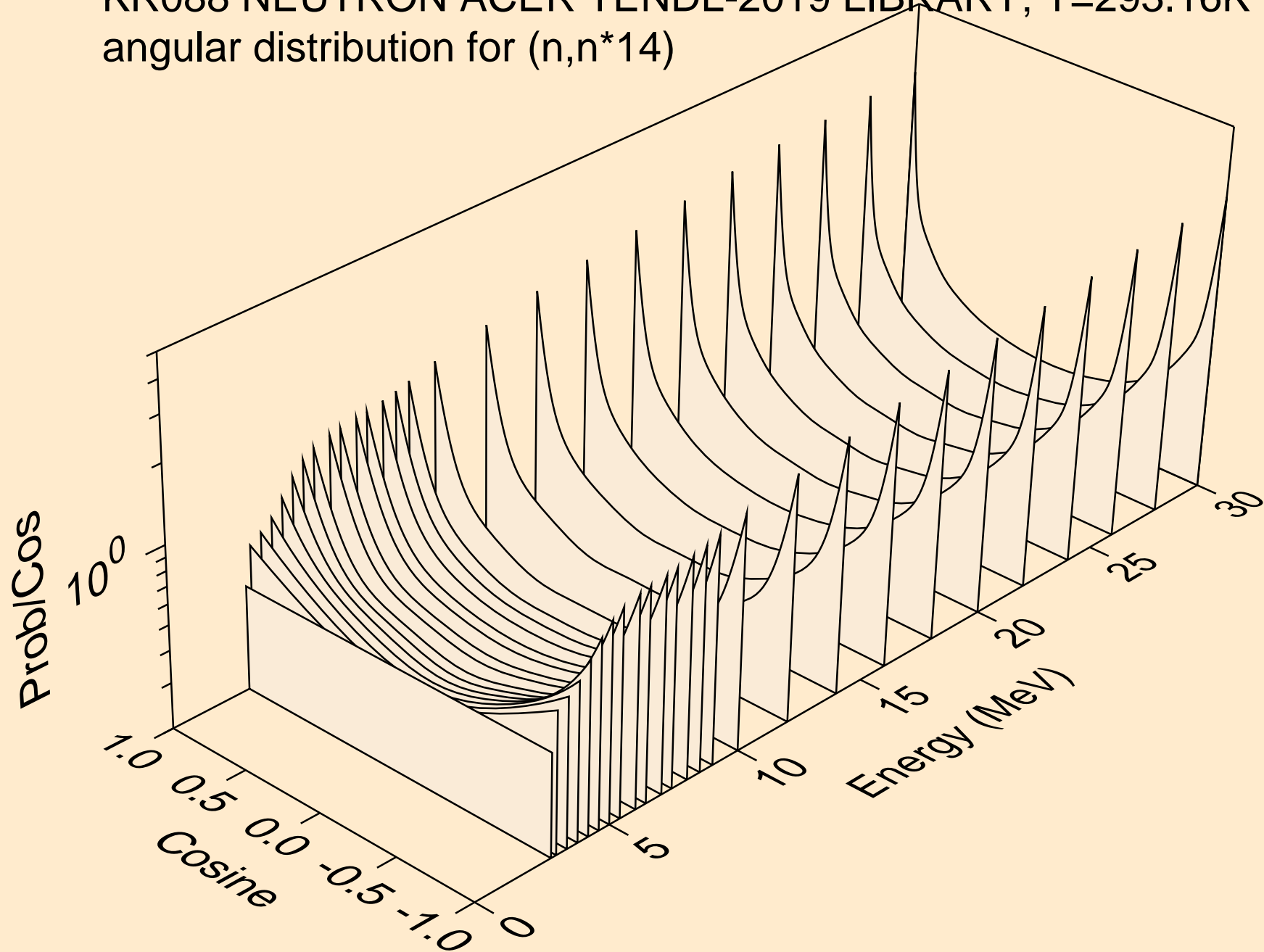

KR088 NEUTRON ACER TENDL-2019 LIBRARY; T=293.16K
angular distribution for (n,n*15)

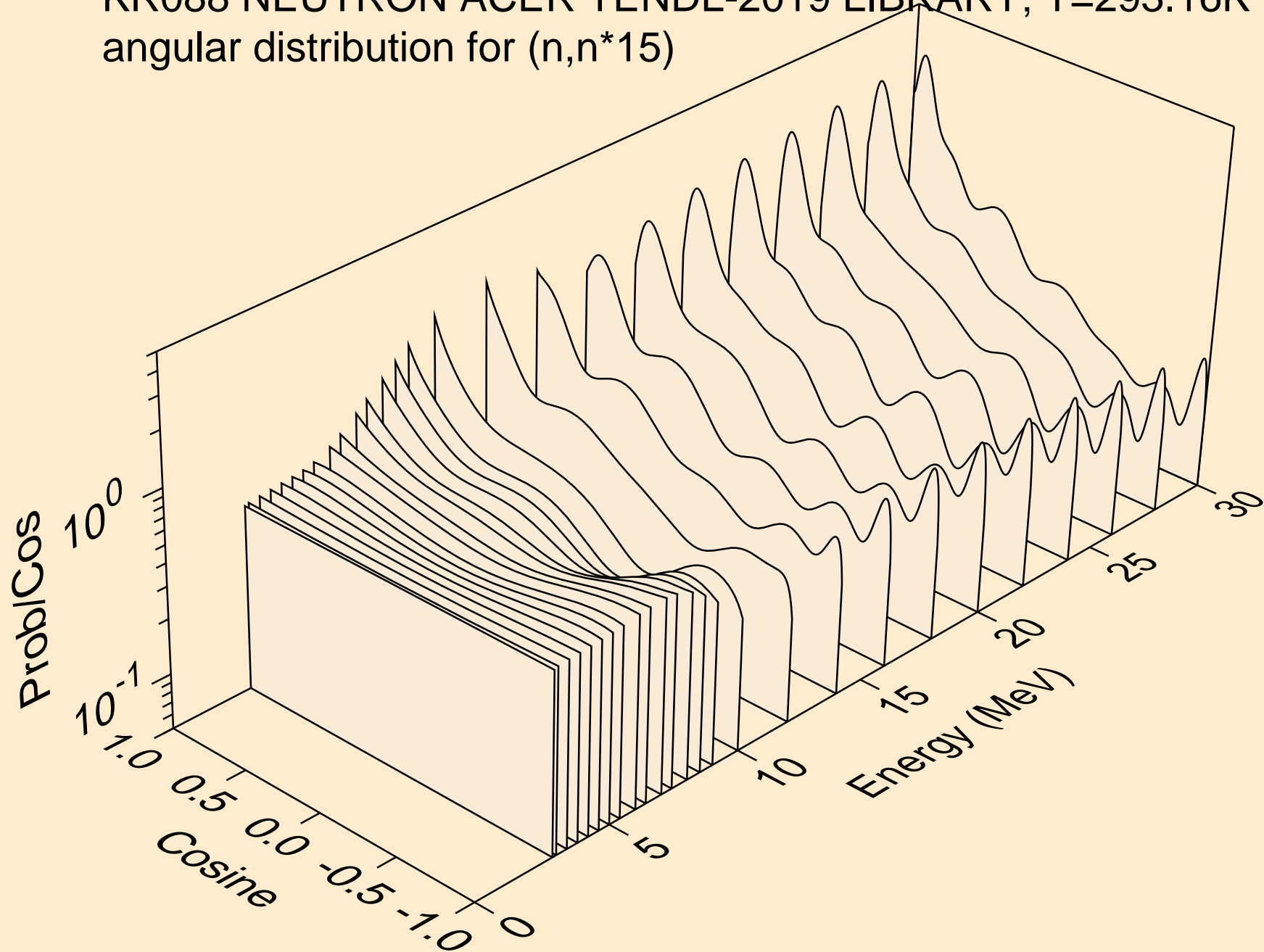

KR088 NEUTRON ACER TENDL-2019 LIBRARY; T=293.16K
angular distribution for (n,n*16)

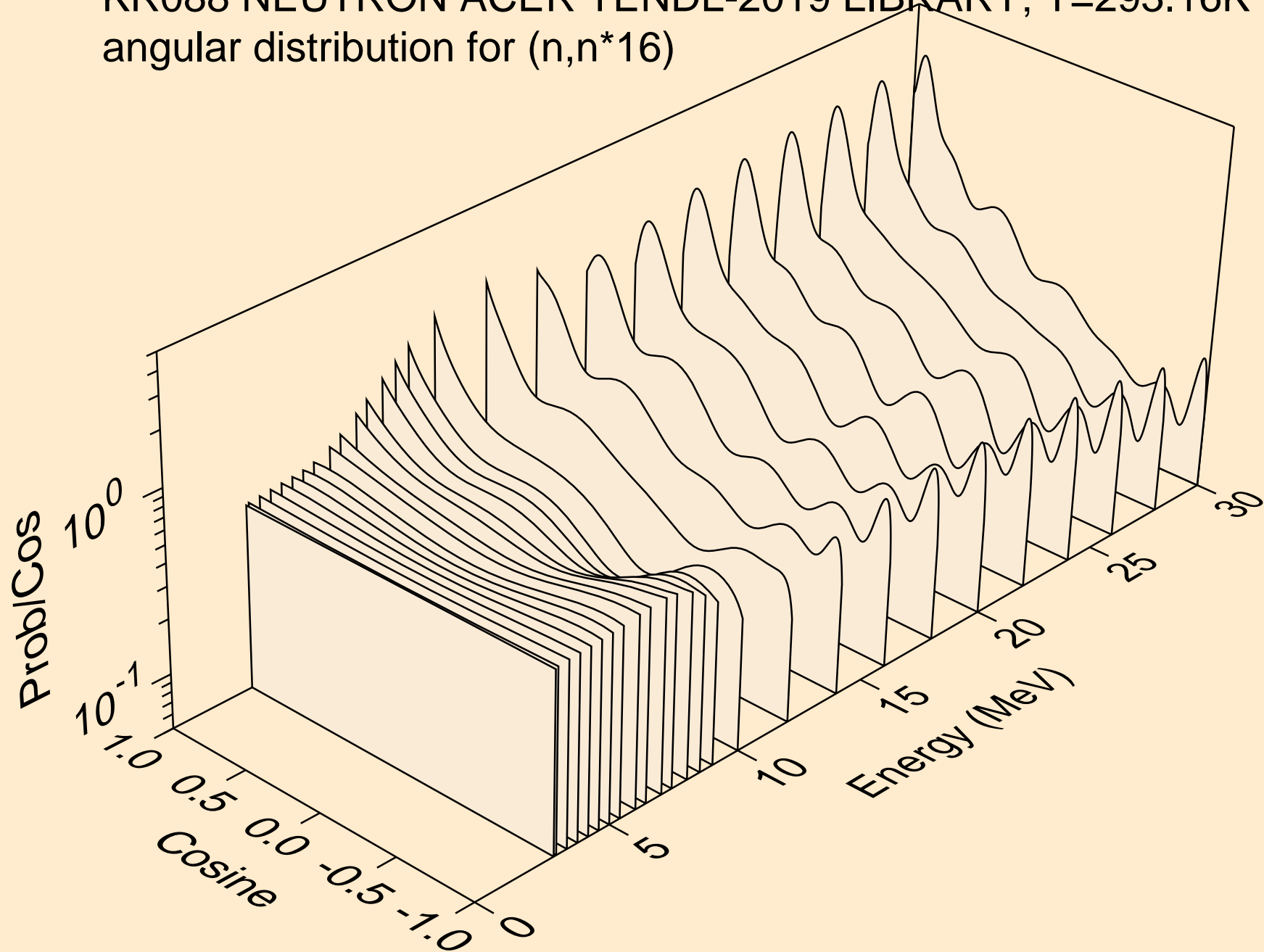

KR088 NEUTRON ACER TENDL-2019 LIBRARY; T=293.16K
angular distribution for (n,n*17)

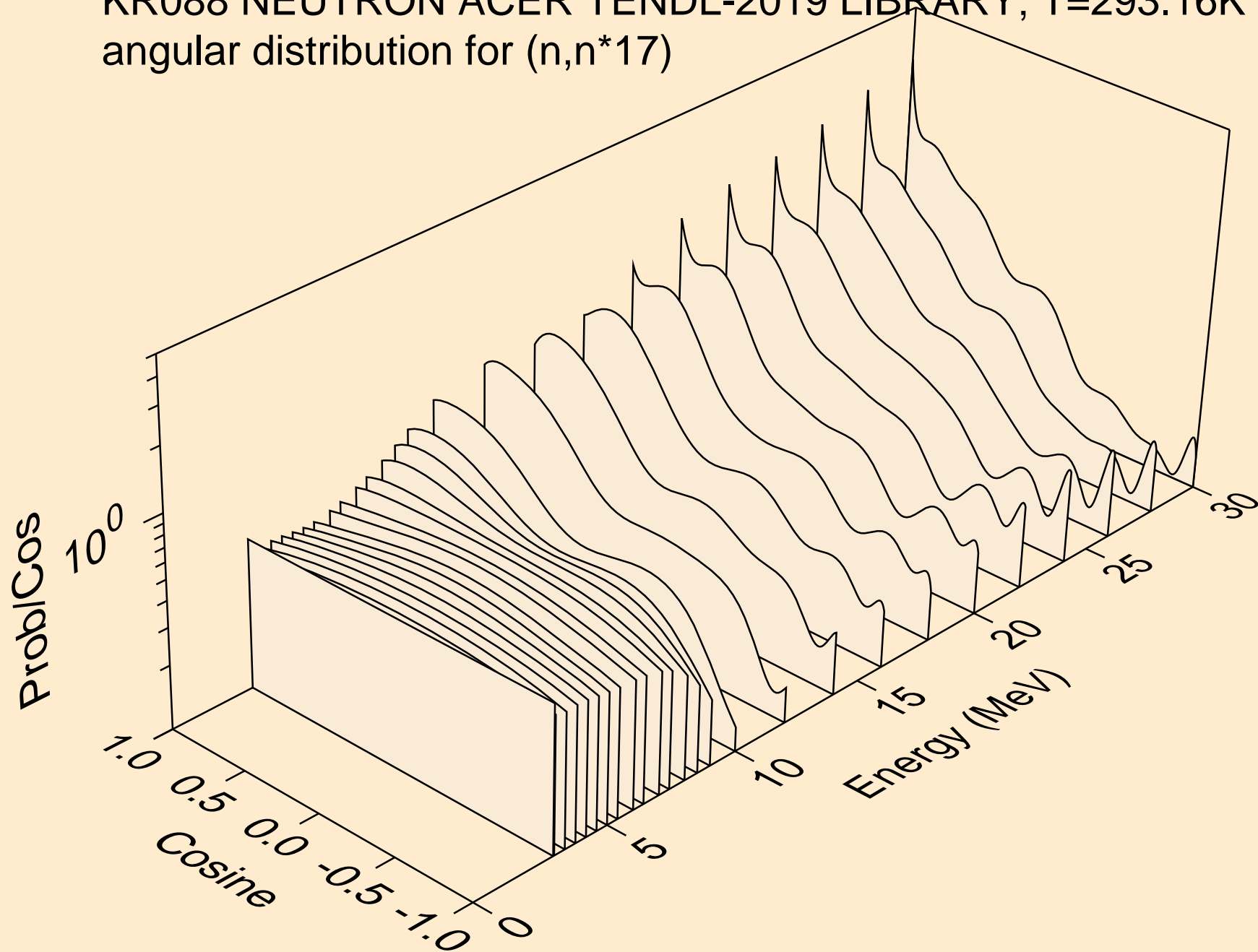

KR088 NEUTRON ACER TENDL-2019 LIBRARY; T=293.16K
angular distribution for (n,n*18)

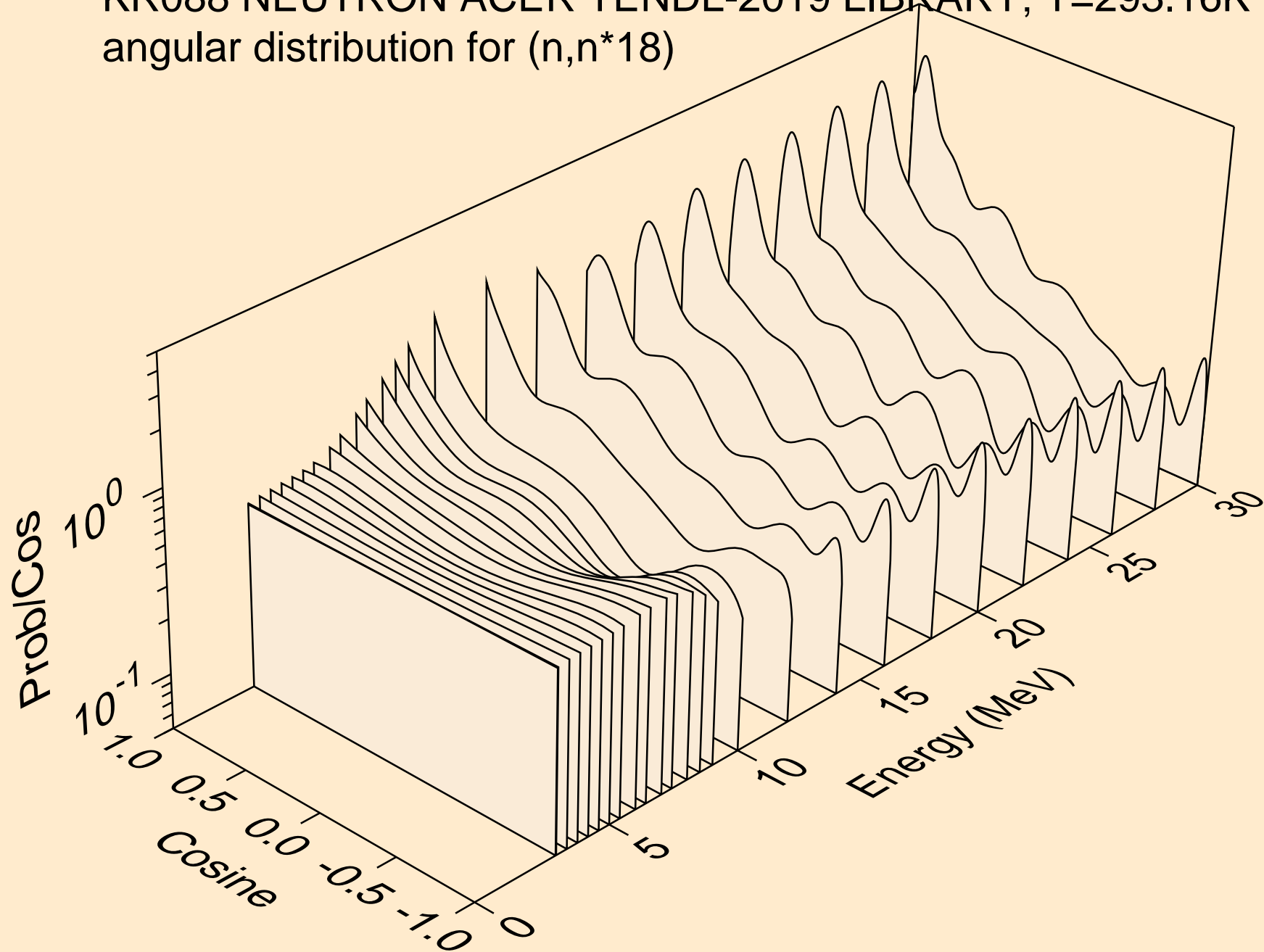

KR088 NEUTRON ACER TENDL-2019 LIBRARY; T=293.16K
angular distribution for (n,n*19)

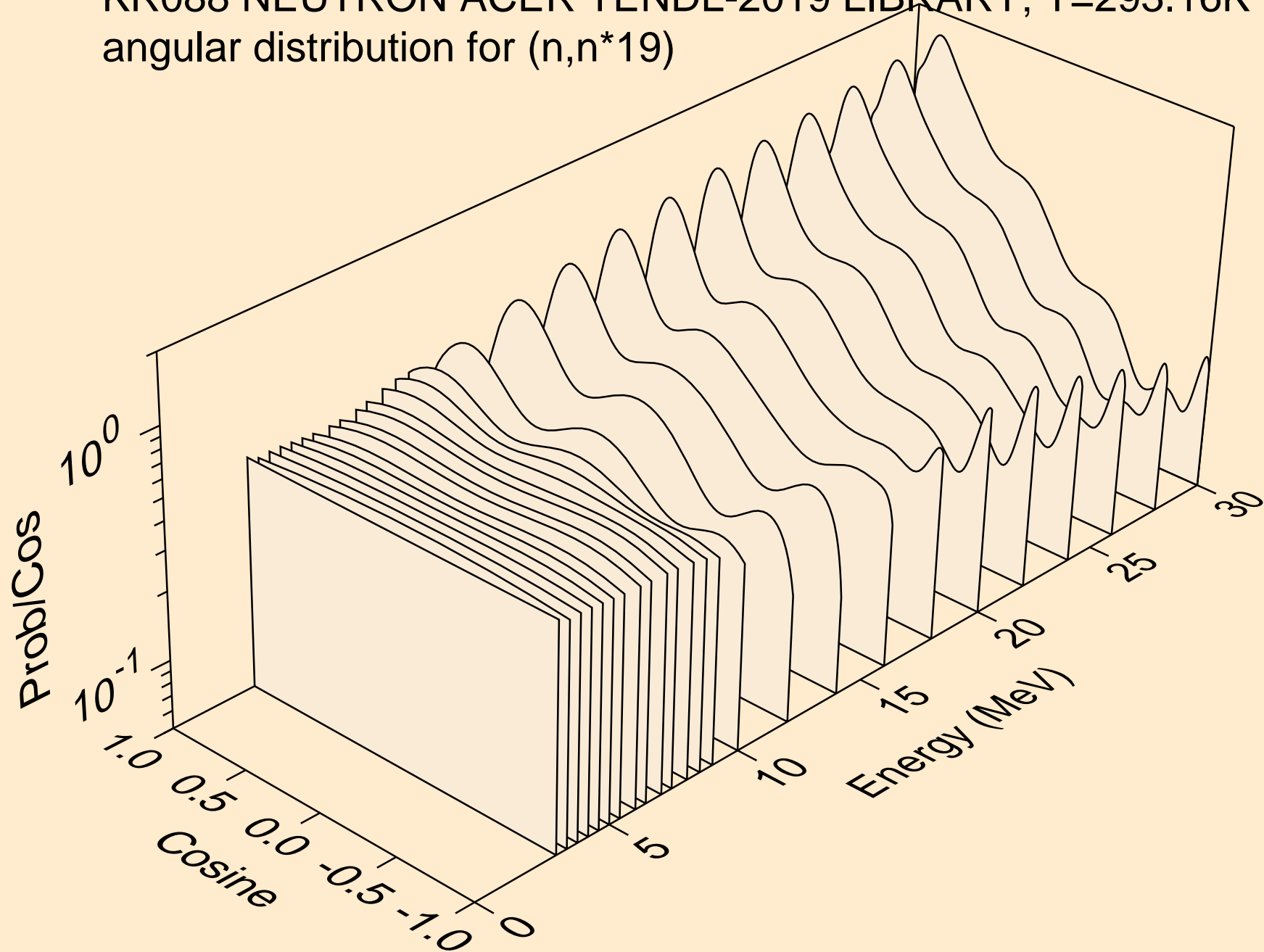

KR088 NEUTRON ACER TENDL-2019 LIBRARY; T=293.16K
angular distribution for (n,n*20)

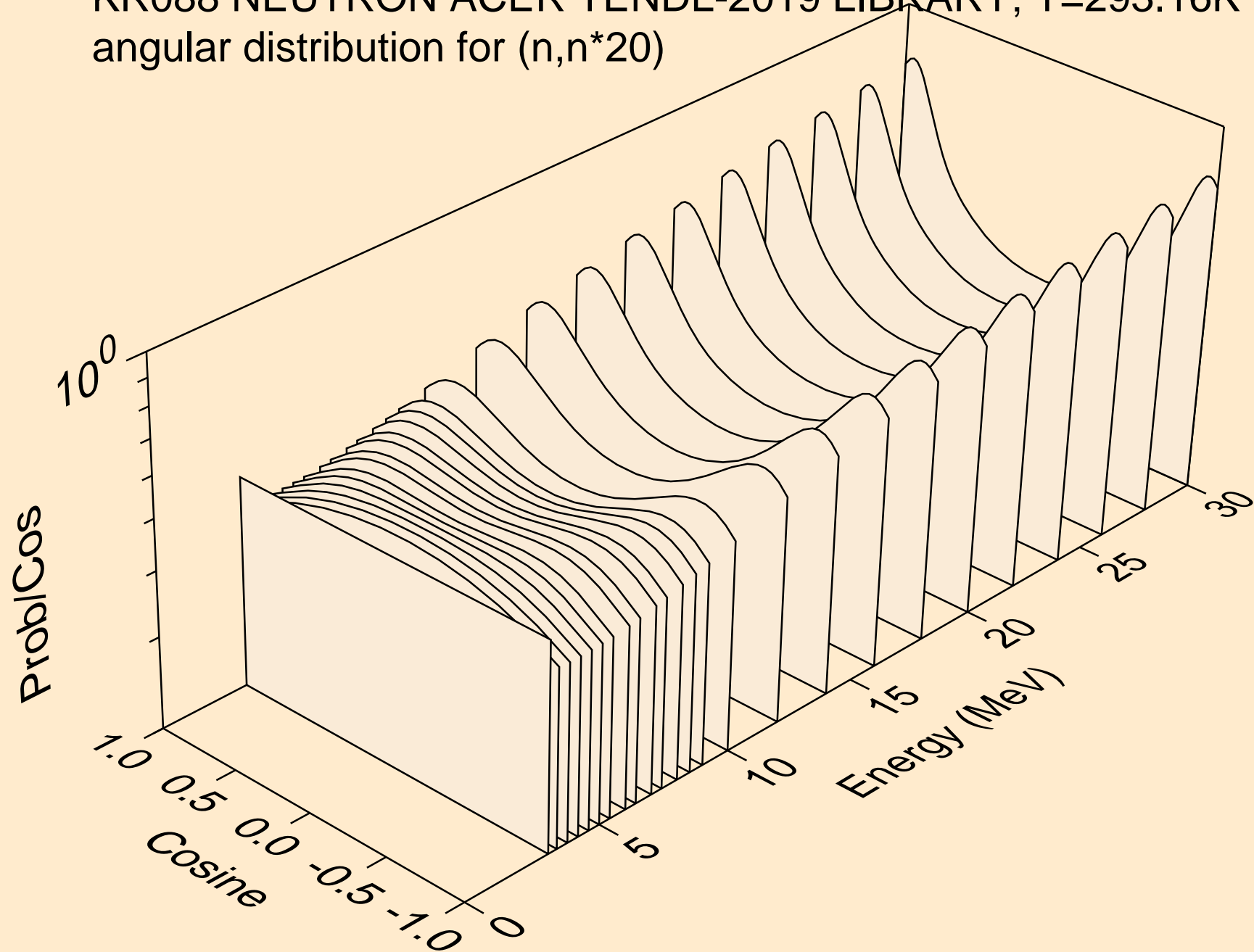

KR088 NEUTRON ACER TENDL-2019 LIBRARY; T=293.16K
angular distribution for (n,n*21)

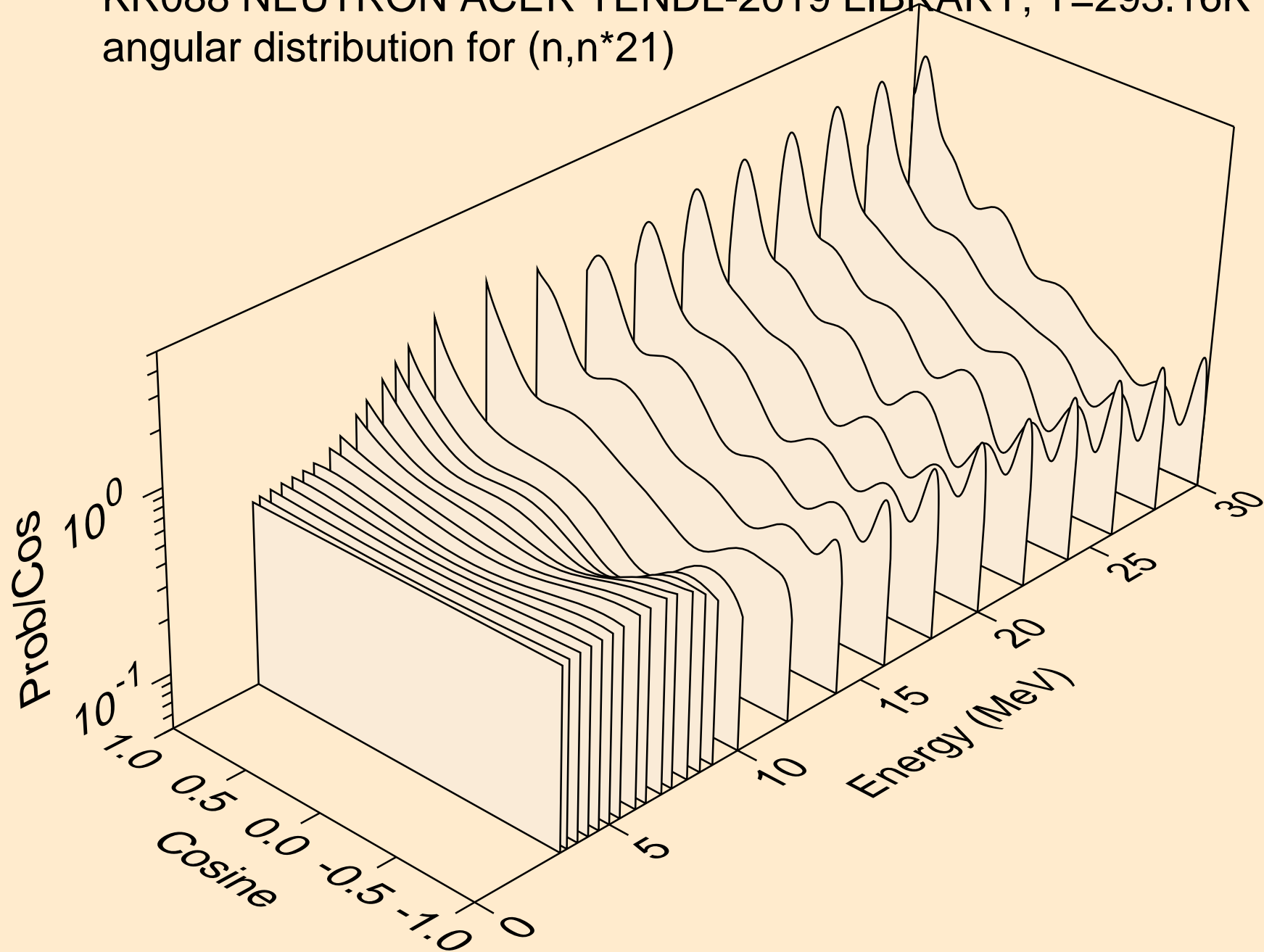

KR088 NEUTRON ACER TENDL-2019 LIBRARY; T=293.16K
angular distribution for (n,n*22)

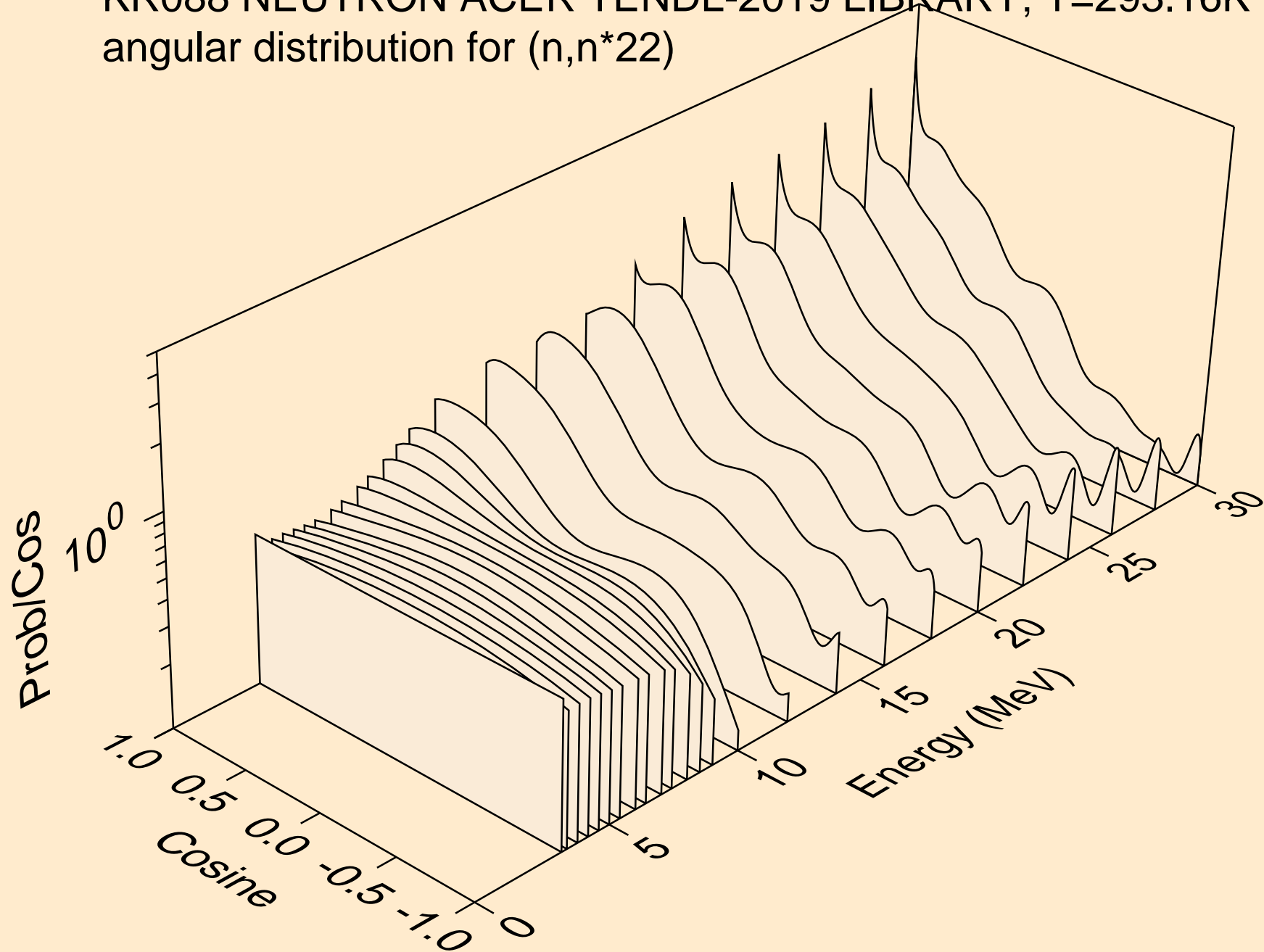

KR088 NEUTRON ACER TENDL-2019 LIBRARY; T=293.16K
angular distribution for (n,n*23)

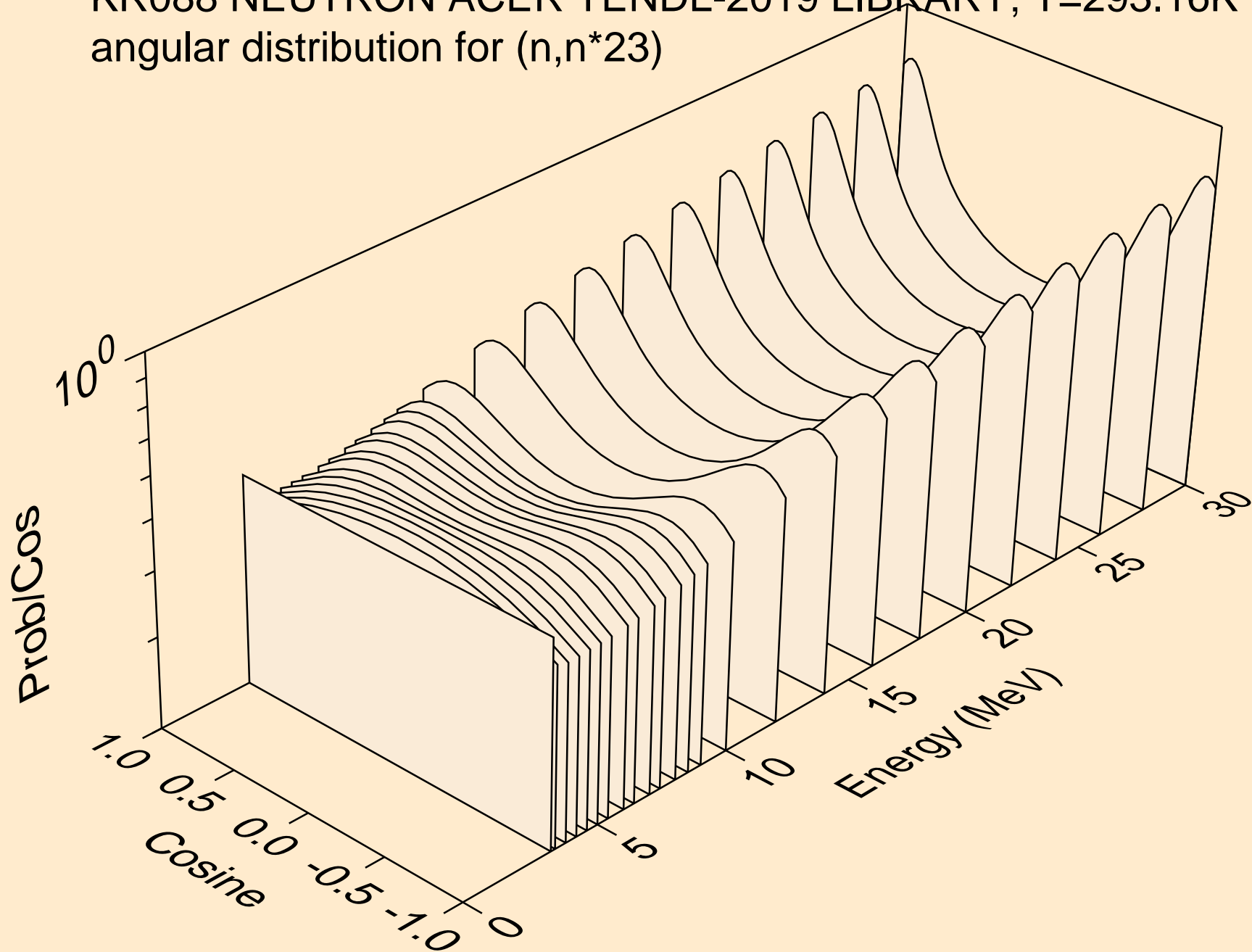

KR088 NEUTRON ACER TENDL-2019 LIBRARY; T=293.16K
angular distribution for (n,n*24)

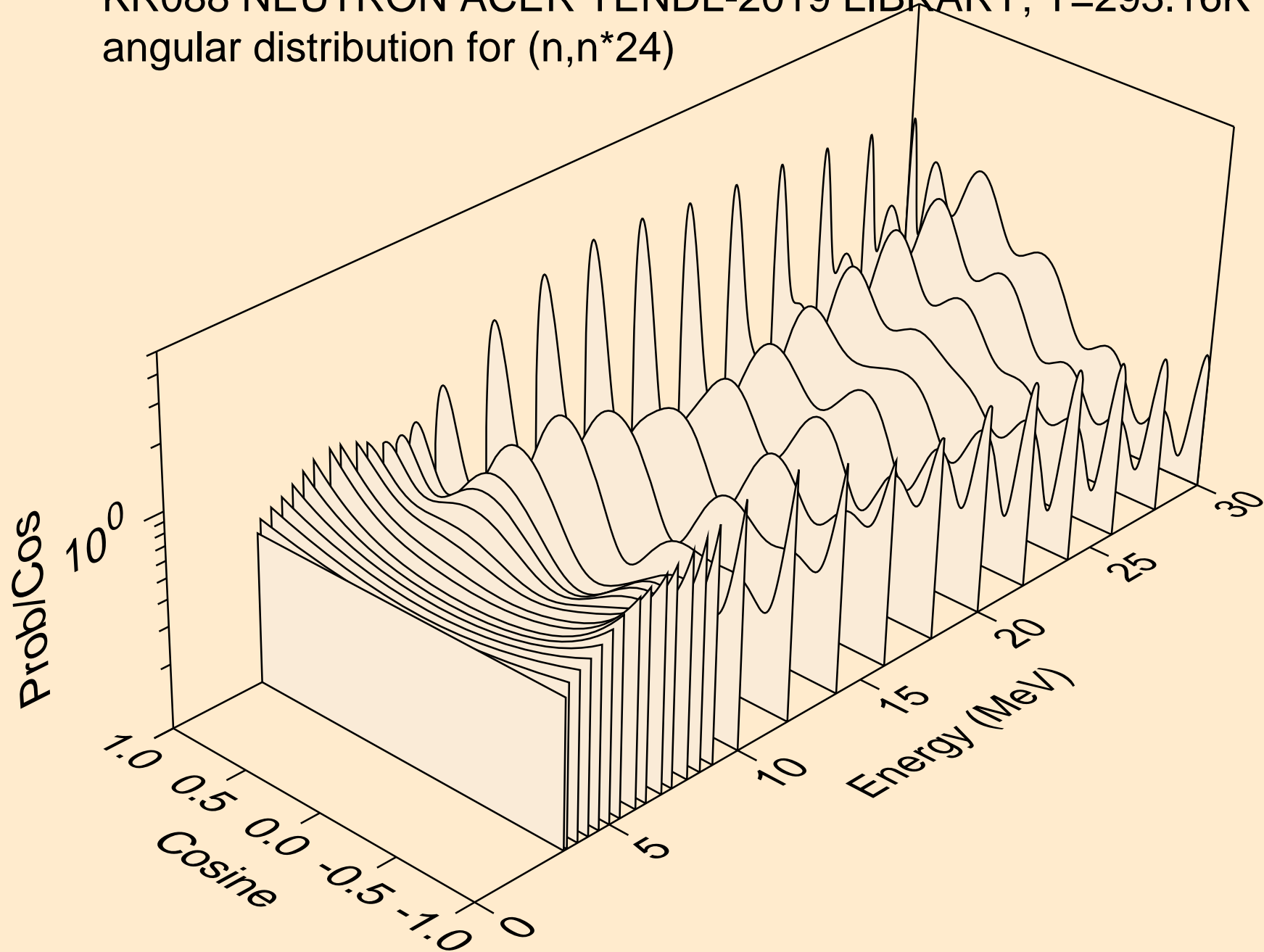

KR088 NEUTRON ACER TENDL-2019 LIBRARY; T=293.16K
angular distribution for (n,n*25)

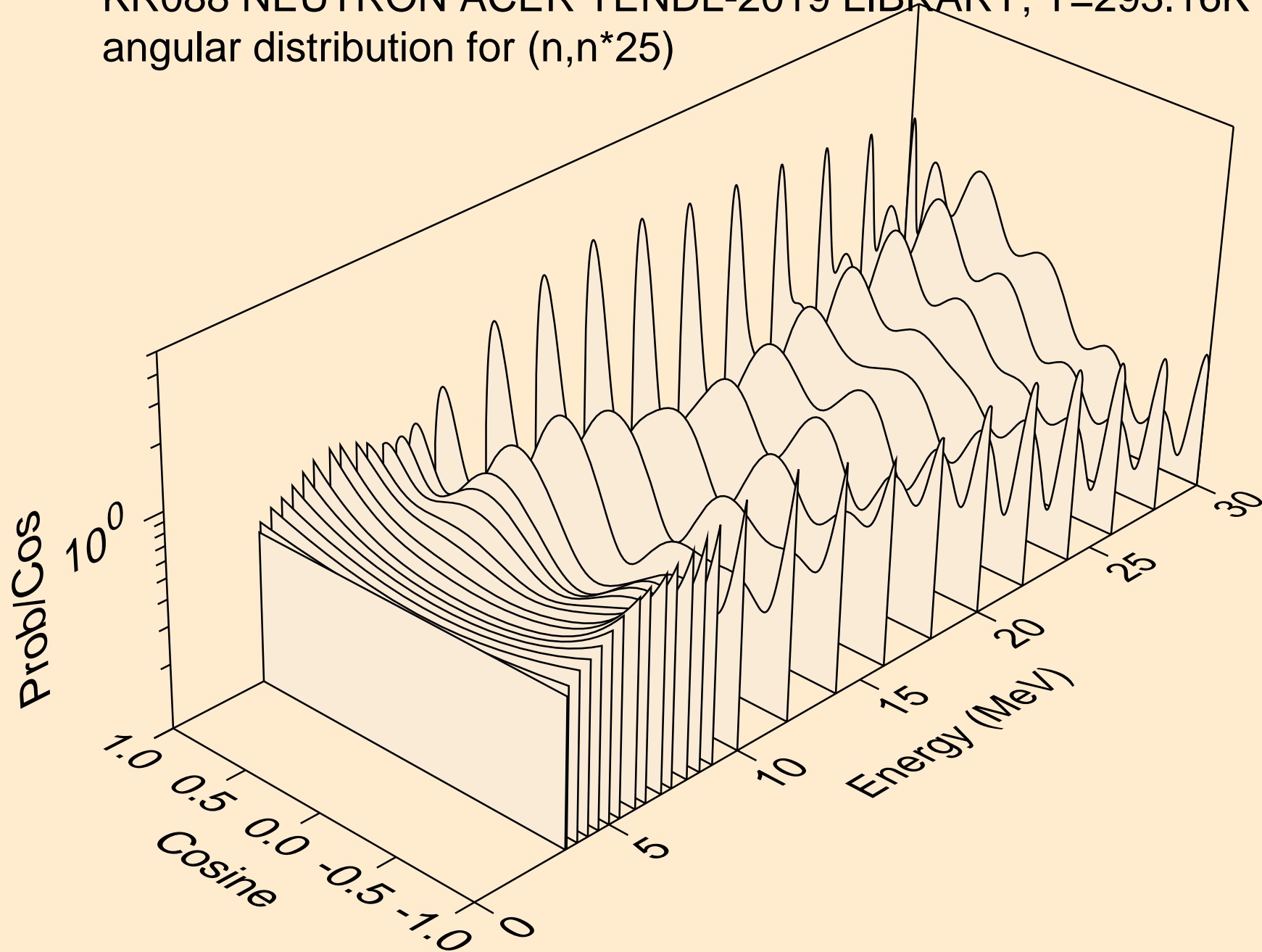

KR088 NEUTRON ACER TENDL-2019 LIBRARY; T=293.16K
angular distribution for (n,n*26)

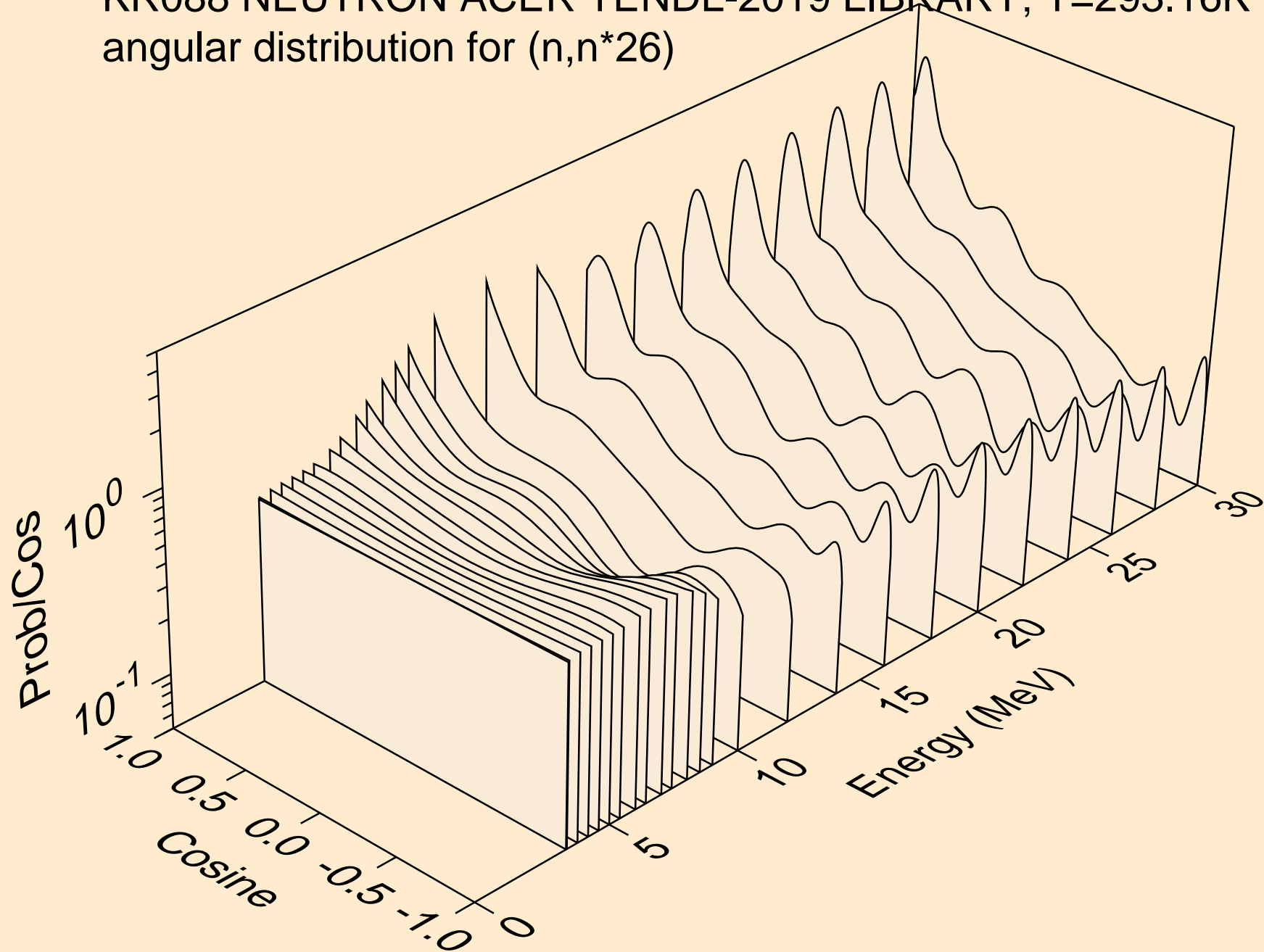

KR088 NEUTRON ACER TENDL-2019 LIBRARY; T=293.16K
angular distribution for (n,n*27)

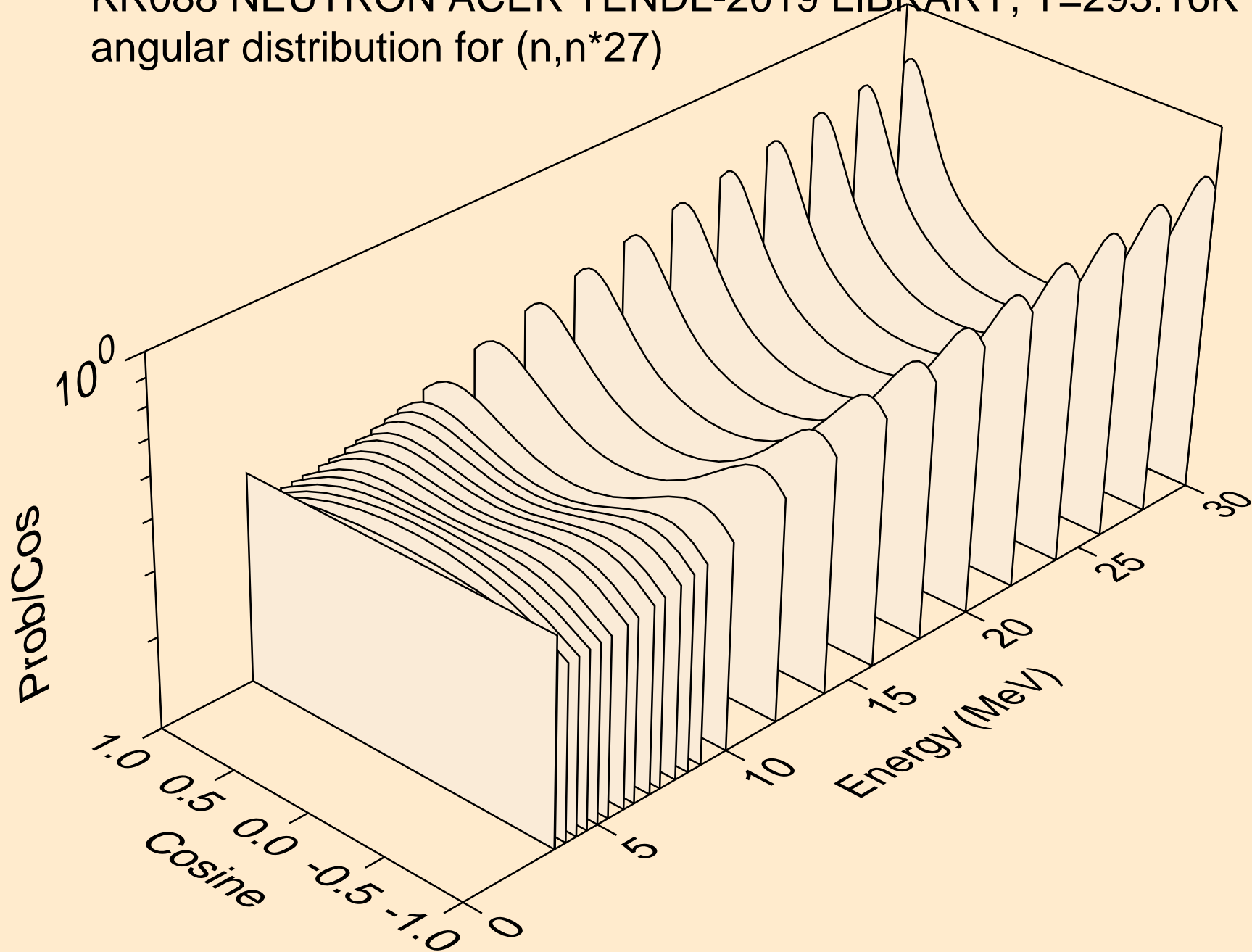

KR088 NEUTRON ACER TENDL-2019 LIBRARY; T=293.16K
angular distribution for (n,n*28)

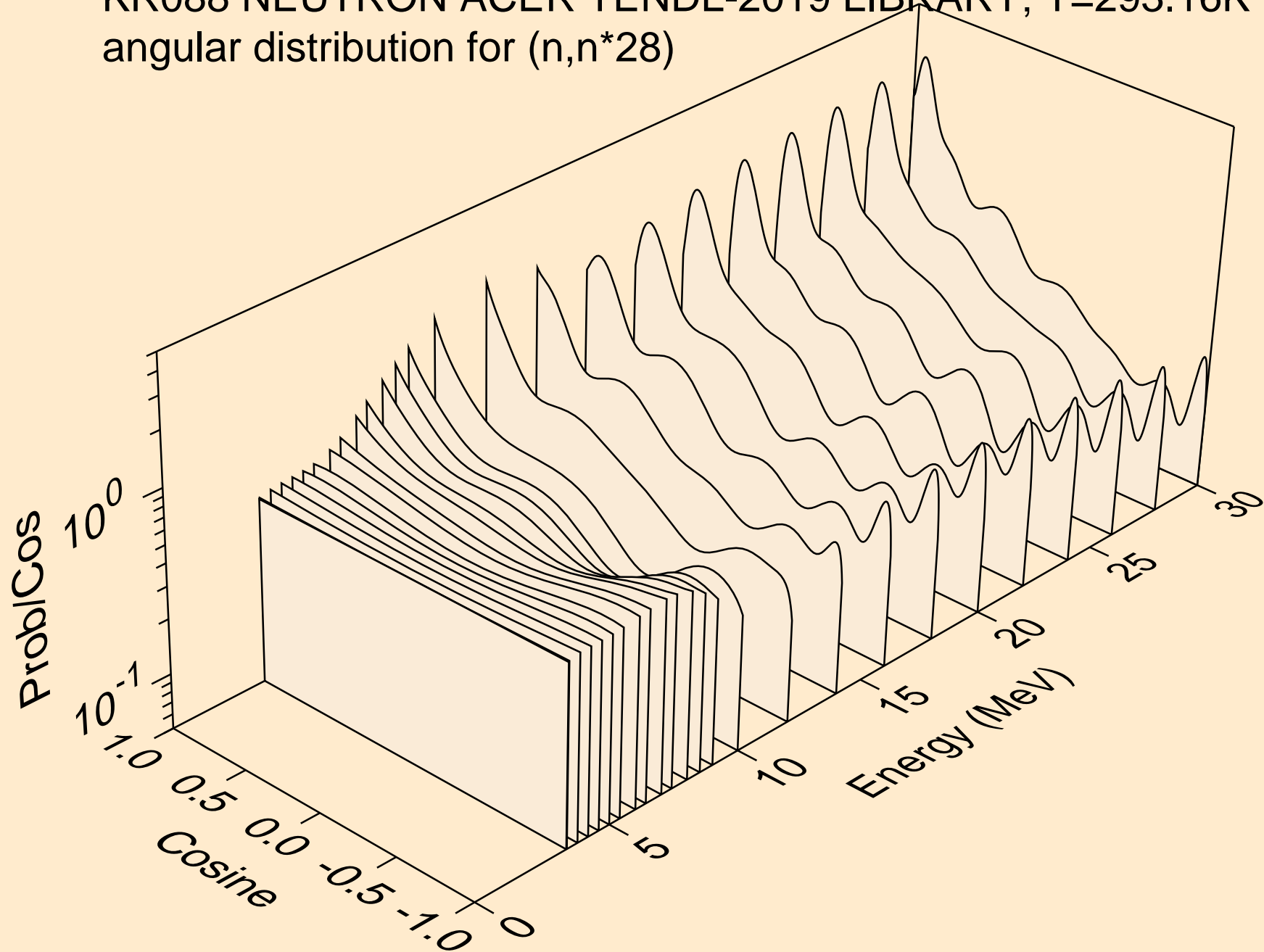

KR088 NEUTRON ACER TENDL-2019 LIBRARY; T=293.16K
angular distribution for (n,n*29)

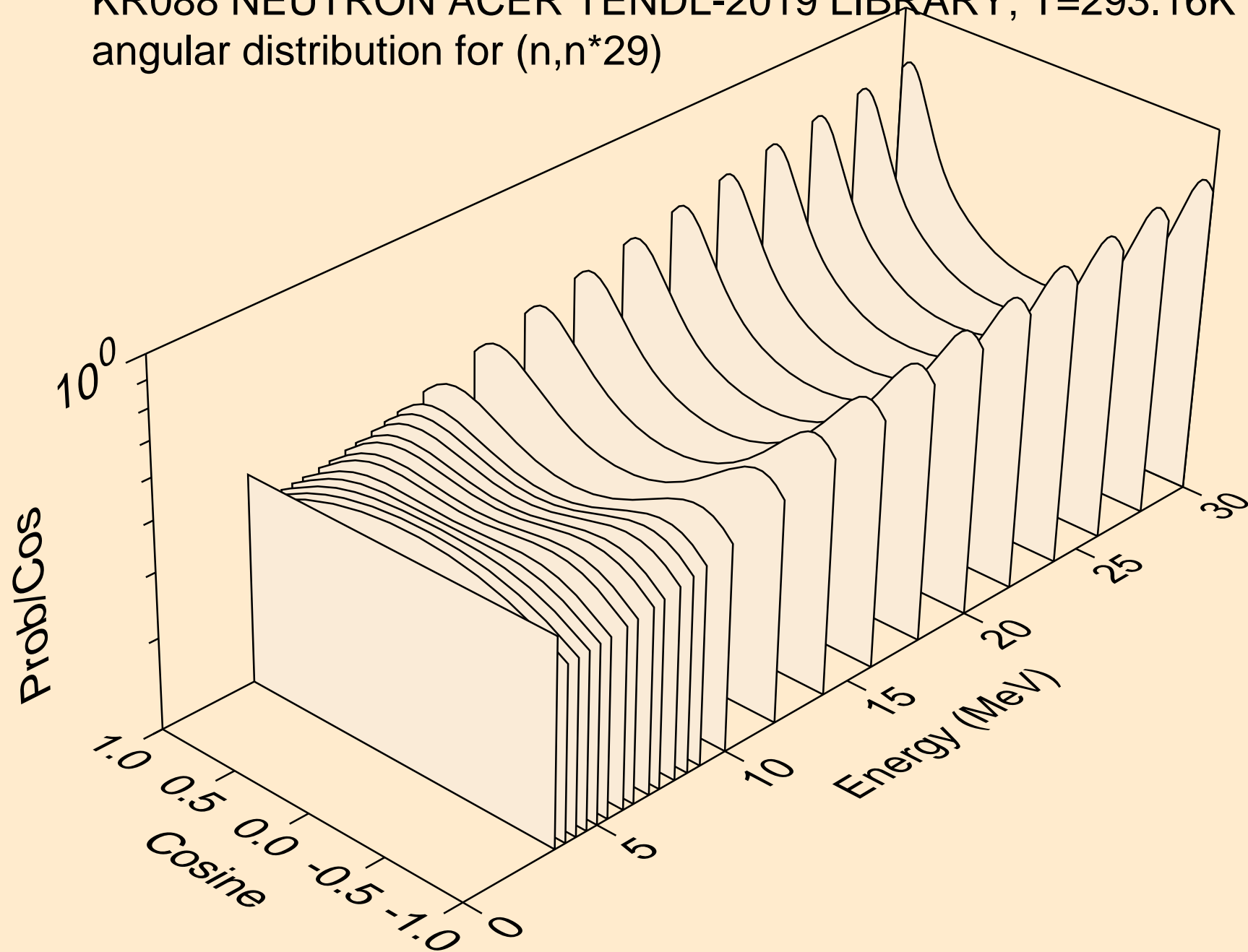

KR088 NEUTRON ACER TENDL-2019 LIBRARY; T=293.16K
angular distribution for (n,n*30)

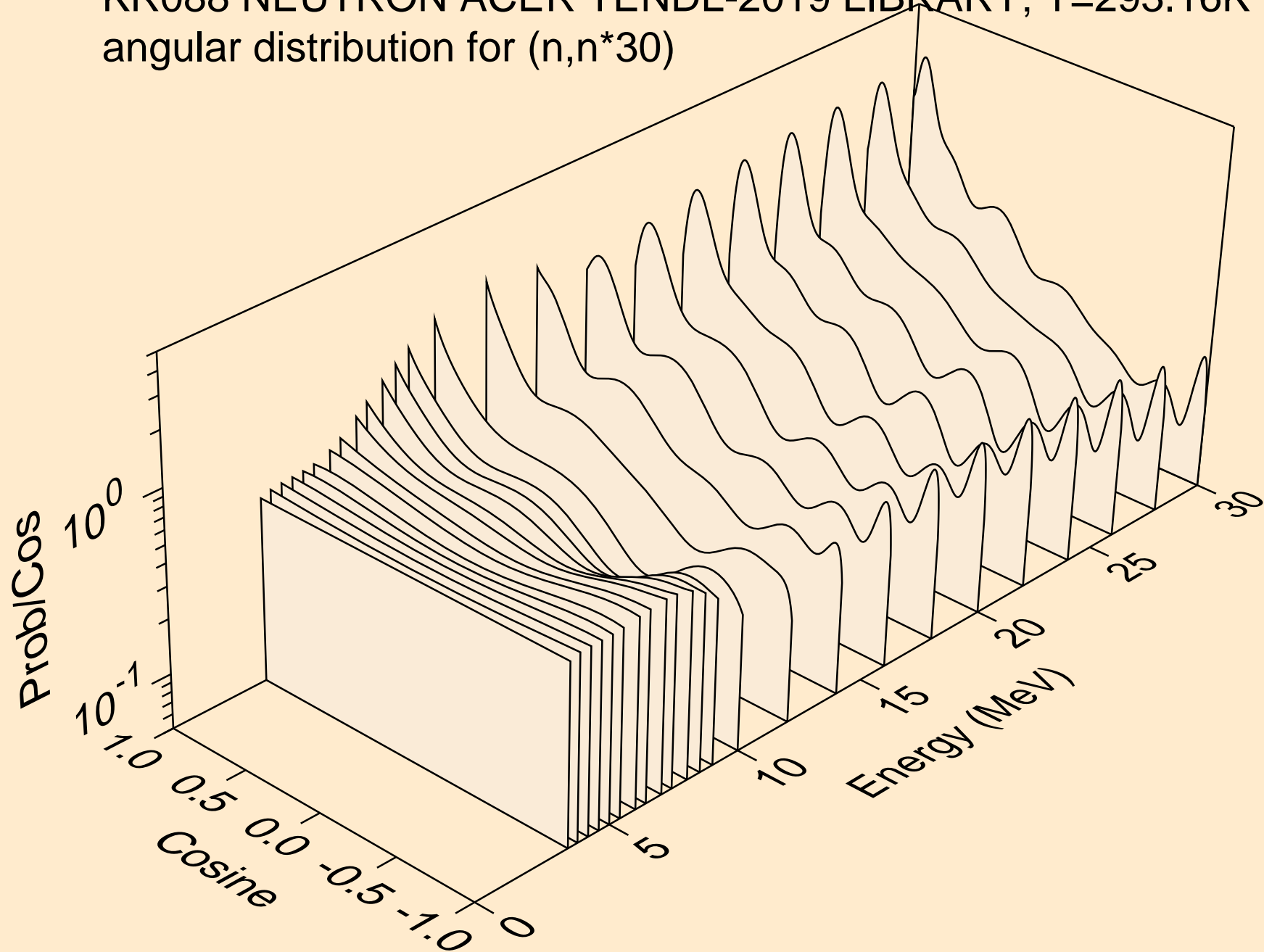

KR088 NEUTRON ACER TENDL-2019 LIBRARY; T=293.16K
Neutron emission for (n,x)

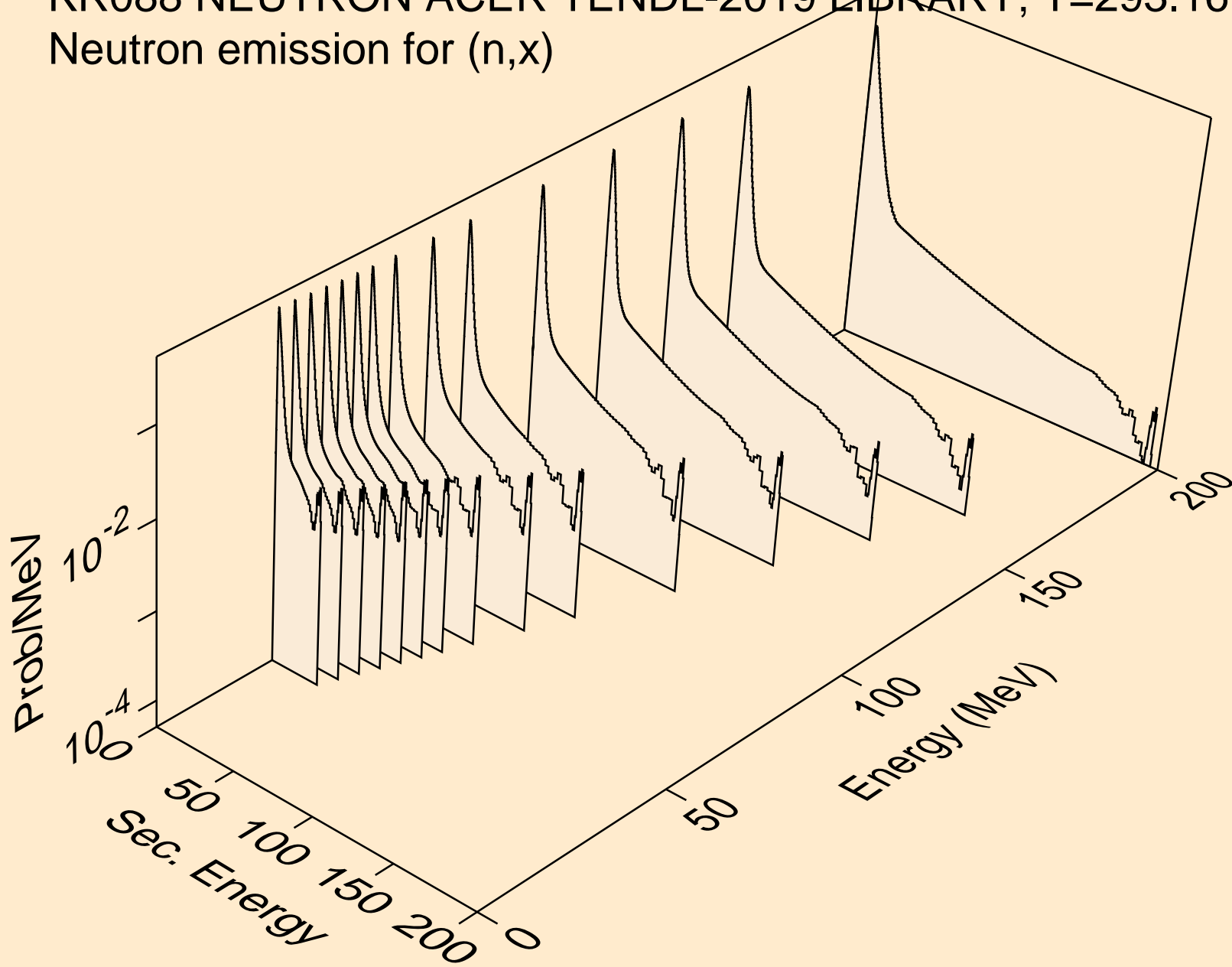

KR088 NEUTRON ACER TENDL-2019 LIBRARY; T=293.16K
Neutron emission for (n,2nd)

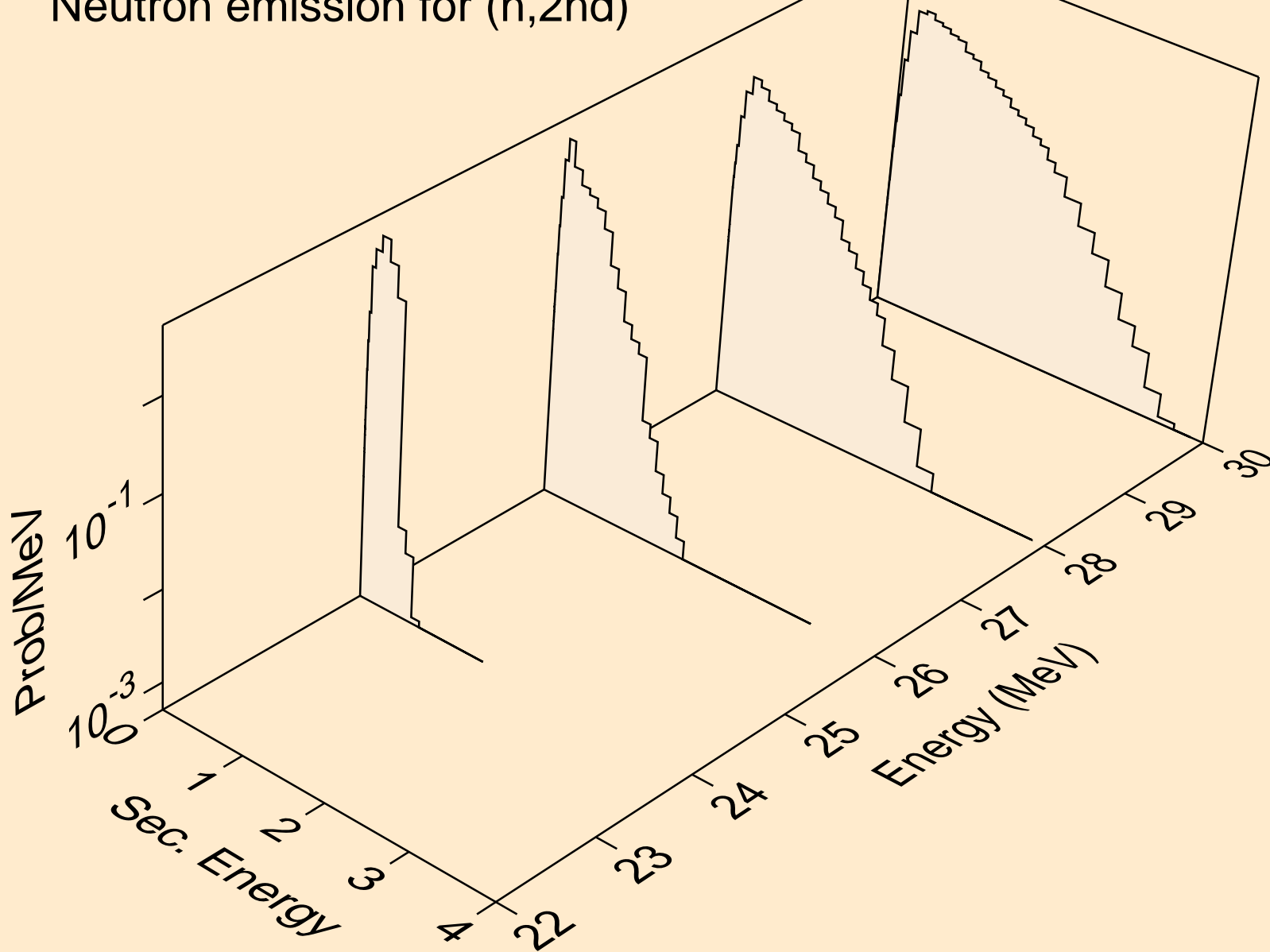

KR088 NEUTRON ACER TENDL-2019 LIBRARY; T=293.16K
Neutron emission for (n,2n)

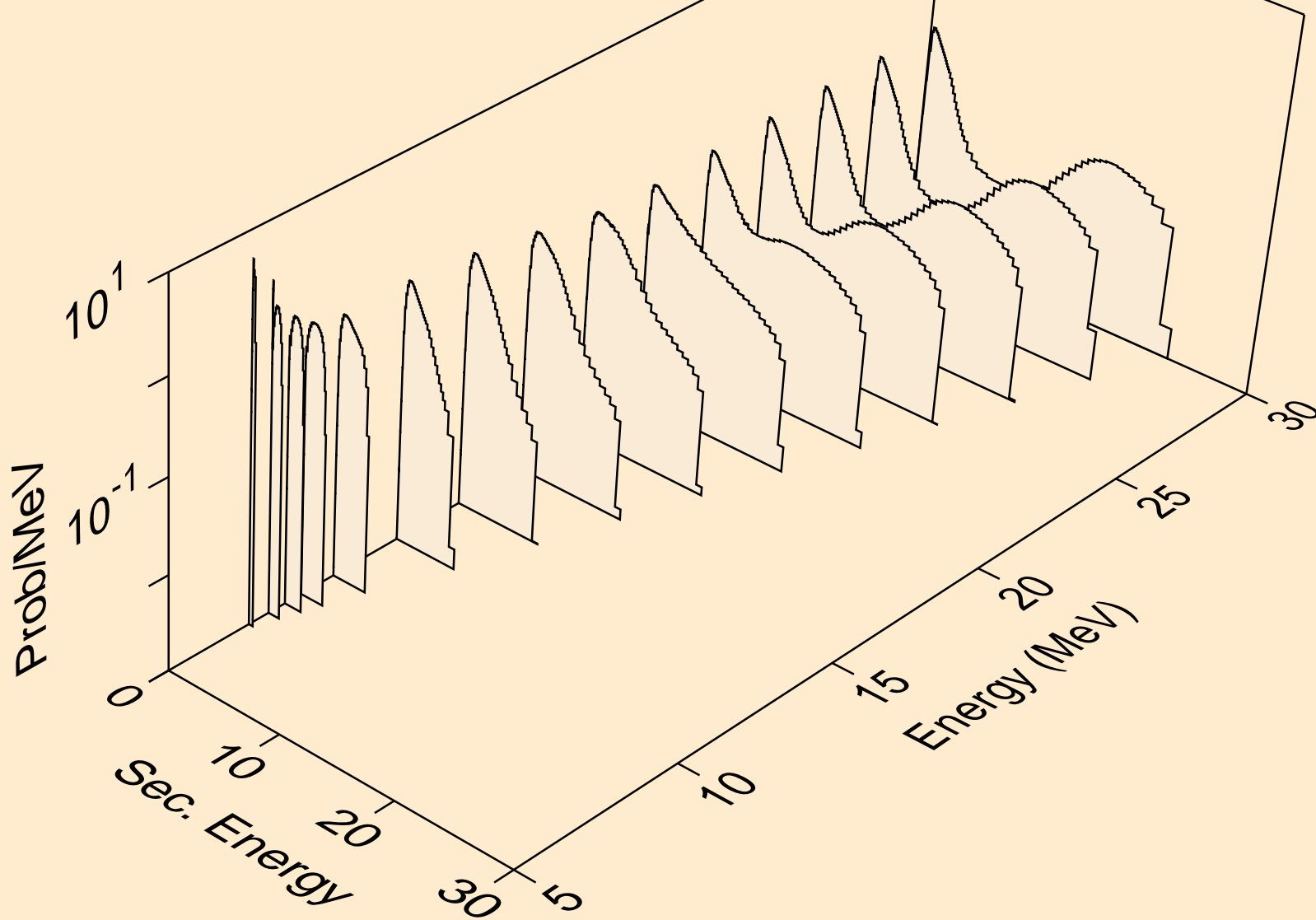

KR088 NEUTRON ACER TENDL-2019 LIBRARY; T=293.16K
Neutron emission for (n,3n)

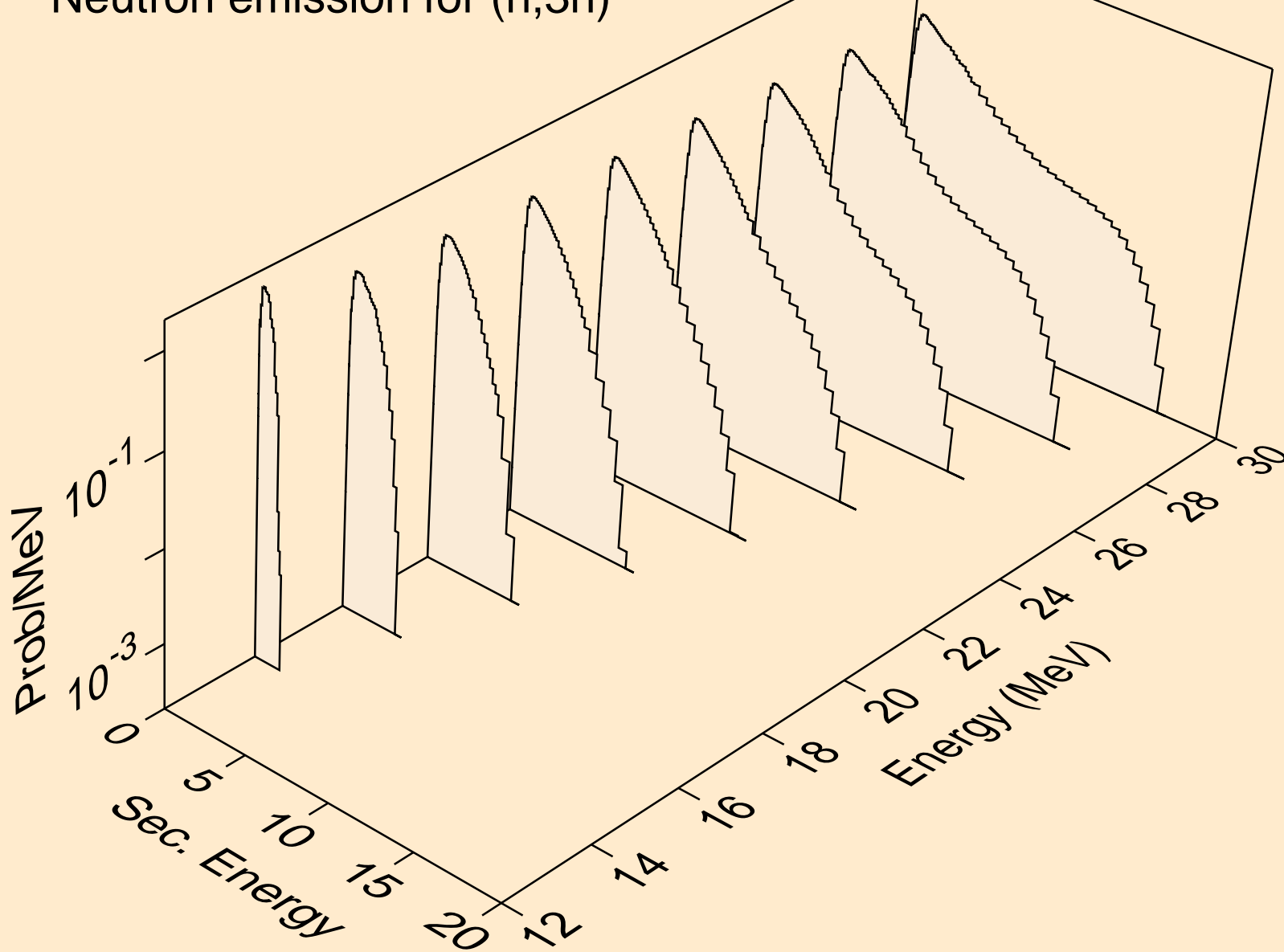

KR088 NEUTRON ACER TENDL-2019 LIBRARY; T=293.16K
Neutron emission for (n,n*)a

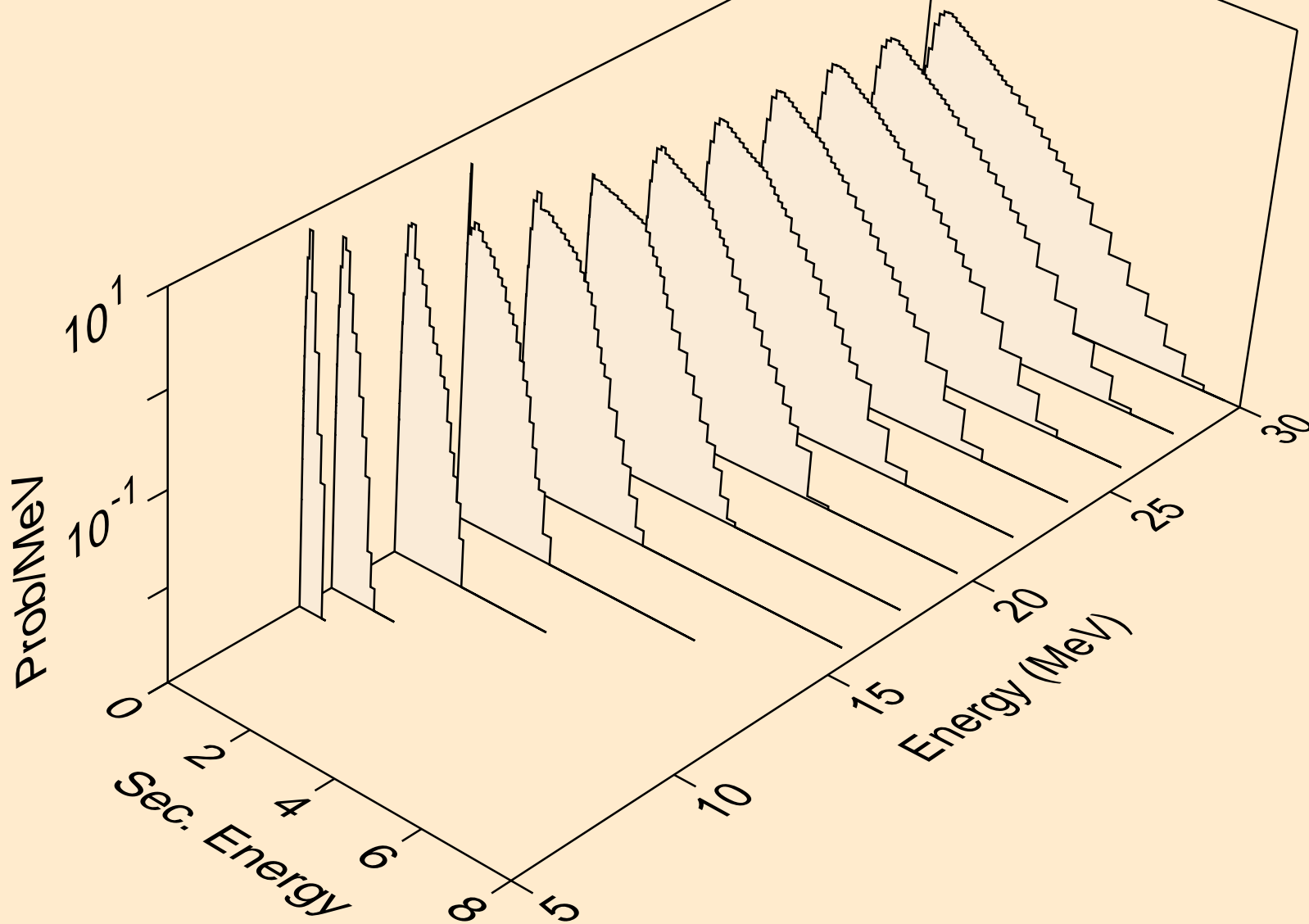

KR088 NEUTRON ACER TENDL-2019 LIBRARY; T=293.16K
Neutron emission for (n,2n)a

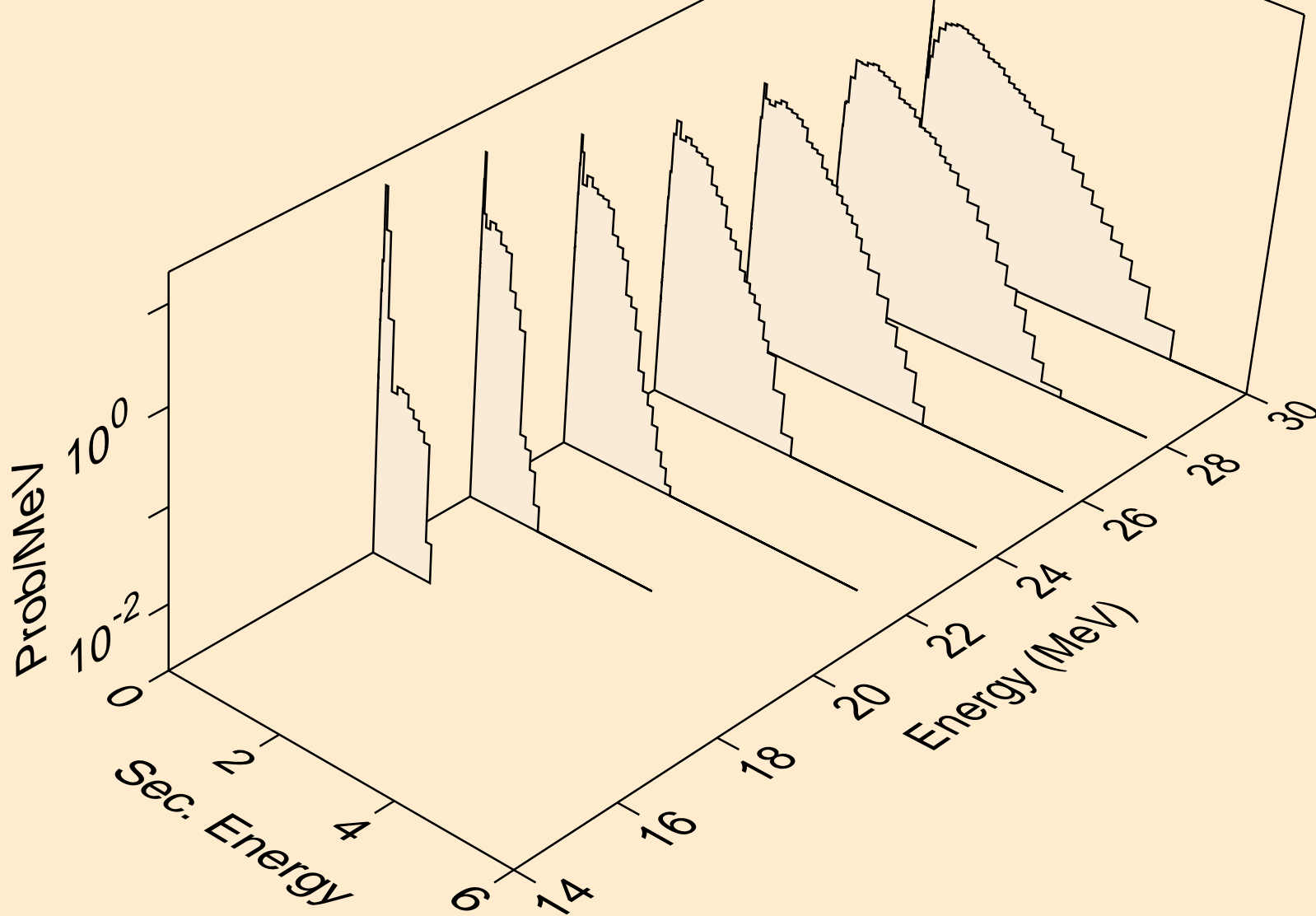

KR088 NEUTRON ACER TENDL-2019 LIBRARY; T=293.16K
Neutron emission for (n,3n)a

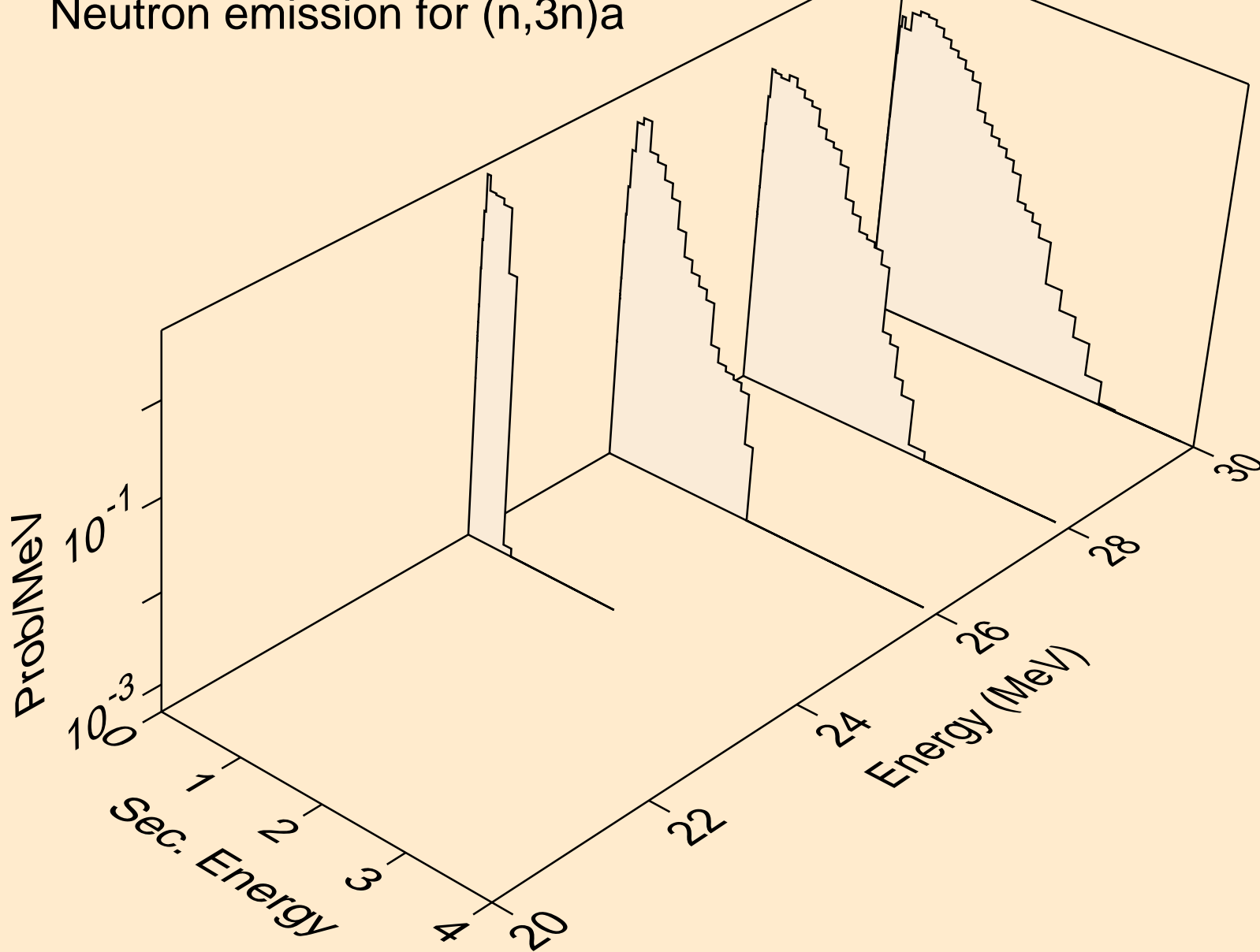

KR088 NEUTRON ACER TENDL-2019 LIBRARY; T=293.16K
Neutron emission for (n,n*)p

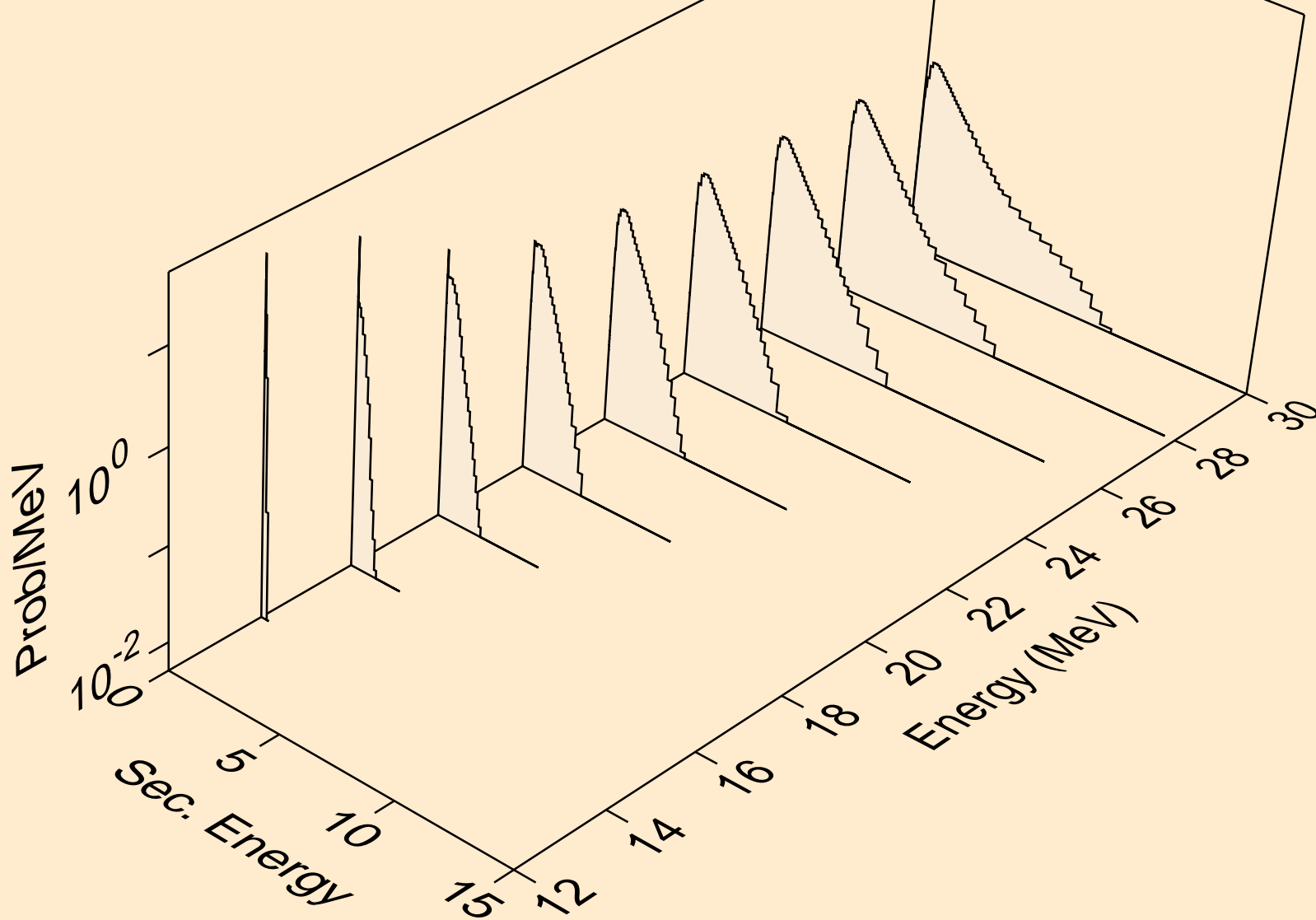

KR088 NEUTRON ACER TENDL-2019 LIBRARY; T=293.16K
Neutron emission for (n,n*)d

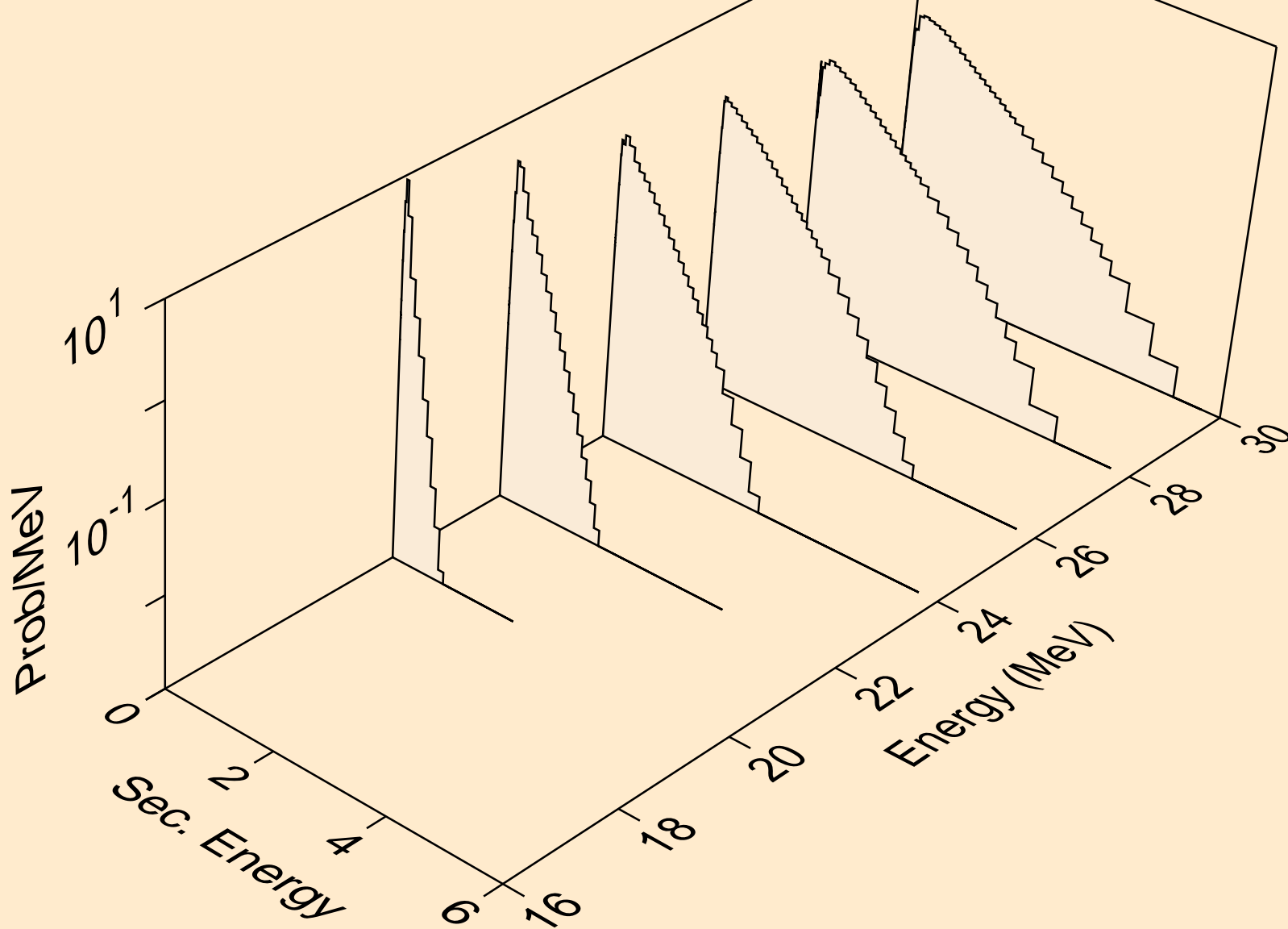

KR088 NEUTRON ACER TENDL-2019 LIBRARY; T=293.16K
Neutron emission for (n,n*)t

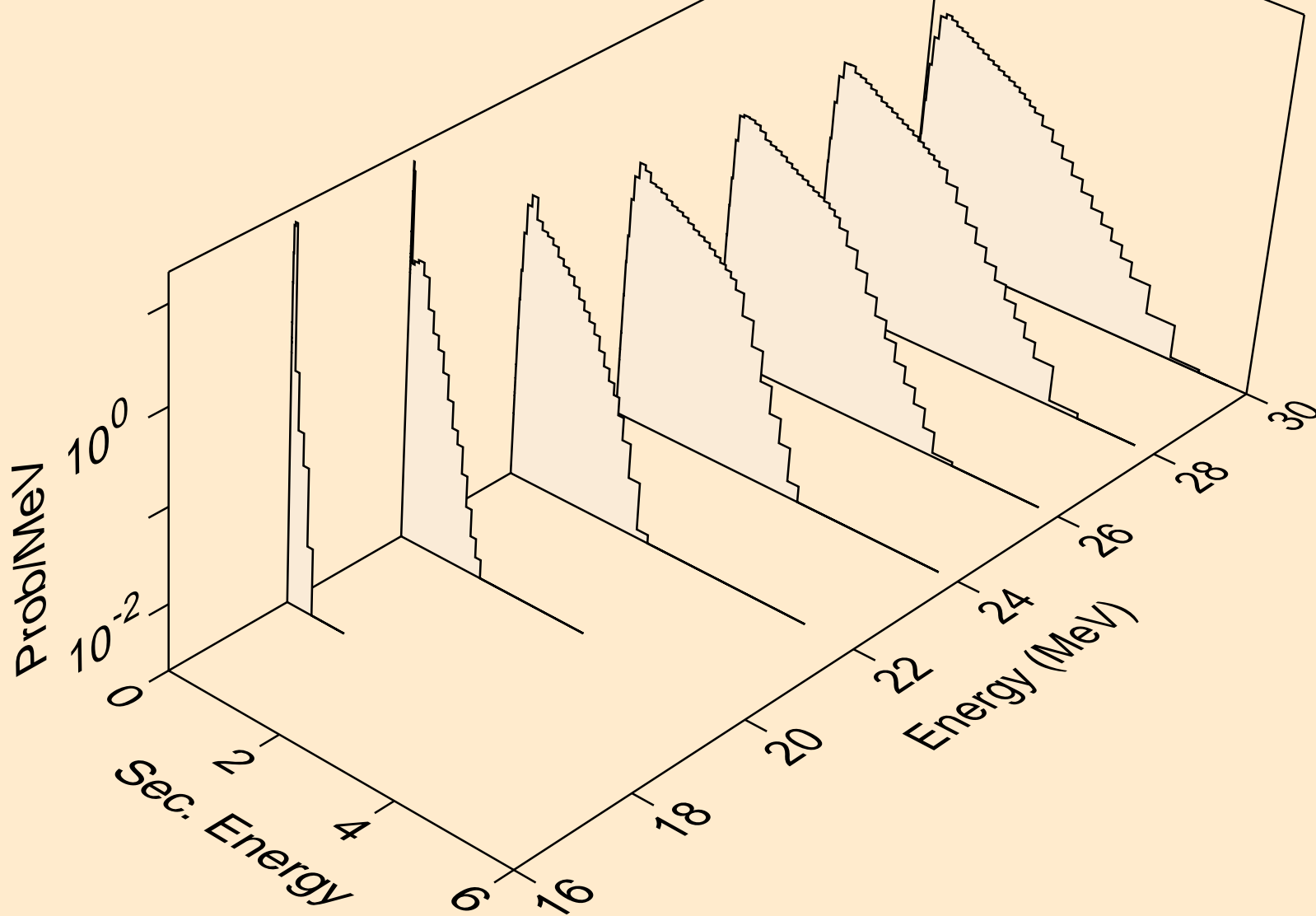

KR088 NEUTRON ACER TENDL-2019 LIBRARY; T=293.16K
Neutron emission for (n,n*)he3

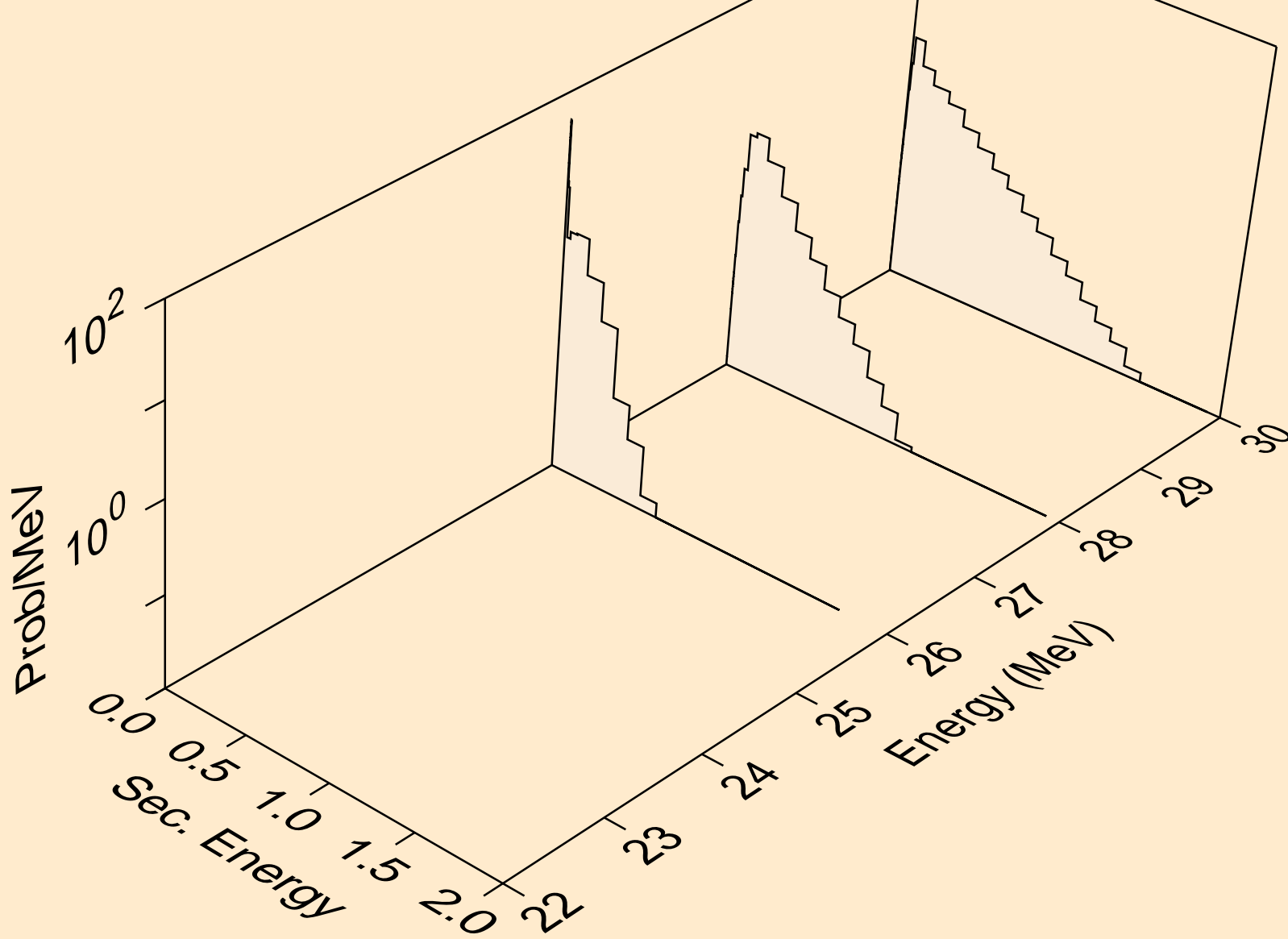

KR088 NEUTRON ACER TENDL-2019 LIBRARY; T=293.16K
Neutron emission for (n,4n)

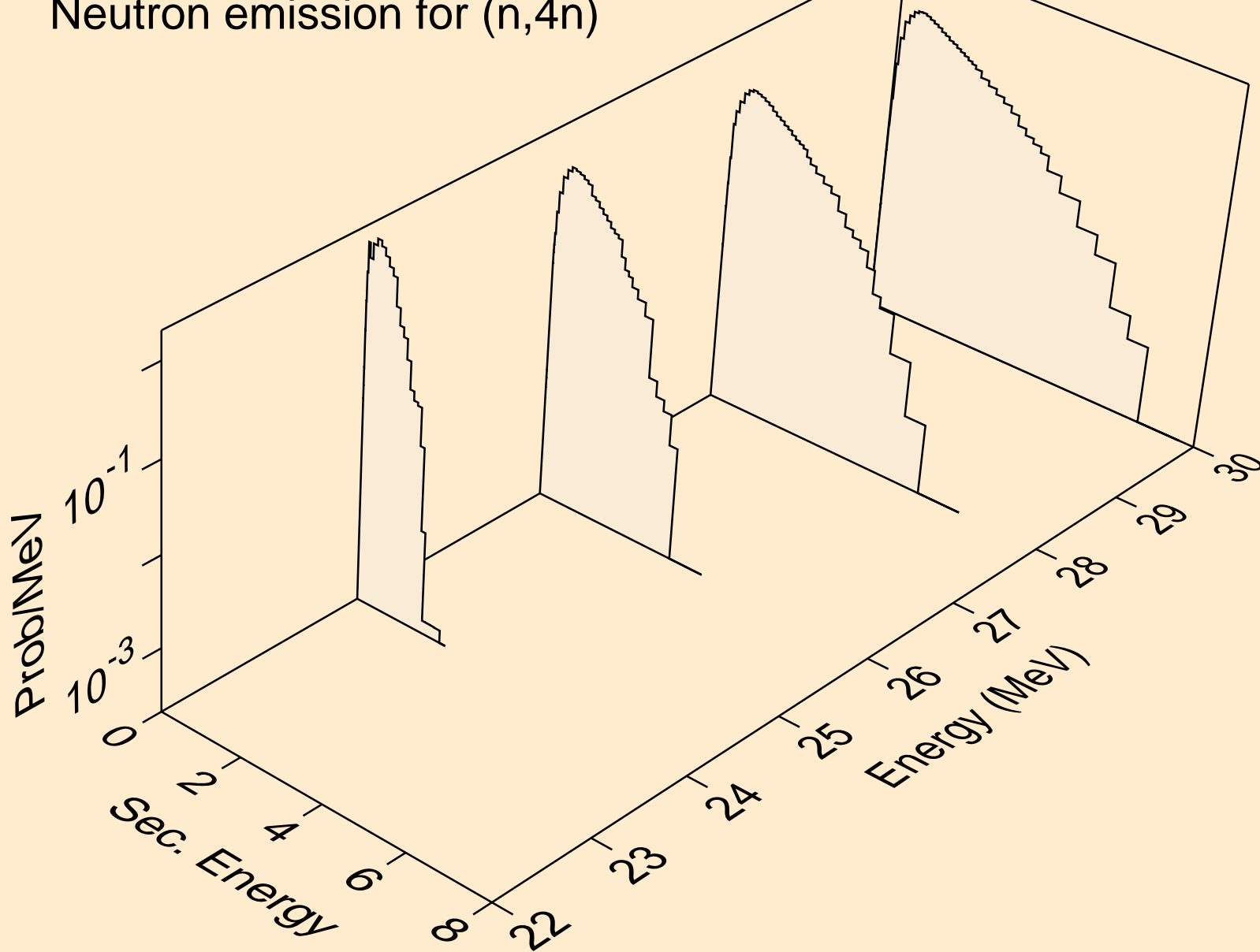

KR088 NEUTRON ACER TENDL-2019 LIBRARY; T=293.16K
Neutron emission for (n,2np)

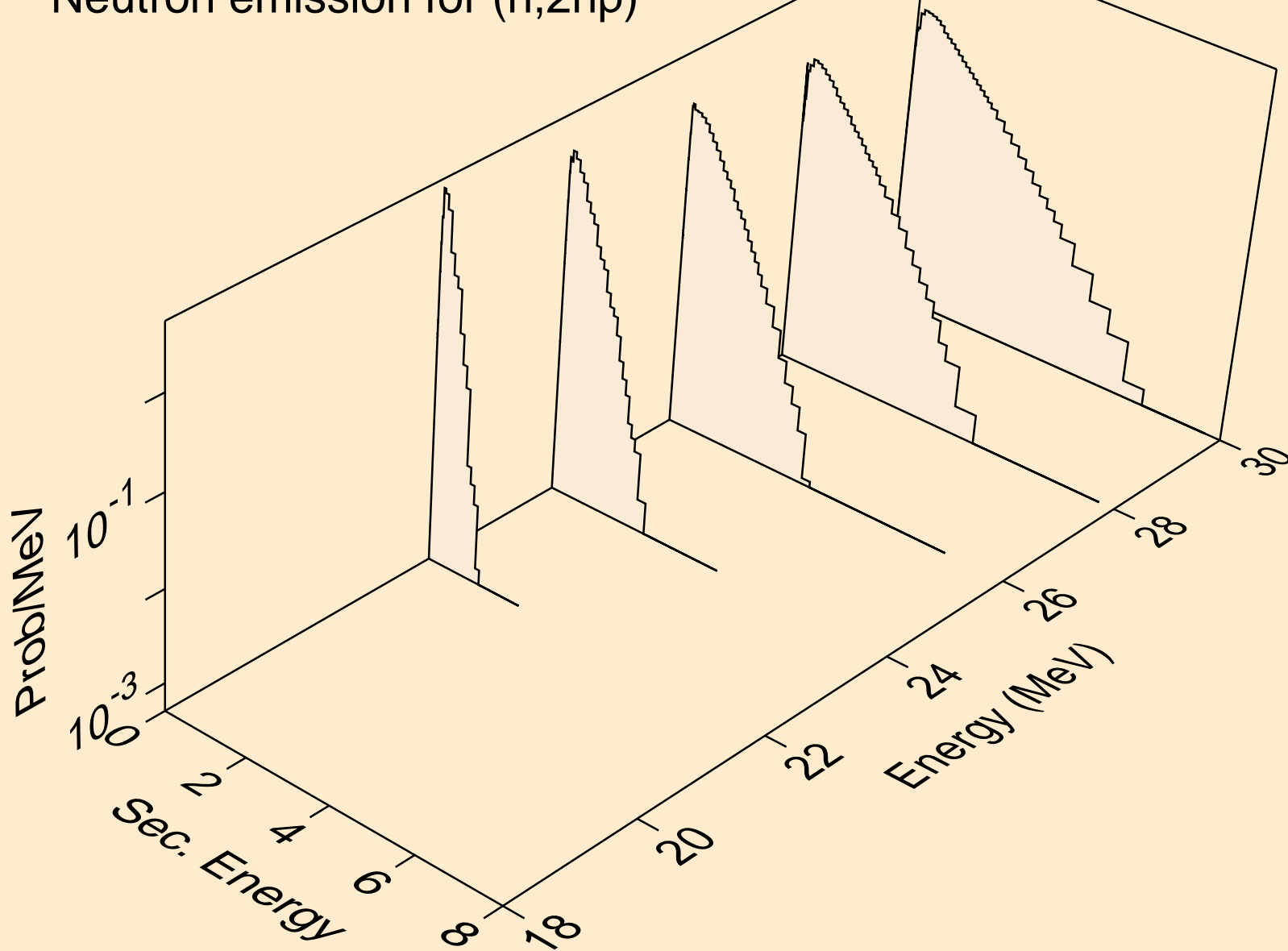

KR088 NEUTRON ACER TENDL-2019 LIBRARY; T=293.16K
Neutron emission for (n,3np)

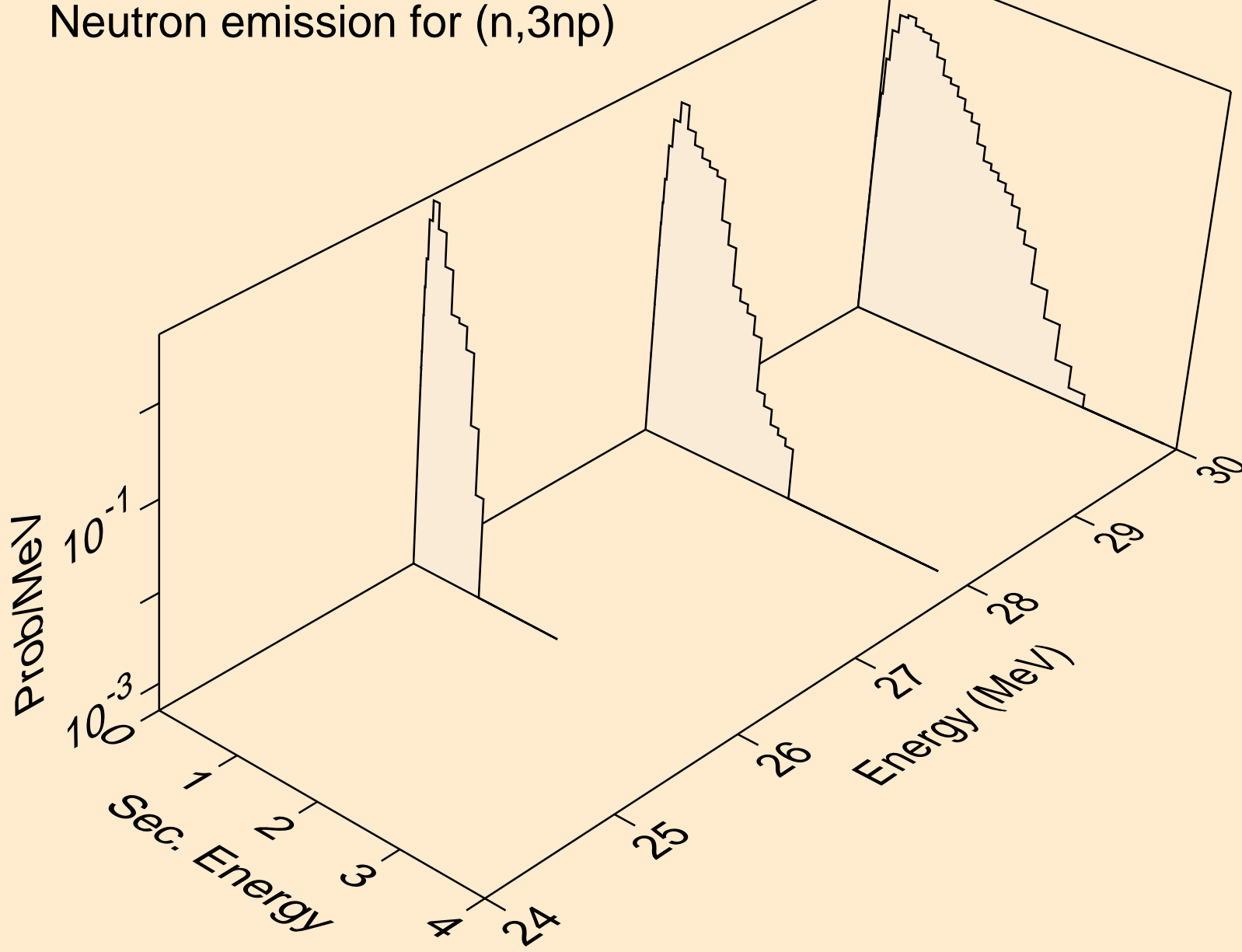

KR088 NEUTRON ACER TENDL-2019 LIBRARY; T=293.16K
Neutron emission for (n,n*c)

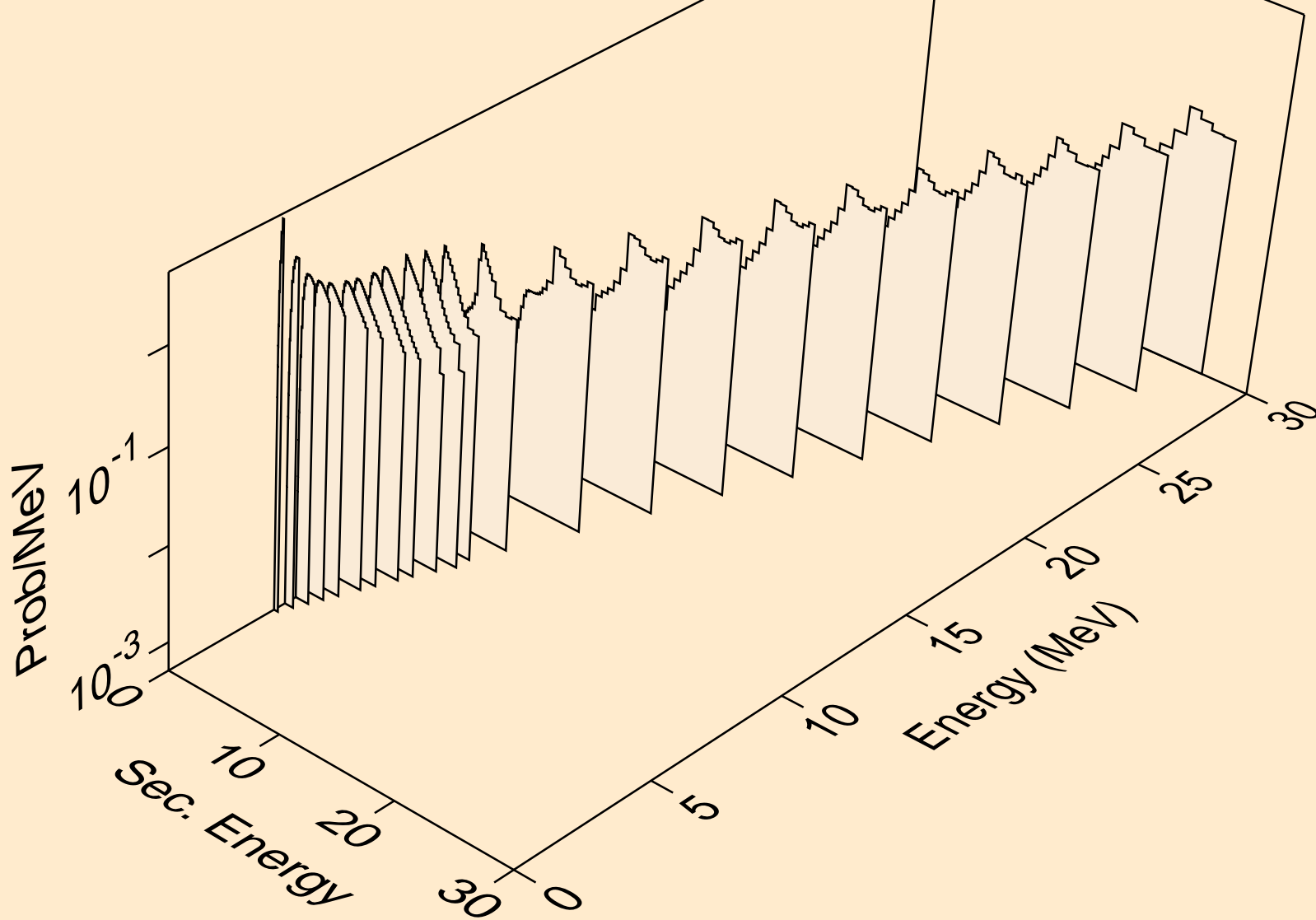

KR088 NEUTRON ACER TENDL-2019 LIBRARY; T=293.16K
Photon emission for (n,x)

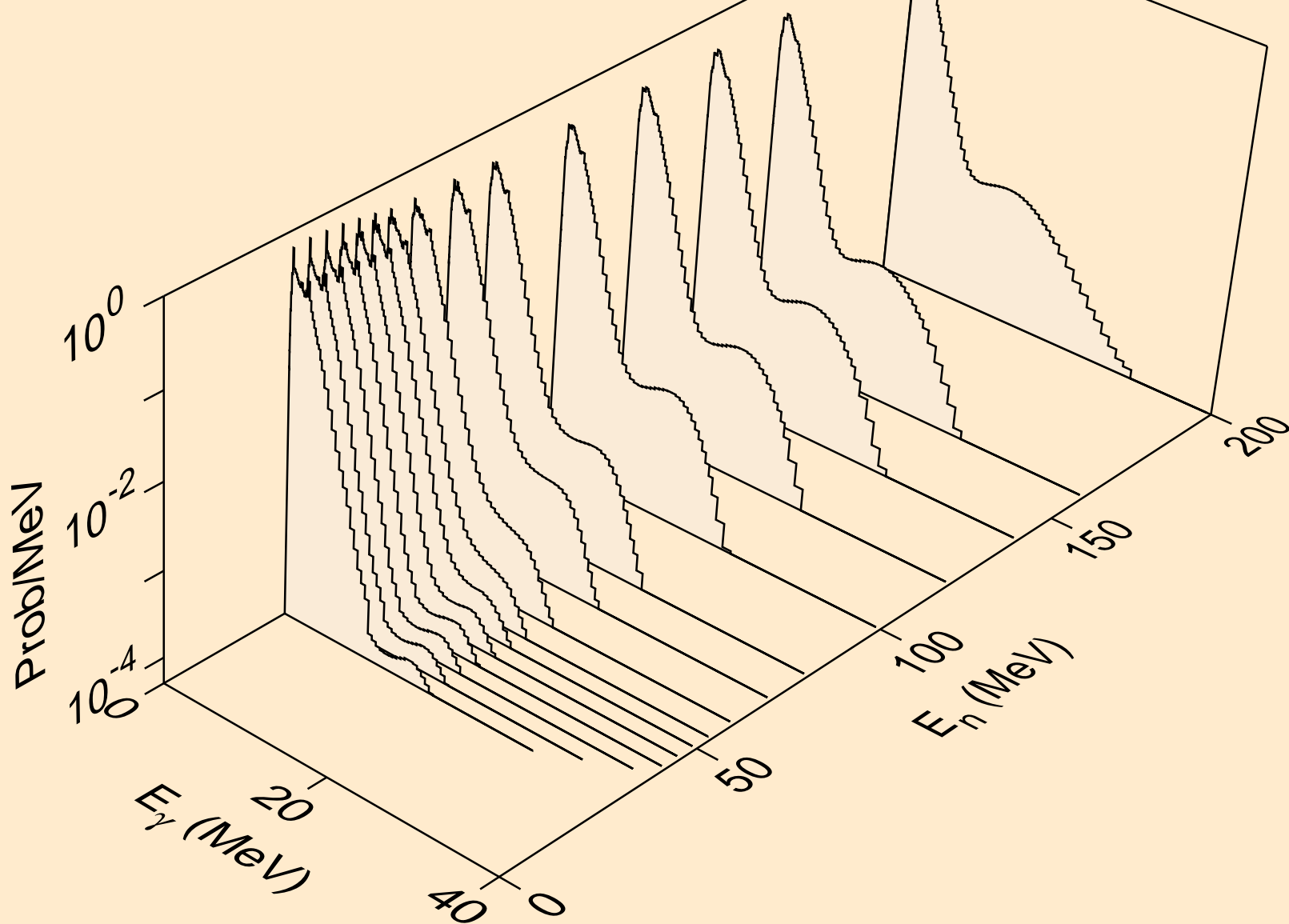

KR088 NEUTRON ACER TENDL-2019 LIBRARY; T=293.16K
Photon emission for (n,2nd)

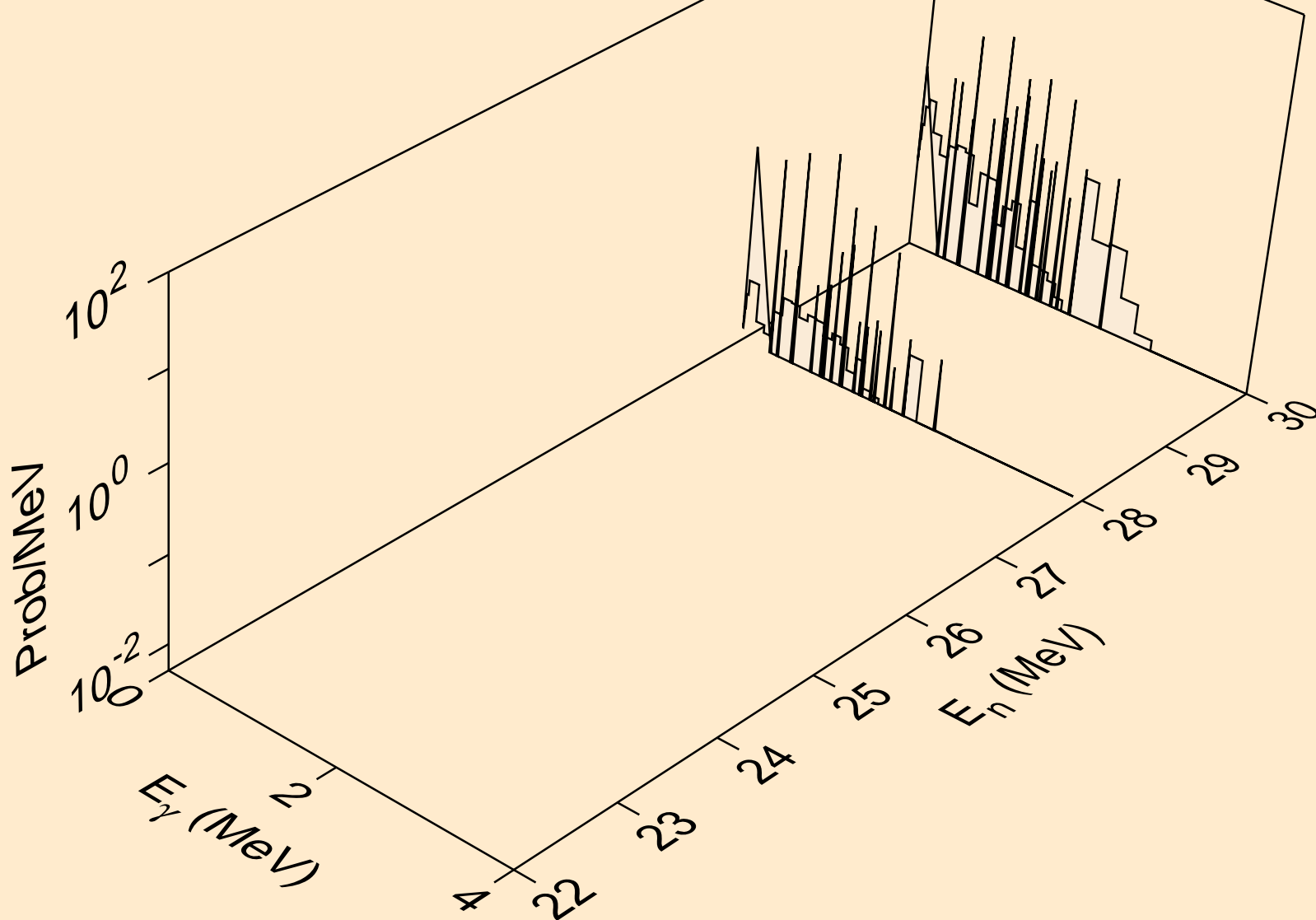

KR088 NEUTRON ACER TENDL-2019 LIBRARY; T=293.16K
Photon emission for (n,2n)

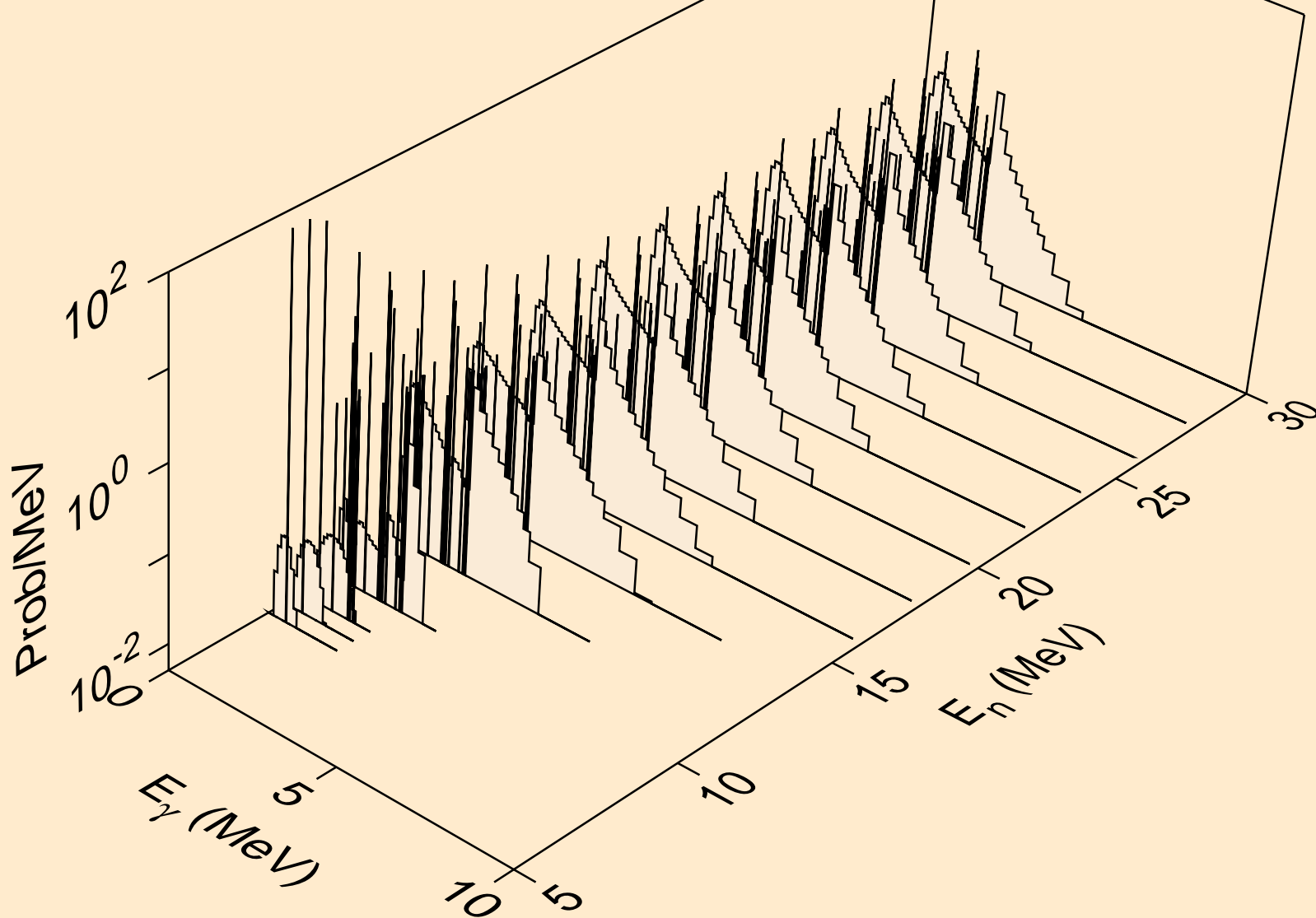

KR088 NEUTRON ACER TENDL-2019 LIBRARY; T=293.16K
Photon emission for (n,3n)

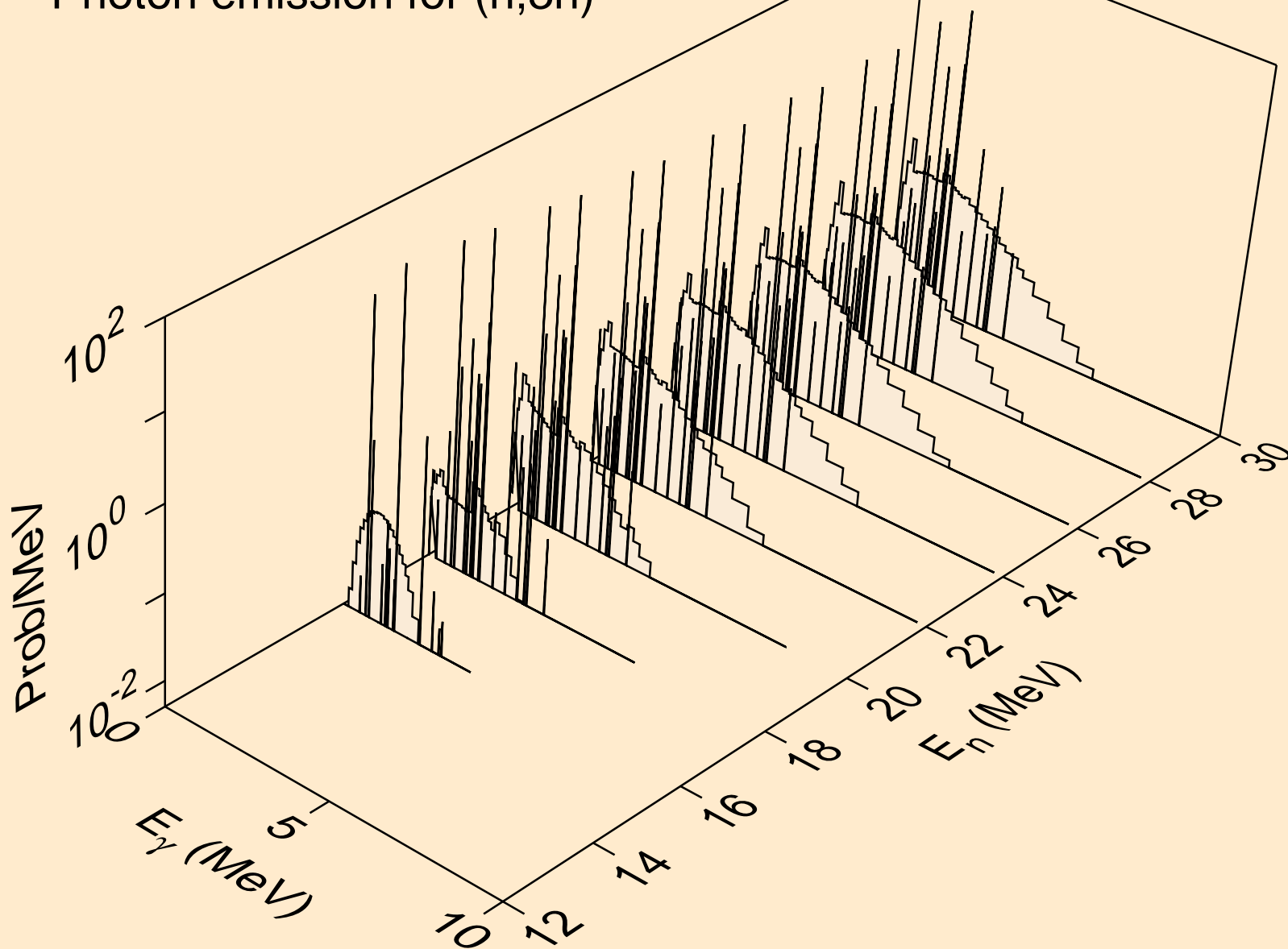

KR088 NEUTRON ACER TENDL-2019 LIBRARY; T=293.16K
Photon emission for (n,n*)a

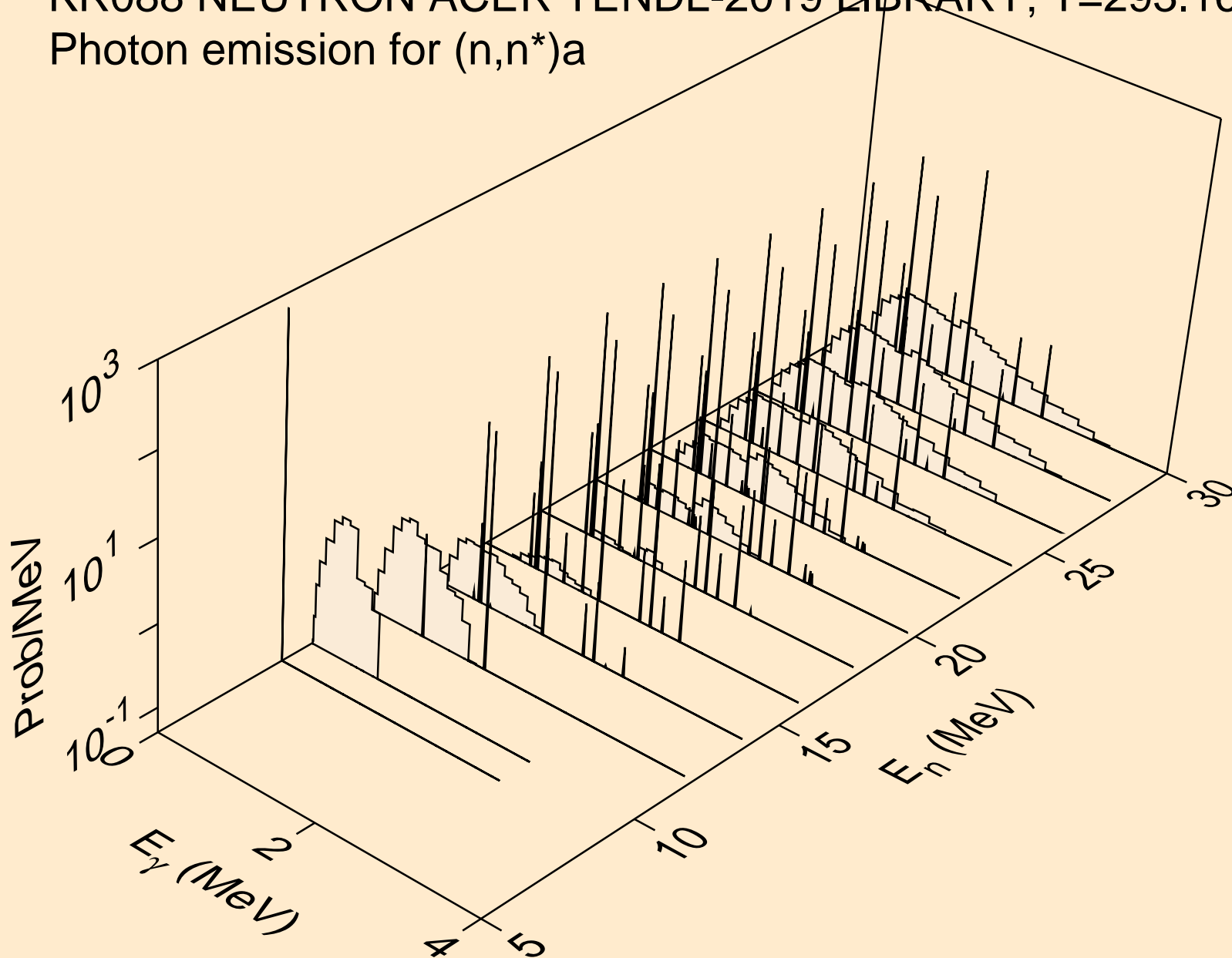

KR088 NEUTRON ACER TENDL-2019 LIBRARY; T=293.16K
Photon emission for (n,2n)a

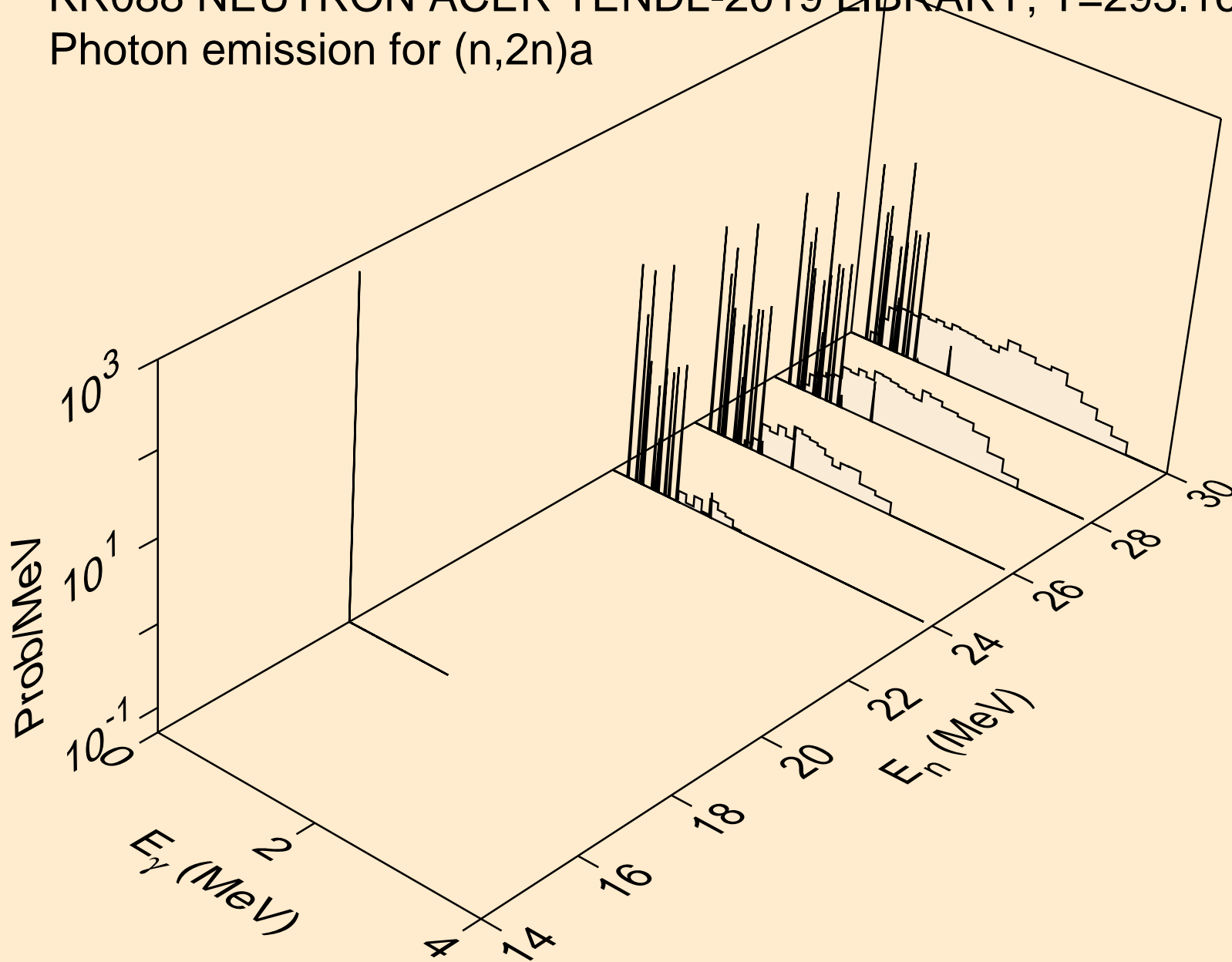

KR088 NEUTRON ACER TENDL-2019 LIBRARY; T=293.16K
Photon emission for (n,3n)a

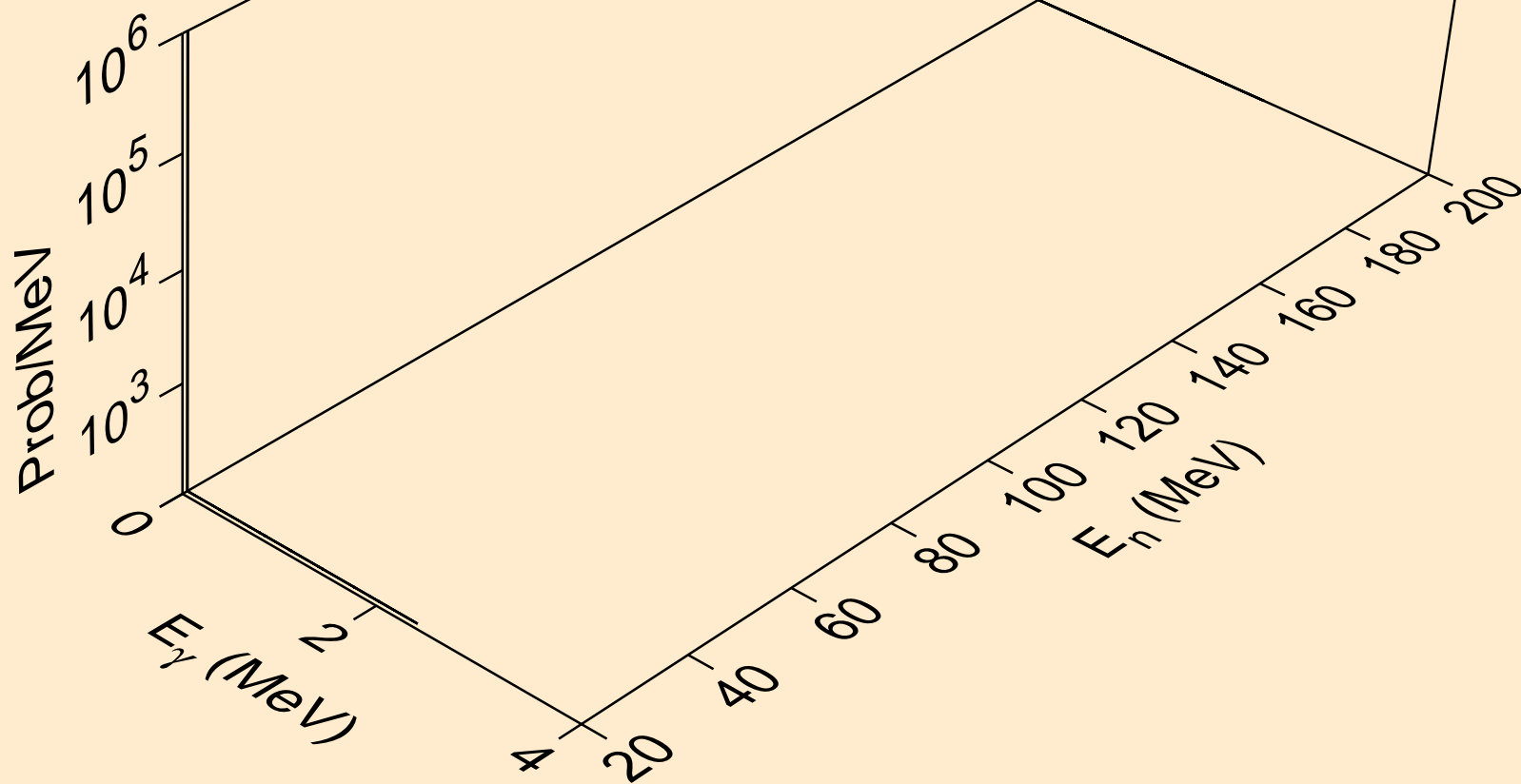

KR088 NEUTRON ACER TENDL-2019 LIBRARY; T=293.16K
Photon emission for (n,n*)p

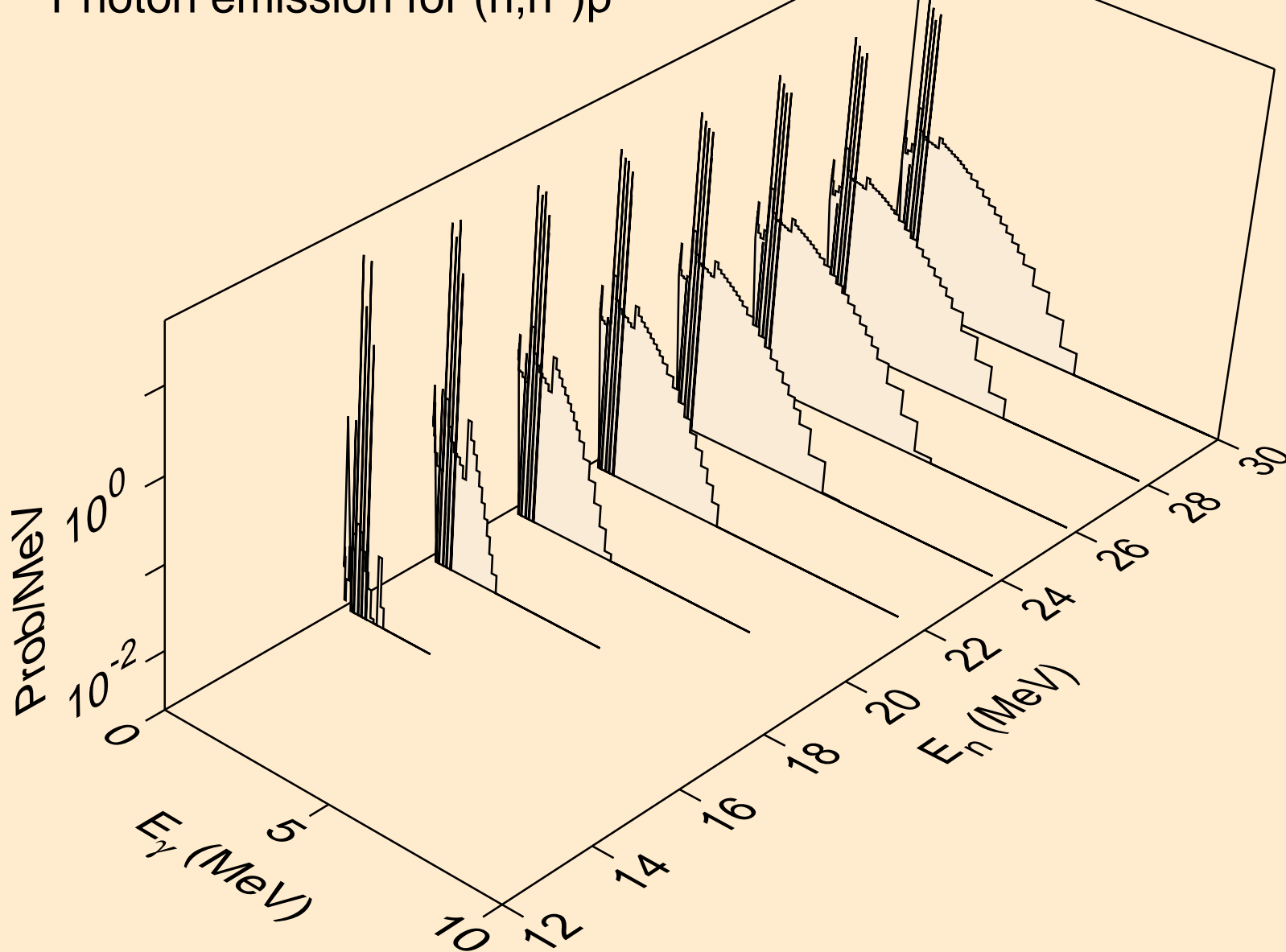

KR088 NEUTRON ACER TENDL-2019 LIBRARY; T=293.16K
Photon emission for (n,n*)d

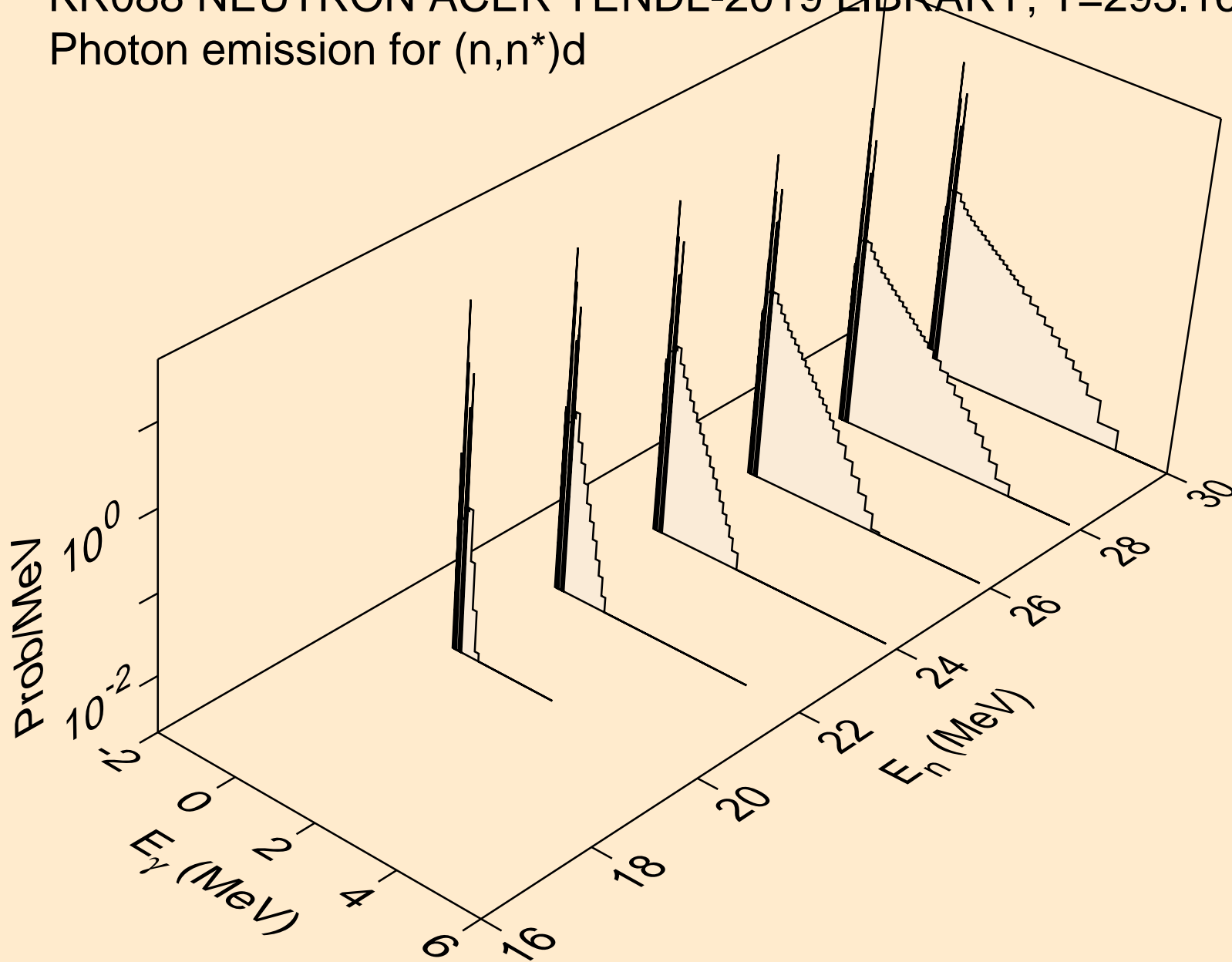

KR088 NEUTRON ACER TENDL-2019 LIBRARY; T=293.16K
Photon emission for (n,n*)t

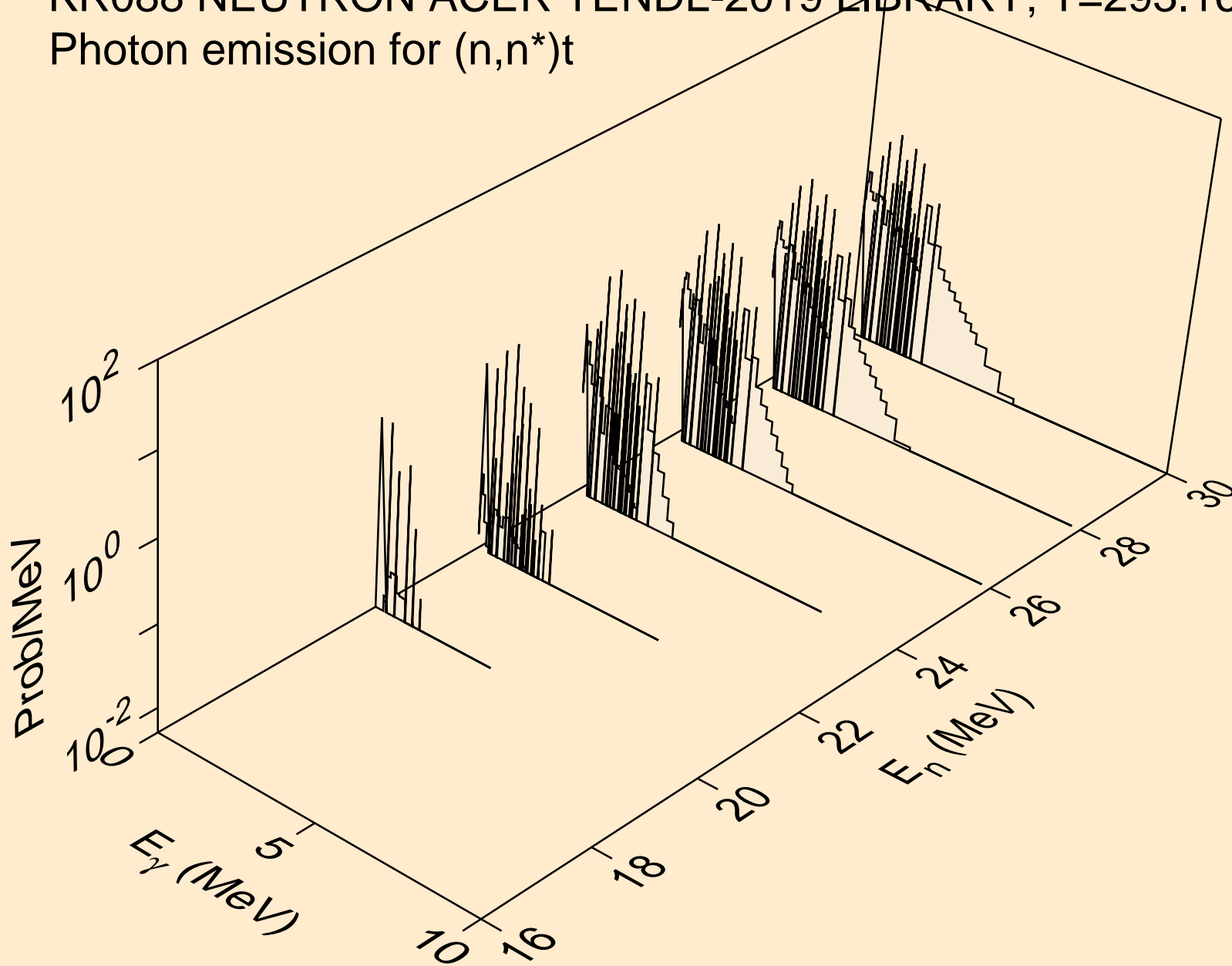

KR088 NEUTRON ACER TENDL-2019 LIBRARY; T=293.16K
Photon emission for (n,n*)he3

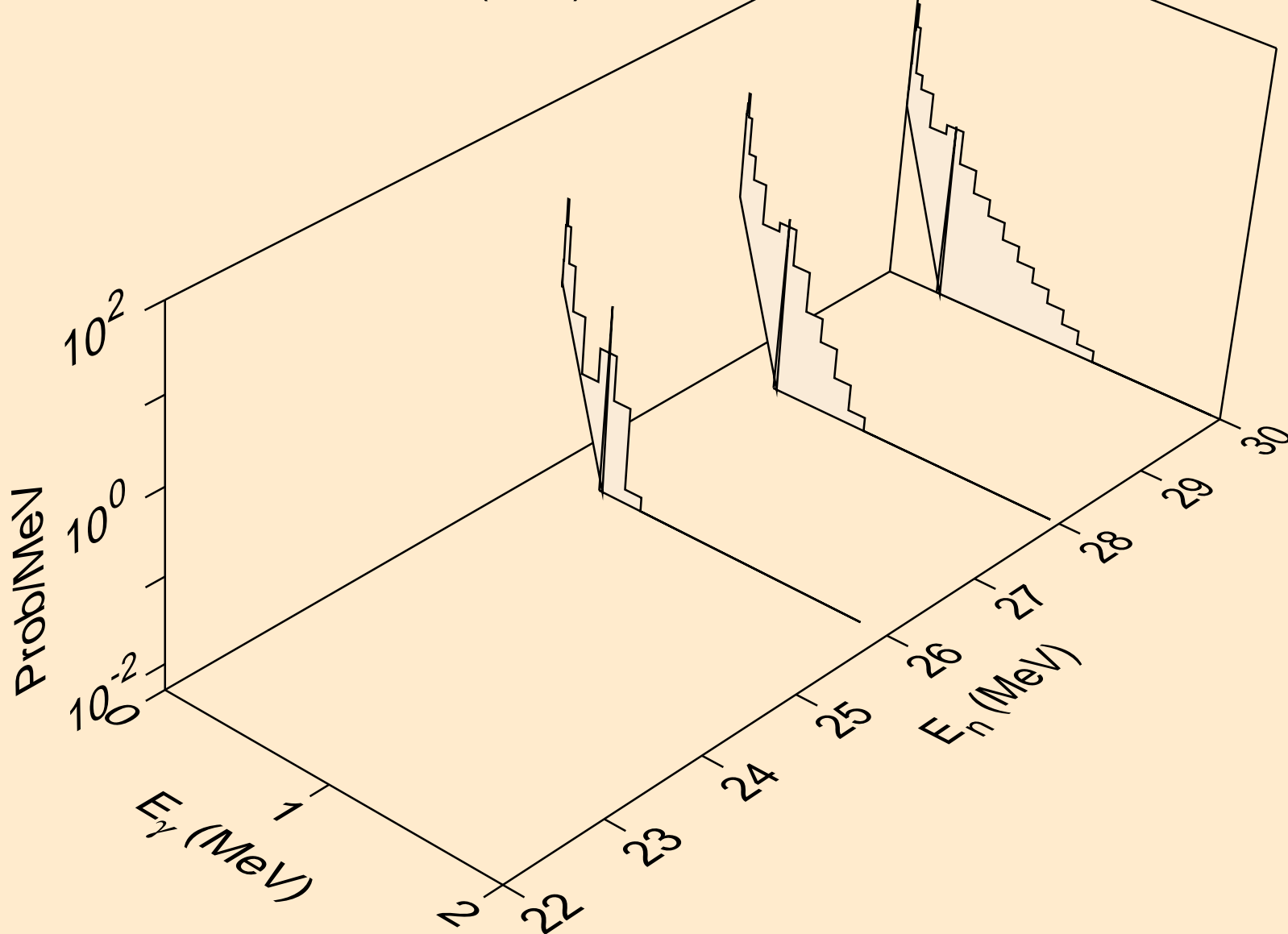

KR088 NEUTRON ACER TENDL-2019 LIBRARY; T=293.16K
Photon emission for (n,4n)

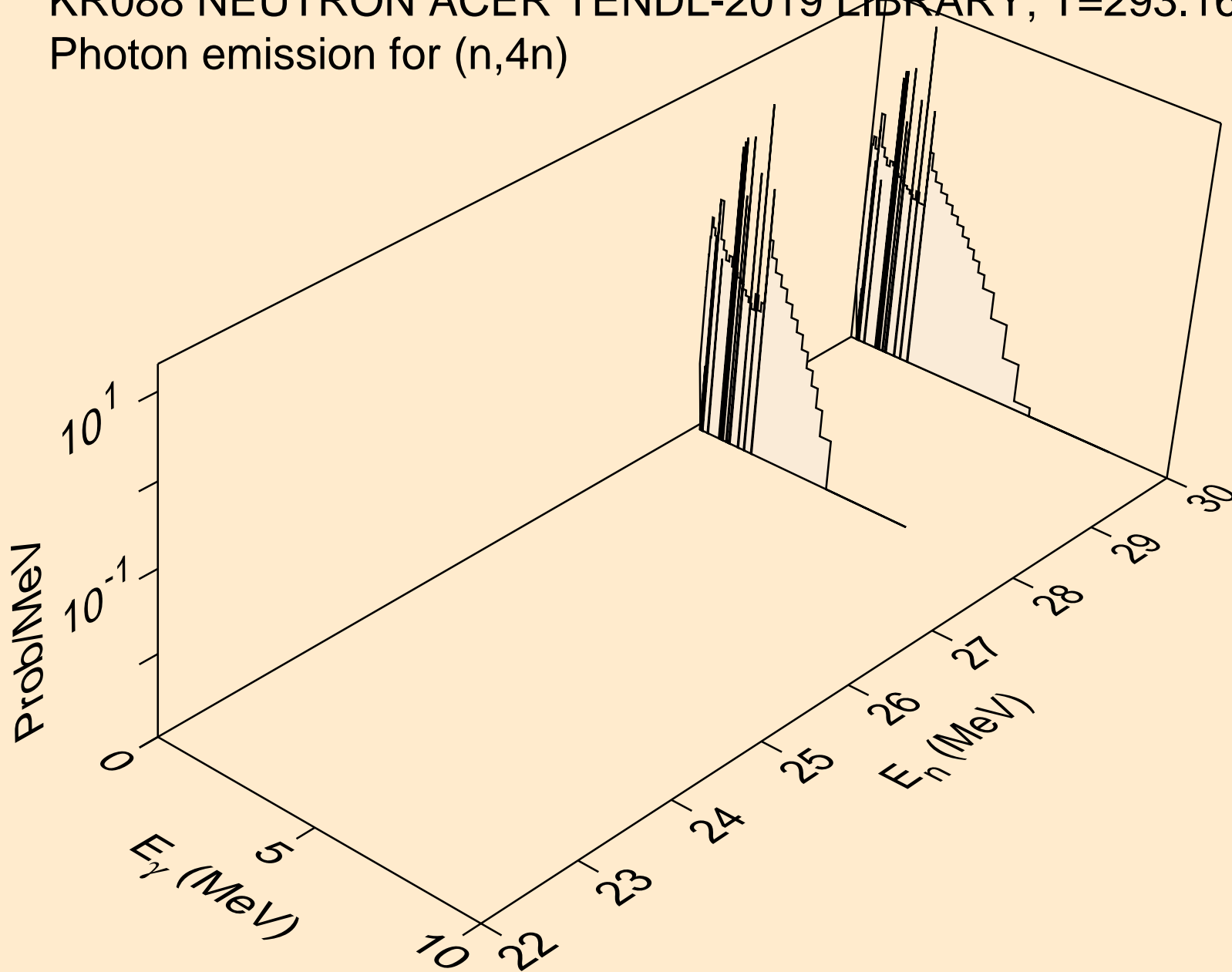

KR088 NEUTRON ACER TENDL-2019 LIBRARY; T=293.16K
Photon emission for (n,2np)

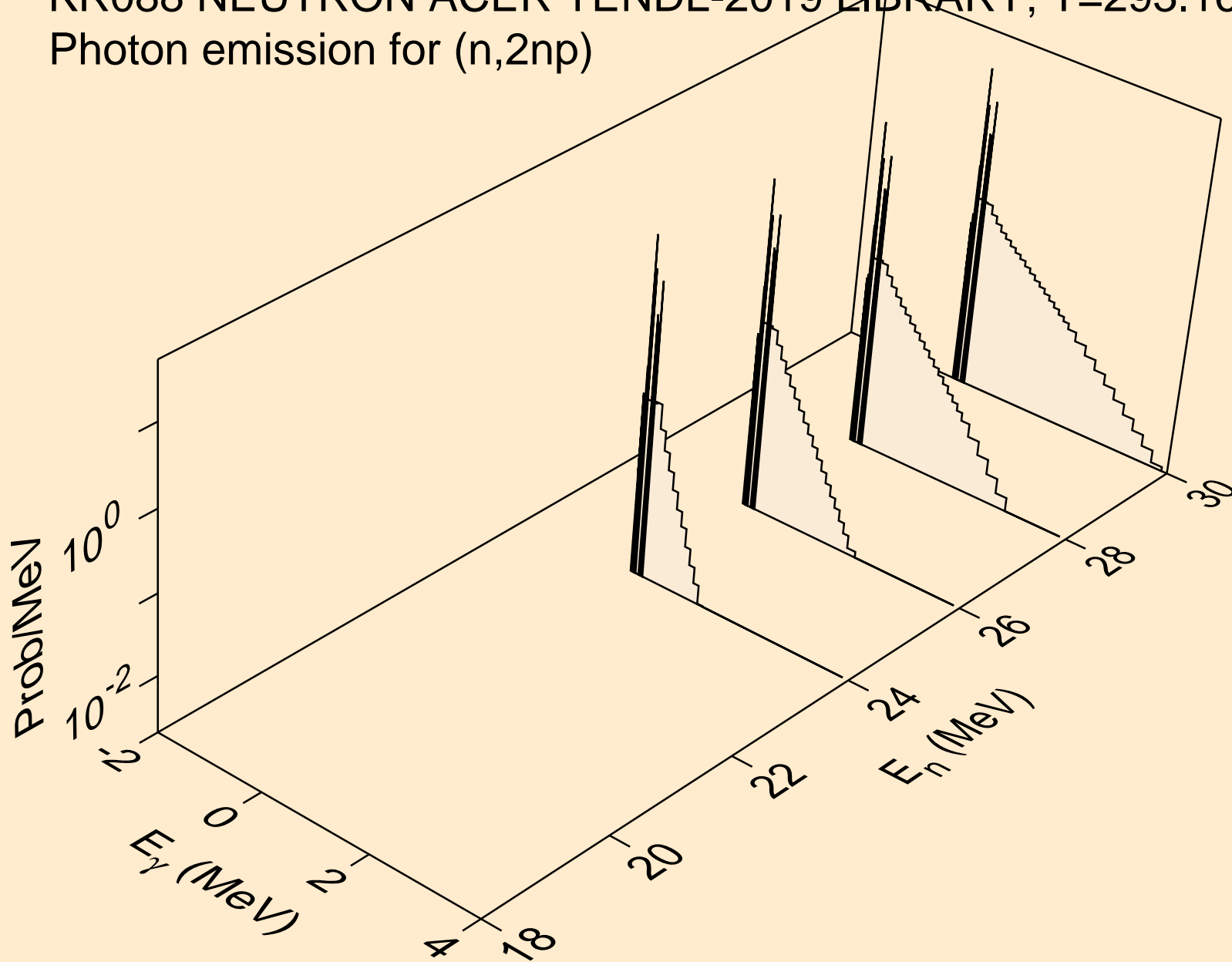

KR088 NEUTRON ACER TENDL-2019 LIBRARY; T=293.16K
Photon emission for (n,3np)

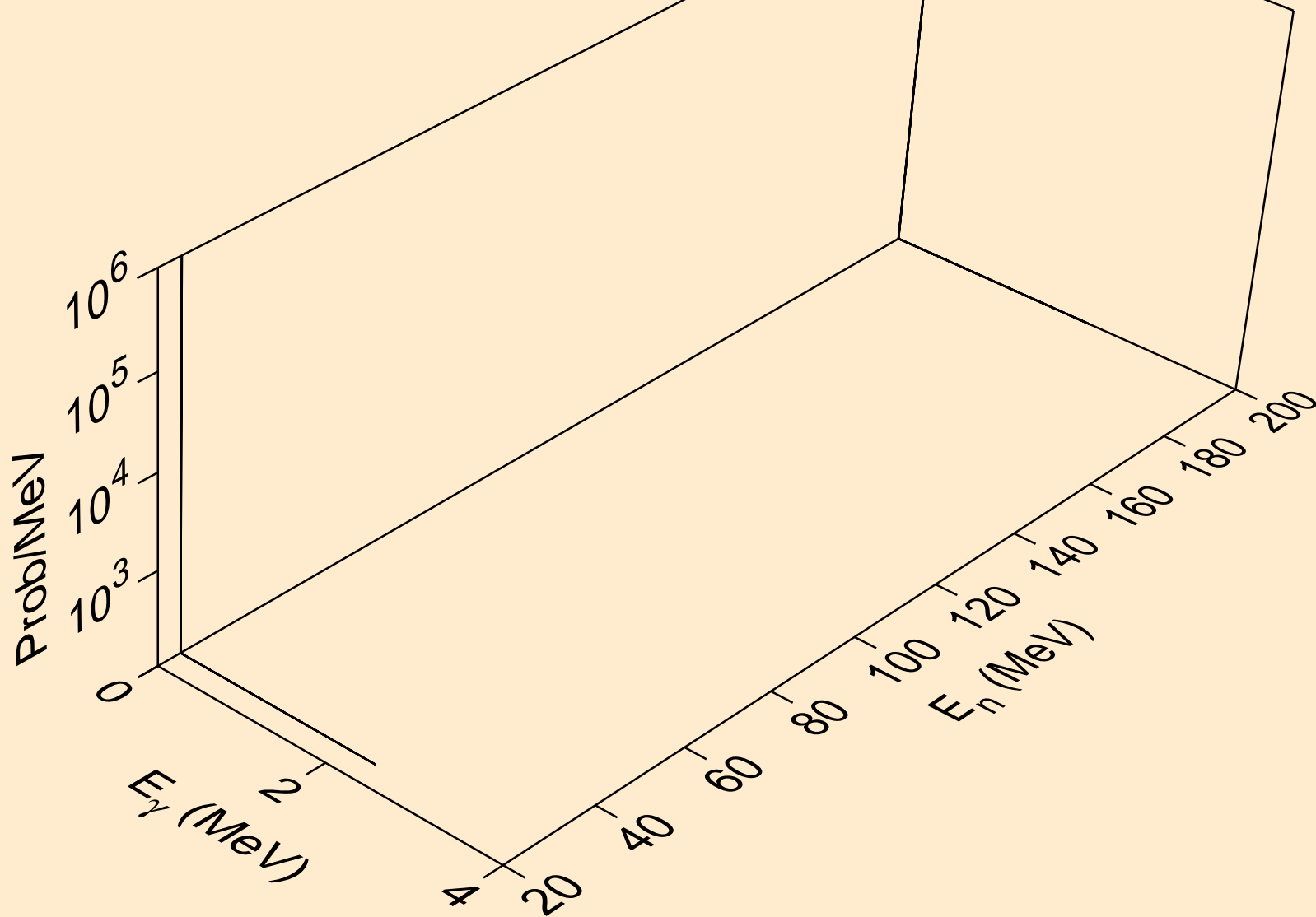

KR088 NEUTRON ACER TENDL-2019 LIBRARY; T=293.16K
Photon emission for (n,n*c)

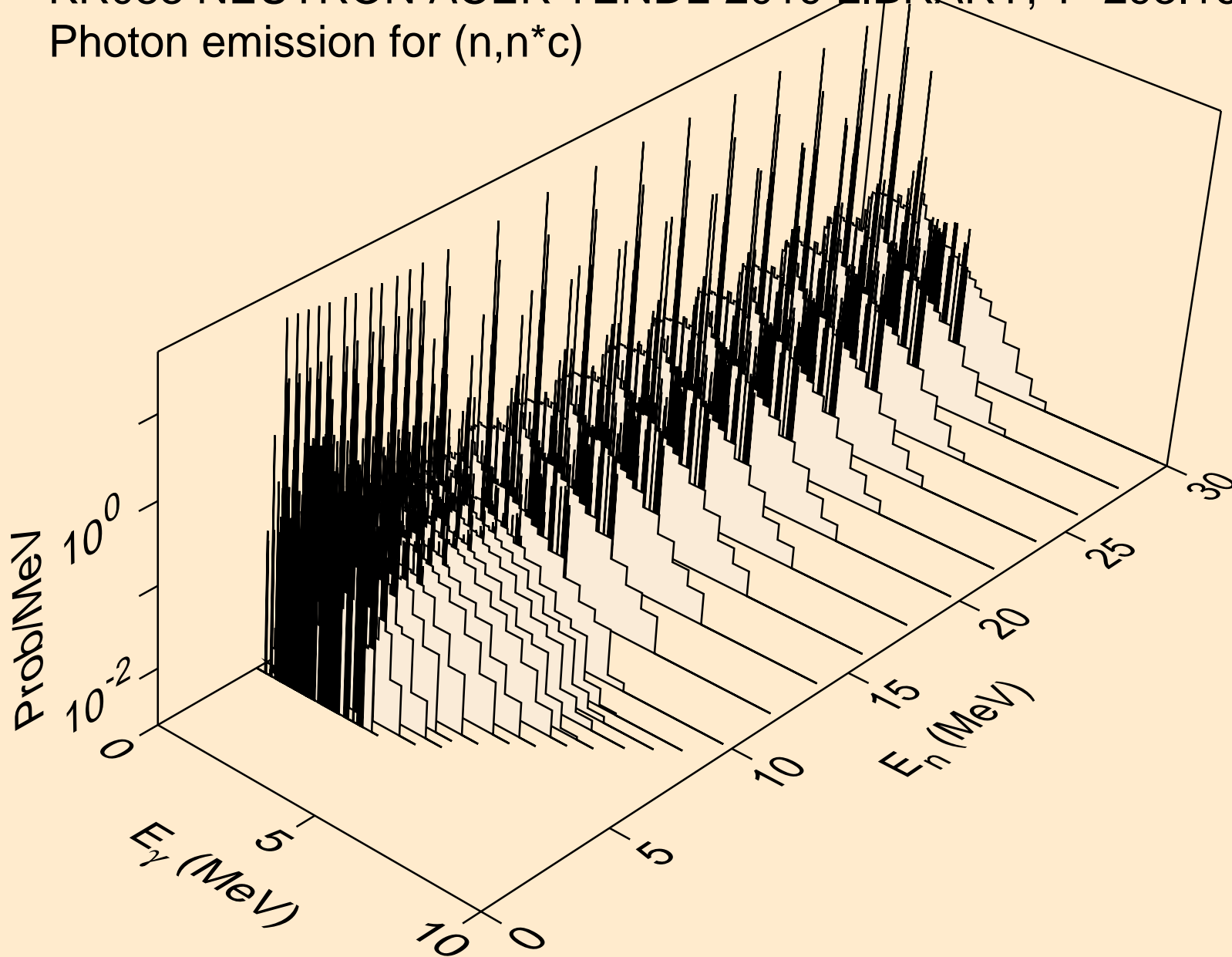

KR088 NEUTRON ACER TENDL-2019 LIBRARY; T=293.16K
Photon emission for (n,gma)

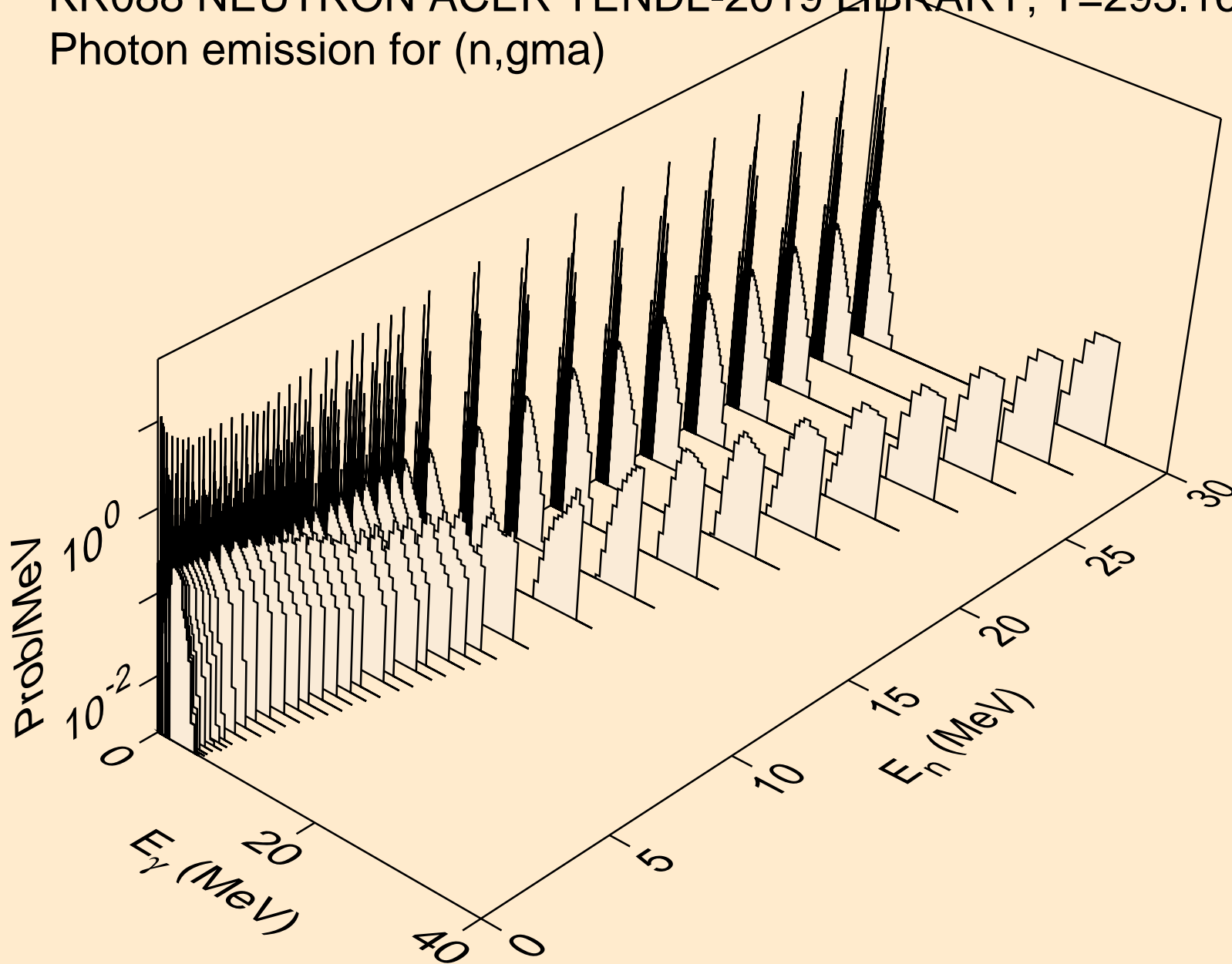

KR088 NEUTRON ACER TENDL-2019 LIBRARY; T=293.16K
Photon emission for (n,p)

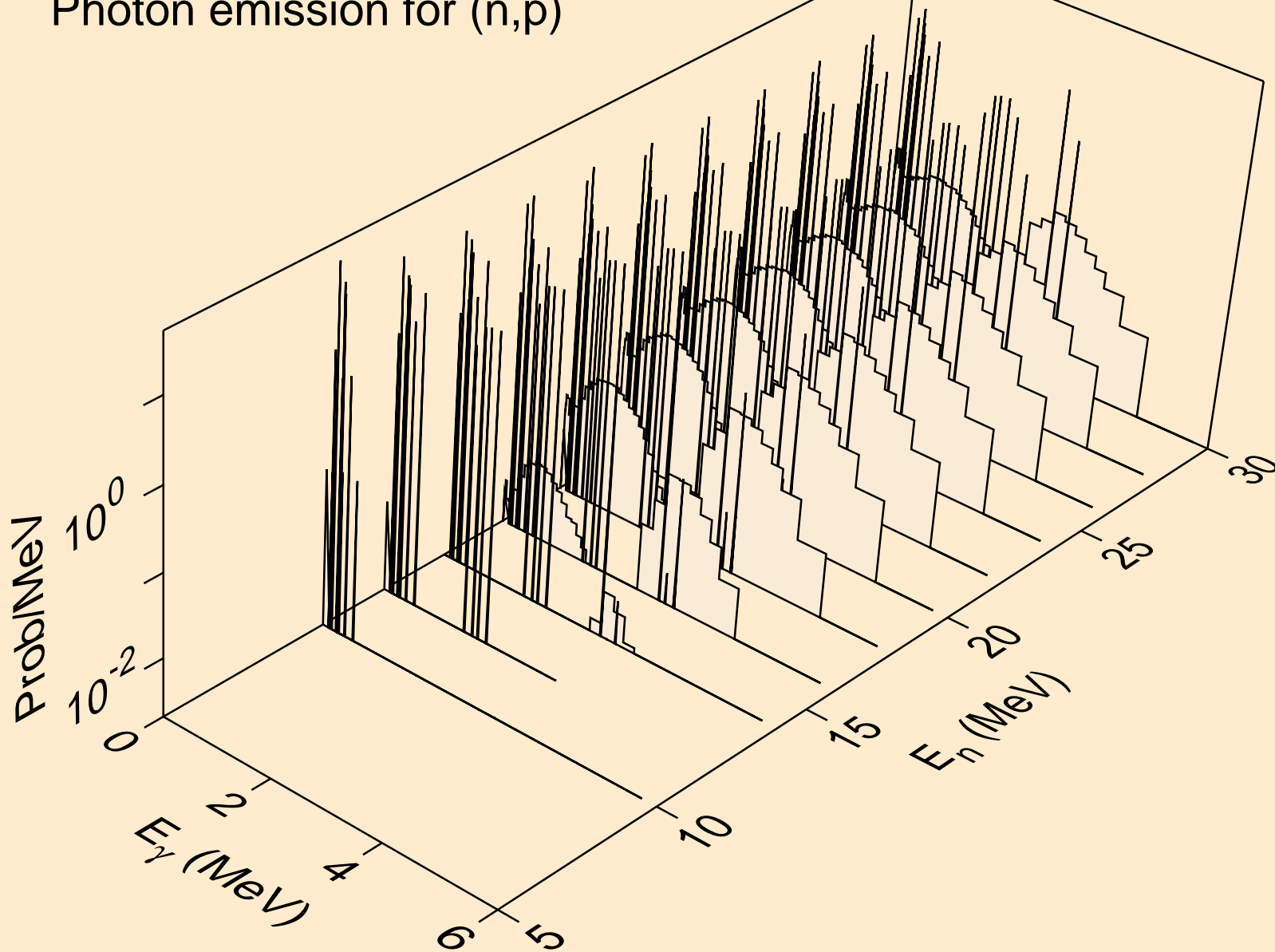

KR088 NEUTRON ACER TENDL-2019 LIBRARY; T=293.16K
Photon emission for (n,d)

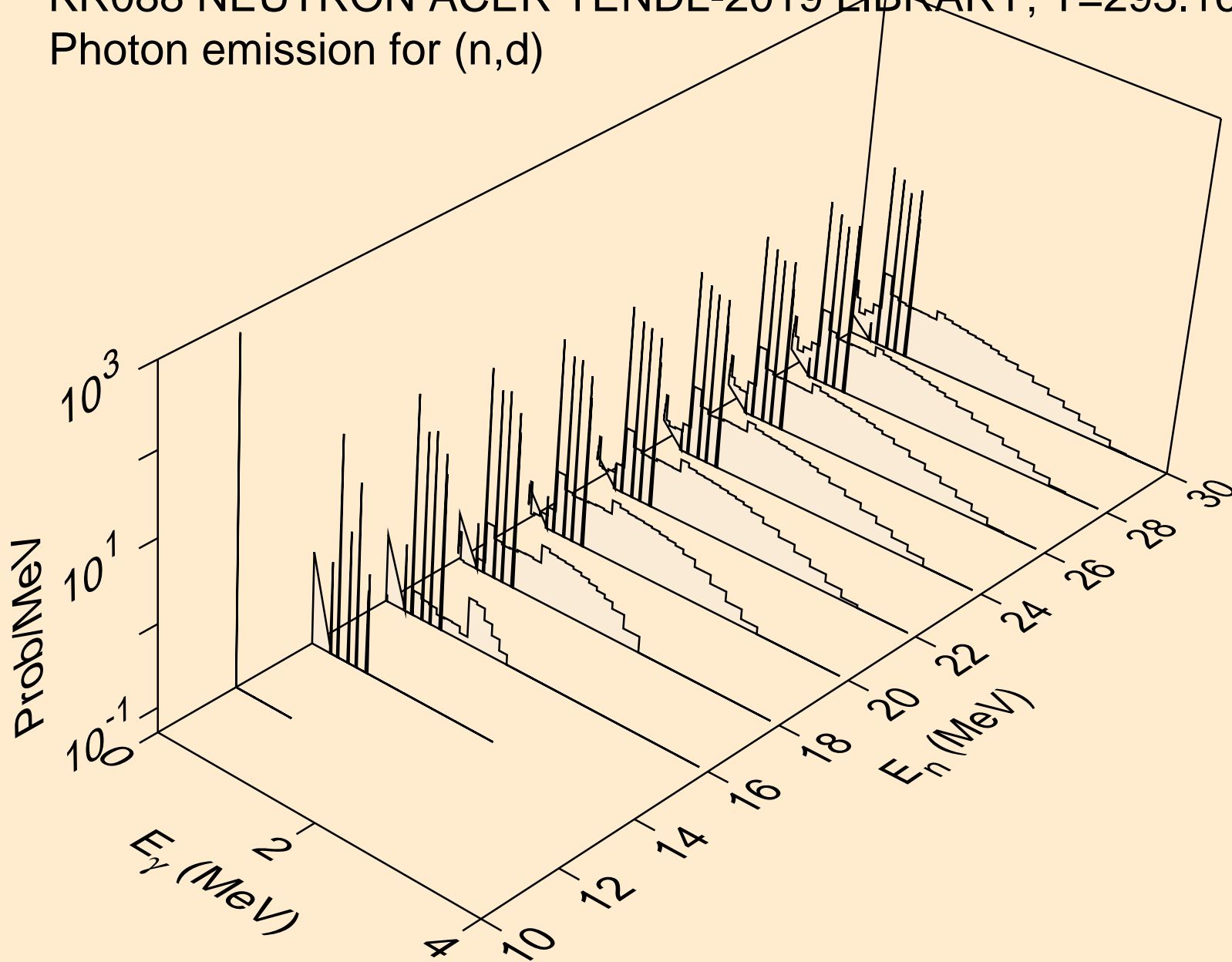

KR088 NEUTRON ACER TENDL-2019 LIBRARY; T=293.16K
Photon emission for (n,t)

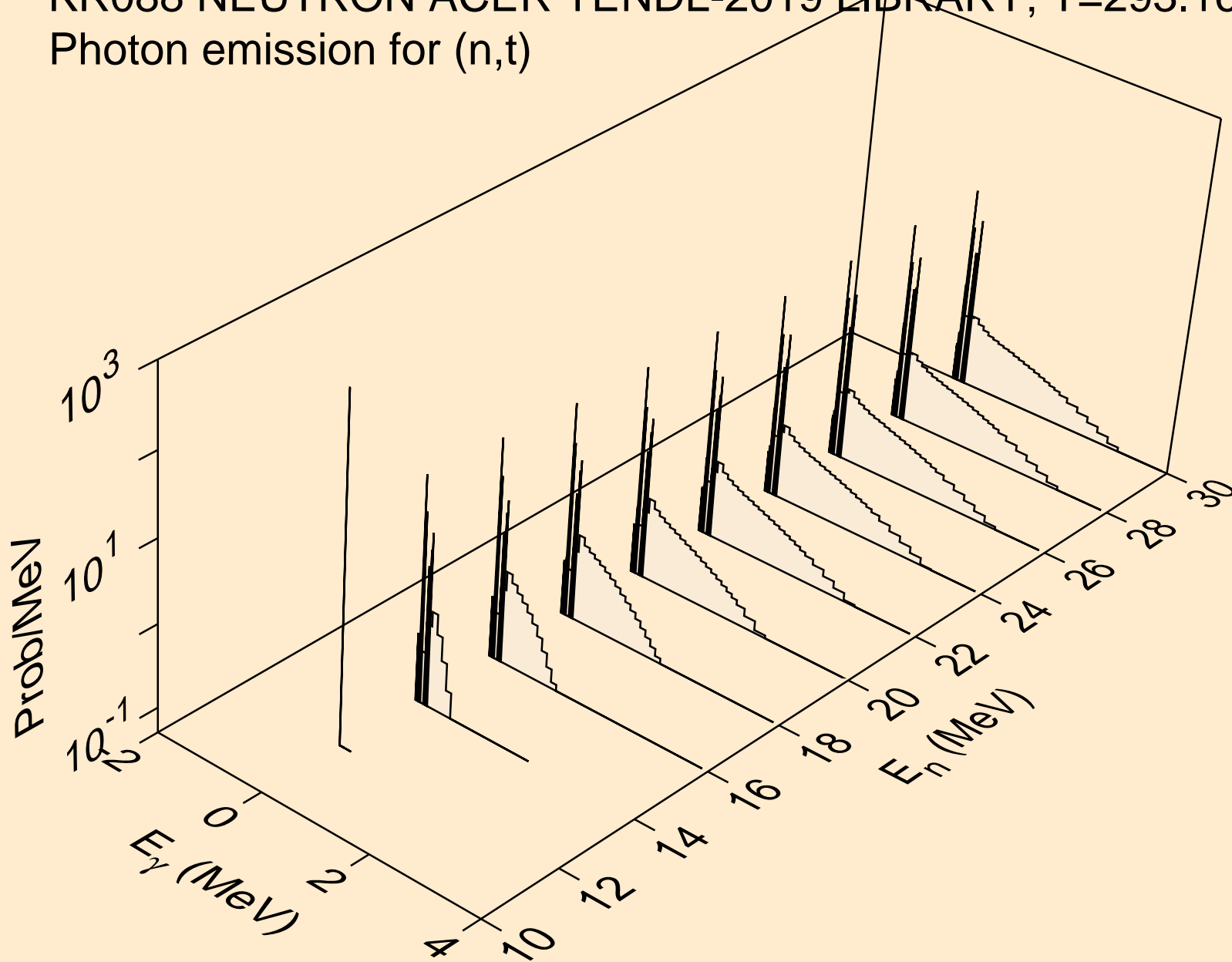

KR088 NEUTRON ACER TENDL-2019 LIBRARY; T=293.16K
Photon emission for (n,he3)

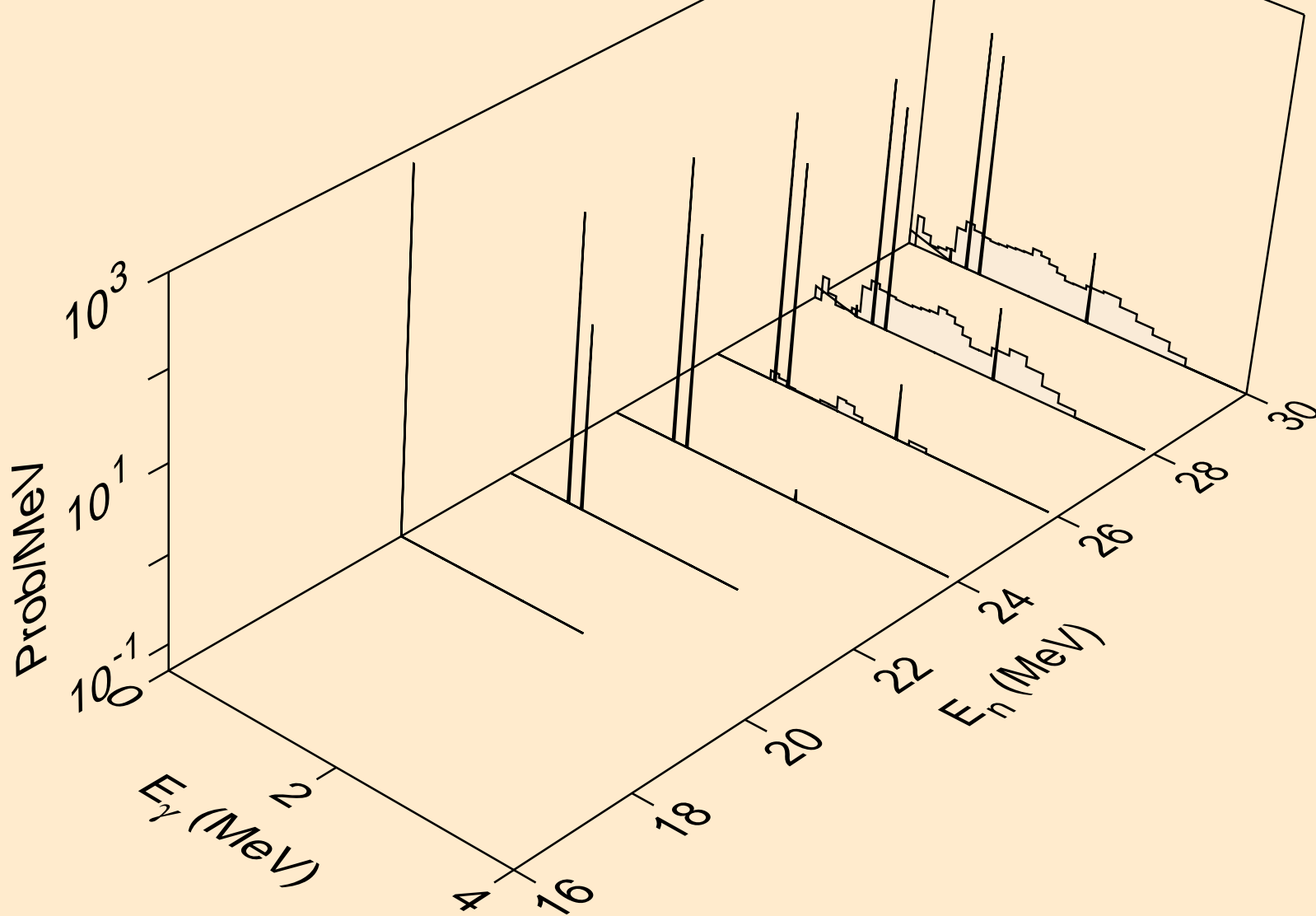

KR088 NEUTRON ACER TENDL-2019 LIBRARY; T=293.16K
Photon emission for (n,a)

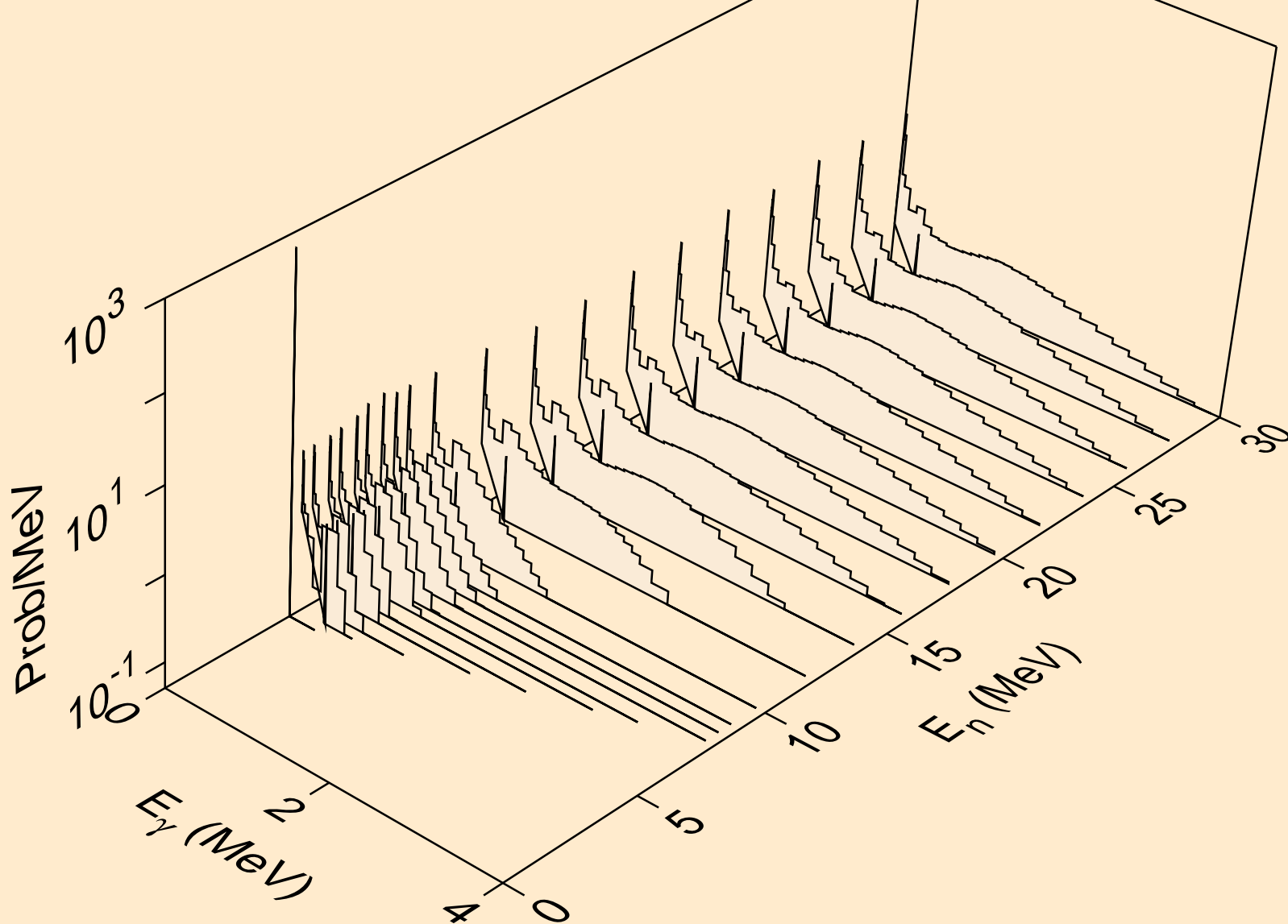

KR088 NEUTRON ACER TENDL-2019 LIBRARY; T=293.16K
Photon emission for (n,2p)

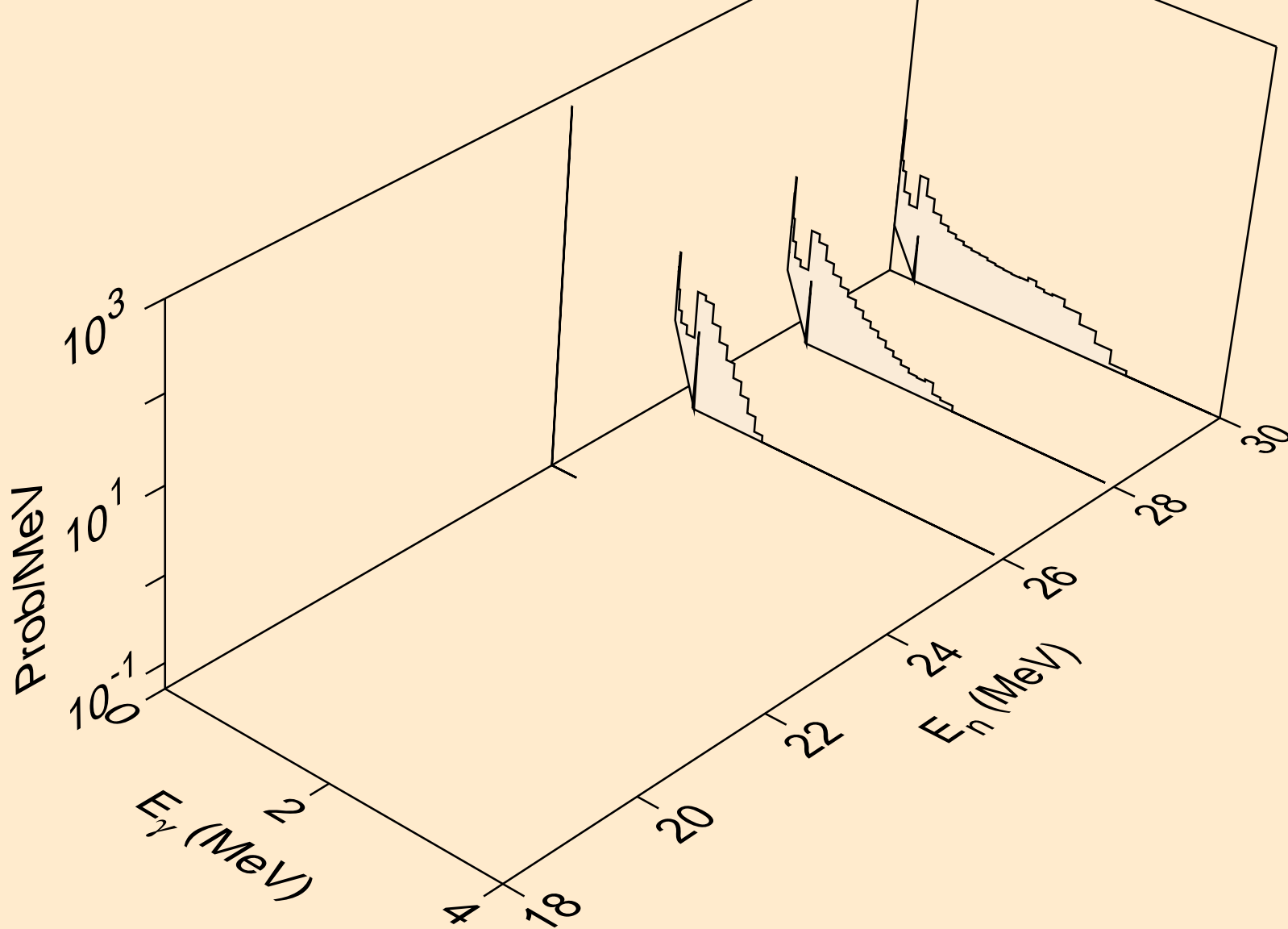

KR088 NEUTRON ACER TENDL-2019 LIBRARY; T=293.16K
Photon emission for (n,p α)

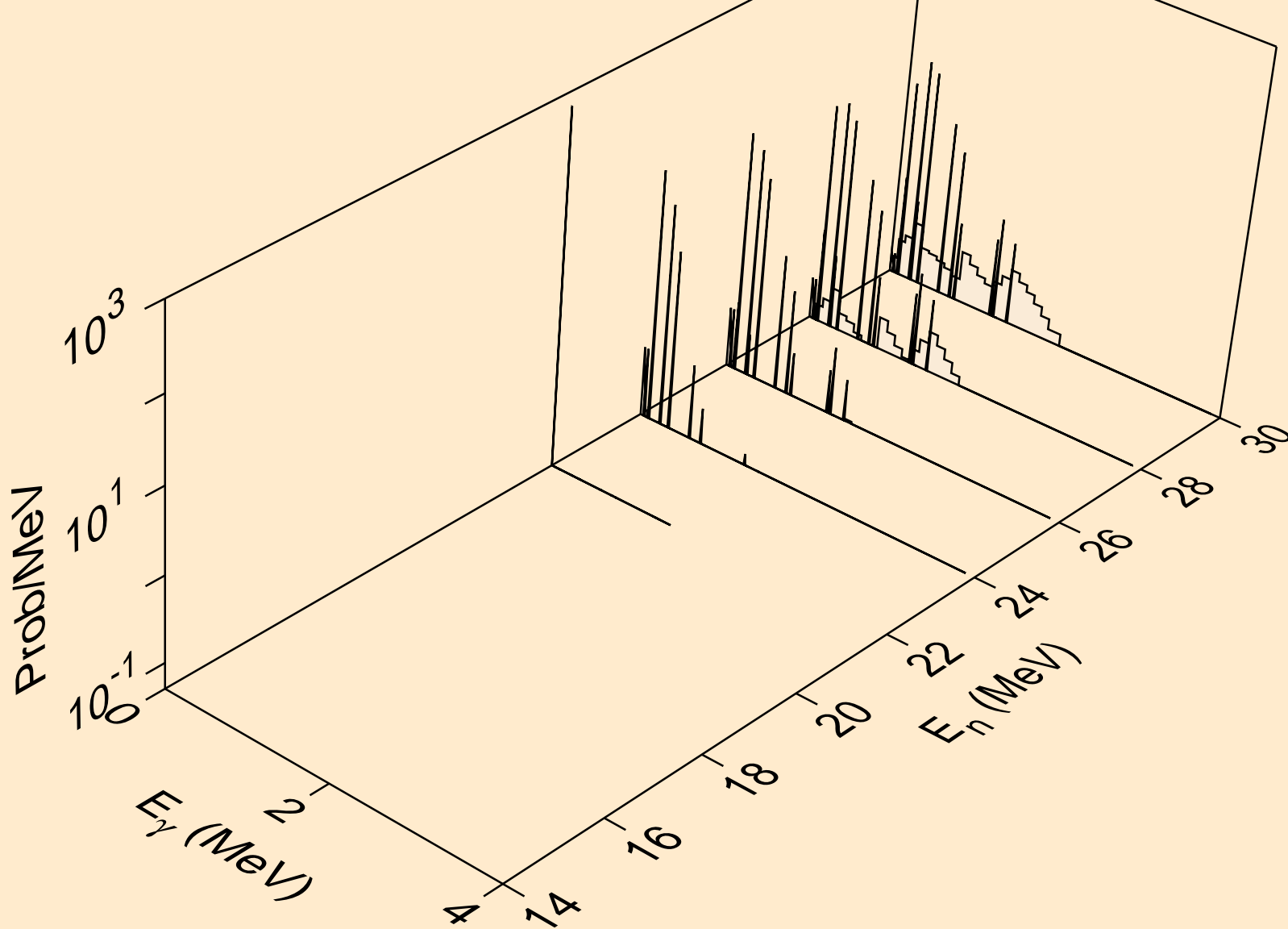

KR088 NEUTRON ACER TENDL-2019 LIBRARY; T=293.16K
thermal capture photon spectrum

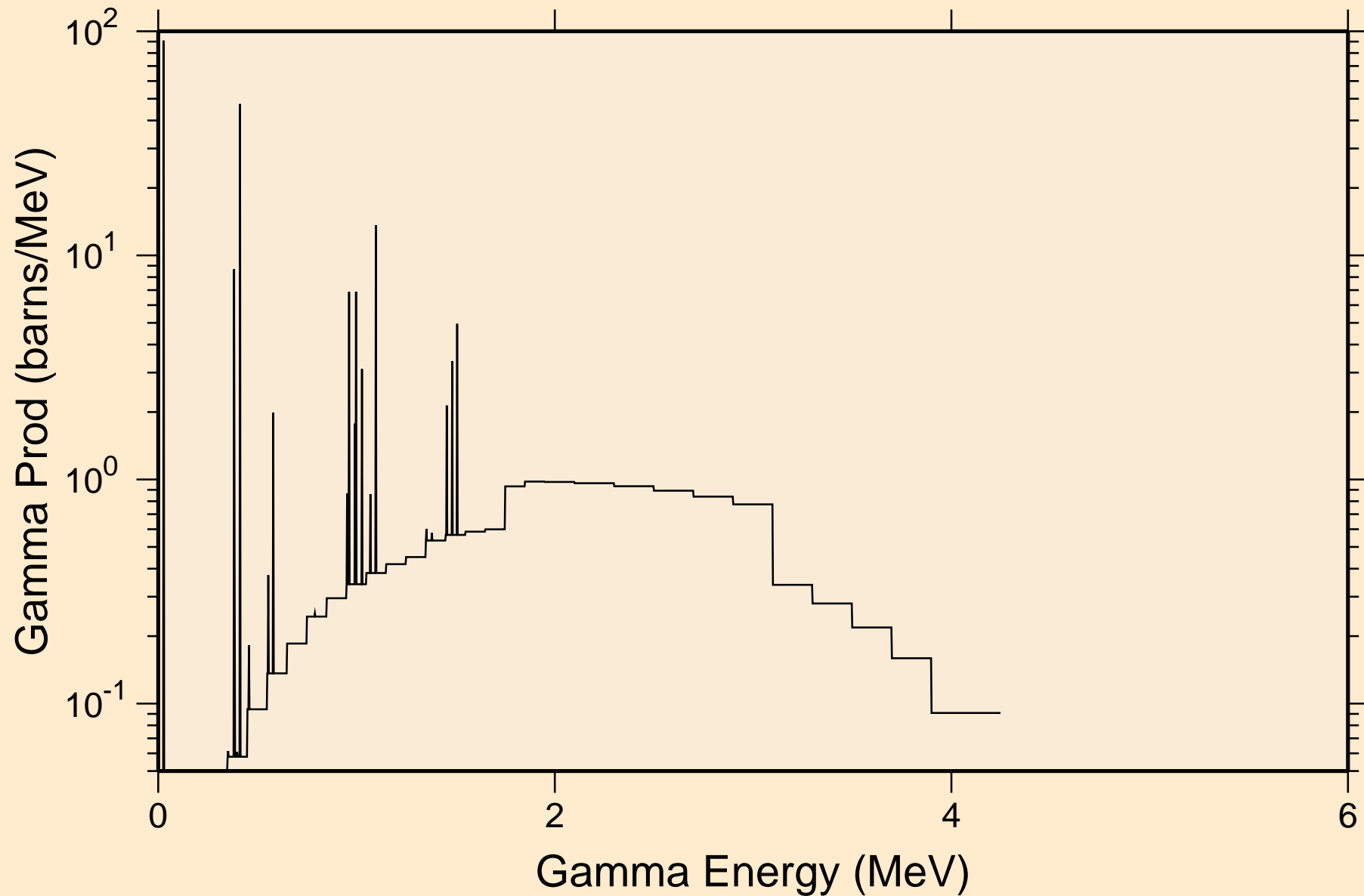

KR088 NEUTRON ACER TENDL-2019 LIBRARY; T=293.16K
14 MeV photon spectrum

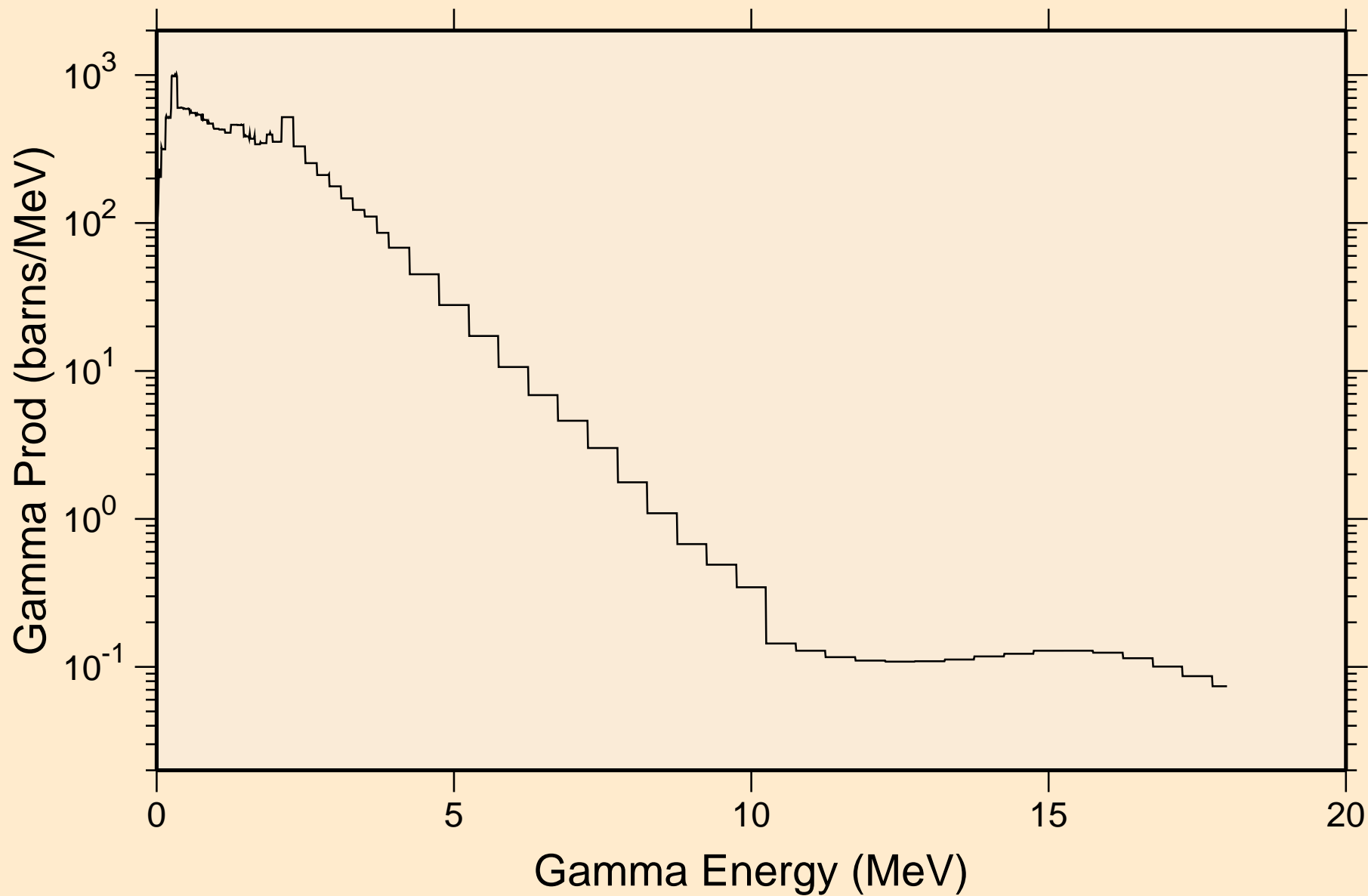

KR088 NEUTRON ACER TENDL-2019 LIBRARY; T=293.16K
Particle heating contributions

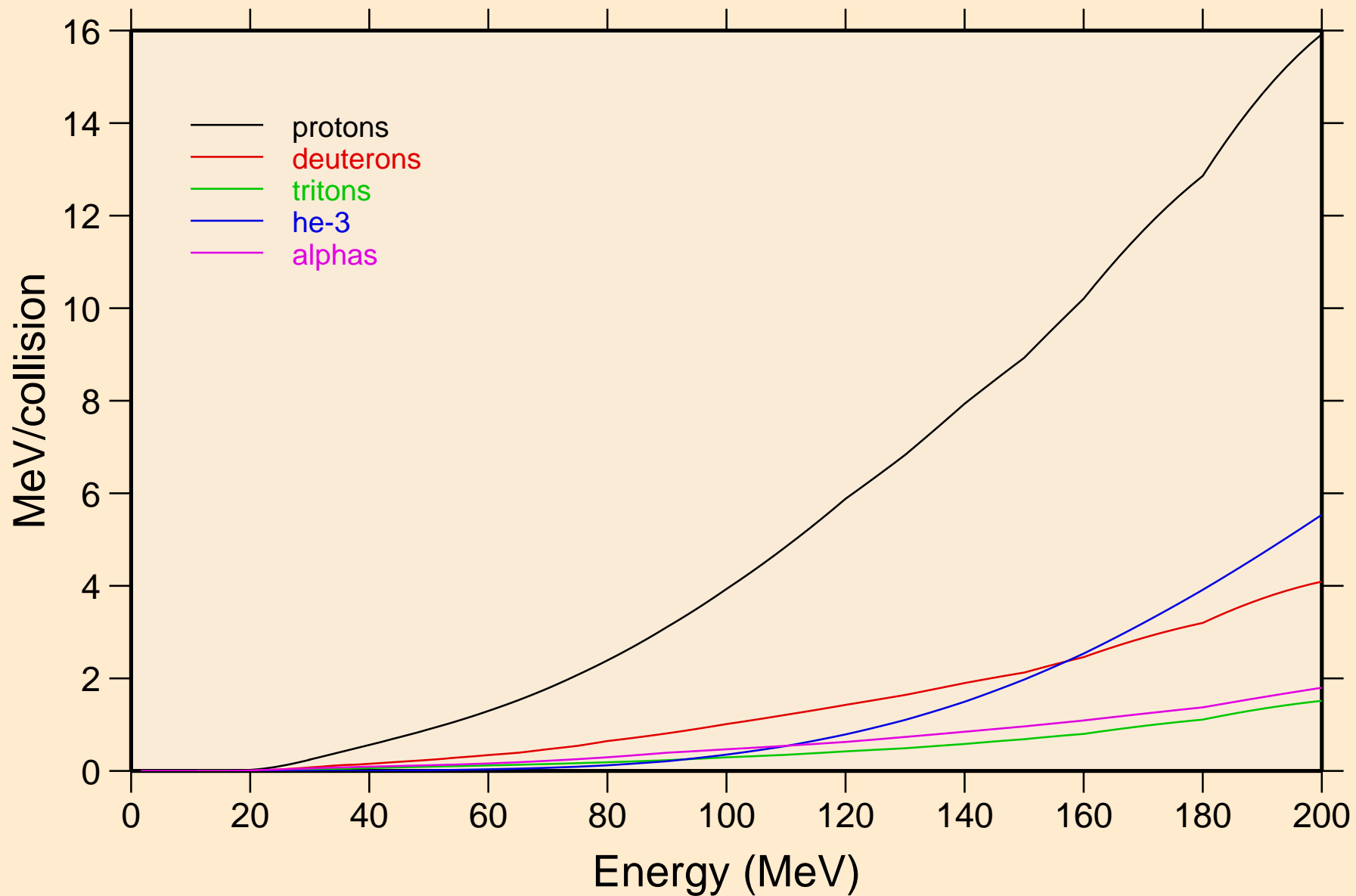

KR088 NEUTRON ACER TENDL-2019 LIBRARY; T=293.16K
Recoil Heating

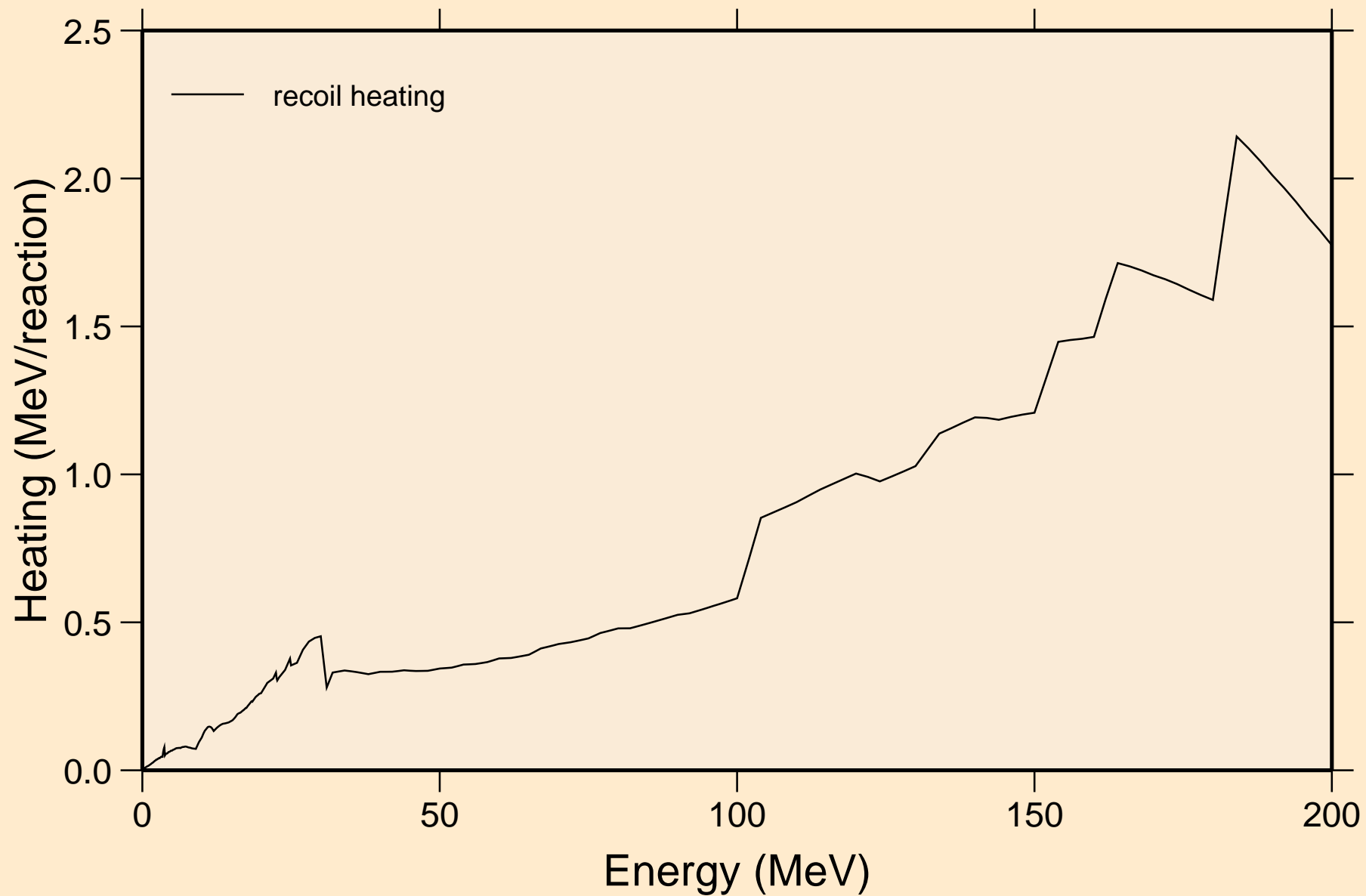

KR088 NEUTRON ACER TENDL-2019 LIBRARY; T=293.16K
Particle production cross sections

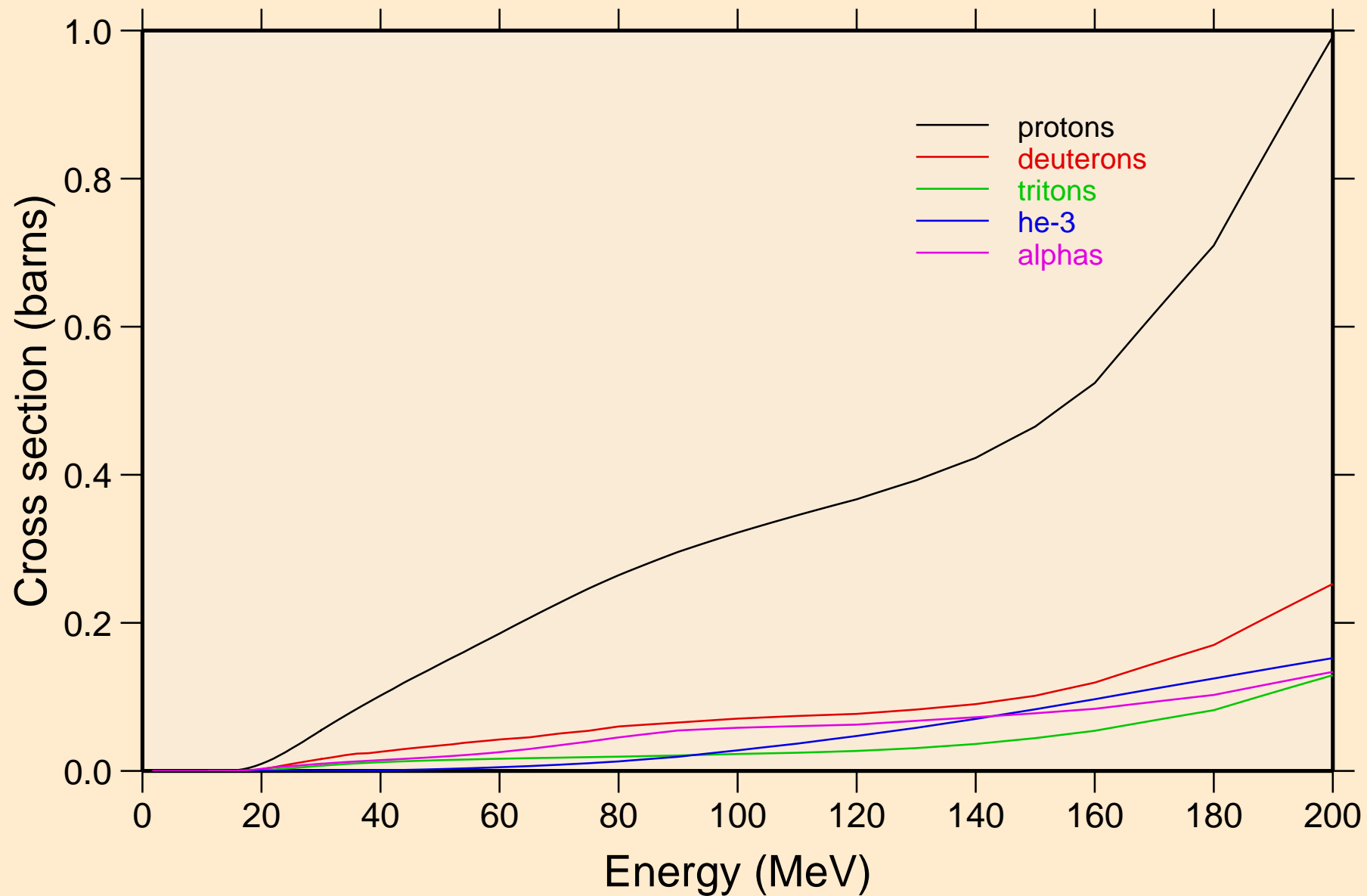

KR088 NEUTRON ACER TENDL-2019 LIBRARY; T=293.16K
protons from (n,x)

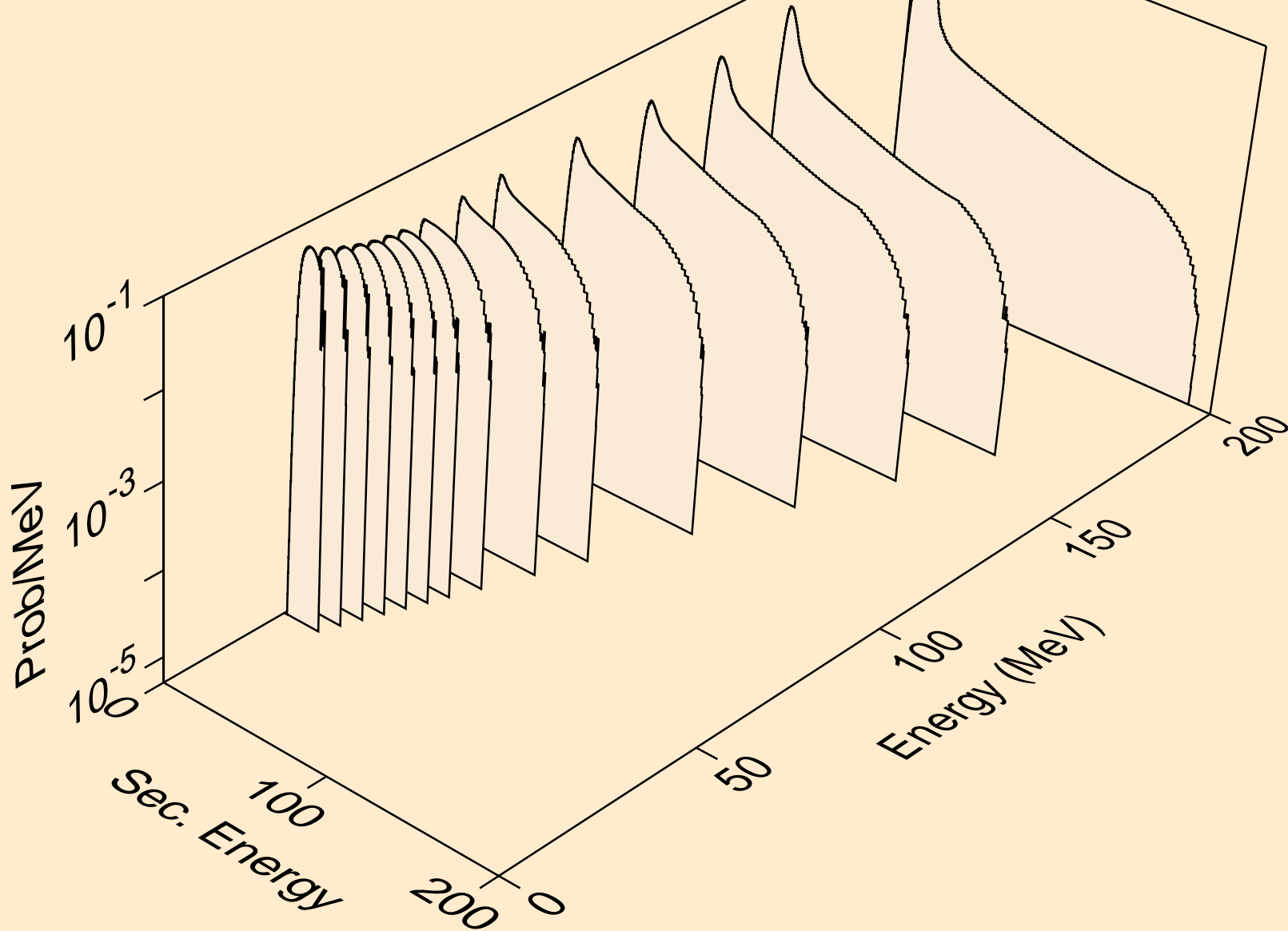

KR088 NEUTRON ACER TENDL-2019 LIBRARY; T=293.16K
protons from (n,n*)p

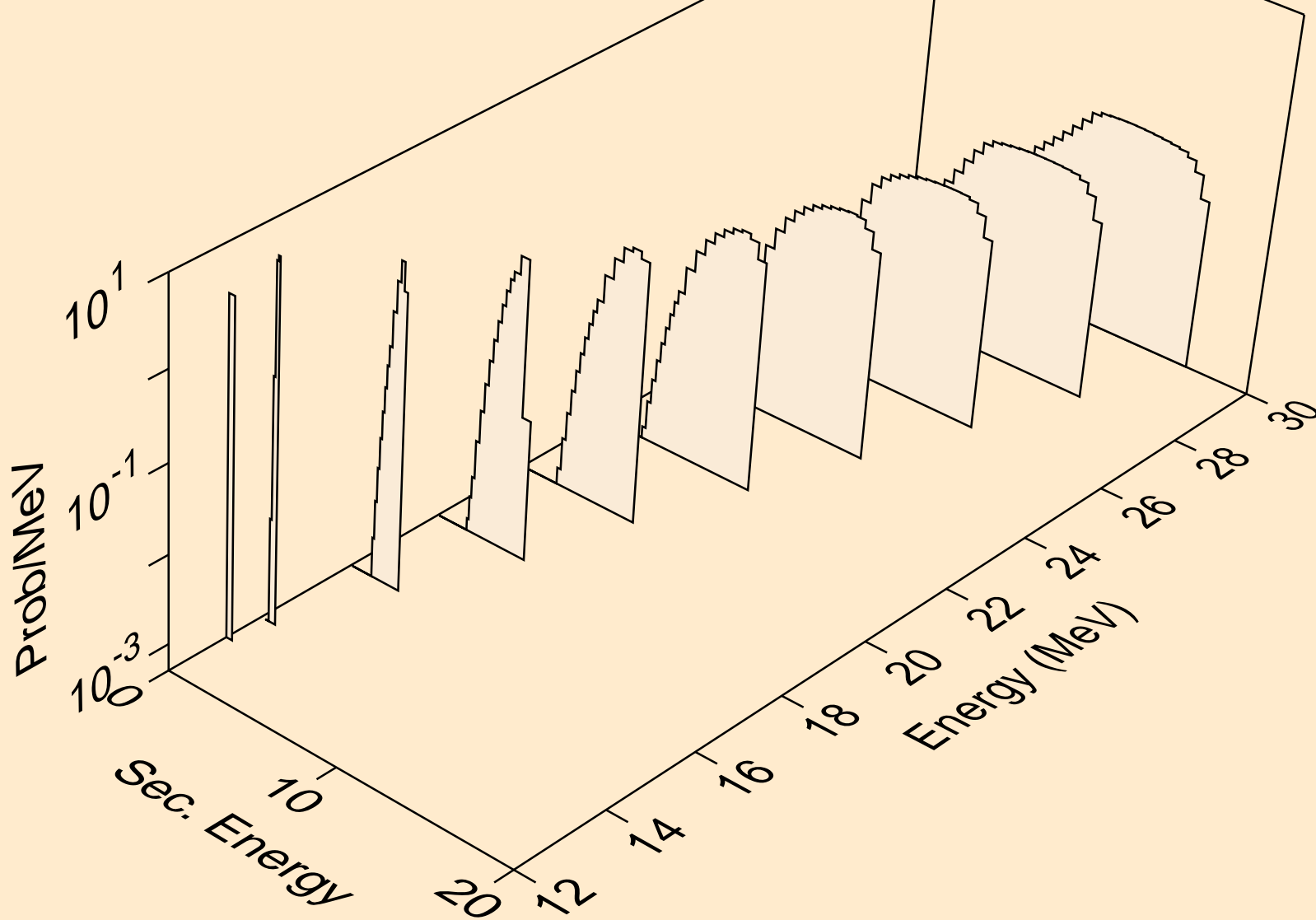

KR088 NEUTRON ACER TENDL-2019 LIBRARY; T=293.16K
protons from (n,2np)

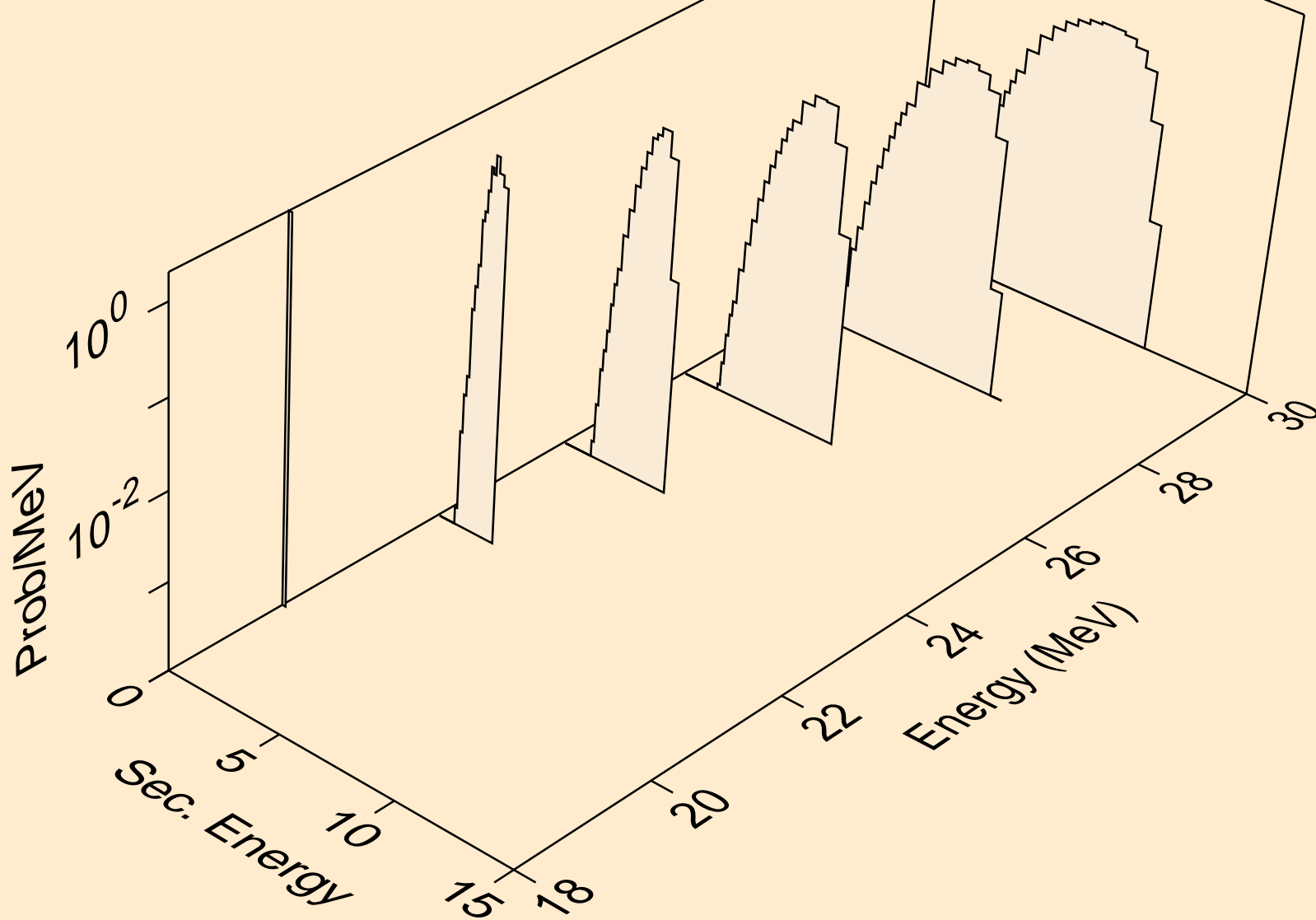

KR088 NEUTRON ACER TENDL-2019 LIBRARY; T=293.16K
protons from (n,3np)

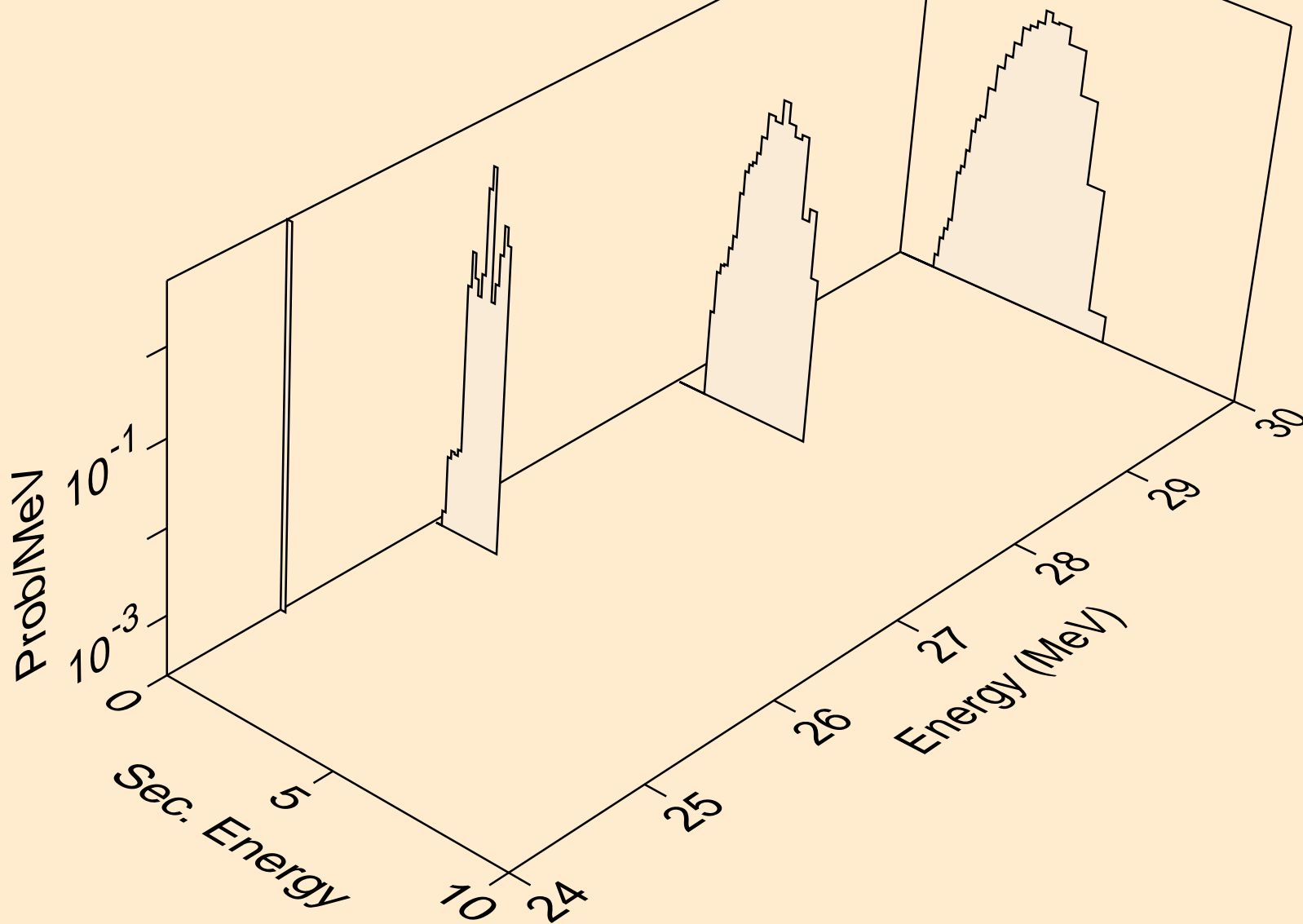

KR088 NEUTRON ACER TENDL-2019 LIBRARY; T=293.16K
protons from (n,p)

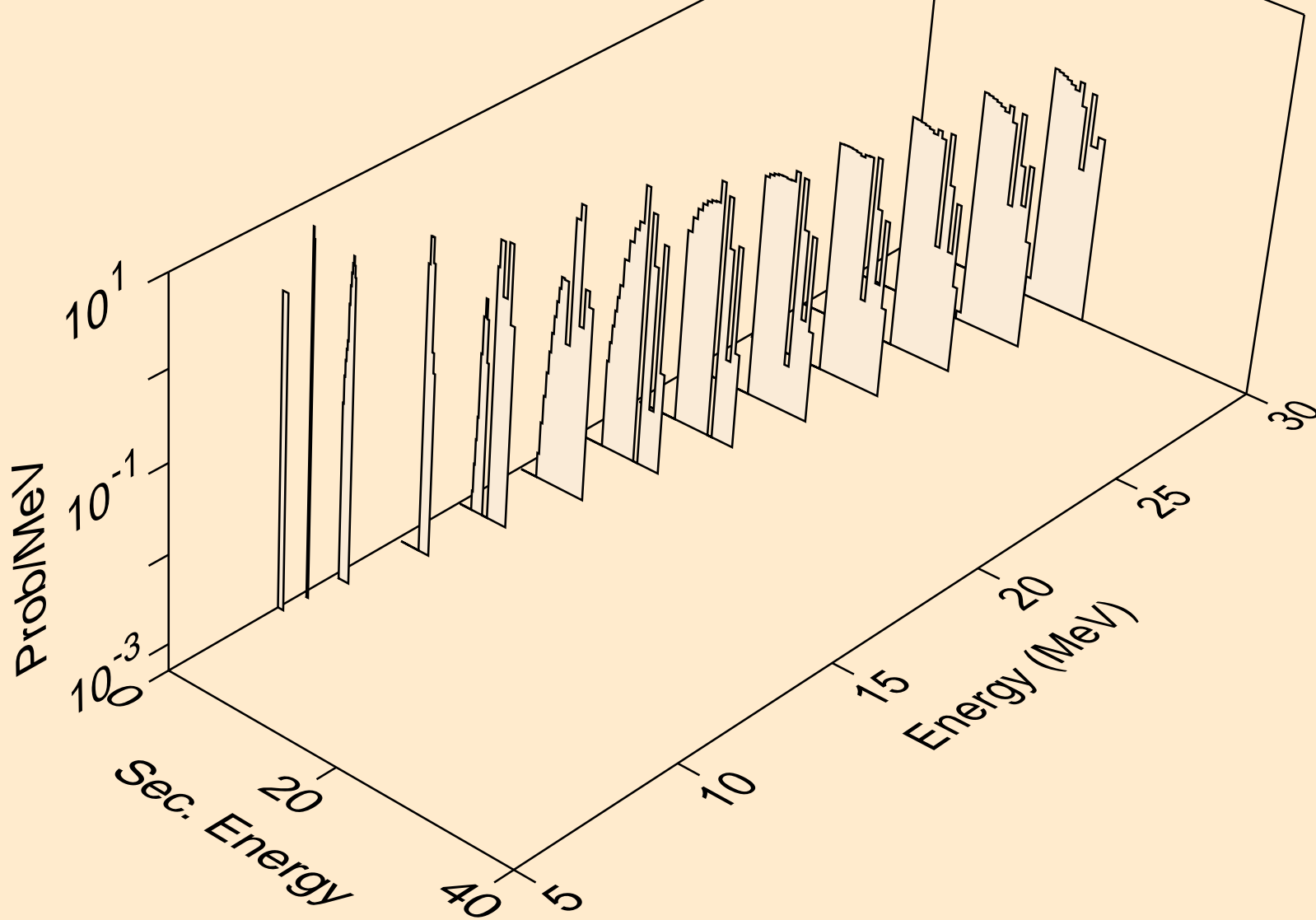

KR088 NEUTRON ACER TENDL-2019 LIBRARY; T=293.16K
protons from (n,2p)

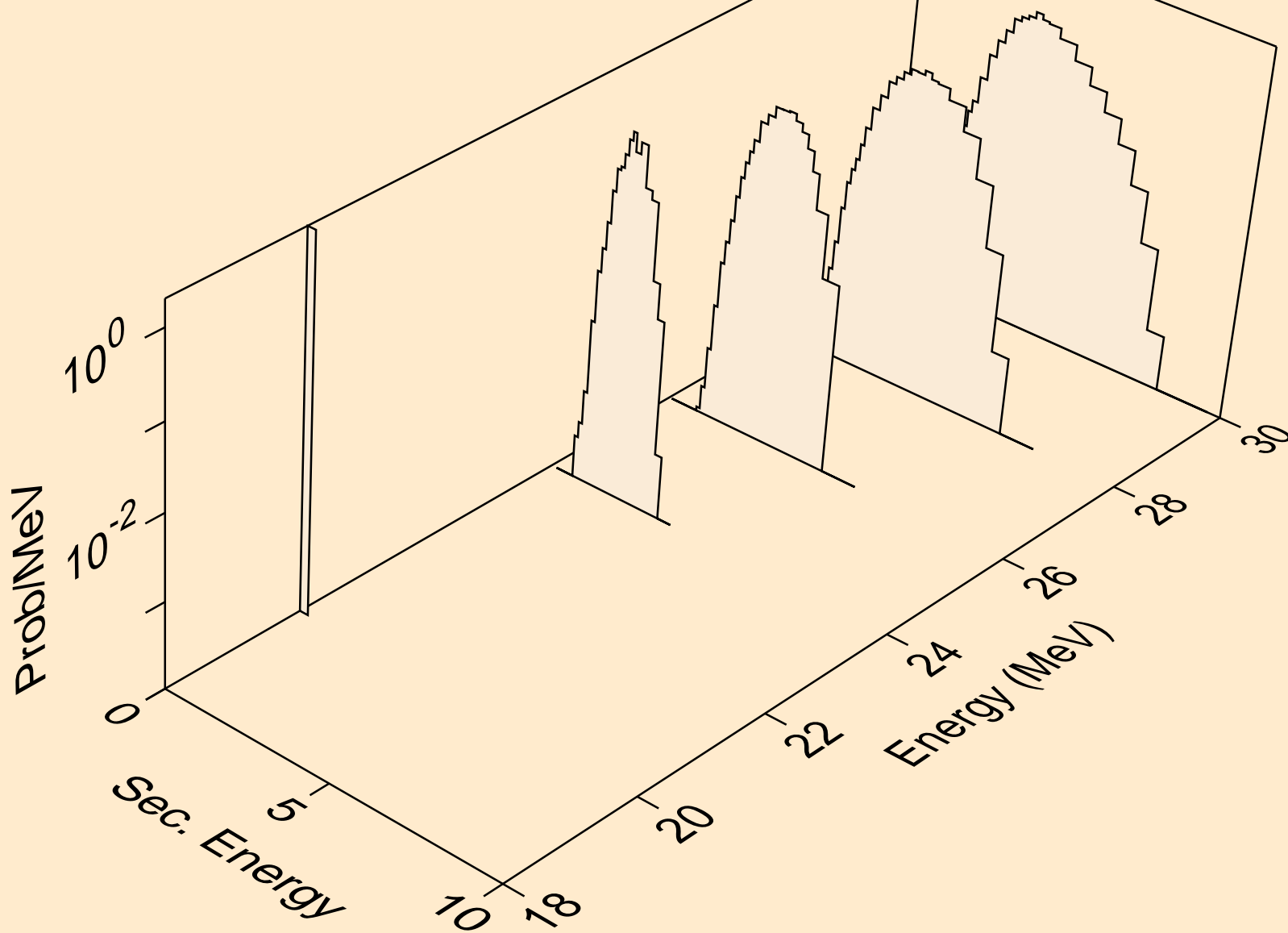

KR088 NEUTRON ACER TENDL-2019 LIBRARY; T=293.16K
protons from (n,p)

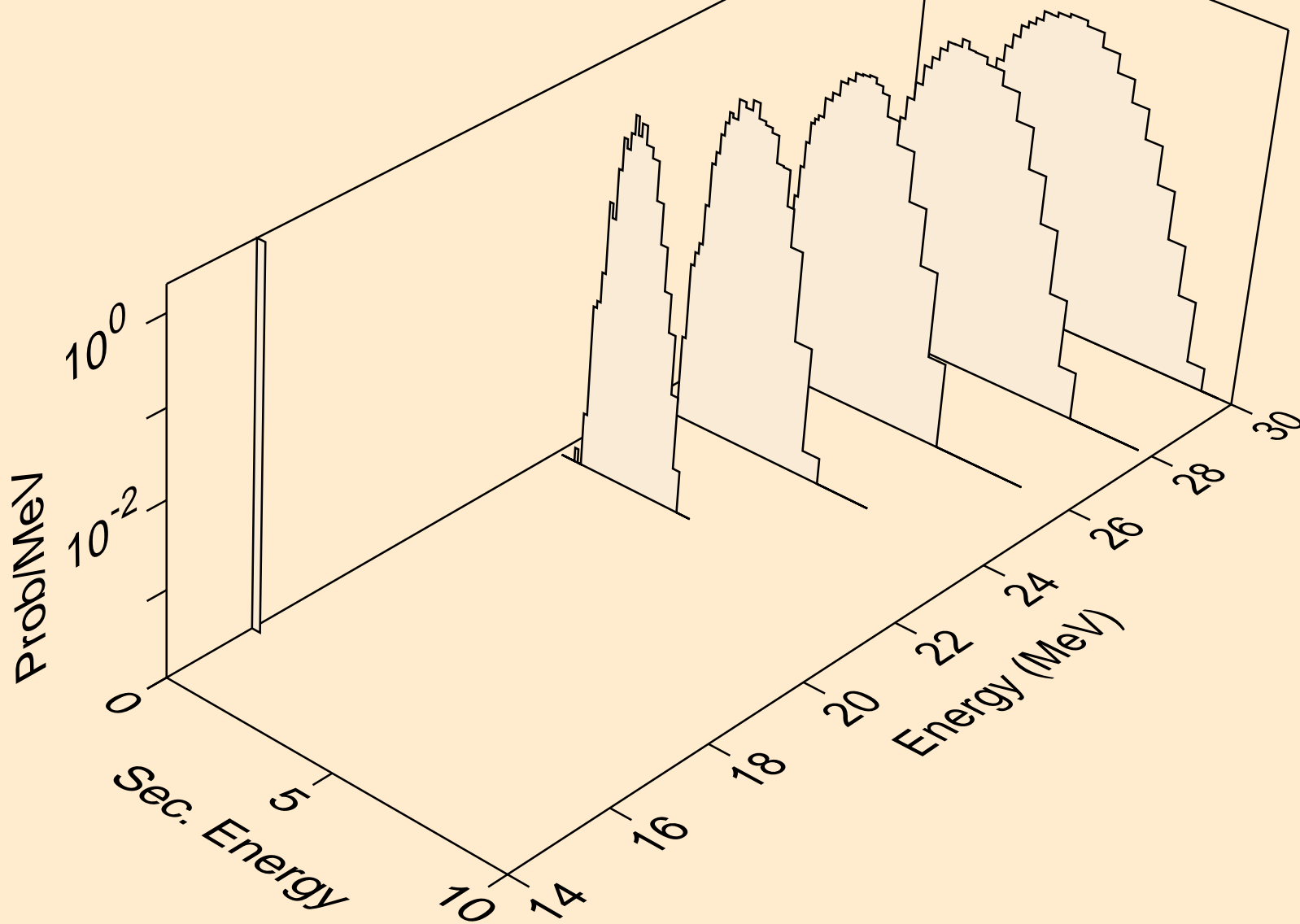

KR088 NEUTRON ACER TENDL-2019 LIBRARY; T=293.16K
deuterons from (n,x)

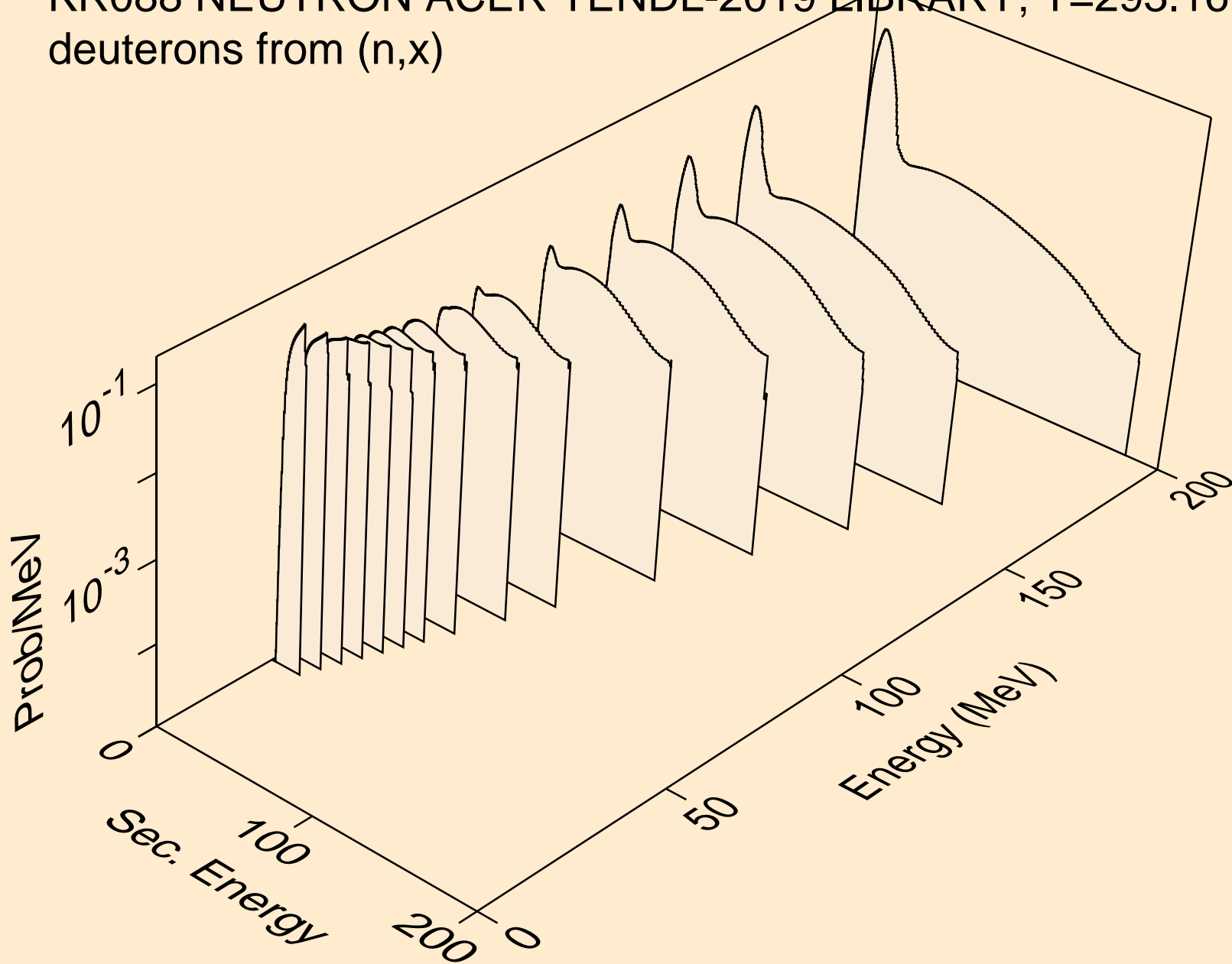

KR088 NEUTRON ACER TENDL-2019 LIBRARY; T=293.16K
deuterons from (n,2nd)

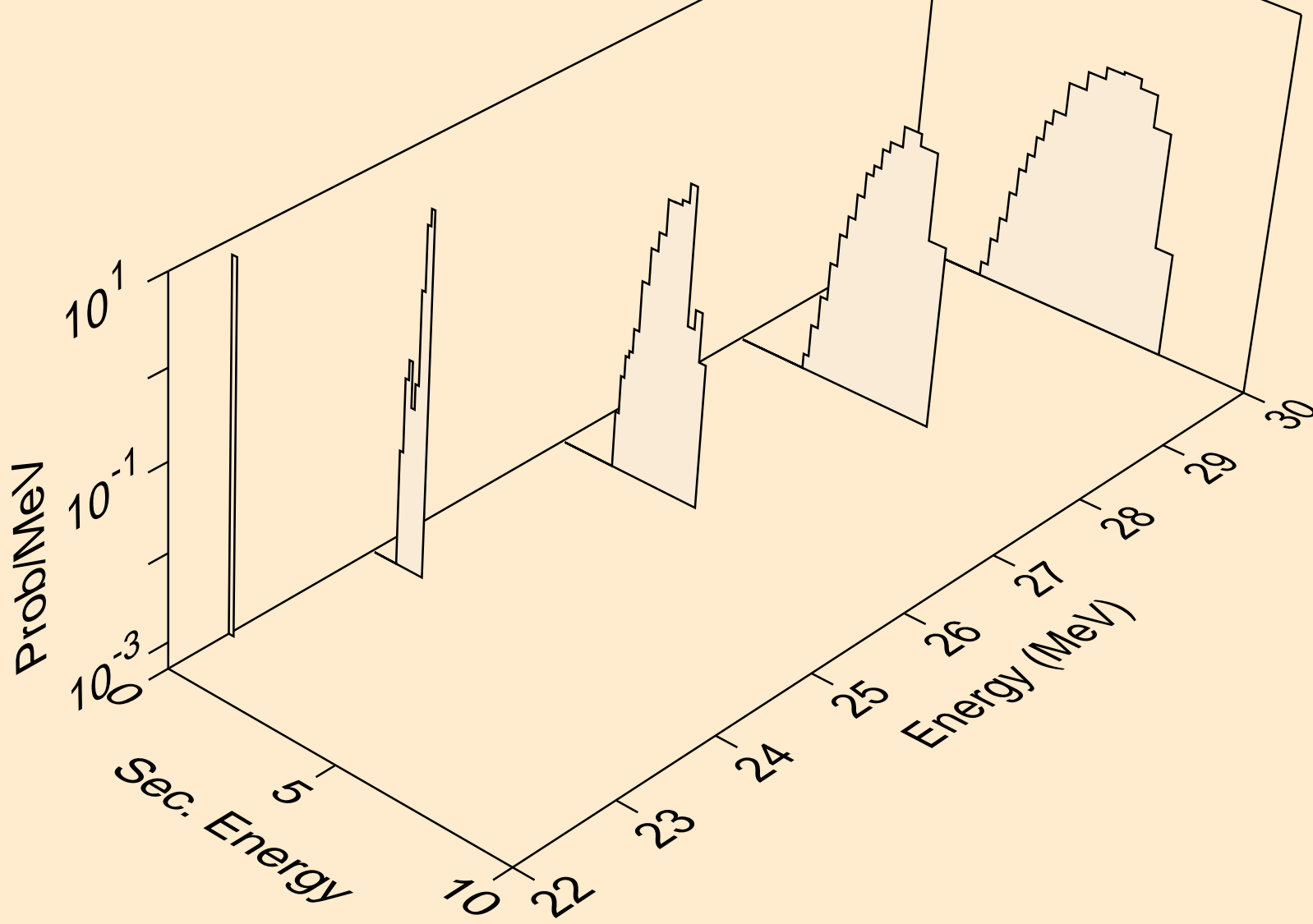

KR088 NEUTRON ACER TENDL-2019 LIBRARY; T=293.16K
deuterons from (n,n*)d

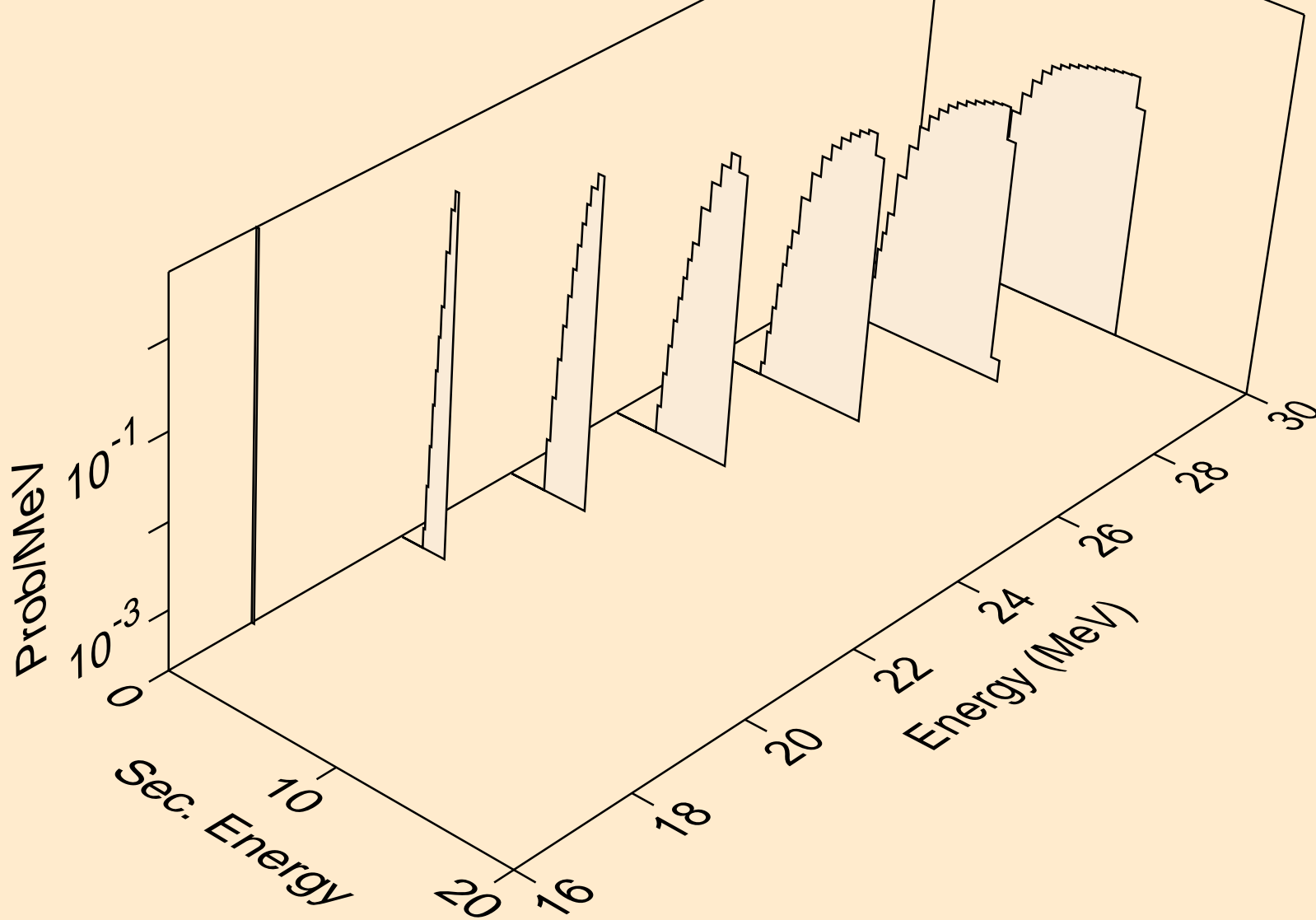

KR088 NEUTRON ACER TENDL-2019 LIBRARY; T=293.16K
deuterons from (n,d)

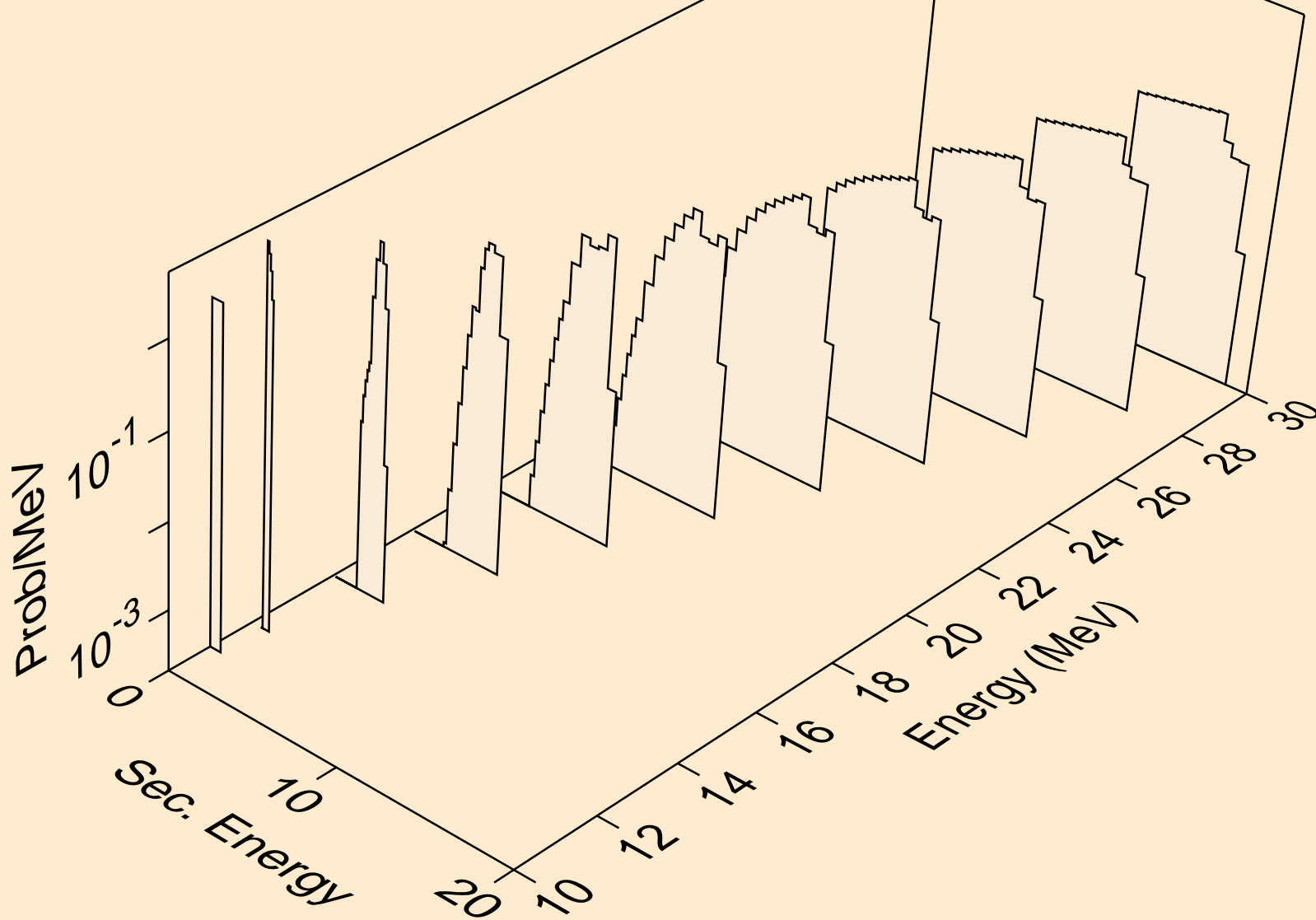

KR088 NEUTRON ACER TENDL-2019 LIBRARY; T=293.16K
tritons from (n,x)

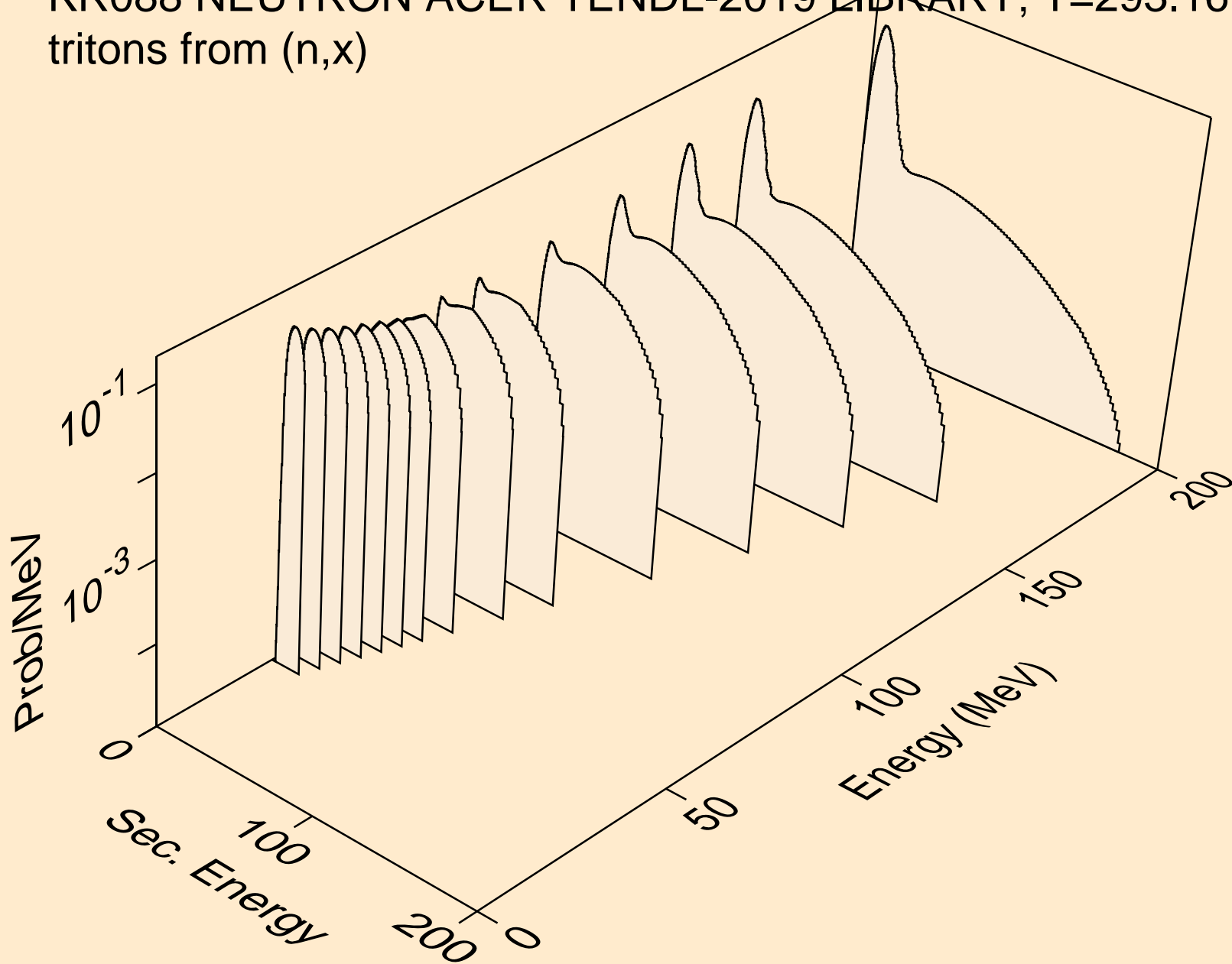

KR088 NEUTRON ACER TENDL-2019 LIBRARY; T=293.16K
tritons from (n,n*)t

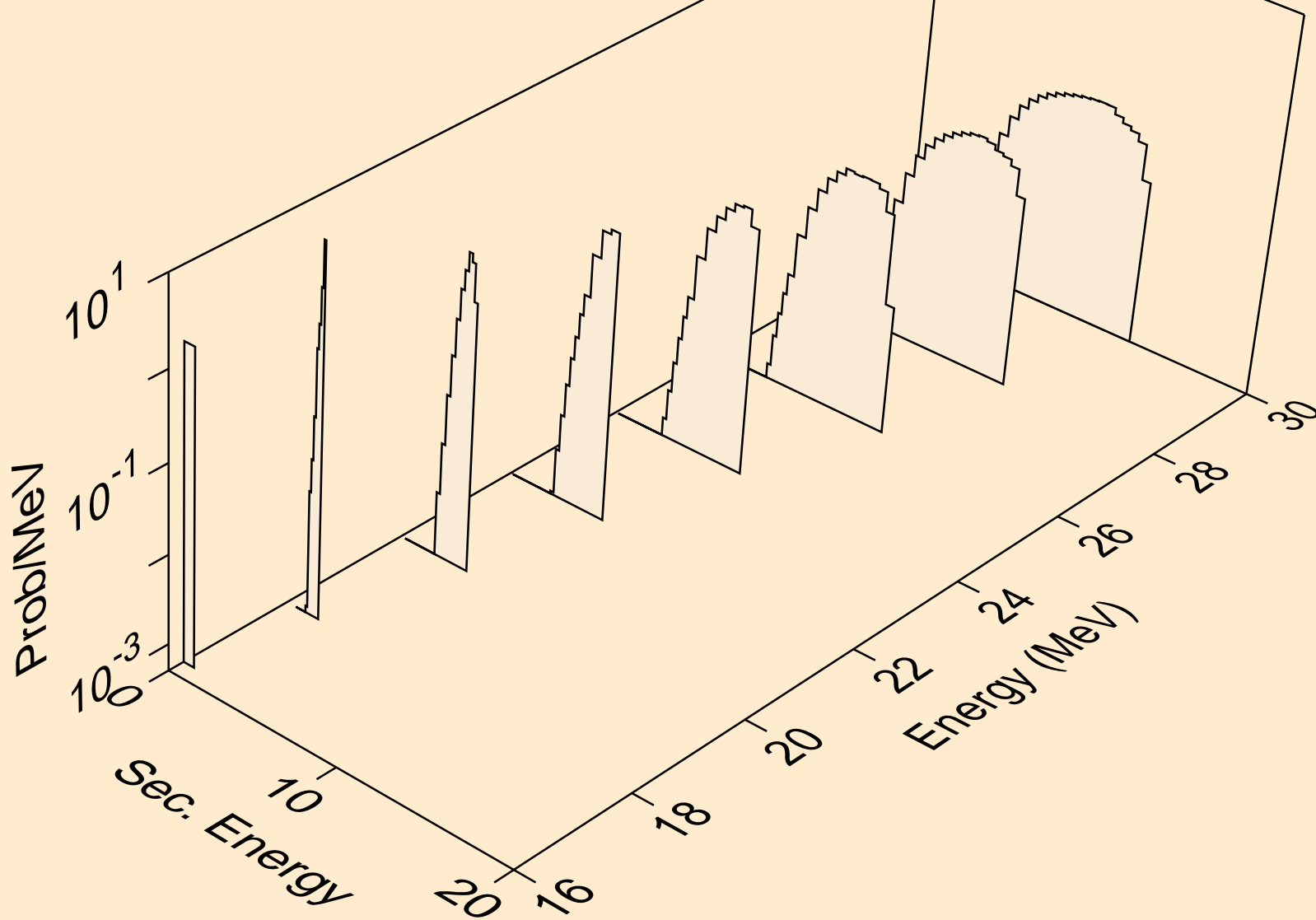

KR088 NEUTRON ACER TENDL-2019 LIBRARY; T=293.16K
tritons from (n,t)

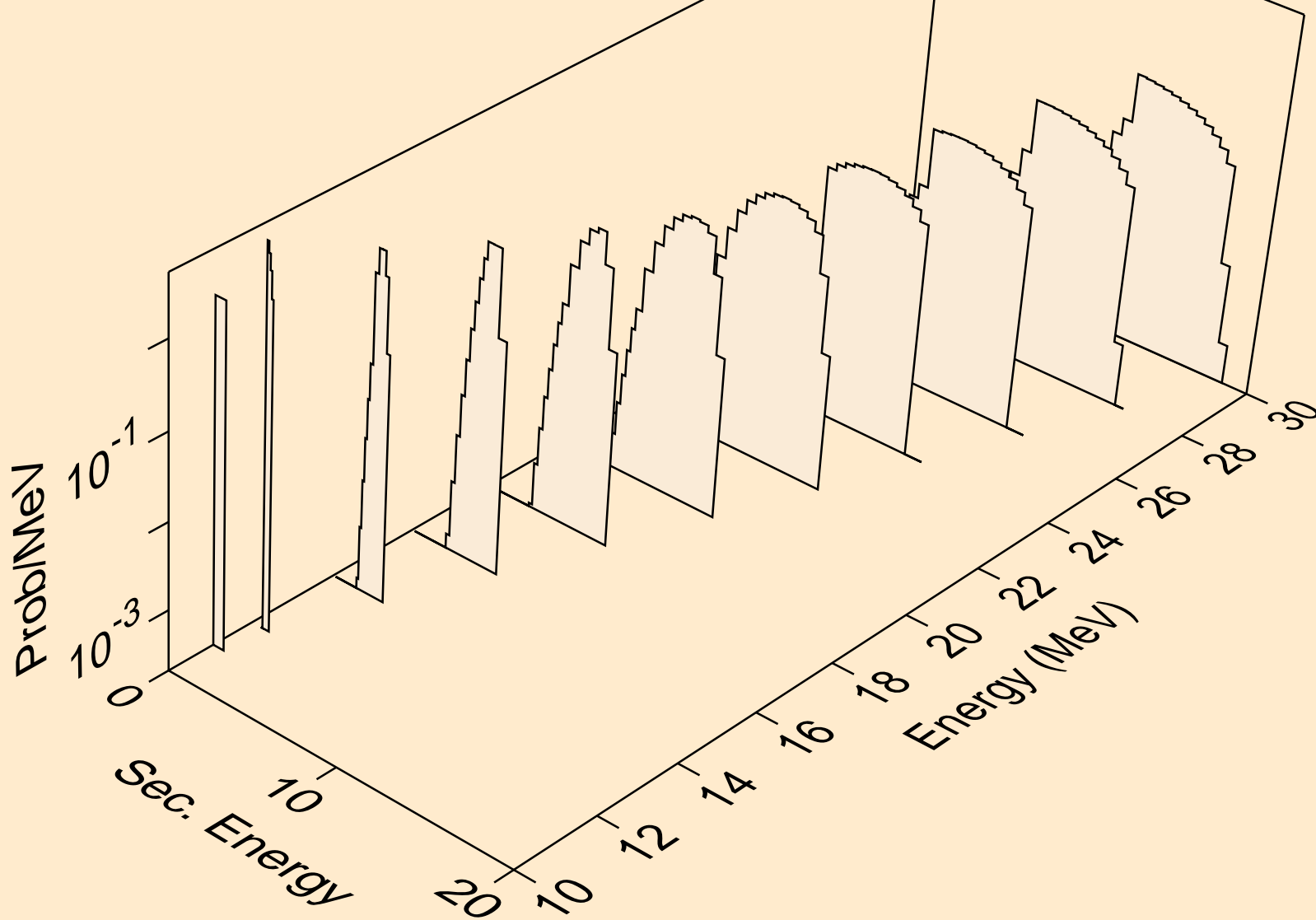

KR088 NEUTRON ACER TENDL-2019 LIBRARY; T=293.16K
he3s from (n,x)

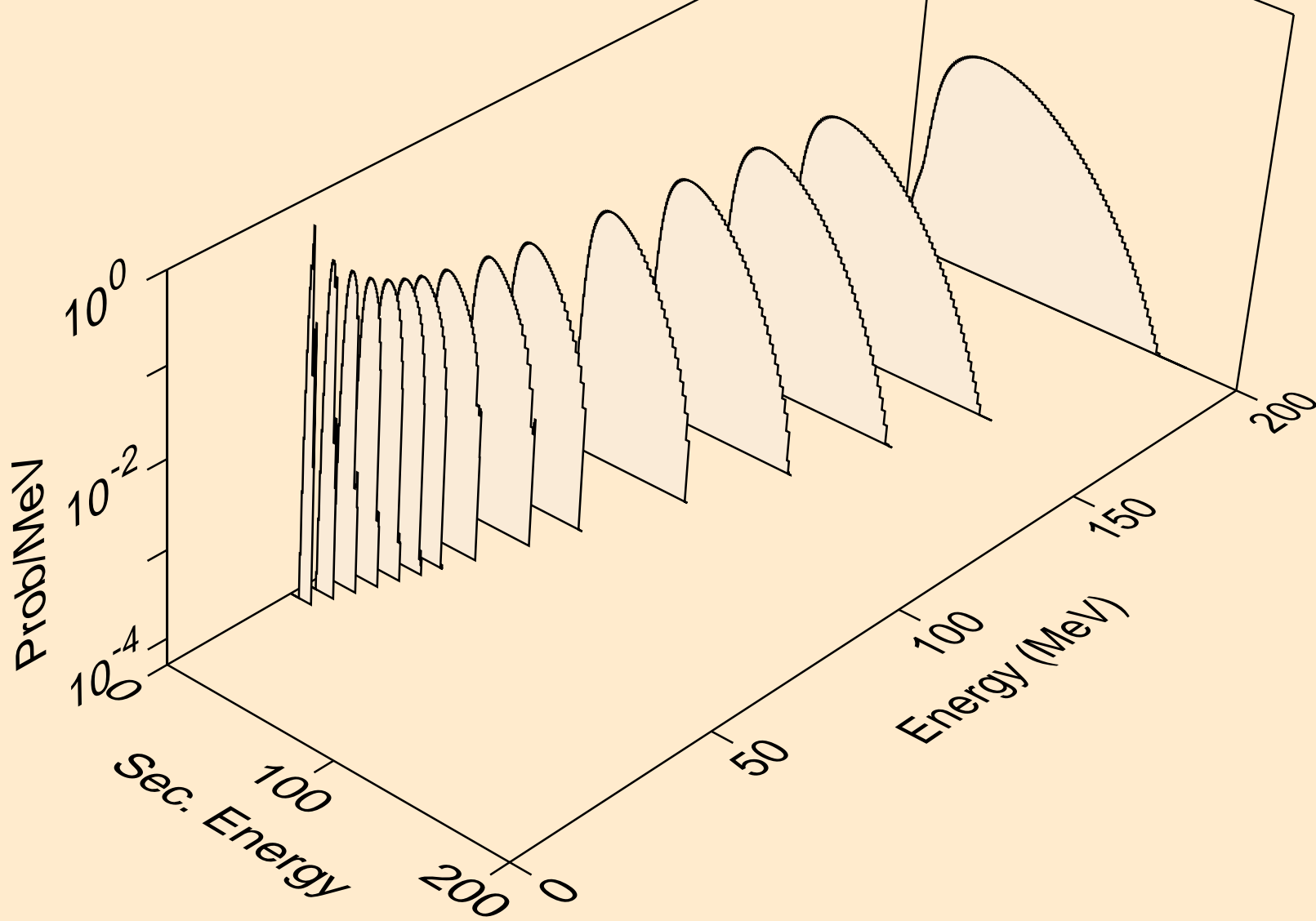

KR088 NEUTRON ACER TENDL-2019 LIBRARY; T=293.16K
he3s from (n,n*)he3

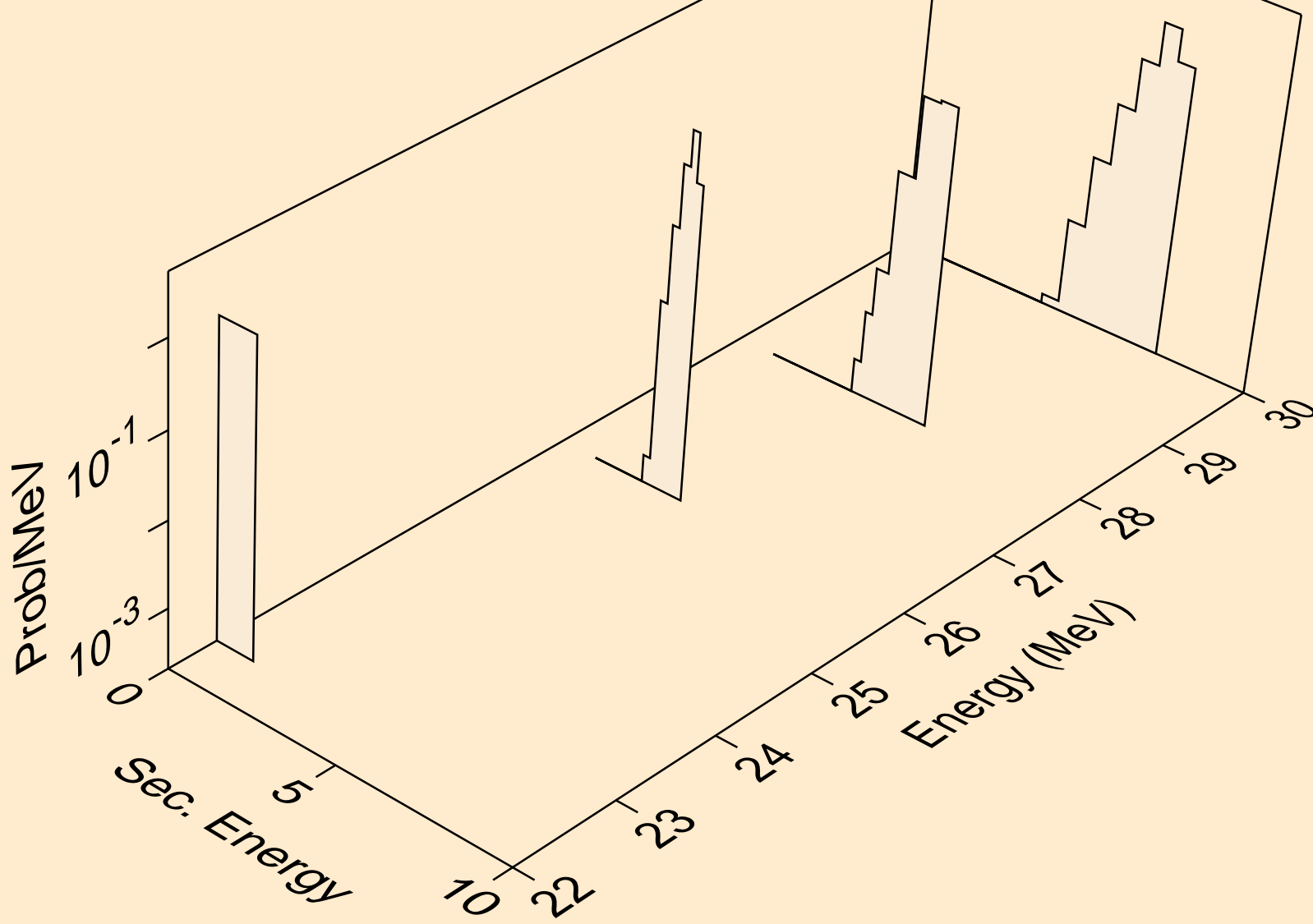

KR088 NEUTRON ACER TENDL-2019 LIBRARY; T=293.16K
he3s from (n,he3)

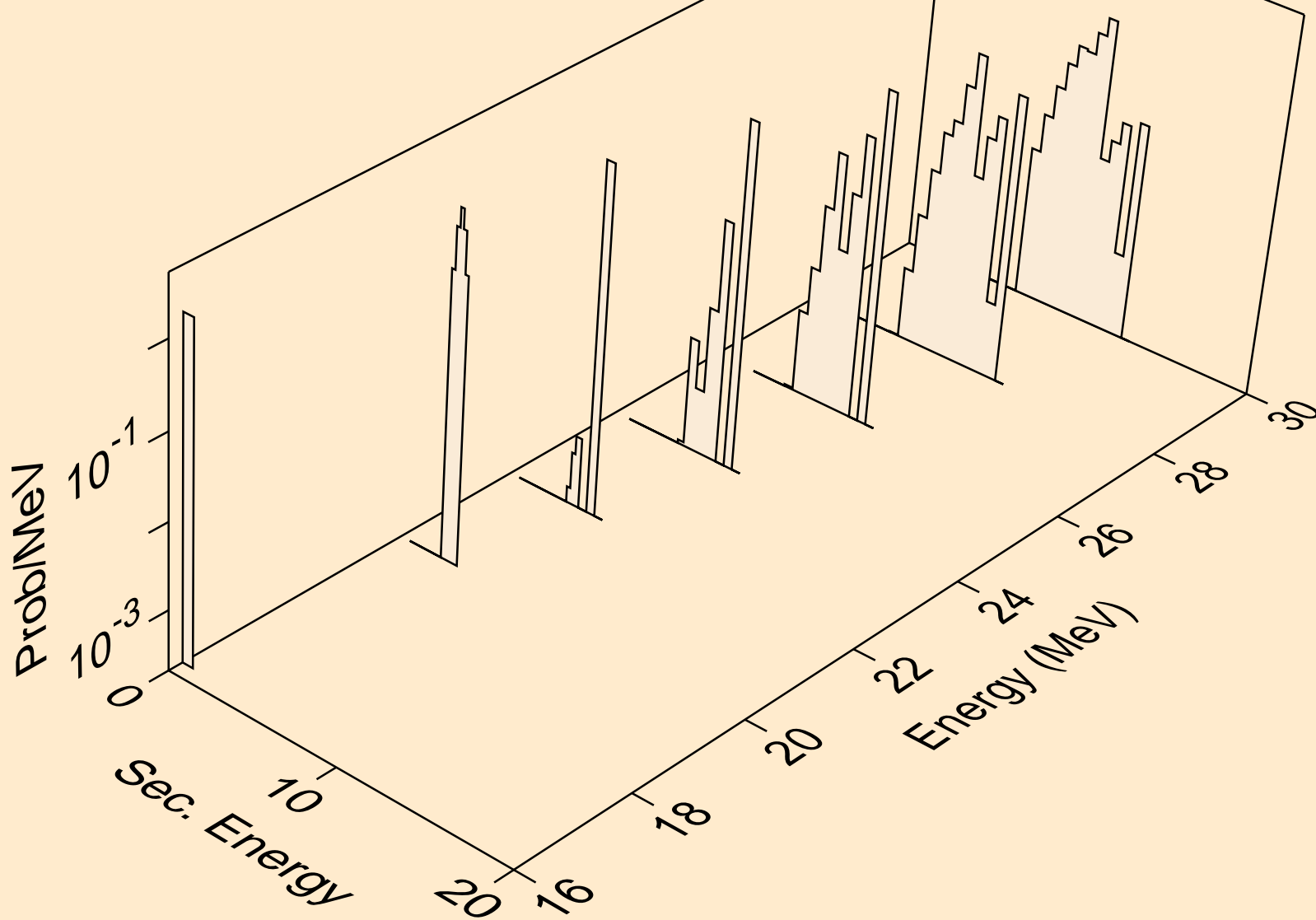

KR088 NEUTRON ACER TENDL-2019 LIBRARY; T=293.16K
alphas from (n,x)

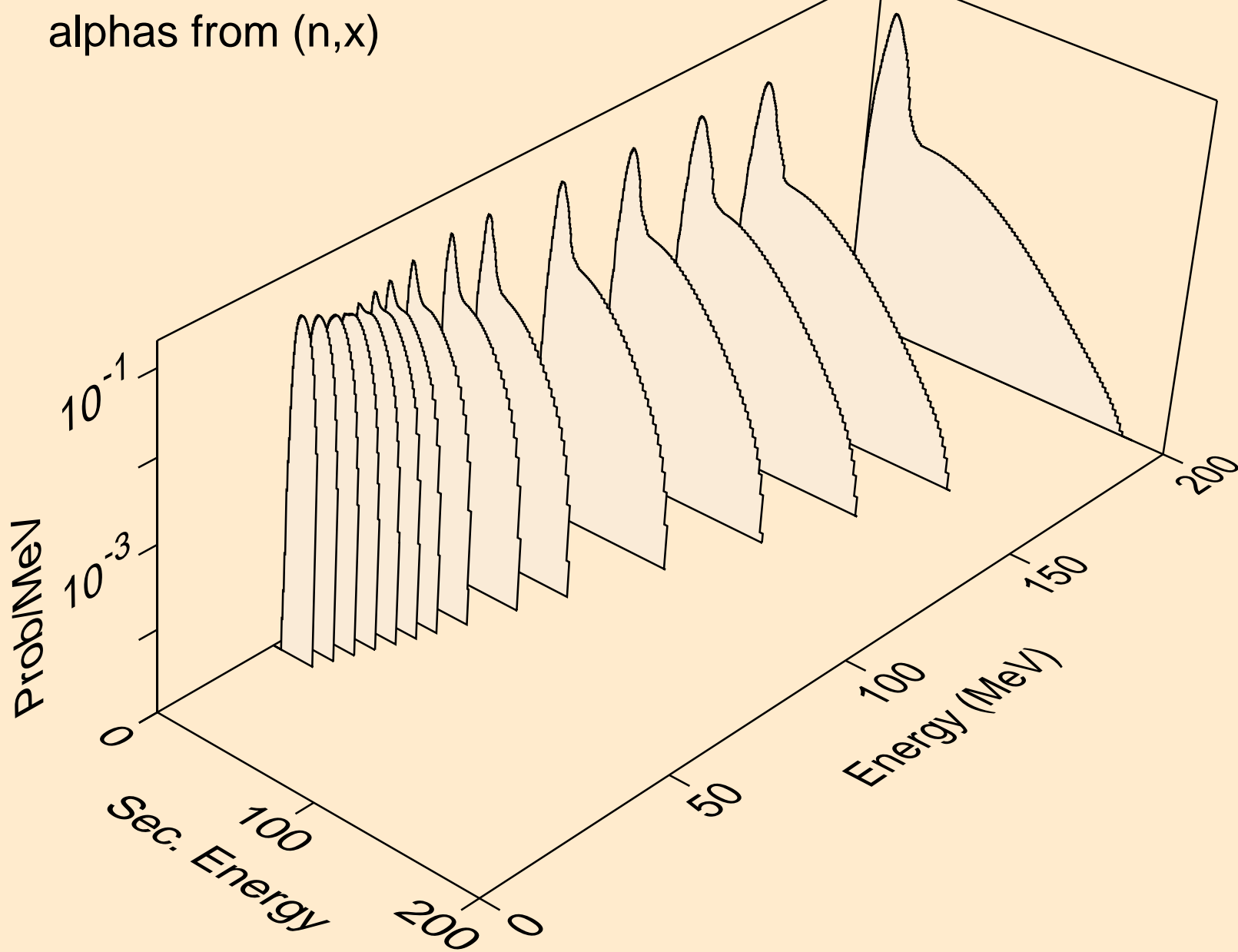

KR088 NEUTRON ACER TENDL-2019 LIBRARY; T=293.16K
alphas from (n,n*)a

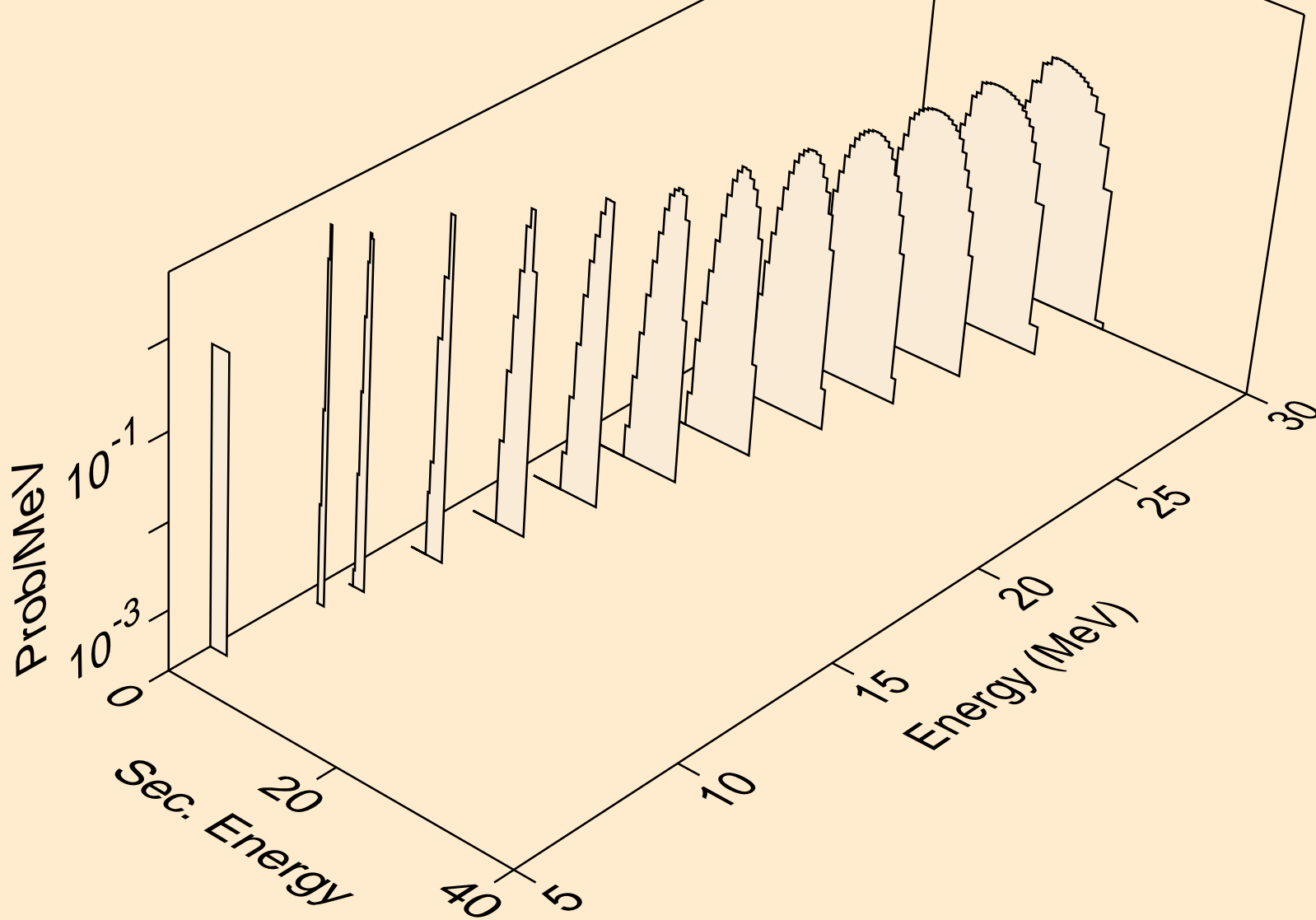

KR088 NEUTRON ACER TENDL-2019 LIBRARY; T=293.16K
alphas from (n,2n)a

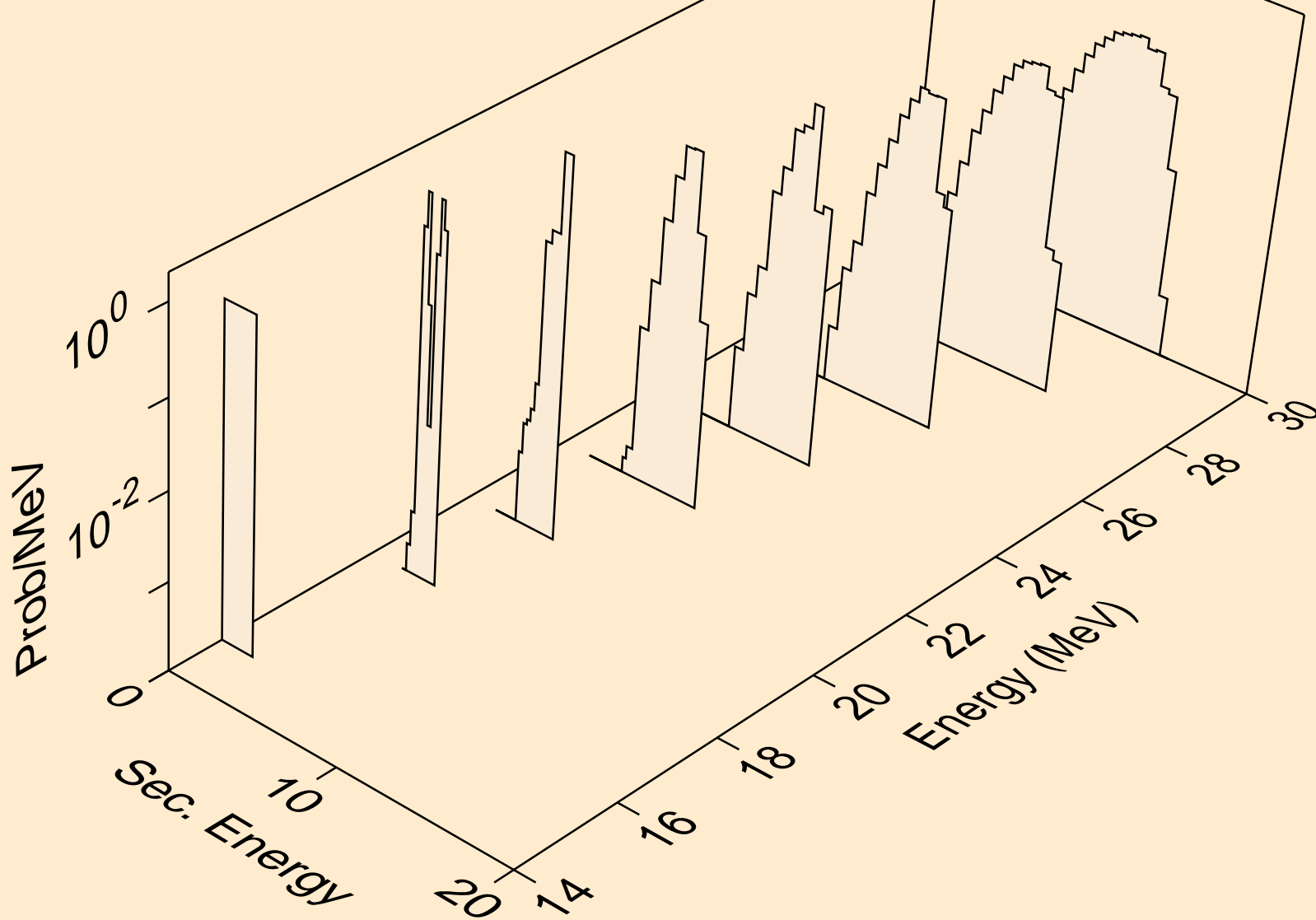

KR088 NEUTRON ACER TENDL-2019 LIBRARY; T=293.16K
alphas from (n,3n)a

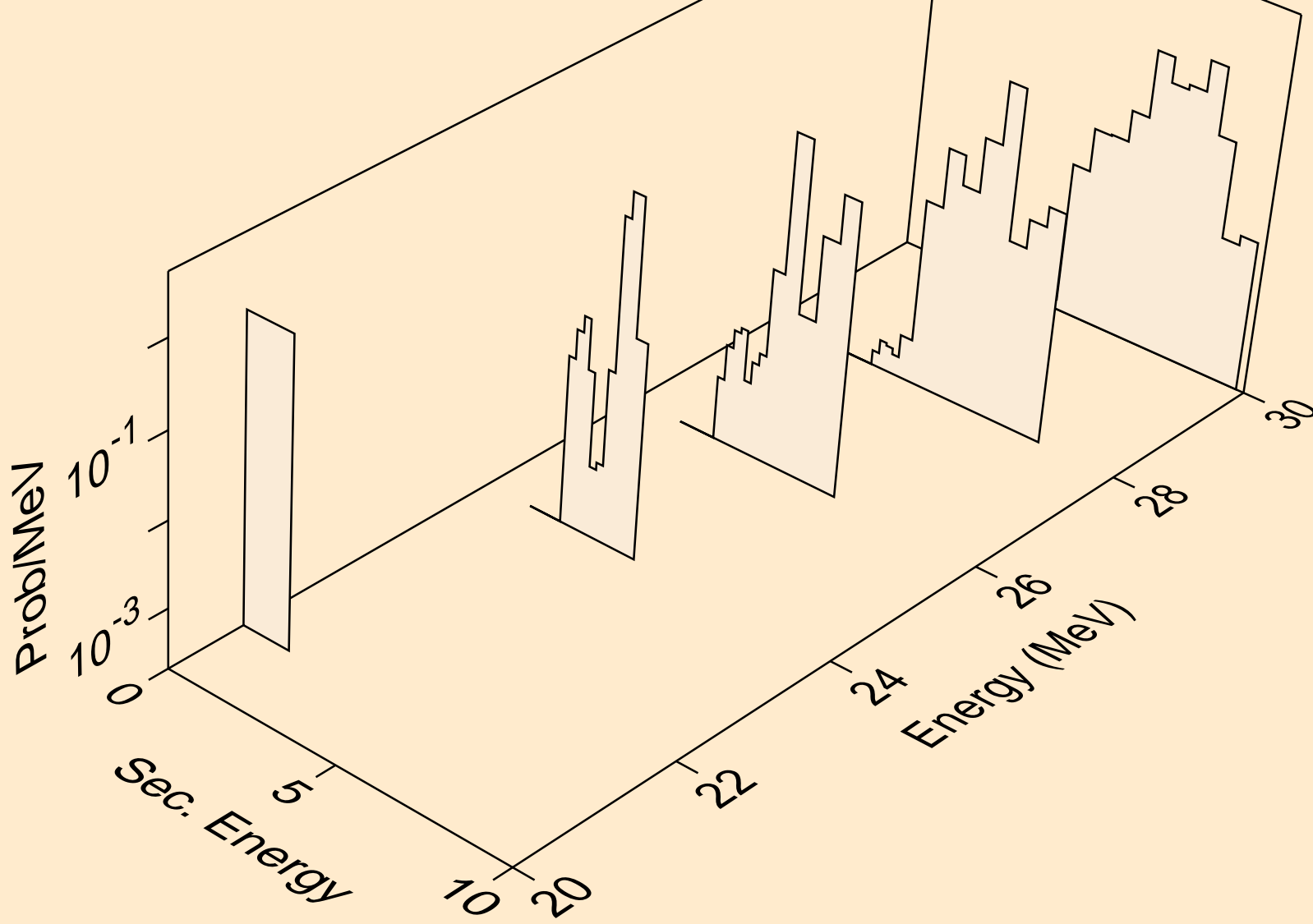

KR088 NEUTRON ACER TENDL-2019 LIBRARY; T=293.16K
alphas from (n,a)

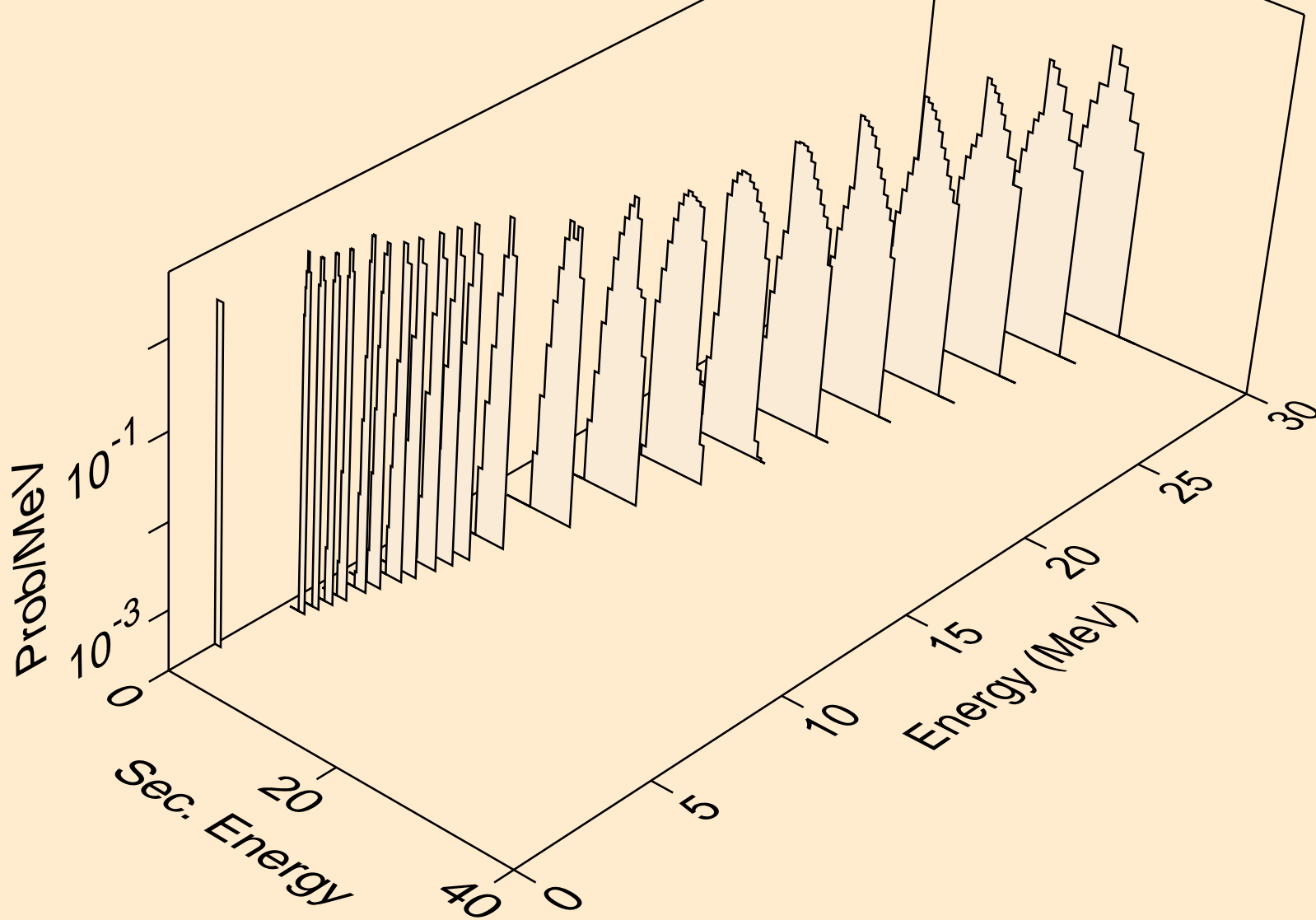

KR088 NEUTRON ACER TENDL-2019 LIBRARY; T=293.16K
alphas from (n,pa)

