

MG024 NEUTRON ACER TENDL-2019 LIBRARY; T=293.16K

Principal cross sections

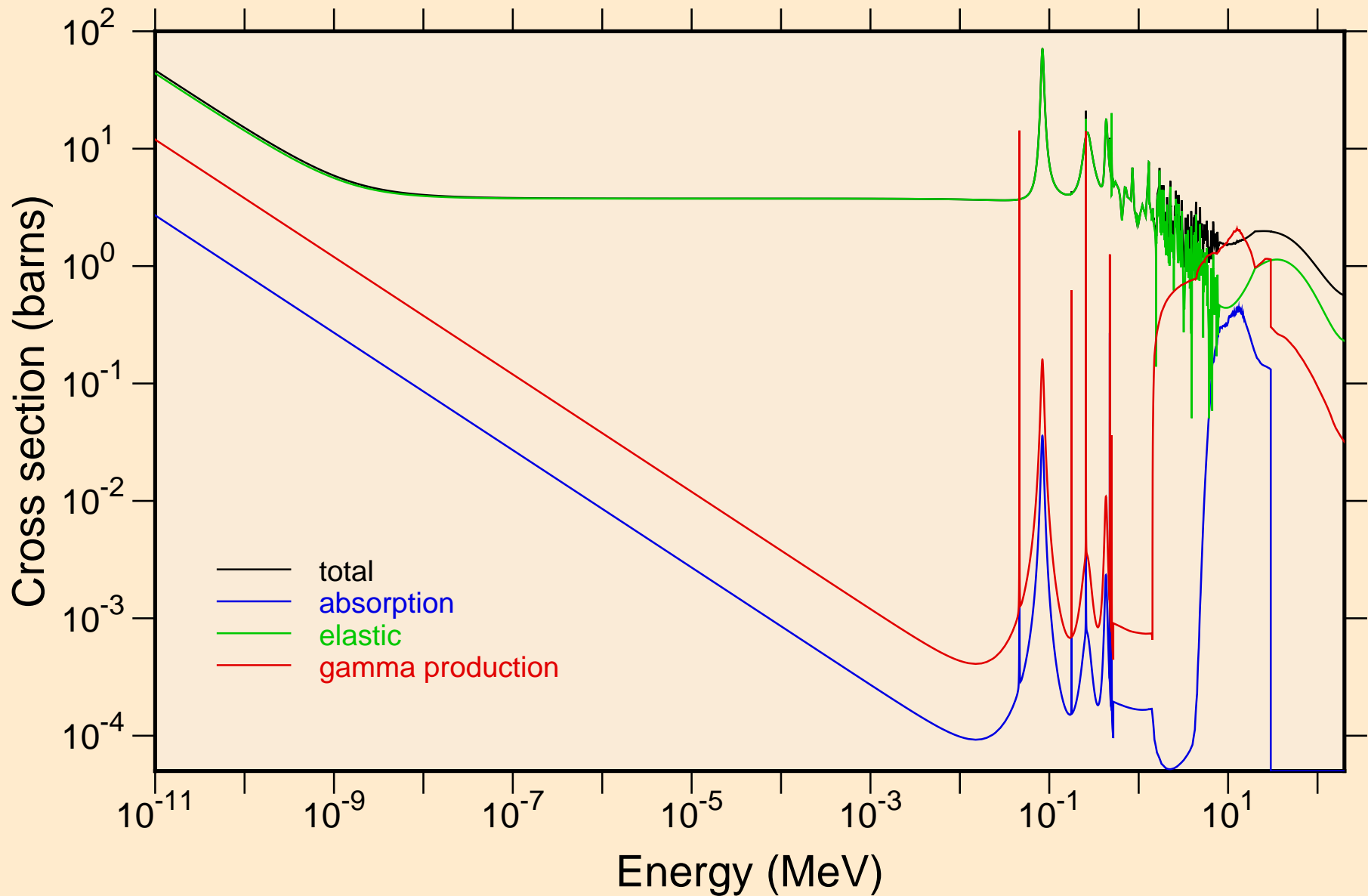

MG024 NEUTRON ACER TENDL-2019 LIBRARY; T=293.16K
resonance total cross section

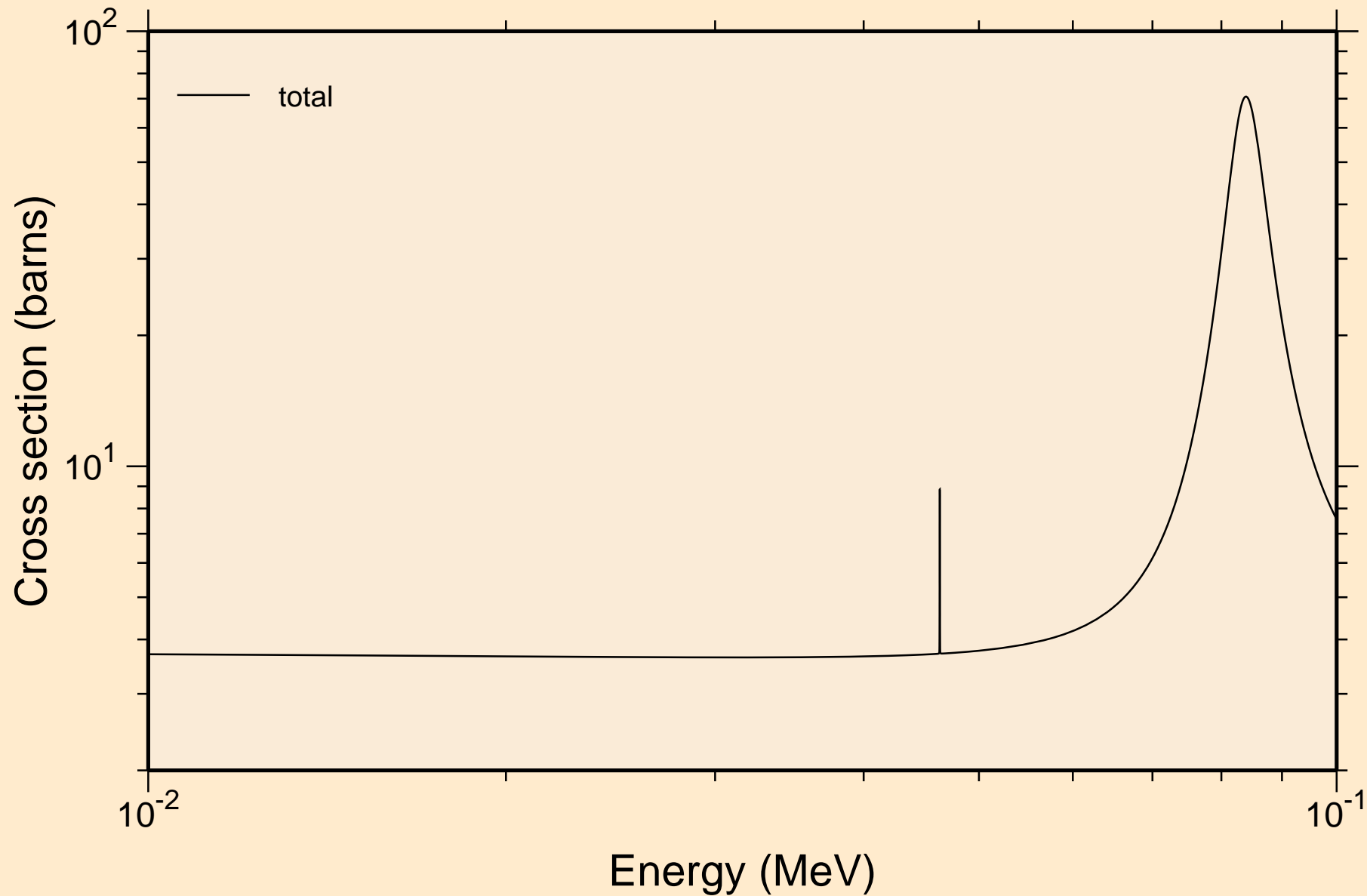

MG024 NEUTRON ACER TENDL-2019 LIBRARY; T=293.16K
resonance total cross section

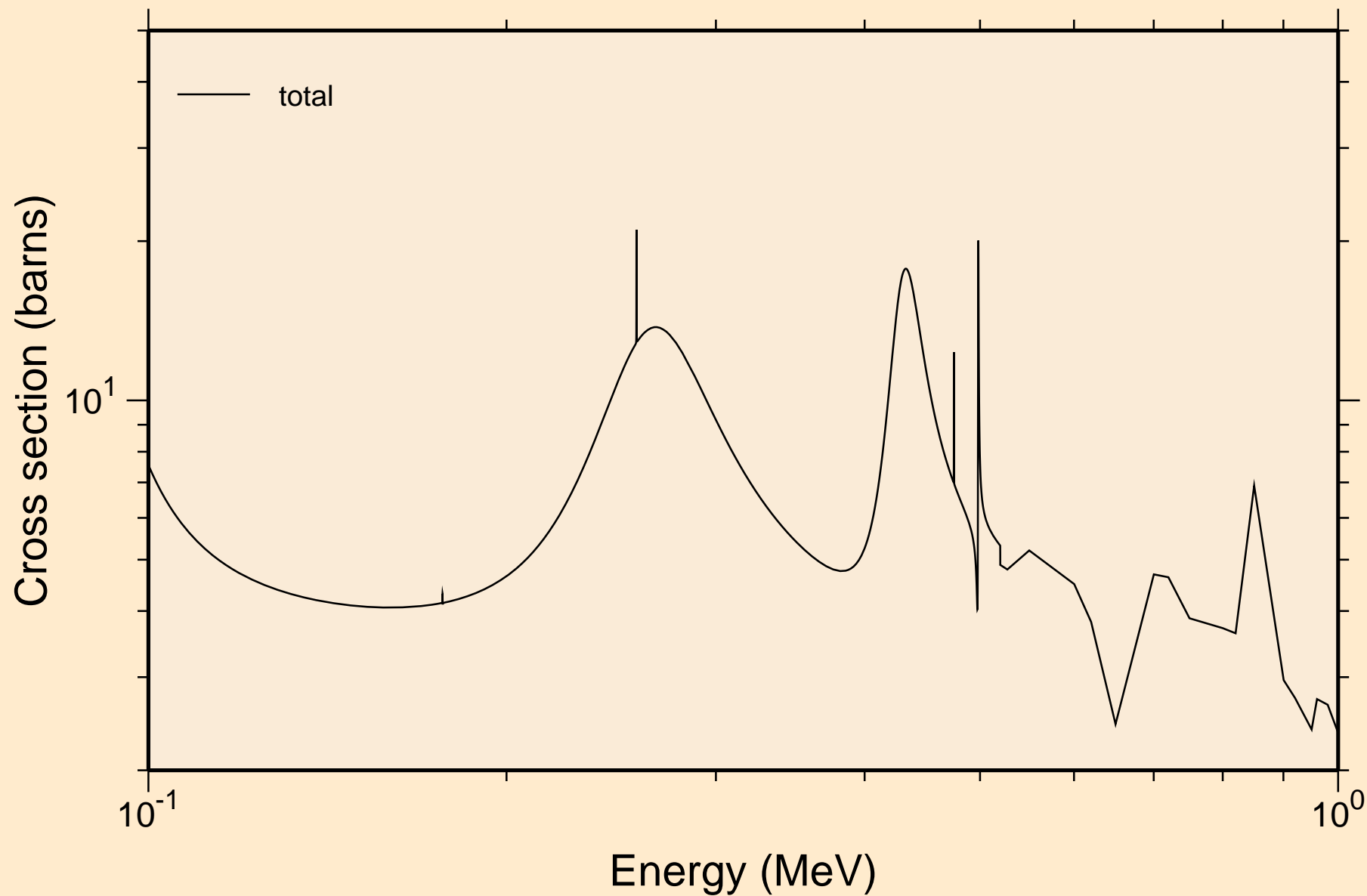

MG024 NEUTRON ACER TENDL-2019 LIBRARY; T=293.16K
resonance total cross section

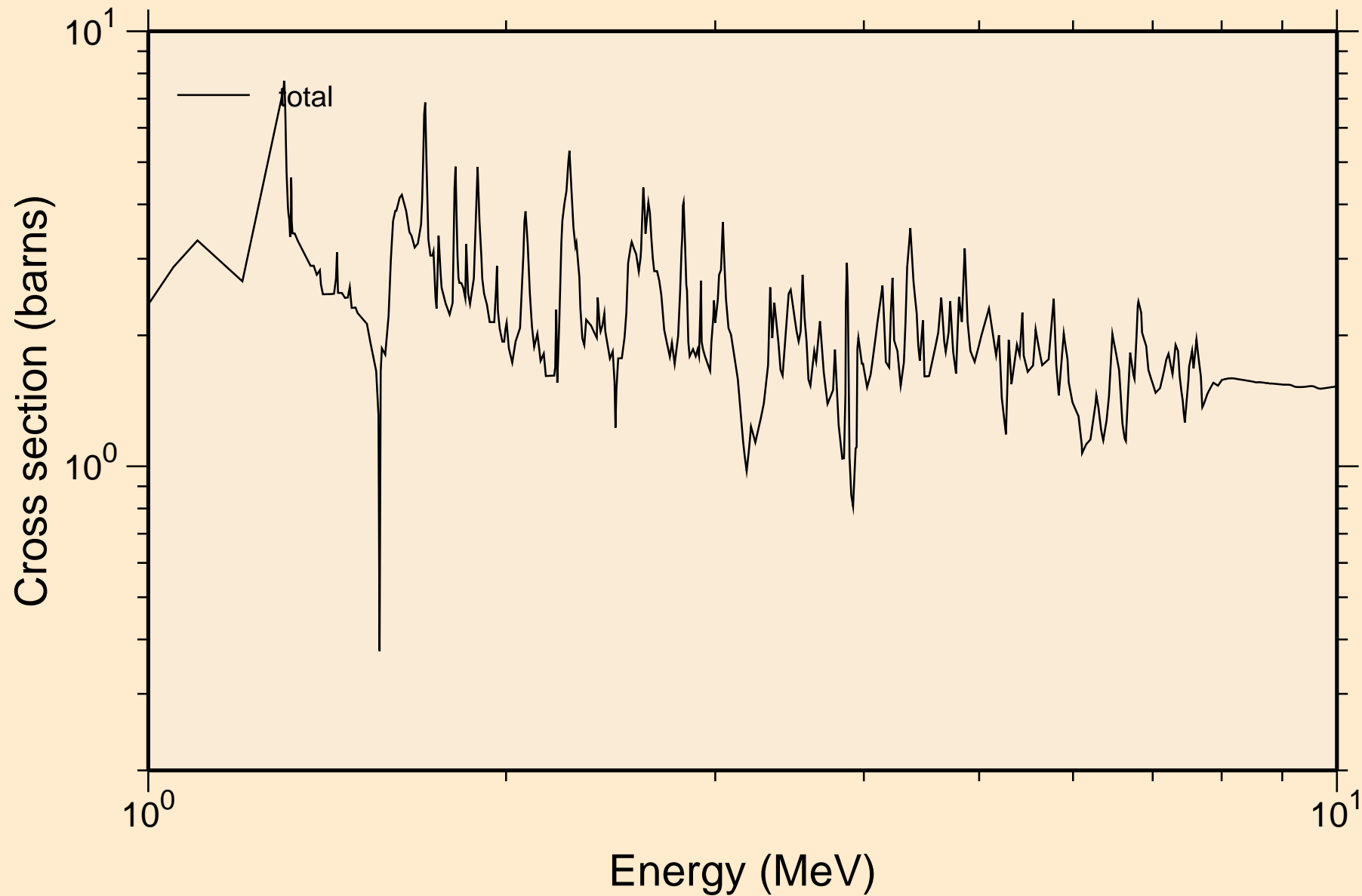

MG024 NEUTRON ACER TENDL-2019 LIBRARY; T=293.16K
resonance absorption cross sections

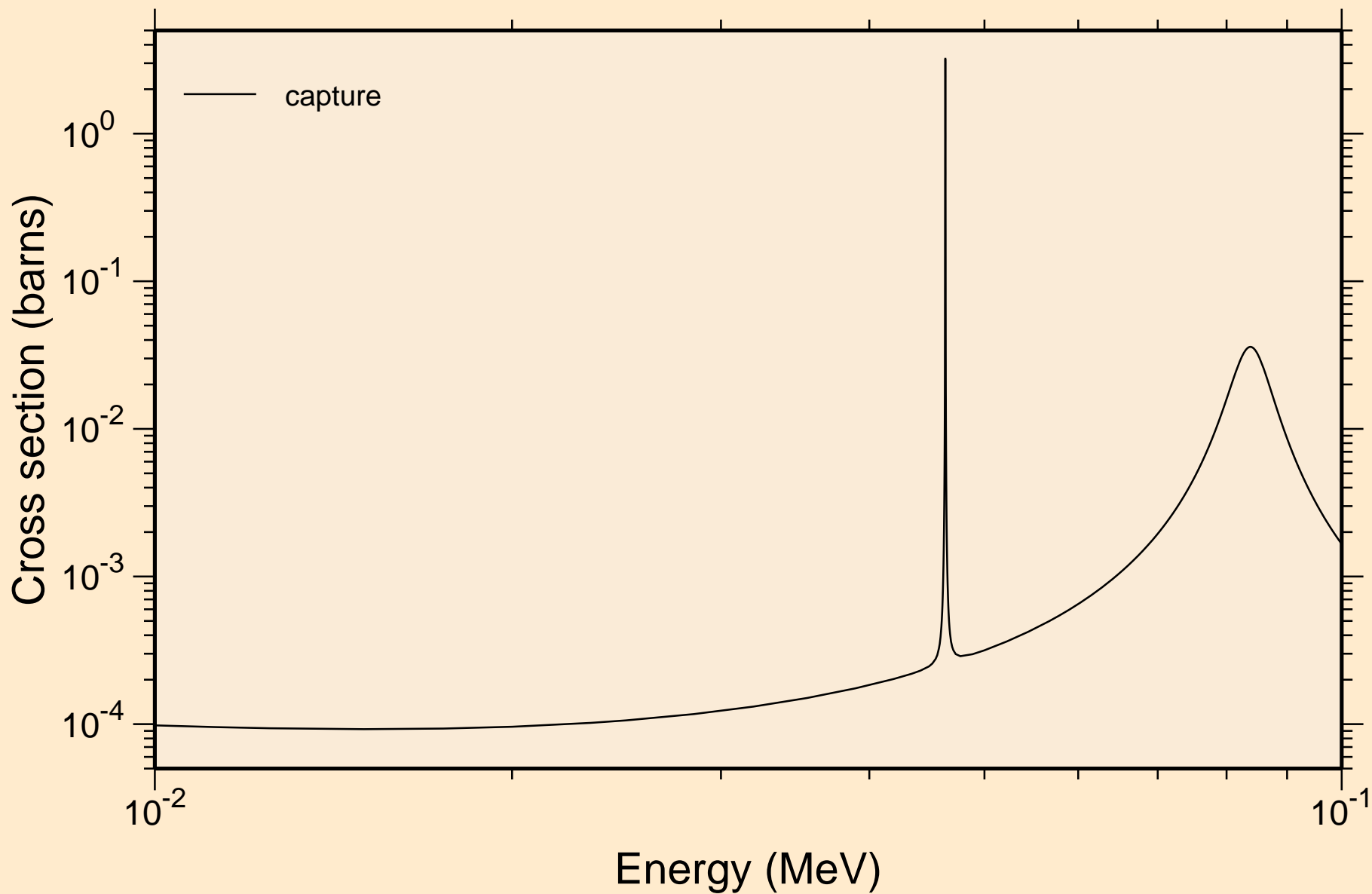

MG024 NEUTRON ACER TENDL-2019 LIBRARY; T=293.16K
resonance absorption cross sections

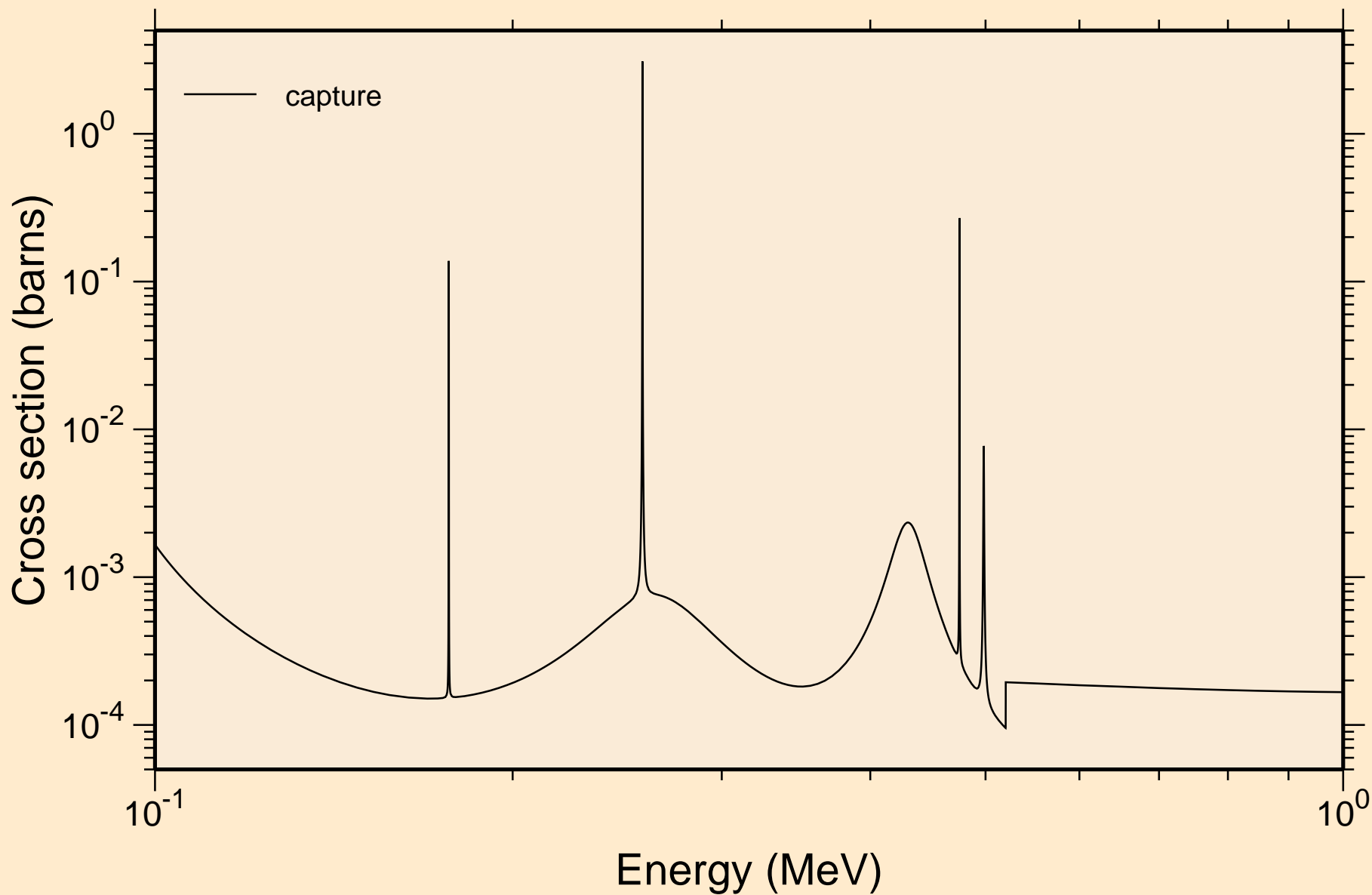

MG024 NEUTRON ACER TENDL-2019 LIBRARY; T=293.16K
resonance absorption cross sections

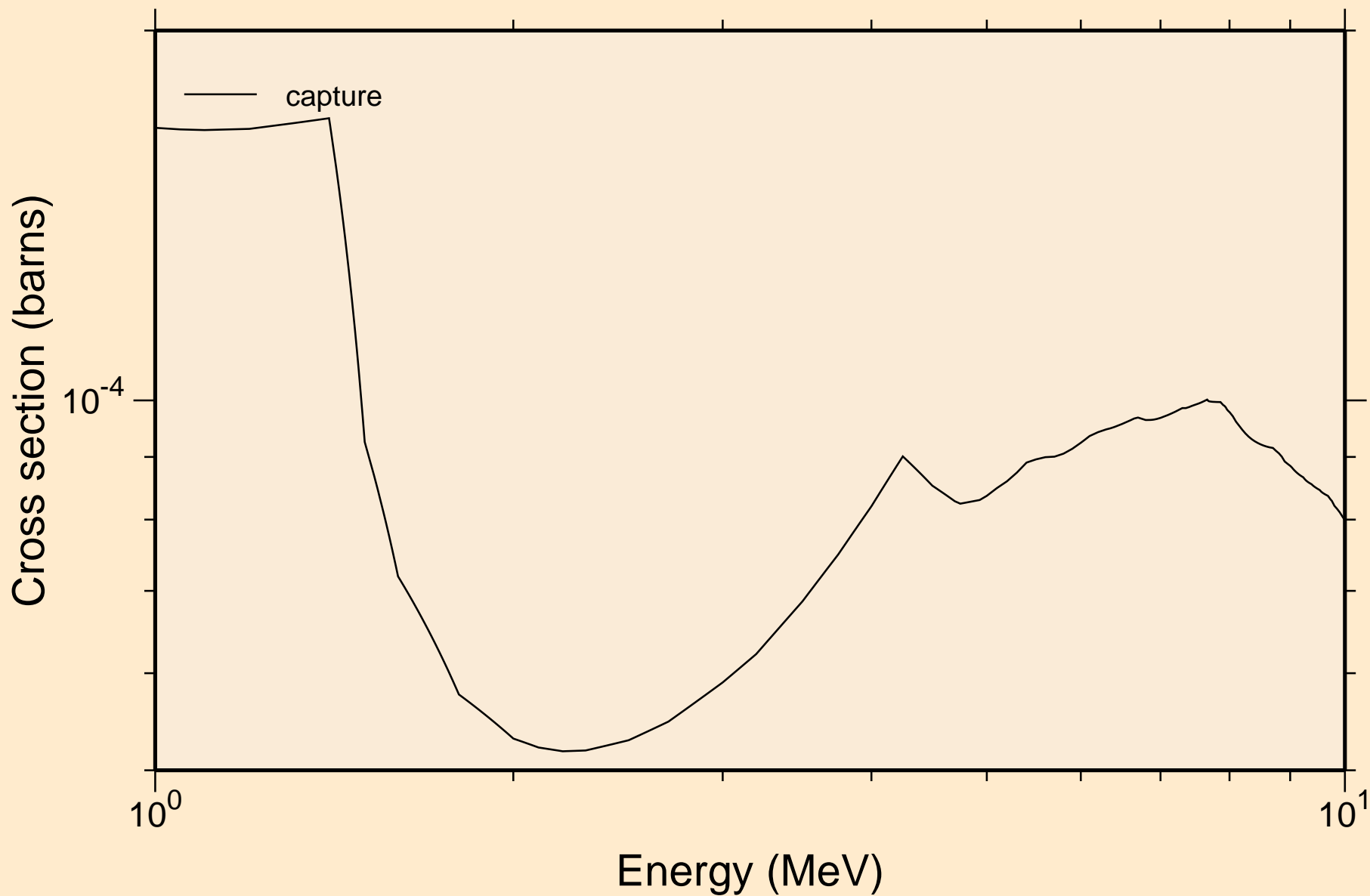

MG024 NEUTRON ACER TENDL-2019 LIBRARY; T=293.16K
Heating

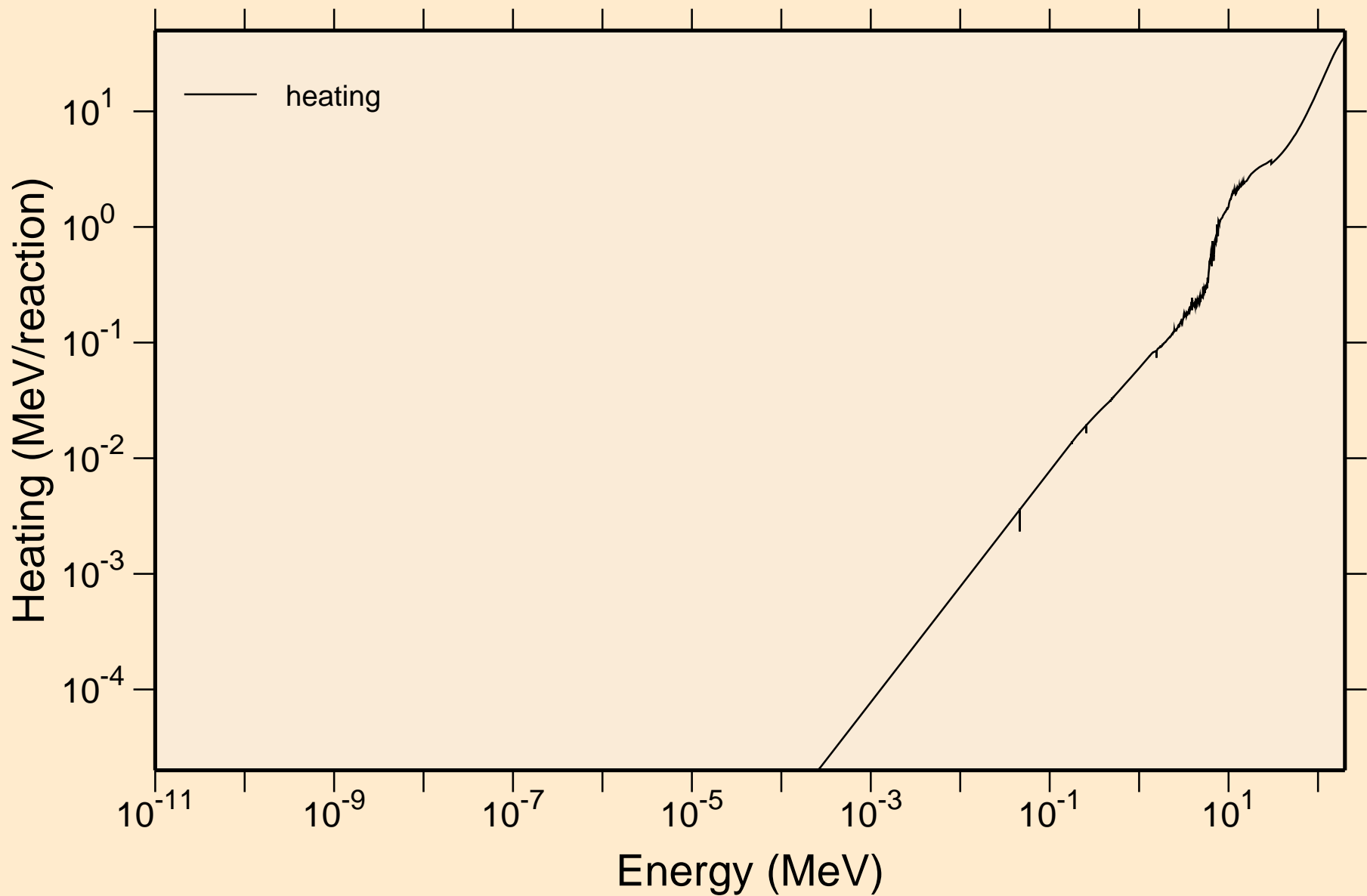

MG024 NEUTRON ACER TENDL-2019 LIBRARY; T=293.16K Damage

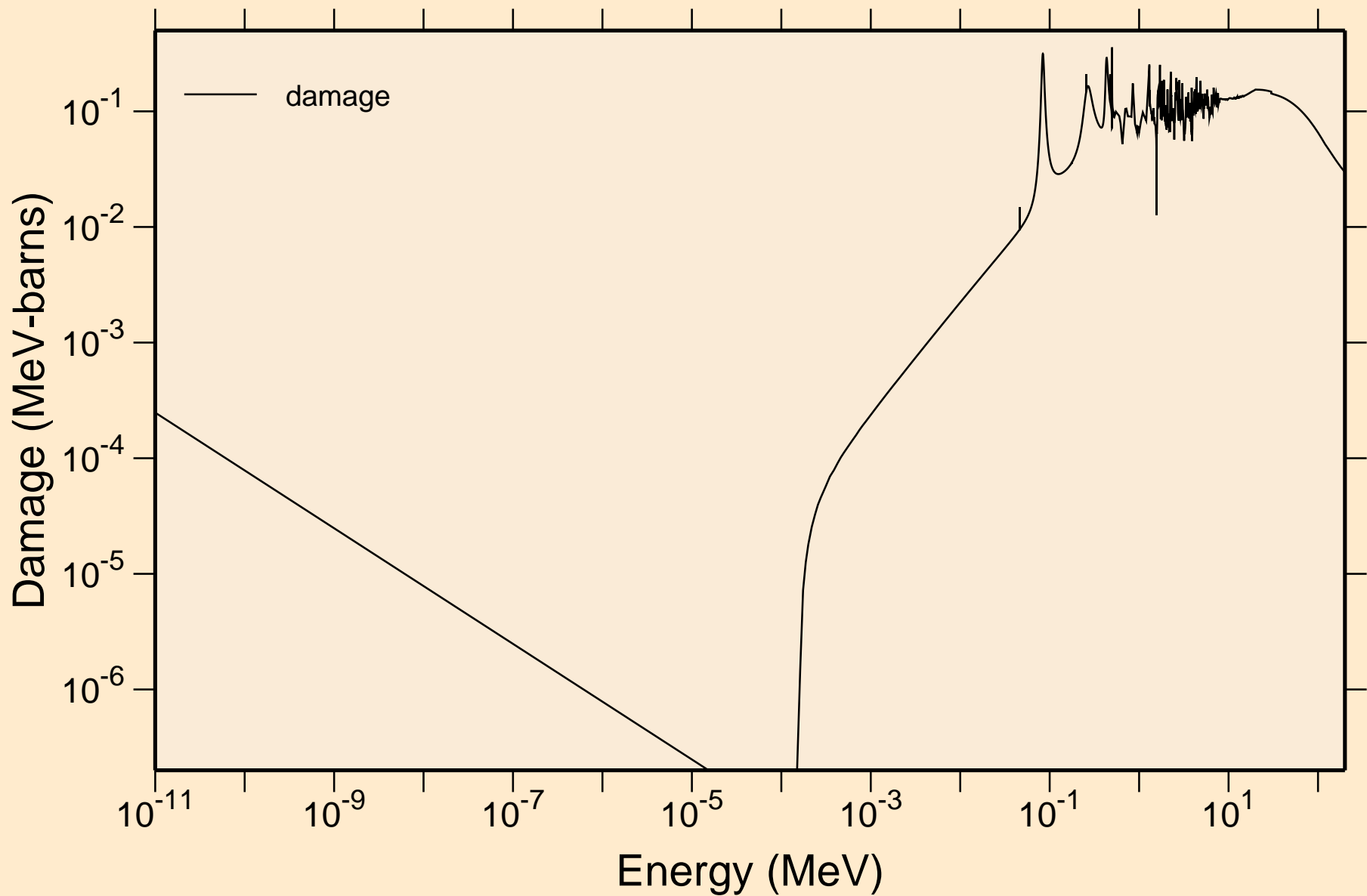

MG024 NEUTRON ACER TENDL-2019 LIBRARY; T=293.16K
Non-threshold reactions

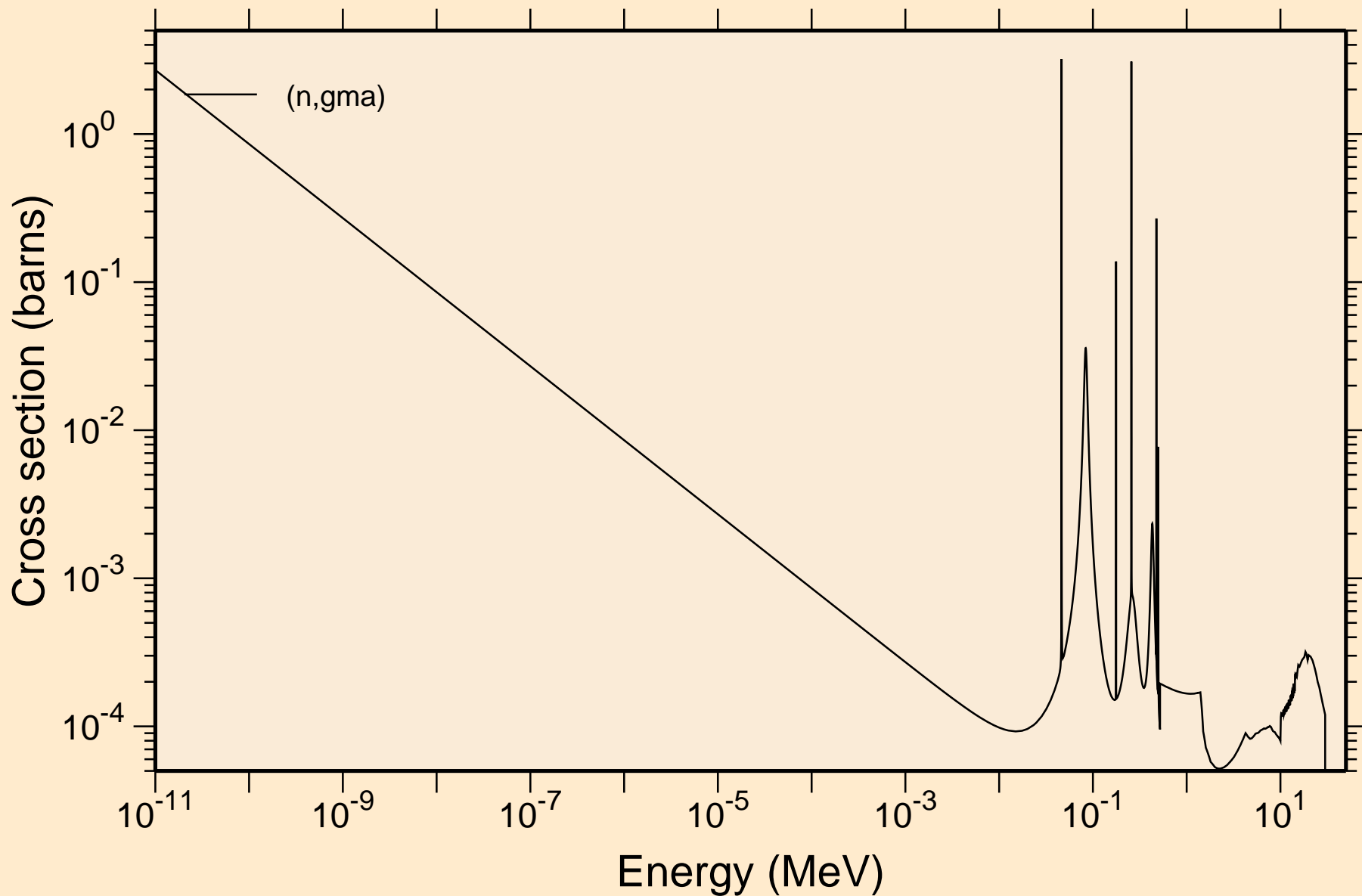

MG024 NEUTRON ACER TENDL-2019 LIBRARY; T=293.16K
Principal cross sections

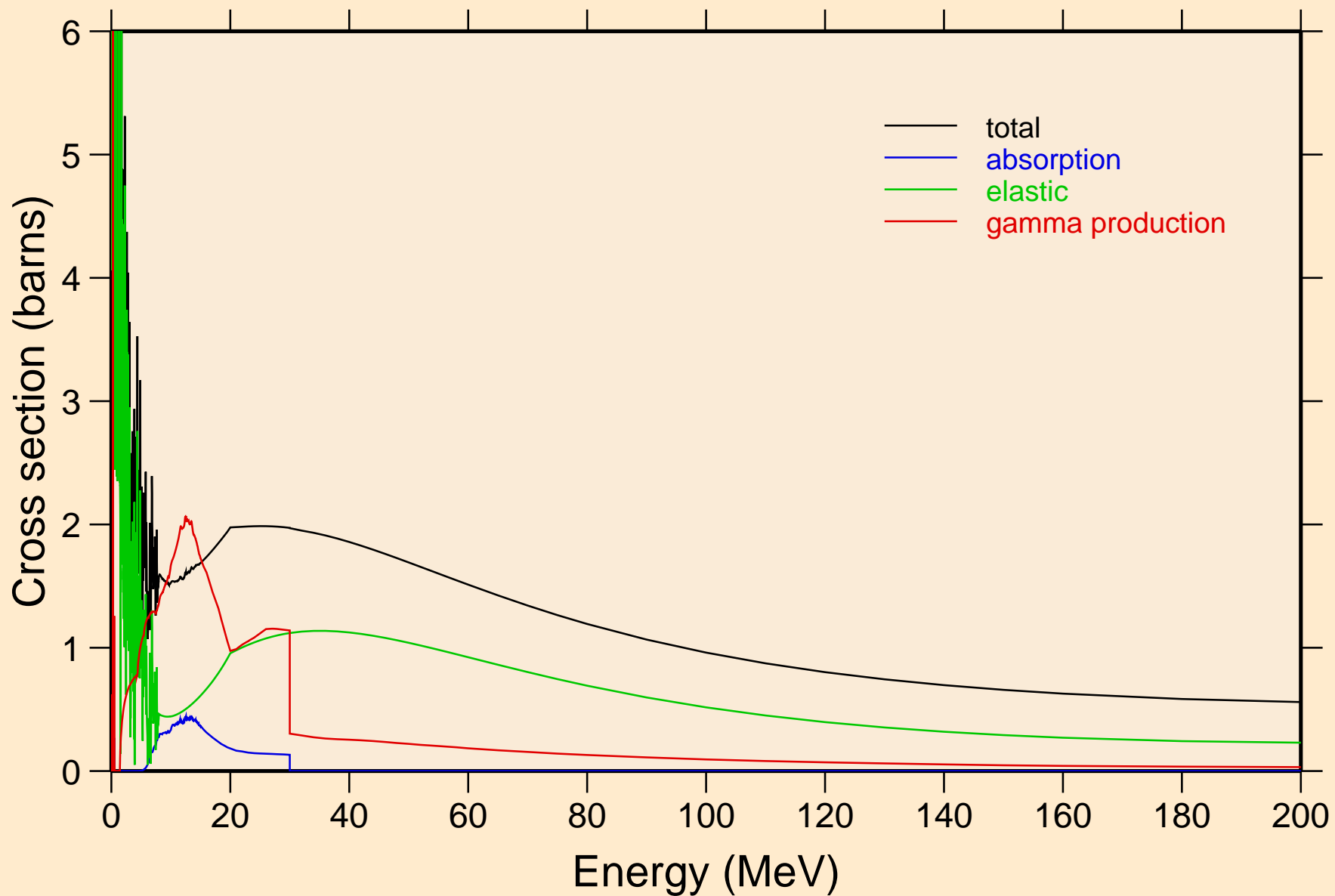

MG024 NEUTRON ACER TENDL-2019 LIBRARY; T=293.16K
Heating

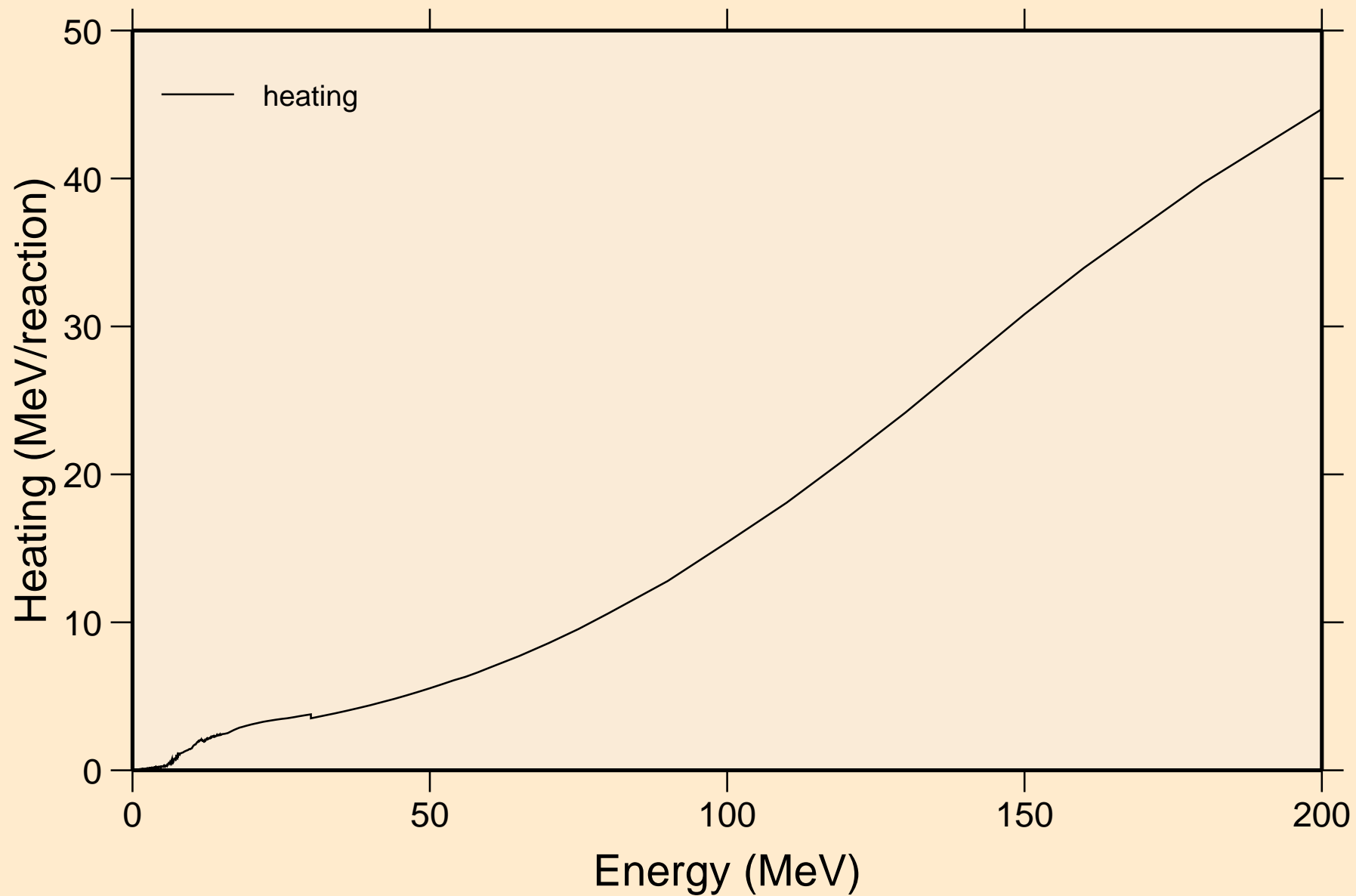

MG024 NEUTRON ACER TENDL-2019 LIBRARY; T=293.16K
Damage

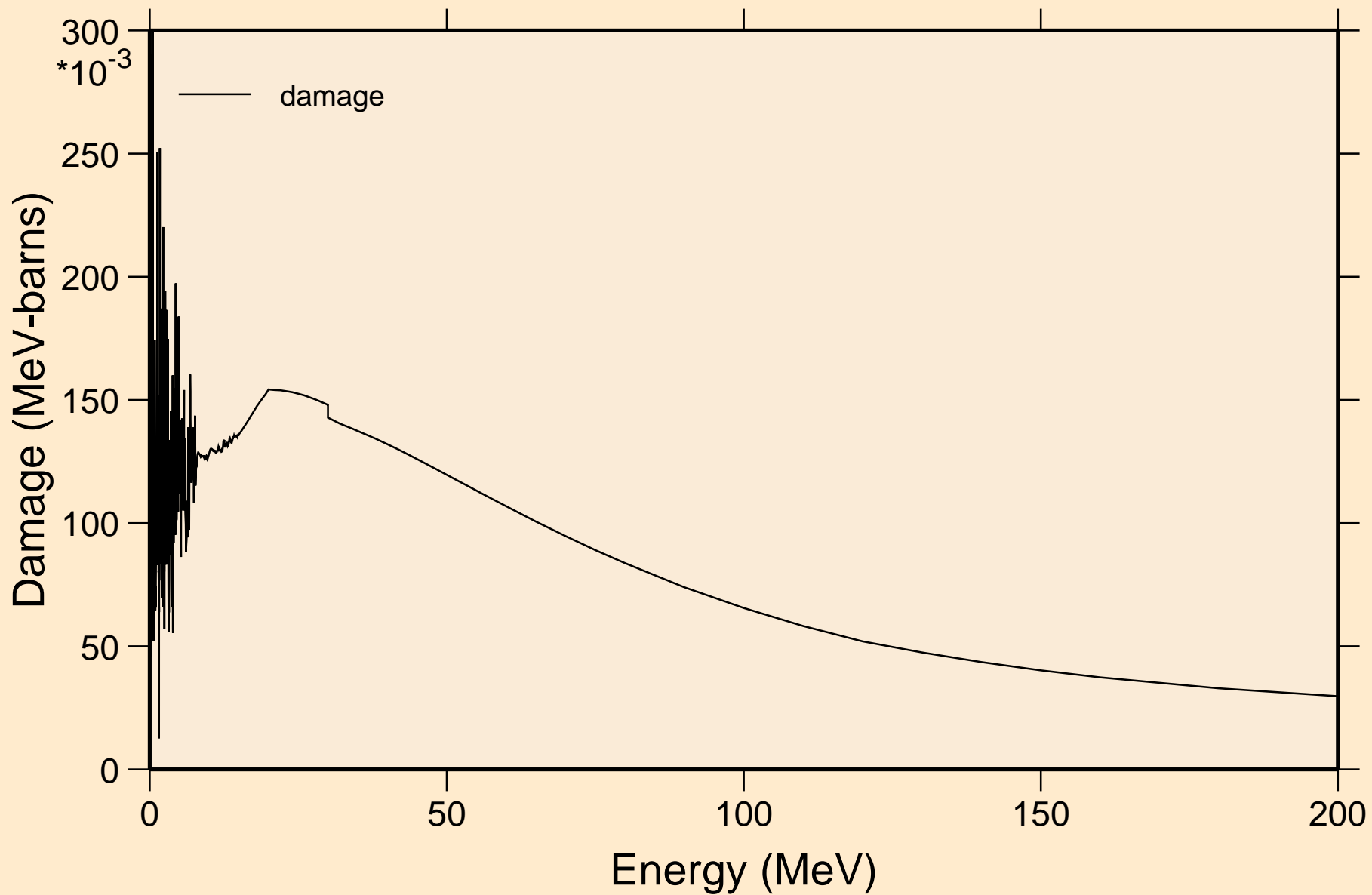

MG024 NEUTRON ACER TENDL-2019 LIBRARY; T=293.16K
Non-threshold reactions

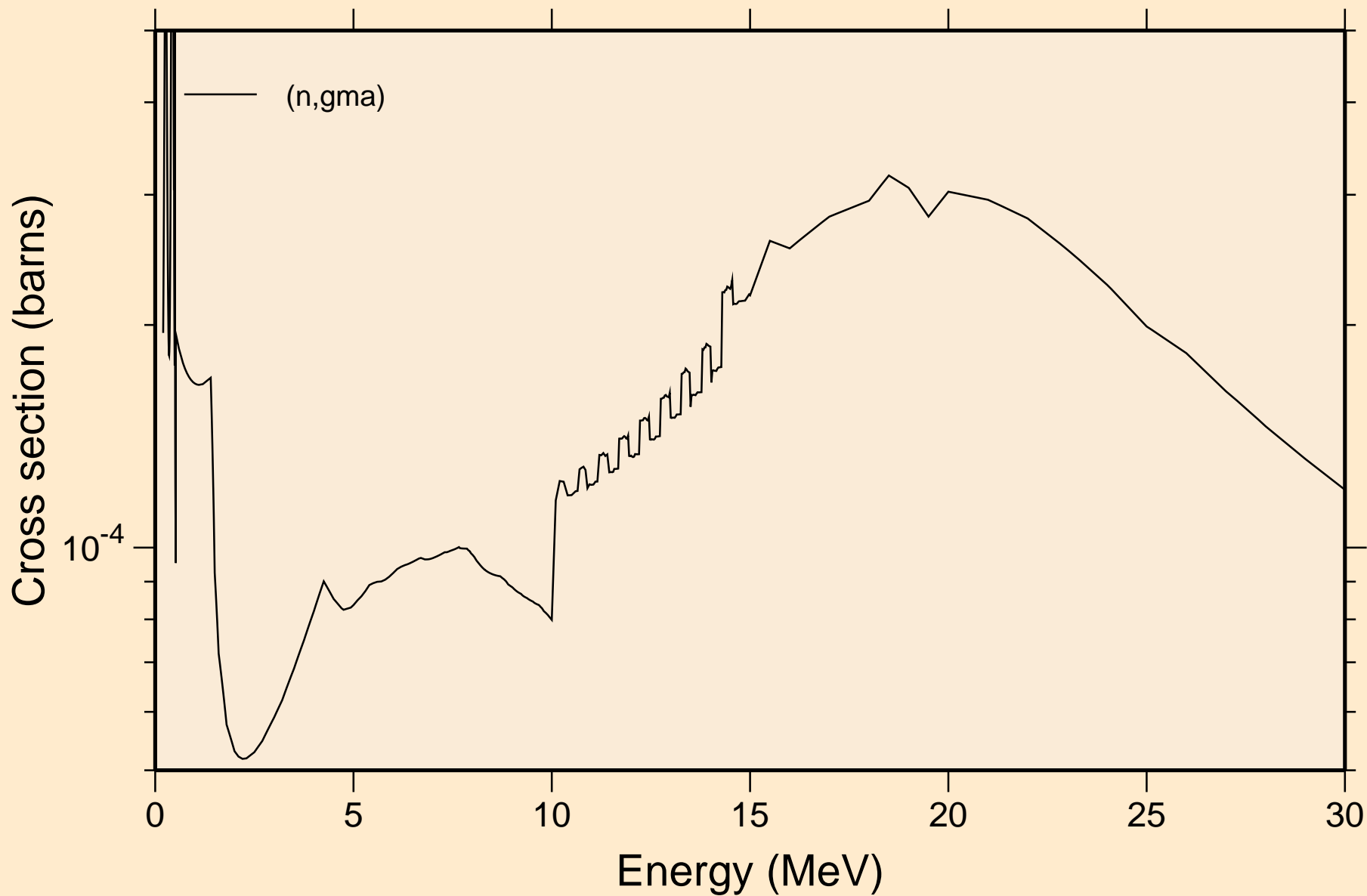

MG024 NEUTRON ACER TENDL-2019 LIBRARY; T=293.16K
Inelastic levels

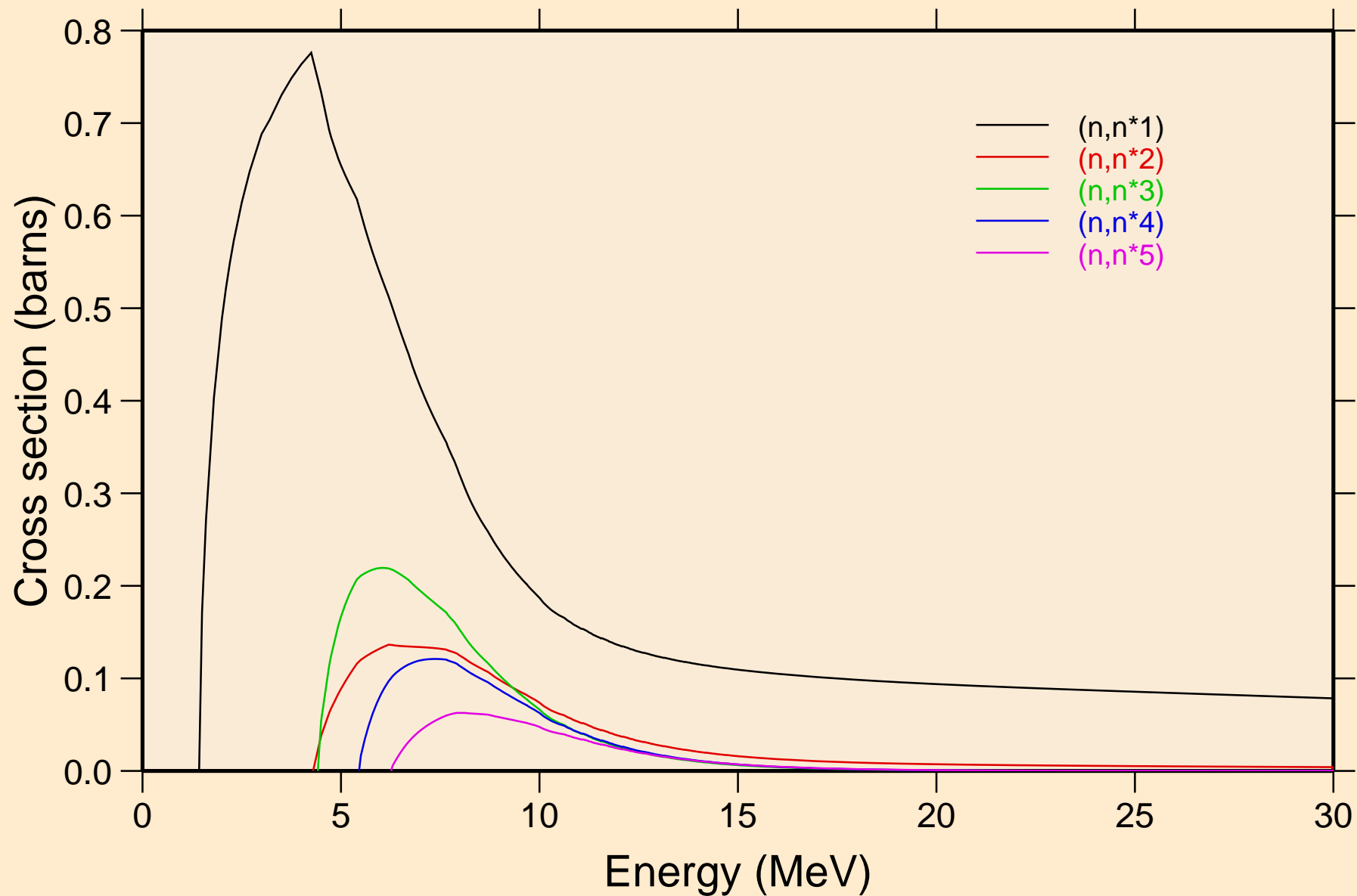

MG024 NEUTRON ACER TENDL-2019 LIBRARY; T=293.16K
Inelastic levels

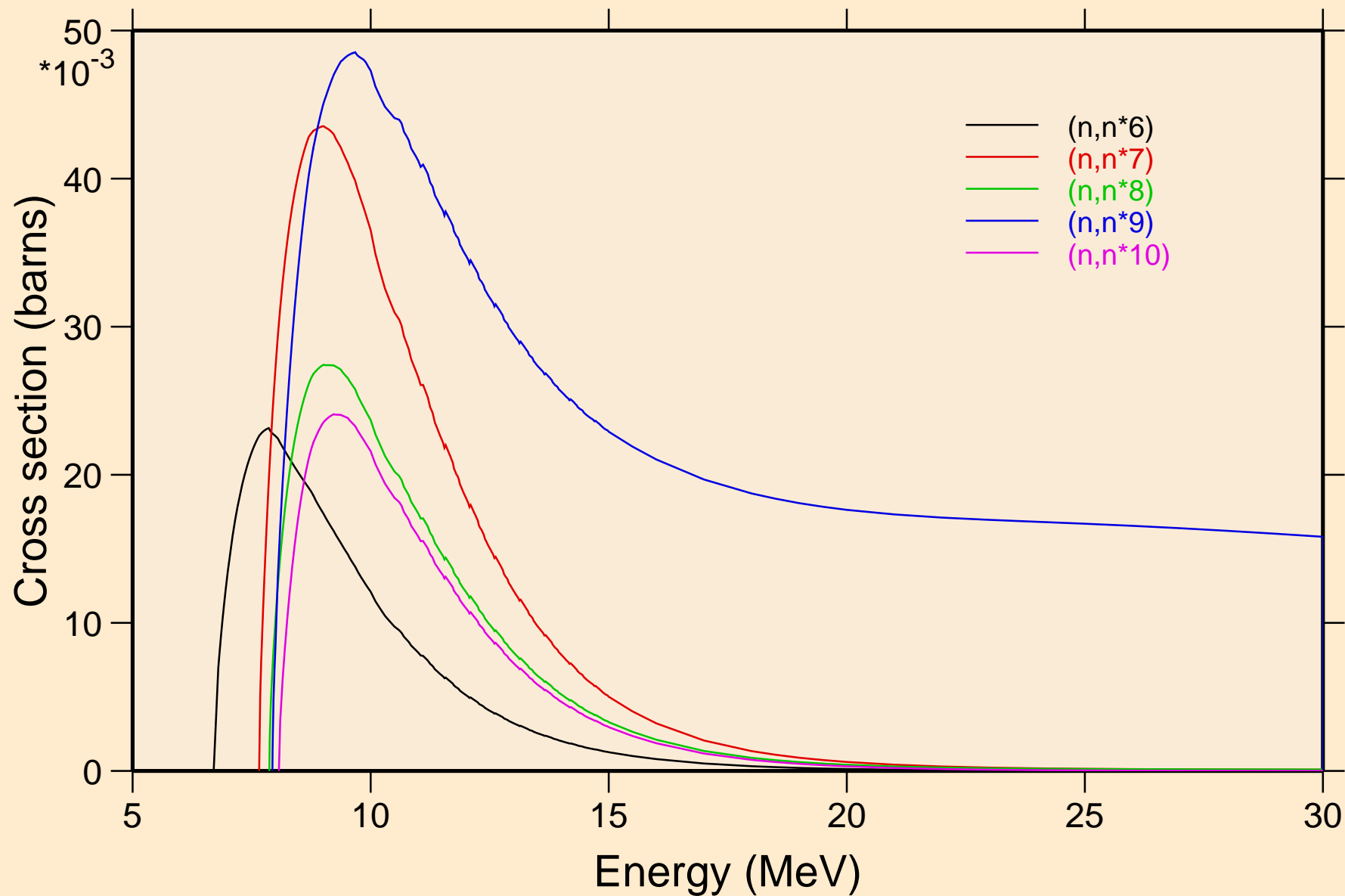

MG024 NEUTRON ACER TENDL-2019 LIBRARY; T=293.16K
Inelastic levels

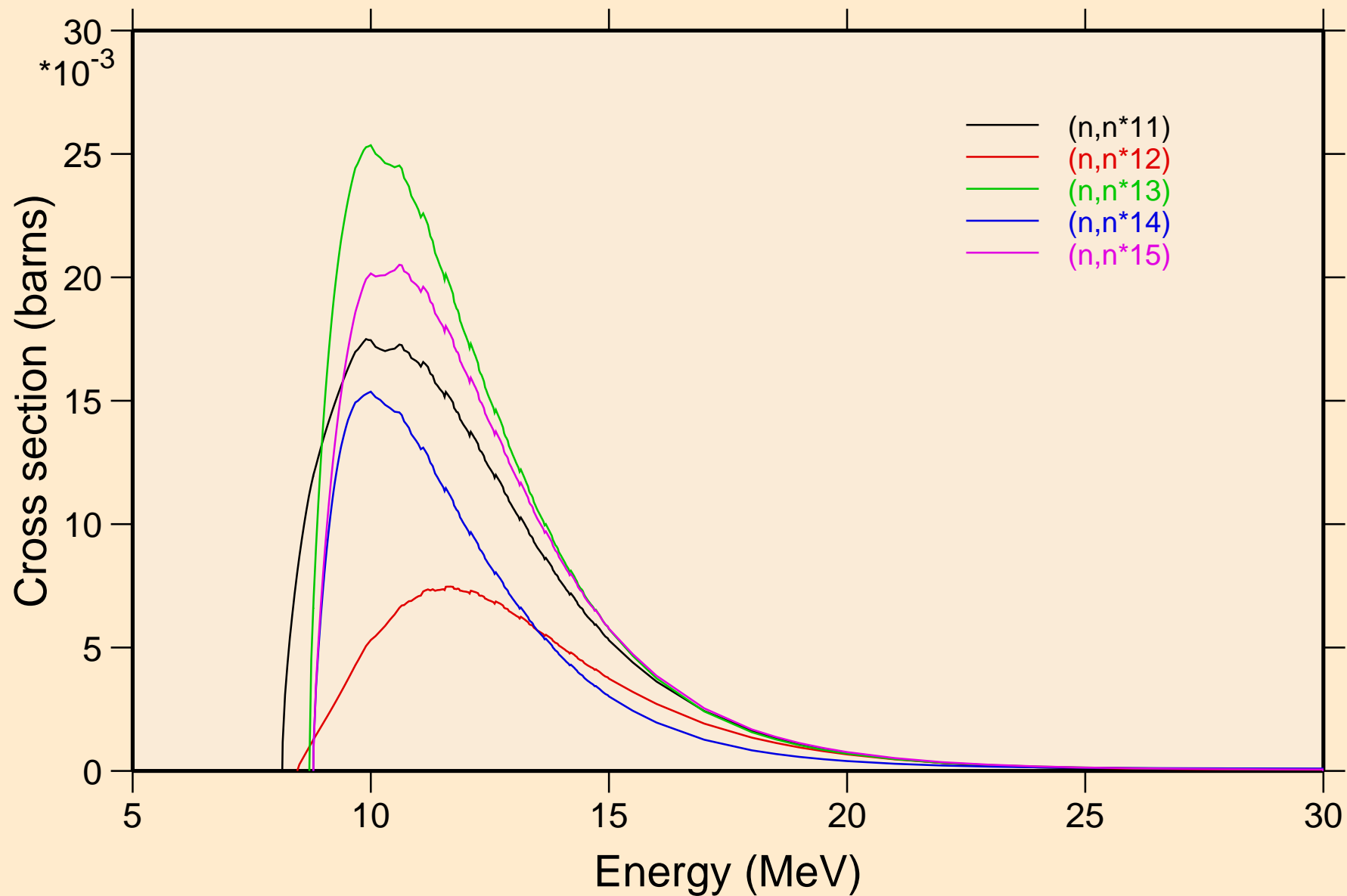

MG024 NEUTRON ACER TENDL-2019 LIBRARY; T=293.16K
Inelastic levels

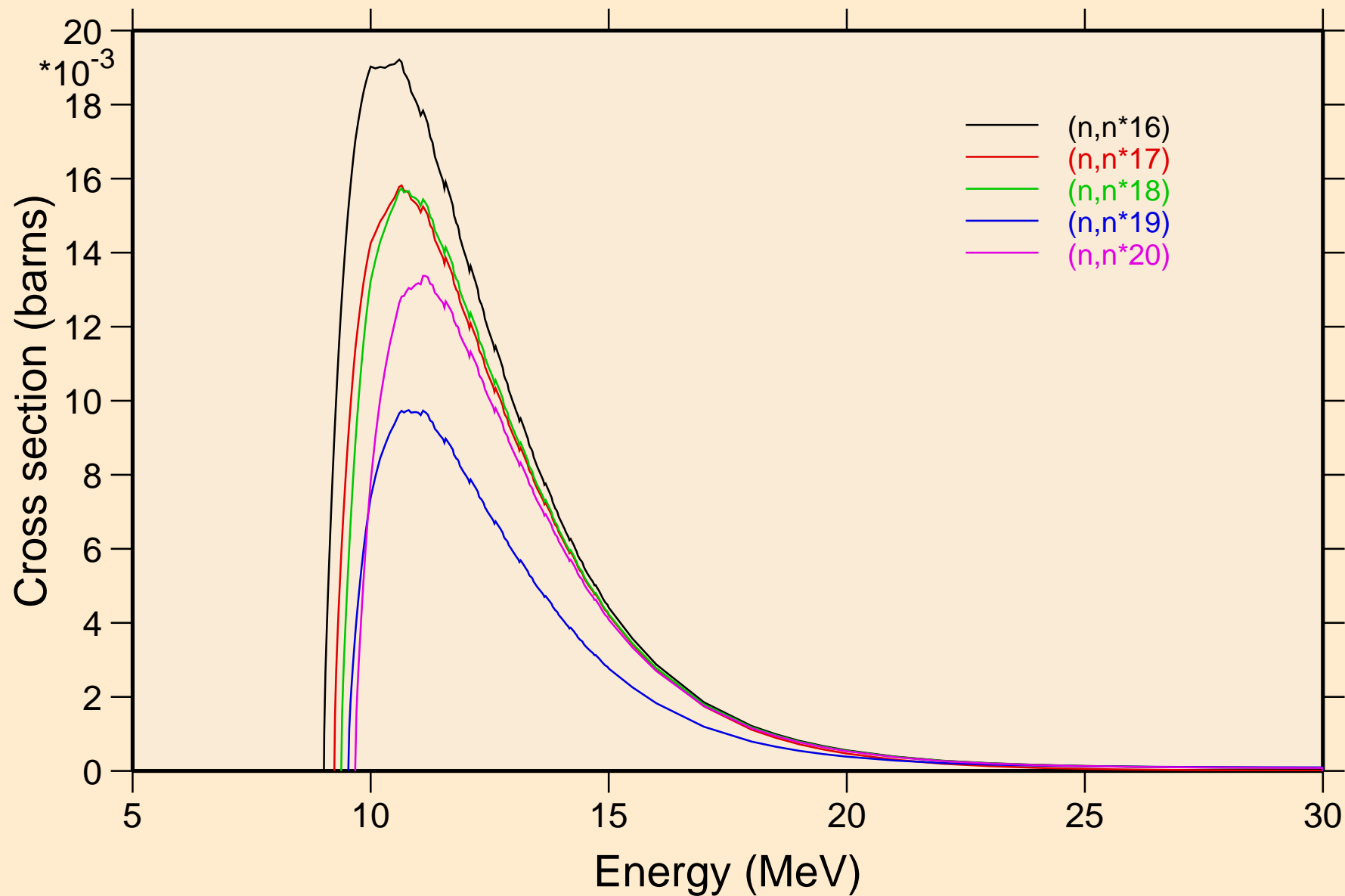

MG024 NEUTRON ACER TENDL-2019 LIBRARY; T=293.16K
Inelastic levels

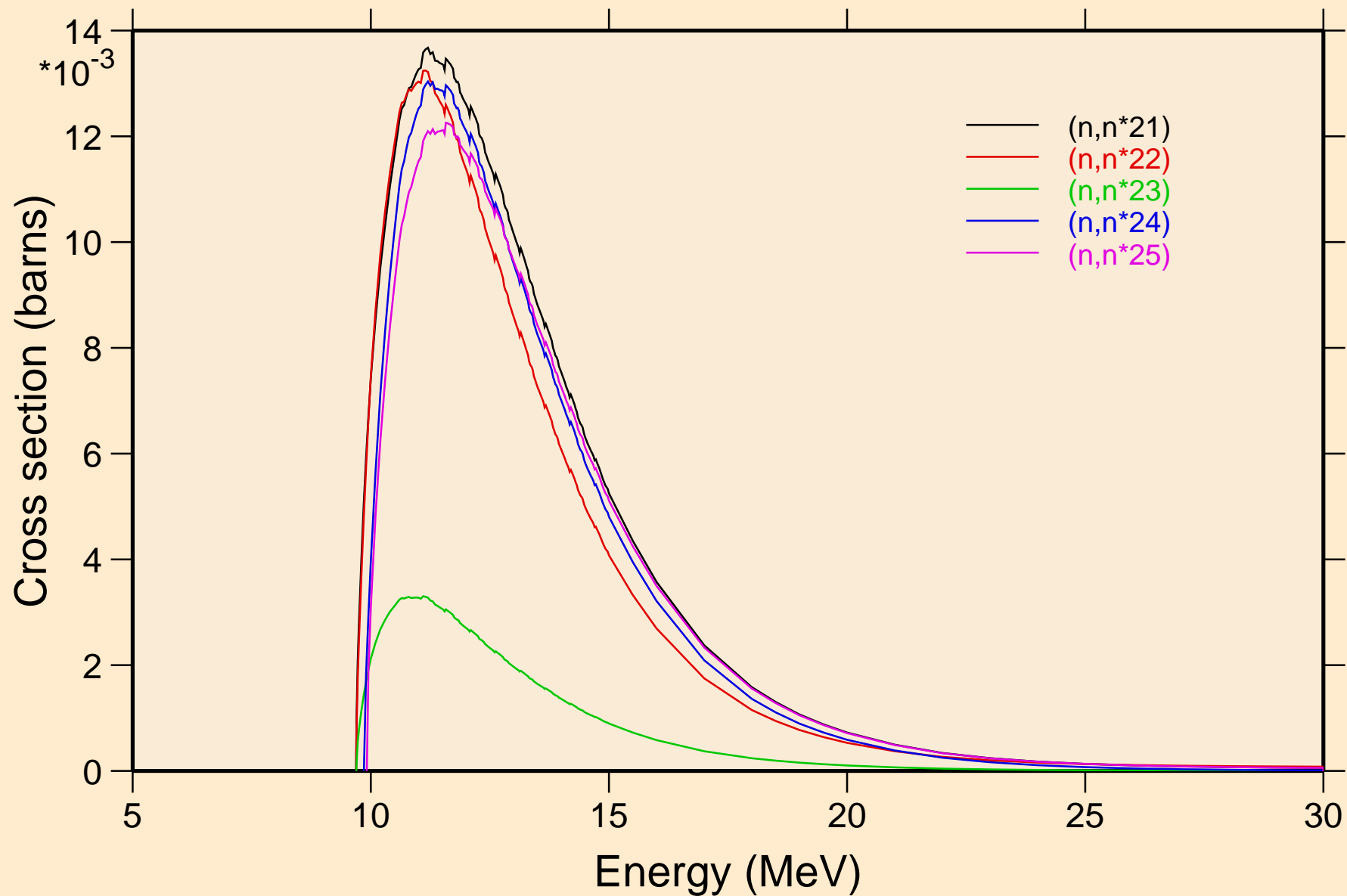

MG024 NEUTRON ACER TENDL-2019 LIBRARY; T=293.16K
Inelastic levels

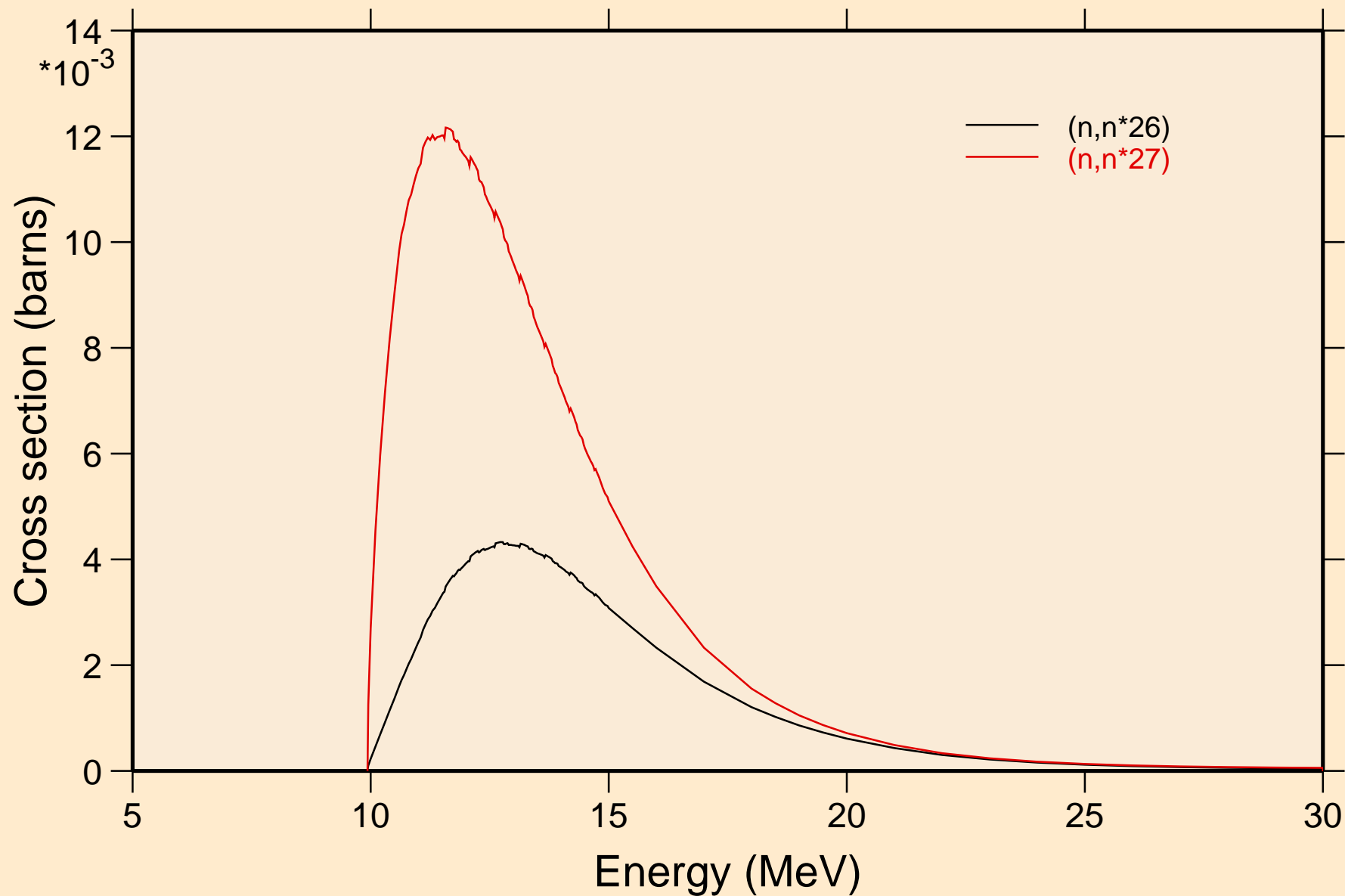

MG024 NEUTRON ACER TENDL-2019 LIBRARY; T=293.16K
Threshold reactions

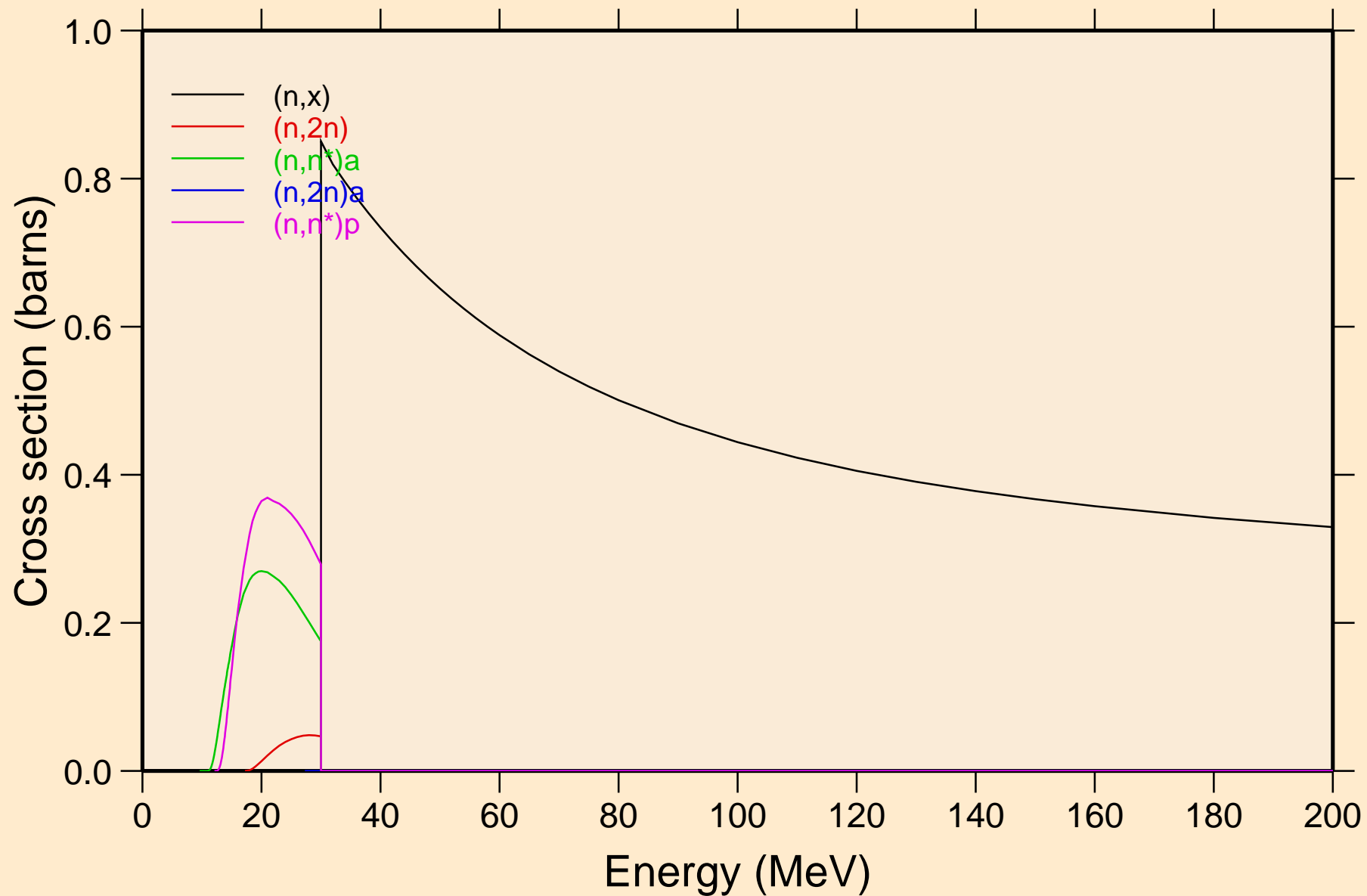

MG024 NEUTRON ACER TENDL-2019 LIBRARY; T=293.16K
Threshold reactions

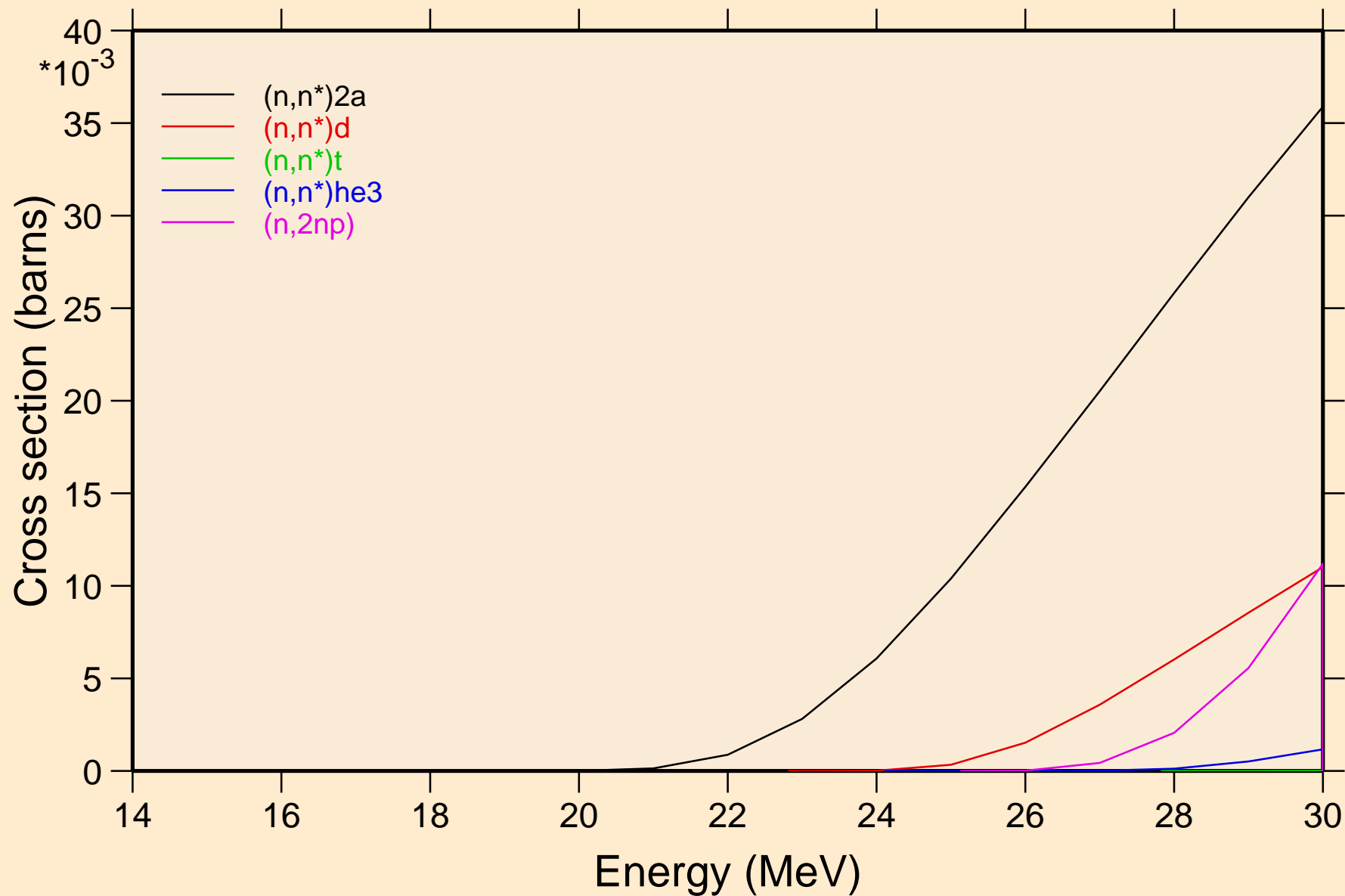

MG024 NEUTRON ACER TENDL-2019 LIBRARY; T=293.16K
Threshold reactions

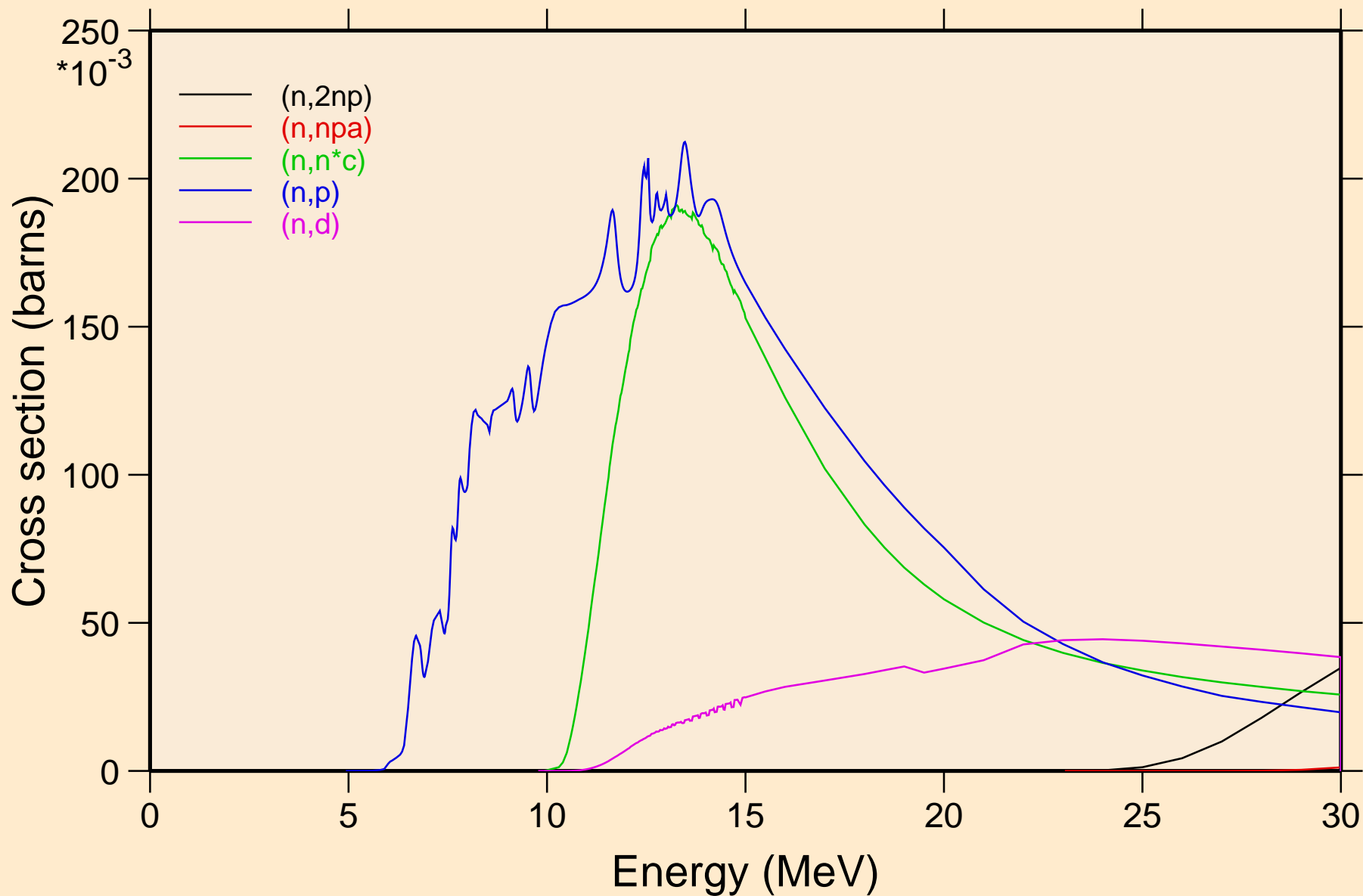

MG024 NEUTRON ACER TENDL-2019 LIBRARY; T=293.16K
Threshold reactions

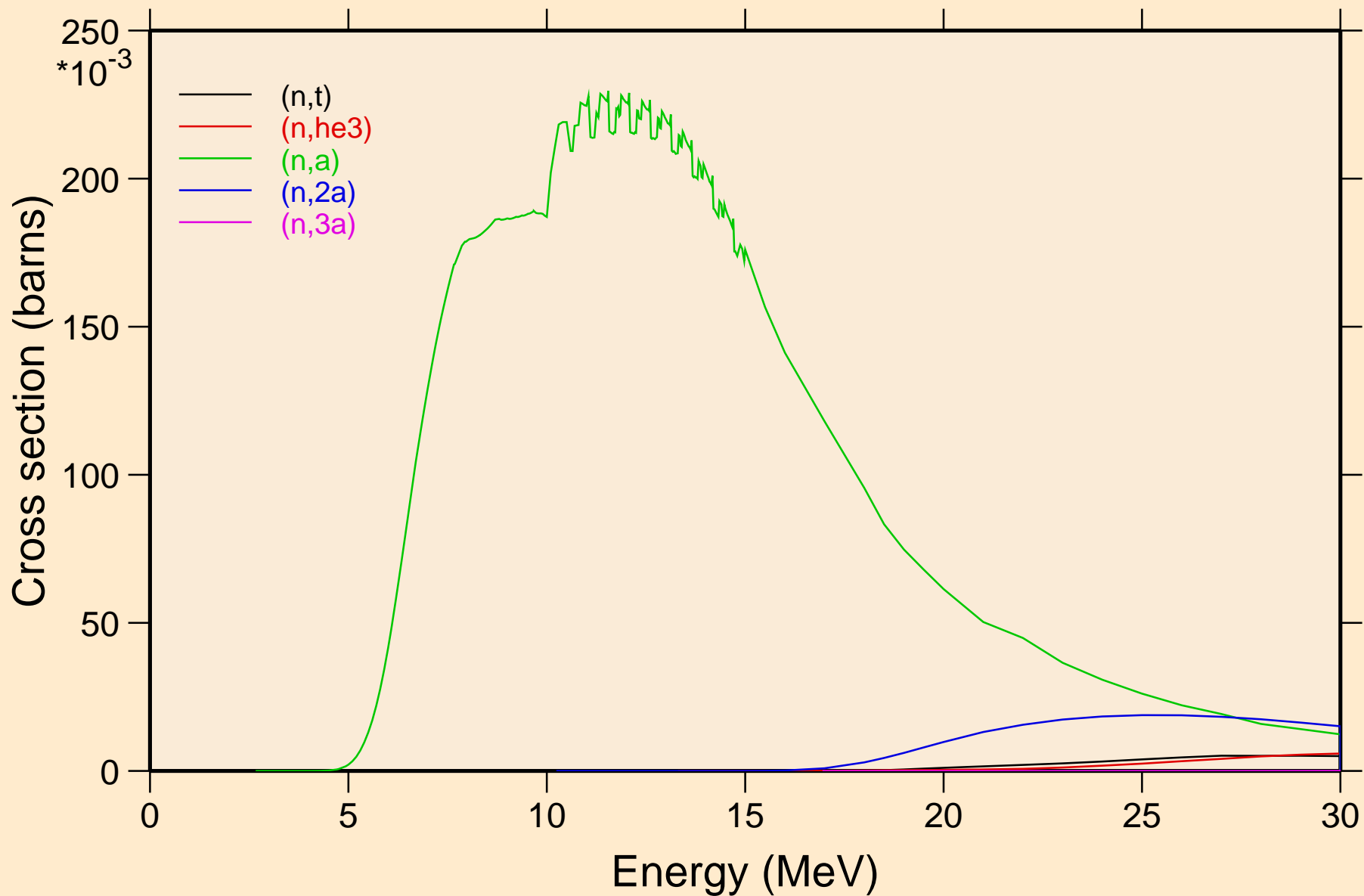

MG024 NEUTRON ACER TENDL-2019 LIBRARY; T=293.16K
Threshold reactions

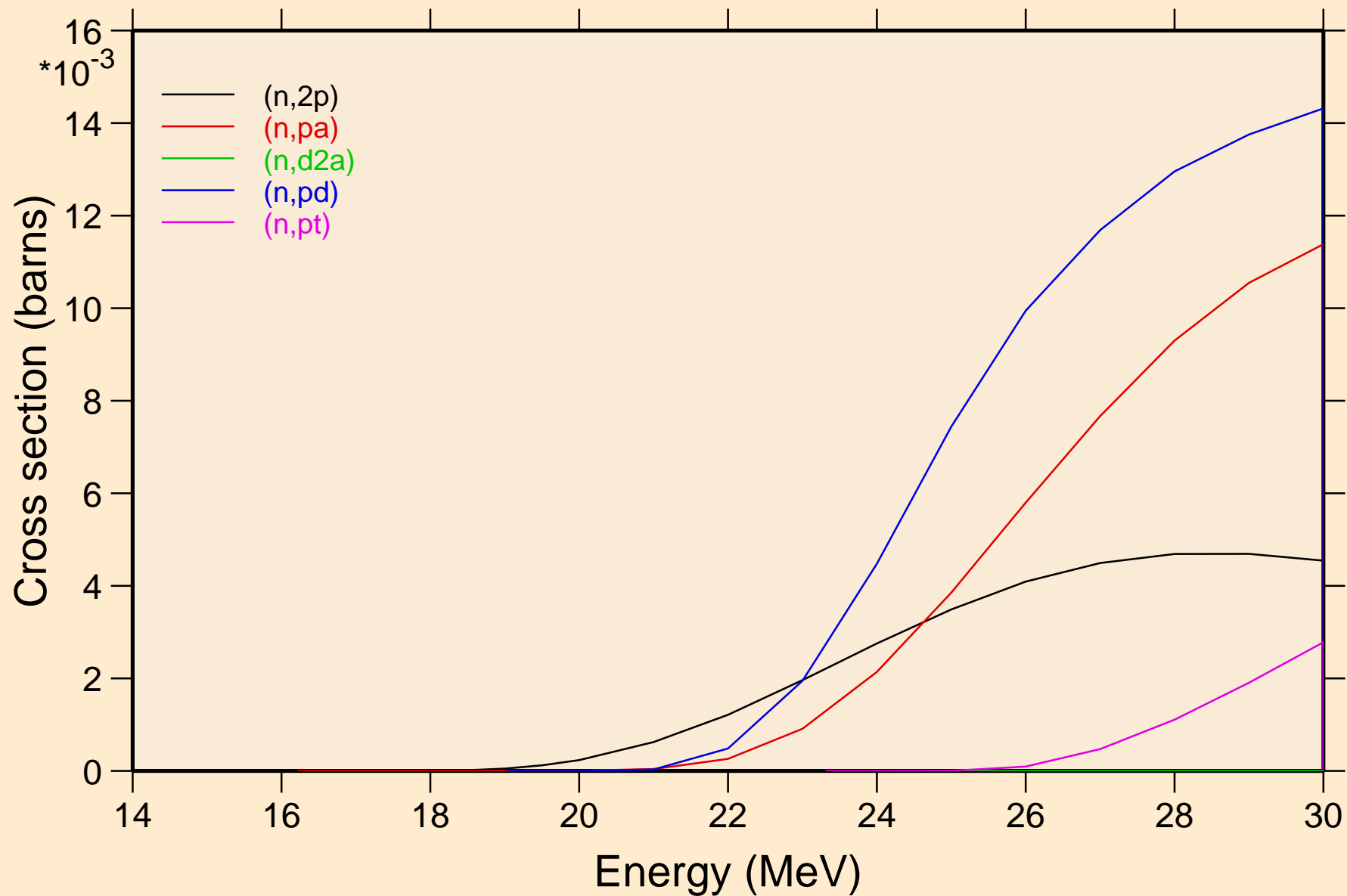

MG024 NEUTRON ACER TENDL-2019 LIBRARY; T=293.16K
Threshold reactions

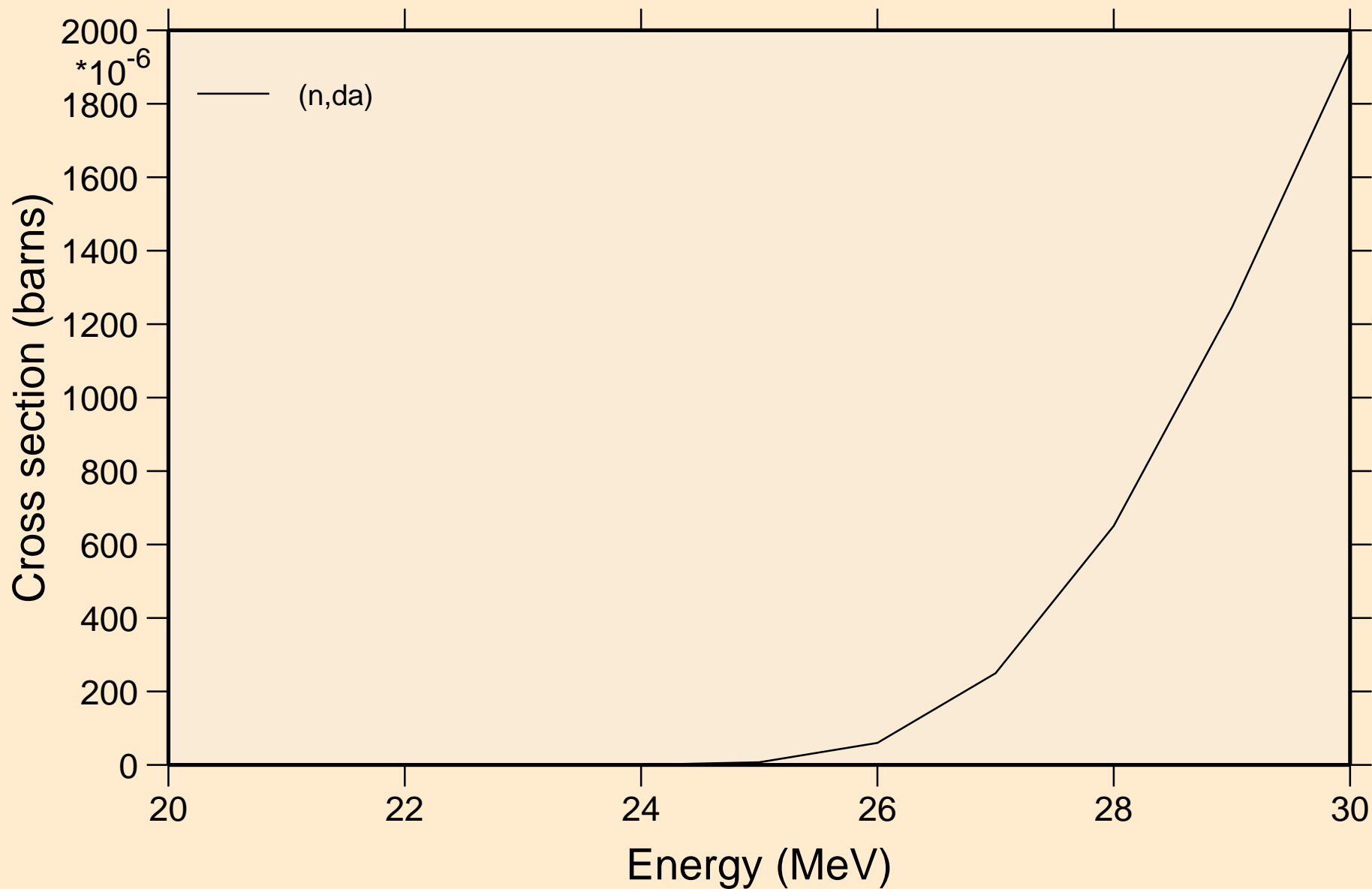

MG024 NEUTRON ACER TENDL-2019 LIBRARY; T=293.16K
Threshold reactions

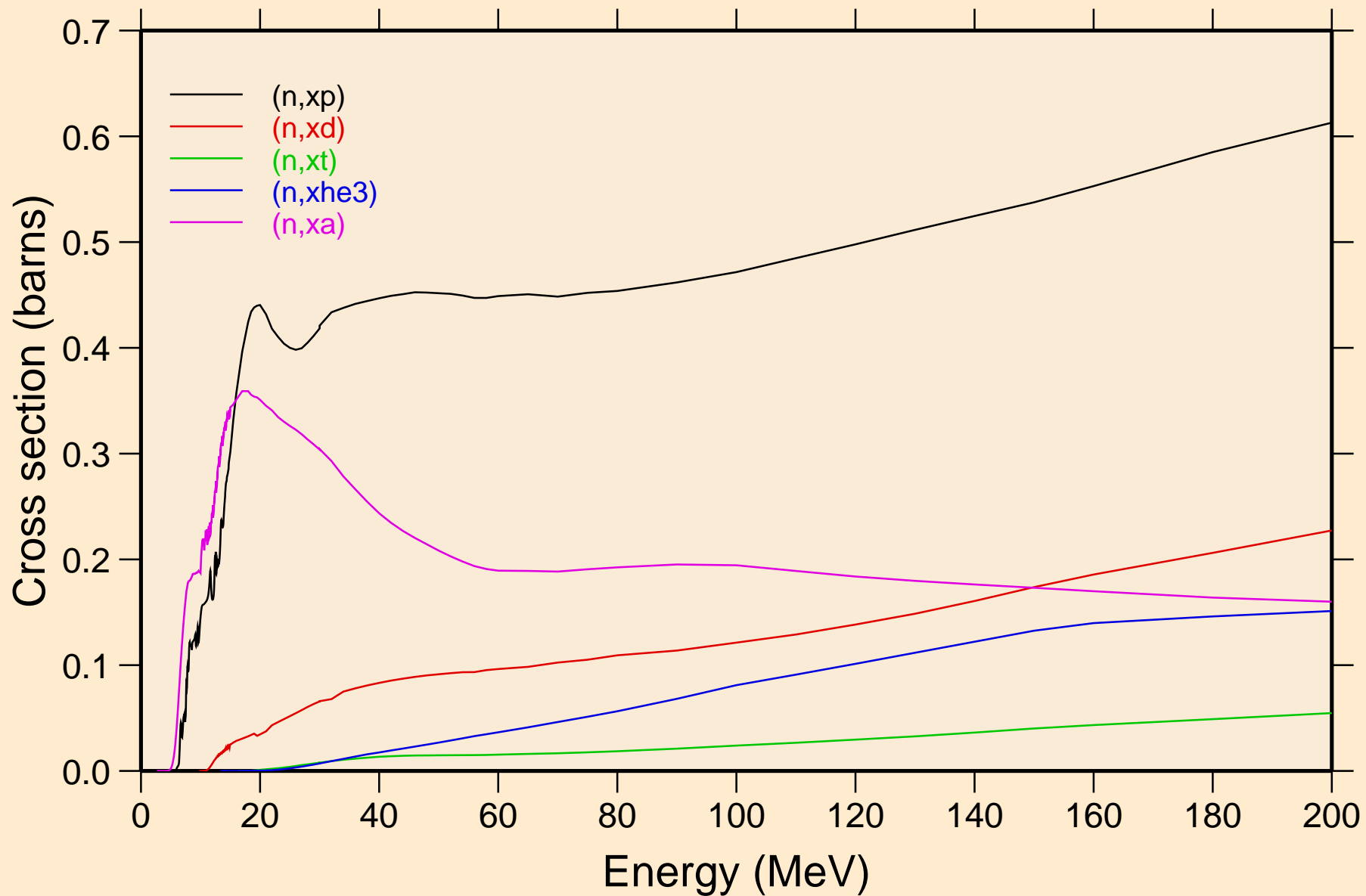

MG024 NEUTRON ACER TENDL-2019 LIBRARY; T=293.16K
angular distribution for elastic

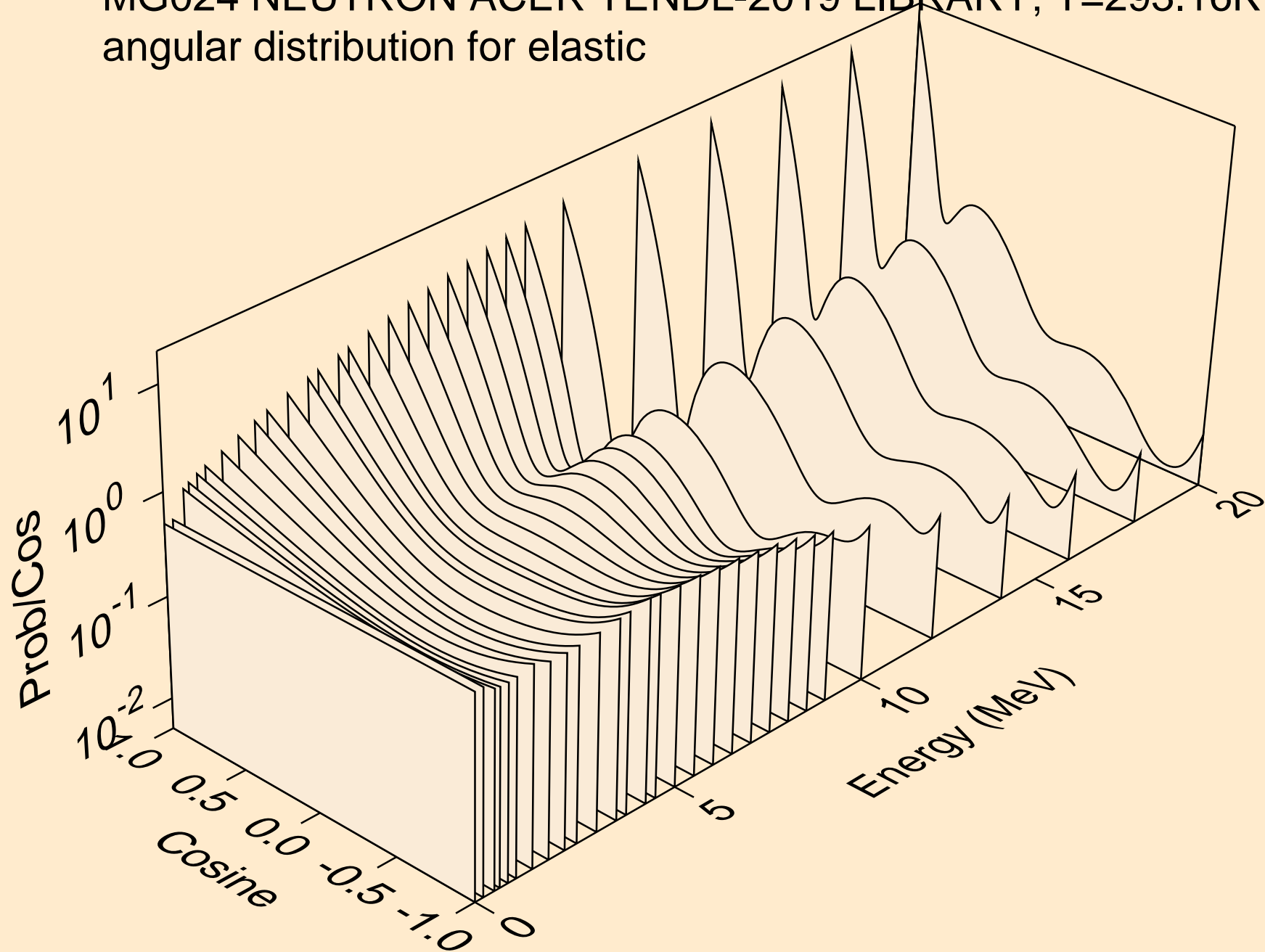

MG024 NEUTRON ACER TENDL-2019 LIBRARY; T=293.16K
angular distribution for elastic

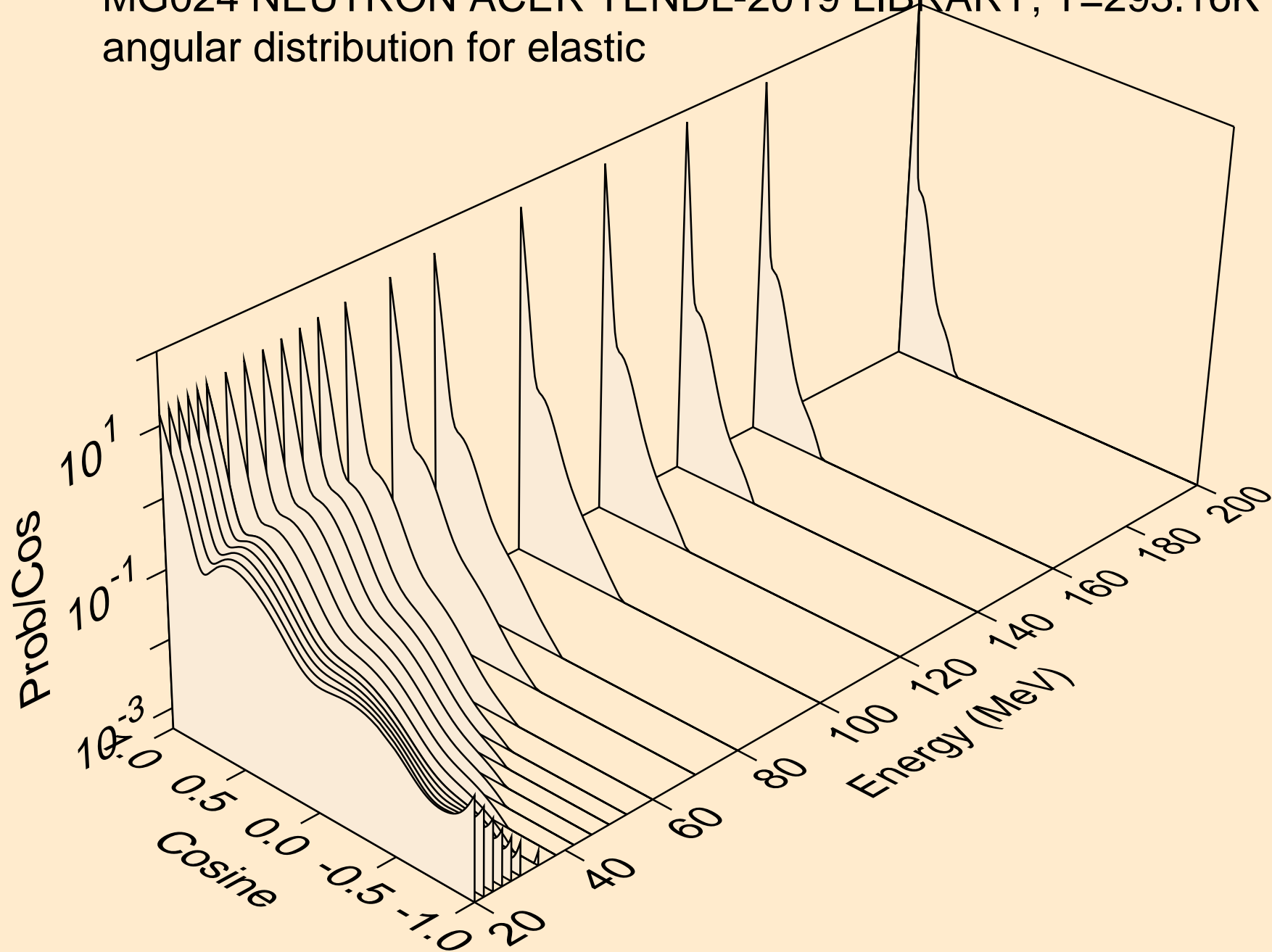

MG024 NEUTRON ACER TENDL-2019 LIBRARY; T=293.16K
angular distribution for (n,n*1)

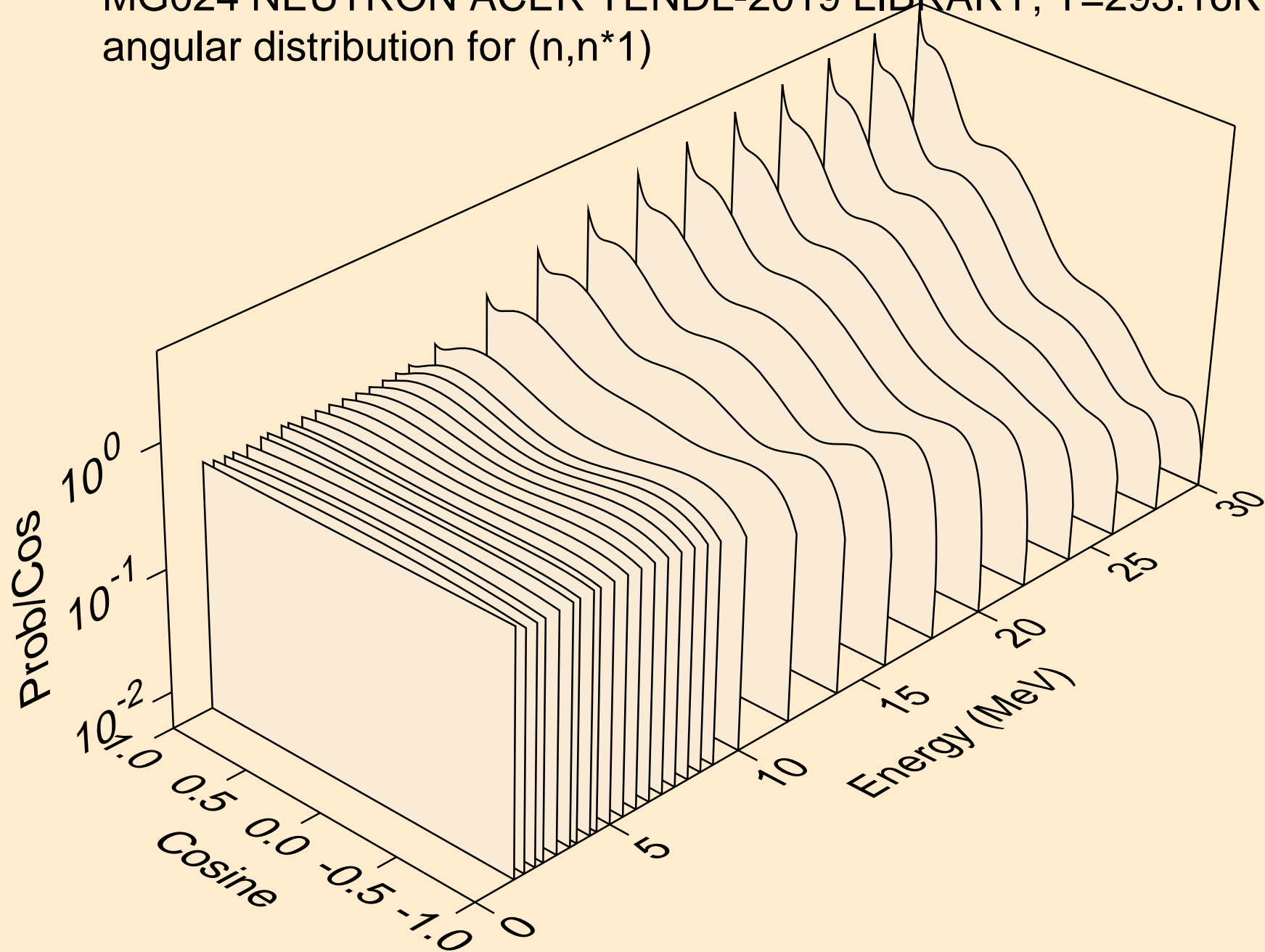

MG024 NEUTRON ACER TENDL-2019 LIBRARY; T=293.16K
angular distribution for (n,n*2)

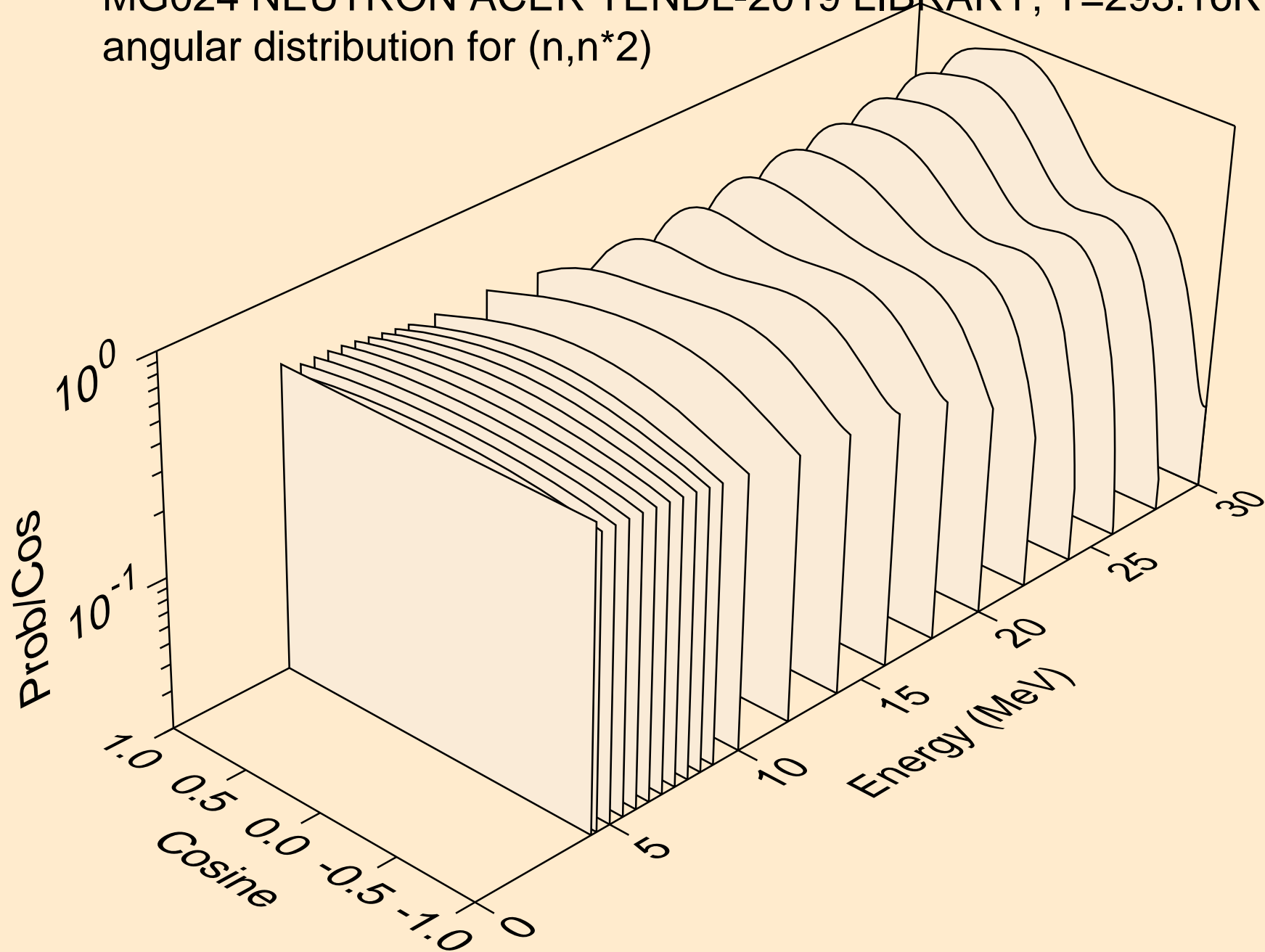

MG024 NEUTRON ACER TENDL-2019 LIBRARY; T=293.16K
angular distribution for (n,n*3)

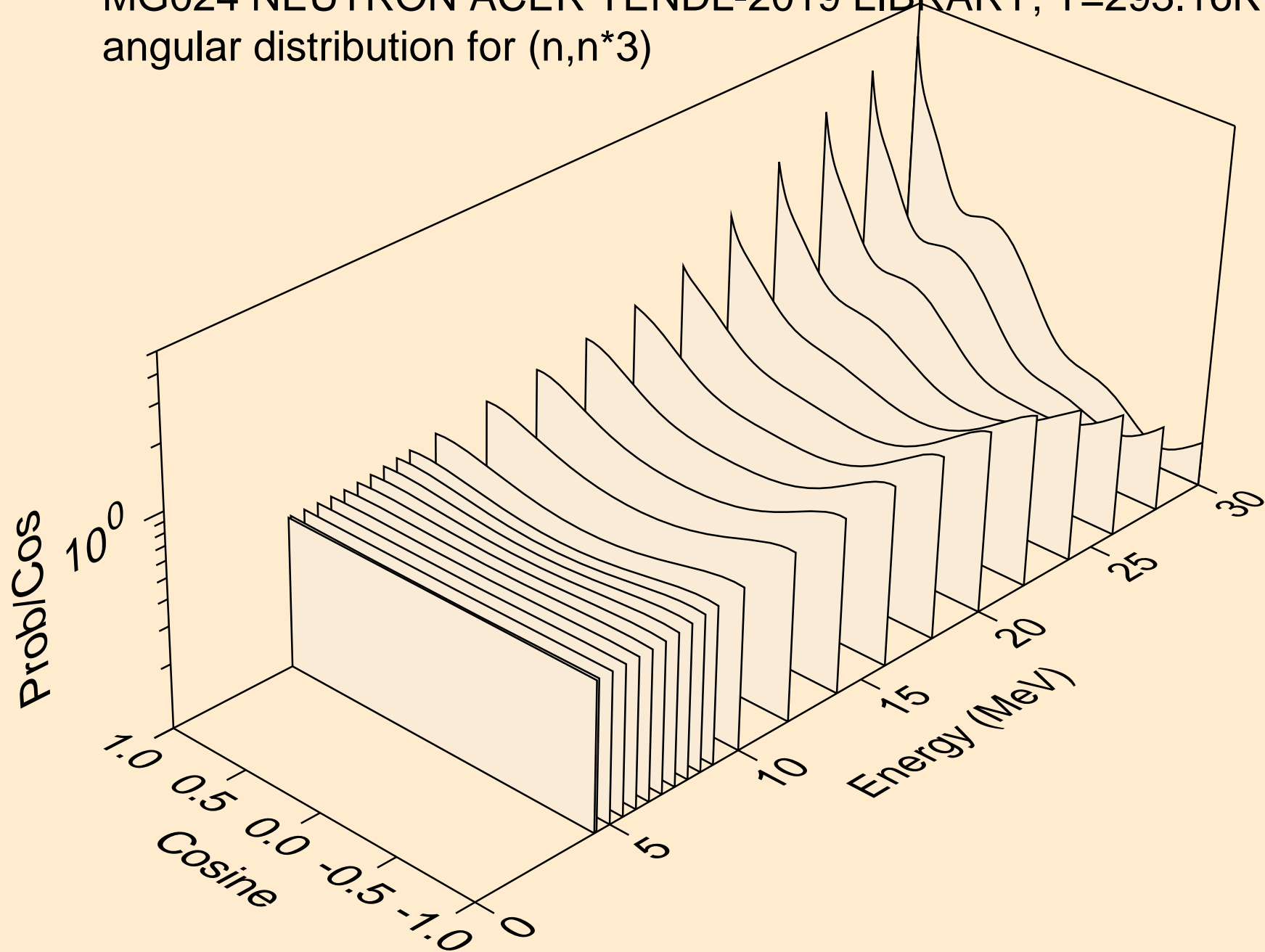

MG024 NEUTRON ACER TENDL-2019 LIBRARY; T=293.16K
angular distribution for (n,n*4)

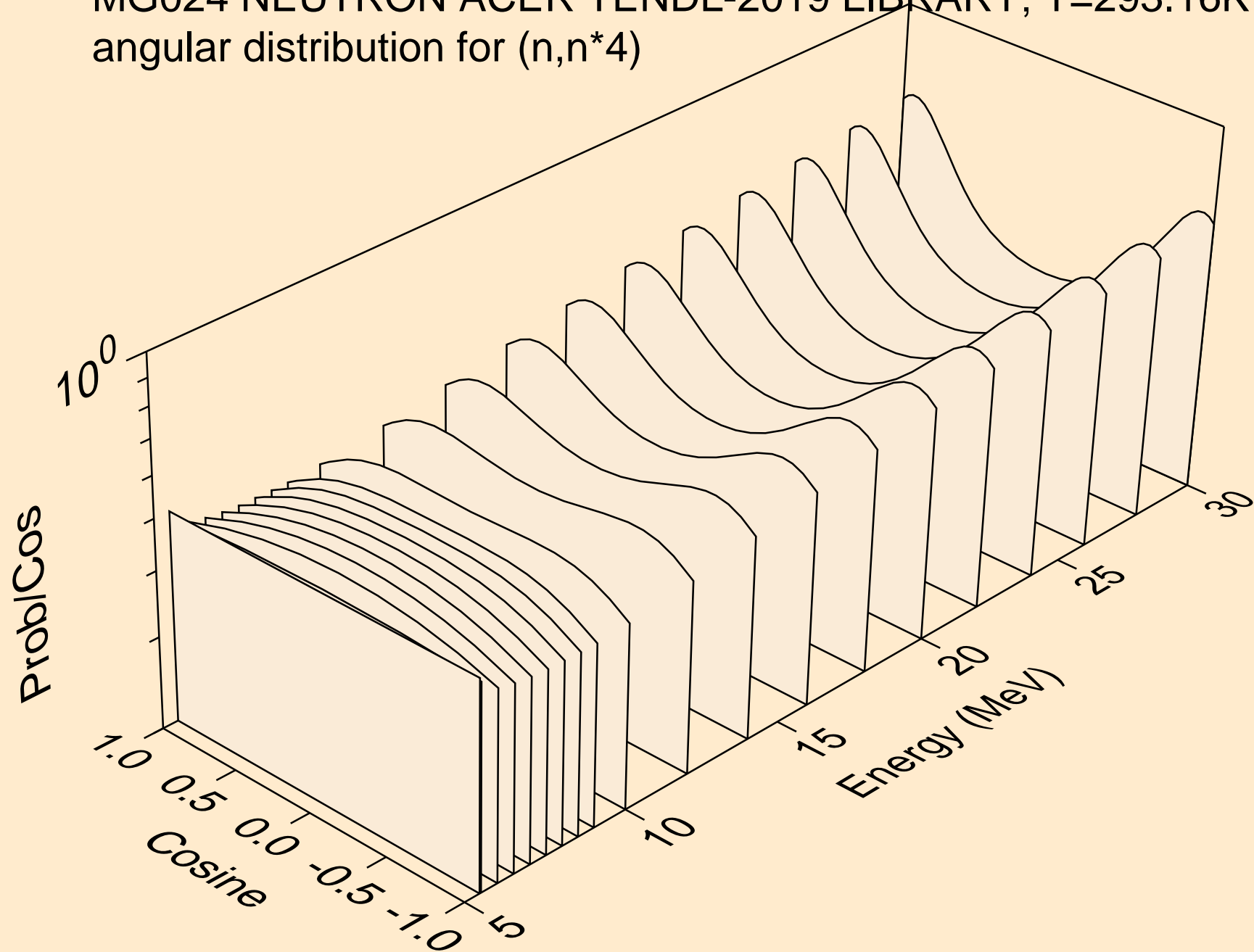

MG024 NEUTRON ACER TENDL-2019 LIBRARY; T=293.16K
angular distribution for (n,n*5)

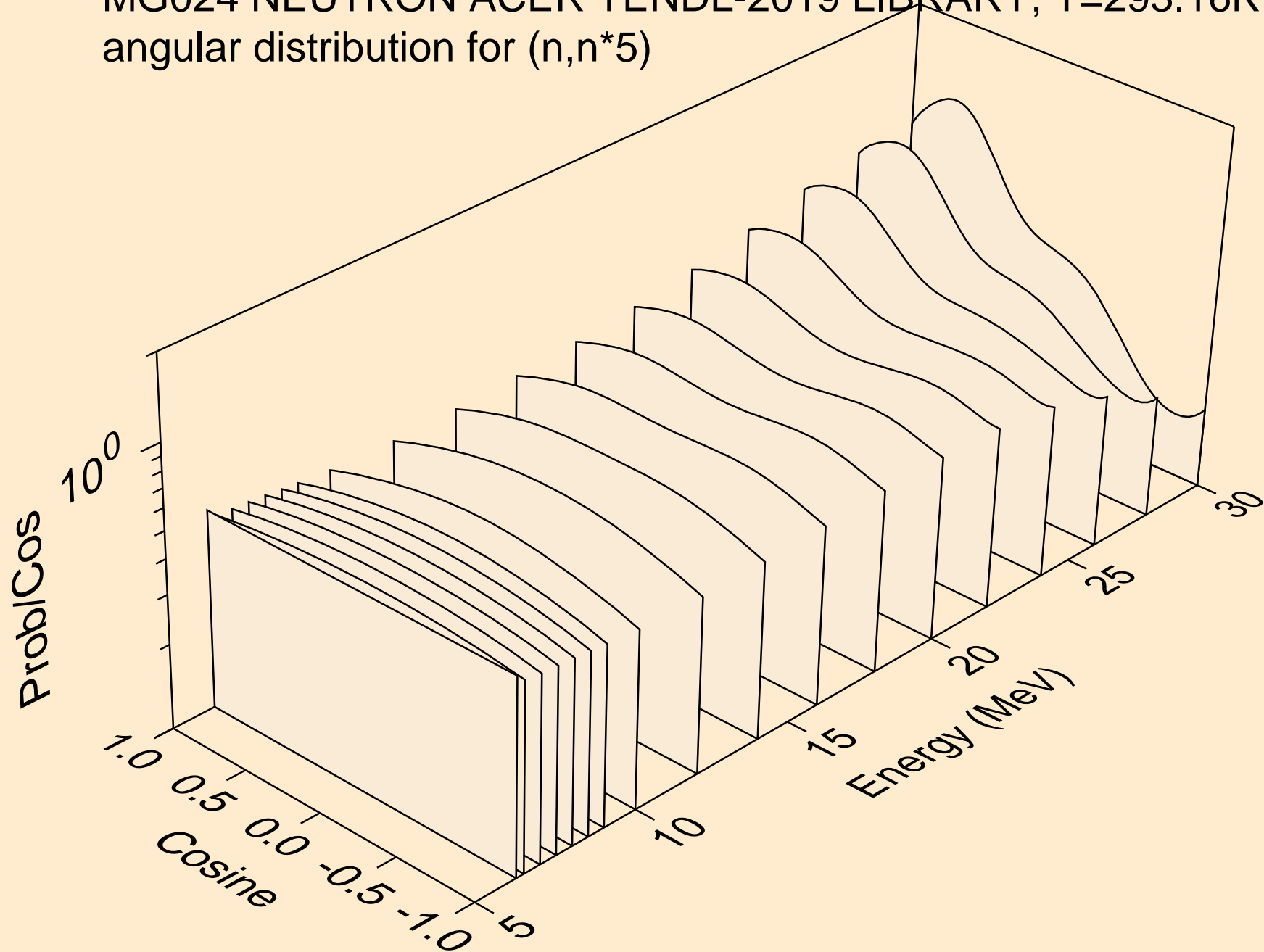

MG024 NEUTRON ACER TENDL-2019 LIBRARY; T=293.16K
angular distribution for (n,n*6)

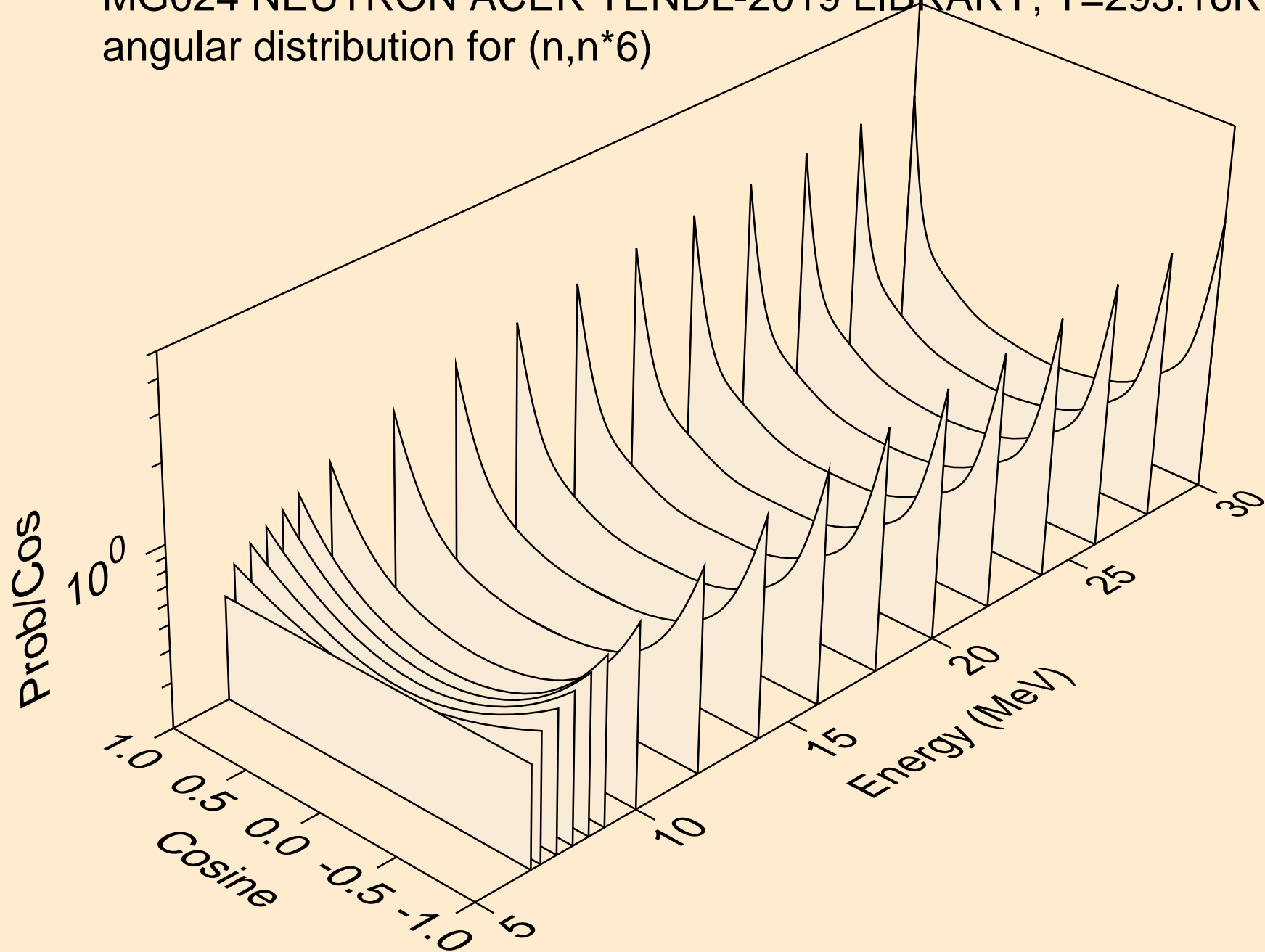

MG024 NEUTRON ACER TENDL-2019 LIBRARY; T=293.16K
angular distribution for (n,n*7)

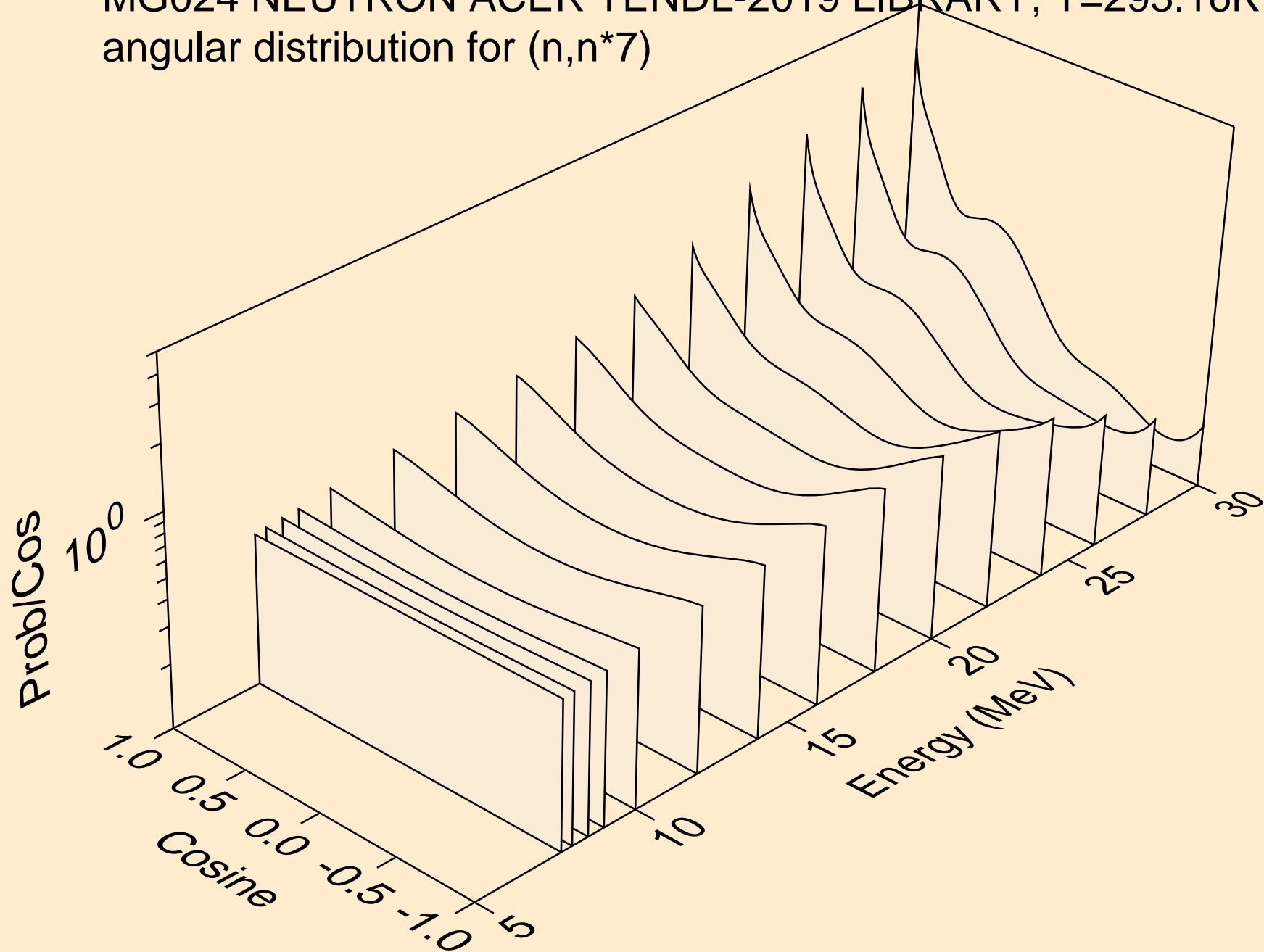

MG024 NEUTRON ACER TENDL-2019 LIBRARY; T=293.16K
angular distribution for (n,n*8)

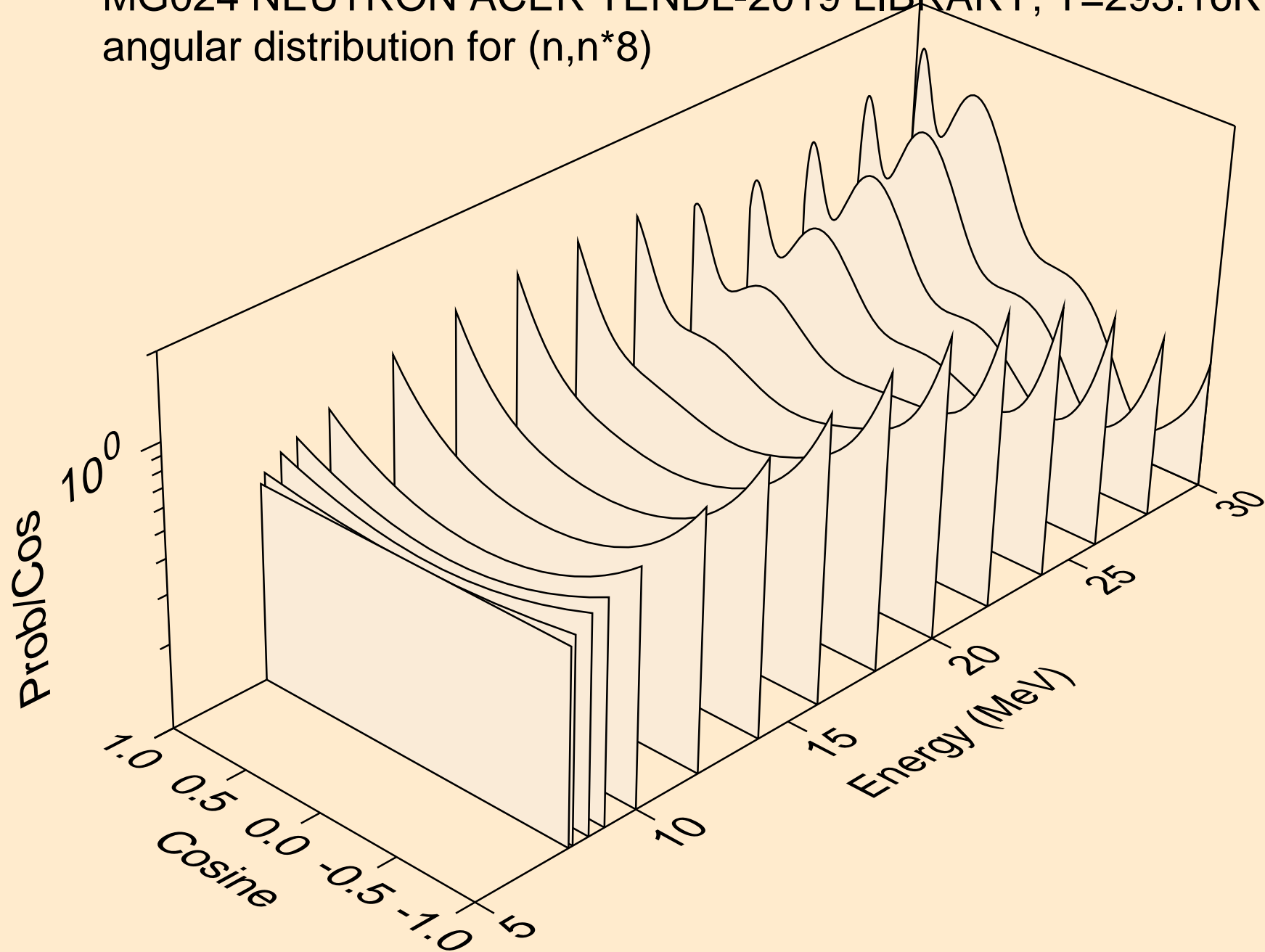

MG024 NEUTRON ACER TENDL-2019 LIBRARY; T=293.16K
angular distribution for (n,n*9)

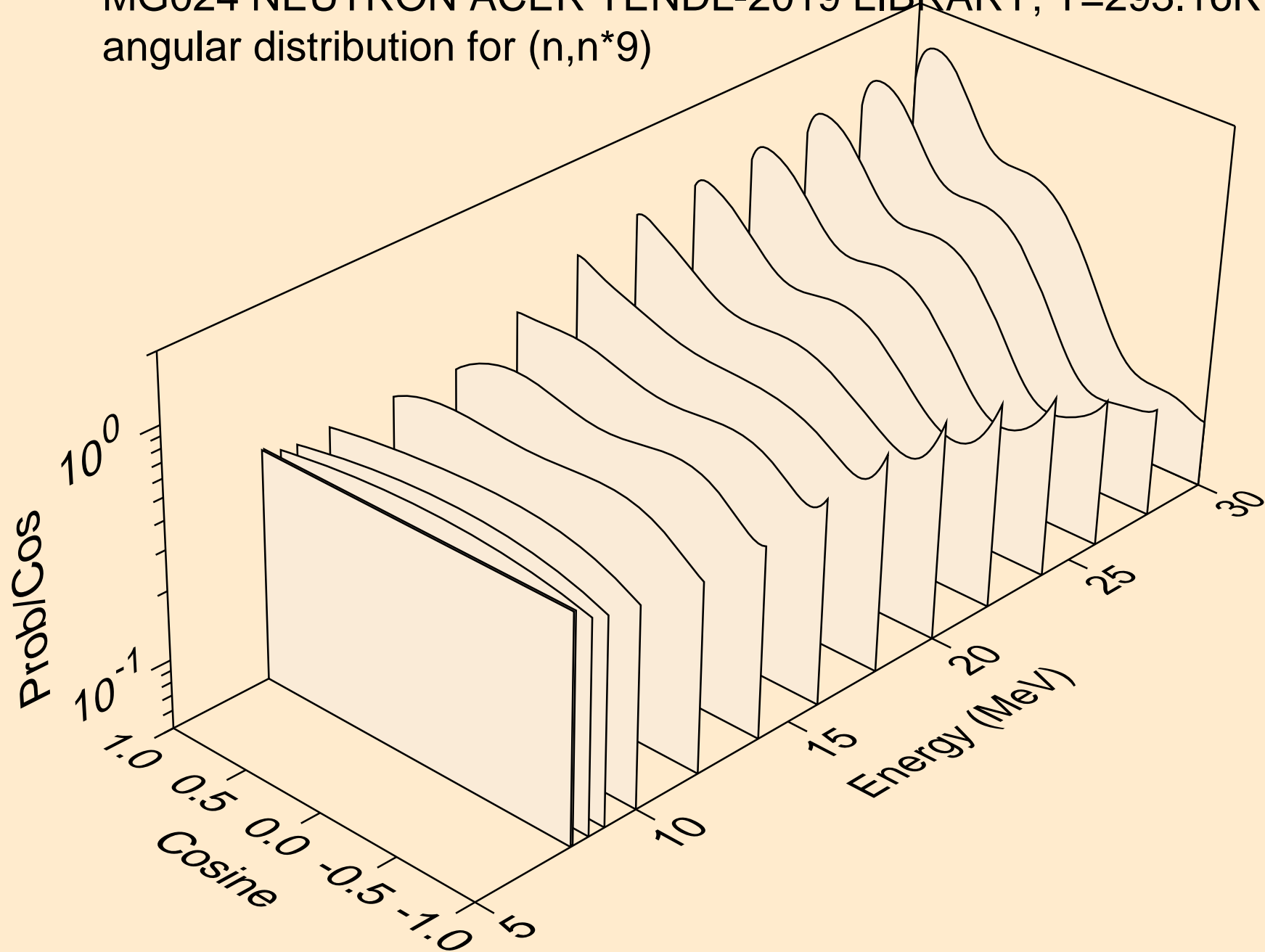

MG024 NEUTRON ACER TENDL-2019 LIBRARY; T=293.16K
angular distribution for (n,n*10)

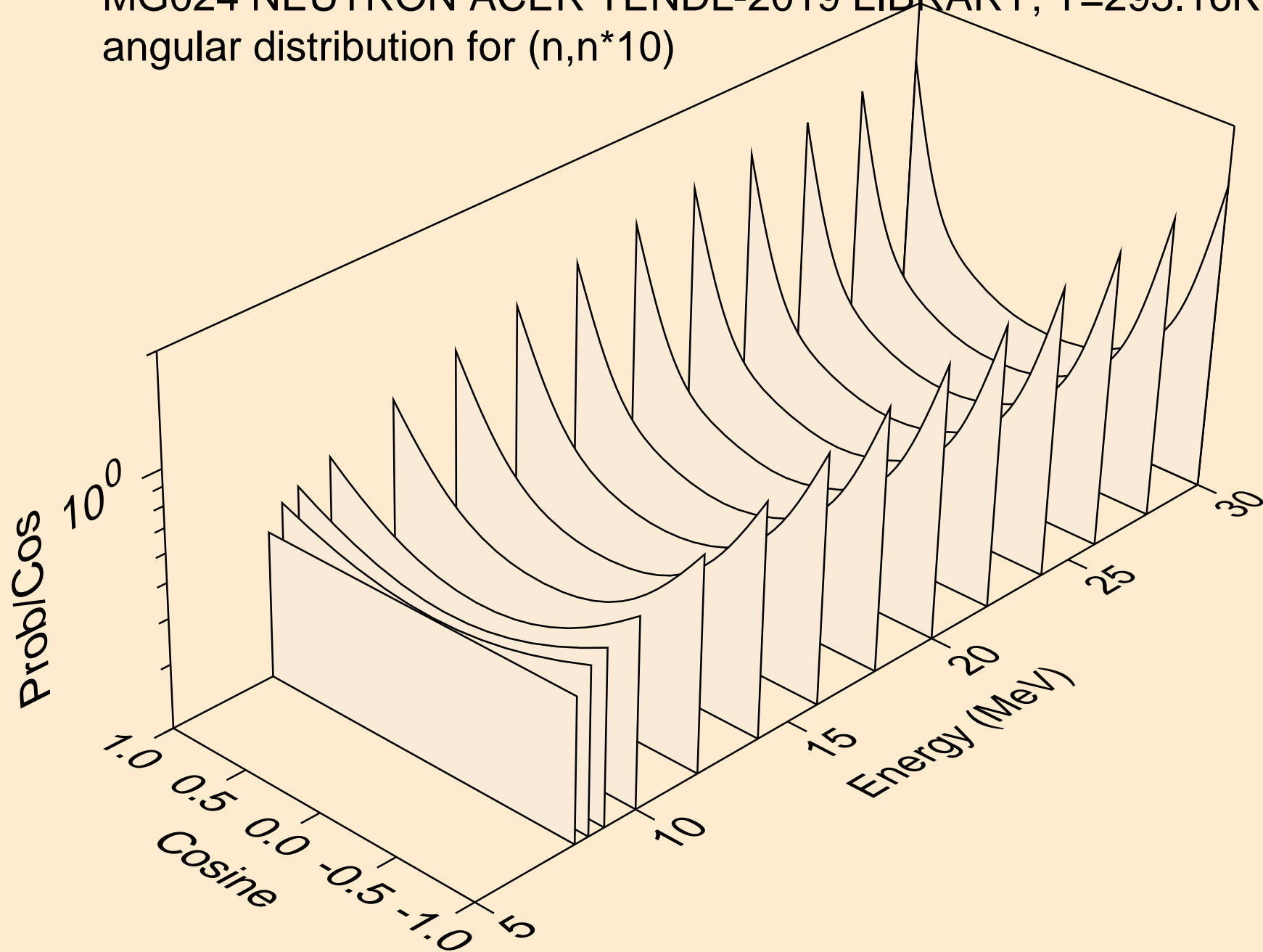

MG024 NEUTRON ACER TENDL-2019 LIBRARY; T=293.16K
angular distribution for (n,n*11)

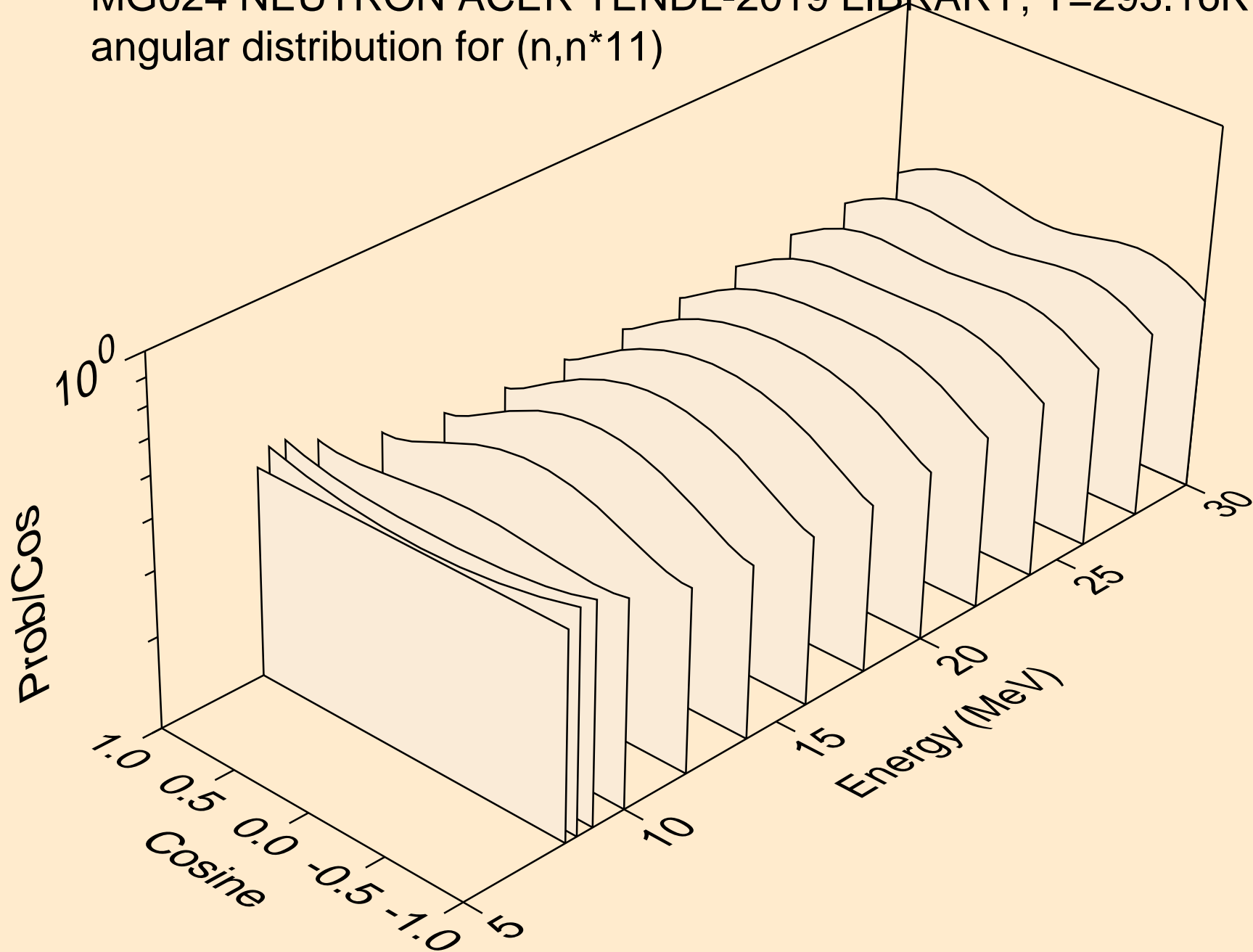

MG024 NEUTRON ACER TENDL-2019 LIBRARY; T=293.16K
angular distribution for (n,n*12)

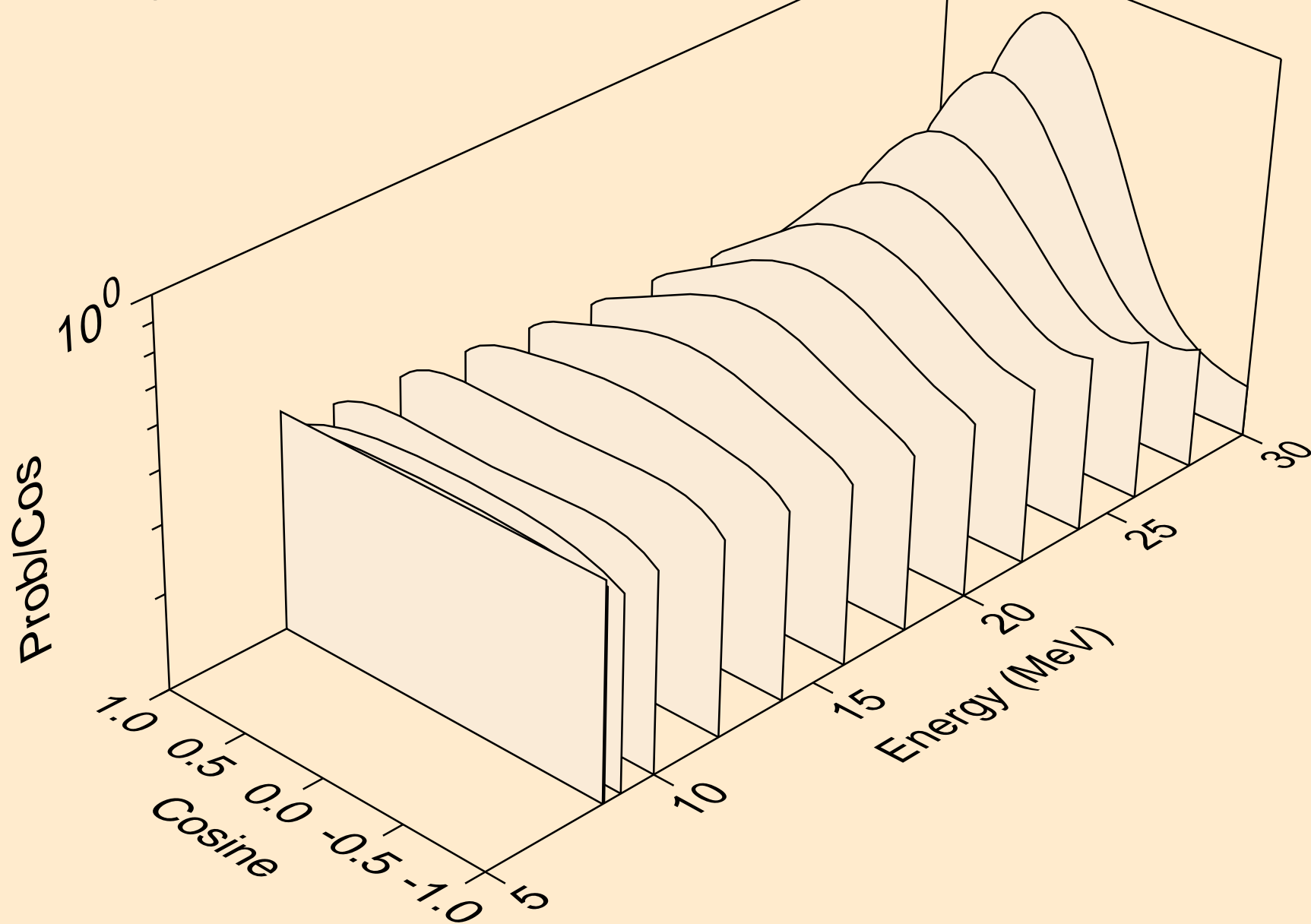

MG024 NEUTRON ACER TENDL-2019 LIBRARY; T=293.16K
angular distribution for (n,n*13)

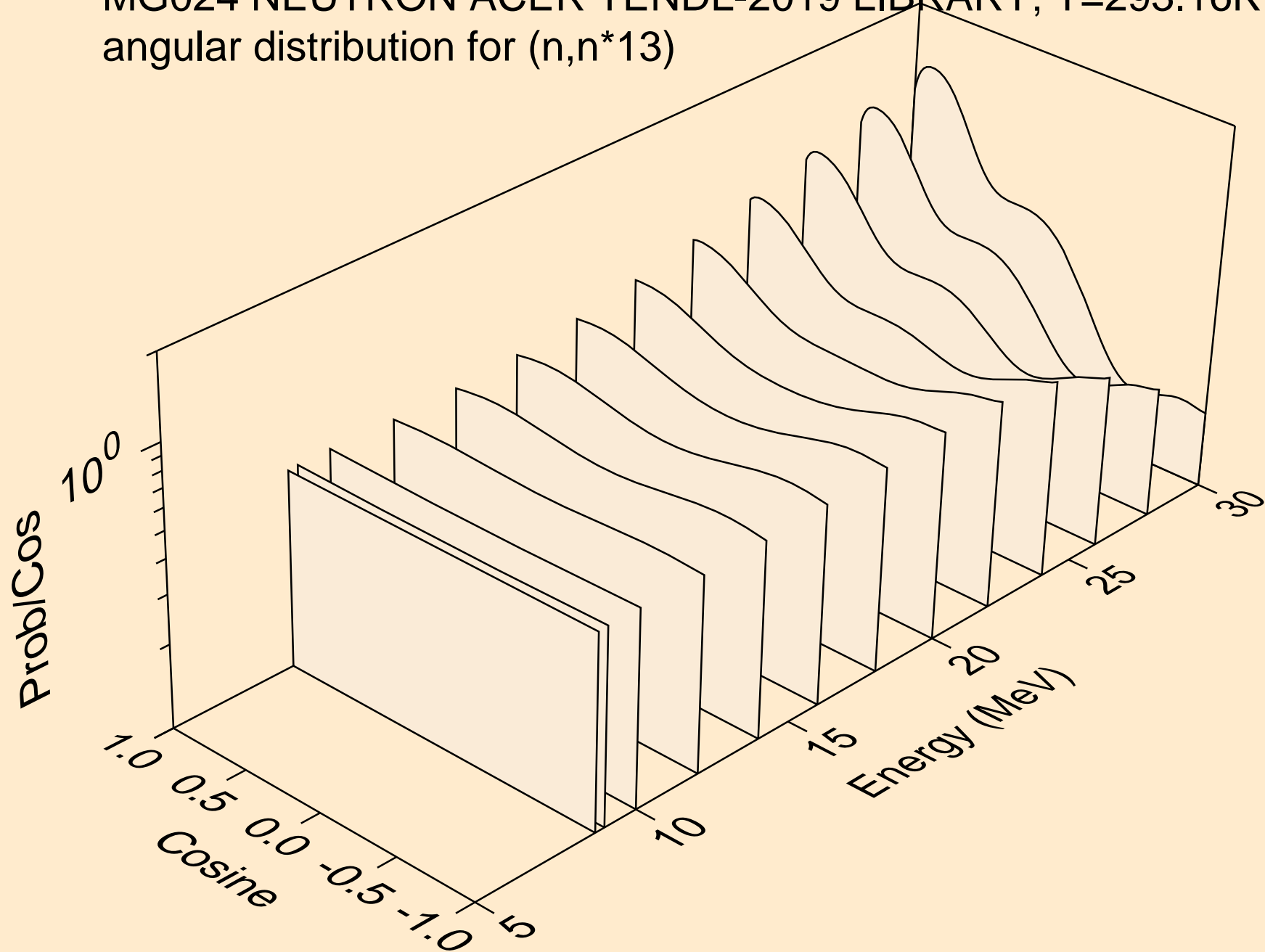

MG024 NEUTRON ACER TENDL-2019 LIBRARY; T=293.16K
angular distribution for (n,n*14)

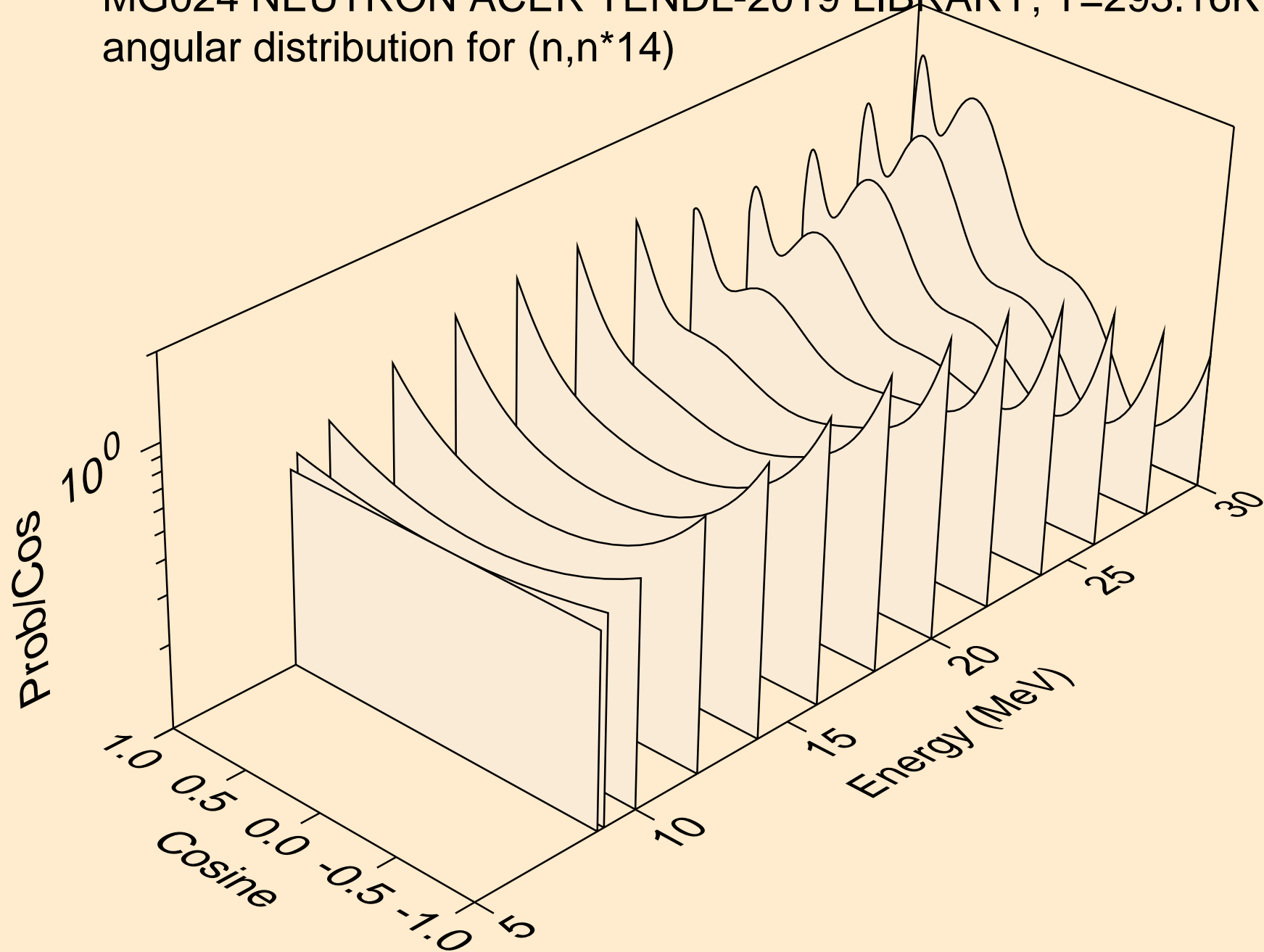

MG024 NEUTRON ACER TENDL-2019 LIBRARY; T=293.16K
angular distribution for (n,n*15)

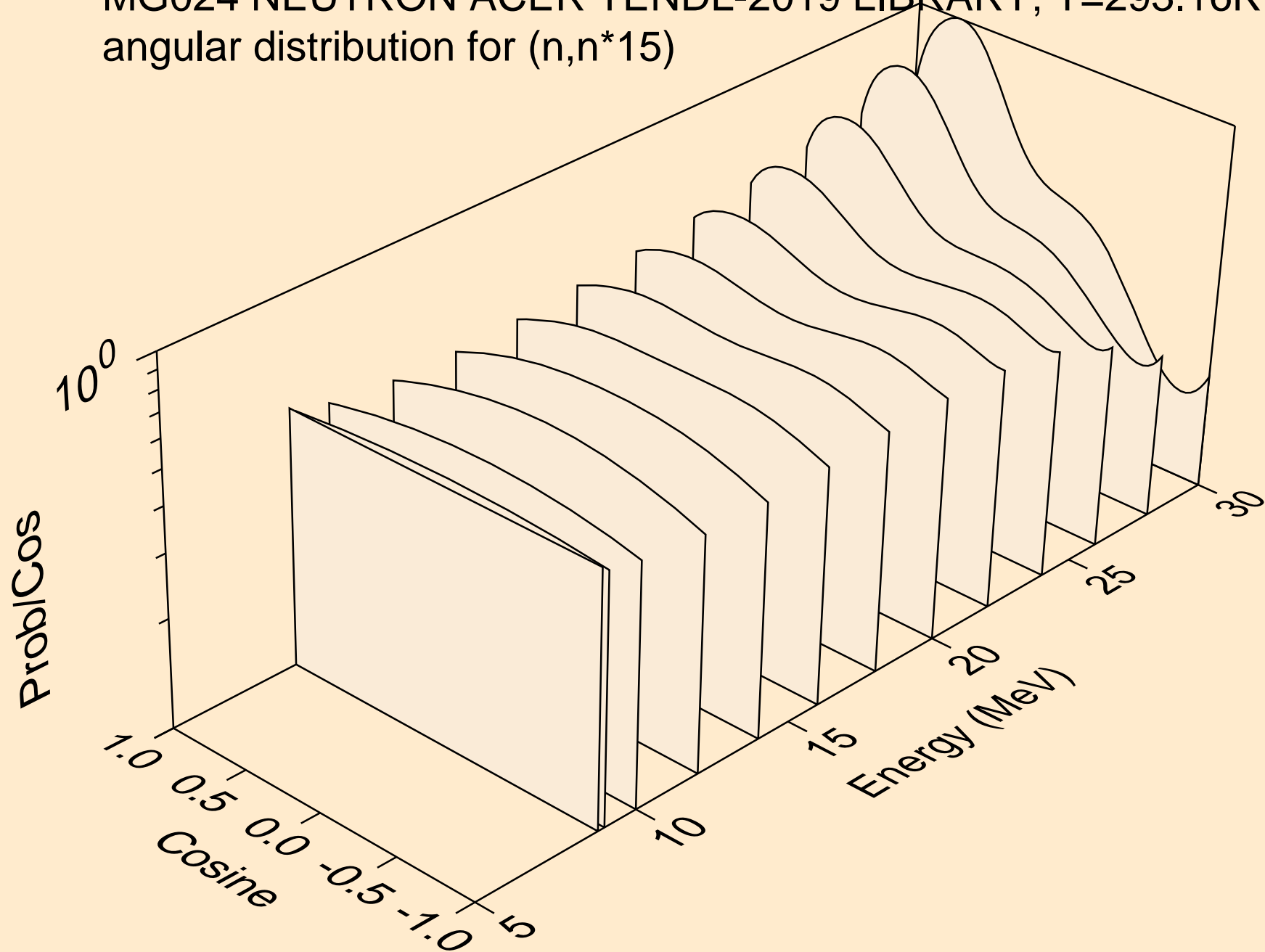

MG024 NEUTRON ACER TENDL-2019 LIBRARY; T=293.16K
angular distribution for (n,n*16)

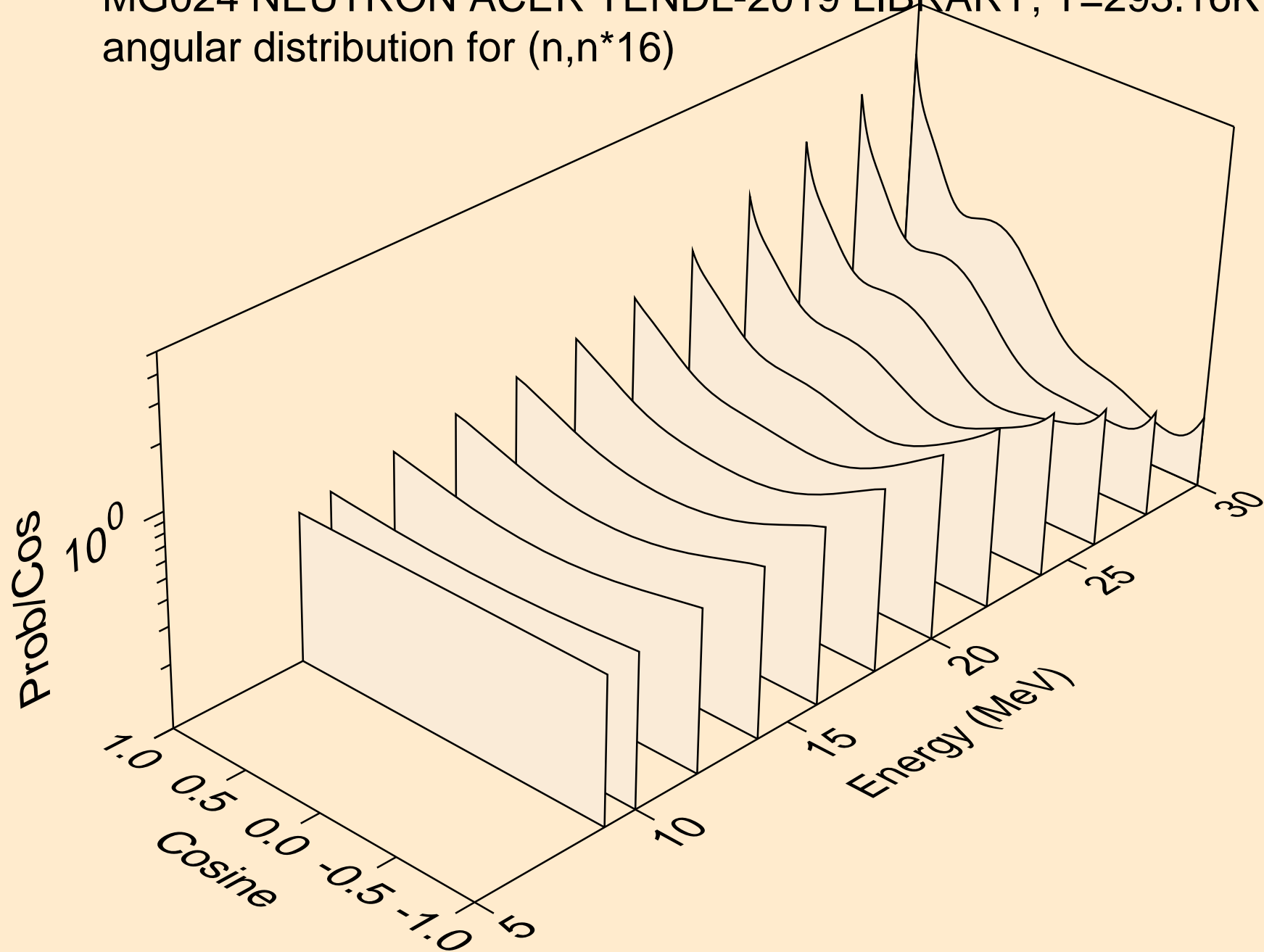

MG024 NEUTRON ACER TENDL-2019 LIBRARY; T=293.16K
angular distribution for (n,n*17)

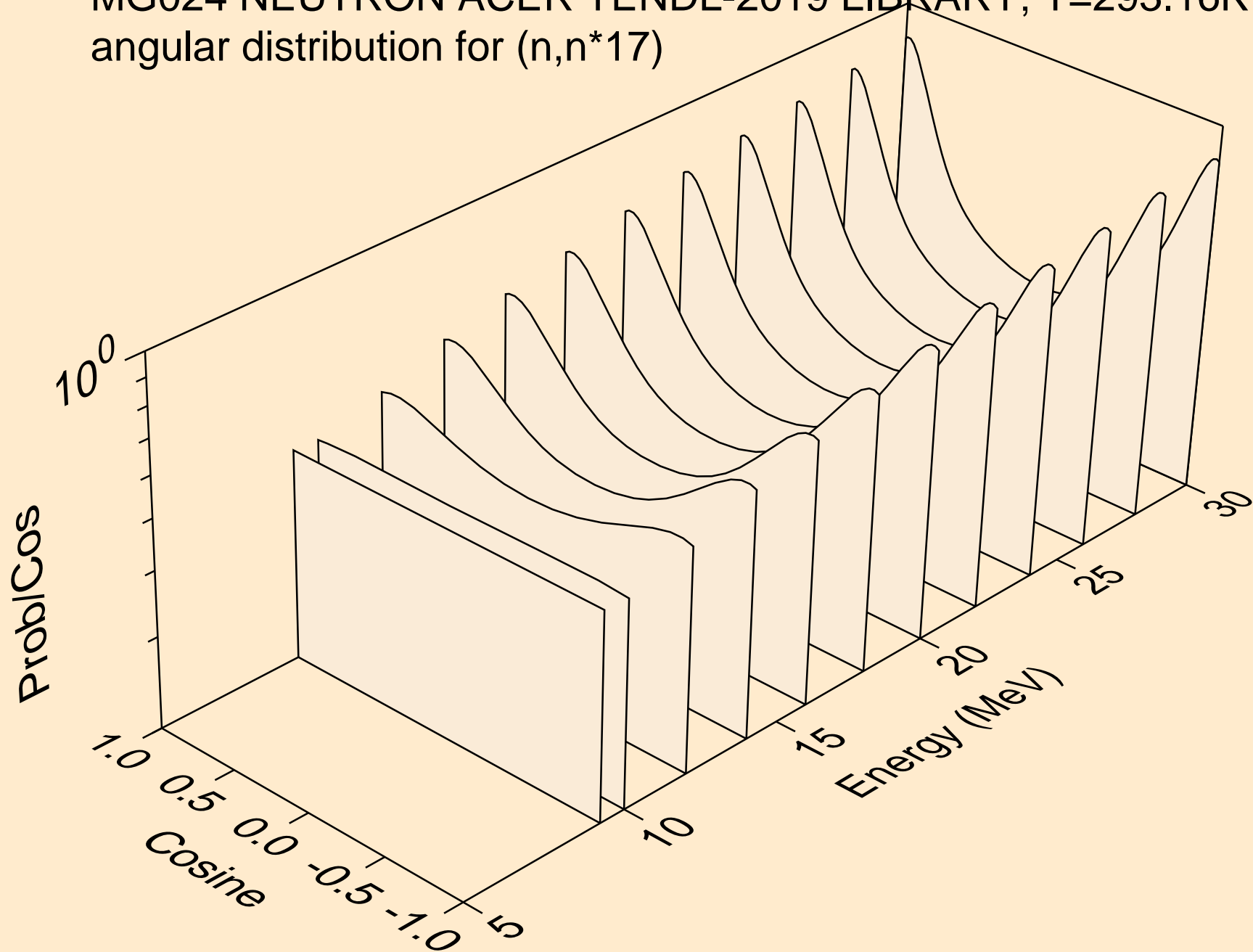

MG024 NEUTRON ACER TENDL-2019 LIBRARY; T=293.16K
angular distribution for (n,n*18)

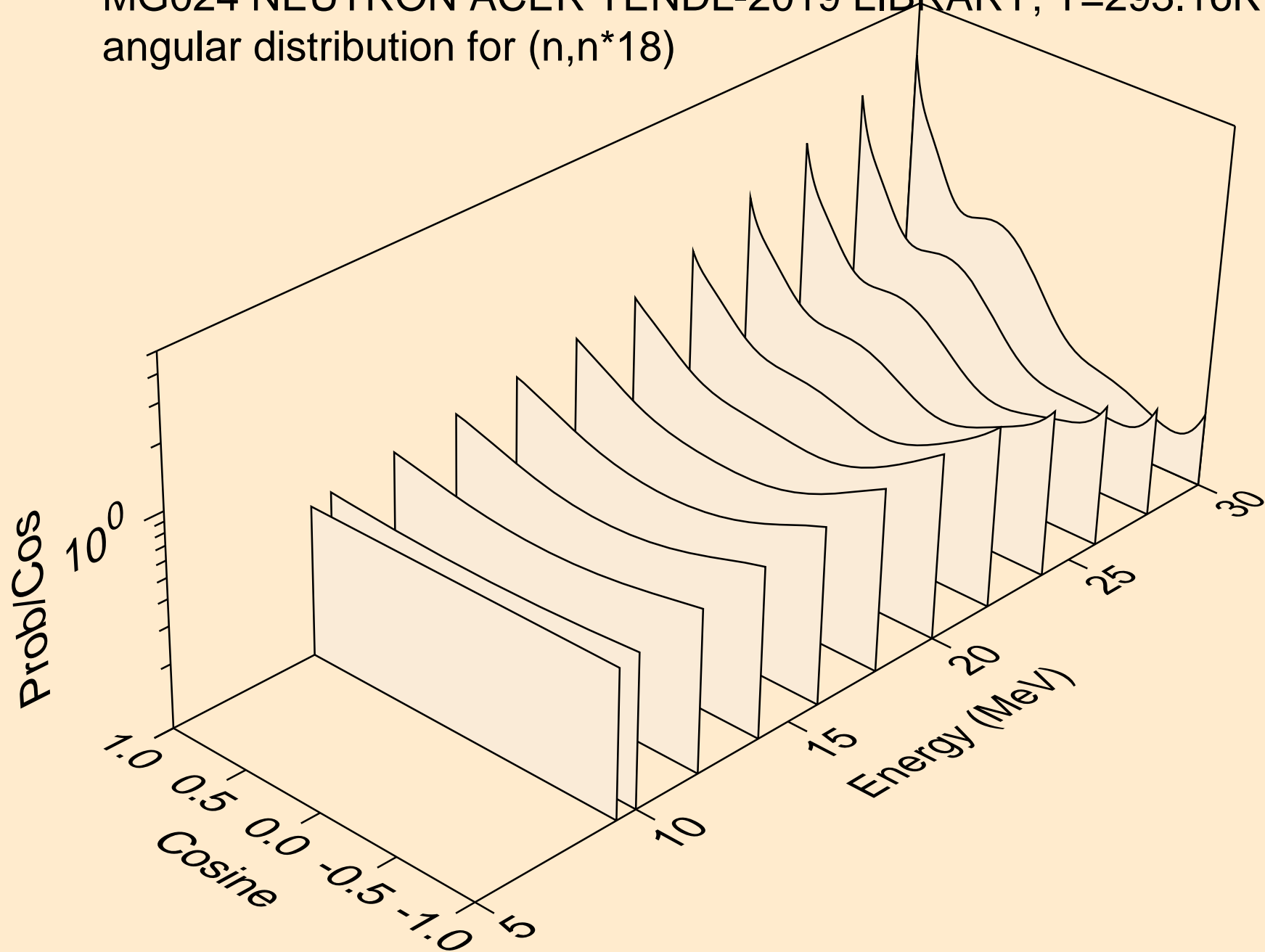

MG024 NEUTRON ACER TENDL-2019 LIBRARY; T=293.16K
angular distribution for (n,n*19)

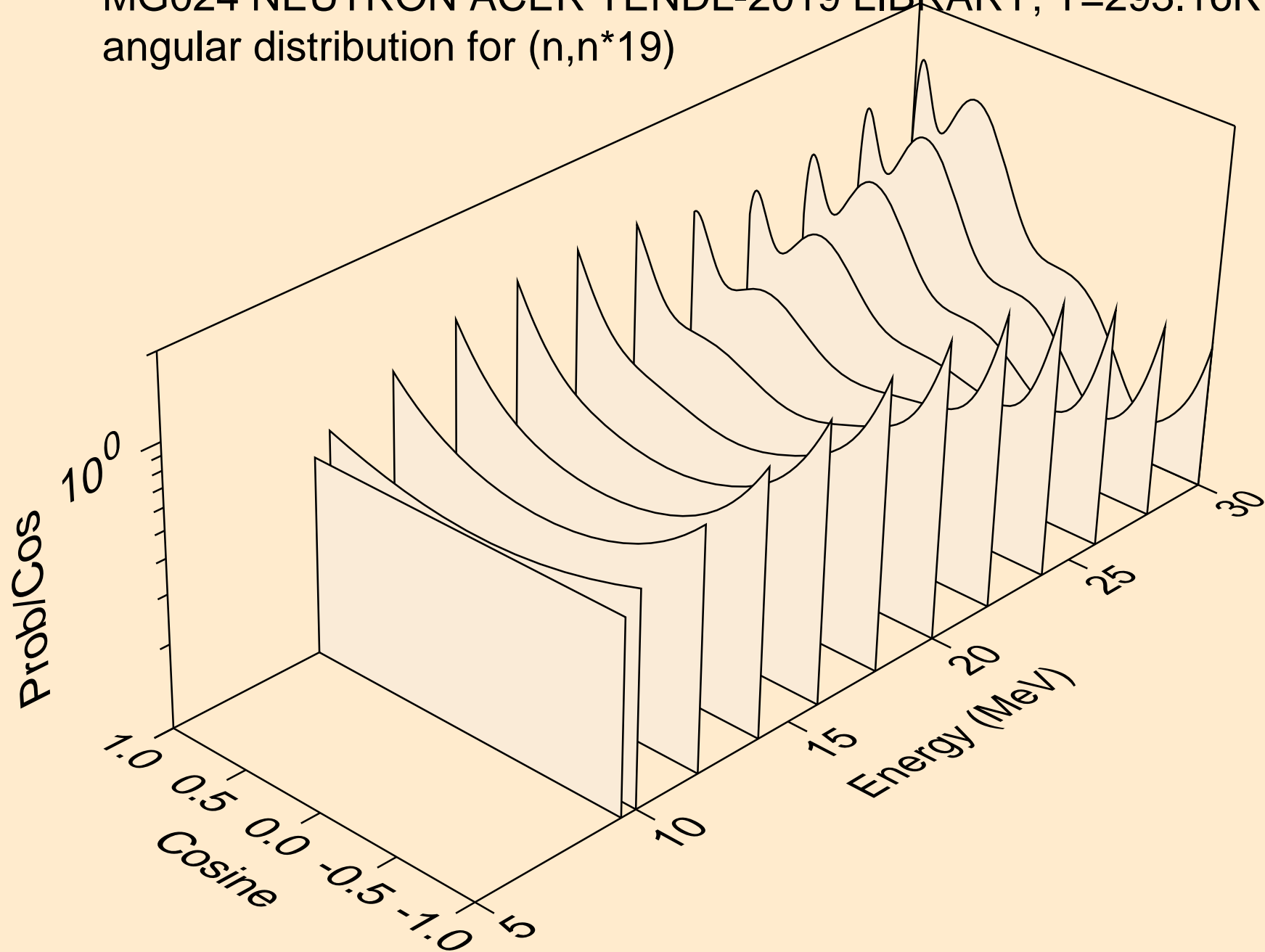

MG024 NEUTRON ACER TENDL-2019 LIBRARY; T=293.16K
angular distribution for (n,n*20)

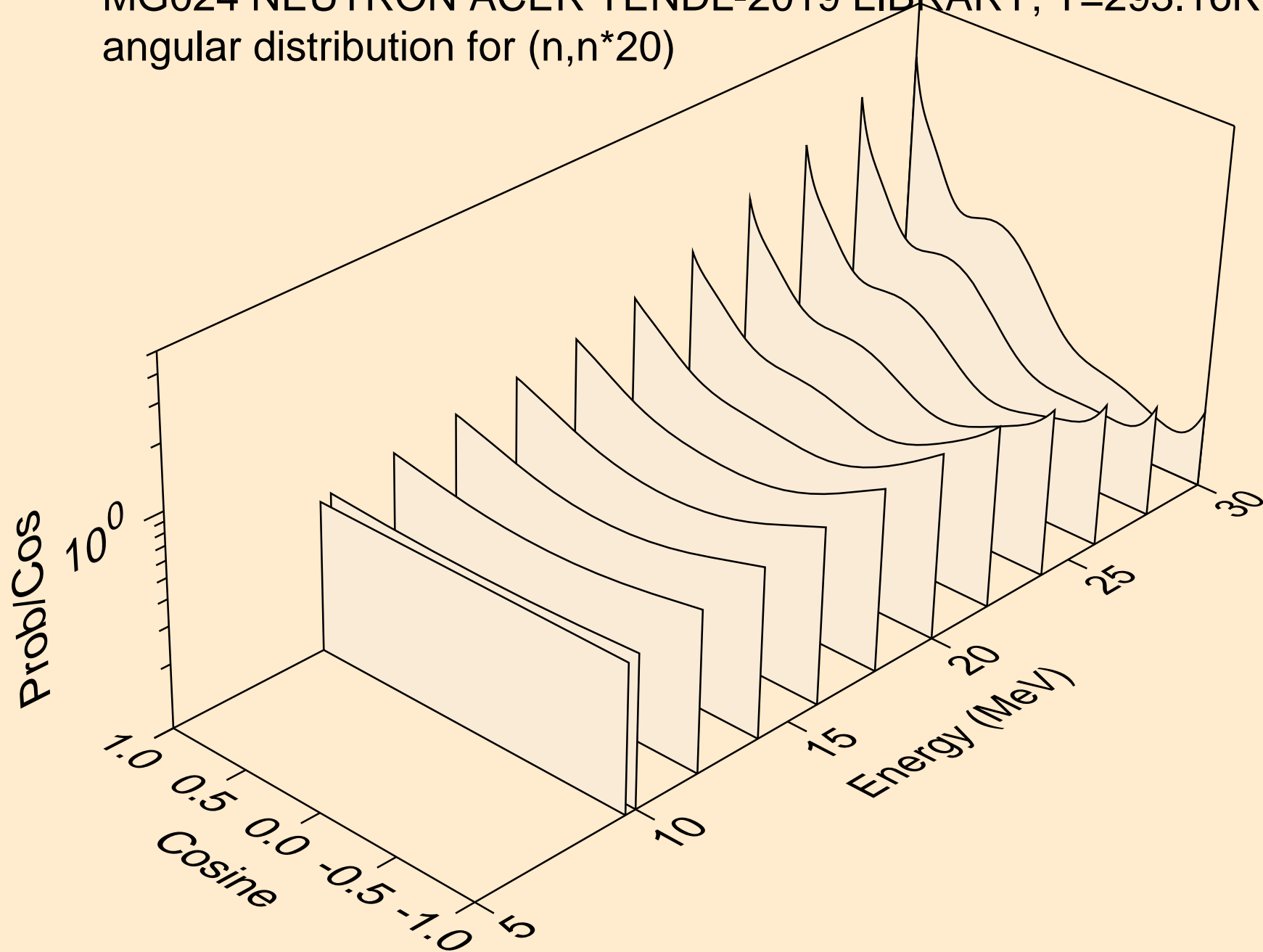

MG024 NEUTRON ACER TENDL-2019 LIBRARY; T=293.16K
angular distribution for (n,n*21)

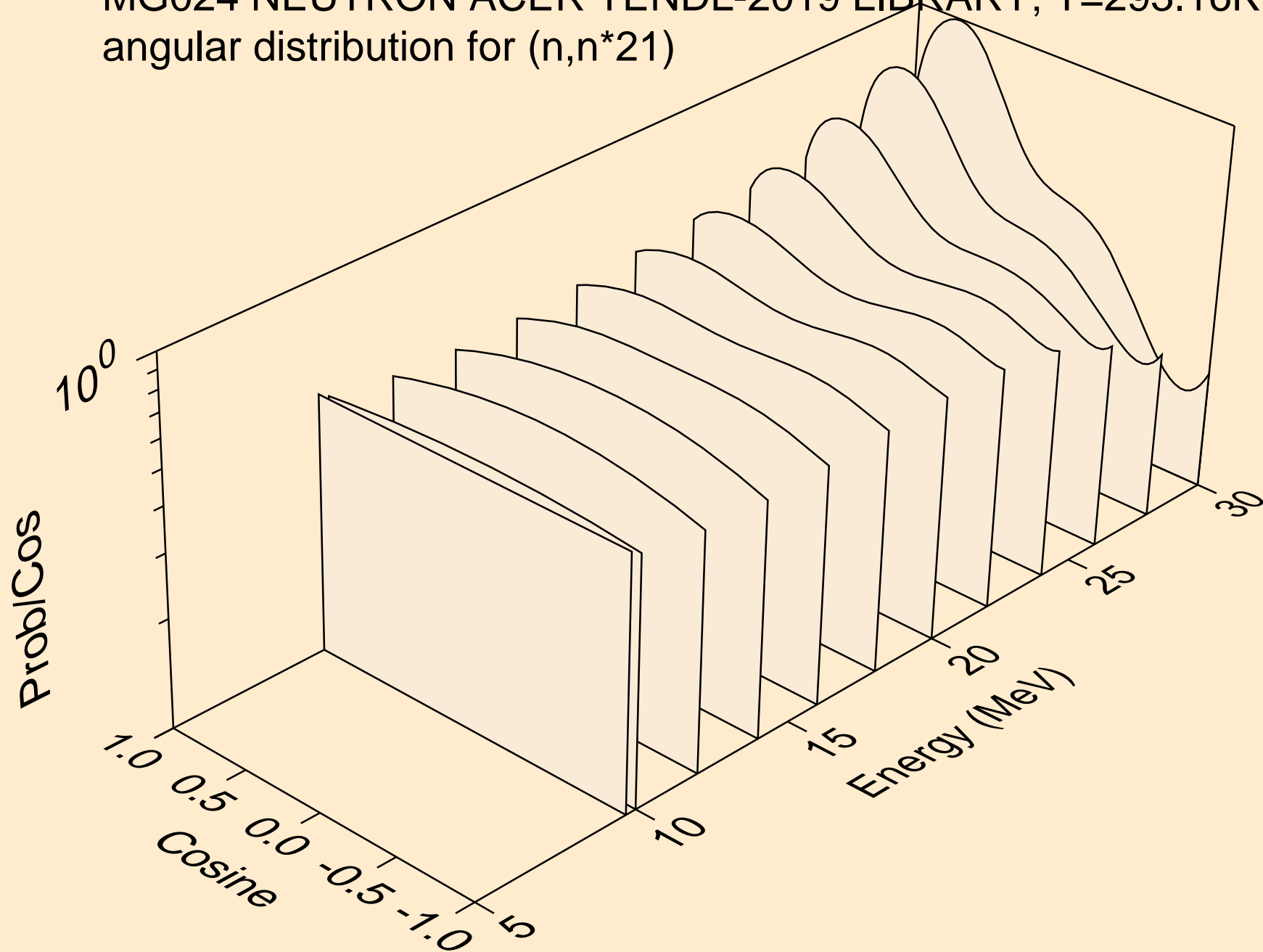

MG024 NEUTRON ACER TENDL-2019 LIBRARY; T=293.16K
angular distribution for (n,n*22)

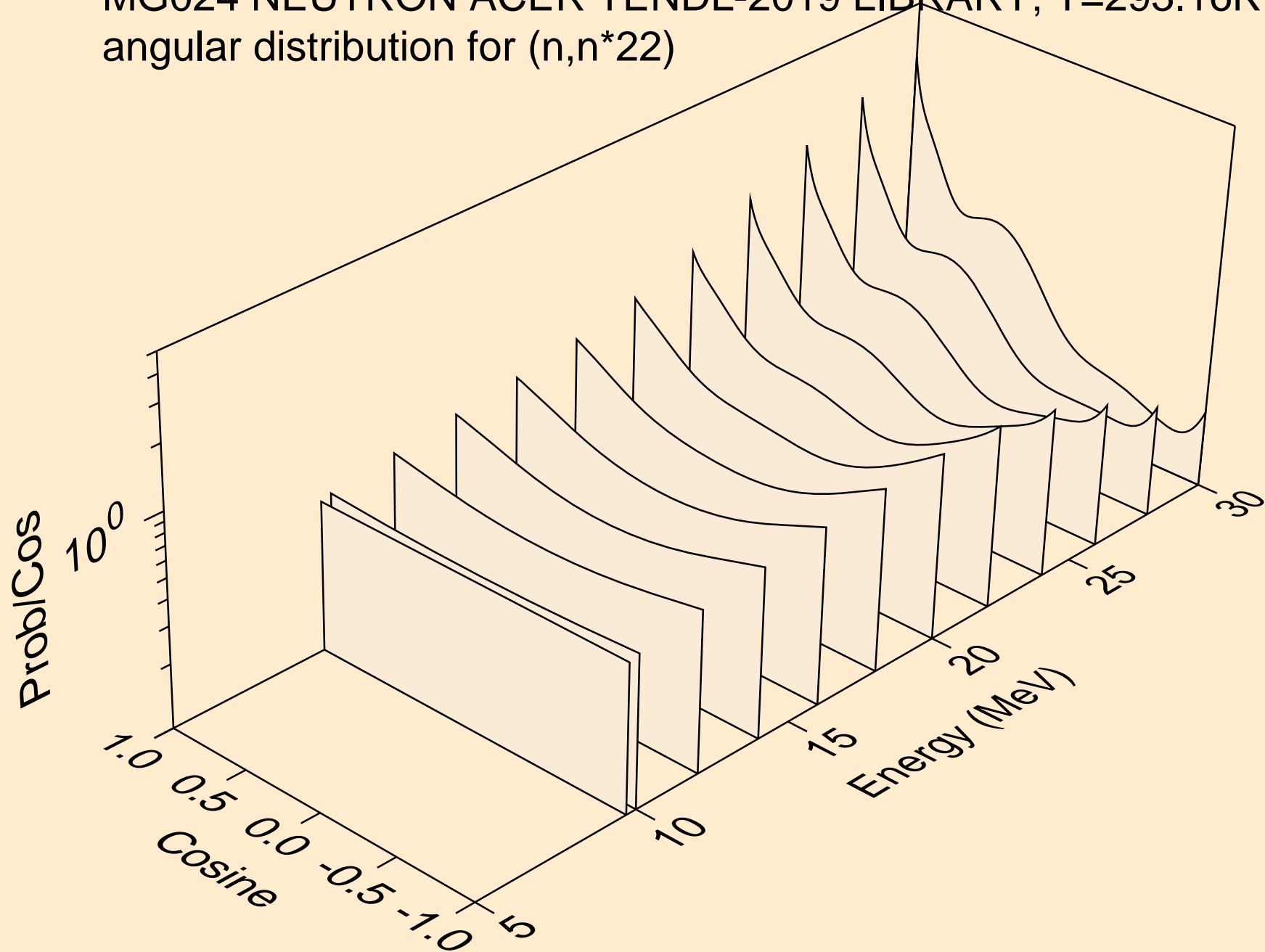

MG024 NEUTRON ACER TENDL-2019 LIBRARY; T=293.16K
angular distribution for (n,n*23)

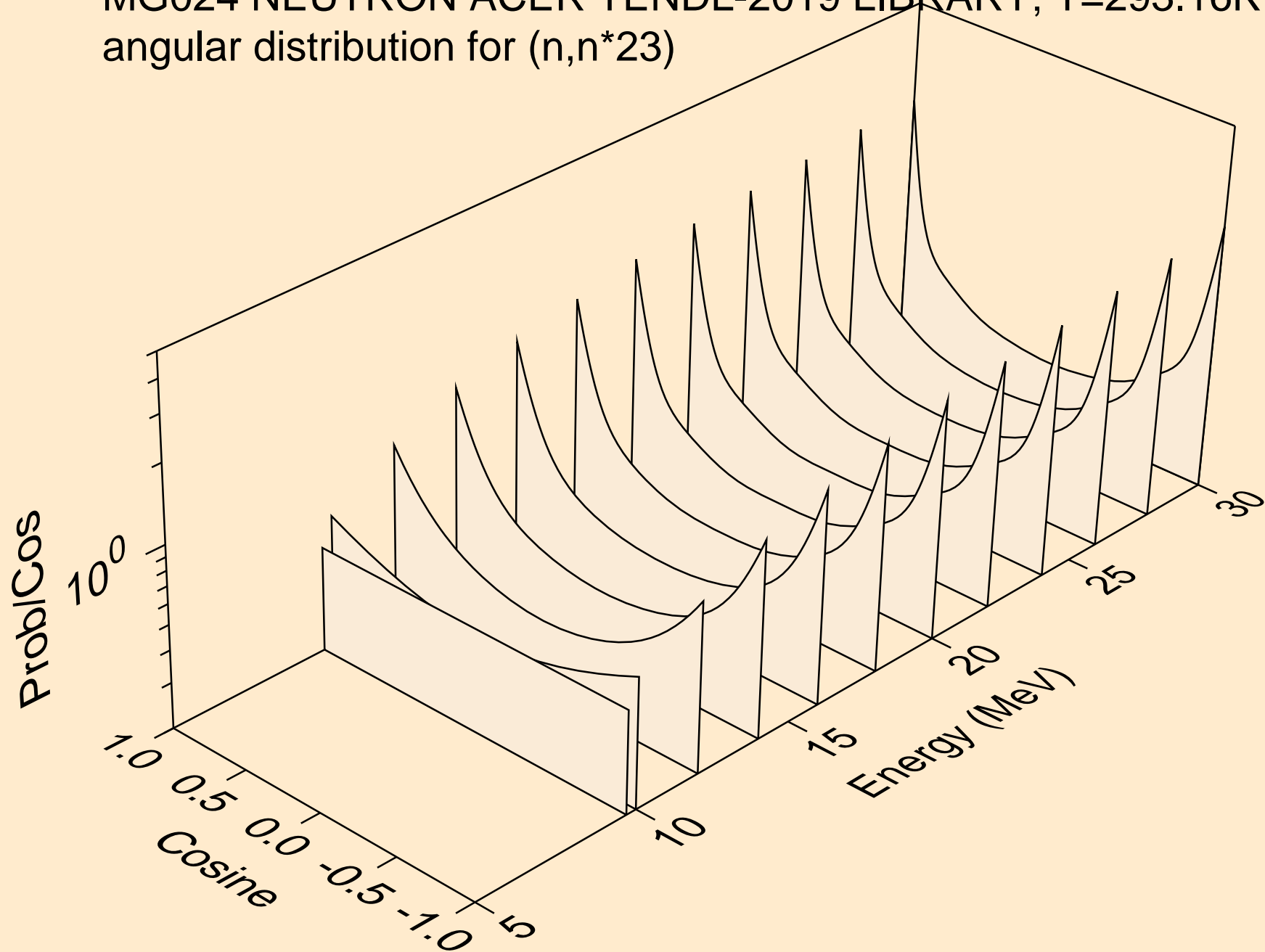

MG024 NEUTRON ACER TENDL-2019 LIBRARY; T=293.16K
angular distribution for (n,n*24)

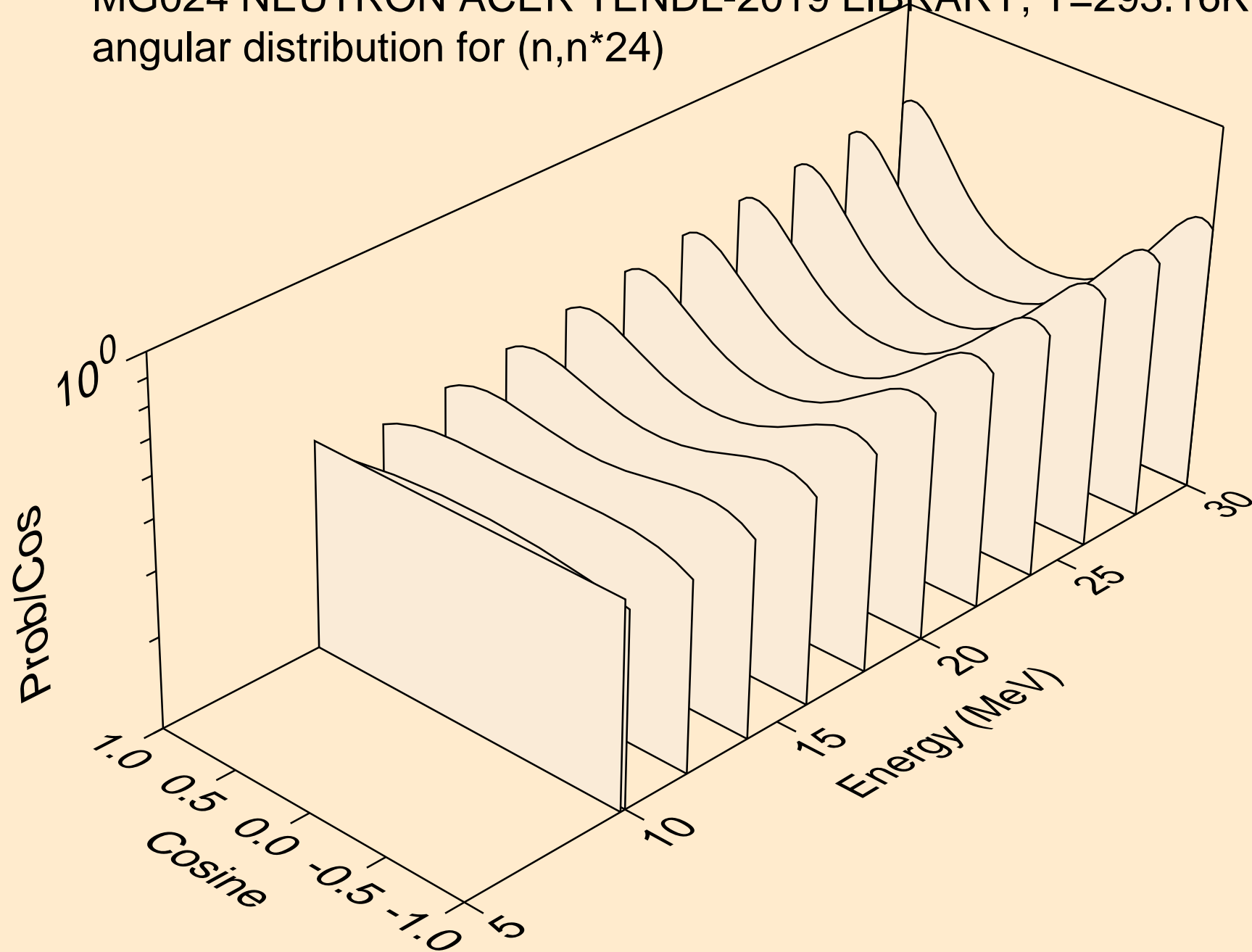

MG024 NEUTRON ACER TENDL-2019 LIBRARY; T=293.16K
angular distribution for (n,n*25)

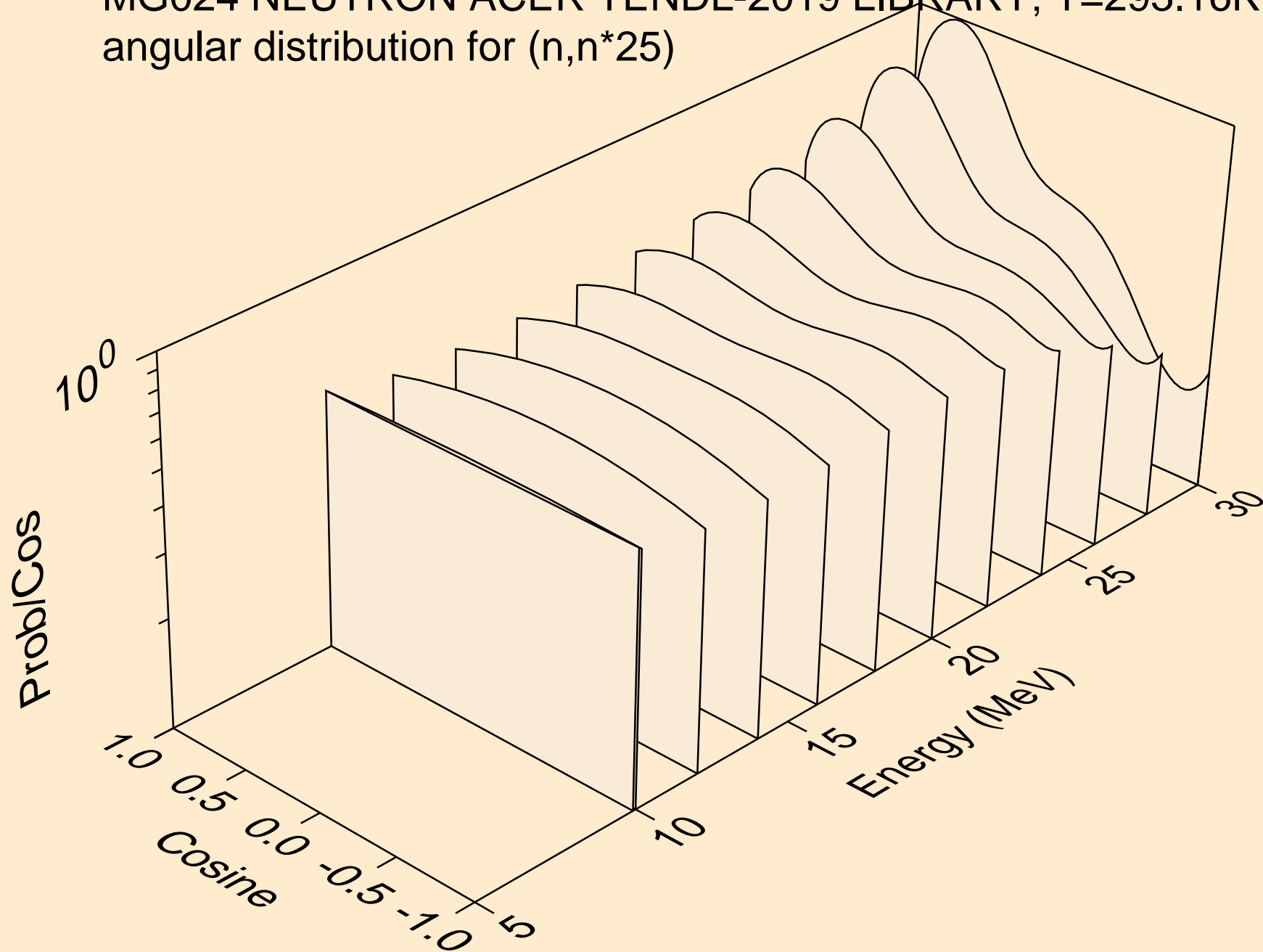

MG024 NEUTRON ACER TENDL-2019 LIBRARY; T=293.16K
angular distribution for (n,n*26)

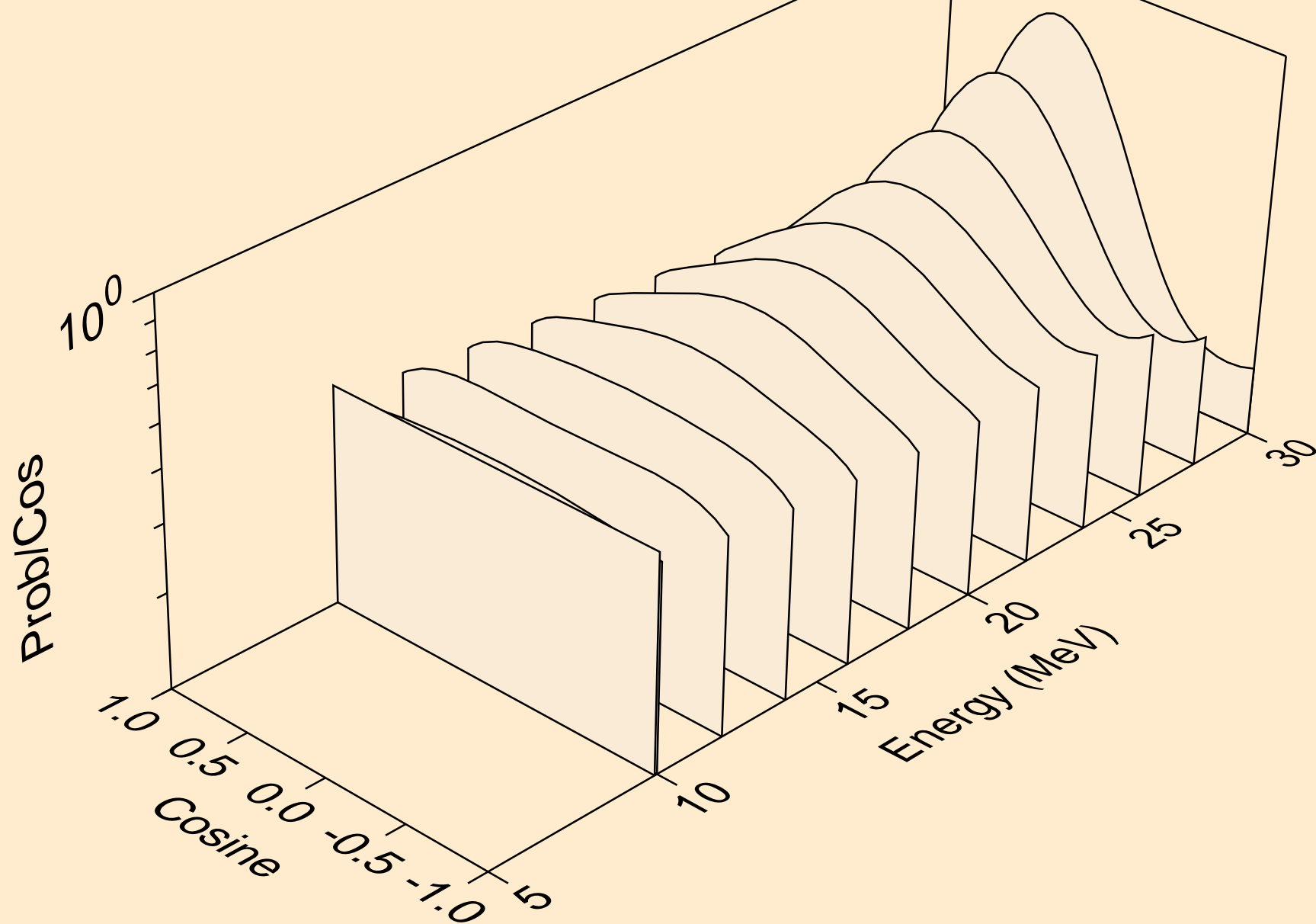

MG024 NEUTRON ACER TENDL-2019 LIBRARY; T=293.16K
angular distribution for (n,n*27)

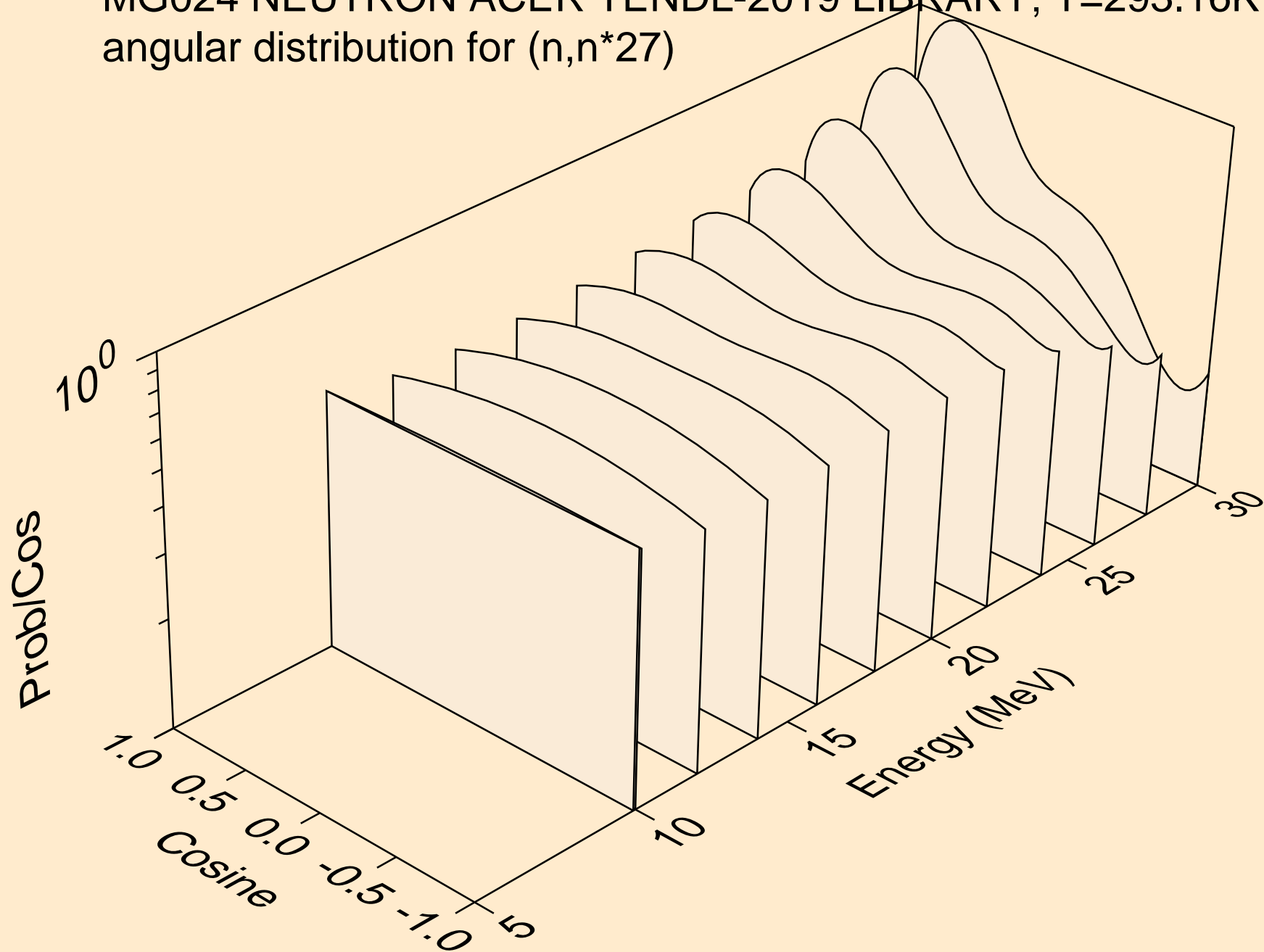

MG024 NEUTRON ACER TENDL-2019 LIBRARY; T=293.16K
Neutron emission for (n,x)

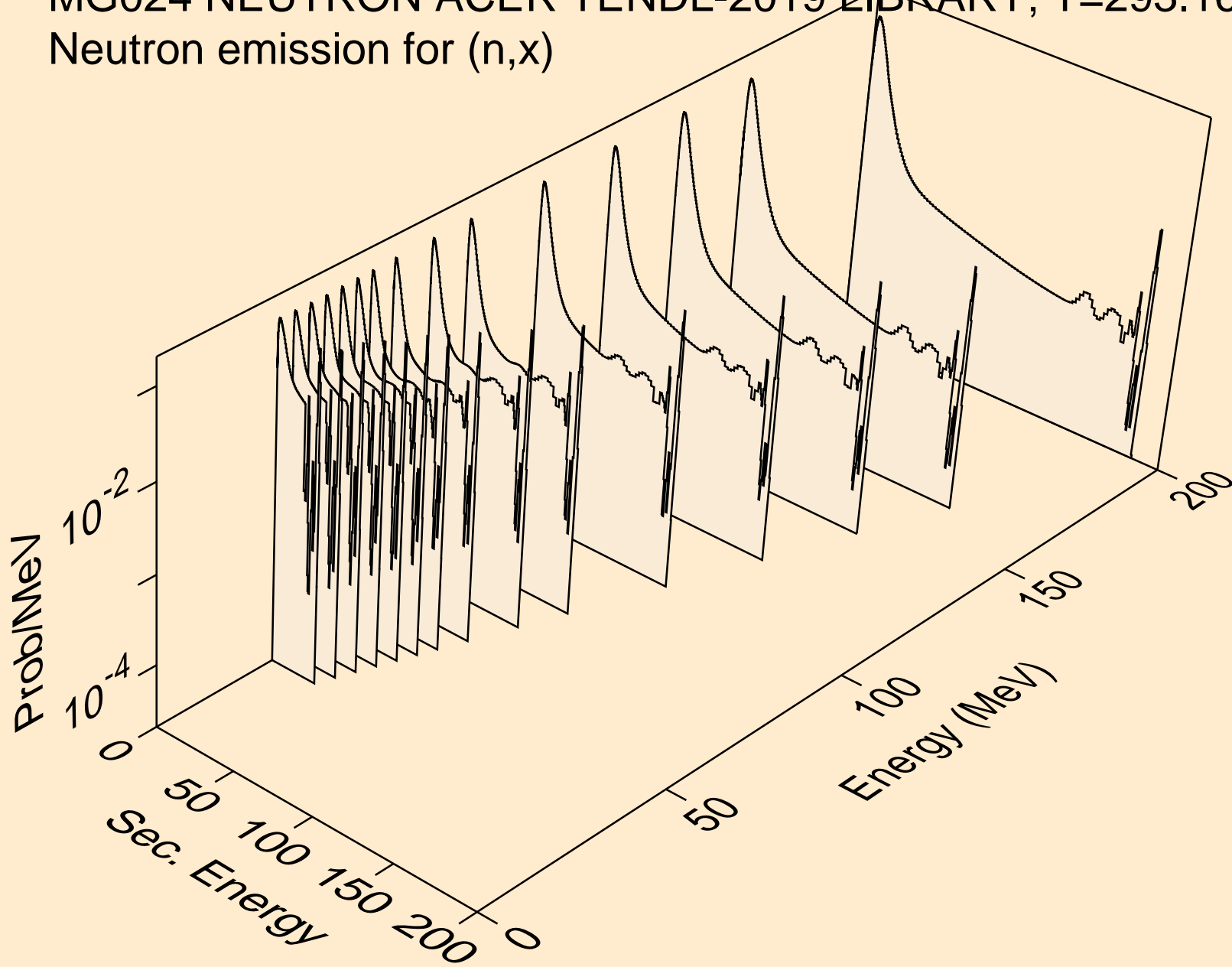

MG024 NEUTRON ACER TENDL-2019 LIBRARY; T=293.16K
Neutron emission for (n,2n)

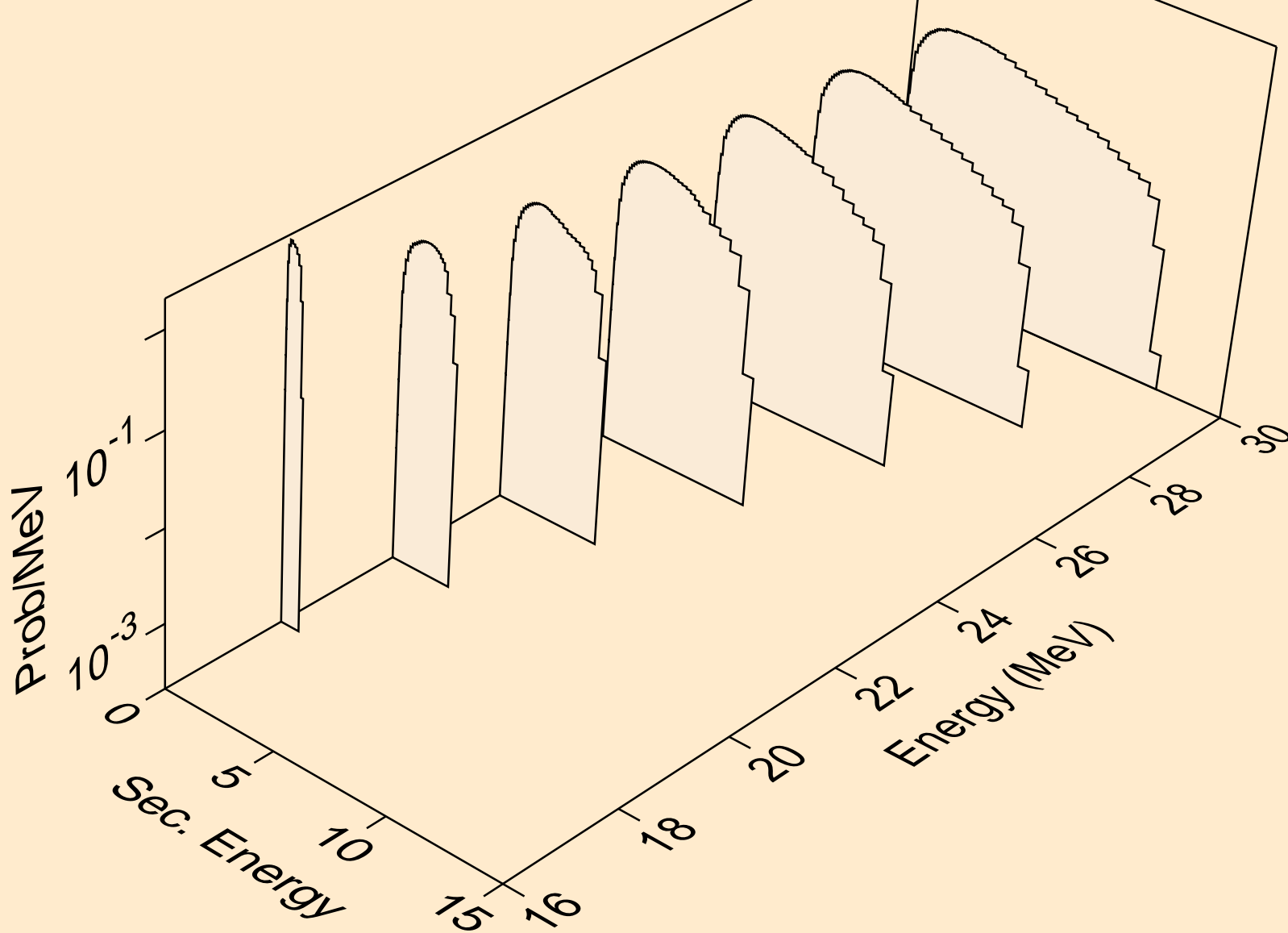

MG024 NEUTRON ACER TENDL-2019 LIBRARY; T=293.16K
Neutron emission for (n,n*)a

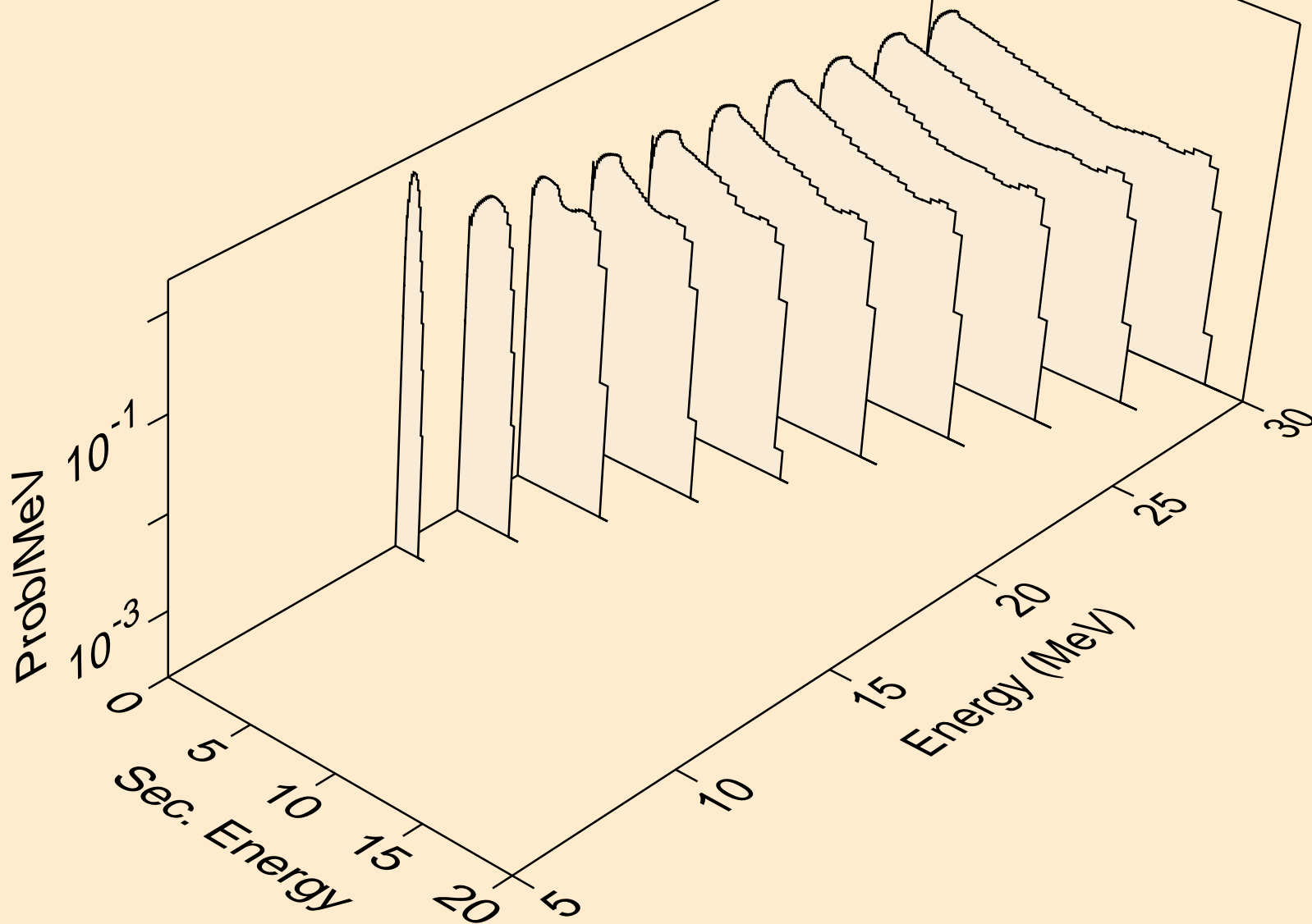

MG024 NEUTRON ACER TENDL-2019 LIBRARY; T=293.16K
Neutron emission for (n,2n)a

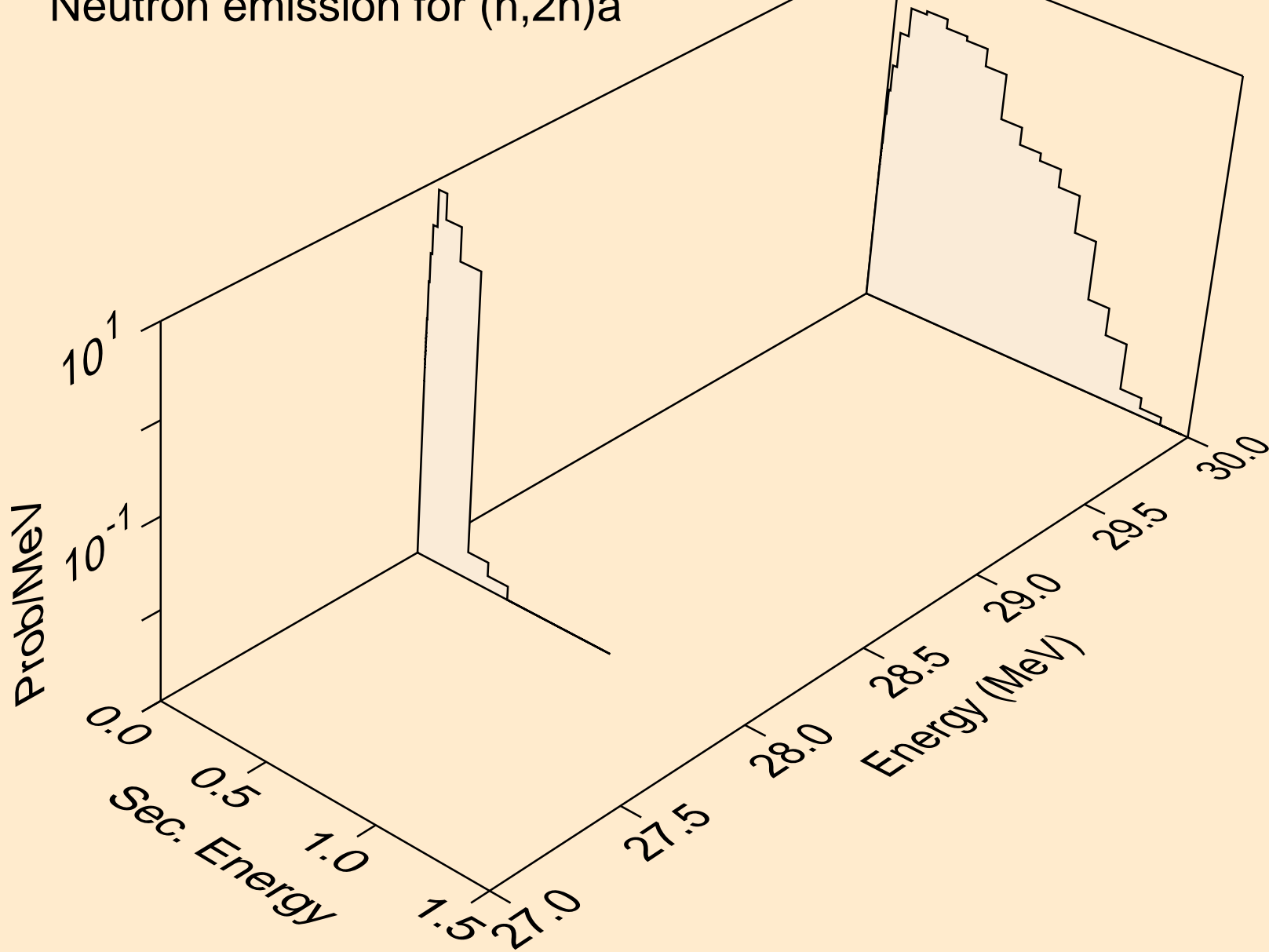

MG024 NEUTRON ACER TENDL-2019 LIBRARY; T=293.16K
Neutron emission for (n,n*)p

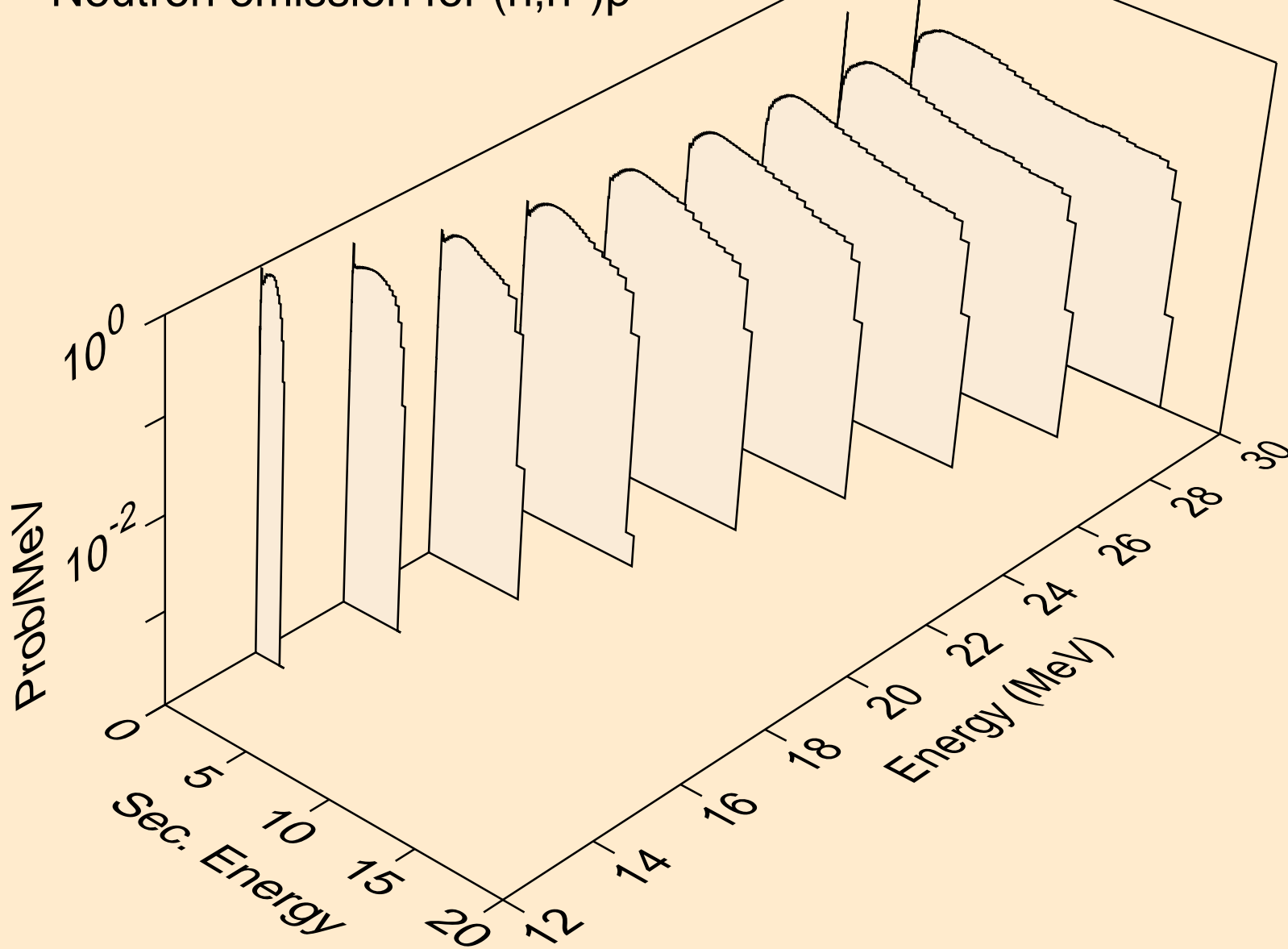

MG024 NEUTRON ACER TENDL-2019 LIBRARY; T=293.16K
Neutron emission for (n,n*)2a

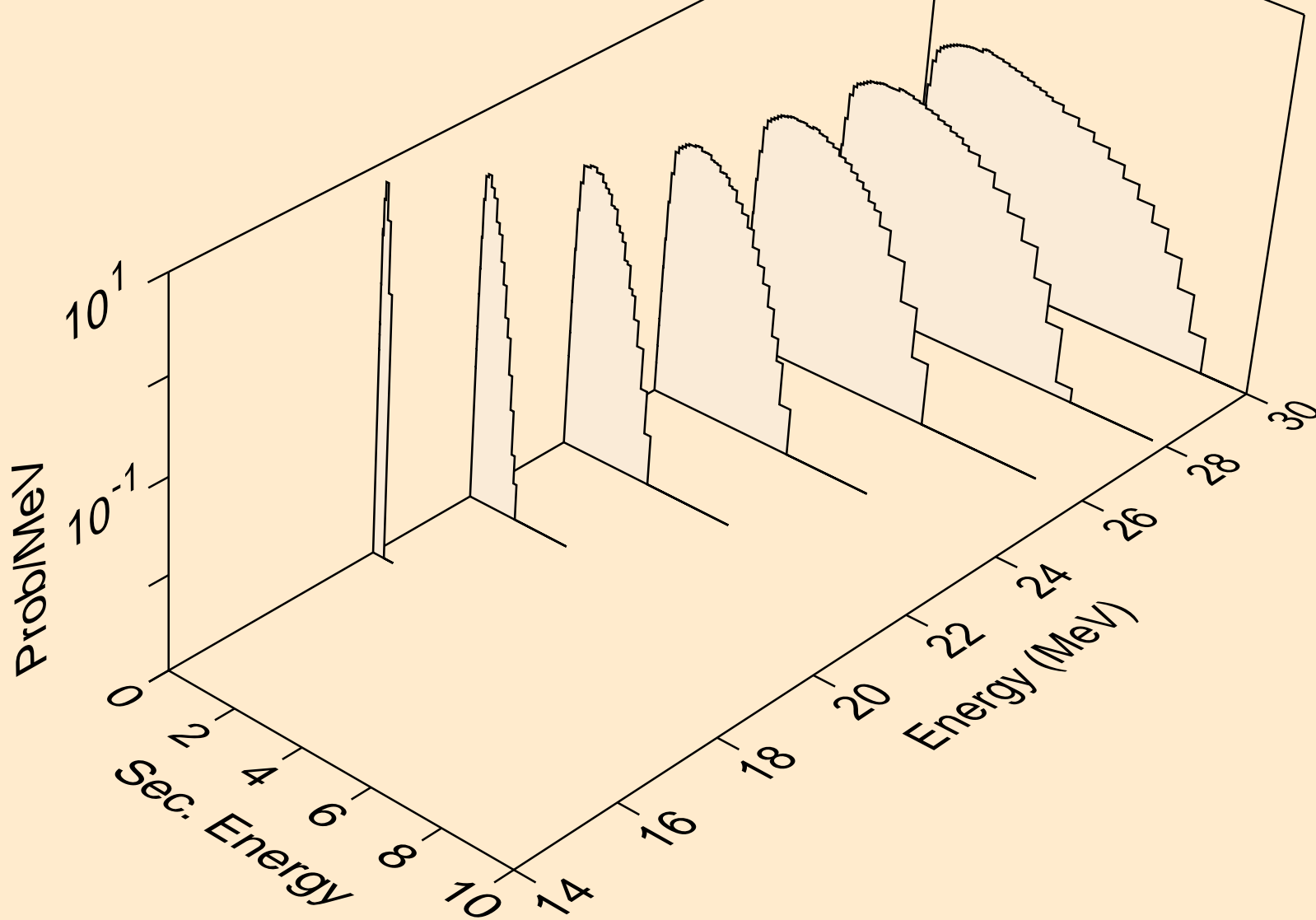

MG024 NEUTRON ACER TENDL-2019 LIBRARY; T=293.16K
Neutron emission for (n,n*)d

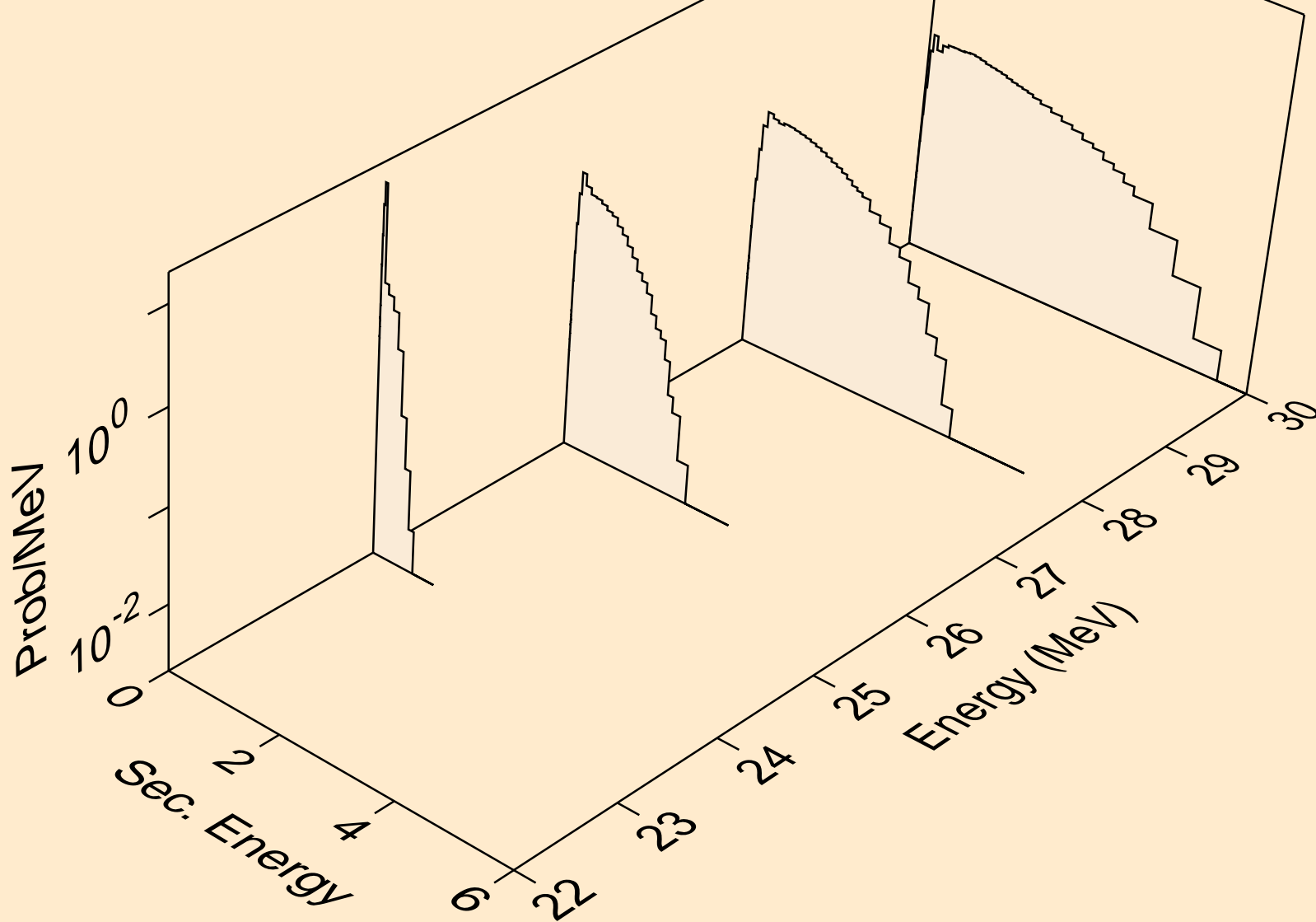

MG024 NEUTRON ACER TENDL-2019 LIBRARY; T=293.16K
Neutron emission for (n,n*)t

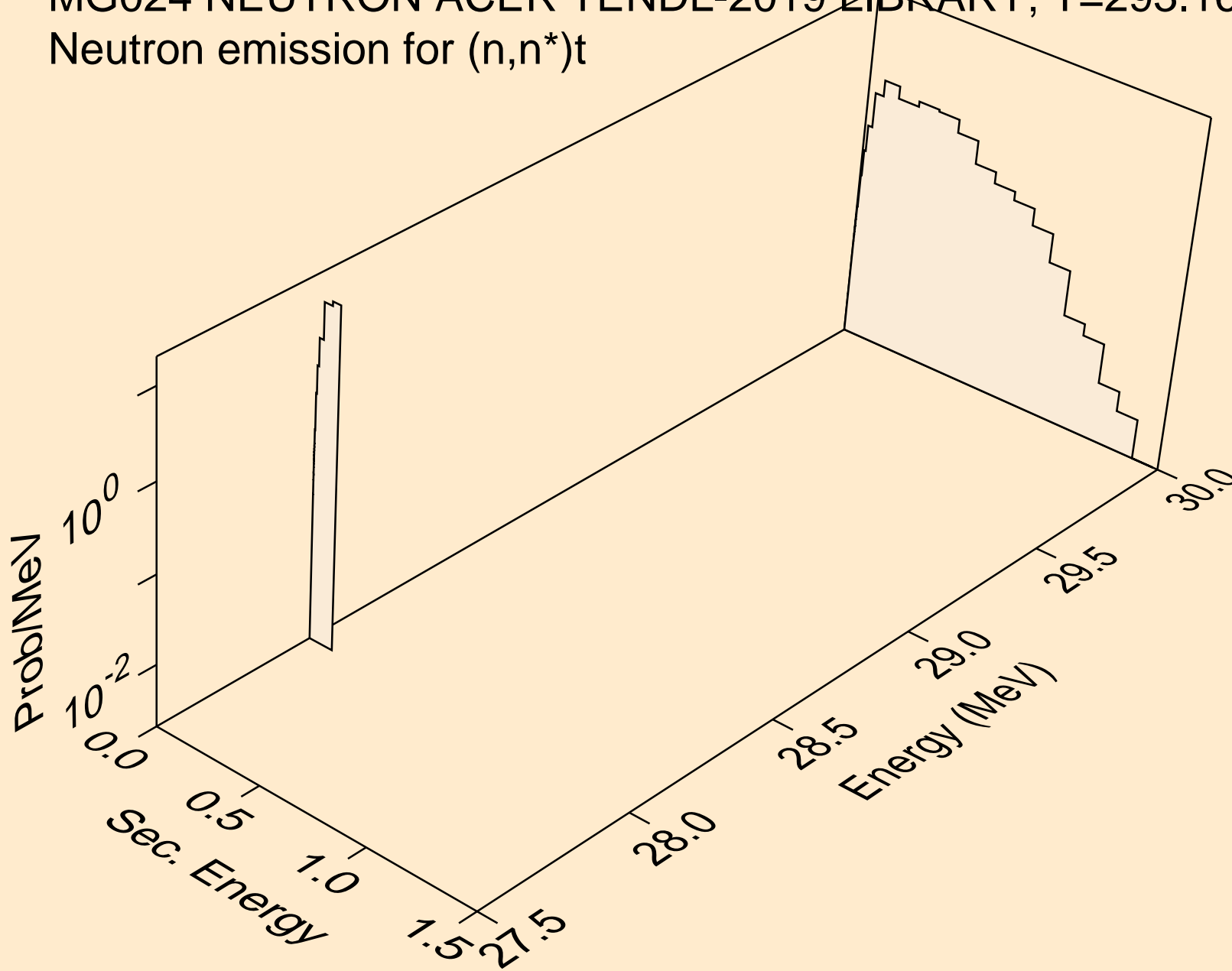

MG024 NEUTRON ACER TENDL-2019 LIBRARY; T=293.16K
Neutron emission for (n,n*)he3

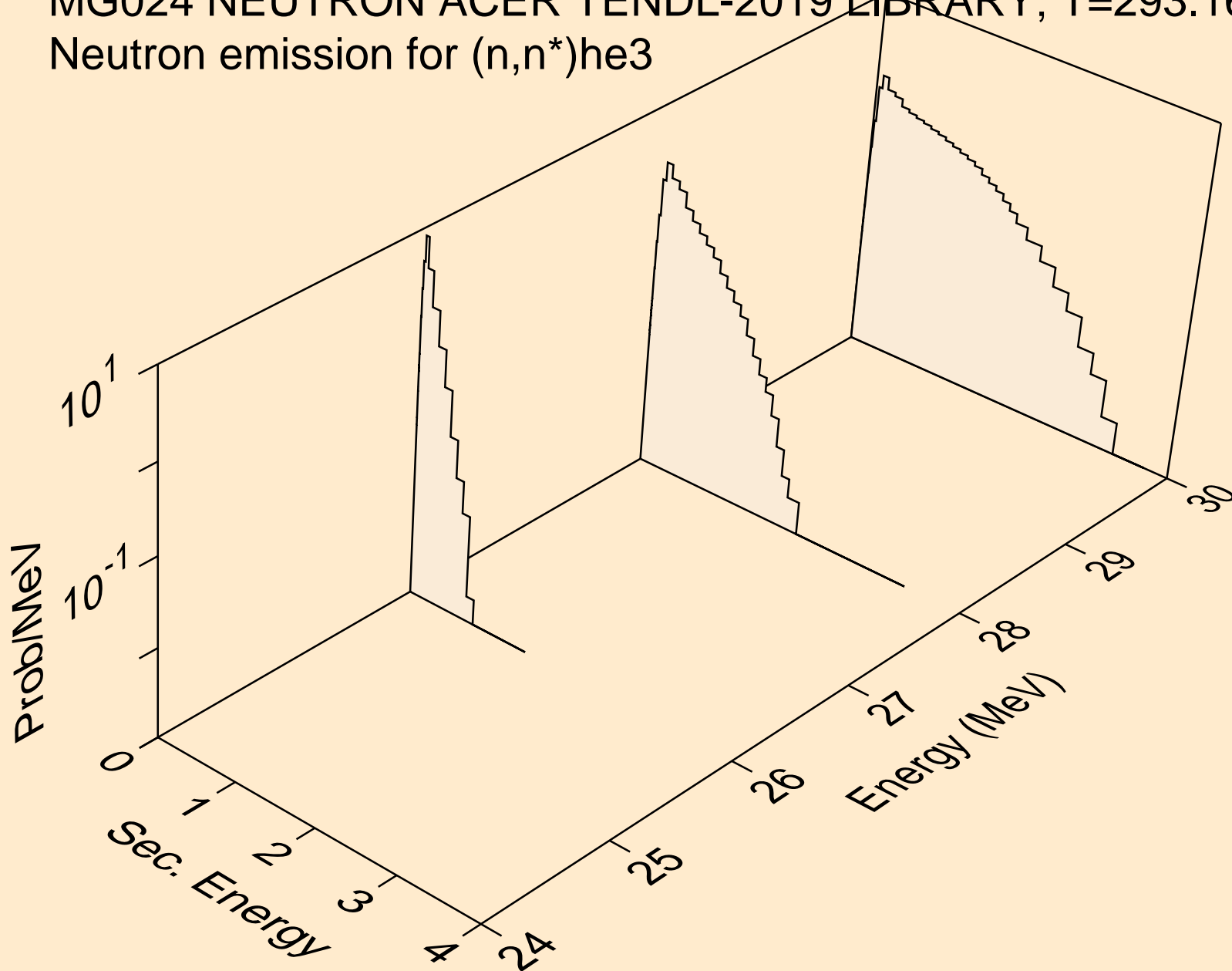

MG024 NEUTRON ACER TENDL-2019 LIBRARY; T=293.16K
Neutron emission for (n,2np)

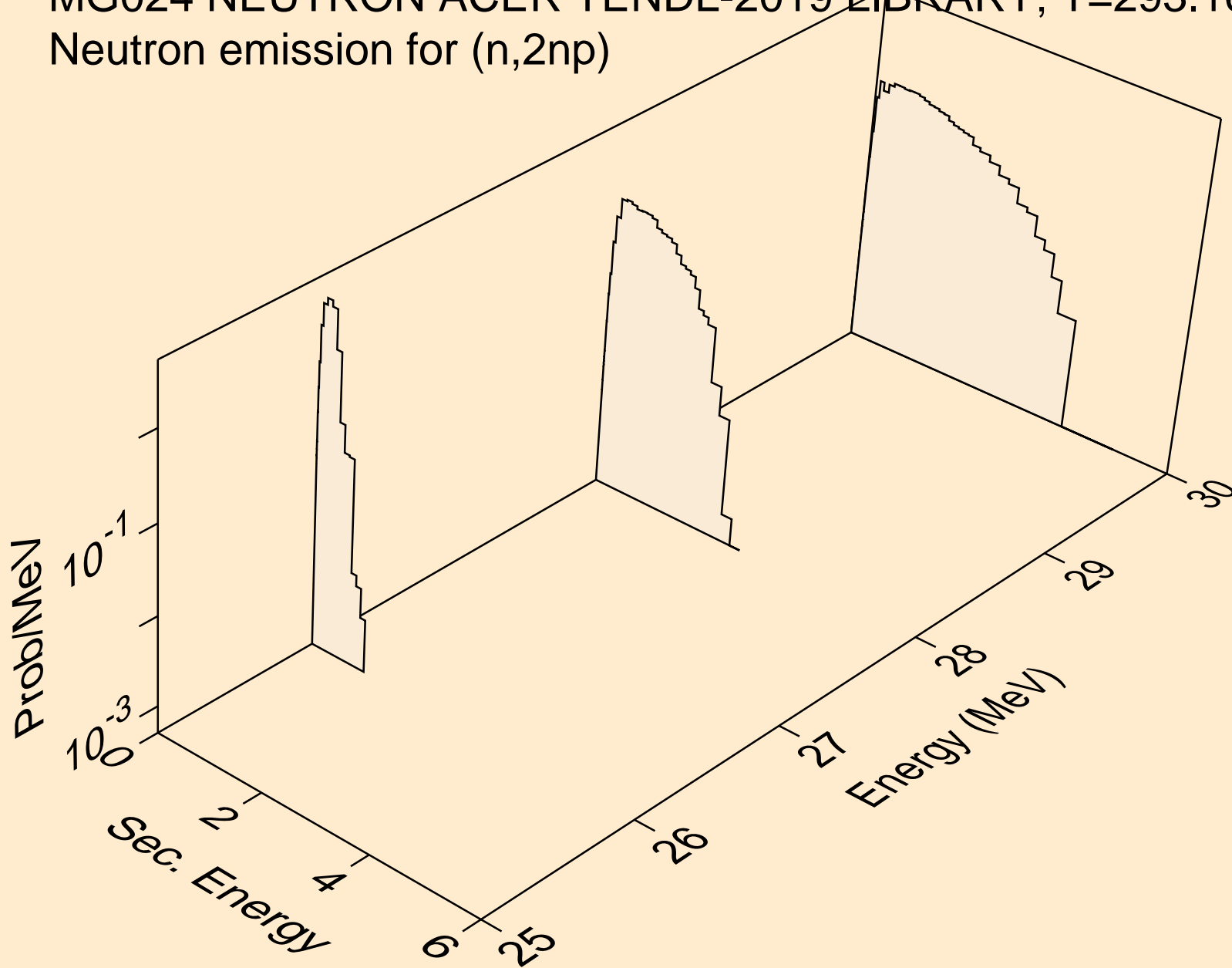

MG024 NEUTRON ACER TENDL-2019 LIBRARY; T=293.16K
Neutron emission for (n,2np)

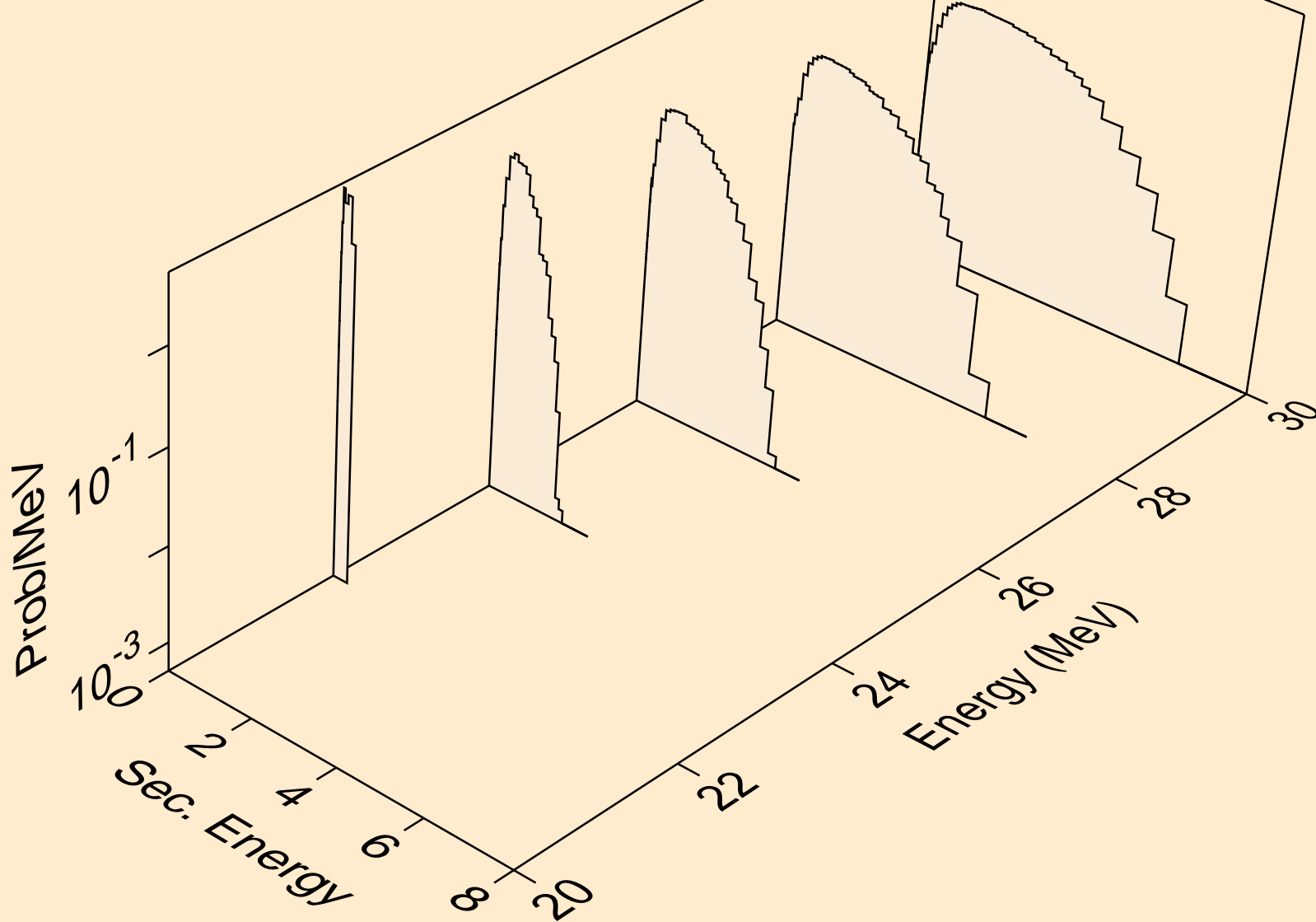

MG024 NEUTRON ACER TENDL-2019 LIBRARY; T=293.16K
Neutron emission for (n,npa)

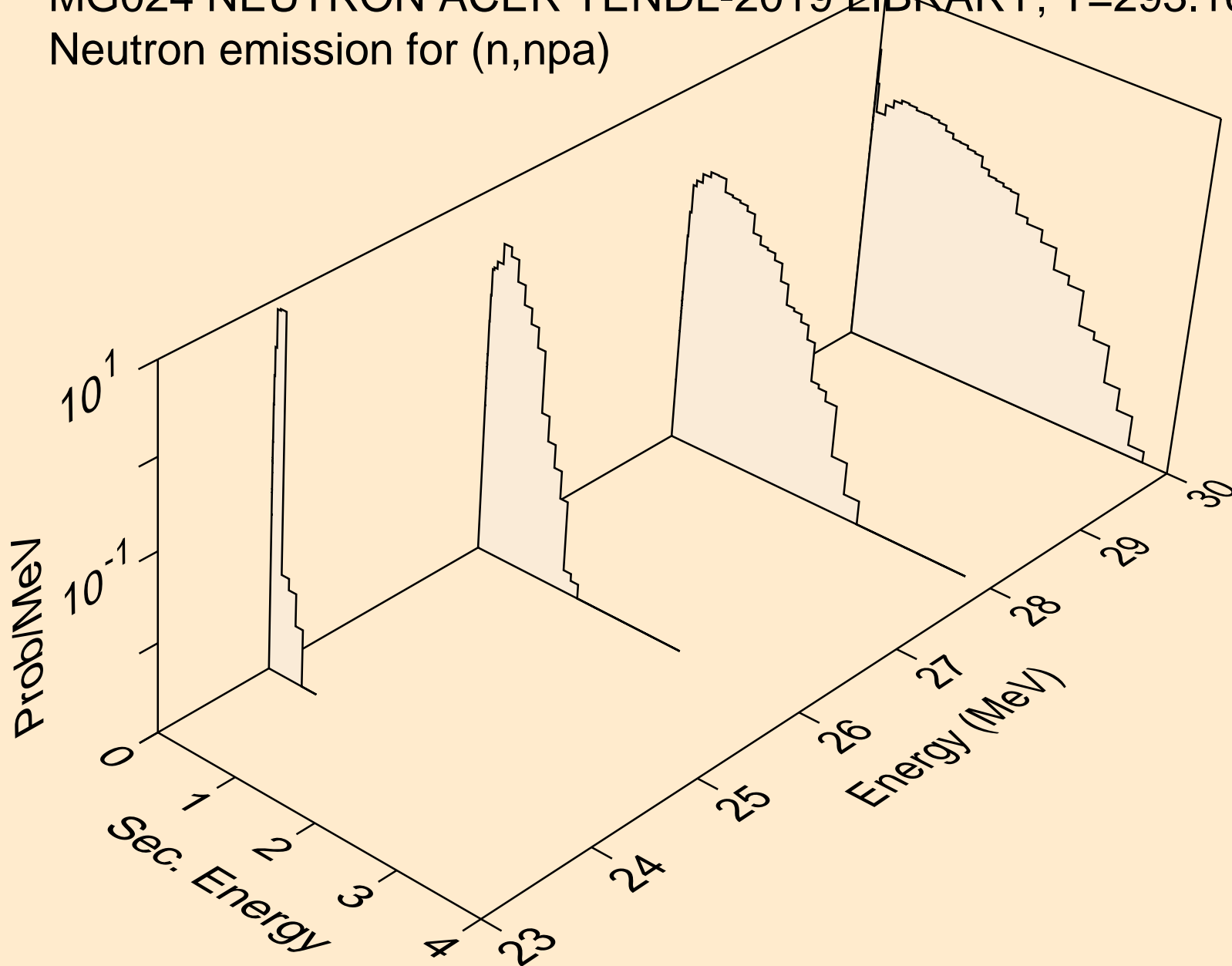

MG024 NEUTRON ACER TENDL-2019 LIBRARY; T=293.16K
Neutron emission for (n,n*c)

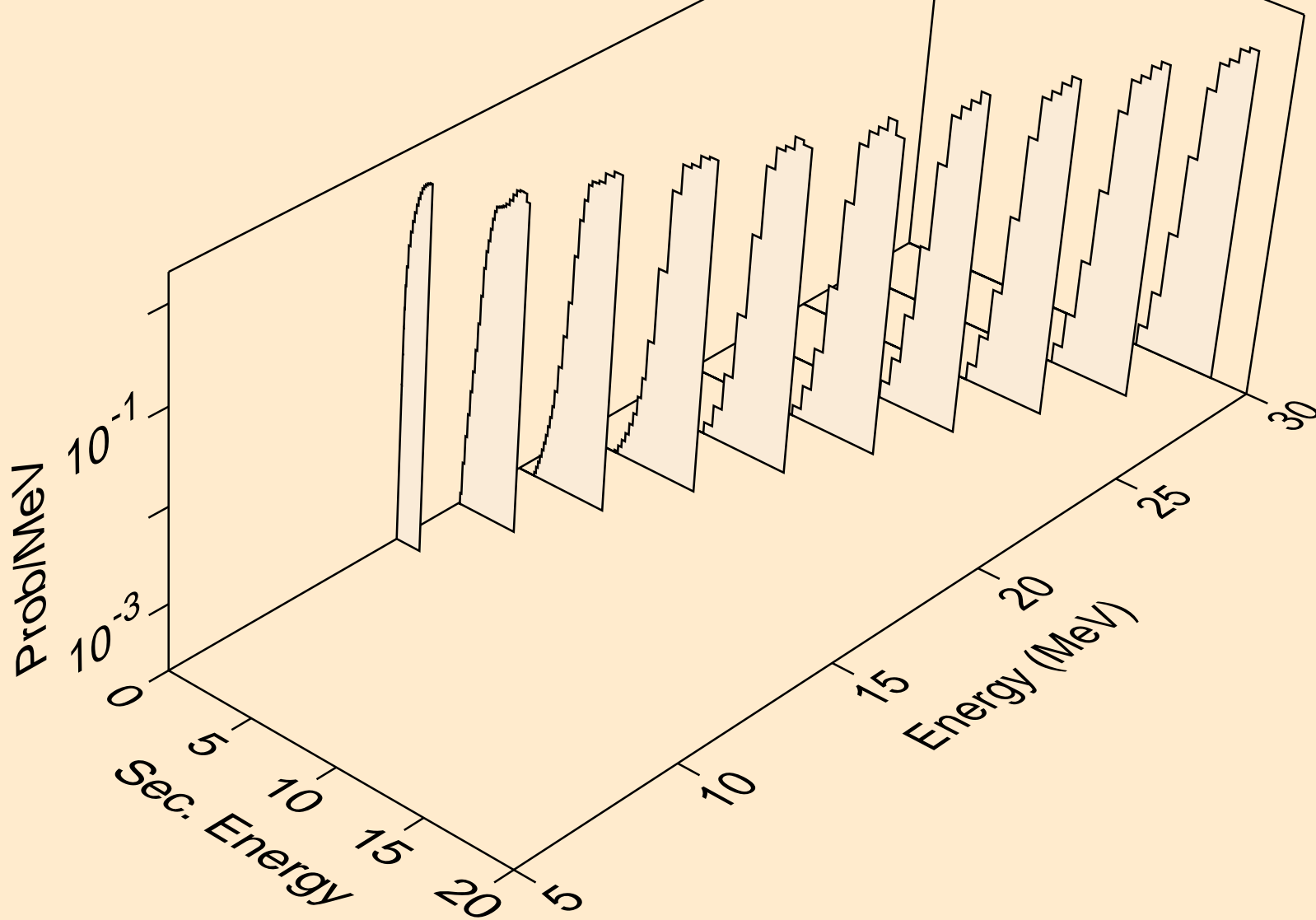

MG024 NEUTRON ACER TENDL-2019 LIBRARY; T=293.16K
Photon emission for (n,x)

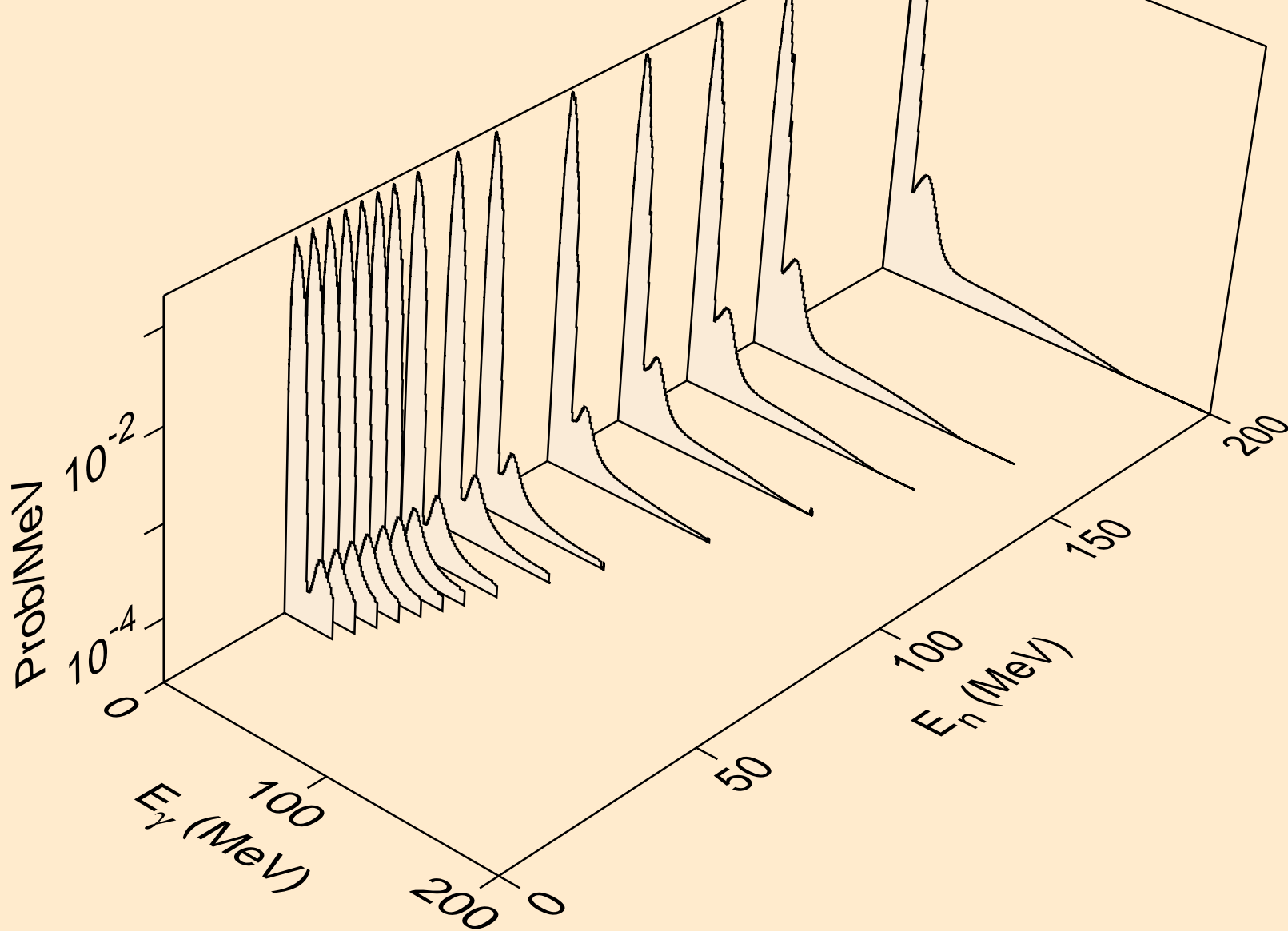

MG024 NEUTRON ACER TENDL-2019 LIBRARY; T=293.16K
Photon emission for (n,2n)

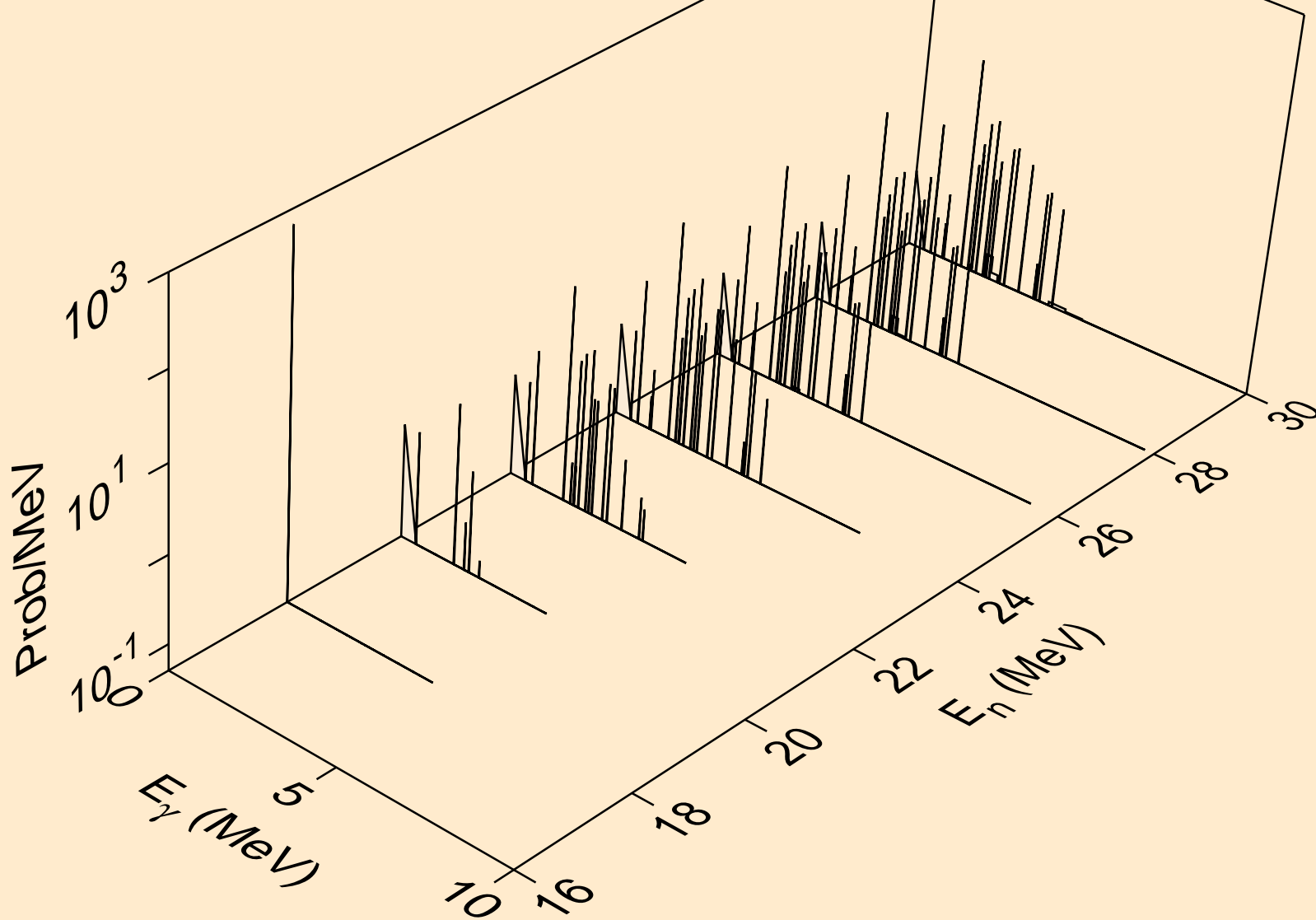

MG024 NEUTRON ACER TENDL-2019 LIBRARY; T=293.16K
Photon emission for (n,n*)a

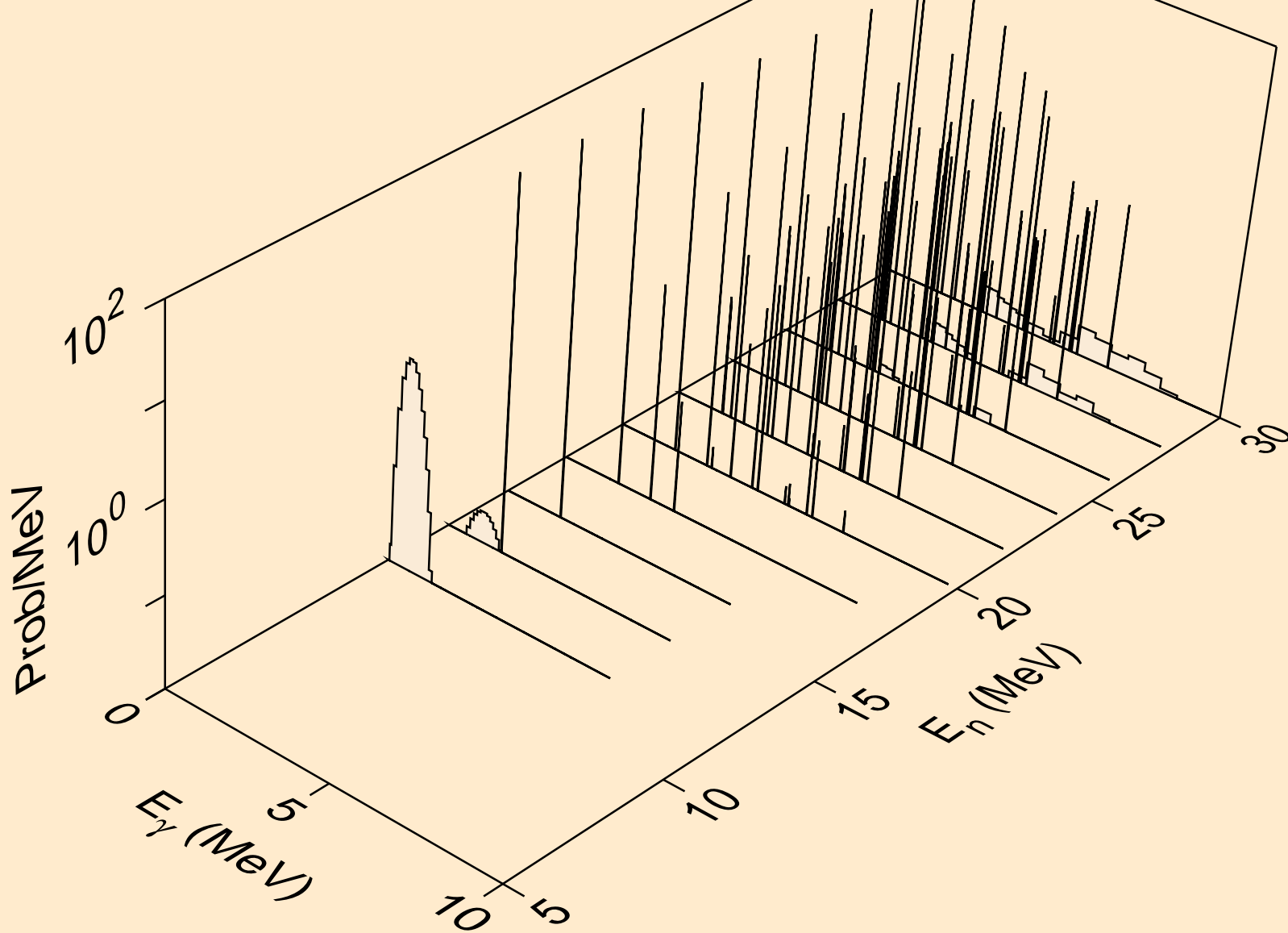

MG024 NEUTRON ACER TENDL-2019 LIBRARY; T=293.16K
Photon emission for (n,2n)a

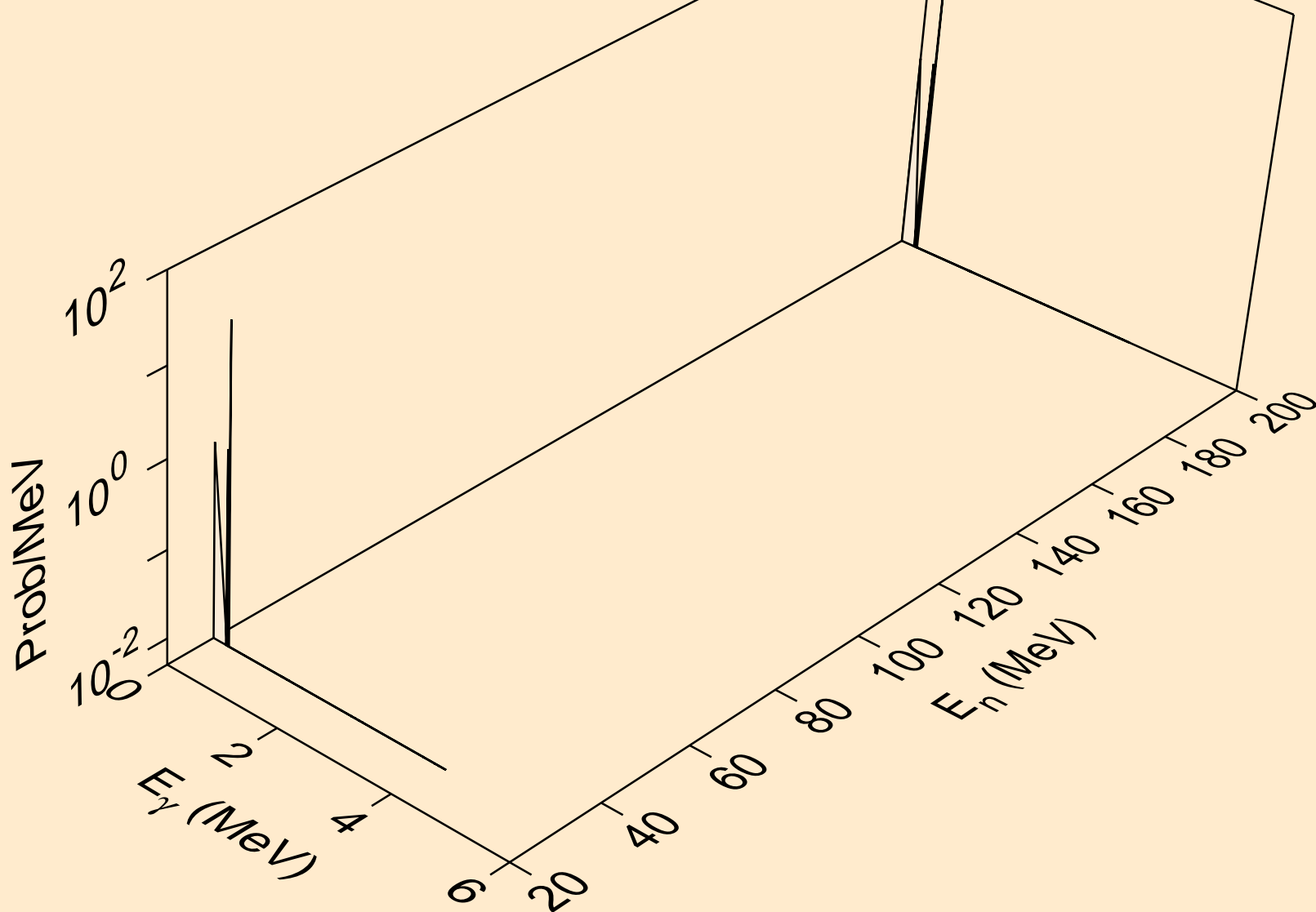

MG024 NEUTRON ACER TENDL-2019 LIBRARY; T=293.16K
Photon emission for (n,n*)p

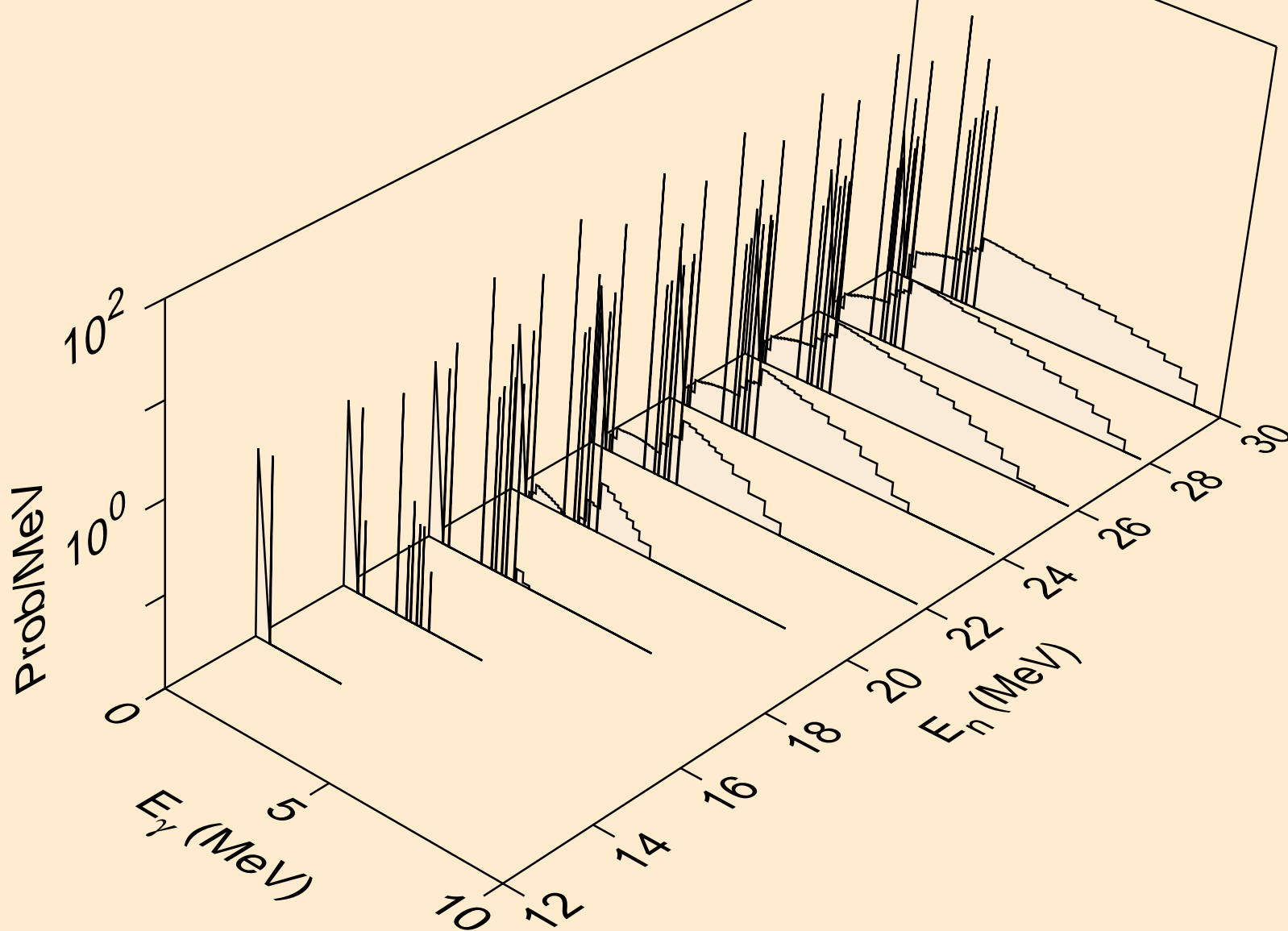

MG024 NEUTRON ACER TENDL-2019 LIBRARY; T=293.16K
Photon emission for (n,n*)2a

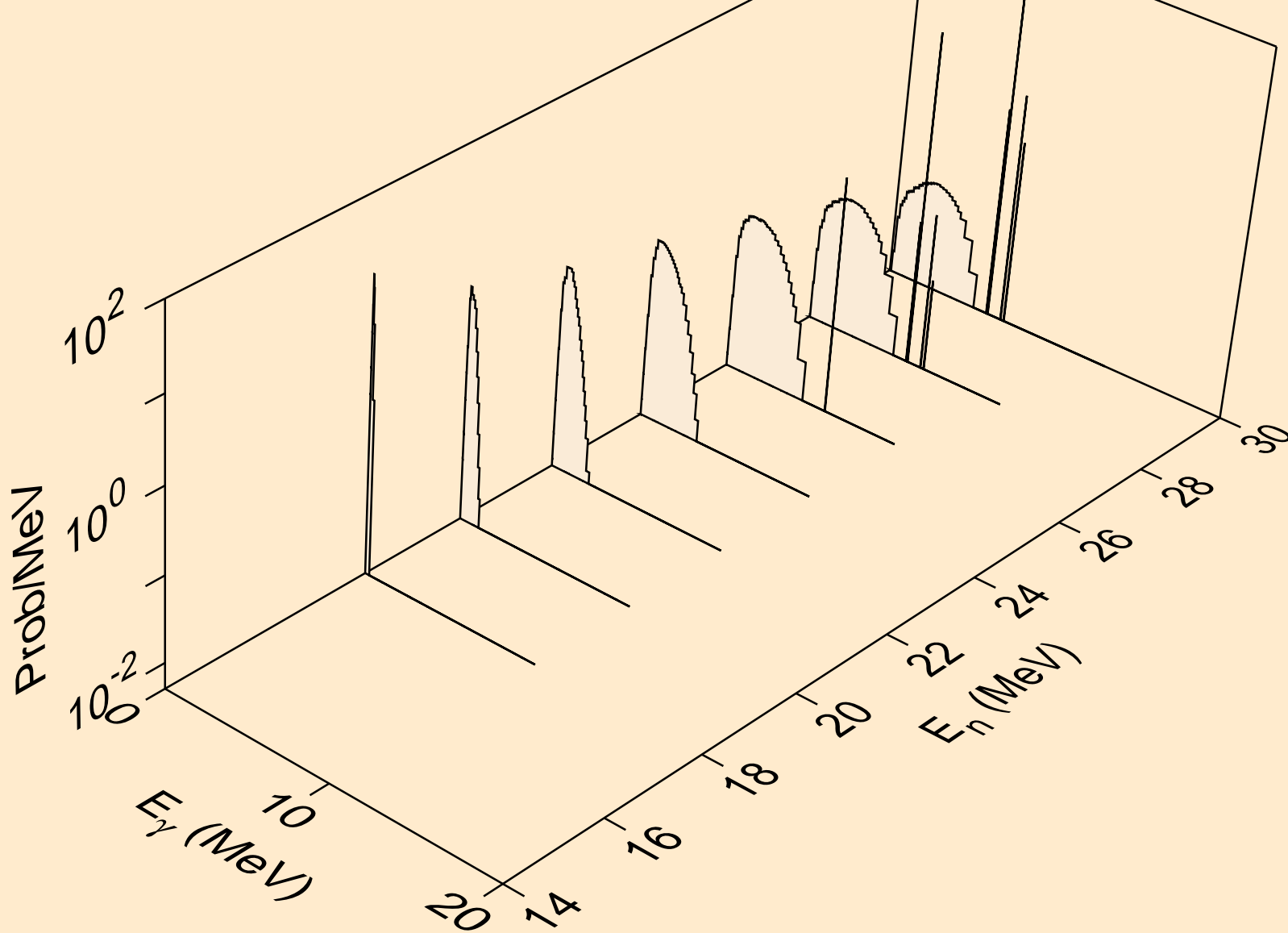

MG024 NEUTRON ACER TENDL-2019 LIBRARY; T=293.16K
Photon emission for (n,n*)d

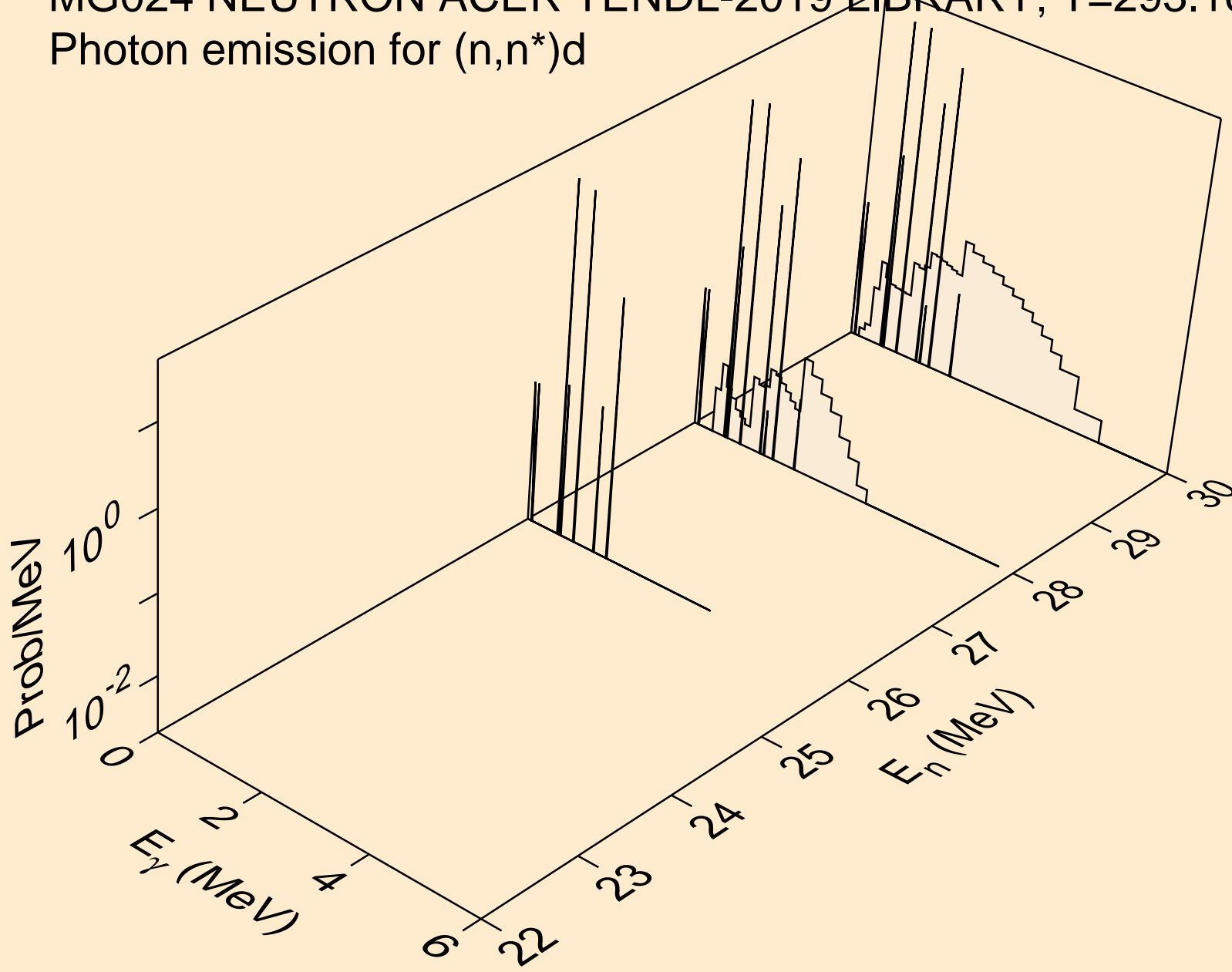

MG024 NEUTRON ACER TENDL-2019 LIBRARY; T=293.16K
Photon emission for (n,n*)t

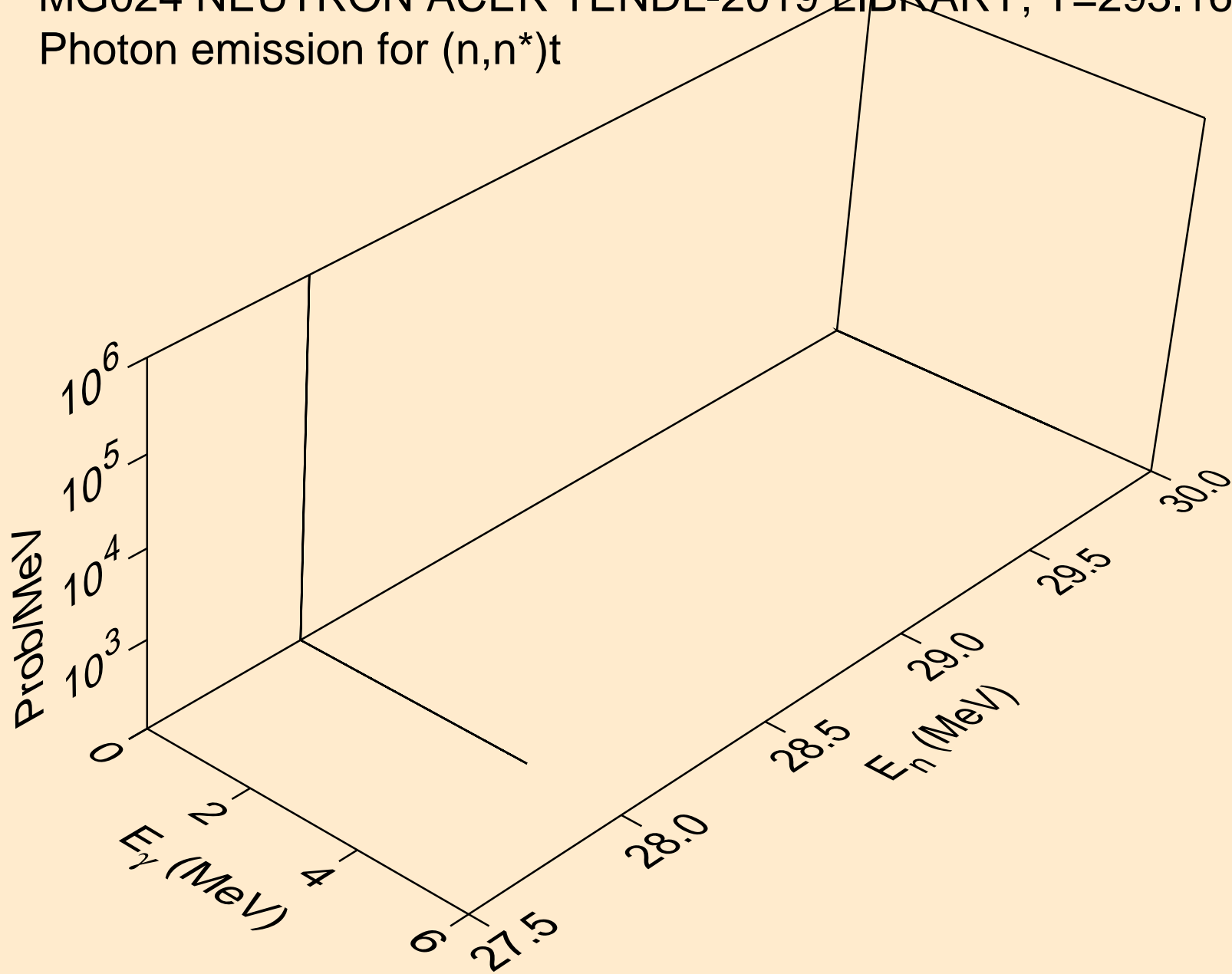

MG024 NEUTRON ACER TENDL-2019 LIBRARY; T=293.16K
Photon emission for (n,n*)he3

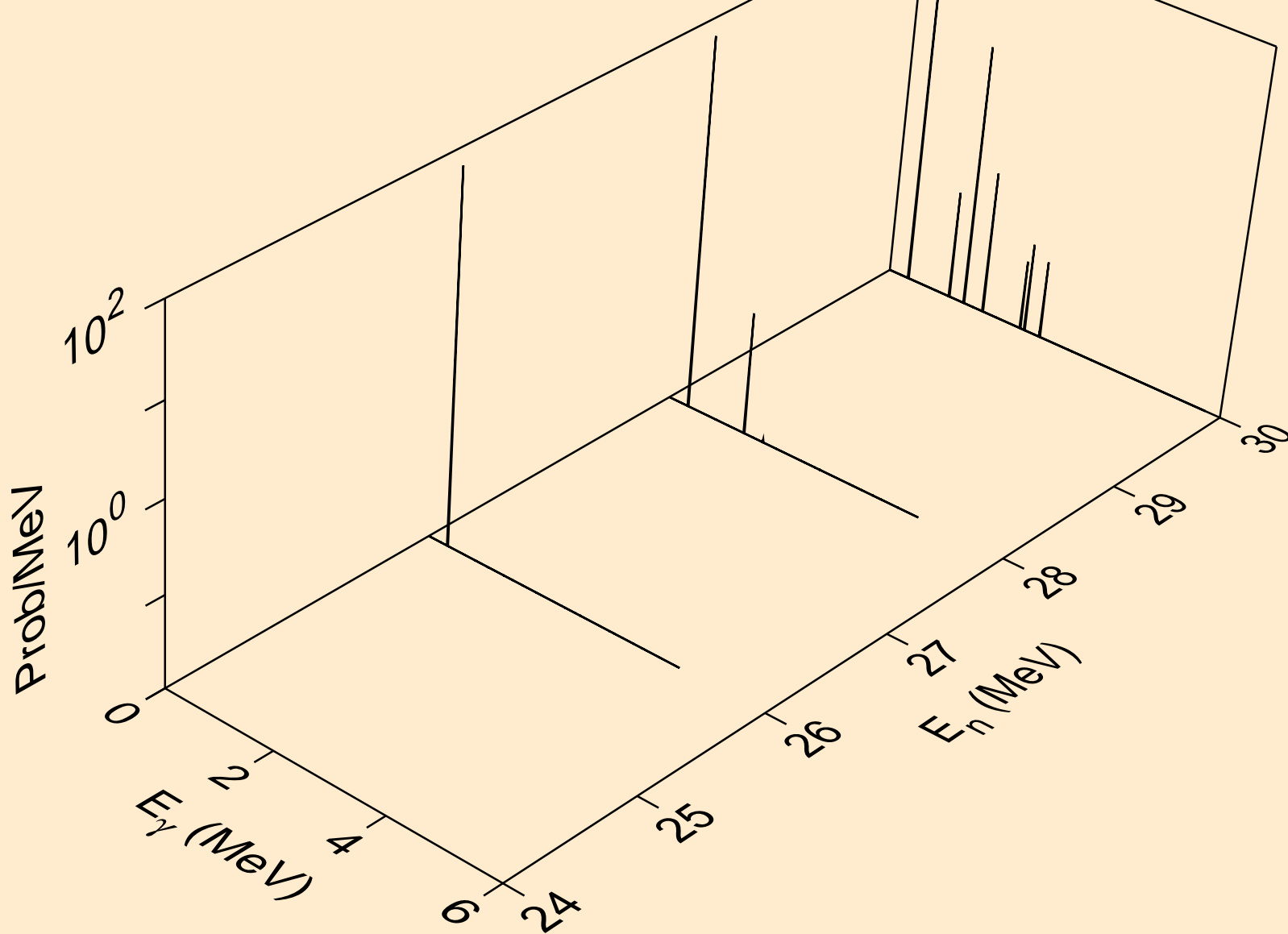

MG024 NEUTRON ACER TENDL-2019 LIBRARY; T=293.16K
Photon emission for (n,2np)

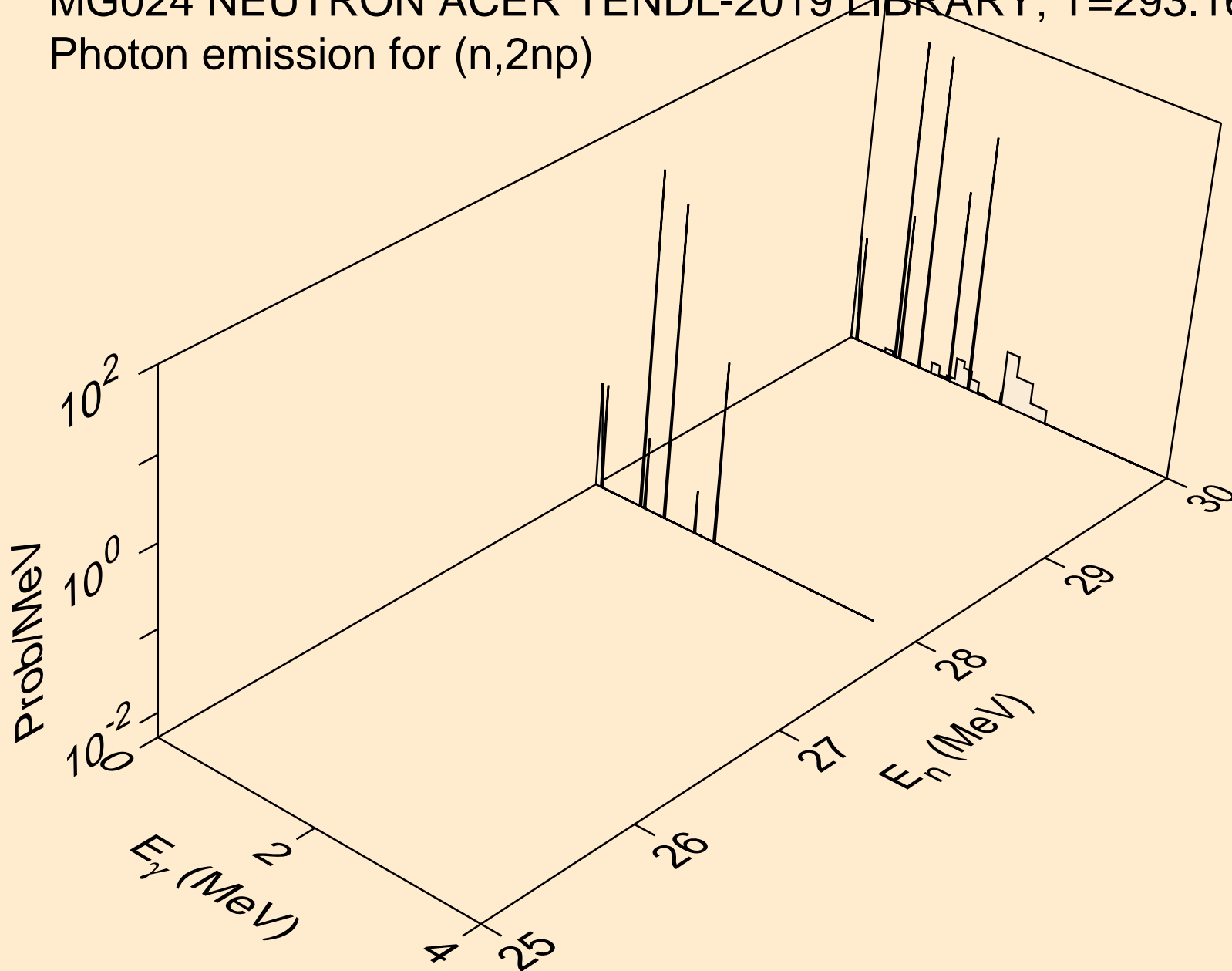

MG024 NEUTRON ACER TENDL-2019 LIBRARY; T=293.16K
Photon emission for (n,2np)

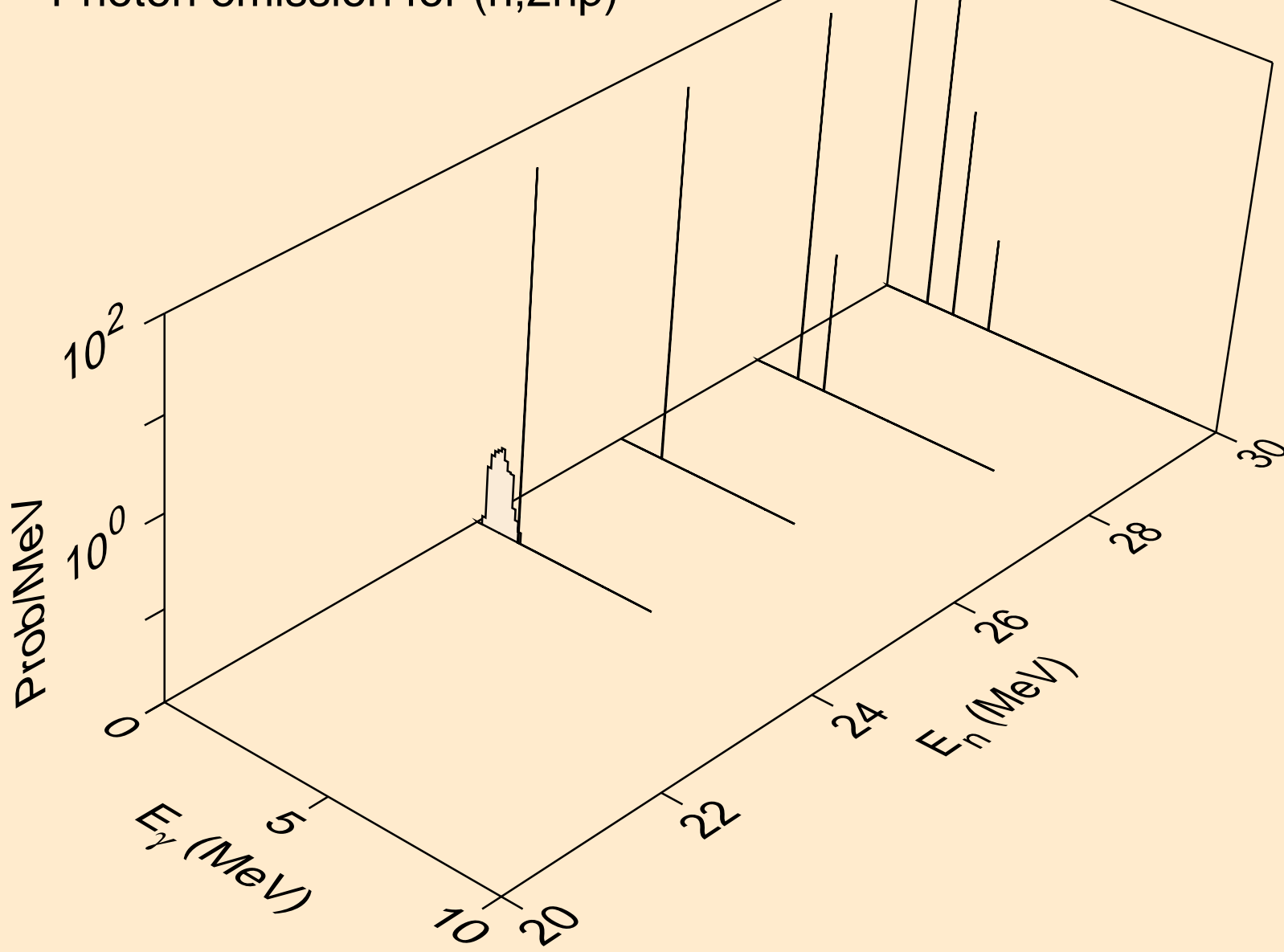

MG024 NEUTRON ACER TENDL-2019 LIBRARY; T=293.16K
Photon emission for (n,npa)

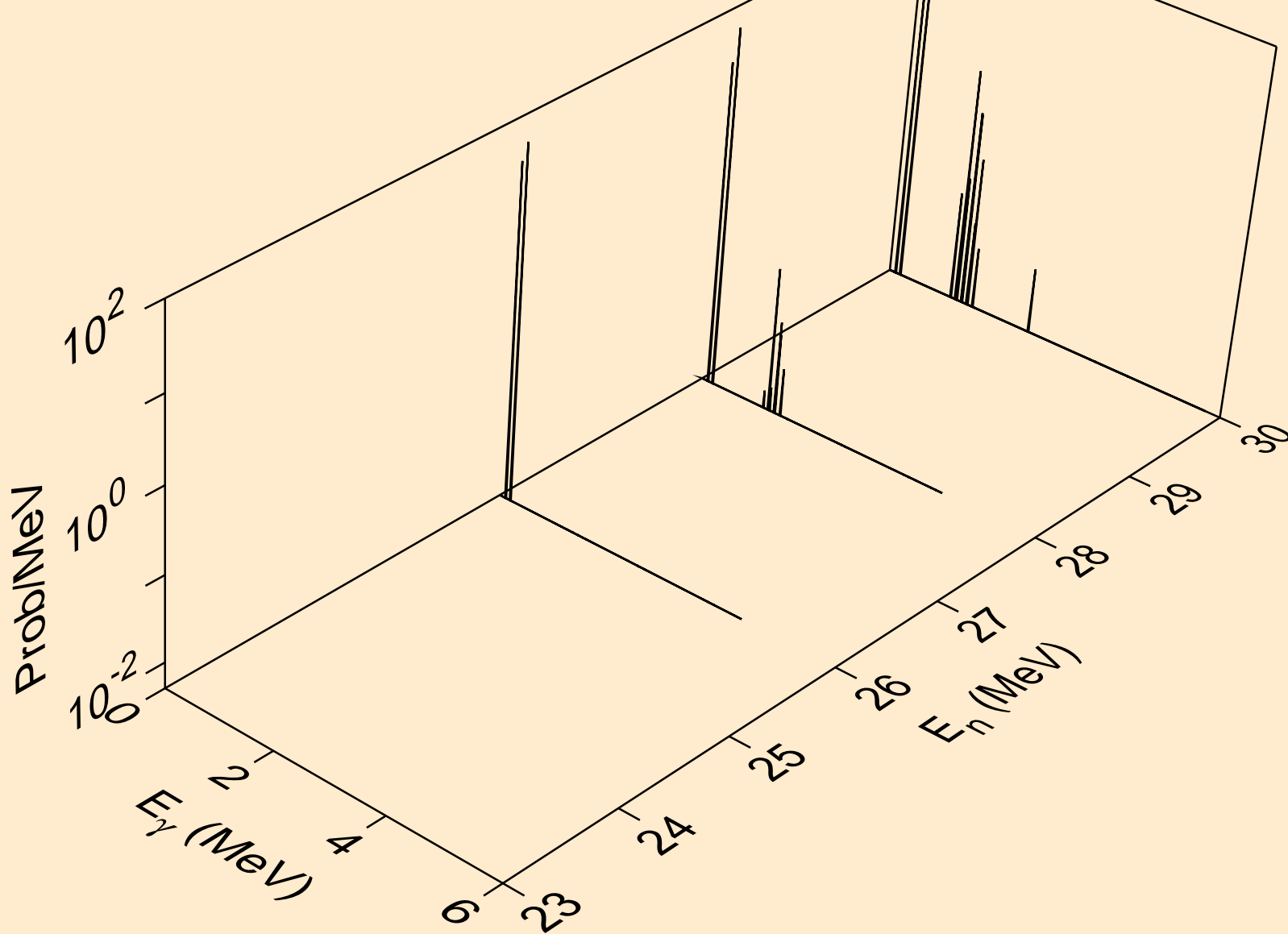

MG024 NEUTRON ACER TENDL-2019 LIBRARY; T=293.16K
Photon emission for (n,n*c)

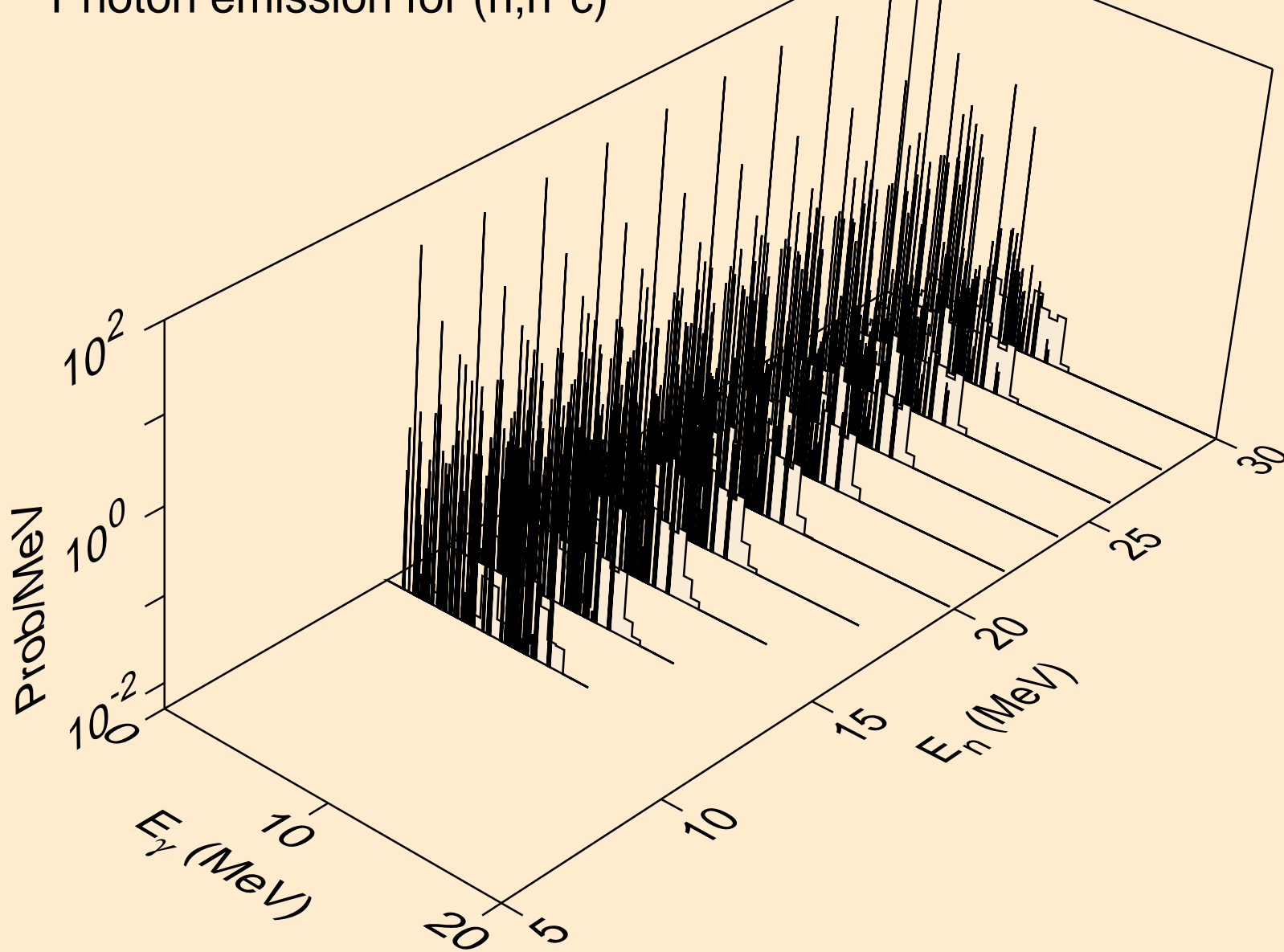

MG024 NEUTRON ACER TENDL-2019 LIBRARY; T=293.16K
Photon emission for (n,gma)

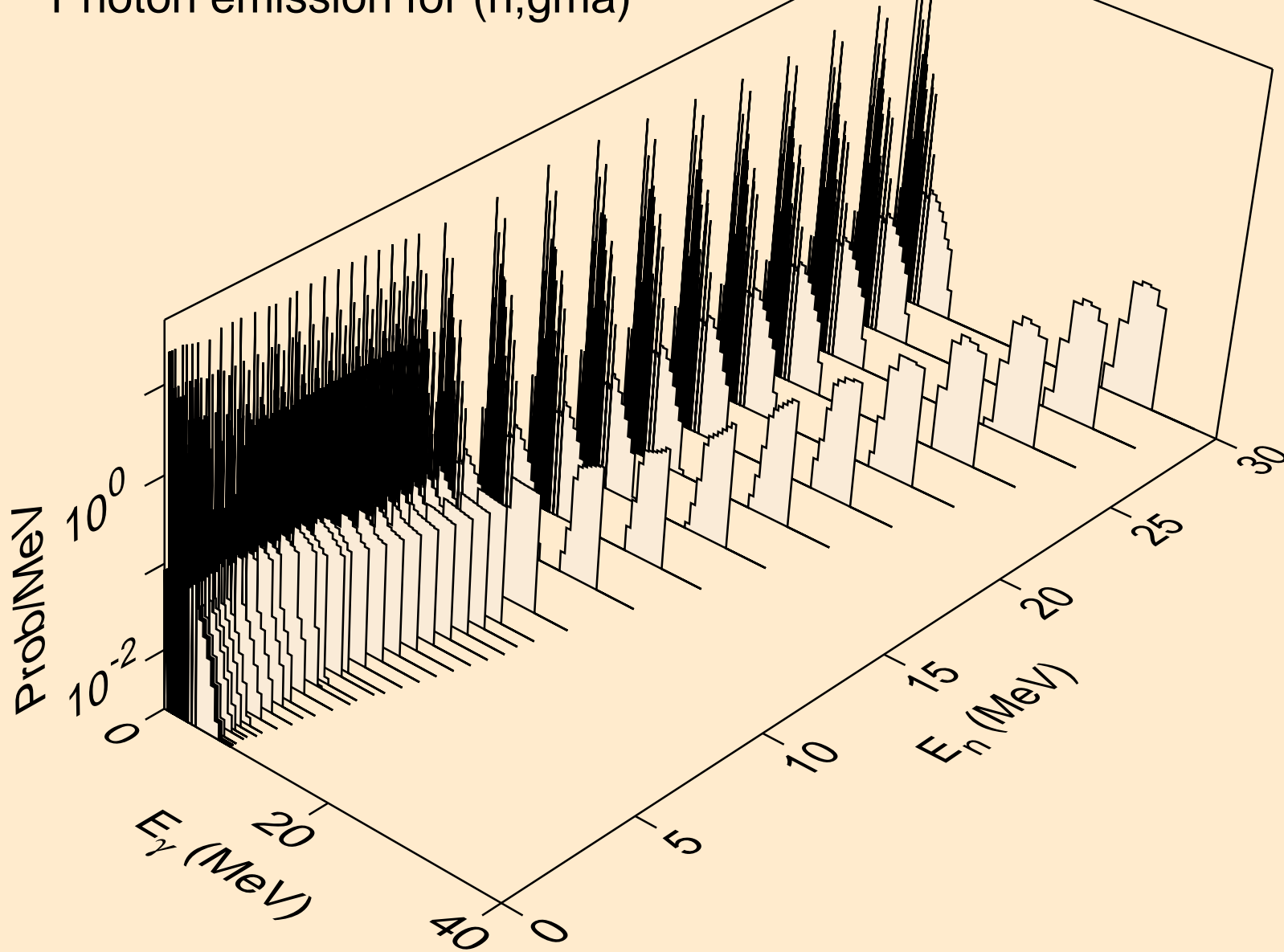

MG024 NEUTRON ACER TENDL-2019 LIBRARY; T=293.16K
Photon emission for (n,p)

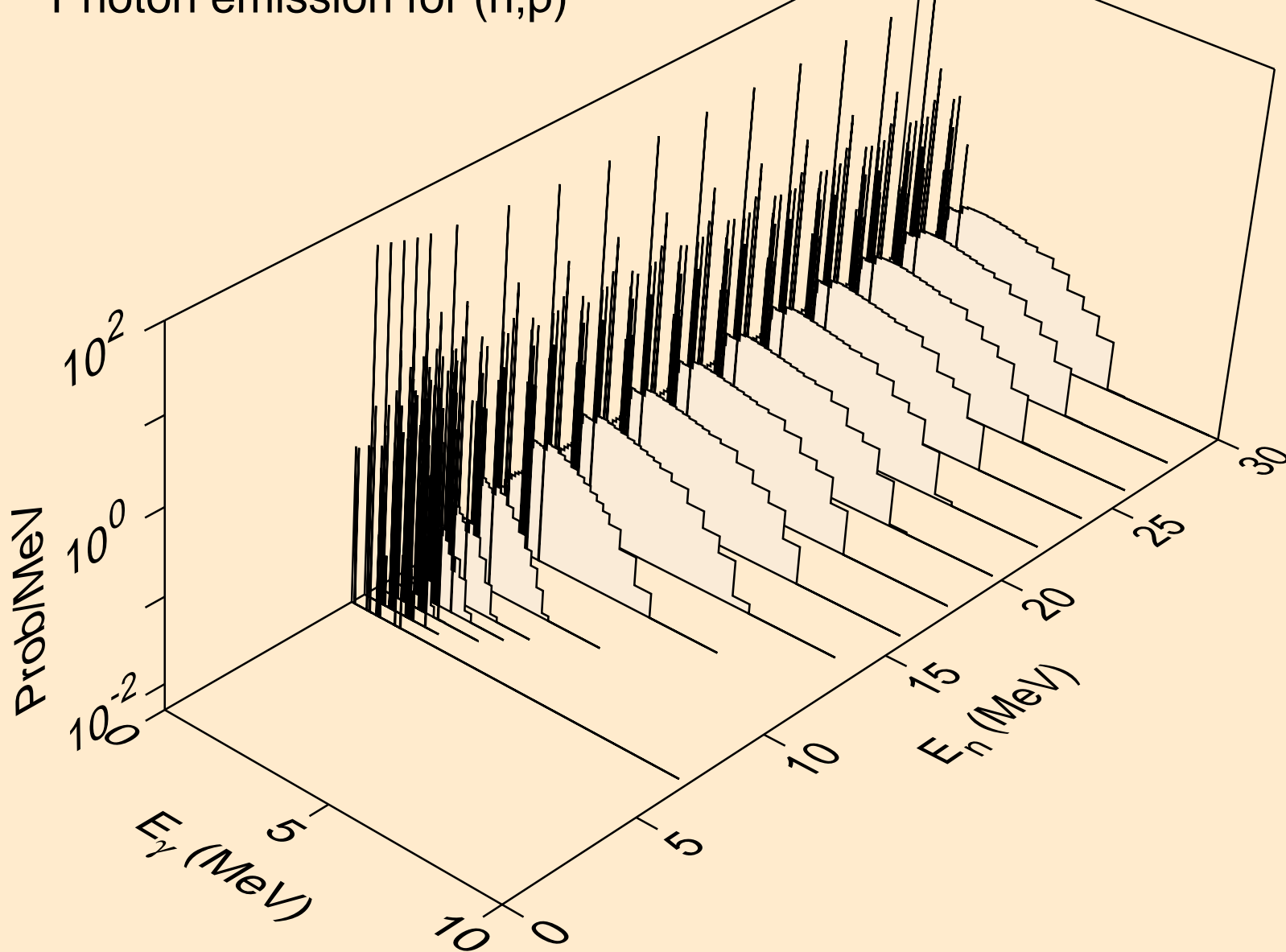

MG024 NEUTRON ACER TENDL-2019 LIBRARY; T=293.16K
Photon emission for (n,d)

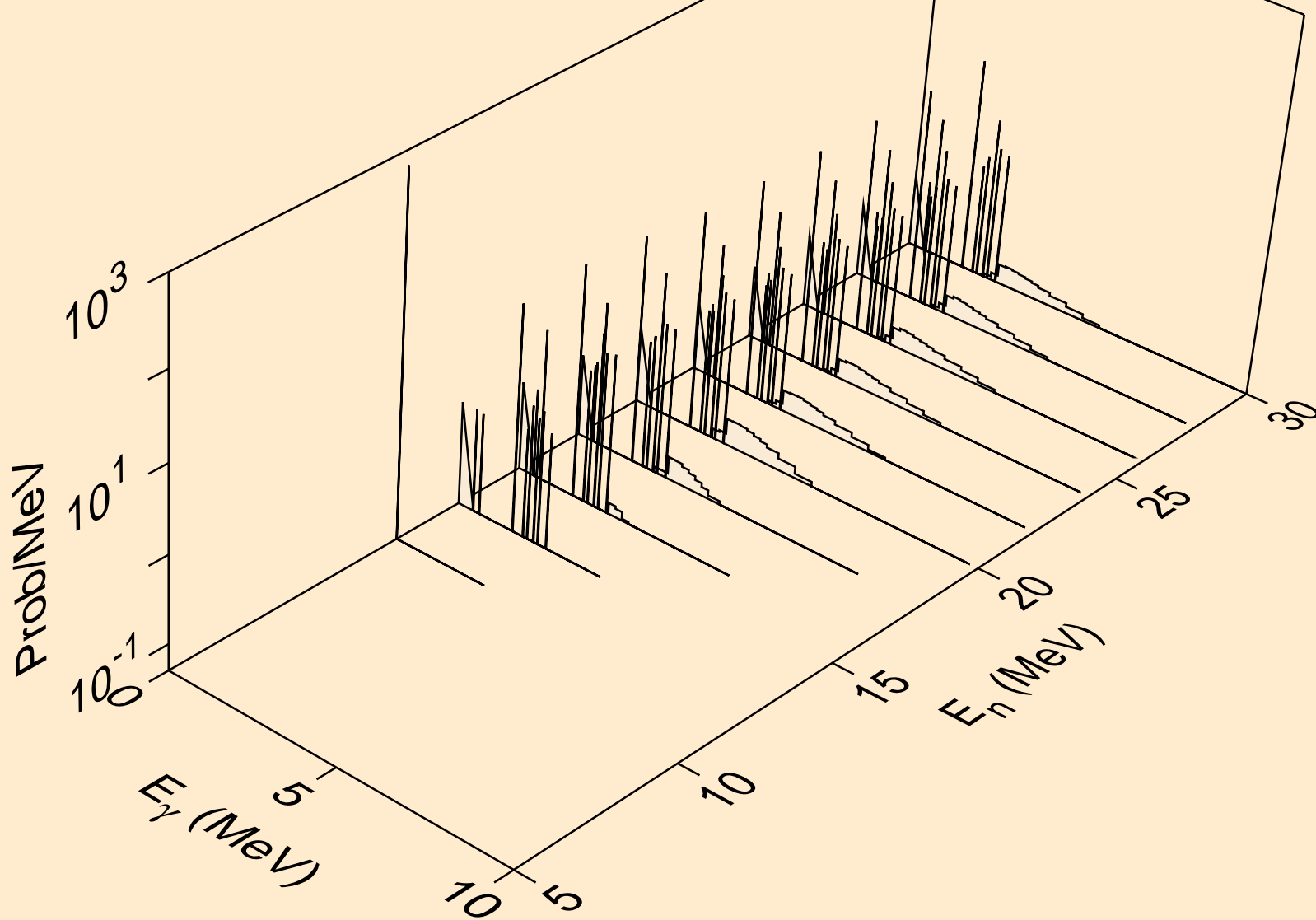

MG024 NEUTRON ACER TENDL-2019 LIBRARY; T=293.16K
Photon emission for (n,t)

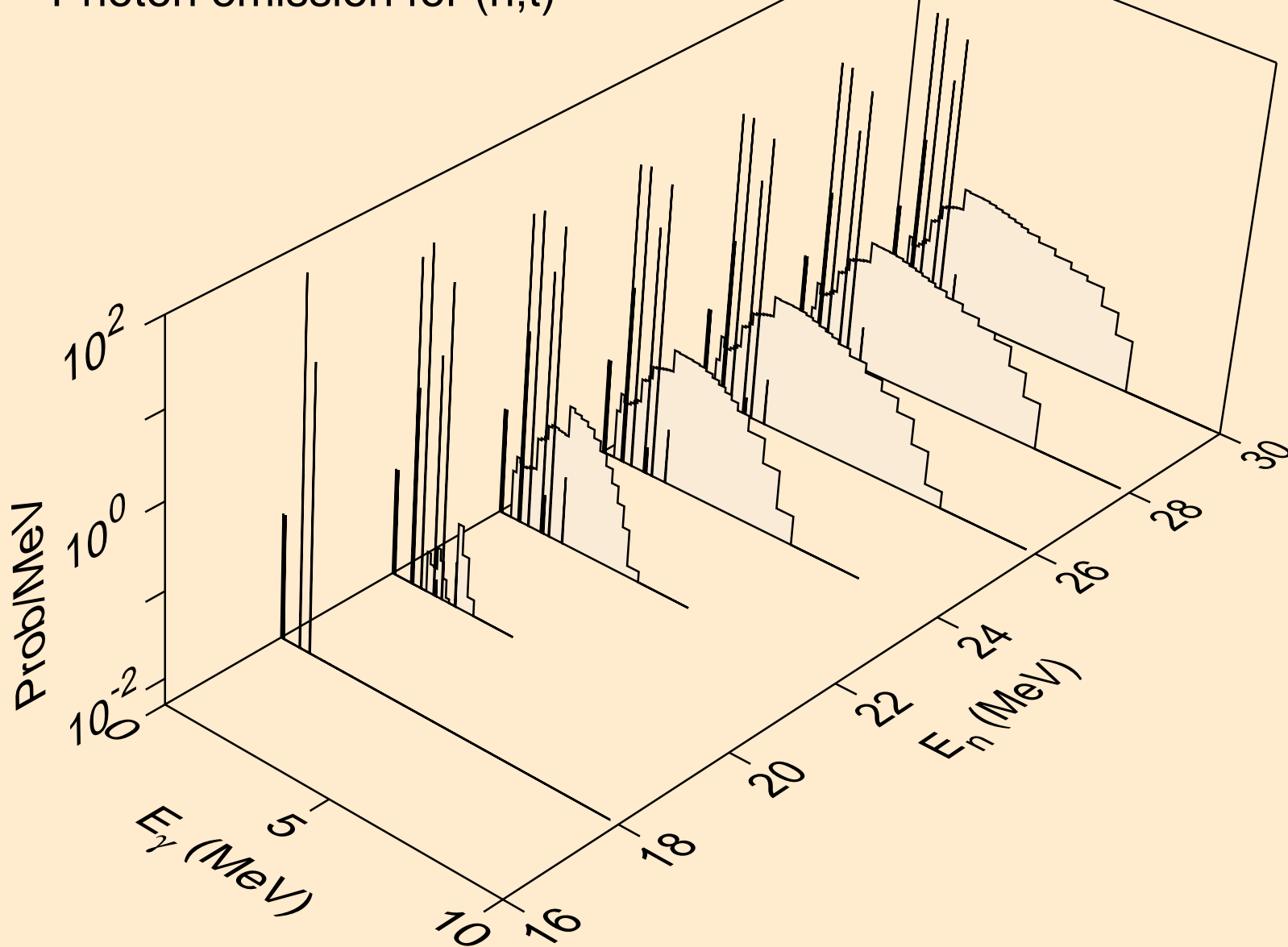

MG024 NEUTRON ACER TENDL-2019 LIBRARY; T=293.16K
Photon emission for (n,he3)

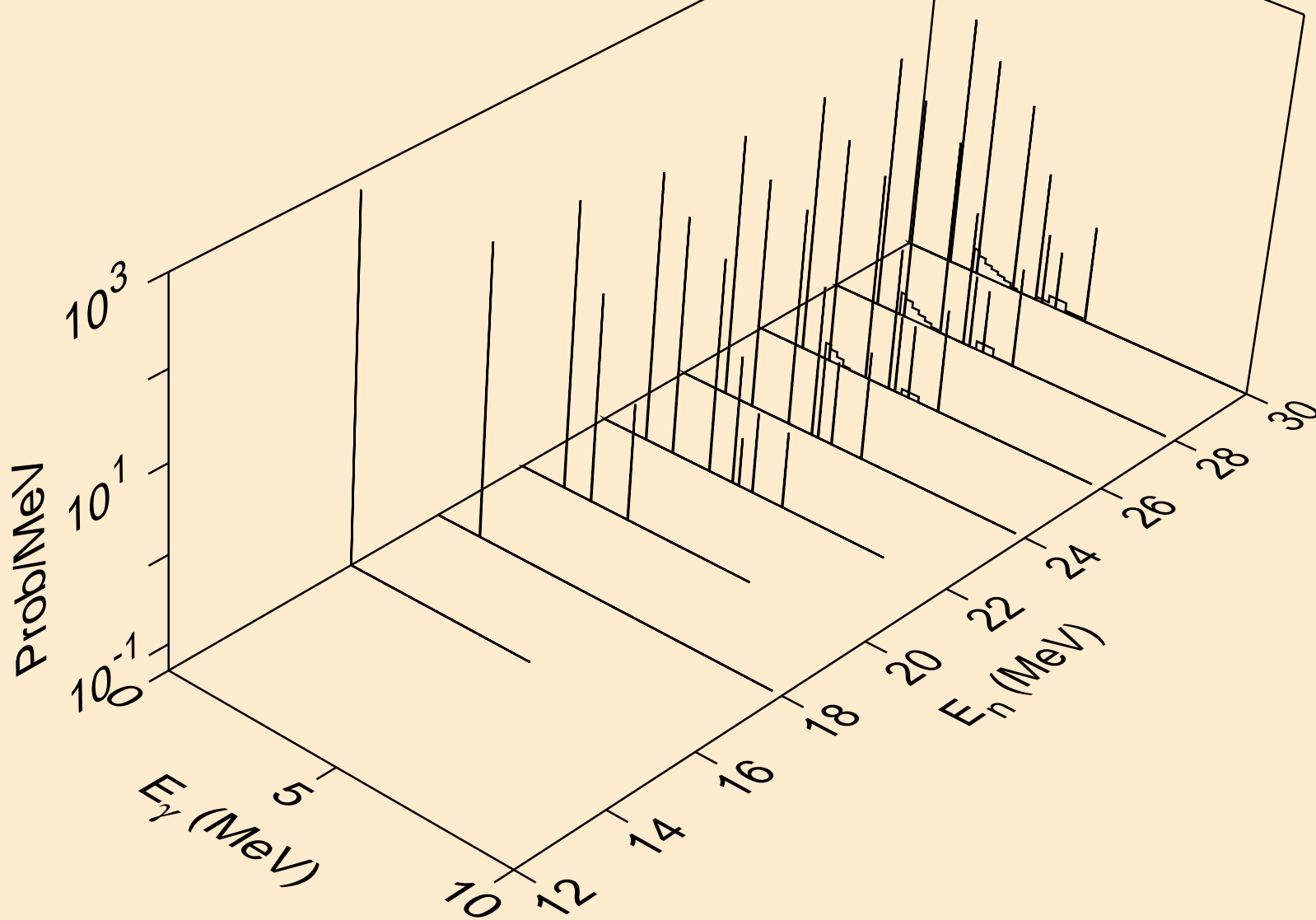

MG024 NEUTRON ACER TENDL-2019 LIBRARY; T=293.16K
Photon emission for (n,a)

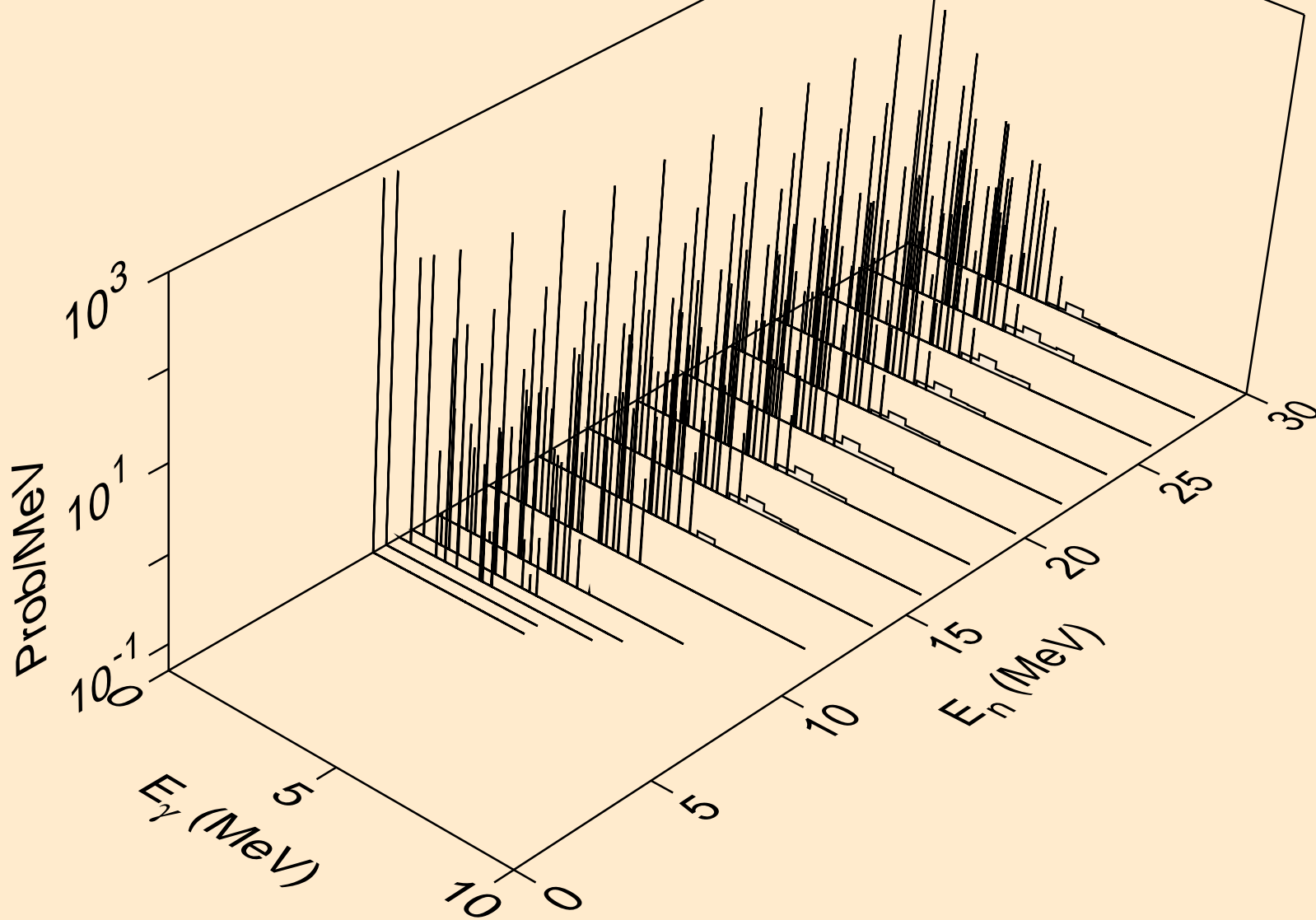

MG024 NEUTRON ACER TENDL-2019 LIBRARY; T=293.16K
Photon emission for (n,2a)

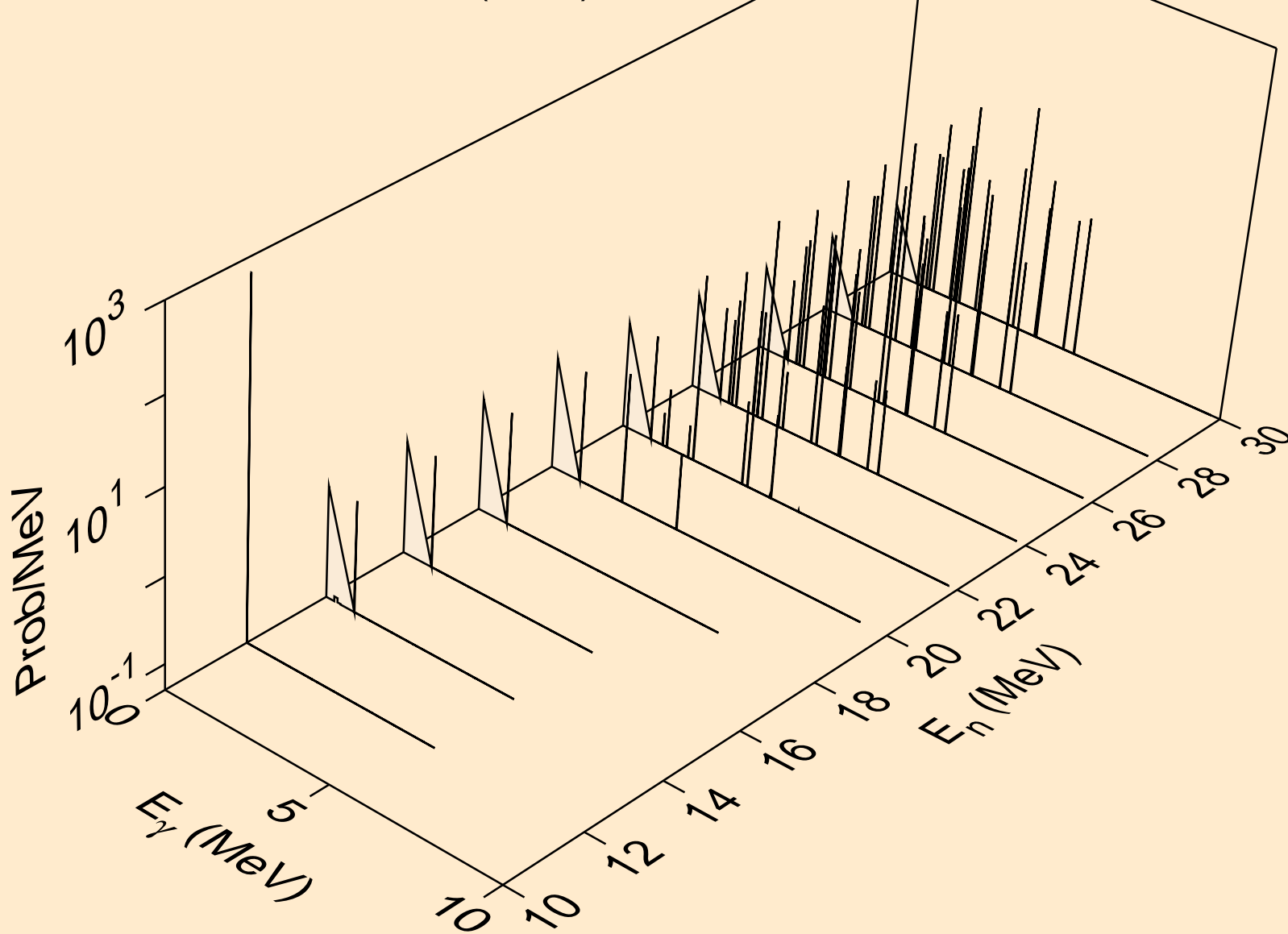

MG024 NEUTRON ACER TENDL-2019 LIBRARY; T=293.16K
Photon emission for (n,3a)

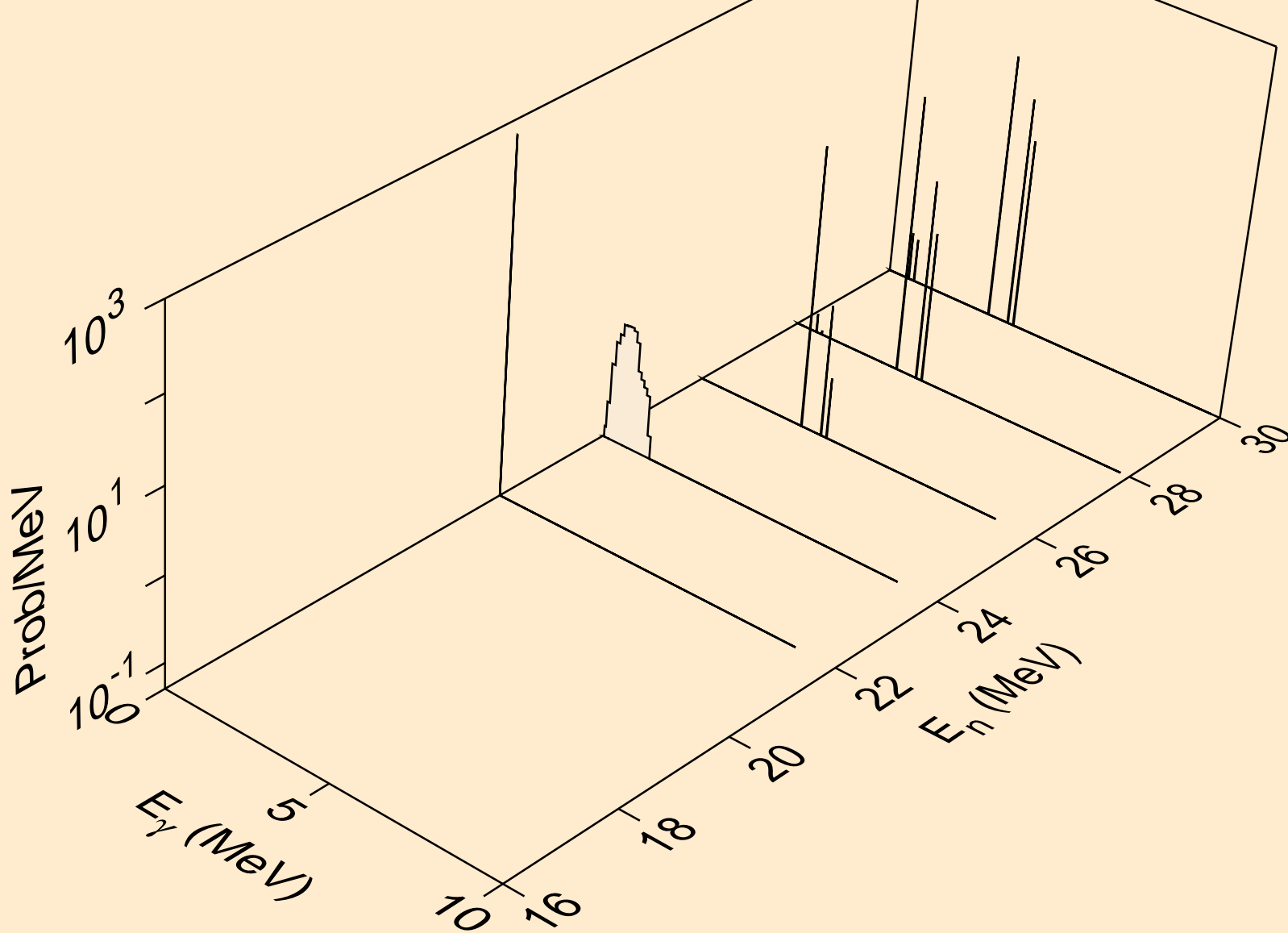

MG024 NEUTRON ACER TENDL-2019 LIBRARY; T=293.16K
Photon emission for (n,2p)

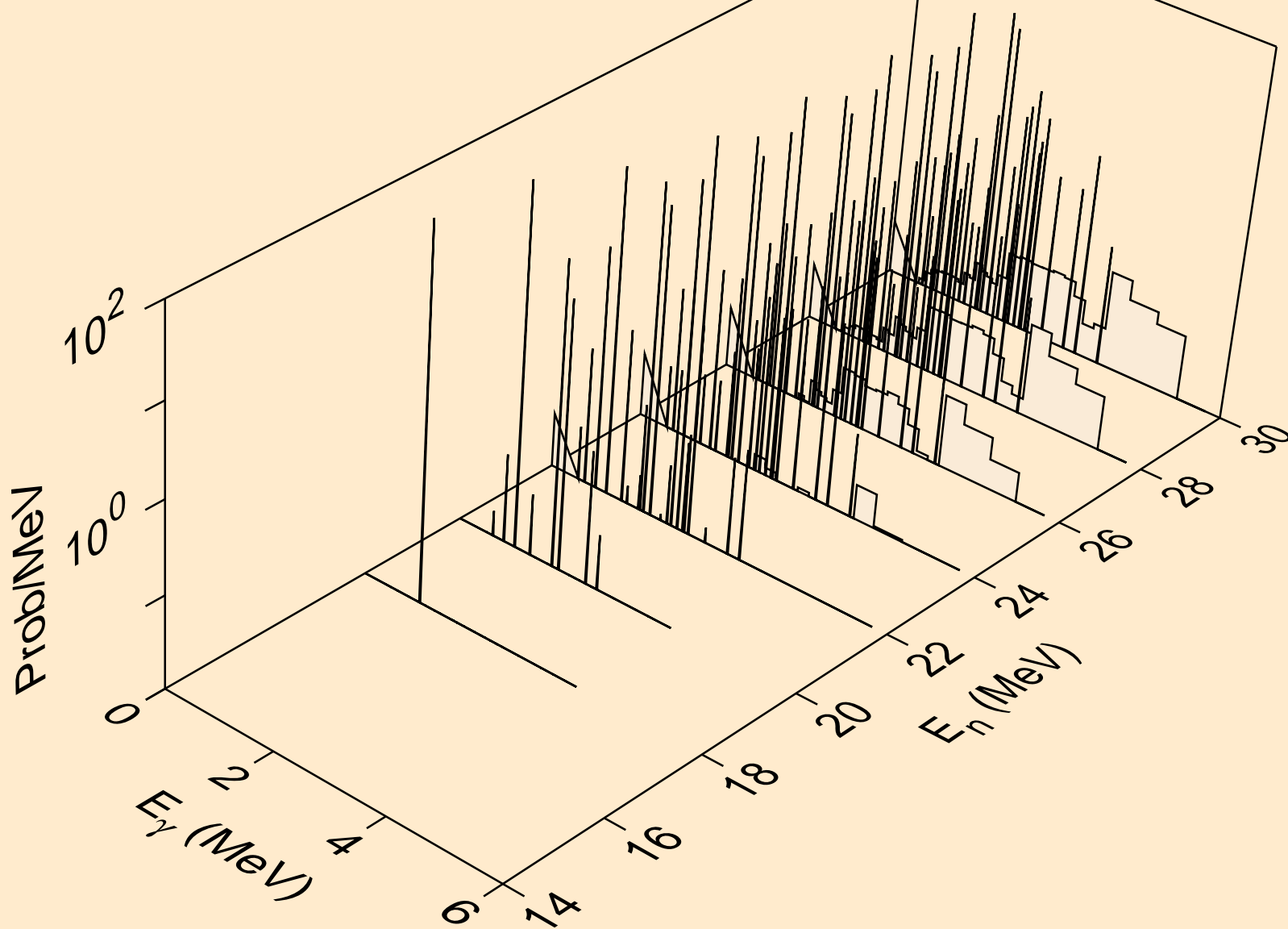

MG024 NEUTRON ACER TENDL-2019 LIBRARY; T=293.16K
Photon emission for (n,p α)

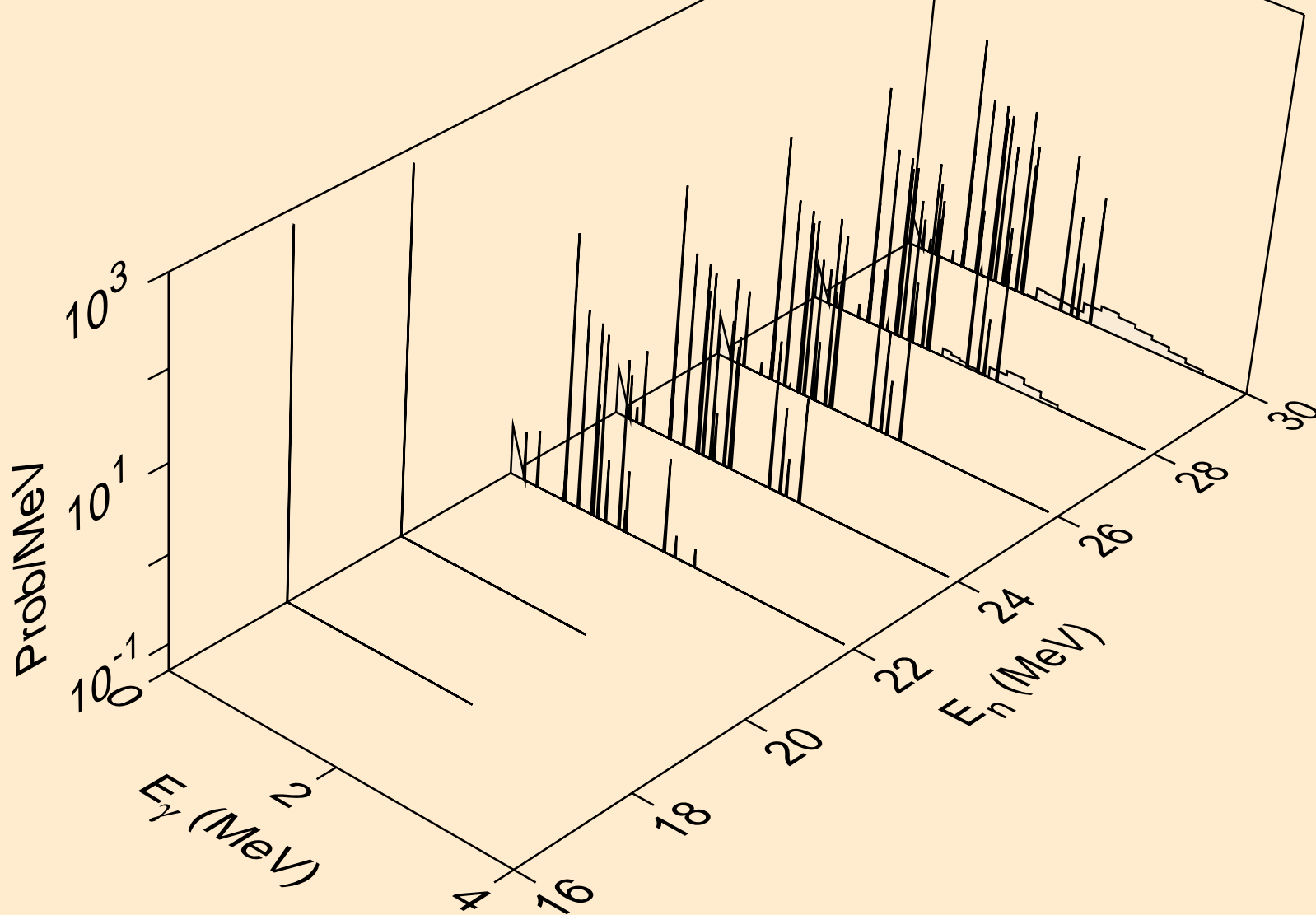

MG024 NEUTRON ACER TENDL-2019 LIBRARY; T=293.16K
Photon emission for (n,d2a)

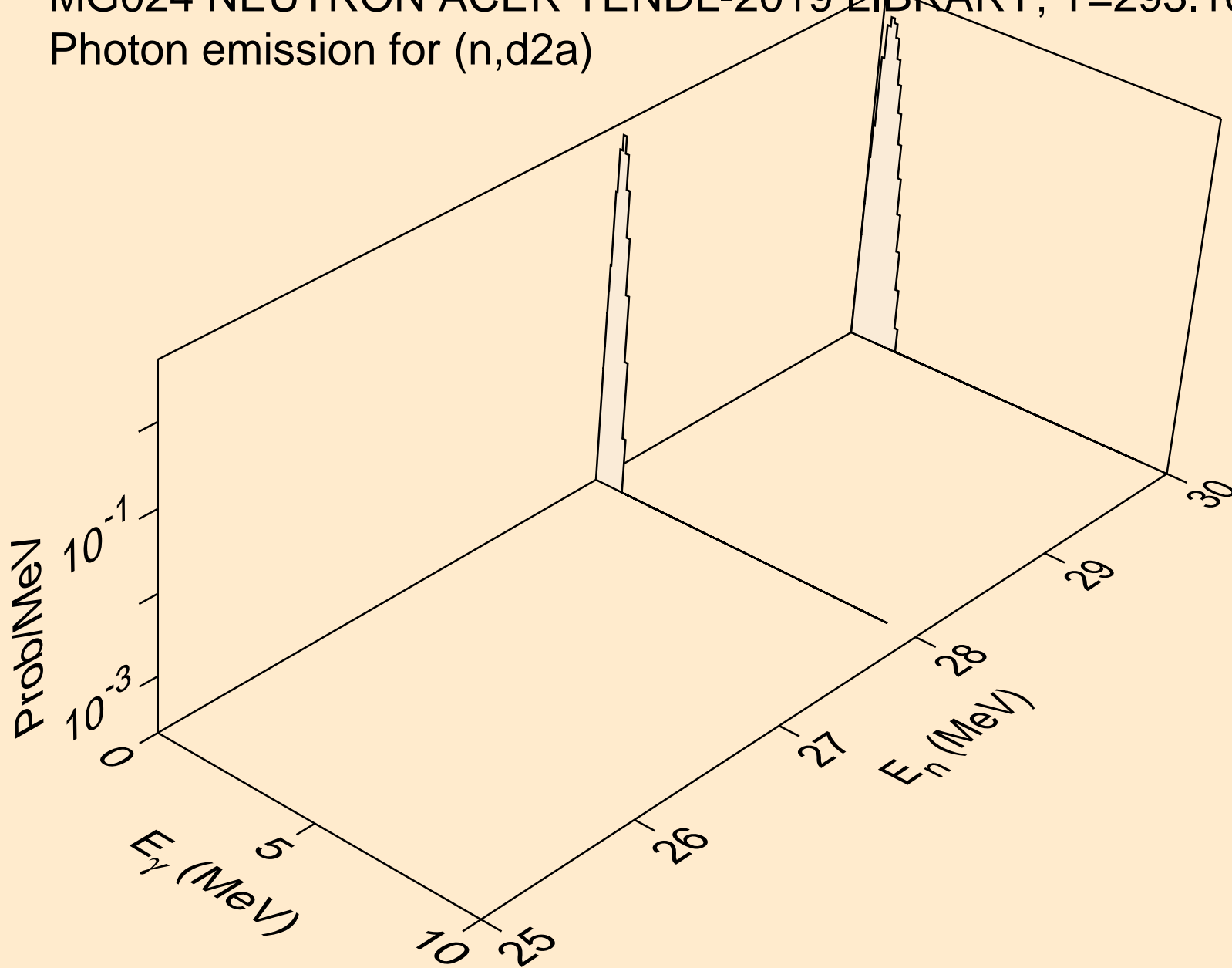

MG024 NEUTRON ACER TENDL-2019 LIBRARY; T=293.16K
Photon emission for (n,pd)

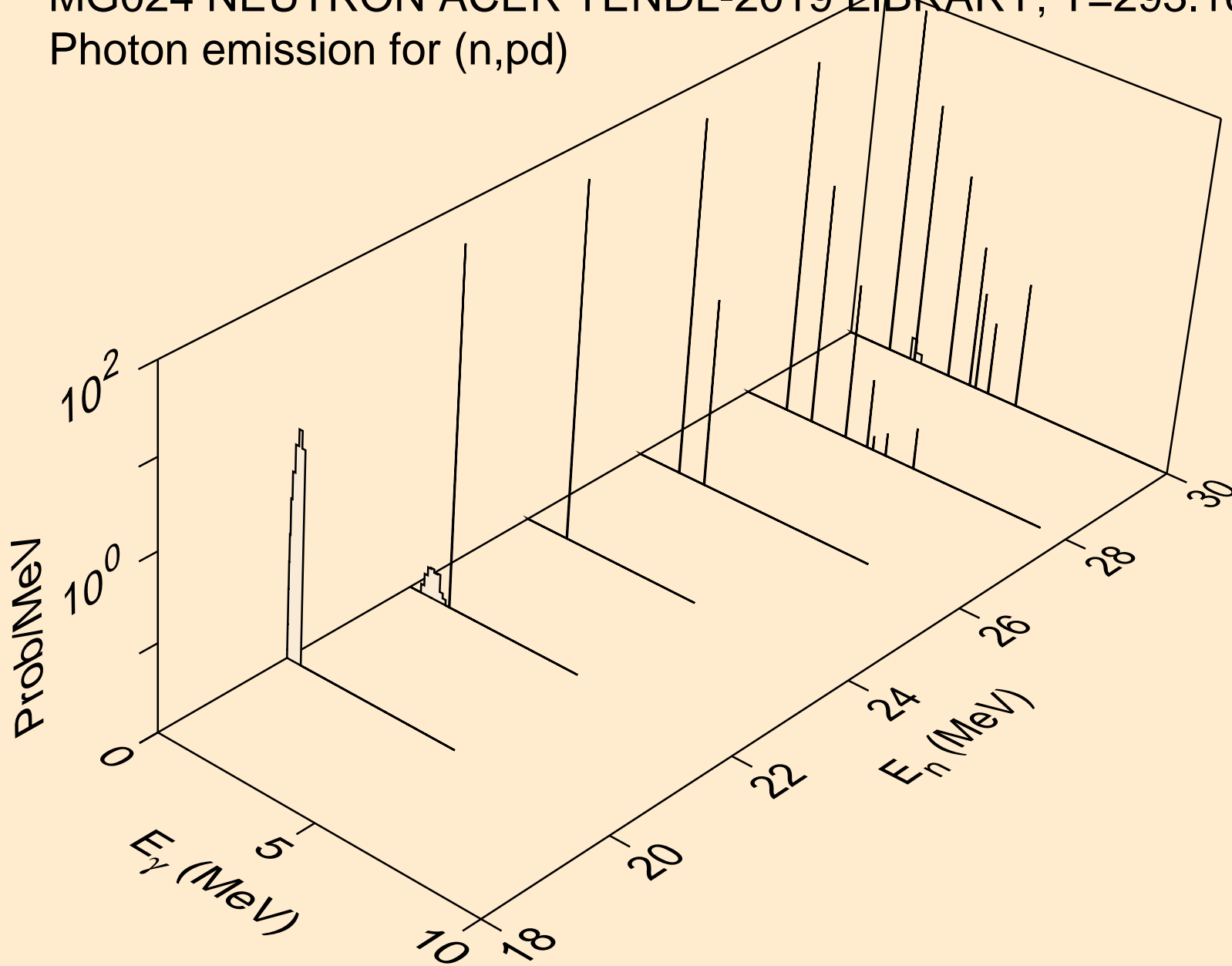

MG024 NEUTRON ACER TENDL-2019 LIBRARY; T=293.16K
Photon emission for (n,pt)

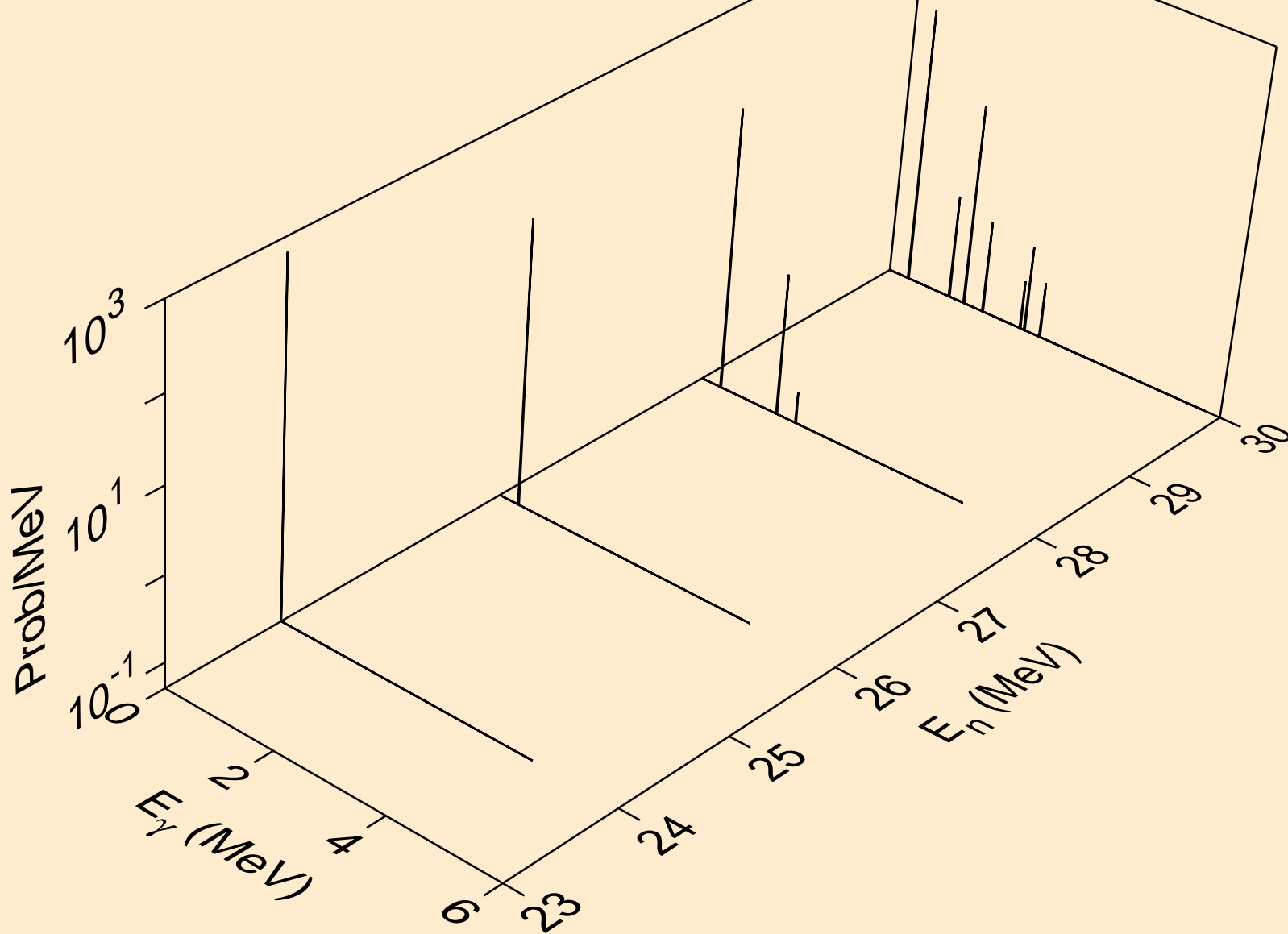

MG024 NEUTRON ACER TENDL-2019 LIBRARY; T=293.16K
Photon emission for (n,da)

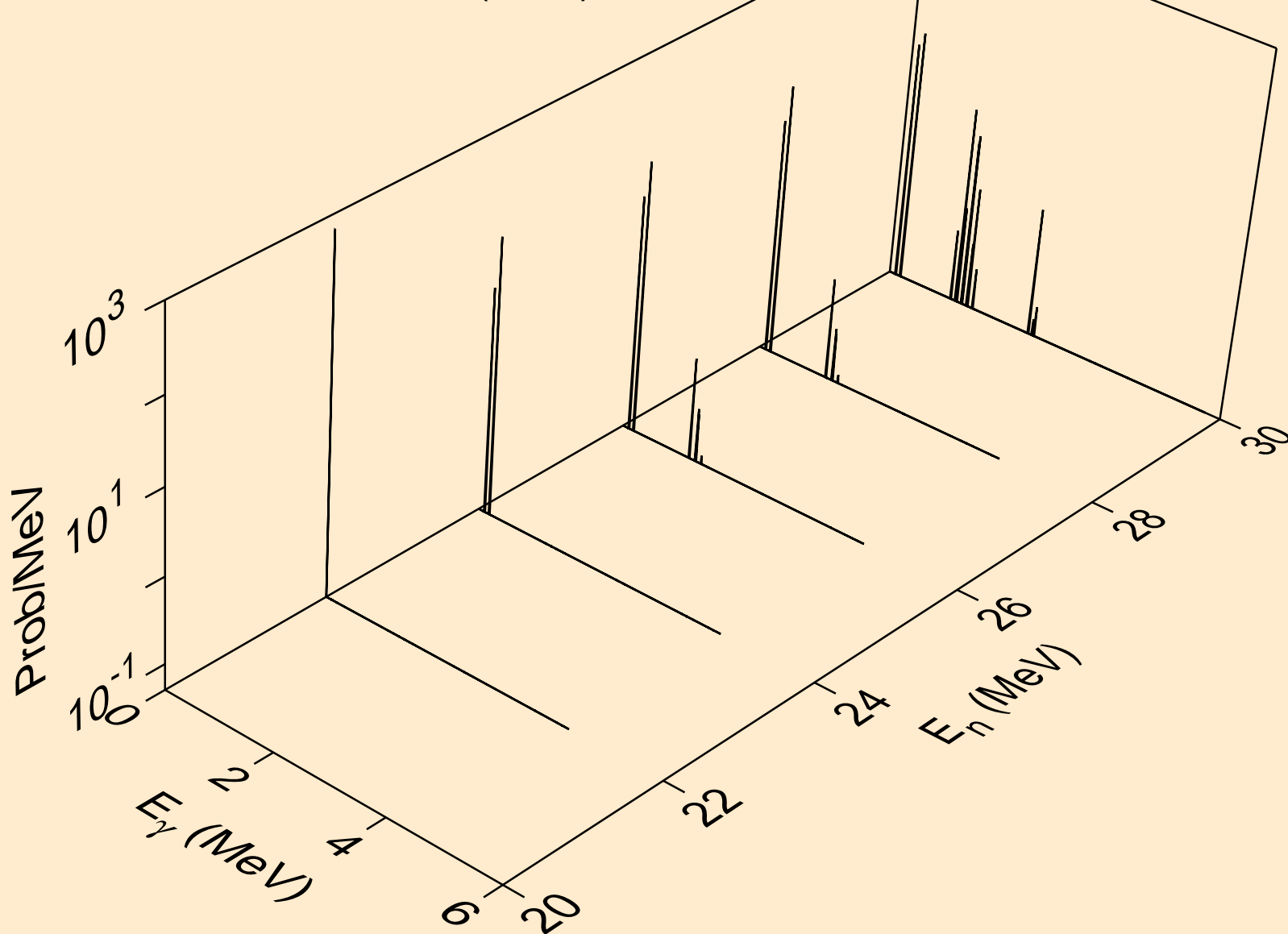

MG024 NEUTRON ACER TENDL-2019 LIBRARY; T=293.16K
thermal capture photon spectrum

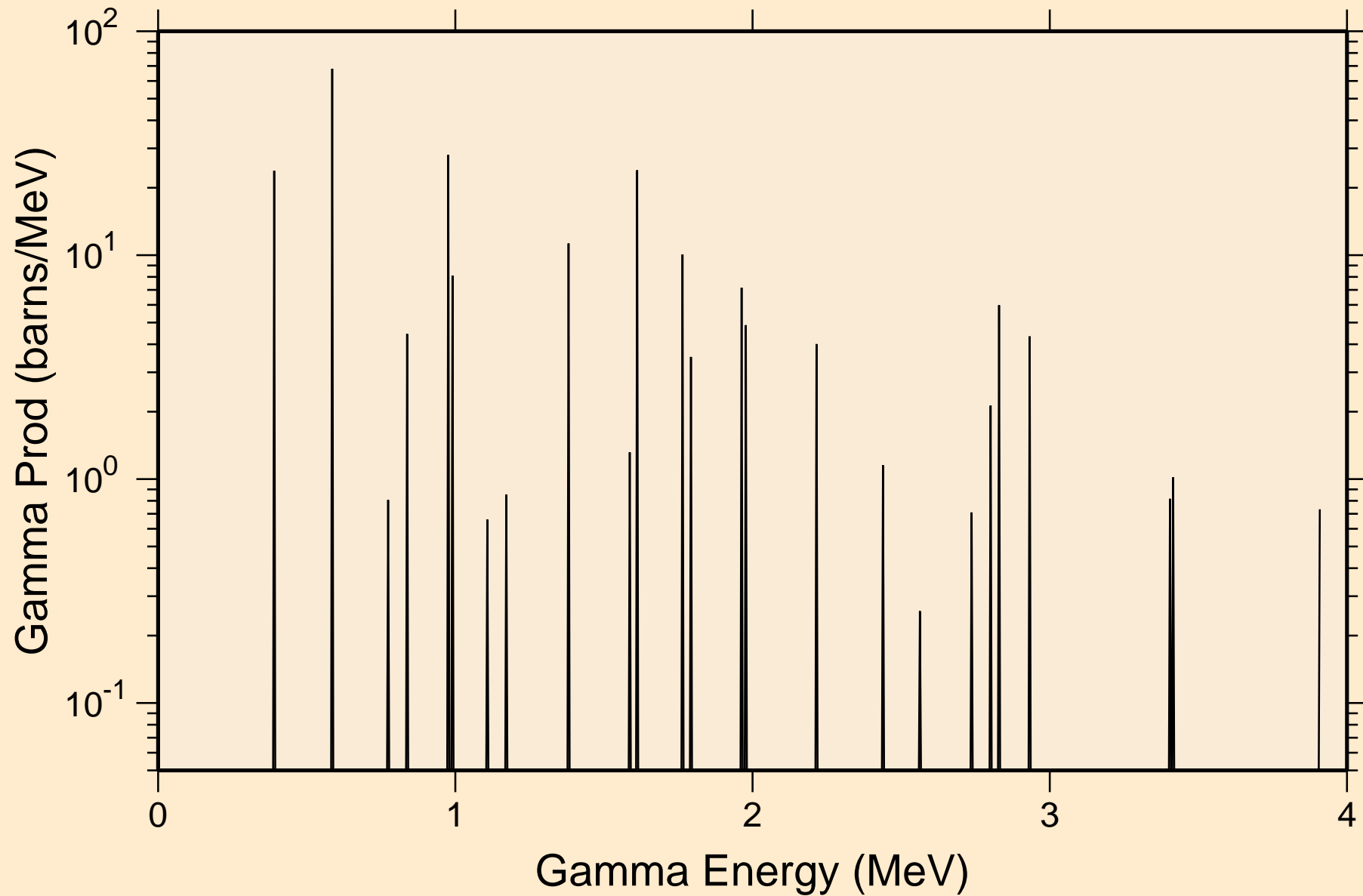

MG024 NEUTRON ACER TENDL-2019 LIBRARY; T=293.16K
14 MeV photon spectrum

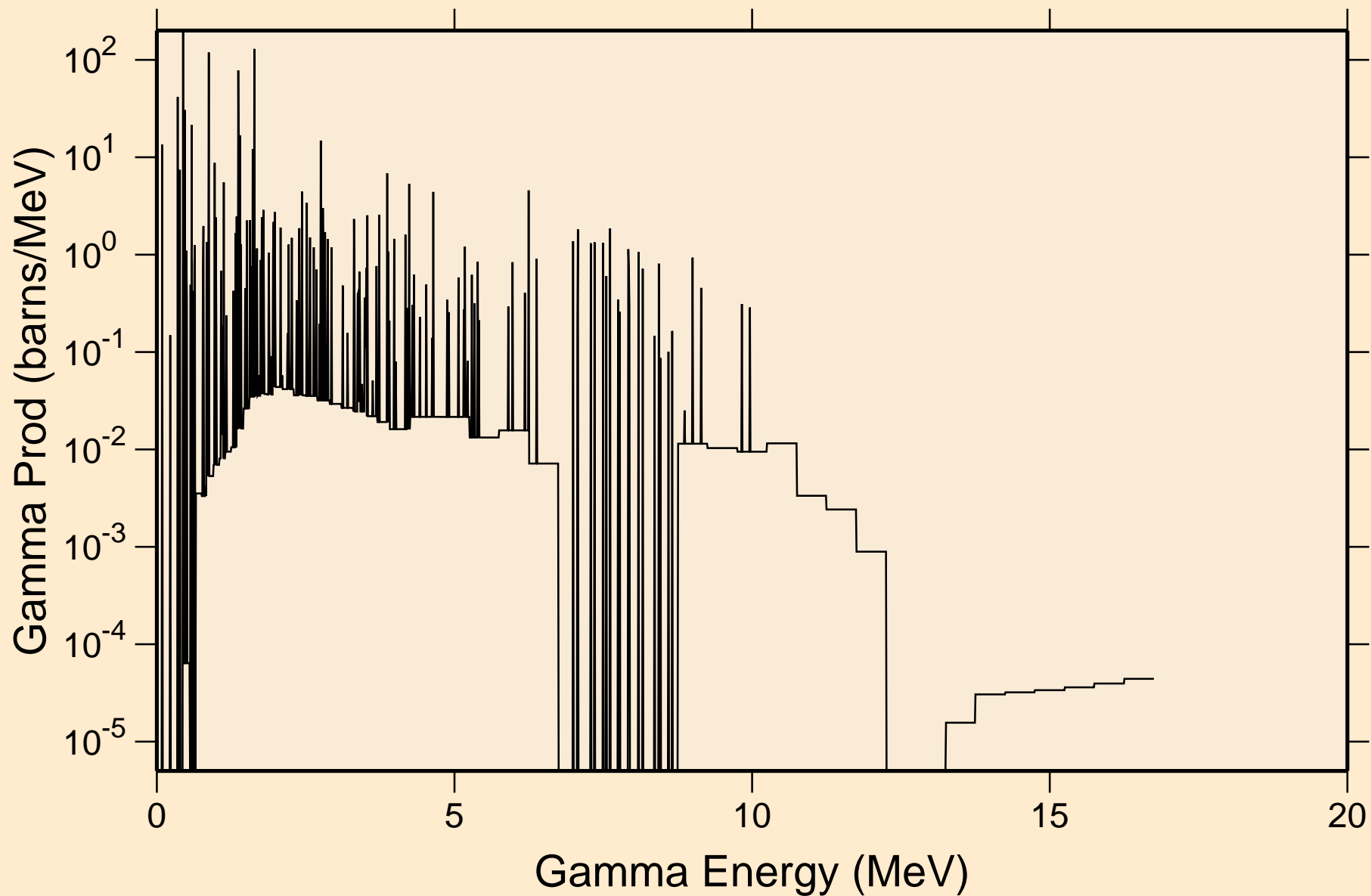

MG024 NEUTRON ACER TENDL-2019 LIBRARY; T=293.16K

Particle heating contributions

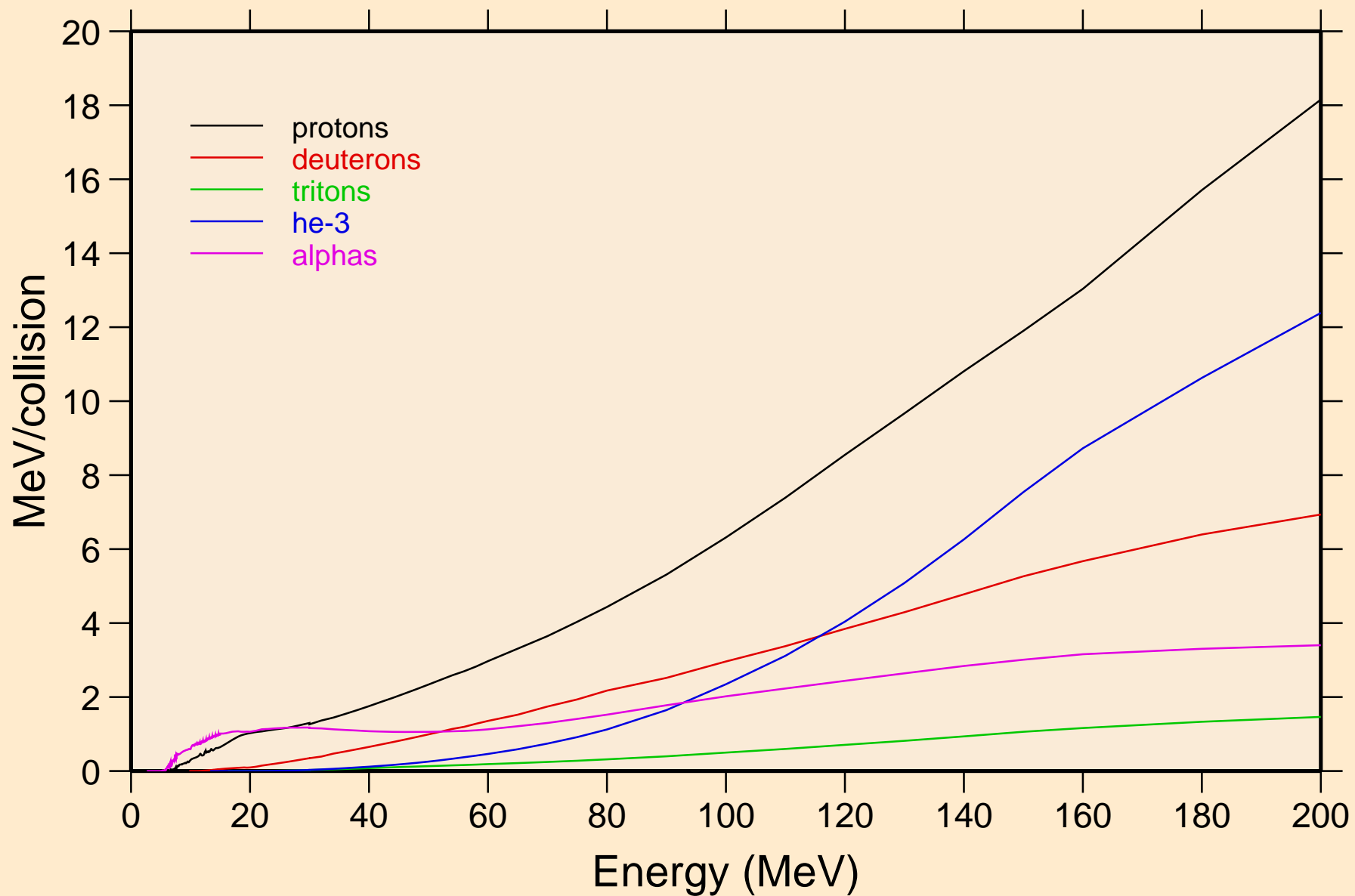

MG024 NEUTRON ACER TENDL-2019 LIBRARY; T=293.16K
Recoil Heating

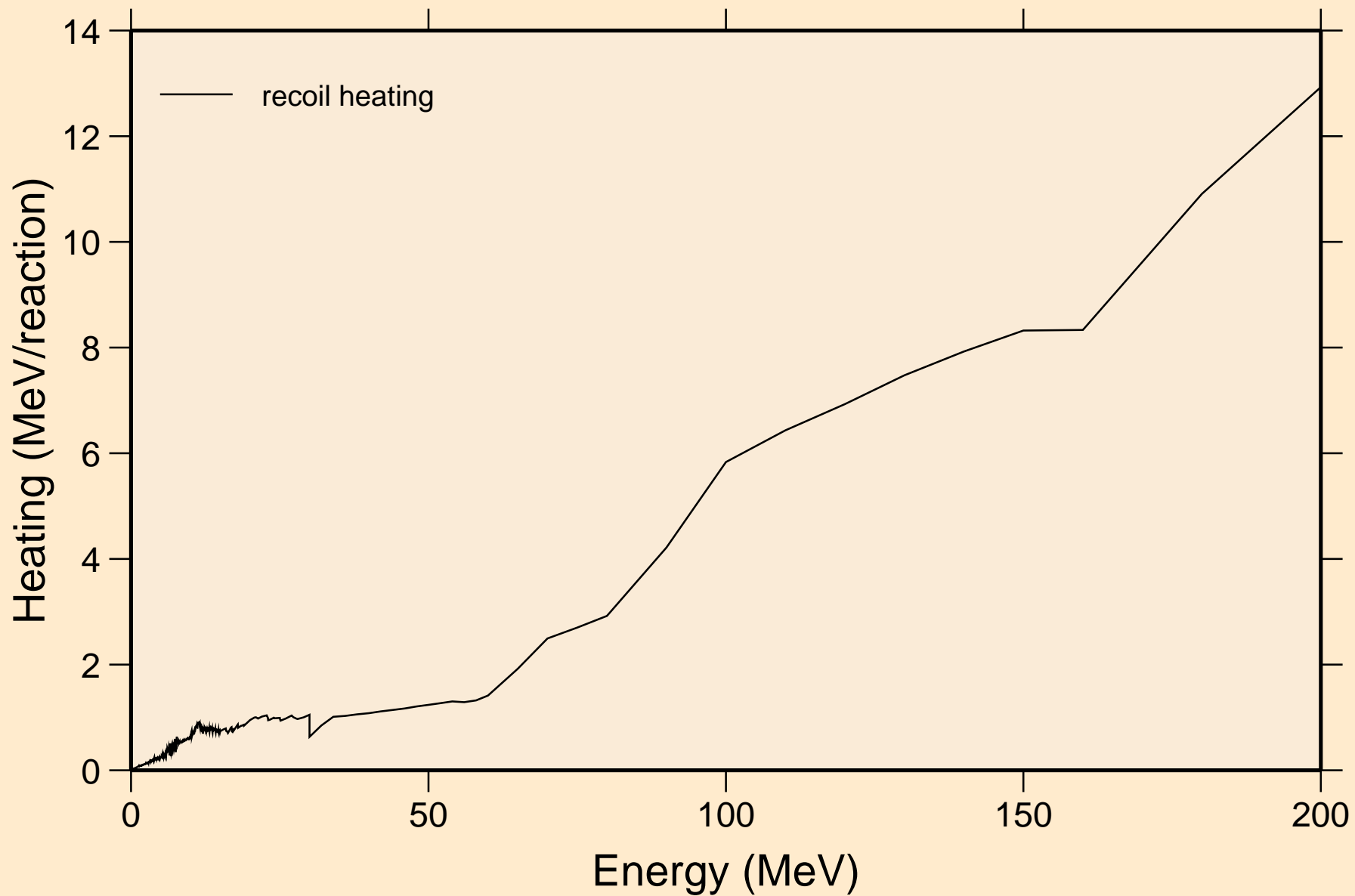

MG024 NEUTRON ACER TENDL-2019 LIBRARY; T=293.16K
Particle production cross sections

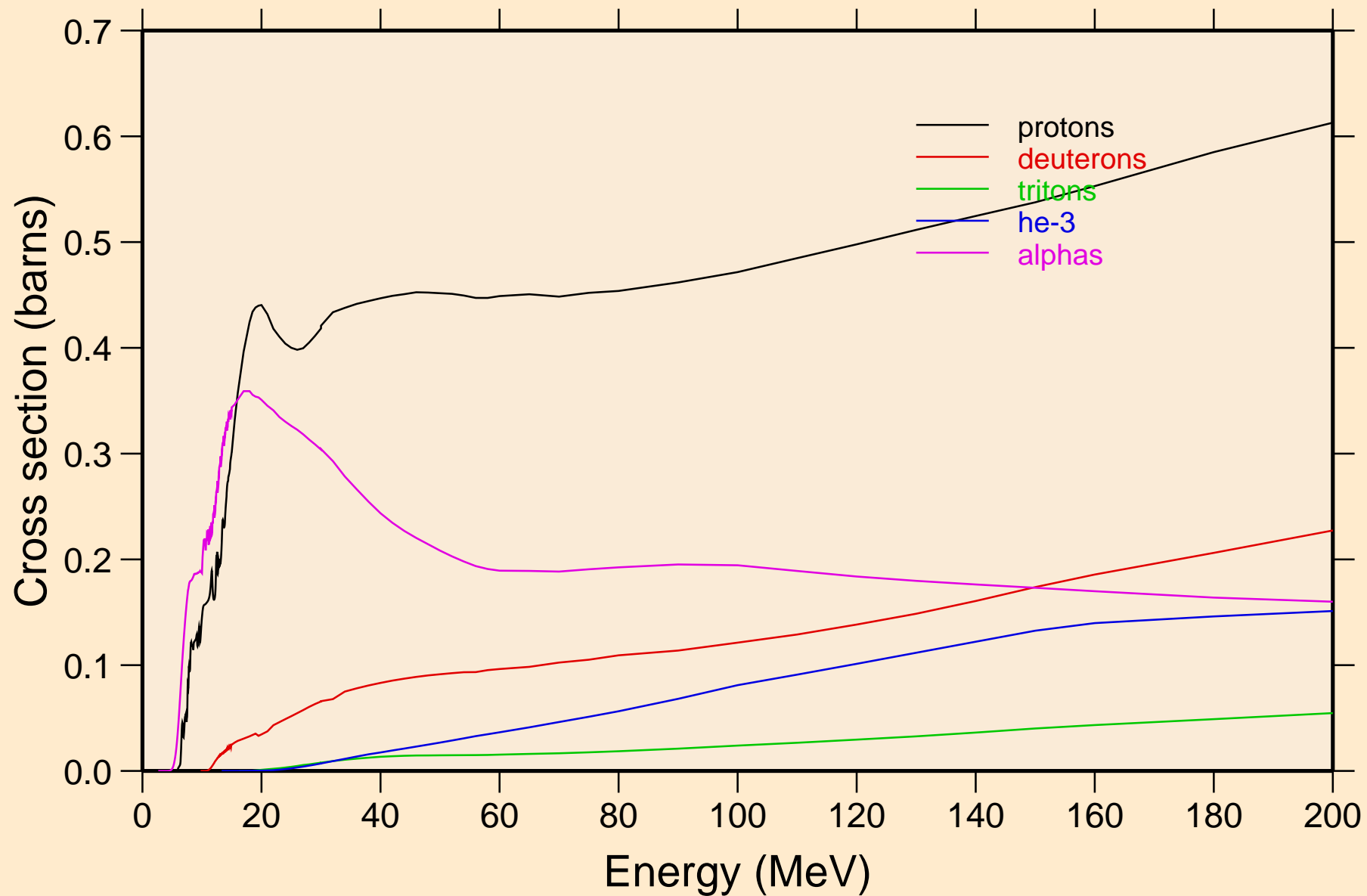

MG024 NEUTRON ACER TENDL-2019 LIBRARY; T=293.16K
protons from (n,x)

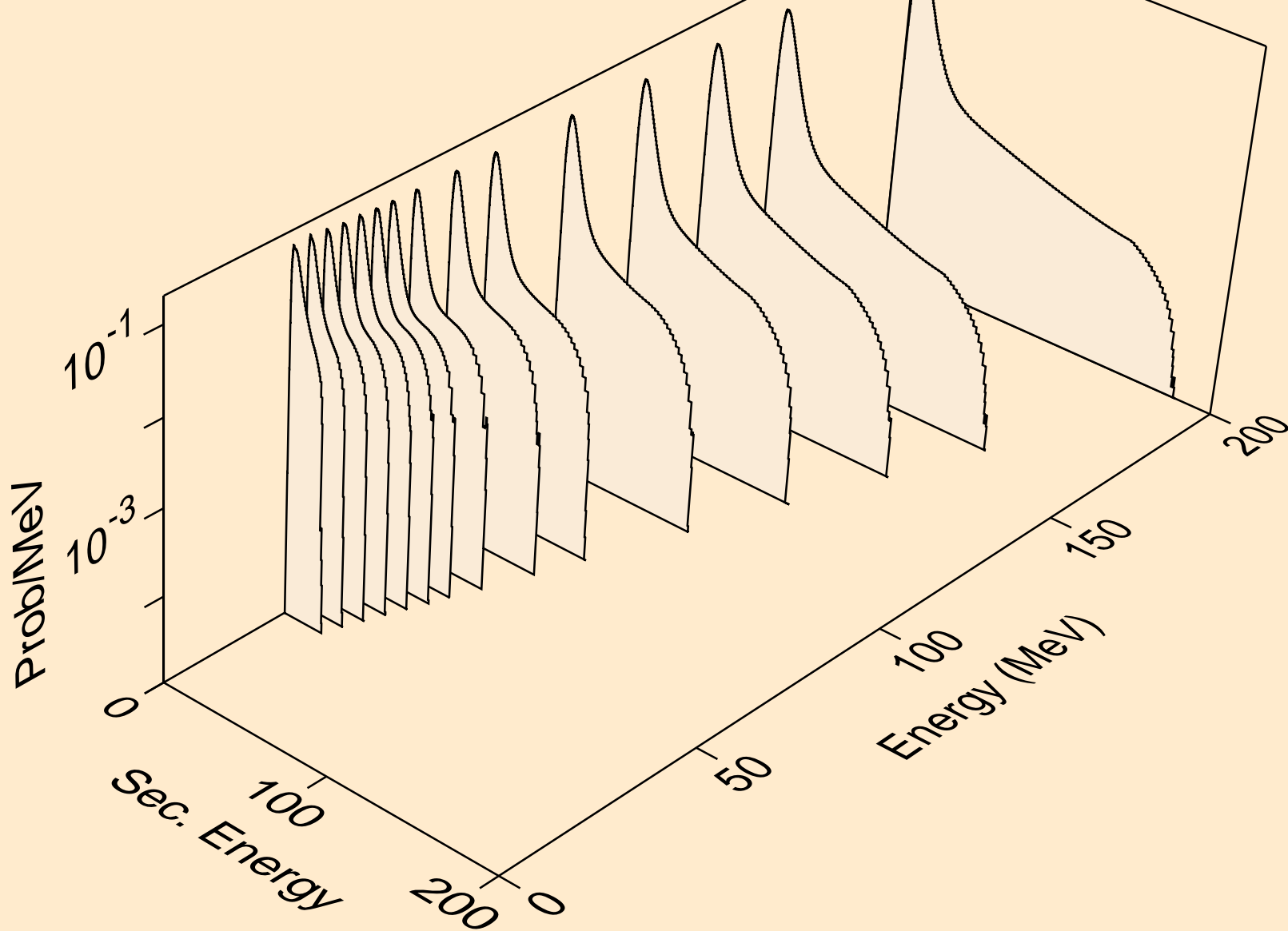

MG024 NEUTRON ACER TENDL-2019 LIBRARY; T=293.16K
protons from (n,n*)p

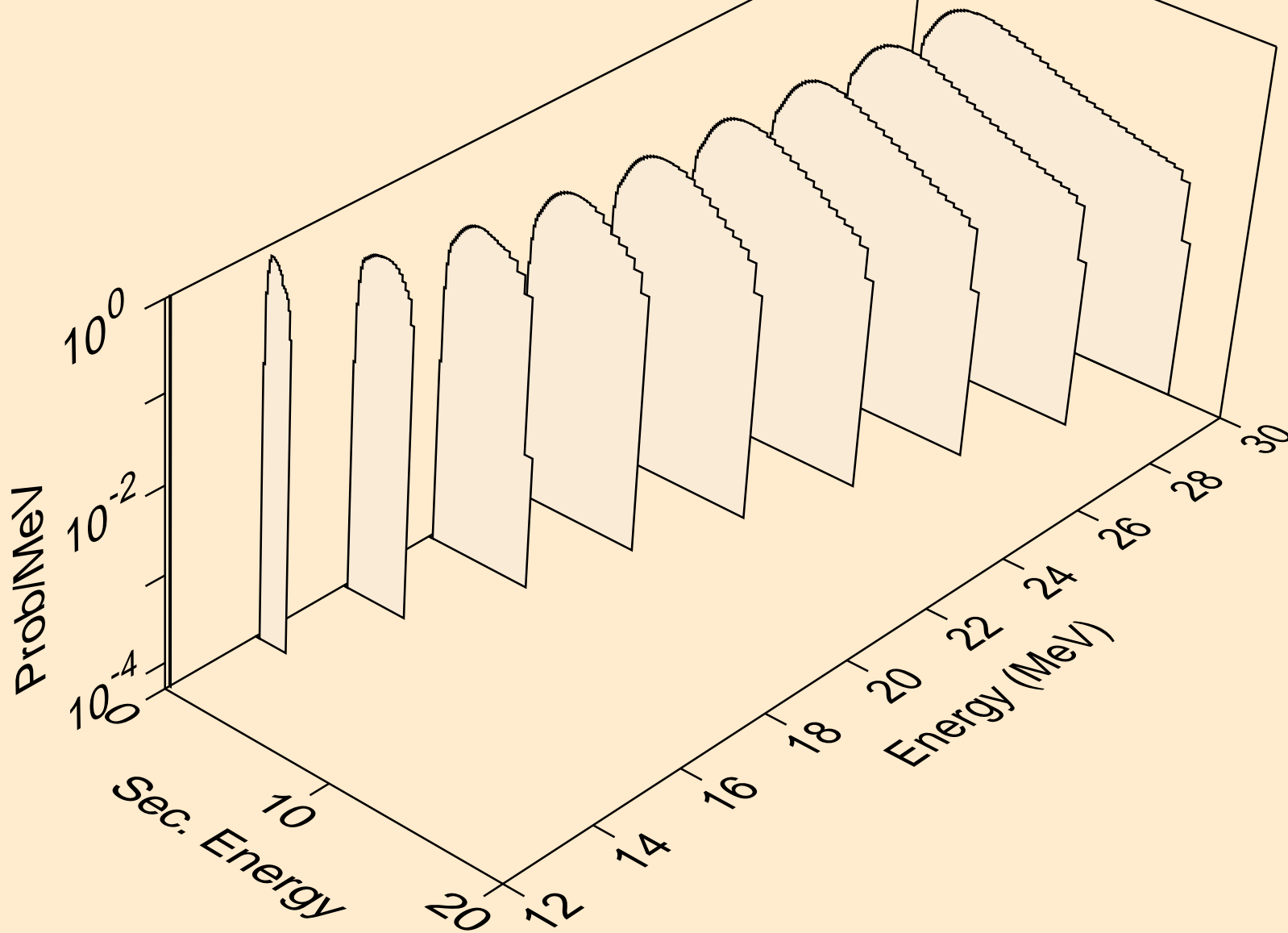

MG024 NEUTRON ACER TENDL-2019 LIBRARY; T=293.16K
protons from (n,2np)

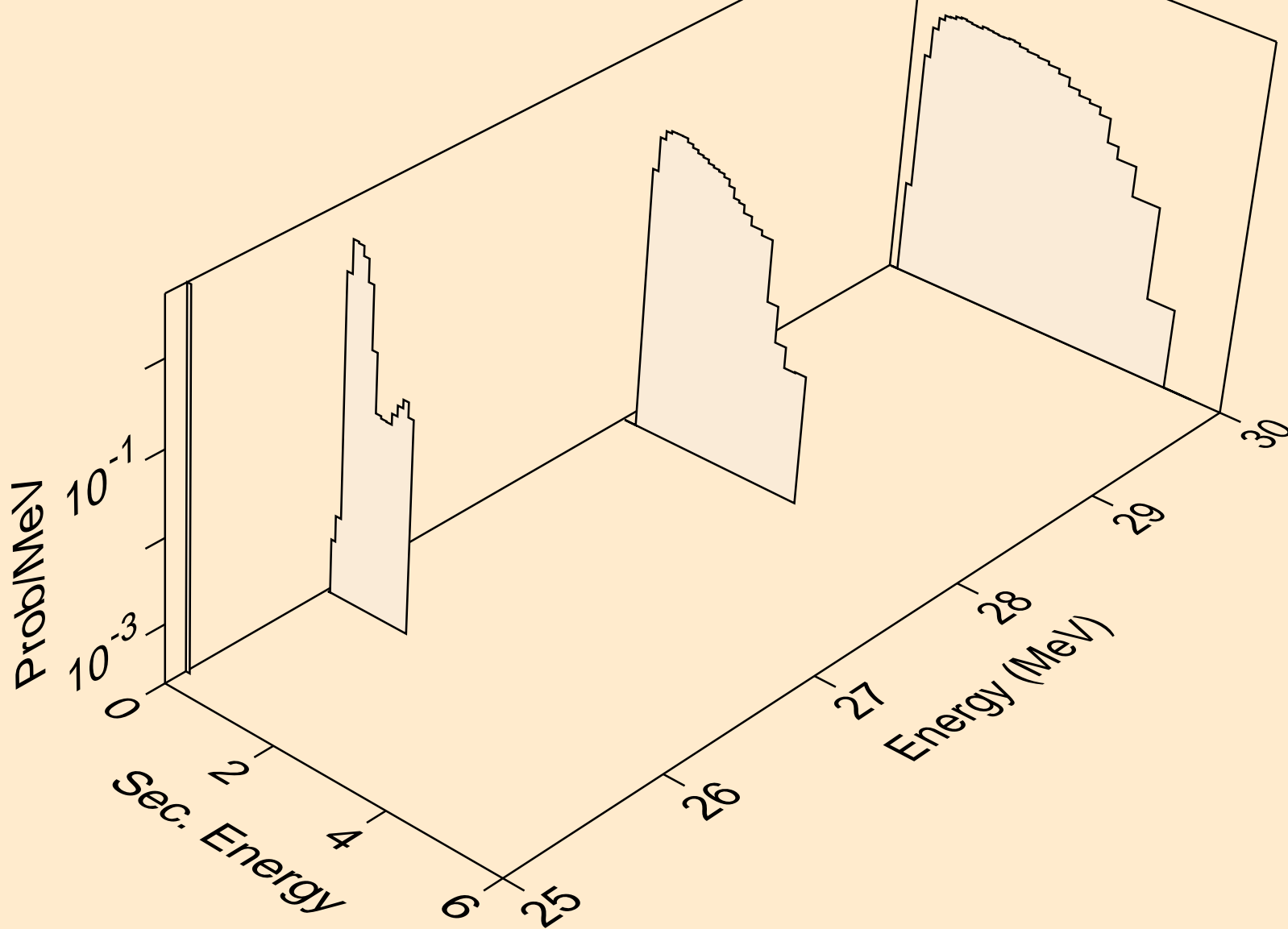

MG024 NEUTRON ACER TENDL-2019 LIBRARY; T=293.16K
protons from (n,2np)

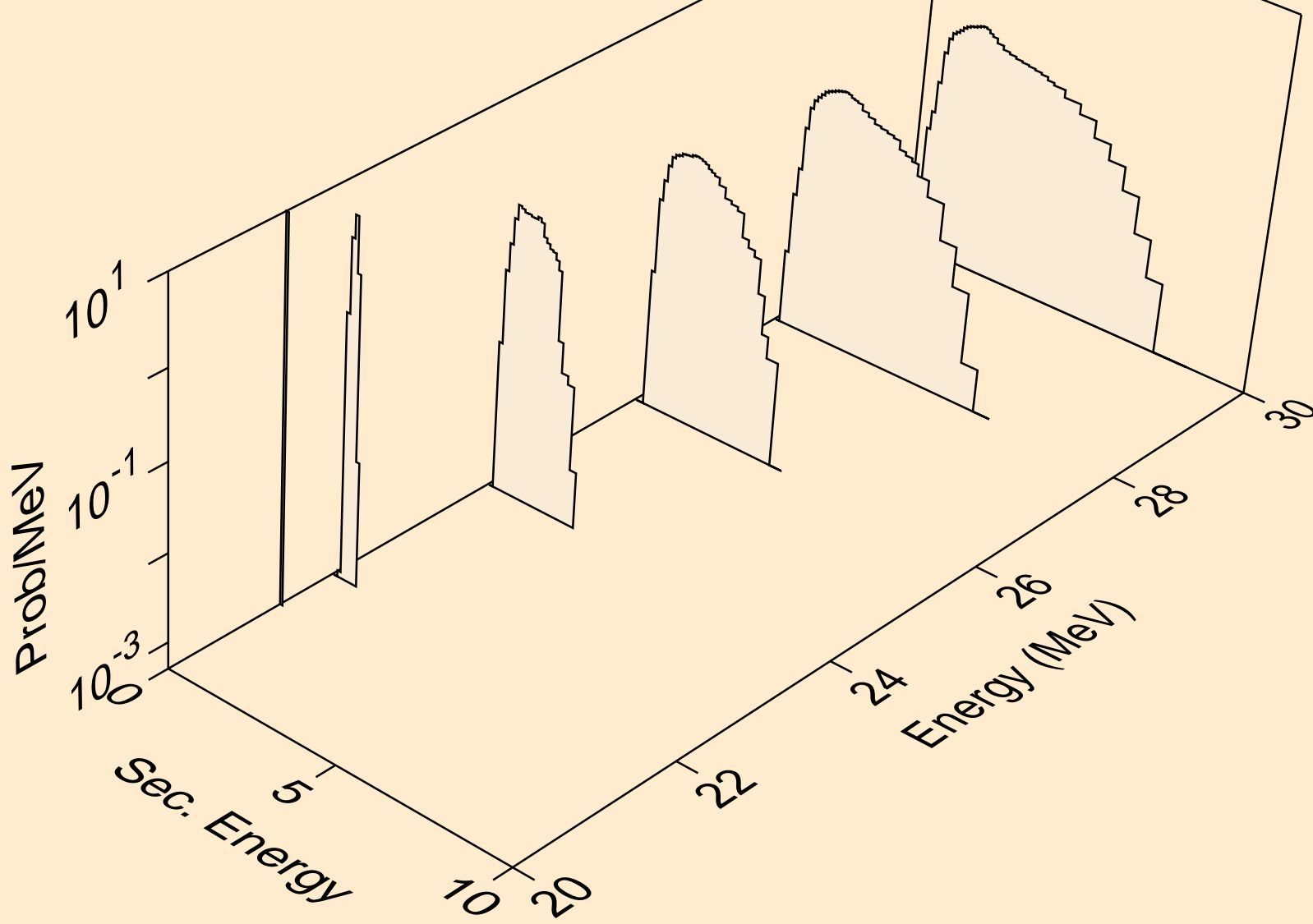

MG024 NEUTRON ACER TENDL-2019 LIBRARY; T=293.16K
protons from (n,npa)

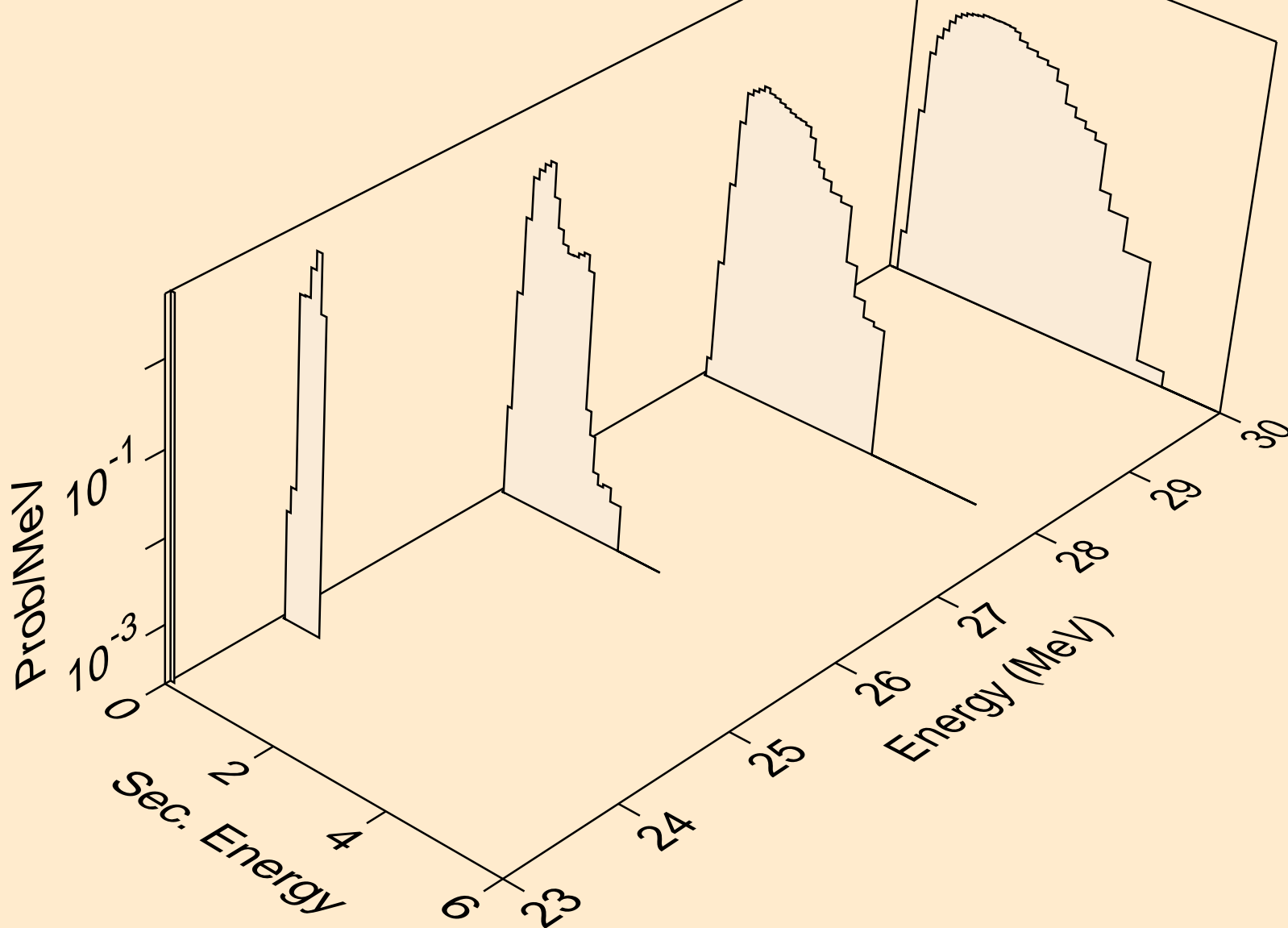

MG024 NEUTRON ACER TENDL-2019 LIBRARY; T=293.16K
protons from (n,p)

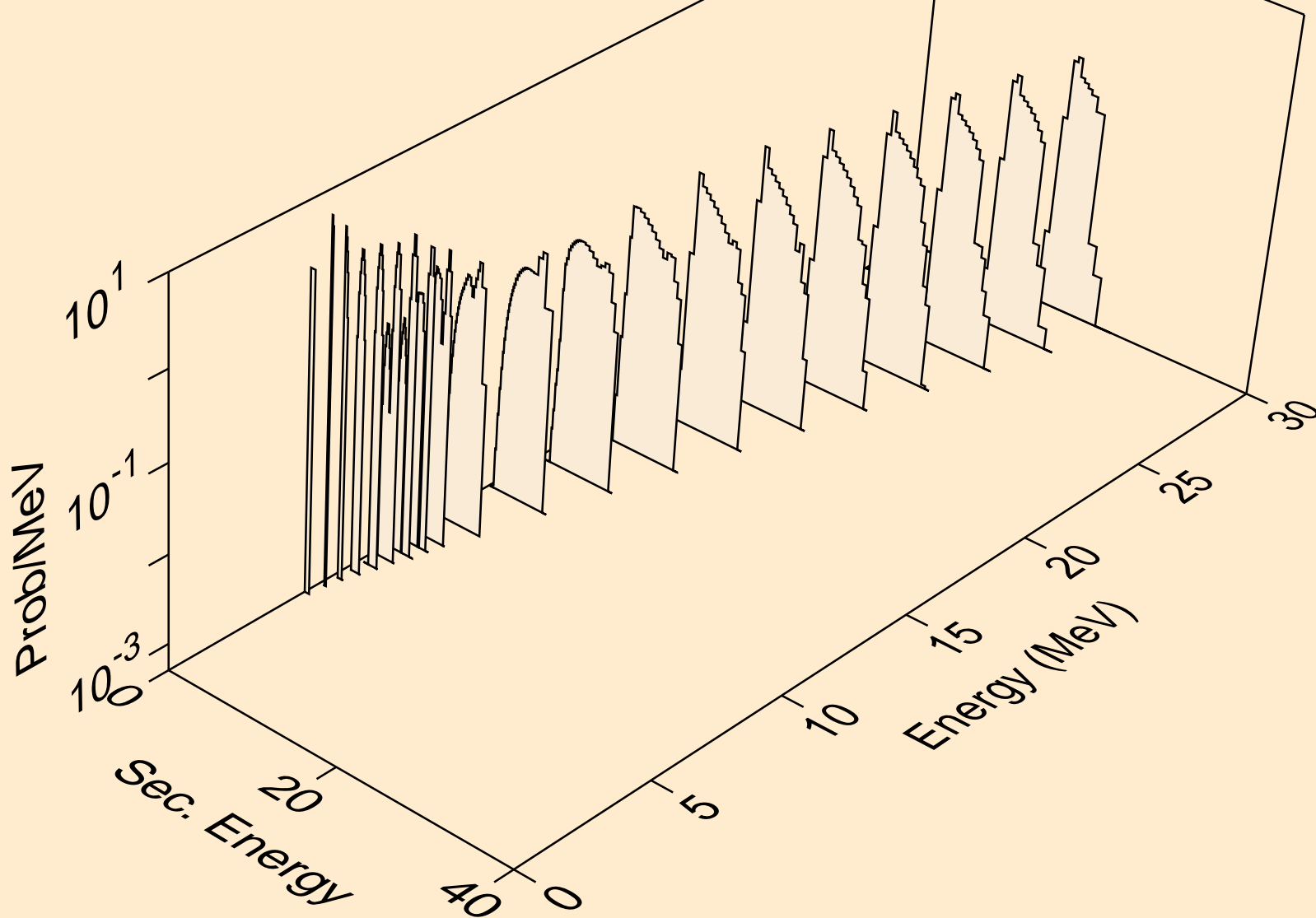

MG024 NEUTRON ACER TENDL-2019 LIBRARY; T=293.16K
protons from (n,2p)

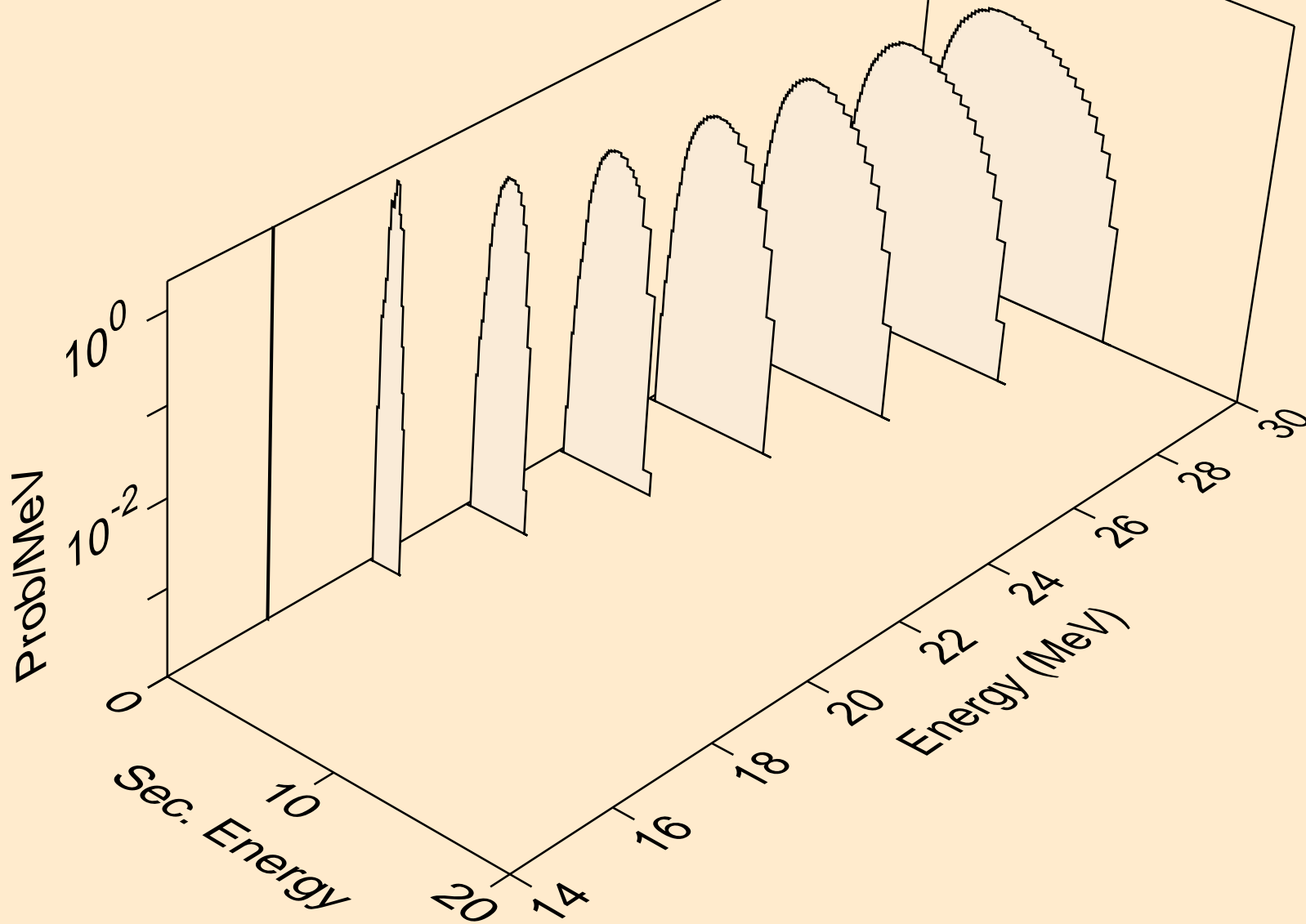

MG024 NEUTRON ACER TENDL-2019 LIBRARY; T=293.16K
protons from (n,p)

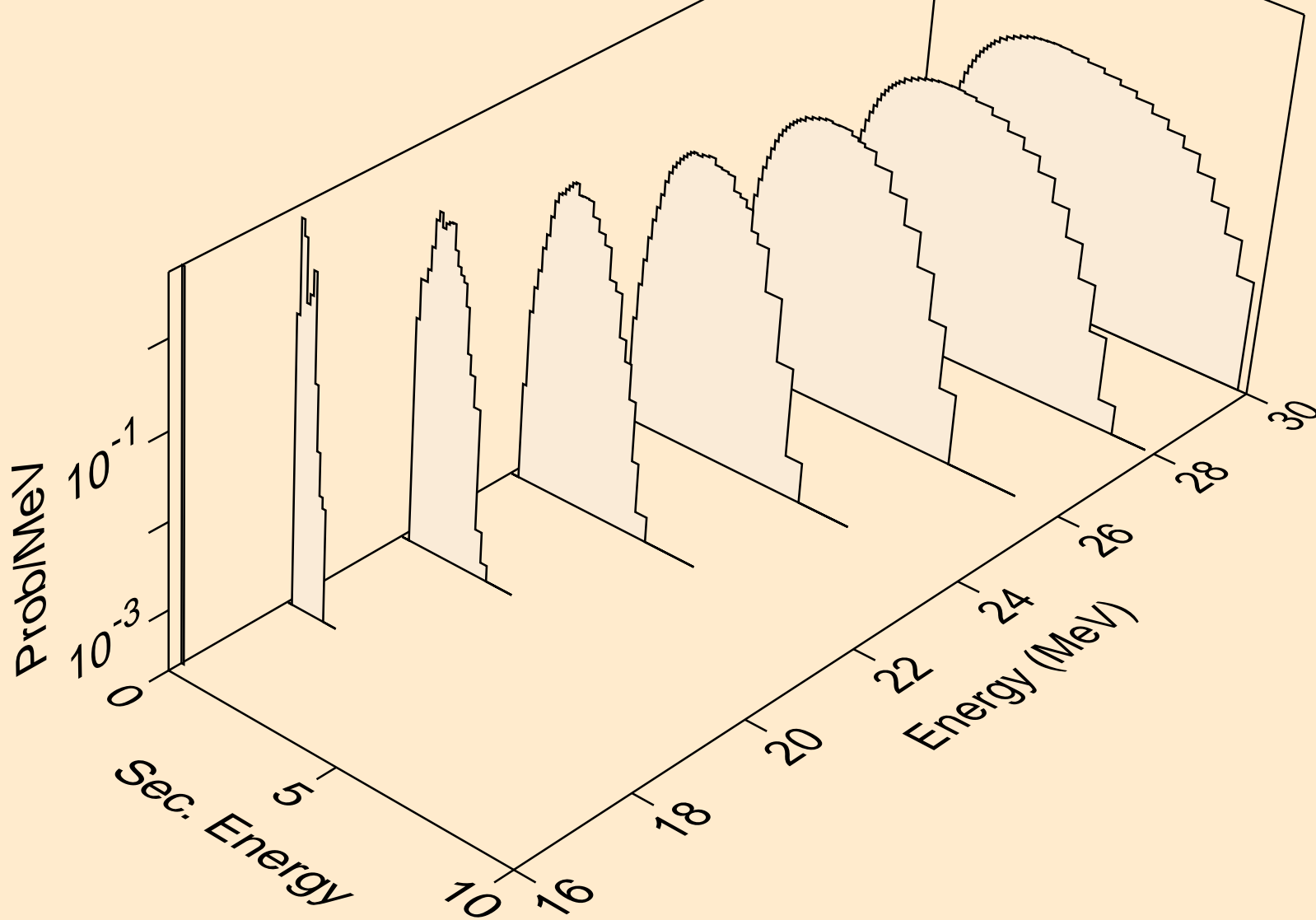

MG024 NEUTRON ACER TENDL-2019 LIBRARY; T=293.16K
protons from (n,pd)

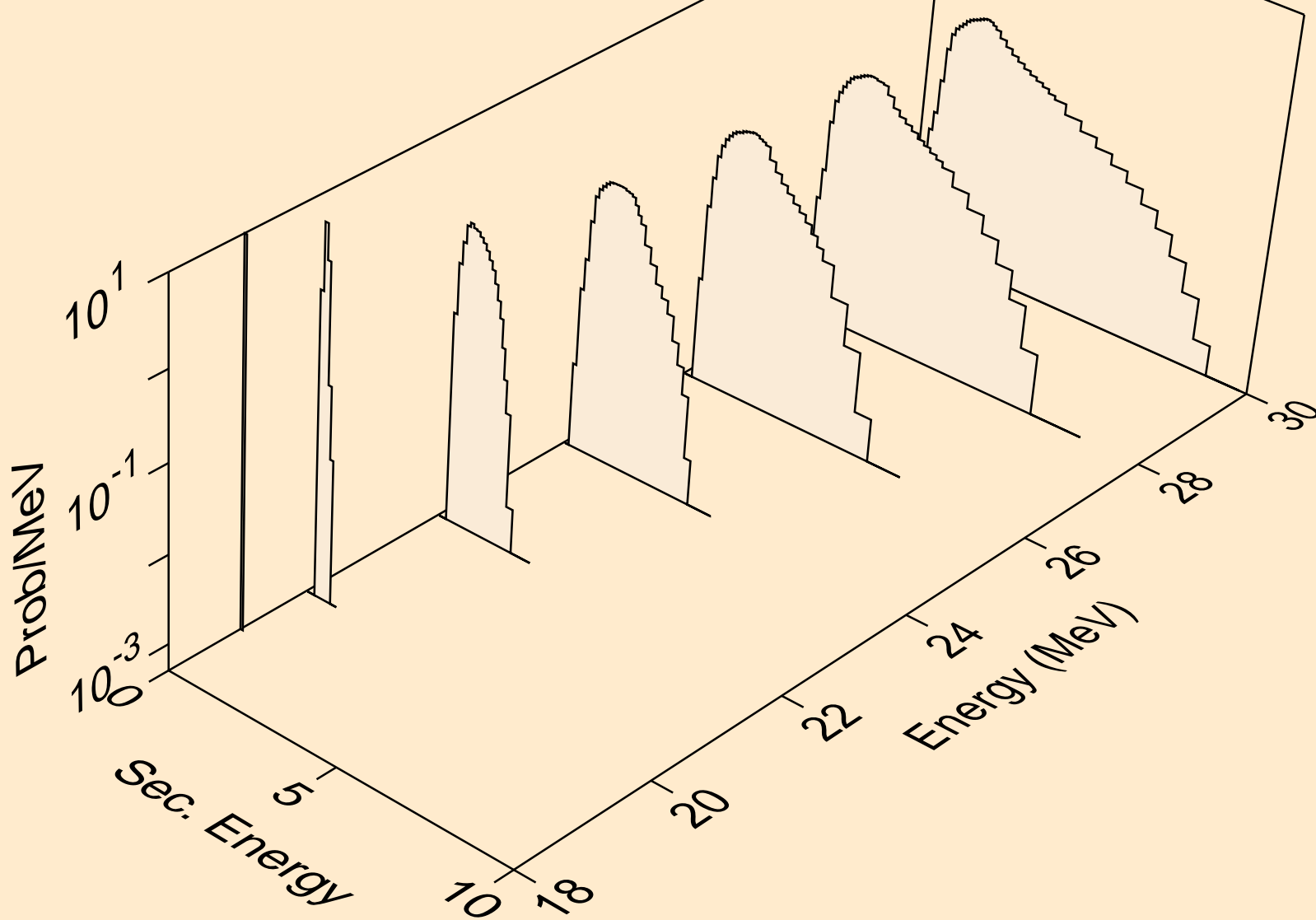

MG024 NEUTRON ACER TENDL-2019 LIBRARY; T=293.16K
protons from (n,pt)

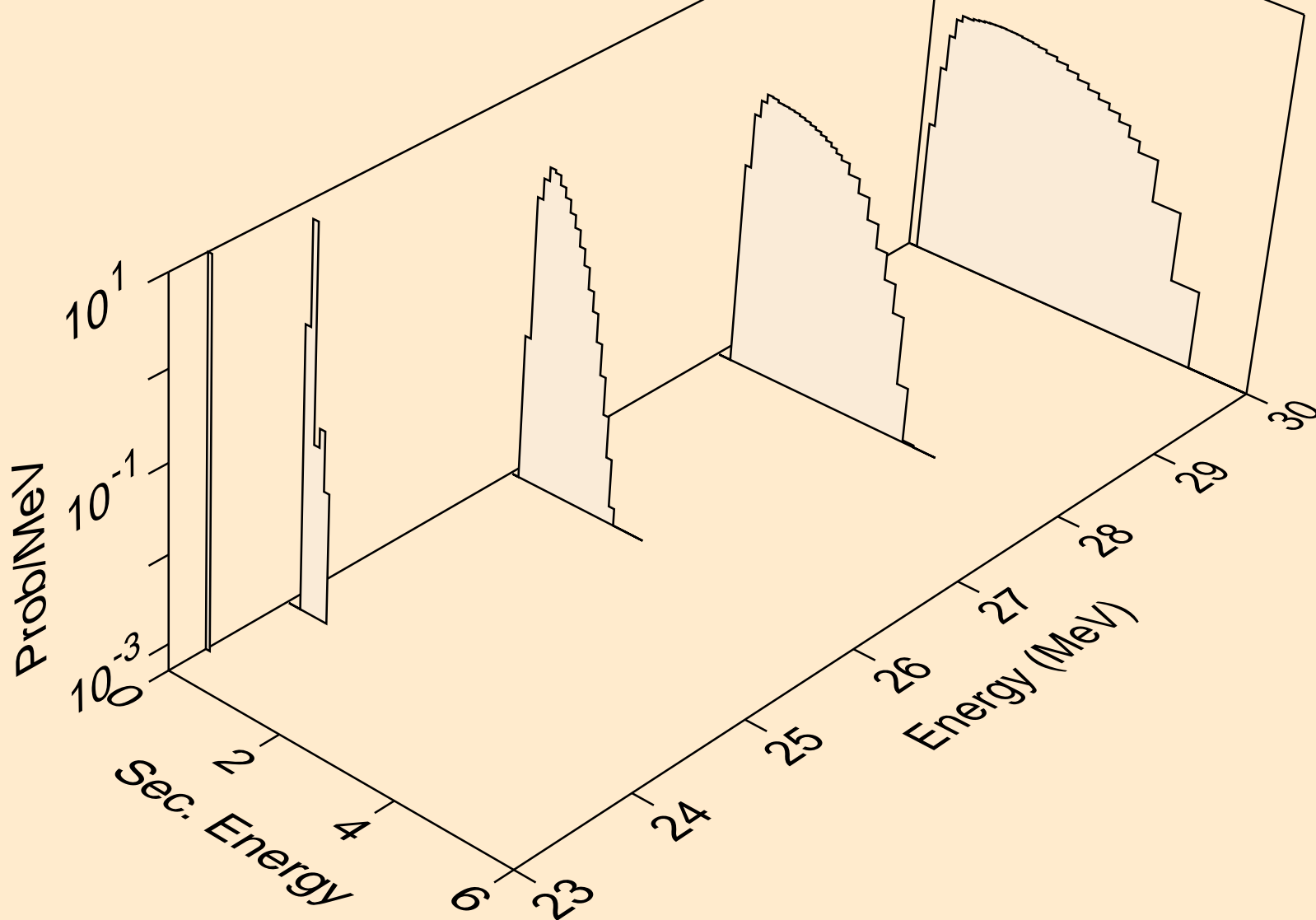

MG024 NEUTRON ACER TENDL-2019 LIBRARY; T=293.16K
deuterons from (n,x)

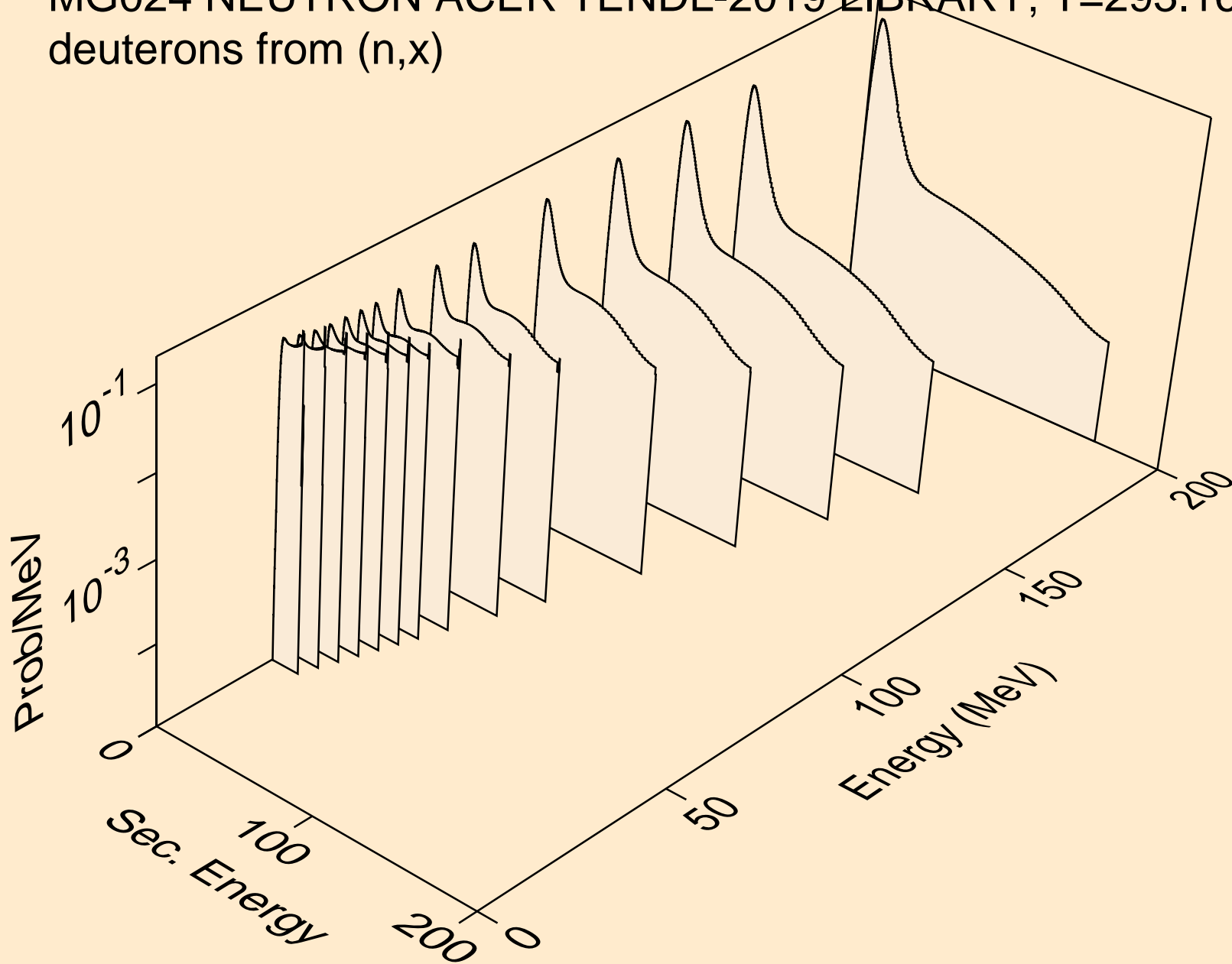

MG024 NEUTRON ACER TENDL-2019 LIBRARY; T=293.16K
deuterons from (n,n*)d

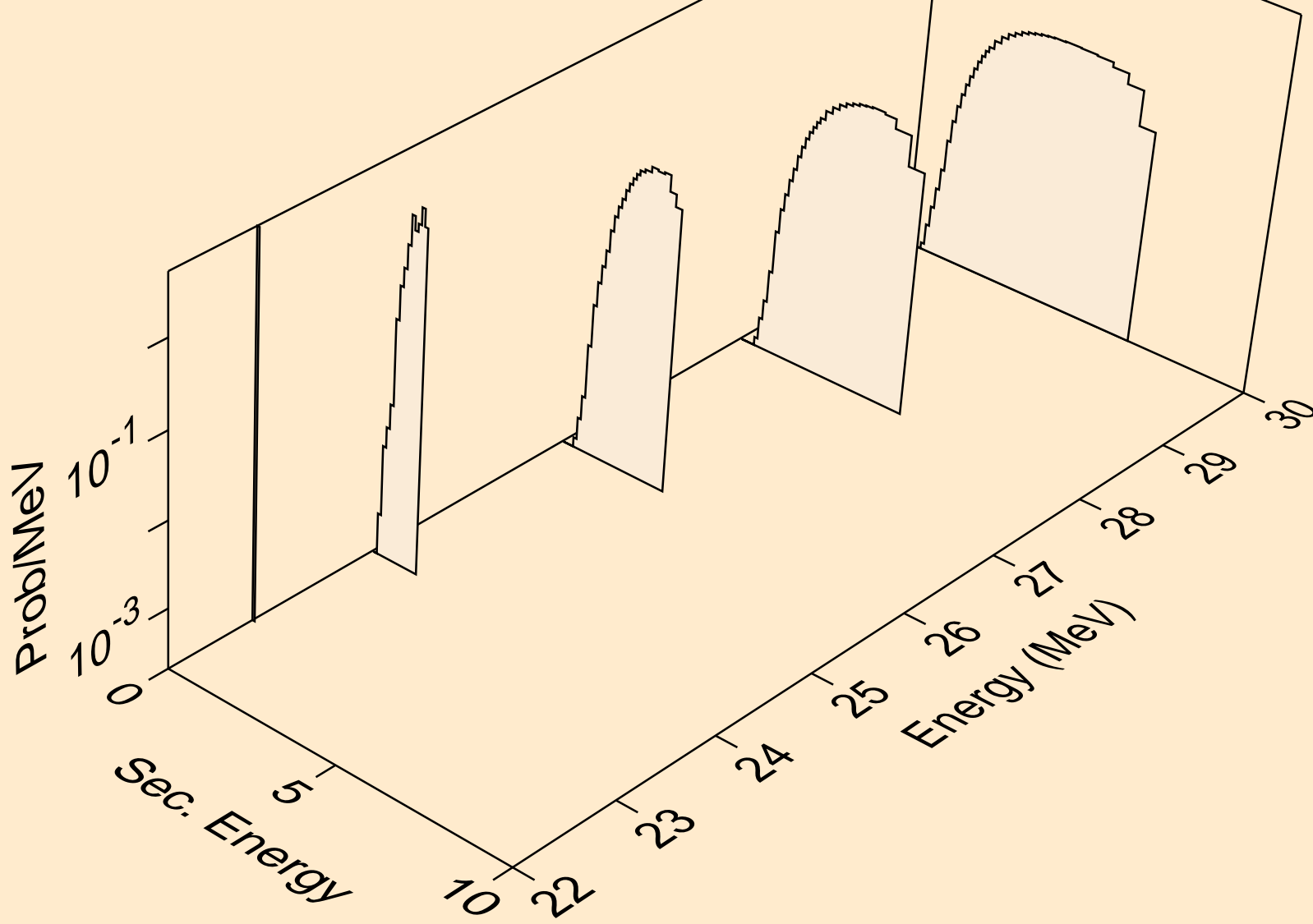

MG024 NEUTRON ACER TENDL-2019 LIBRARY; T=293.16K
deuterons from (n,d)

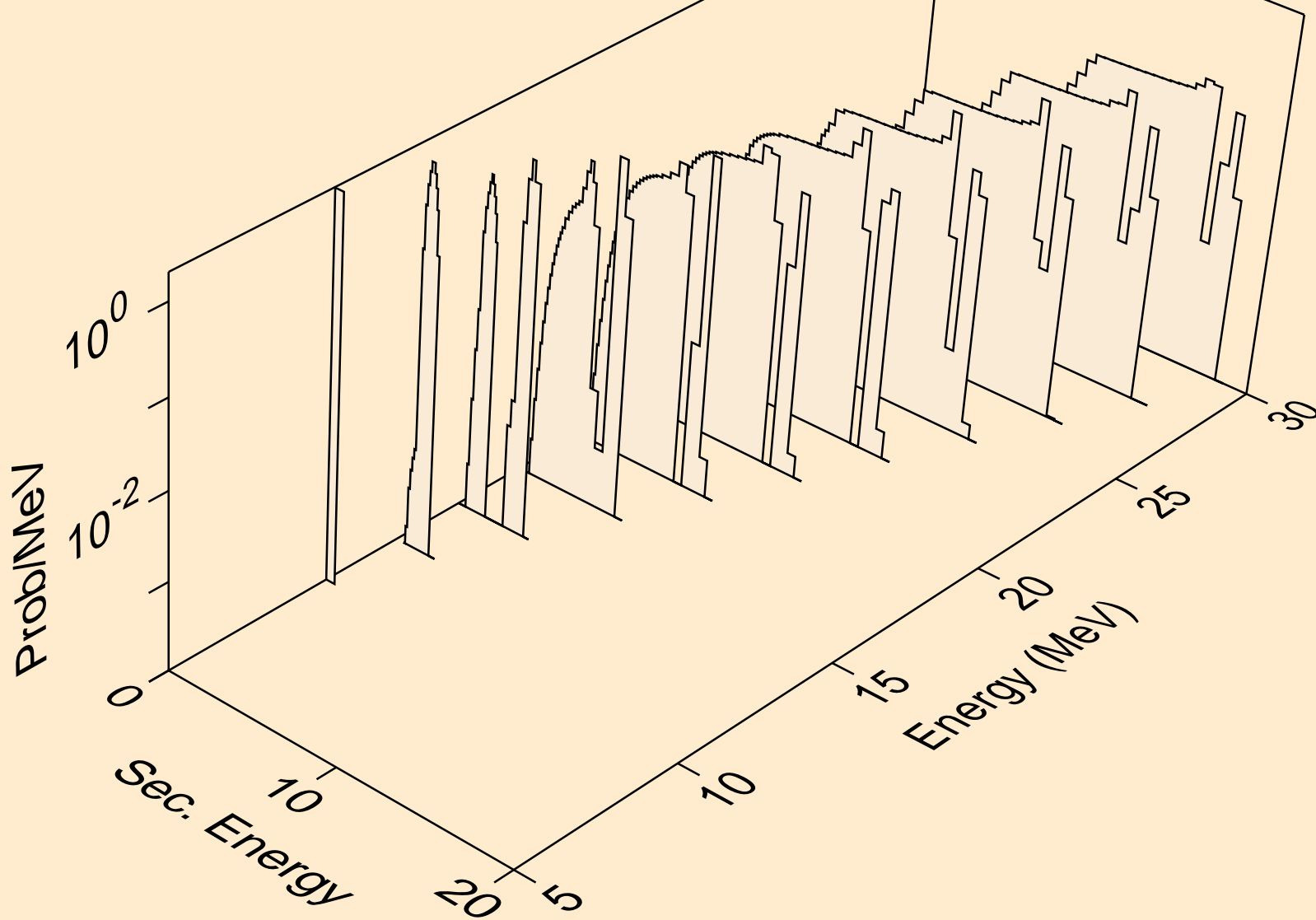

MG024 NEUTRON ACER TENDL-2019 LIBRARY; T=293.16K
deuterons from (n,d2a)

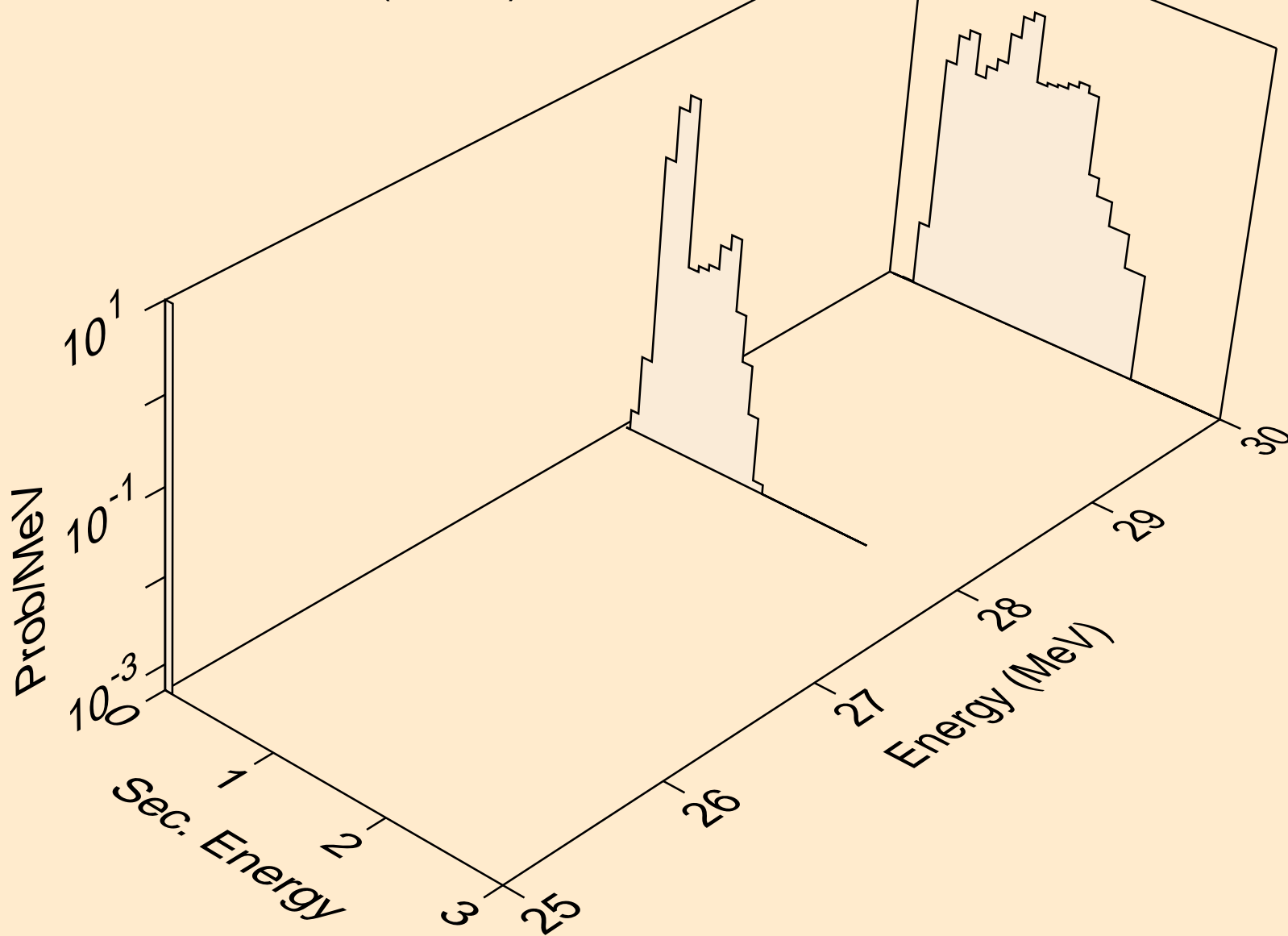

MG024 NEUTRON ACER TENDL-2019 LIBRARY; T=293.16K
deuterons from (n,pd)

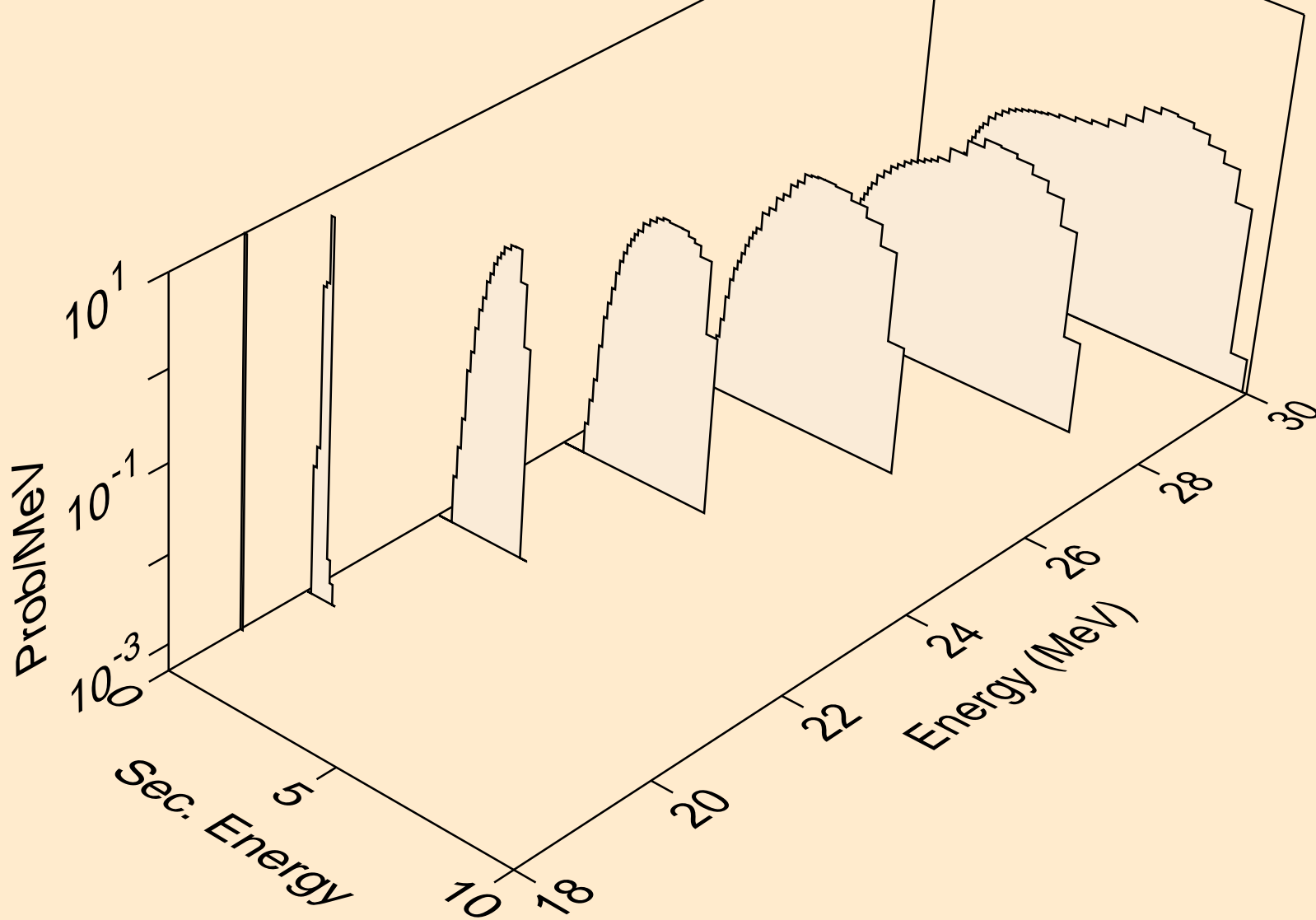

MG024 NEUTRON ACER TENDL-2019 LIBRARY; T=293.16K
deuterons from (n,da)

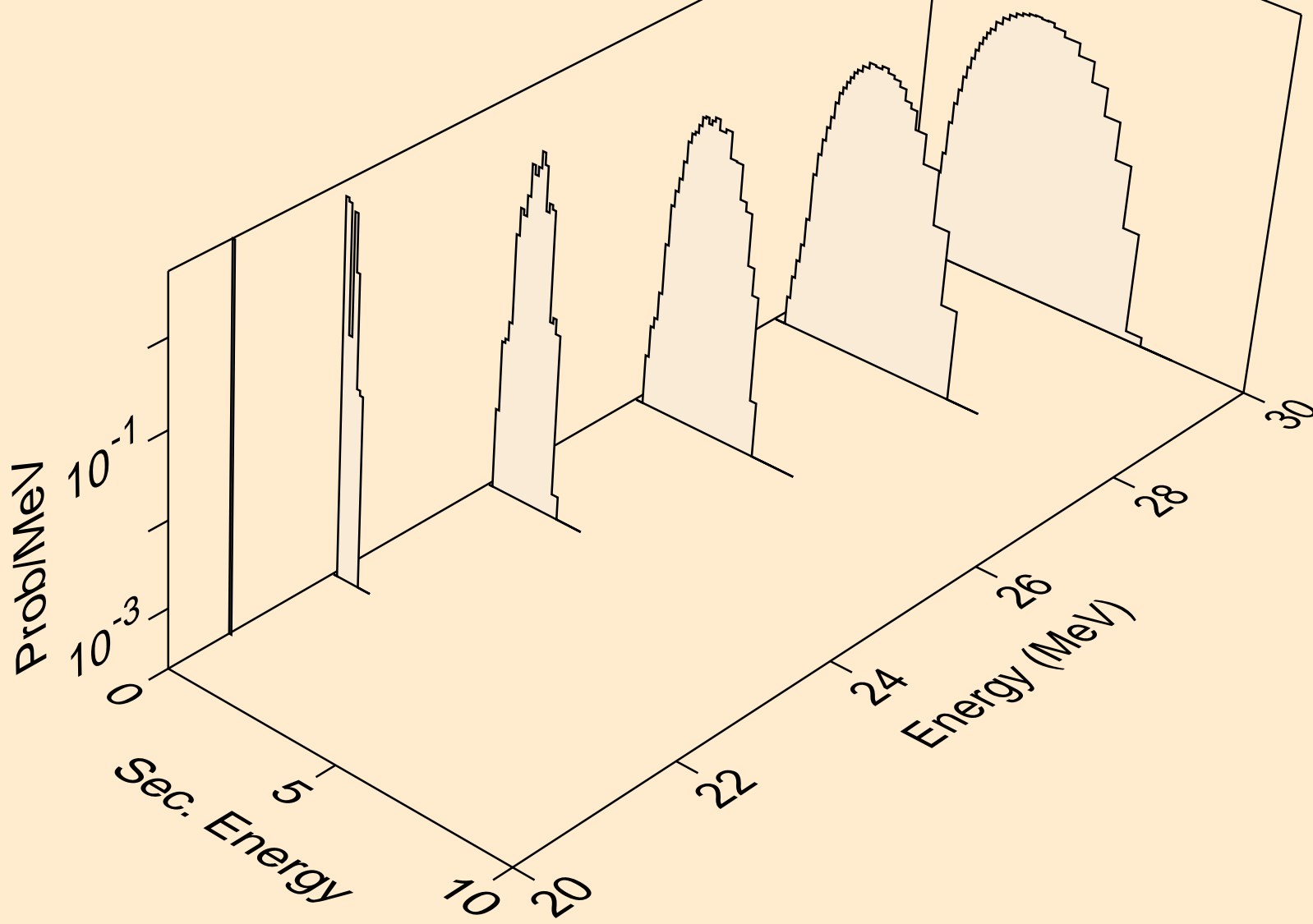

MG024 NEUTRON ACER TENDL-2019 LIBRARY; T=293.16K
tritons from (n,x)

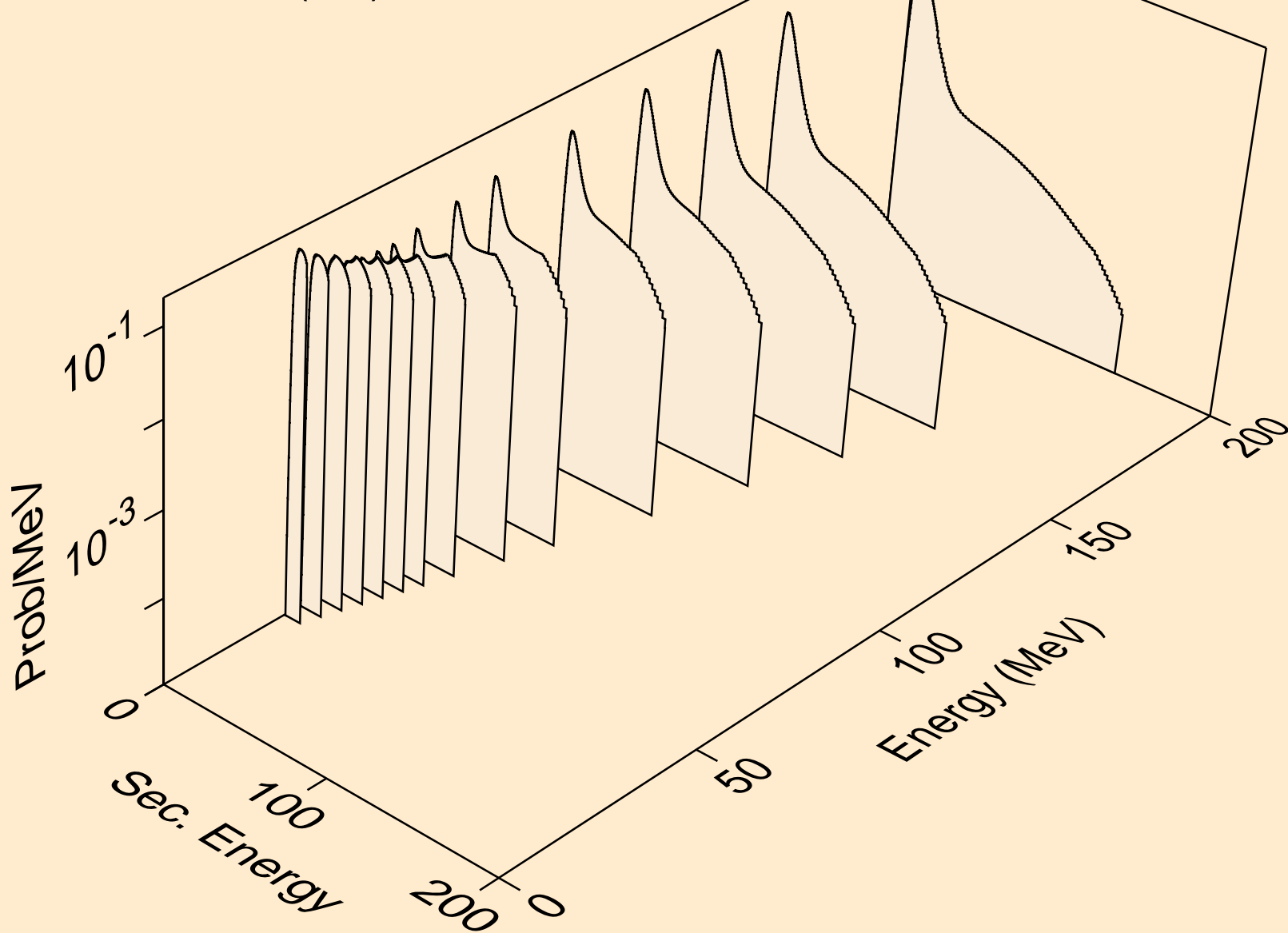

MG024 NEUTRON ACER TENDL-2019 LIBRARY; T=293.16K
tritons from (n,n*)t

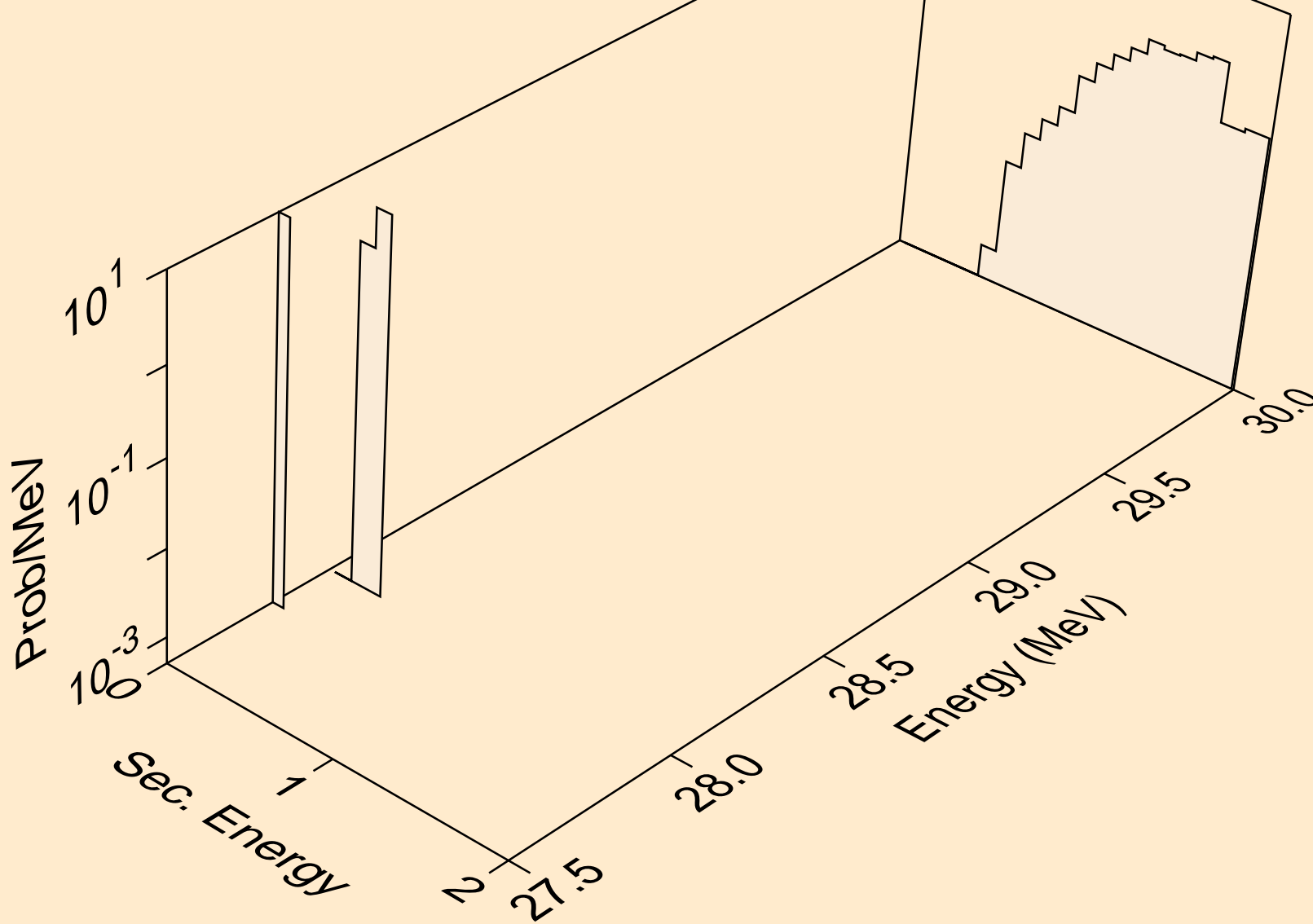

MG024 NEUTRON ACER TENDL-2019 LIBRARY; T=293.16K
tritons from (n,t)

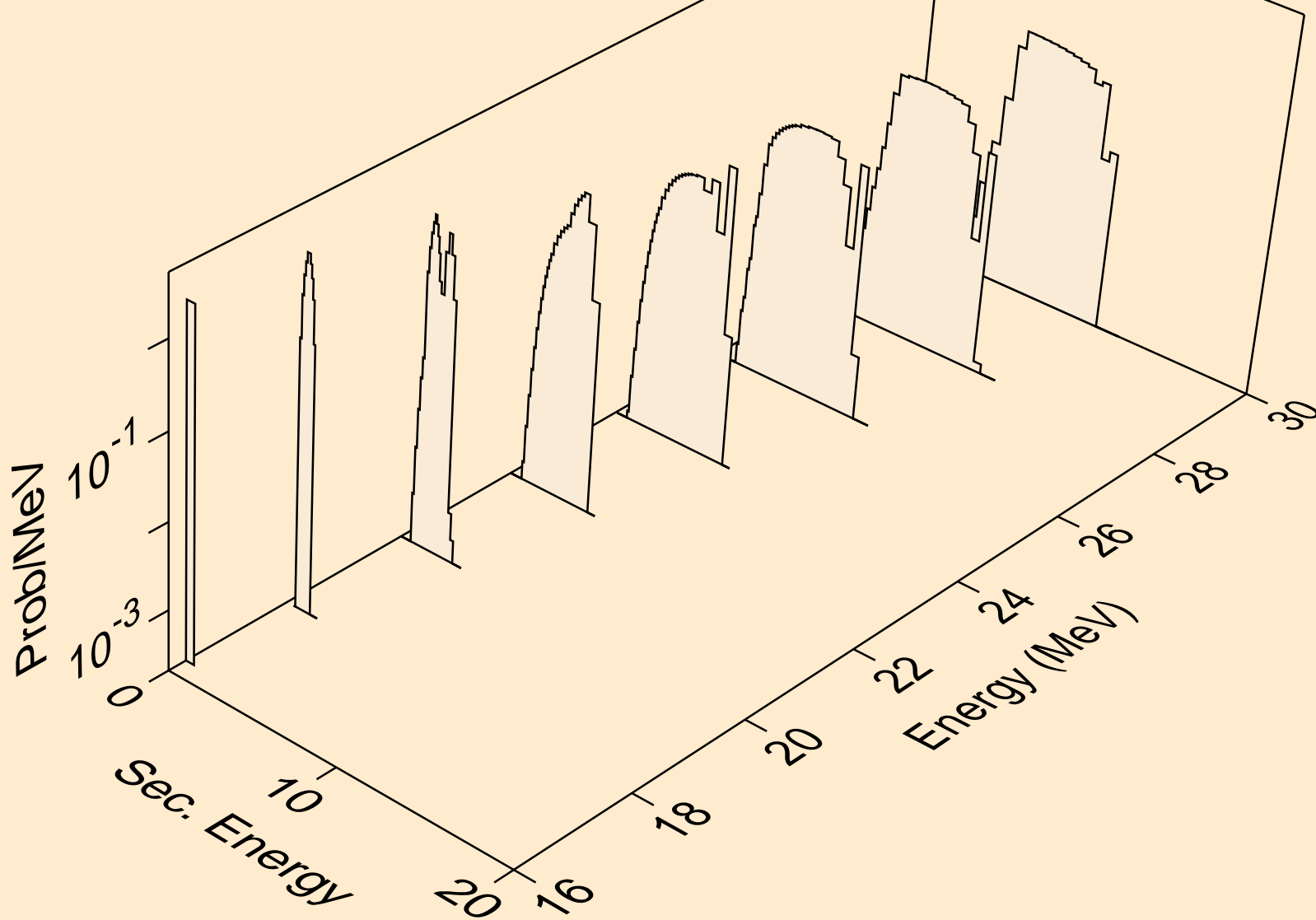

MG024 NEUTRON ACER TENDL-2019 LIBRARY; T=293.16K
tritons from (n,pt)

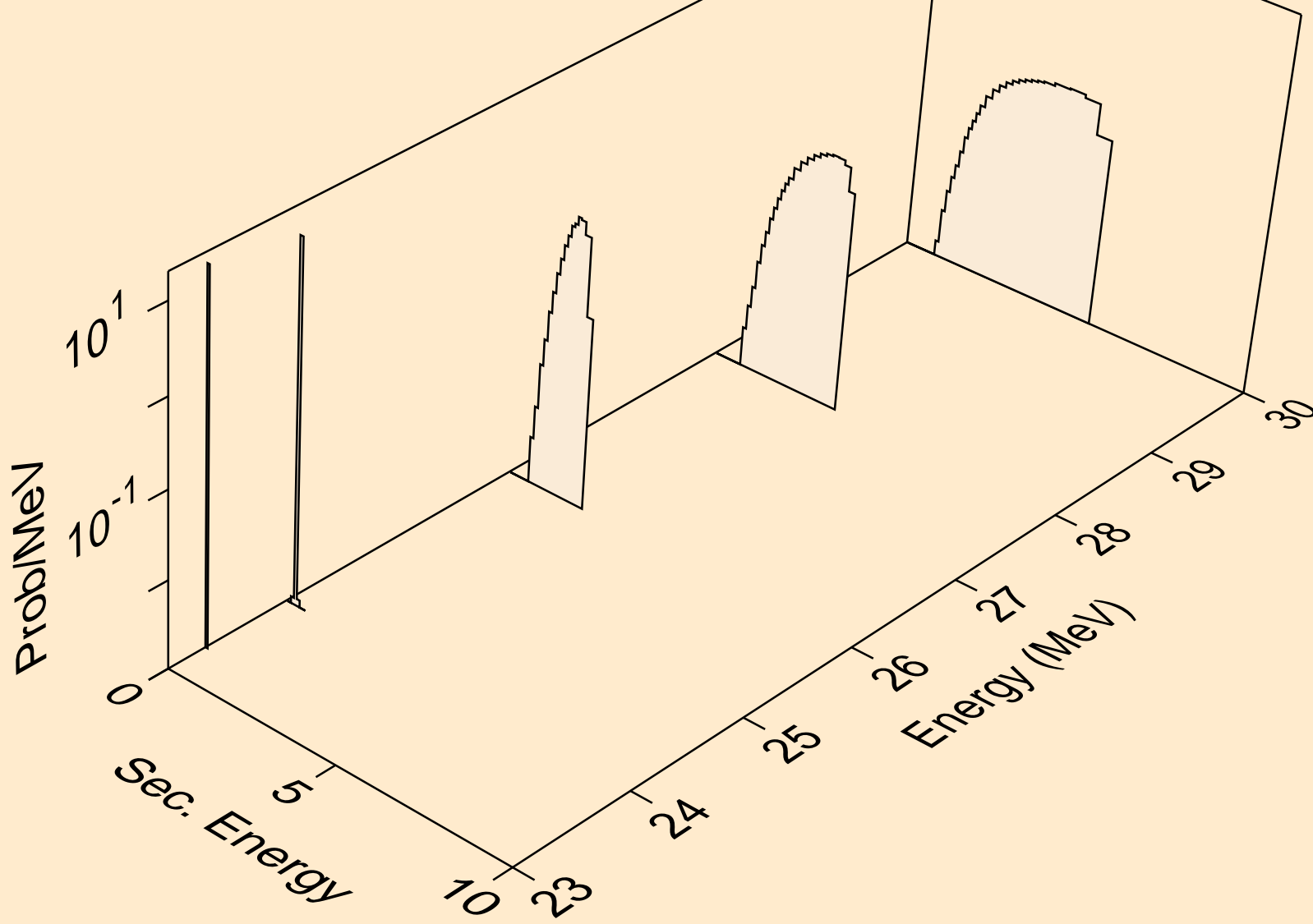

MG024 NEUTRON ACER TENDL-2019 LIBRARY; T=293.16K
he3s from (n,x)

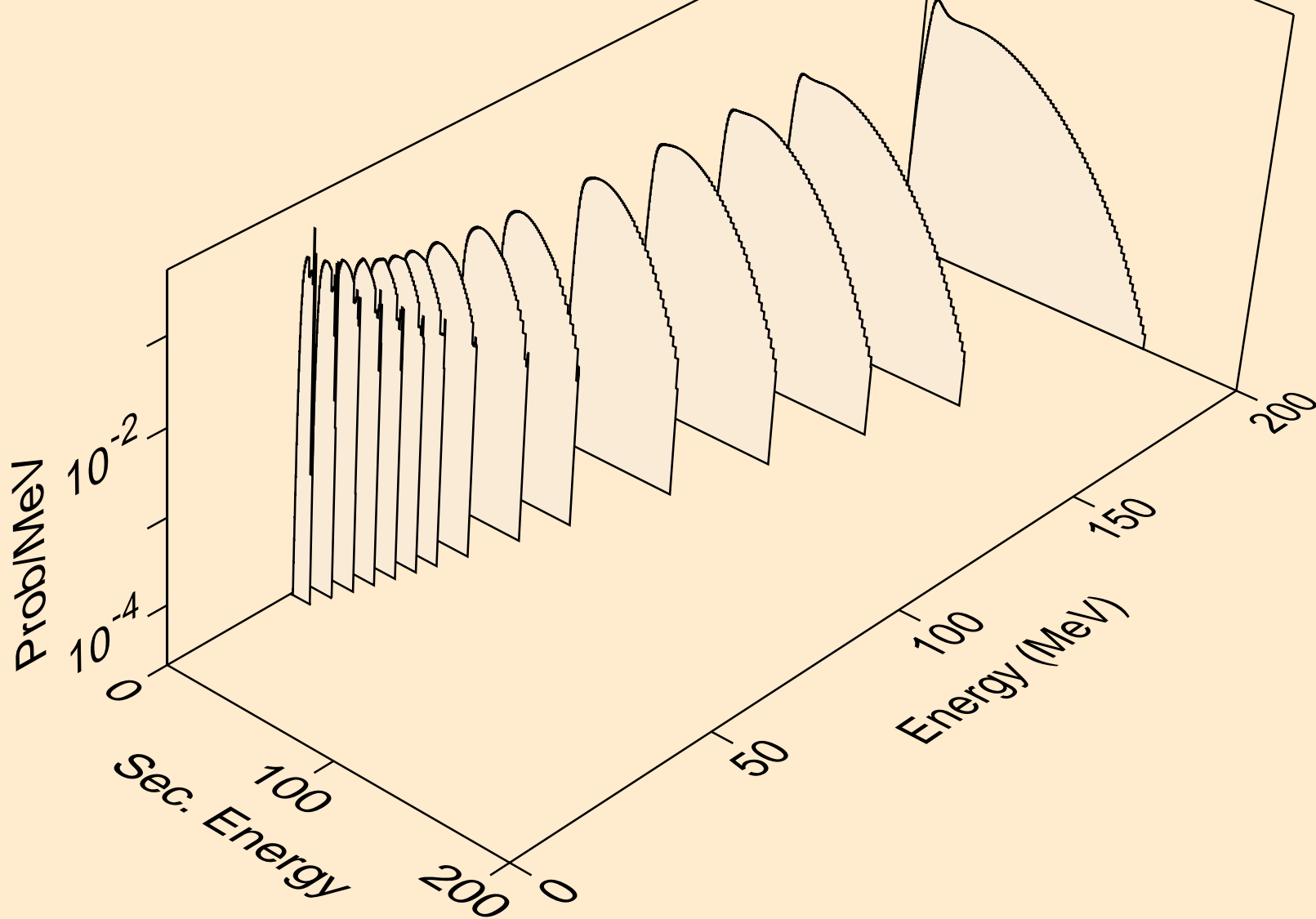

MG024 NEUTRON ACER TENDL-2019 LIBRARY; T=293.16K
he3s from (n,n*)he3

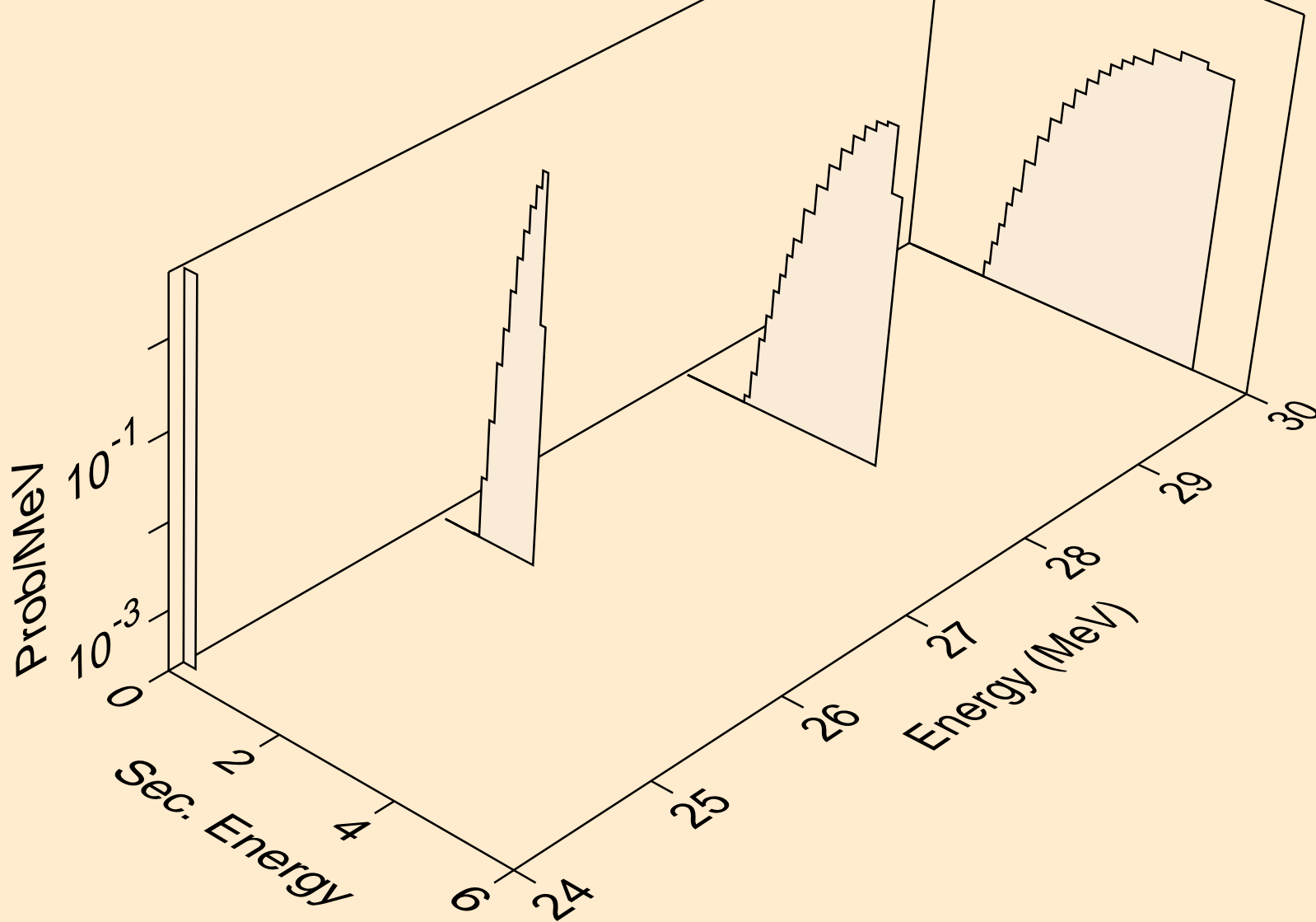

MG024 NEUTRON ACER TENDL-2019 LIBRARY; T=293.16K
he3s from (n,he3)

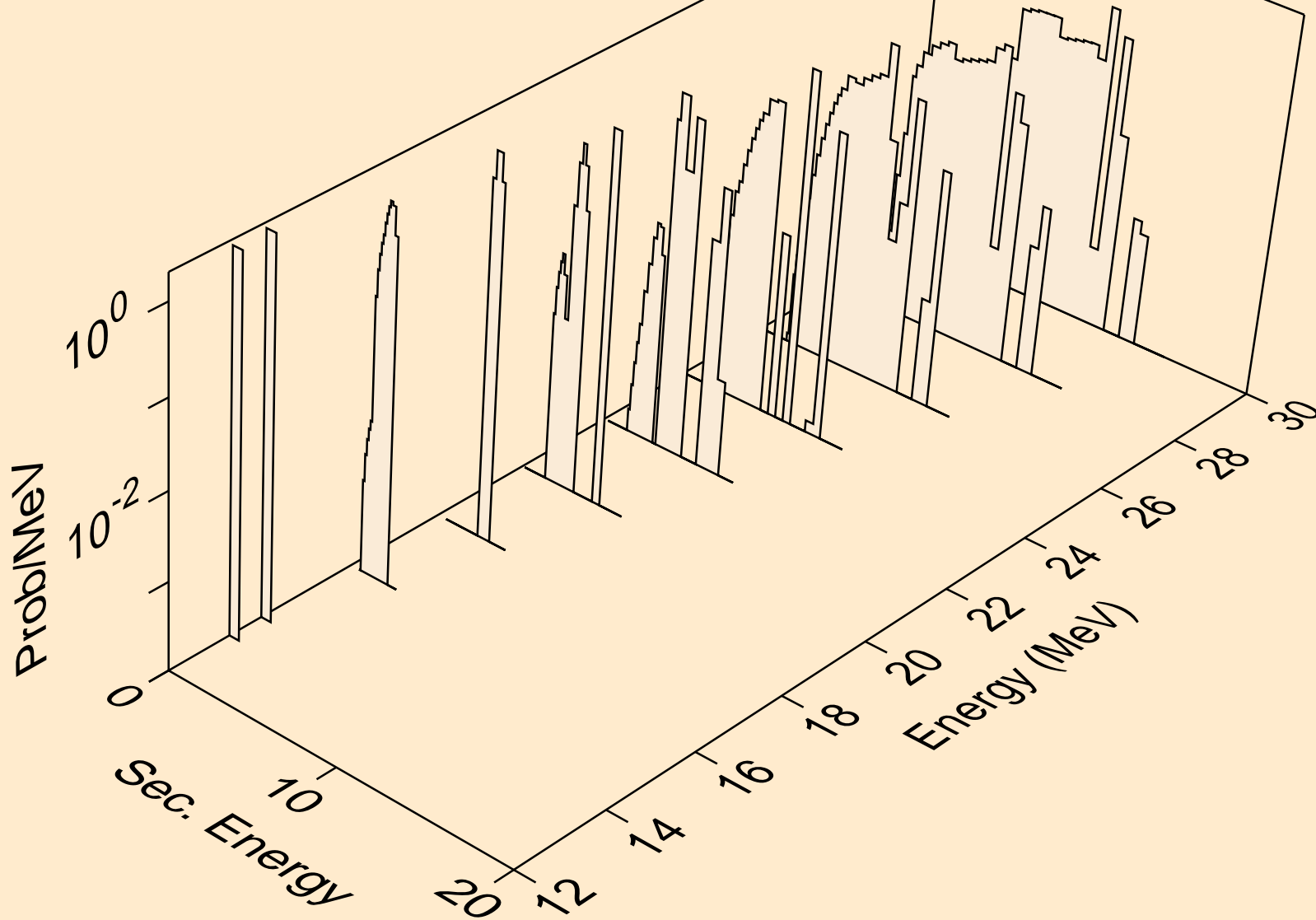

MG024 NEUTRON ACER TENDL-2019 LIBRARY; T=293.16K
alphas from (n,x)

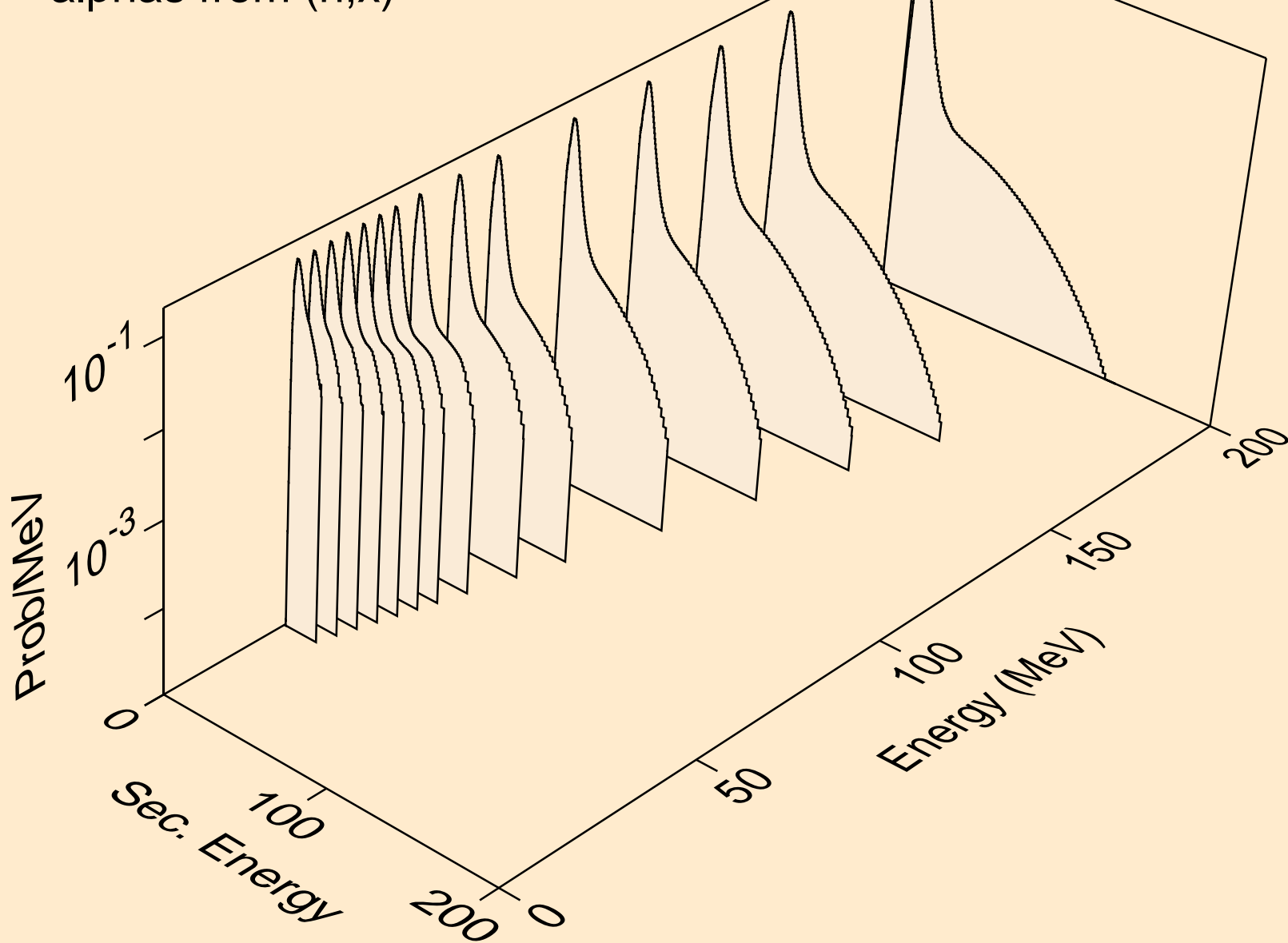

MG024 NEUTRON ACER TENDL-2019 LIBRARY; T=293.16K
alphas from (n,n*)a

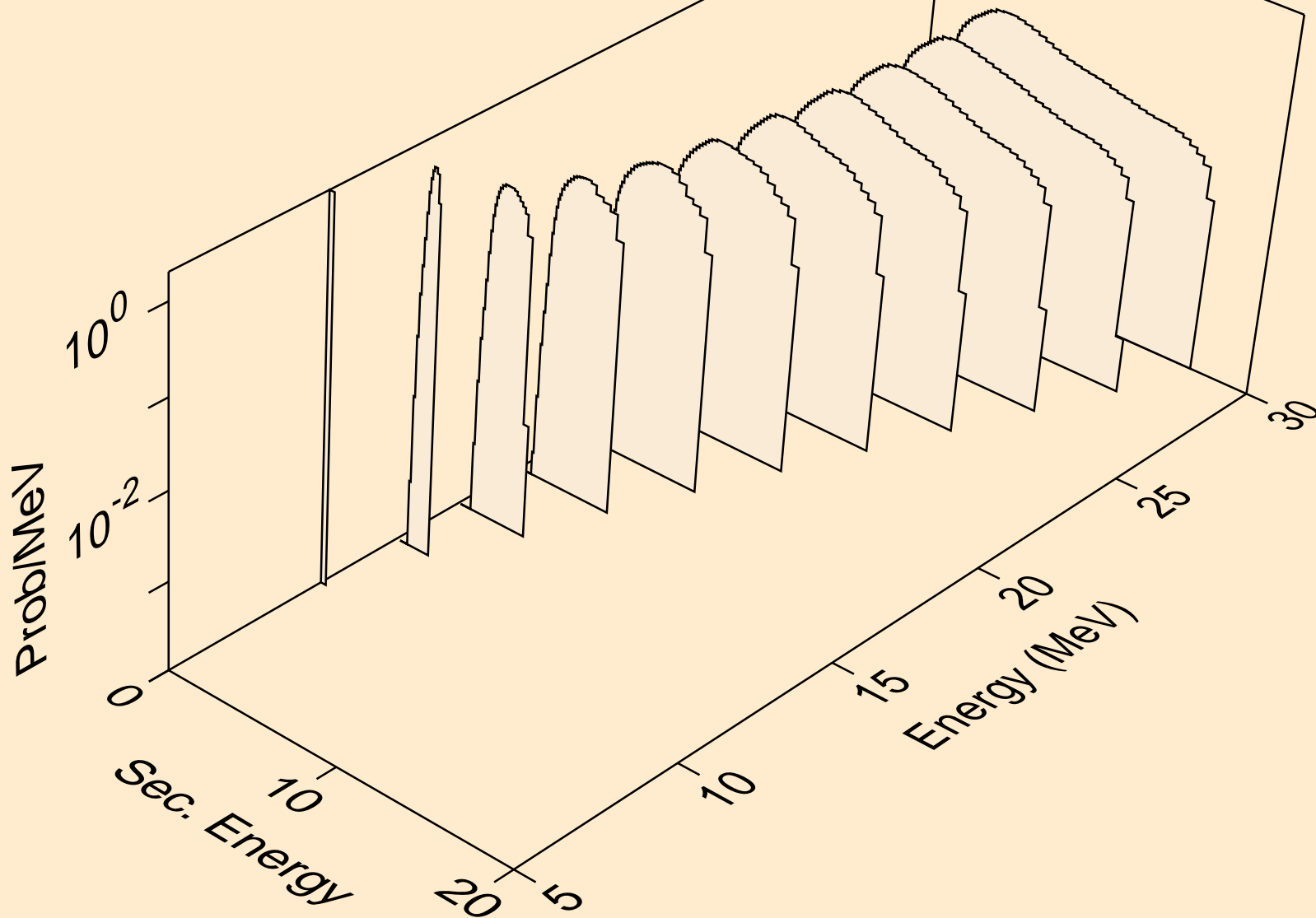

MG024 NEUTRON ACER TENDL-2019 LIBRARY; T=293.16K
alphas from (n,2n)a

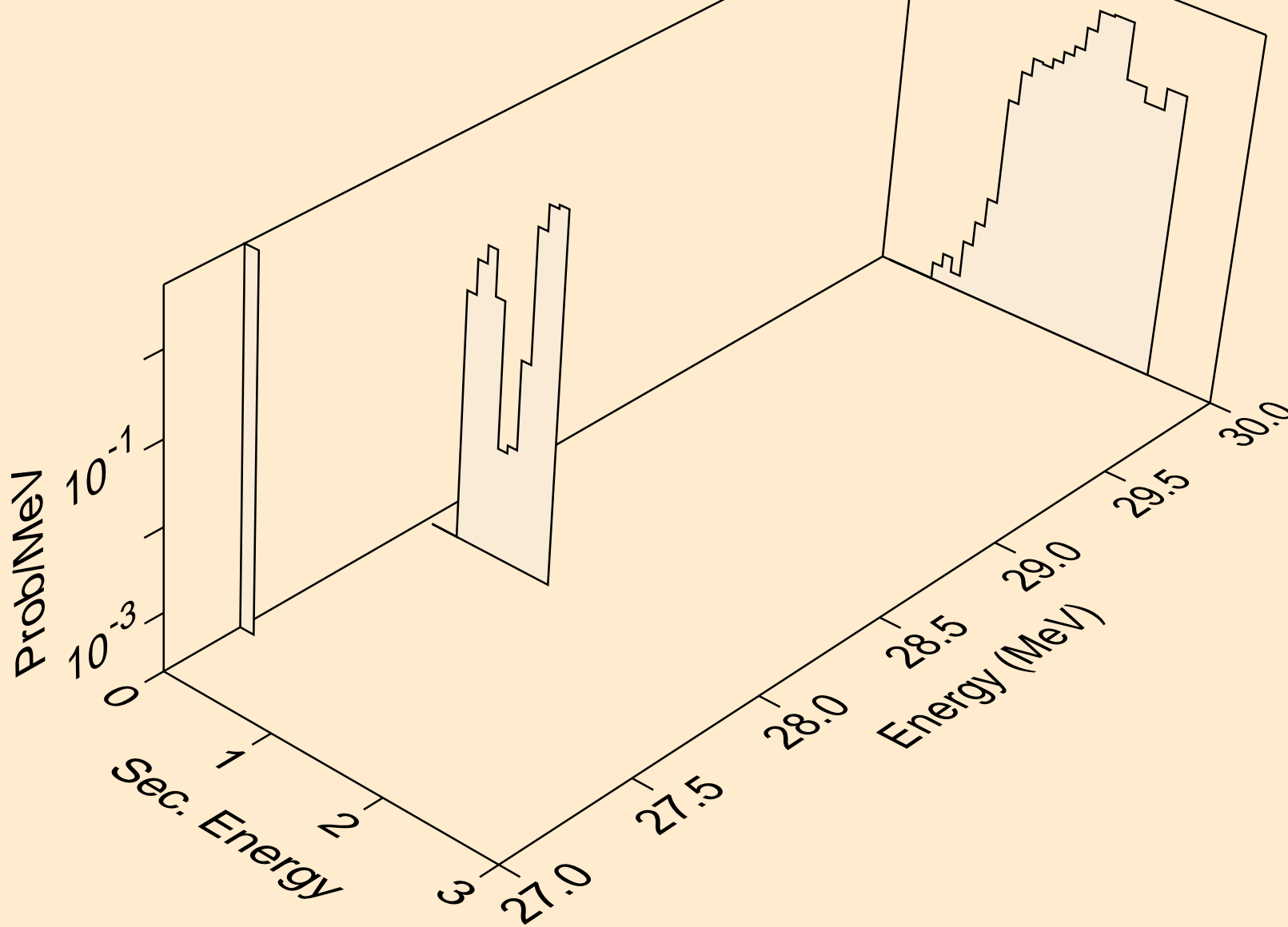

MG024 NEUTRON ACER TENDL-2019 LIBRARY; T=293.16K
alphas from (n,n*)2a

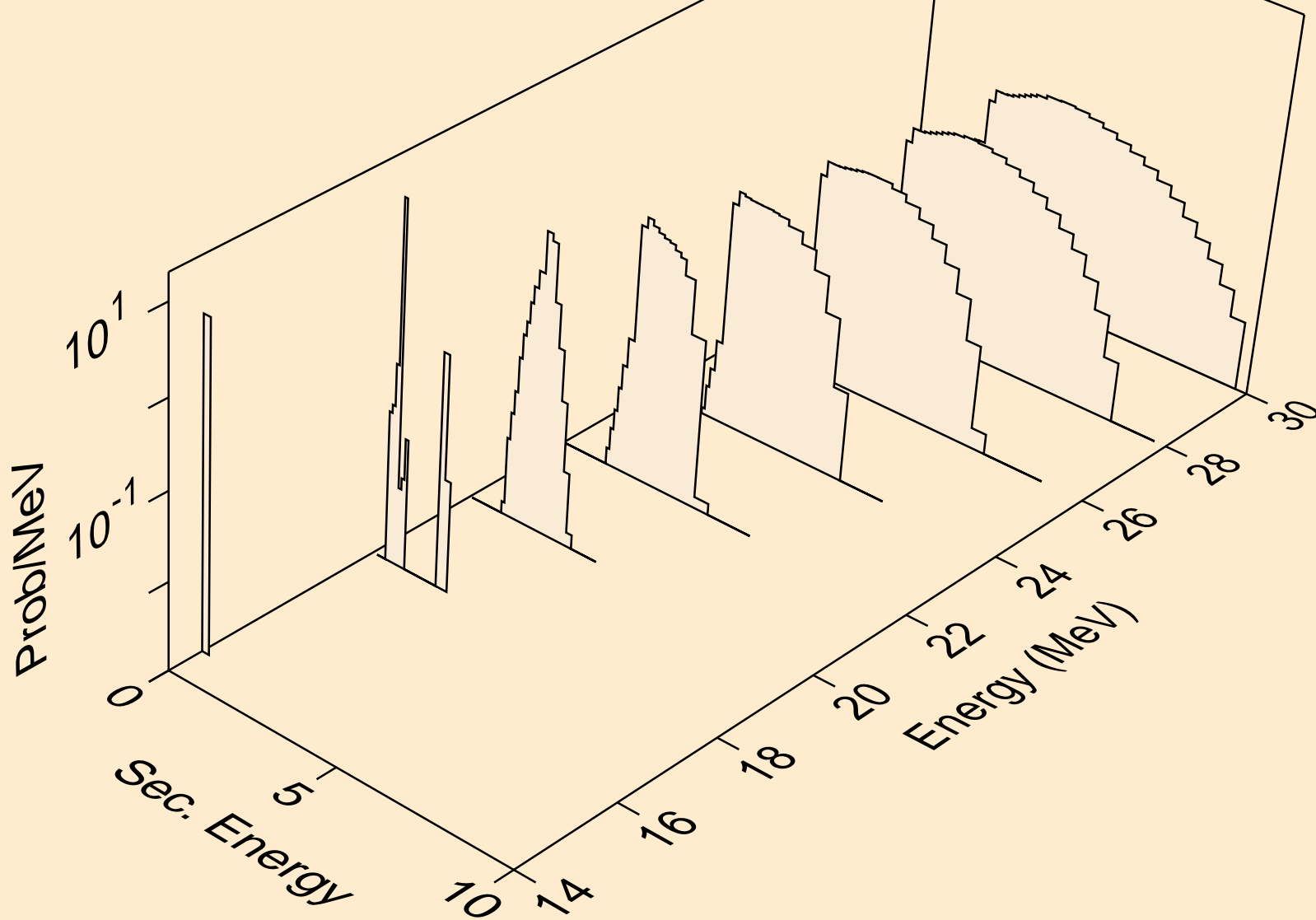

MG024 NEUTRON ACER TENDL-2019 LIBRARY; T=293.16K
alphas from (n,npa)

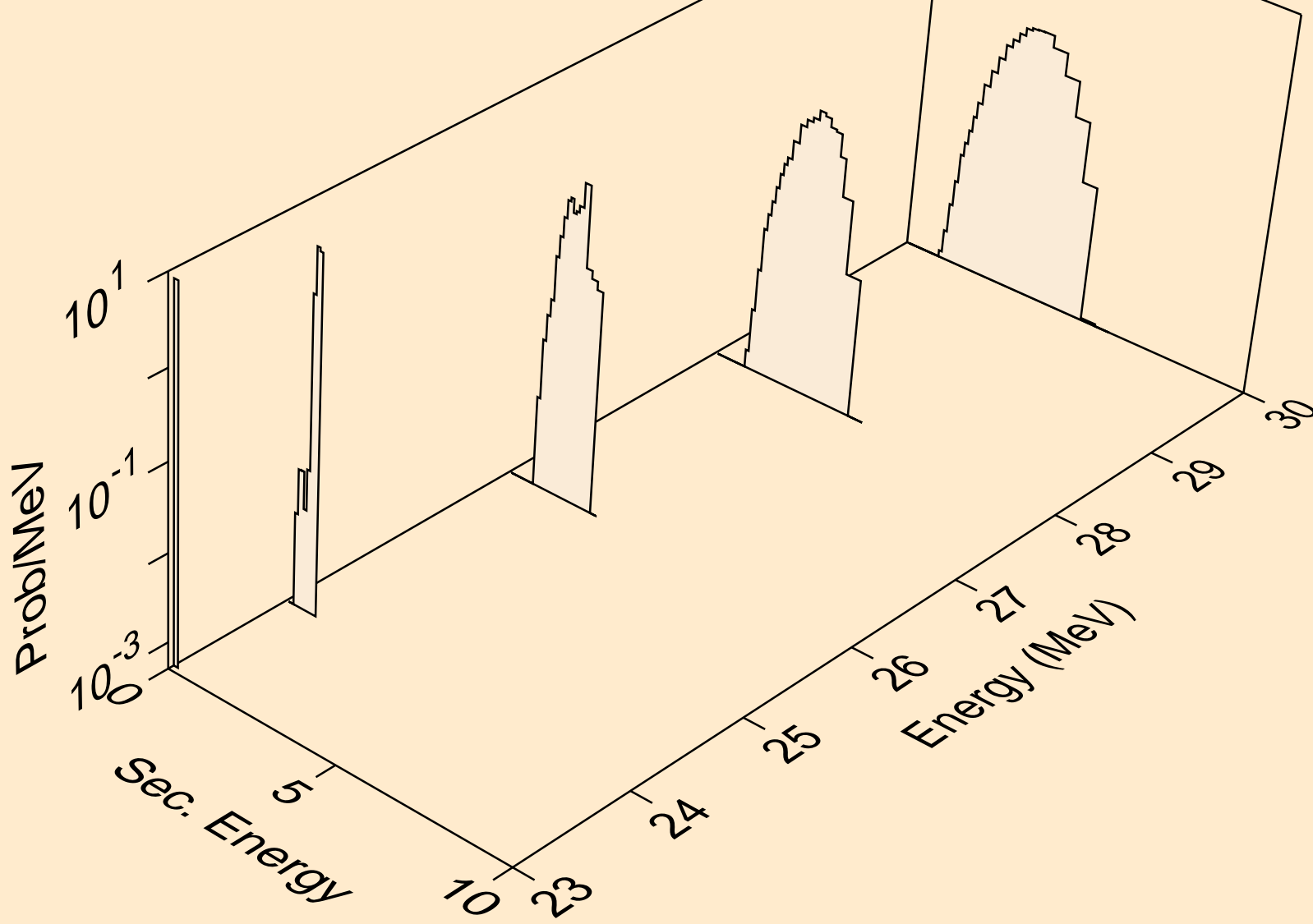

MG024 NEUTRON ACER TENDL-2019 LIBRARY; T=293.16K
alphas from (n,a)

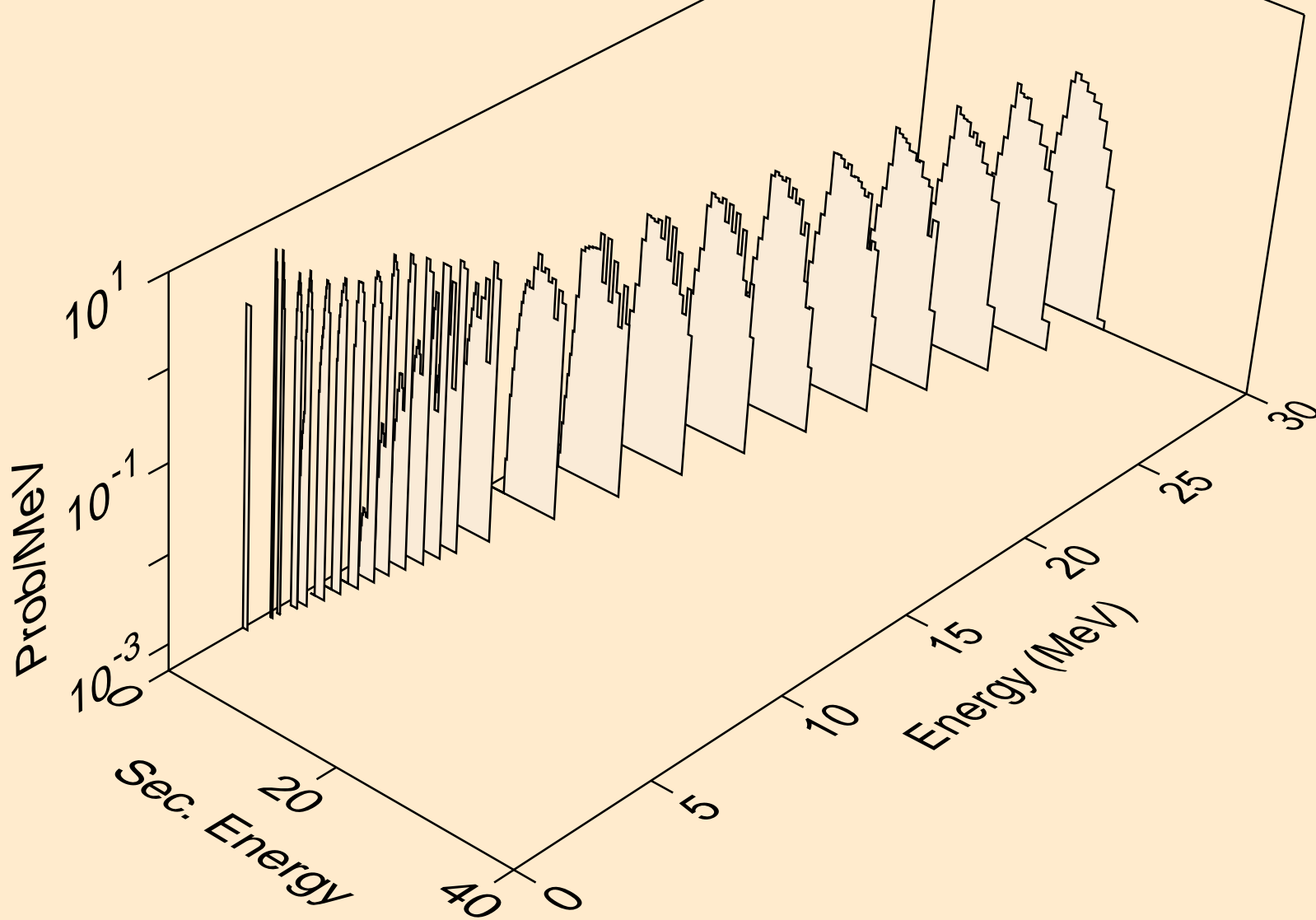

MG024 NEUTRON ACER TENDL-2019 LIBRARY; T=293.16K
alphas from (n,2a)

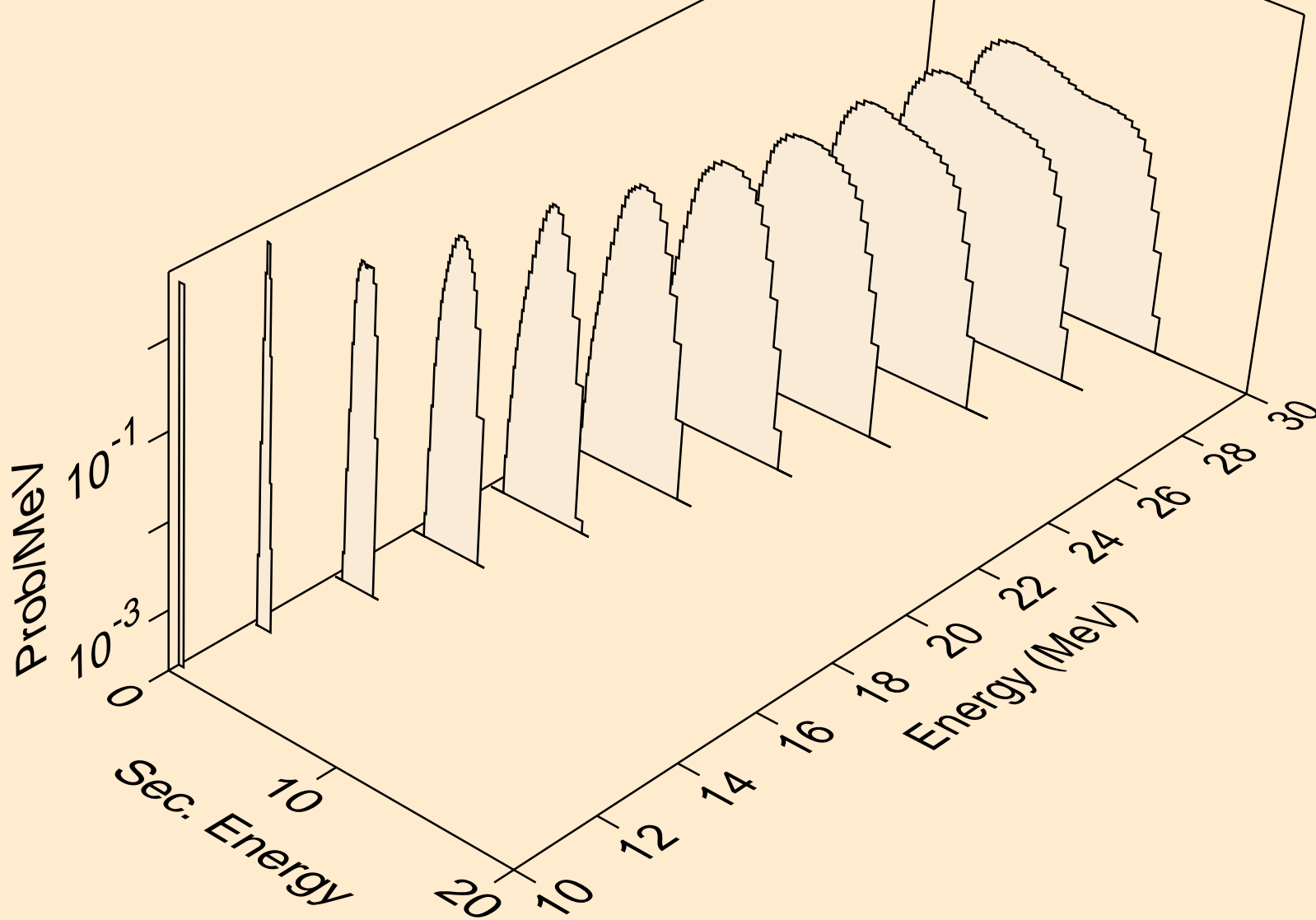

MG024 NEUTRON ACER TENDL-2019 LIBRARY; T=293.16K
alphas from (n,3a)

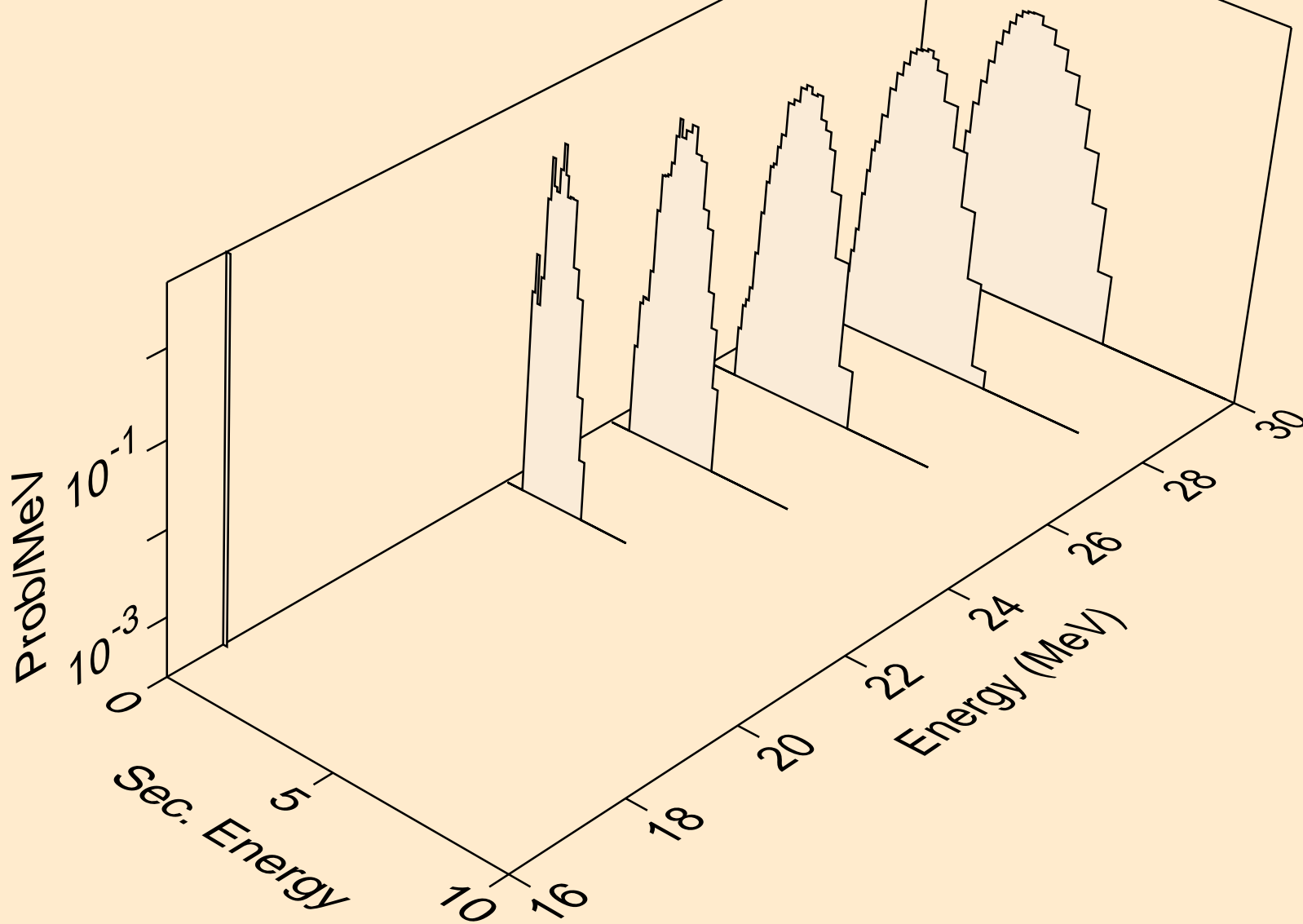

MG024 NEUTRON ACER TENDL-2019 LIBRARY; T=293.16K
alphas from (n,pa)

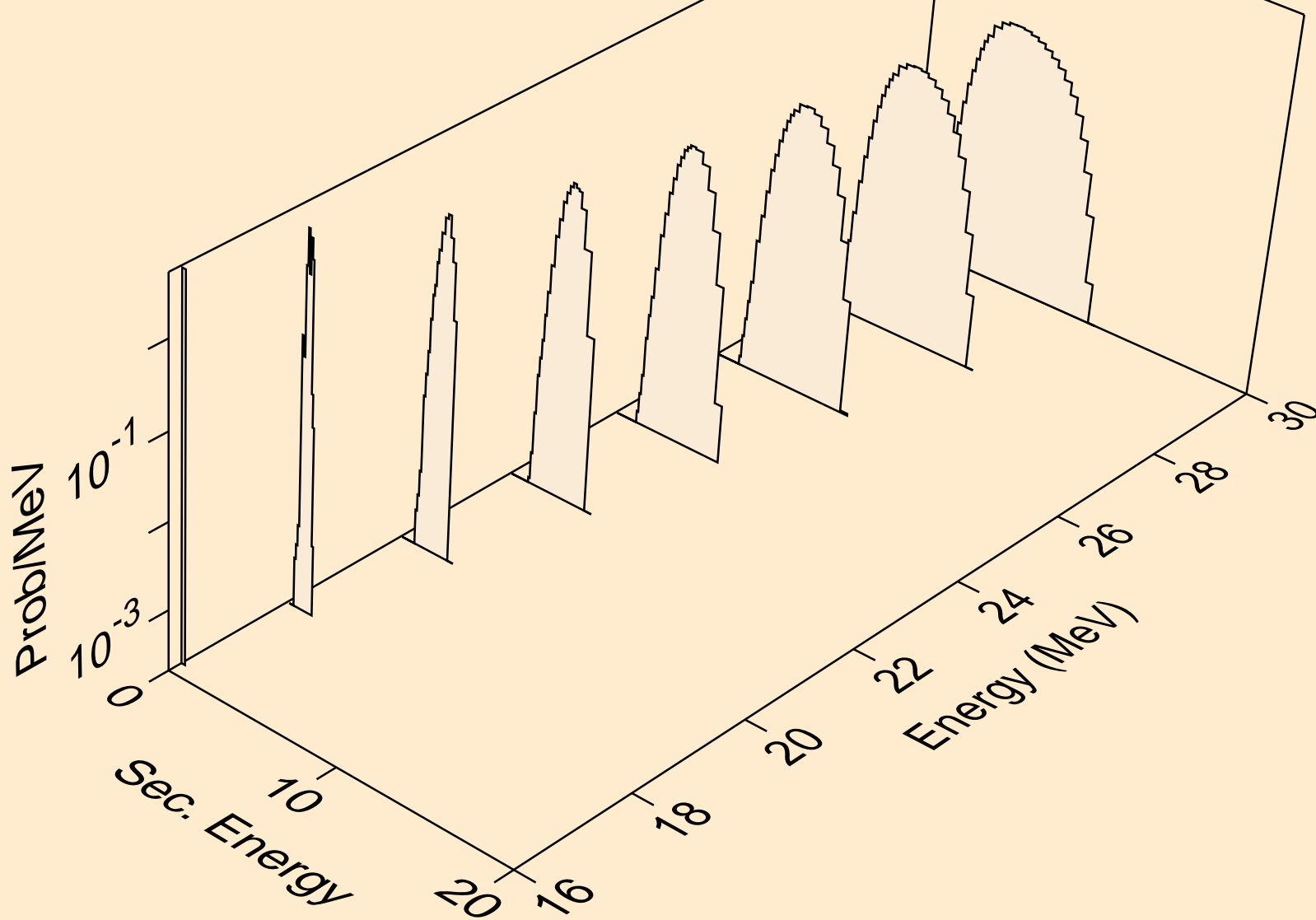

MG024 NEUTRON ACER TENDL-2019 LIBRARY; T=293.16K
alphas from (n,d2a)

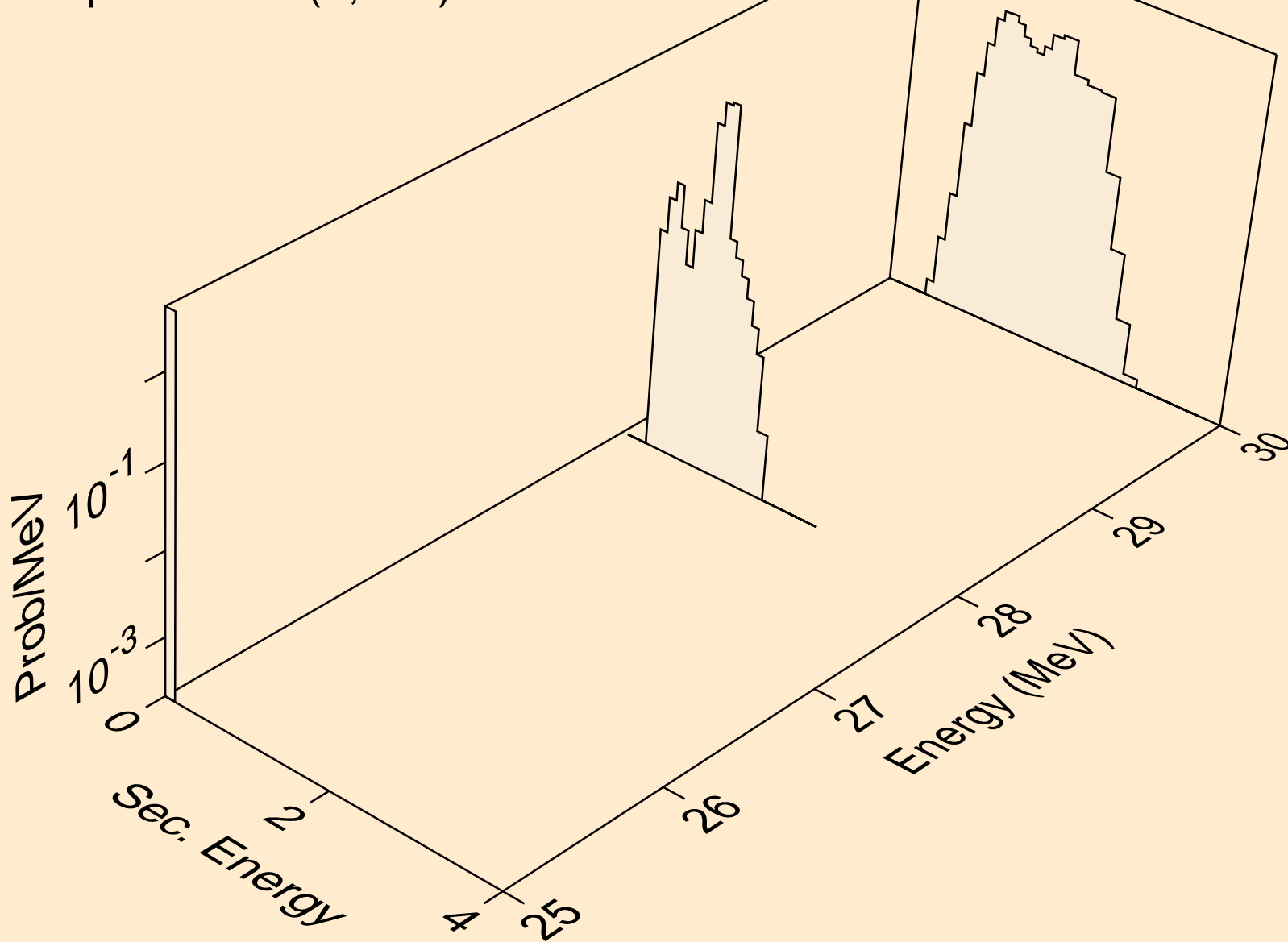

MG024 NEUTRON ACER TENDL-2019 LIBRARY; T=293.16K
alphas from (n,da)

