

MG026 NEUTRON ACER TENDL-2019 LIBRARY; T=293.16K
Principal cross sections

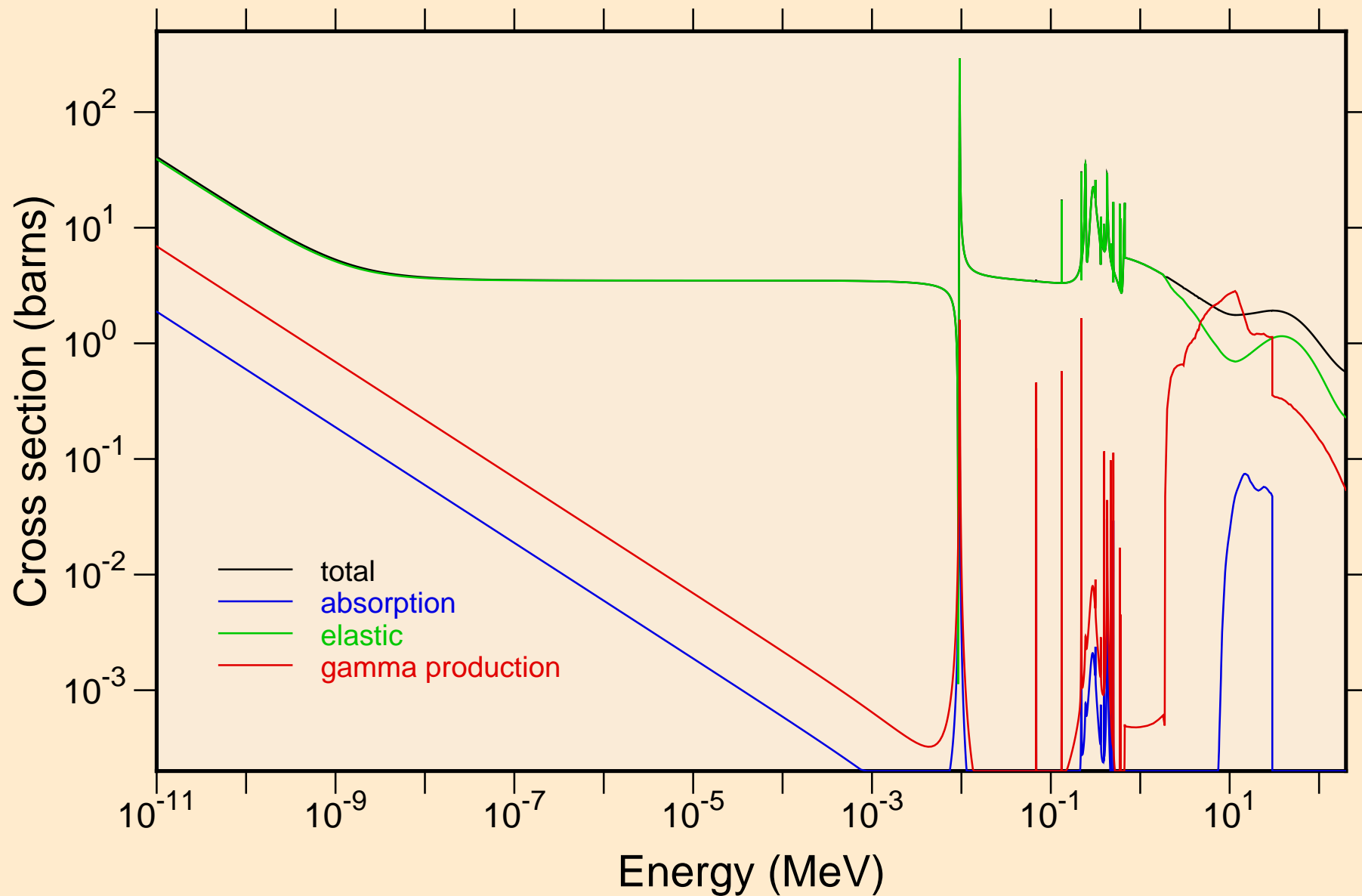

MG026 NEUTRON ACER TENDL-2019 LIBRARY; T=293.16K
resonance total cross section

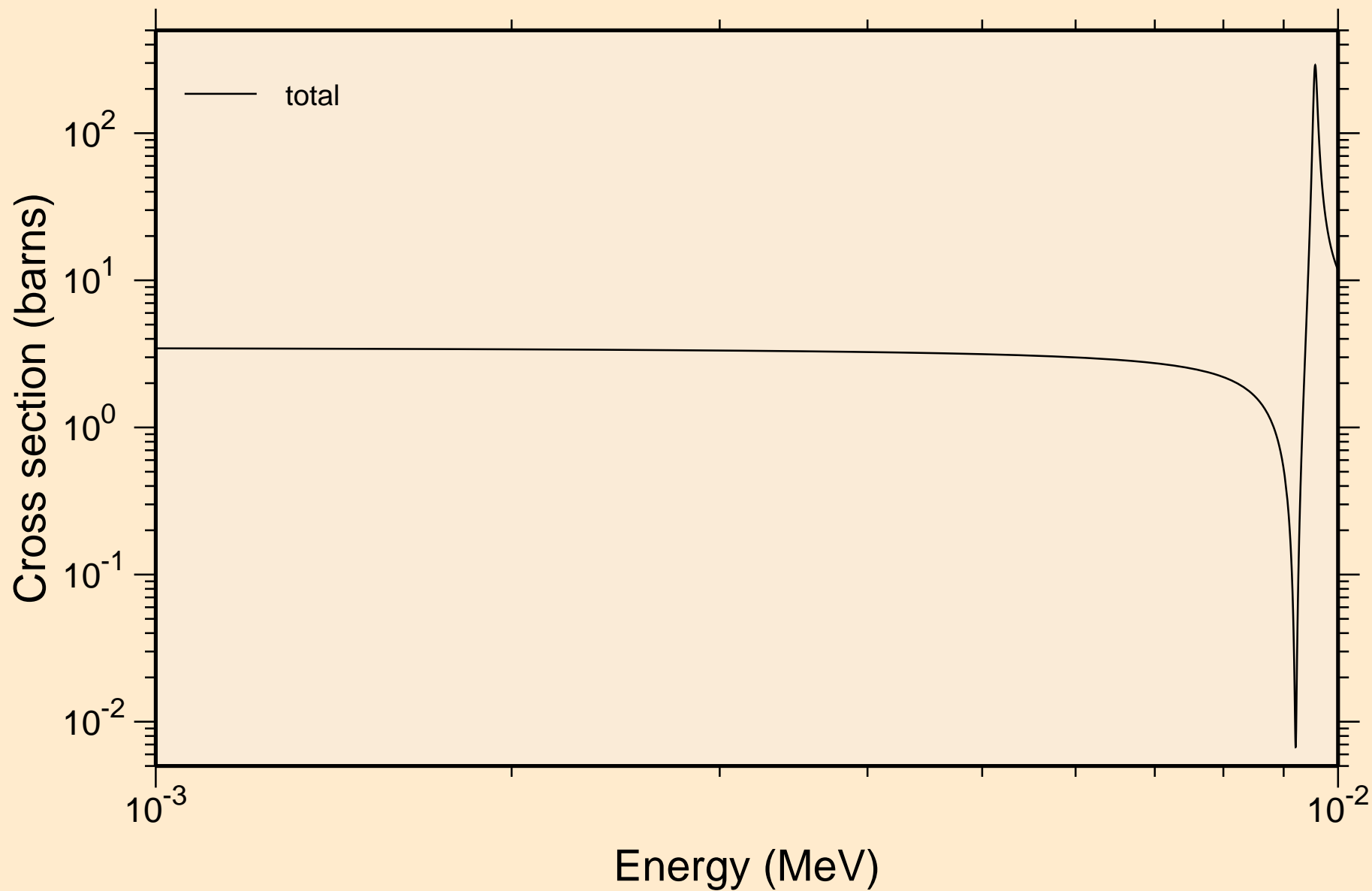

MG026 NEUTRON ACER TENDL-2019 LIBRARY; T=293.16K
resonance total cross section

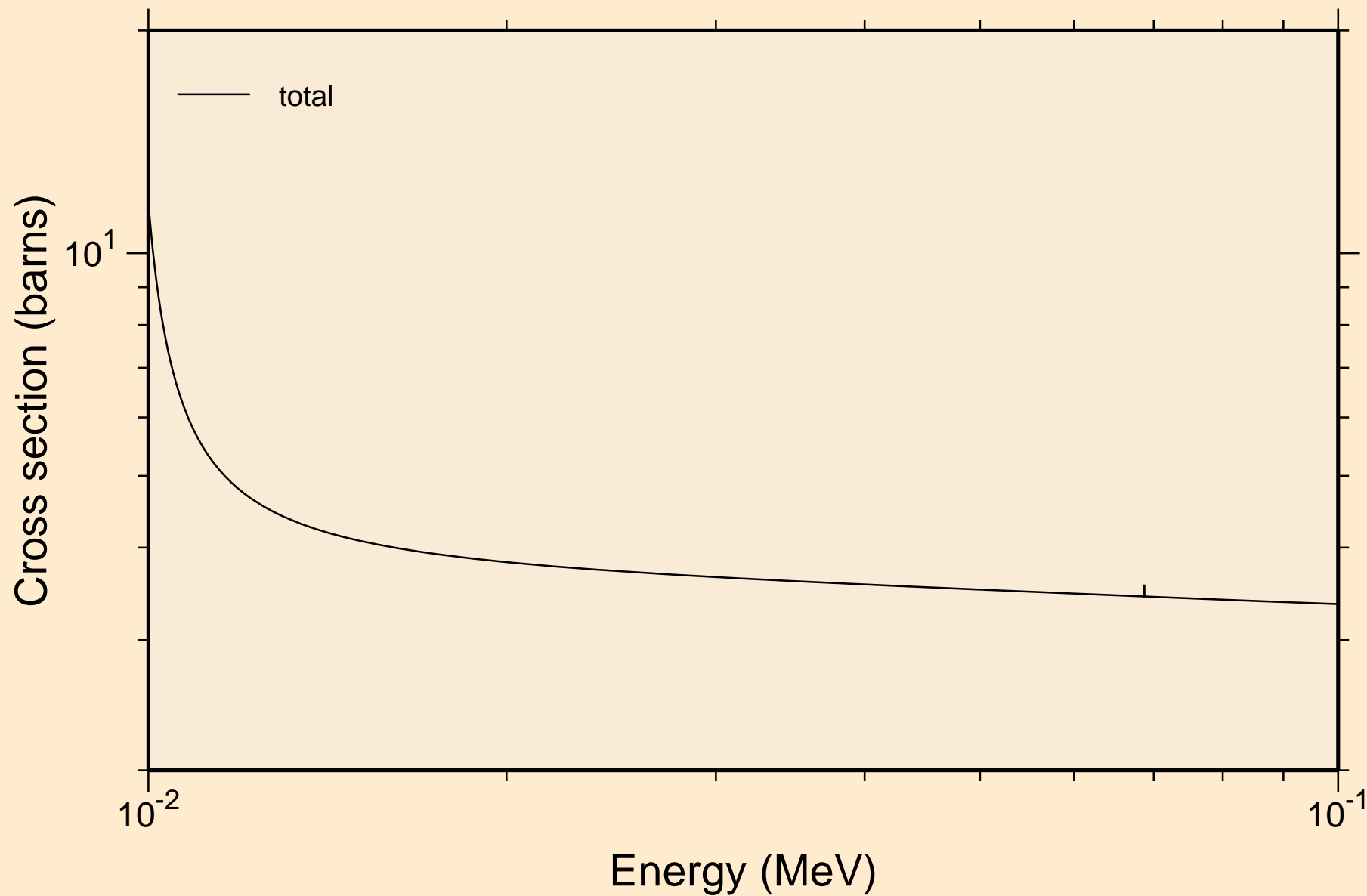

MG026 NEUTRON ACER TENDL-2019 LIBRARY; T=293.16K
resonance total cross section

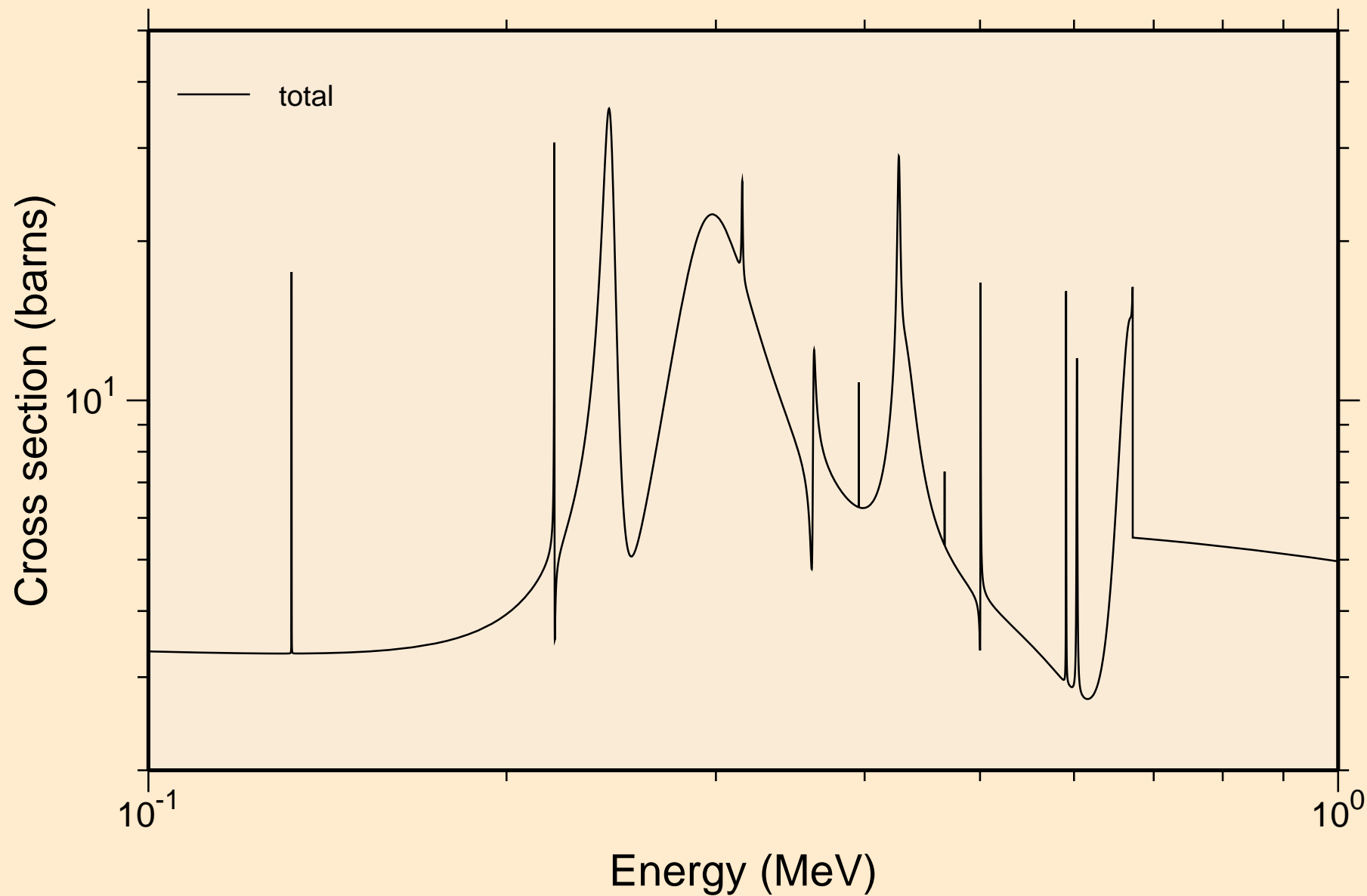

MG026 NEUTRON ACER TENDL-2019 LIBRARY; T=293.16K
resonance total cross section

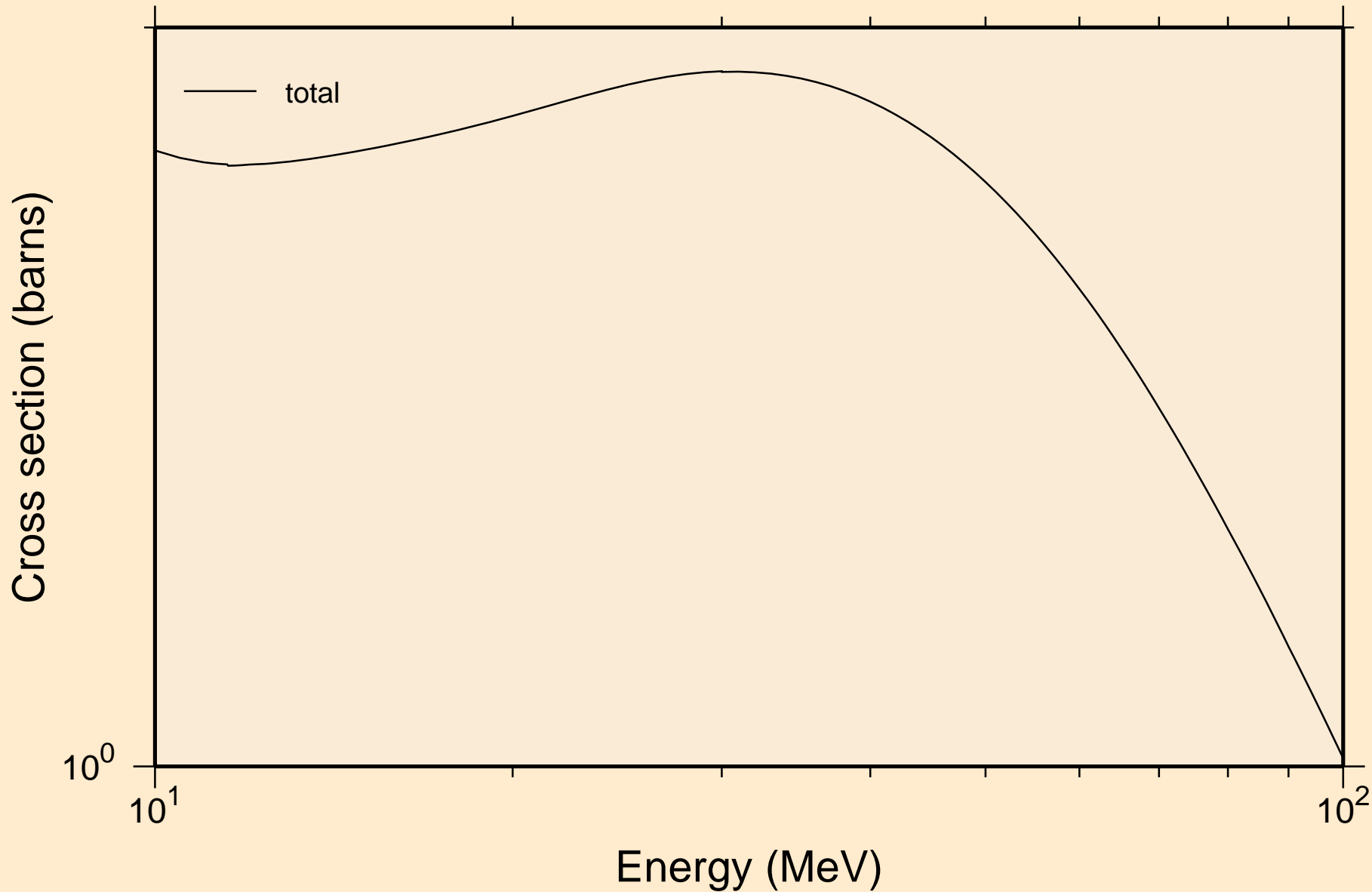

MG026 NEUTRON ACER TENDL-2019 LIBRARY; T=293.16K
resonance absorption cross sections

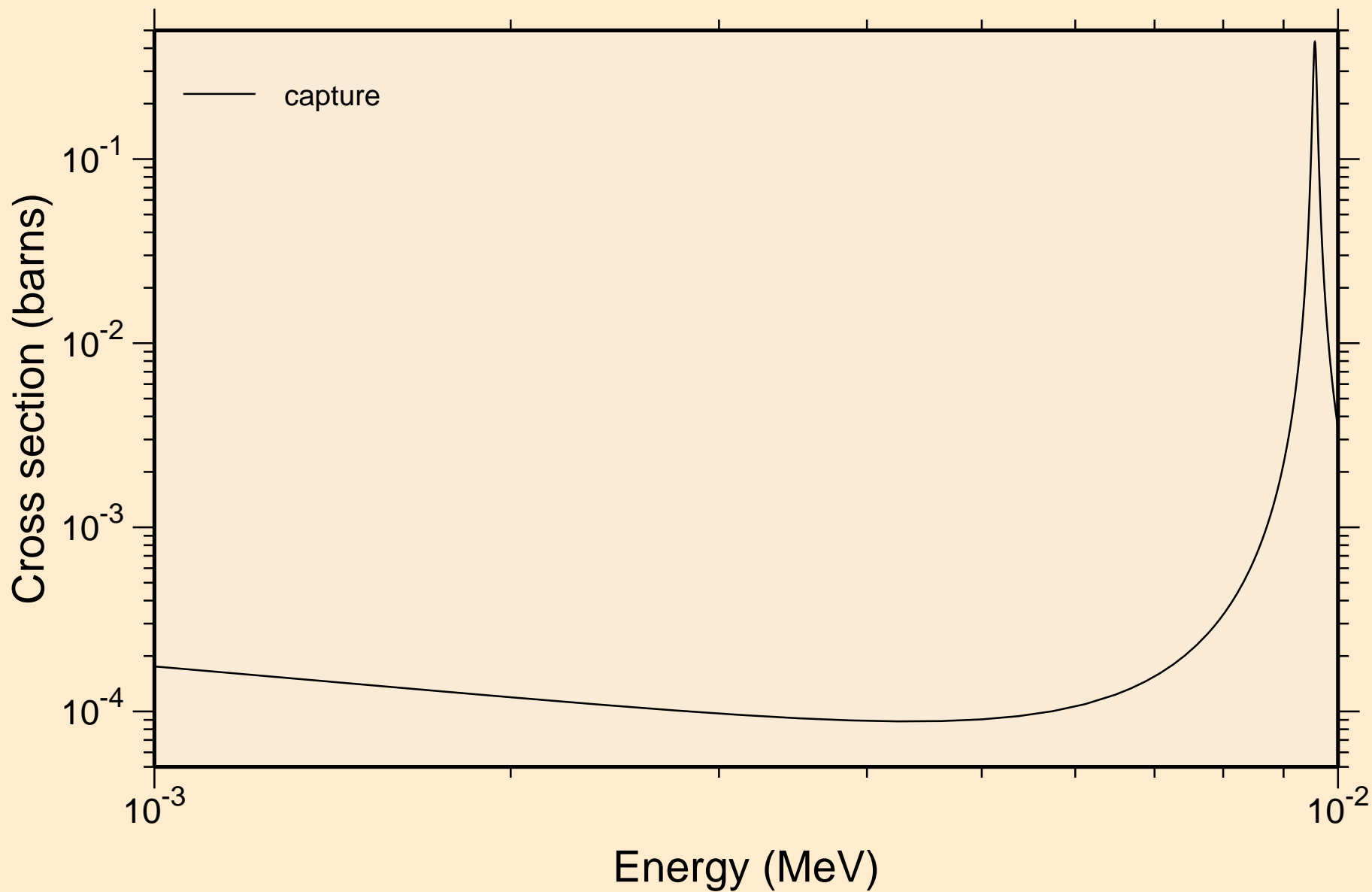

MG026 NEUTRON ACER TENDL-2019 LIBRARY; T=293.16K
resonance absorption cross sections

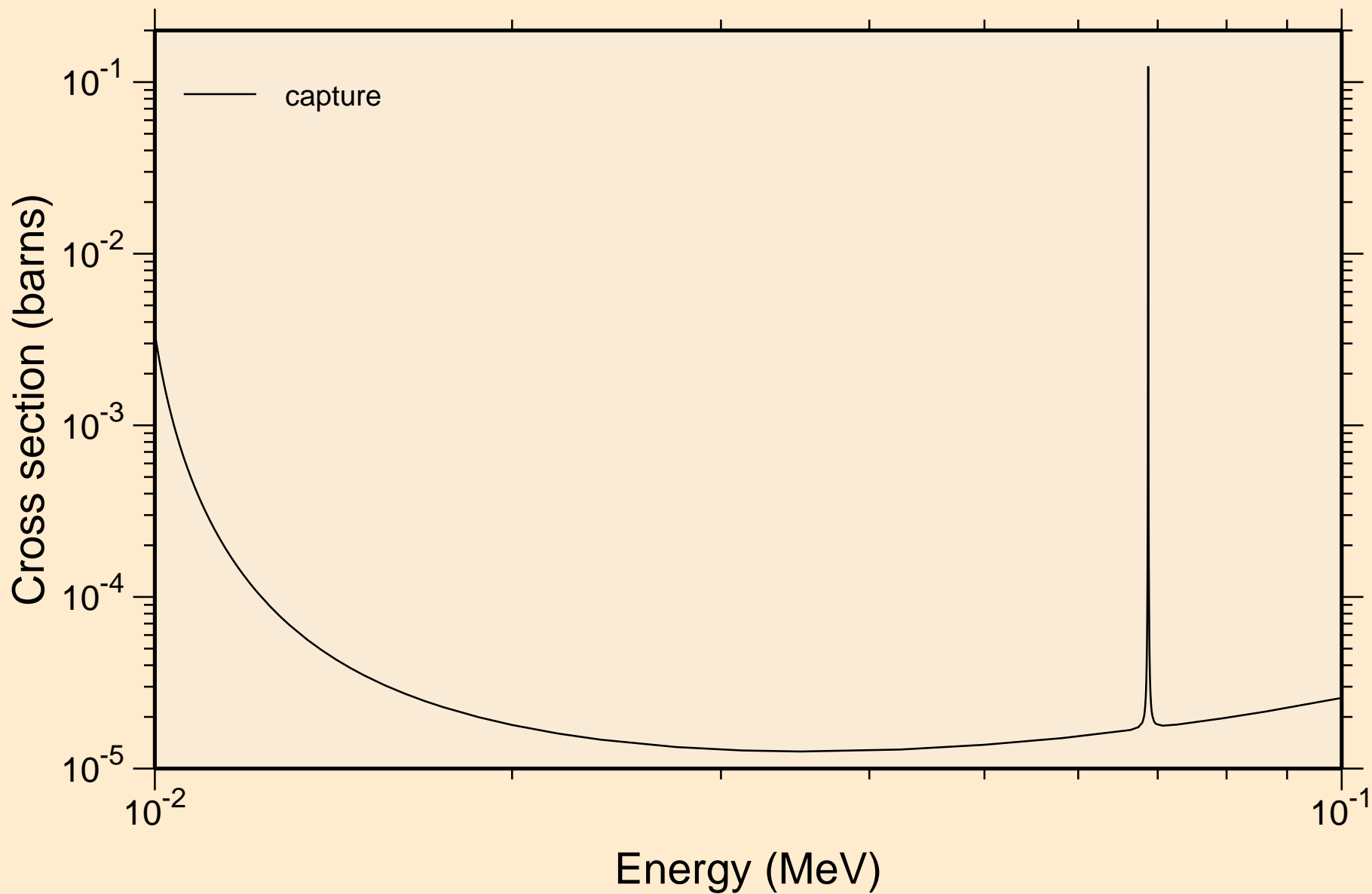

MG026 NEUTRON ACER TENDL-2019 LIBRARY; T=293.16K
resonance absorption cross sections

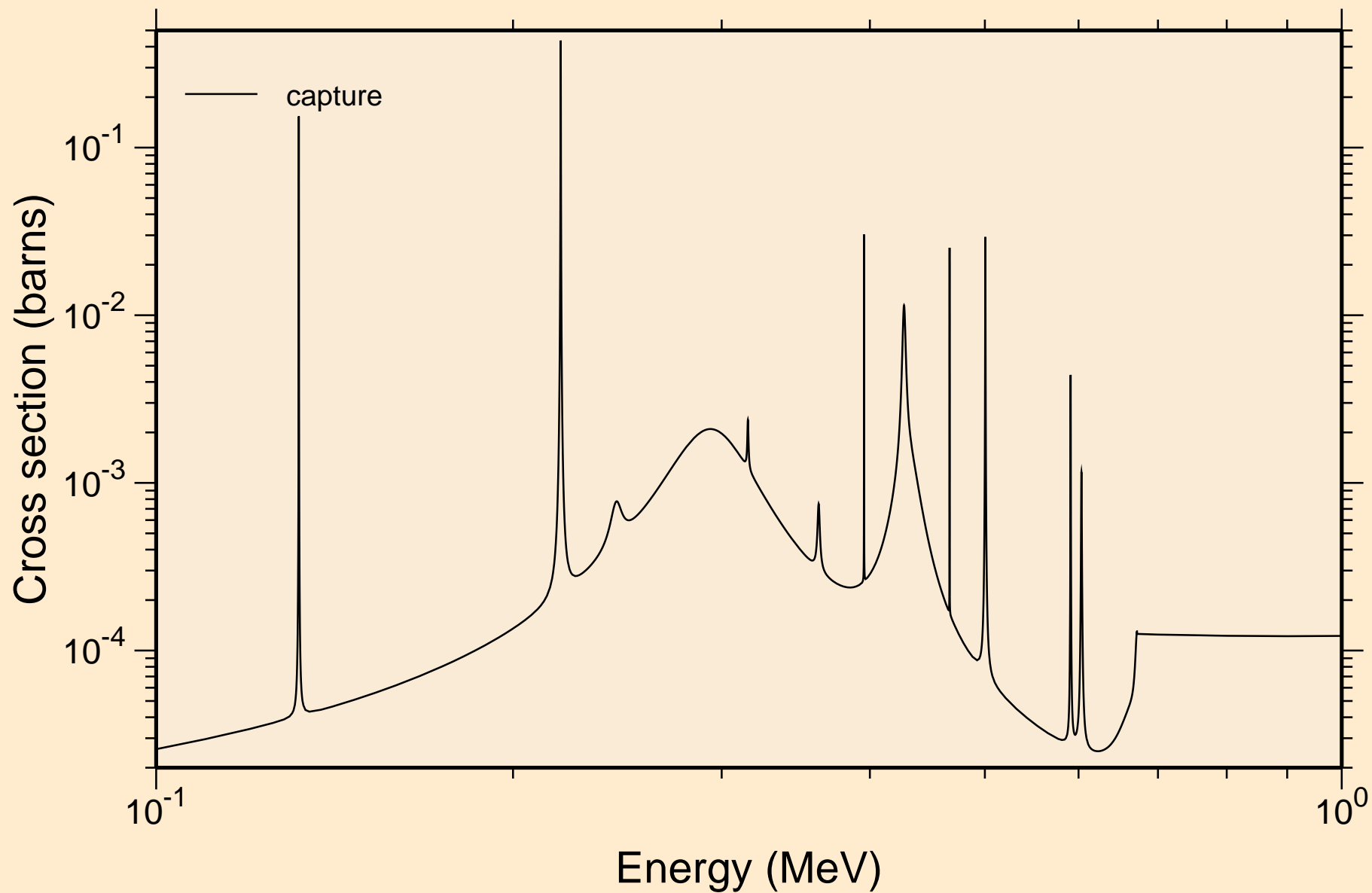

MG026 NEUTRON ACER TENDL-2019 LIBRARY; T=293.16K
resonance absorption cross sections

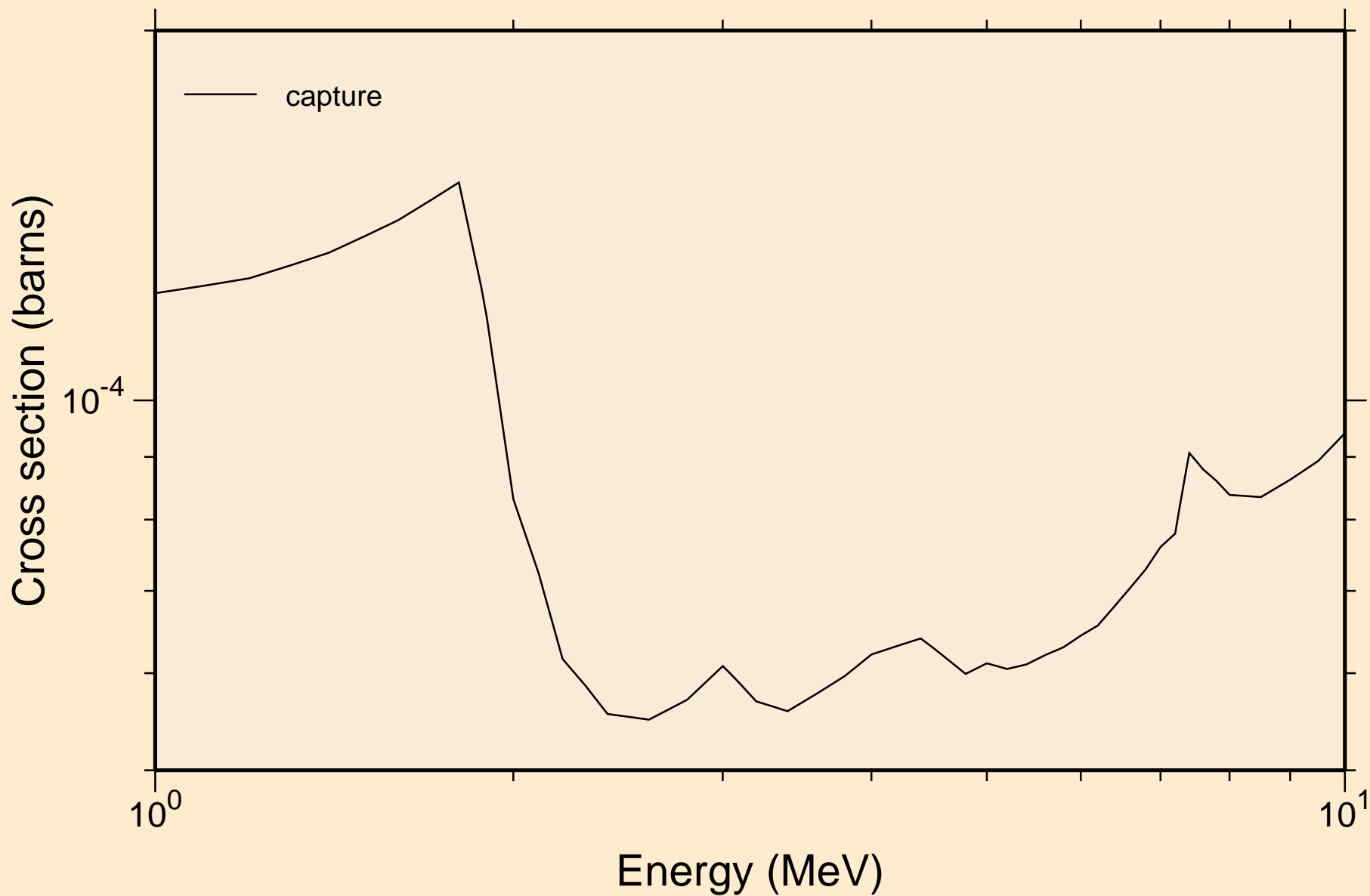

MG026 NEUTRON ACER TENDL-2019 LIBRARY; T=293.16K
Heating

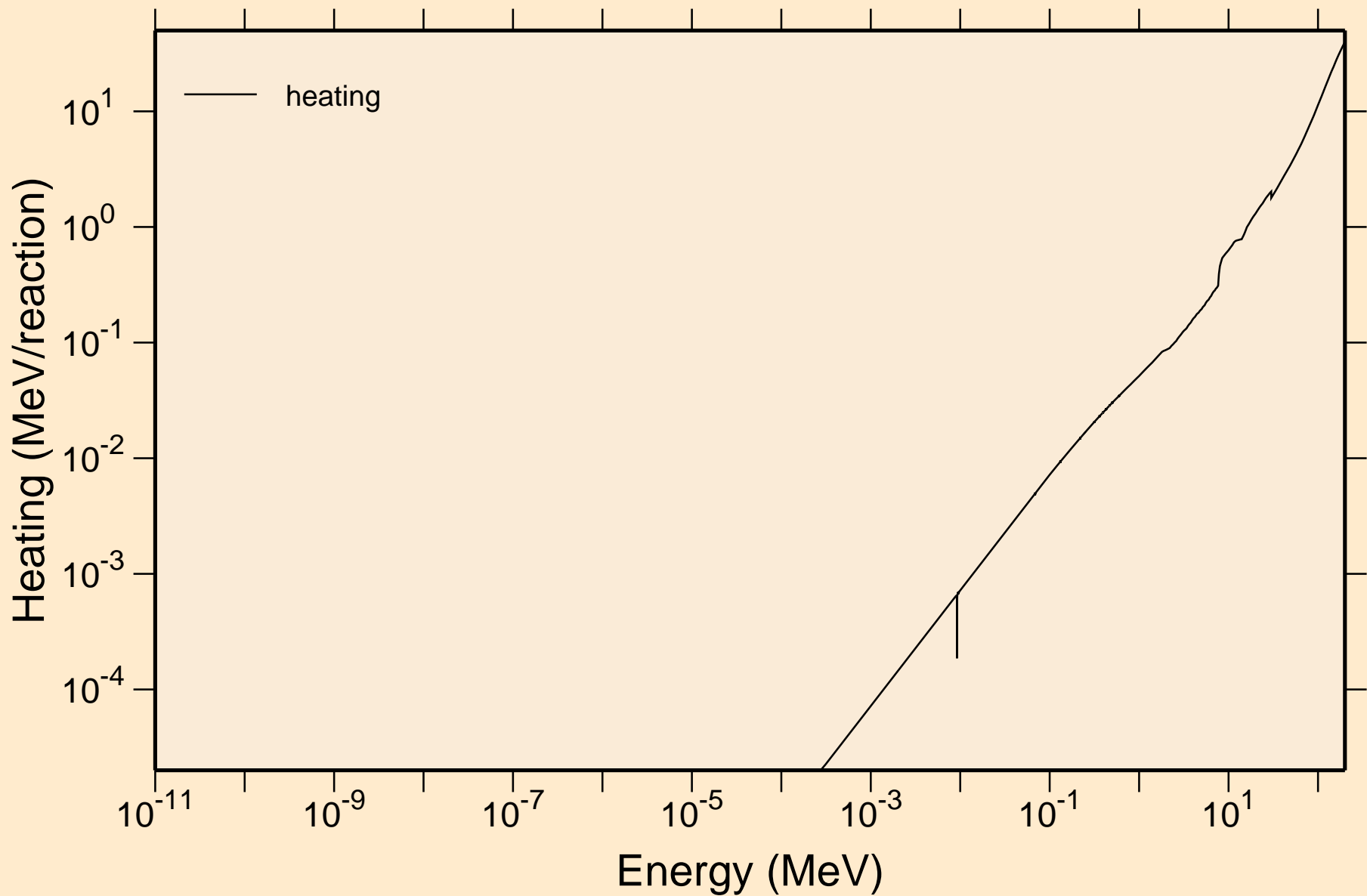

MG026 NEUTRON ACER TENDL-2019 LIBRARY; T=293.16K
Damage

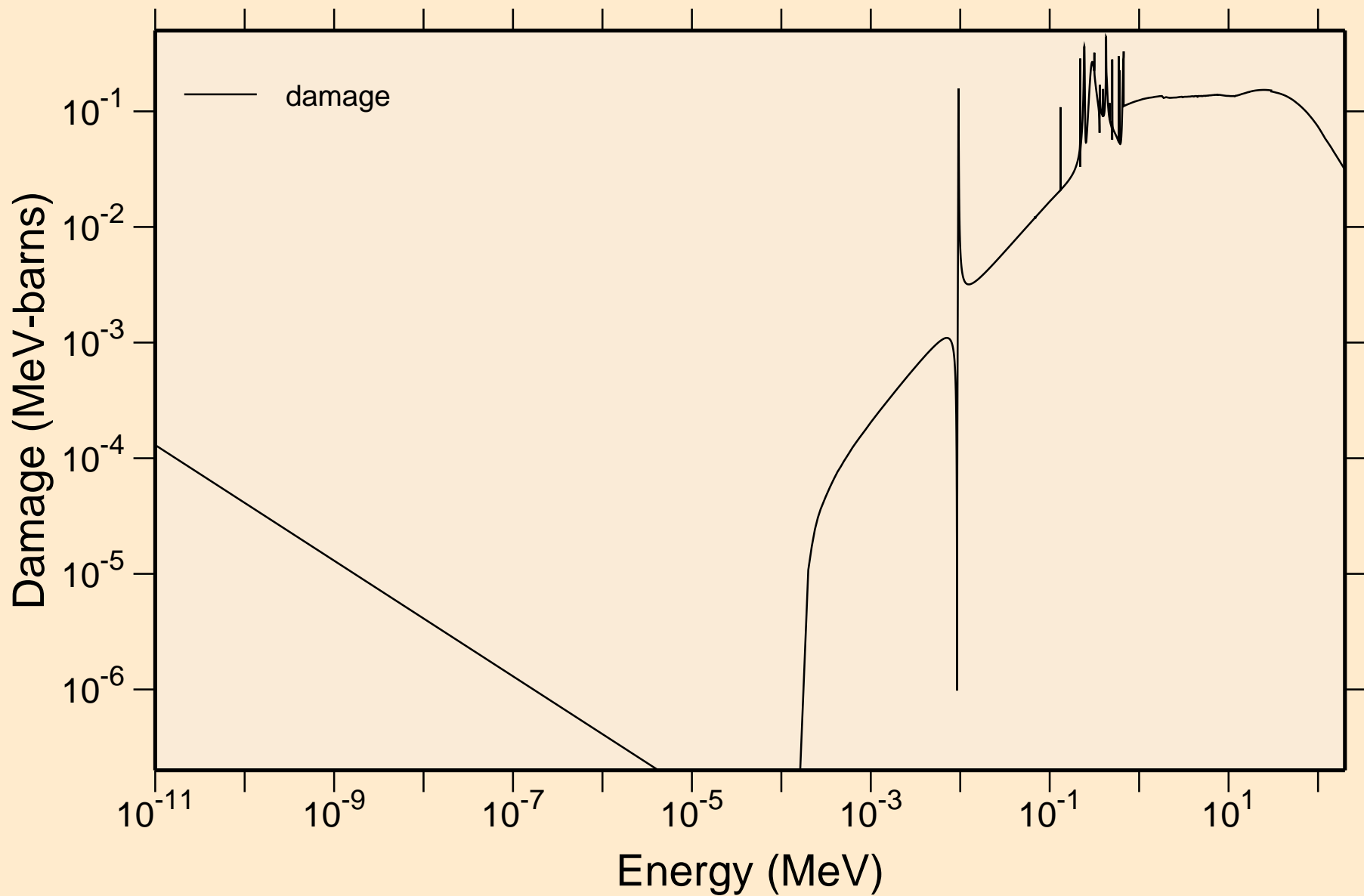

MG026 NEUTRON ACER TENDL-2019 LIBRARY; T=293.16K
Non-threshold reactions

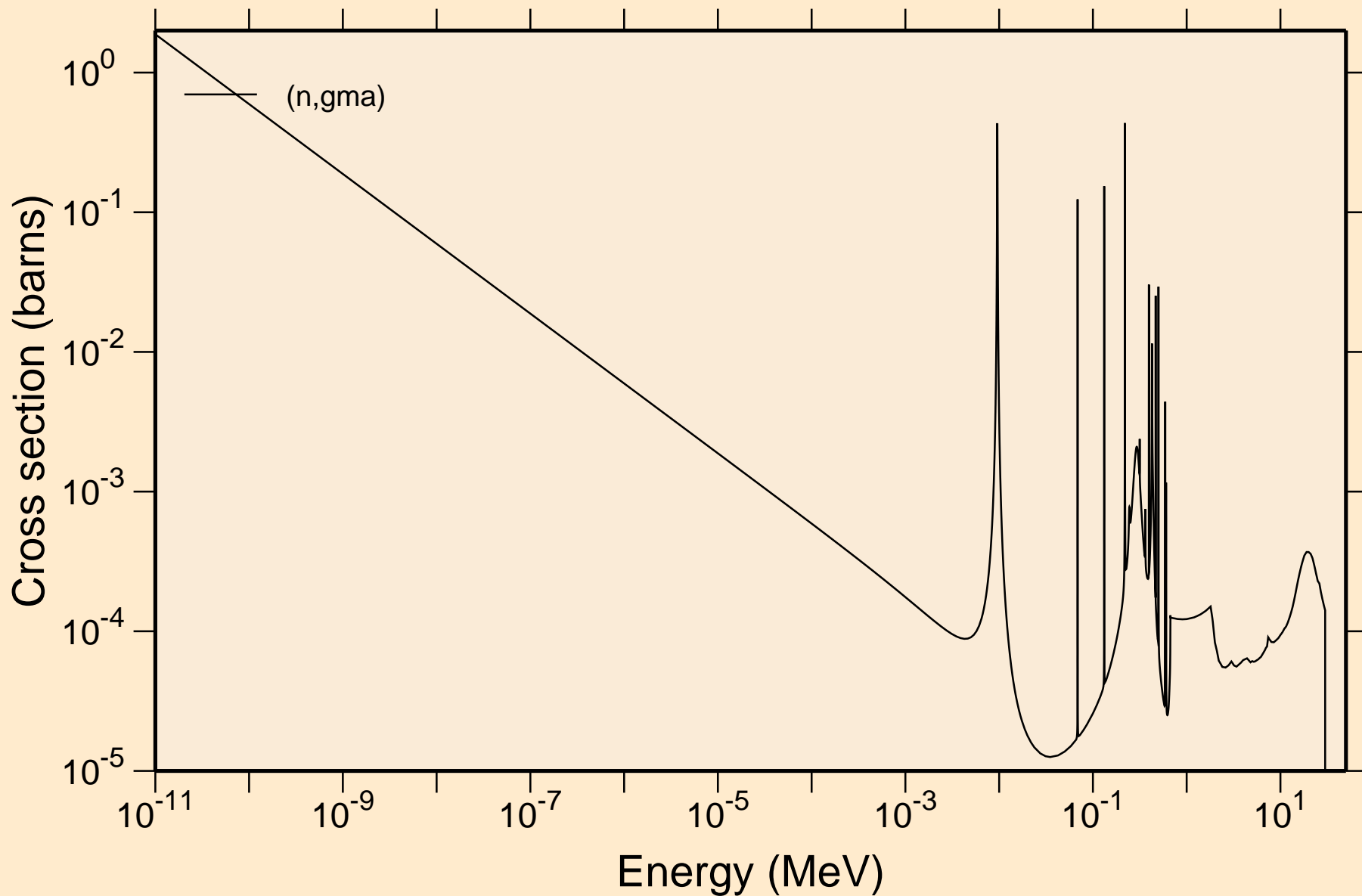

MG026 NEUTRON ACER TENDL-2019 LIBRARY; T=293.16K
Principal cross sections

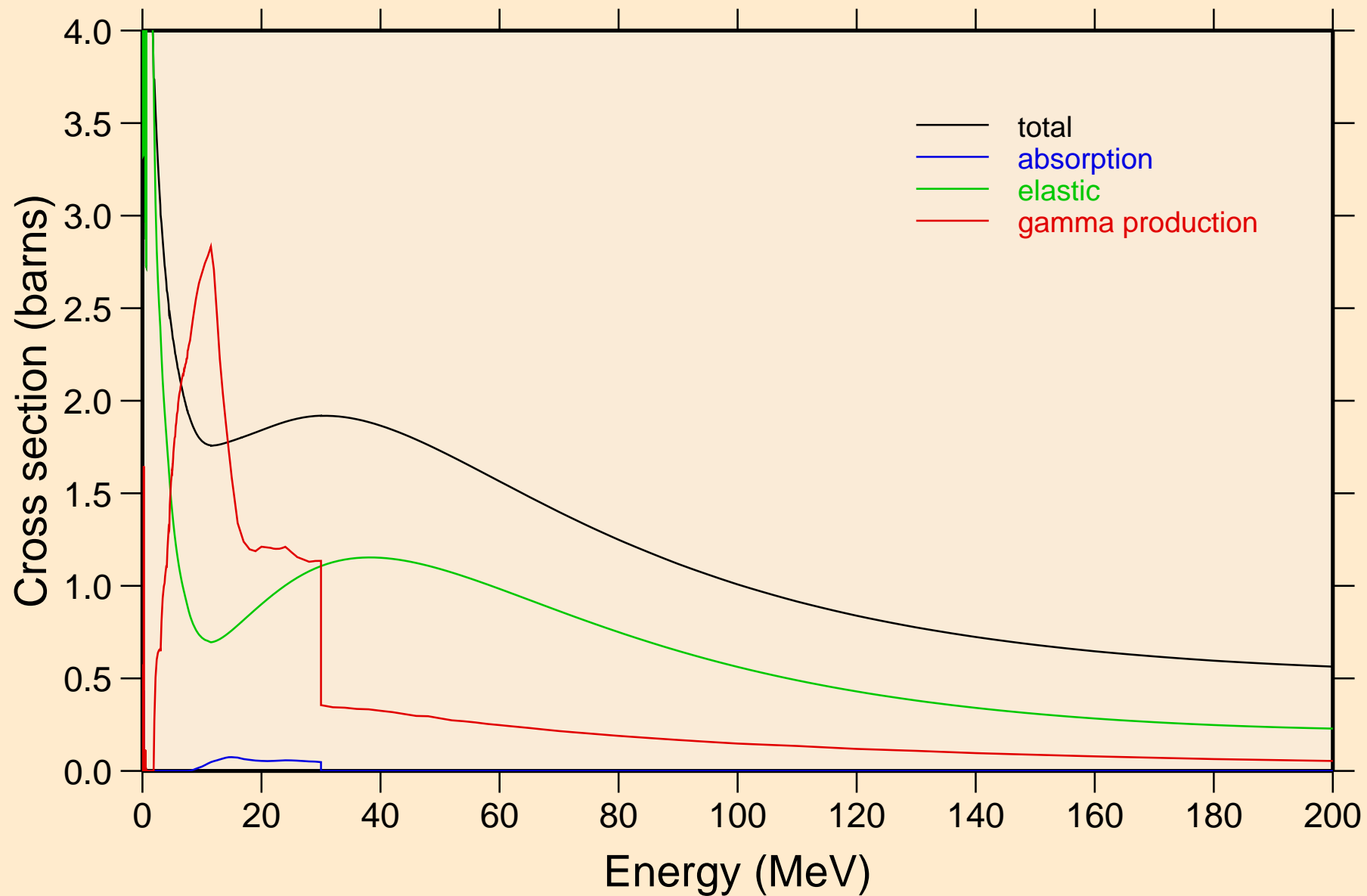

MG026 NEUTRON ACER TENDL-2019 LIBRARY; T=293.16K
Heating

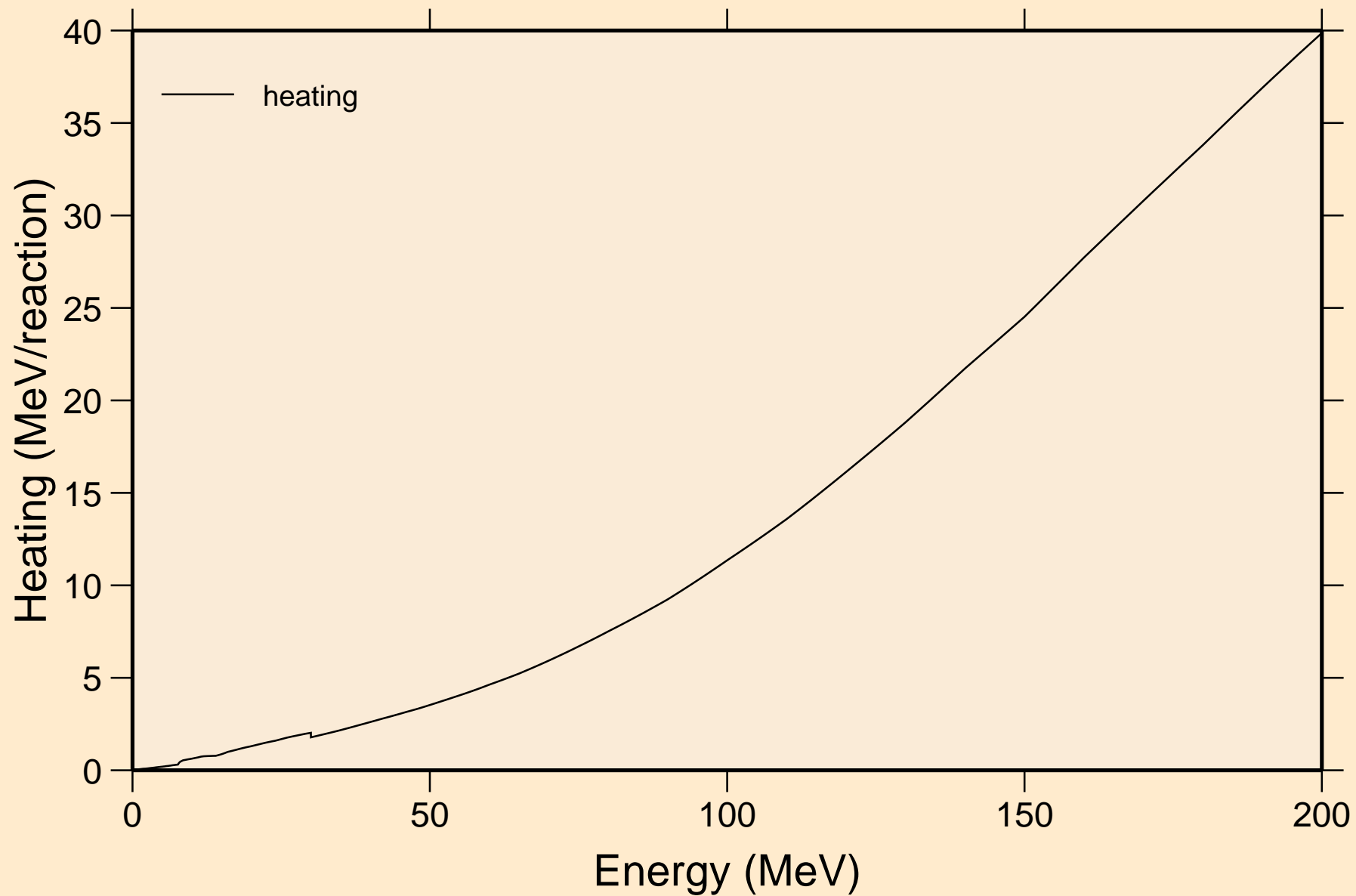

MG026 NEUTRON ACER TENDL-2019 LIBRARY; T=293.16K
Damage

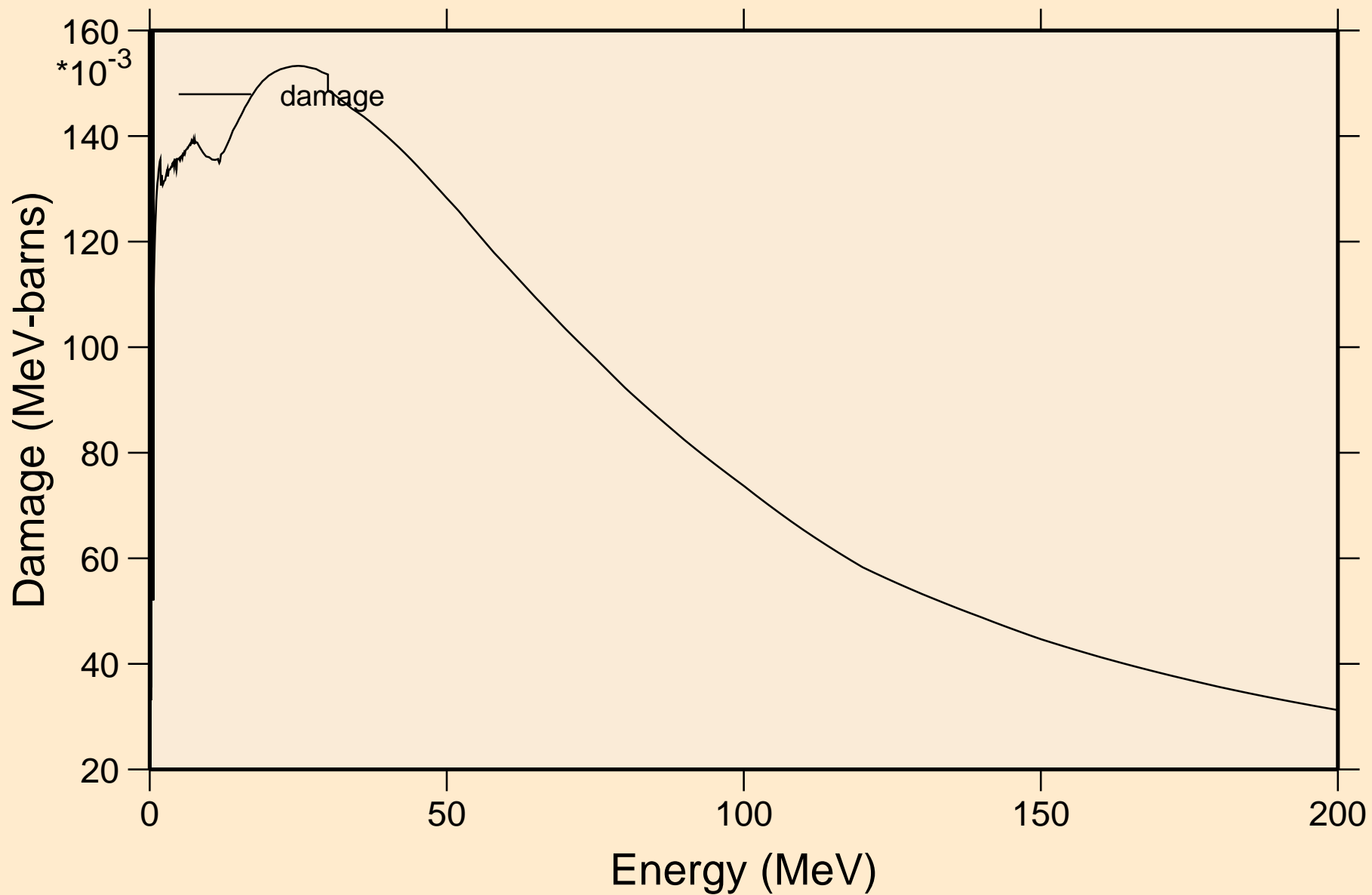

MG026 NEUTRON ACER TENDL-2019 LIBRARY; T=293.16K
Non-threshold reactions

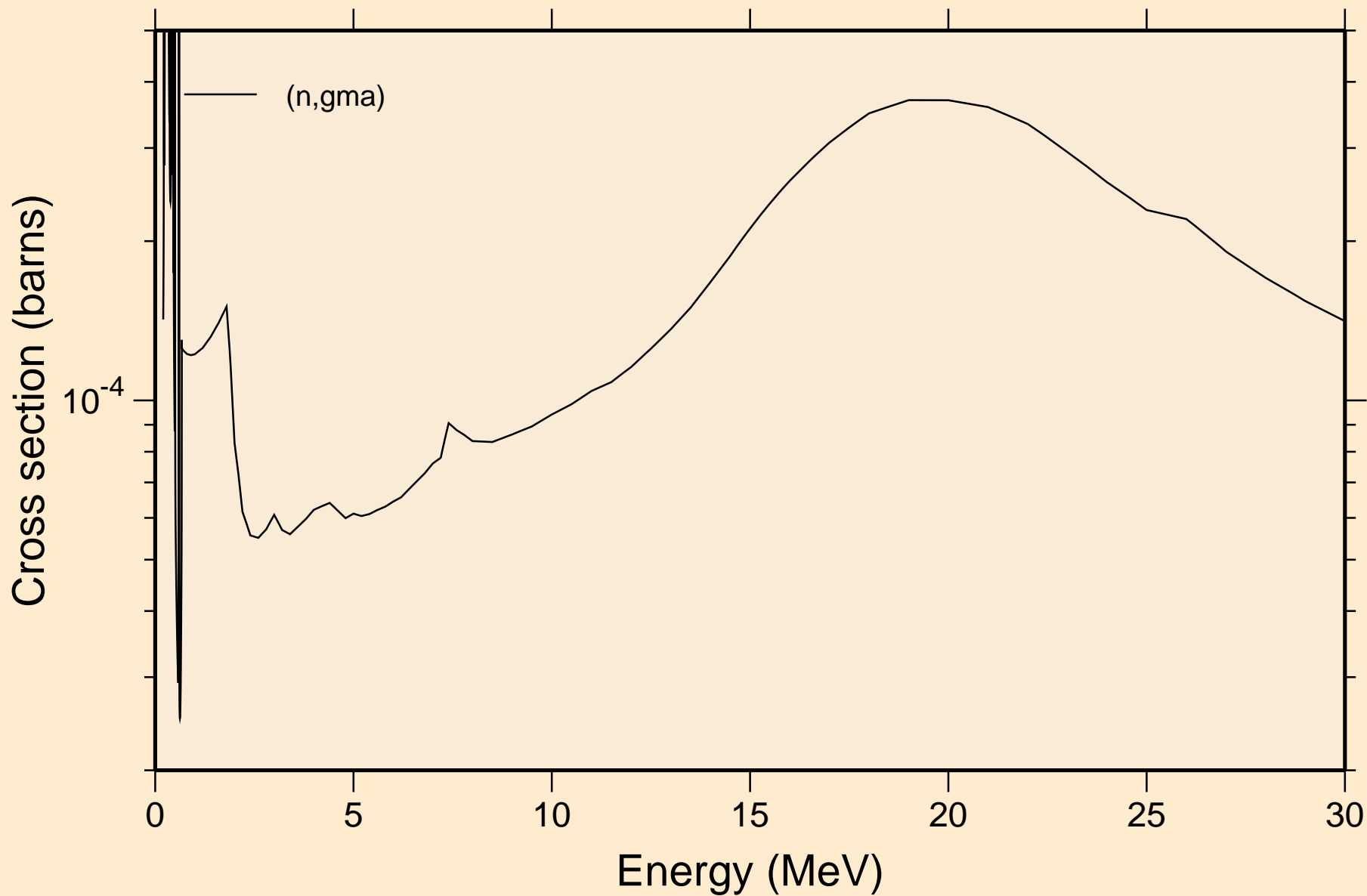

MG026 NEUTRON ACER TENDL-2019 LIBRARY; T=293.16K
Inelastic levels

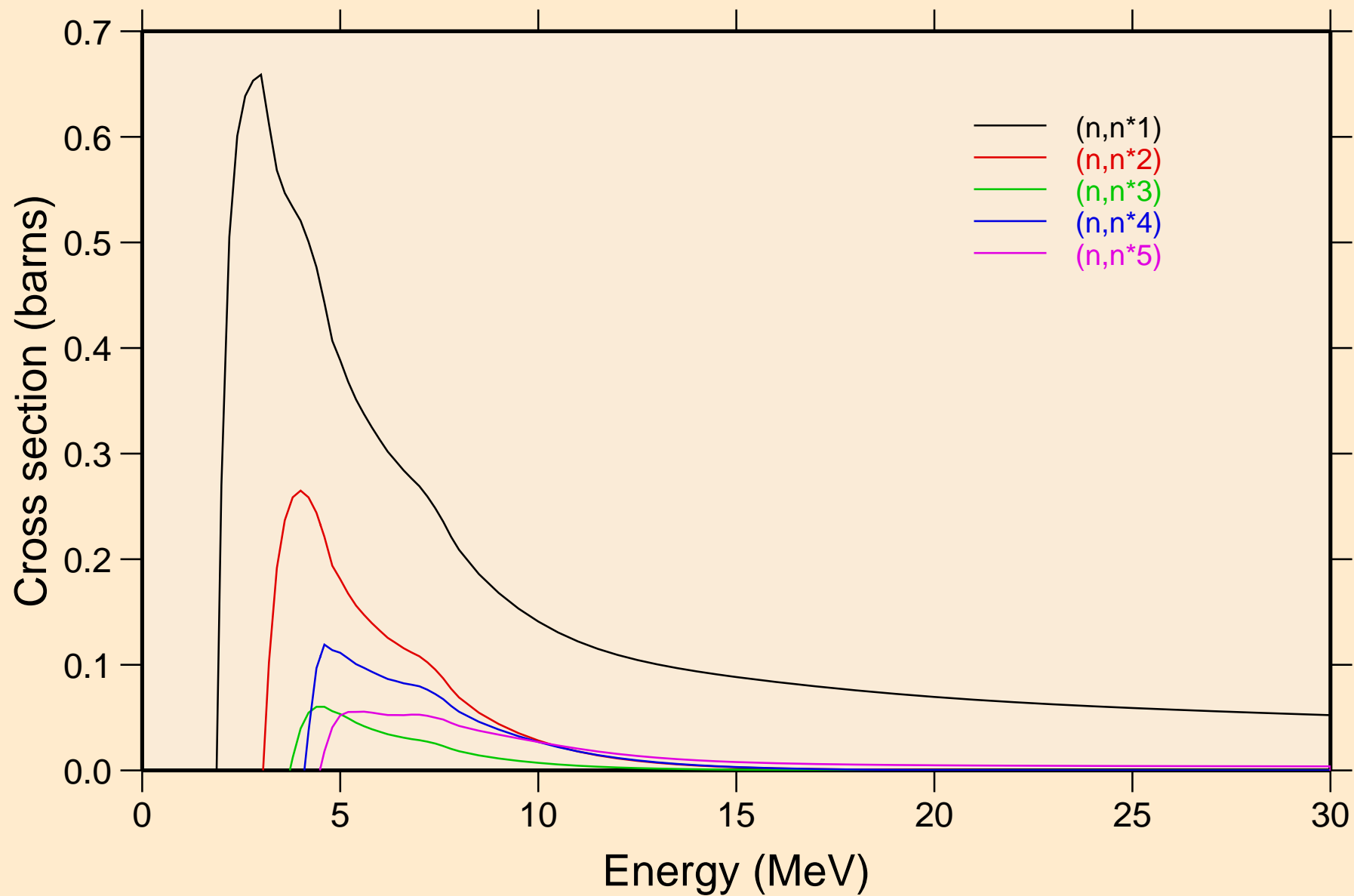

MG026 NEUTRON ACER TENDL-2019 LIBRARY; T=293.16K
Inelastic levels

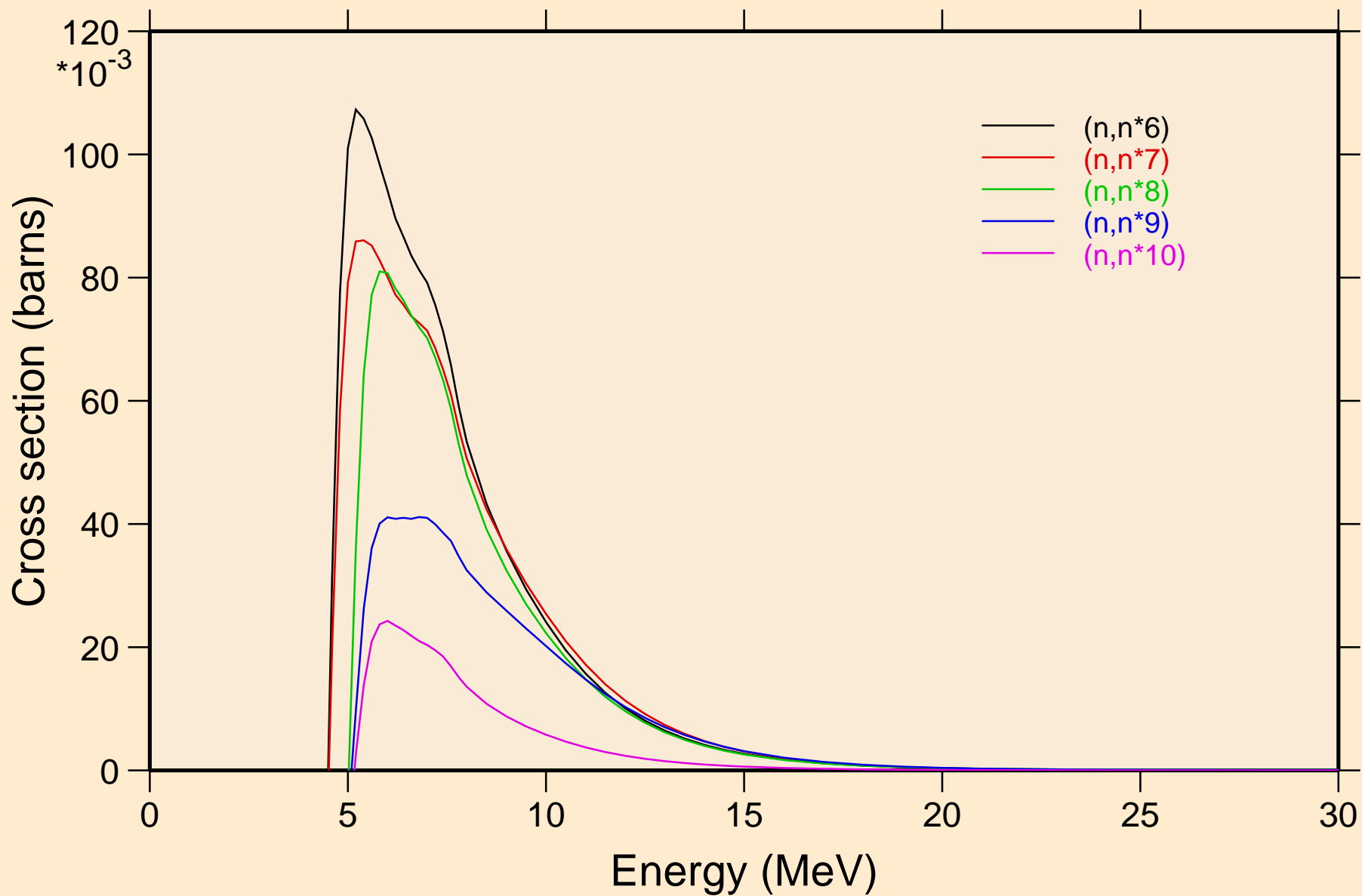

MG026 NEUTRON ACER TENDL-2019 LIBRARY; T=293.16K
Inelastic levels

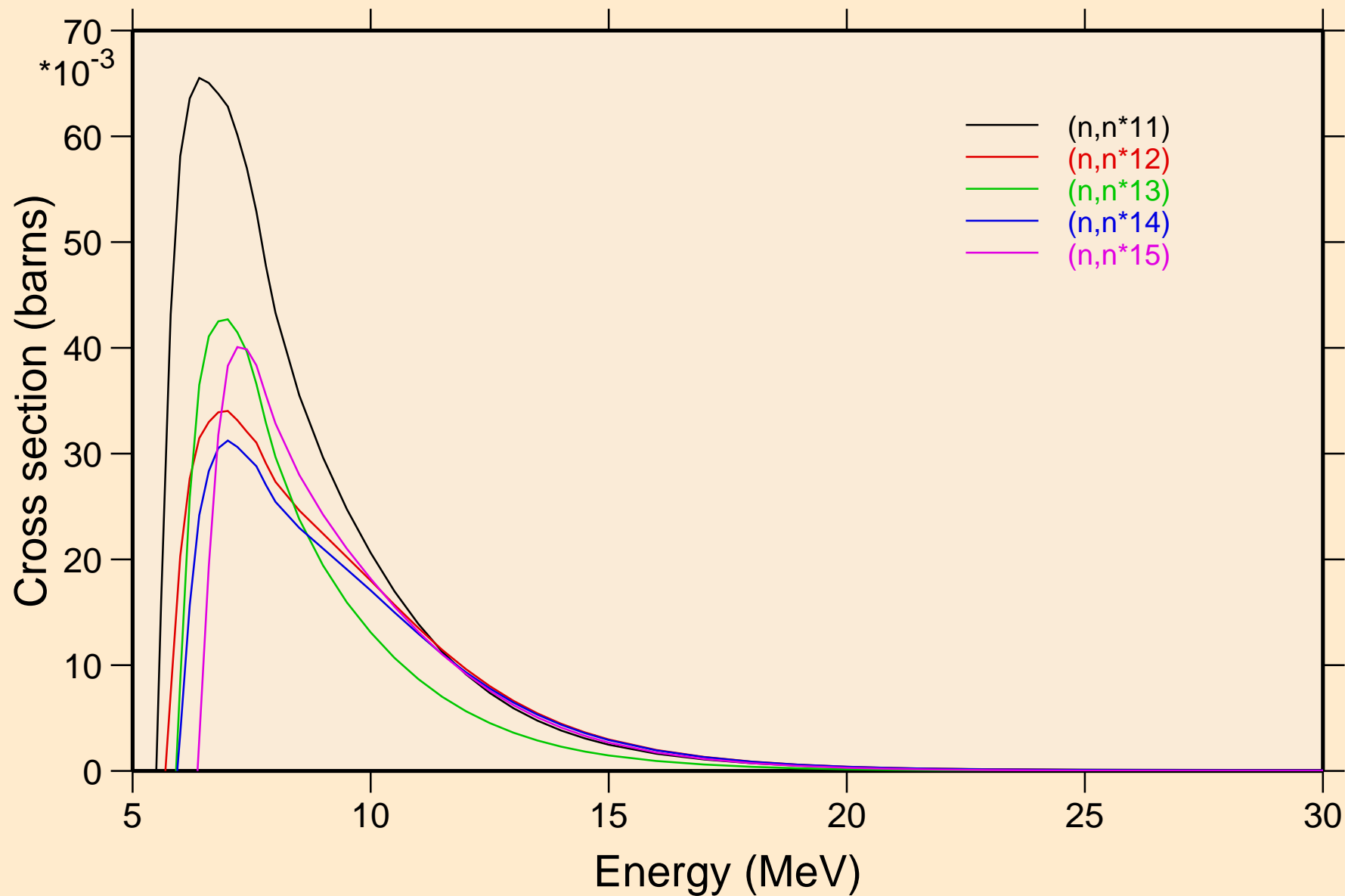

MG026 NEUTRON ACER TENDL-2019 LIBRARY; T=293.16K
Inelastic levels

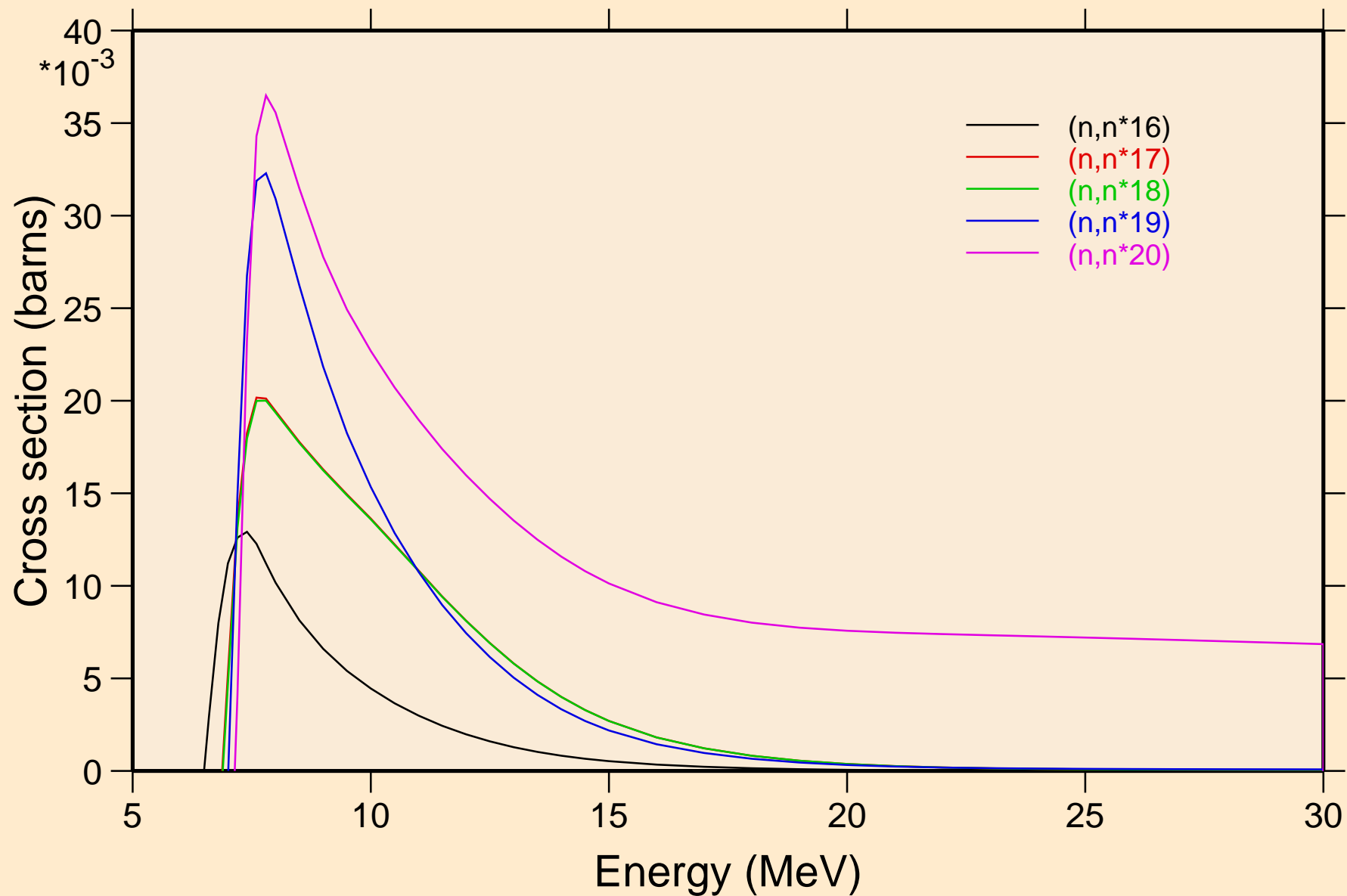

MG026 NEUTRON ACER TENDL-2019 LIBRARY; T=293.16K
Inelastic levels

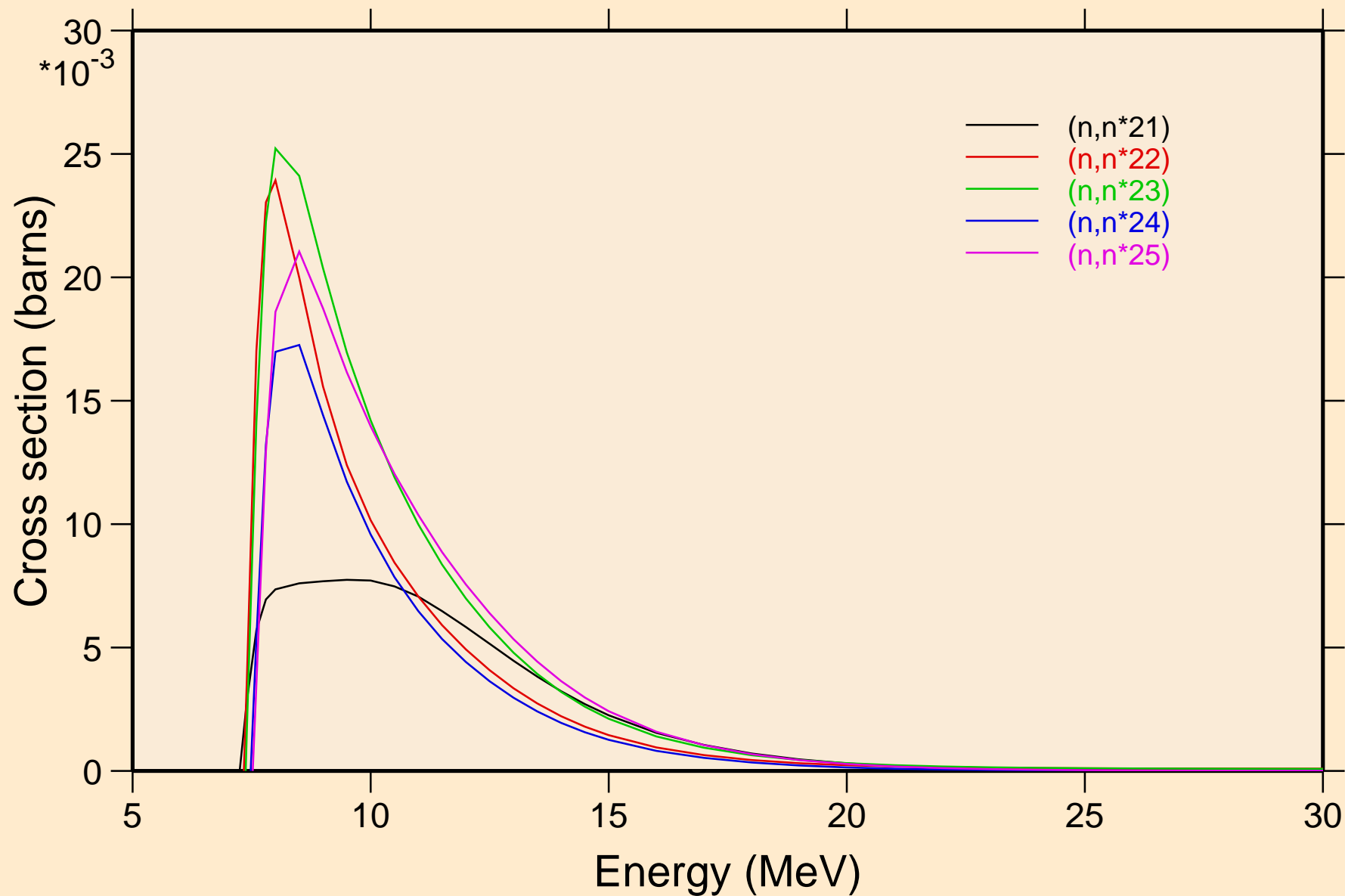

MG026 NEUTRON ACER TENDL-2019 LIBRARY; T=293.16K
Inelastic levels

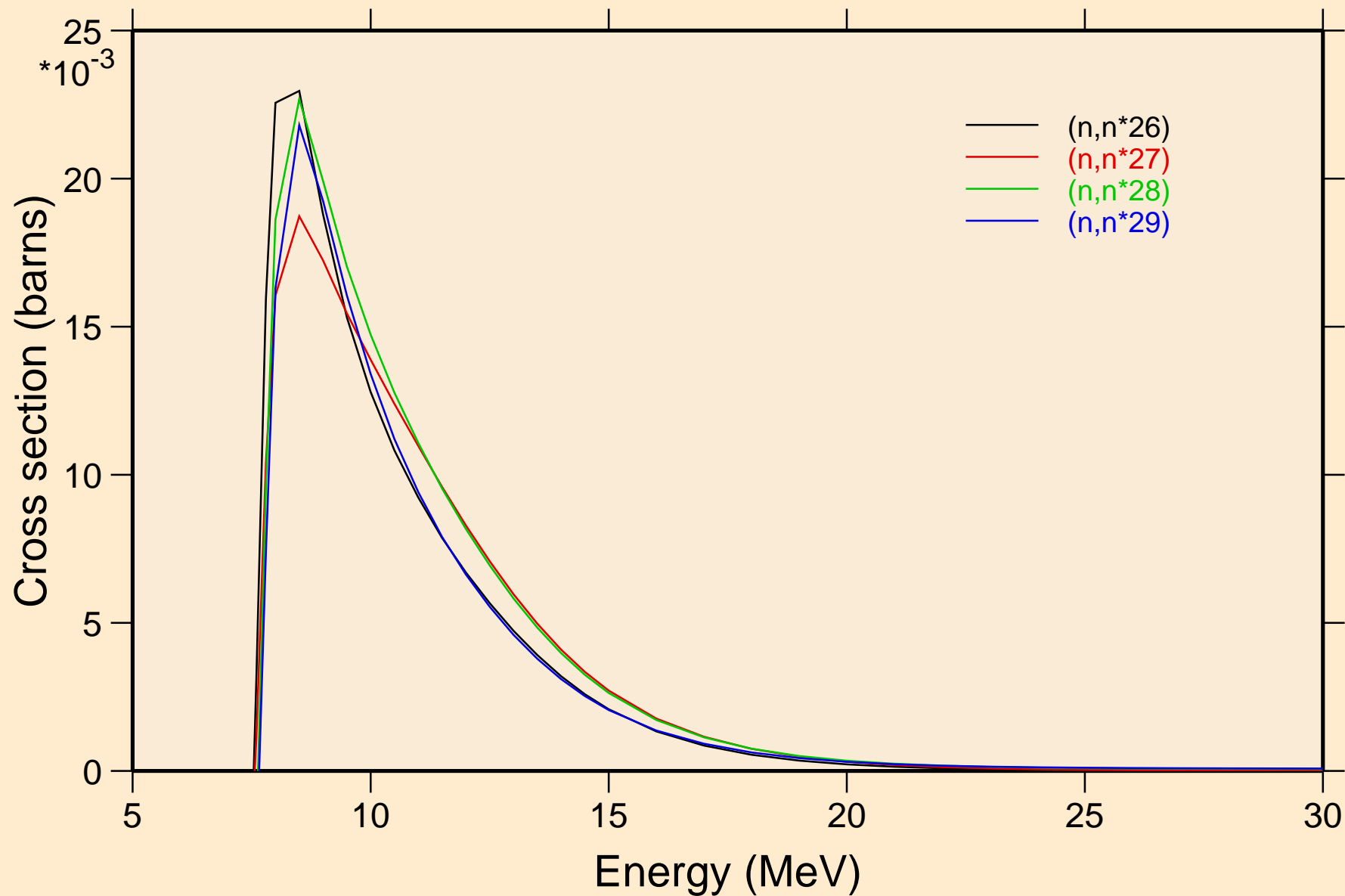

MG026 NEUTRON ACER TENDL-2019 LIBRARY; T=293.16K
Threshold reactions

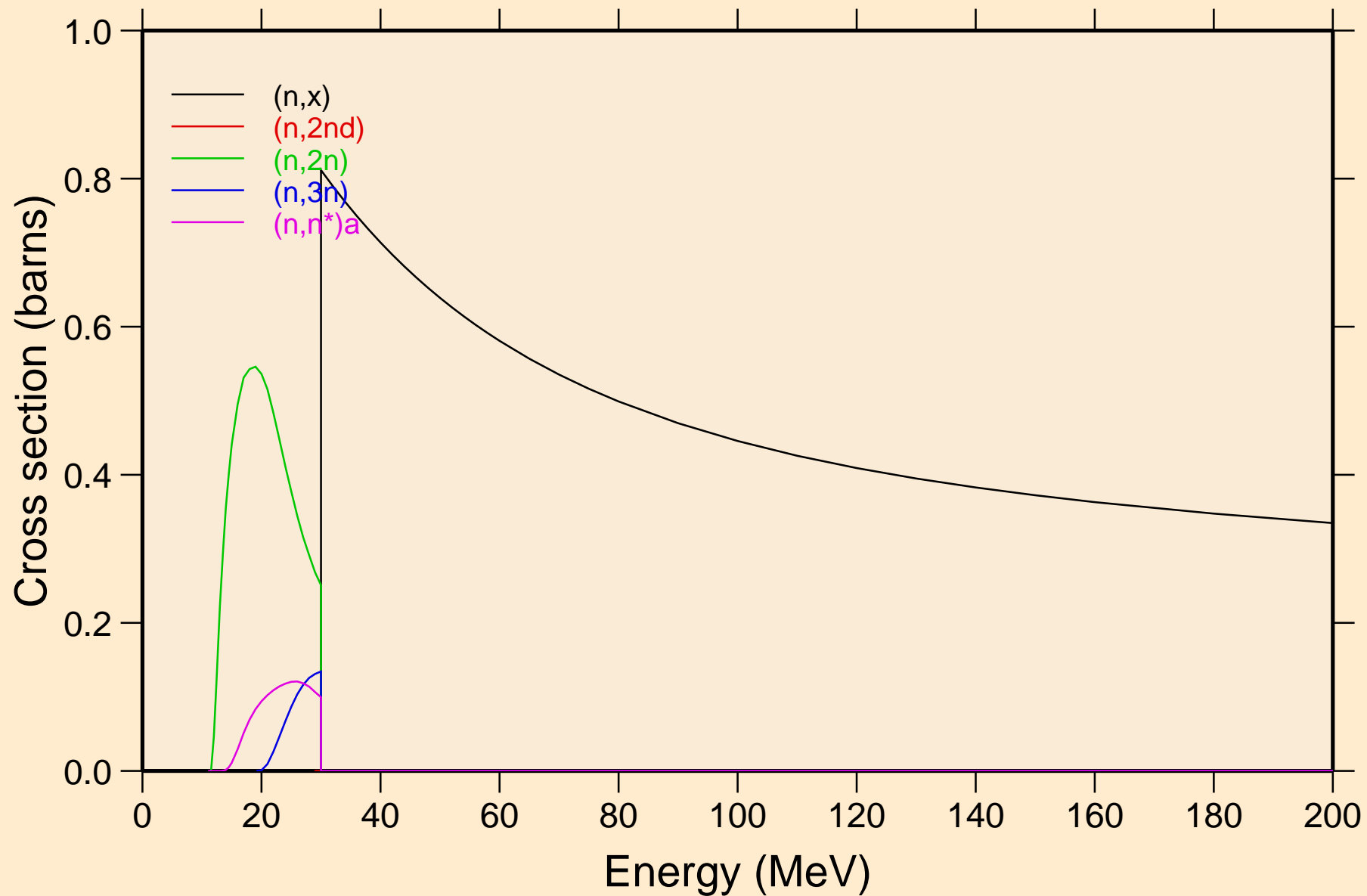

MG026 NEUTRON ACER TENDL-2019 LIBRARY; T=293.16K
Threshold reactions

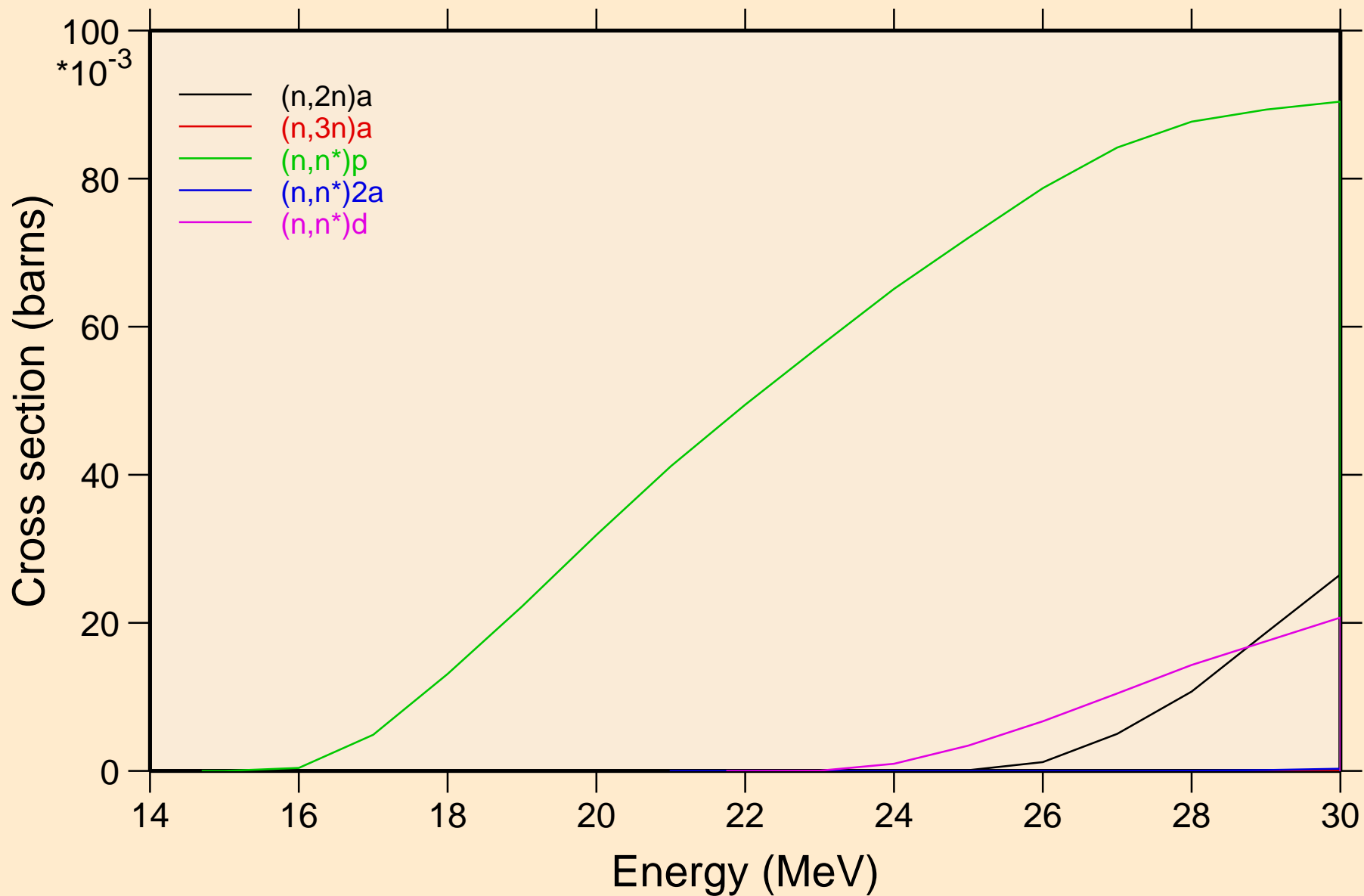

MG026 NEUTRON ACER TENDL-2019 LIBRARY; T=293.16K
Threshold reactions

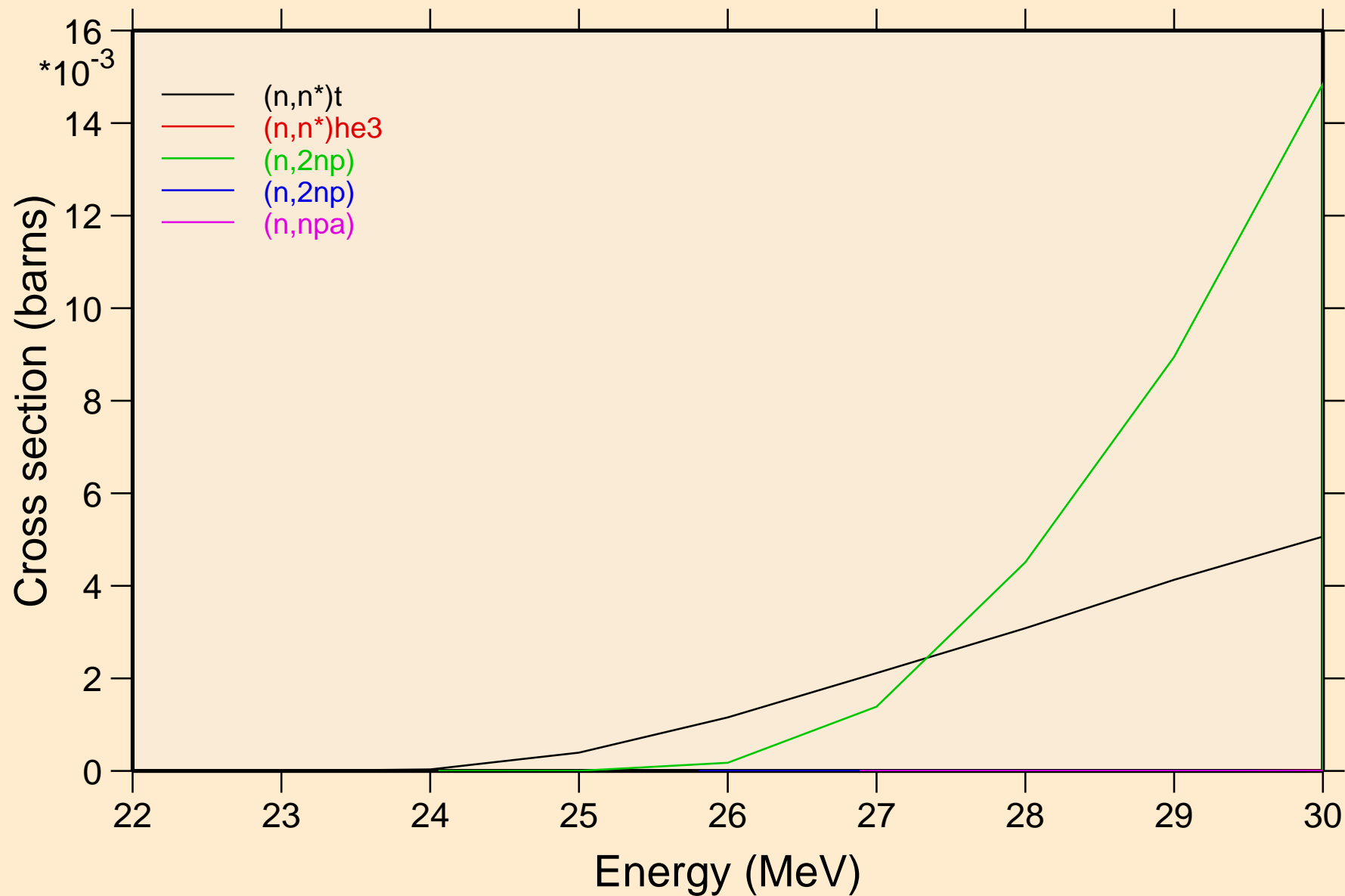

MG026 NEUTRON ACER TENDL-2019 LIBRARY; T=293.16K
Threshold reactions

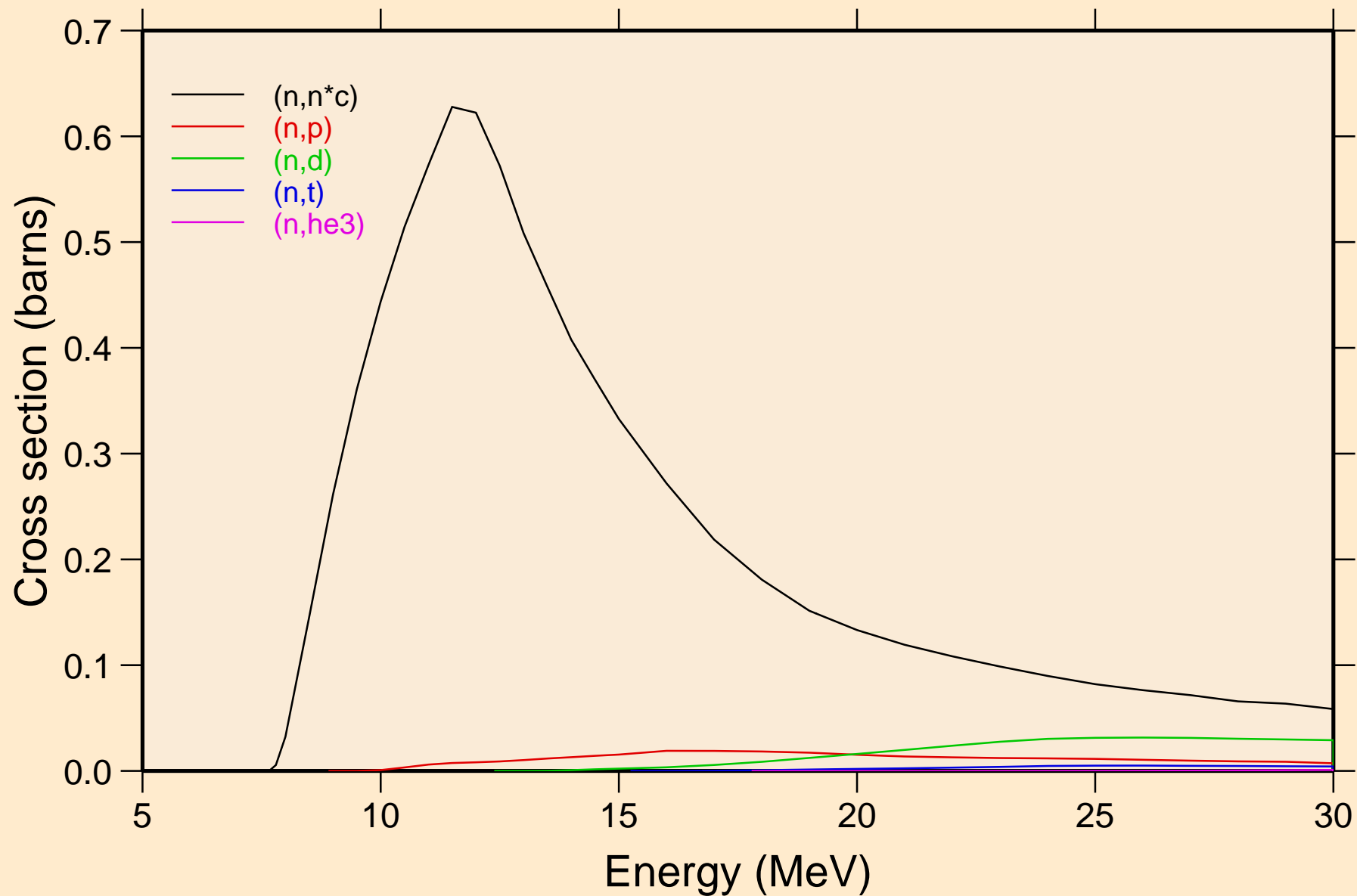

MG026 NEUTRON ACER TENDL-2019 LIBRARY; T=293.16K
Threshold reactions

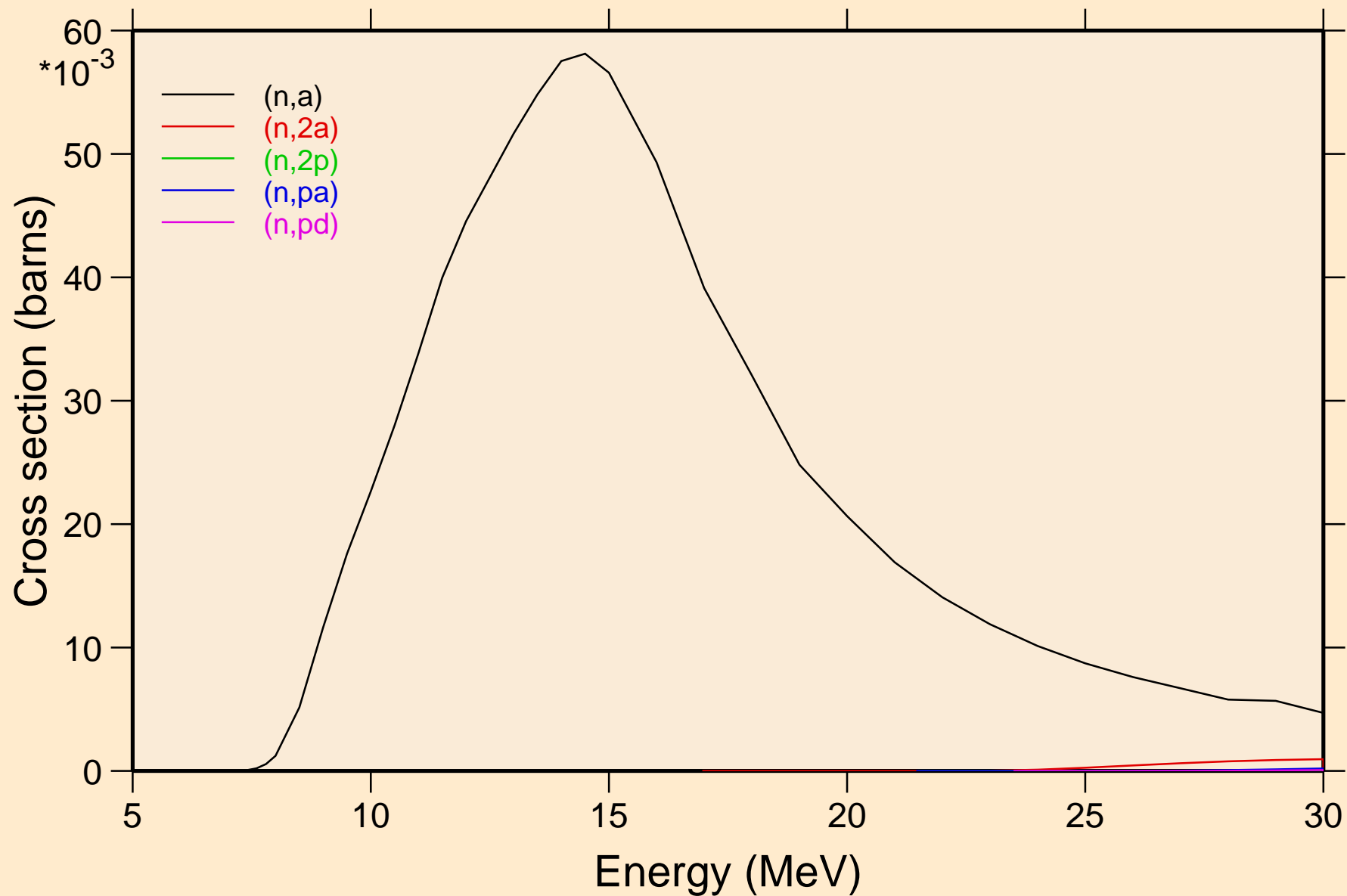

MG026 NEUTRON ACER TENDL-2019 LIBRARY; T=293.16K
Threshold reactions

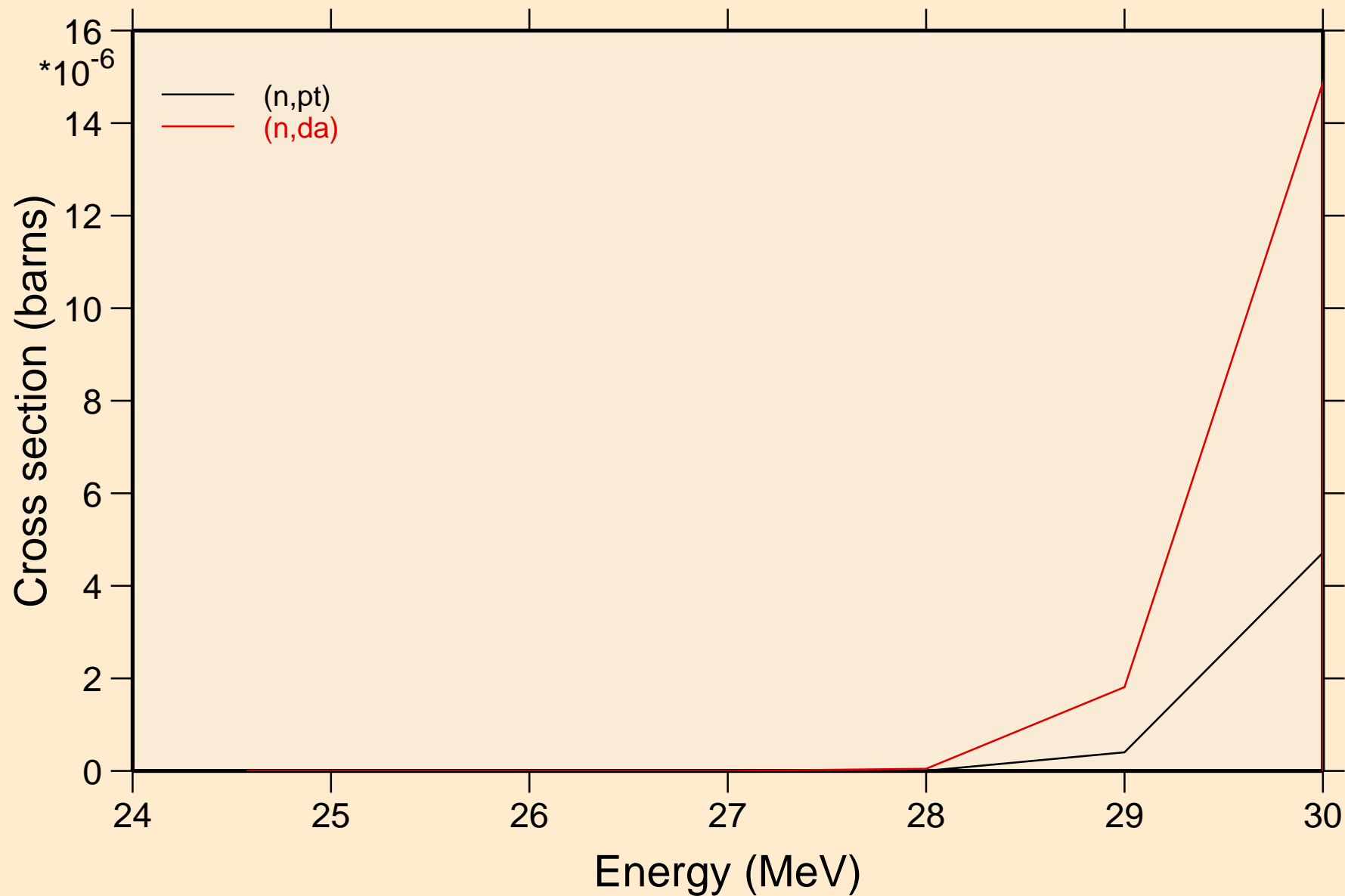

MG026 NEUTRON ACER TENDL-2019 LIBRARY; T=293.16K
Threshold reactions

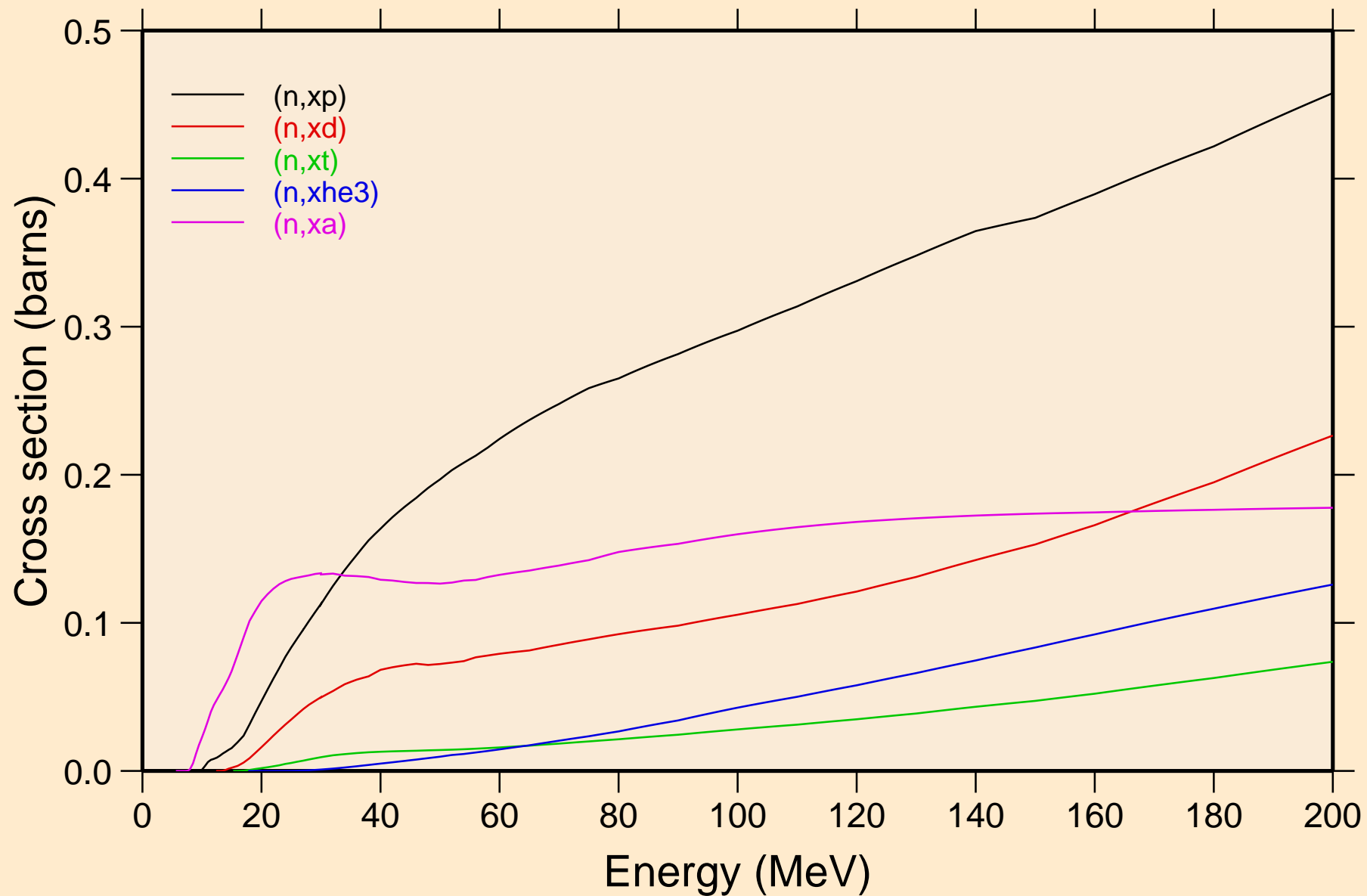

MG026 NEUTRON ACER TENDL-2019 LIBRARY; T=293.16K
angular distribution for elastic

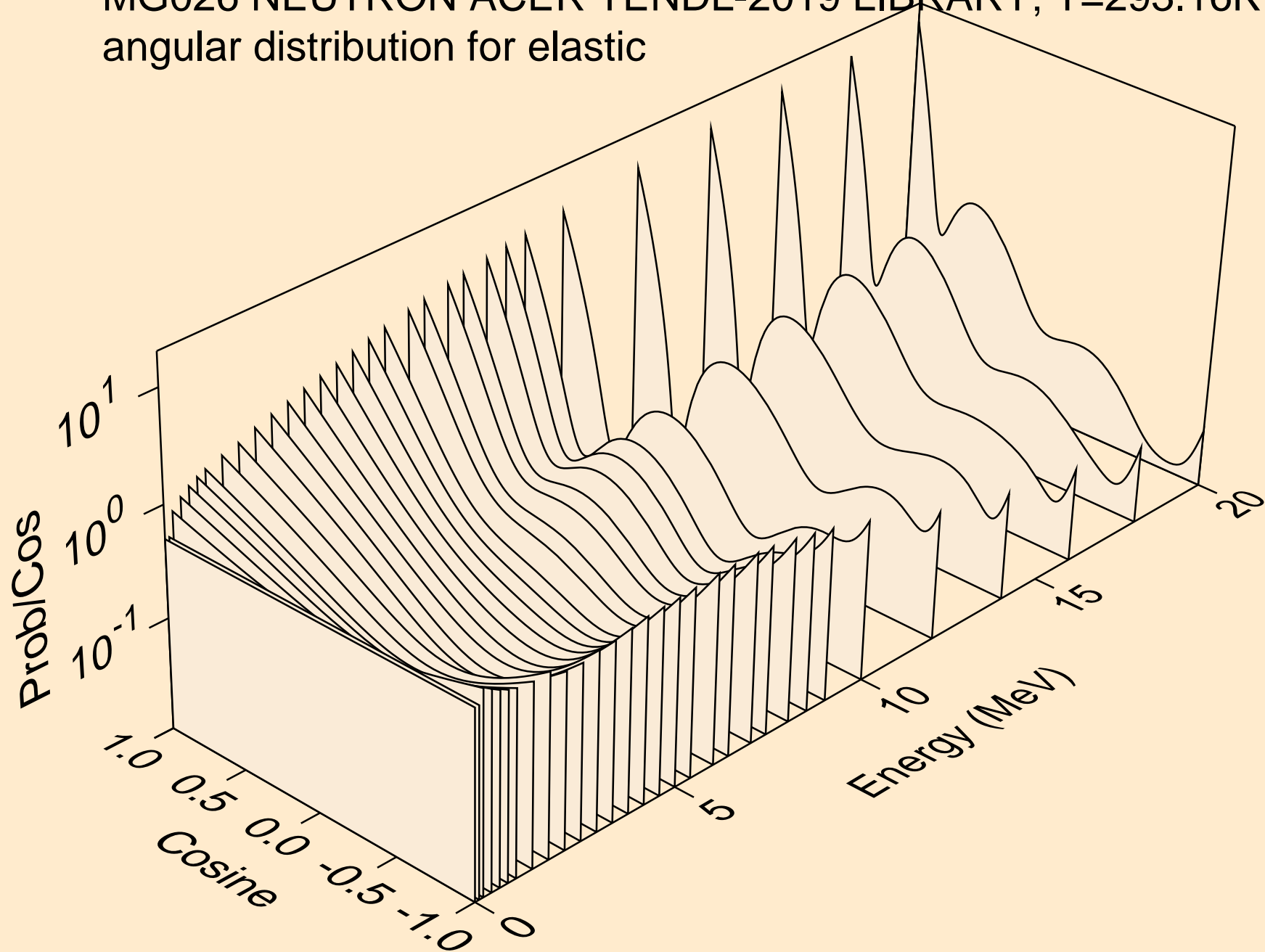

MG026 NEUTRON ACER TENDL-2019 LIBRARY; T=293.16K
angular distribution for elastic

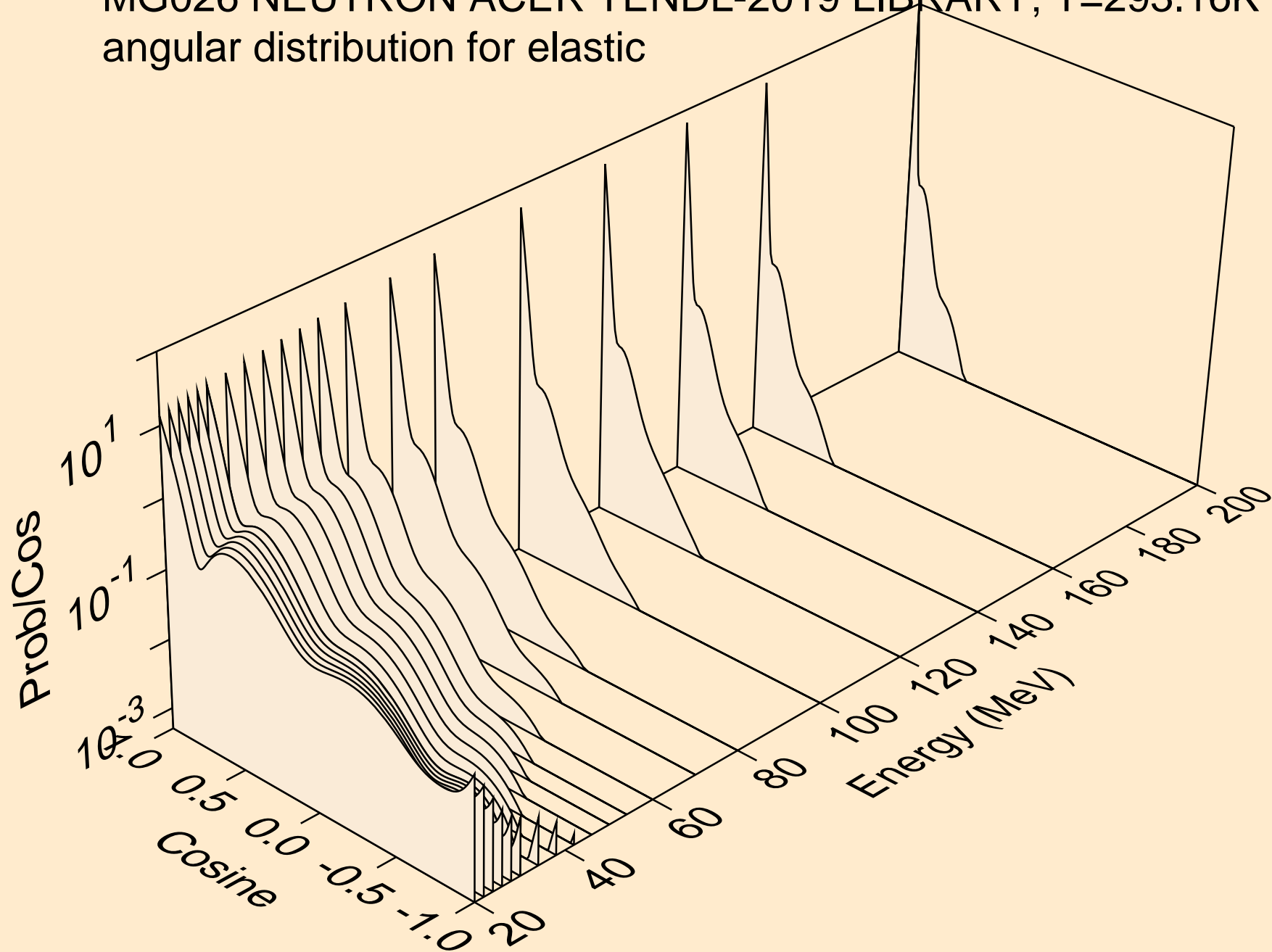

MG026 NEUTRON ACER TENDL-2019 LIBRARY; T=293.16K
angular distribution for (n,n*1)

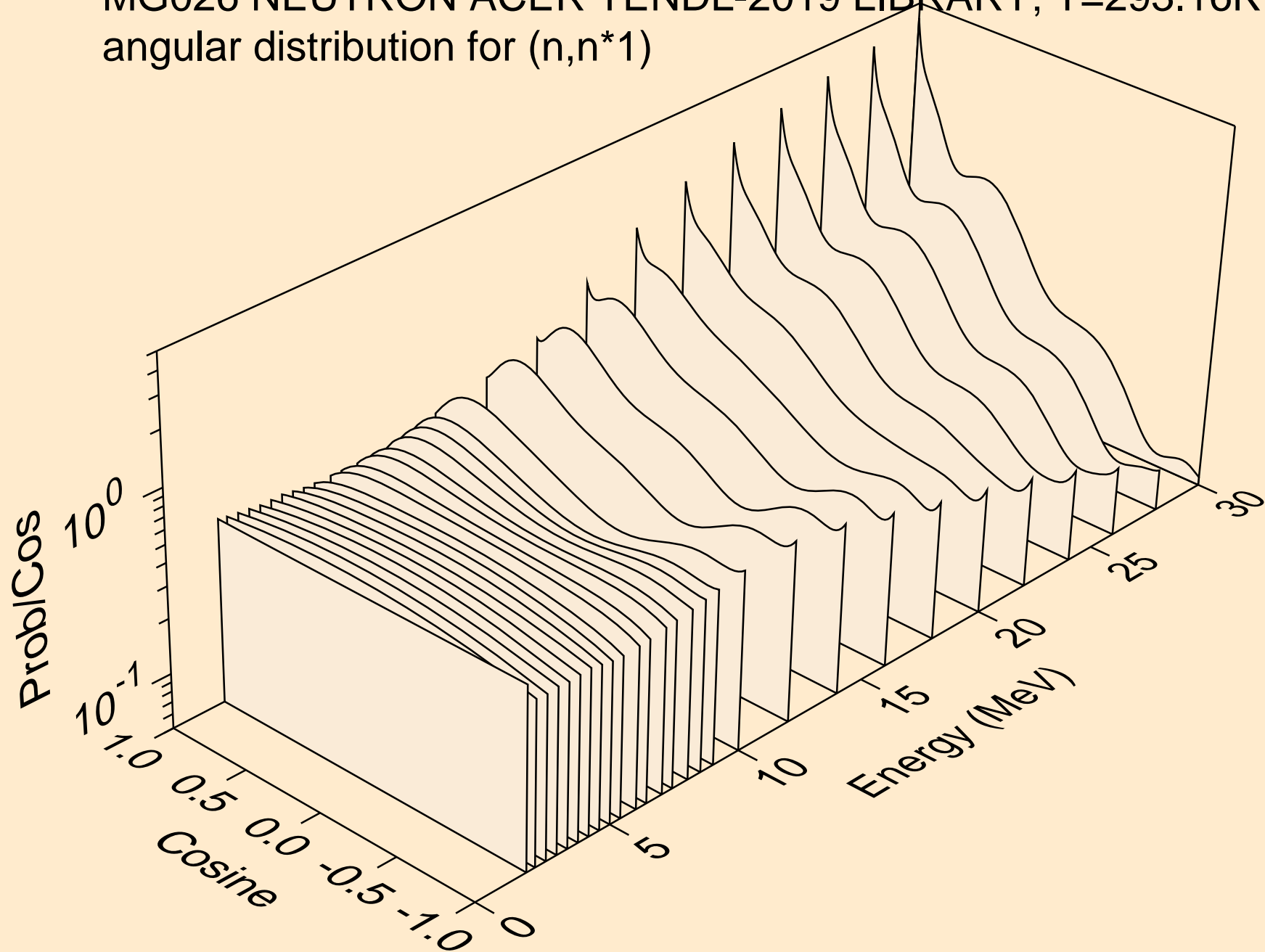

MG026 NEUTRON ACER TENDL-2019 LIBRARY; T=293.16K
angular distribution for (n,n*2)

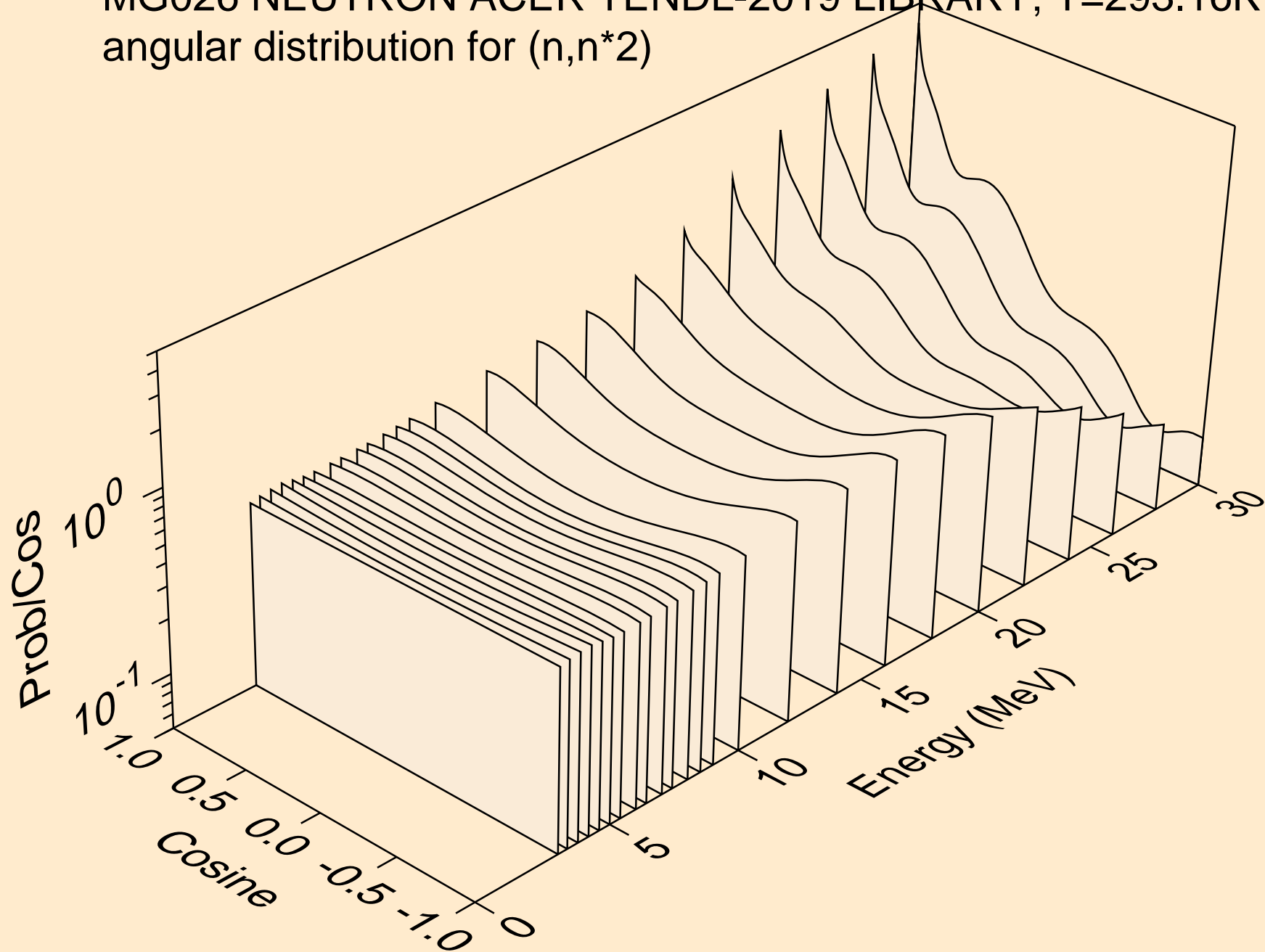

MG026 NEUTRON ACER TENDL-2019 LIBRARY; T=293.16K
angular distribution for (n,n*3)

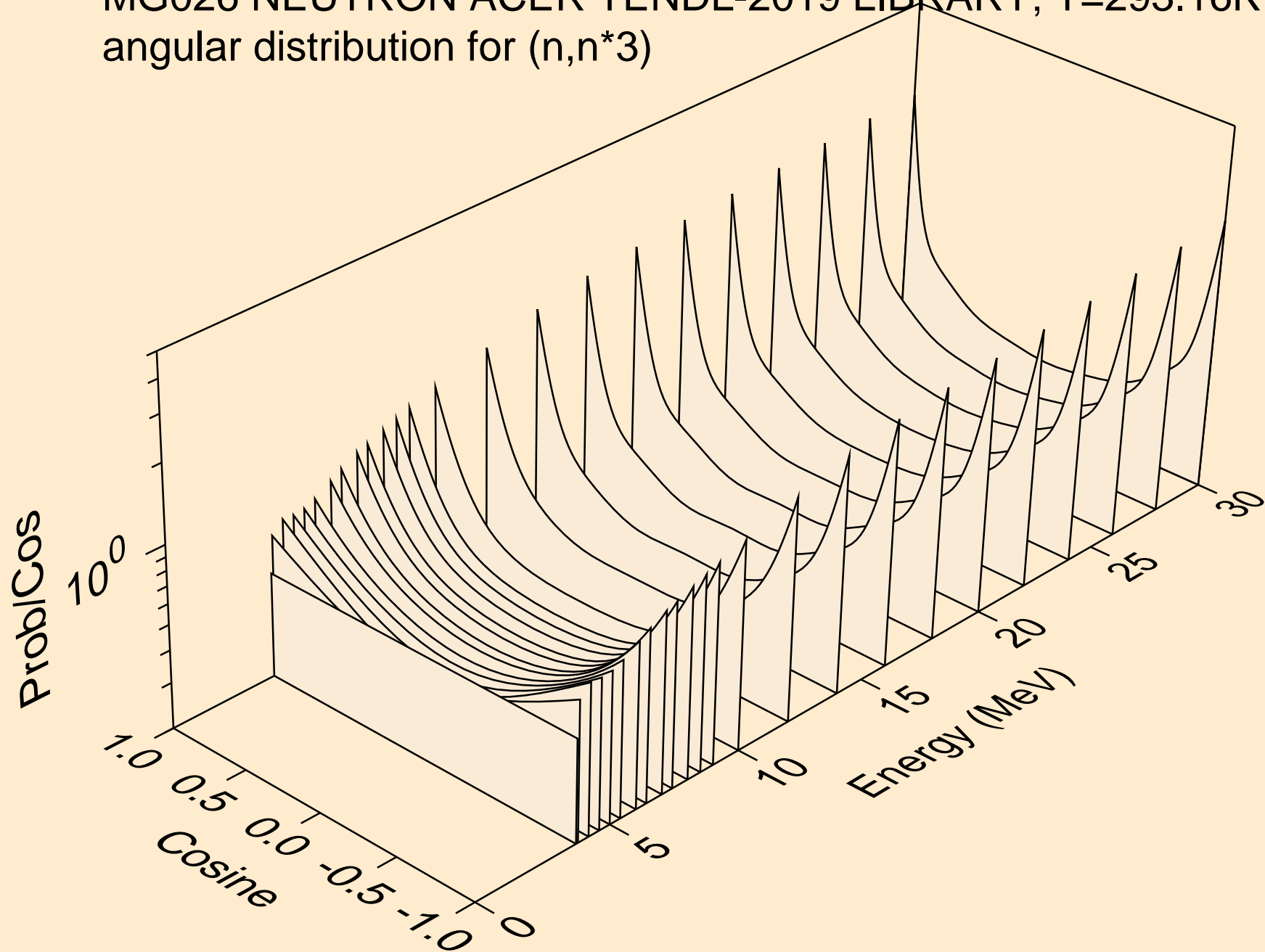

MG026 NEUTRON ACER TENDL-2019 LIBRARY; T=293.16K
angular distribution for (n,n*4)

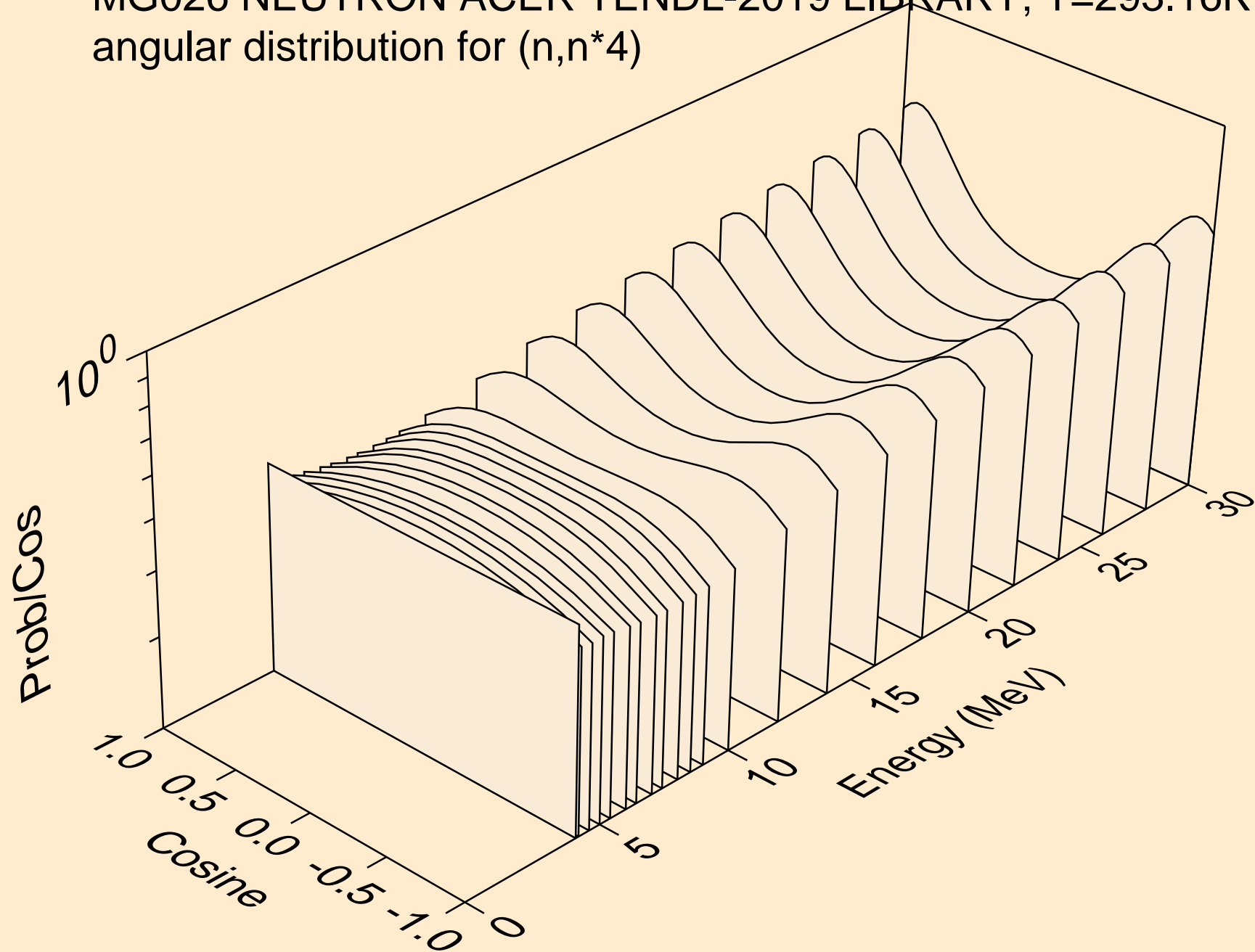

MG026 NEUTRON ACER TENDL-2019 LIBRARY; T=293.16K
angular distribution for (n,n*5)

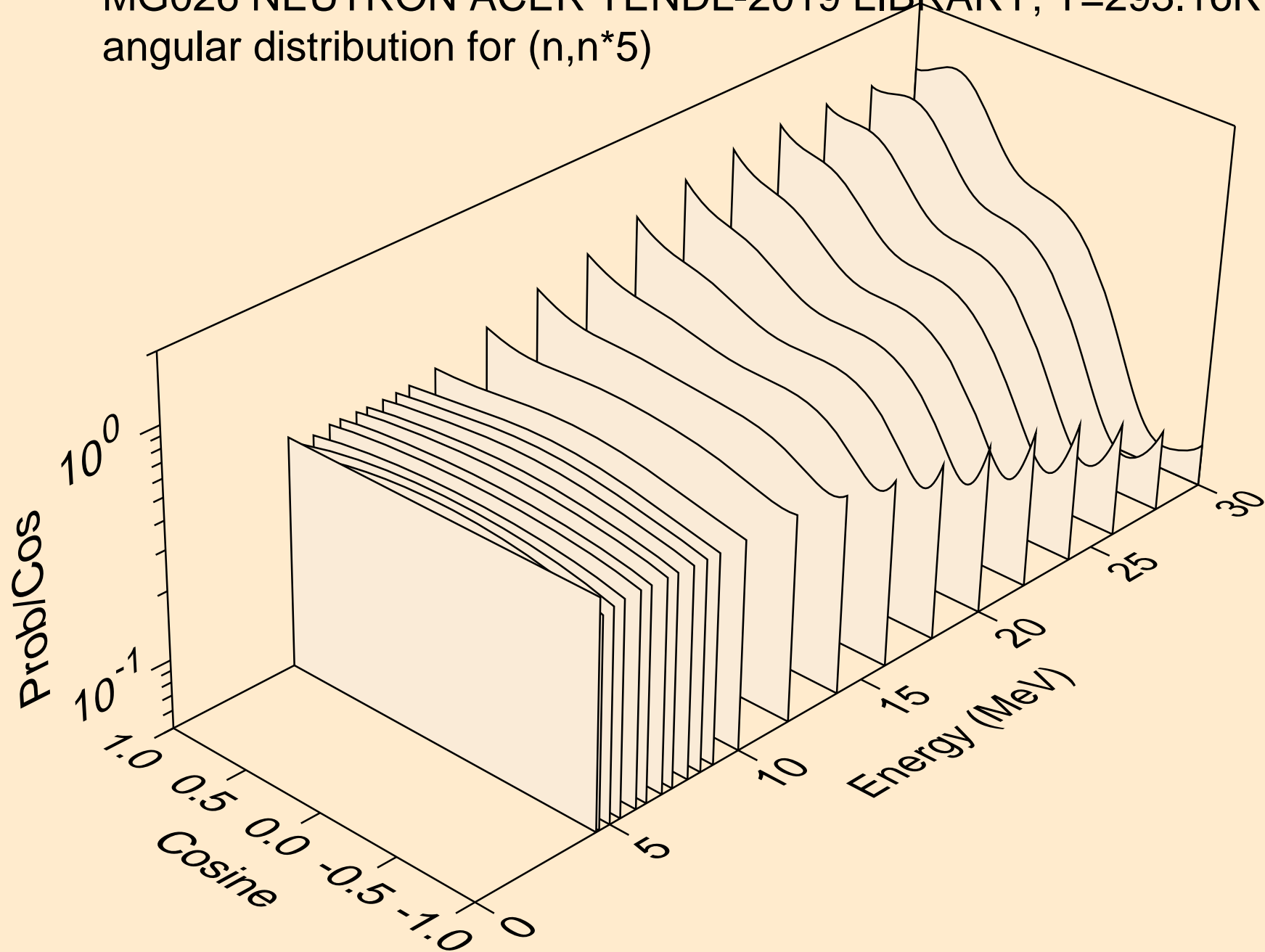

MG026 NEUTRON ACER TENDL-2019 LIBRARY; T=293.16K
angular distribution for (n,n*6)

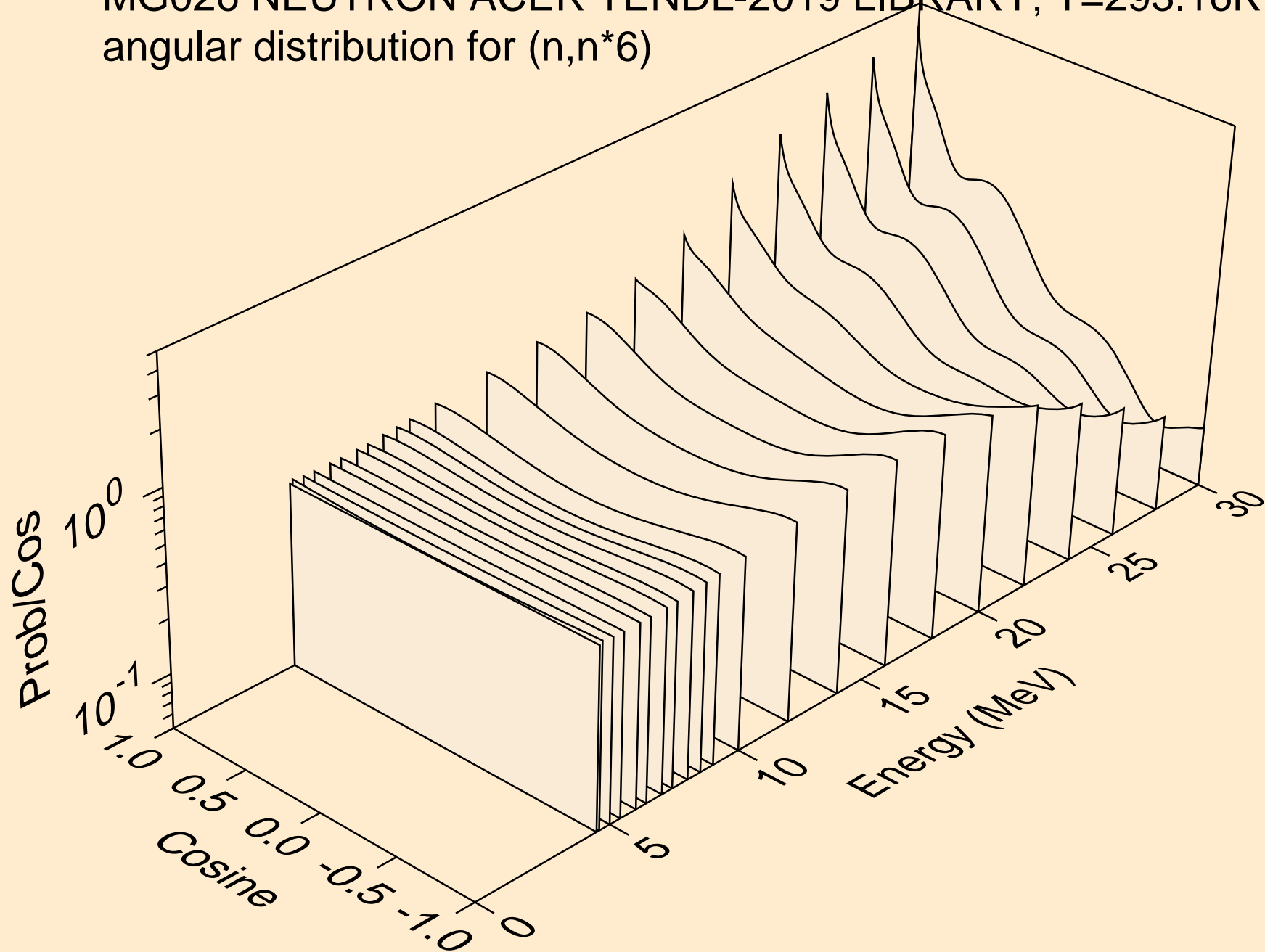

MG026 NEUTRON ACER TENDL-2019 LIBRARY; T=293.16K
angular distribution for (n,n*7)

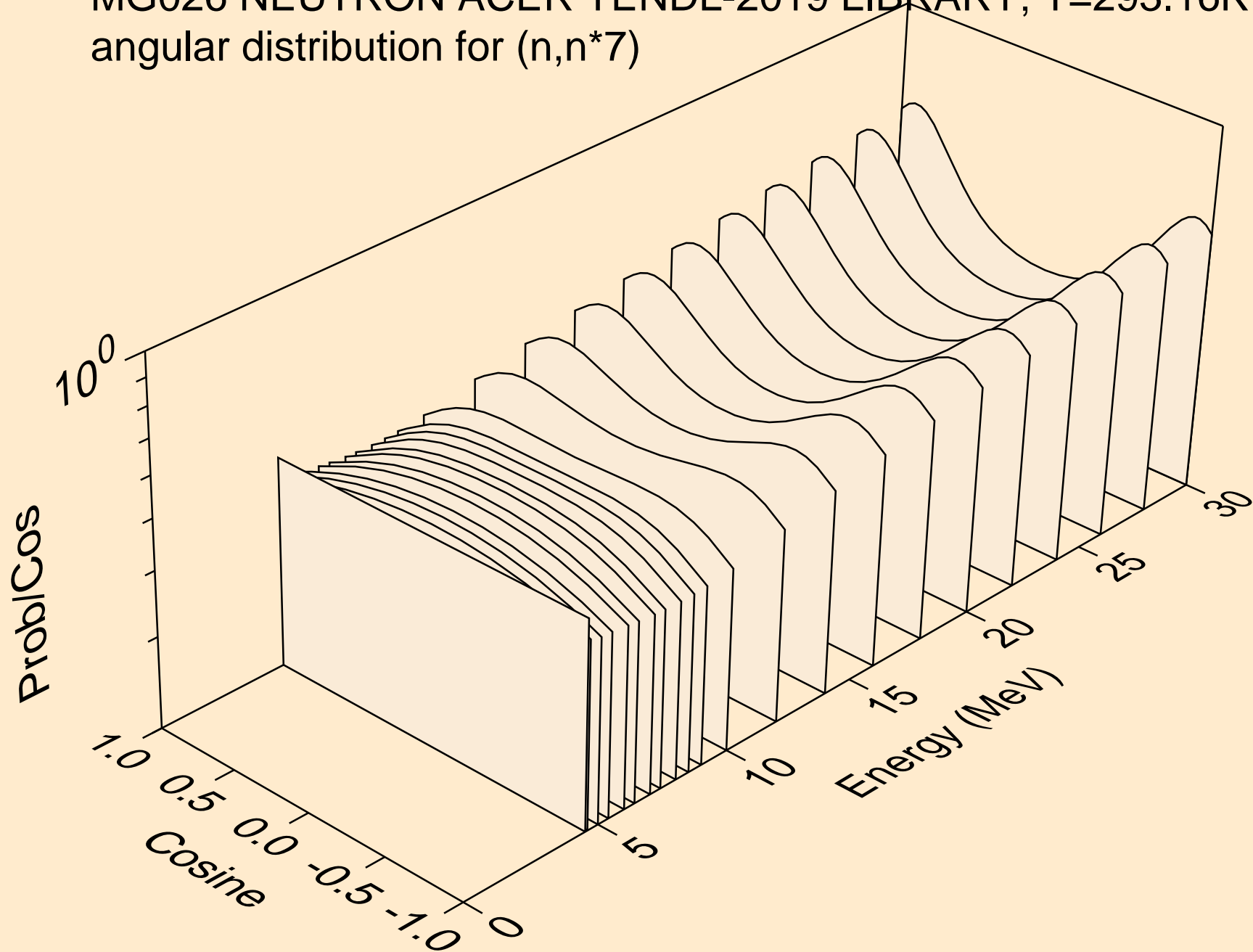

MG026 NEUTRON ACER TENDL-2019 LIBRARY; T=293.16K
angular distribution for (n,n*8)

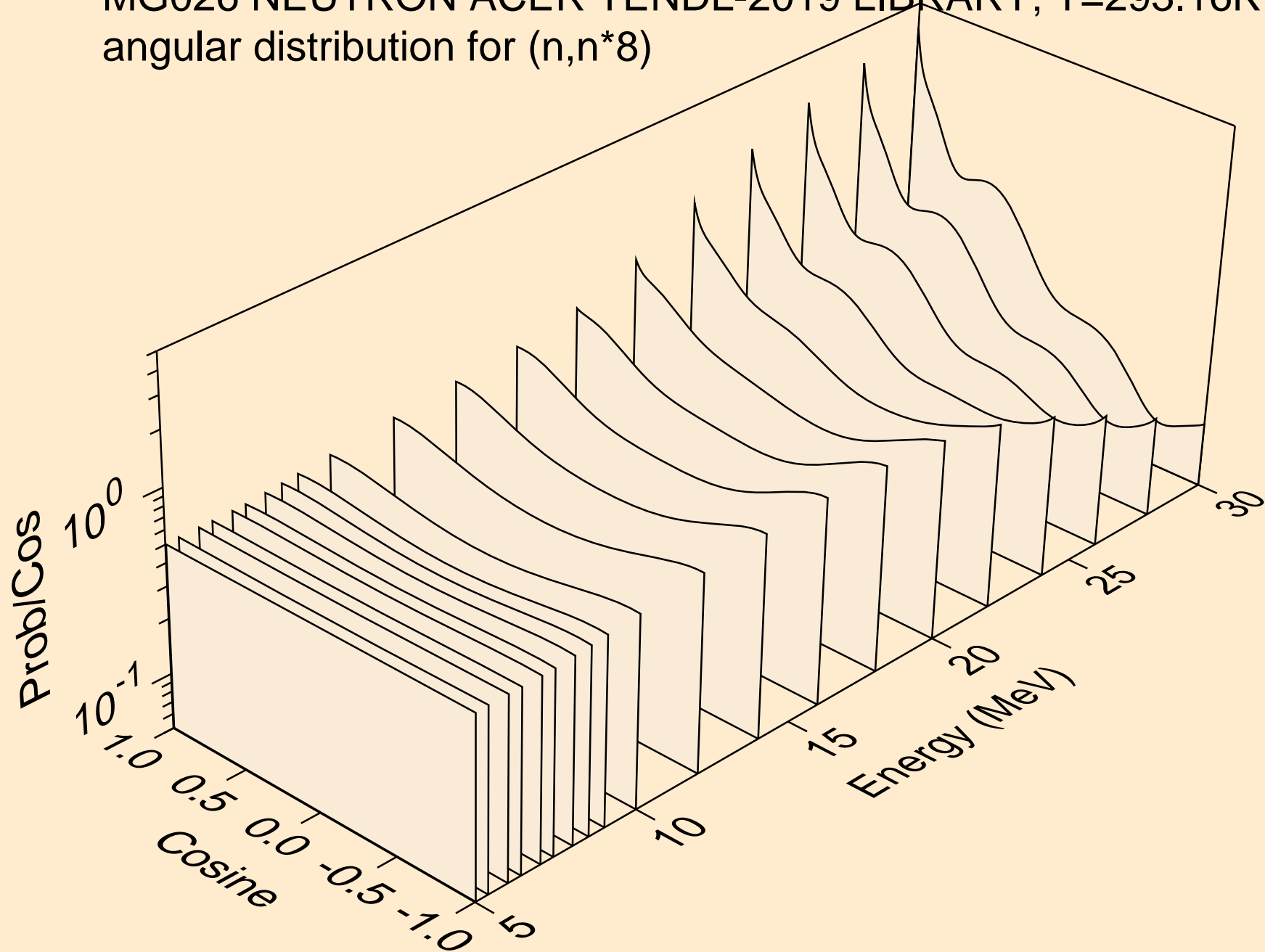

MG026 NEUTRON ACER TENDL-2019 LIBRARY; T=293.16K
angular distribution for (n,n*9)

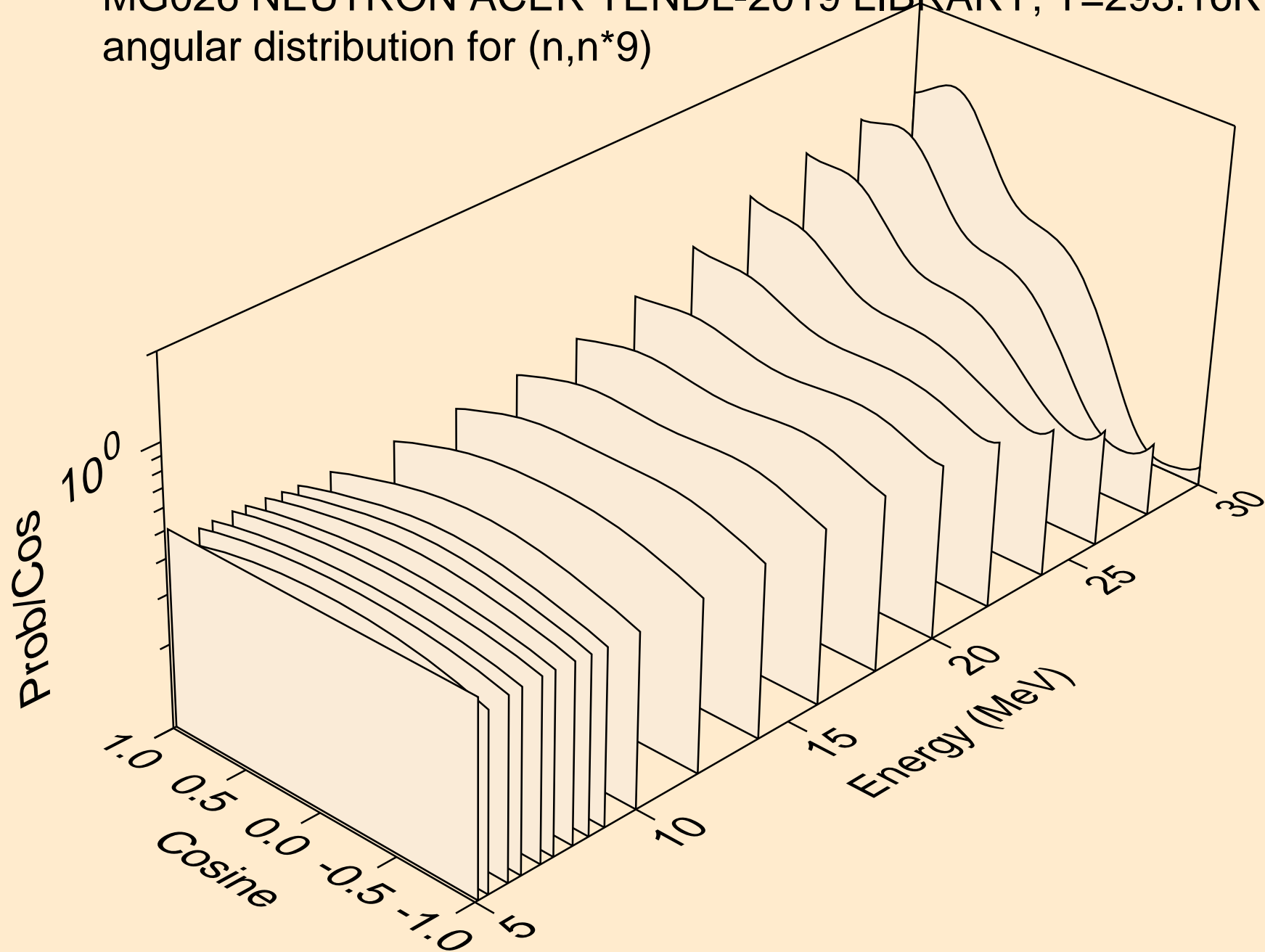

MG026 NEUTRON ACER TENDL-2019 LIBRARY; T=293.16K
angular distribution for (n,n*10)

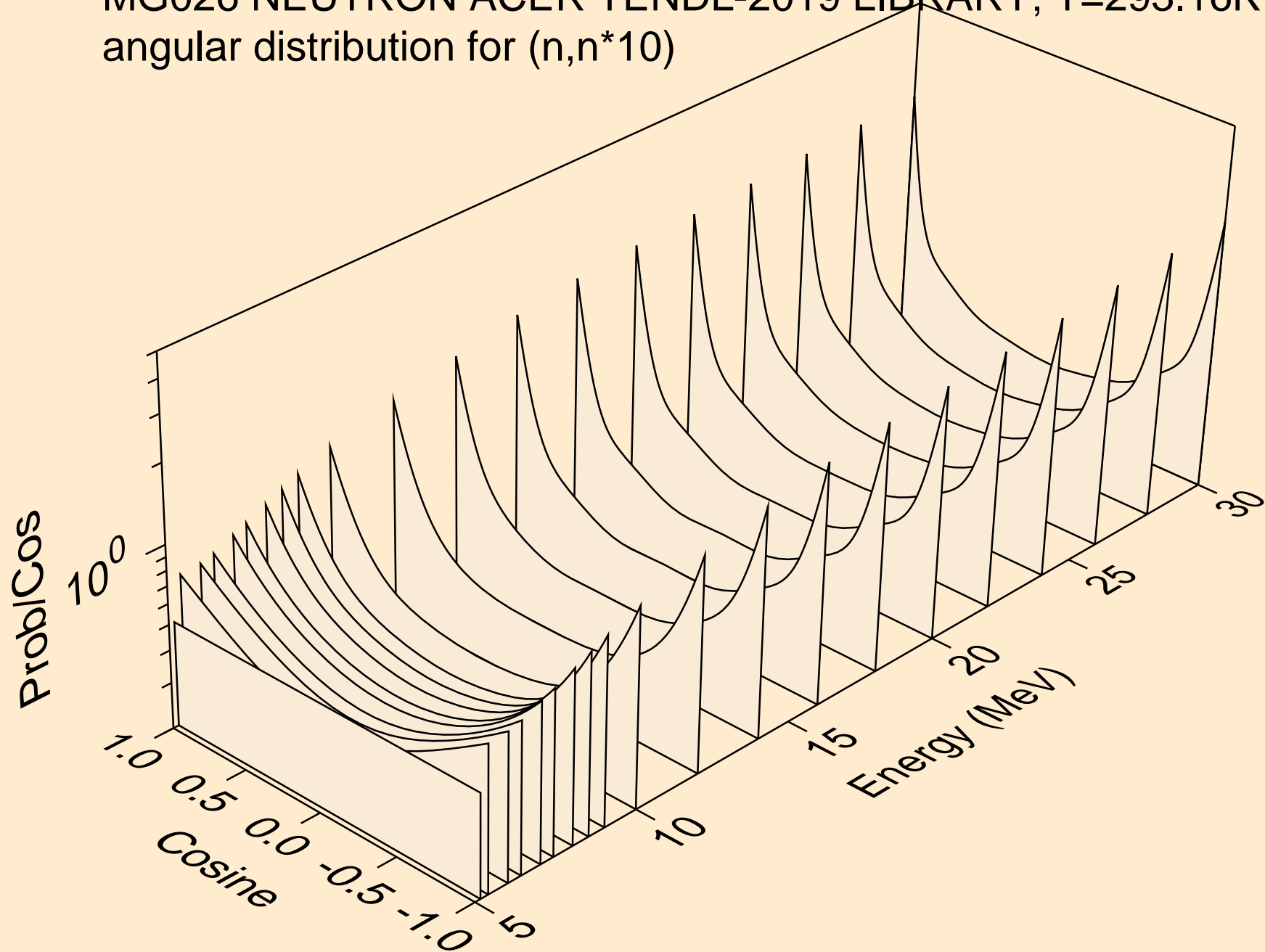

MG026 NEUTRON ACER TENDL-2019 LIBRARY; T=293.16K
angular distribution for (n,n*11)

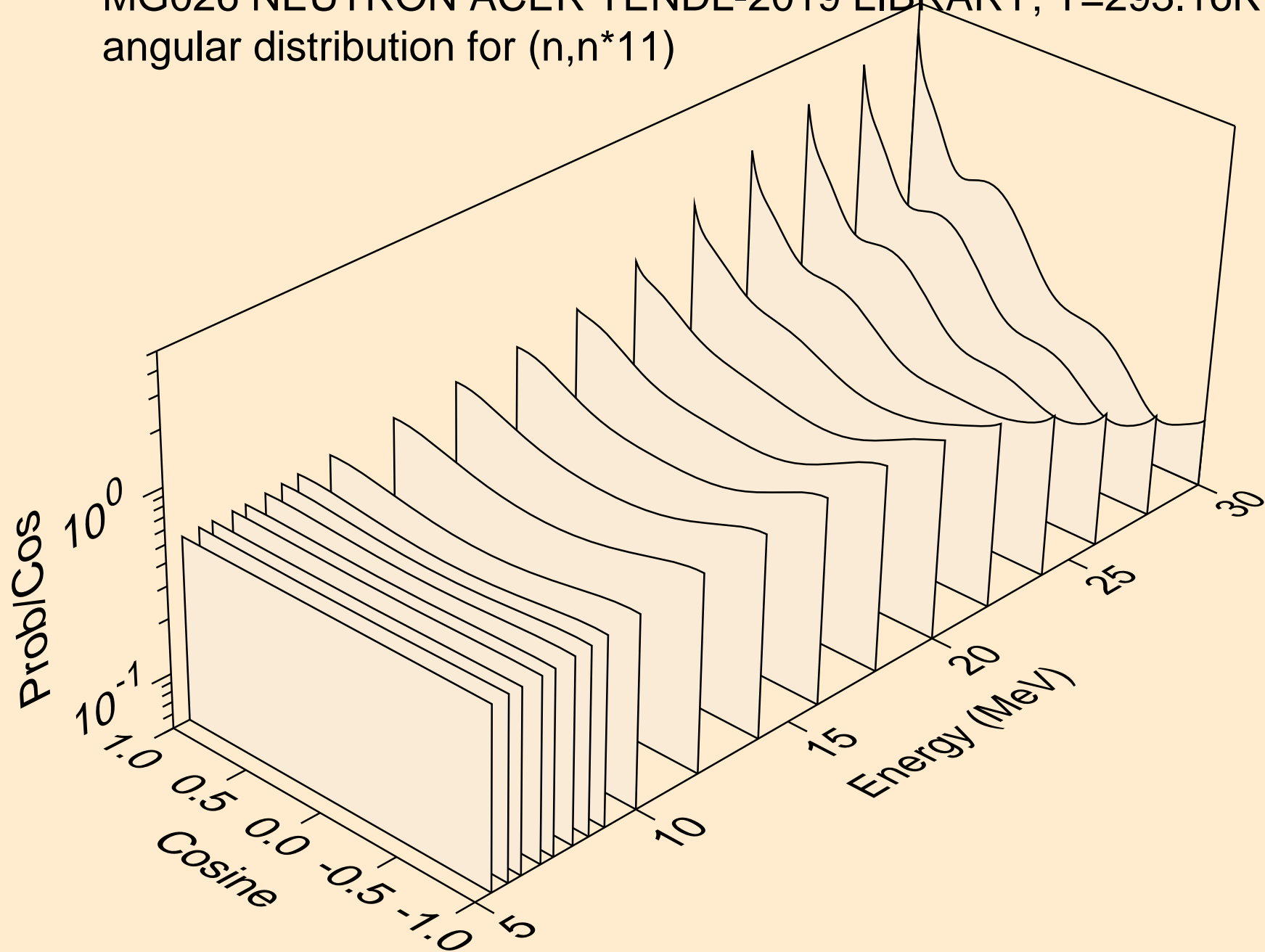

MG026 NEUTRON ACER TENDL-2019 LIBRARY; T=293.16K
angular distribution for (n,n*12)

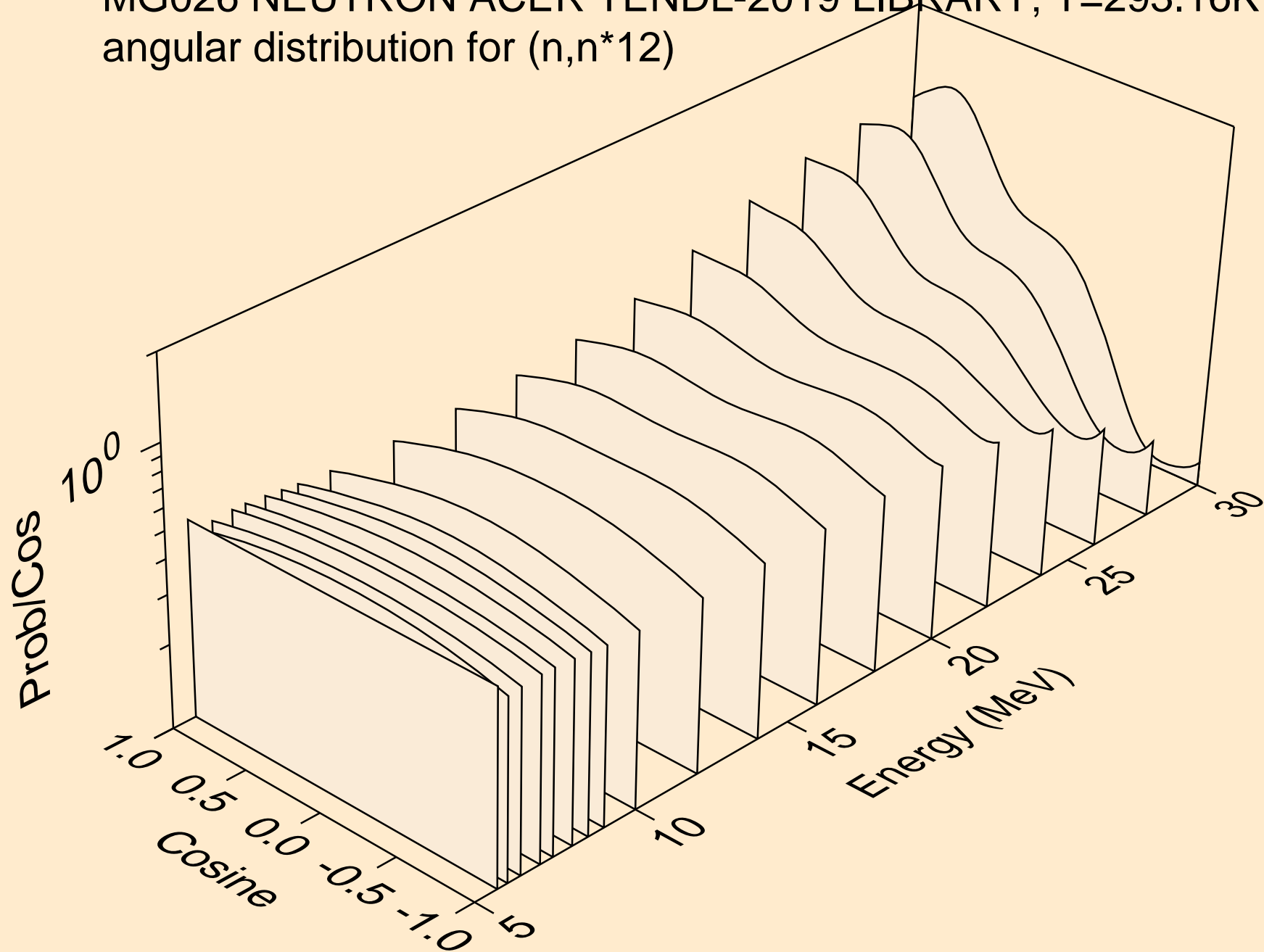

MG026 NEUTRON ACER TENDL-2019 LIBRARY; T=293.16K
angular distribution for (n,n*13)

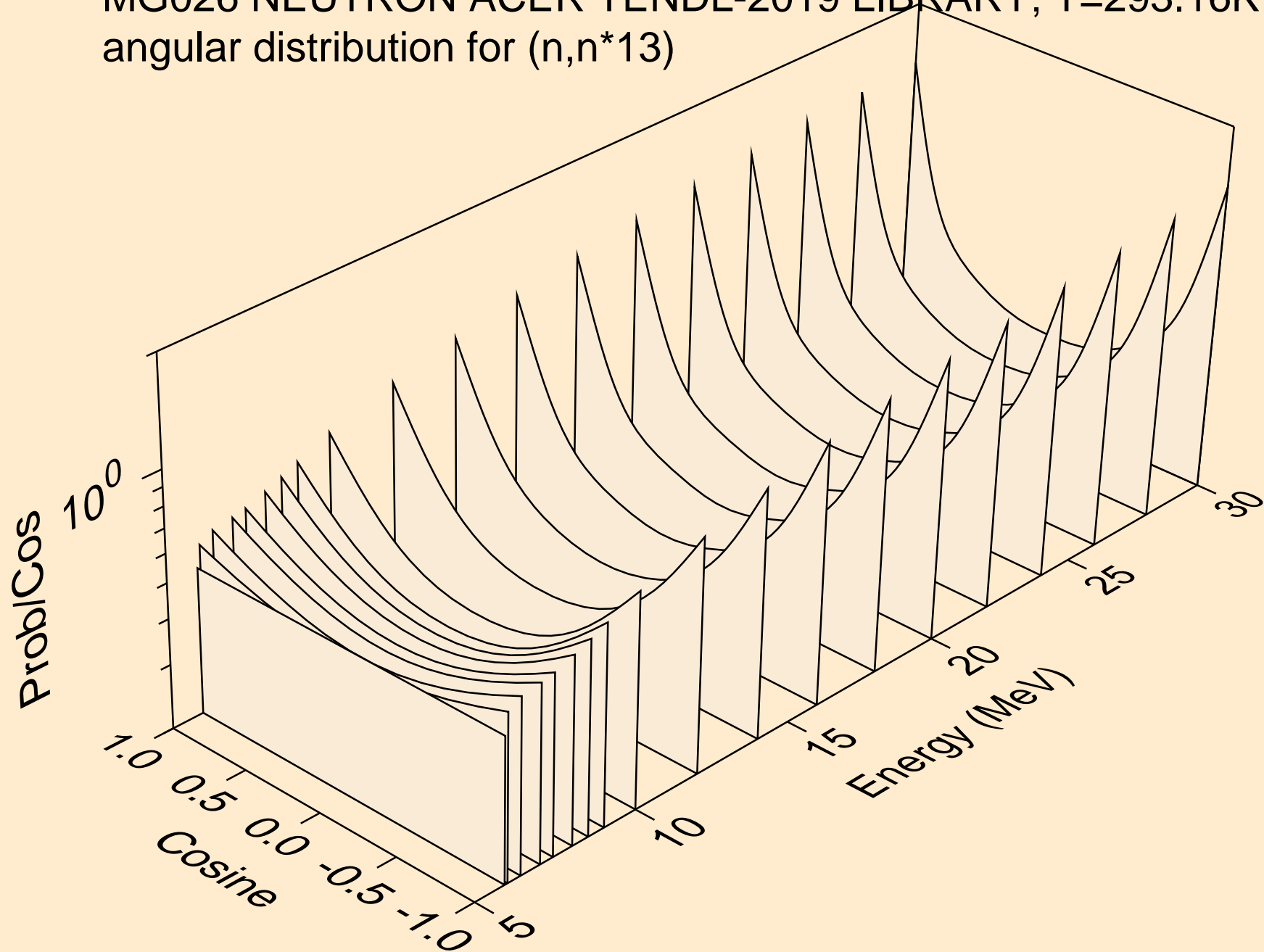

MG026 NEUTRON ACER TENDL-2019 LIBRARY; T=293.16K
angular distribution for (n,n*14)

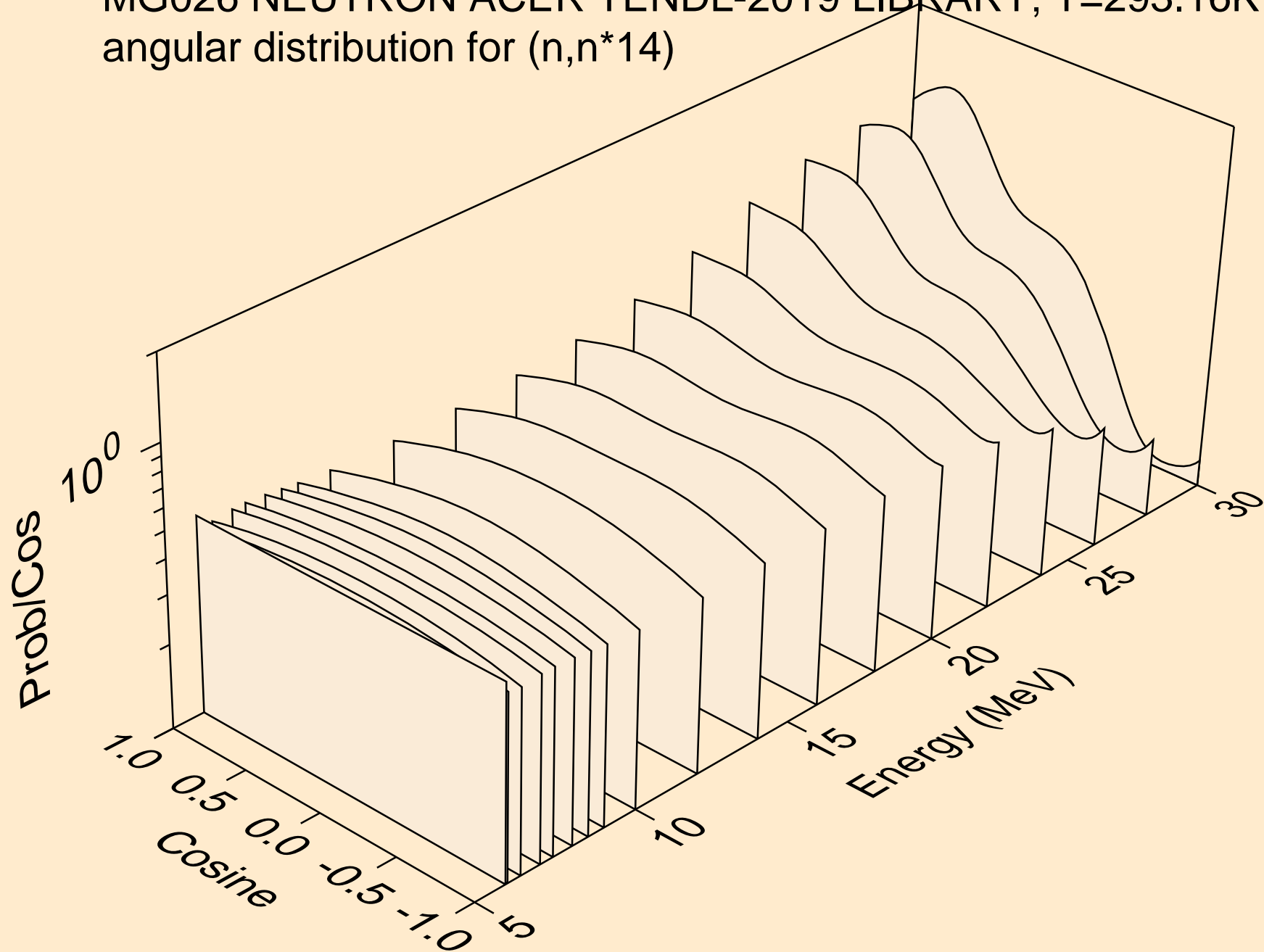

MG026 NEUTRON ACER TENDL-2019 LIBRARY; T=293.16K
angular distribution for (n,n*15)

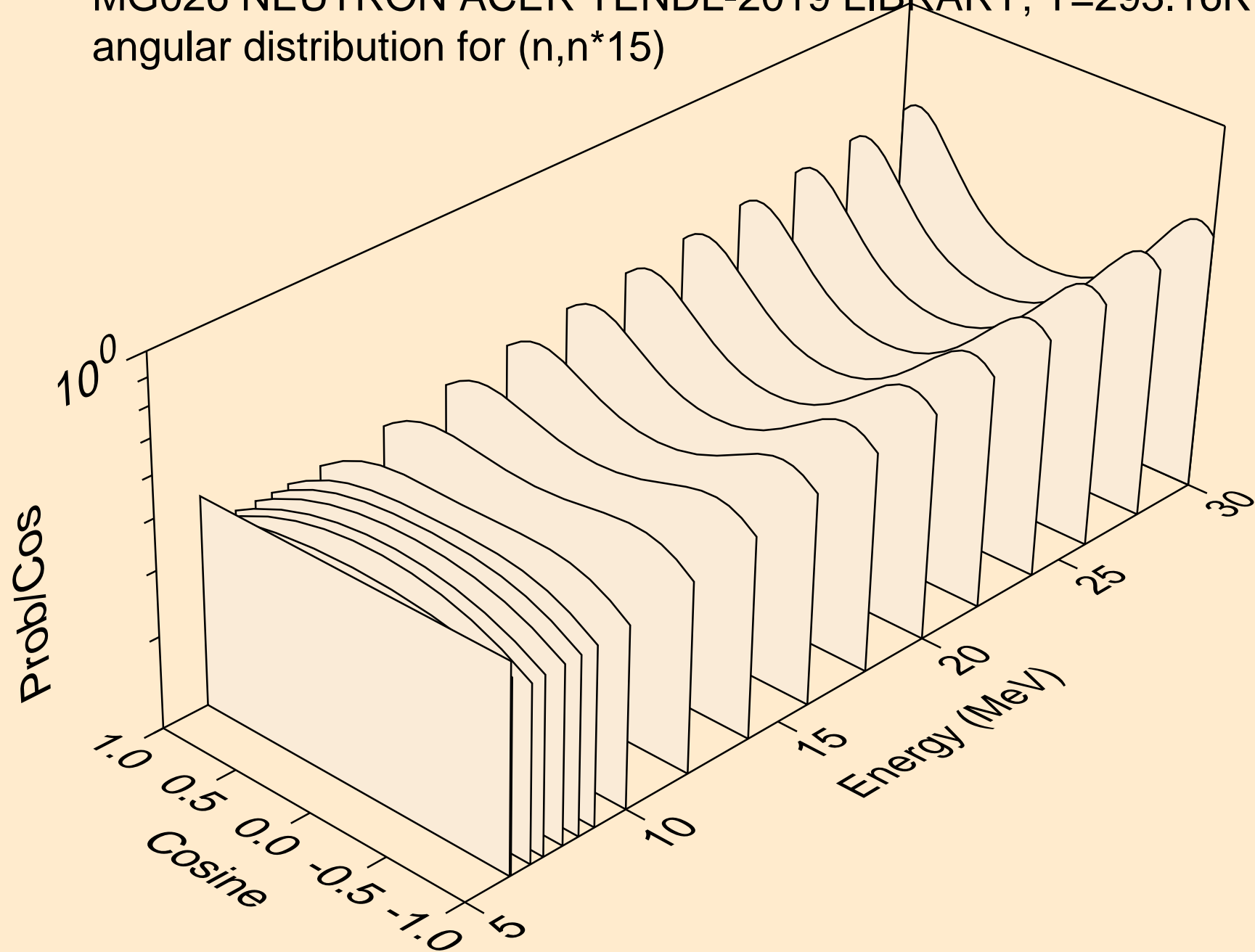

MG026 NEUTRON ACER TENDL-2019 LIBRARY; T=293.16K
angular distribution for (n,n*16)

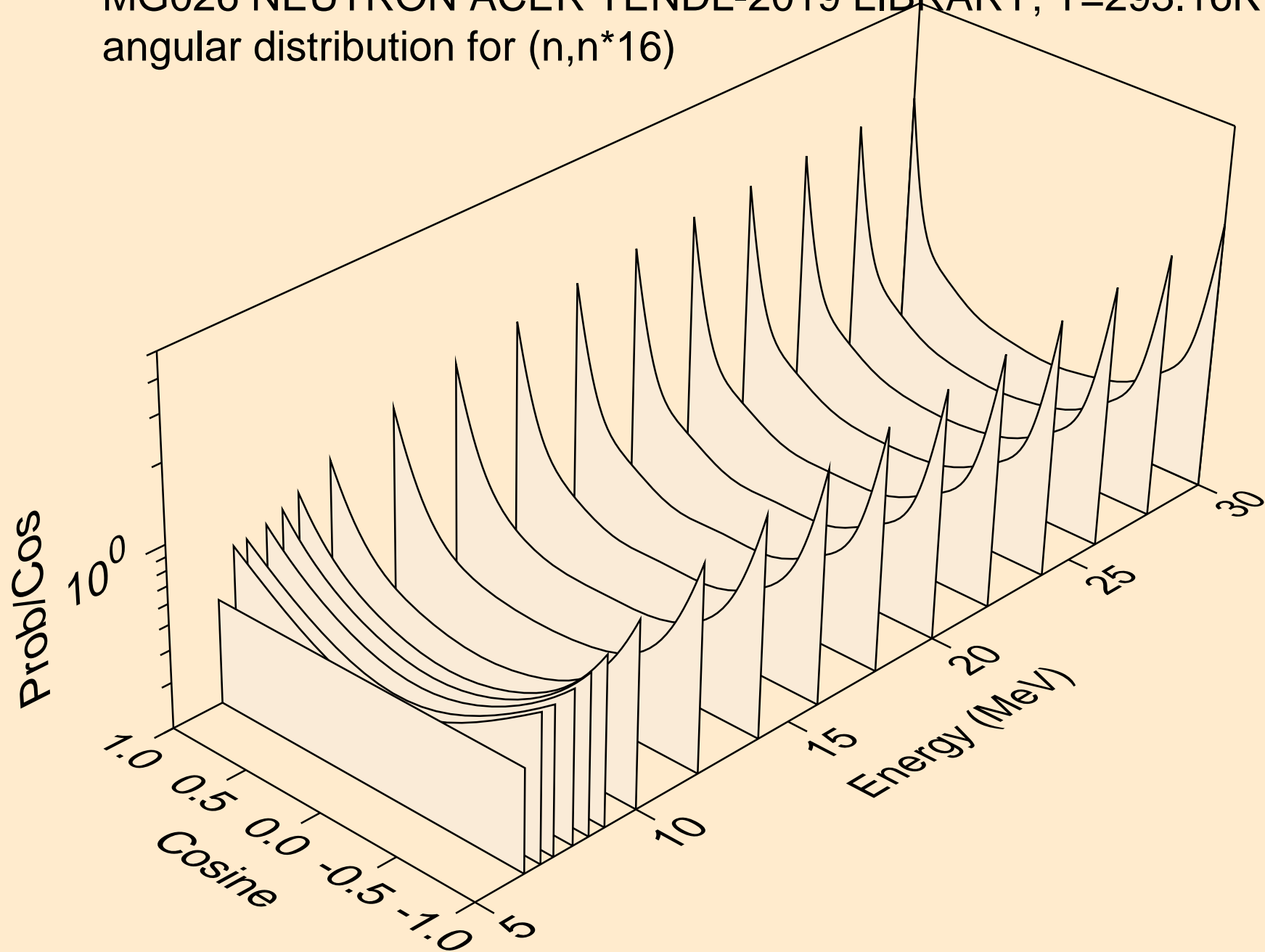

MG026 NEUTRON ACER TENDL-2019 LIBRARY; T=293.16K
angular distribution for (n,n*17)

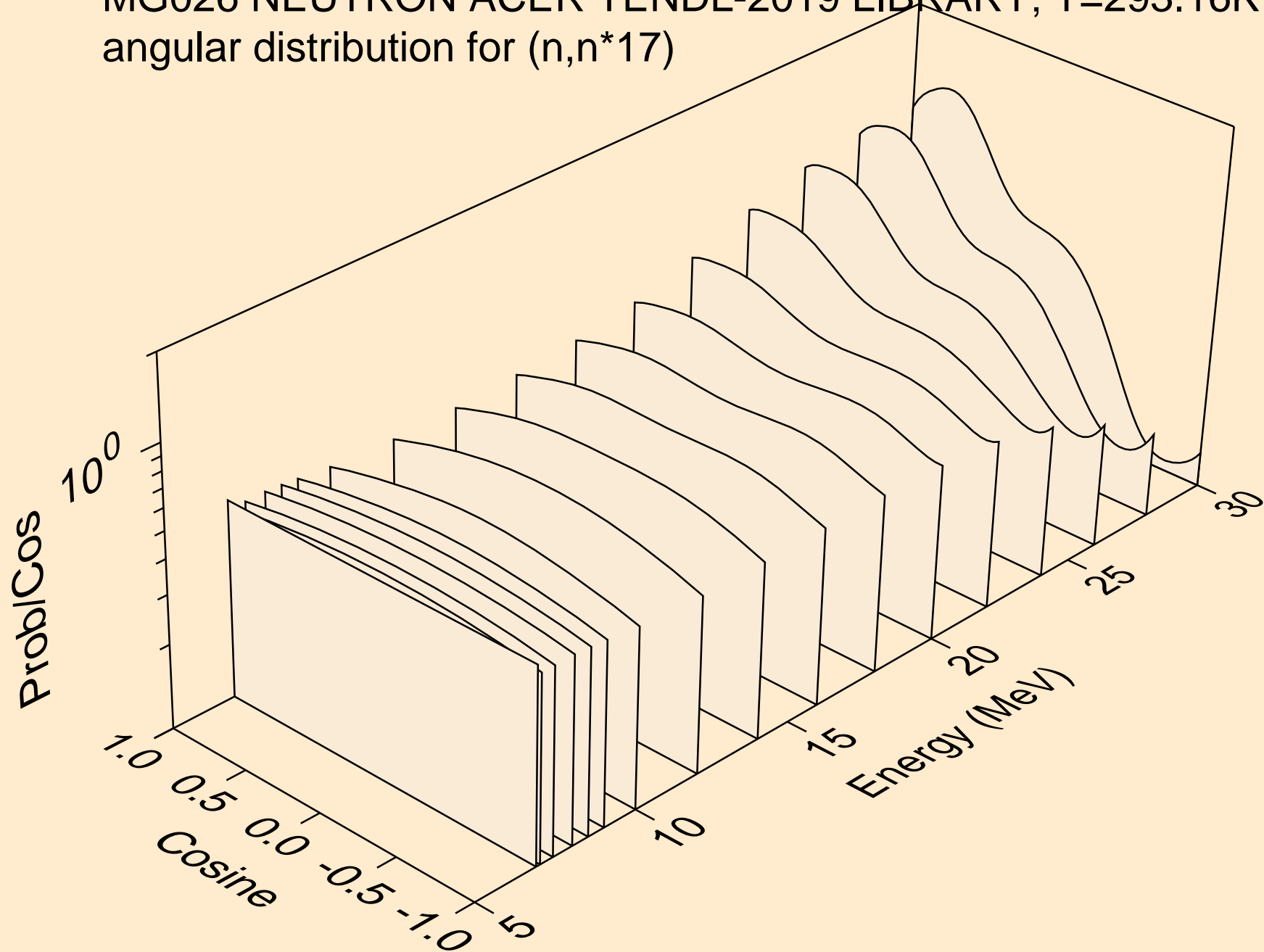

MG026 NEUTRON ACER TENDL-2019 LIBRARY; T=293.16K
angular distribution for (n,n*18)

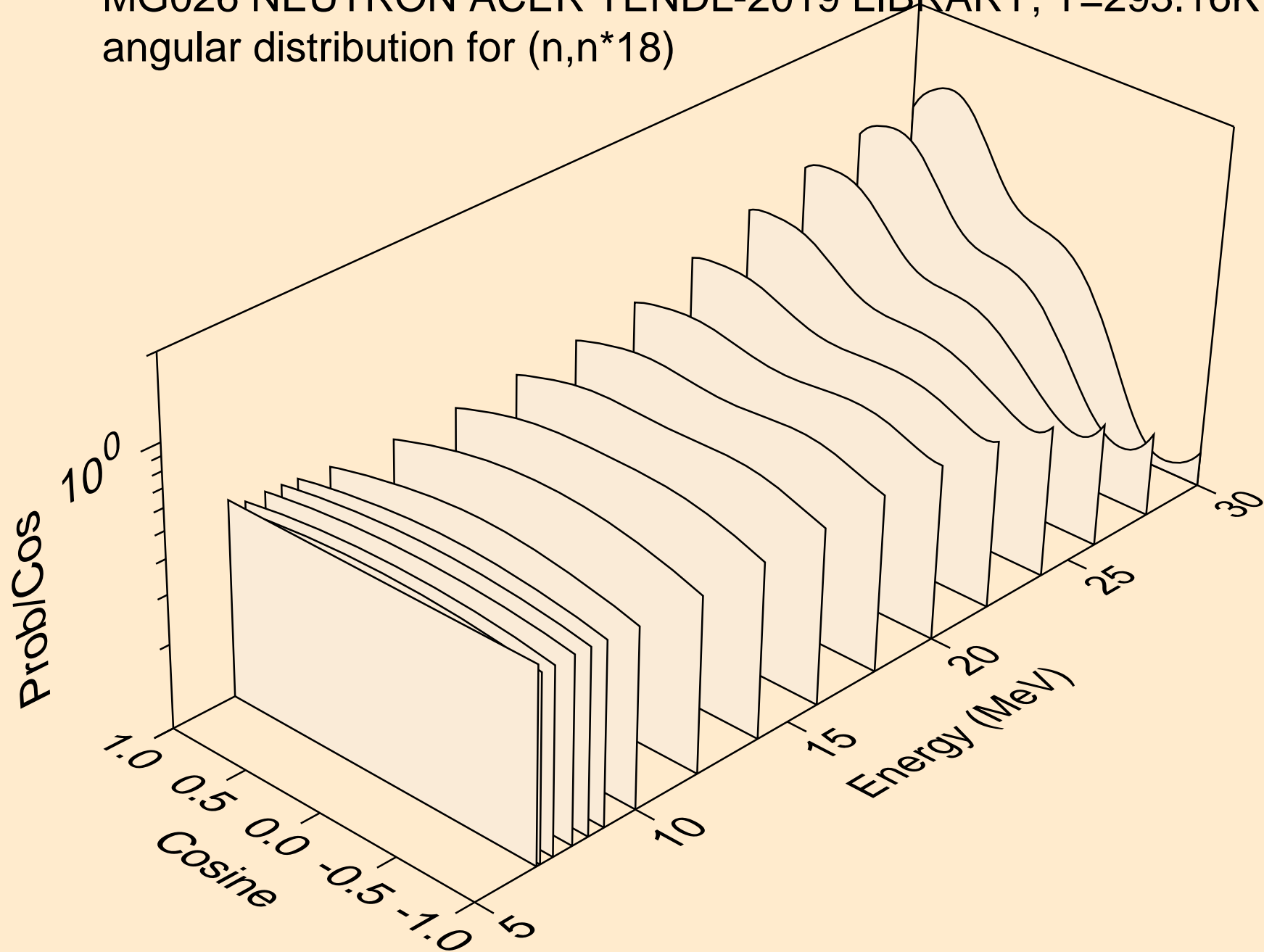

MG026 NEUTRON ACER TENDL-2019 LIBRARY; T=293.16K
angular distribution for (n,n*19)

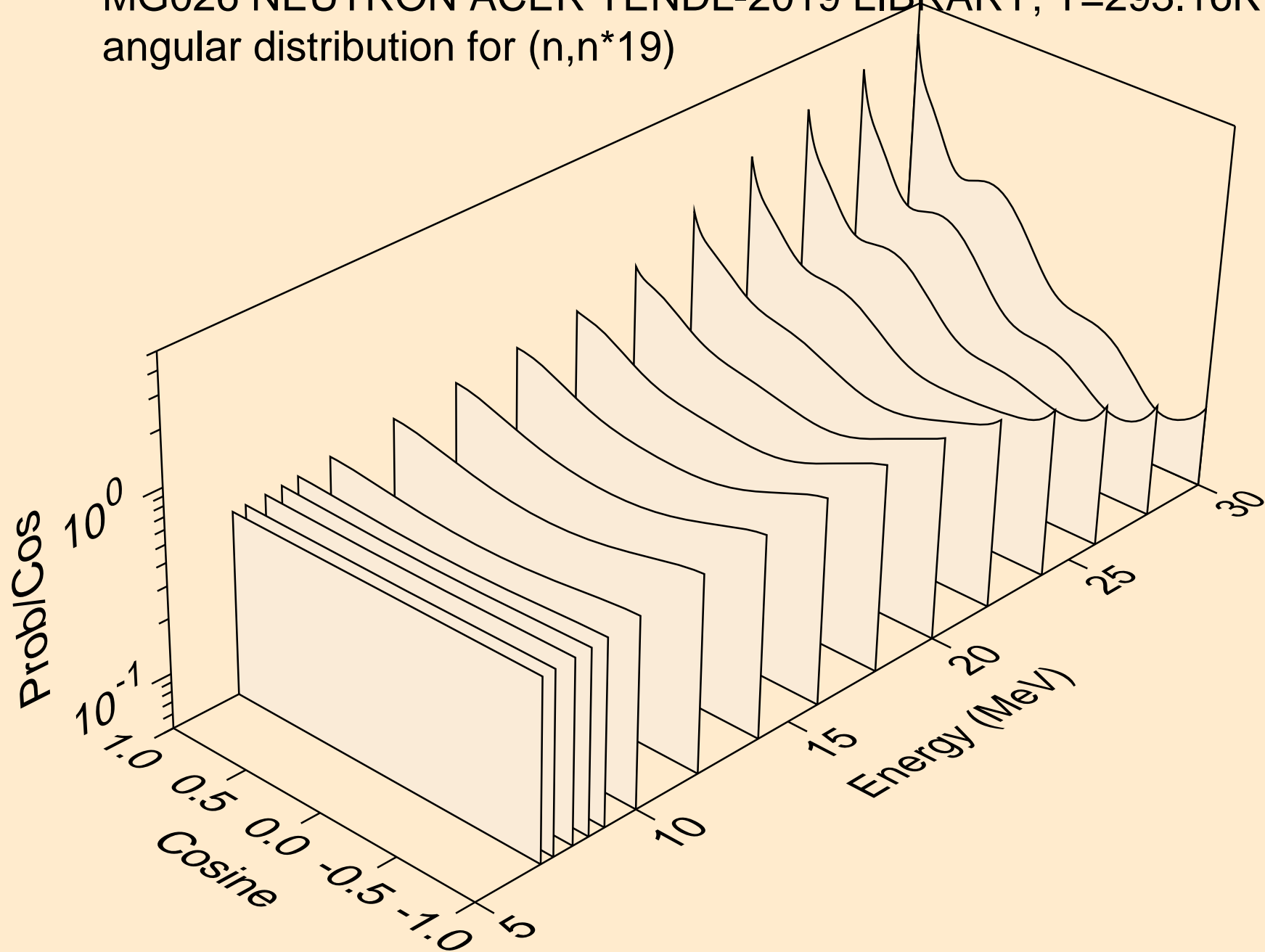

MG026 NEUTRON ACER TENDL-2019 LIBRARY; T=293.16K
angular distribution for (n,n*20)

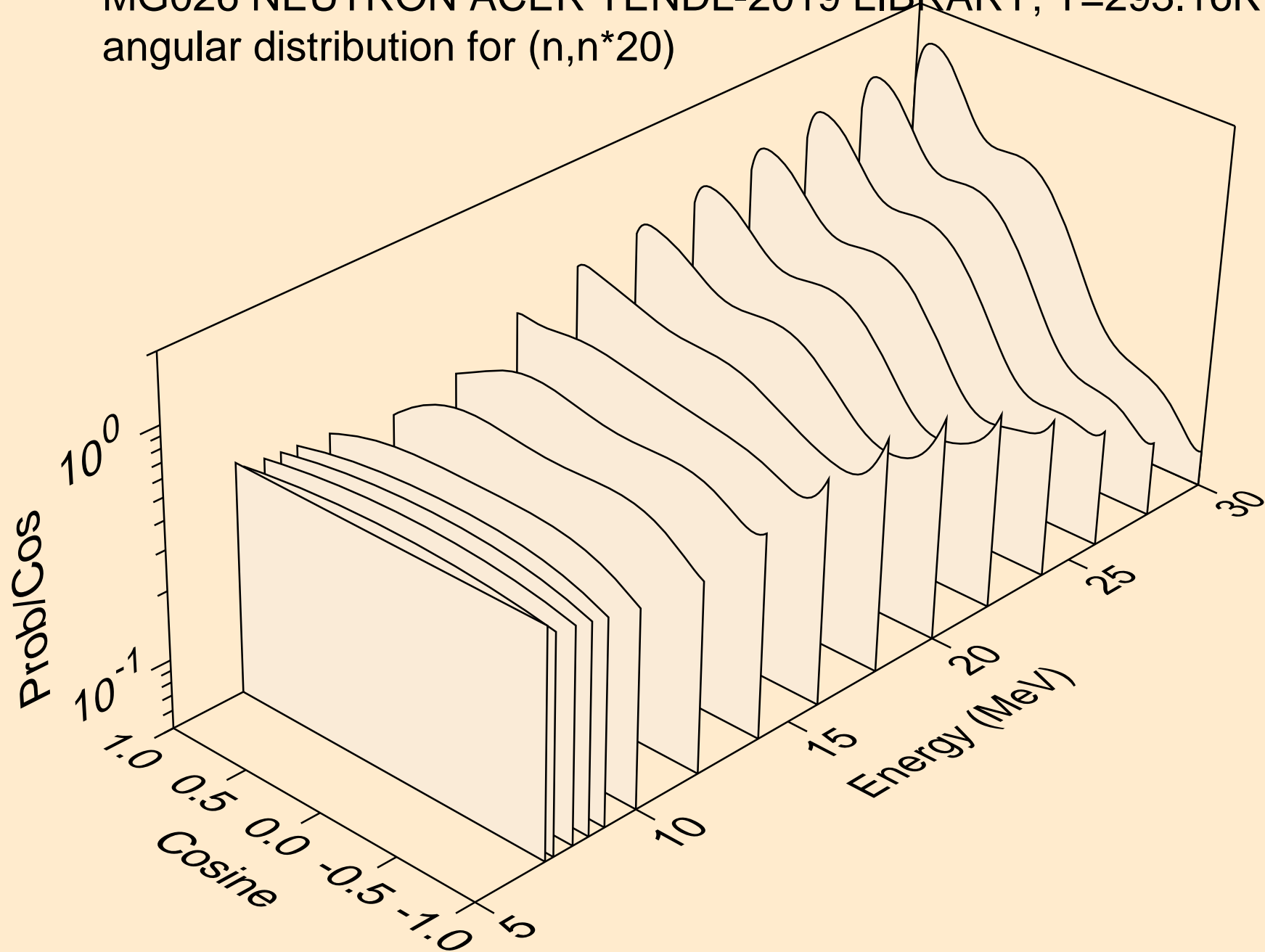

MG026 NEUTRON ACER TENDL-2019 LIBRARY; T=293.16K
angular distribution for (n,n*21)

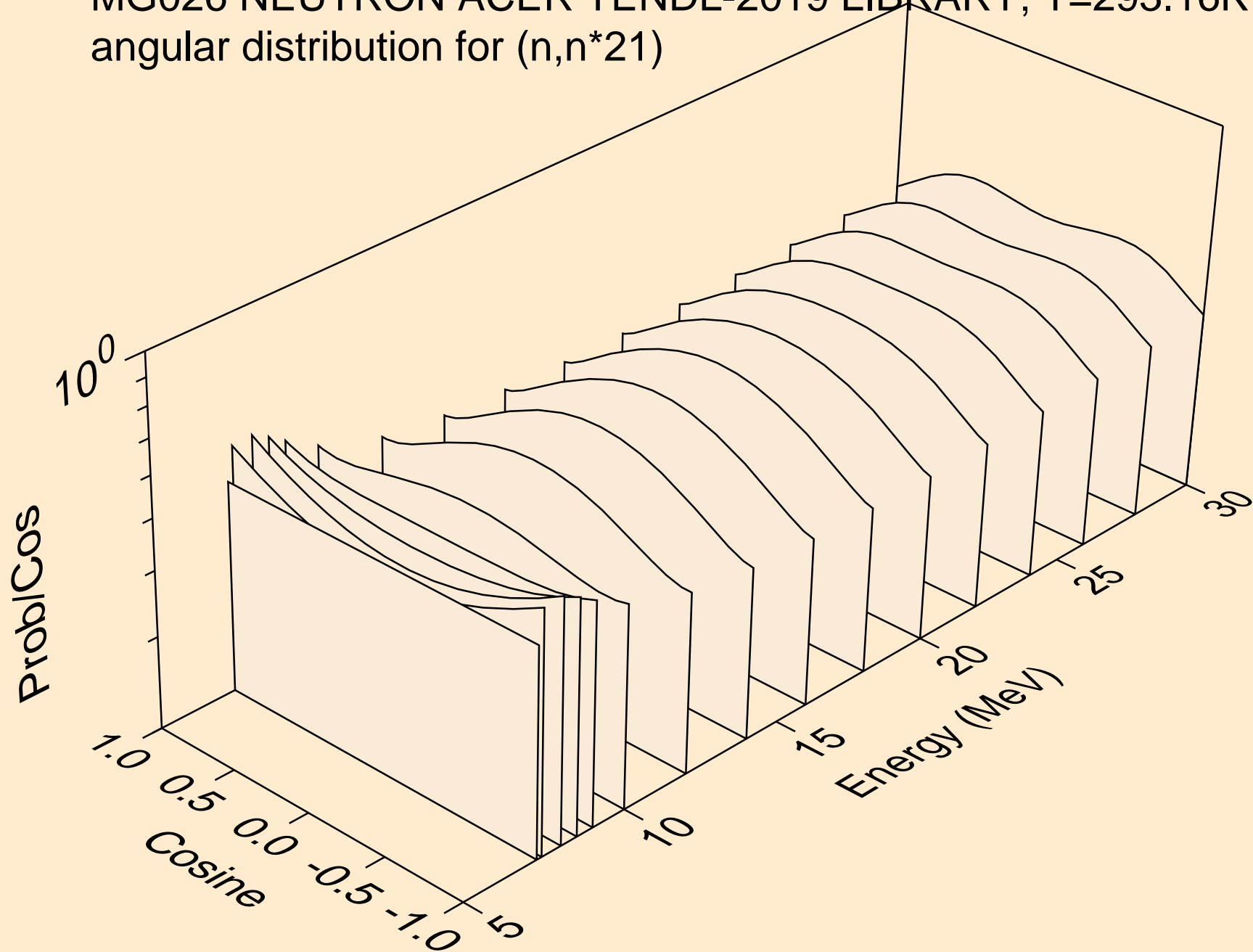

MG026 NEUTRON ACER TENDL-2019 LIBRARY; T=293.16K
angular distribution for (n,n*22)

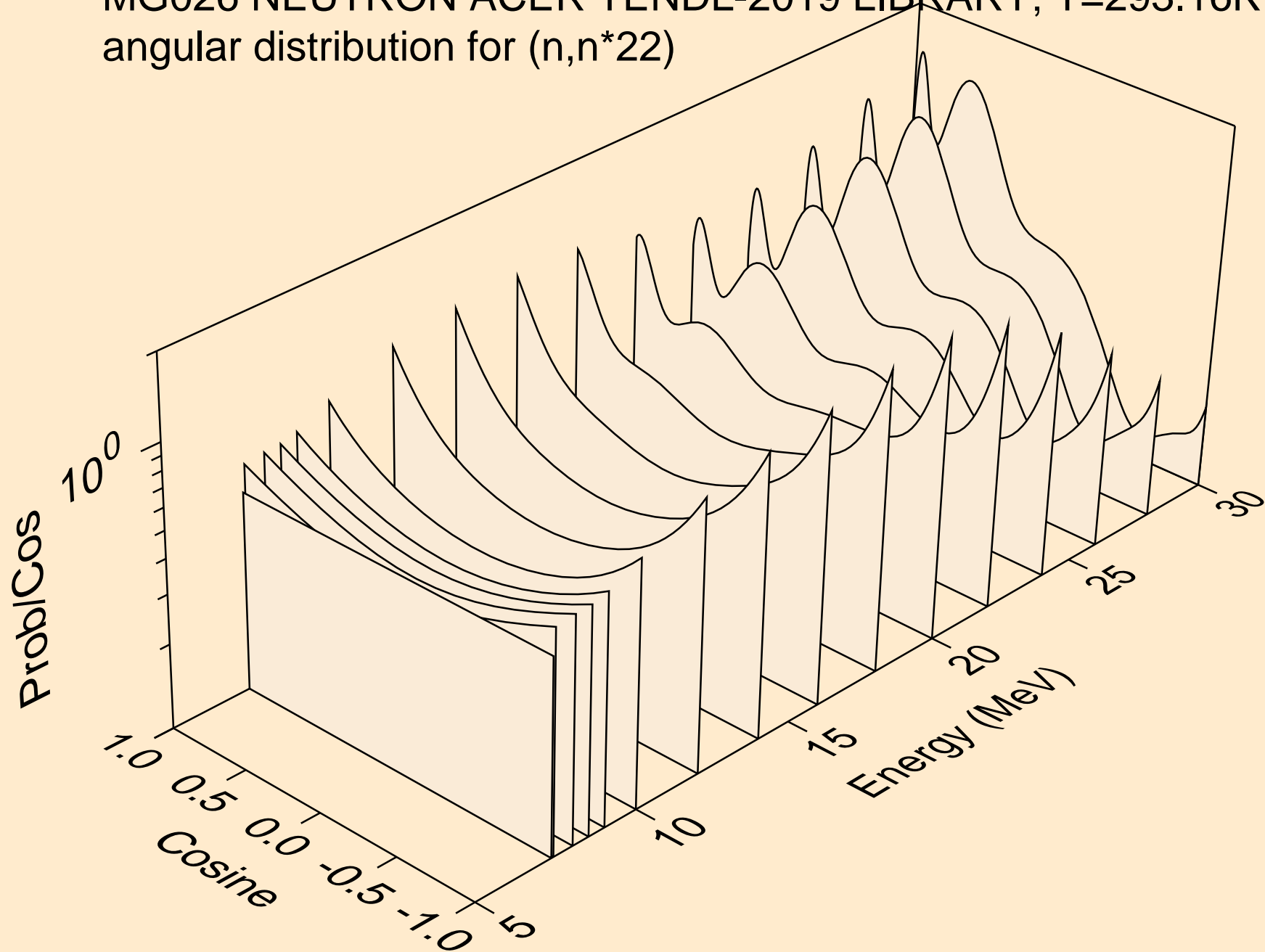

MG026 NEUTRON ACER TENDL-2019 LIBRARY; T=293.16K
angular distribution for (n,n*23)

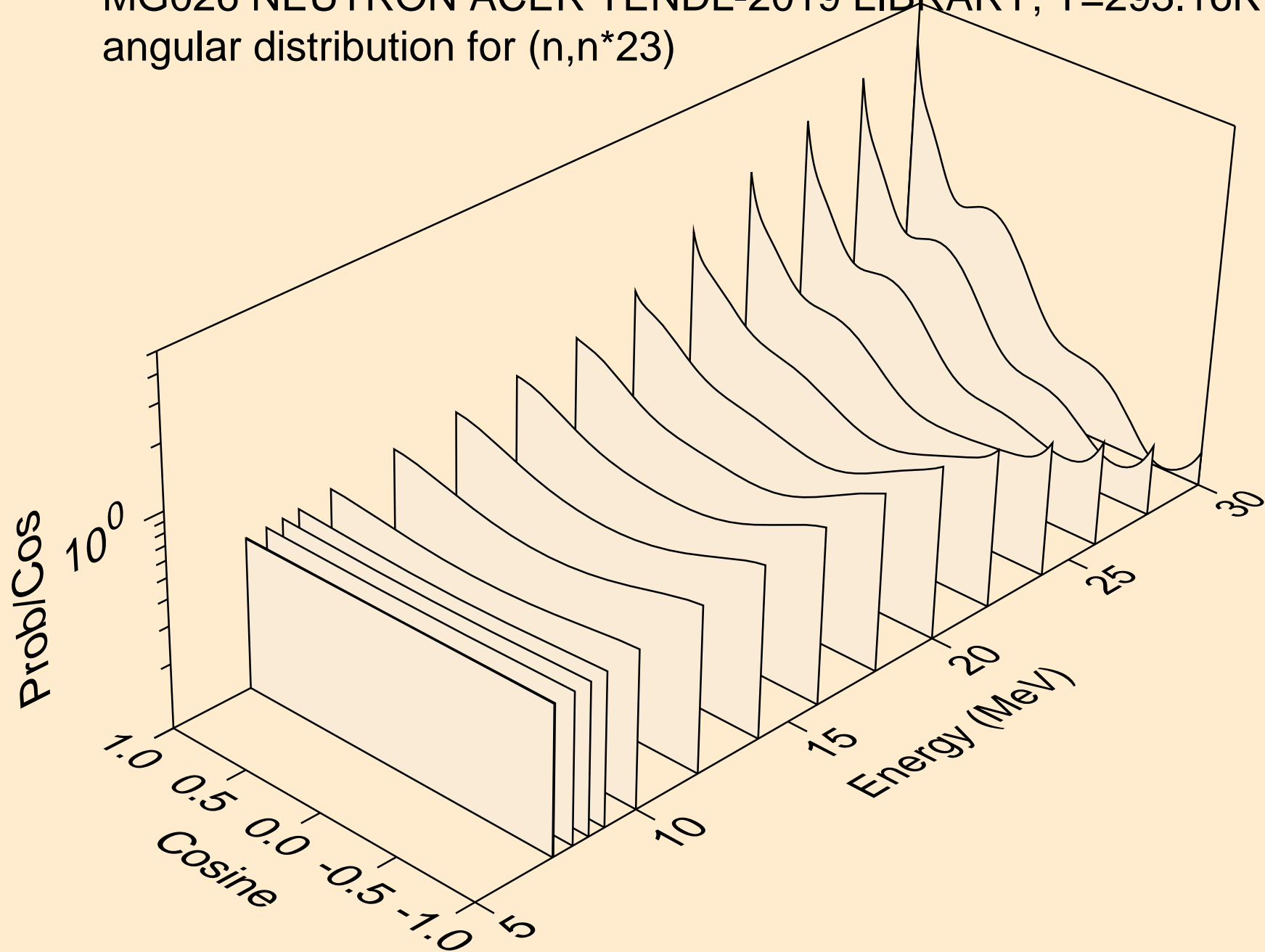

MG026 NEUTRON ACER TENDL-2019 LIBRARY; T=293.16K
angular distribution for (n,n*24)

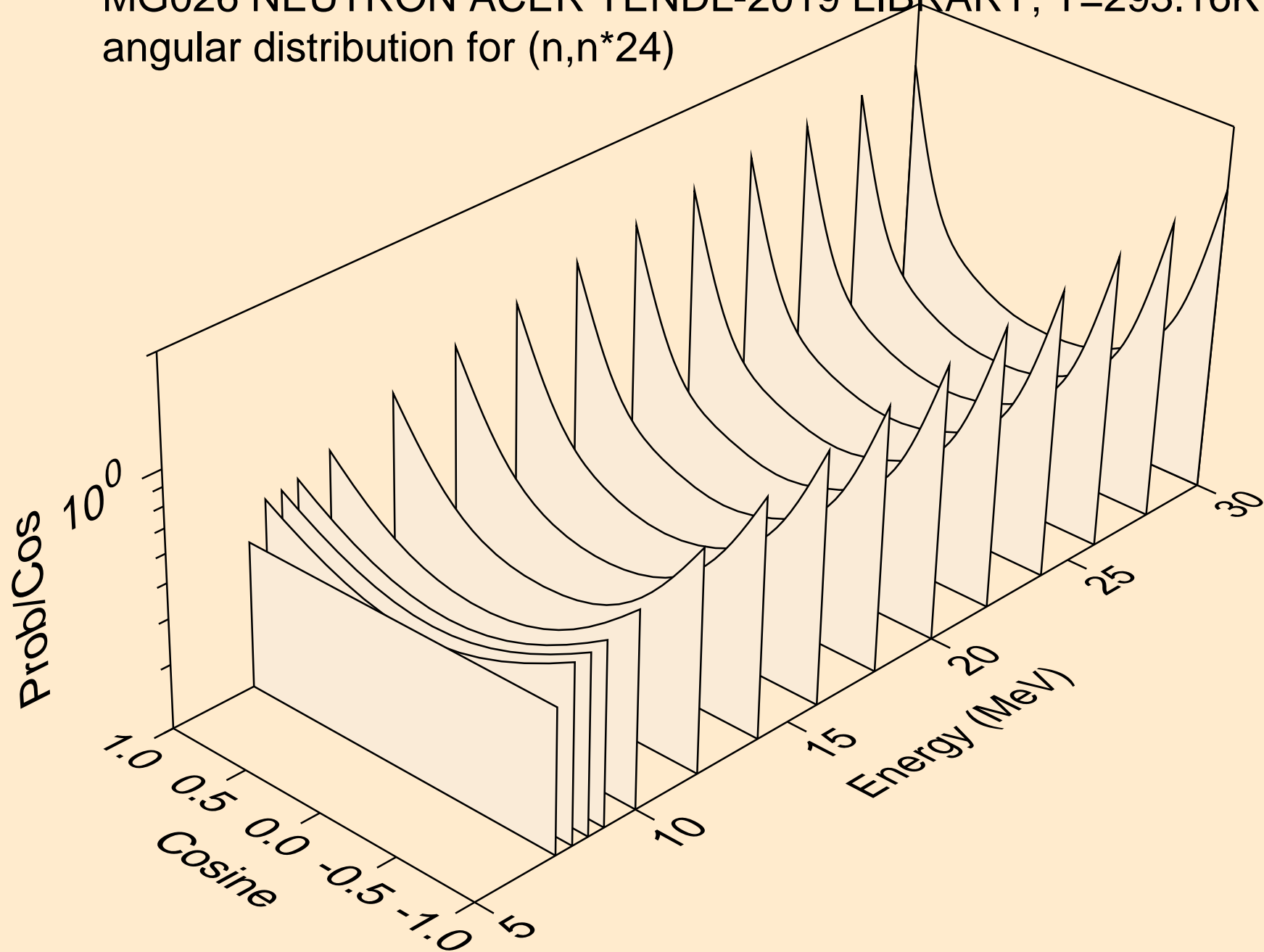

MG026 NEUTRON ACER TENDL-2019 LIBRARY; T=293.16K
angular distribution for (n,n*25)

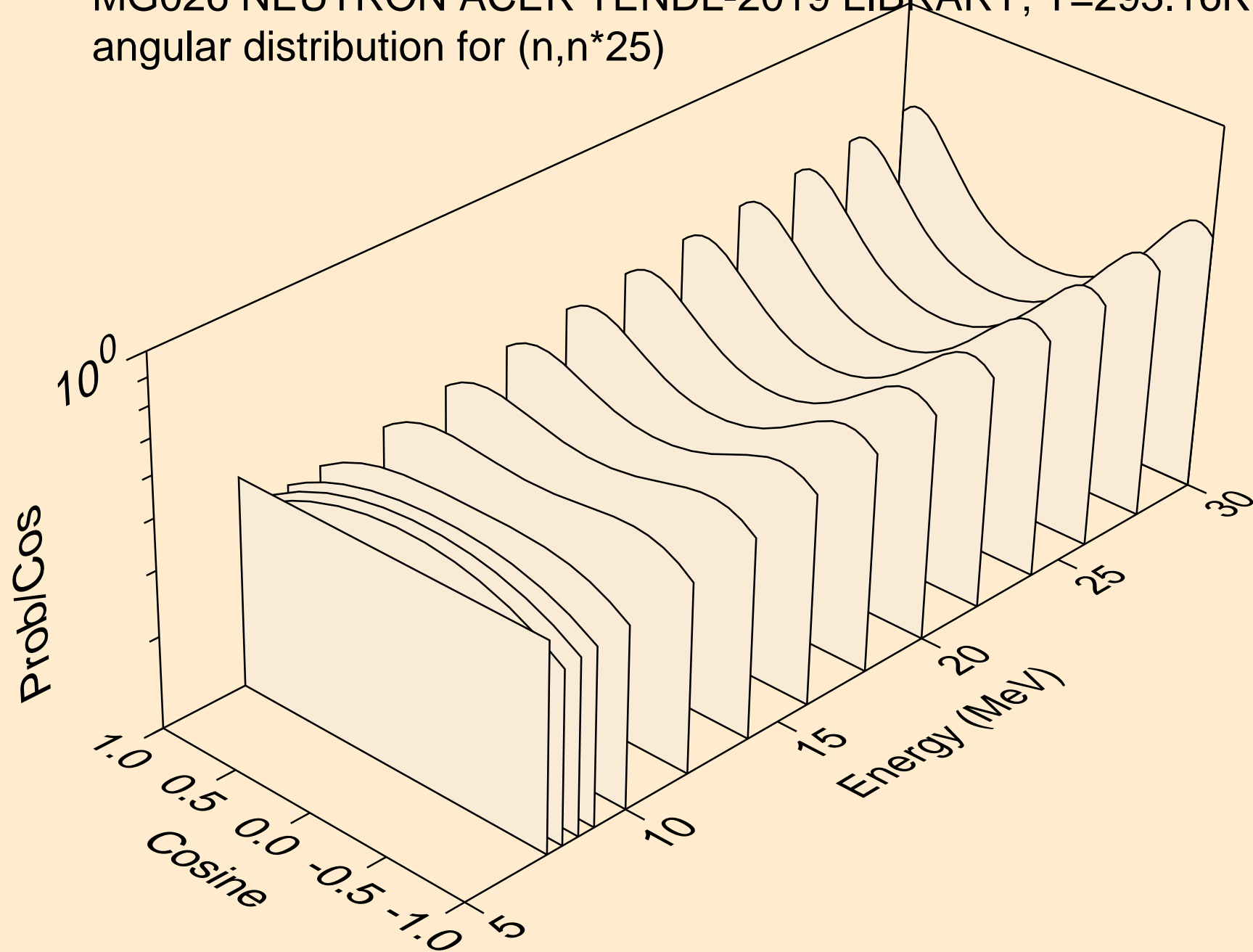

MG026 NEUTRON ACER TENDL-2019 LIBRARY; T=293.16K
angular distribution for (n,n*26)

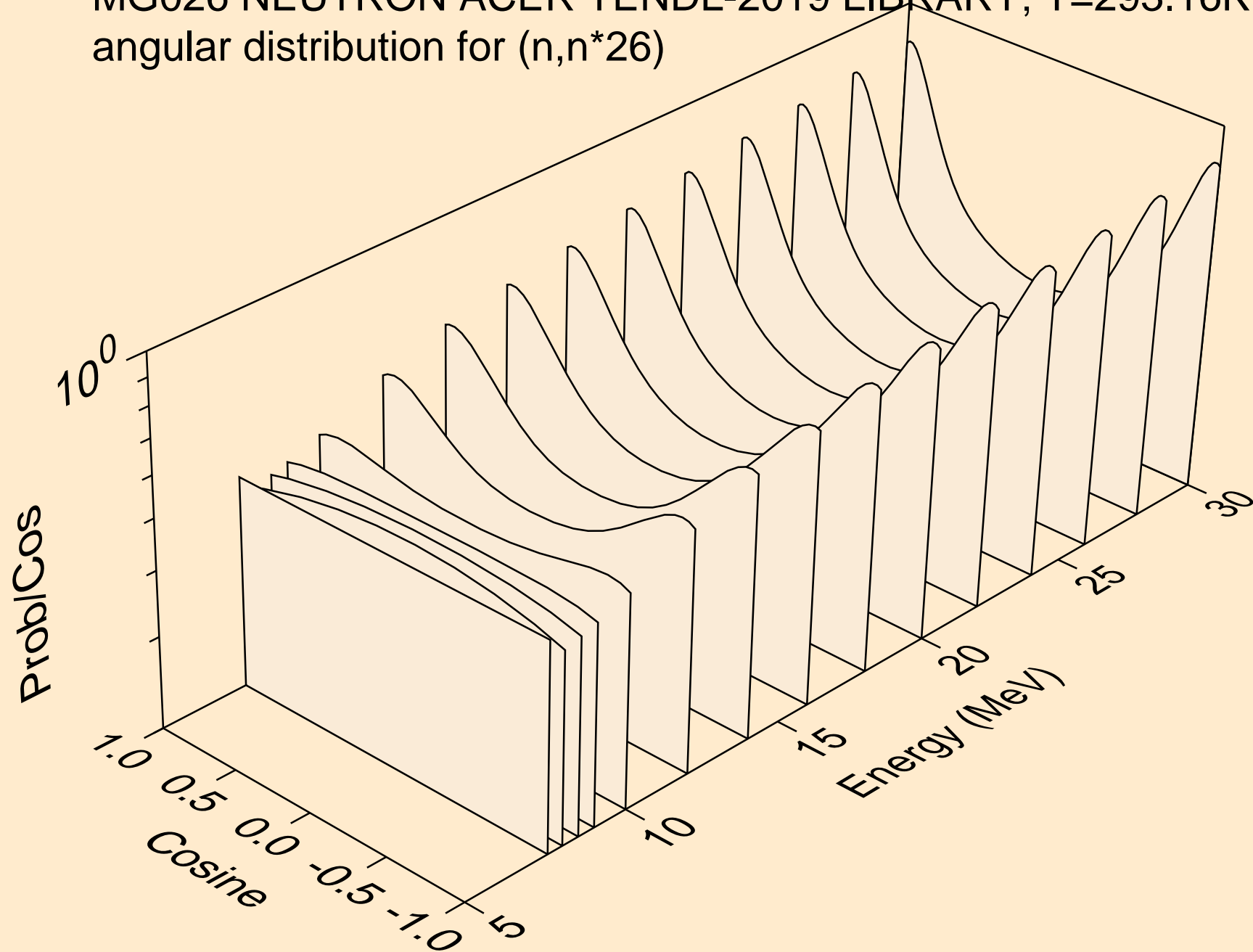

MG026 NEUTRON ACER TENDL-2019 LIBRARY; T=293.16K
angular distribution for (n,n*27)

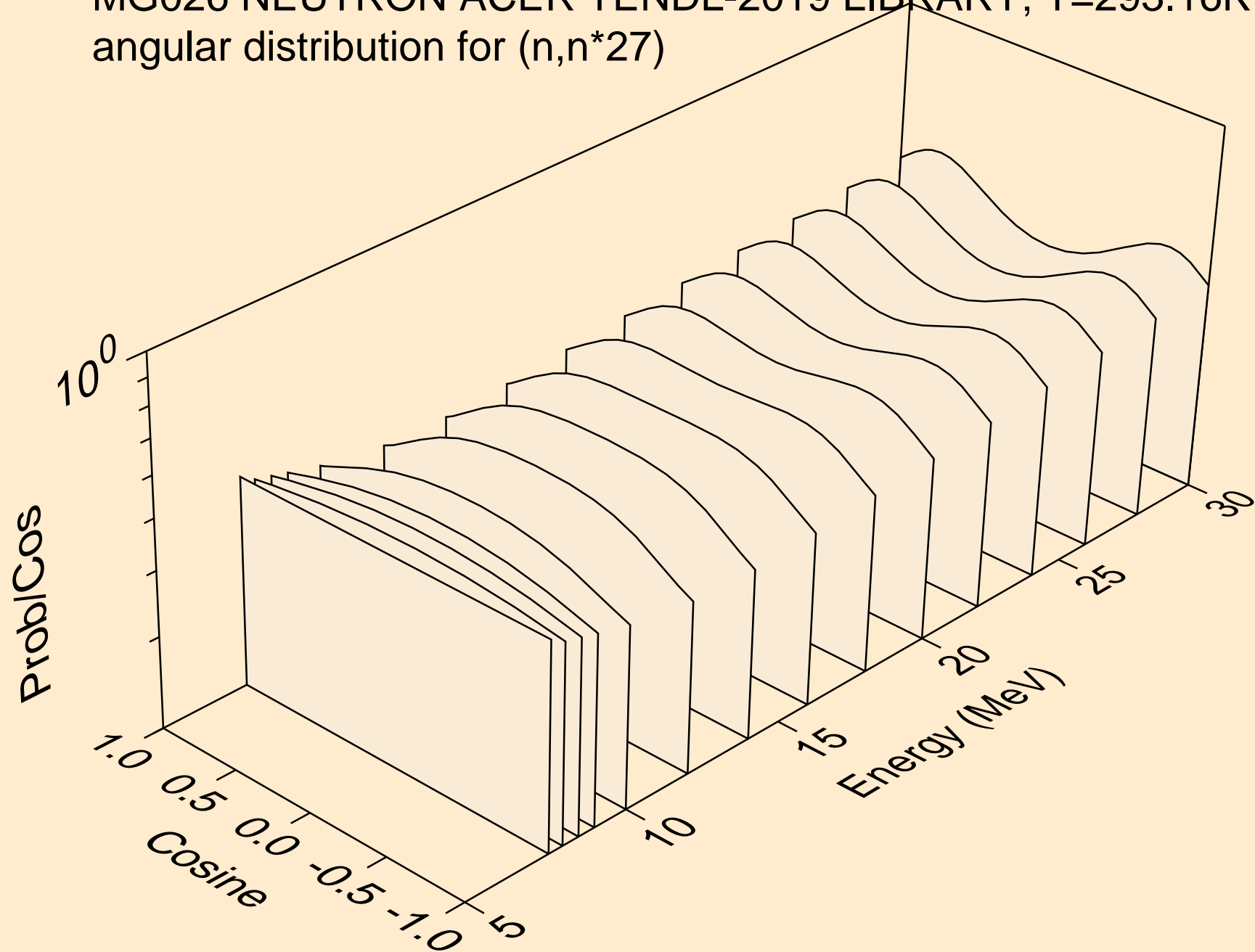

MG026 NEUTRON ACER TENDL-2019 LIBRARY; T=293.16K
angular distribution for (n,n*28)

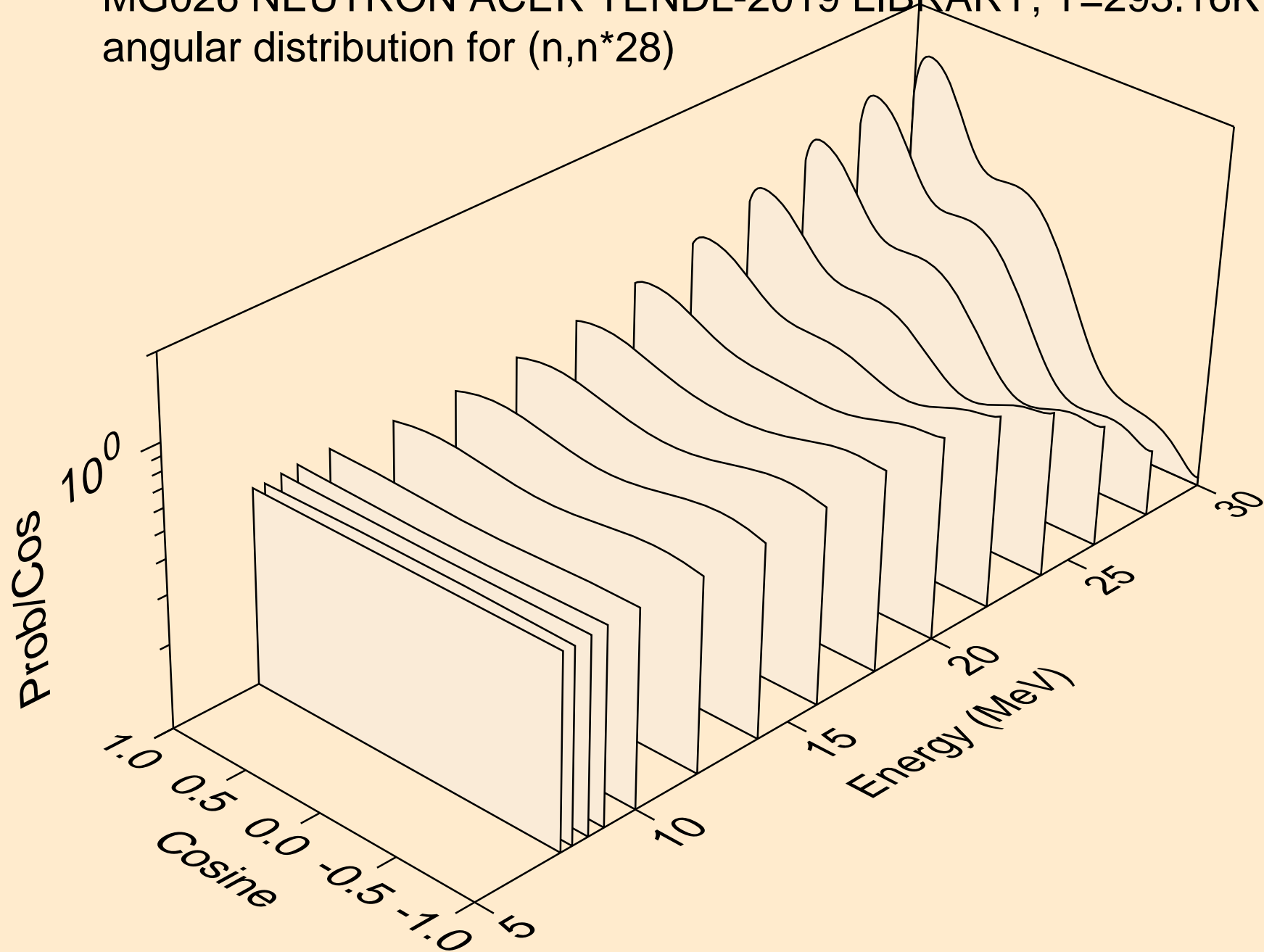

MG026 NEUTRON ACER TENDL-2019 LIBRARY; T=293.16K
angular distribution for (n,n*29)

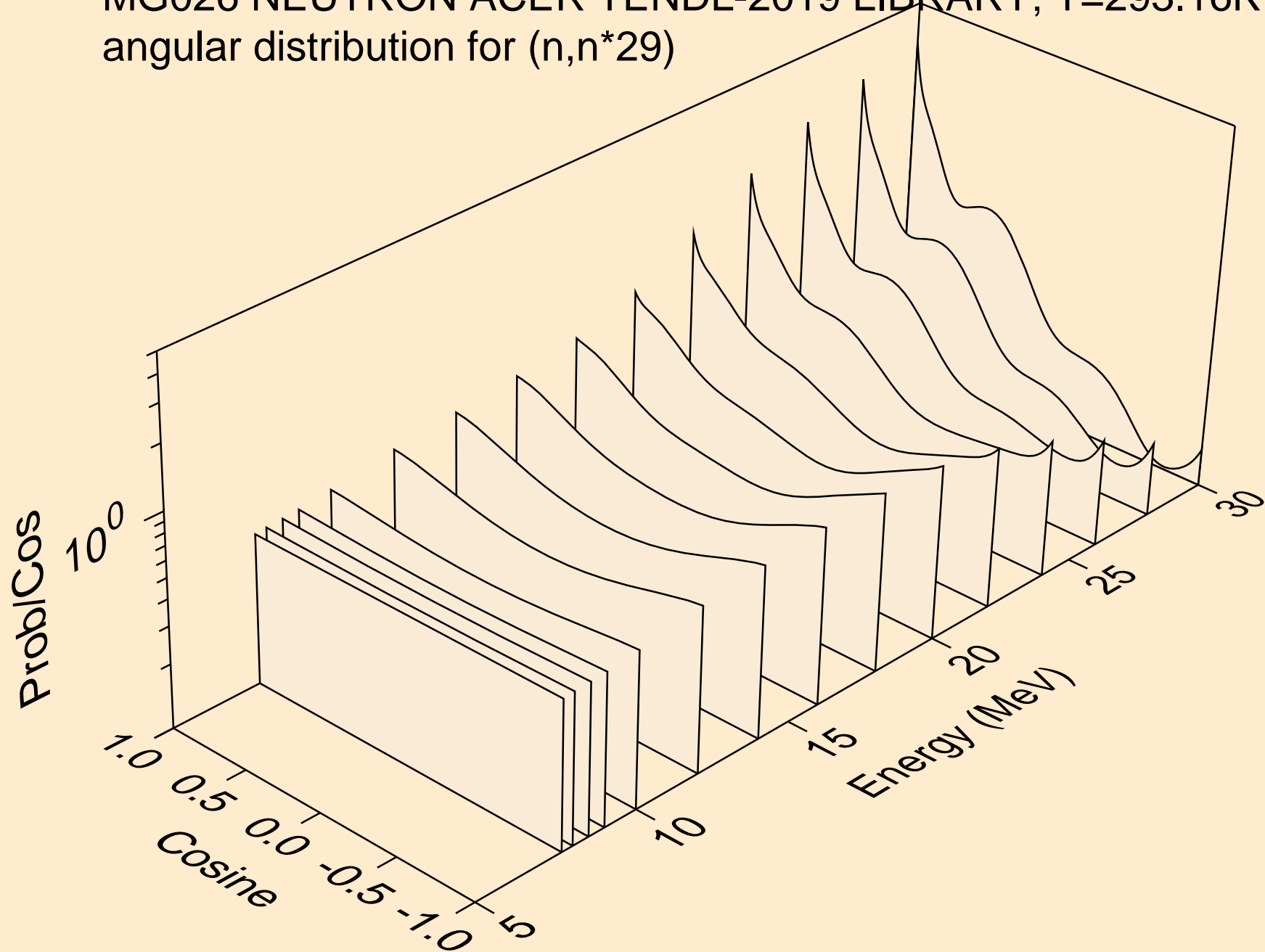

MG026 NEUTRON ACER TENDL-2019 LIBRARY; T=293.16K
Neutron emission for (n,x)

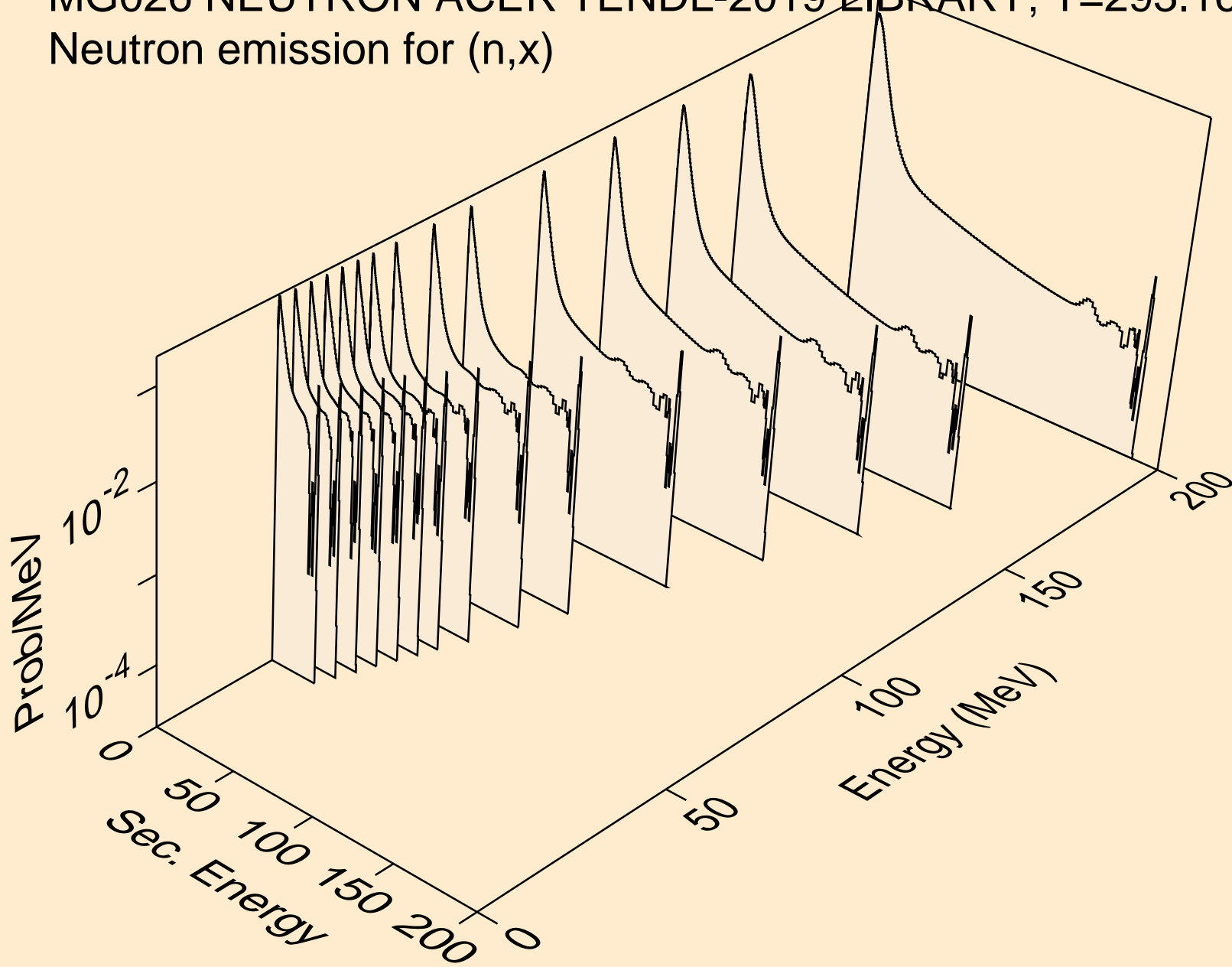

MG026 NEUTRON ACER TENDL-2019 LIBRARY; T=293.16K
Neutron emission for (n,2nd)

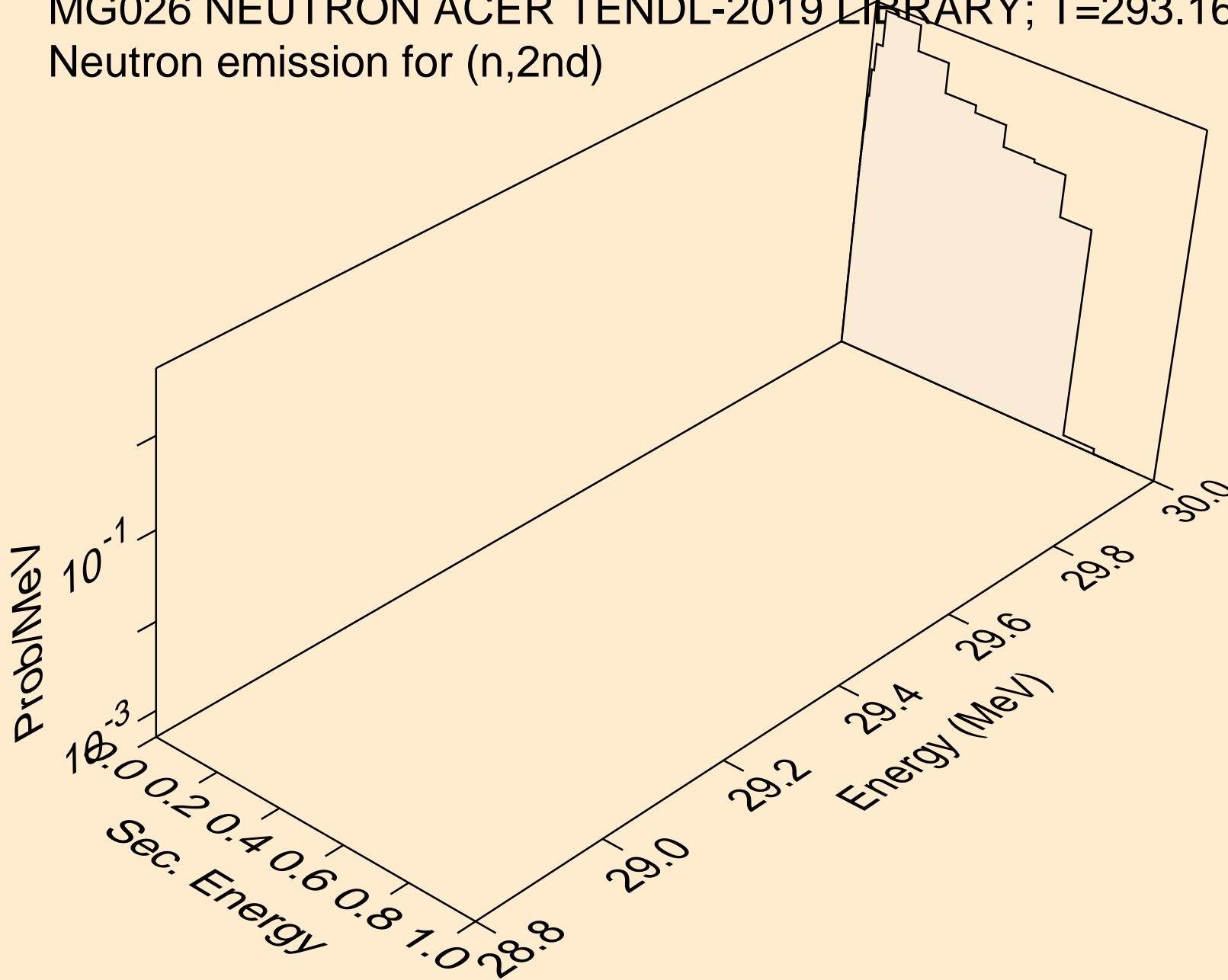

MG026 NEUTRON ACER TENDL-2019 LIBRARY; T=293.16K
Neutron emission for (n,2n)

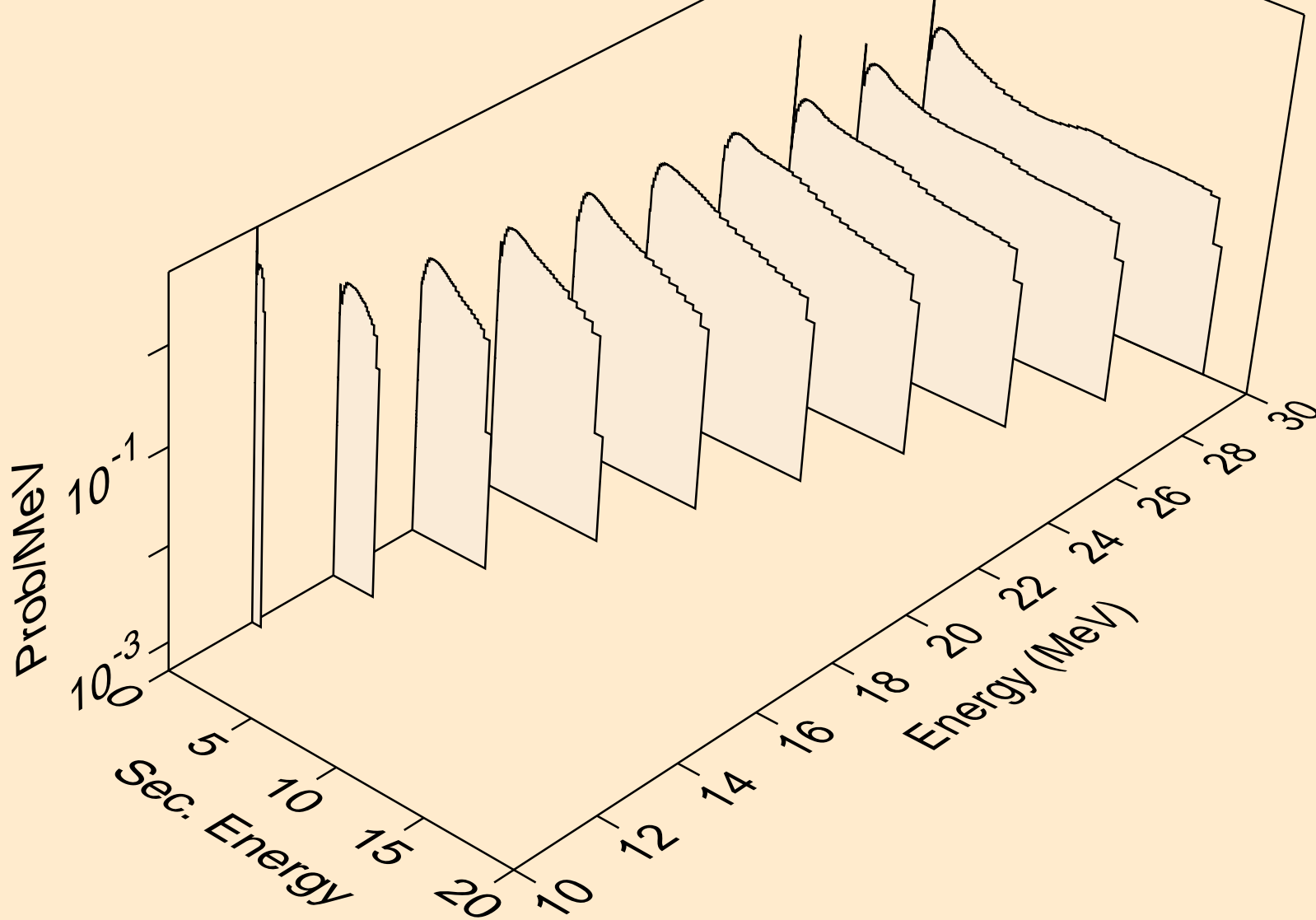

MG026 NEUTRON ACER TENDL-2019 LIBRARY; T=293.16K
Neutron emission for (n,3n)

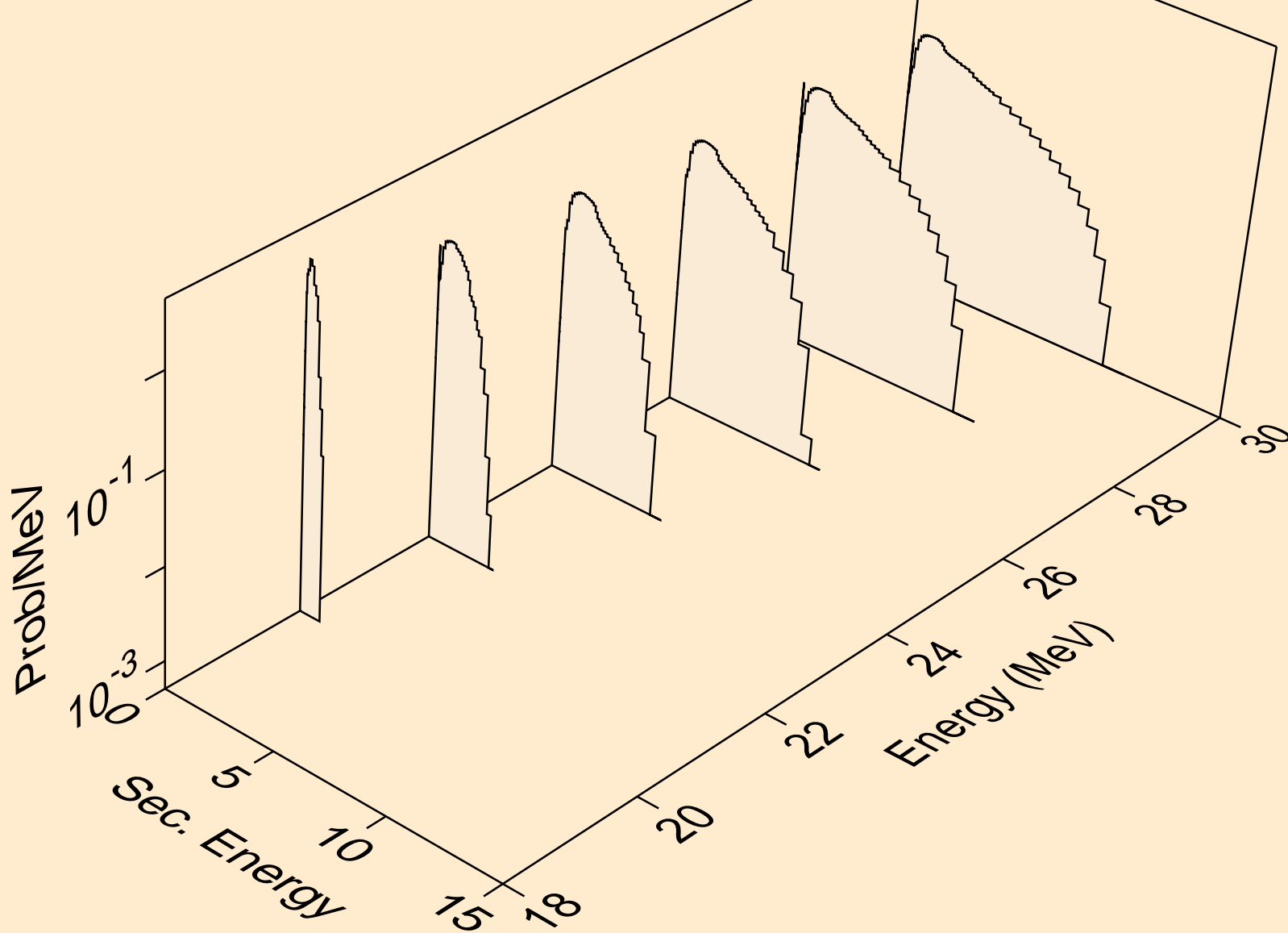

MG026 NEUTRON ACER TENDL-2019 LIBRARY; T=293.16K
Neutron emission for (n,n*)a

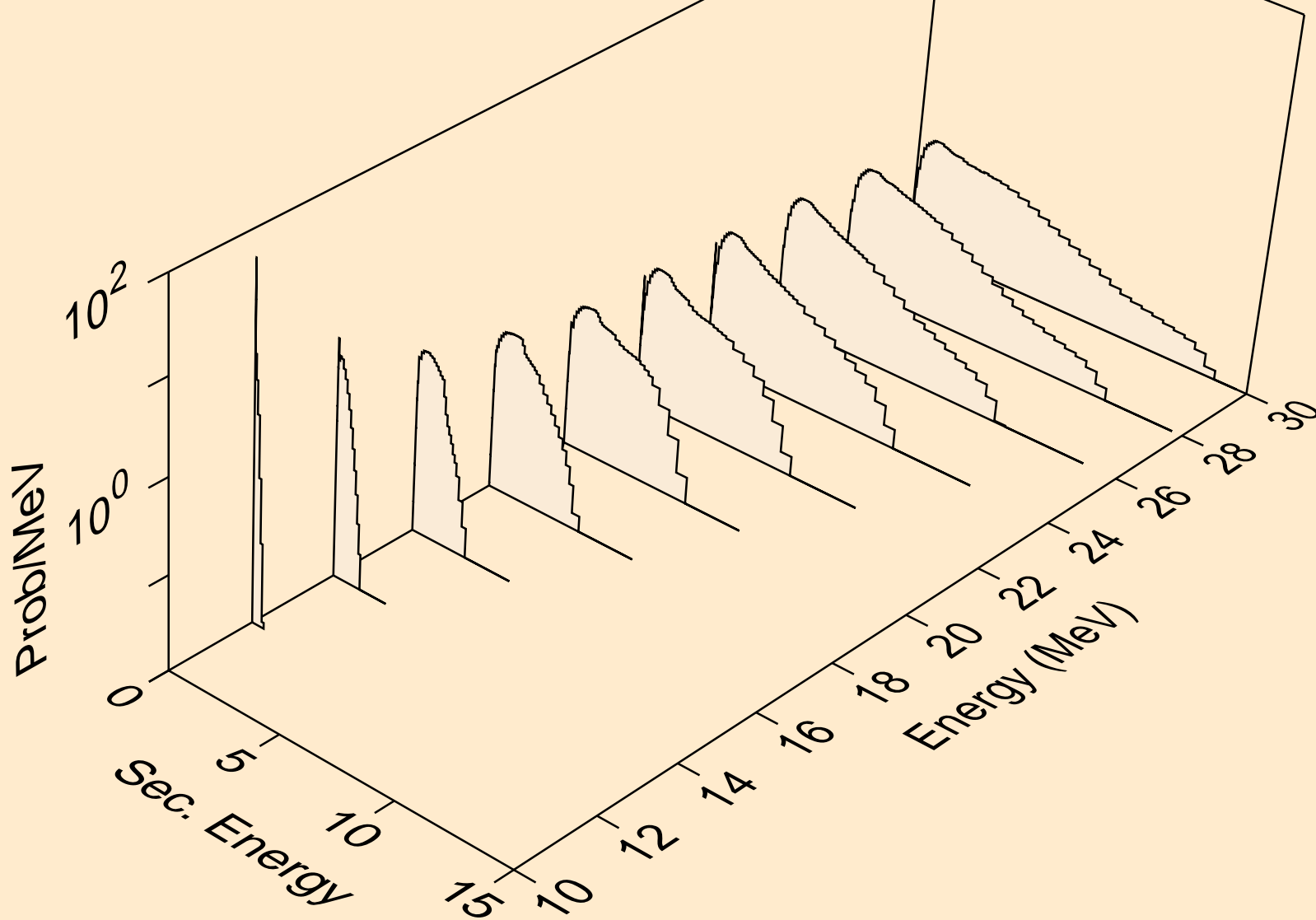

MG026 NEUTRON ACER TENDL-2019 LIBRARY; T=293.16K
Neutron emission for (n,2n)_a

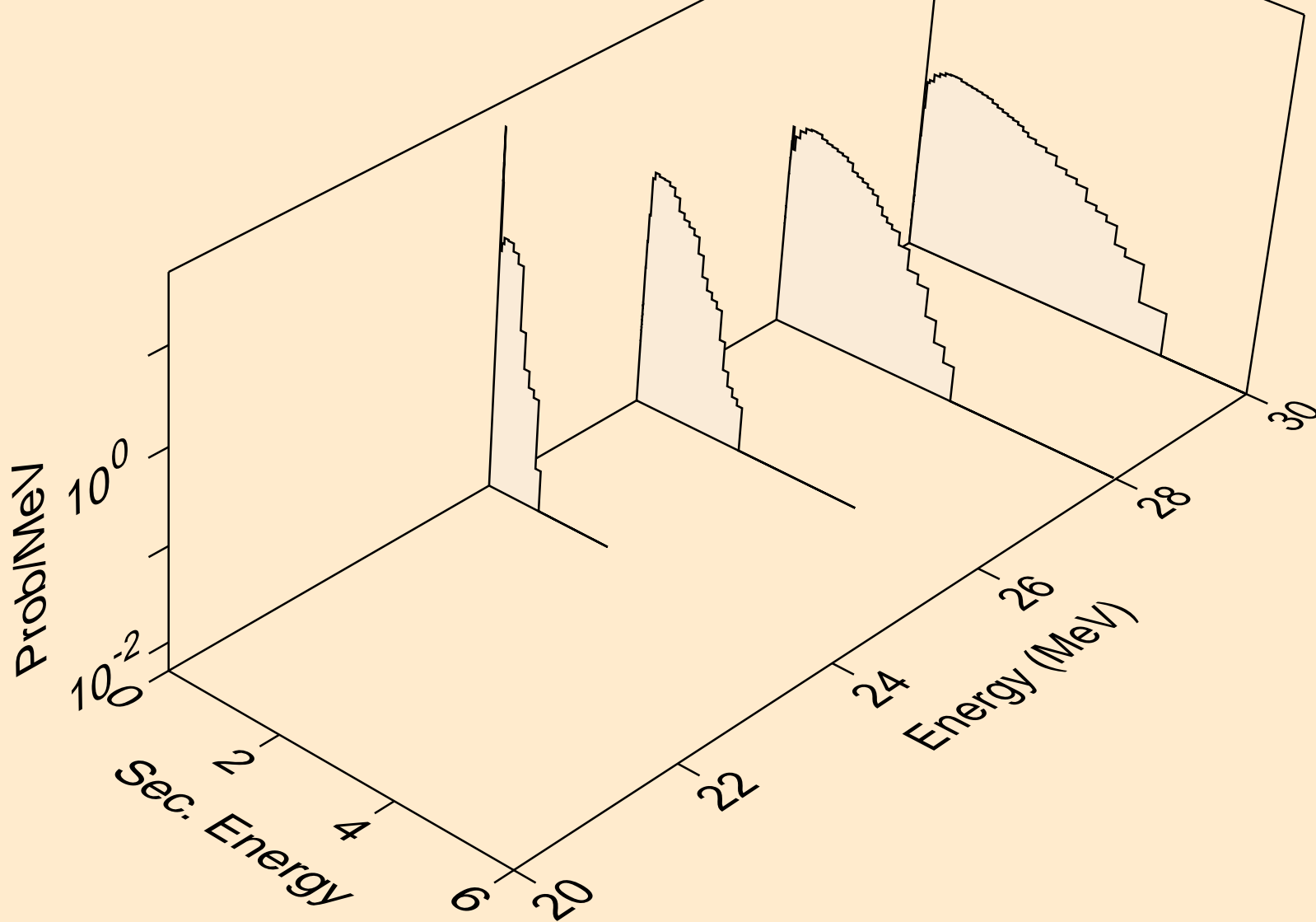

MG026 NEUTRON ACER TENDL-2019 LIBRARY; T=293.16K
Neutron emission for (n,3n)a

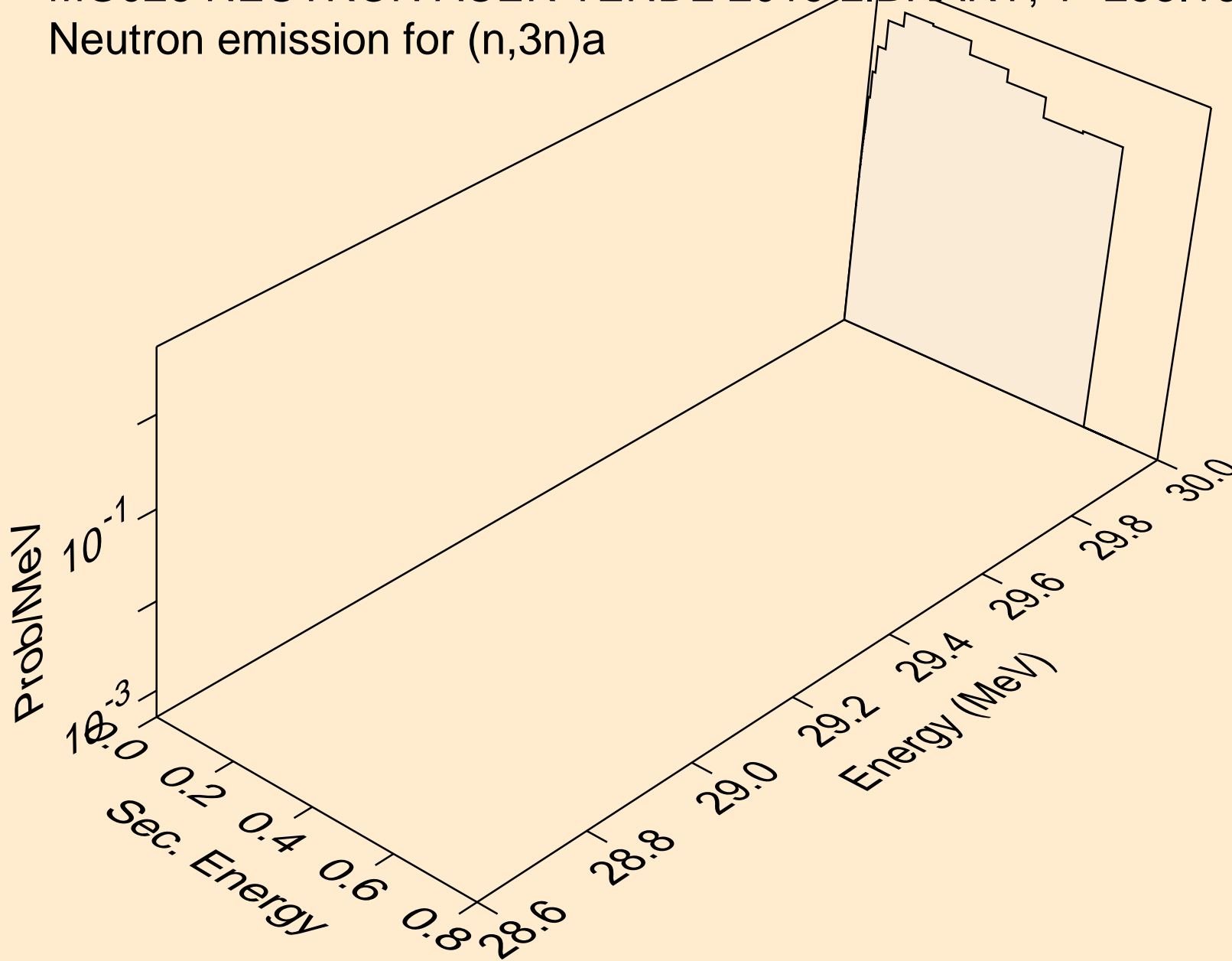

MG026 NEUTRON ACER TENDL-2019 LIBRARY; T=293.16K
Neutron emission for (n,n*)p

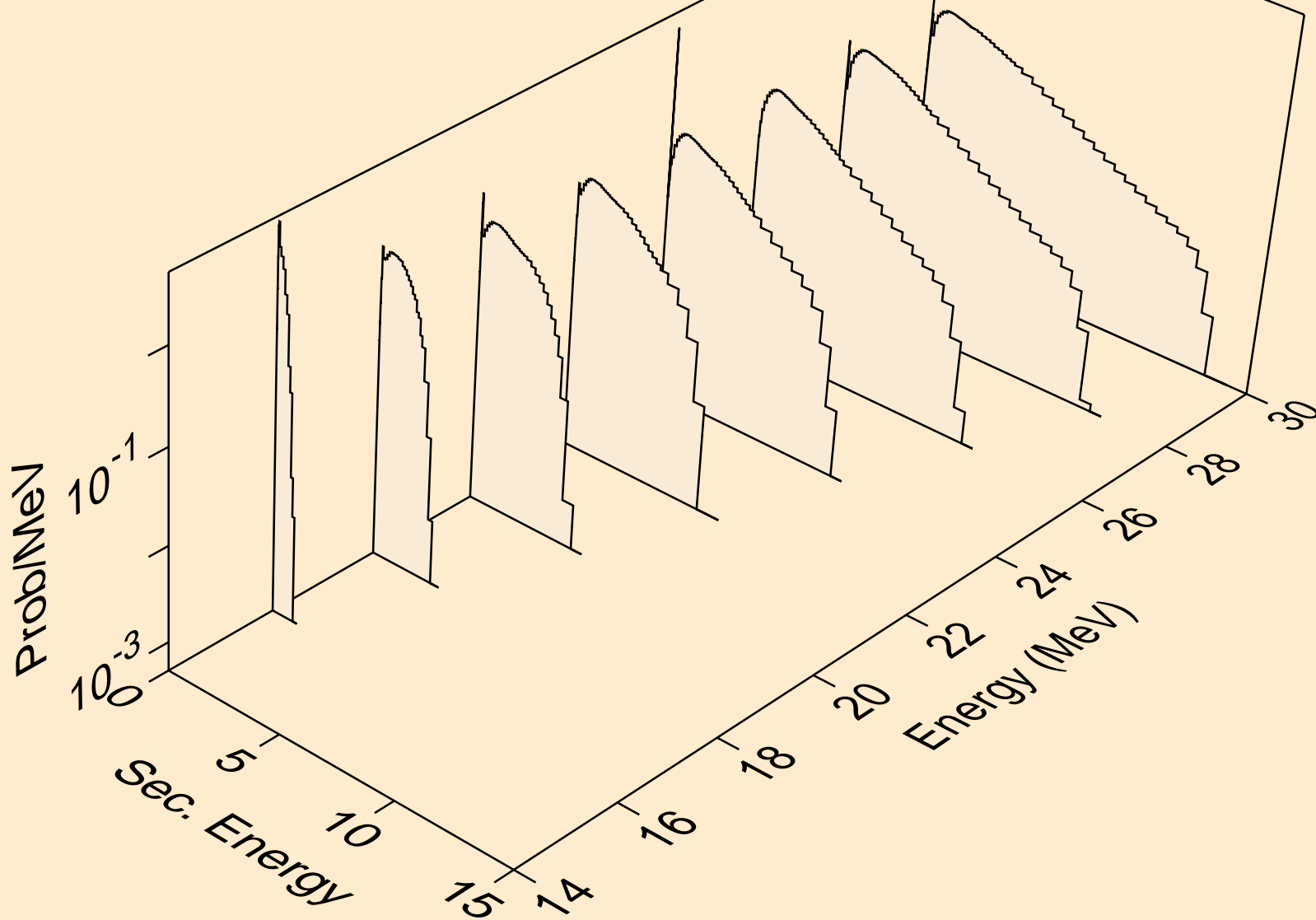

MG026 NEUTRON ACER TENDL-2019 LIBRARY; T=293.16K
Neutron emission for (n,n*)2a

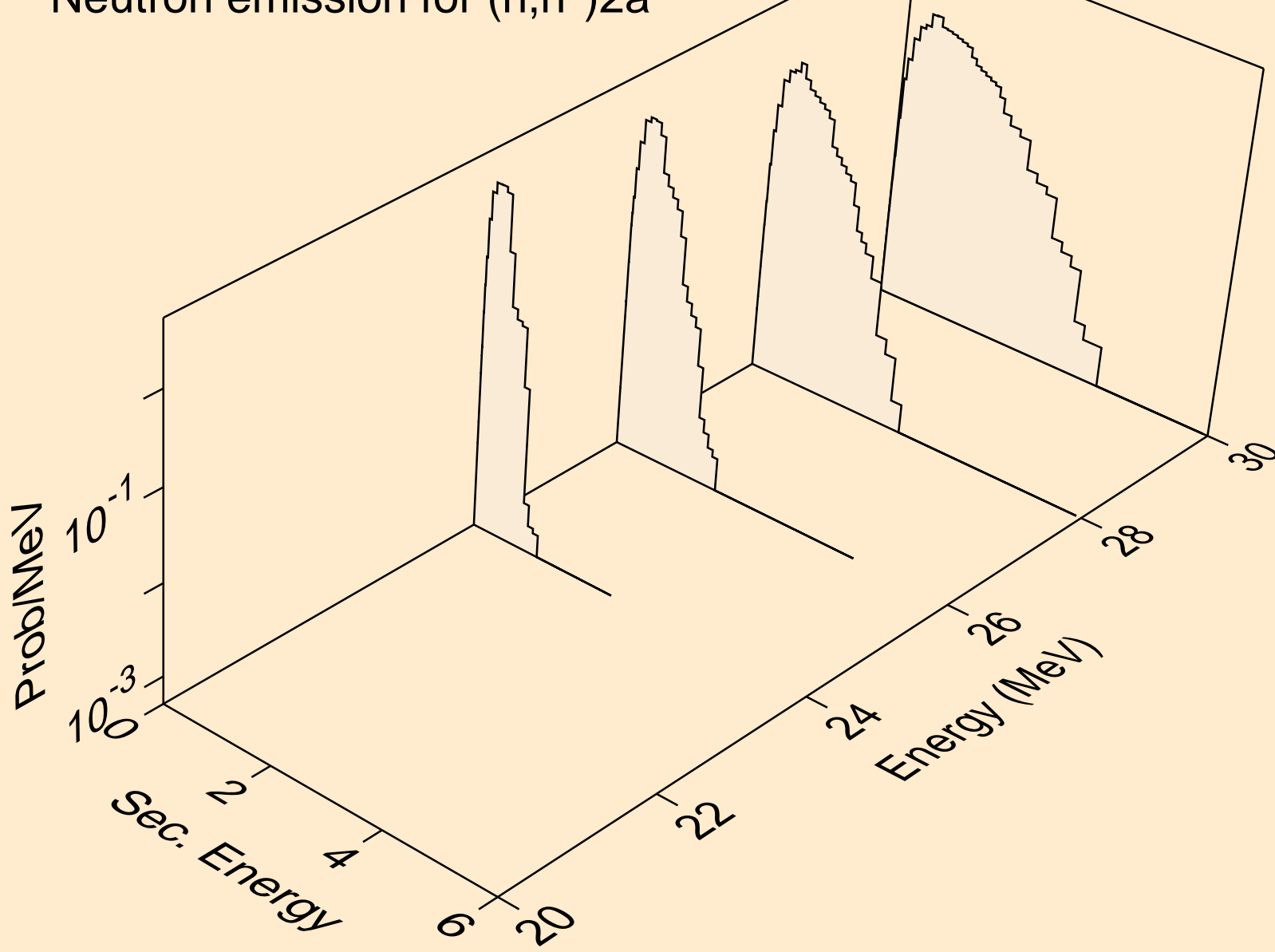

MG026 NEUTRON ACER TENDL-2019 LIBRARY; T=293.16K
Neutron emission for (n,n*)d

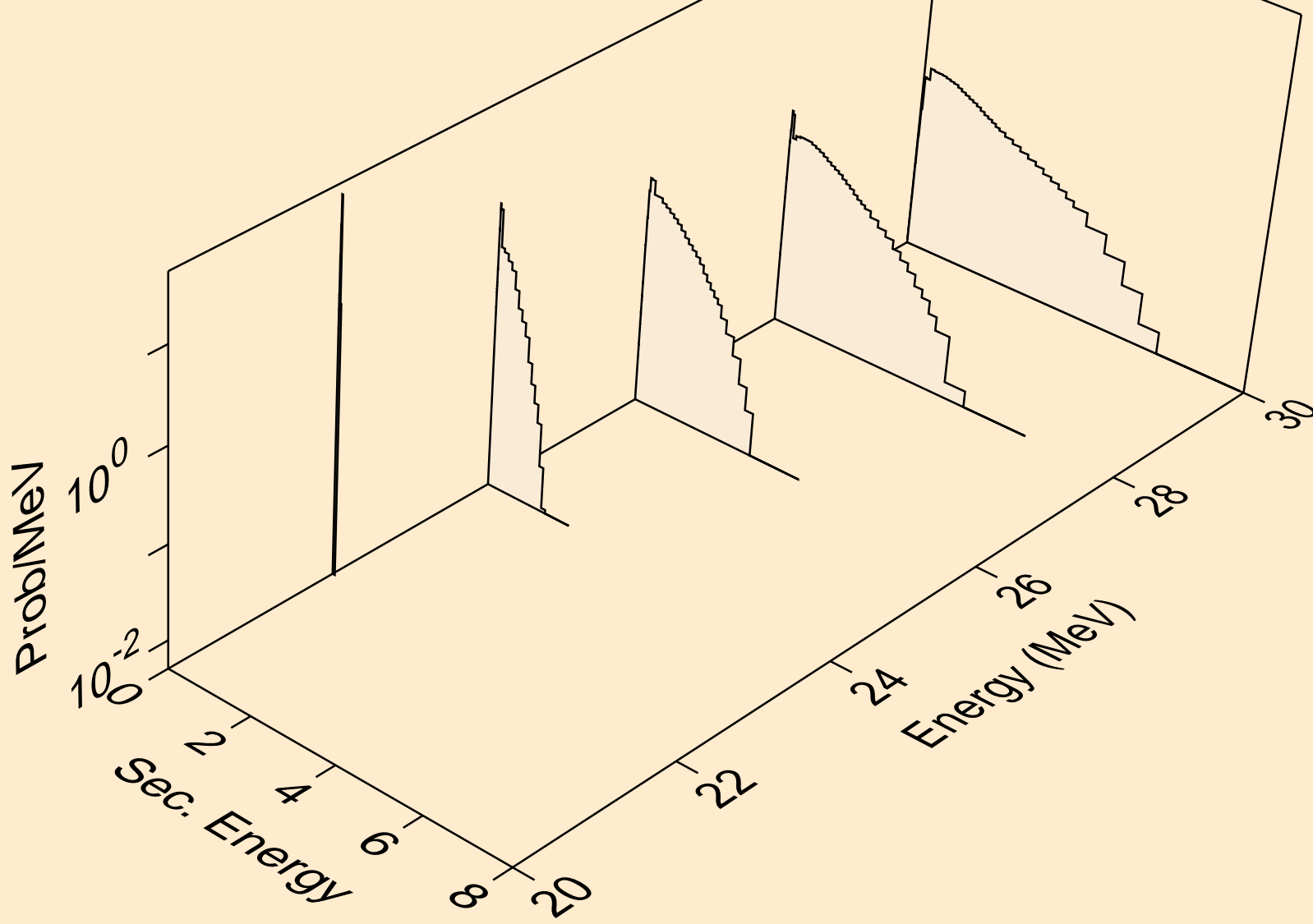

MG026 NEUTRON ACER TENDL-2019 LIBRARY; T=293.16K
Neutron emission for (n,n*)t

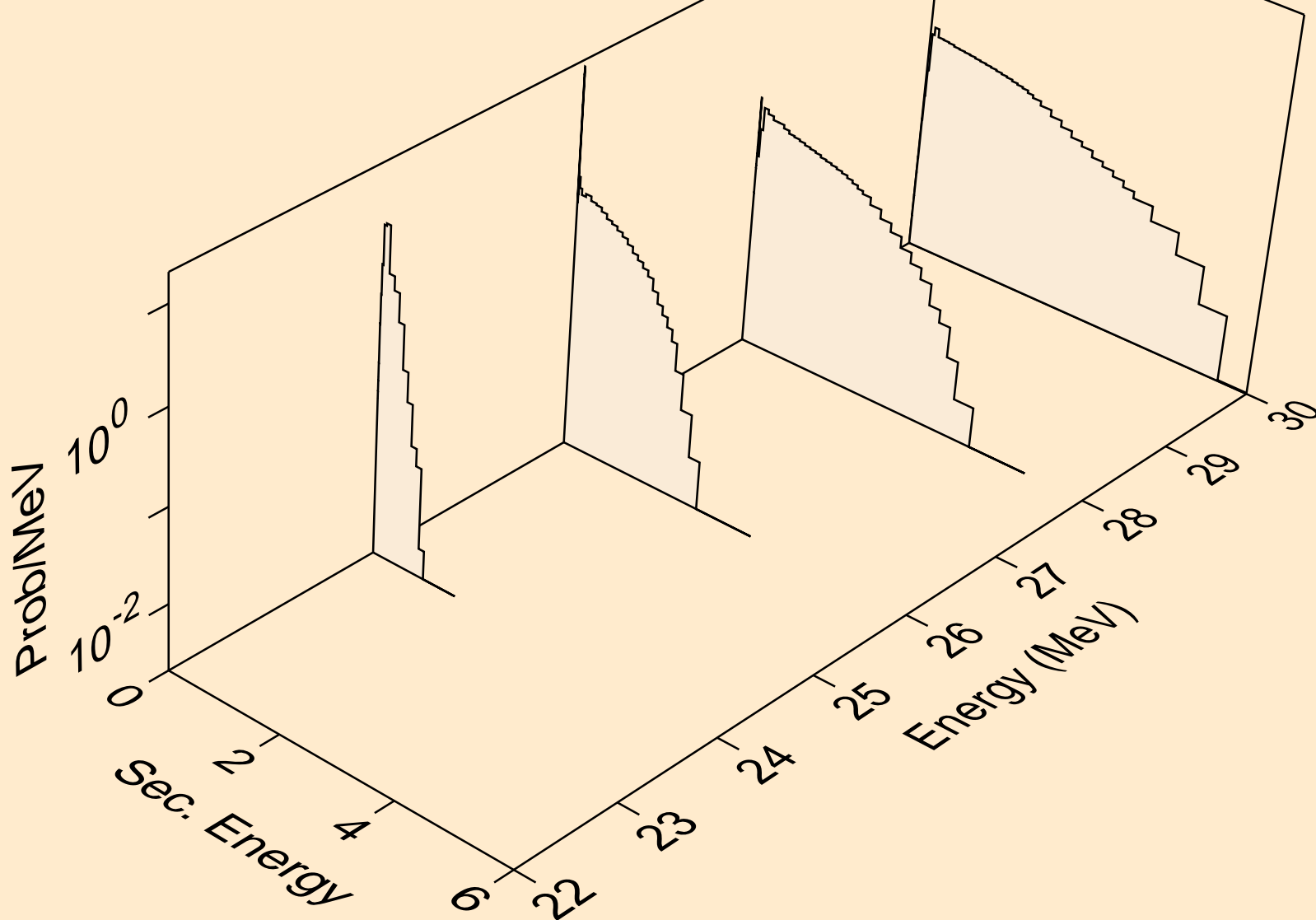

MG026 NEUTRON ACER TENDL-2019 LIBRARY; T=293.16K
Neutron emission for (n,n*)he3

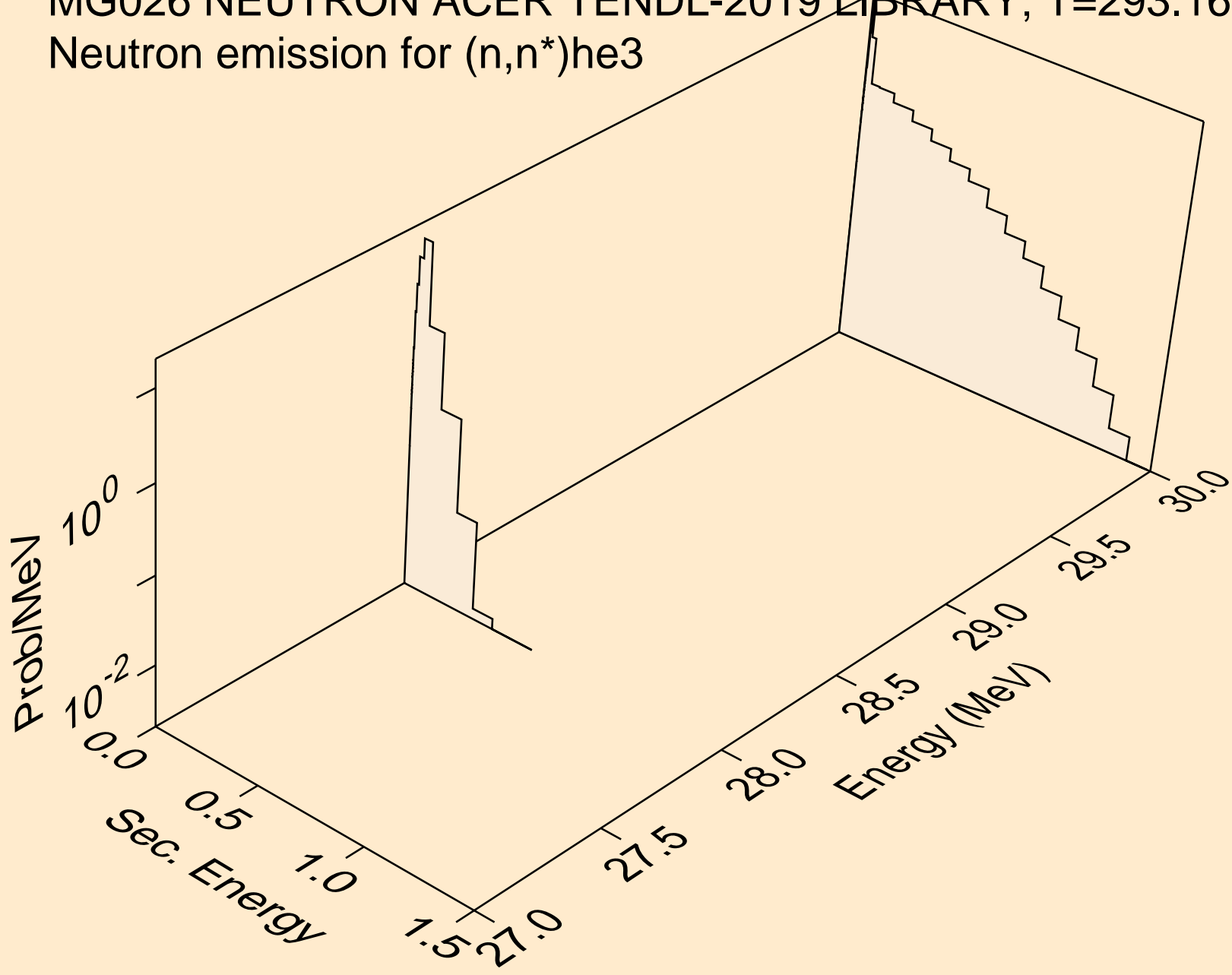

MG026 NEUTRON ACER TENDL-2019 LIBRARY; T=293.16K
Neutron emission for (n,2np)

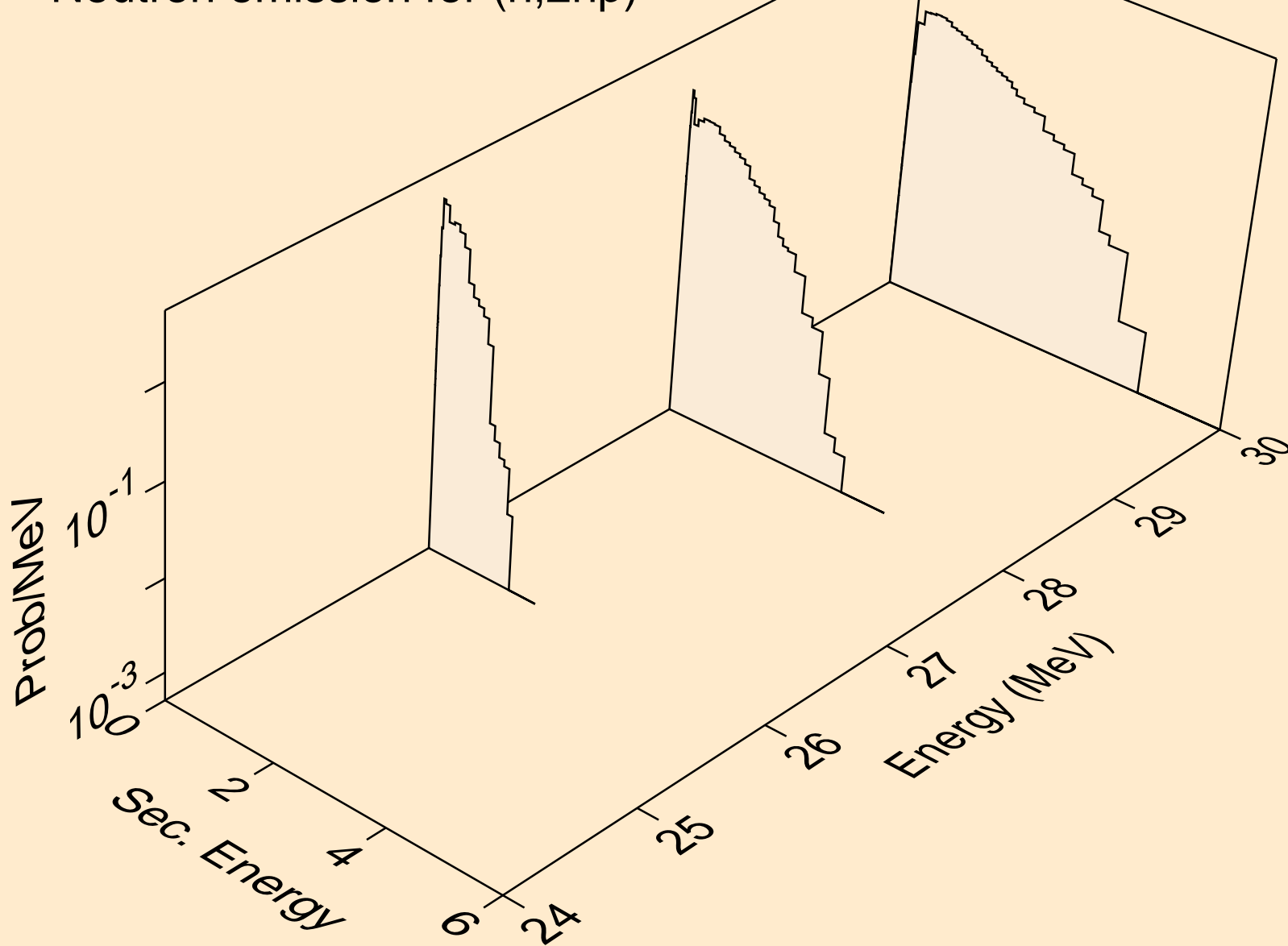

MG026 NEUTRON ACER TENDL-2019 LIBRARY; T=293.16K
Neutron emission for (n,2np)

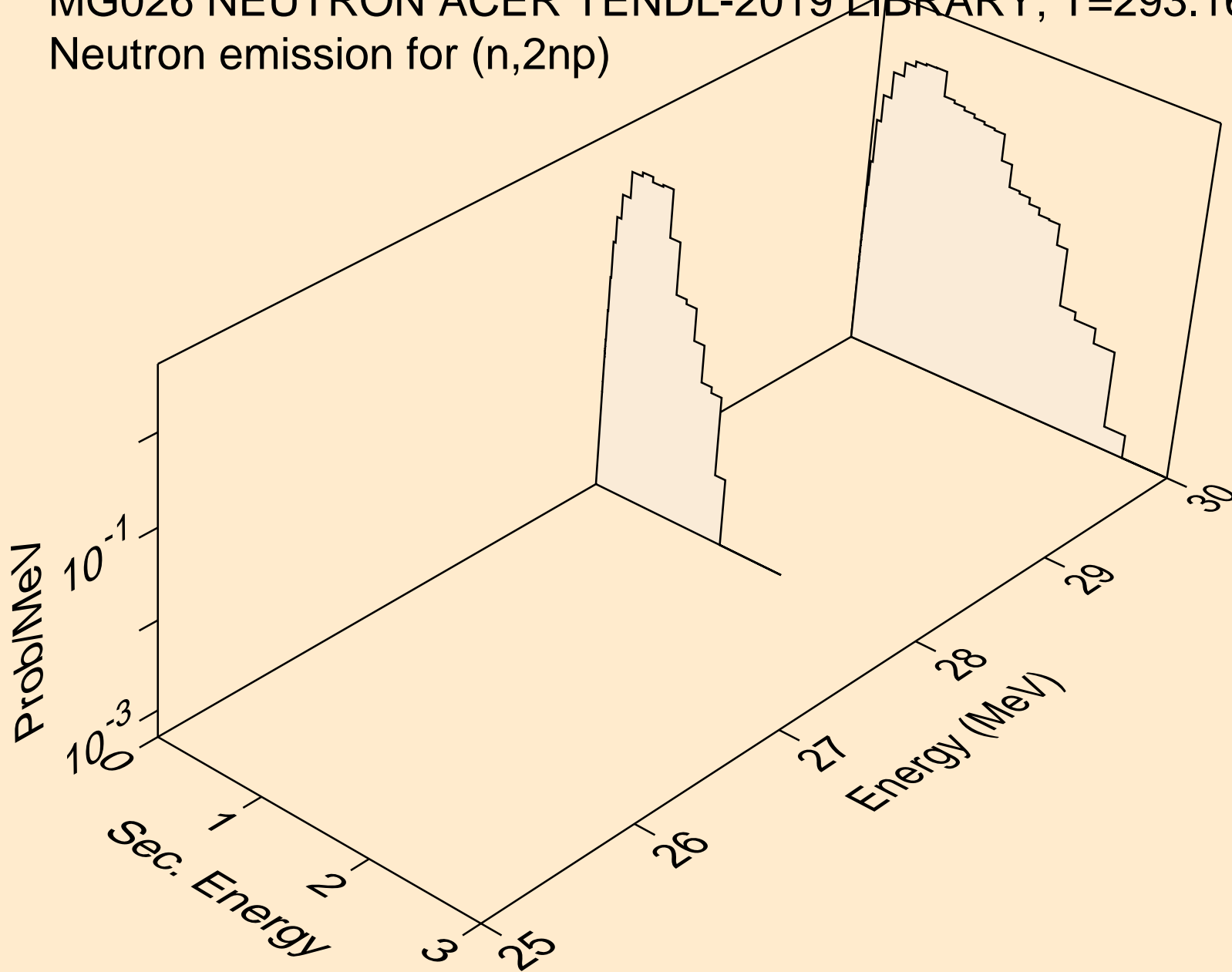

MG026 NEUTRON ACER TENDL-2019 LIBRARY; T=293.16K
Neutron emission for (n,npa)

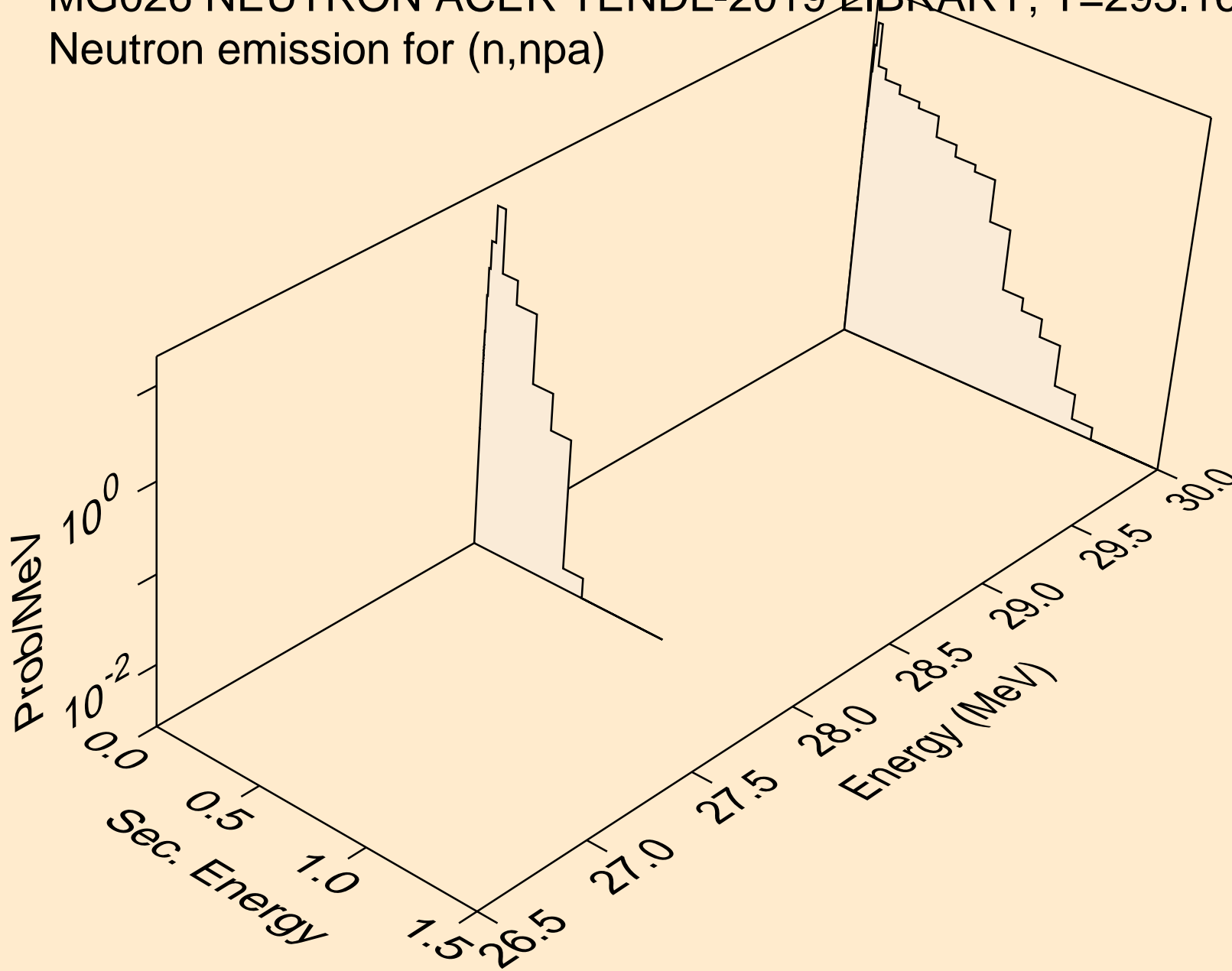

MG026 NEUTRON ACER TENDL-2019 LIBRARY; T=293.16K
Neutron emission for (n,n*c)

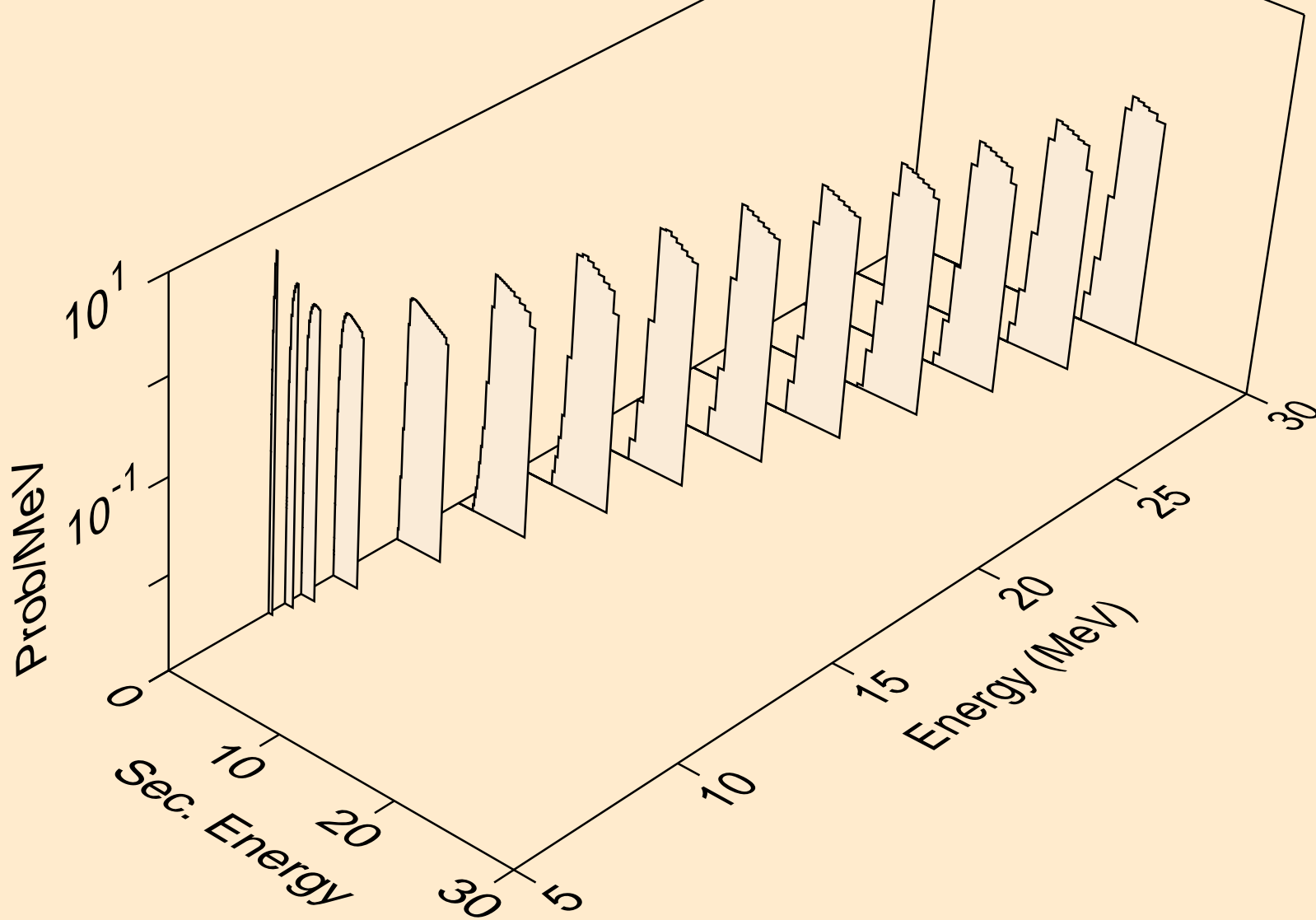

MG026 NEUTRON ACER TENDL-2019 LIBRARY; T=293.16K
Photon emission for (n,x)

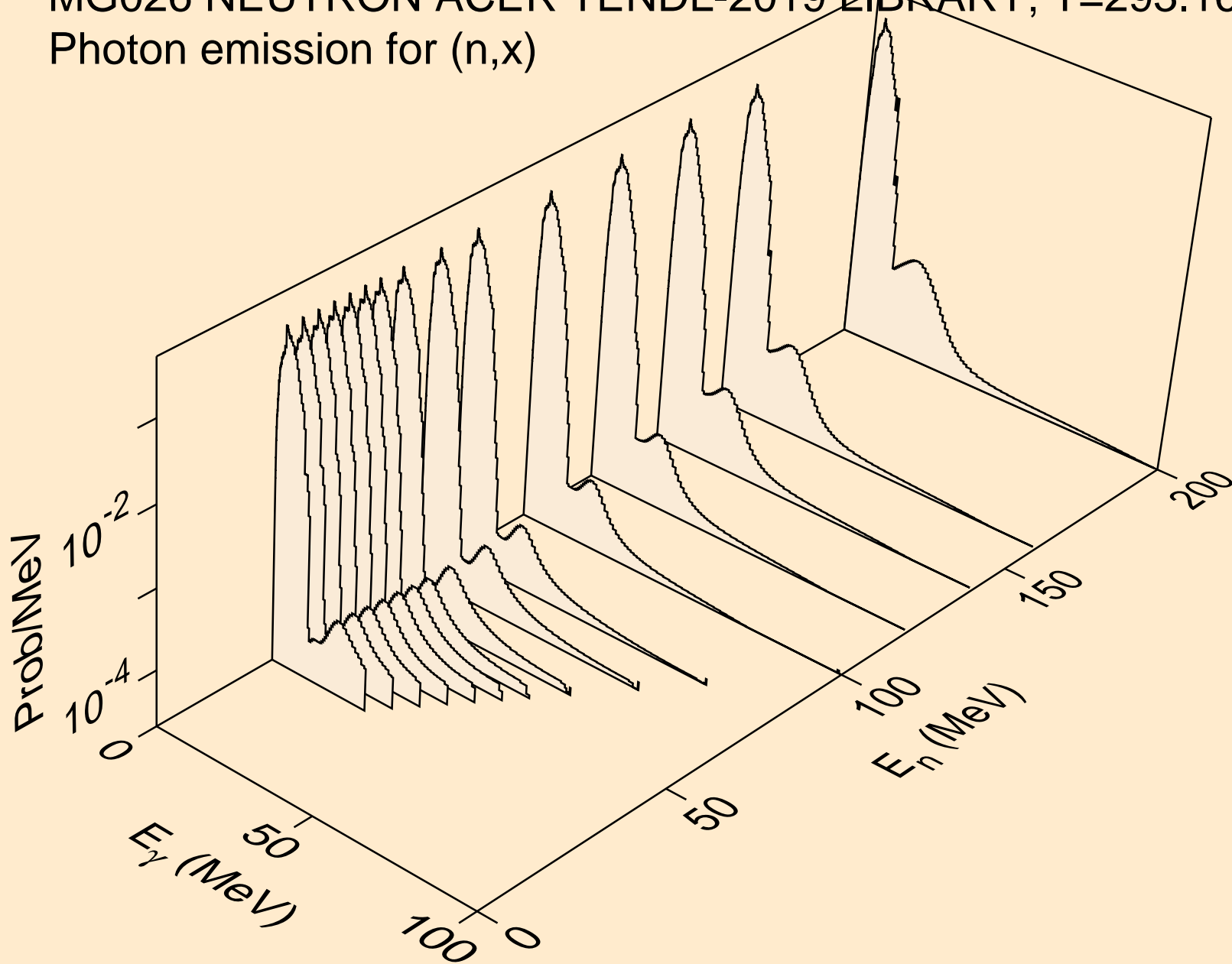

MG026 NEUTRON ACER TENDL-2019 LIBRARY; T=293.16K
Photon emission for (n,2nd)

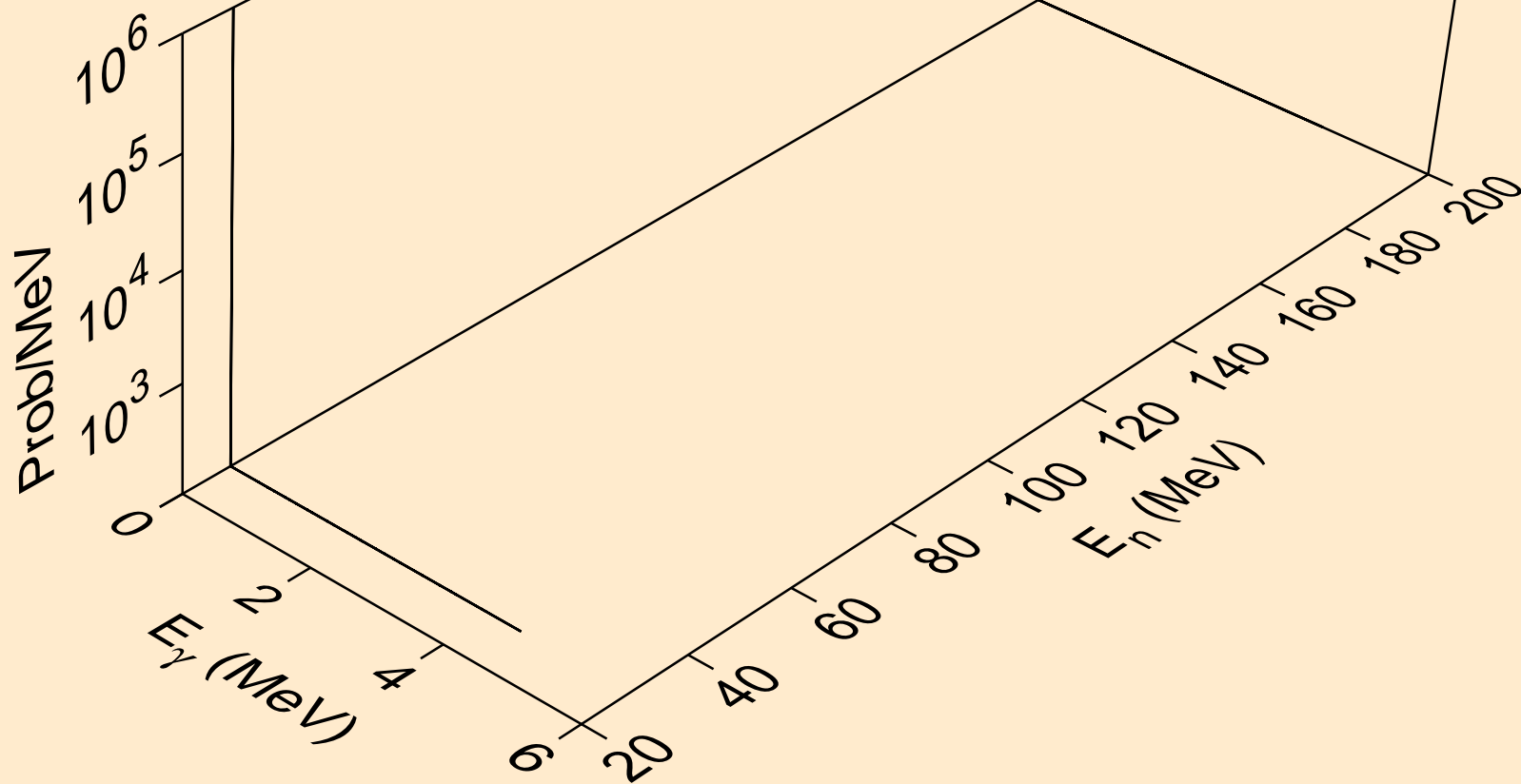

MG026 NEUTRON ACER TENDL-2019 LIBRARY; T=293.16K
Photon emission for (n,2n)

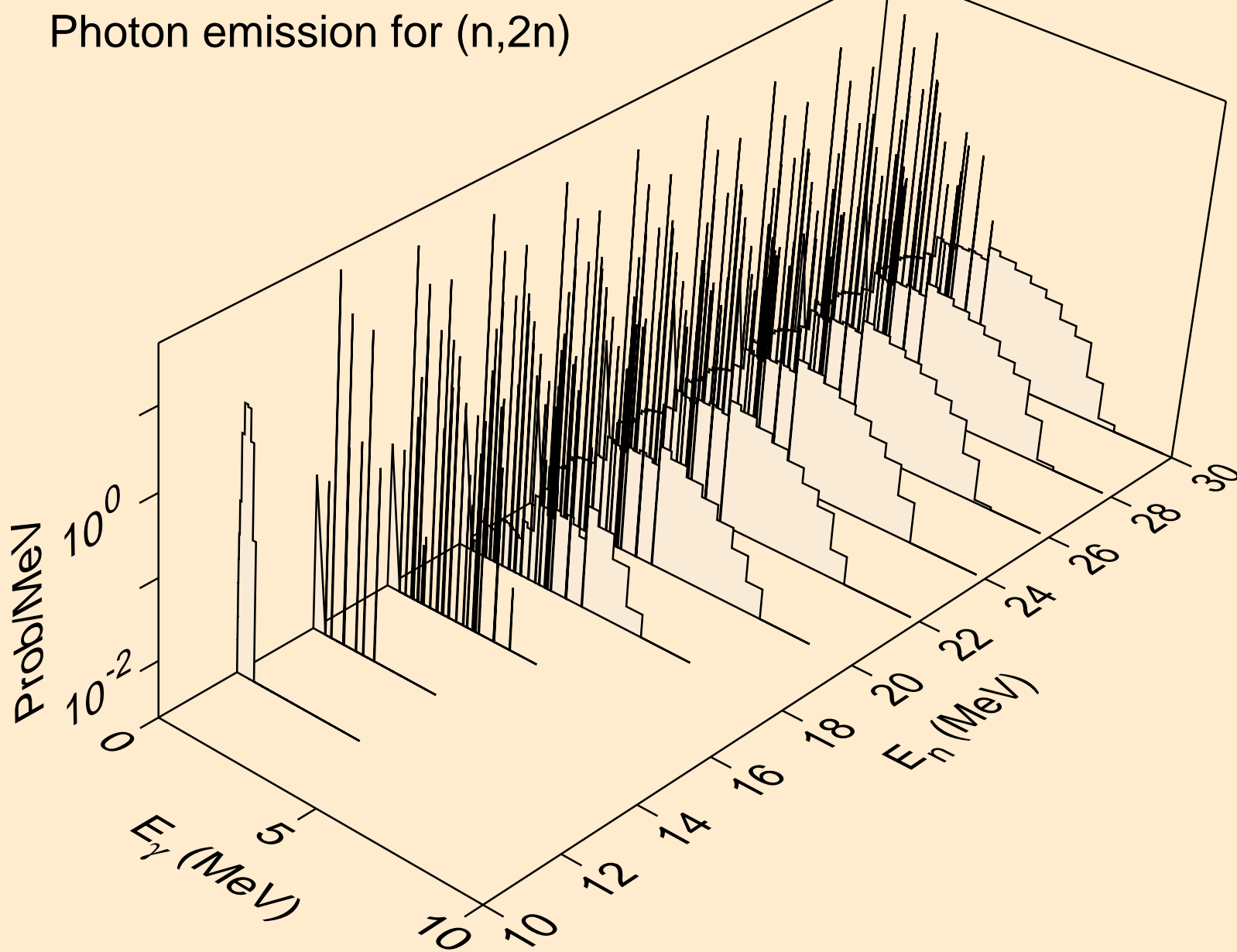

MG026 NEUTRON ACER TENDL-2019 LIBRARY; T=293.16K
Photon emission for (n,3n)

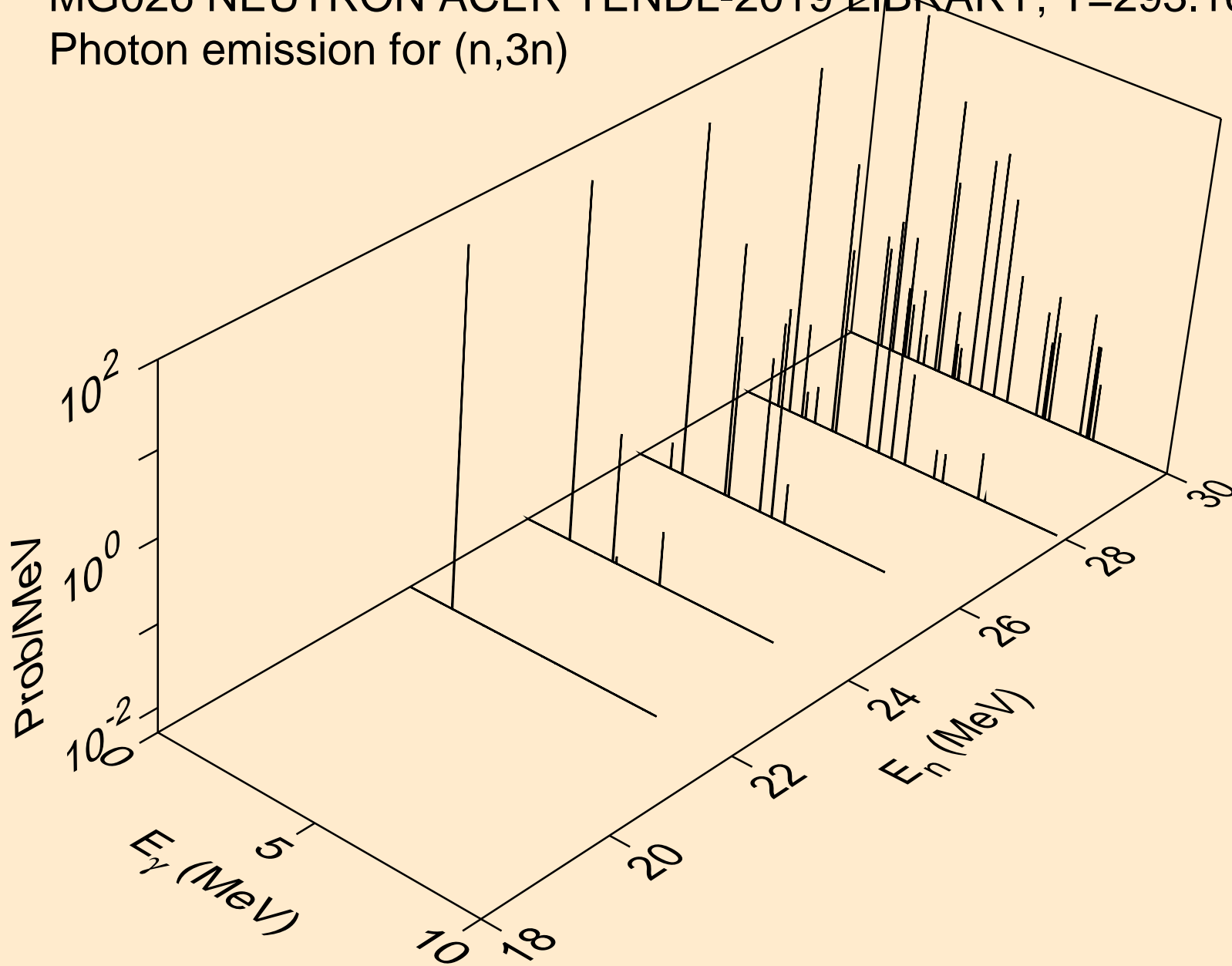

MG026 NEUTRON ACER TENDL-2019 LIBRARY; T=293.16K
Photon emission for (n,n*)a

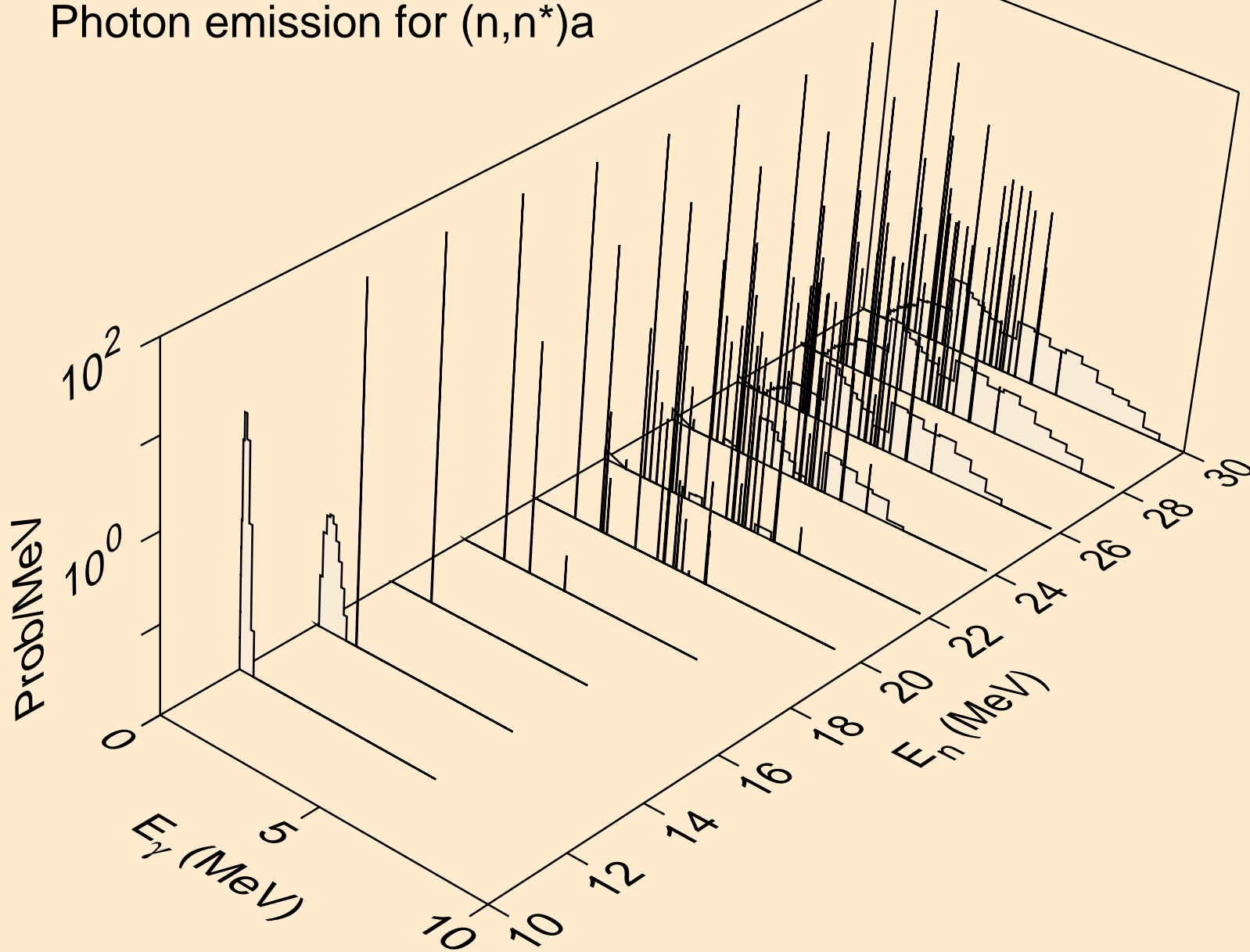

MG026 NEUTRON ACER TENDL-2019 LIBRARY; T=293.16K
Photon emission for (n,2n)a

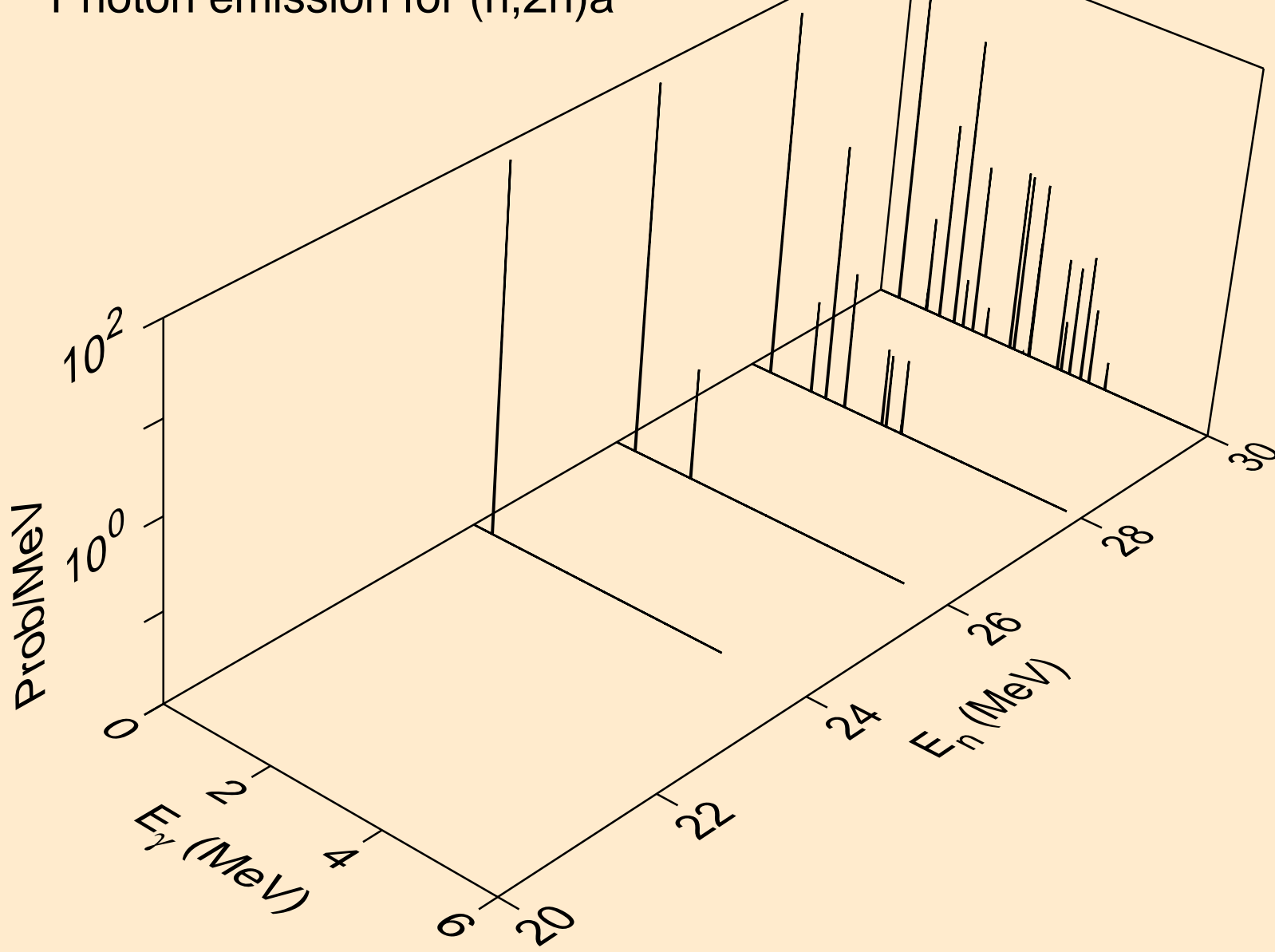

MG026 NEUTRON ACER TENDL-2019 LIBRARY; T=293.16K
Photon emission for (n,3n)a

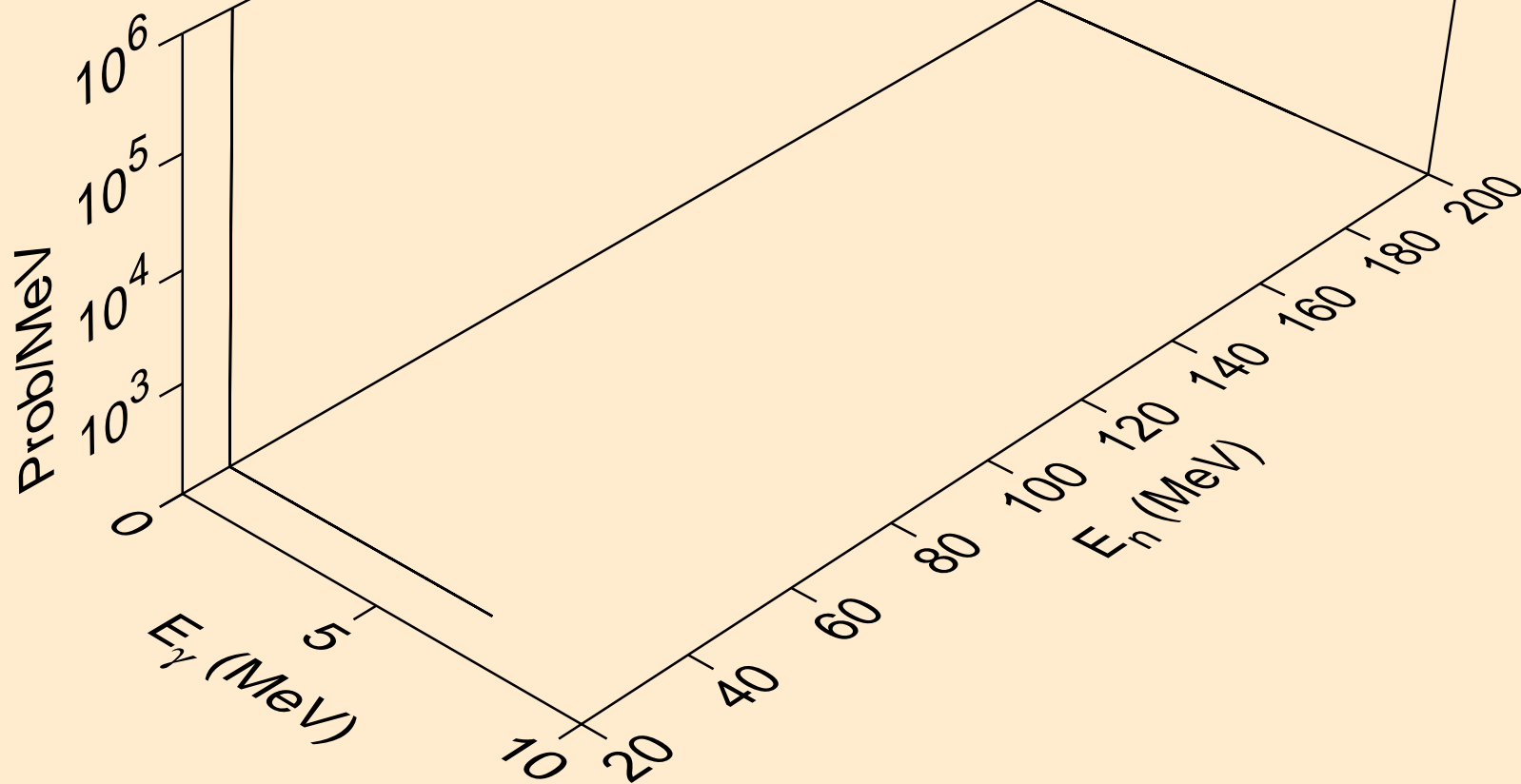

MG026 NEUTRON ACER TENDL-2019 LIBRARY; T=293.16K
Photon emission for (n,n*)p

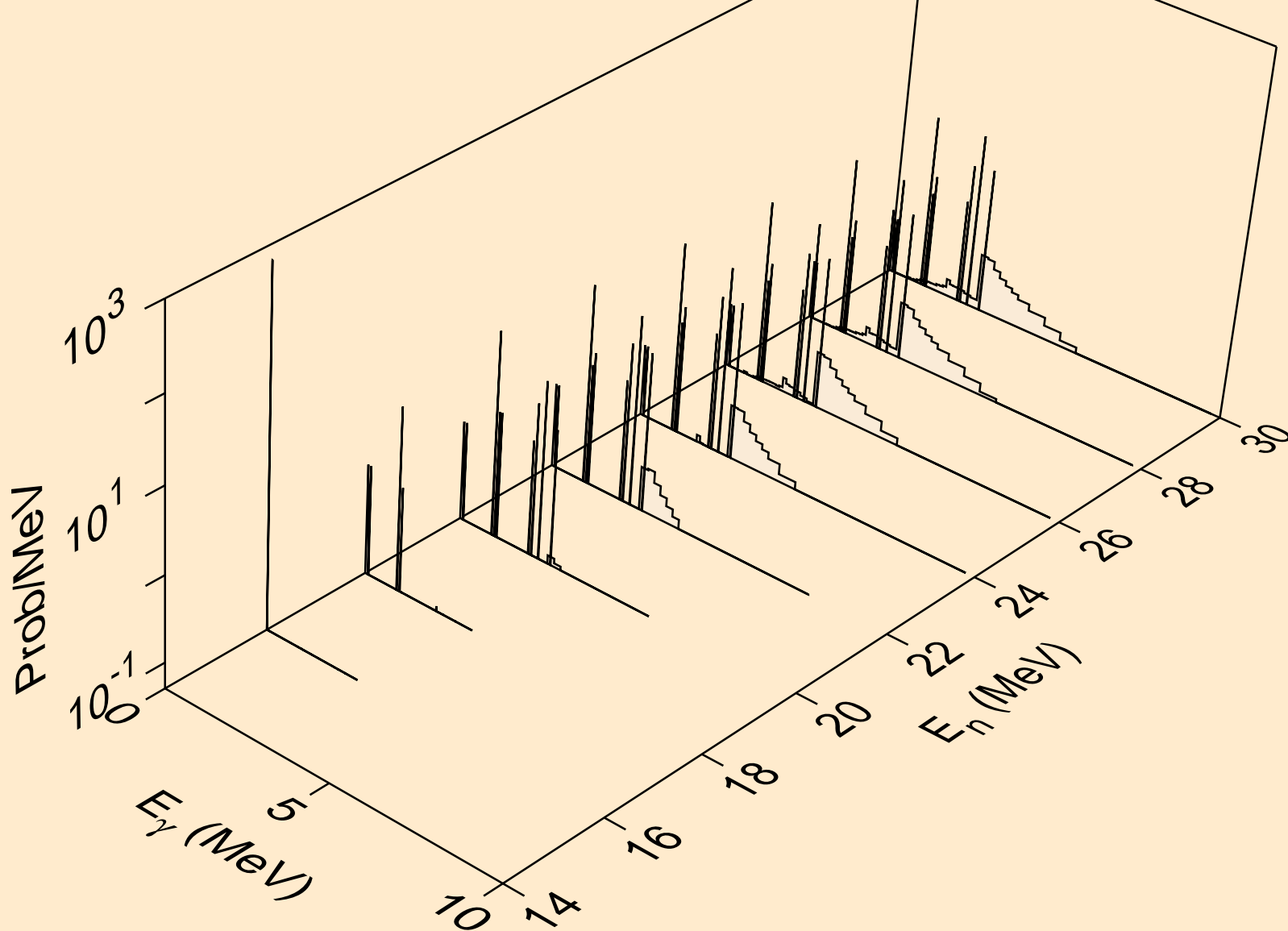

MG026 NEUTRON ACER TENDL-2019 LIBRARY; T=293.16K
Photon emission for (n,n*)2a

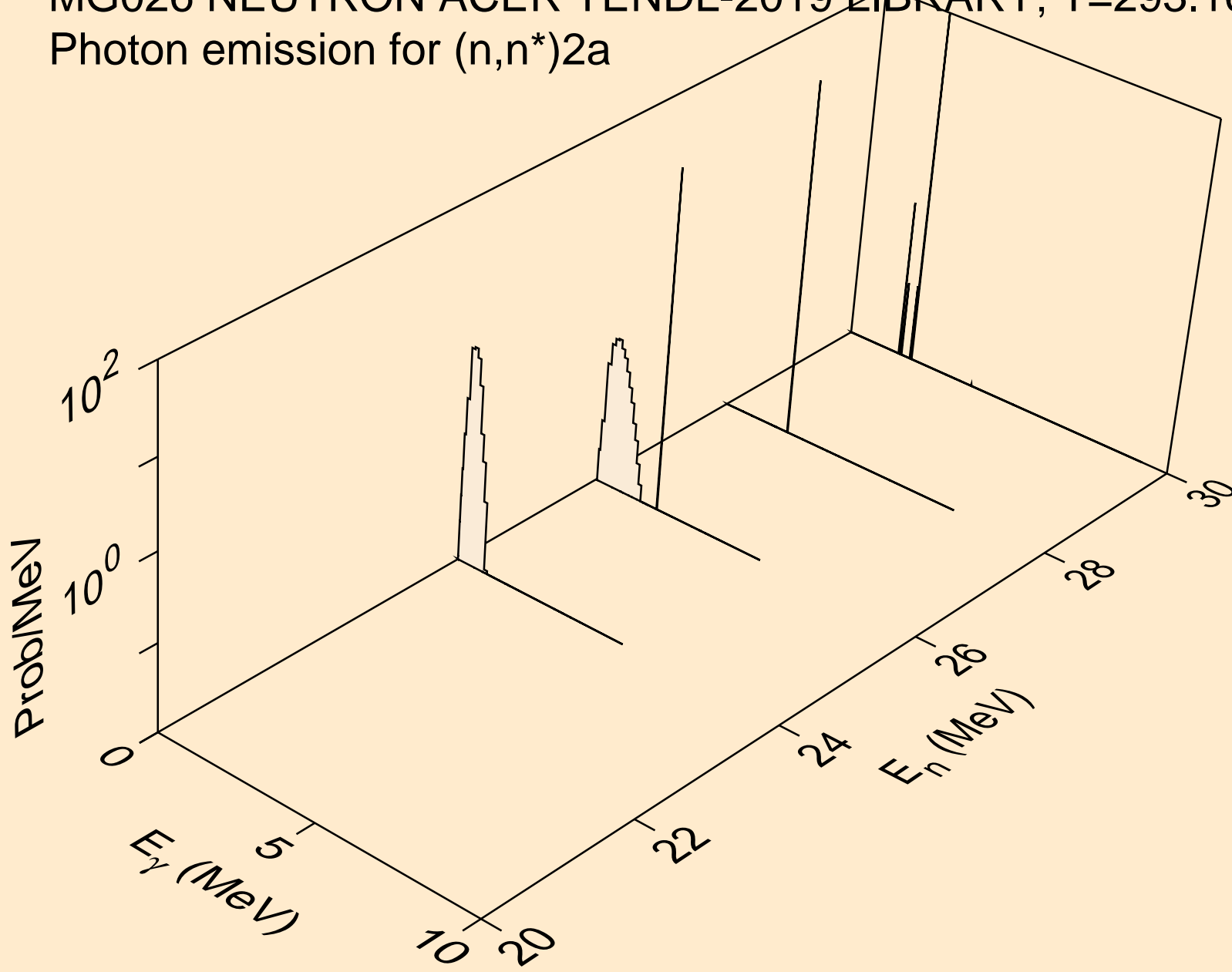

MG026 NEUTRON ACER TENDL-2019 LIBRARY; T=293.16K
Photon emission for (n,n*)d

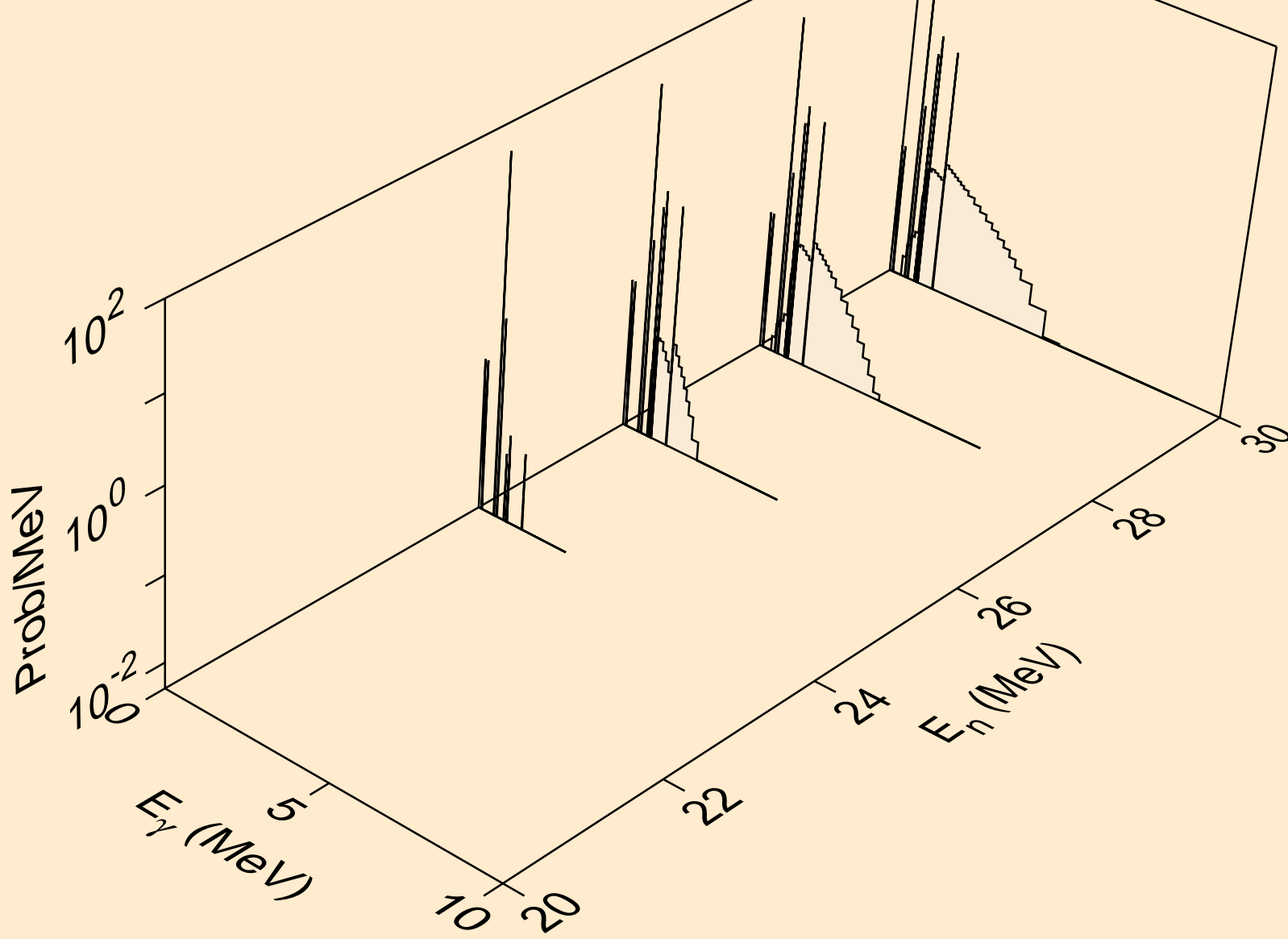

MG026 NEUTRON ACER TENDL-2019 LIBRARY; T=293.16K
Photon emission for (n,n*)t

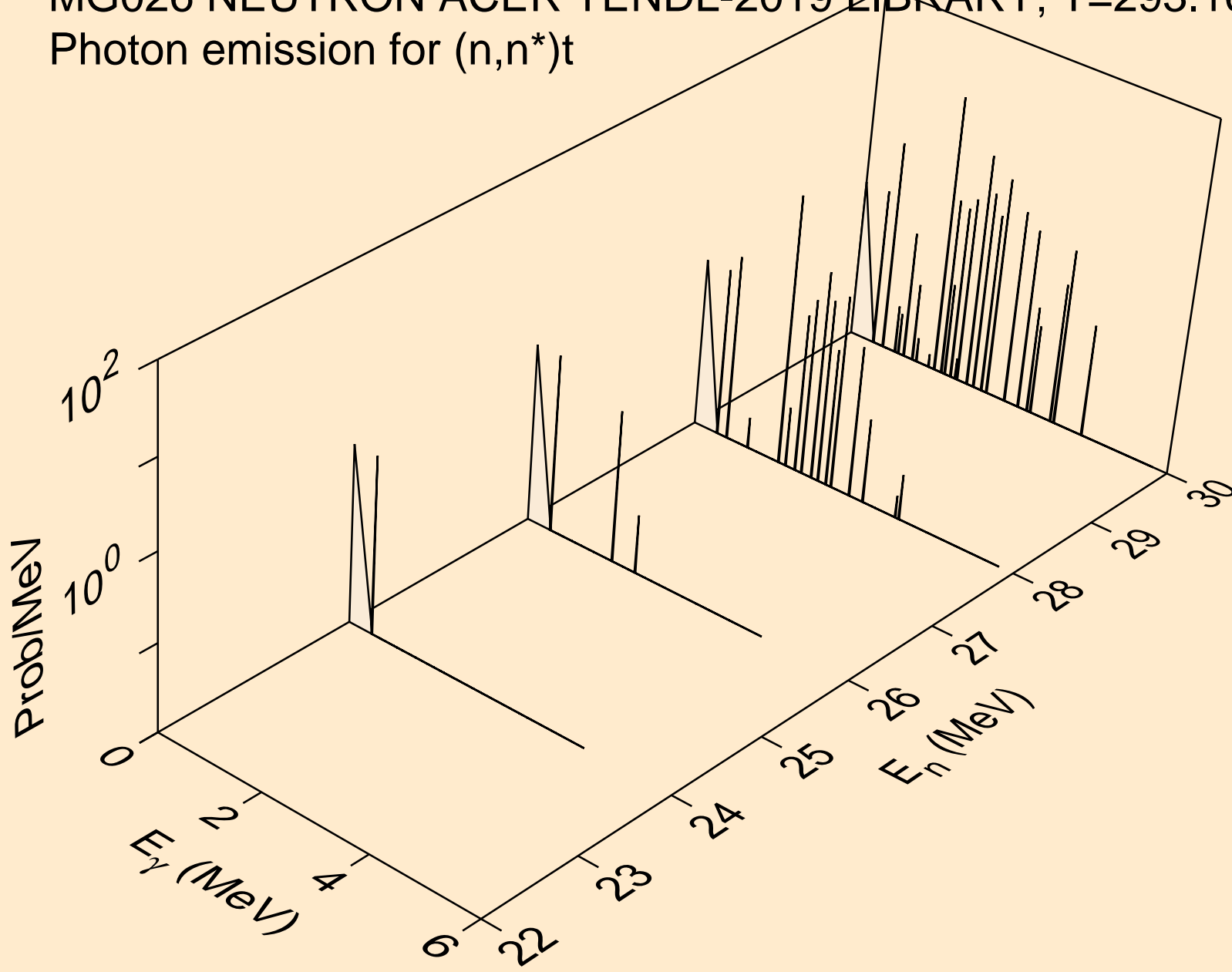

MG026 NEUTRON ACER TENDL-2019 LIBRARY; T=293.16K
Photon emission for (n,n*)he3

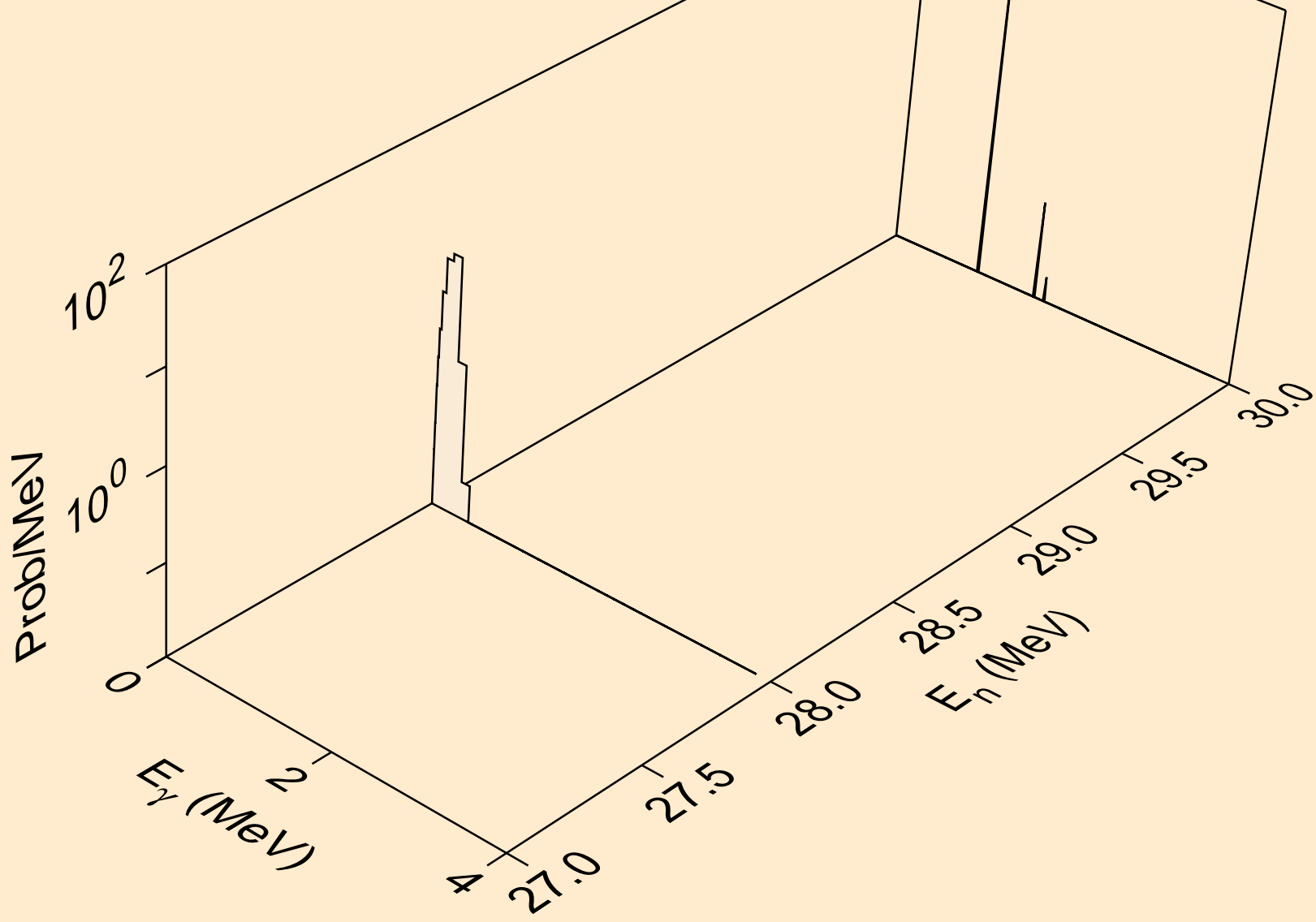

MG026 NEUTRON ACER TENDL-2019 LIBRARY; T=293.16K
Photon emission for (n,2np)

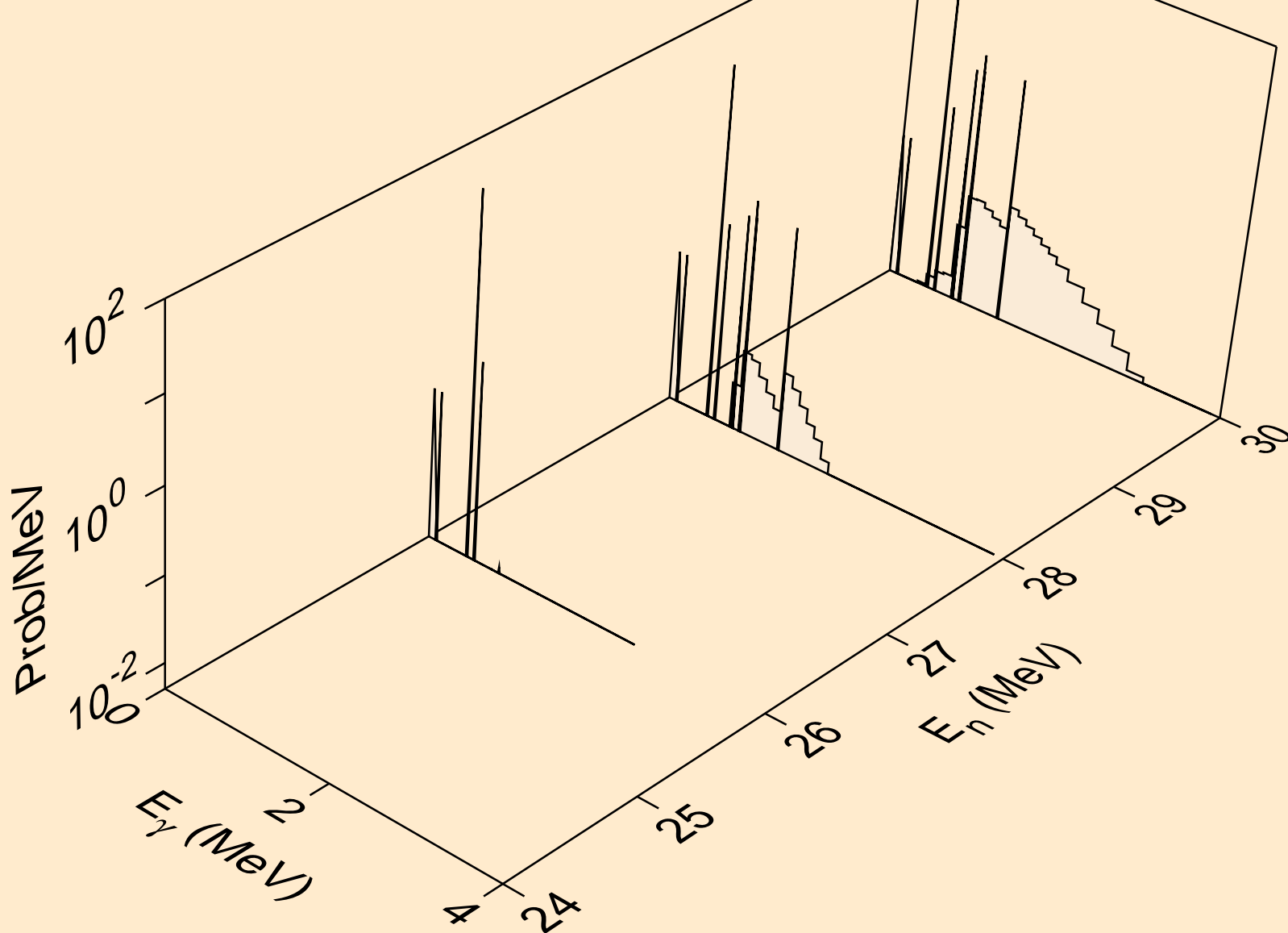

MG026 NEUTRON ACER TENDL-2019 LIBRARY; T=293.16K
Photon emission for (n,2np)

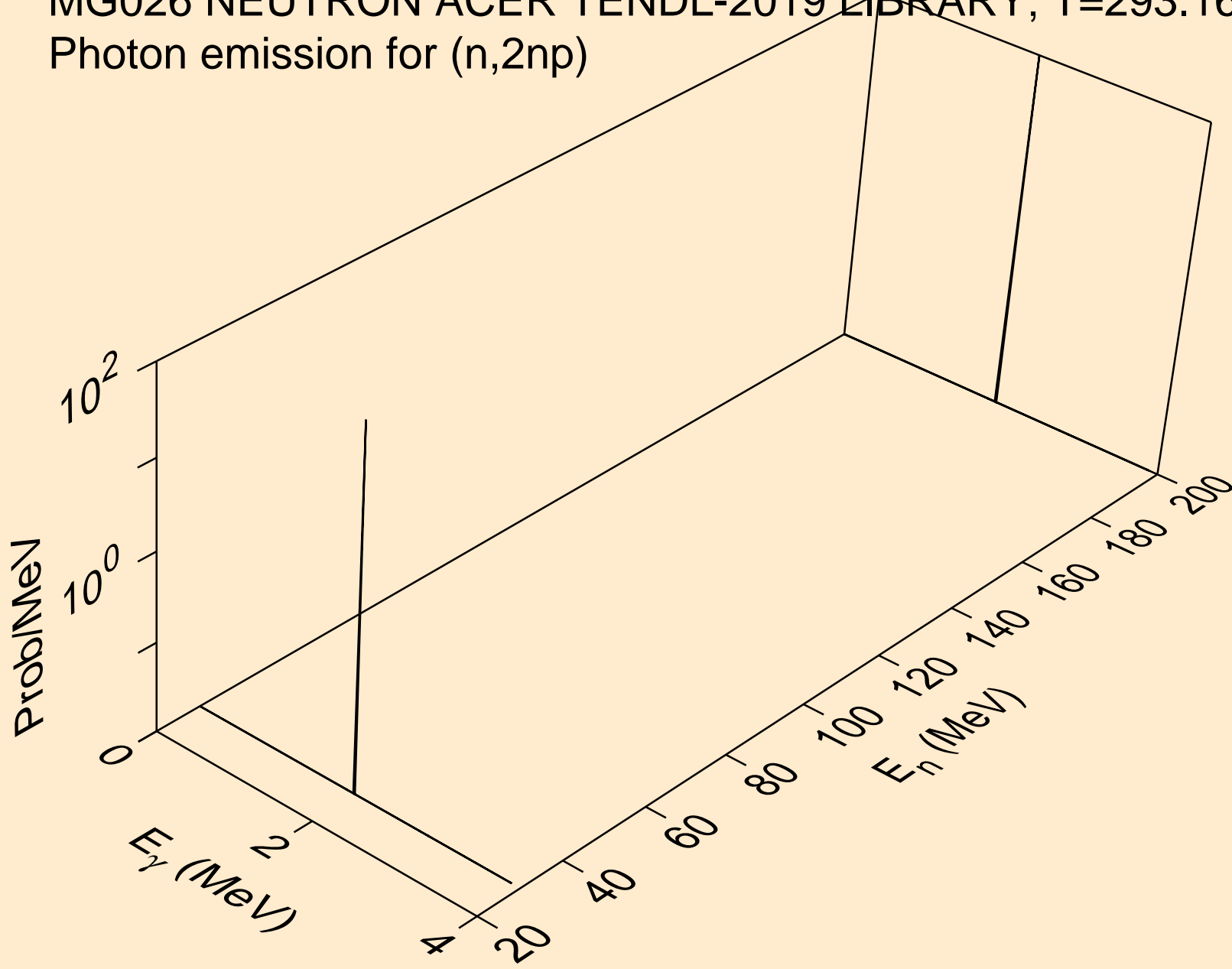

MG026 NEUTRON ACER TENDL-2019 LIBRARY; T=293.16K
Photon emission for (n,npa)

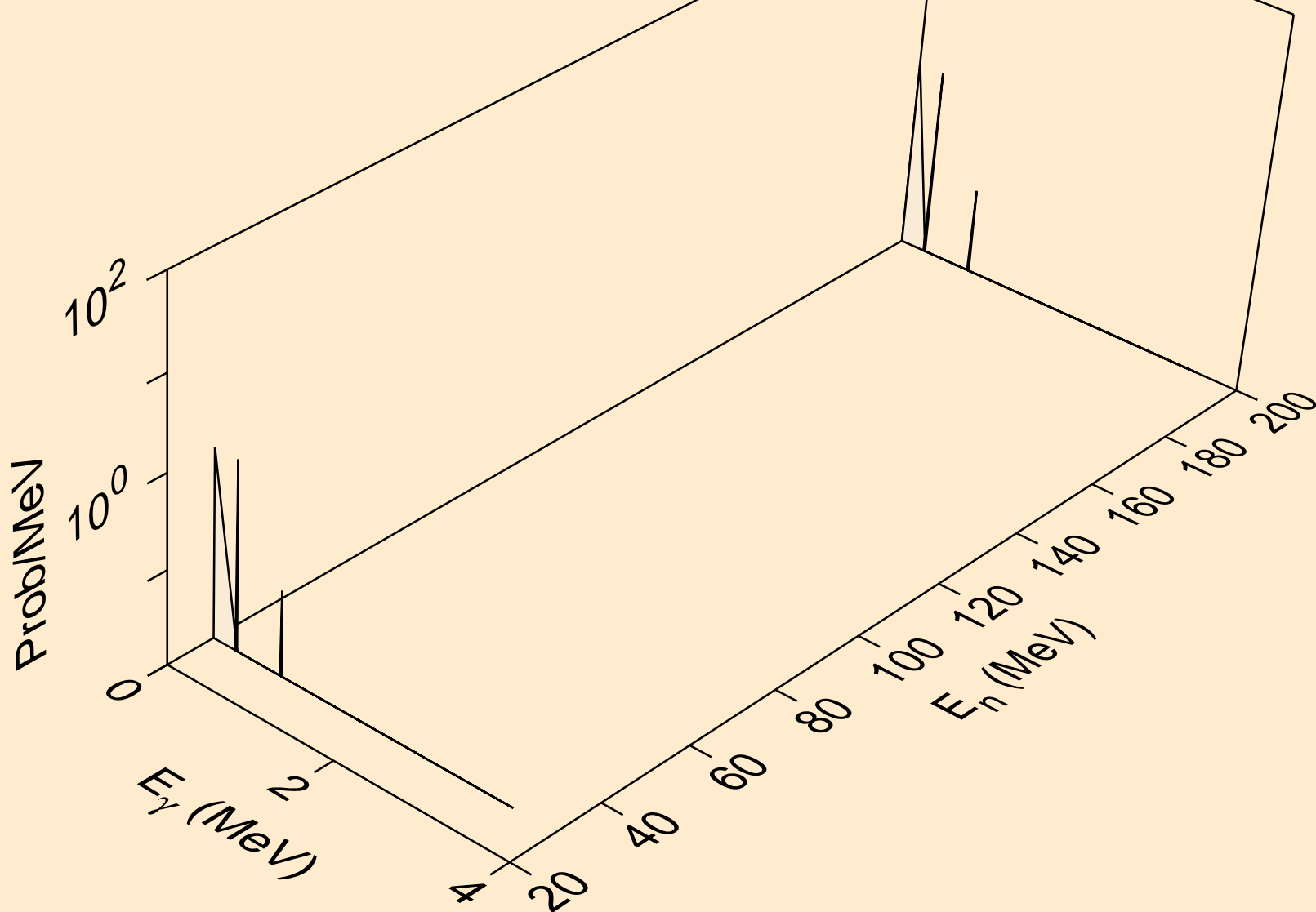

MG026 NEUTRON ACER TENDL-2019 LIBRARY; T=293.16K
Photon emission for (n,n*c)

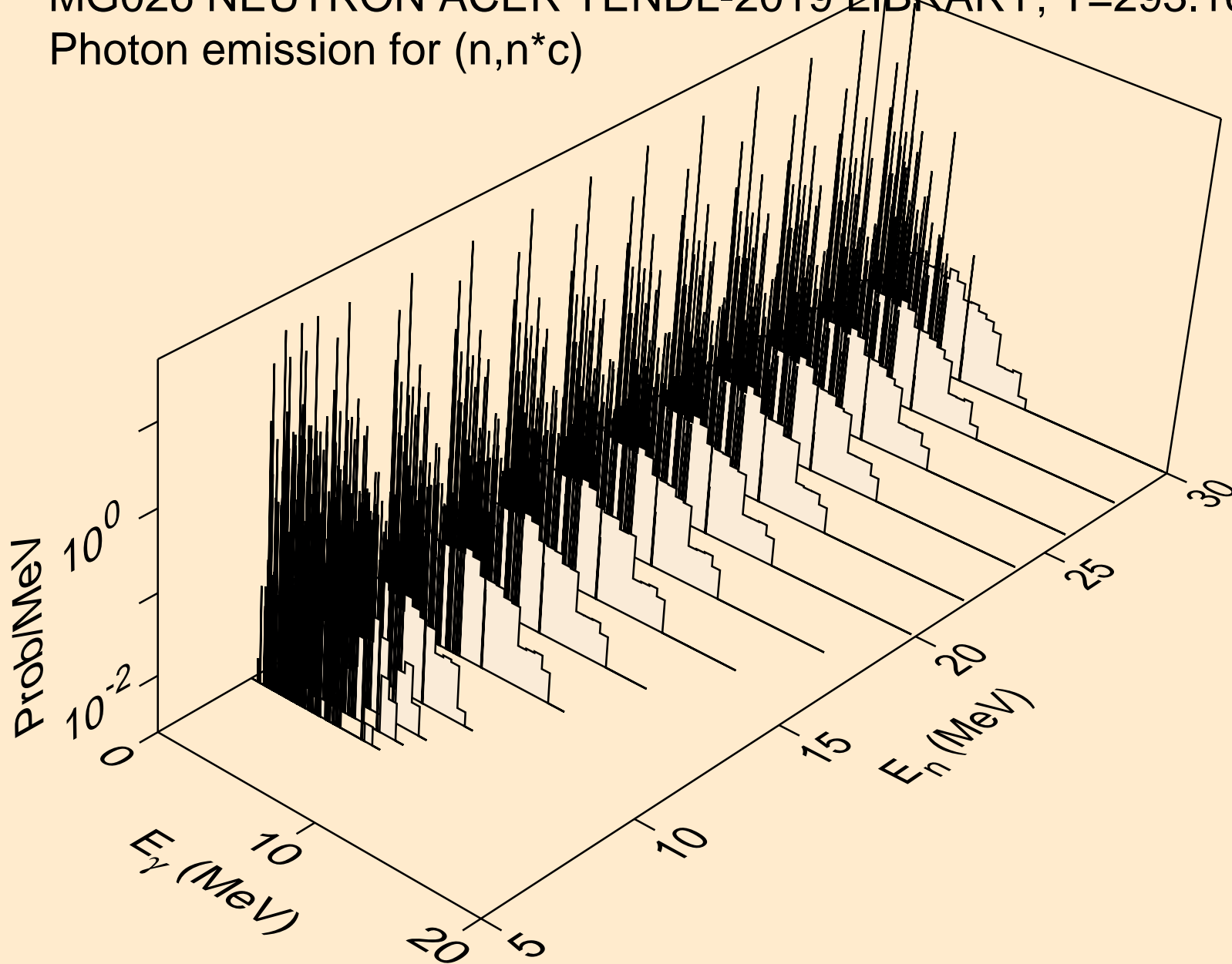

MG026 NEUTRON ACER TENDL-2019 LIBRARY; T=293.16K
Photon emission for (n,gma)

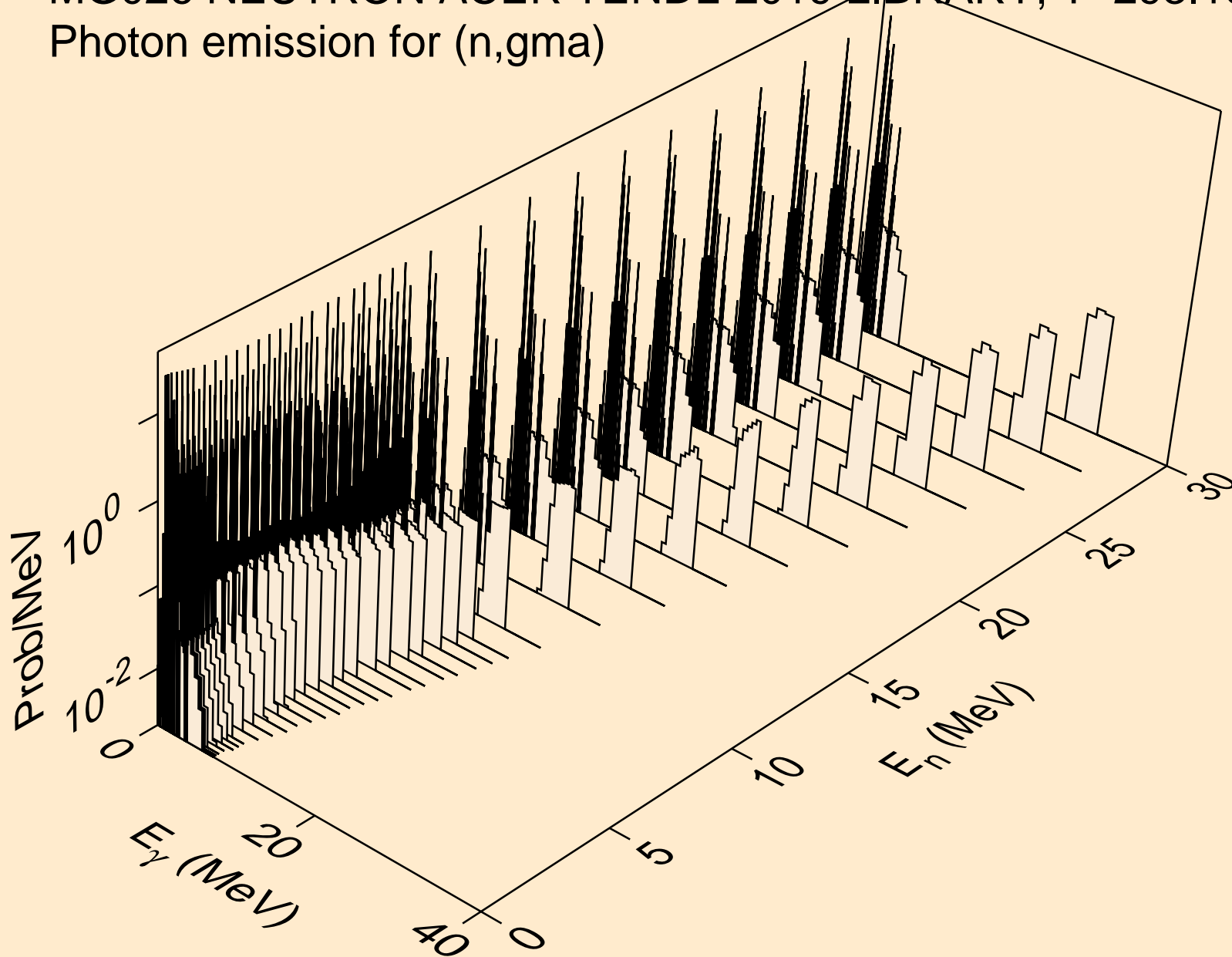

MG026 NEUTRON ACER TENDL-2019 LIBRARY; T=293.16K
Photon emission for (n,p)

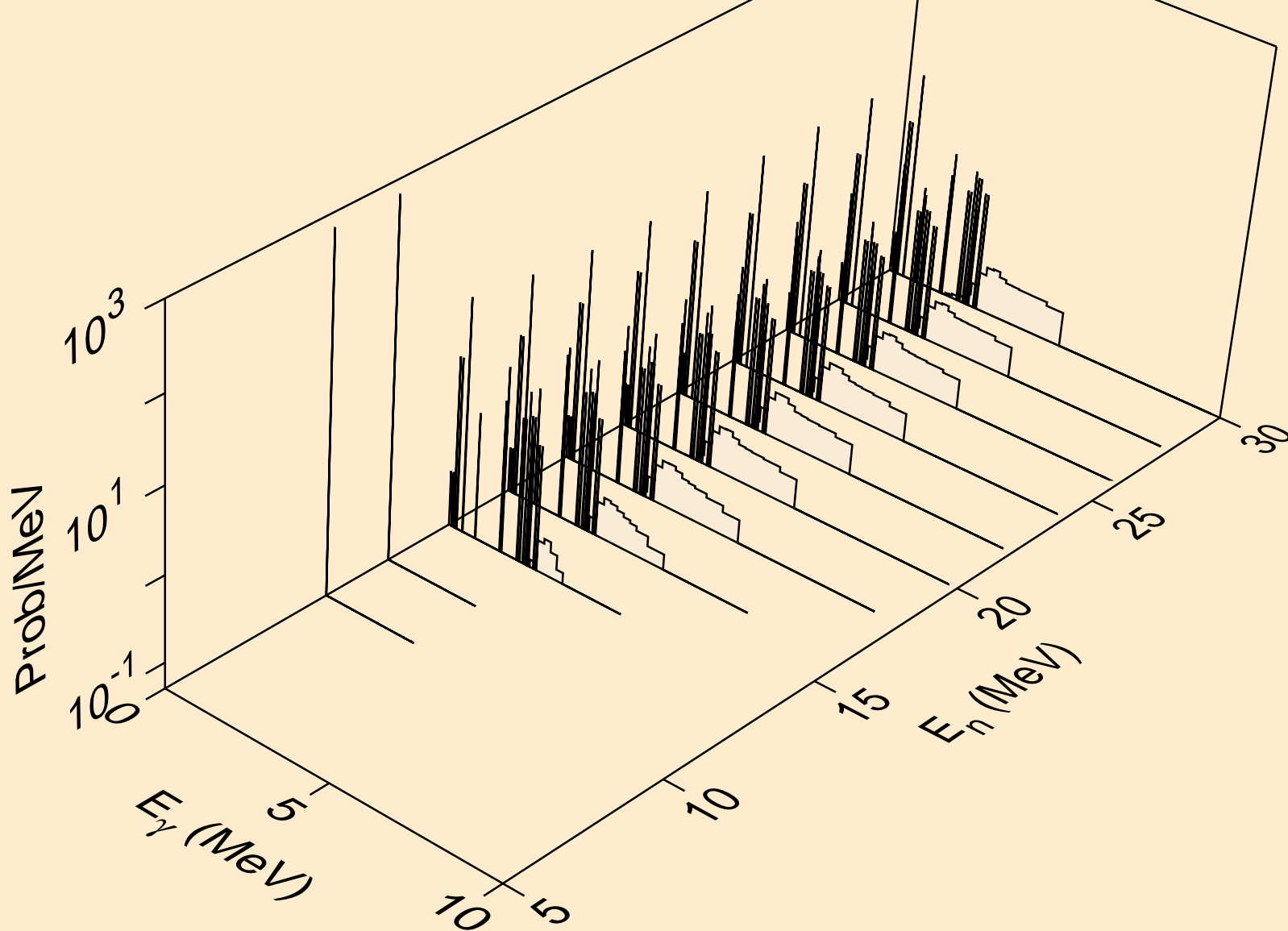

MG026 NEUTRON ACER TENDL-2019 LIBRARY; T=293.16K
Photon emission for (n,d)

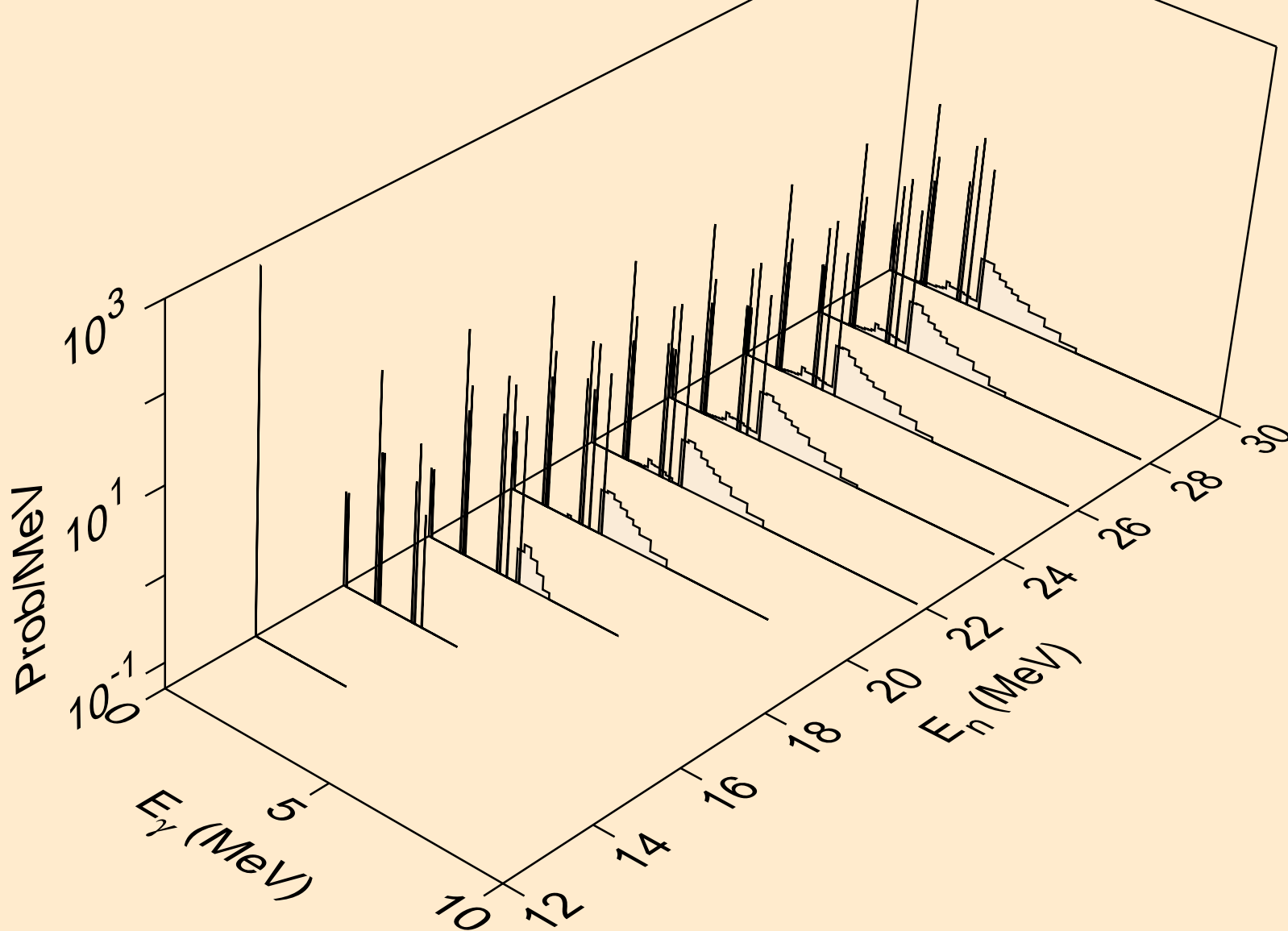

MG026 NEUTRON ACER TENDL-2019 LIBRARY; T=293.16K
Photon emission for (n,t)

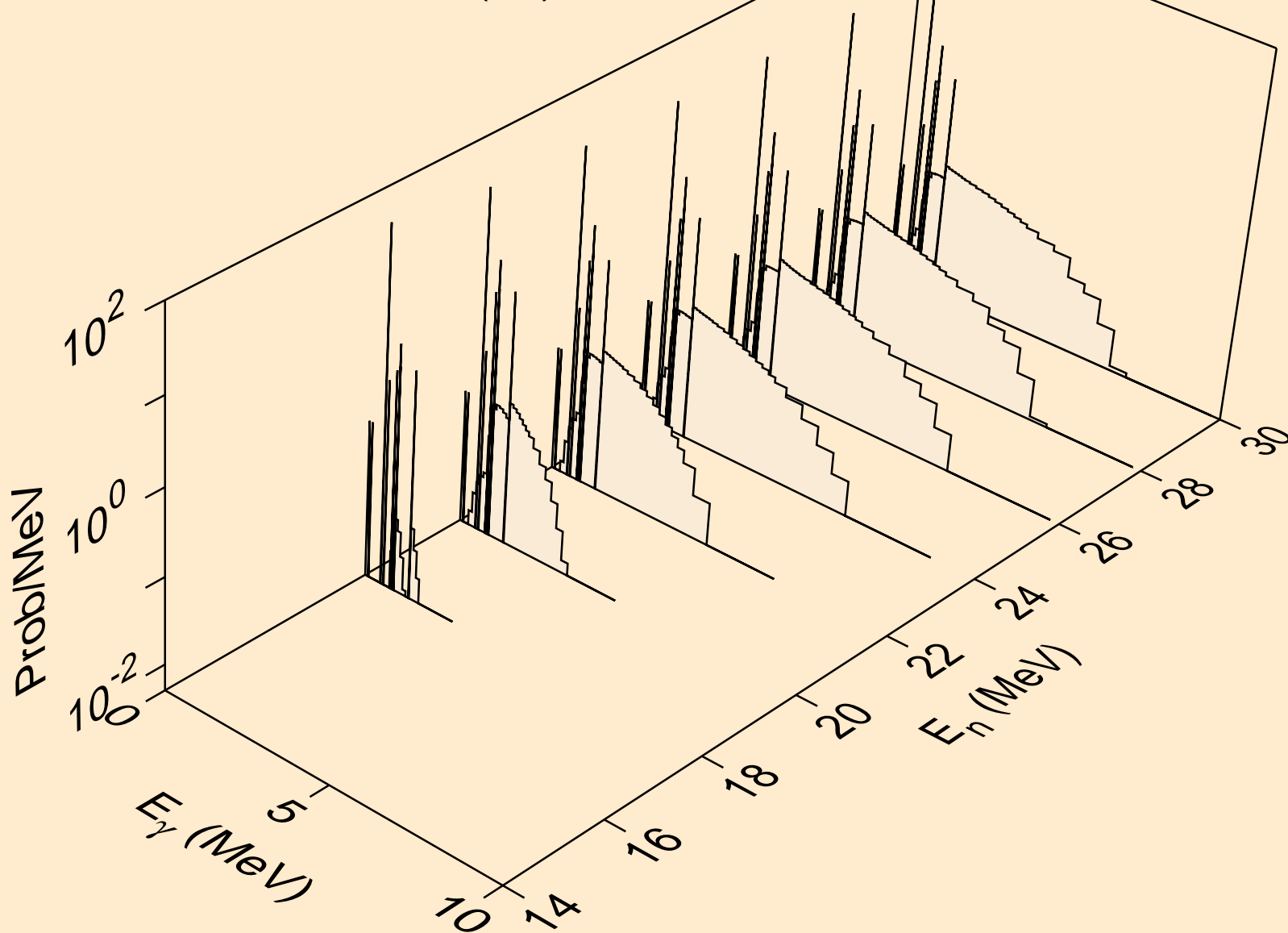

MG026 NEUTRON ACER TENDL-2019 LIBRARY; T=293.16K
Photon emission for (n,he3)

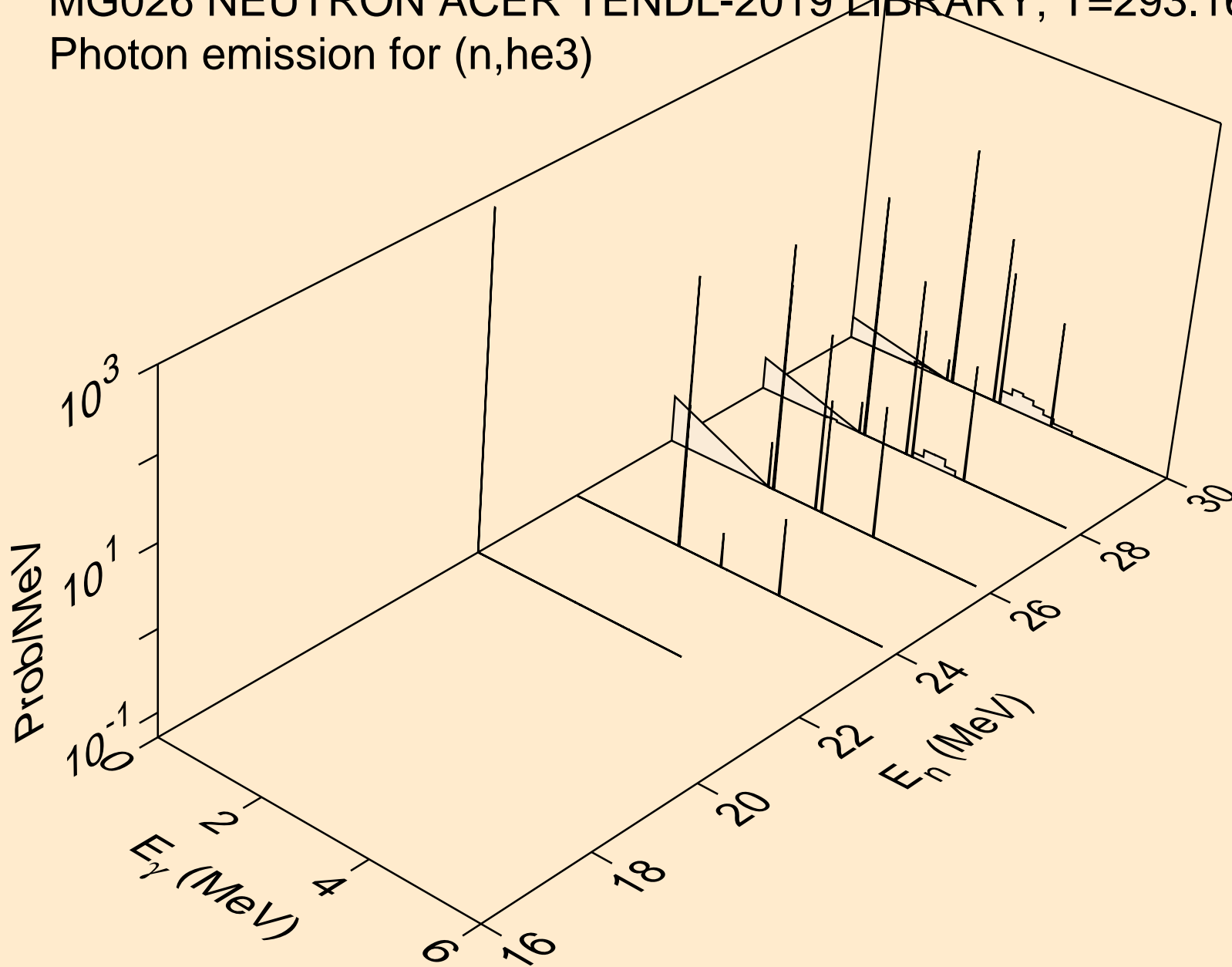

MG026 NEUTRON ACER TENDL-2019 LIBRARY; T=293.16K
Photon emission for (n,a)

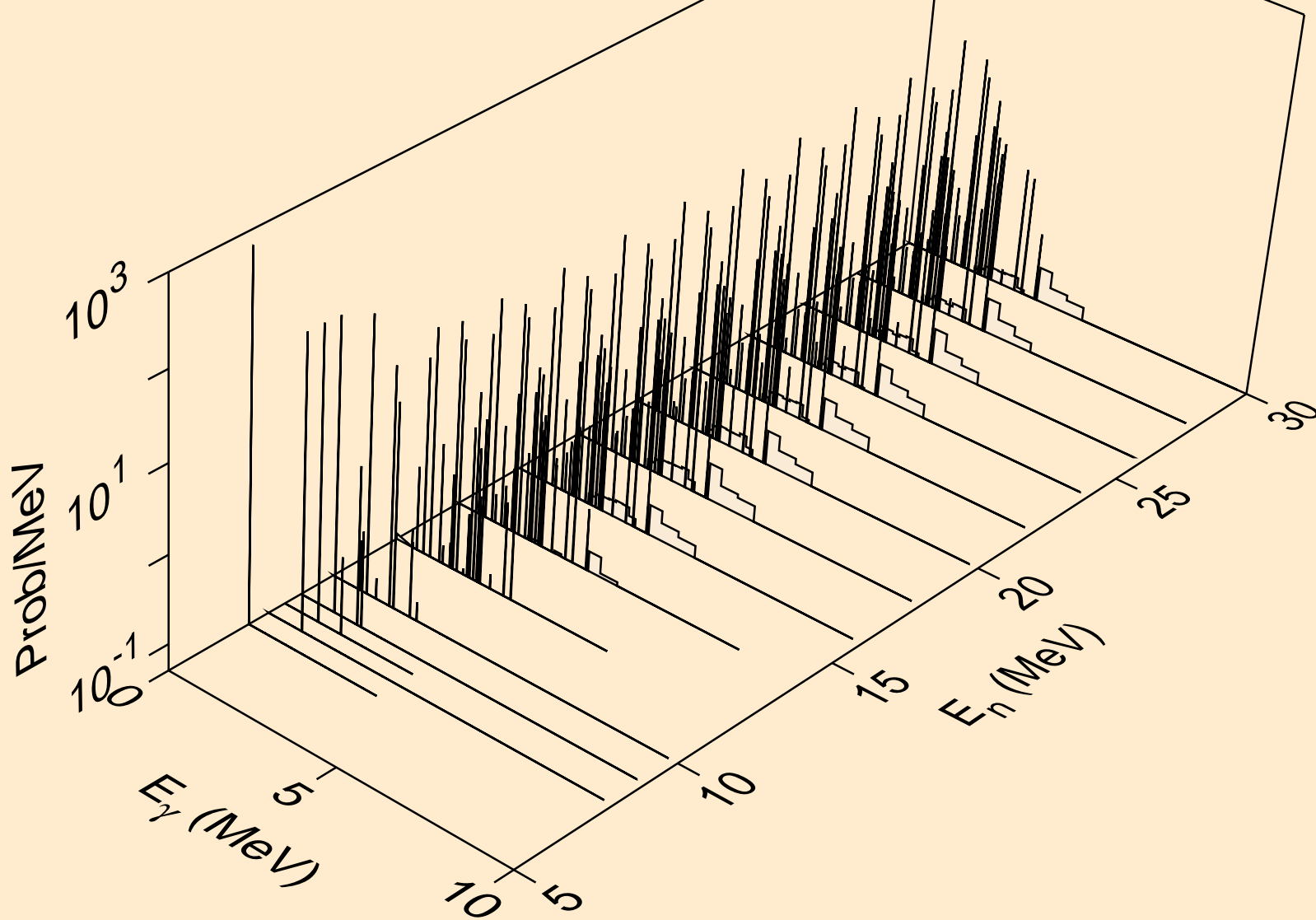

MG026 NEUTRON ACER TENDL-2019 LIBRARY; T=293.16K
Photon emission for (n,2a)

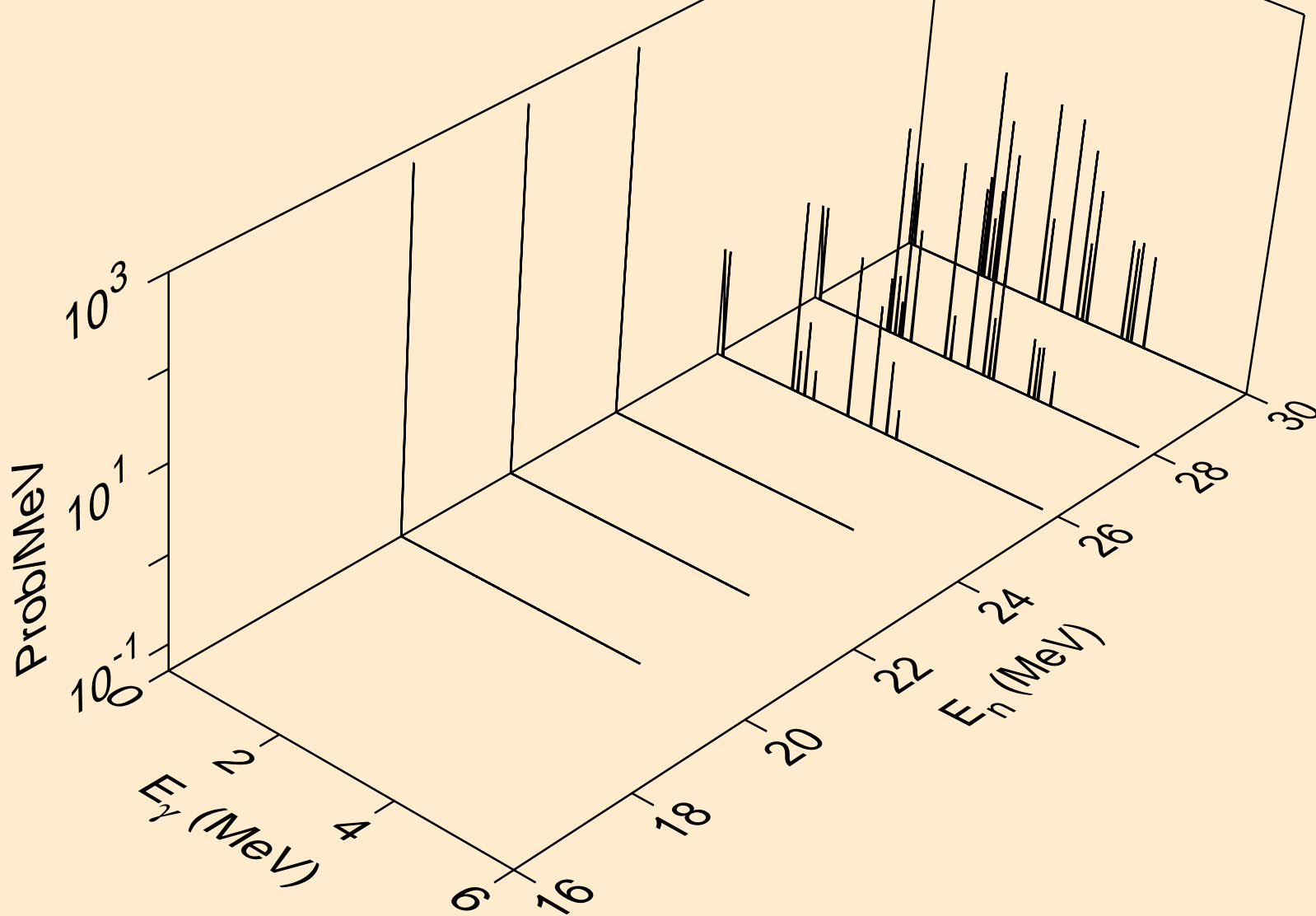

MG026 NEUTRON ACER TENDL-2019 LIBRARY; T=293.16K
Photon emission for (n,2p)

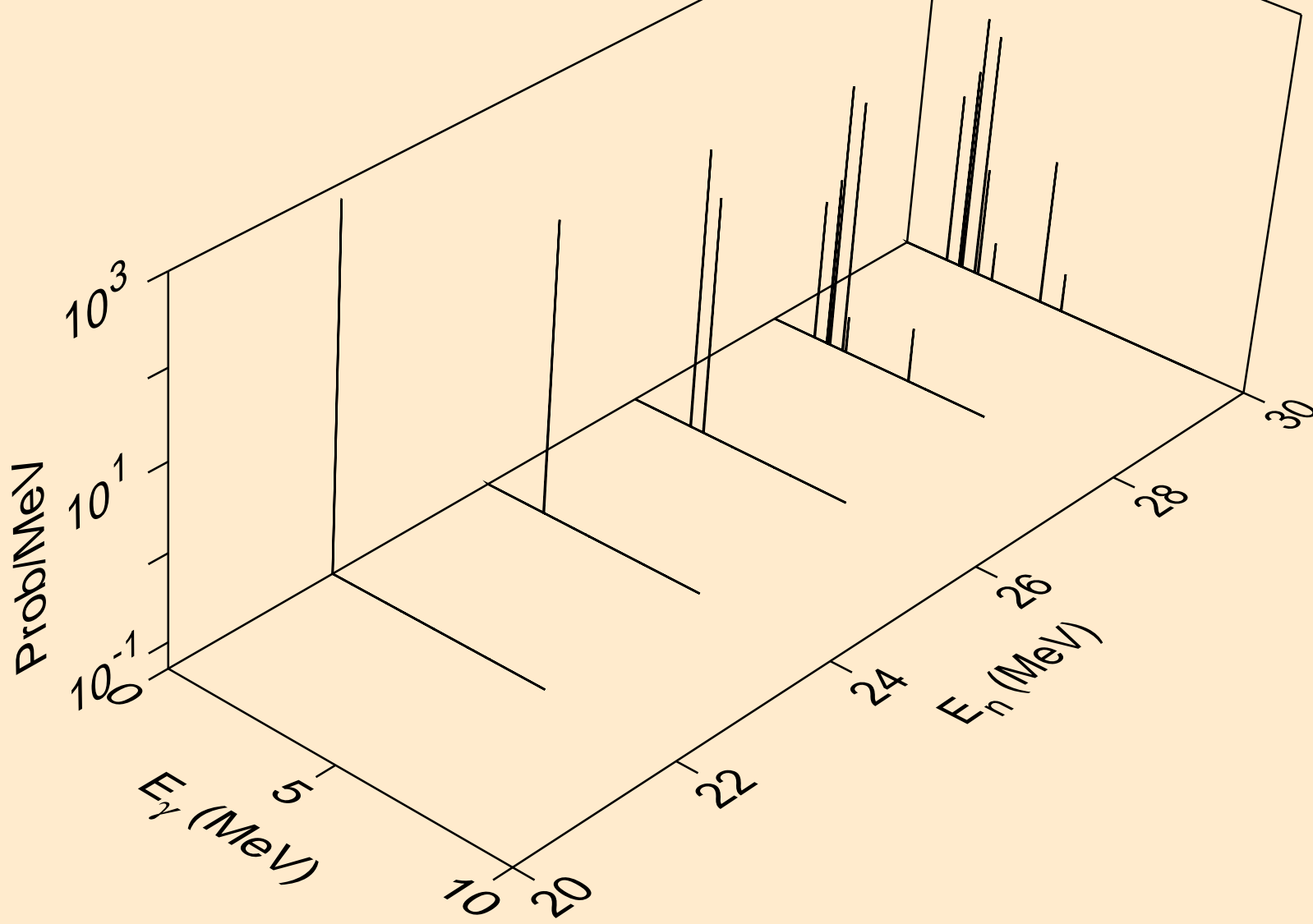

MG026 NEUTRON ACER TENDL-2019 LIBRARY; T=293.16K
Photon emission for (n,p α)

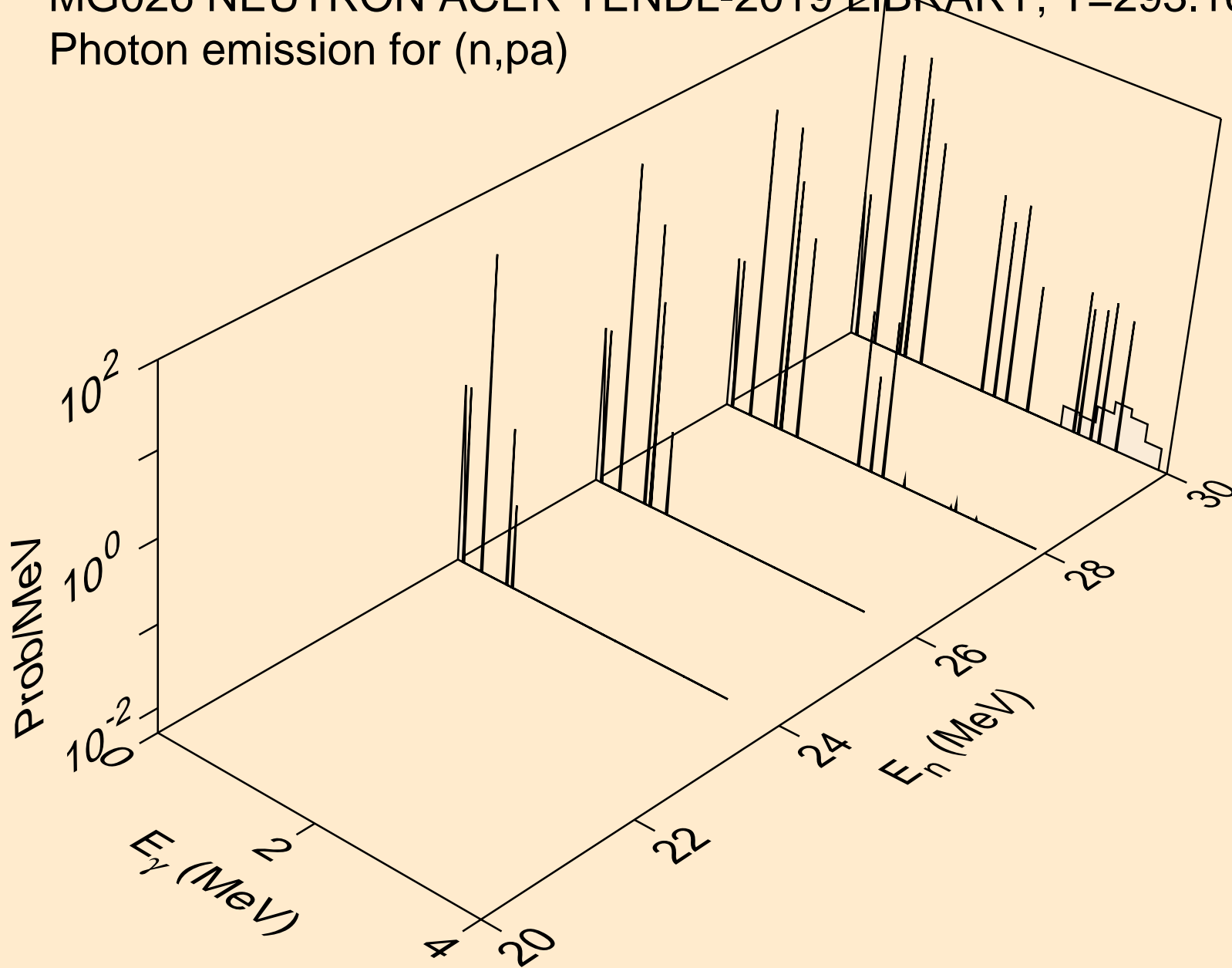

MG026 NEUTRON ACER TENDL-2019 LIBRARY; T=293.16K
Photon emission for (n,pd)

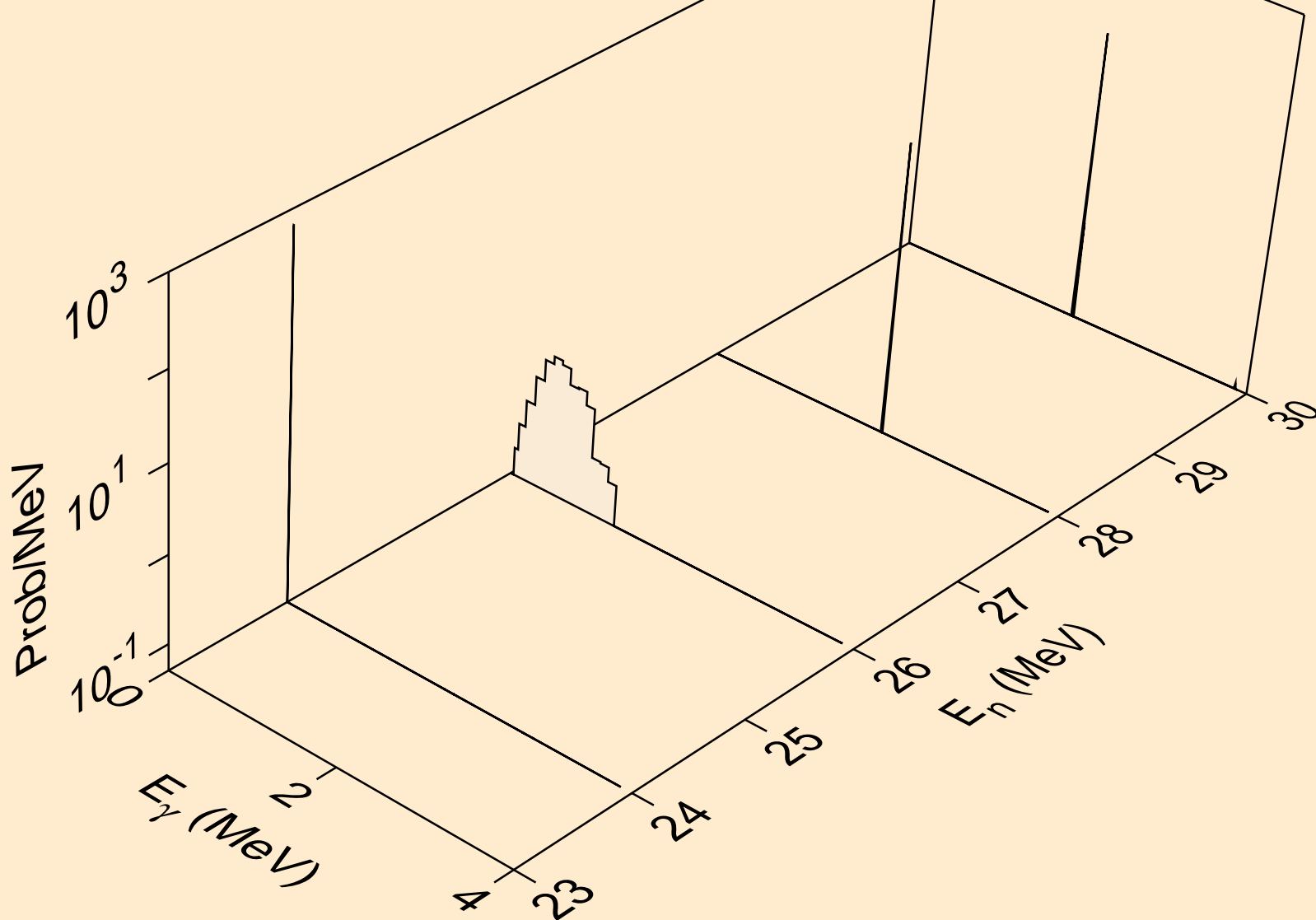

MG026 NEUTRON ACER TENDL-2019 LIBRARY; T=293.16K
Photon emission for (n,pt)

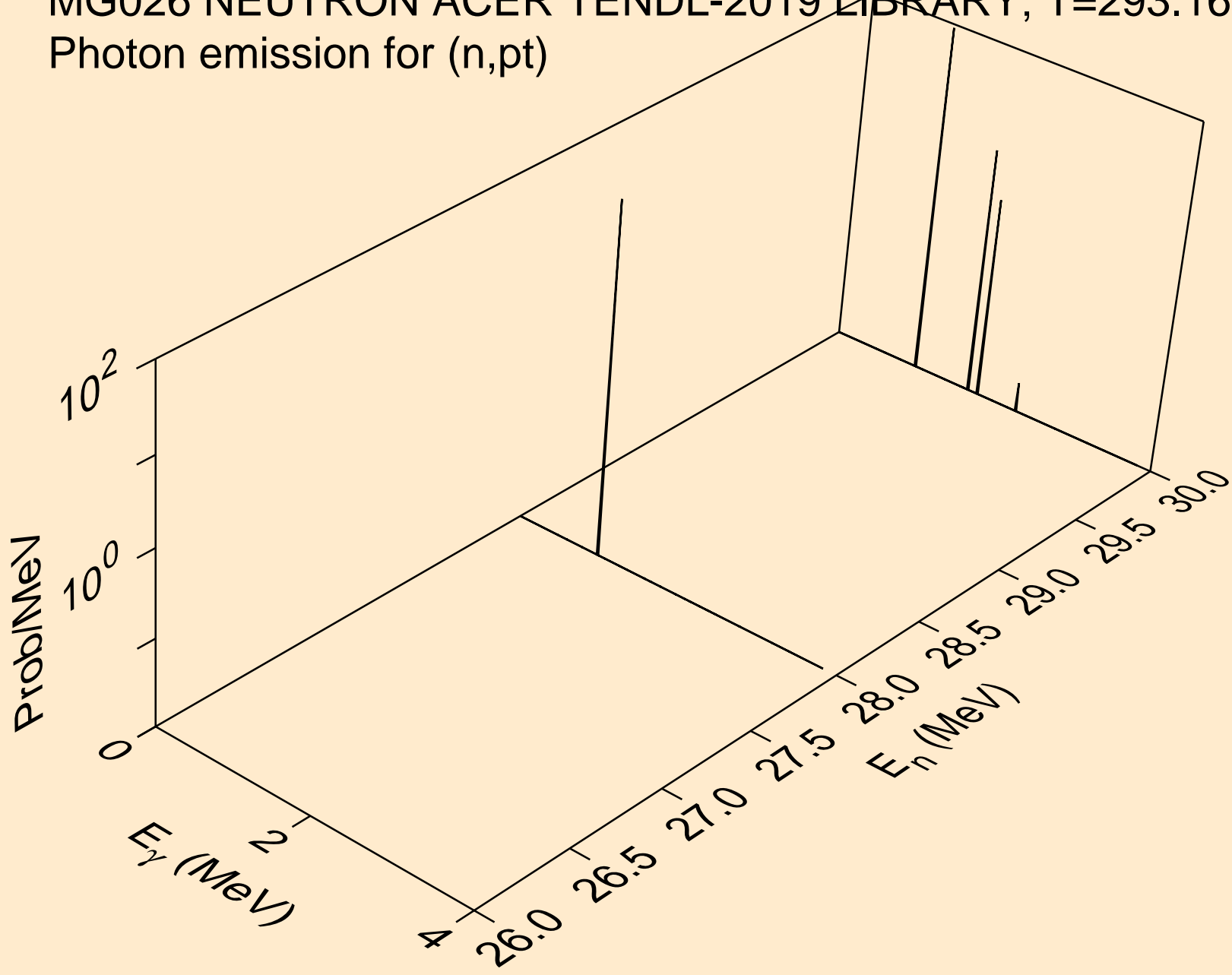

MG026 NEUTRON ACER TENDL-2019 LIBRARY; T=293.16K
Photon emission for (n,da)

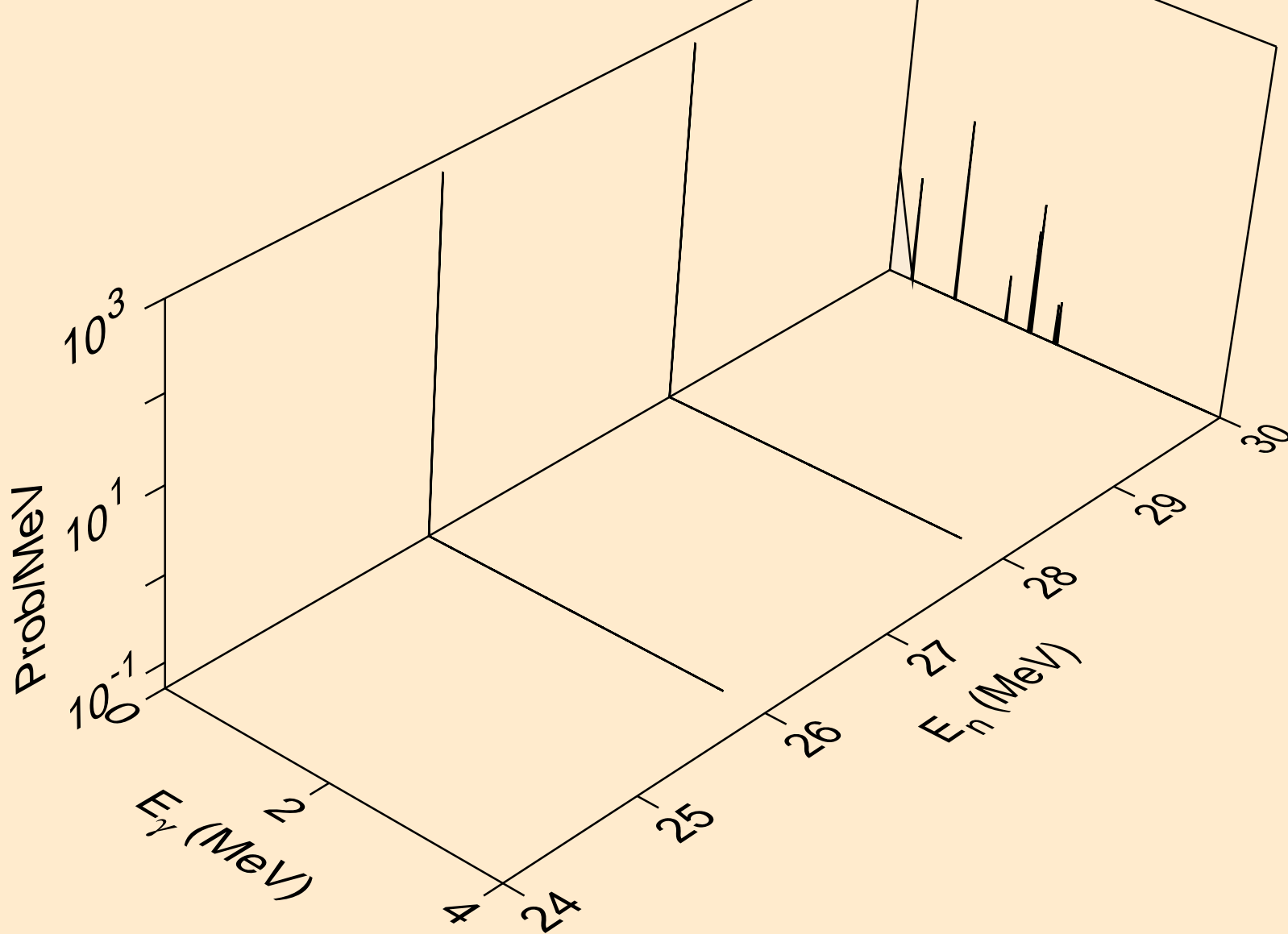

MG026 NEUTRON ACER TENDL-2019 LIBRARY; T=293.16K
thermal capture photon spectrum

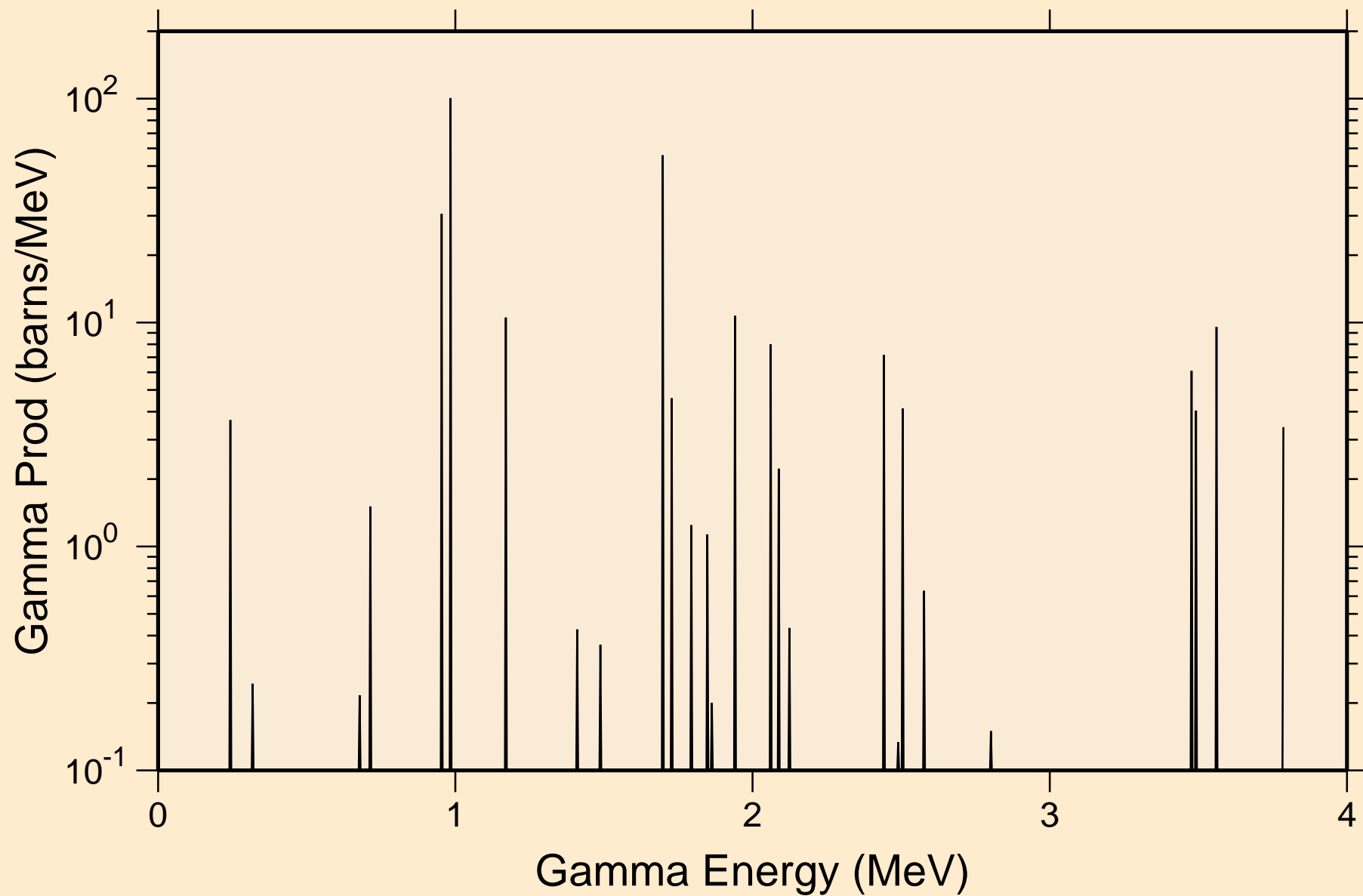

MG026 NEUTRON ACER TENDL-2019 LIBRARY; T=293.16K
14 MeV photon spectrum

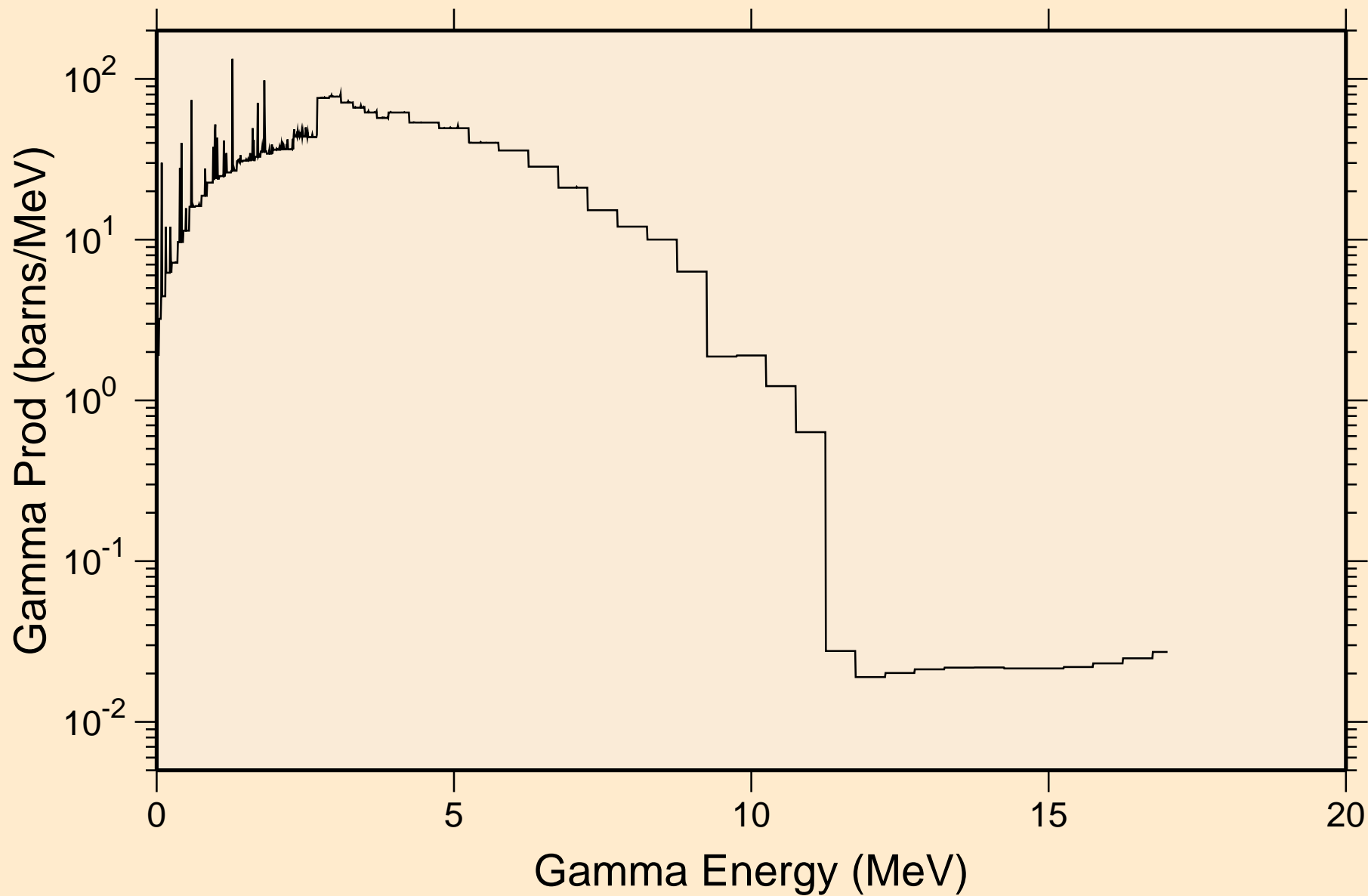

MG026 NEUTRON ACER TENDL-2019 LIBRARY; T=293.16K

Particle heating contributions

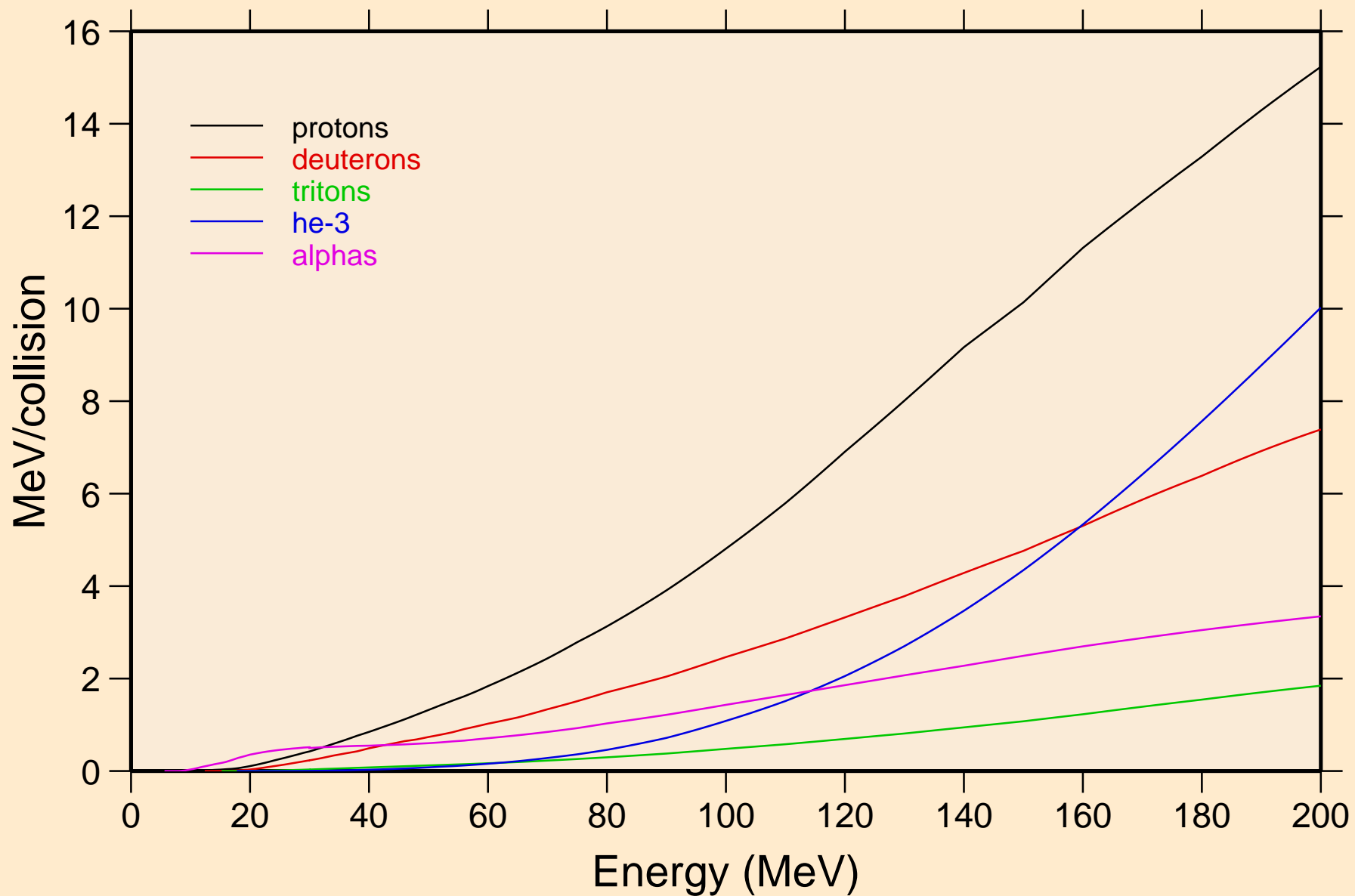

MG026 NEUTRON ACER TENDL-2019 LIBRARY; T=293.16K
Recoil Heating

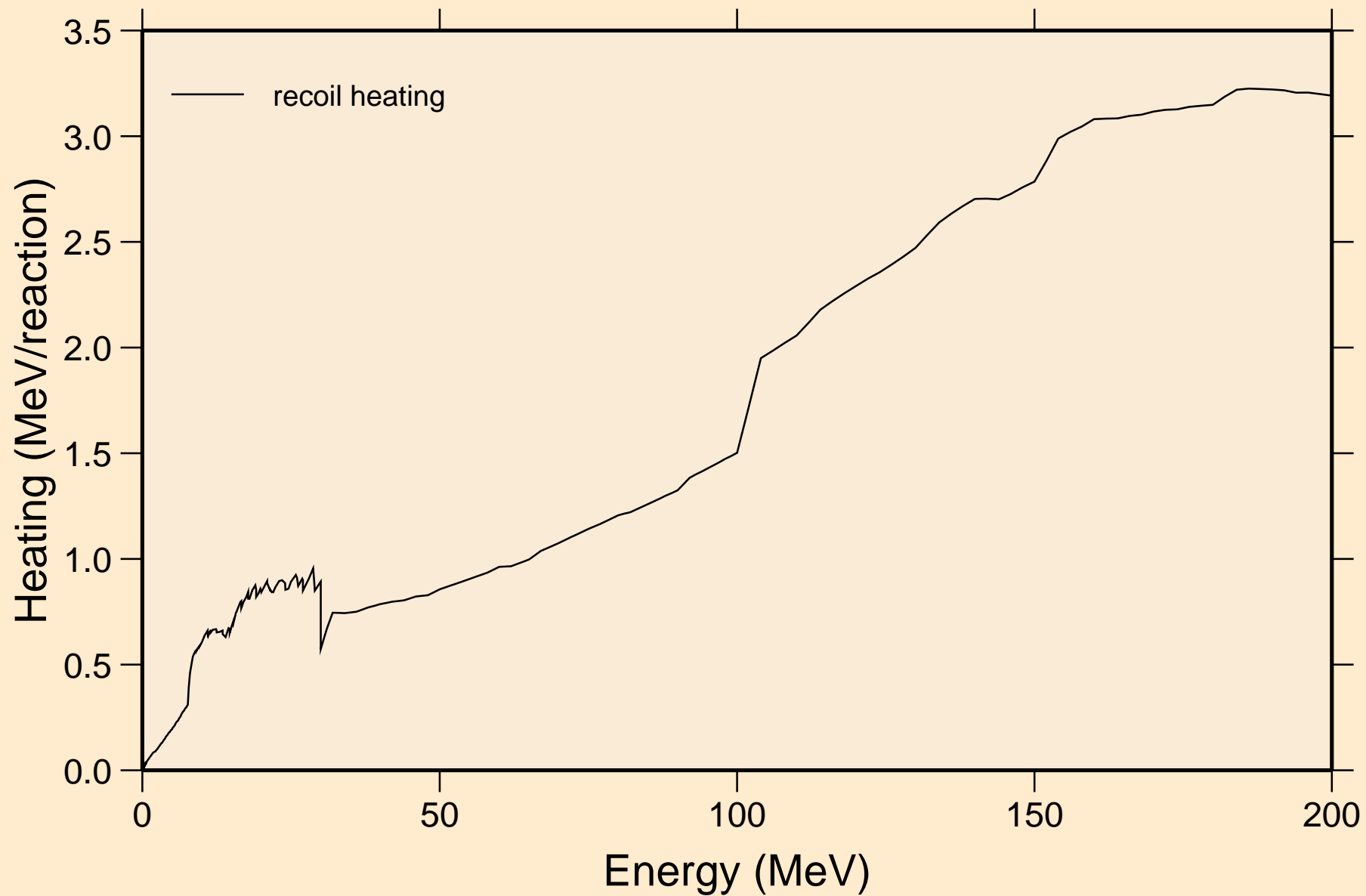

MG026 NEUTRON ACER TENDL-2019 LIBRARY; T=293.16K
Particle production cross sections

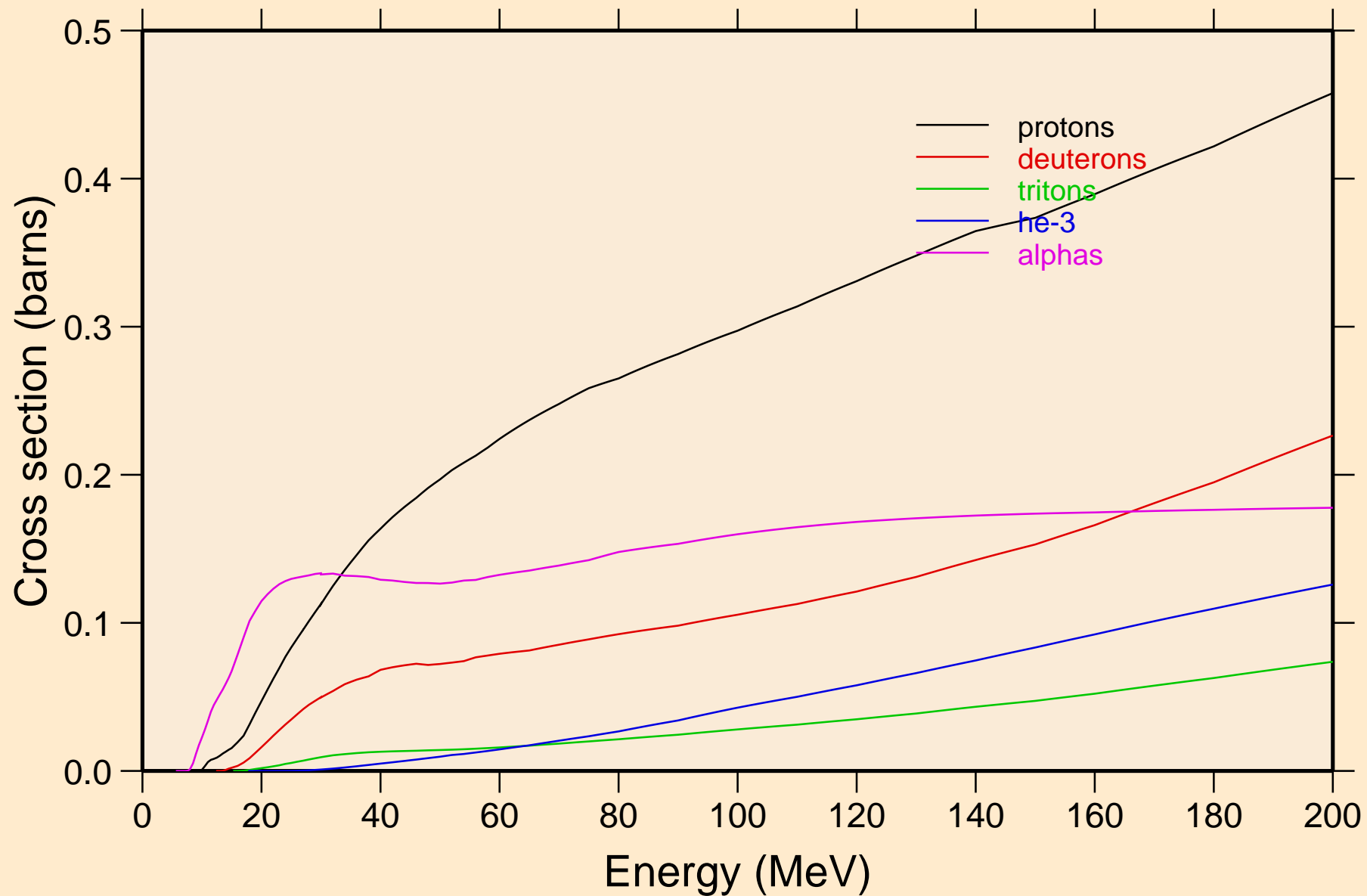

MG026 NEUTRON ACER TENDL-2019 LIBRARY; T=293.16K
protons from (n,x)

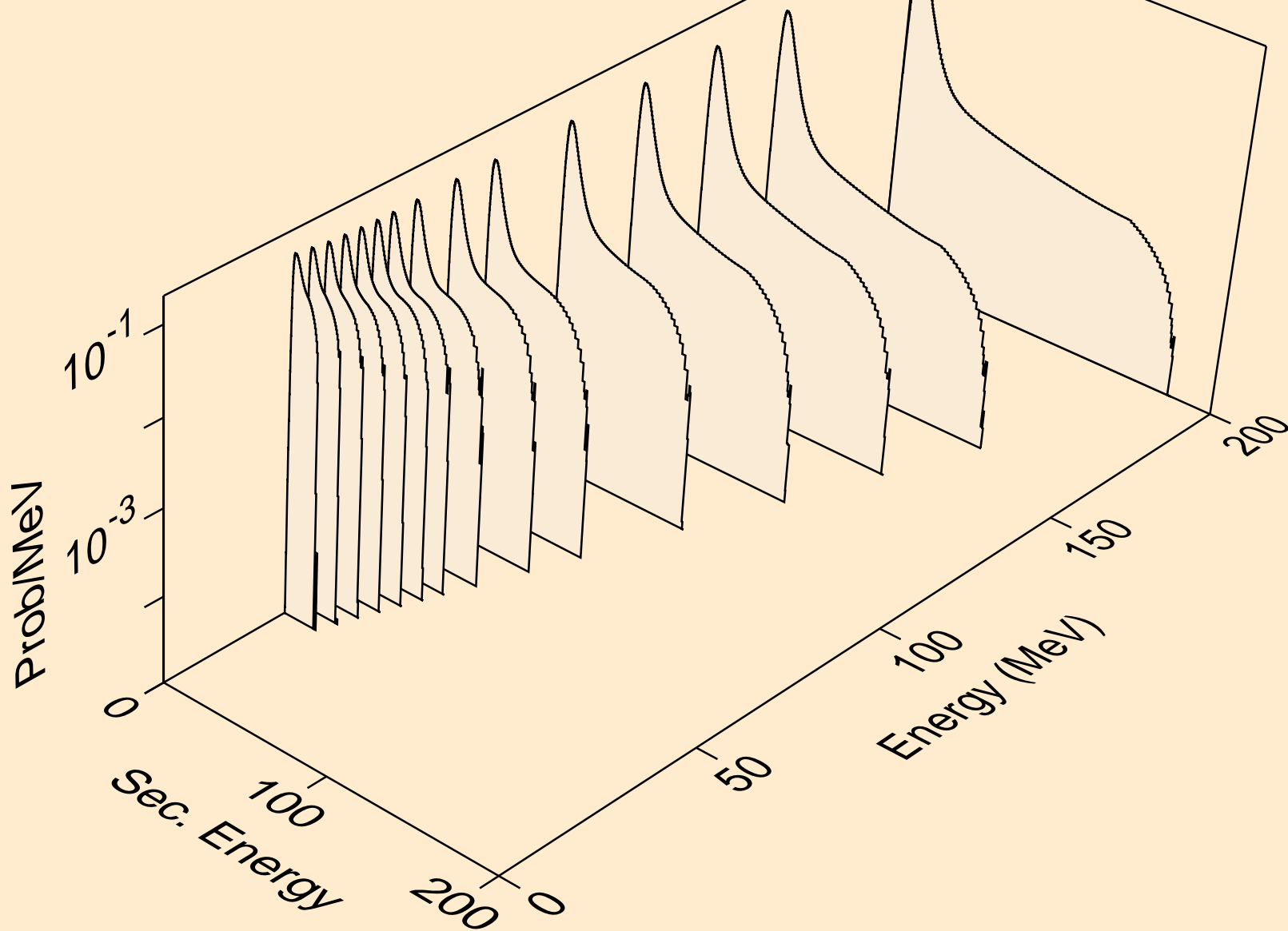

MG026 NEUTRON ACER TENDL-2019 LIBRARY; T=293.16K
protons from (n,n*)p

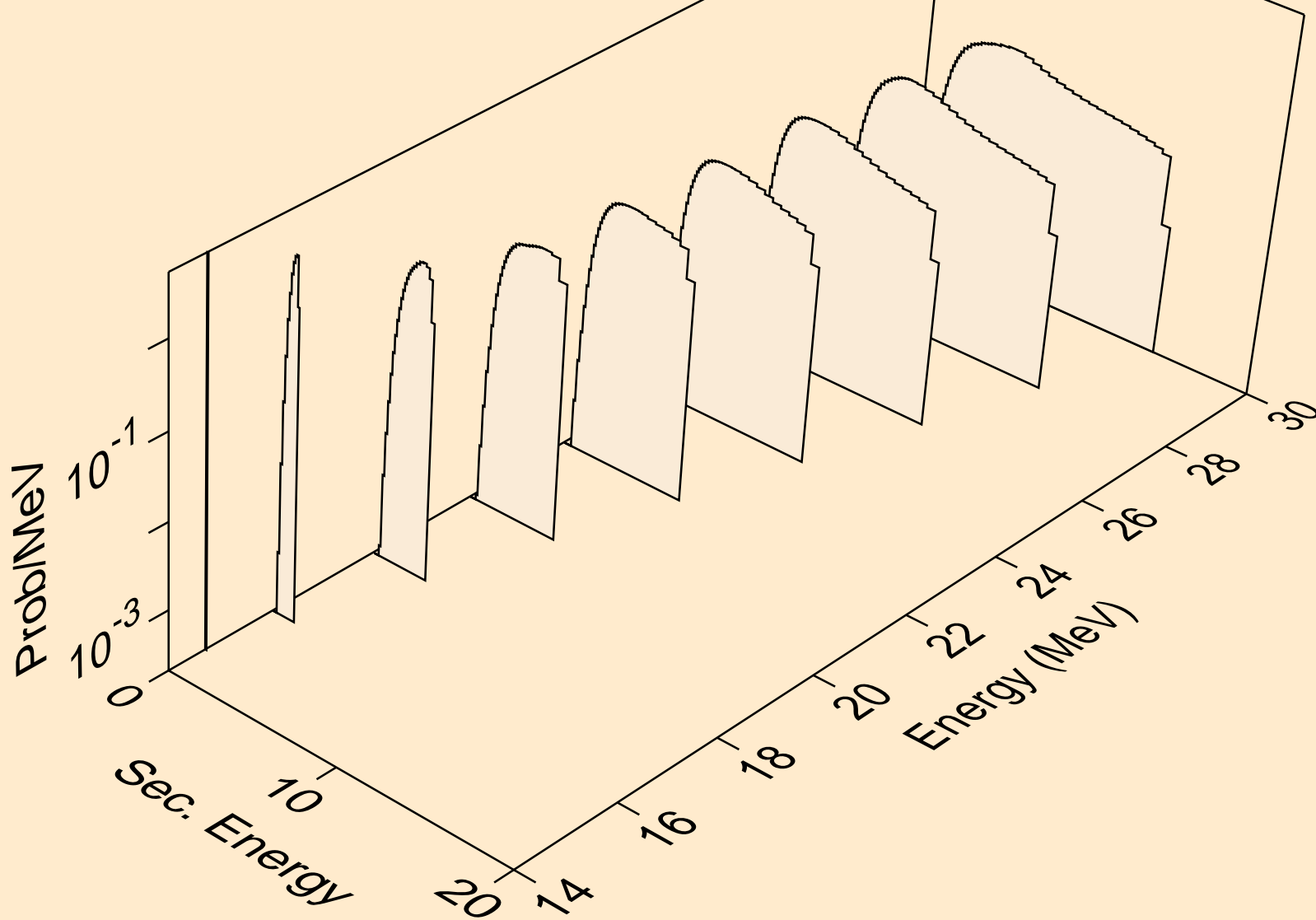

MG026 NEUTRON ACER TENDL-2019 LIBRARY; T=293.16K
protons from (n,2np)

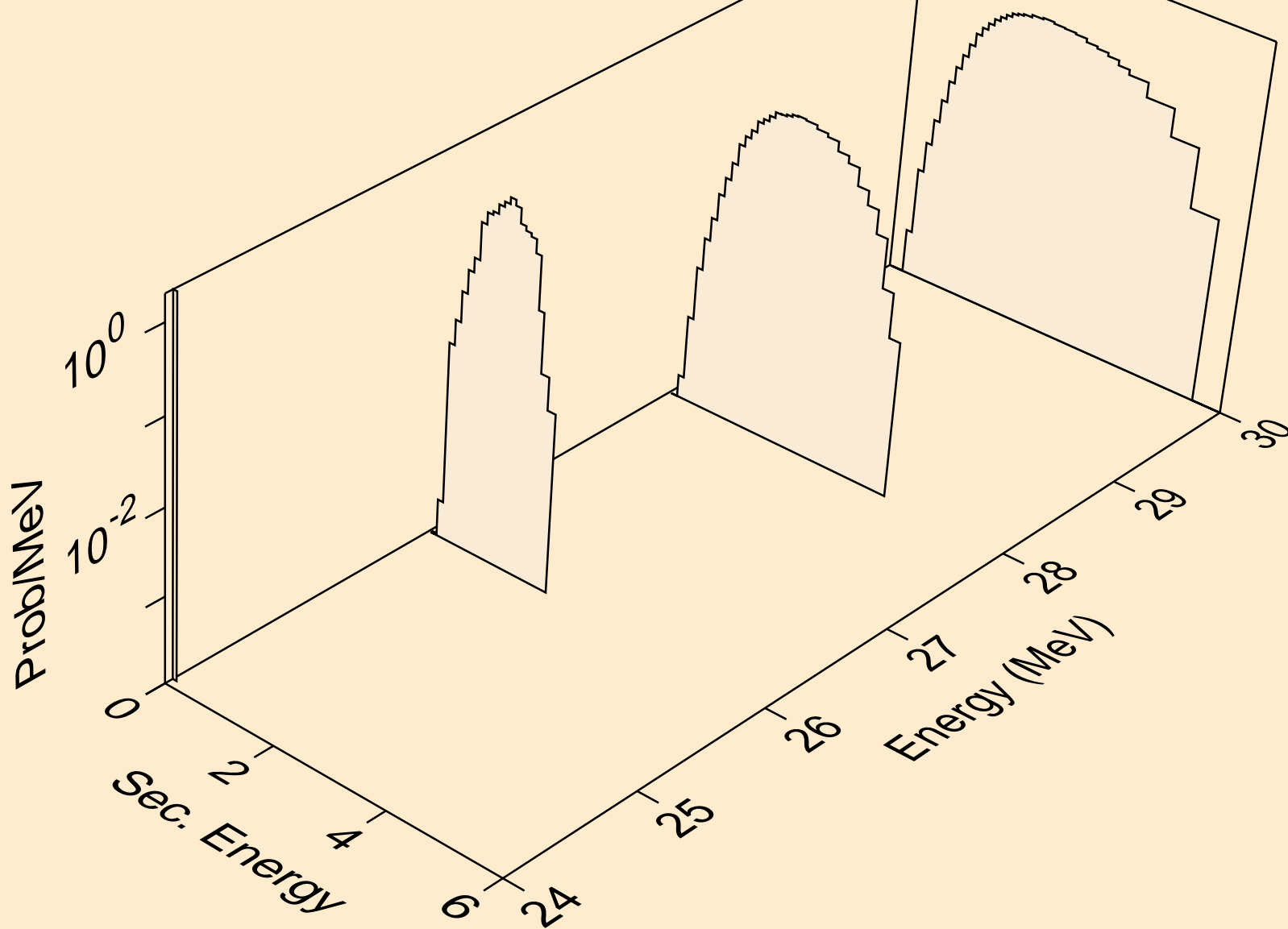

MG026 NEUTRON ACER TENDL-2019 LIBRARY; T=293.16K
protons from (n,2np)

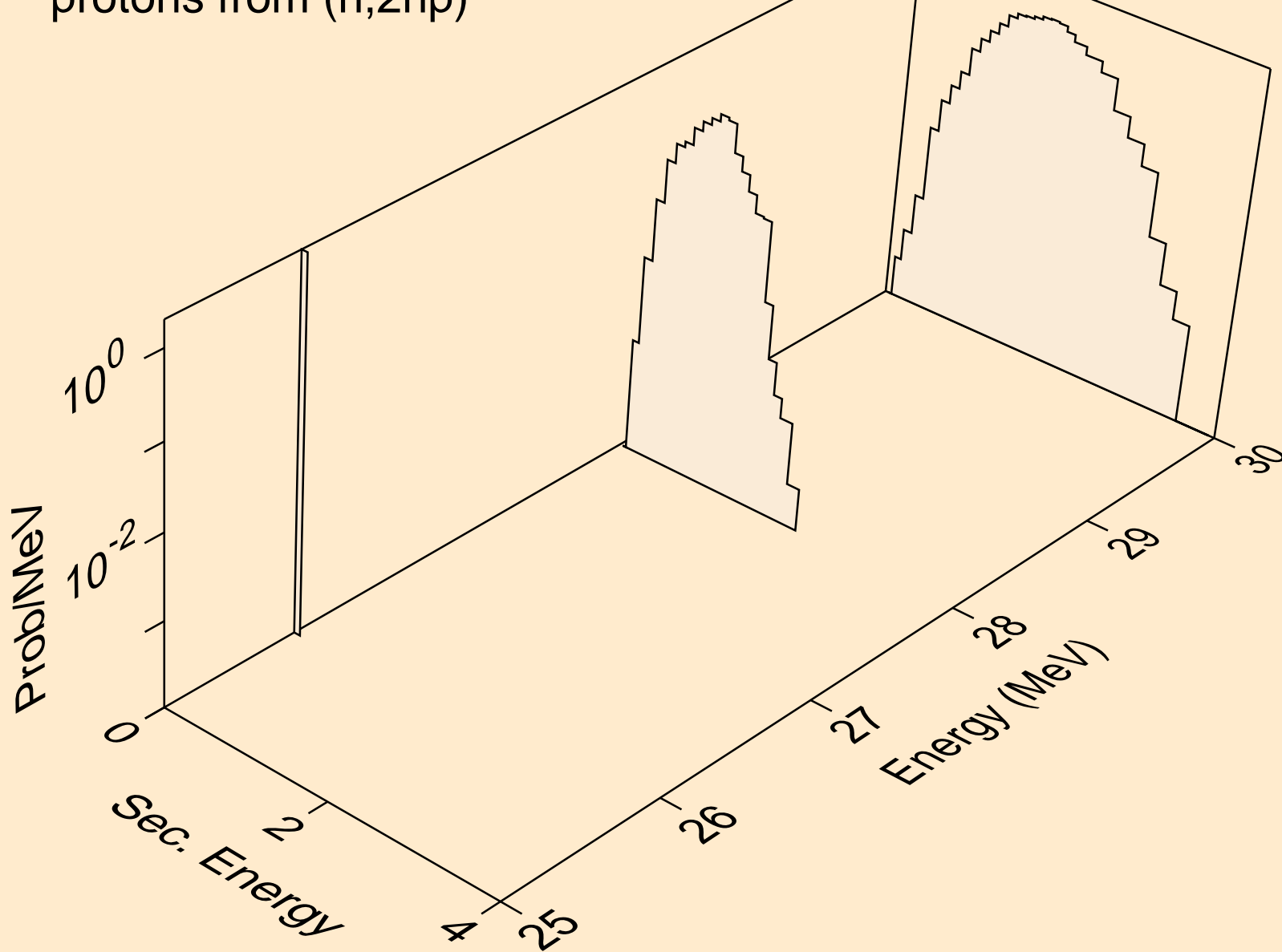

MG026 NEUTRON ACER TENDL-2019 LIBRARY; T=293.16K
protons from (n,npa)

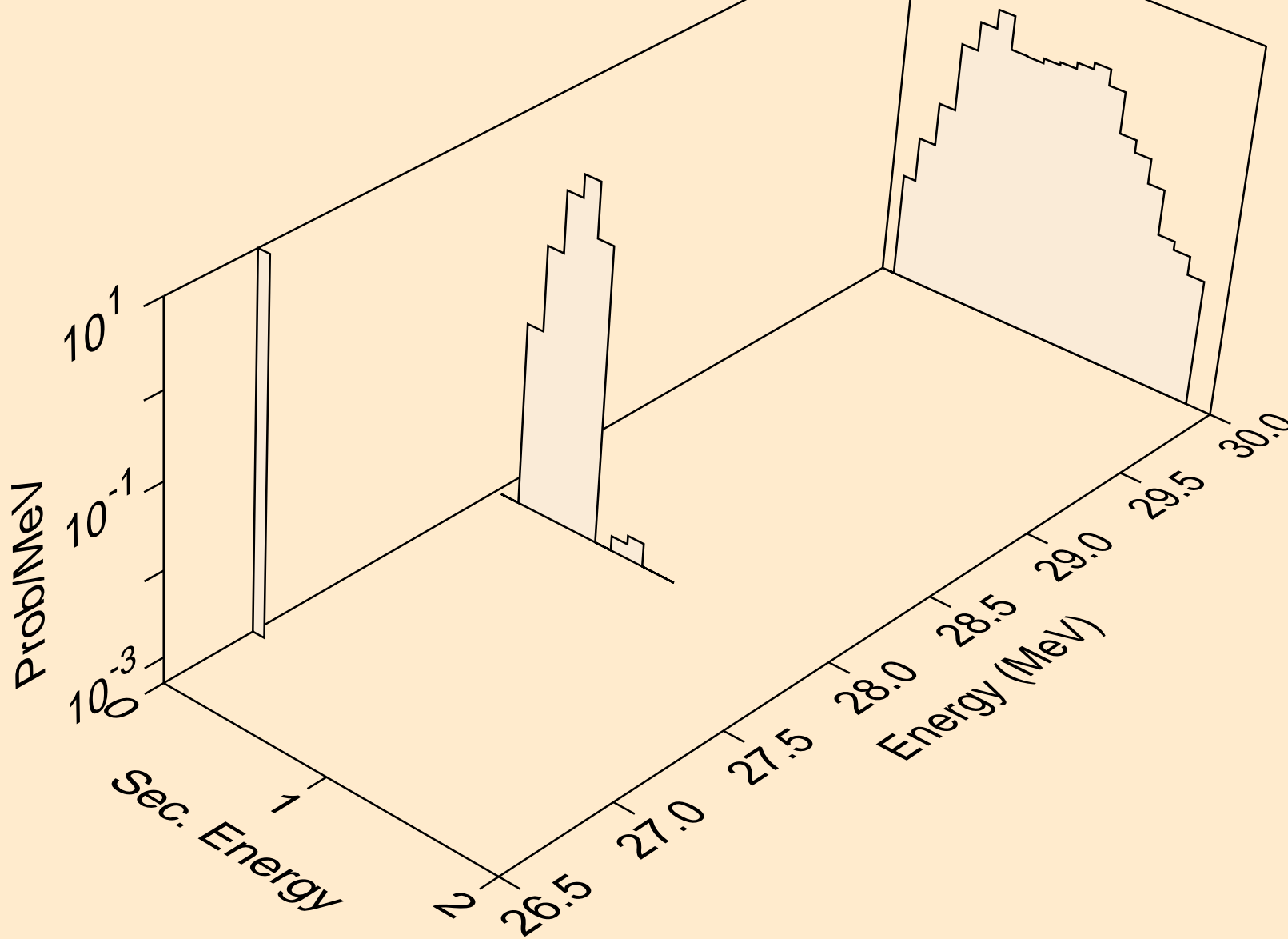

MG026 NEUTRON ACER TENDL-2019 LIBRARY; T=293.16K
protons from (n,p)

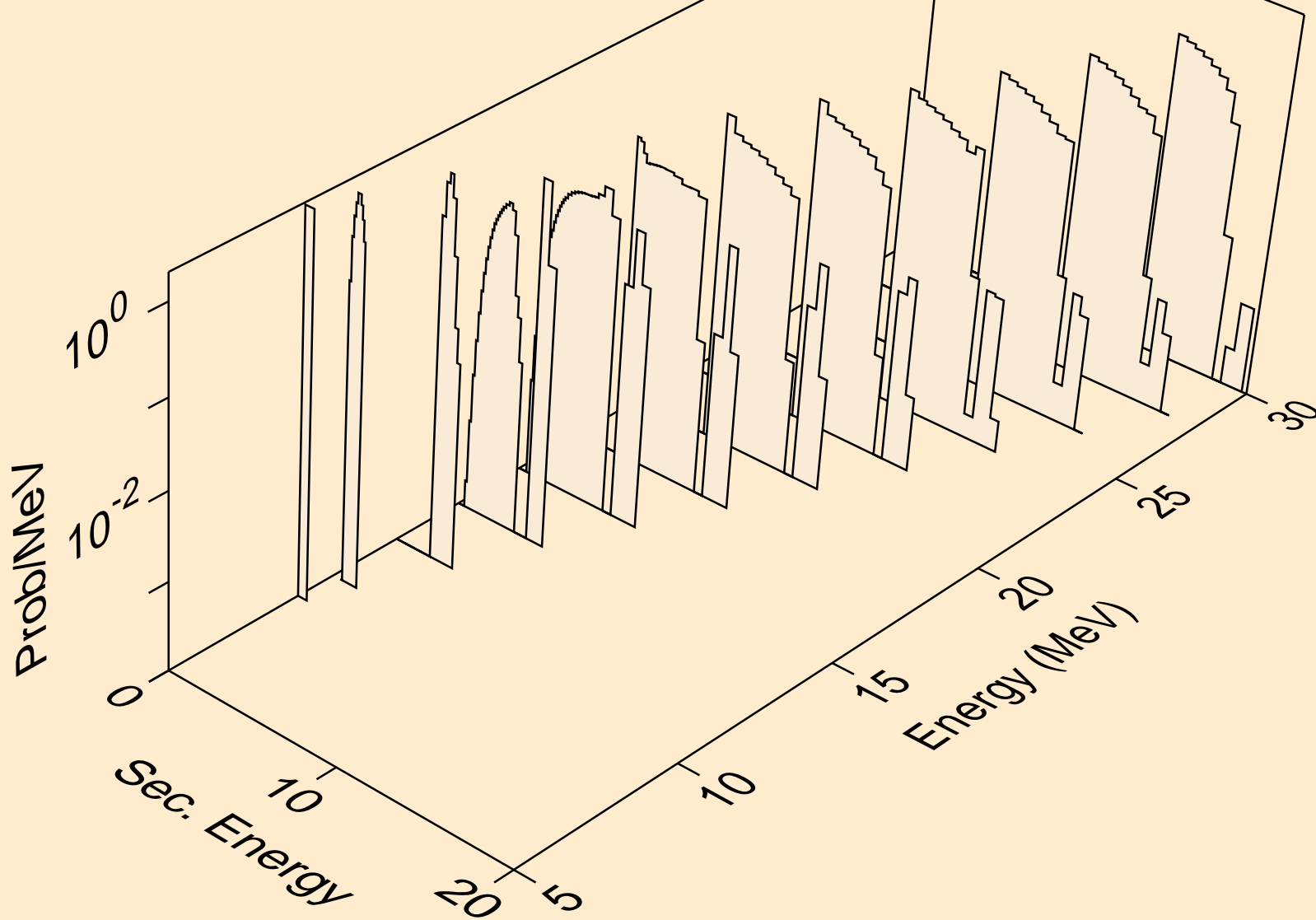

MG026 NEUTRON ACER TENDL-2019 LIBRARY; T=293.16K
protons from (n,2p)

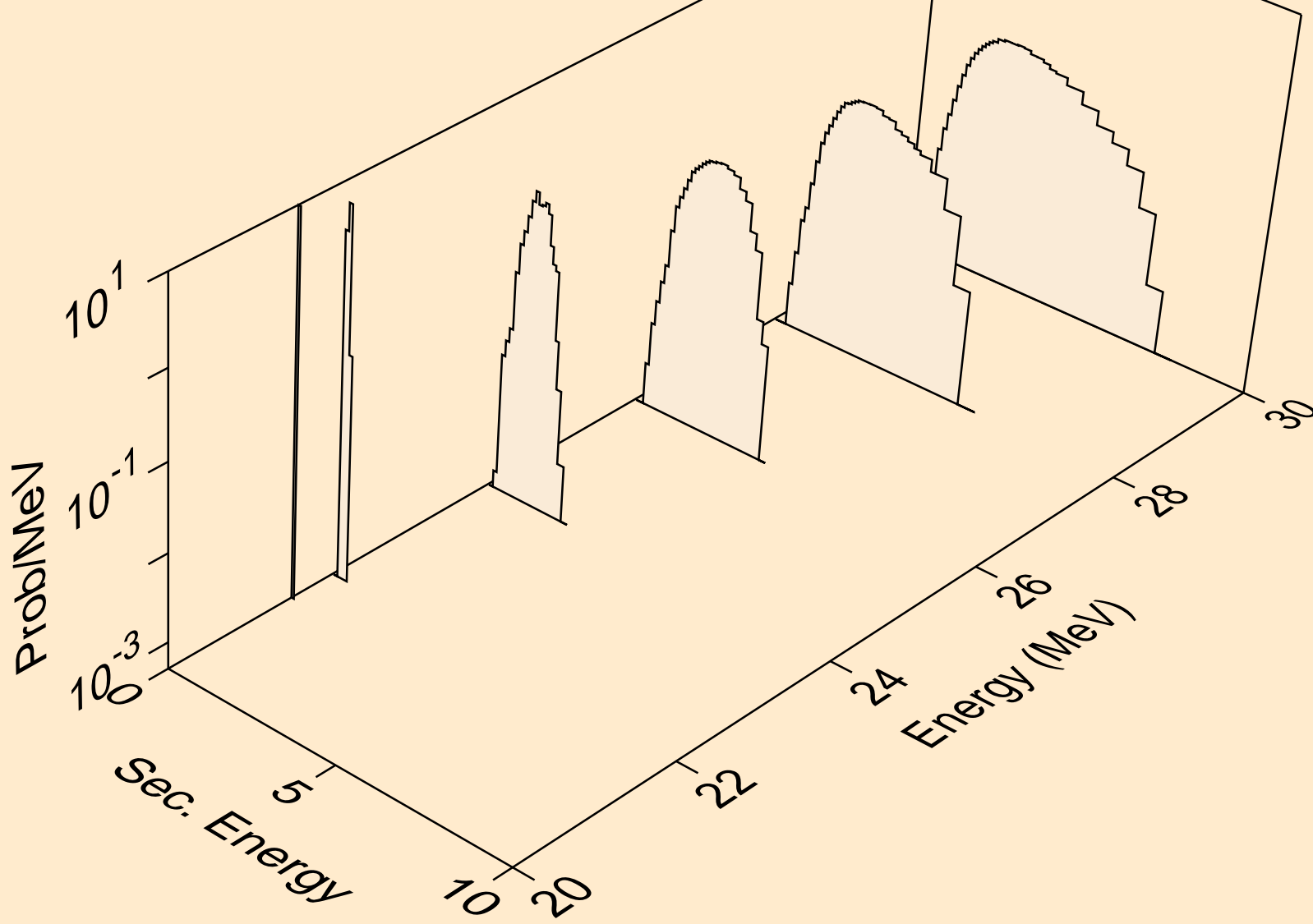

MG026 NEUTRON ACER TENDL-2019 LIBRARY; T=293.16K
protons from (n,p)

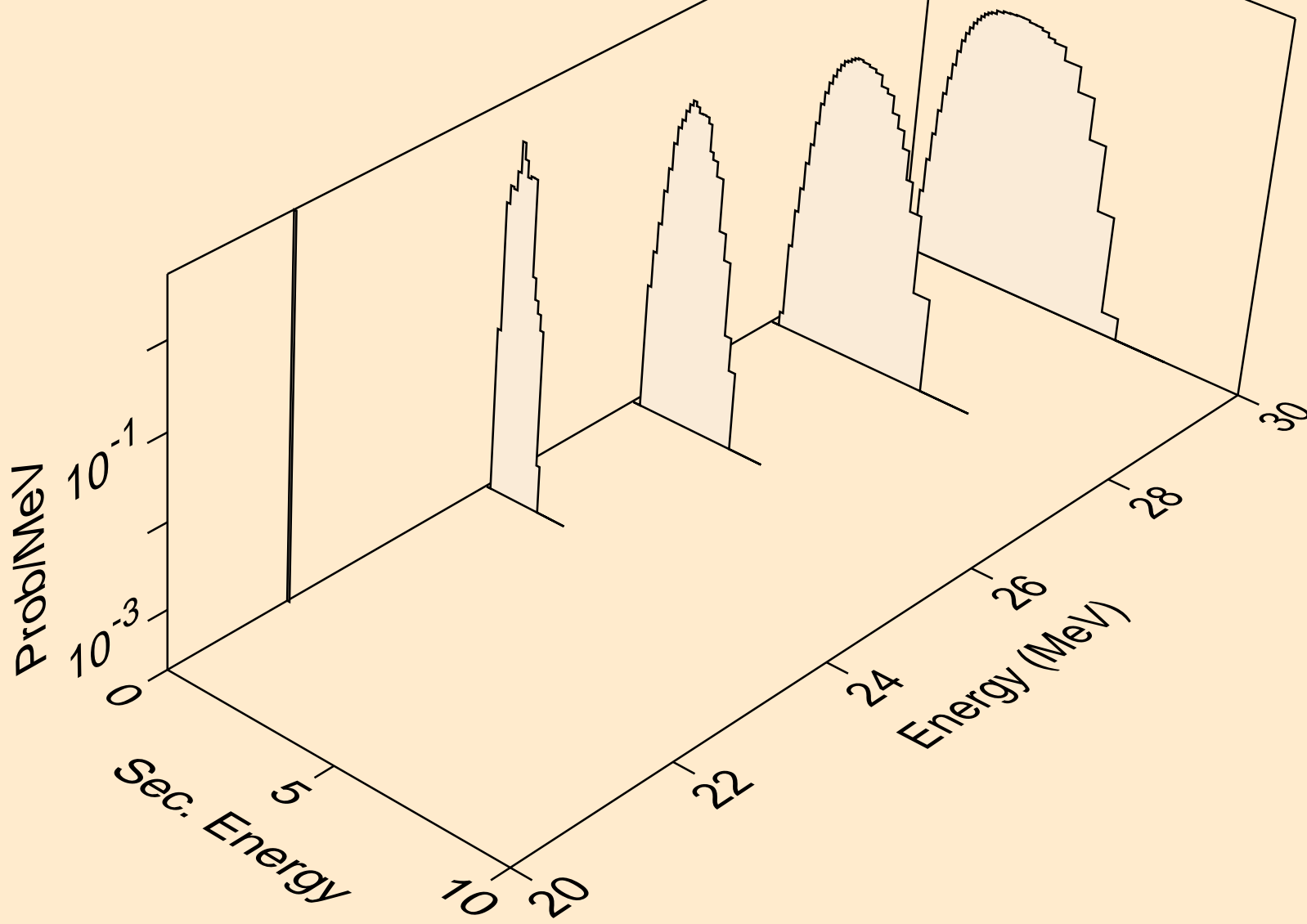

MG026 NEUTRON ACER TENDL-2019 LIBRARY; T=293.16K
protons from (n,pd)

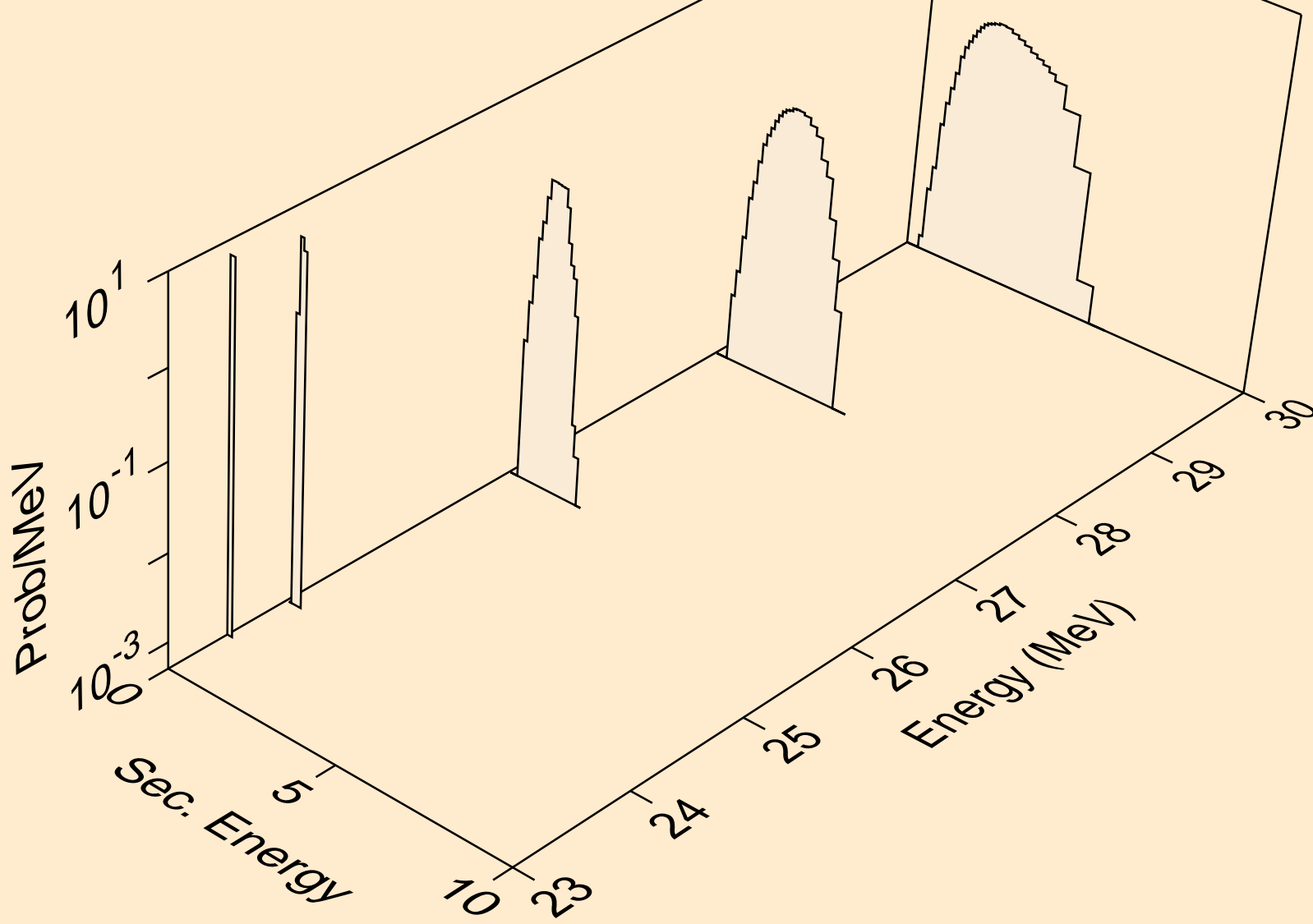

MG026 NEUTRON ACER TENDL-2019 LIBRARY; T=293.16K
protons from (n,pt)

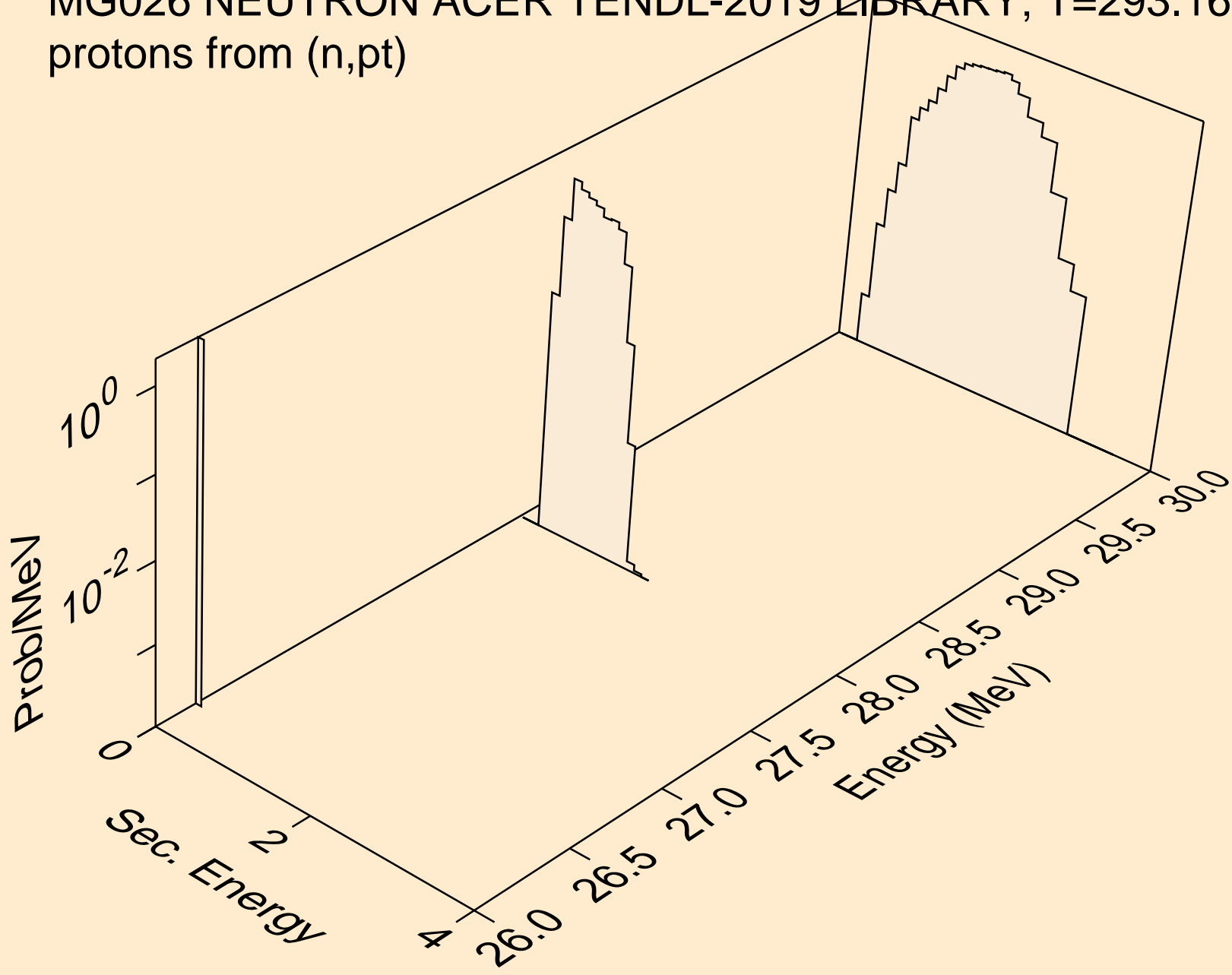

MG026 NEUTRON ACER TENDL-2019 LIBRARY; T=293.16K
deuterons from (n,x)

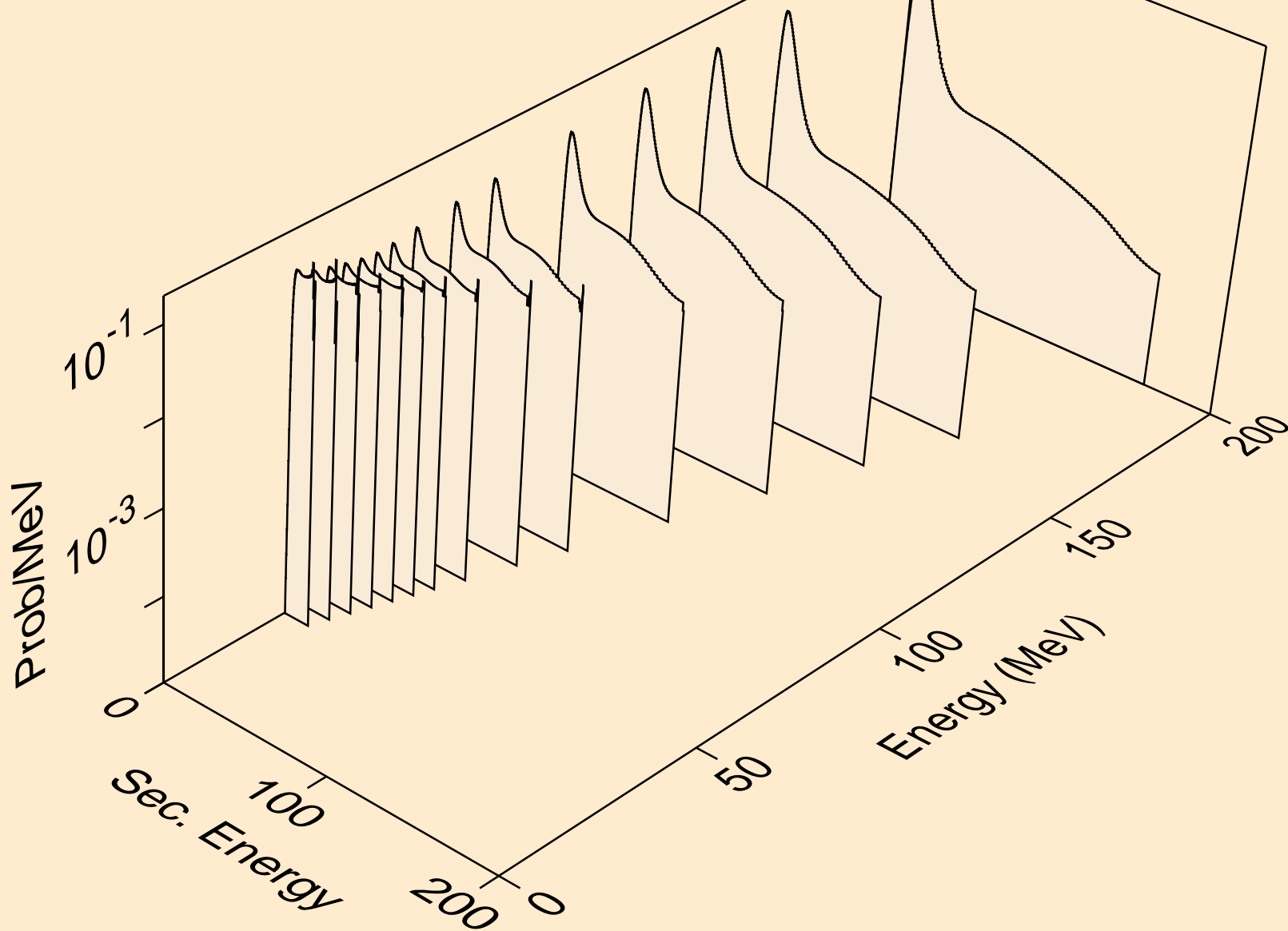

MG026 NEUTRON ACER TENDL-2019 LIBRARY; T=293.16K
deuterons from (n,2nd)

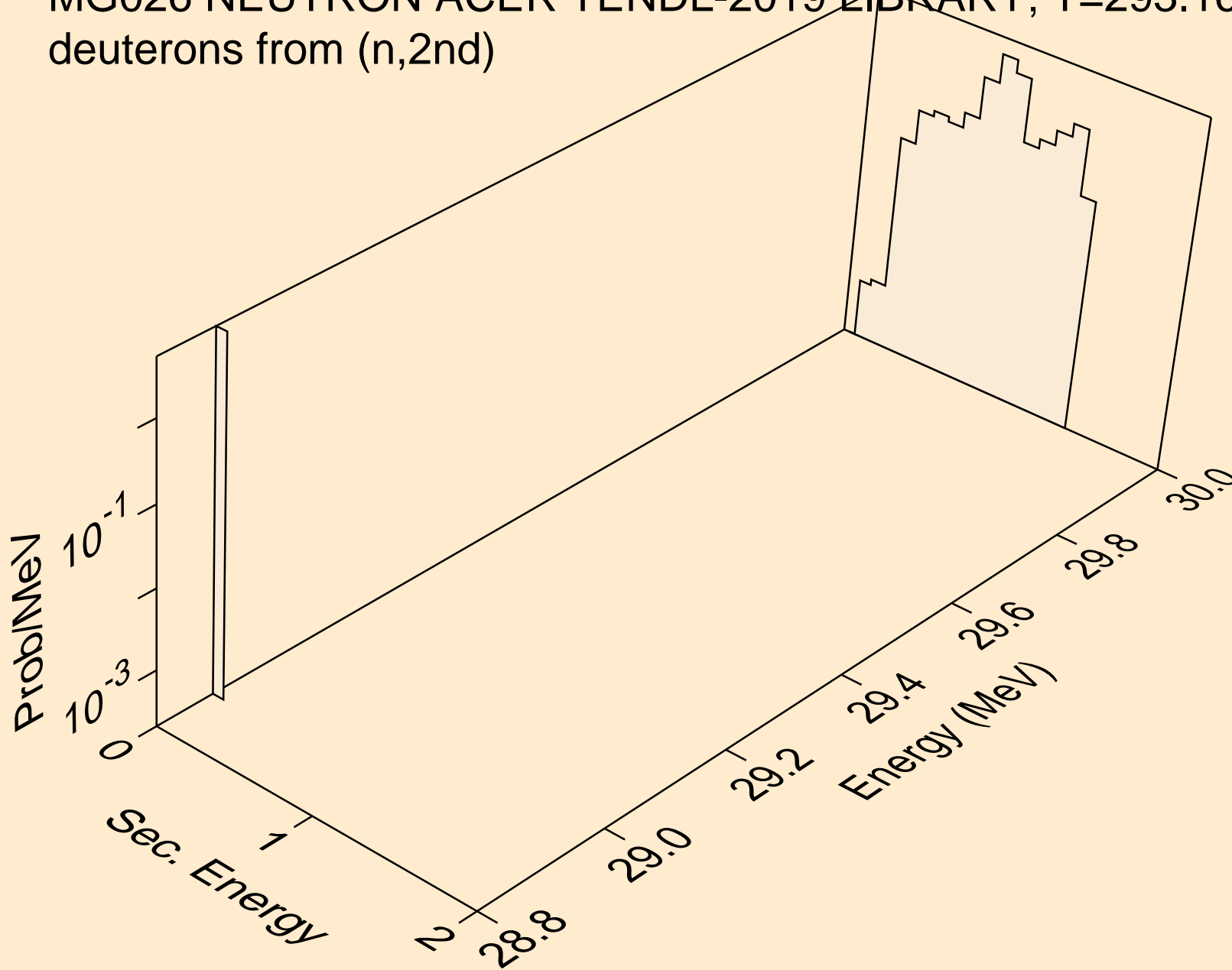

MG026 NEUTRON ACER TENDL-2019 LIBRARY; T=293.16K
deuterons from (n,n*)d

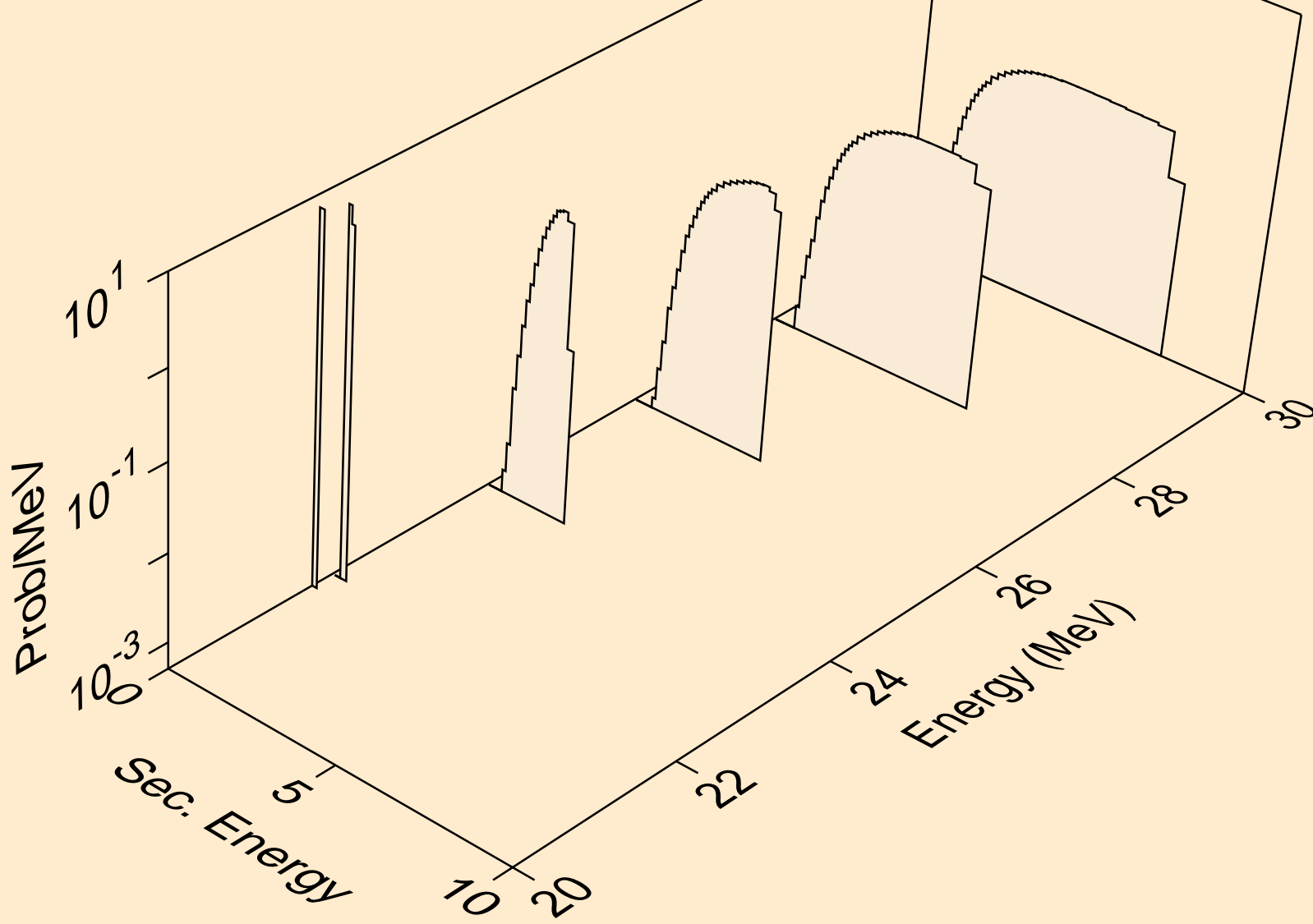

MG026 NEUTRON ACER TENDL-2019 LIBRARY; T=293.16K
deuterons from (n,d)

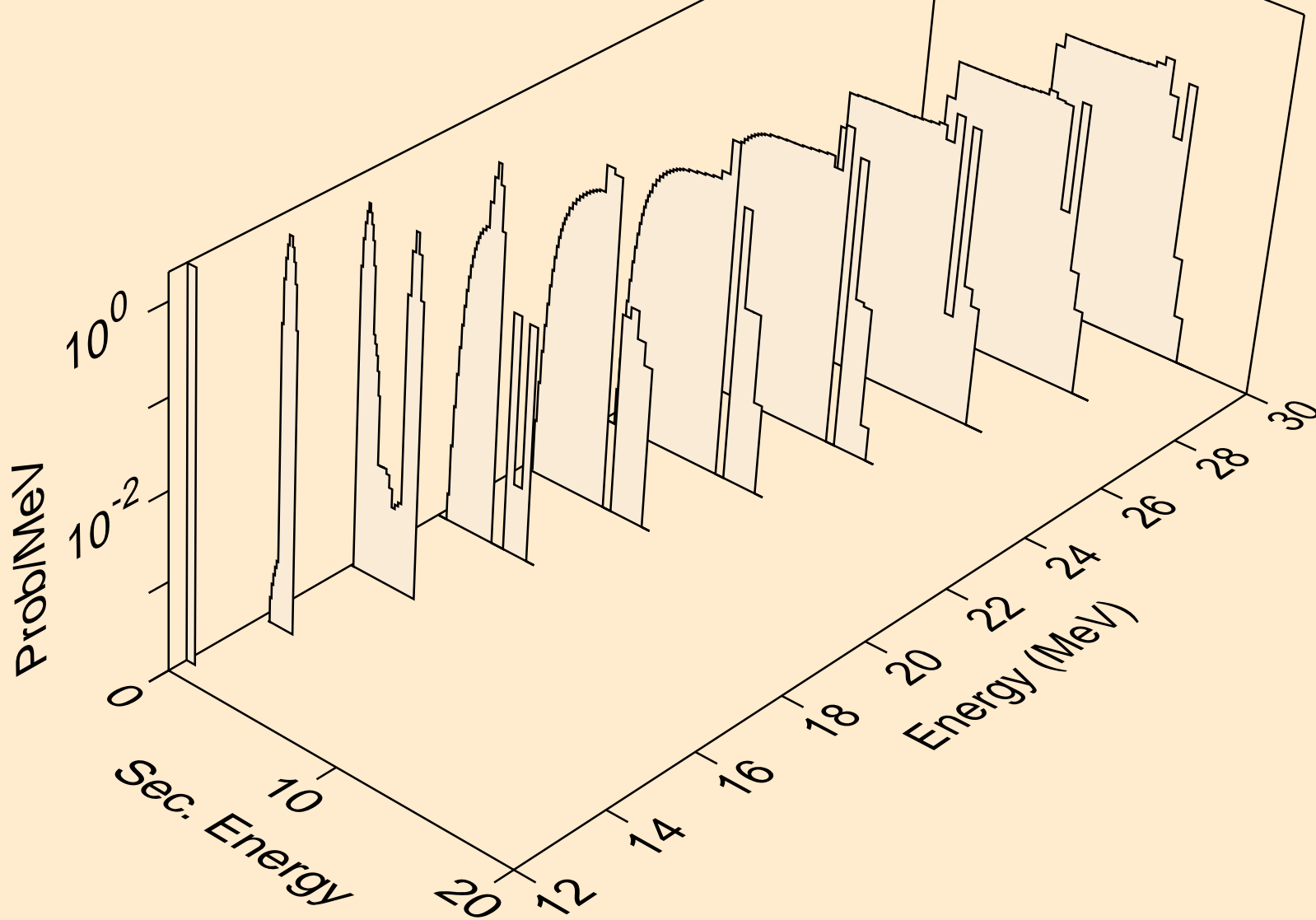

MG026 NEUTRON ACER TENDL-2019 LIBRARY; T=293.16K
deuterons from (n,pd)

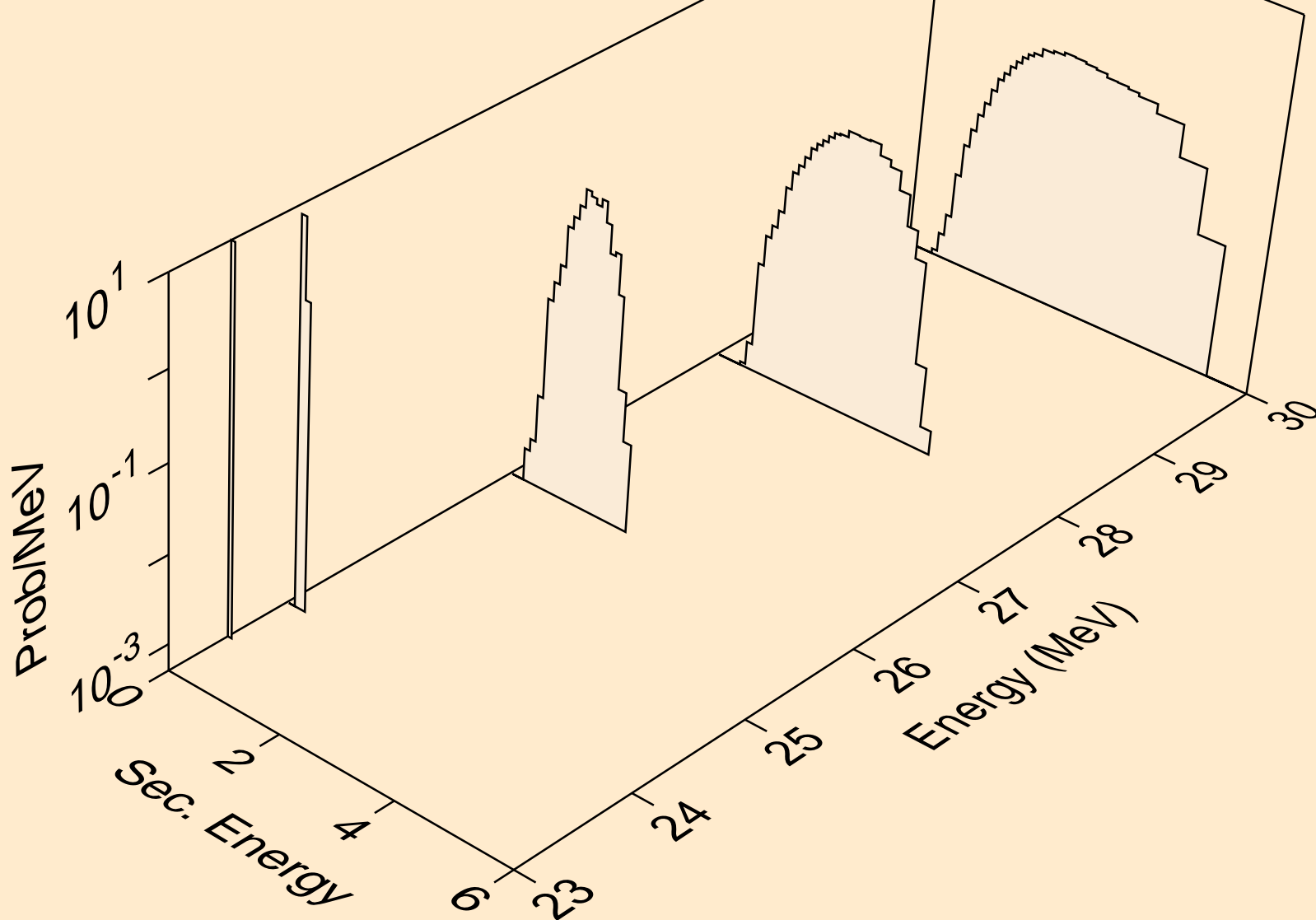

MG026 NEUTRON ACER TENDL-2019 LIBRARY; T=293.16K
deuterons from (n,da)

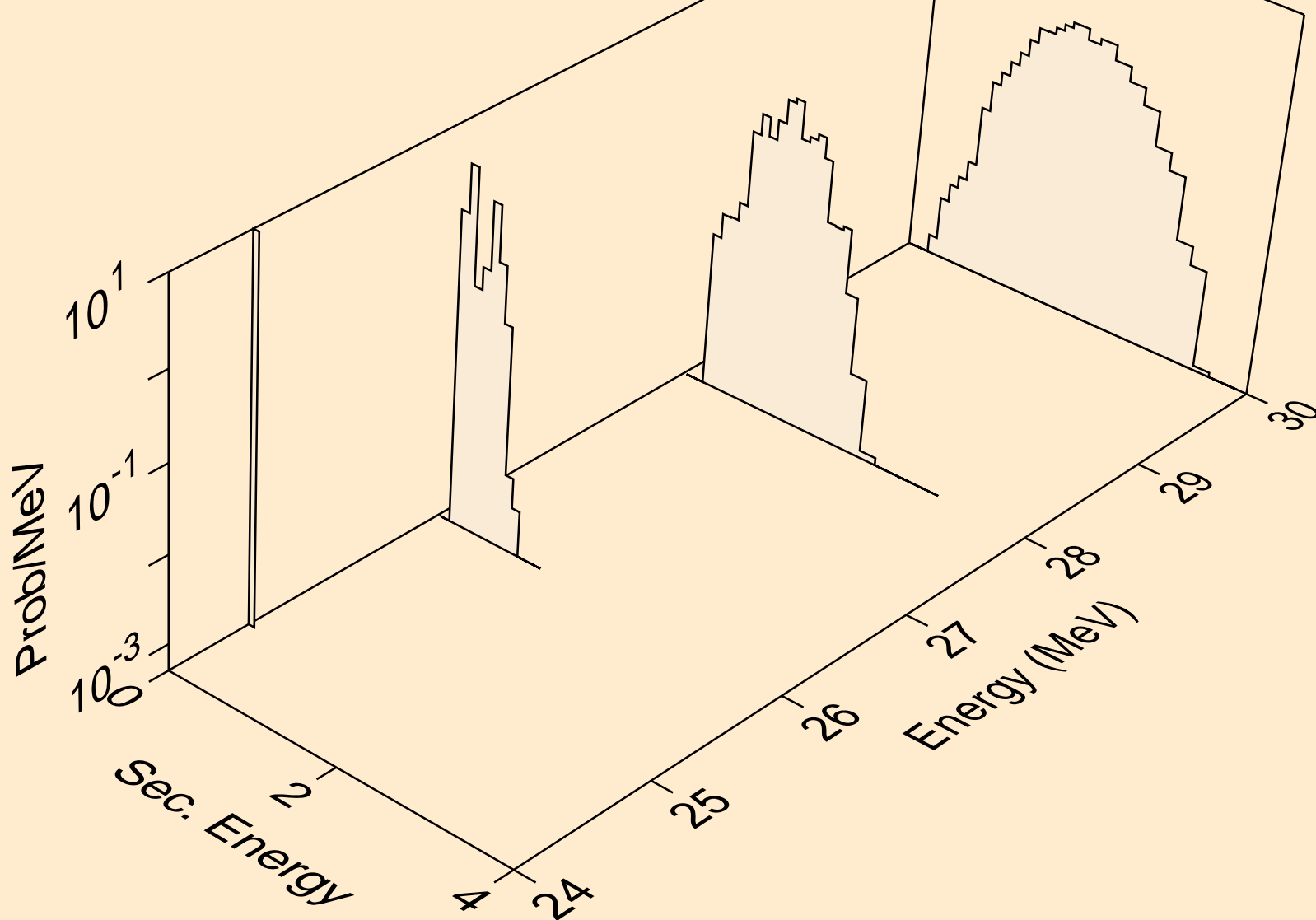

MG026 NEUTRON ACER TENDL-2019 LIBRARY; T=293.16K
tritons from (n,x)

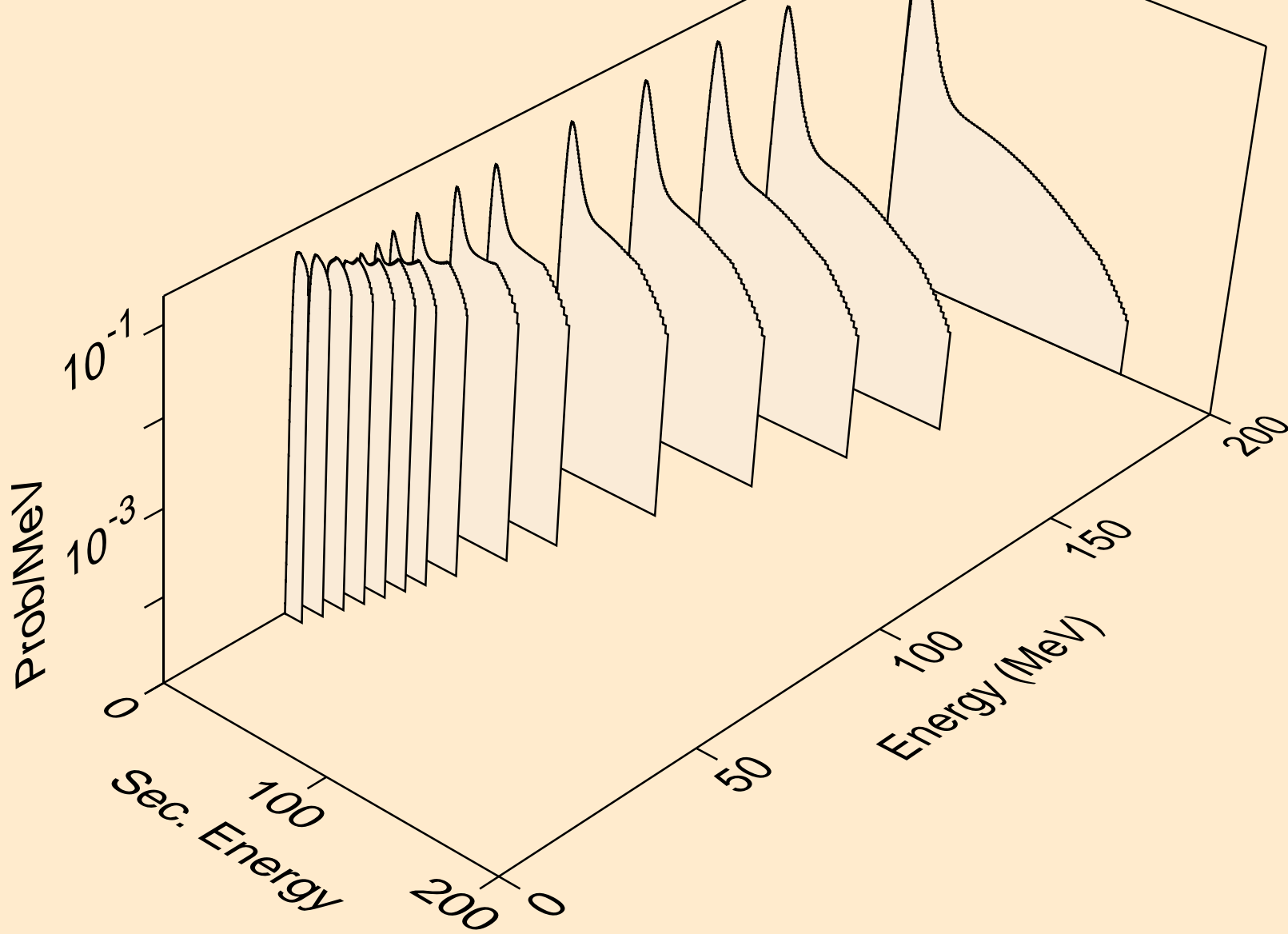

MG026 NEUTRON ACER TENDL-2019 LIBRARY; T=293.16K
tritons from (n,n*)t

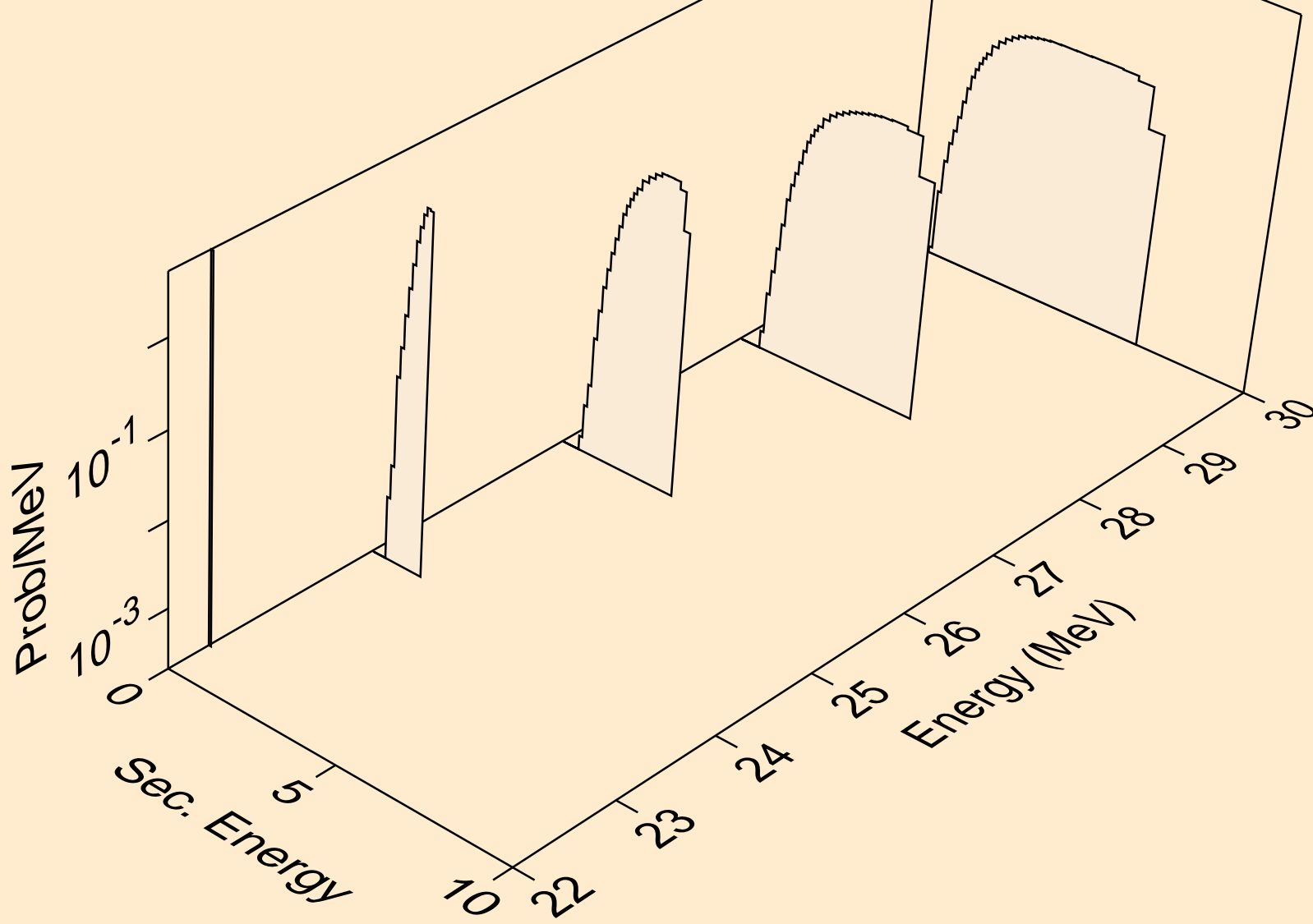

MG026 NEUTRON ACER TENDL-2019 LIBRARY; T=293.16K
tritons from (n,t)

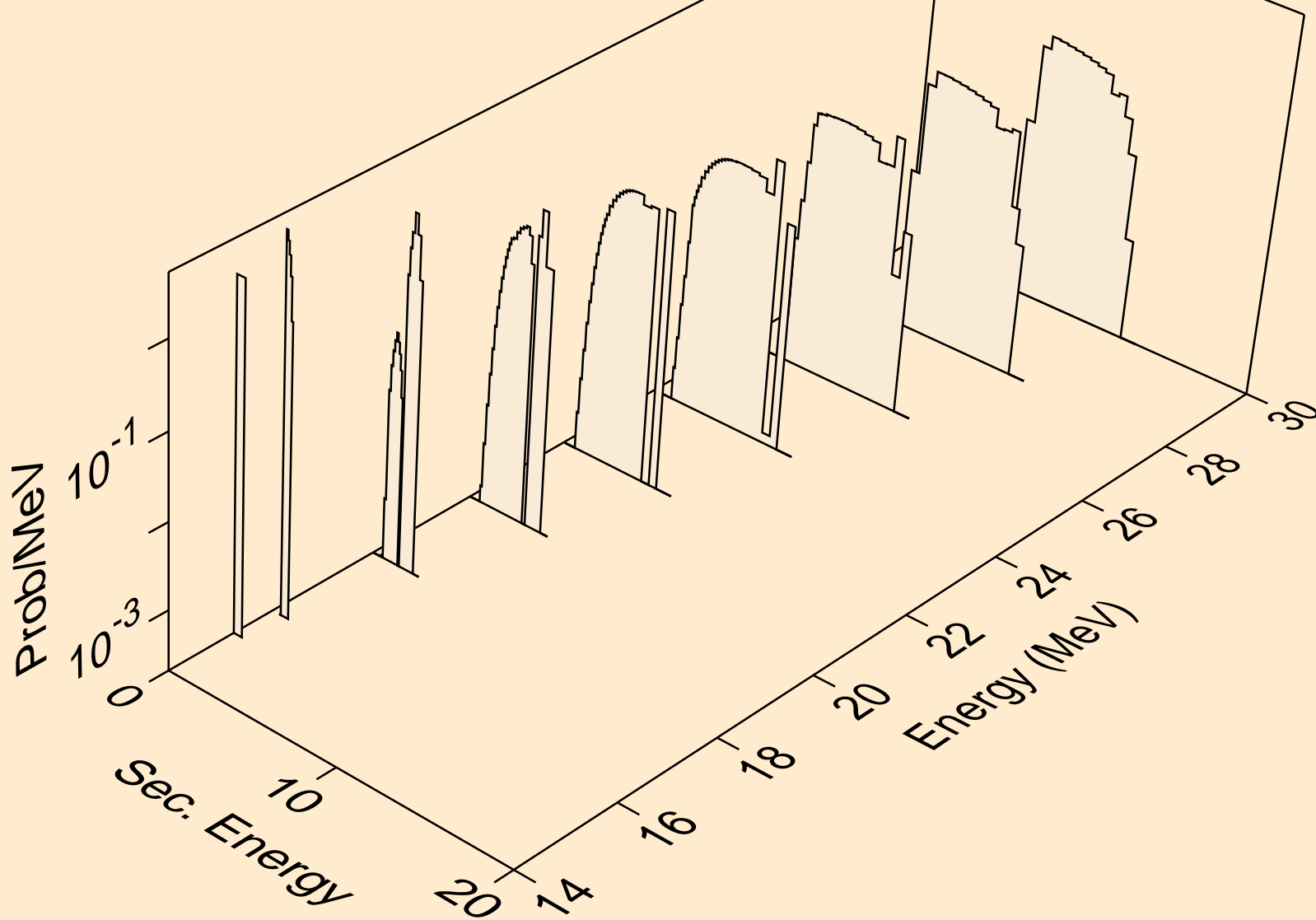

MG026 NEUTRON ACER TENDL-2019 LIBRARY; T=293.16K
tritons from (n,pt)

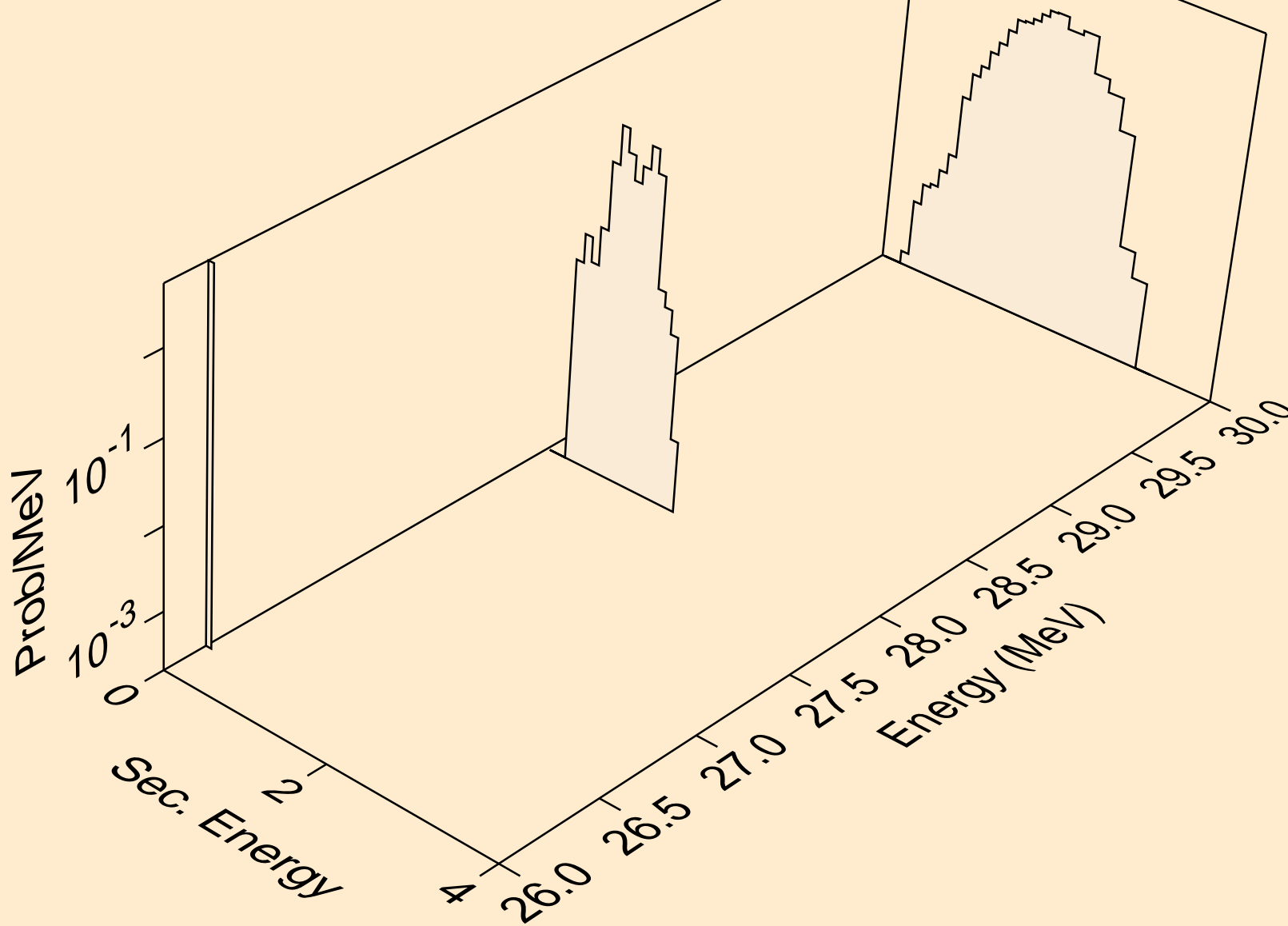

MG026 NEUTRON ACER TENDL-2019 LIBRARY; T=293.16K
he3s from (n,x)

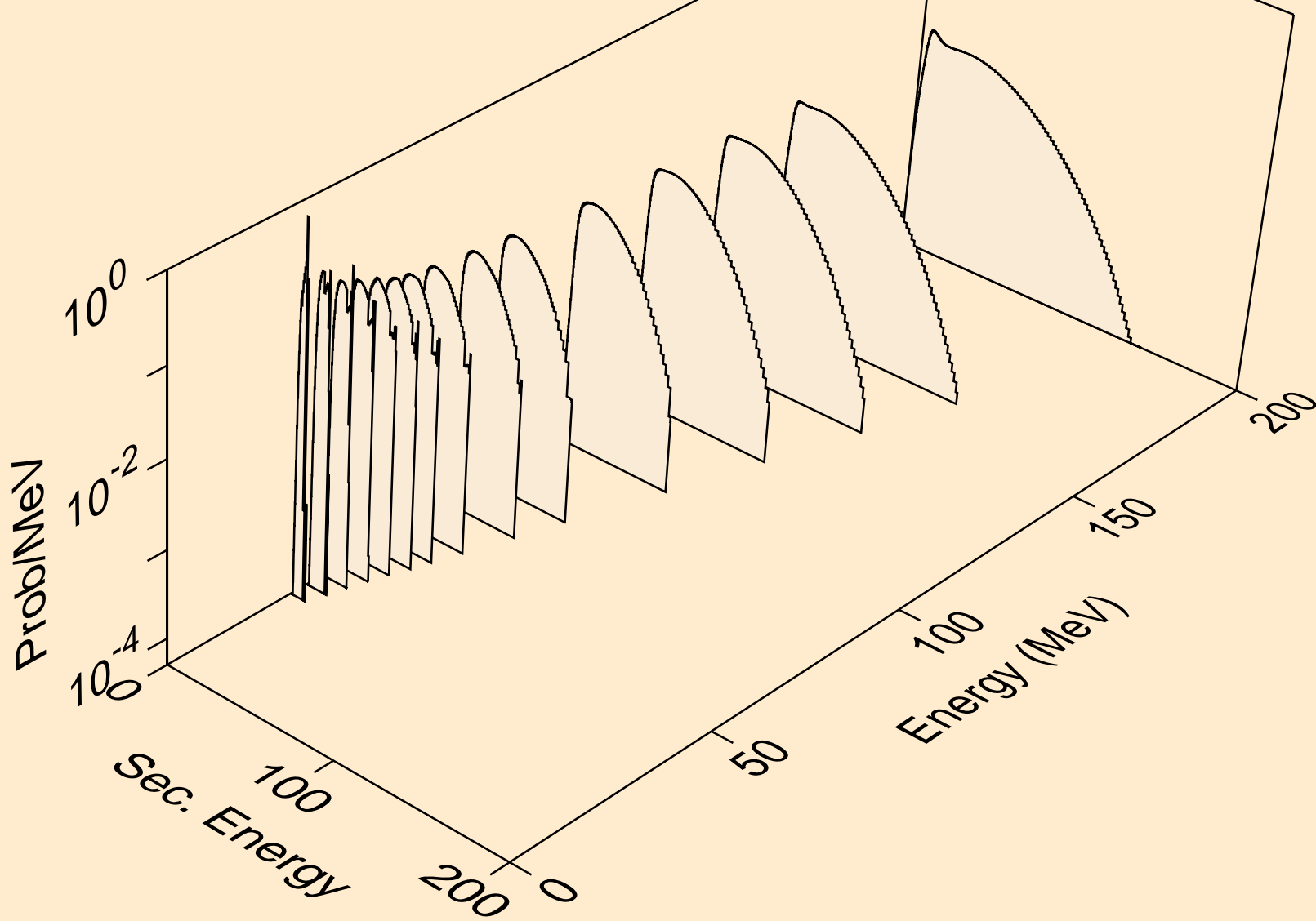

MG026 NEUTRON ACER TENDL-2019 LIBRARY; T=293.16K
he3s from (n,n*)he3

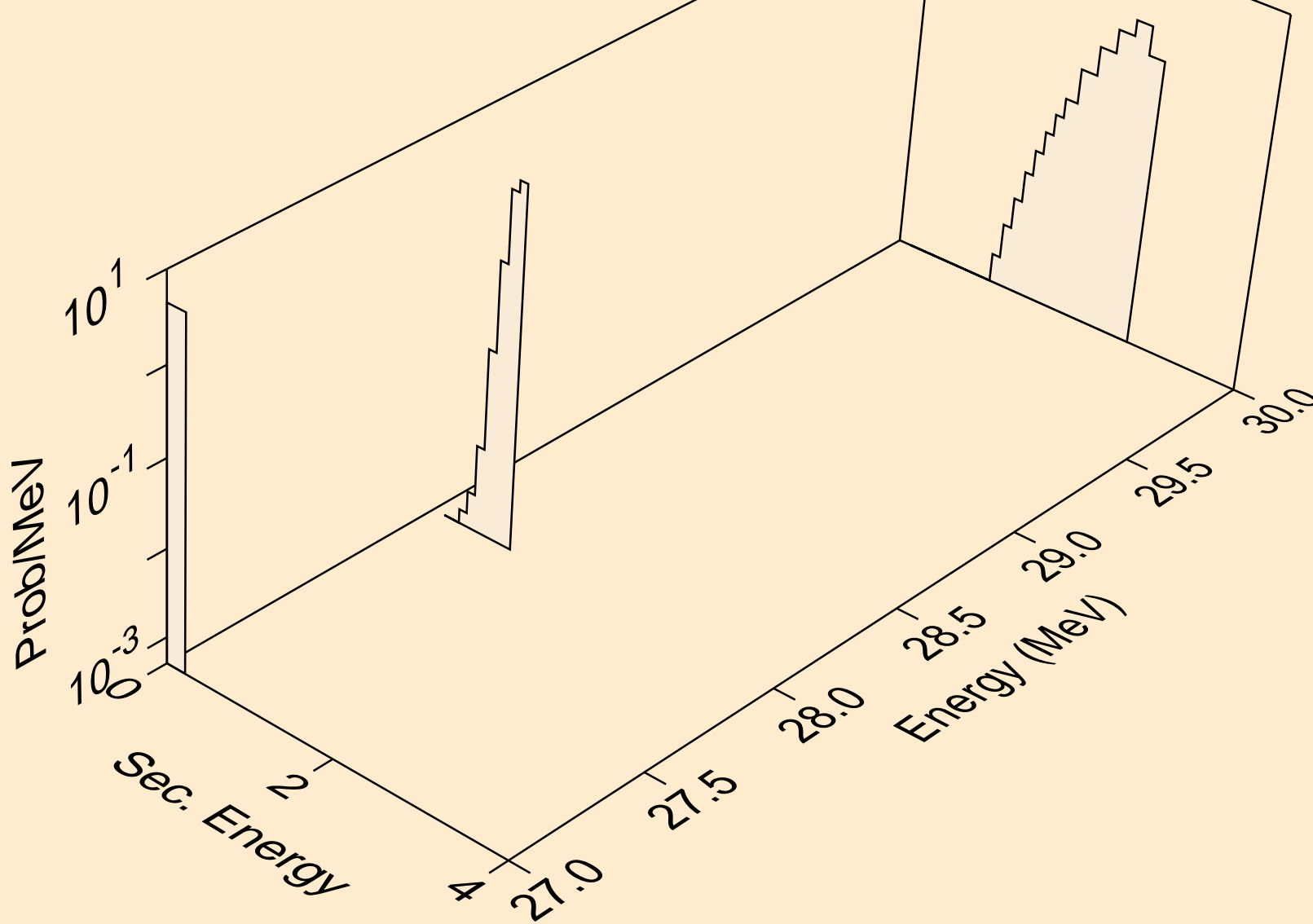

MG026 NEUTRON ACER TENDL-2019 LIBRARY; T=293.16K
he3s from (n,he3)

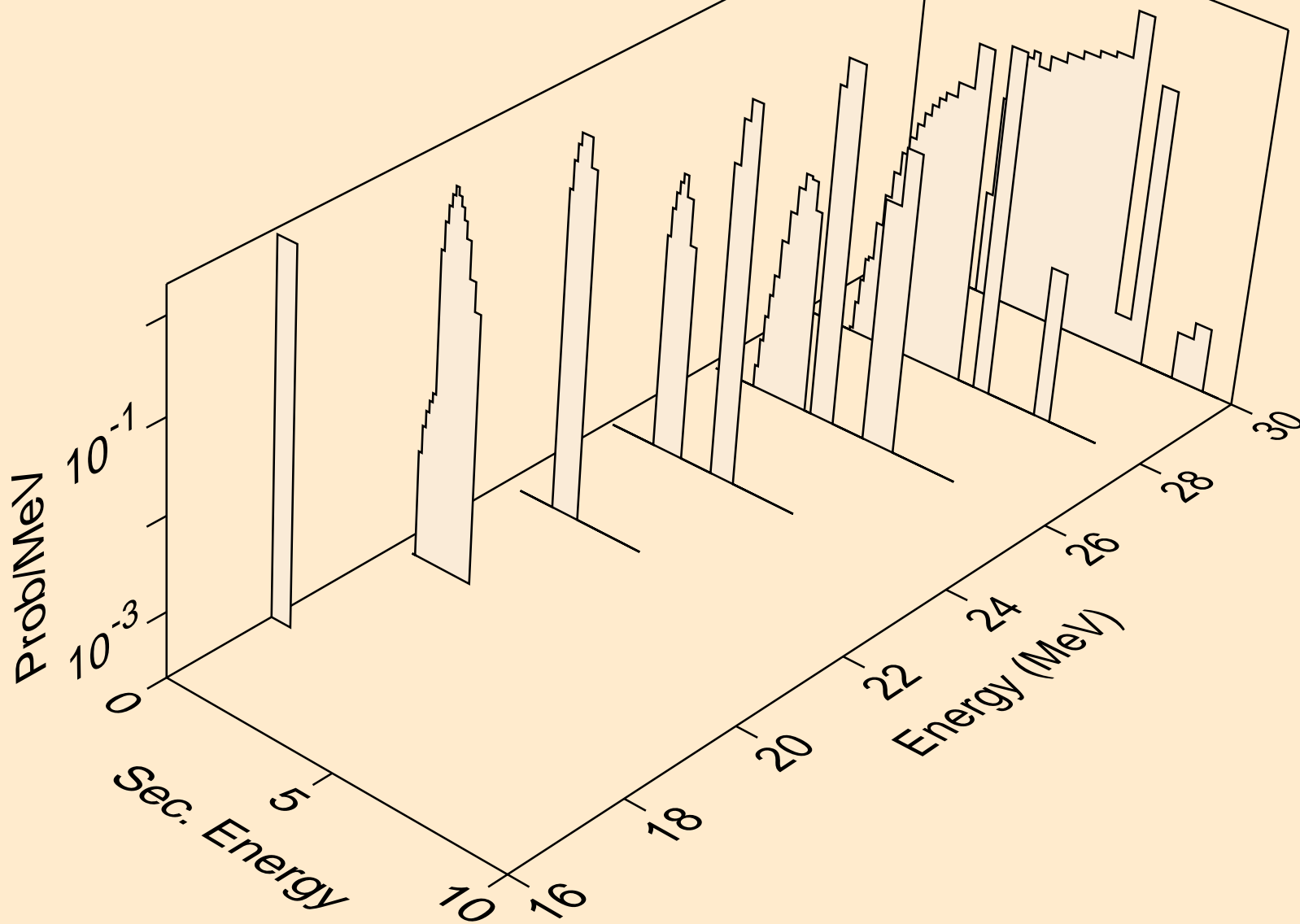

MG026 NEUTRON ACER TENDL-2019 LIBRARY; T=293.16K
alphas from (n,x)

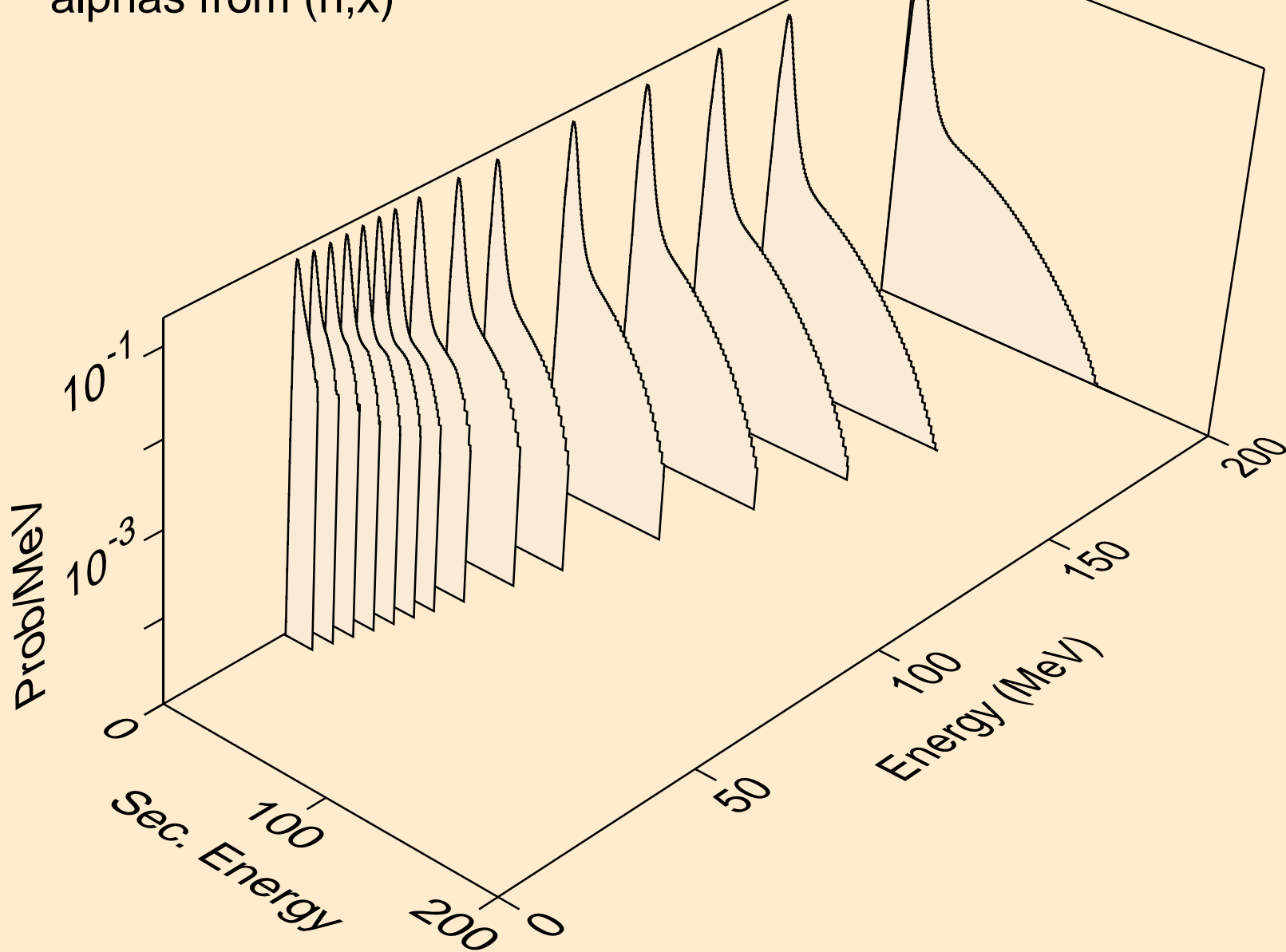

MG026 NEUTRON ACER TENDL-2019 LIBRARY; T=293.16K
alphas from (n,n*)a

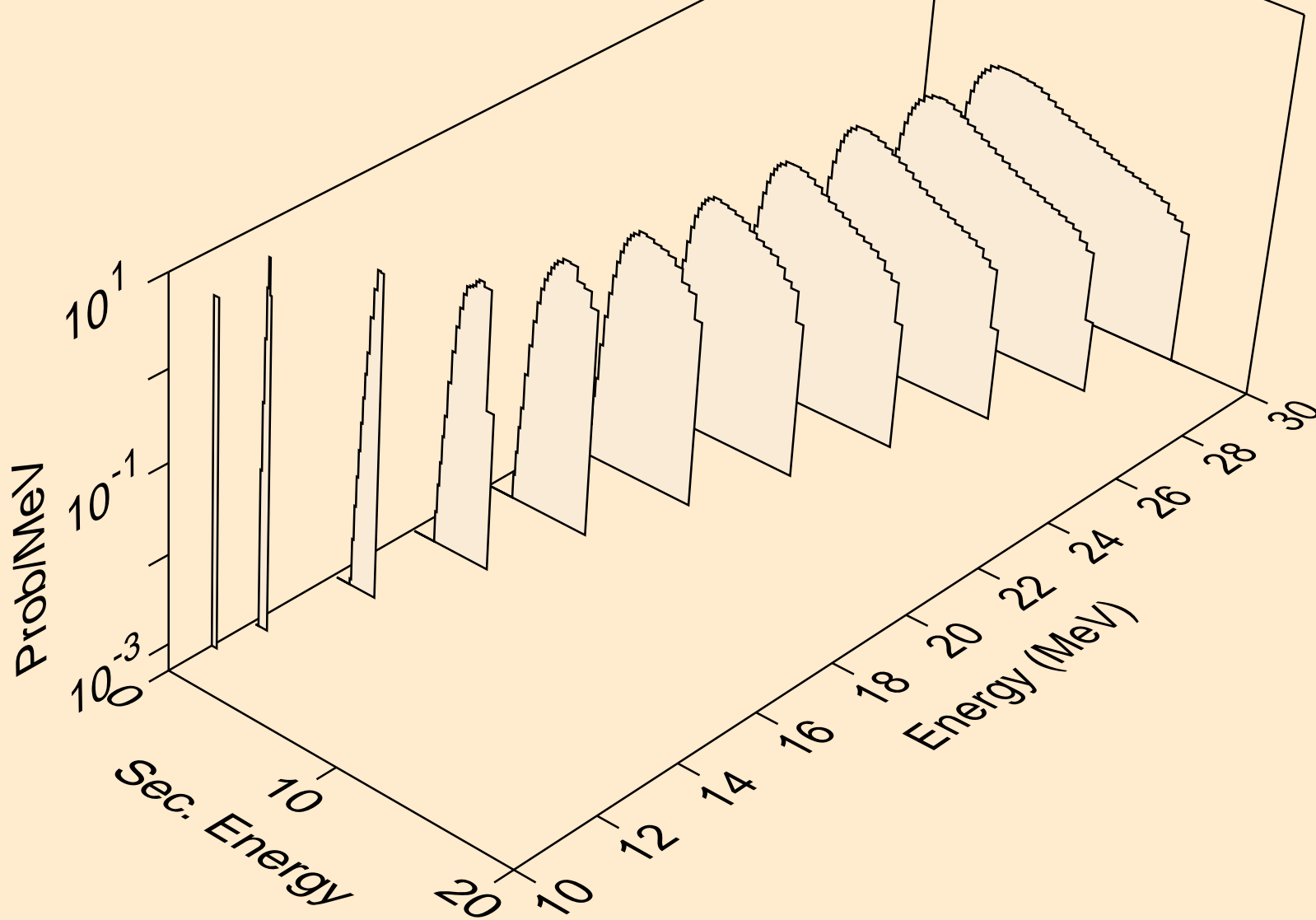

MG026 NEUTRON ACER TENDL-2019 LIBRARY; T=293.16K
alphas from (n,2n)a

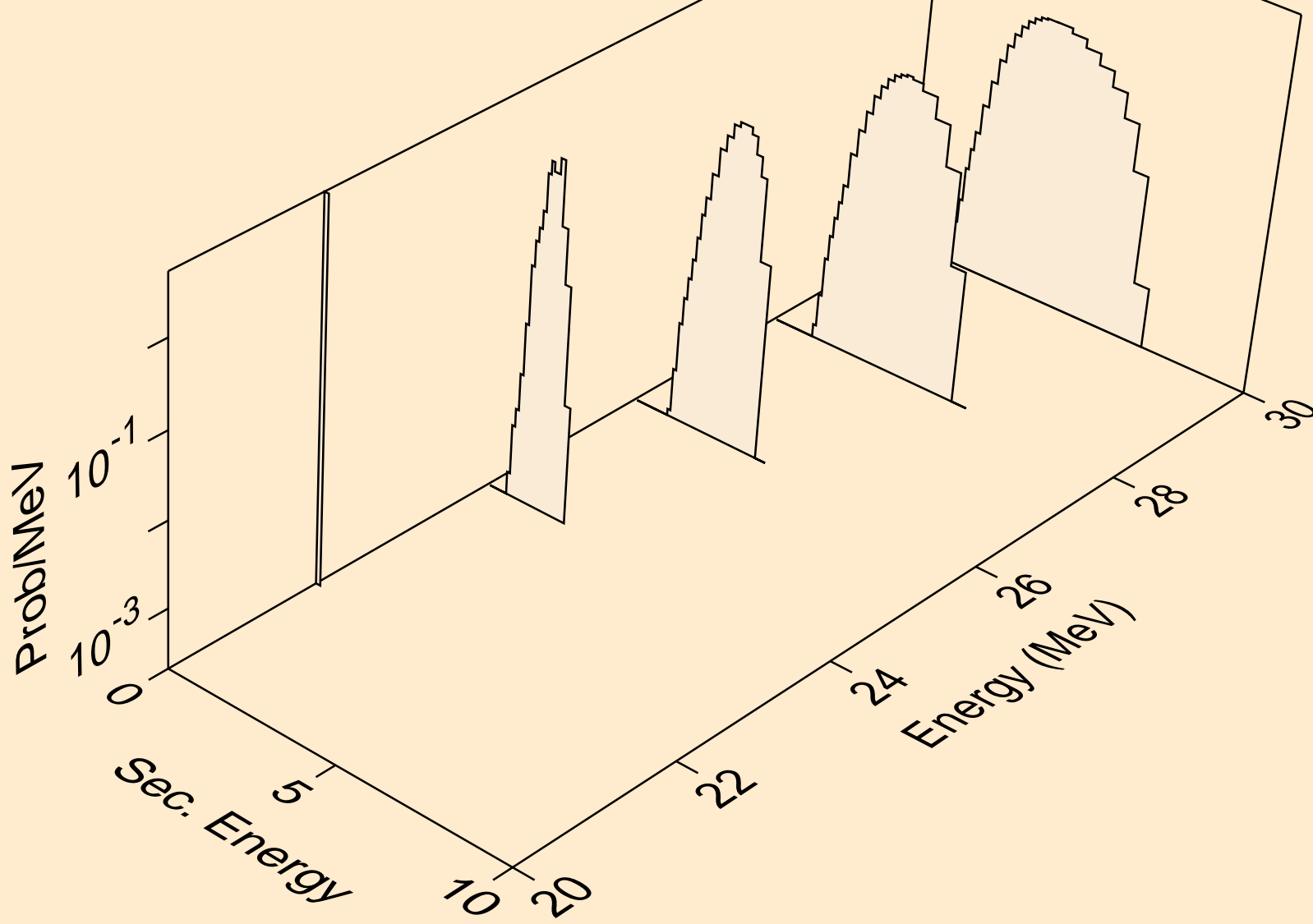

MG026 NEUTRON ACER TENDL-2019 LIBRARY; T=293.16K
alphas from (n,3n)a

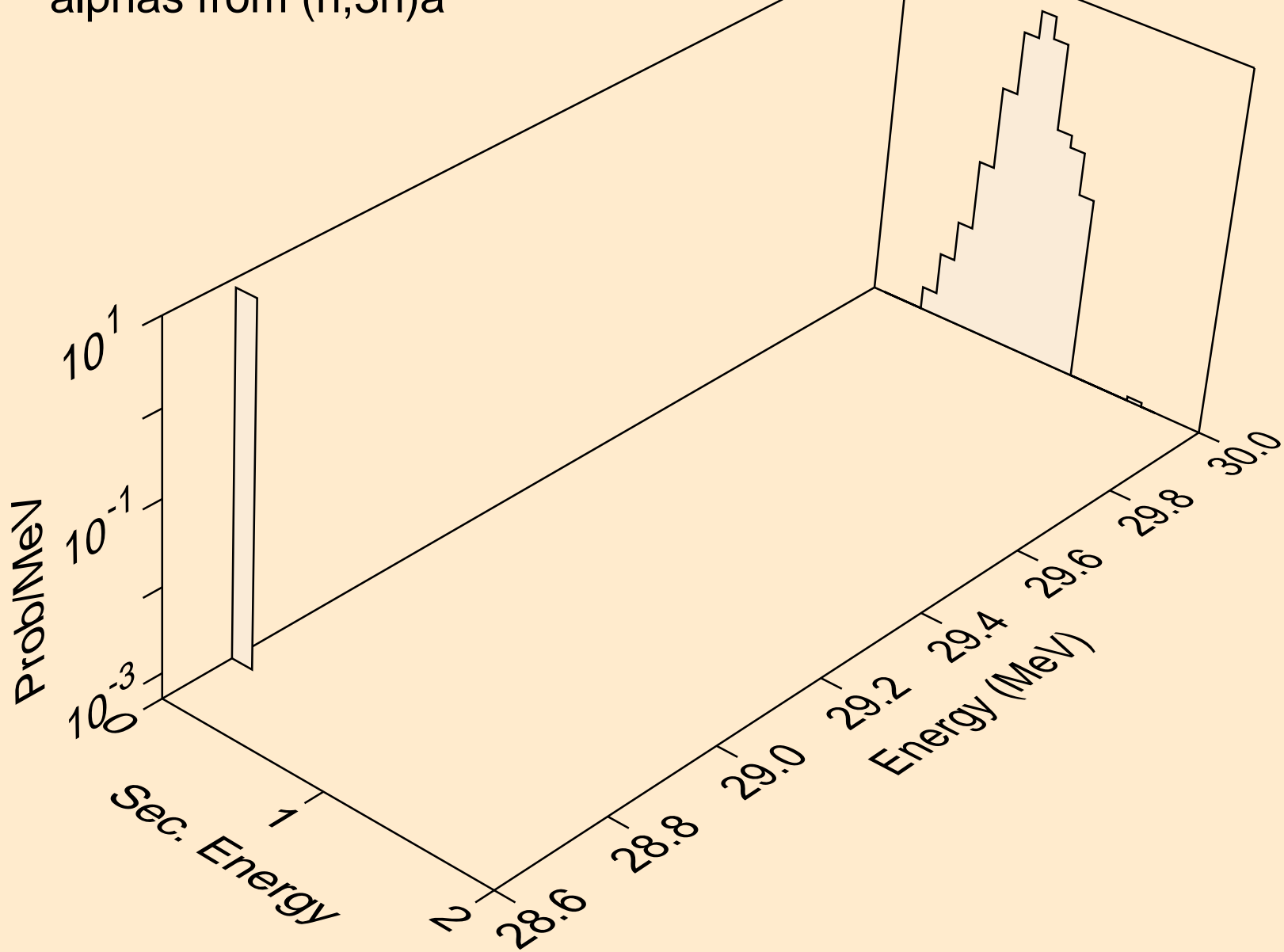

MG026 NEUTRON ACER TENDL-2019 LIBRARY; T=293.16K
alphas from (n,n*)2a

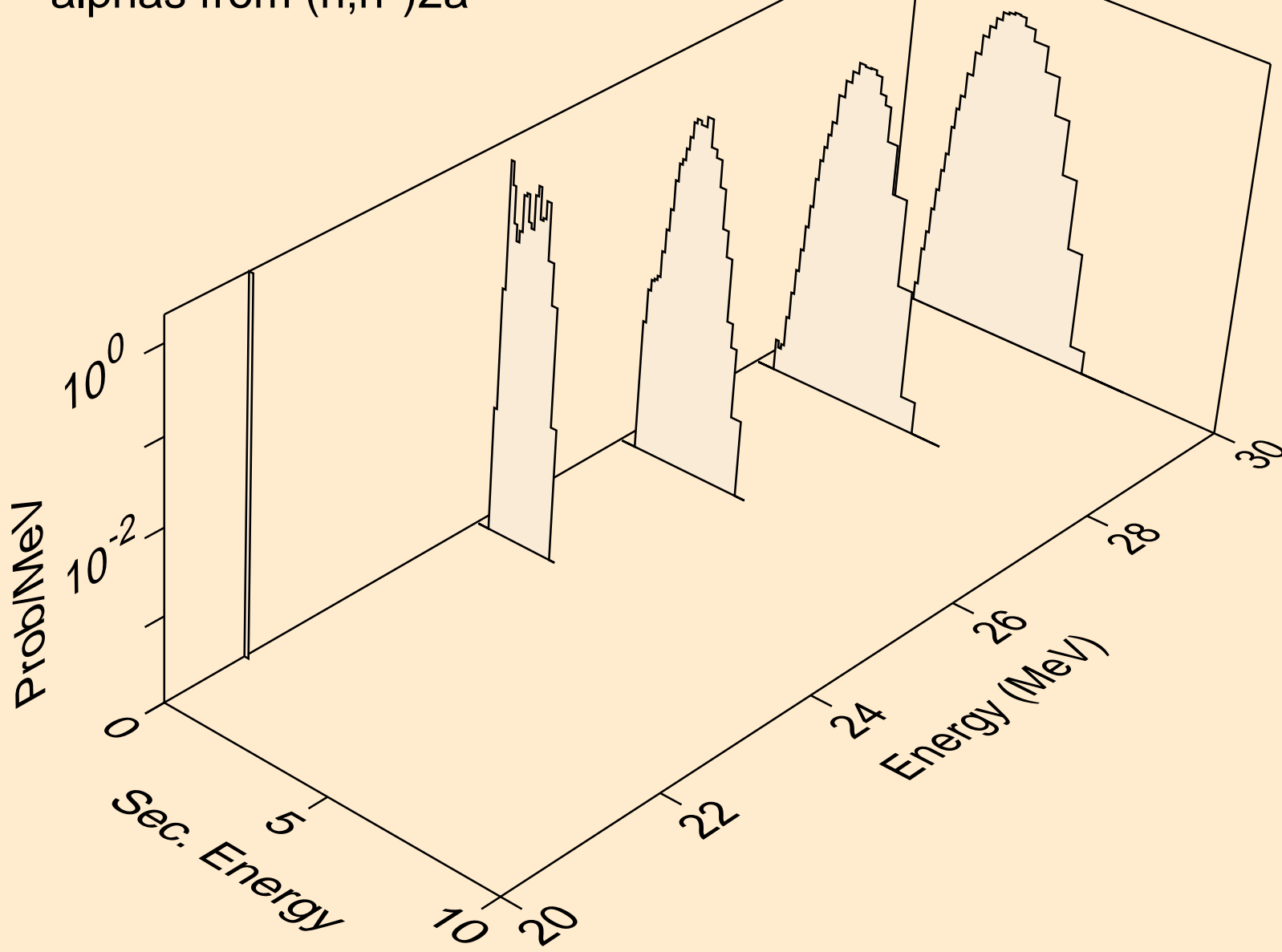

MG026 NEUTRON ACER TENDL-2019 LIBRARY; T=293.16K
alphas from (n,npa)

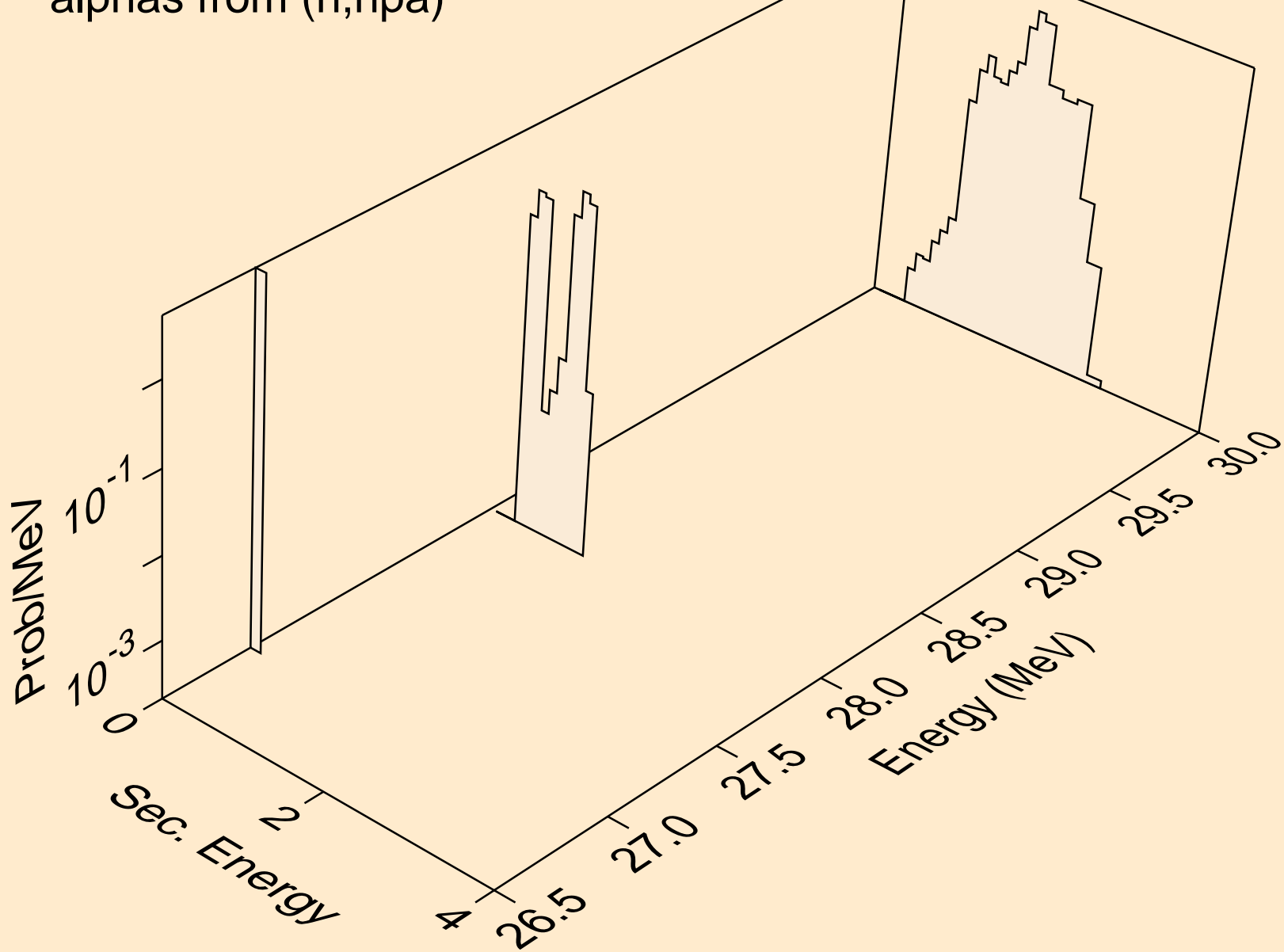

MG026 NEUTRON ACER TENDL-2019 LIBRARY; T=293.16K
alphas from (n,a)

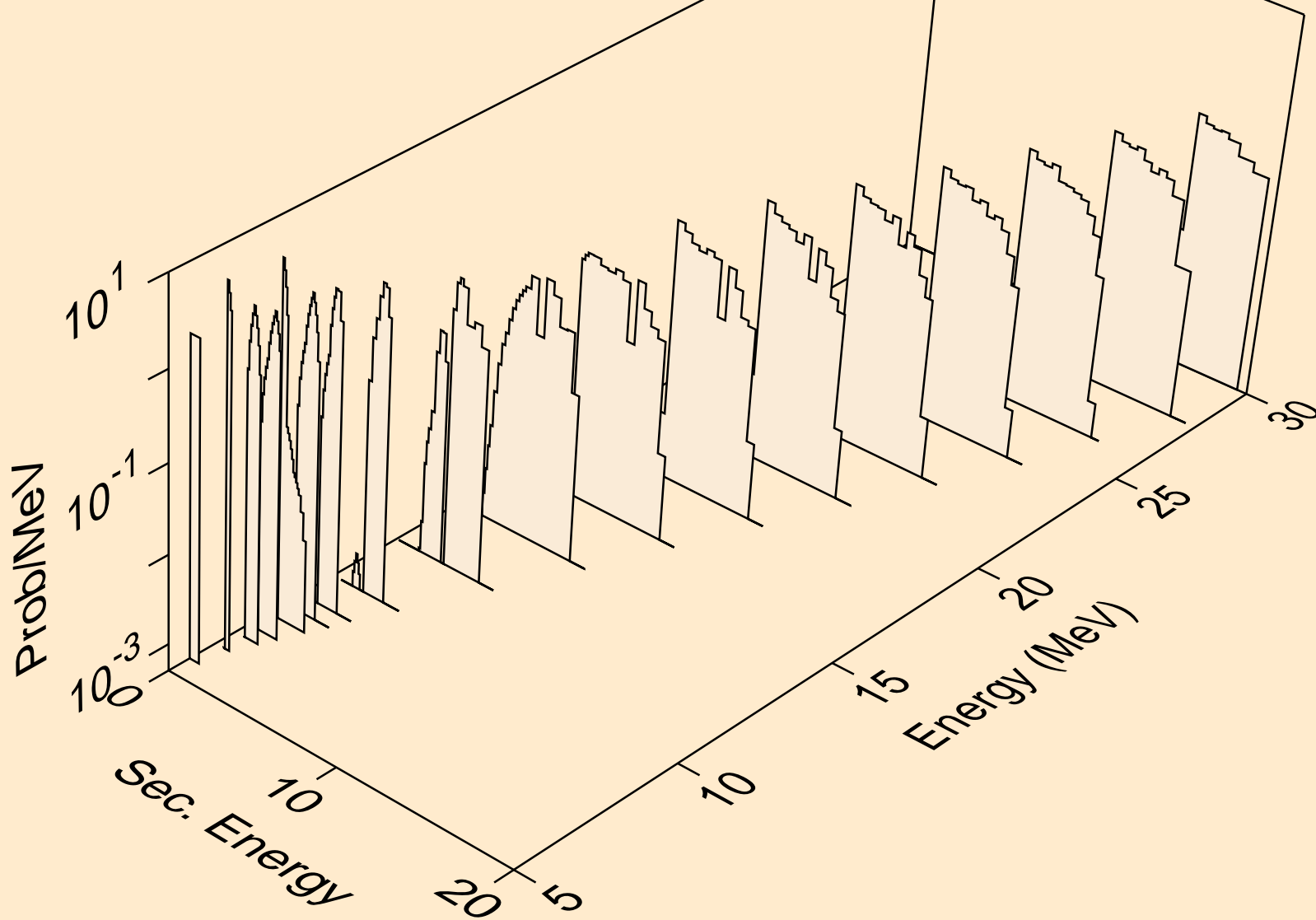

MG026 NEUTRON ACER TENDL-2019 LIBRARY; T=293.16K
alphas from (n,2a)

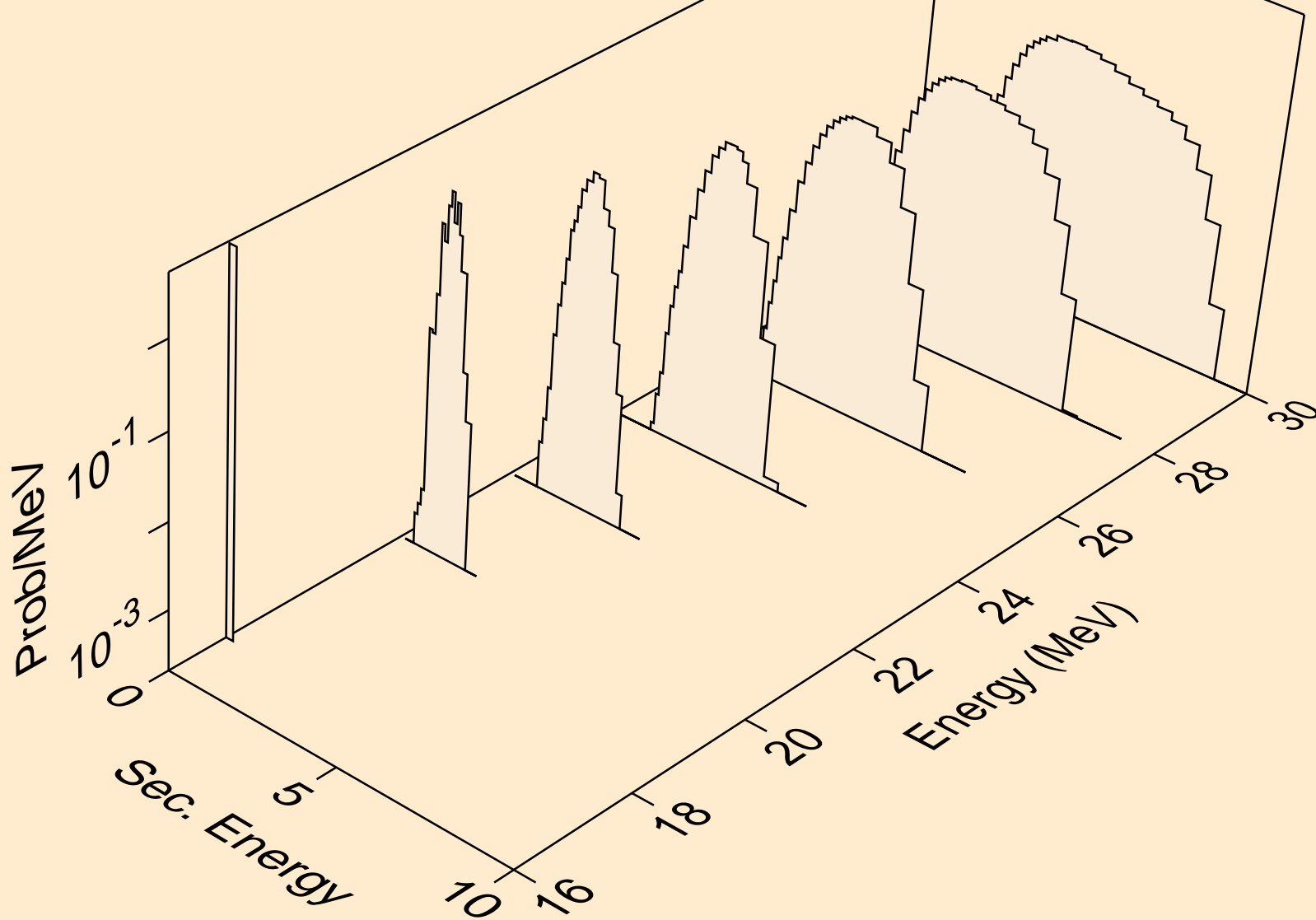

MG026 NEUTRON ACER TENDL-2019 LIBRARY; T=293.16K
alphas from (n,pa)

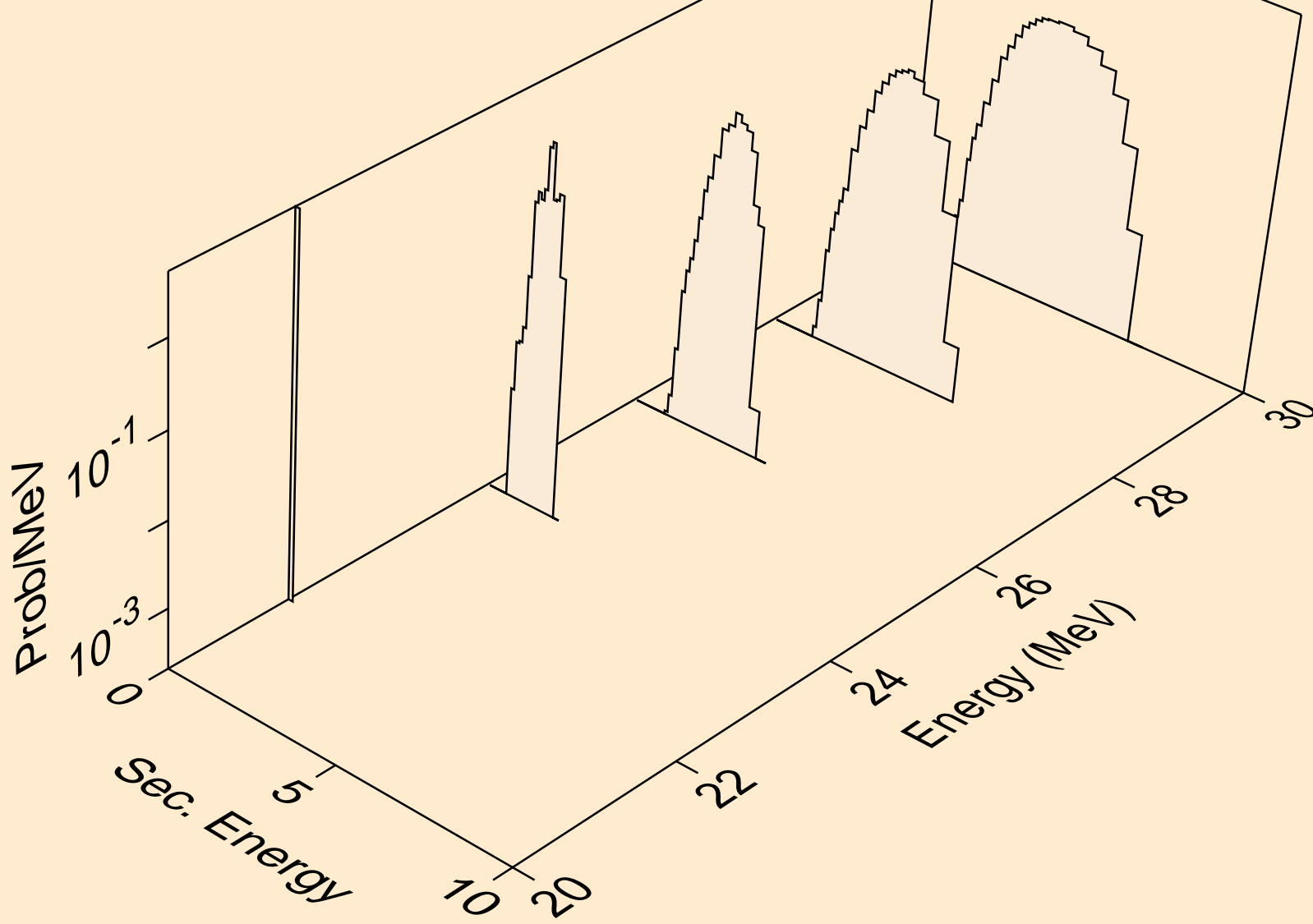

MG026 NEUTRON ACER TENDL-2019 LIBRARY; T=293.16K
alphas from (n,da)

