

MG028 NEUTRON ACER TENDL-2019 LIBRARY; T=293.16K

Principal cross sections

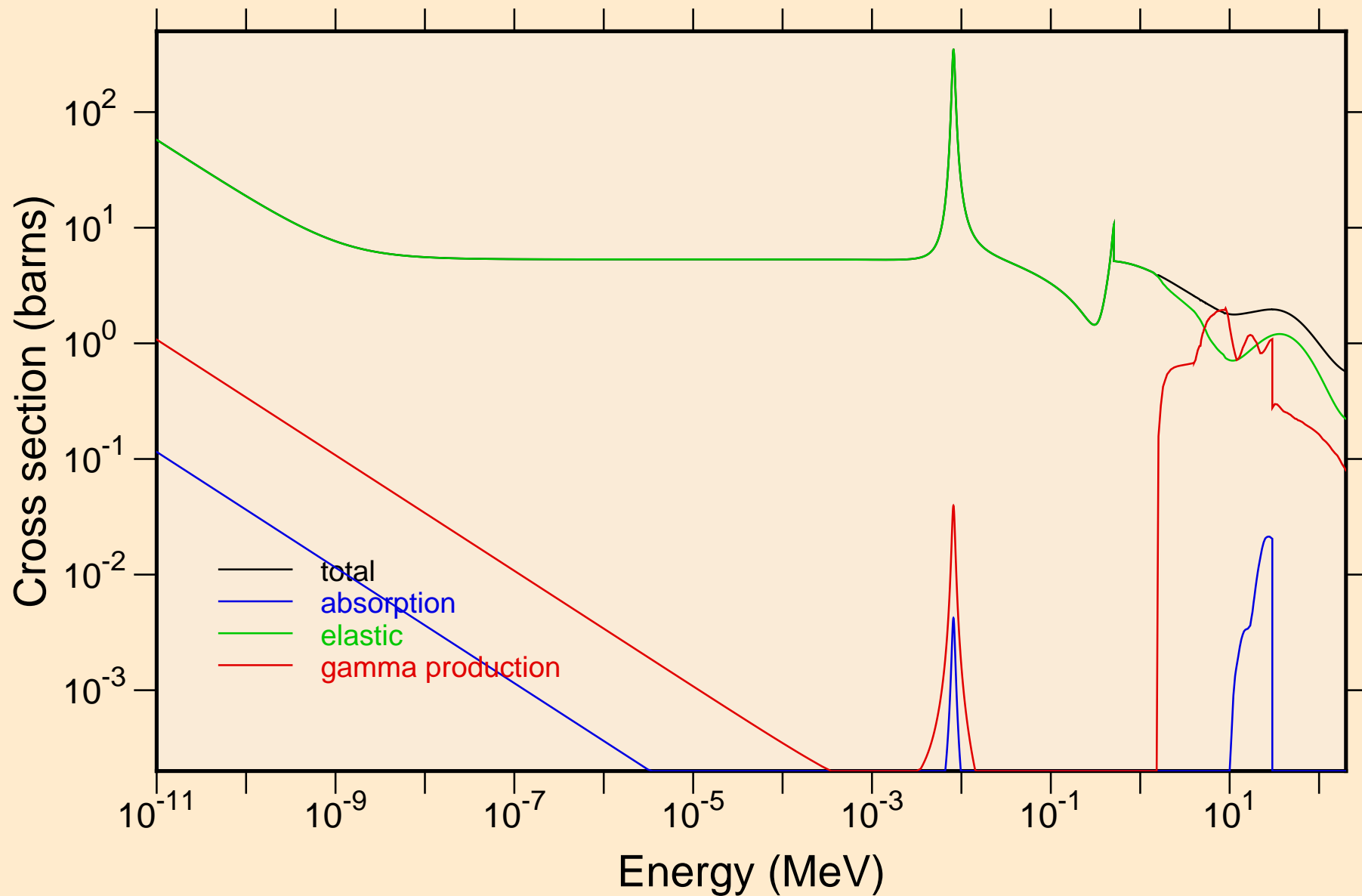

MG028 NEUTRON ACER TENDL-2019 LIBRARY; T=293.16K
Heating

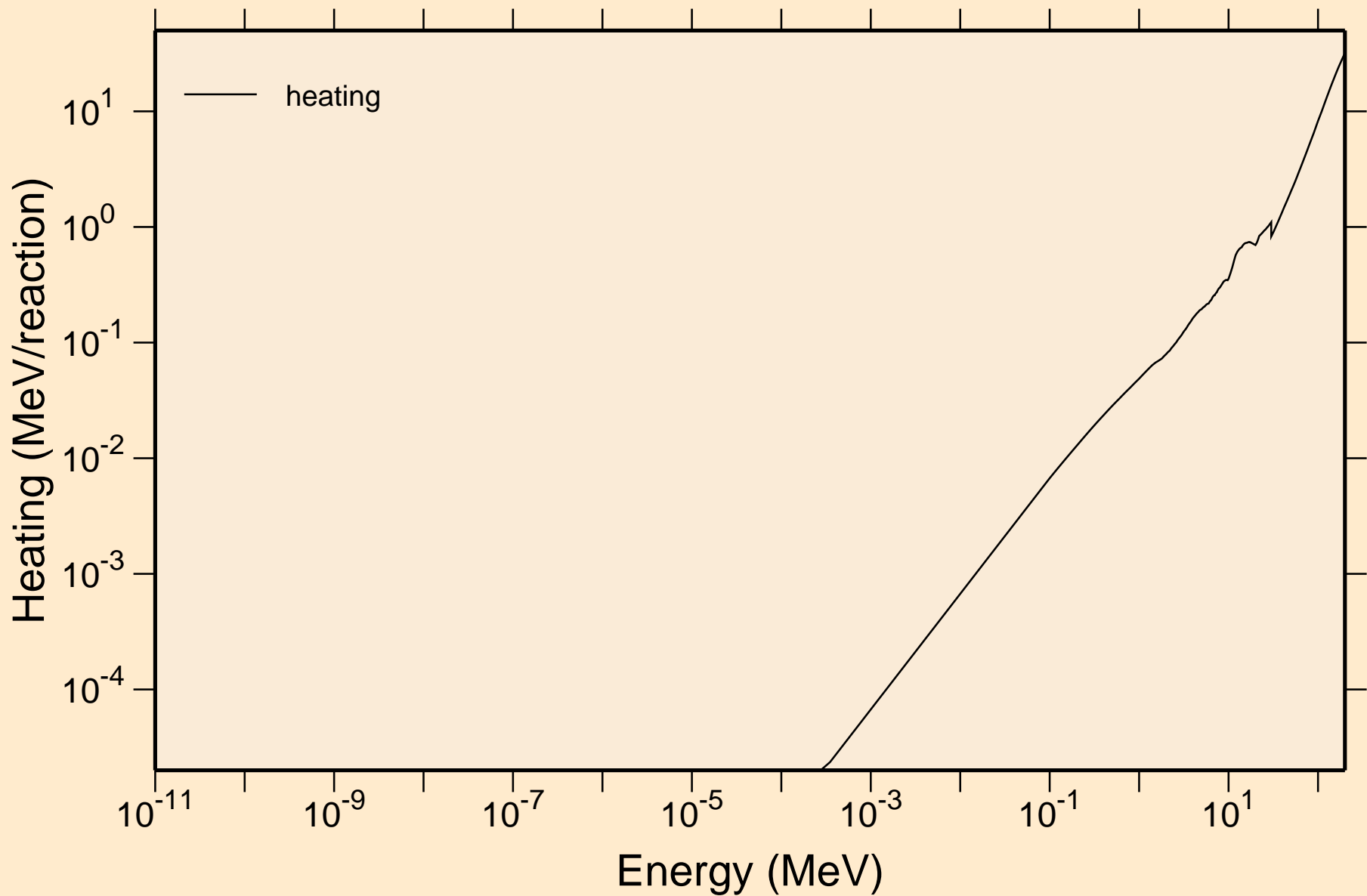

MG028 NEUTRON ACER TENDL-2019 LIBRARY; T=293.16K
Damage

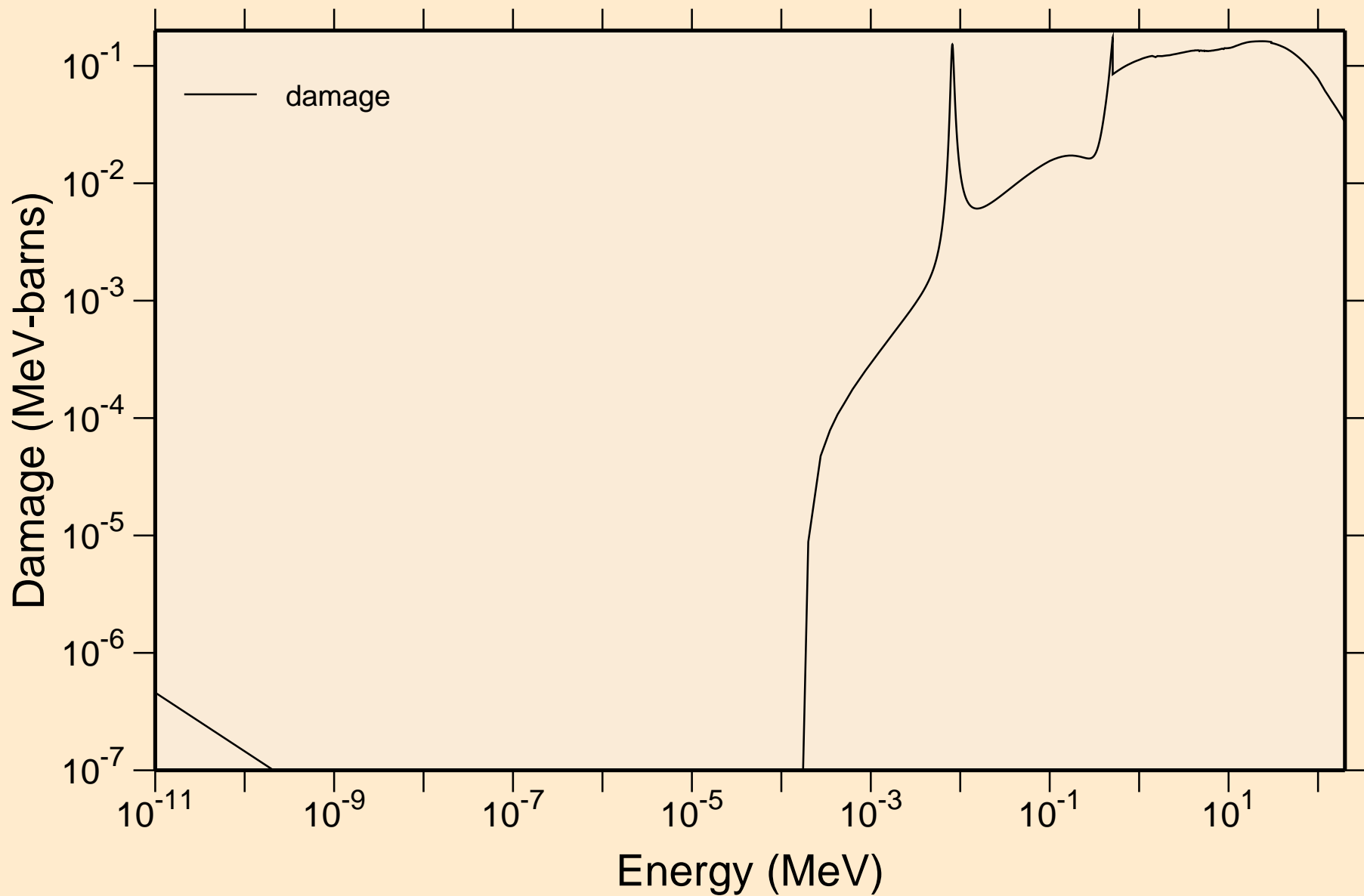

MG028 NEUTRON ACER TENDL-2019 LIBRARY; T=293.16K
Non-threshold reactions

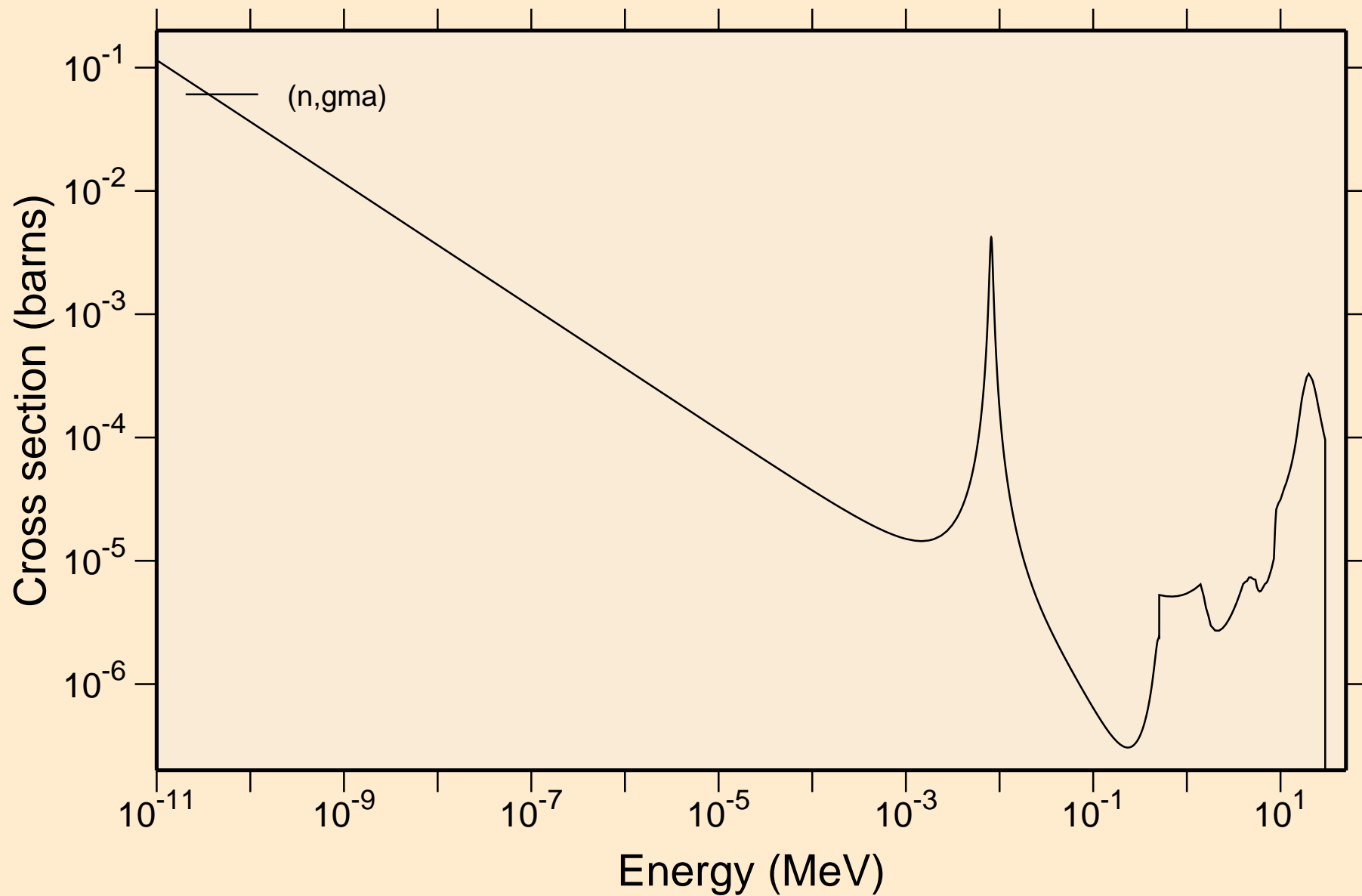

MG028 NEUTRON ACER TENDL-2019 LIBRARY; T=293.16K
Principal cross sections

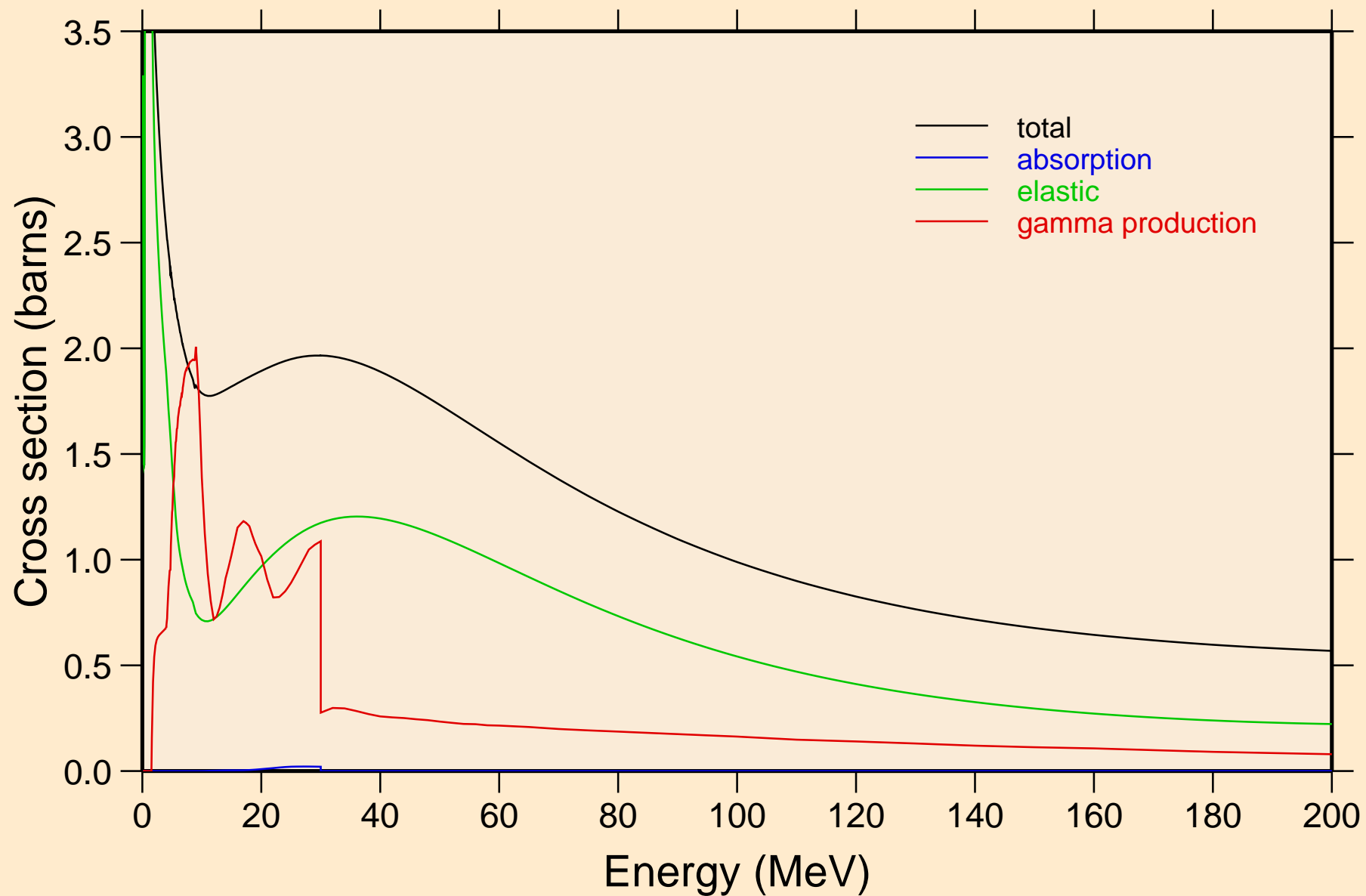

MG028 NEUTRON ACER TENDL-2019 LIBRARY; T=293.16K
Heating

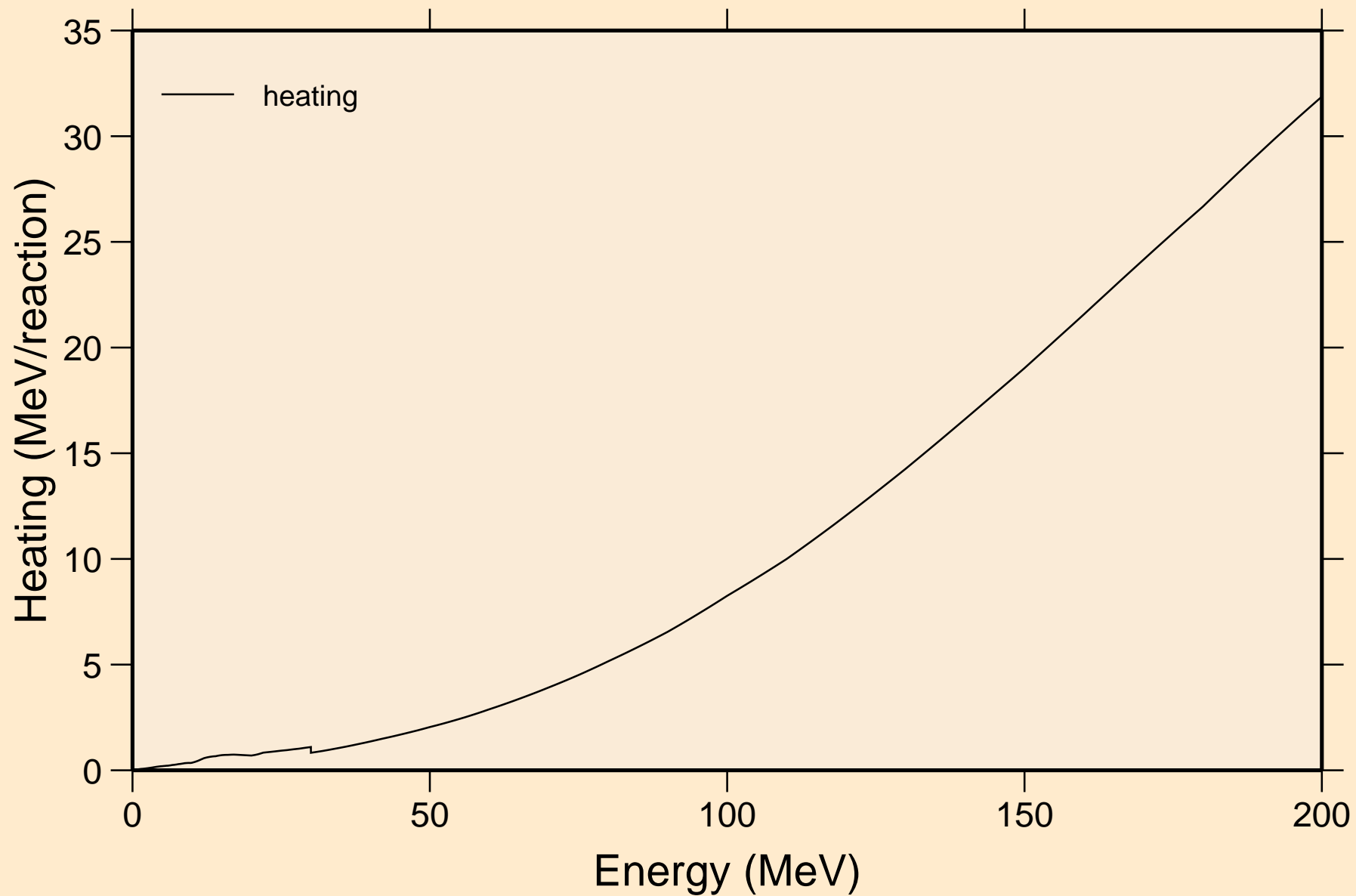

MG028 NEUTRON ACER TENDL-2019 LIBRARY; T=293.16K
Damage

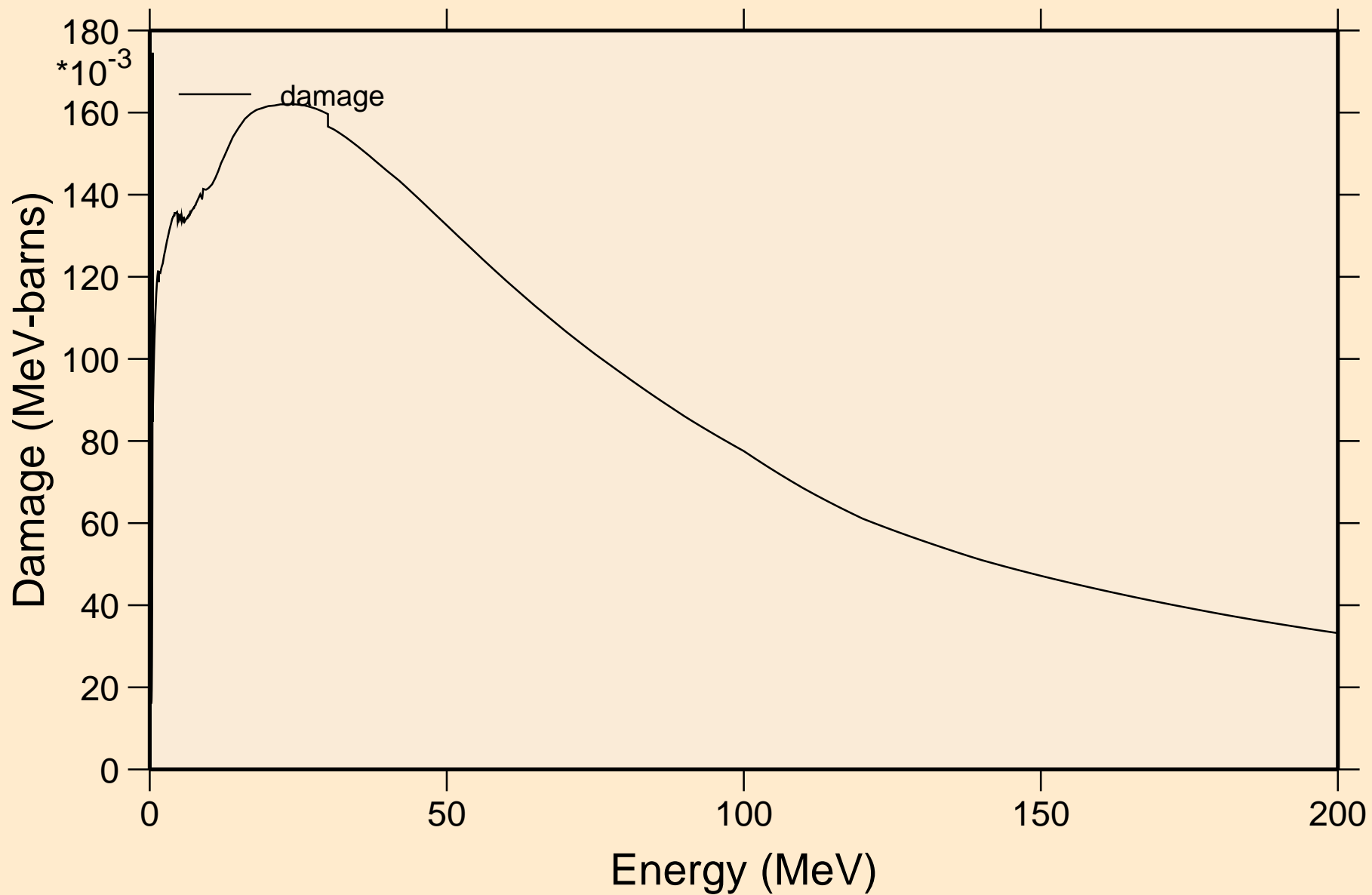

MG028 NEUTRON ACER TENDL-2019 LIBRARY; T=293.16K
Non-threshold reactions

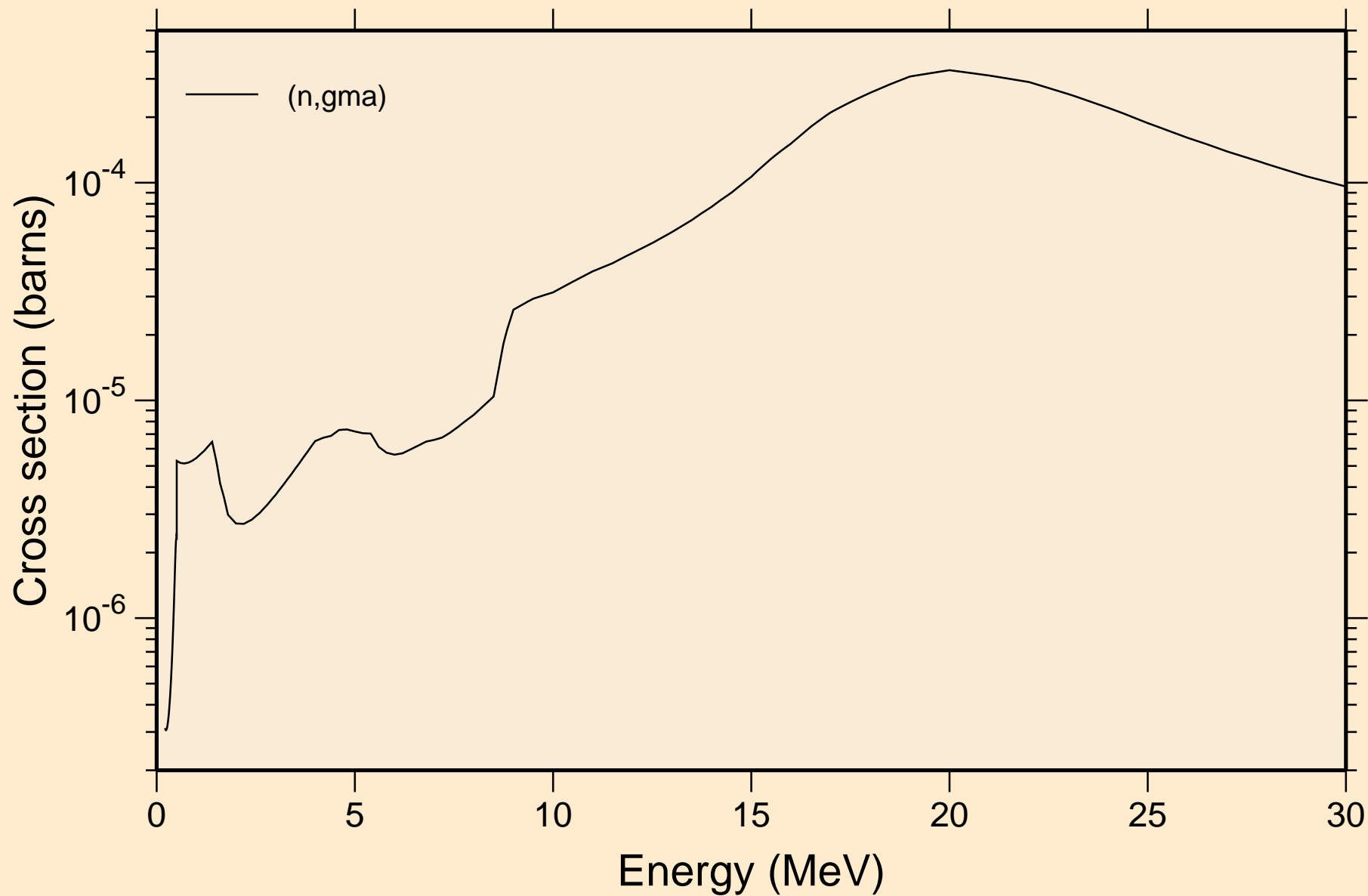

MG028 NEUTRON ACER TENDL-2019 LIBRARY; T=293.16K
Inelastic levels

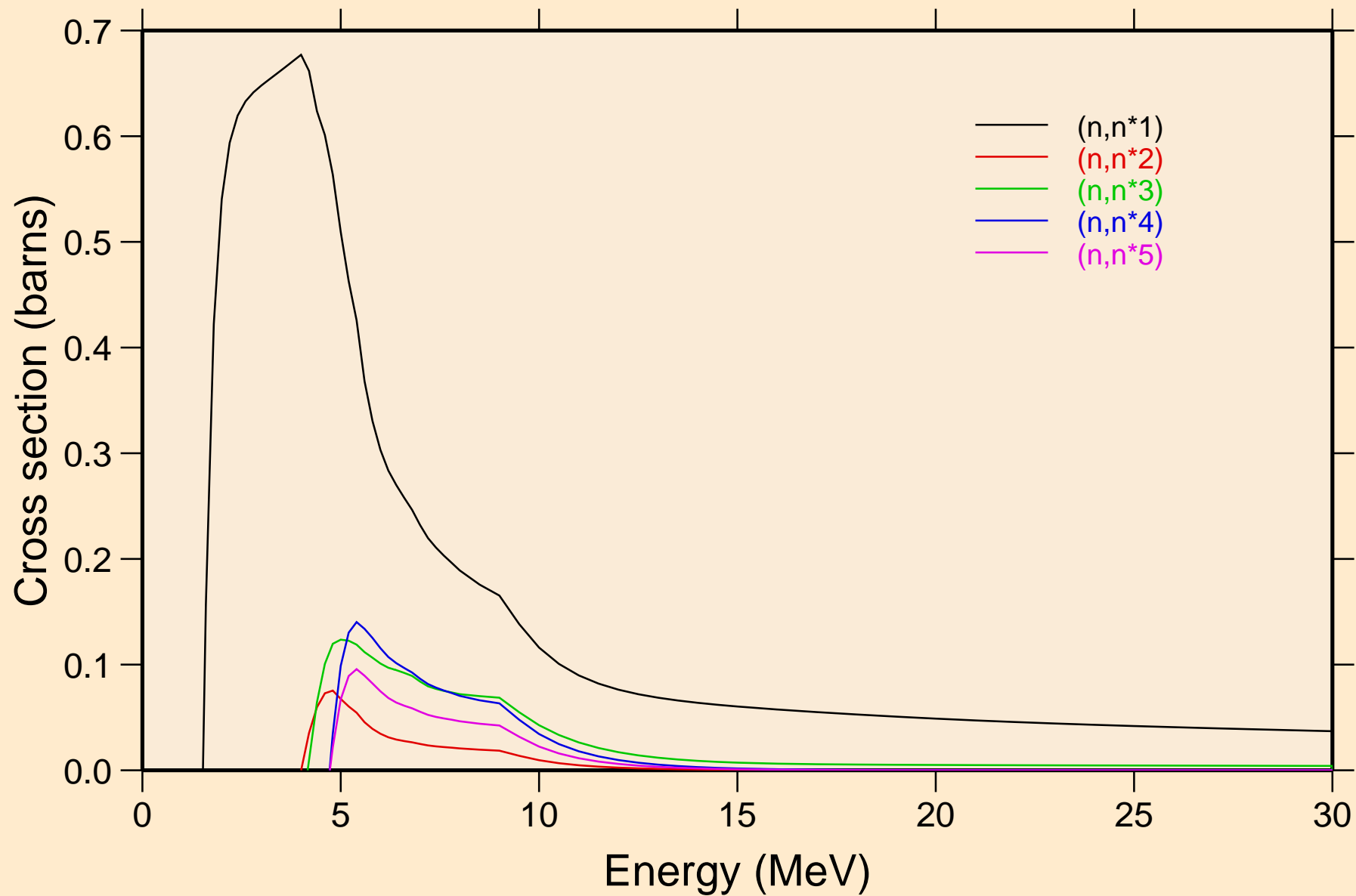

MG028 NEUTRON ACER TENDL-2019 LIBRARY; T=293.16K
Inelastic levels

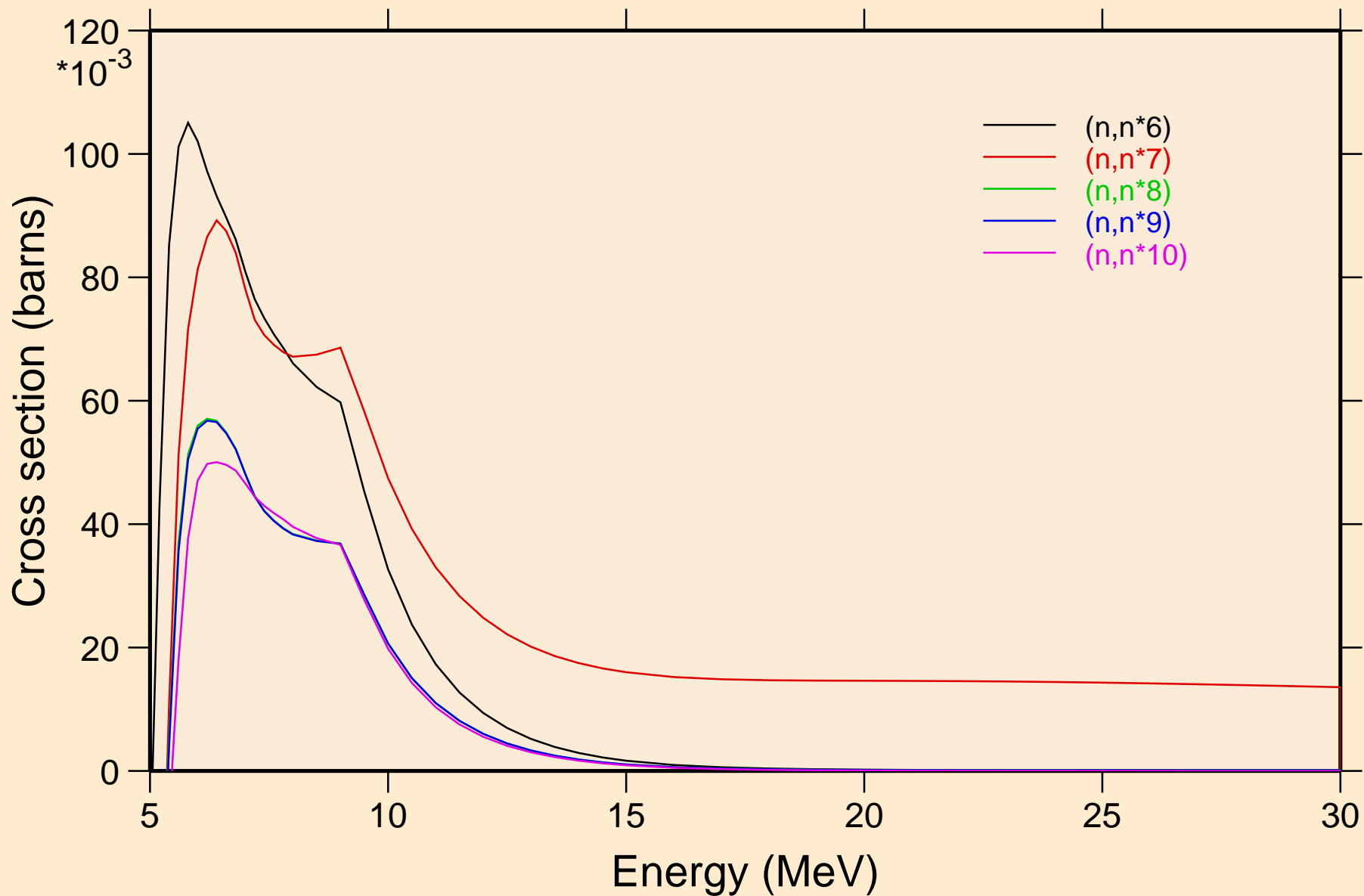

MG028 NEUTRON ACER TENDL-2019 LIBRARY; T=293.16K
Inelastic levels

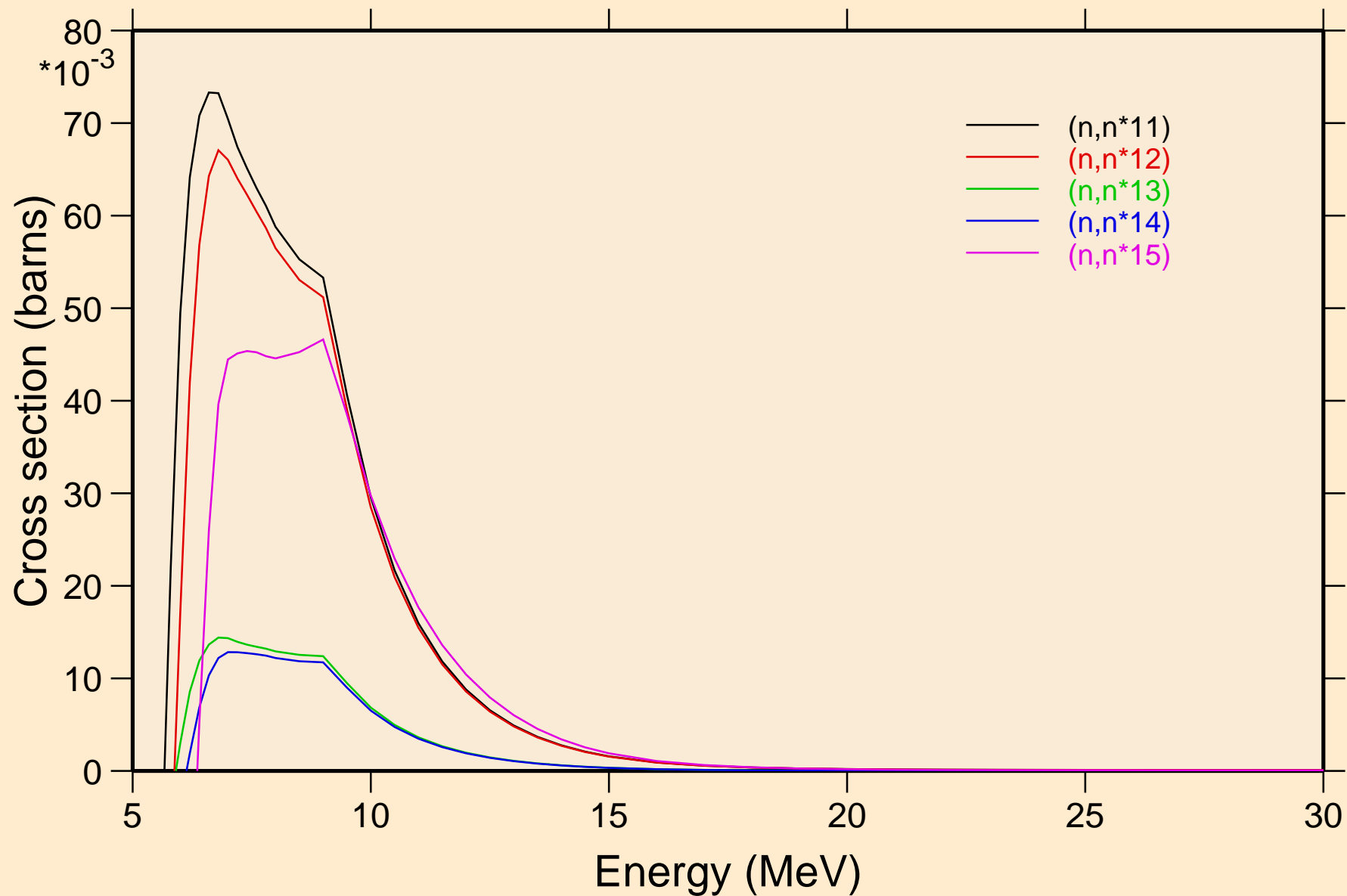

MG028 NEUTRON ACER TENDL-2019 LIBRARY; T=293.16K
Inelastic levels

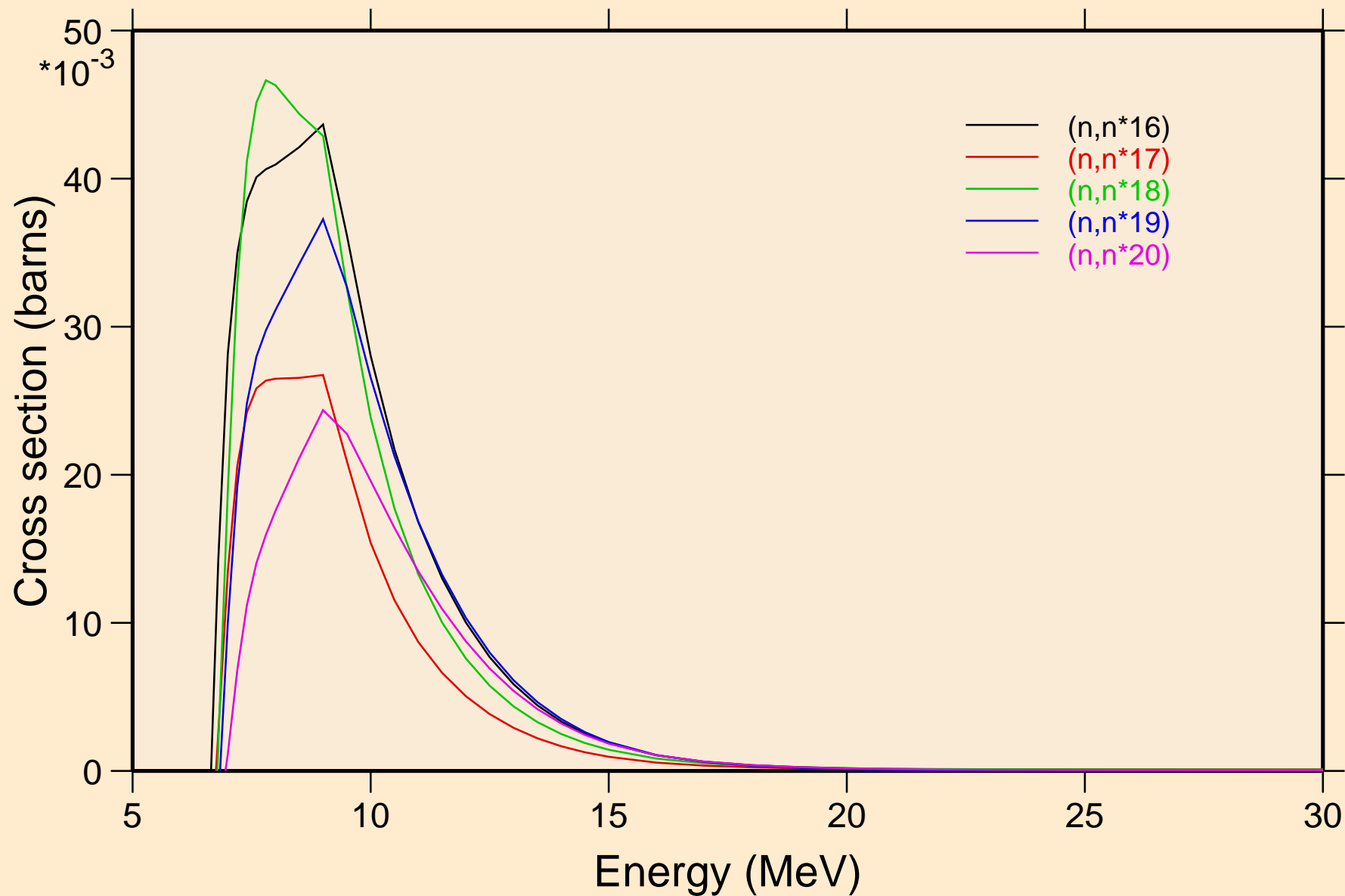

MG028 NEUTRON ACER TENDL-2019 LIBRARY; T=293.16K
Inelastic levels

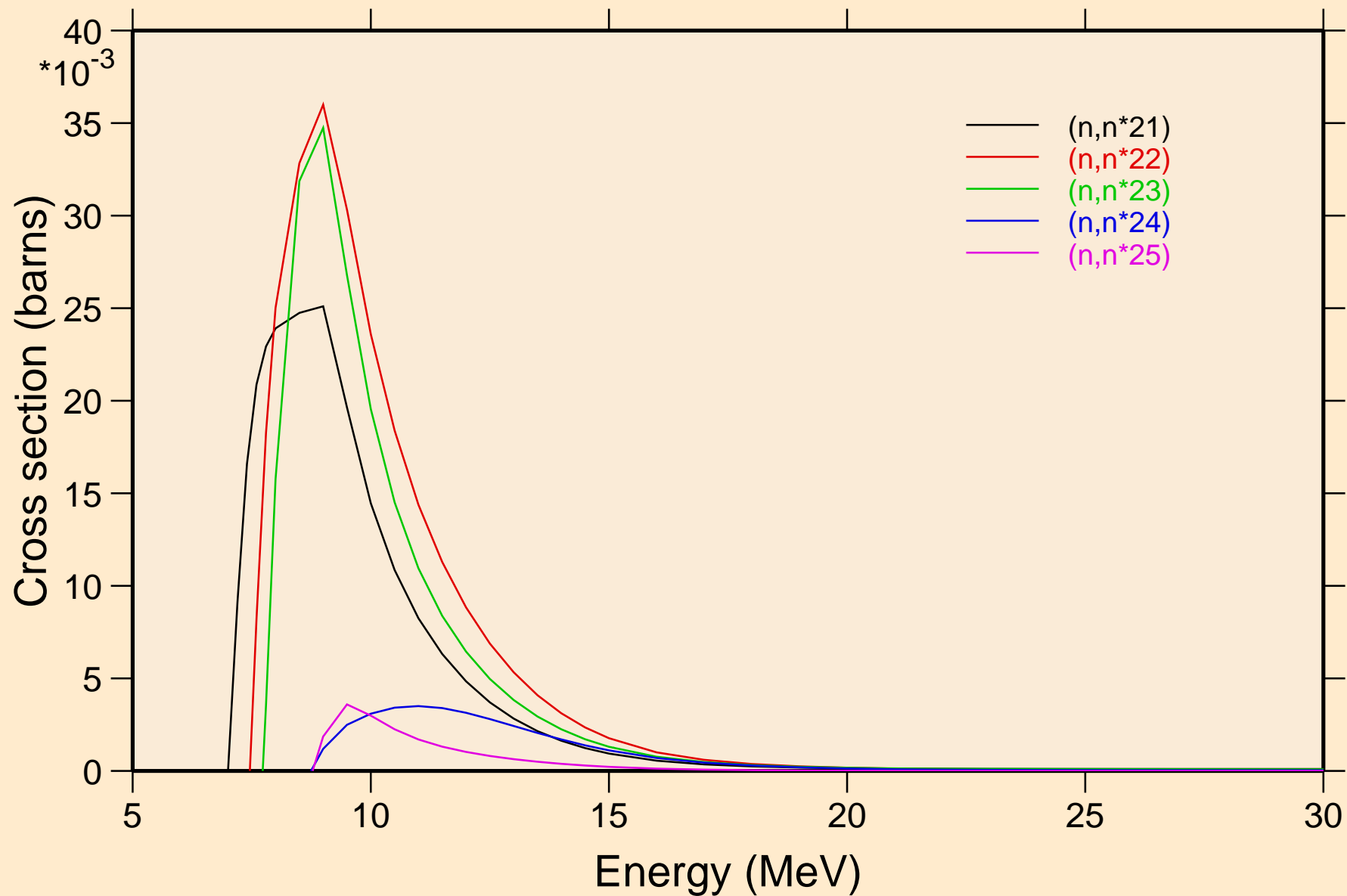

MG028 NEUTRON ACER TENDL-2019 LIBRARY; T=293.16K
Inelastic levels

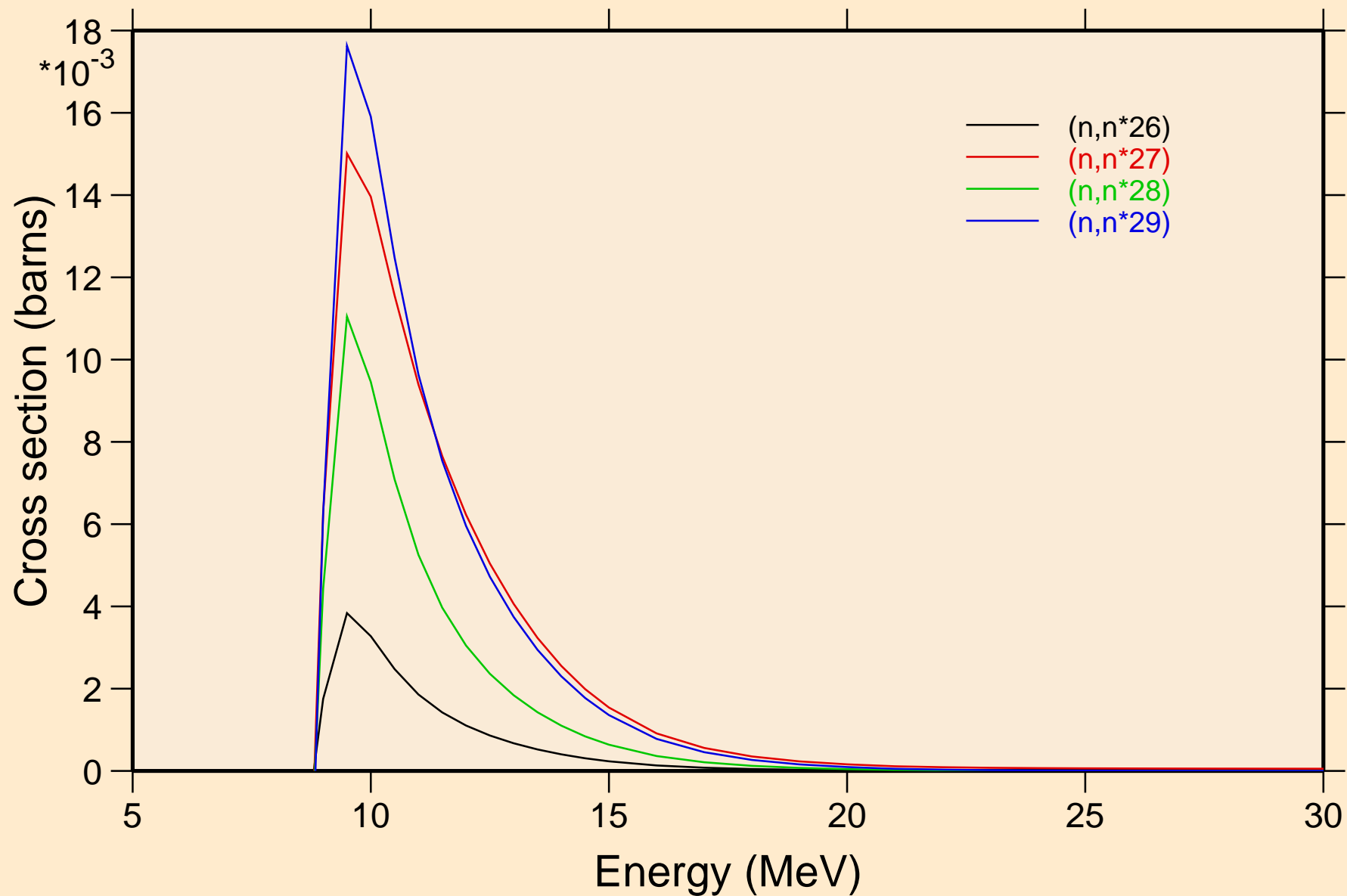

MG028 NEUTRON ACER TENDL-2019 LIBRARY; T=293.16K
Threshold reactions

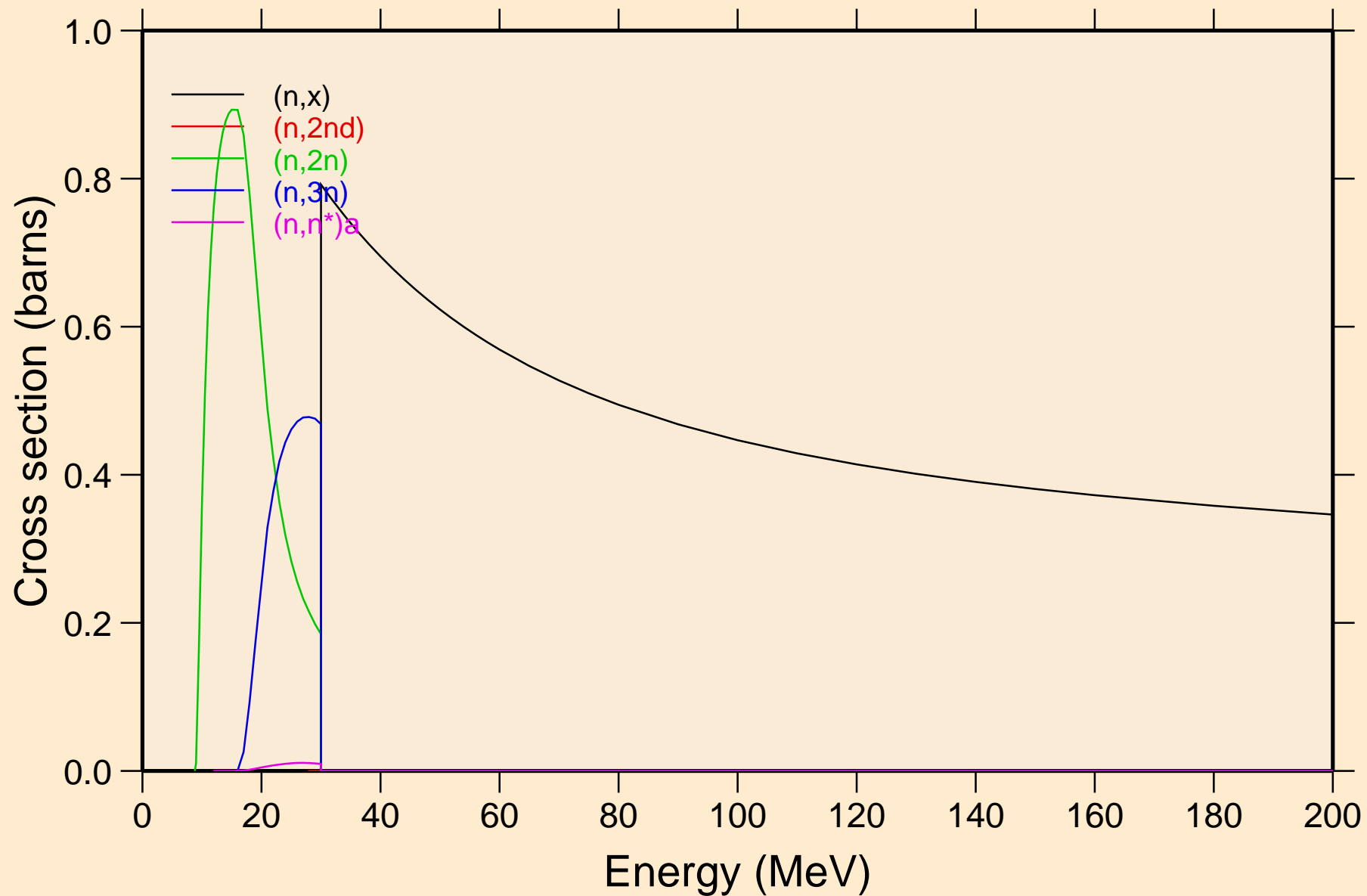

MG028 NEUTRON ACER TENDL-2019 LIBRARY; T=293.16K
Threshold reactions

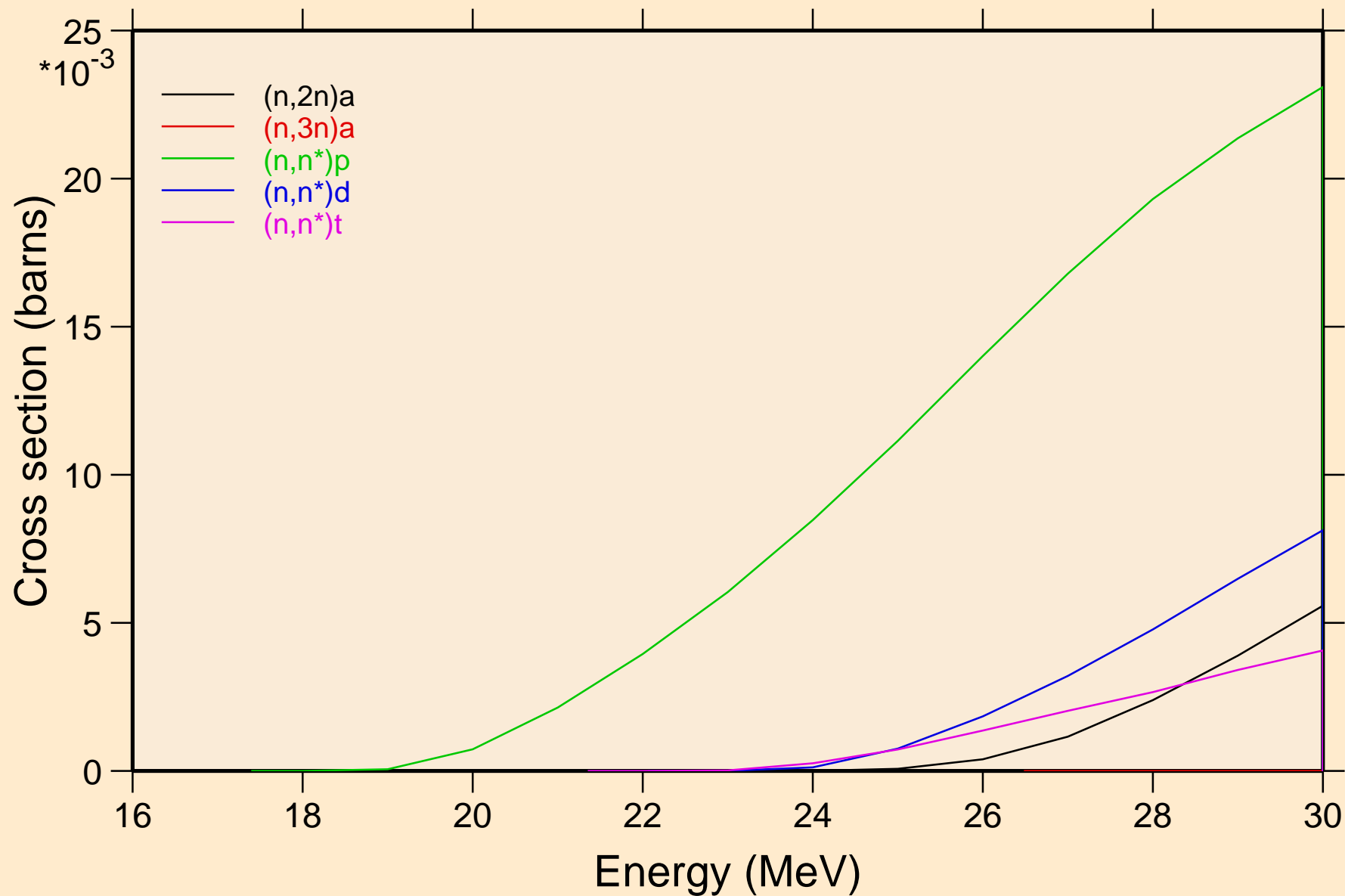

MG028 NEUTRON ACER TENDL-2019 LIBRARY; T=293.16K
Threshold reactions

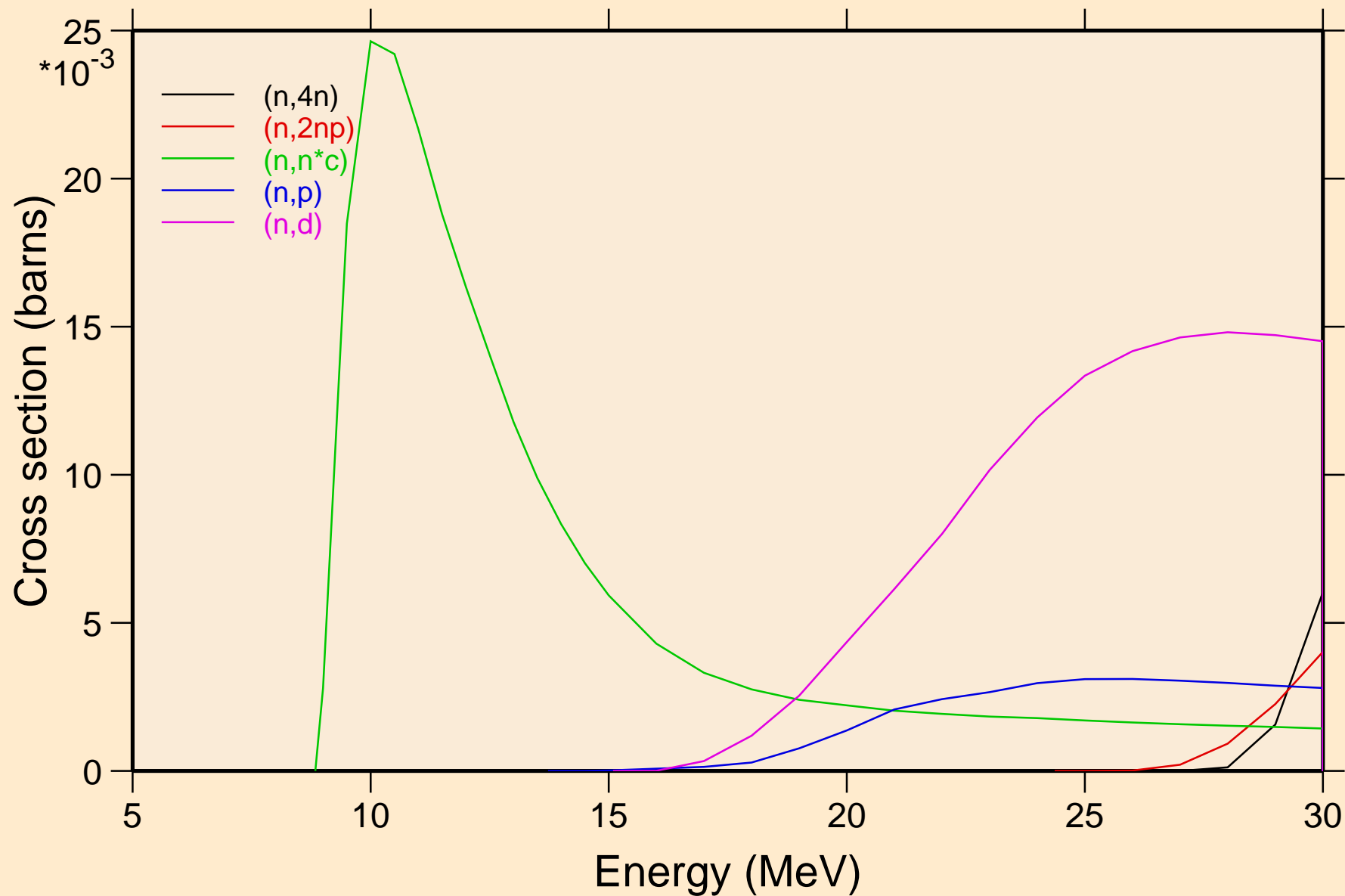

MG028 NEUTRON ACER TENDL-2019 LIBRARY; T=293.16K
Threshold reactions

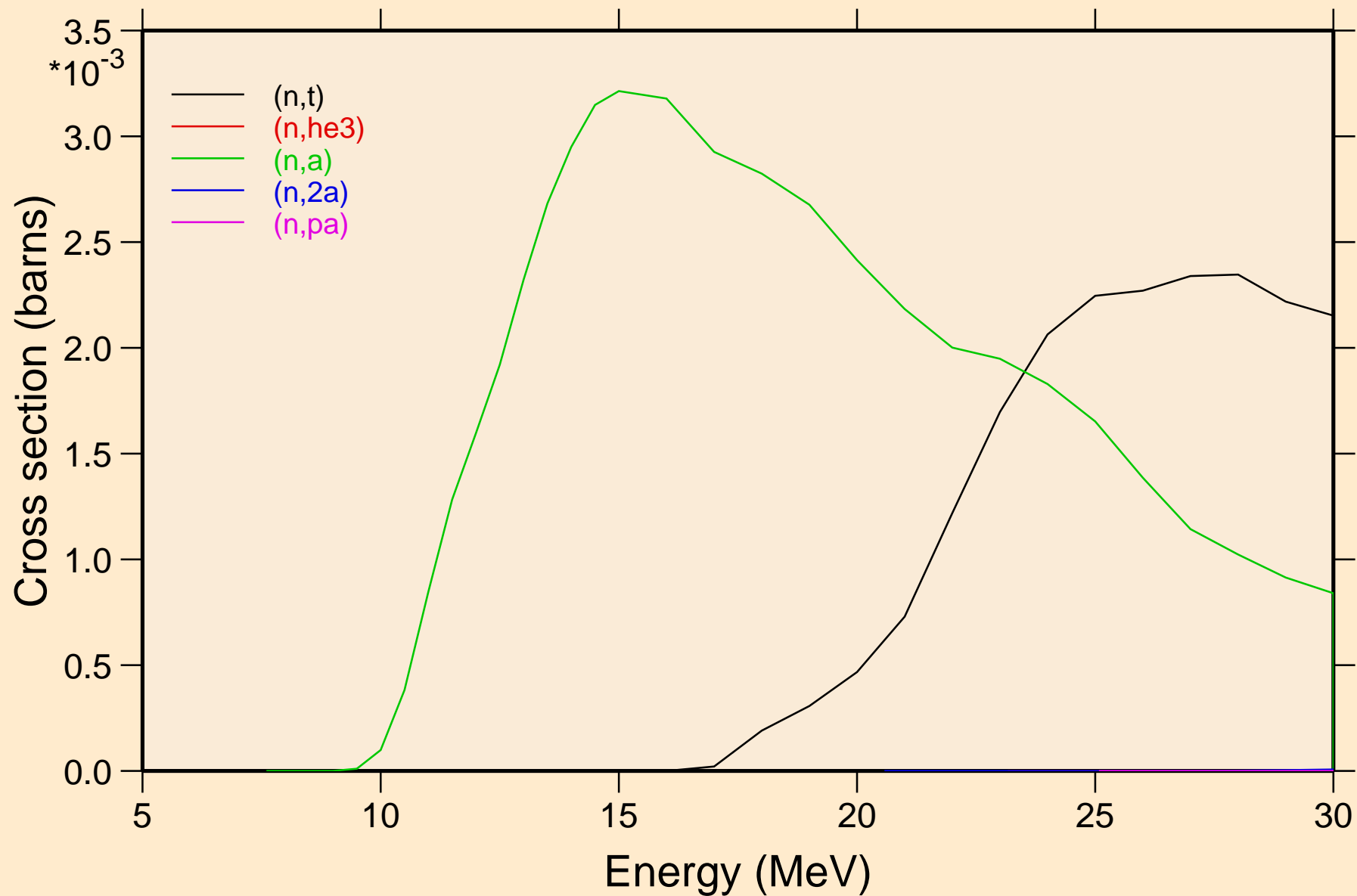

MG028 NEUTRON ACER TENDL-2019 LIBRARY; T=293.16K

Threshold reactions

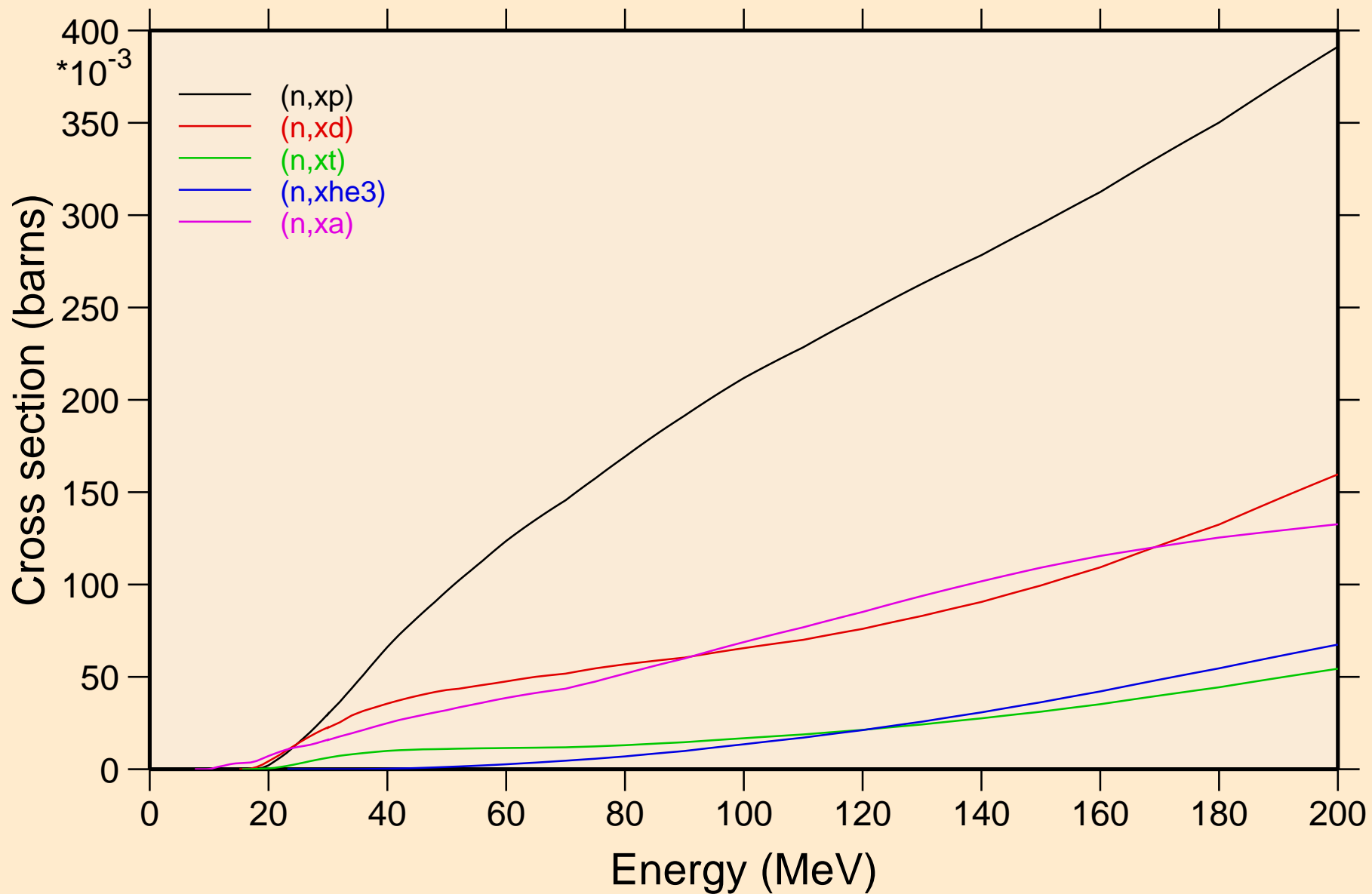

MG028 NEUTRON ACER TENDL-2019 LIBRARY; T=293.16K
angular distribution for elastic

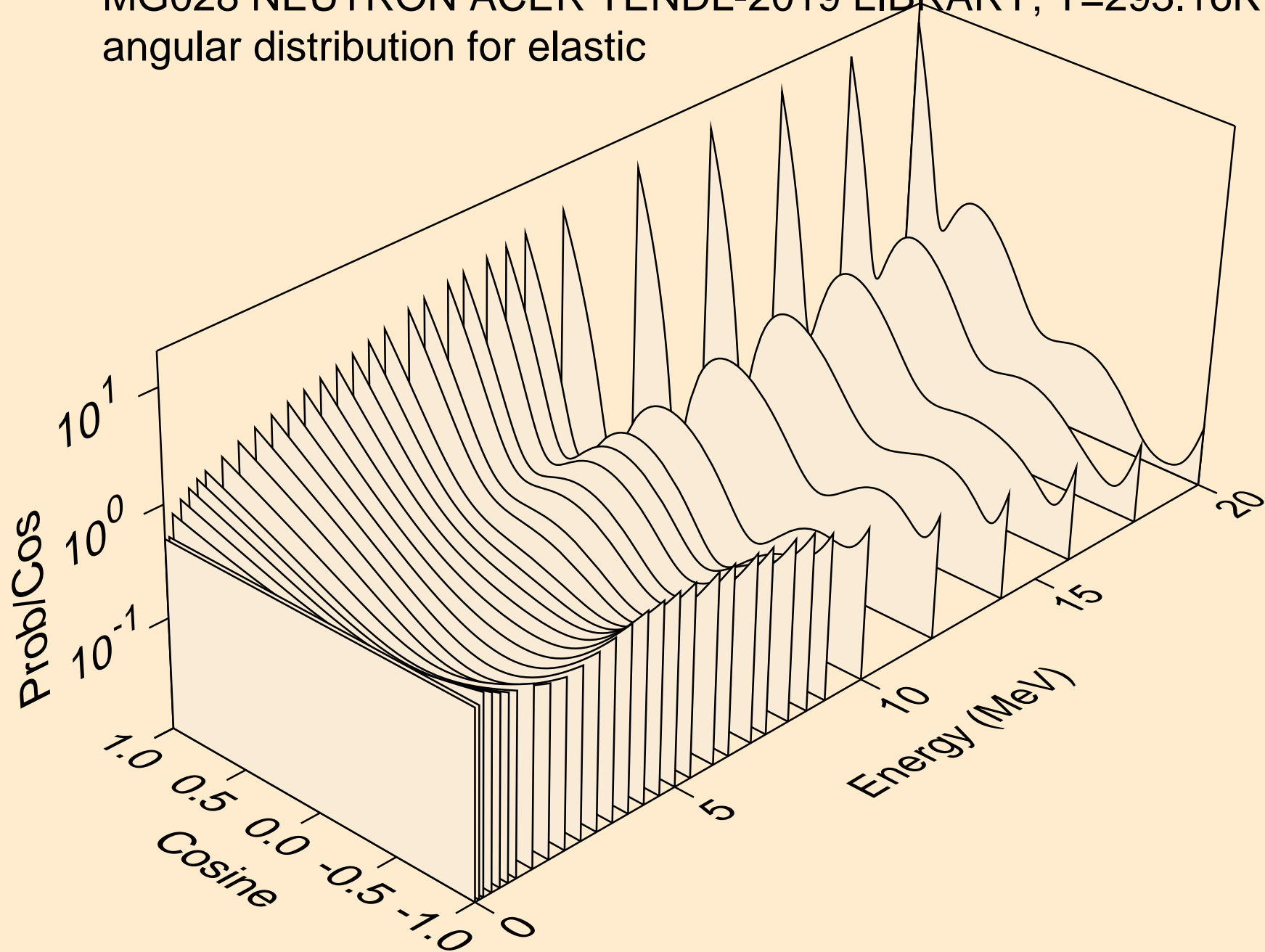

MG028 NEUTRON ACER TENDL-2019 LIBRARY; T=293.16K
angular distribution for elastic

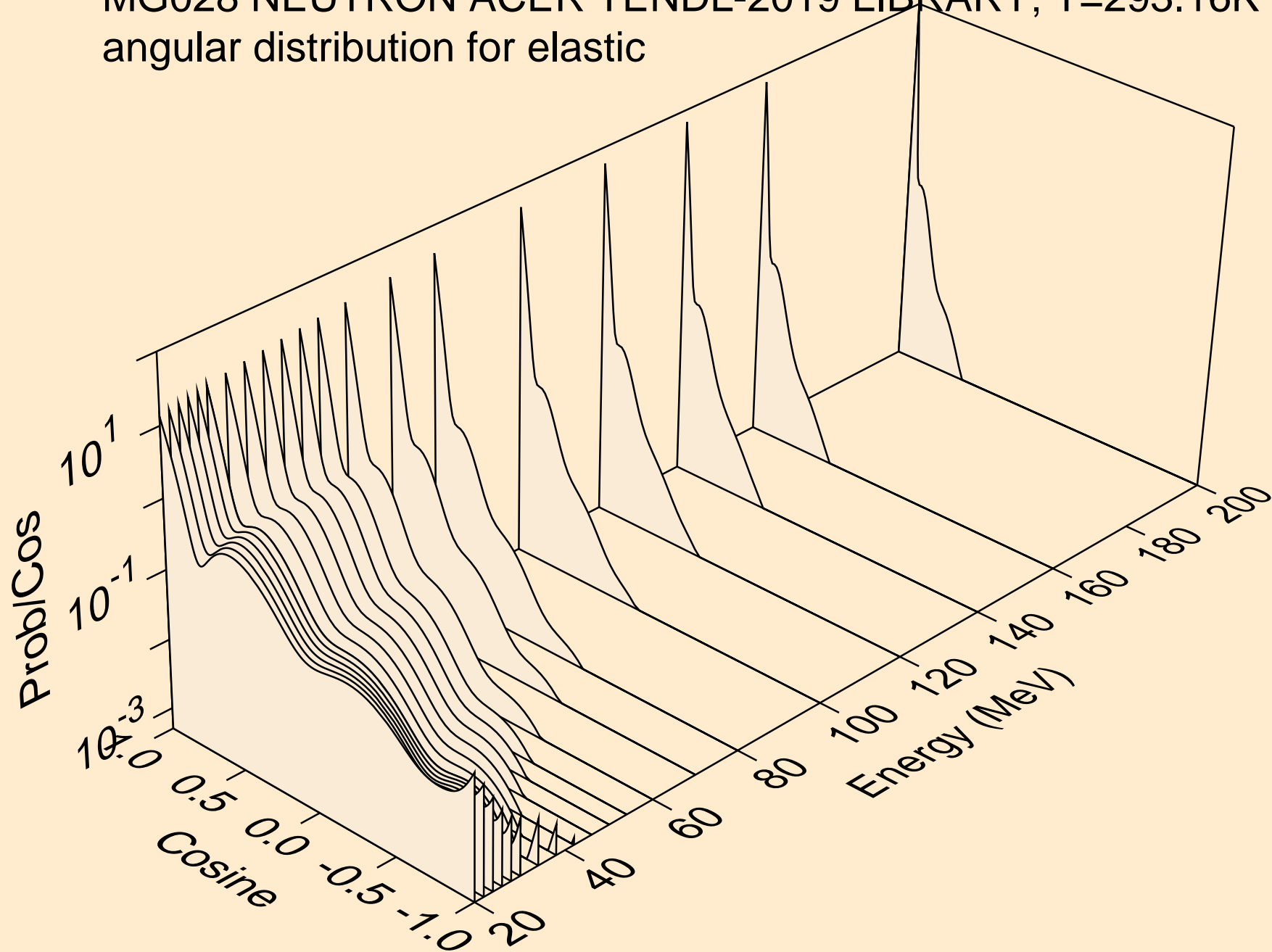

MG028 NEUTRON ACER TENDL-2019 LIBRARY; T=293.16K
angular distribution for (n,n*1)

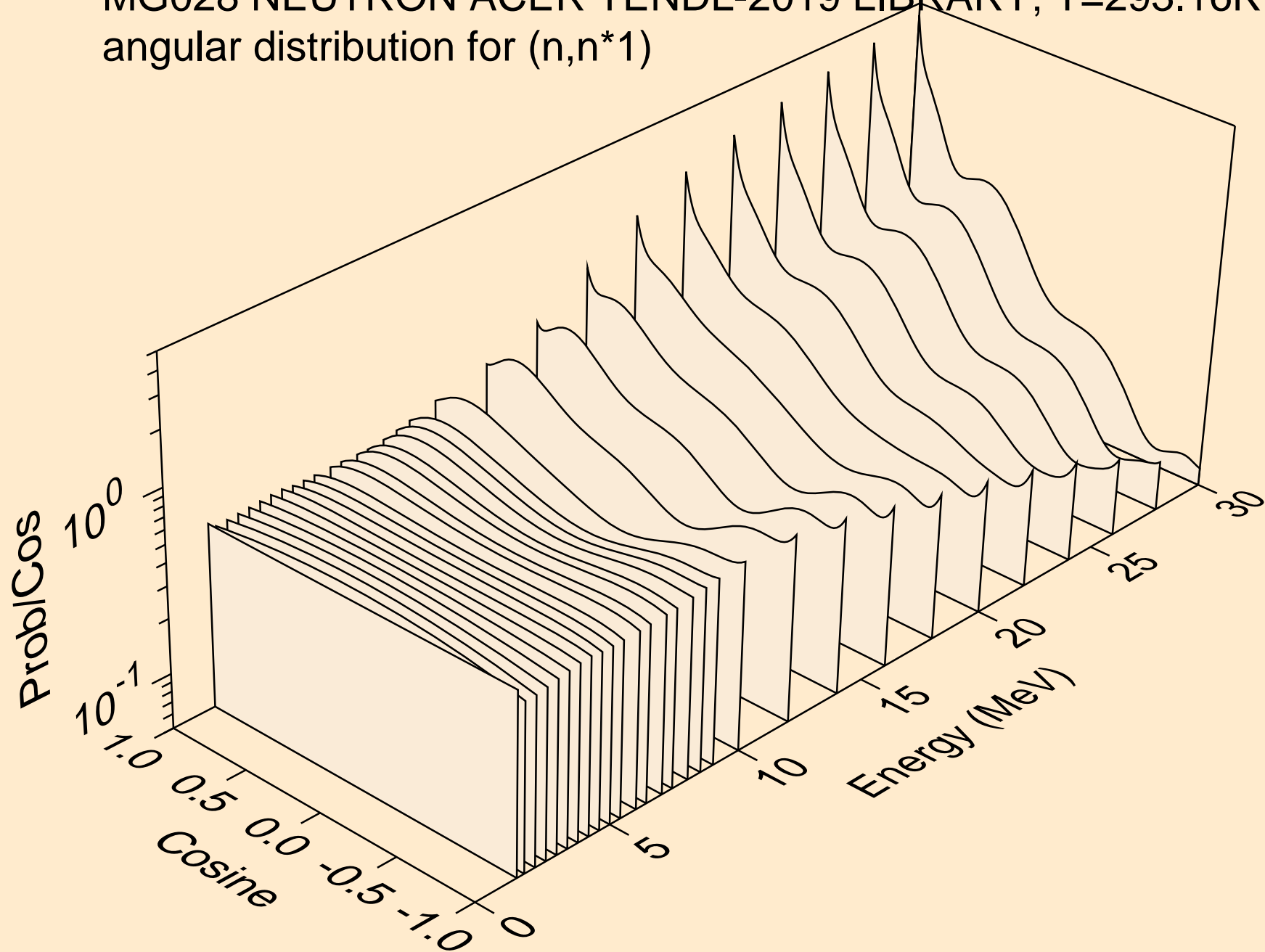

MG028 NEUTRON ACER TENDL-2019 LIBRARY; T=293.16K
angular distribution for (n,n*2)

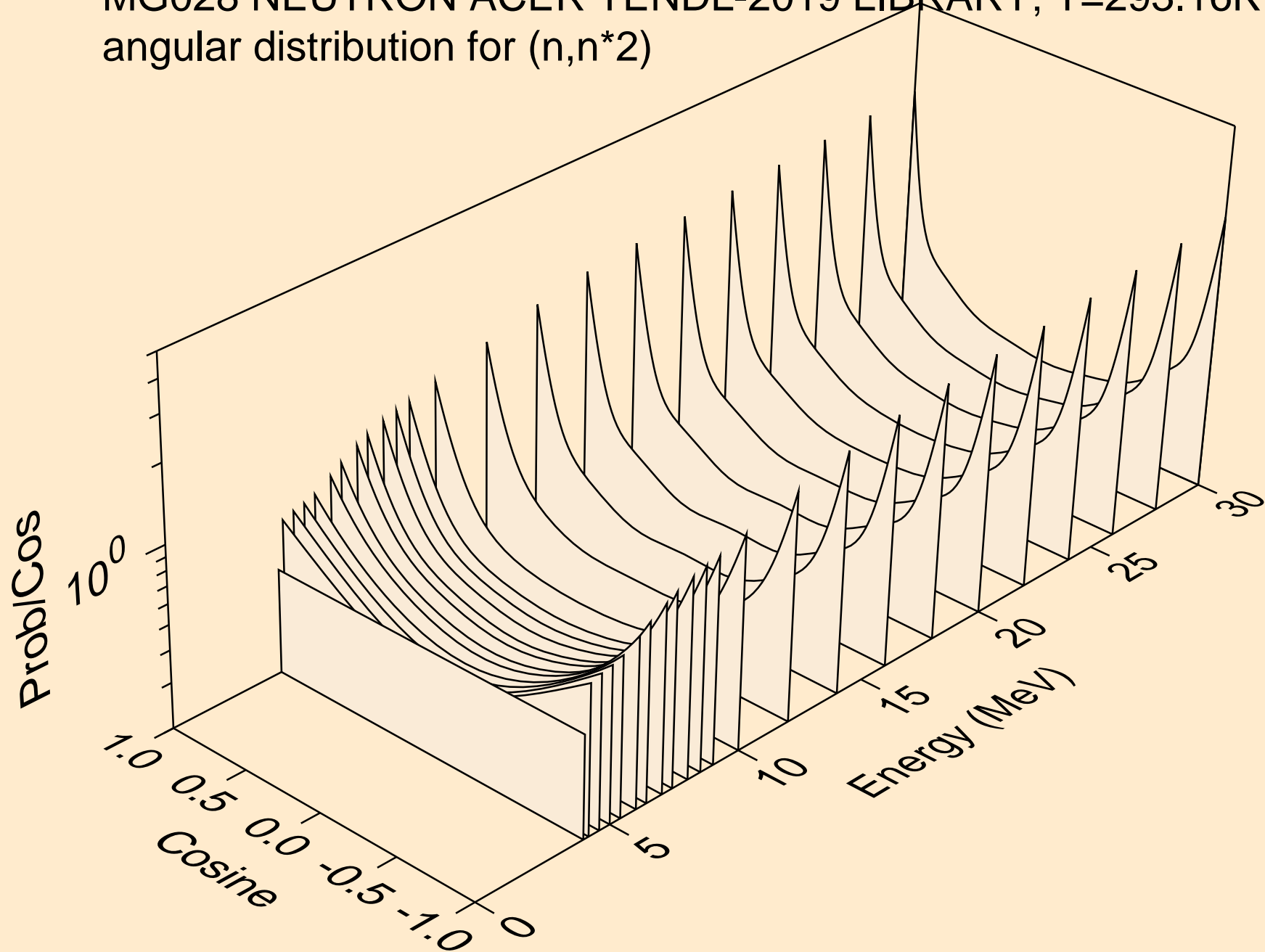

MG028 NEUTRON ACER TENDL-2019 LIBRARY; T=293.16K
angular distribution for (n,n*3)

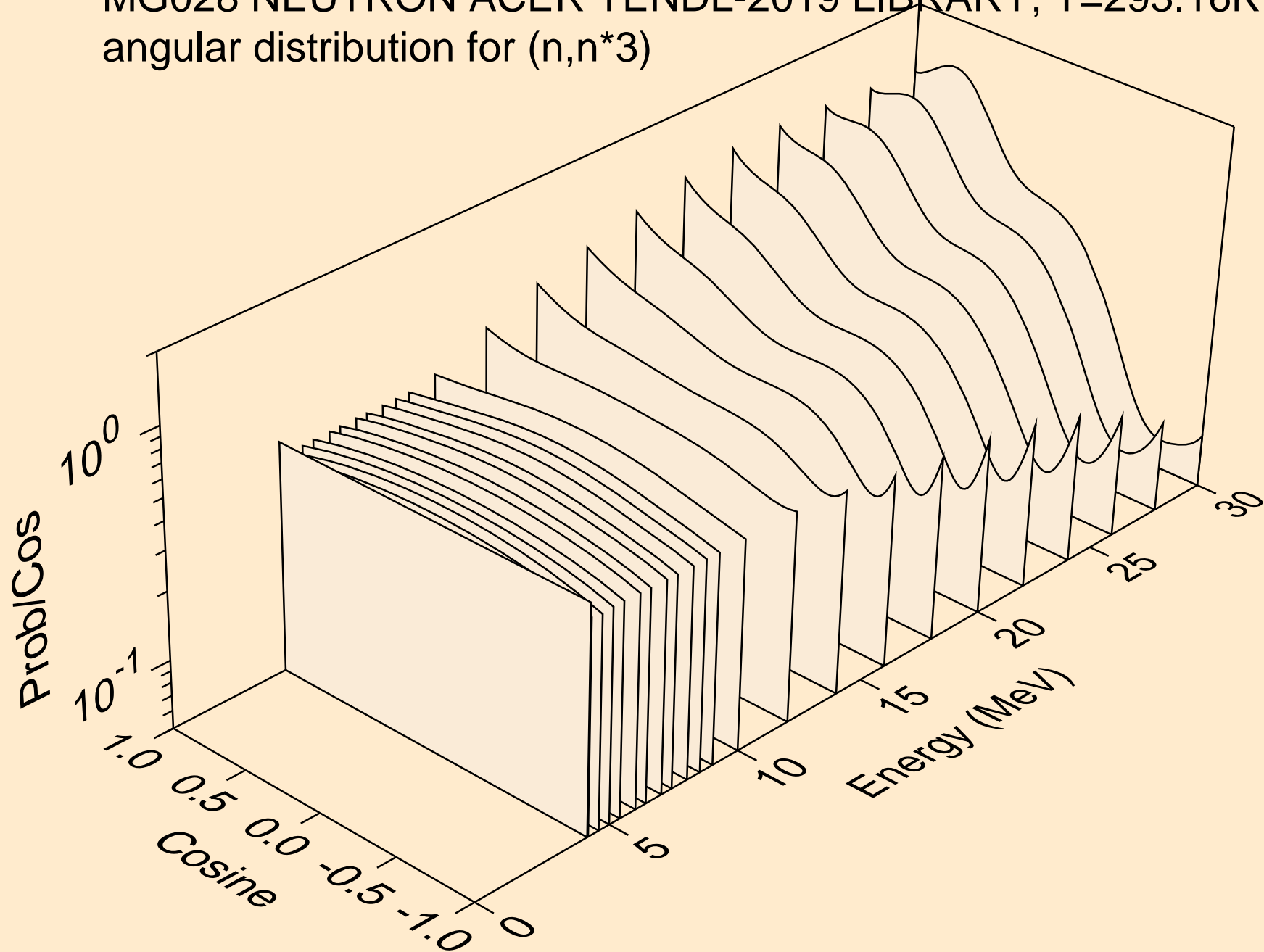

MG028 NEUTRON ACER TENDL-2019 LIBRARY; T=293.16K
angular distribution for (n,n*4)

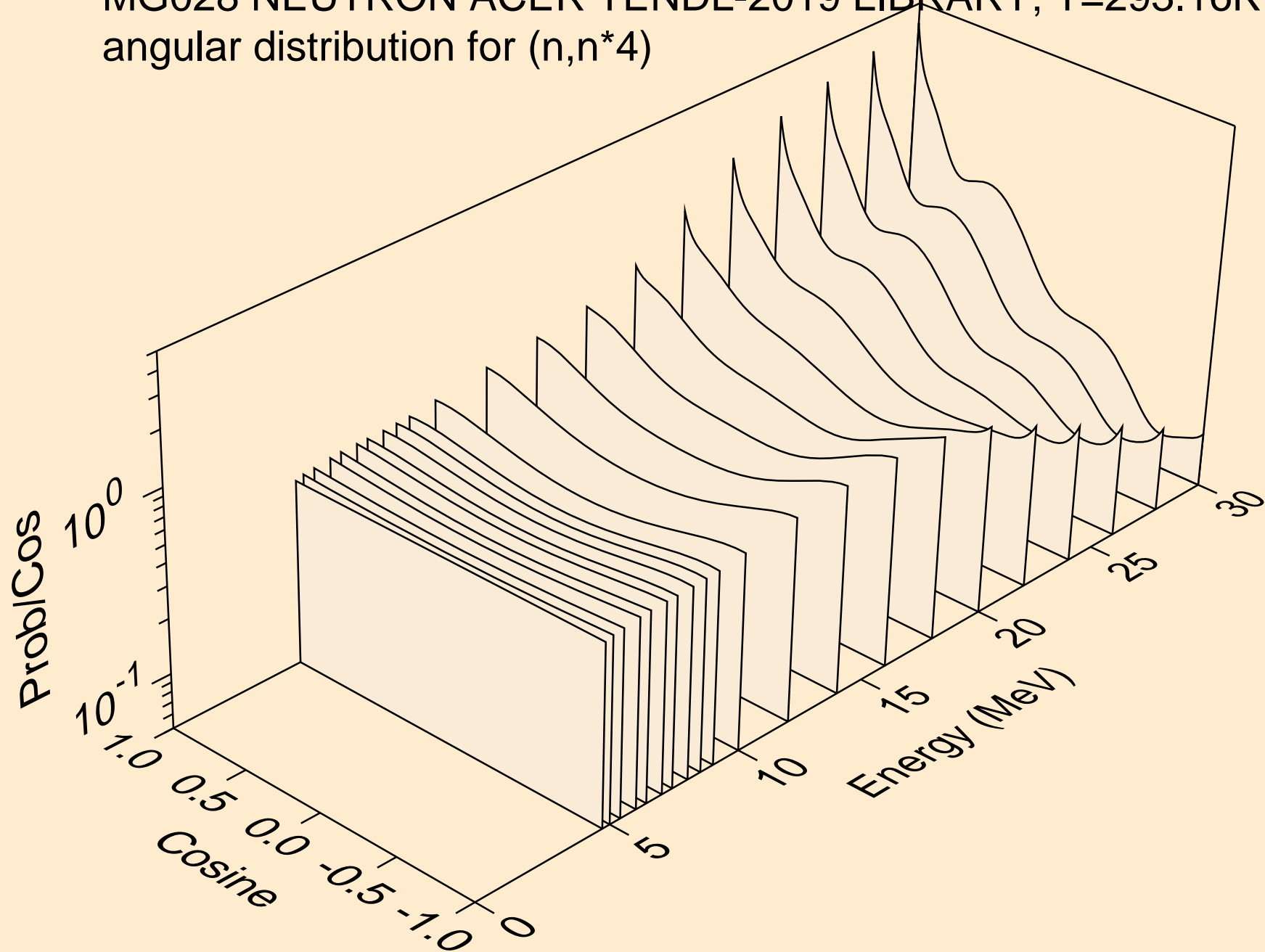

MG028 NEUTRON ACER TENDL-2019 LIBRARY; T=293.16K
angular distribution for (n,n*5)

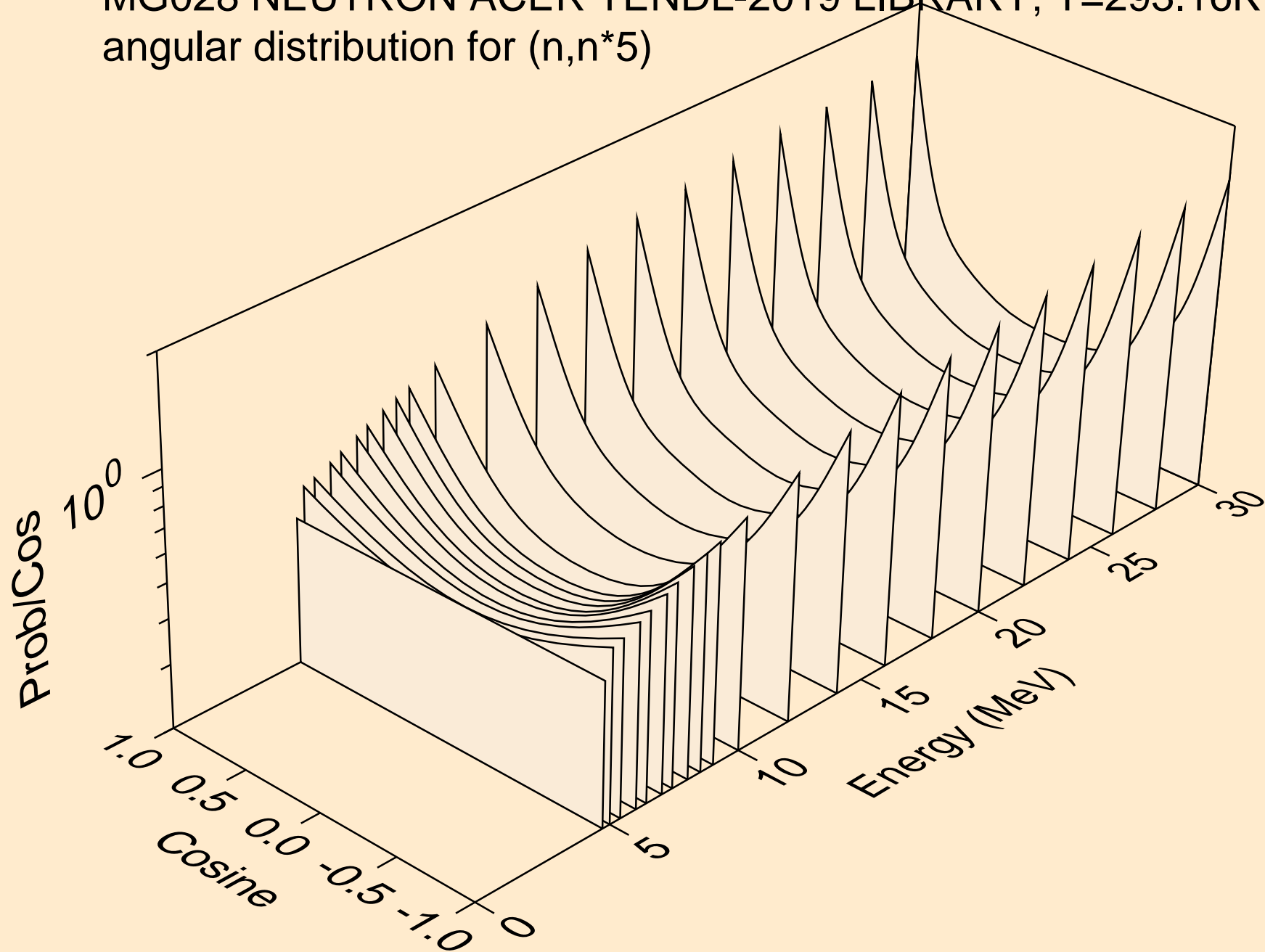

MG028 NEUTRON ACER TENDL-2019 LIBRARY; T=293.16K
angular distribution for (n,n*6)

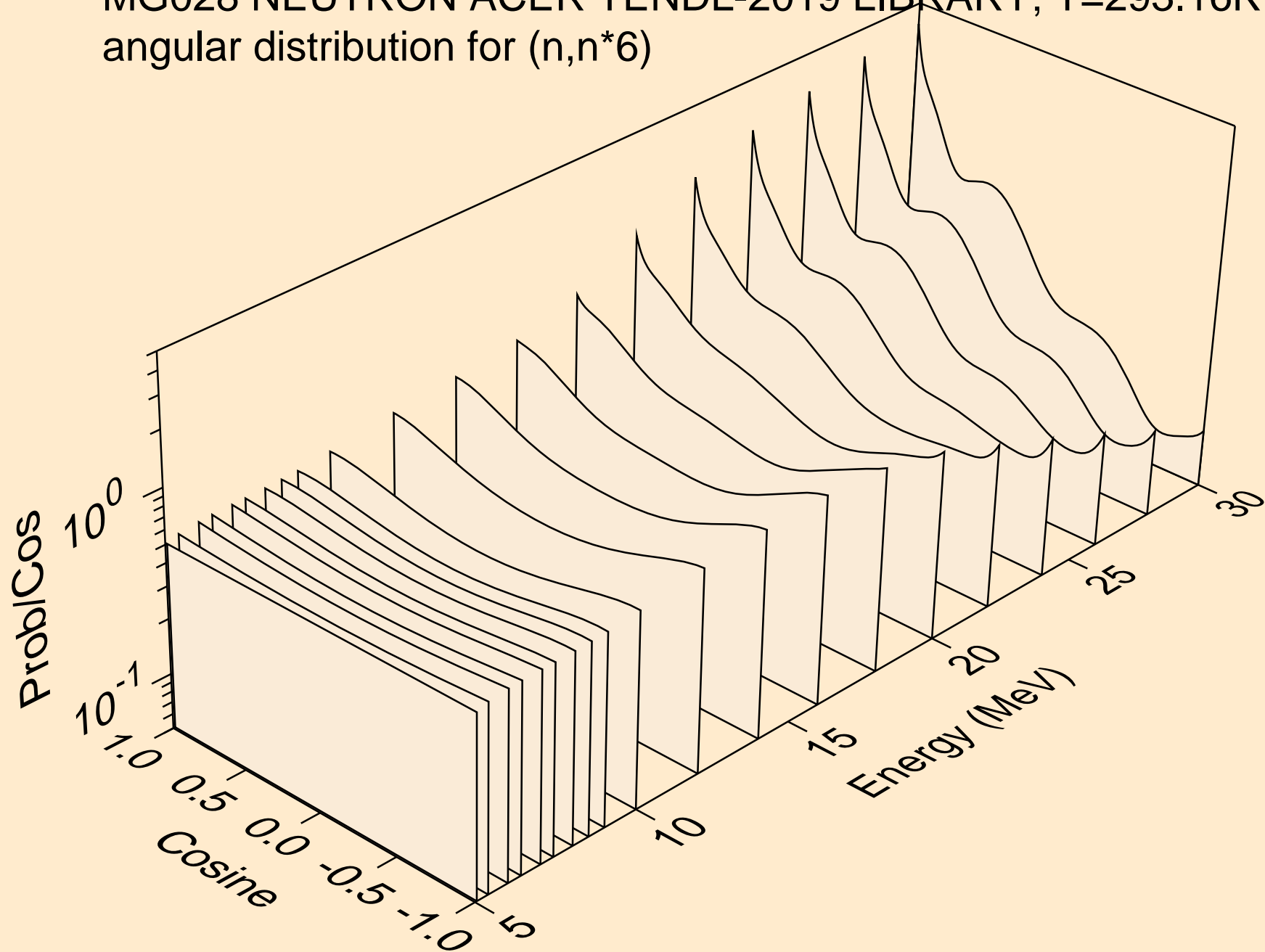

MG028 NEUTRON ACER TENDL-2019 LIBRARY; T=293.16K
angular distribution for (n,n*7)

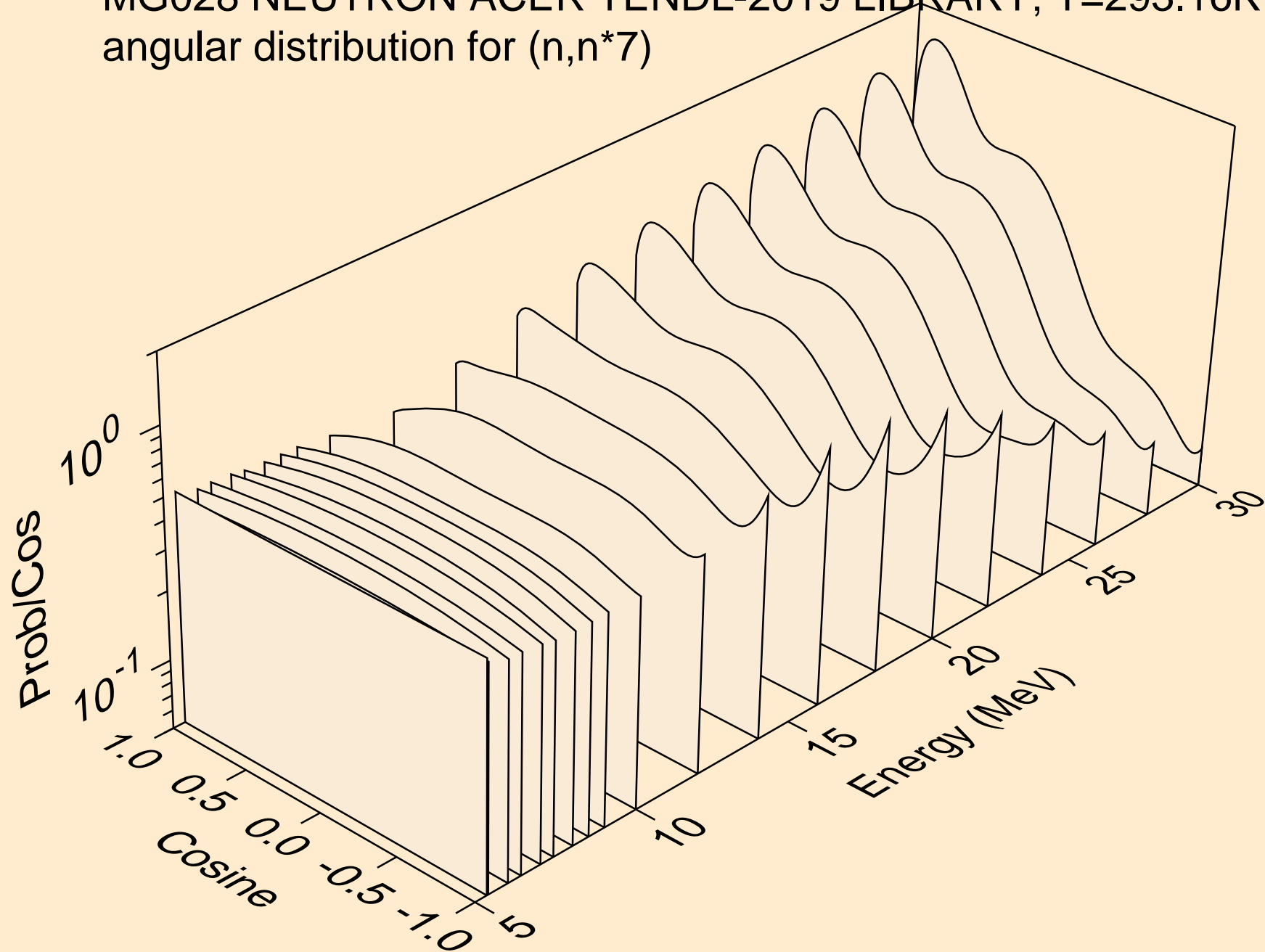

MG028 NEUTRON ACER TENDL-2019 LIBRARY; T=293.16K
angular distribution for (n,n*8)

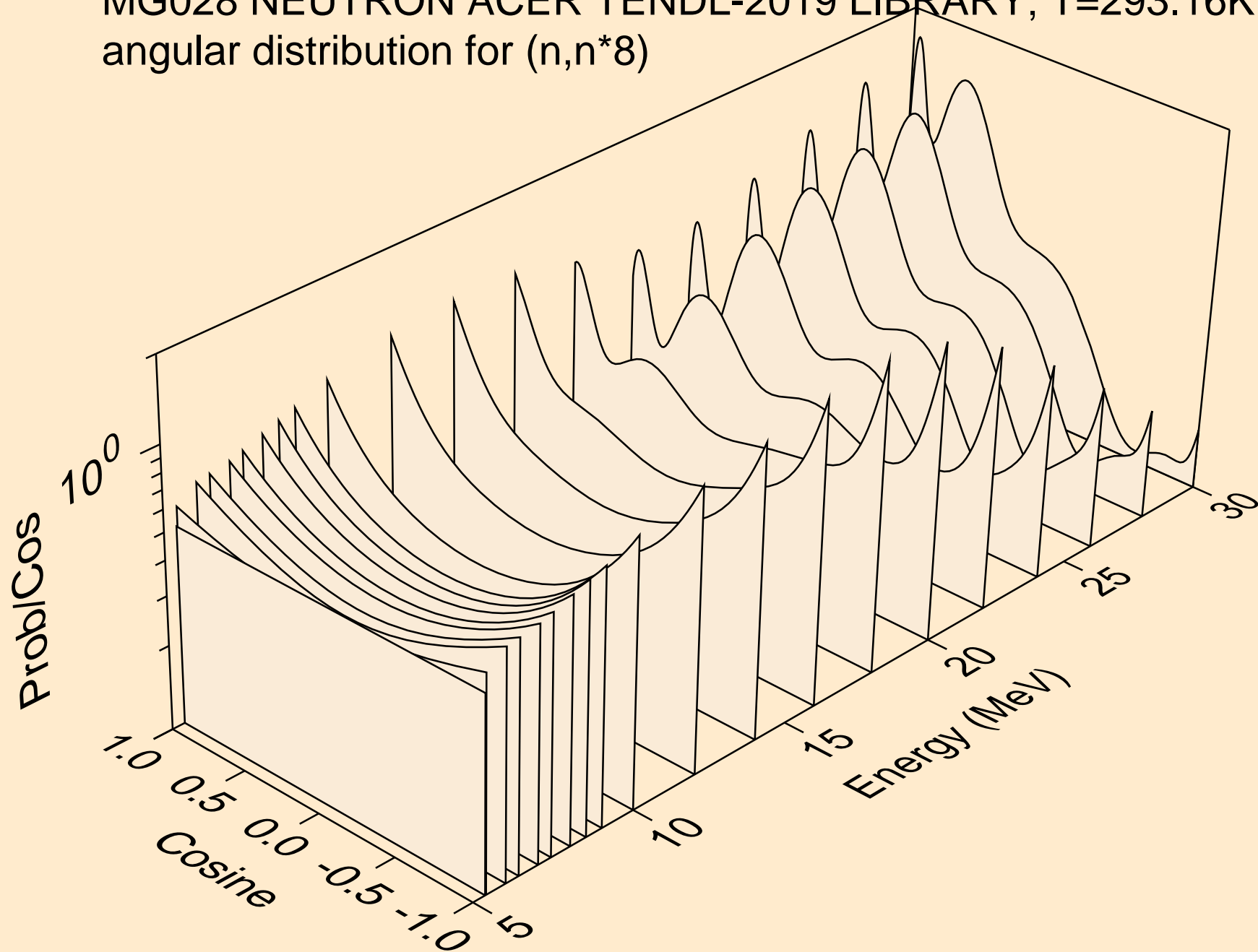

MG028 NEUTRON ACER TENDL-2019 LIBRARY; T=293.16K
angular distribution for (n,n*9)

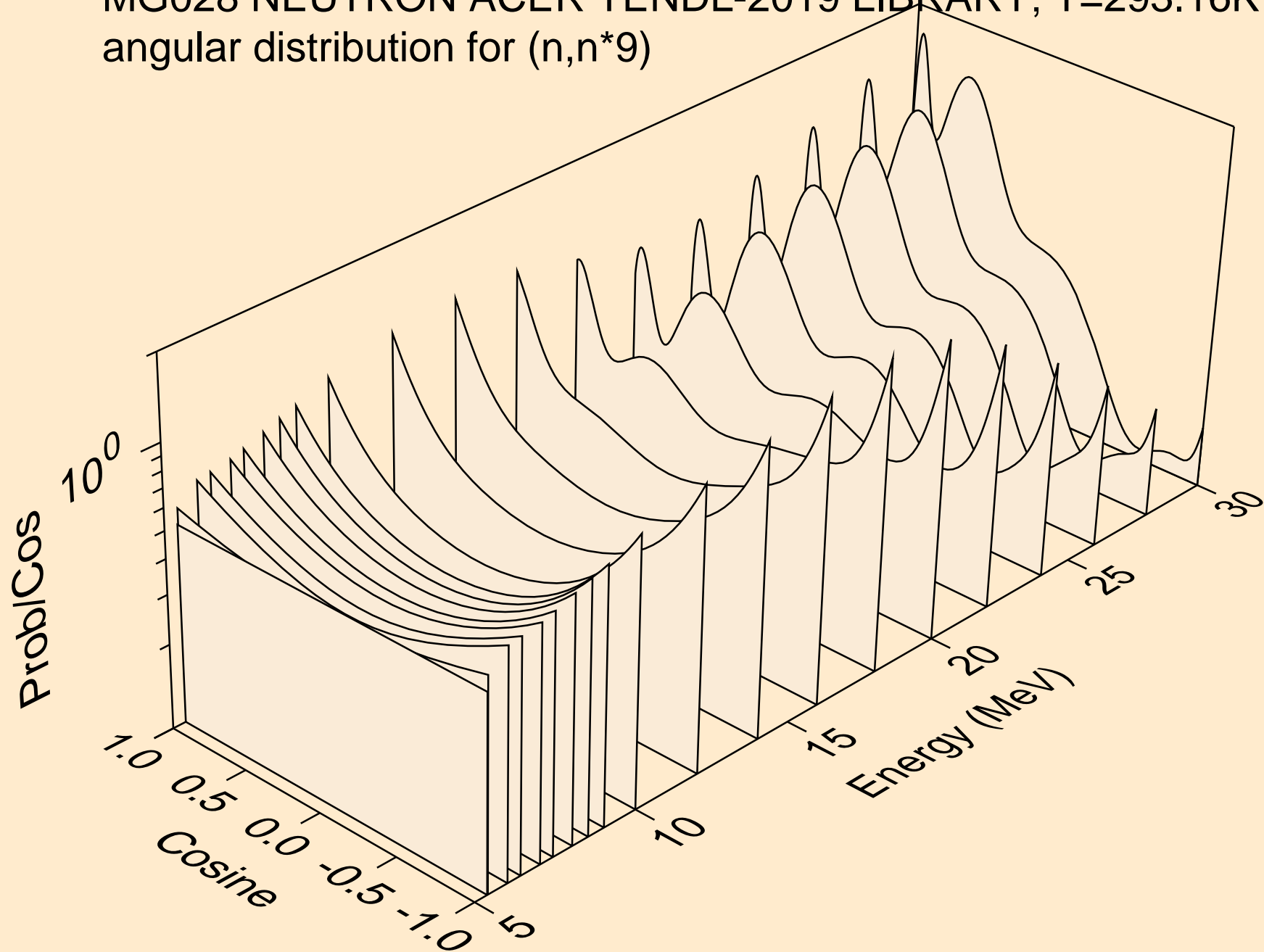

MG028 NEUTRON ACER TENDL-2019 LIBRARY; T=293.16K
angular distribution for (n,n*10)

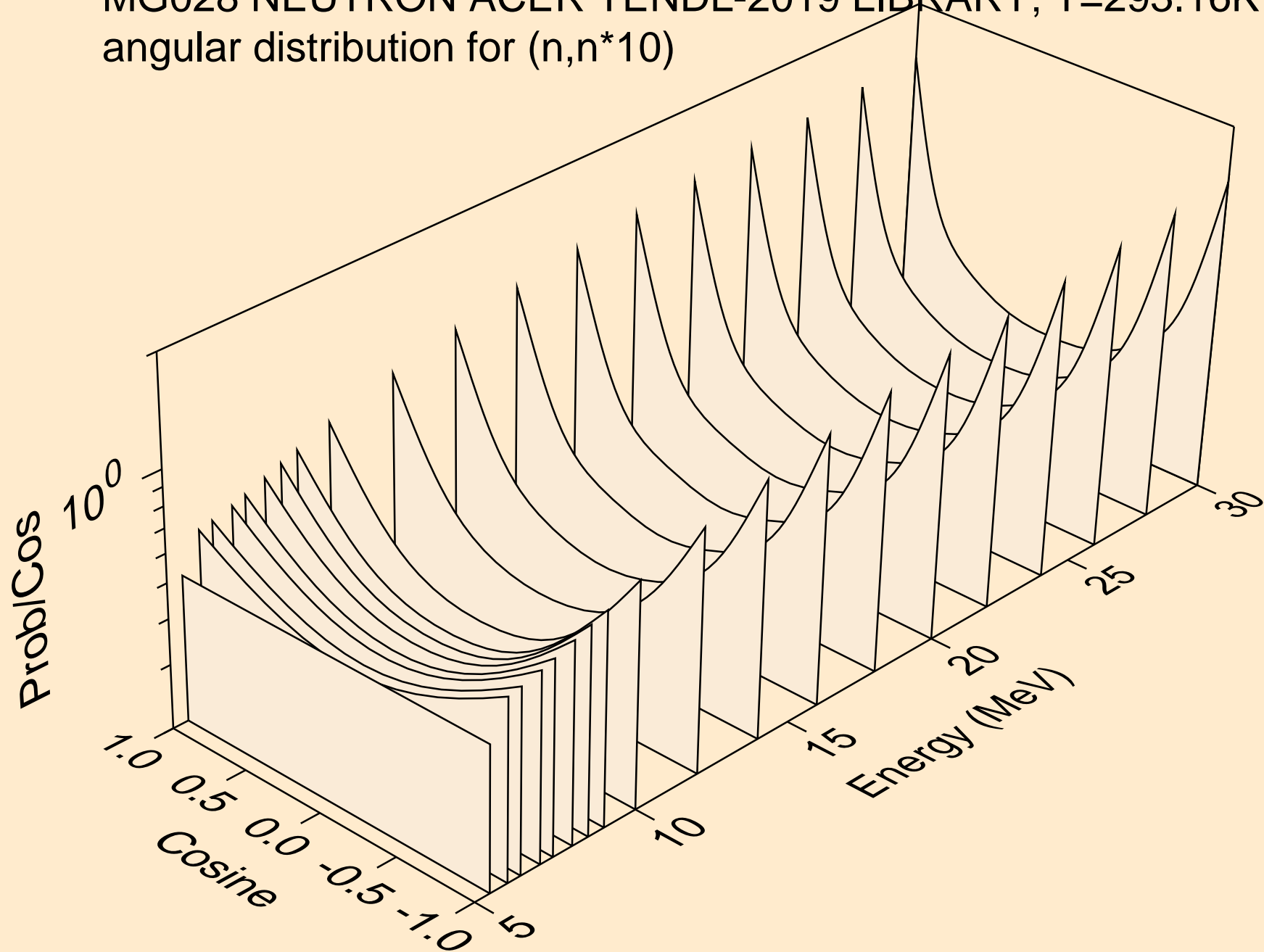

MG028 NEUTRON ACER TENDL-2019 LIBRARY; T=293.16K
angular distribution for (n,n*11)

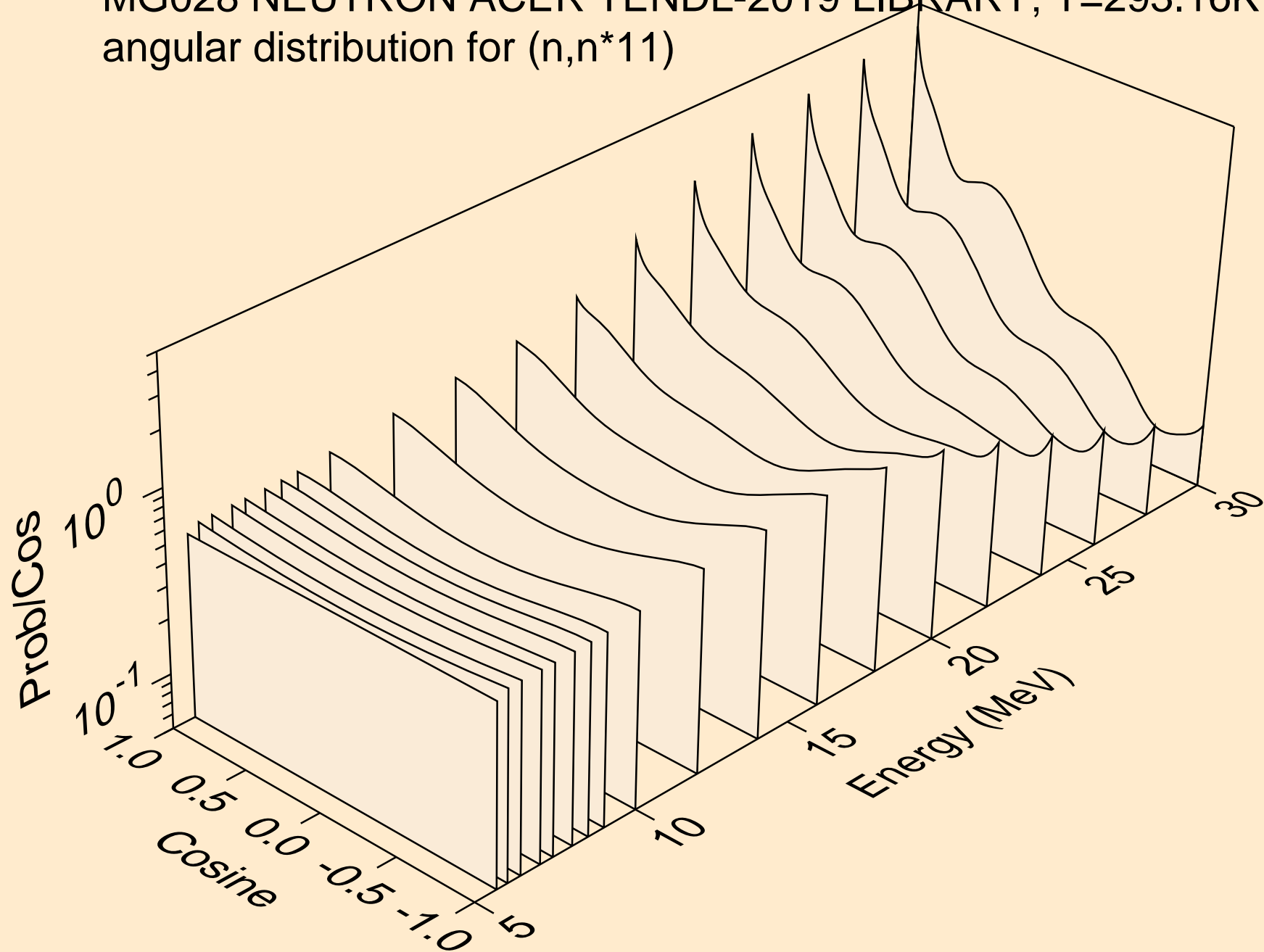

MG028 NEUTRON ACER TENDL-2019 LIBRARY; T=293.16K
angular distribution for (n,n*12)

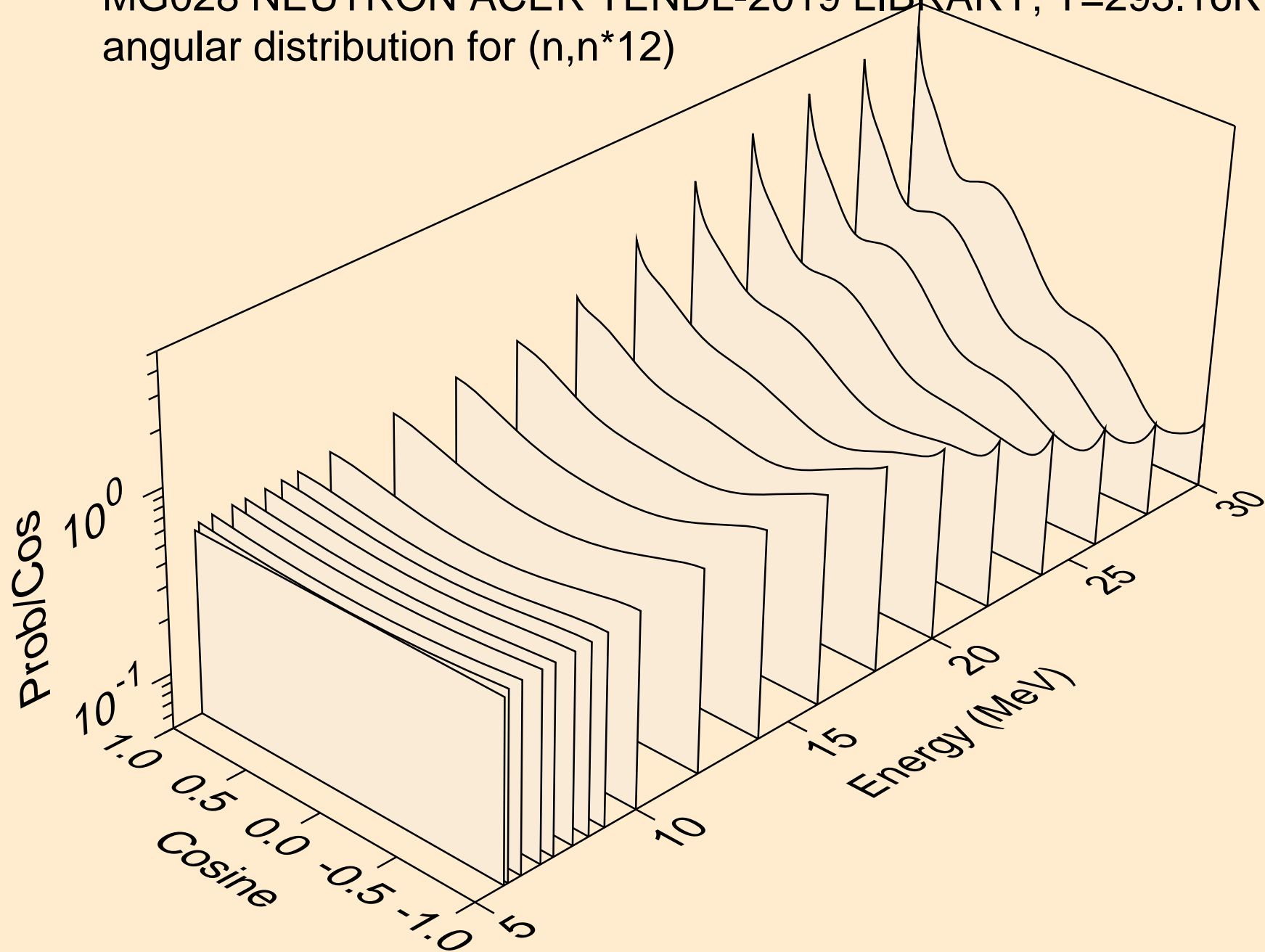

MG028 NEUTRON ACER TENDL-2019 LIBRARY; T=293.16K
angular distribution for (n,n*13)

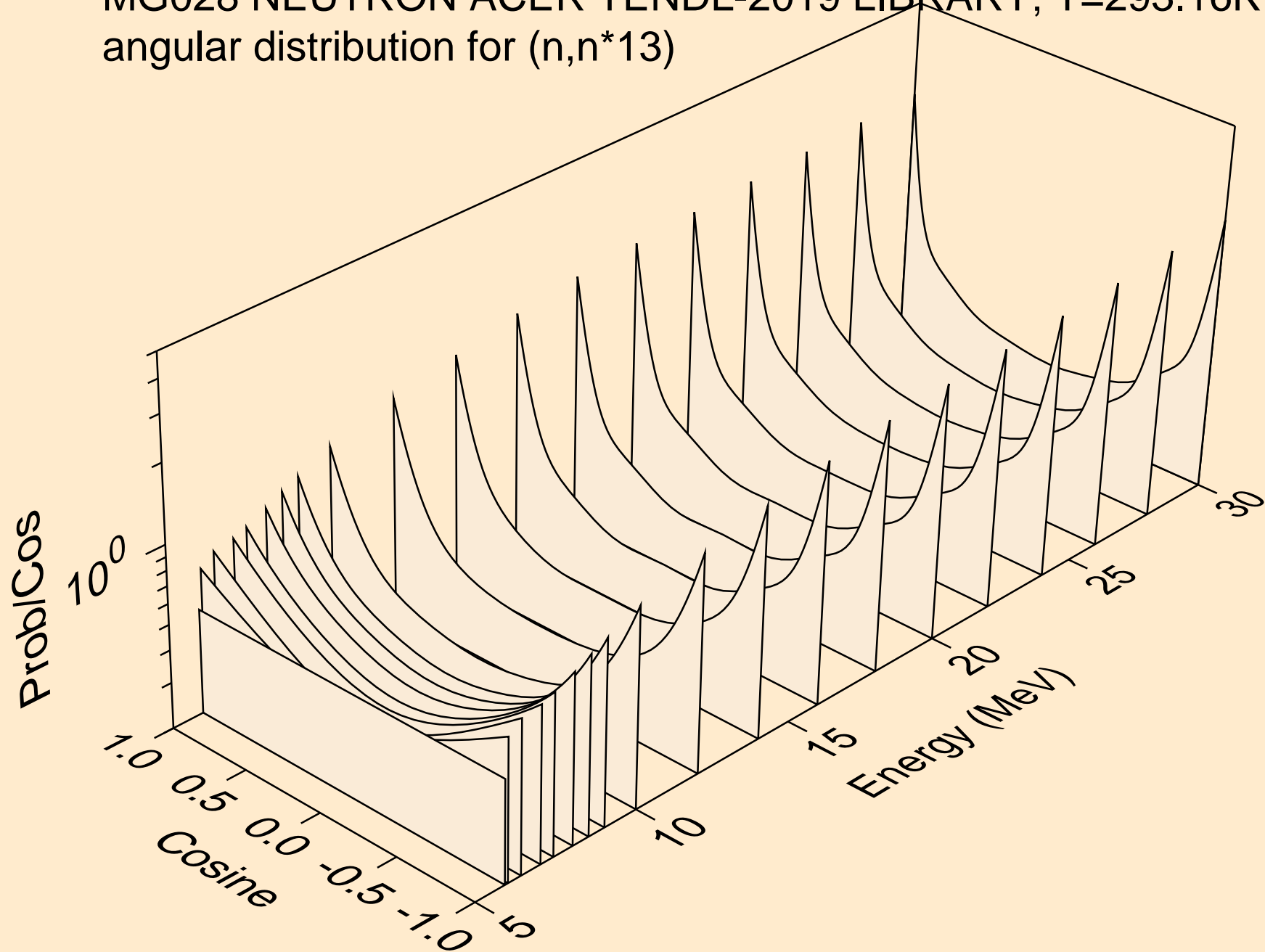

MG028 NEUTRON ACER TENDL-2019 LIBRARY; T=293.16K
angular distribution for (n,n*14)

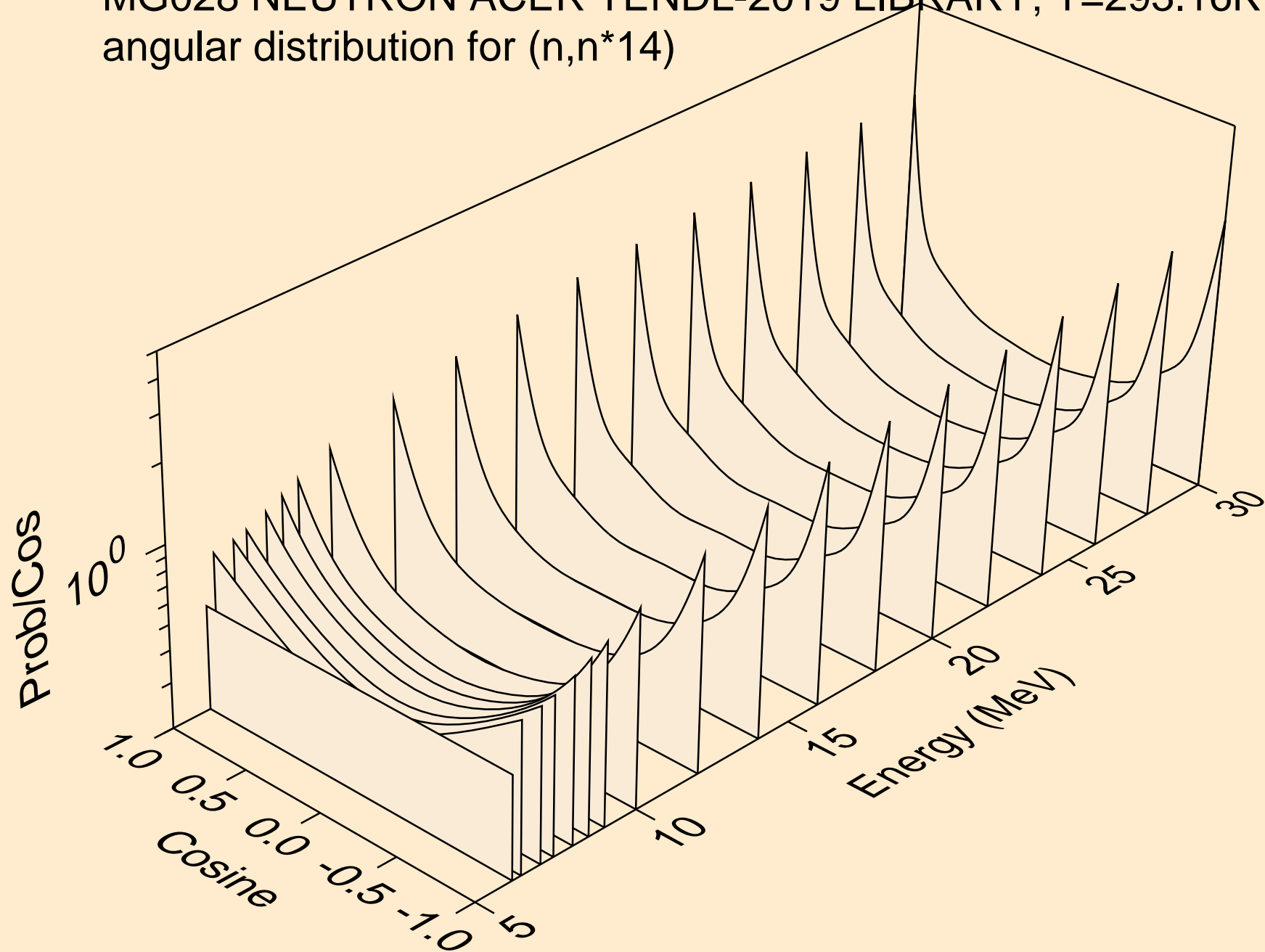

MG028 NEUTRON ACER TENDL-2019 LIBRARY; T=293.16K
angular distribution for (n,n*15)

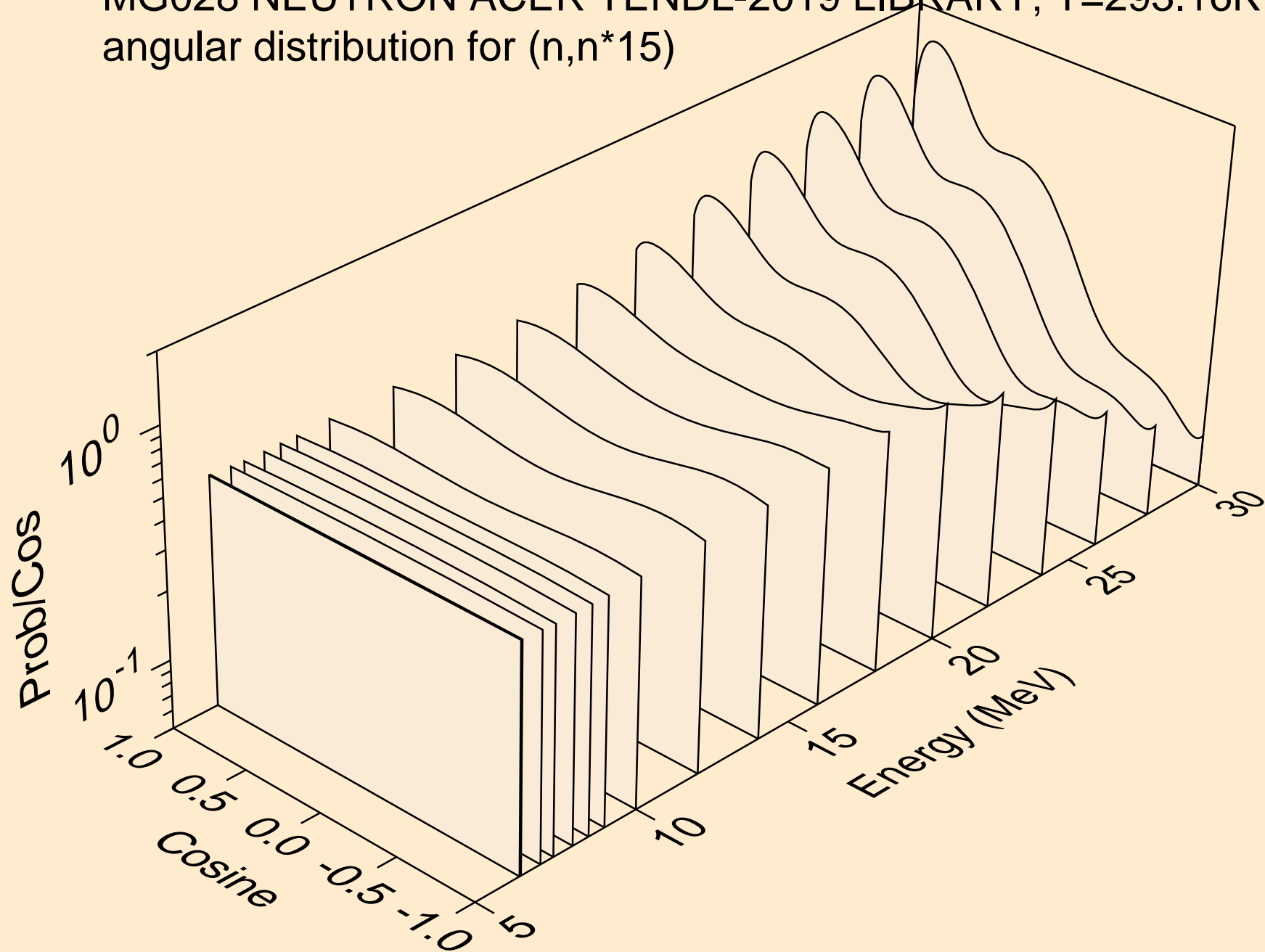

MG028 NEUTRON ACER TENDL-2019 LIBRARY; T=293.16K
angular distribution for (n,n*16)

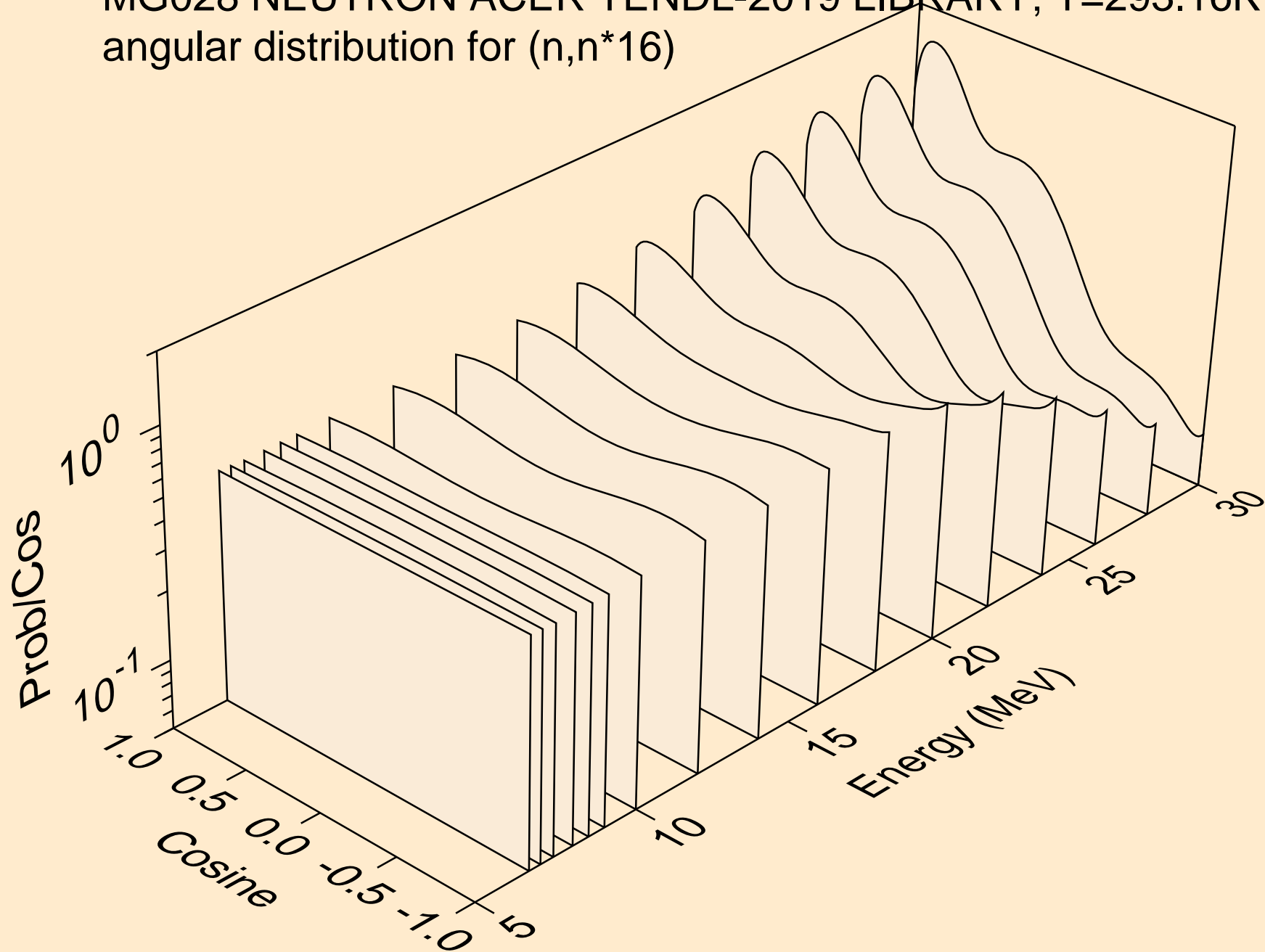

MG028 NEUTRON ACER TENDL-2019 LIBRARY; T=293.16K
angular distribution for (n,n*17)

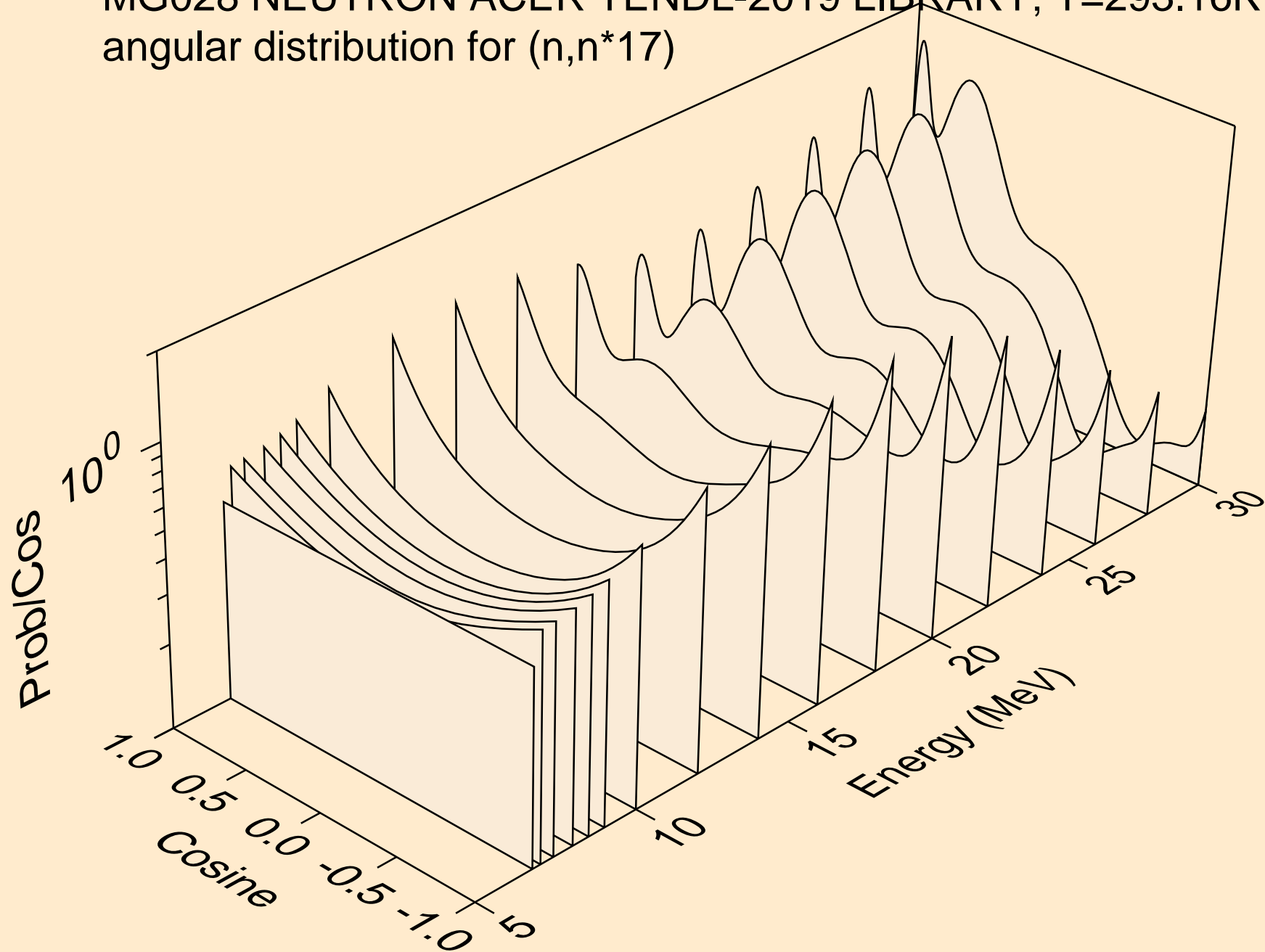

MG028 NEUTRON ACER TENDL-2019 LIBRARY; T=293.16K
angular distribution for (n,n*18)

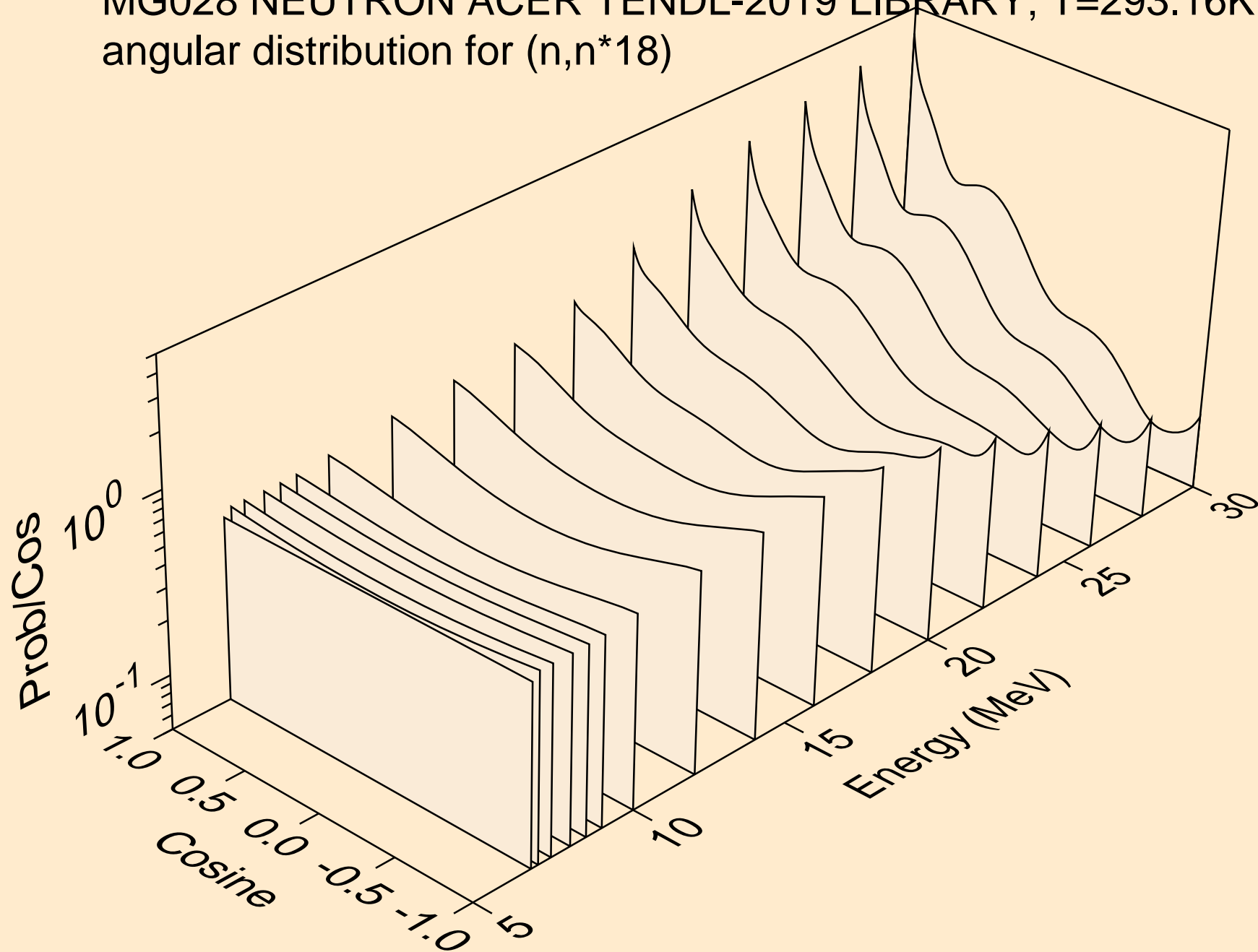

MG028 NEUTRON ACER TENDL-2019 LIBRARY; T=293.16K
angular distribution for (n,n*19)

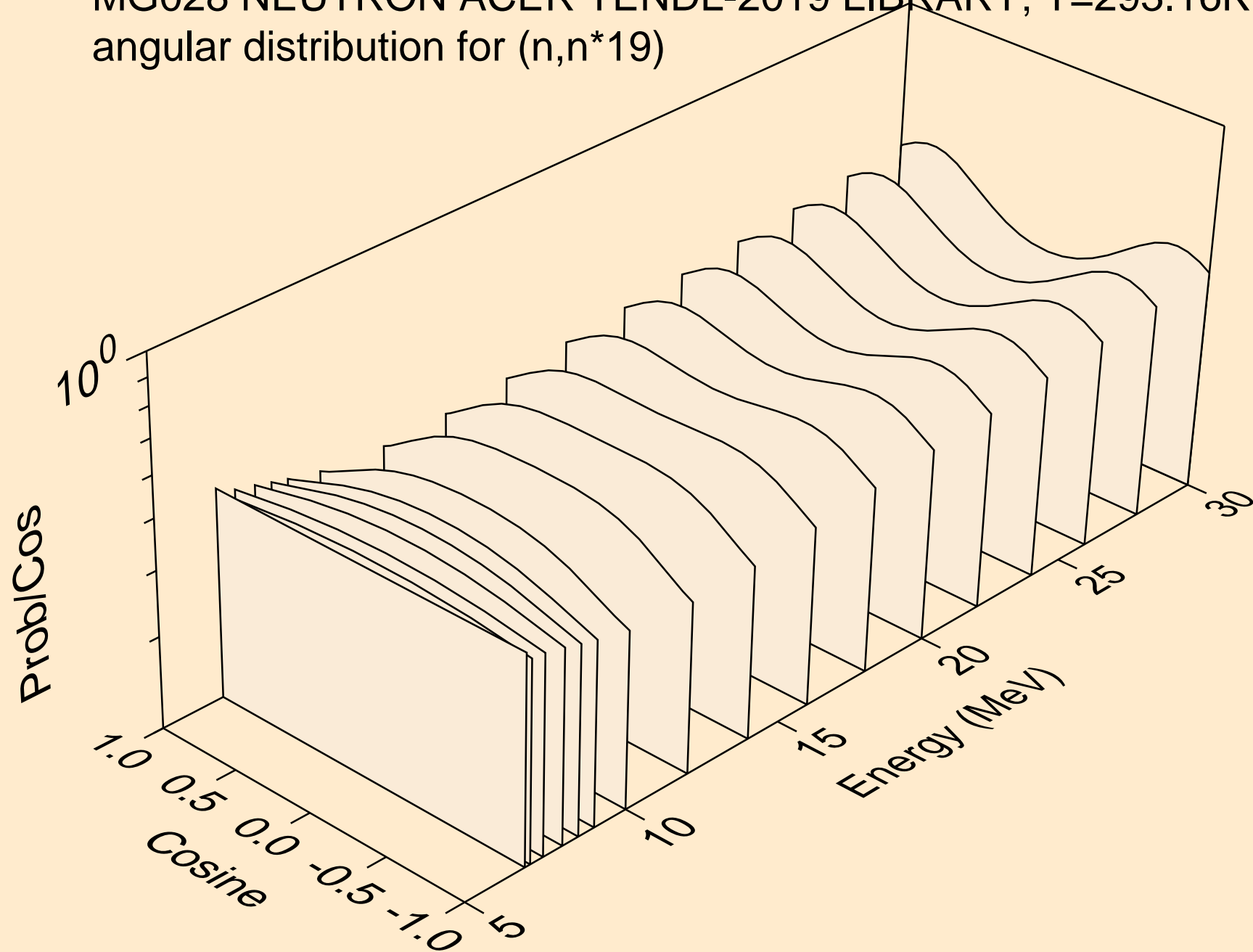

MG028 NEUTRON ACER TENDL-2019 LIBRARY; T=293.16K
angular distribution for (n,n*20)

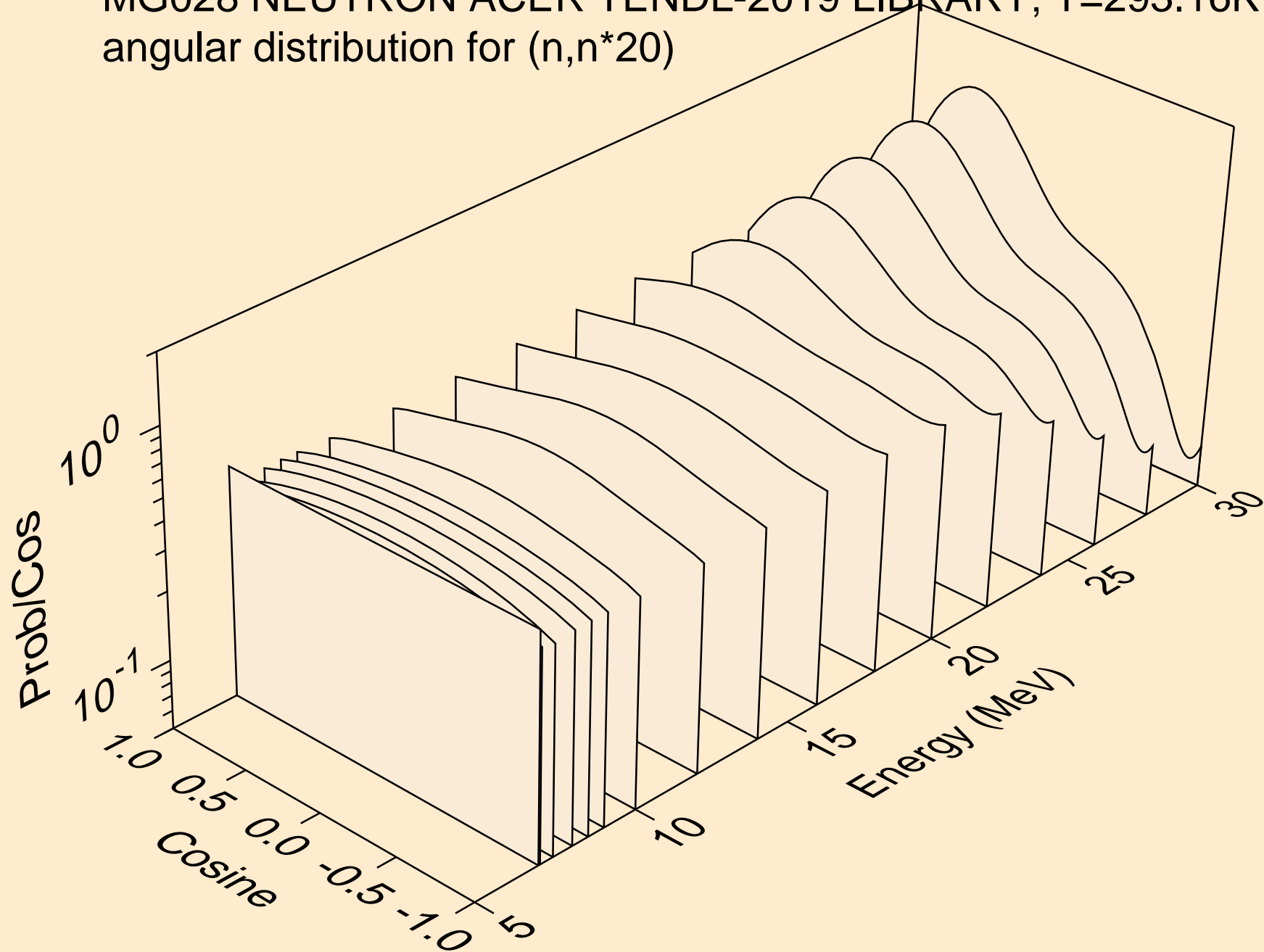

MG028 NEUTRON ACER TENDL-2019 LIBRARY; T=293.16K
angular distribution for (n,n*21)

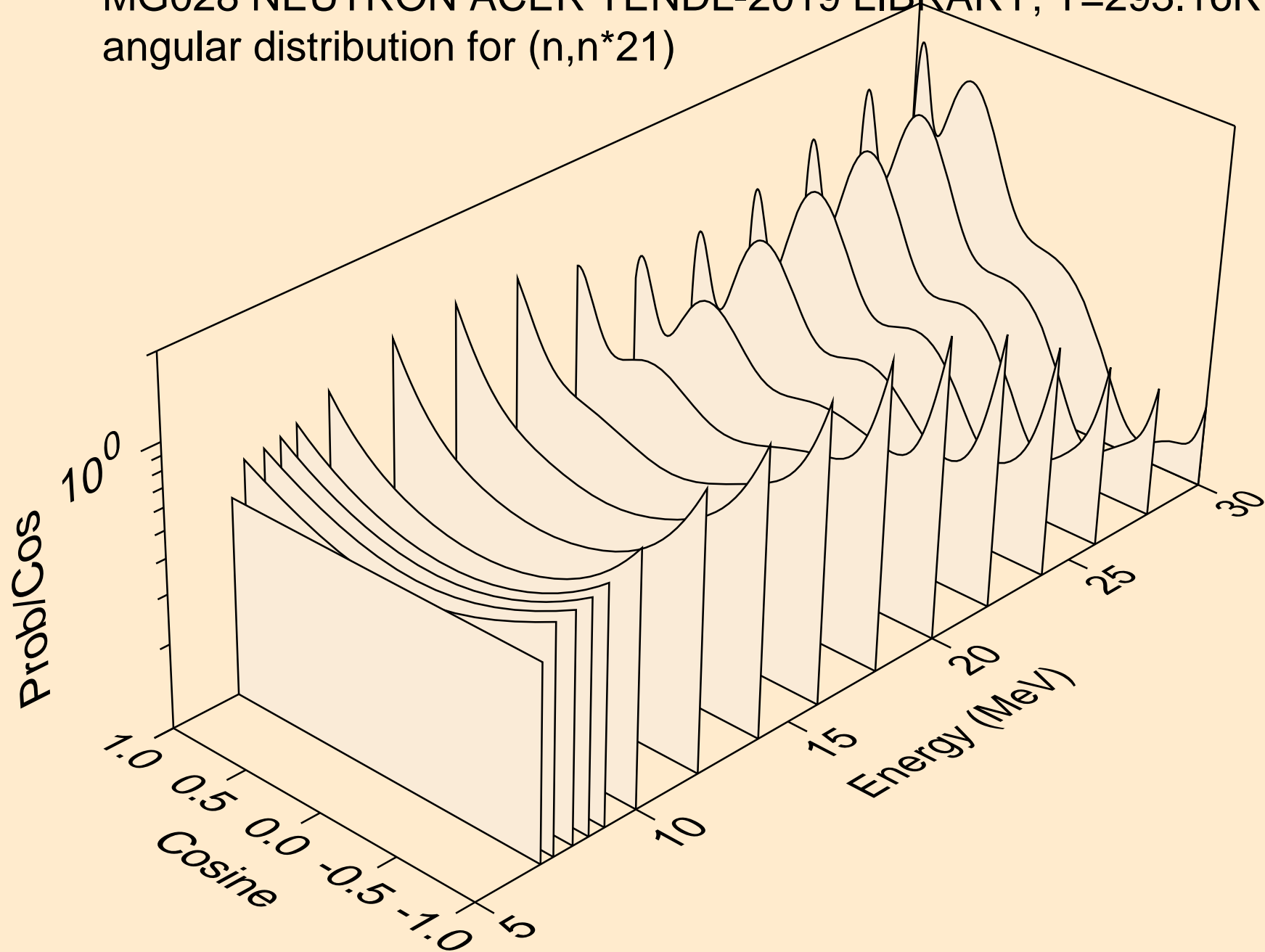

MG028 NEUTRON ACER TENDL-2019 LIBRARY; T=293.16K
angular distribution for (n,n*22)

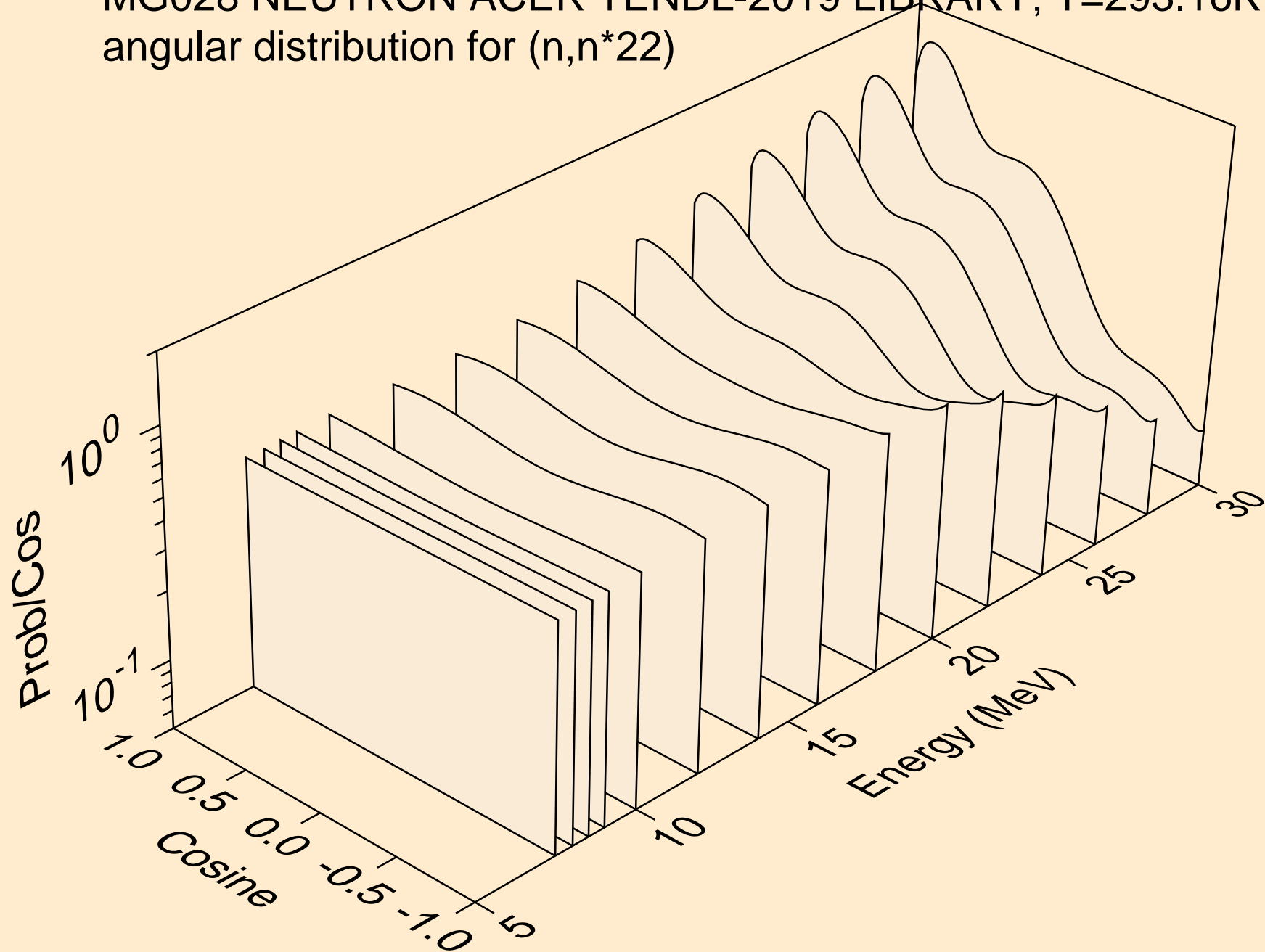

MG028 NEUTRON ACER TENDL-2019 LIBRARY; T=293.16K
angular distribution for (n,n*23)

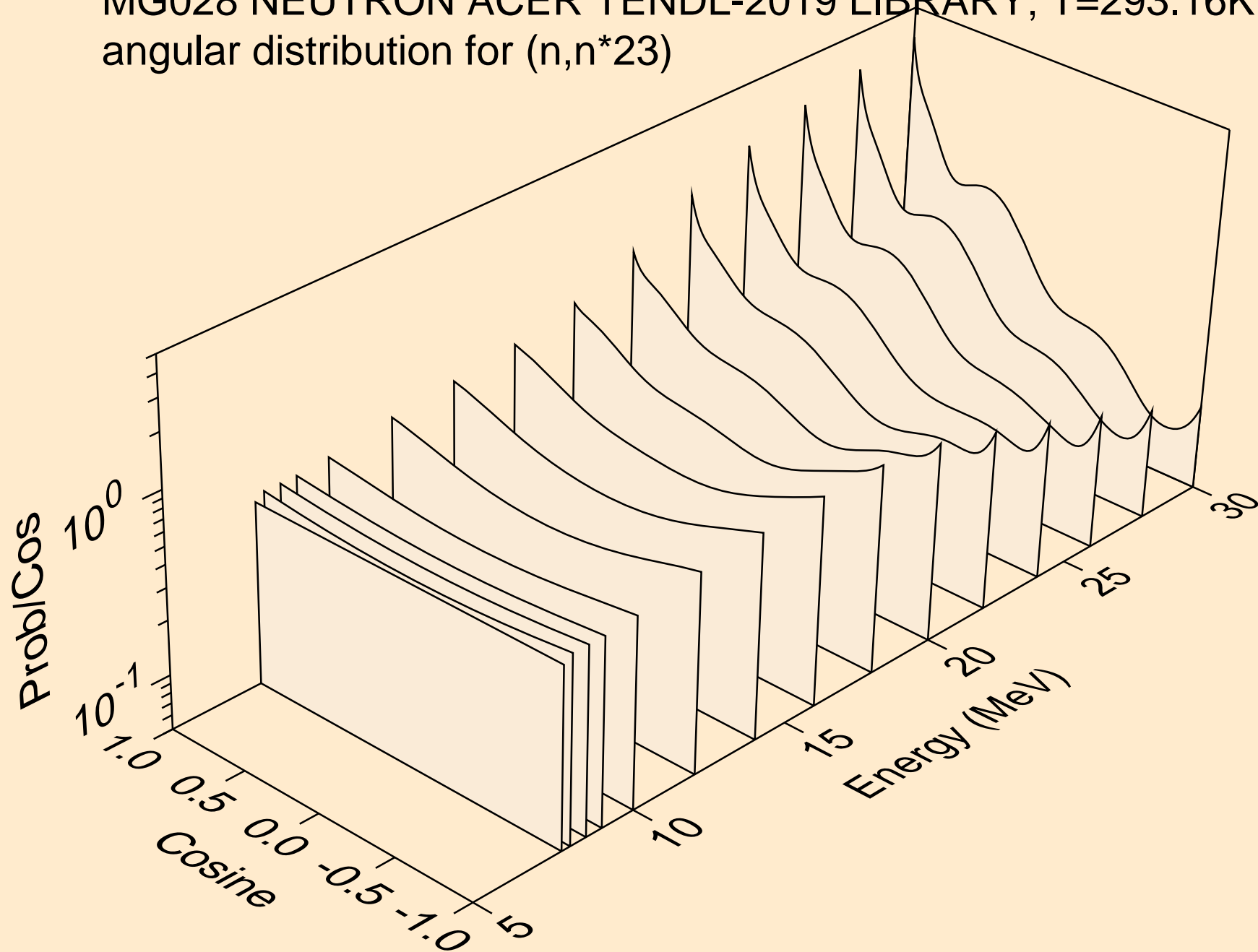

MG028 NEUTRON ACER TENDL-2019 LIBRARY; T=293.16K
angular distribution for (n,n*24)

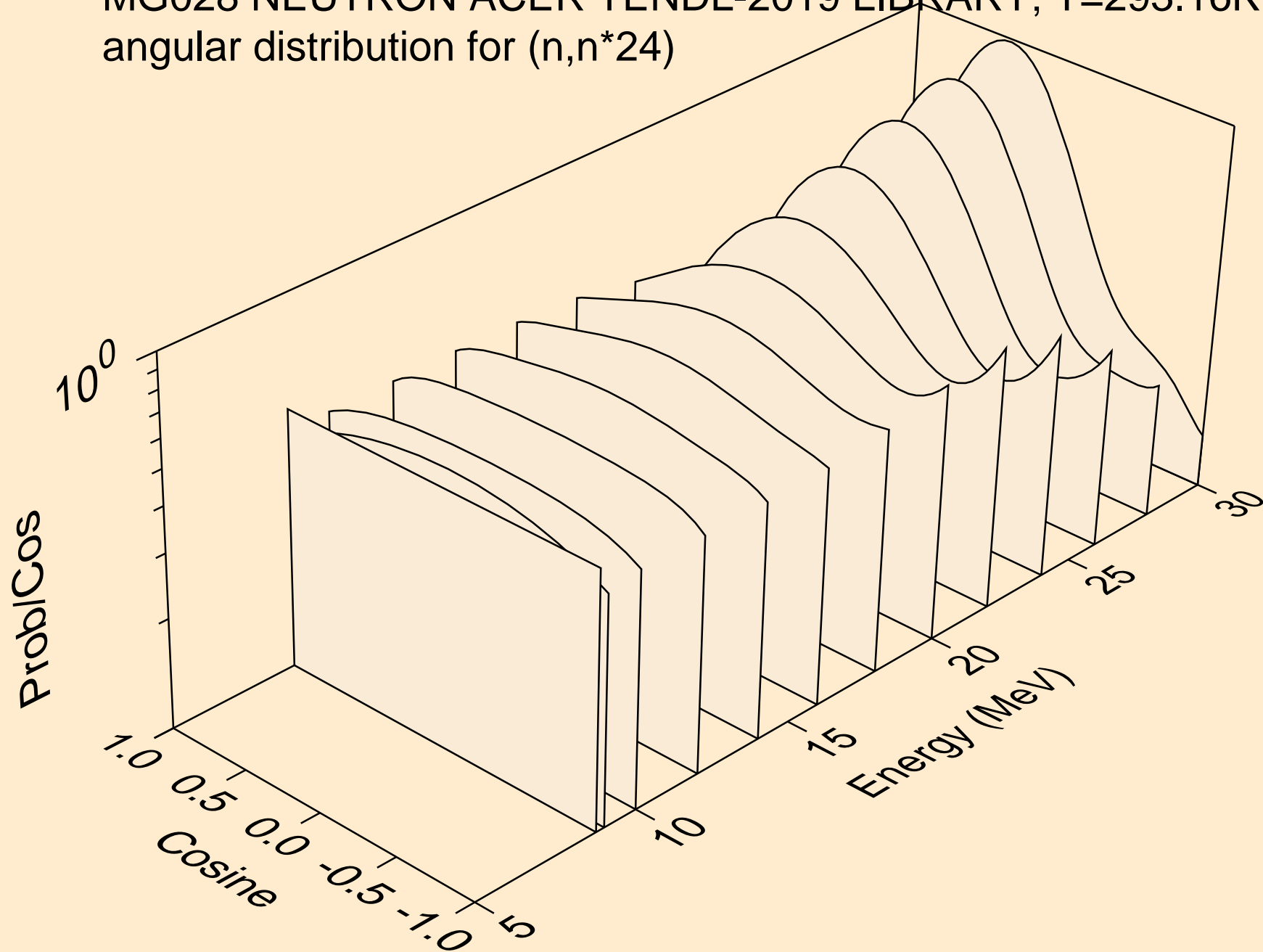

MG028 NEUTRON ACER TENDL-2019 LIBRARY; T=293.16K
angular distribution for (n,n*25)

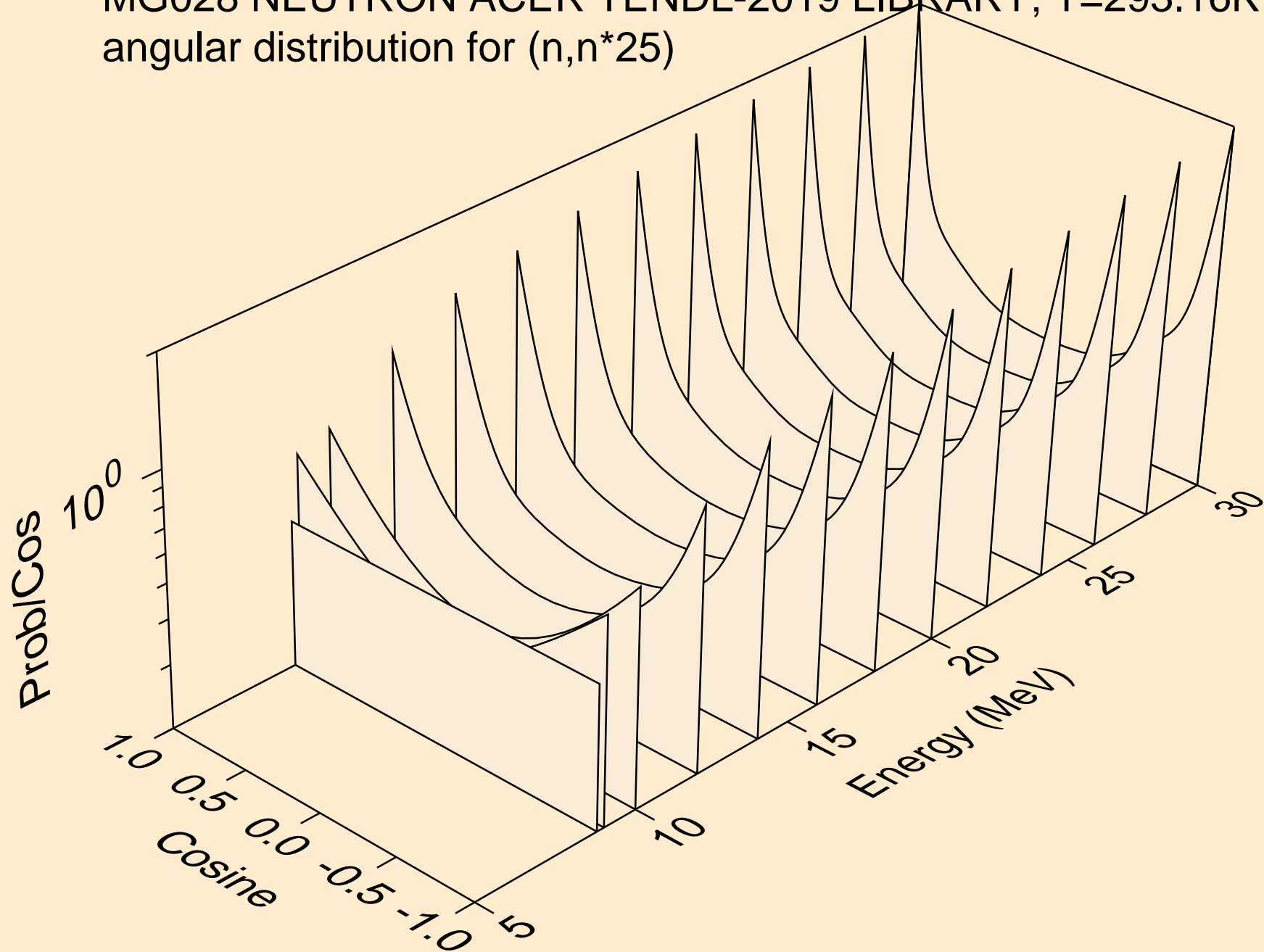

MG028 NEUTRON ACER TENDL-2019 LIBRARY; T=293.16K
angular distribution for (n,n*26)

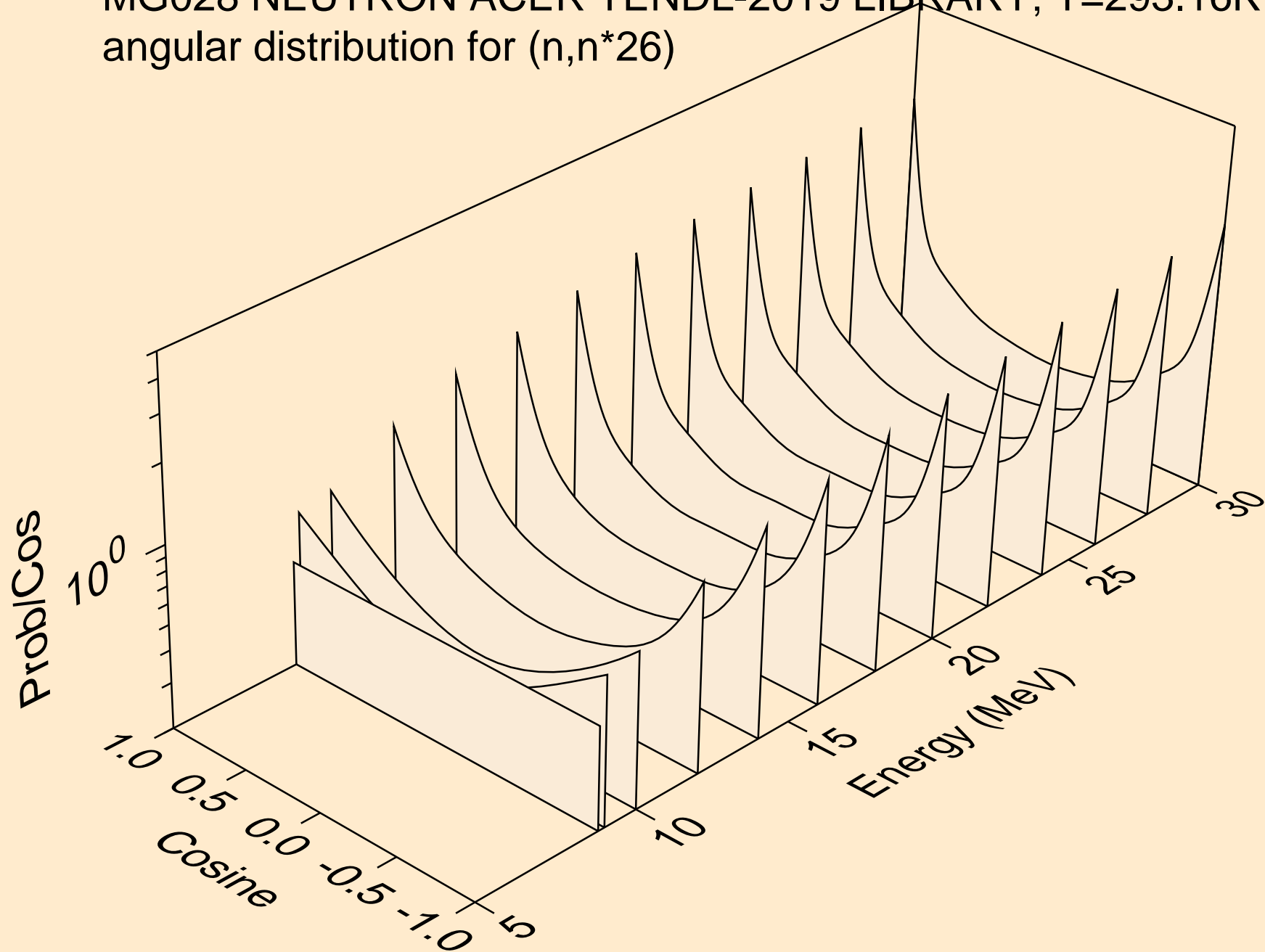

MG028 NEUTRON ACER TENDL-2019 LIBRARY; T=293.16K
angular distribution for (n,n*27)

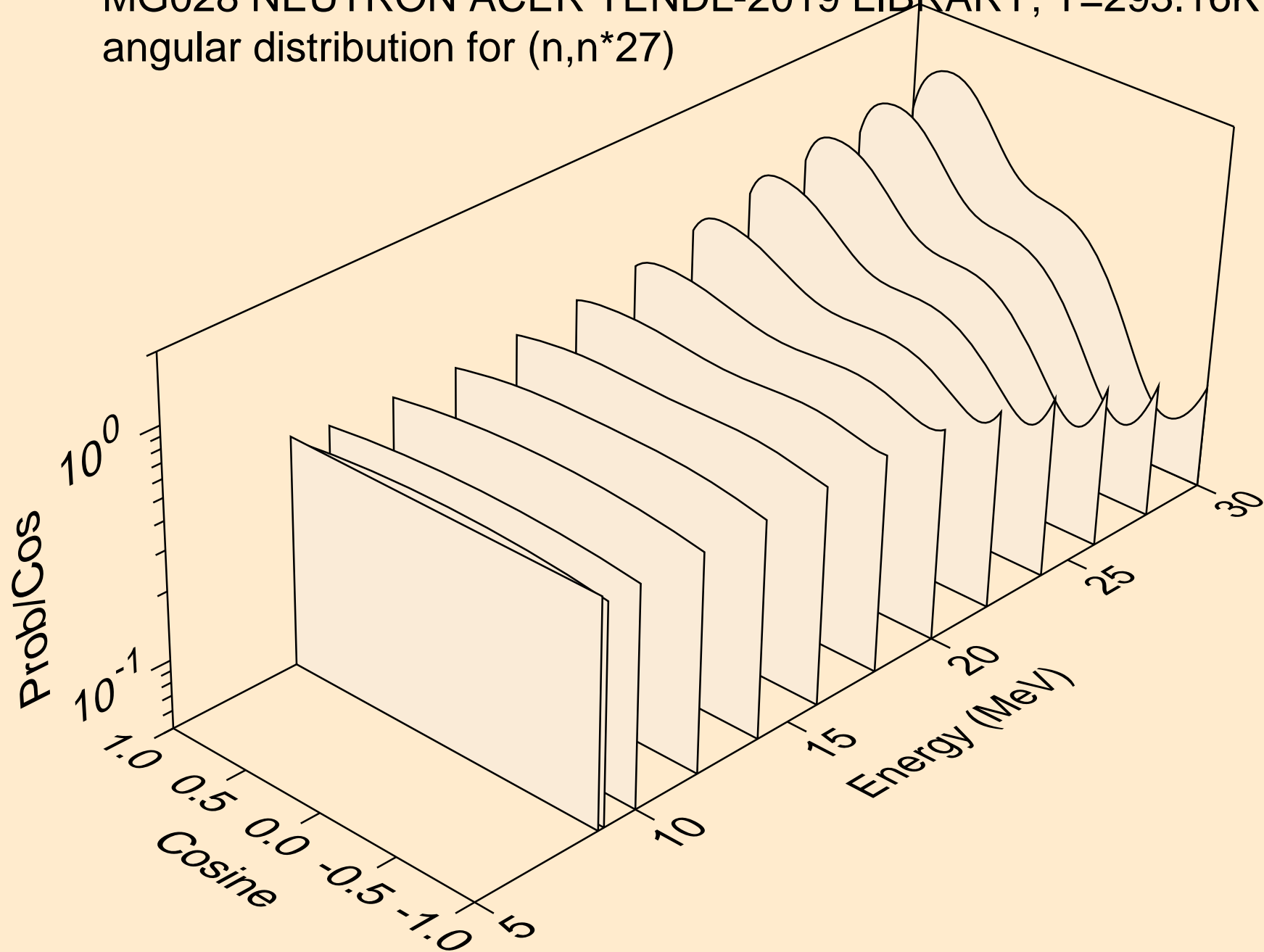

MG028 NEUTRON ACER TENDL-2019 LIBRARY; T=293.16K
angular distribution for (n,n*28)

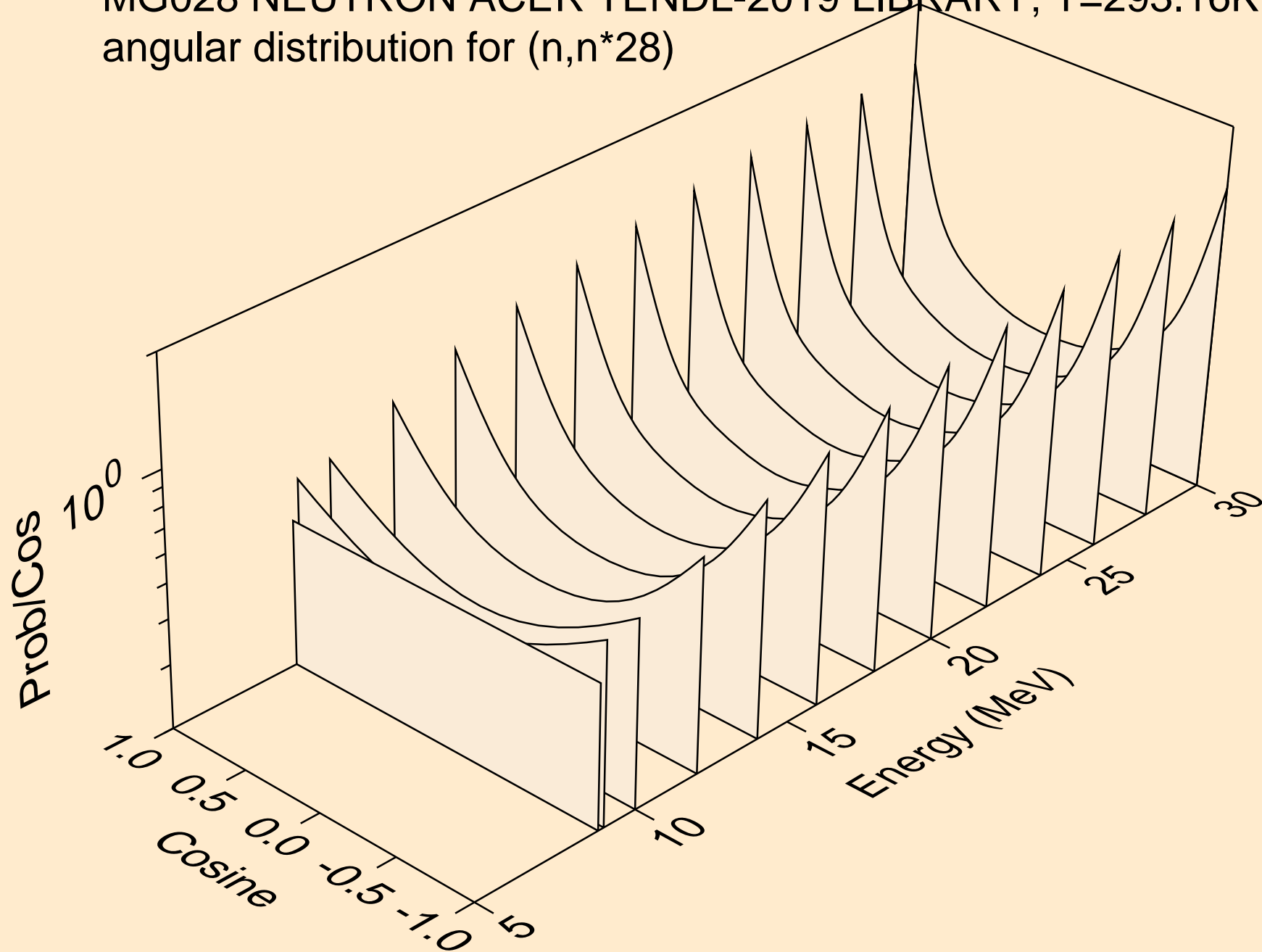

MG028 NEUTRON ACER TENDL-2019 LIBRARY; T=293.16K
angular distribution for (n,n*29)

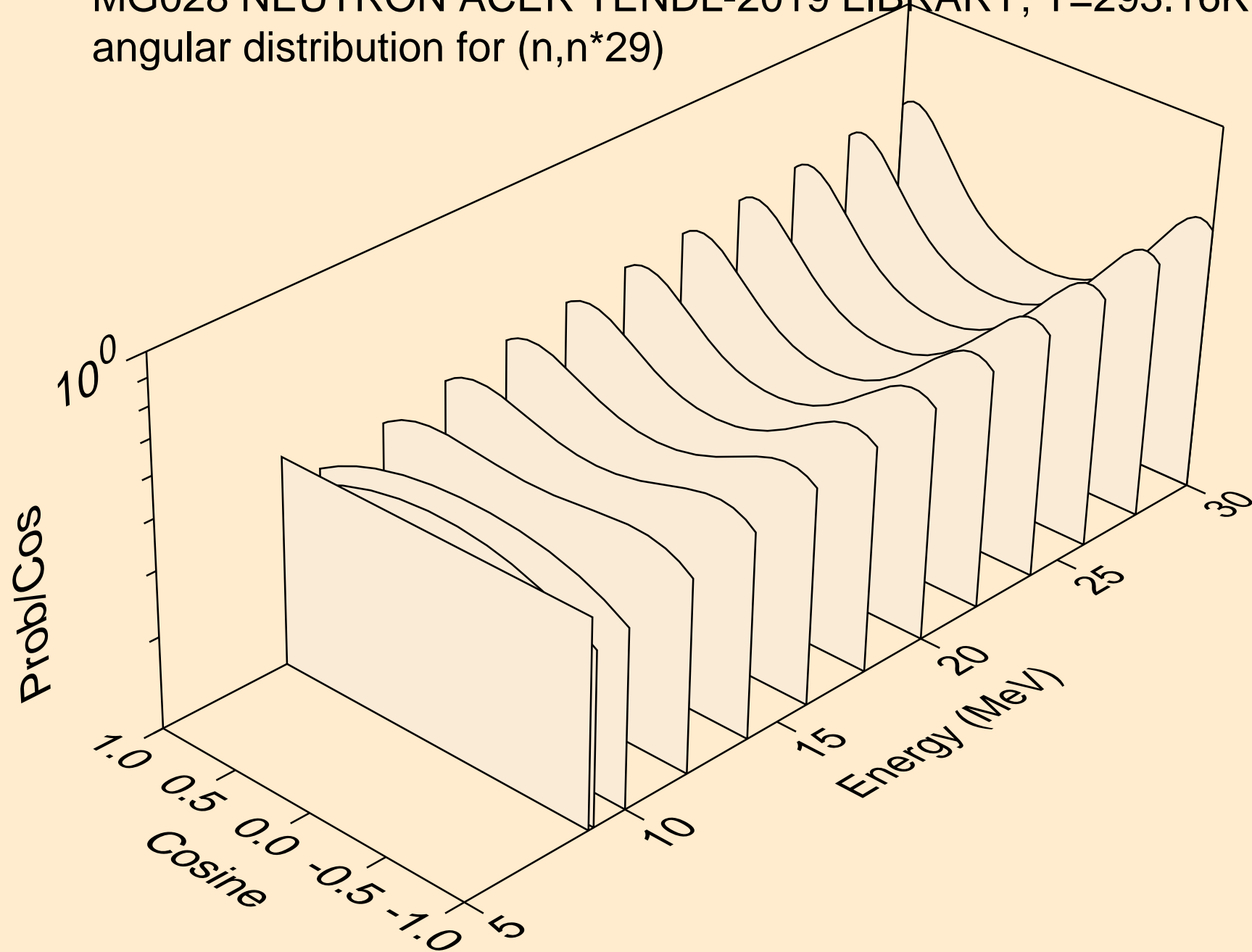

MG028 NEUTRON ACER TENDL-2019 LIBRARY; T=293.16K
Neutron emission for (n,x)

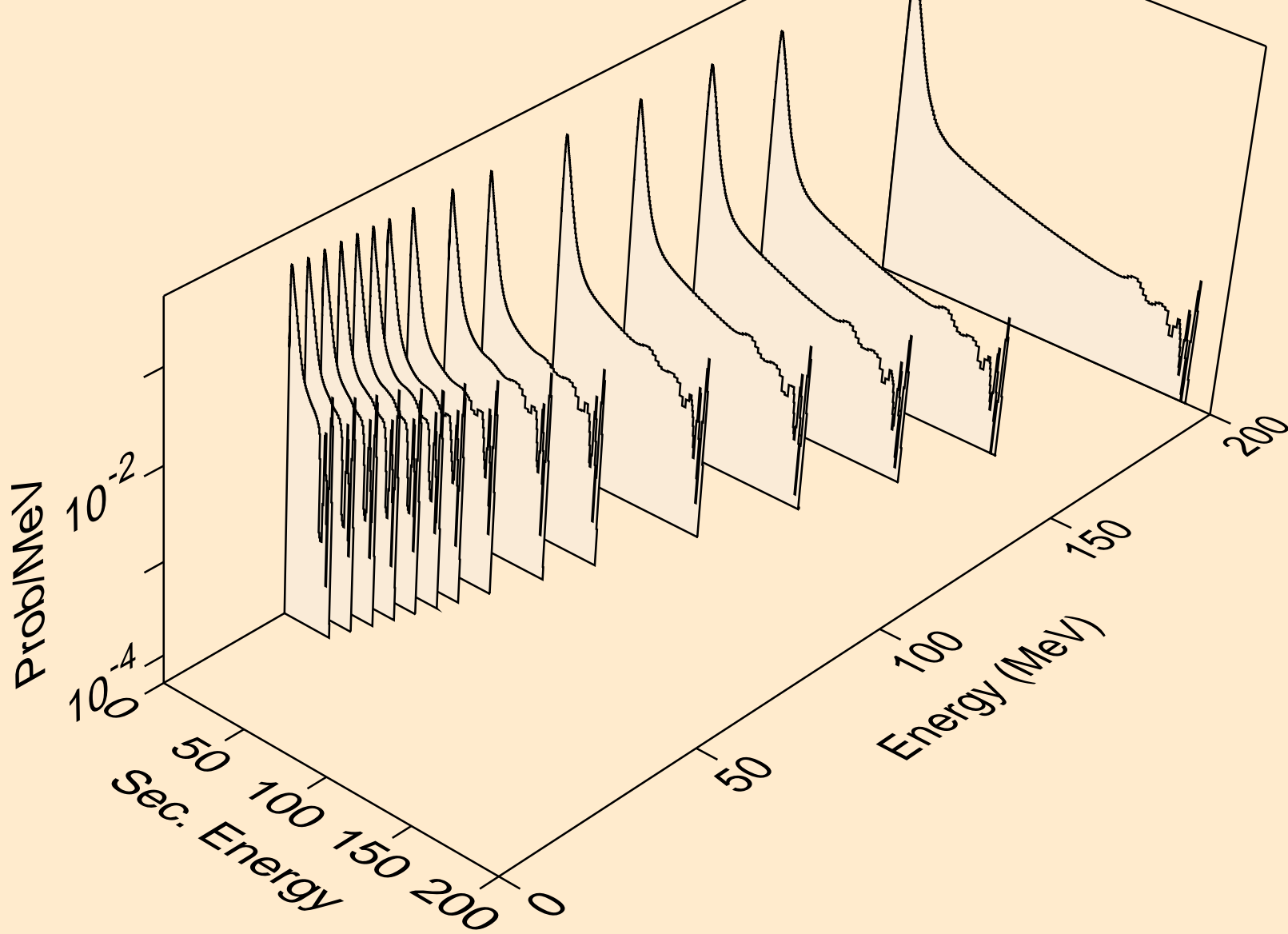

MG028 NEUTRON ACER TENDL-2019 LIBRARY; T=293.16K
Neutron emission for (n,2nd)

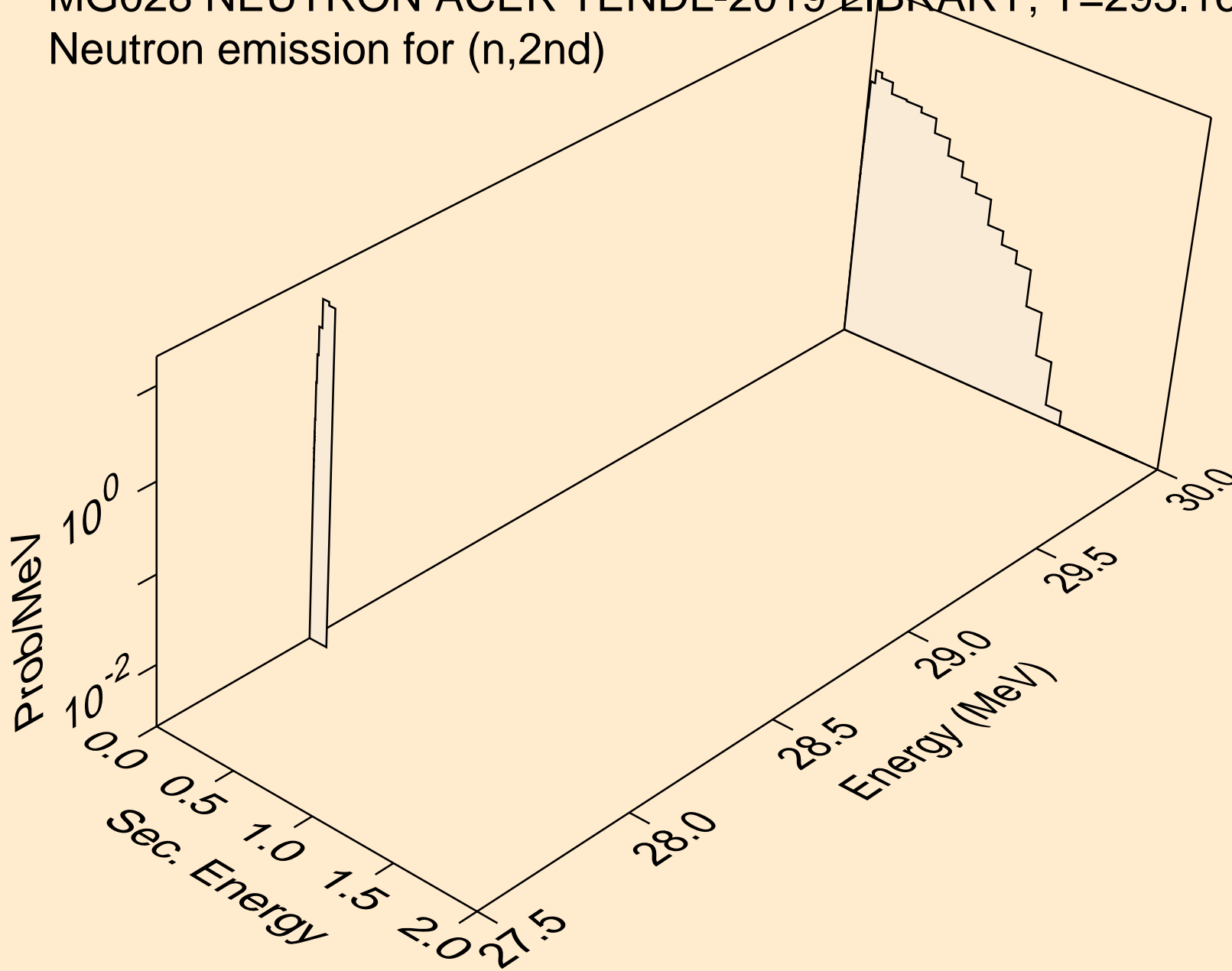

MG028 NEUTRON ACER TENDL-2019 LIBRARY; T=293.16K
Neutron emission for (n,2n)

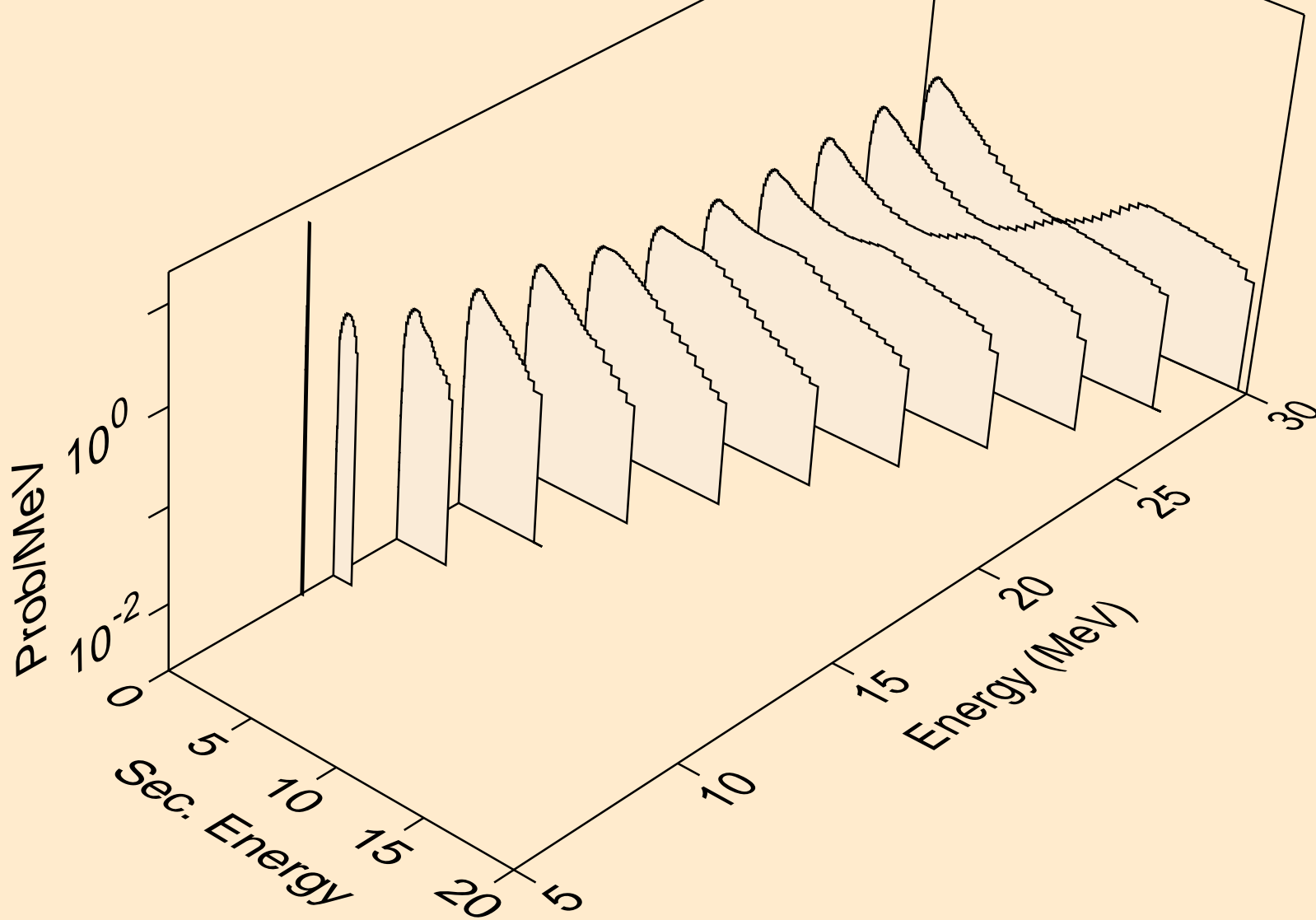

MG028 NEUTRON ACER TENDL-2019 LIBRARY; T=293.16K
Neutron emission for (n,3n)

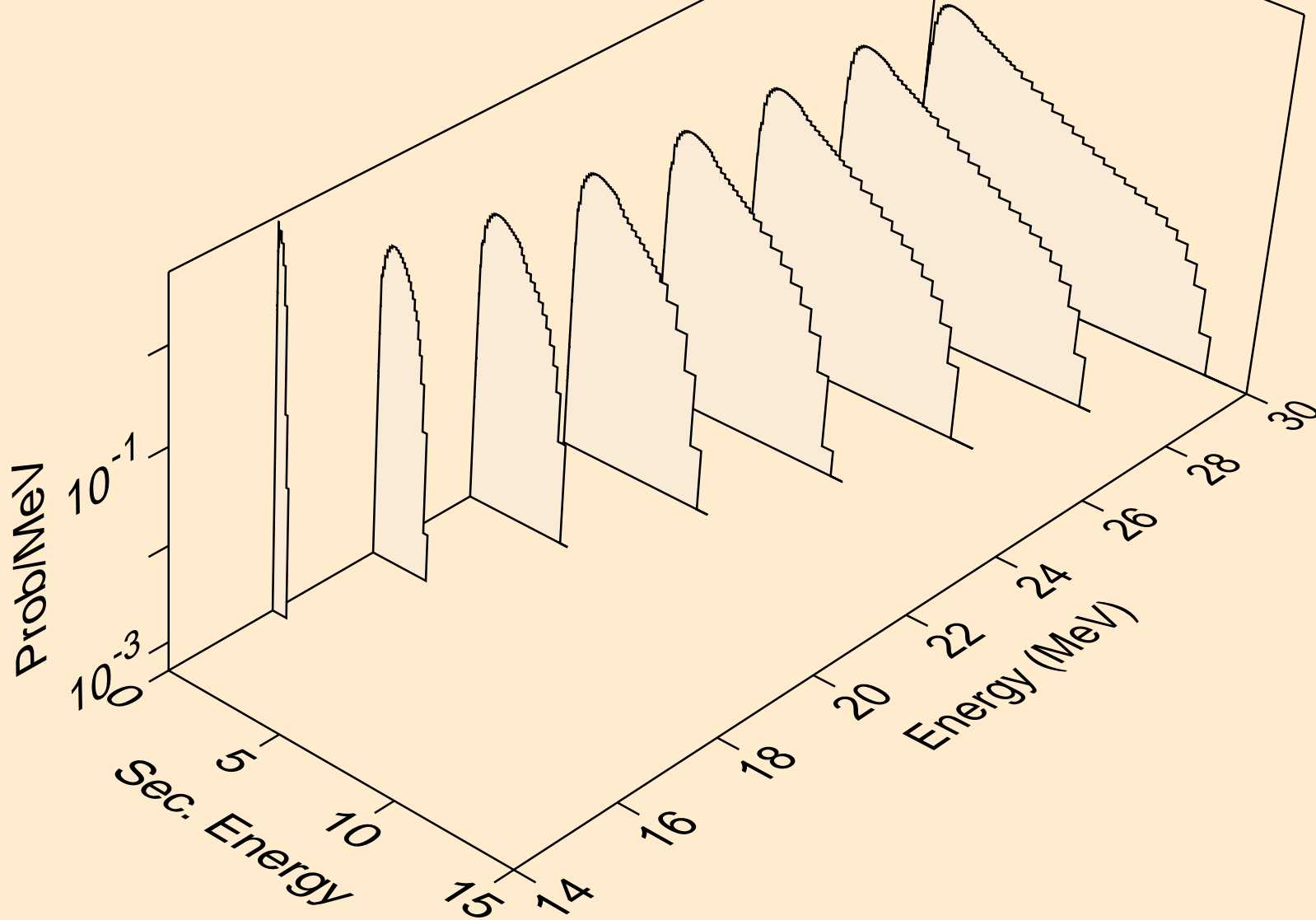

MG028 NEUTRON ACER TENDL-2019 LIBRARY; T=293.16K
Neutron emission for (n,n*)a

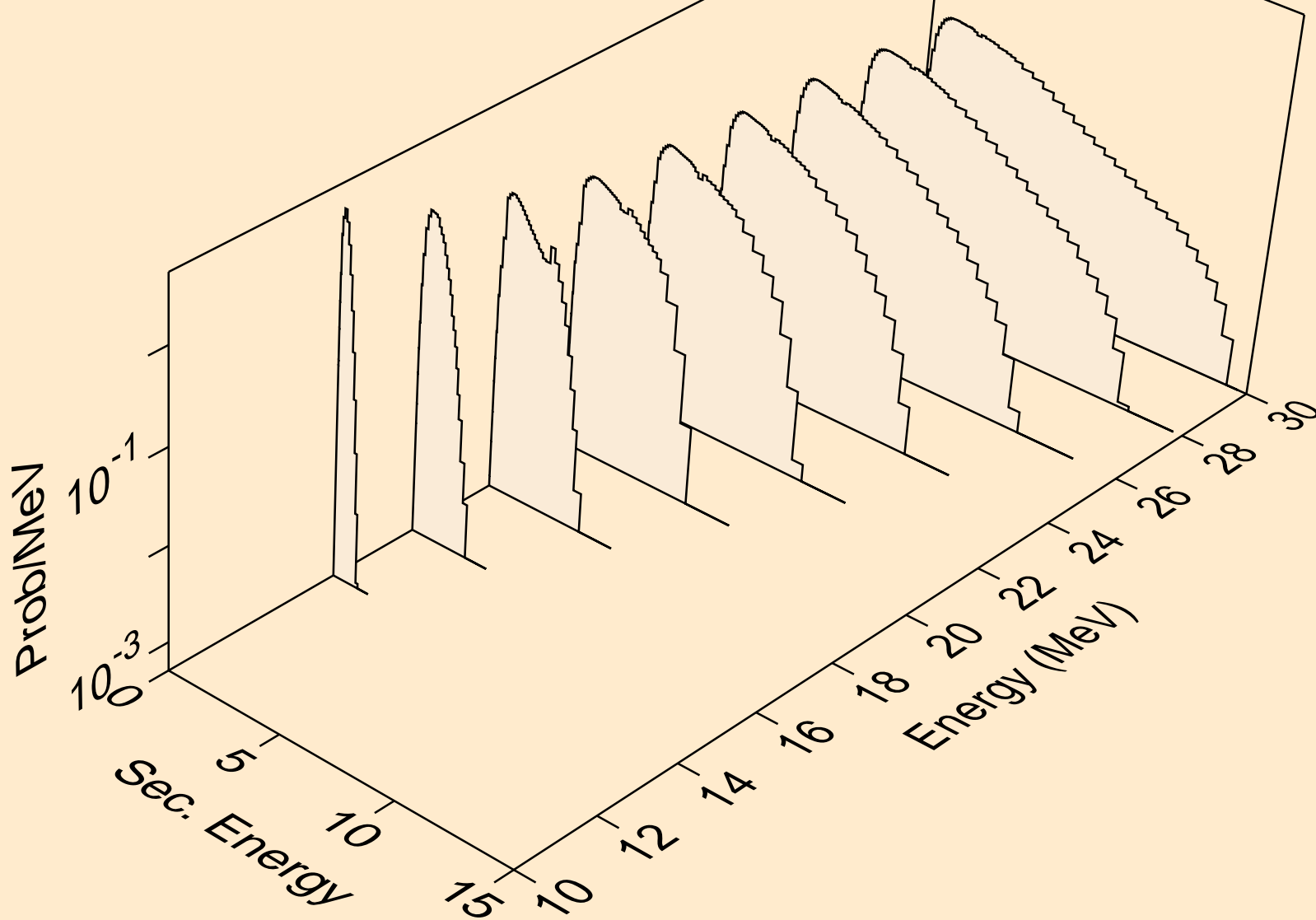

MG028 NEUTRON ACER TENDL-2019 LIBRARY; T=293.16K
Neutron emission for (n,2n)a

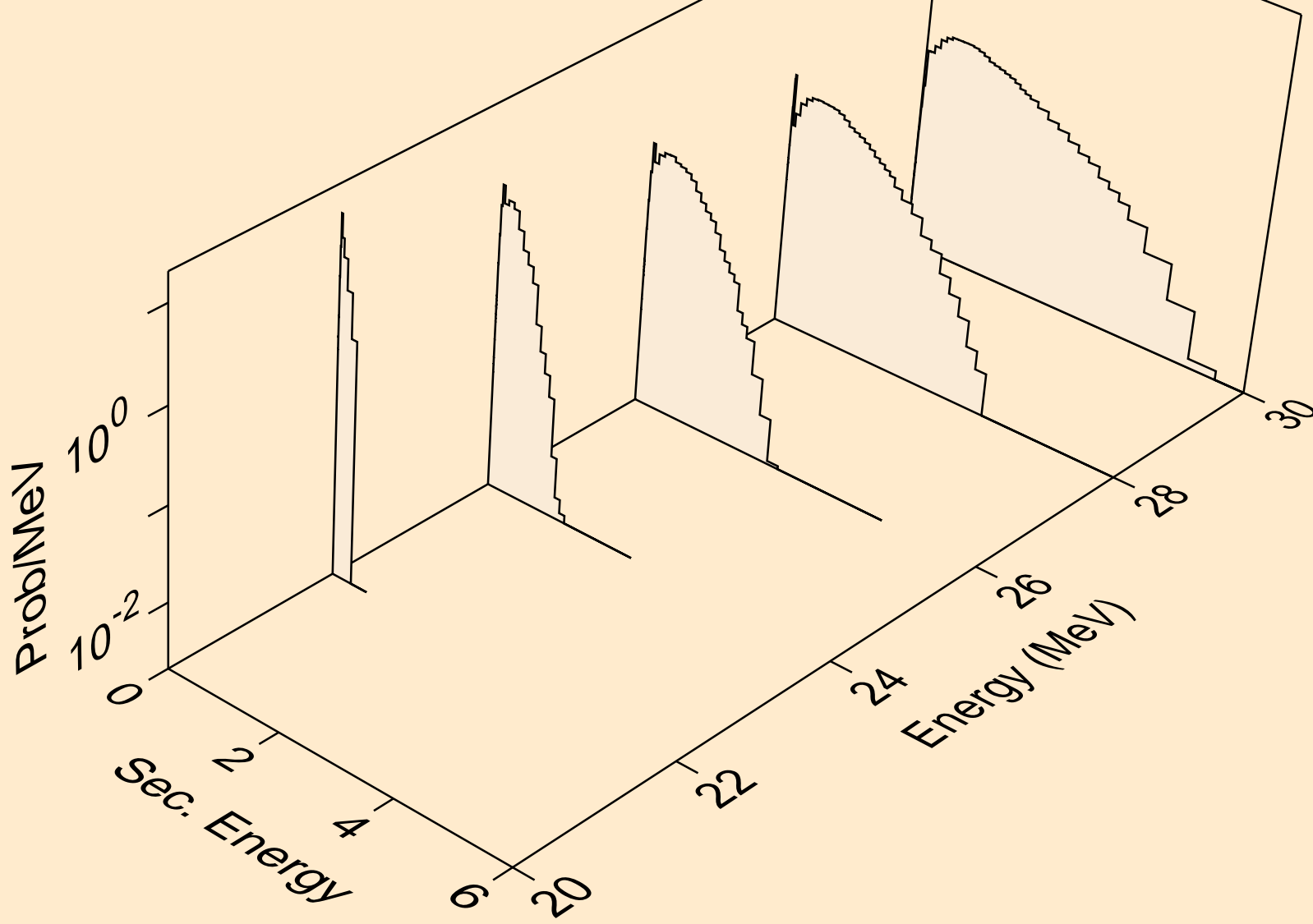

MG028 NEUTRON ACER TENDL-2019 LIBRARY; T=293.16K
Neutron emission for (n,3n)a

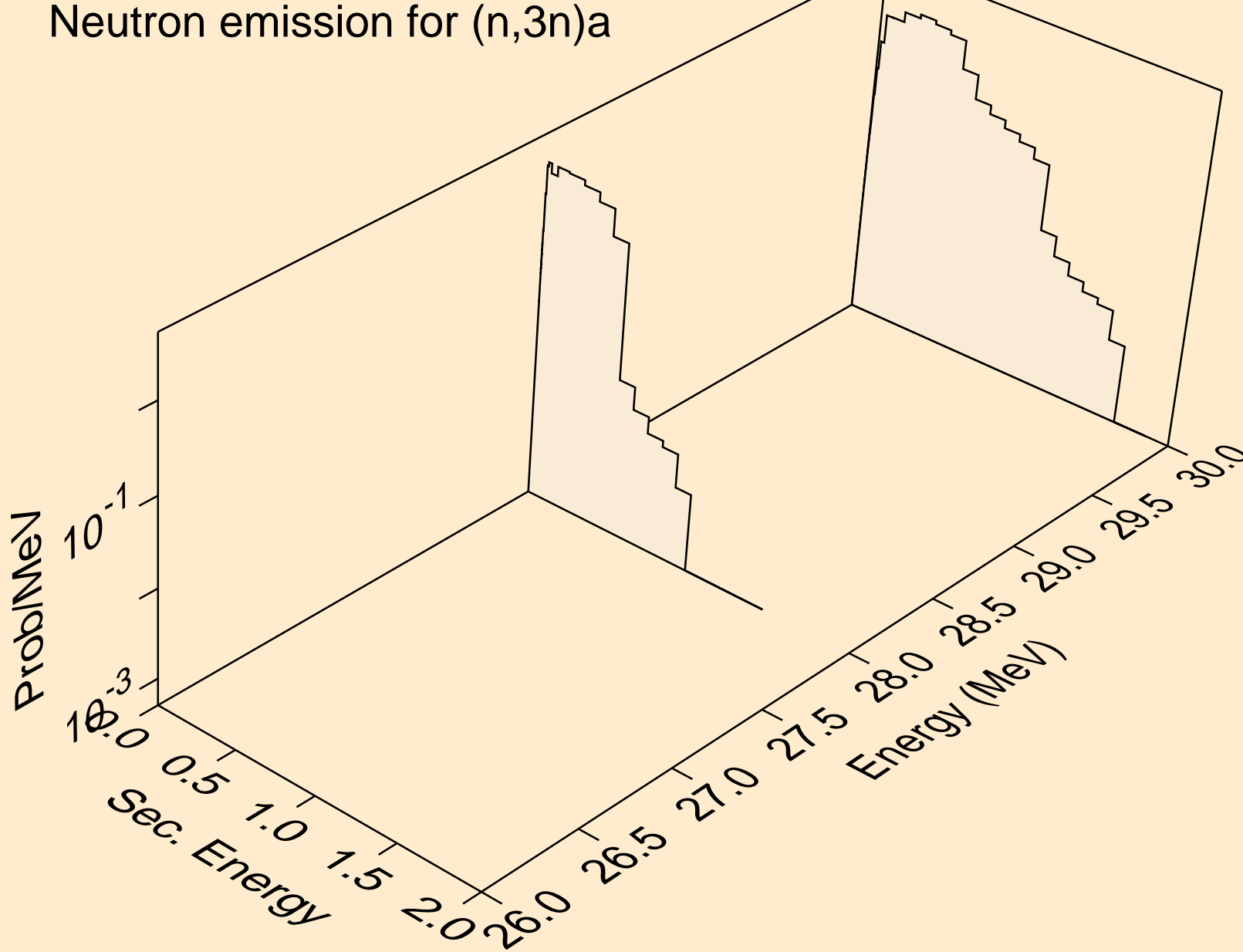

MG028 NEUTRON ACER TENDL-2019 LIBRARY; T=293.16K
Neutron emission for (n,n*)p

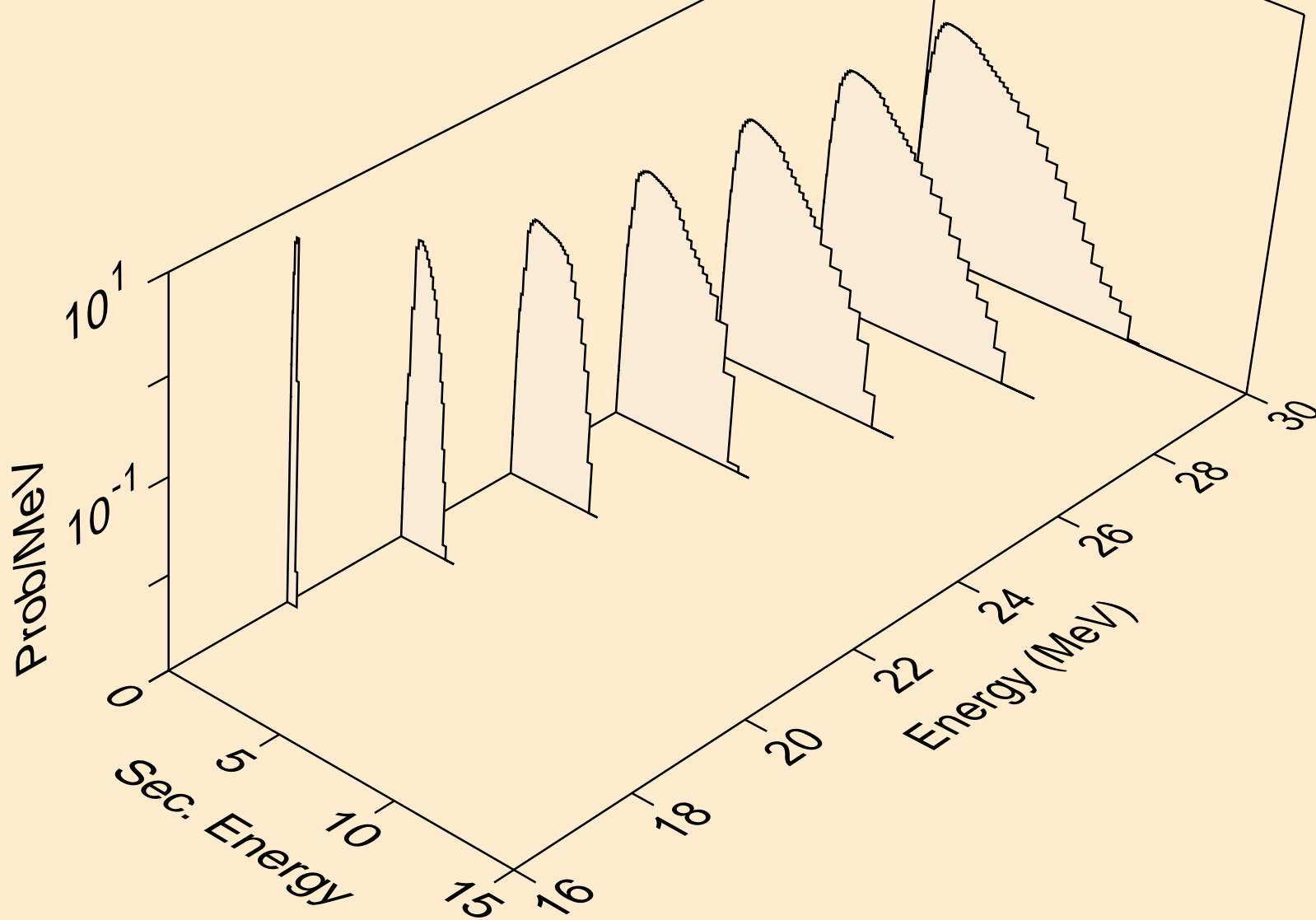

MG028 NEUTRON ACER TENDL-2019 LIBRARY; T=293.16K
Neutron emission for (n,n*)d

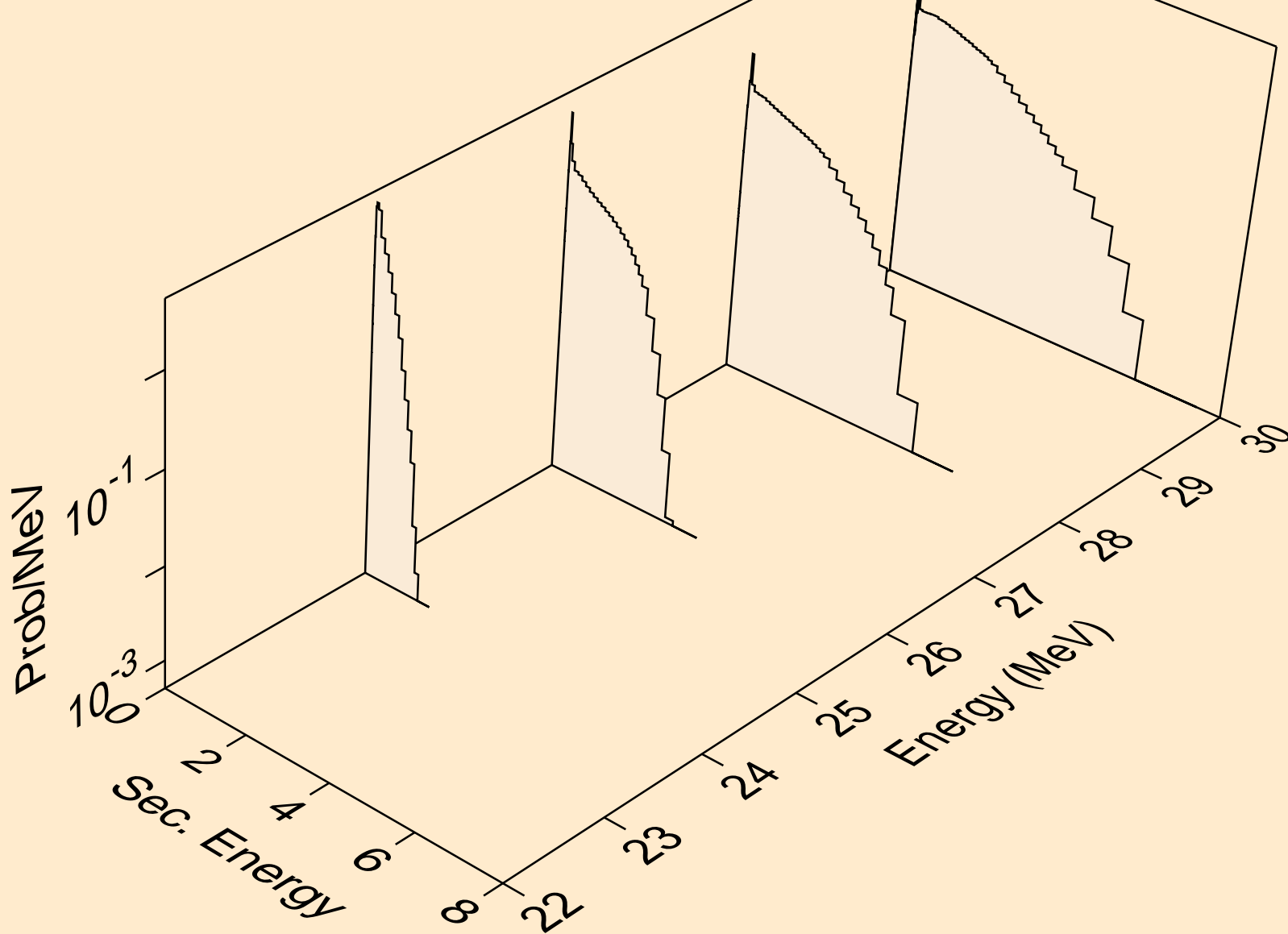

MG028 NEUTRON ACER TENDL-2019 LIBRARY; T=293.16K
Neutron emission for (n,n*)t

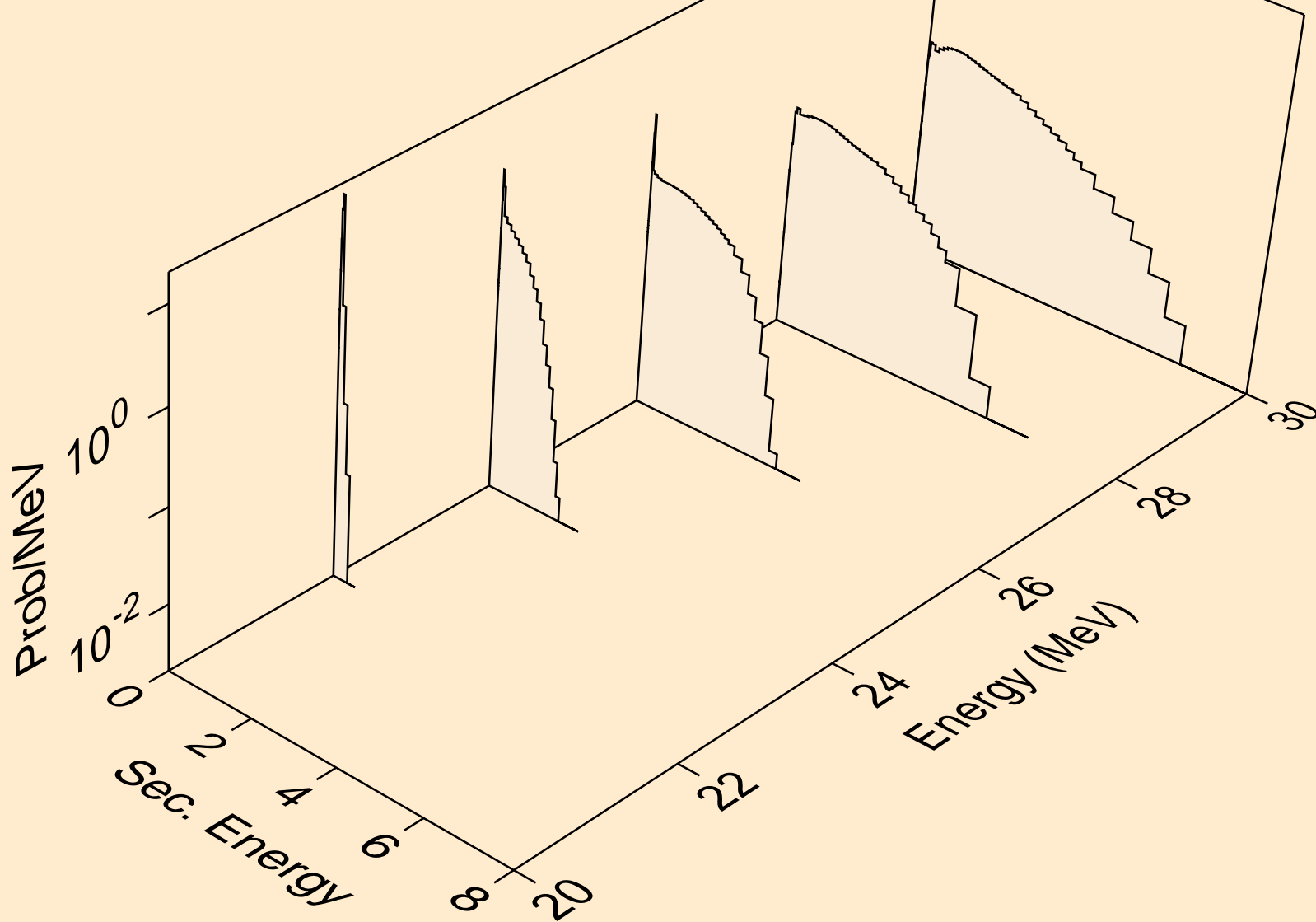

MG028 NEUTRON ACER TENDL-2019 LIBRARY; T=293.16K
Neutron emission for (n,4n)

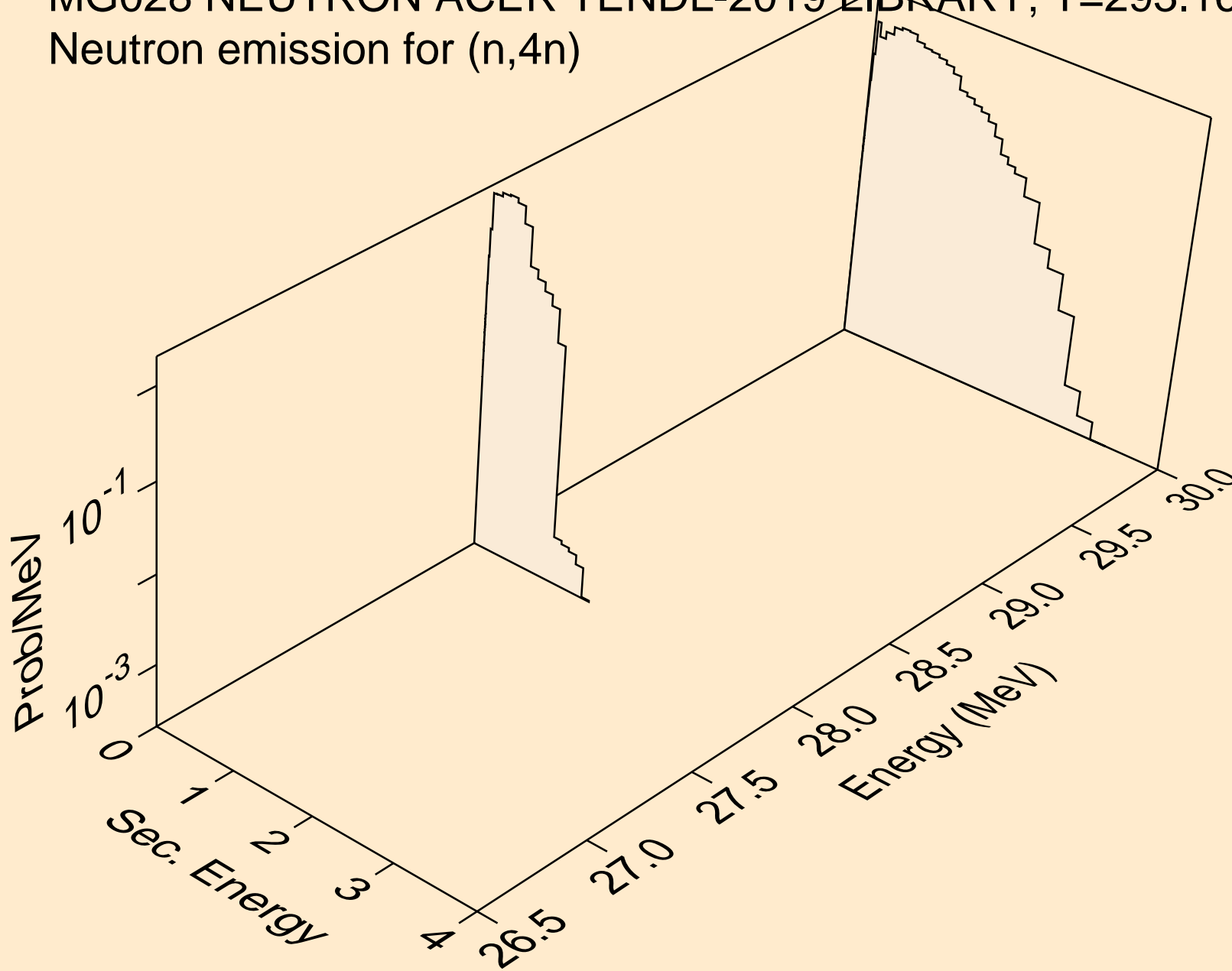

MG028 NEUTRON ACER TENDL-2019 LIBRARY; T=293.16K
Neutron emission for (n,2np)

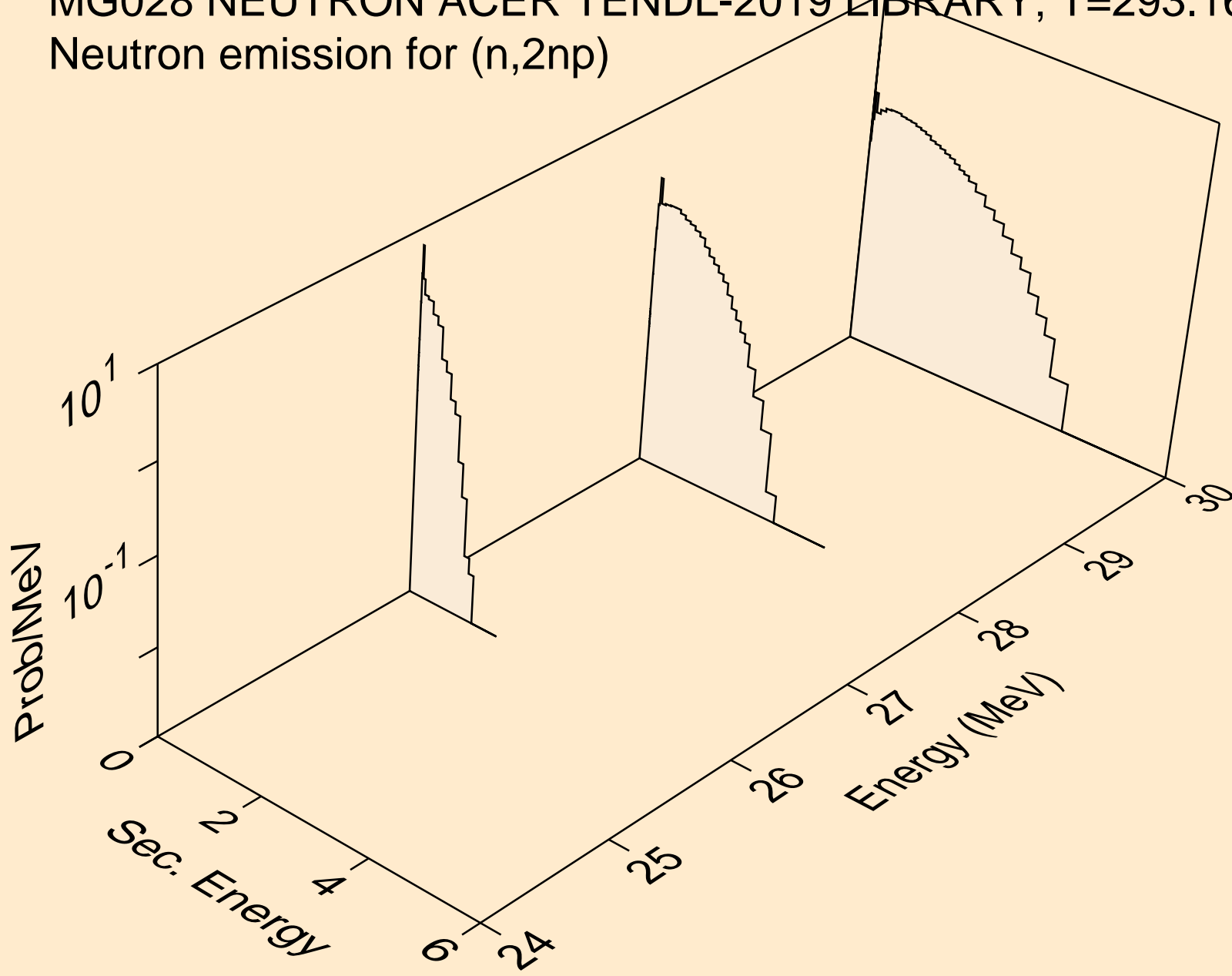

MG028 NEUTRON ACER TENDL-2019 LIBRARY; T=293.16K
Neutron emission for (n,n*c)

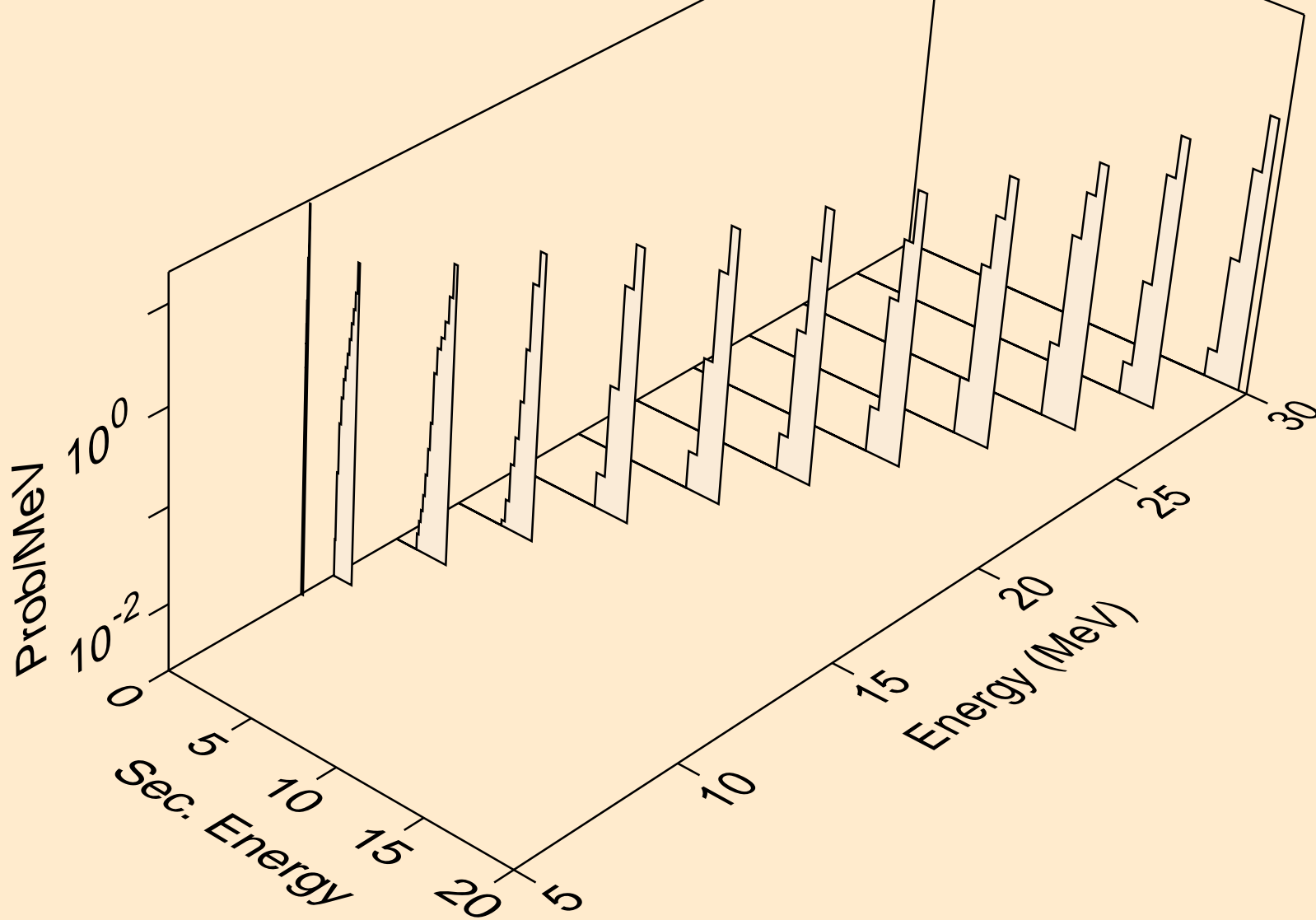

MG028 NEUTRON ACER TENDL-2019 LIBRARY; T=293.16K
Photon emission for (n,x)

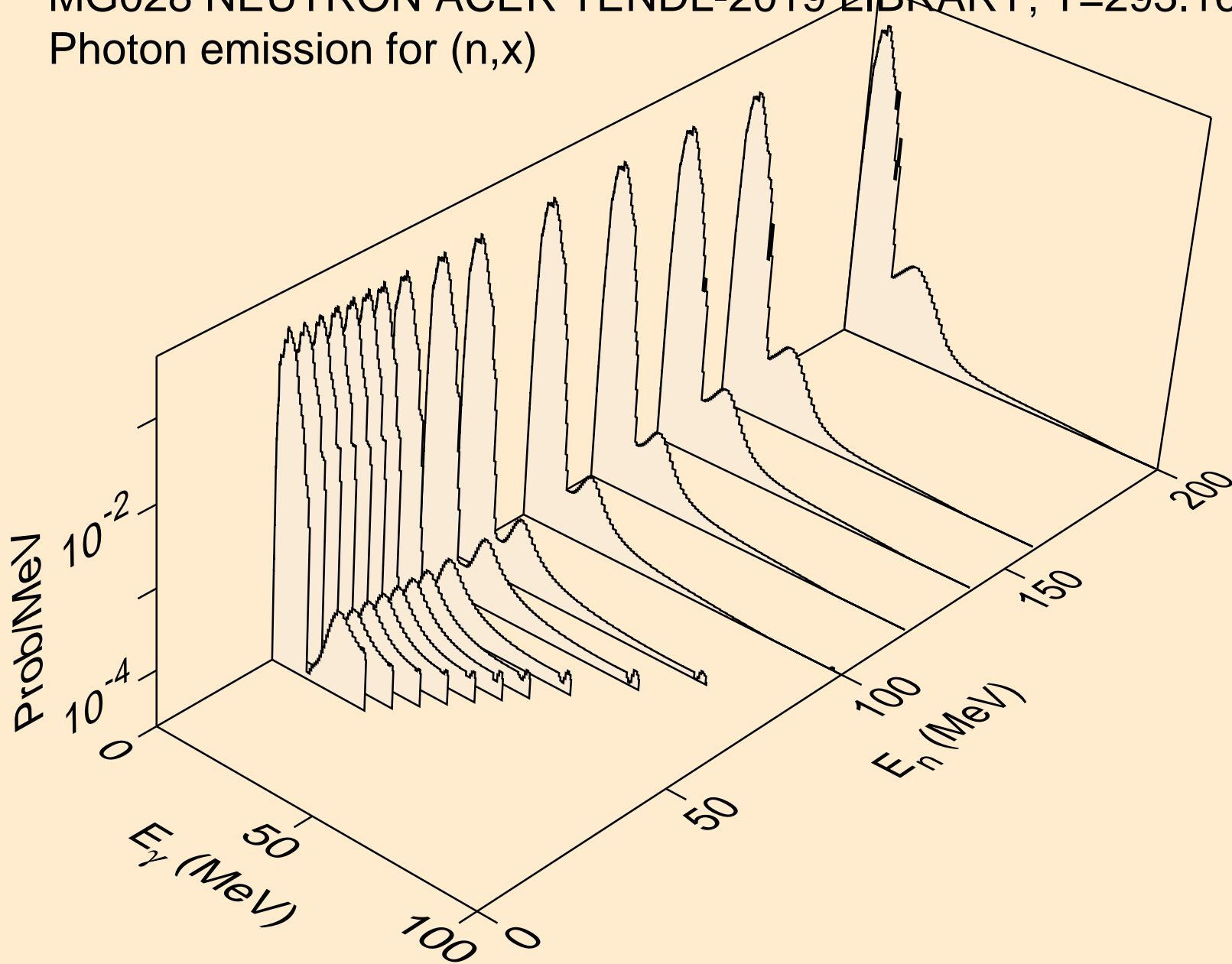

MG028 NEUTRON ACER TENDL-2019 LIBRARY; T=293.16K
Photon emission for (n,2nd)

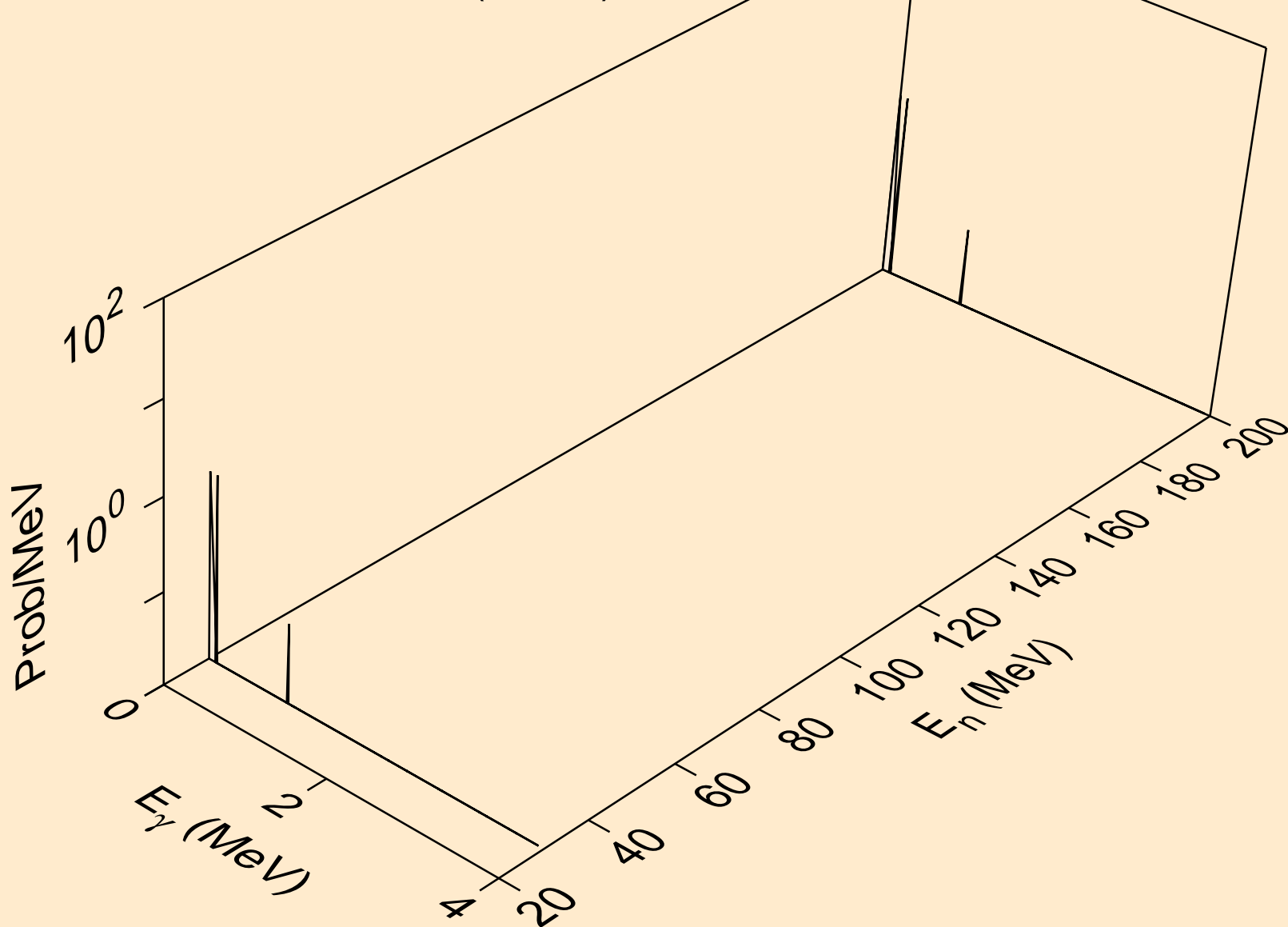

MG028 NEUTRON ACER TENDL-2019 LIBRARY; T=293.16K
Photon emission for (n,2n)

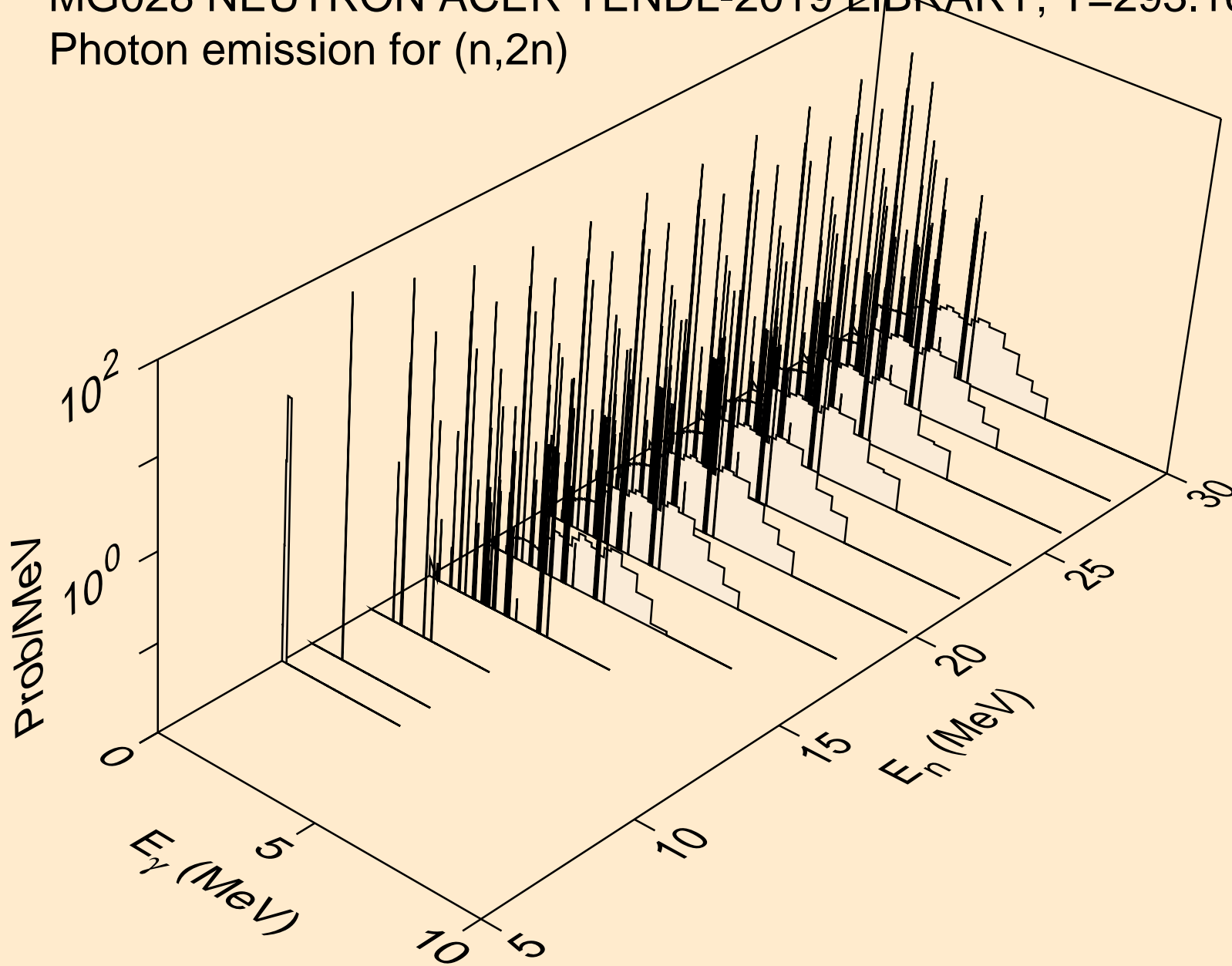

MG028 NEUTRON ACER TENDL-2019 LIBRARY; T=293.16K
Photon emission for (n,3n)

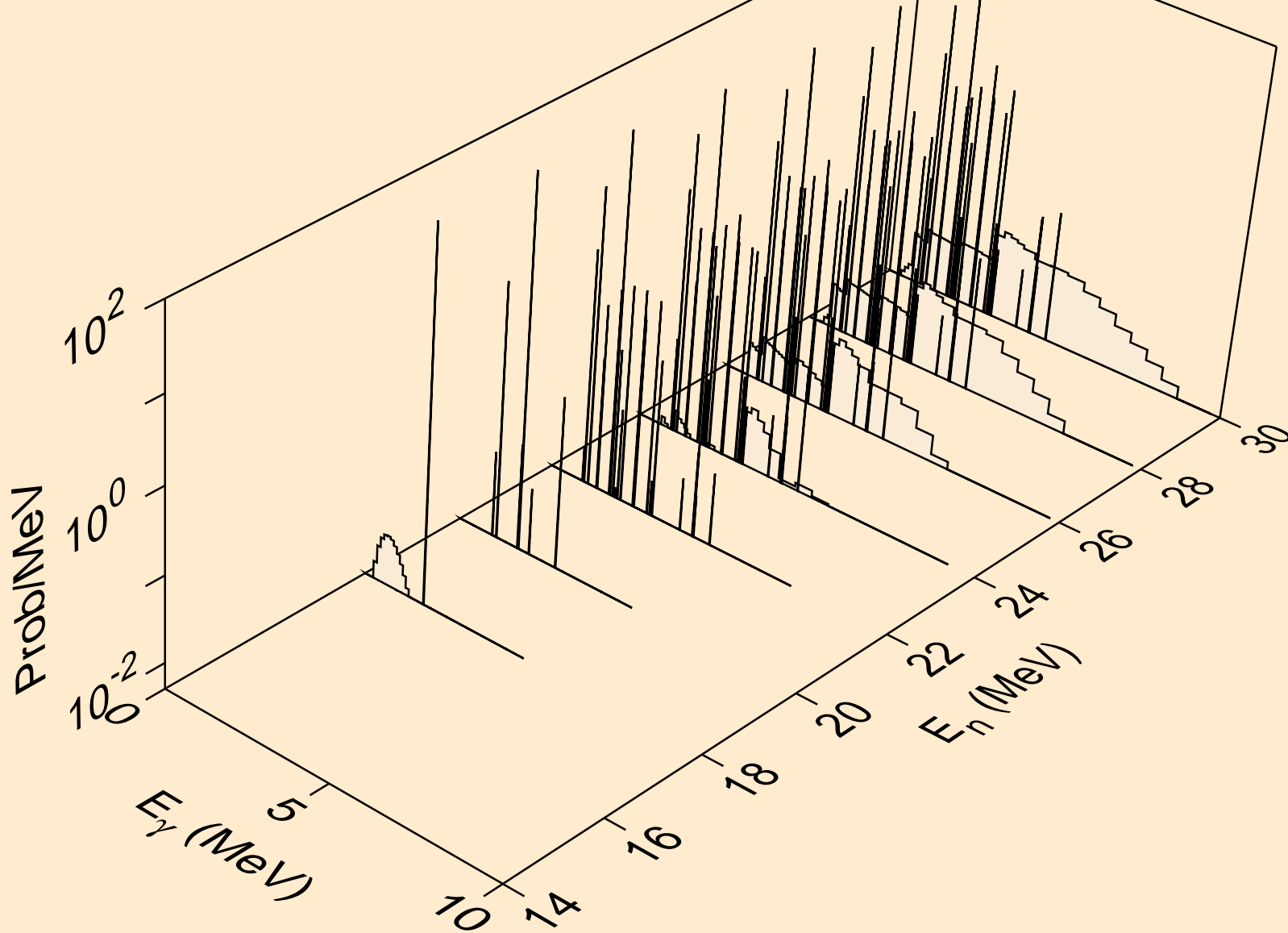

MG028 NEUTRON ACER TENDL-2019 LIBRARY; T=293.16K
Photon emission for (n,n*)a

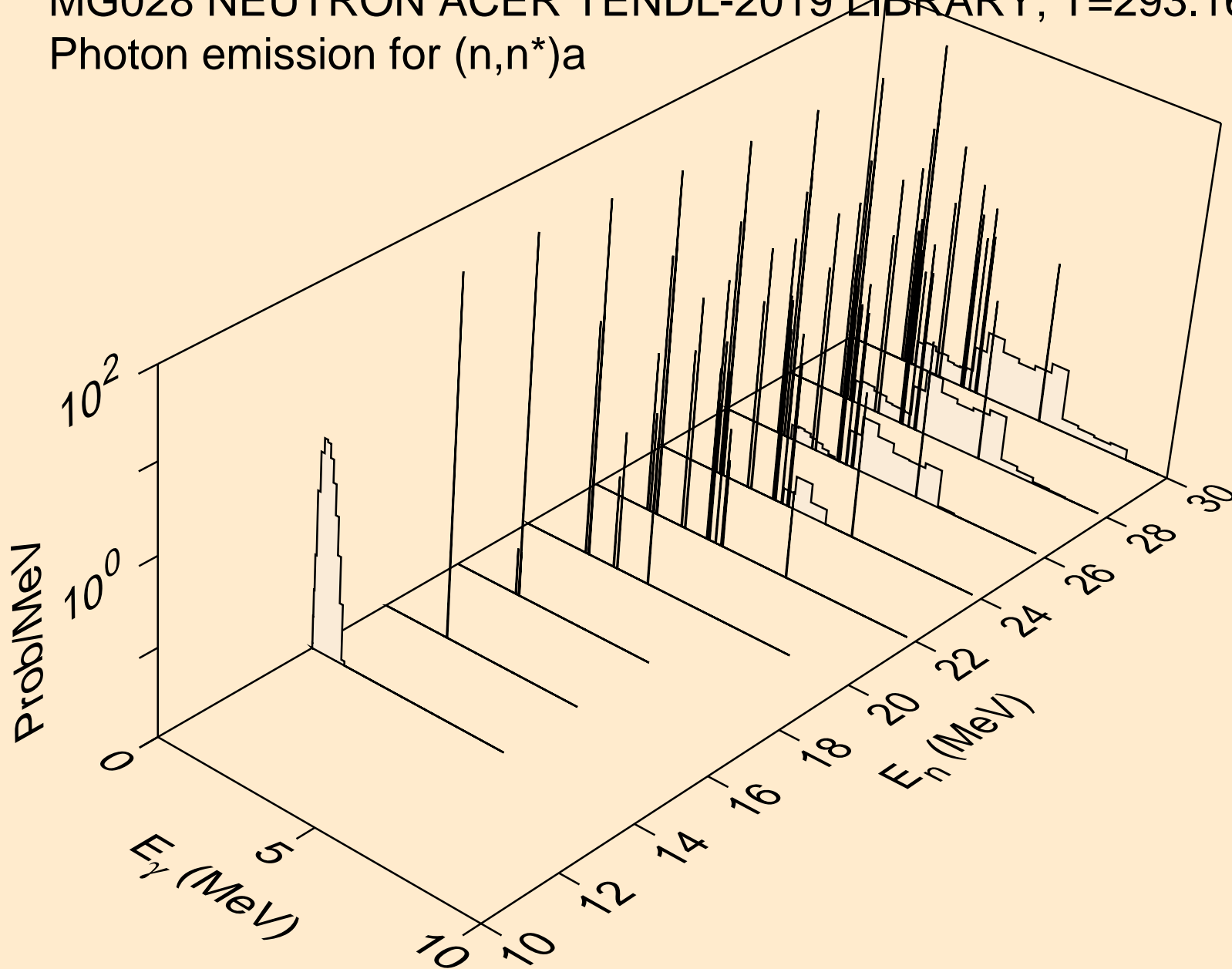

MG028 NEUTRON ACER TENDL-2019 LIBRARY; T=293.16K
Photon emission for (n,2n)a

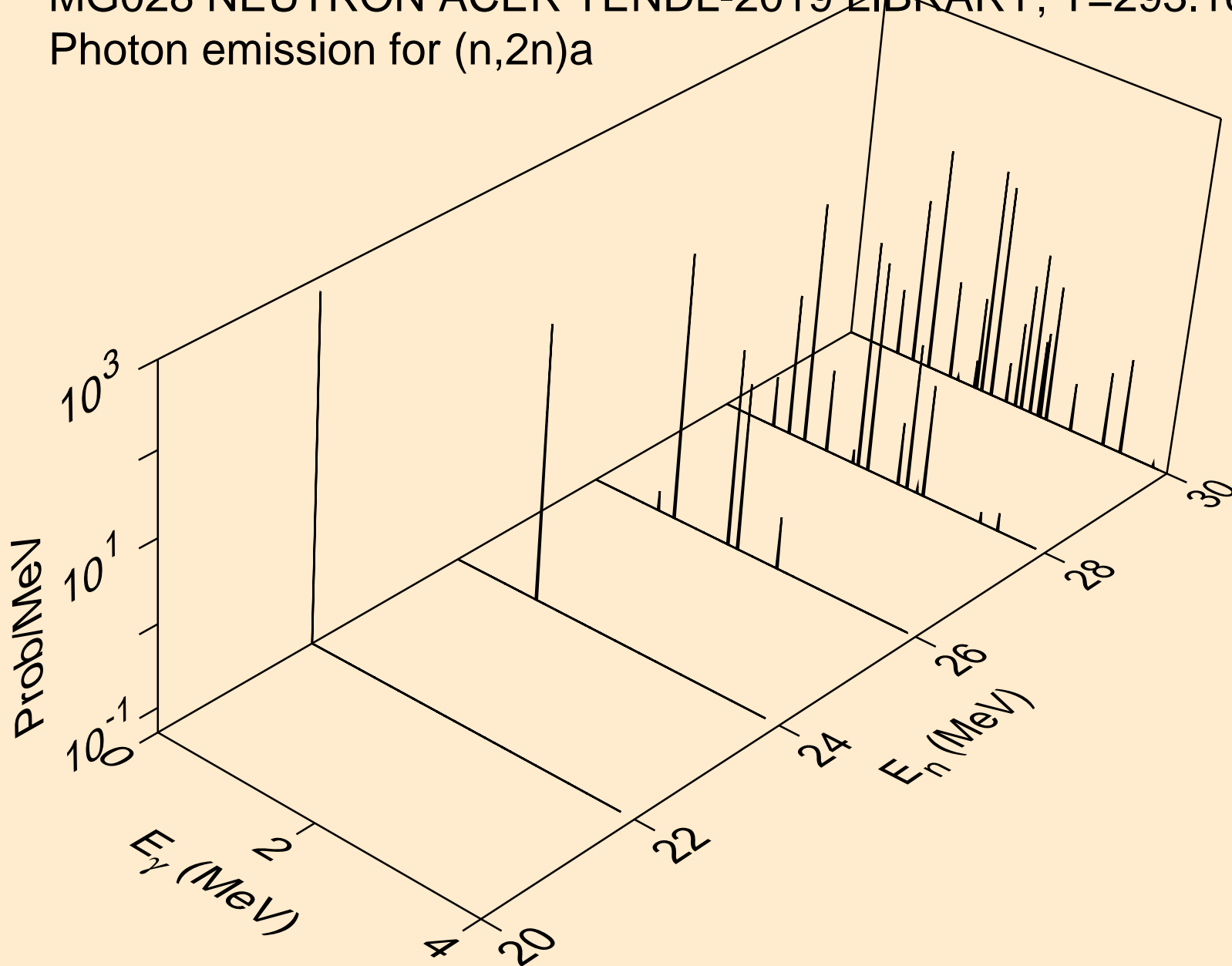

MG028 NEUTRON ACER TENDL-2019 LIBRARY; T=293.16K
Photon emission for (n,3n)a

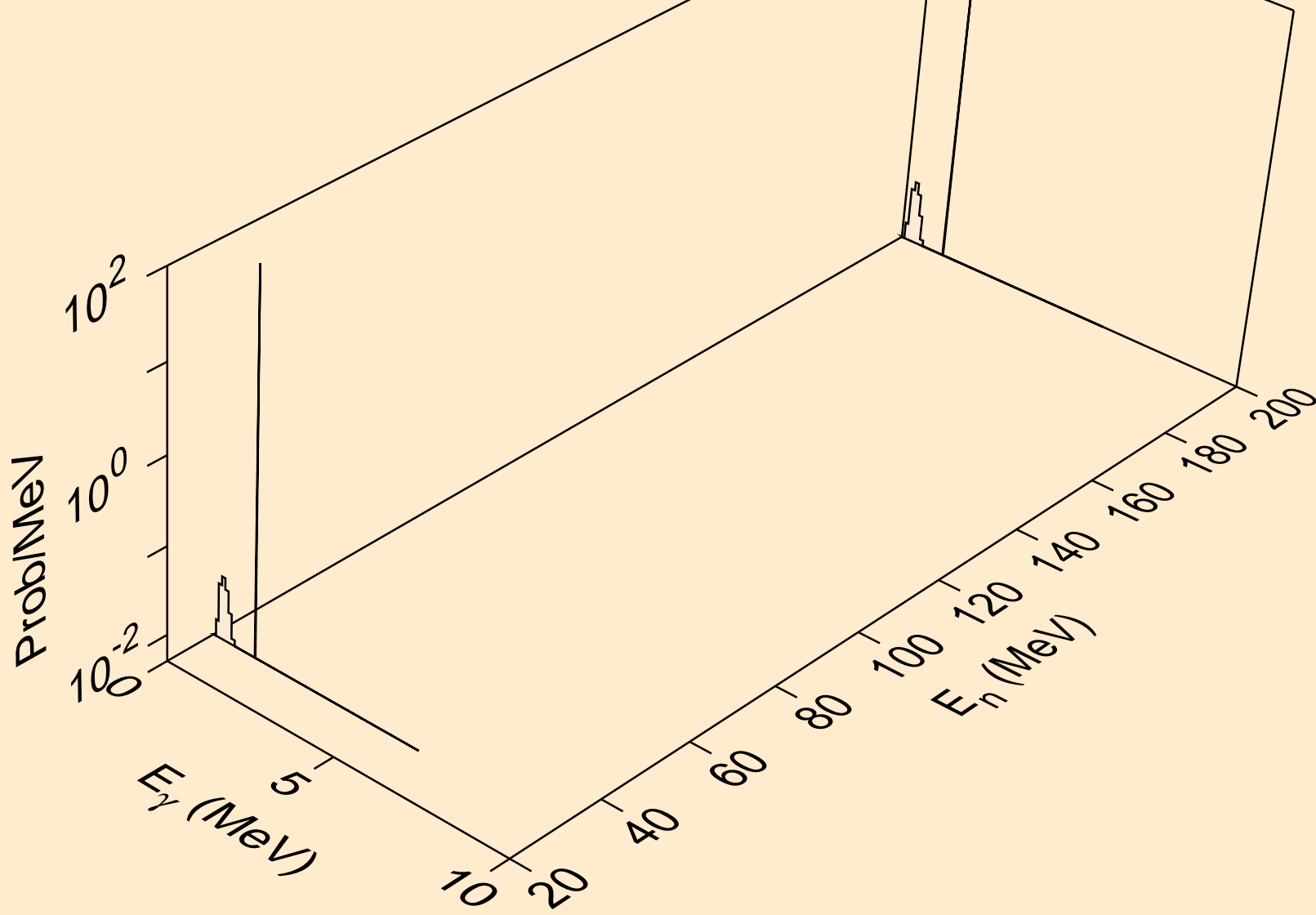

MG028 NEUTRON ACER TENDL-2019 LIBRARY; T=293.16K
Photon emission for (n,n*)p

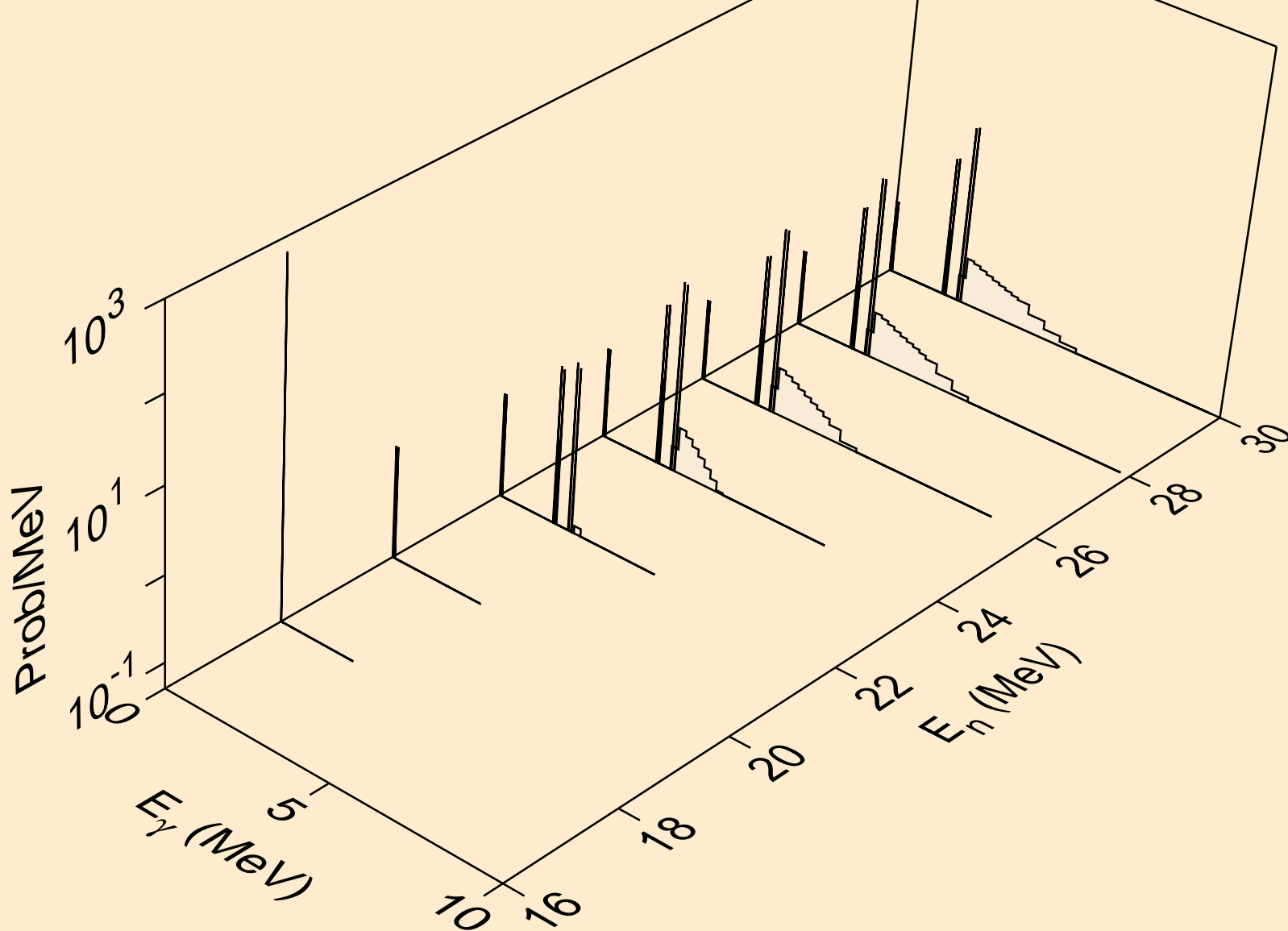

MG028 NEUTRON ACER TENDL-2019 LIBRARY; T=293.16K
Photon emission for (n,n*)d

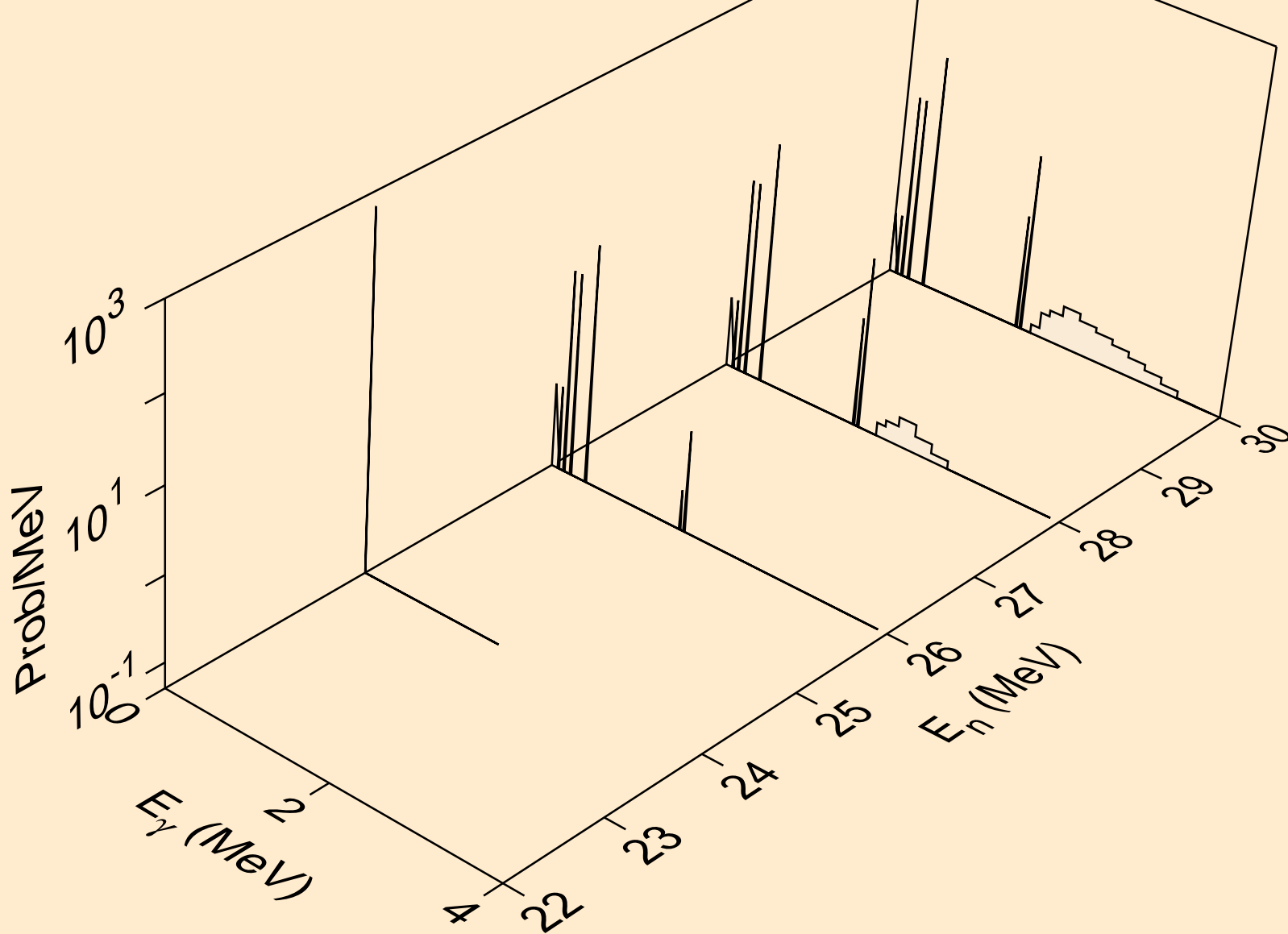

MG028 NEUTRON ACER TENDL-2019 LIBRARY; T=293.16K
Photon emission for (n,n*)t

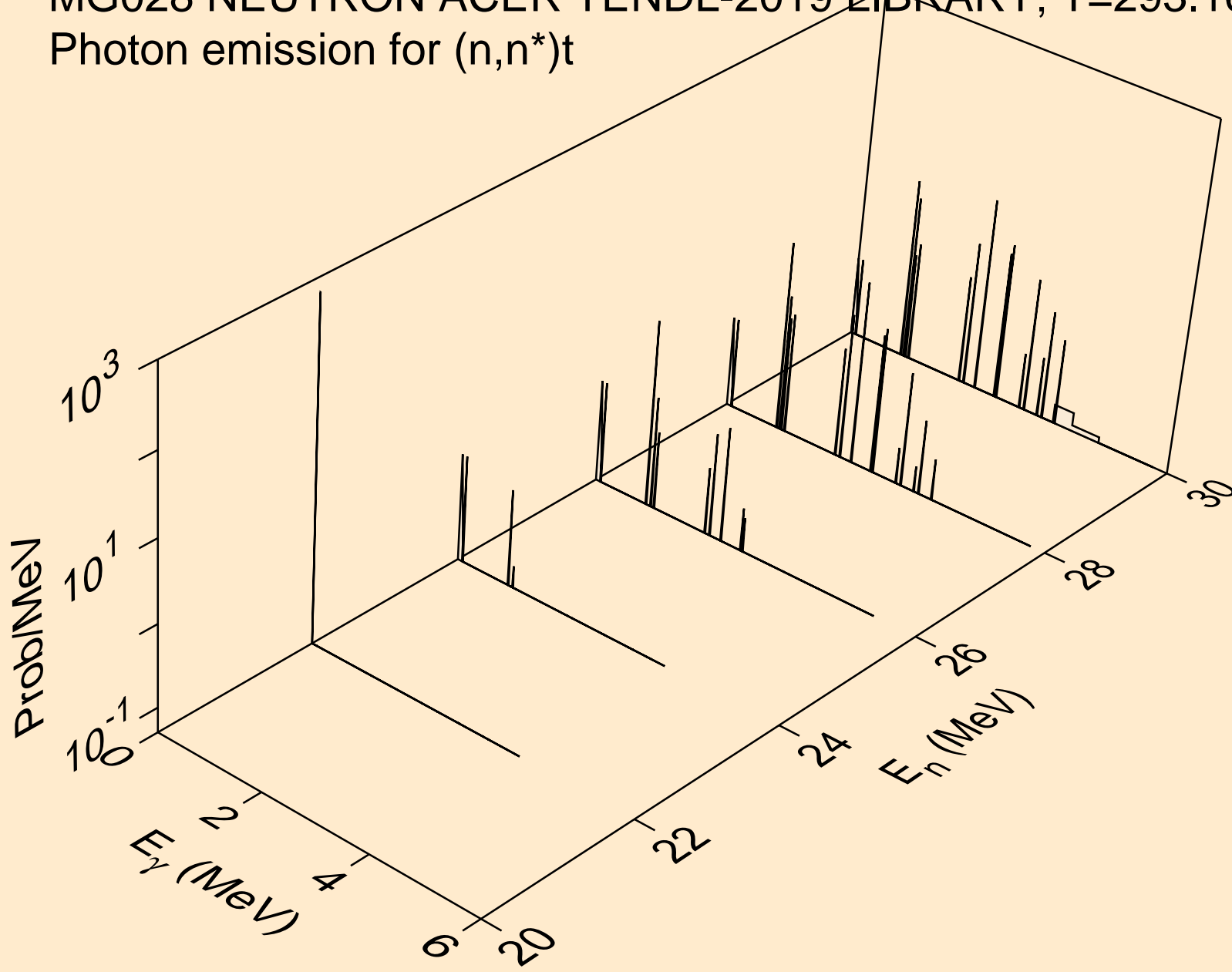

MG028 NEUTRON ACER TENDL-2019 LIBRARY; T=293.16K
Photon emission for (n,4n)

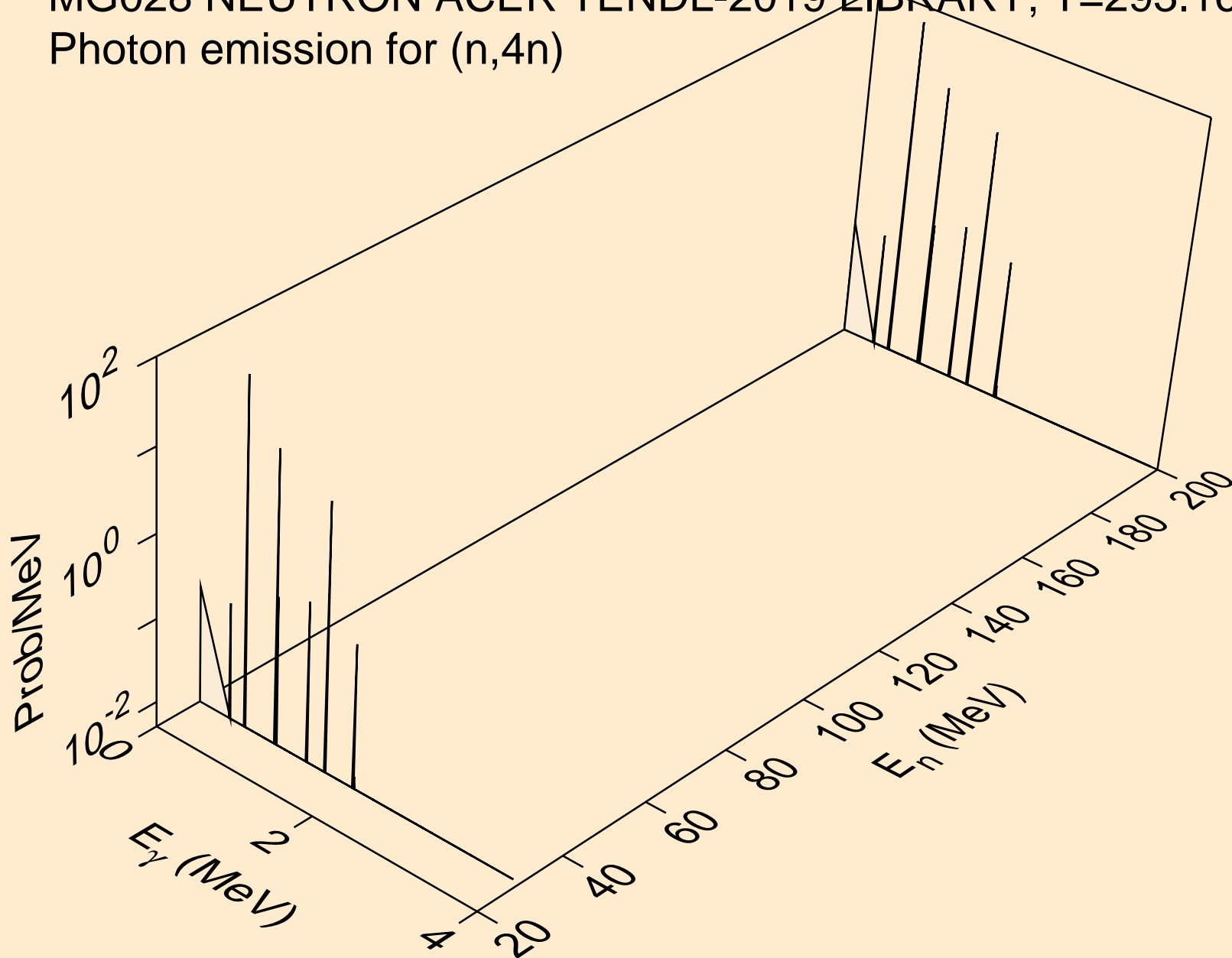

MG028 NEUTRON ACER TENDL-2019 LIBRARY; T=293.16K
Photon emission for (n,2np)

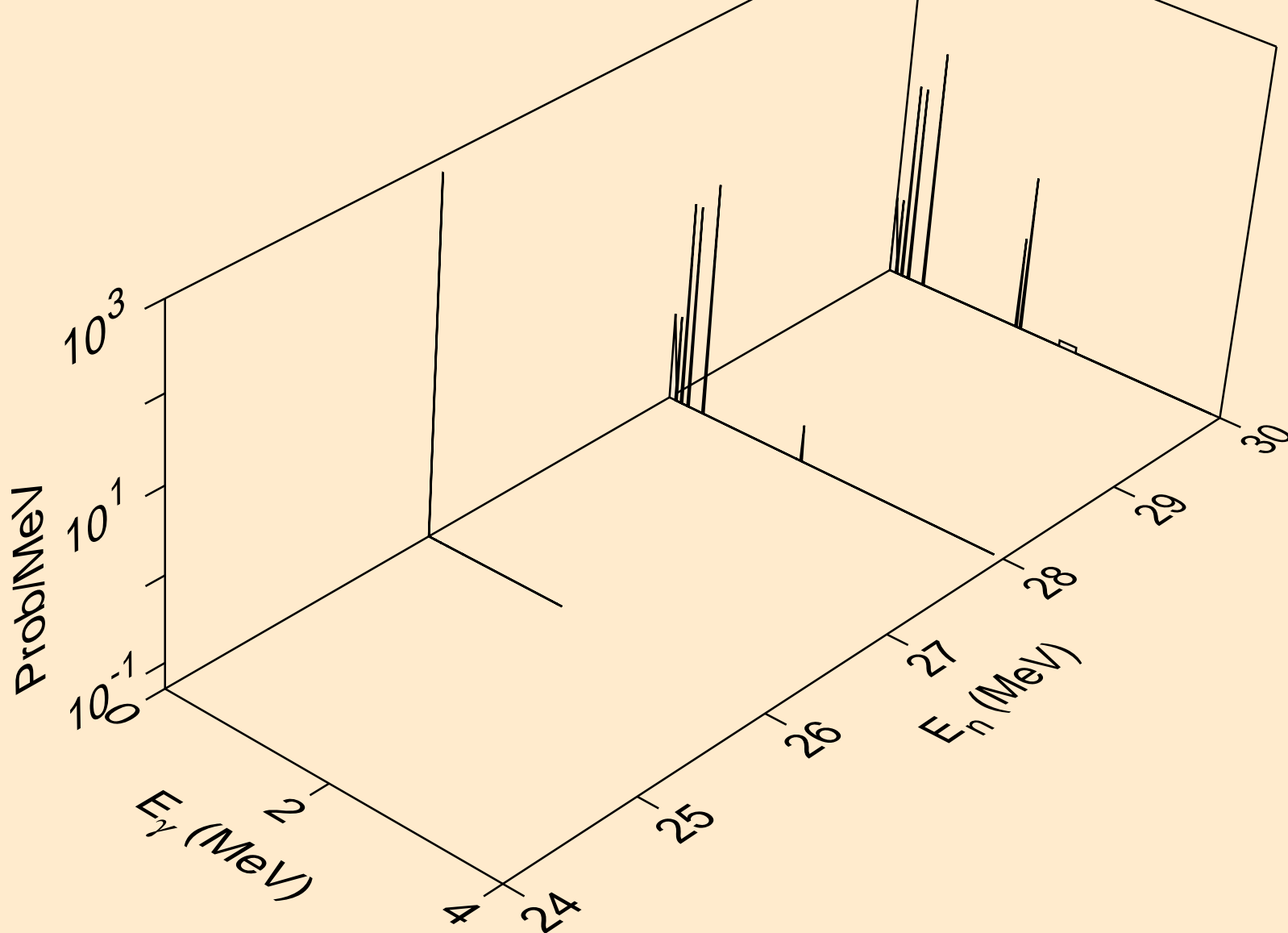

MG028 NEUTRON ACER TENDL-2019 LIBRARY; T=293.16K
Photon emission for (n,n*c)

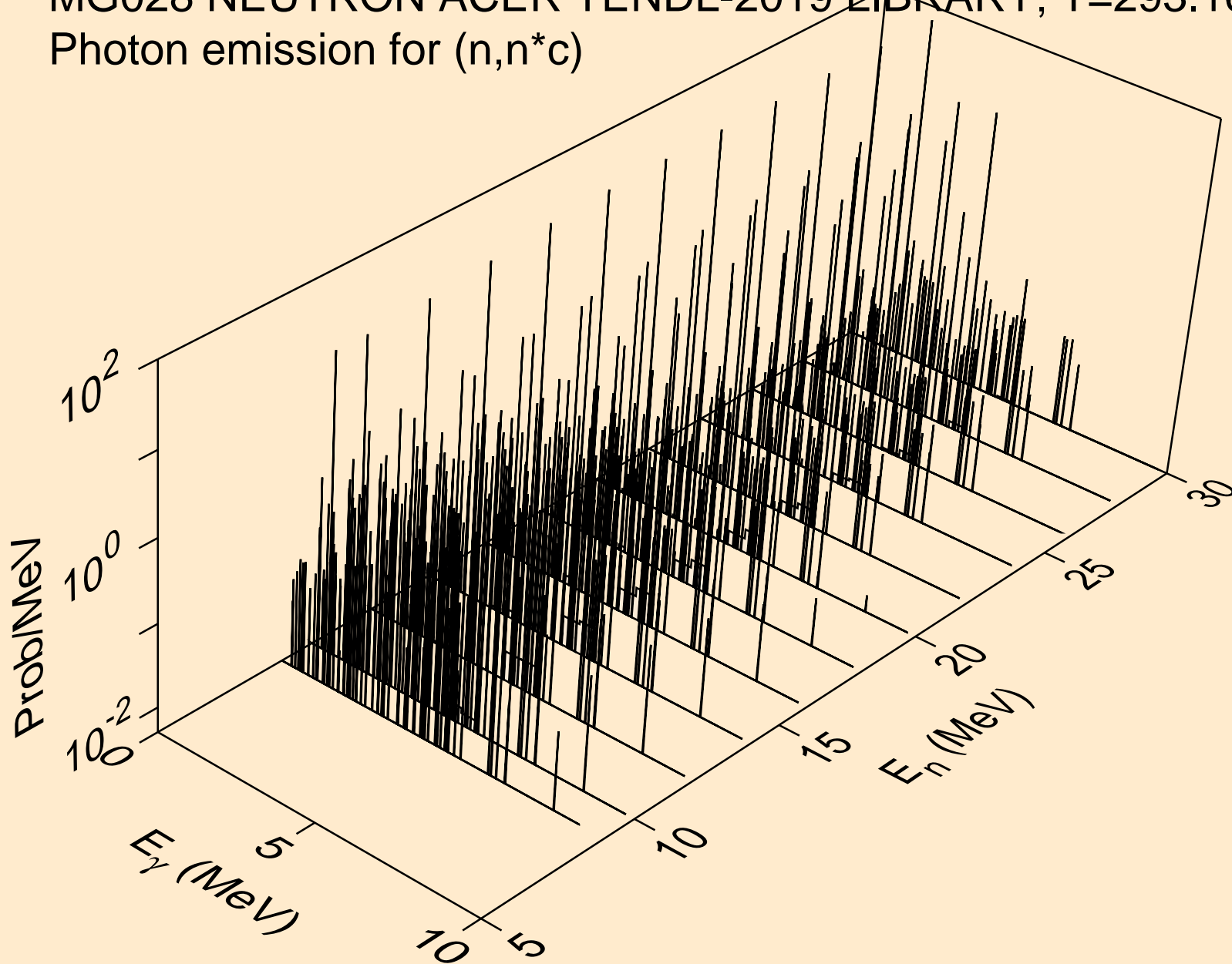

MG028 NEUTRON ACER TENDL-2019 LIBRARY; T=293.16K
Photon emission for (n,gma)

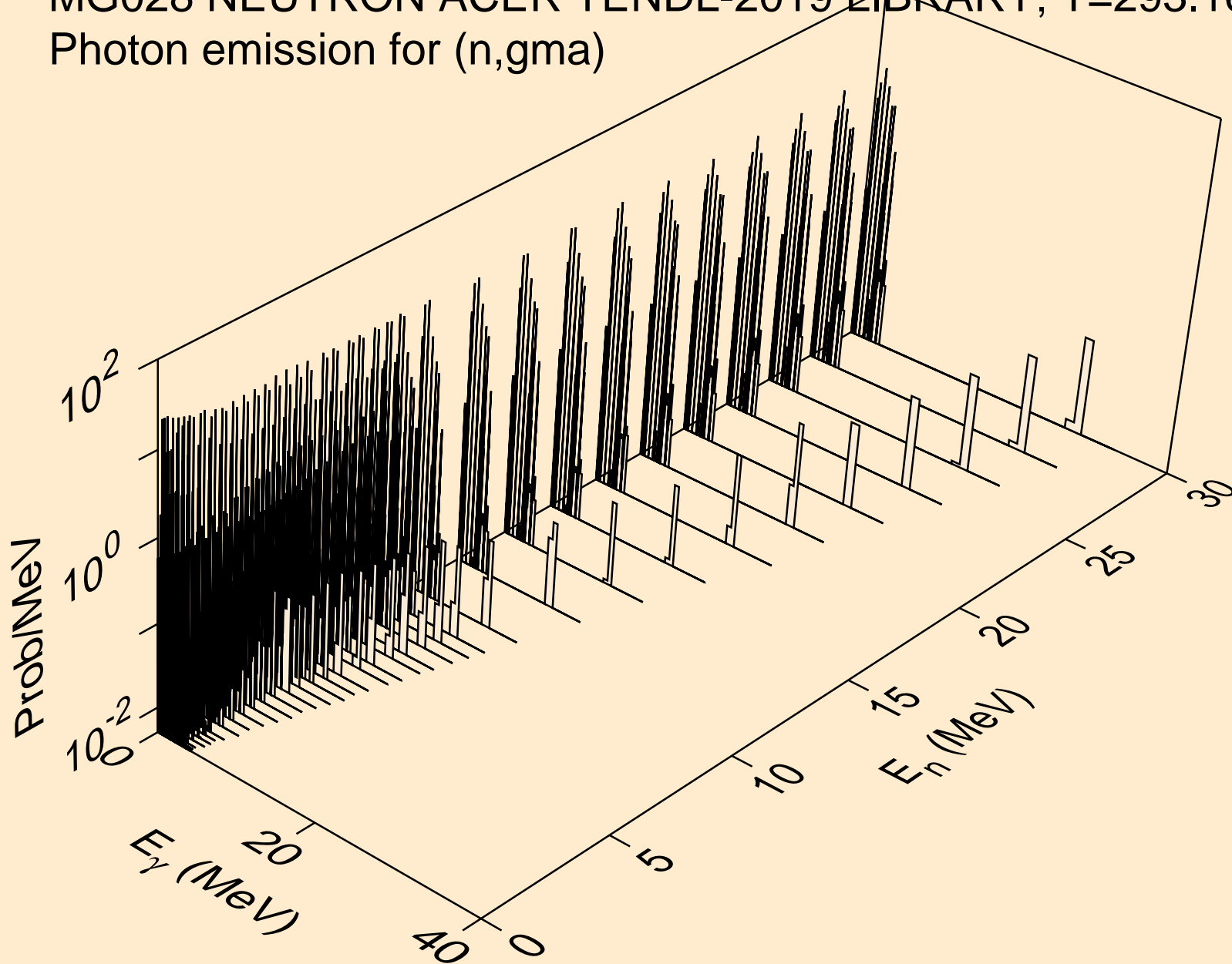

MG028 NEUTRON ACER TENDL-2019 LIBRARY; T=293.16K
Photon emission for (n,p)

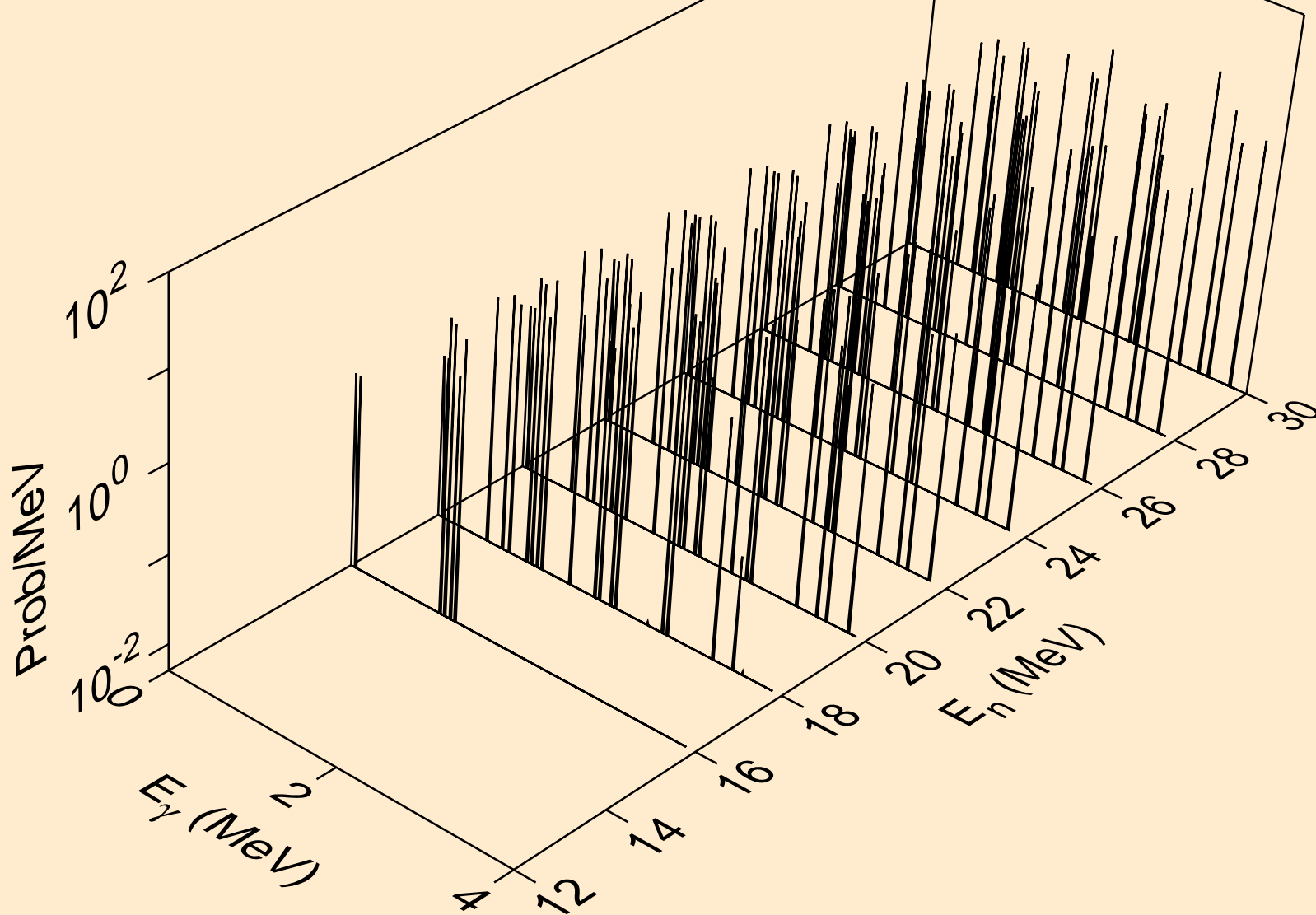

MG028 NEUTRON ACER TENDL-2019 LIBRARY; T=293.16K
Photon emission for (n,d)

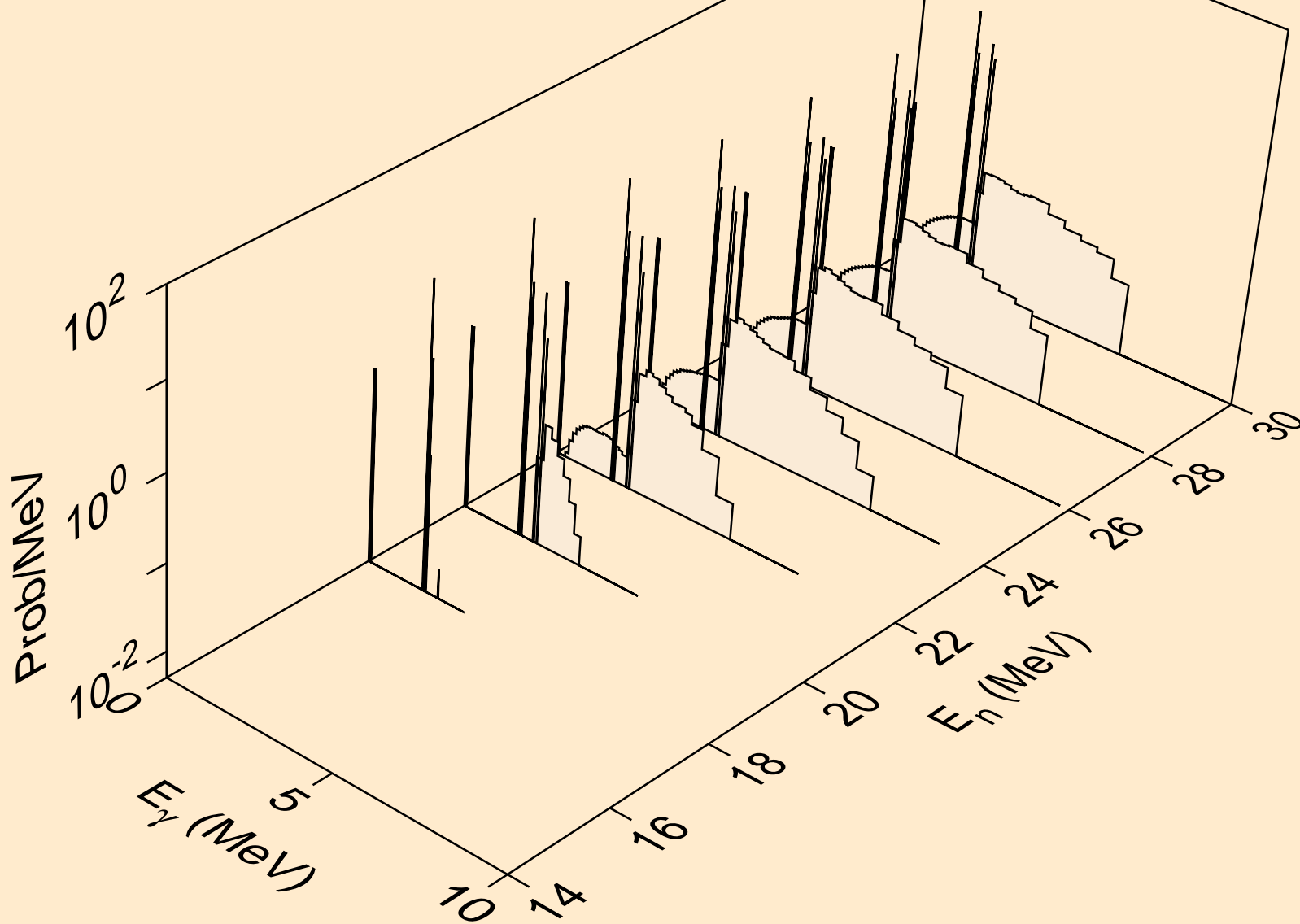

MG028 NEUTRON ACER TENDL-2019 LIBRARY; T=293.16K
Photon emission for (n,t)

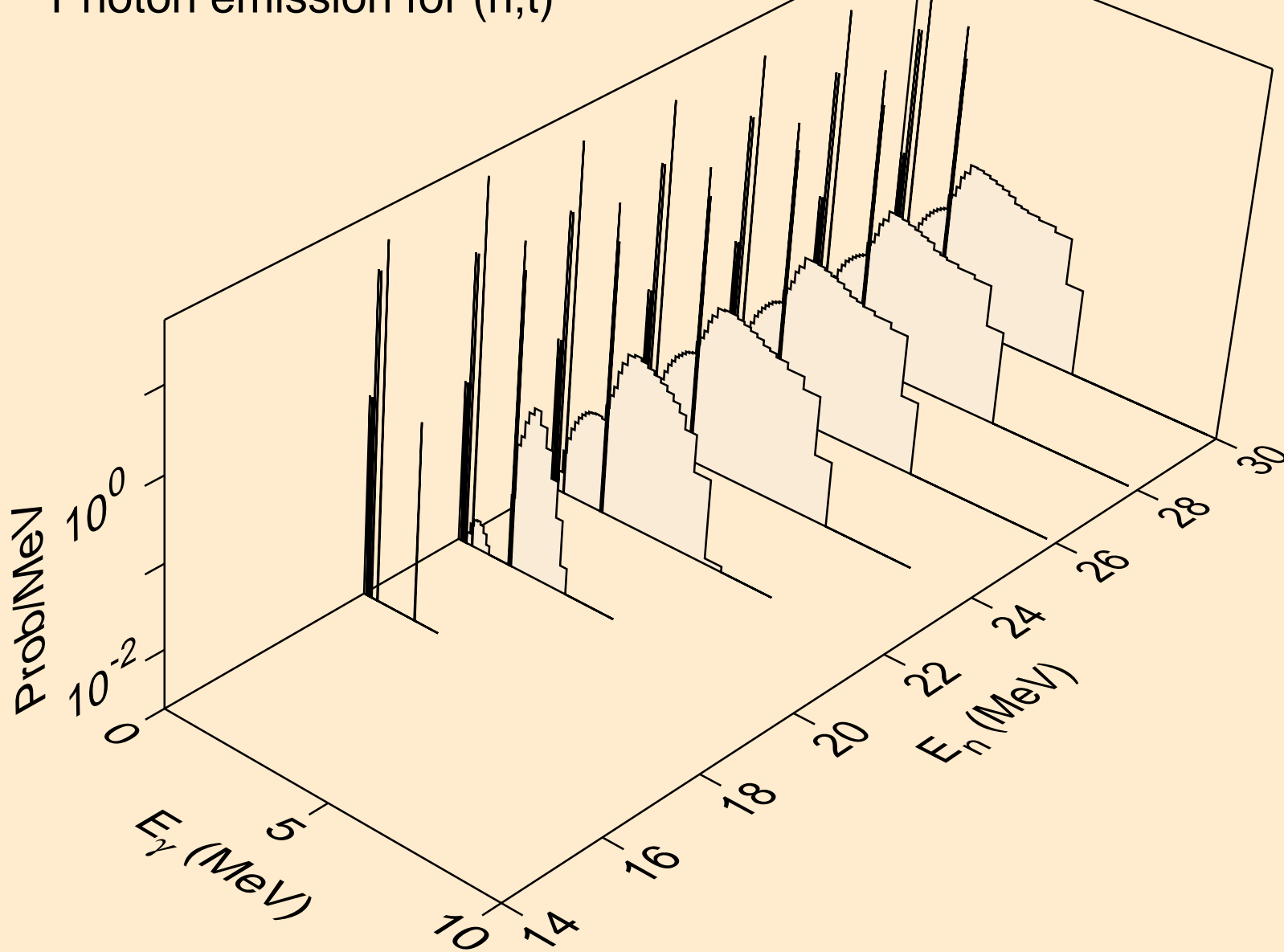

MG028 NEUTRON ACER TENDL-2019 LIBRARY; T=293.16K
Photon emission for (n,he3)

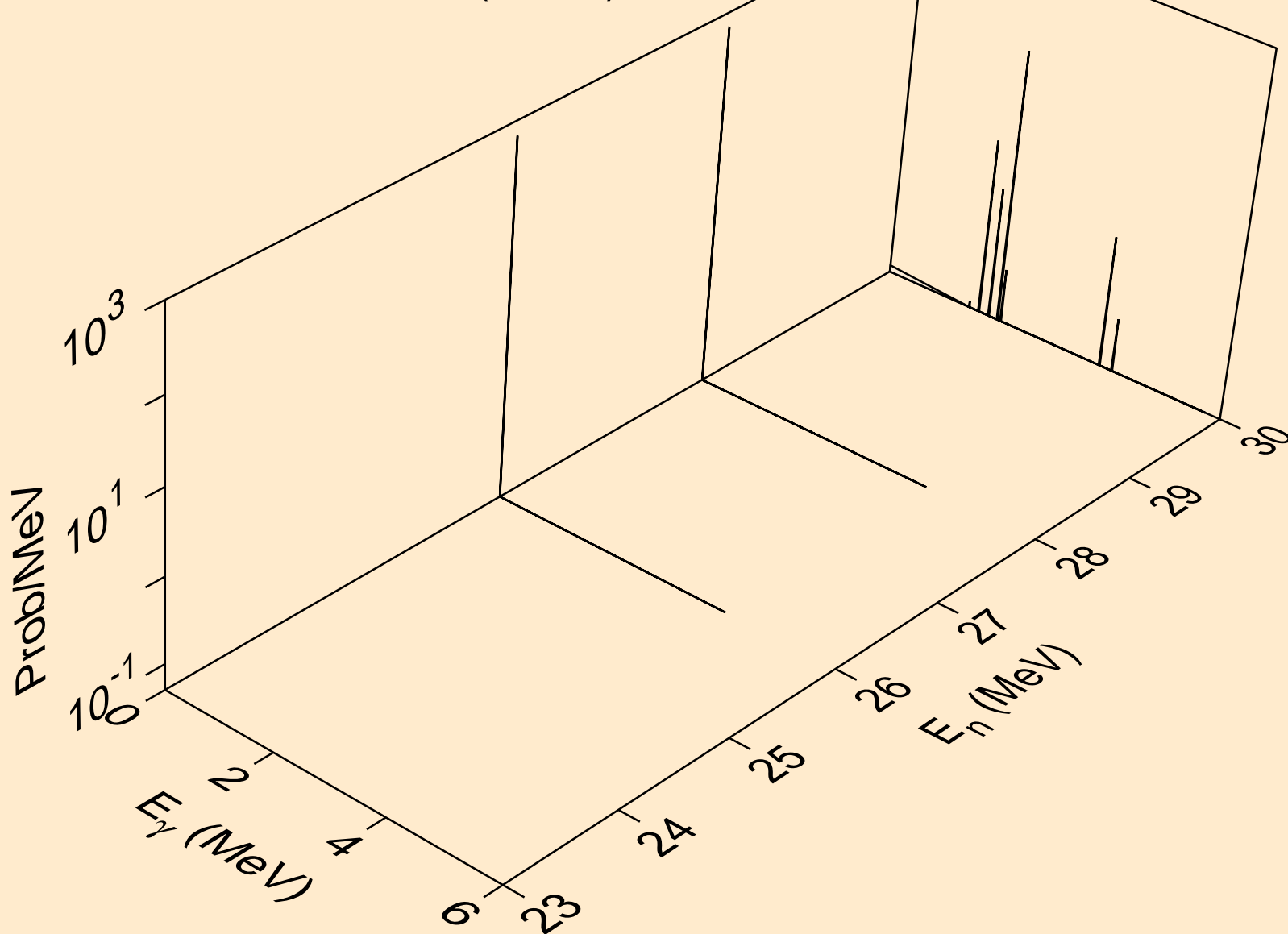

MG028 NEUTRON ACER TENDL-2019 LIBRARY; T=293.16K
Photon emission for (n,a)

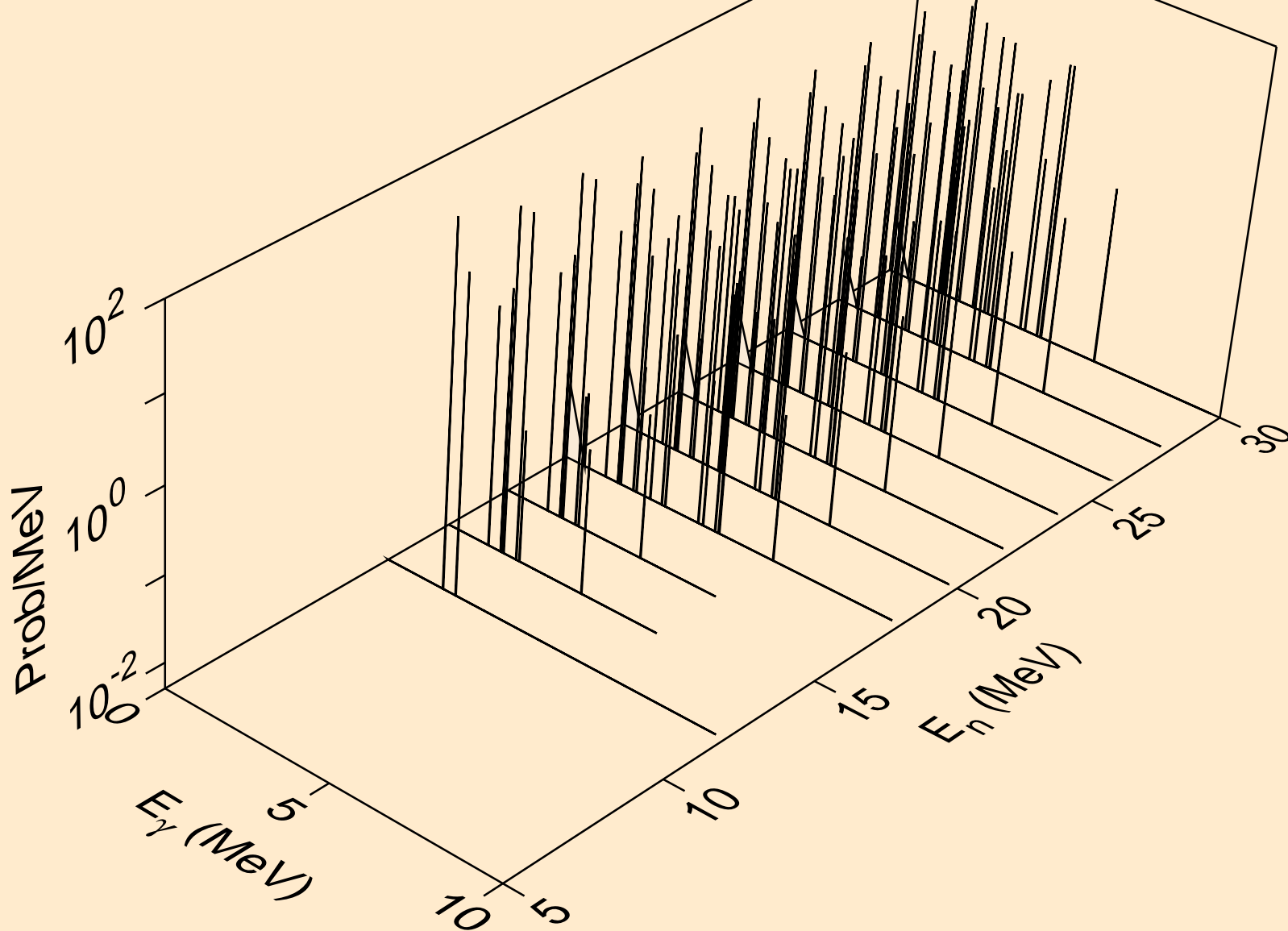

MG028 NEUTRON ACER TENDL-2019 LIBRARY; T=293.16K
Photon emission for (n,2a)

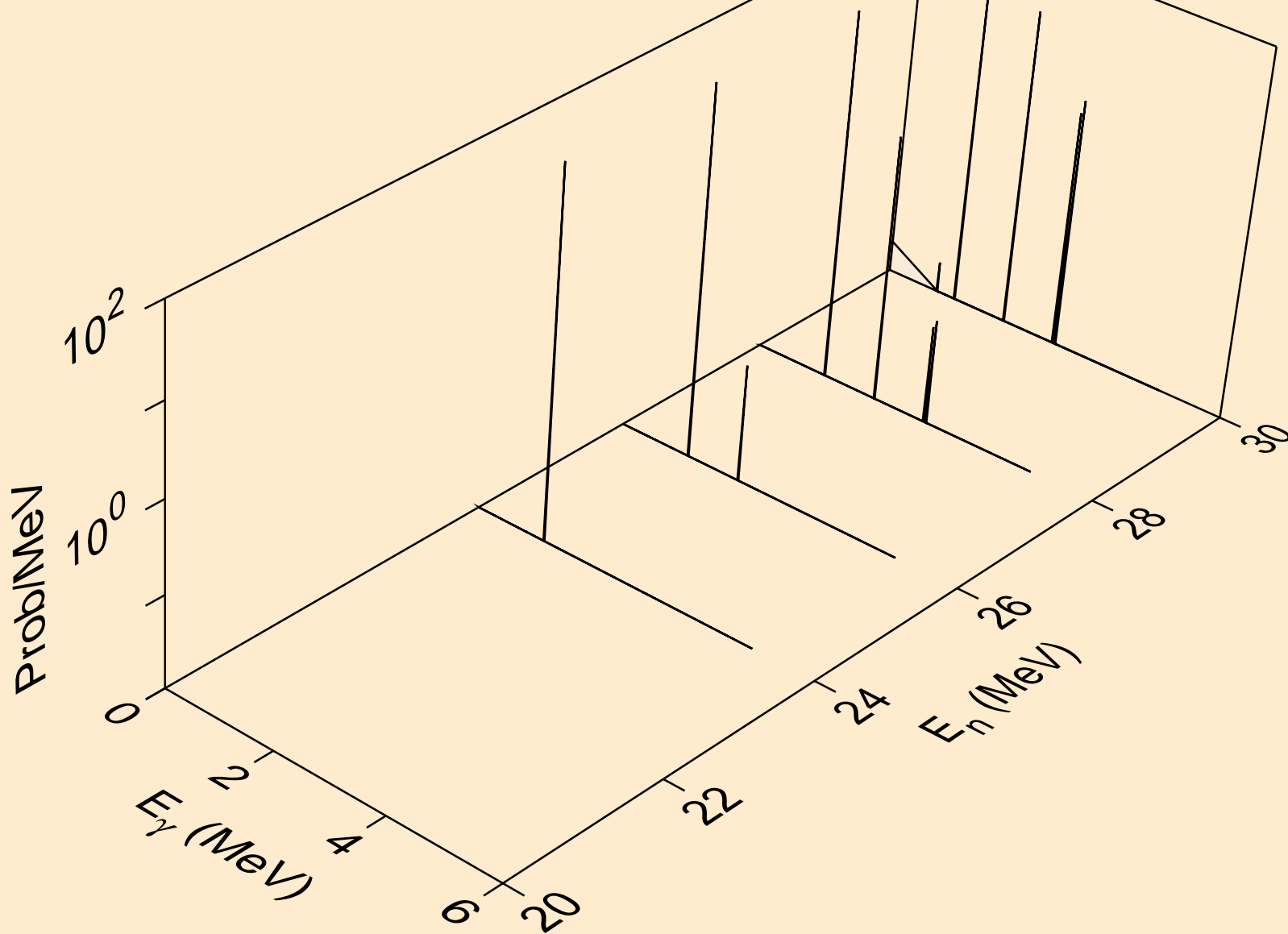

MG028 NEUTRON ACER TENDL-2019 LIBRARY; T=293.16K
Photon emission for (n,p α)

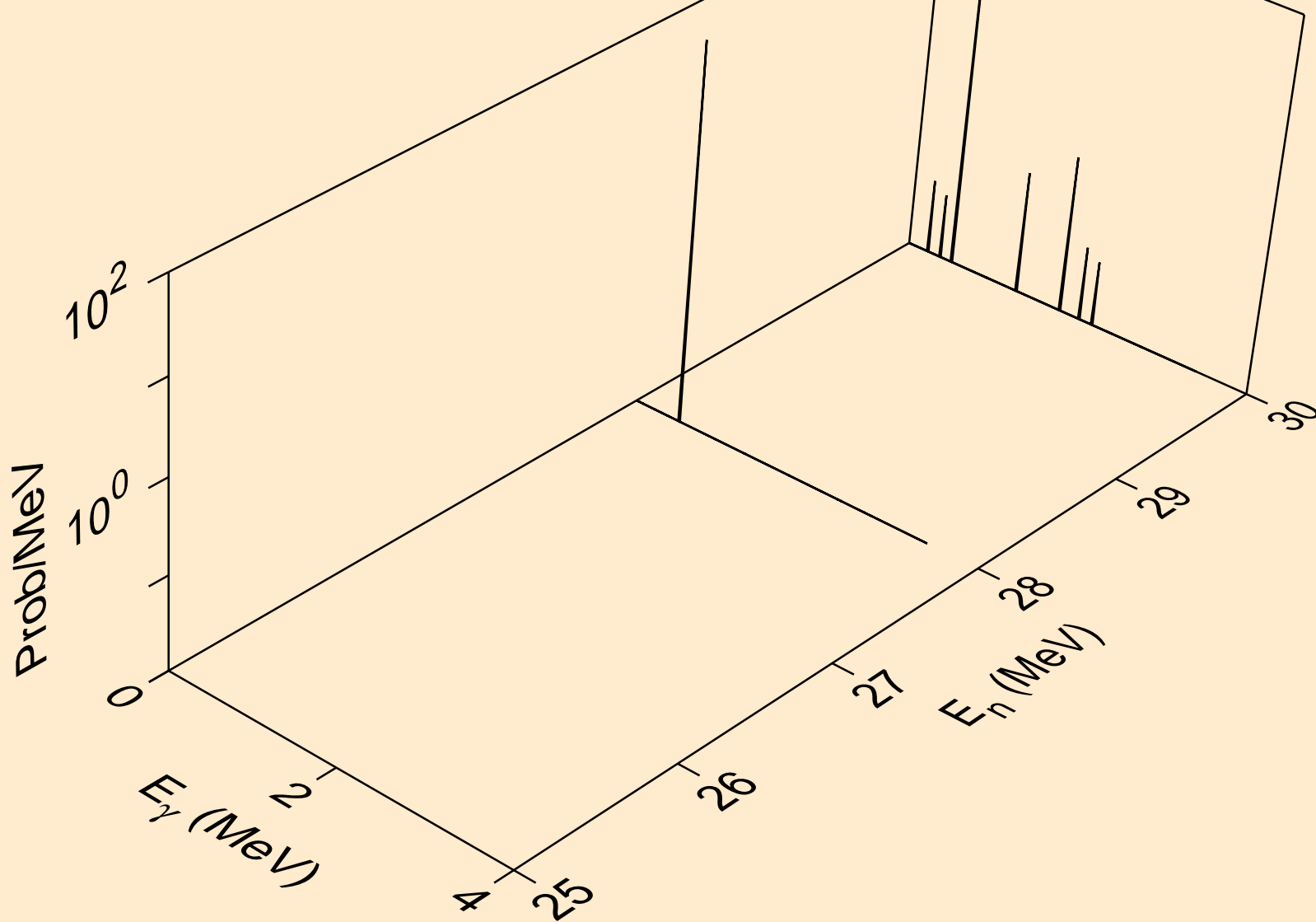

MG028 NEUTRON ACER TENDL-2019 LIBRARY; T=293.16K
thermal capture photon spectrum

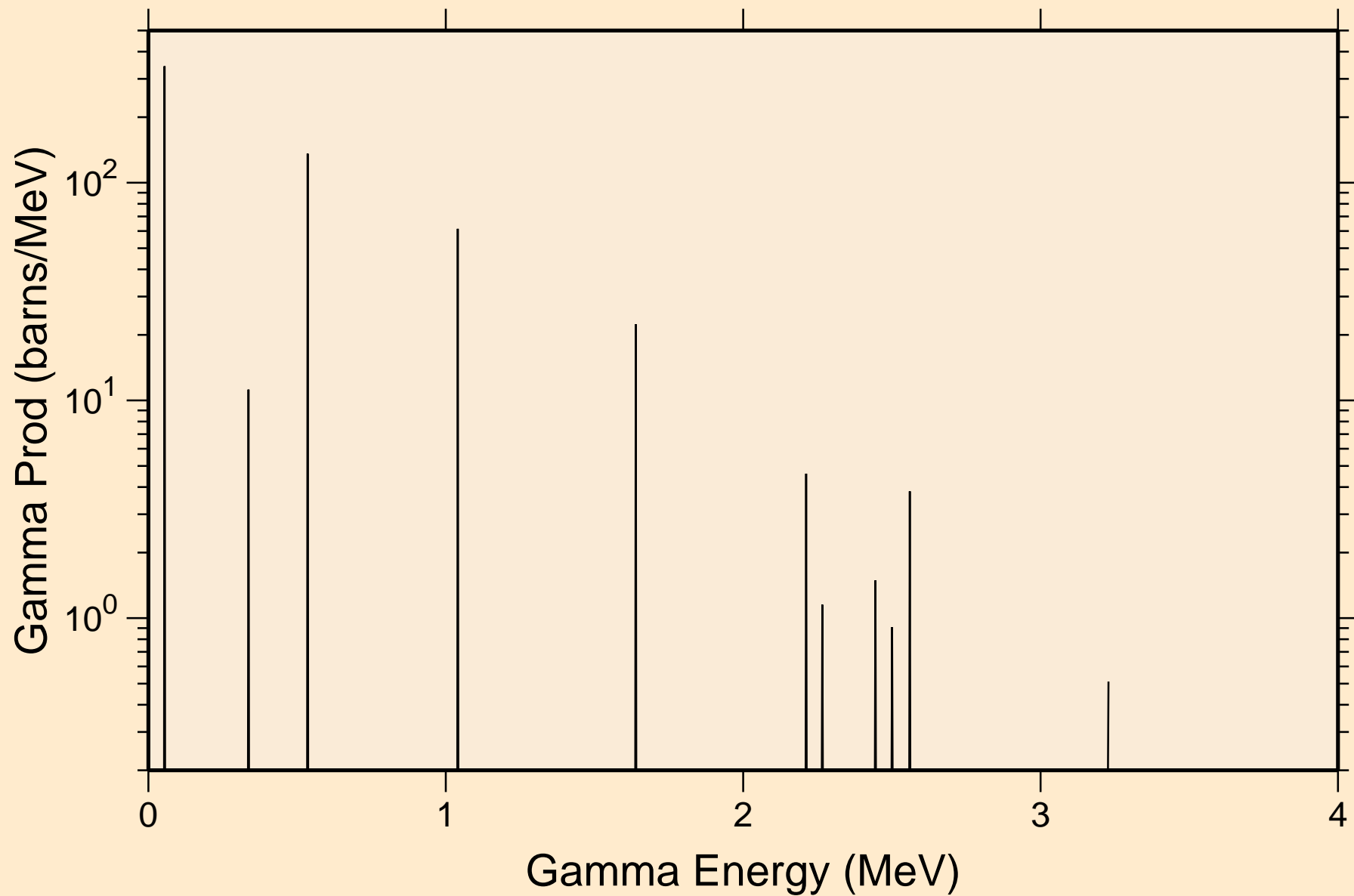

MG028 NEUTRON ACER TENDL-2019 LIBRARY; T=293.16K
14 MeV photon spectrum

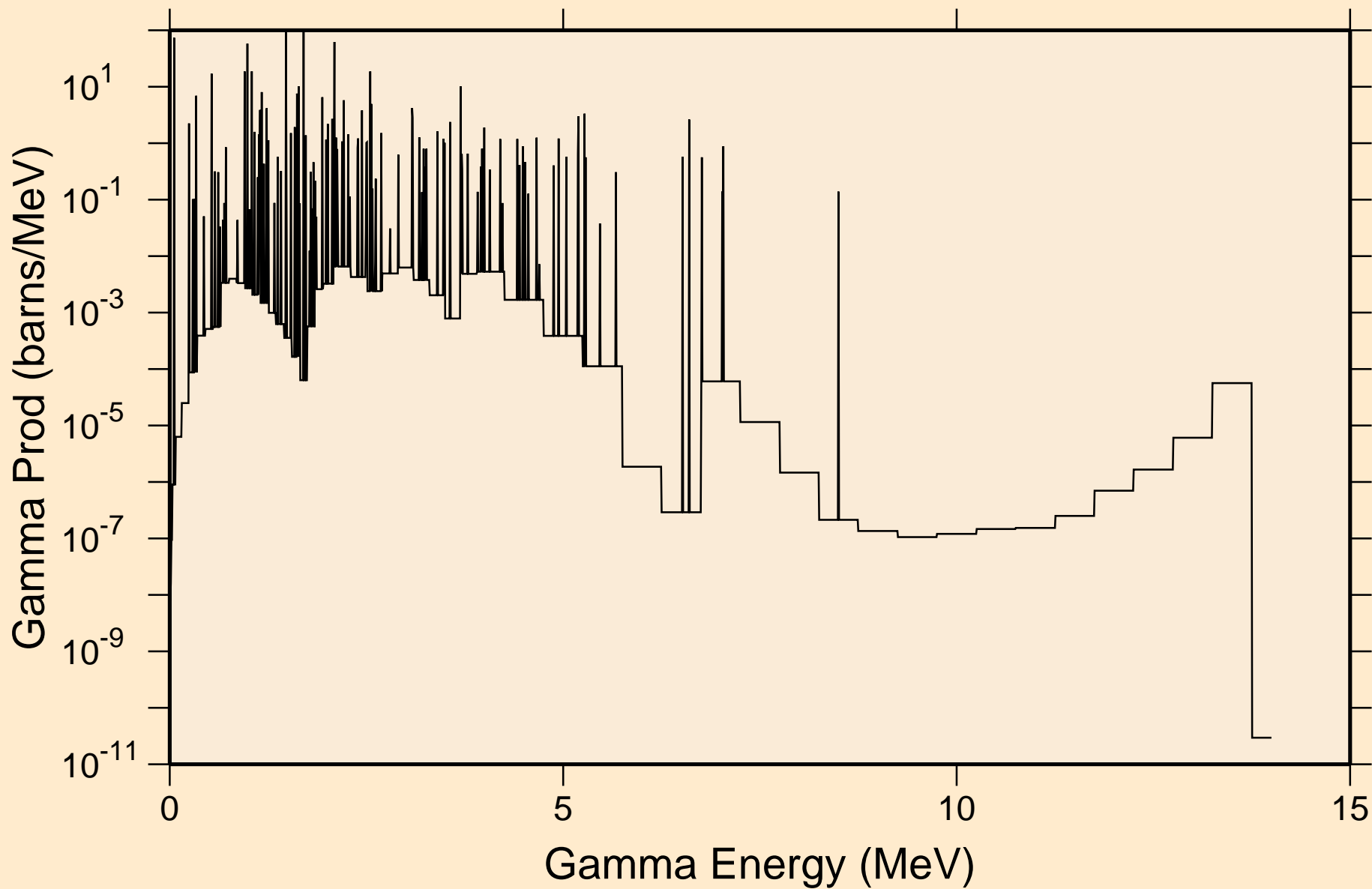

MG028 NEUTRON ACER TENDL-2019 LIBRARY; T=293.16K
Particle heating contributions

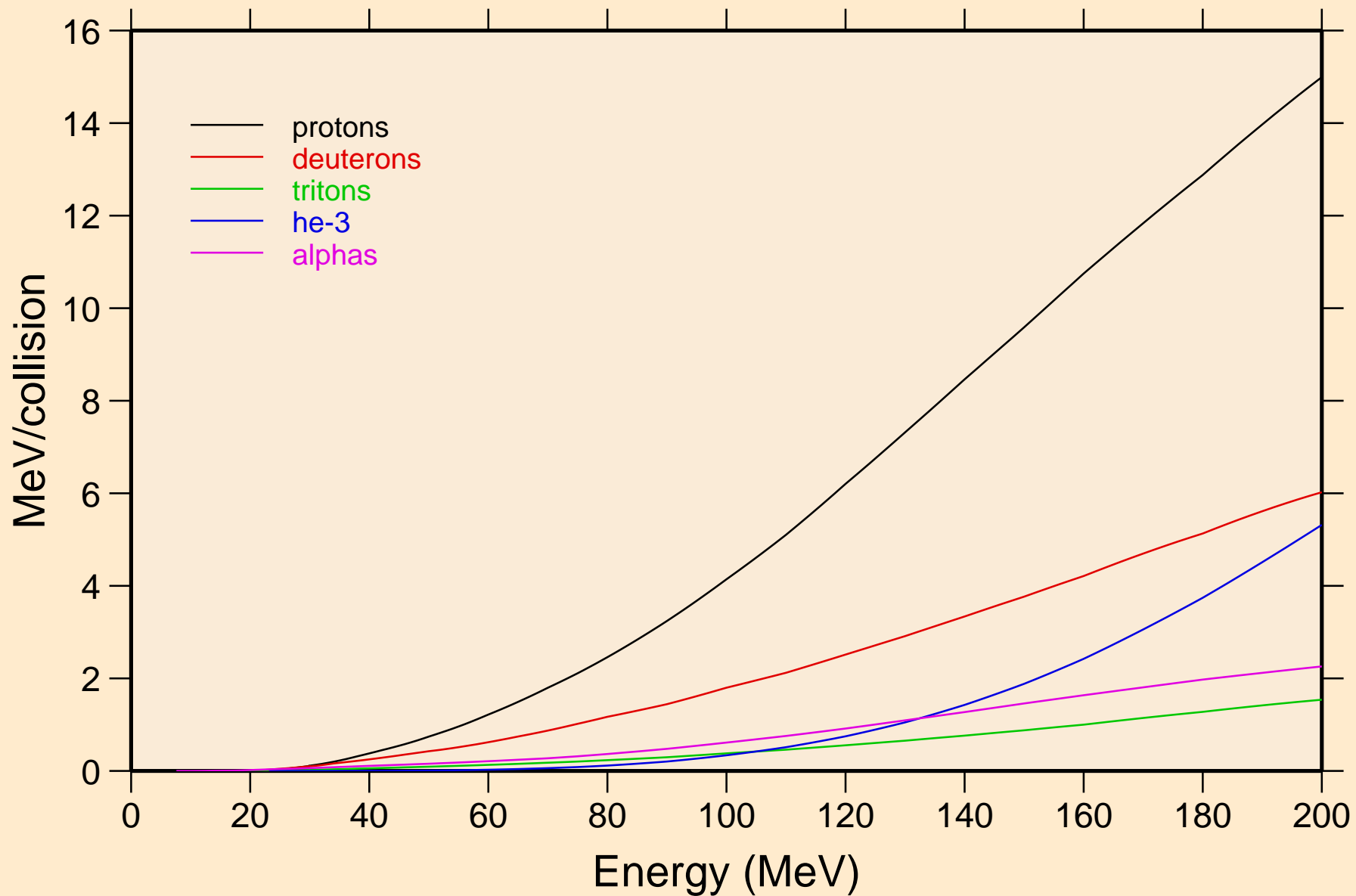

MG028 NEUTRON ACER TENDL-2019 LIBRARY; T=293.16K
Recoil Heating

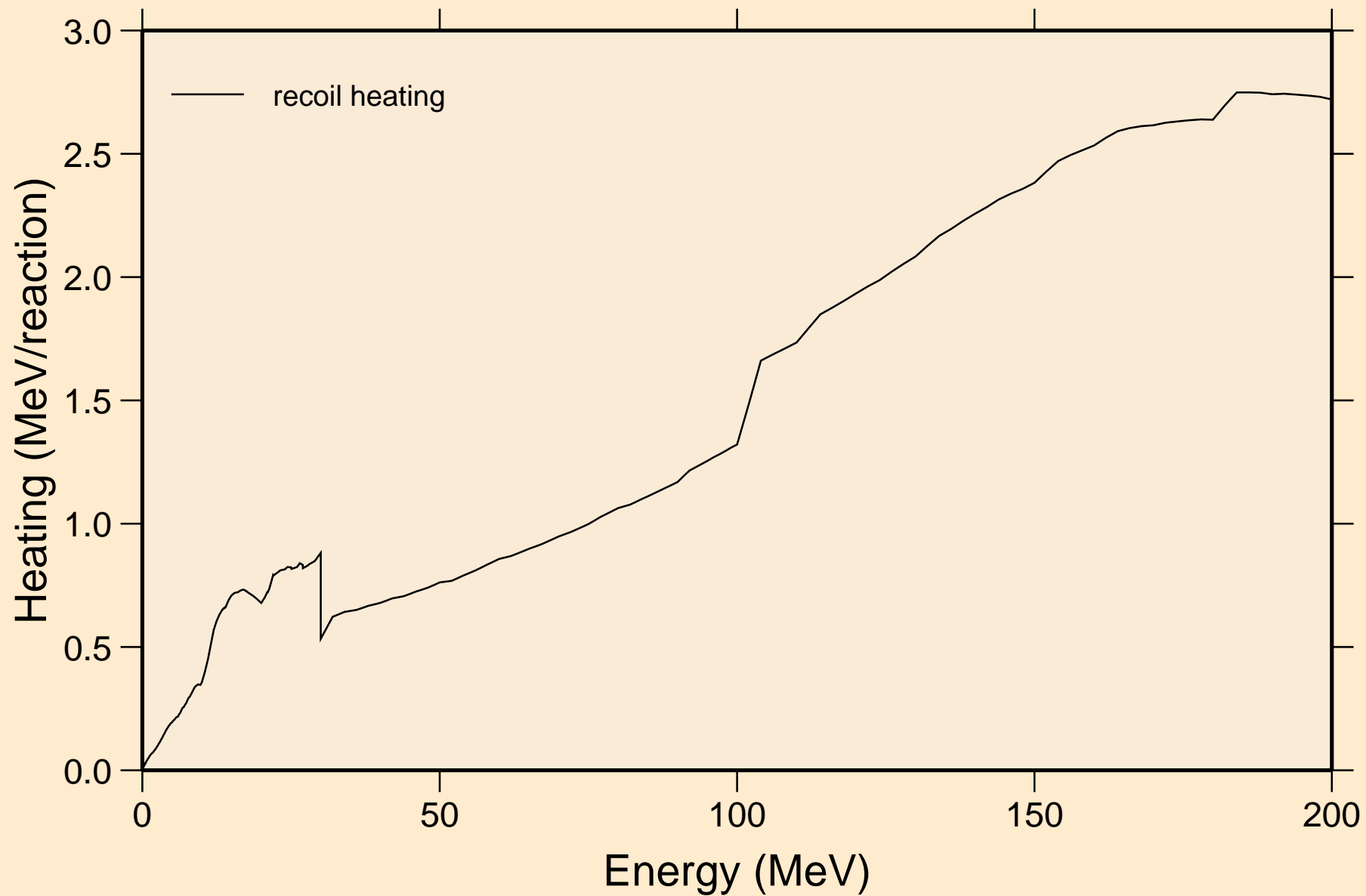

MG028 NEUTRON ACER TENDL-2019 LIBRARY; T=293.16K

Particle production cross sections

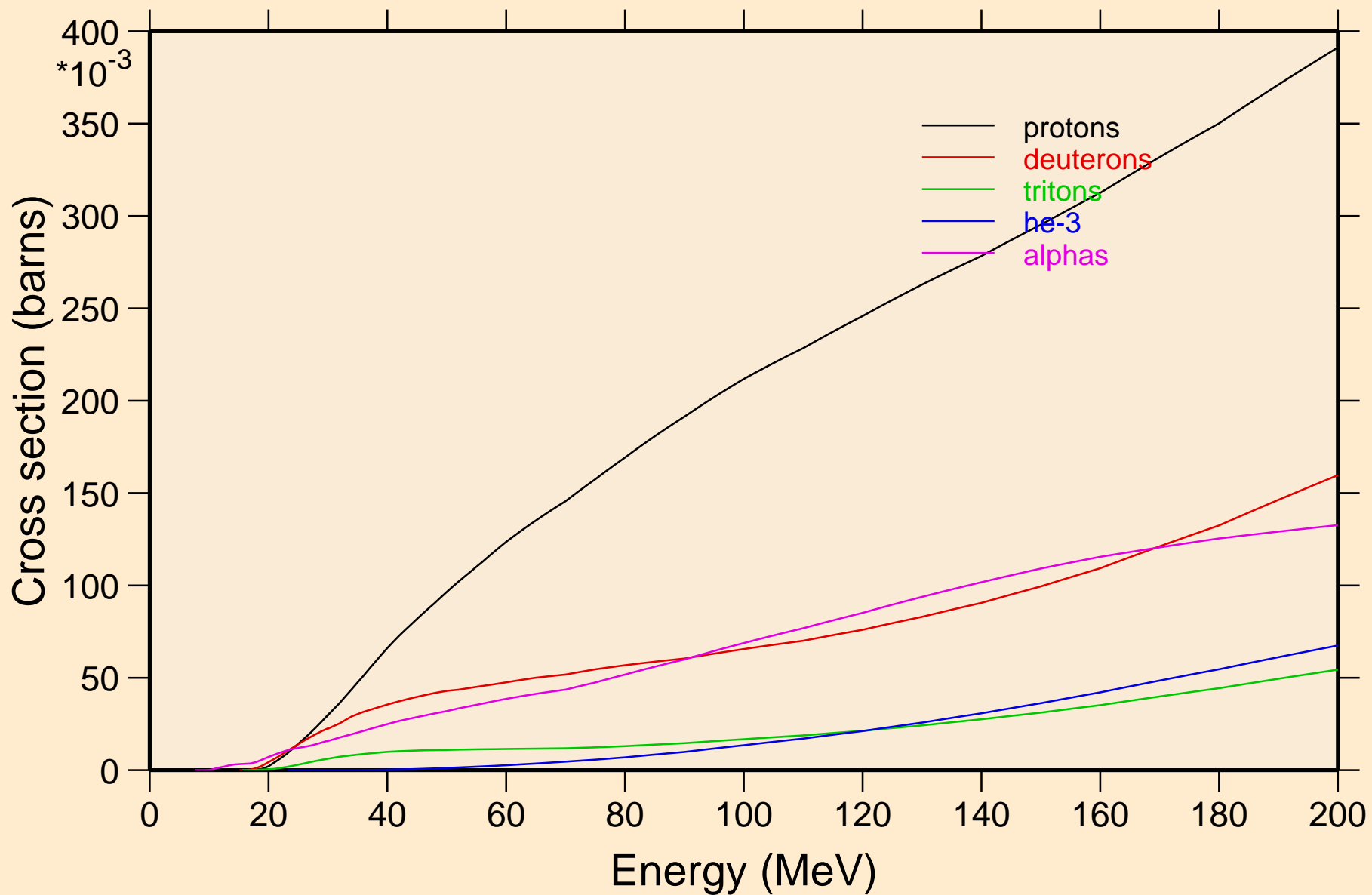

MG028 NEUTRON ACER TENDL-2019 LIBRARY; T=293.16K
protons from (n,x)

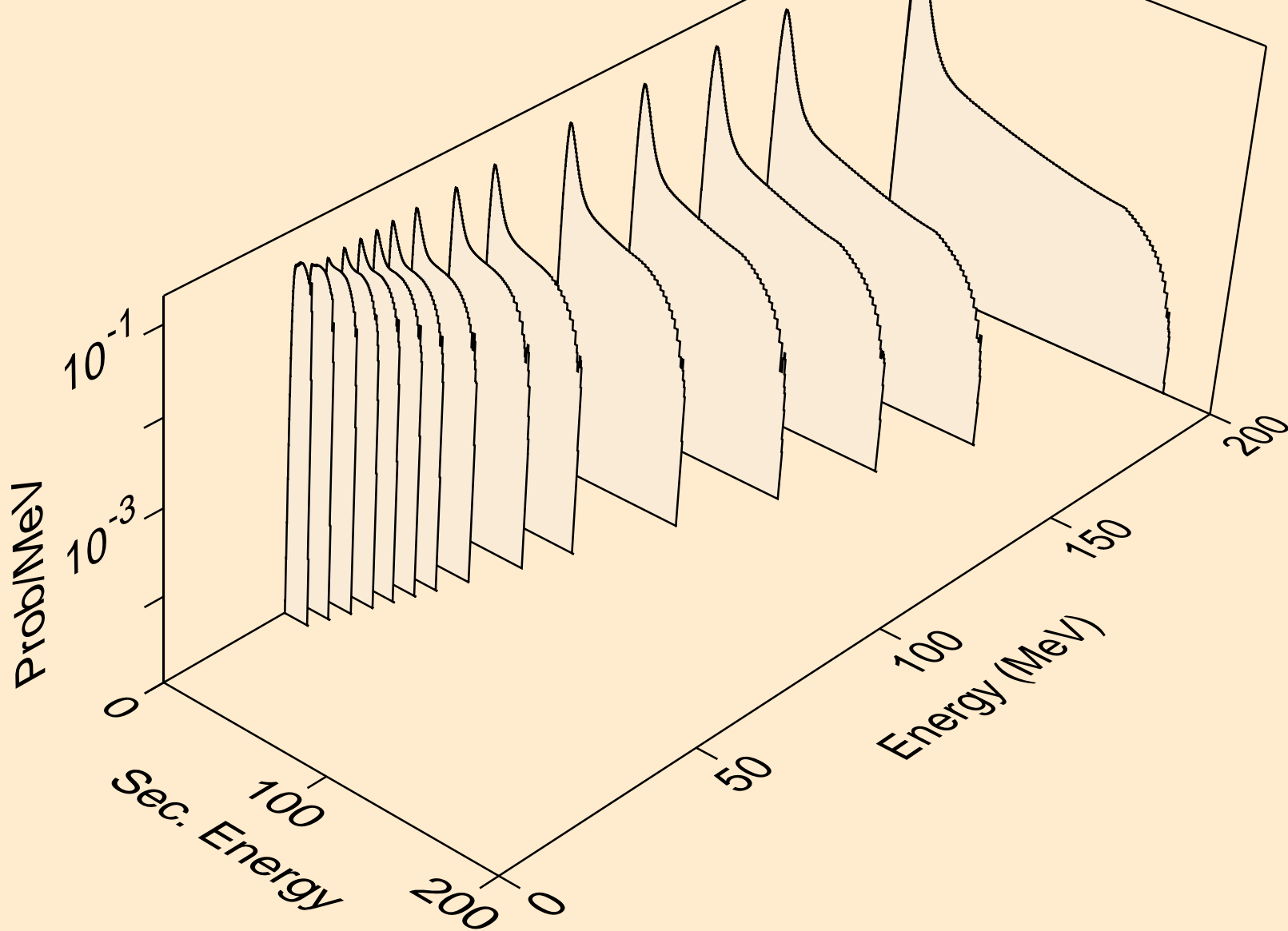

MG028 NEUTRON ACER TENDL-2019 LIBRARY; T=293.16K
protons from (n,n*)p

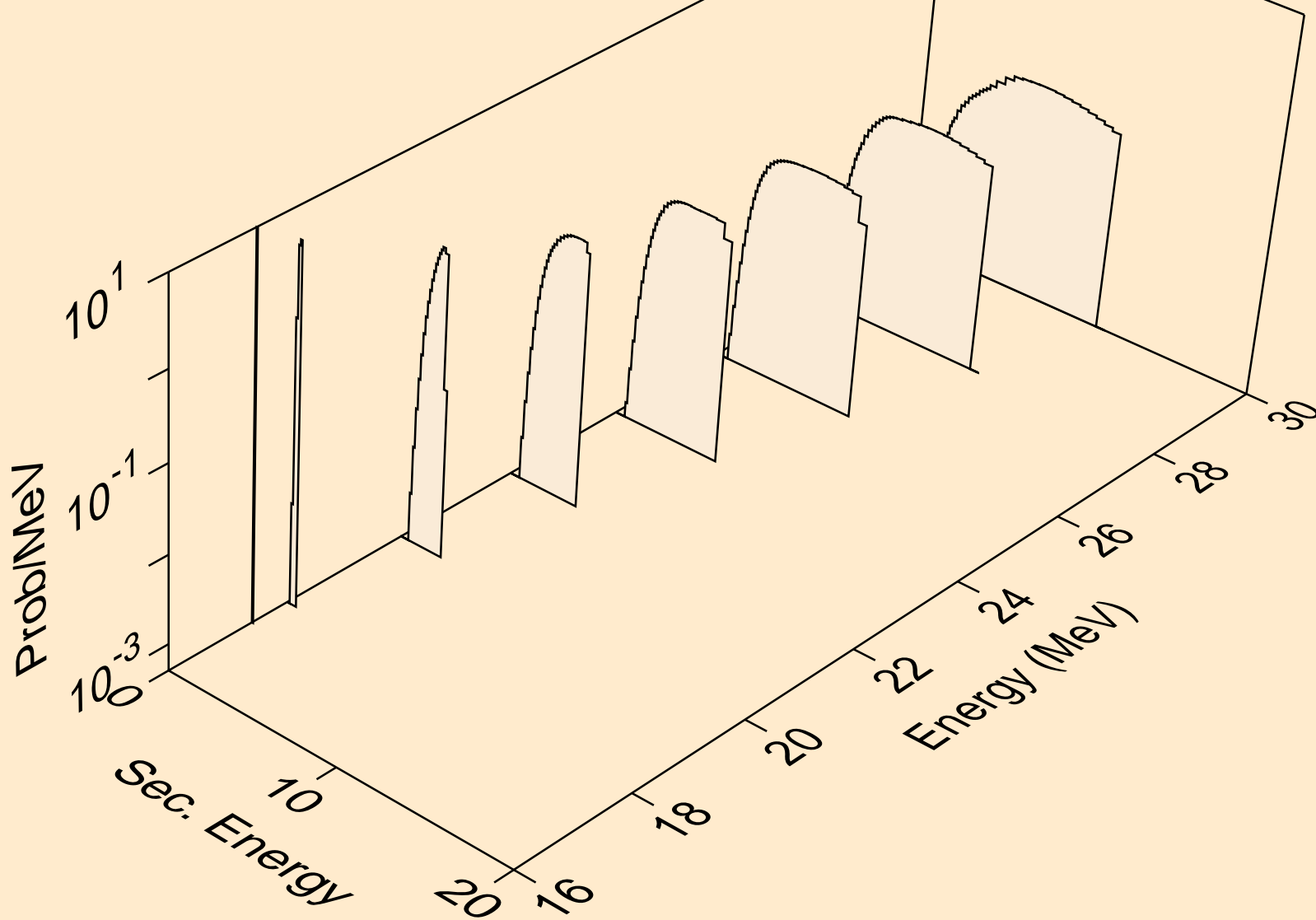

MG028 NEUTRON ACER TENDL-2019 LIBRARY; T=293.16K
protons from (n,2np)

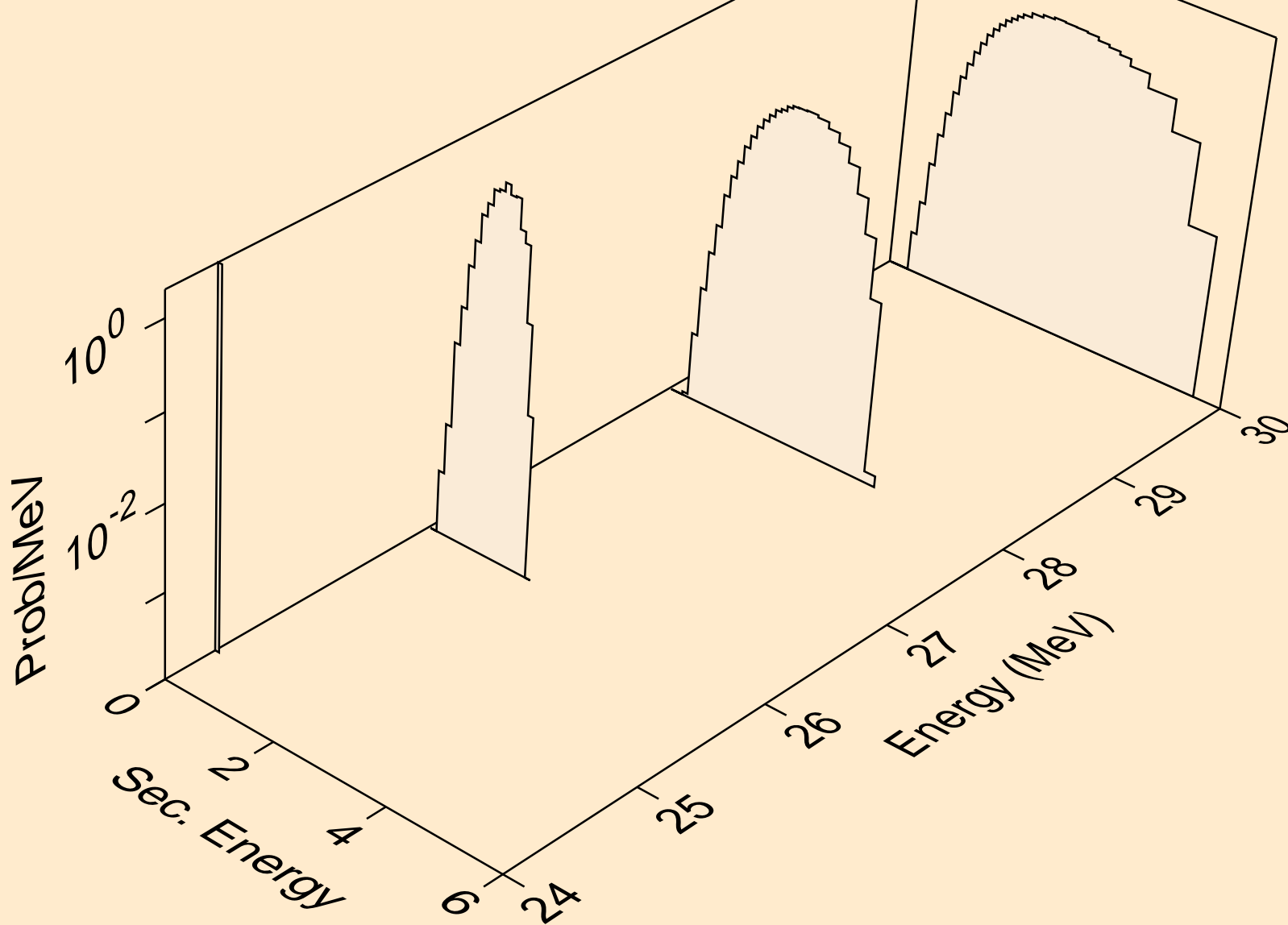

MG028 NEUTRON ACER TENDL-2019 LIBRARY; T=293.16K
protons from (n,p)

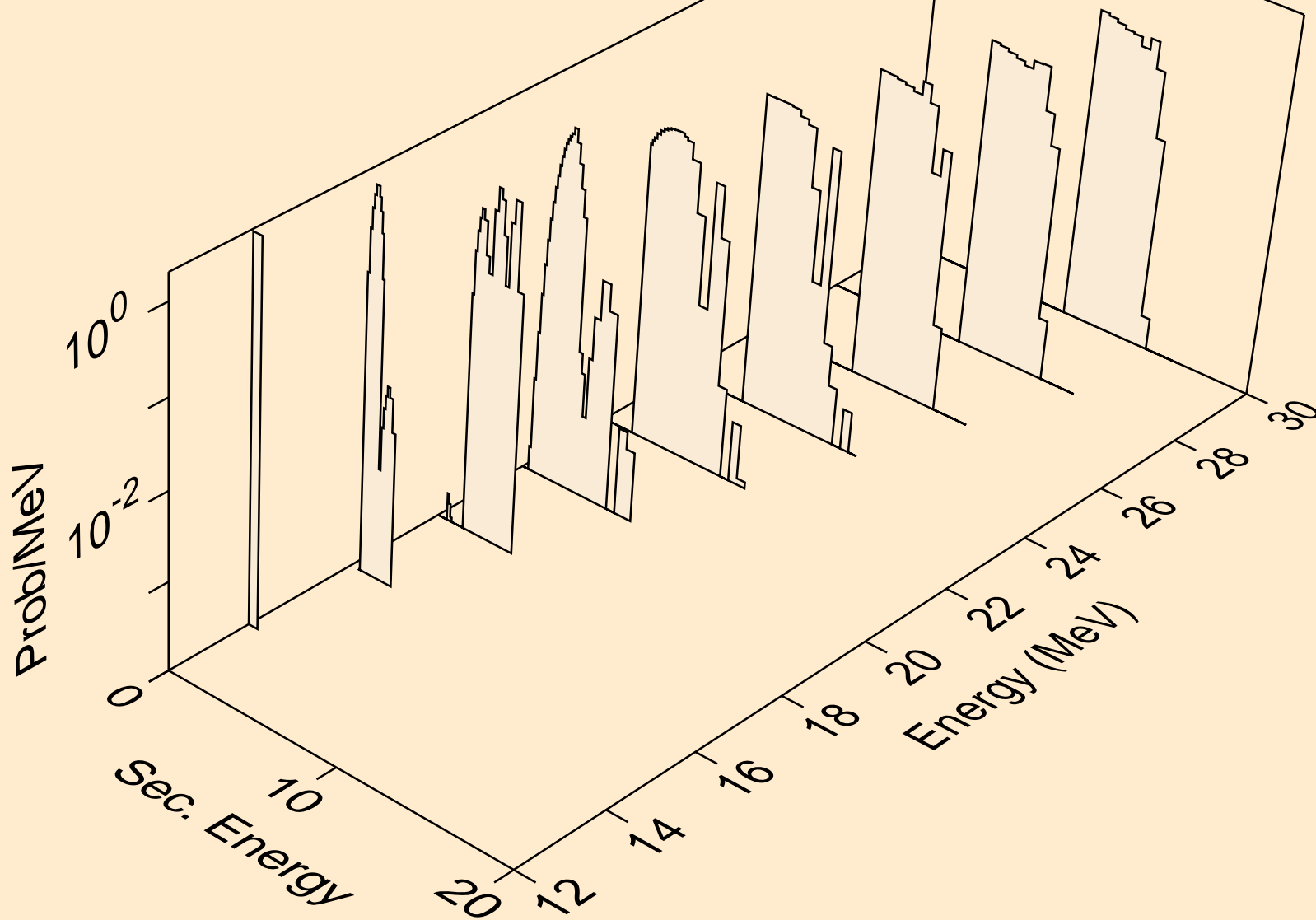

MG028 NEUTRON ACER TENDL-2019 LIBRARY; T=293.16K
protons from (n,p)

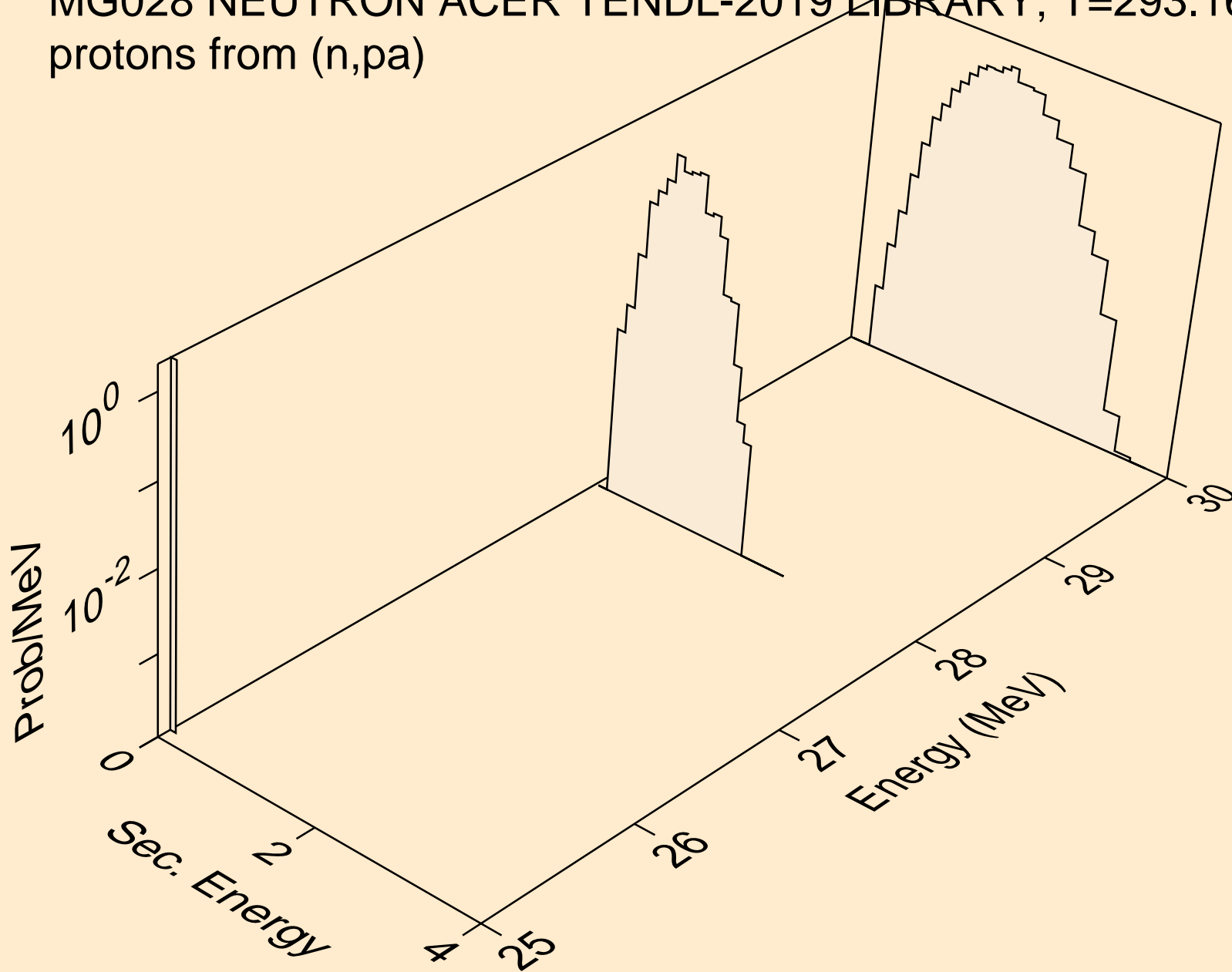

MG028 NEUTRON ACER TENDL-2019 LIBRARY; T=293.16K
deuterons from (n,x)

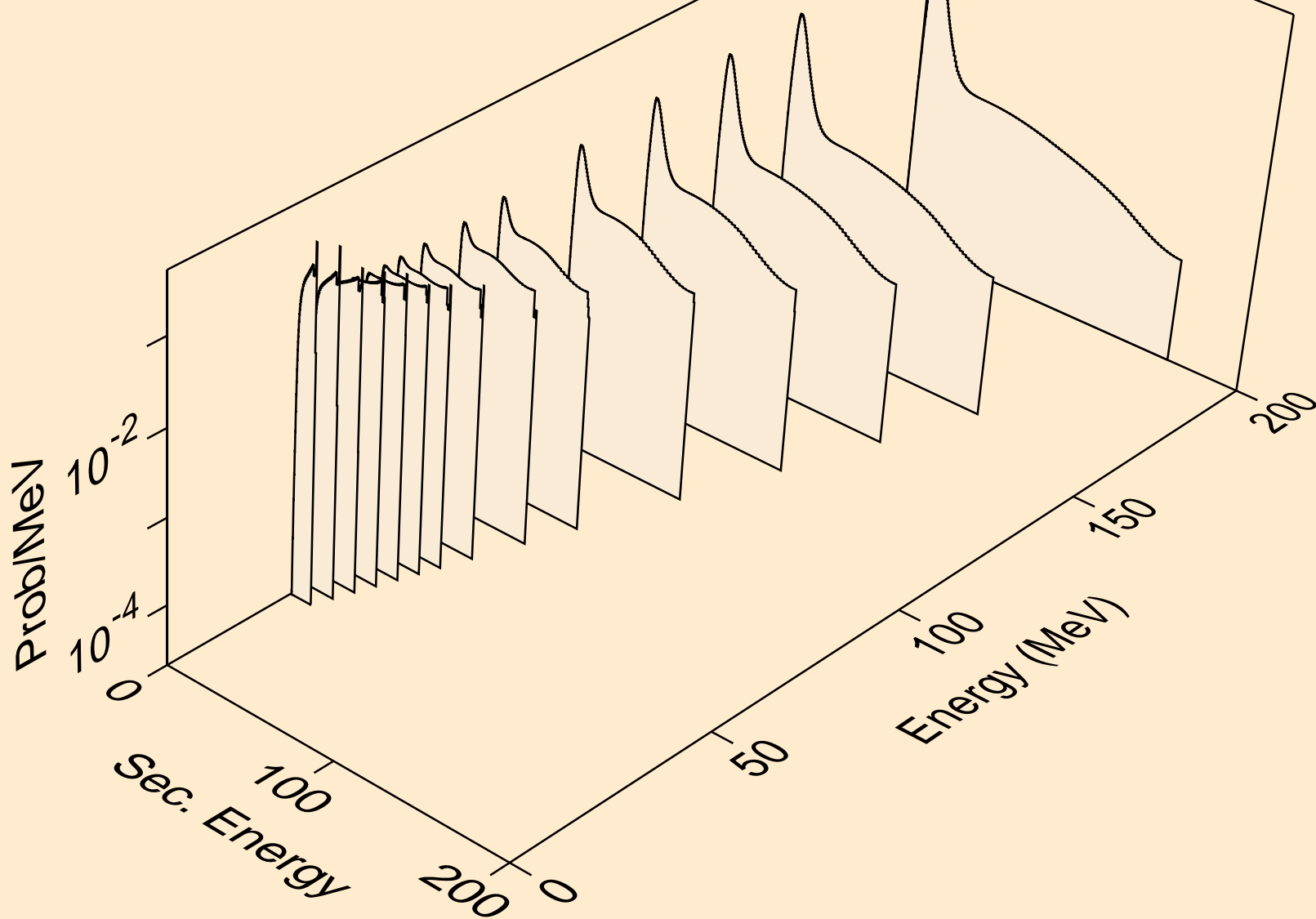

MG028 NEUTRON ACER TENDL-2019 LIBRARY; T=293.16K
deuterons from (n,2nd)

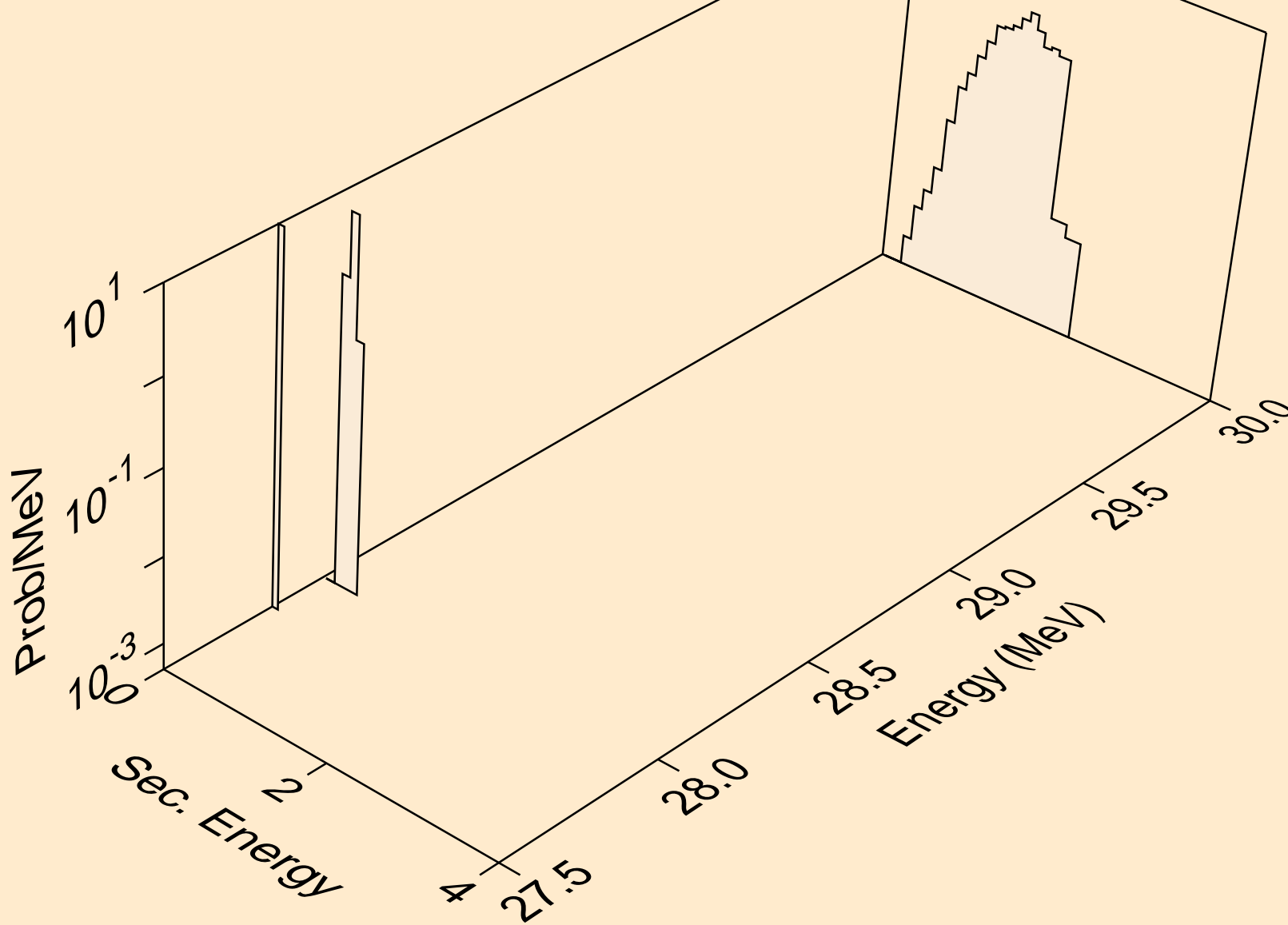

MG028 NEUTRON ACER TENDL-2019 LIBRARY; T=293.16K
deuterons from (n,n*)d

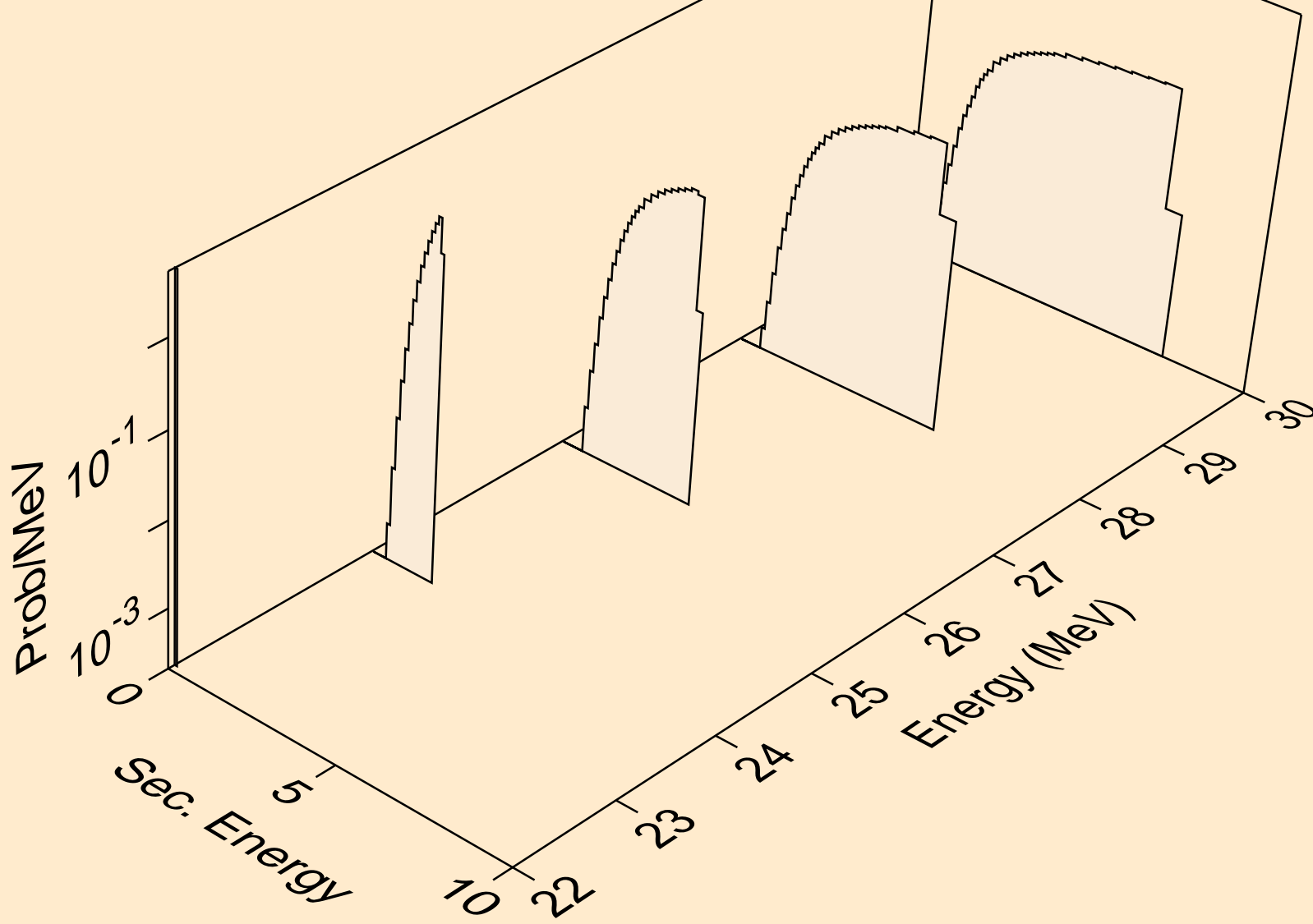

MG028 NEUTRON ACER TENDL-2019 LIBRARY; T=293.16K
deuterons from (n,d)

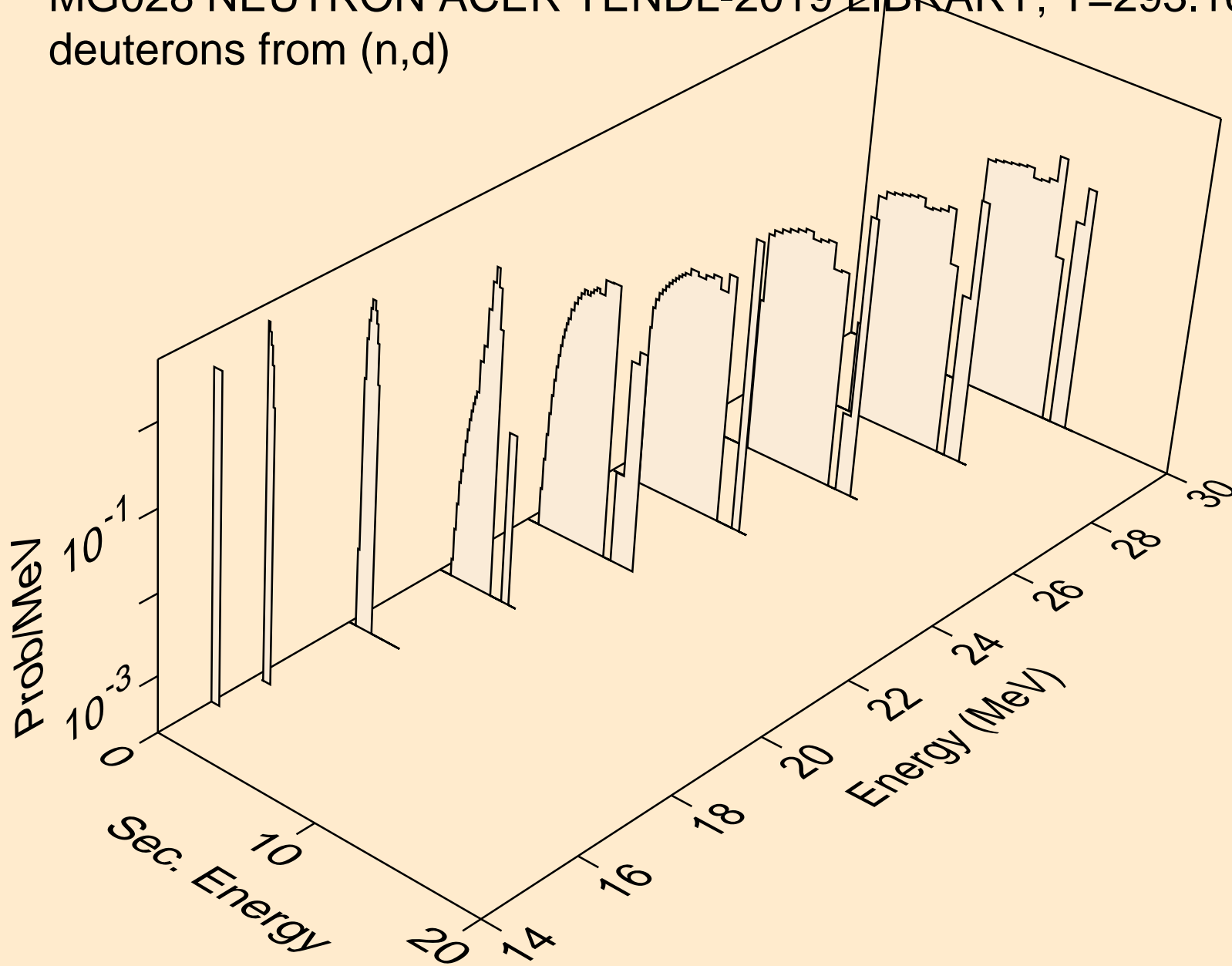

MG028 NEUTRON ACER TENDL-2019 LIBRARY; T=293.16K
tritons from (n,x)

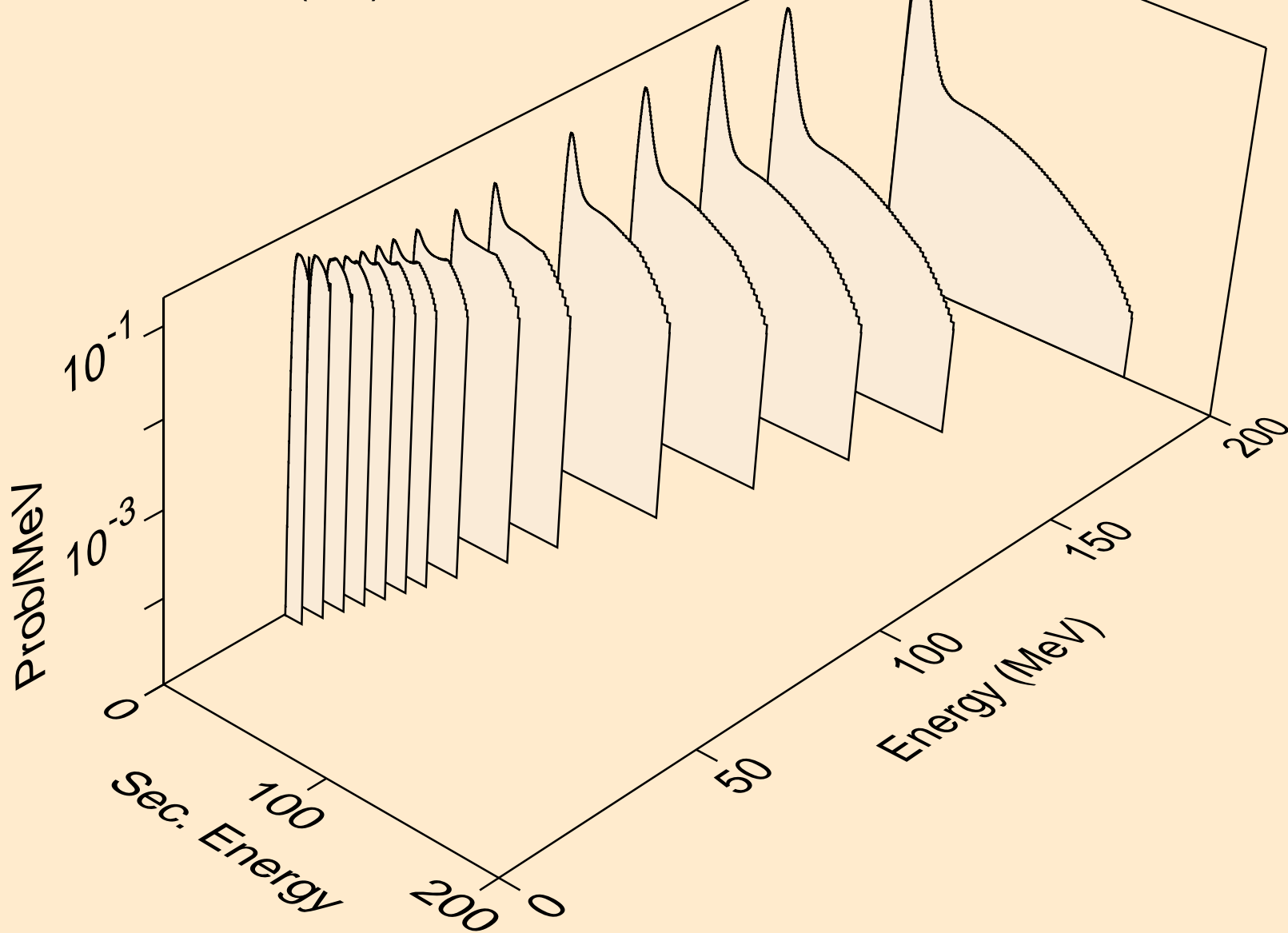

MG028 NEUTRON ACER TENDL-2019 LIBRARY; T=293.16K
tritons from (n,n*)t

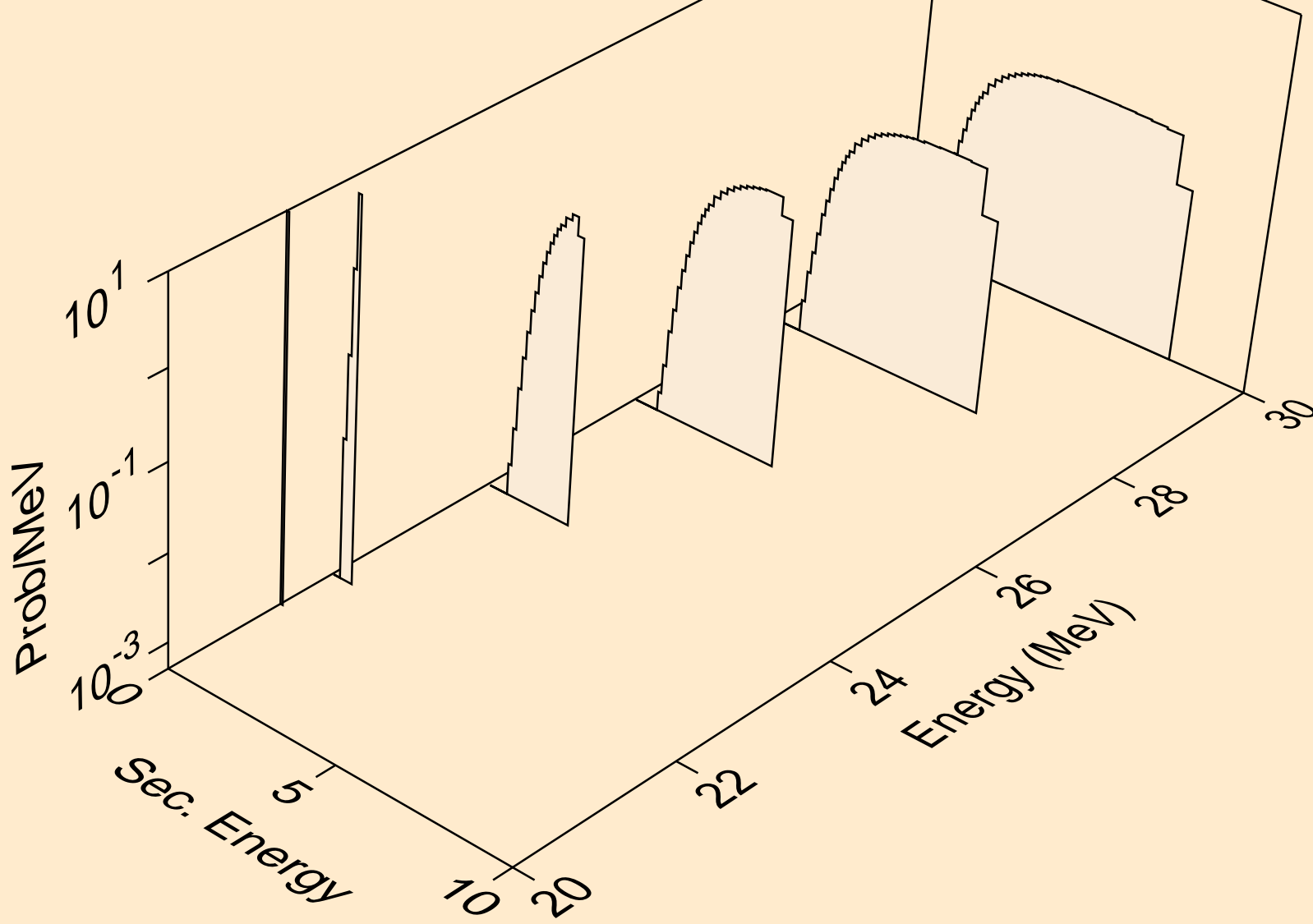

MG028 NEUTRON ACER TENDL-2019 LIBRARY; T=293.16K
tritons from (n,t)

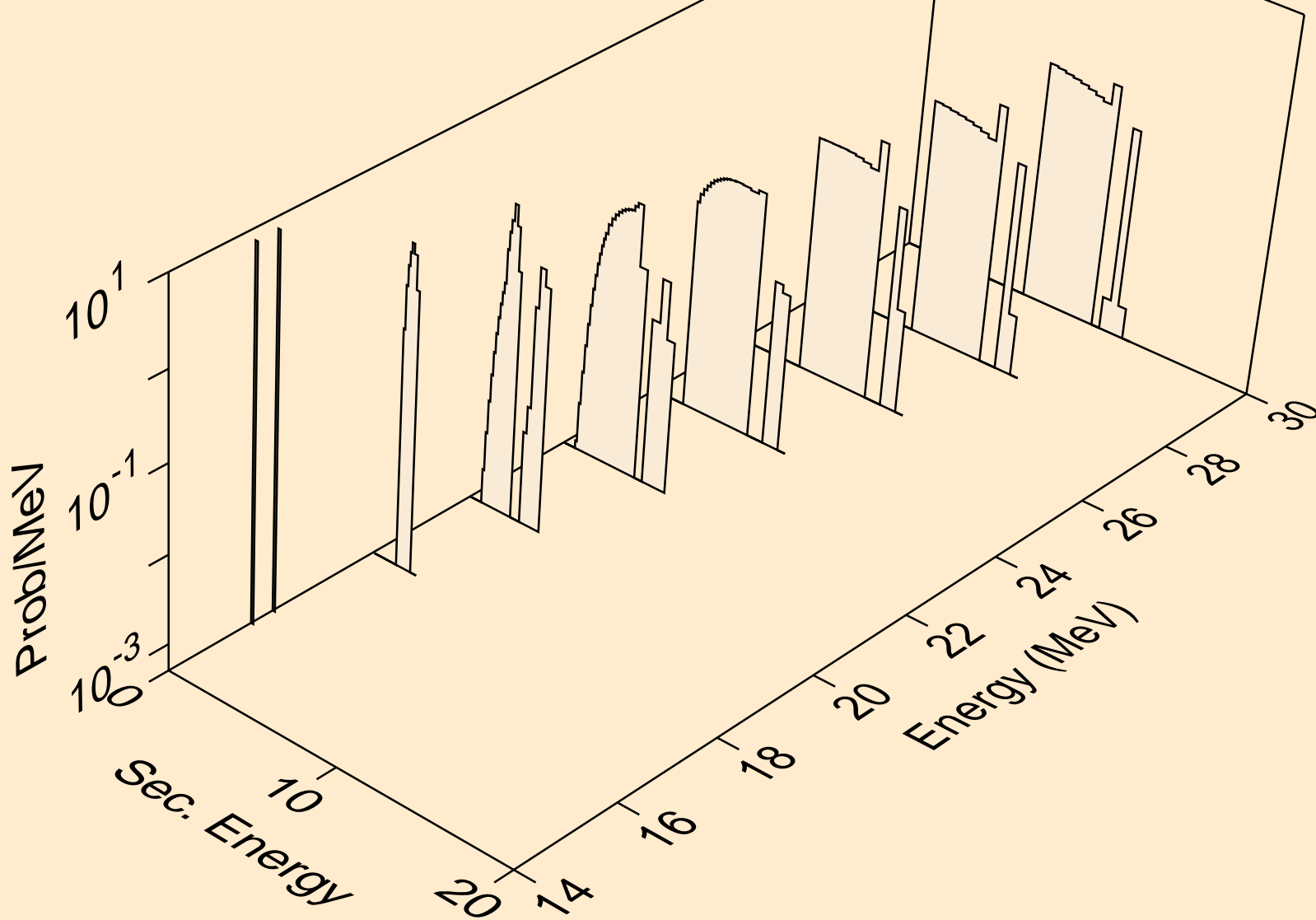

MG028 NEUTRON ACER TENDL-2019 LIBRARY; T=293.16K
he3s from (n,x)

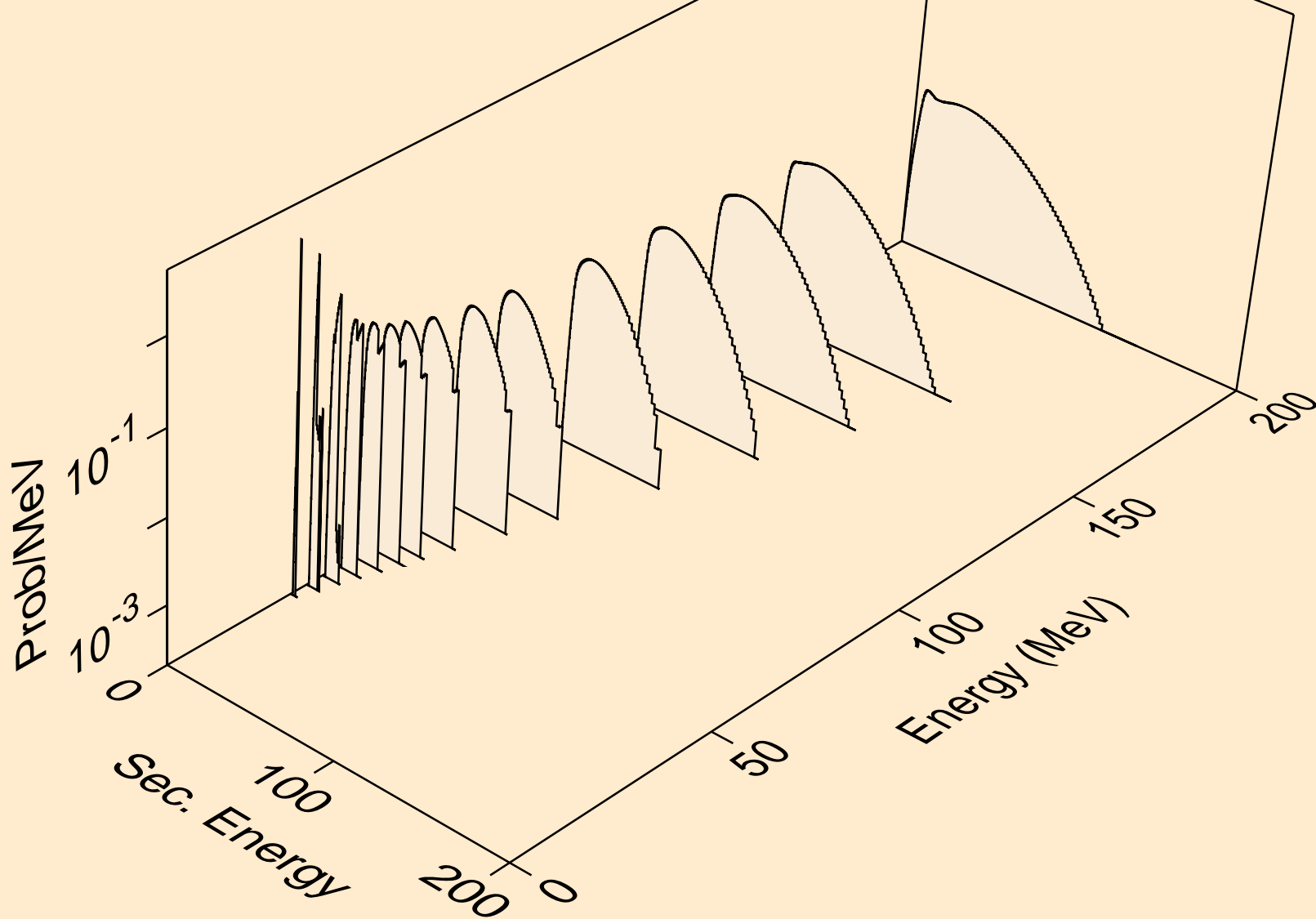

MG028 NEUTRON ACER TENDL-2019 LIBRARY; T=293.16K
he3s from (n,he3)

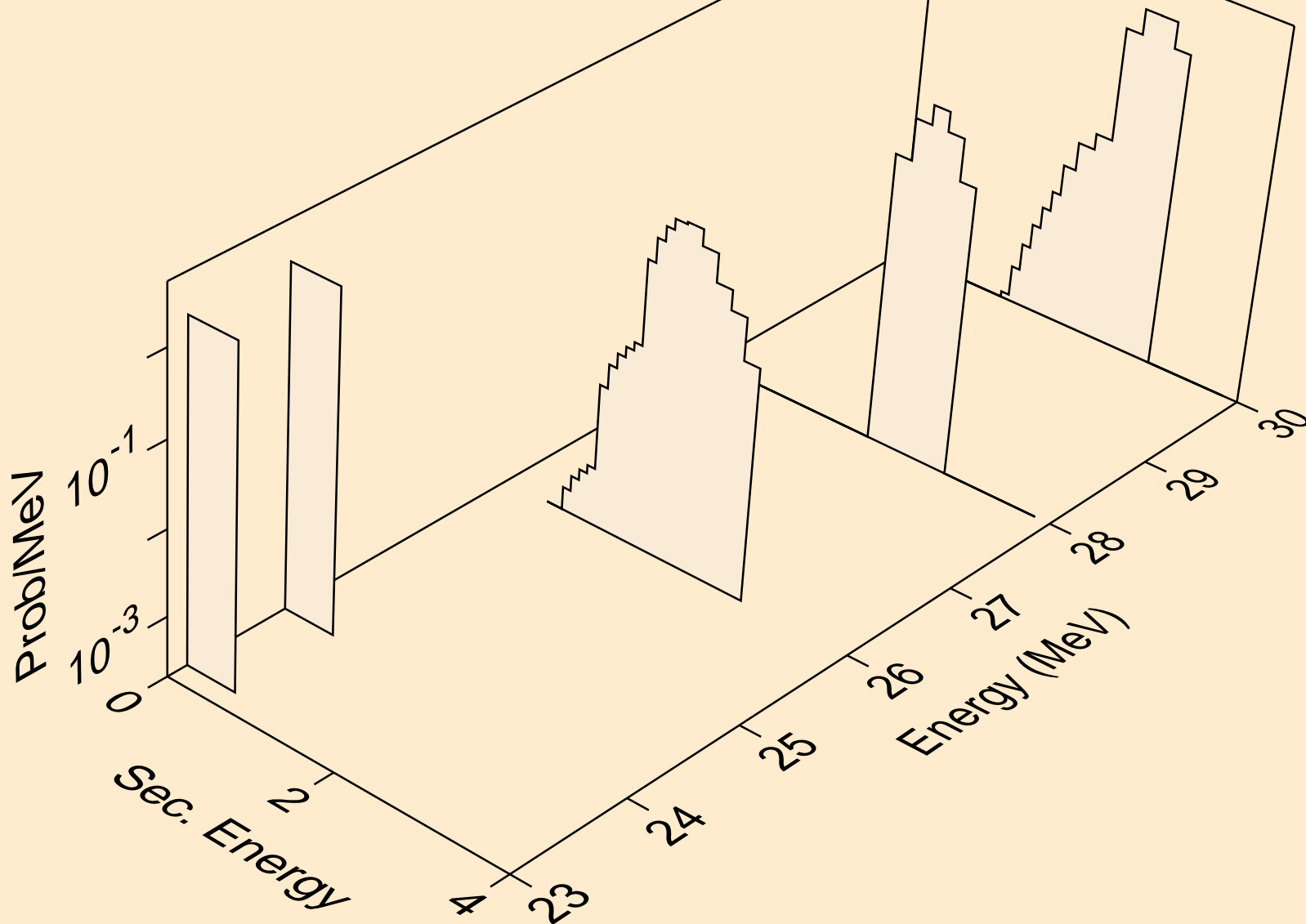

MG028 NEUTRON ACER TENDL-2019 LIBRARY; T=293.16K
alphas from (n,x)

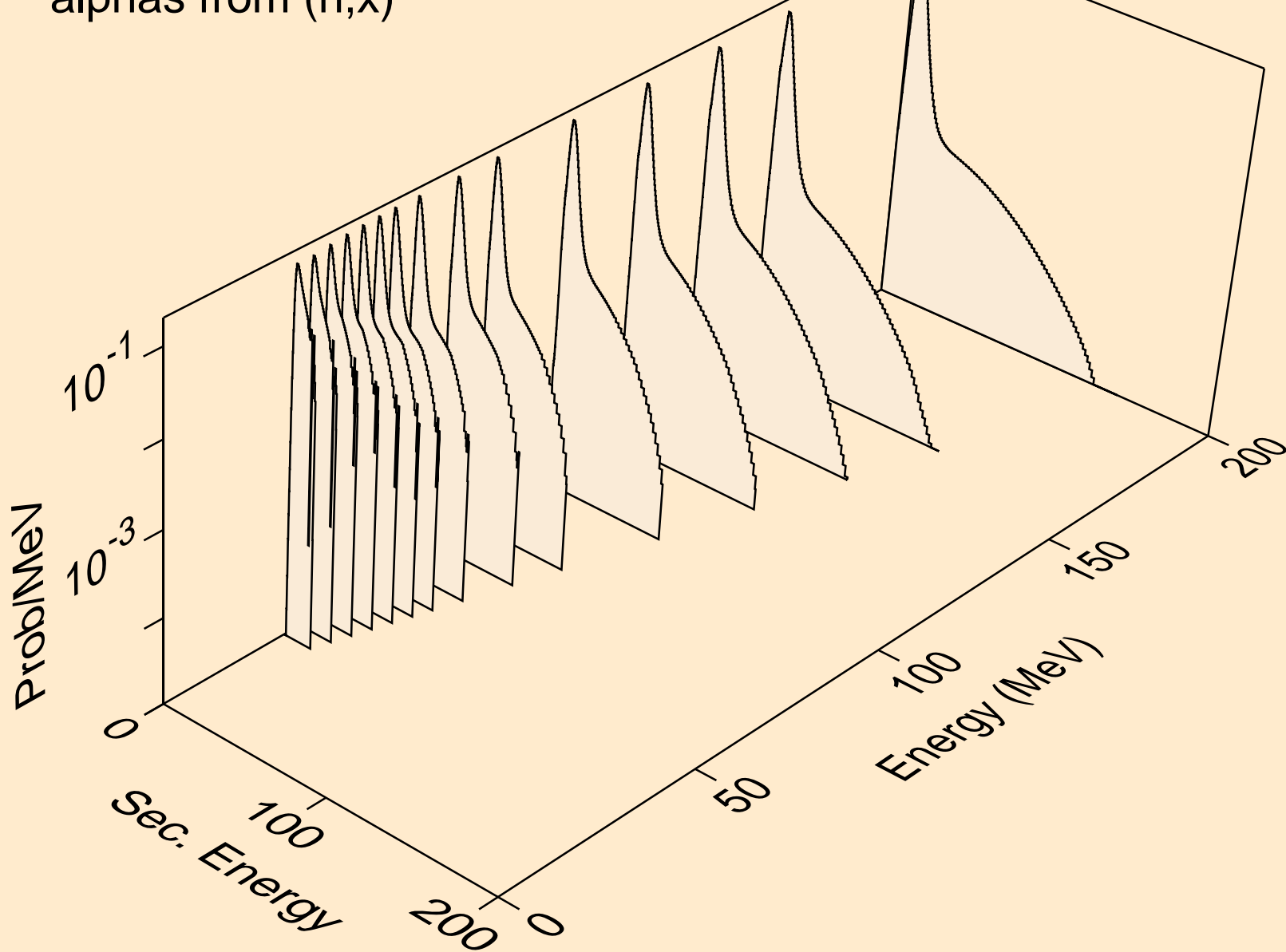

MG028 NEUTRON ACER TENDL-2019 LIBRARY; T=293.16K
alphas from (n,n*)a

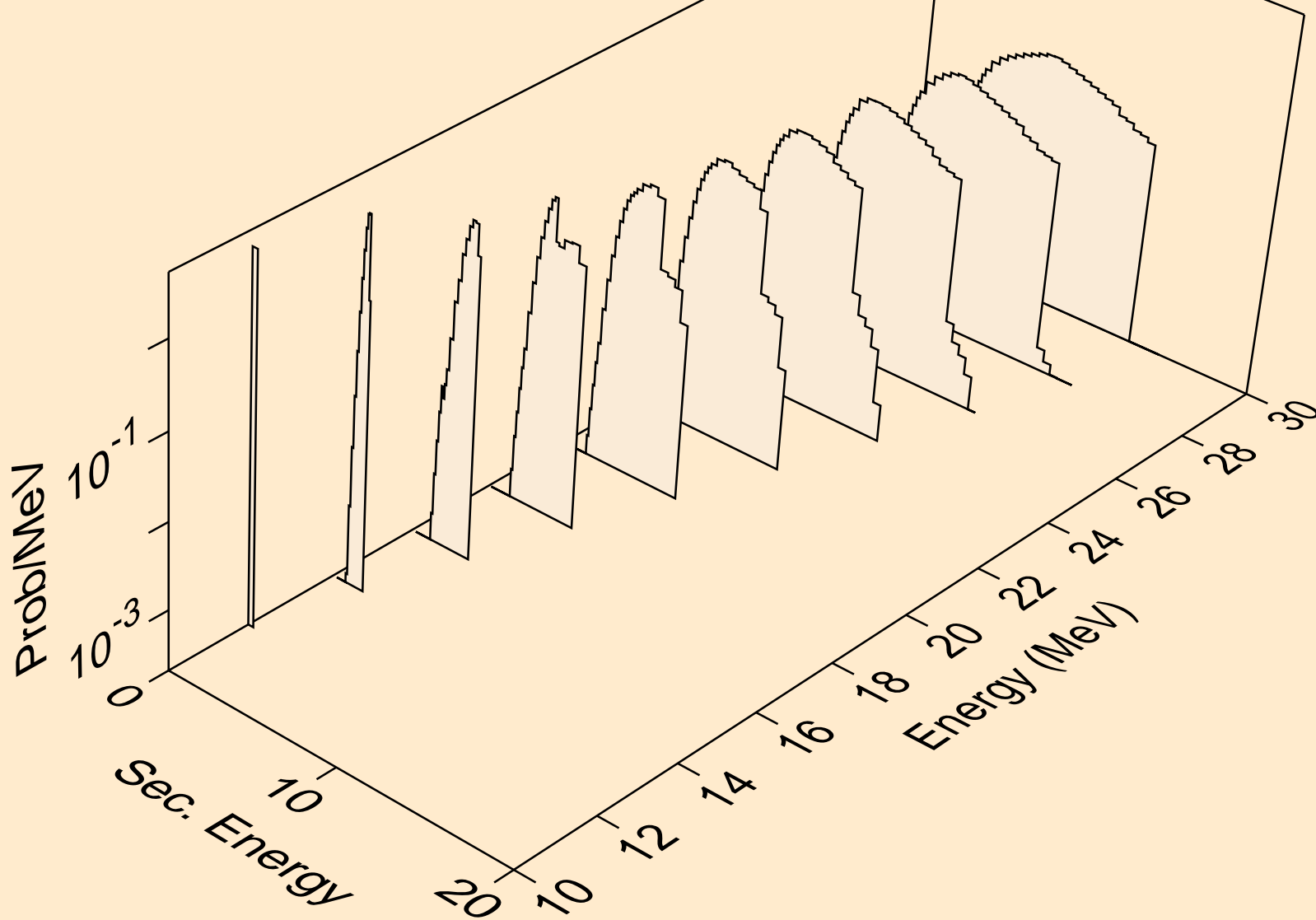

MG028 NEUTRON ACER TENDL-2019 LIBRARY; T=293.16K
alphas from (n,2n)a

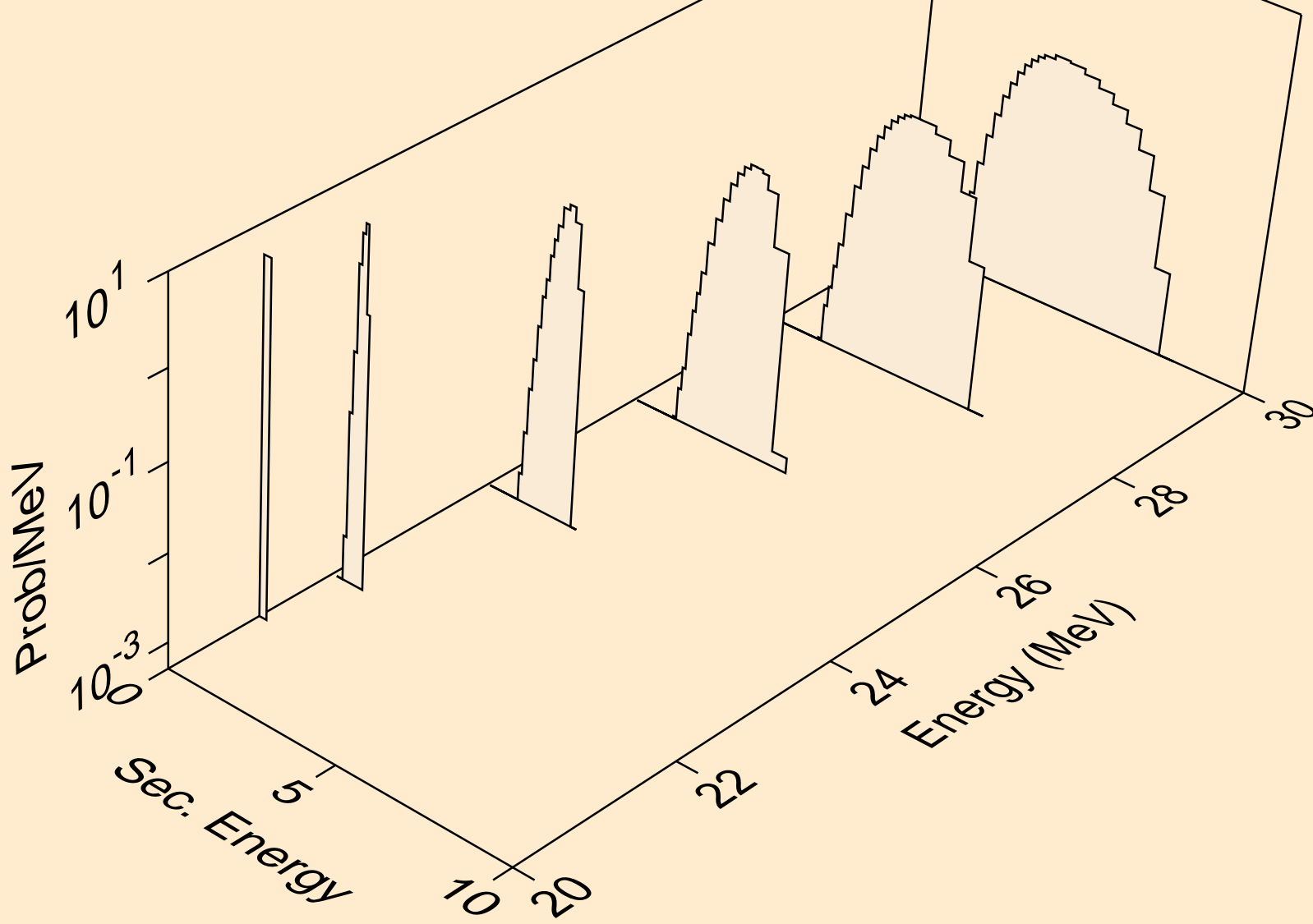

MG028 NEUTRON ACER TENDL-2019 LIBRARY; T=293.16K
alphas from (n,3n)a

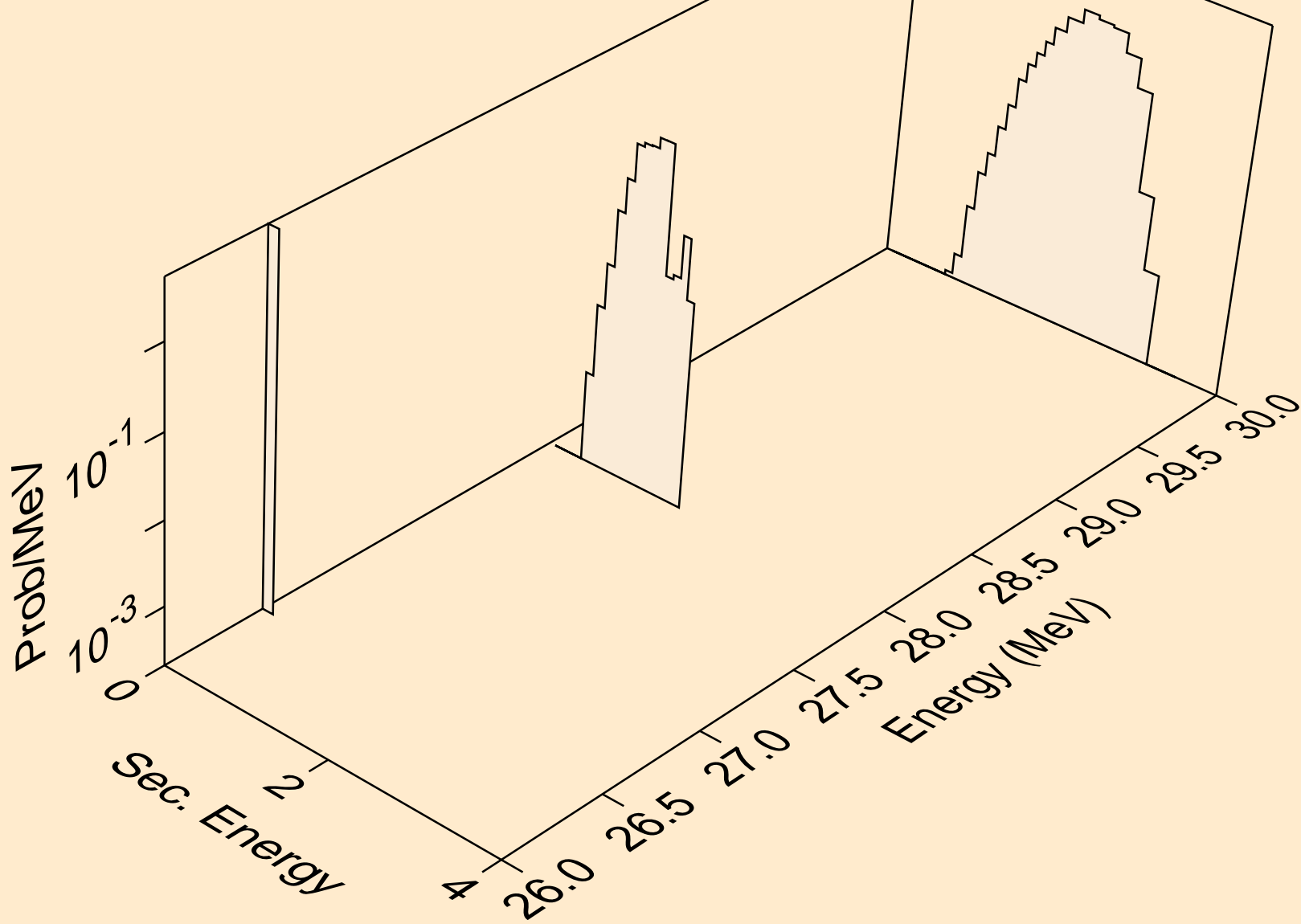

MG028 NEUTRON ACER TENDL-2019 LIBRARY; T=293.16K
alphas from (n,a)

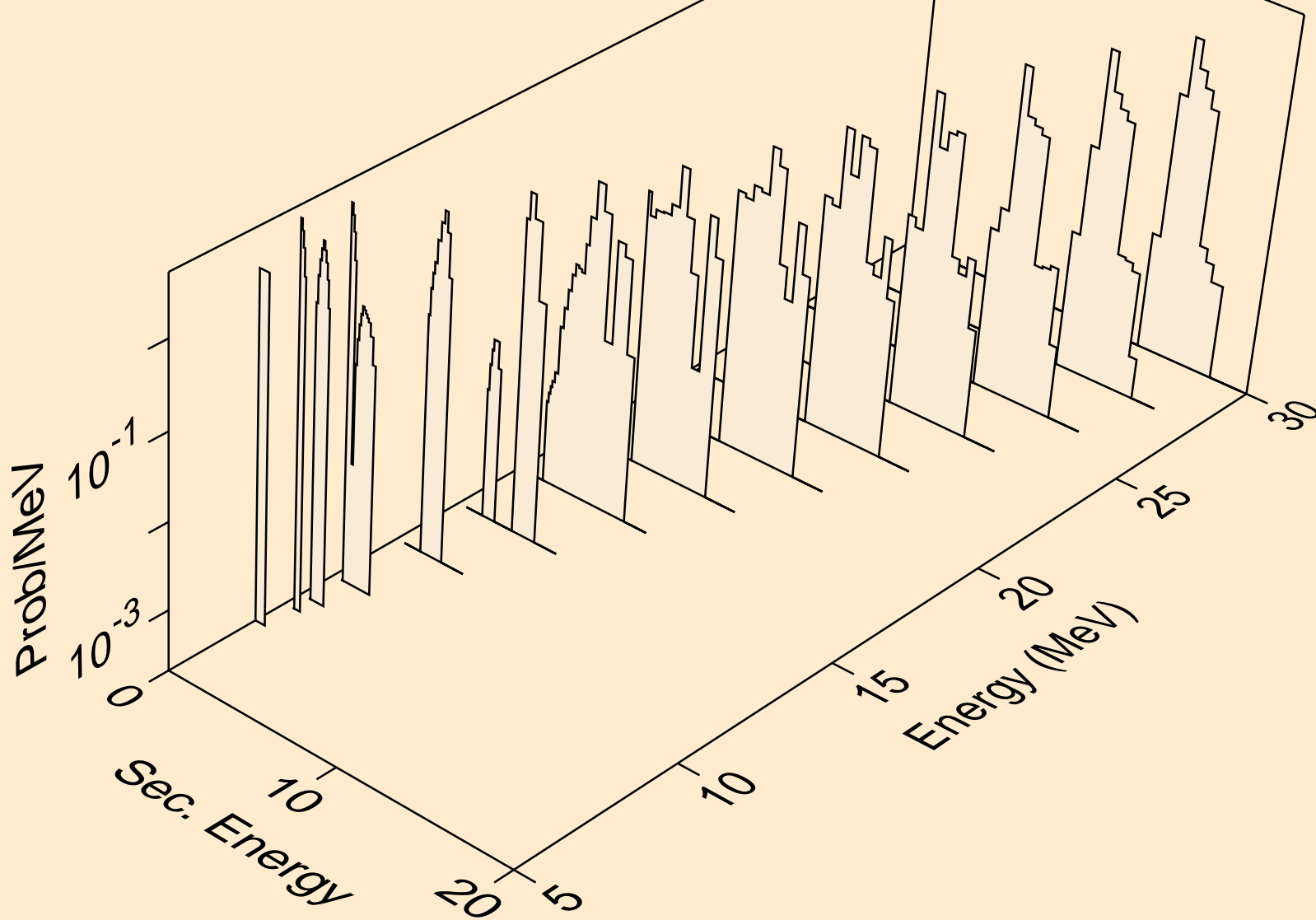

MG028 NEUTRON ACER TENDL-2019 LIBRARY; T=293.16K
alphas from (n,2a)

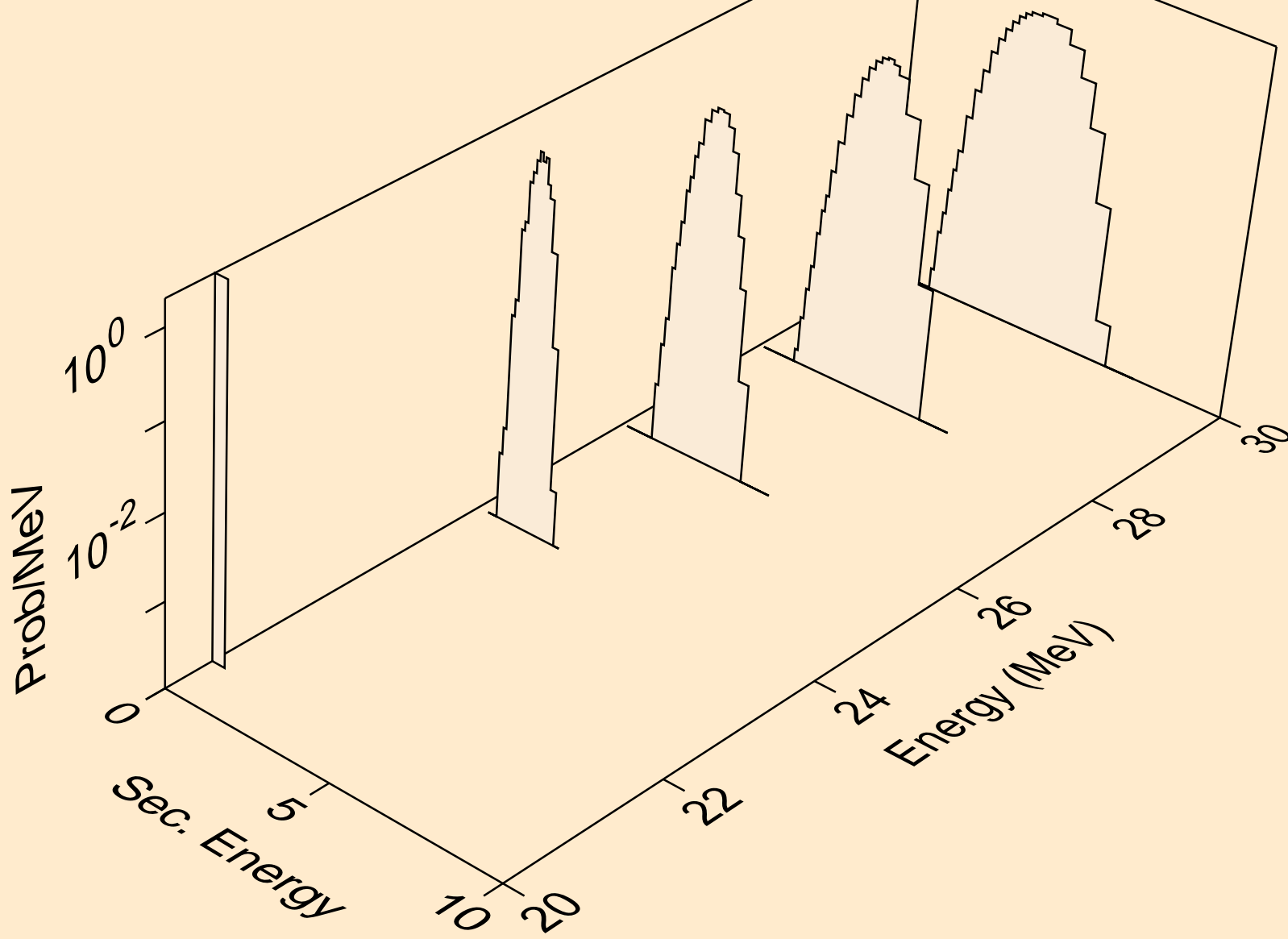

MG028 NEUTRON ACER TENDL-2019 LIBRARY; T=293.16K
alphas from (n,pa)

