

MO086 NEUTRON ACER TENDL-2019 LIBRARY; T=293.16K  
Principal cross sections

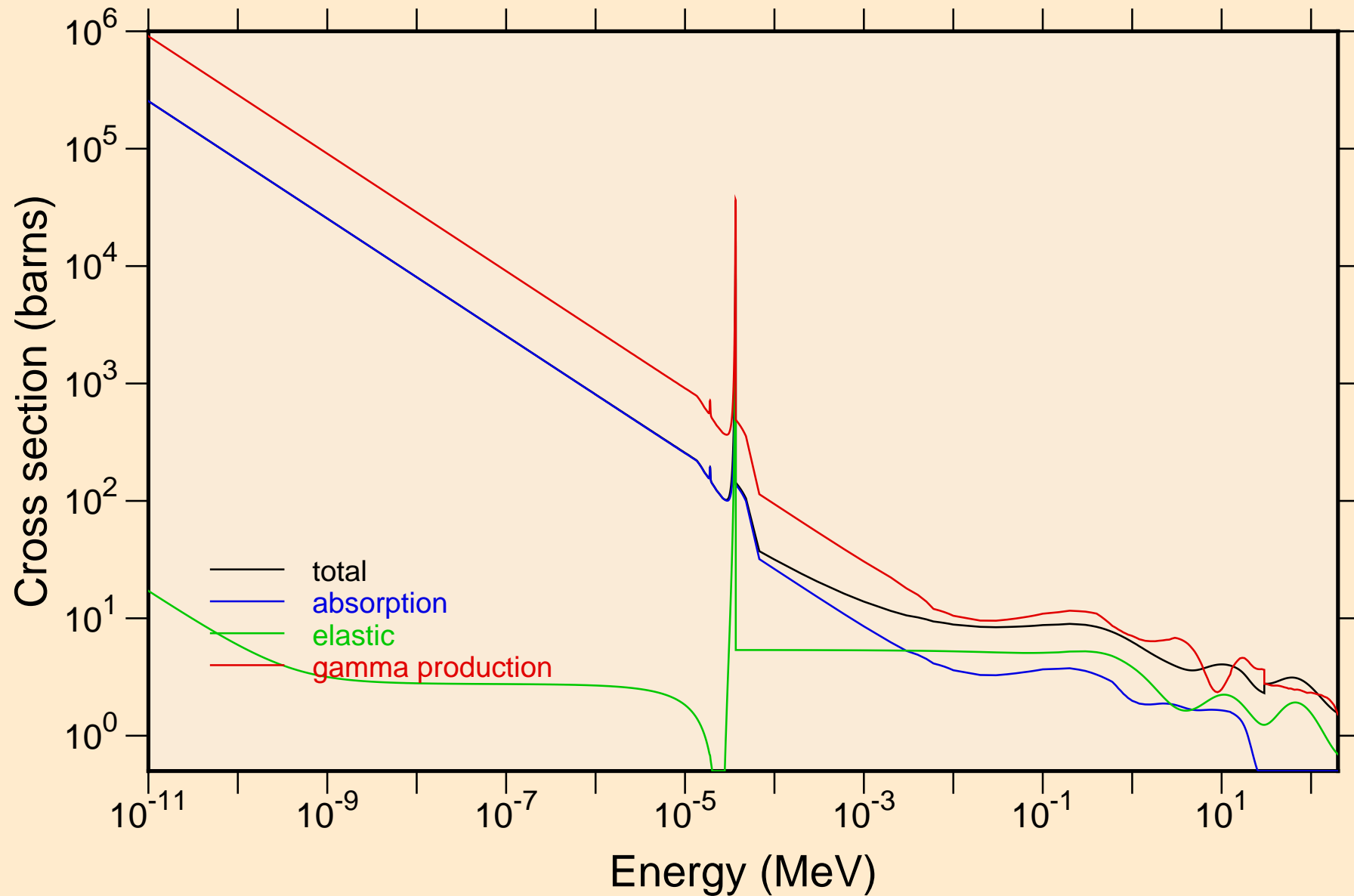

MO086 NEUTRON ACER TENDL-2019 LIBRARY; T=293.16K  
Heating

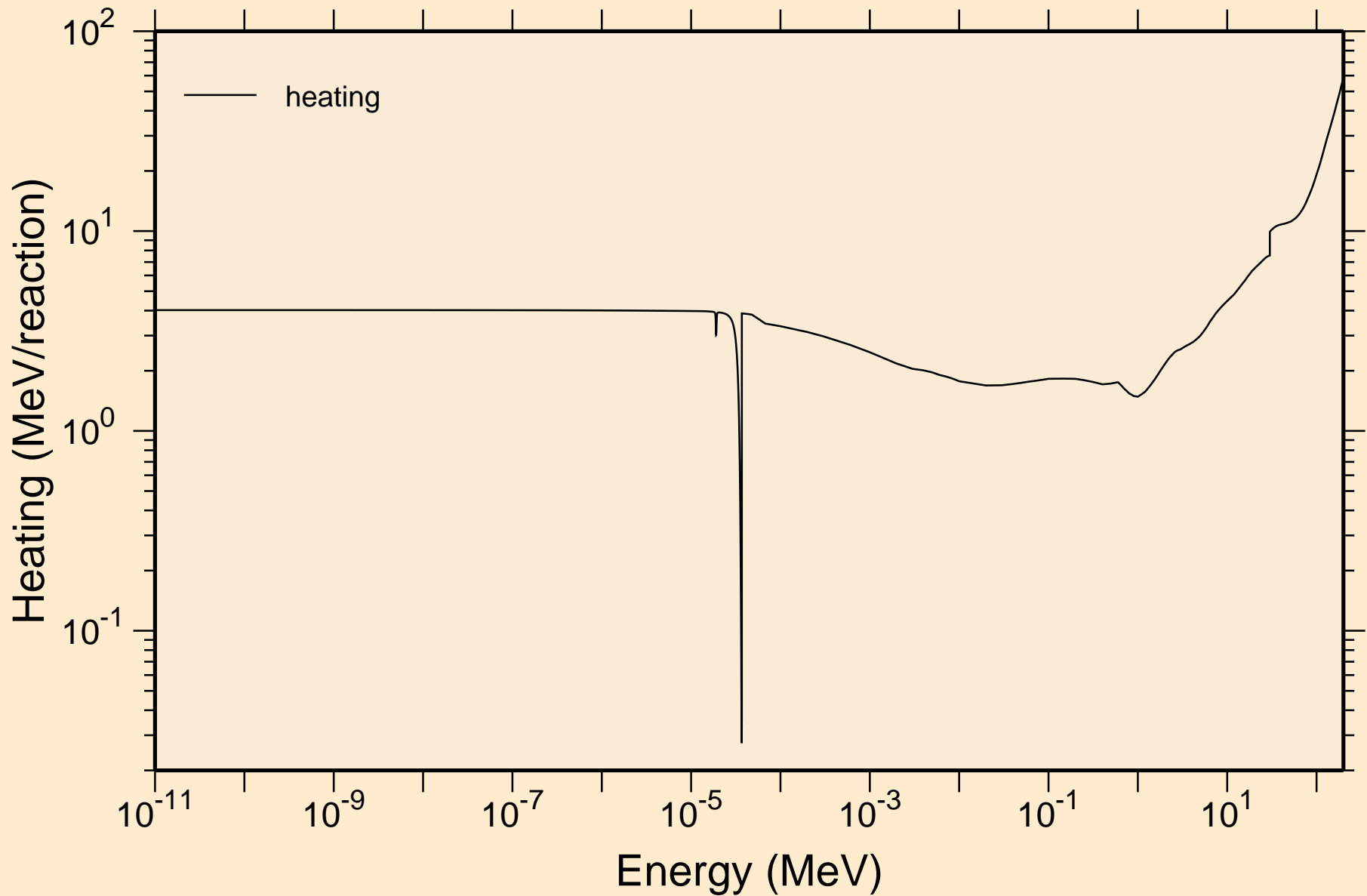

MO086 NEUTRON ACER TENDL-2019 LIBRARY; T=293.16K  
Damage

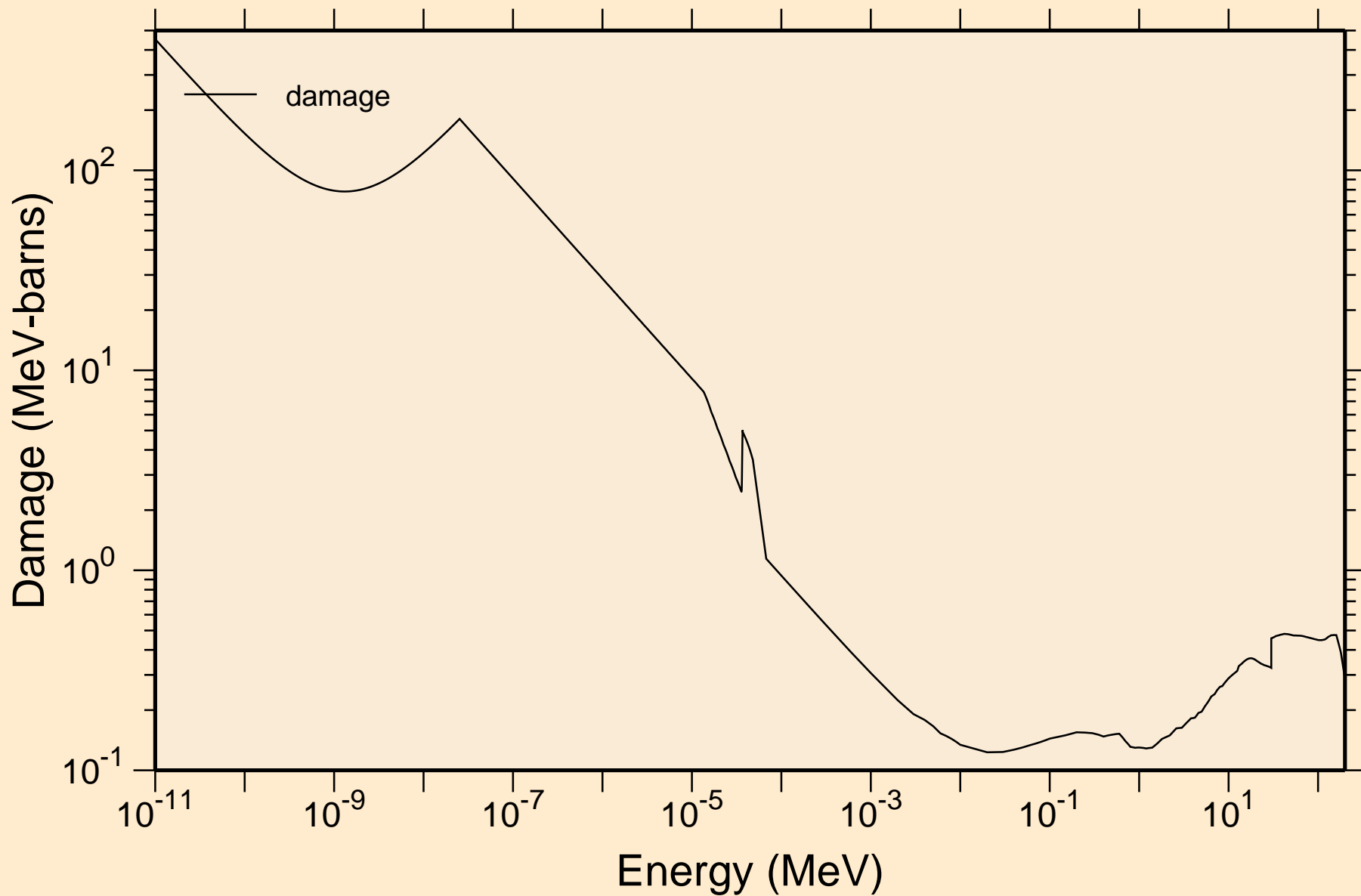

MO086 NEUTRON ACER TENDL-2019 LIBRARY; T=293.16K  
Non-threshold reactions

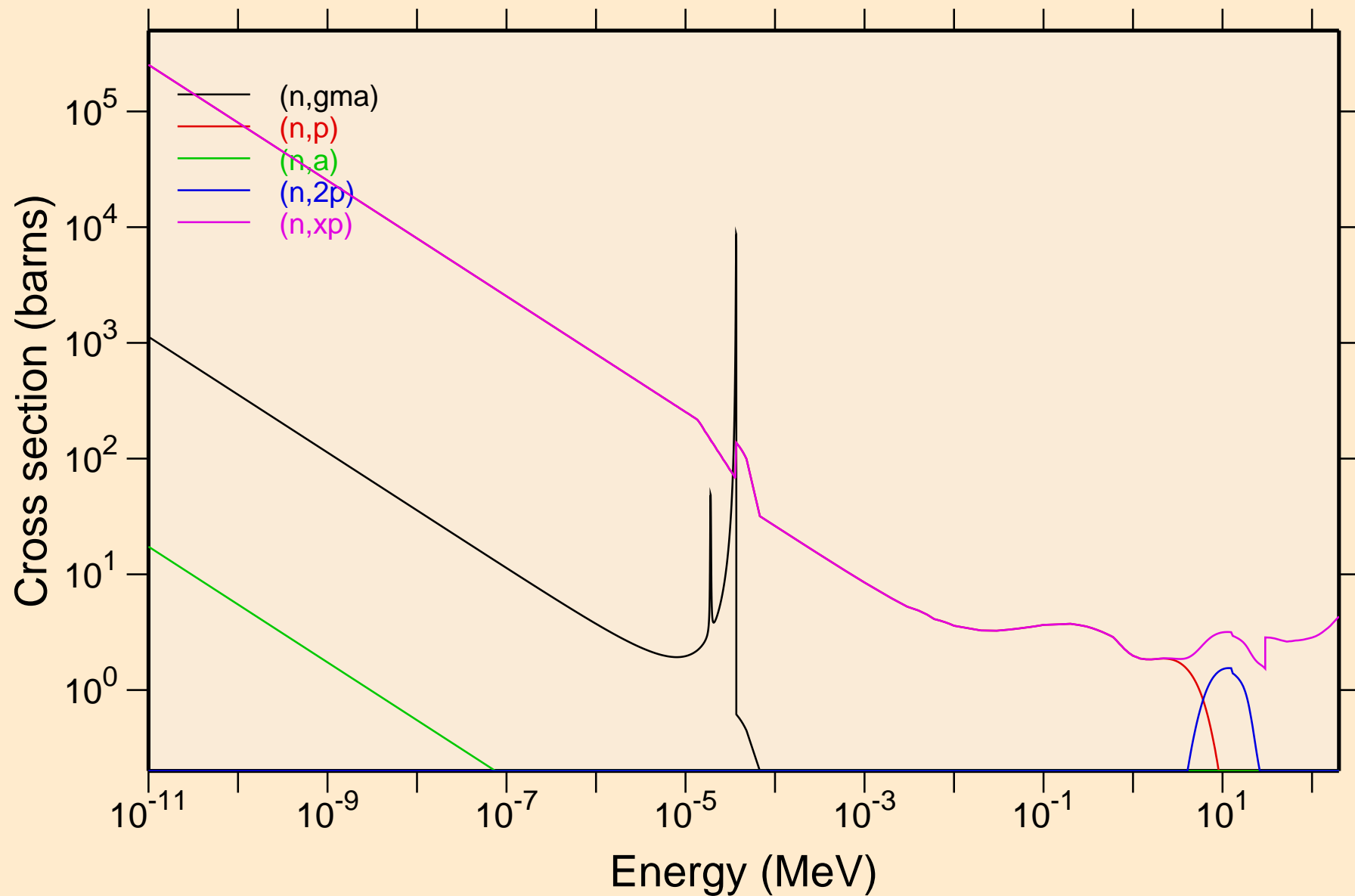

MO086 NEUTRON ACER TENDL-2019 LIBRARY; T=293.16K  
Non-threshold reactions

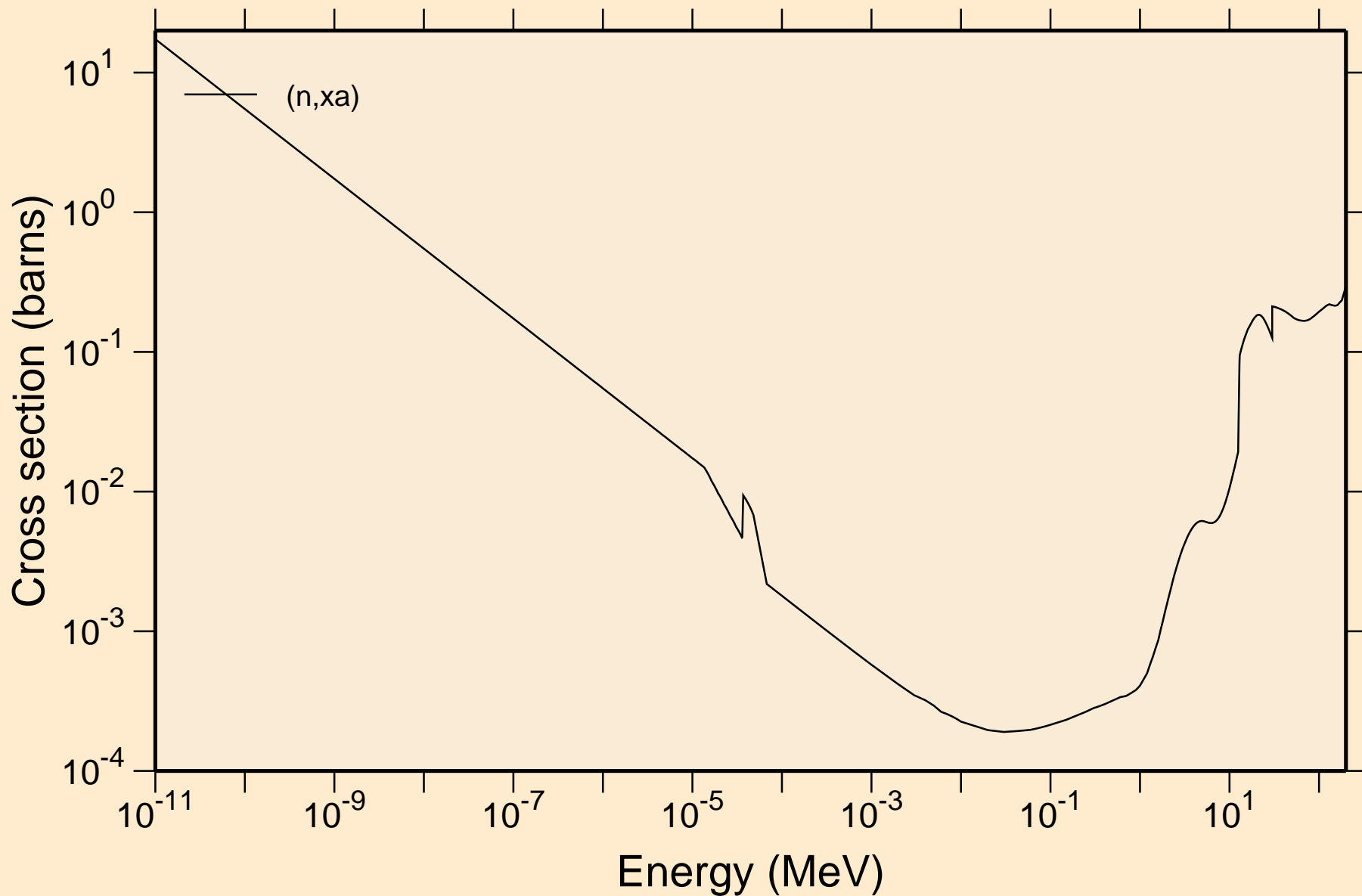

MO086 NEUTRON ACER TENDL-2019 LIBRARY; T=293.16K  
Principal cross sections

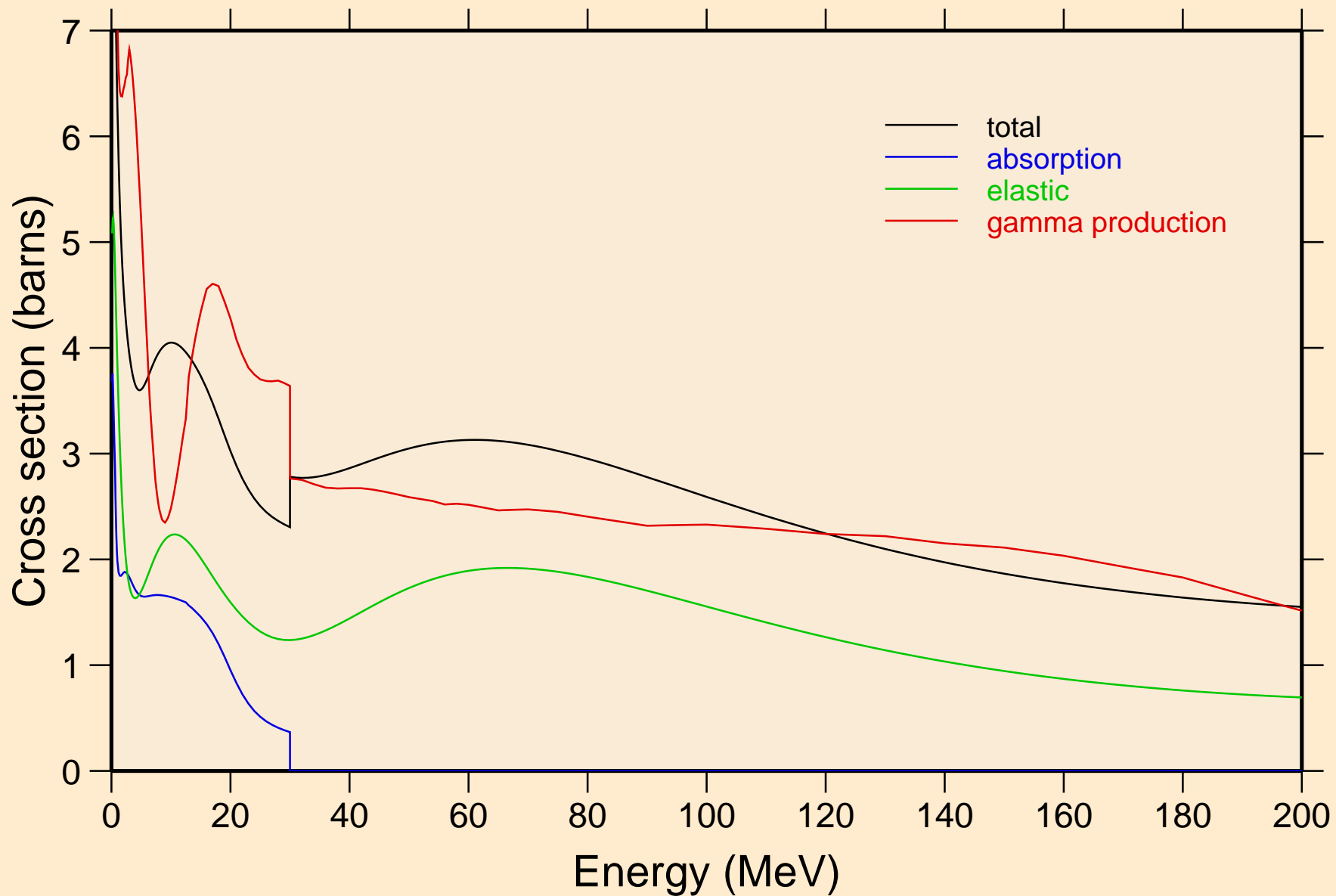

MO086 NEUTRON ACER TENDL-2019 LIBRARY; T=293.16K  
Heating

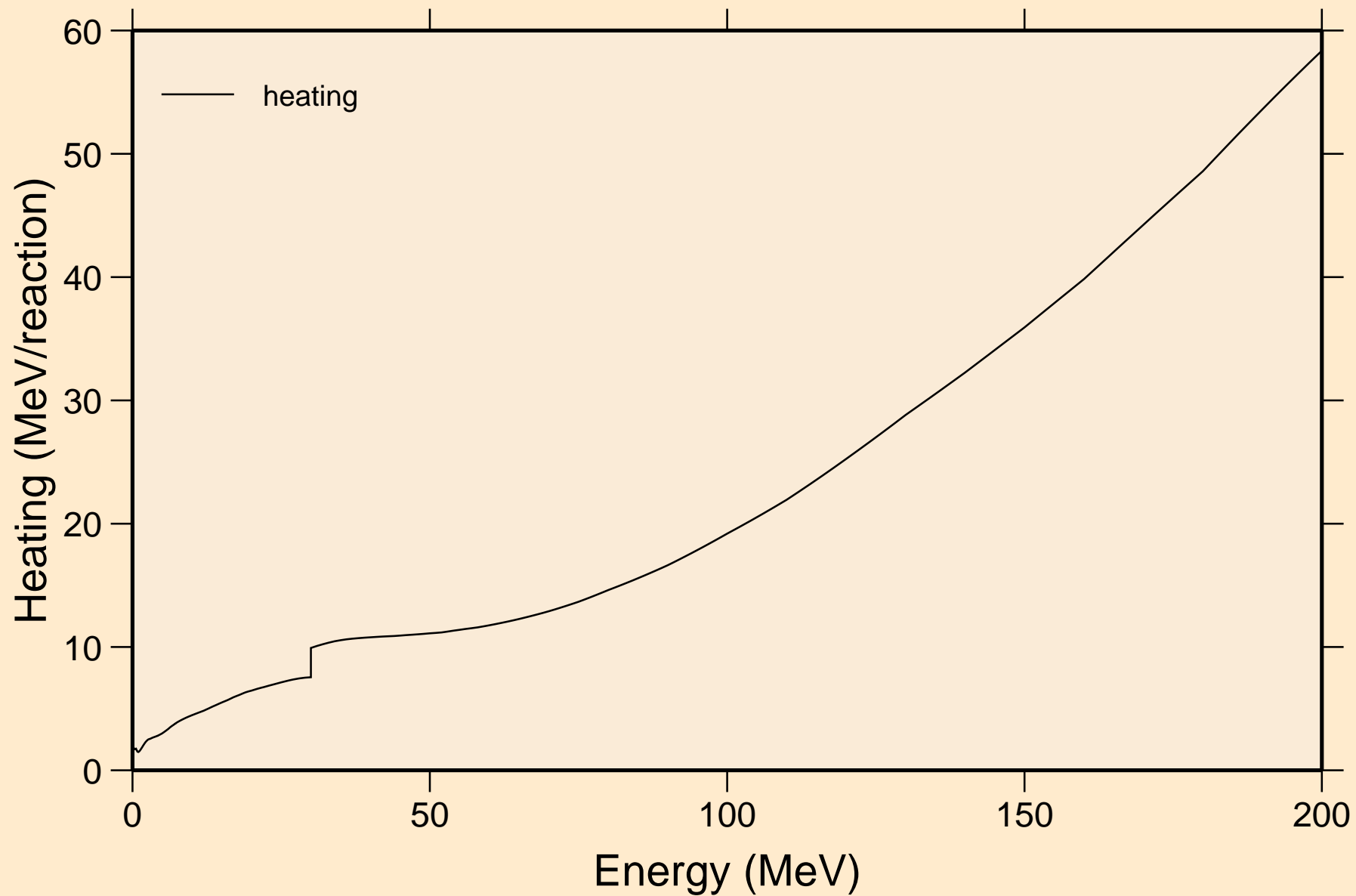

MO086 NEUTRON ACER TENDL-2019 LIBRARY; T=293.16K  
Damage

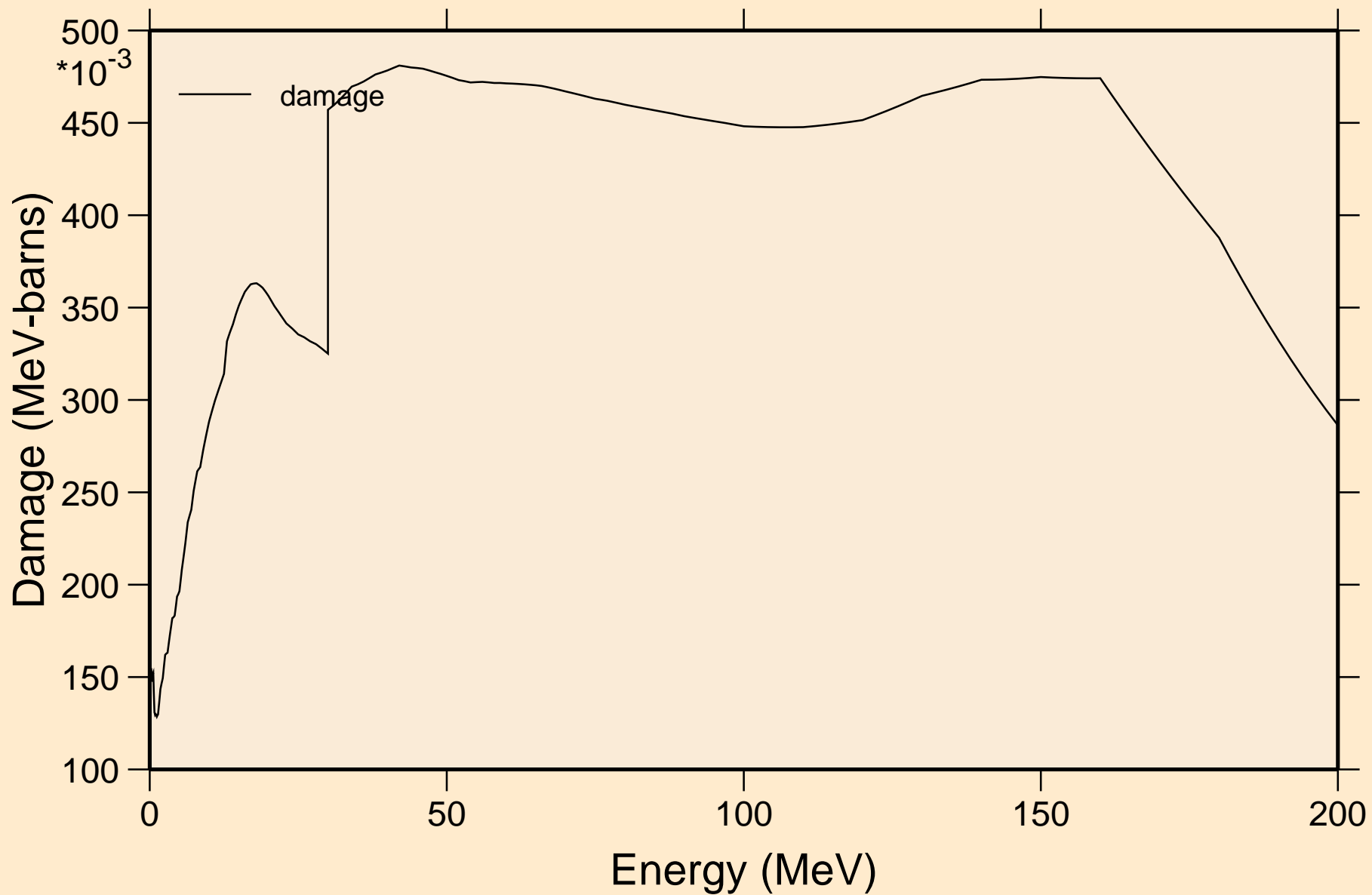



MO086 NEUTRON ACER TENDL-2019 LIBRARY; T=293.16K  
Non-threshold reactions

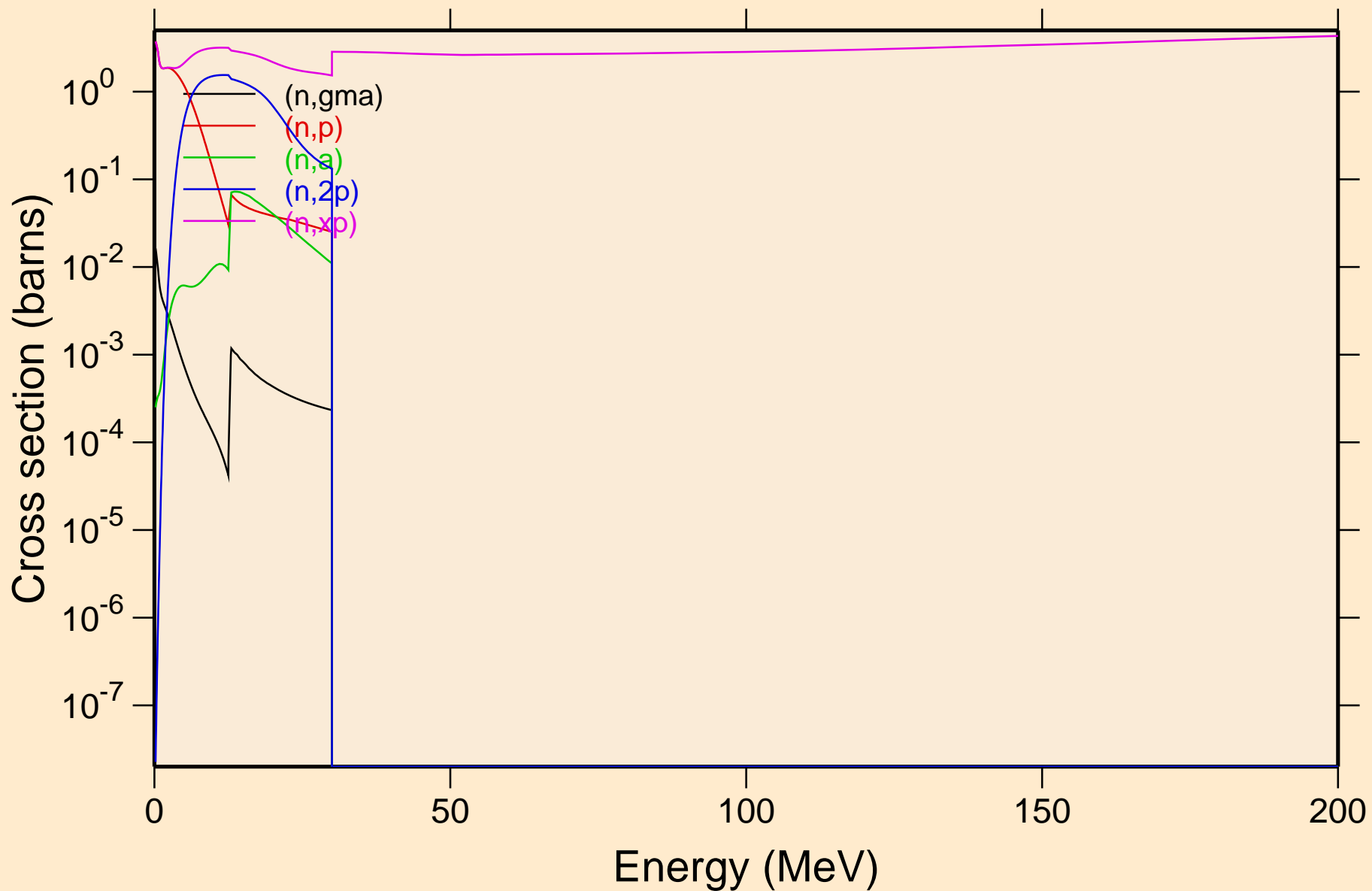

MO086 NEUTRON ACER TENDL-2019 LIBRARY; T=293.16K  
Non-threshold reactions

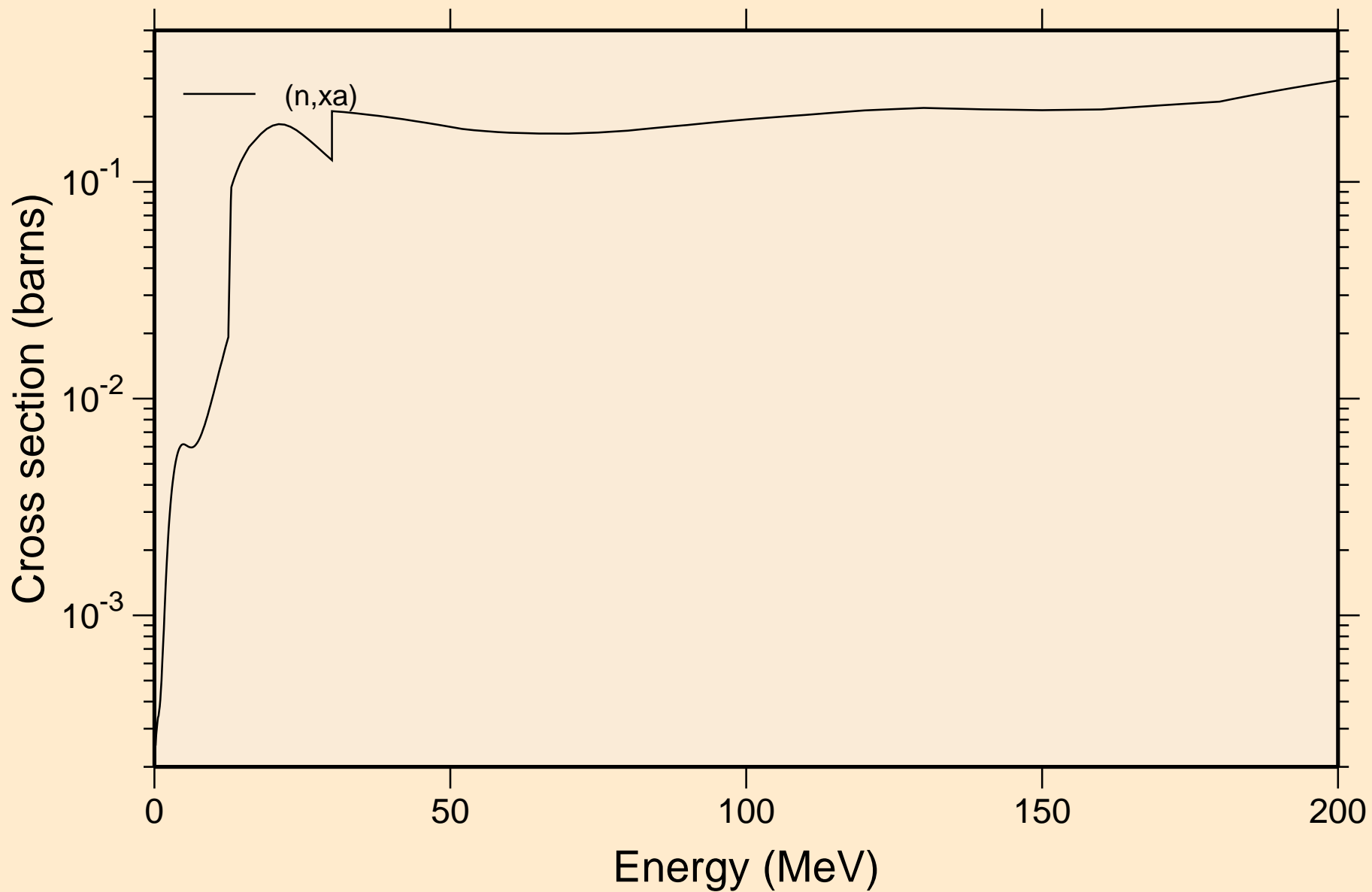

MO086 NEUTRON ACER TENDL-2019 LIBRARY; T=293.16K  
Inelastic levels

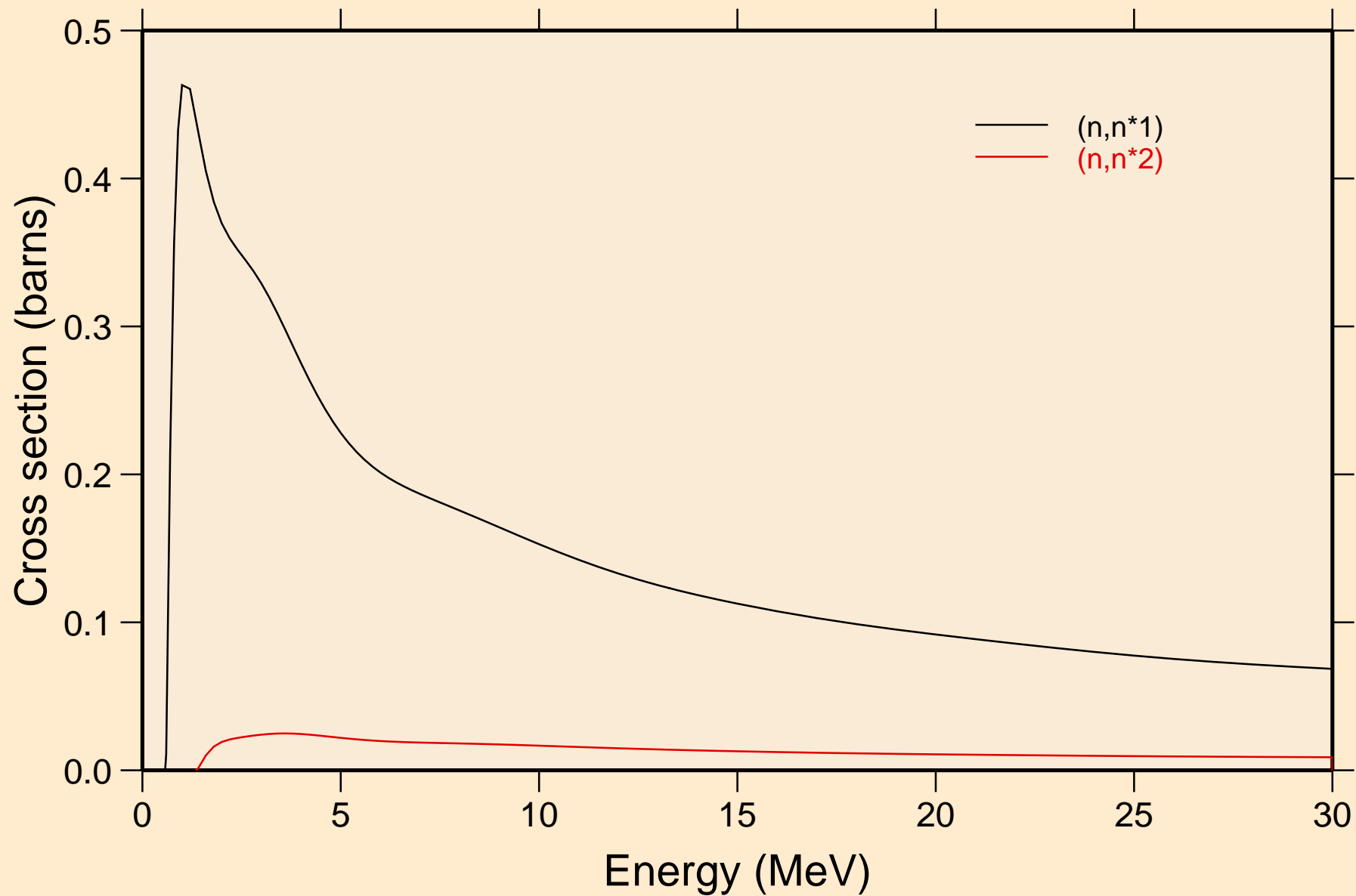

MO086 NEUTRON ACER TENDL-2019 LIBRARY; T=293.16K  
Threshold reactions

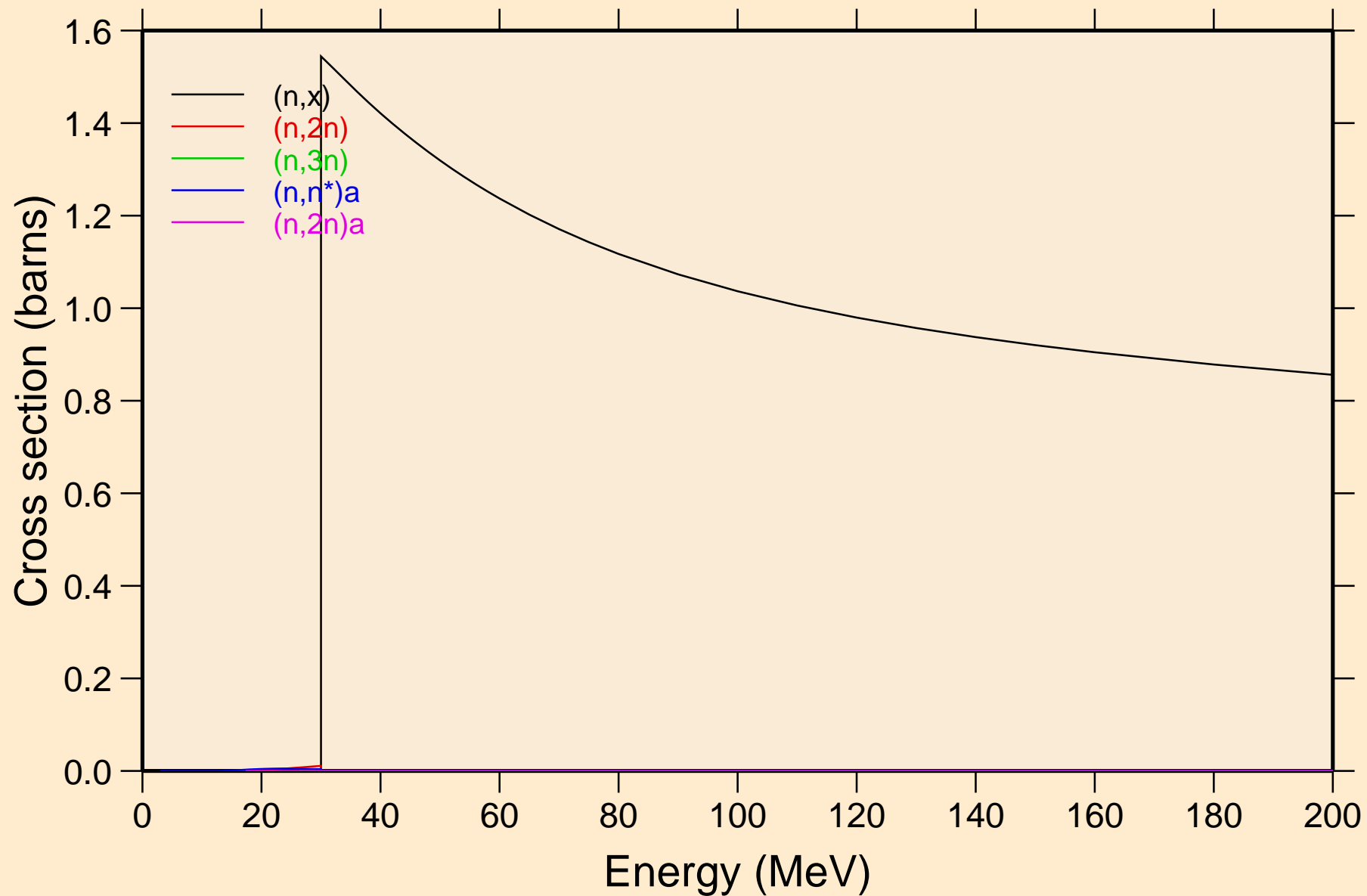

MO086 NEUTRON ACER TENDL-2019 LIBRARY; T=293.16K  
Threshold reactions

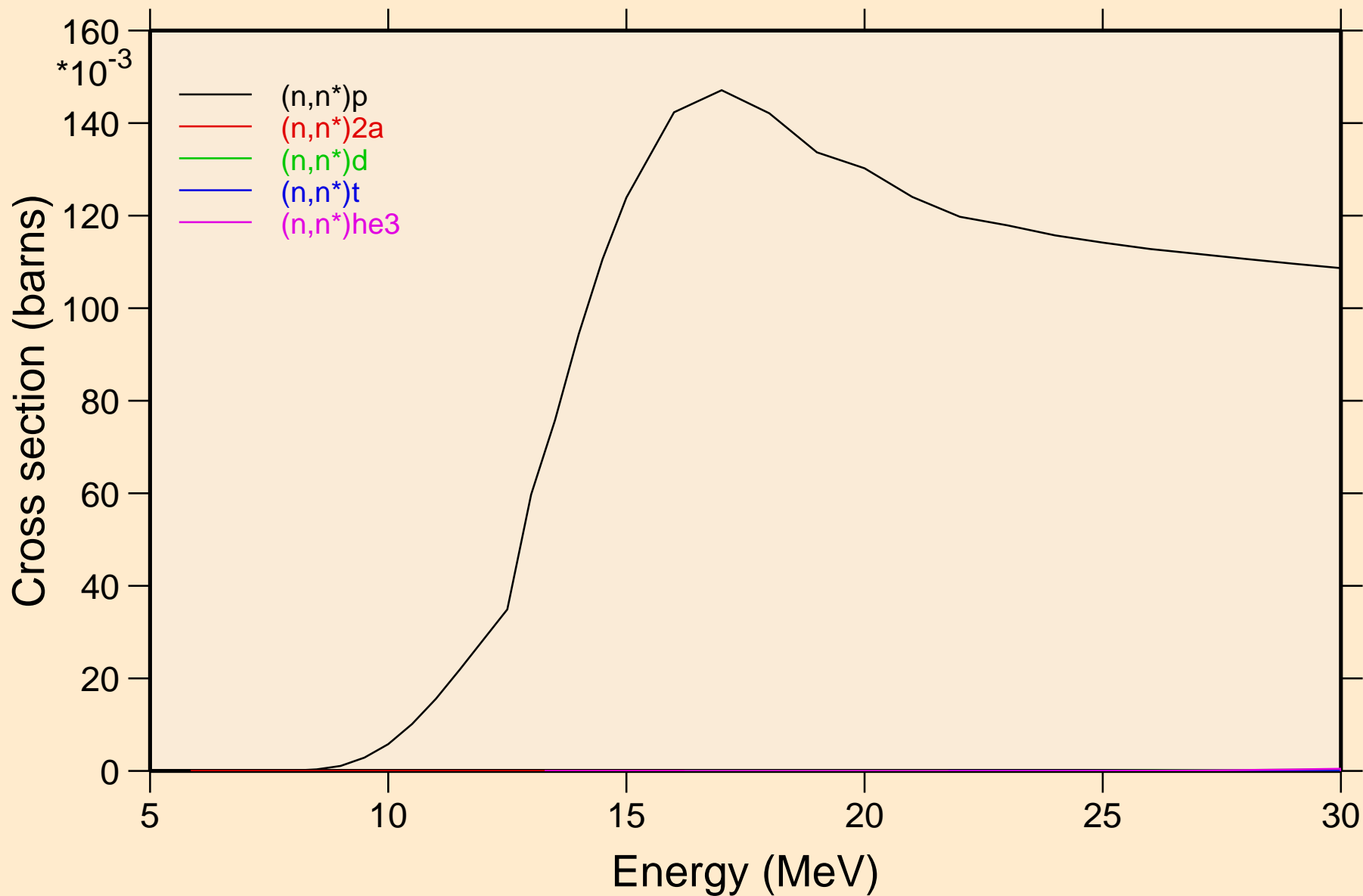

MO086 NEUTRON ACER TENDL-2019 LIBRARY; T=293.16K  
Threshold reactions

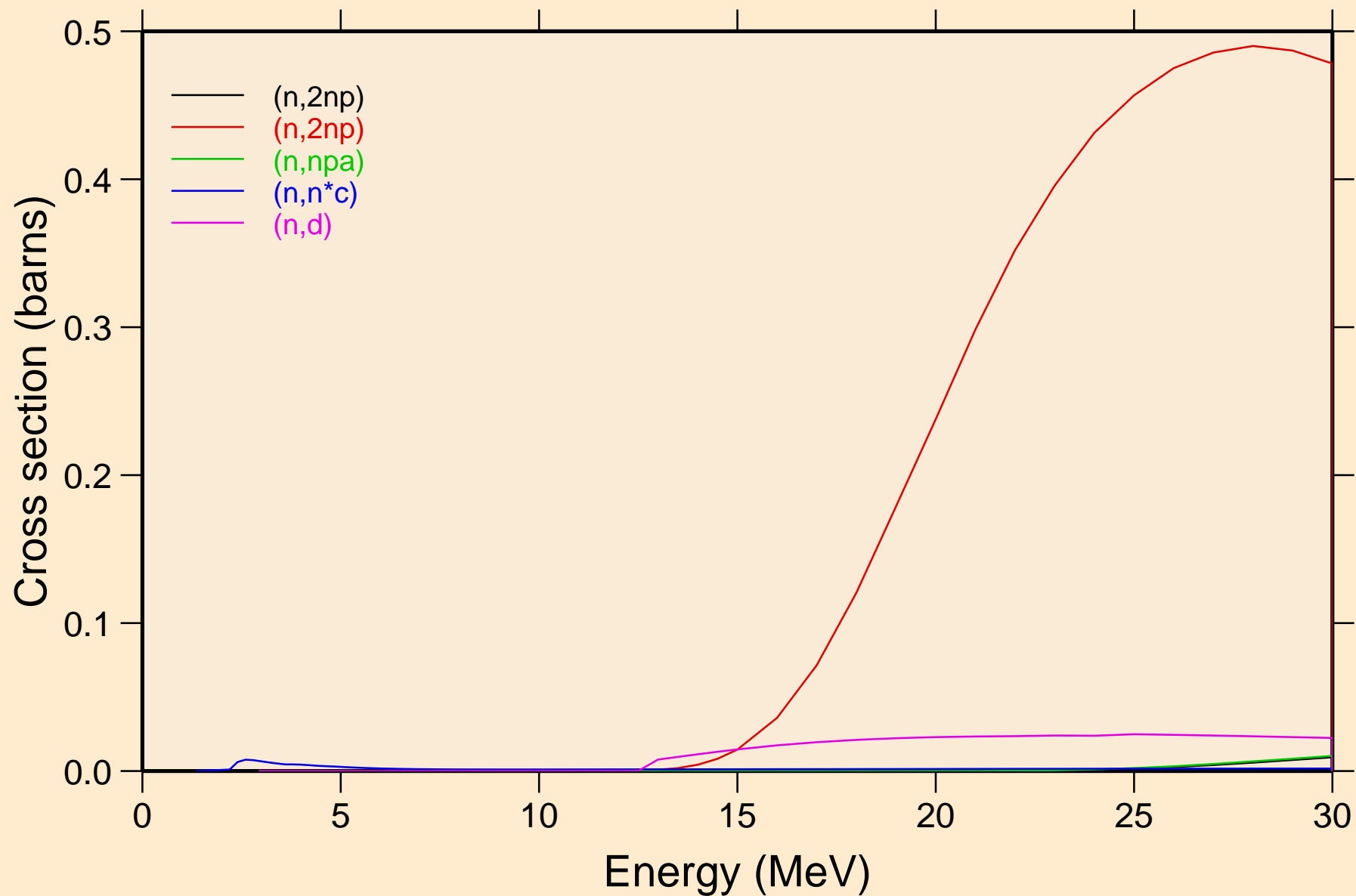

MO086 NEUTRON ACER TENDL-2019 LIBRARY; T=293.16K  
Threshold reactions

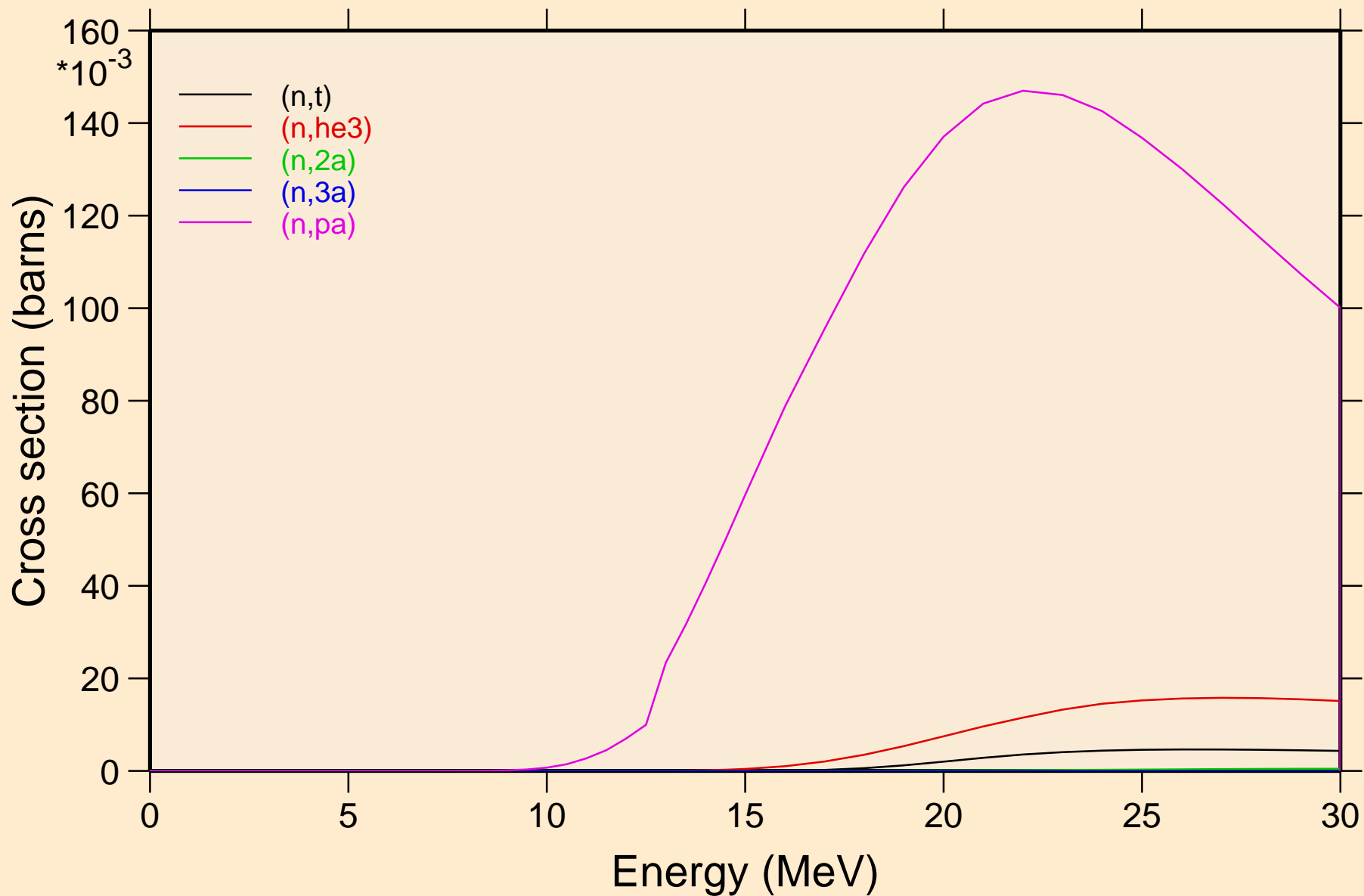

MO086 NEUTRON ACER TENDL-2019 LIBRARY; T=293.16K  
Threshold reactions

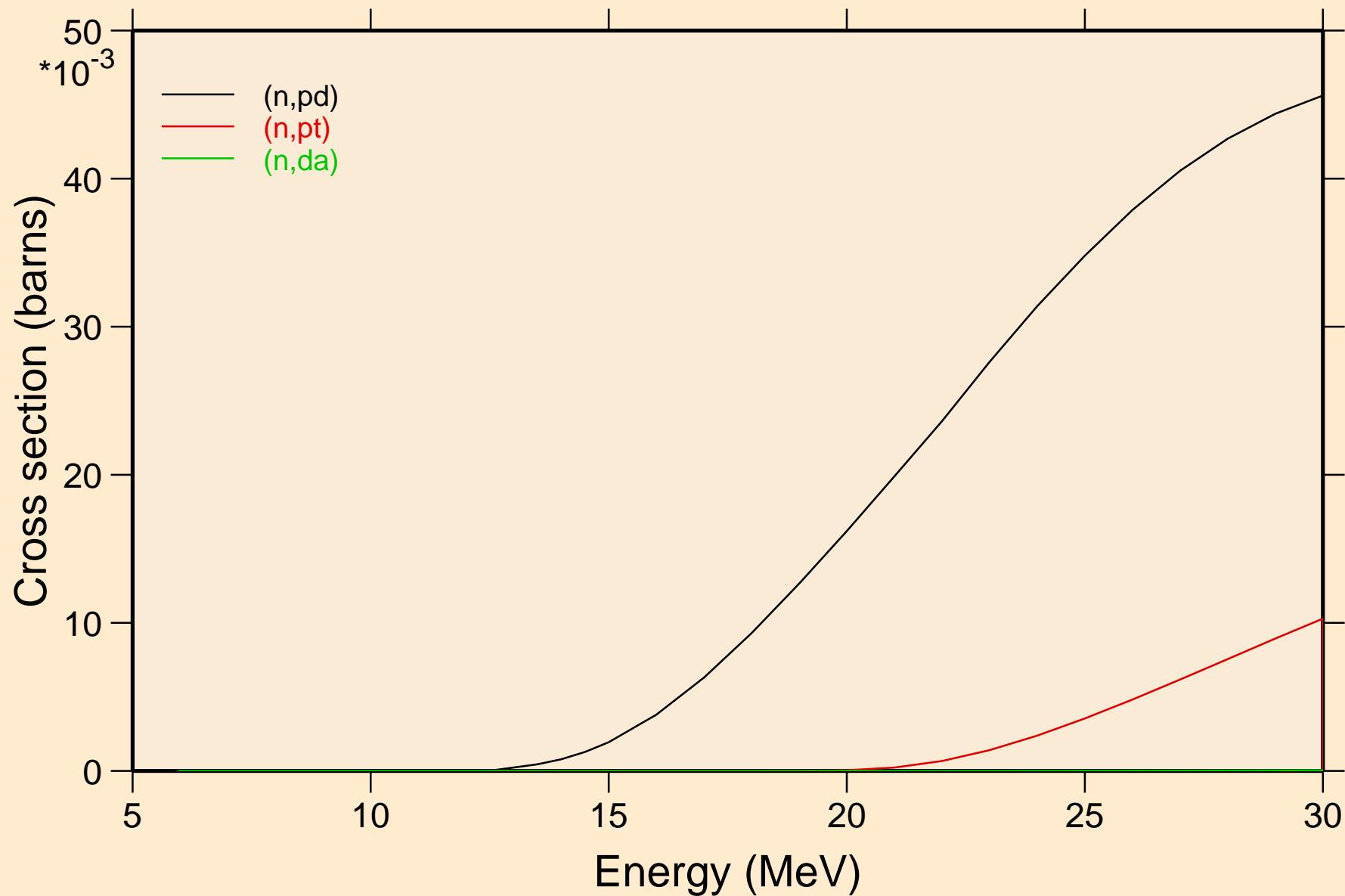



MO086 NEUTRON ACER TENDL-2019 LIBRARY; T=293.16K  
Threshold reactions

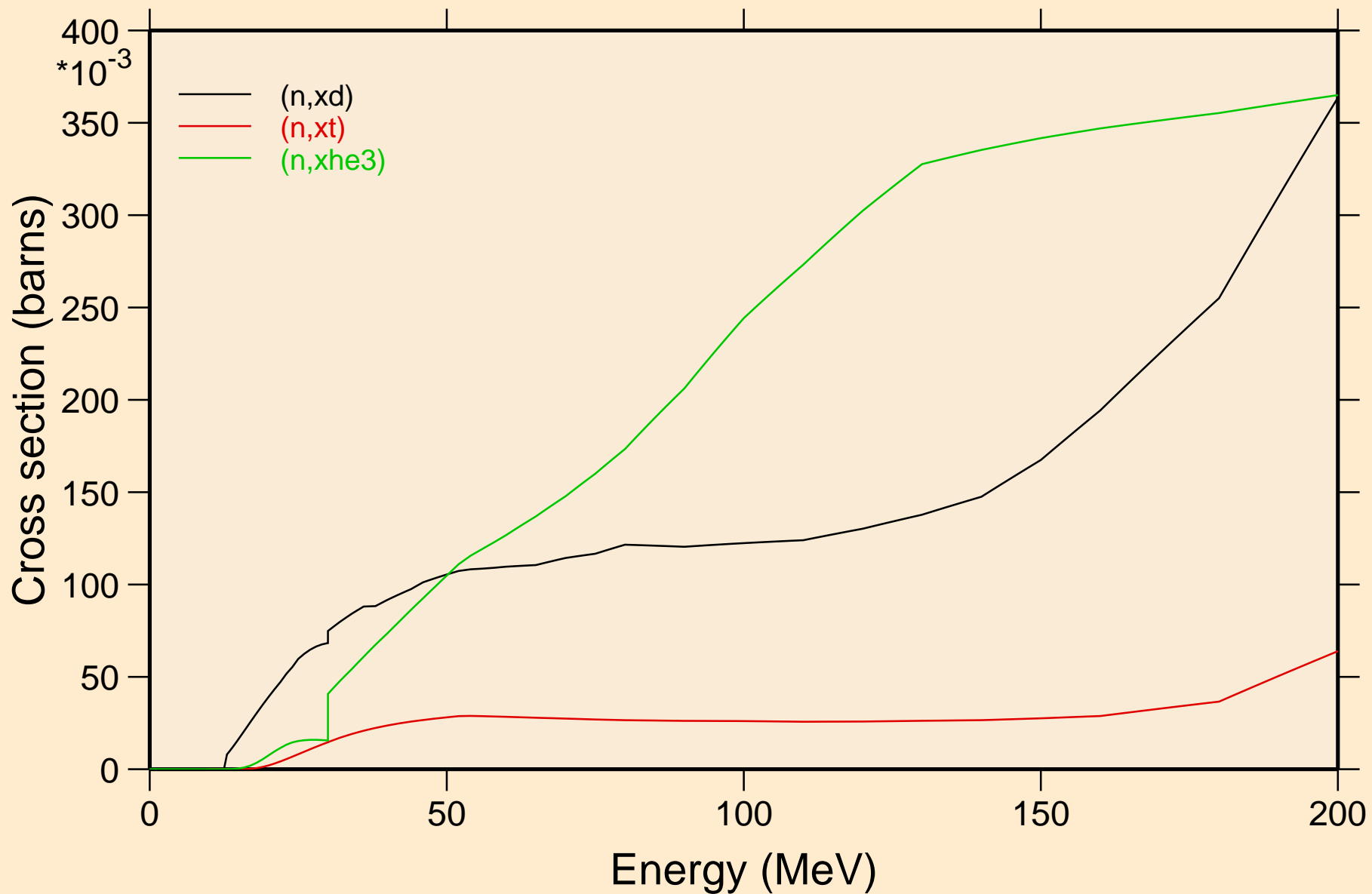

MO086 NEUTRON ACER TENDL-2019 LIBRARY; T=293.16K  
angular distribution for elastic

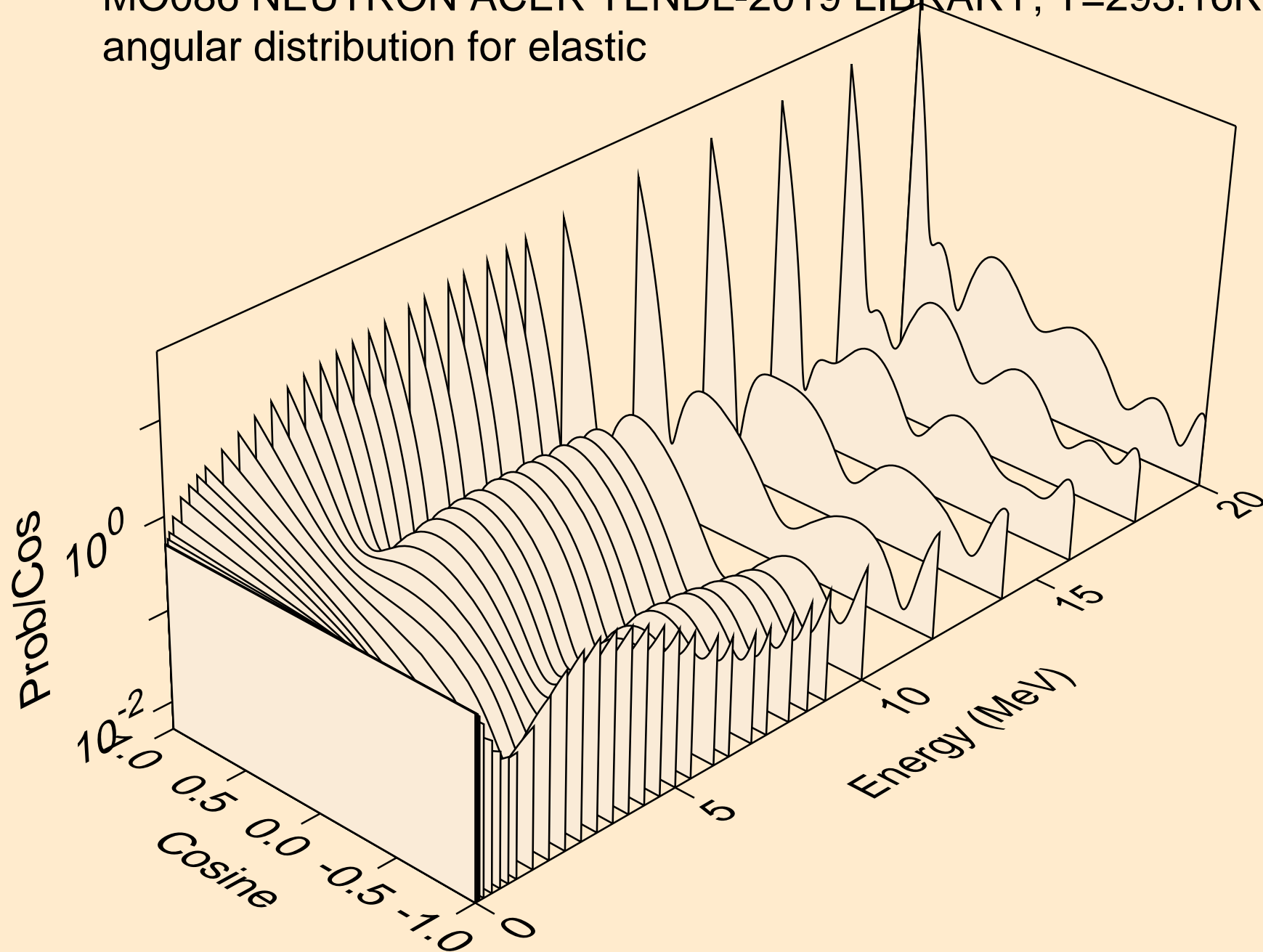

MO086 NEUTRON ACER TENDL-2019 LIBRARY; T=293.16K  
angular distribution for elastic

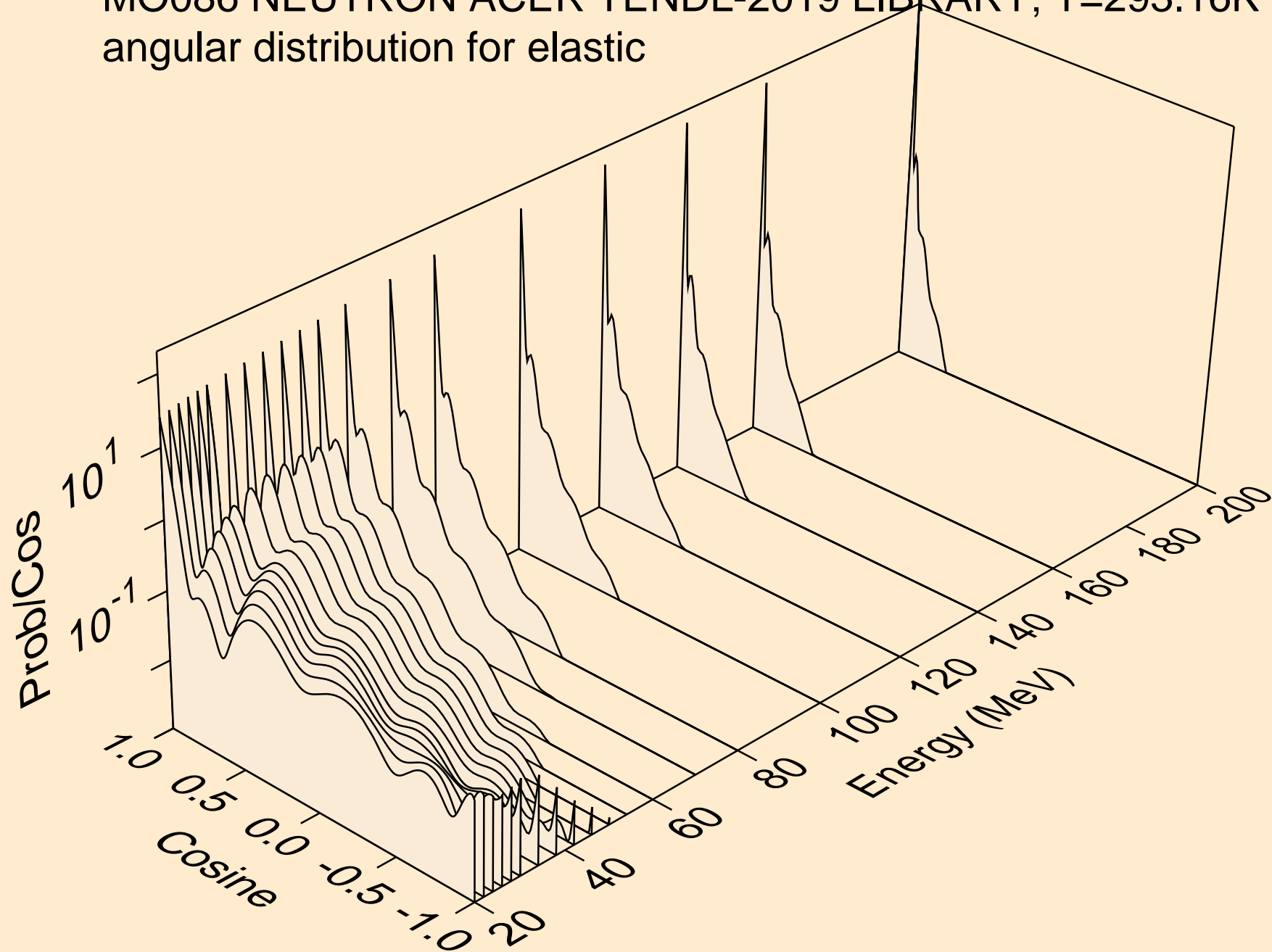

MO086 NEUTRON ACER TENDL-2019 LIBRARY; T=293.16K  
angular distribution for (n,n\*1)

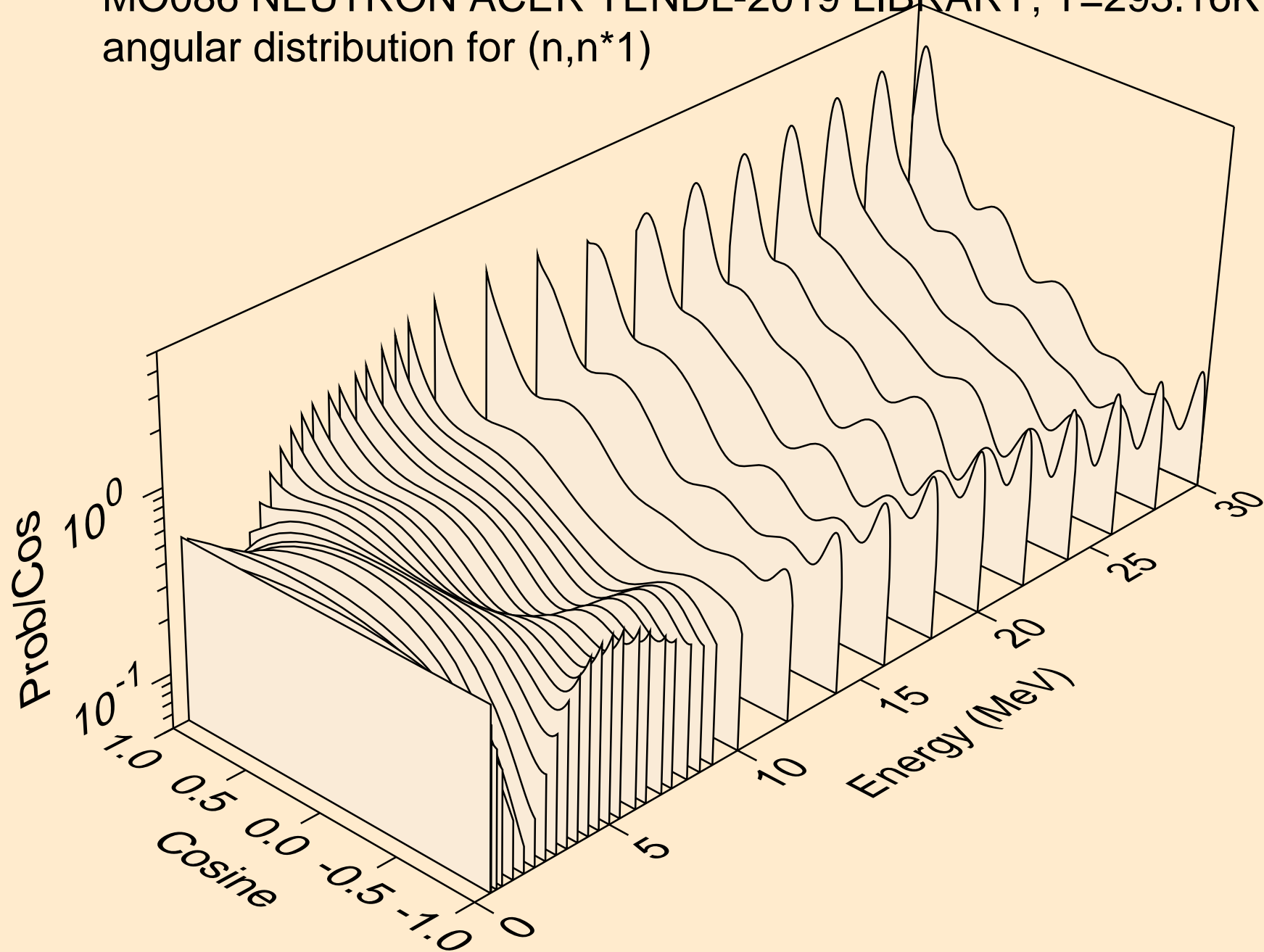

MO086 NEUTRON ACER TENDL-2019 LIBRARY; T=293.16K  
angular distribution for (n,n\*2)

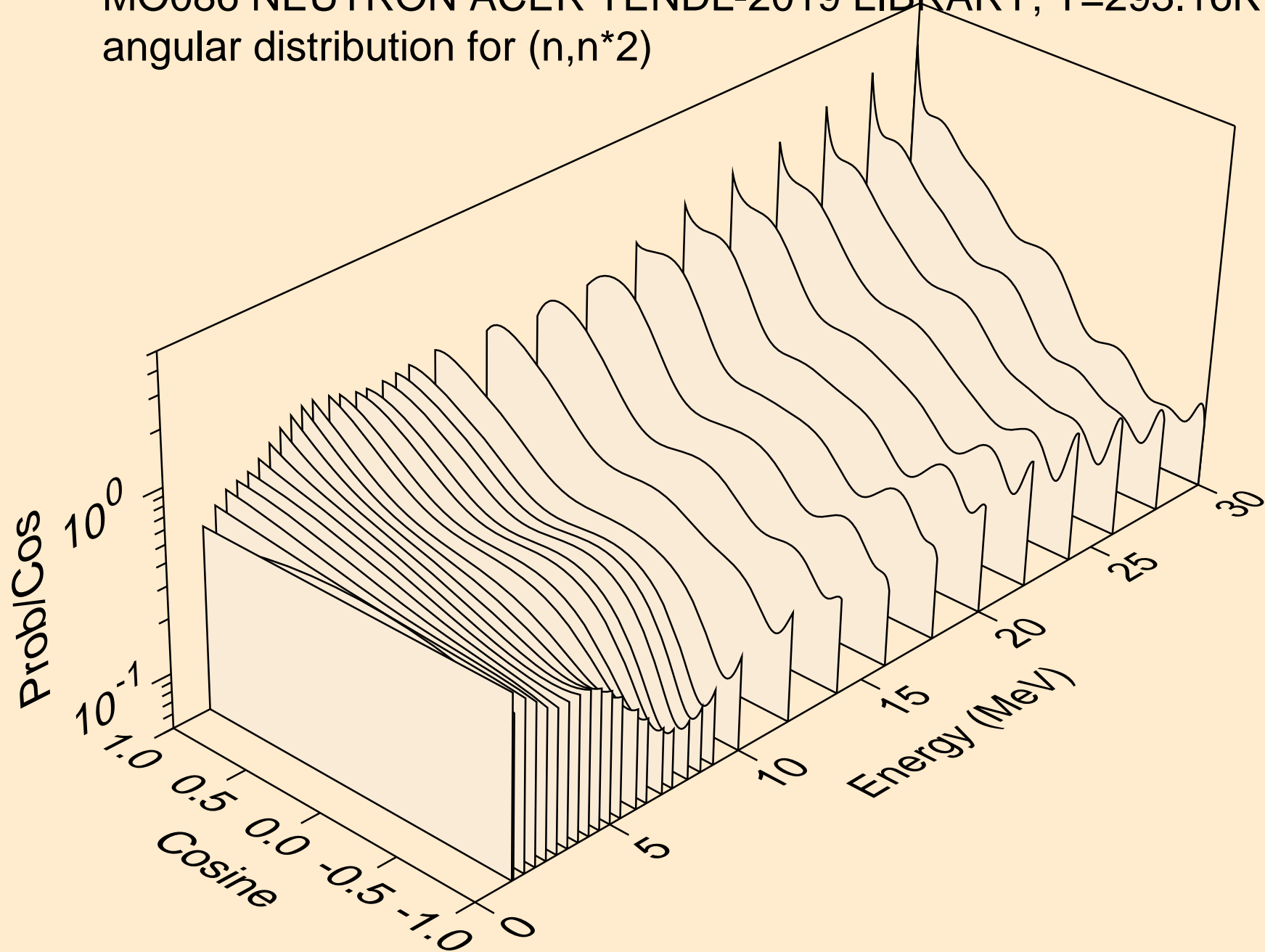

MO086 NEUTRON ACER TENDL-2019 LIBRARY; T=293.16K  
Neutron emission for (n,x)

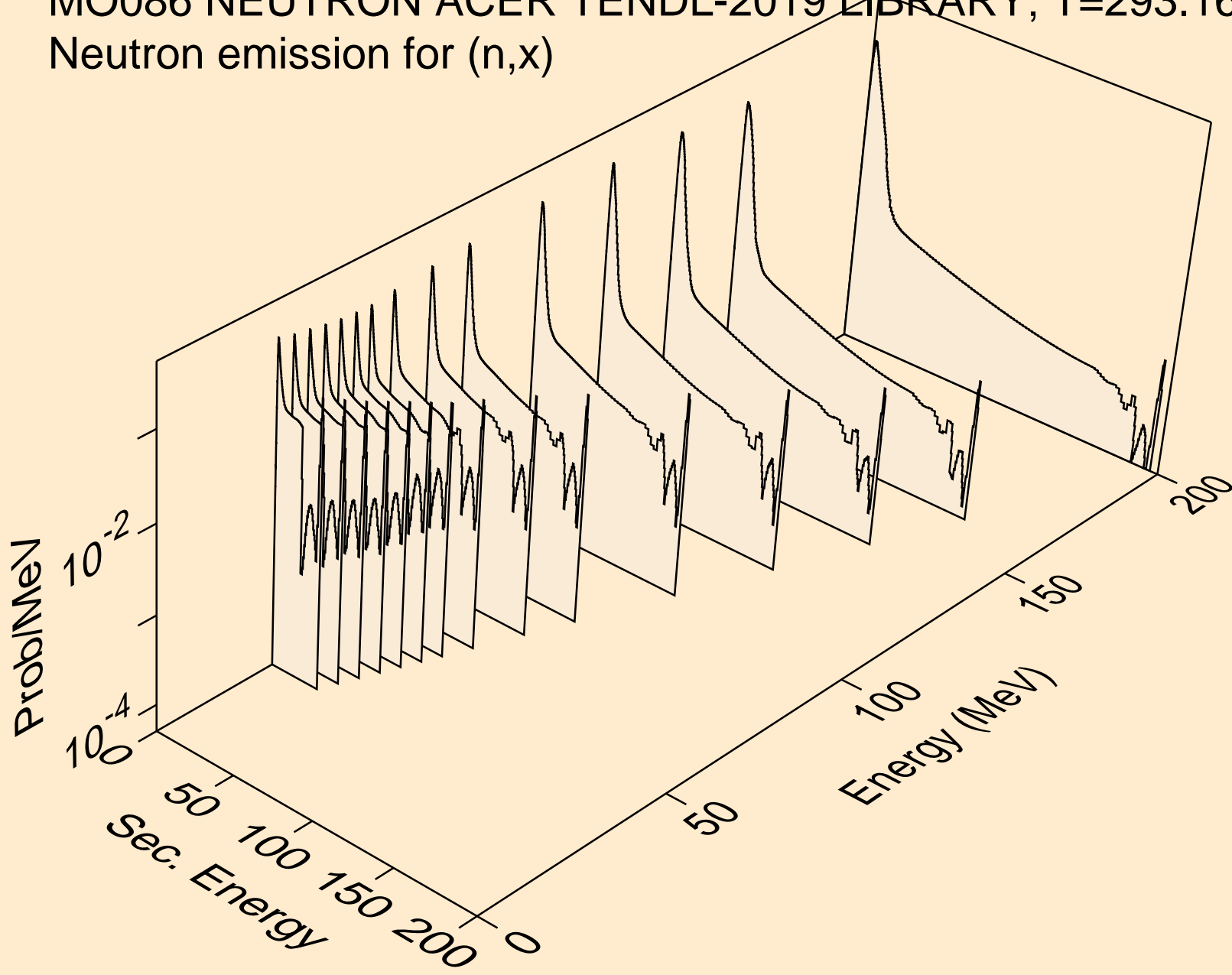

MO086 NEUTRON ACER TENDL-2019 LIBRARY; T=293.16K  
Neutron emission for (n,2n)

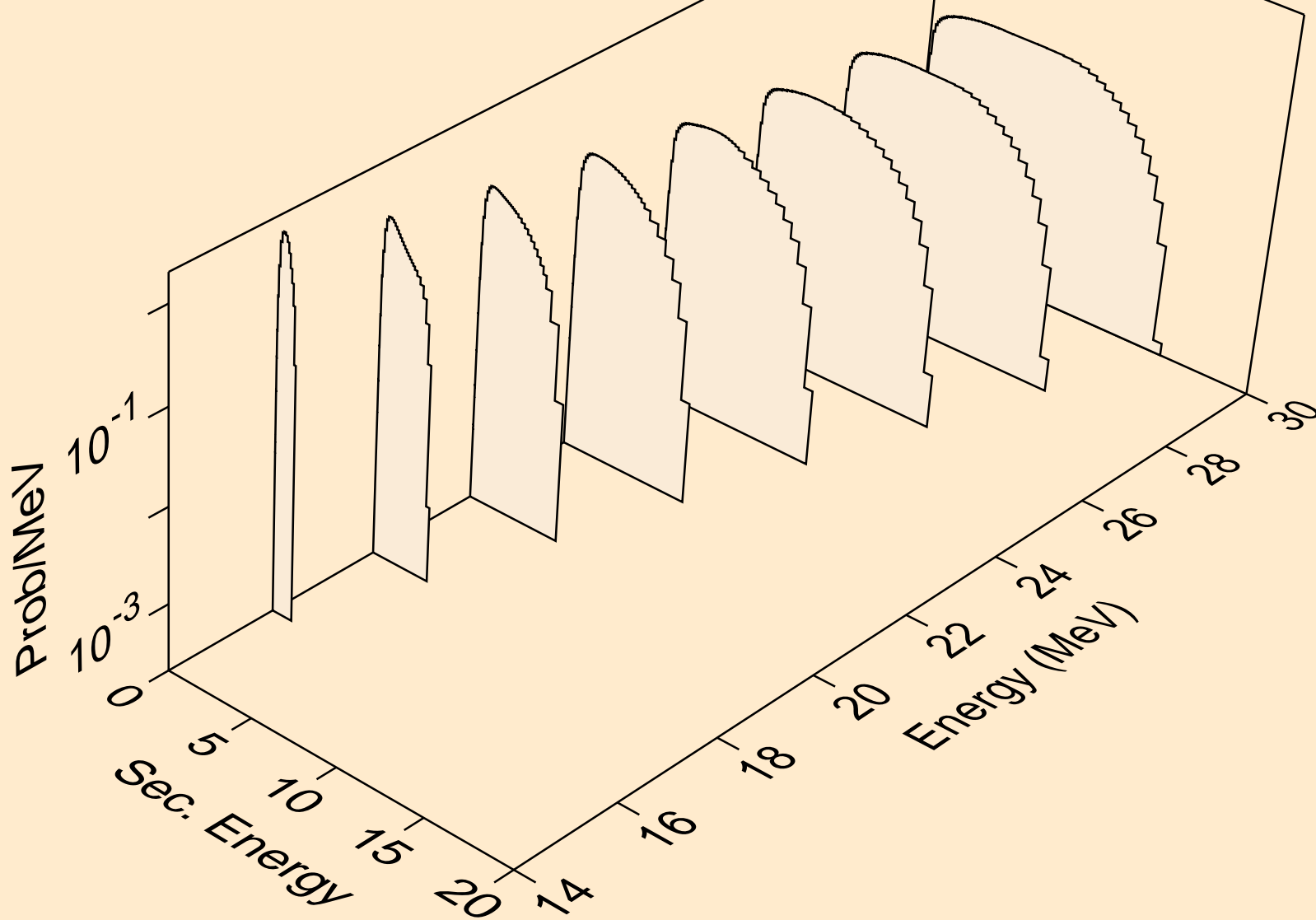

MO086 NEUTRON ACER TENDL-2019 LIBRARY; T=293.16K  
Neutron emission for (n,3n)

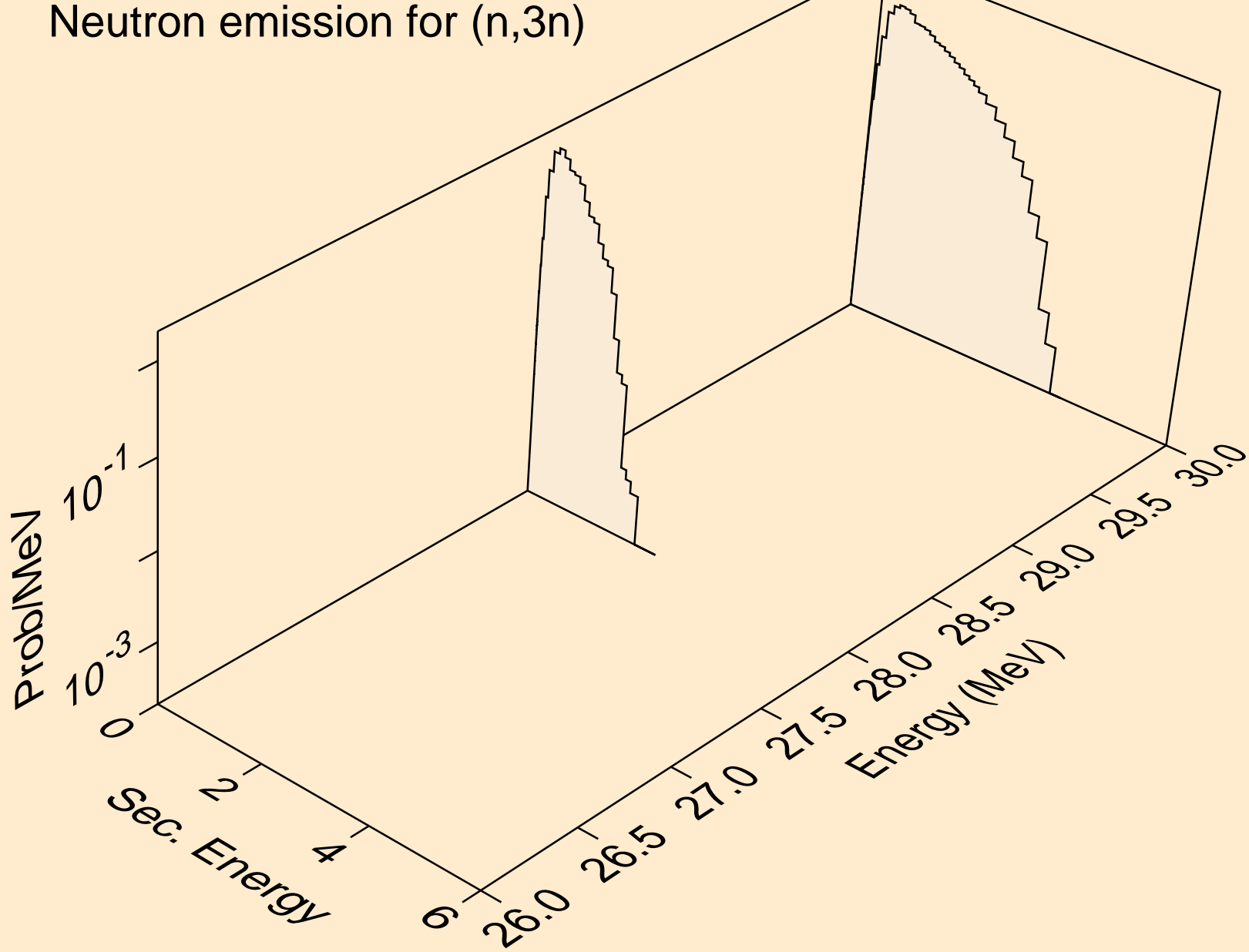



MO086 NEUTRON ACER TENDL-2019 LIBRARY; T=293.16K  
Neutron emission for (n,n\*)a

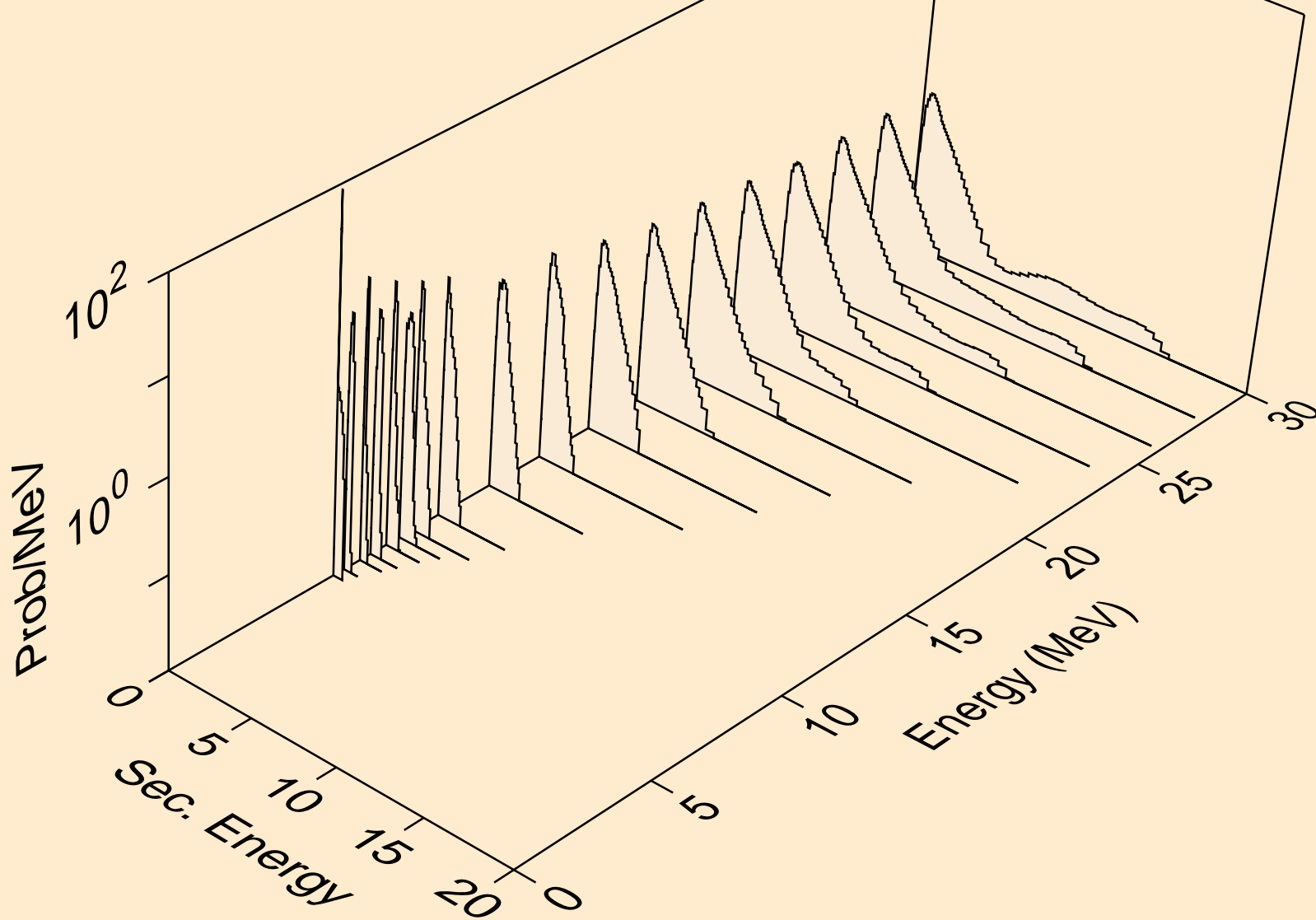

MO086 NEUTRON ACER TENDL-2019 LIBRARY; T=293.16K  
Neutron emission for (n,2n)<sub>a</sub>

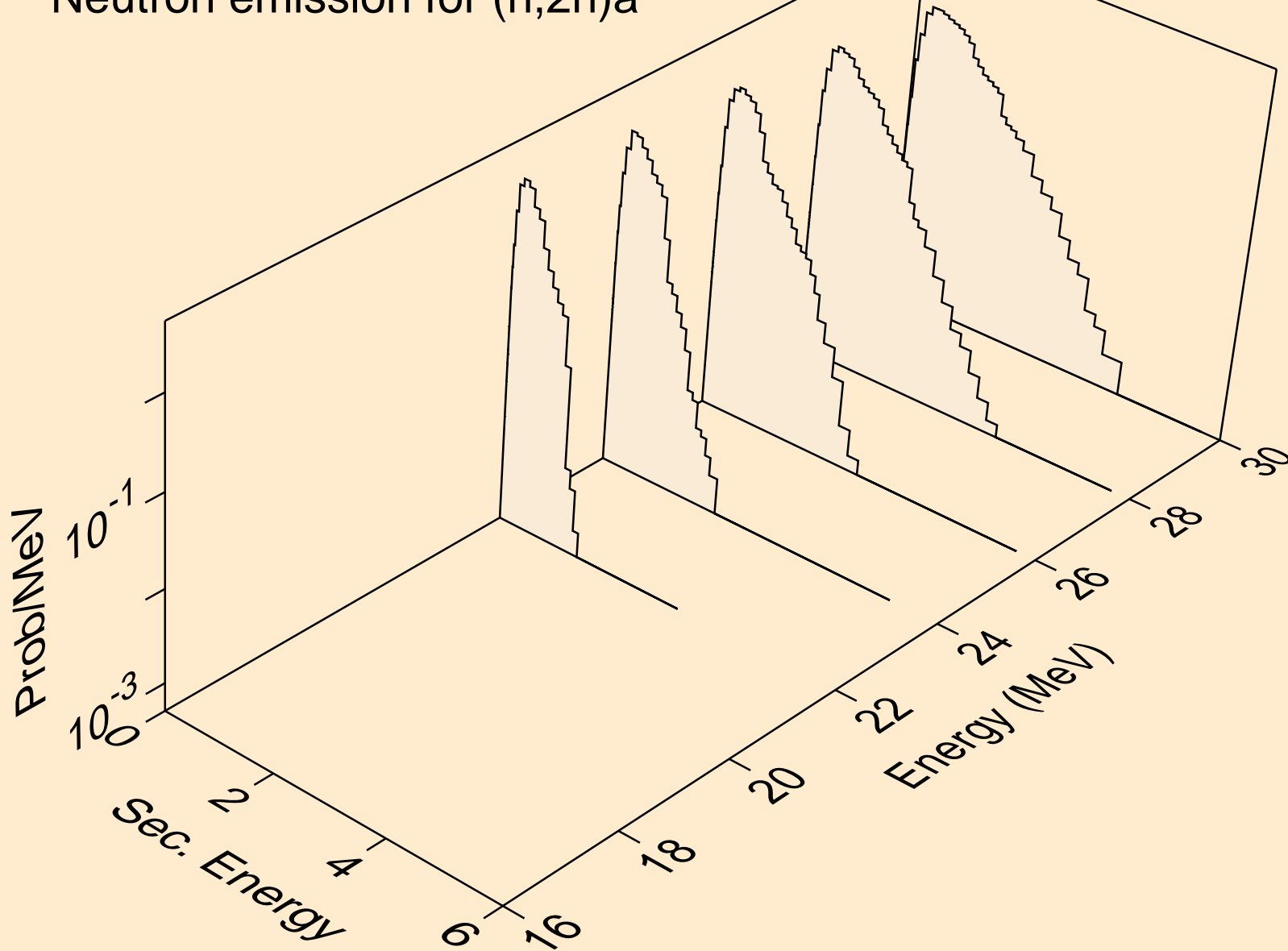

MO086 NEUTRON ACER TENDL-2019 LIBRARY; T=293.16K  
Neutron emission for (n,n\*)p

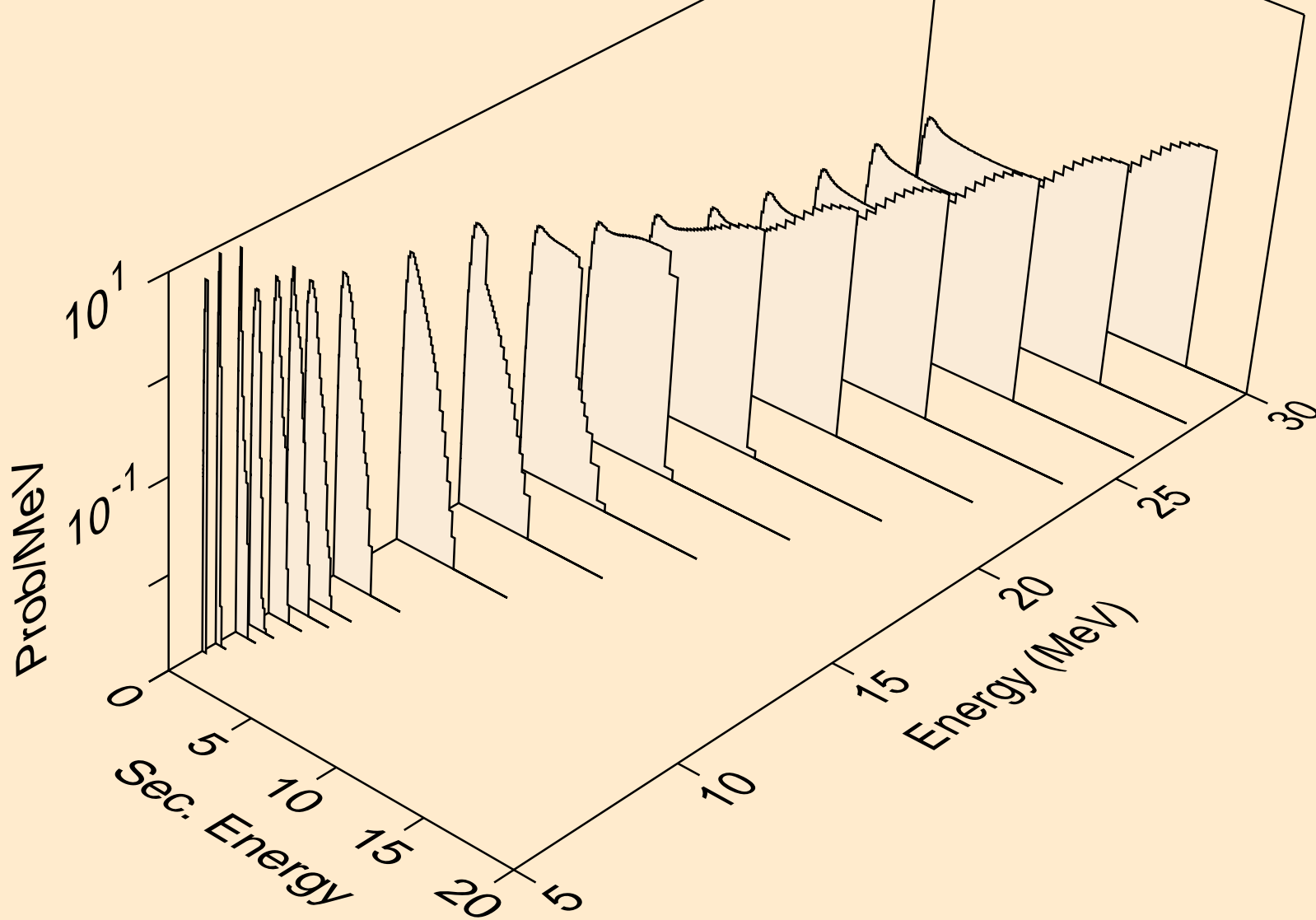

MO086 NEUTRON ACER TENDL-2019 LIBRARY; T=293.16K  
Neutron emission for (n,n\*)2a

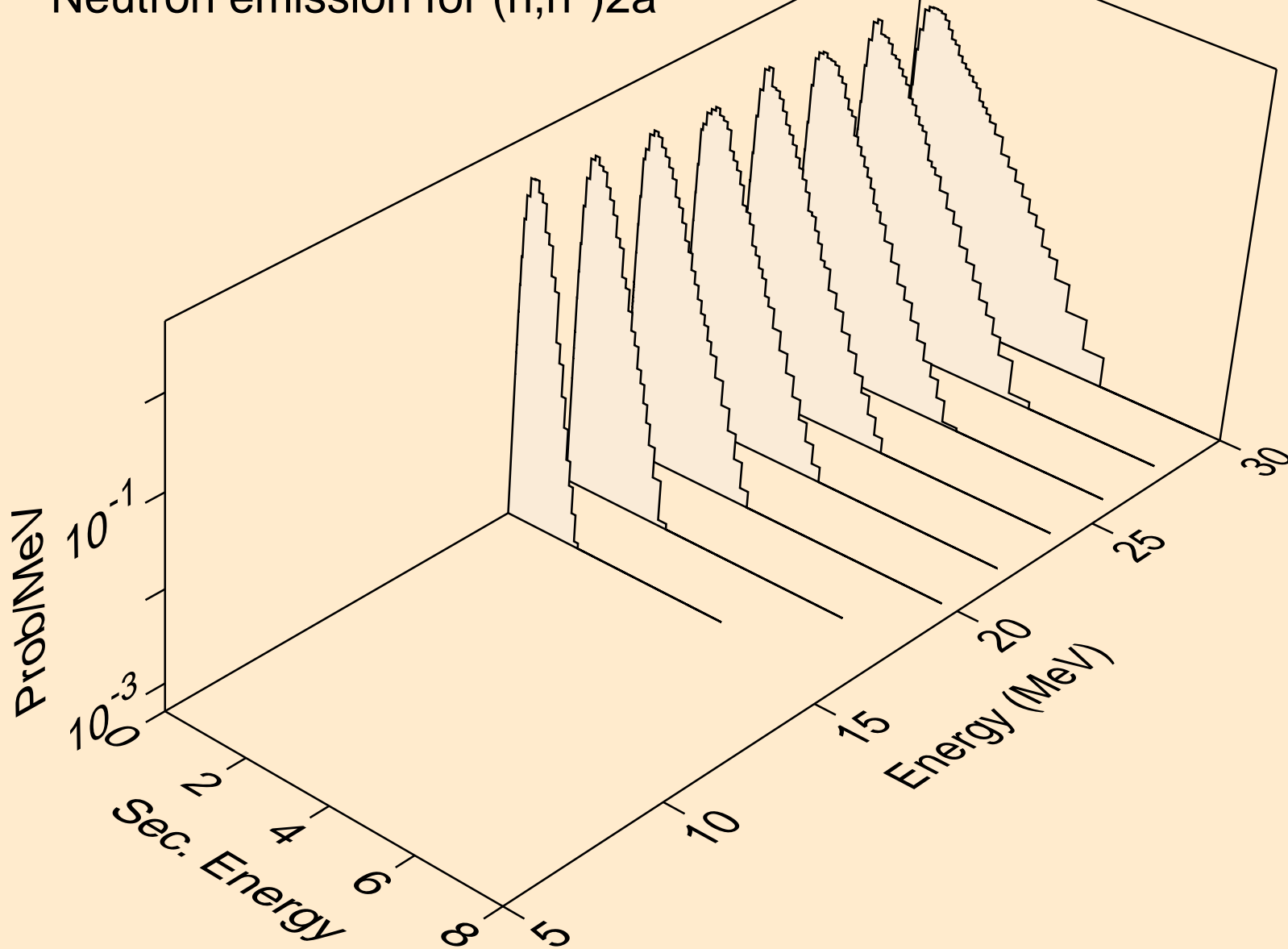

MO086 NEUTRON ACER TENDL-2019 LIBRARY; T=293.16K  
Neutron emission for (n,n\*)d

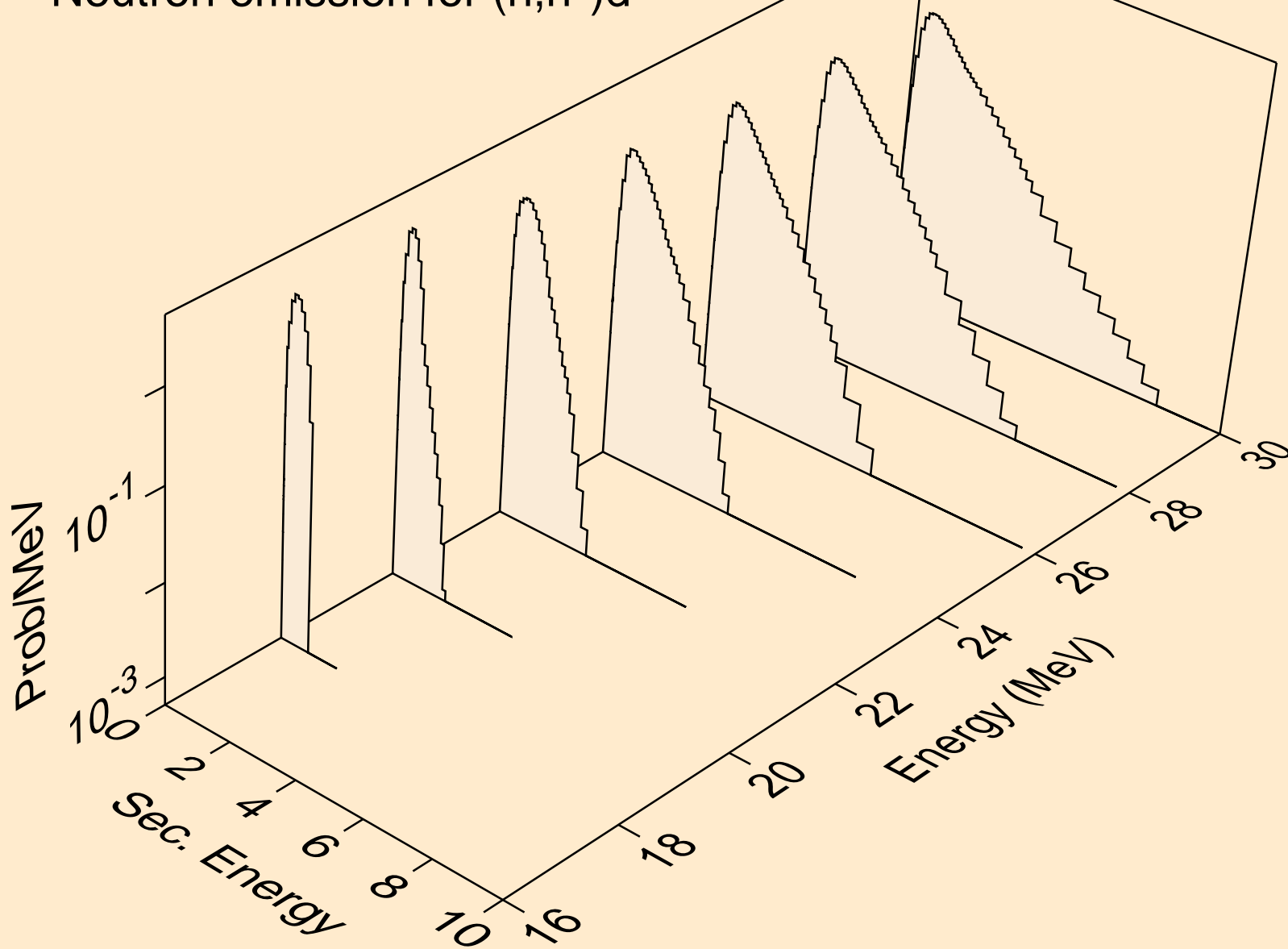

MO086 NEUTRON ACER TENDL-2019 LIBRARY; T=293.16K  
Neutron emission for (n,n\*)t

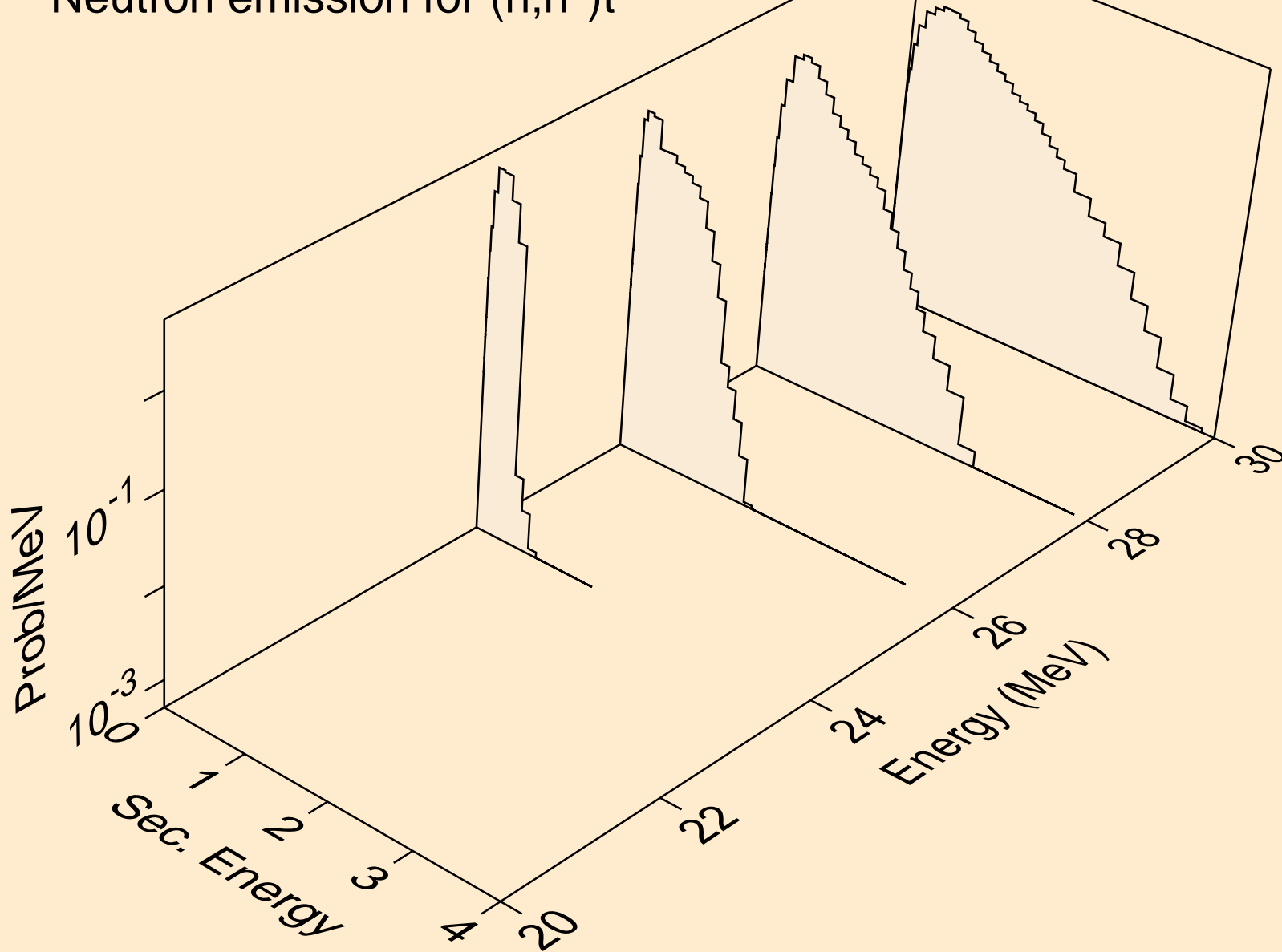

MO086 NEUTRON ACER TENDL-2019 LIBRARY; T=293.16K  
Neutron emission for (n,n\*)he3

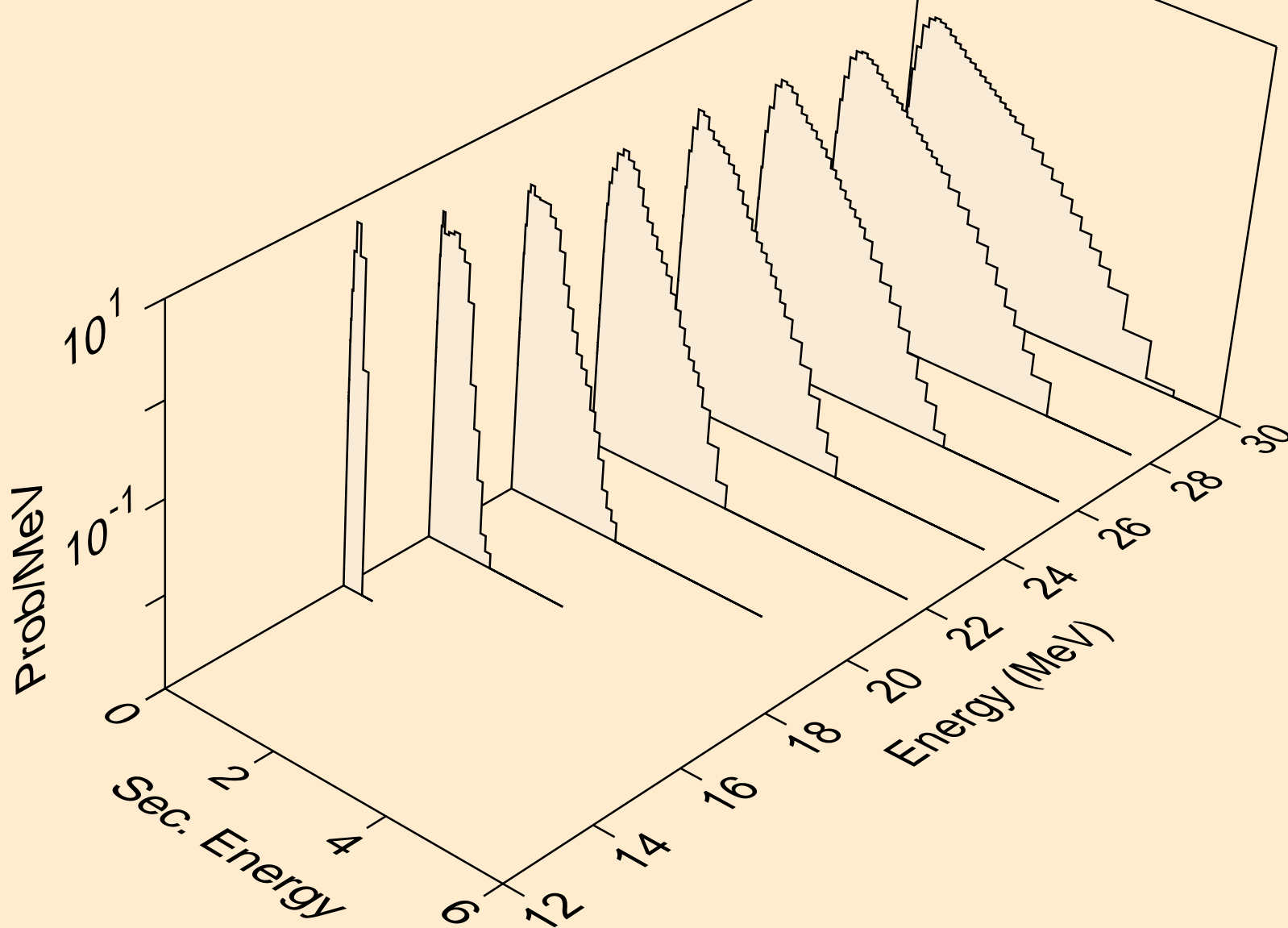

MO086 NEUTRON ACER TENDL-2019 LIBRARY; T=293.16K  
Neutron emission for (n,2np)

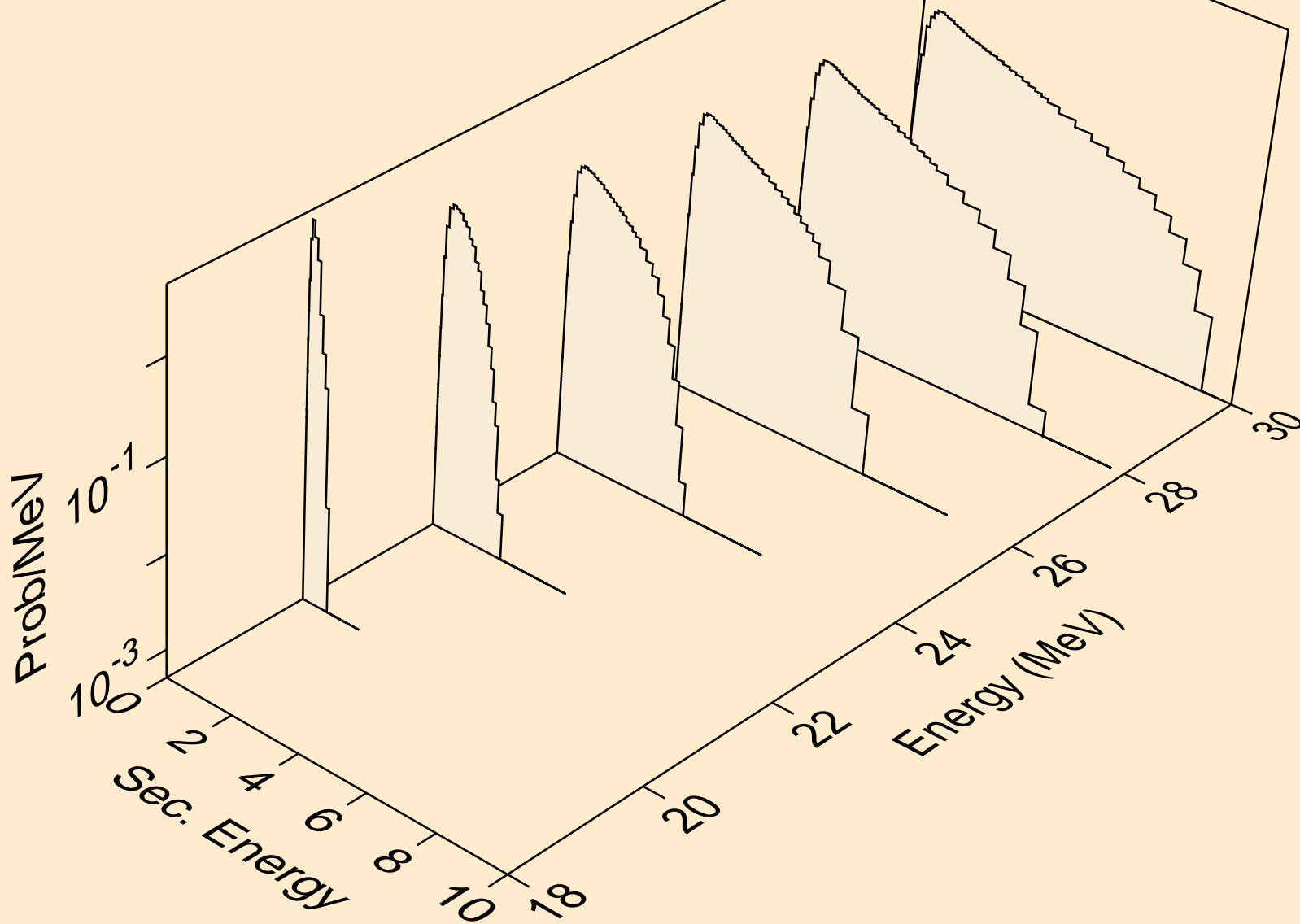



MO086 NEUTRON ACER TENDL-2019 LIBRARY; T=293.16K  
Neutron emission for (n,2np)

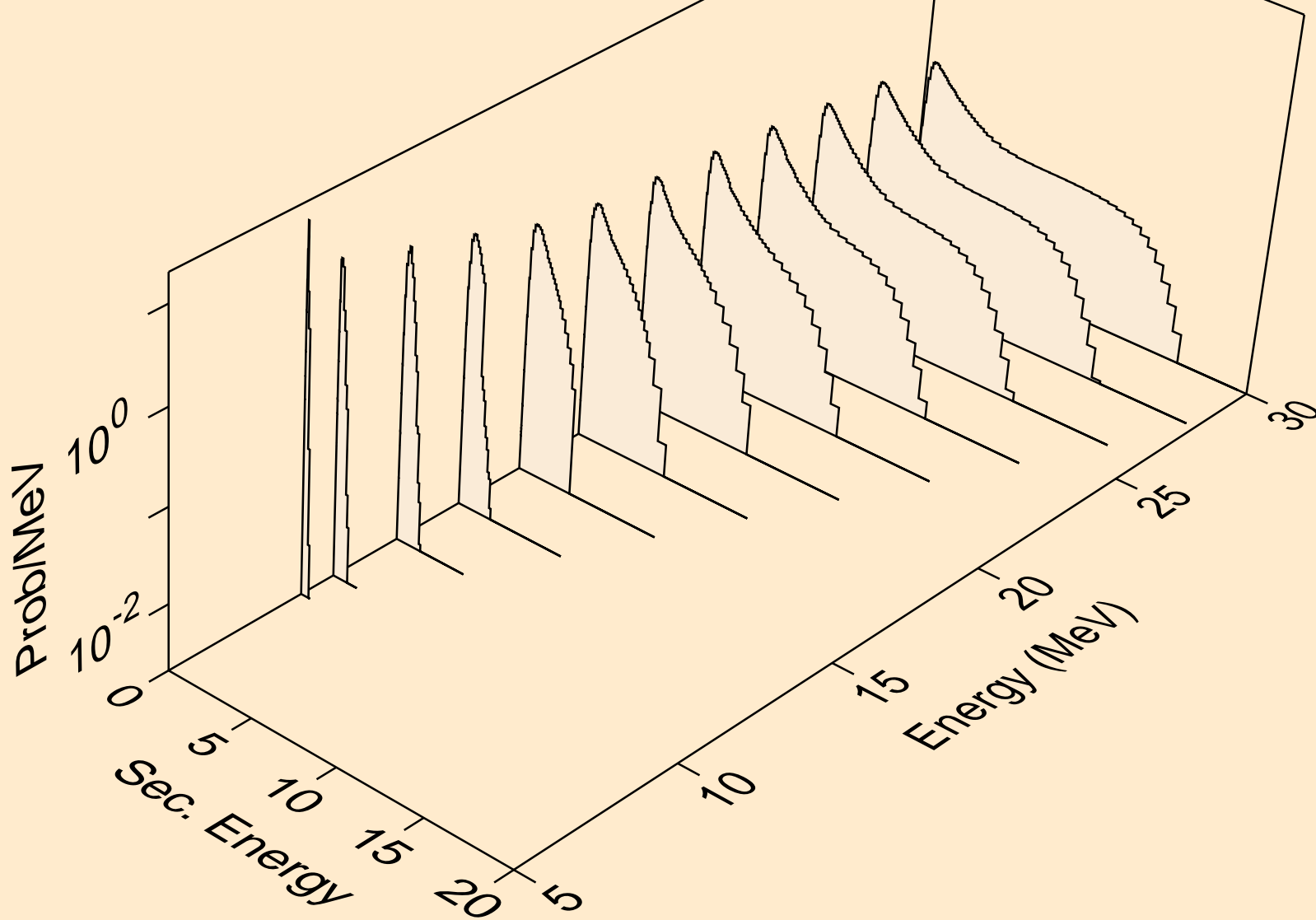

MO086 NEUTRON ACER TENDL-2019 LIBRARY; T=293.16K  
Neutron emission for (n,npa)

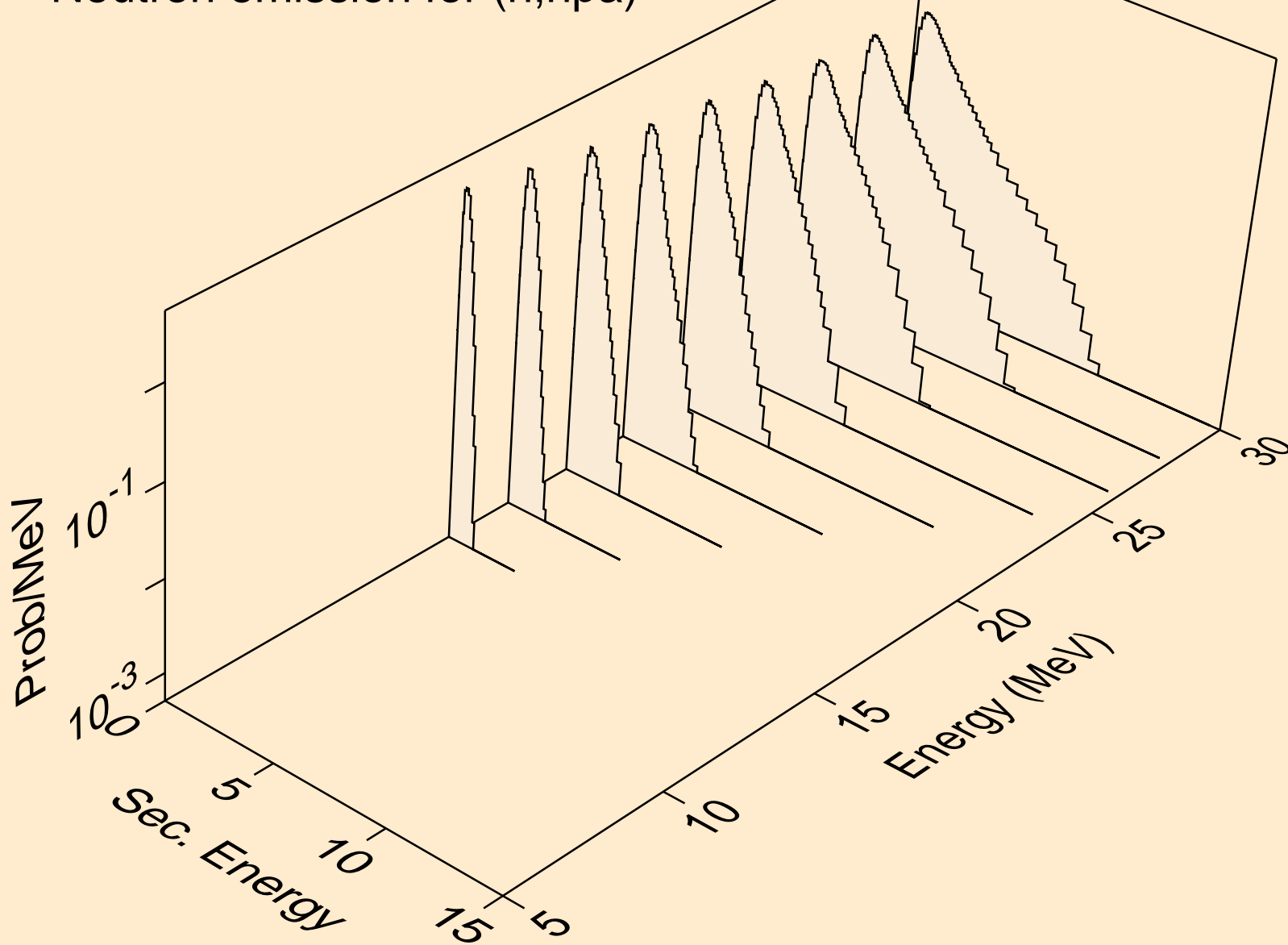

MO086 NEUTRON ACER TENDL-2019 LIBRARY; T=293.16K  
Neutron emission for (n,n\*c)

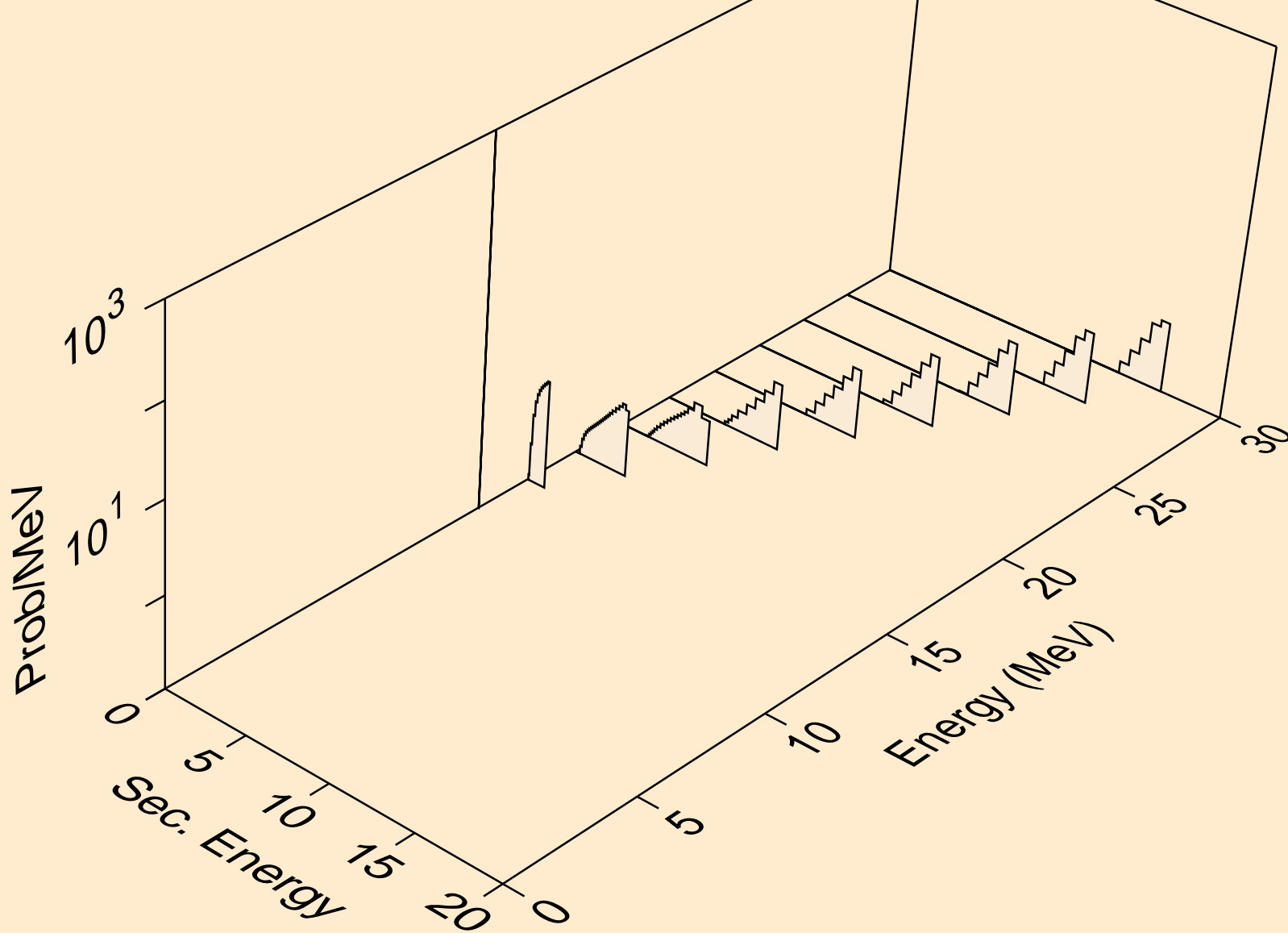

MO086 NEUTRON ACER TENDL-2019 LIBRARY; T=293.16K  
Photon emission for (n,x)

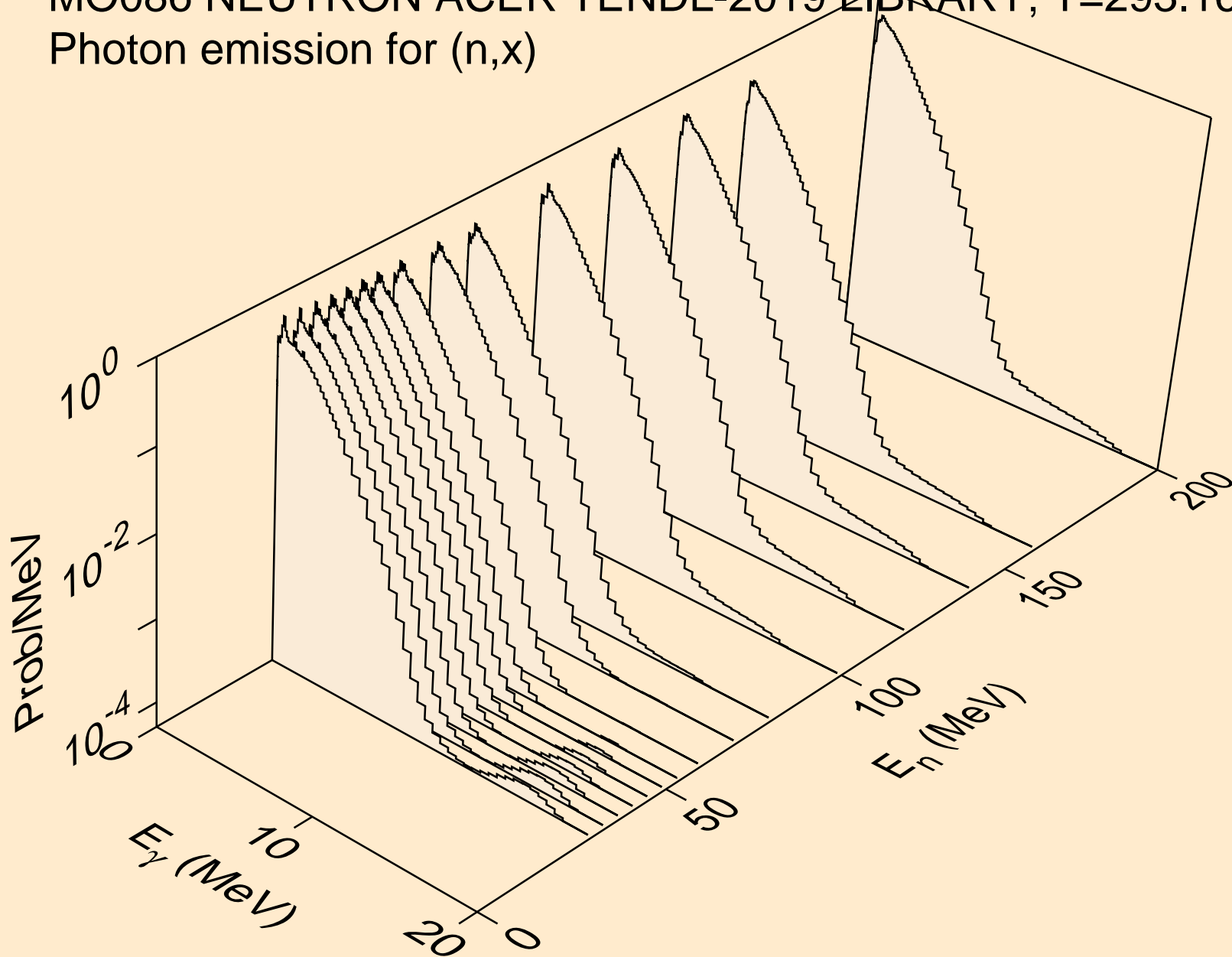

MO086 NEUTRON ACER TENDL-2019 LIBRARY; T=293.16K  
Photon emission for (n,2n)

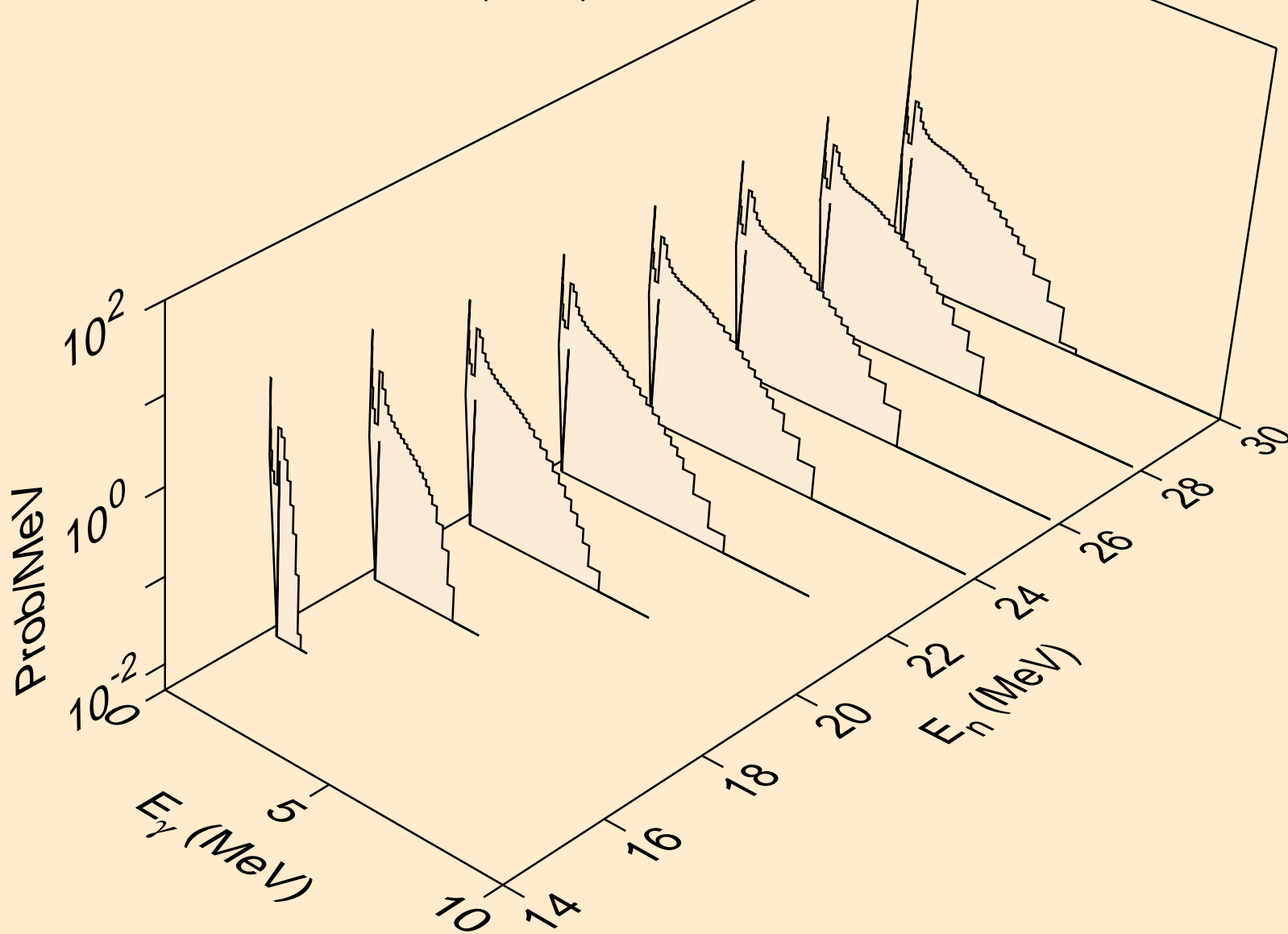

MO086 NEUTRON ACER TENDL-2019 LIBRARY; T=293.16K  
Photon emission for (n,3n)

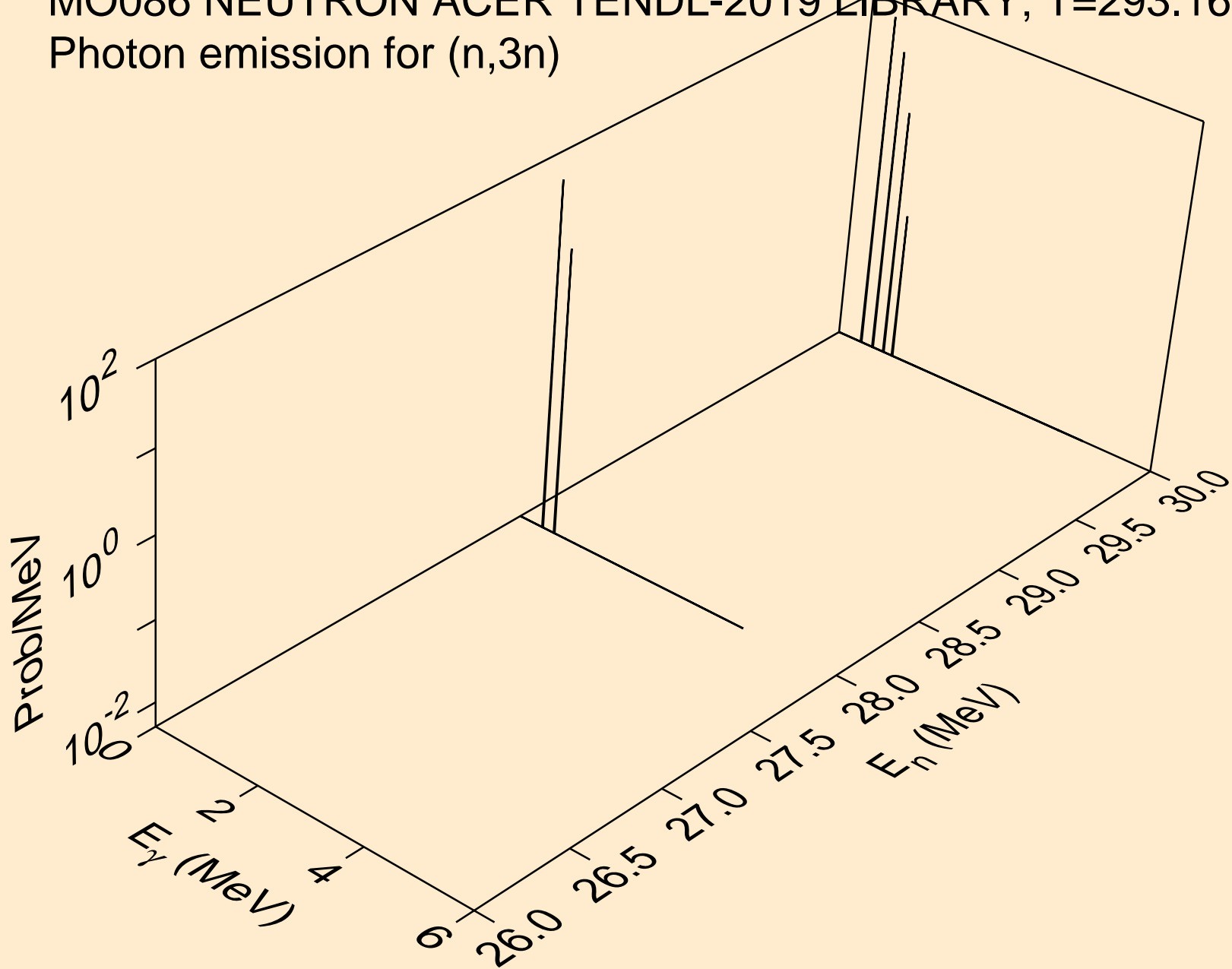

MO086 NEUTRON ACER TENDL-2019 LIBRARY; T=293.16K  
Photon emission for (n,n\*)a

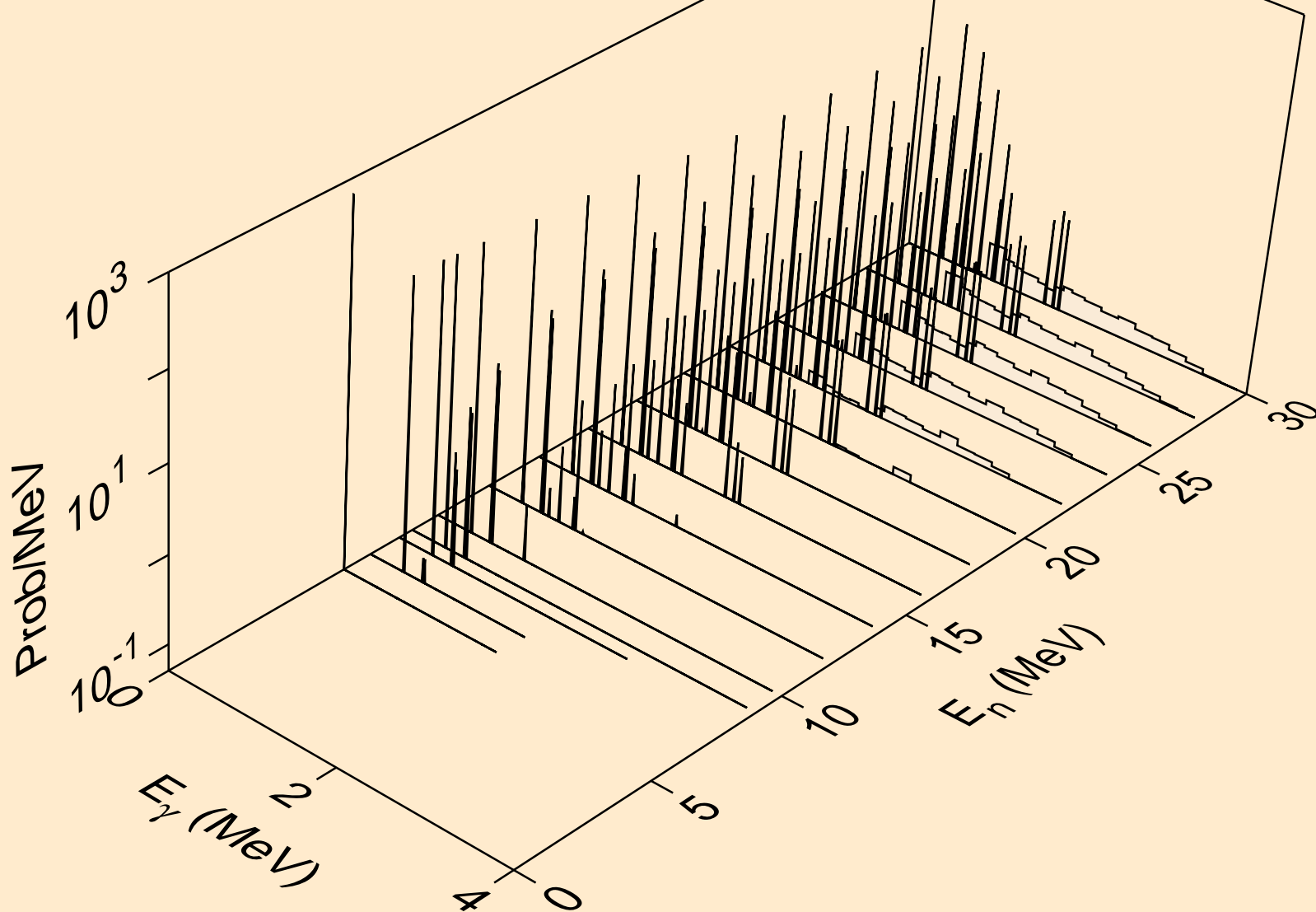

MO086 NEUTRON ACER TENDL-2019 LIBRARY; T=293.16K  
Photon emission for (n,2n)a

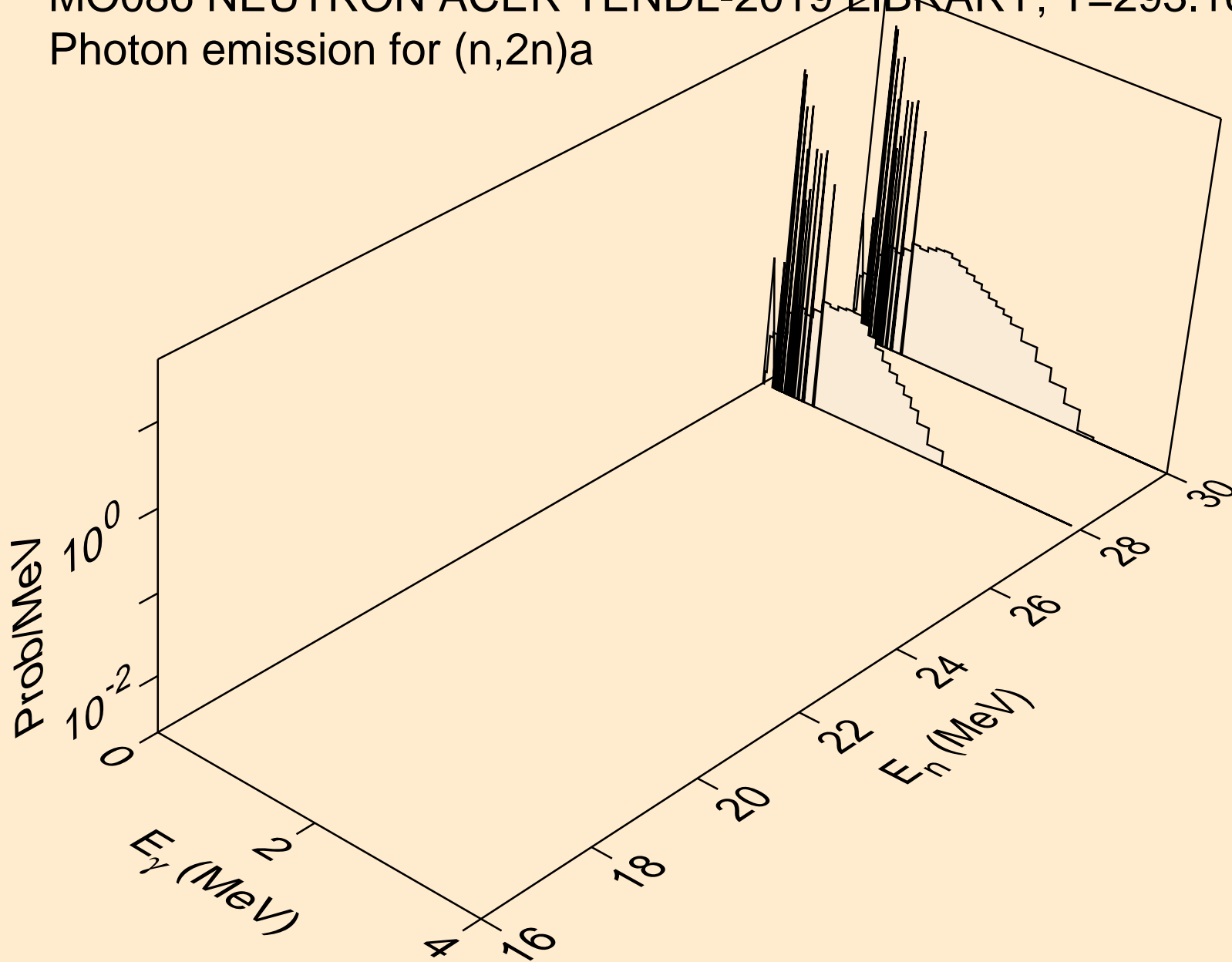



MO086 NEUTRON ACER TENDL-2019 LIBRARY; T=293.16K  
Photon emission for (n,n\*)p

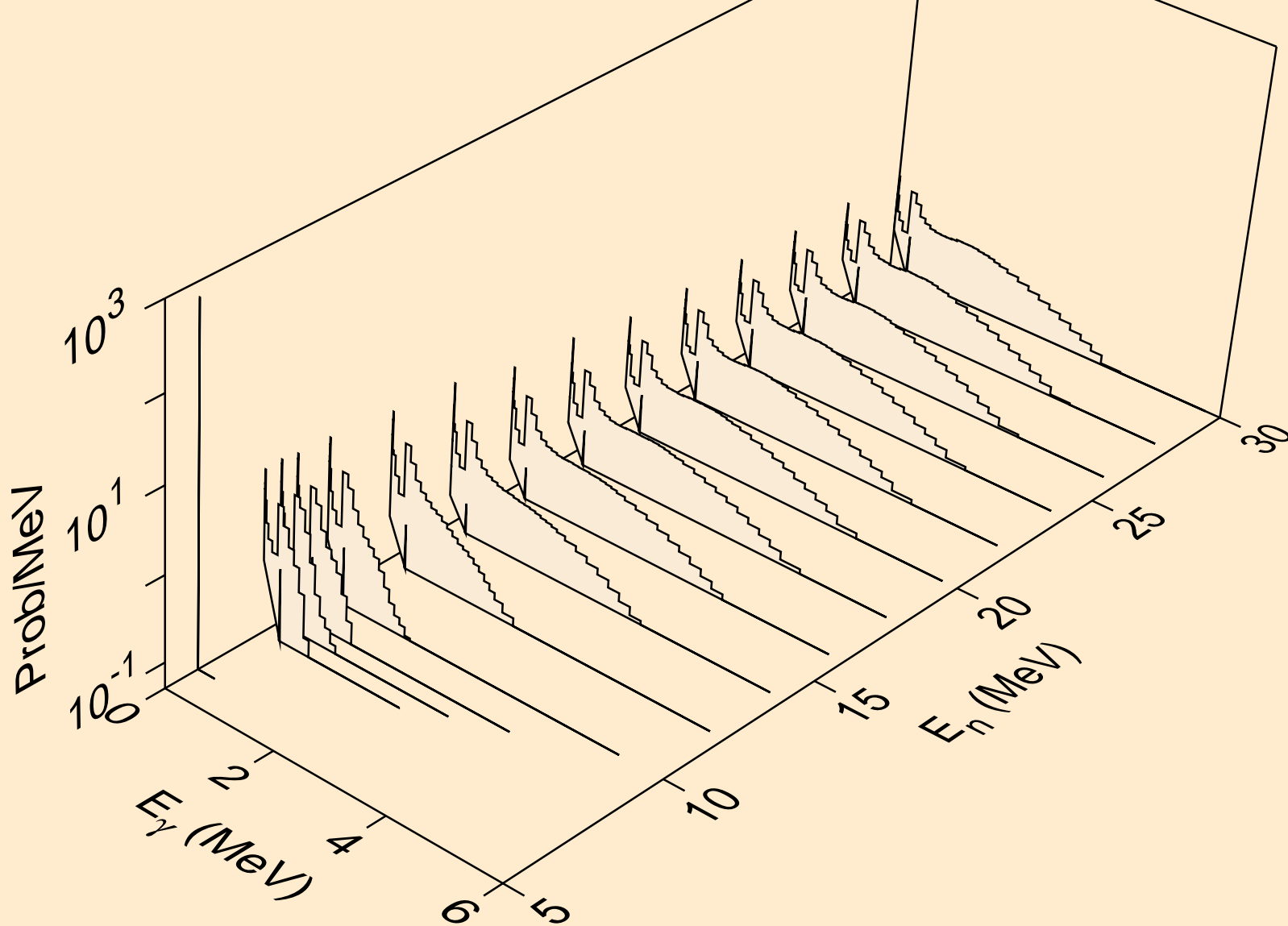

MO086 NEUTRON ACER TENDL-2019 LIBRARY; T=293.16K  
Photon emission for (n,n\*)2a

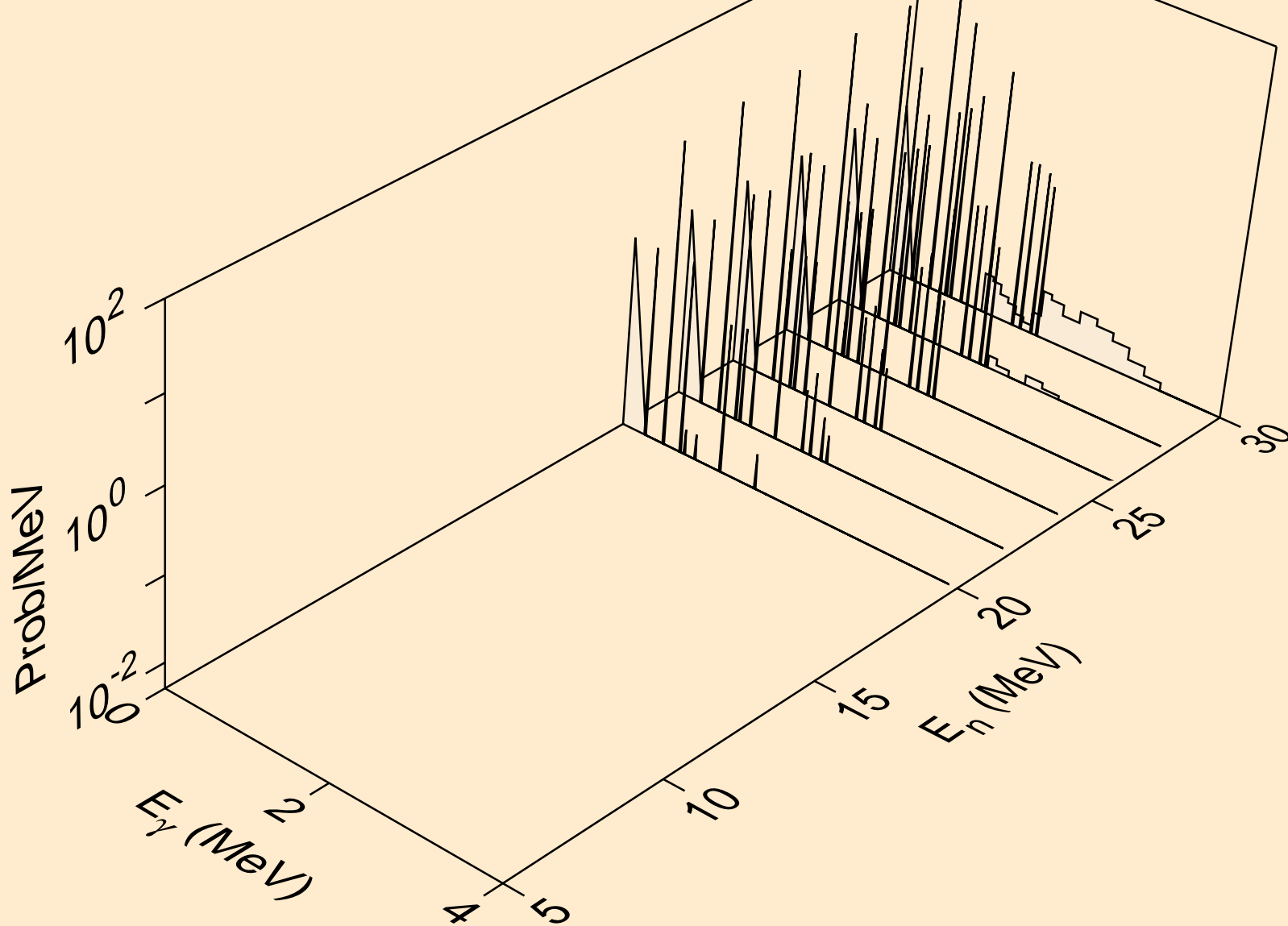

MO086 NEUTRON ACER TENDL-2019 LIBRARY; T=293.16K  
Photon emission for (n,n\*)d

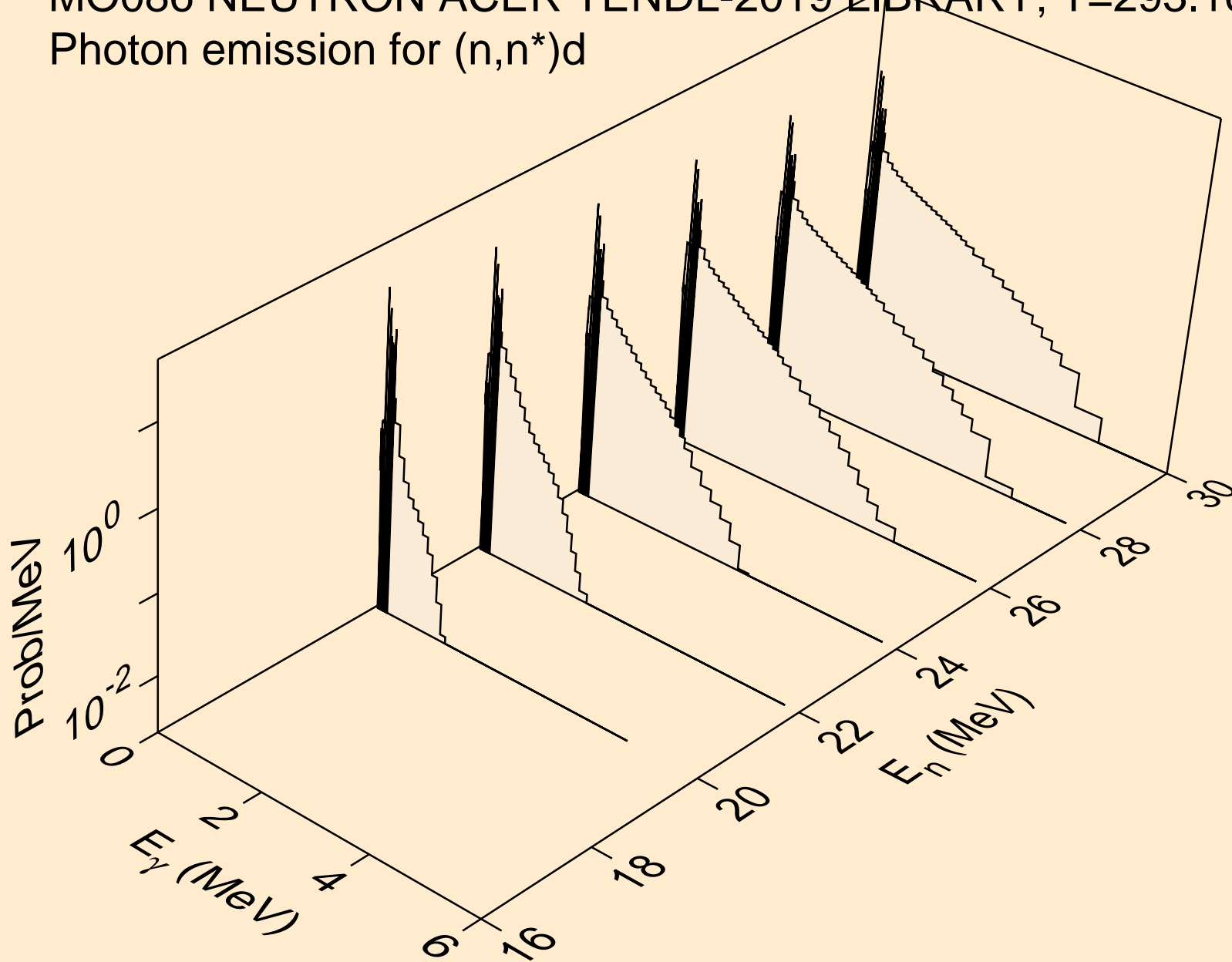

MO086 NEUTRON ACER TENDL-2019 LIBRARY; T=293.16K  
Photon emission for (n,n\*)t

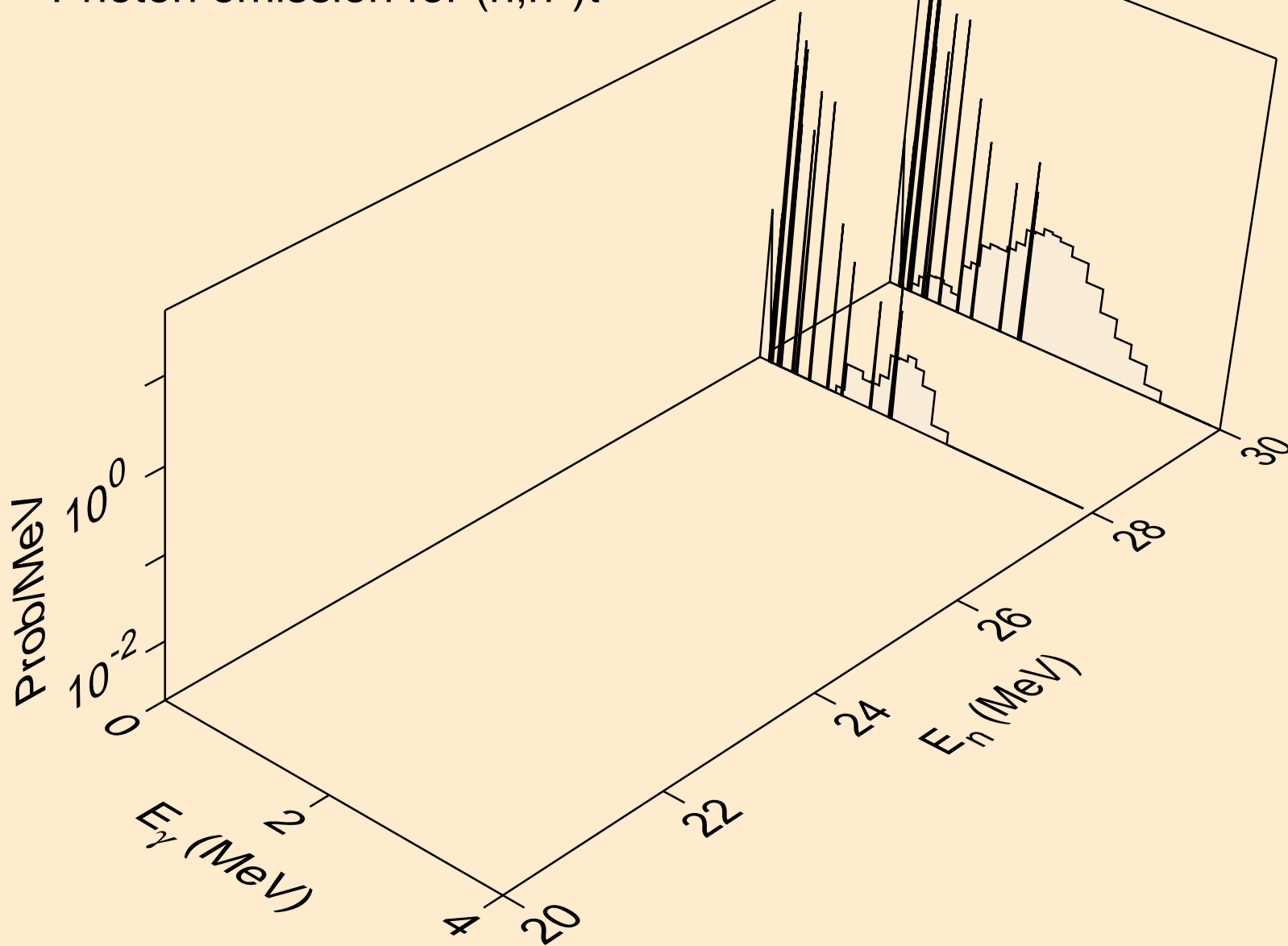

MO086 NEUTRON ACER TENDL-2019 LIBRARY; T=293.16K  
Photon emission for (n,n\*)he3

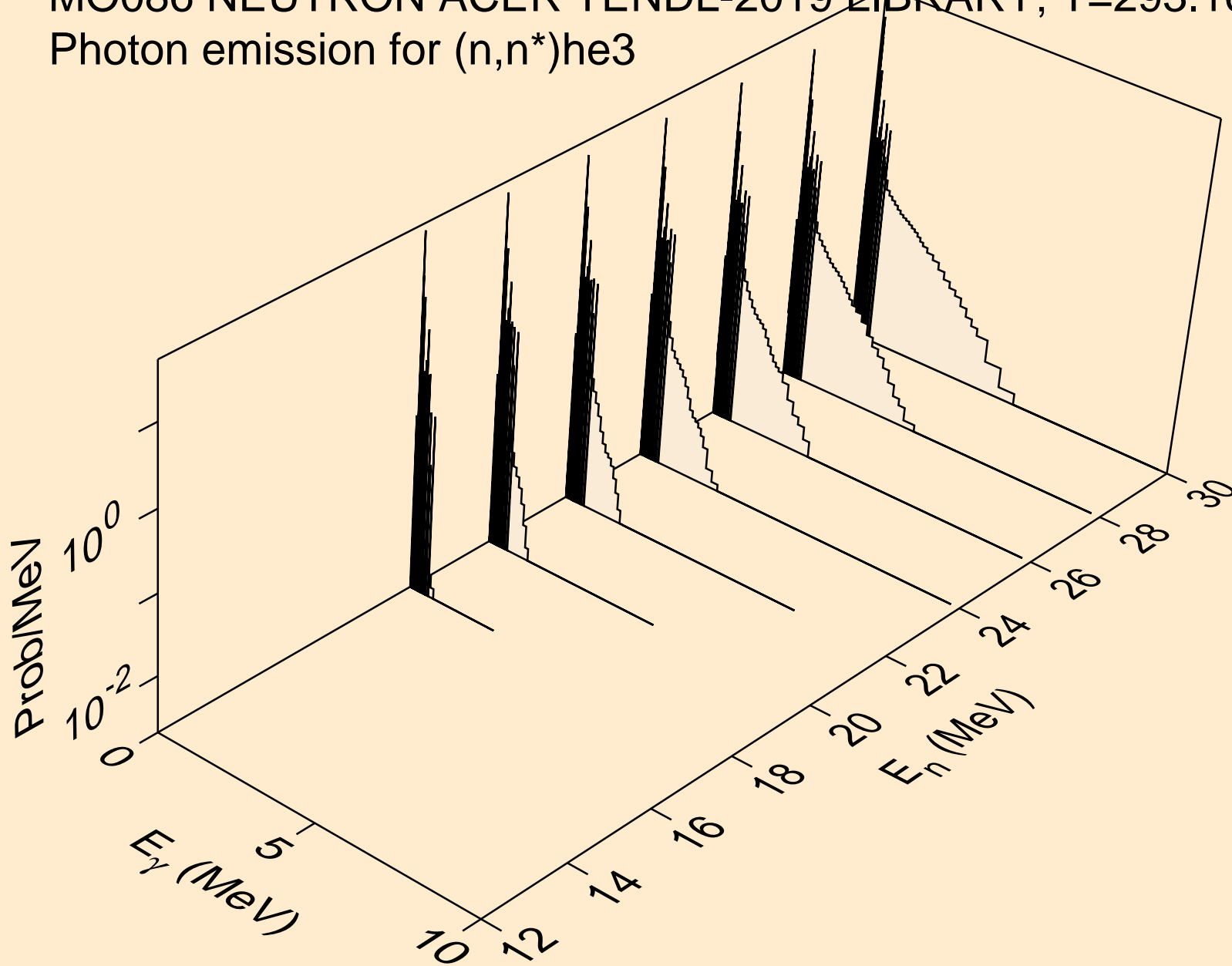

MO086 NEUTRON ACER TENDL-2019 LIBRARY; T=293.16K  
Photon emission for (n,2np)

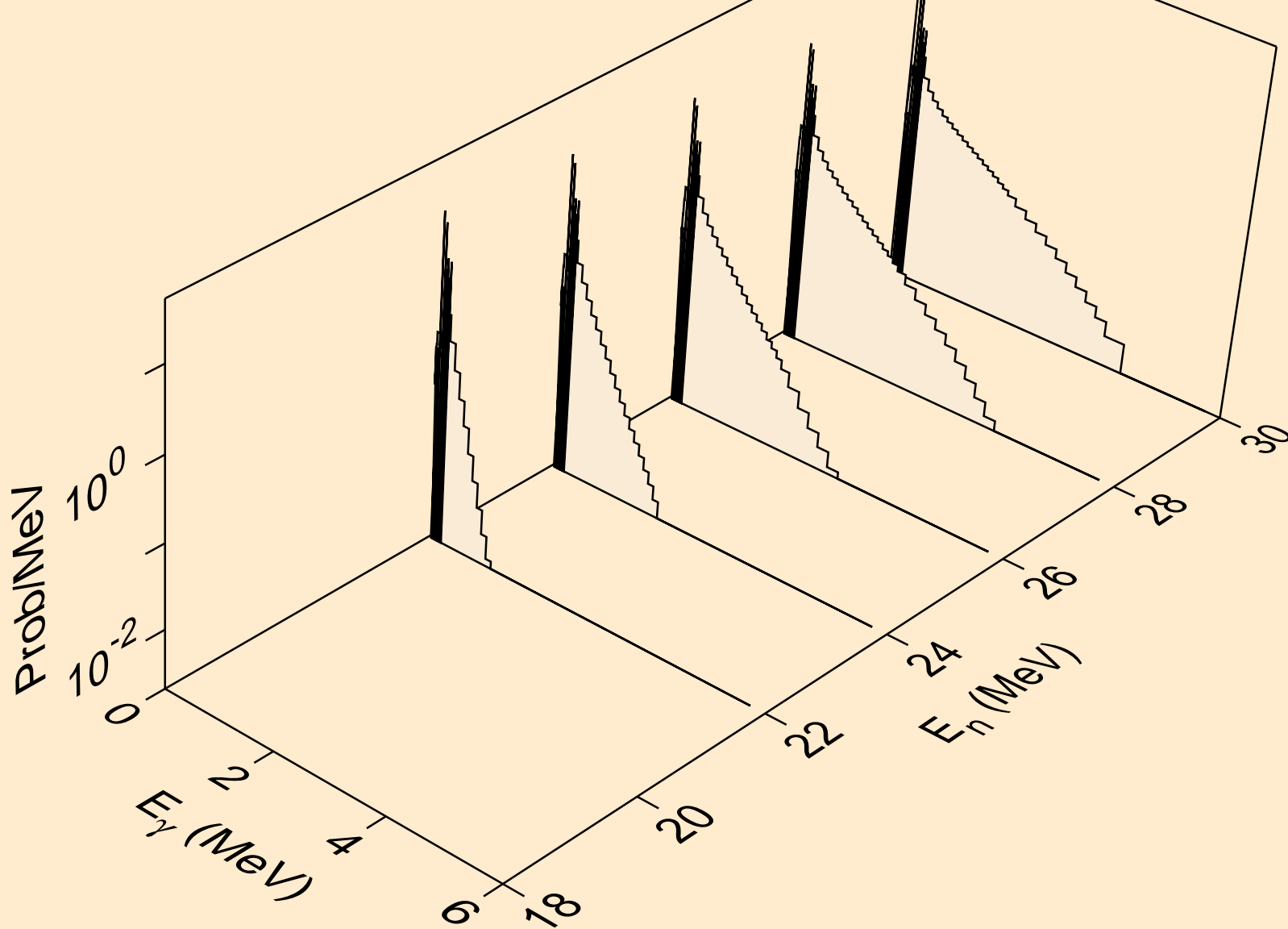

MO086 NEUTRON ACER TENDL-2019 LIBRARY; T=293.16K  
Photon emission for (n,2np)

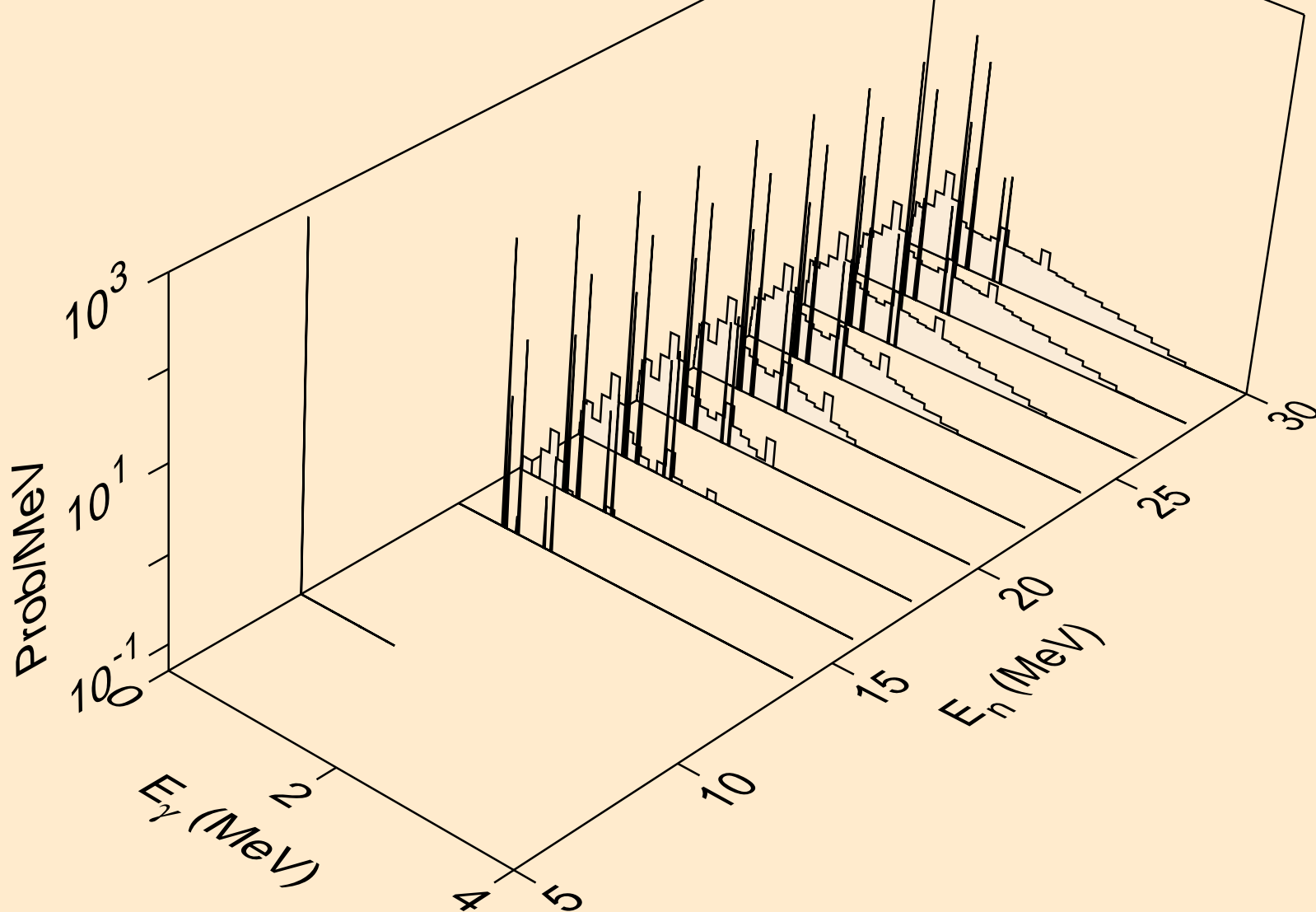

MO086 NEUTRON ACER TENDL-2019 LIBRARY; T=293.16K  
Photon emission for (n,npa)

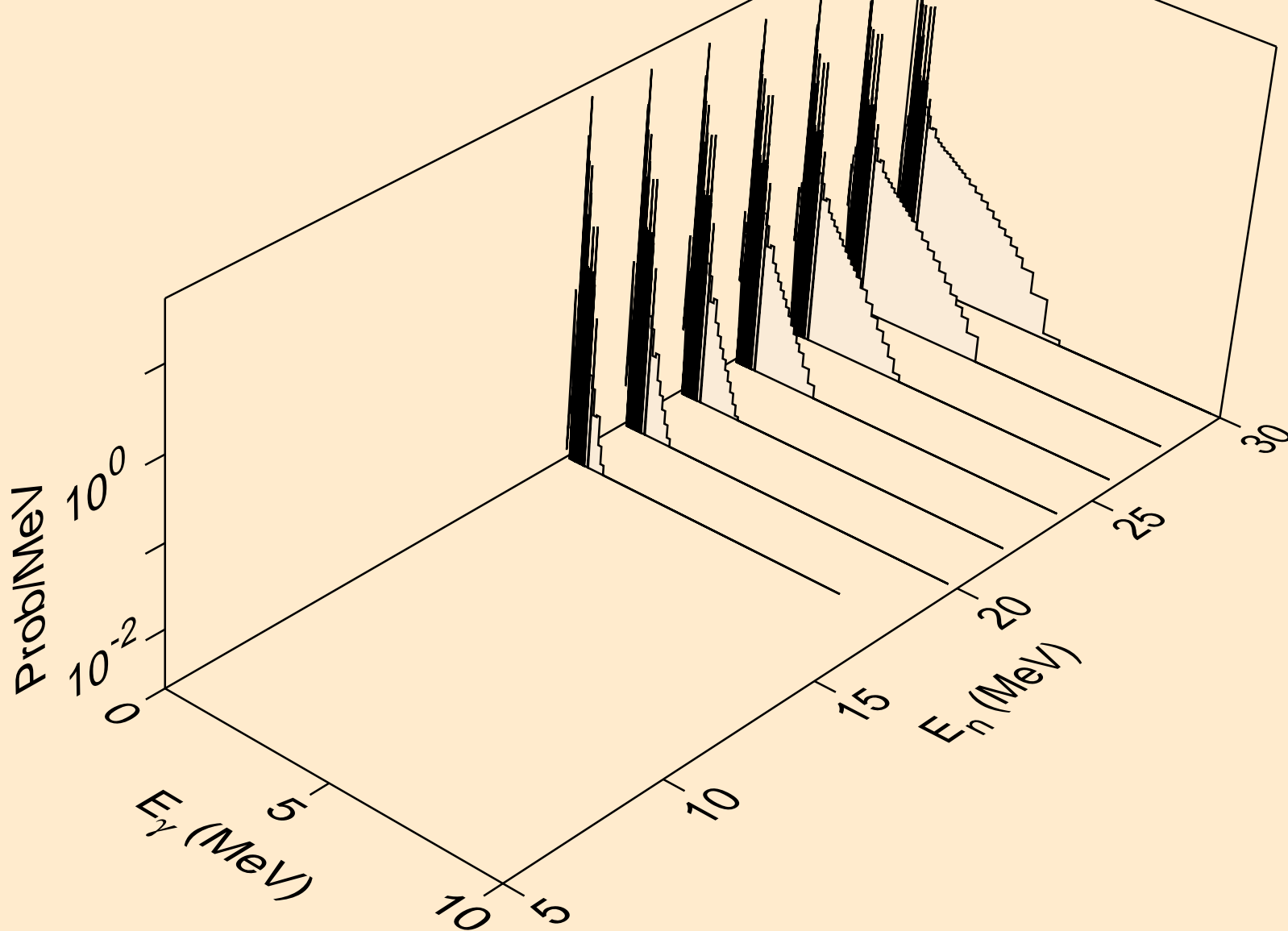



MO086 NEUTRON ACER TENDL-2019 LIBRARY; T=293.16K  
Photon emission for (n,n\*c)

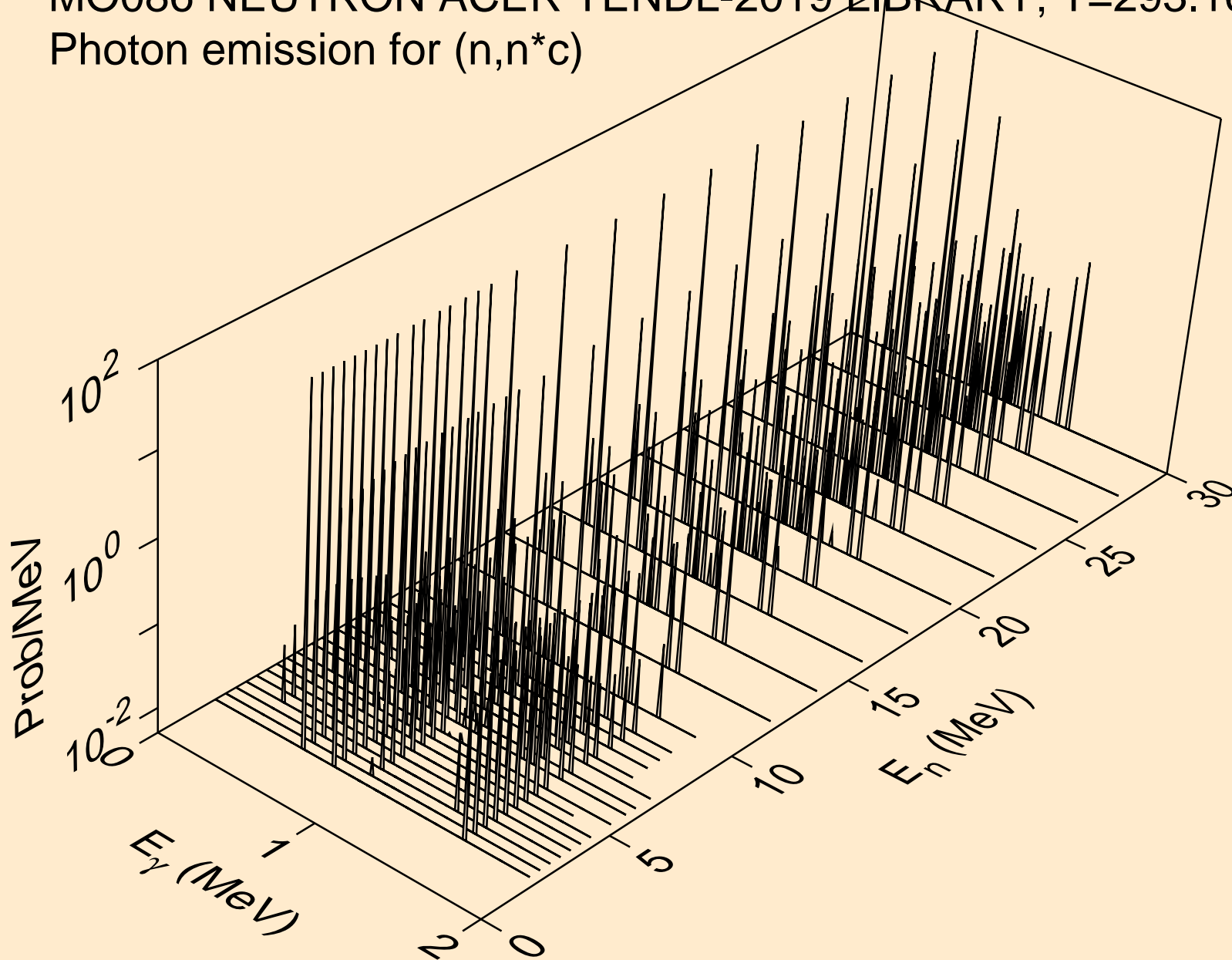

MO086 NEUTRON ACER TENDL-2019 LIBRARY; T=293.16K  
Photon emission for (n,gma)

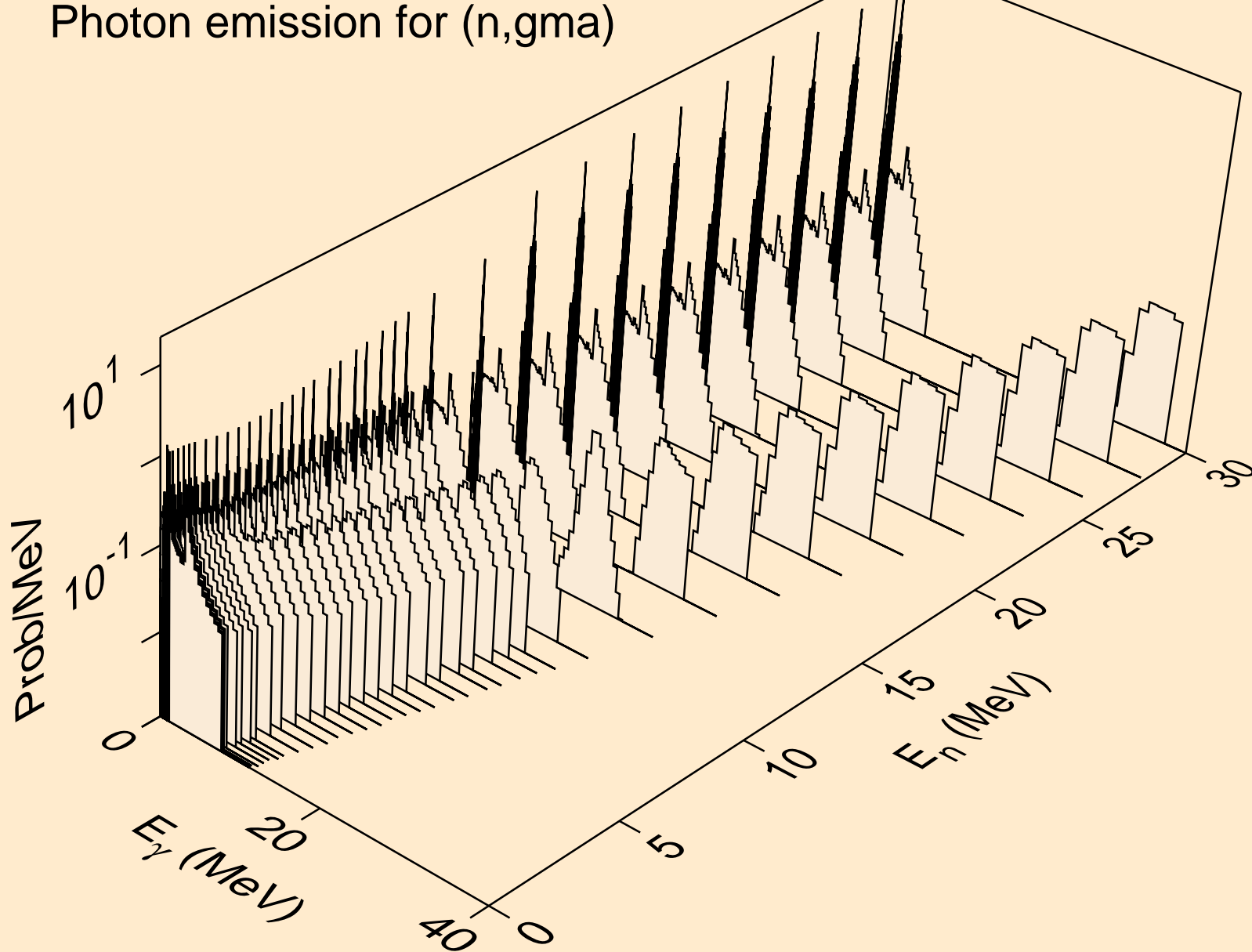

MO086 NEUTRON ACER TENDL-2019 LIBRARY; T=293.16K  
Photon emission for (n,p)

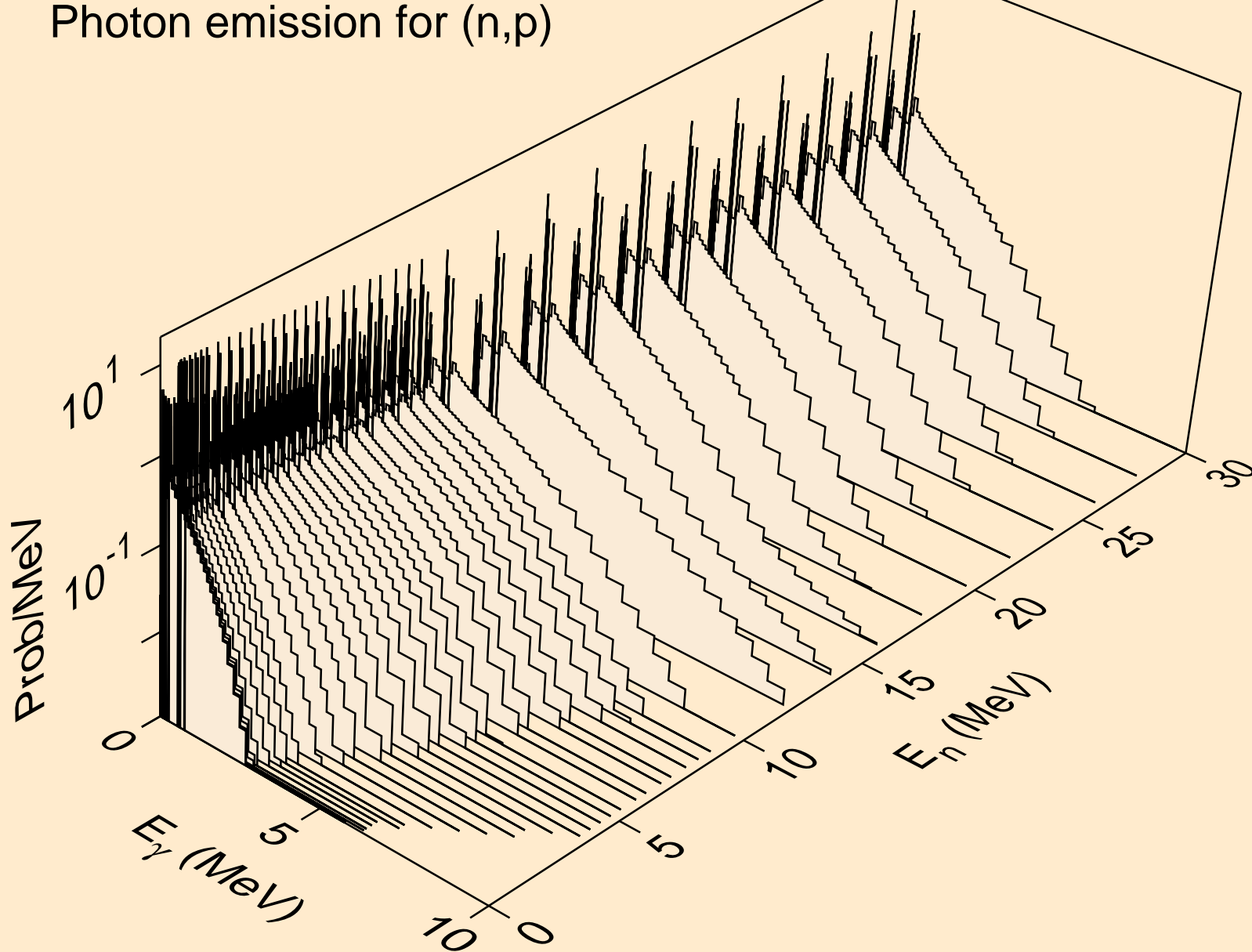

MO086 NEUTRON ACER TENDL-2019 LIBRARY; T=293.16K  
Photon emission for (n,d)

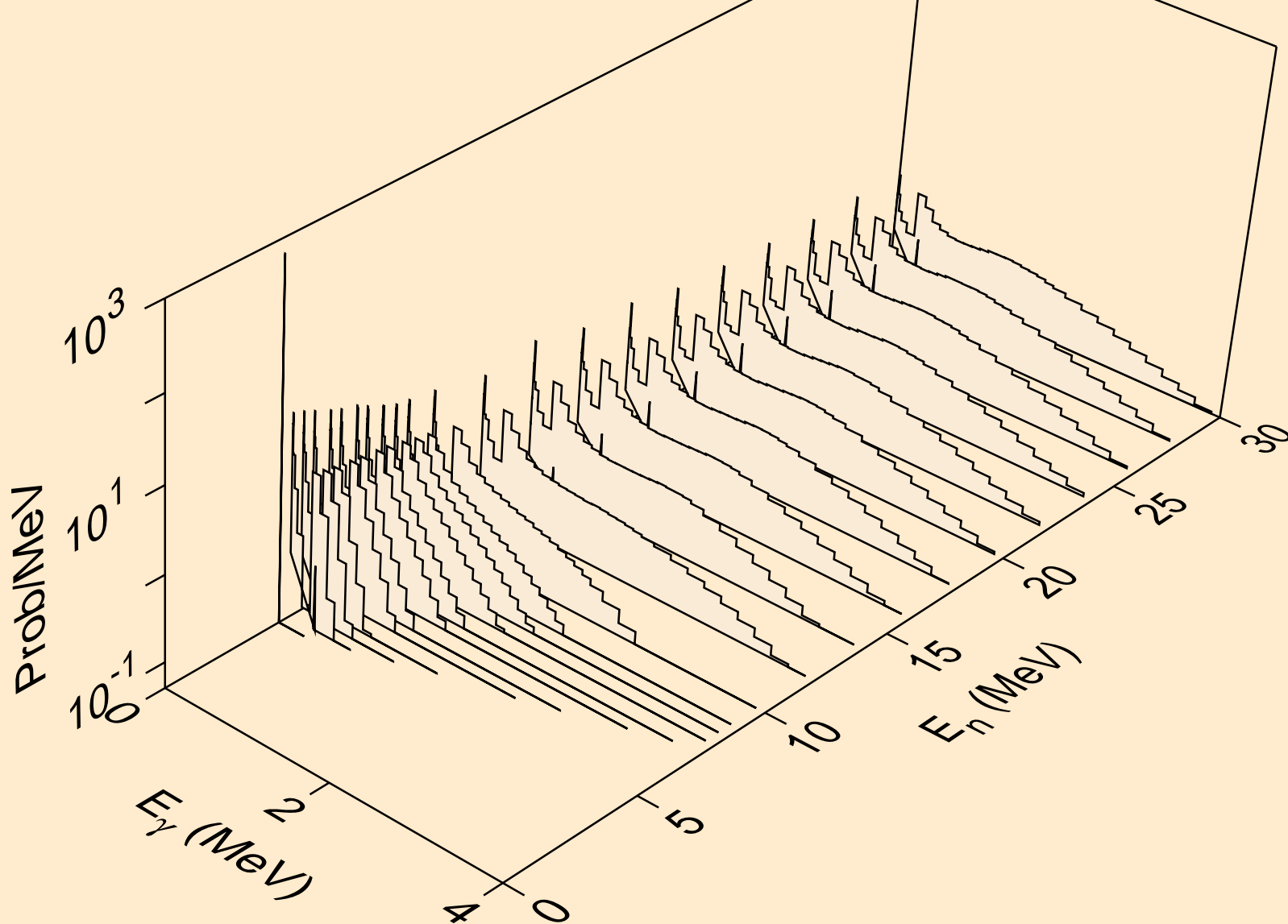

MO086 NEUTRON ACER TENDL-2019 LIBRARY; T=293.16K  
Photon emission for (n,t)

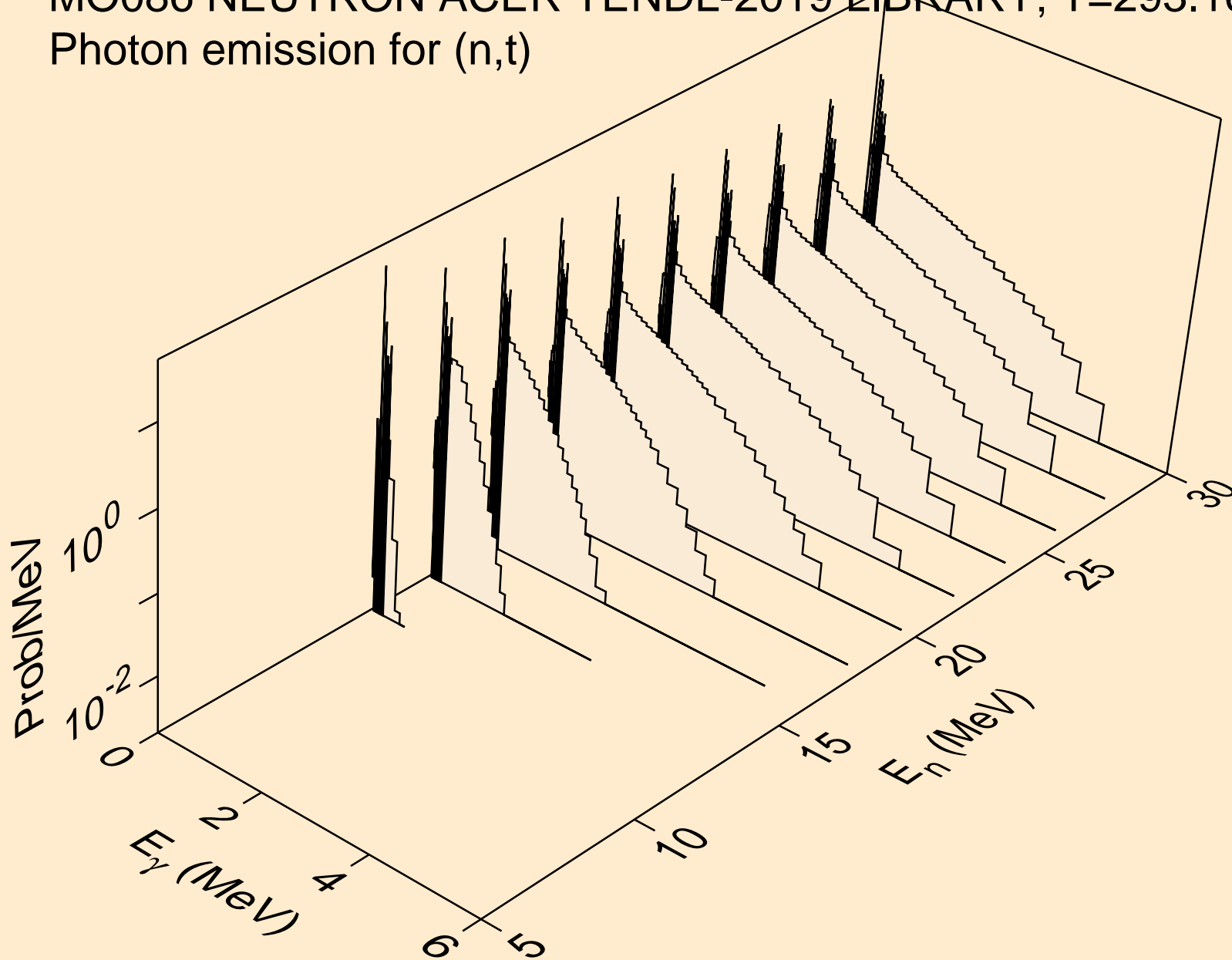

MO086 NEUTRON ACER TENDL-2019 LIBRARY; T=293.16K  
Photon emission for (n,he3)

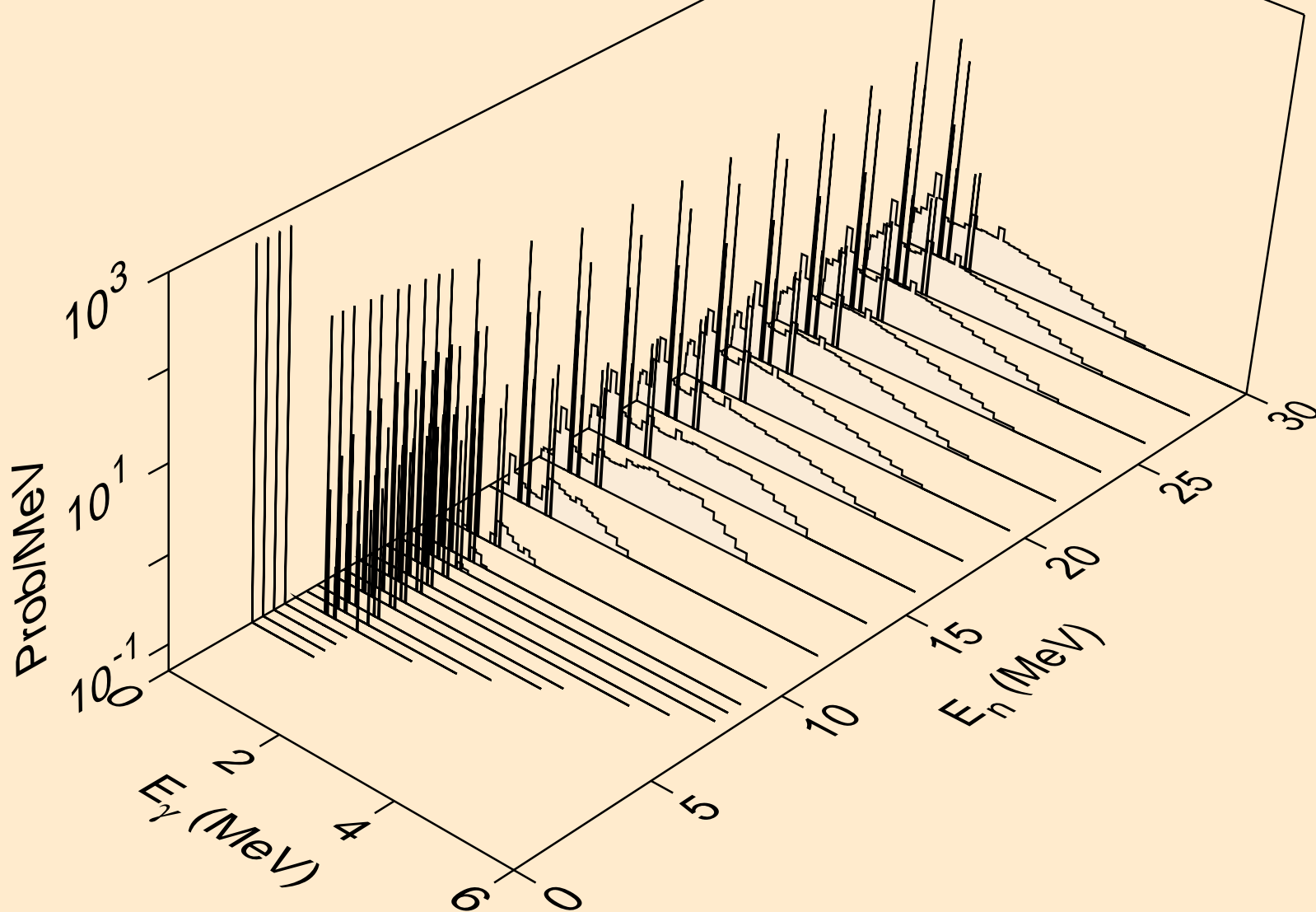

MO086 NEUTRON ACER TENDL-2019 LIBRARY; T=293.16K  
Photon emission for (n,a)

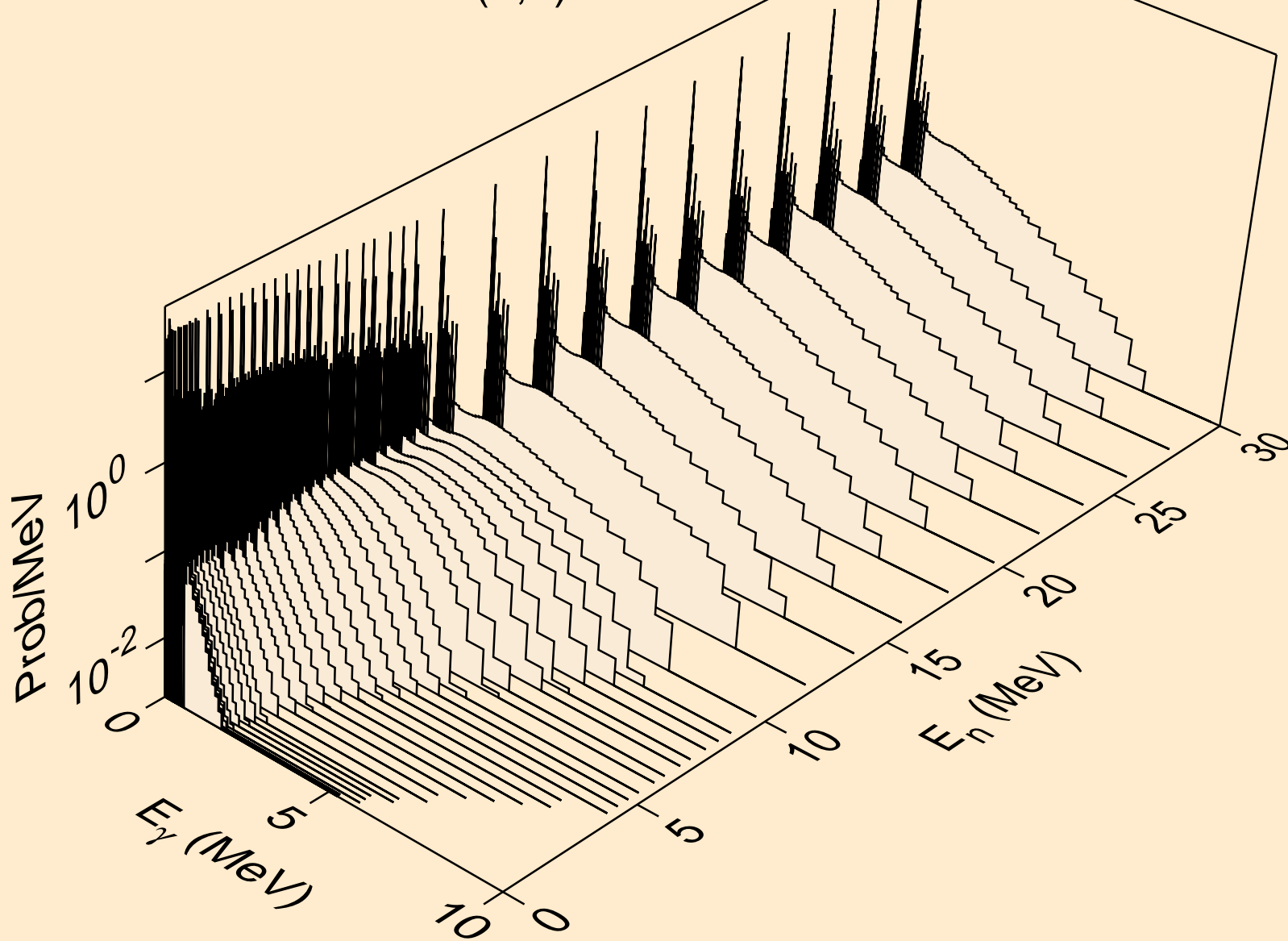

MO086 NEUTRON ACER TENDL-2019 LIBRARY; T=293.16K  
Photon emission for (n,2a)

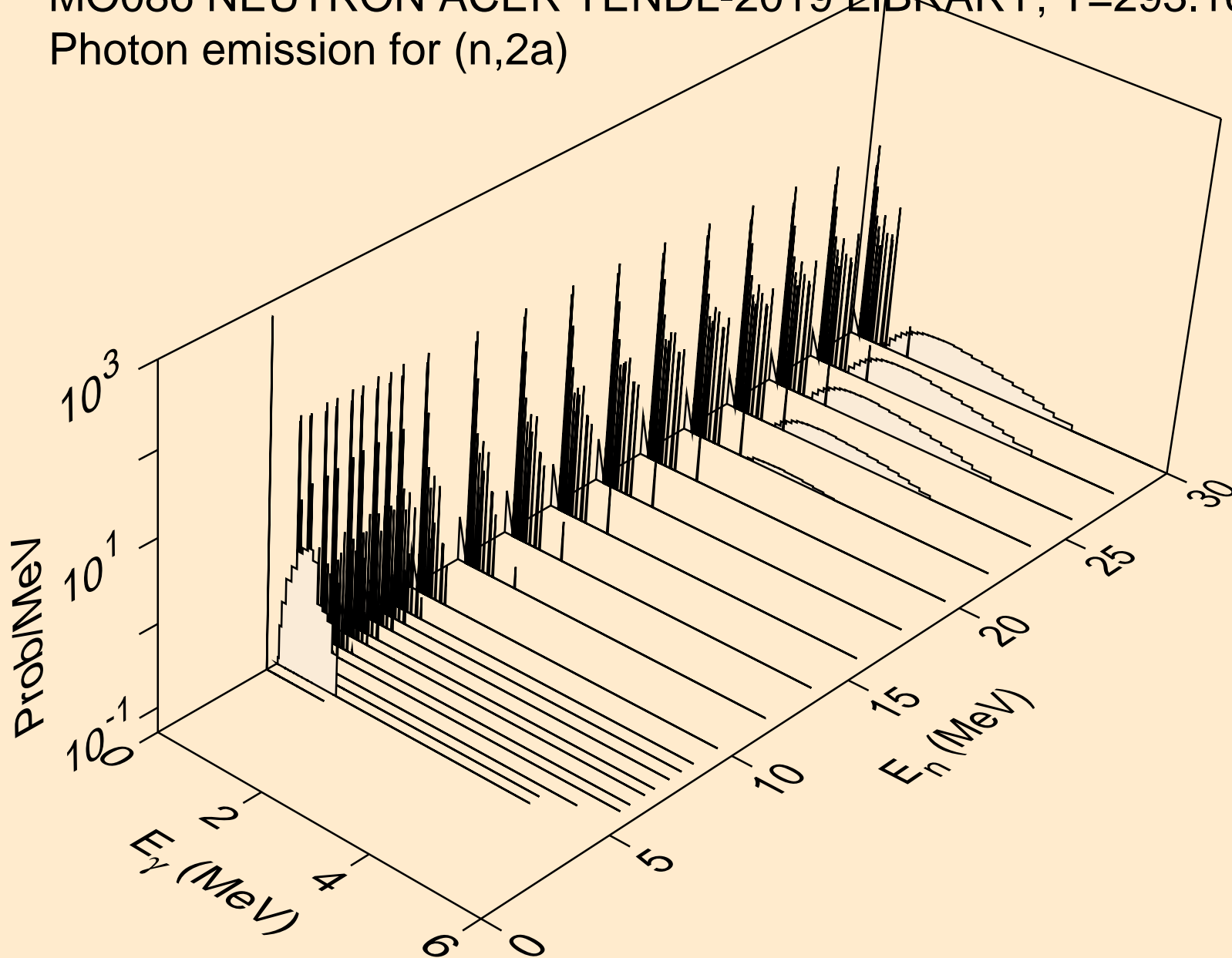



MO086 NEUTRON ACER TENDL-2019 LIBRARY; T=293.16K  
Photon emission for (n,3a)

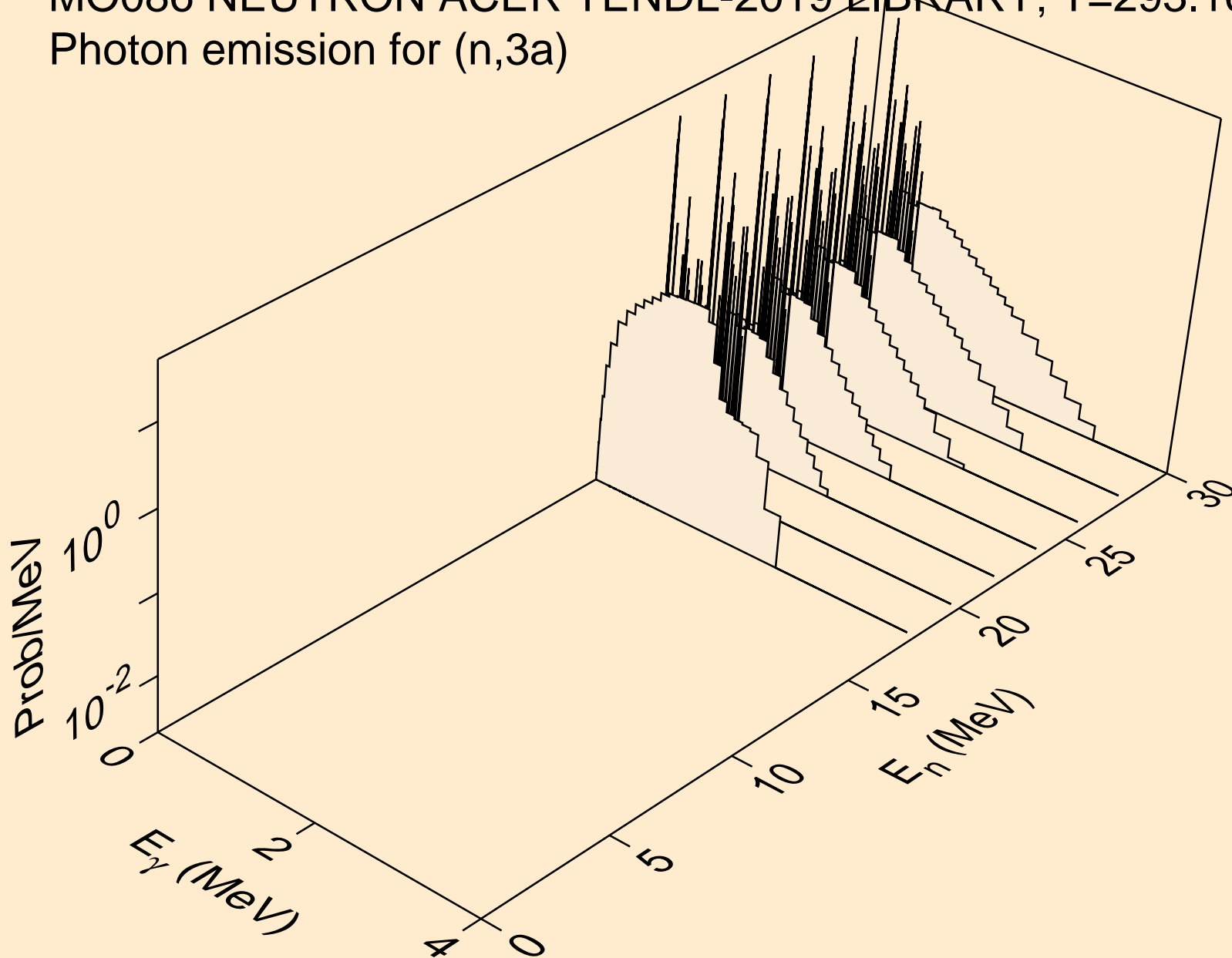

MO086 NEUTRON ACER TENDL-2019 LIBRARY; T=293.16K  
Photon emission for (n,2p)

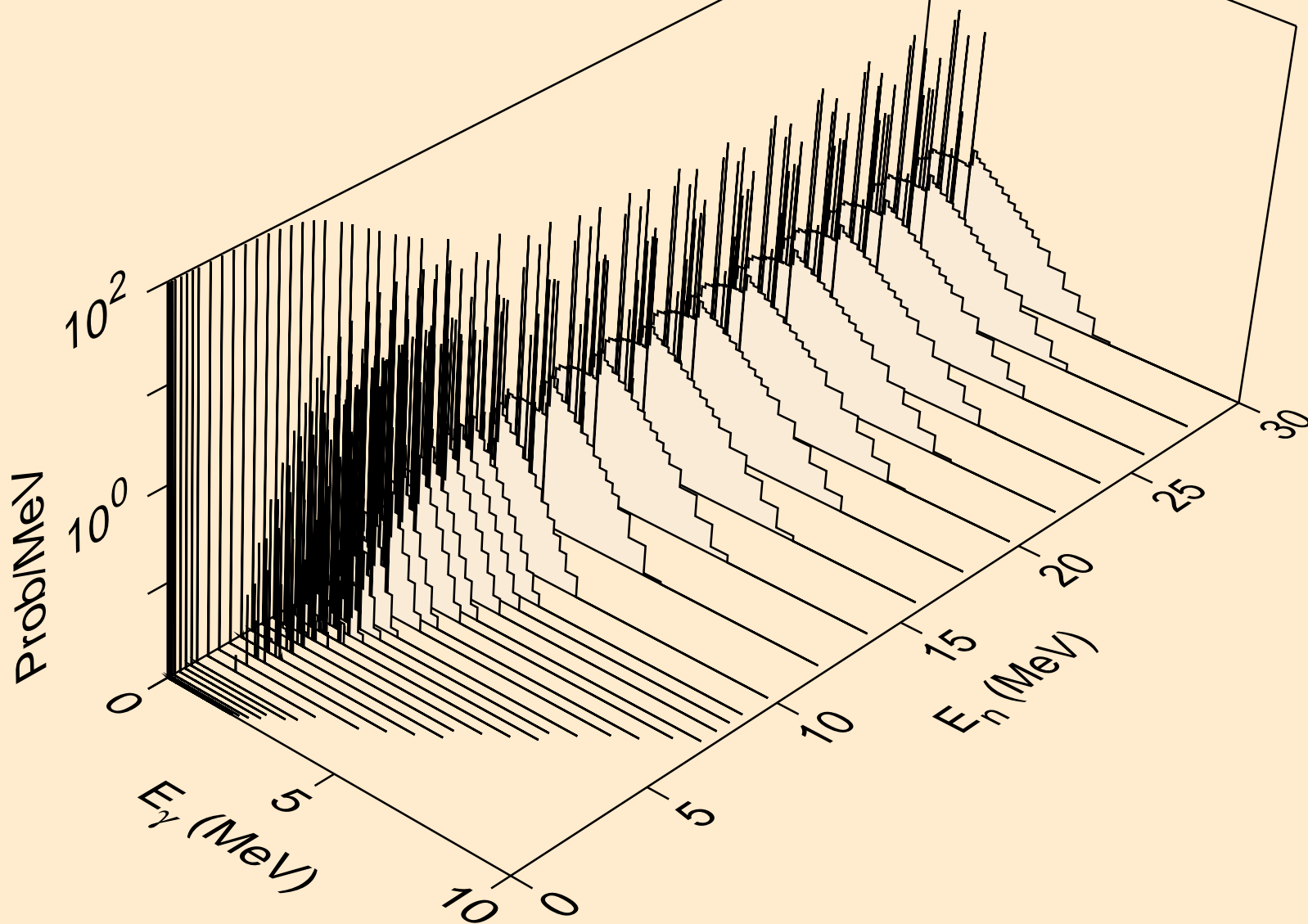

MO086 NEUTRON ACER TENDL-2019 LIBRARY; T=293.16K  
Photon emission for (n,p $\alpha$ )

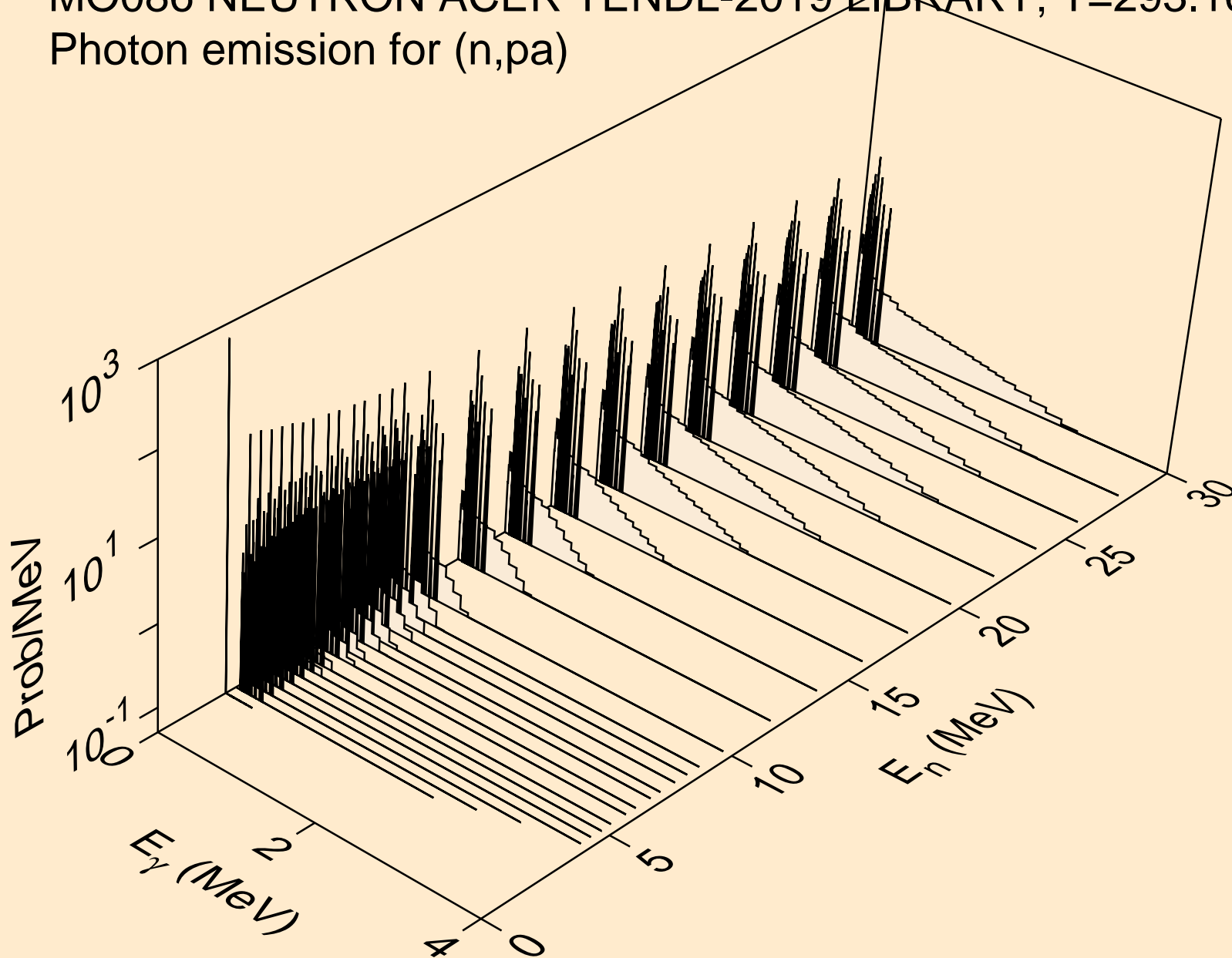

MO086 NEUTRON ACER TENDL-2019 LIBRARY; T=293.16K  
Photon emission for (n,pd)

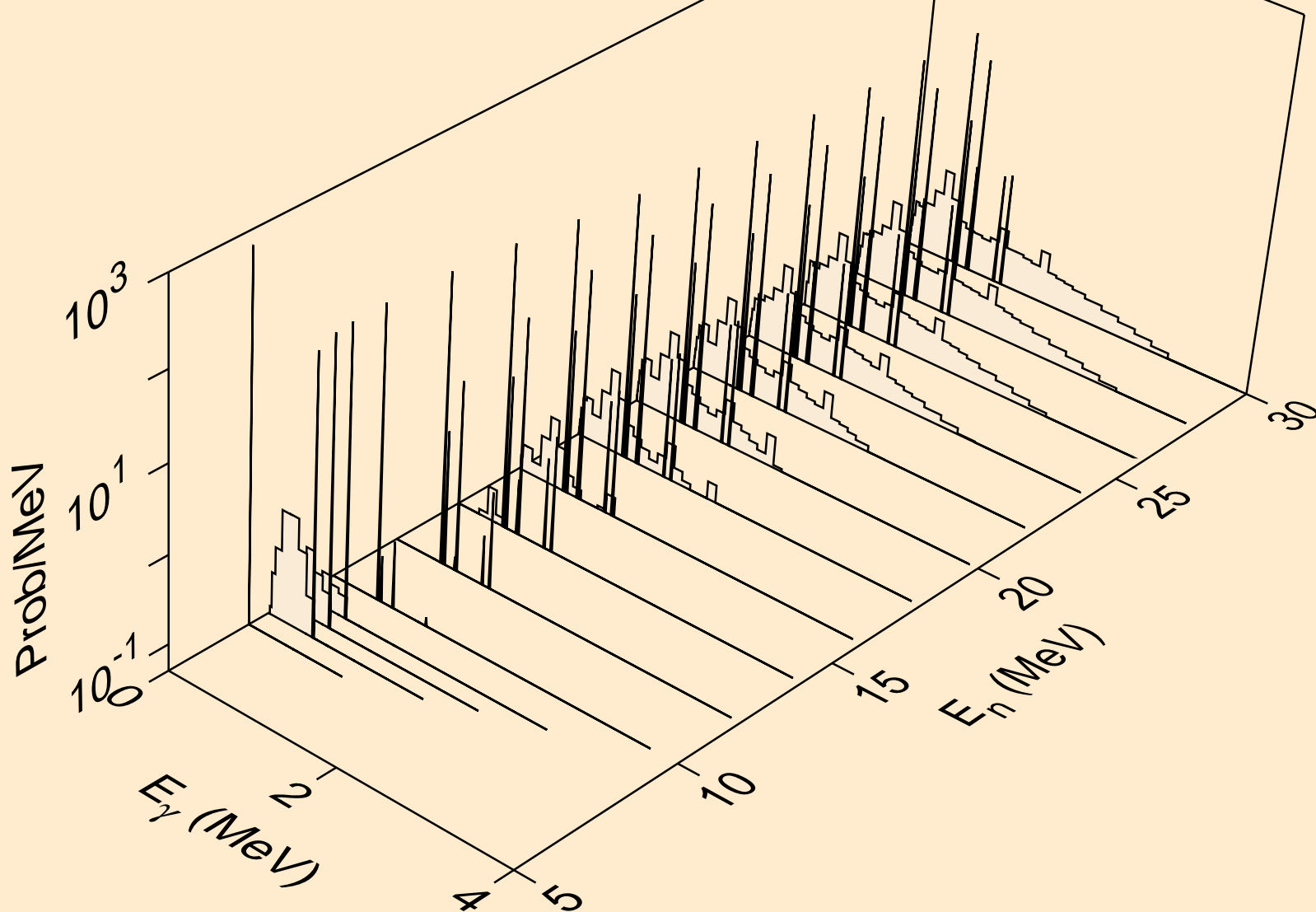

MO086 NEUTRON ACER TENDL-2019 LIBRARY; T=293.16K  
Photon emission for (n,pt)

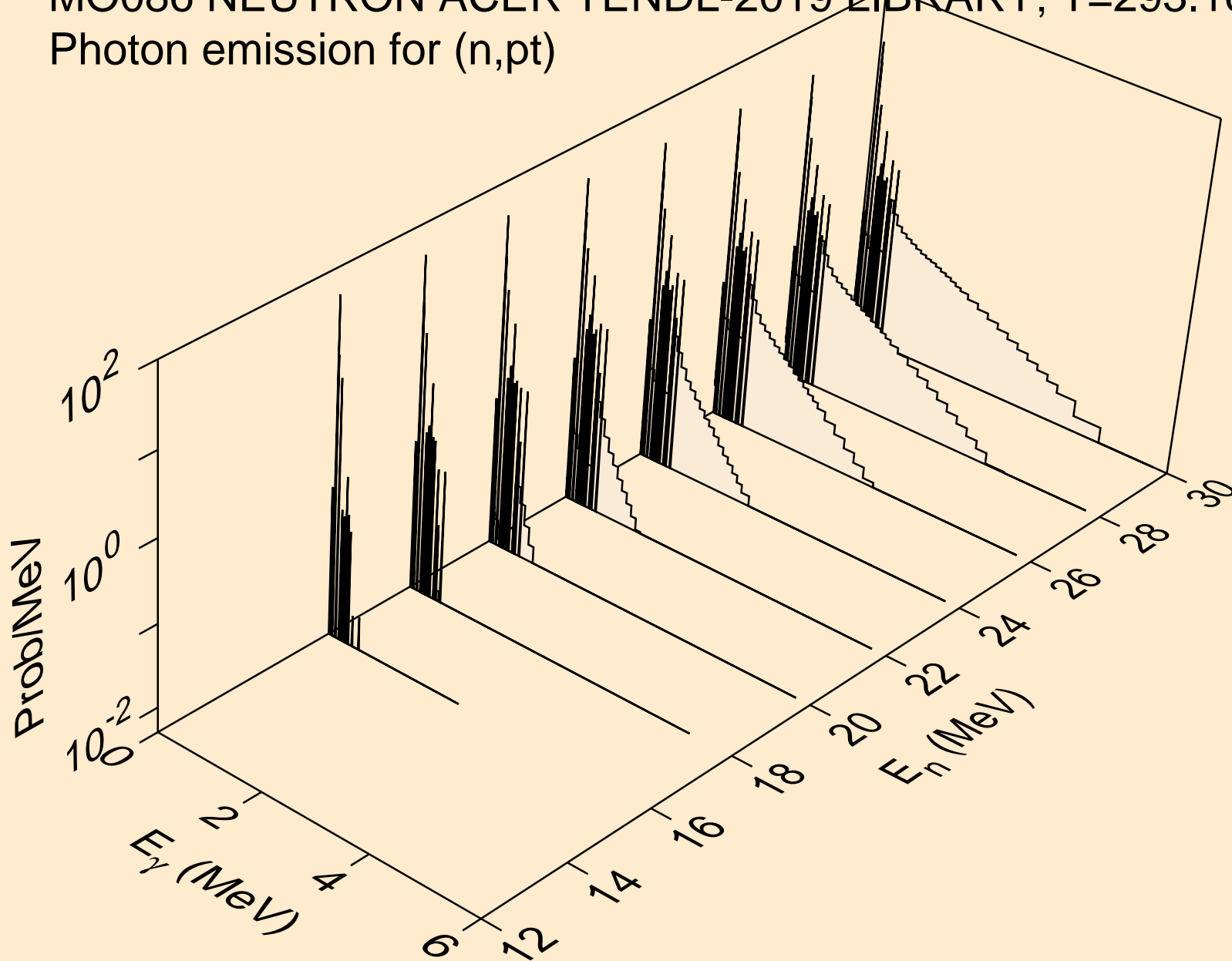

MO086 NEUTRON ACER TENDL-2019 LIBRARY; T=293.16K  
Photon emission for (n,da)

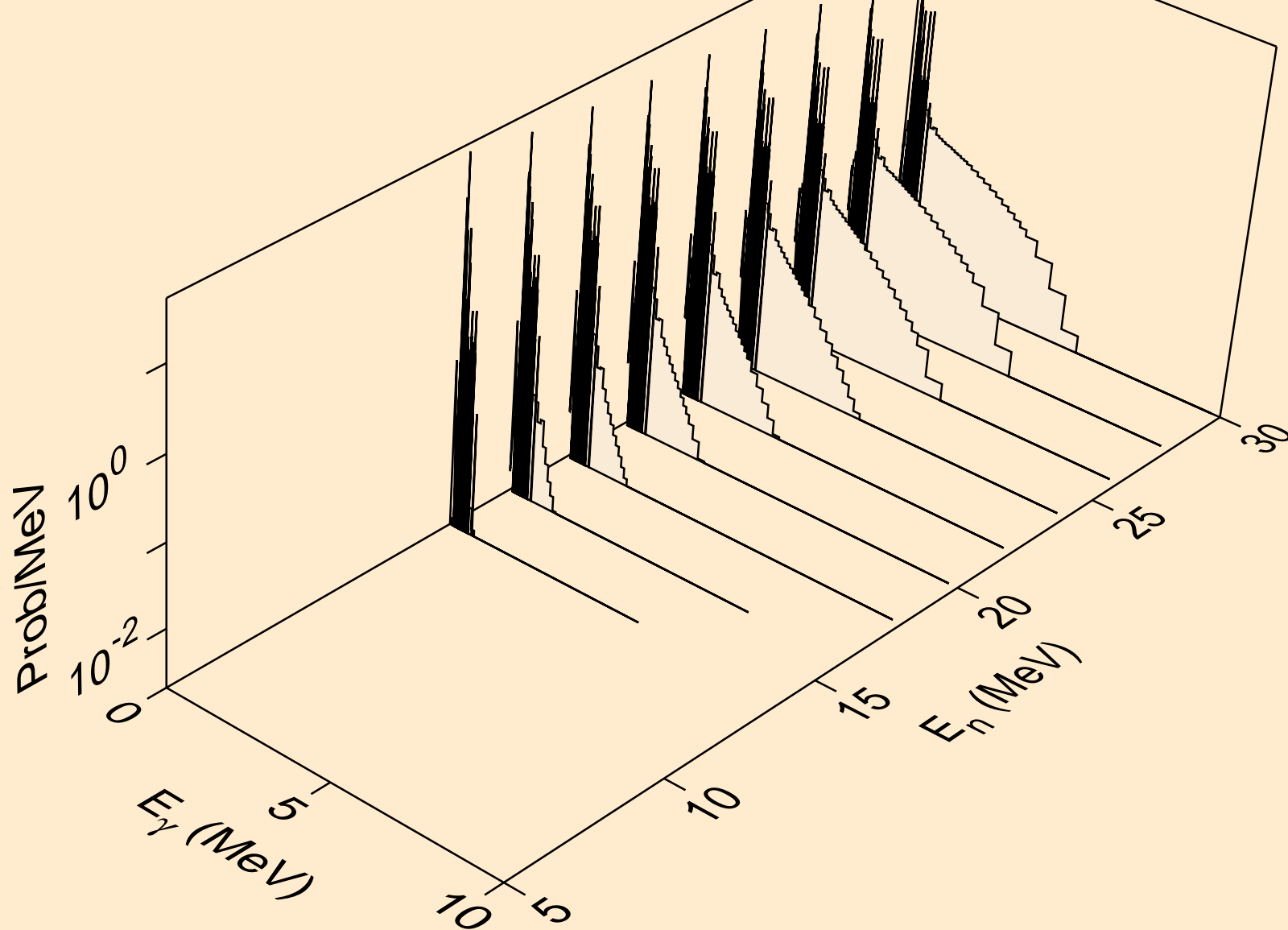

MO086 NEUTRON ACER TENDL-2019 LIBRARY; T=293.16K  
thermal capture photon spectrum

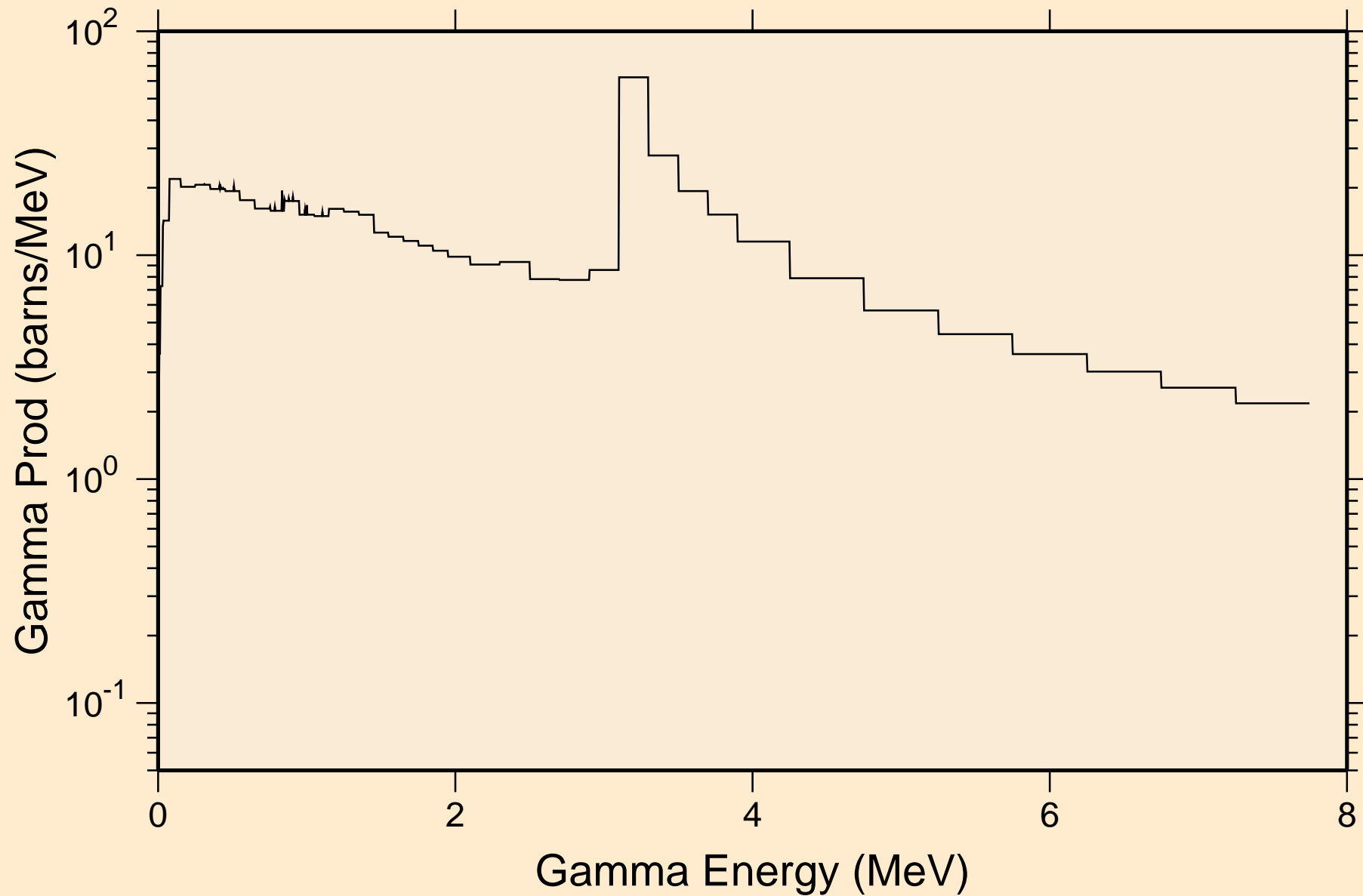

MO086 NEUTRON ACER TENDL-2019 LIBRARY; T=293.16K  
14 MeV photon spectrum

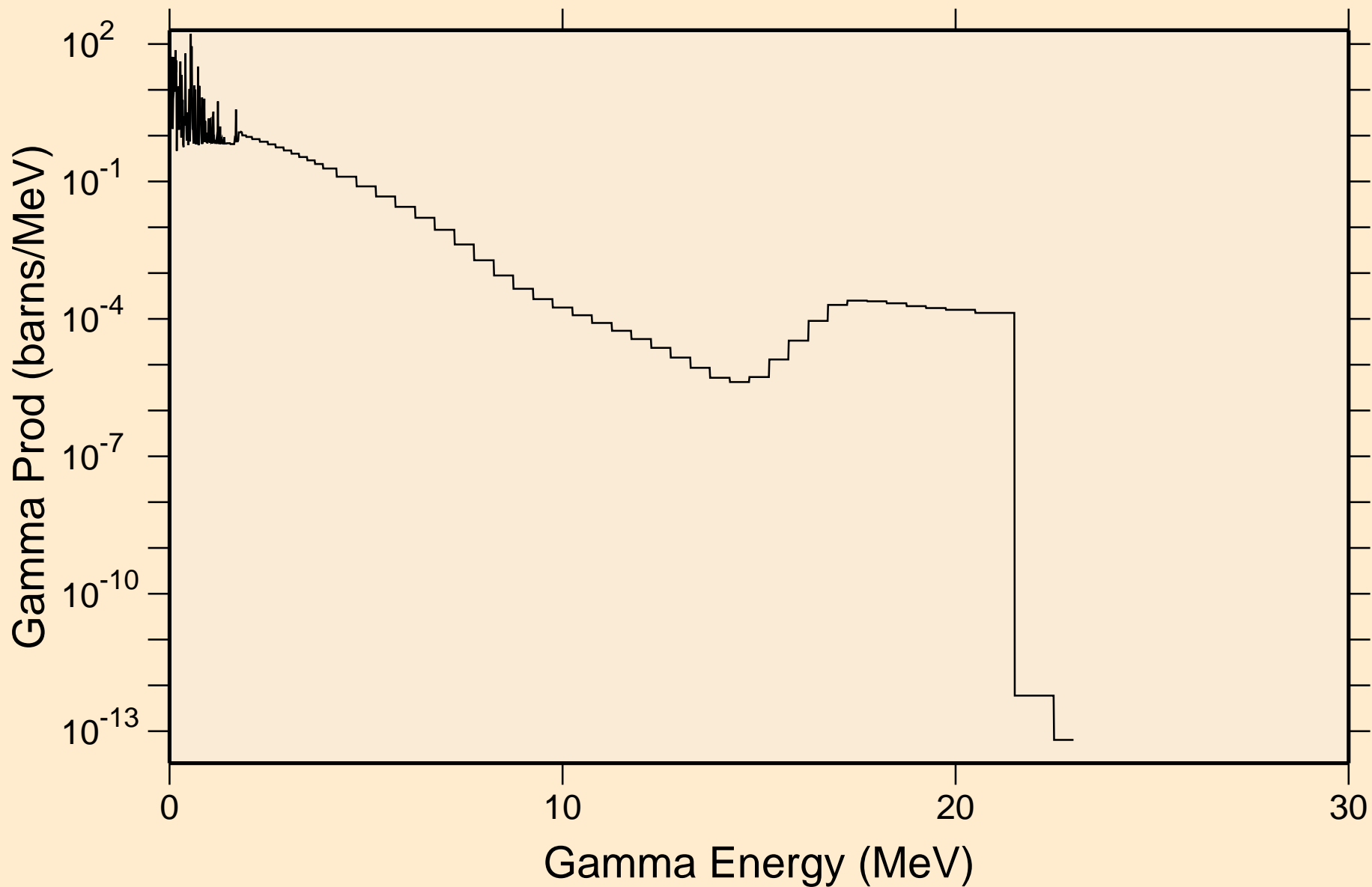



MO086 NEUTRON ACER TENDL-2019 LIBRARY; T=293.16K  
Particle heating contributions

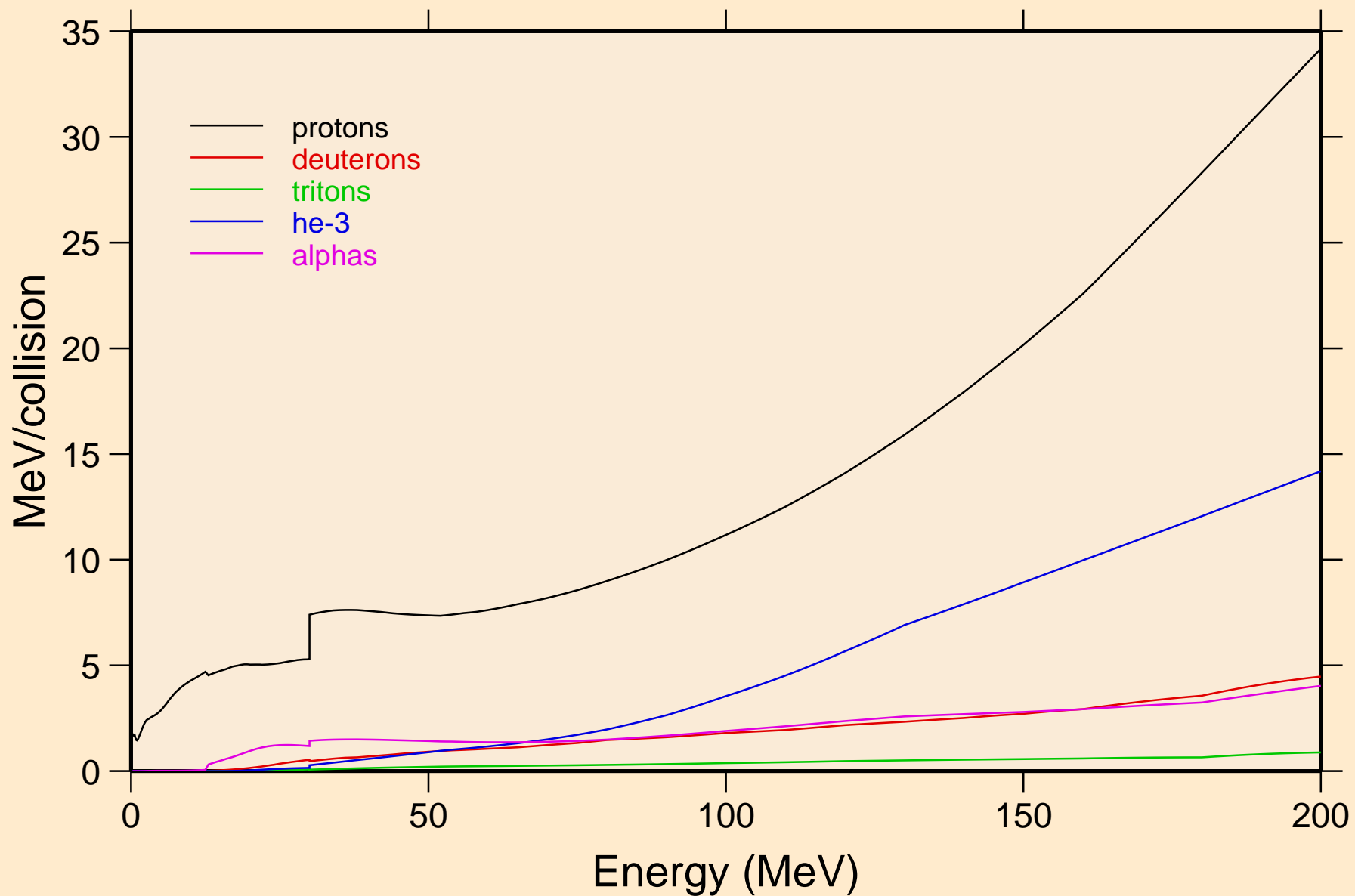

MO086 NEUTRON ACER TENDL-2019 LIBRARY; T=293.16K  
Recoil Heating

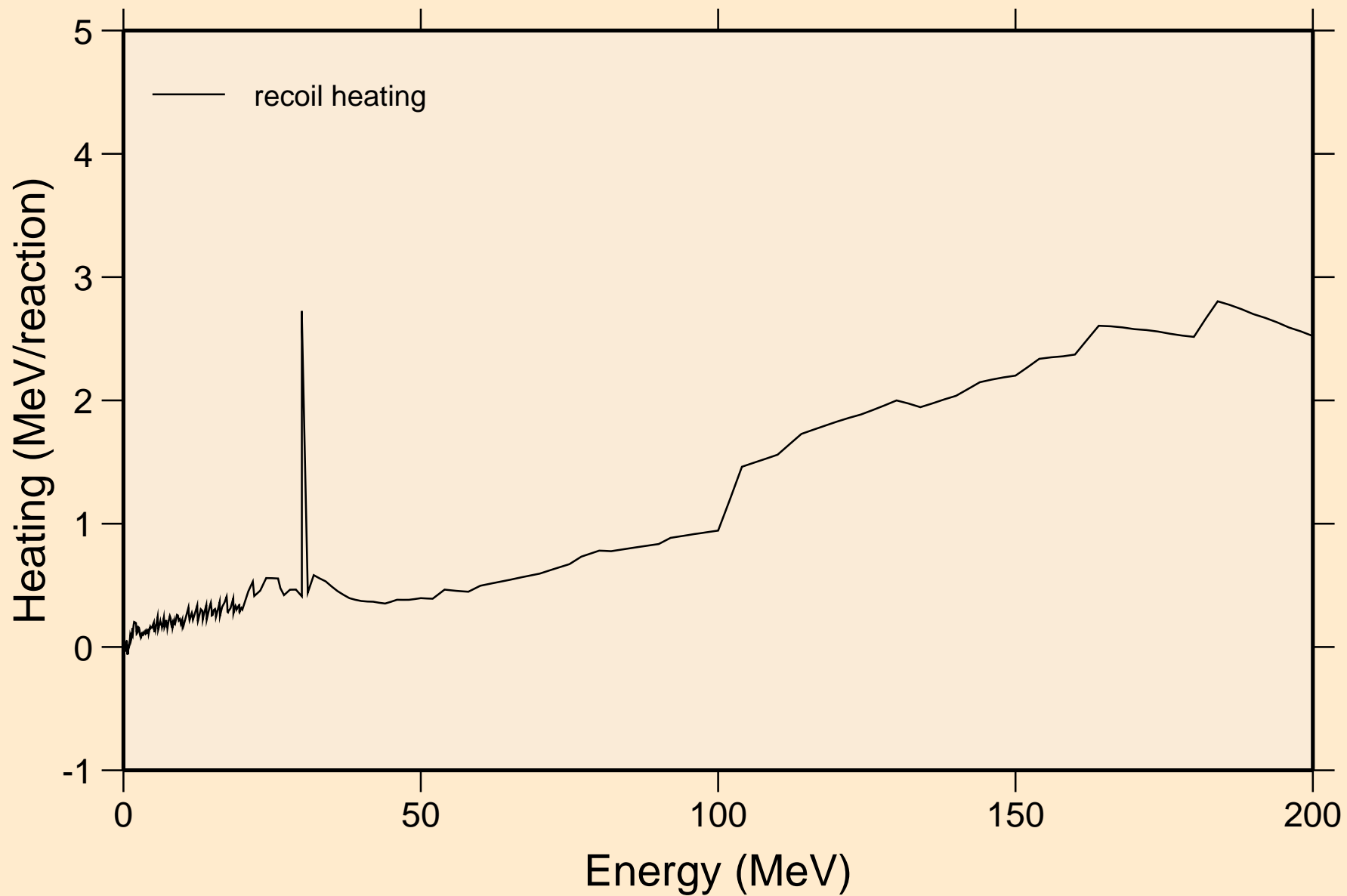

MO086 NEUTRON ACER TENDL-2019 LIBRARY; T=293.16K  
Particle production cross sections

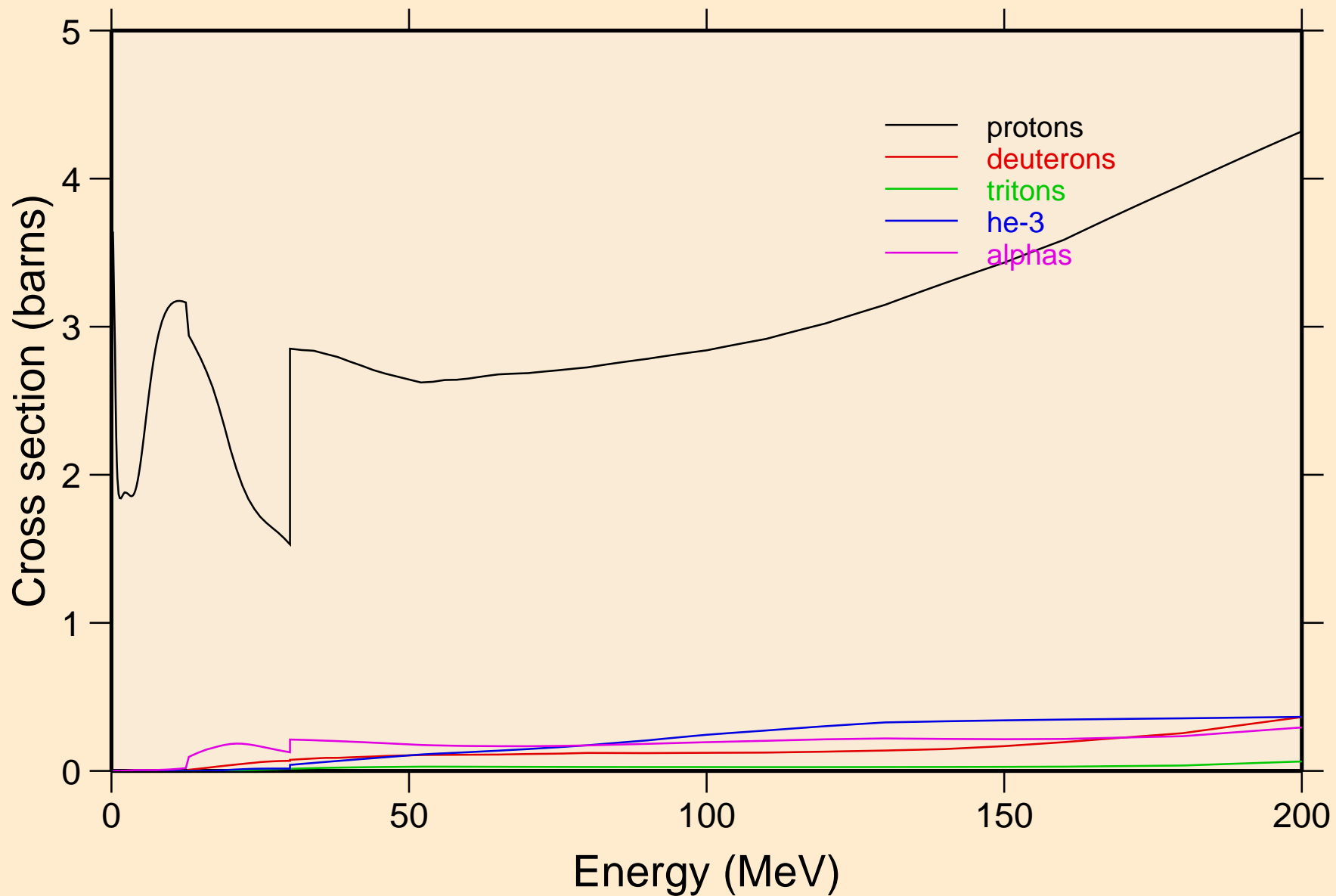

MO086 NEUTRON ACER TENDL-2019 LIBRARY; T=293.16K  
protons from (n,x)

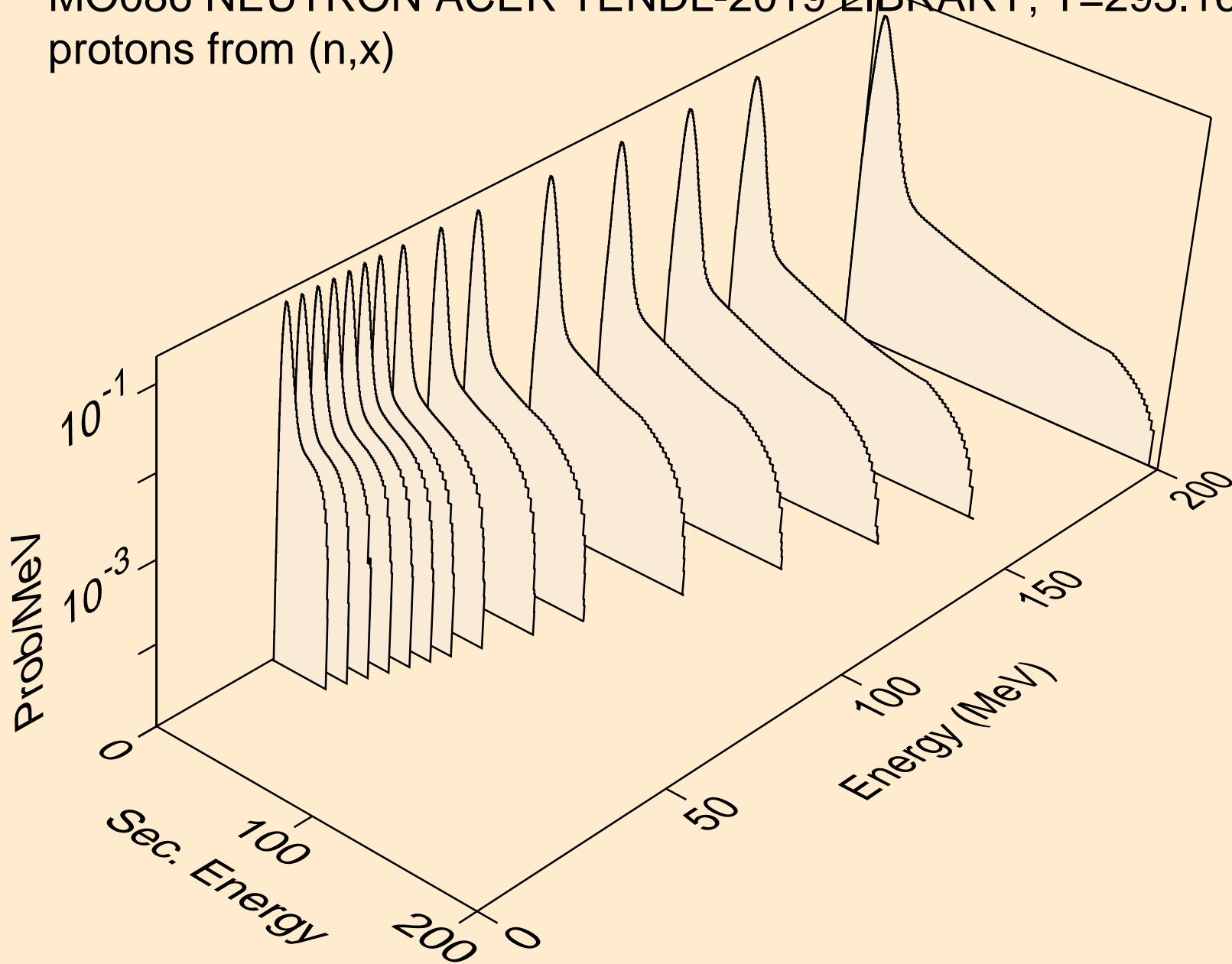

MO086 NEUTRON ACER TENDL-2019 LIBRARY; T=293.16K  
protons from (n,n\*)p

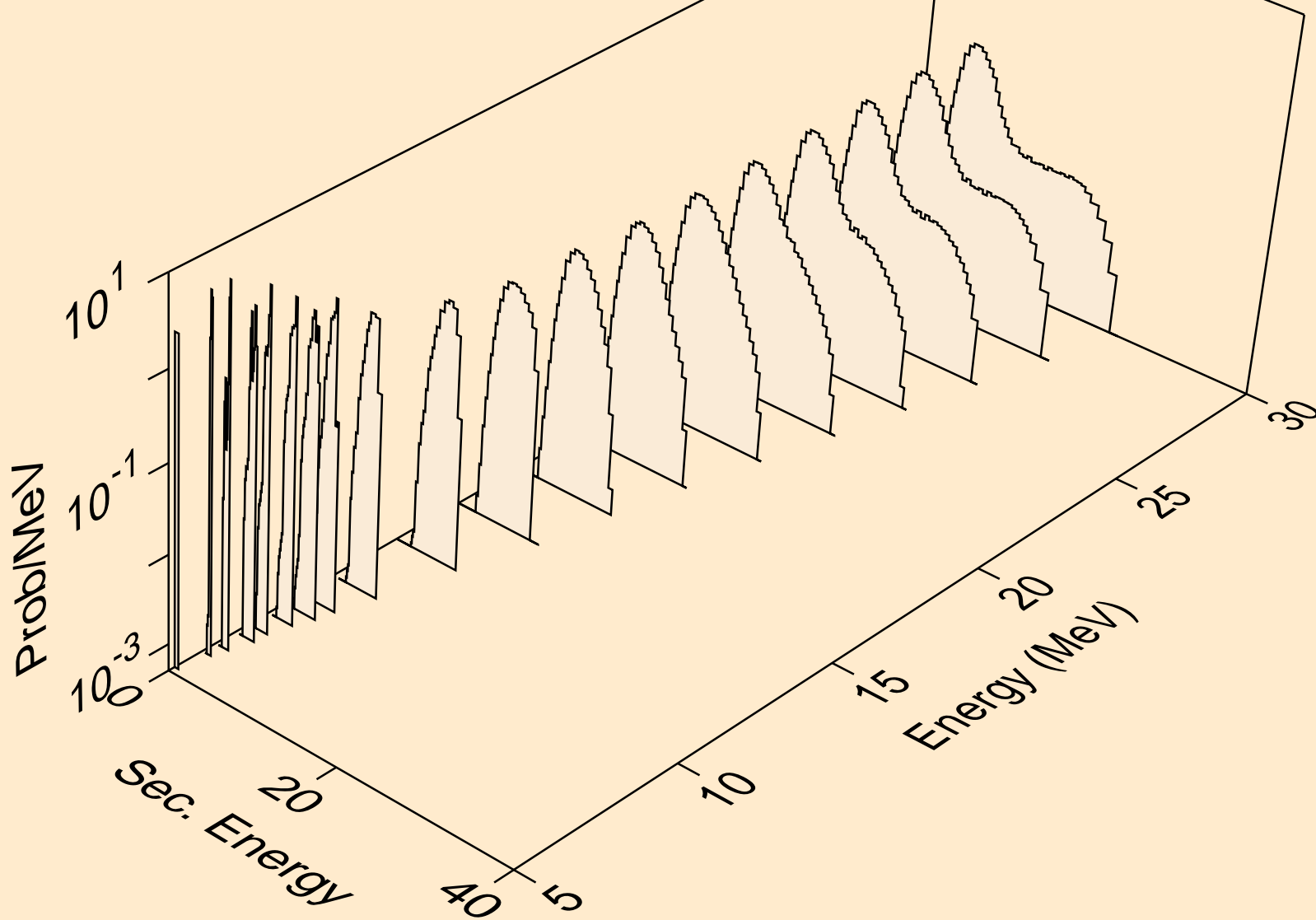

MO086 NEUTRON ACER TENDL-2019 LIBRARY; T=293.16K  
protons from (n,2np)

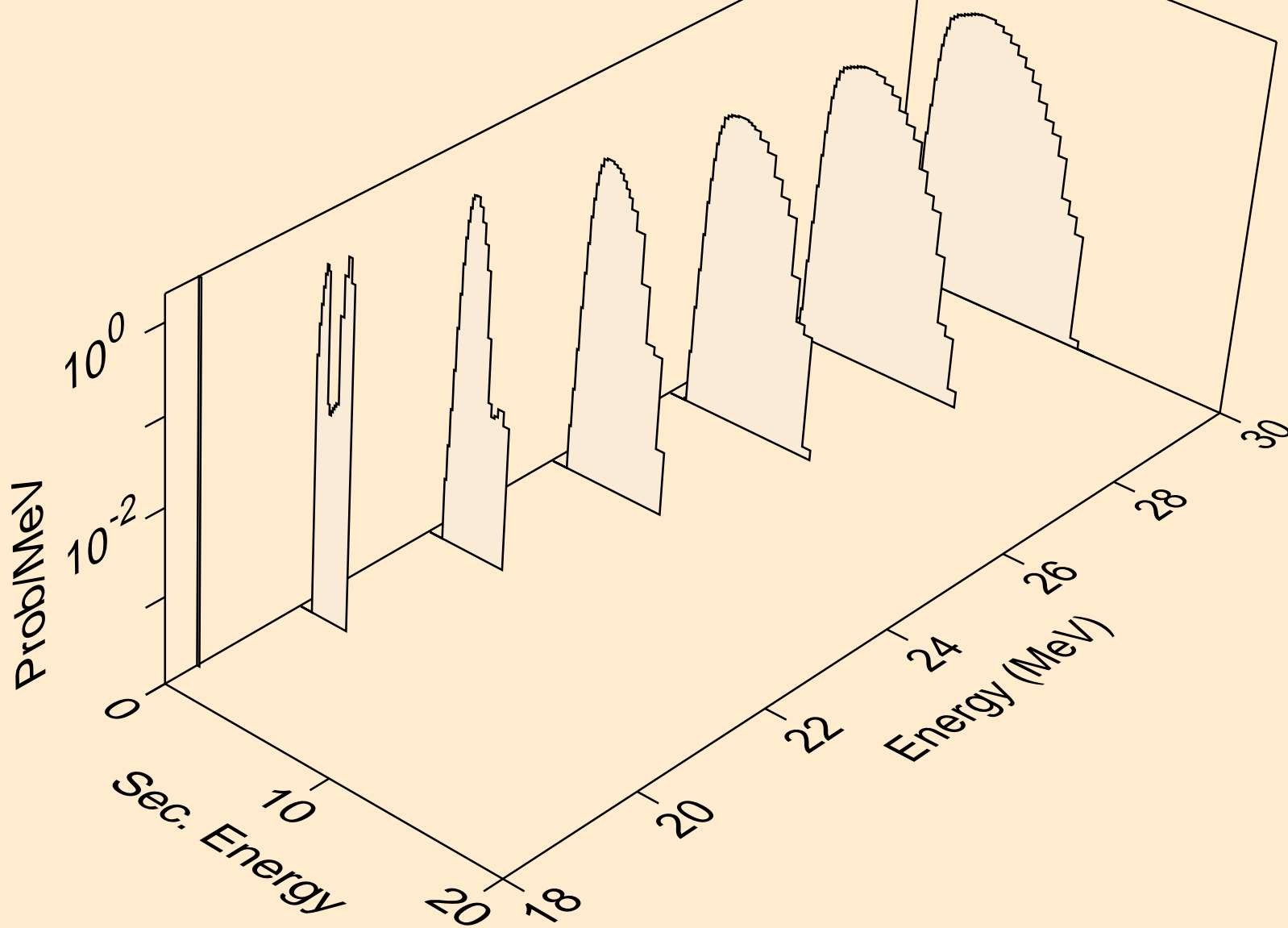

MO086 NEUTRON ACER TENDL-2019 LIBRARY; T=293.16K  
protons from (n,2np)

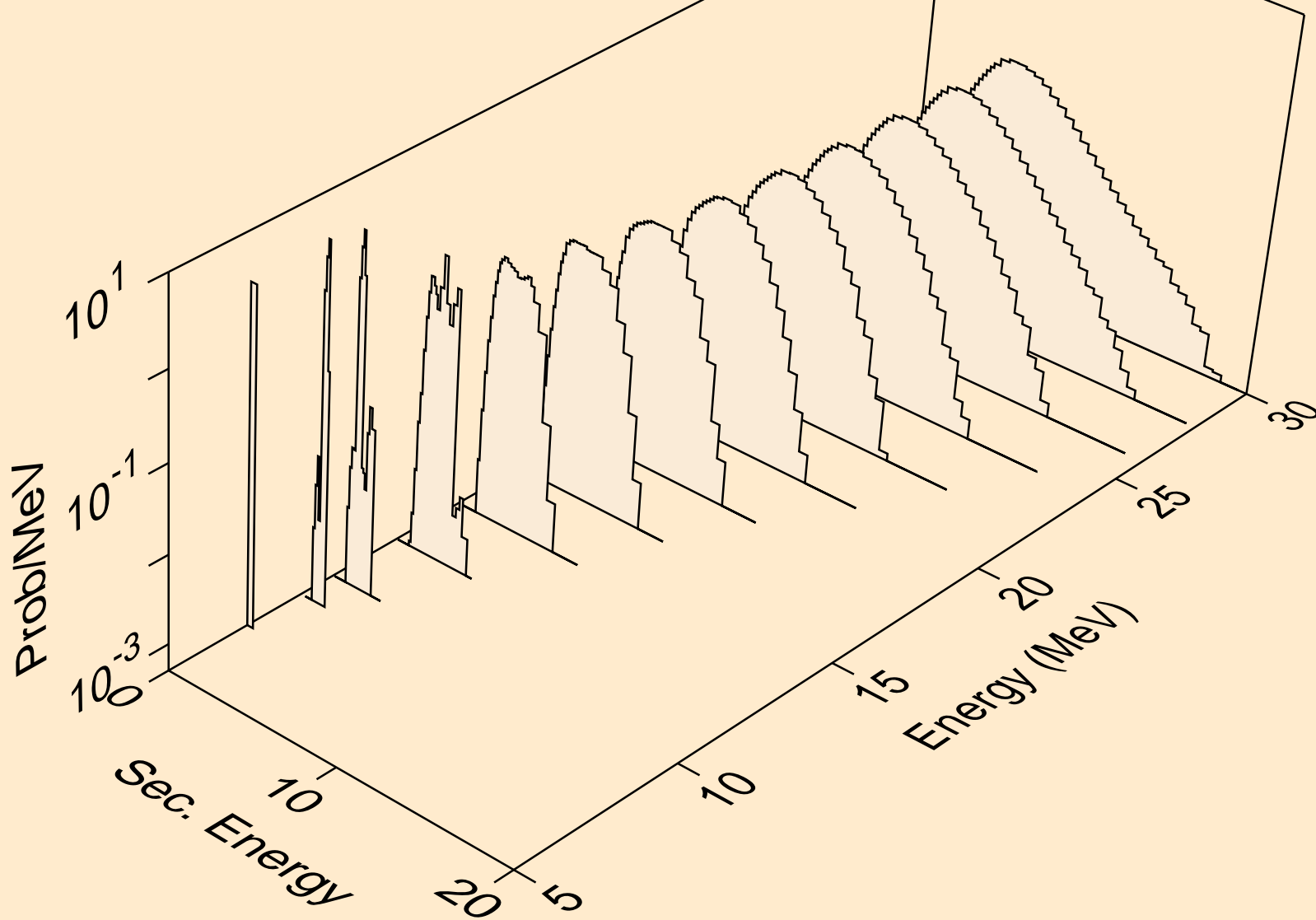

MO086 NEUTRON ACER TENDL-2019 LIBRARY; T=293.16K  
protons from (n,npa)

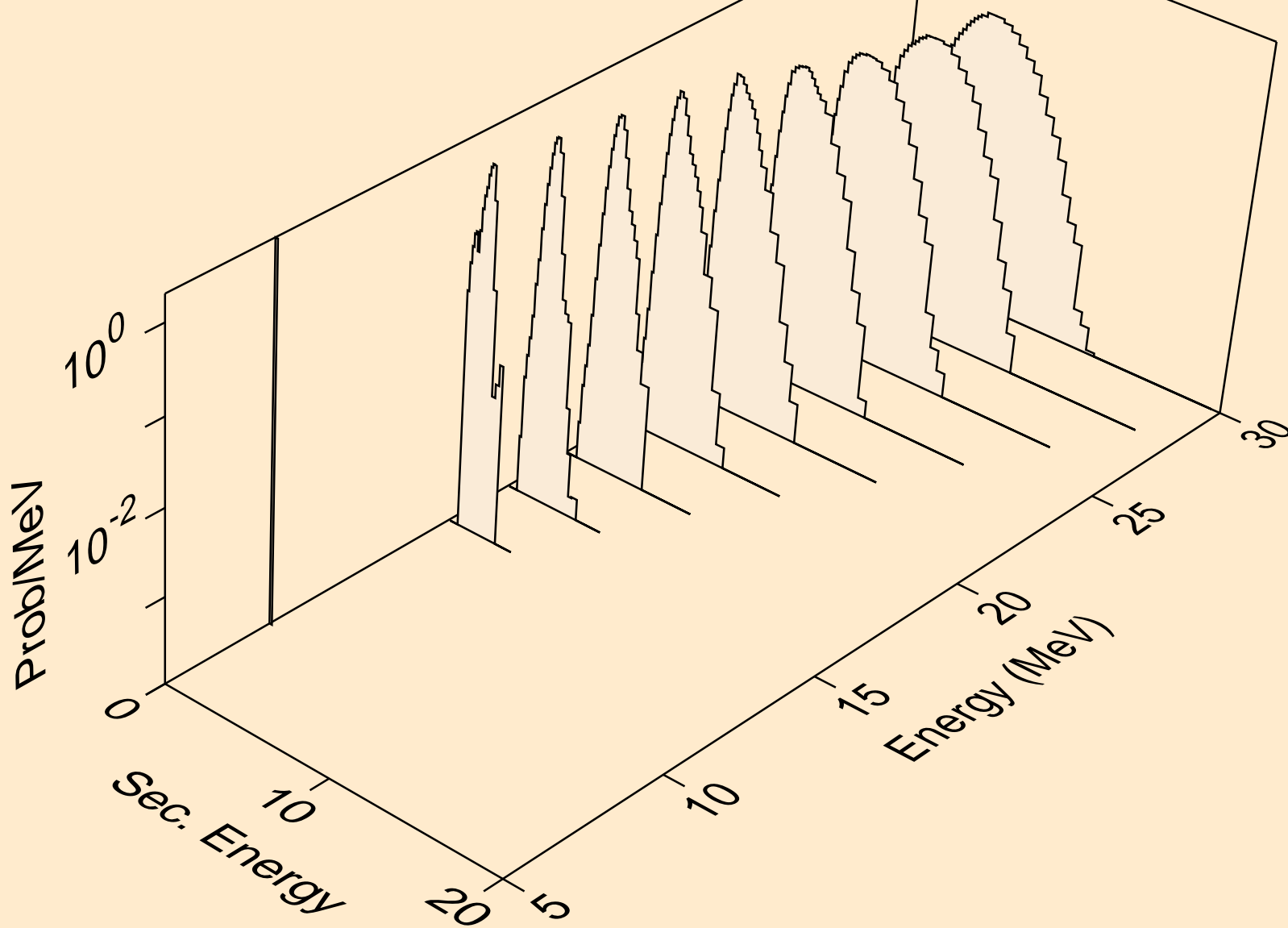



MO086 NEUTRON ACER TENDL-2019 LIBRARY; T=293.16K  
protons from (n,p)

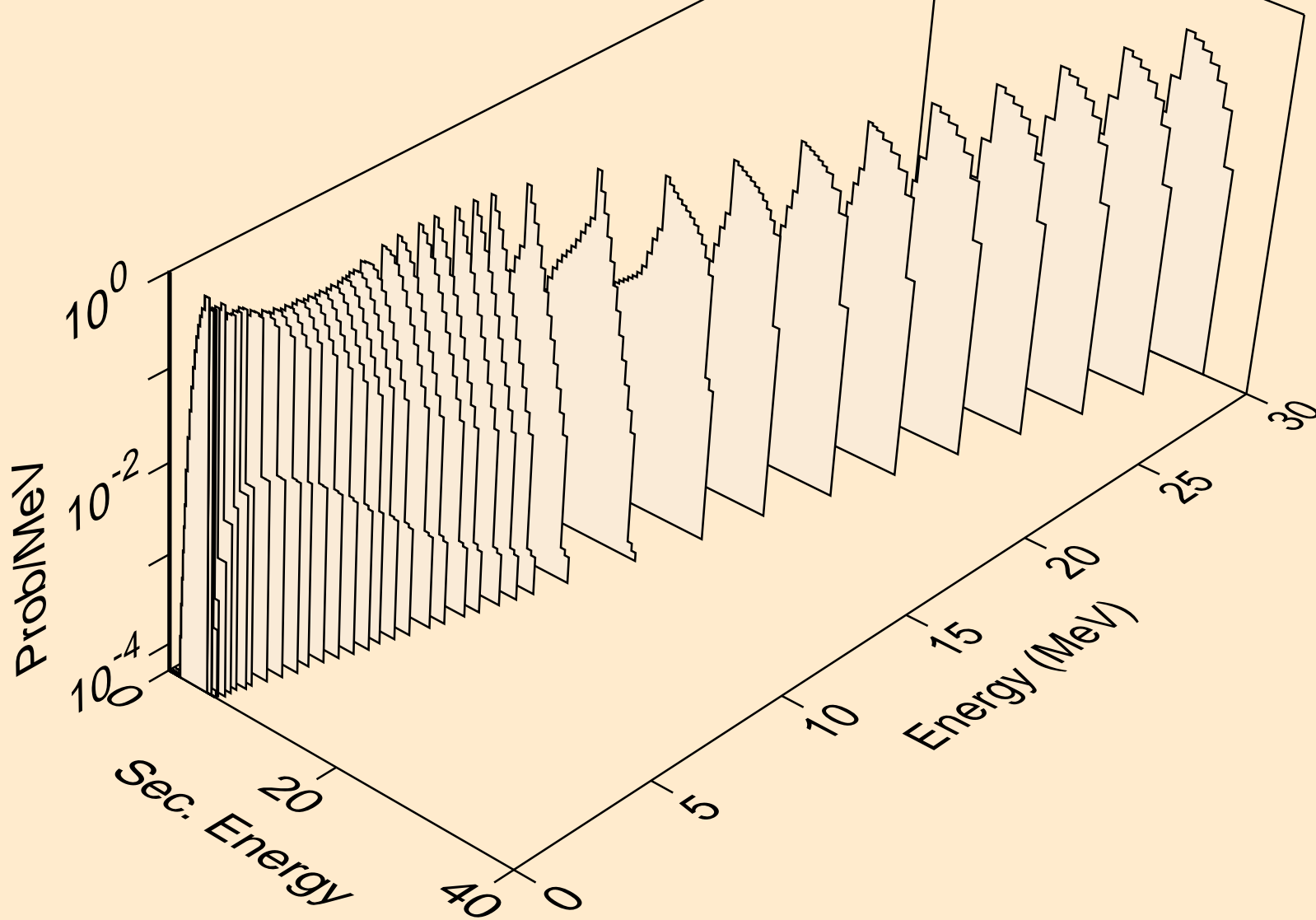

MO086 NEUTRON ACER TENDL-2019 LIBRARY; T=293.16K  
protons from (n,2p)

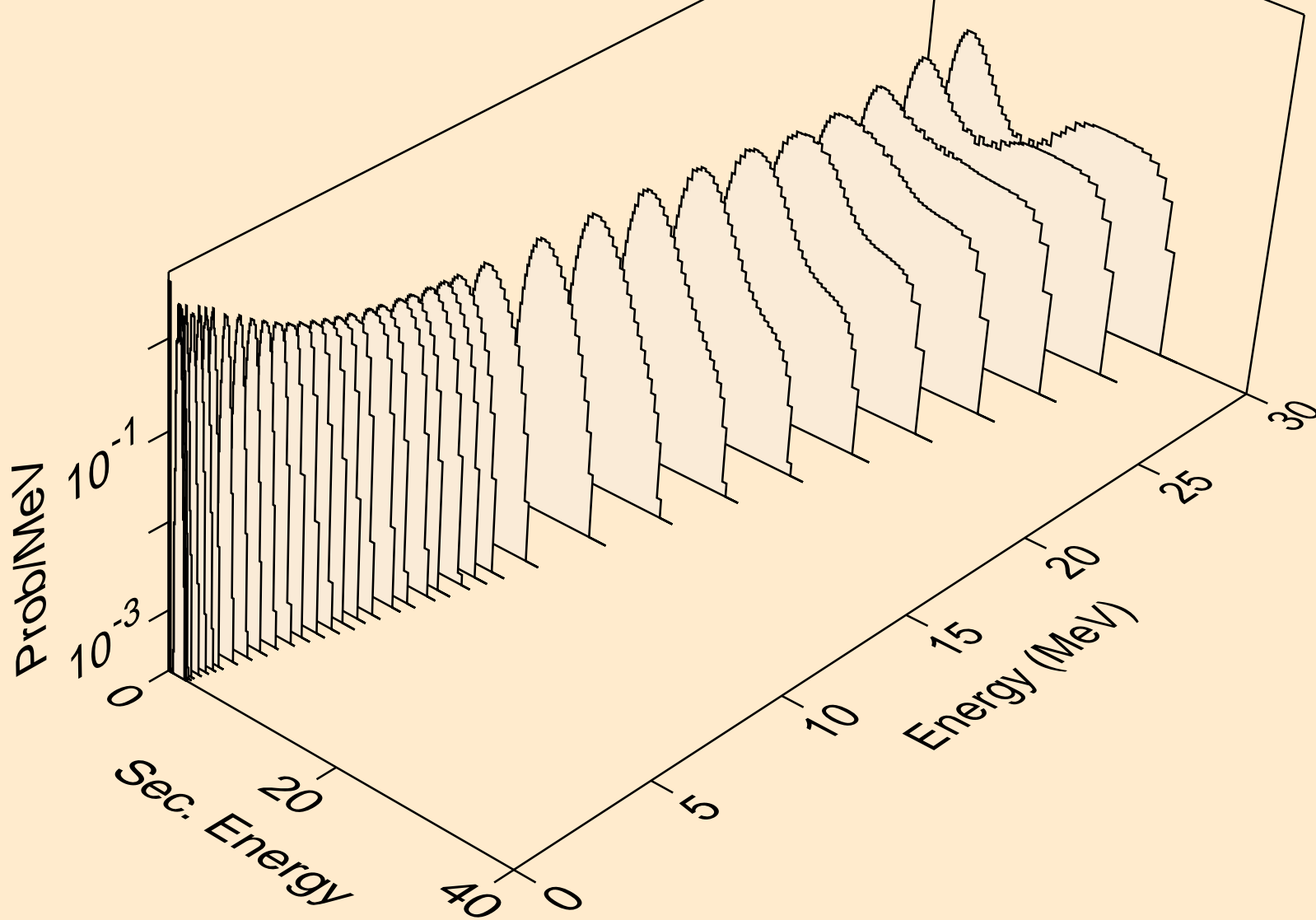

MO086 NEUTRON ACER TENDL-2019 LIBRARY; T=293.16K  
protons from (n,p)

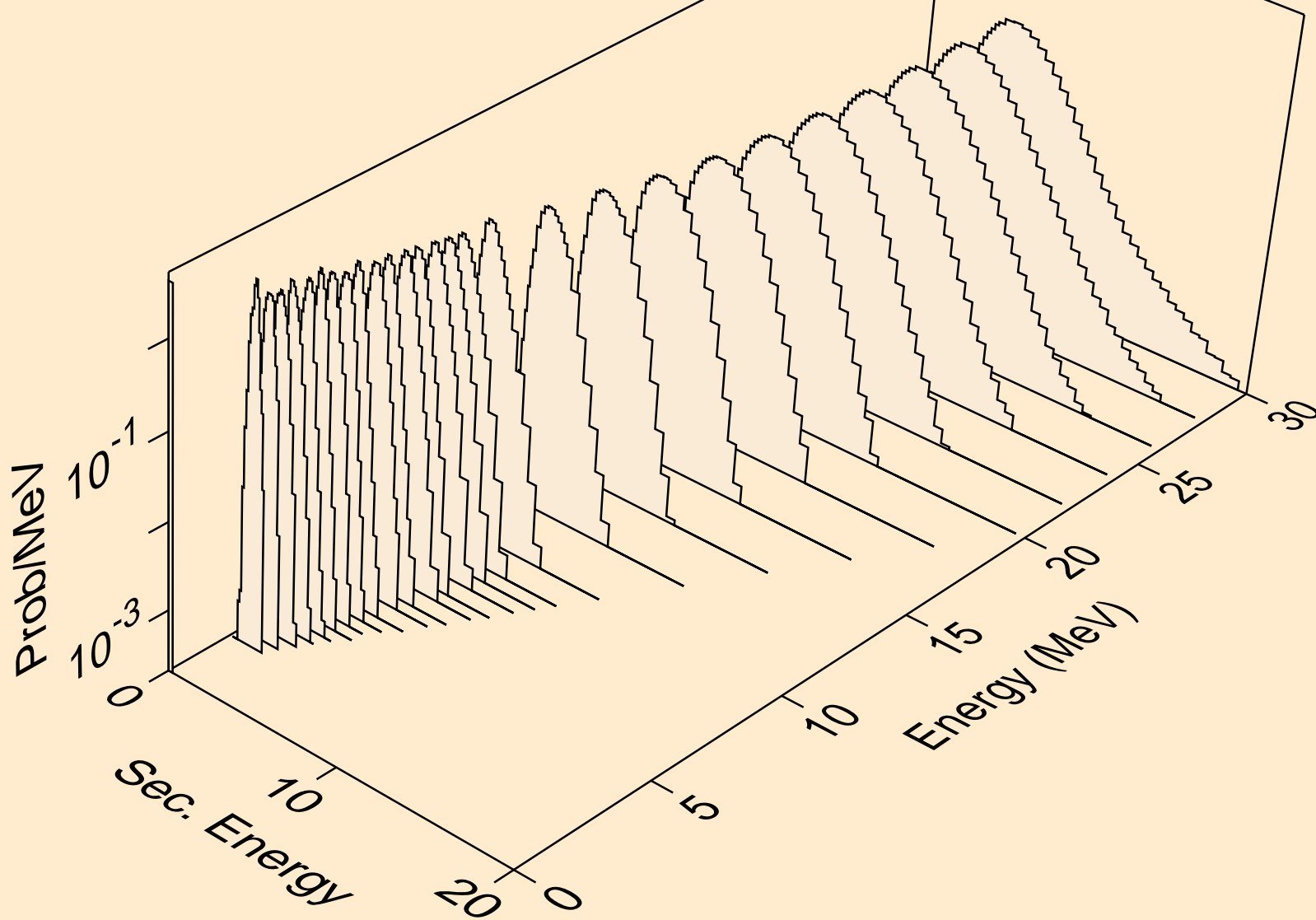

MO086 NEUTRON ACER TENDL-2019 LIBRARY; T=293.16K  
protons from (n,pd)

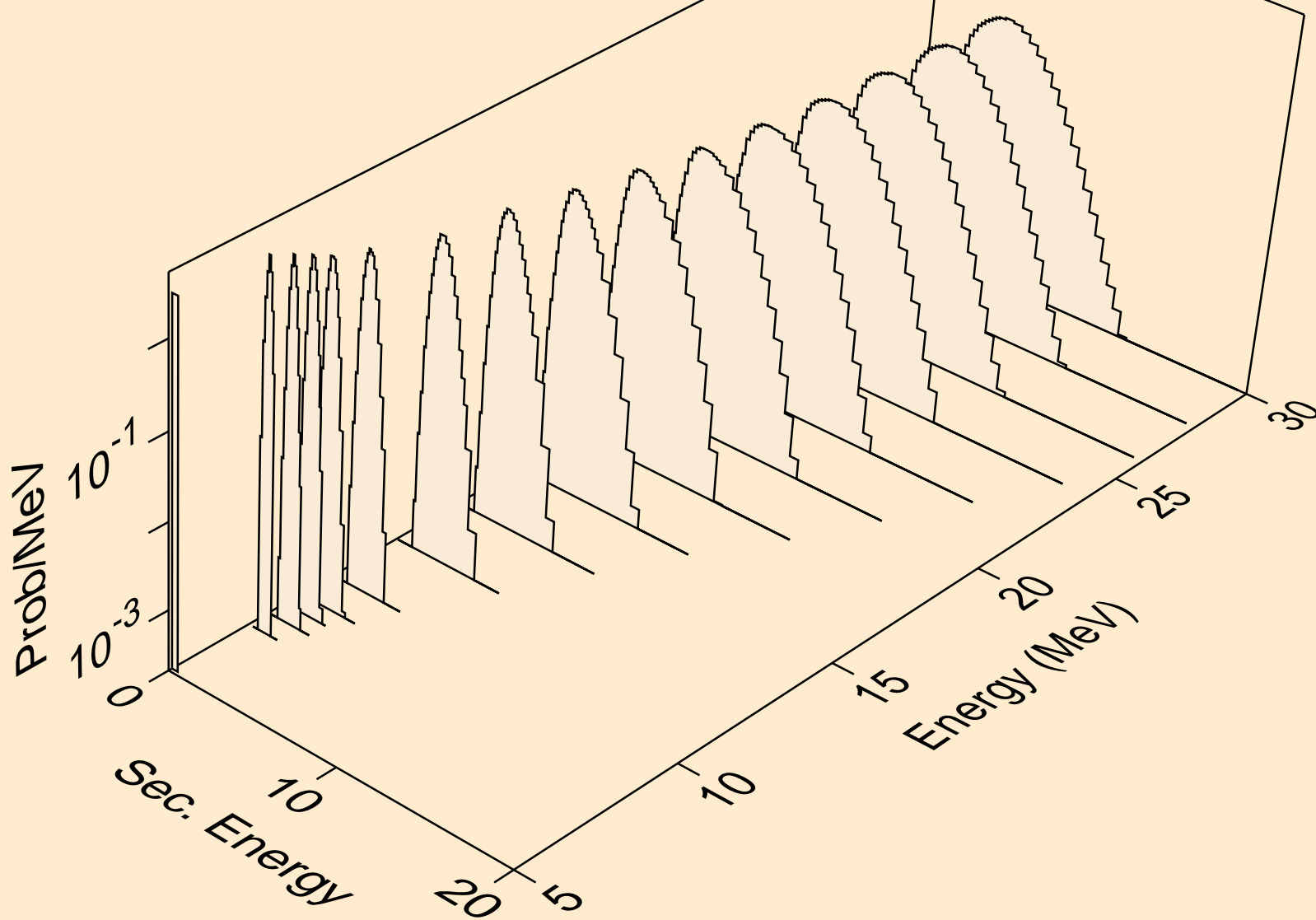

MO086 NEUTRON ACER TENDL-2019 LIBRARY; T=293.16K  
protons from (n,pt)

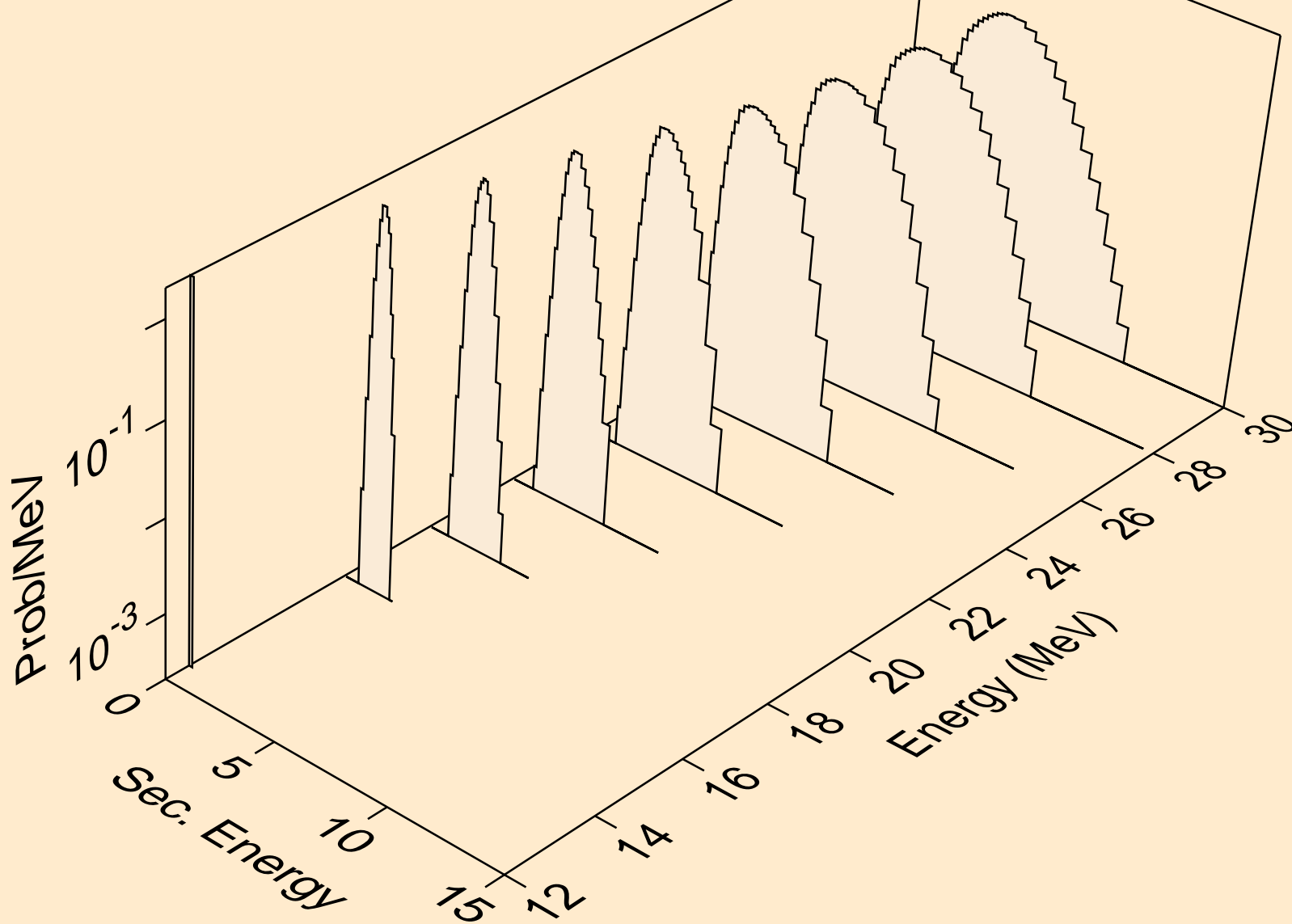

MO086 NEUTRON ACER TENDL-2019 LIBRARY; T=293.16K  
deuterons from (n,x)

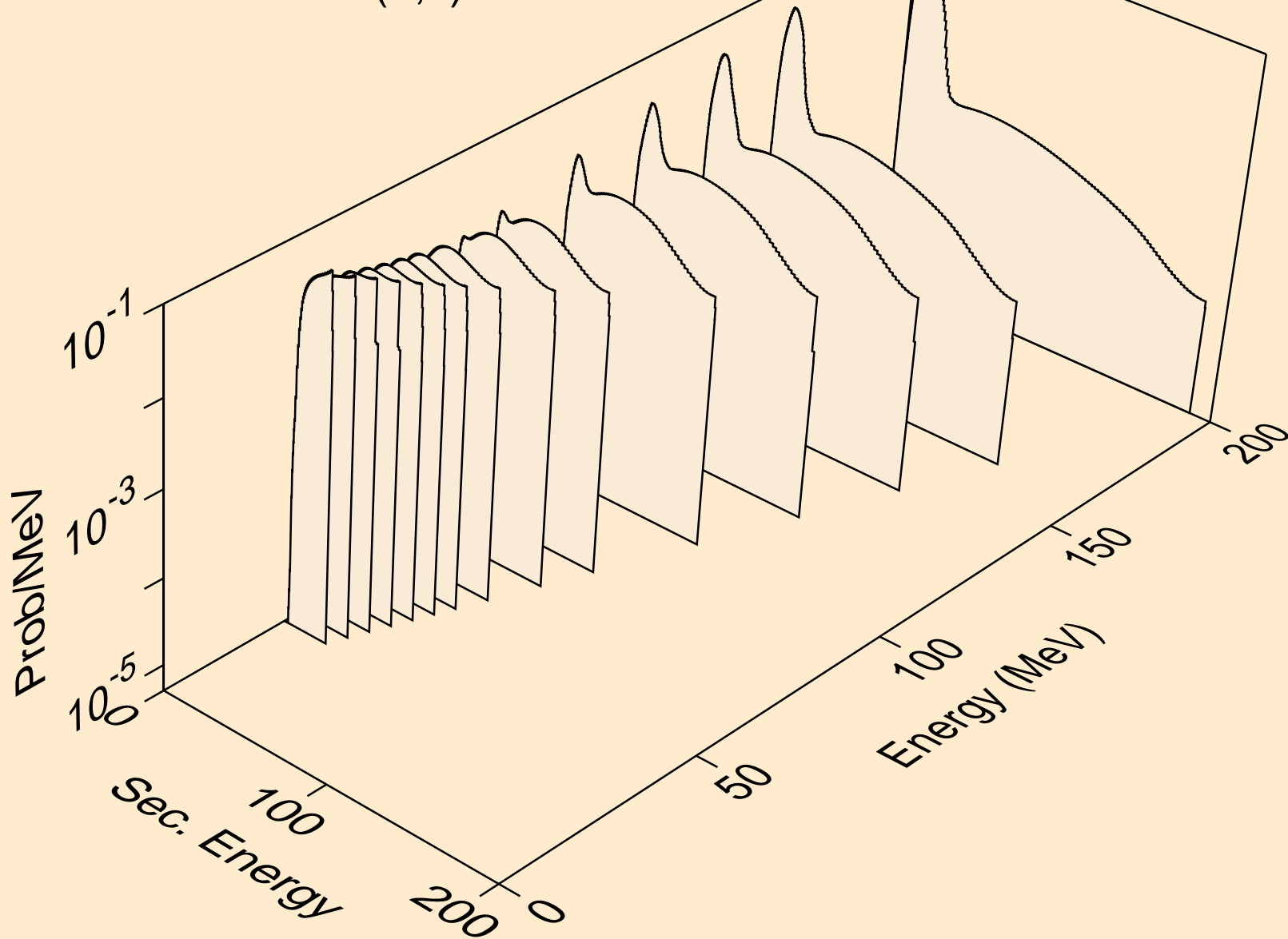

MO086 NEUTRON ACER TENDL-2019 LIBRARY; T=293.16K  
deuterons from (n,n\*)d

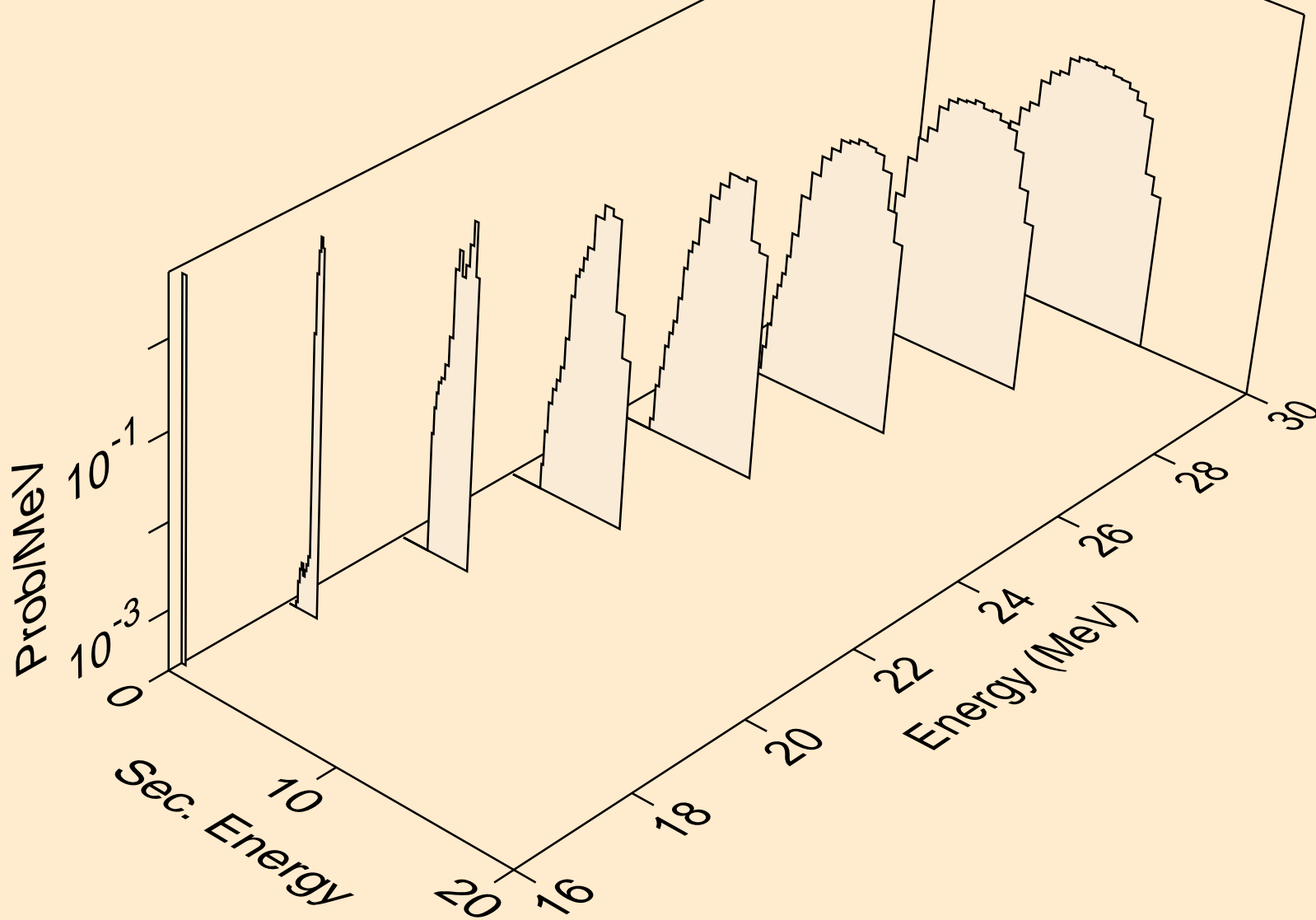

MO086 NEUTRON ACER TENDL-2019 LIBRARY; T=293.16K  
deuterons from (n,d)

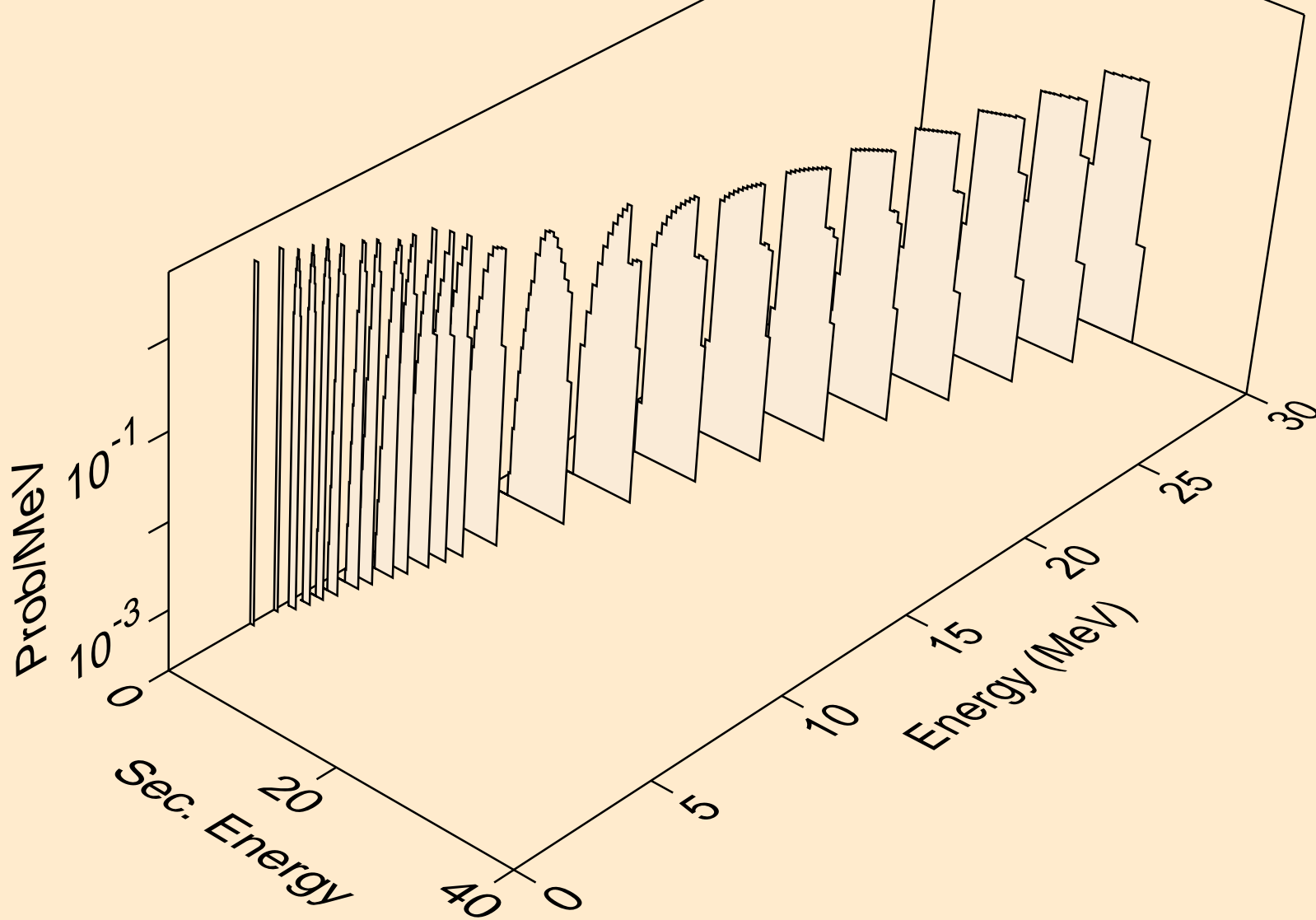



MO086 NEUTRON ACER TENDL-2019 LIBRARY; T=293.16K  
deuterons from (n,pd)

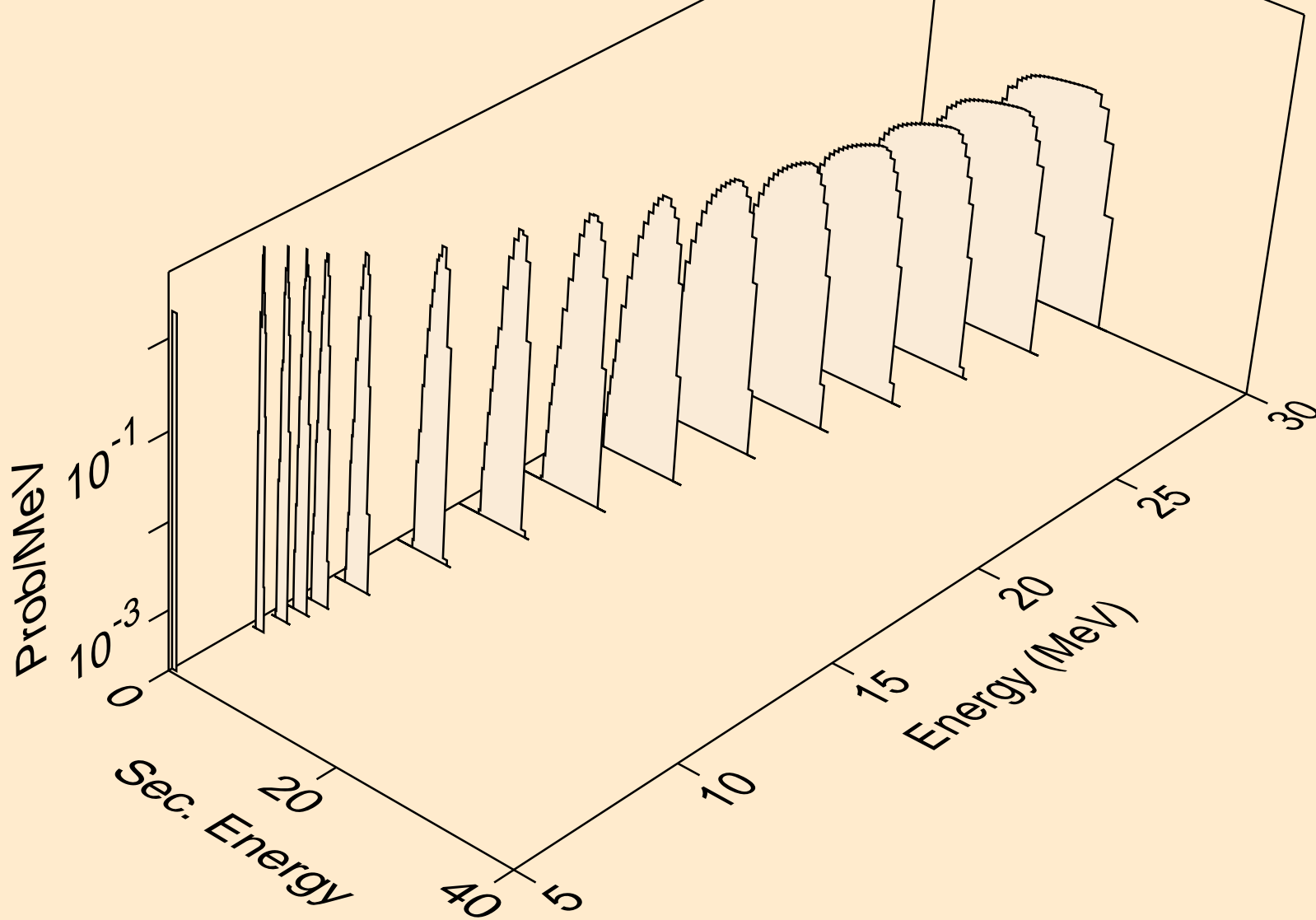

MO086 NEUTRON ACER TENDL-2019 LIBRARY; T=293.16K  
deuterons from (n,da)

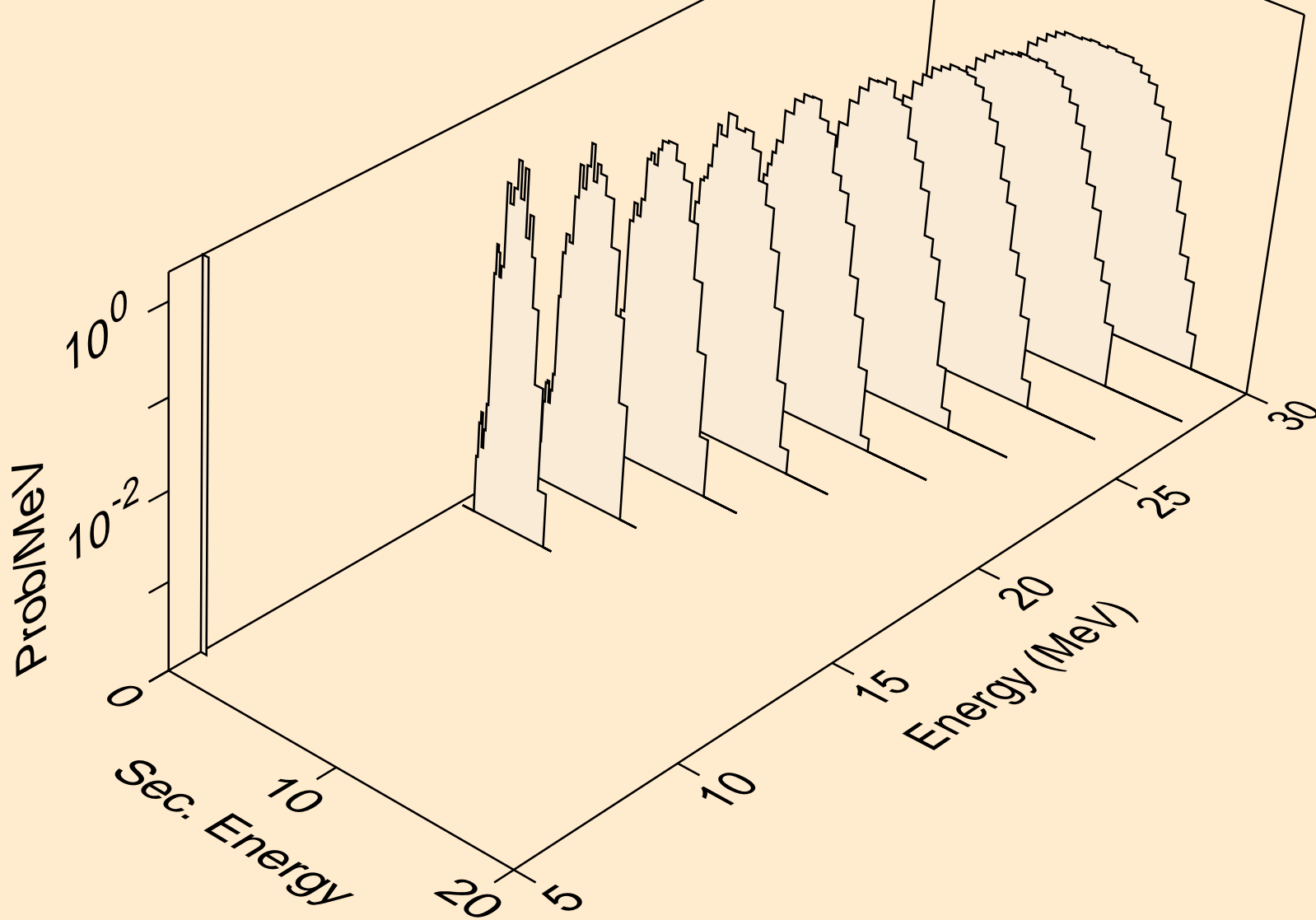

MO086 NEUTRON ACER TENDL-2019 LIBRARY; T=293.16K  
tritons from (n,x)

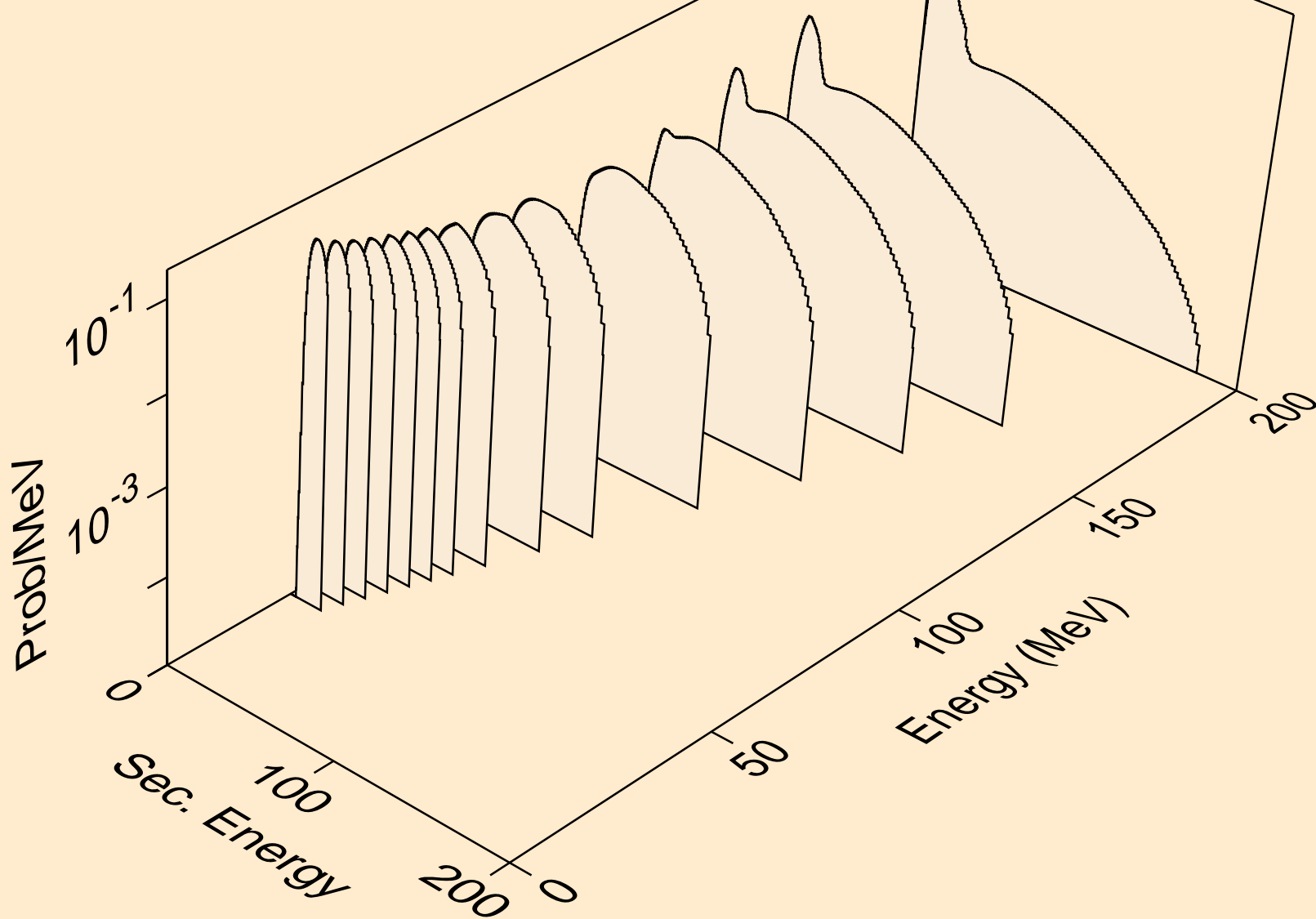

MO086 NEUTRON ACER TENDL-2019 LIBRARY; T=293.16K  
tritons from (n,n\*)t

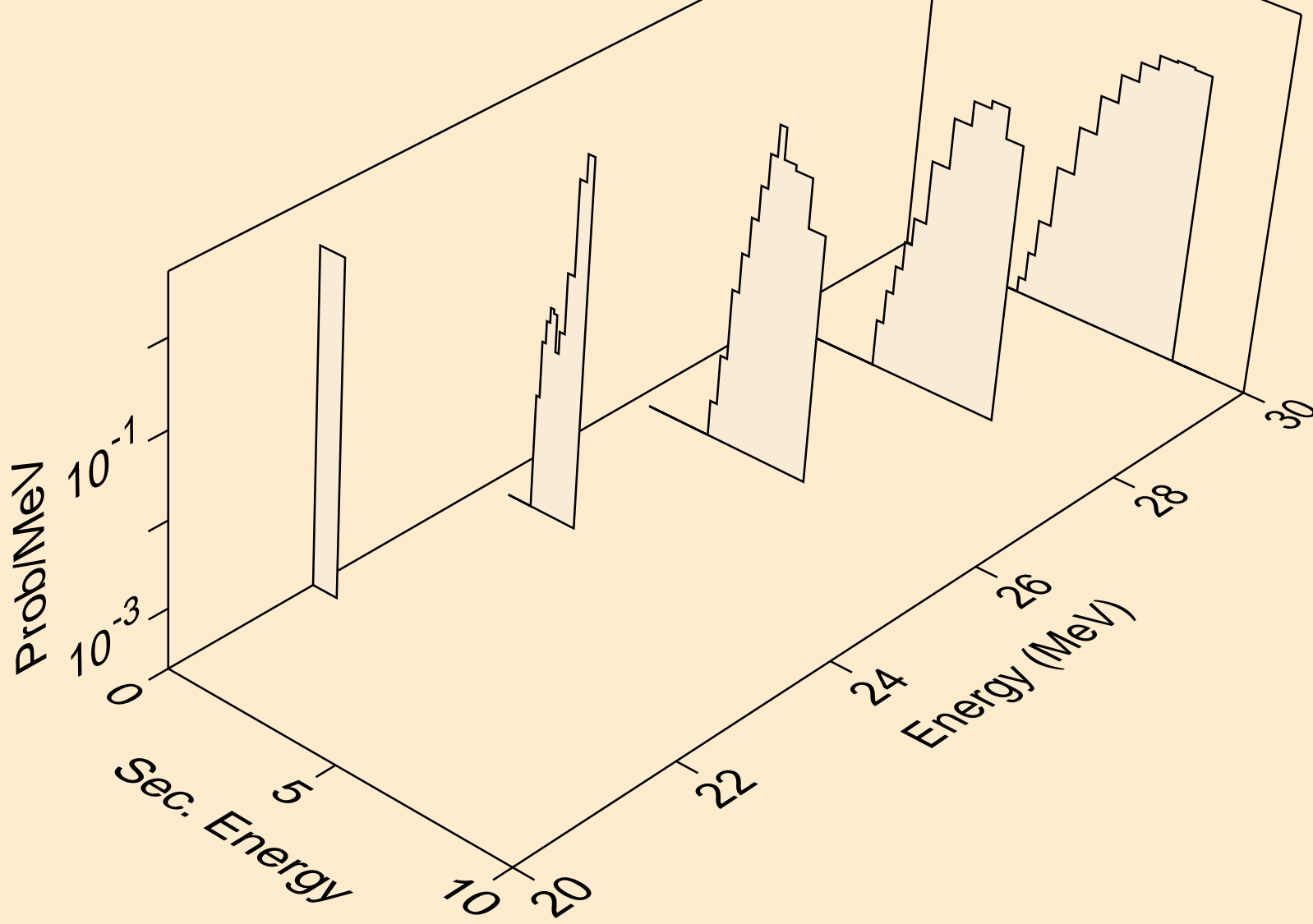

MO086 NEUTRON ACER TENDL-2019 LIBRARY; T=293.16K  
tritons from (n,t)

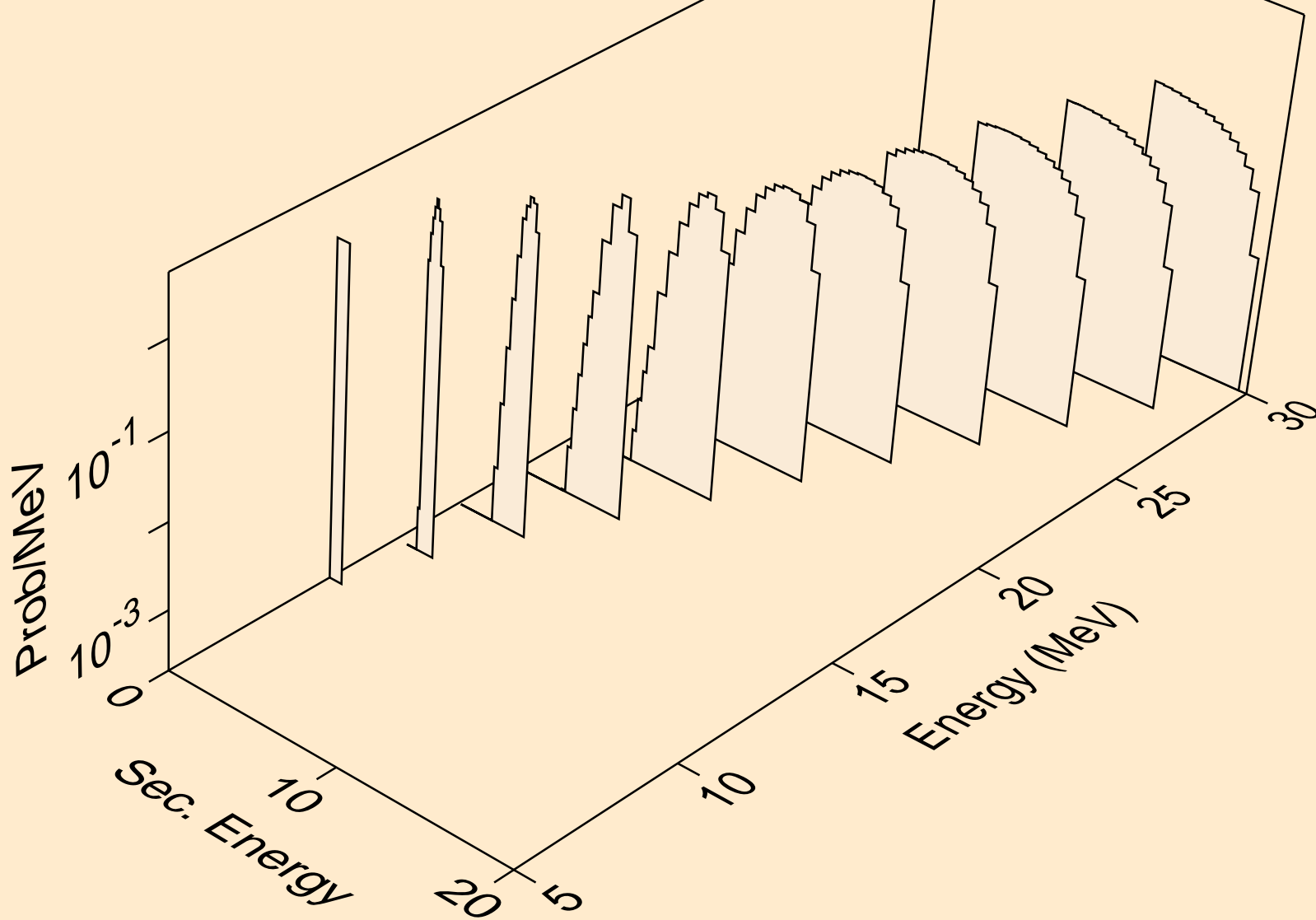

MO086 NEUTRON ACER TENDL-2019 LIBRARY; T=293.16K  
tritons from (n,pt)

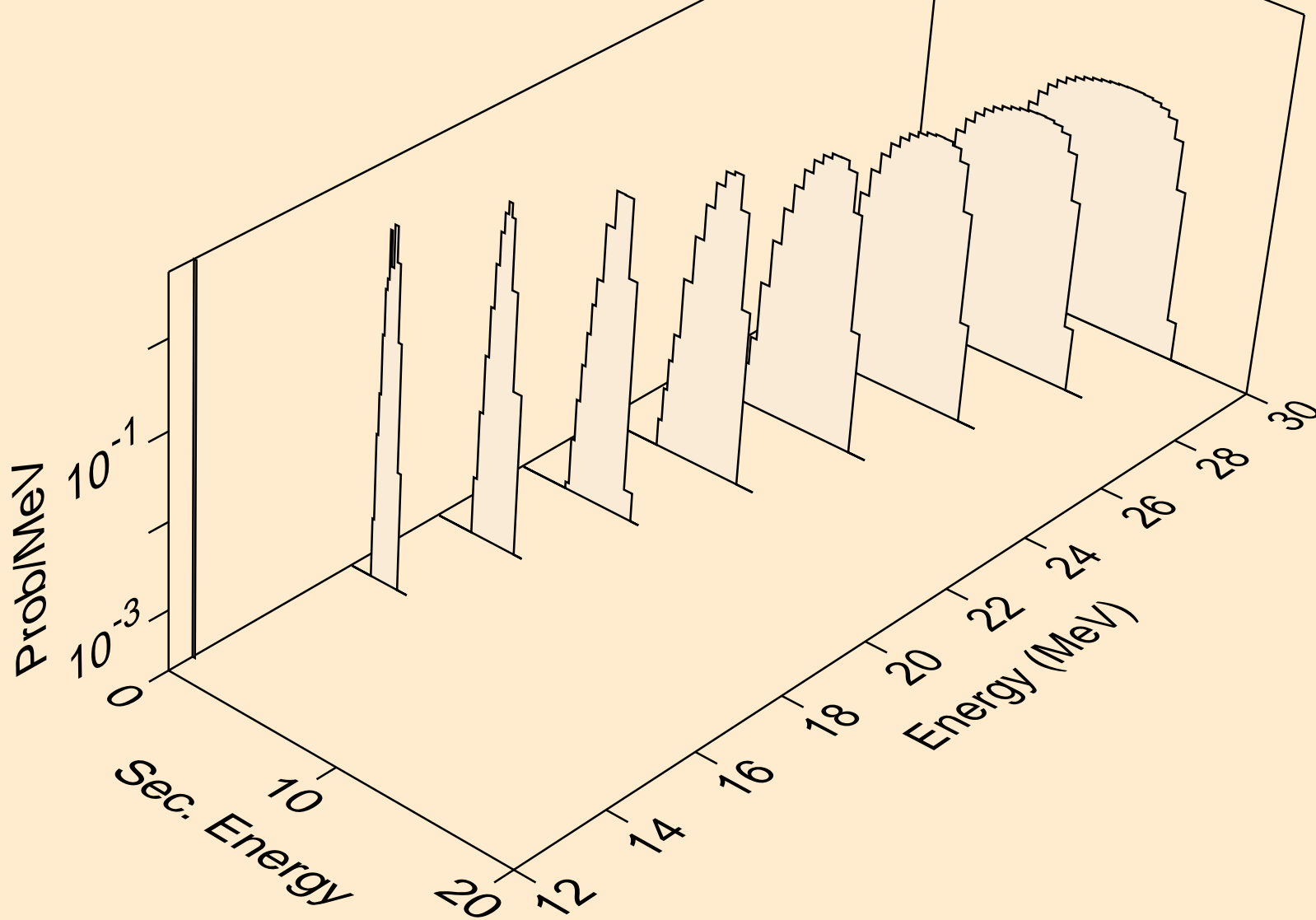

MO086 NEUTRON ACER TENDL-2019 LIBRARY; T=293.16K  
he3s from (n,x)

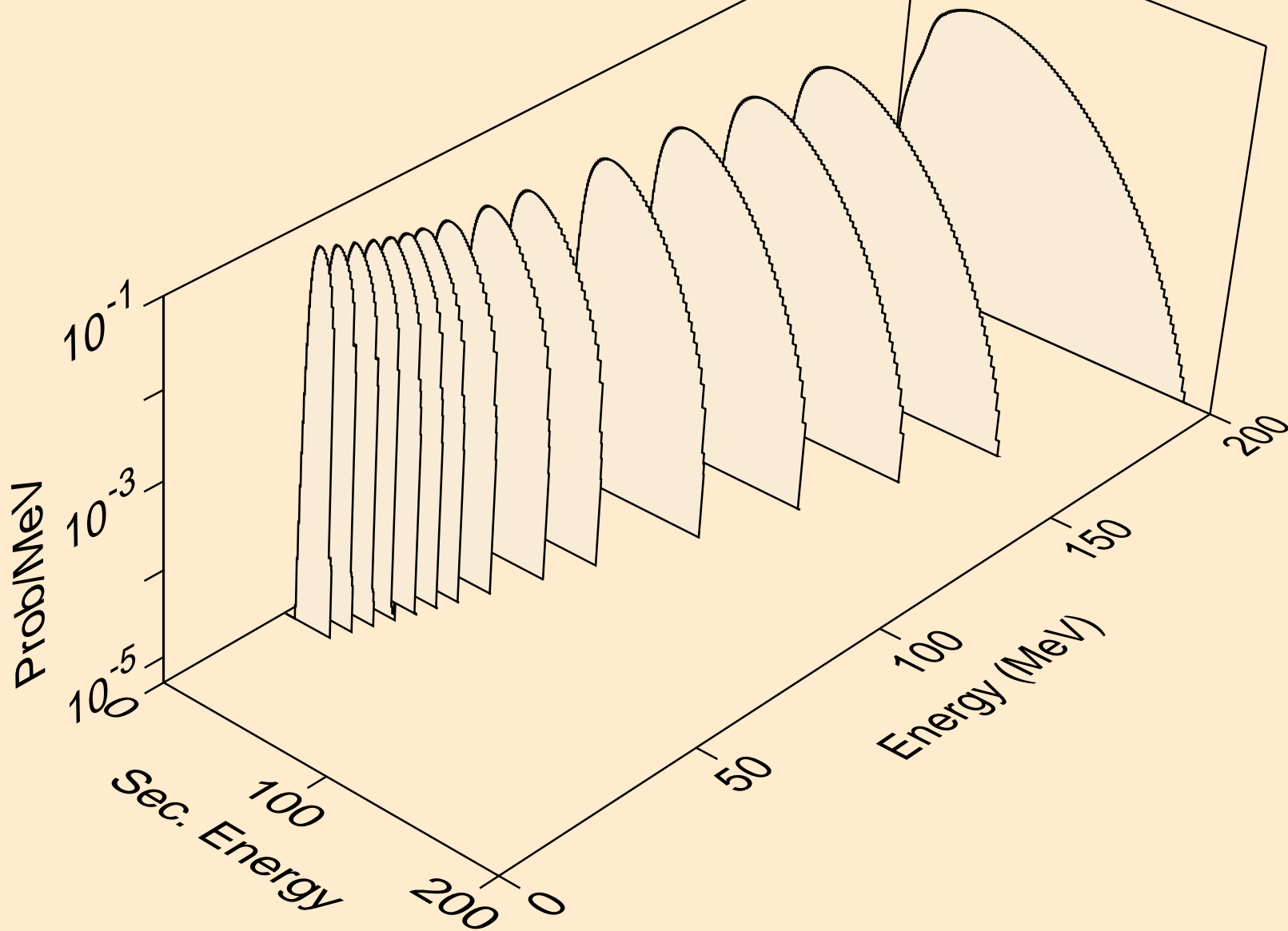

MO086 NEUTRON ACER TENDL-2019 LIBRARY; T=293.16K  
he3s from (n,n\*)he3

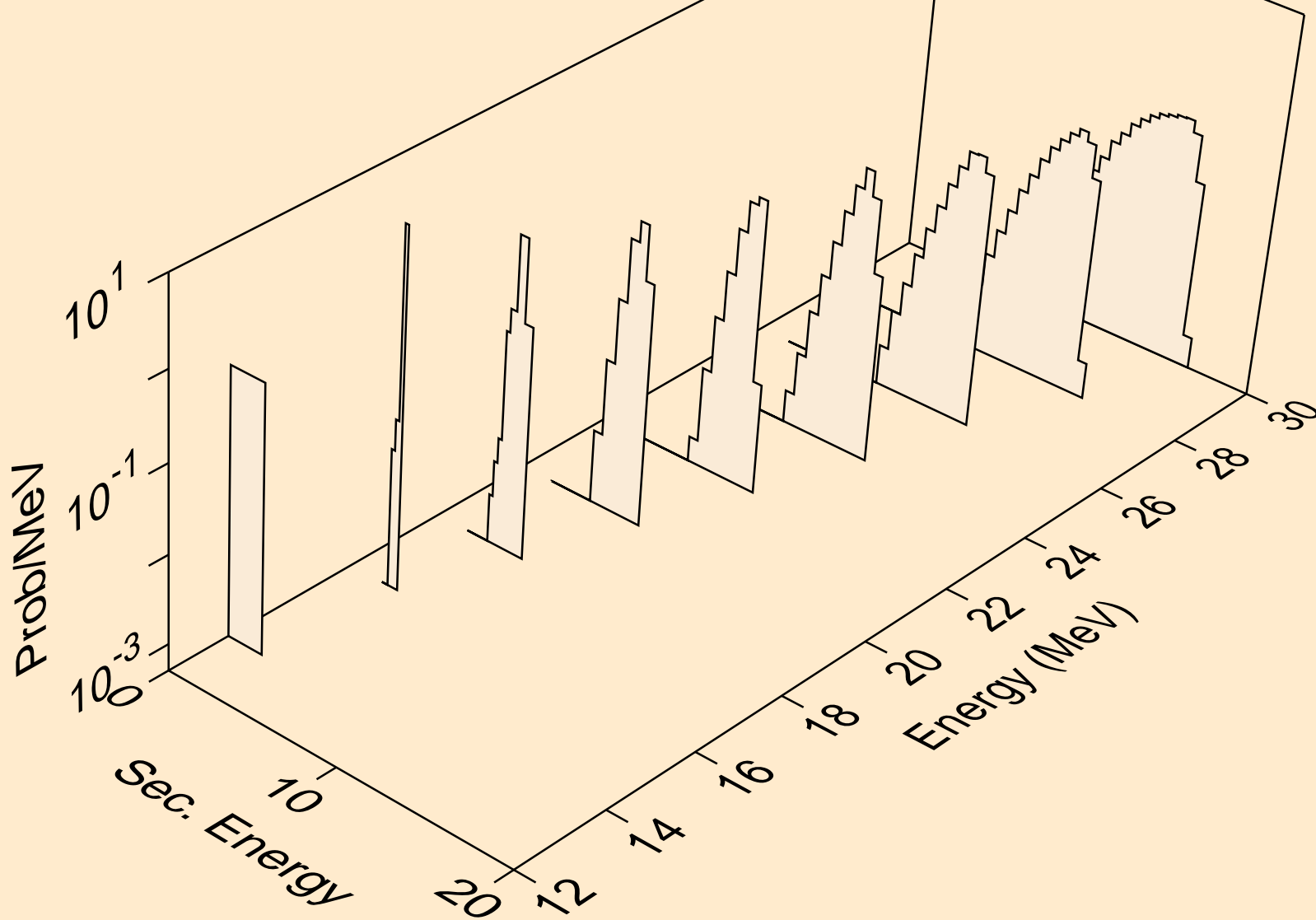



MO086 NEUTRON ACER TENDL-2019 LIBRARY; T=293.16K  
he3s from (n,he3)

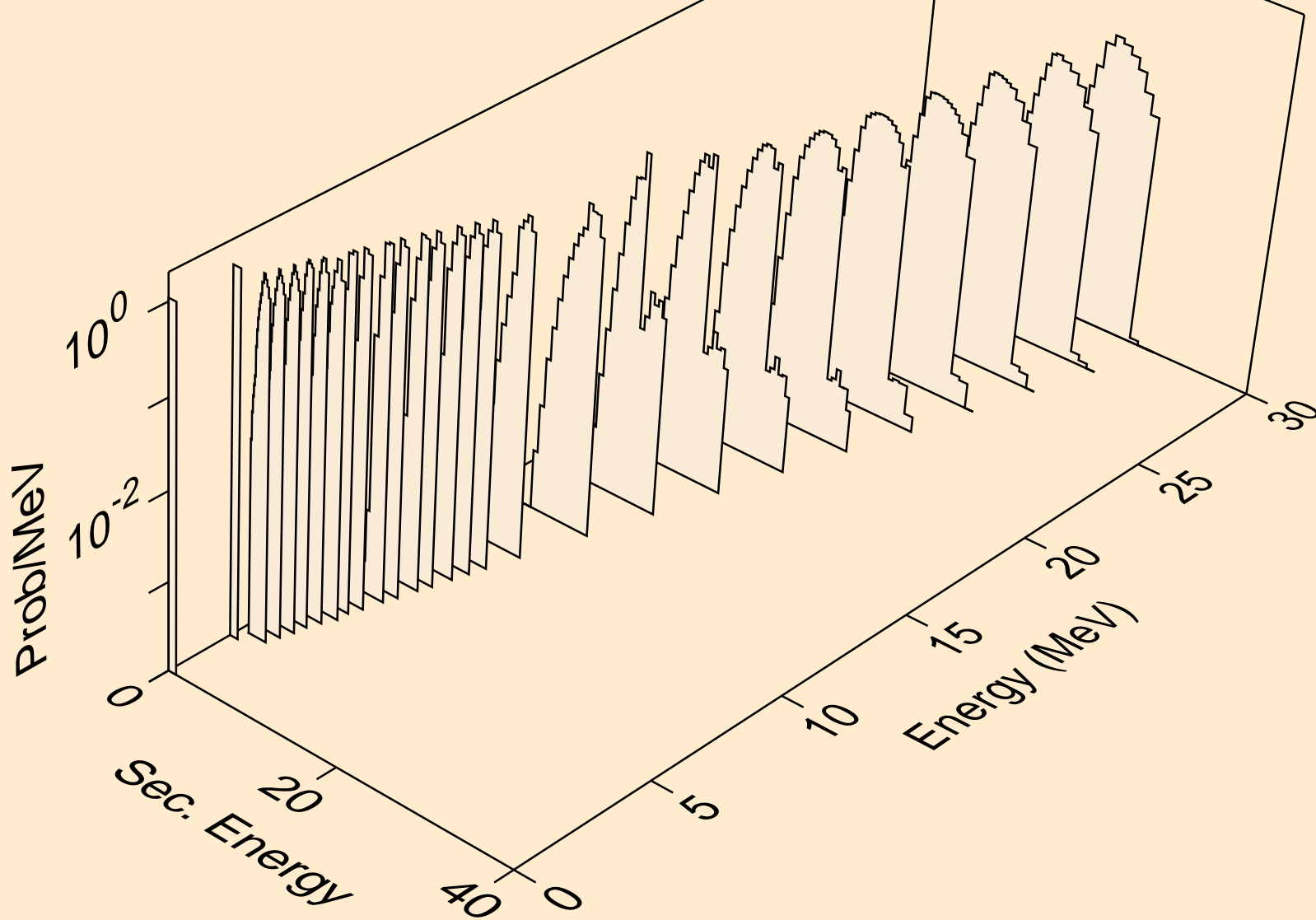

MO086 NEUTRON ACER TENDL-2019 LIBRARY; T=293.16K  
alphas from (n,x)

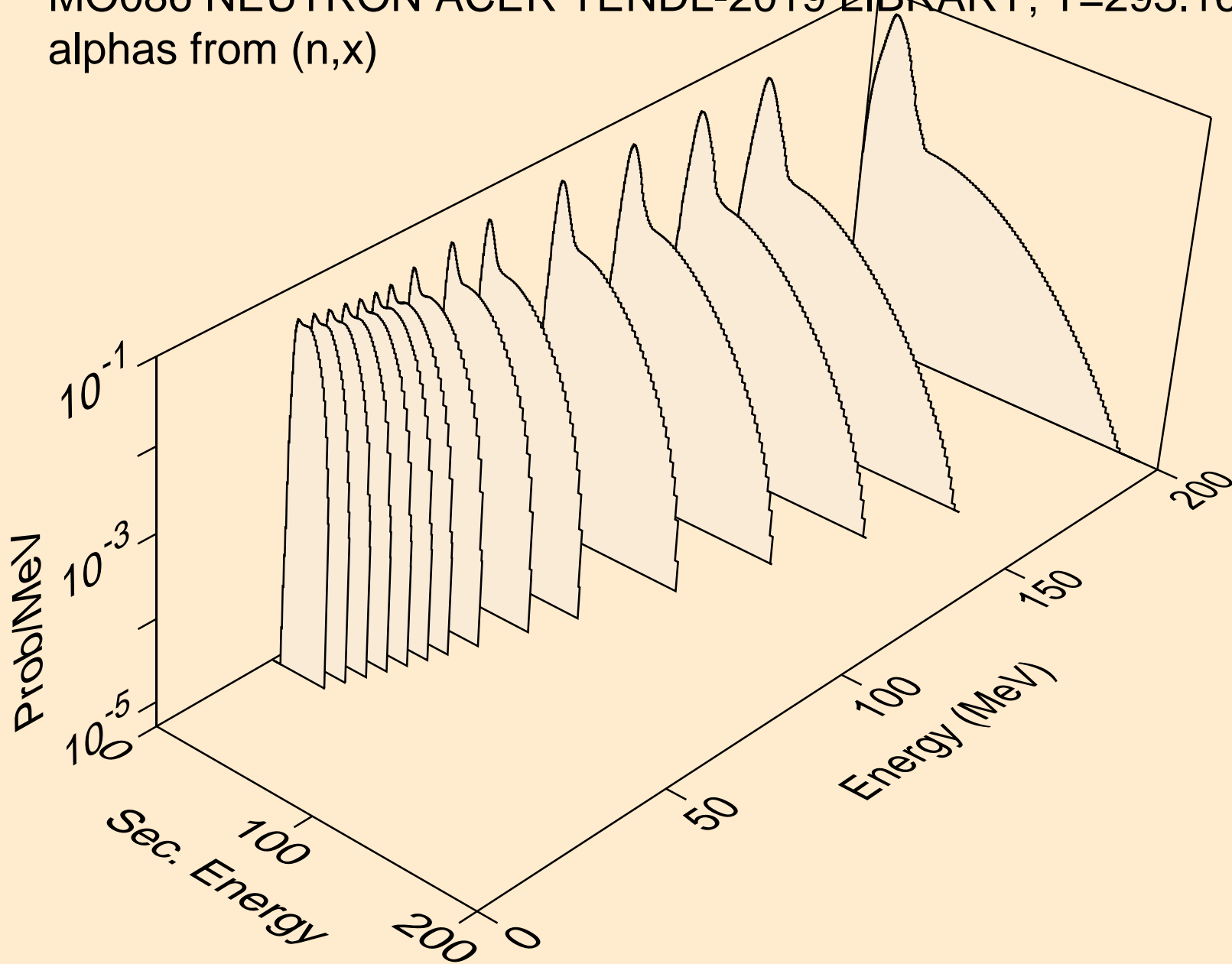

MO086 NEUTRON ACER TENDL-2019 LIBRARY; T=293.16K  
alphas from (n,n\*)a

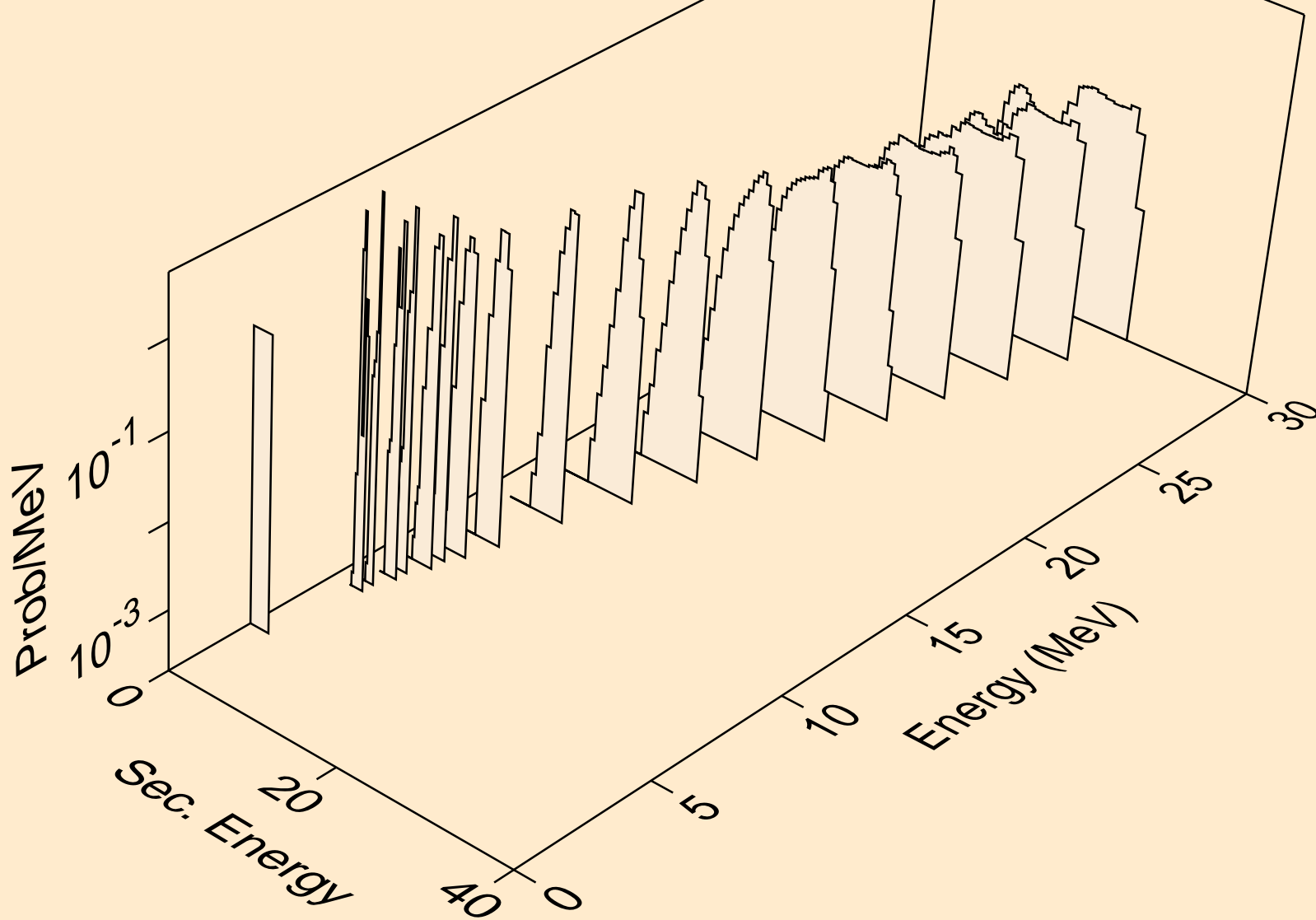

MO086 NEUTRON ACER TENDL-2019 LIBRARY; T=293.16K  
alphas from (n,2n)a

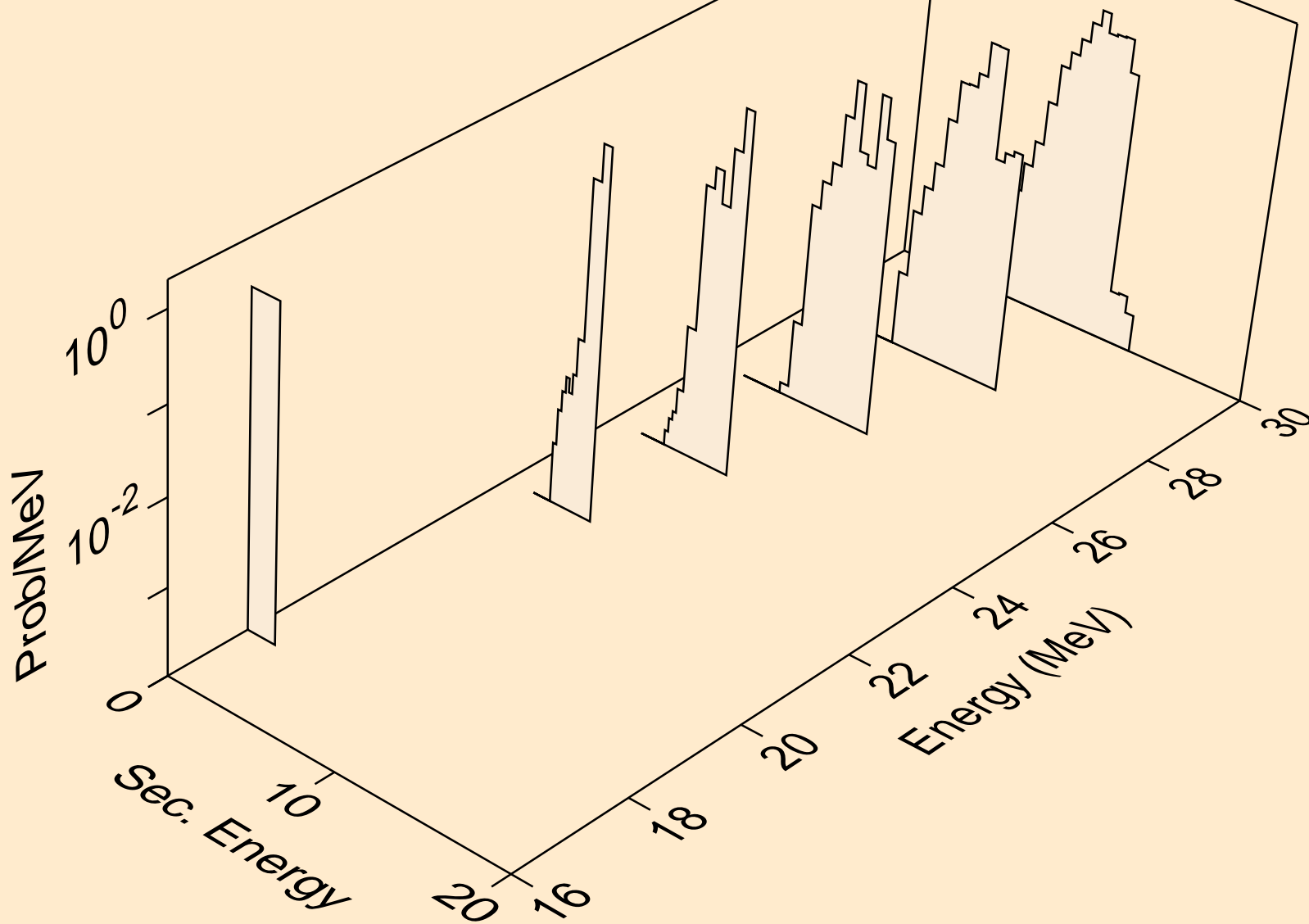

MO086 NEUTRON ACER TENDL-2019 LIBRARY; T=293.16K  
alphas from (n,n\*)2a

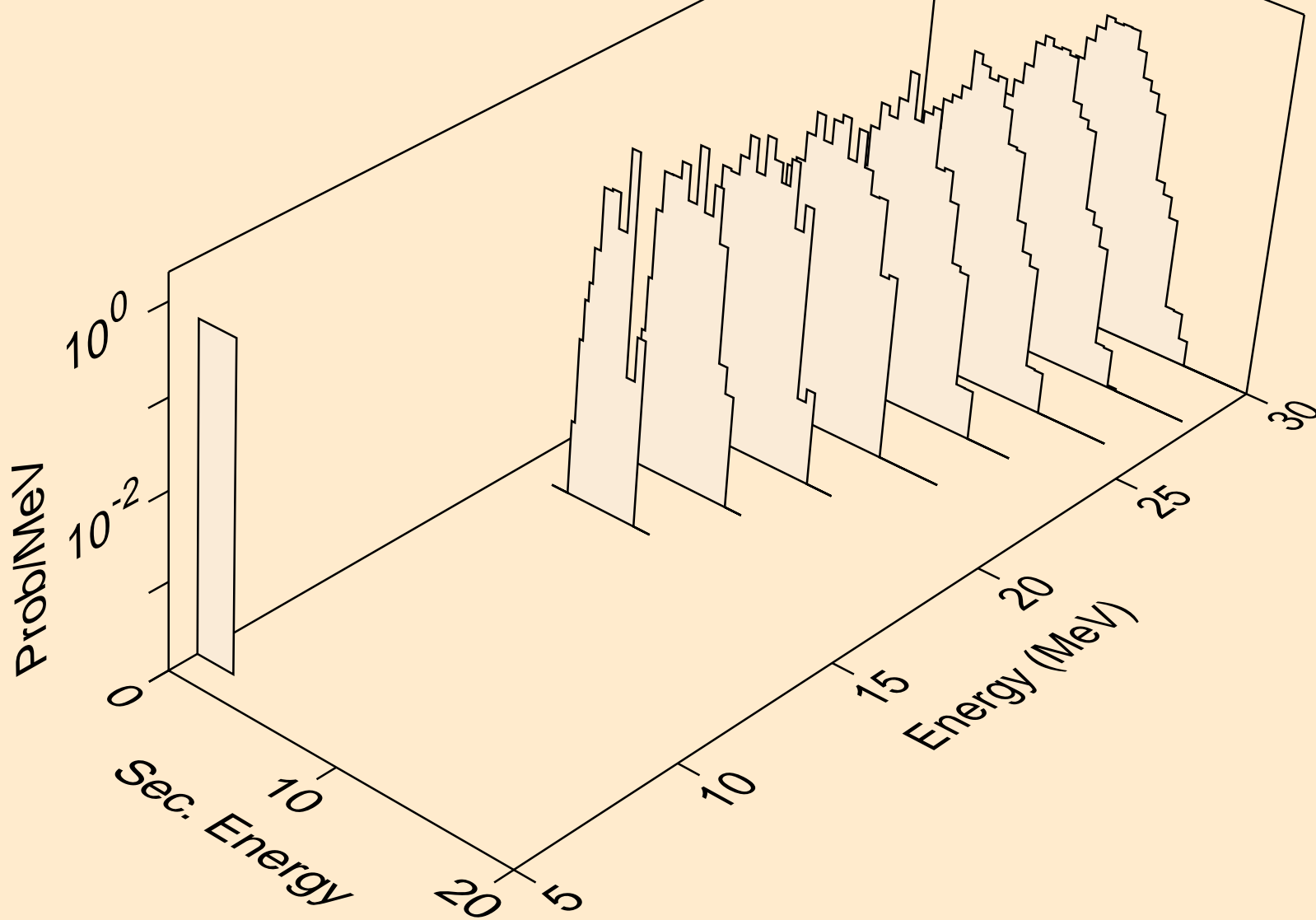

MO086 NEUTRON ACER TENDL-2019 LIBRARY; T=293.16K  
alphas from (n,npa)

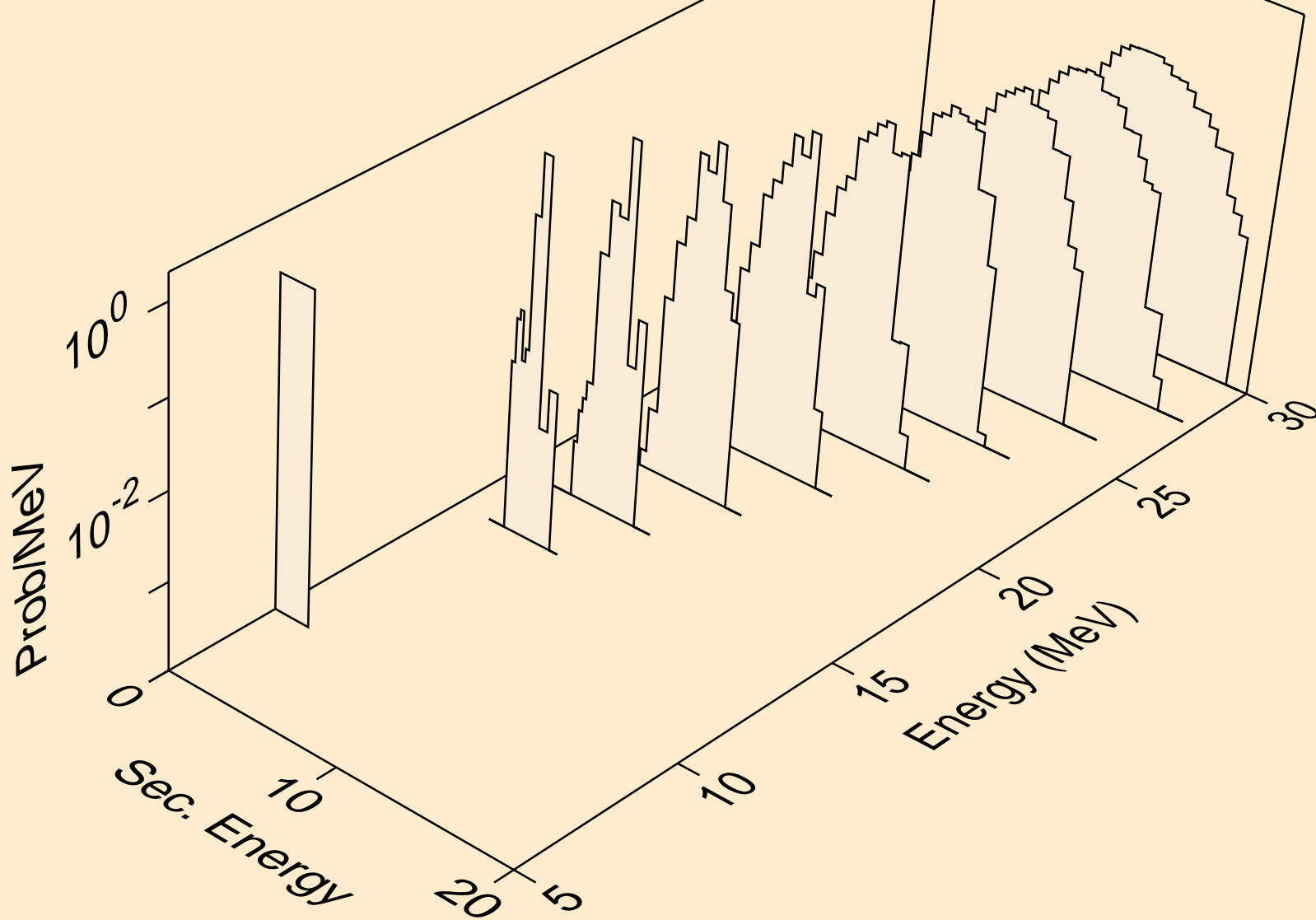

MO086 NEUTRON ACER TENDL-2019 LIBRARY; T=293.16K  
alphas from (n,a)

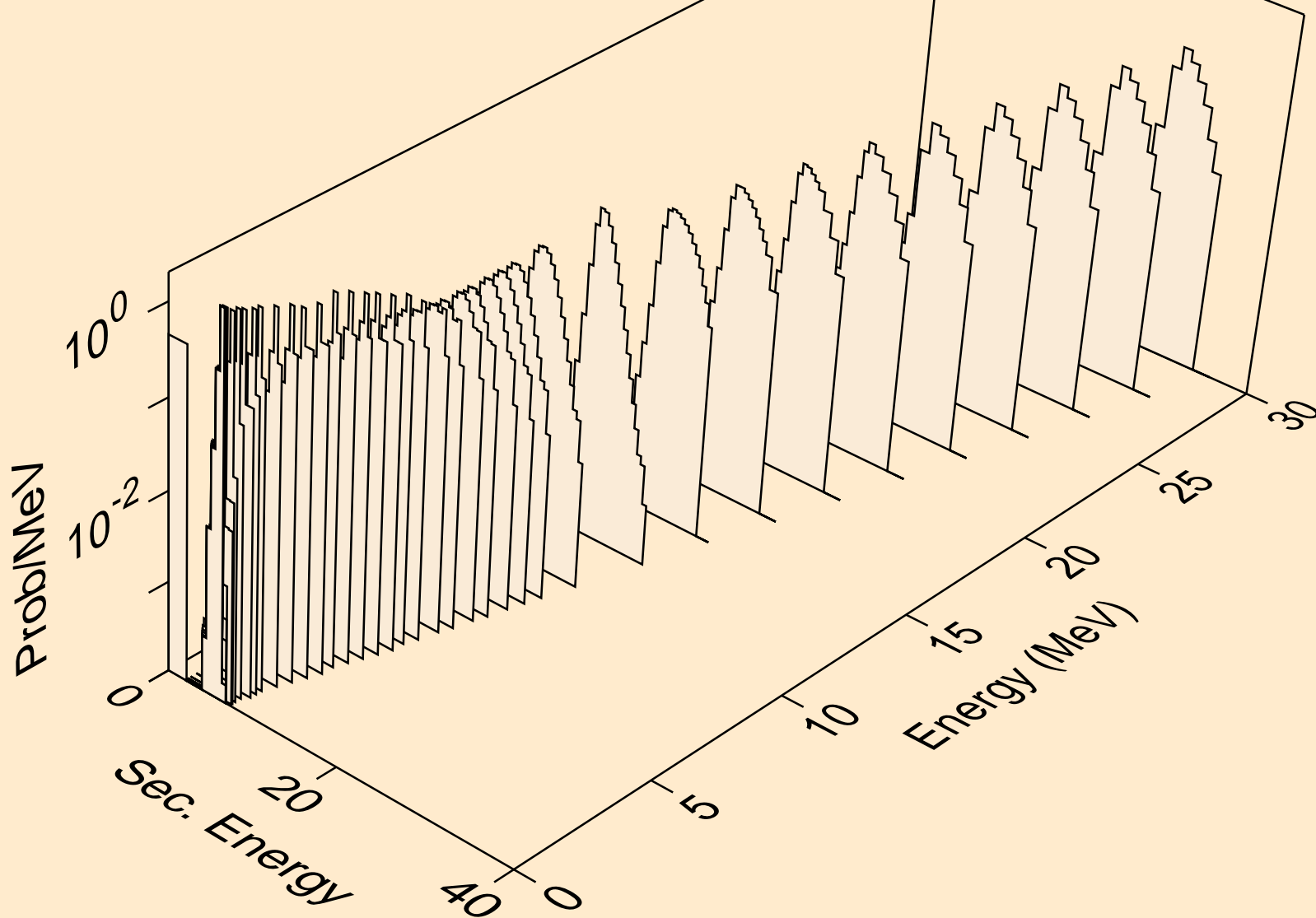

MO086 NEUTRON ACER TENDL-2019 LIBRARY; T=293.16K  
alphas from (n,2a)

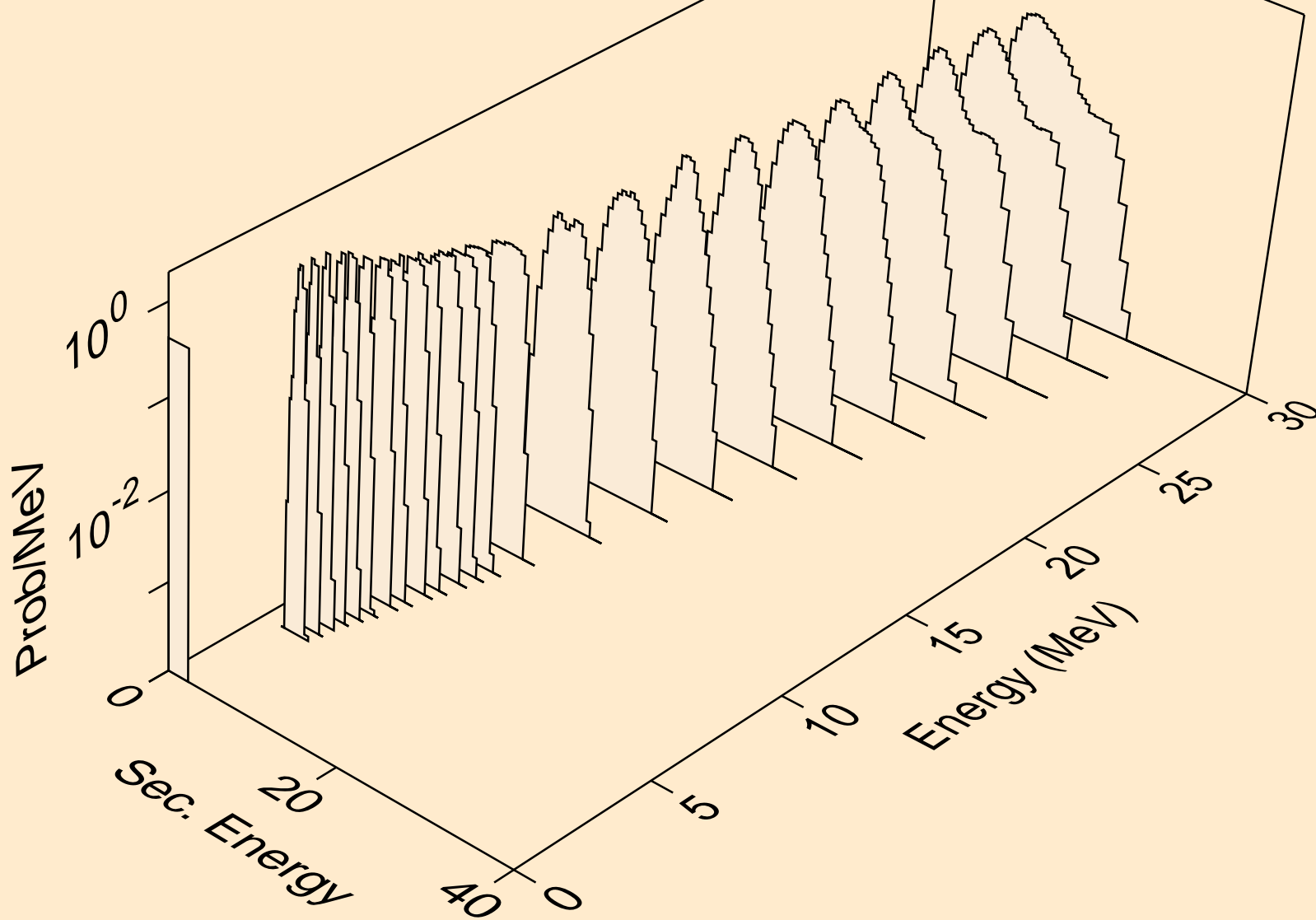



MO086 NEUTRON ACER TENDL-2019 LIBRARY; T=293.16K  
alphas from (n,3a)

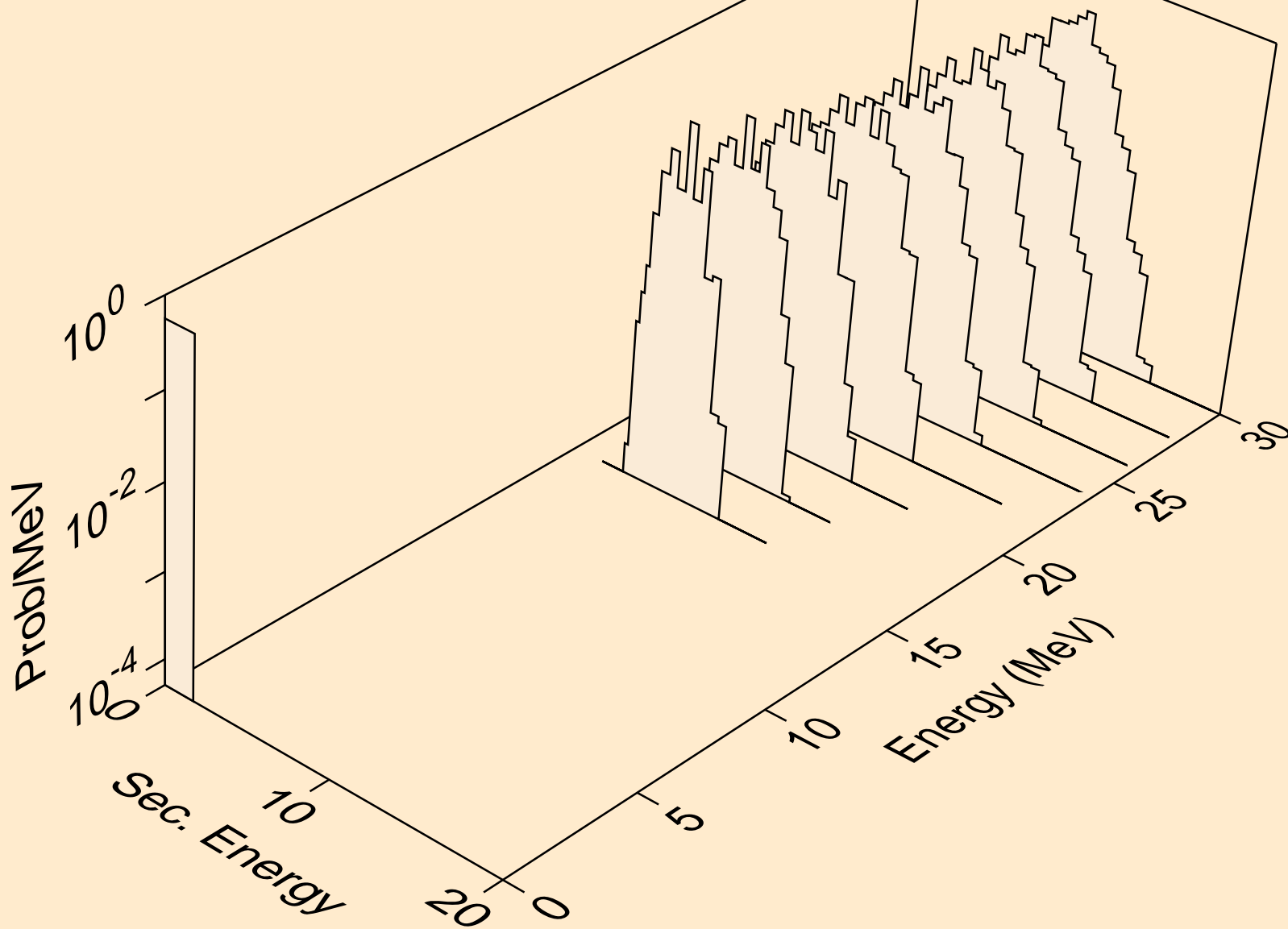

MO086 NEUTRON ACER TENDL-2019 LIBRARY; T=293.16K  
alphas from (n,pa)

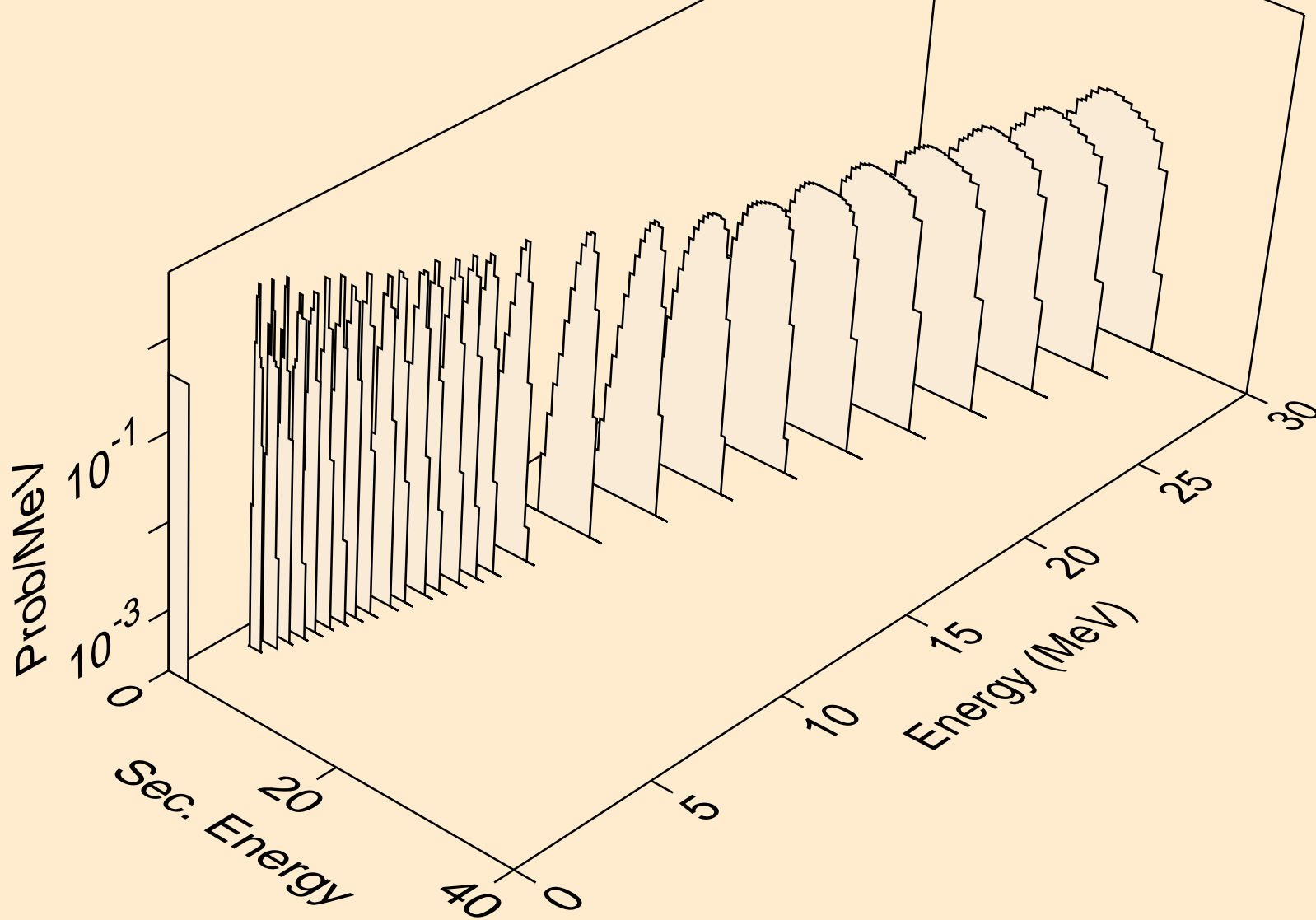

MO086 NEUTRON ACER TENDL-2019 LIBRARY; T=293.16K  
alphas from (n,da)

