

MO092 NEUTRON ACER TENDL-2019 LIBRARY; T=293.16K
Principal cross sections

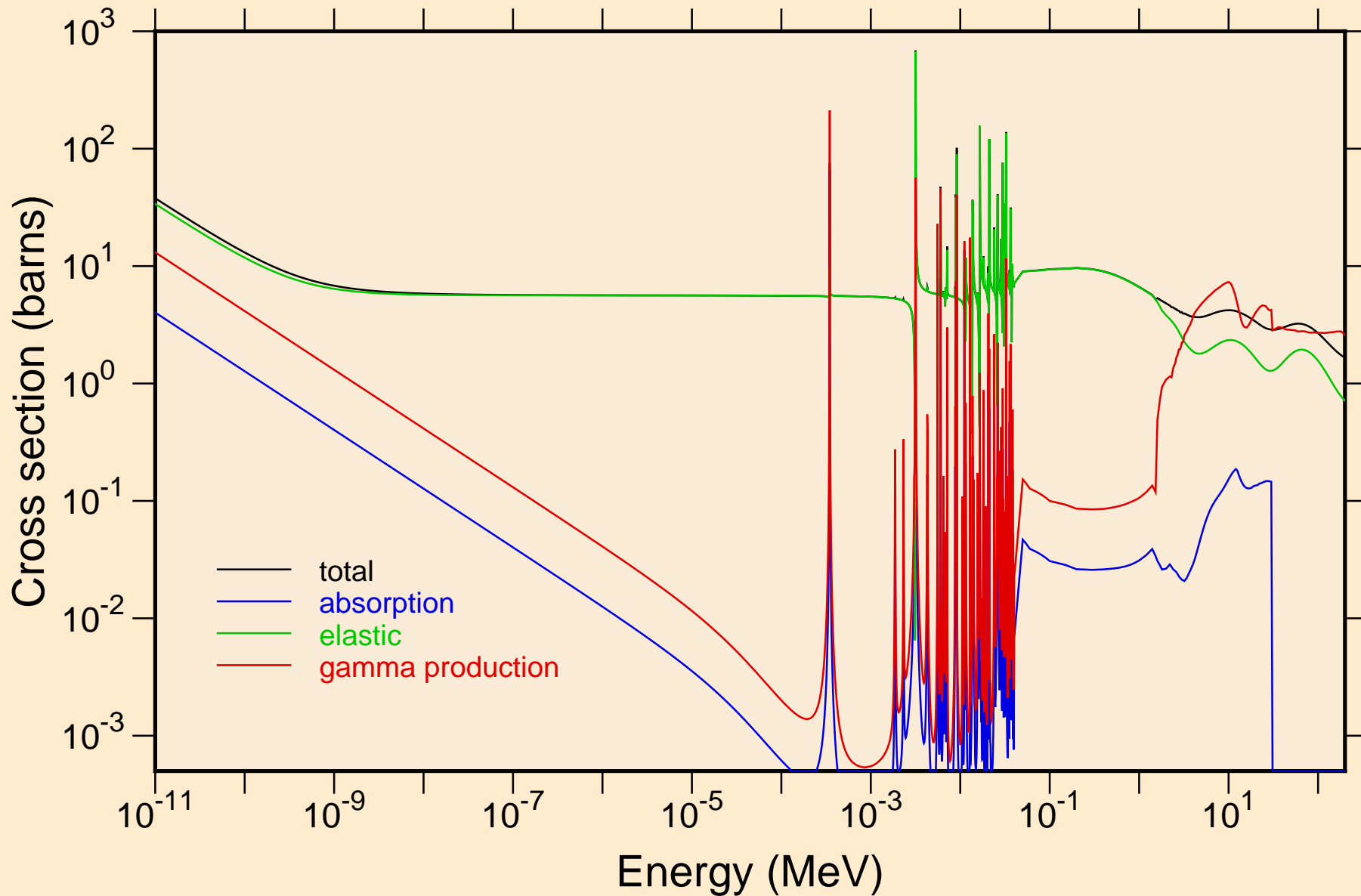

MO092 NEUTRON ACER TENDL-2019 LIBRARY; T=293.16K
resonance total cross section

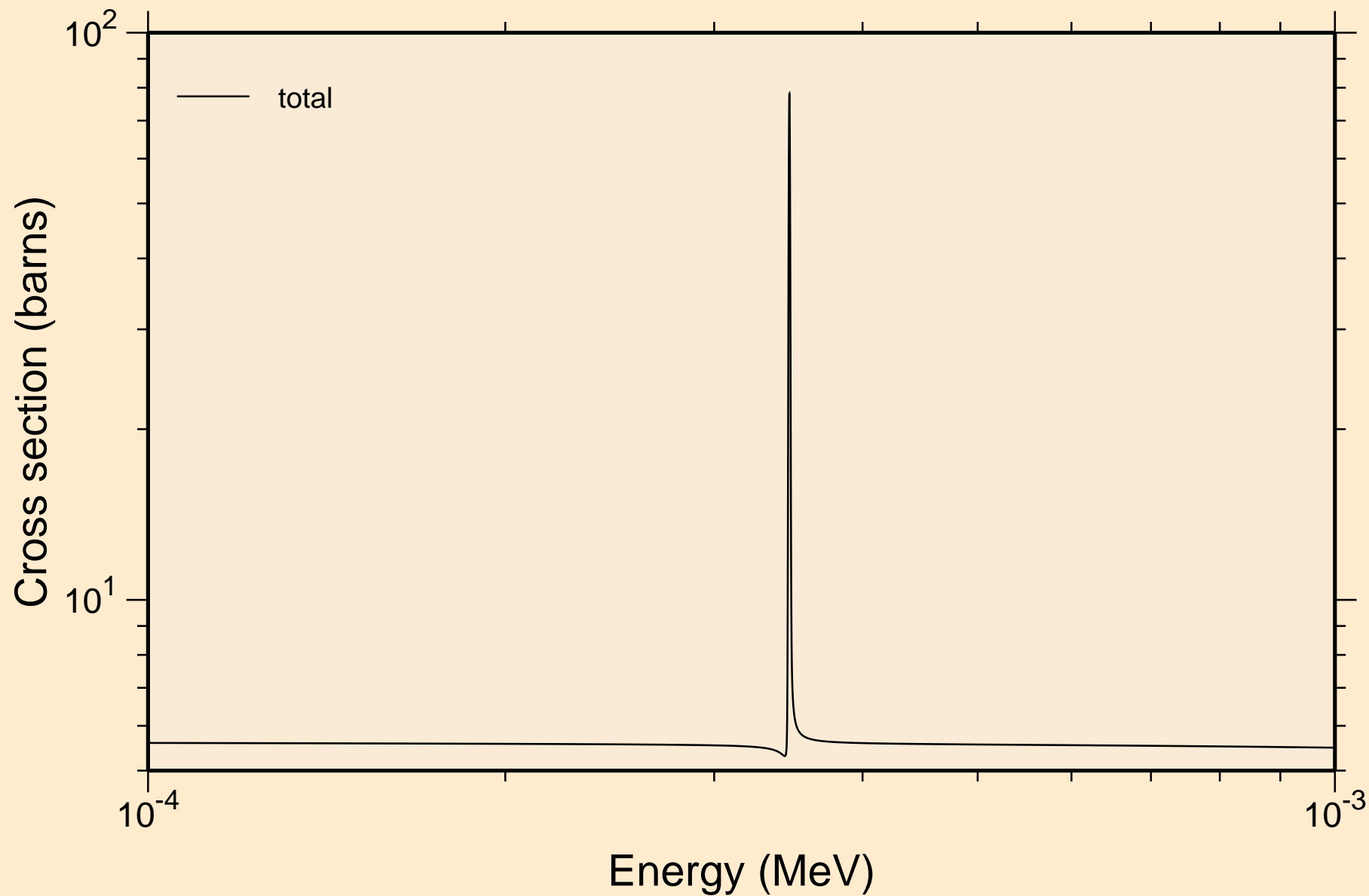

MO092 NEUTRON ACER TENDL-2019 LIBRARY; T=293.16K
resonance total cross section

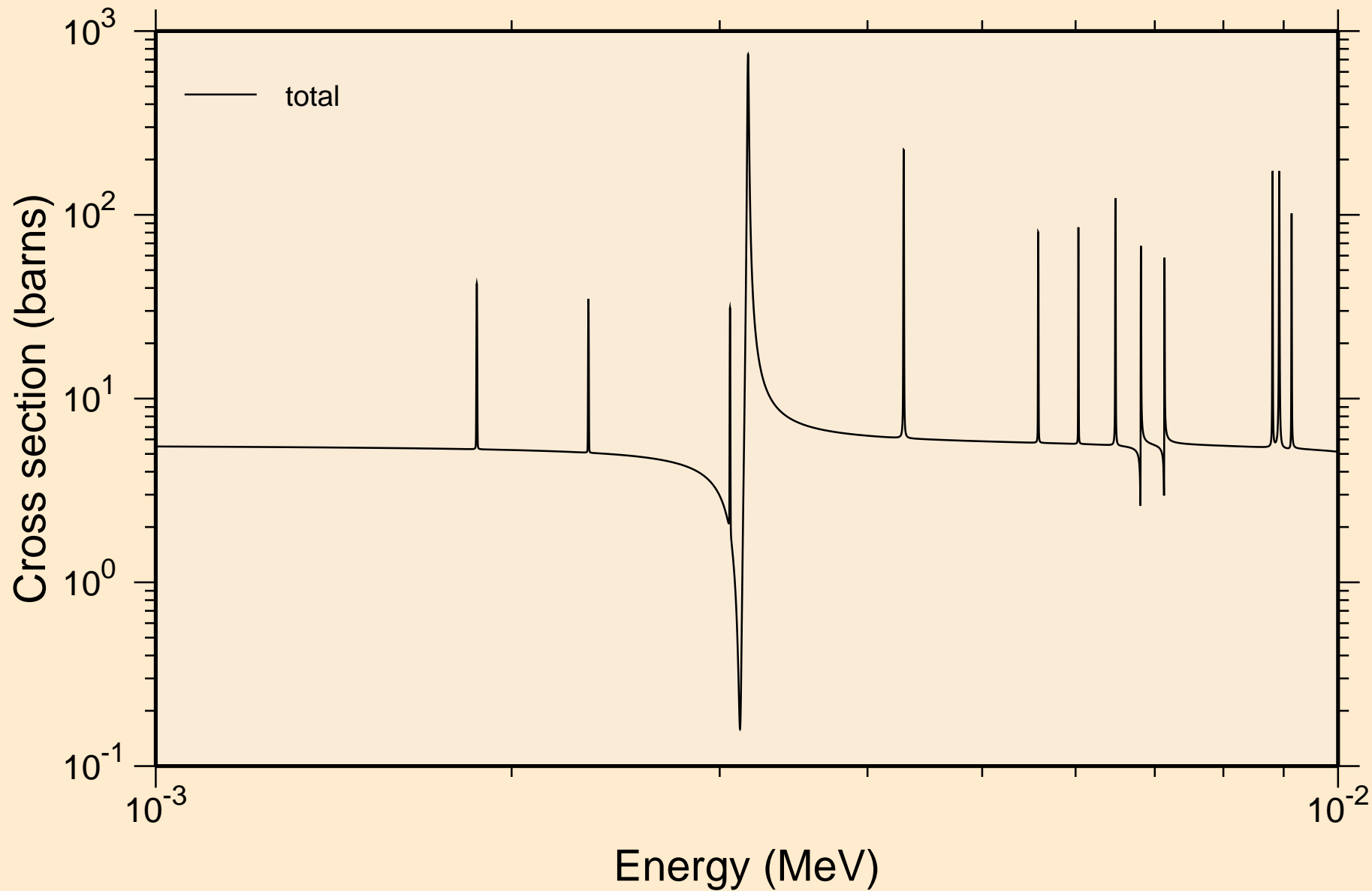

MO092 NEUTRON ACER TENDL-2019 LIBRARY; T=293.16K
resonance total cross section

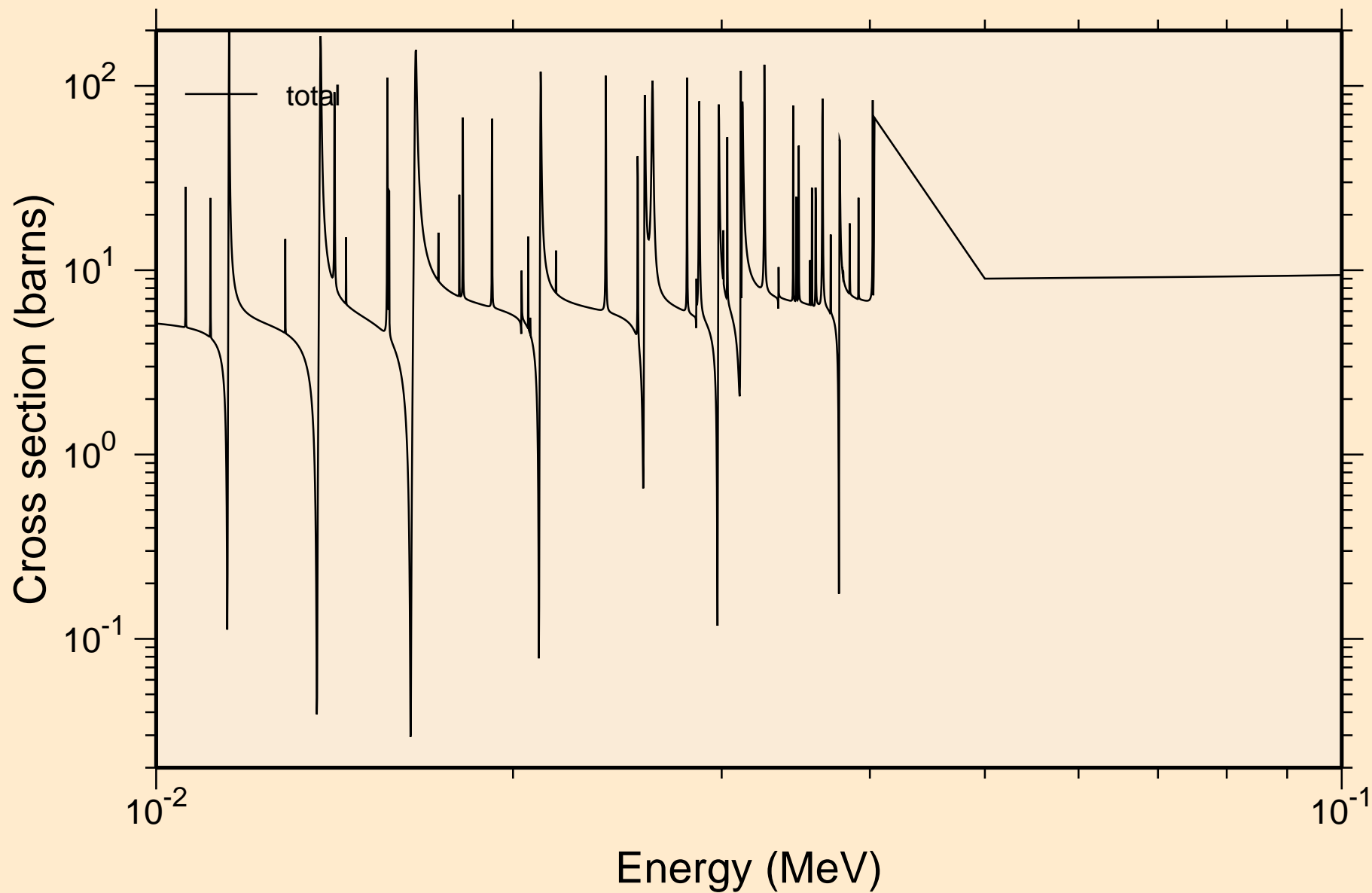

MO092 NEUTRON ACER TENDL-2019 LIBRARY; T=293.16K
resonance total cross section

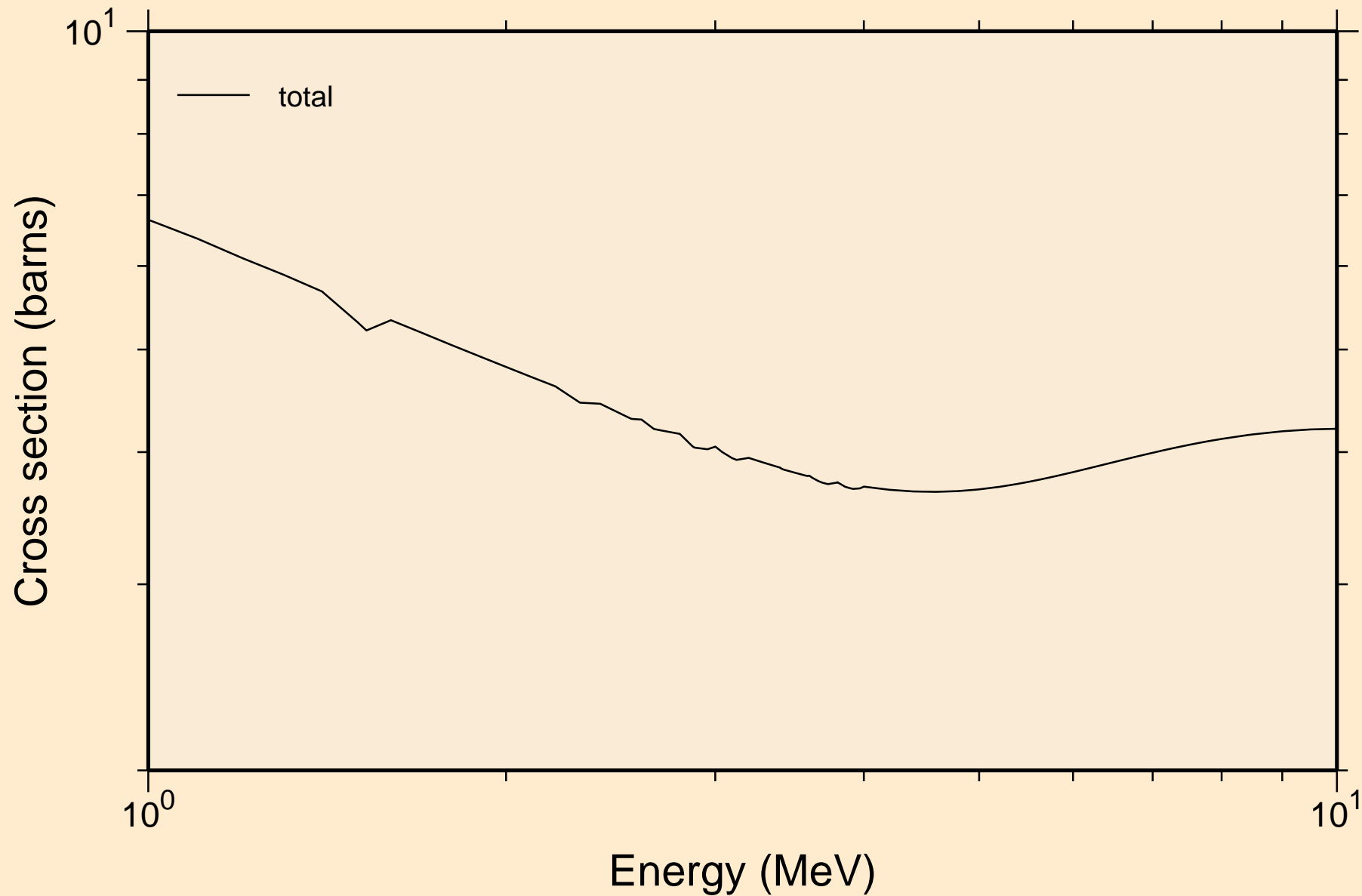

MO092 NEUTRON ACER TENDL-2019 LIBRARY; T=293.16K
resonance absorption cross sections

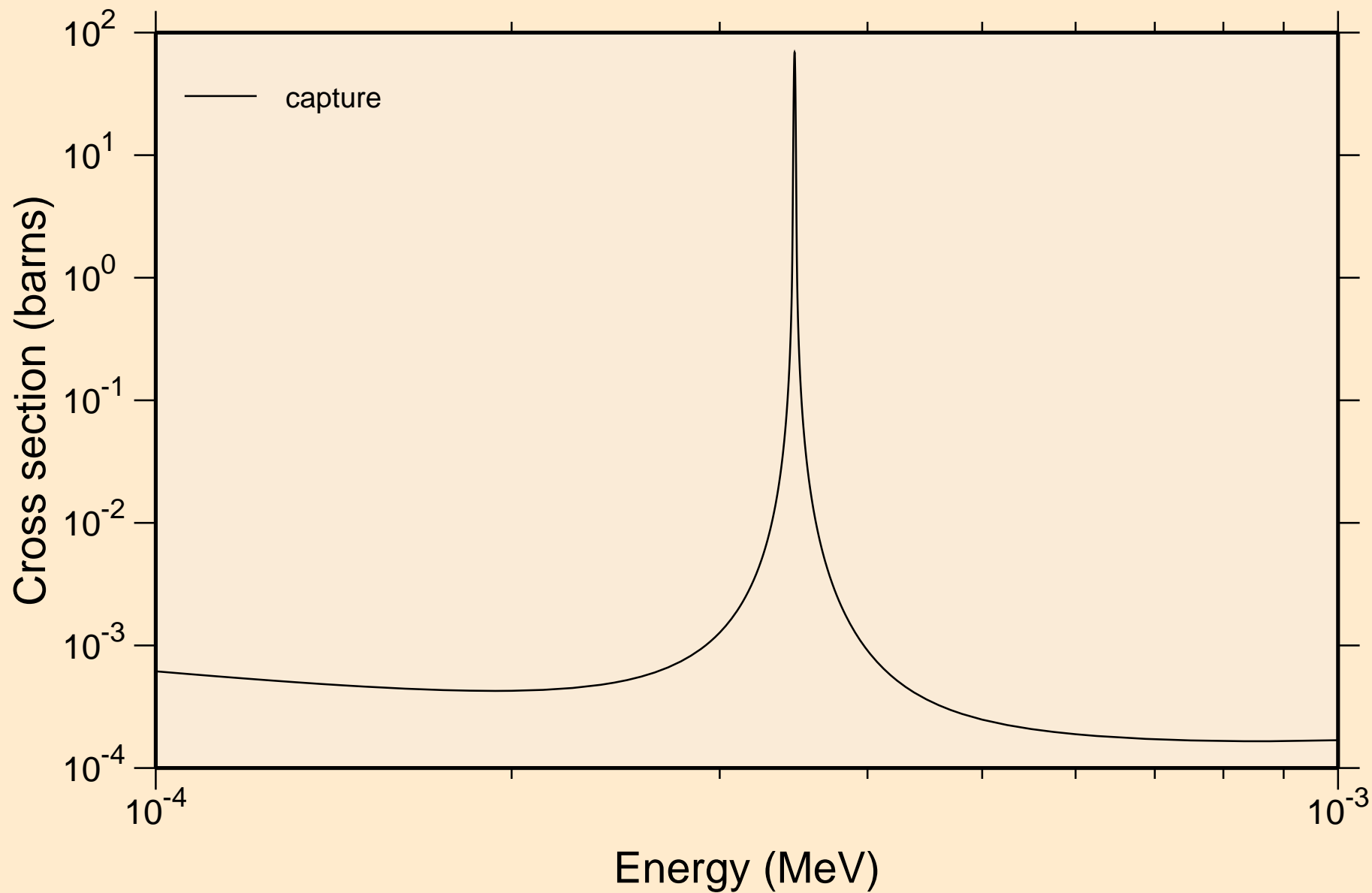

MO092 NEUTRON ACER TENDL-2019 LIBRARY; T=293.16K
resonance absorption cross sections

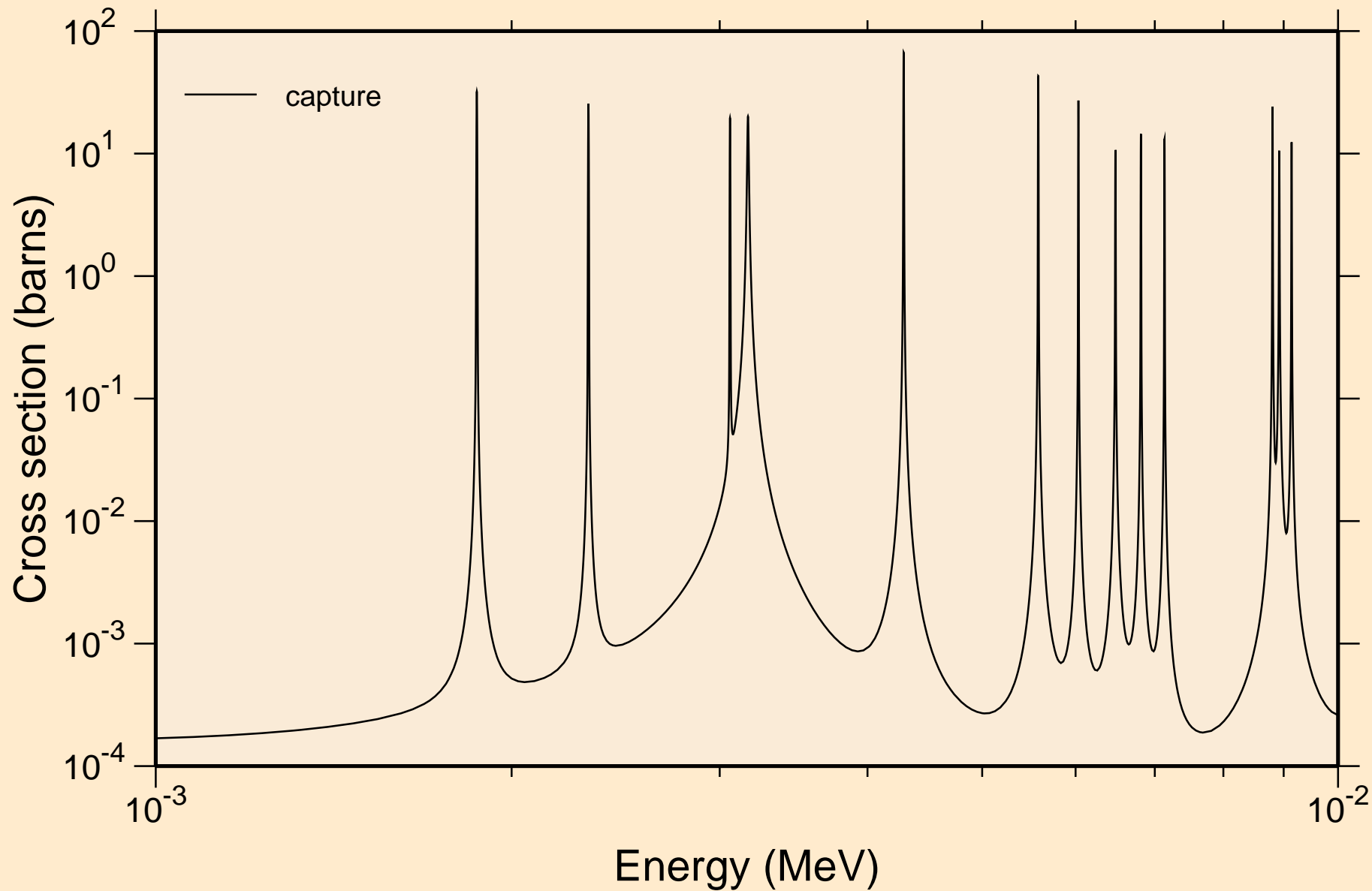

MO092 NEUTRON ACER TENDL-2019 LIBRARY; T=293.16K
resonance absorption cross sections

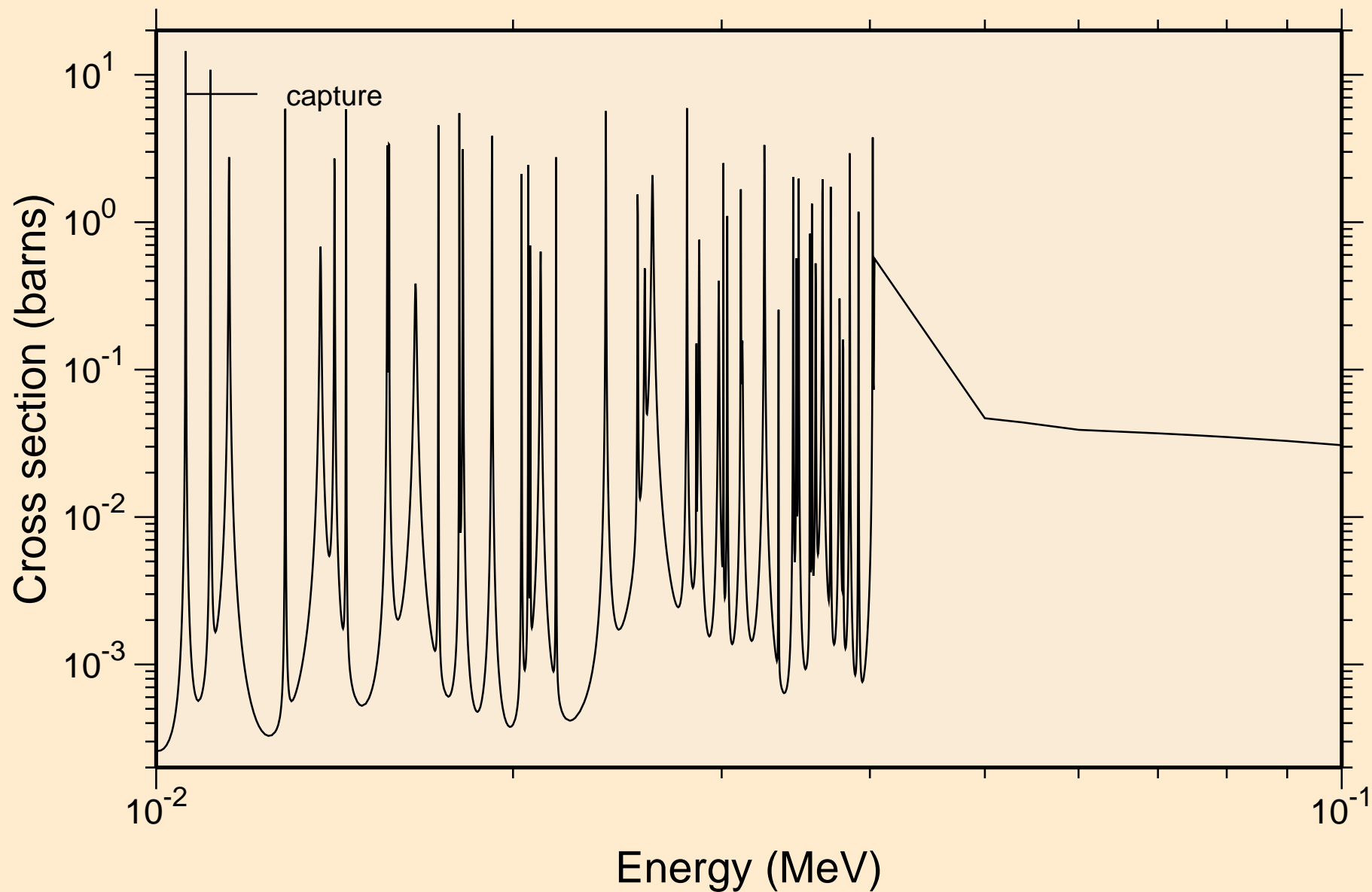

MO092 NEUTRON ACER TENDL-2019 LIBRARY; T=293.16K
resonance absorption cross sections

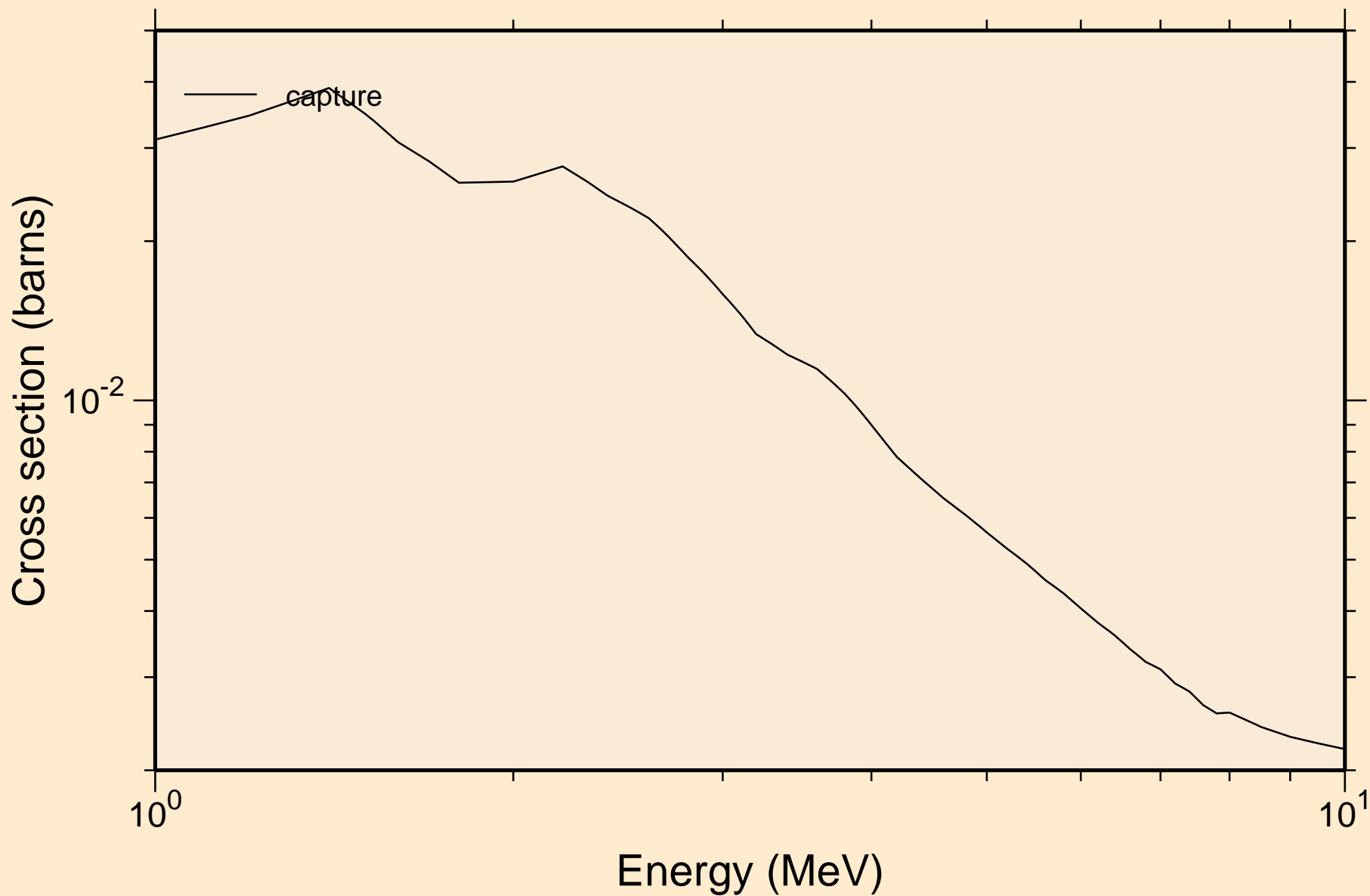

MO092 NEUTRON ACER TENDL-2019 LIBRARY; T=293.16K
Heating

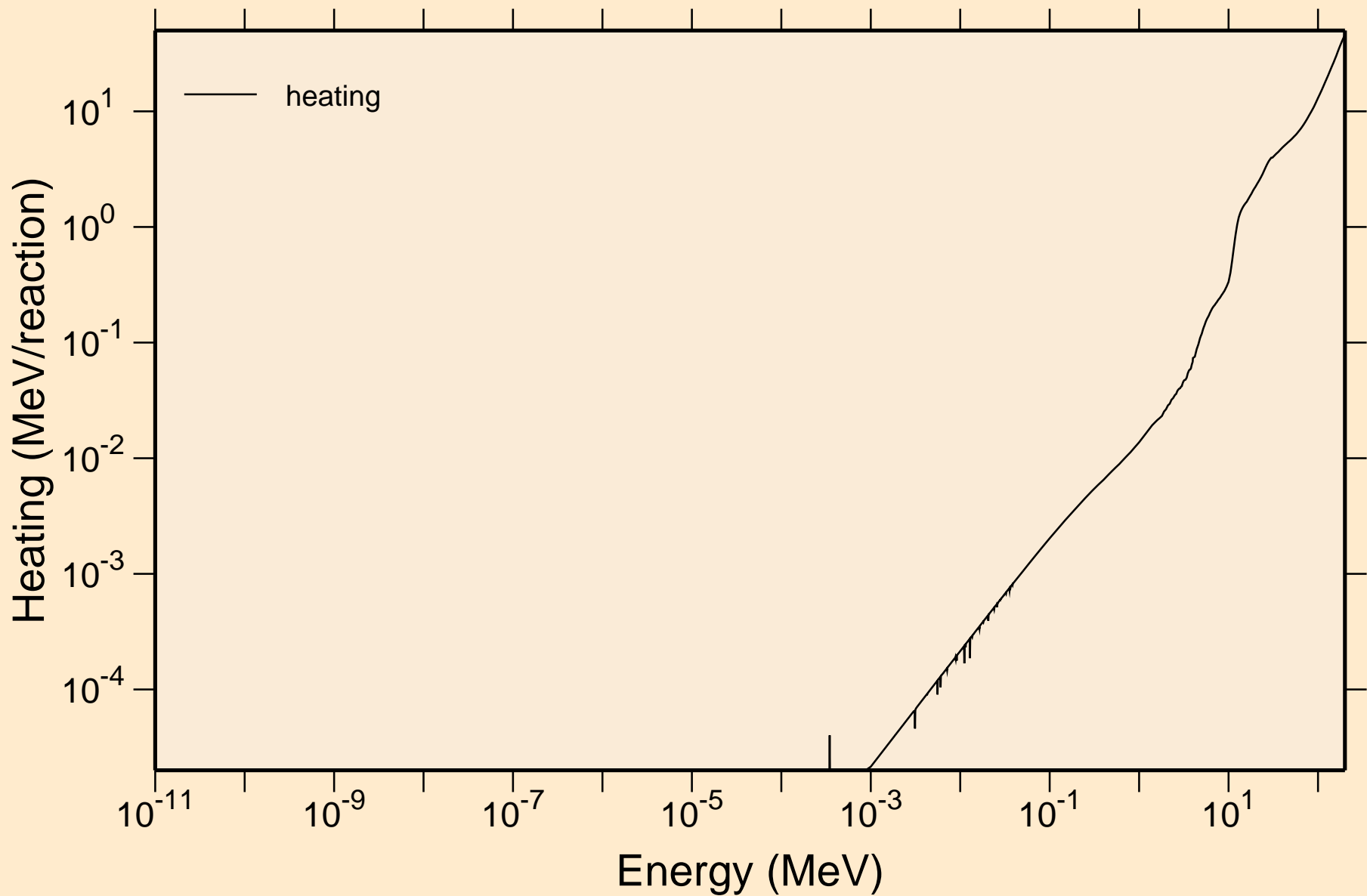

MO092 NEUTRON ACER TENDL-2019 LIBRARY; T=293.16K
Damage

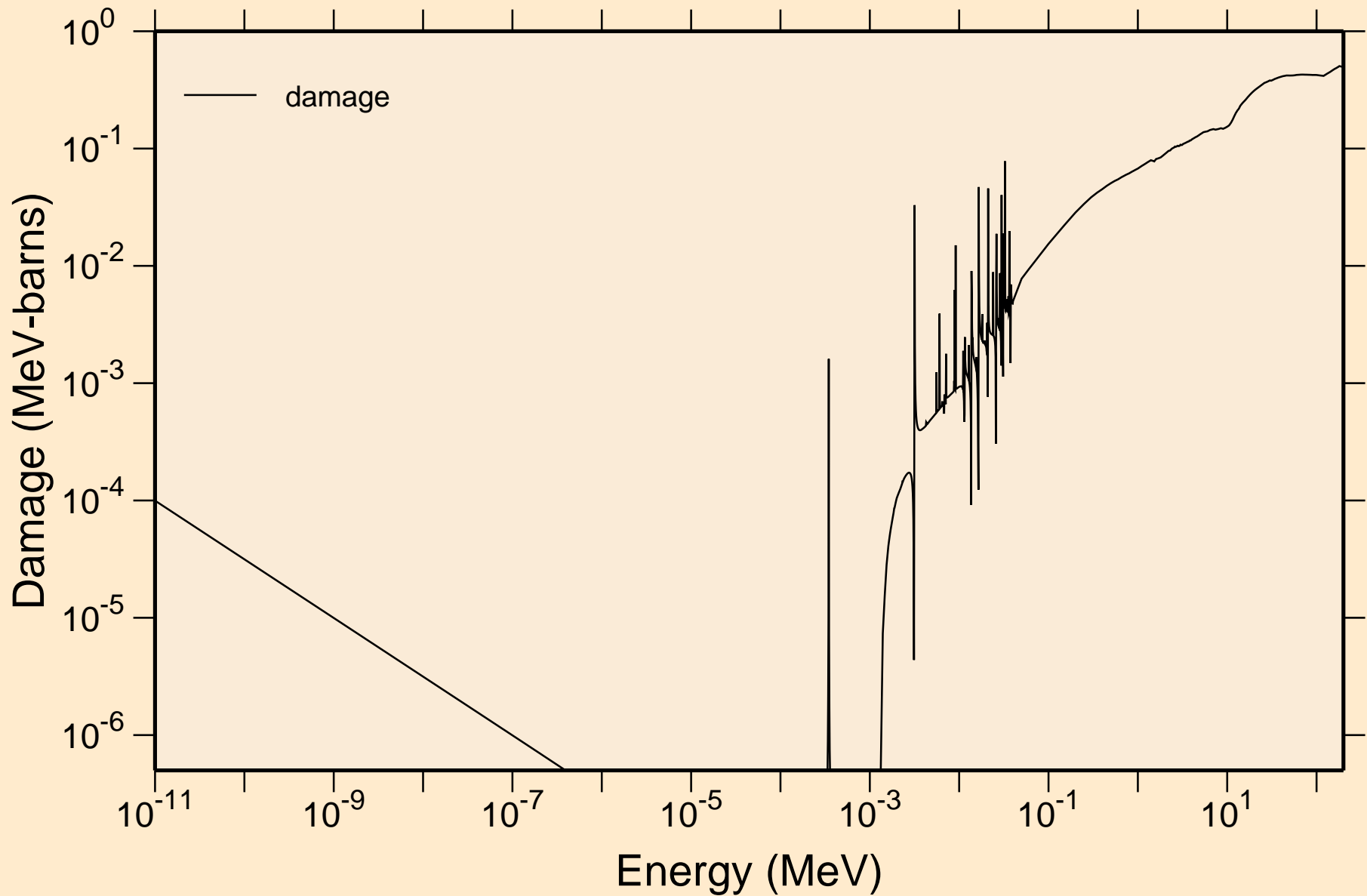

MO092 NEUTRON ACER TENDL-2019 LIBRARY; T=293.16K
Non-threshold reactions

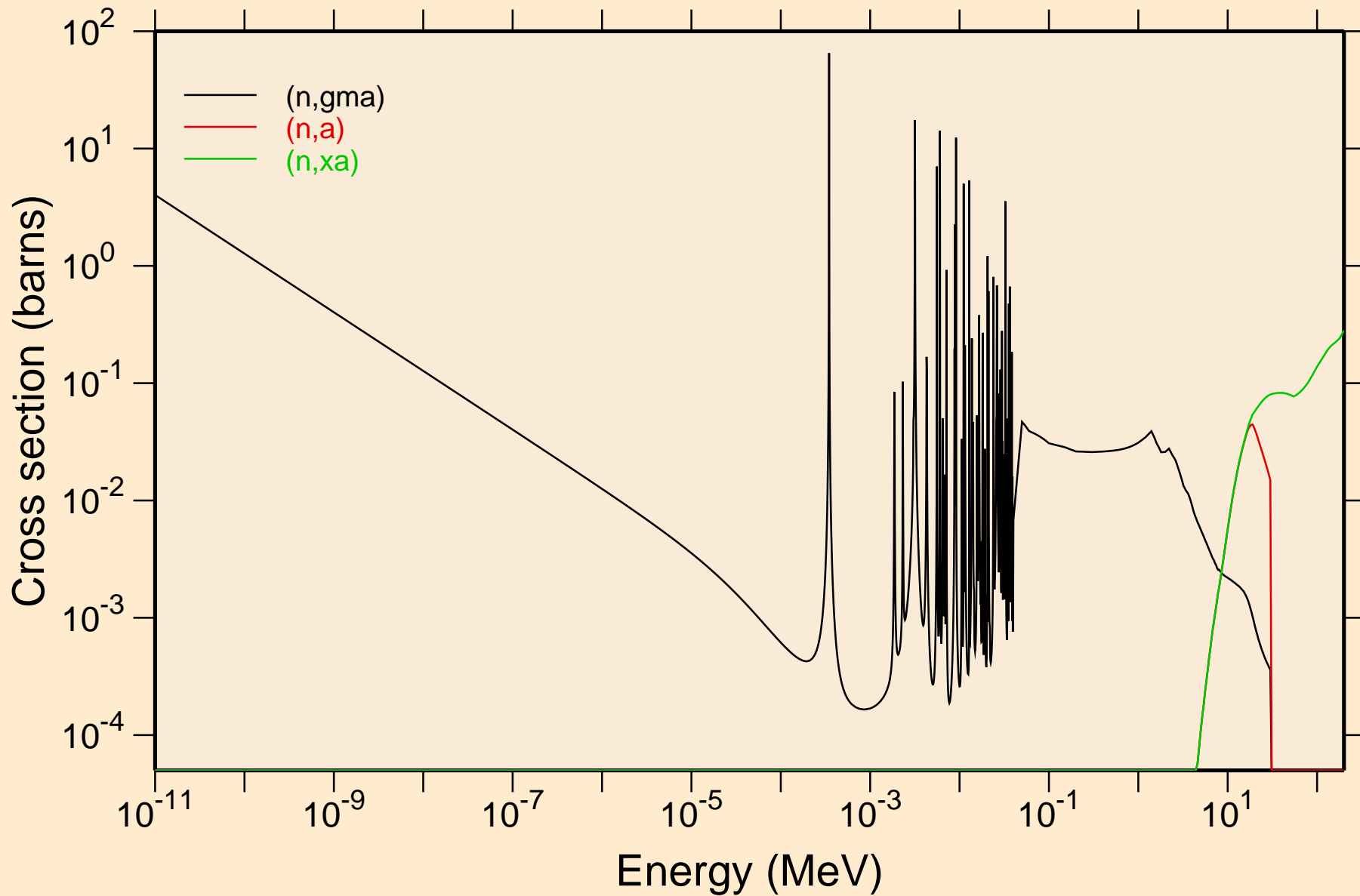

MO092 NEUTRON ACER TENDL-2019 LIBRARY; T=293.16K
Principal cross sections

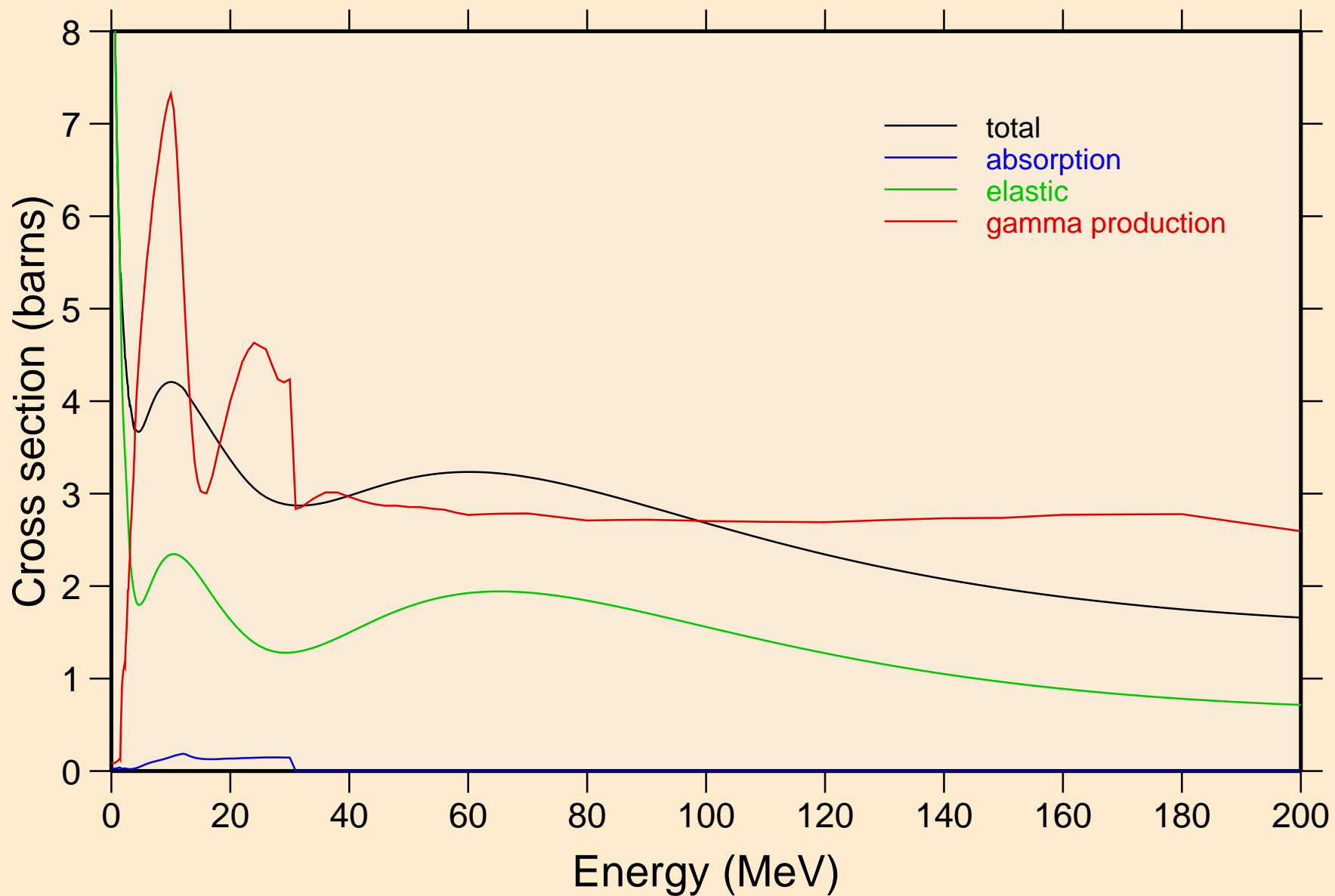

MO092 NEUTRON ACER TENDL-2019 LIBRARY; T=293.16K
Heating

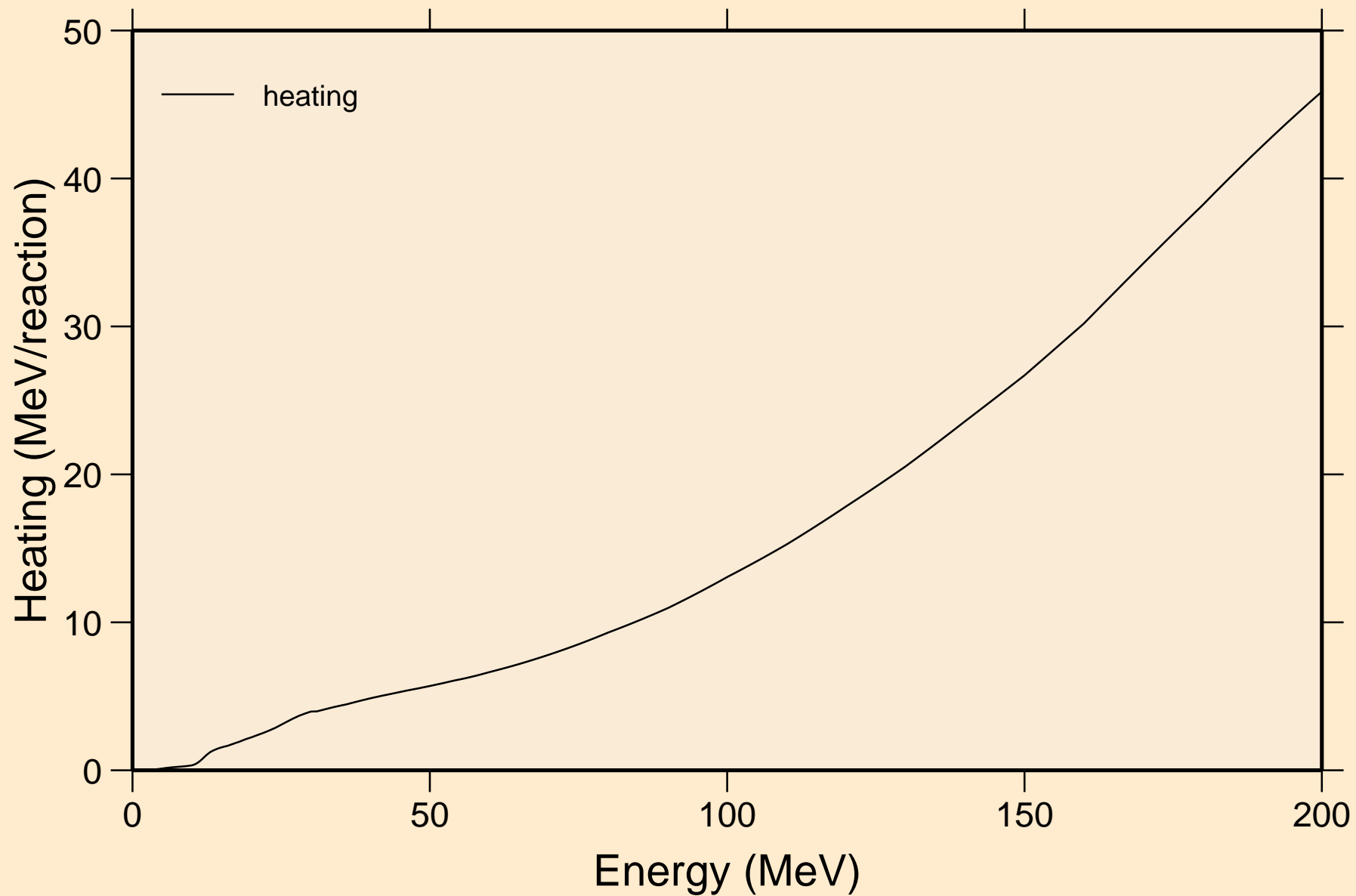

MO092 NEUTRON ACER TENDL-2019 LIBRARY; T=293.16K
Damage

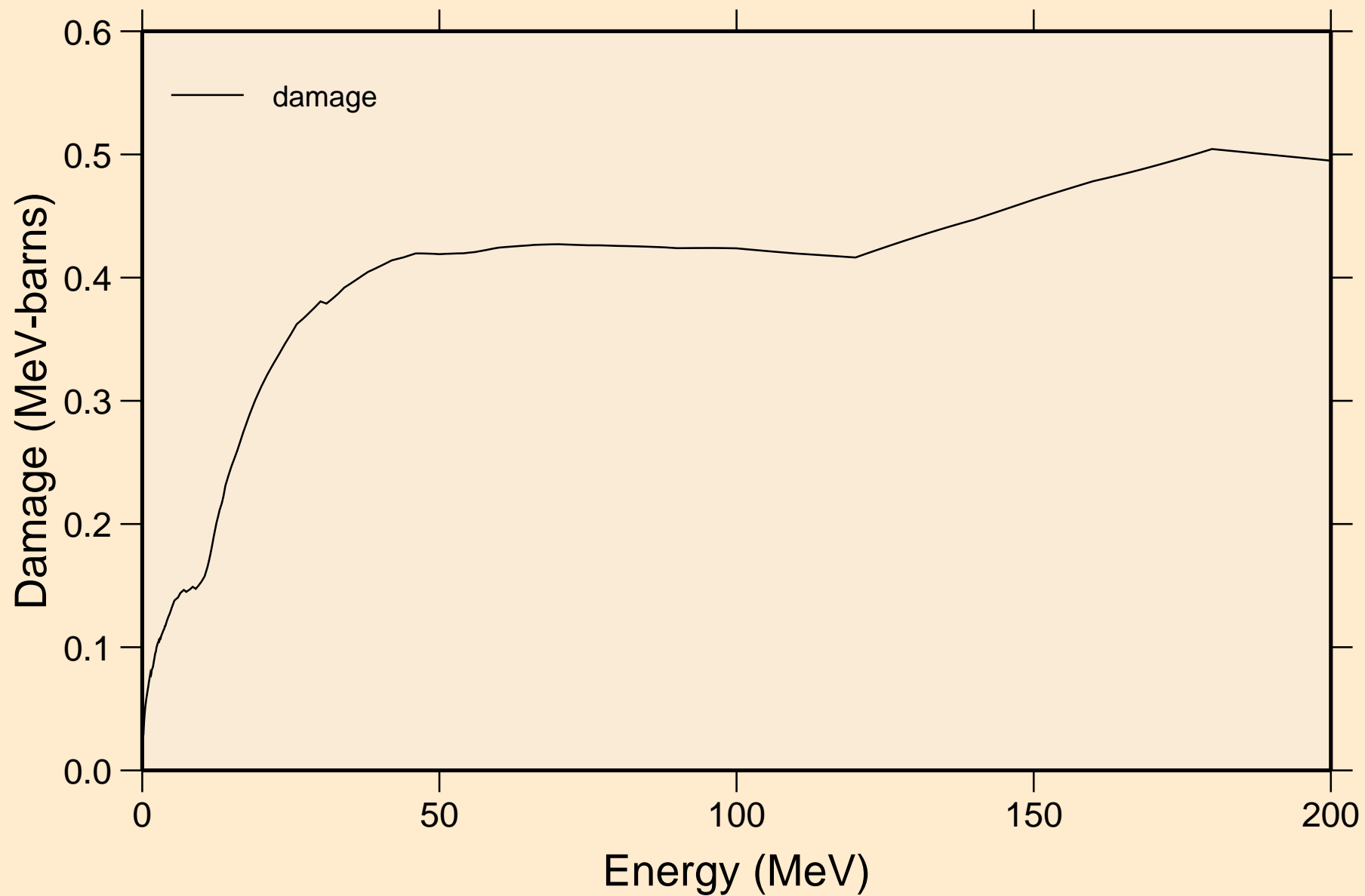

MO092 NEUTRON ACER TENDL-2019 LIBRARY; T=293.16K
Non-threshold reactions

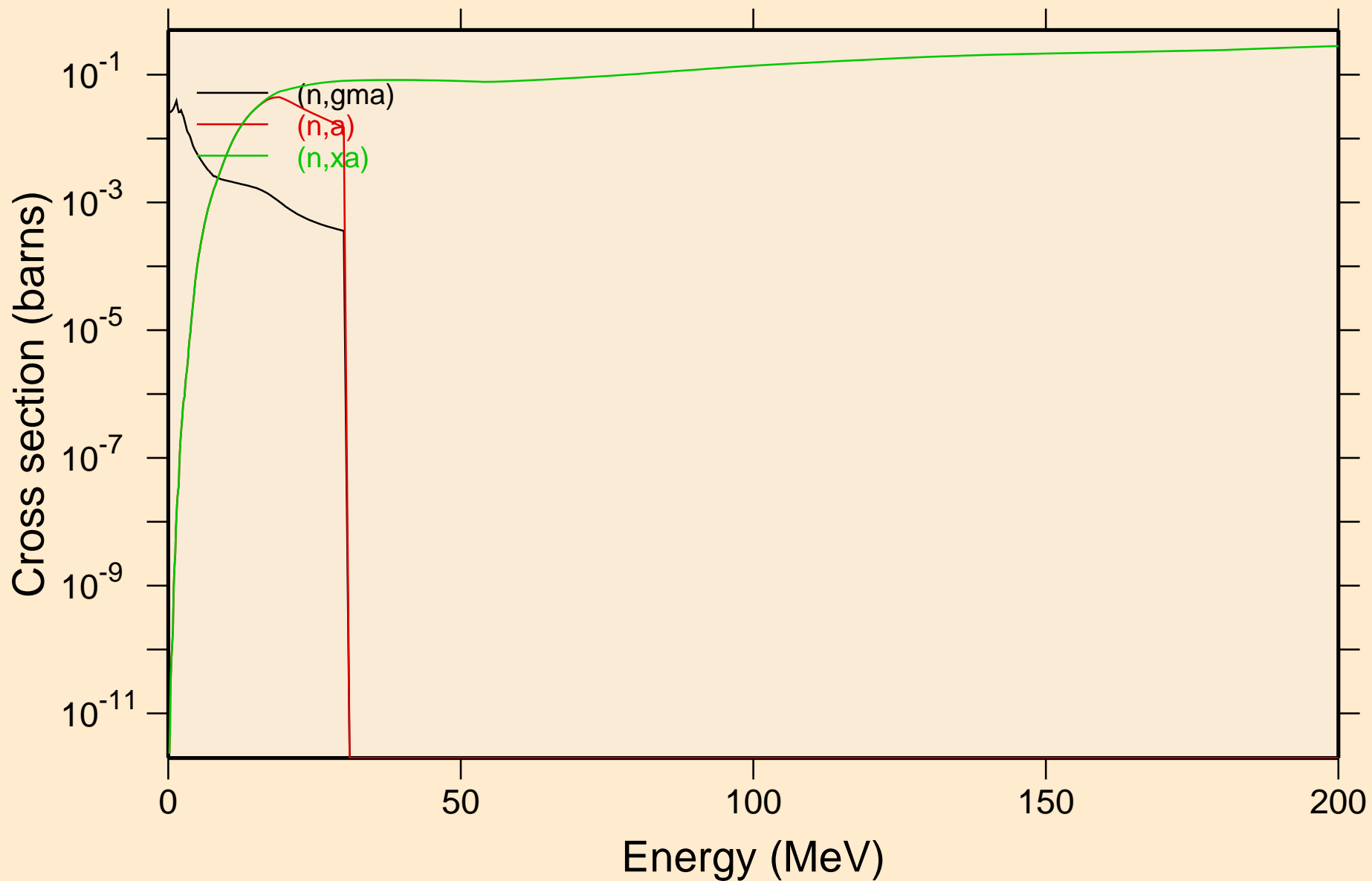

MO092 NEUTRON ACER TENDL-2019 LIBRARY; T=293.16K
Inelastic levels

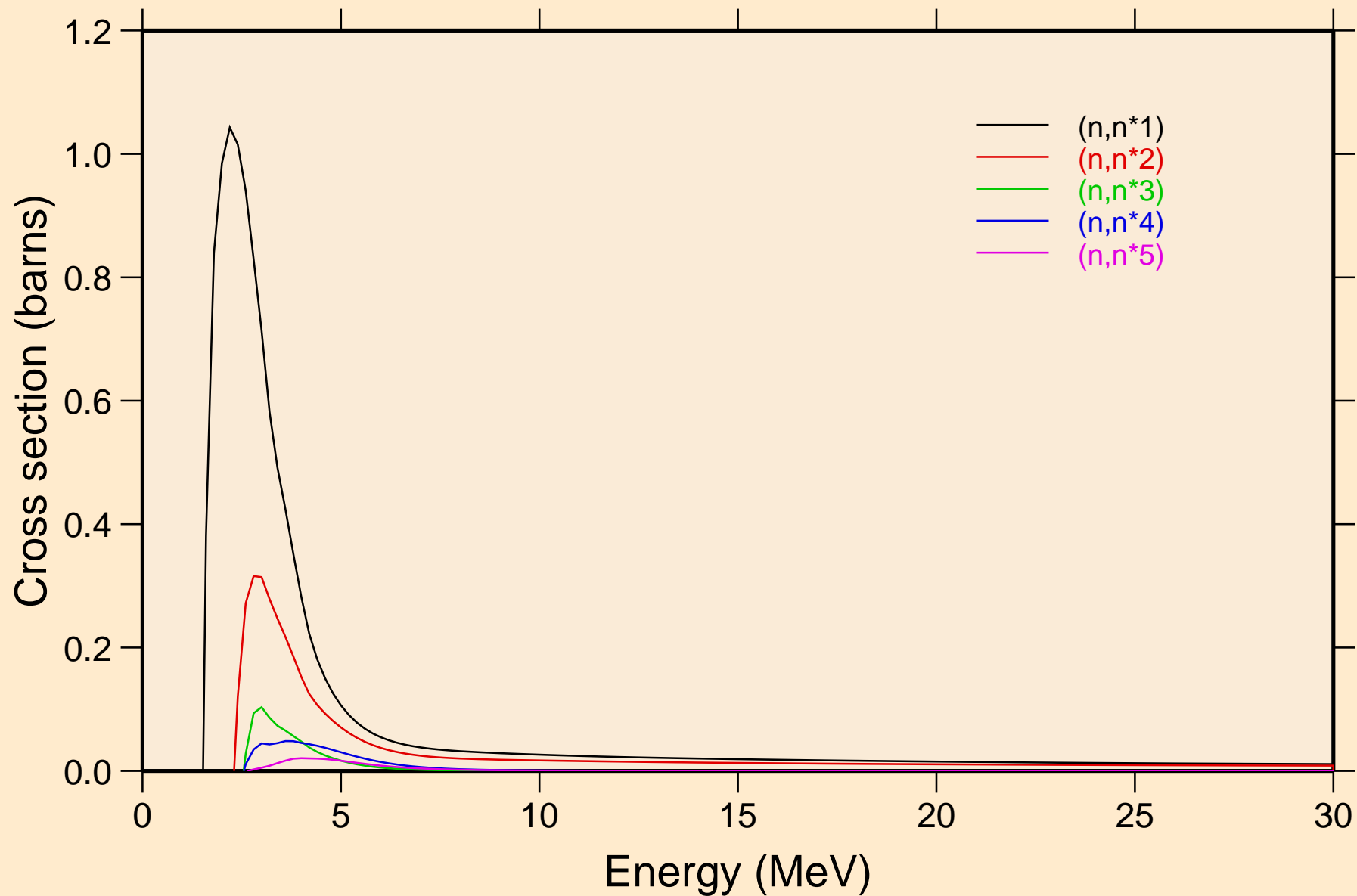

MO092 NEUTRON ACER TENDL-2019 LIBRARY; T=293.16K
Inelastic levels

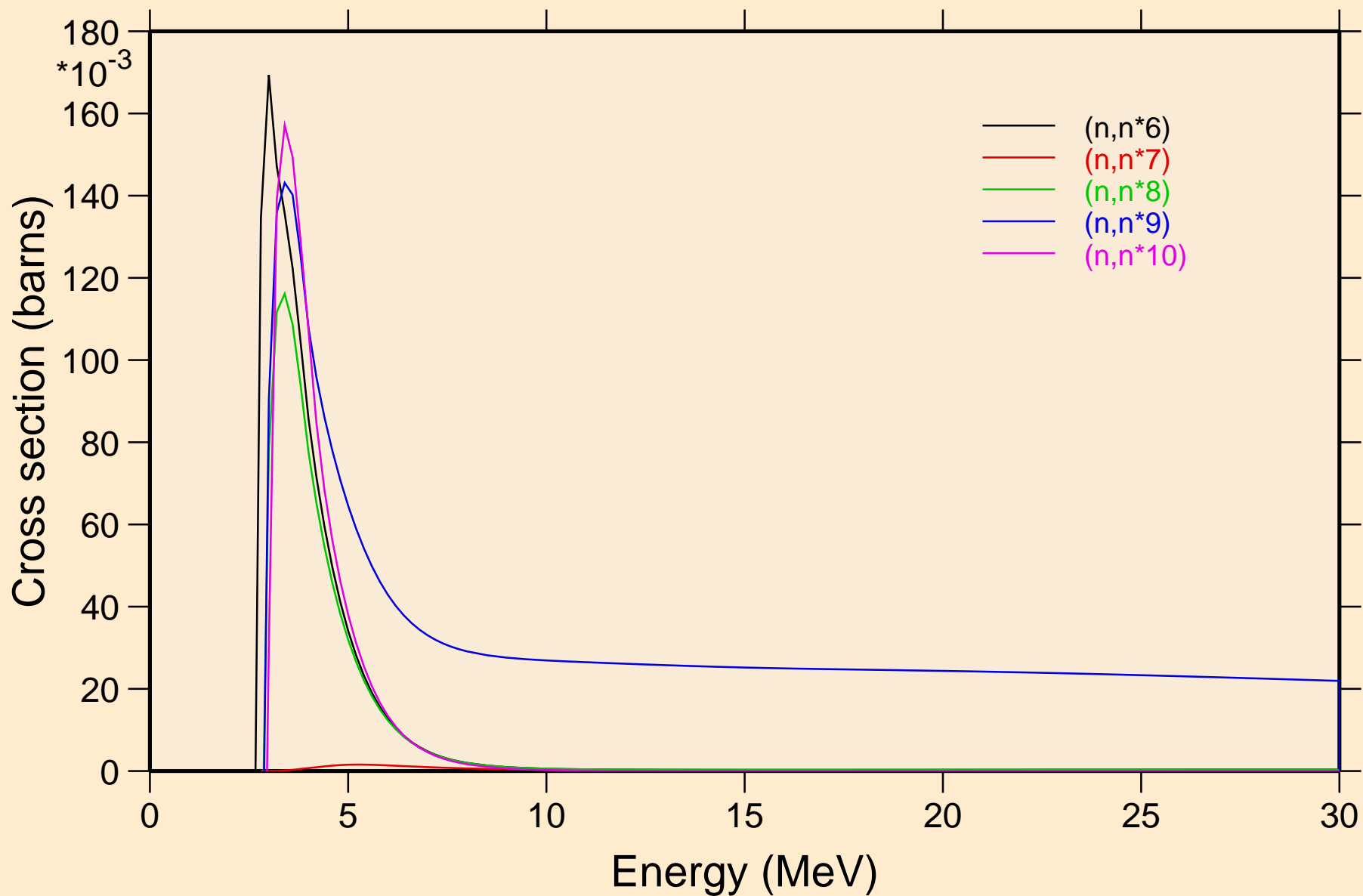

MO092 NEUTRON ACER TENDL-2019 LIBRARY; T=293.16K
Inelastic levels

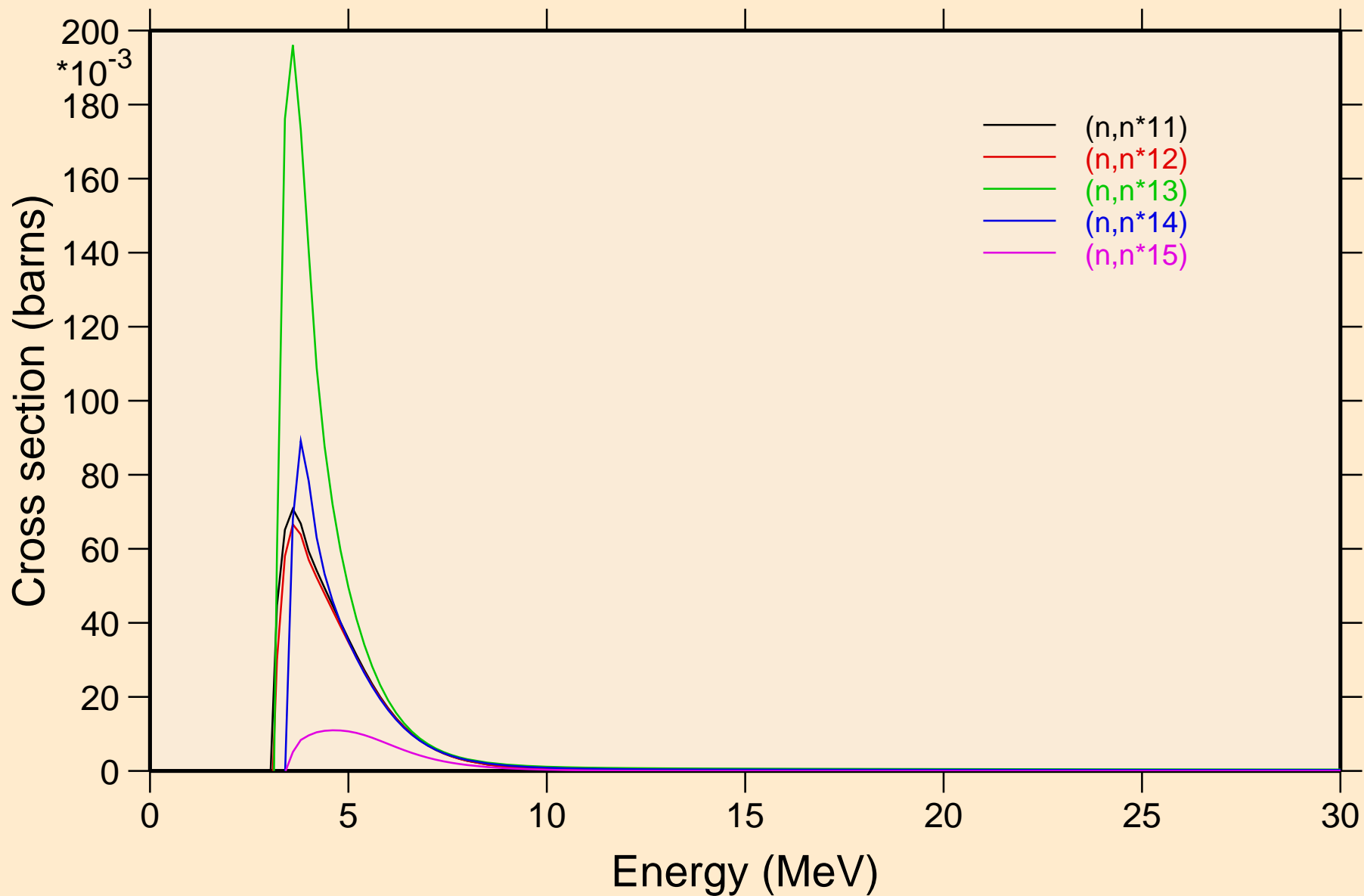

MO092 NEUTRON ACER TENDL-2019 LIBRARY; T=293.16K
Inelastic levels

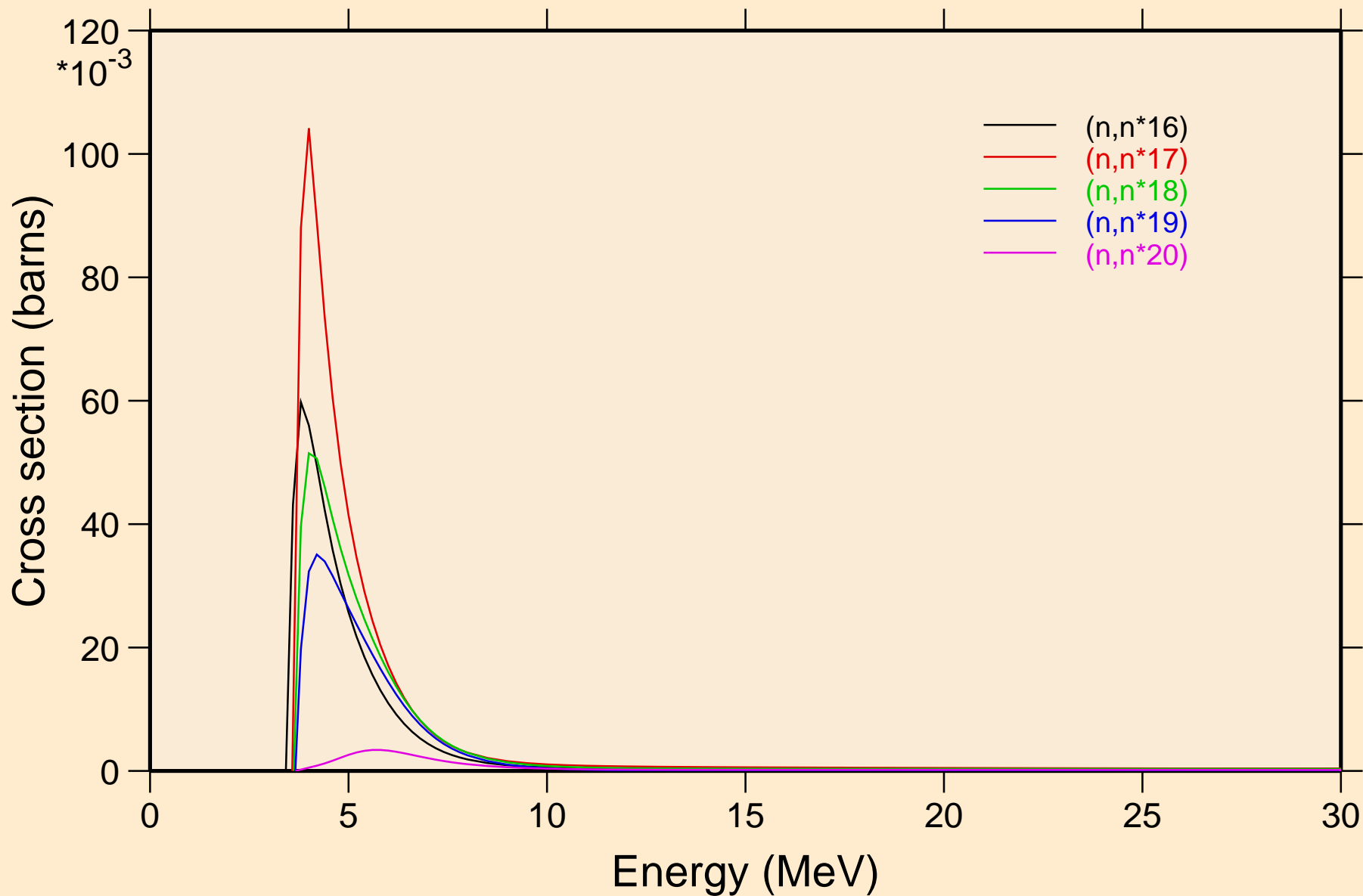

MO092 NEUTRON ACER TENDL-2019 LIBRARY; T=293.16K
Inelastic levels

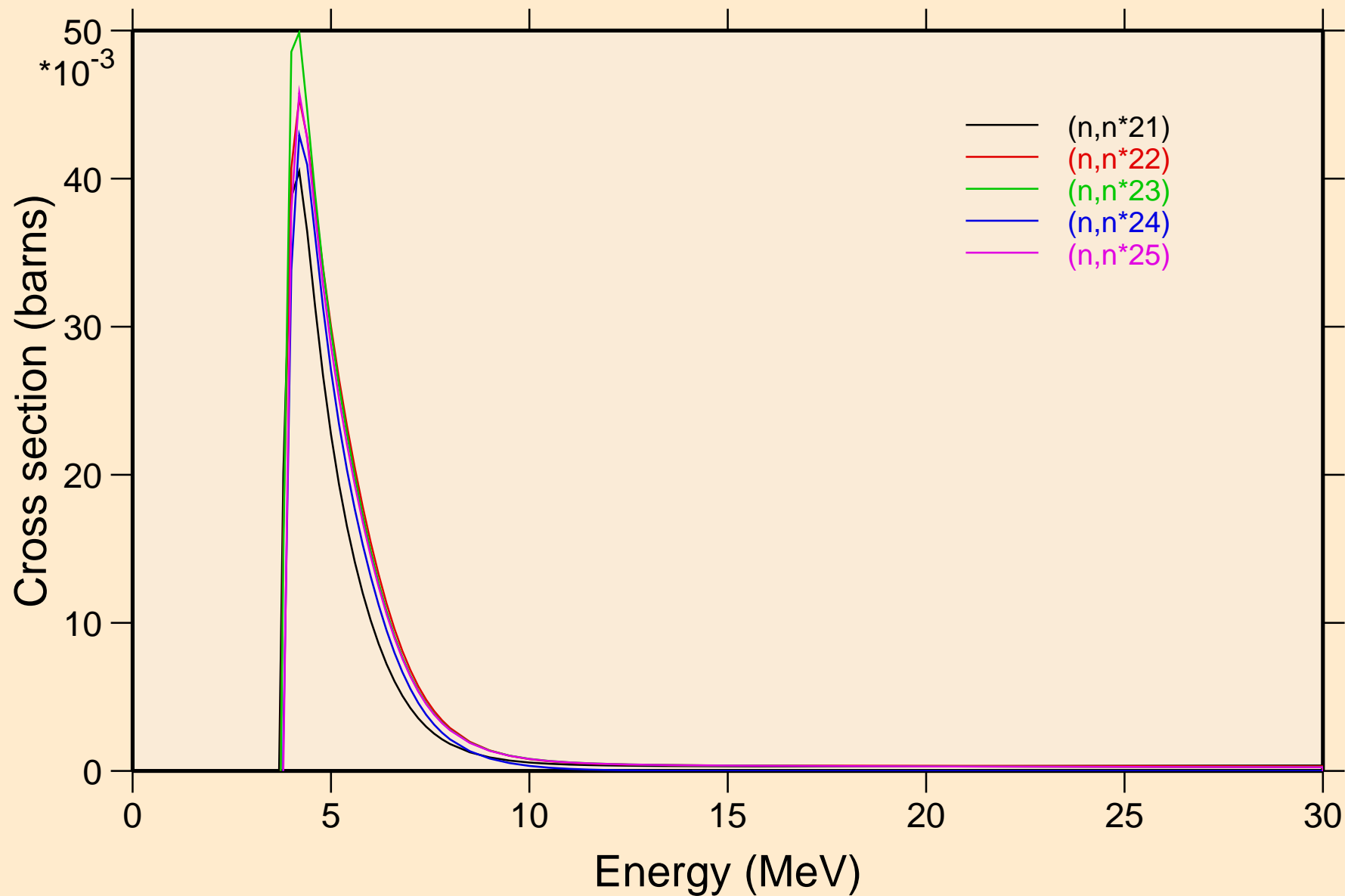

MO092 NEUTRON ACER TENDL-2019 LIBRARY; T=293.16K
Inelastic levels

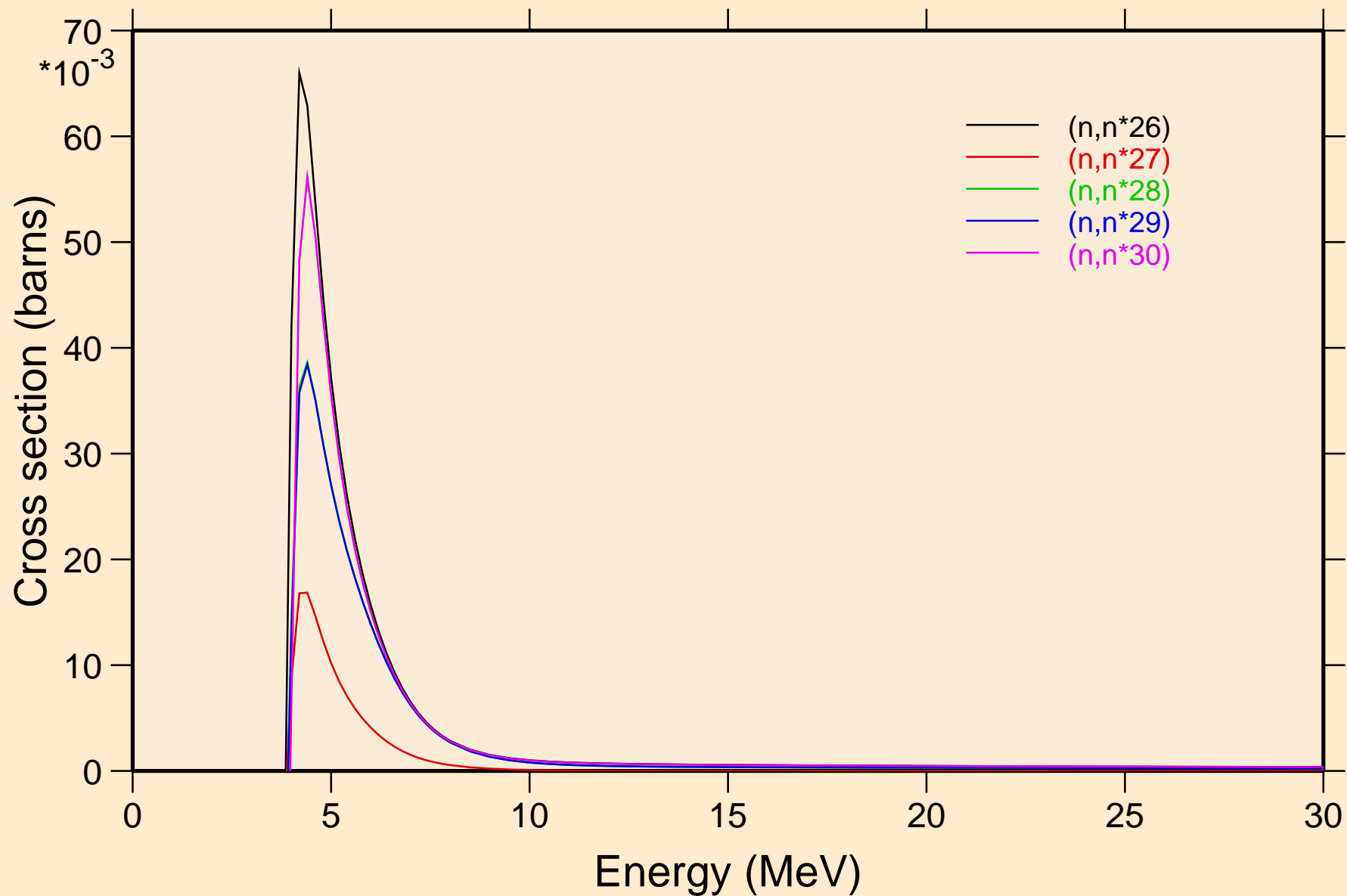

MO092 NEUTRON ACER TENDL-2019 LIBRARY; T=293.16K
Threshold reactions

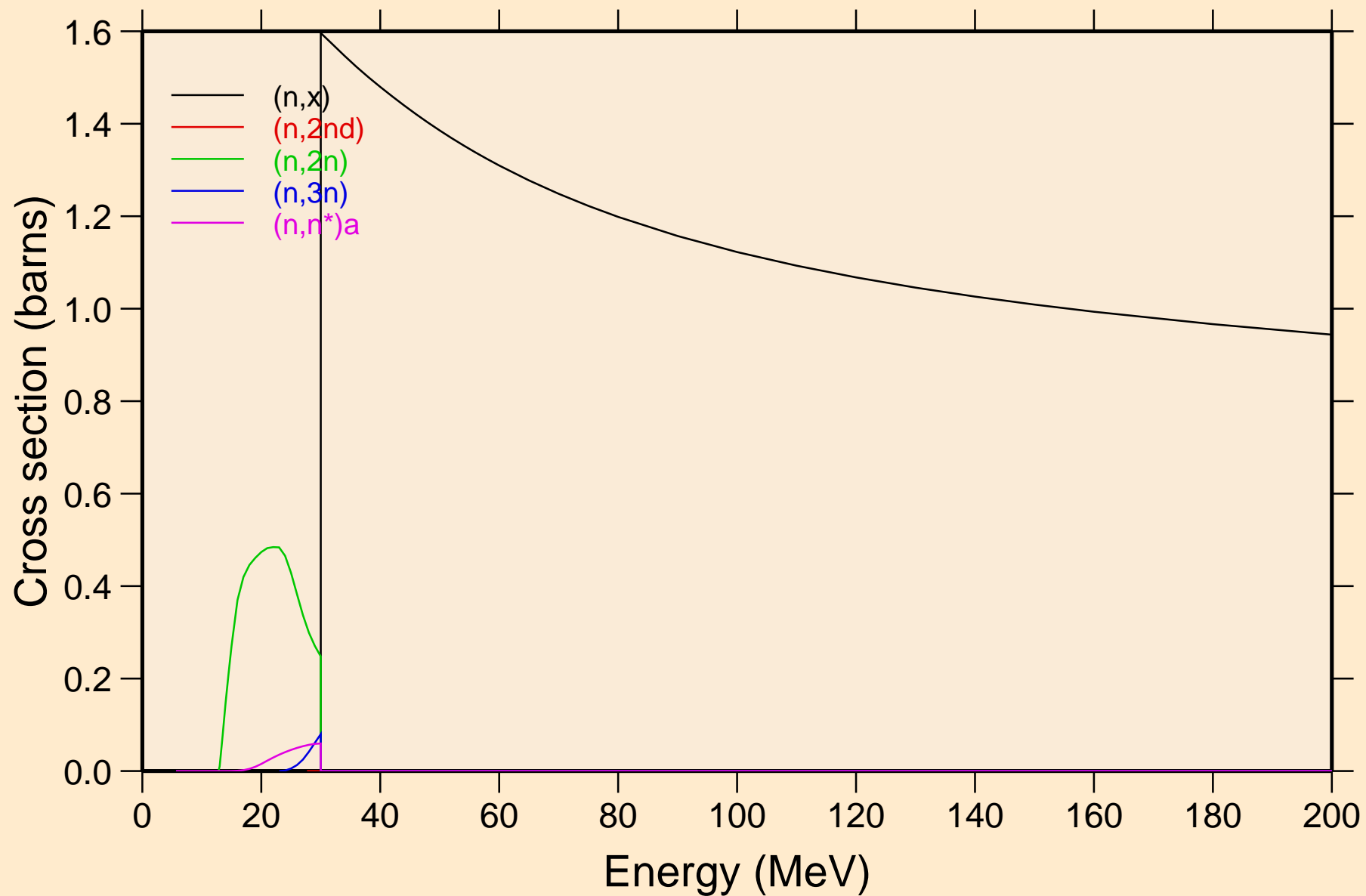

MO092 NEUTRON ACER TENDL-2019 LIBRARY; T=293.16K
Threshold reactions

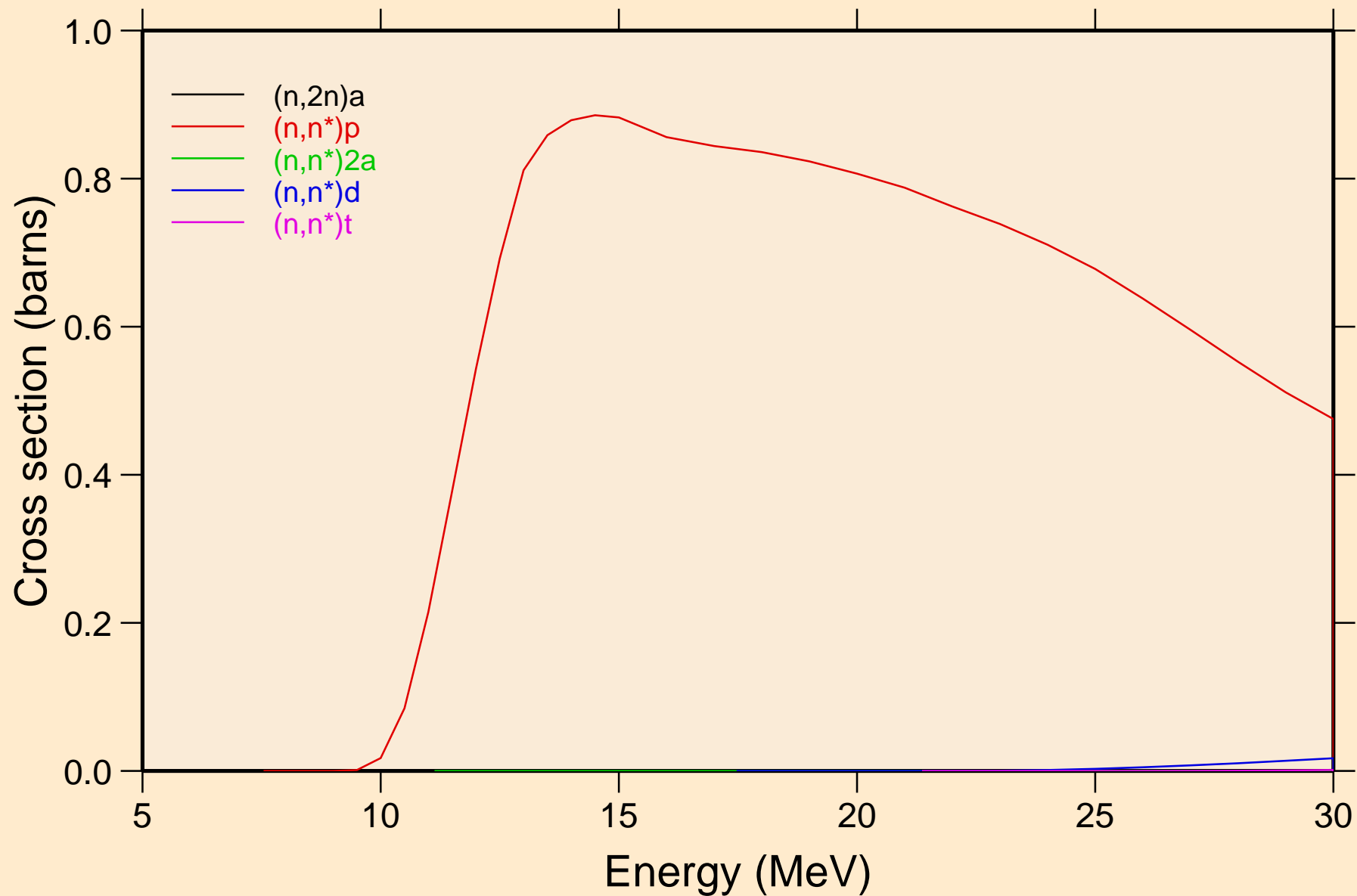

MO092 NEUTRON ACER TENDL-2019 LIBRARY; T=293.16K
Threshold reactions

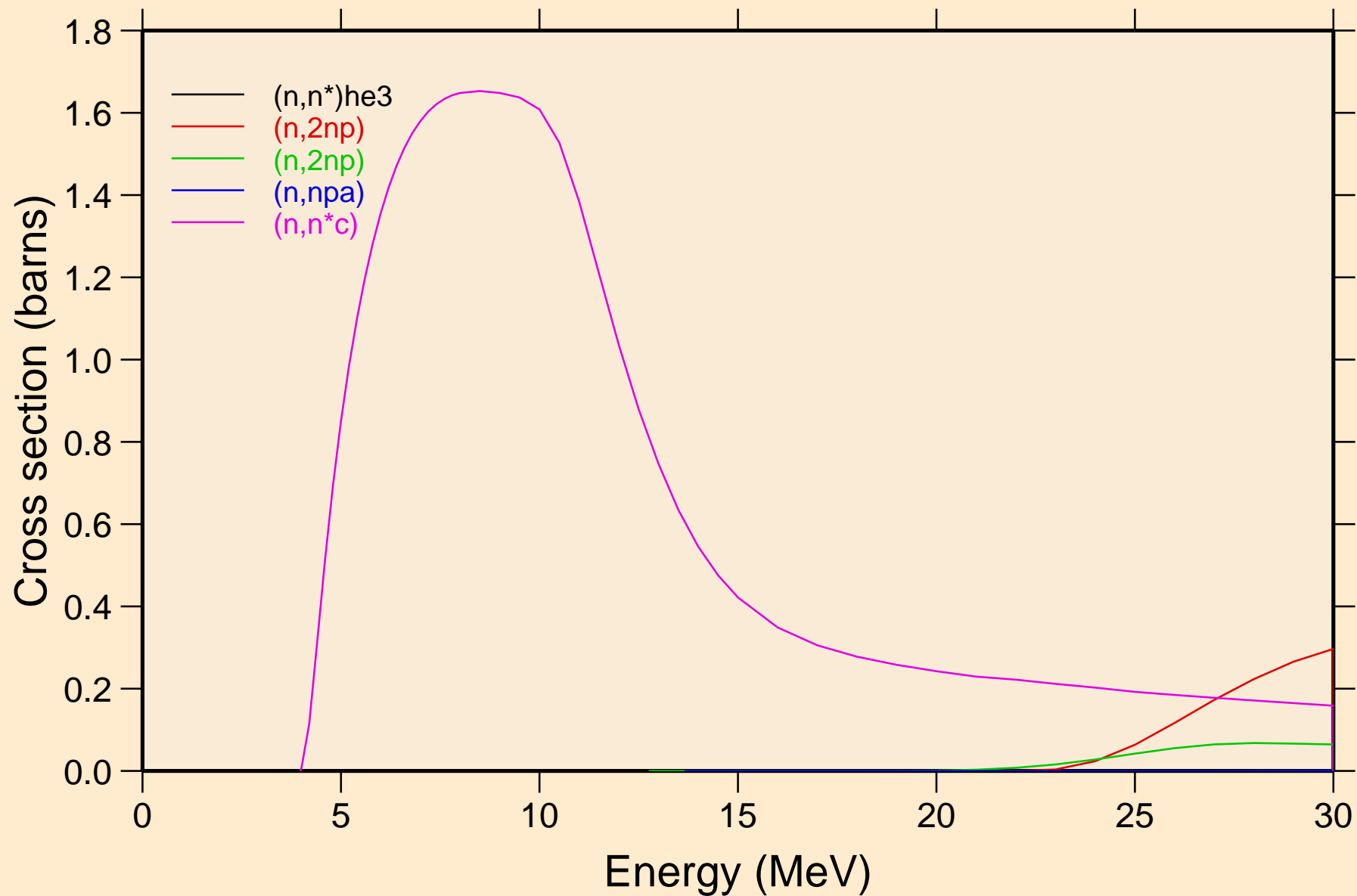

MO092 NEUTRON ACER TENDL-2019 LIBRARY; T=293.16K
Threshold reactions

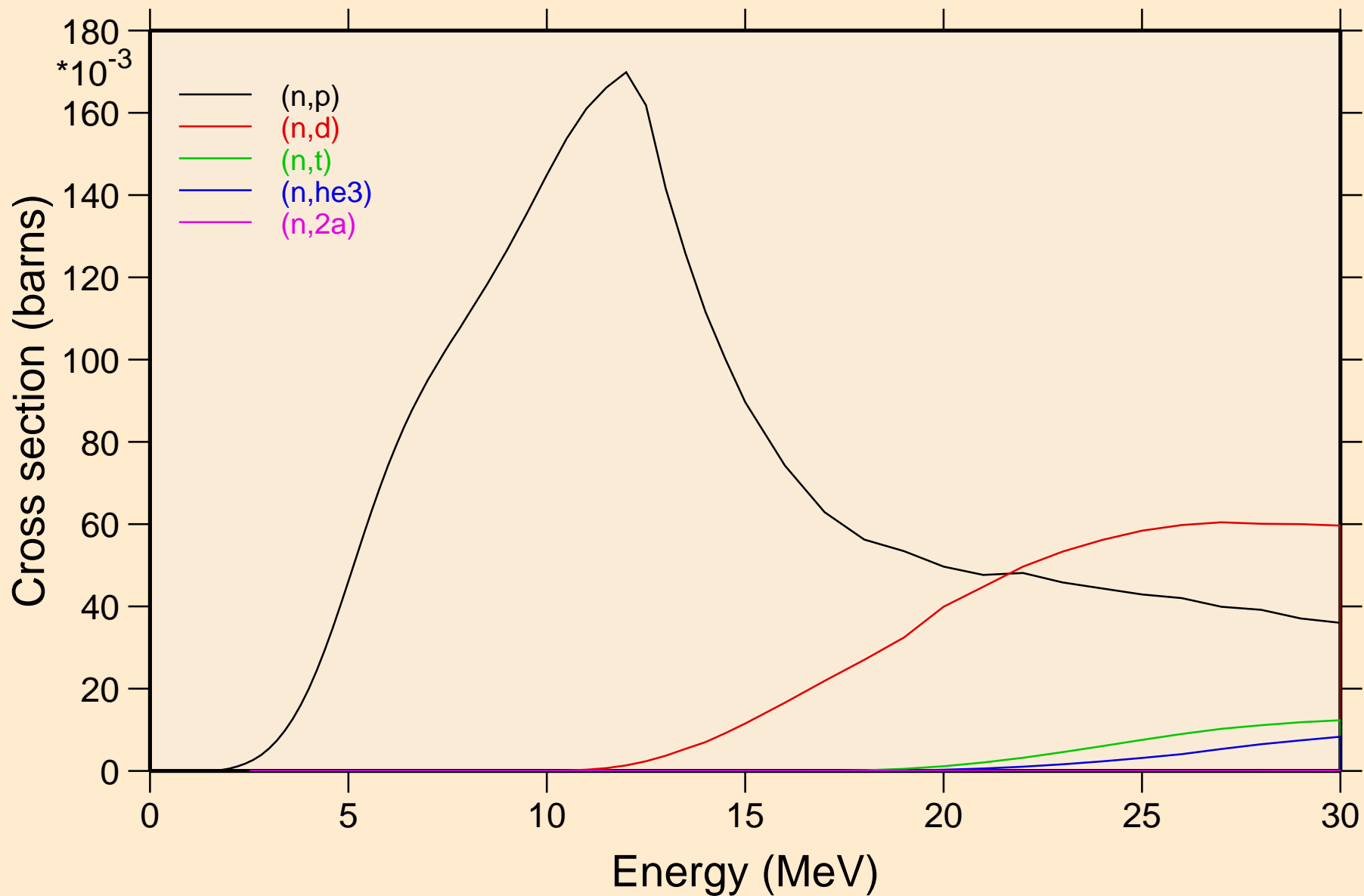

MO092 NEUTRON ACER TENDL-2019 LIBRARY; T=293.16K
Threshold reactions

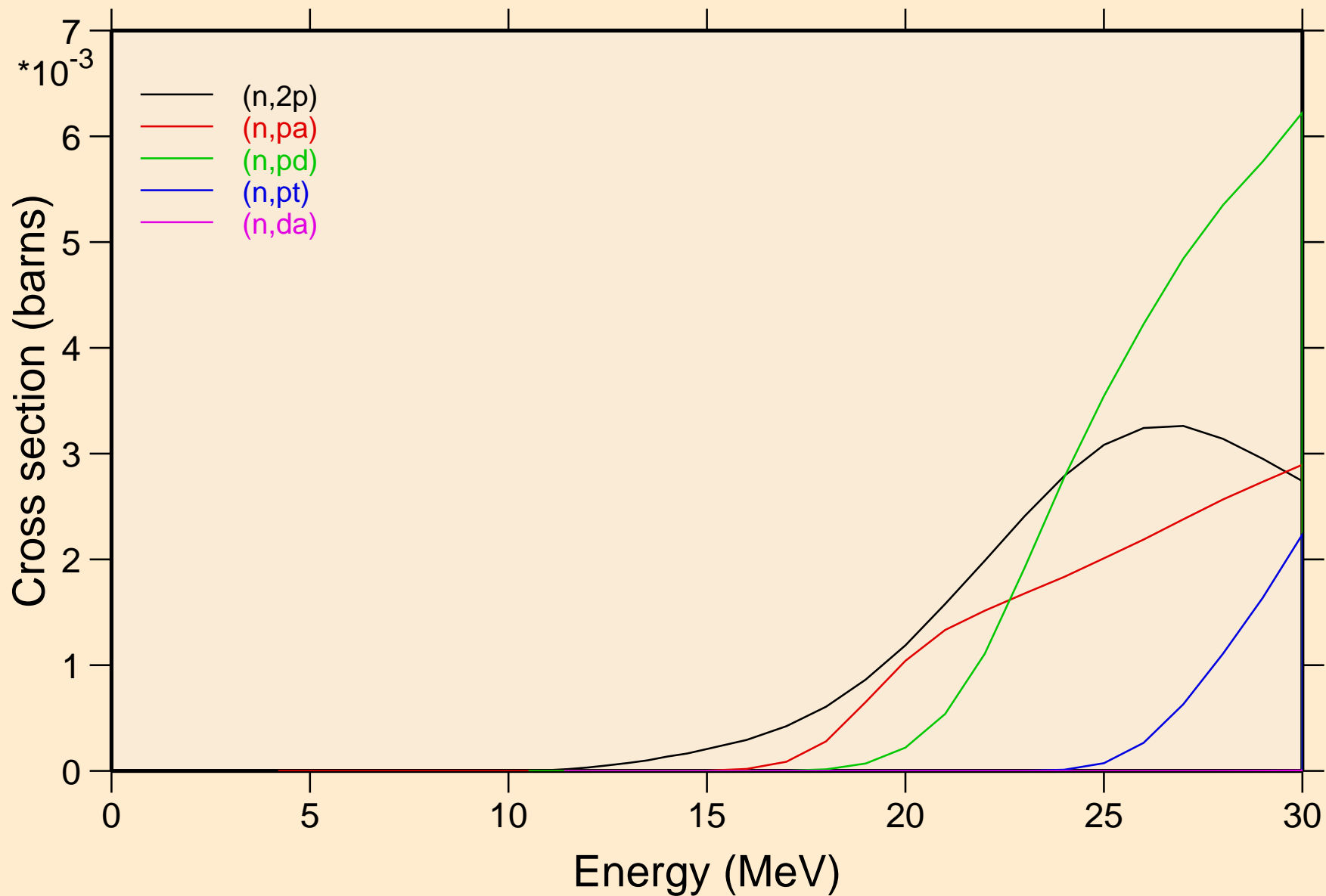

MO092 NEUTRON ACER TENDL-2019 LIBRARY; T=293.16K
Threshold reactions

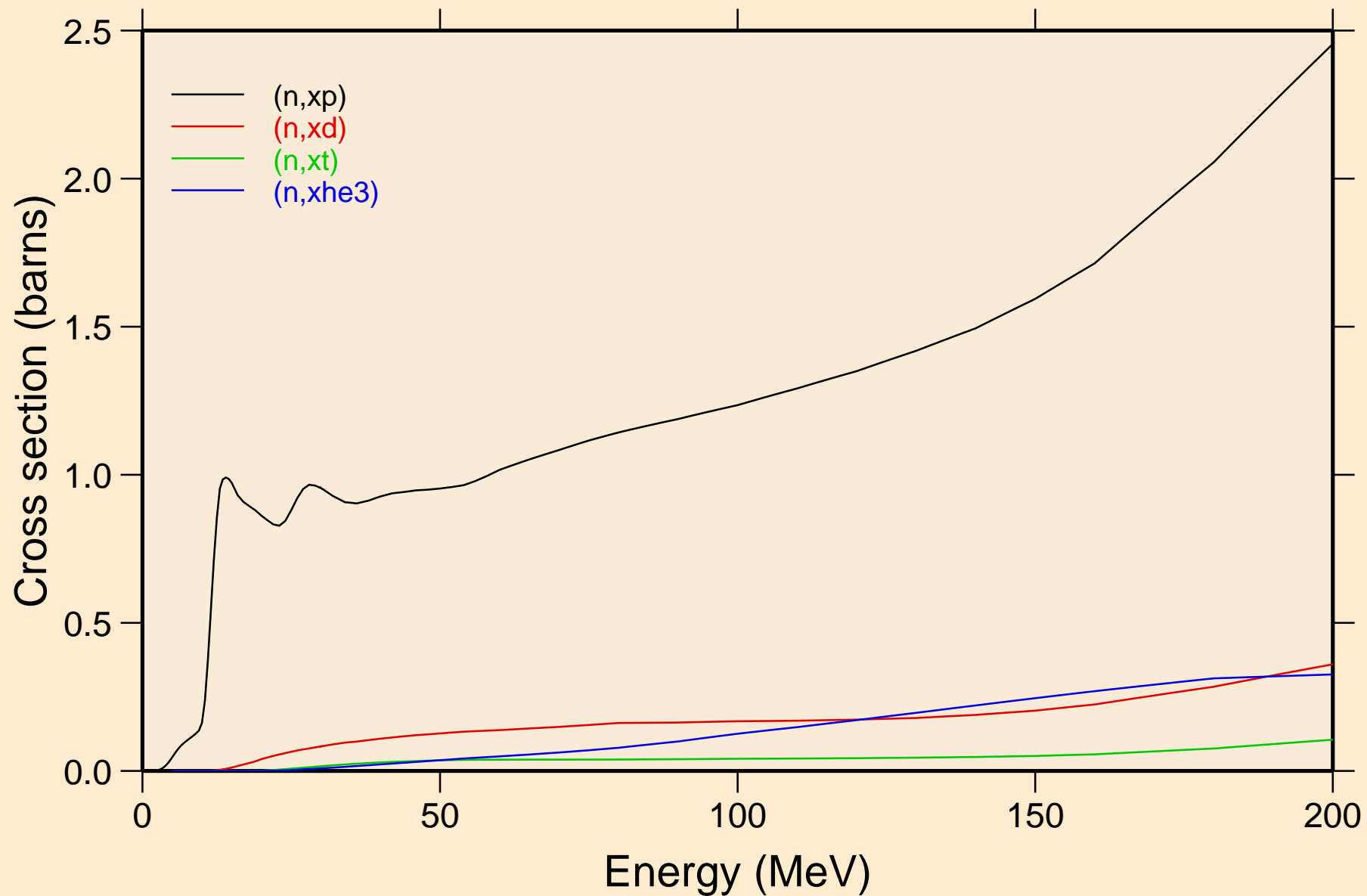

MO092 NEUTRON ACER TENDL-2019 LIBRARY; T=293.16K
angular distribution for elastic

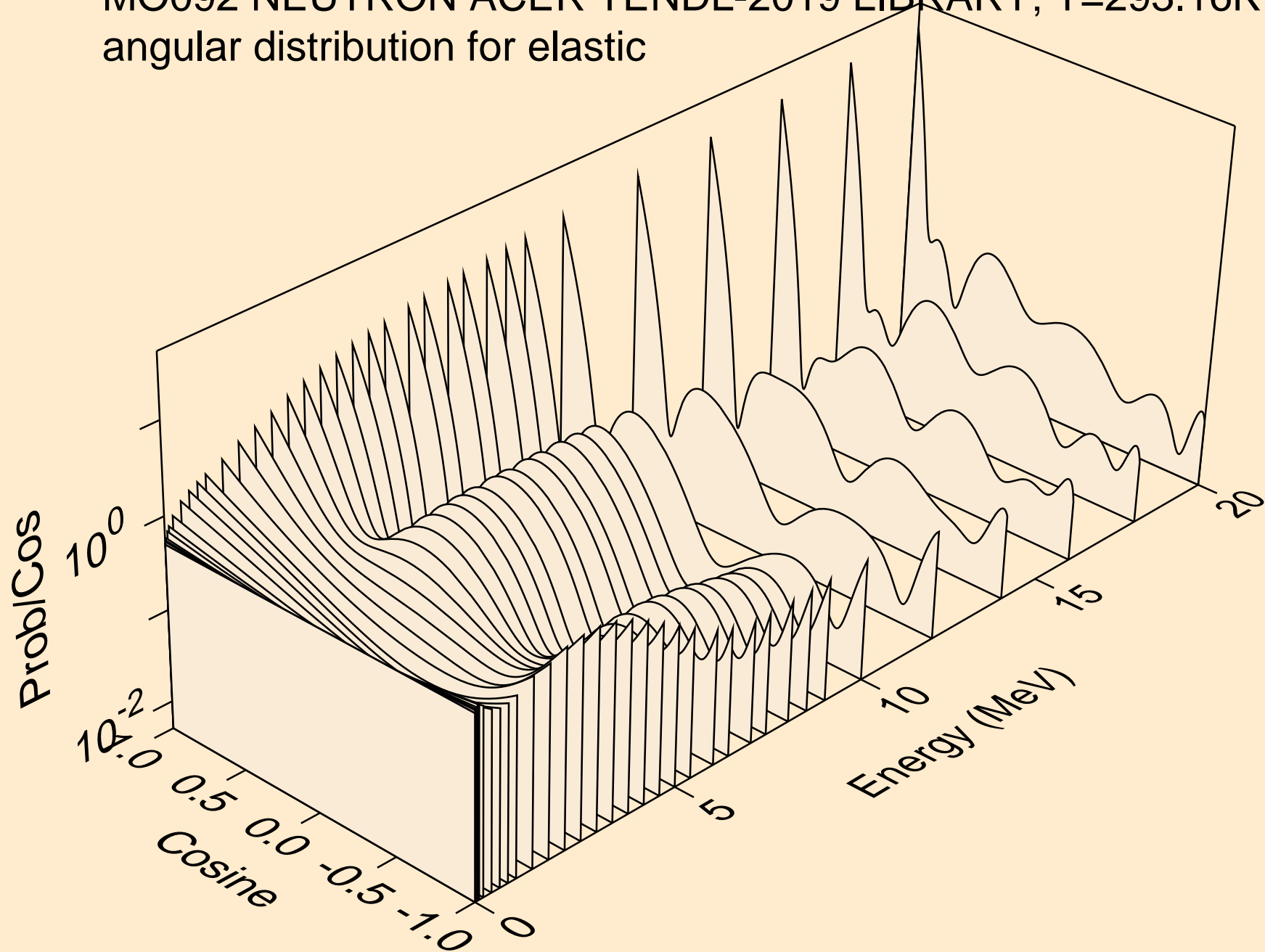

MO092 NEUTRON ACER TENDL-2019 LIBRARY; T=293.16K
angular distribution for elastic

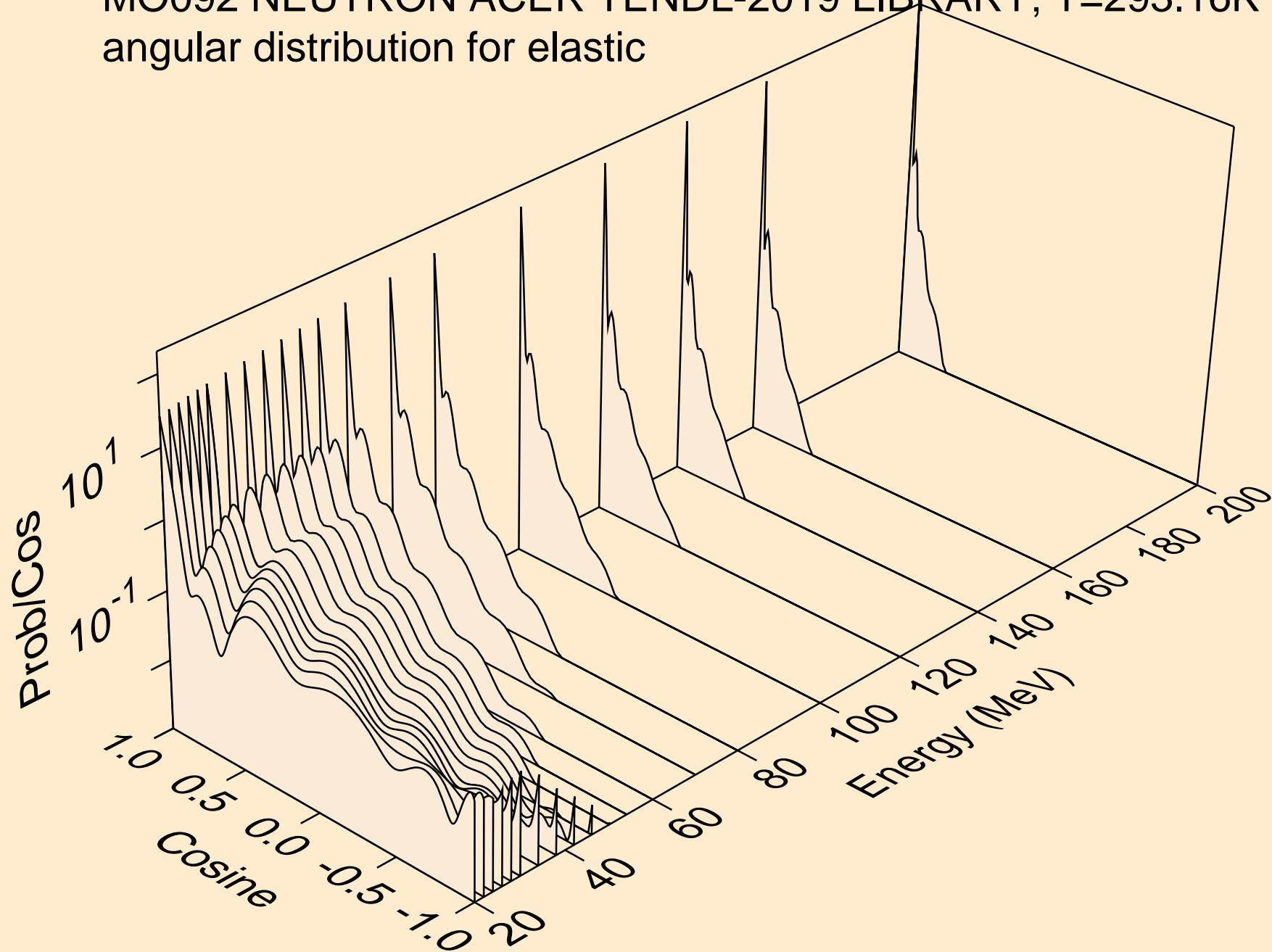

MO092 NEUTRON ACER TENDL-2019 LIBRARY; T=293.16K
angular distribution for (n,n*1)

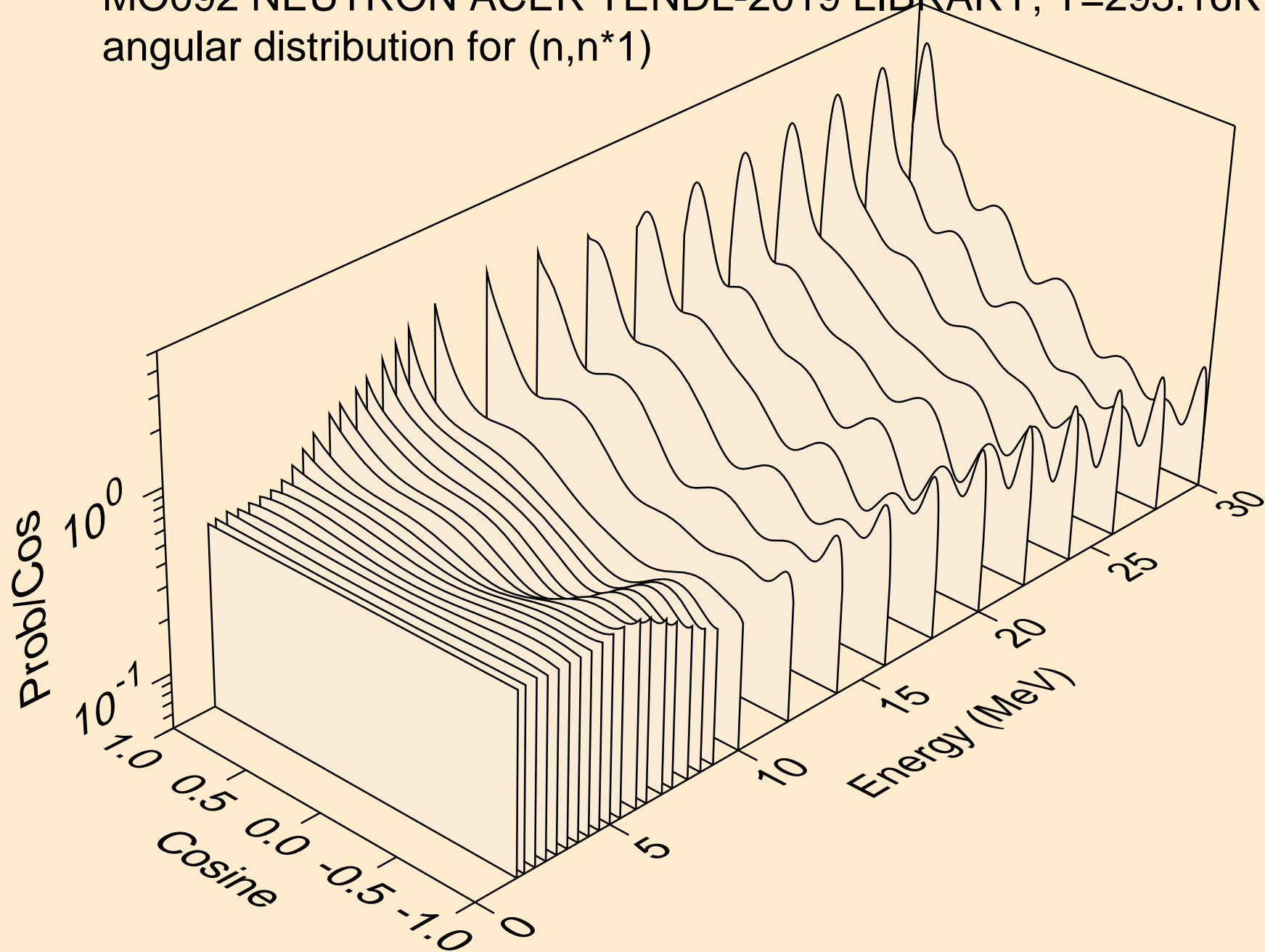

MO092 NEUTRON ACER TENDL-2019 LIBRARY; T=293.16K
angular distribution for (n,n*2)

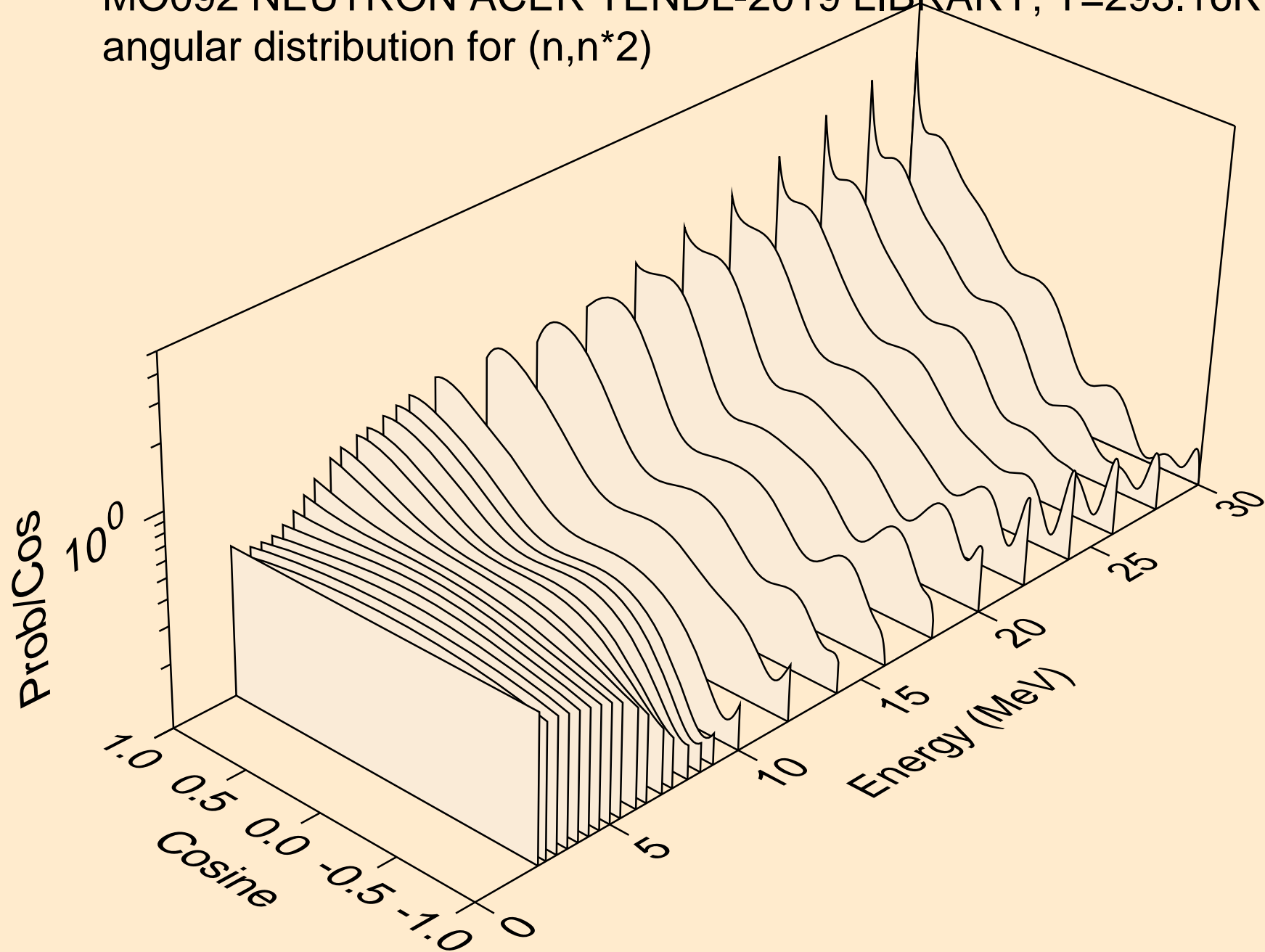

MO092 NEUTRON ACER TENDL-2019 LIBRARY; T=293.16K
angular distribution for (n,n*3)

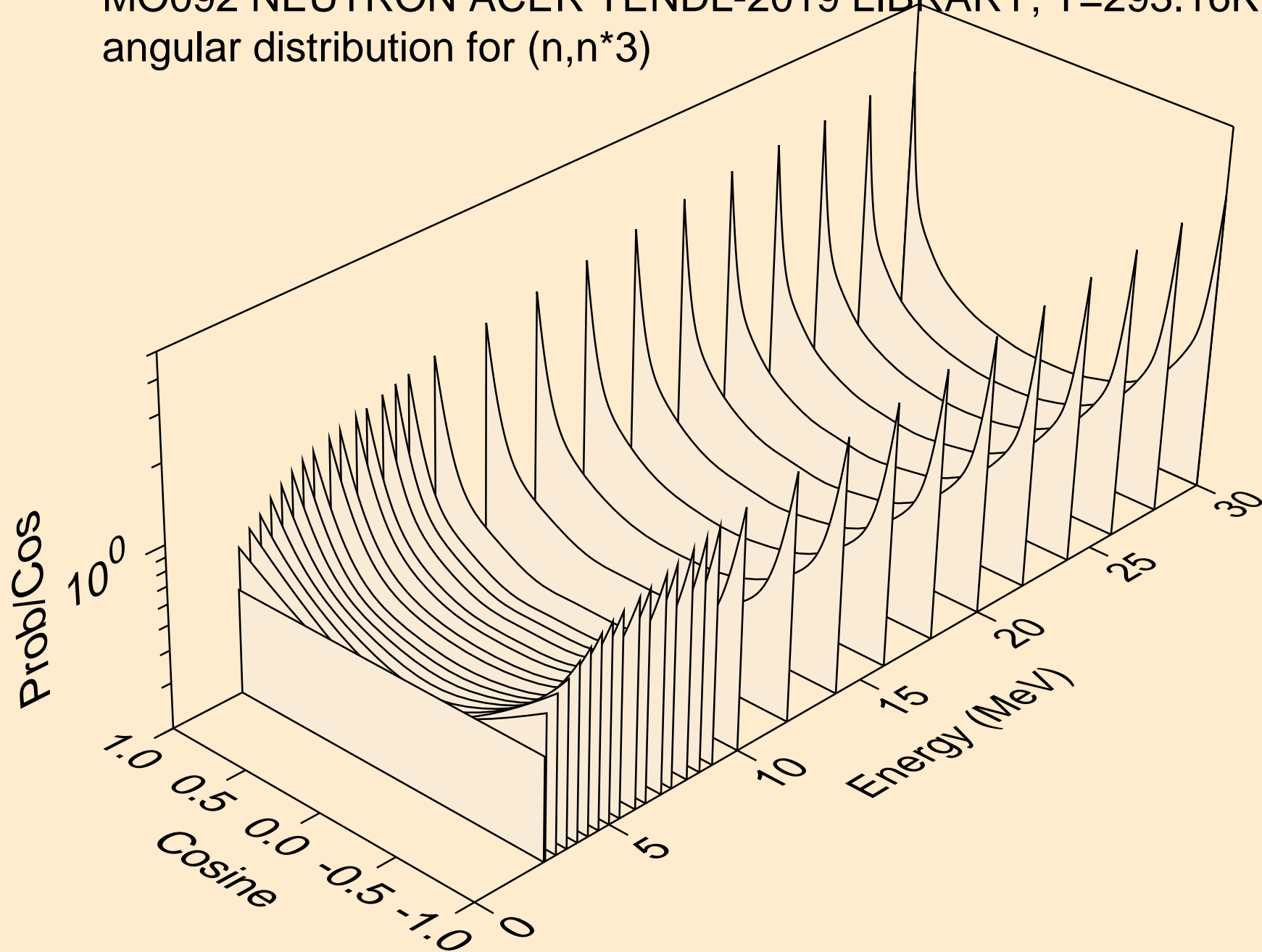

MO092 NEUTRON ACER TENDL-2019 LIBRARY; T=293.16K
angular distribution for (n,n*4)

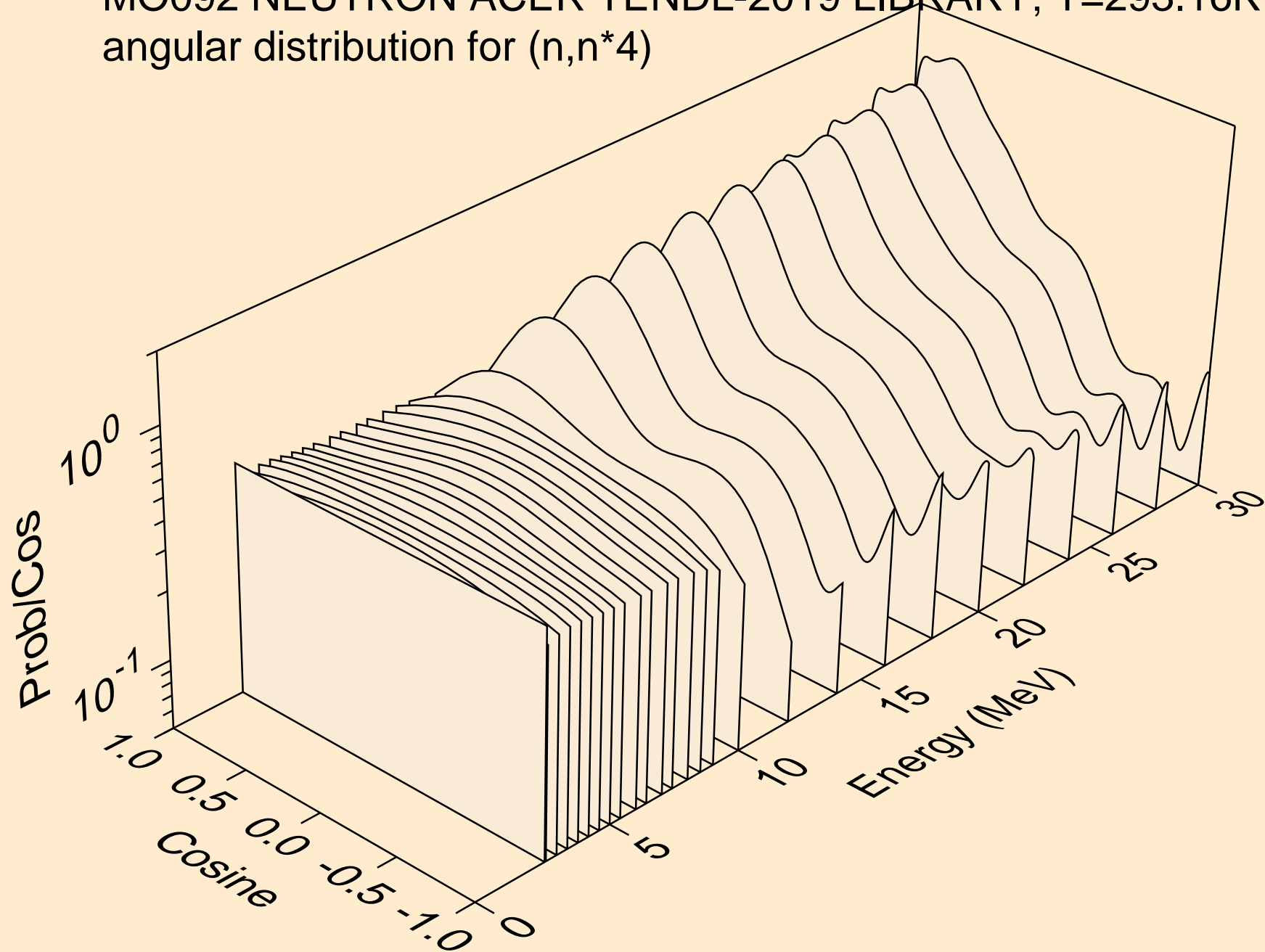

MO092 NEUTRON ACER TENDL-2019 LIBRARY; T=293.16K
angular distribution for (n,n*5)

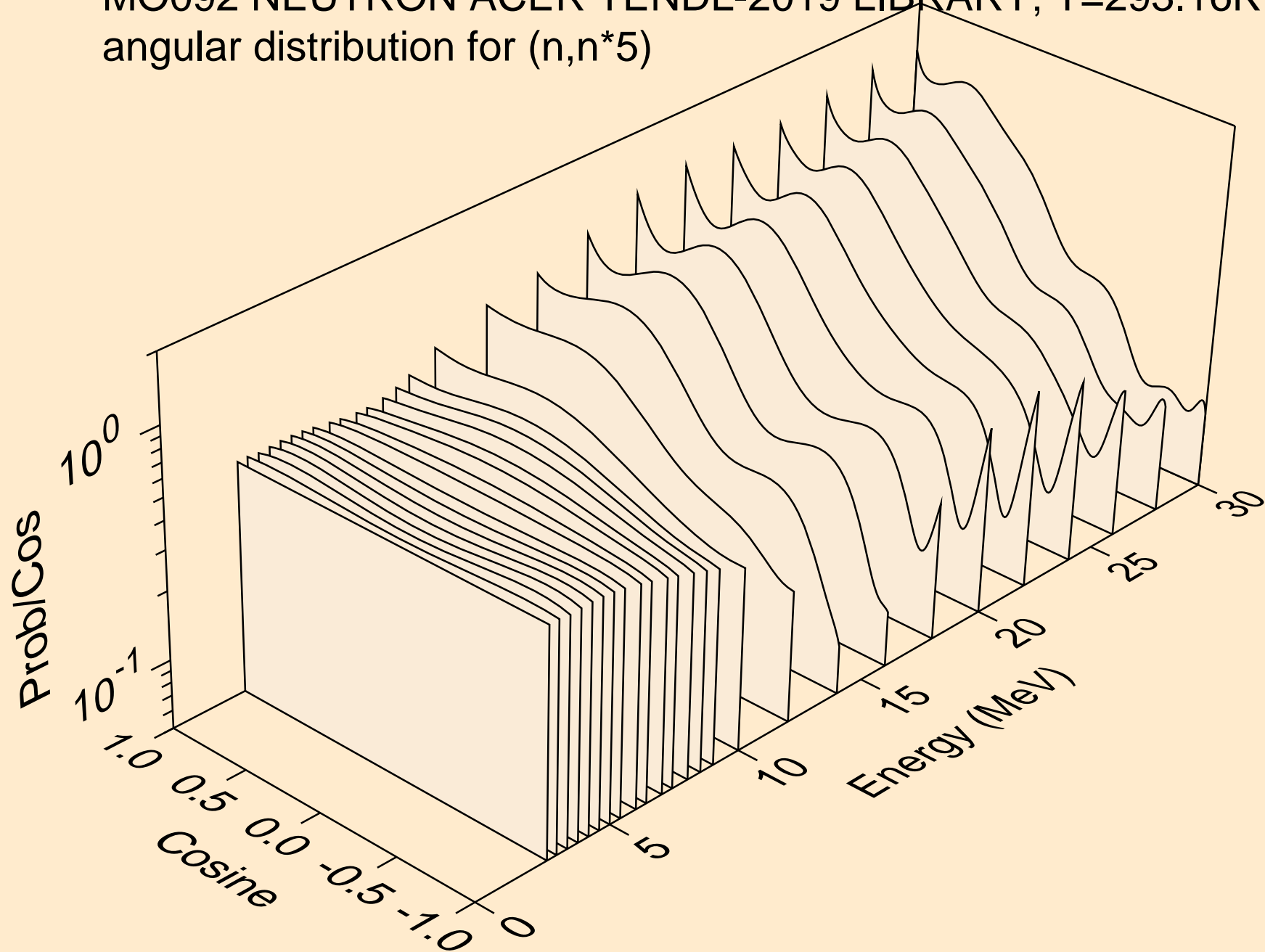

MO092 NEUTRON ACER TENDL-2019 LIBRARY; T=293.16K
angular distribution for (n,n*6)

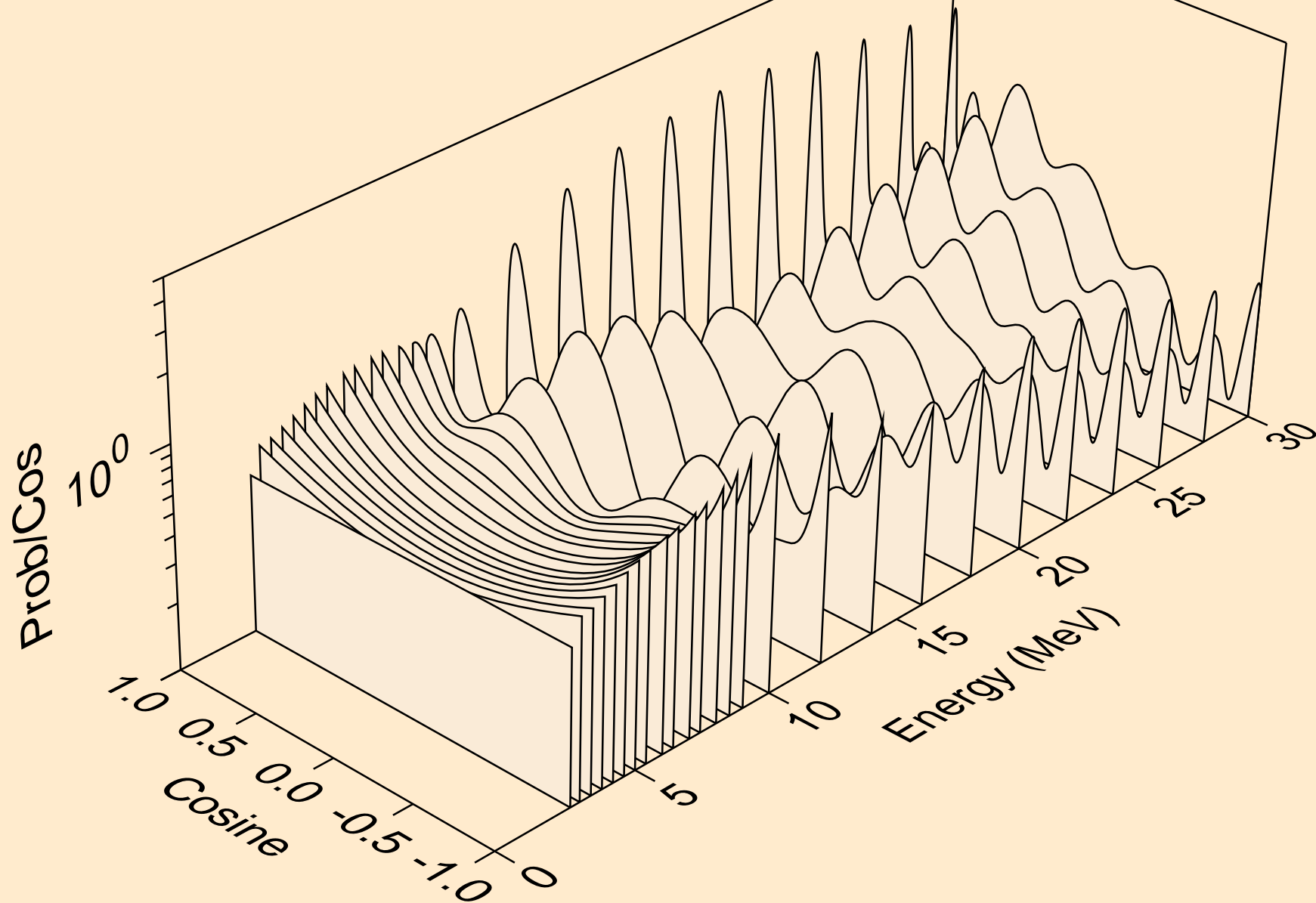

MO092 NEUTRON ACER TENDL-2019 LIBRARY; T=293.16K
angular distribution for (n,n*7)

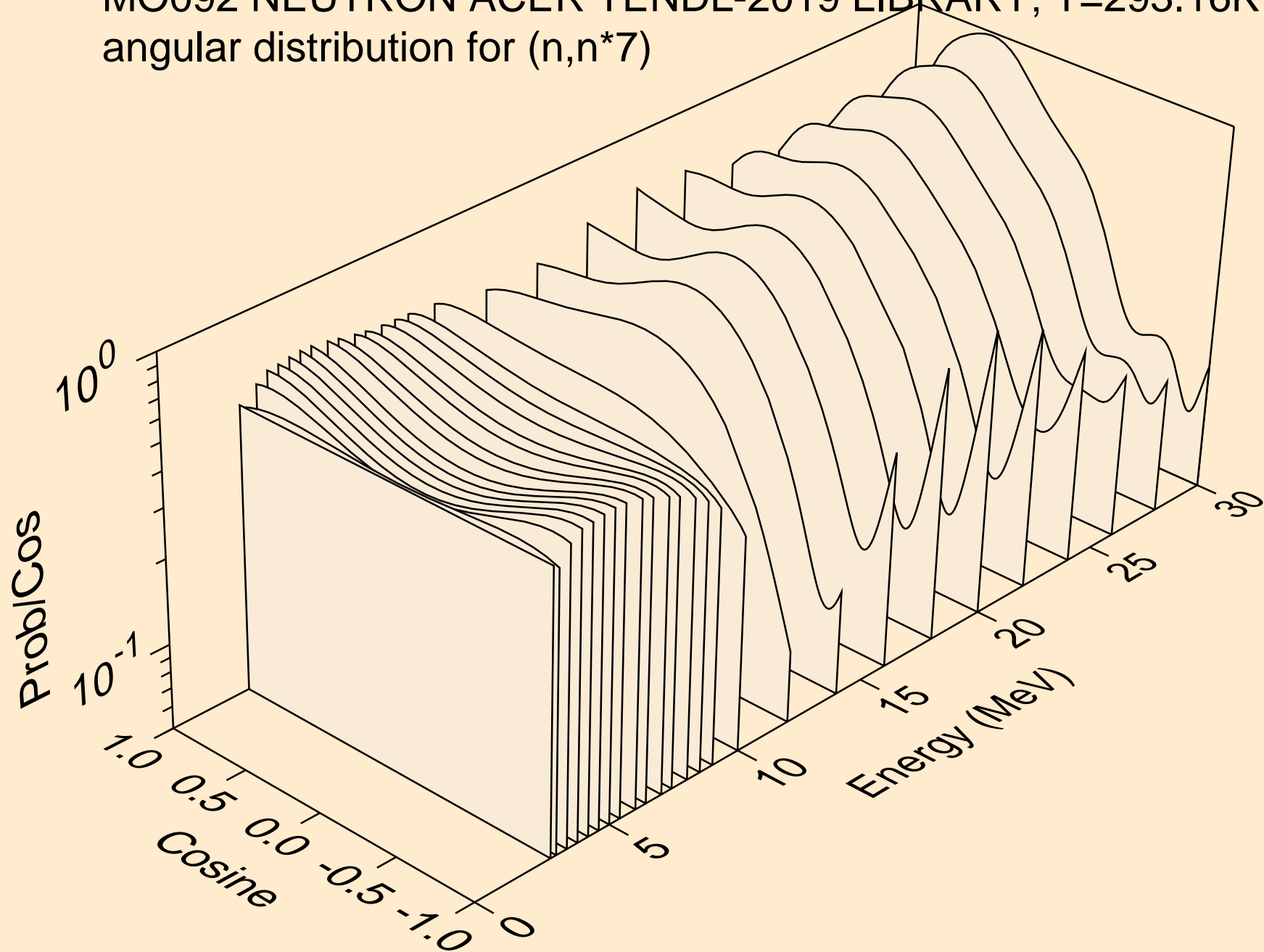

MO092 NEUTRON ACER TENDL-2019 LIBRARY; T=293.16K
angular distribution for (n,n*8)

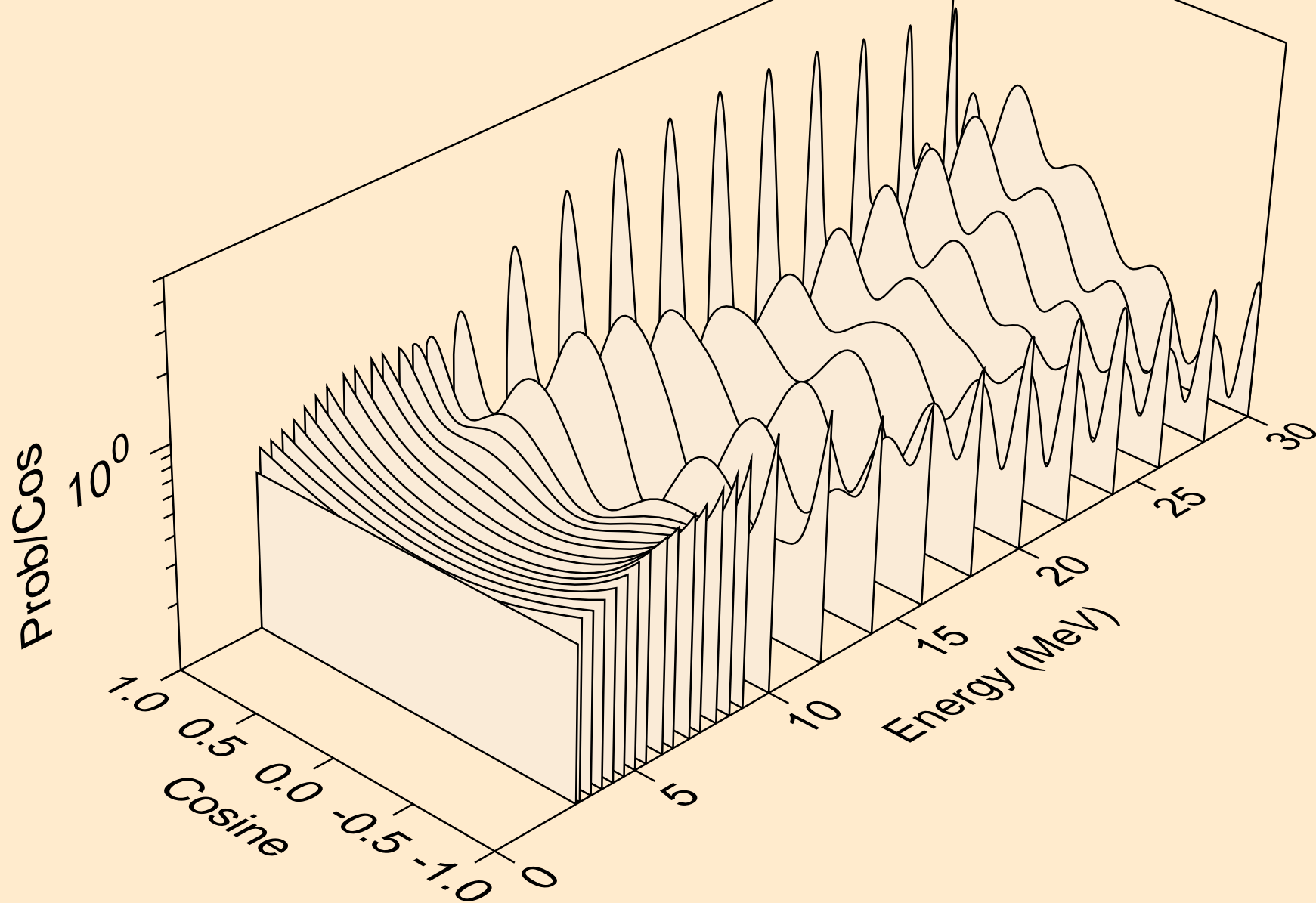

MO092 NEUTRON ACER TENDL-2019 LIBRARY; T=293.16K
angular distribution for (n,n*9)

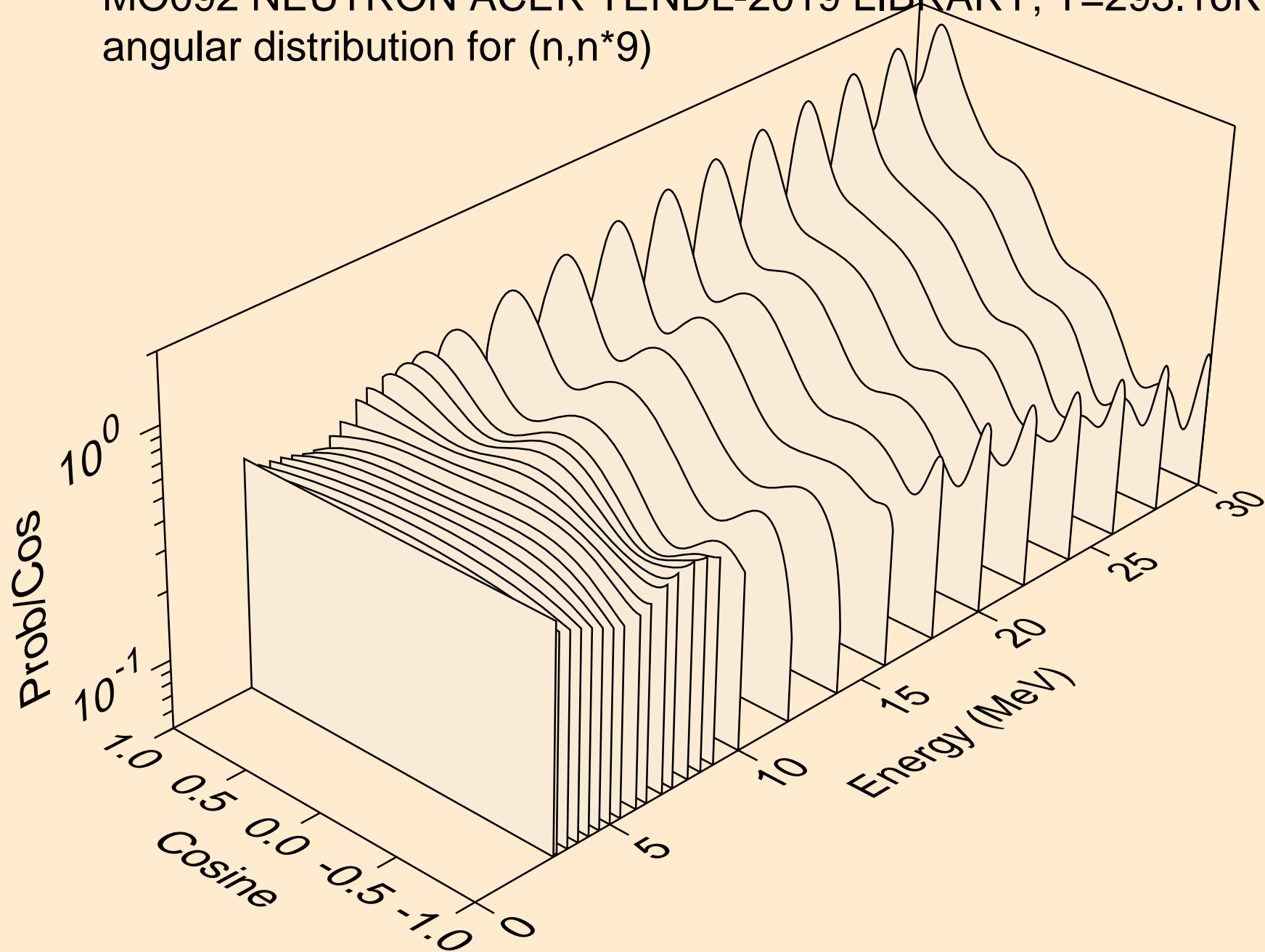

MO092 NEUTRON ACER TENDL-2019 LIBRARY; T=293.16K
angular distribution for (n,n*10)

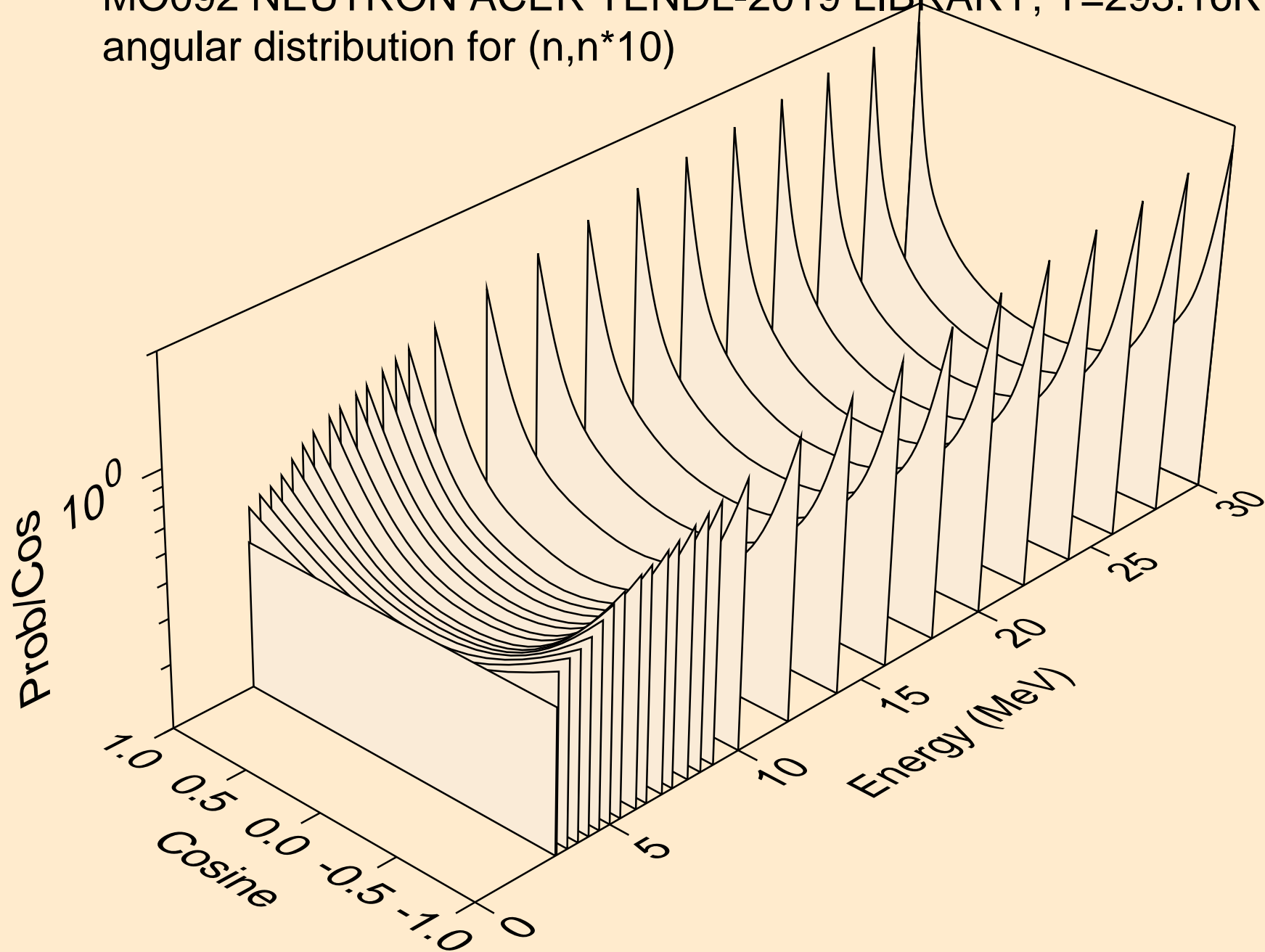

MO092 NEUTRON ACER TENDL-2019 LIBRARY; T=293.16K
angular distribution for (n,n*11)

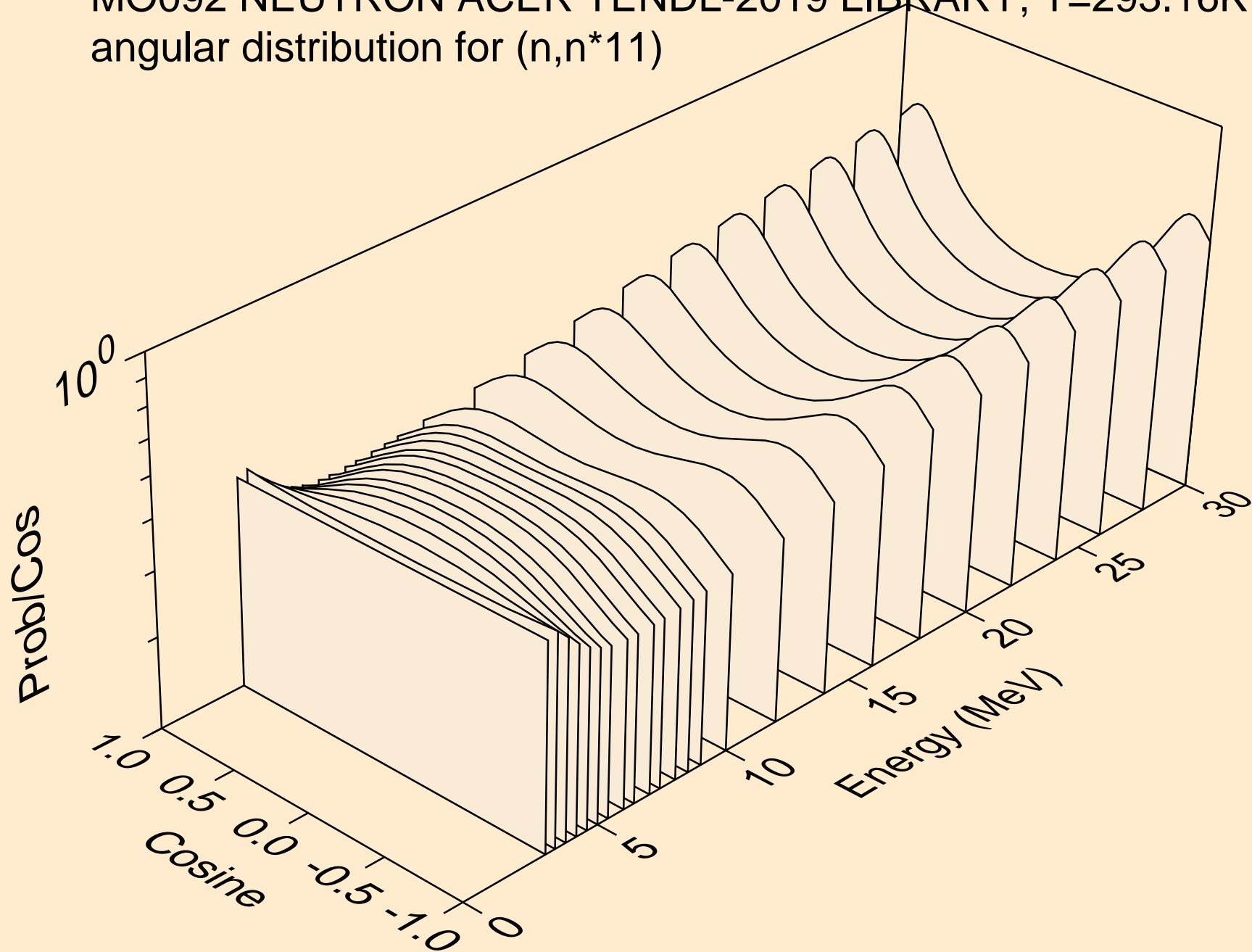

MO092 NEUTRON ACER TENDL-2019 LIBRARY; T=293.16K
angular distribution for (n,n*12)

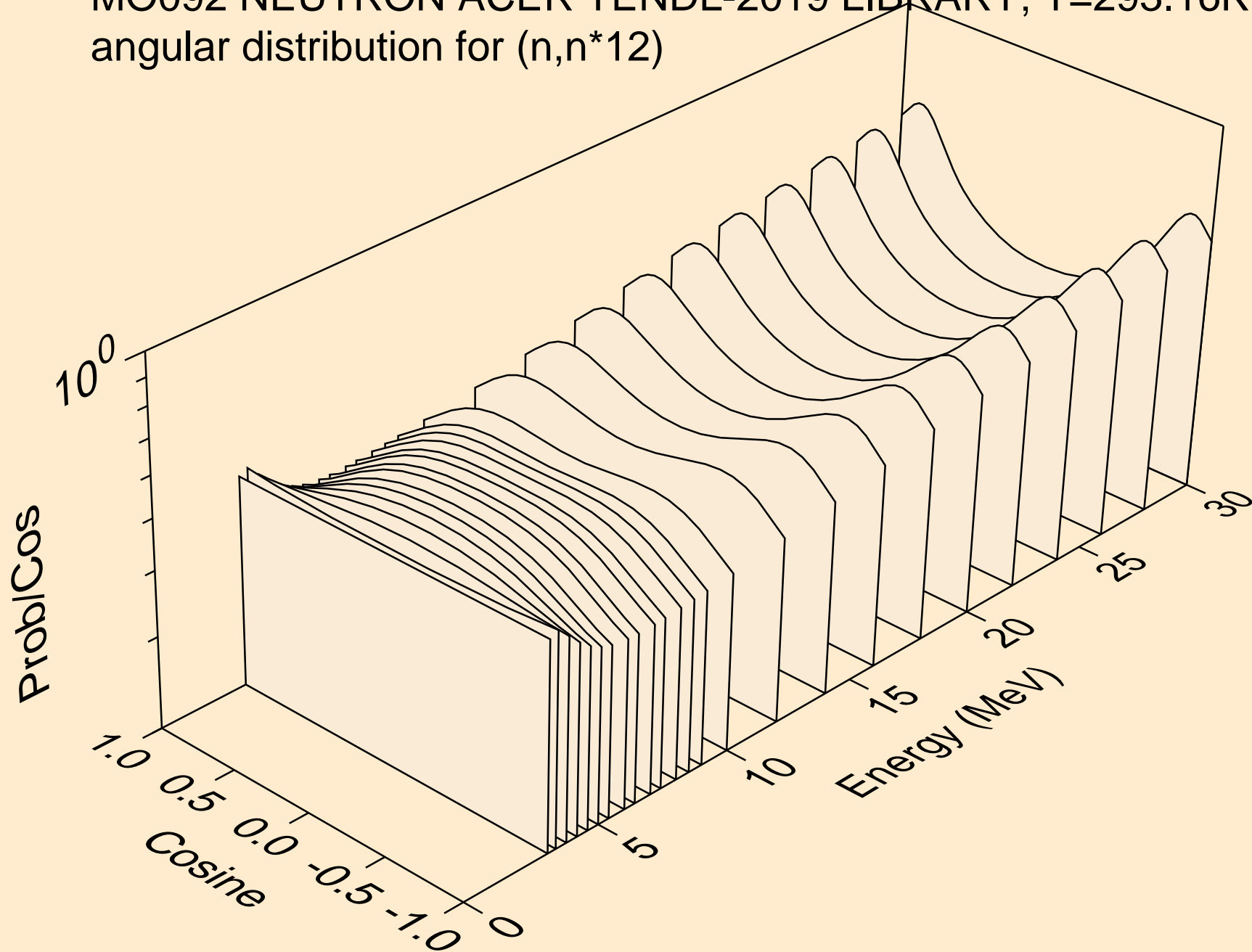

MO092 NEUTRON ACER TENDL-2019 LIBRARY; T=293.16K
angular distribution for (n,n*13)

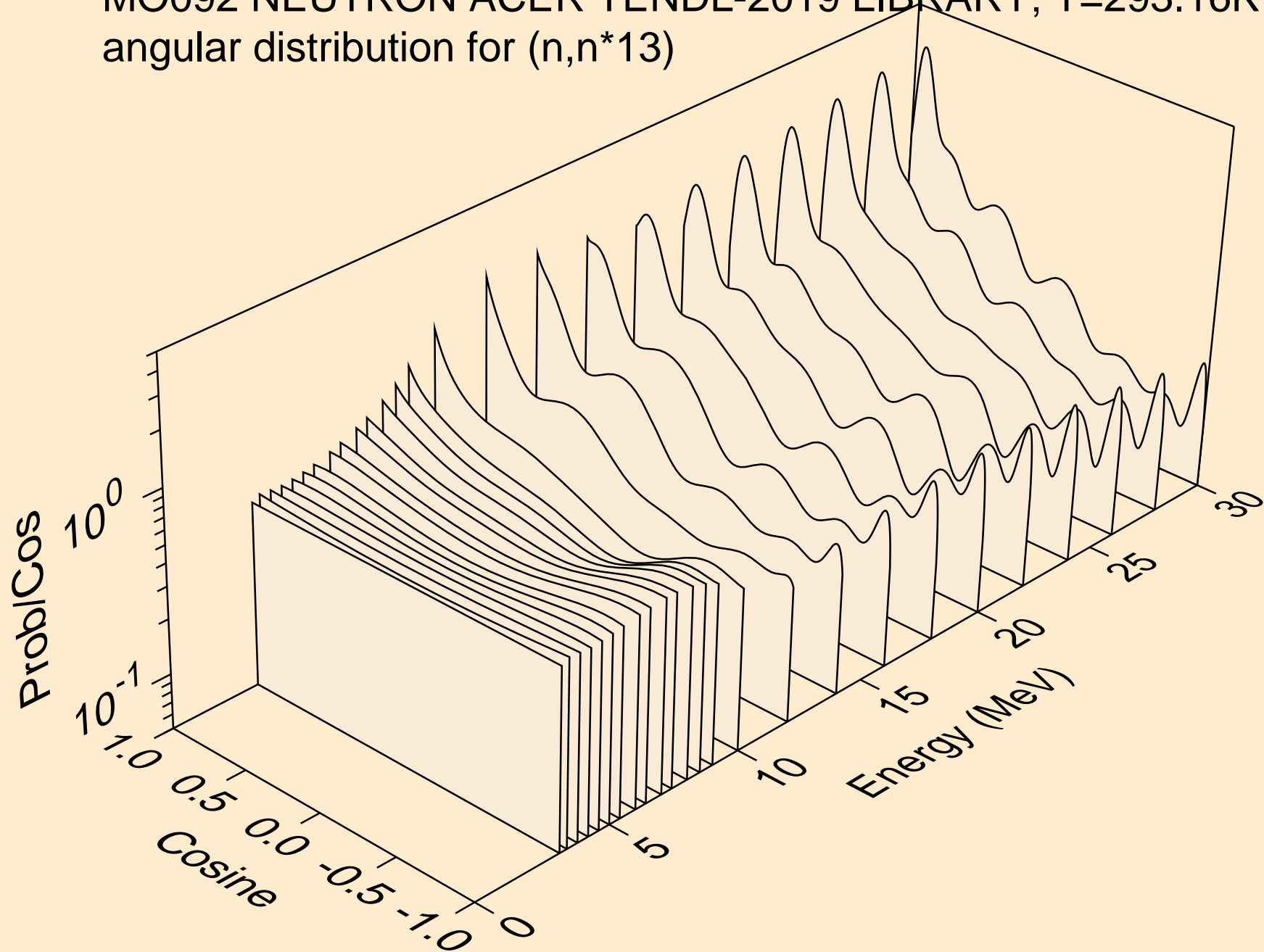

MO092 NEUTRON ACER TENDL-2019 LIBRARY; T=293.16K
angular distribution for (n,n*14)

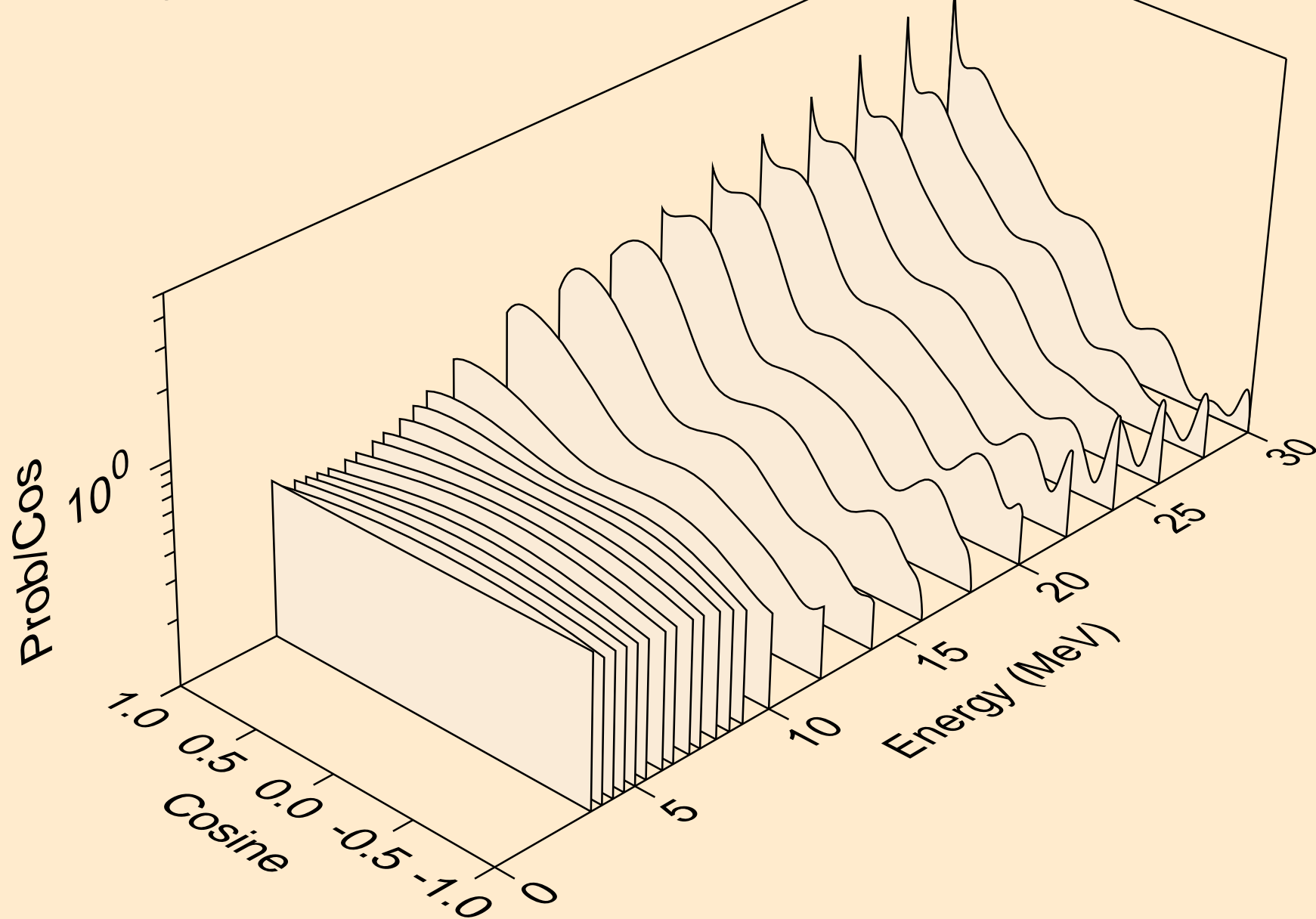

MO092 NEUTRON ACER TENDL-2019 LIBRARY; T=293.16K
angular distribution for (n,n*15)

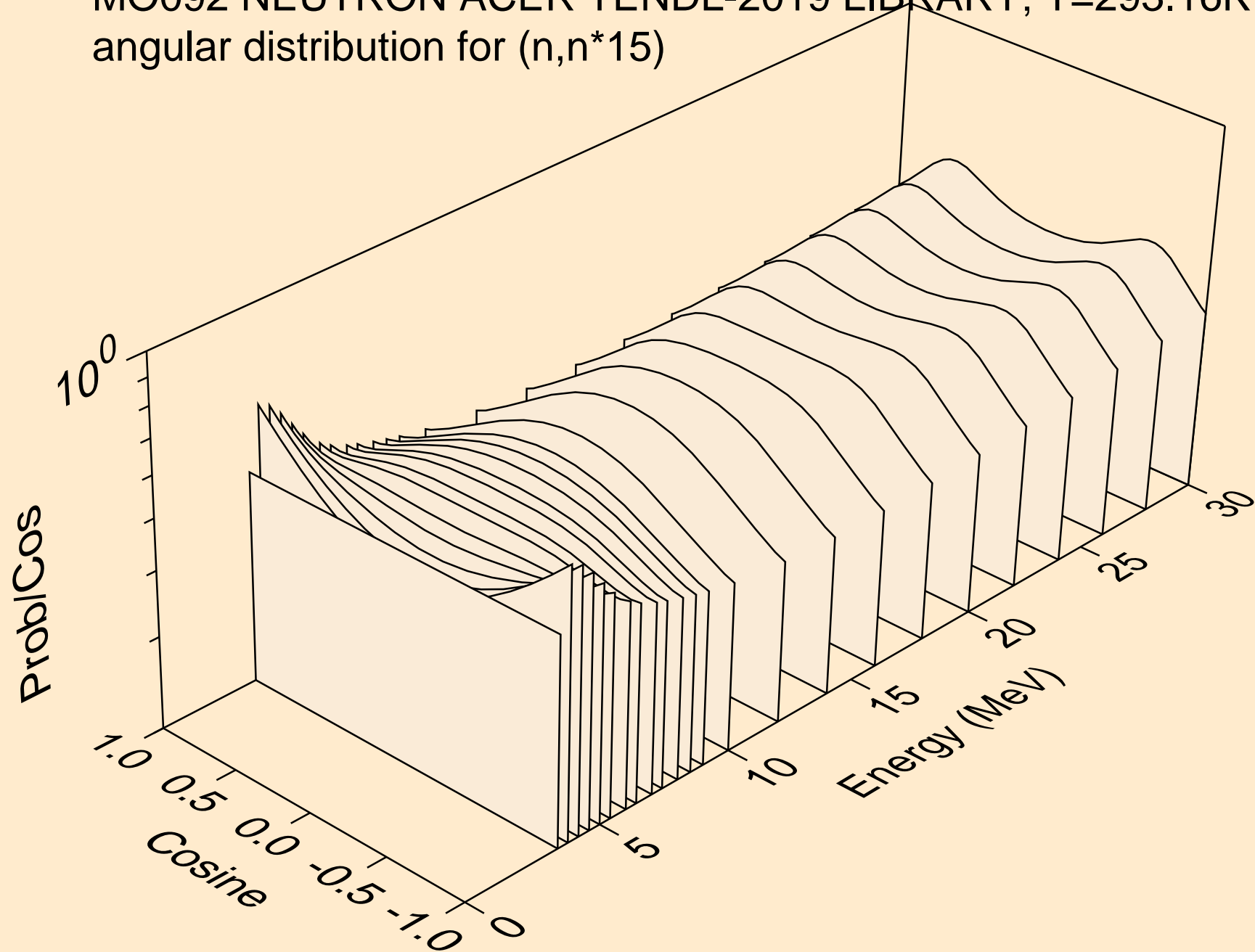

MO092 NEUTRON ACER TENDL-2019 LIBRARY; T=293.16K
angular distribution for (n,n*16)

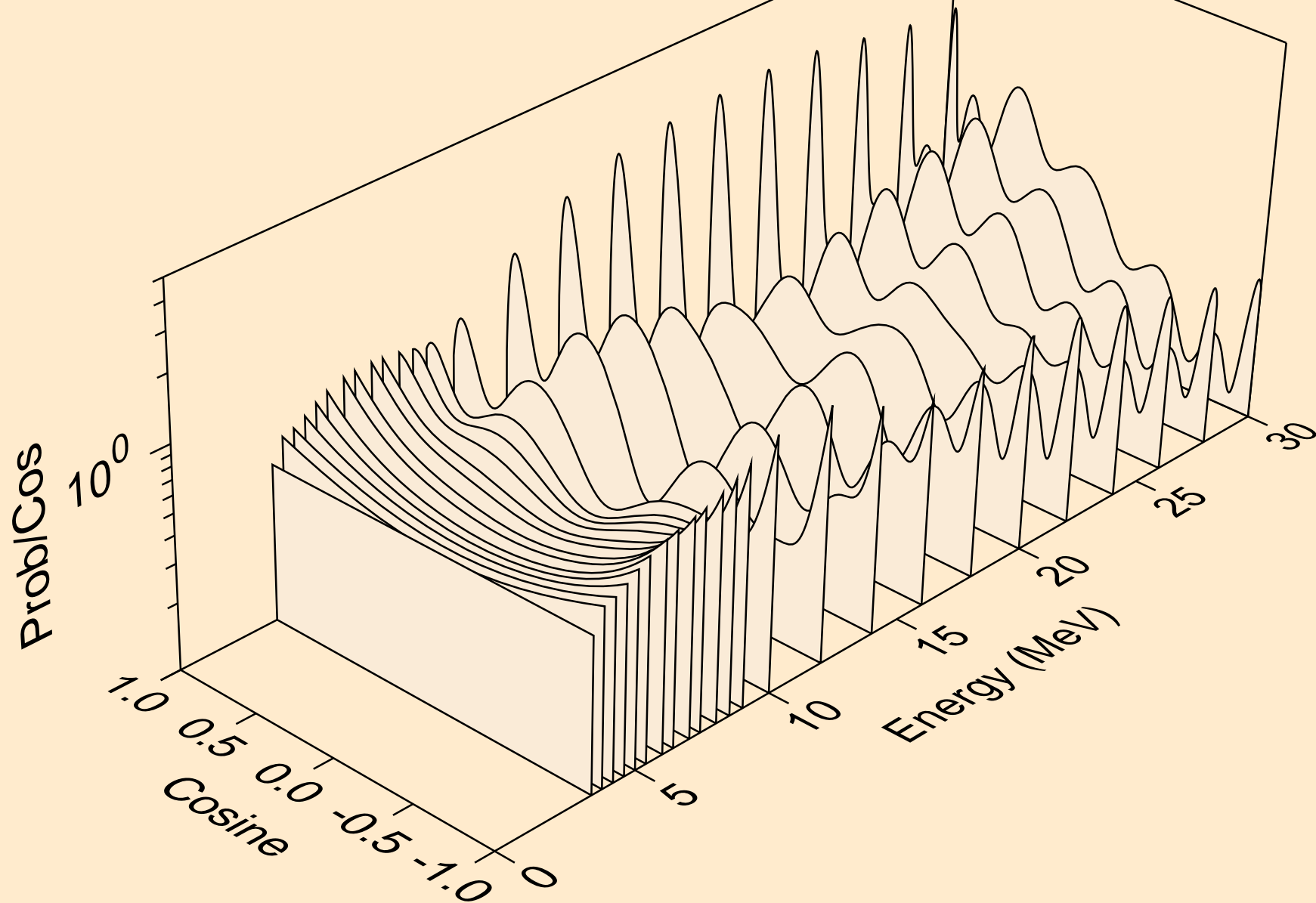

MO092 NEUTRON ACER TENDL-2019 LIBRARY; T=293.16K
angular distribution for (n,n*17)

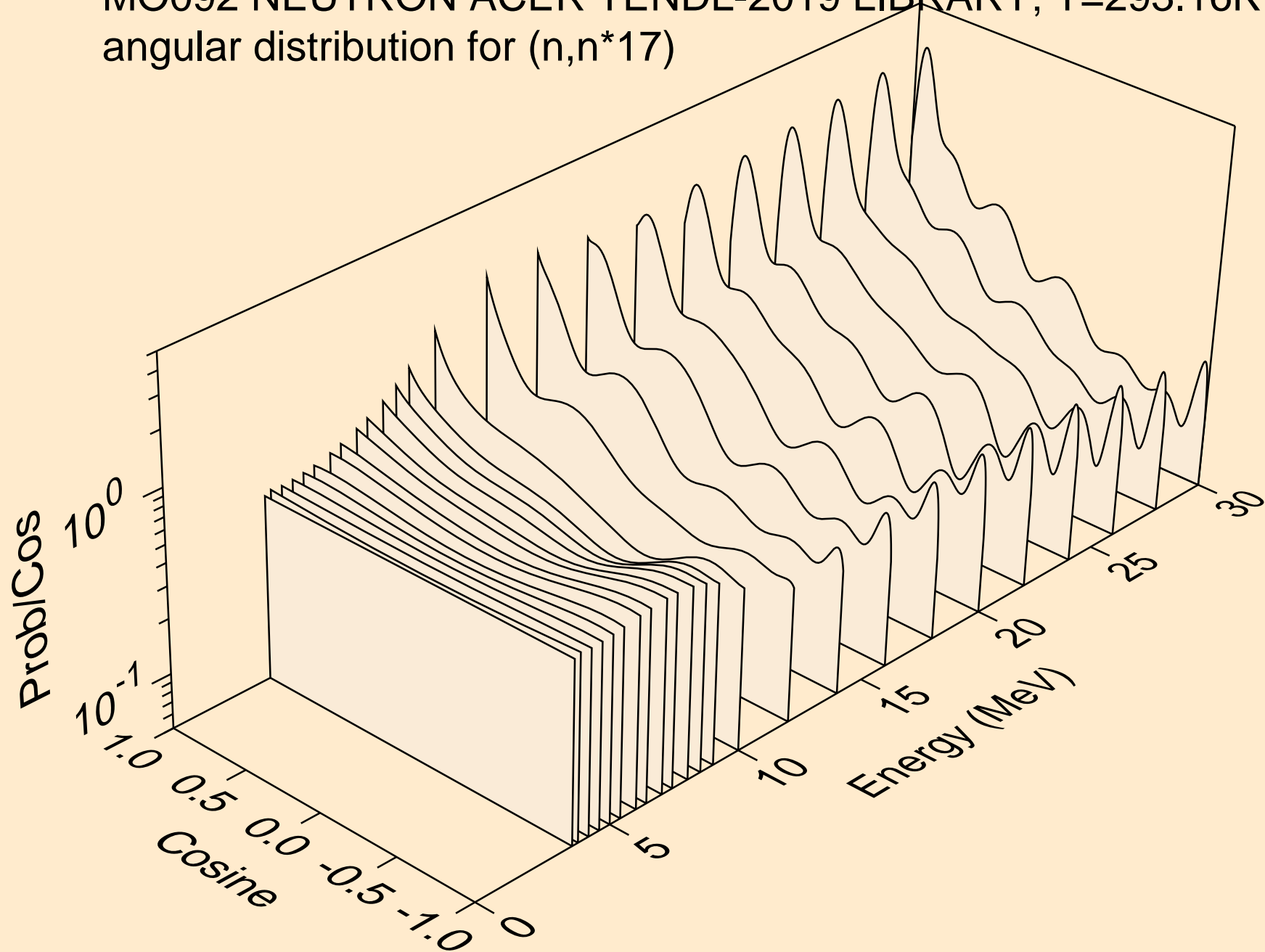

MO092 NEUTRON ACER TENDL-2019 LIBRARY; T=293.16K
angular distribution for (n,n*18)

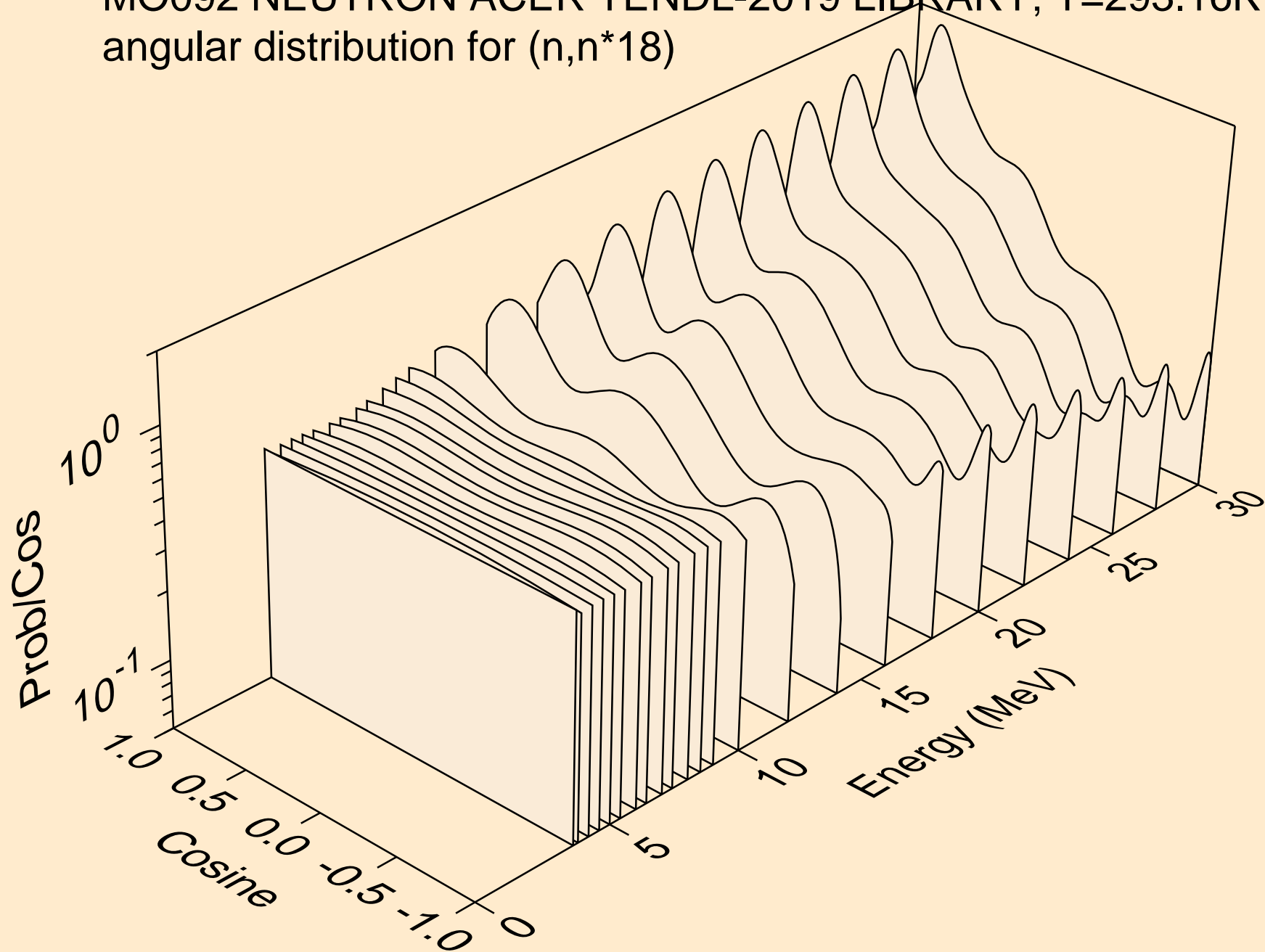

MO092 NEUTRON ACER TENDL-2019 LIBRARY; T=293.16K
angular distribution for (n,n*19)

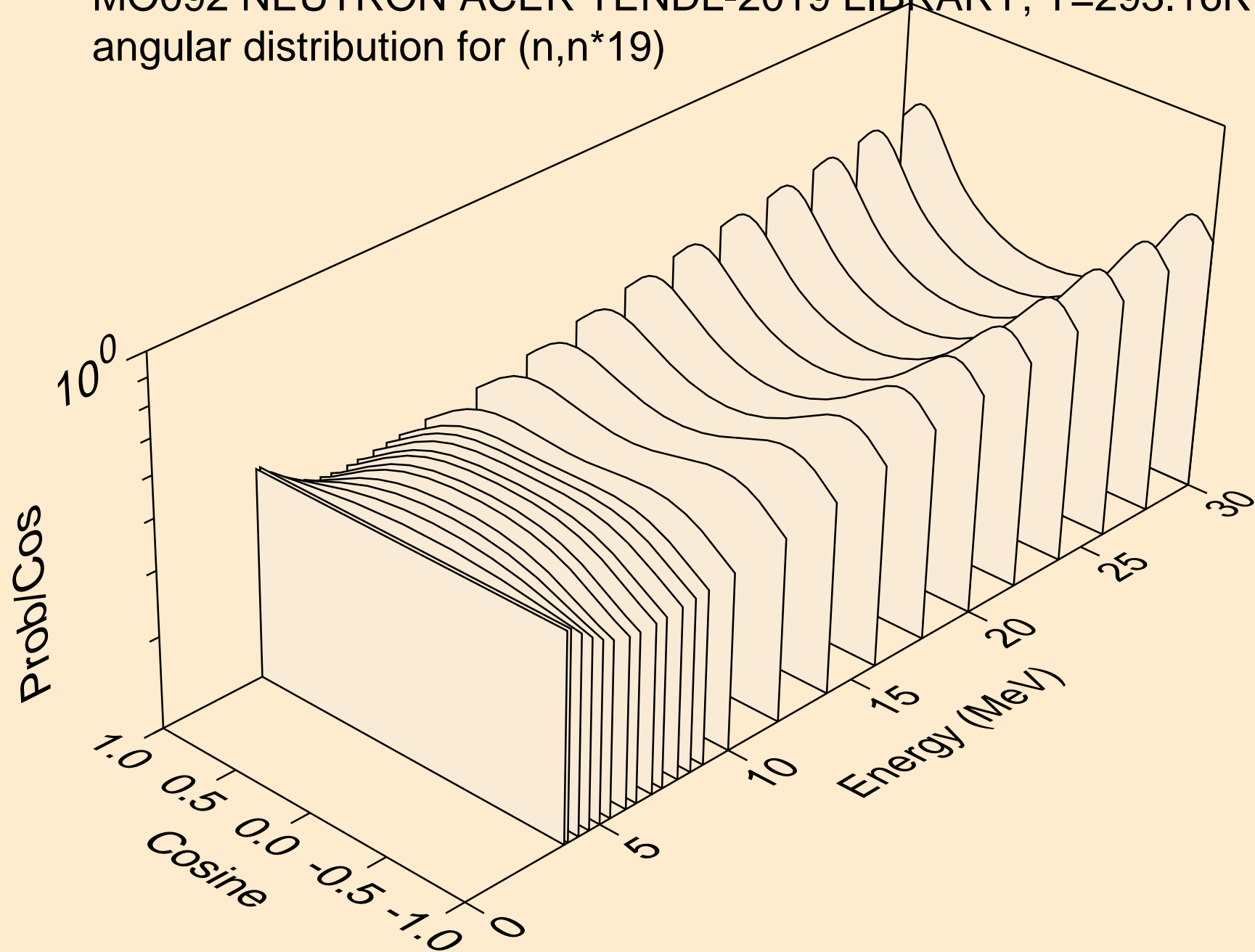

MO092 NEUTRON ACER TENDL-2019 LIBRARY; T=293.16K
angular distribution for (n,n*20)

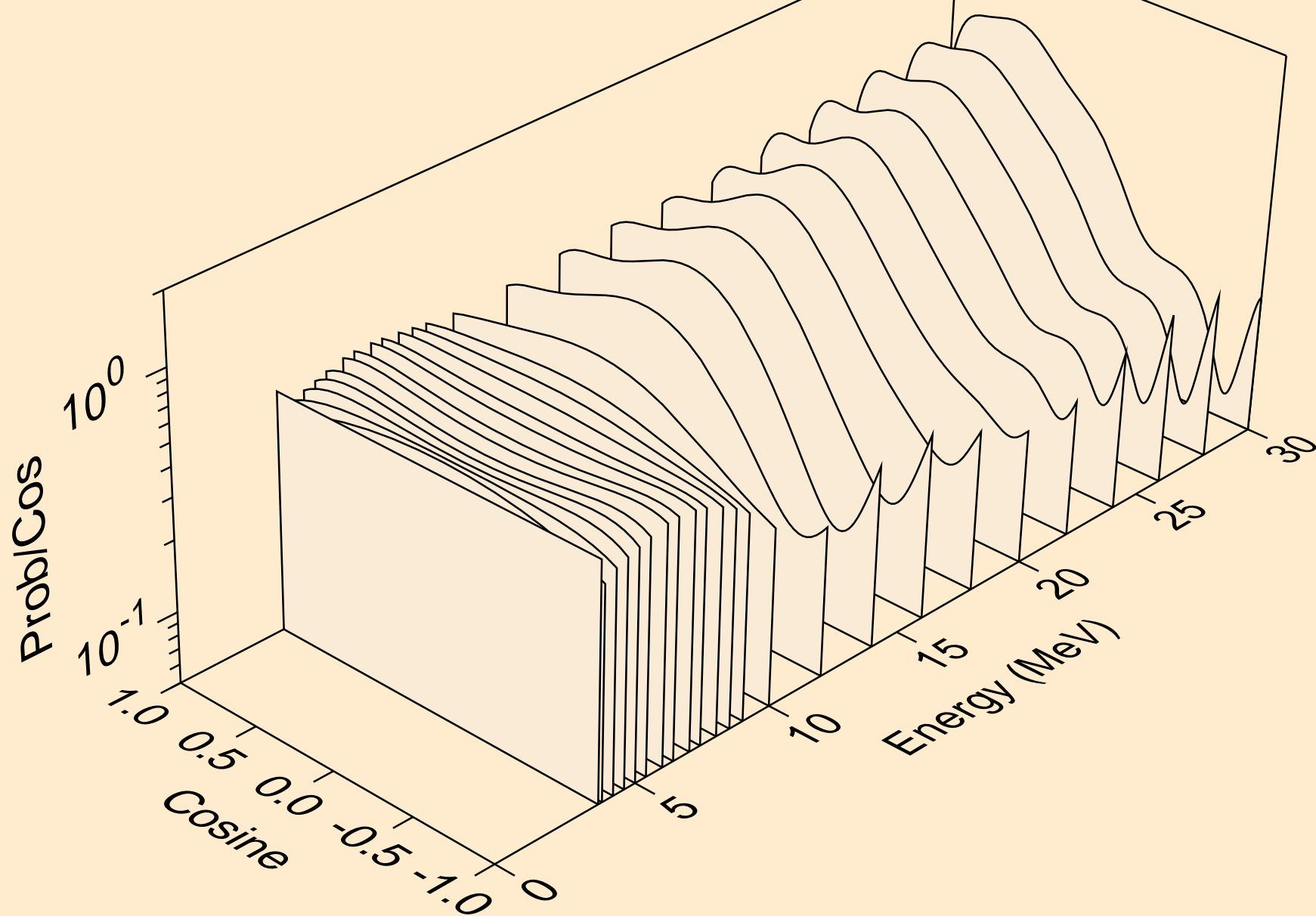

MO092 NEUTRON ACER TENDL-2019 LIBRARY; T=293.16K
angular distribution for (n,n*21)

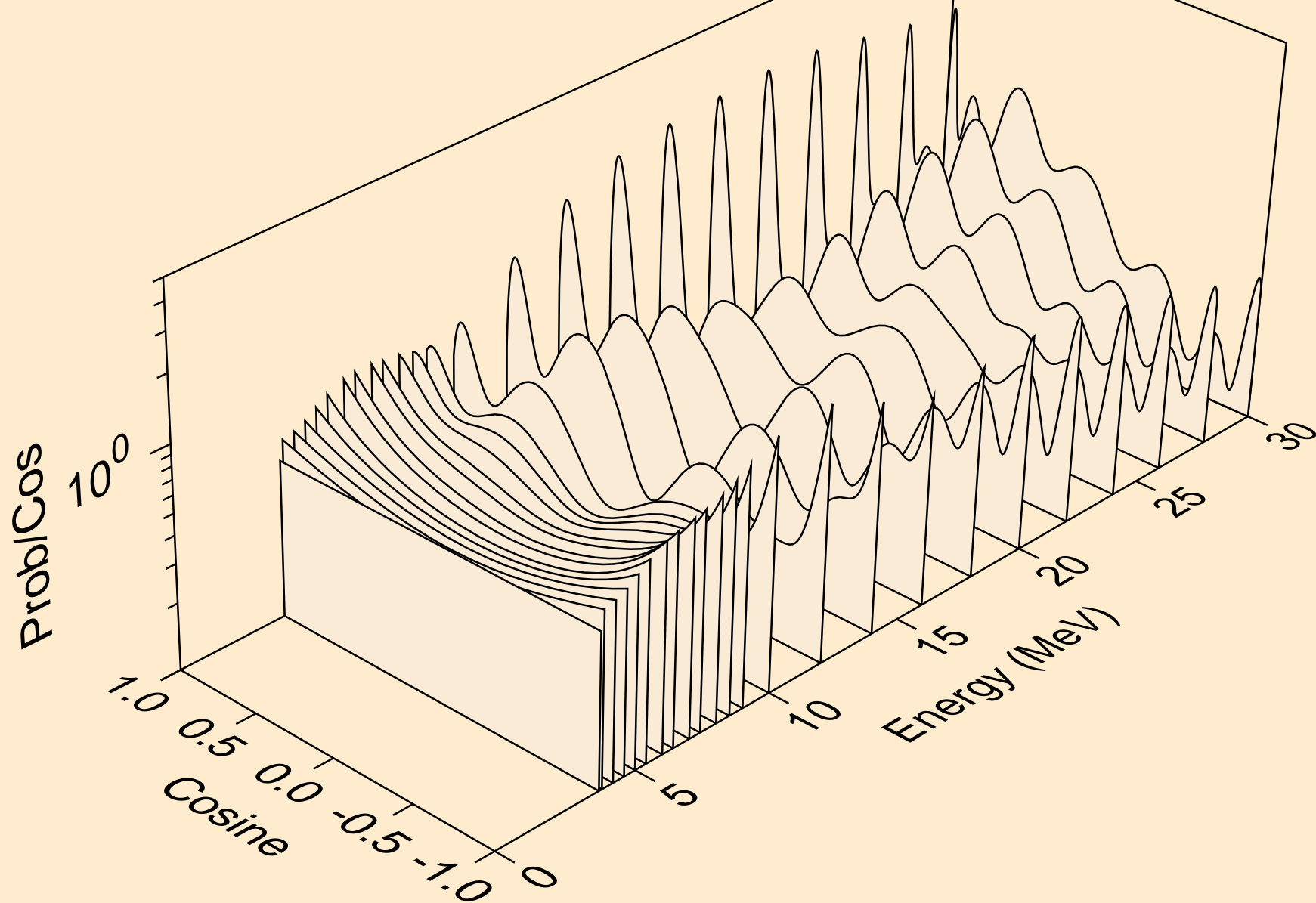

MO092 NEUTRON ACER TENDL-2019 LIBRARY; T=293.16K
angular distribution for (n,n*22)

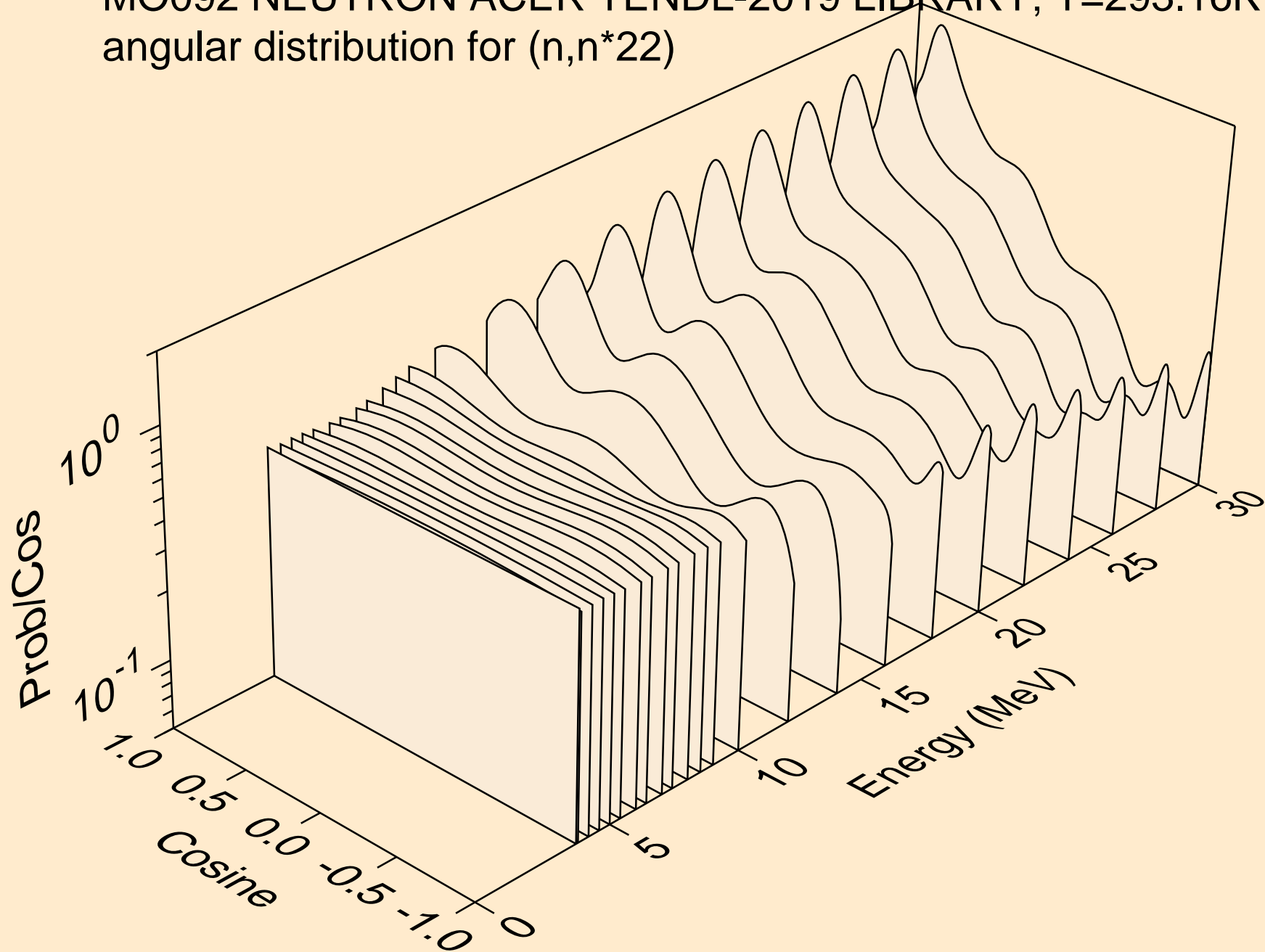

MO092 NEUTRON ACER TENDL-2019 LIBRARY; T=293.16K
angular distribution for (n,n*23)

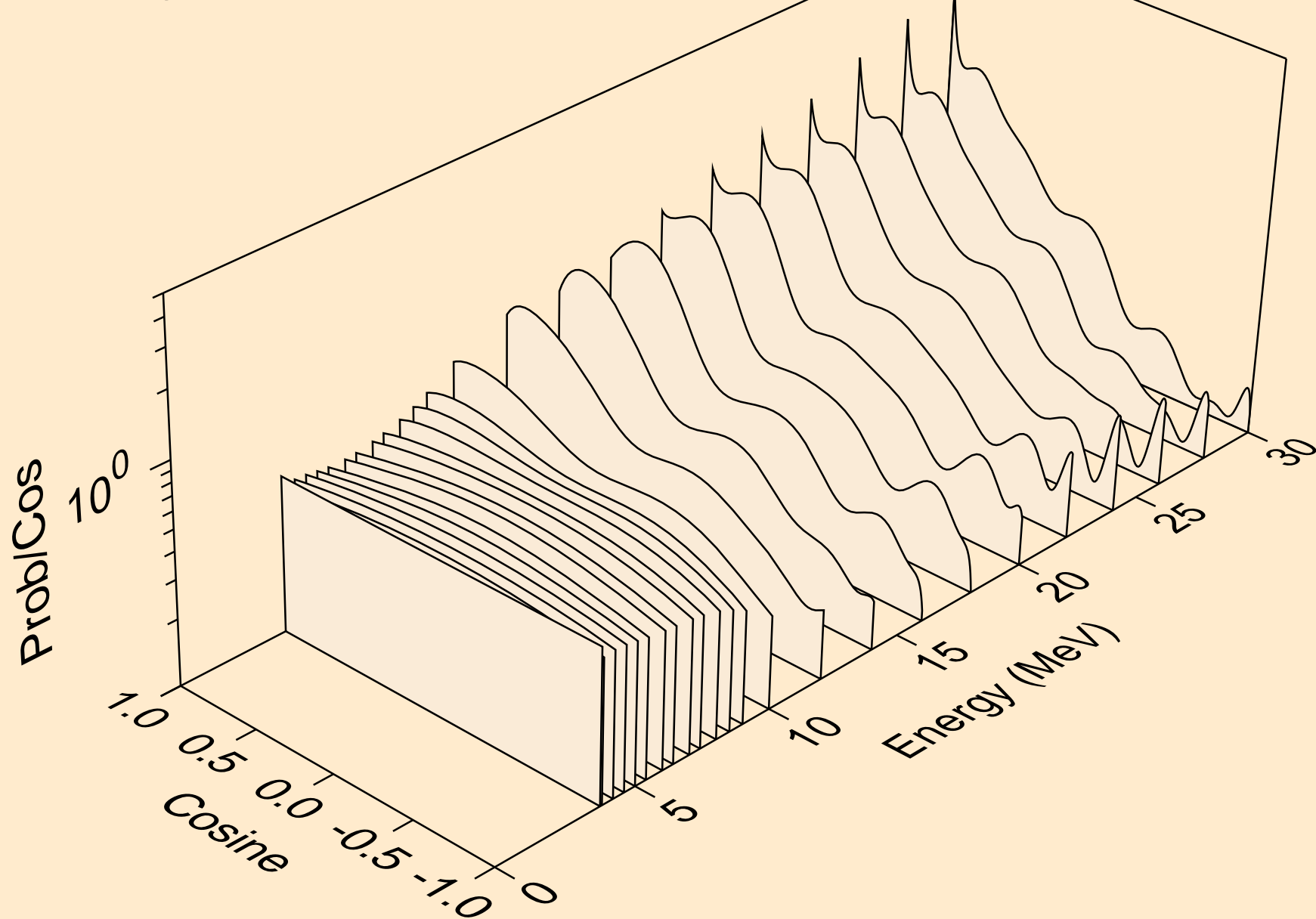

MO092 NEUTRON ACER TENDL-2019 LIBRARY; T=293.16K
angular distribution for (n,n*24)

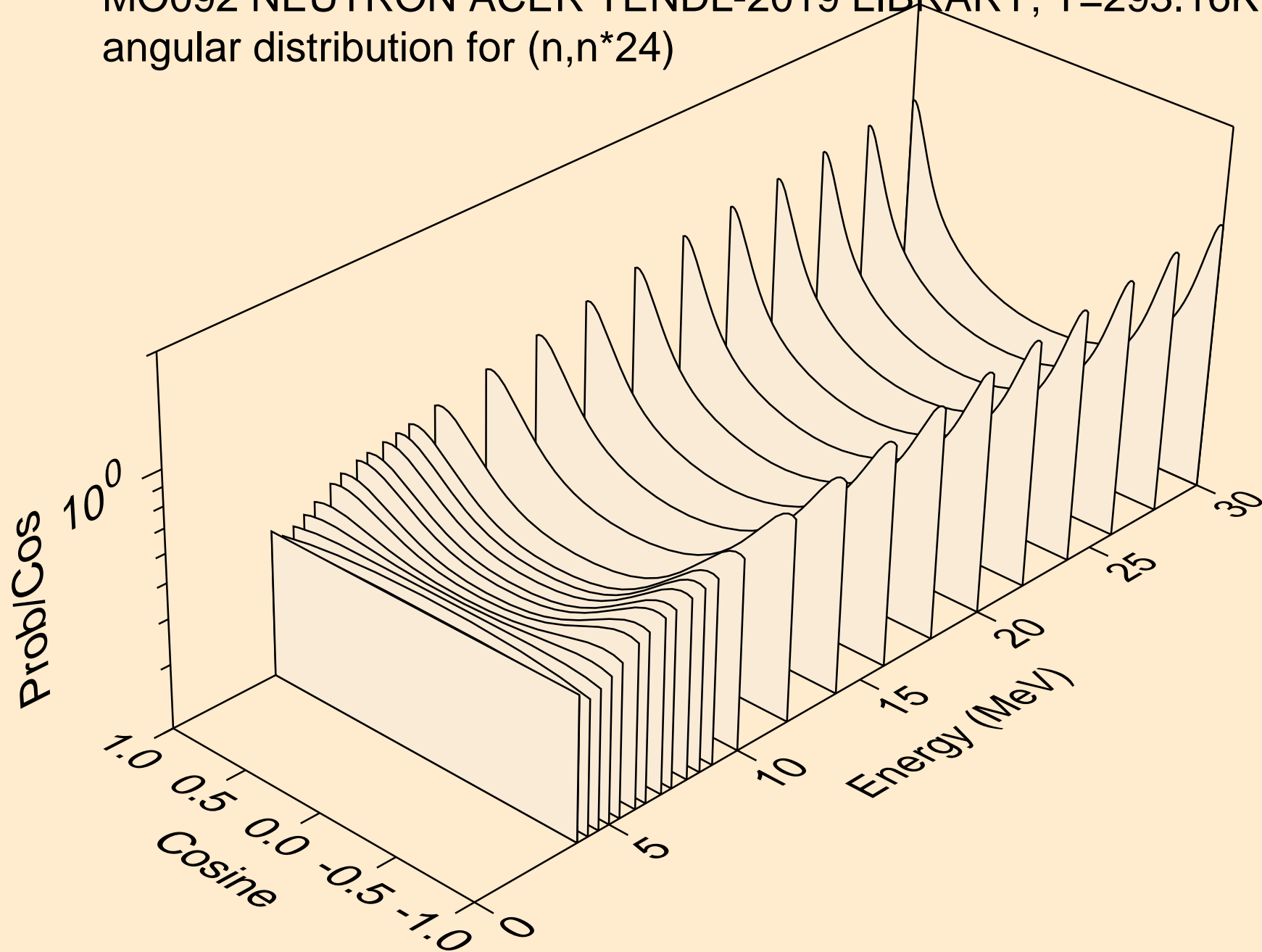

MO092 NEUTRON ACER TENDL-2019 LIBRARY; T=293.16K
angular distribution for (n,n*25)

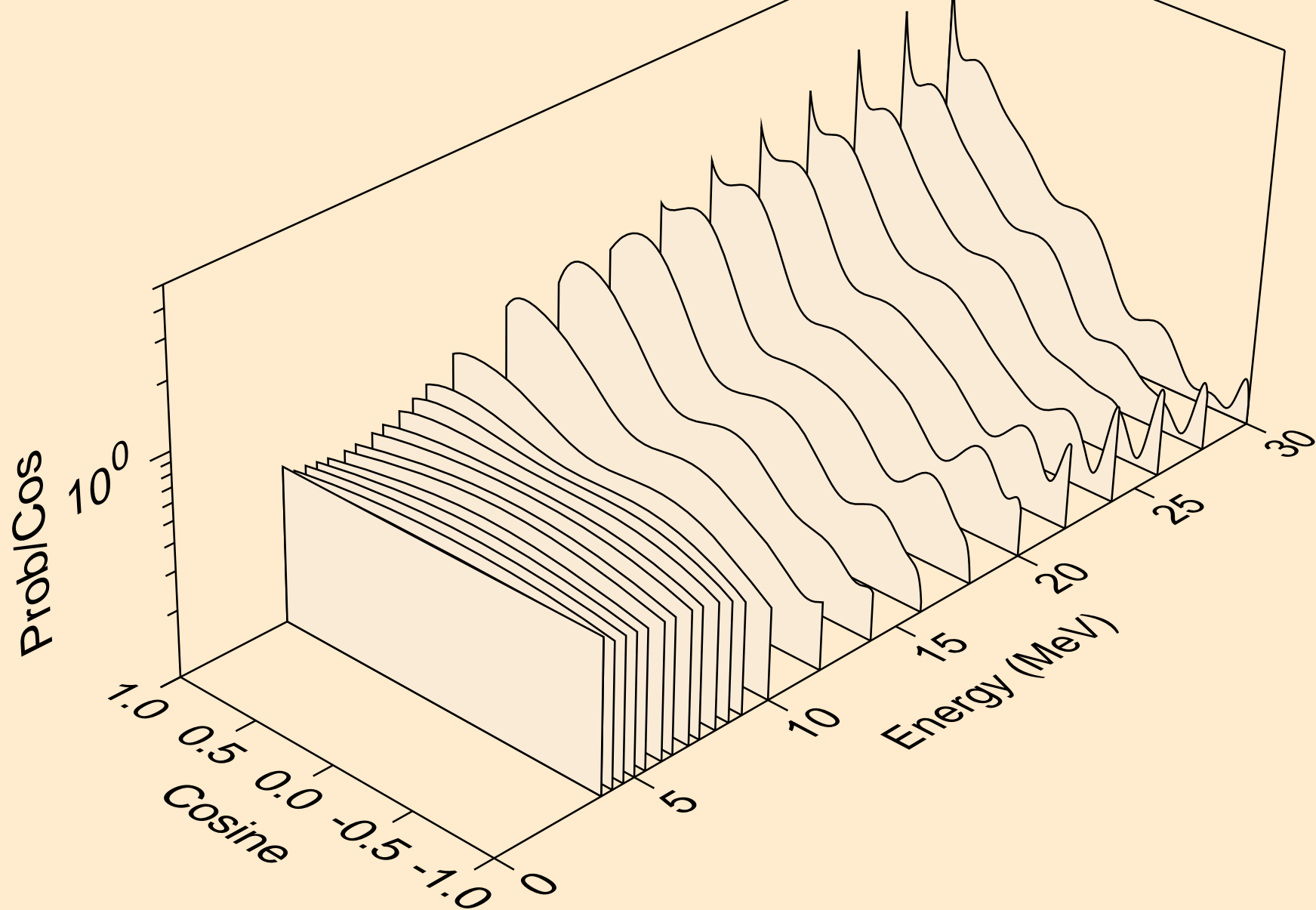

MO092 NEUTRON ACER TENDL-2019 LIBRARY; T=293.16K
angular distribution for (n,n*26)

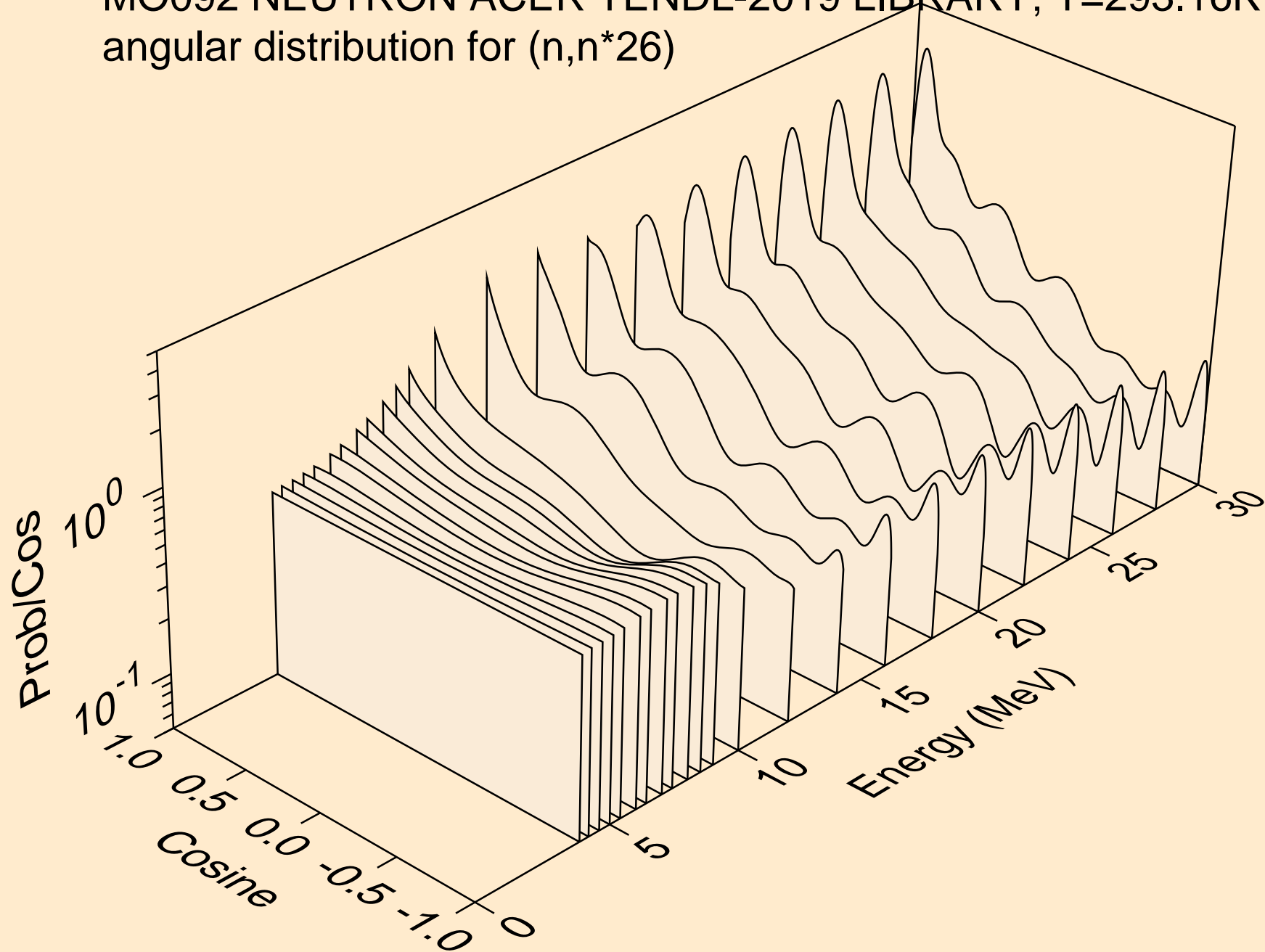

MO092 NEUTRON ACER TENDL-2019 LIBRARY; T=293.16K
angular distribution for (n,n*27)

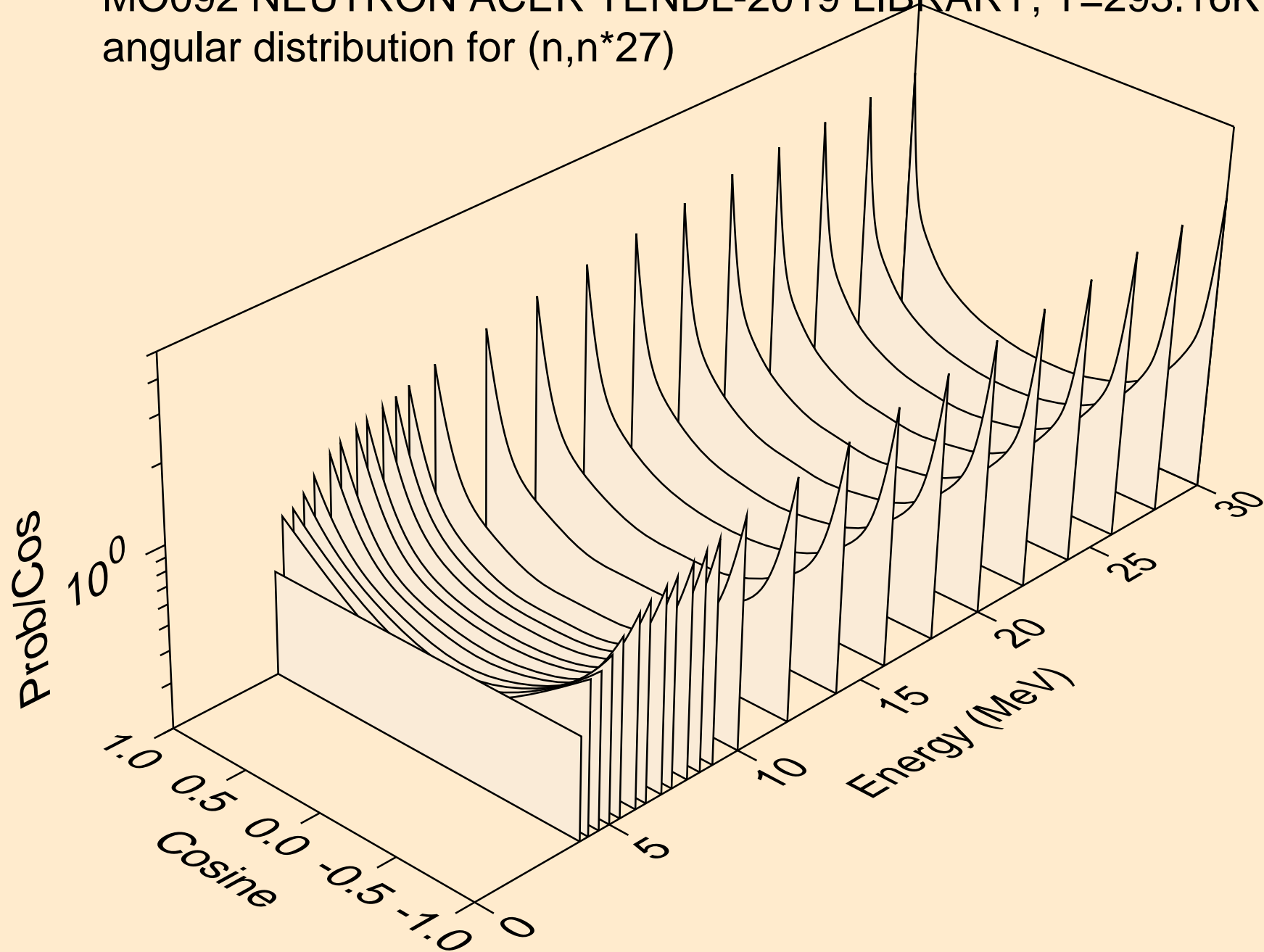

MO092 NEUTRON ACER TENDL-2019 LIBRARY; T=293.16K
angular distribution for (n,n*28)

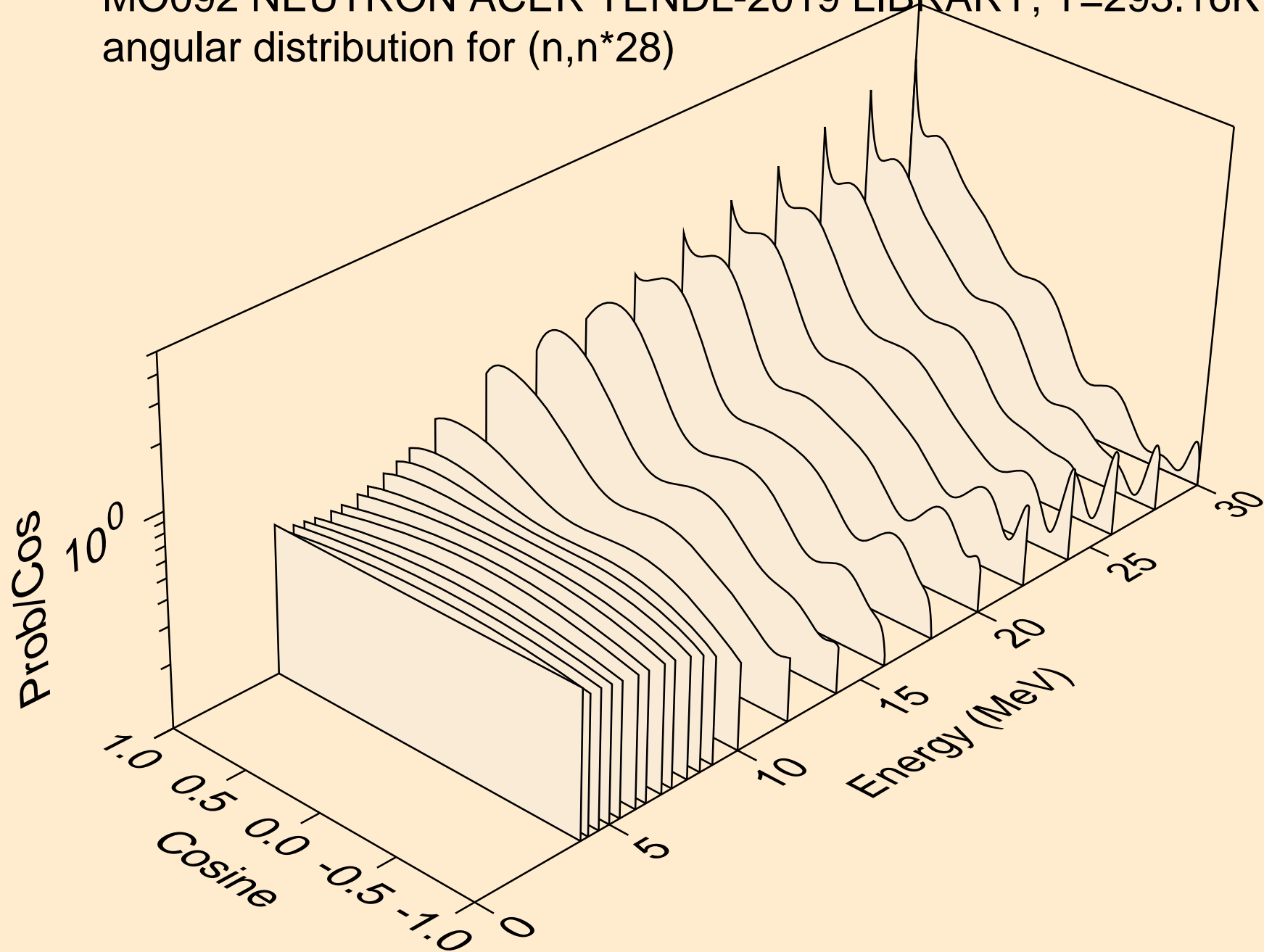

MO092 NEUTRON ACER TENDL-2019 LIBRARY; T=293.16K
angular distribution for (n,n*29)

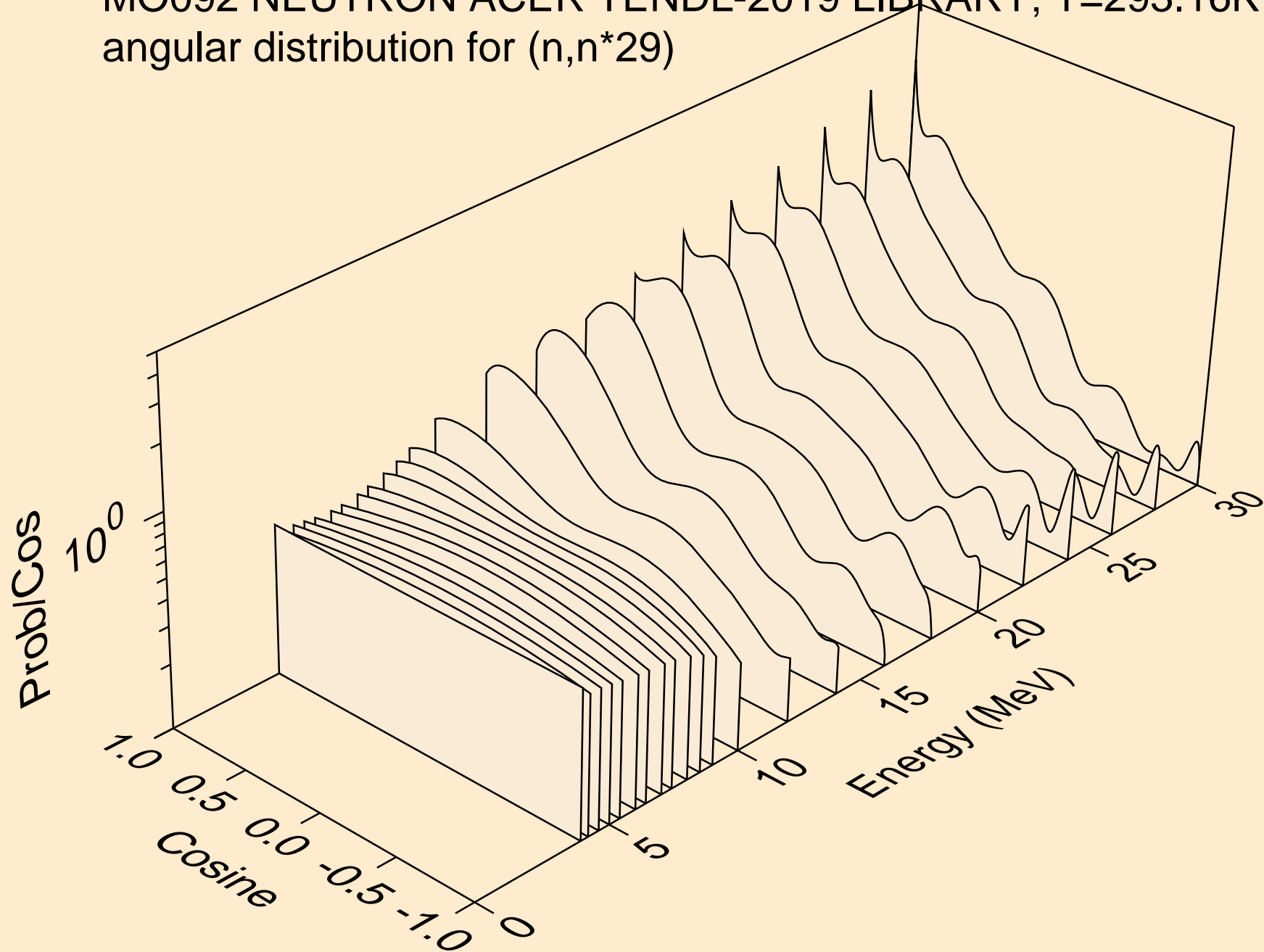

MO092 NEUTRON ACER TENDL-2019 LIBRARY; T=293.16K
angular distribution for (n,n*30)

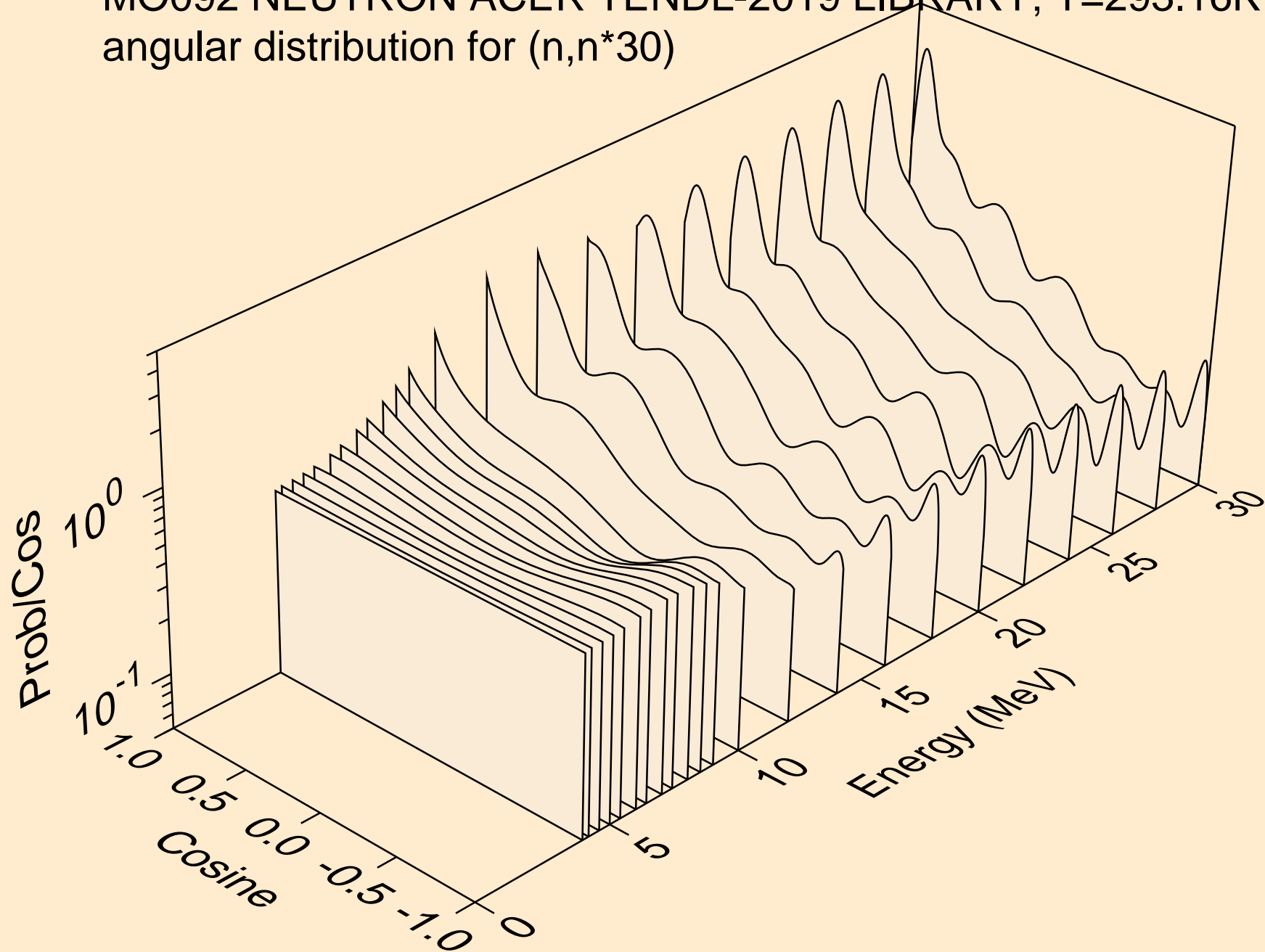

MO092 NEUTRON ACER TENDL-2019 LIBRARY; T=293.16K
Neutron emission for (n,x)

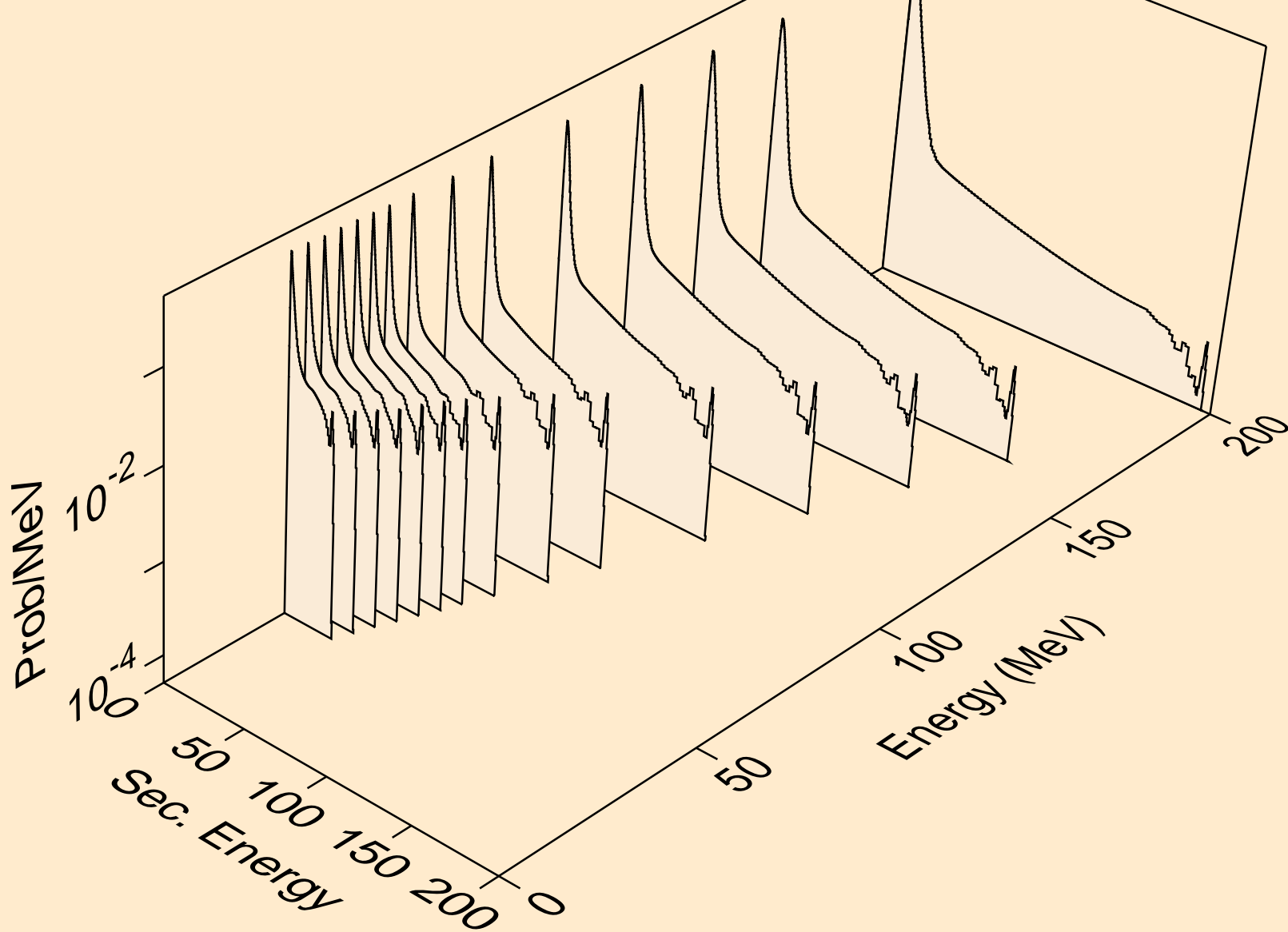

MO092 NEUTRON ACER TENDL-2019 LIBRARY; T=293.16K
Neutron emission for (n,2nd)

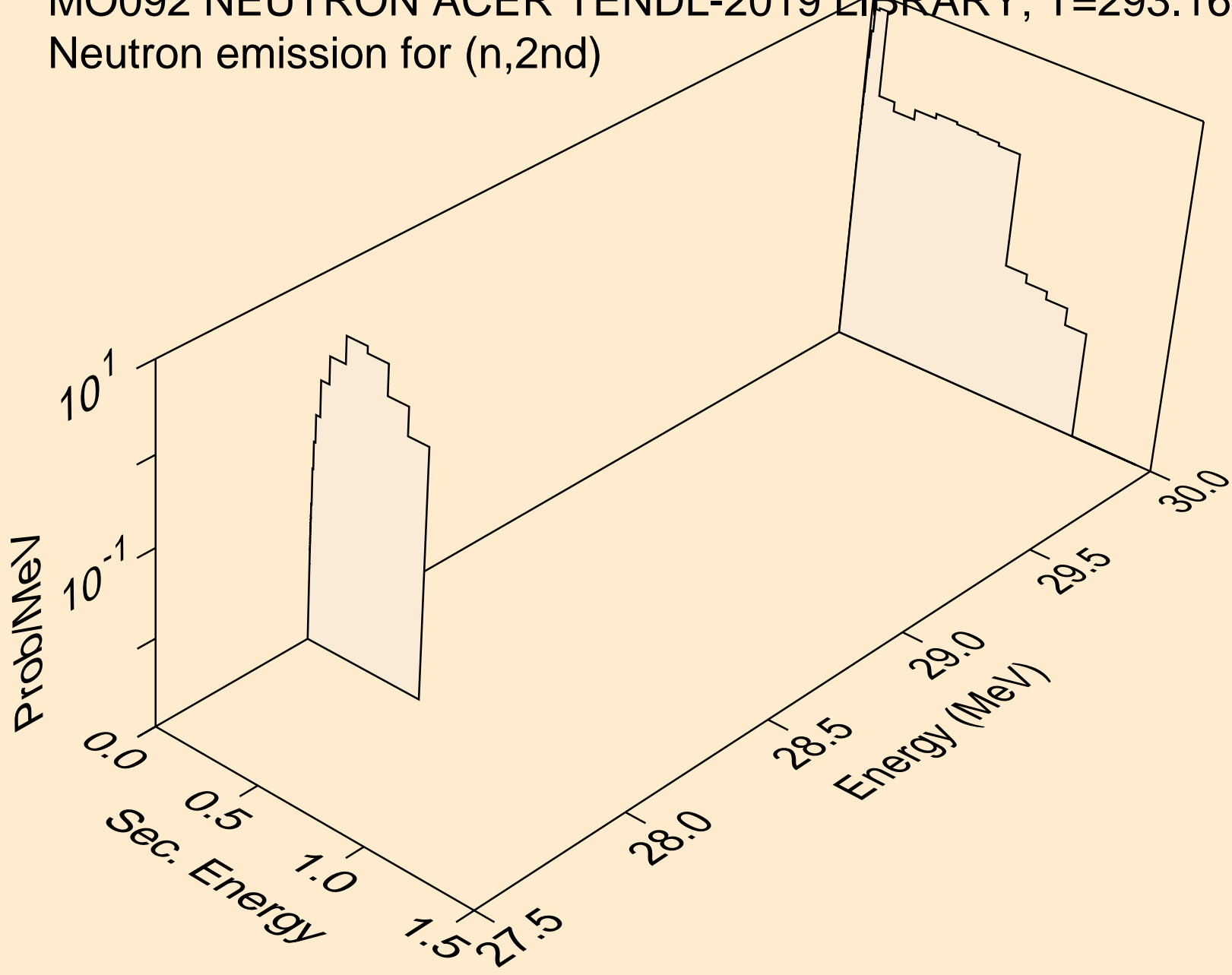

MO092 NEUTRON ACER TENDL-2019 LIBRARY; T=293.16K
Neutron emission for (n,2n)

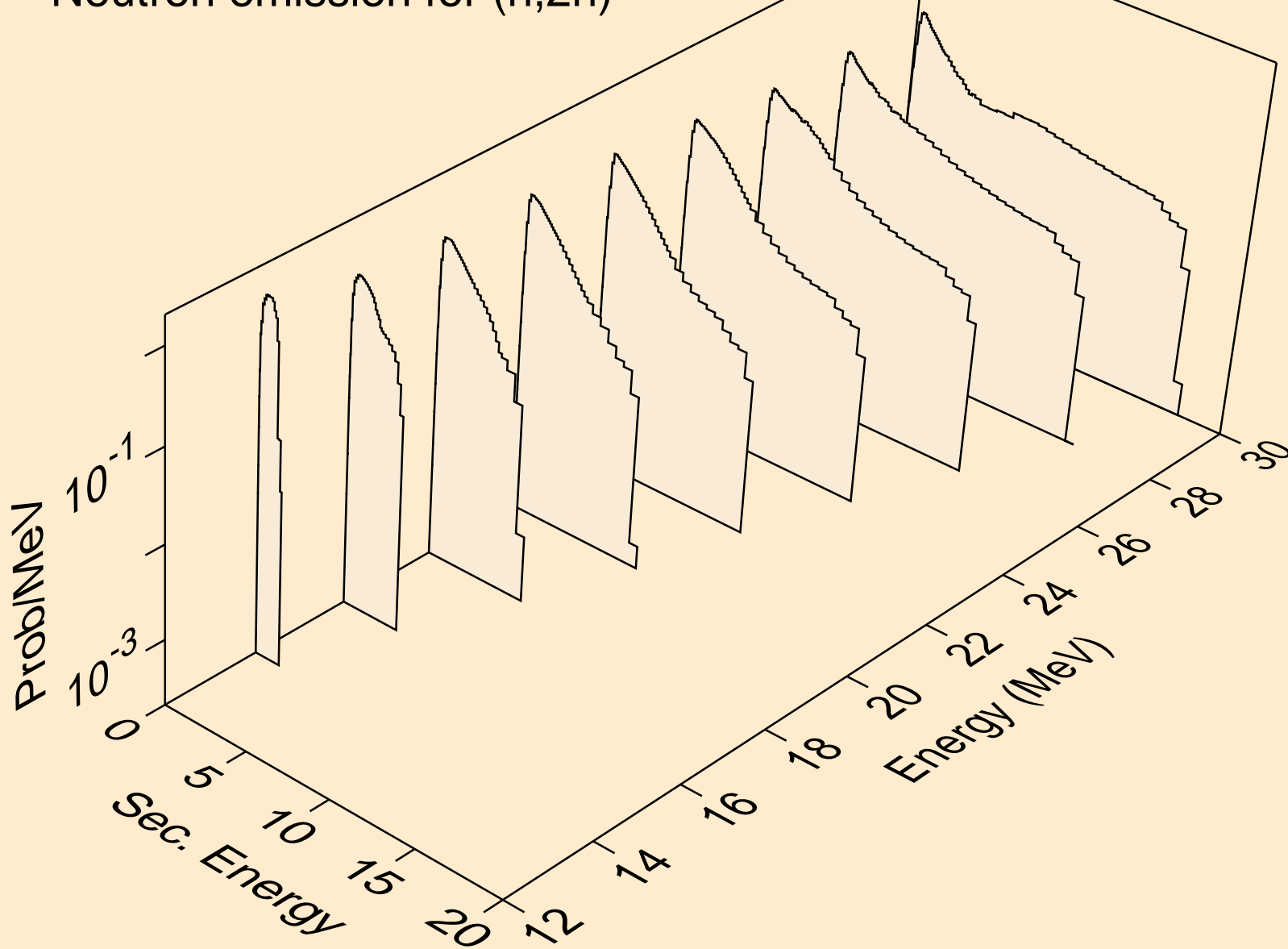

MO092 NEUTRON ACER TENDL-2019 LIBRARY; T=293.16K
Neutron emission for (n,3n)

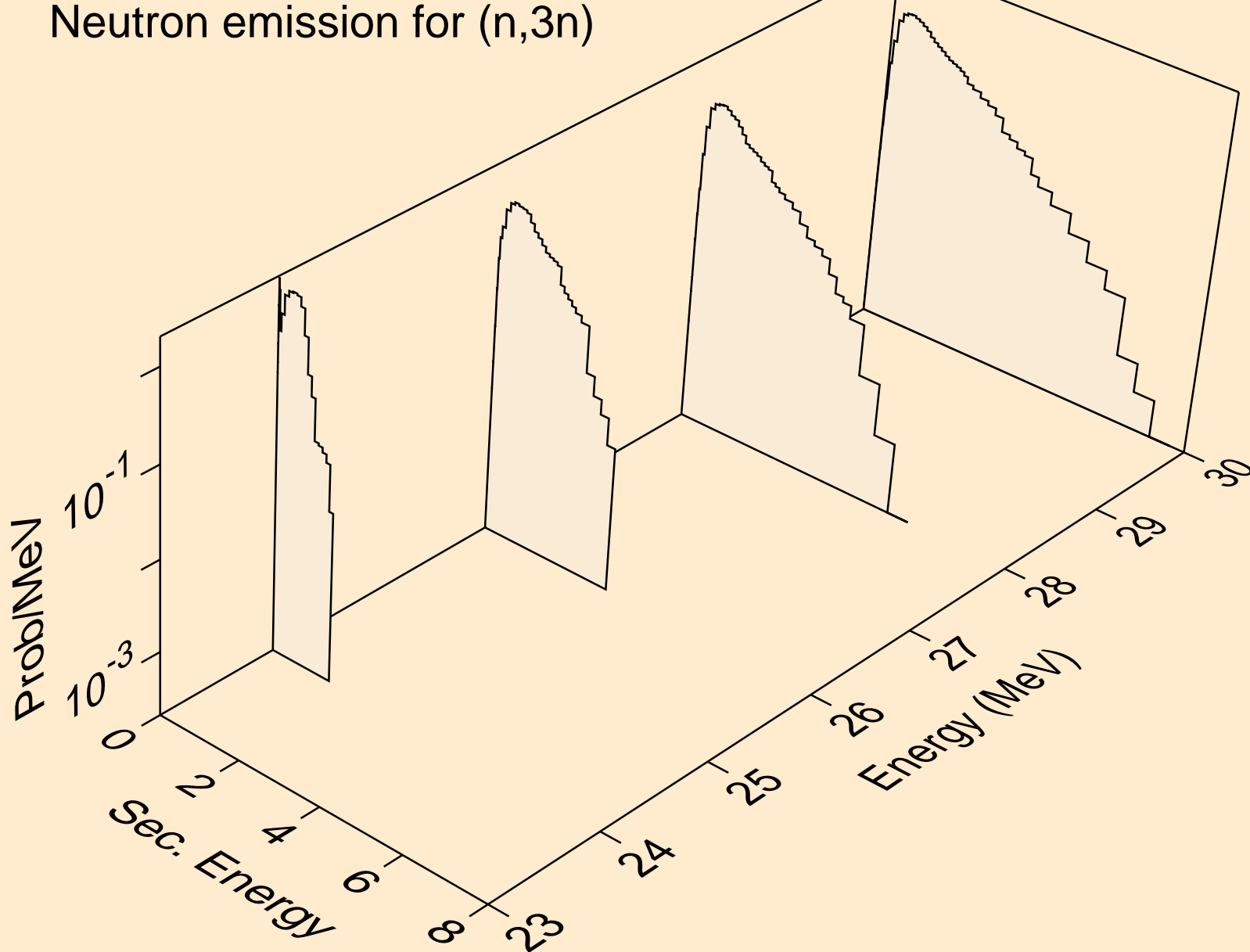

MO092 NEUTRON ACER TENDL-2019 LIBRARY; T=293.16K
Neutron emission for (n,n*)a

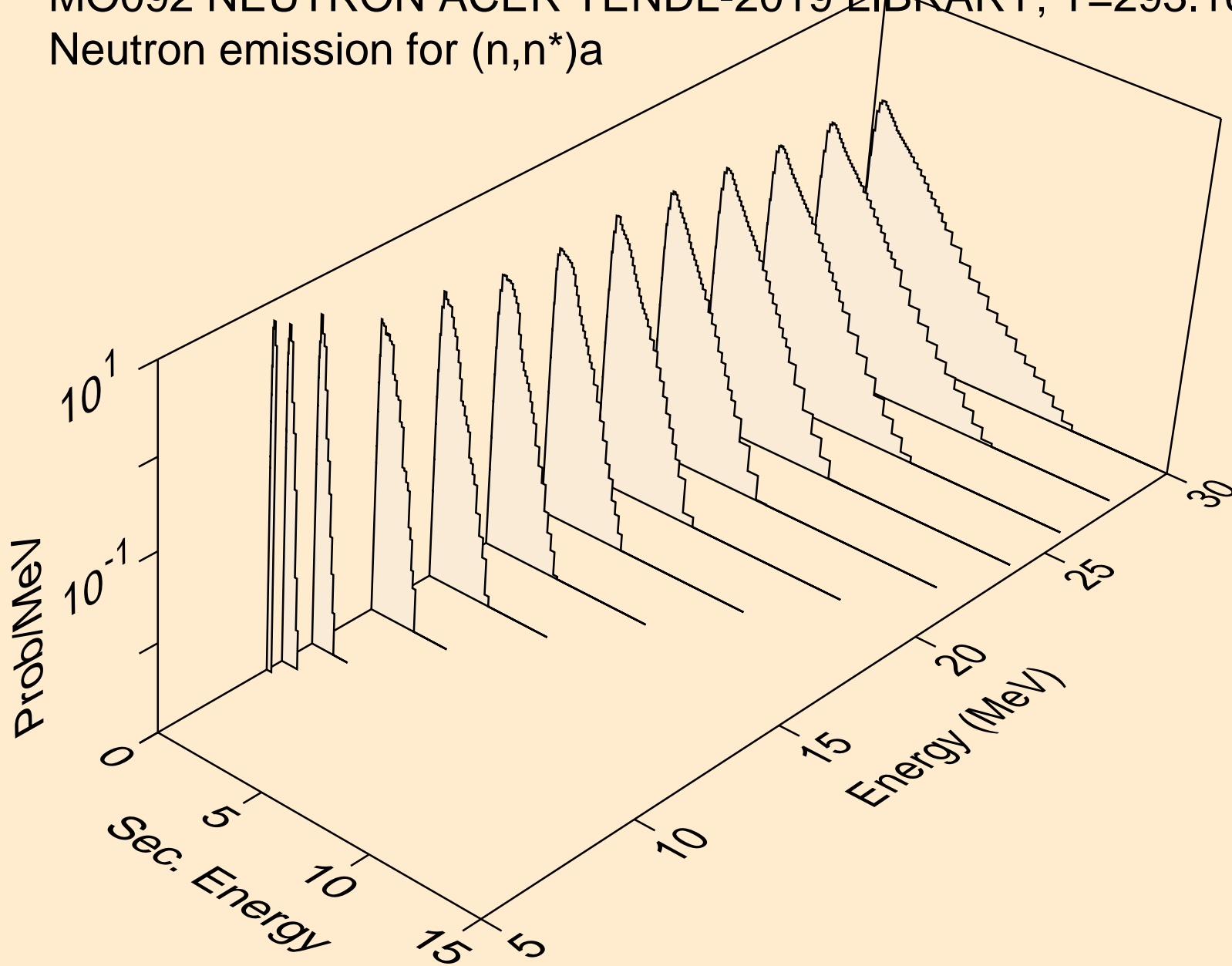

MO092 NEUTRON ACER TENDL-2019 LIBRARY; T=293.16K
Neutron emission for (n,2n)a

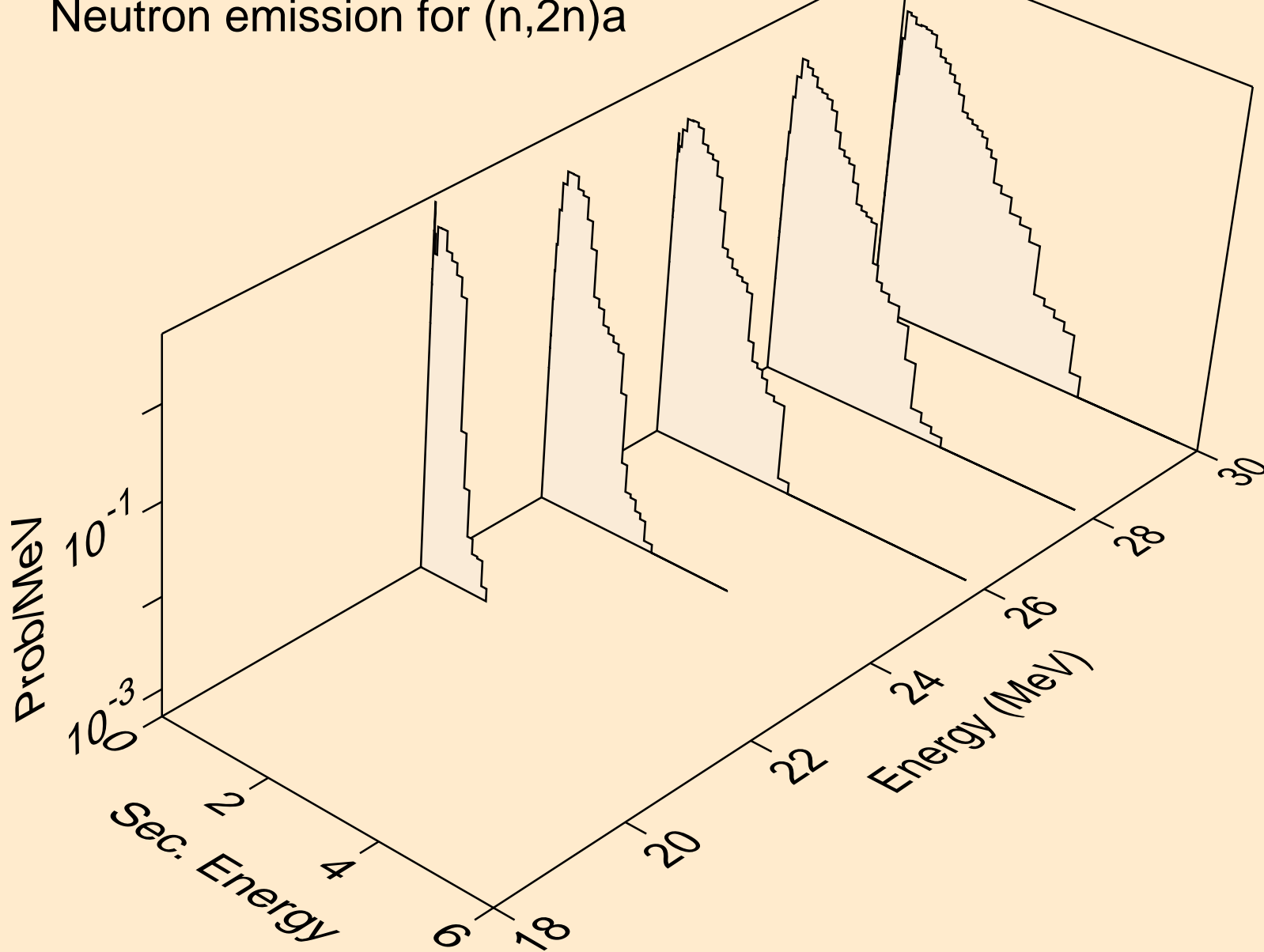

MO092 NEUTRON ACER TENDL-2019 LIBRARY; T=293.16K
Neutron emission for (n,n*)p

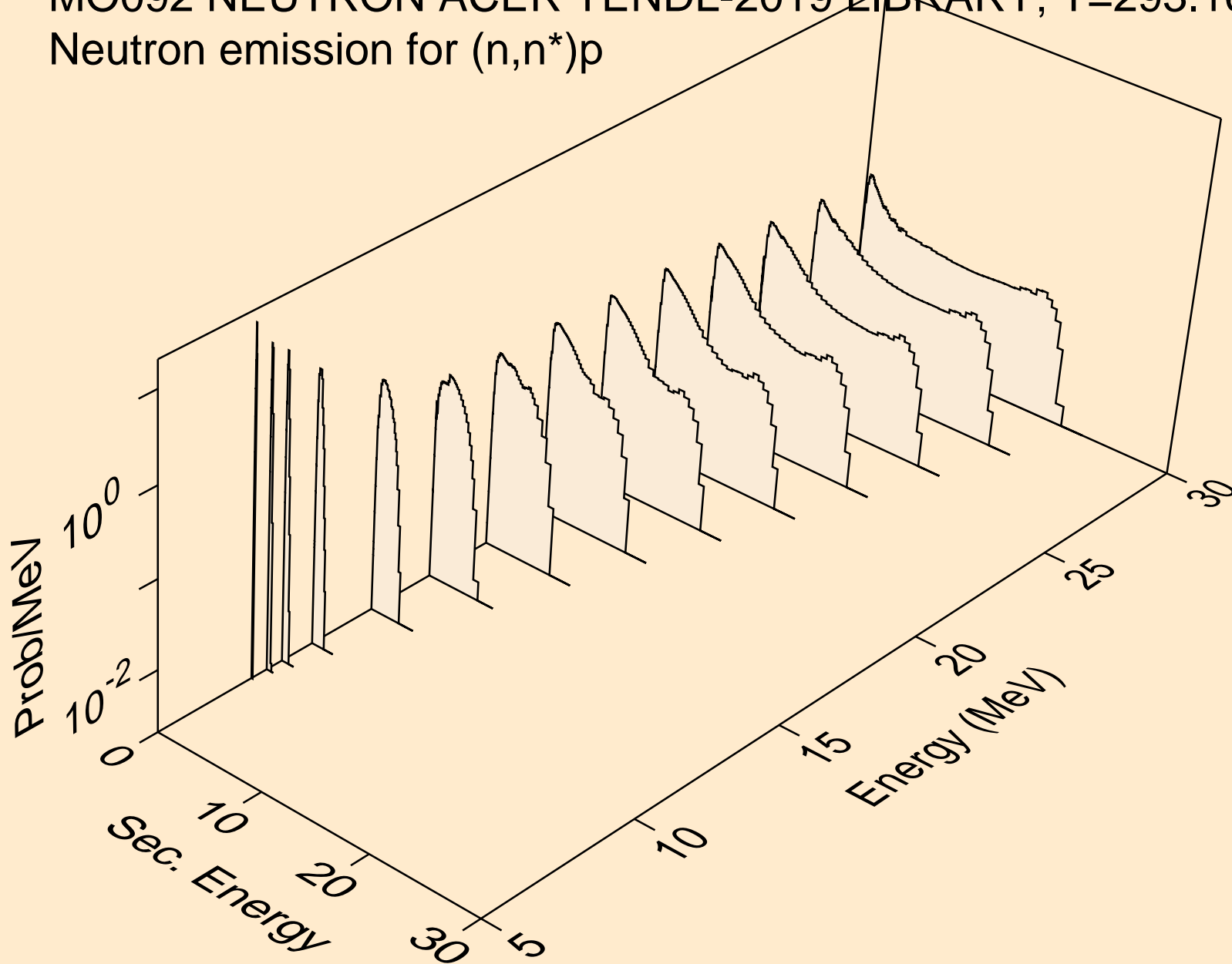

MO092 NEUTRON ACER TENDL-2019 LIBRARY; T=293.16K
Neutron emission for (n,n*)2a

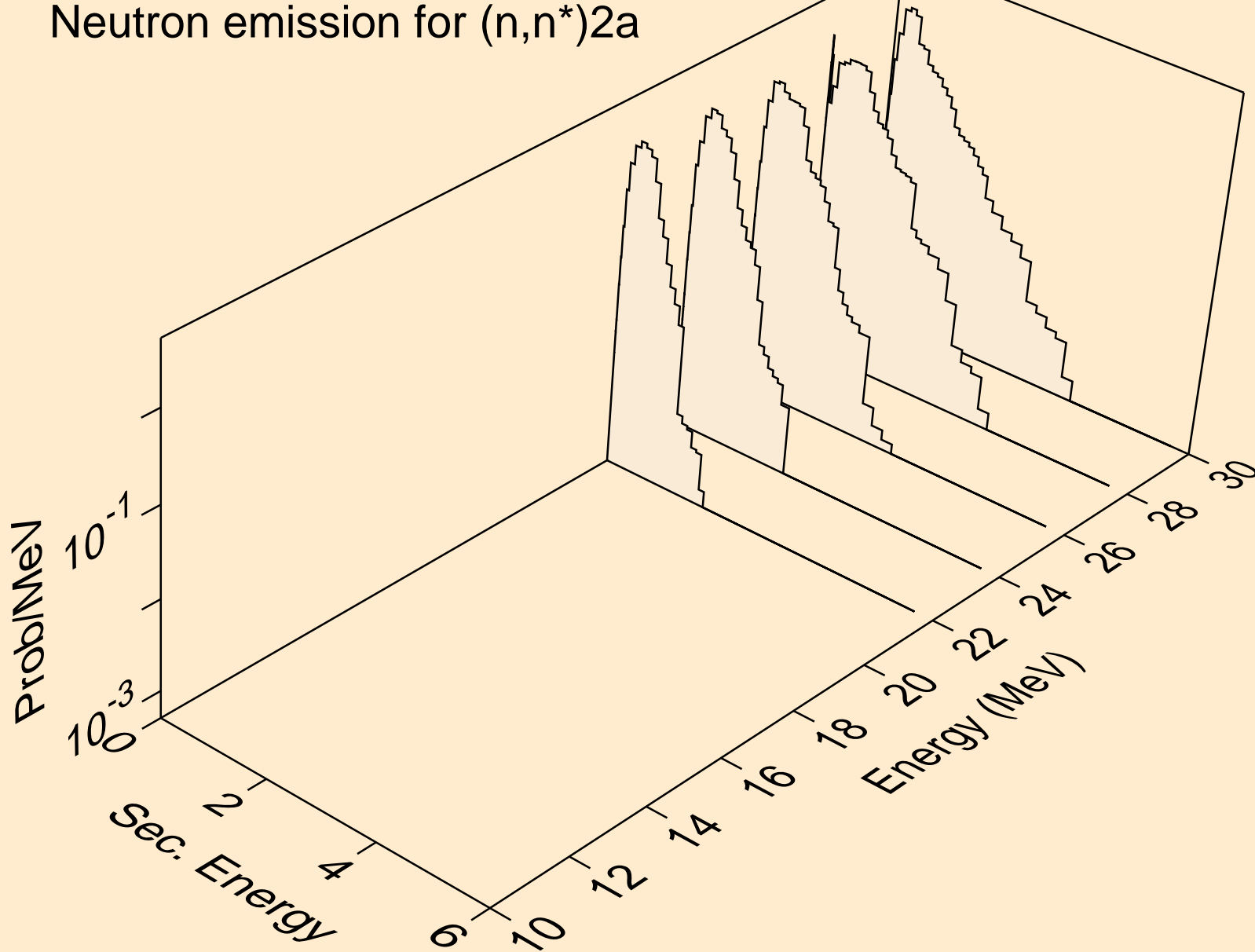

MO092 NEUTRON ACER TENDL-2019 LIBRARY; T=293.16K
Neutron emission for (n,n*)d

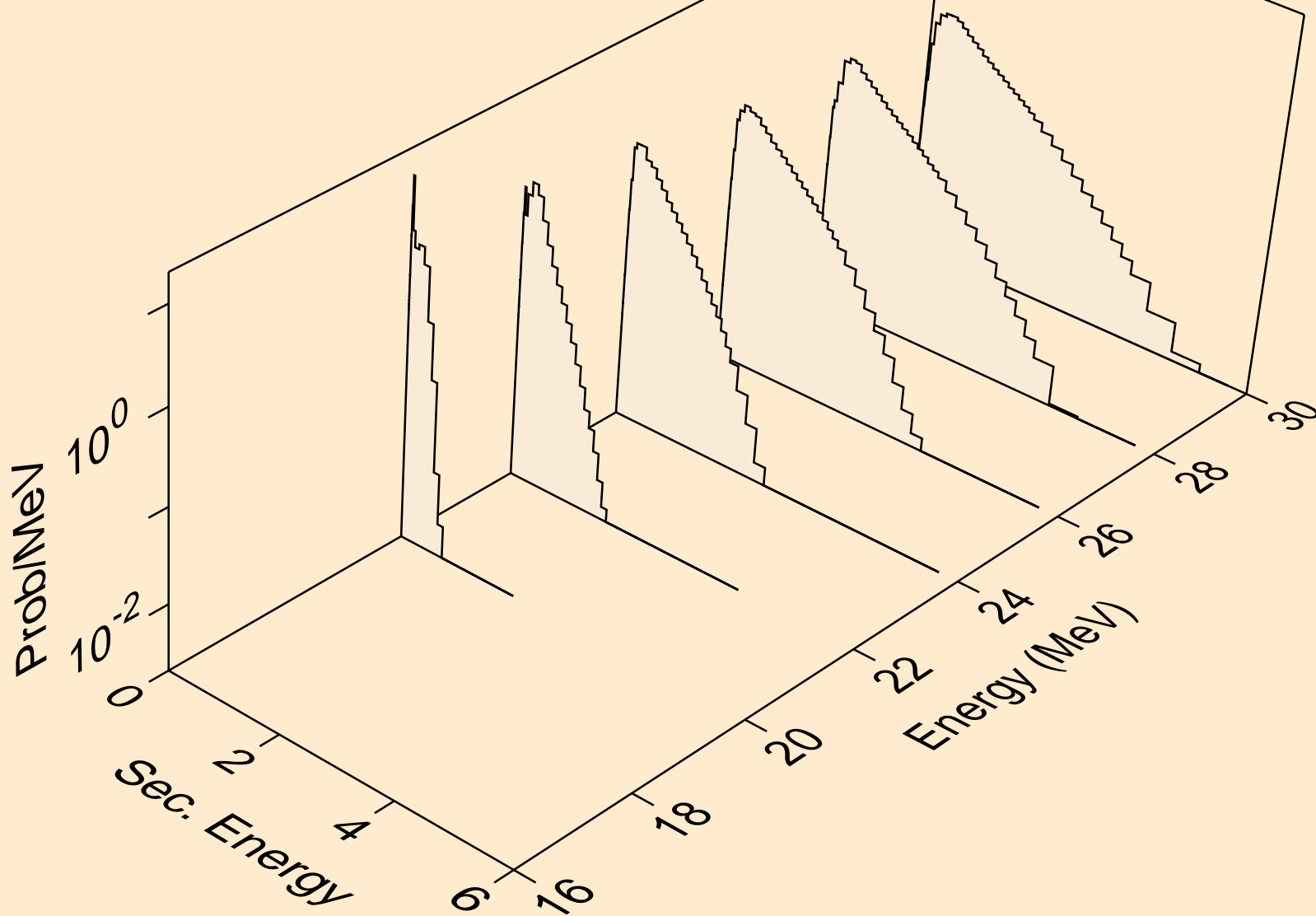

MO092 NEUTRON ACER TENDL-2019 LIBRARY; T=293.16K
Neutron emission for (n,n*)t

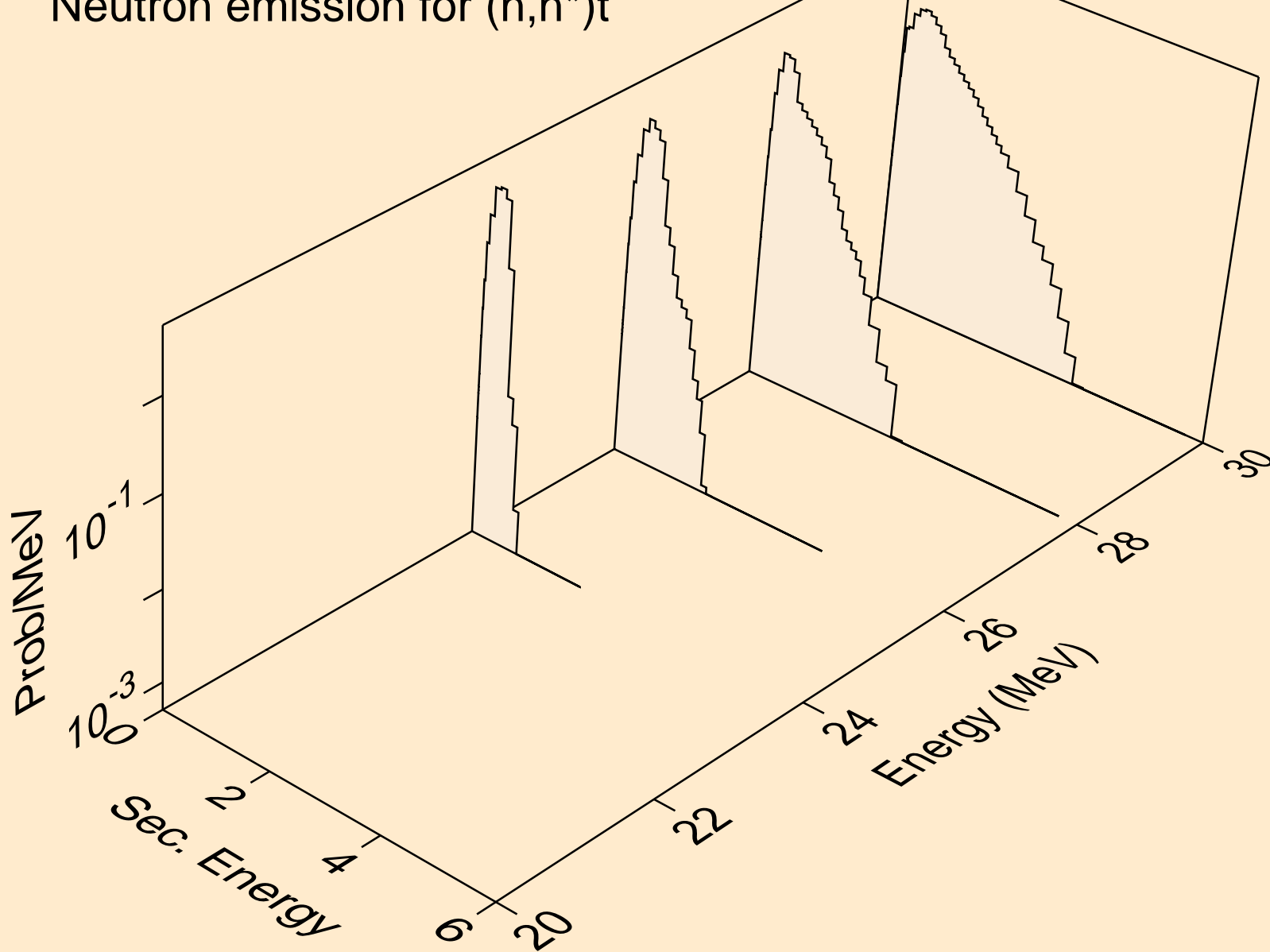

MO092 NEUTRON ACER TENDL-2019 LIBRARY; T=293.16K
Neutron emission for (n,n*)he3

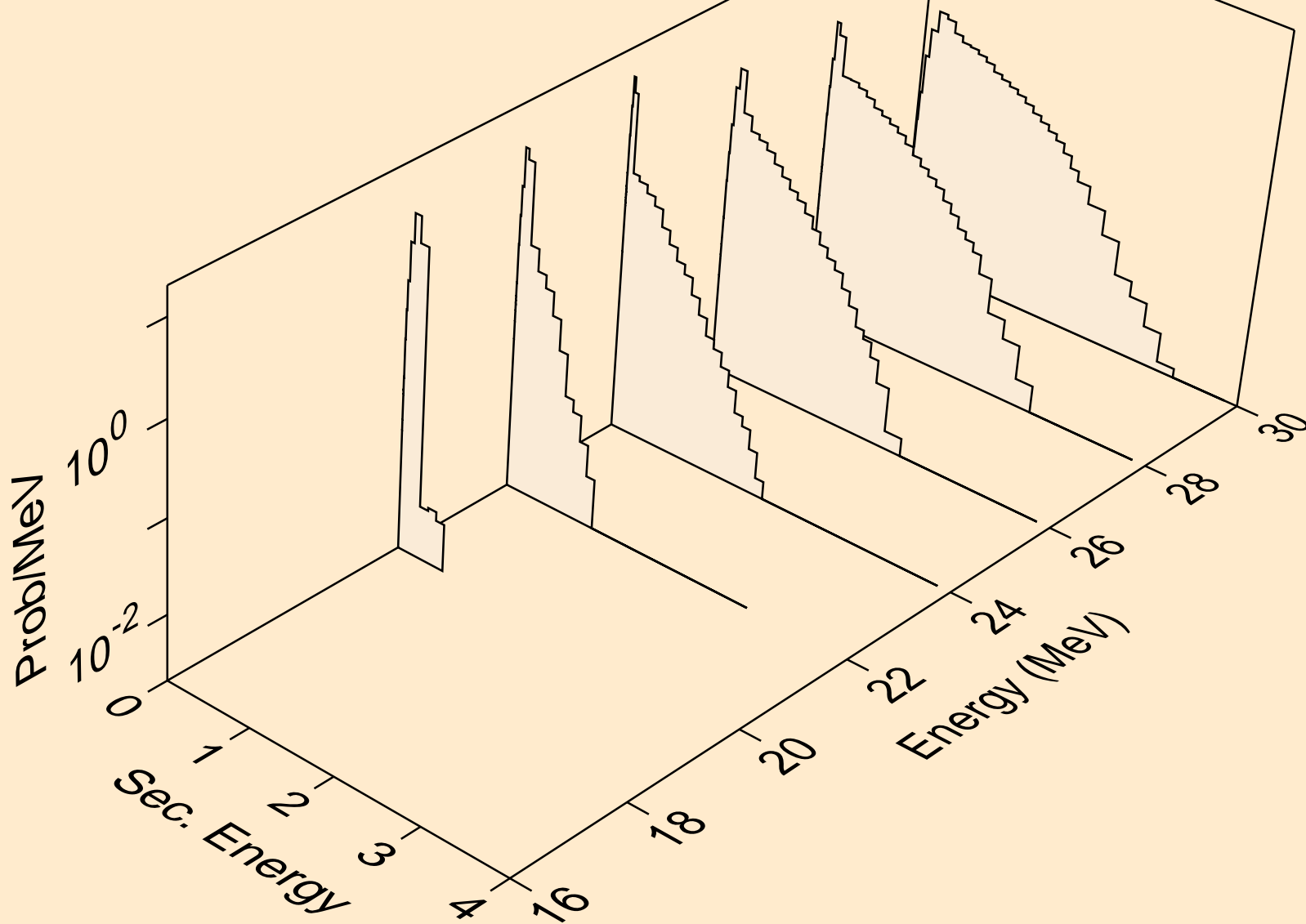

MO092 NEUTRON ACER TENDL-2019 LIBRARY; T=293.16K
Neutron emission for (n,2np)

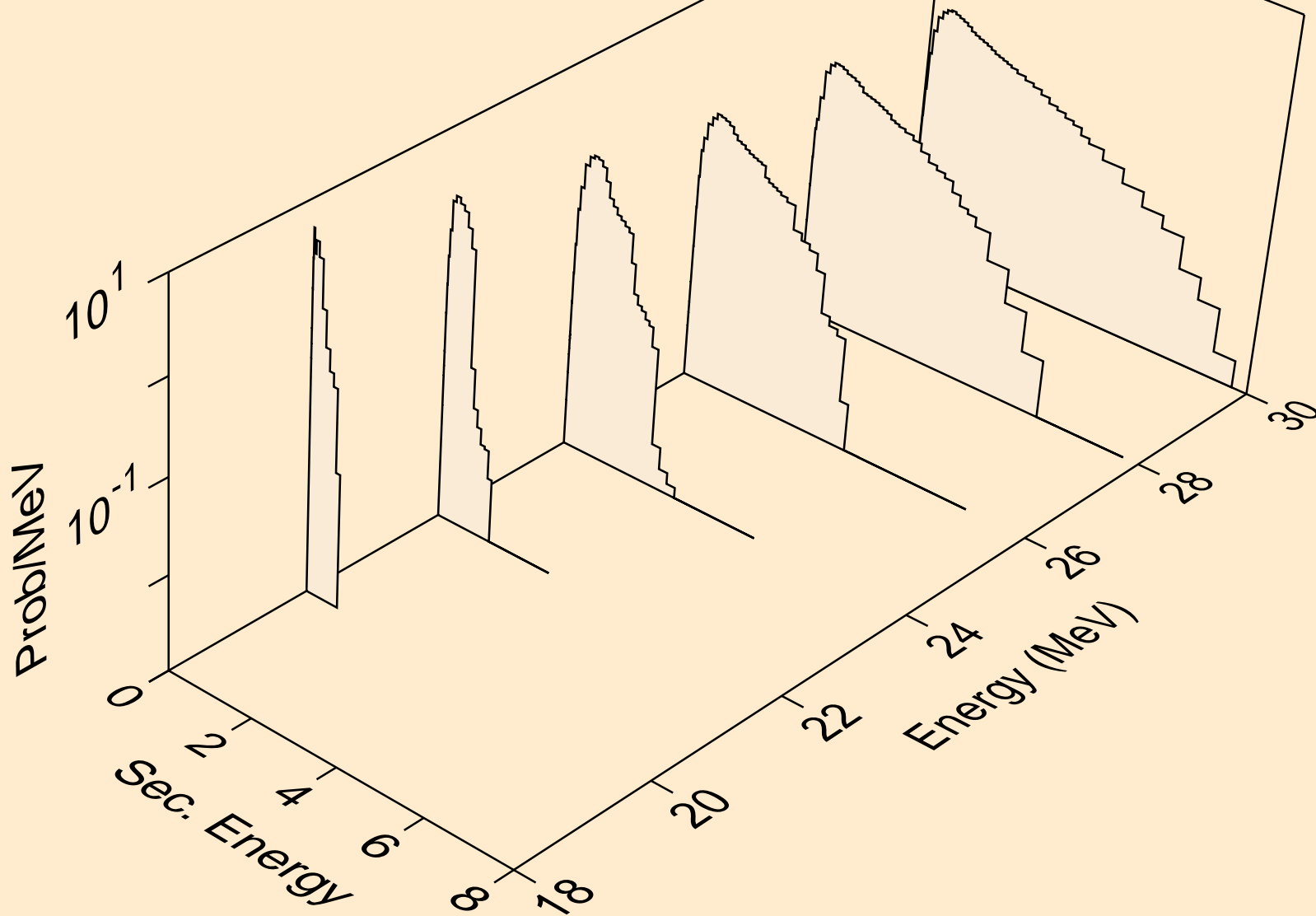

MO092 NEUTRON ACER TENDL-2019 LIBRARY; T=293.16K
Neutron emission for (n,2np)

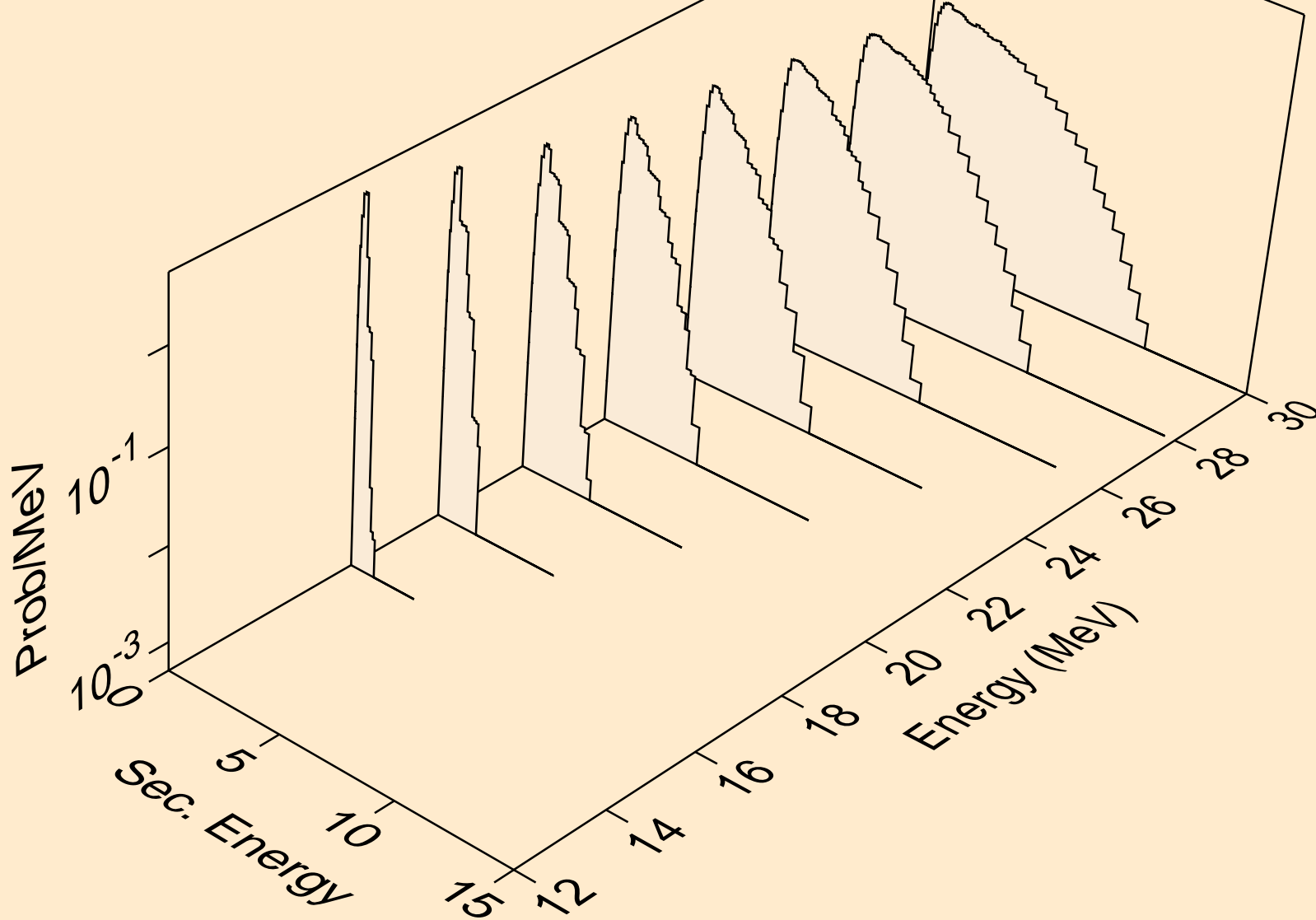

MO092 NEUTRON ACER TENDL-2019 LIBRARY; T=293.16K
Neutron emission for (n,npa)

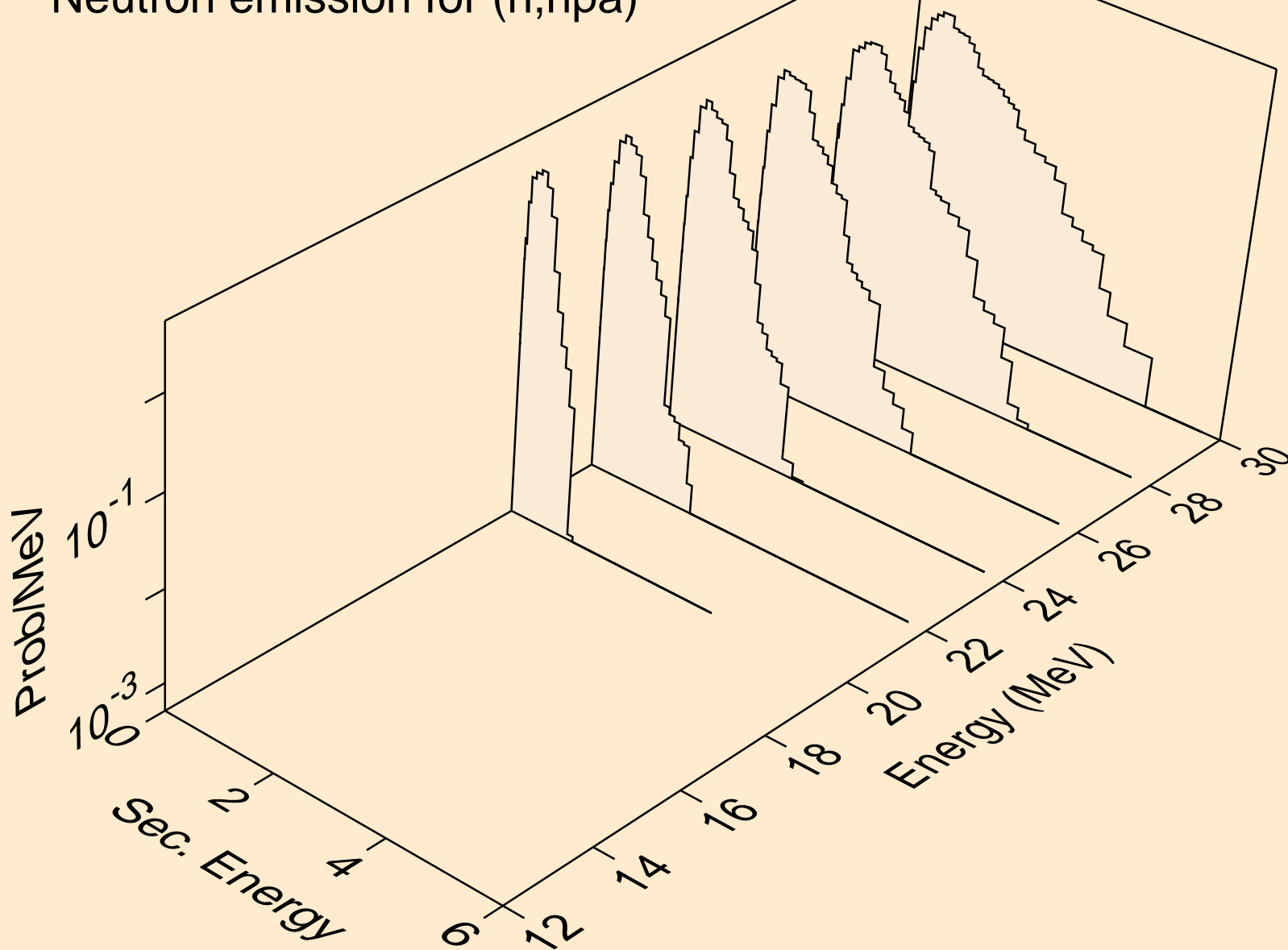

MO092 NEUTRON ACER TENDL-2019 LIBRARY; T=293.16K
Neutron emission for (n,n*c)

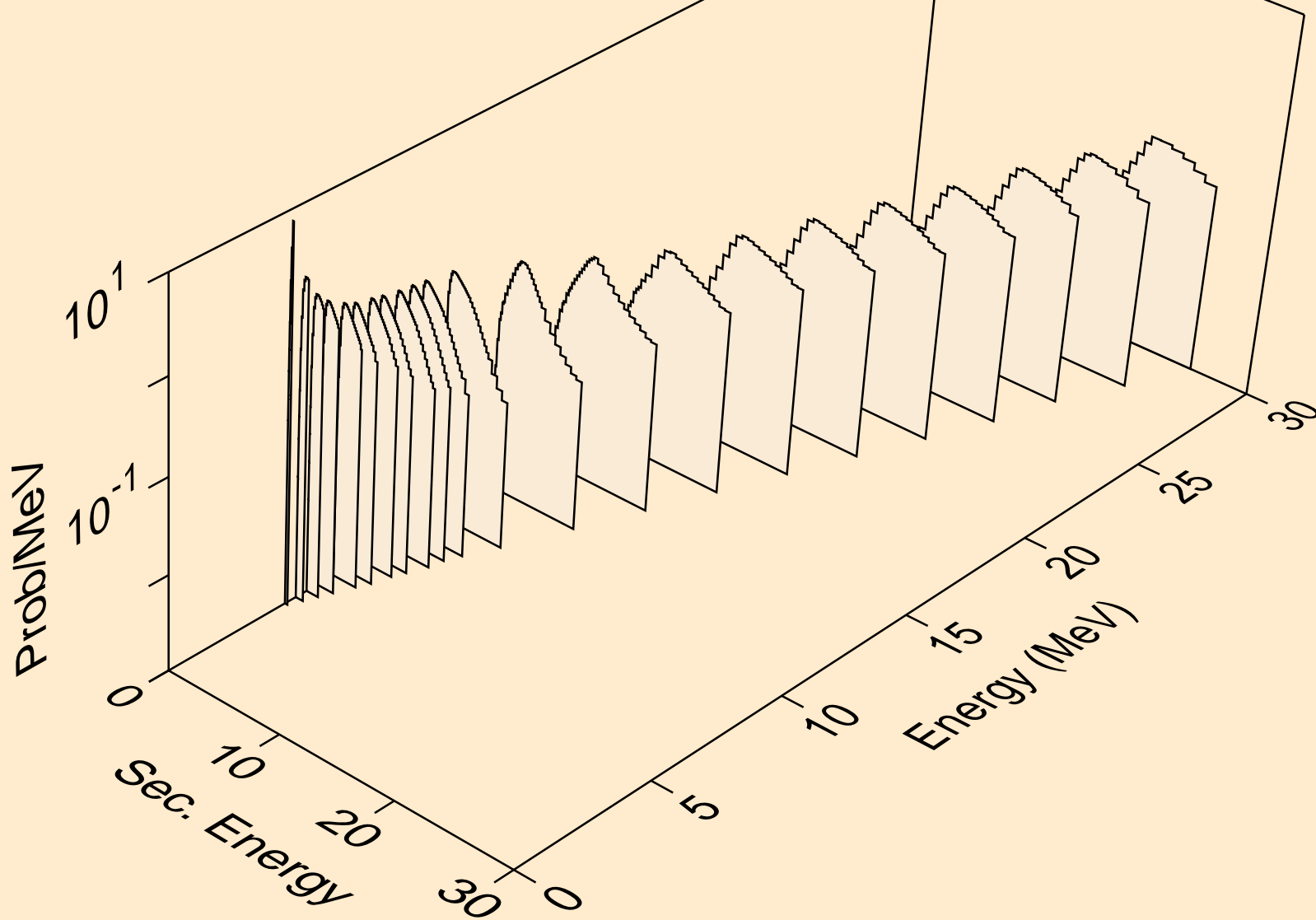

MO092 NEUTRON ACER TENDL-2019 LIBRARY; T=293.16K
Photon emission for (n,x)

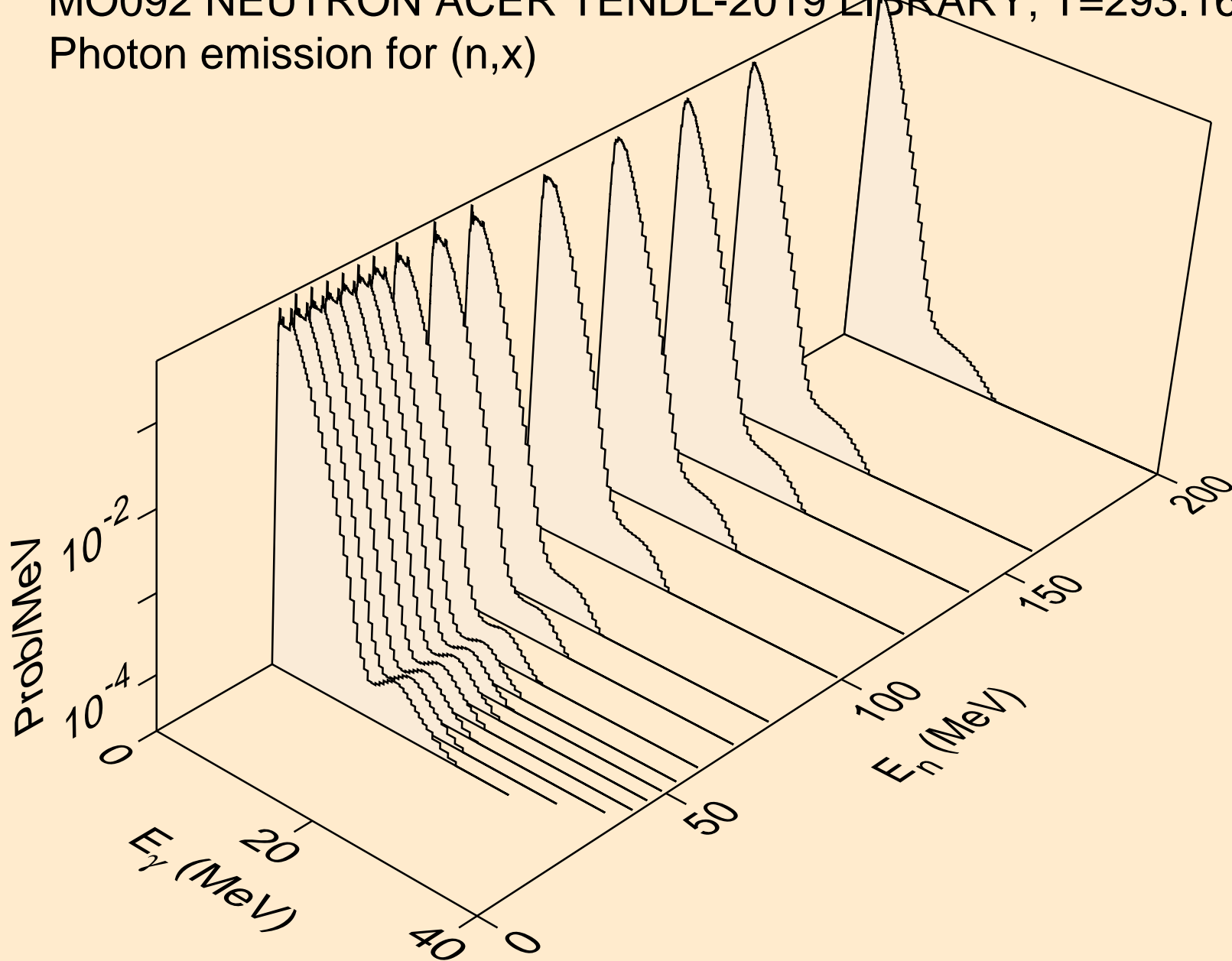

MO092 NEUTRON ACER TENDL-2019 LIBRARY; T=293.16K
Photon emission for (n,2nd)

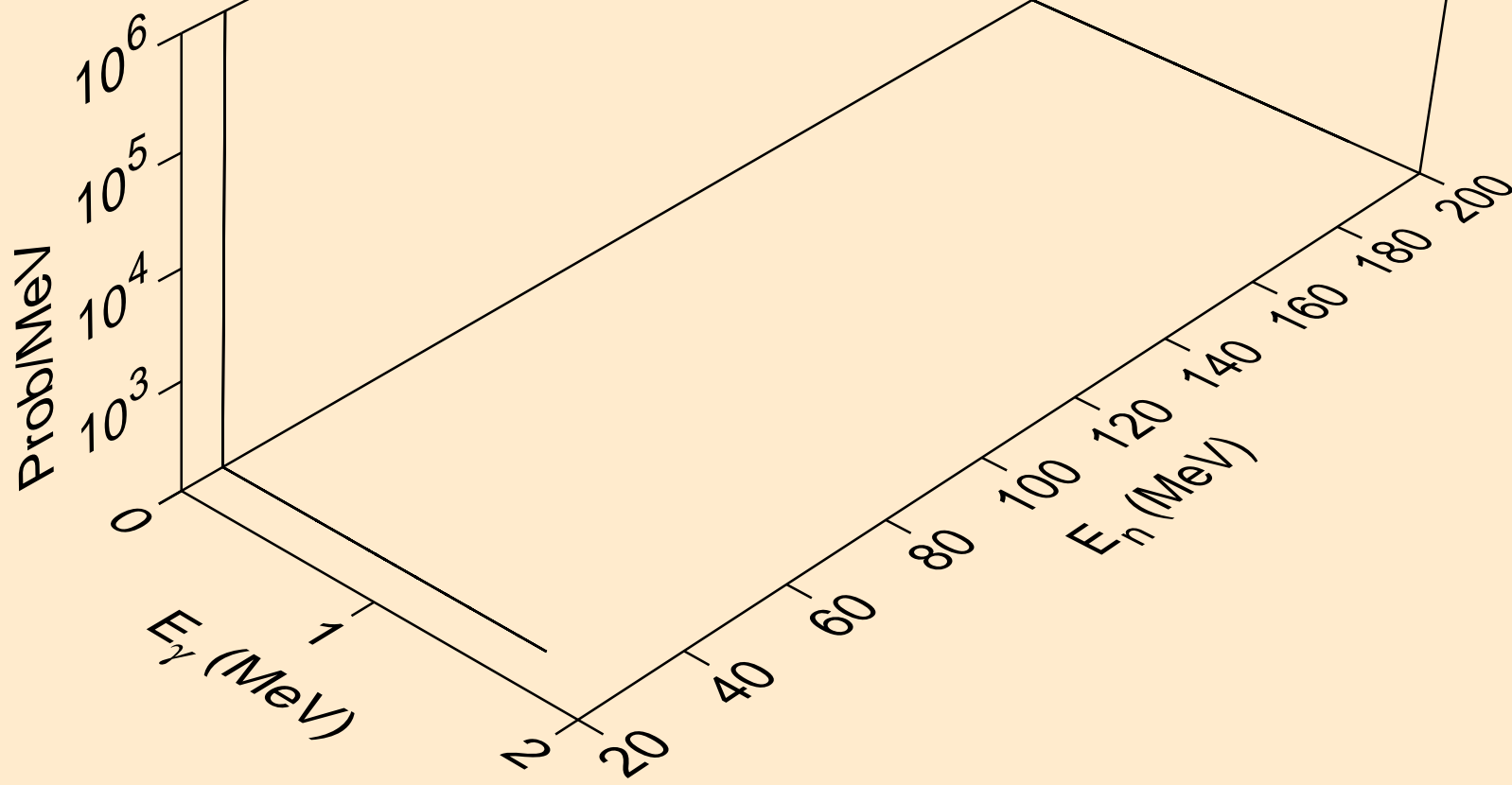

MO092 NEUTRON ACER TENDL-2019 LIBRARY; T=293.16K
Photon emission for (n,2n)

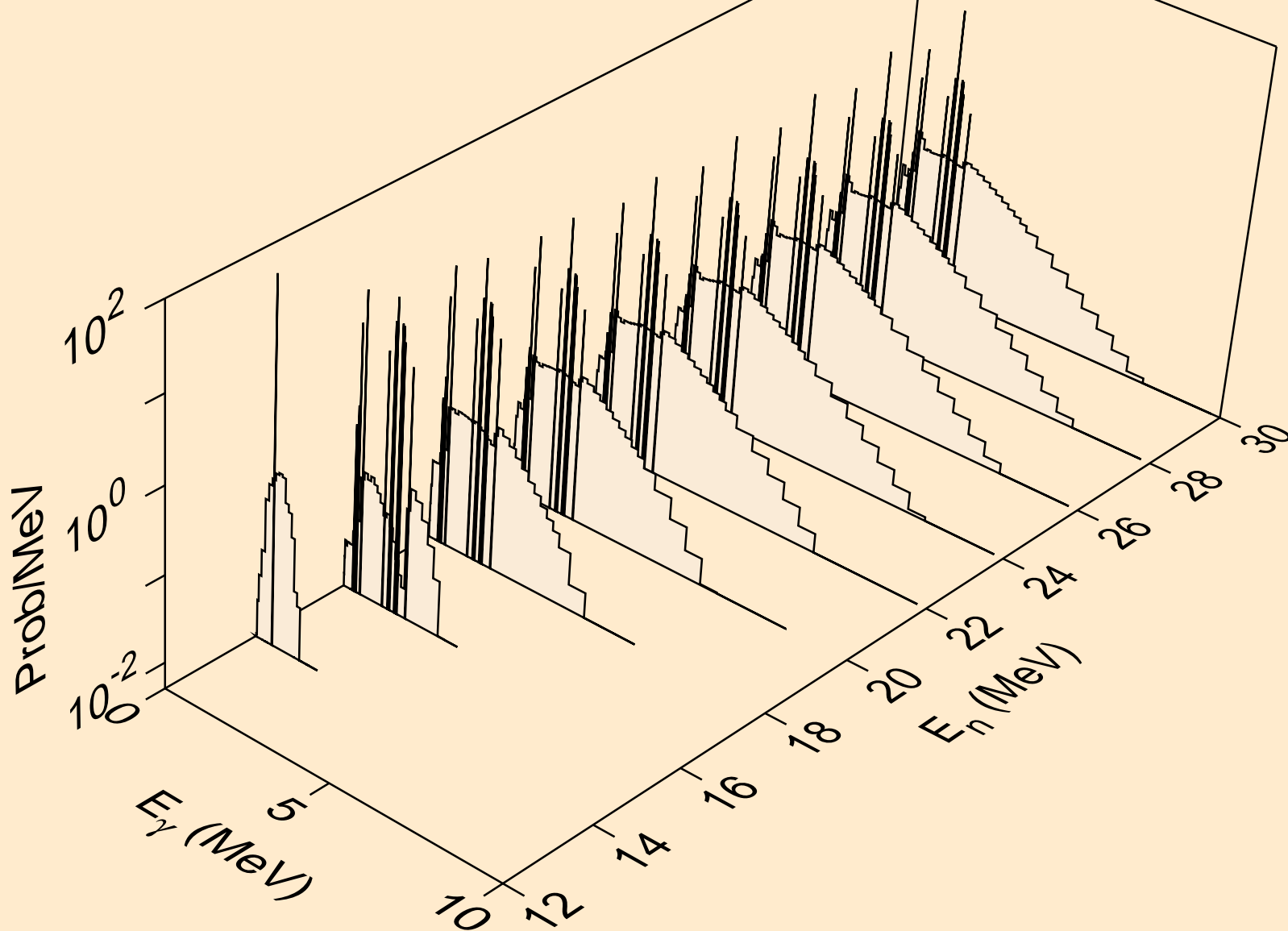

MO092 NEUTRON ACER TENDL-2019 LIBRARY; T=293.16K
Photon emission for (n,3n)

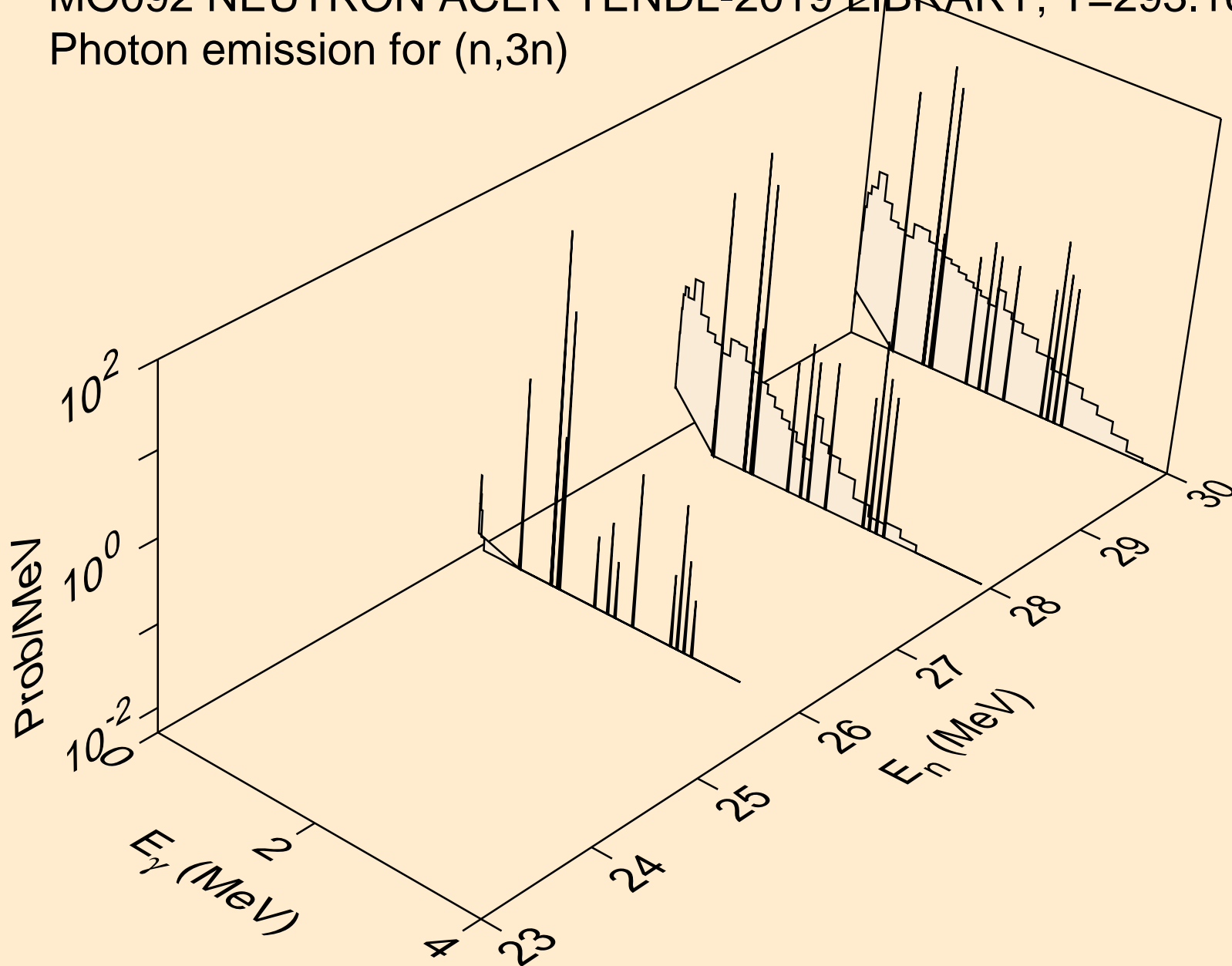

MO092 NEUTRON ACER TENDL-2019 LIBRARY; T=293.16K
Photon emission for (n,n*)a

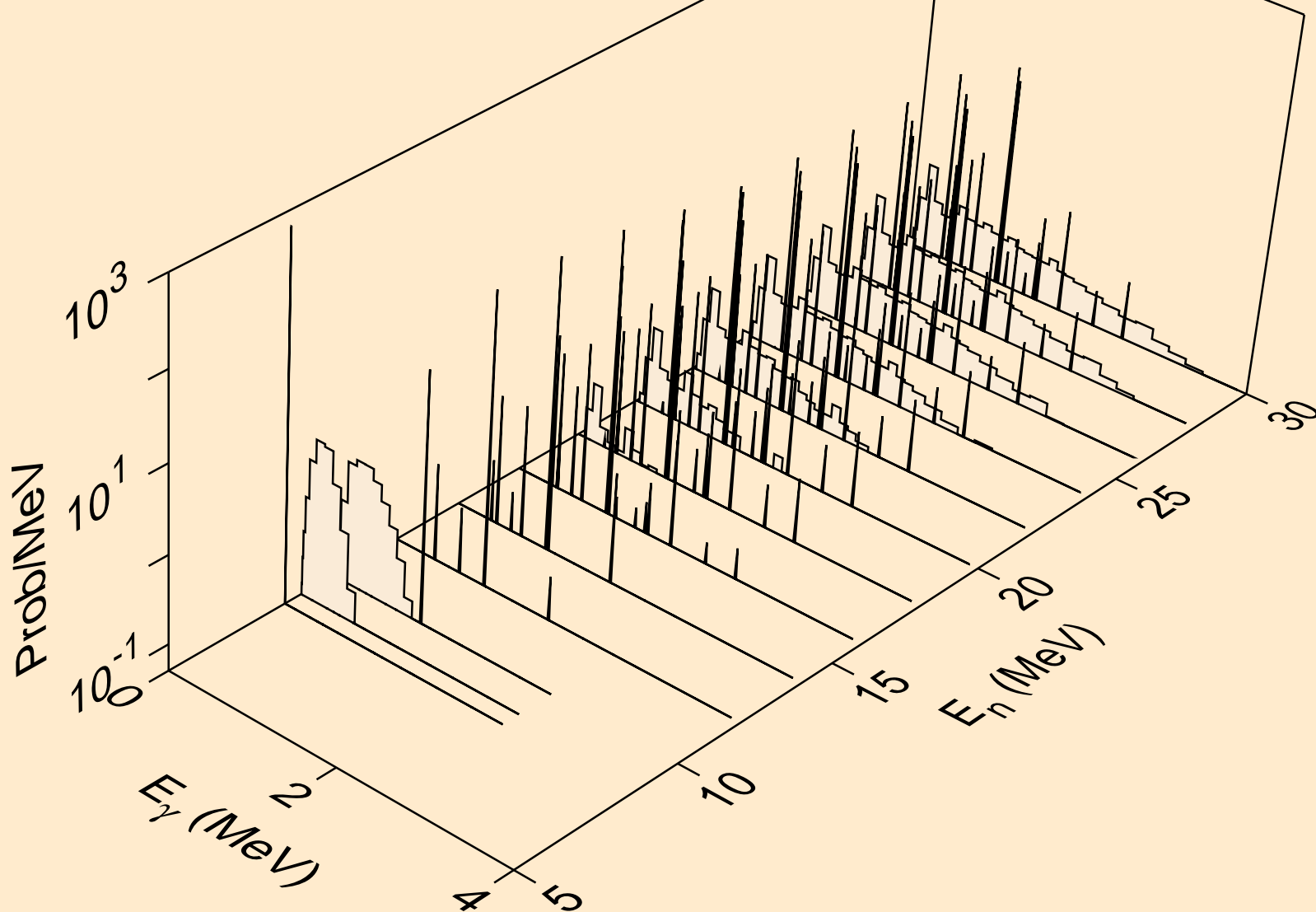

MO092 NEUTRON ACER TENDL-2019 LIBRARY; T=293.16K
Photon emission for (n,2n)a

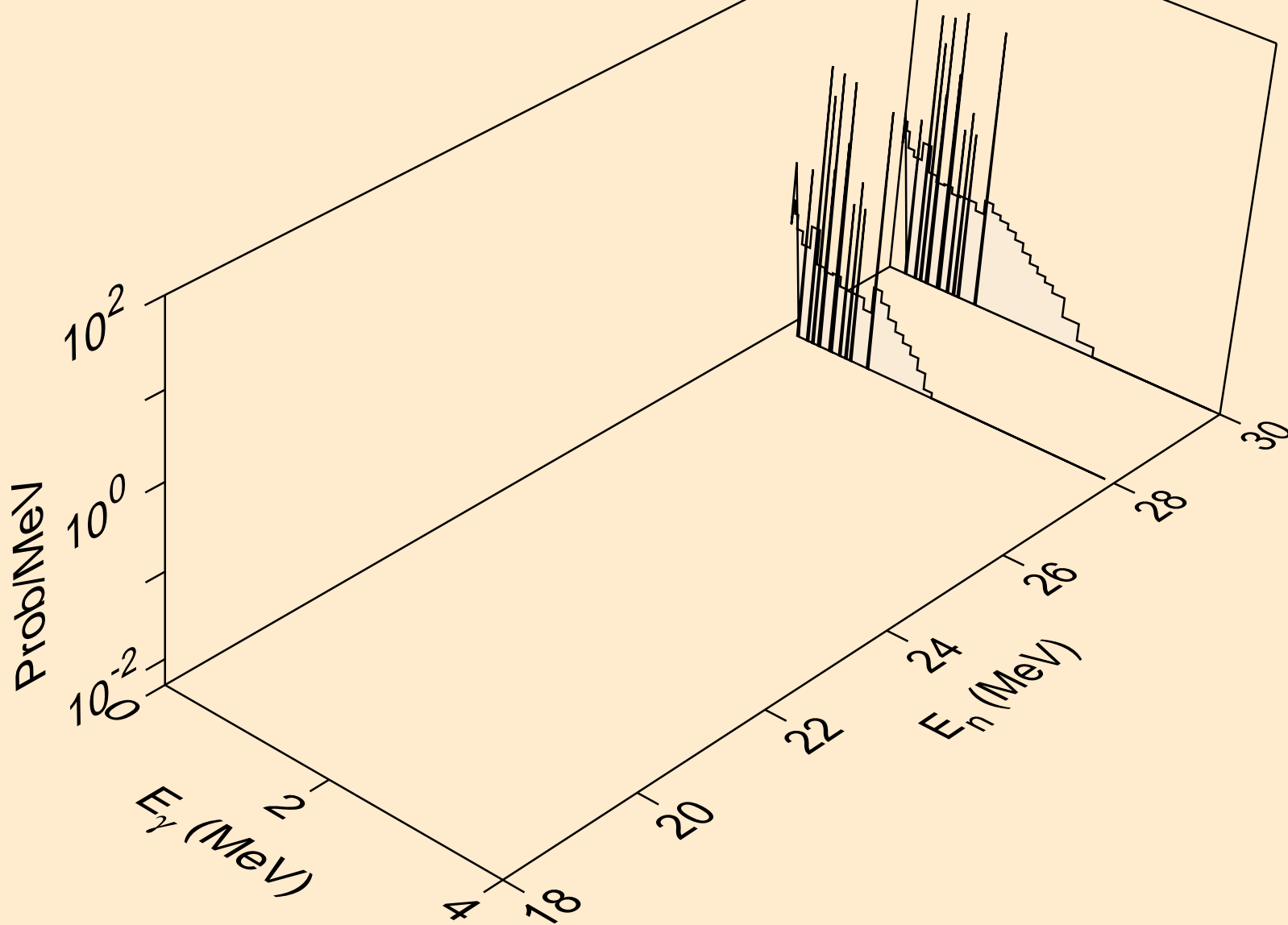

MO092 NEUTRON ACER TENDL-2019 LIBRARY; T=293.16K
Photon emission for (n,n*)p

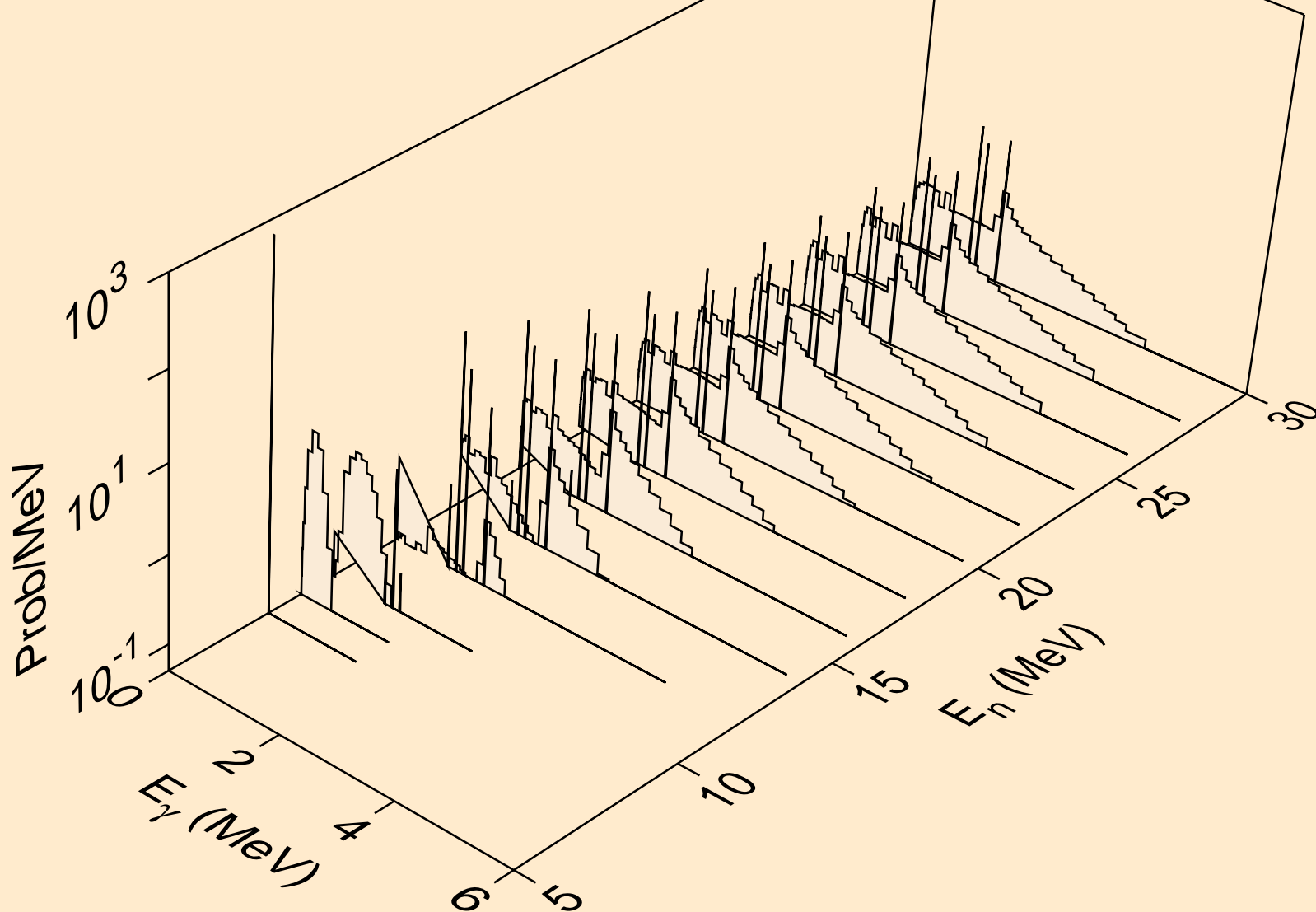

MO092 NEUTRON ACER TENDL-2019 LIBRARY; T=293.16K
Photon emission for (n,n*)2a

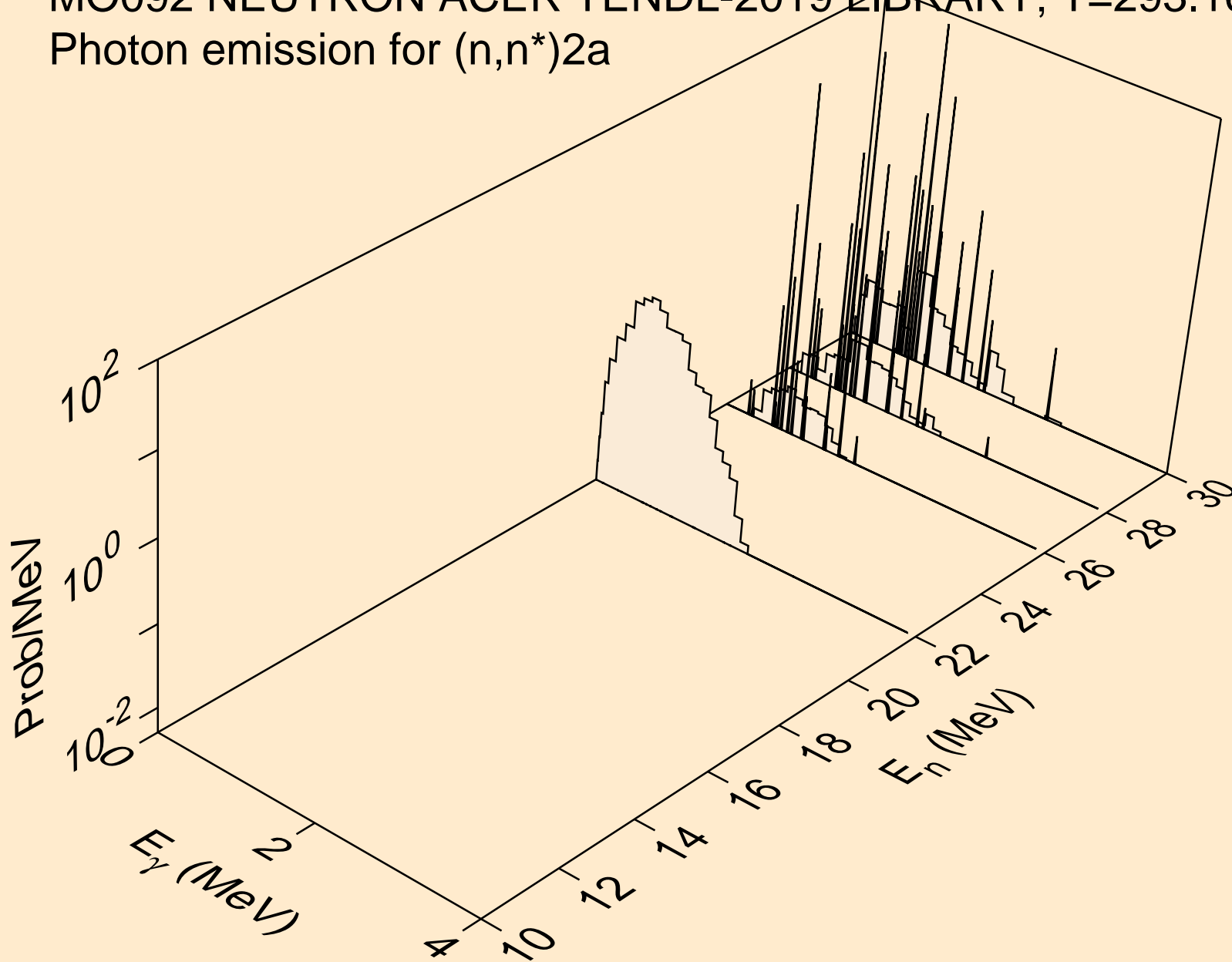

MO092 NEUTRON ACER TENDL-2019 LIBRARY; T=293.16K
Photon emission for (n,n*)d

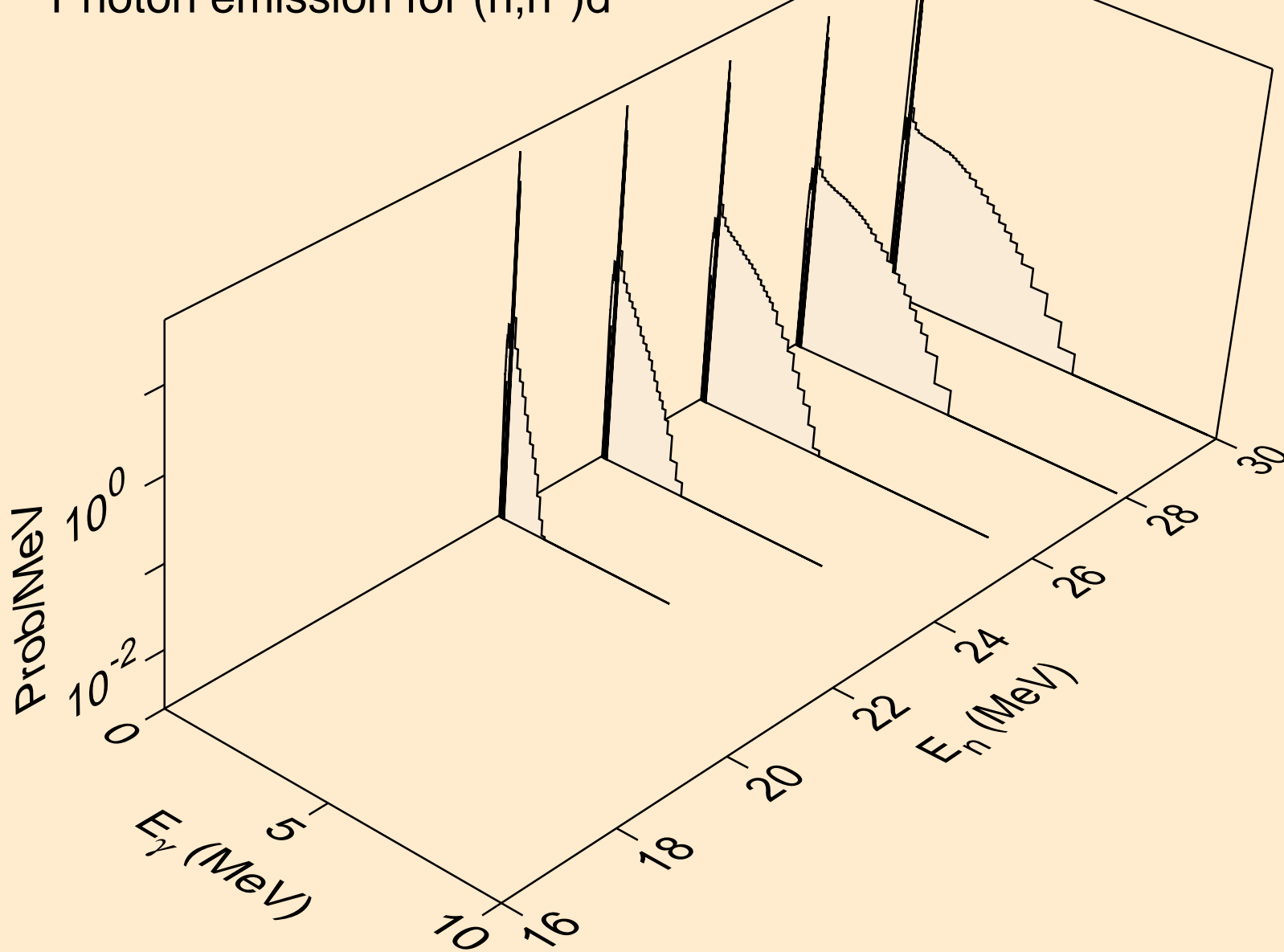

MO092 NEUTRON ACER TENDL-2019 LIBRARY; T=293.16K
Photon emission for (n,n*)t

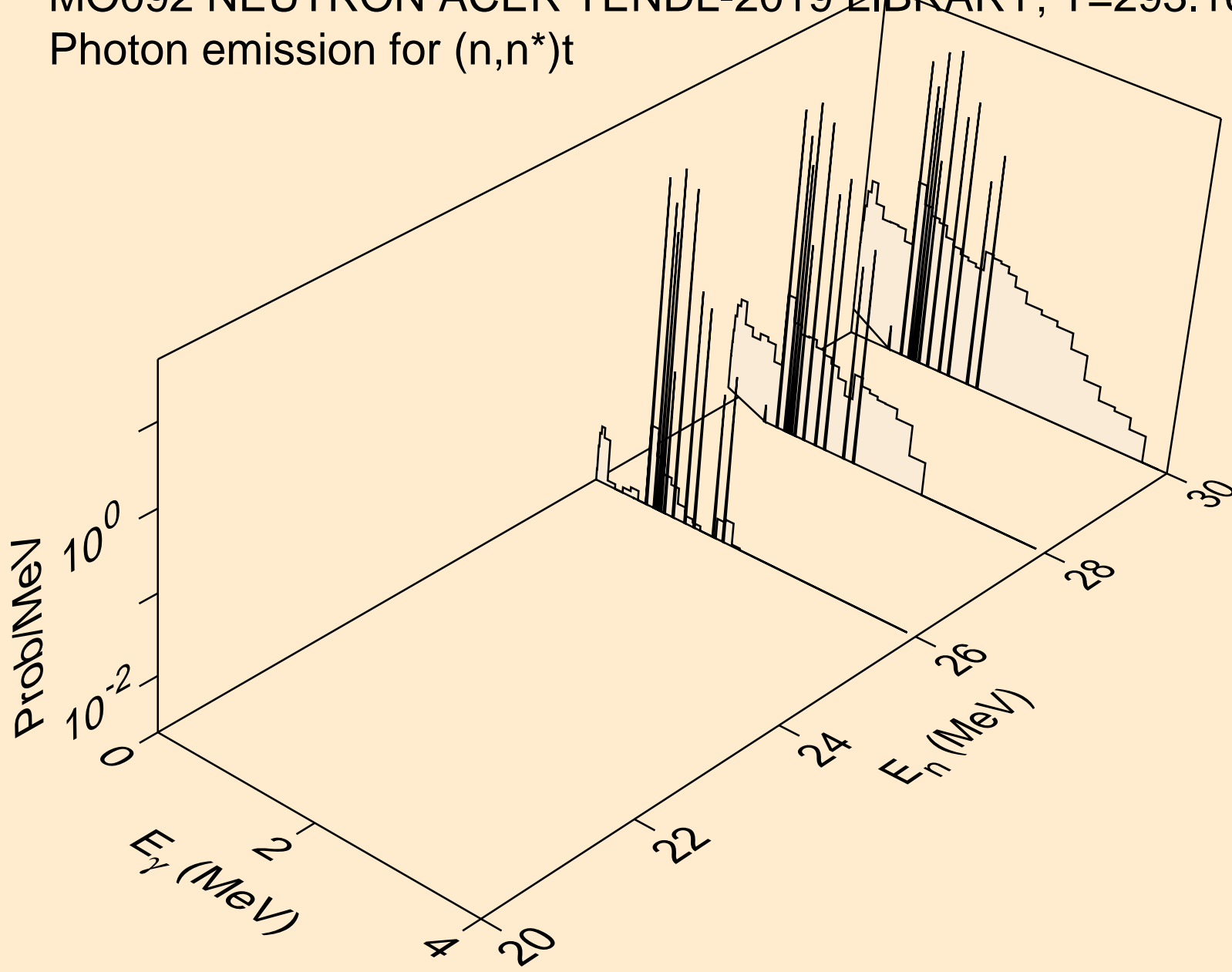

MO092 NEUTRON ACER TENDL-2019 LIBRARY; T=293.16K
Photon emission for (n,n*)he3

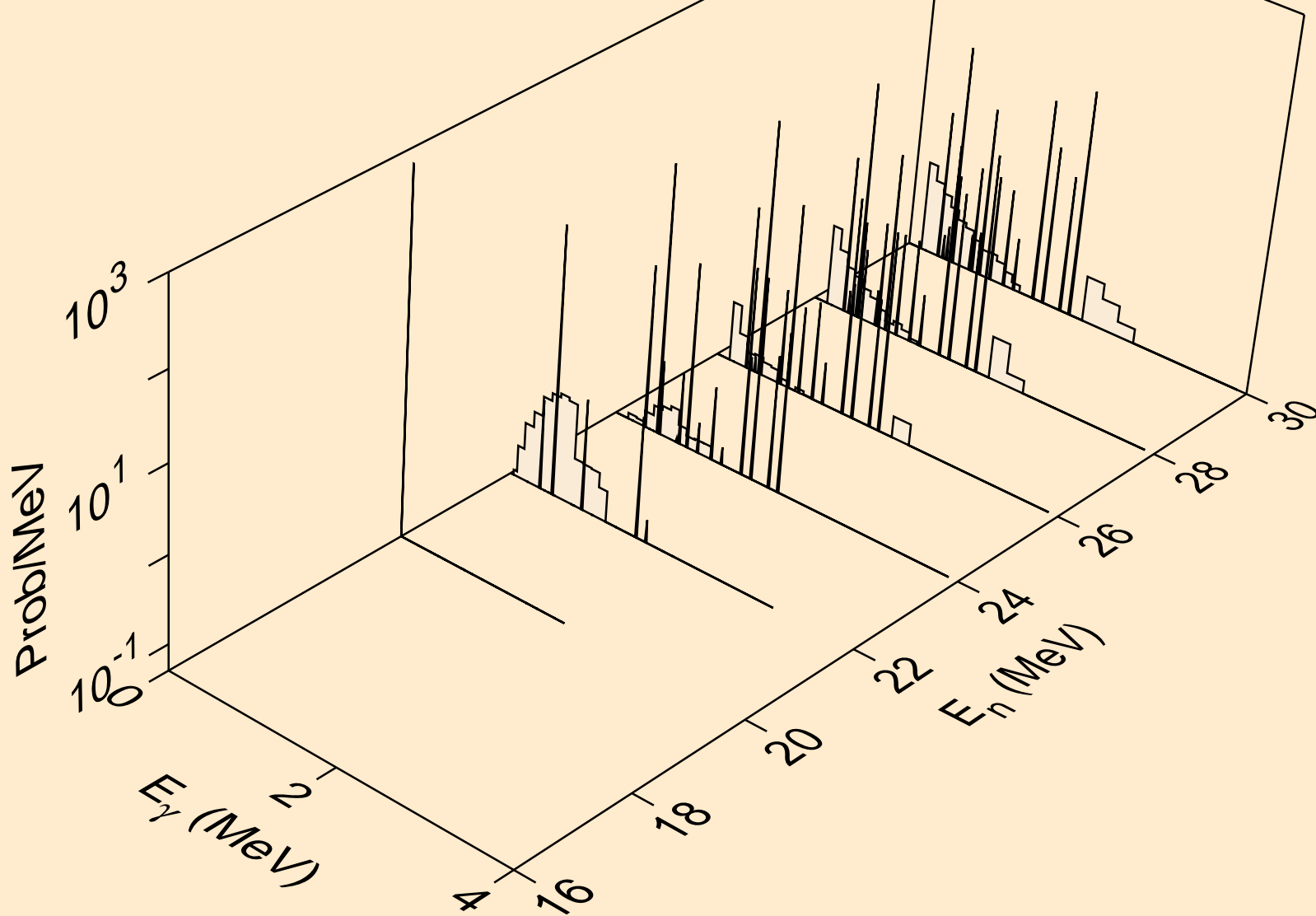

MO092 NEUTRON ACER TENDL-2019 LIBRARY; T=293.16K
Photon emission for (n,2np)

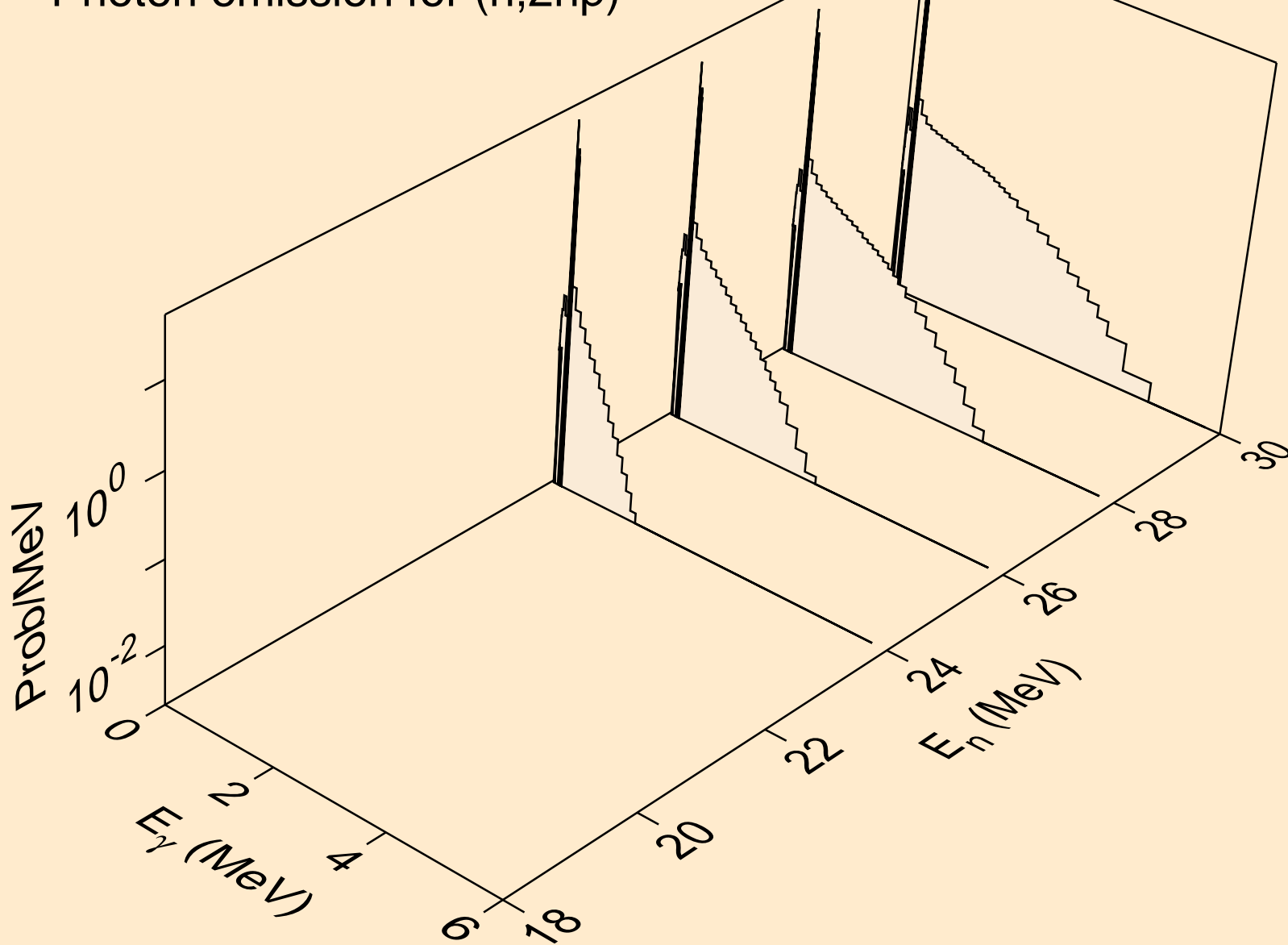

MO092 NEUTRON ACER TENDL-2019 LIBRARY; T=293.16K
Photon emission for (n,2np)

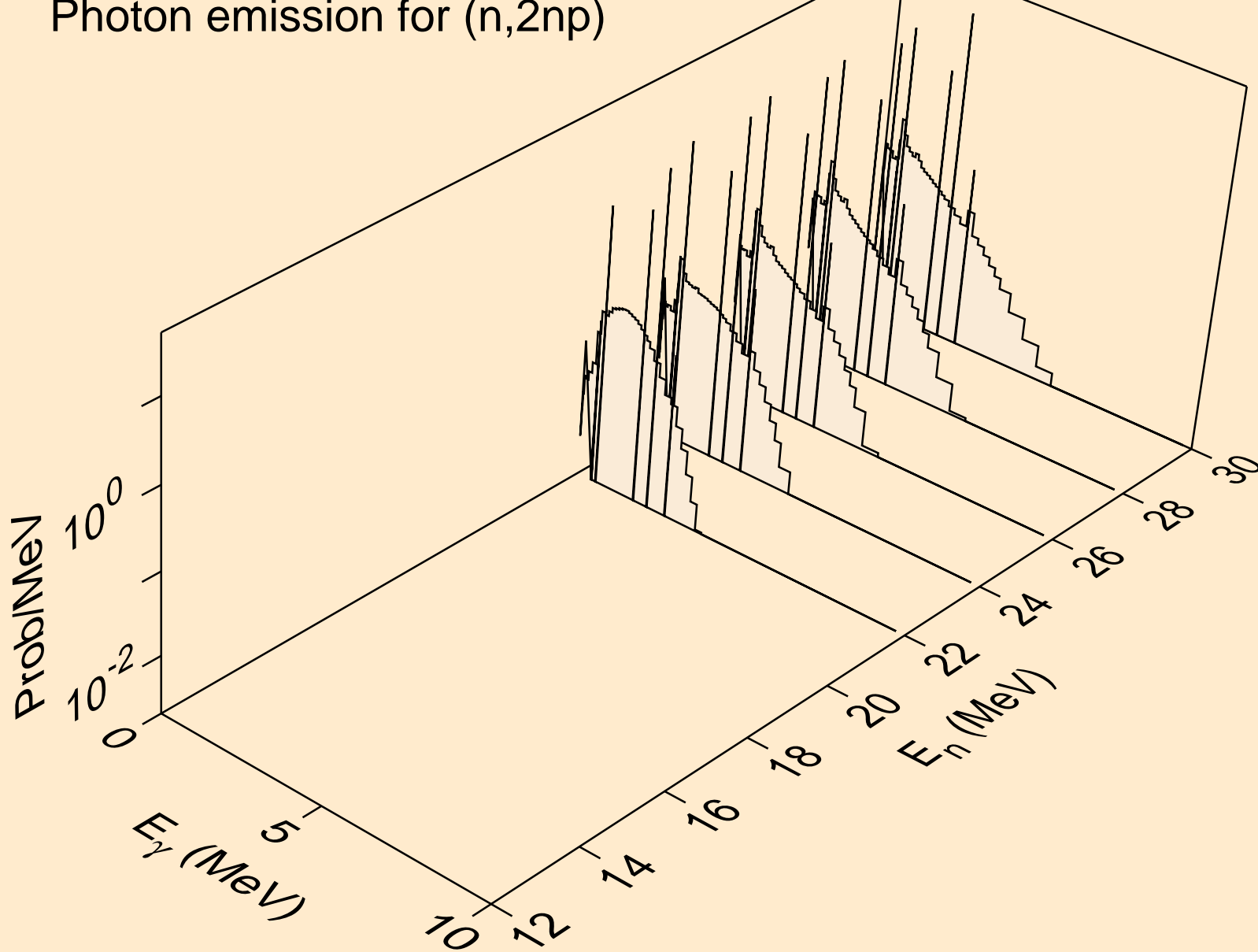

MO092 NEUTRON ACER TENDL-2019 LIBRARY; T=293.16K
Photon emission for (n,npa)

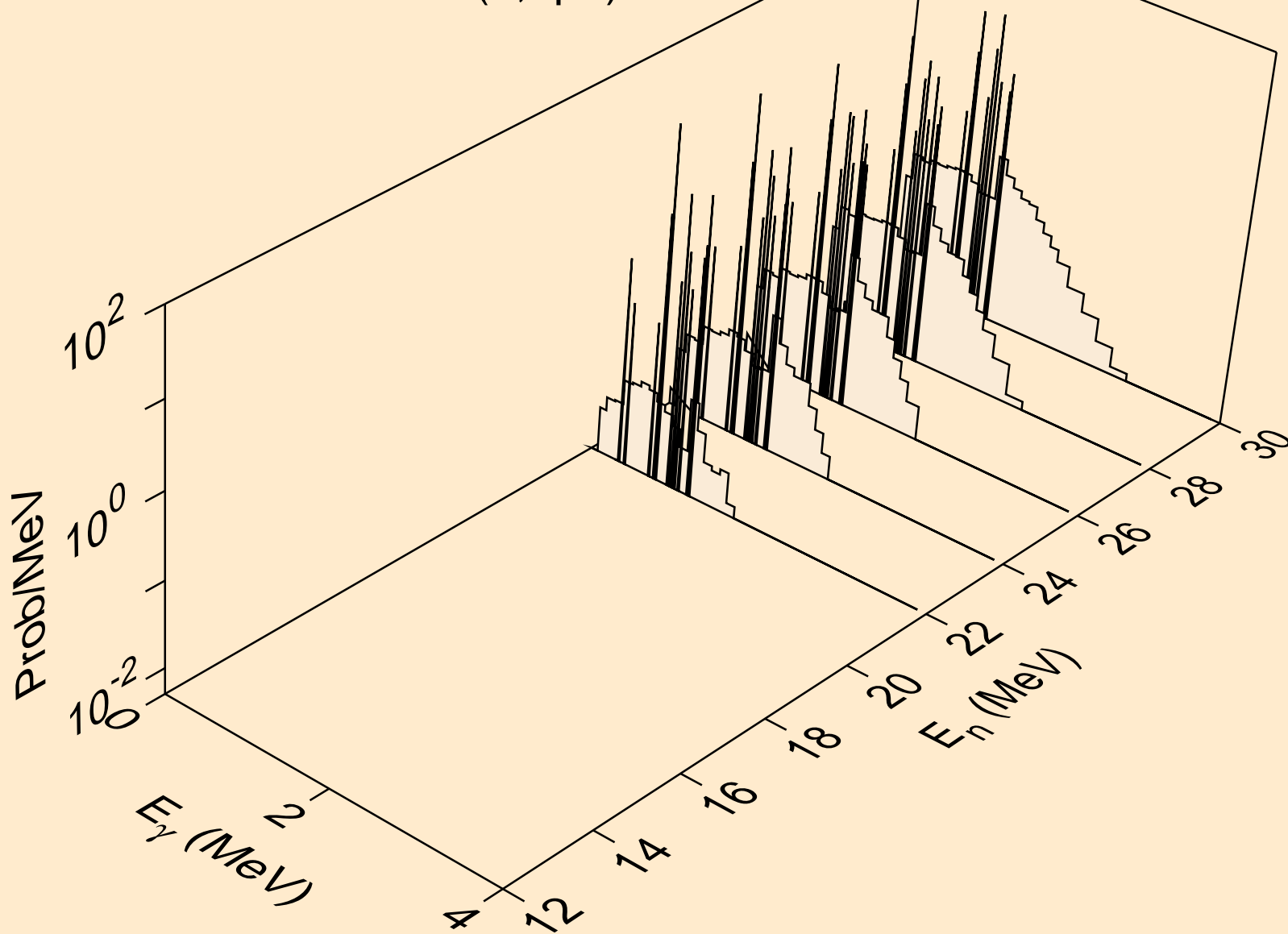

MO092 NEUTRON ACER TENDL-2019 LIBRARY; T=293.16K
Photon emission for (n,n*c)

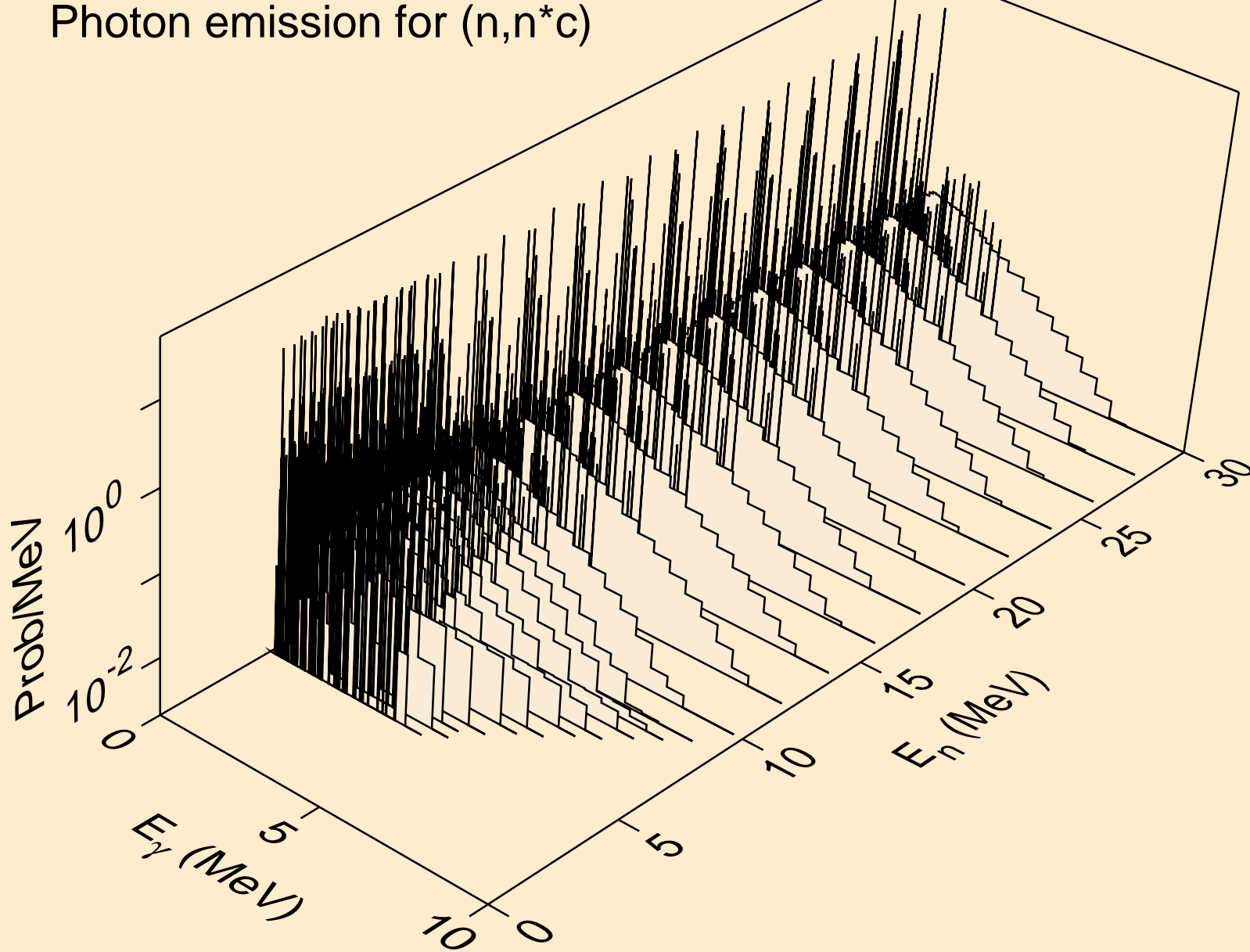

MO092 NEUTRON ACER TENDL-2019 LIBRARY; T=293.16K
Photon emission for (n,gma)

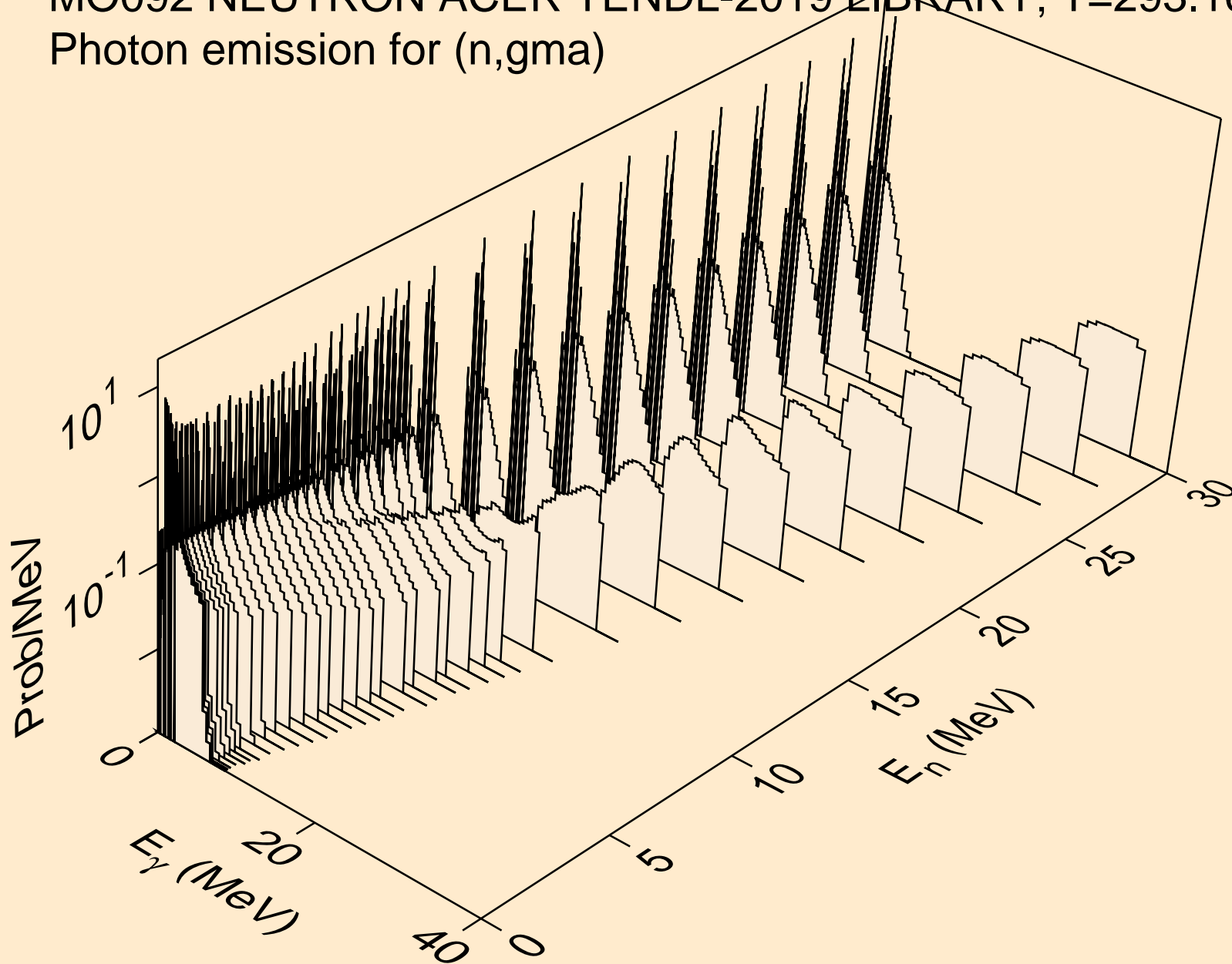

MO092 NEUTRON ACER TENDL-2019 LIBRARY; T=293.16K
Photon emission for (n,p)

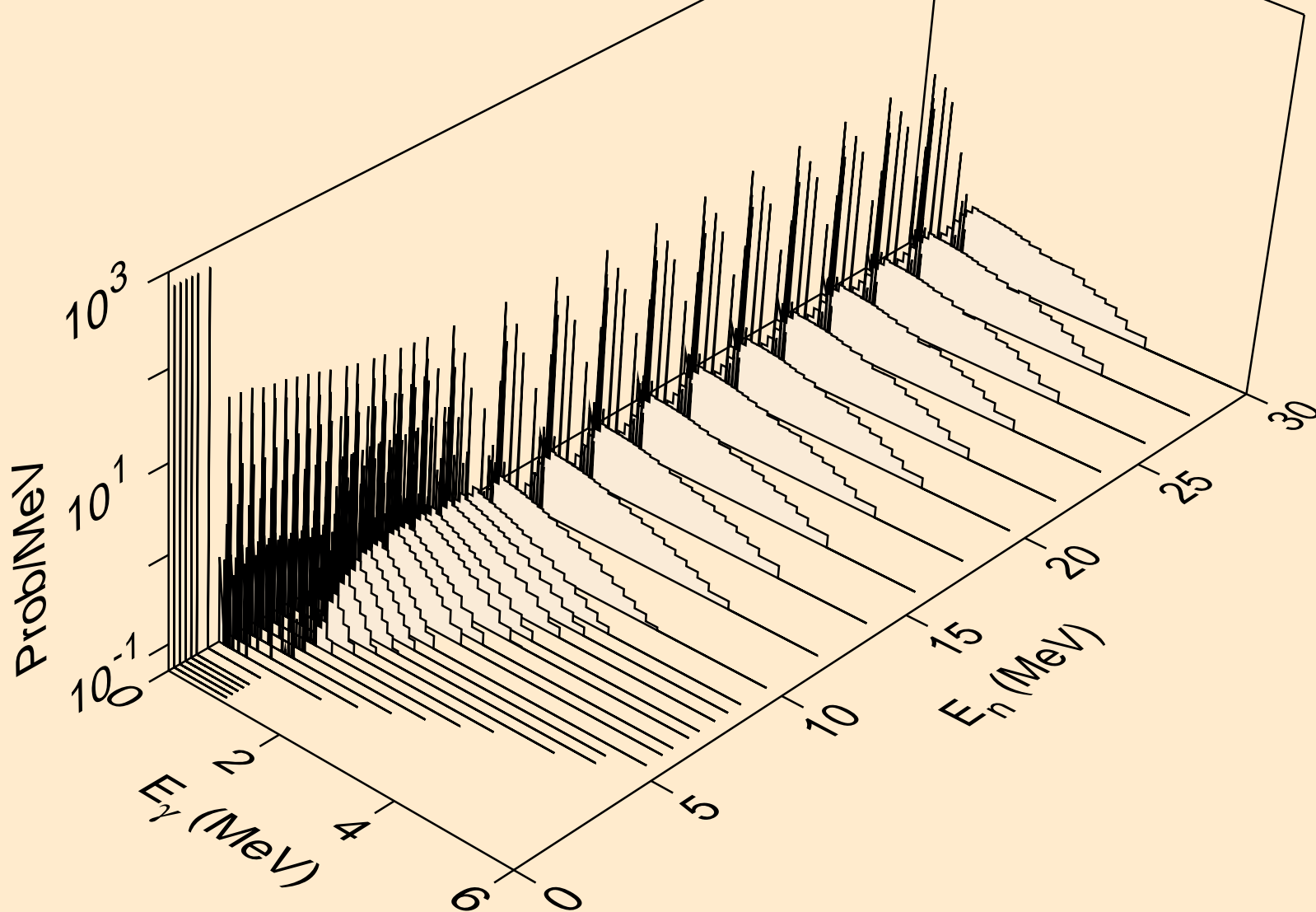

MO092 NEUTRON ACER TENDL-2019 LIBRARY; T=293.16K
Photon emission for (n,d)

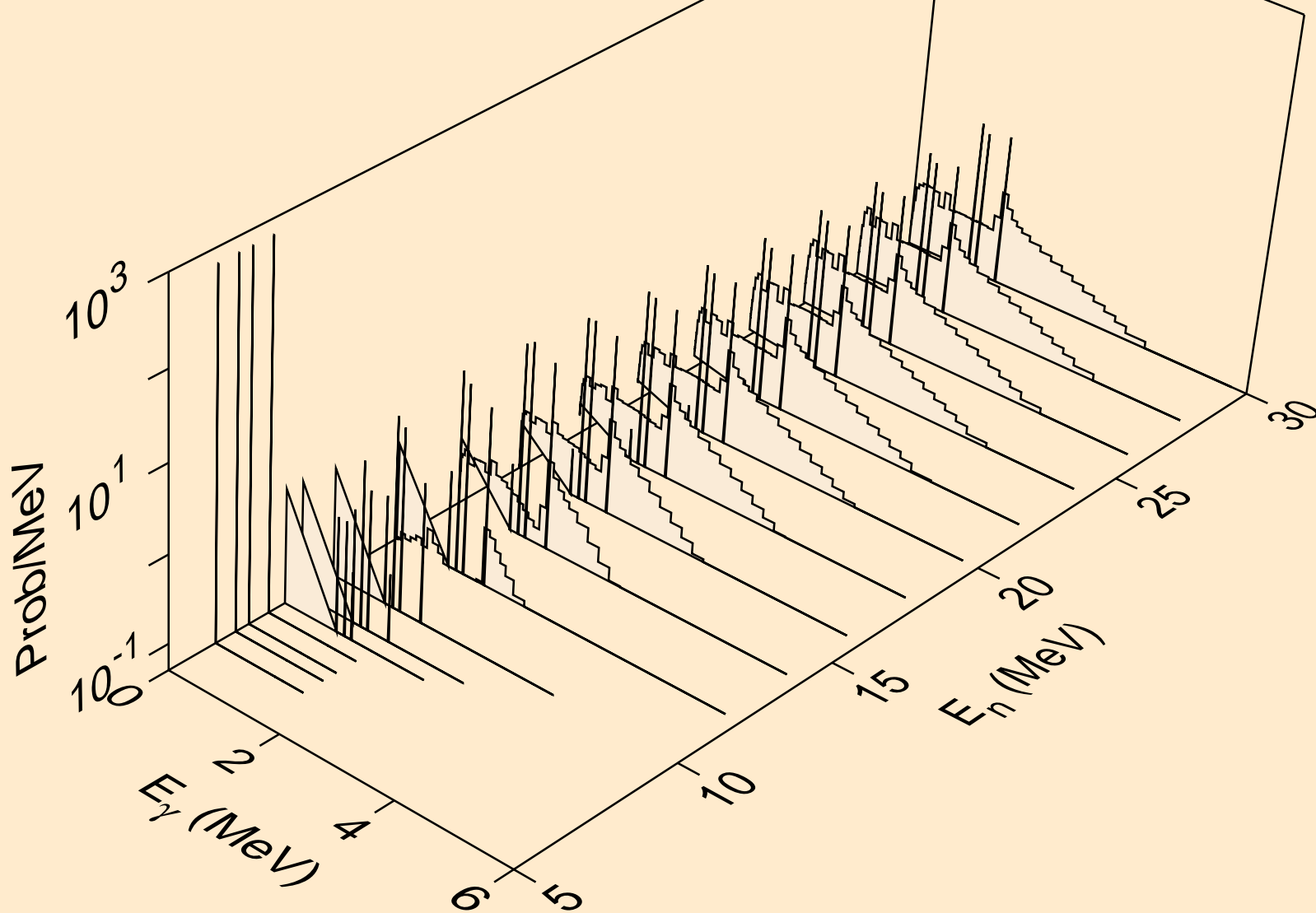

MO092 NEUTRON ACER TENDL-2019 LIBRARY; T=293.16K
Photon emission for (n,t)

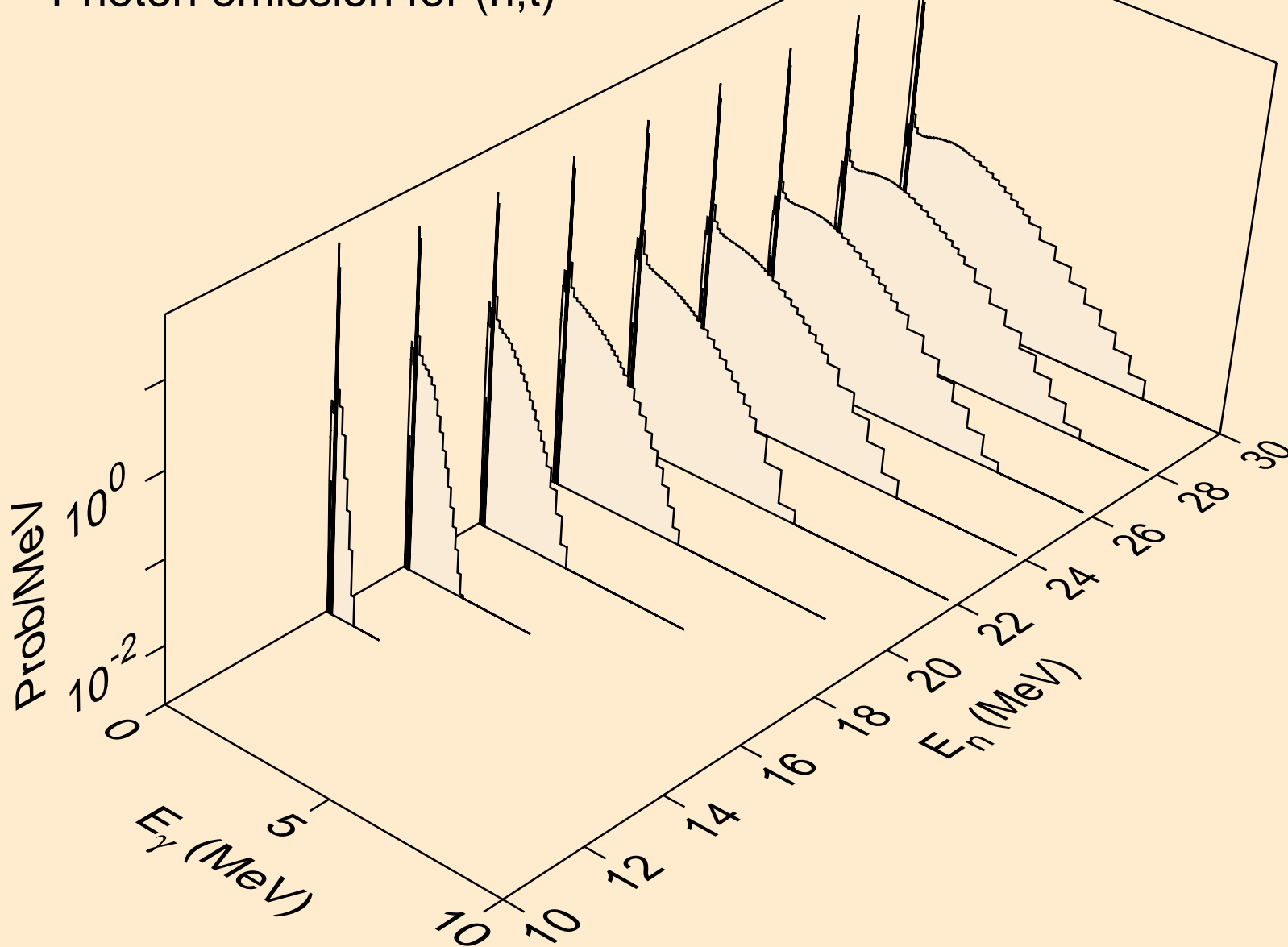

MO092 NEUTRON ACER TENDL-2019 LIBRARY; T=293.16K
Photon emission for (n,he3)

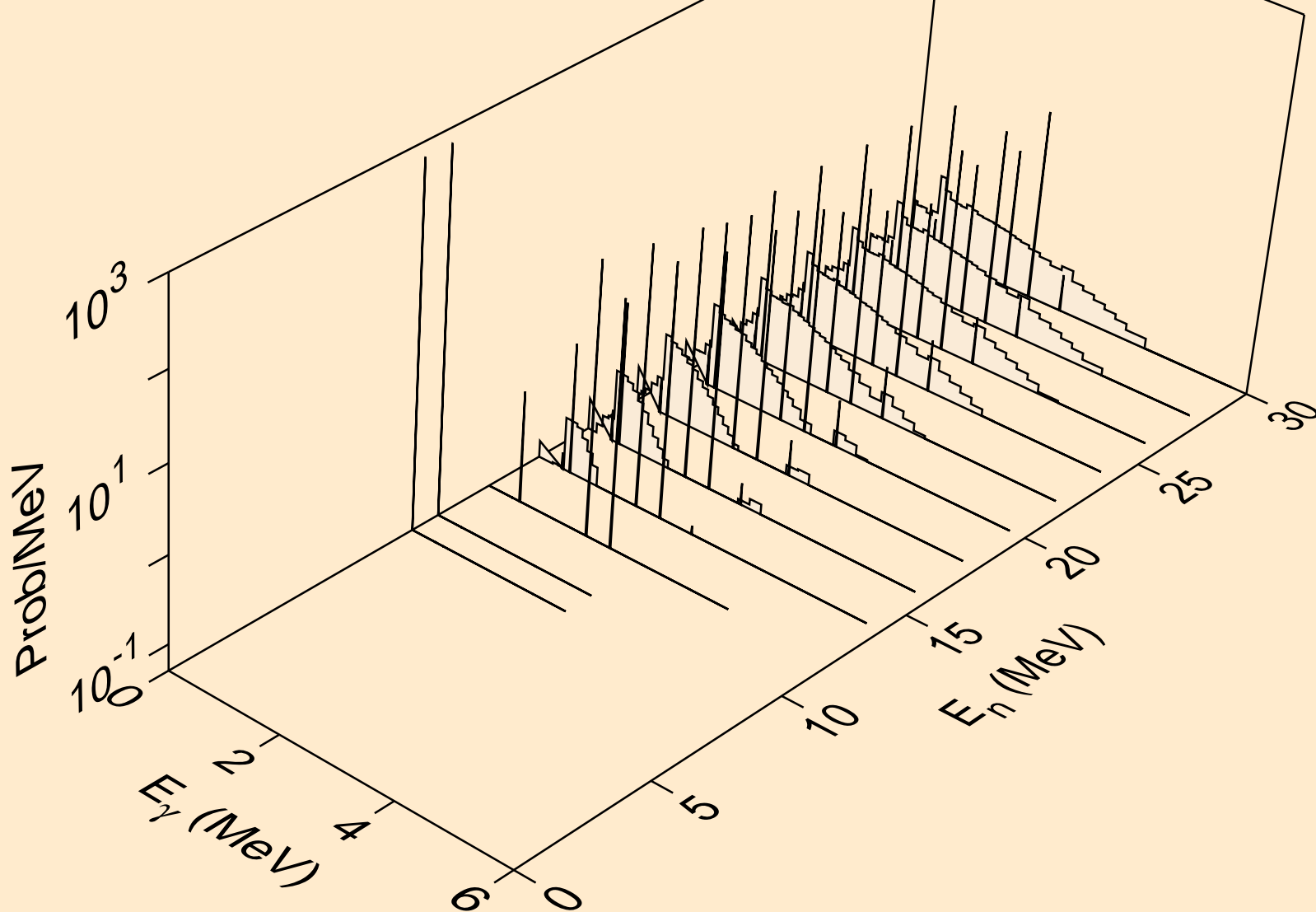

MO092 NEUTRON ACER TENDL-2019 LIBRARY; T=293.16K
Photon emission for (n,a)

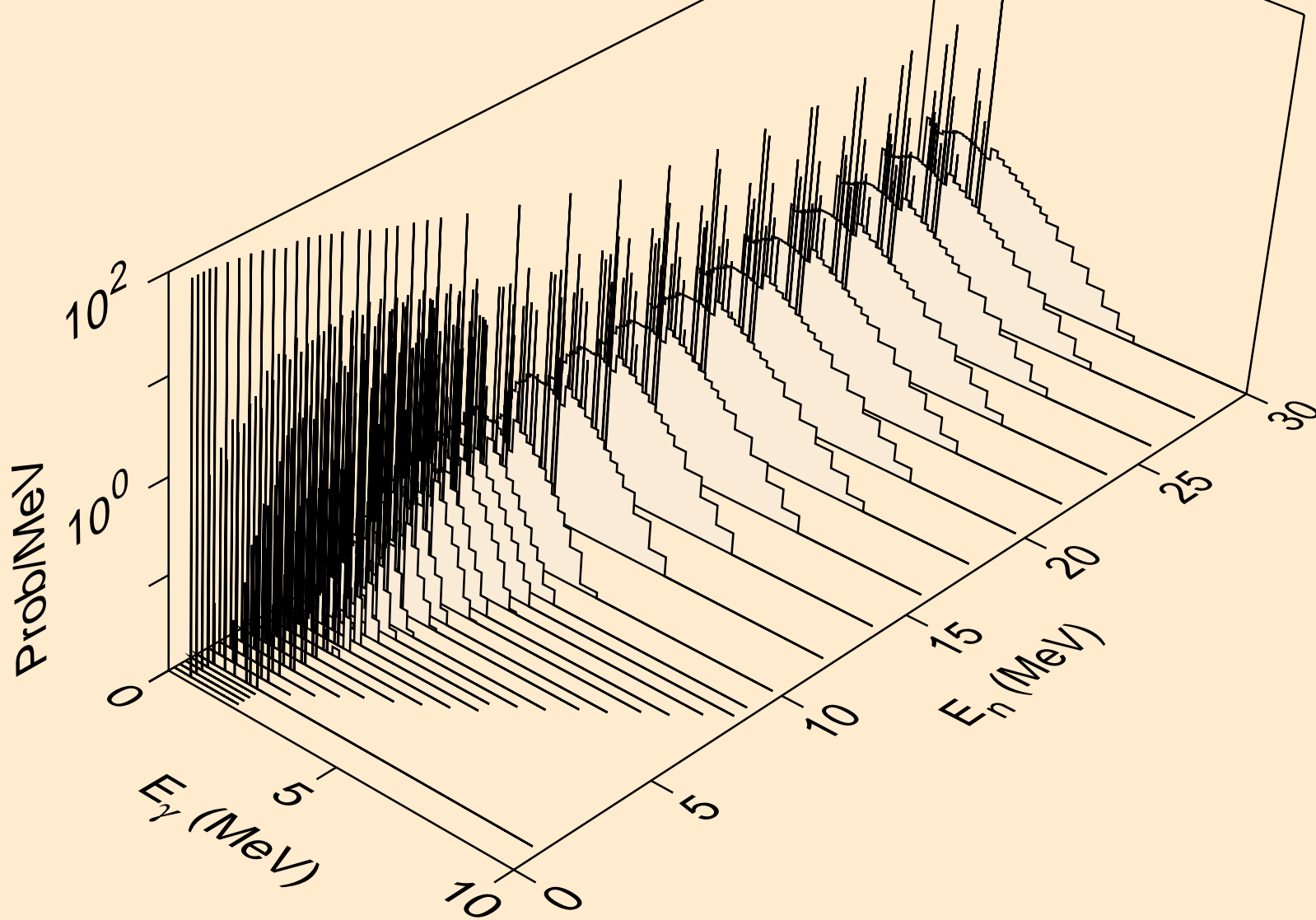

MO092 NEUTRON ACER TENDL-2019 LIBRARY; T=293.16K
Photon emission for (n,2a)

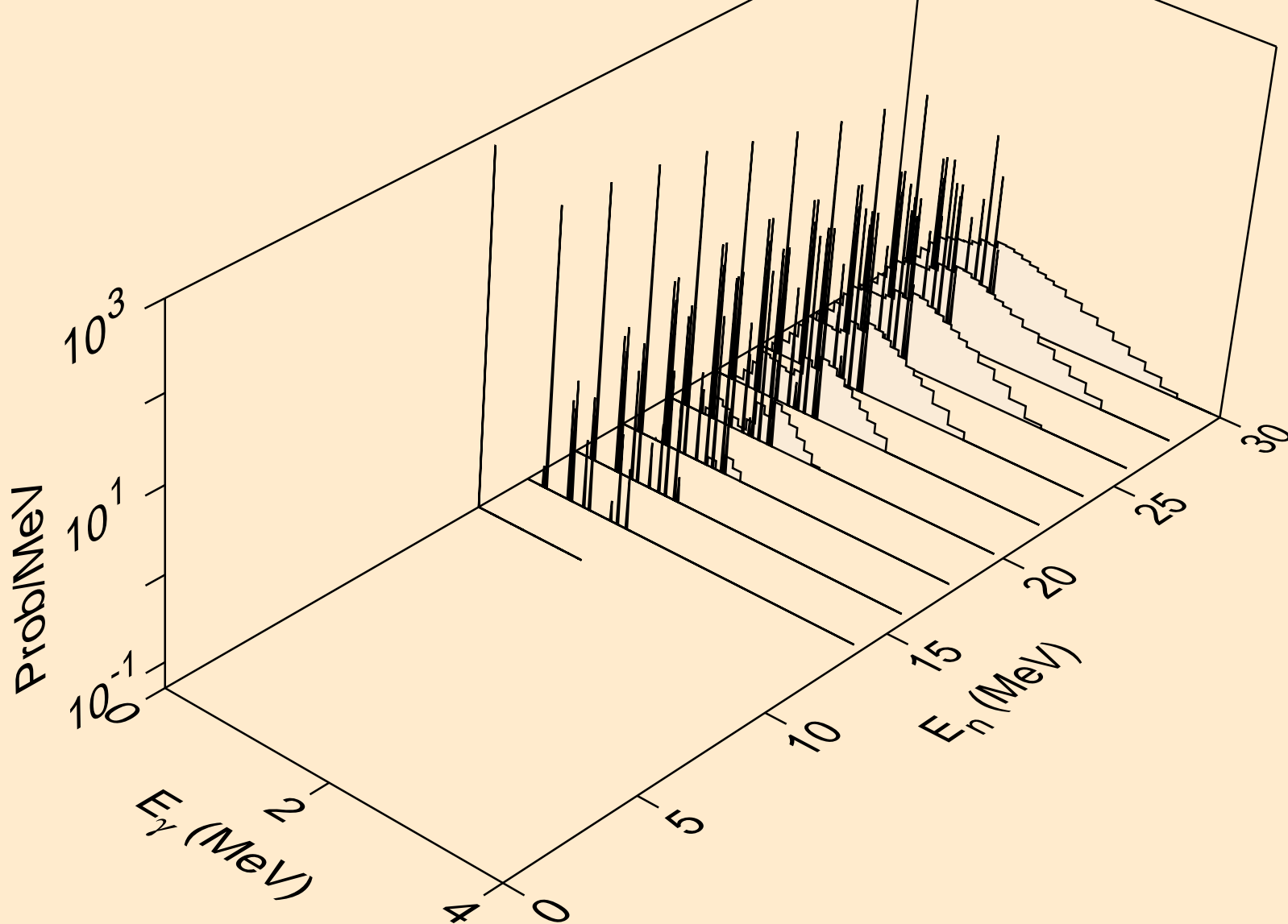

MO092 NEUTRON ACER TENDL-2019 LIBRARY; T=293.16K
Photon emission for (n,2p)

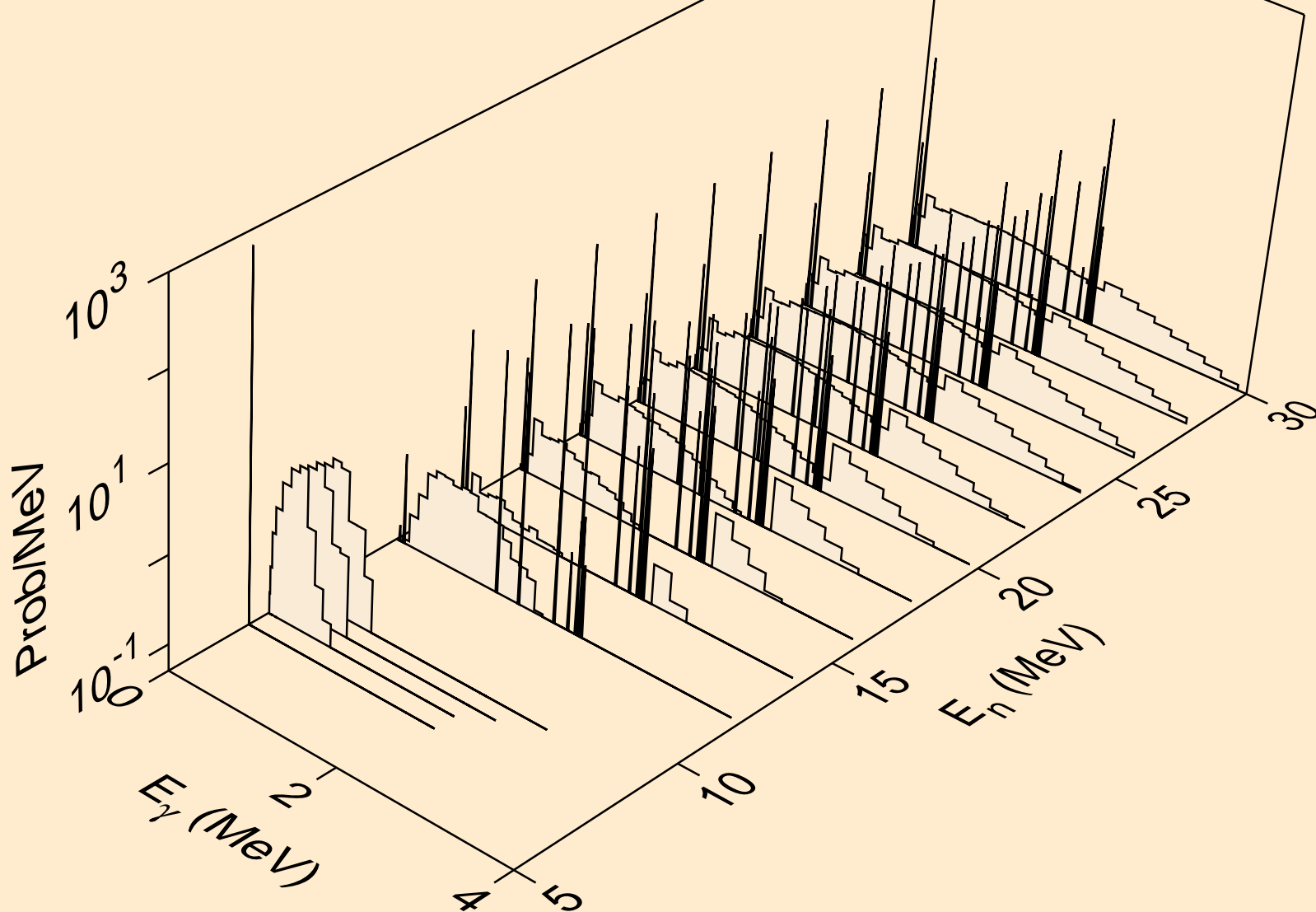

MO092 NEUTRON ACER TENDL-2019 LIBRARY; T=293.16K
Photon emission for (n,p)

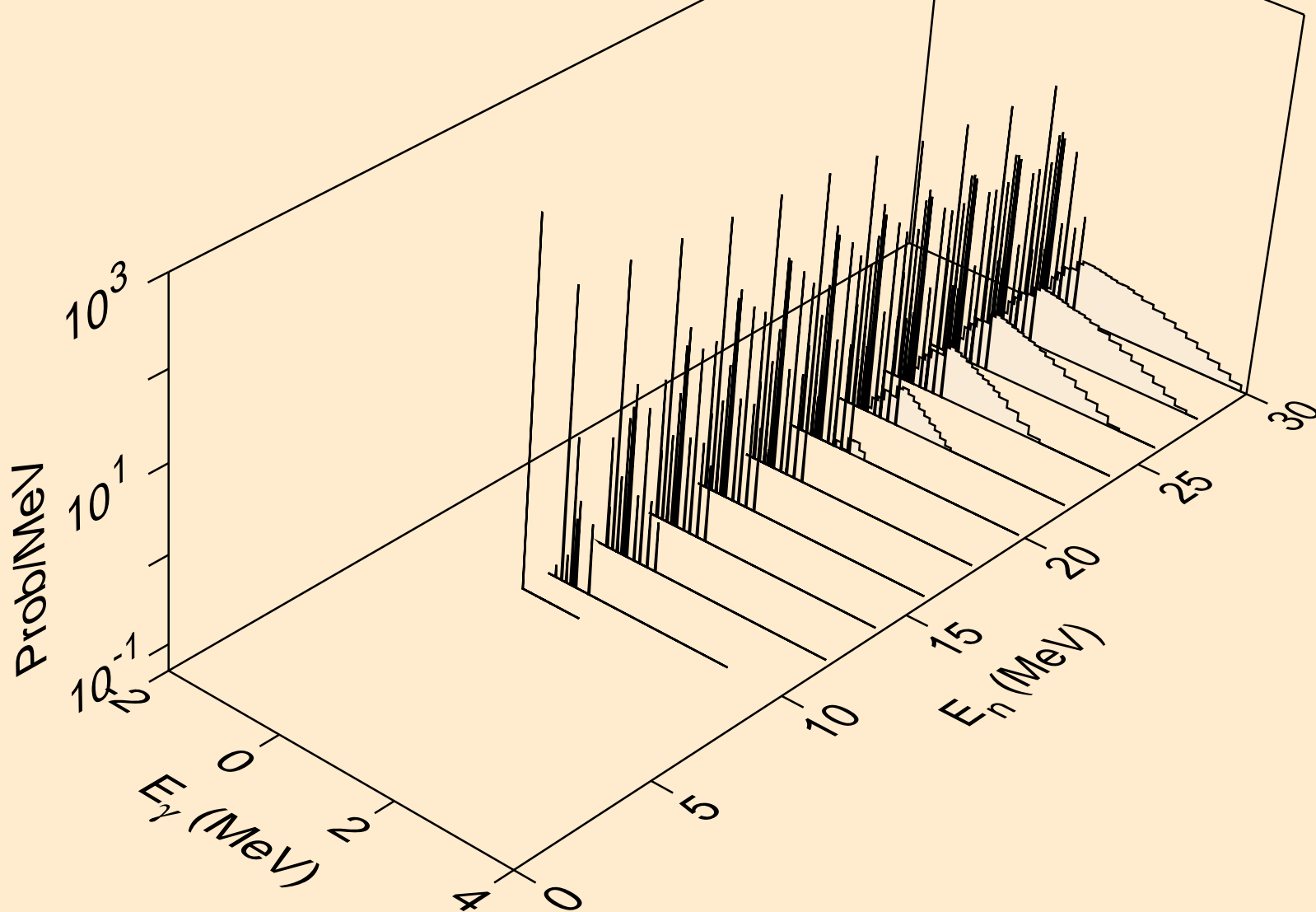

MO092 NEUTRON ACER TENDL-2019 LIBRARY; T=293.16K
Photon emission for (n,pd)

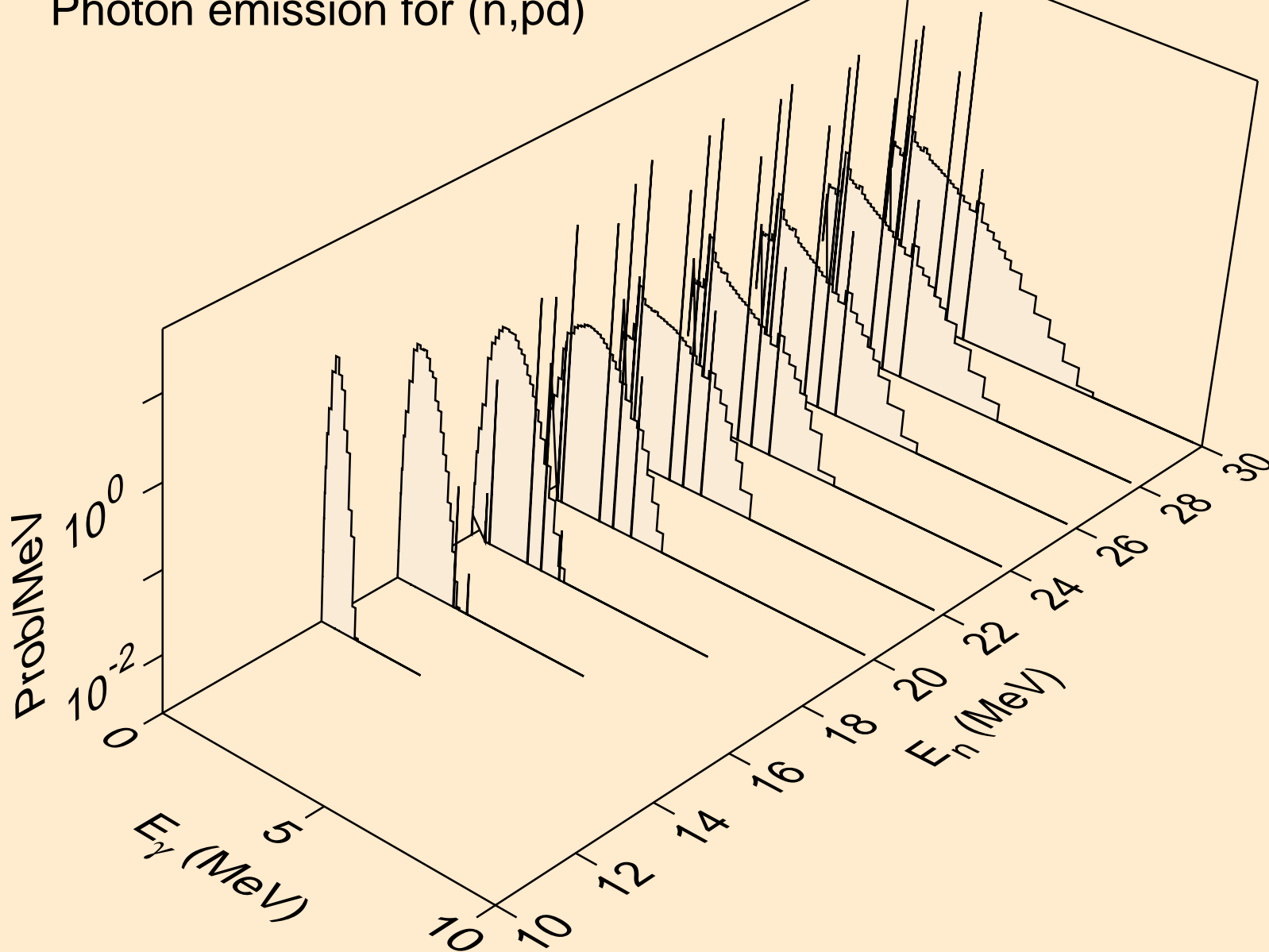

MO092 NEUTRON ACER TENDL-2019 LIBRARY; T=293.16K
Photon emission for (n,pt)

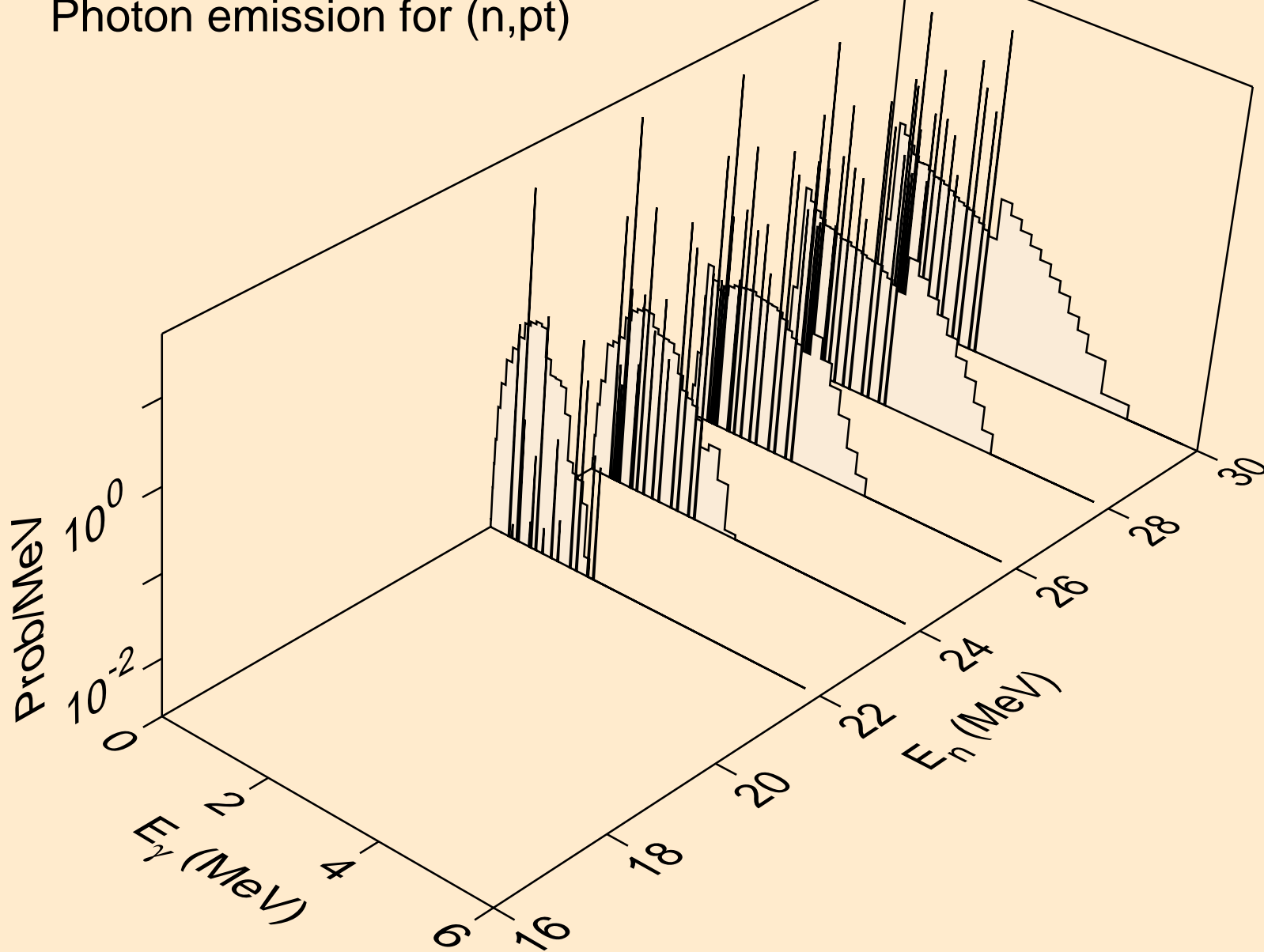

MO092 NEUTRON ACER TENDL-2019 LIBRARY; T=293.16K
Photon emission for (n,da)

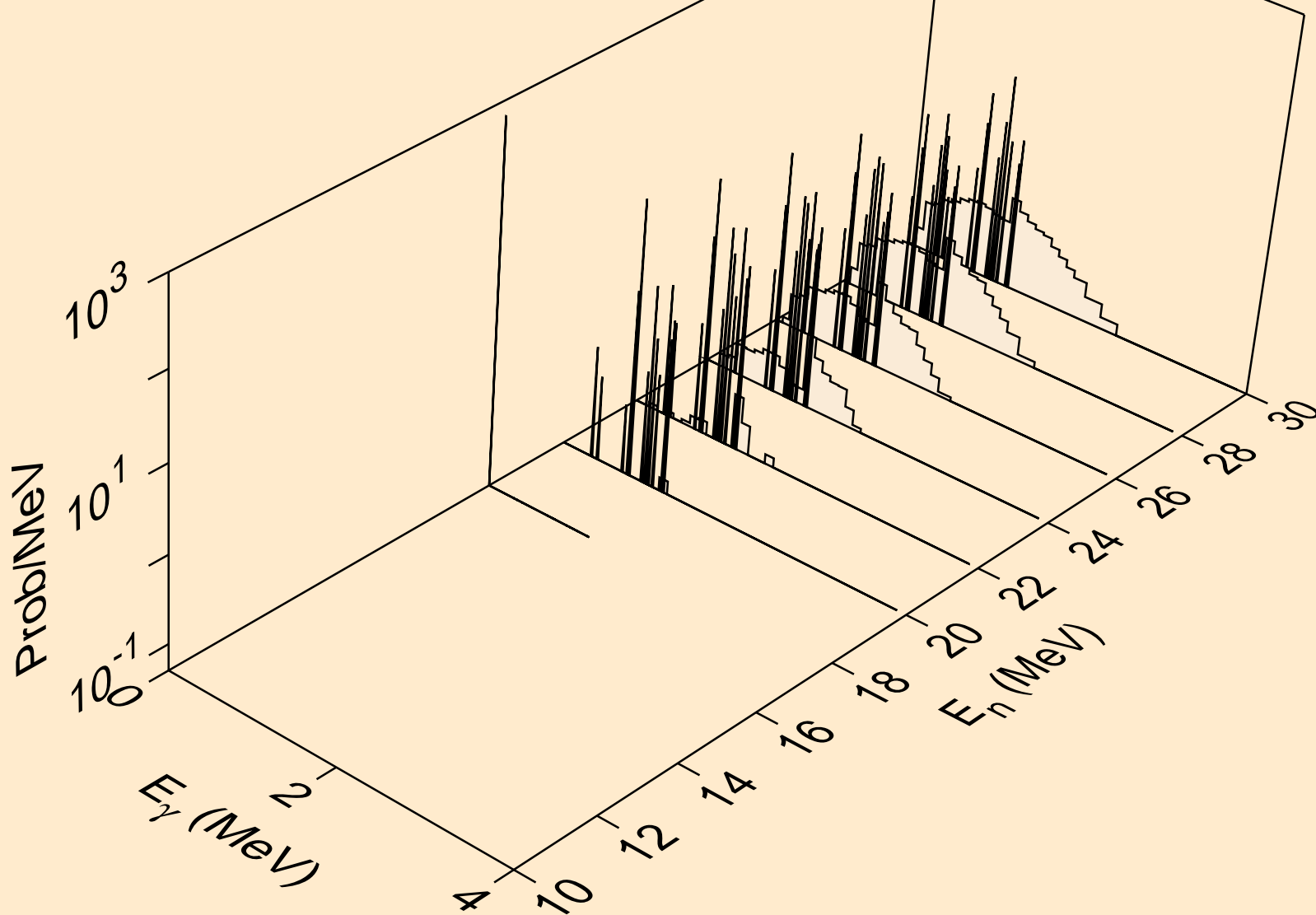

MO092 NEUTRON ACER TENDL-2019 LIBRARY; T=293.16K
thermal capture photon spectrum

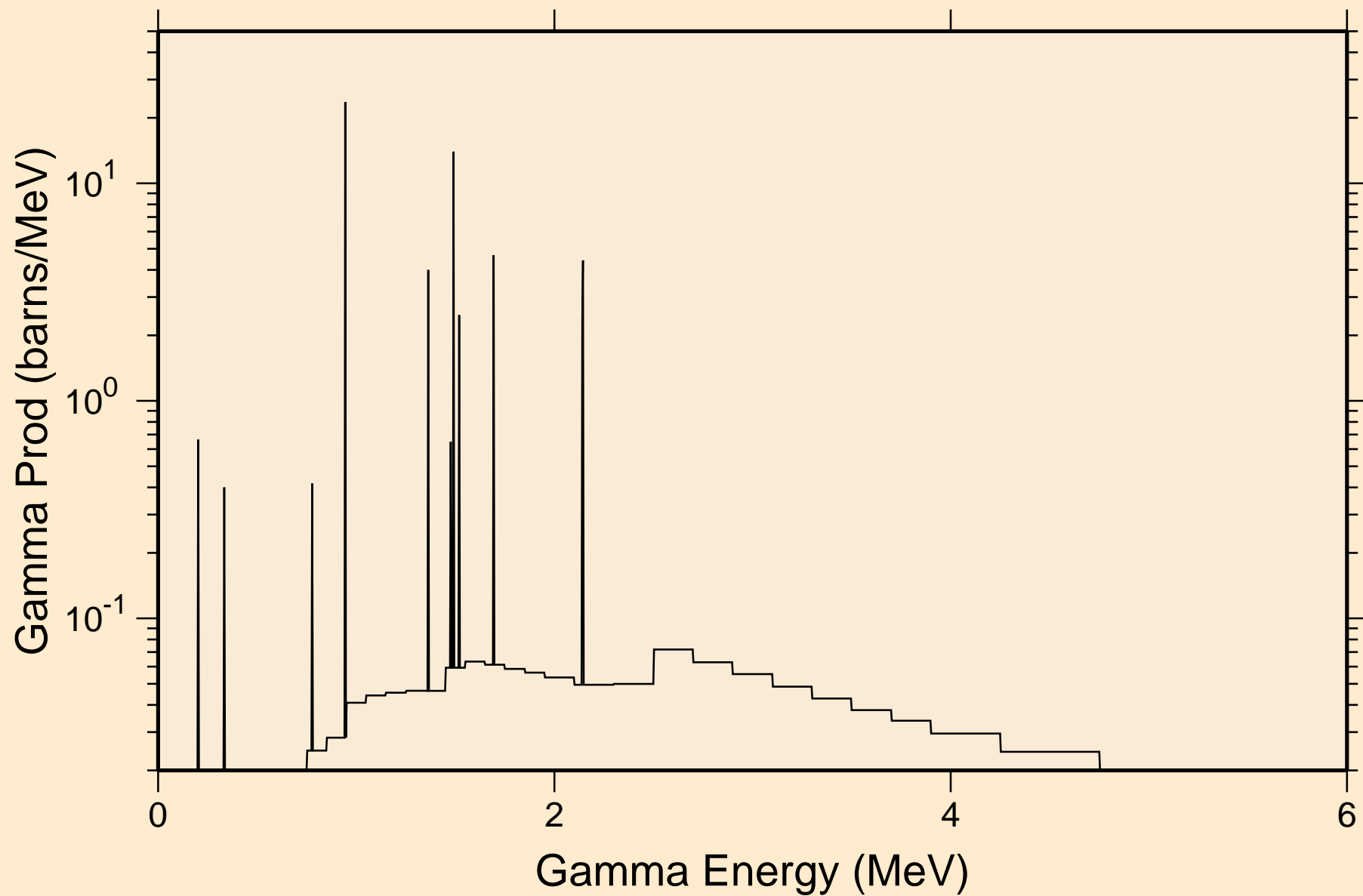

MO092 NEUTRON ACER TENDL-2019 LIBRARY; T=293.16K
14 MeV photon spectrum

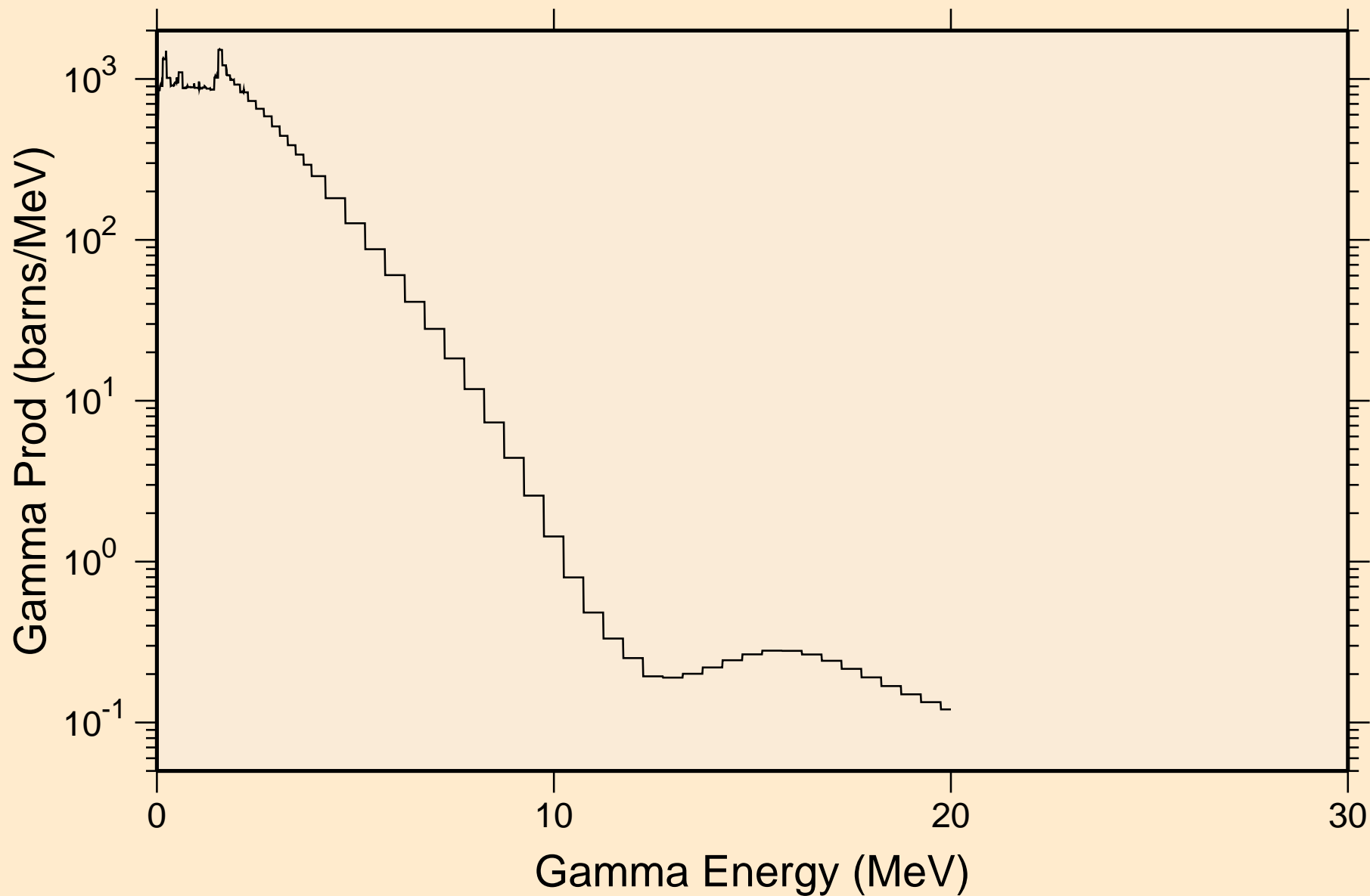

MO092 NEUTRON ACER TENDL-2019 LIBRARY; T=293.16K
Particle heating contributions

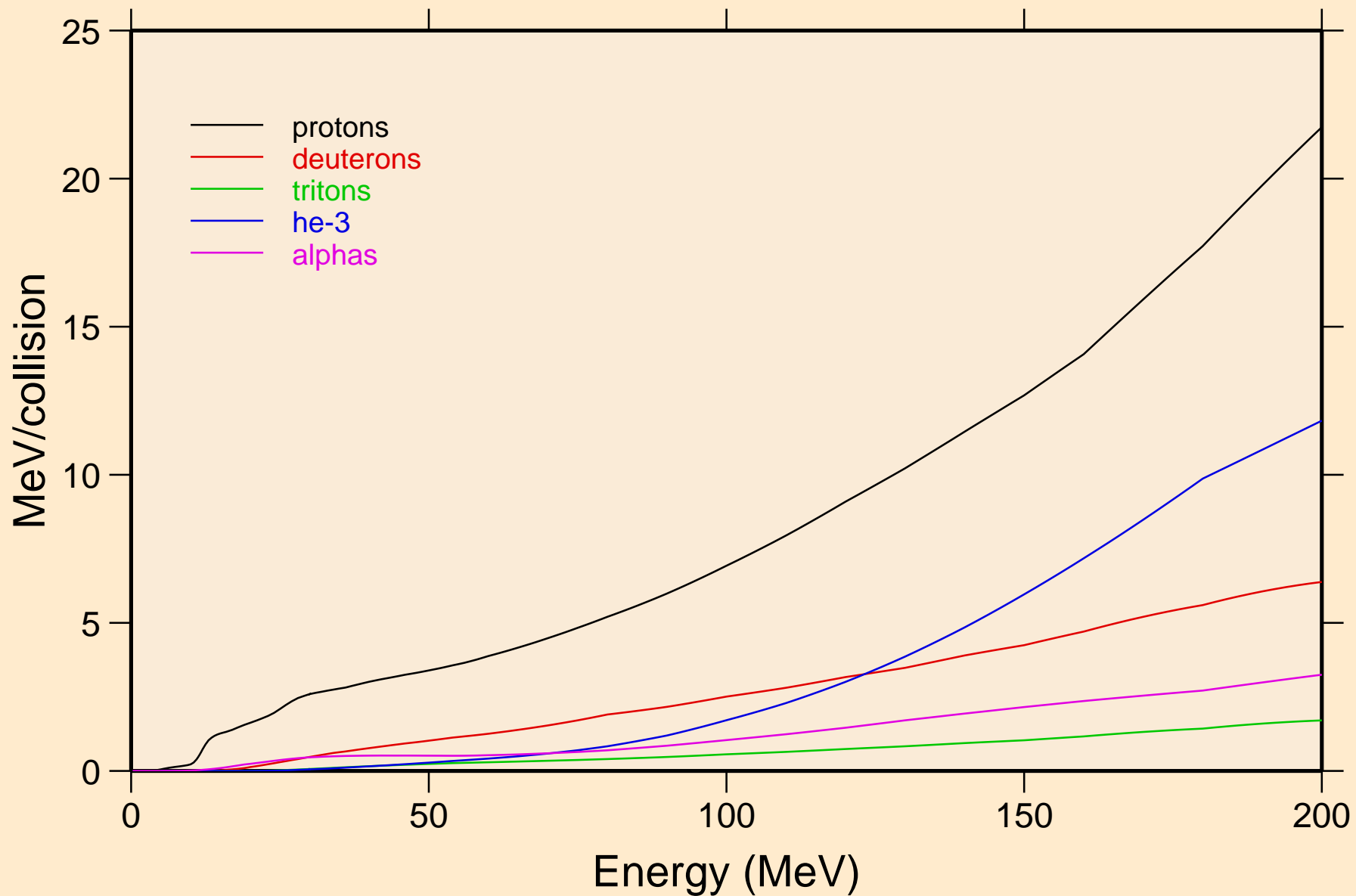

MO092 NEUTRON ACER TENDL-2019 LIBRARY; T=293.16K
Recoil Heating

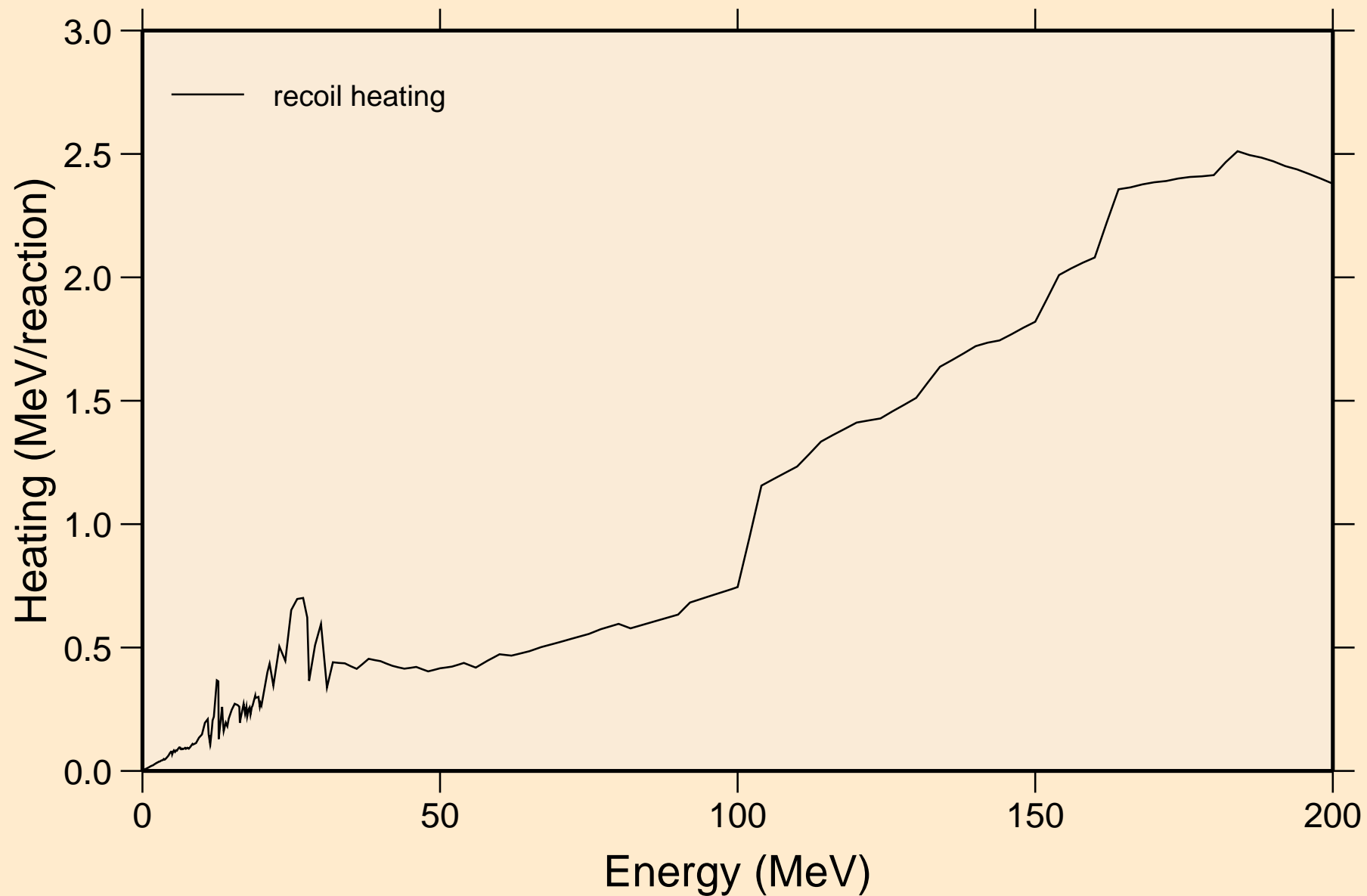

MO092 NEUTRON ACER TENDL-2019 LIBRARY; T=293.16K
Particle production cross sections

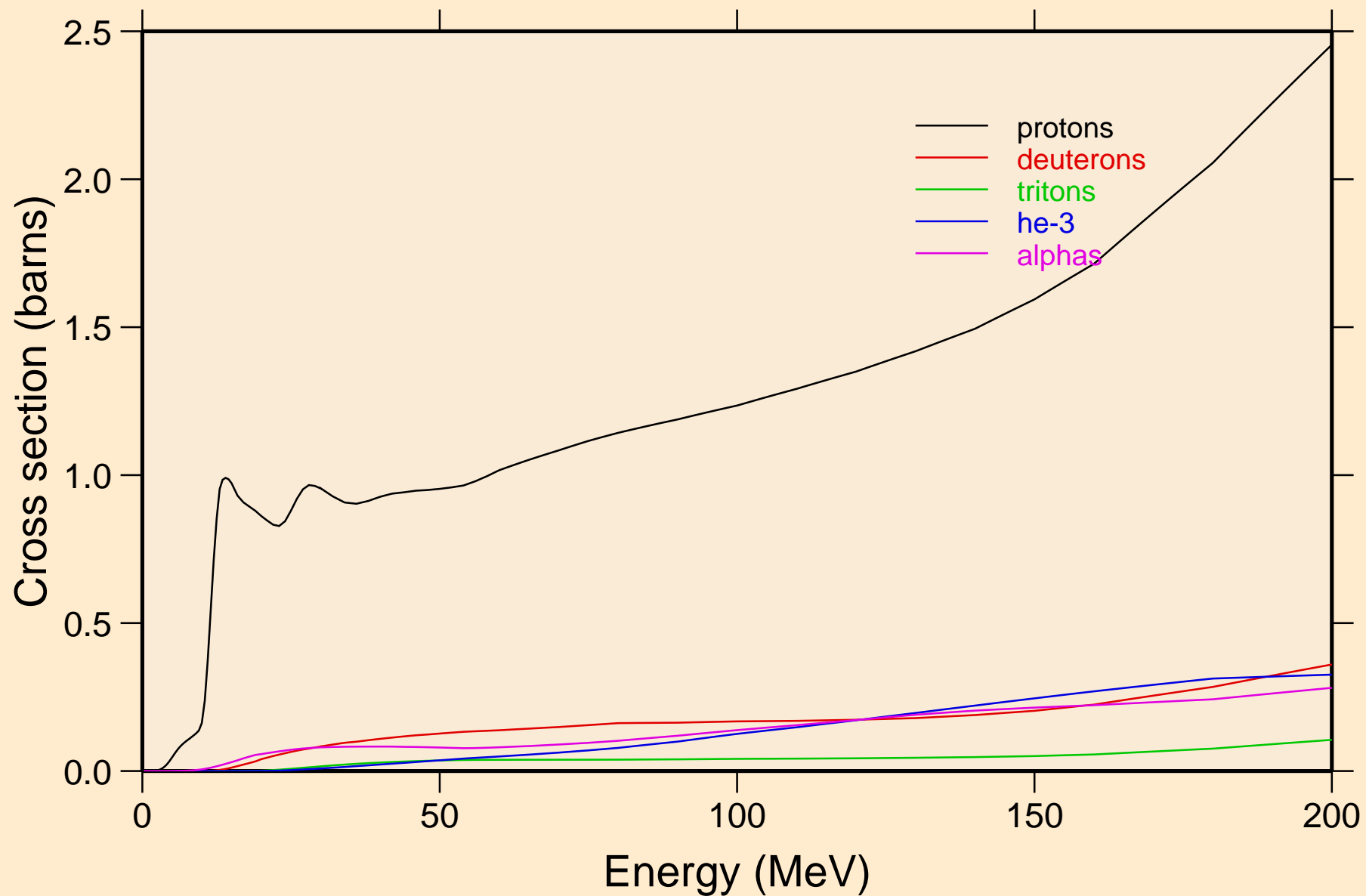

MO092 NEUTRON ACER TENDL-2019 LIBRARY; T=293.16K
protons from (n,x)

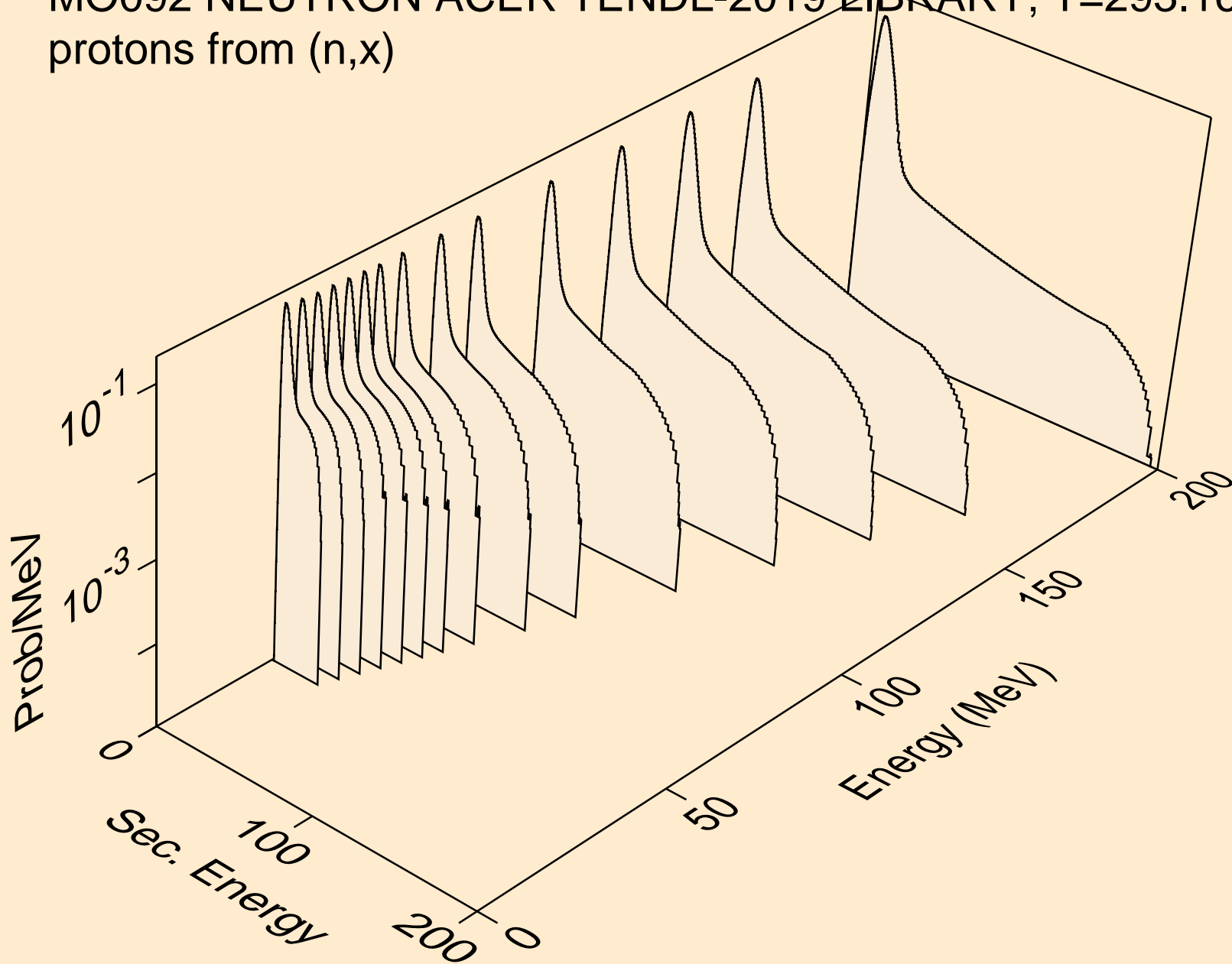

MO092 NEUTRON ACER TENDL-2019 LIBRARY; T=293.16K
protons from (n,n*)p

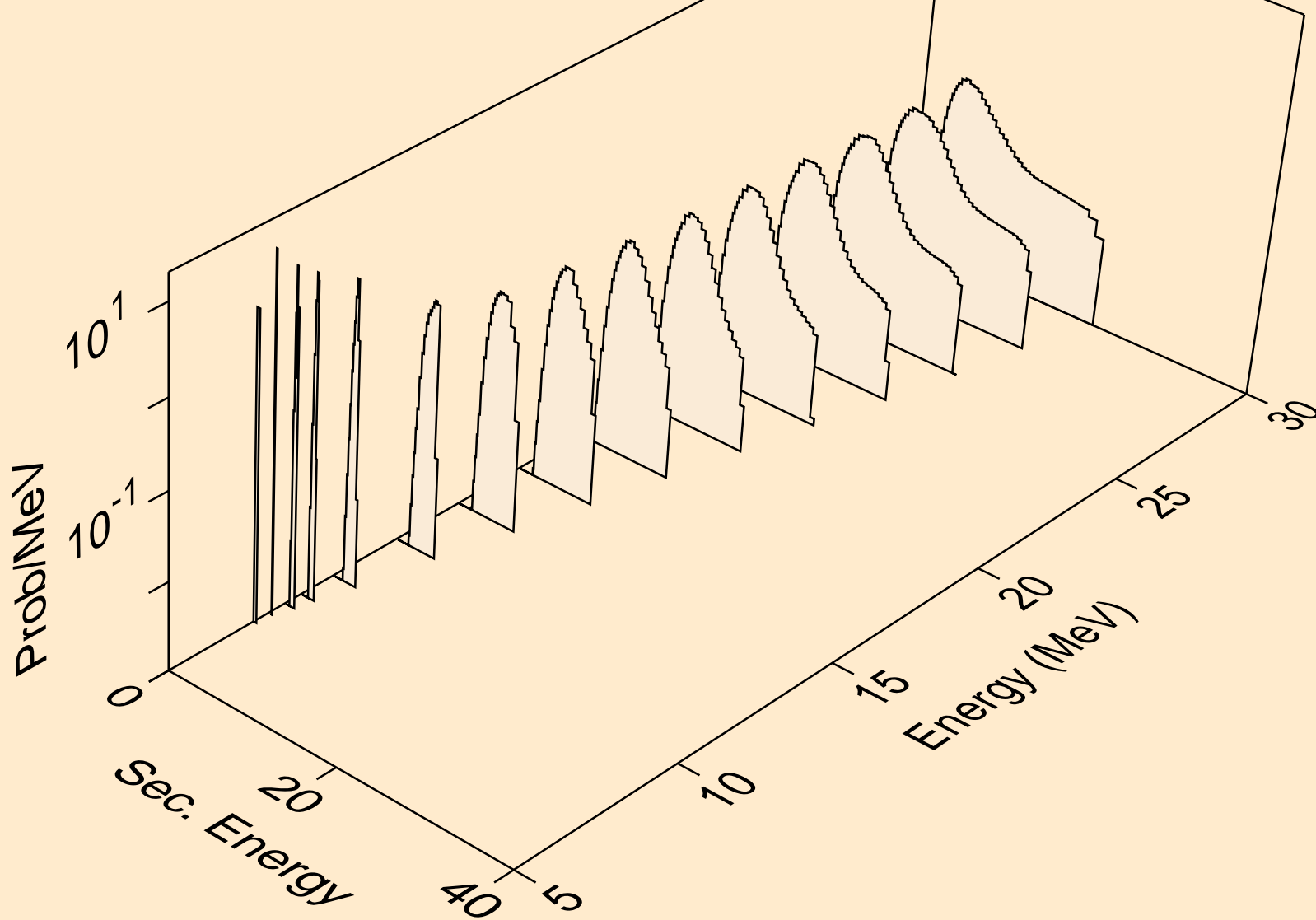

MO092 NEUTRON ACER TENDL-2019 LIBRARY; T=293.16K
protons from (n,2np)

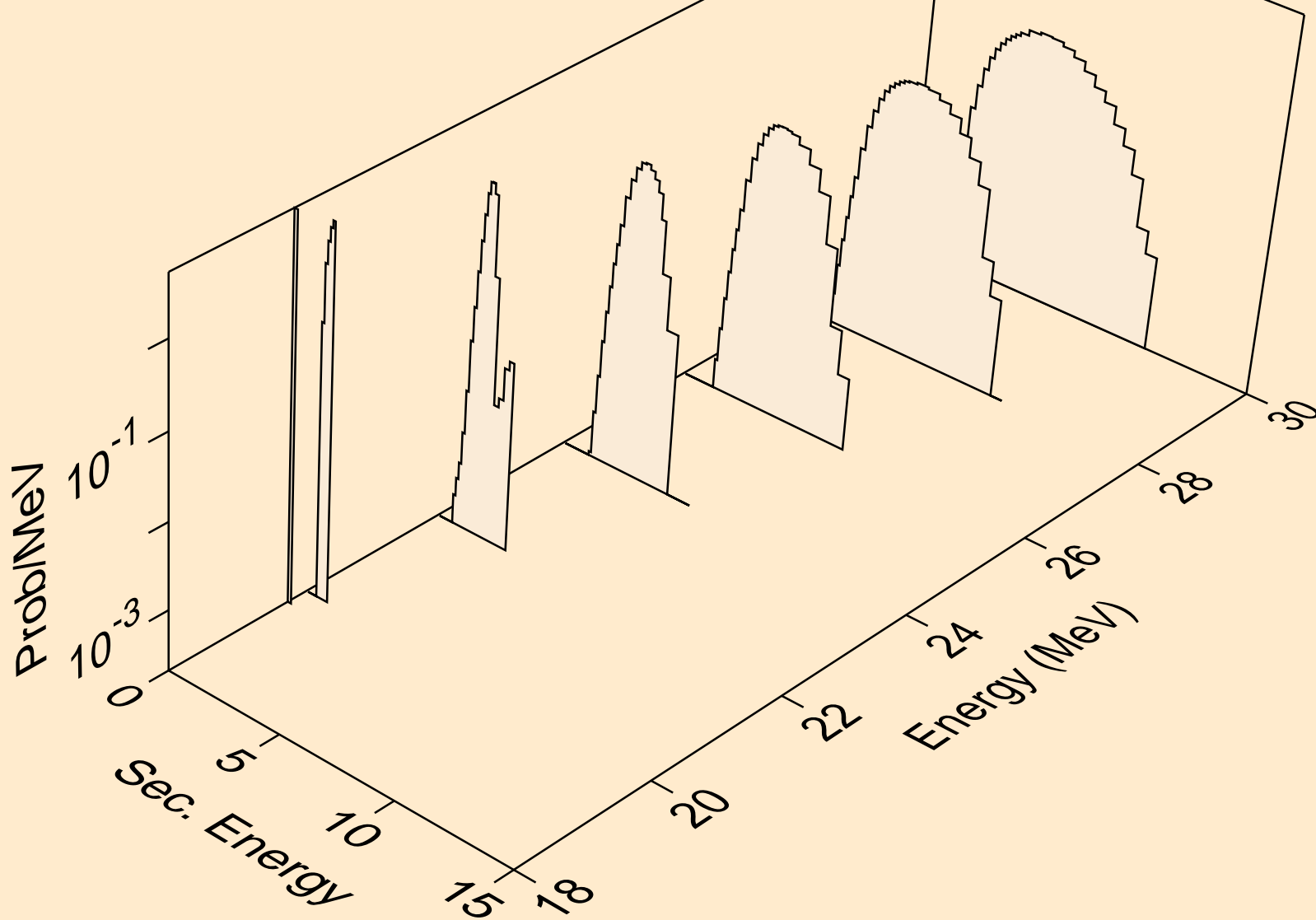

MO092 NEUTRON ACER TENDL-2019 LIBRARY; T=293.16K
protons from (n,2np)

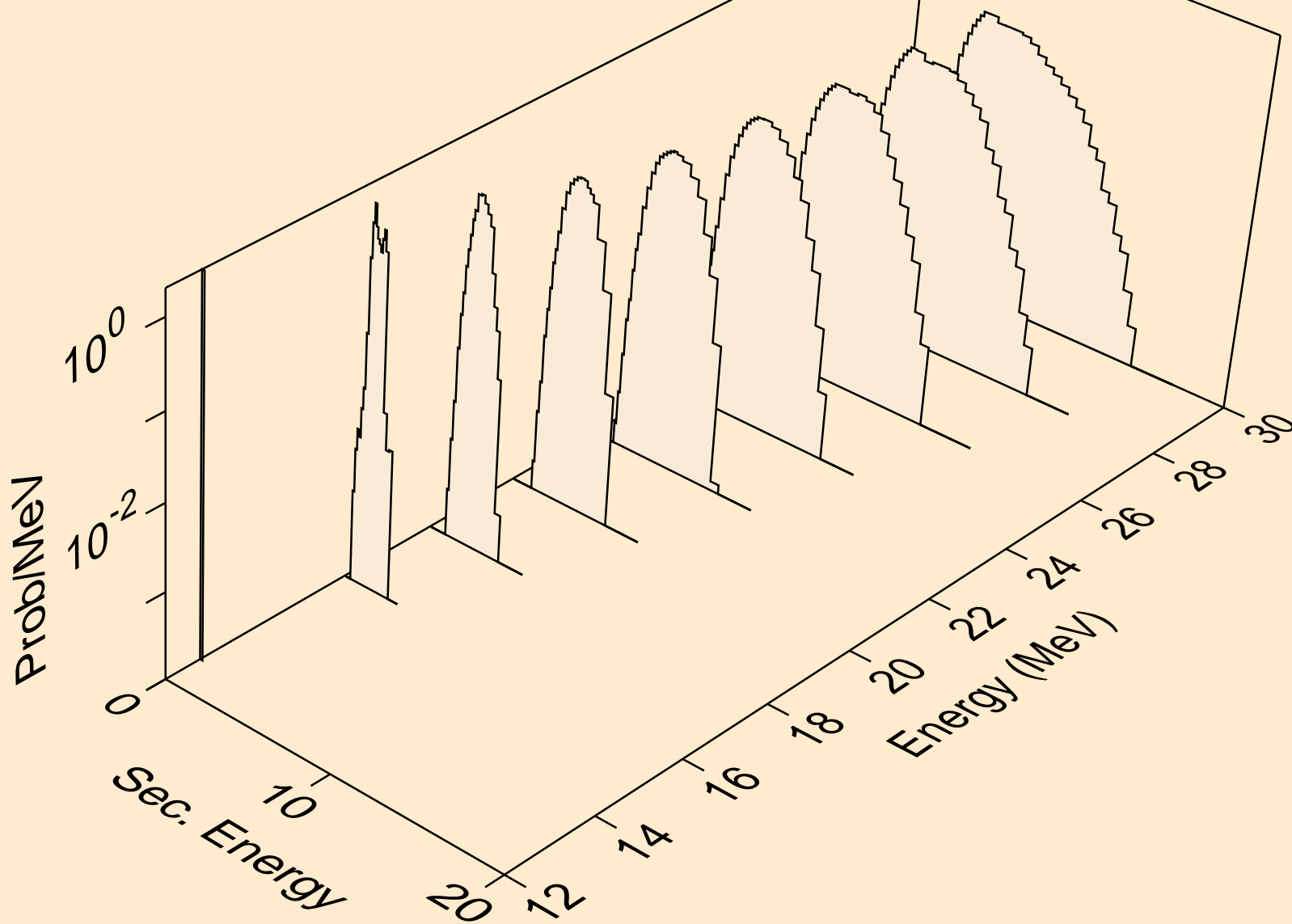

MO092 NEUTRON ACER TENDL-2019 LIBRARY; T=293.16K
protons from (n,npa)

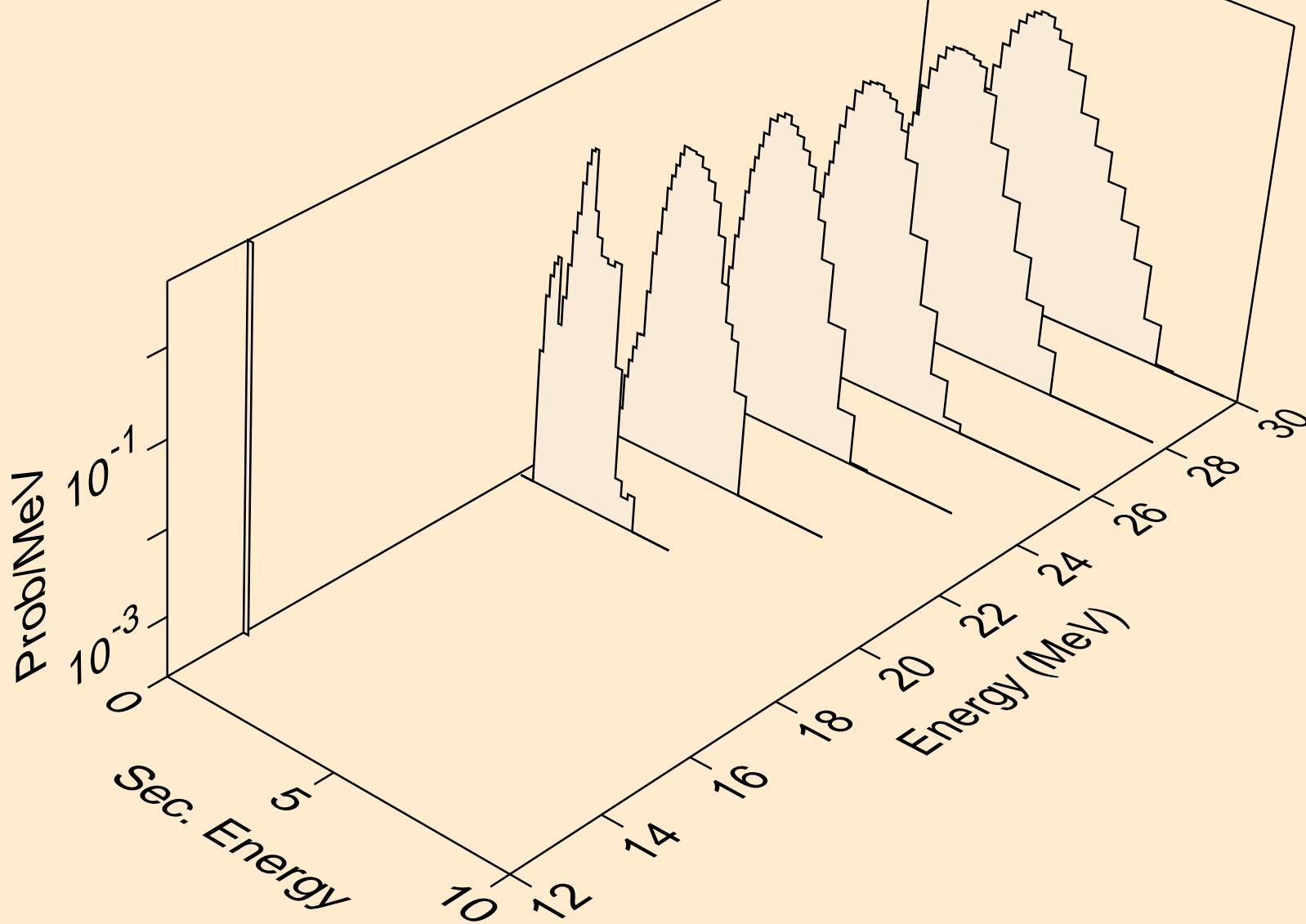

MO092 NEUTRON ACER TENDL-2019 LIBRARY; T=293.16K
protons from (n,p)

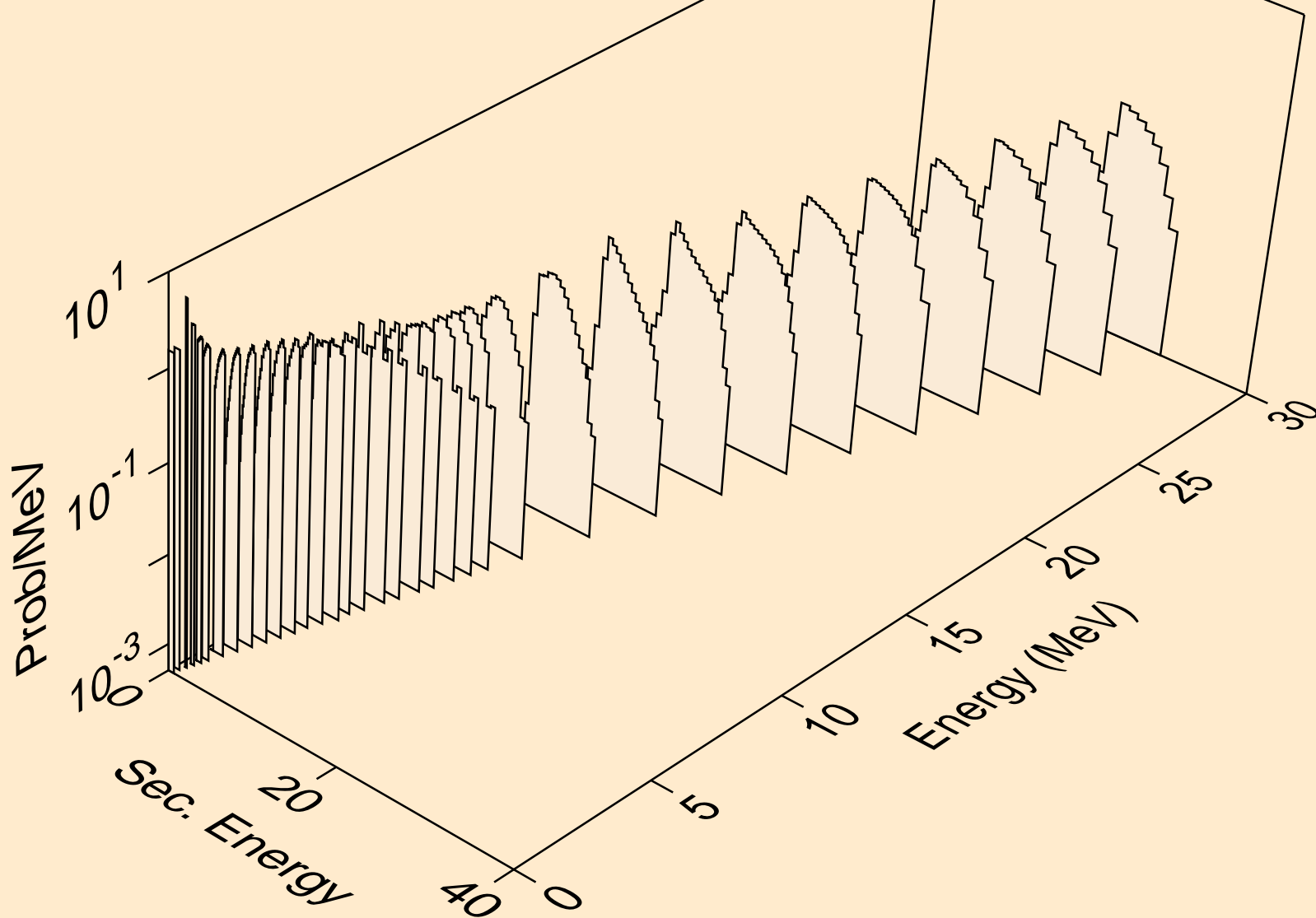

MO092 NEUTRON ACER TENDL-2019 LIBRARY; T=293.16K
protons from (n,2p)

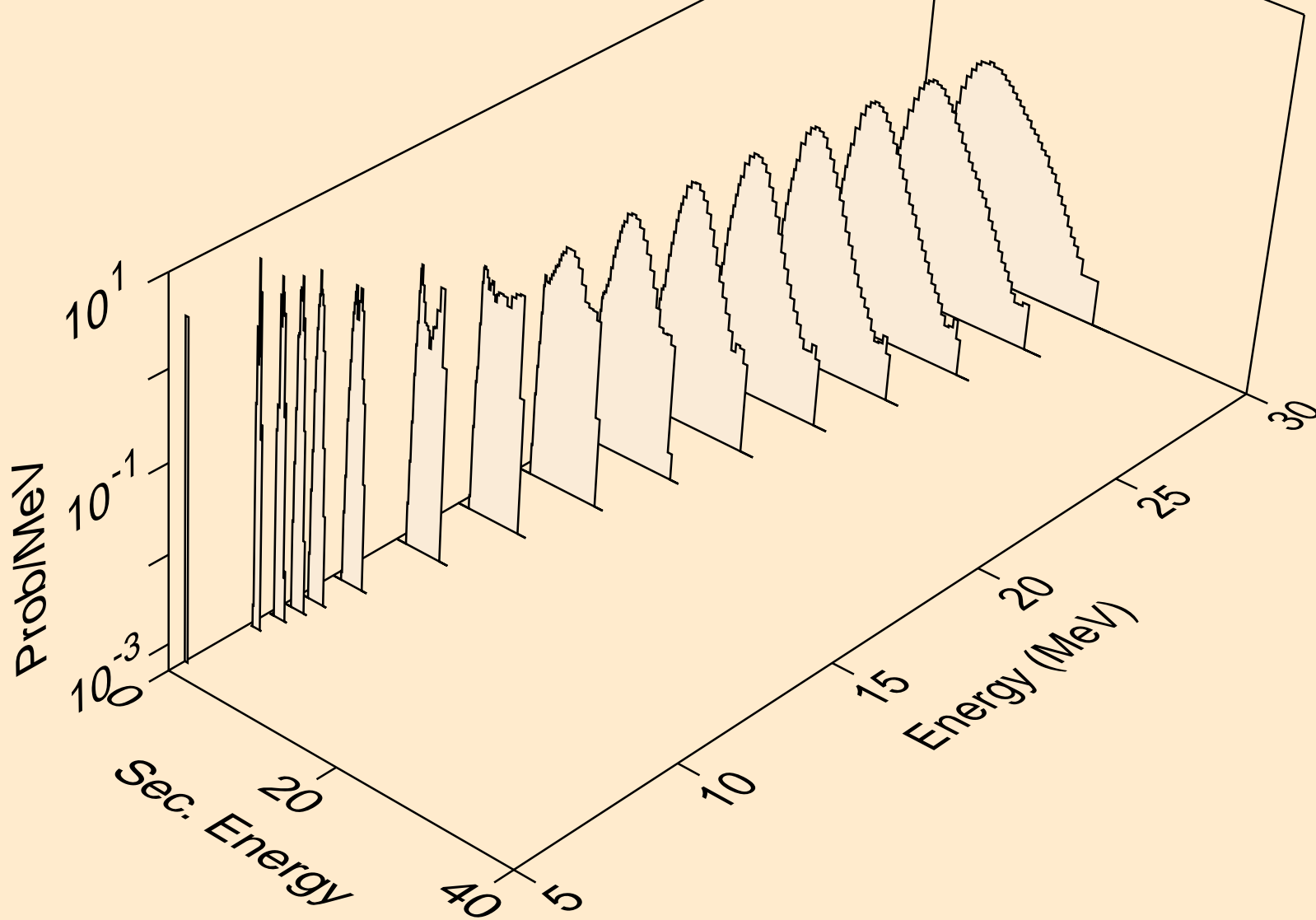

MO092 NEUTRON ACER TENDL-2019 LIBRARY; T=293.16K
protons from (n,p)

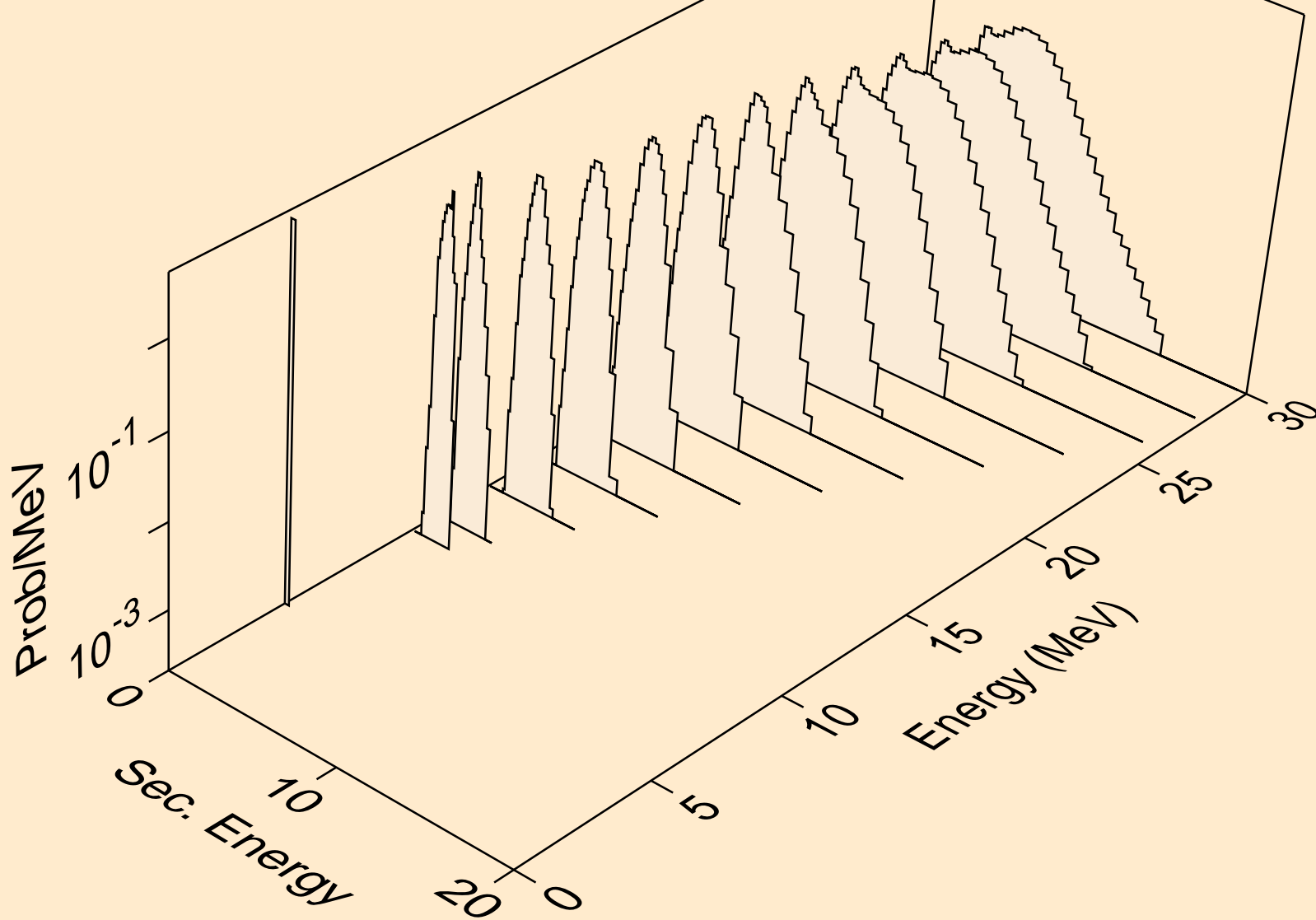

MO092 NEUTRON ACER TENDL-2019 LIBRARY; T=293.16K
protons from (n,pd)

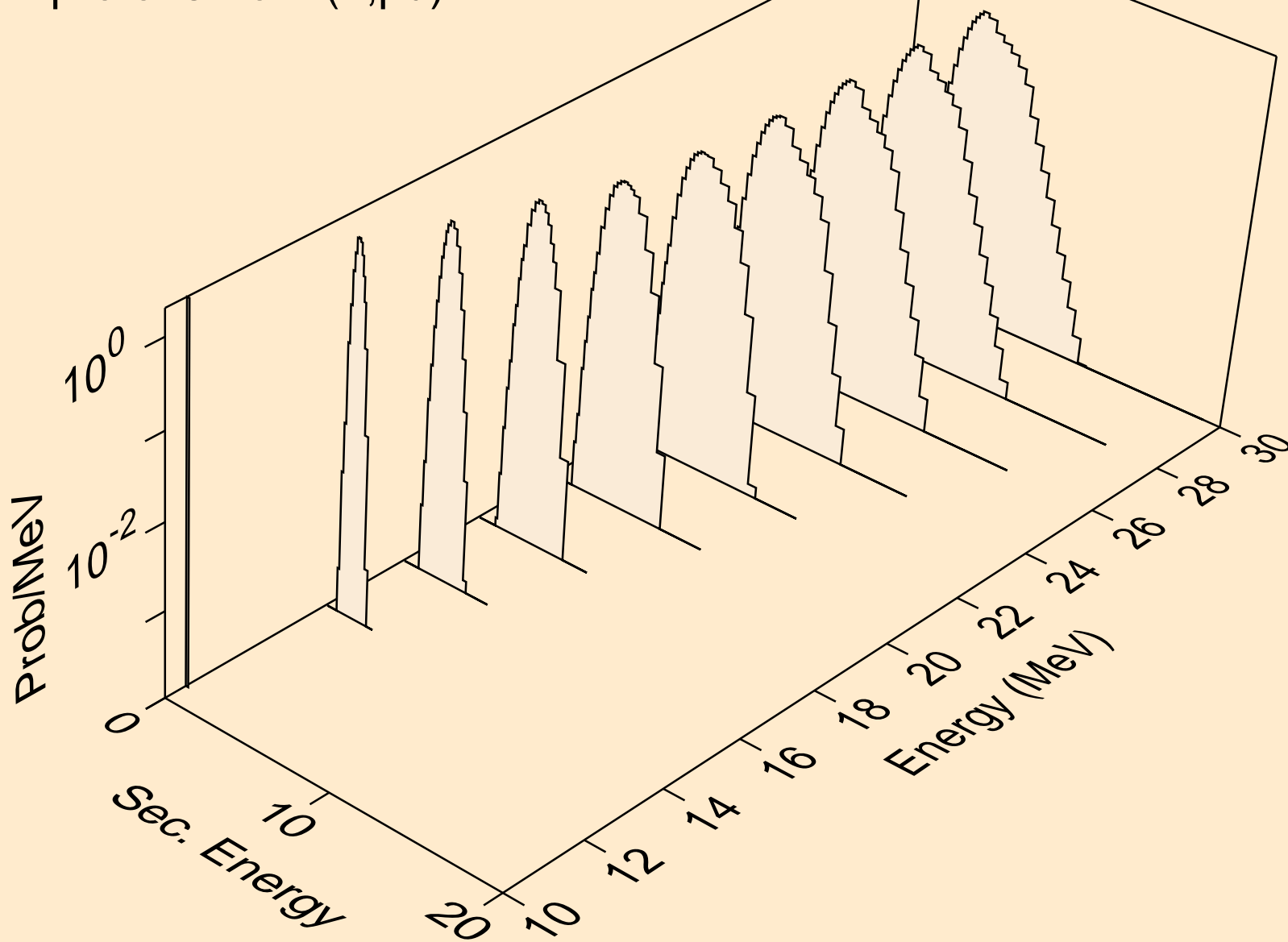

MO092 NEUTRON ACER TENDL-2019 LIBRARY; T=293.16K
protons from (n,pt)

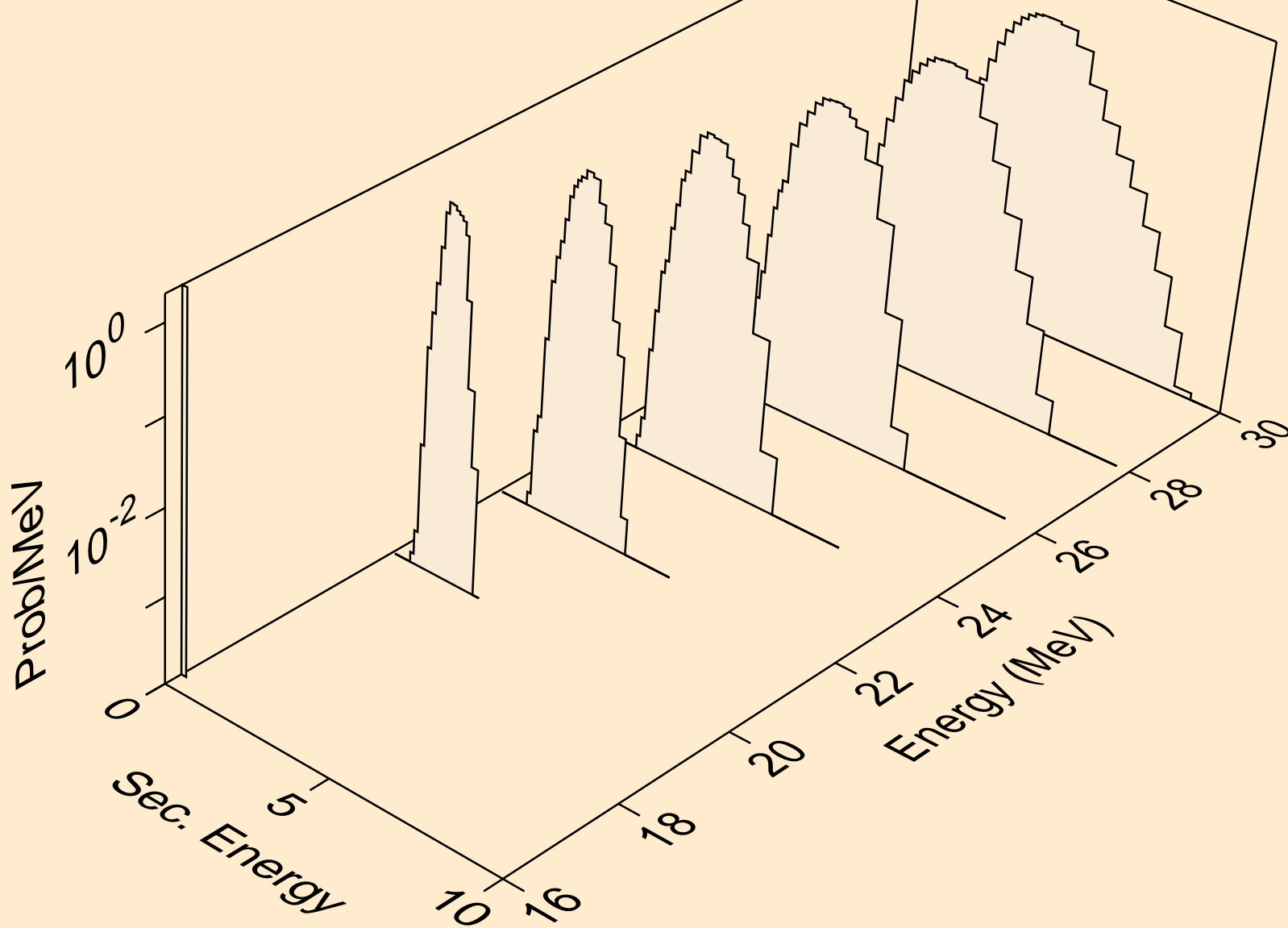

MO092 NEUTRON ACER TENDL-2019 LIBRARY; T=293.16K
deuterons from (n,x)

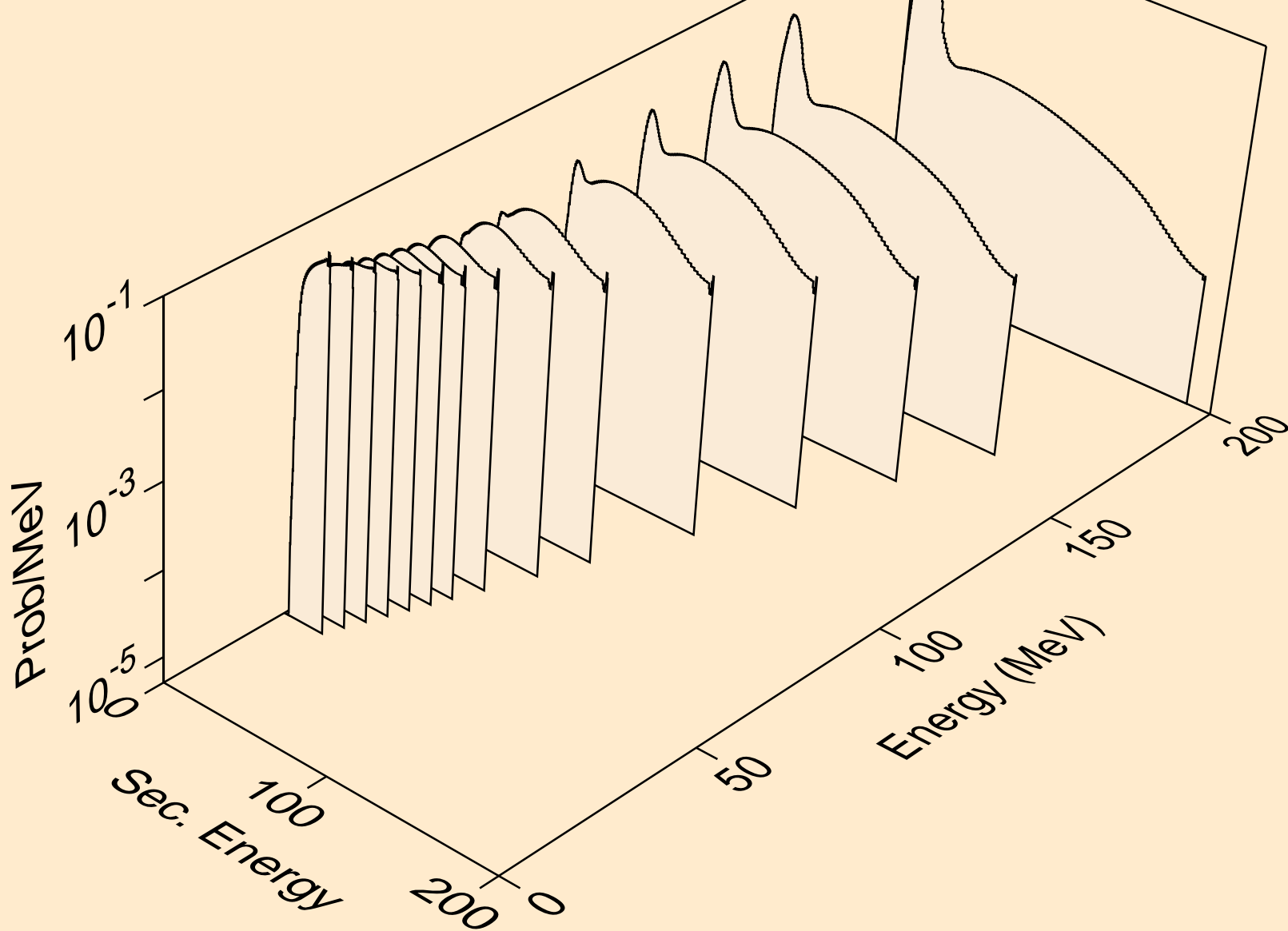

MO092 NEUTRON ACER TENDL-2019 LIBRARY; T=293.16K
deuterons from (n,2nd)

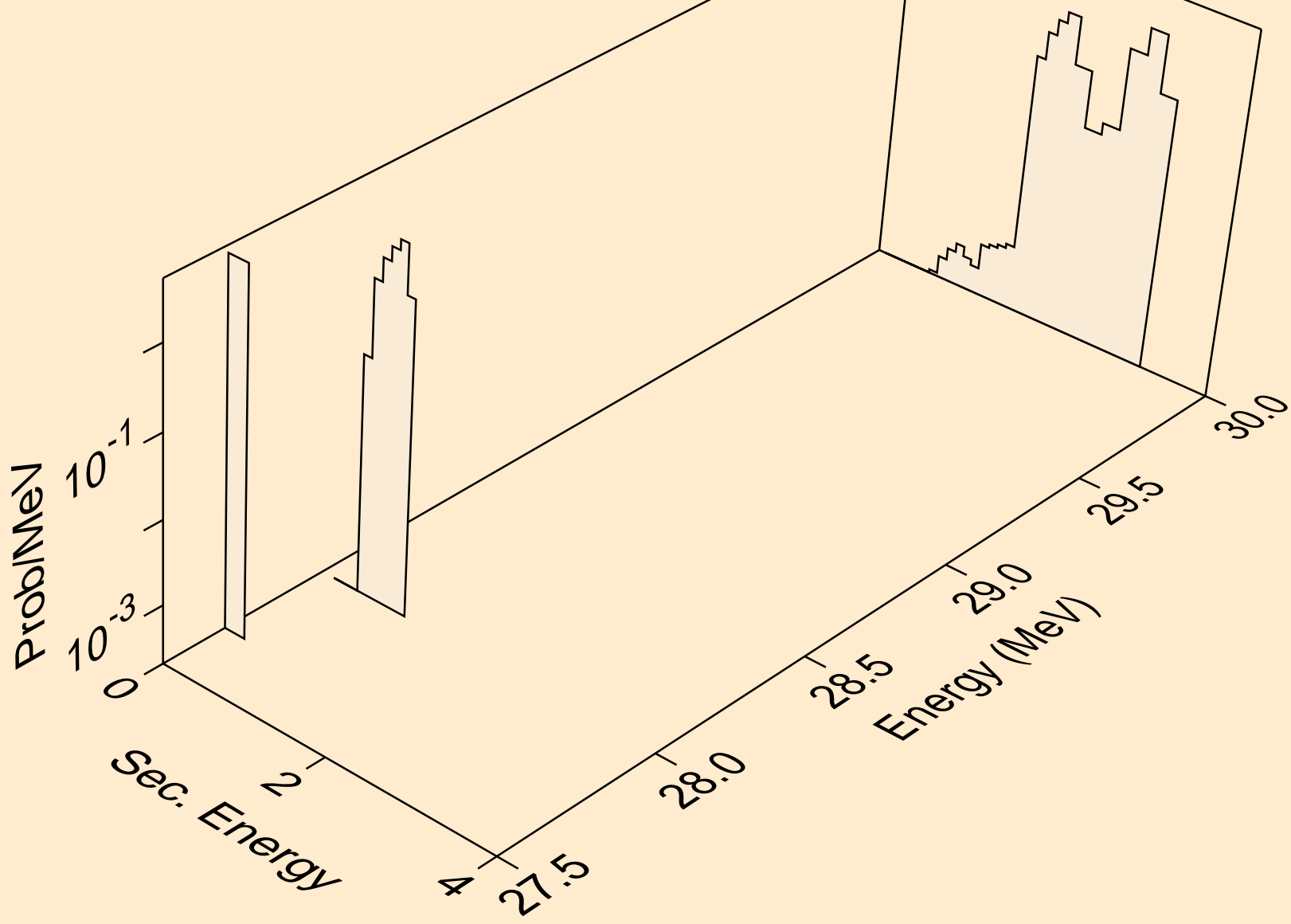

MO092 NEUTRON ACER TENDL-2019 LIBRARY; T=293.16K
deuterons from (n,n*)d

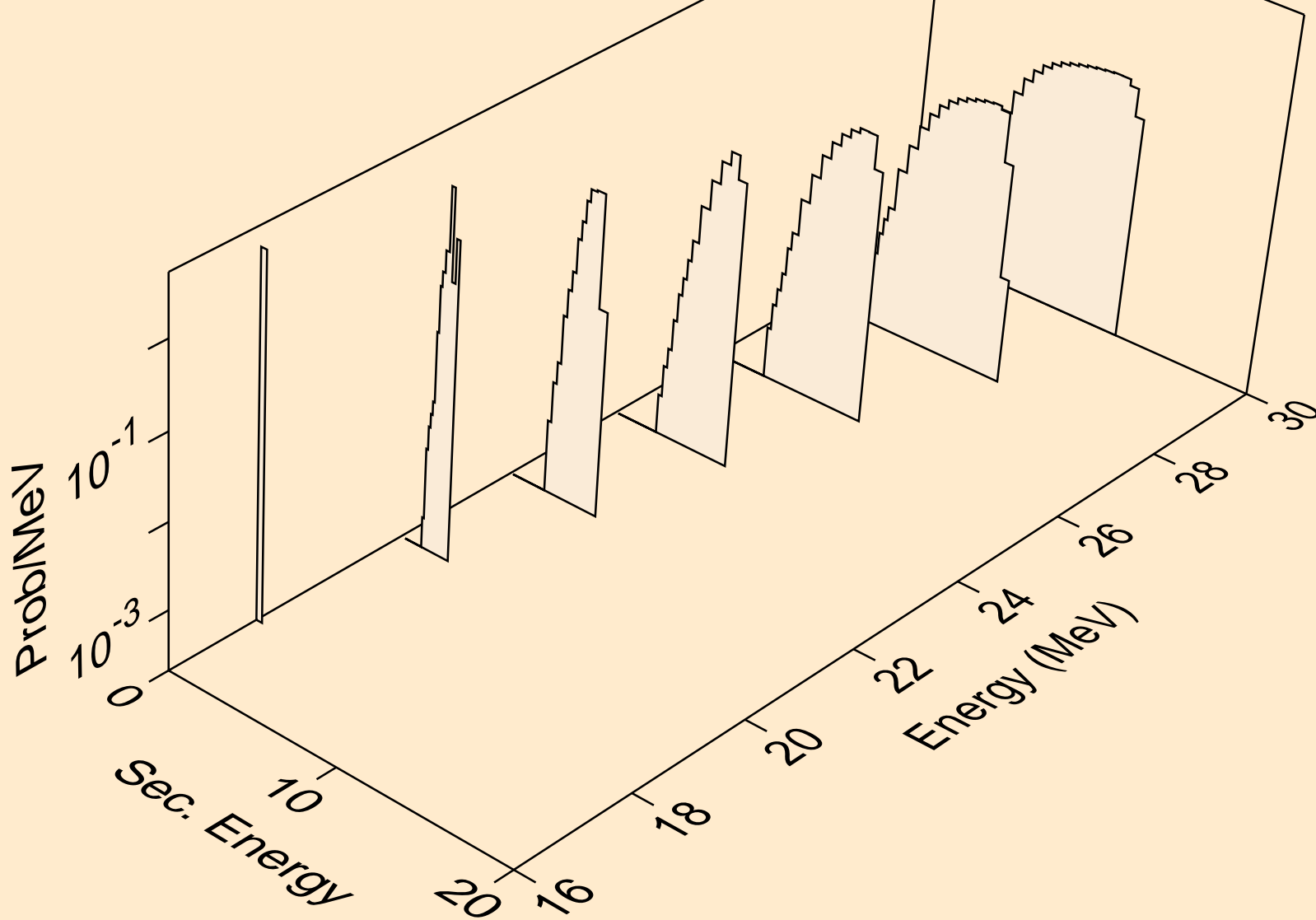

MO092 NEUTRON ACER TENDL-2019 LIBRARY; T=293.16K
deuterons from (n,d)

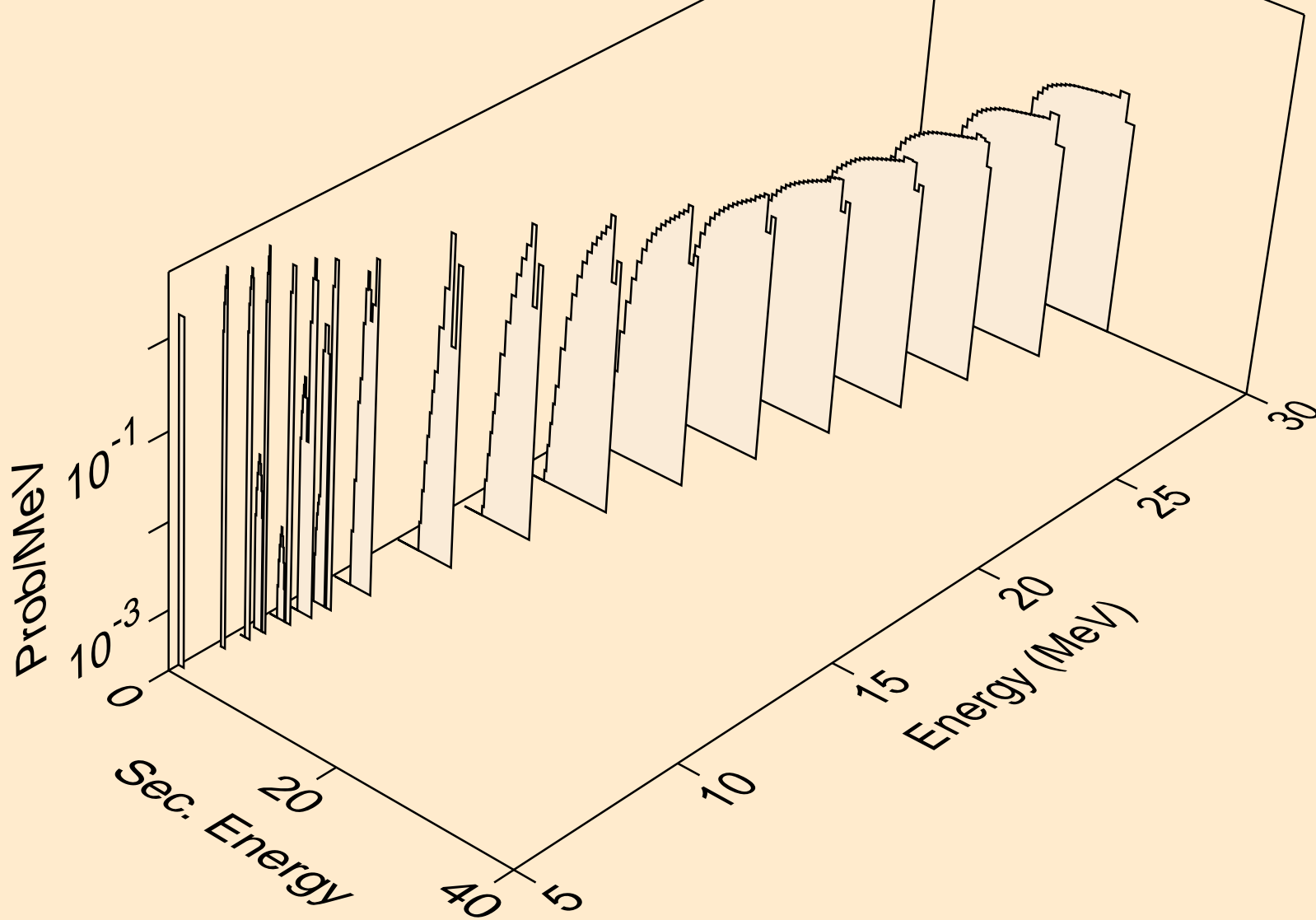

MO092 NEUTRON ACER TENDL-2019 LIBRARY; T=293.16K
deuterons from (n,pd)

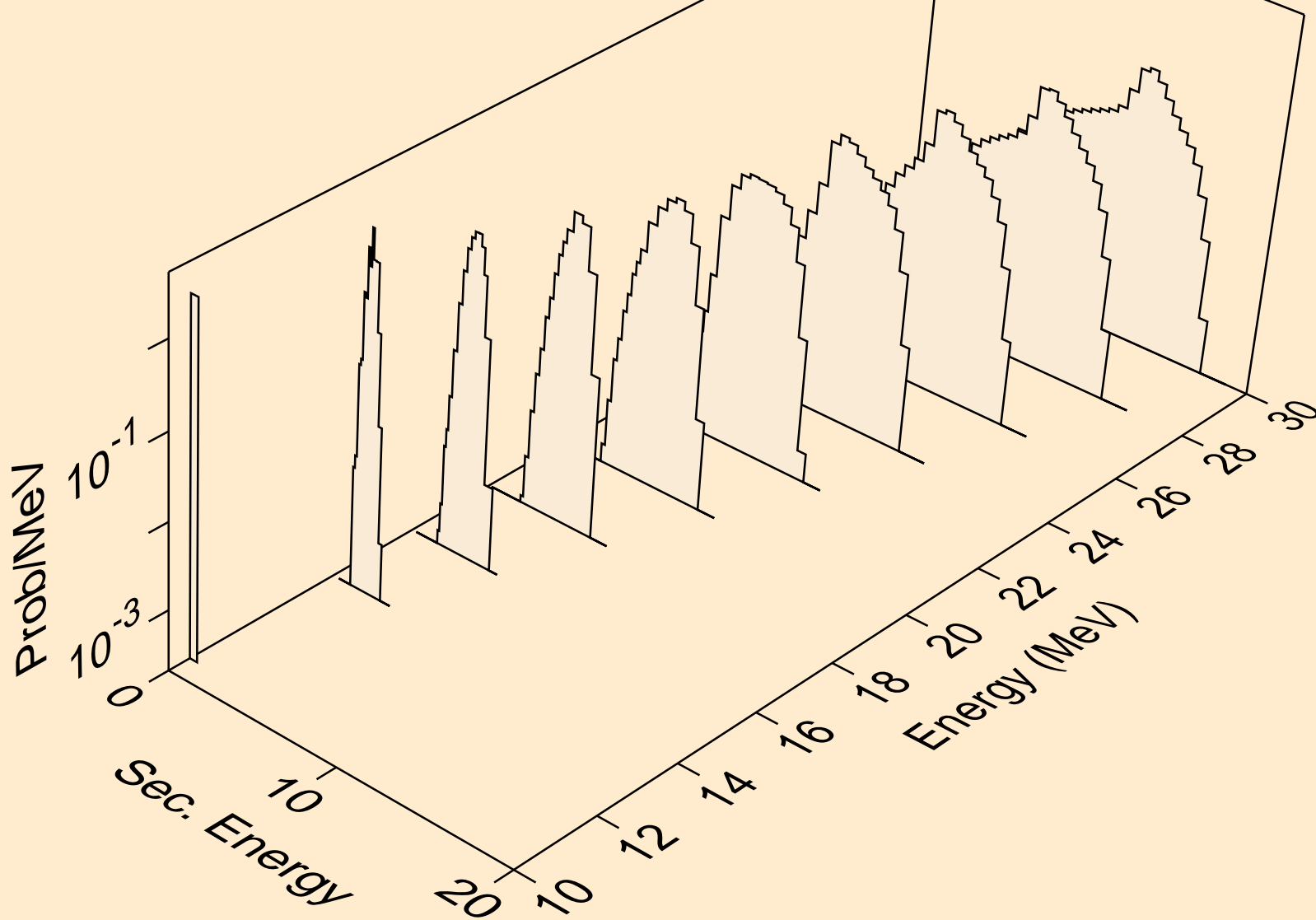

MO092 NEUTRON ACER TENDL-2019 LIBRARY; T=293.16K
deuterons from (n,da)

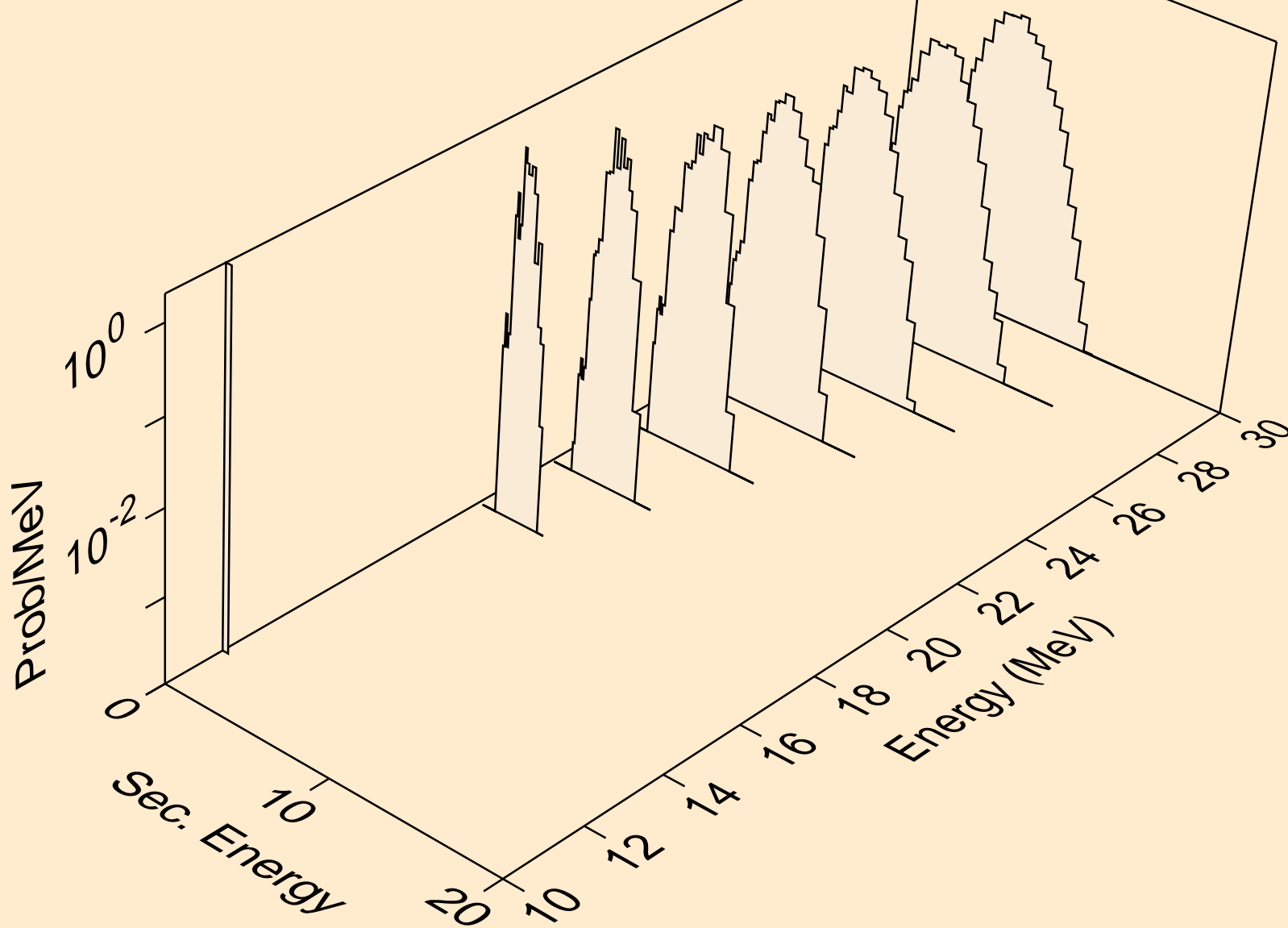

MO092 NEUTRON ACER TENDL-2019 LIBRARY; T=293.16K
tritons from (n,x)

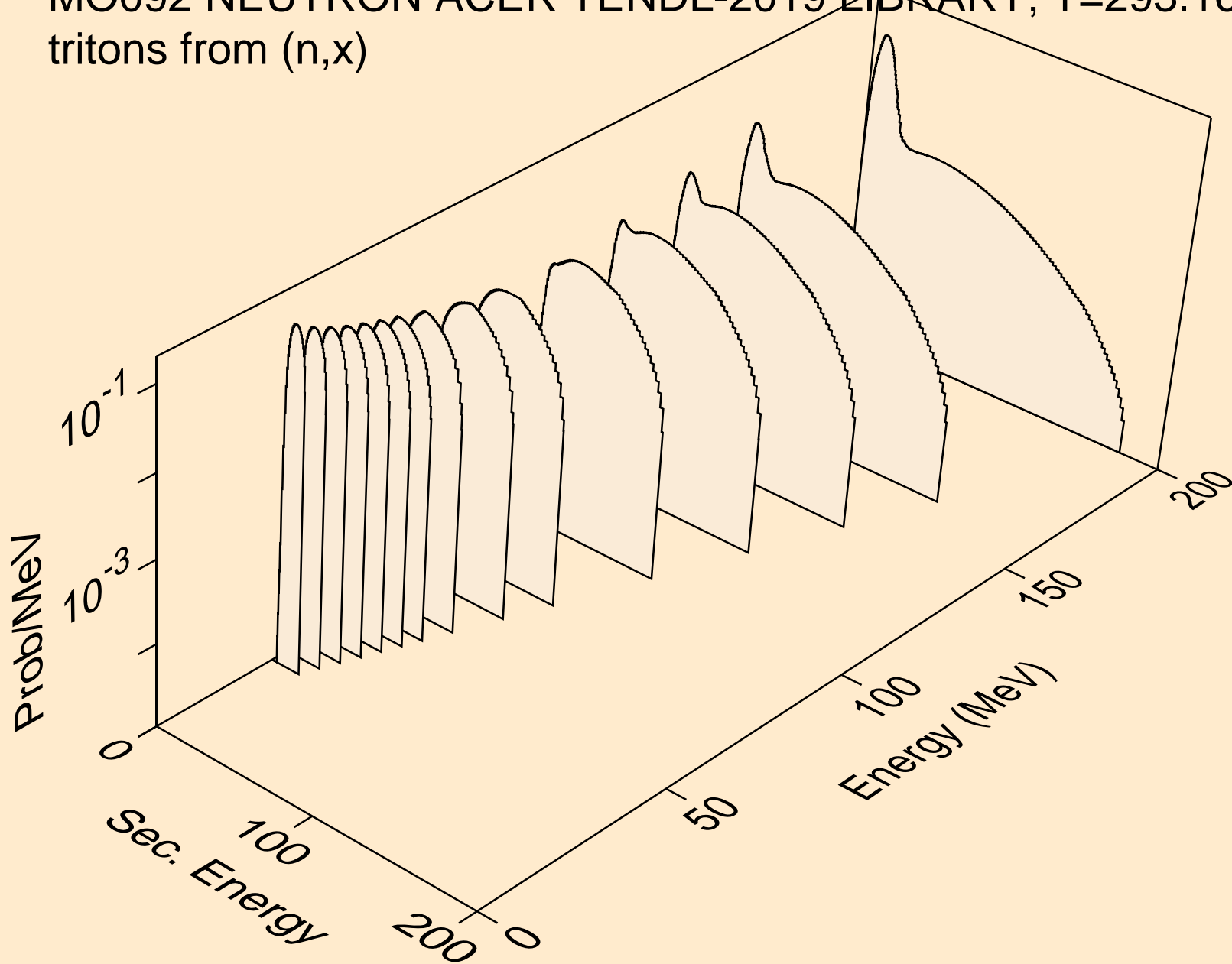

MO092 NEUTRON ACER TENDL-2019 LIBRARY; T=293.16K
tritons from (n,n*)t

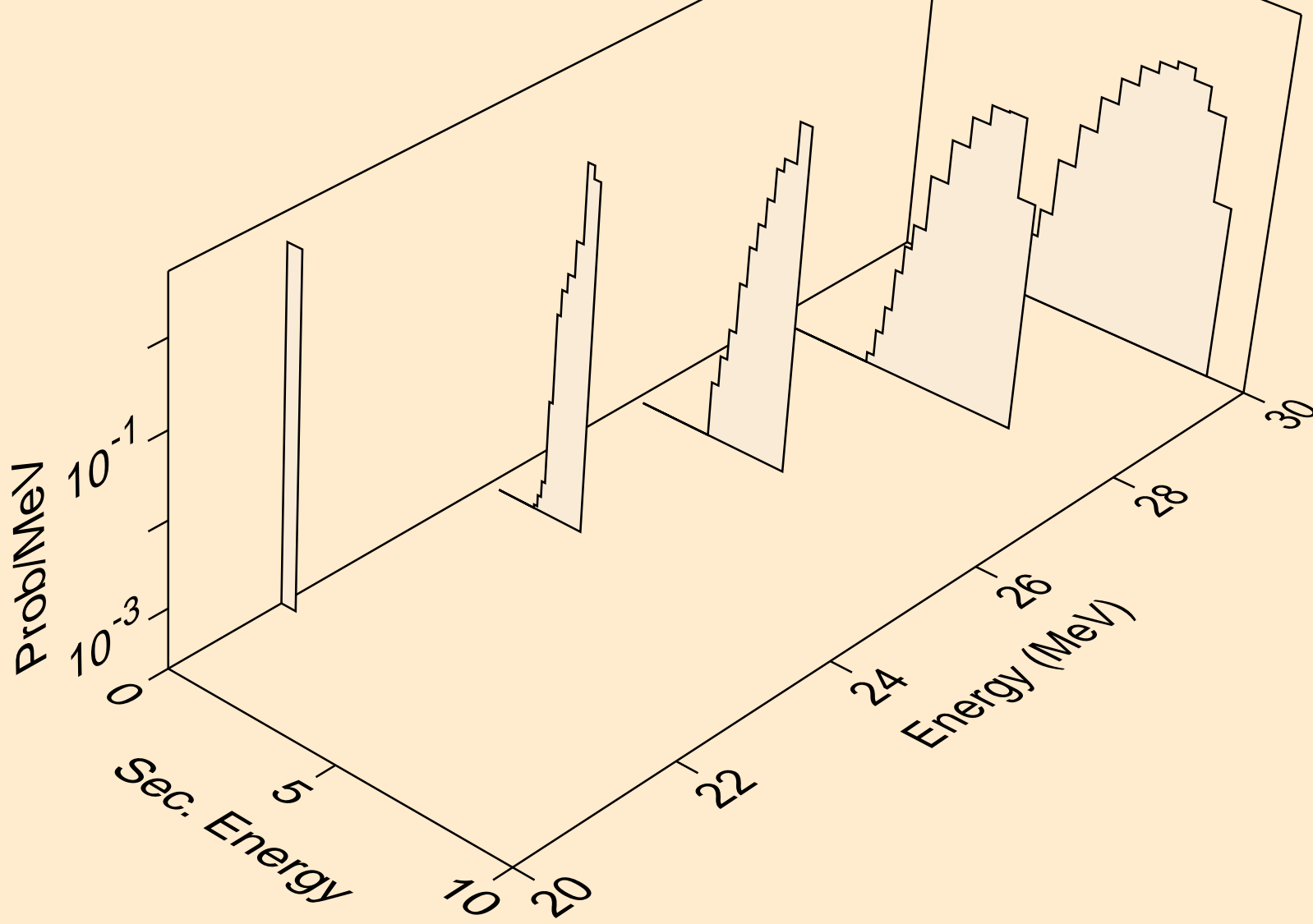

MO092 NEUTRON ACER TENDL-2019 LIBRARY; T=293.16K
tritons from (n,t)

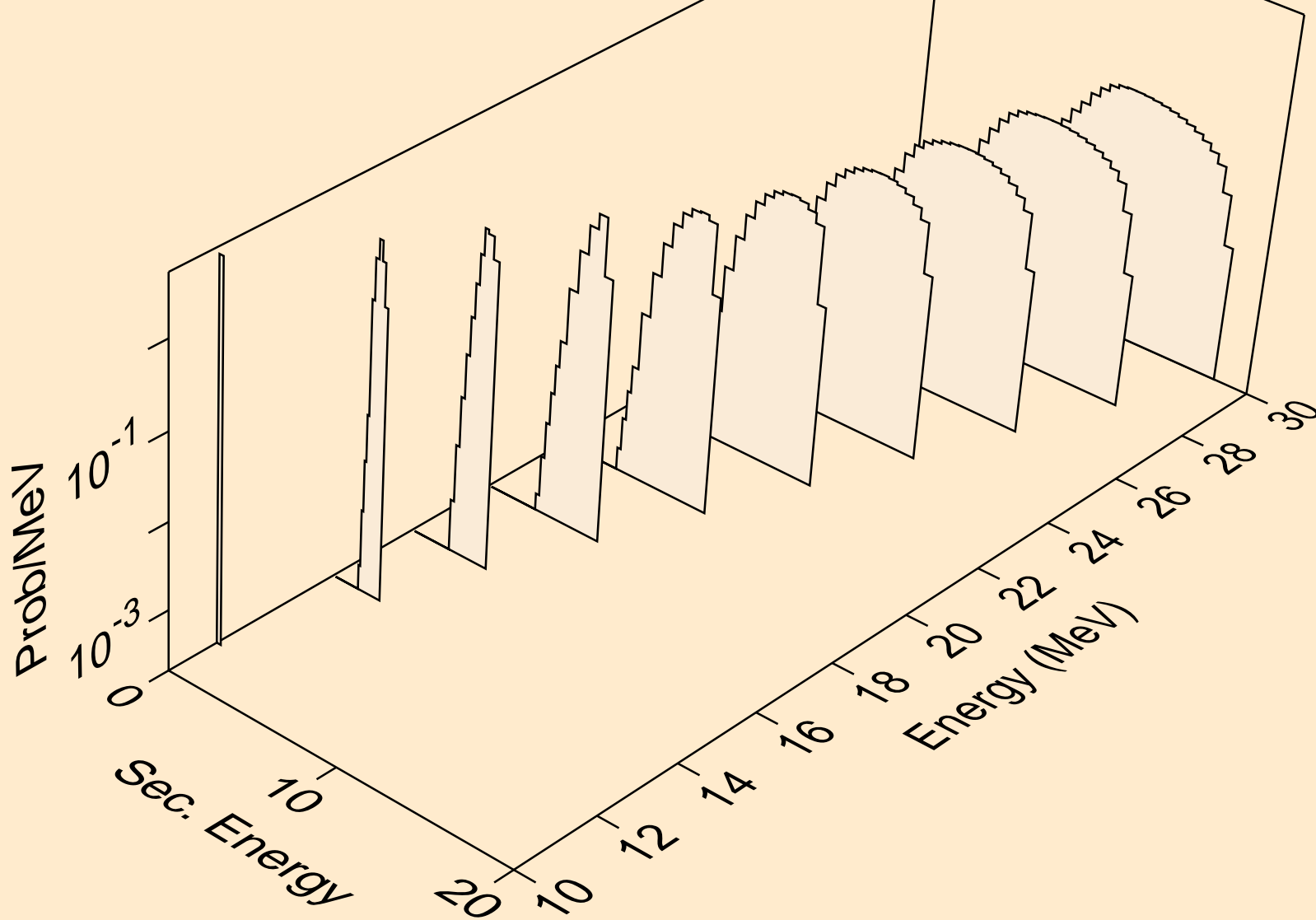

MO092 NEUTRON ACER TENDL-2019 LIBRARY; T=293.16K
tritons from (n,pt)

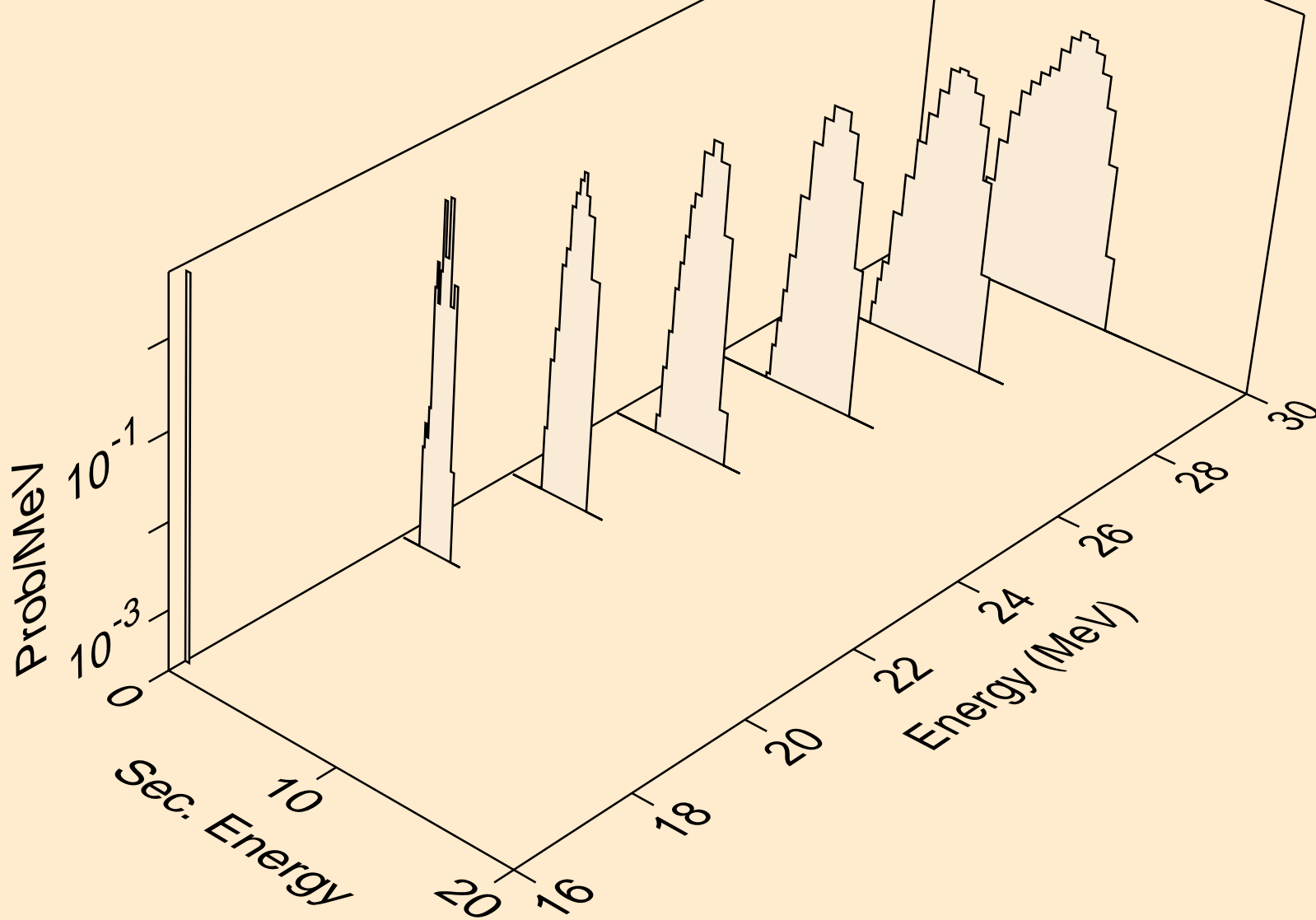

MO092 NEUTRON ACER TENDL-2019 LIBRARY; T=293.16K
he3s from (n,x)

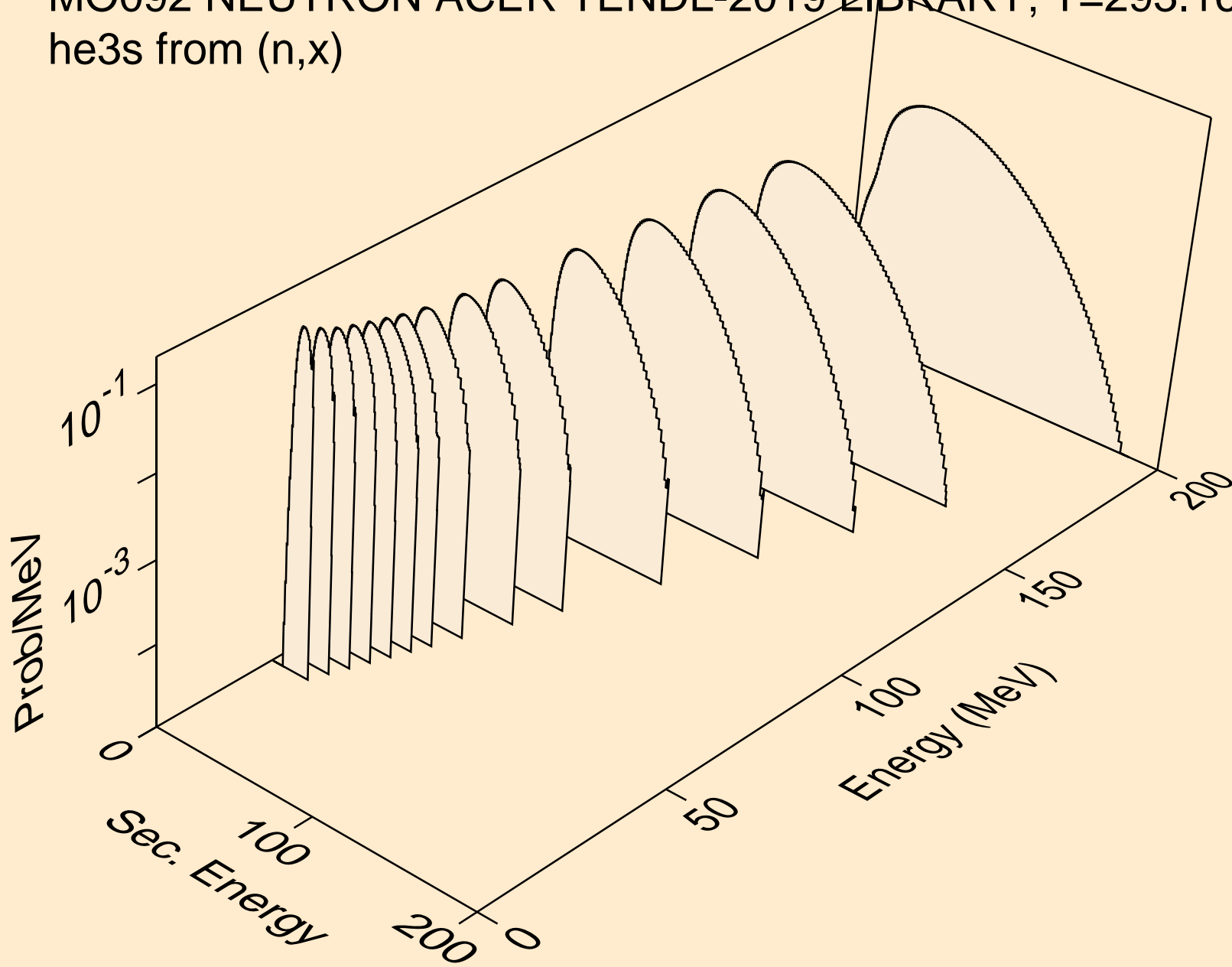

MO092 NEUTRON ACER TENDL-2019 LIBRARY; T=293.16K
he3s from (n,n*)he3

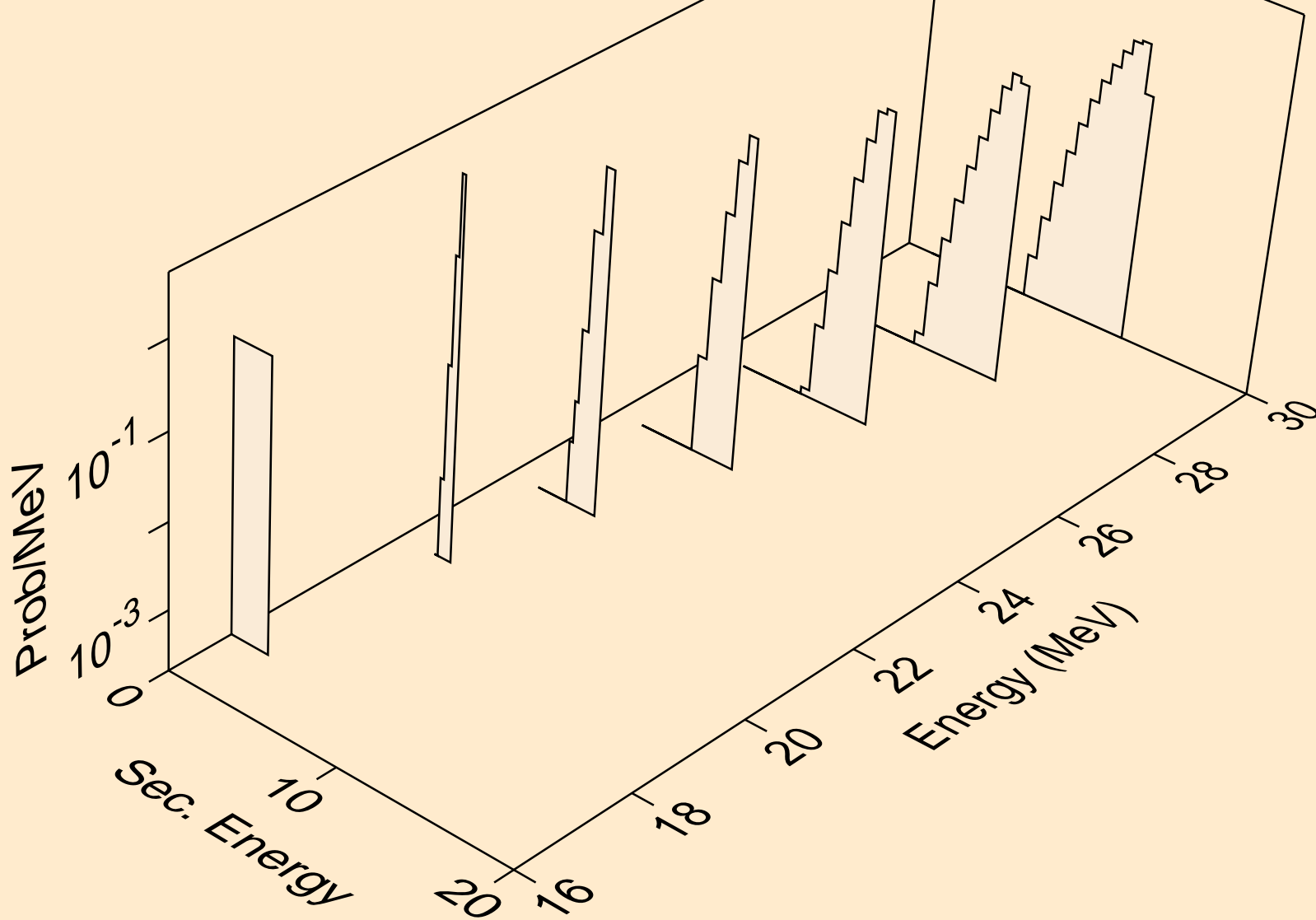

MO092 NEUTRON ACER TENDL-2019 LIBRARY; T=293.16K
he3s from (n,he3)

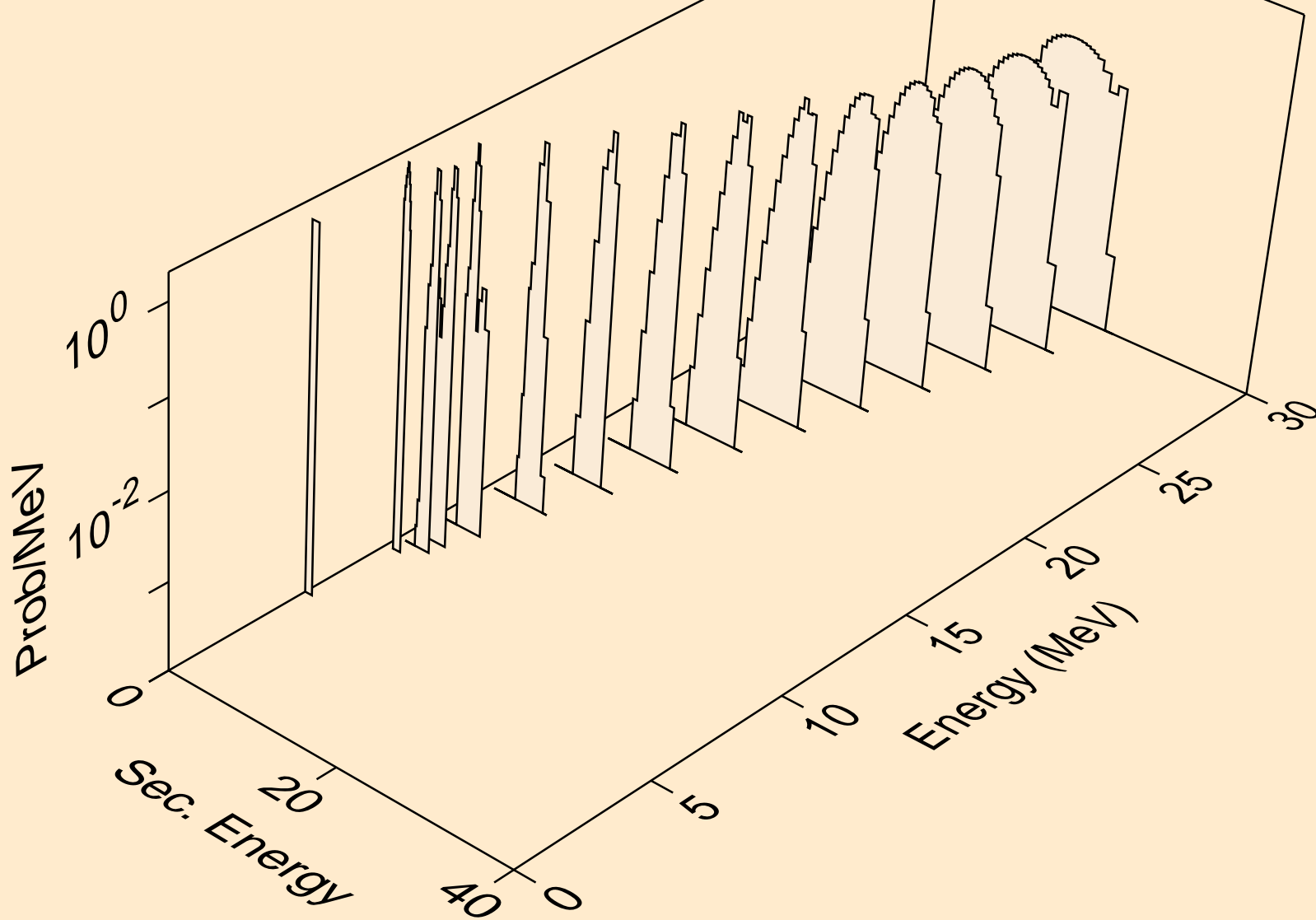

MO092 NEUTRON ACER TENDL-2019 LIBRARY; T=293.16K
alphas from (n,x)

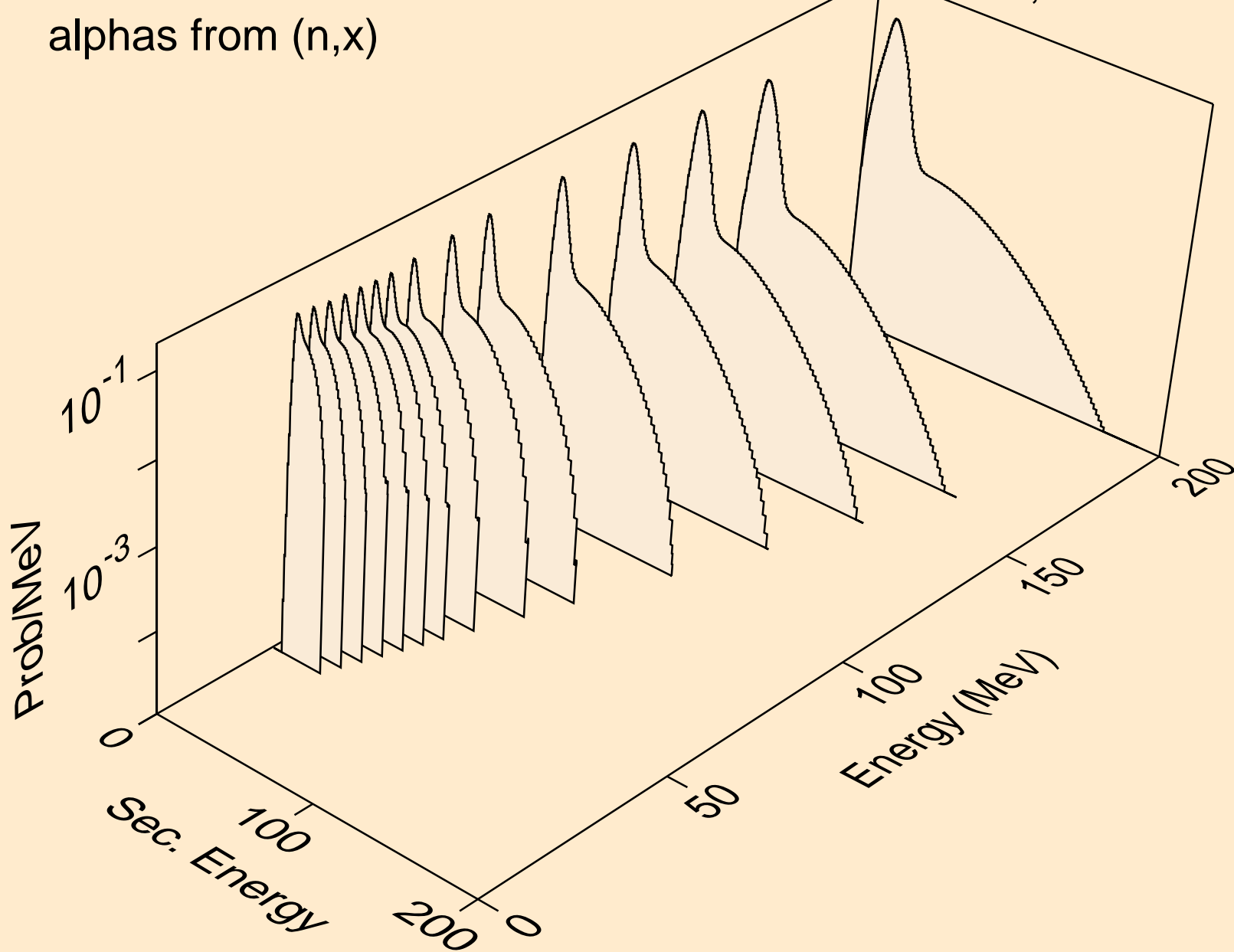

MO092 NEUTRON ACER TENDL-2019 LIBRARY; T=293.16K
alphas from (n,n*)a

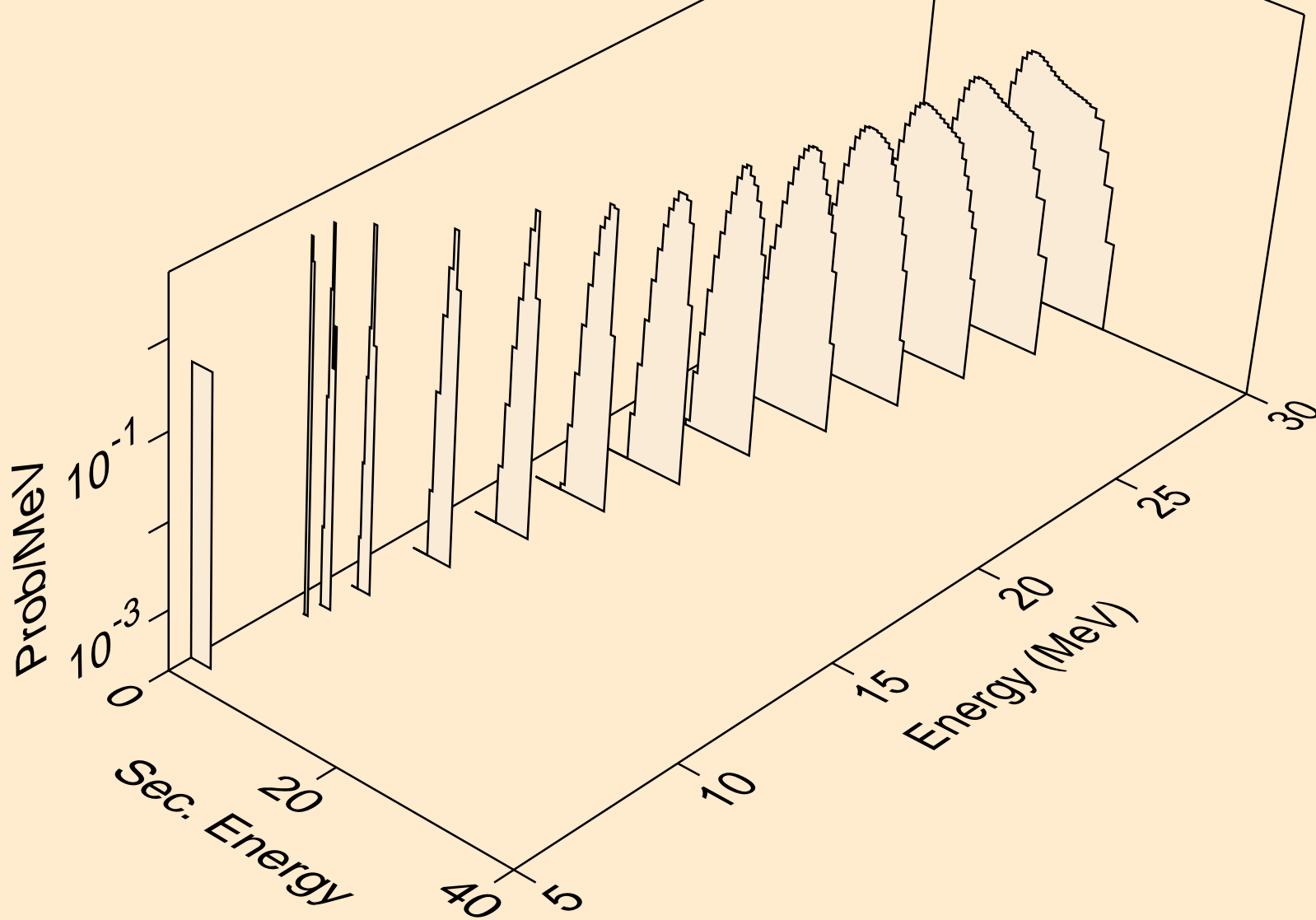

MO092 NEUTRON ACER TENDL-2019 LIBRARY; T=293.16K
alphas from (n,2n)a

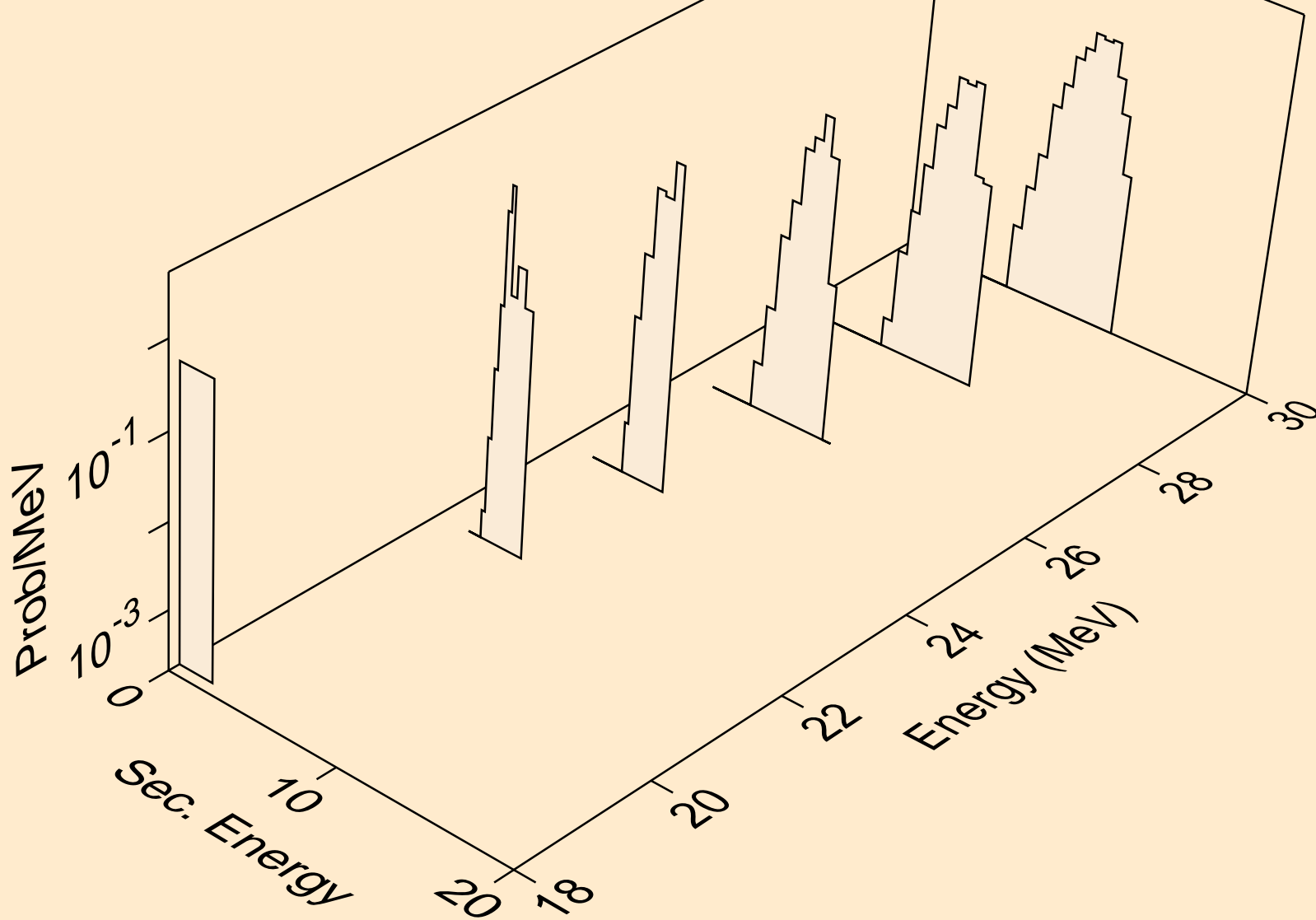

MO092 NEUTRON ACER TENDL-2019 LIBRARY; T=293.16K
alphas from (n,n*)2a

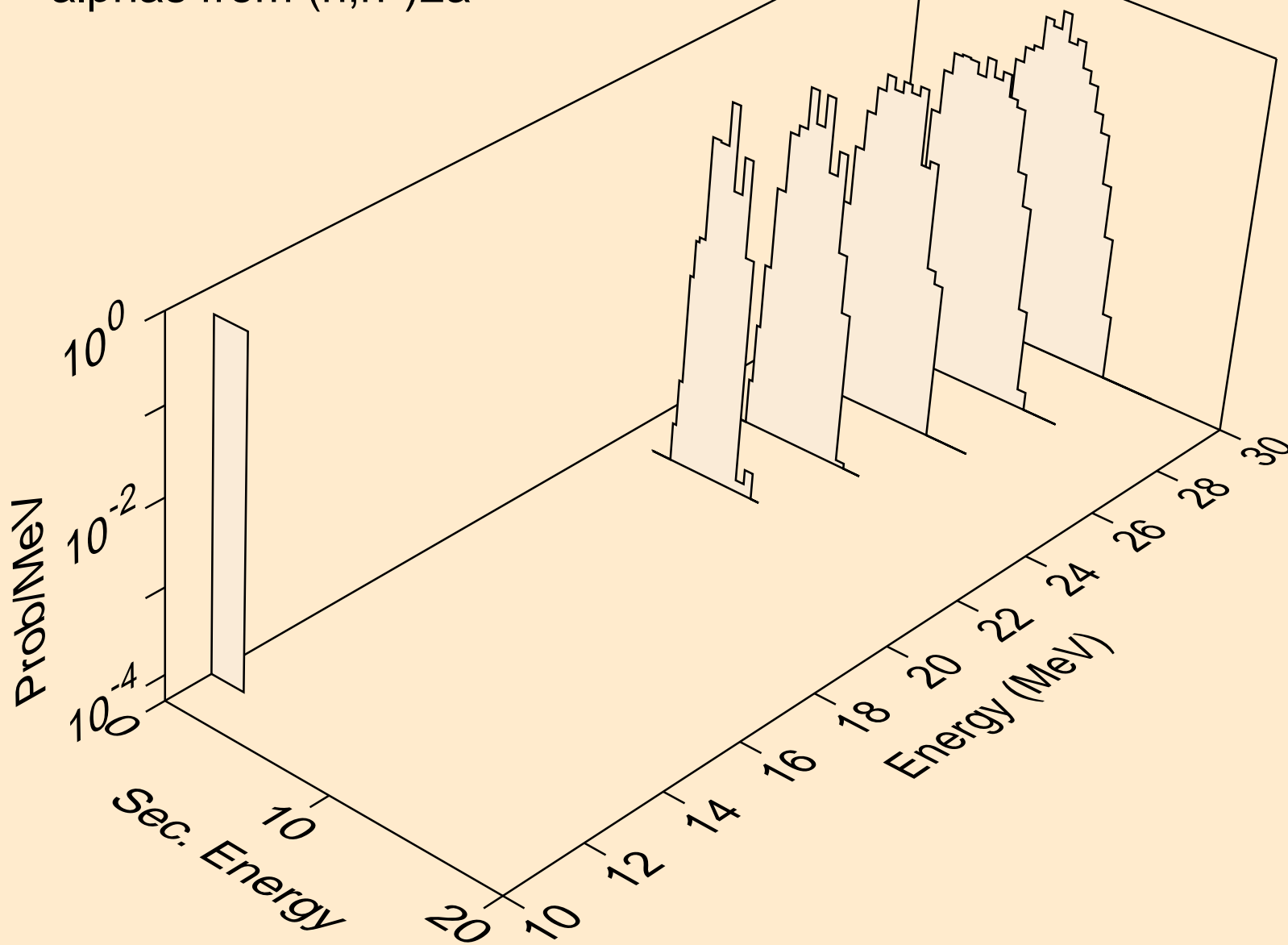

MO092 NEUTRON ACER TENDL-2019 LIBRARY; T=293.16K
alphas from (n,npa)

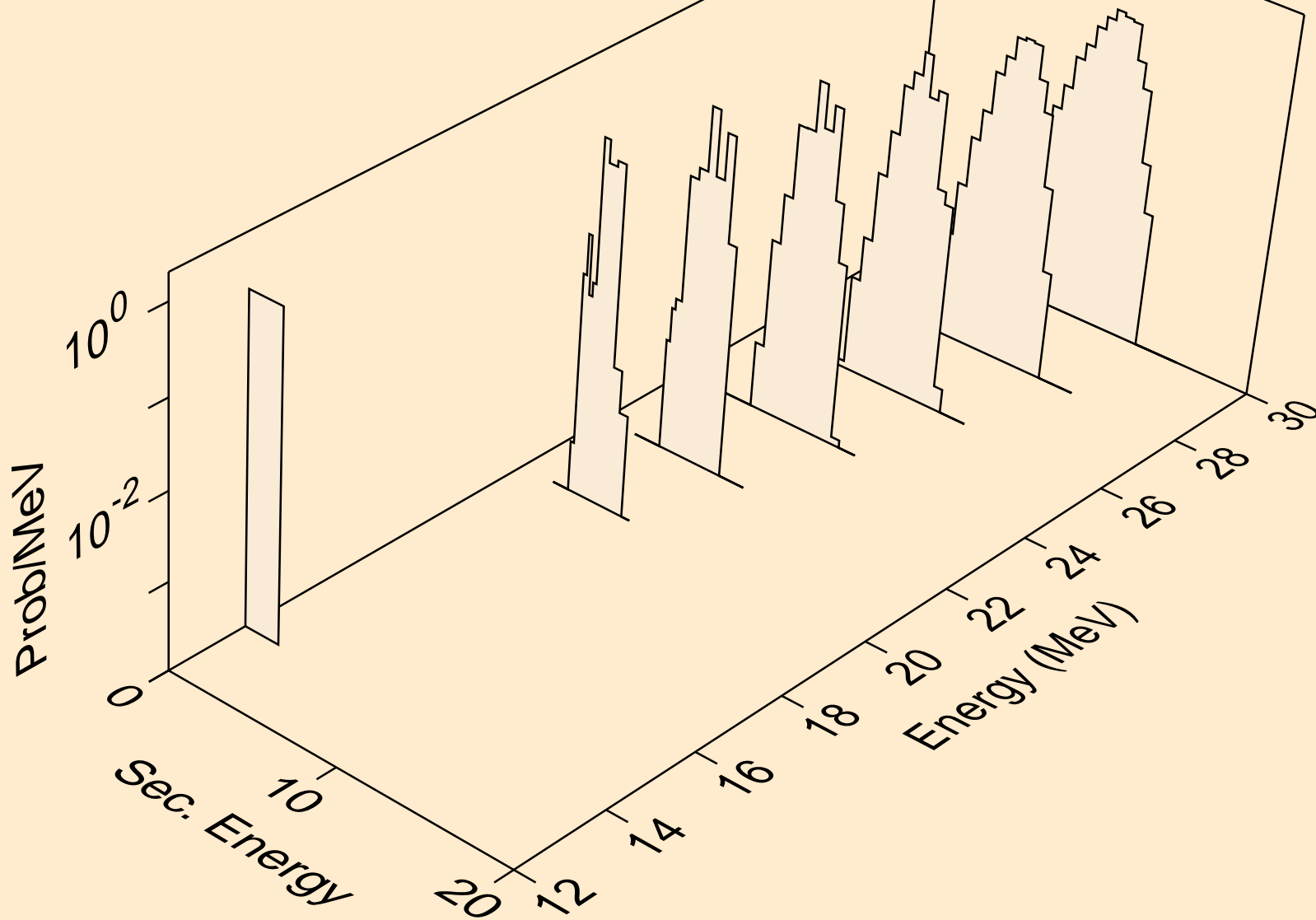

MO092 NEUTRON ACER TENDL-2019 LIBRARY; T=293.16K
alphas from (n,a)

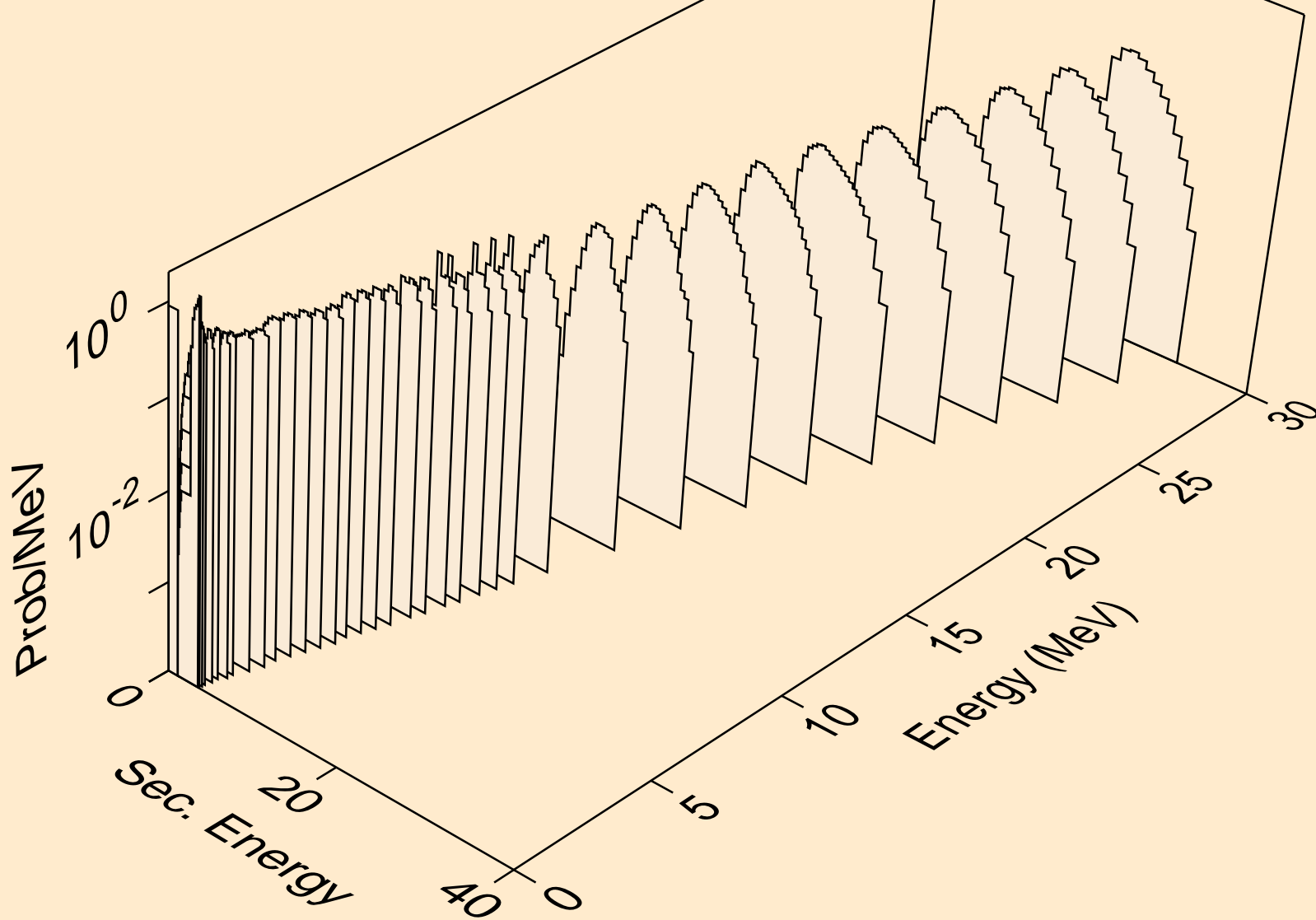

MO092 NEUTRON ACER TENDL-2019 LIBRARY; T=293.16K
alphas from (n,2a)

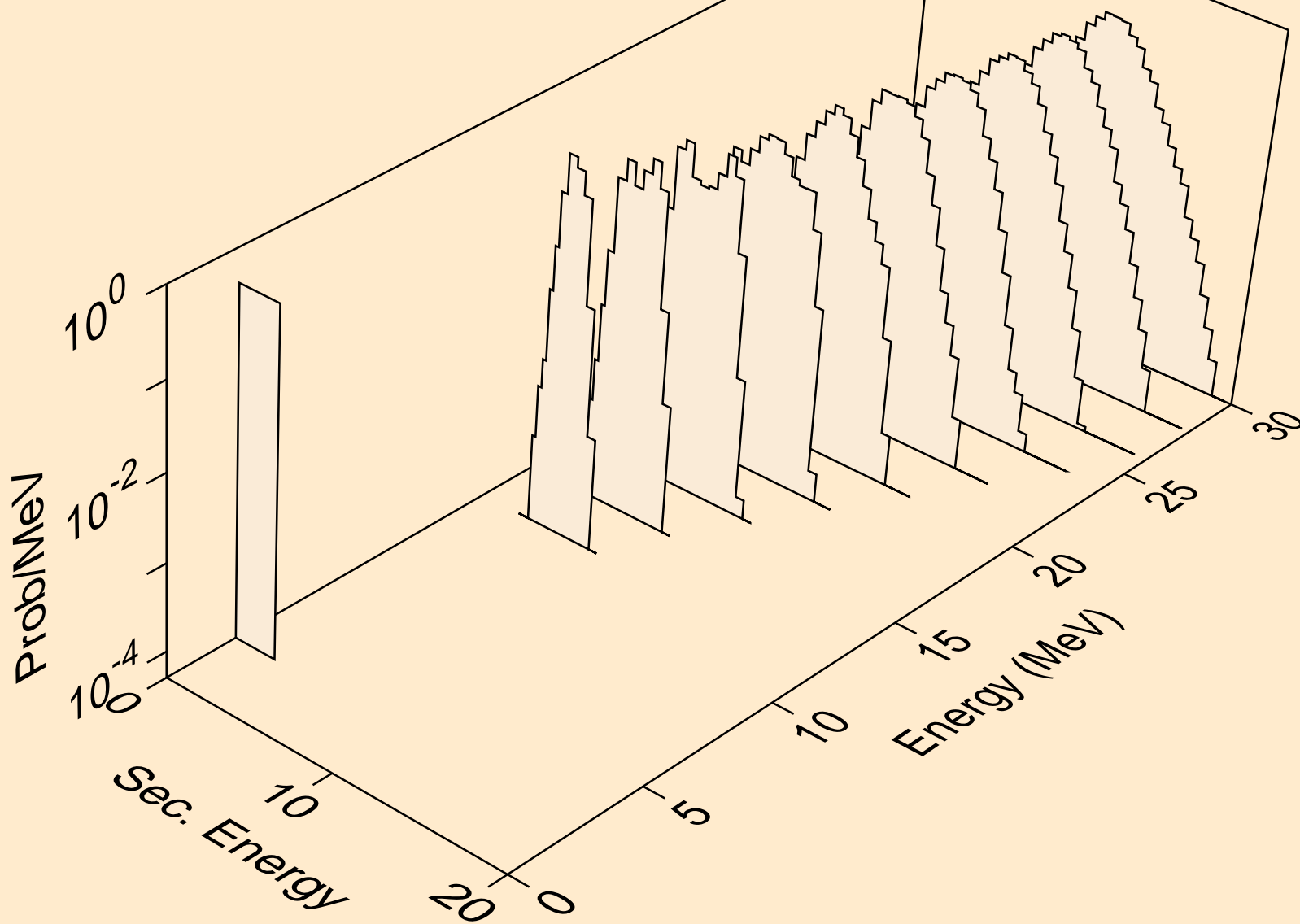

MO092 NEUTRON ACER TENDL-2019 LIBRARY; T=293.16K
alphas from (n,pa)

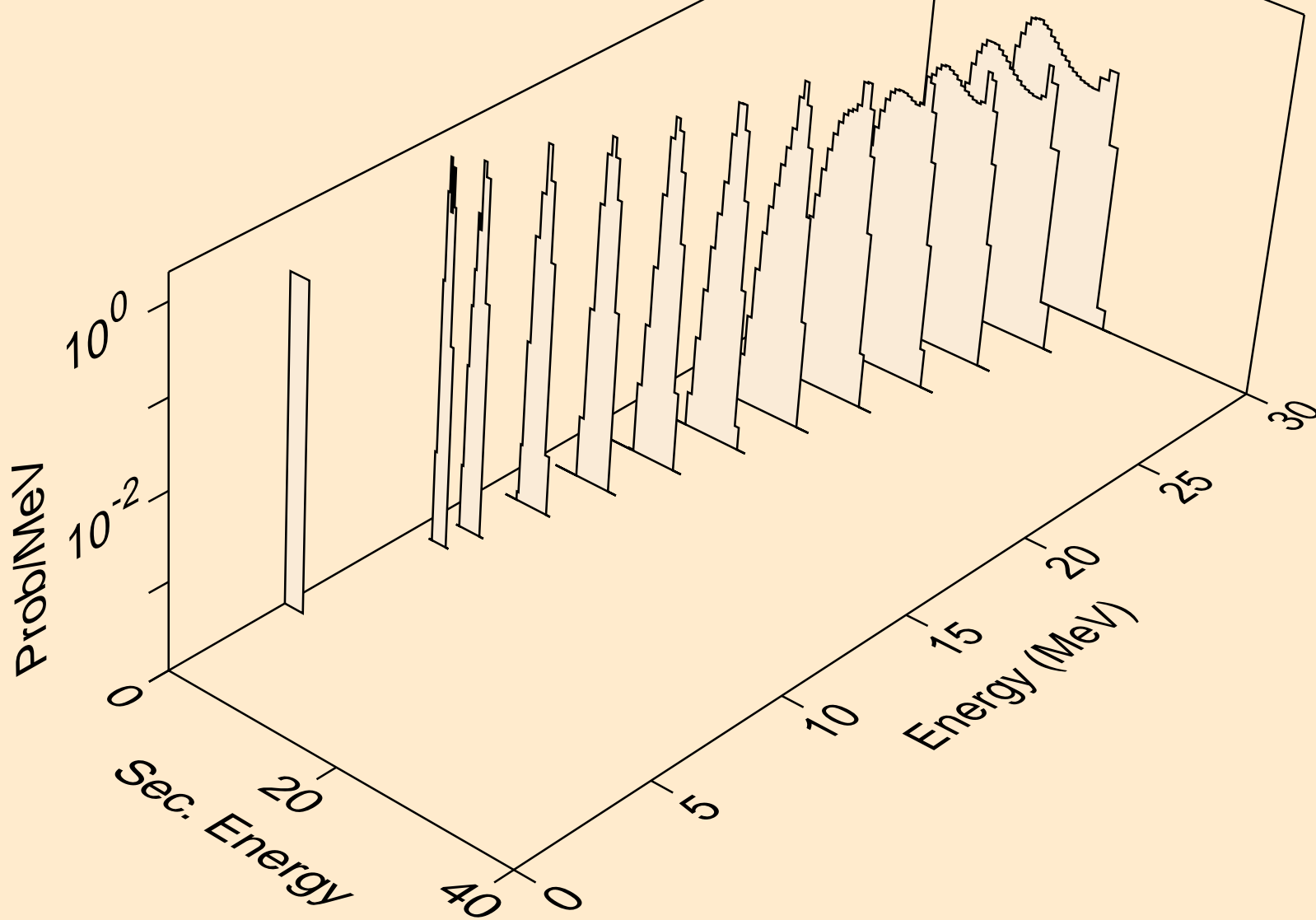

MO092 NEUTRON ACER TENDL-2019 LIBRARY; T=293.16K
alphas from (n,da)

