

MO105 NEUTRON ACER TENDL-2019 LIBRARY; T=293.16K
Principal cross sections

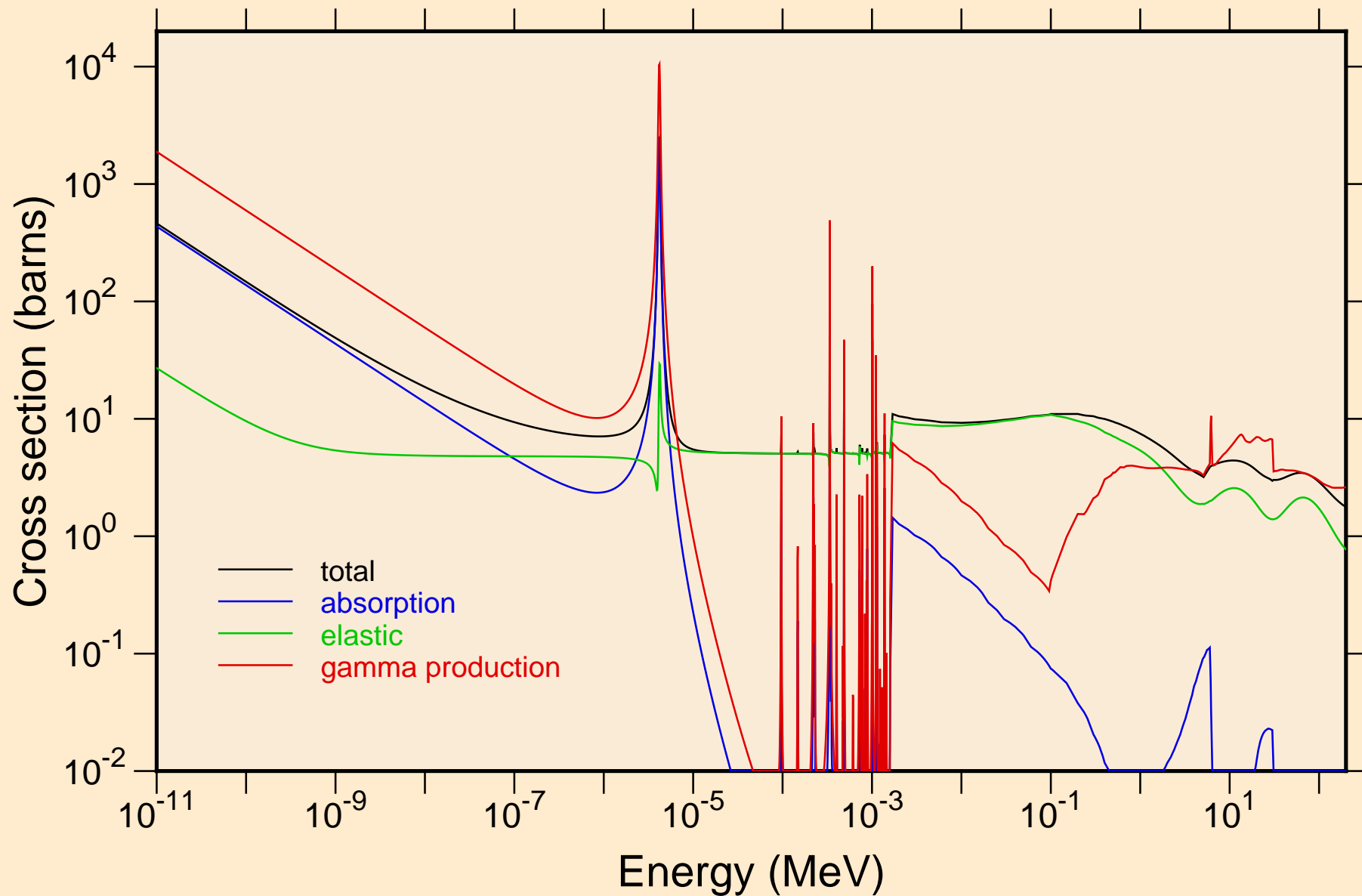

MO105 NEUTRON ACER TENDL-2019 LIBRARY; T=293.16K
resonance total cross section

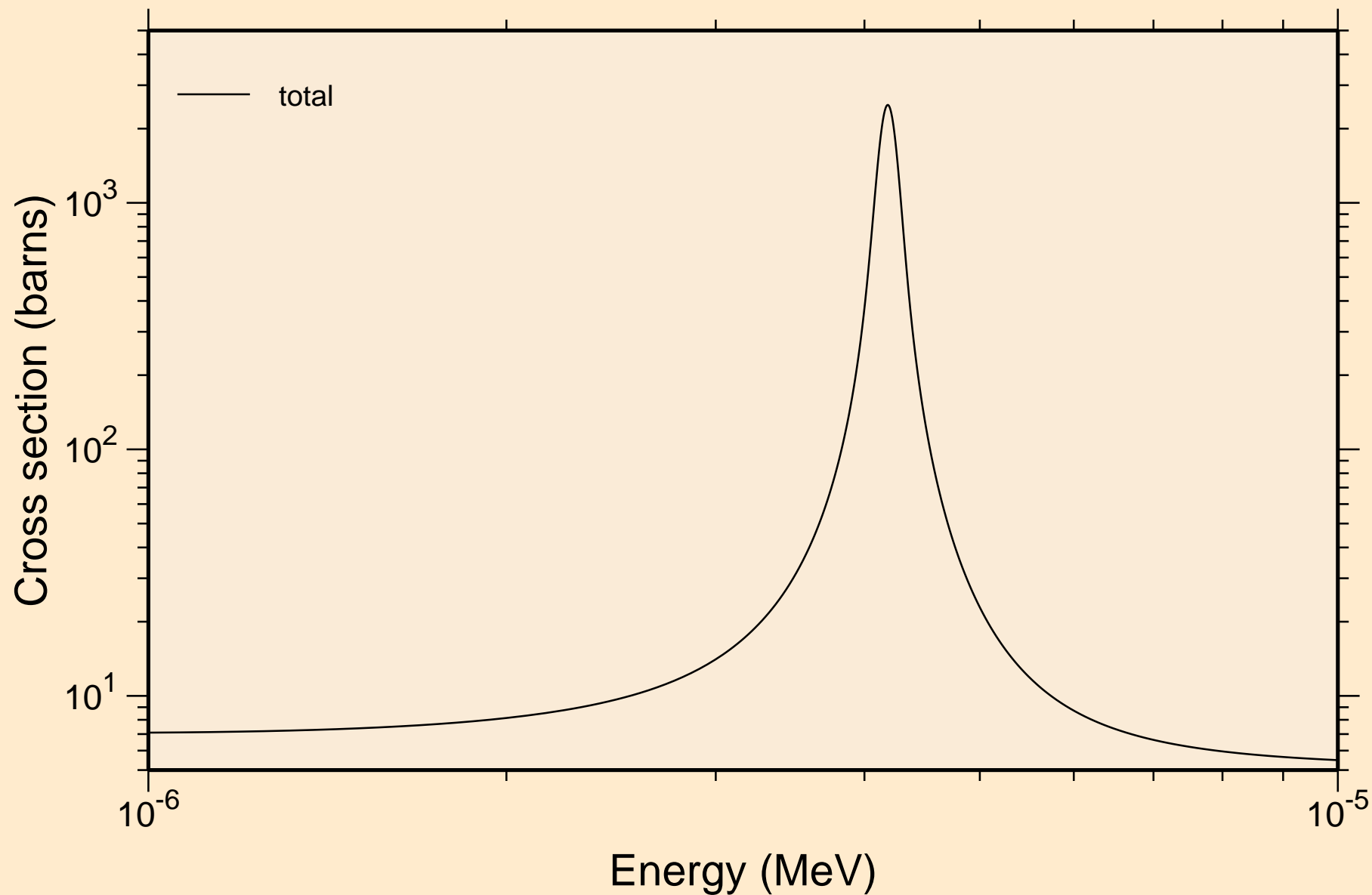

MO105 NEUTRON ACER TENDL-2019 LIBRARY; T=293.16K
resonance total cross section

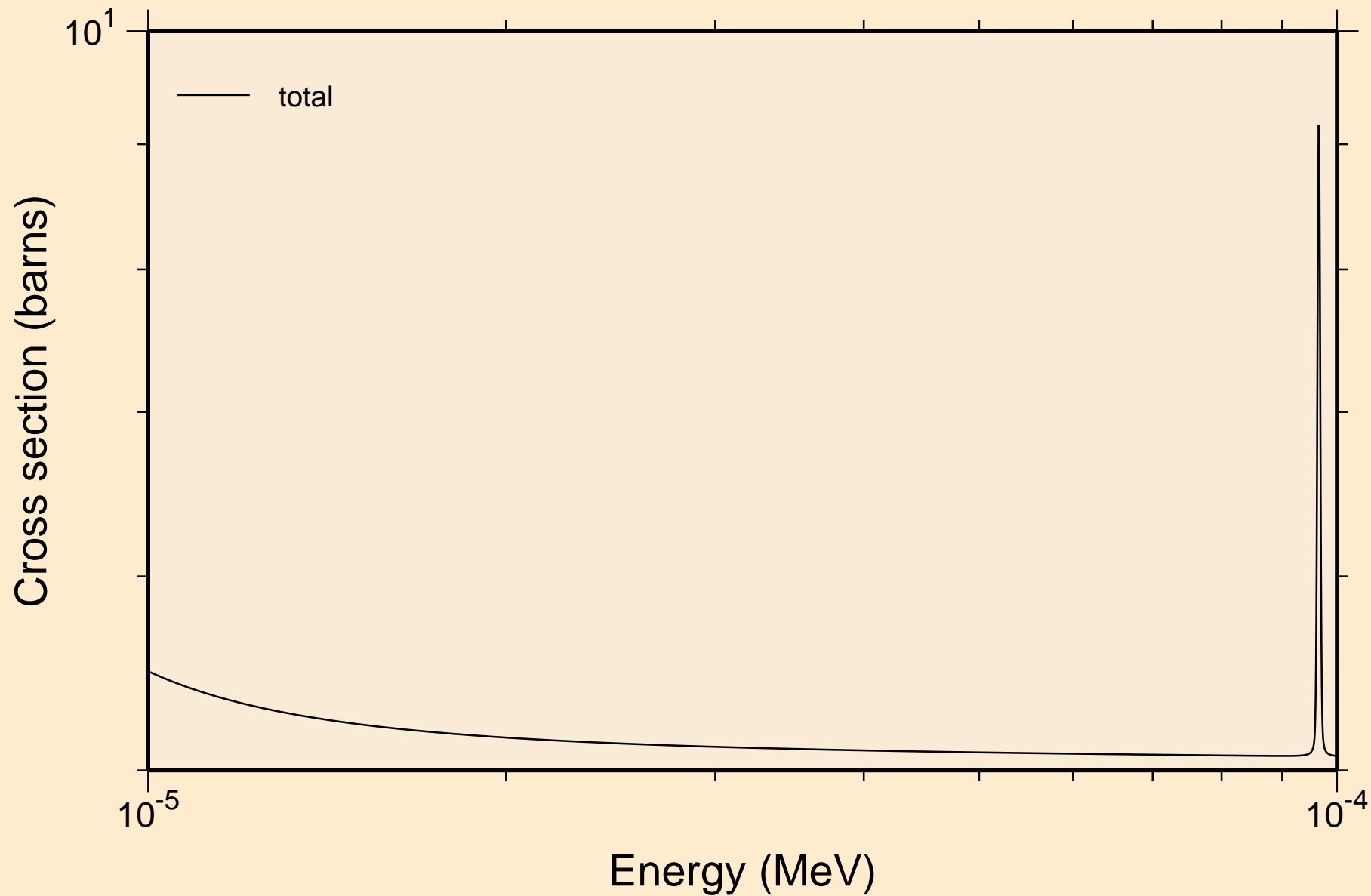

MO105 NEUTRON ACER TENDL-2019 LIBRARY; T=293.16K
resonance total cross section

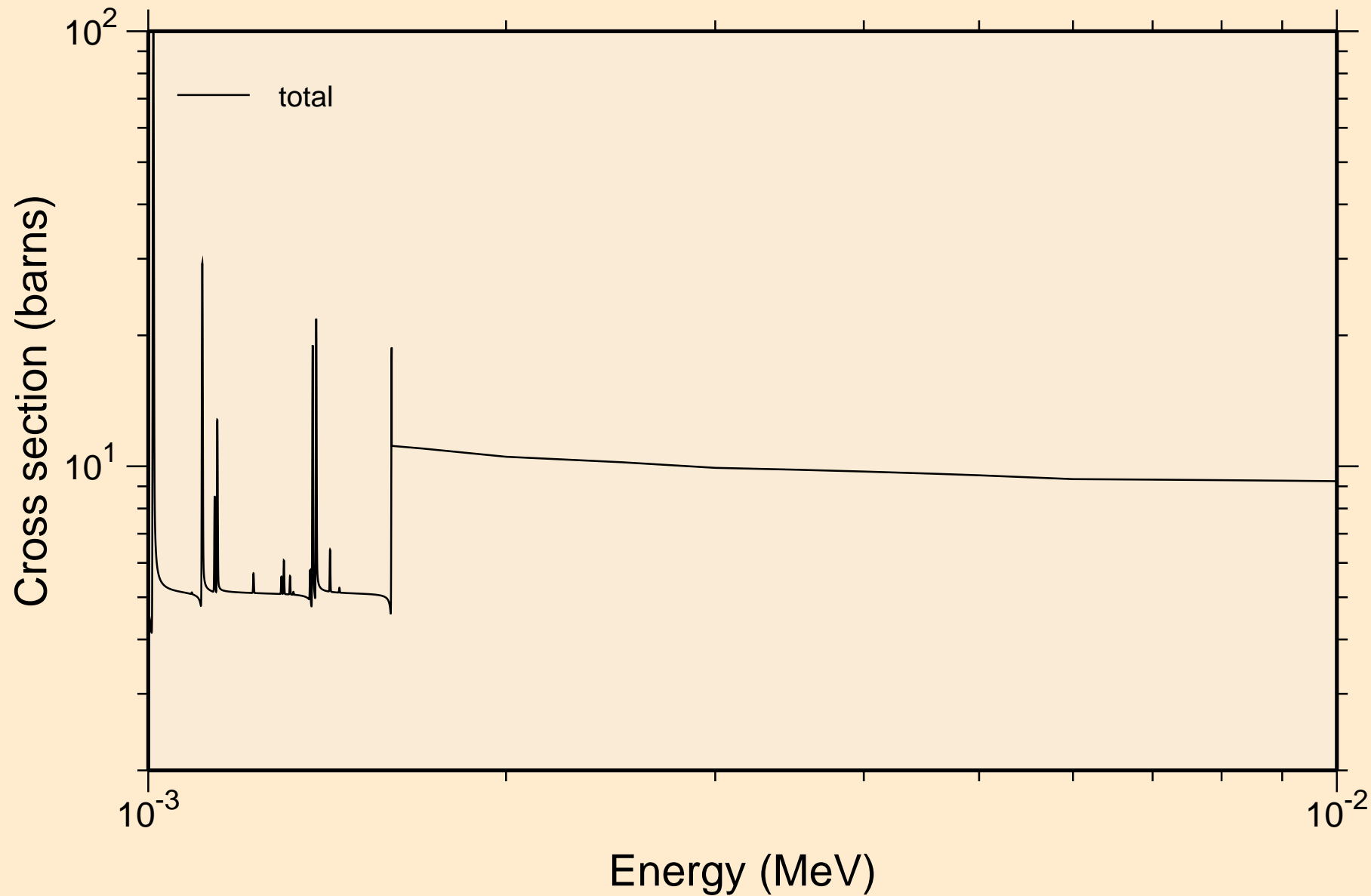

M0105 NEUTRON ACER TENDL-2019 LIBRARY; T=293.16K
resonance total cross section

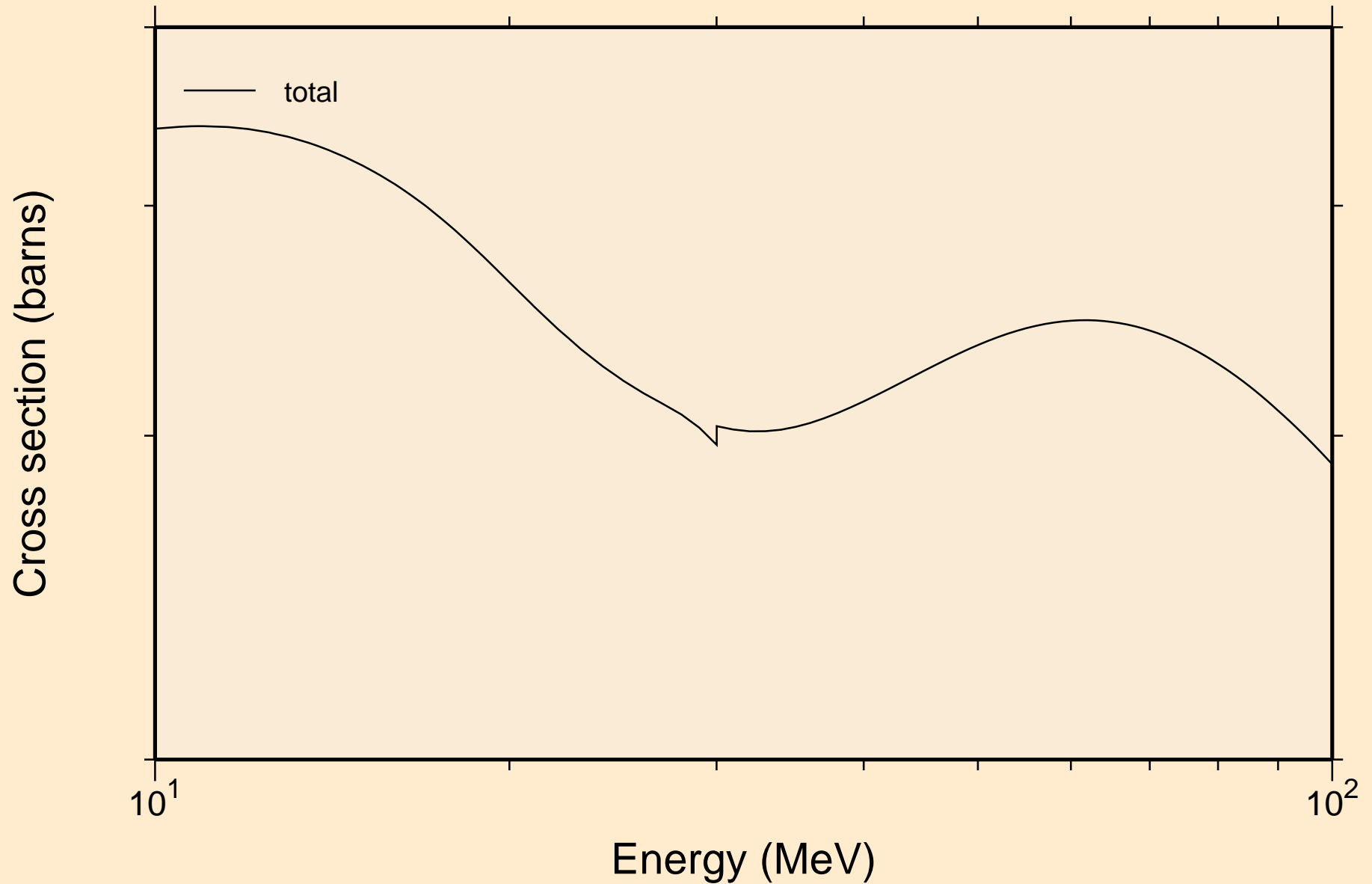

MO105 NEUTRON ACER TENDL-2019 LIBRARY; T=293.16K
resonance absorption cross sections

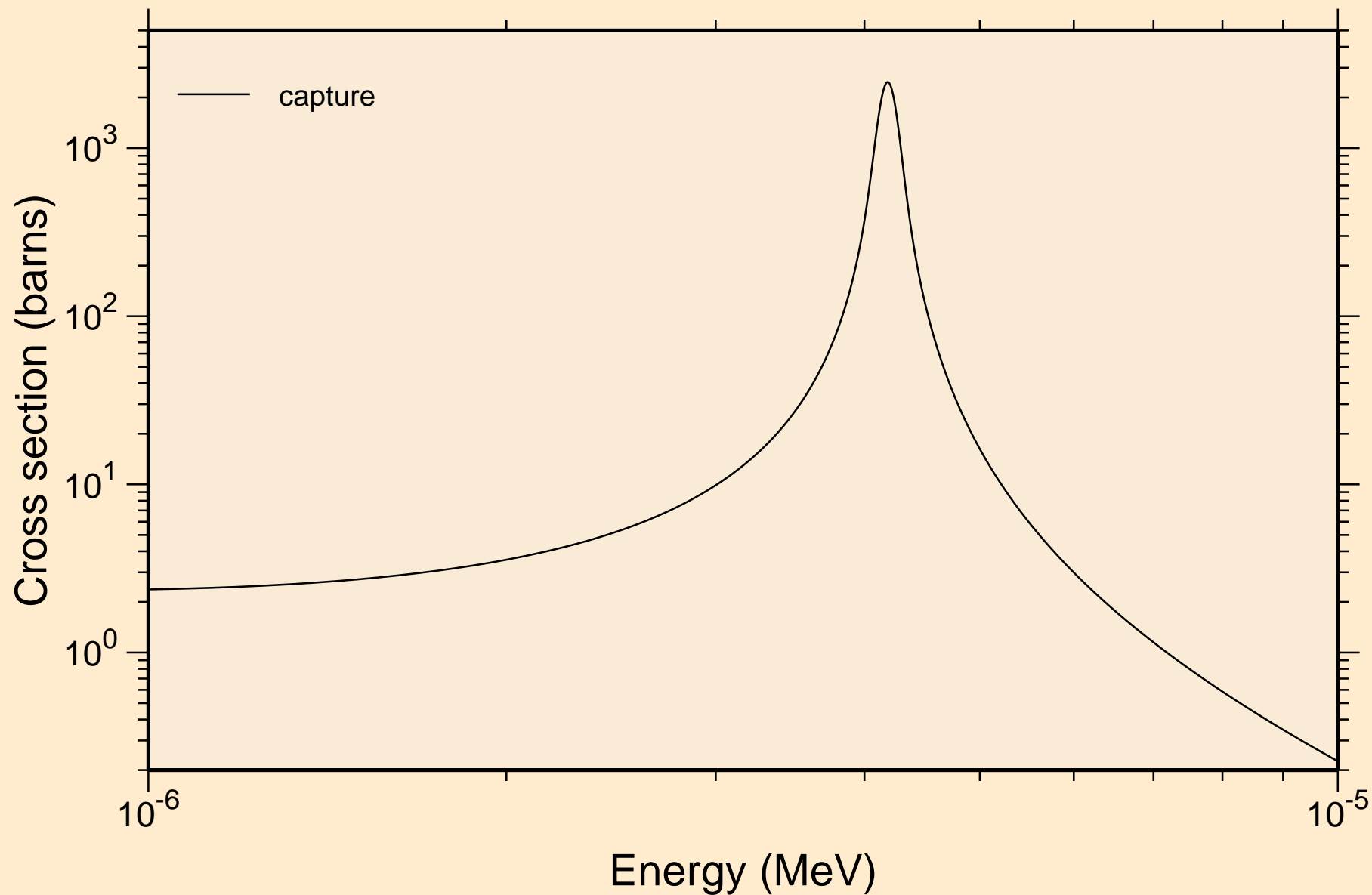

MO105 NEUTRON ACER TENDL-2019 LIBRARY; T=293.16K
resonance absorption cross sections

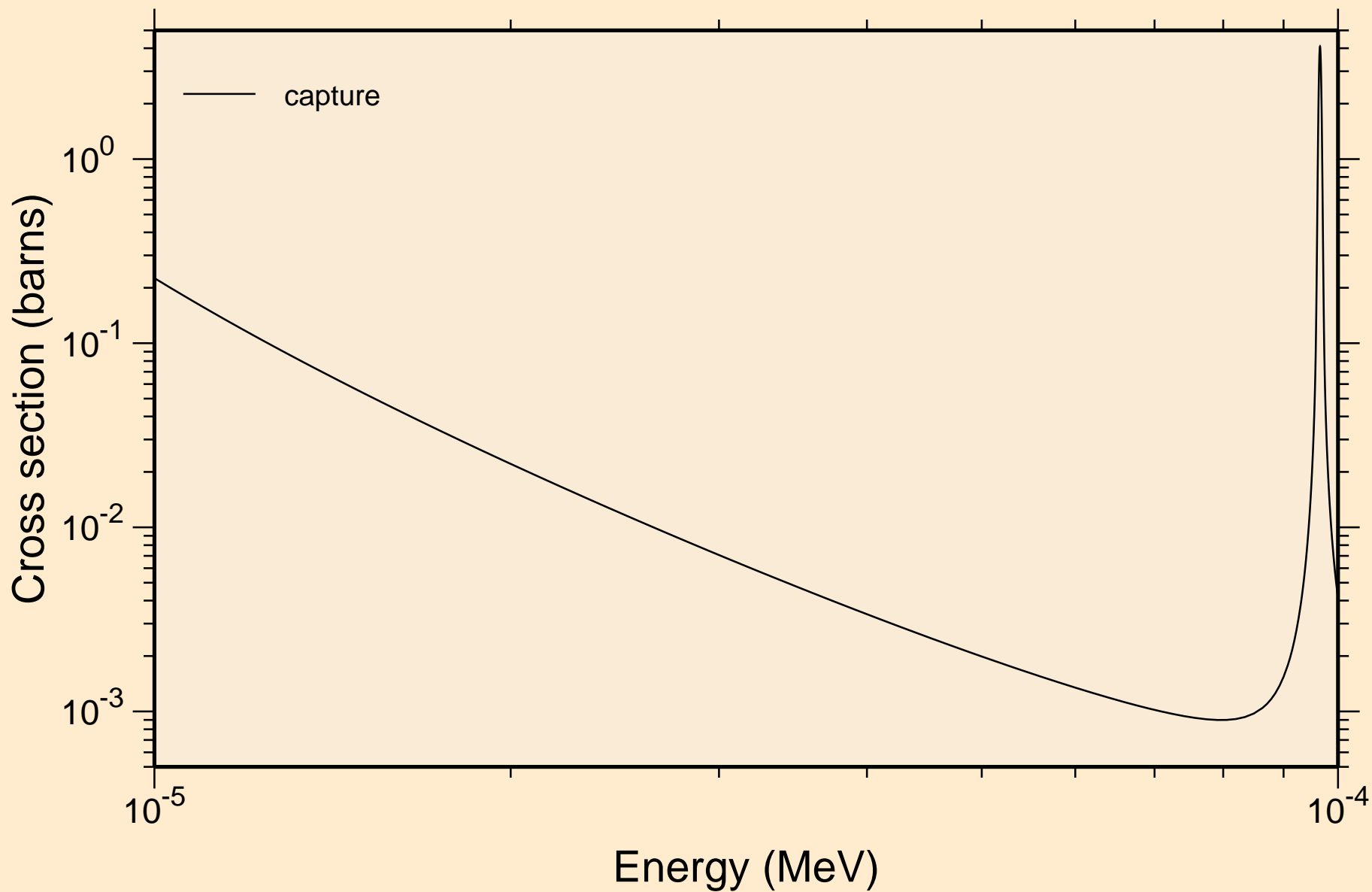

MO105 NEUTRON ACER TENDL-2019 LIBRARY; T=293.16K
resonance absorption cross sections

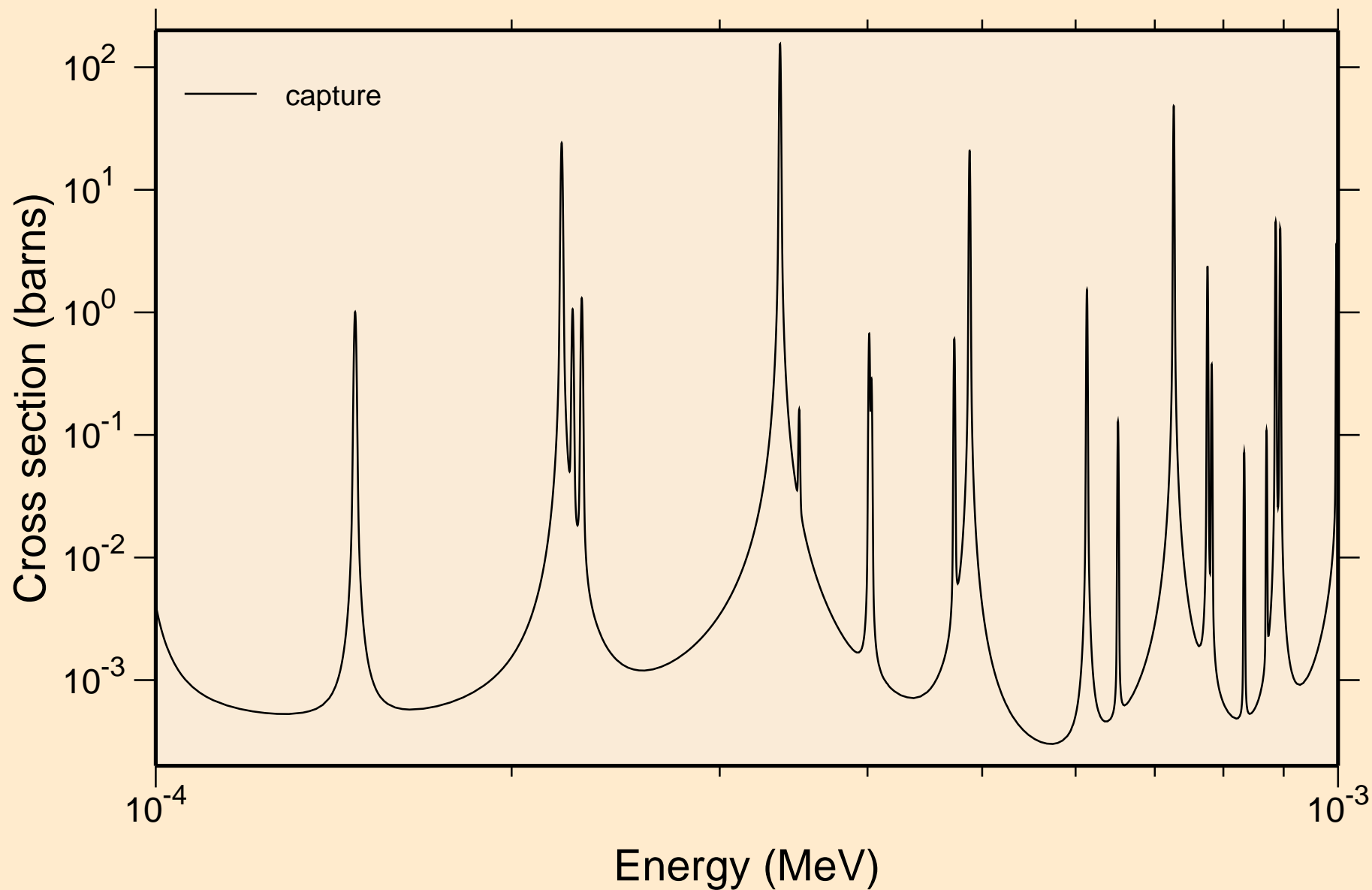

MO105 NEUTRON ACER TENDL-2019 LIBRARY; T=293.16K
resonance absorption cross sections

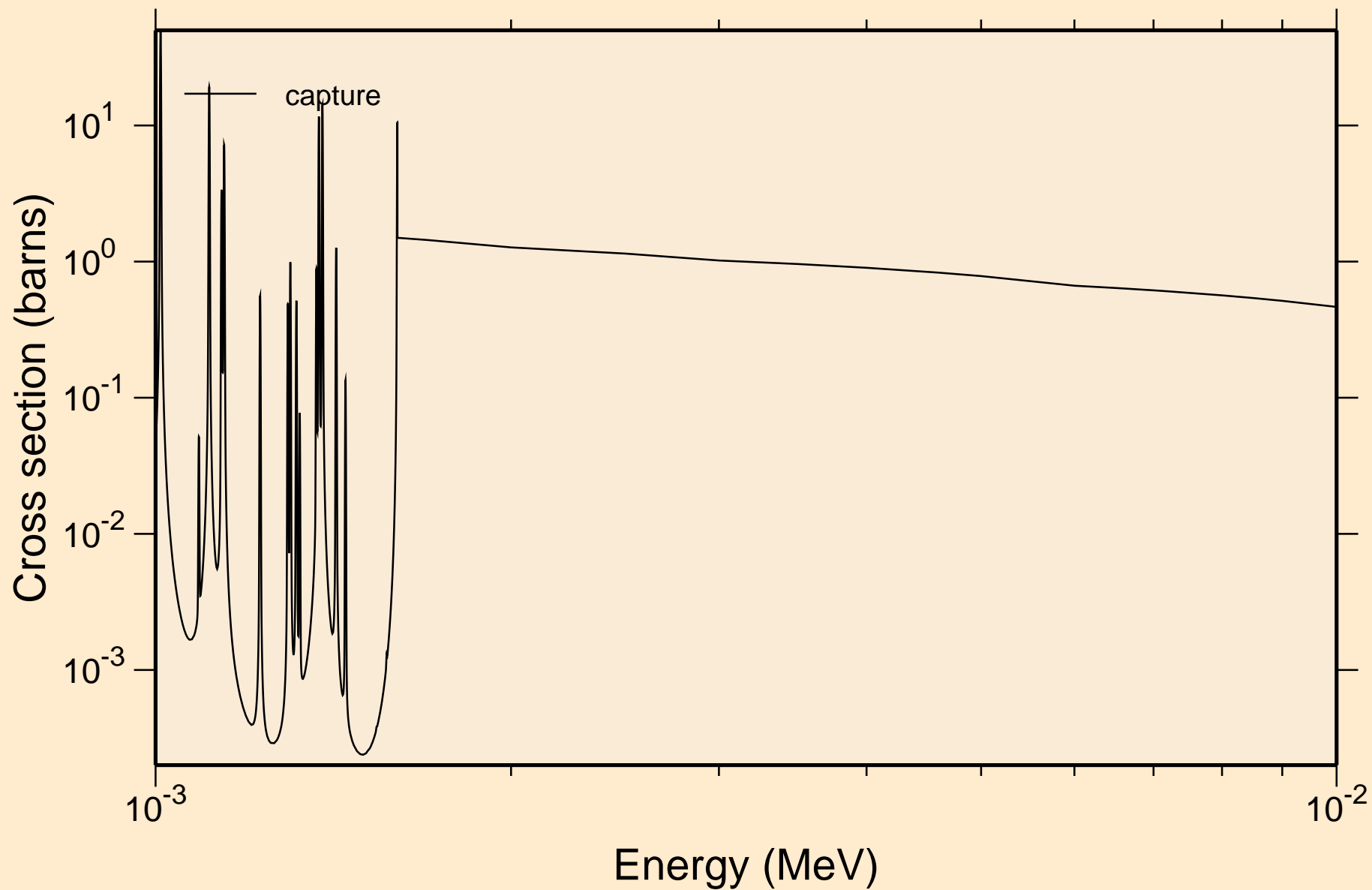

MO105 NEUTRON ACER TENDL-2019 LIBRARY; T=293.16K
resonance absorption cross sections

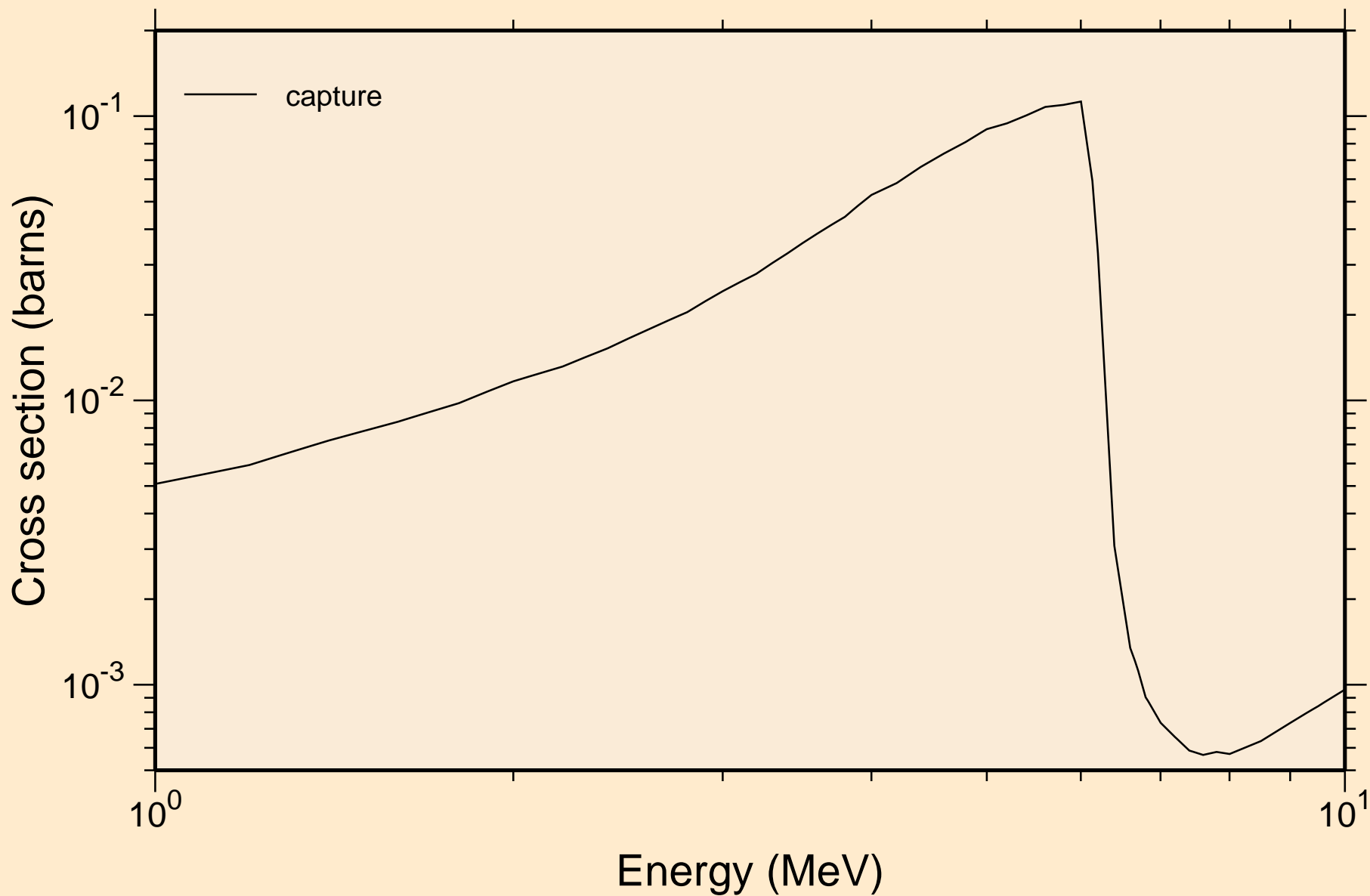

MO105 NEUTRON ACER TENDL-2019 LIBRARY; T=293.16K
Heating

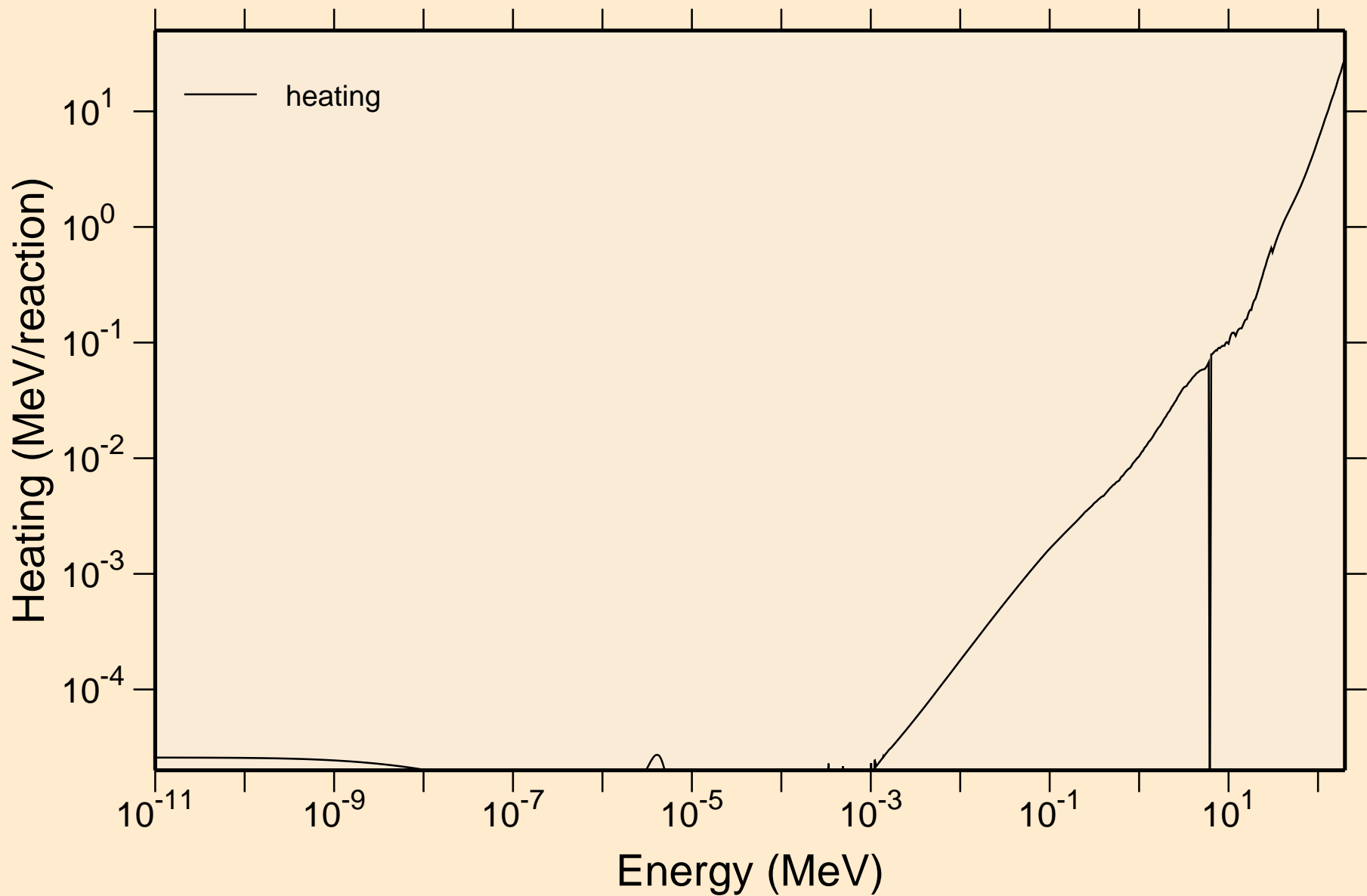

MO105 NEUTRON ACER TENDL-2019 LIBRARY; T=293.16K
Damage

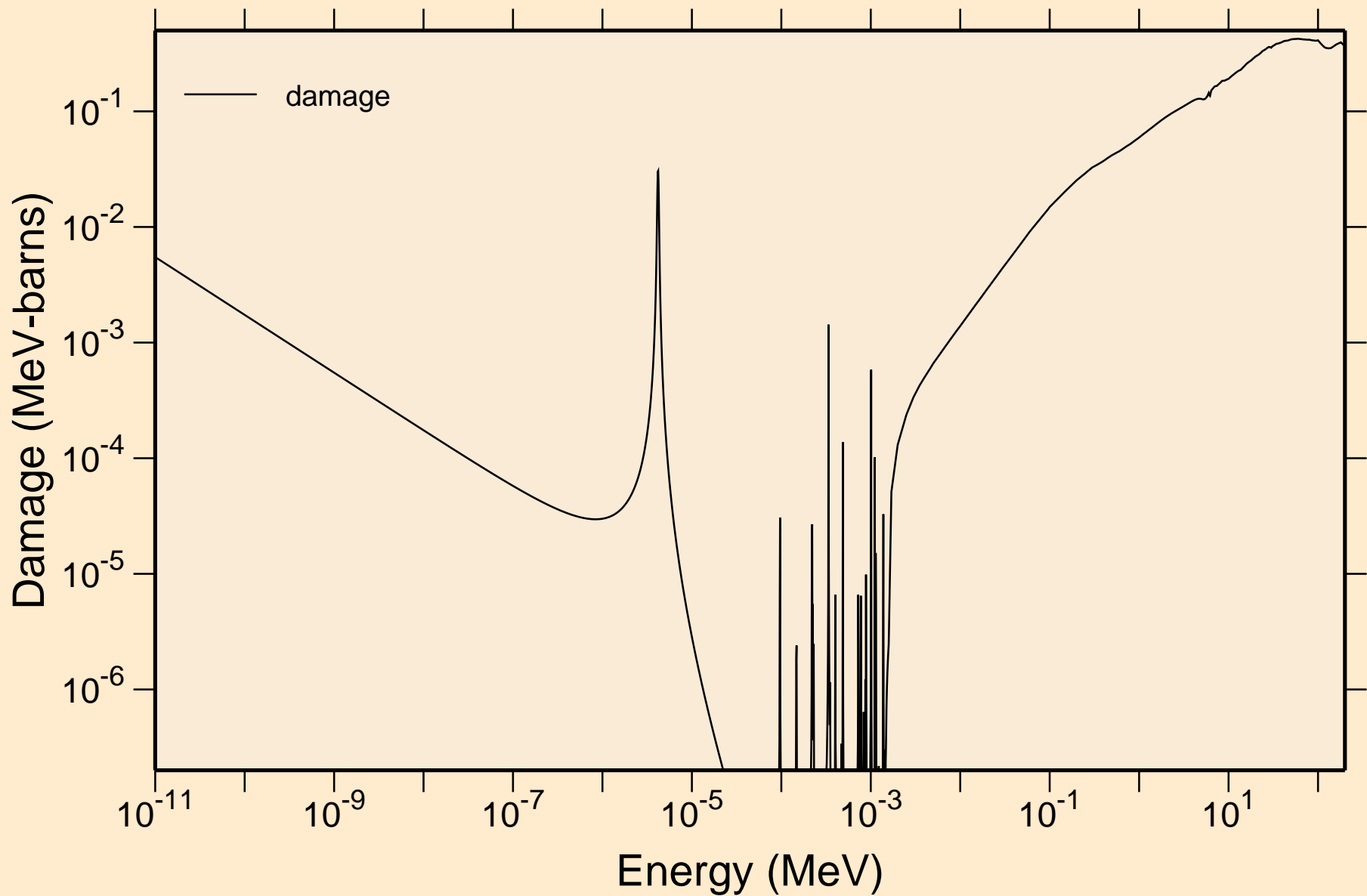

MO105 NEUTRON ACER TENDL-2019 LIBRARY; T=293.16K
Non-threshold reactions

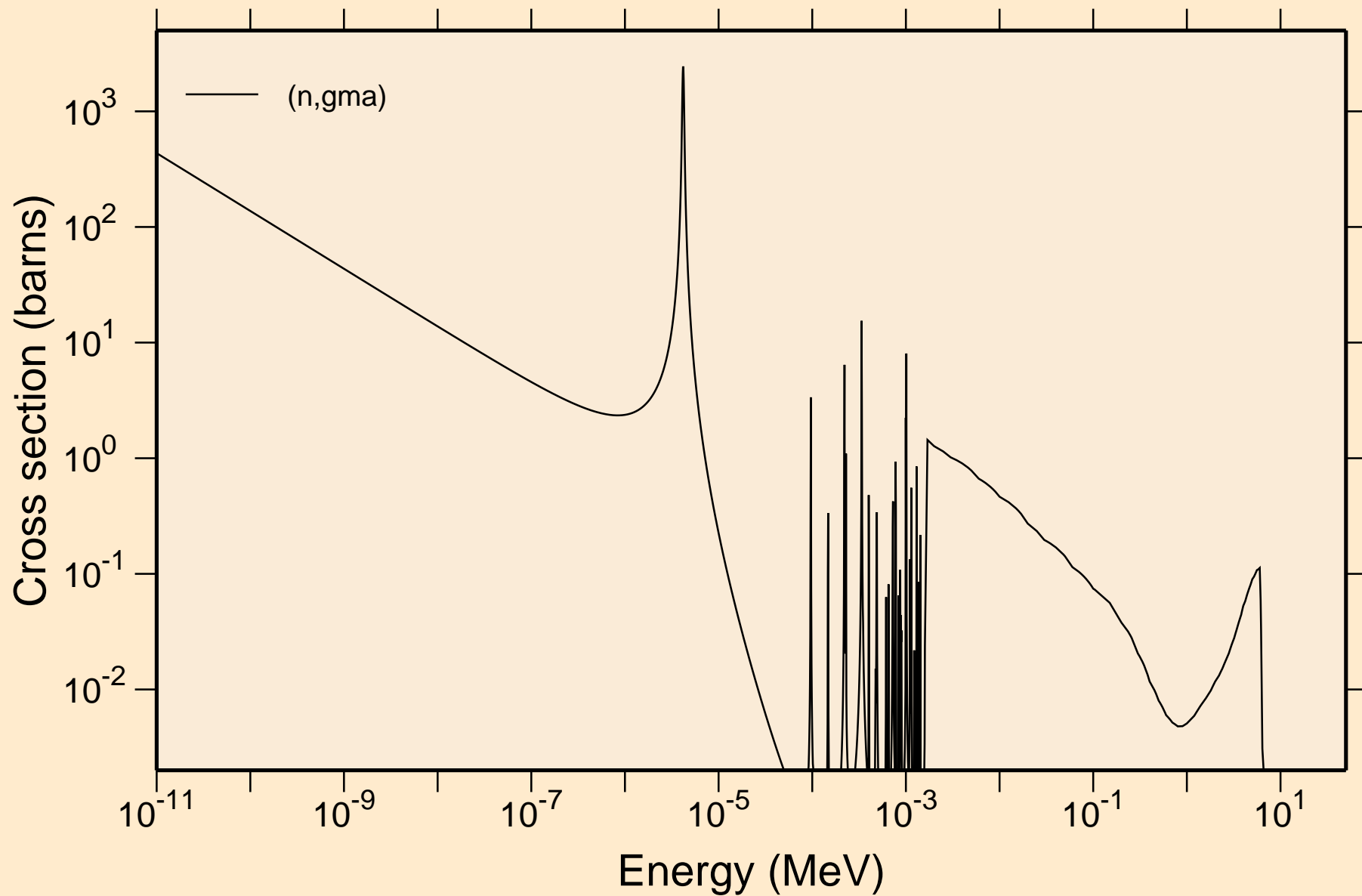

MO105 NEUTRON ACER TENDL-2019 LIBRARY; T=293.16K
Principal cross sections

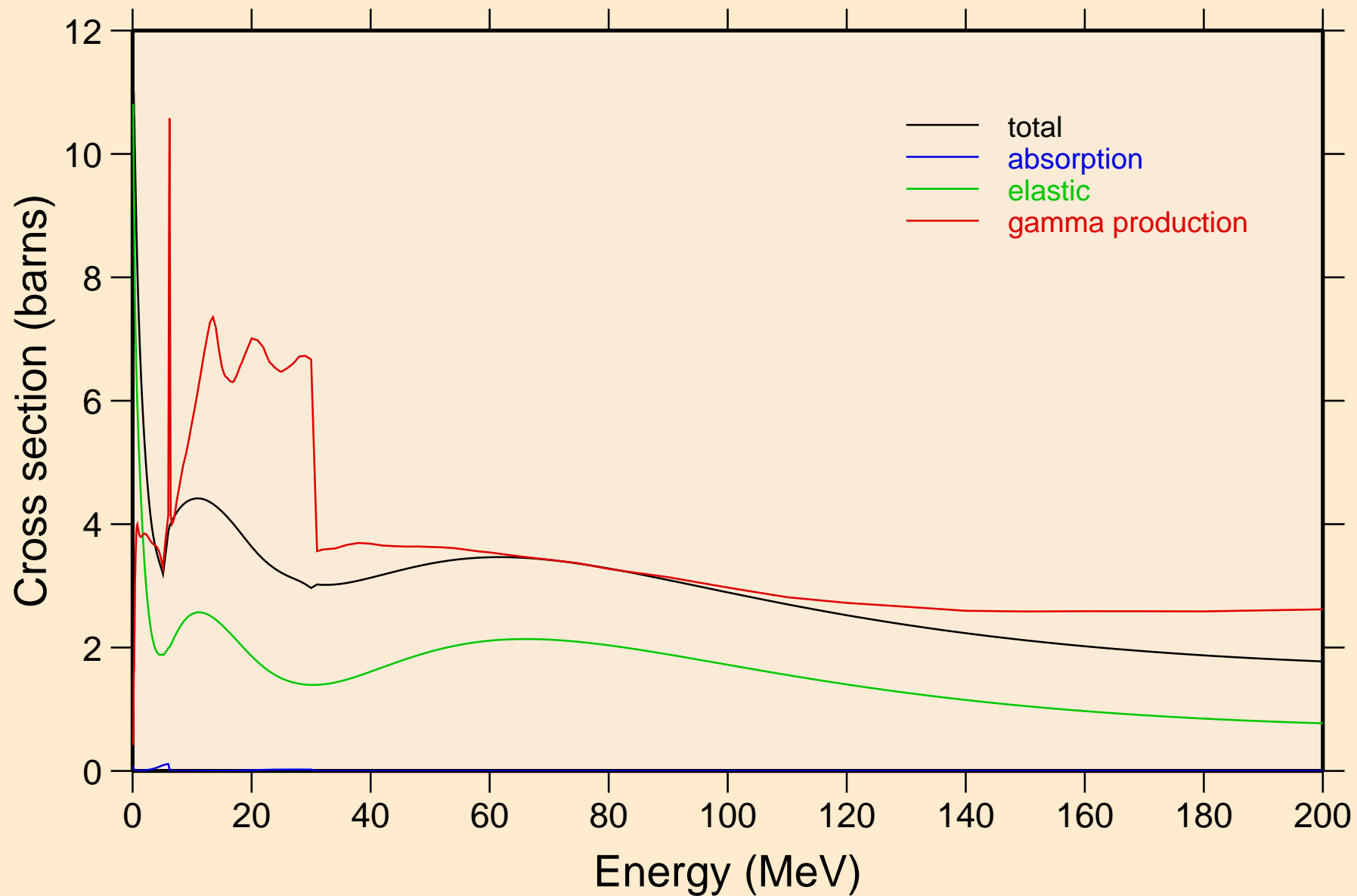

MO105 NEUTRON ACER TENDL-2019 LIBRARY; T=293.16K
Heating

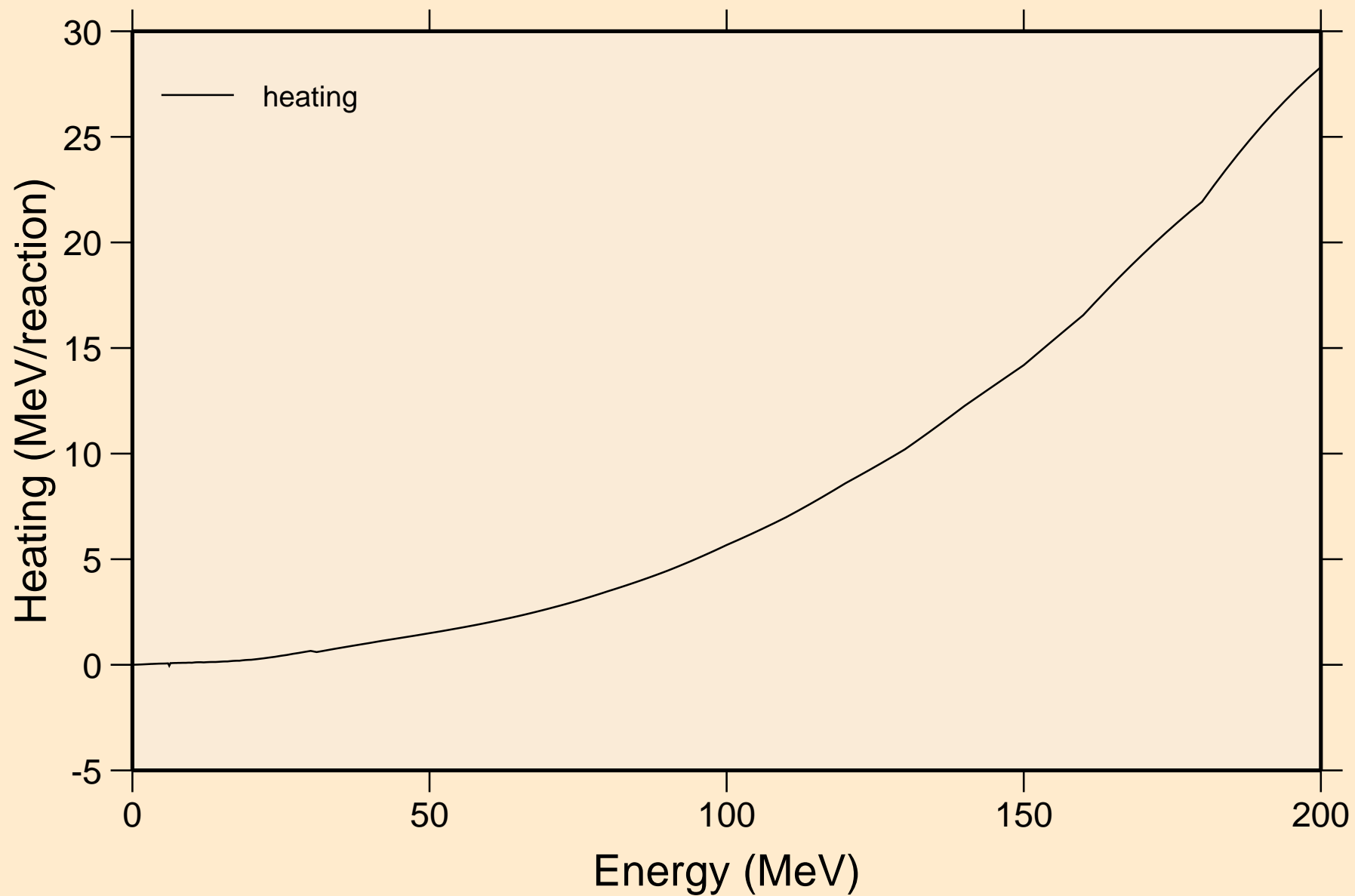

MO105 NEUTRON ACER TENDL-2019 LIBRARY; T=293.16K
Damage

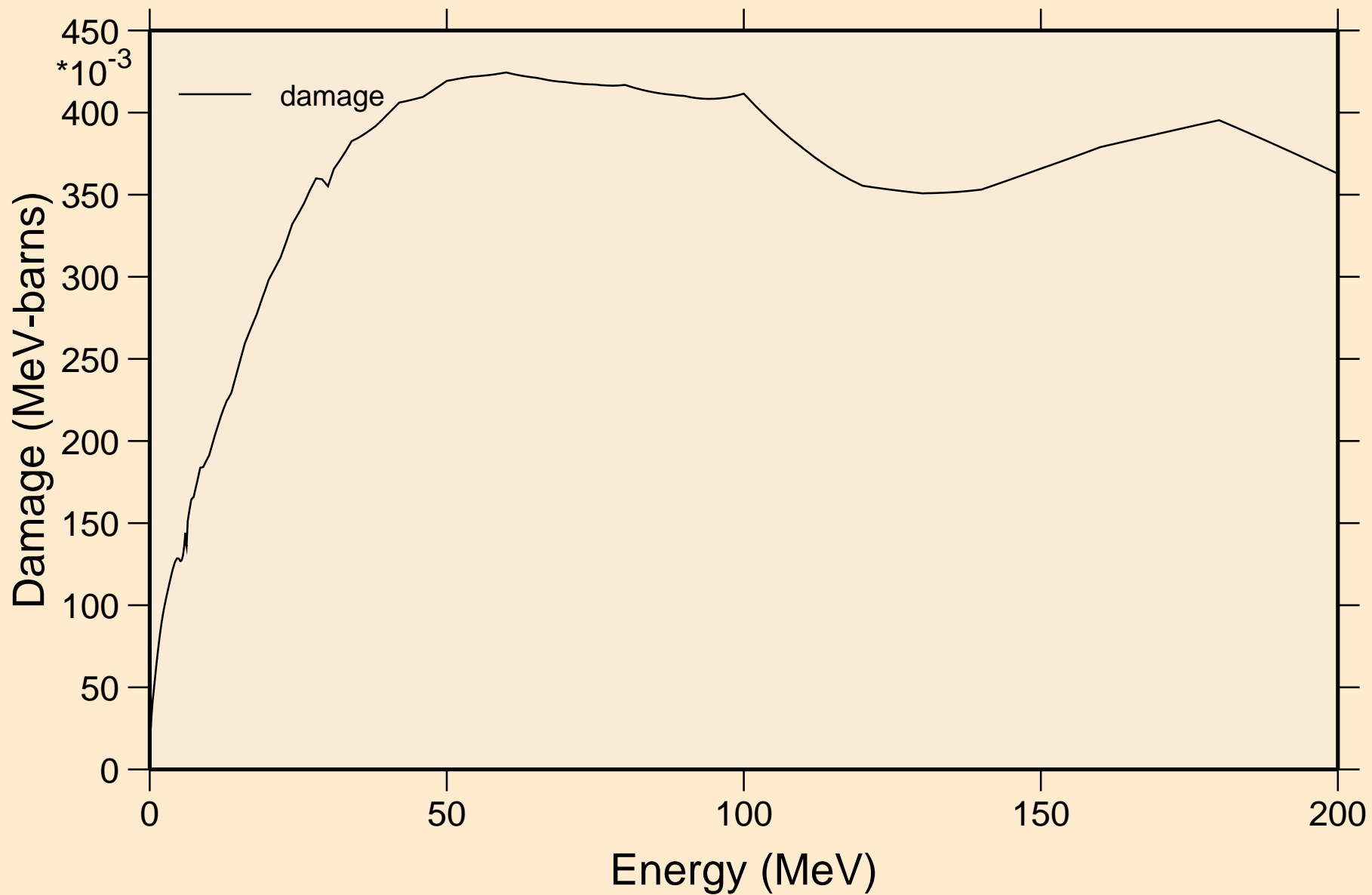

MO105 NEUTRON ACER TENDL-2019 LIBRARY; T=293.16K
Non-threshold reactions

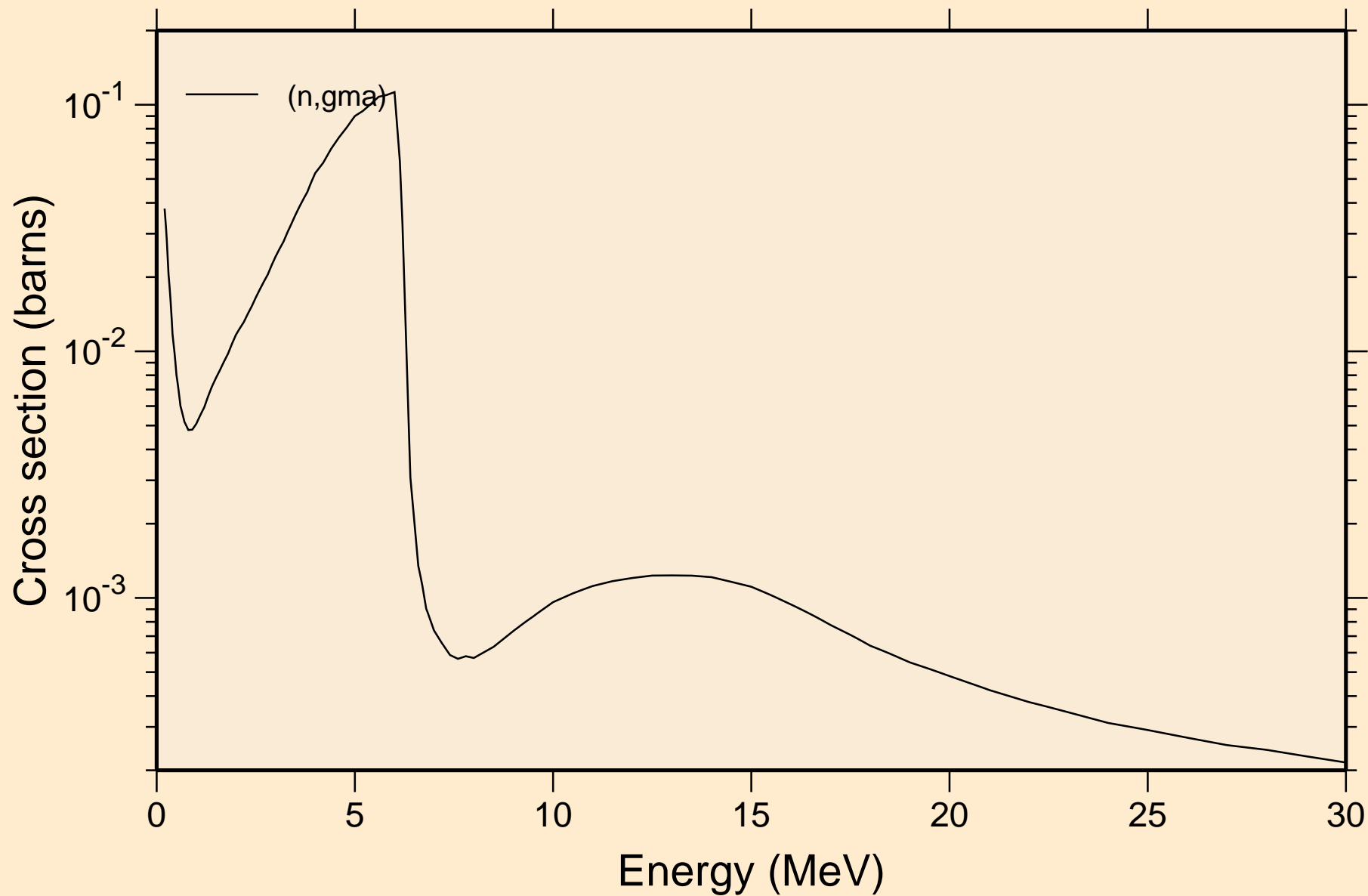

MO105 NEUTRON ACER TENDL-2019 LIBRARY; T=293.16K
Inelastic levels

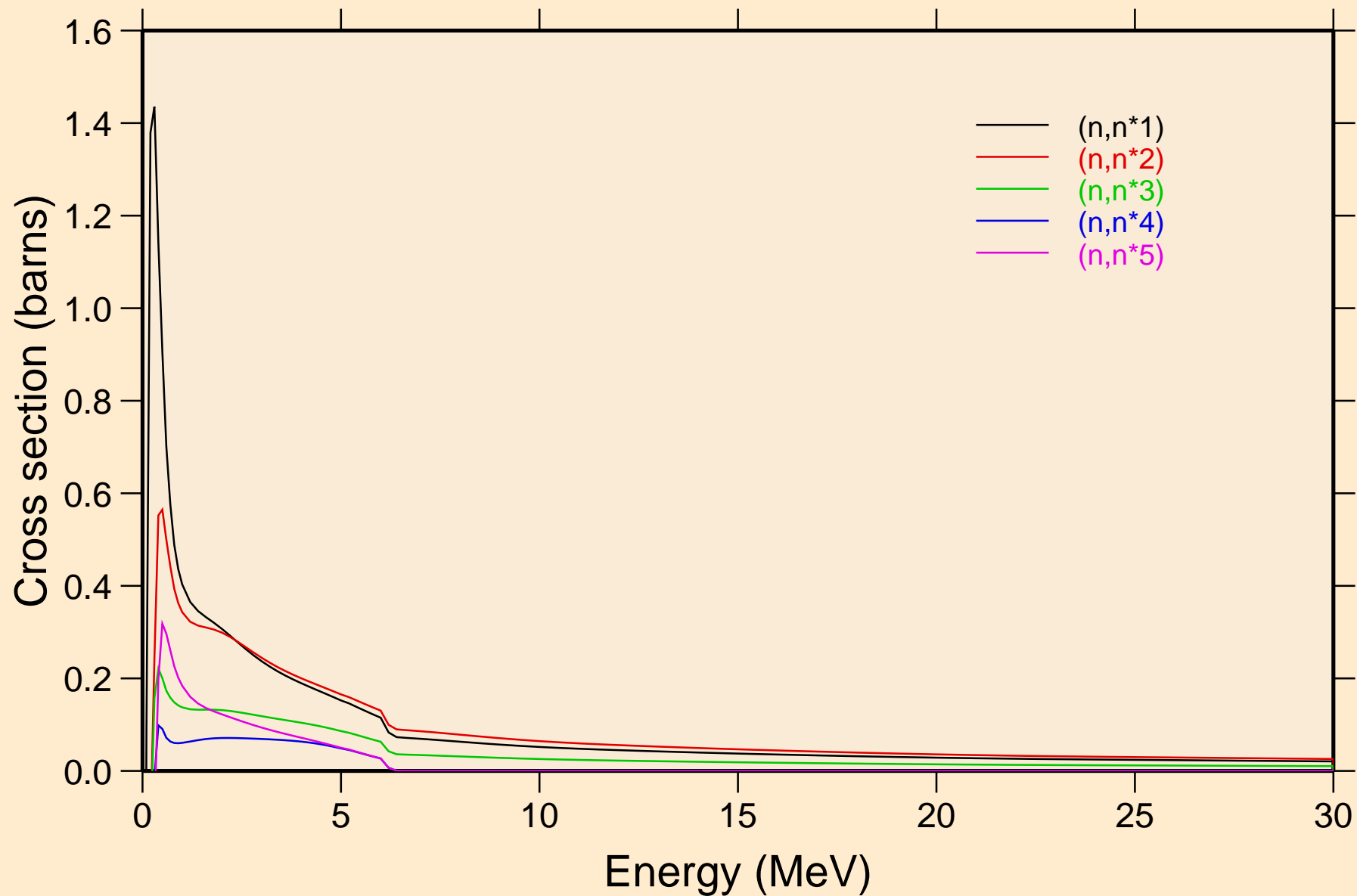

MO105 NEUTRON ACER TENDL-2019 LIBRARY; T=293.16K
Inelastic levels

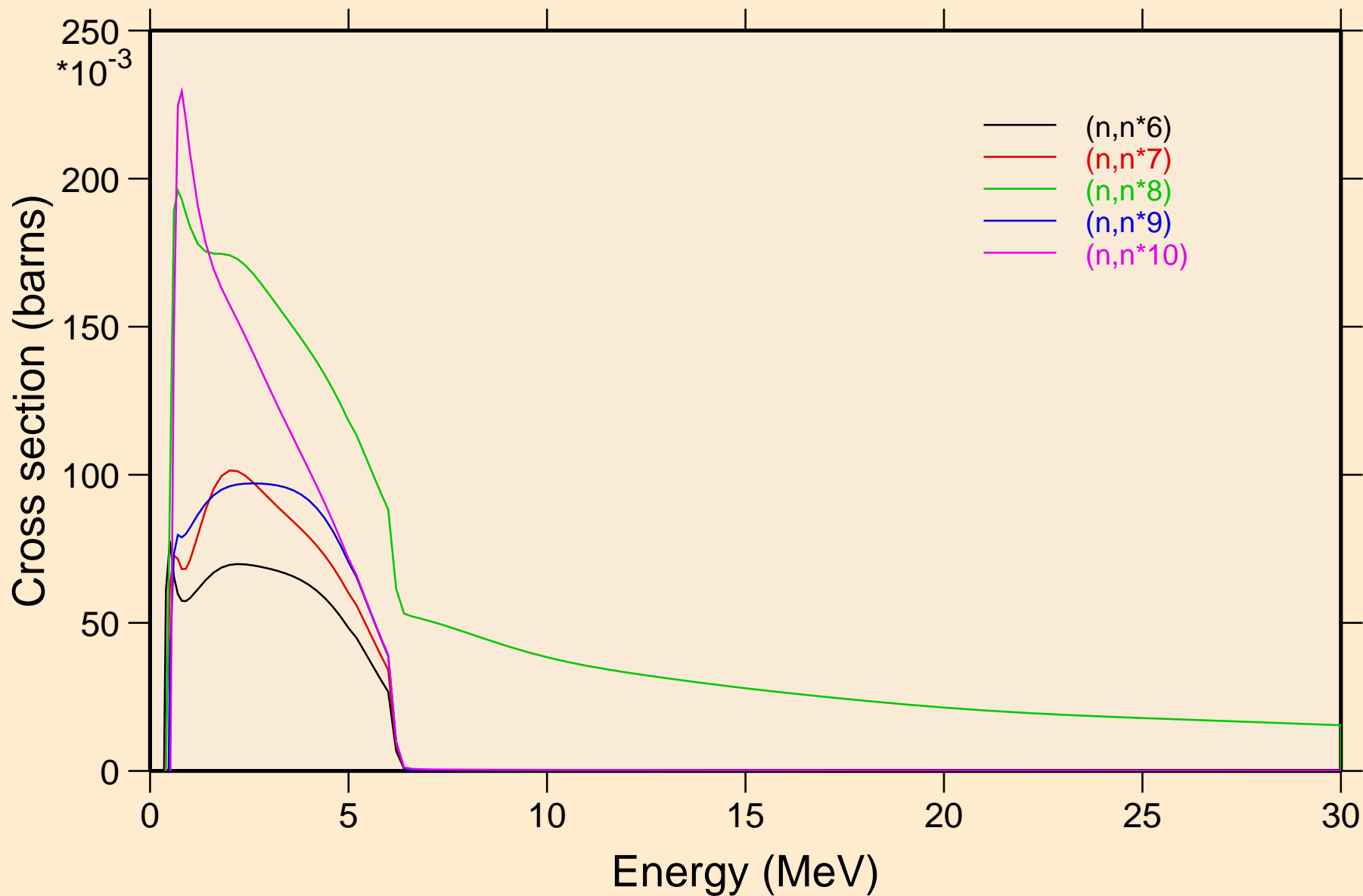

MO105 NEUTRON ACER TENDL-2019 LIBRARY; T=293.16K
Inelastic levels

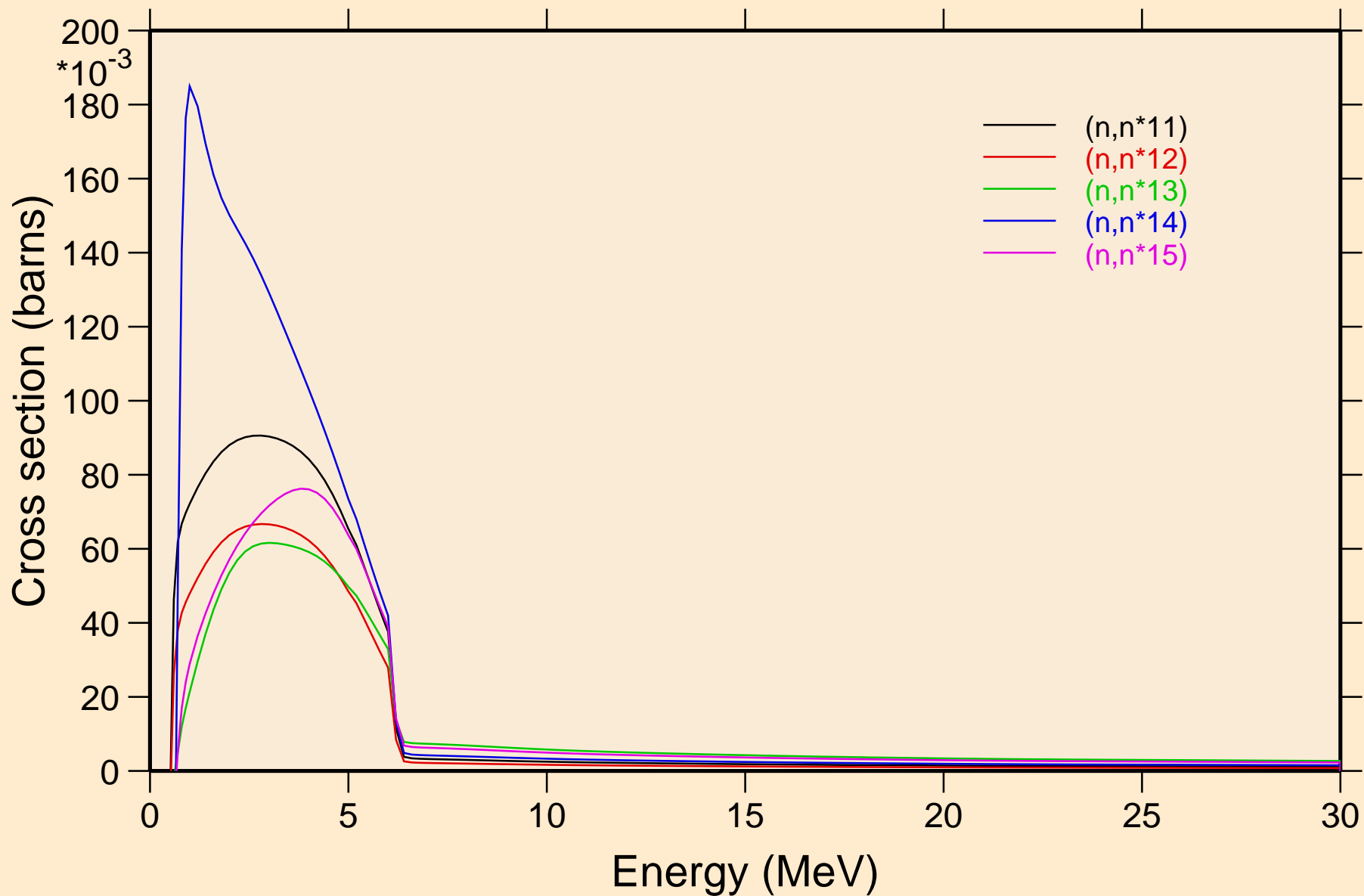

MO105 NEUTRON ACER TENDL-2019 LIBRARY; T=293.16K
Inelastic levels

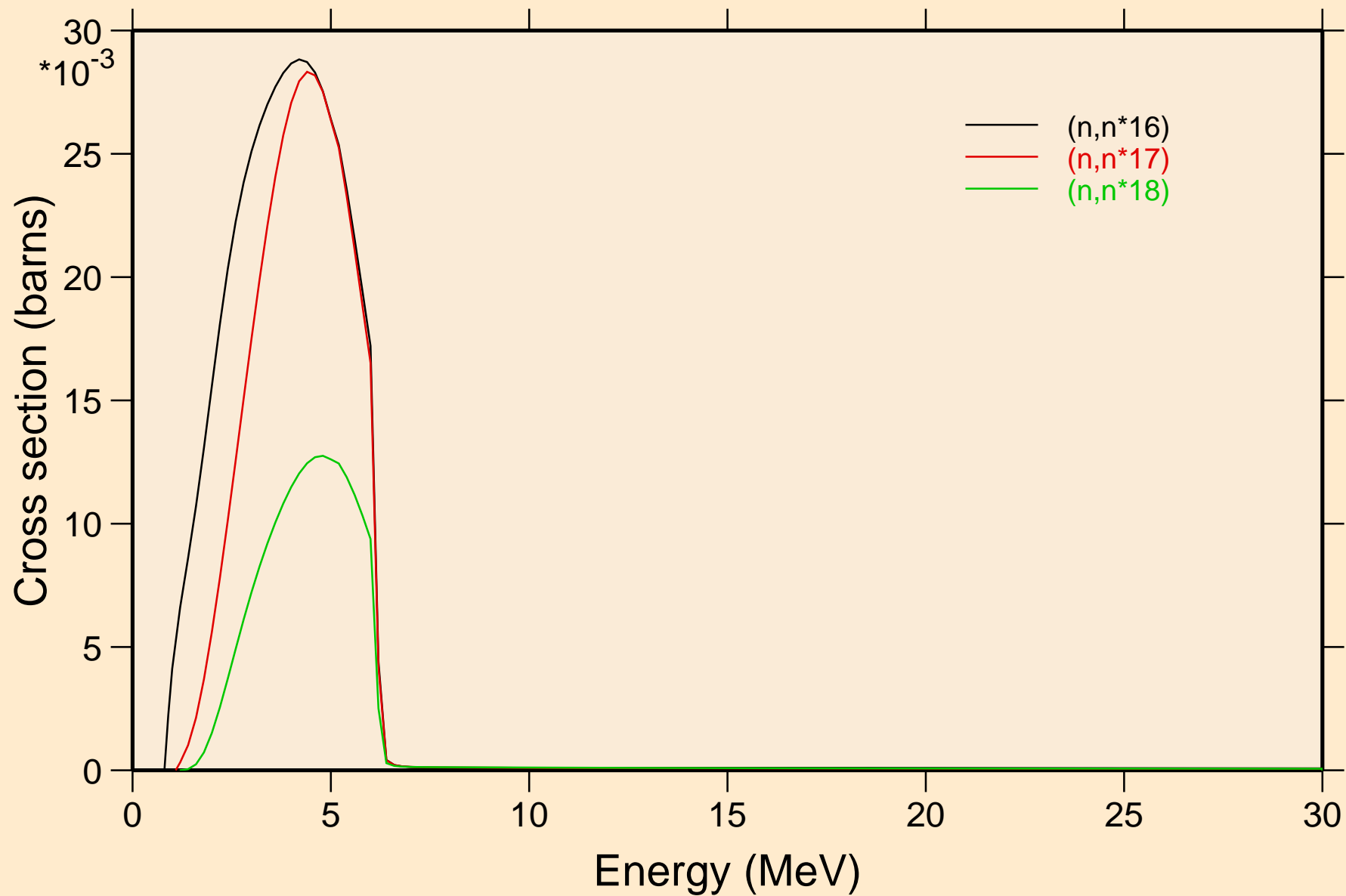

MO105 NEUTRON ACER TENDL-2019 LIBRARY; T=293.16K
Threshold reactions

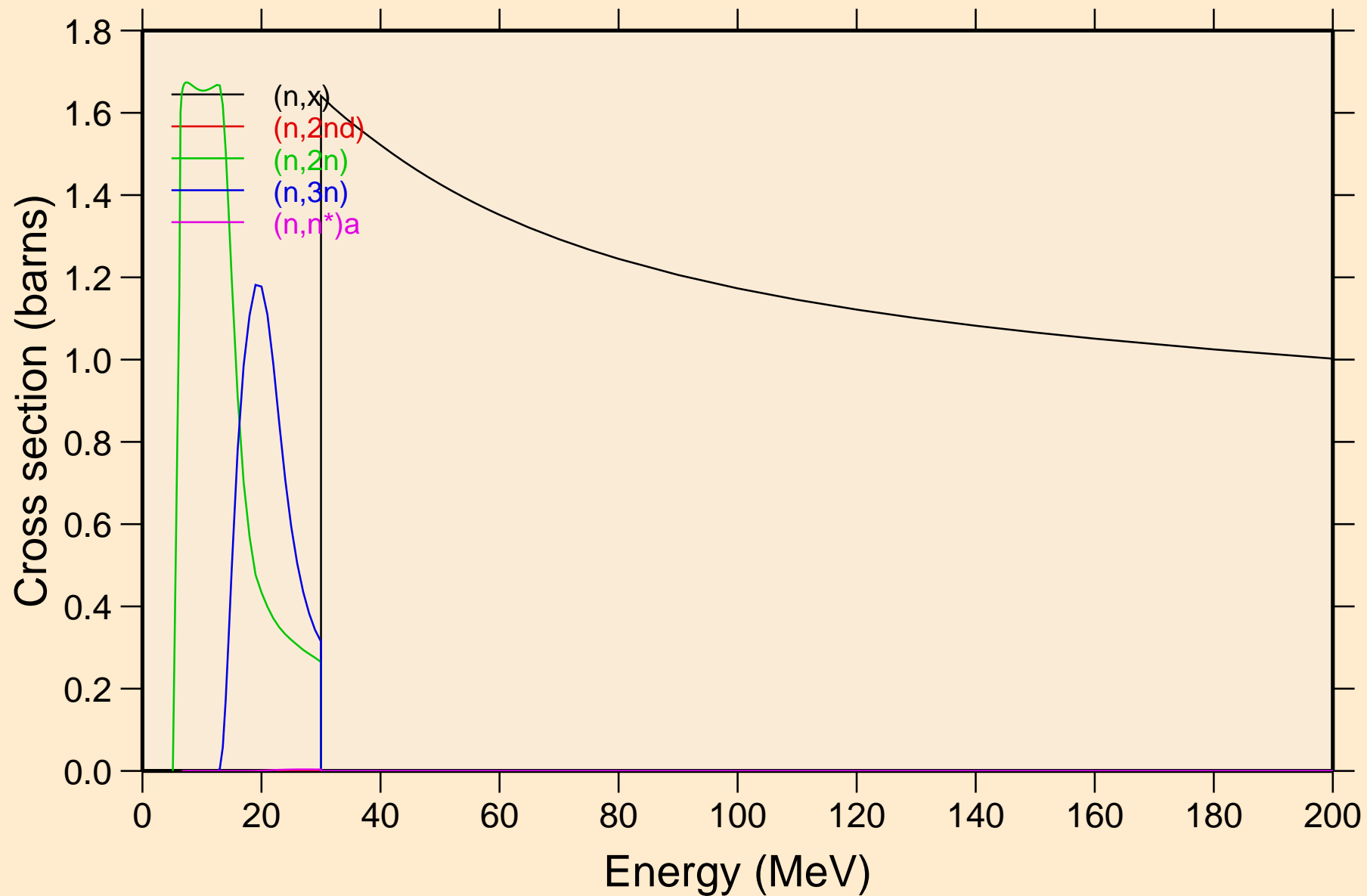

MO105 NEUTRON ACER TENDL-2019 LIBRARY; T=293.16K
Threshold reactions

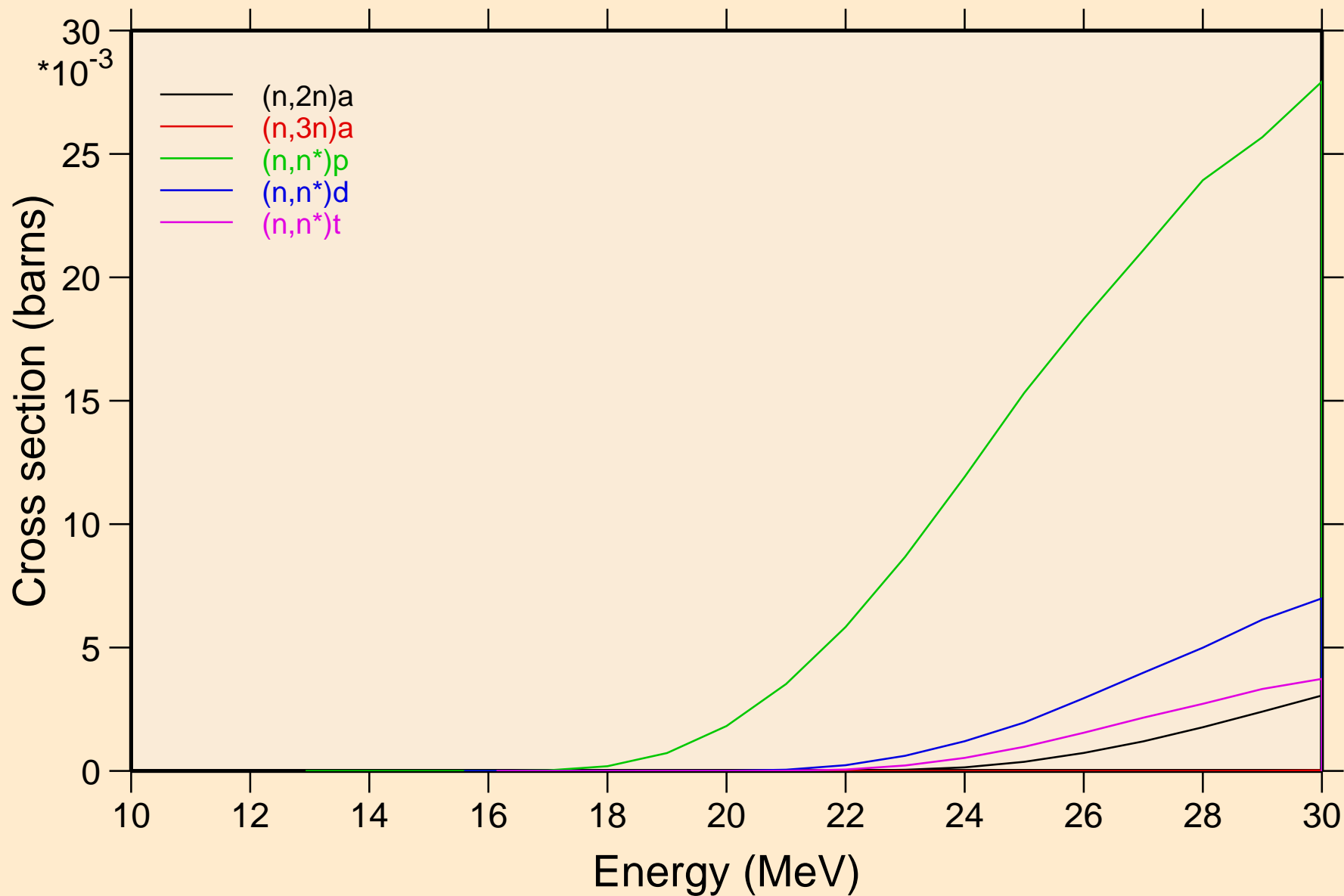

MO105 NEUTRON ACER TENDL-2019 LIBRARY; T=293.16K
Threshold reactions

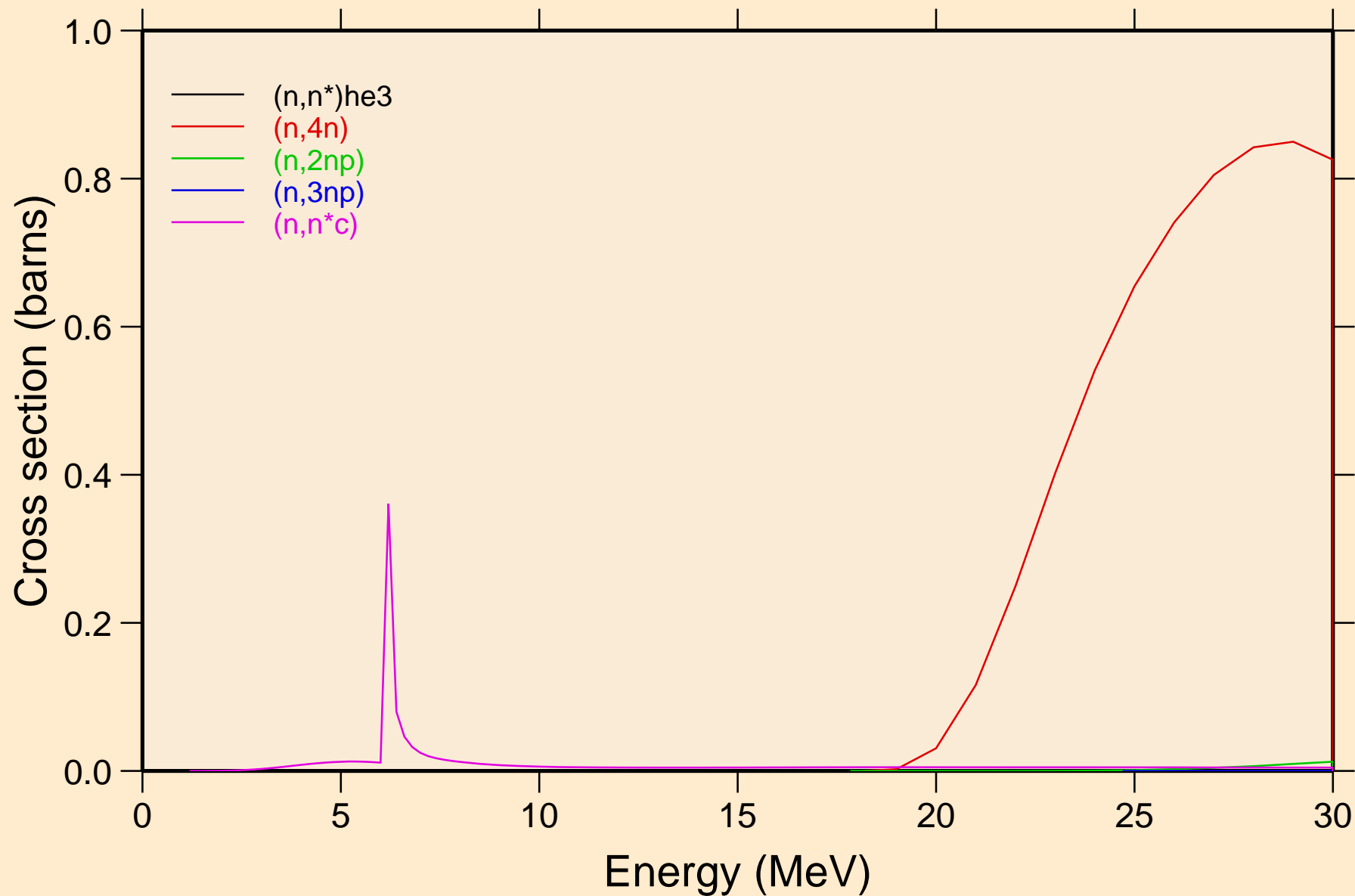

MO105 NEUTRON ACER TENDL-2019 LIBRARY; T=293.16K
Threshold reactions

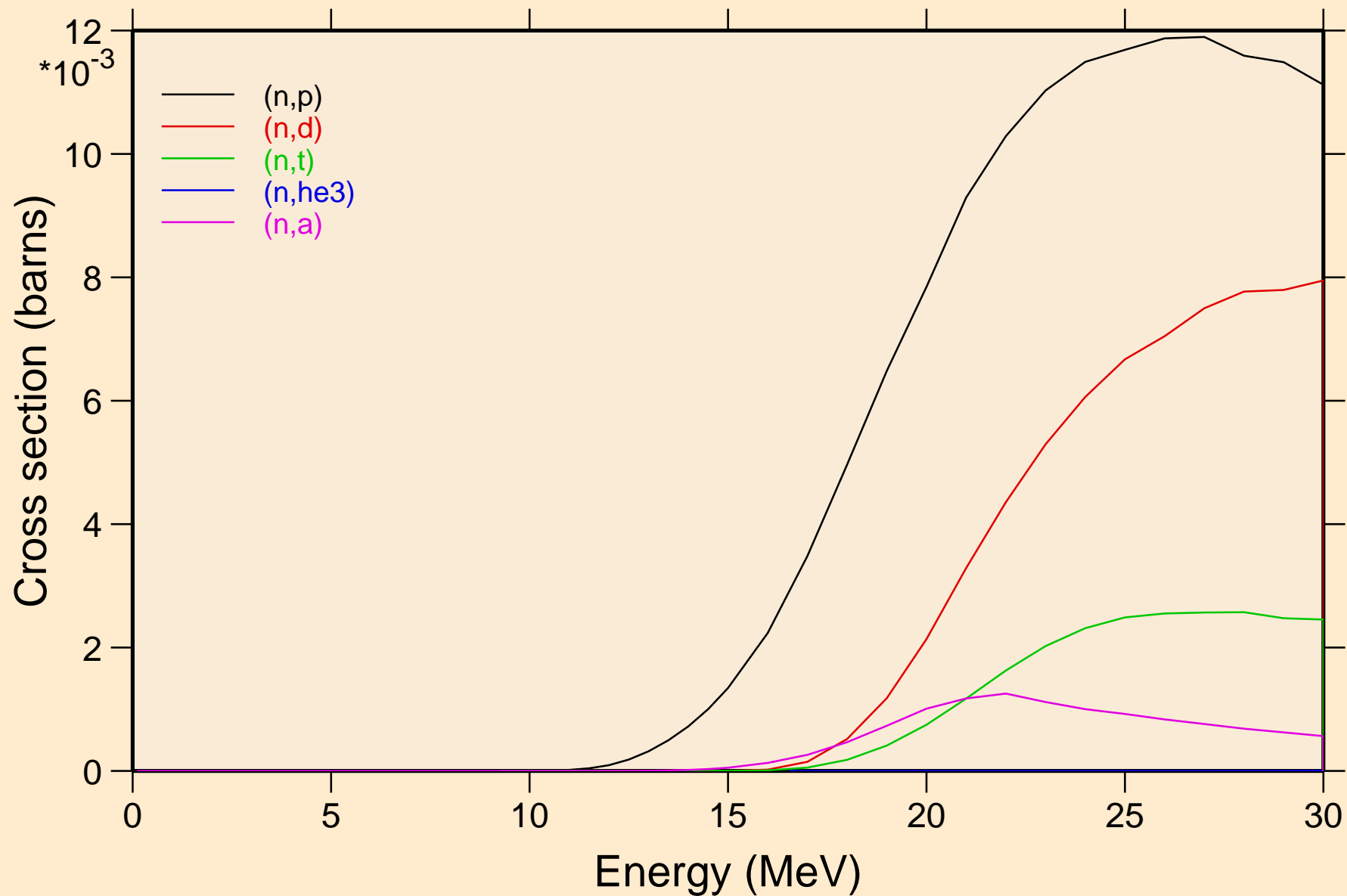

MO105 NEUTRON ACER TENDL-2019 LIBRARY; T=293.16K
Threshold reactions

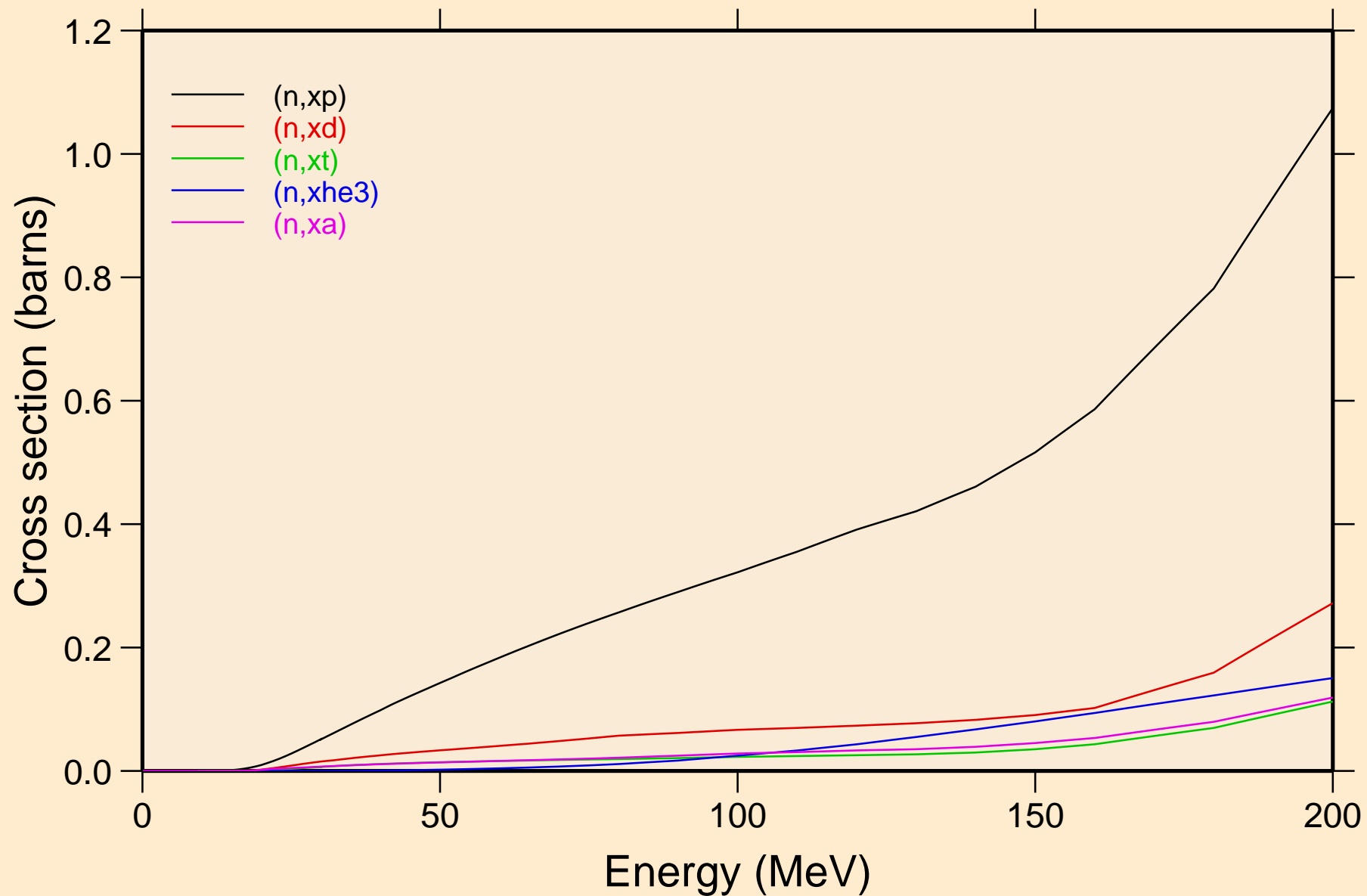

MO105 NEUTRON ACER TENDL-2019 LIBRARY; T=293.16K
angular distribution for elastic

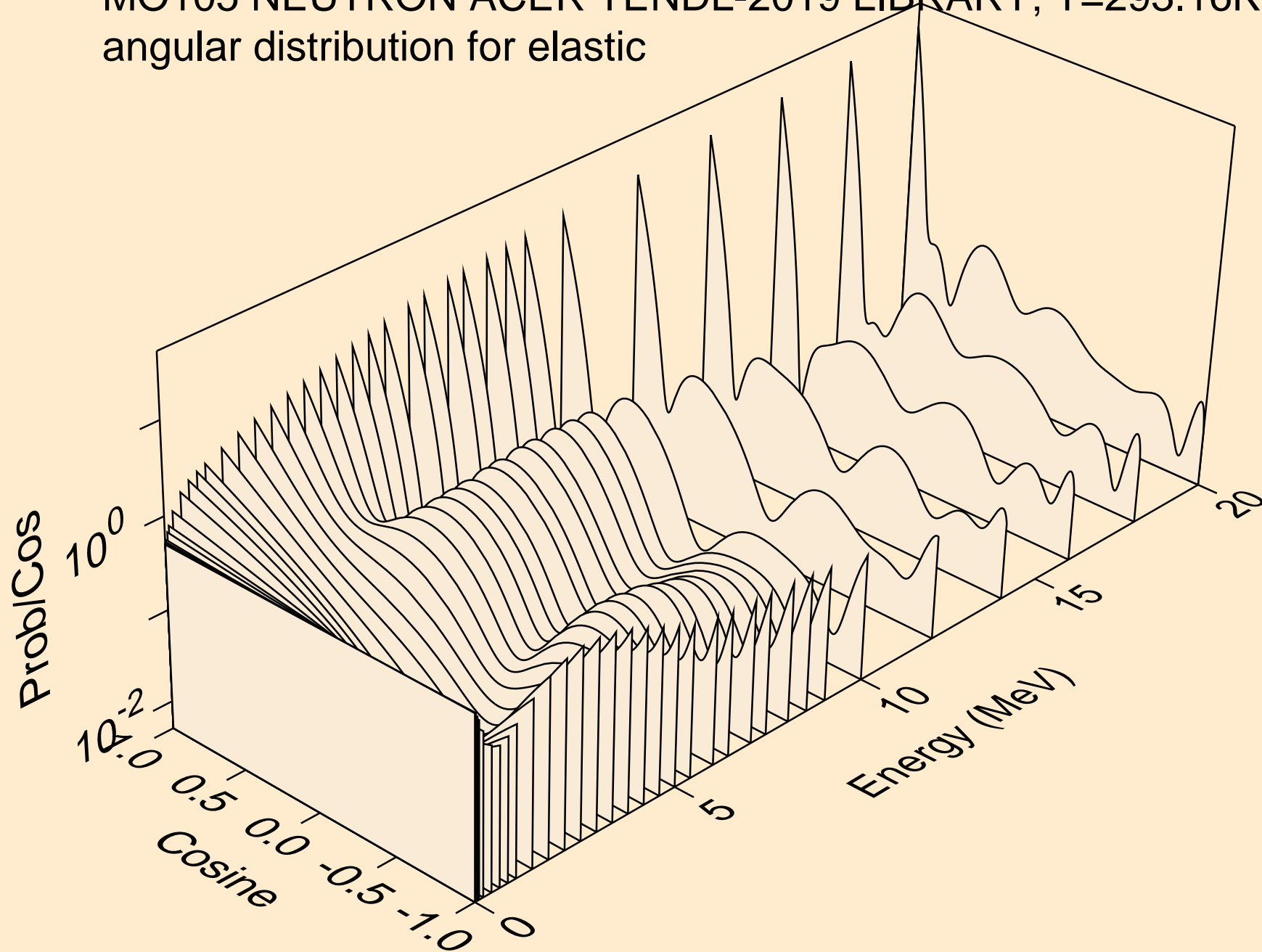

MO105 NEUTRON ACER TENDL-2019 LIBRARY; T=293.16K
angular distribution for elastic

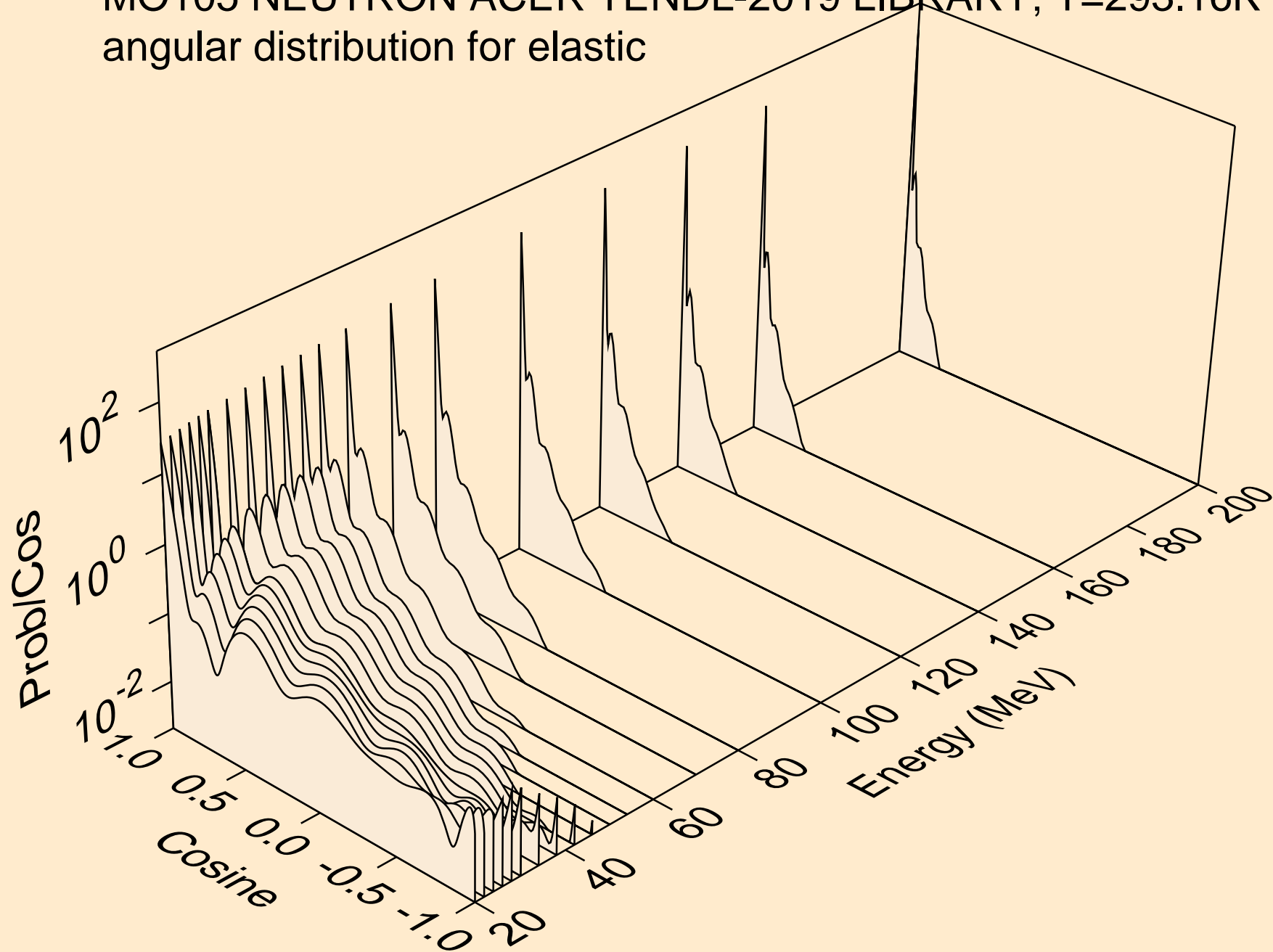

MO105 NEUTRON ACER TENDL-2019 LIBRARY; T=293.16K
angular distribution for (n,n*1)

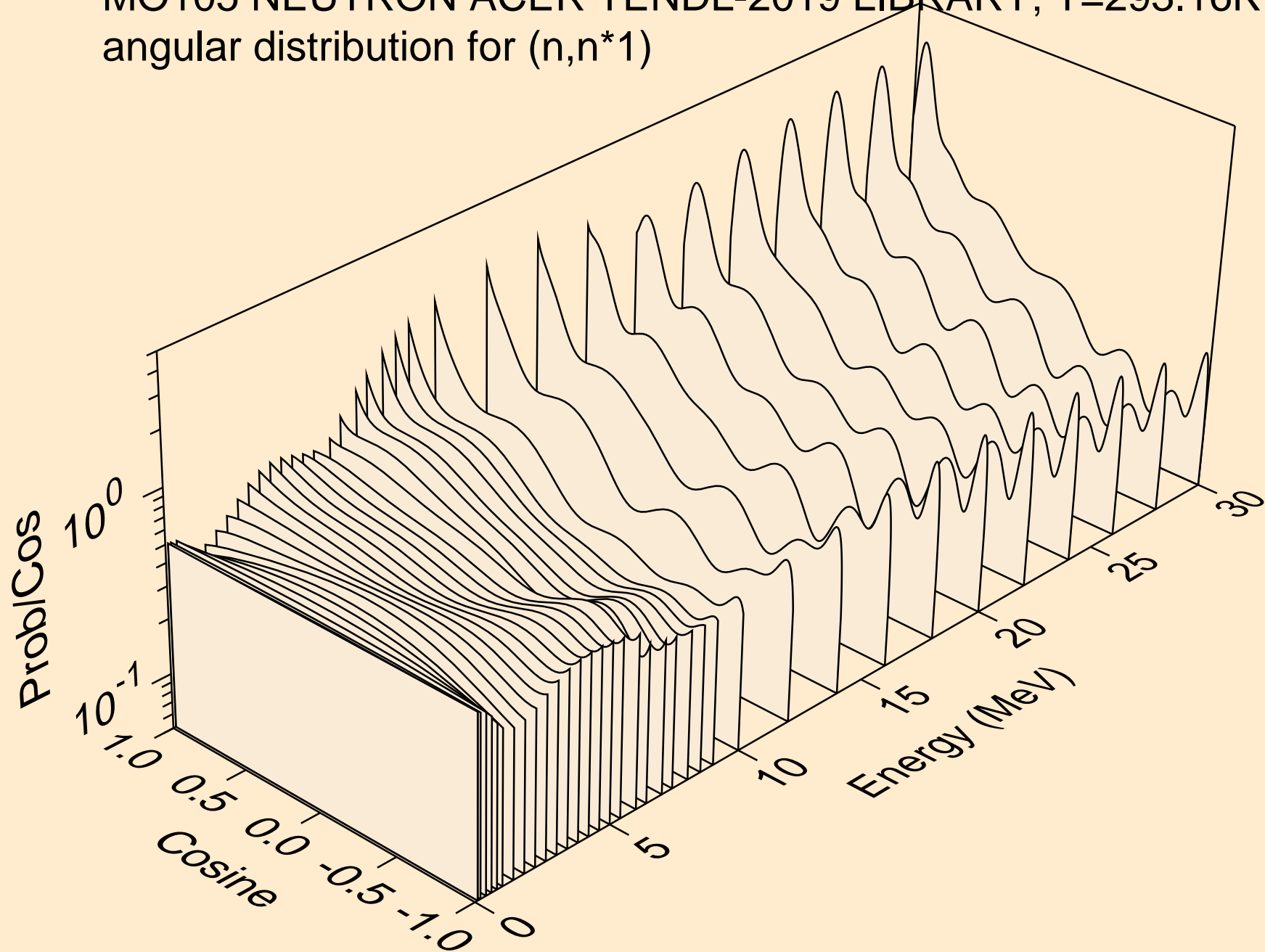

MO105 NEUTRON ACER TENDL-2019 LIBRARY; T=293.16K
angular distribution for (n,n*2)

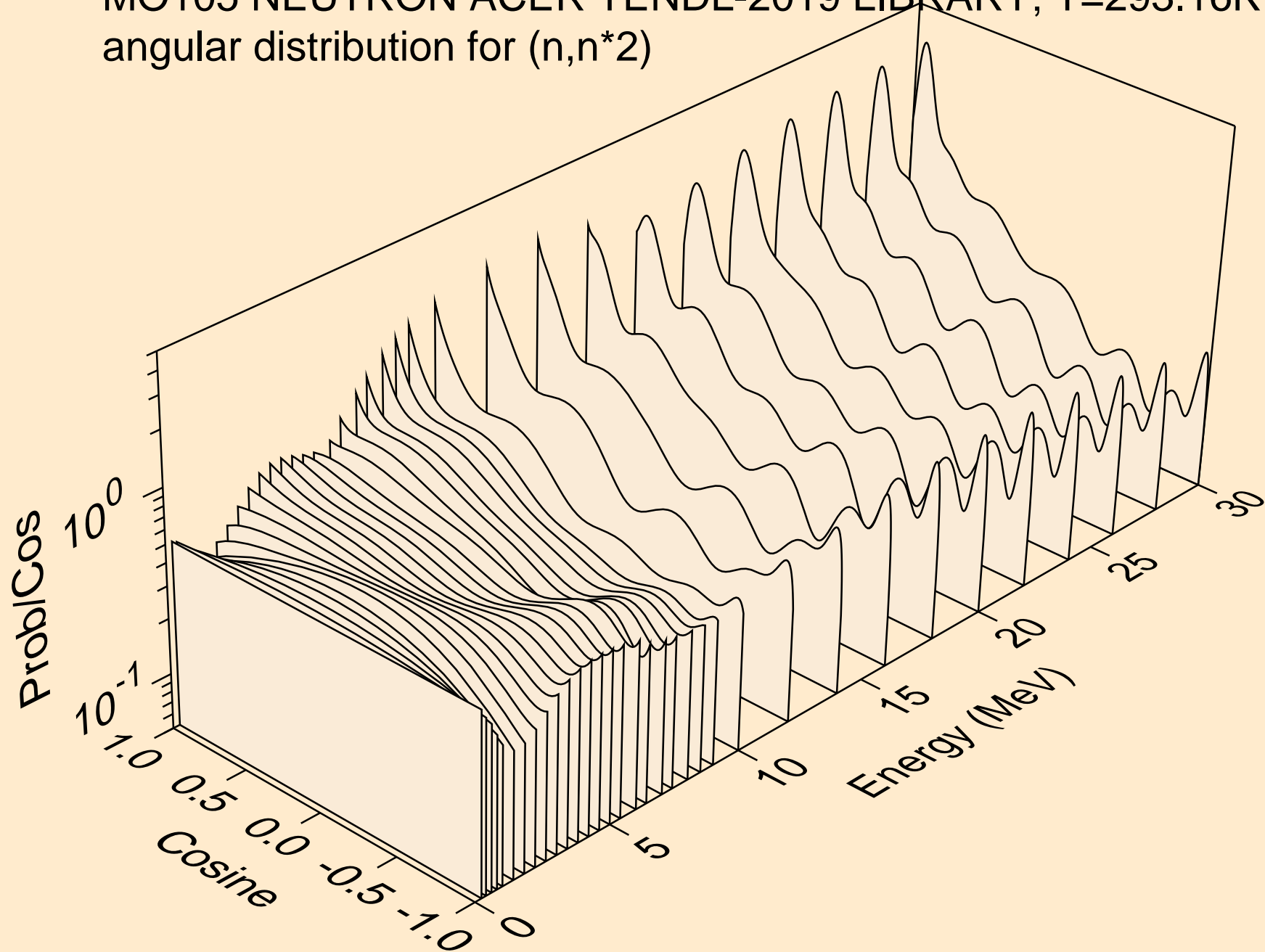

MO105 NEUTRON ACER TENDL-2019 LIBRARY; T=293.16K
angular distribution for (n,n*3)

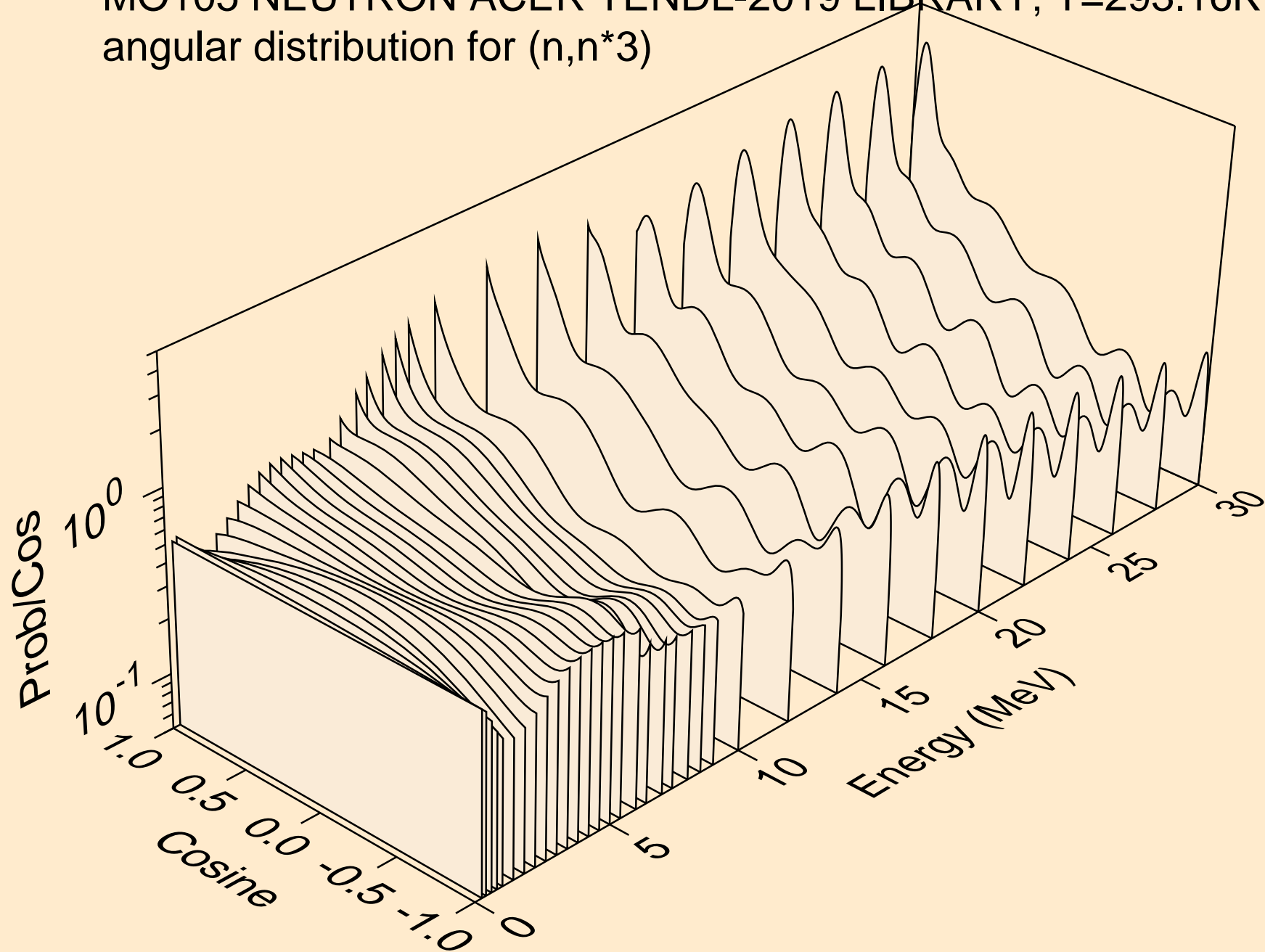

MO105 NEUTRON ACER TENDL-2019 LIBRARY; T=293.16K
angular distribution for (n,n*4)

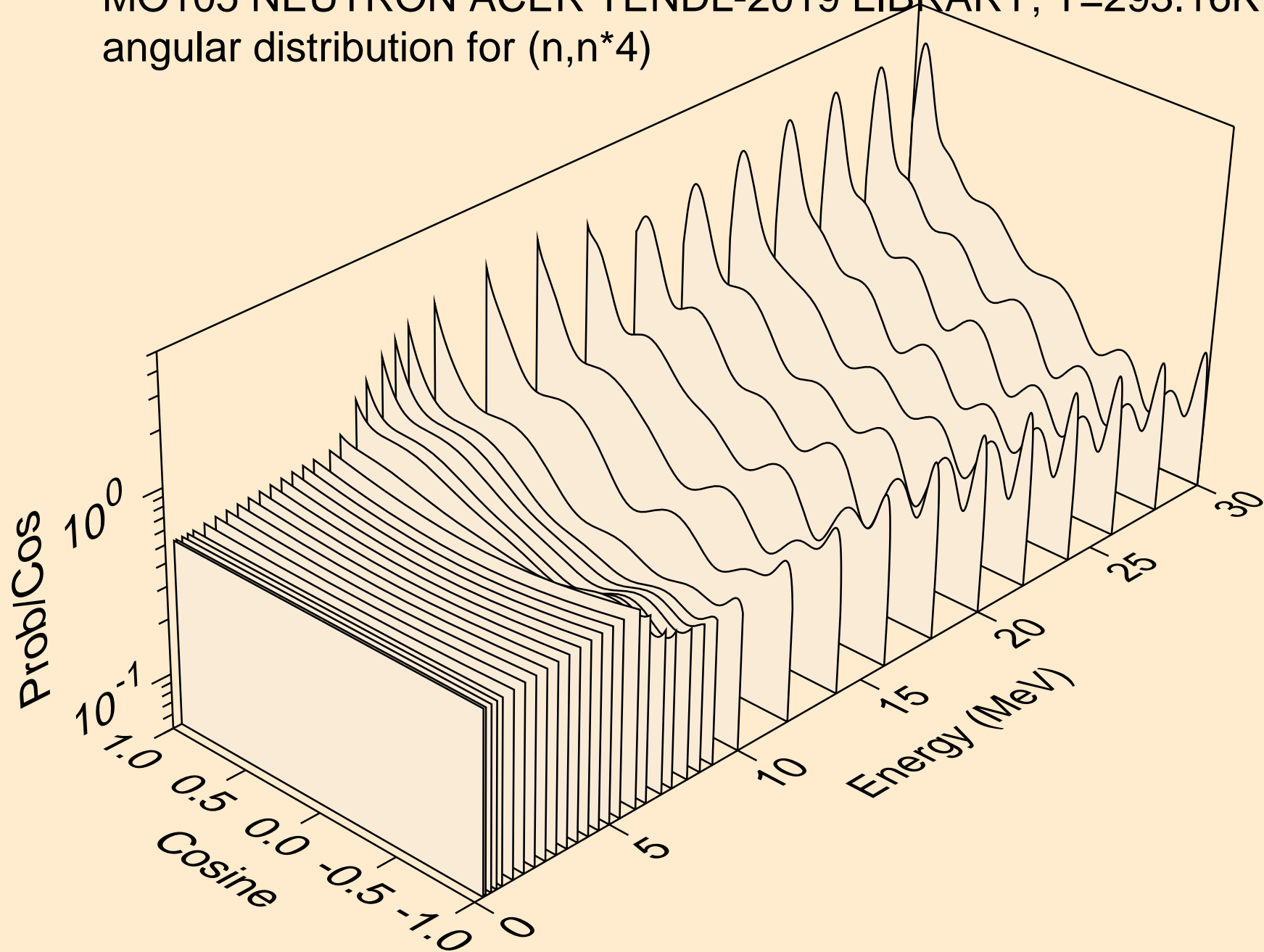

MO105 NEUTRON ACER TENDL-2019 LIBRARY; T=293.16K
angular distribution for (n,n*5)

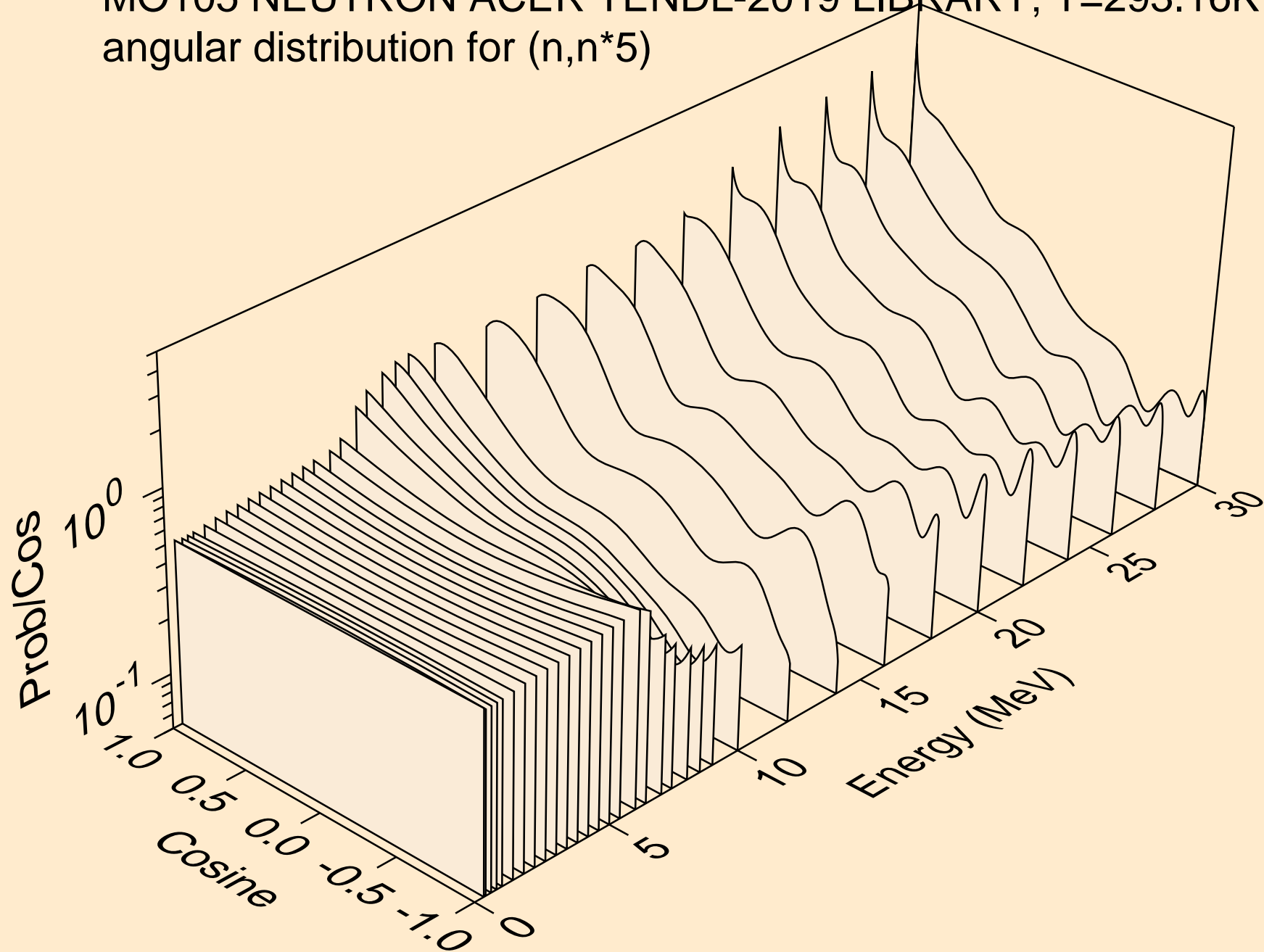

MO105 NEUTRON ACER TENDL-2019 LIBRARY; T=293.16K
angular distribution for (n,n*6)

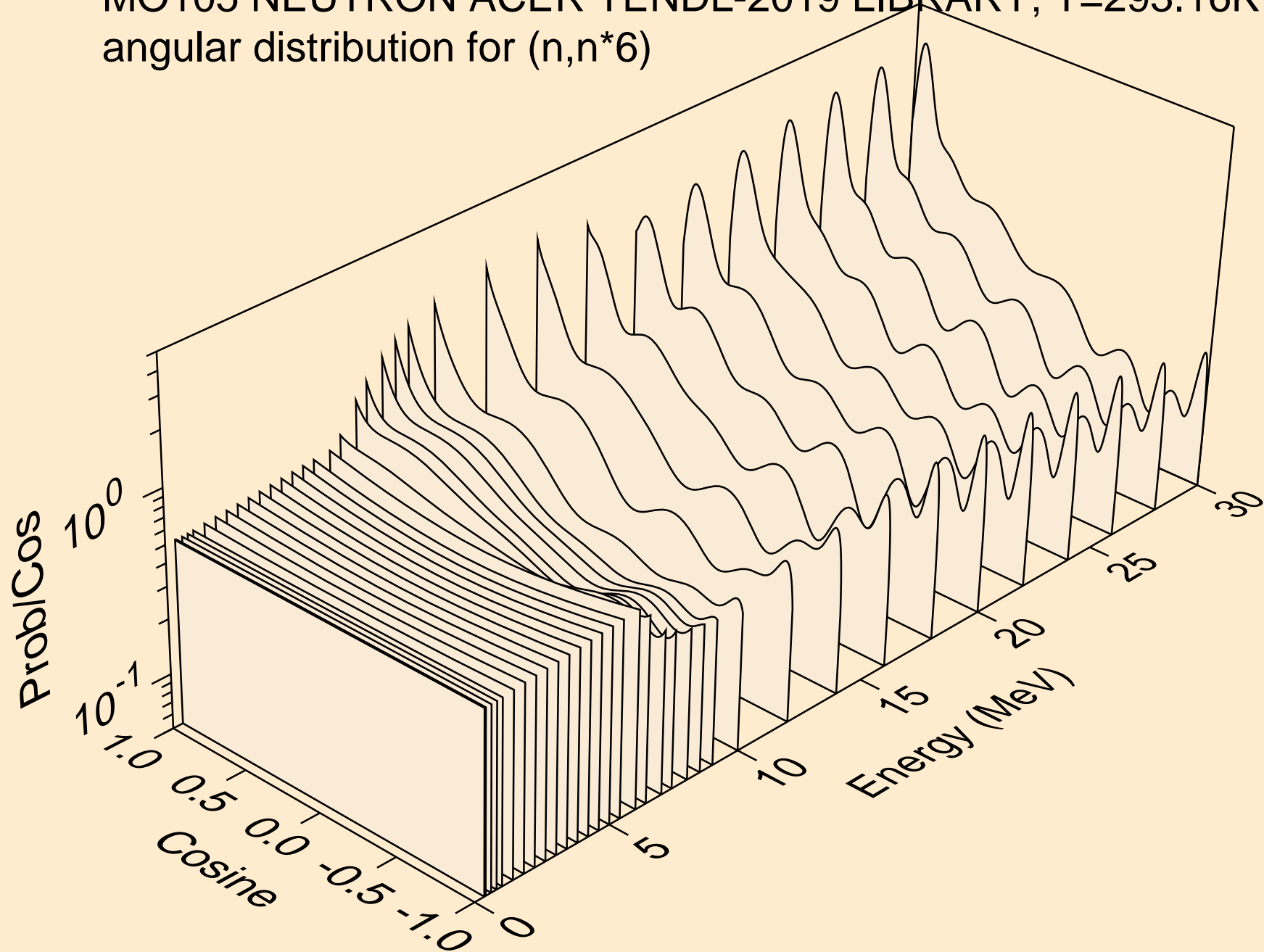

MO105 NEUTRON ACER TENDL-2019 LIBRARY; T=293.16K
angular distribution for (n,n*7)

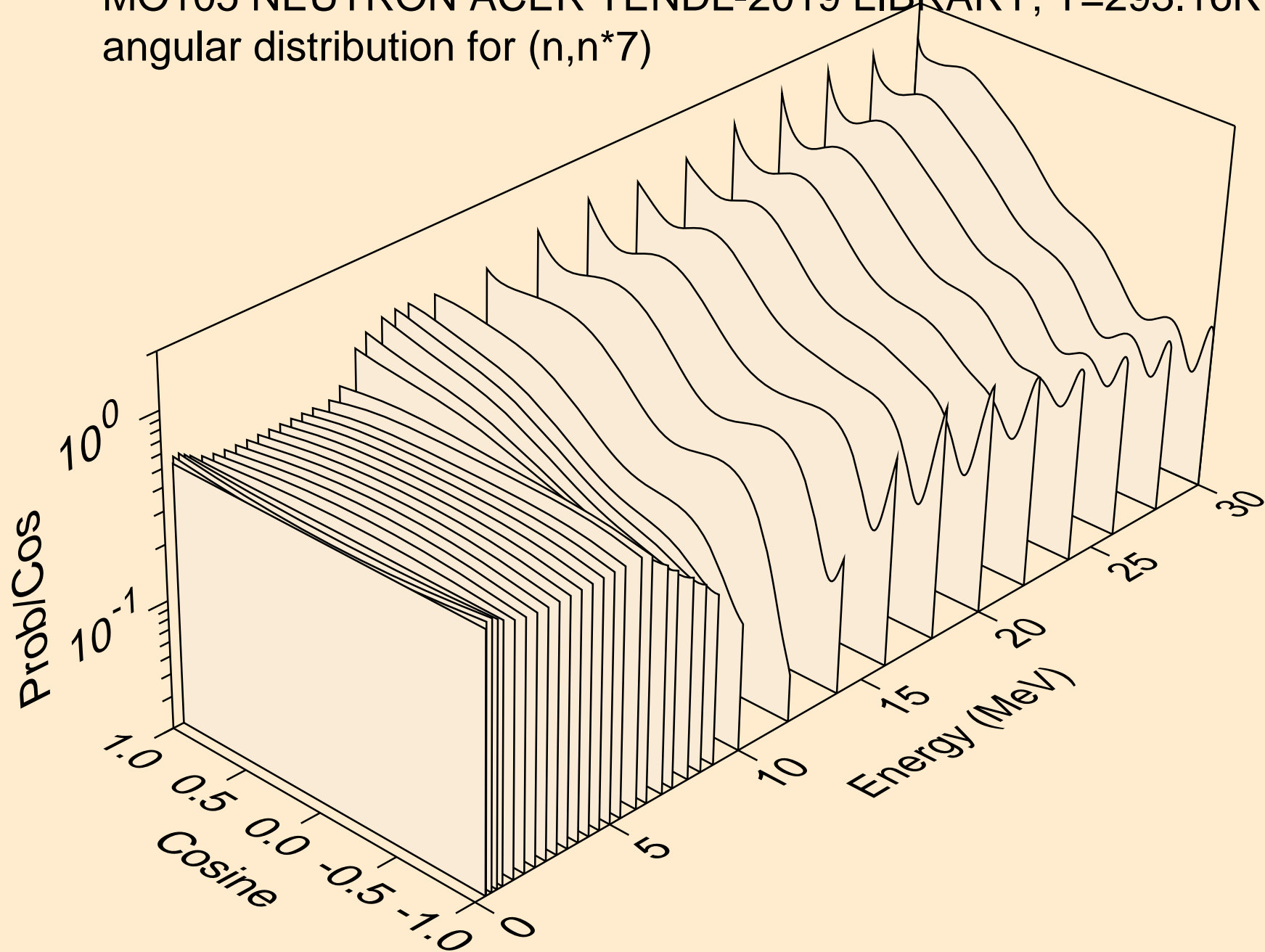

MO105 NEUTRON ACER TENDL-2019 LIBRARY; T=293.16K
angular distribution for (n,n*8)

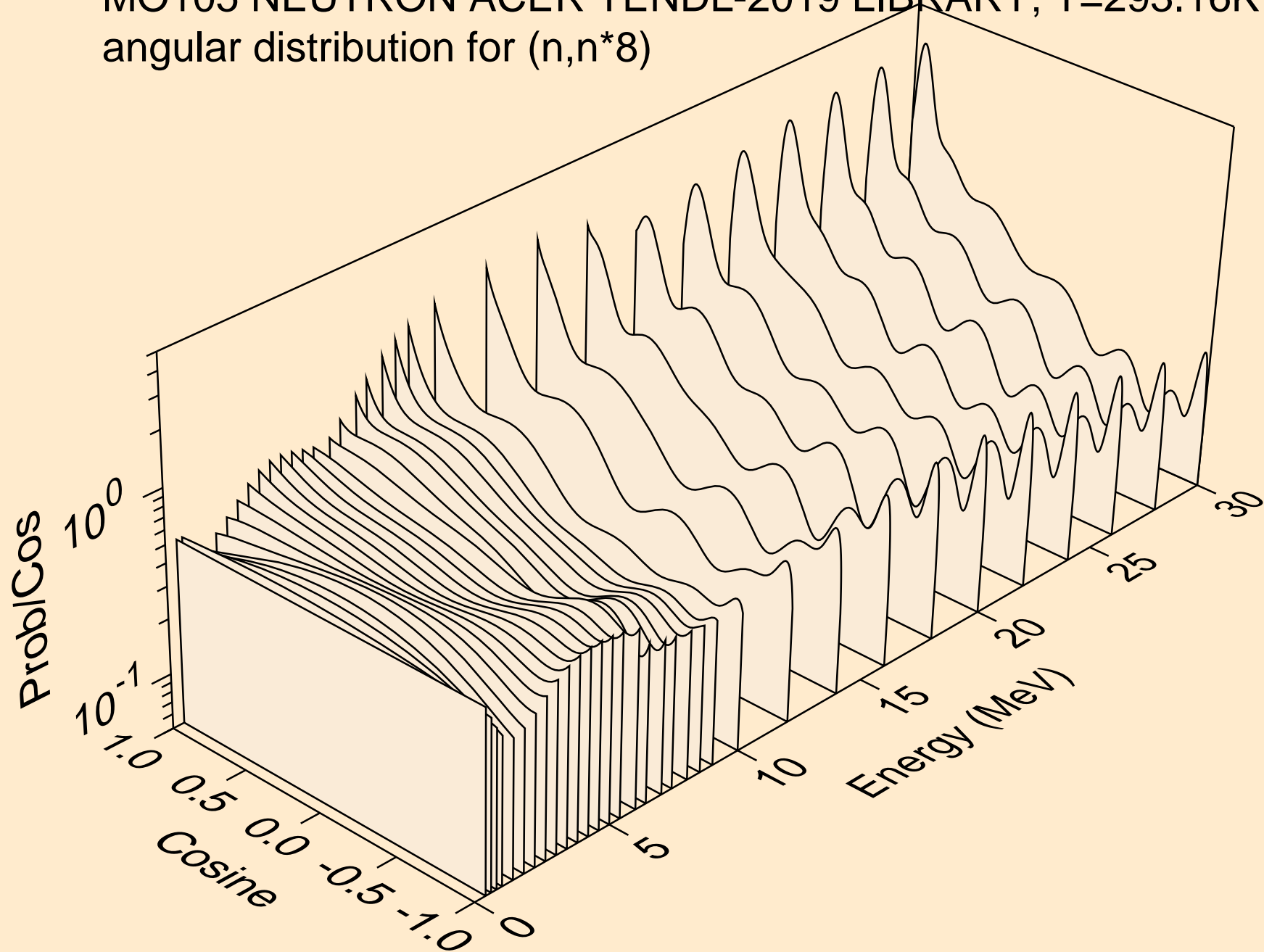

MO105 NEUTRON ACER TENDL-2019 LIBRARY; T=293.16K
angular distribution for (n,n*9)

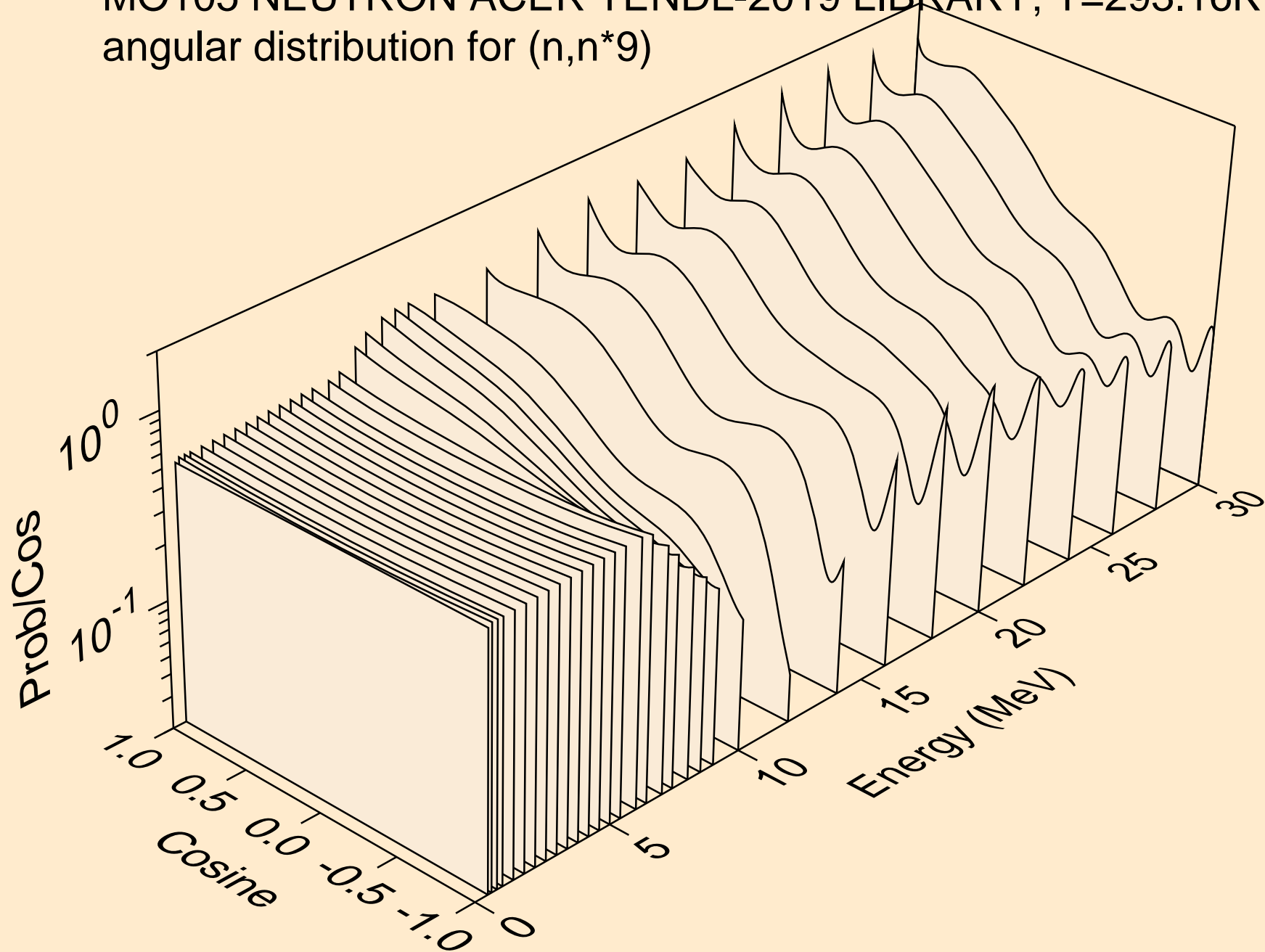

MO105 NEUTRON ACER TENDL-2019 LIBRARY; T=293.16K
angular distribution for (n,n*10)

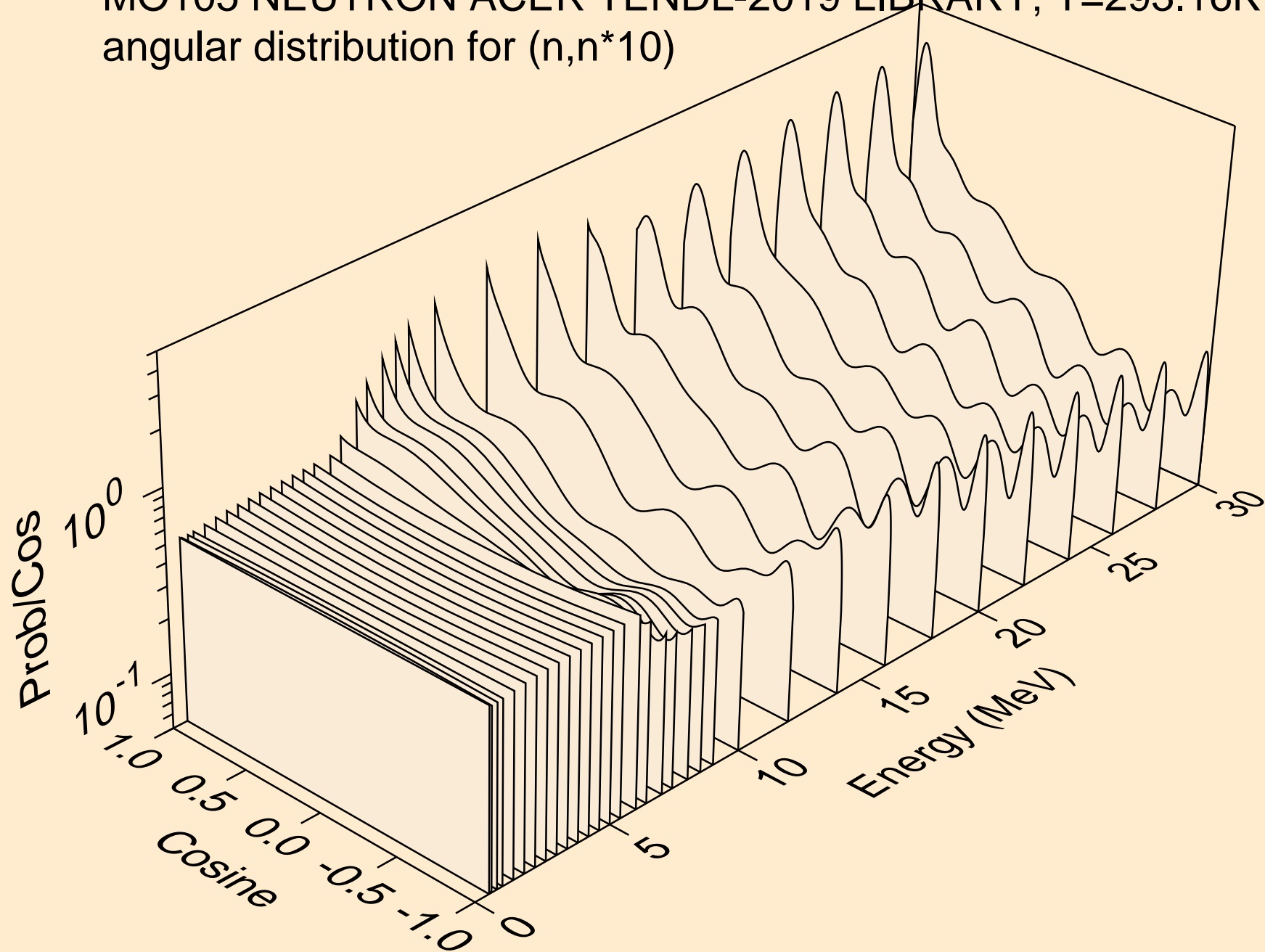

MO105 NEUTRON ACER TENDL-2019 LIBRARY; T=293.16K
angular distribution for (n,n*11)

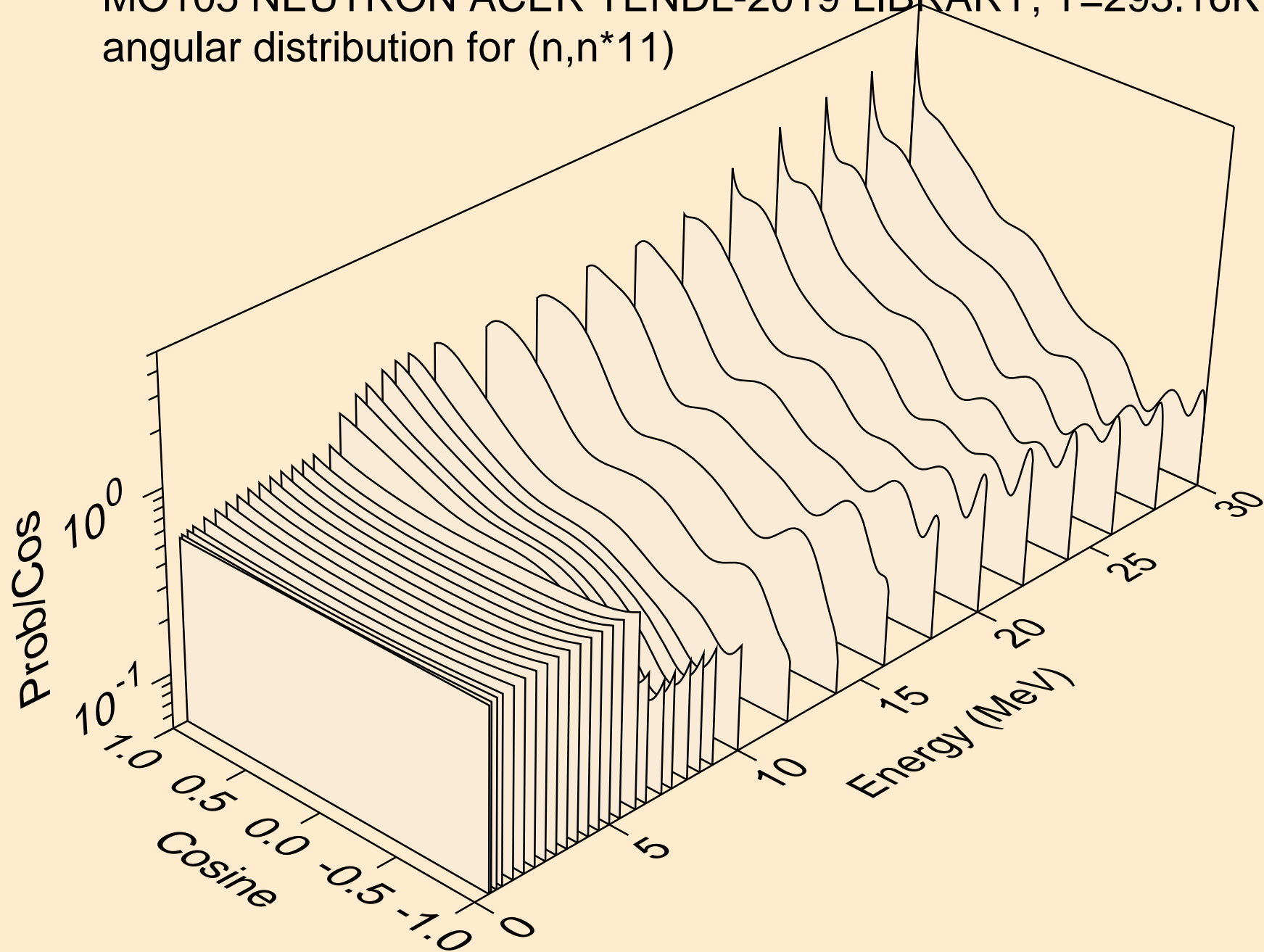

MO105 NEUTRON ACER TENDL-2019 LIBRARY; T=293.16K
angular distribution for (n,n*12)

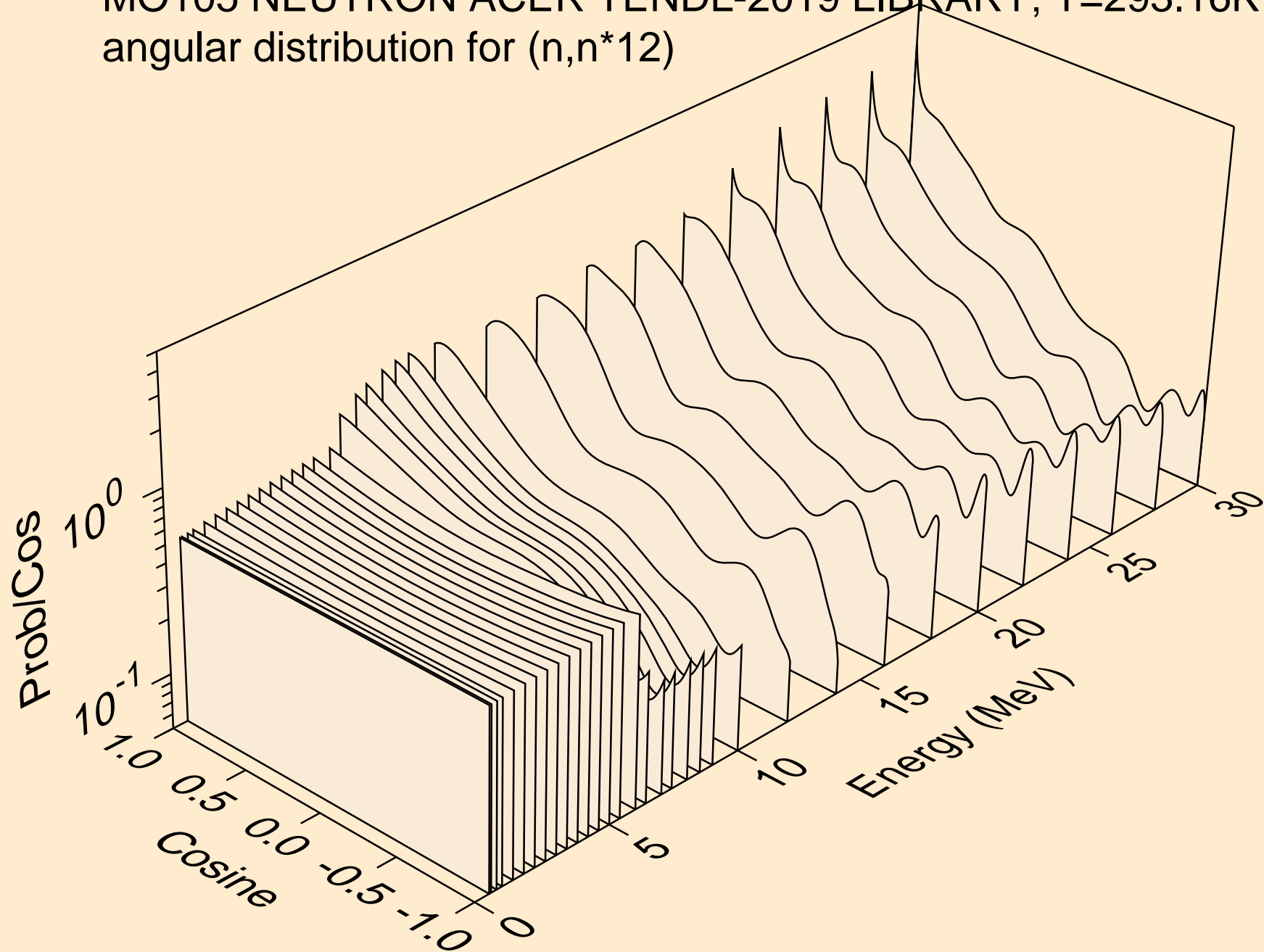

MO105 NEUTRON ACER TENDL-2019 LIBRARY; T=293.16K
angular distribution for (n,n*13)

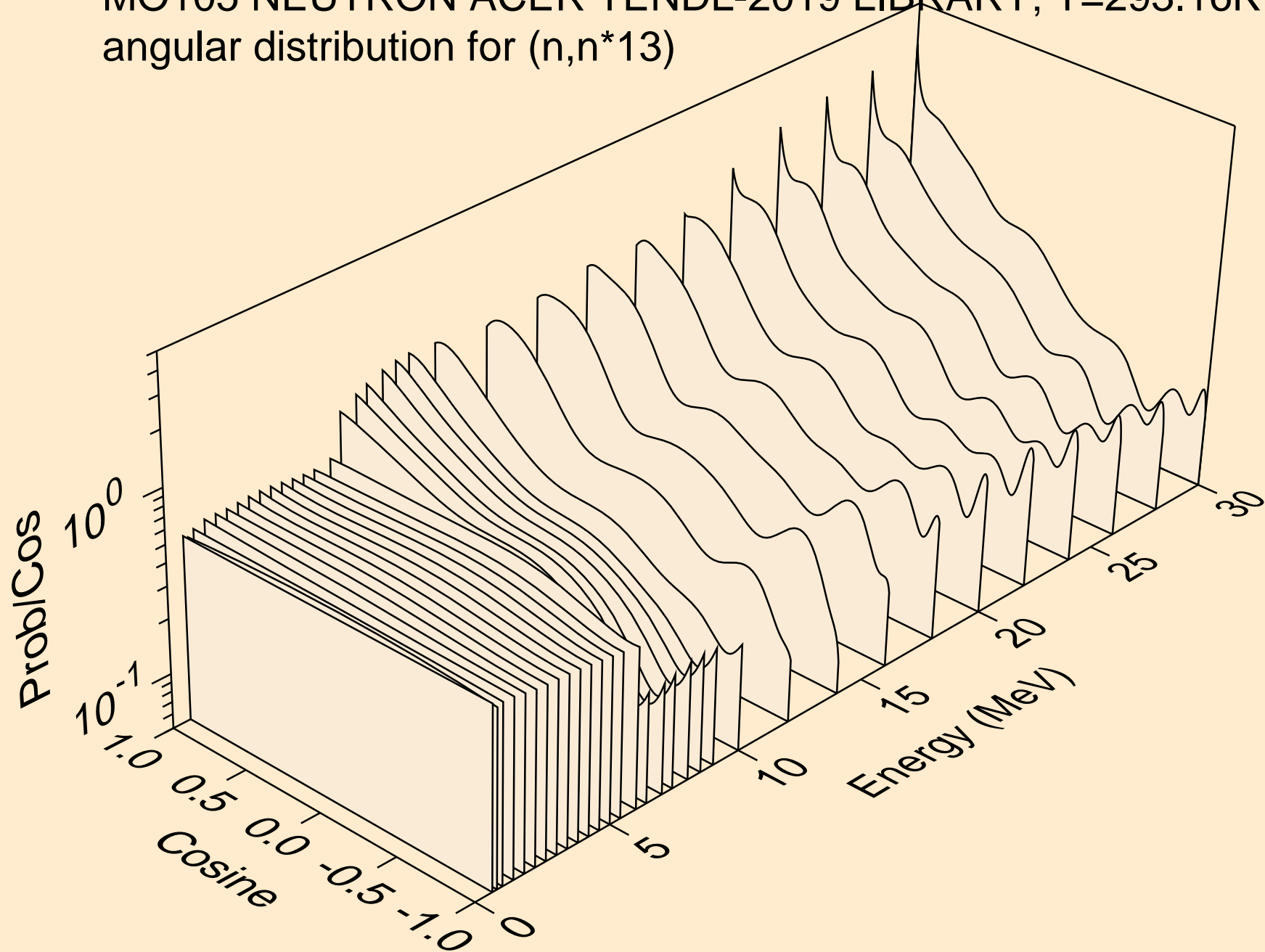

MO105 NEUTRON ACER TENDL-2019 LIBRARY; T=293.16K
angular distribution for (n,n*14)

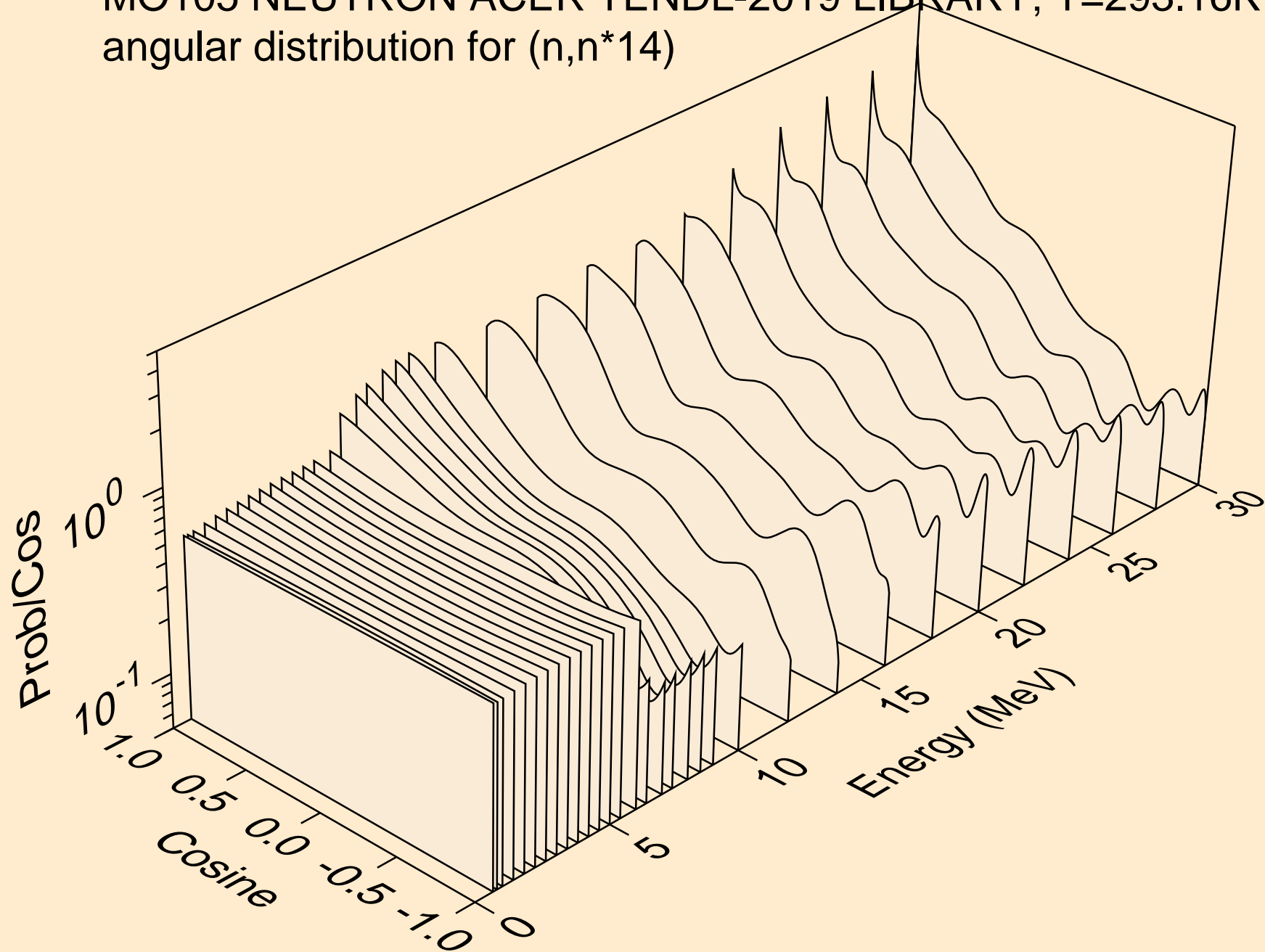

MO105 NEUTRON ACER TENDL-2019 LIBRARY; T=293.16K
angular distribution for (n,n*15)

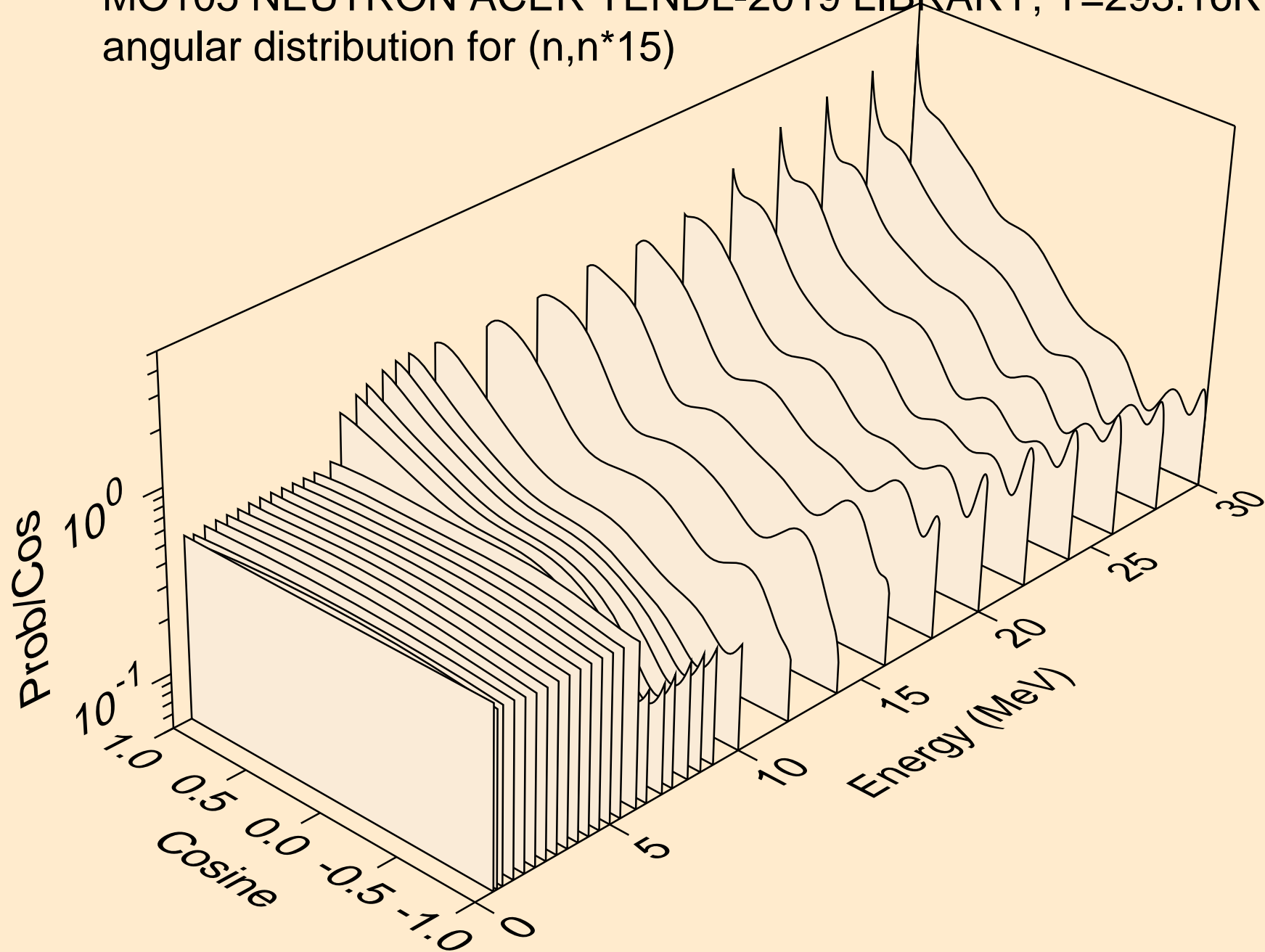

MO105 NEUTRON ACER TENDL-2019 LIBRARY; T=293.16K
angular distribution for (n,n*16)

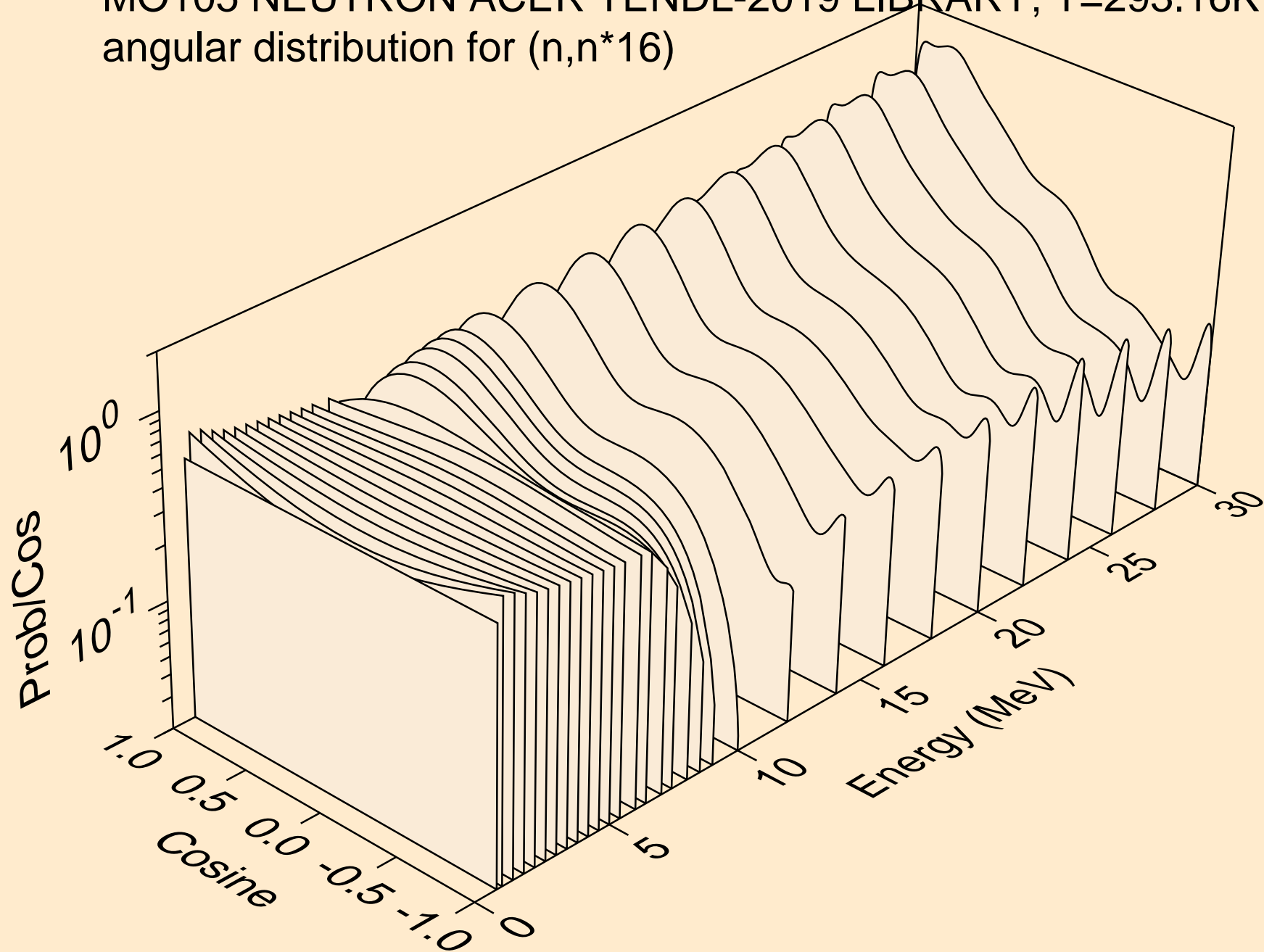

MO105 NEUTRON ACER TENDL-2019 LIBRARY; T=293.16K
angular distribution for (n,n*17)

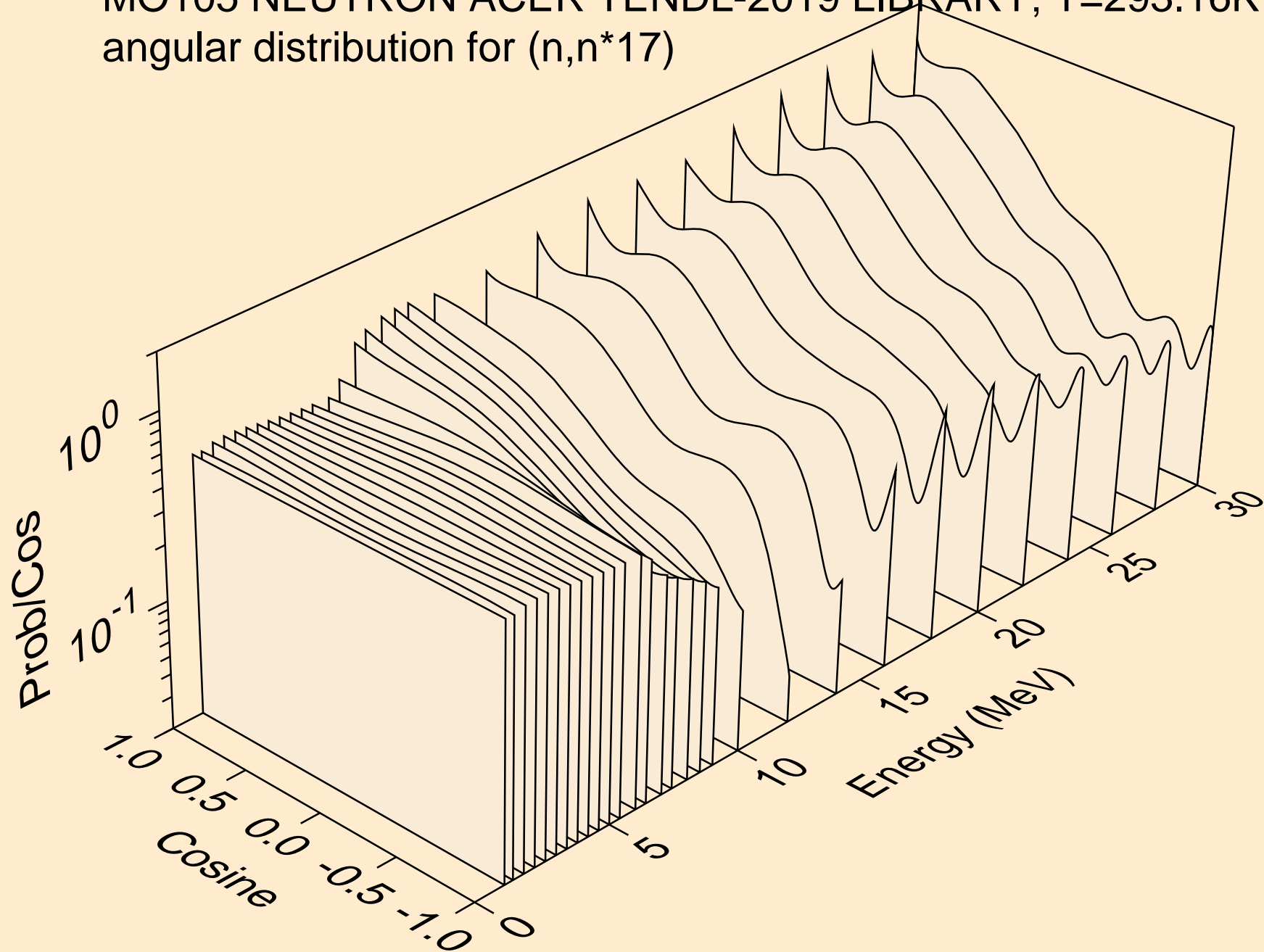

MO105 NEUTRON ACER TENDL-2019 LIBRARY; T=293.16K
angular distribution for (n,n*18)

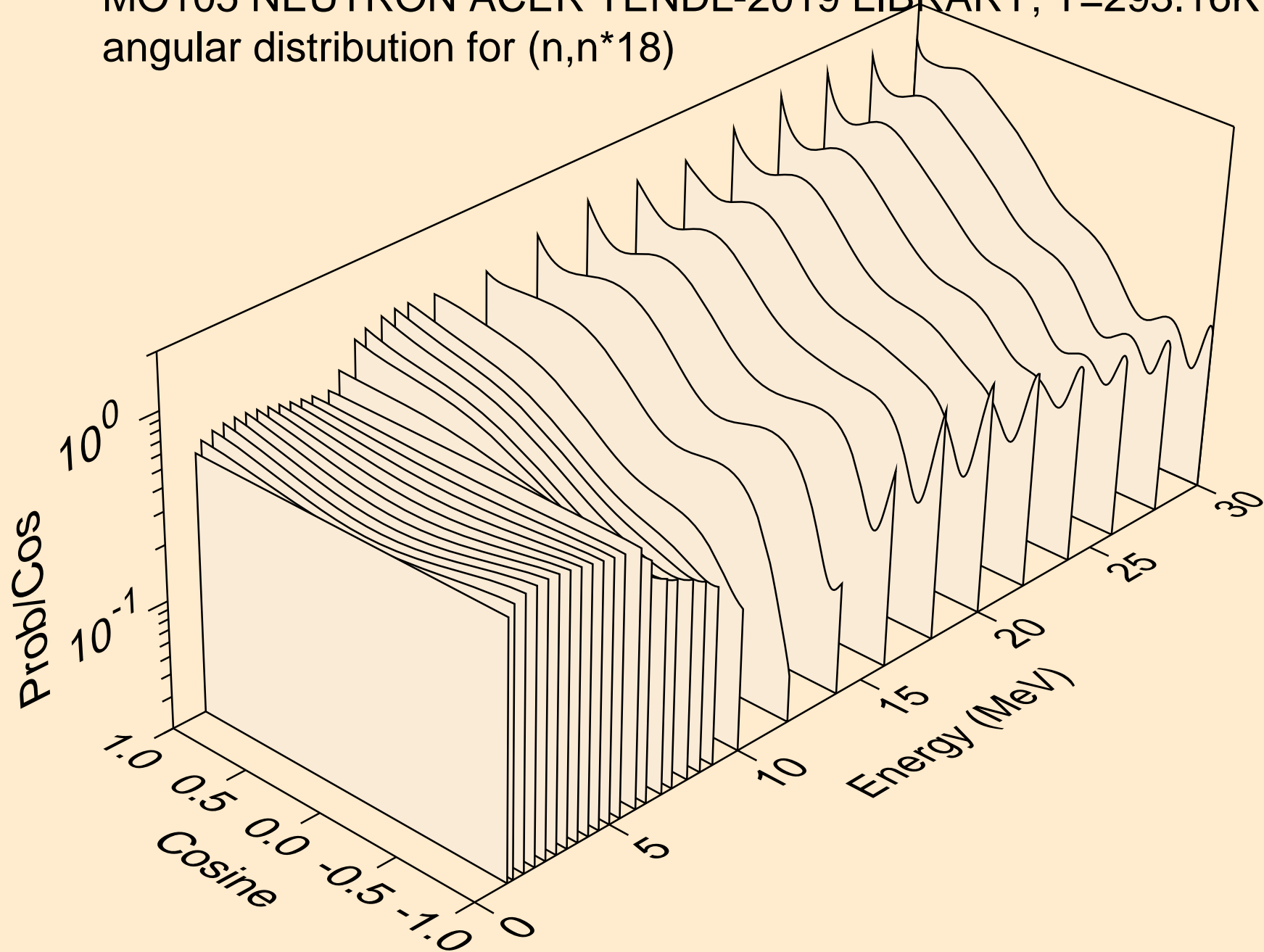

MO105 NEUTRON ACER TENDL-2019 LIBRARY; T=293.16K
Neutron emission for (n,x)

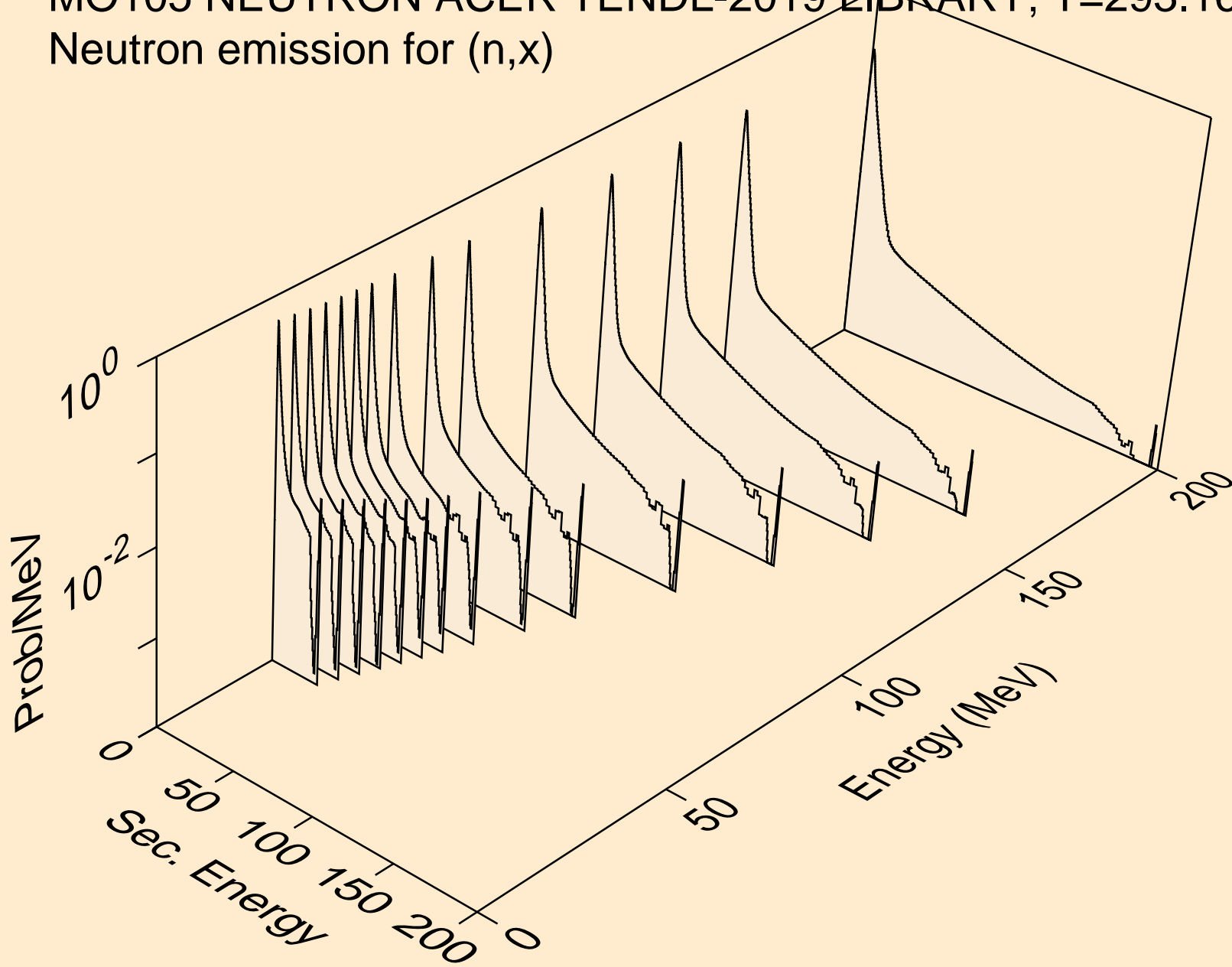

MO105 NEUTRON ACER TENDL-2019 LIBRARY; T=293.16K
Neutron emission for (n,2nd)

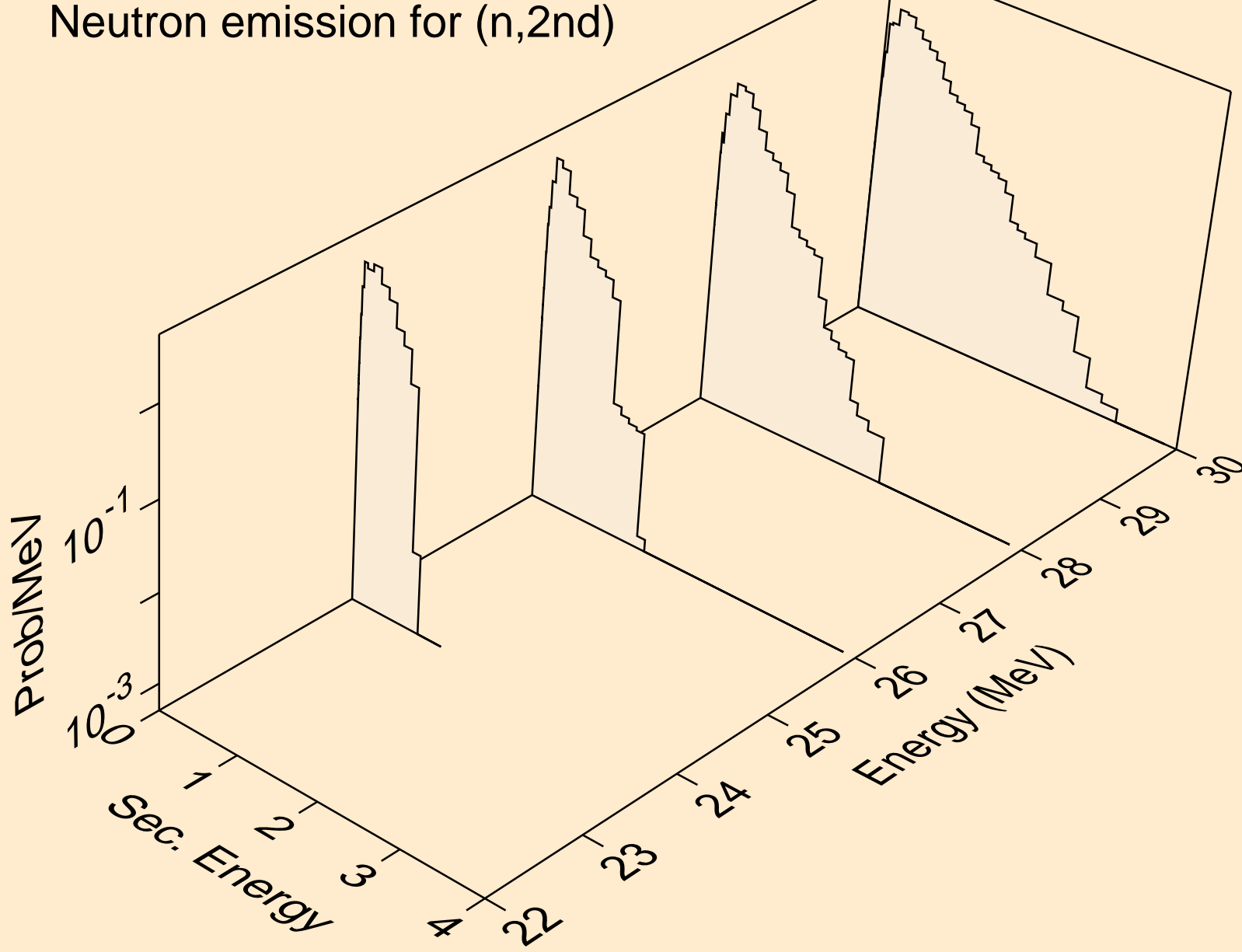

MO105 NEUTRON ACER TENDL-2019 LIBRARY; T=293.16K
Neutron emission for (n,2n)

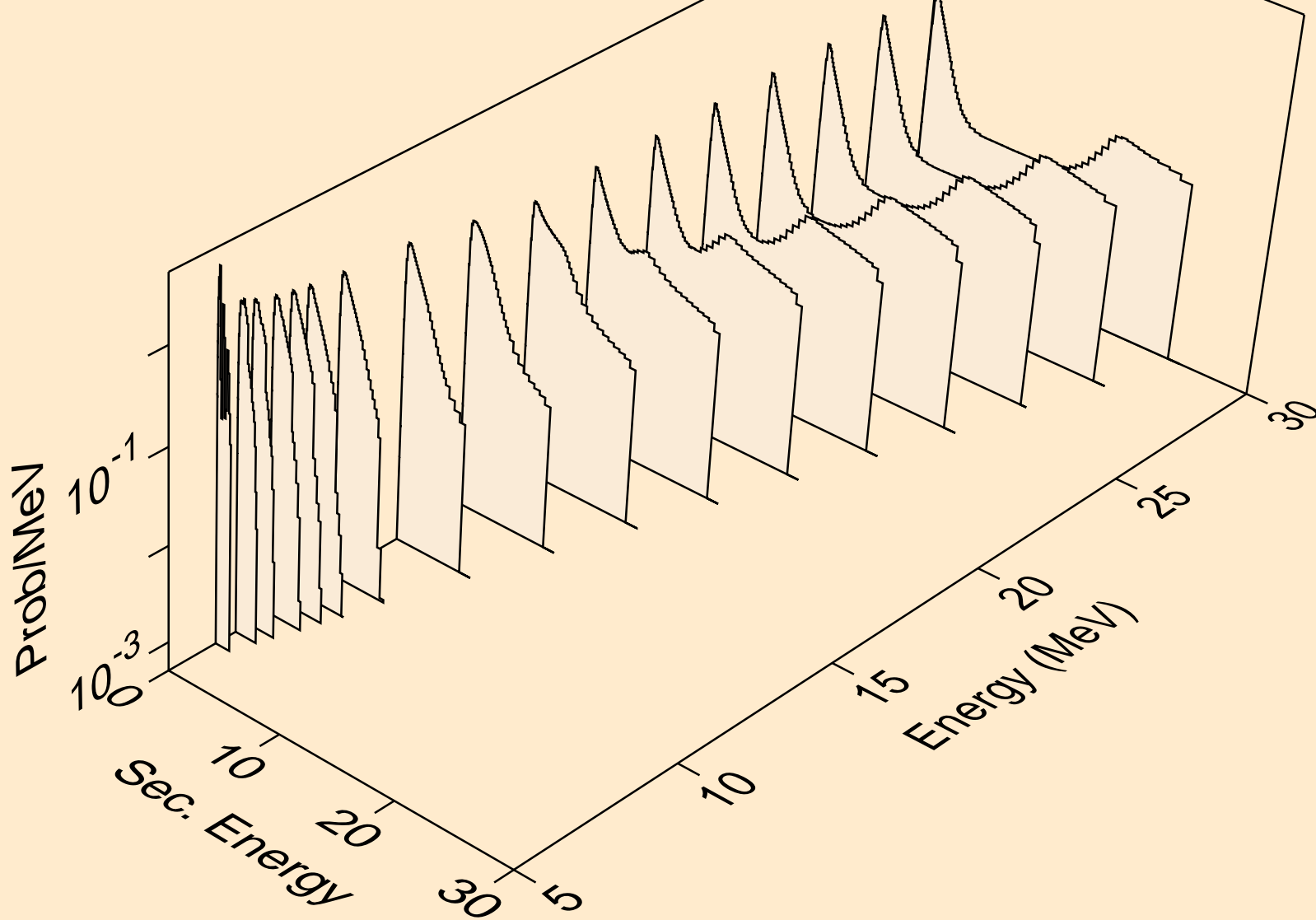

MO105 NEUTRON ACER TENDL-2019 LIBRARY; T=293.16K
Neutron emission for (n,3n)

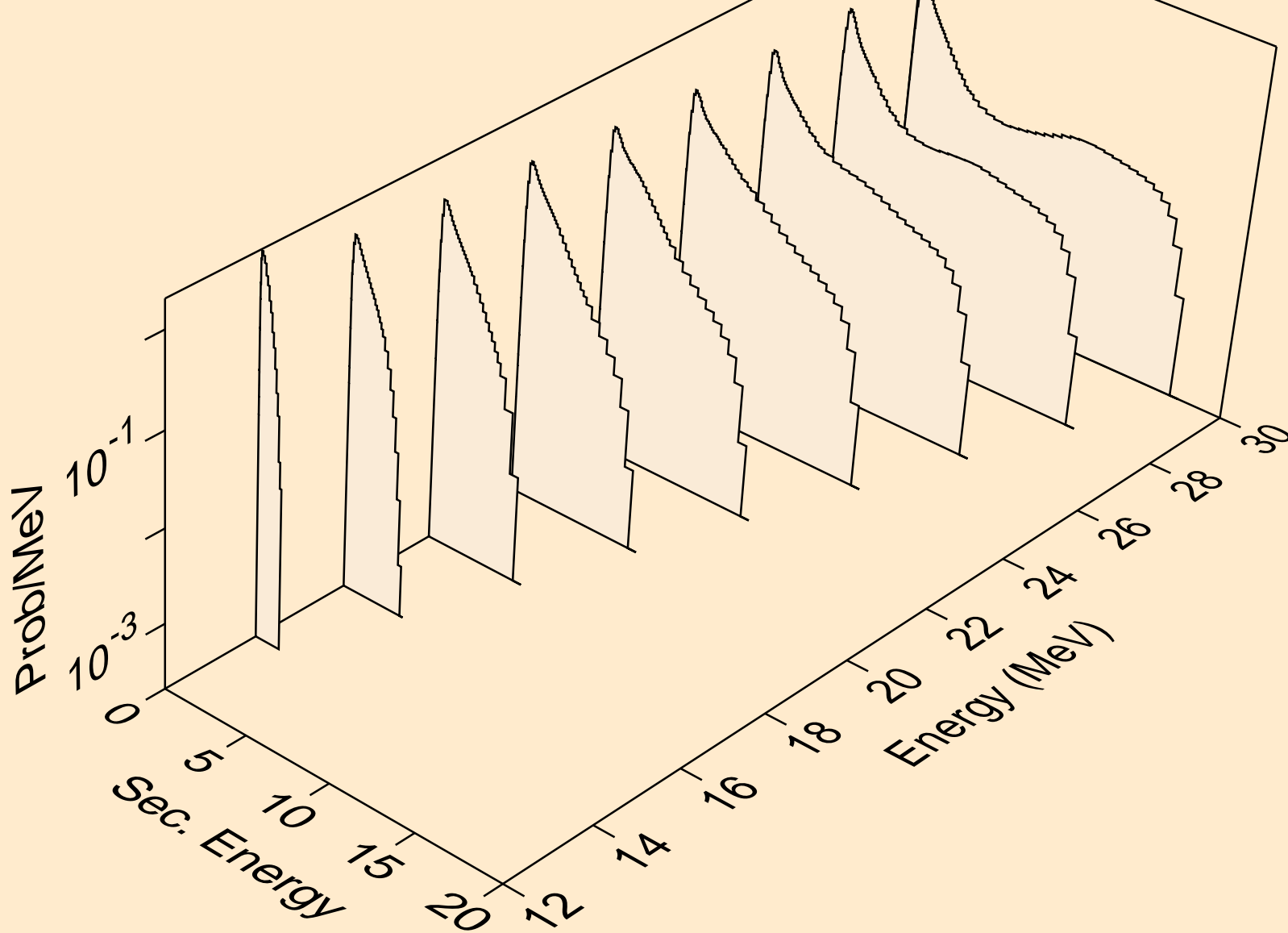

MO105 NEUTRON ACER TENDL-2019 LIBRARY; T=293.16K
Neutron emission for (n,n*)a

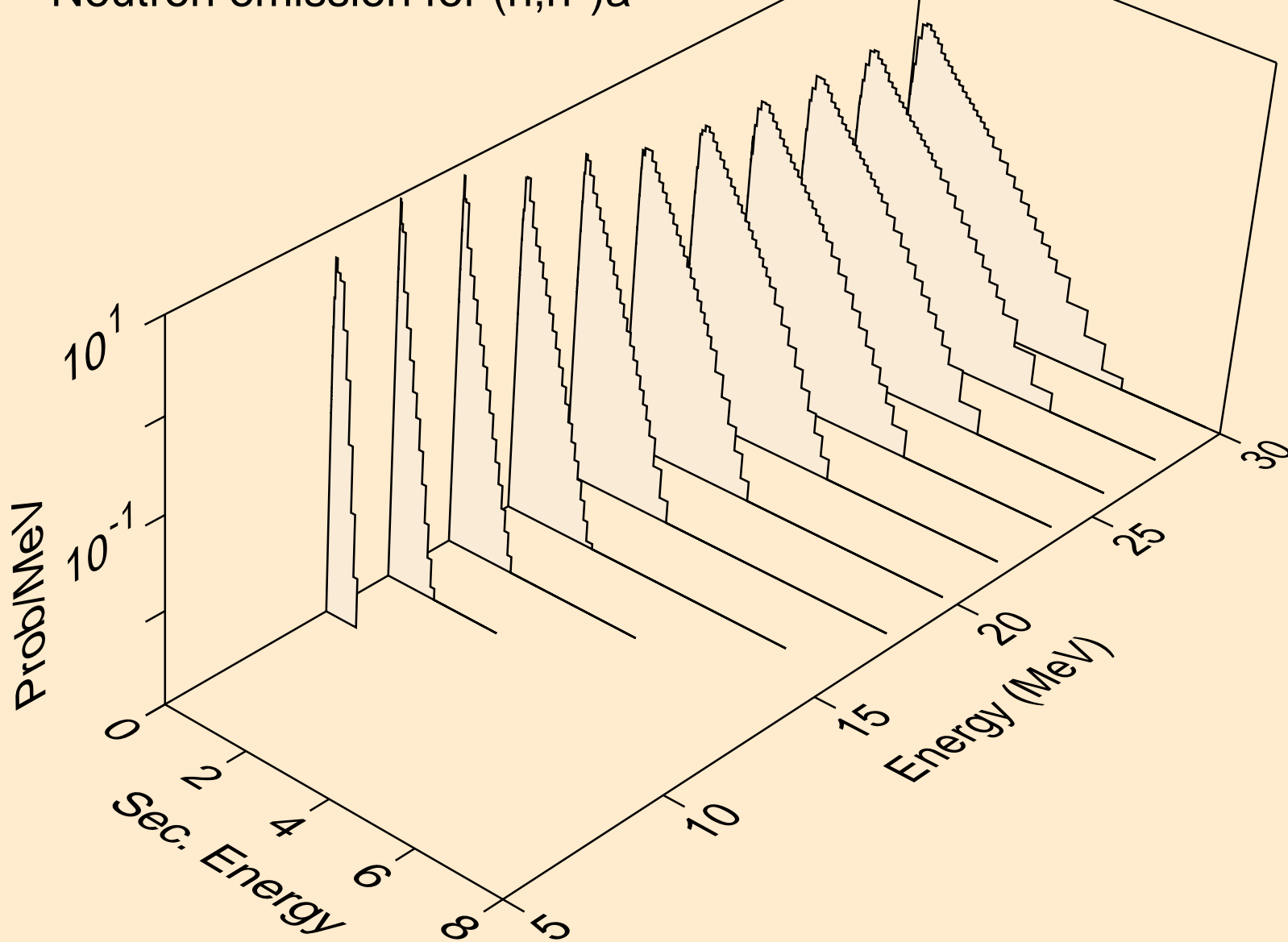

MO105 NEUTRON ACER TENDL-2019 LIBRARY; T=293.16K
Neutron emission for (n,2n)a

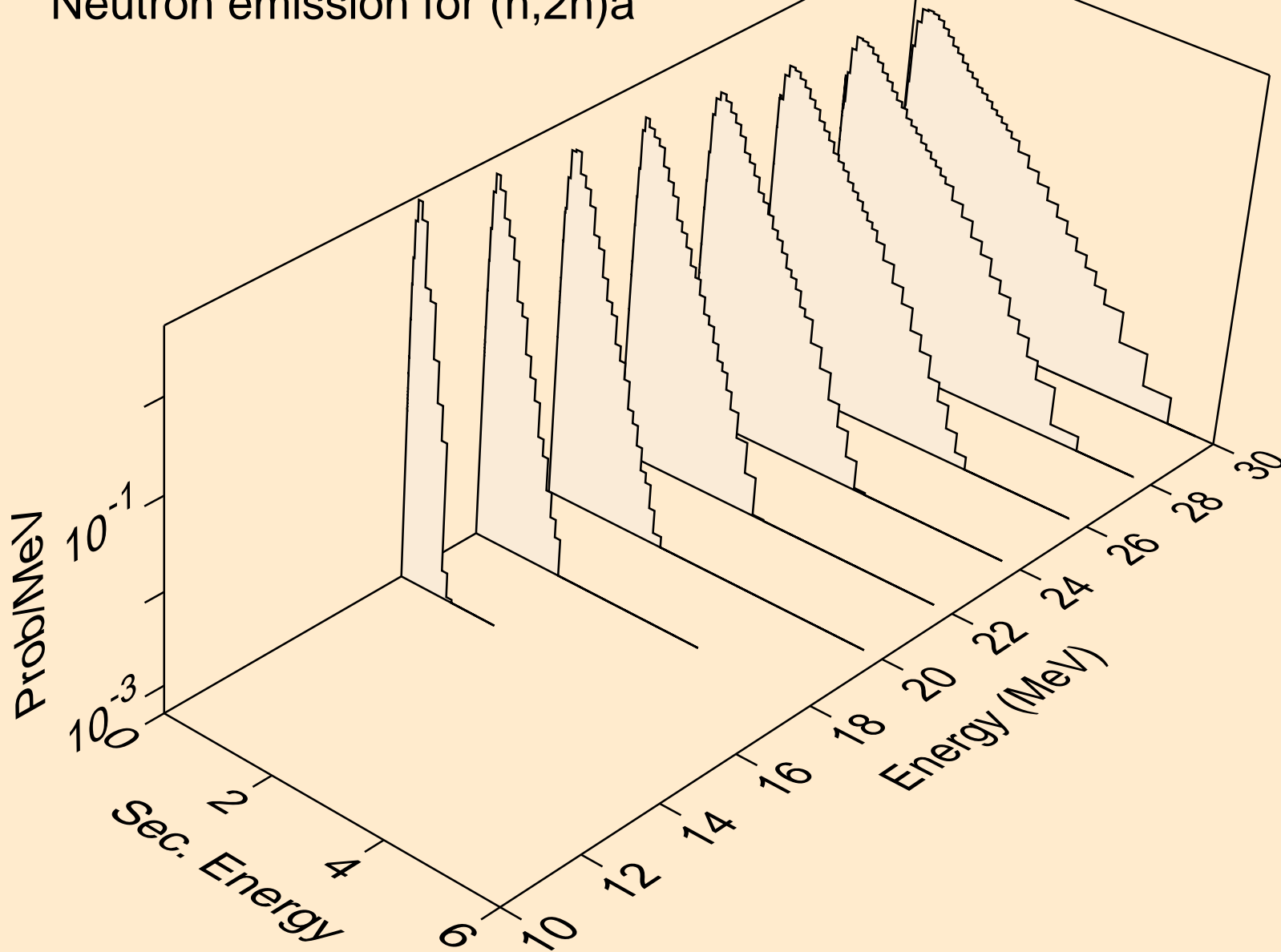

MO105 NEUTRON ACER TENDL-2019 LIBRARY; T=293.16K
Neutron emission for (n,3n)a

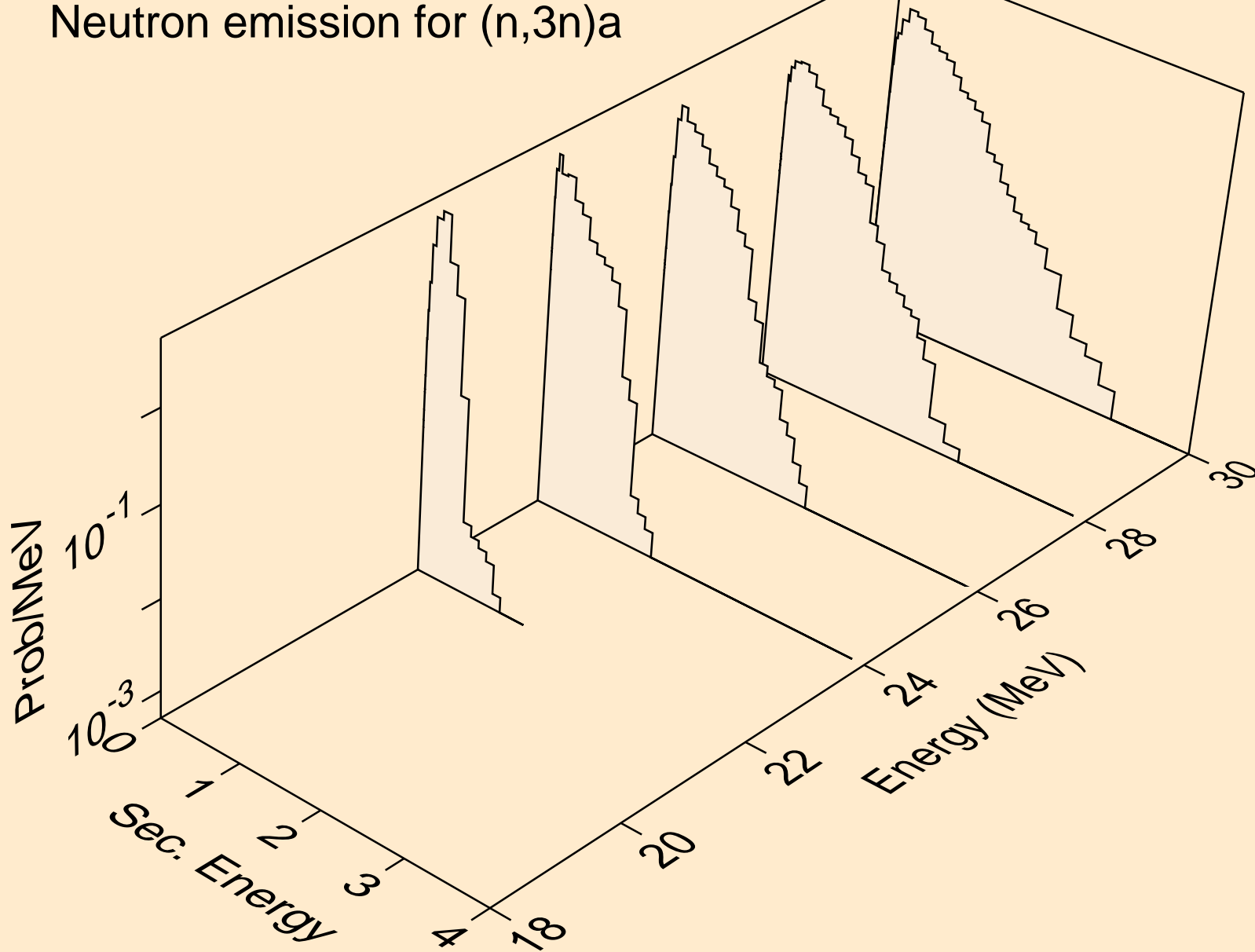

MO105 NEUTRON ACER TENDL-2019 LIBRARY; T=293.16K
Neutron emission for (n,n*)p

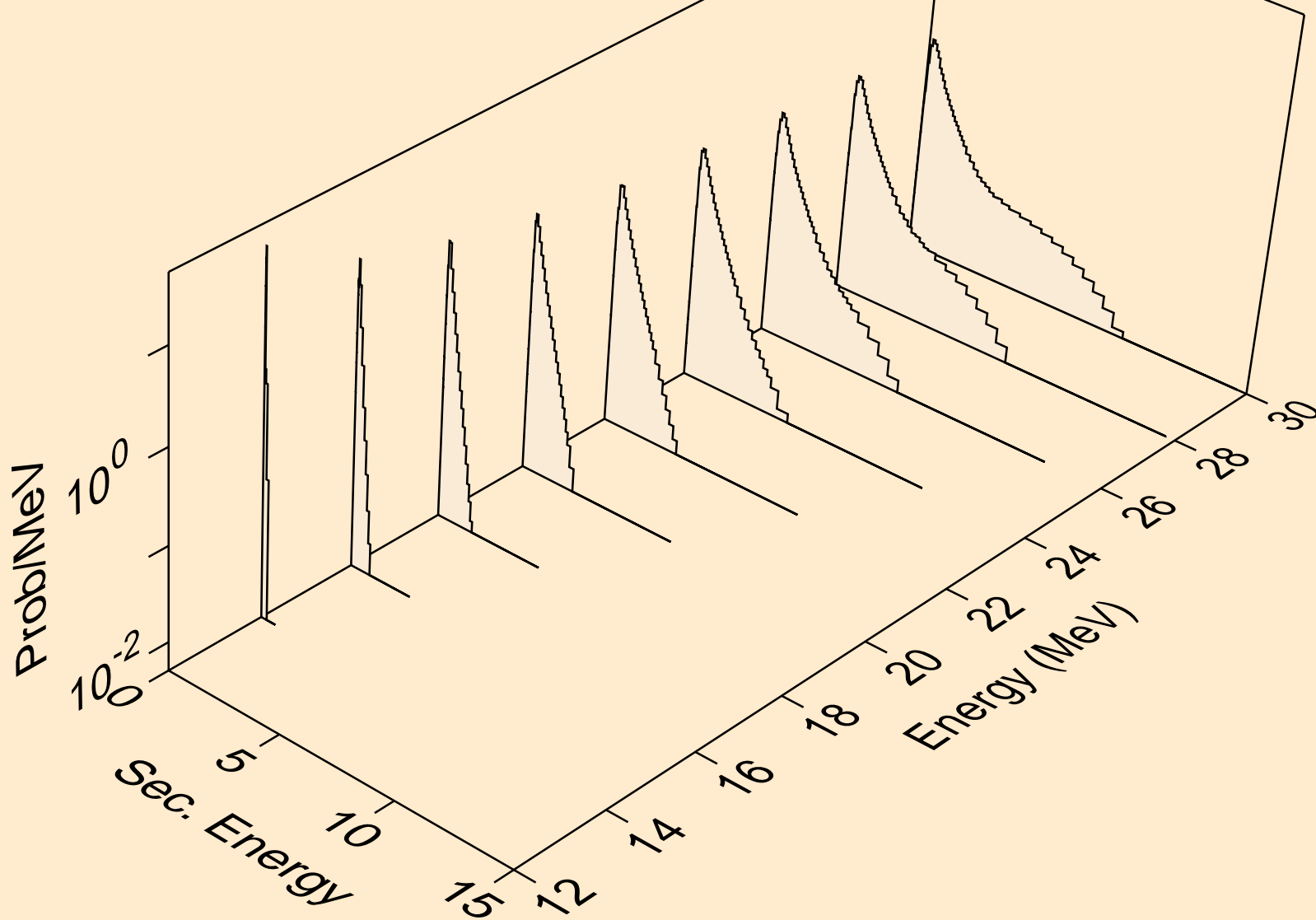

MO105 NEUTRON ACER TENDL-2019 LIBRARY; T=293.16K
Neutron emission for (n,n*)d

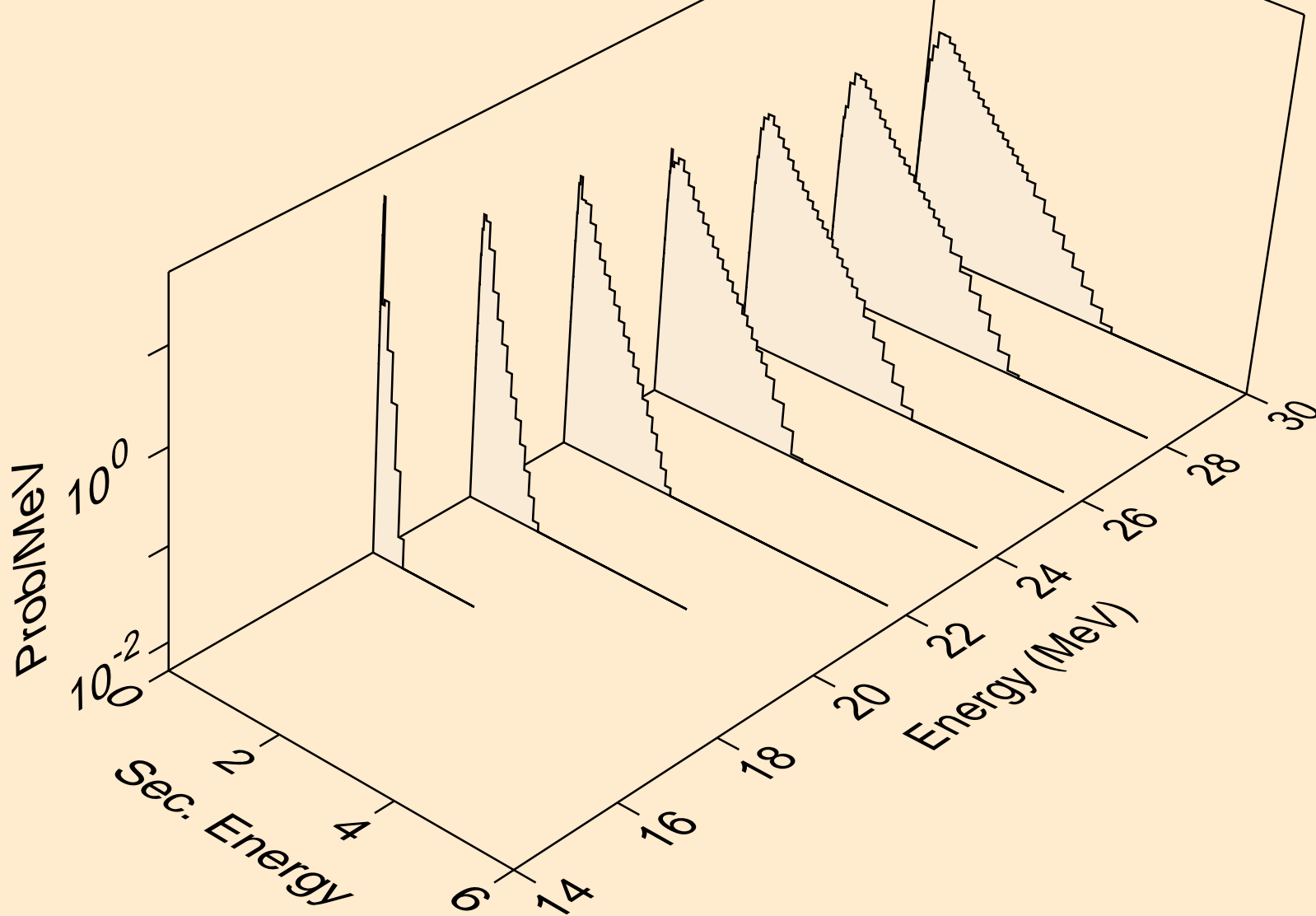

MO105 NEUTRON ACER TENDL-2019 LIBRARY; T=293.16K
Neutron emission for (n,n*)t

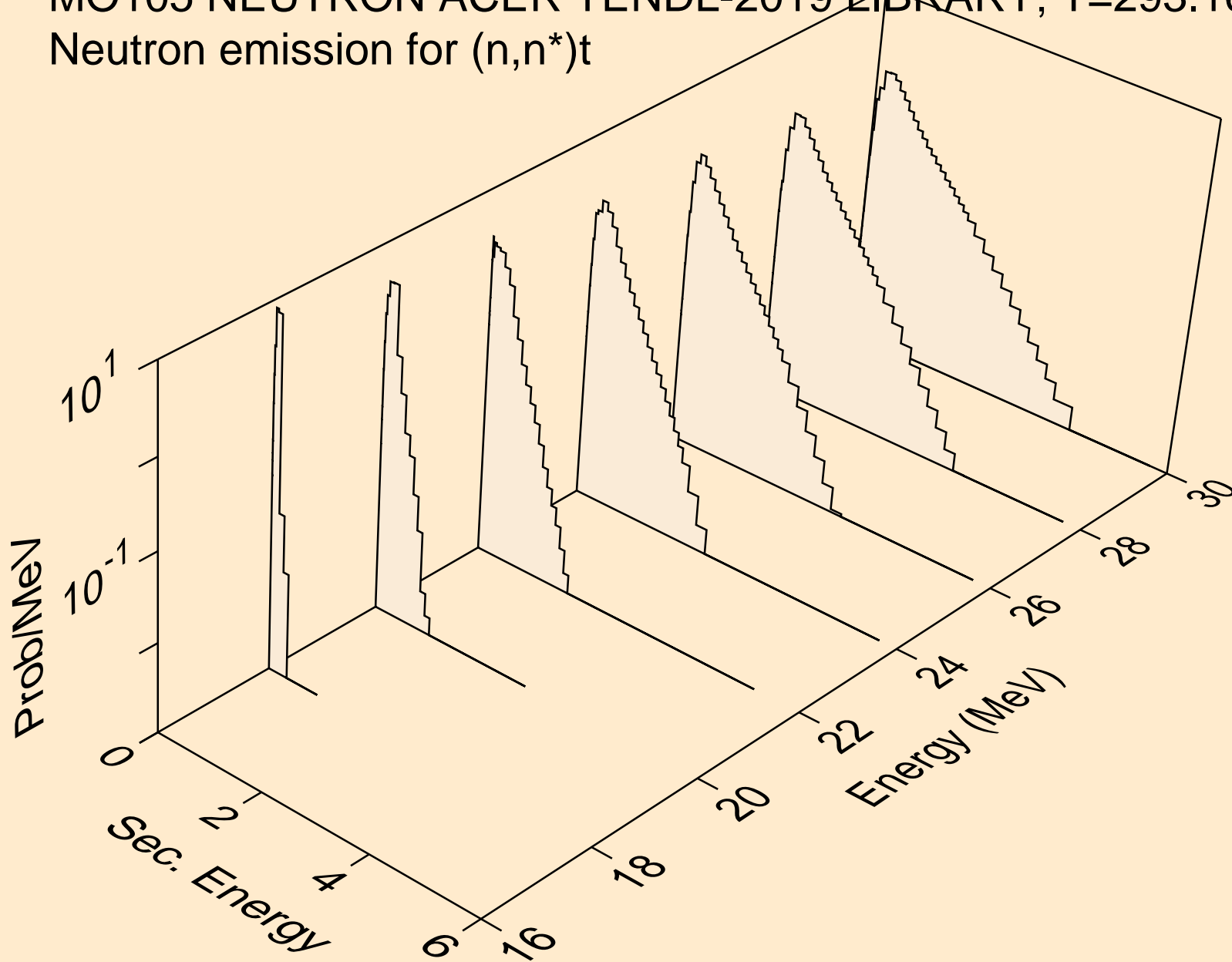

MO105 NEUTRON ACER TENDL-2019 LIBRARY; T=293.16K
Neutron emission for (n,n*)he3

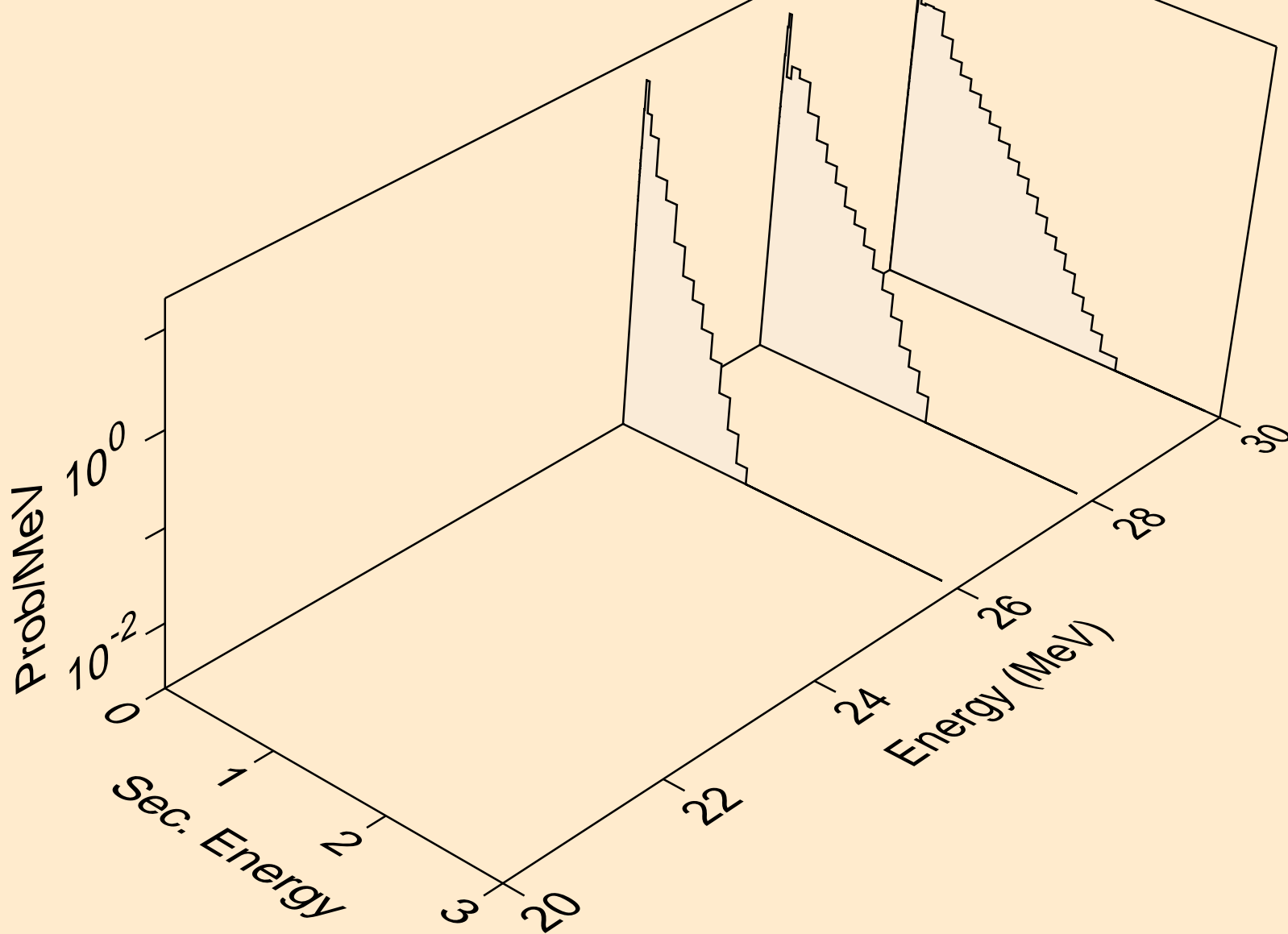

MO105 NEUTRON ACER TENDL-2019 LIBRARY; T=293.16K
Neutron emission for (n,4n)

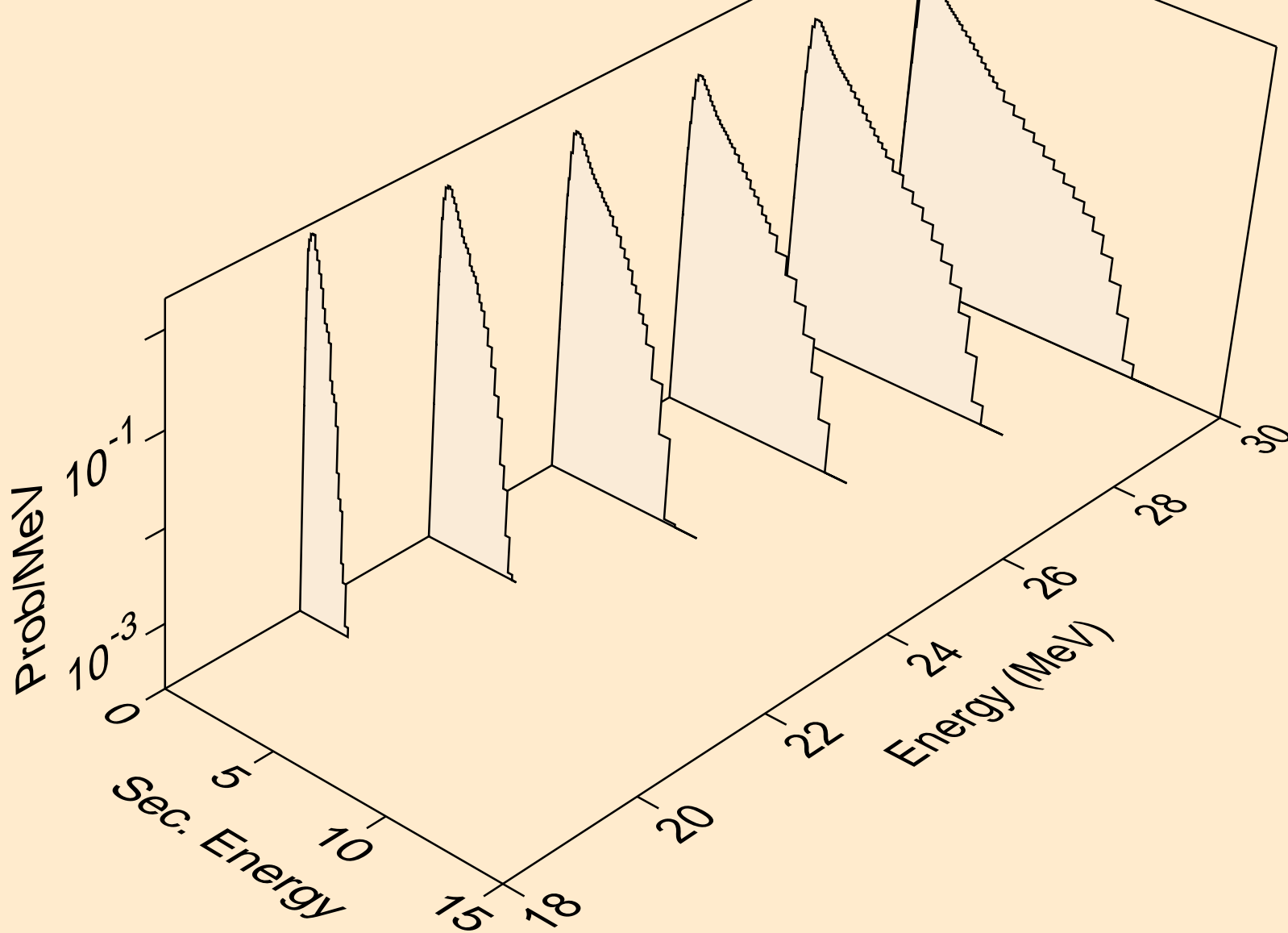

MO105 NEUTRON ACER TENDL-2019 LIBRARY; T=293.16K
Neutron emission for (n,2np)

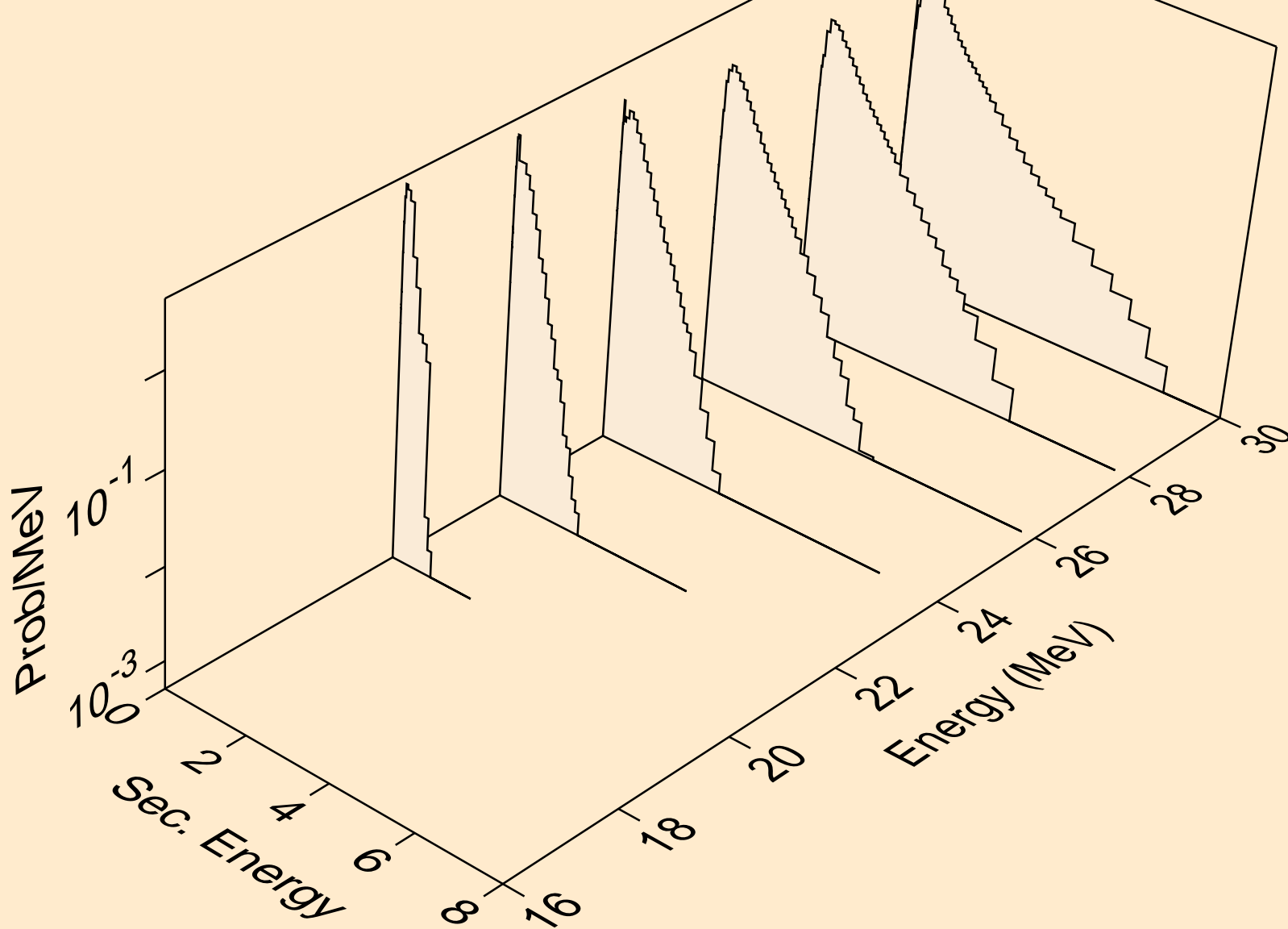

MO105 NEUTRON ACER TENDL-2019 LIBRARY; T=293.16K
Neutron emission for (n,3np)

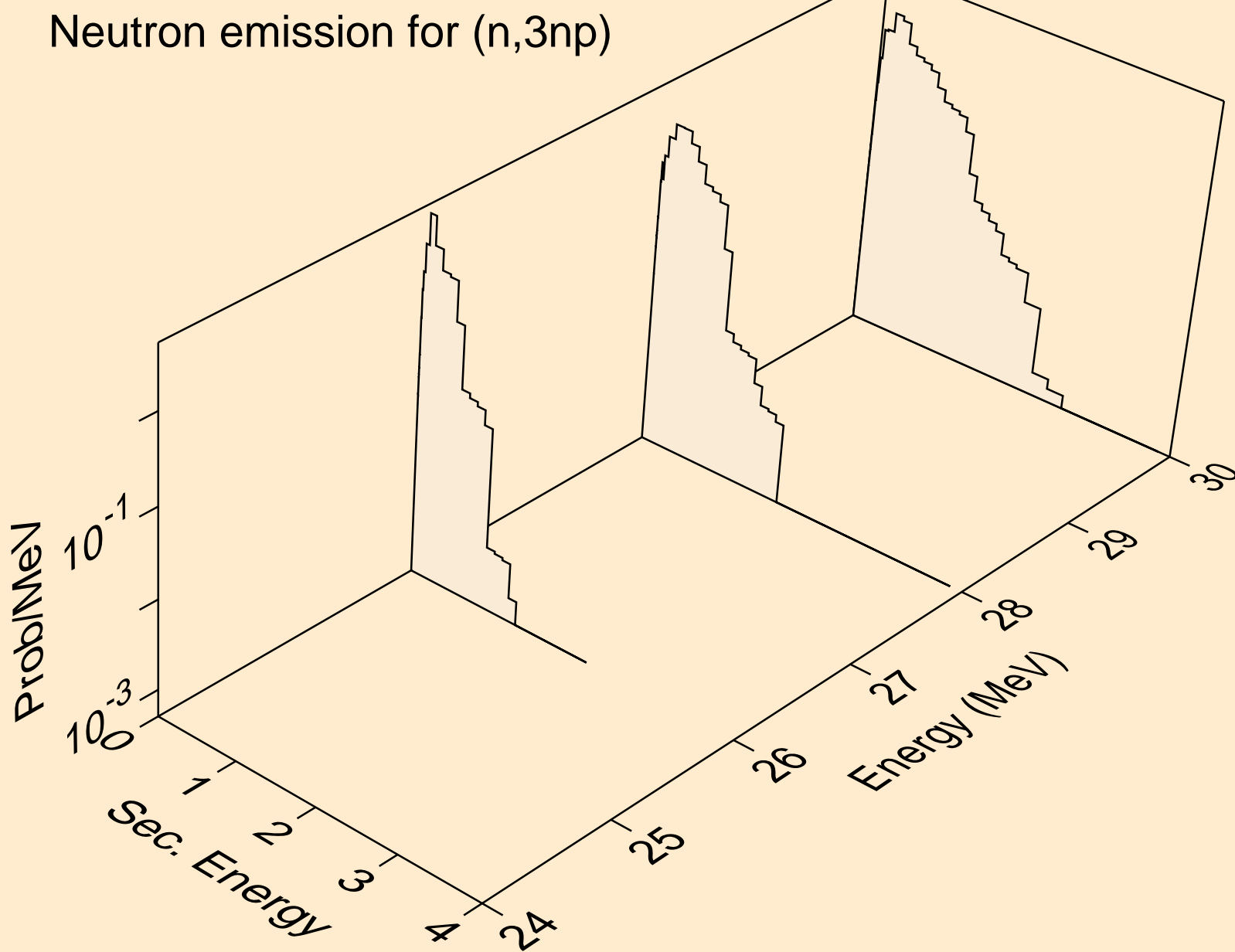

MO105 NEUTRON ACER TENDL-2019 LIBRARY; T=293.16K
Neutron emission for (n,n*c)

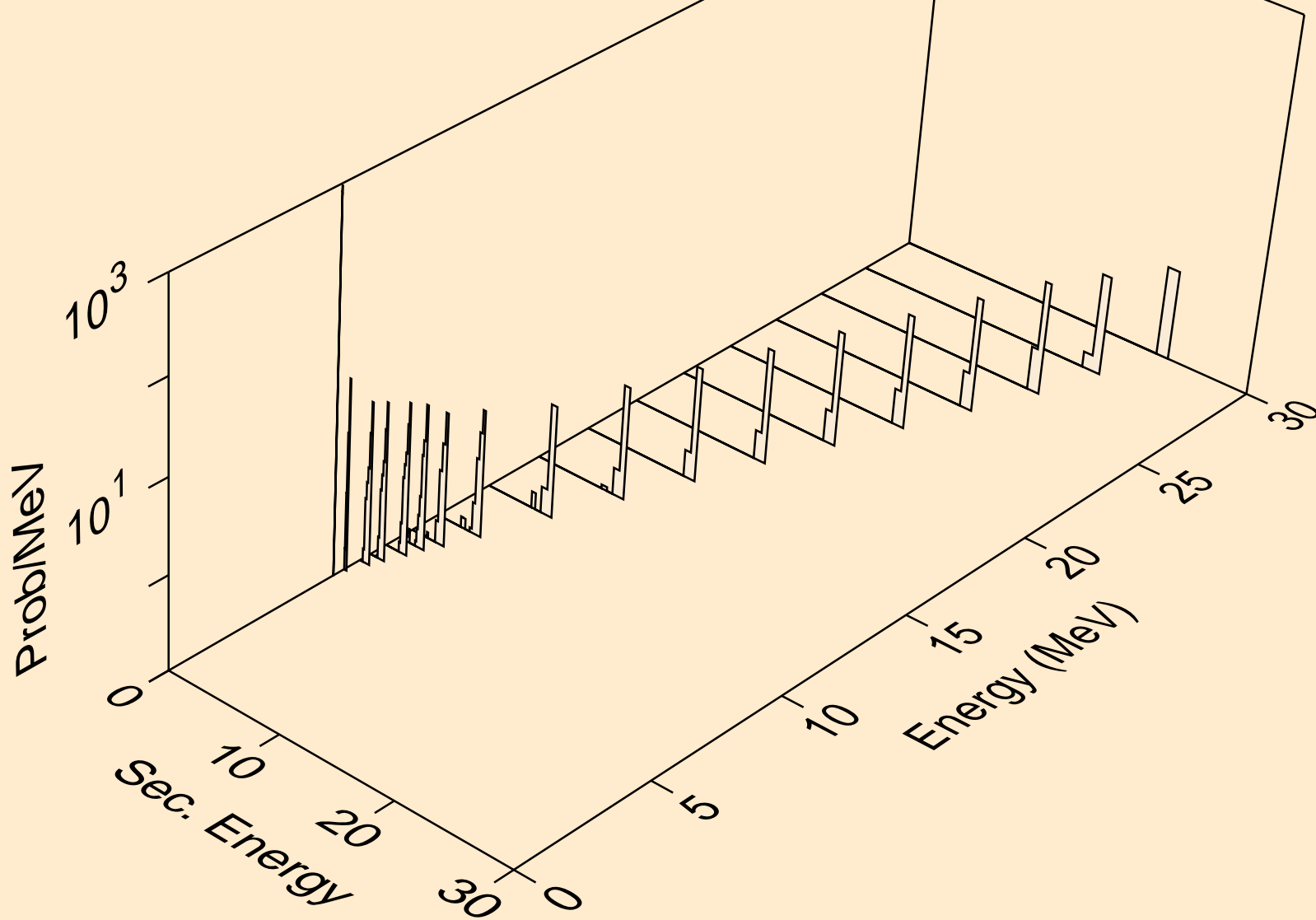

MO105 NEUTRON ACER TENDL-2019 LIBRARY; T=293.16K
Photon emission for (n,x)

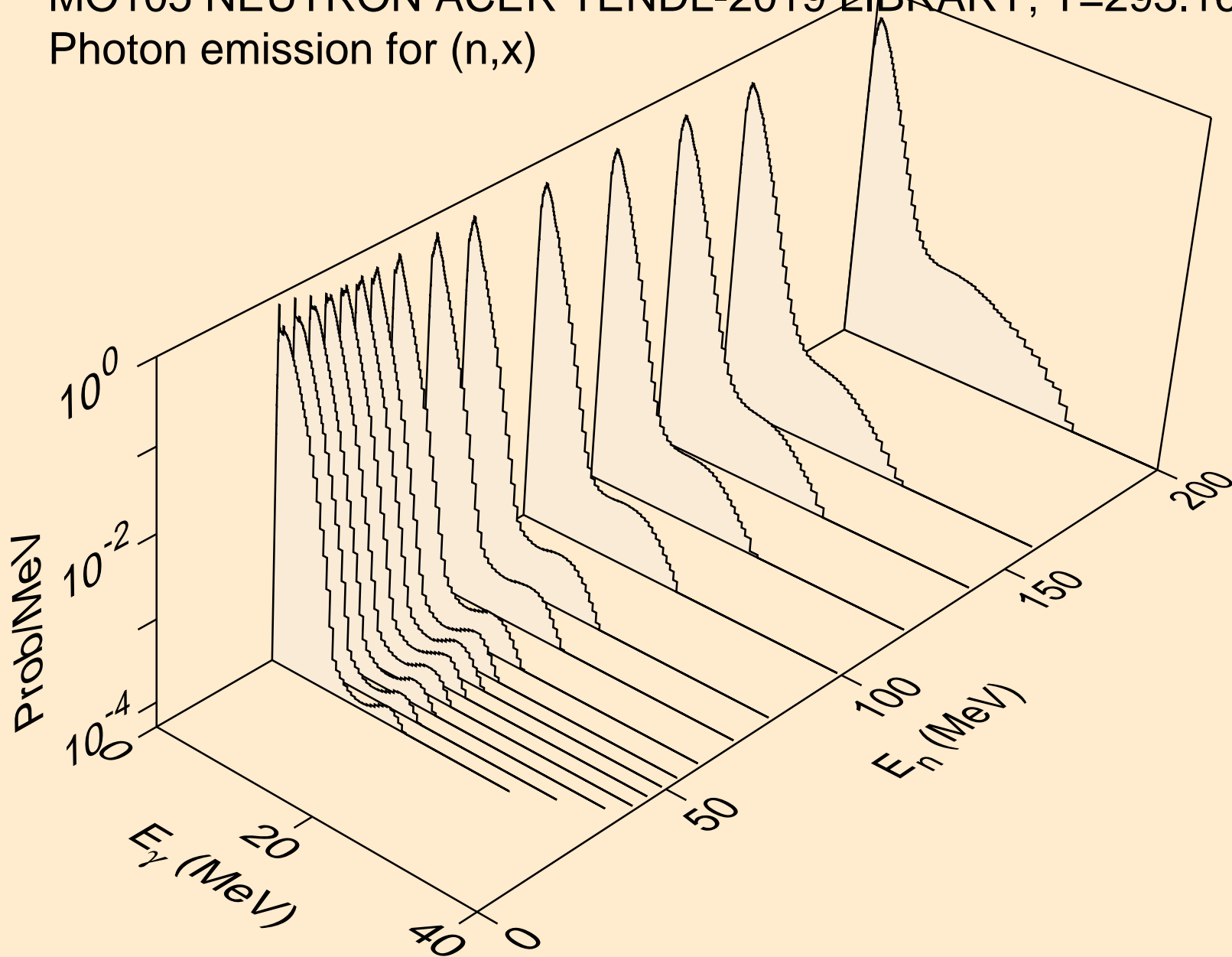

MO105 NEUTRON ACER TENDL-2019 LIBRARY; T=293.16K
Photon emission for (n,2nd)

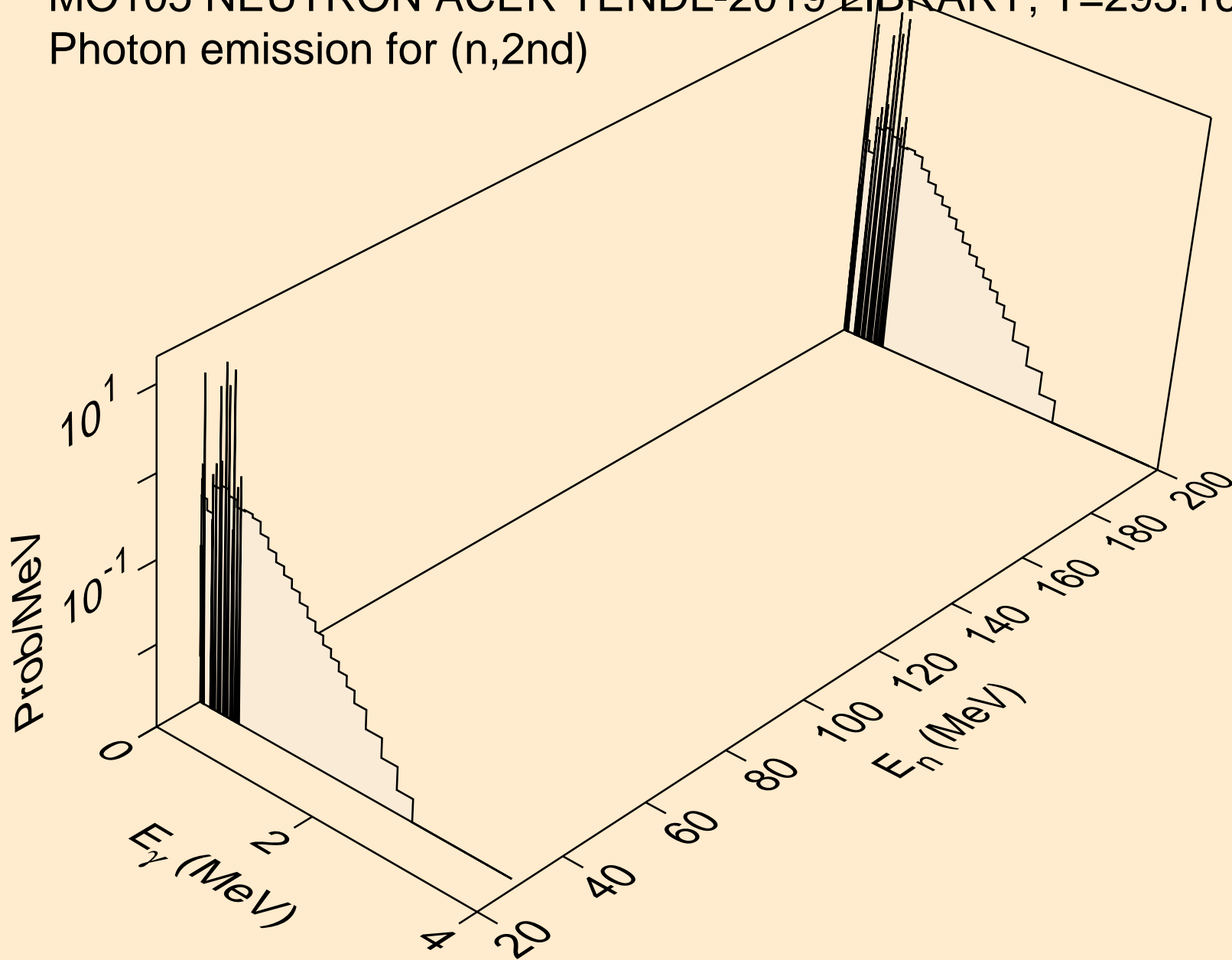

MO105 NEUTRON ACER TENDL-2019 LIBRARY; T=293.16K
Photon emission for (n,2n)

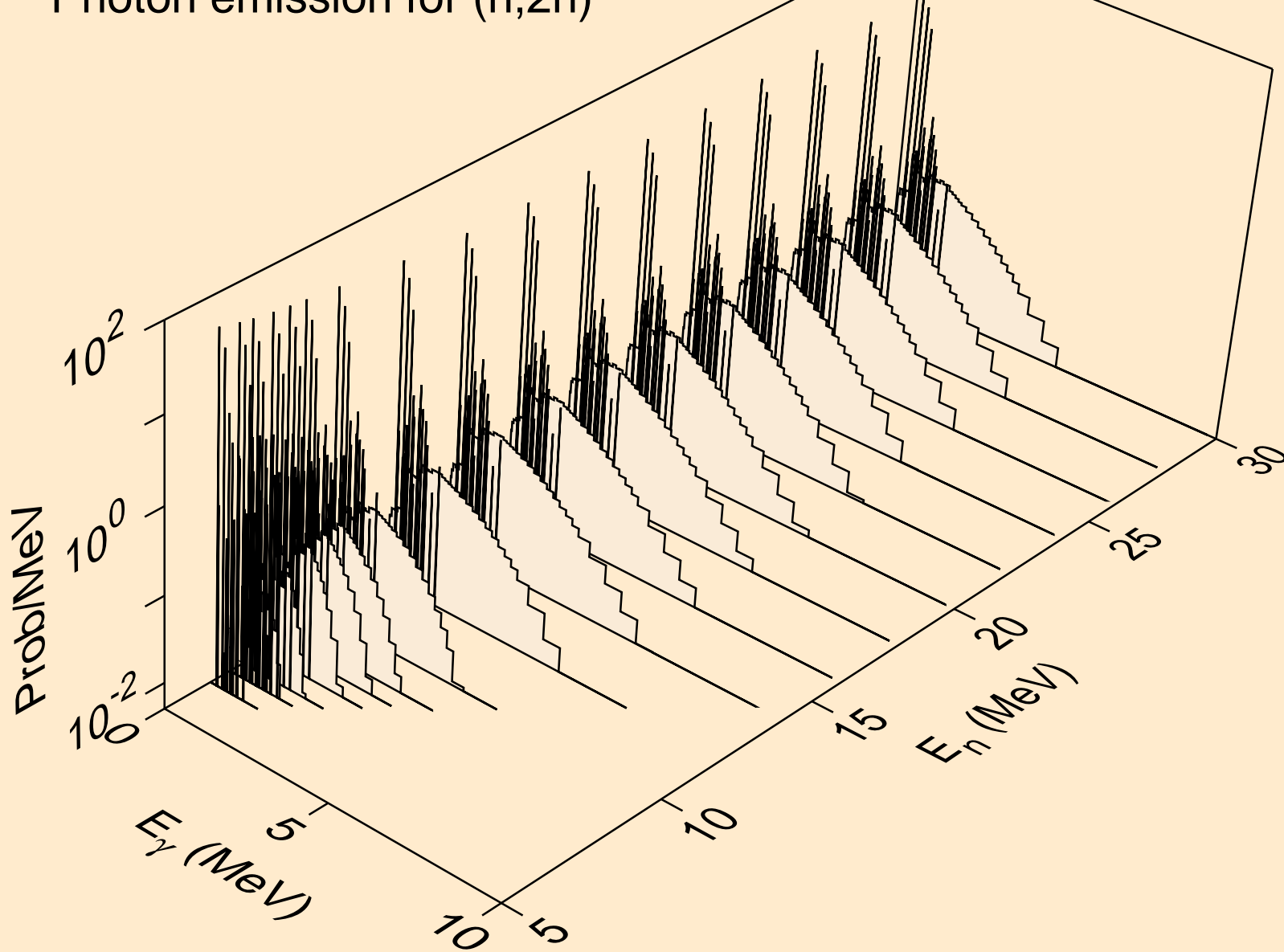

MO105 NEUTRON ACER TENDL-2019 LIBRARY; T=293.16K
Photon emission for (n,3n)

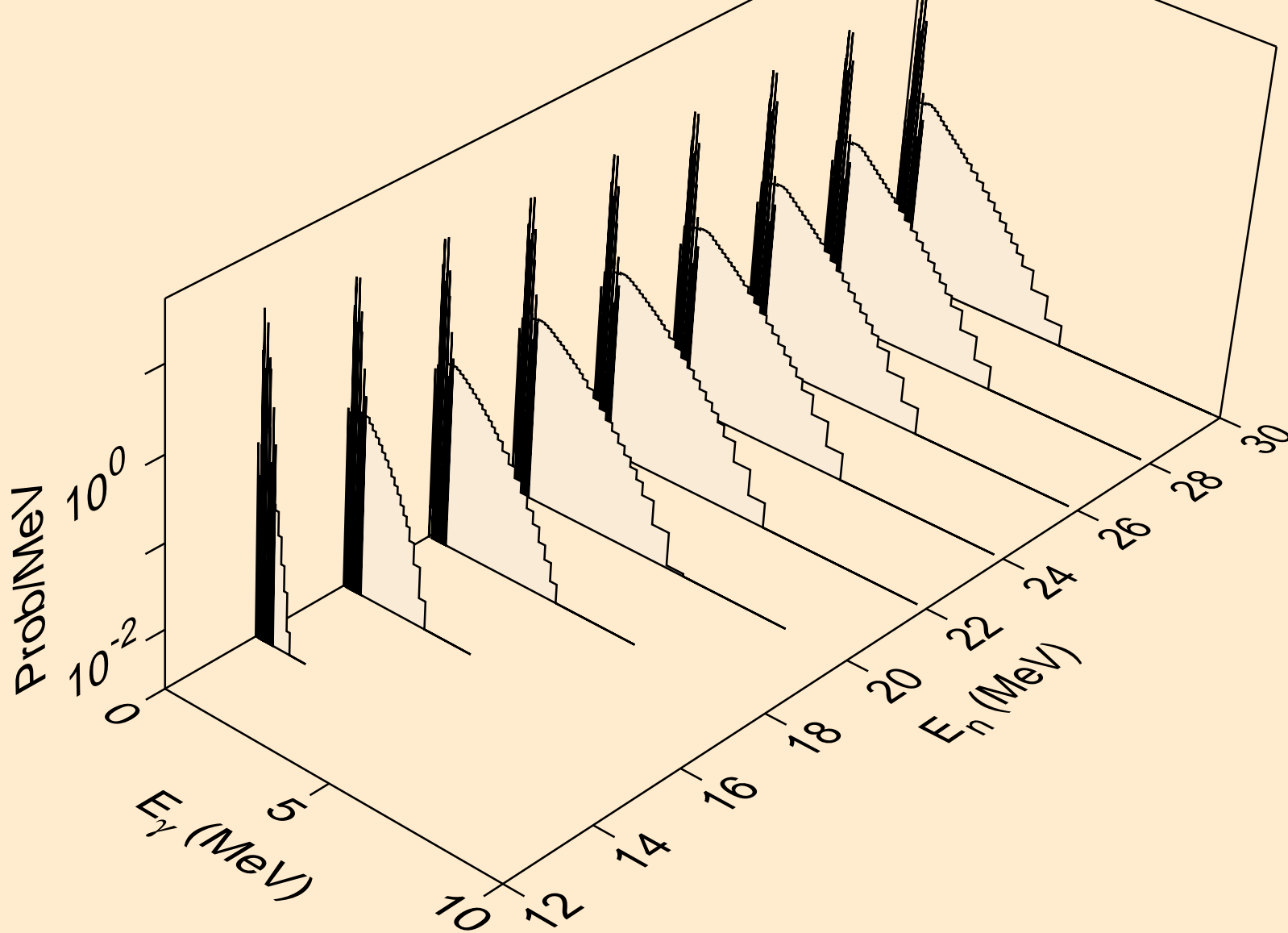

MO105 NEUTRON ACER TENDL-2019 LIBRARY; T=293.16K
Photon emission for (n,n*)a

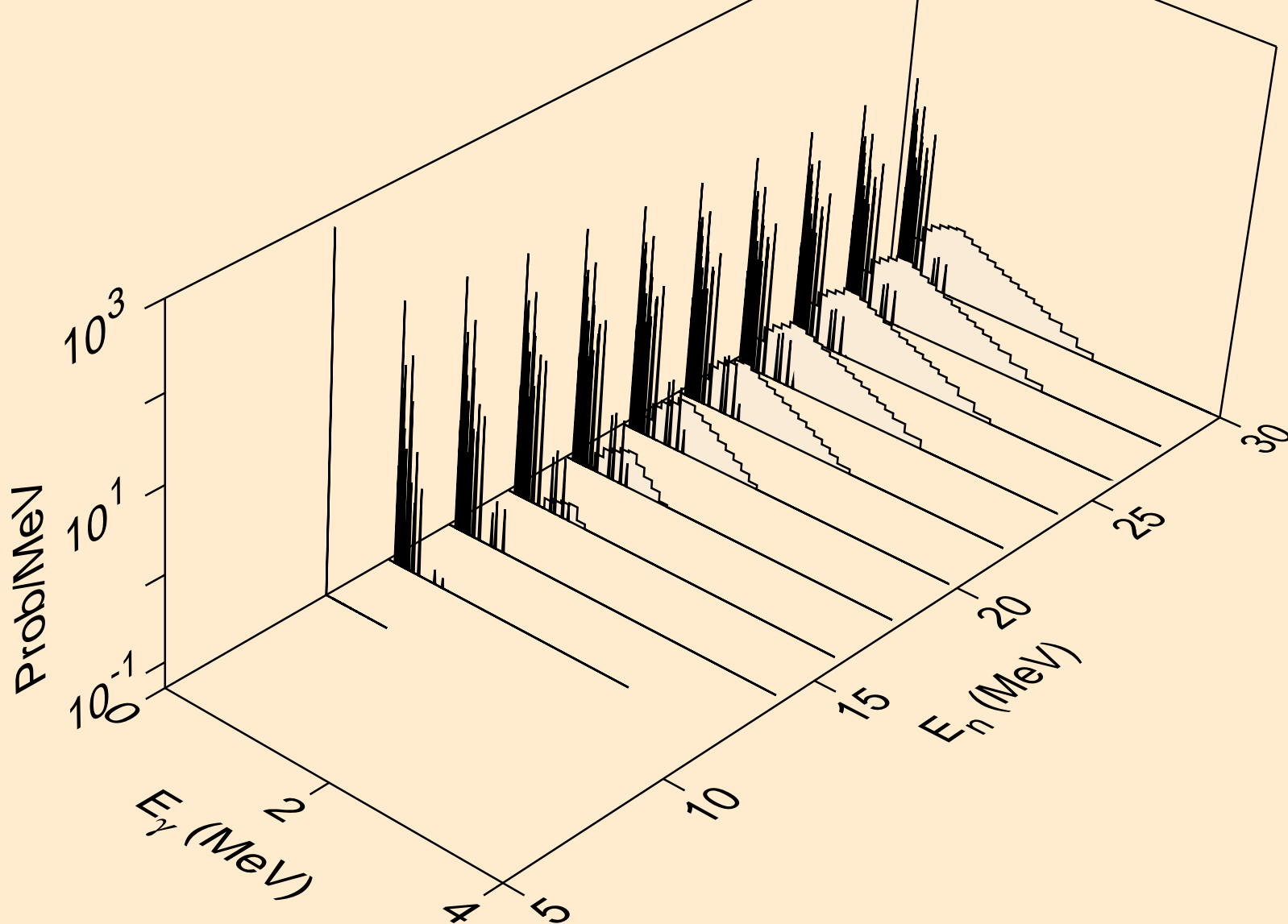

MO105 NEUTRON ACER TENDL-2019 LIBRARY; T=293.16K
Photon emission for (n,2n)a

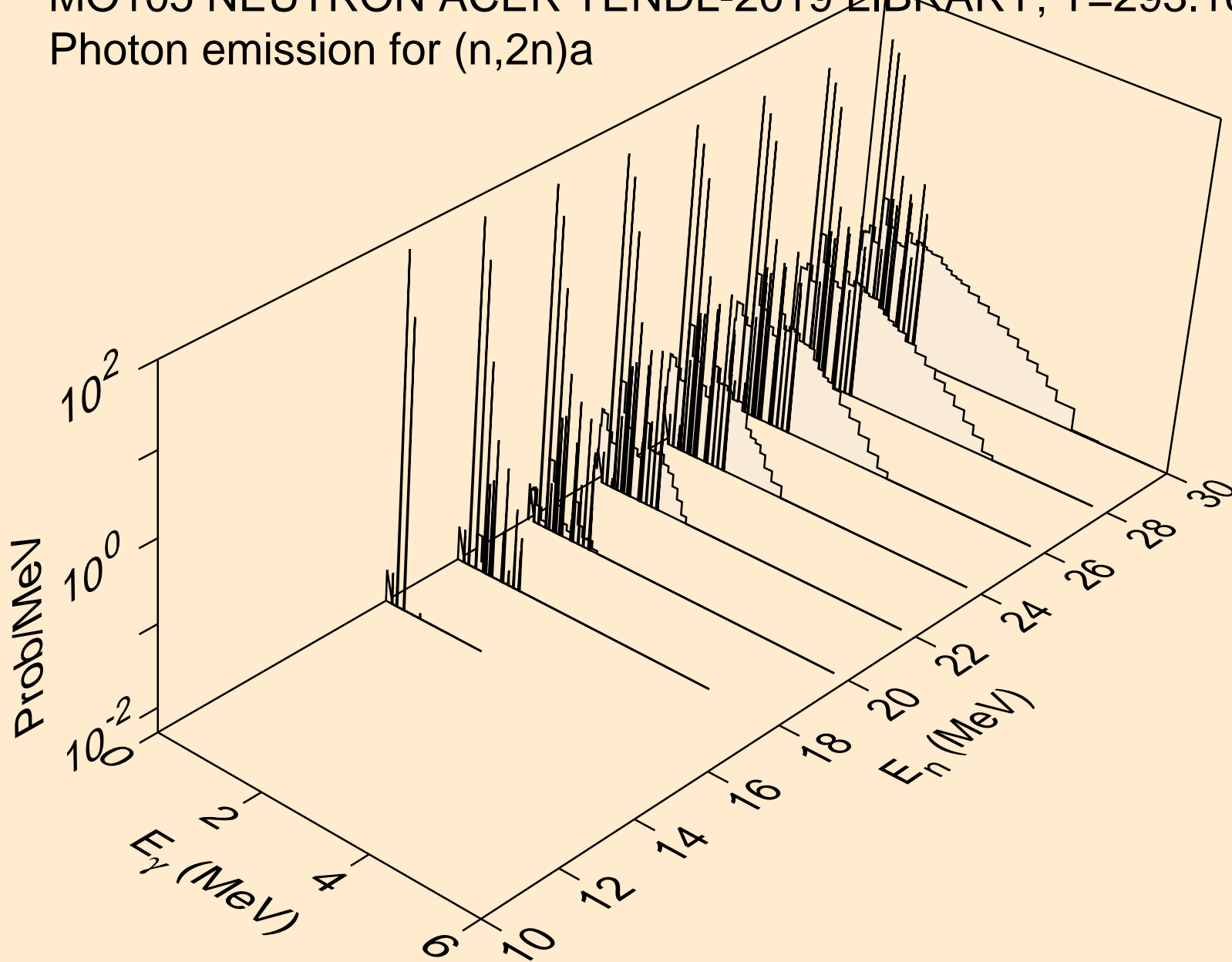

MO105 NEUTRON ACER TENDL-2019 LIBRARY; T=293.16K
Photon emission for (n,3n)a

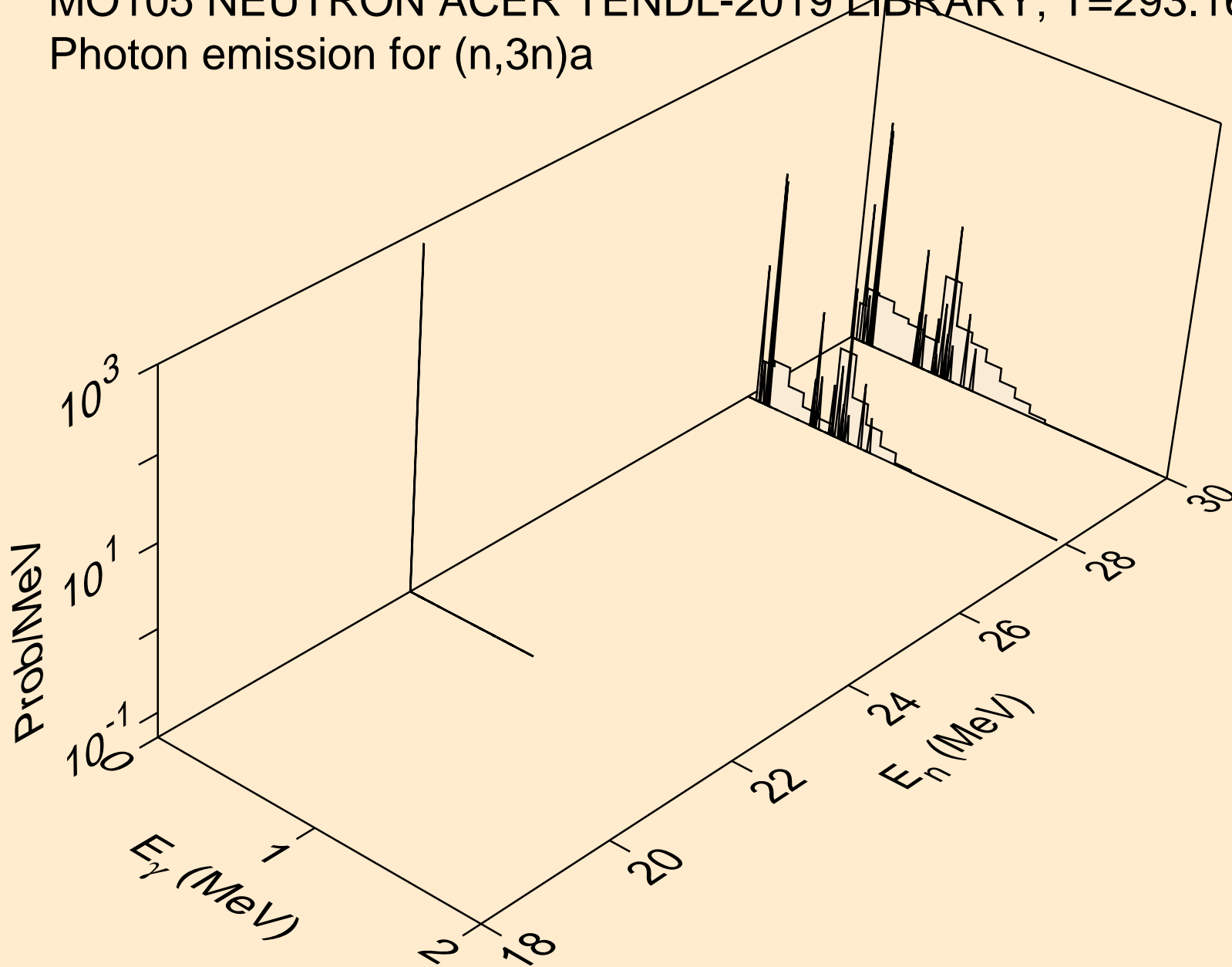

MO105 NEUTRON ACER TENDL-2019 LIBRARY; T=293.16K
Photon emission for (n,n*)p

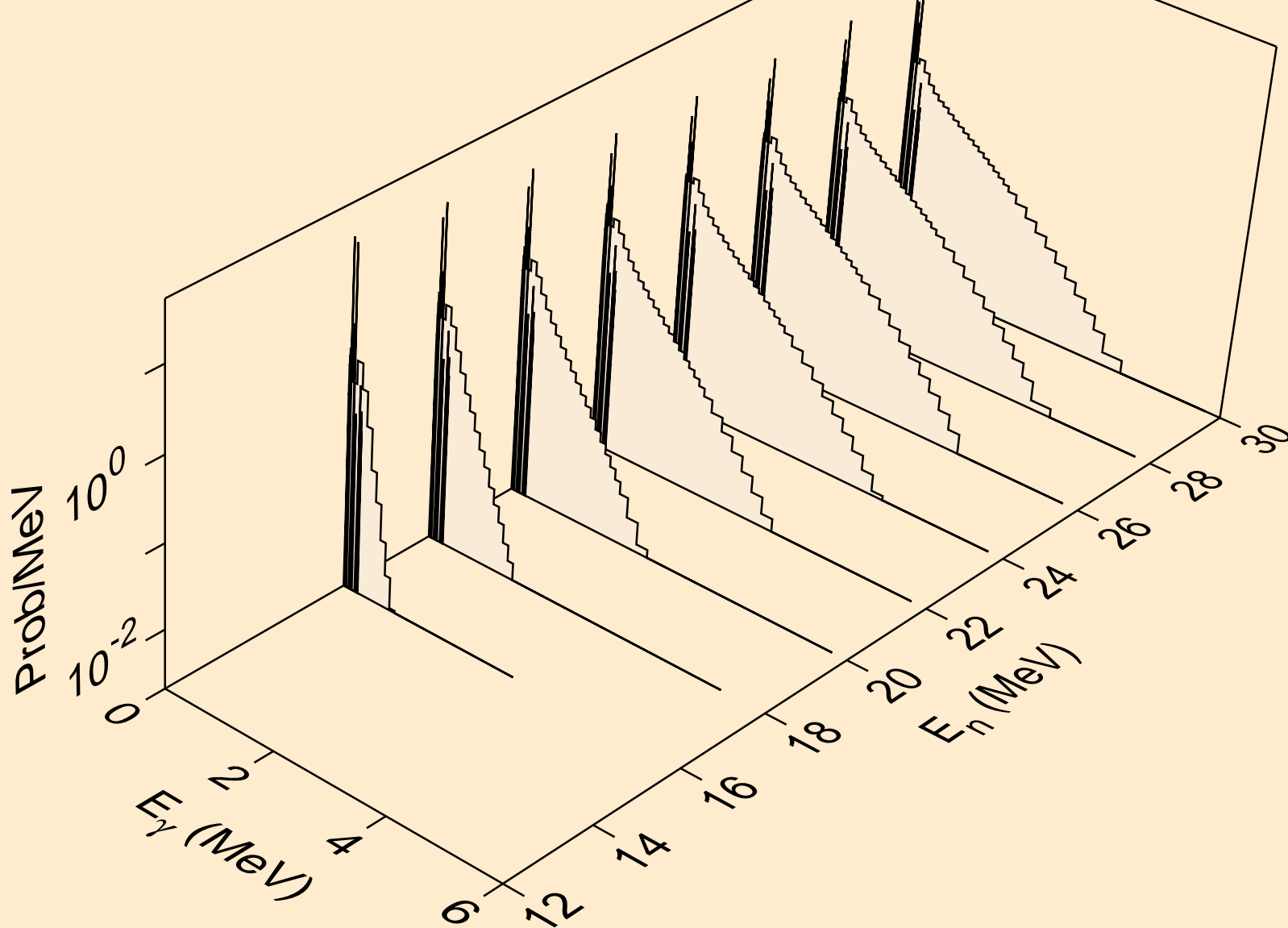

MO105 NEUTRON ACER TENDL-2019 LIBRARY; T=293.16K
Photon emission for (n,n*)d

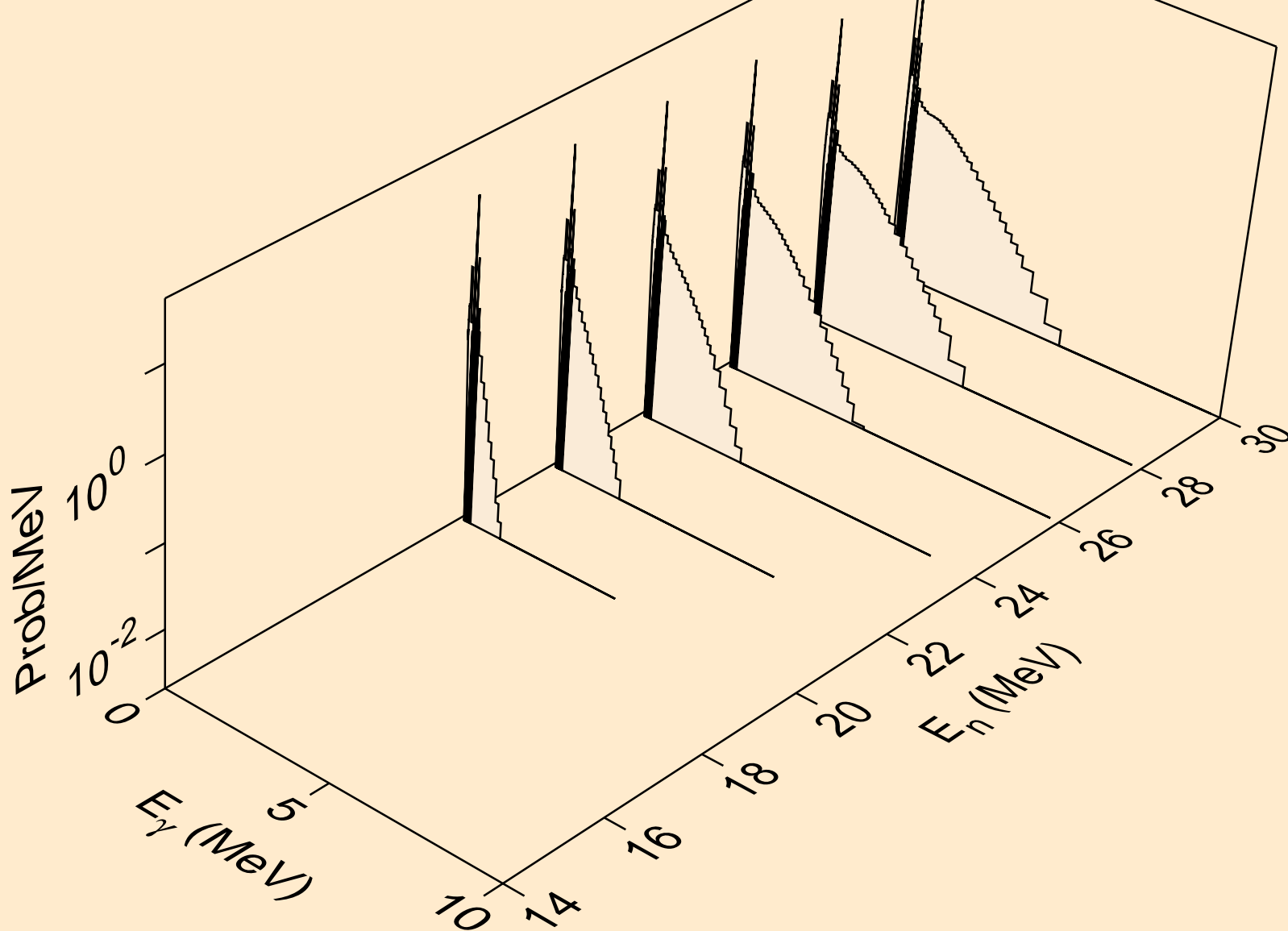

MO105 NEUTRON ACER TENDL-2019 LIBRARY; T=293.16K
Photon emission for (n,n*)t

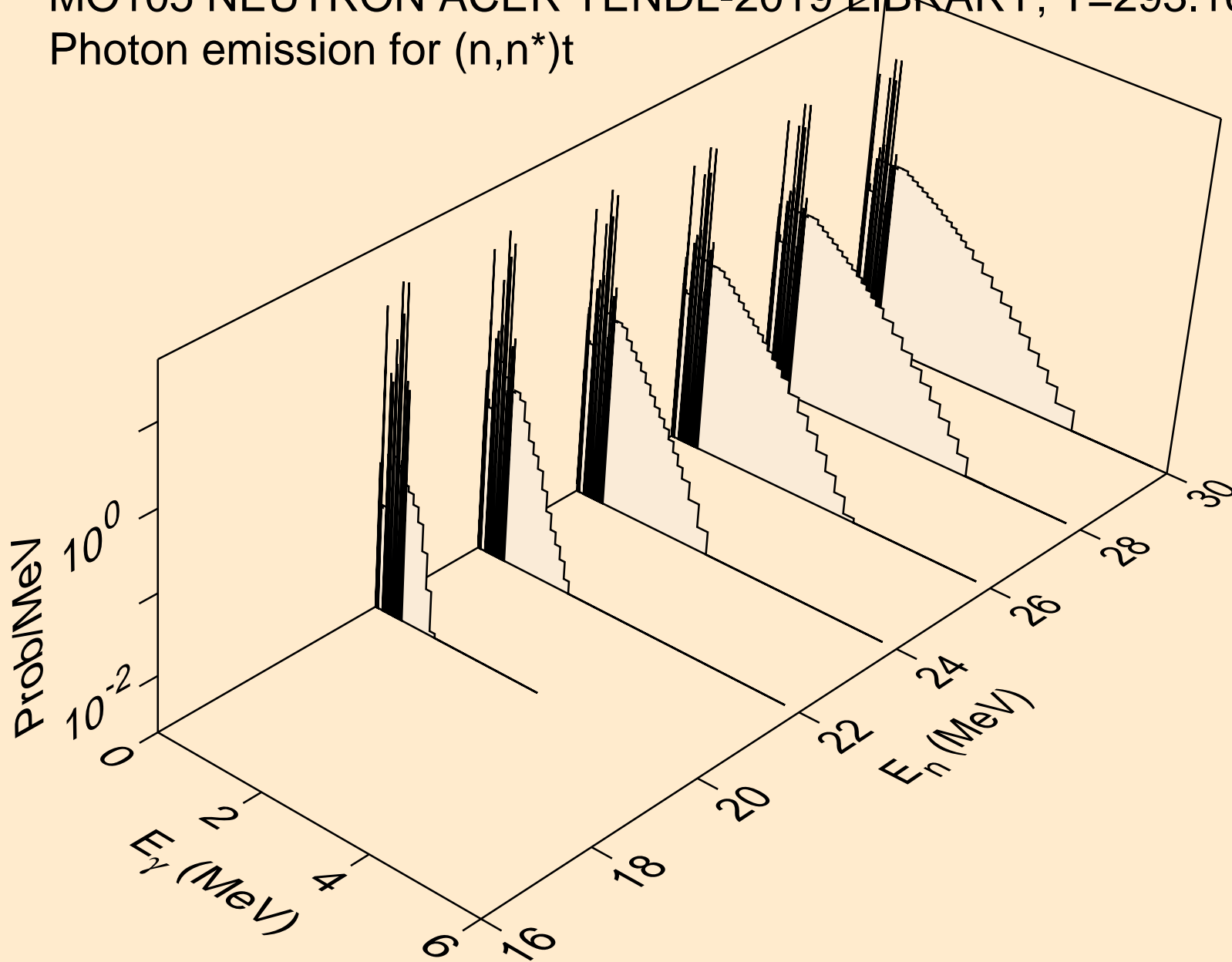

MO105 NEUTRON ACER TENDL-2019 LIBRARY; T=293.16K
Photon emission for (n,n*)he3

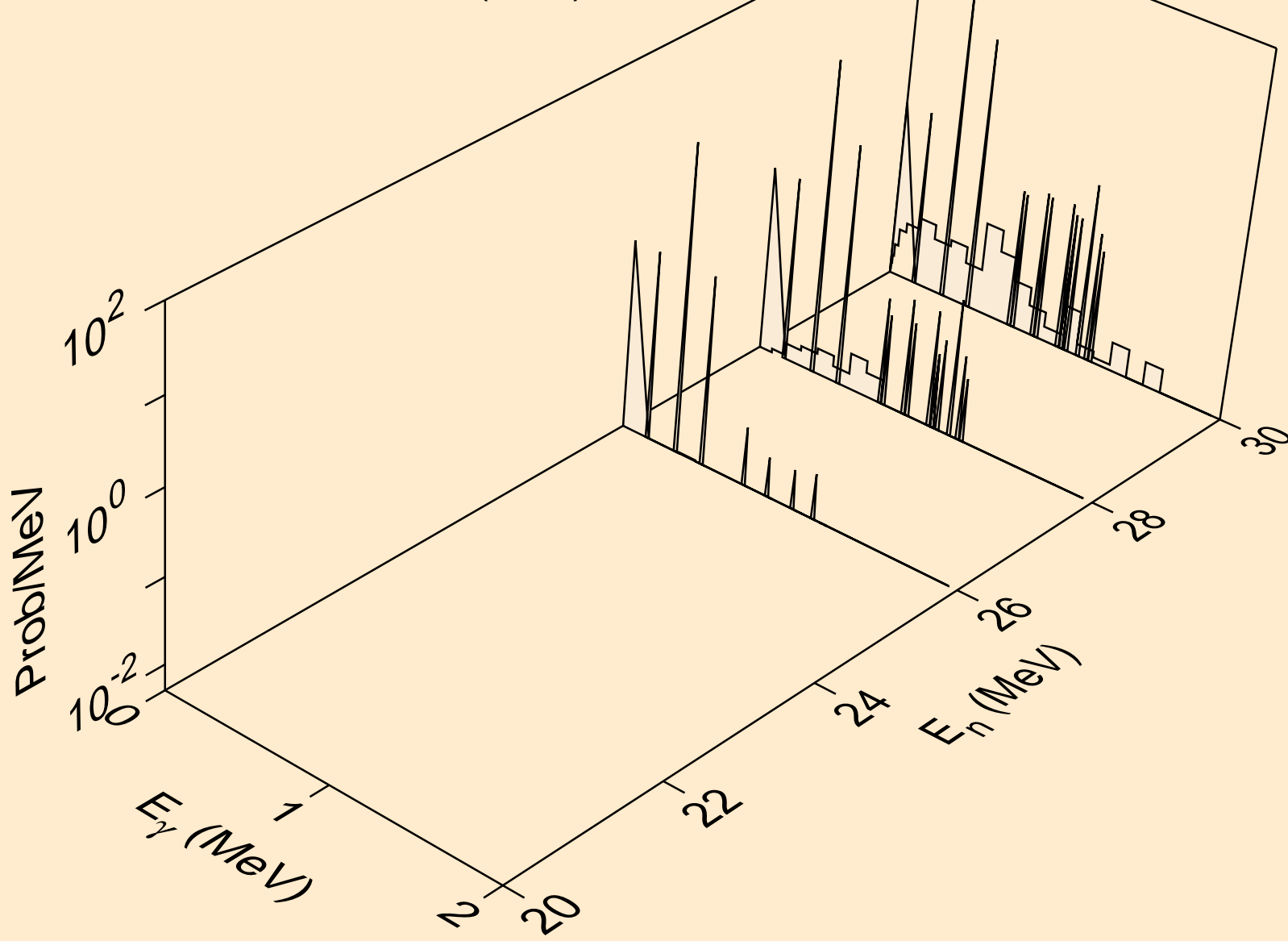

MO105 NEUTRON ACER TENDL-2019 LIBRARY; T=293.16K
Photon emission for (n,4n)

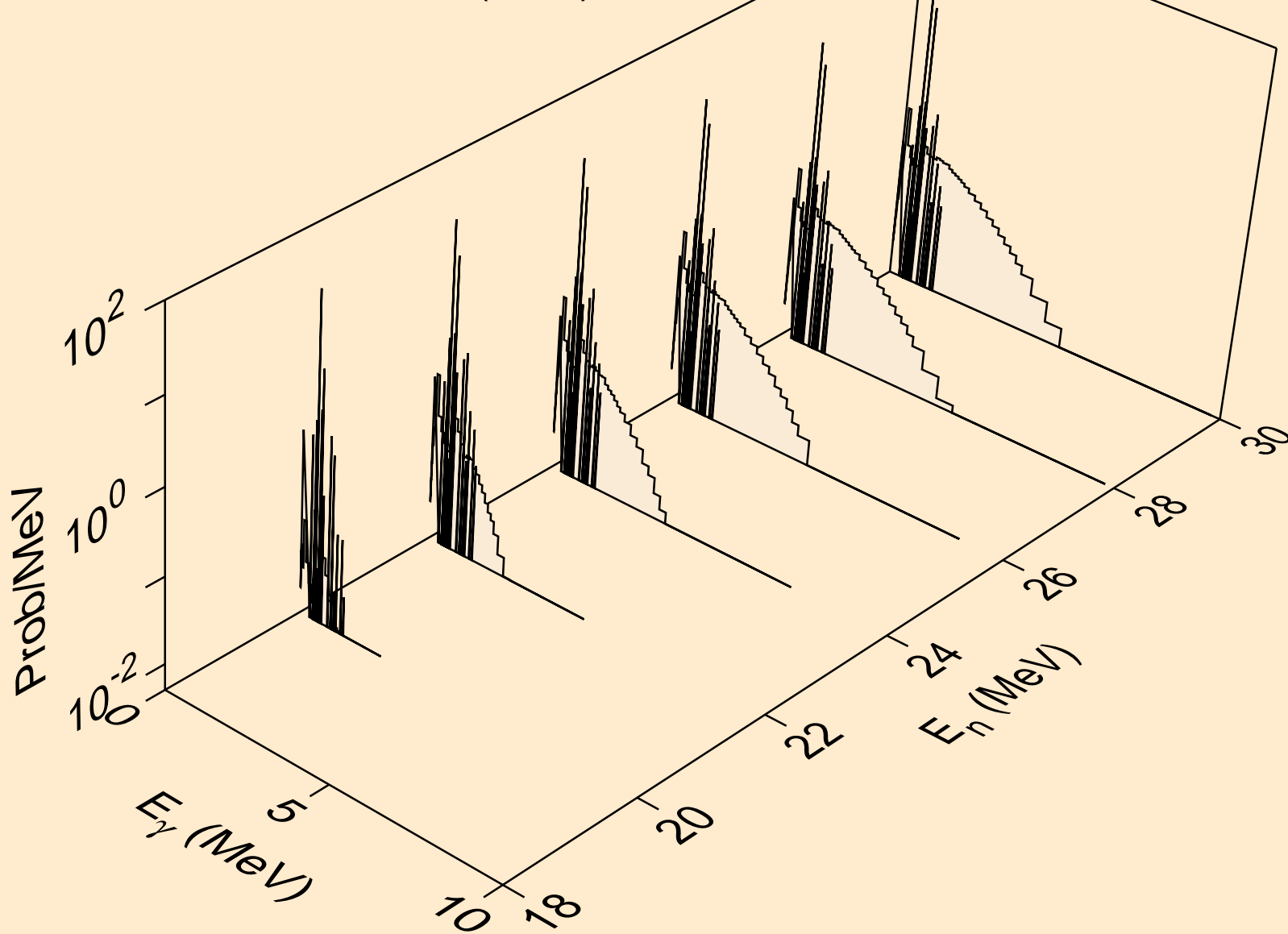

MO105 NEUTRON ACER TENDL-2019 LIBRARY; T=293.16K
Photon emission for (n,2np)

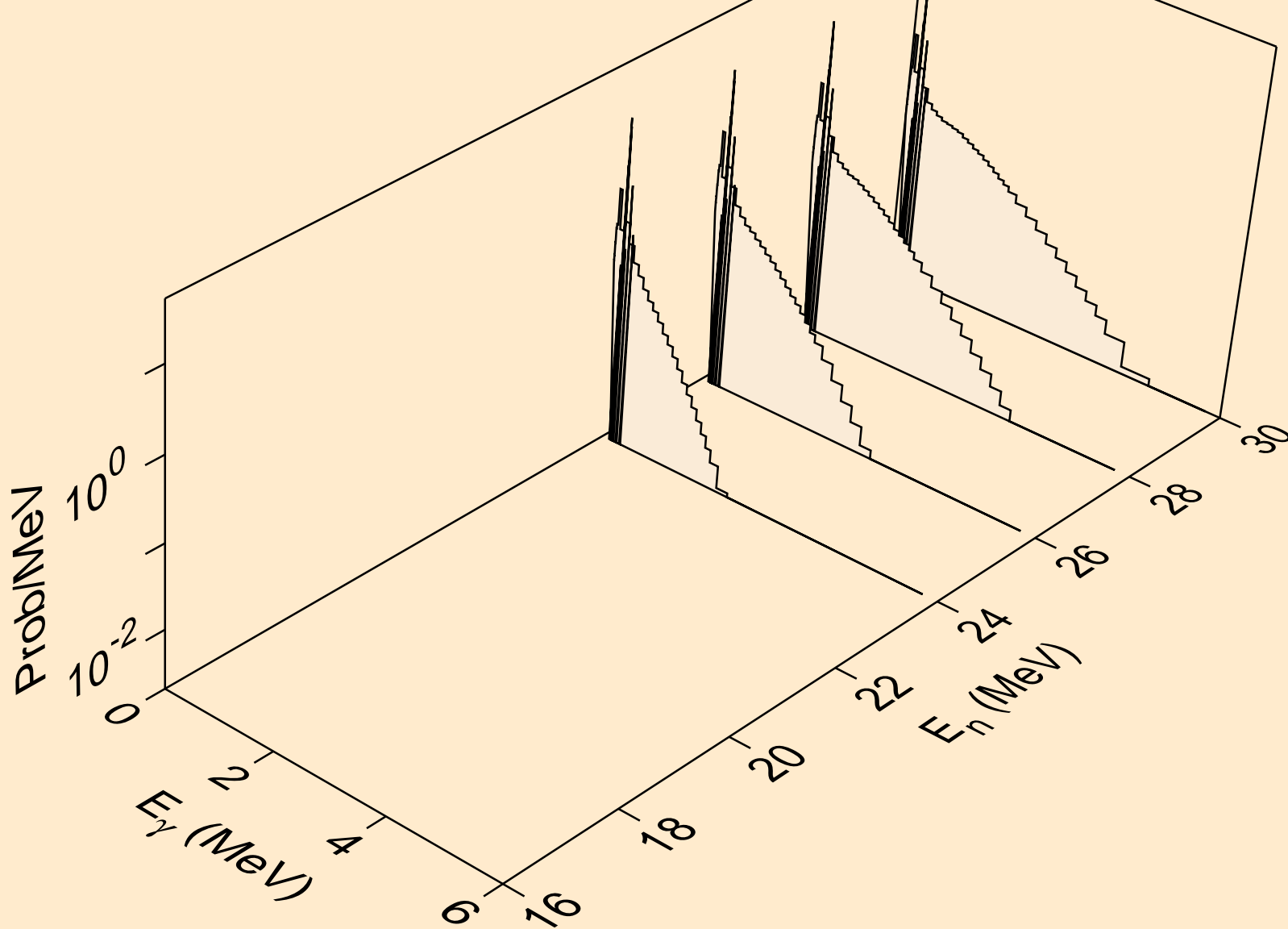

MO105 NEUTRON ACER TENDL-2019 LIBRARY; T=293.16K
Photon emission for (n,3np)

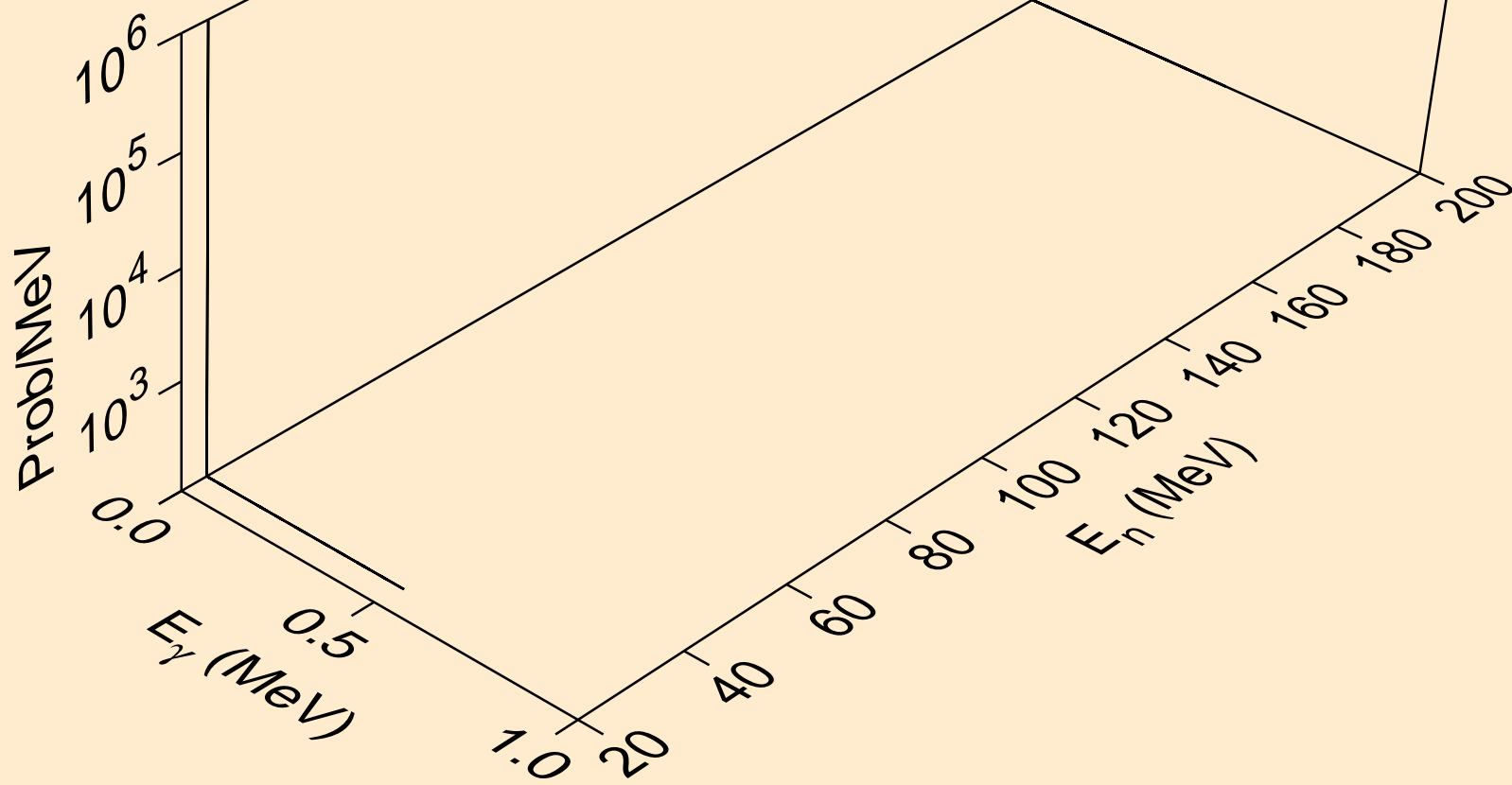

MO105 NEUTRON ACER TENDL-2019 LIBRARY; T=293.16K
Photon emission for (n,n*c)

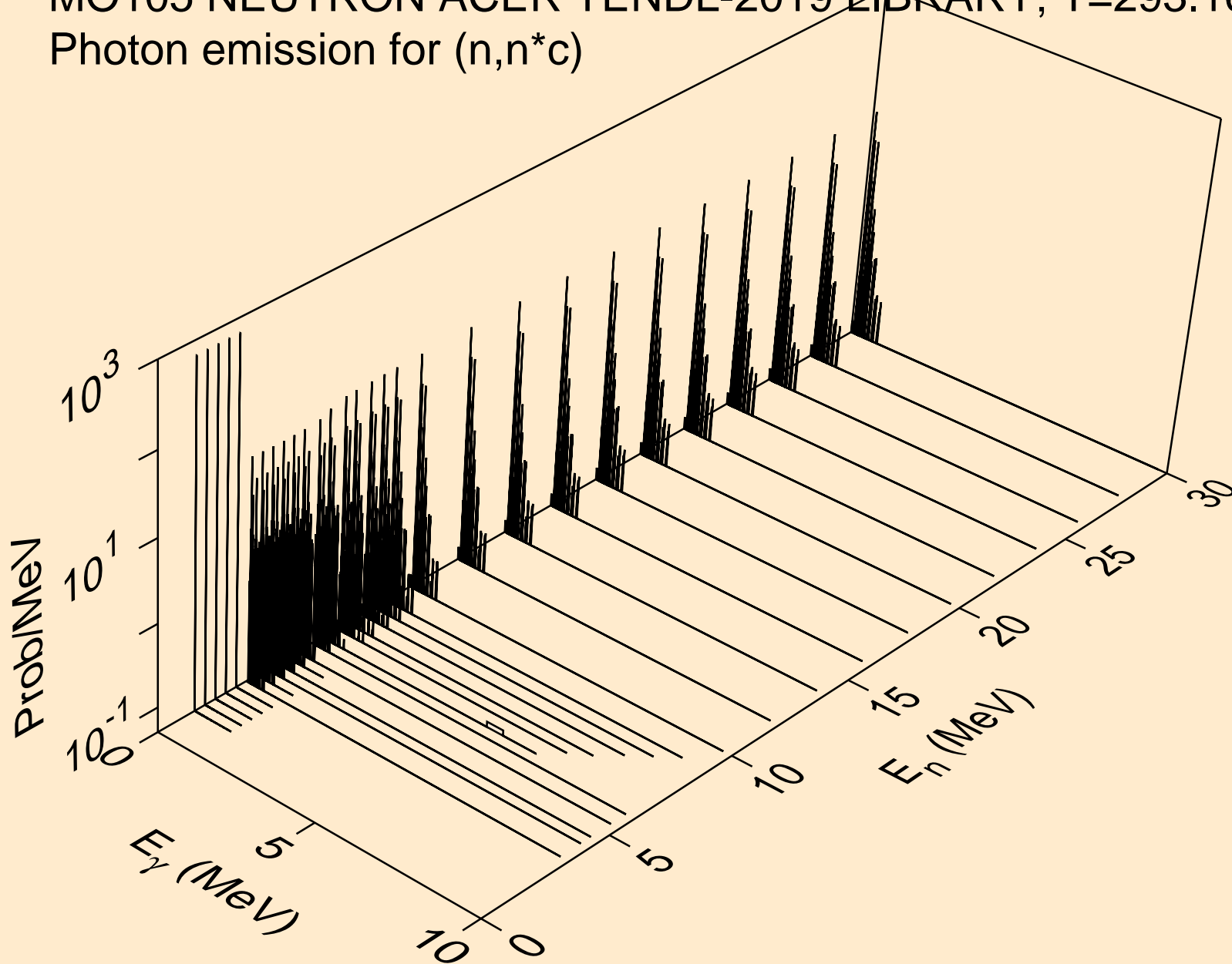

MO105 NEUTRON ACER TENDL-2019 LIBRARY; T=293.16K
Photon emission for (n,gma)

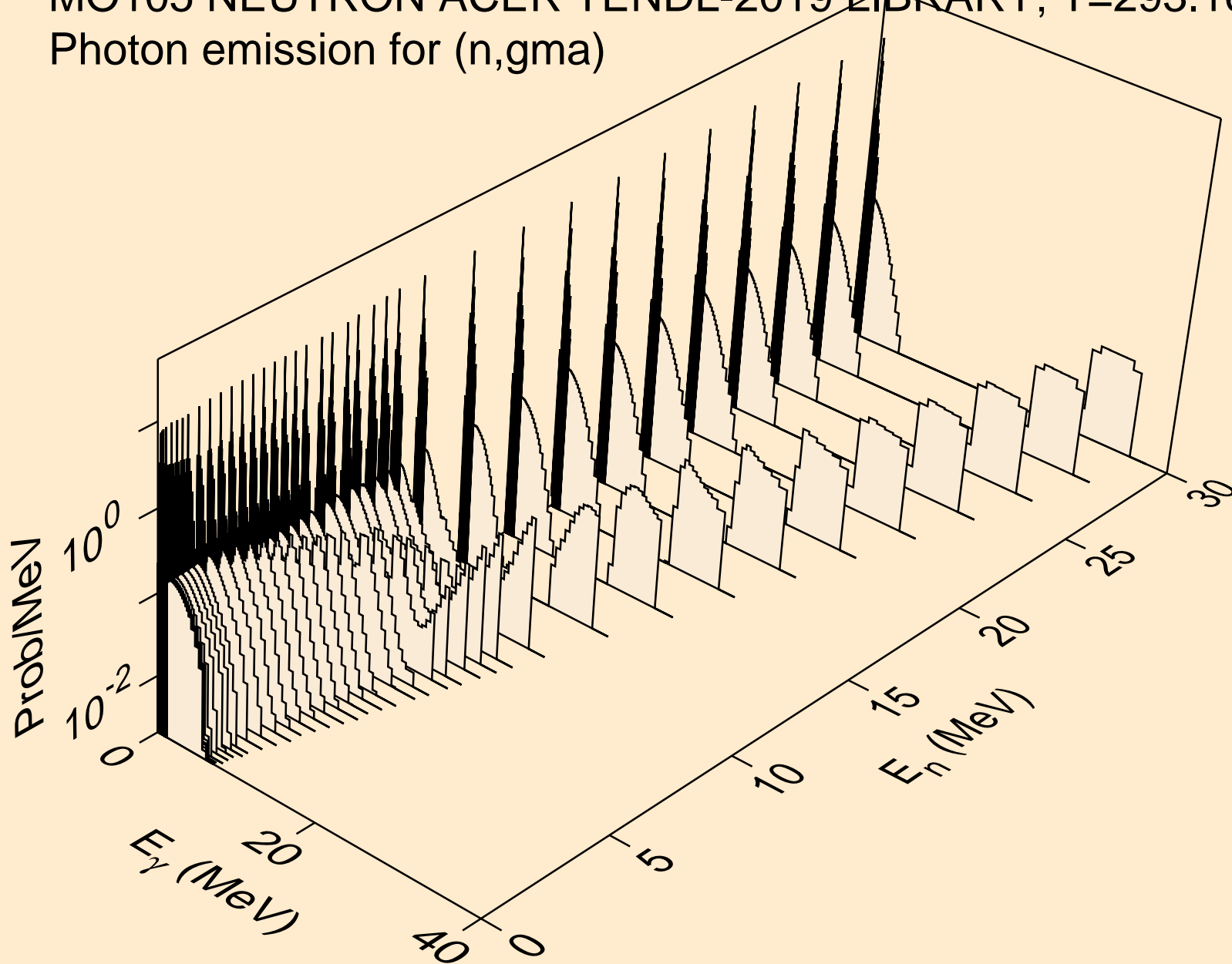

MO105 NEUTRON ACER TENDL-2019 LIBRARY; T=293.16K
Photon emission for (n,p)

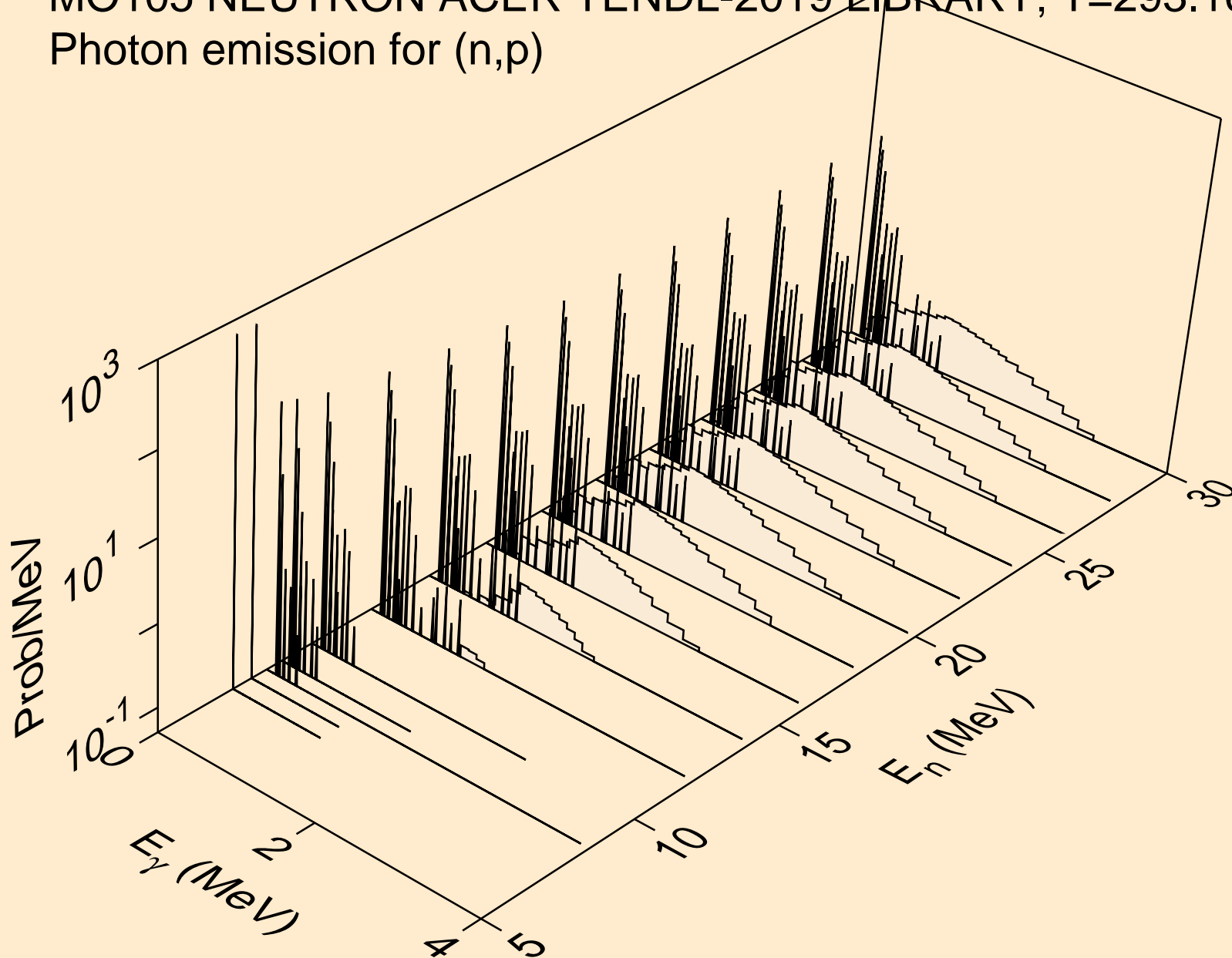

MO105 NEUTRON ACER TENDL-2019 LIBRARY; T=293.16K
Photon emission for (n,d)

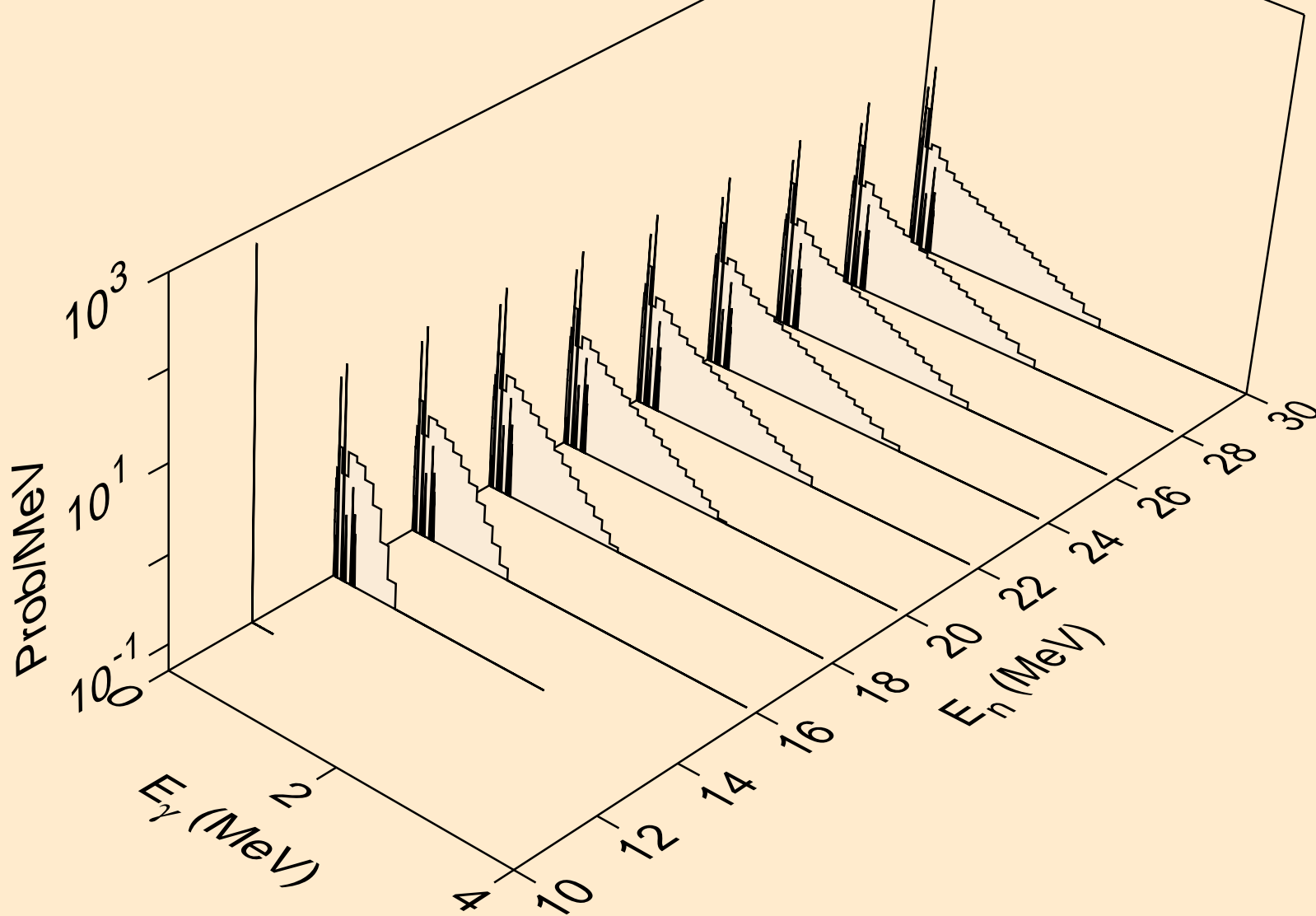

MO105 NEUTRON ACER TENDL-2019 LIBRARY; T=293.16K
Photon emission for (n,t)

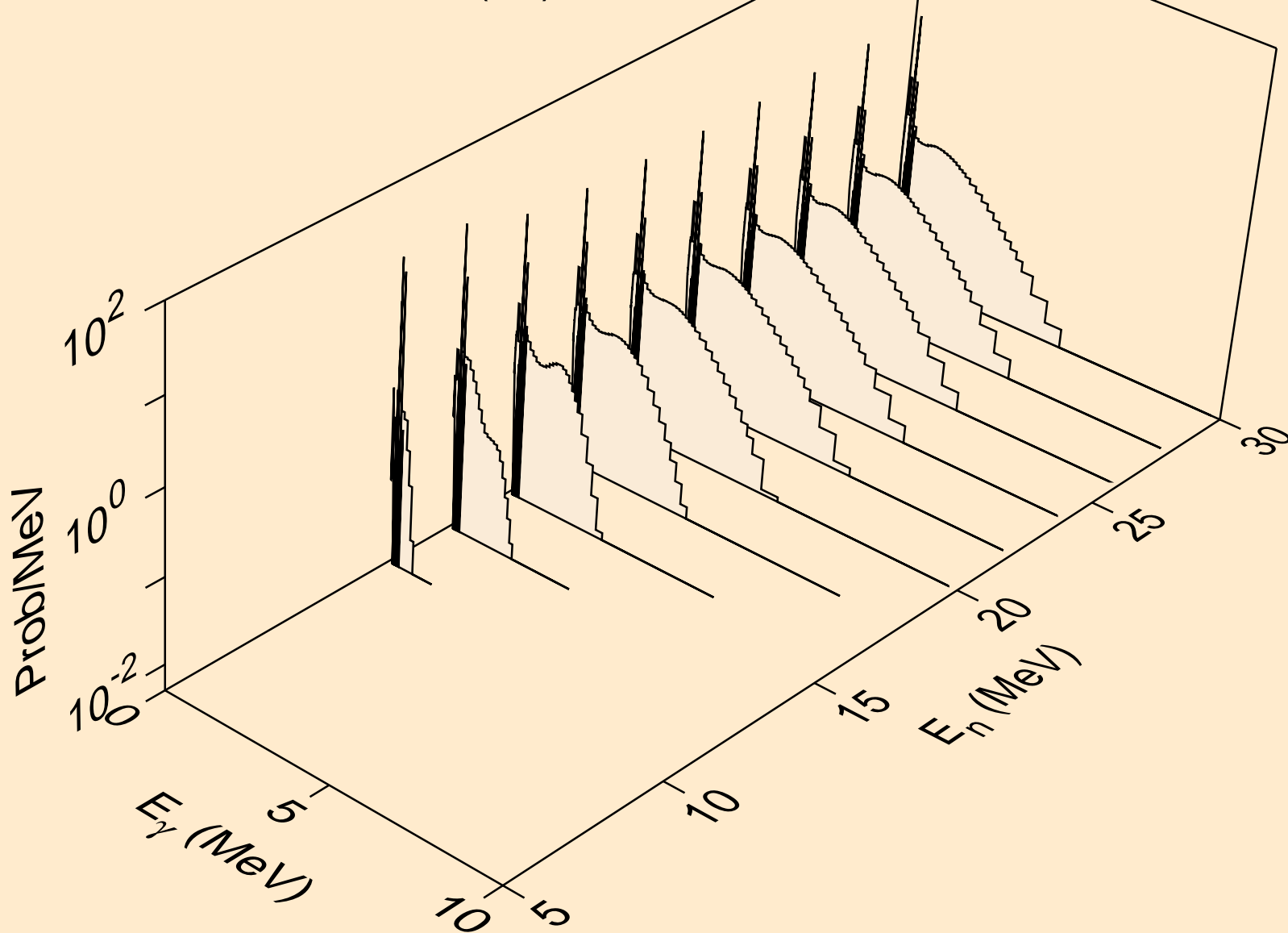

MO105 NEUTRON ACER TENDL-2019 LIBRARY; T=293.16K
Photon emission for (n,he3)

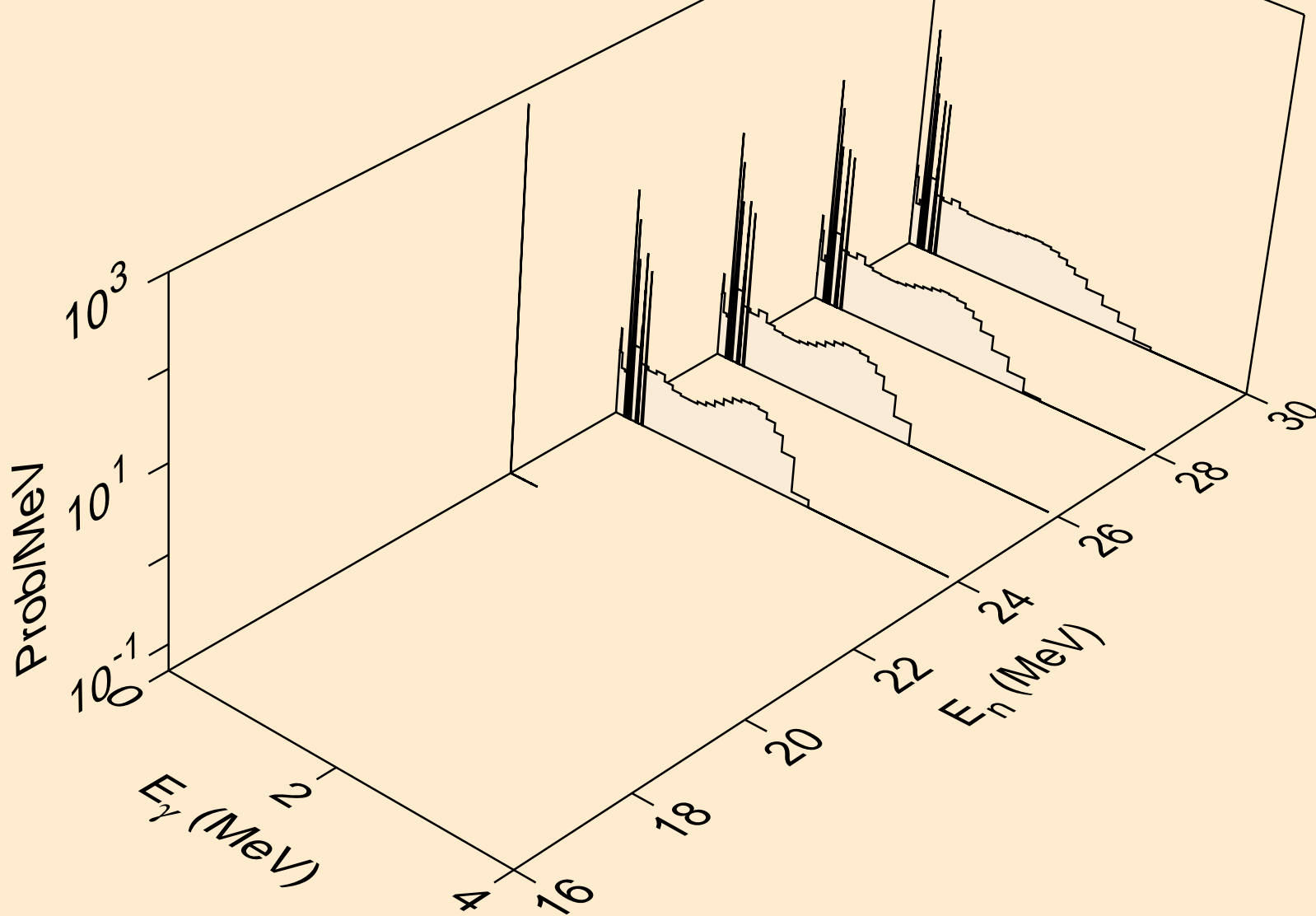

MO105 NEUTRON ACER TENDL-2019 LIBRARY; T=293.16K
Photon emission for (n,a)

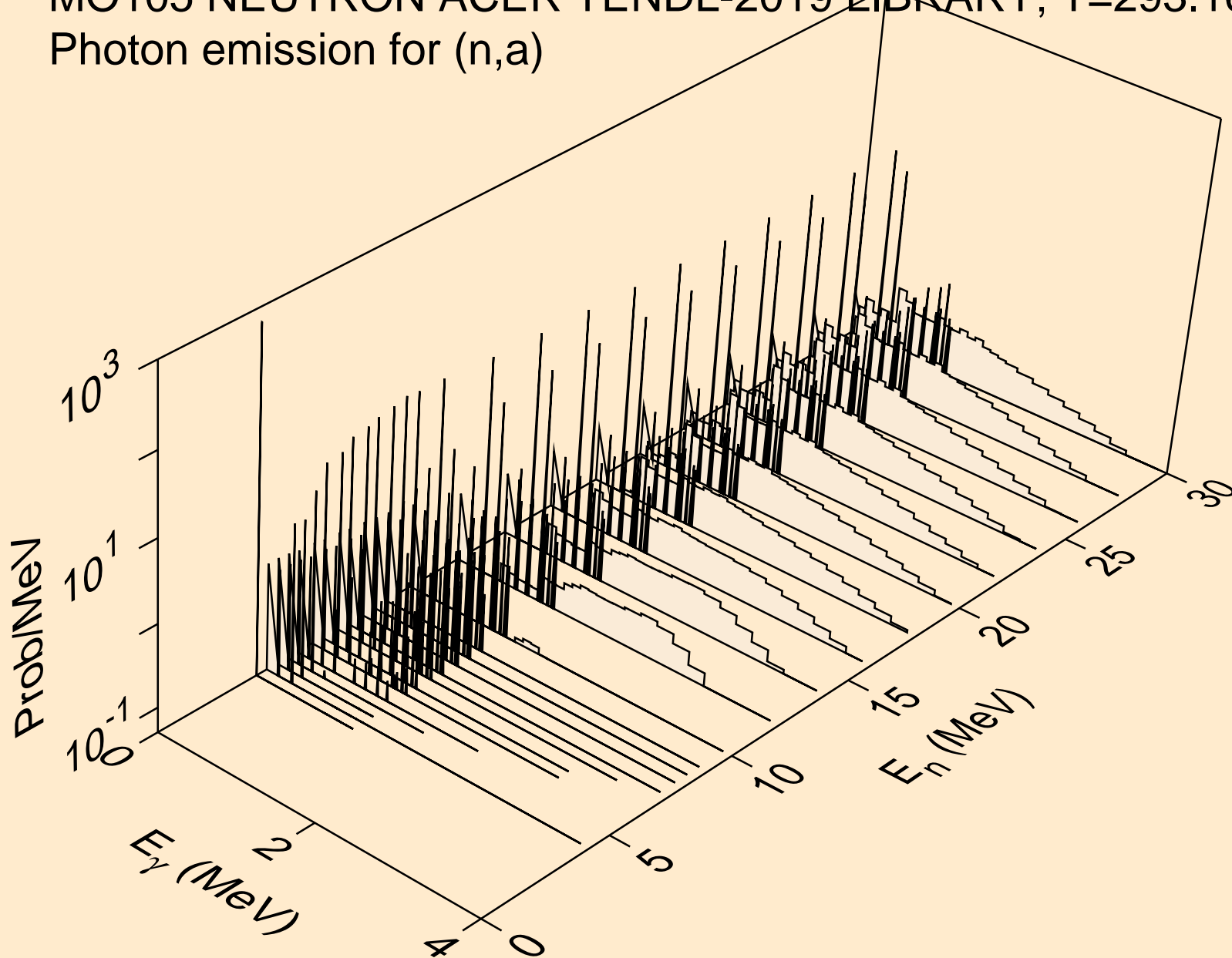

MO105 NEUTRON ACER TENDL-2019 LIBRARY; T=293.16K
thermal capture photon spectrum

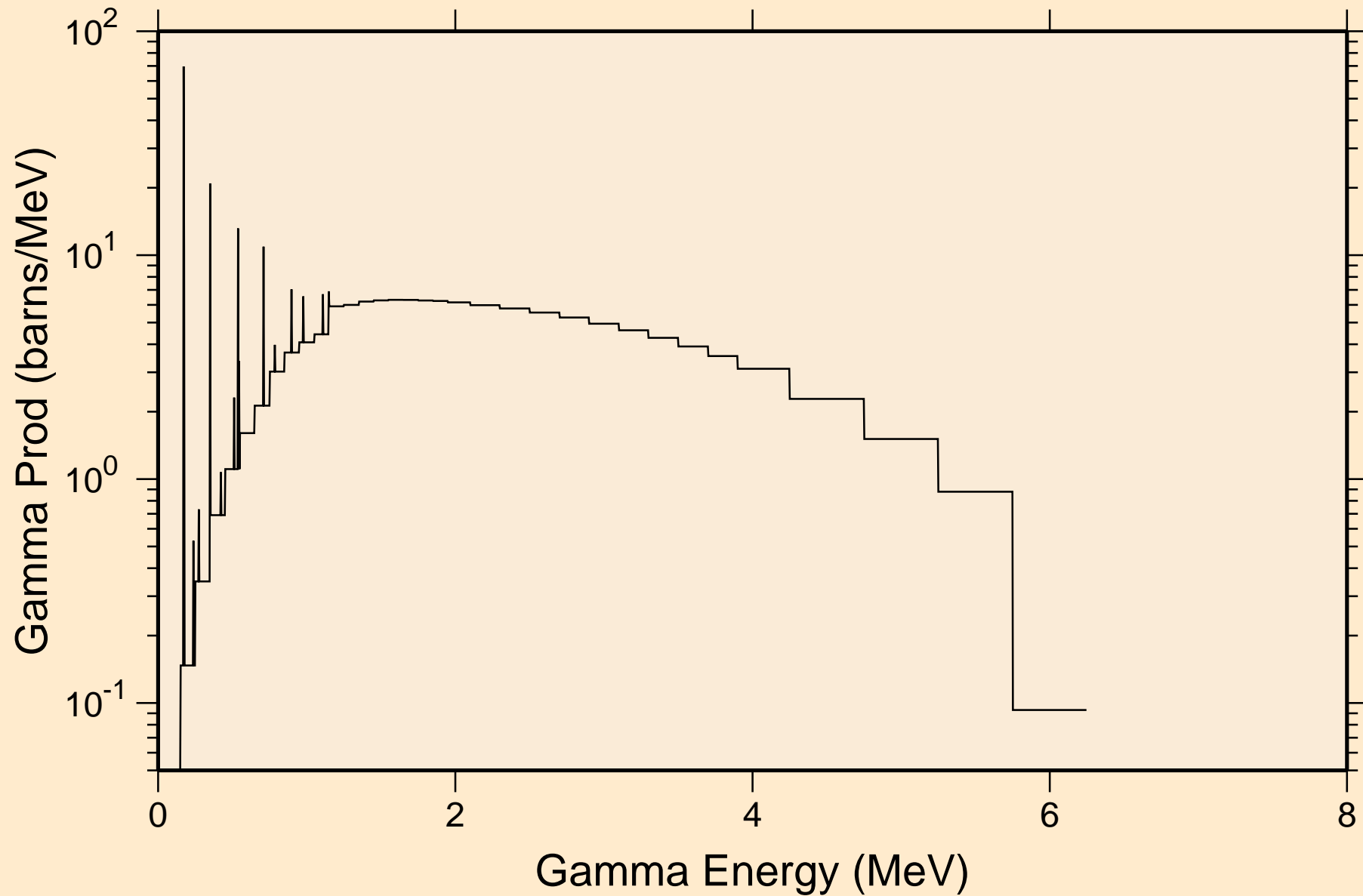

MO105 NEUTRON ACER TENDL-2019 LIBRARY; T=293.16K
14 MeV photon spectrum

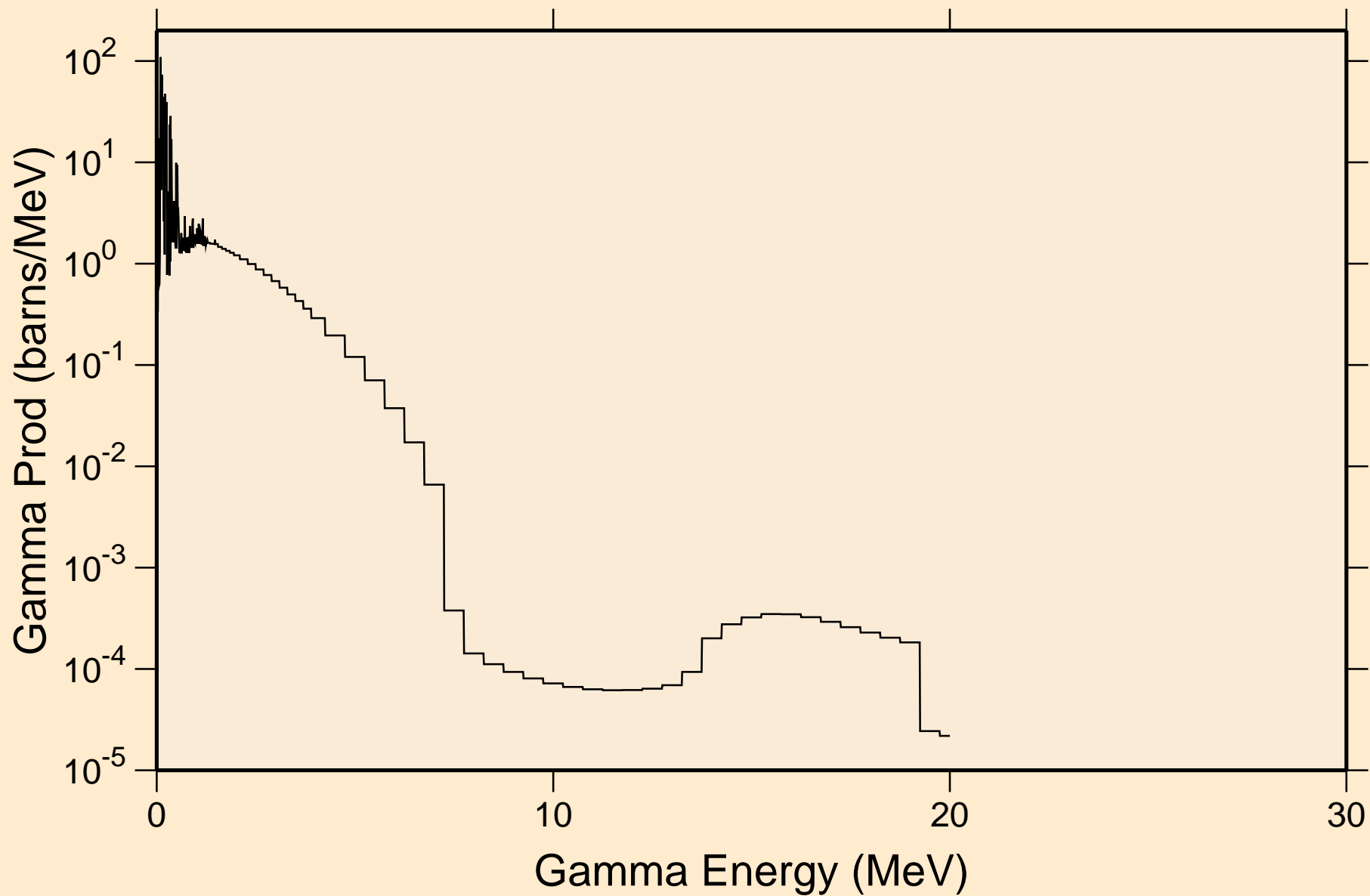

MO105 NEUTRON ACER TENDL-2019 LIBRARY; T=293.16K
Particle heating contributions

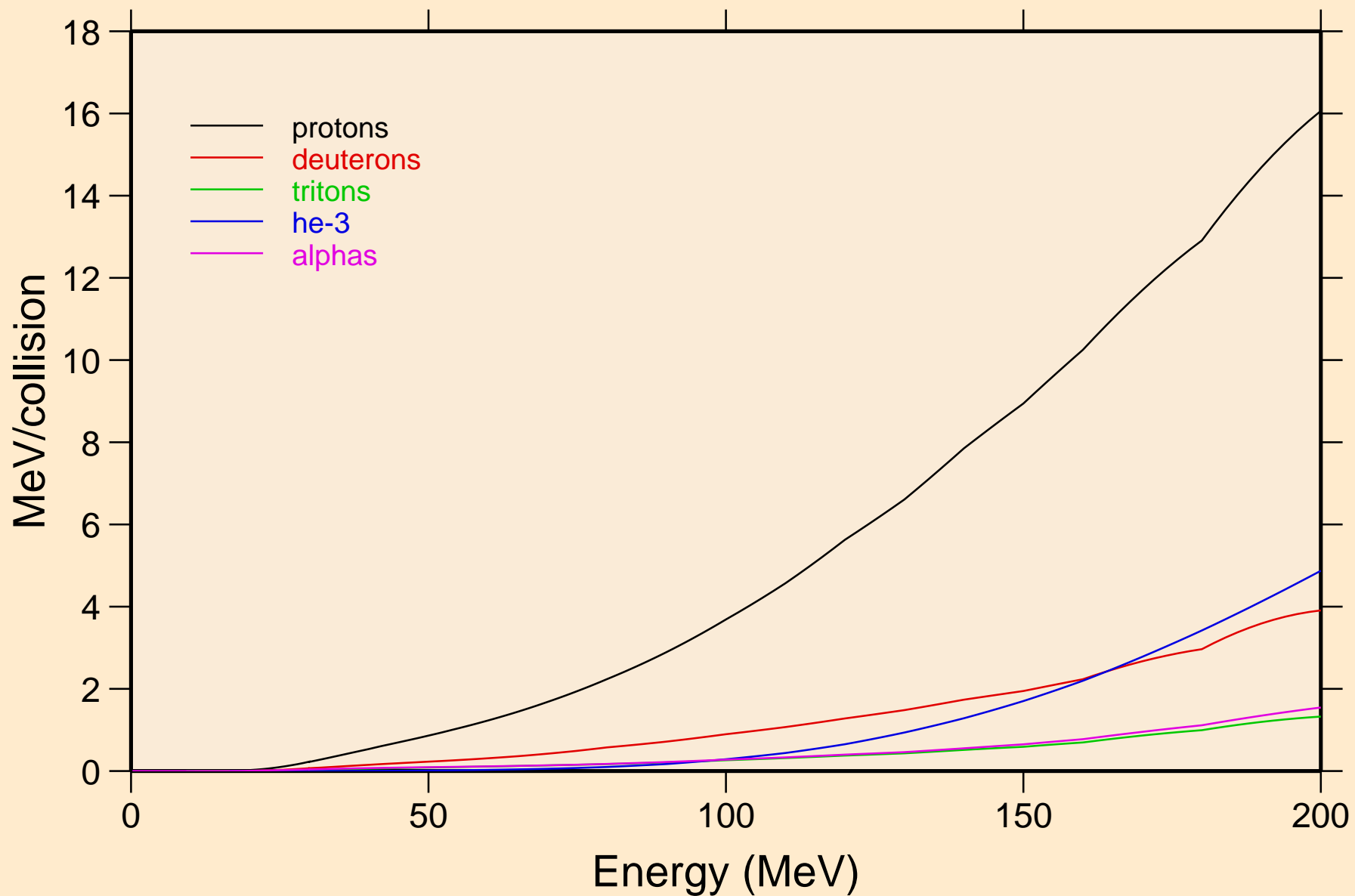

MO105 NEUTRON ACER TENDL-2019 LIBRARY; T=293.16K
Recoil Heating

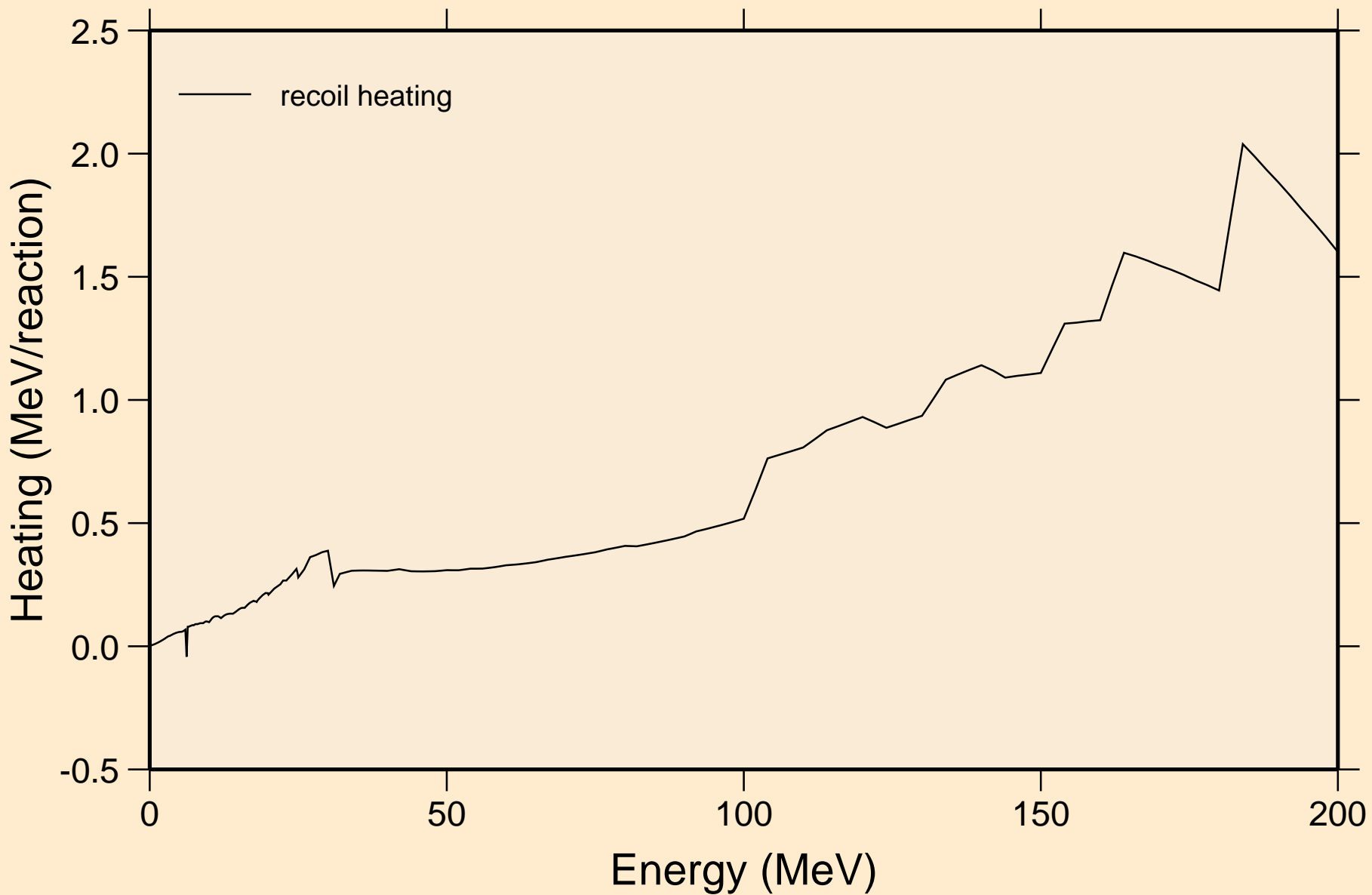

MO105 NEUTRON ACER TENDL-2019 LIBRARY; T=293.16K
Particle production cross sections

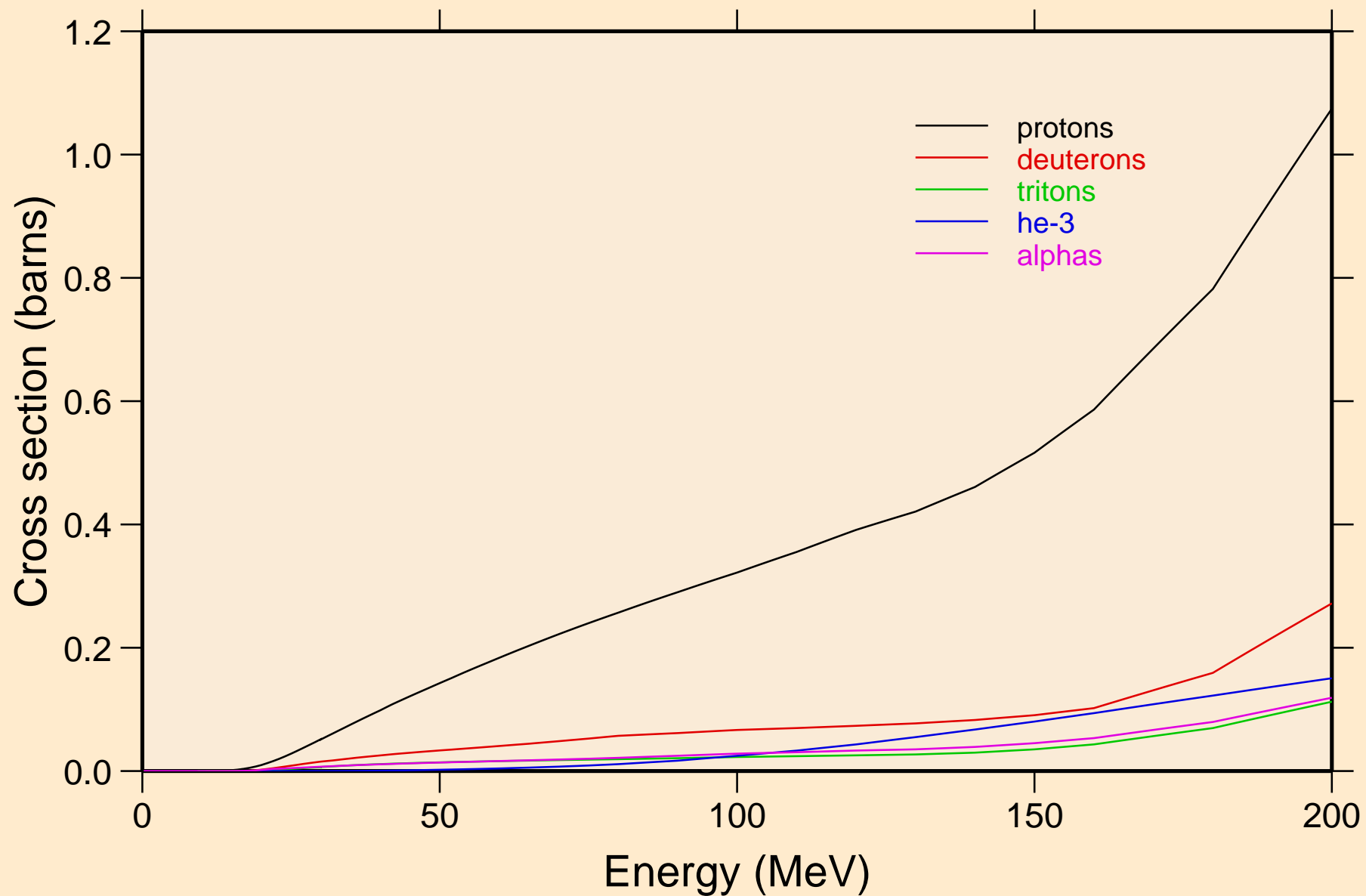

MO105 NEUTRON ACER TENDL-2019 LIBRARY; T=293.16K
protons from (n,x)

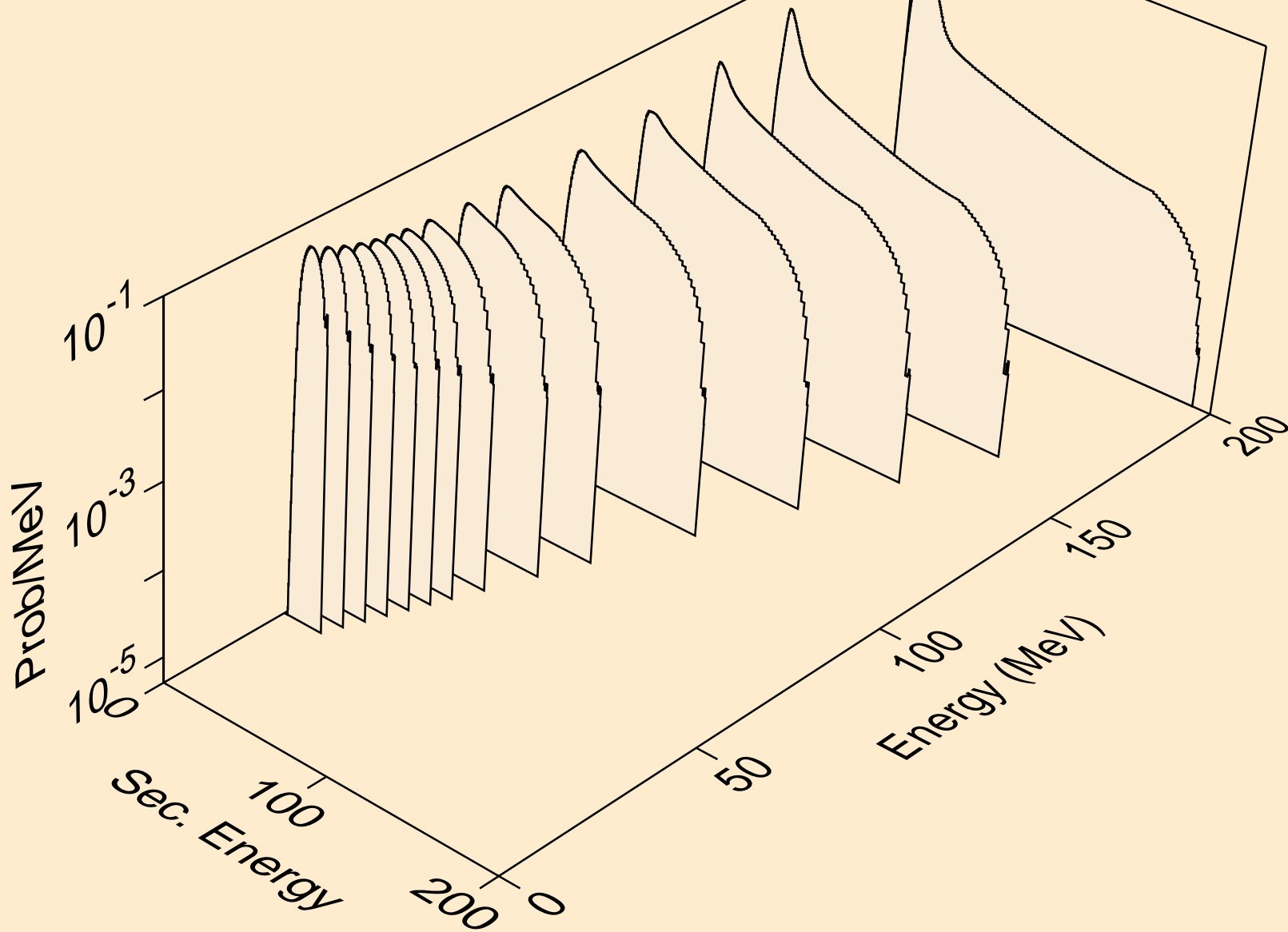

MO105 NEUTRON ACER TENDL-2019 LIBRARY; T=293.16K
protons from (n,n*)p

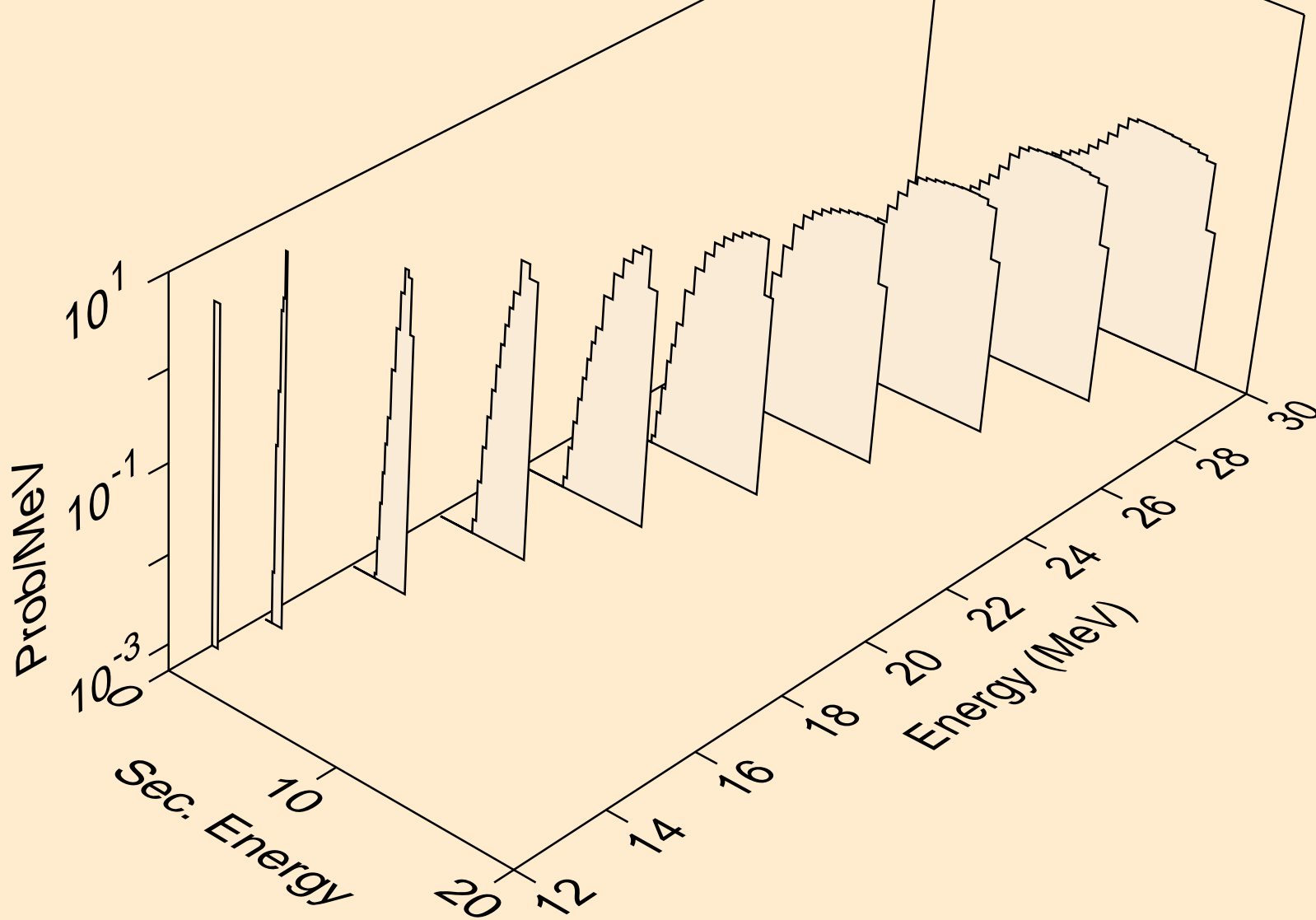

MO105 NEUTRON ACER TENDL-2019 LIBRARY; T=293.16K
protons from (n,2np)

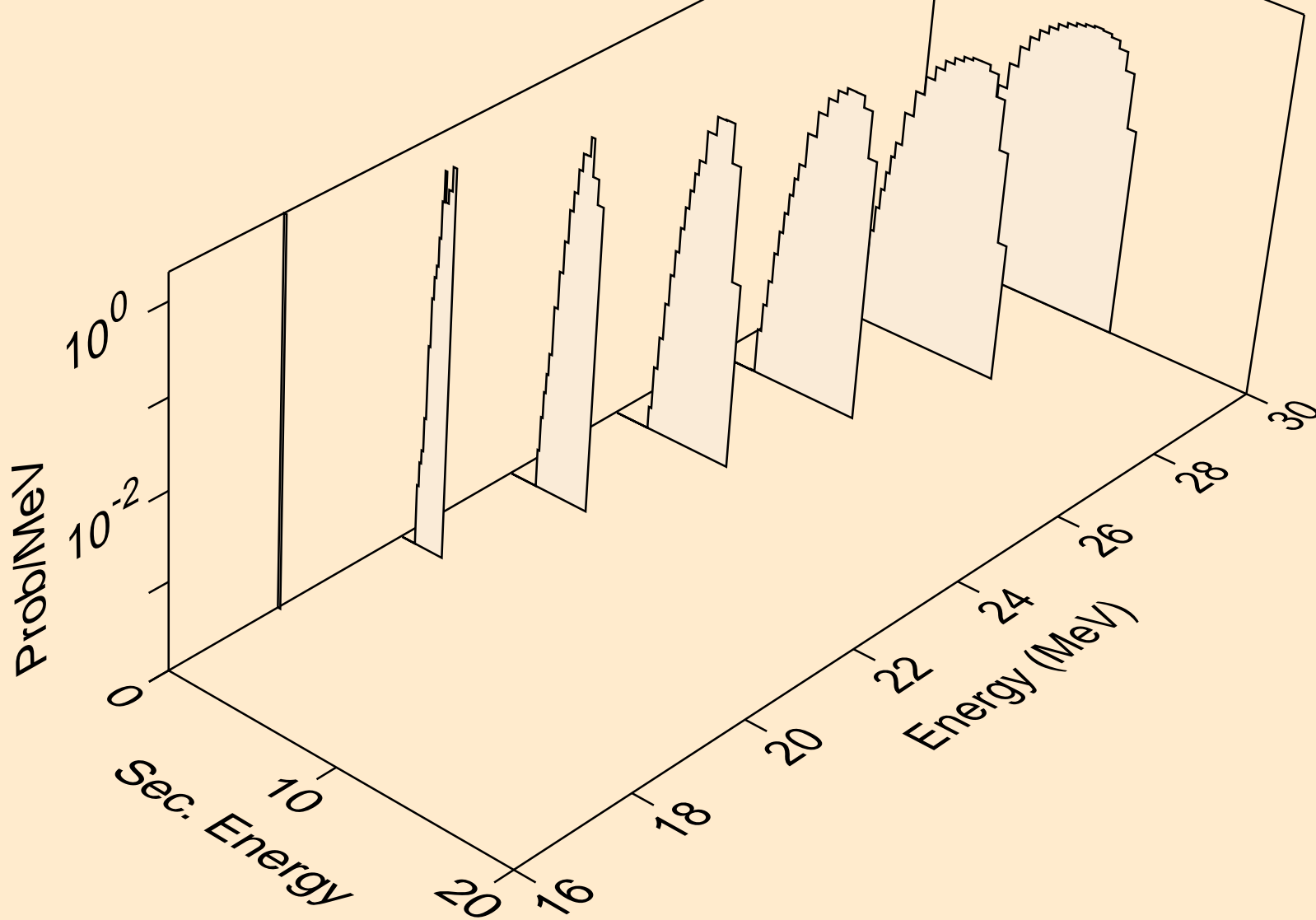

MO105 NEUTRON ACER TENDL-2019 LIBRARY; T=293.16K
protons from (n,3np)

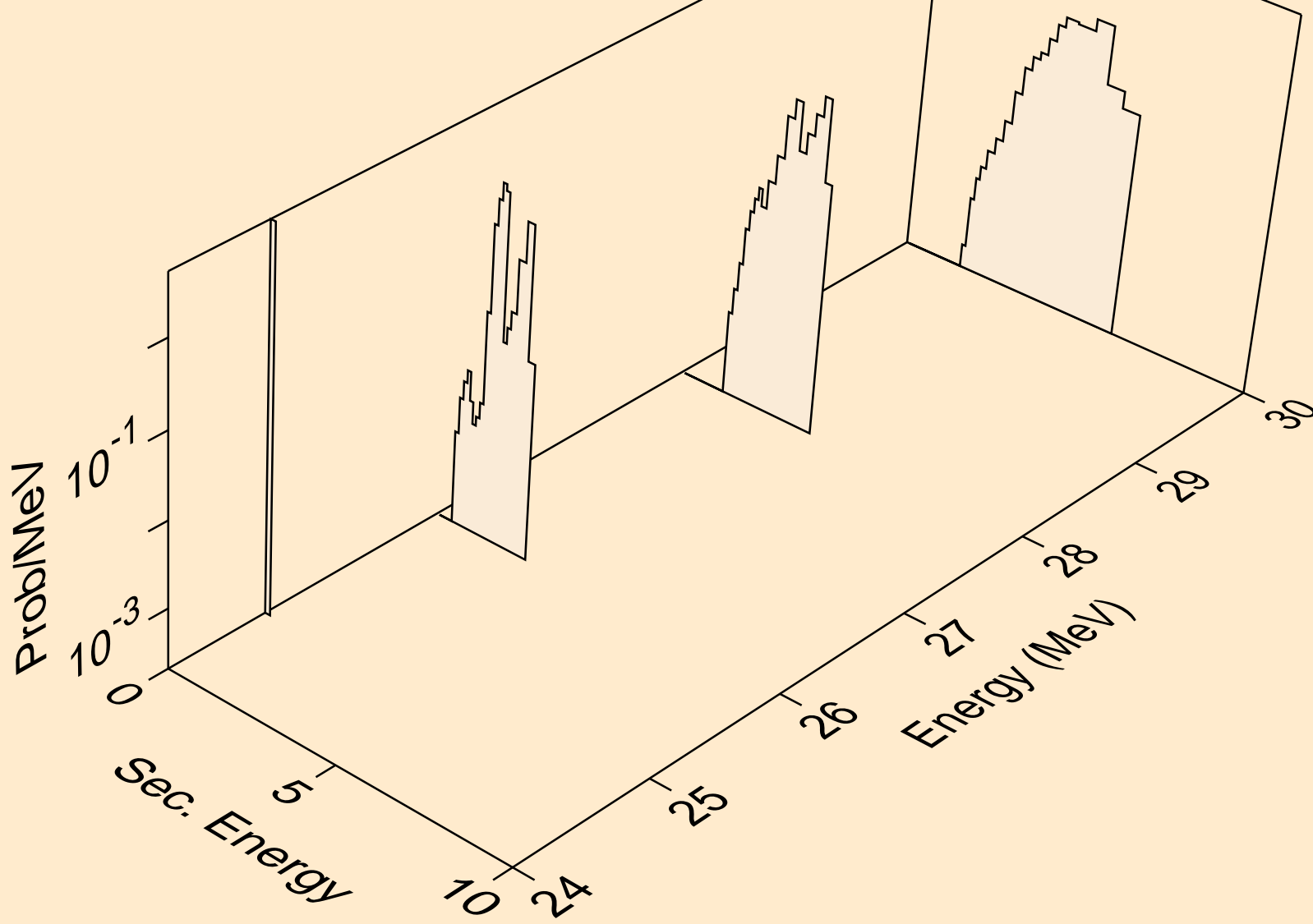

MO105 NEUTRON ACER TENDL-2019 LIBRARY; T=293.16K
protons from (n,p)

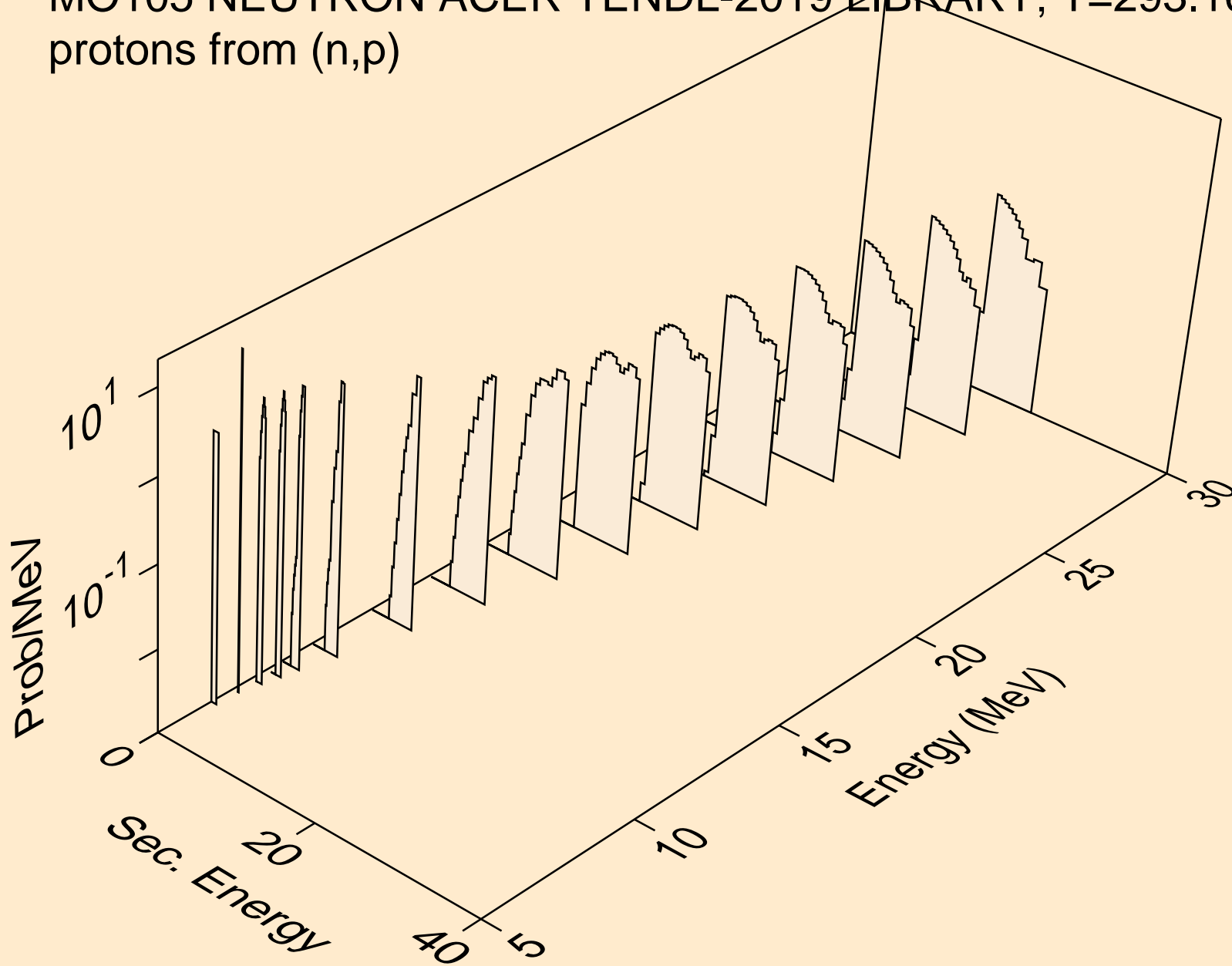

MO105 NEUTRON ACER TENDL-2019 LIBRARY; T=293.16K
deuterons from (n,x)

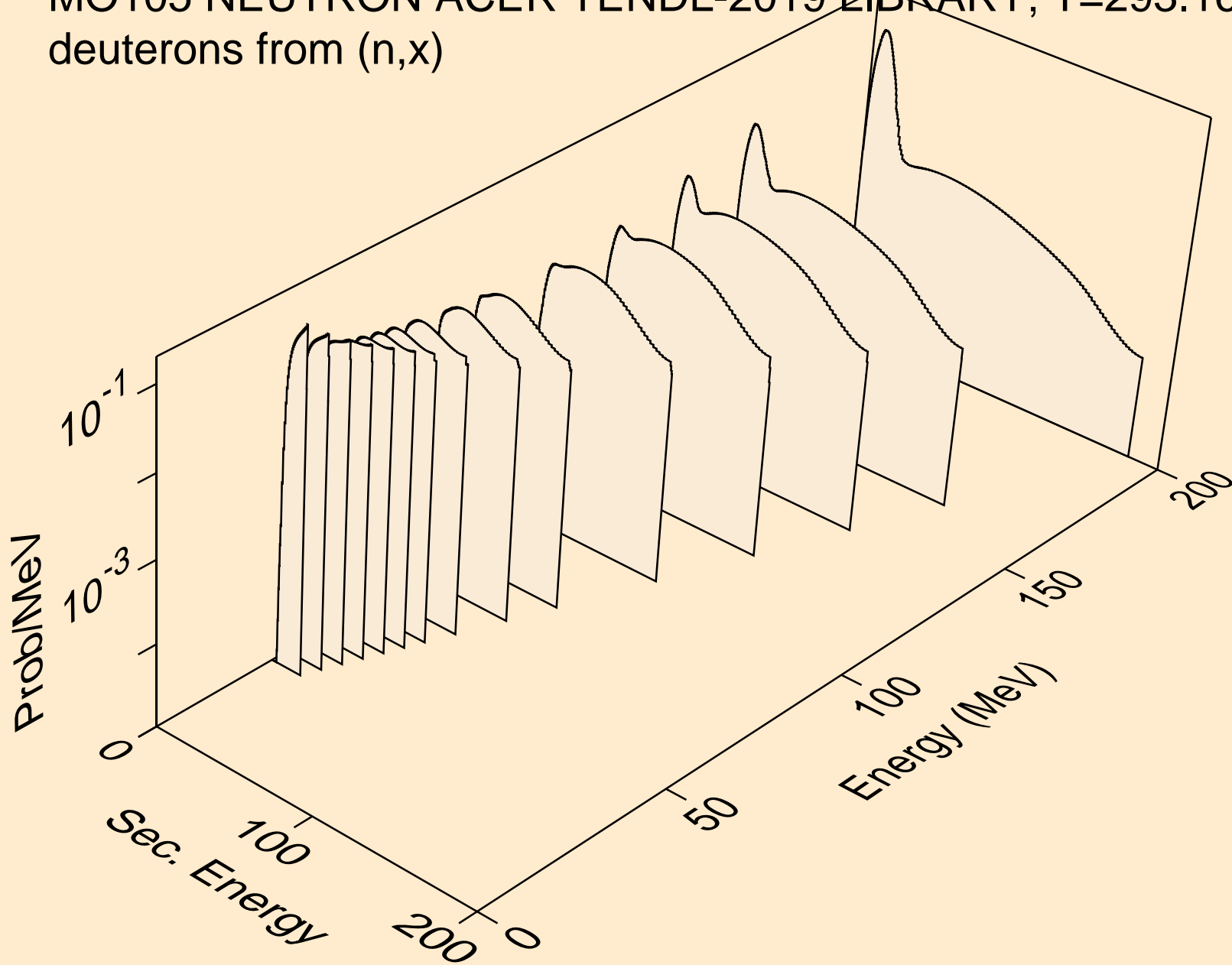

MO105 NEUTRON ACER TENDL-2019 LIBRARY; T=293.16K
deuterons from (n,2nd)

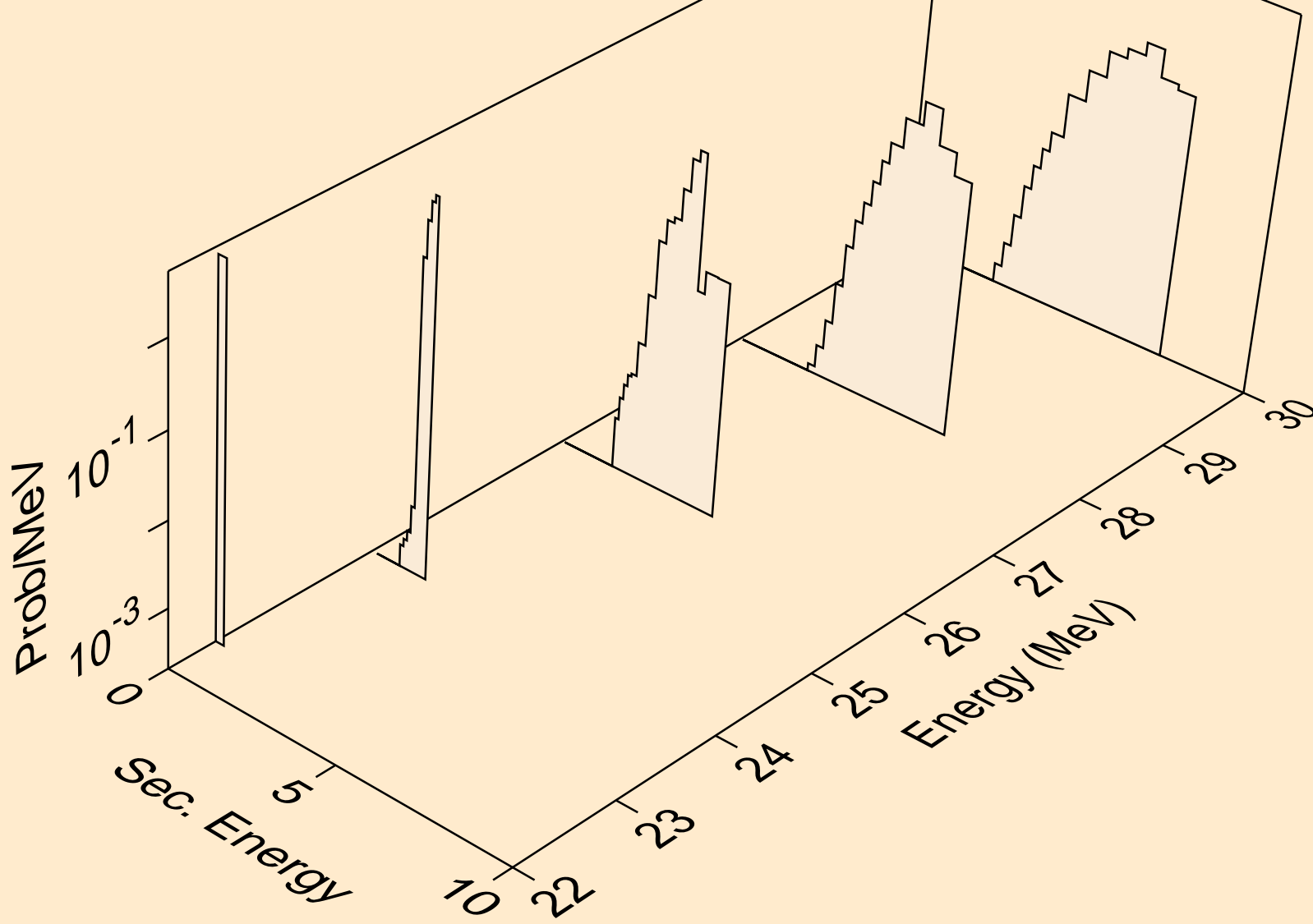

MO105 NEUTRON ACER TENDL-2019 LIBRARY; T=293.16K
deuterons from (n,n*)d

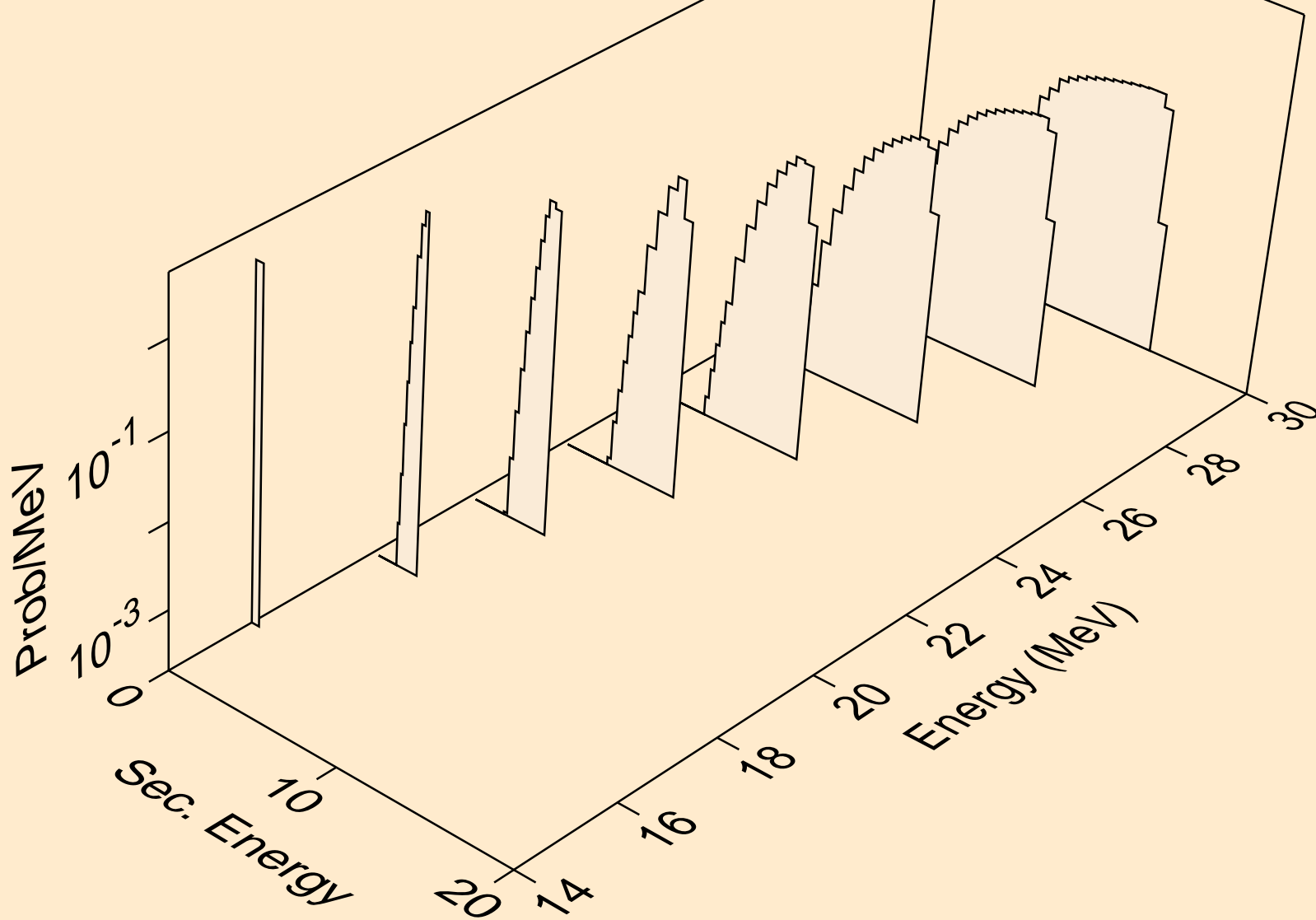

MO105 NEUTRON ACER TENDL-2019 LIBRARY; T=293.16K
deuterons from (n,d)

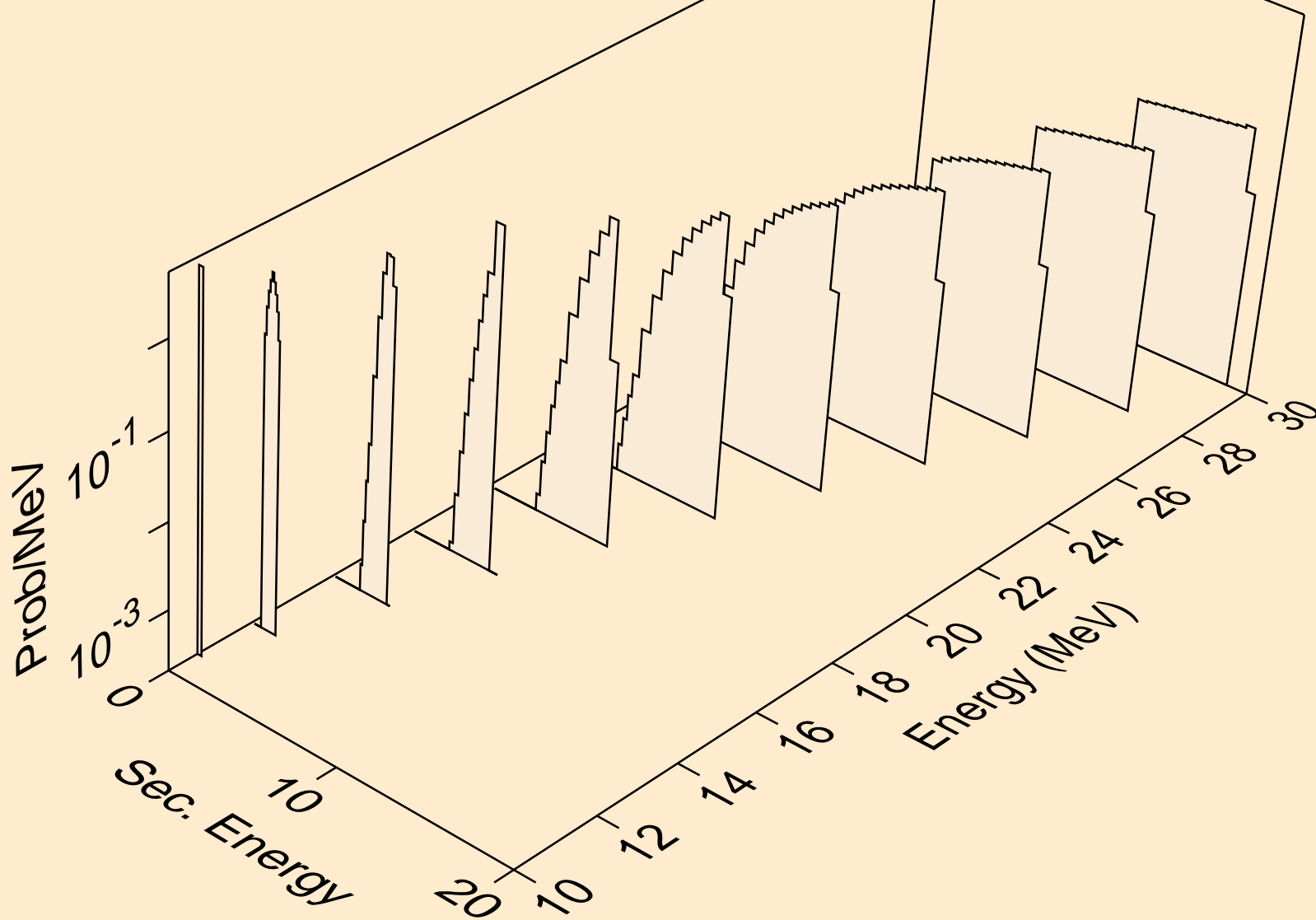

MO105 NEUTRON ACER TENDL-2019 LIBRARY; T=293.16K
tritons from (n,x)

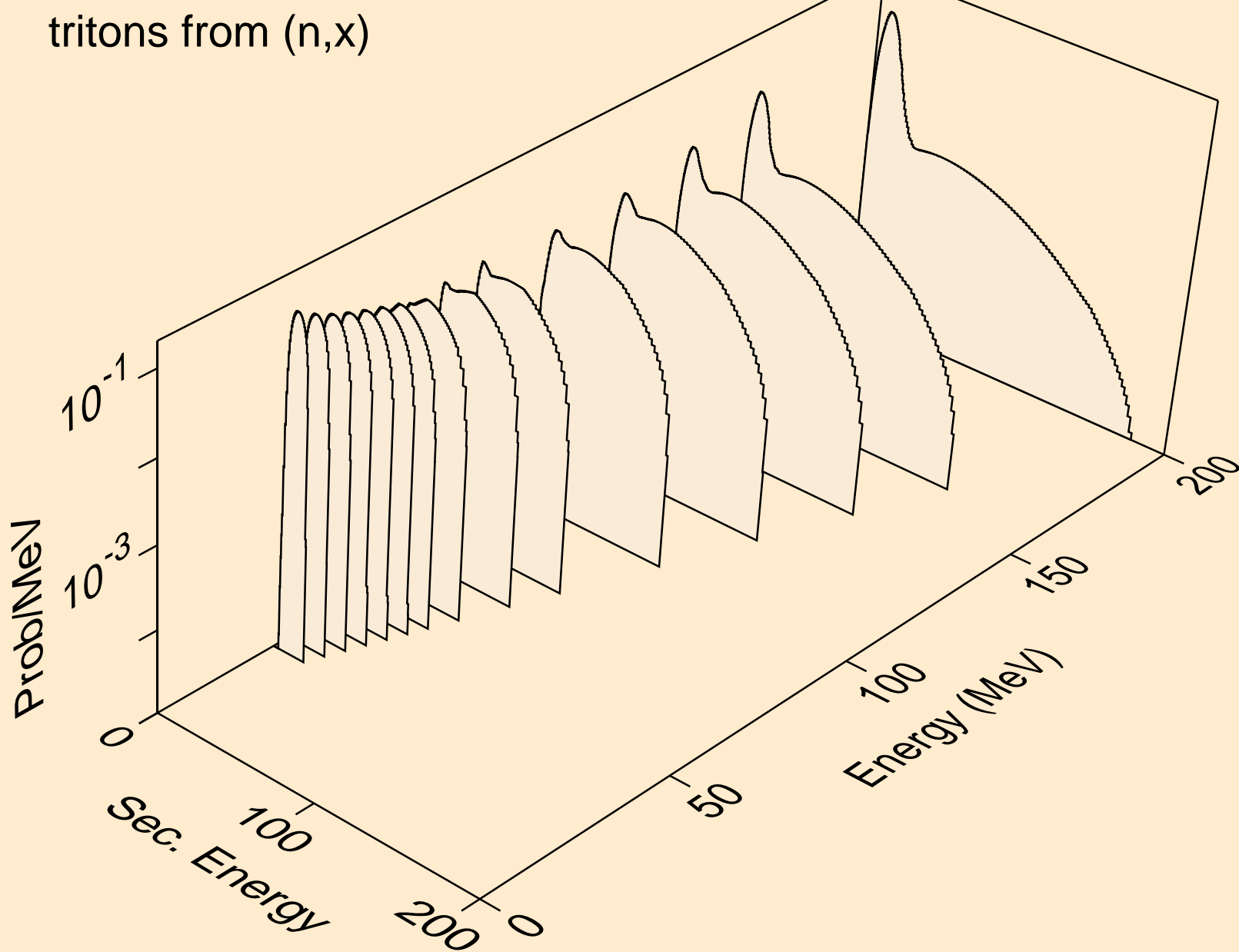

MO105 NEUTRON ACER TENDL-2019 LIBRARY; T=293.16K
tritons from (n,n*)t

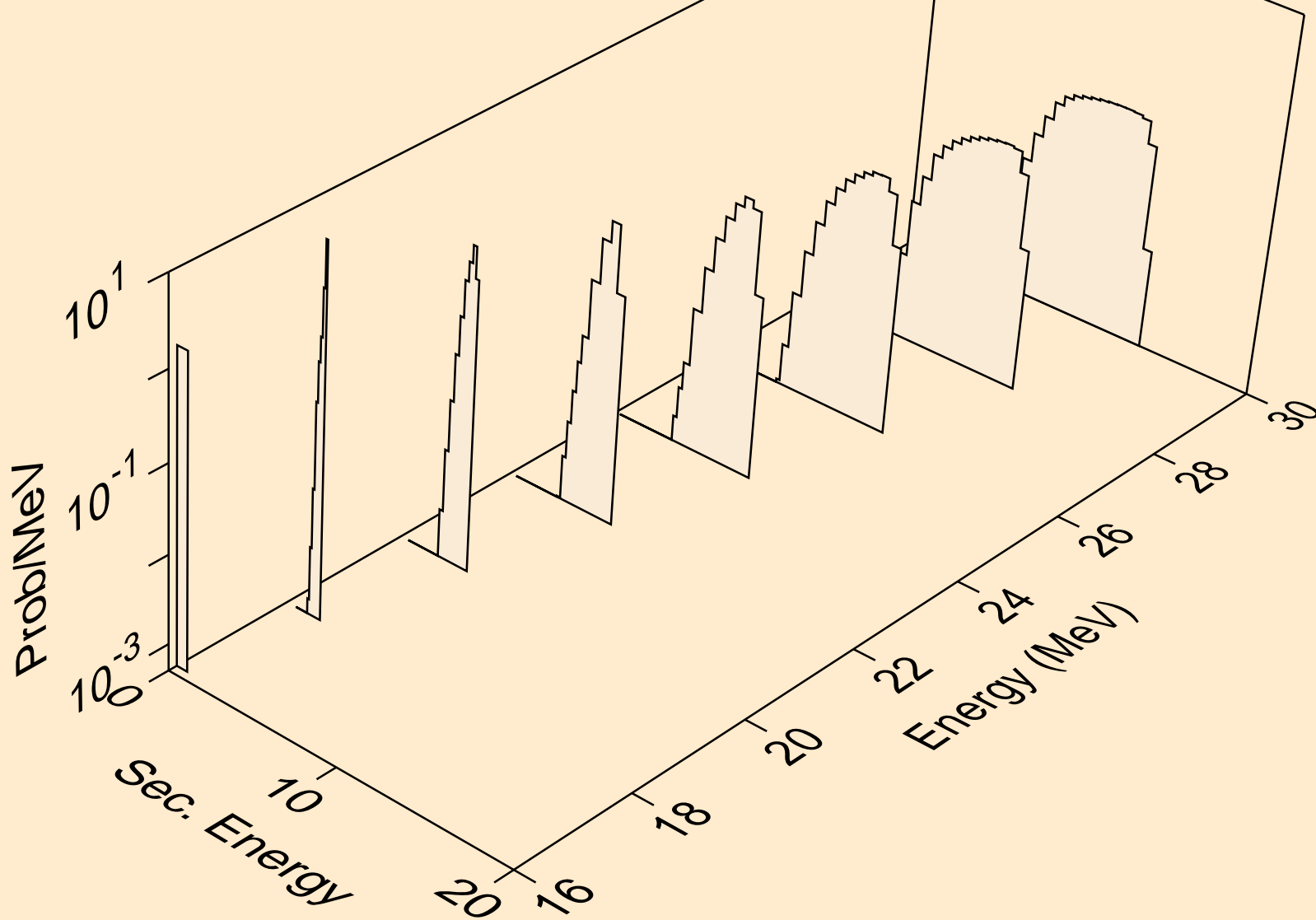

MO105 NEUTRON ACER TENDL-2019 LIBRARY; T=293.16K
tritons from (n,t)

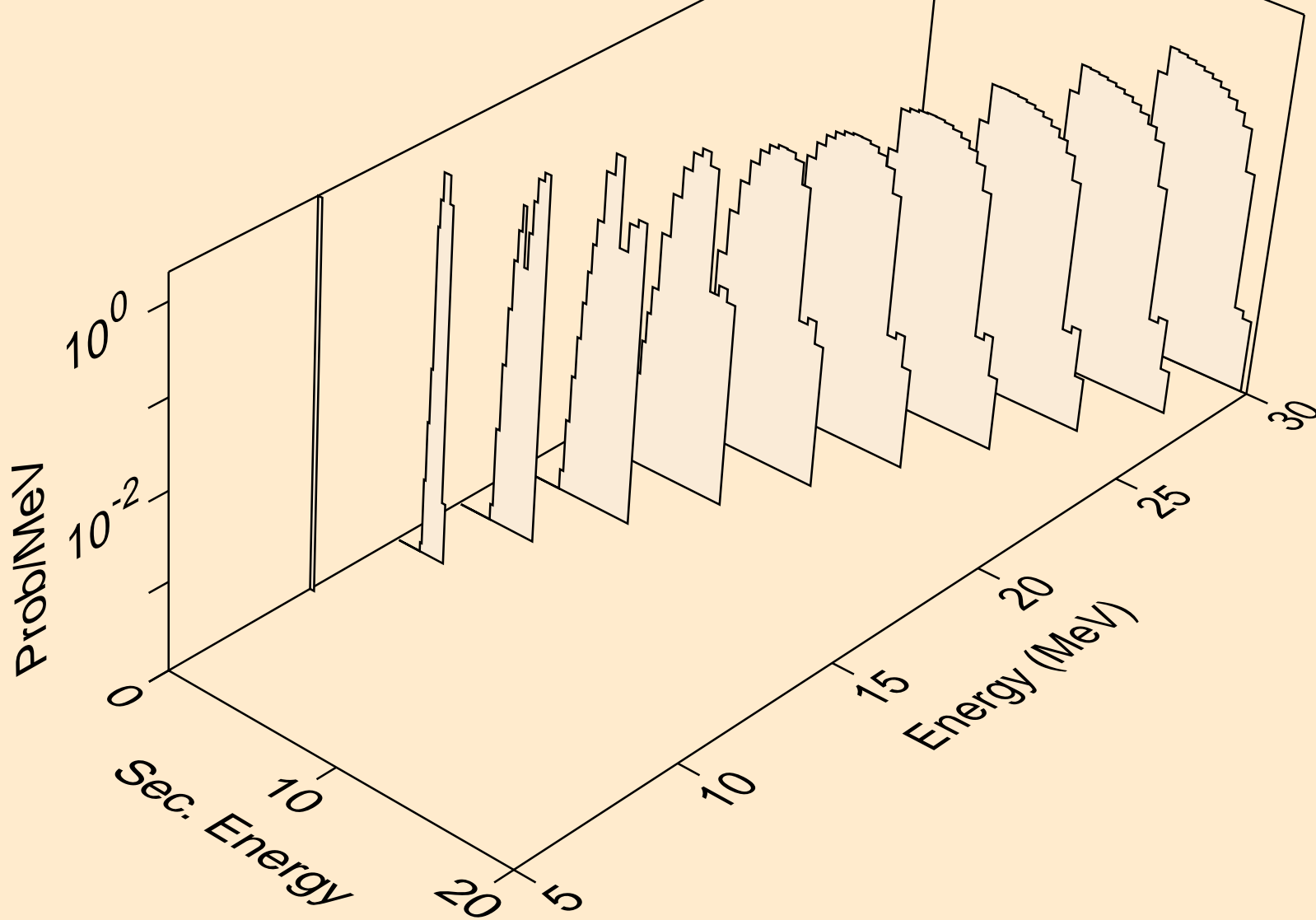

MO105 NEUTRON ACER TENDL-2019 LIBRARY; T=293.16K
he3s from (n,x)

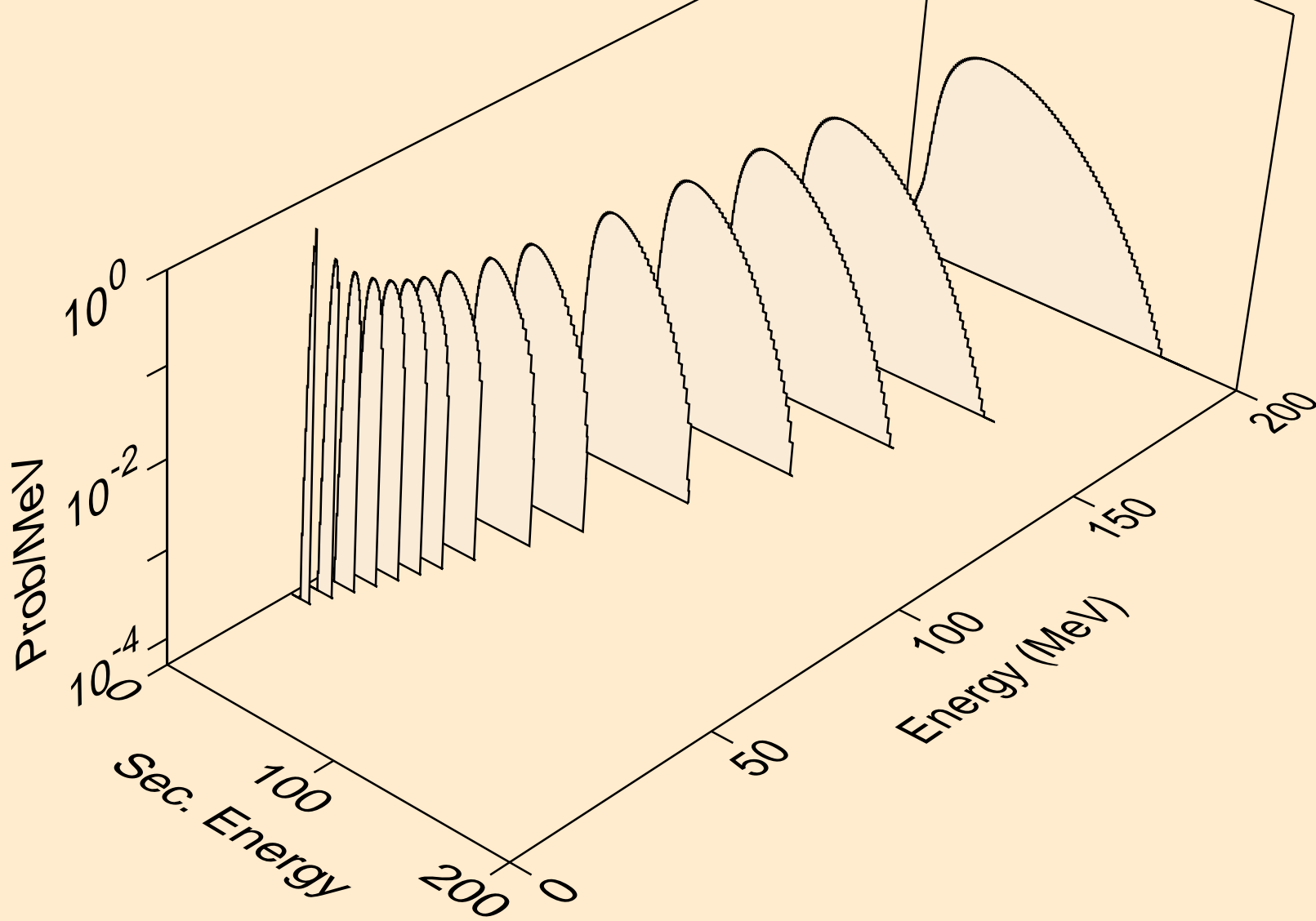

MO105 NEUTRON ACER TENDL-2019 LIBRARY; T=293.16K
he3s from (n,n*)he3

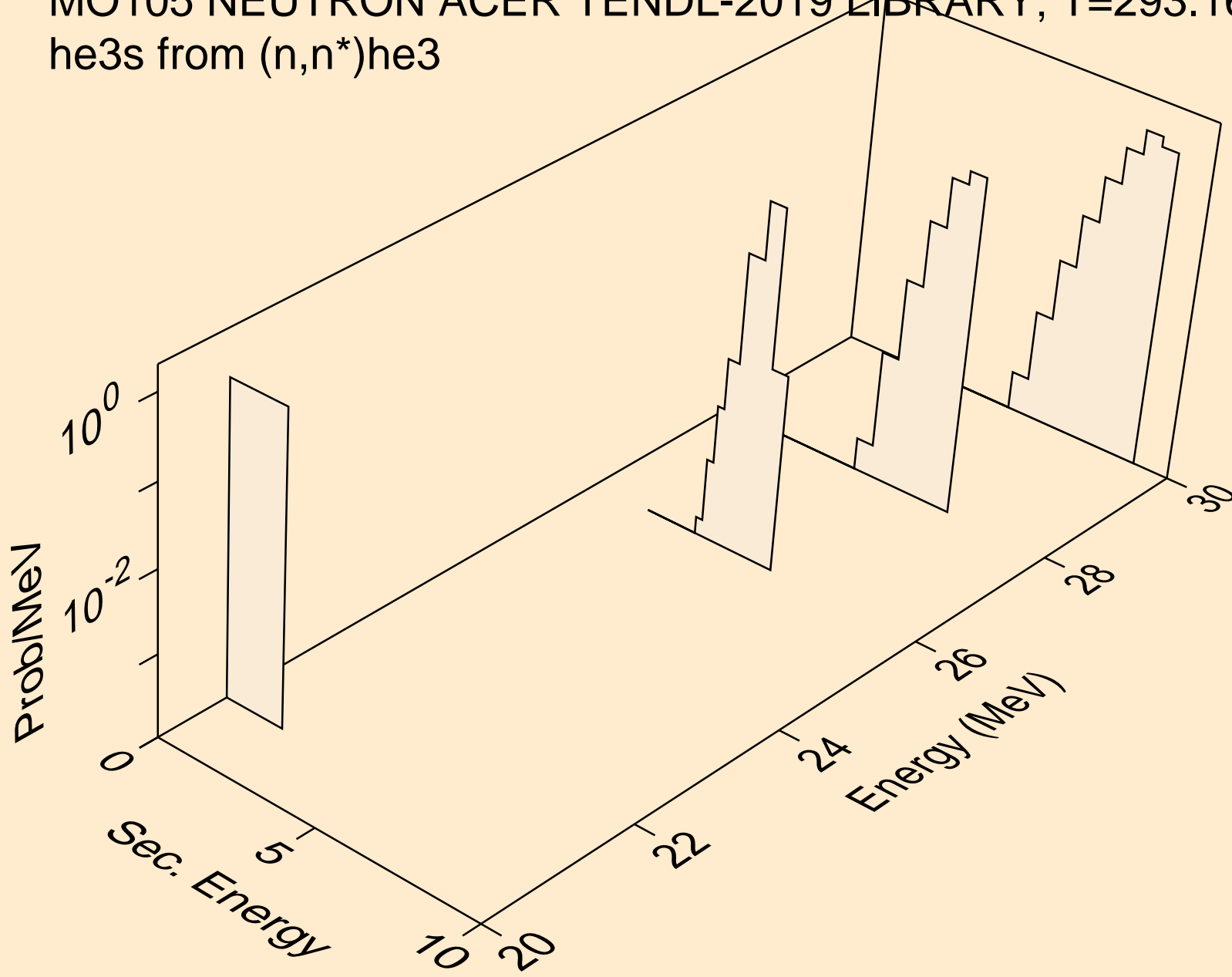

MO105 NEUTRON ACER TENDL-2019 LIBRARY; T=293.16K
he3s from (n,he3)

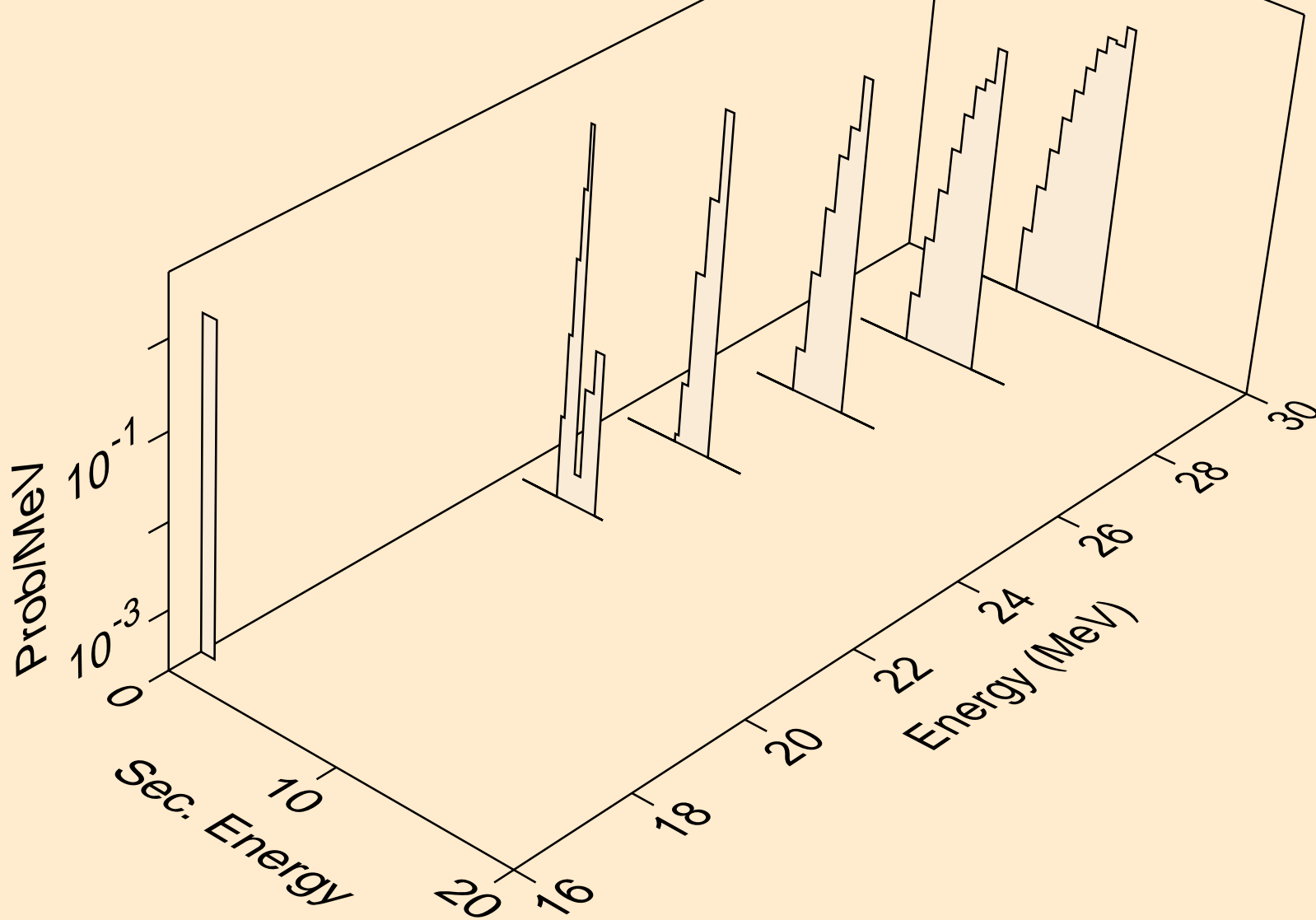

MO105 NEUTRON ACER TENDL-2019 LIBRARY; T=293.16K
alphas from (n,x)

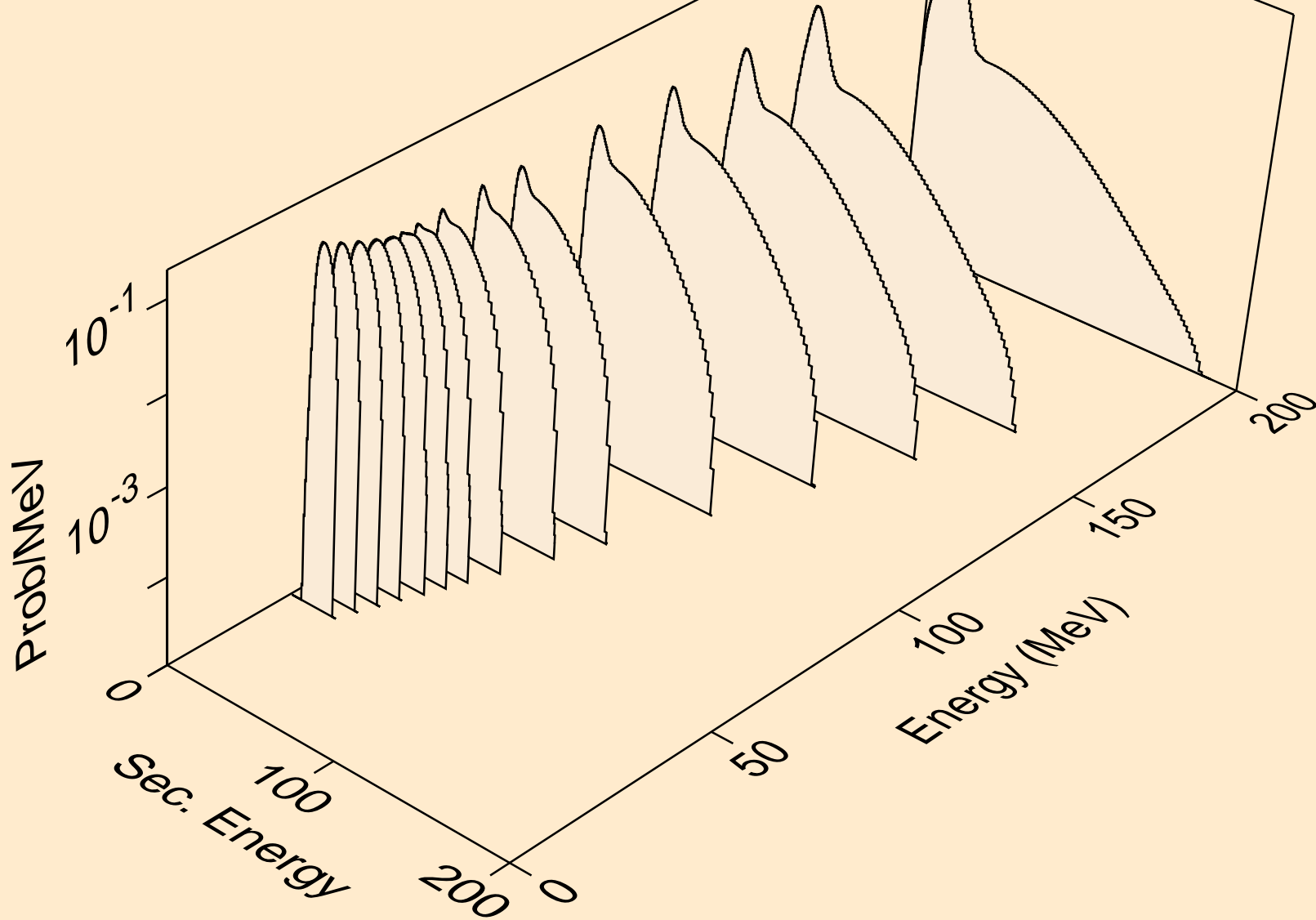

MO105 NEUTRON ACER TENDL-2019 LIBRARY; T=293.16K
alphas from (n,n*)a

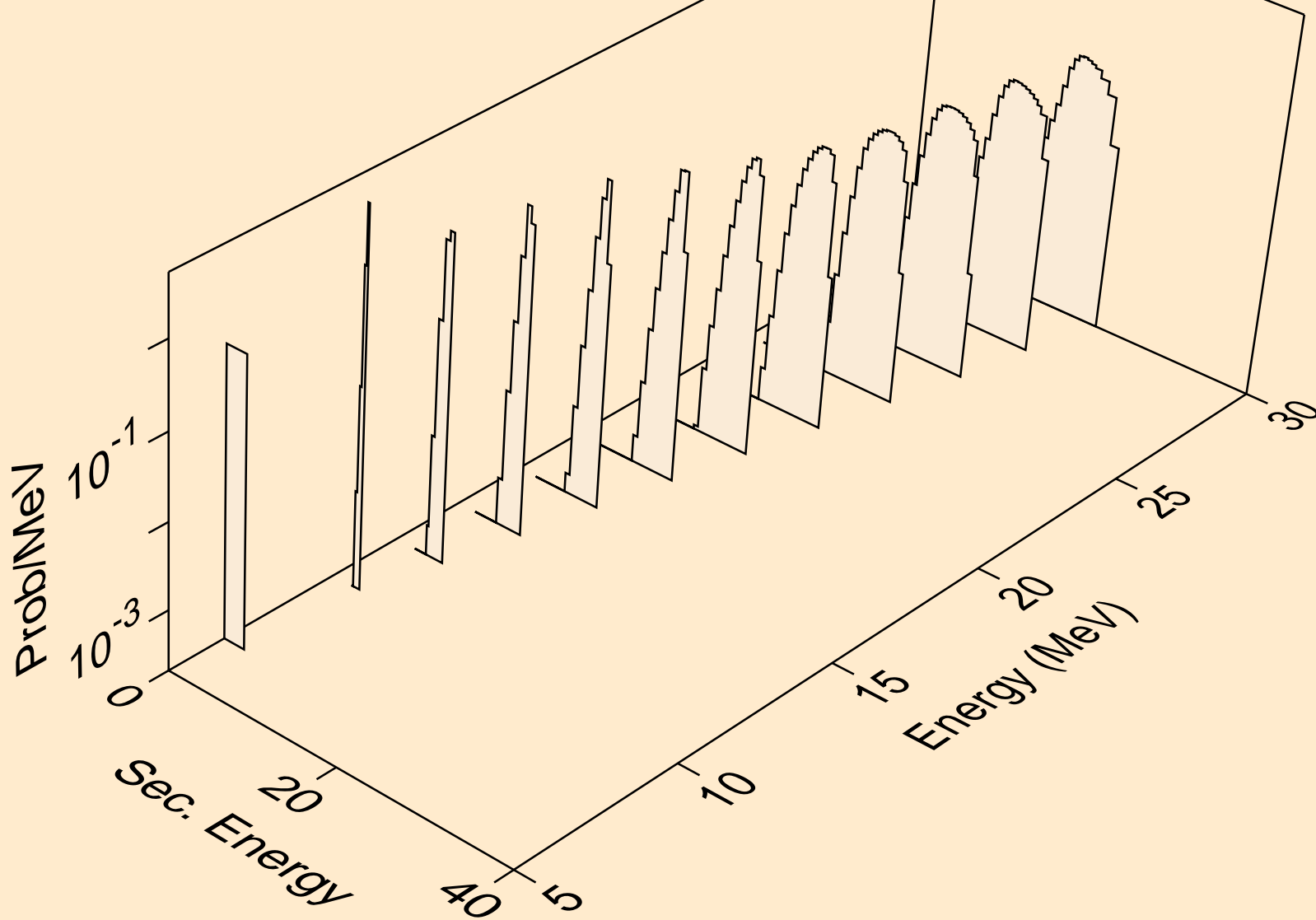

MO105 NEUTRON ACER TENDL-2019 LIBRARY; T=293.16K
alphas from (n,2n)a

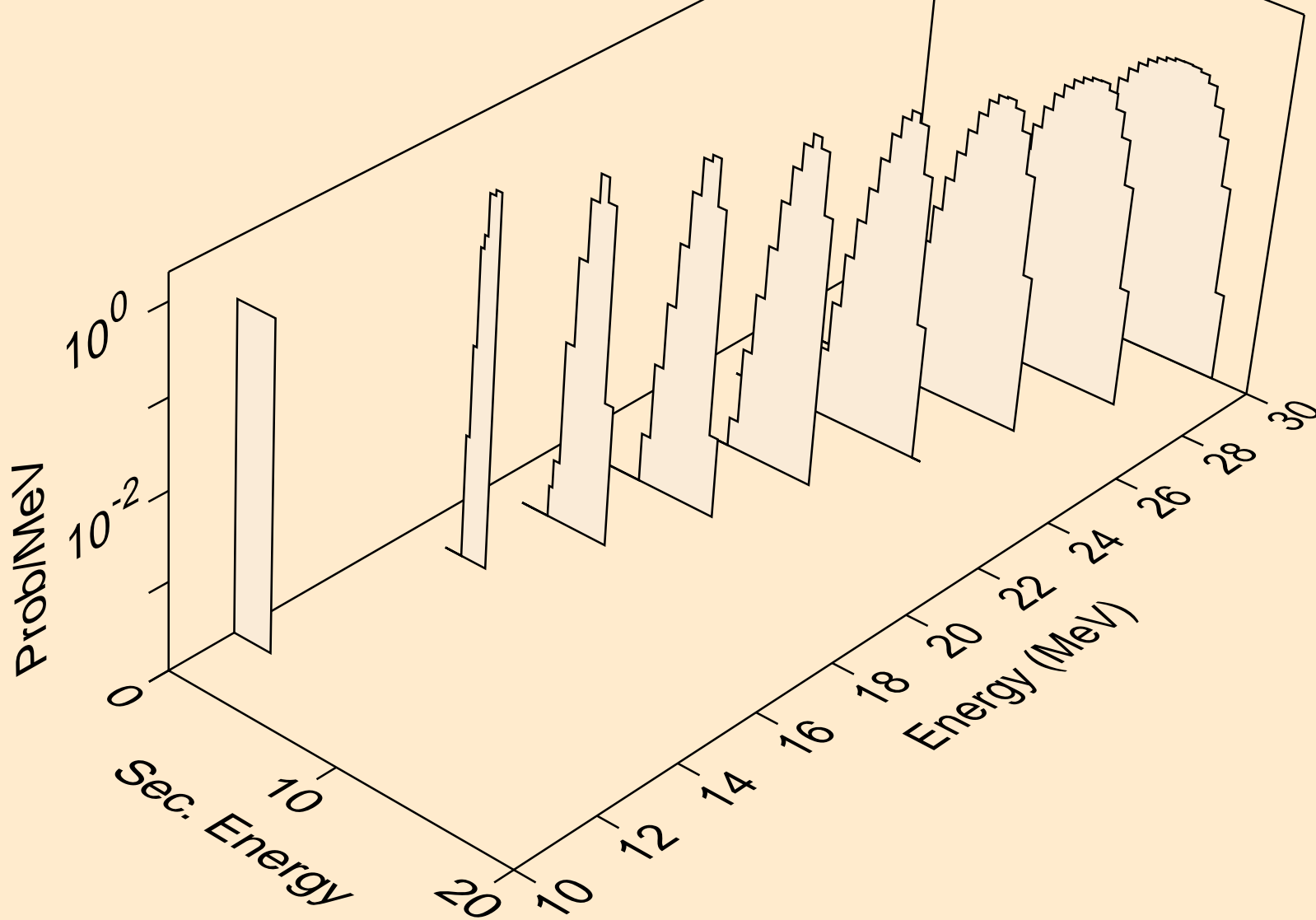

MO105 NEUTRON ACER TENDL-2019 LIBRARY; T=293.16K
alphas from (n,3n)a

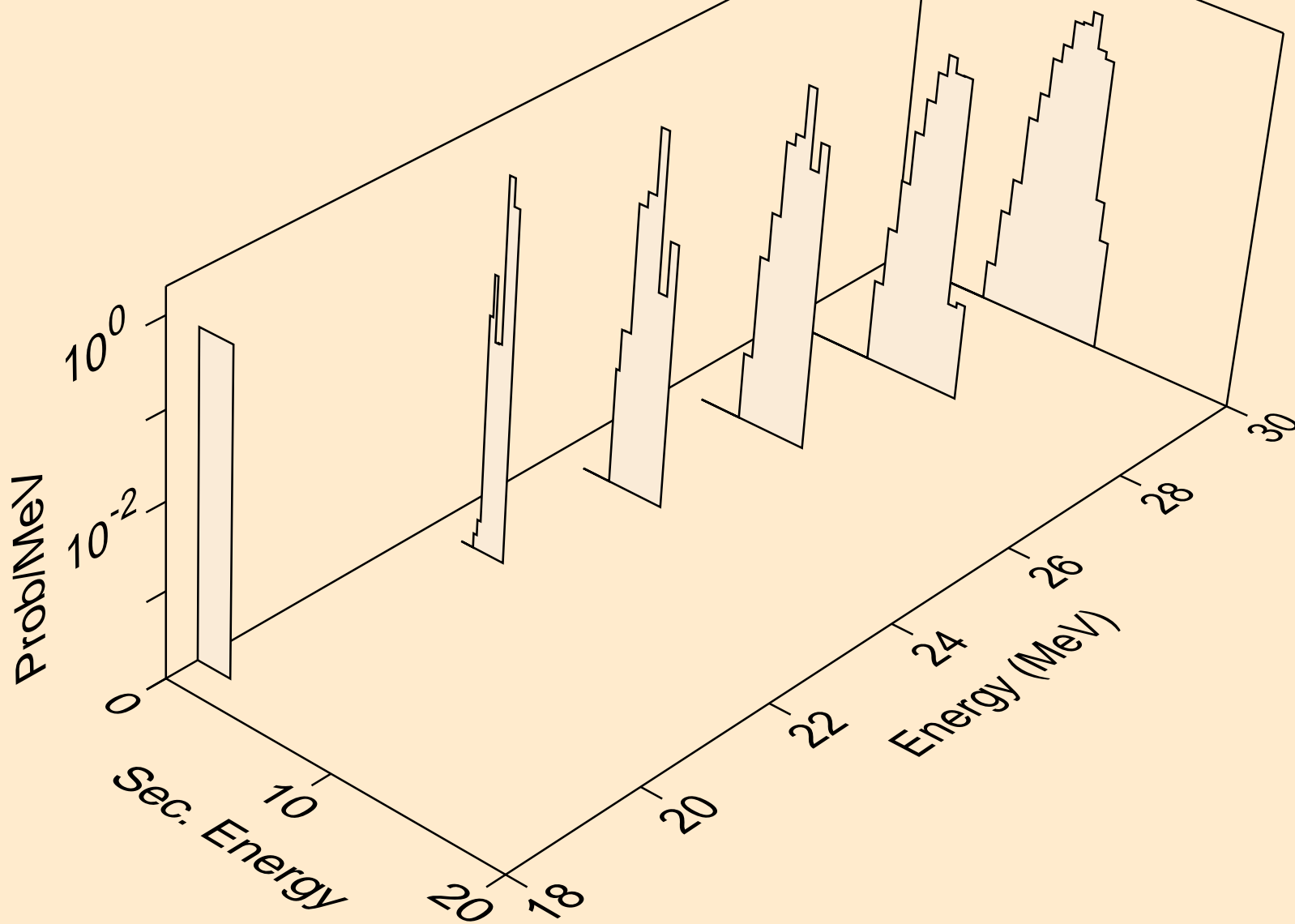

MO105 NEUTRON ACER TENDL-2019 LIBRARY; T=293.16K
alphas from (n,a)

