

MO106 NEUTRON ACER TENDL-2019 LIBRARY; T=293.16K  
Principal cross sections

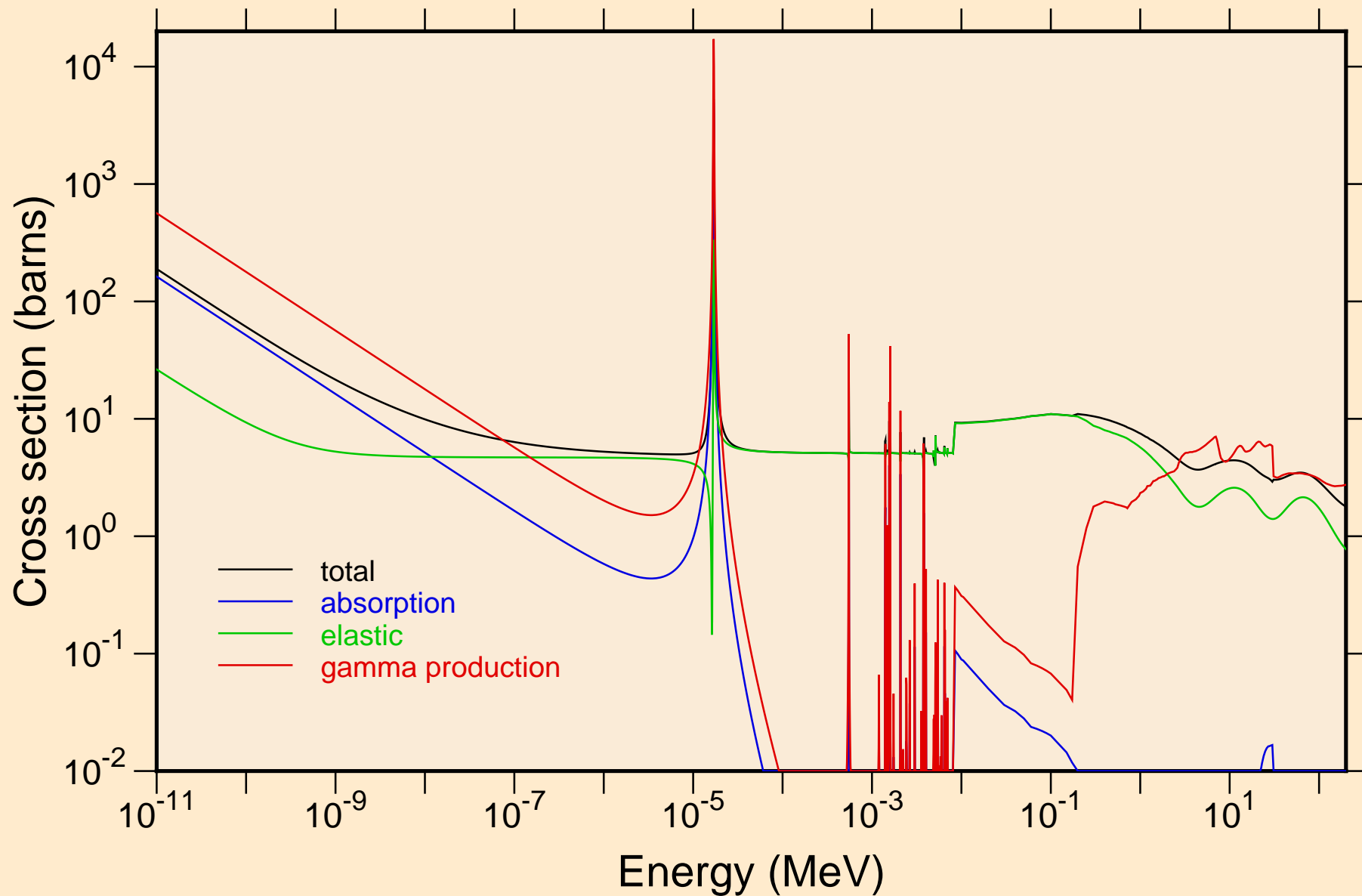

MO106 NEUTRON ACER TENDL-2019 LIBRARY; T=293.16K  
resonance total cross section

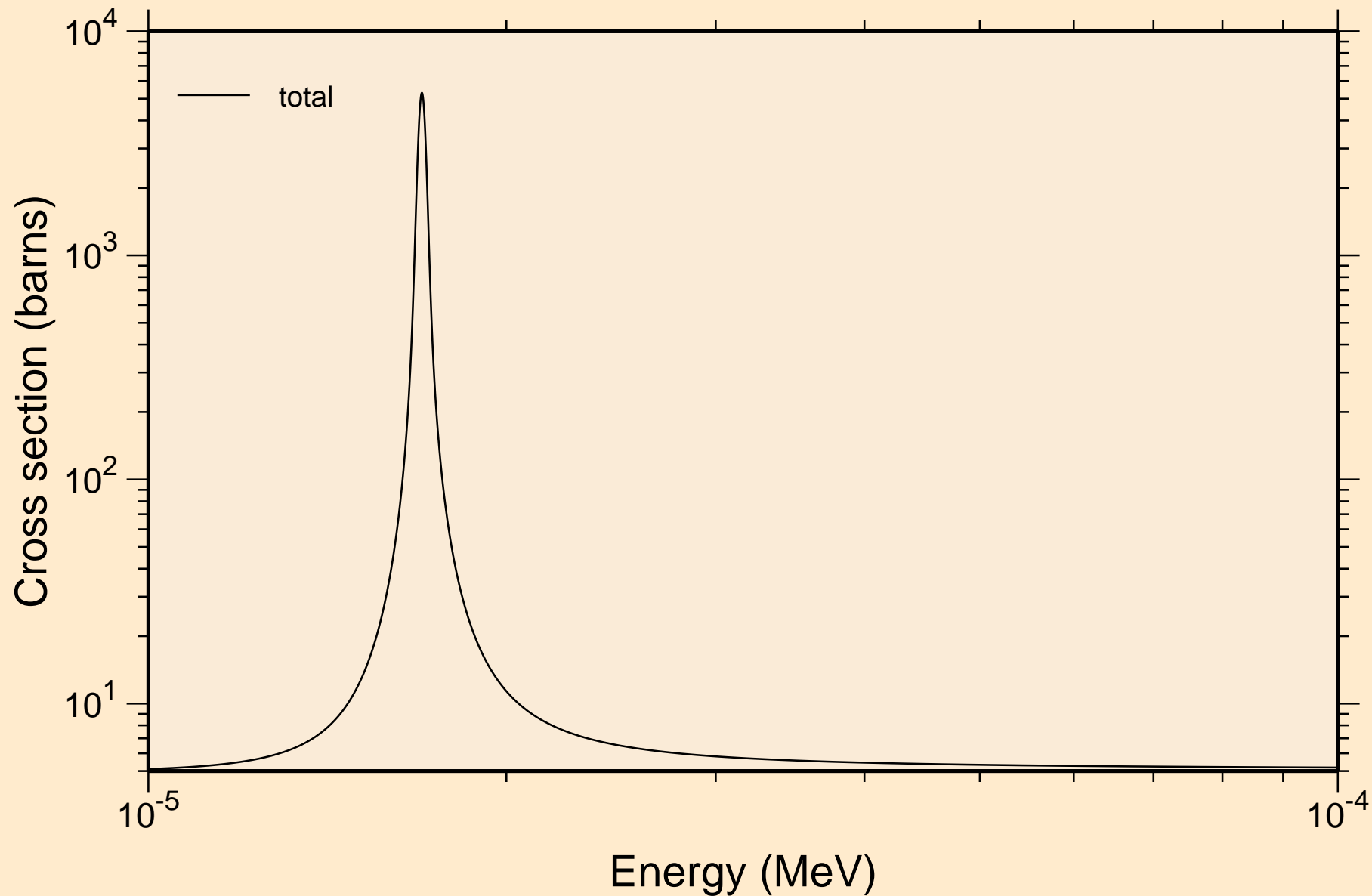

MO106 NEUTRON ACER TENDL-2019 LIBRARY; T=293.16K  
resonance total cross section

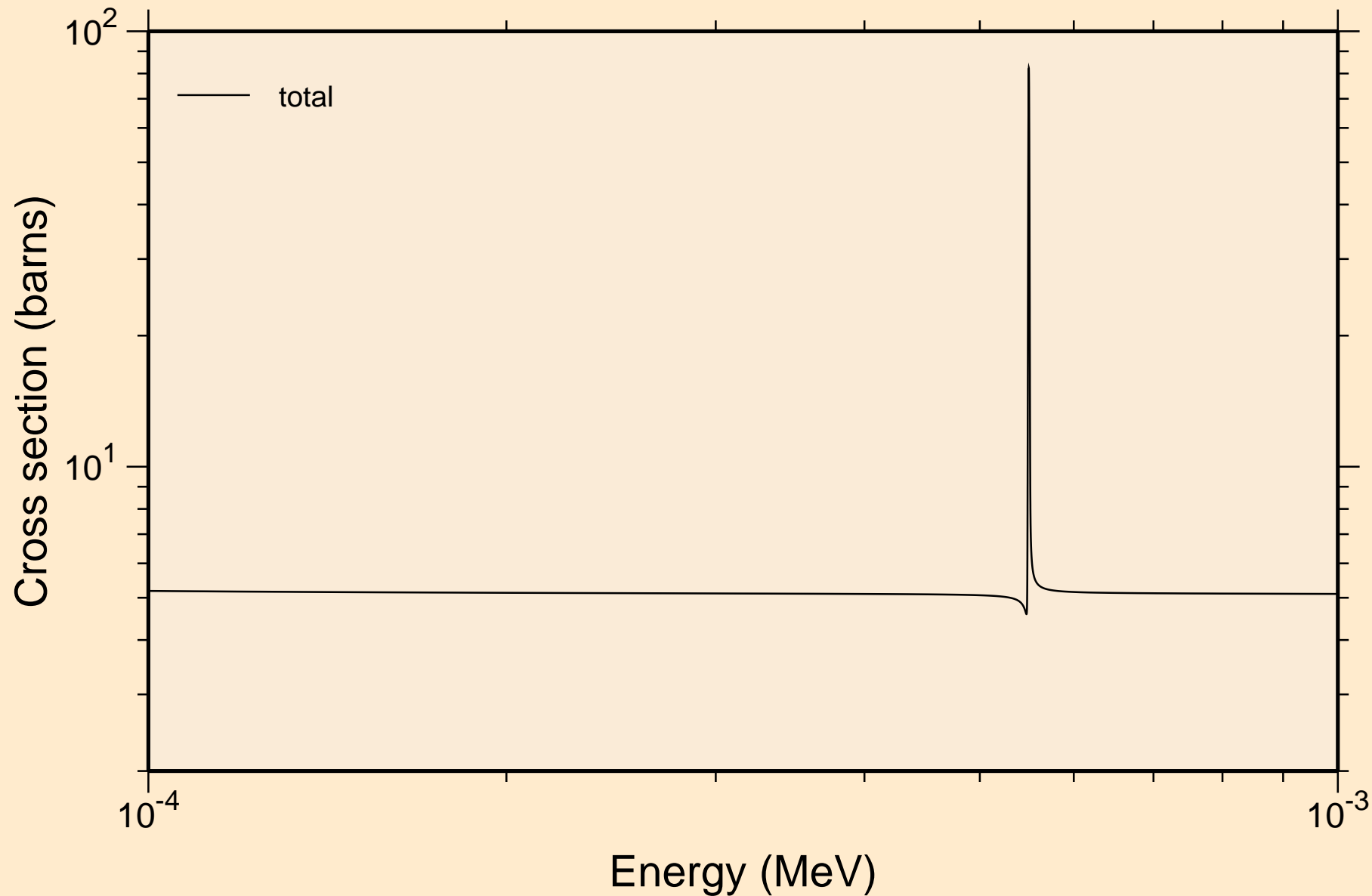

MO106 NEUTRON ACER TENDL-2019 LIBRARY; T=293.16K  
resonance total cross section

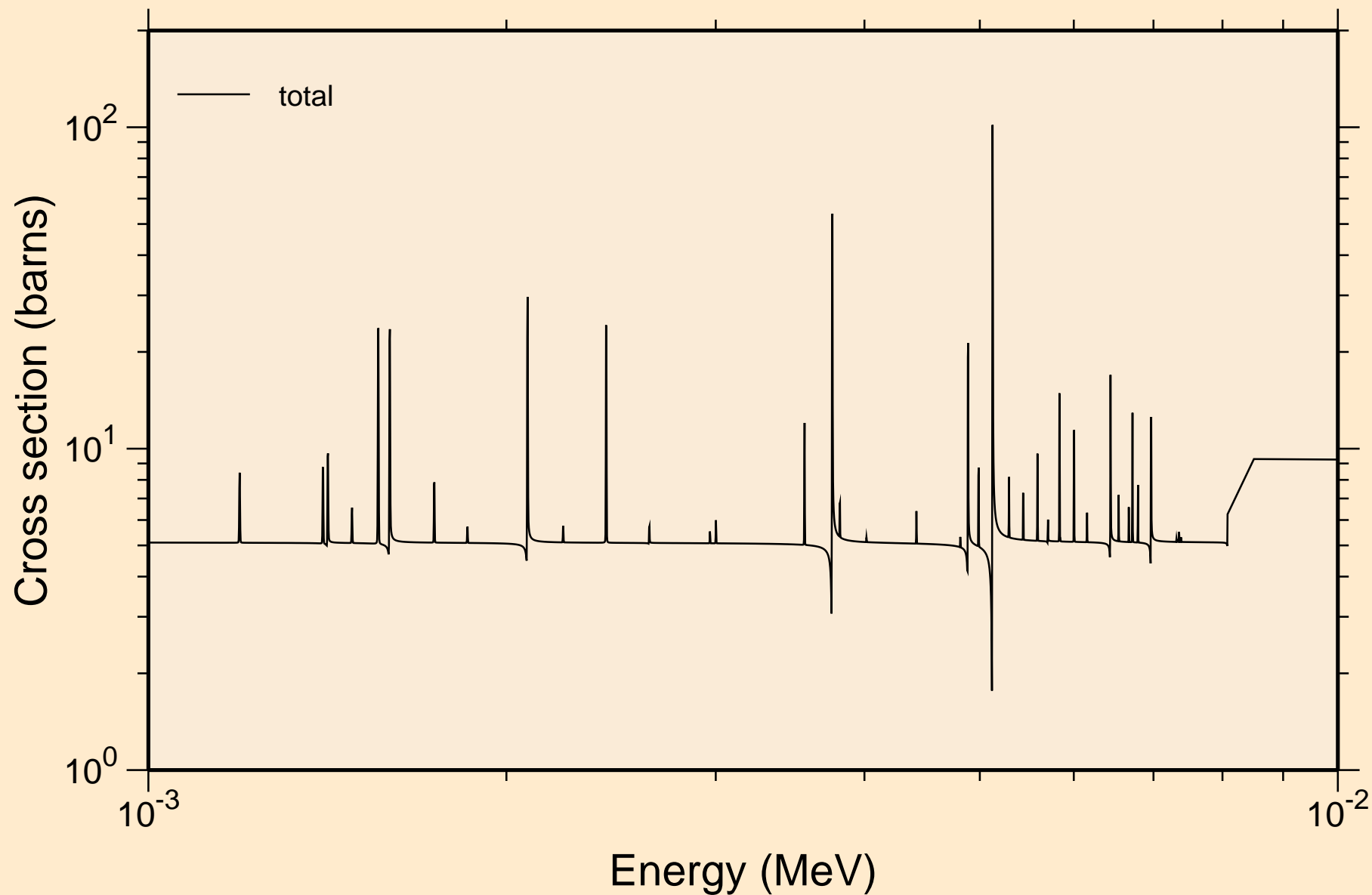

M0106 NEUTRON ACER TENDL-2019 LIBRARY; T=293.16K  
resonance total cross section

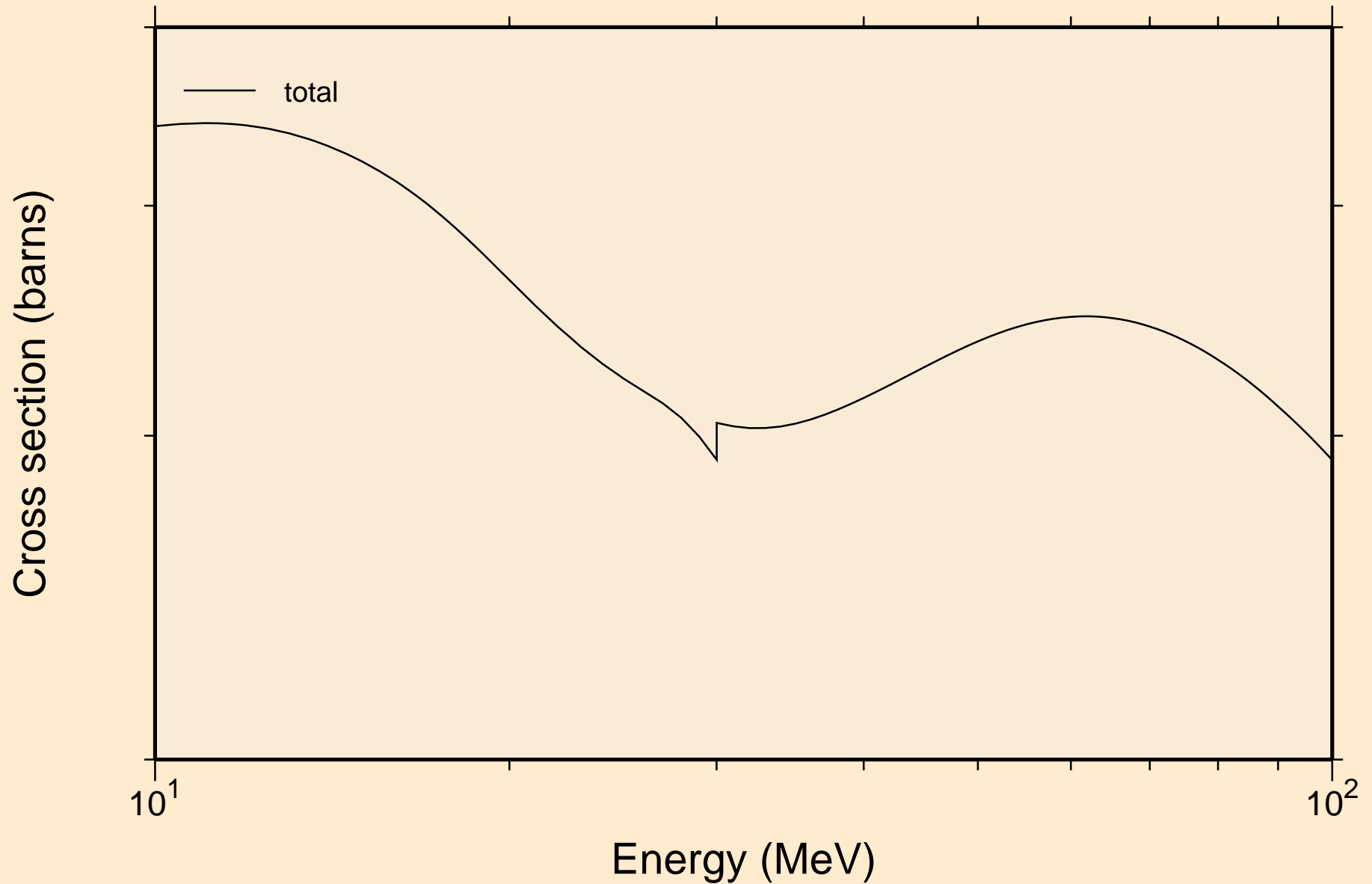

MO106 NEUTRON ACER TENDL-2019 LIBRARY; T=293.16K  
resonance absorption cross sections

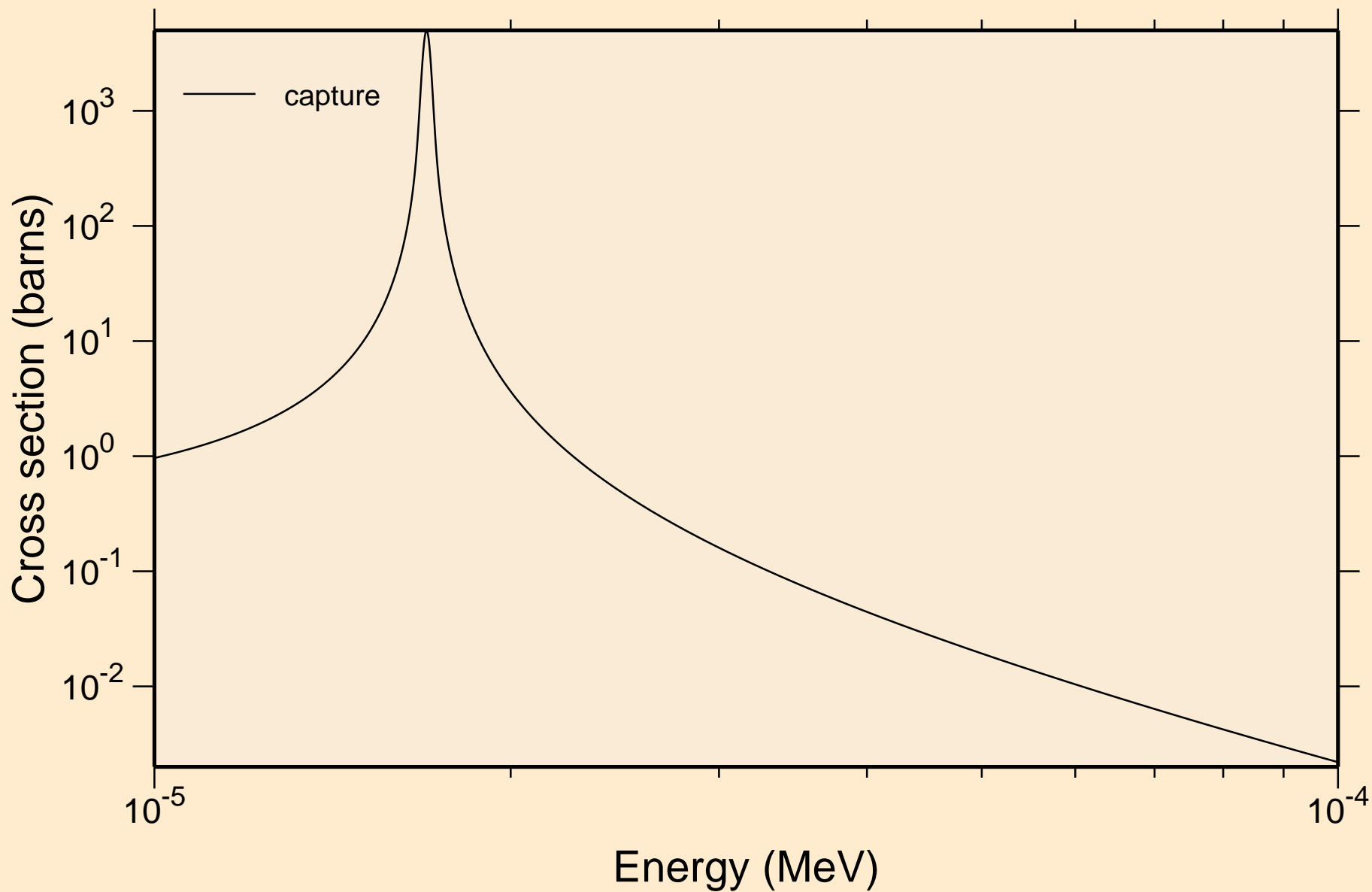

MO106 NEUTRON ACER TENDL-2019 LIBRARY; T=293.16K  
resonance absorption cross sections

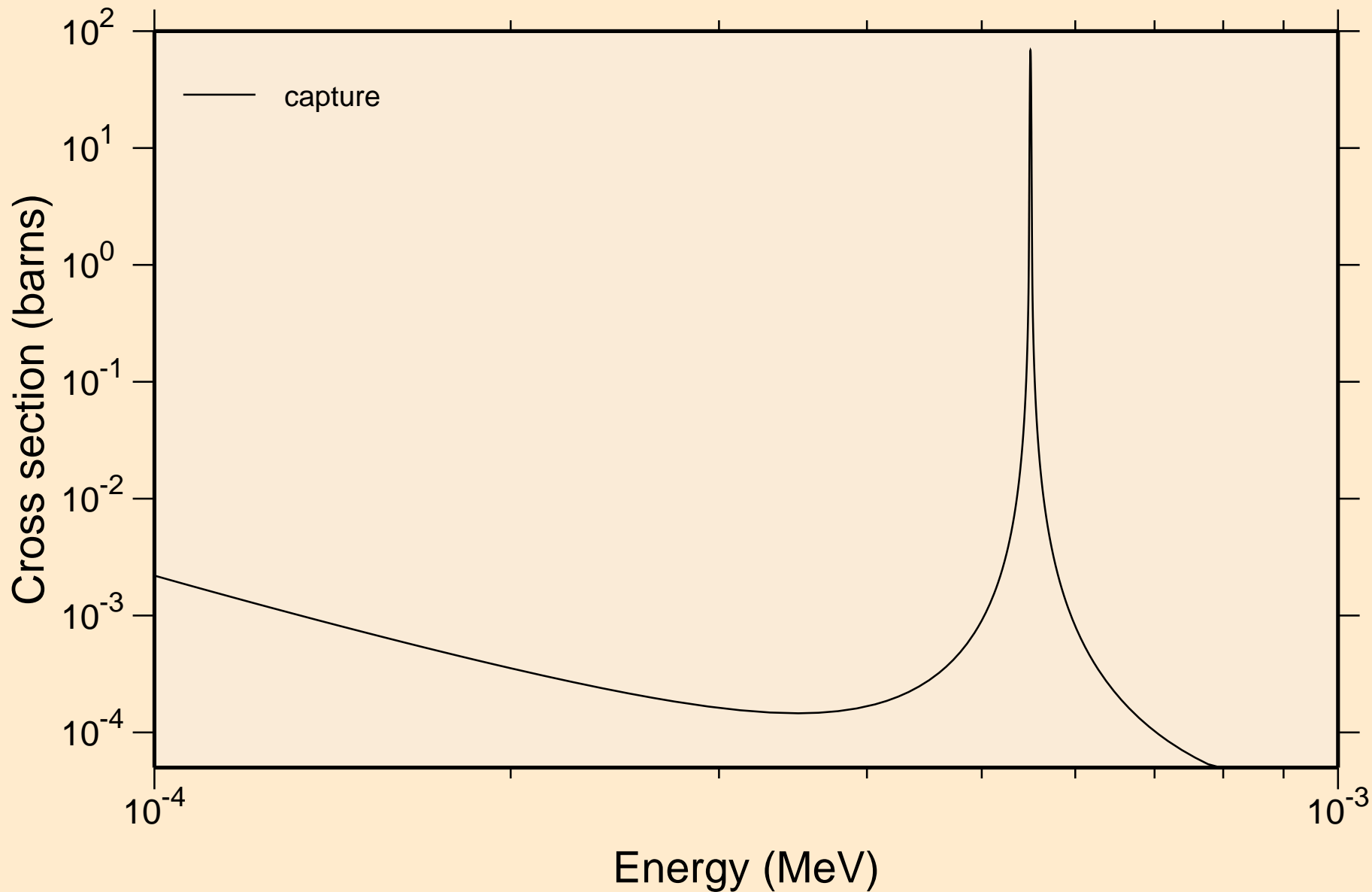

MO106 NEUTRON ACER TENDL-2019 LIBRARY; T=293.16K  
resonance absorption cross sections

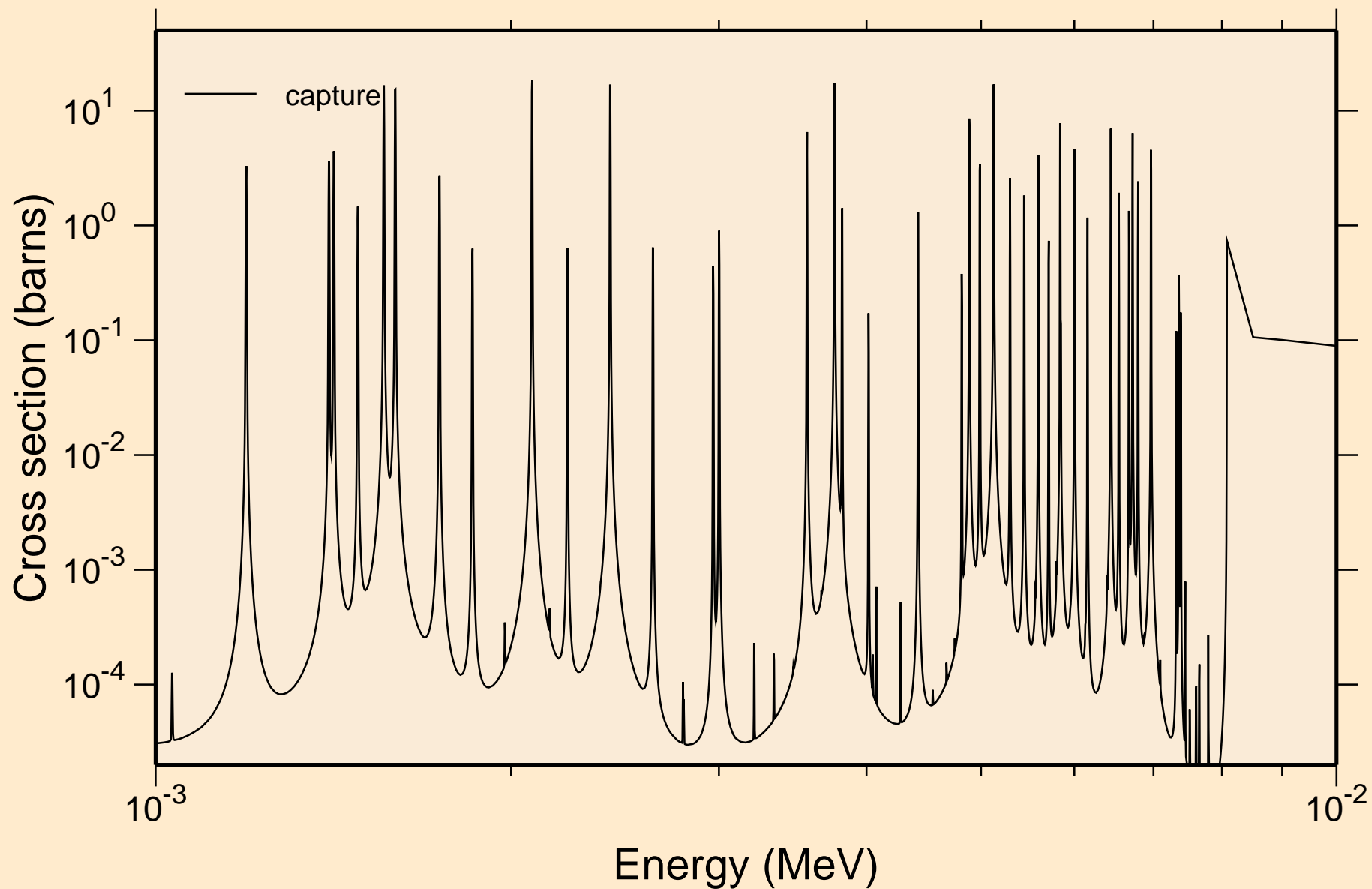



MO106 NEUTRON ACER TENDL-2019 LIBRARY; T=293.16K  
resonance absorption cross sections

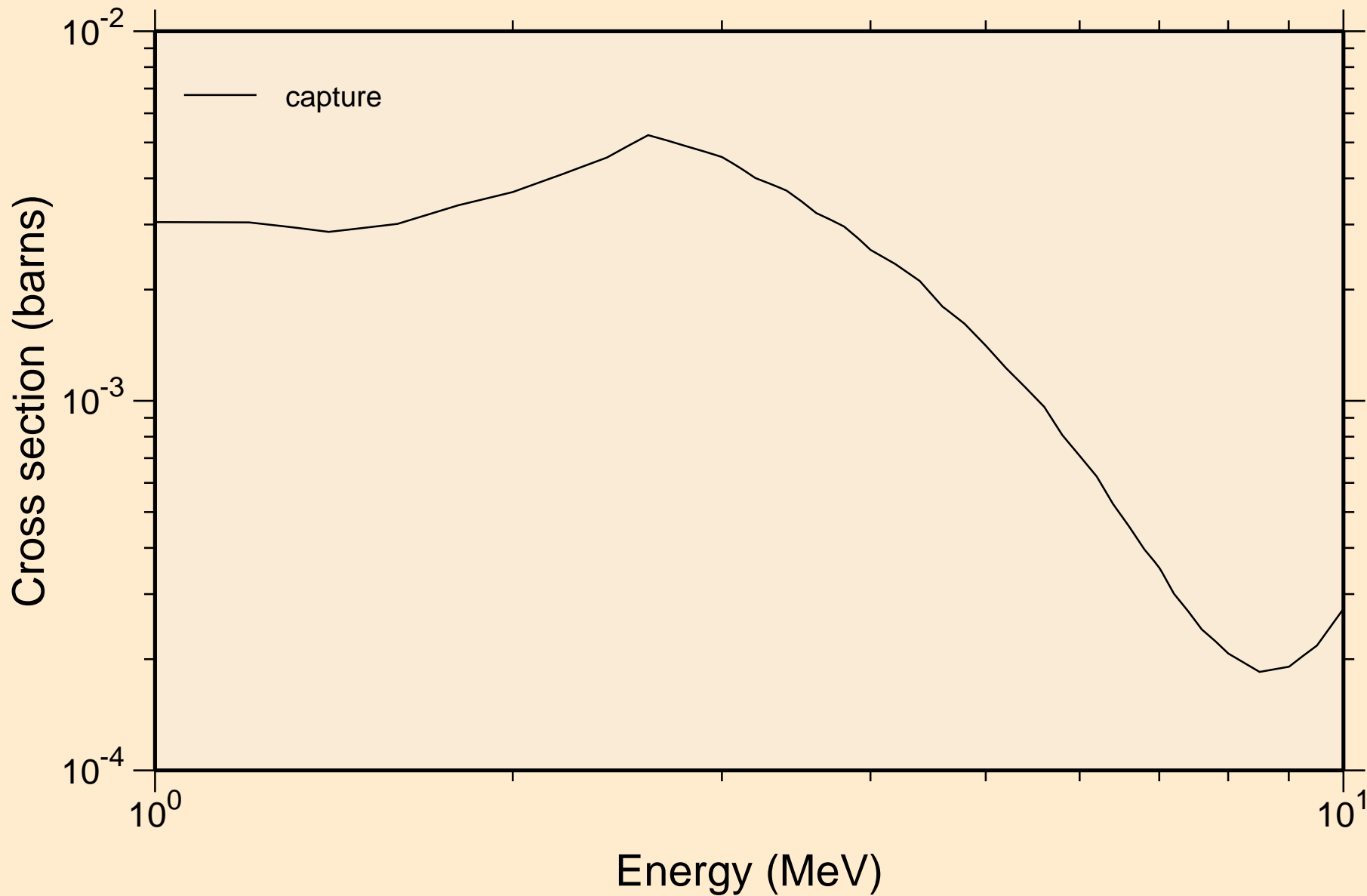

MO106 NEUTRON ACER TENDL-2019 LIBRARY; T=293.16K  
Heating

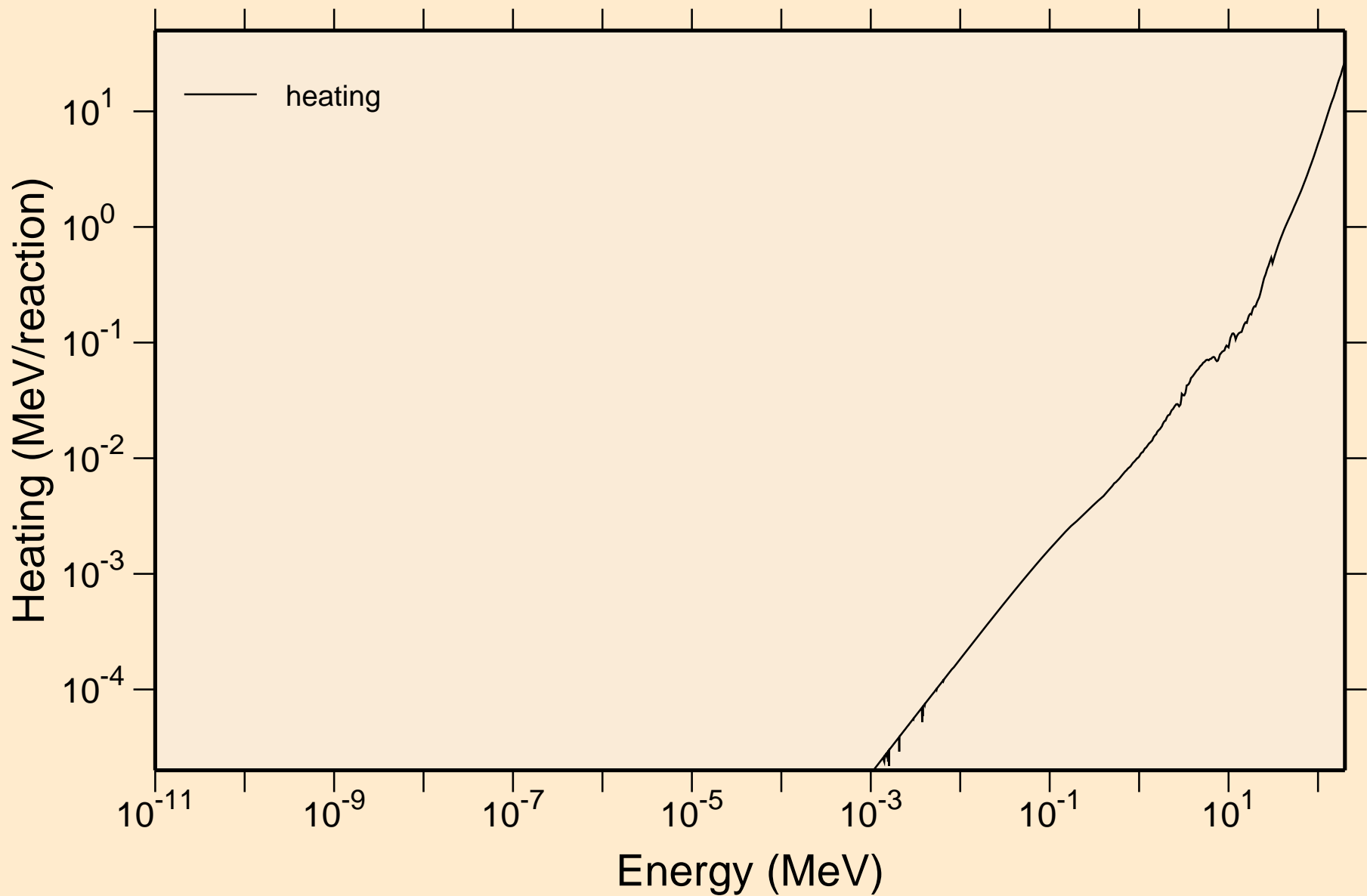

MO106 NEUTRON ACER TENDL-2019 LIBRARY; T=293.16K  
Damage

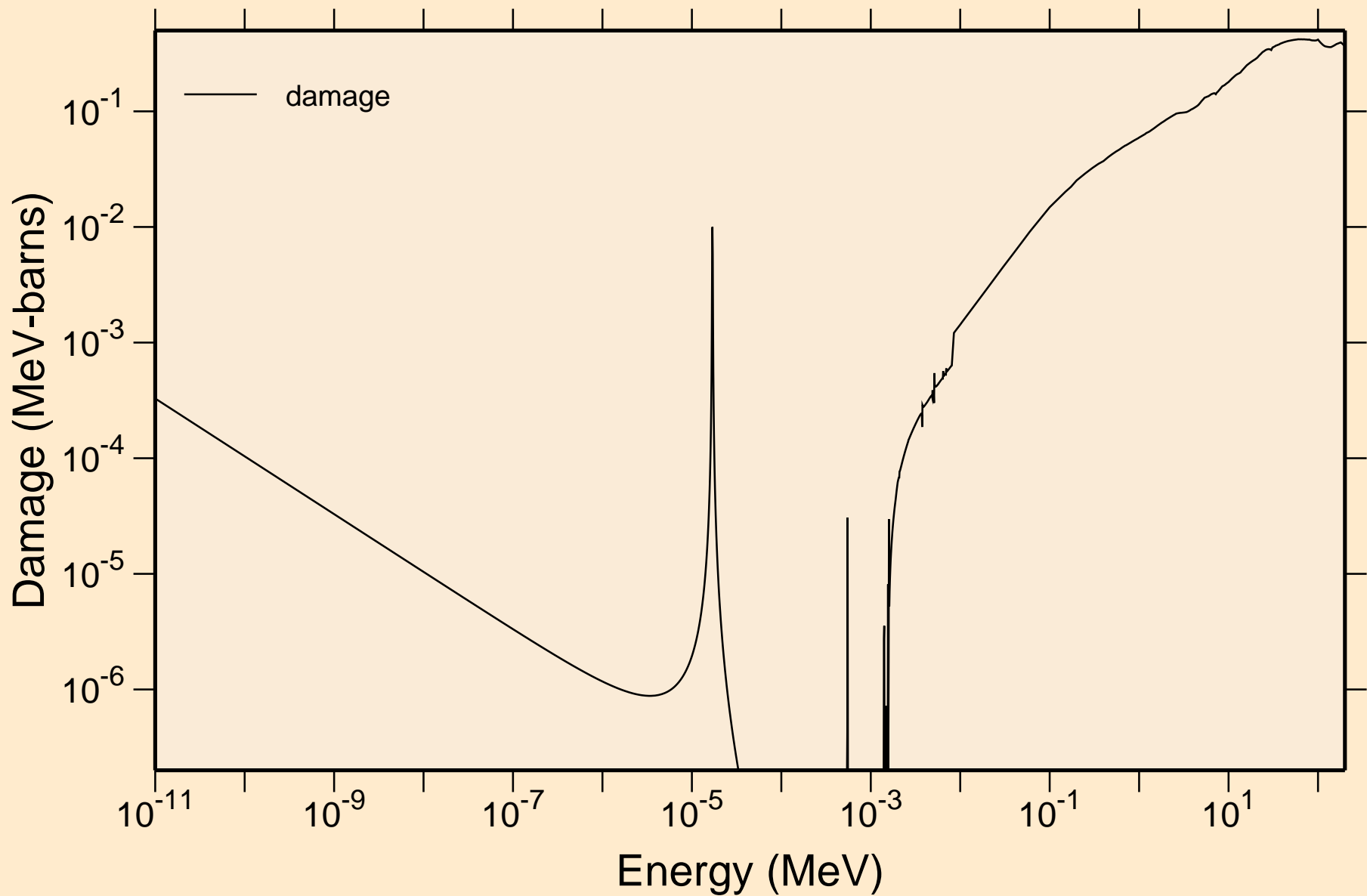

MO106 NEUTRON ACER TENDL-2019 LIBRARY; T=293.16K  
Non-threshold reactions

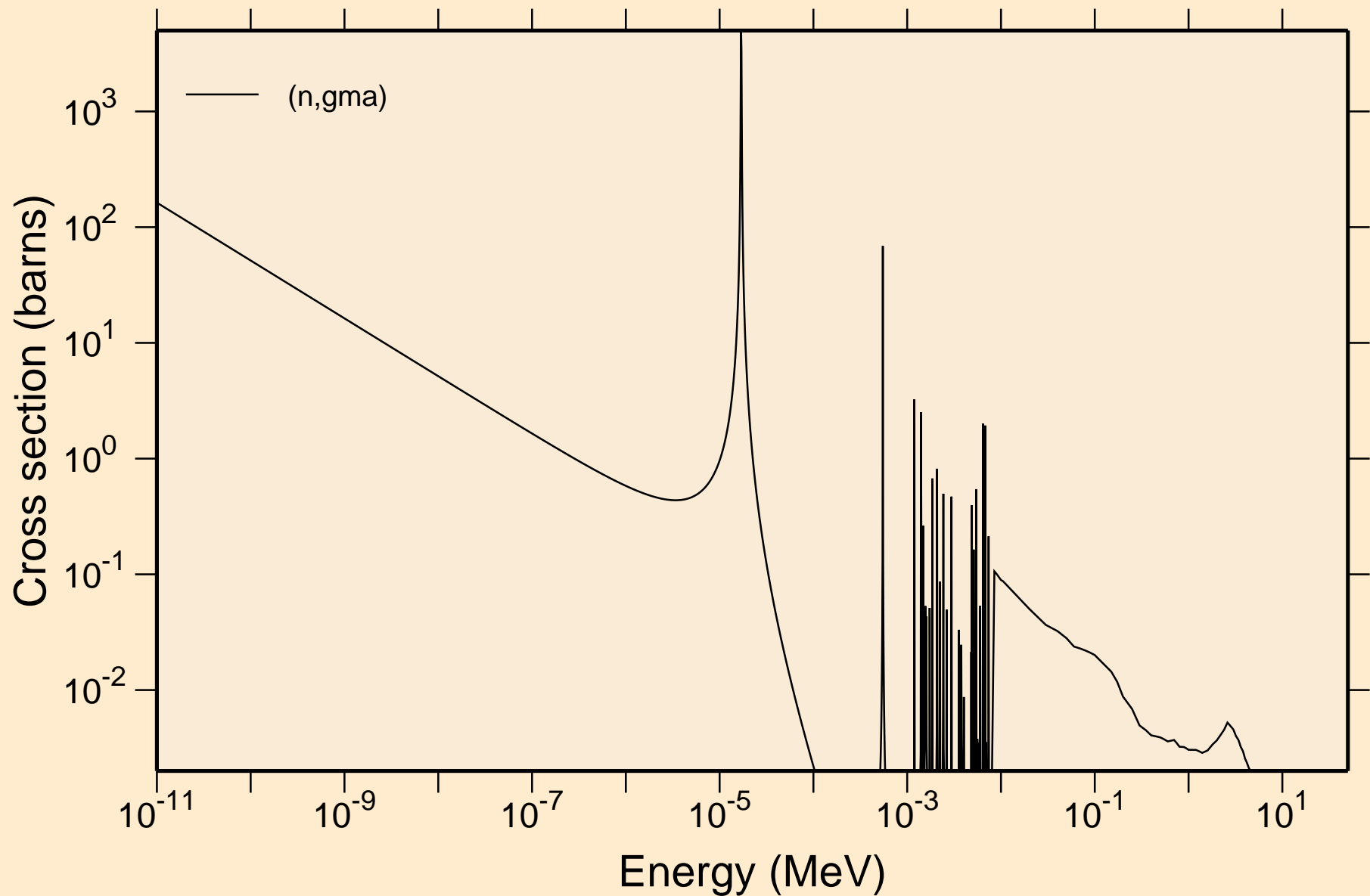

MO106 NEUTRON ACER TENDL-2019 LIBRARY; T=293.16K  
Principal cross sections

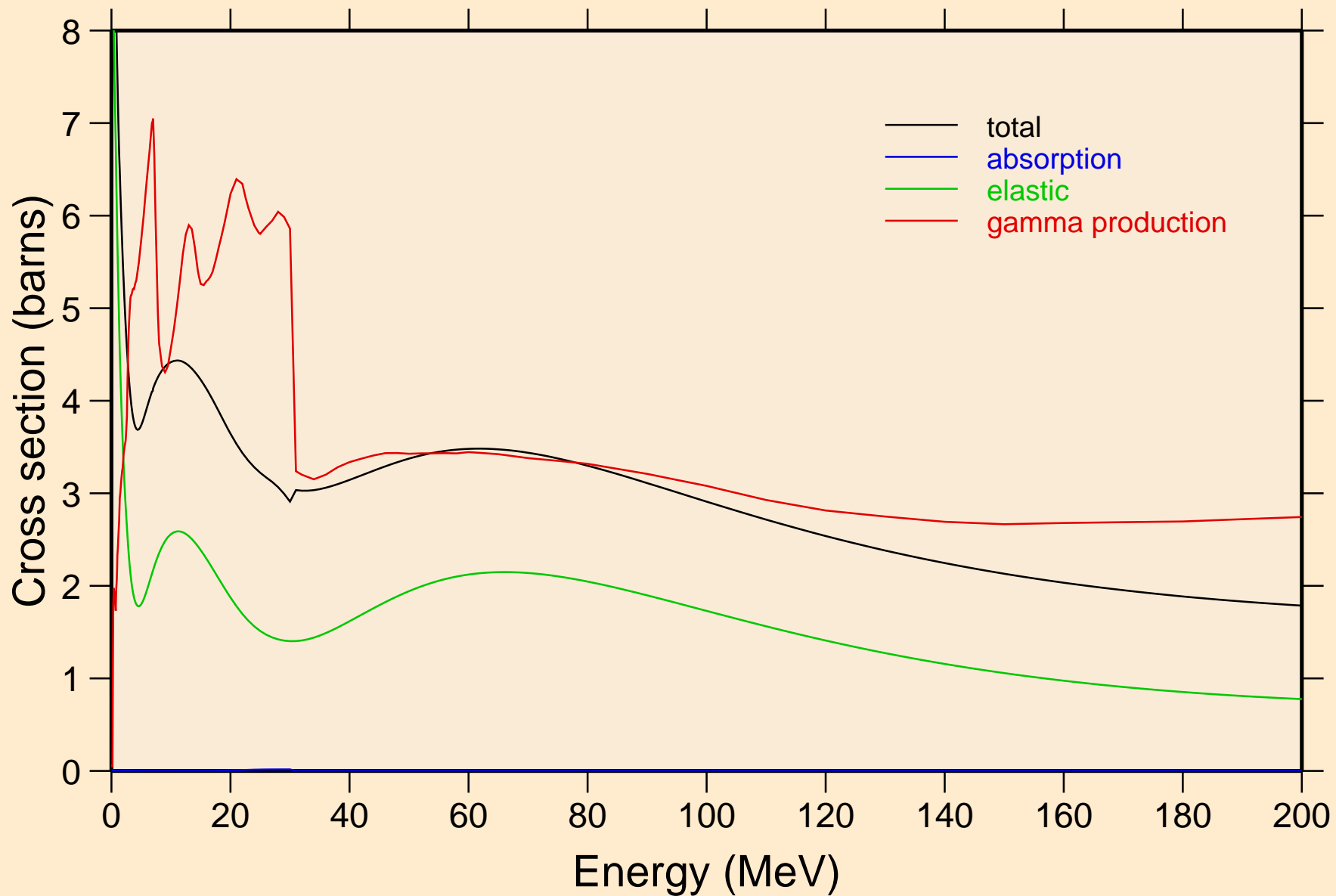

MO106 NEUTRON ACER TENDL-2019 LIBRARY; T=293.16K  
Heating

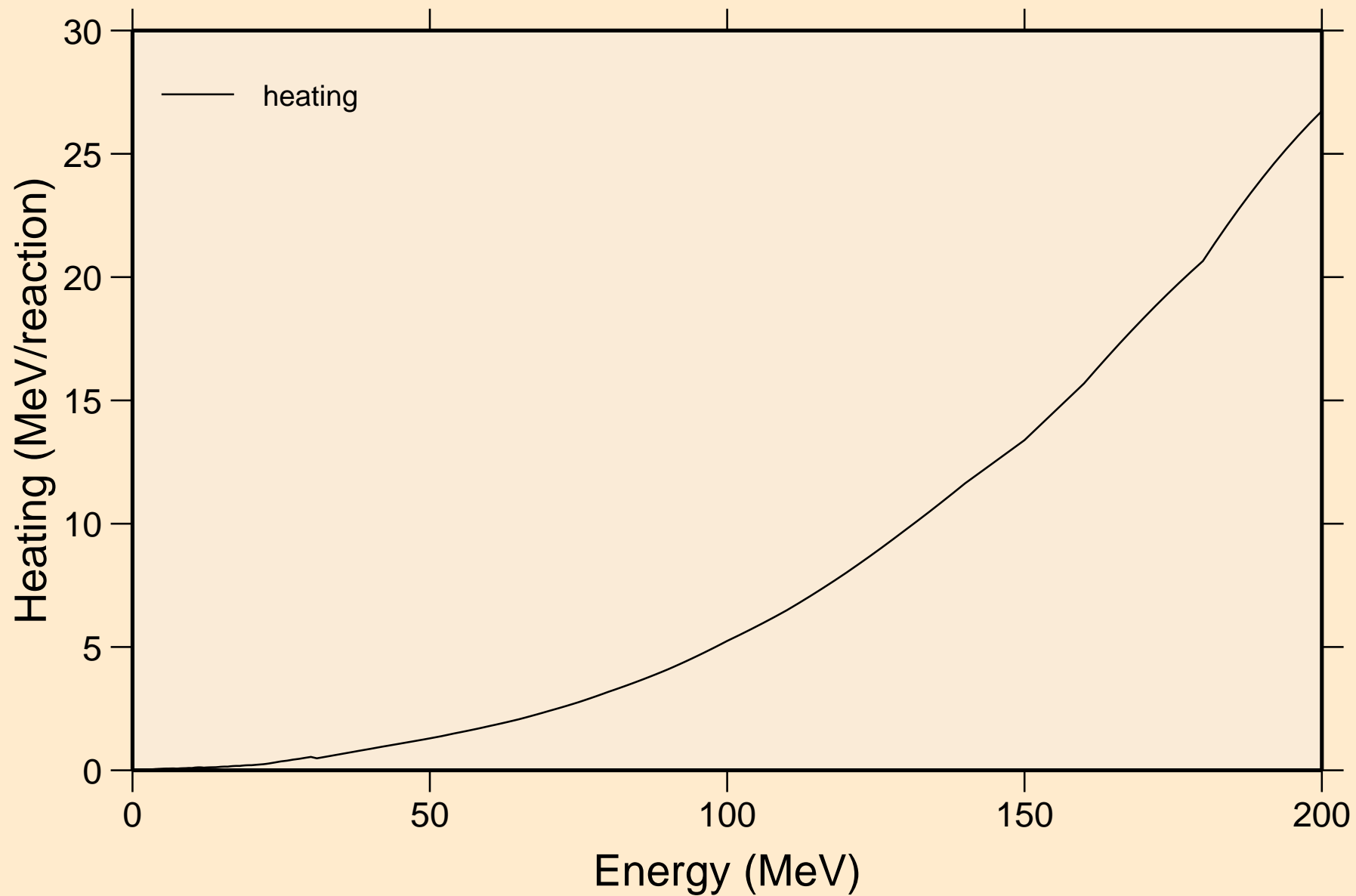

MO106 NEUTRON ACER TENDL-2019 LIBRARY; T=293.16K  
Damage

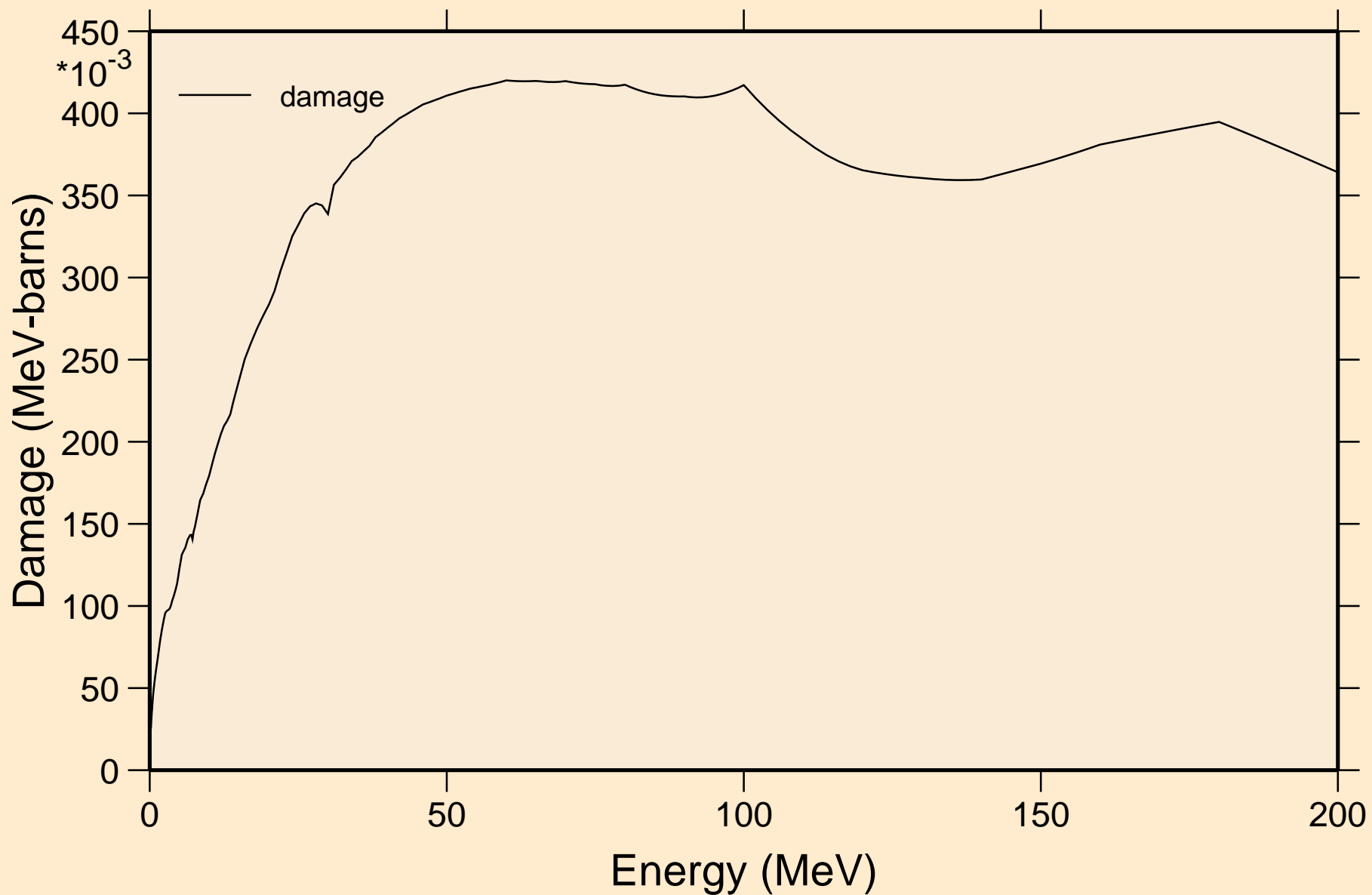

MO106 NEUTRON ACER TENDL-2019 LIBRARY; T=293.16K  
Non-threshold reactions

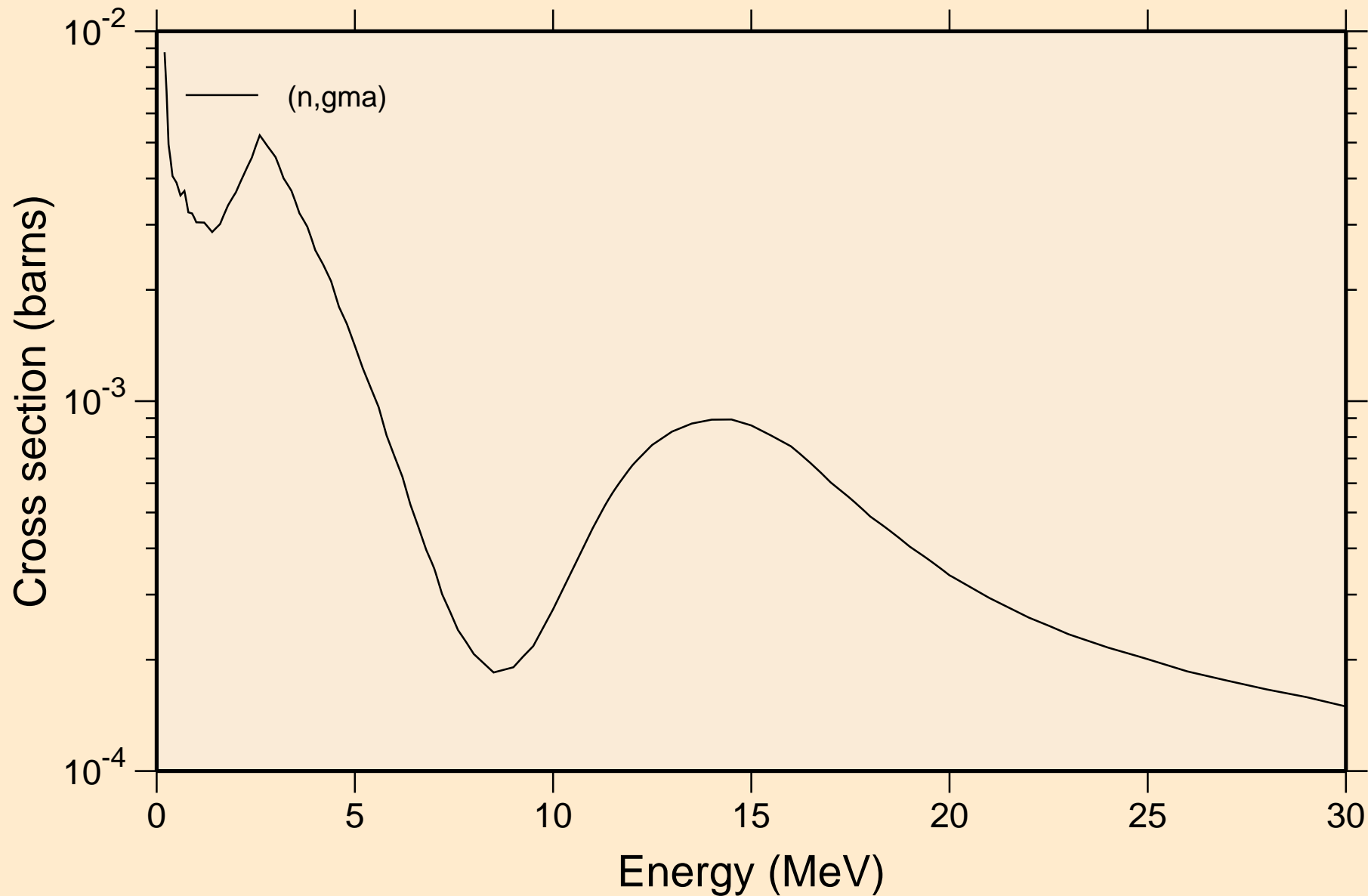



MO106 NEUTRON ACER TENDL-2019 LIBRARY; T=293.16K  
Inelastic levels

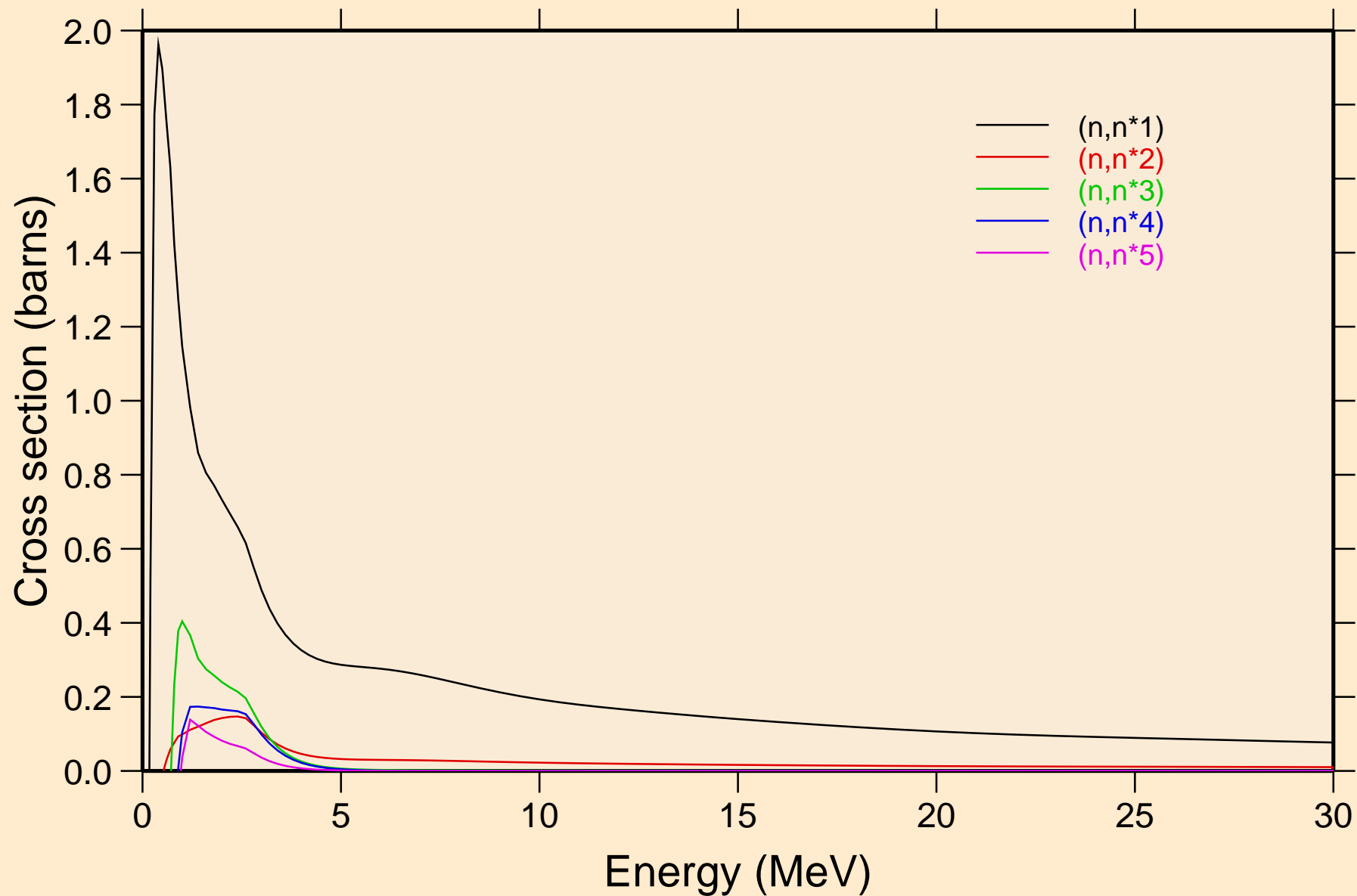

MO106 NEUTRON ACER TENDL-2019 LIBRARY; T=293.16K  
Inelastic levels

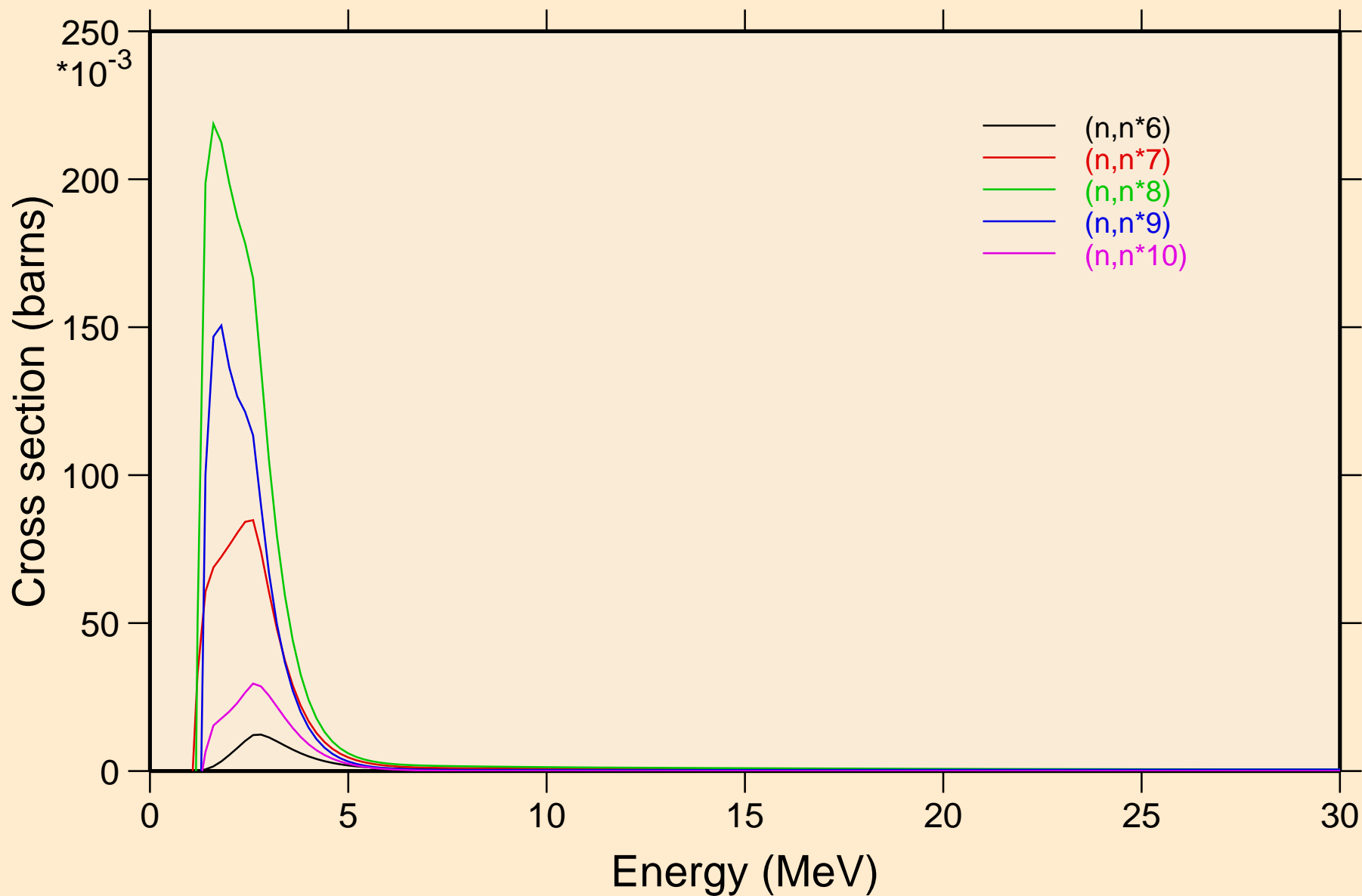

MO106 NEUTRON ACER TENDL-2019 LIBRARY; T=293.16K  
Inelastic levels

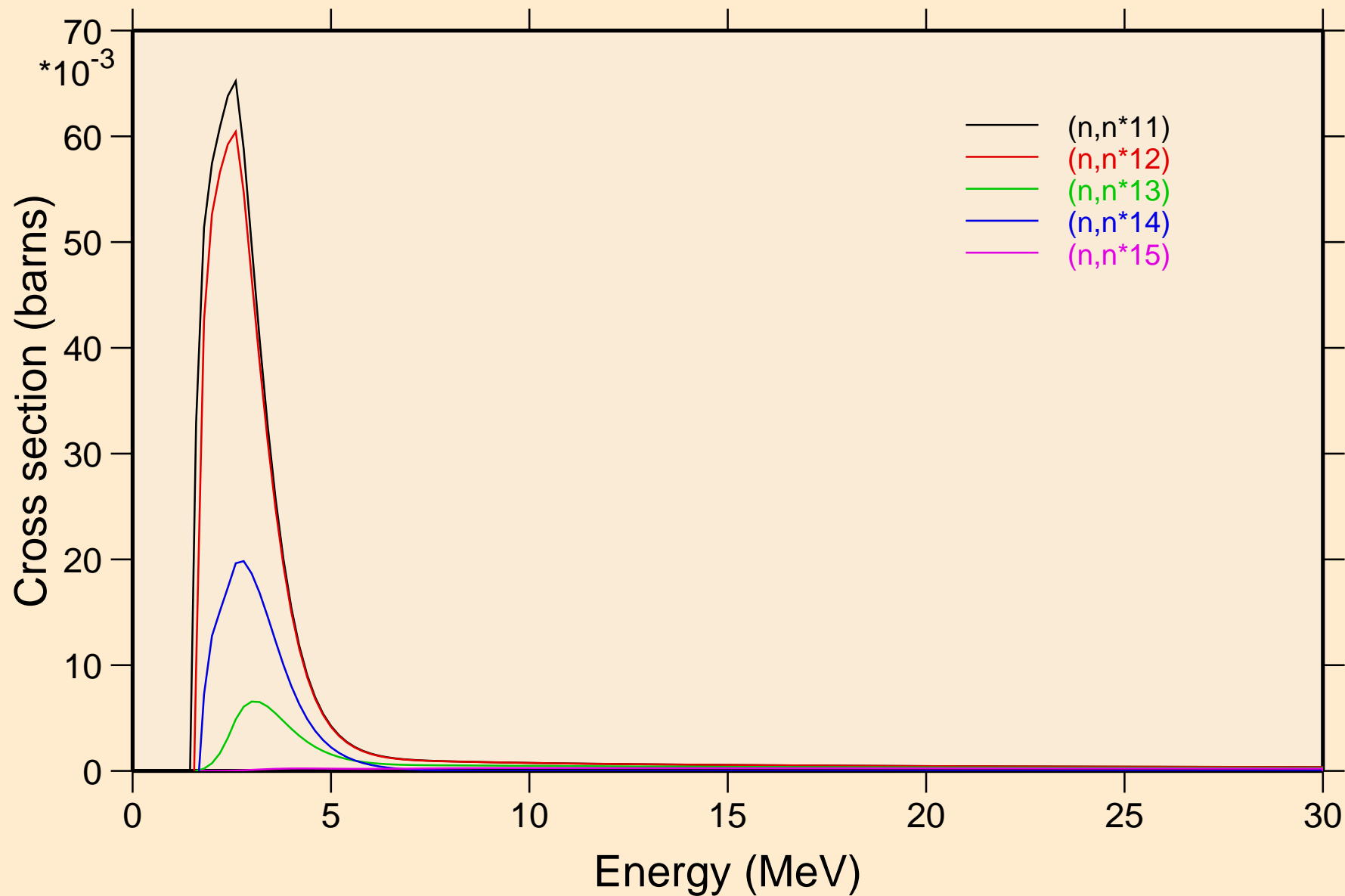

MO106 NEUTRON ACER TENDL-2019 LIBRARY; T=293.16K  
Inelastic levels

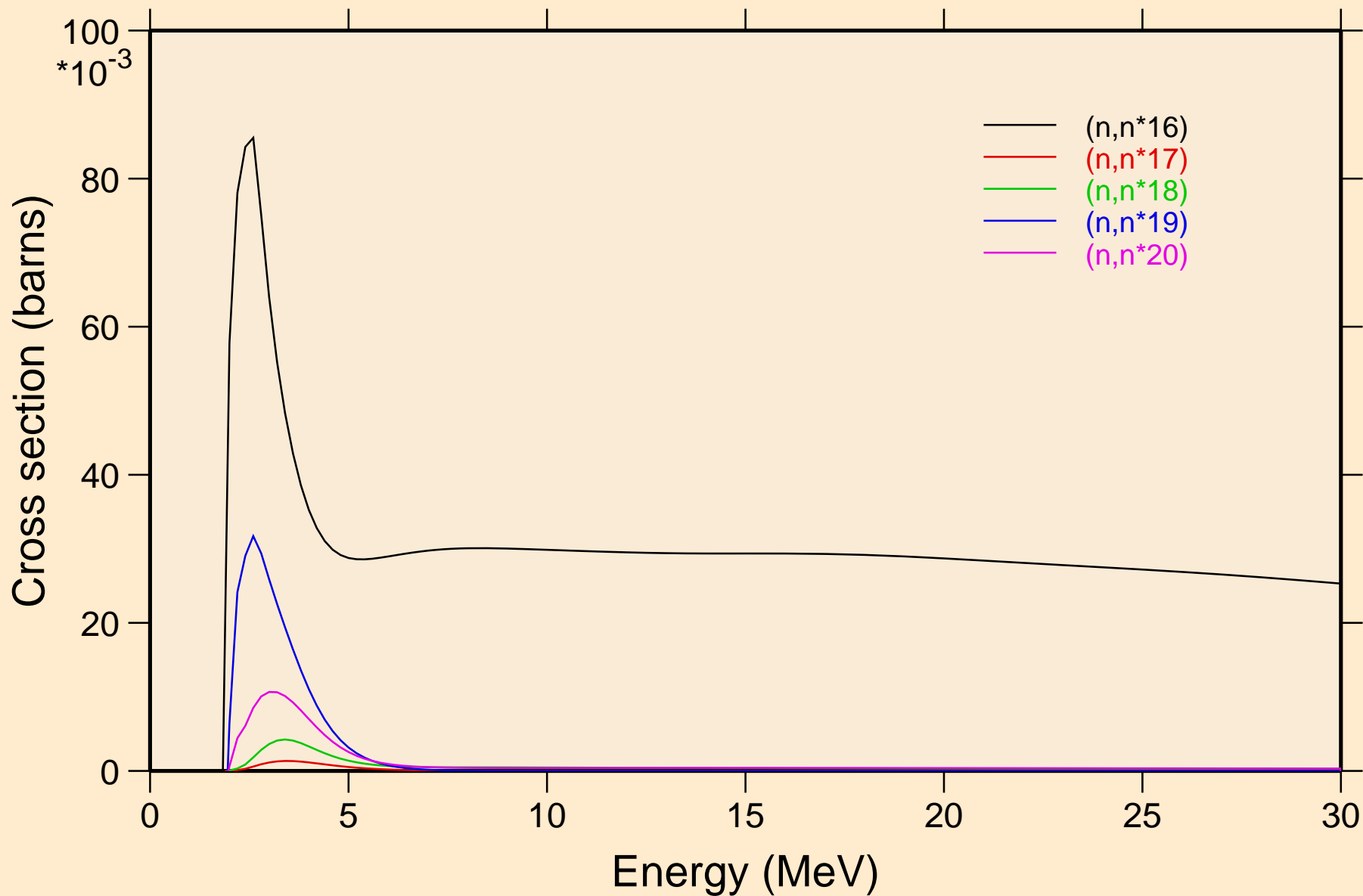

MO106 NEUTRON ACER TENDL-2019 LIBRARY; T=293.16K  
Threshold reactions

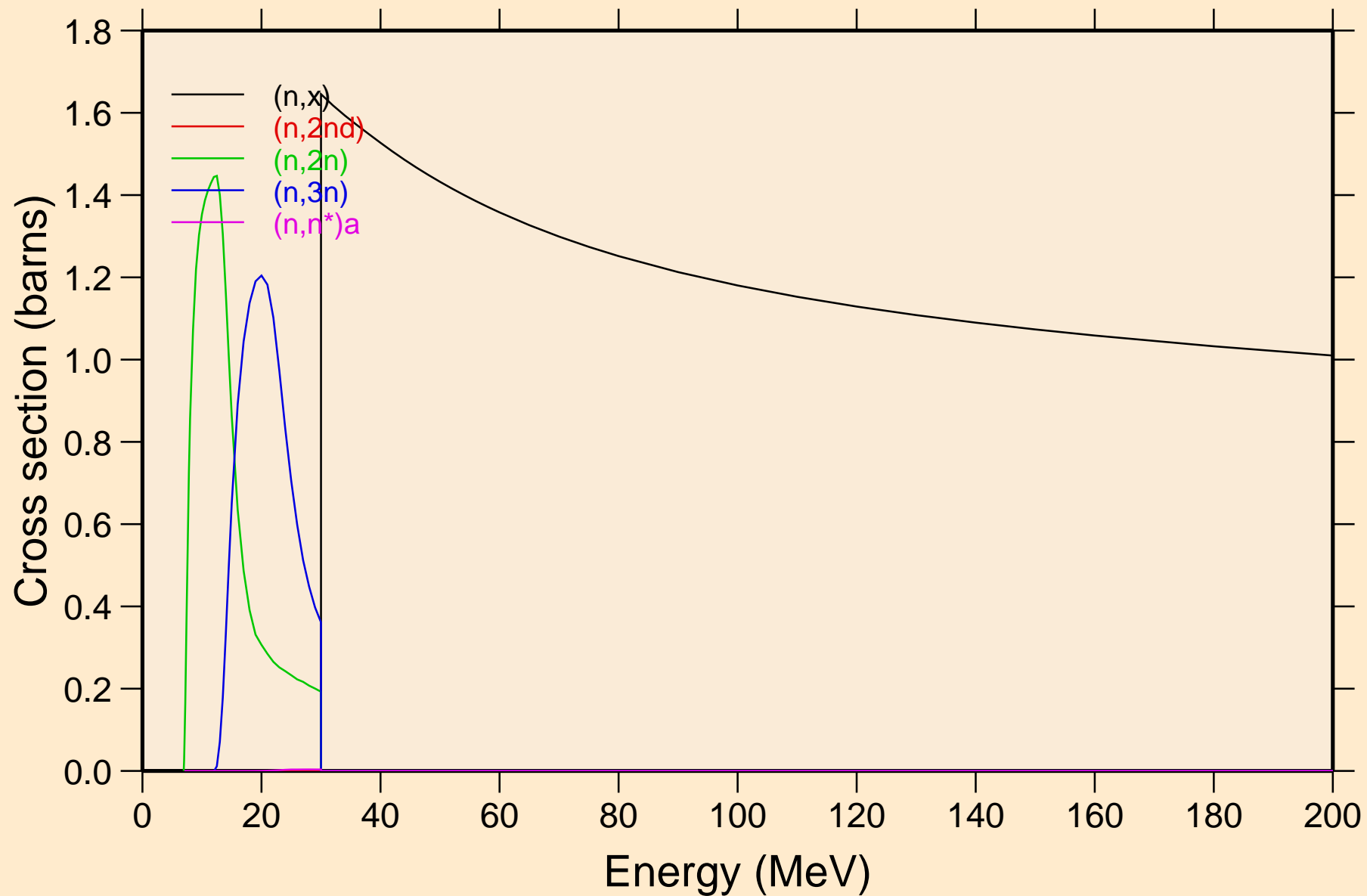

MO106 NEUTRON ACER TENDL-2019 LIBRARY; T=293.16K  
Threshold reactions

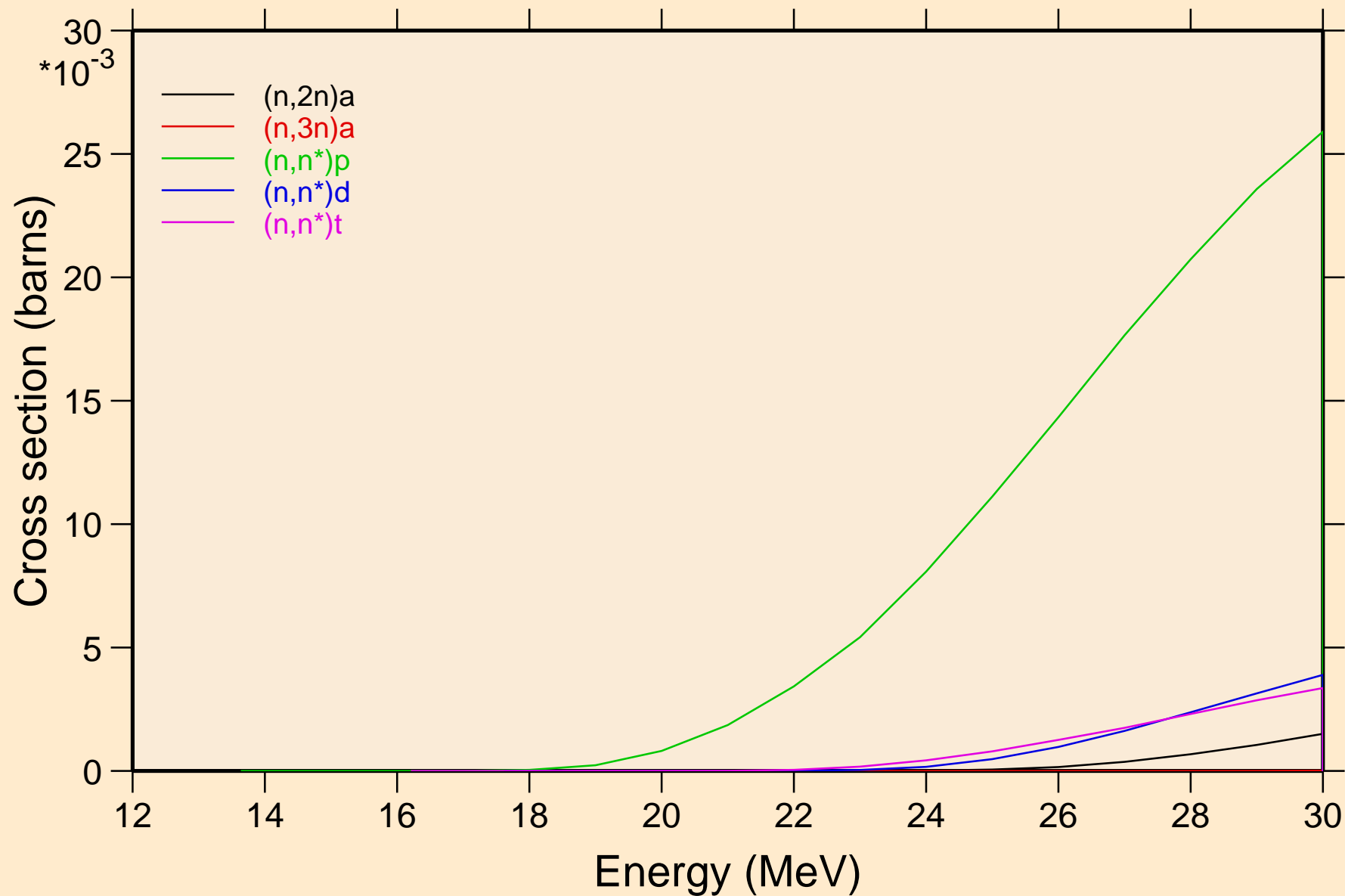

MO106 NEUTRON ACER TENDL-2019 LIBRARY; T=293.16K  
Threshold reactions

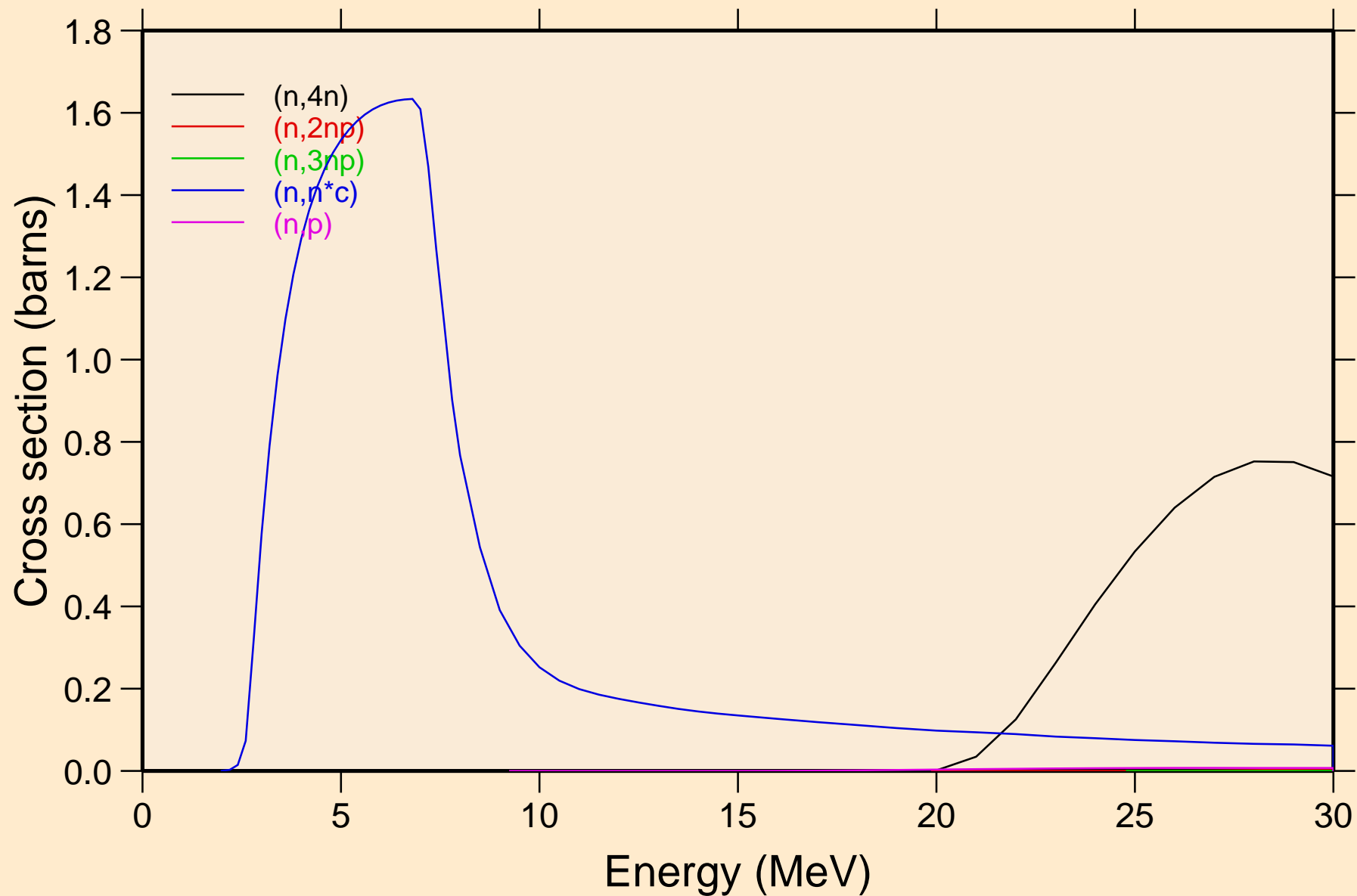

MO106 NEUTRON ACER TENDL-2019 LIBRARY; T=293.16K  
Threshold reactions

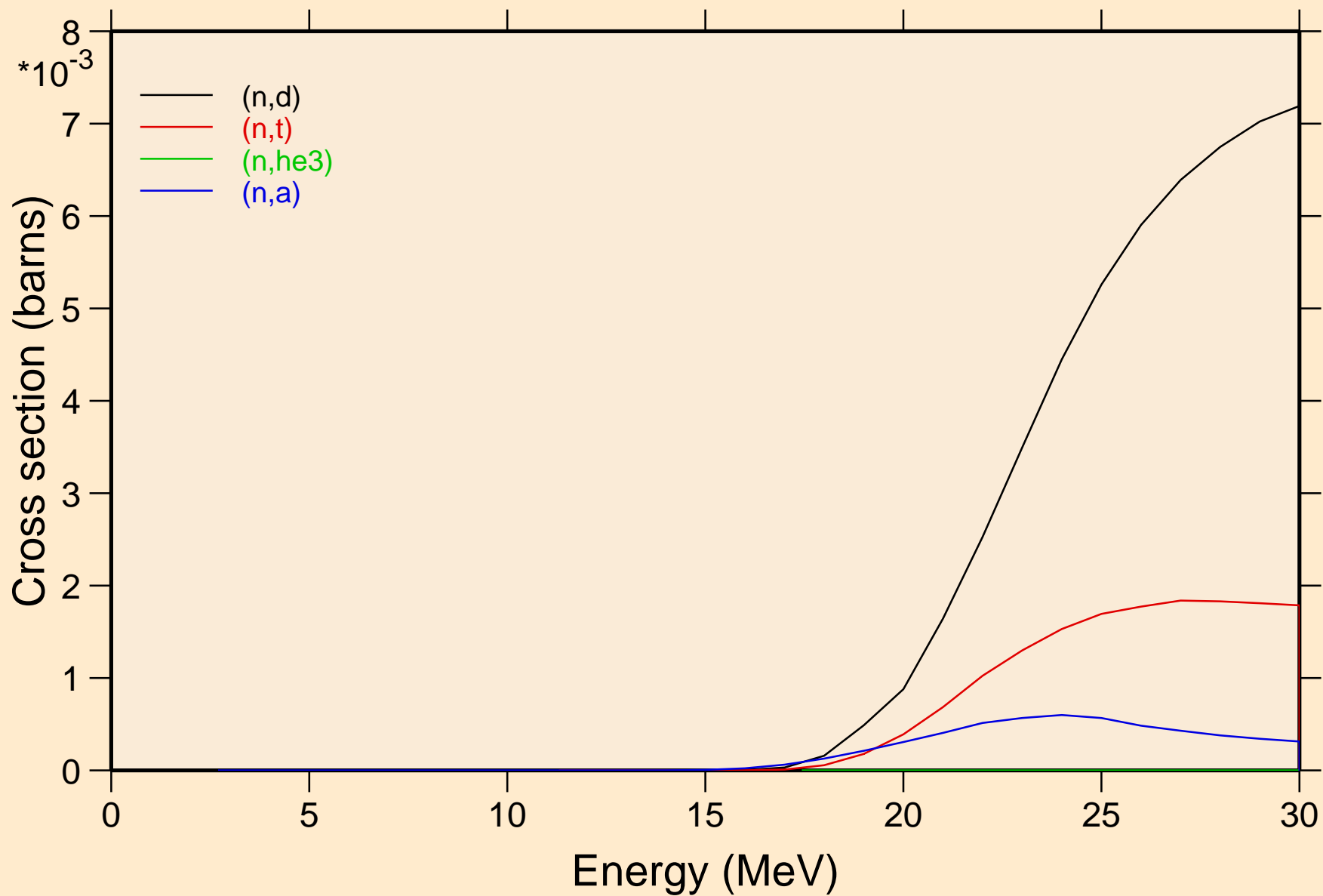



MO106 NEUTRON ACER TENDL-2019 LIBRARY; T=293.16K  
Threshold reactions

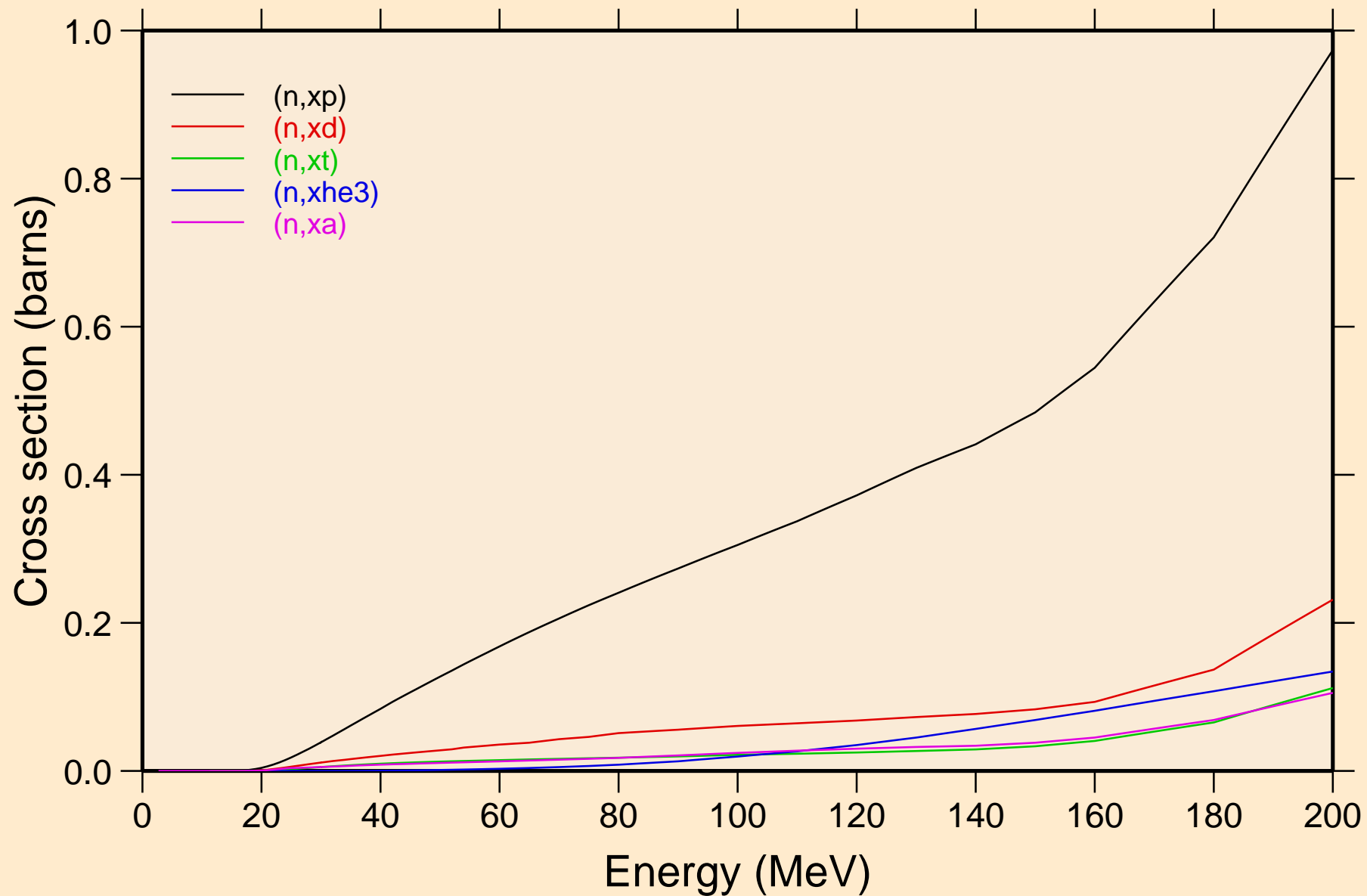

MO106 NEUTRON ACER TENDL-2019 LIBRARY; T=293.16K  
angular distribution for elastic

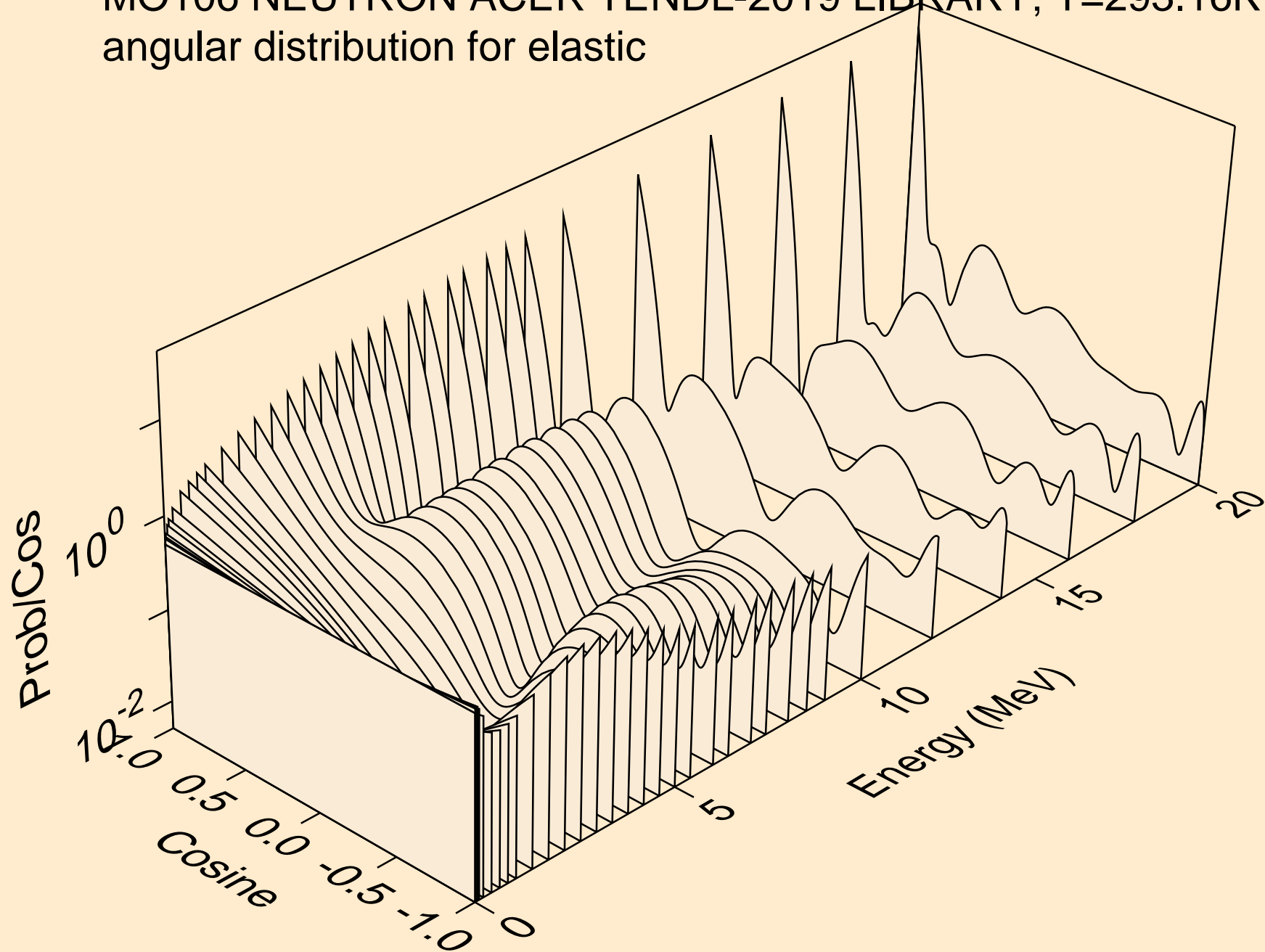

MO106 NEUTRON ACER TENDL-2019 LIBRARY; T=293.16K  
angular distribution for elastic

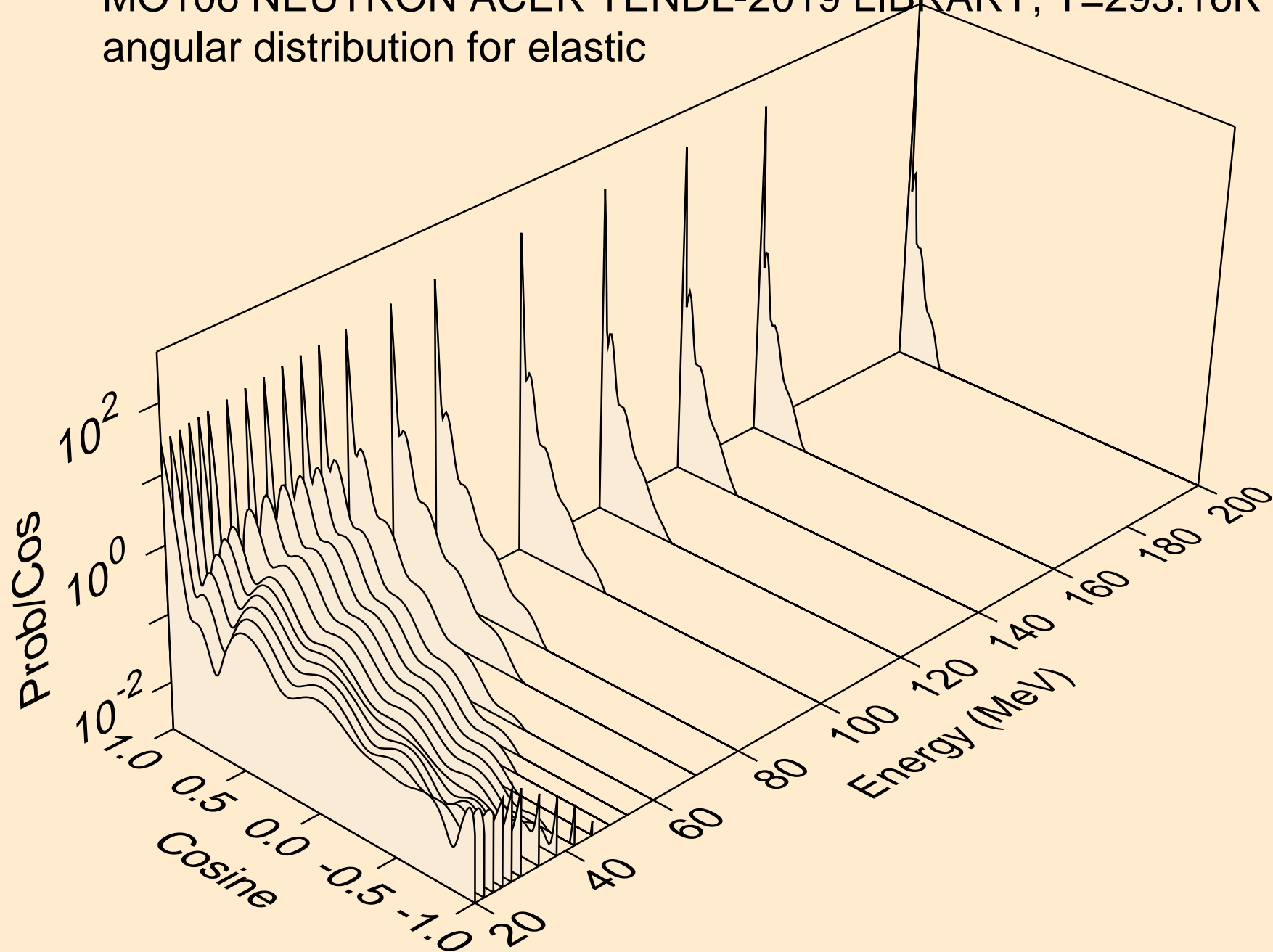

MO106 NEUTRON ACER TENDL-2019 LIBRARY; T=293.16K  
angular distribution for (n,n\*1)

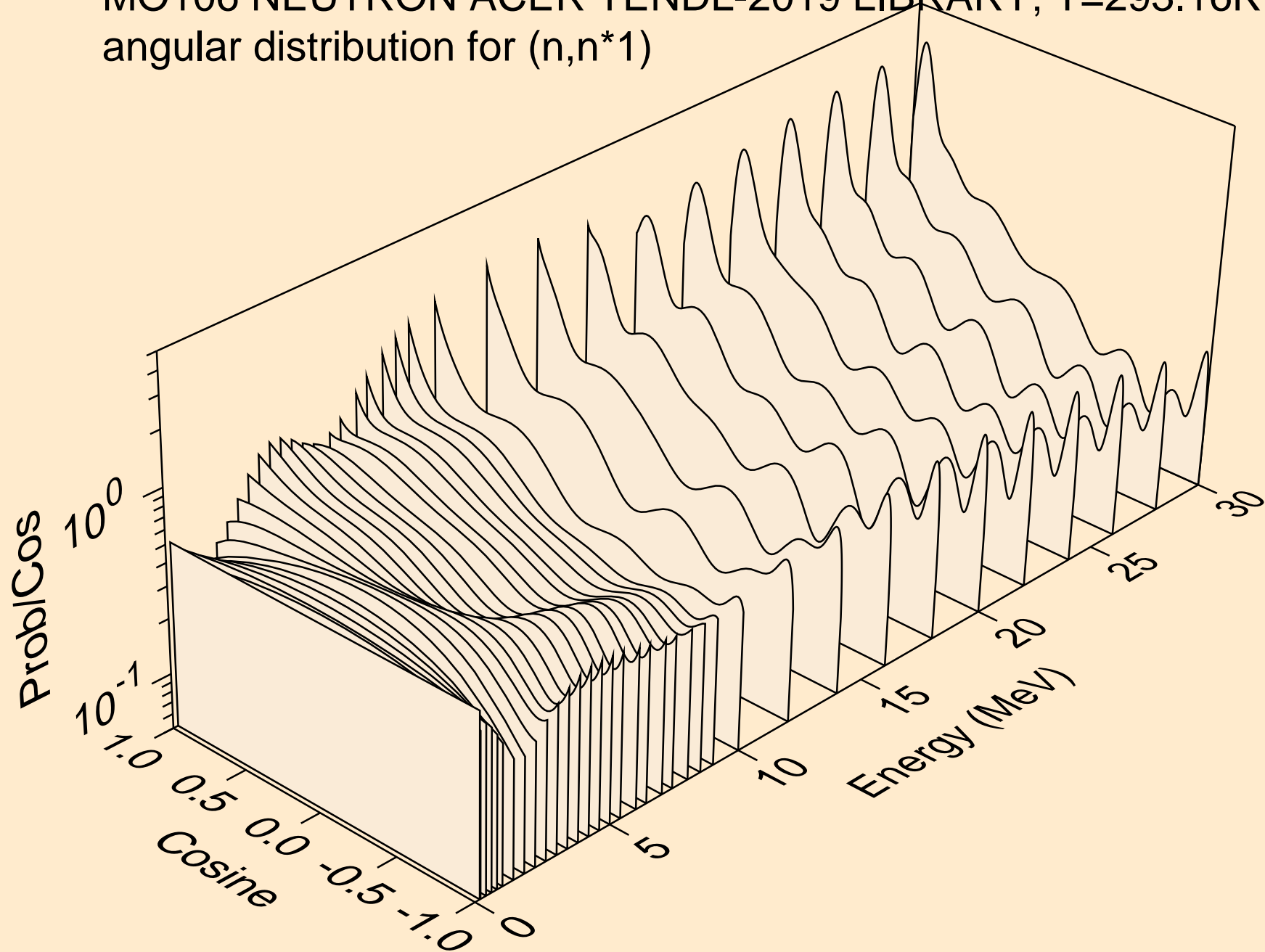

MO106 NEUTRON ACER TENDL-2019 LIBRARY; T=293.16K  
angular distribution for (n,n\*2)

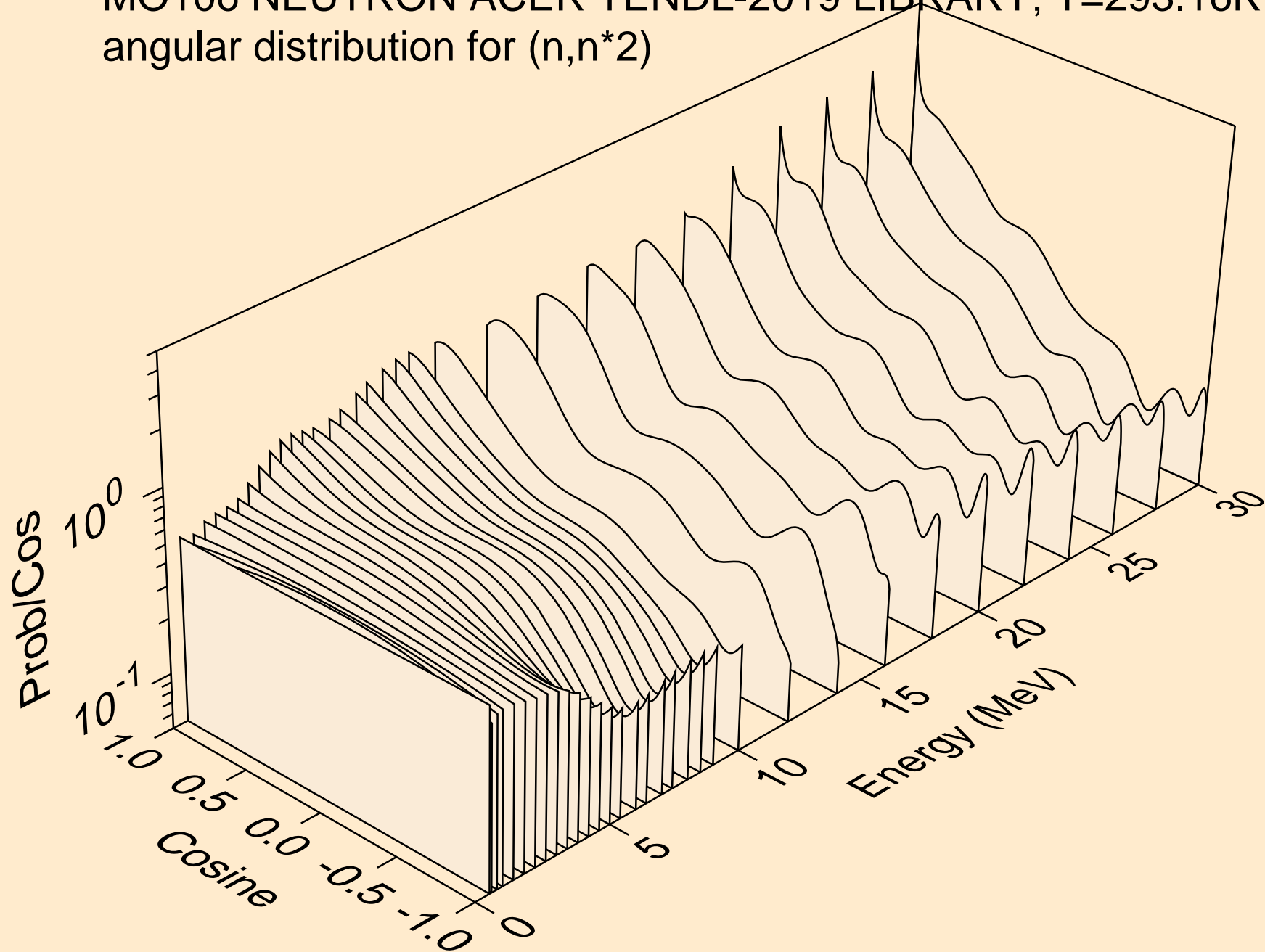

MO106 NEUTRON ACER TENDL-2019 LIBRARY; T=293.16K  
angular distribution for (n,n\*3)

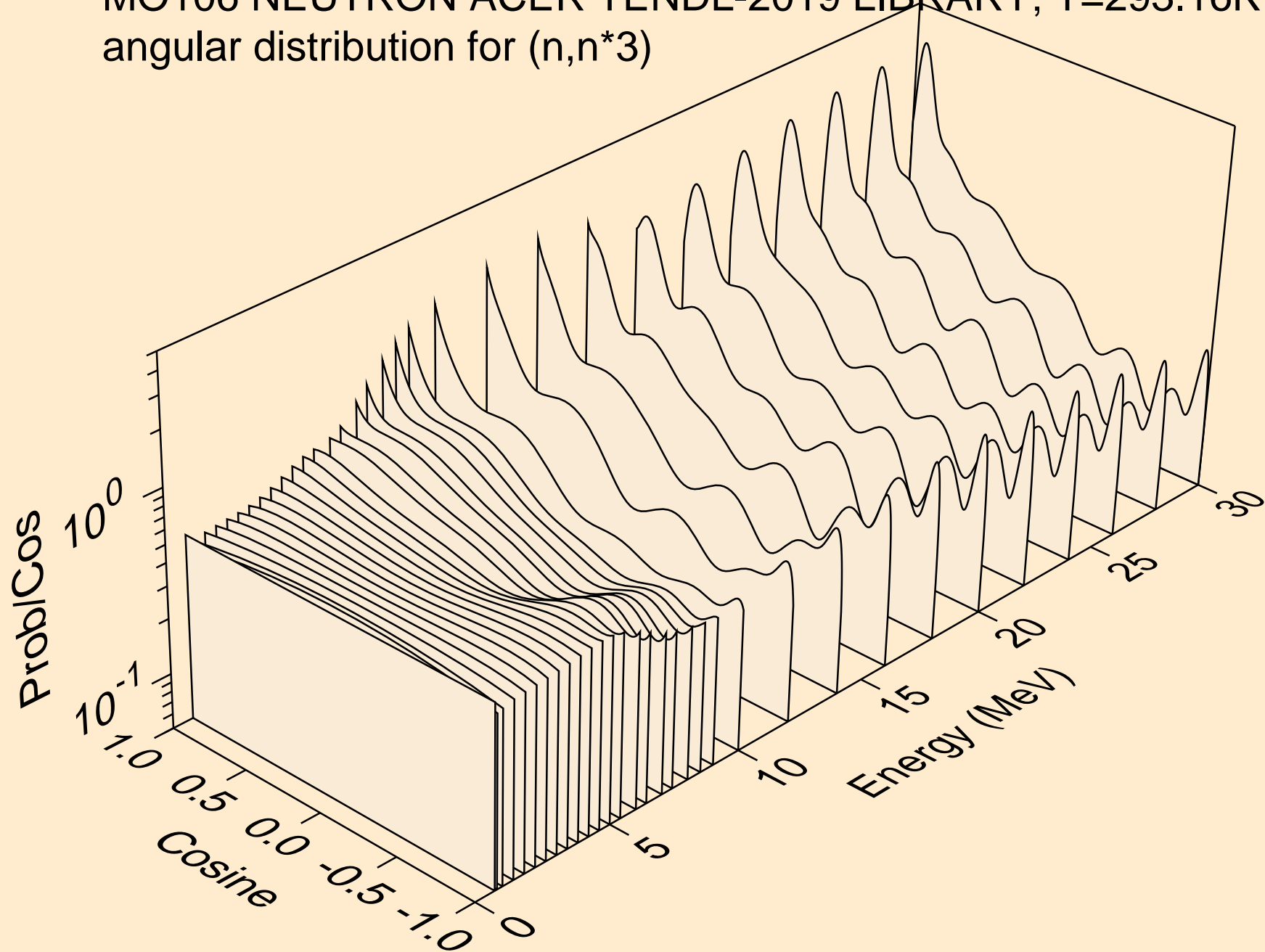

MO106 NEUTRON ACER TENDL-2019 LIBRARY; T=293.16K  
angular distribution for (n,n\*4)

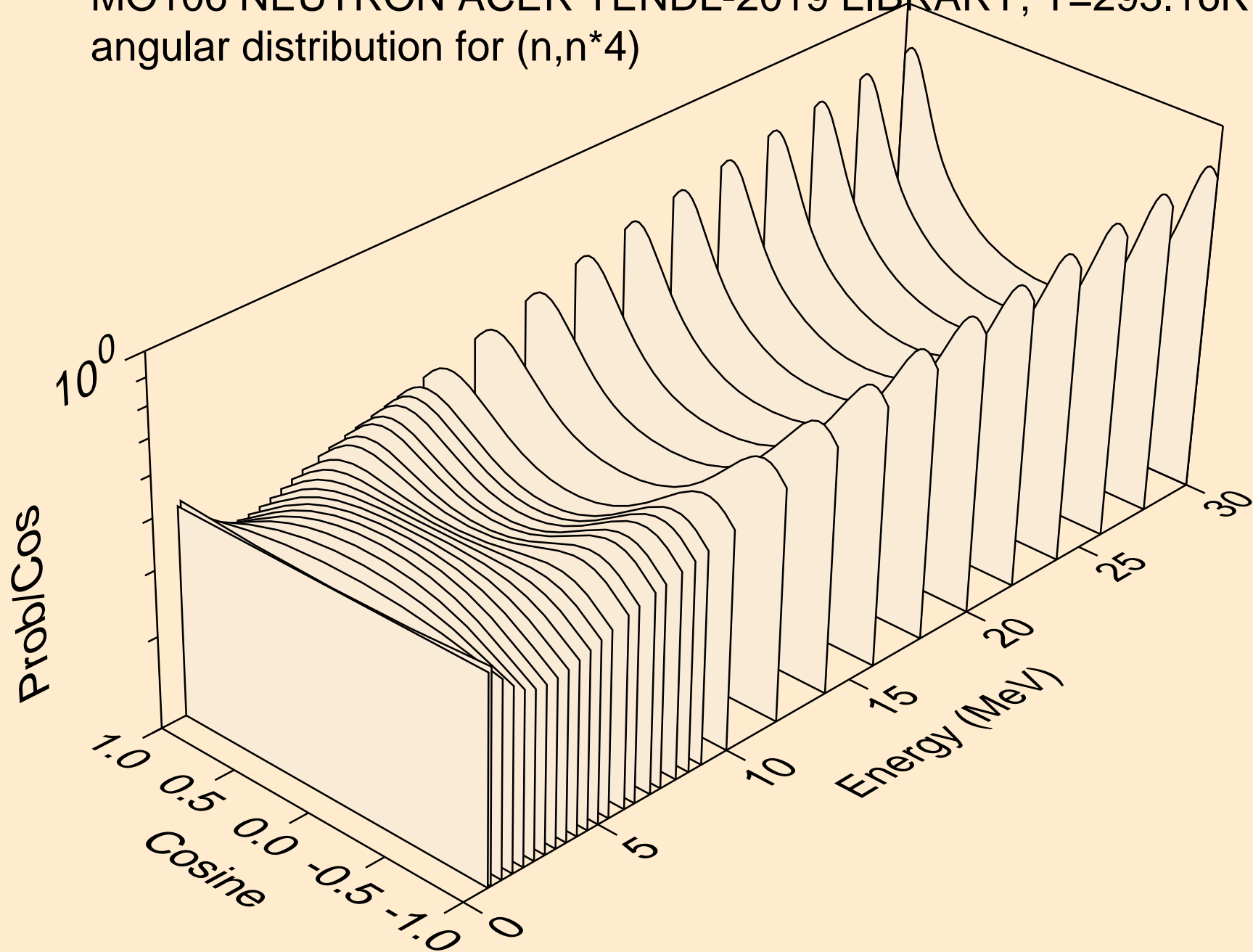

MO106 NEUTRON ACER TENDL-2019 LIBRARY; T=293.16K  
angular distribution for (n,n\*5)

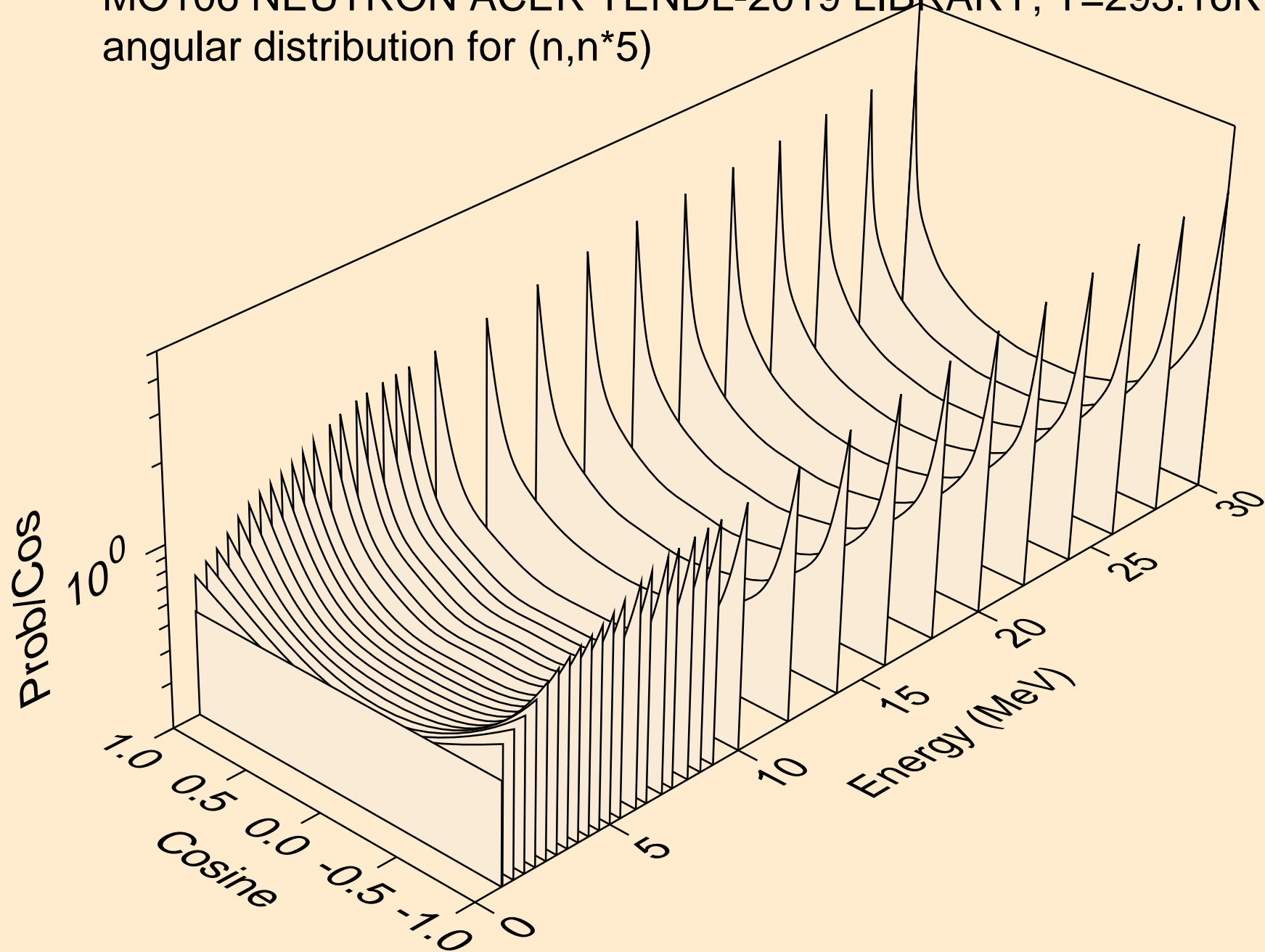



MO106 NEUTRON ACER TENDL-2019 LIBRARY; T=293.16K  
angular distribution for (n,n\*6)

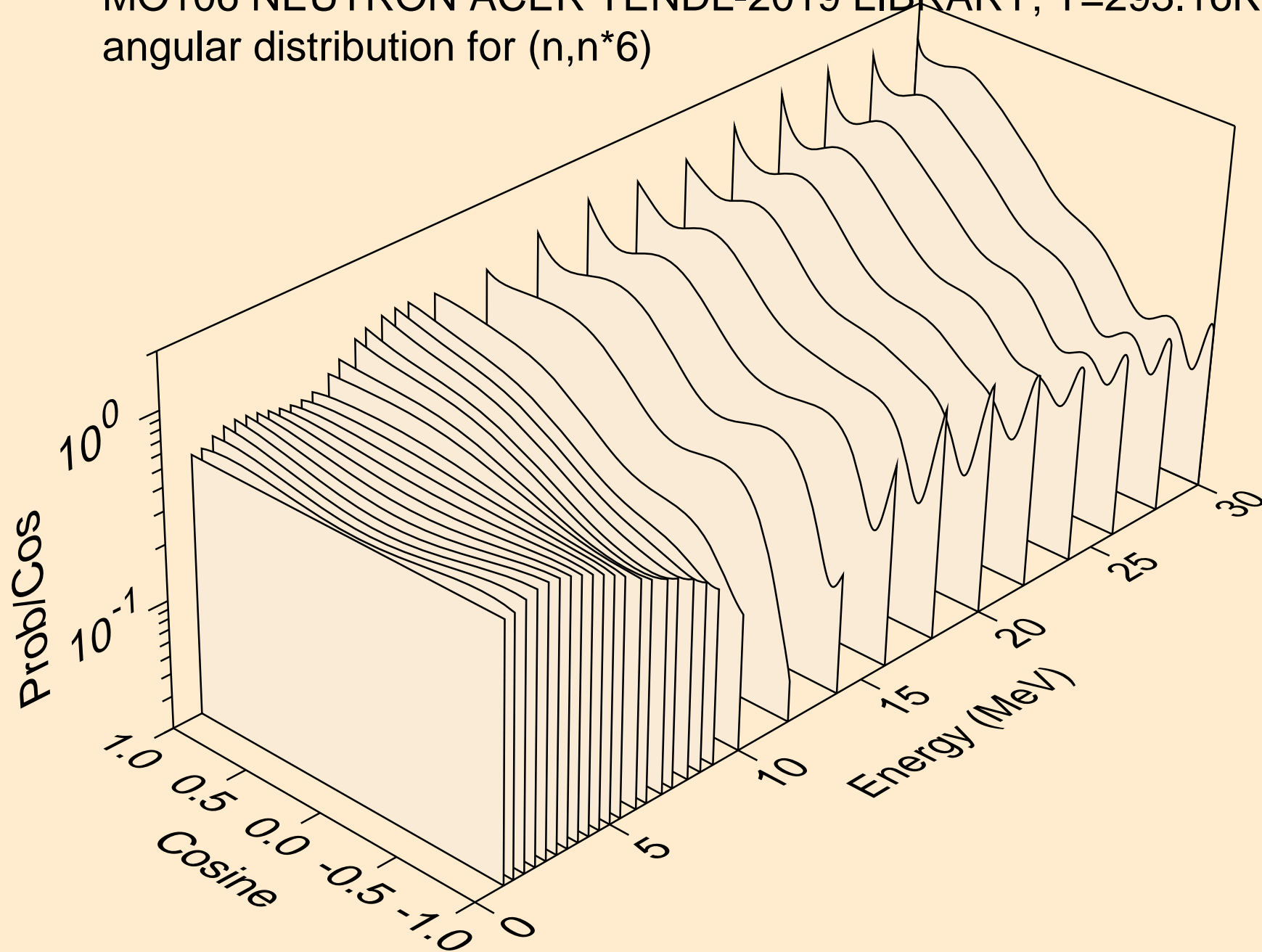

MO106 NEUTRON ACER TENDL-2019 LIBRARY; T=293.16K  
angular distribution for (n,n\*7)

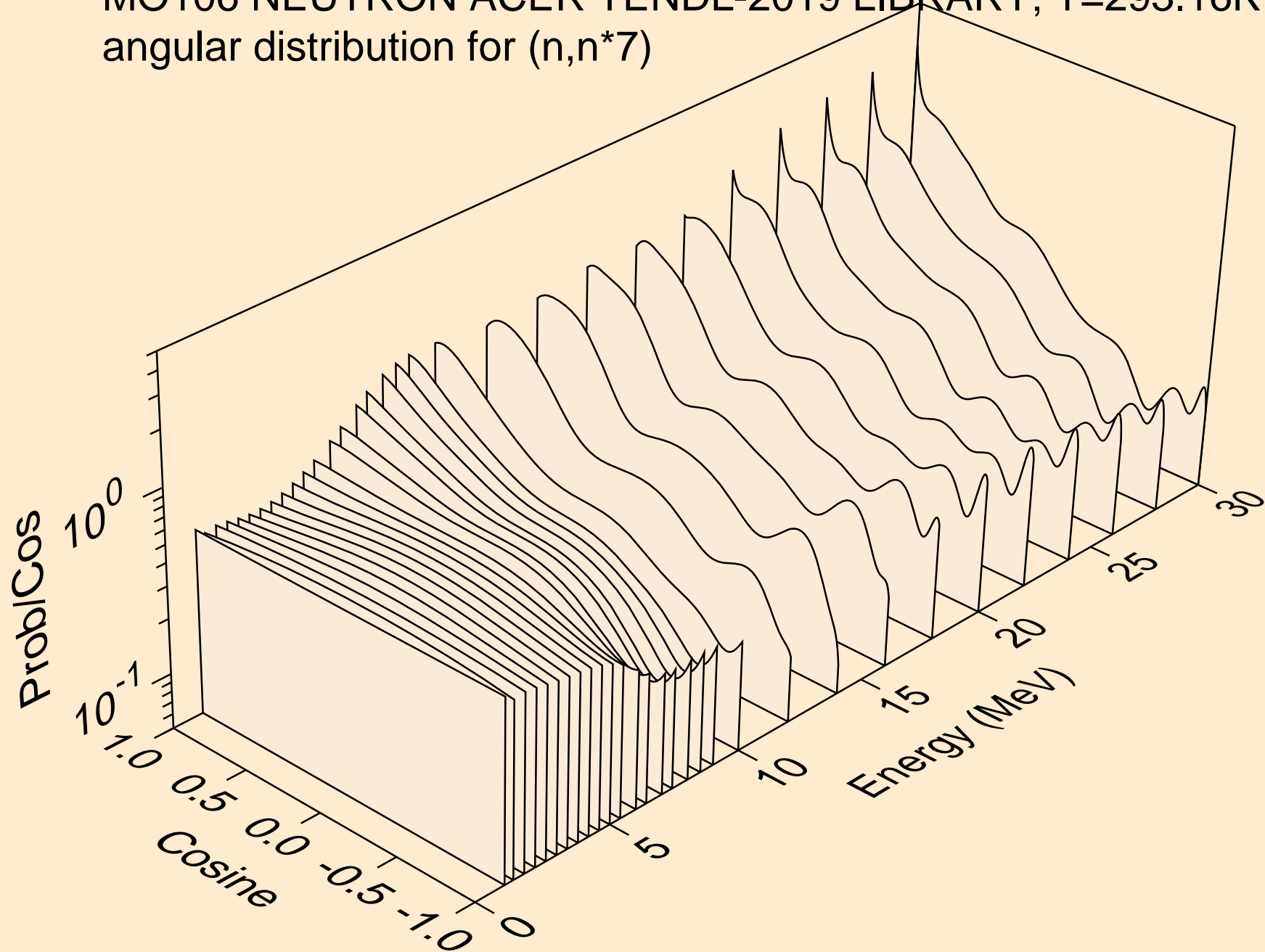

MO106 NEUTRON ACER TENDL-2019 LIBRARY; T=293.16K  
angular distribution for (n,n\*8)

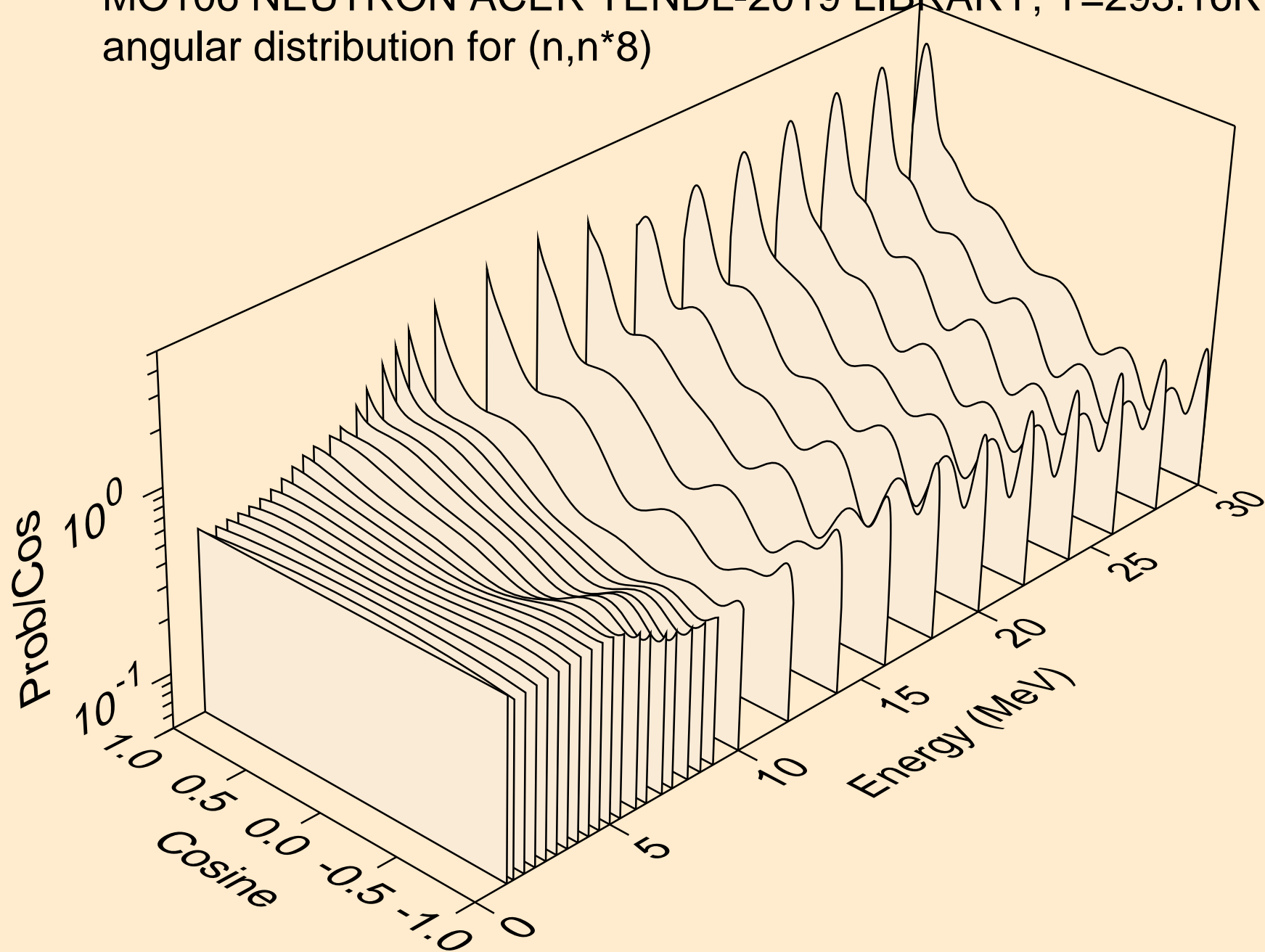

MO106 NEUTRON ACER TENDL-2019 LIBRARY; T=293.16K  
angular distribution for (n,n\*9)

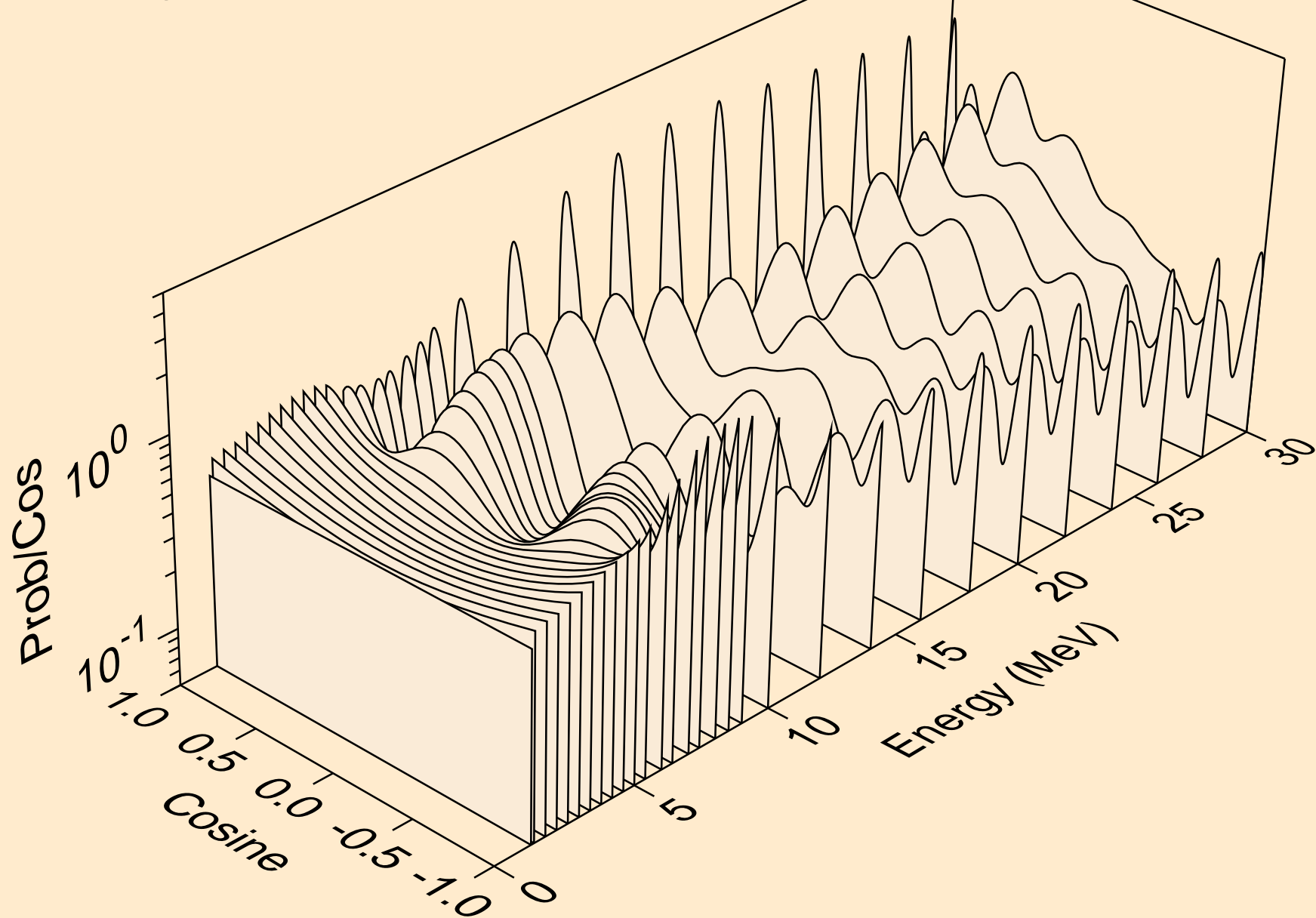

MO106 NEUTRON ACER TENDL-2019 LIBRARY; T=293.16K  
angular distribution for (n,n\*10)

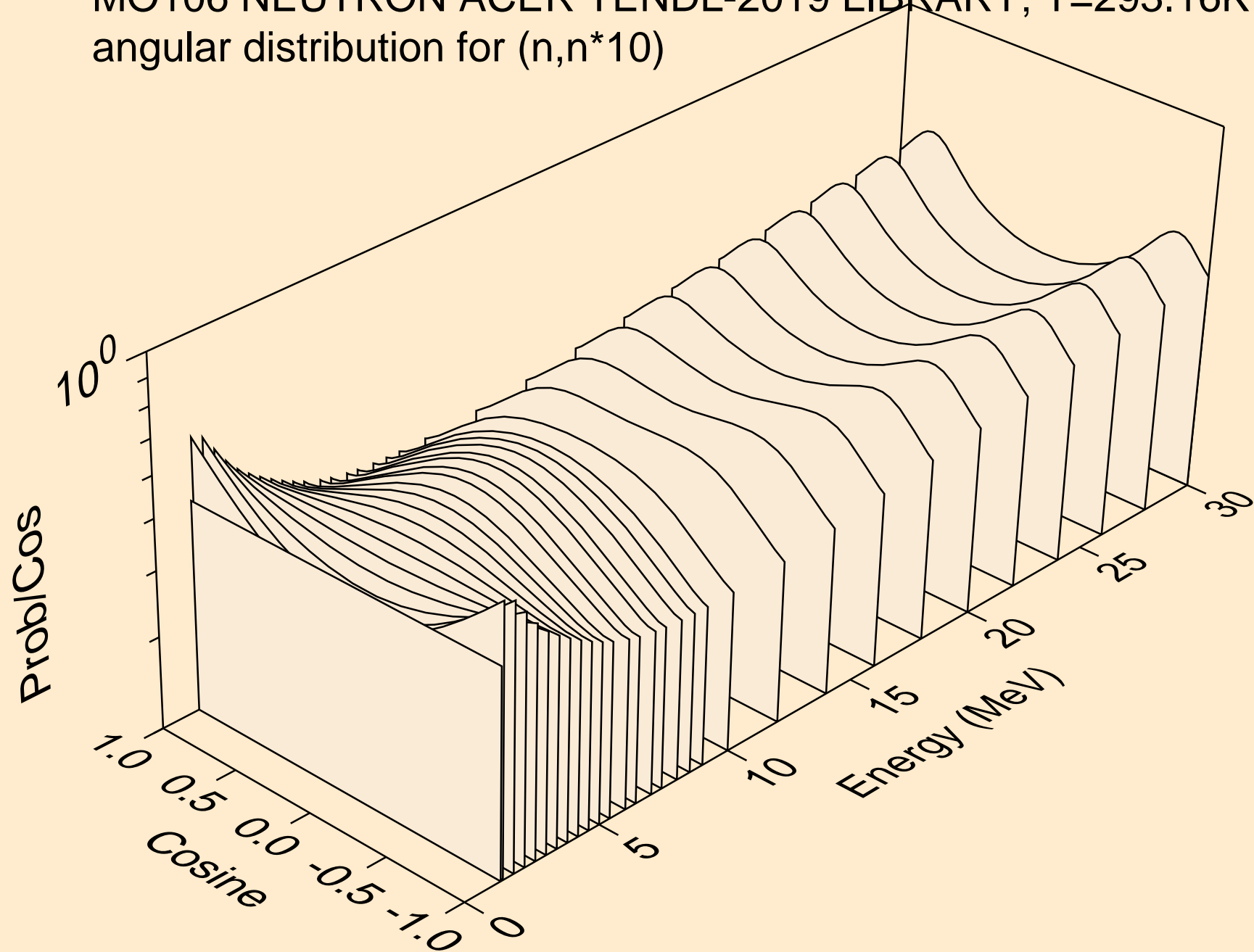

MO106 NEUTRON ACER TENDL-2019 LIBRARY; T=293.16K  
angular distribution for (n,n\*11)

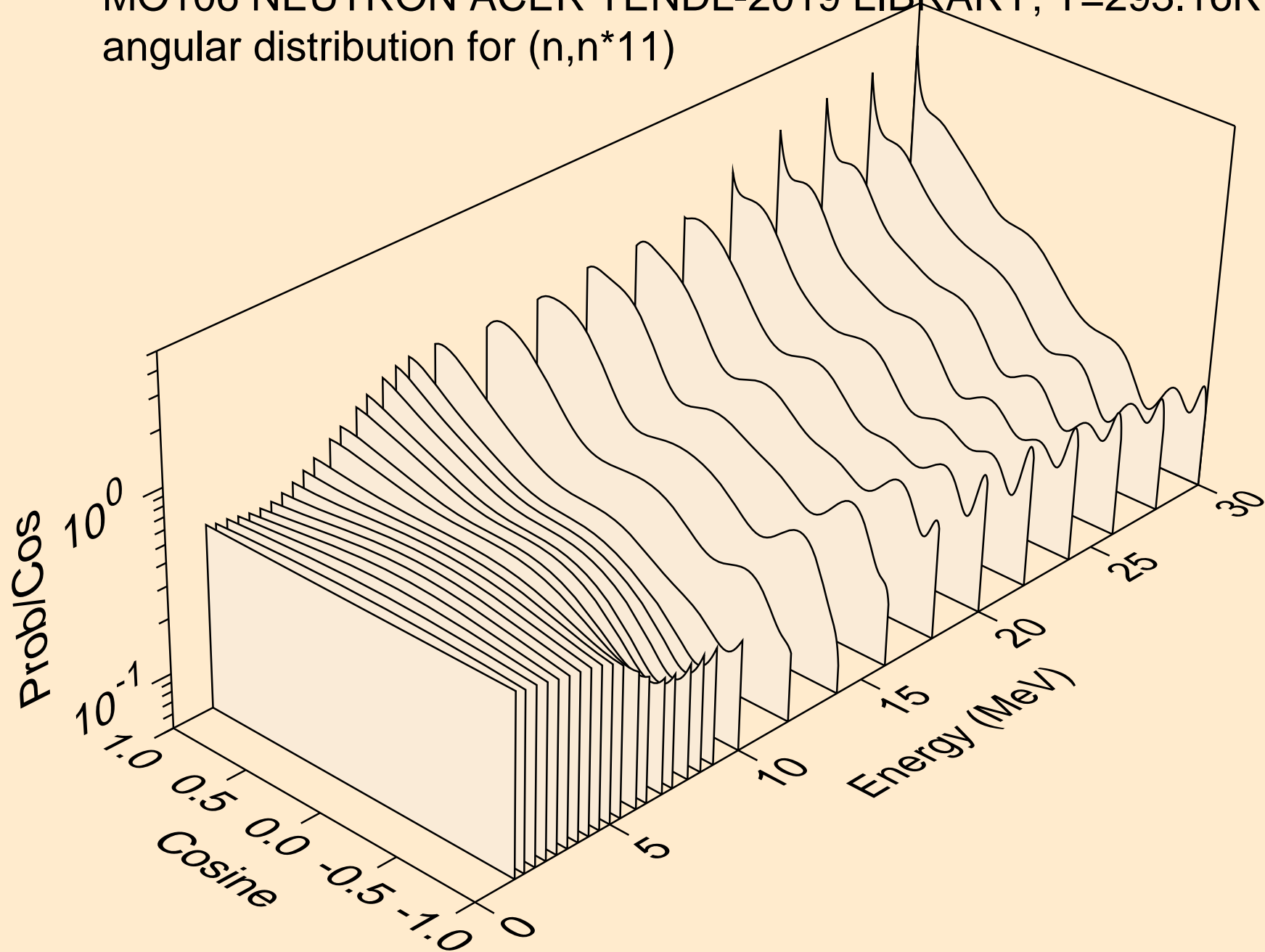

MO106 NEUTRON ACER TENDL-2019 LIBRARY; T=293.16K  
angular distribution for (n,n\*12)

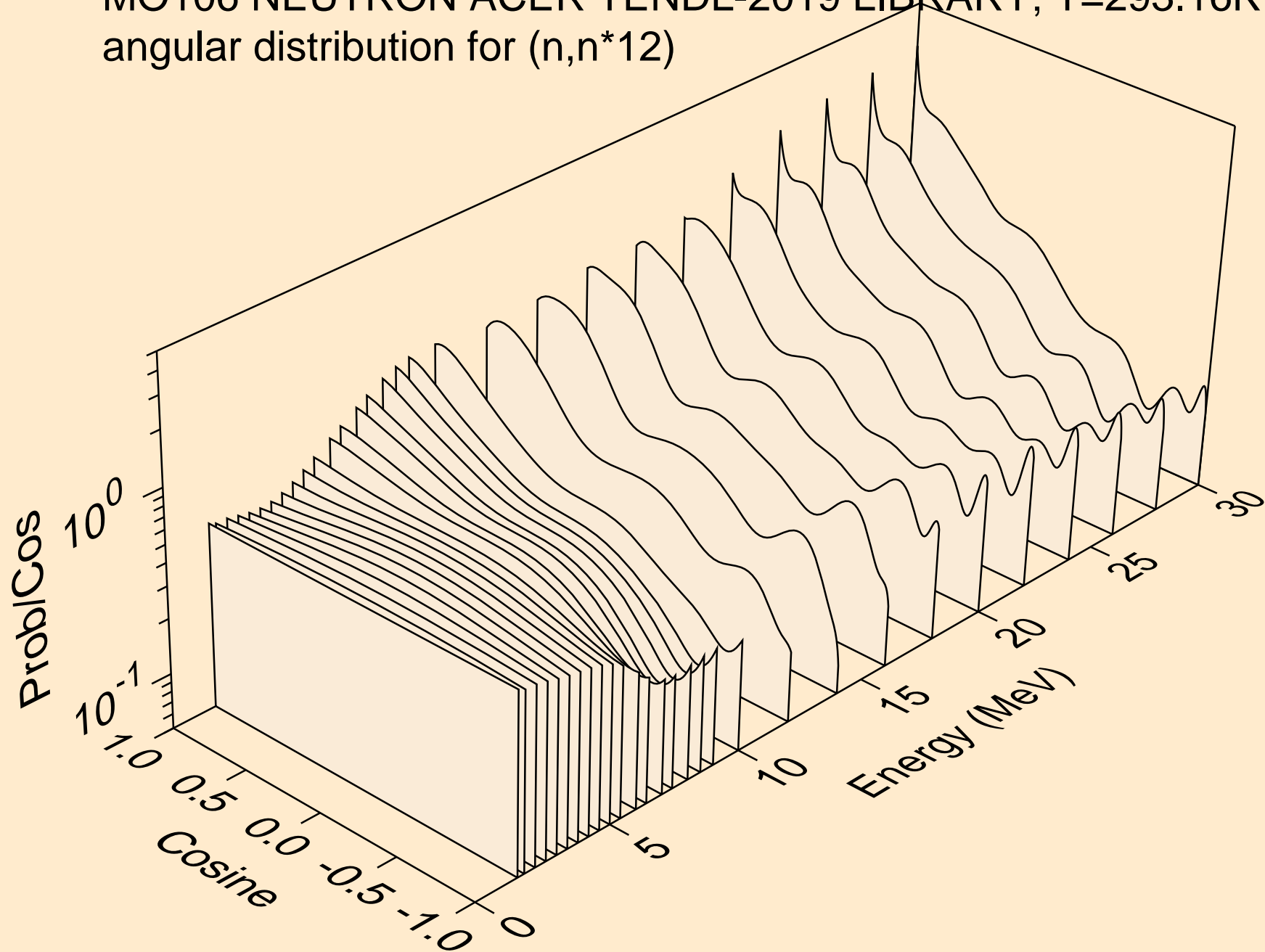

MO106 NEUTRON ACER TENDL-2019 LIBRARY; T=293.16K  
angular distribution for (n,n\*13)

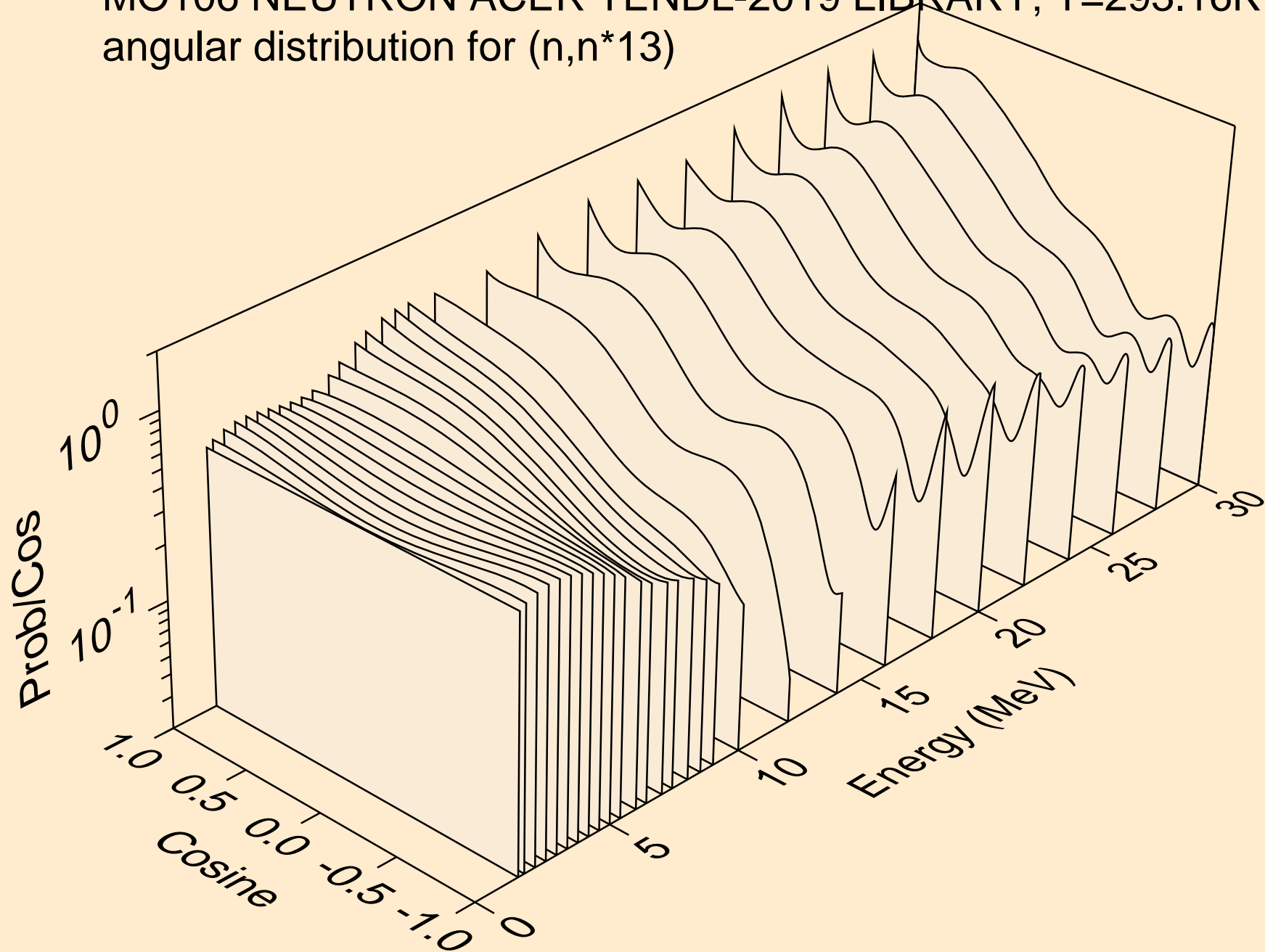



MO106 NEUTRON ACER TENDL-2019 LIBRARY; T=293.16K  
angular distribution for (n,n\*14)

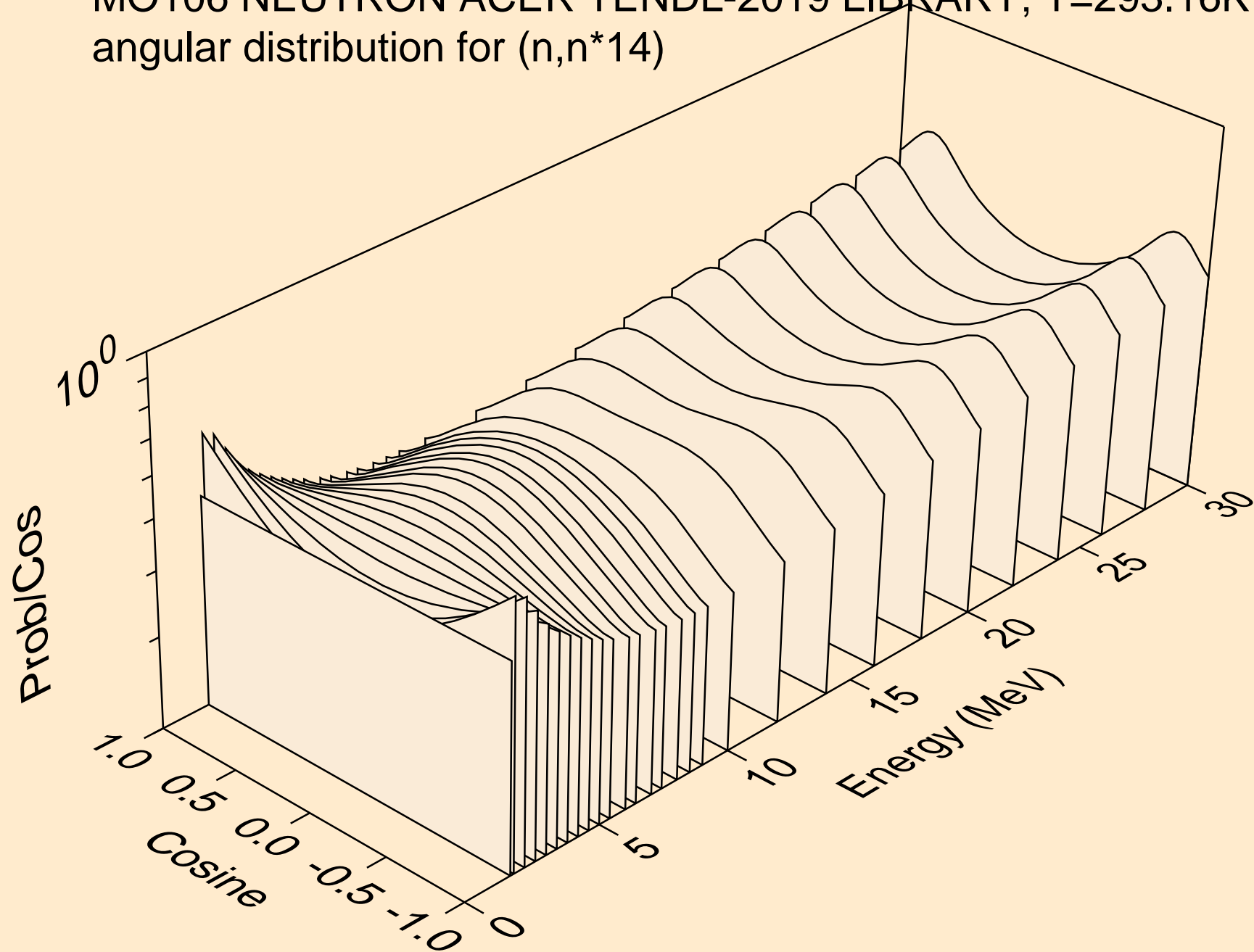

MO106 NEUTRON ACER TENDL-2019 LIBRARY; T=293.16K  
angular distribution for (n,n\*15)

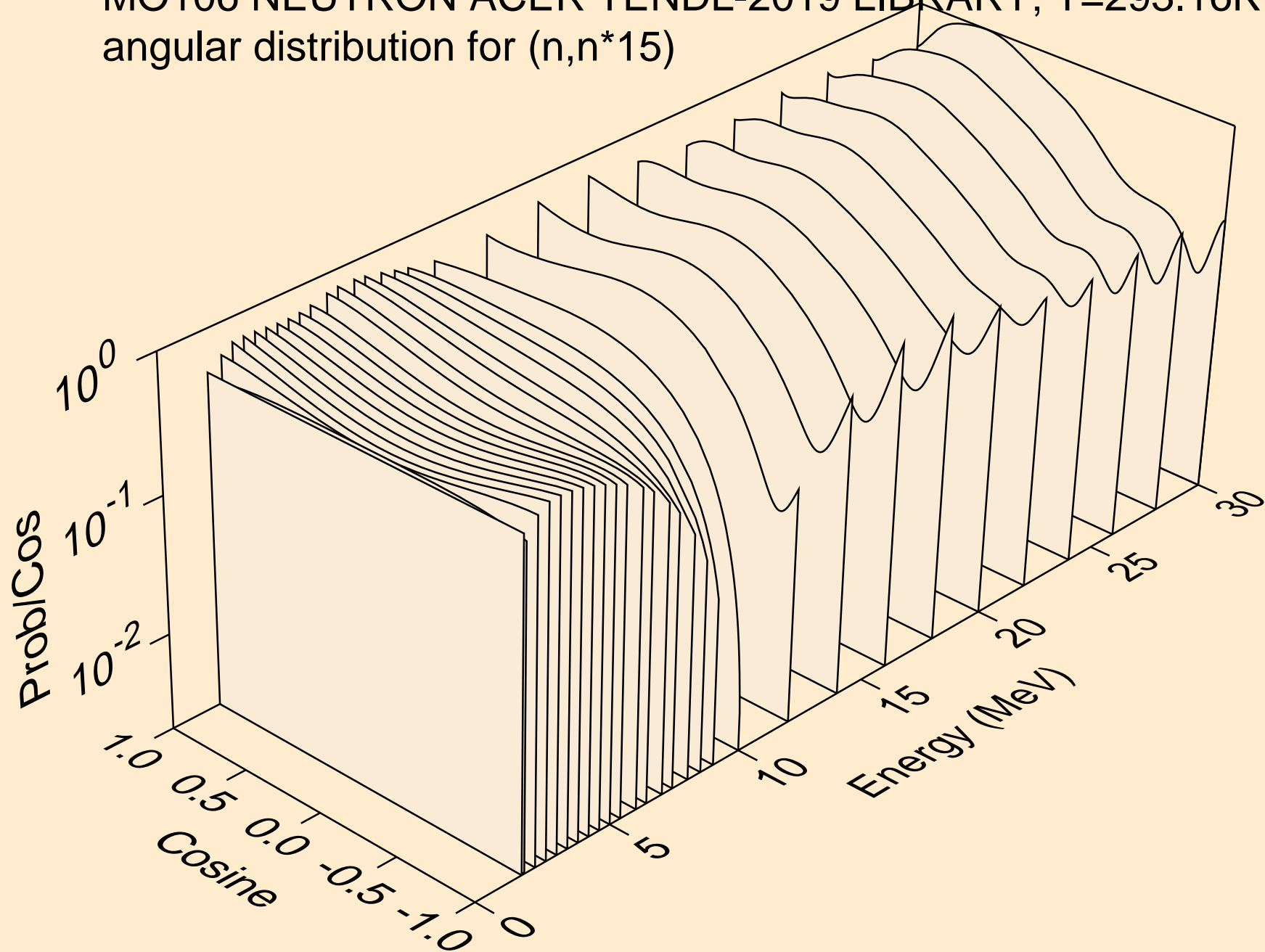

MO106 NEUTRON ACER TENDL-2019 LIBRARY; T=293.16K  
angular distribution for (n,n\*16)

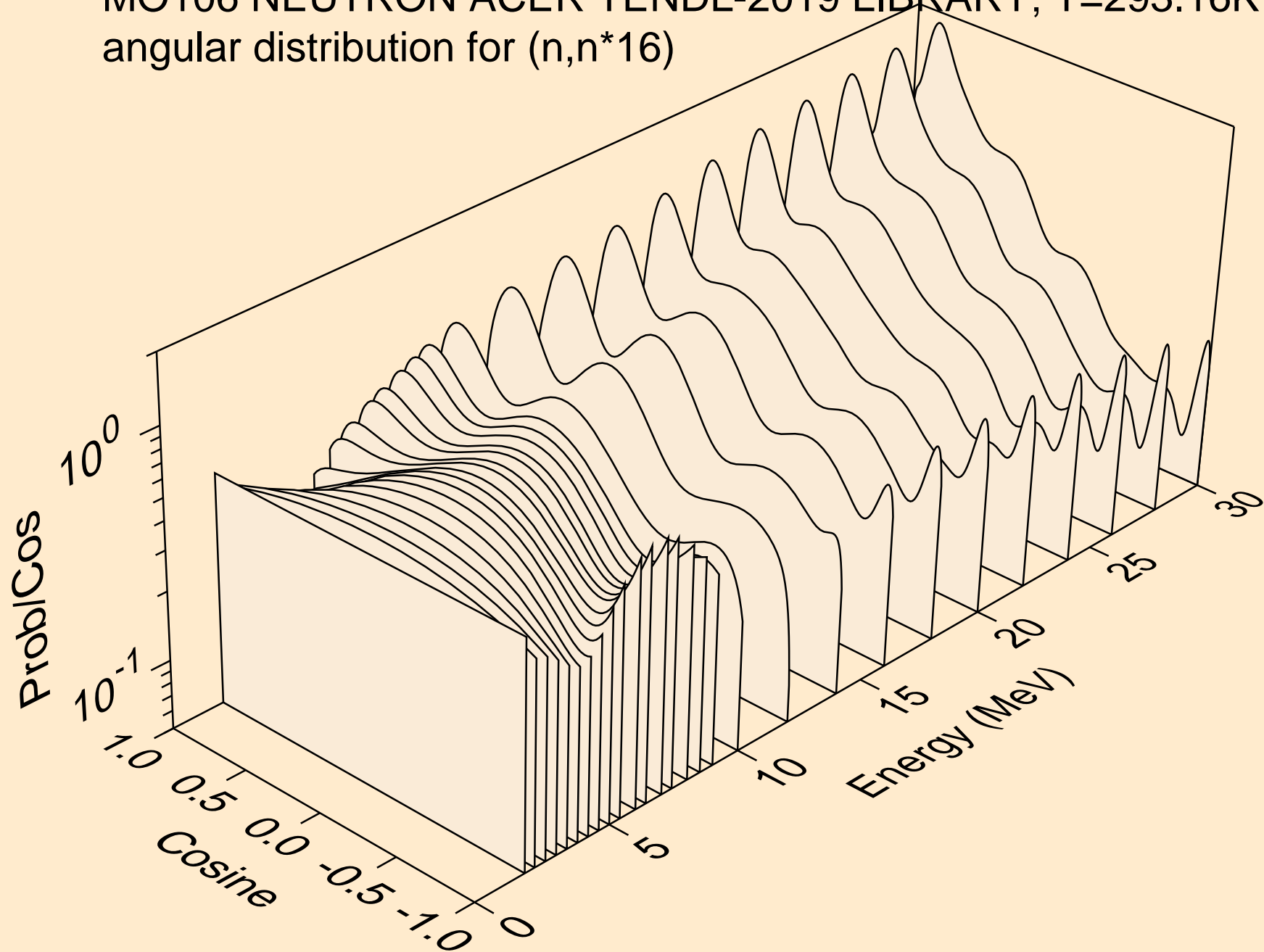

MO106 NEUTRON ACER TENDL-2019 LIBRARY; T=293.16K  
angular distribution for (n,n\*17)

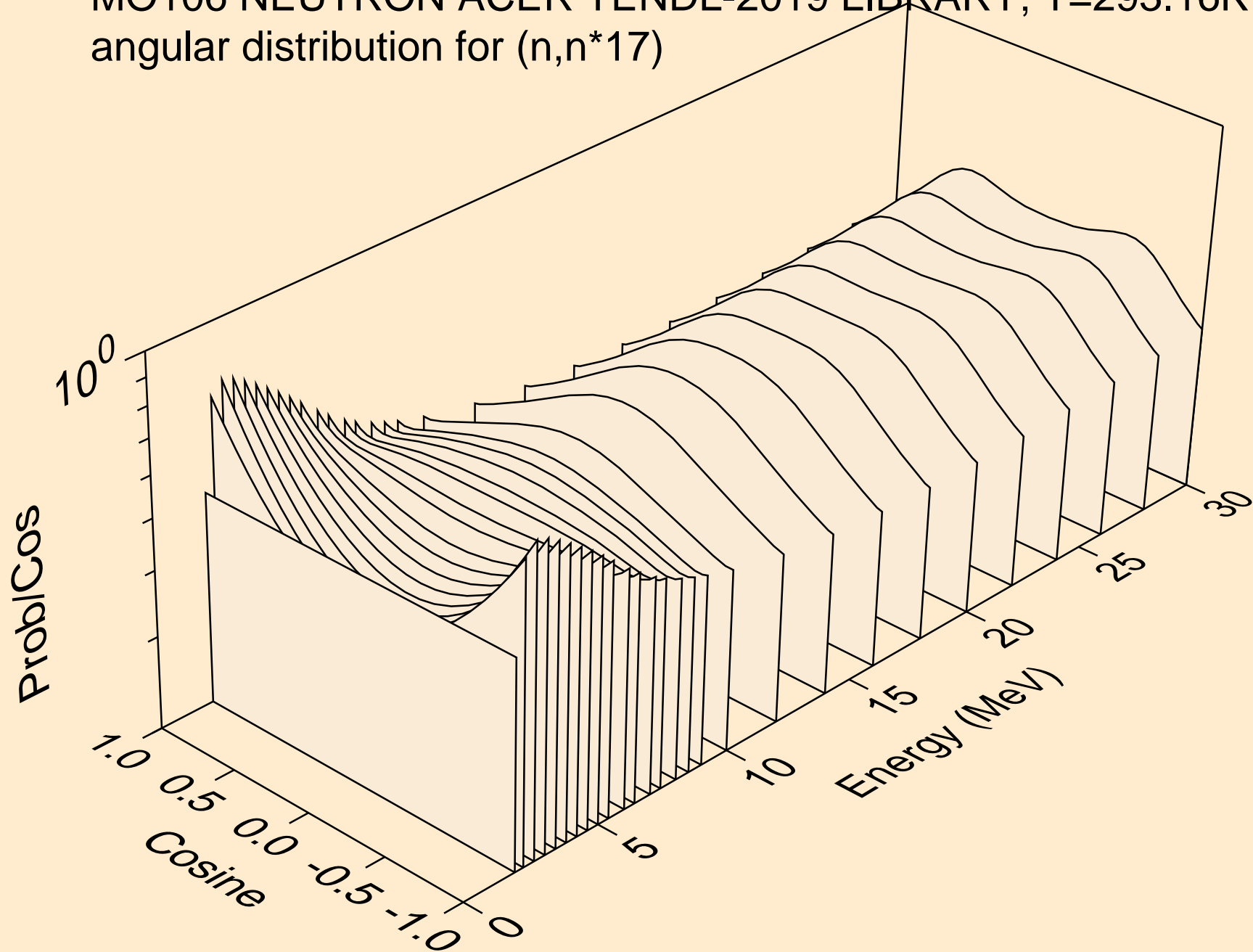

MO106 NEUTRON ACER TENDL-2019 LIBRARY; T=293.16K  
angular distribution for (n,n\*18)

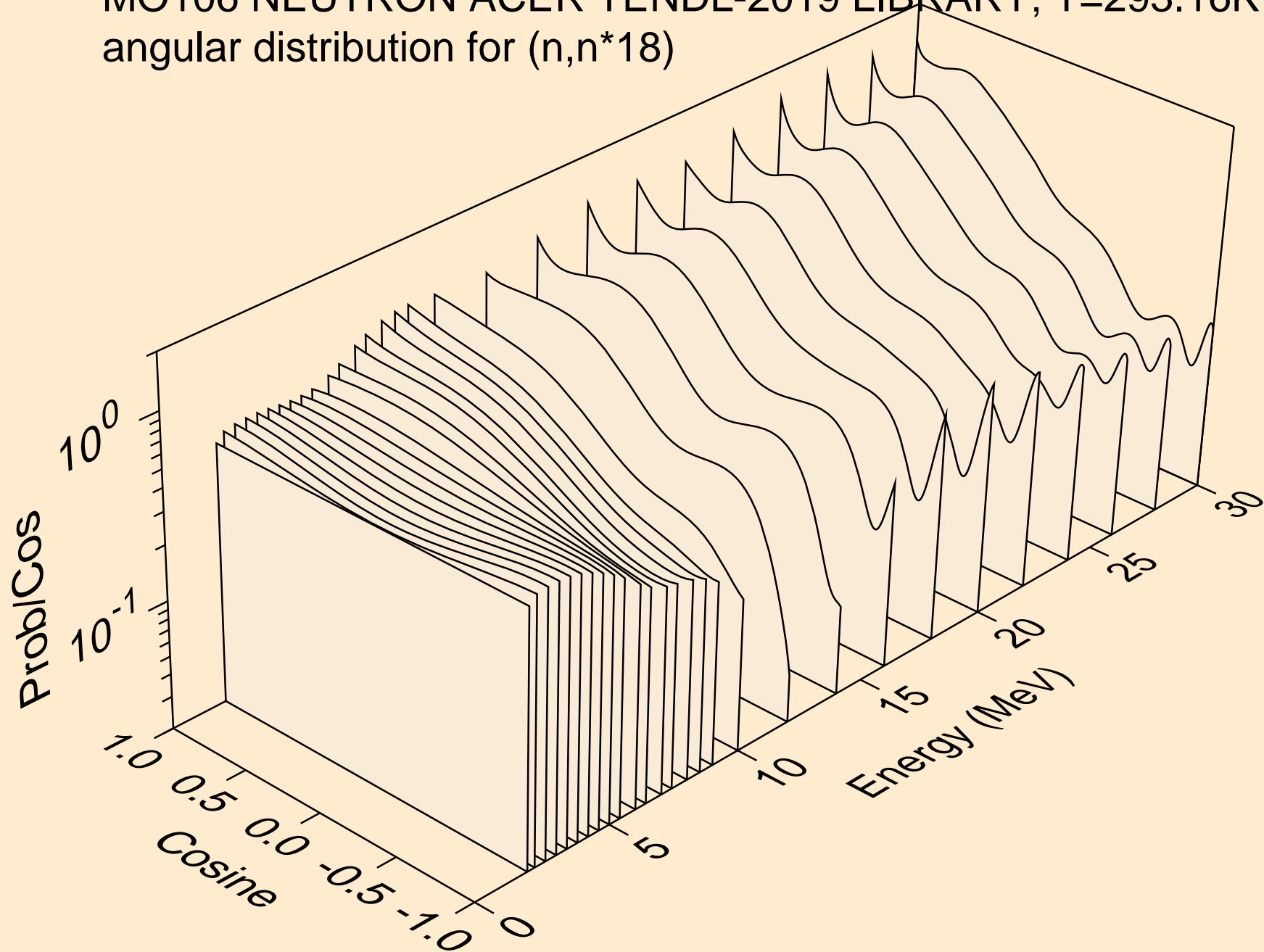

MO106 NEUTRON ACER TENDL-2019 LIBRARY; T=293.16K  
angular distribution for (n,n\*19)

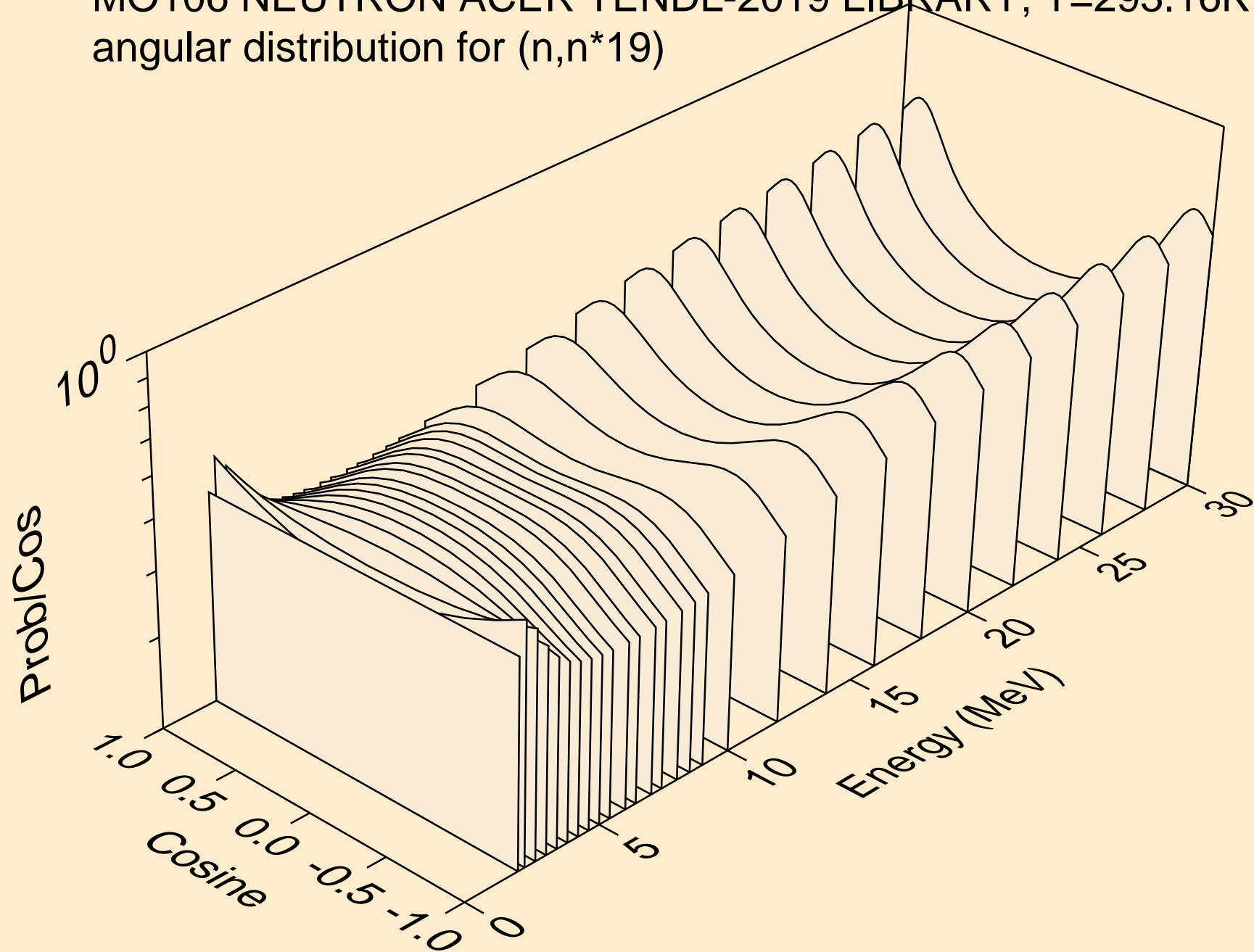

MO106 NEUTRON ACER TENDL-2019 LIBRARY; T=293.16K  
angular distribution for (n,n\*20)

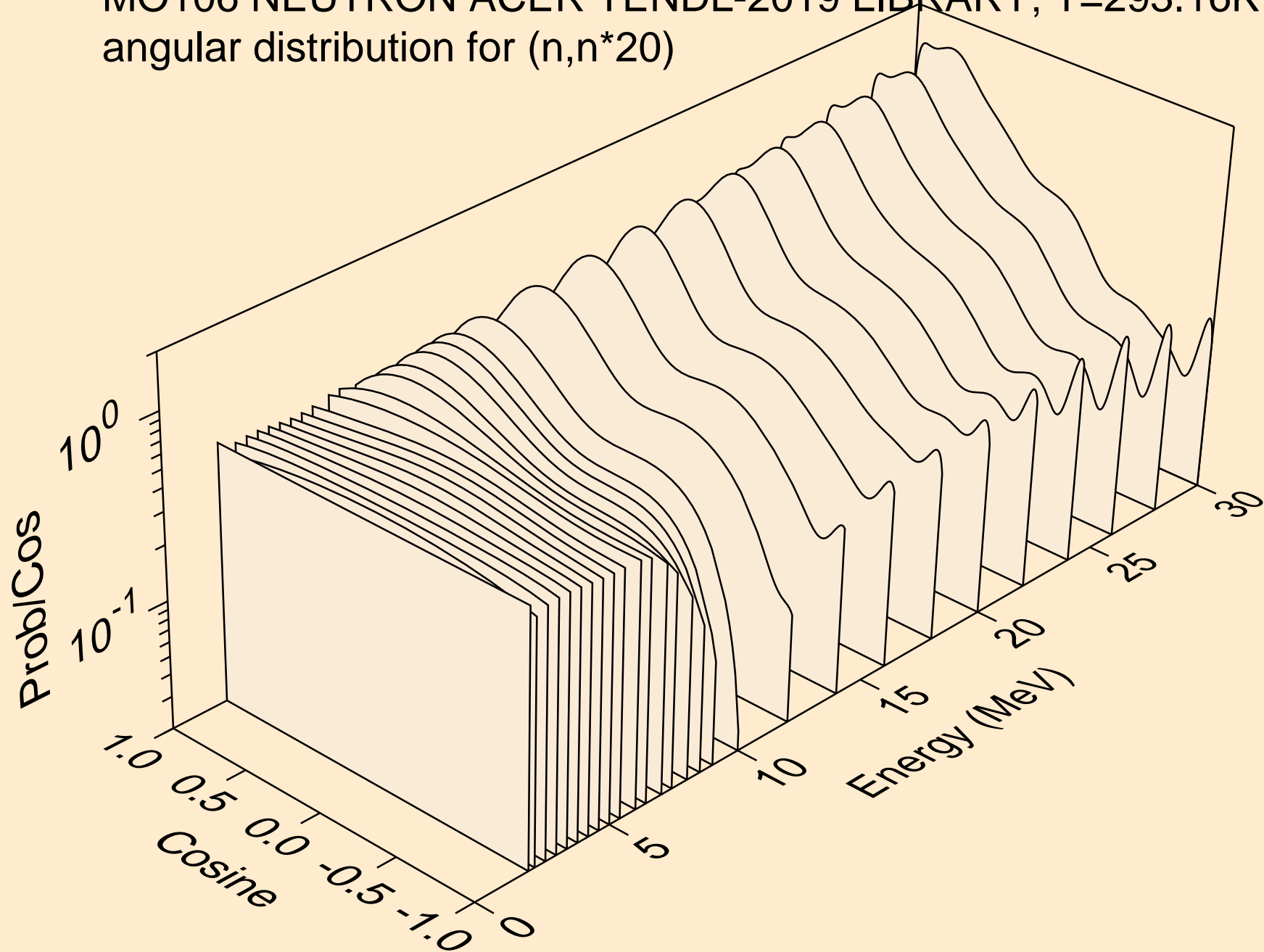

MO106 NEUTRON ACER TENDL-2019 LIBRARY; T=293.16K  
Neutron emission for (n,x)

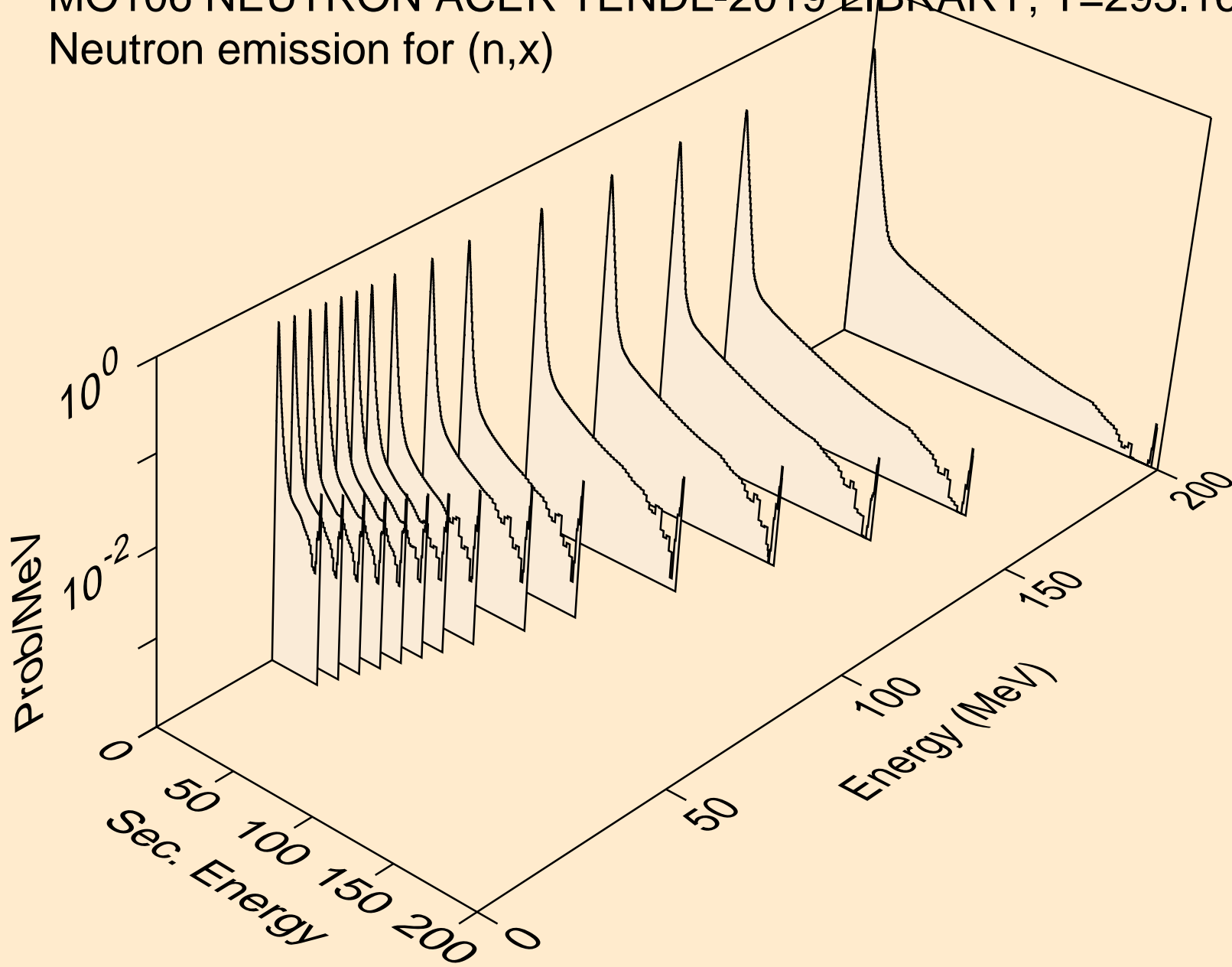



MO106 NEUTRON ACER TENDL-2019 LIBRARY; T=293.16K  
Neutron emission for (n,2nd)

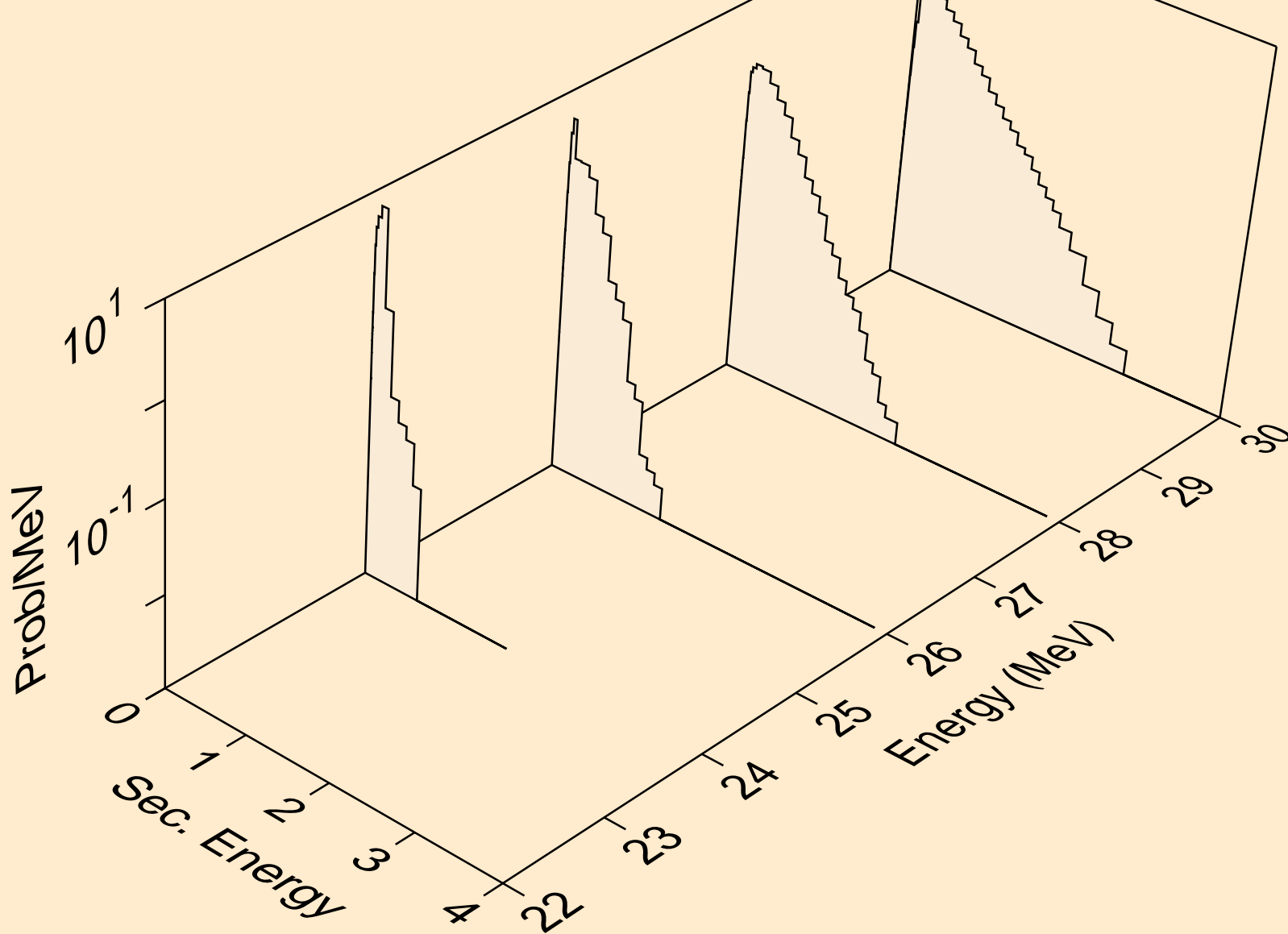

MO106 NEUTRON ACER TENDL-2019 LIBRARY; T=293.16K  
Neutron emission for (n,2n)

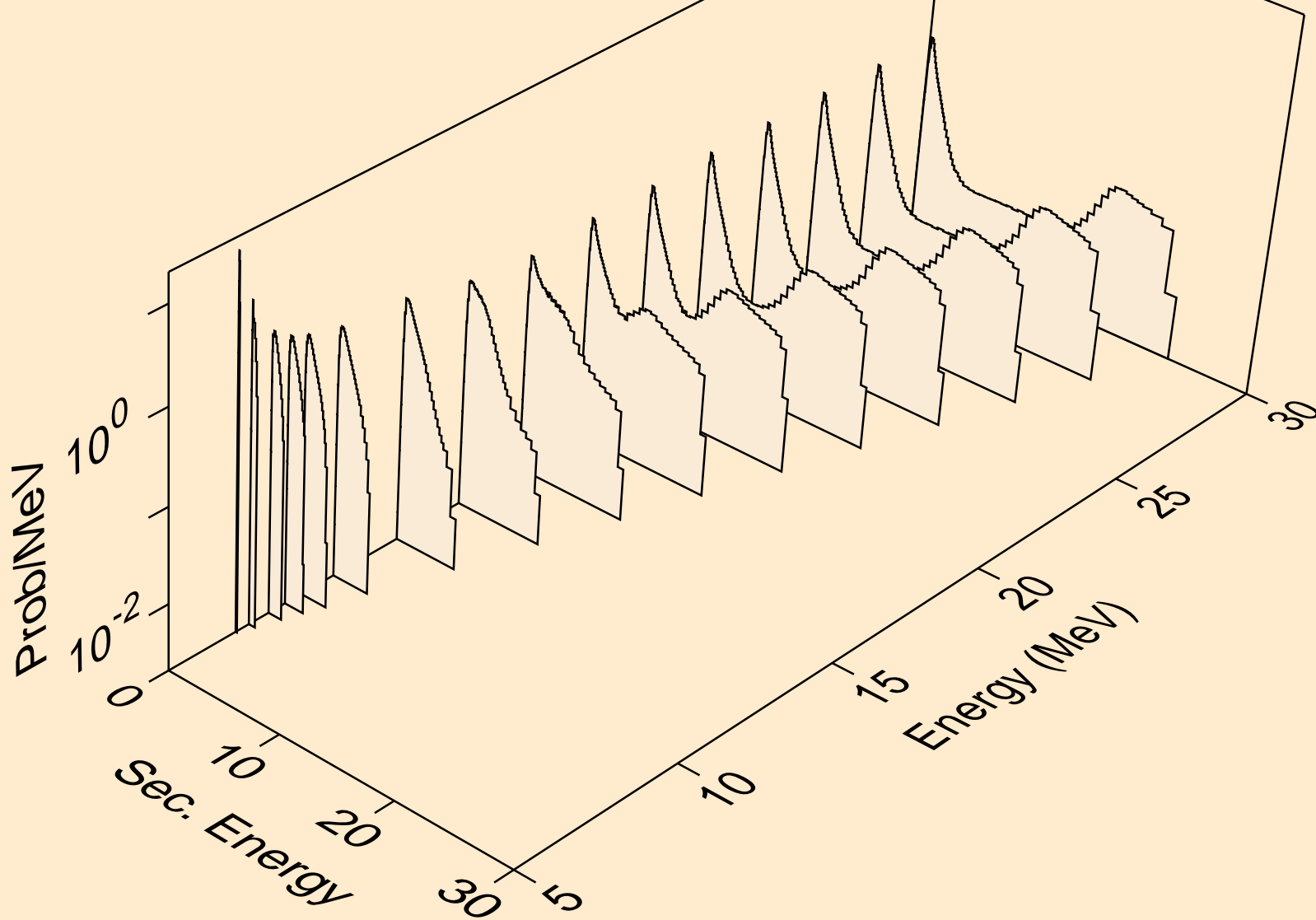

MO106 NEUTRON ACER TENDL-2019 LIBRARY; T=293.16K  
Neutron emission for (n,3n)

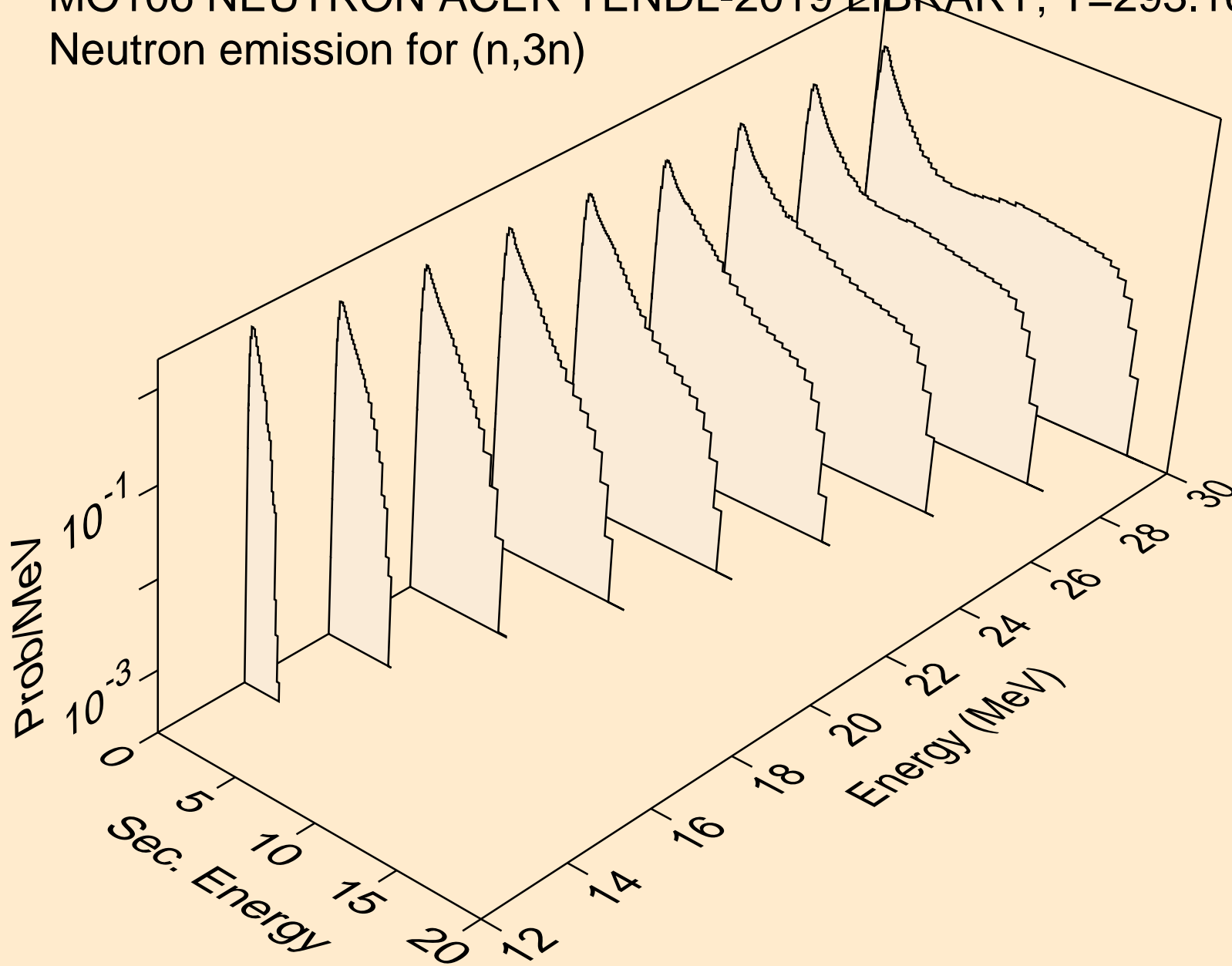

MO106 NEUTRON ACER TENDL-2019 LIBRARY; T=293.16K  
Neutron emission for (n,n\*)a

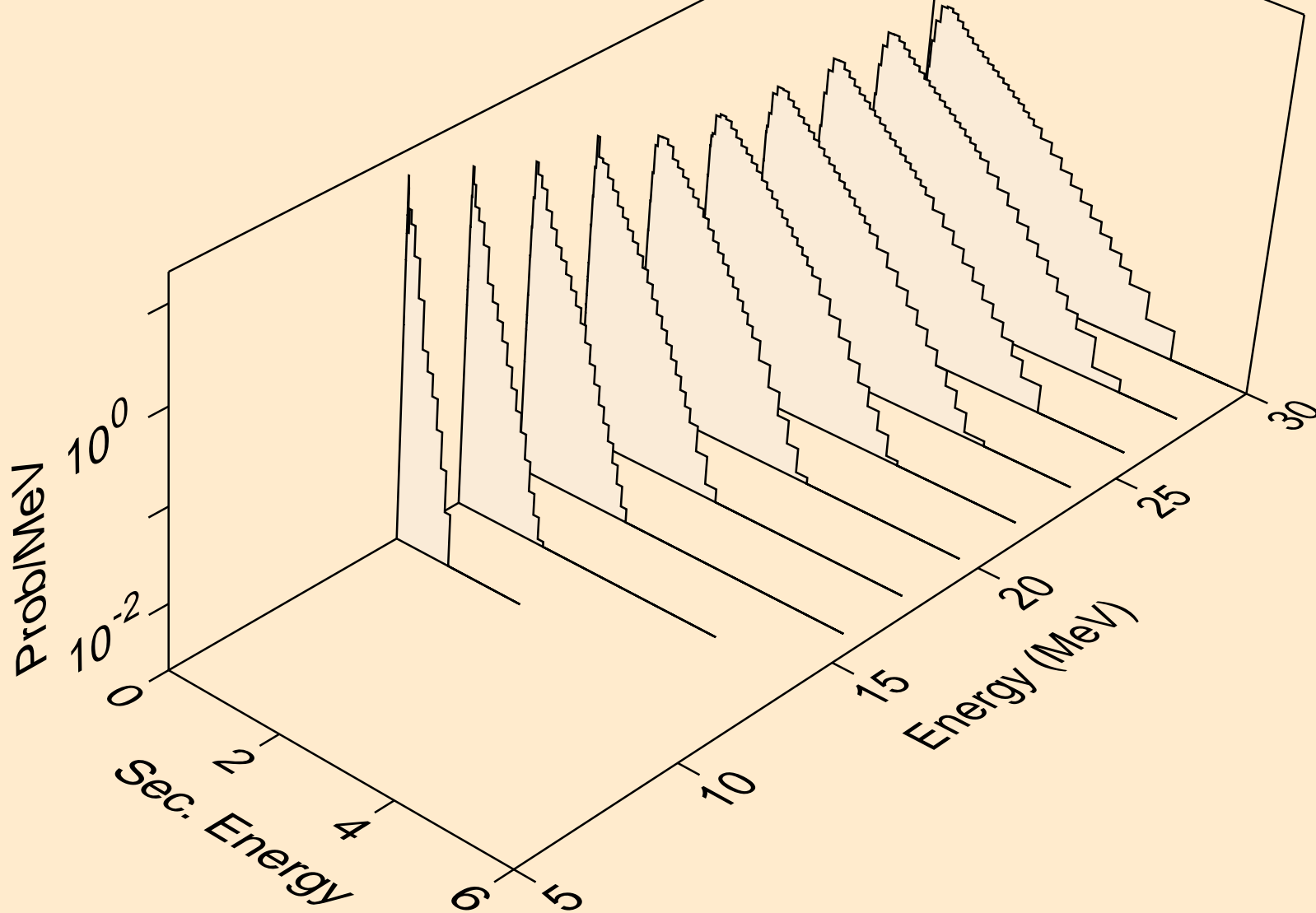

MO106 NEUTRON ACER TENDL-2019 LIBRARY; T=293.16K  
Neutron emission for (n,2n)a

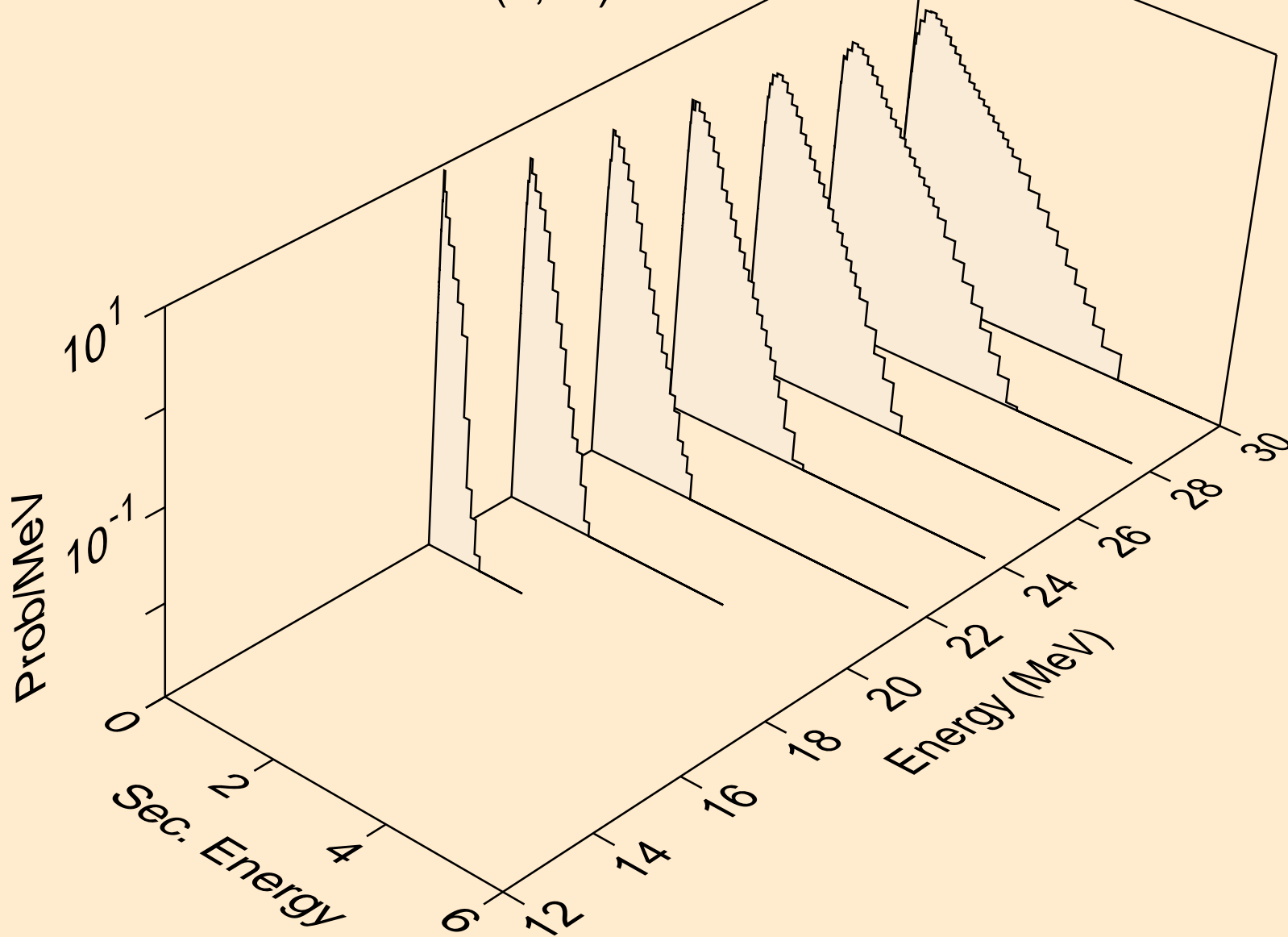

MO106 NEUTRON ACER TENDL-2019 LIBRARY; T=293.16K  
Neutron emission for (n,3n)a

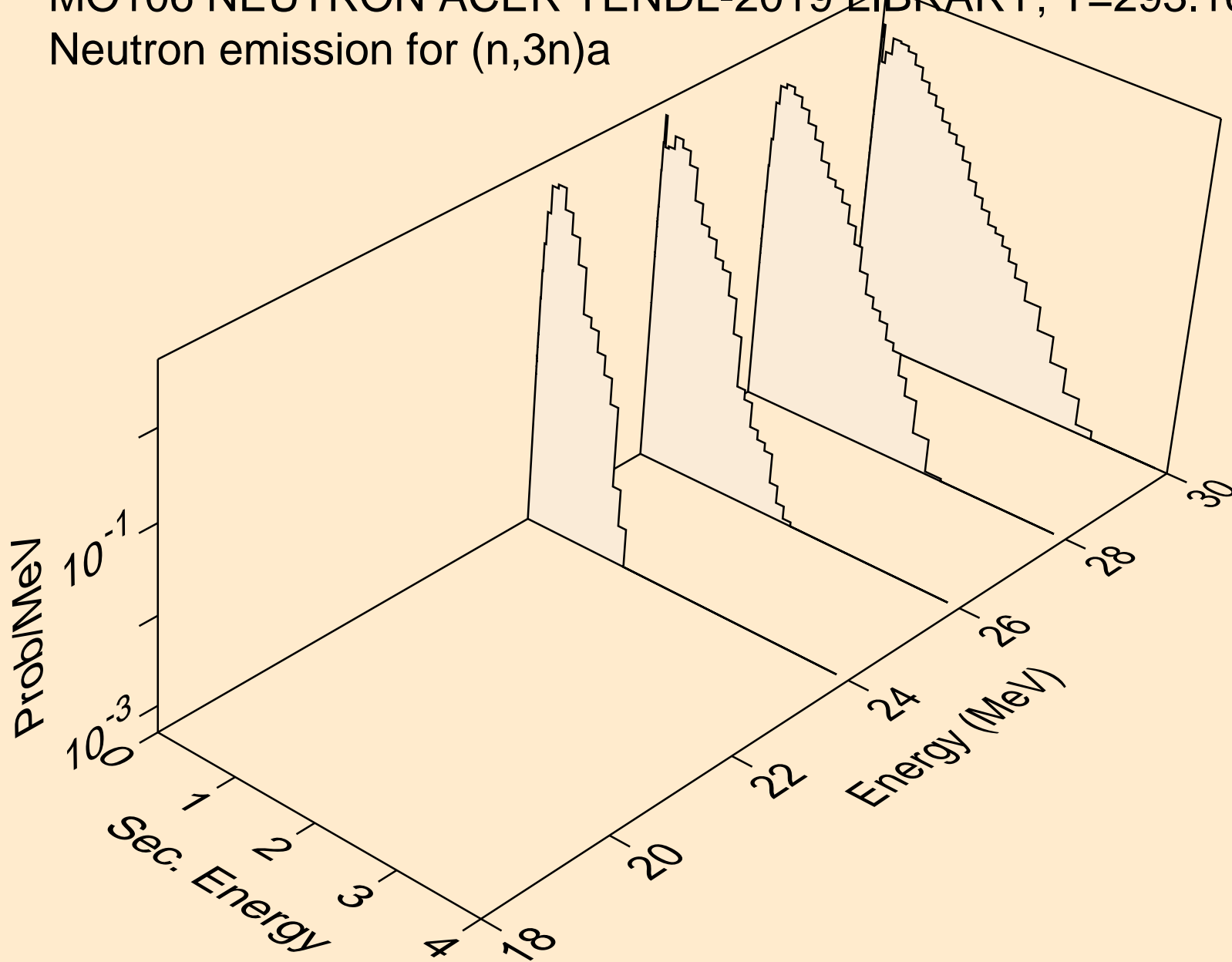

MO106 NEUTRON ACER TENDL-2019 LIBRARY; T=293.16K  
Neutron emission for (n,n\*)p

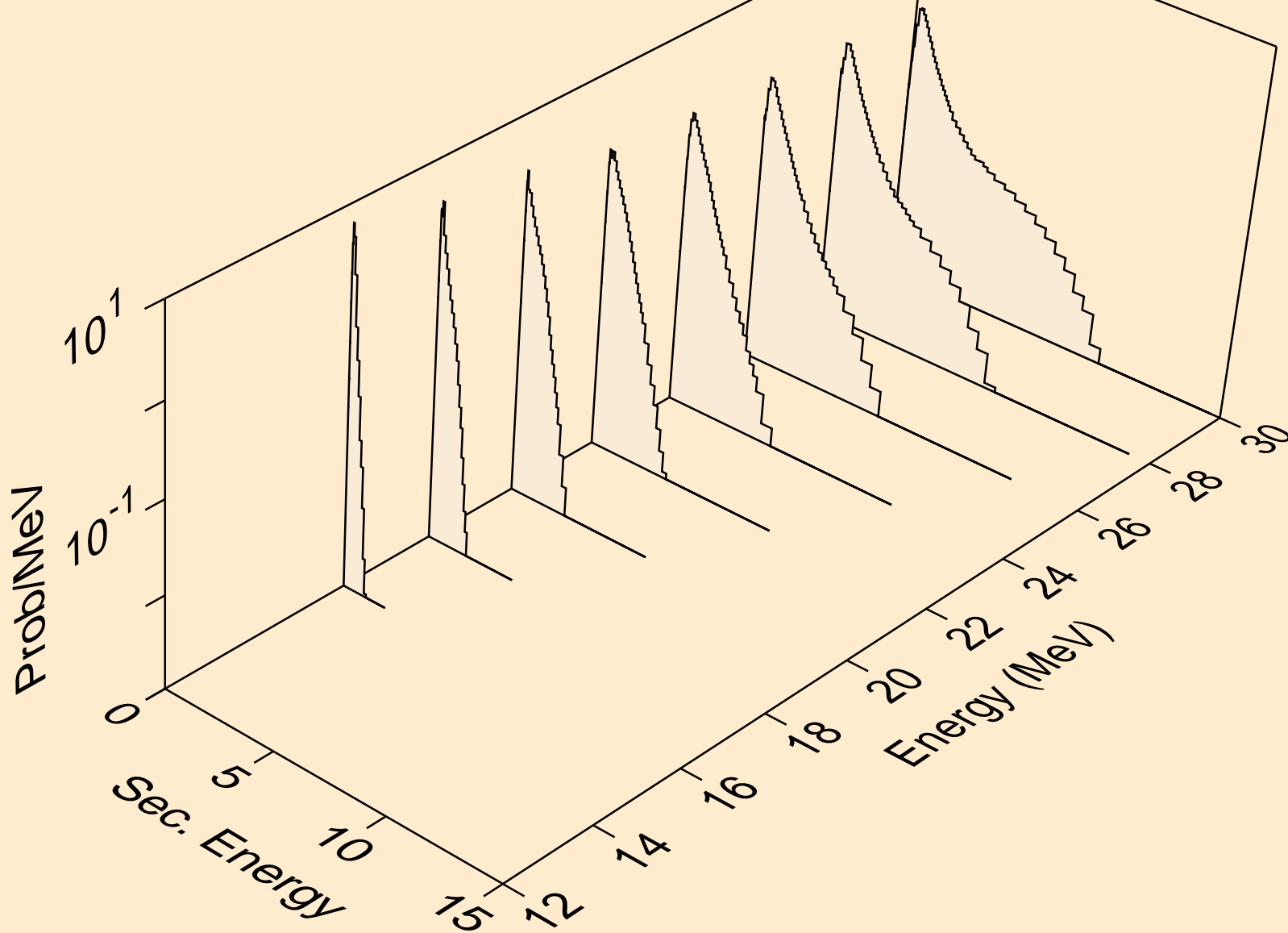

MO106 NEUTRON ACER TENDL-2019 LIBRARY; T=293.16K  
Neutron emission for (n,n\*)d

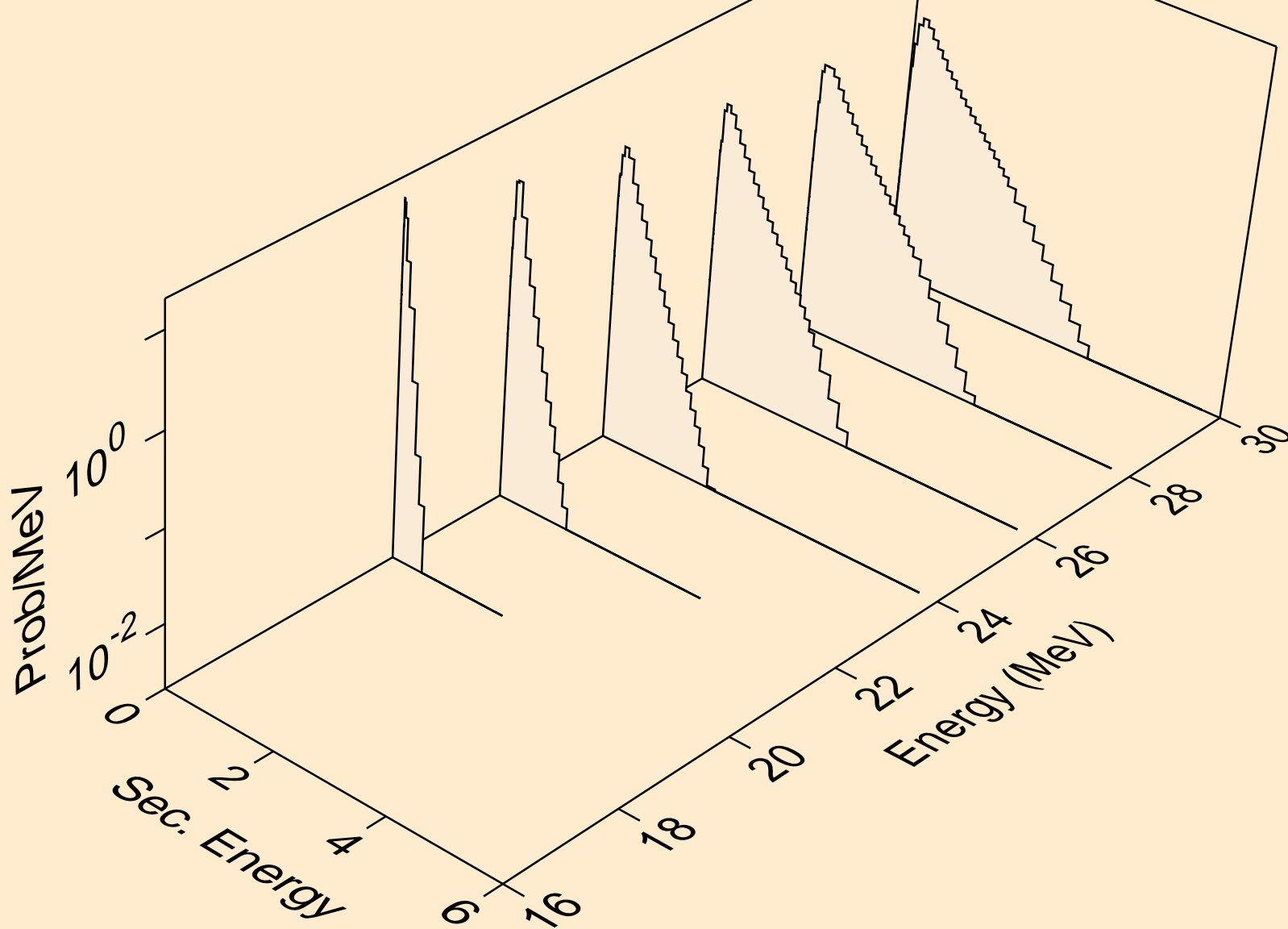



MO106 NEUTRON ACER TENDL-2019 LIBRARY; T=293.16K  
Neutron emission for (n,n\*)t

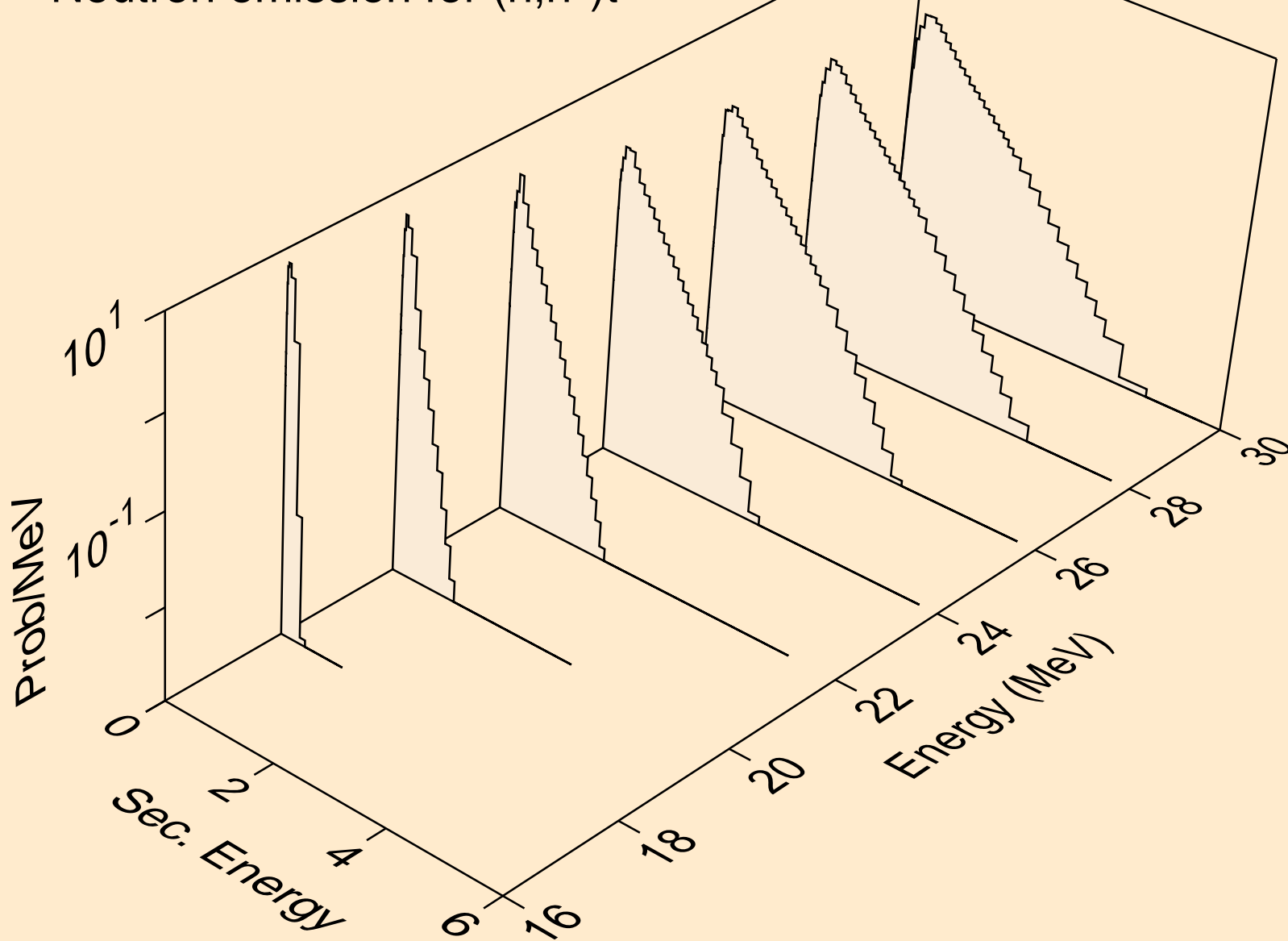

MO106 NEUTRON ACER TENDL-2019 LIBRARY; T=293.16K  
Neutron emission for (n,4n)

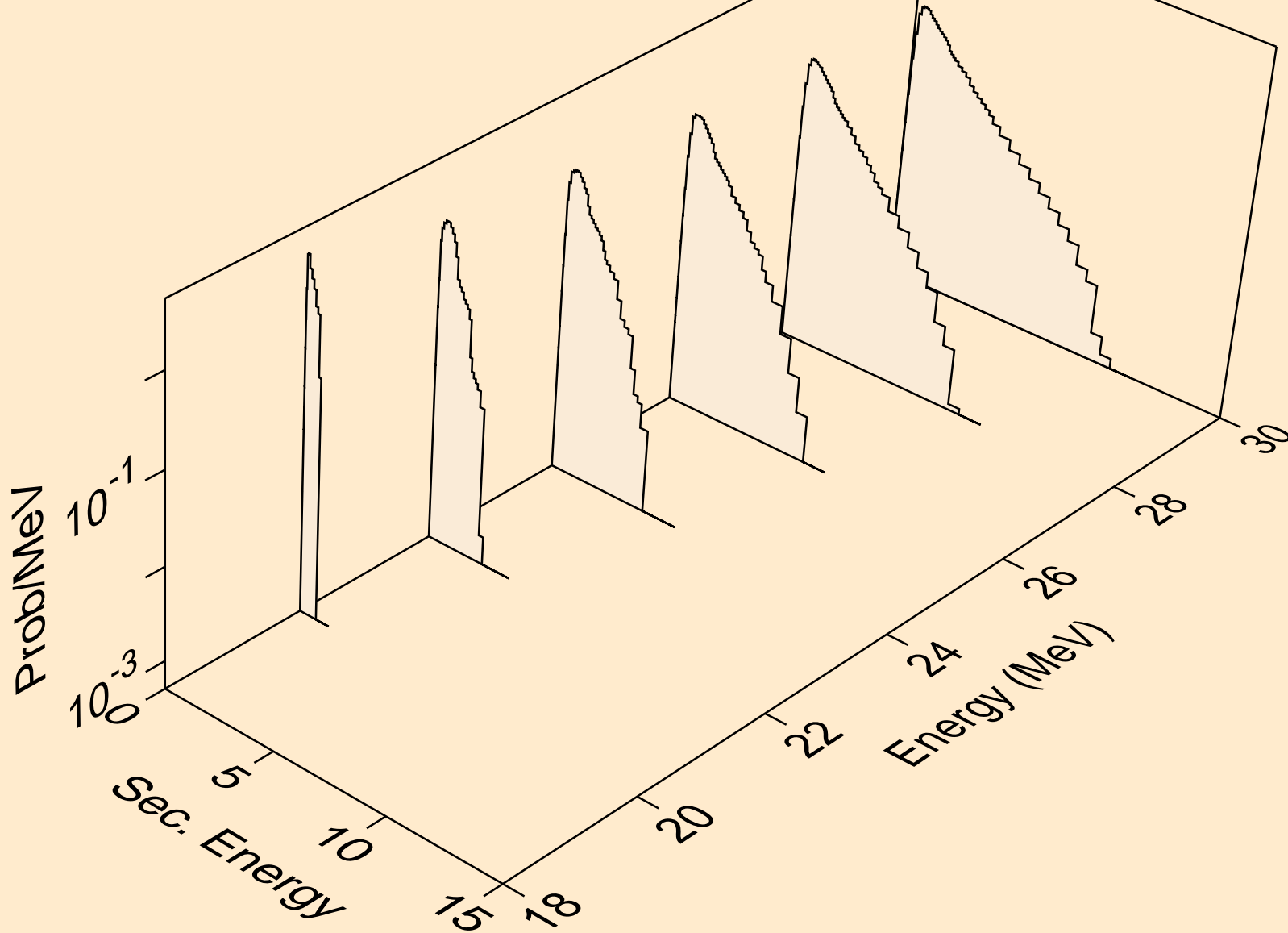

MO106 NEUTRON ACER TENDL-2019 LIBRARY; T=293.16K  
Neutron emission for (n,2np)

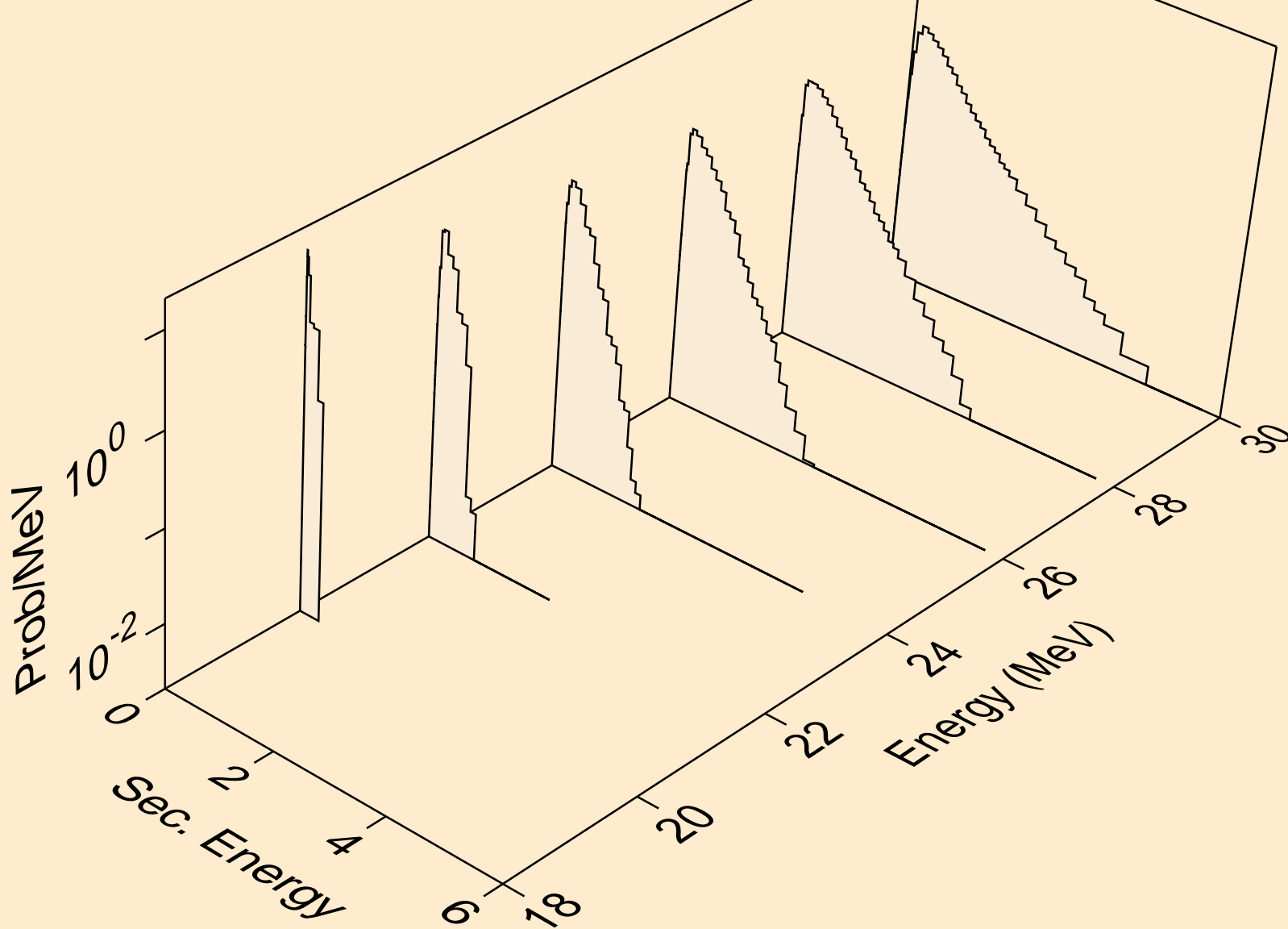

MO106 NEUTRON ACER TENDL-2019 LIBRARY; T=293.16K  
Neutron emission for (n,3np)

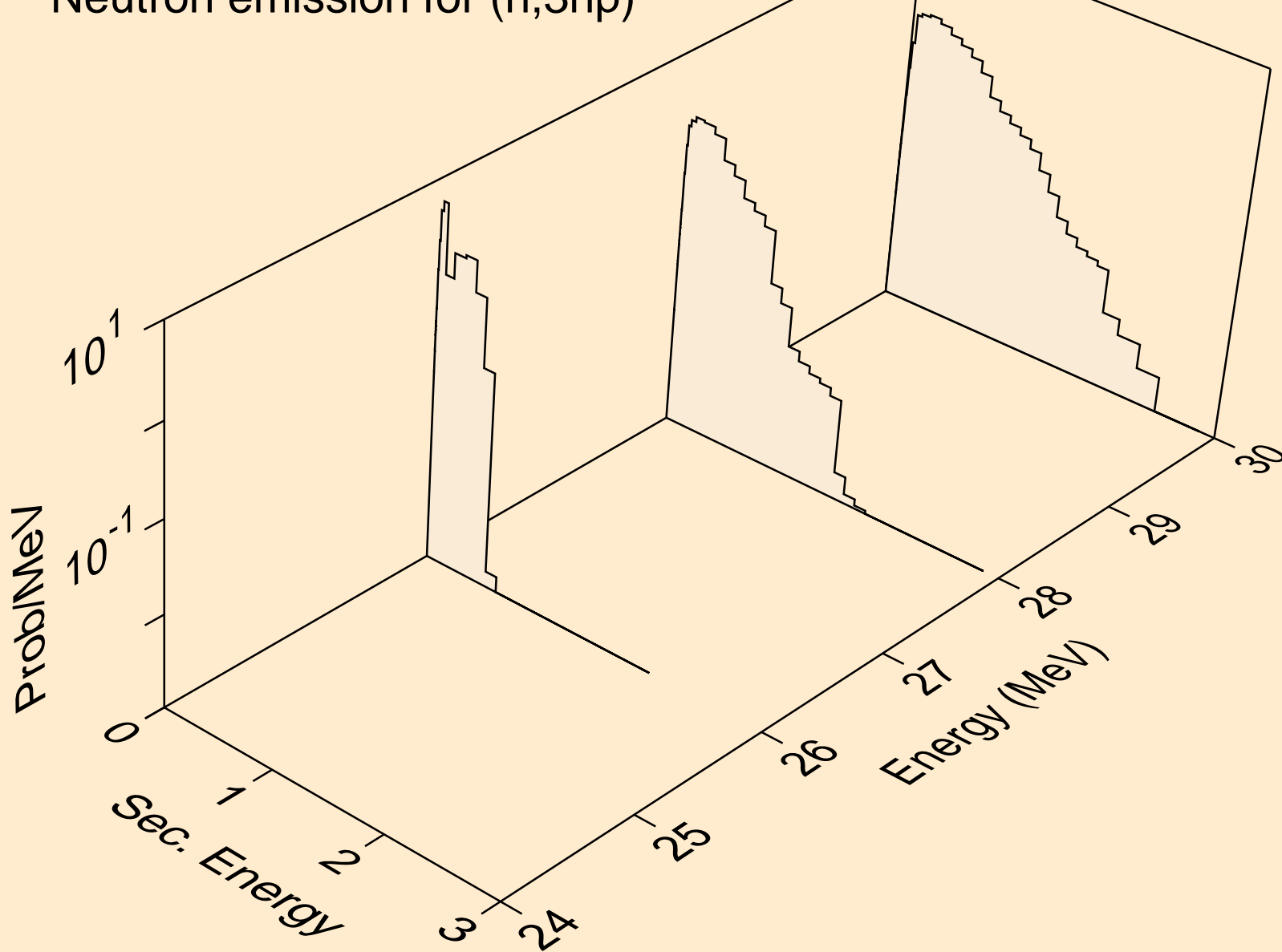

MO106 NEUTRON ACER TENDL-2019 LIBRARY; T=293.16K  
Neutron emission for (n,n\*c)

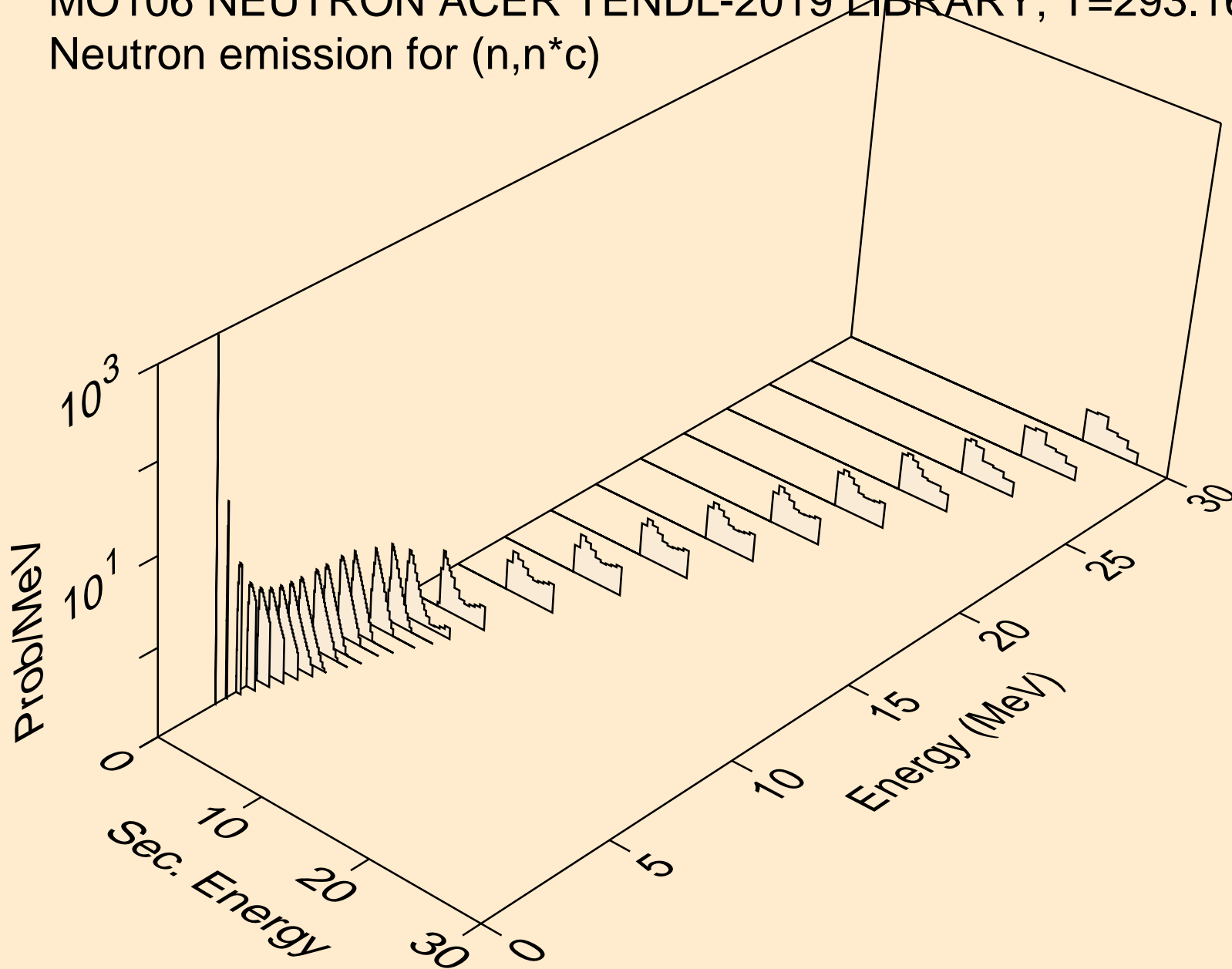

MO106 NEUTRON ACER TENDL-2019 LIBRARY; T=293.16K  
Photon emission for (n,x)

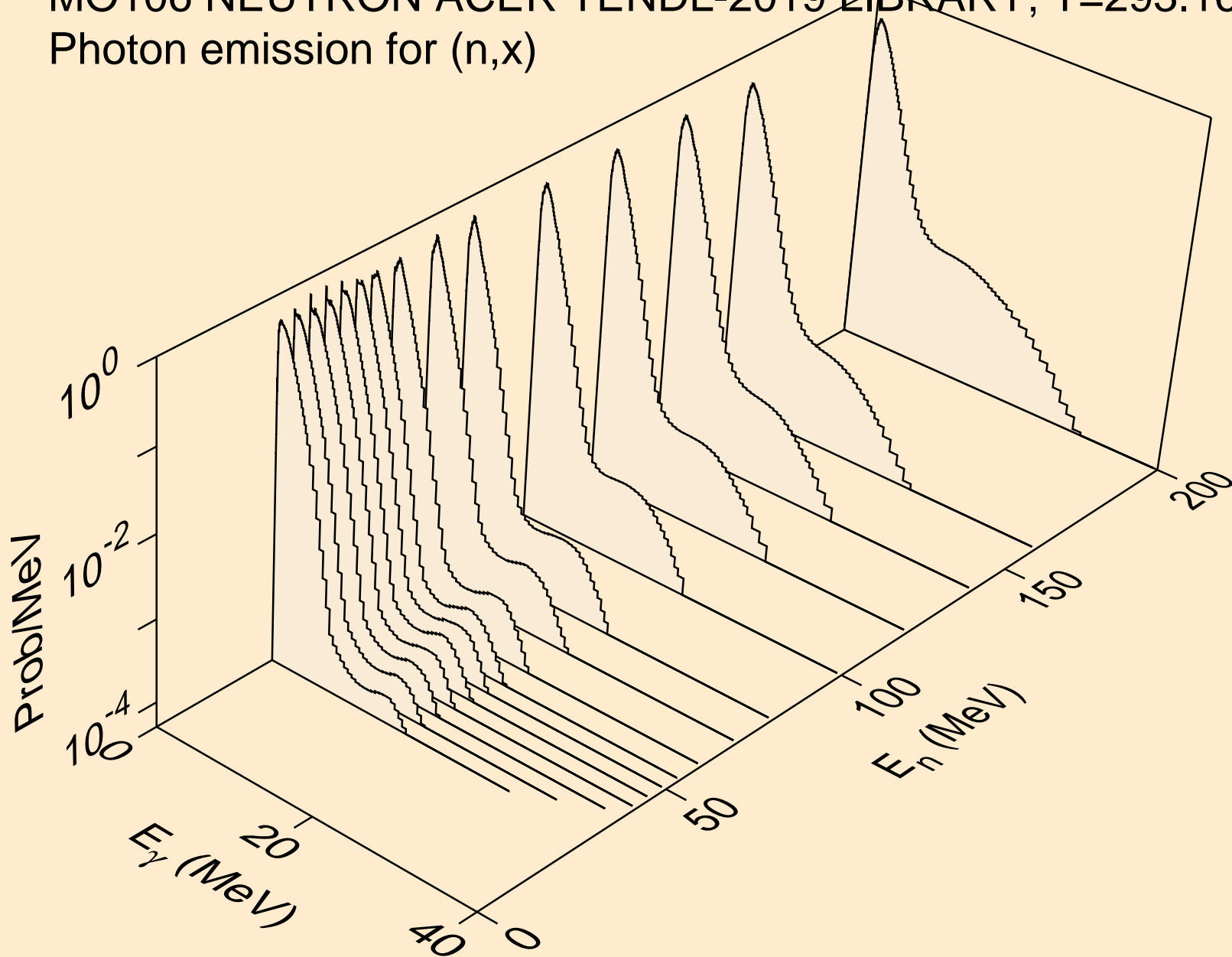

MO106 NEUTRON ACER TENDL-2019 LIBRARY; T=293.16K  
Photon emission for (n,2nd)

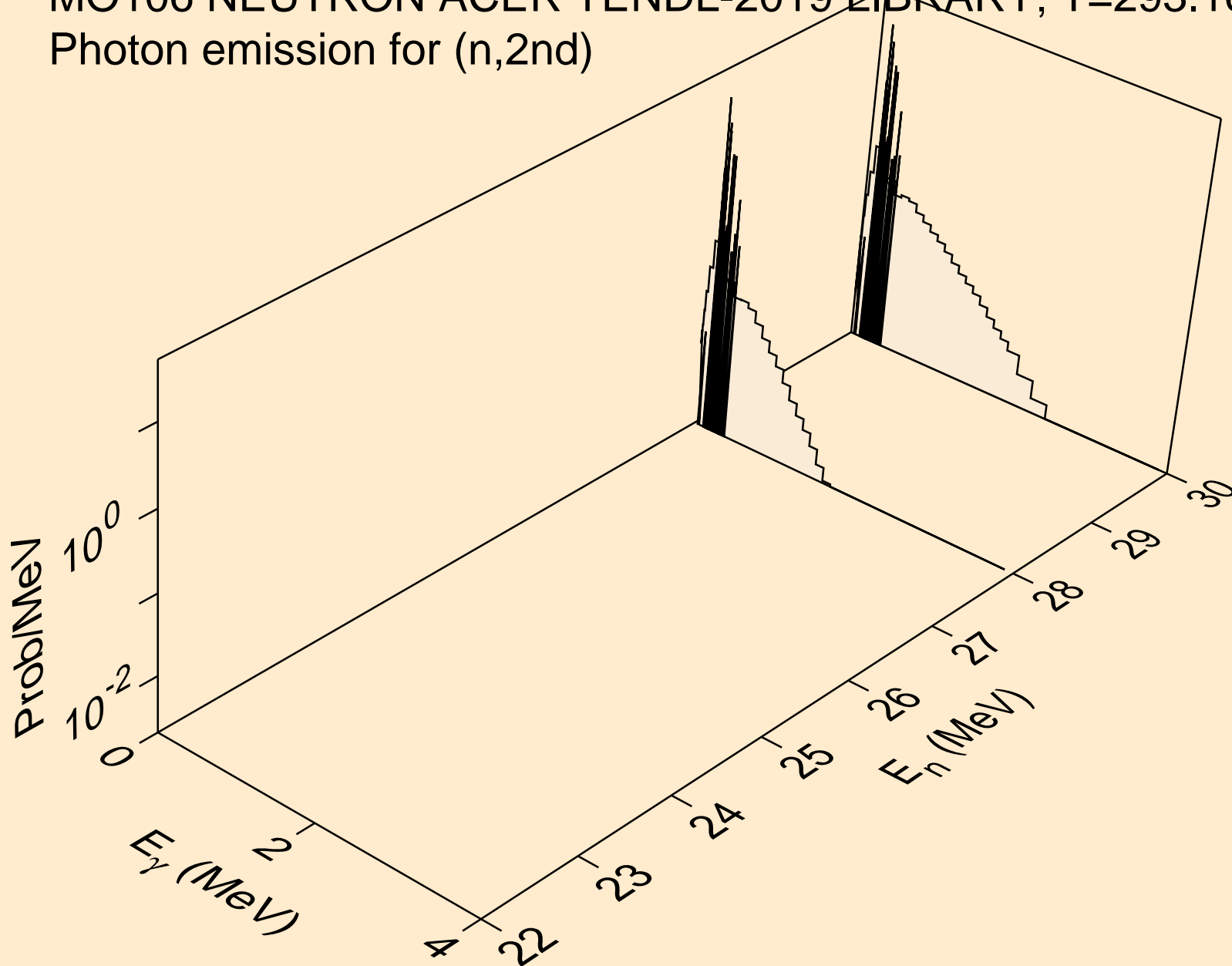

MO106 NEUTRON ACER TENDL-2019 LIBRARY; T=293.16K  
Photon emission for (n,2n)

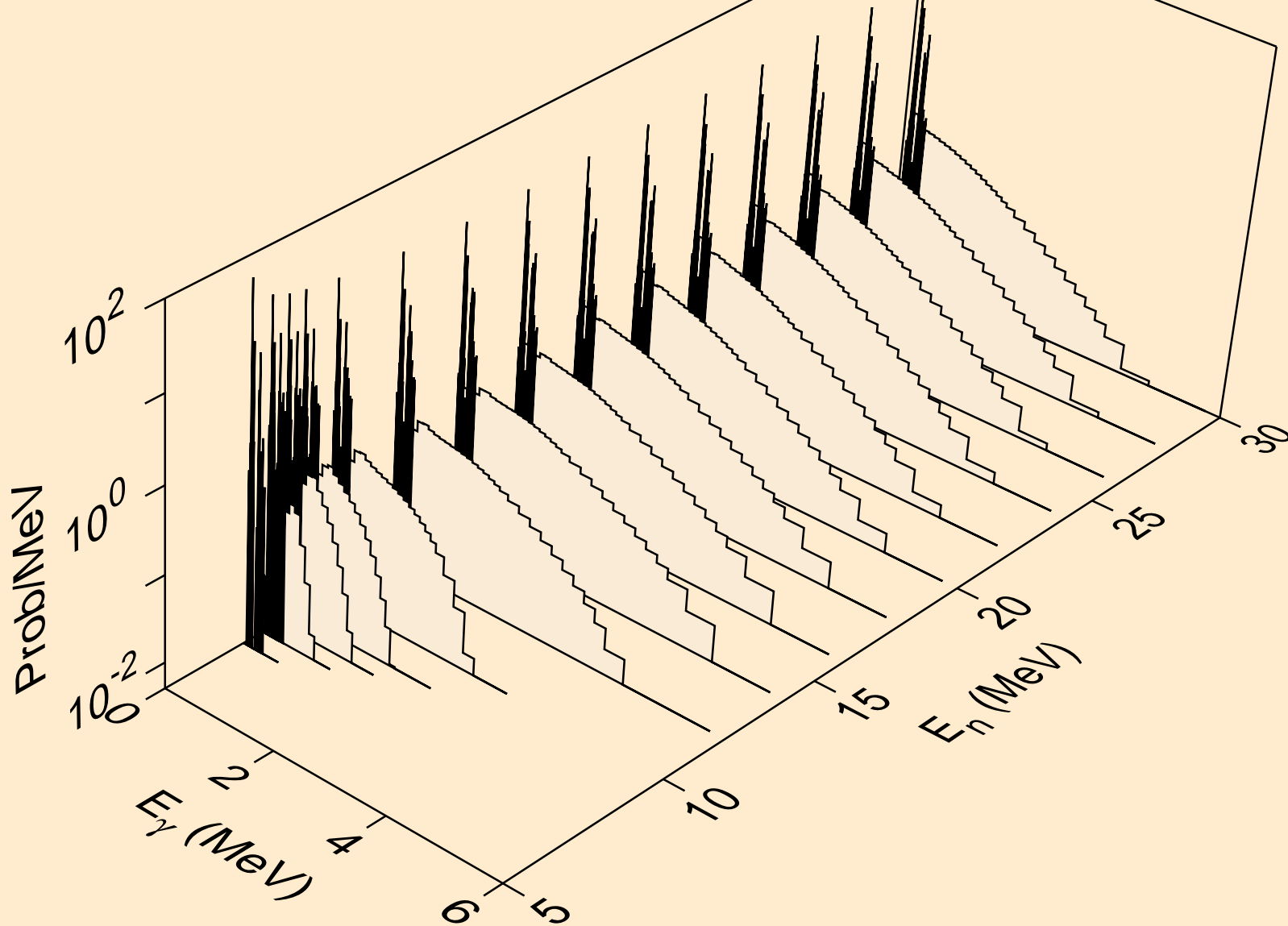



MO106 NEUTRON ACER TENDL-2019 LIBRARY; T=293.16K  
Photon emission for (n,3n)

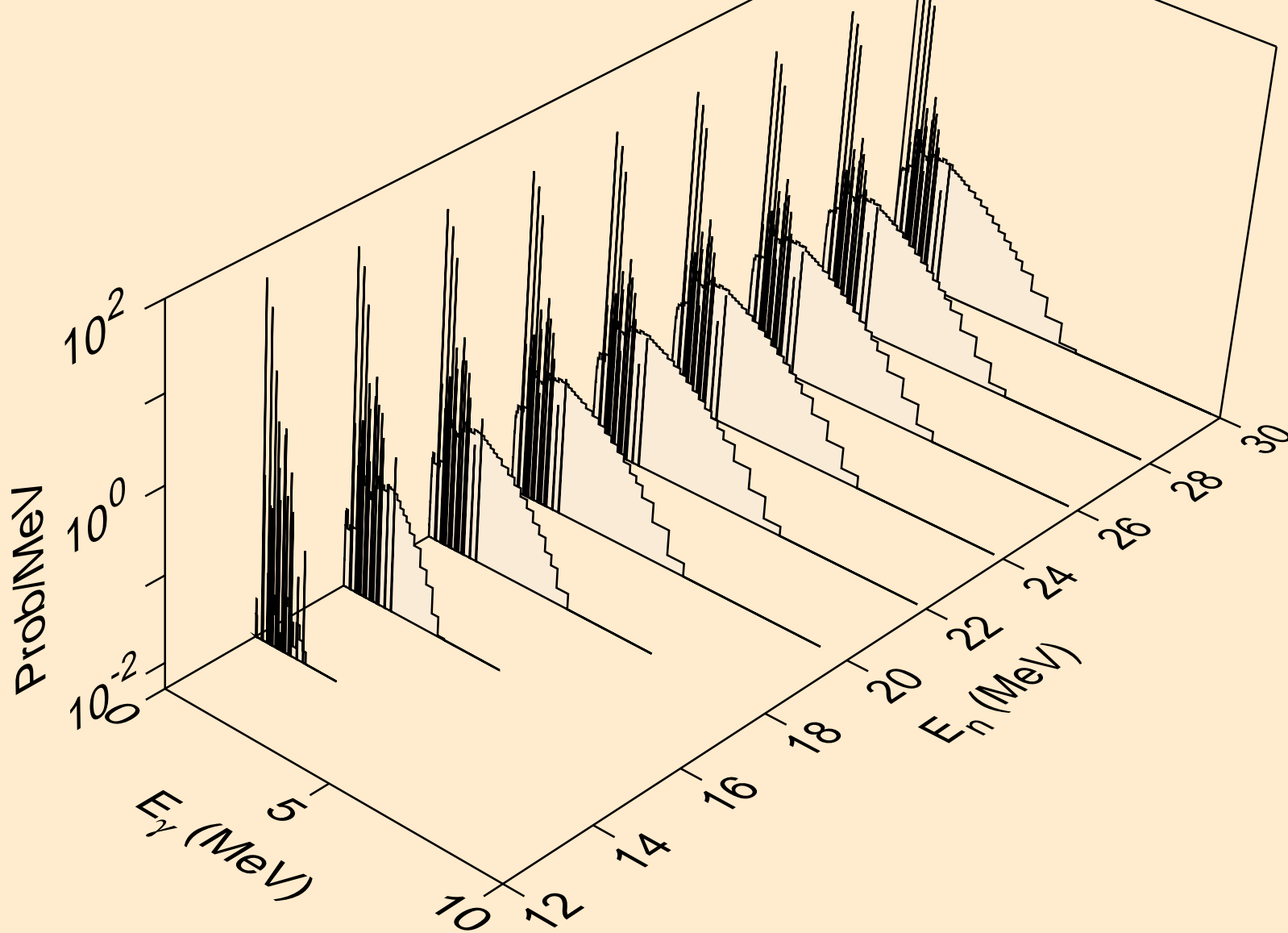

MO106 NEUTRON ACER TENDL-2019 LIBRARY; T=293.16K  
Photon emission for (n,n\*)a

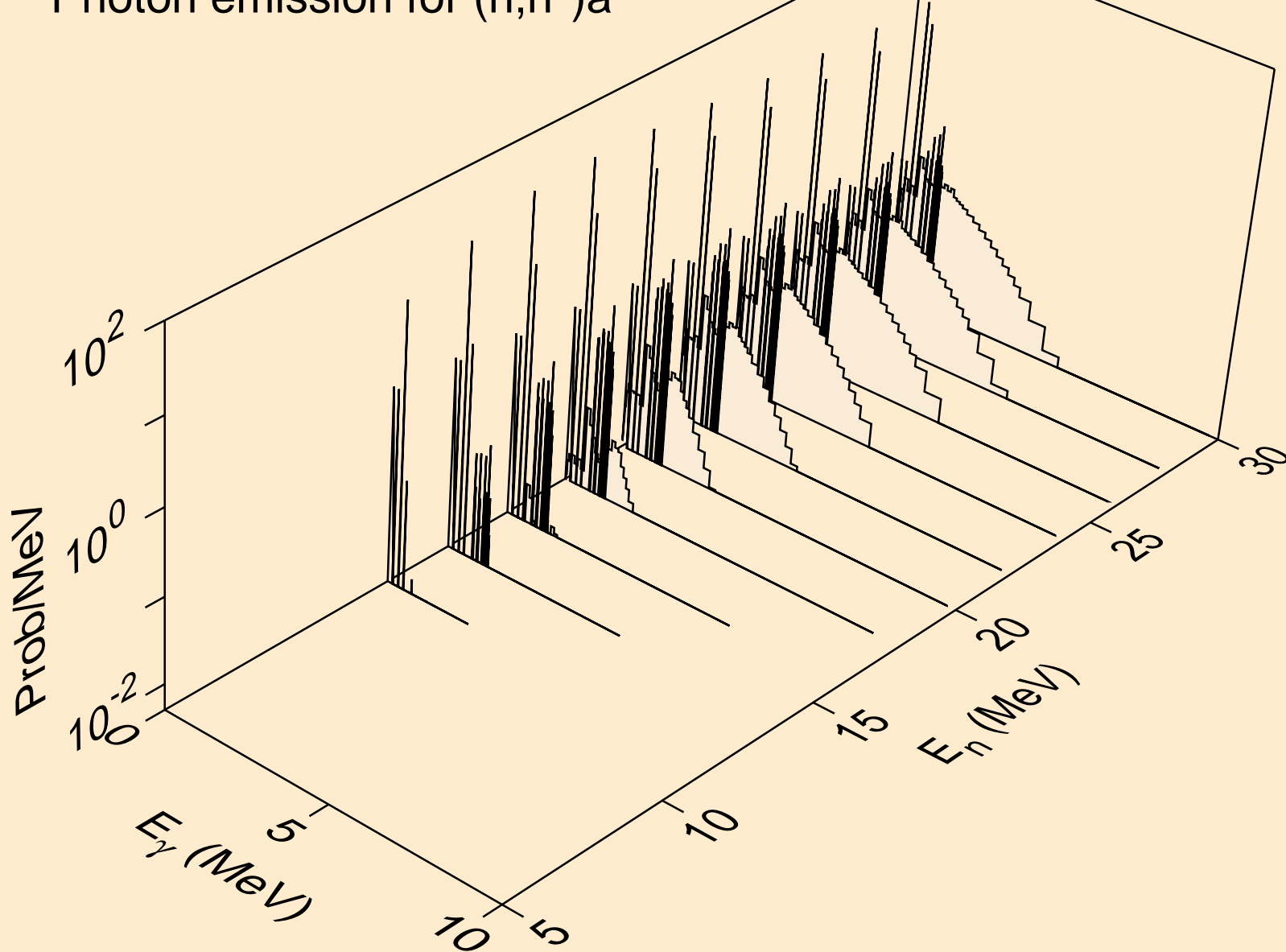

MO106 NEUTRON ACER TENDL-2019 LIBRARY; T=293.16K  
Photon emission for (n,2n)a

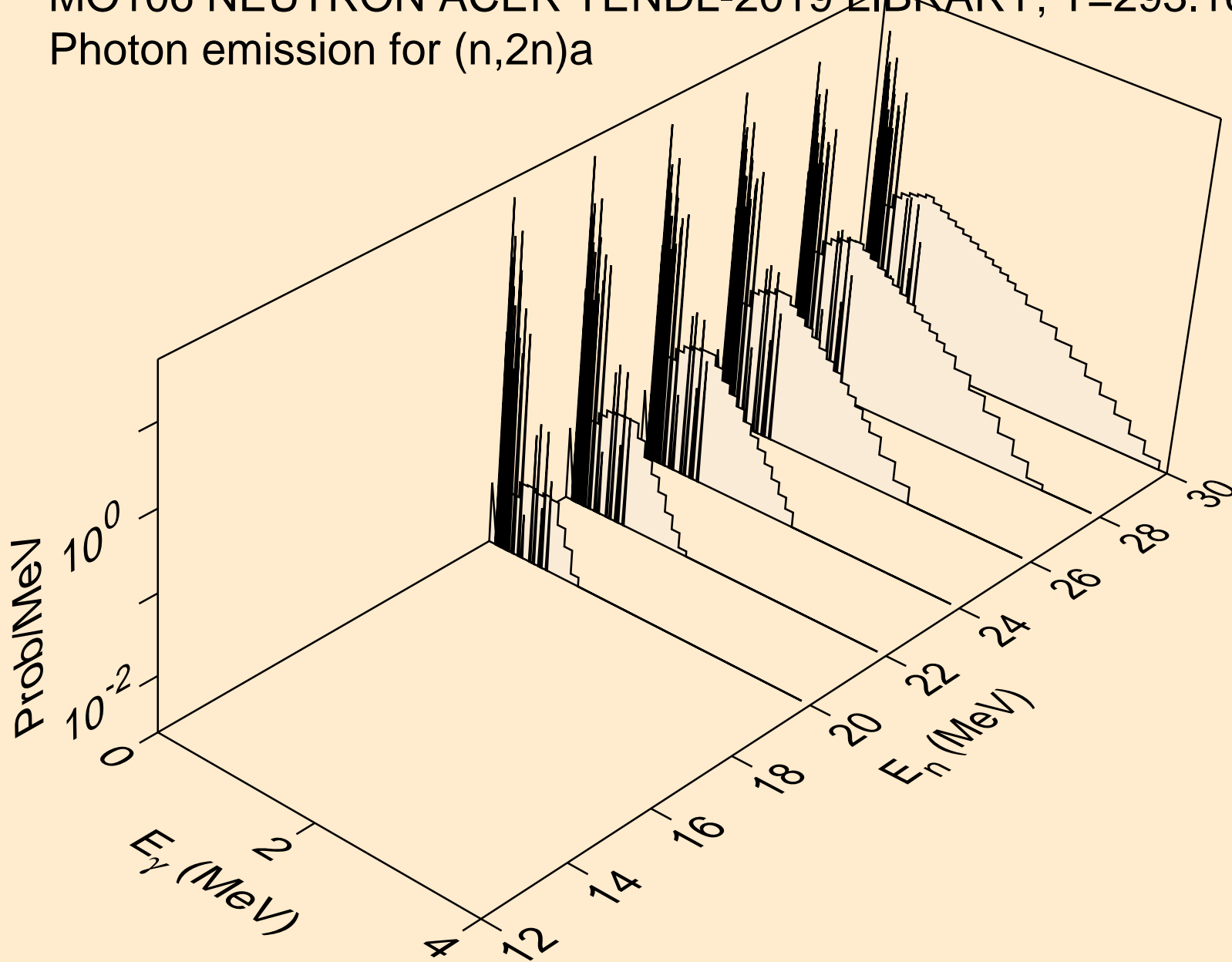

MO106 NEUTRON ACER TENDL-2019 LIBRARY; T=293.16K  
Photon emission for (n,3n)a

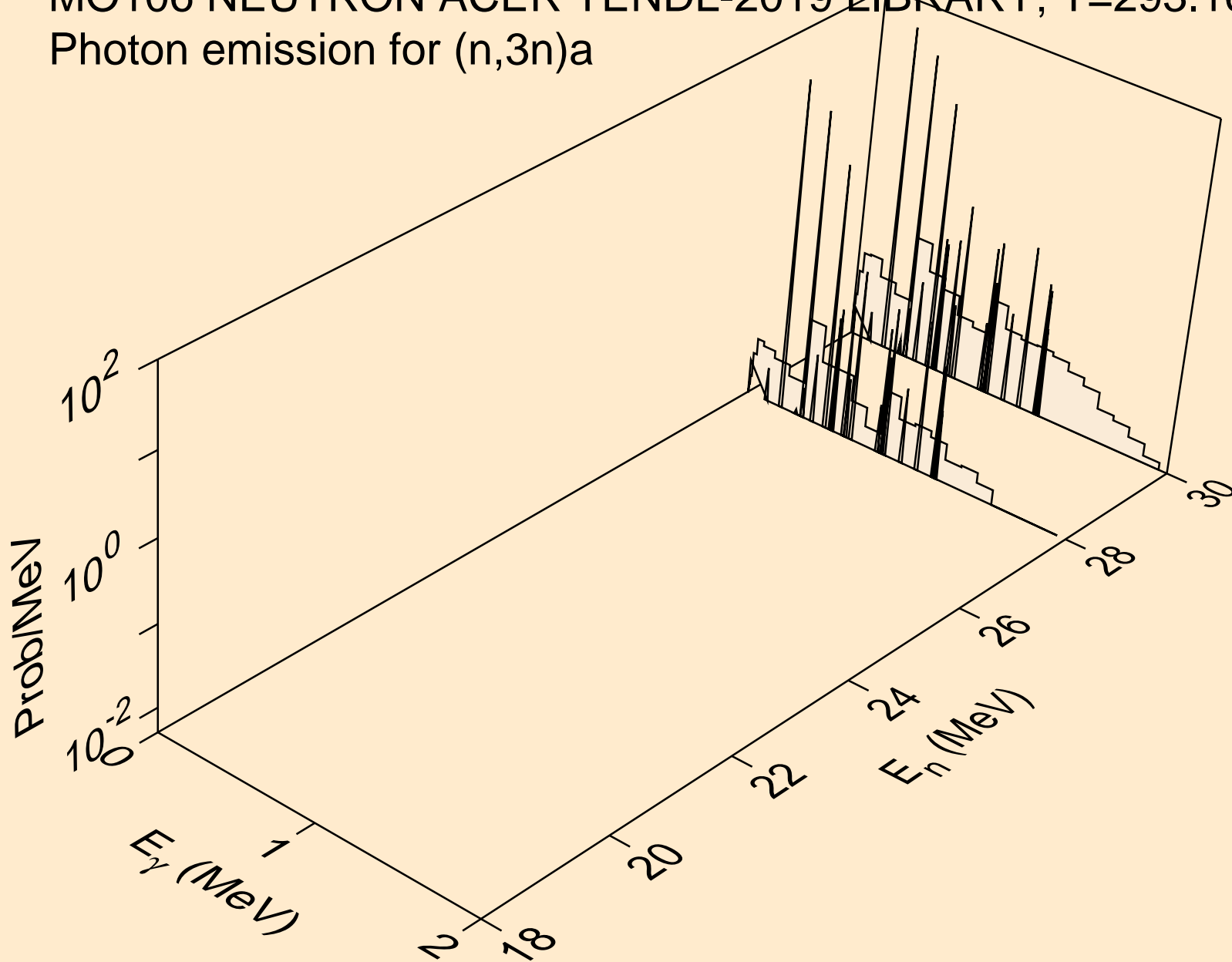

MO106 NEUTRON ACER TENDL-2019 LIBRARY; T=293.16K  
Photon emission for (n,n\*)p

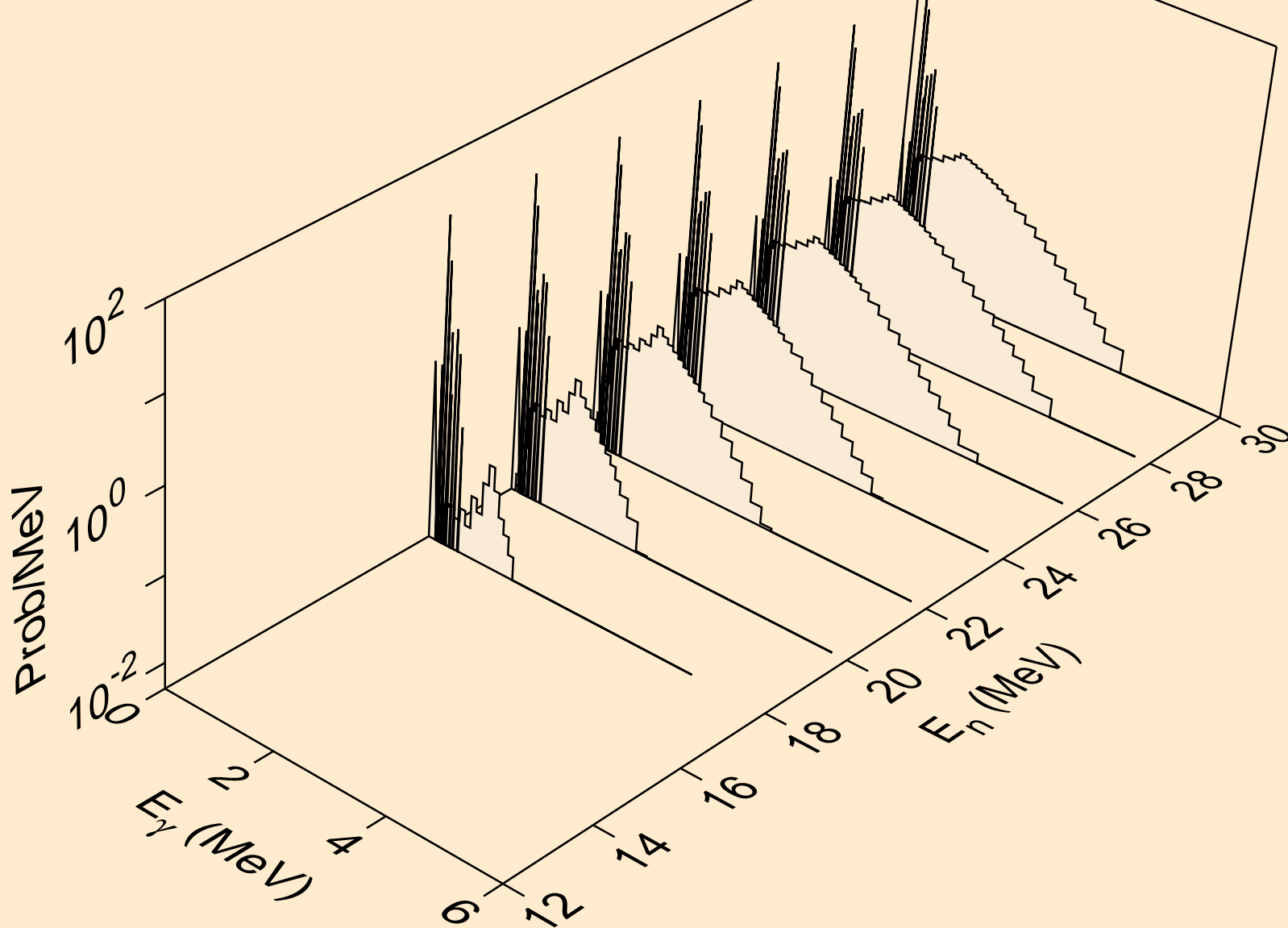

MO106 NEUTRON ACER TENDL-2019 LIBRARY; T=293.16K  
Photon emission for (n,n\*)d

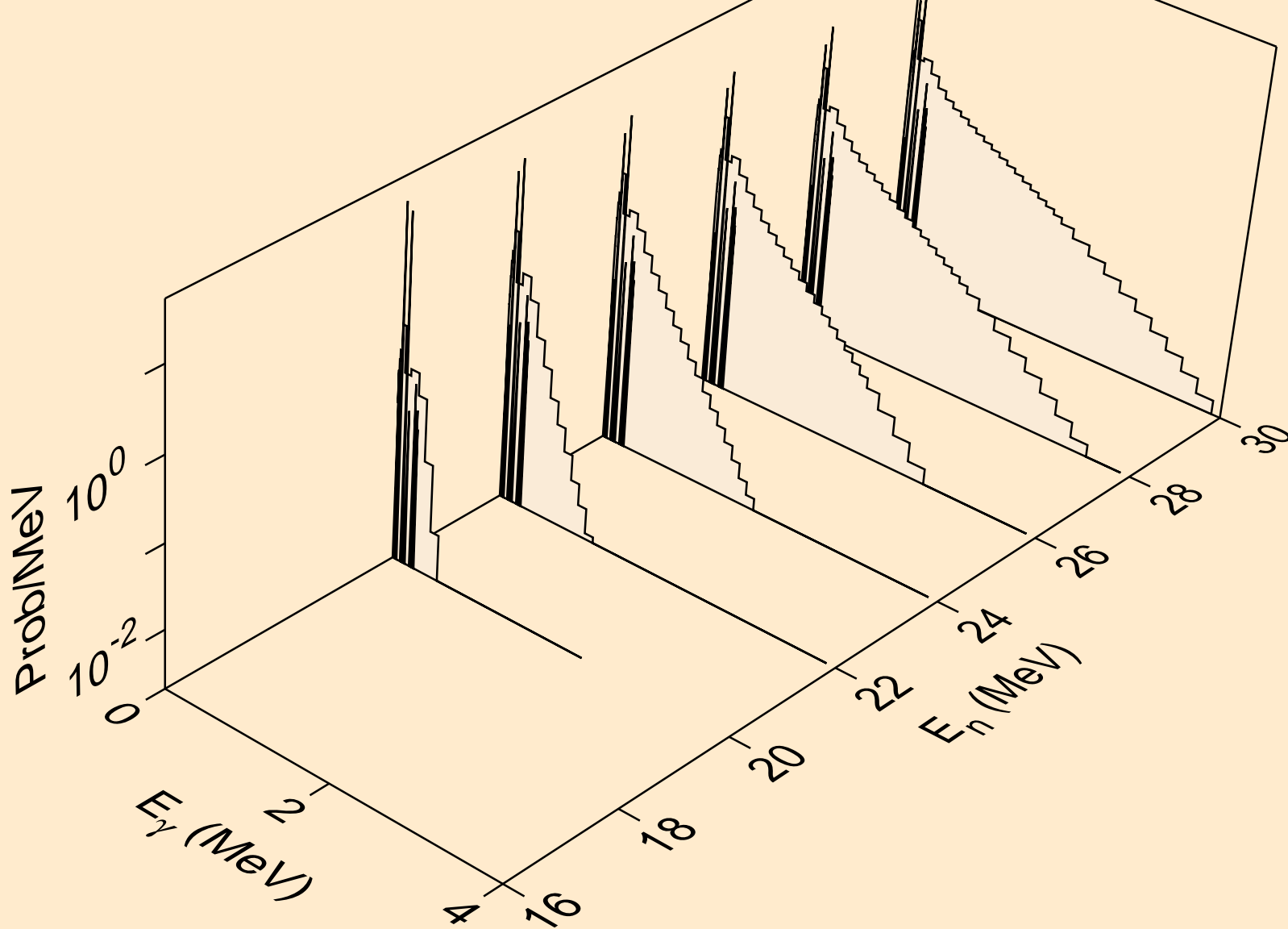

MO106 NEUTRON ACER TENDL-2019 LIBRARY; T=293.16K  
Photon emission for (n,n\*)t

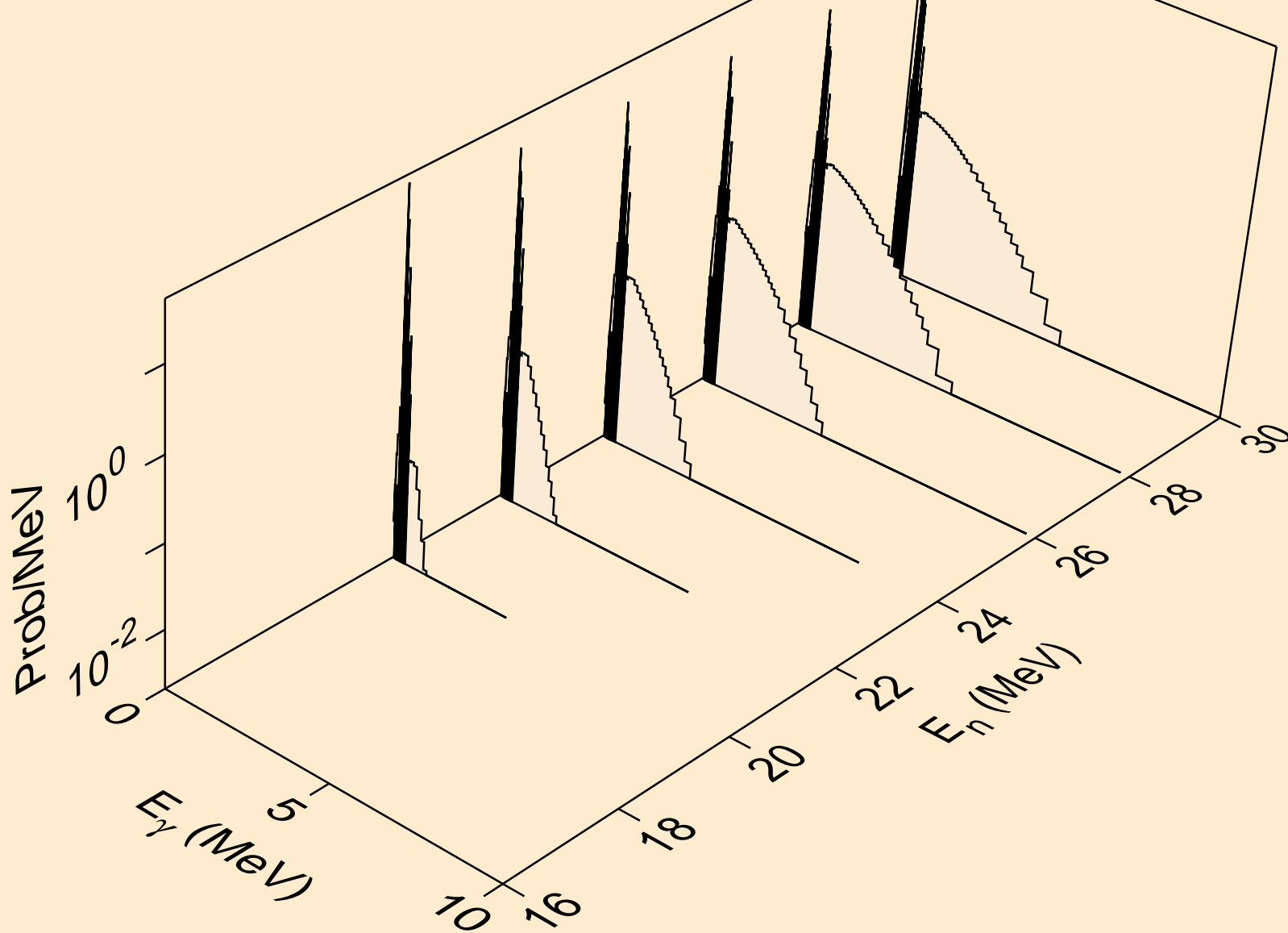

MO106 NEUTRON ACER TENDL-2019 LIBRARY; T=293.16K  
Photon emission for (n,4n)

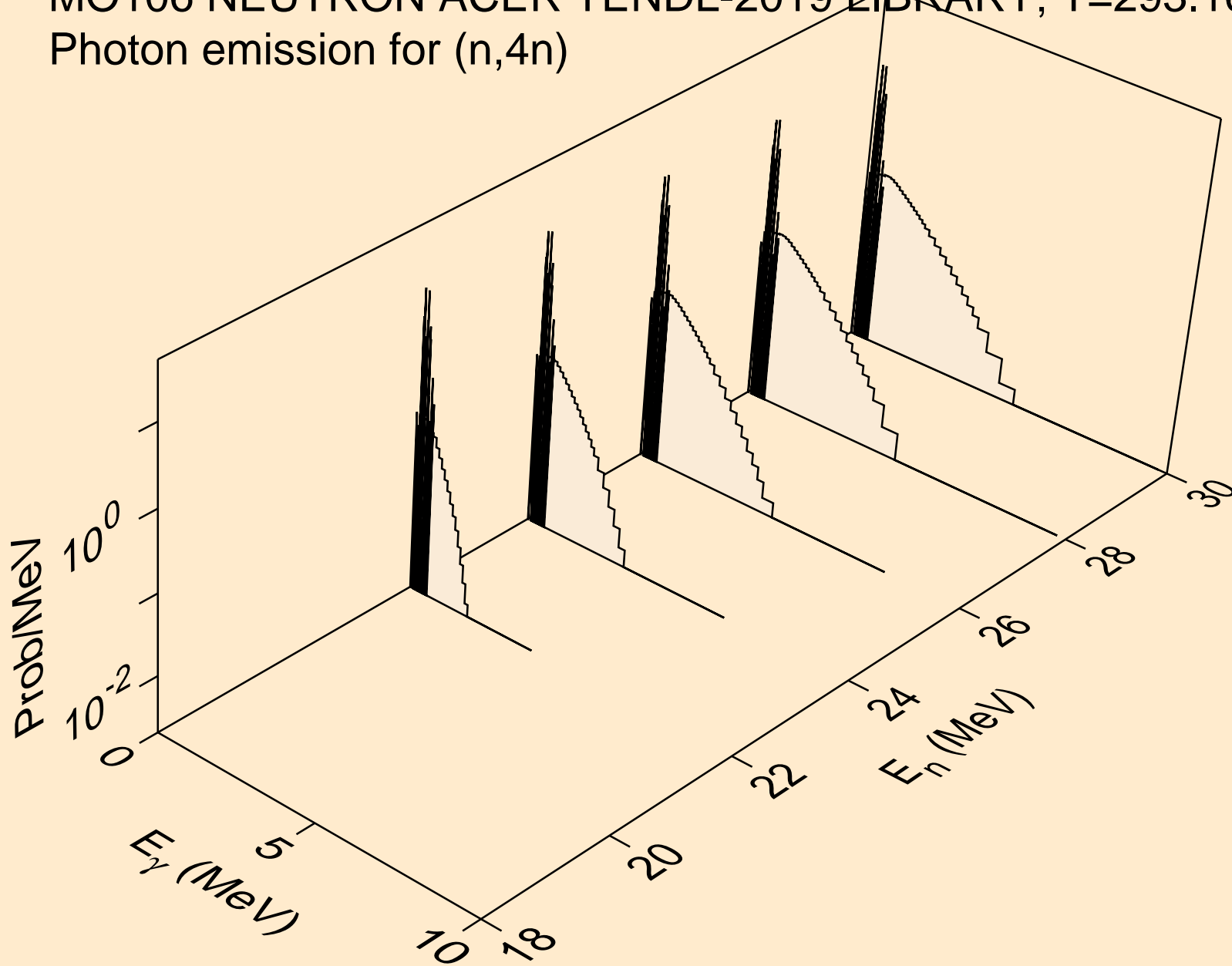



MO106 NEUTRON ACER TENDL-2019 LIBRARY; T=293.16K  
Photon emission for (n,2np)

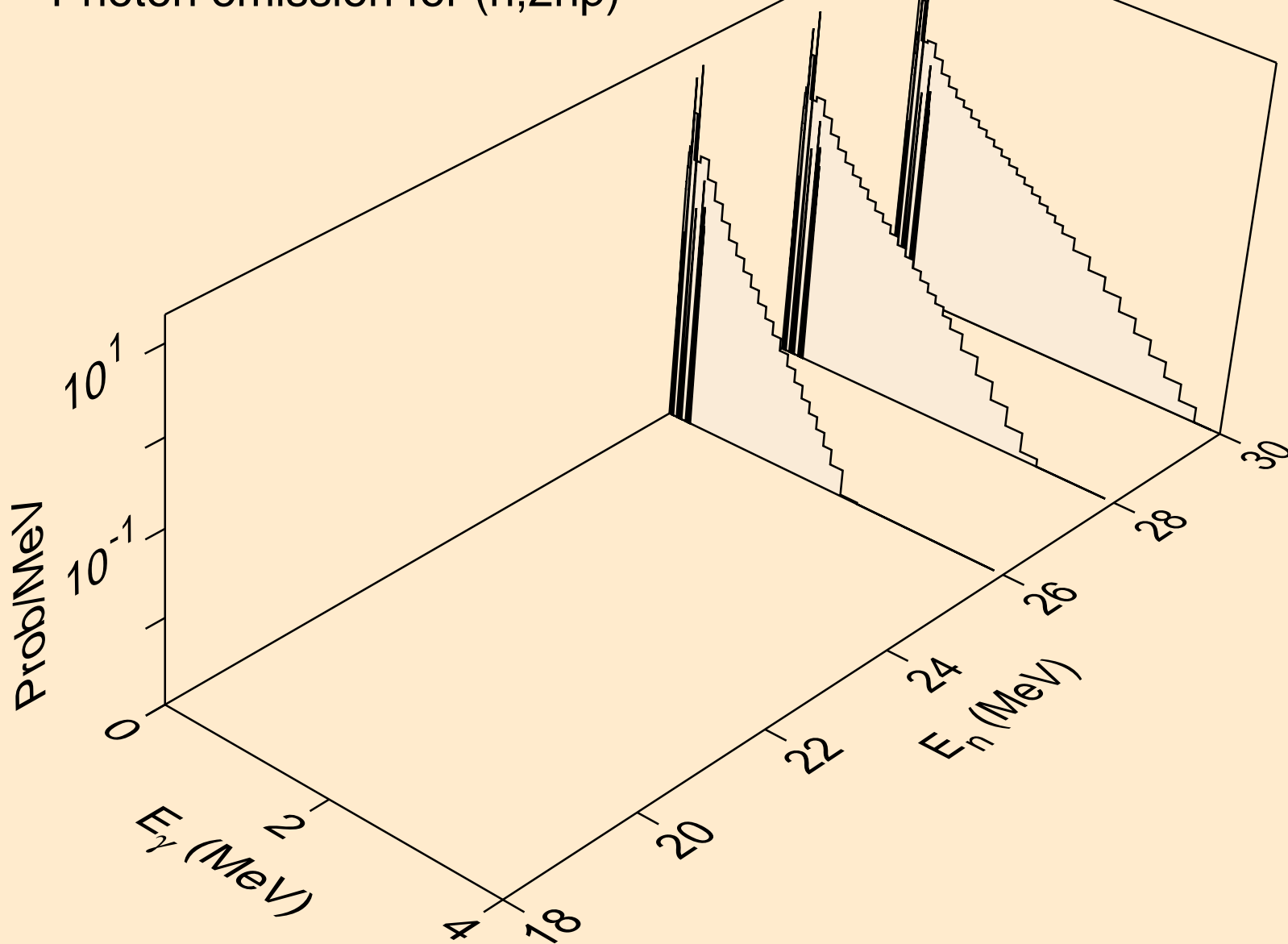

MO106 NEUTRON ACER TENDL-2019 LIBRARY; T=293.16K  
Photon emission for (n,3np)

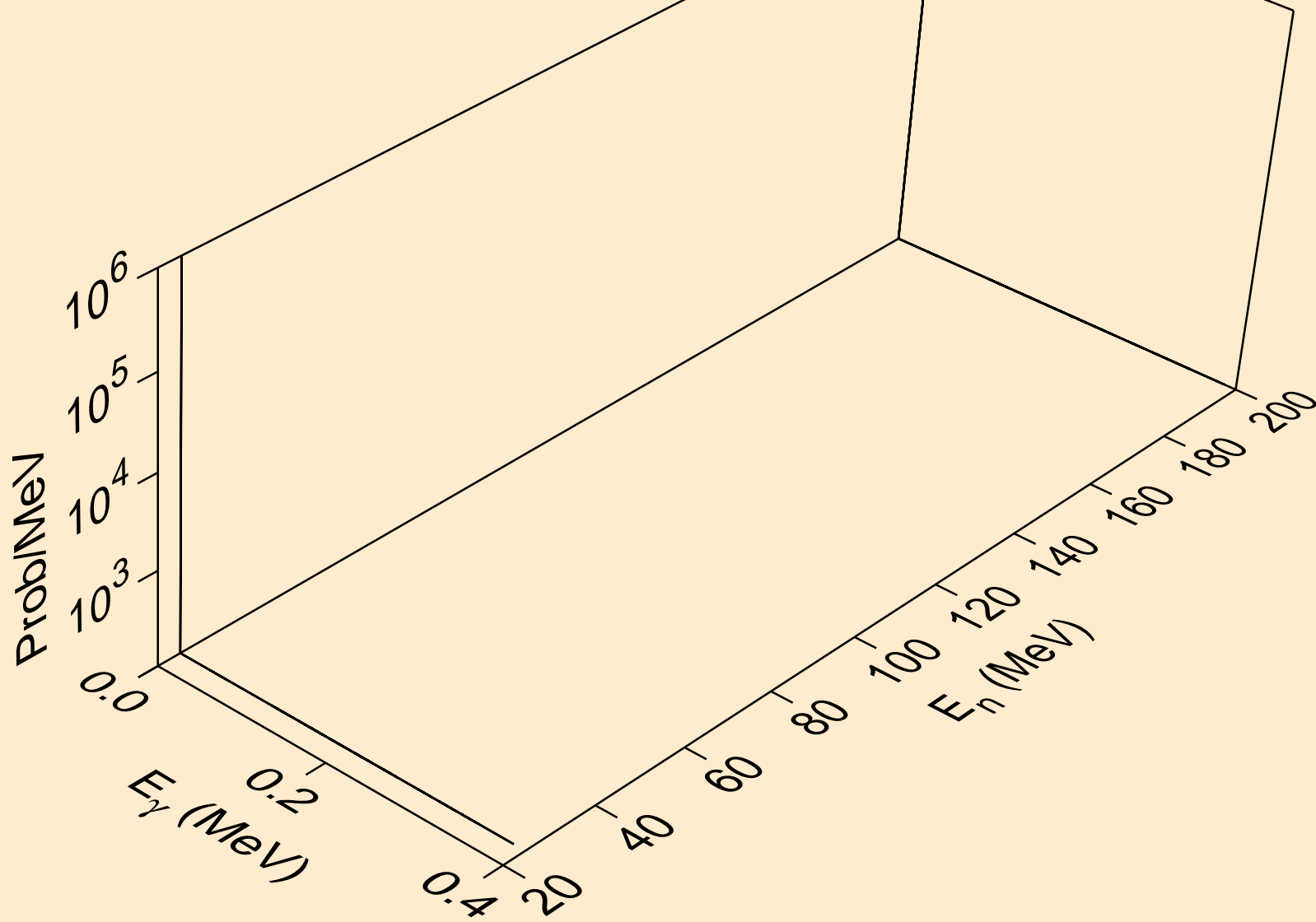

MO106 NEUTRON ACER TENDL-2019 LIBRARY; T=293.16K  
Photon emission for (n,n\*c)

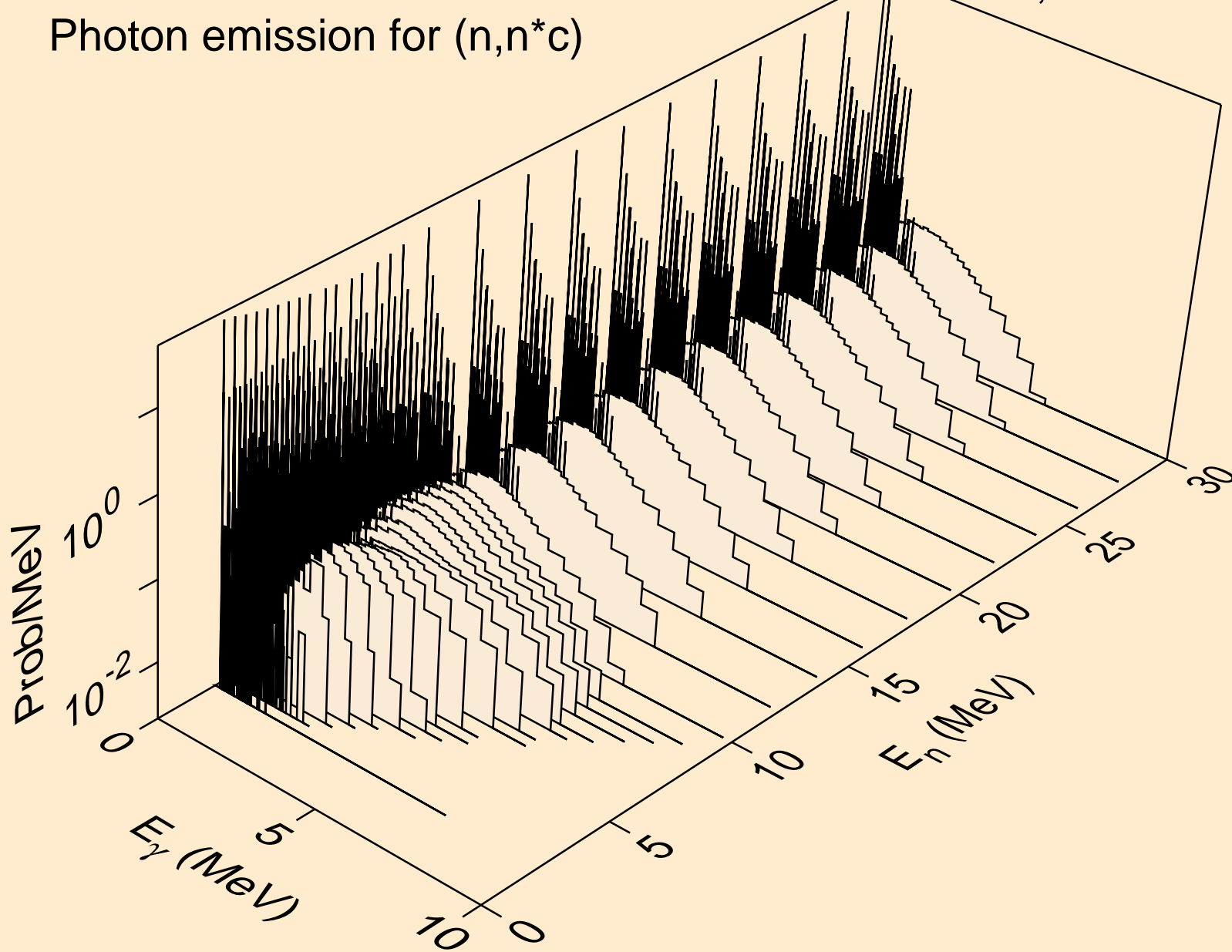

MO106 NEUTRON ACER TENDL-2019 LIBRARY; T=293.16K  
Photon emission for (n,gma)

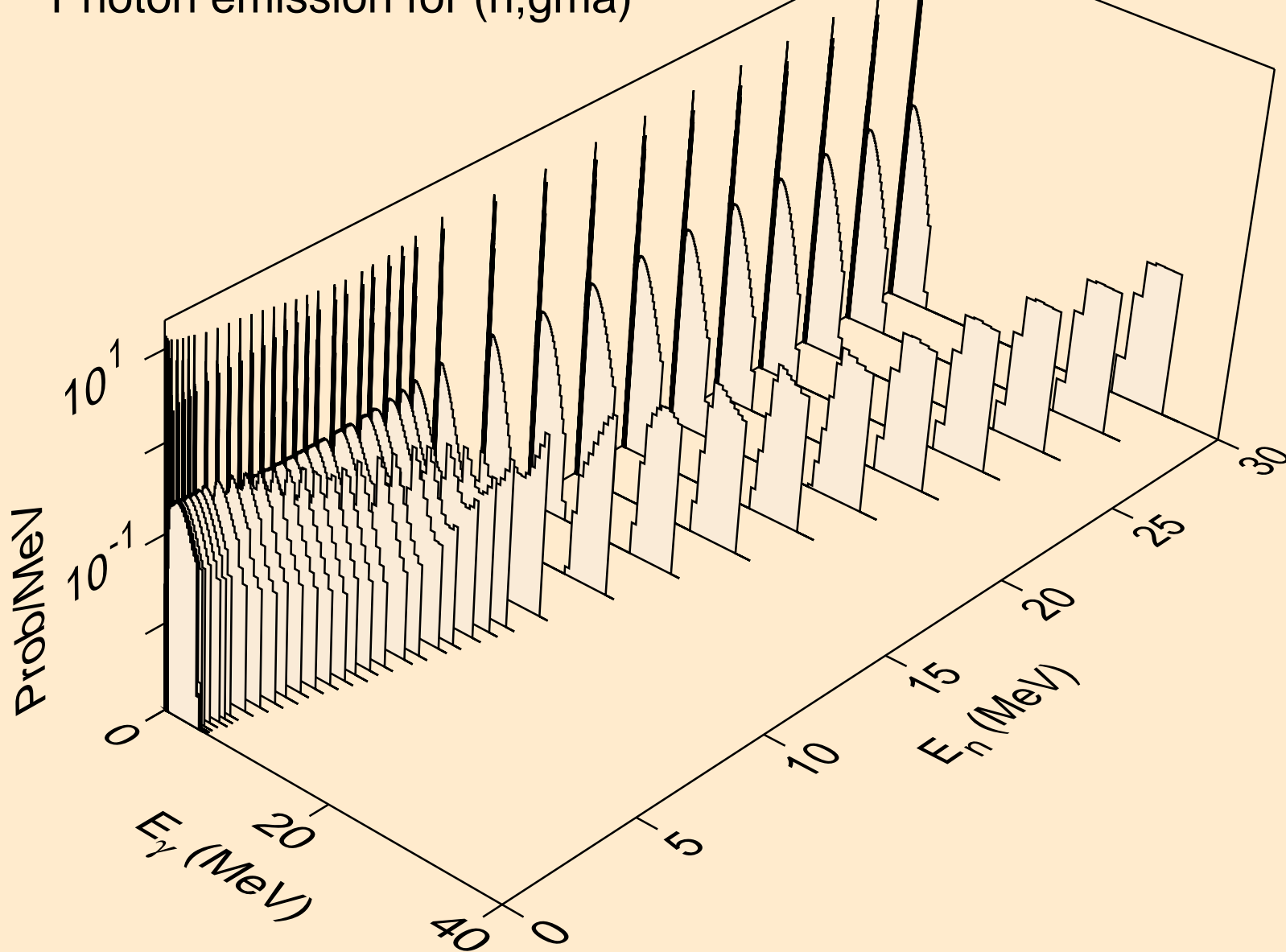

MO106 NEUTRON ACER TENDL-2019 LIBRARY; T=293.16K  
Photon emission for (n,p)

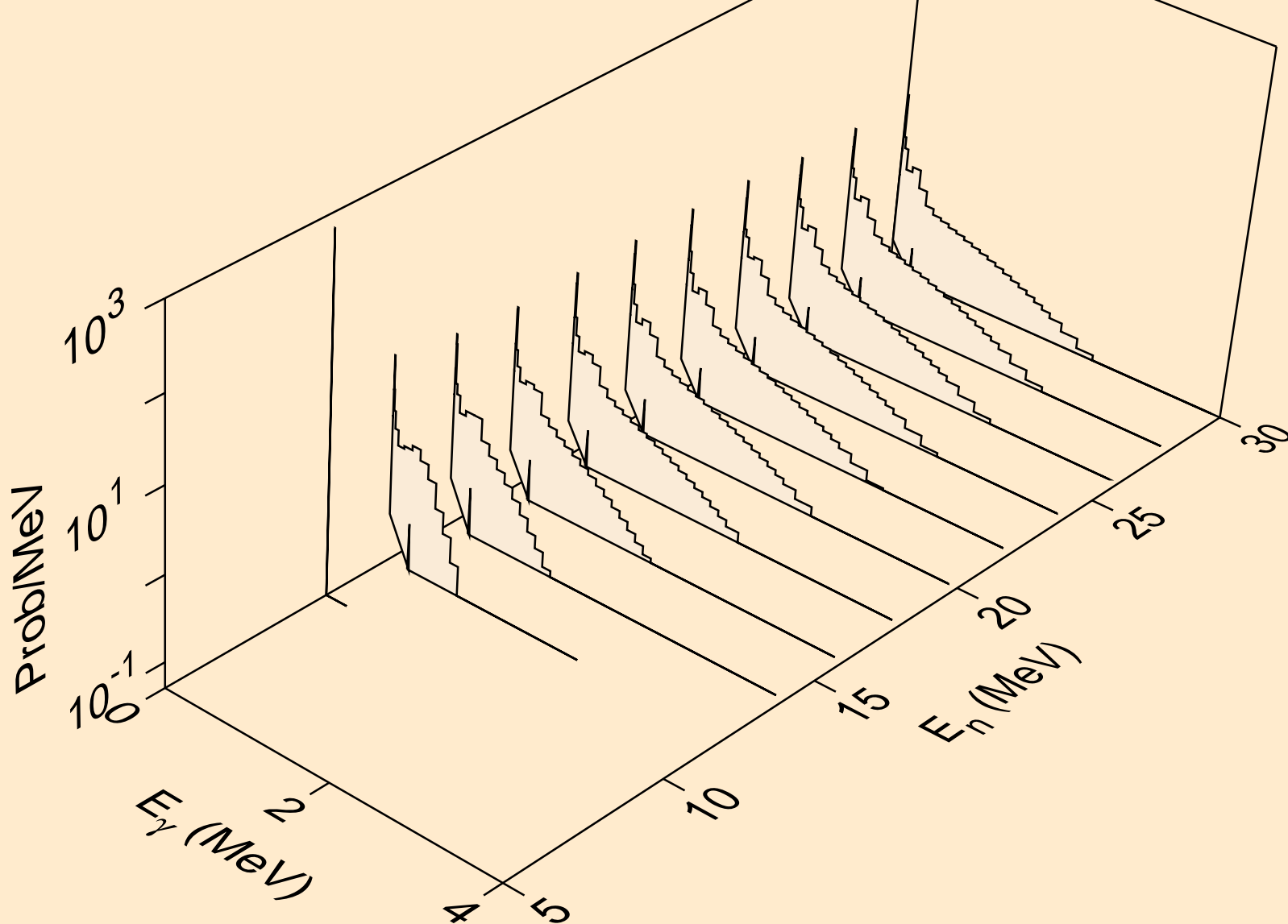

MO106 NEUTRON ACER TENDL-2019 LIBRARY; T=293.16K  
Photon emission for (n,d)

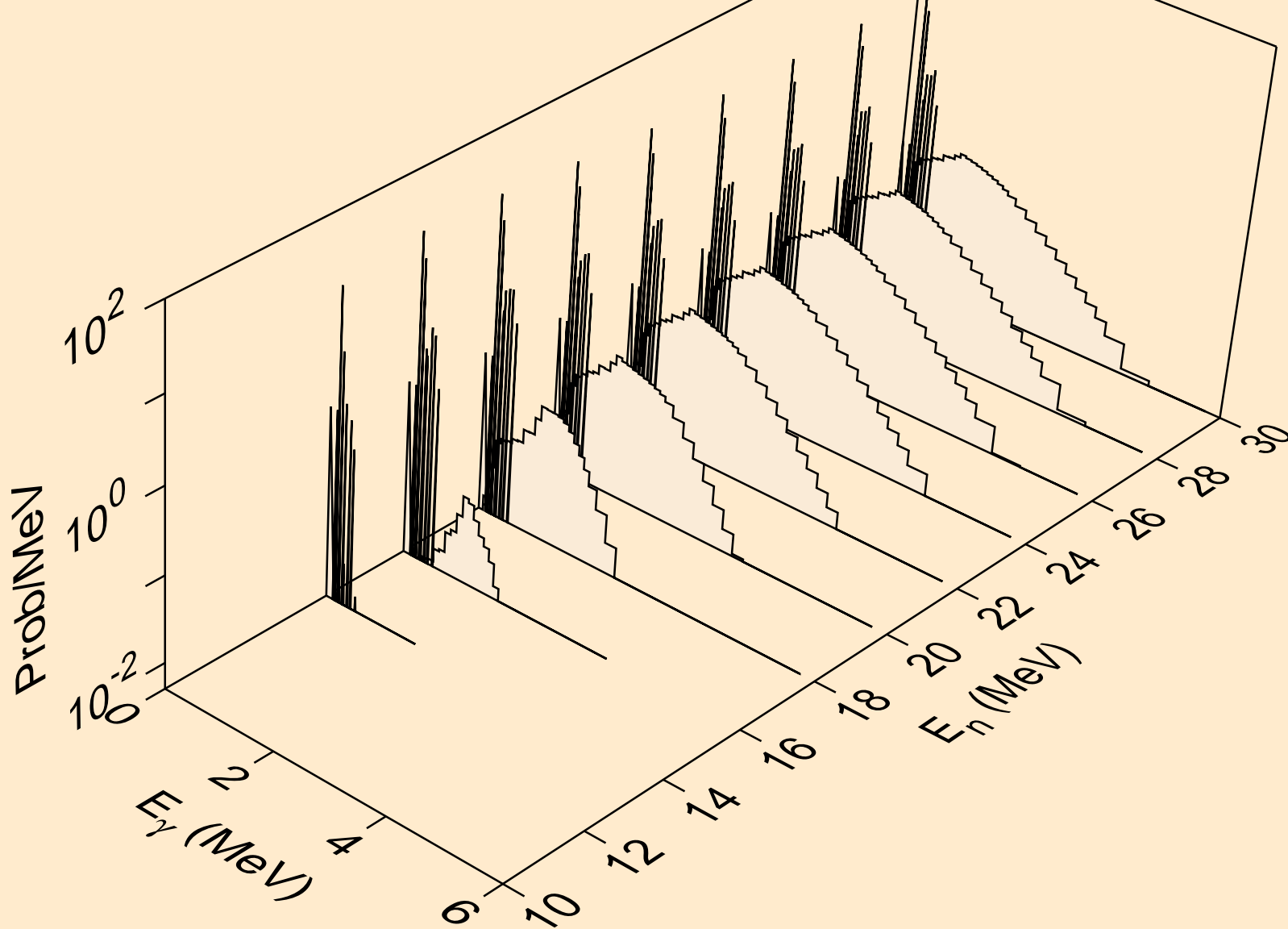

MO106 NEUTRON ACER TENDL-2019 LIBRARY; T=293.16K  
Photon emission for (n,t)

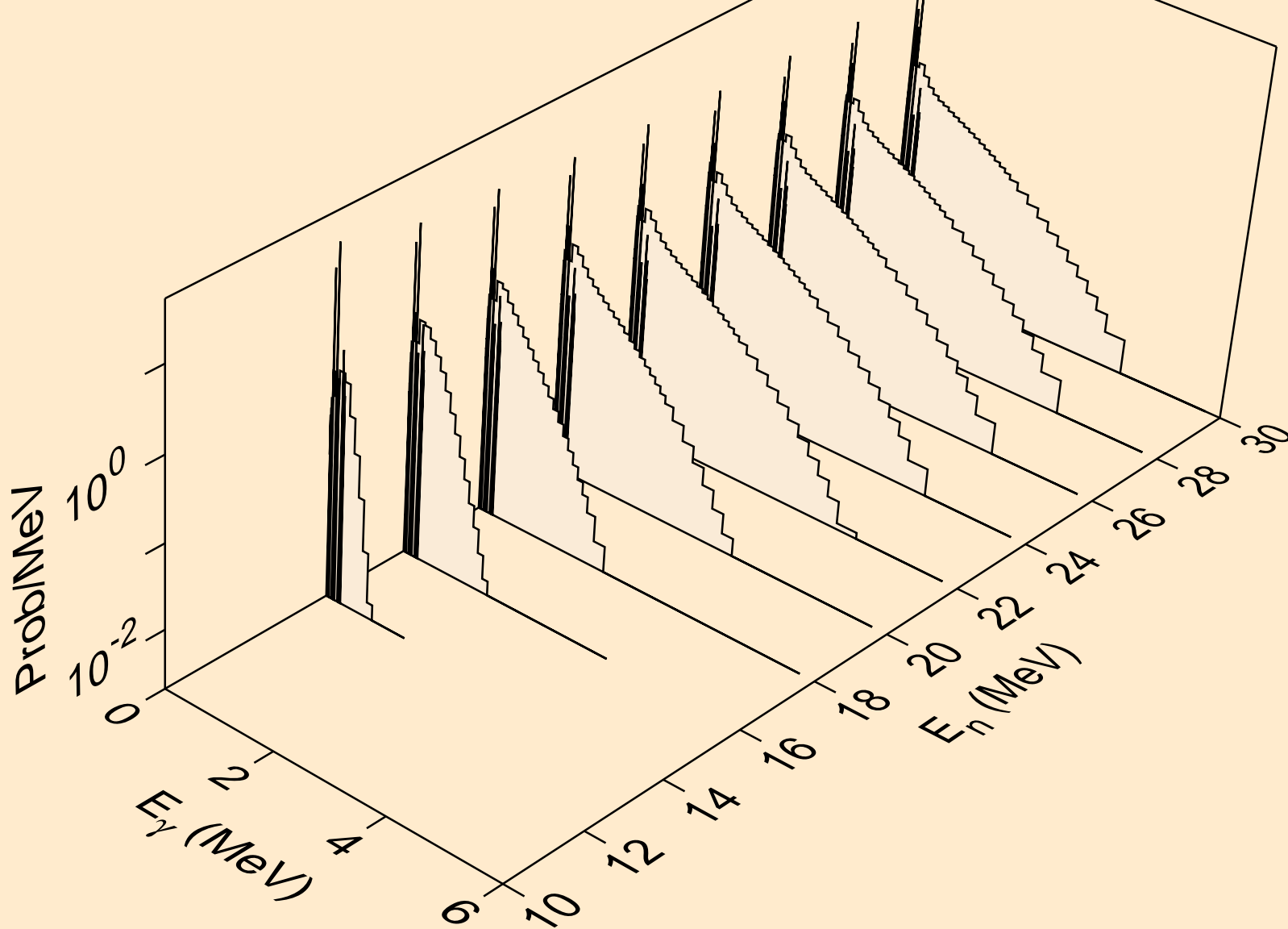

MO106 NEUTRON ACER TENDL-2019 LIBRARY; T=293.16K  
Photon emission for (n,he3)

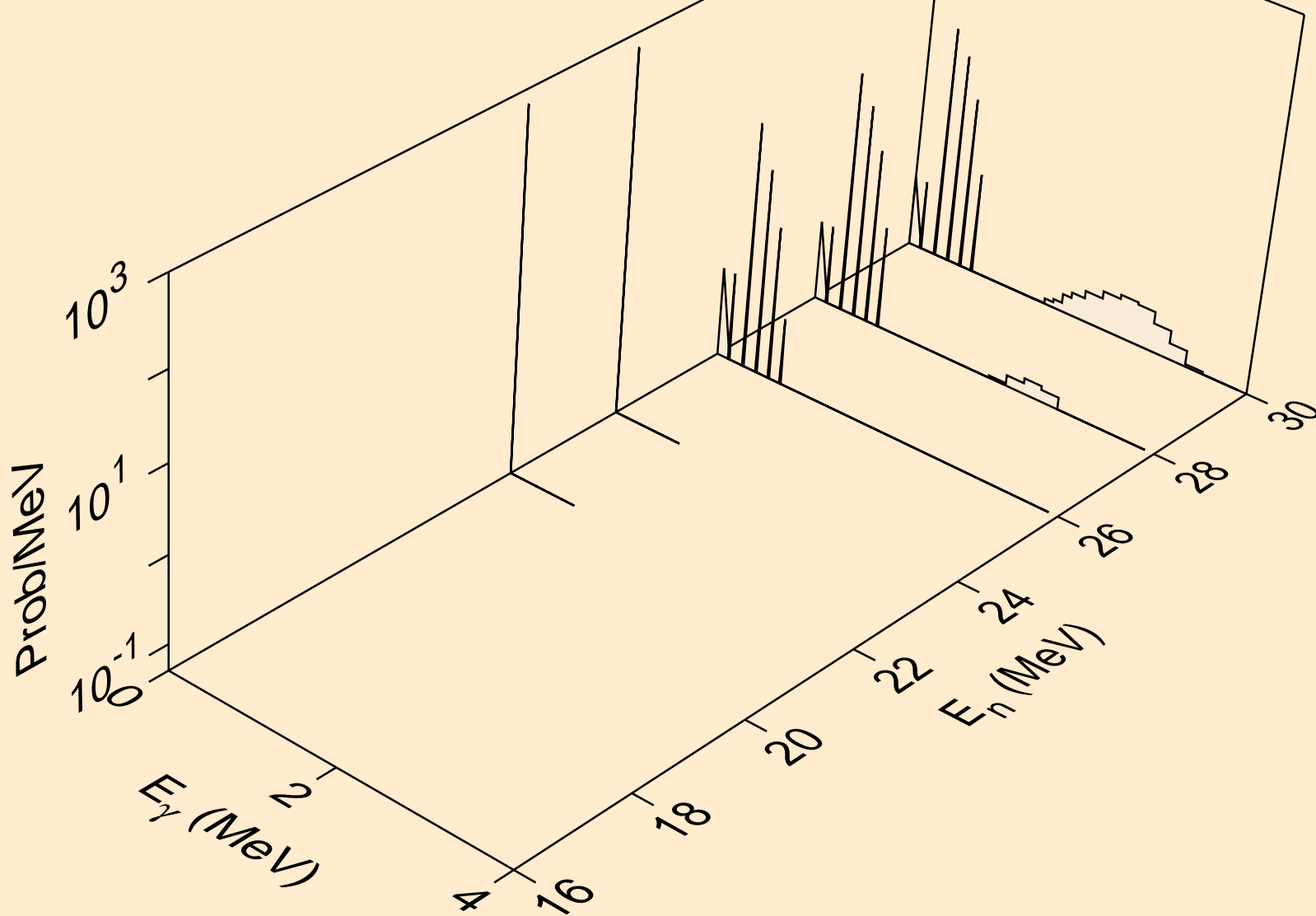



MO106 NEUTRON ACER TENDL-2019 LIBRARY; T=293.16K  
Photon emission for (n,a)

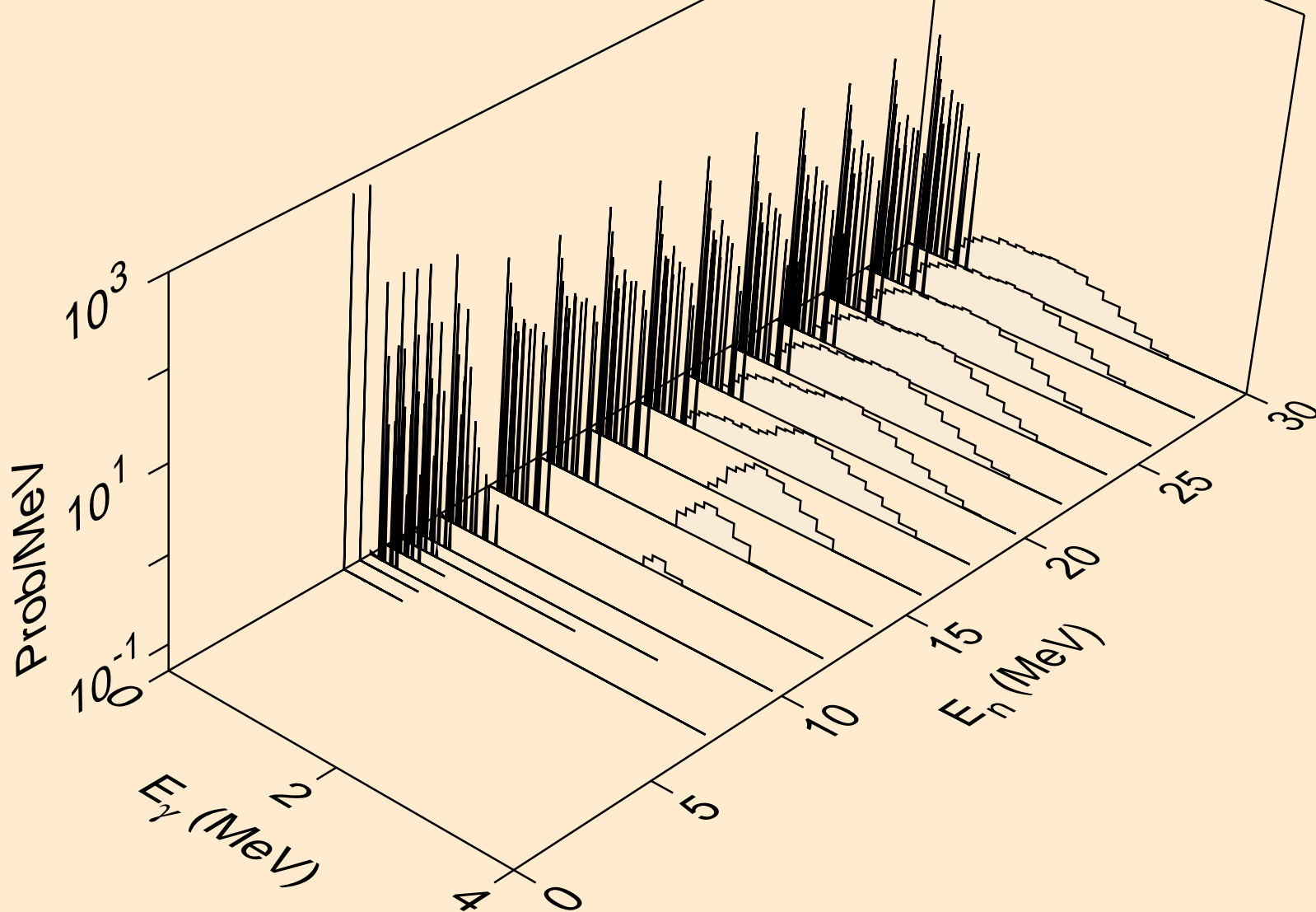

MO106 NEUTRON ACER TENDL-2019 LIBRARY; T=293.16K  
thermal capture photon spectrum

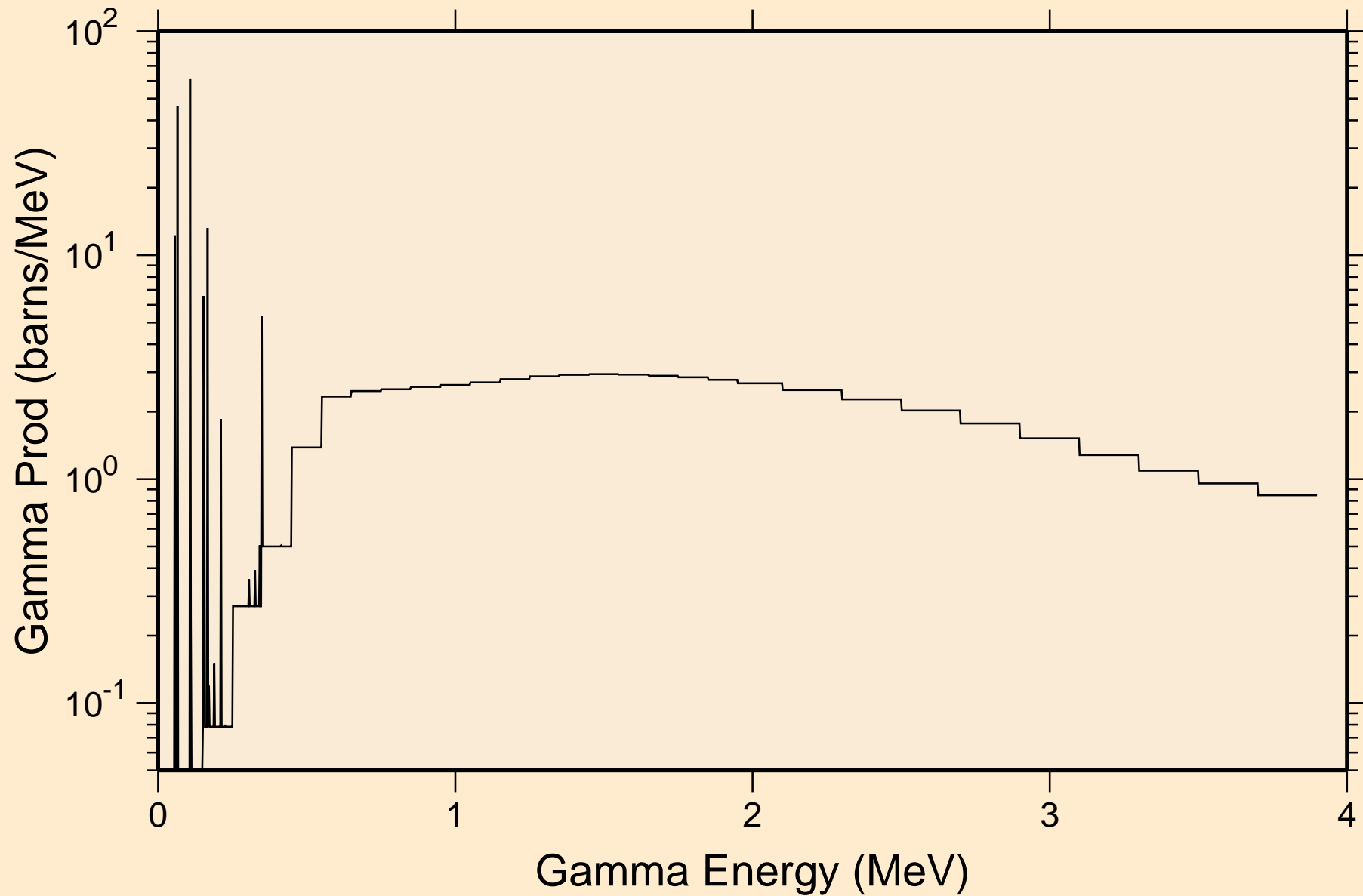

MO106 NEUTRON ACER TENDL-2019 LIBRARY; T=293.16K  
14 MeV photon spectrum

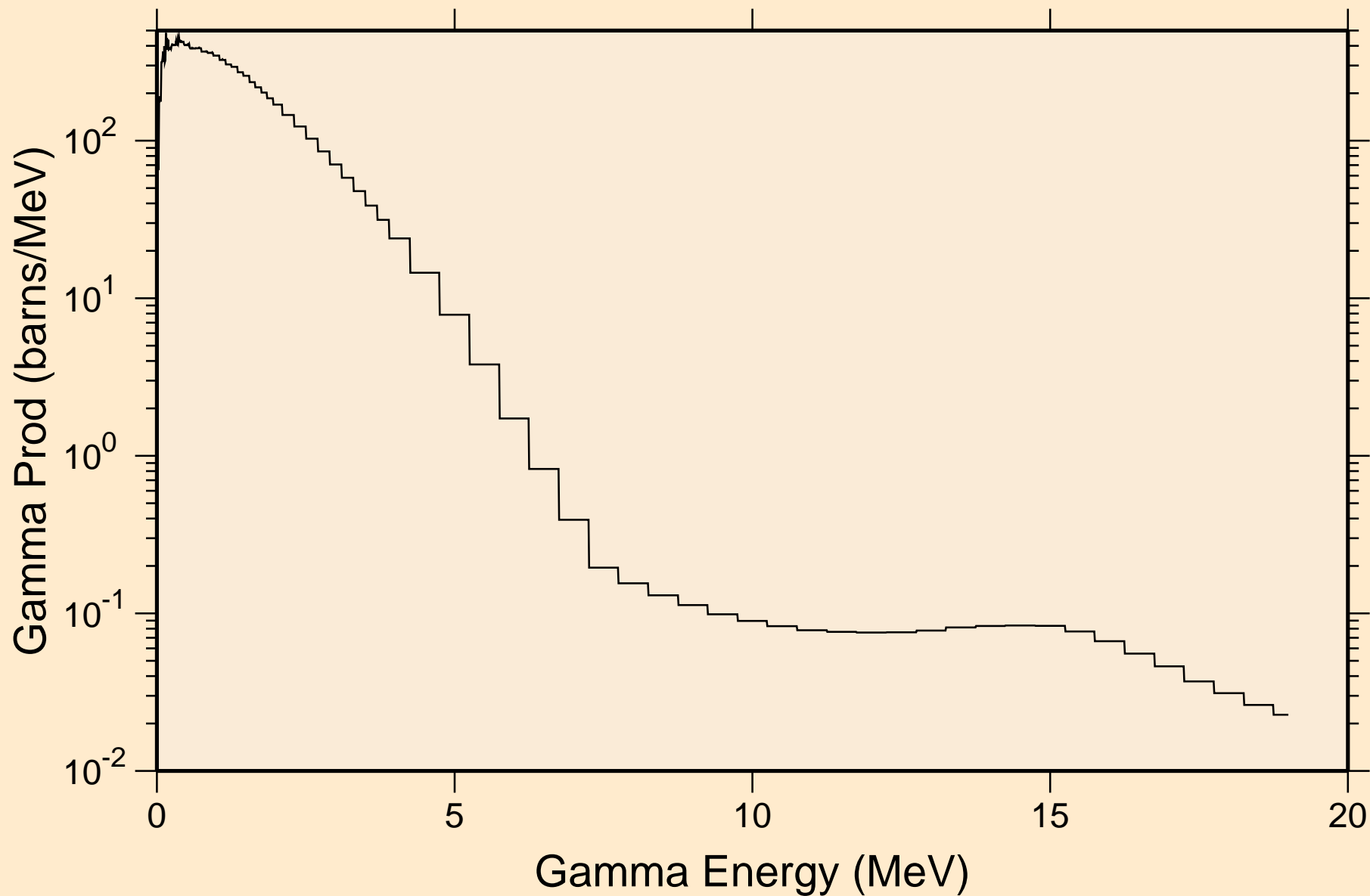

MO106 NEUTRON ACER TENDL-2019 LIBRARY; T=293.16K  
Particle heating contributions

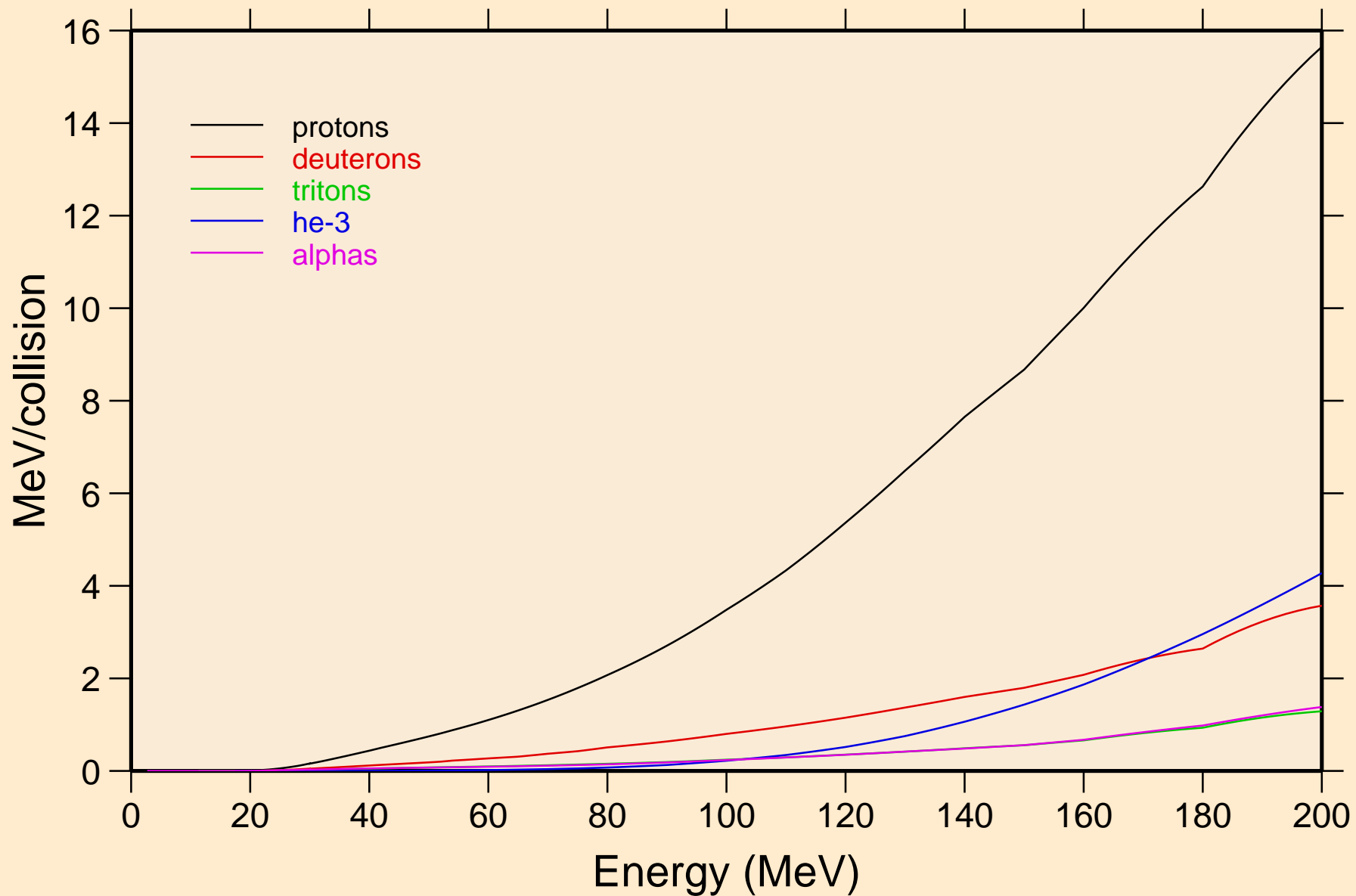

MO106 NEUTRON ACER TENDL-2019 LIBRARY; T=293.16K  
Recoil Heating

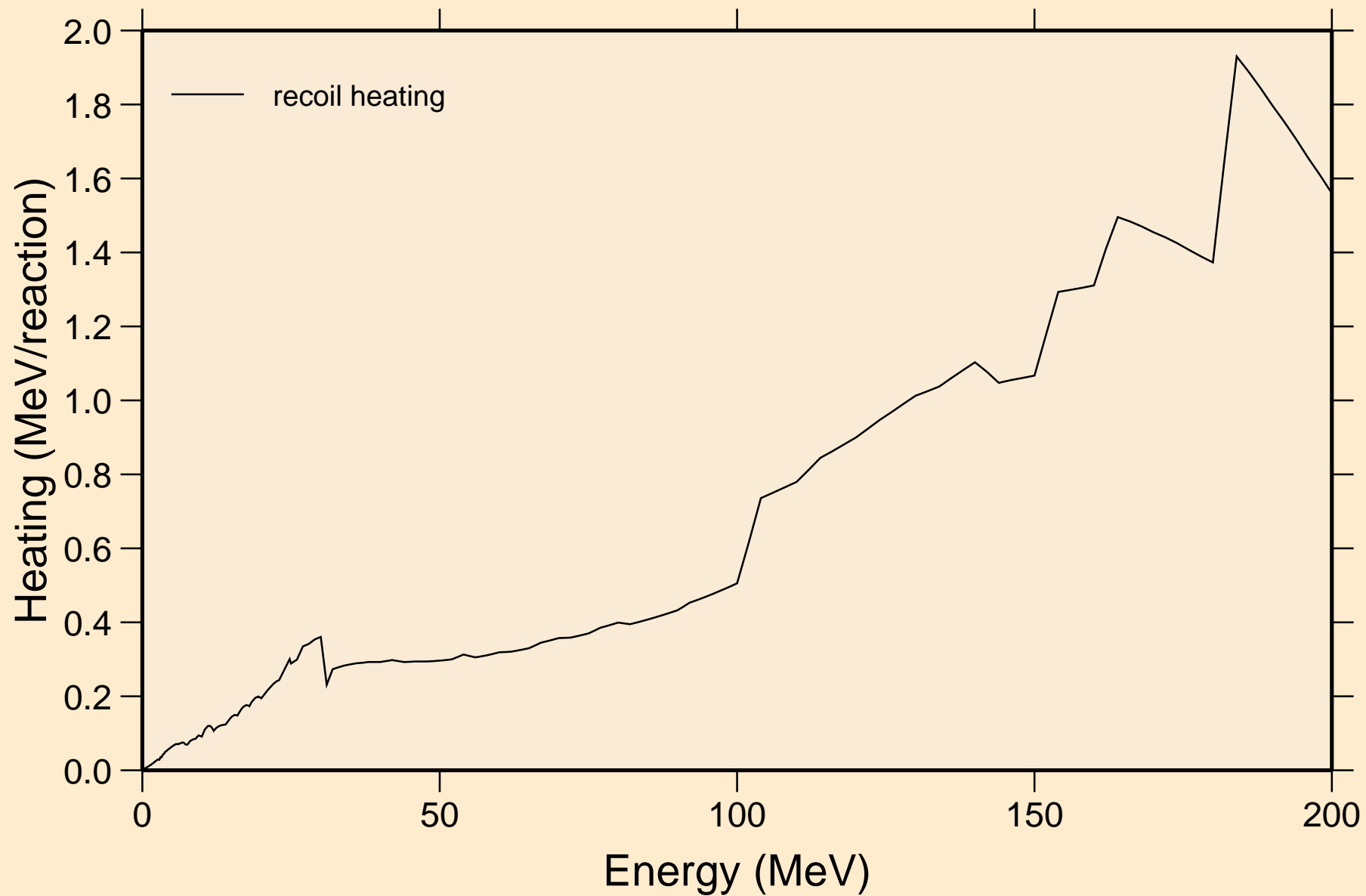

MO106 NEUTRON ACER TENDL-2019 LIBRARY; T=293.16K  
Particle production cross sections

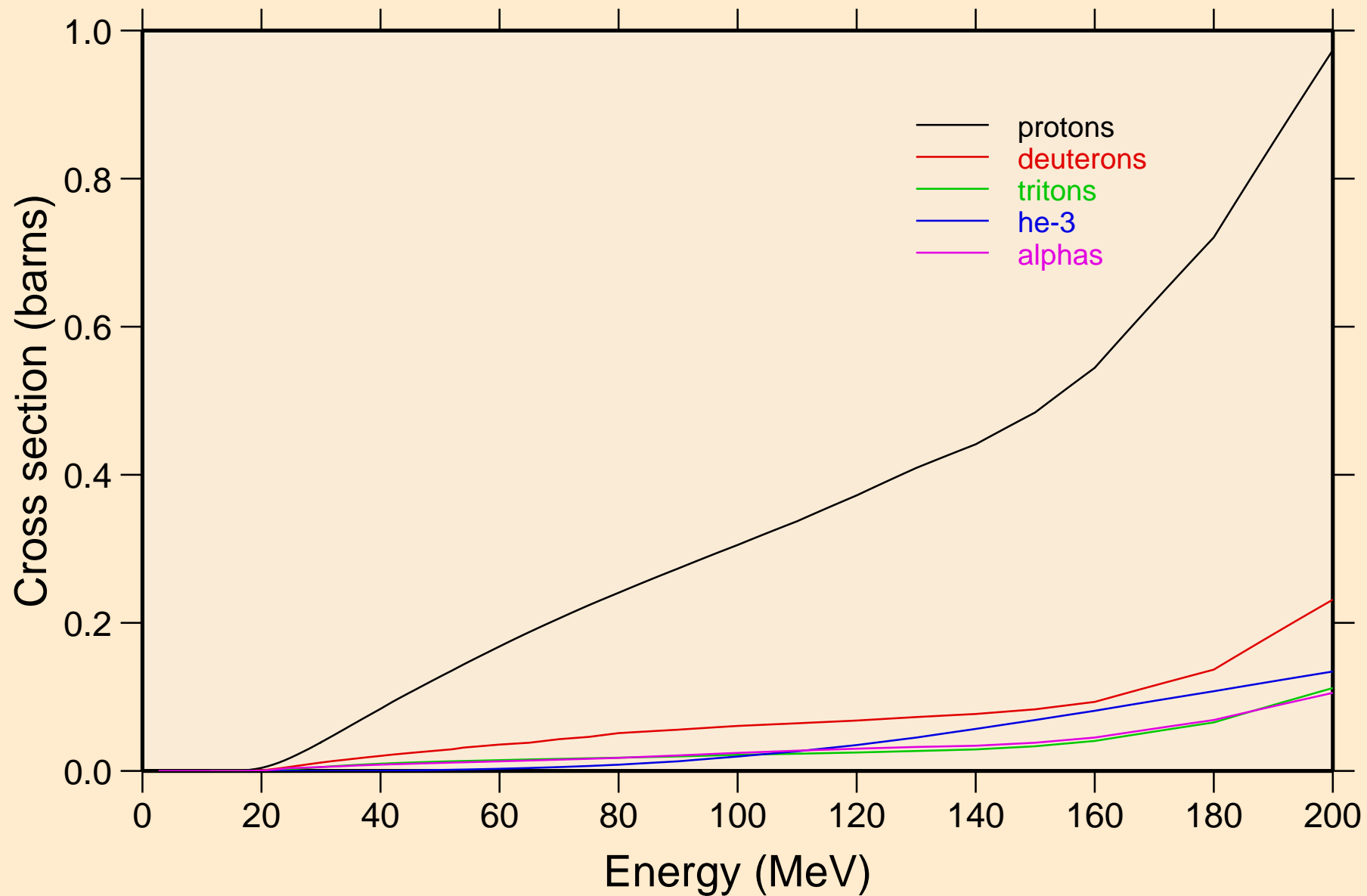

MO106 NEUTRON ACER TENDL-2019 LIBRARY; T=293.16K  
protons from (n,x)

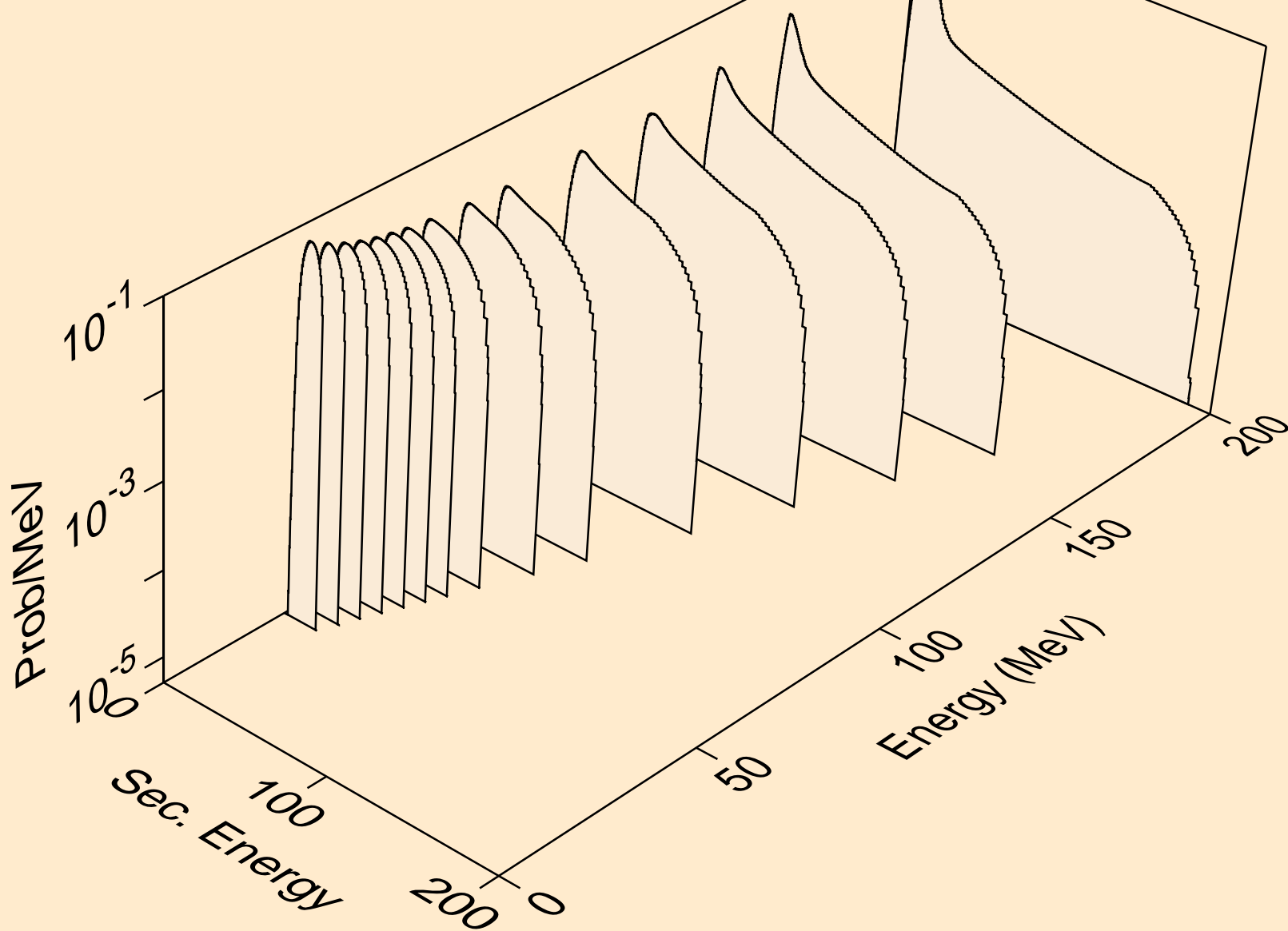

MO106 NEUTRON ACER TENDL-2019 LIBRARY; T=293.16K  
protons from (n,n\*)p

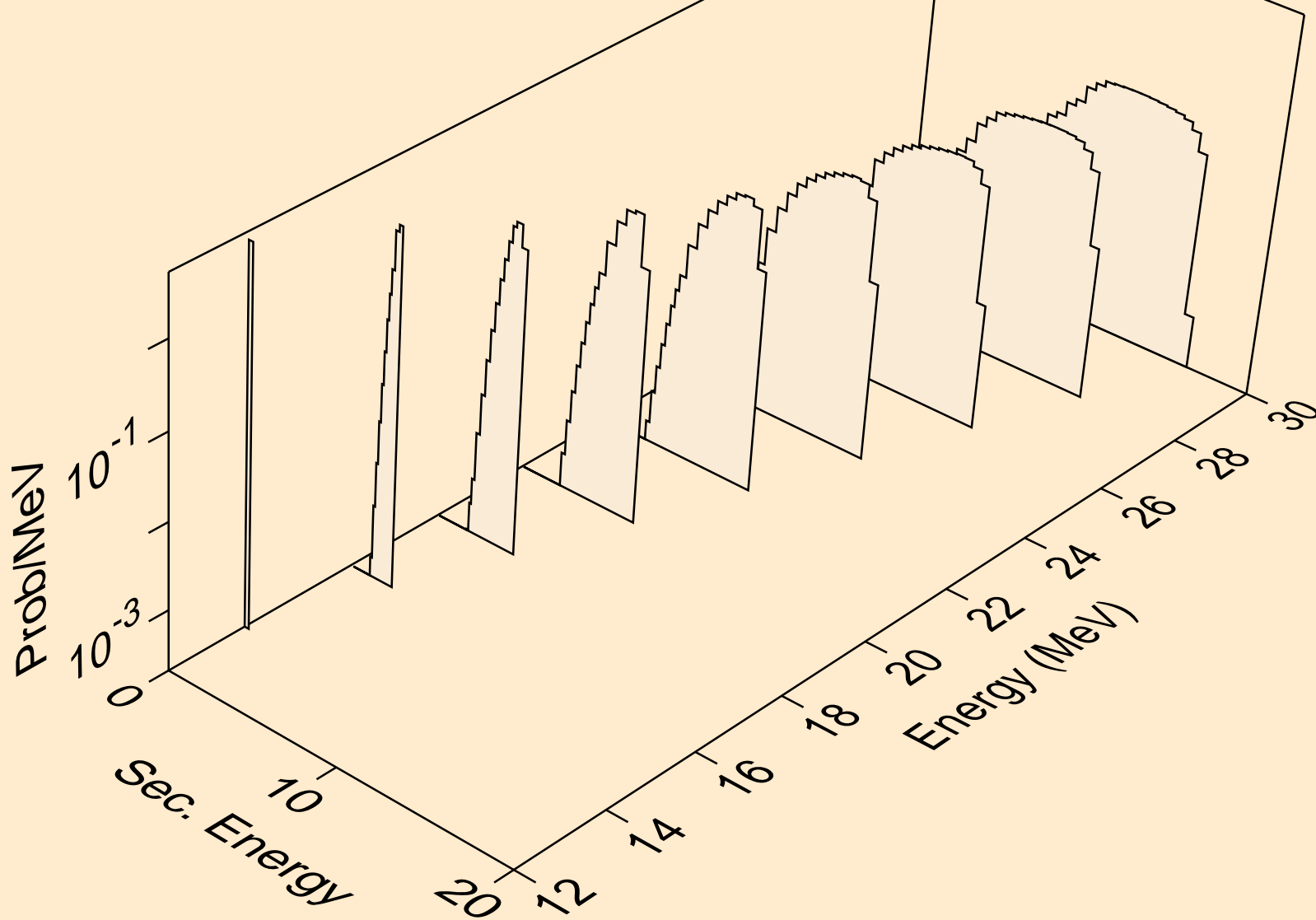



MO106 NEUTRON ACER TENDL-2019 LIBRARY; T=293.16K  
protons from (n,2np)

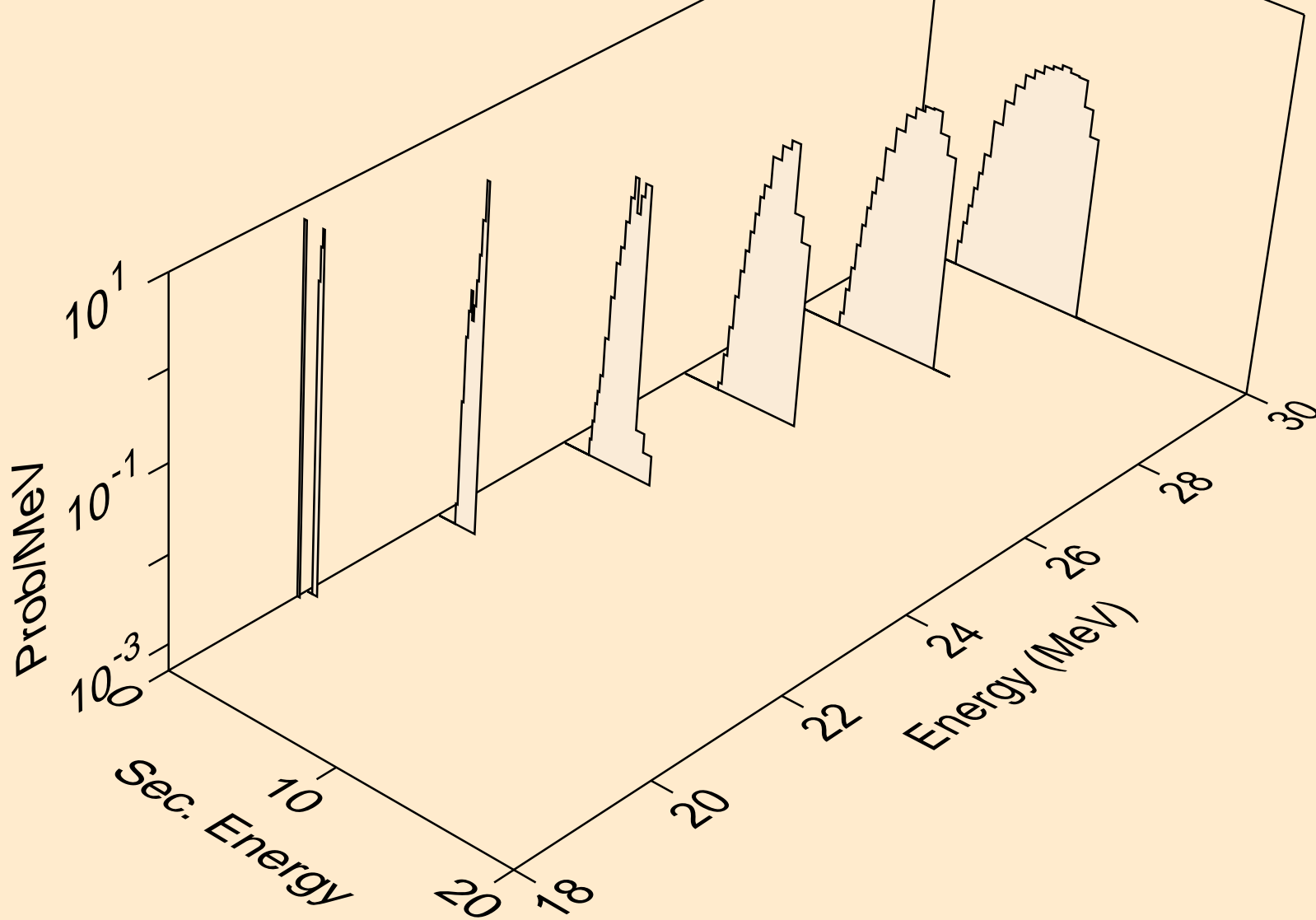

MO106 NEUTRON ACER TENDL-2019 LIBRARY; T=293.16K  
protons from (n,3np)

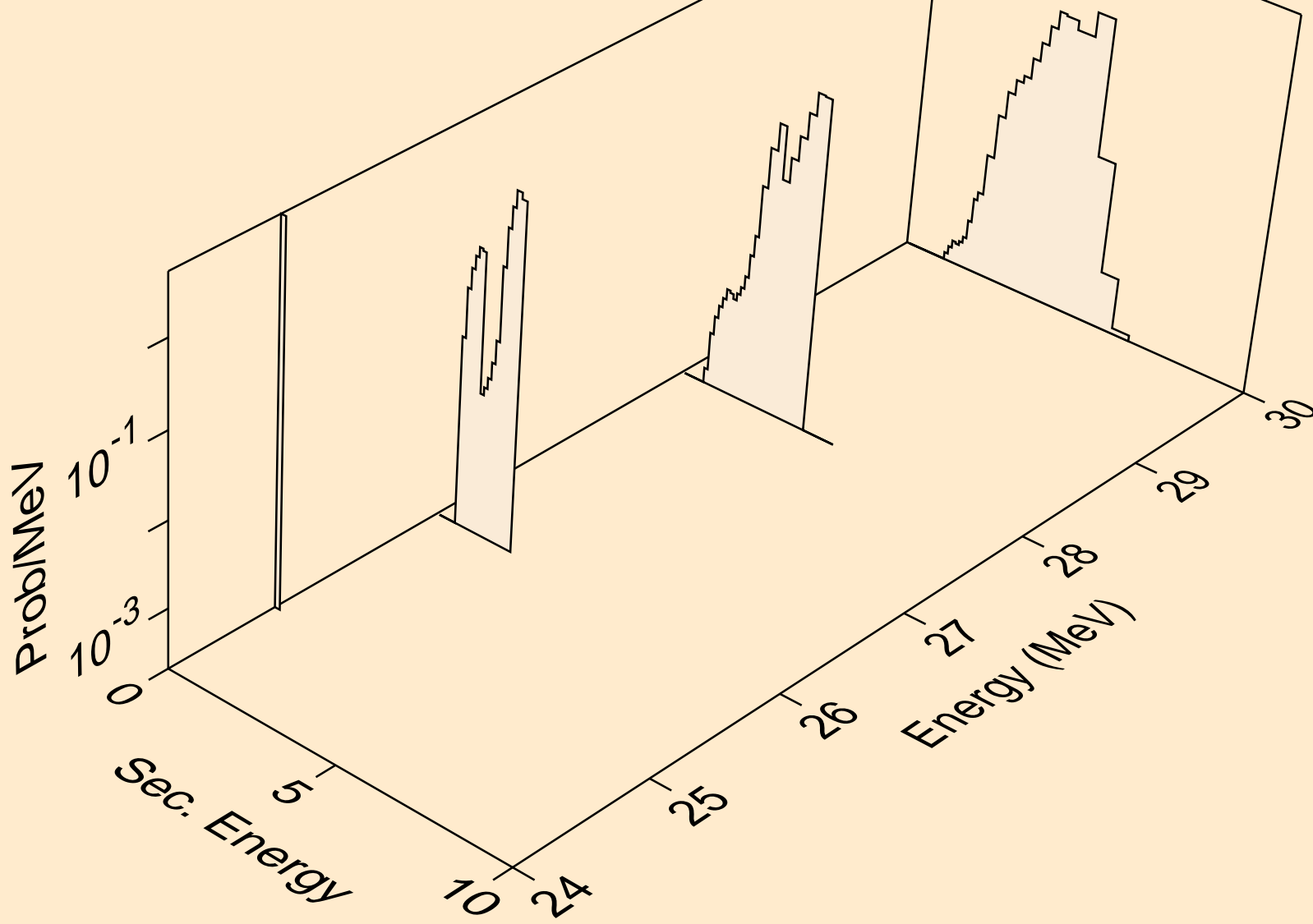

MO106 NEUTRON ACER TENDL-2019 LIBRARY; T=293.16K  
protons from (n,p)

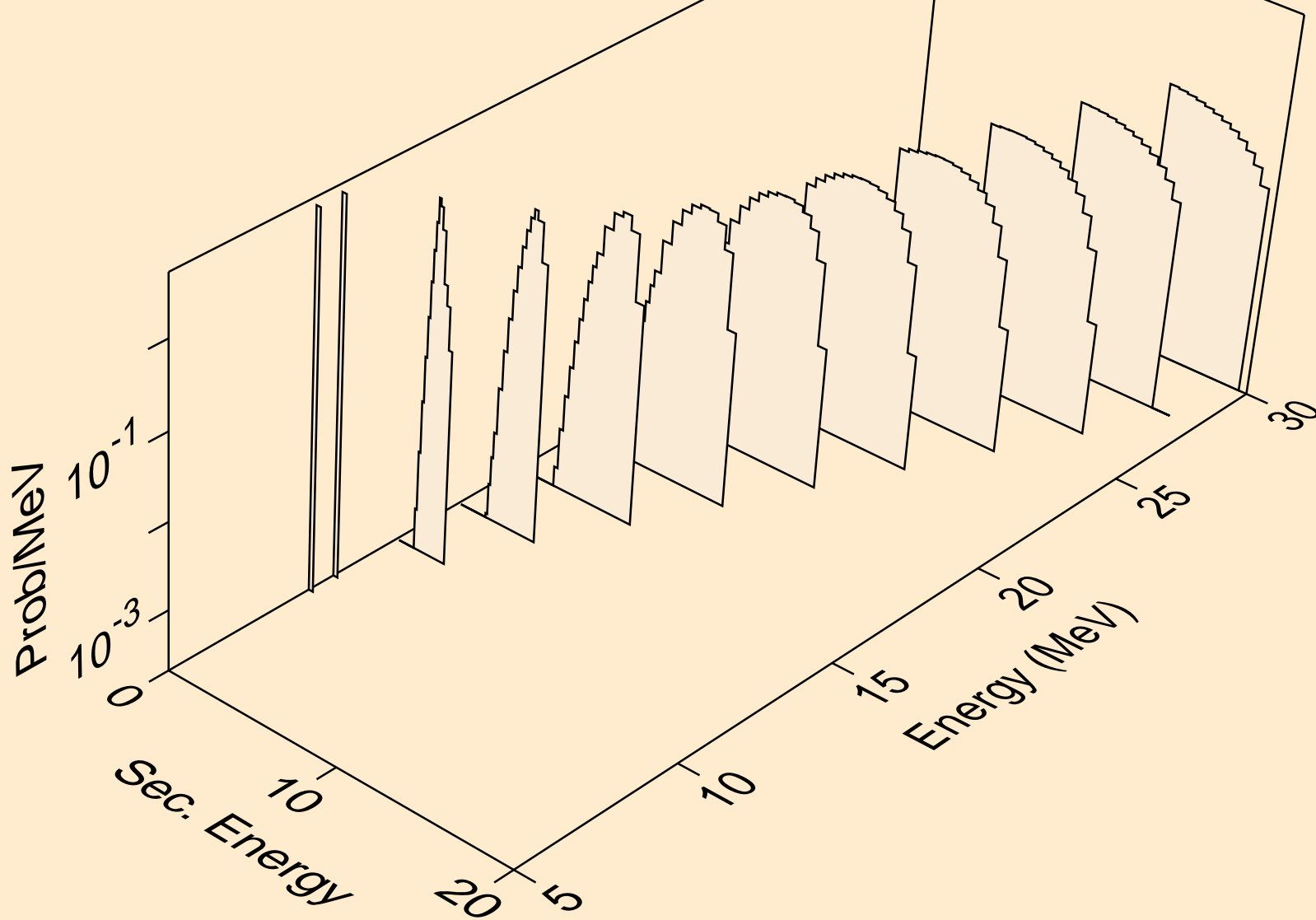

MO106 NEUTRON ACER TENDL-2019 LIBRARY; T=293.16K  
deuterons from (n,x)

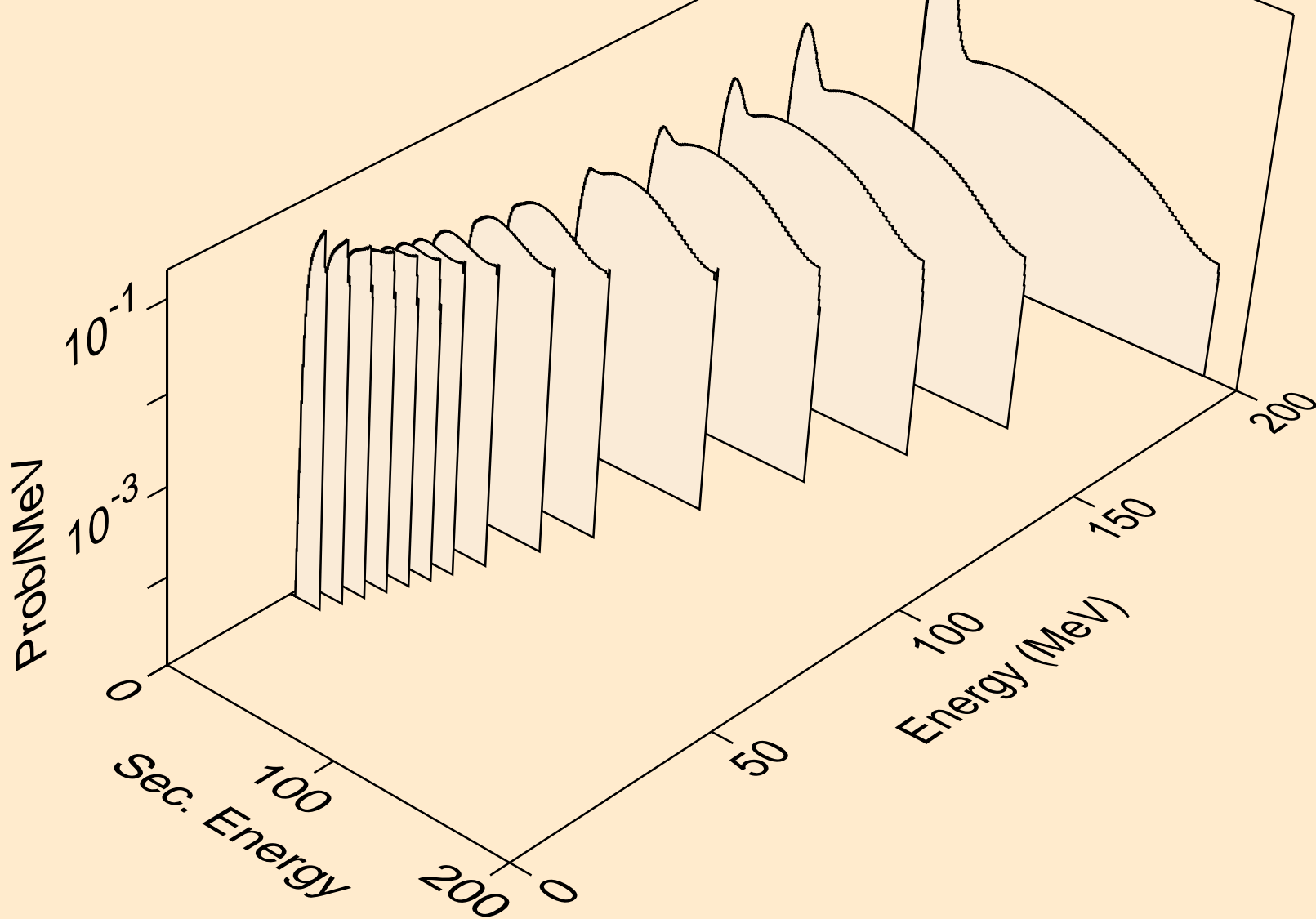

MO106 NEUTRON ACER TENDL-2019 LIBRARY; T=293.16K  
deuterons from (n,2nd)

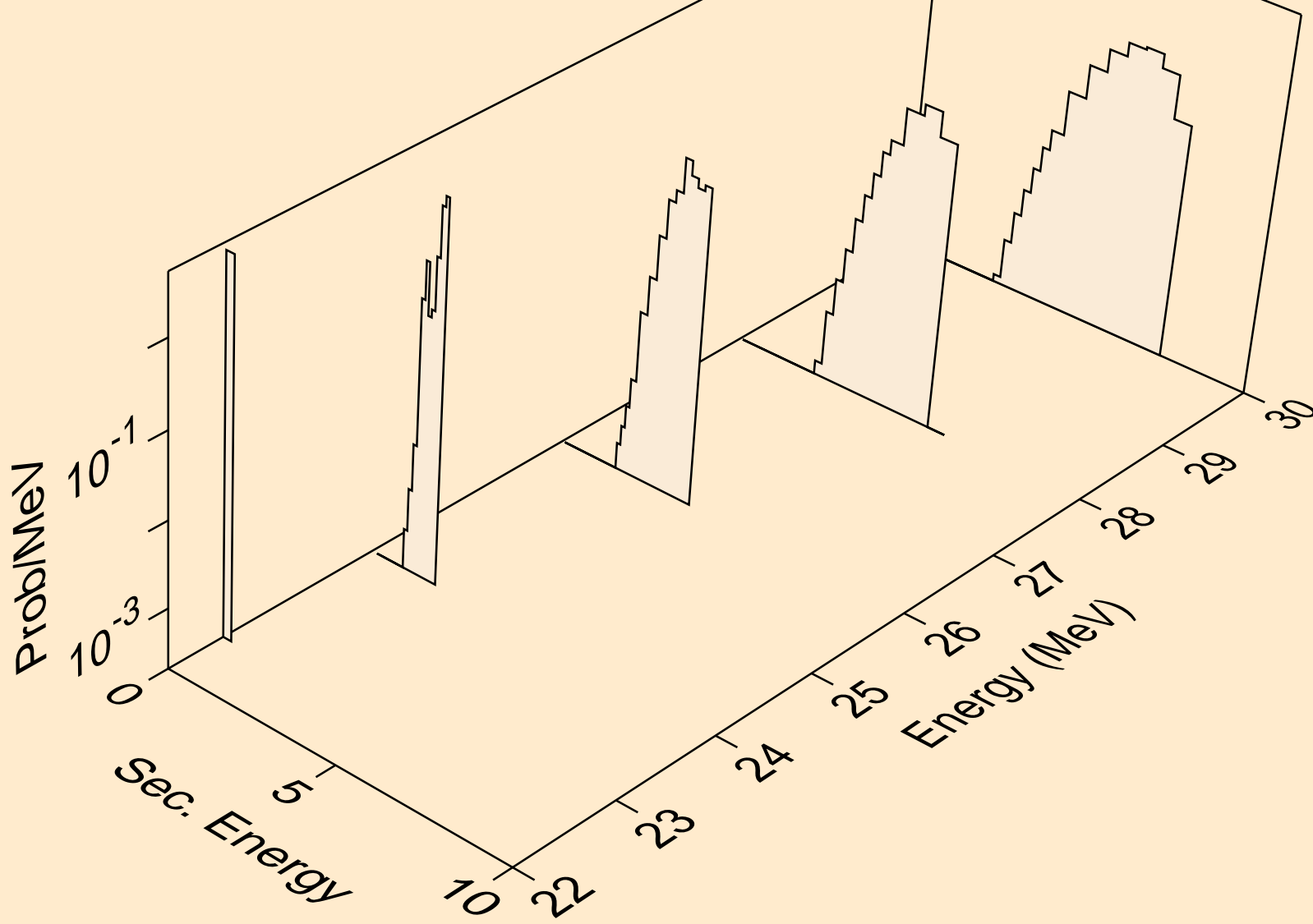

MO106 NEUTRON ACER TENDL-2019 LIBRARY; T=293.16K  
deuterons from (n,n\*)d

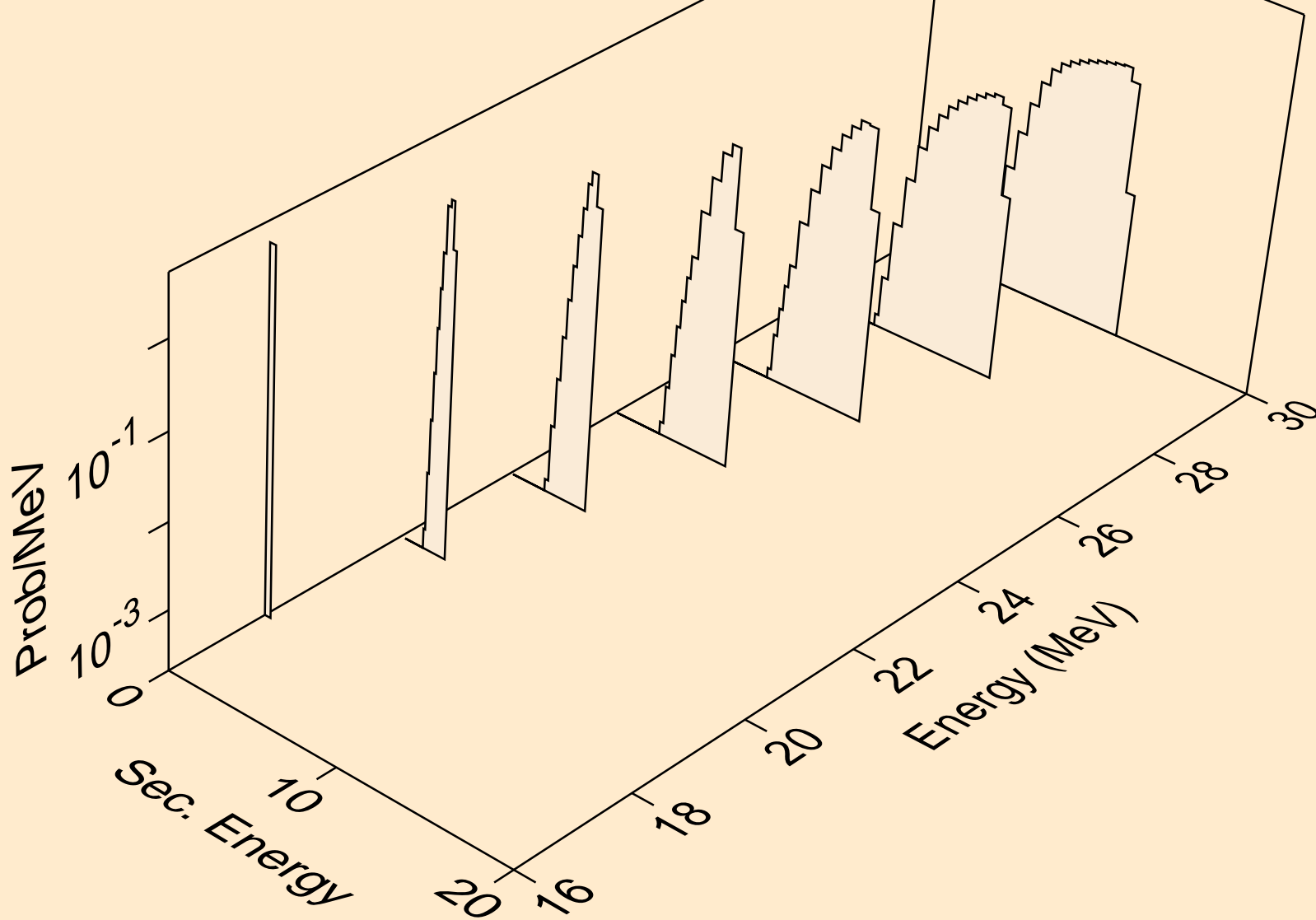

MO106 NEUTRON ACER TENDL-2019 LIBRARY; T=293.16K  
deuterons from (n,d)

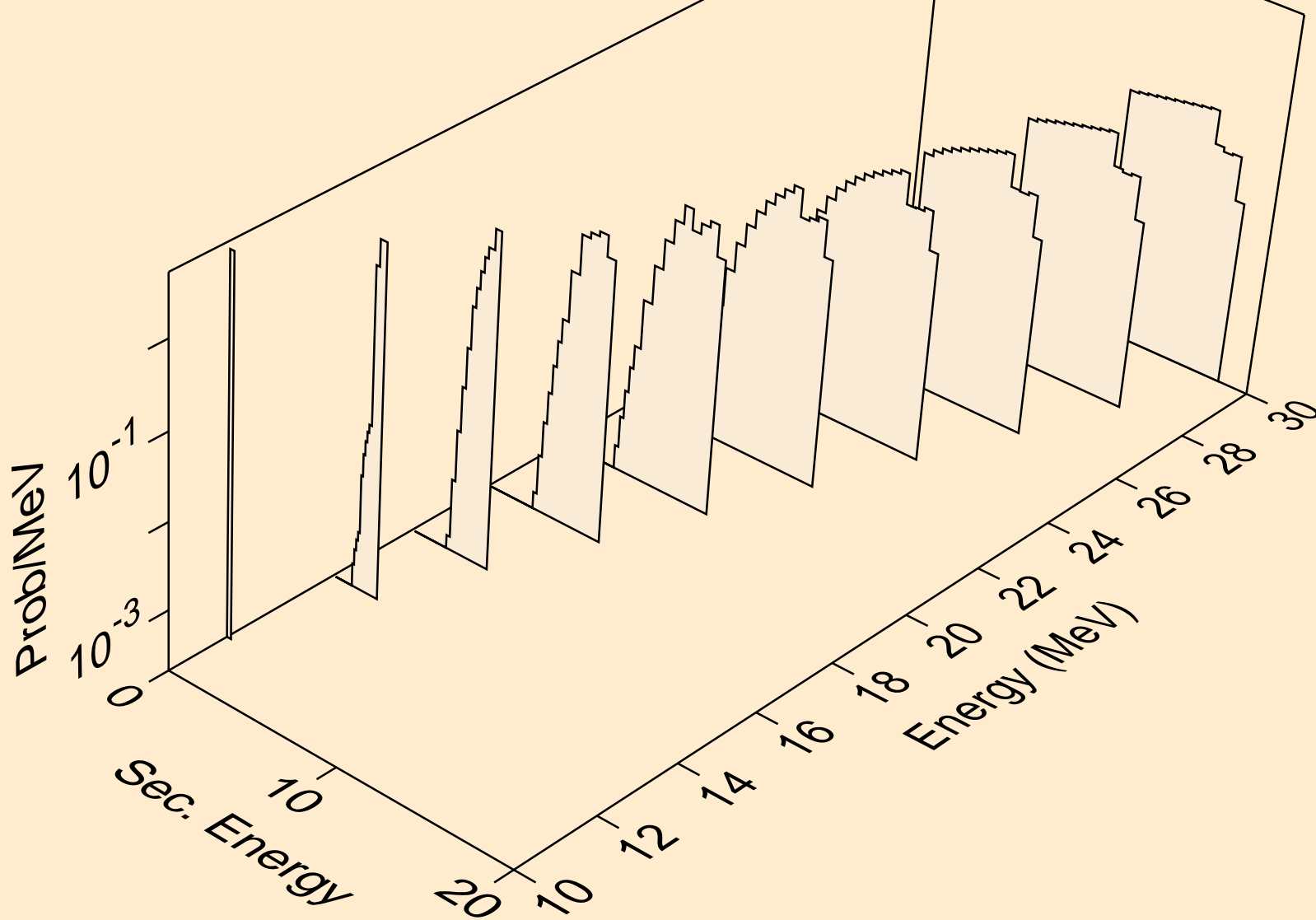

MO106 NEUTRON ACER TENDL-2019 LIBRARY; T=293.16K  
tritons from (n,x)

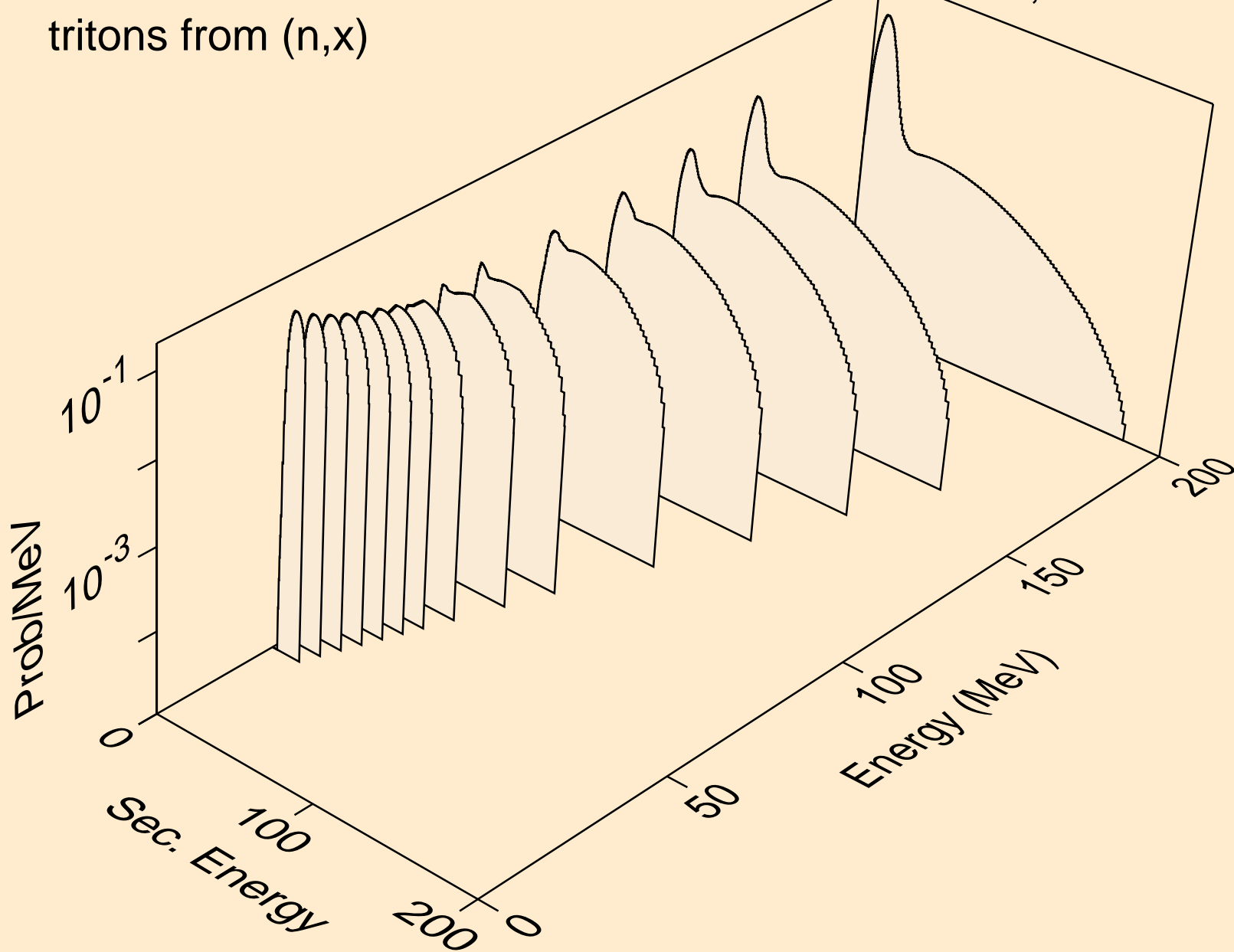



MO106 NEUTRON ACER TENDL-2019 LIBRARY; T=293.16K  
tritons from (n,n\*)t

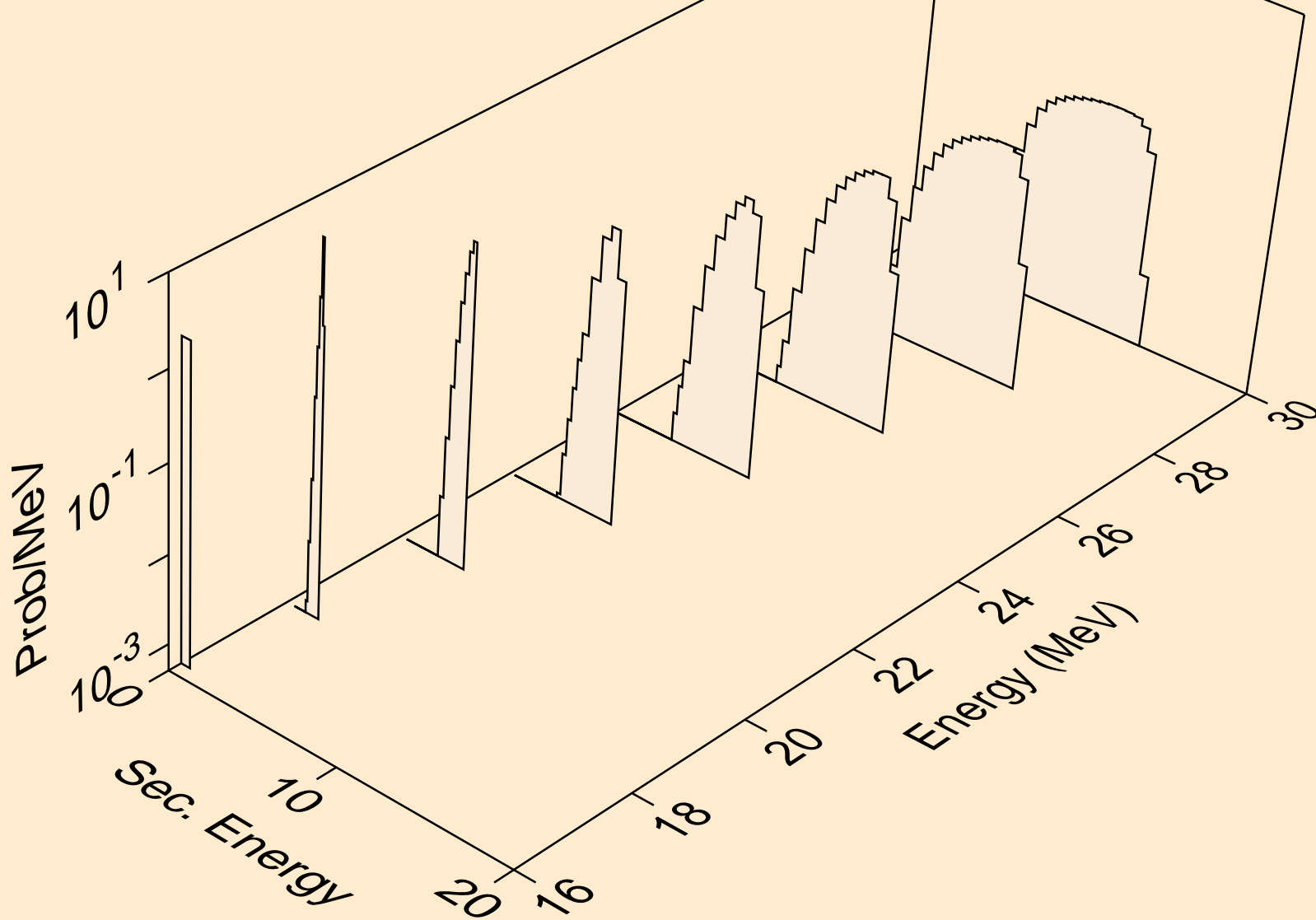

MO106 NEUTRON ACER TENDL-2019 LIBRARY; T=293.16K  
tritons from (n,t)

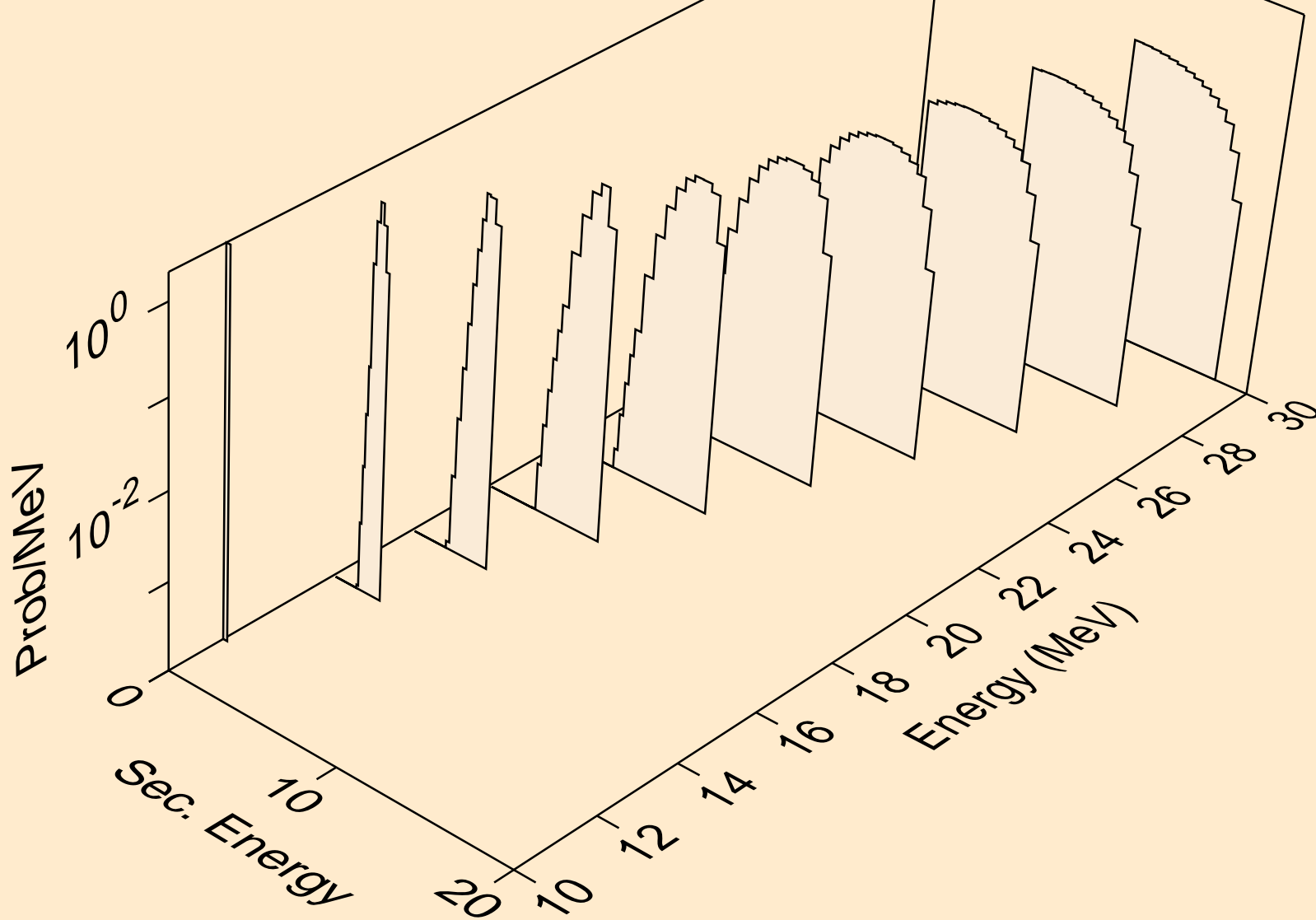

MO106 NEUTRON ACER TENDL-2019 LIBRARY; T=293.16K  
he3s from (n,x)

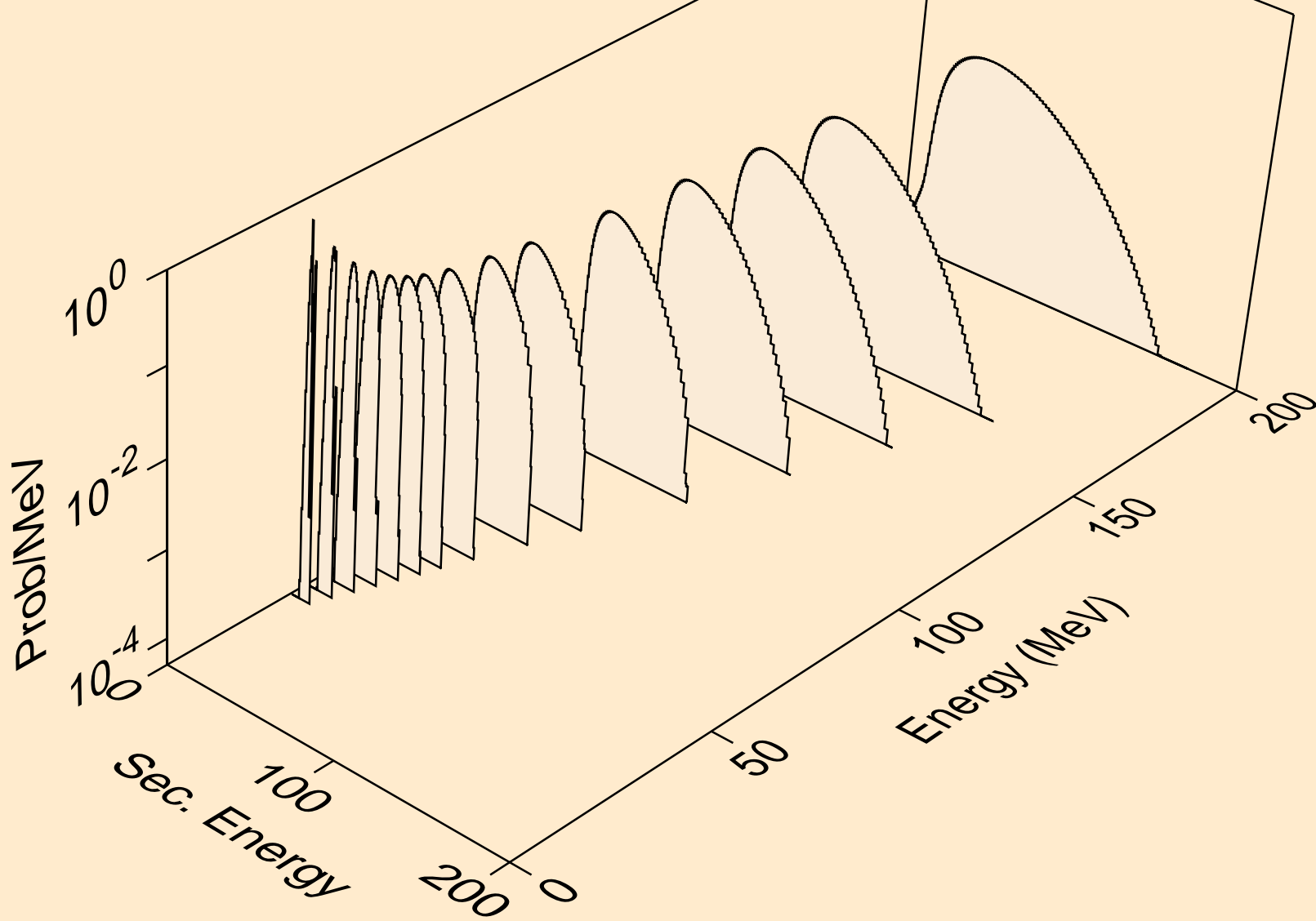

MO106 NEUTRON ACER TENDL-2019 LIBRARY; T=293.16K  
he3s from (n,he3)

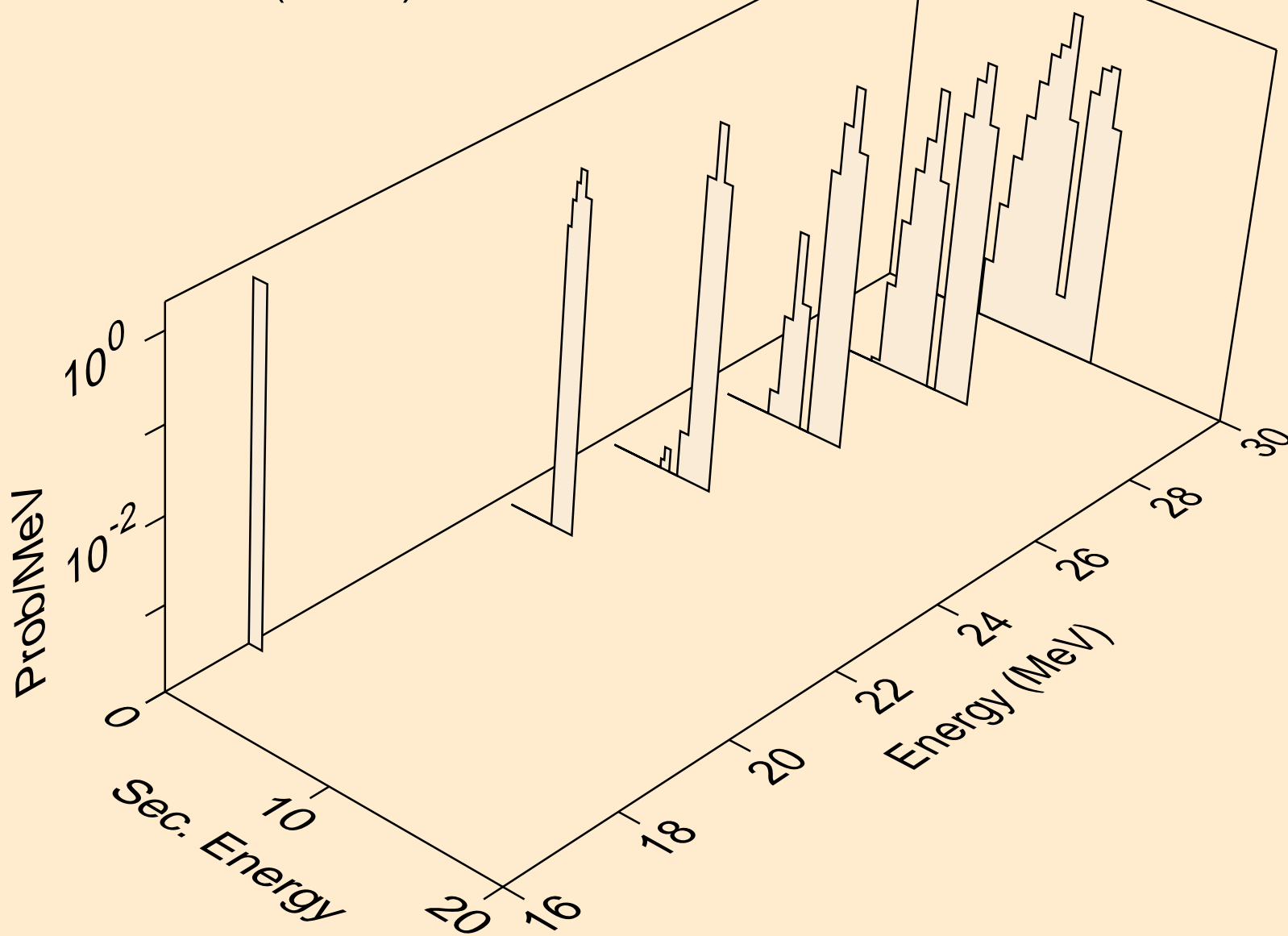

MO106 NEUTRON ACER TENDL-2019 LIBRARY; T=293.16K  
alphas from (n,x)

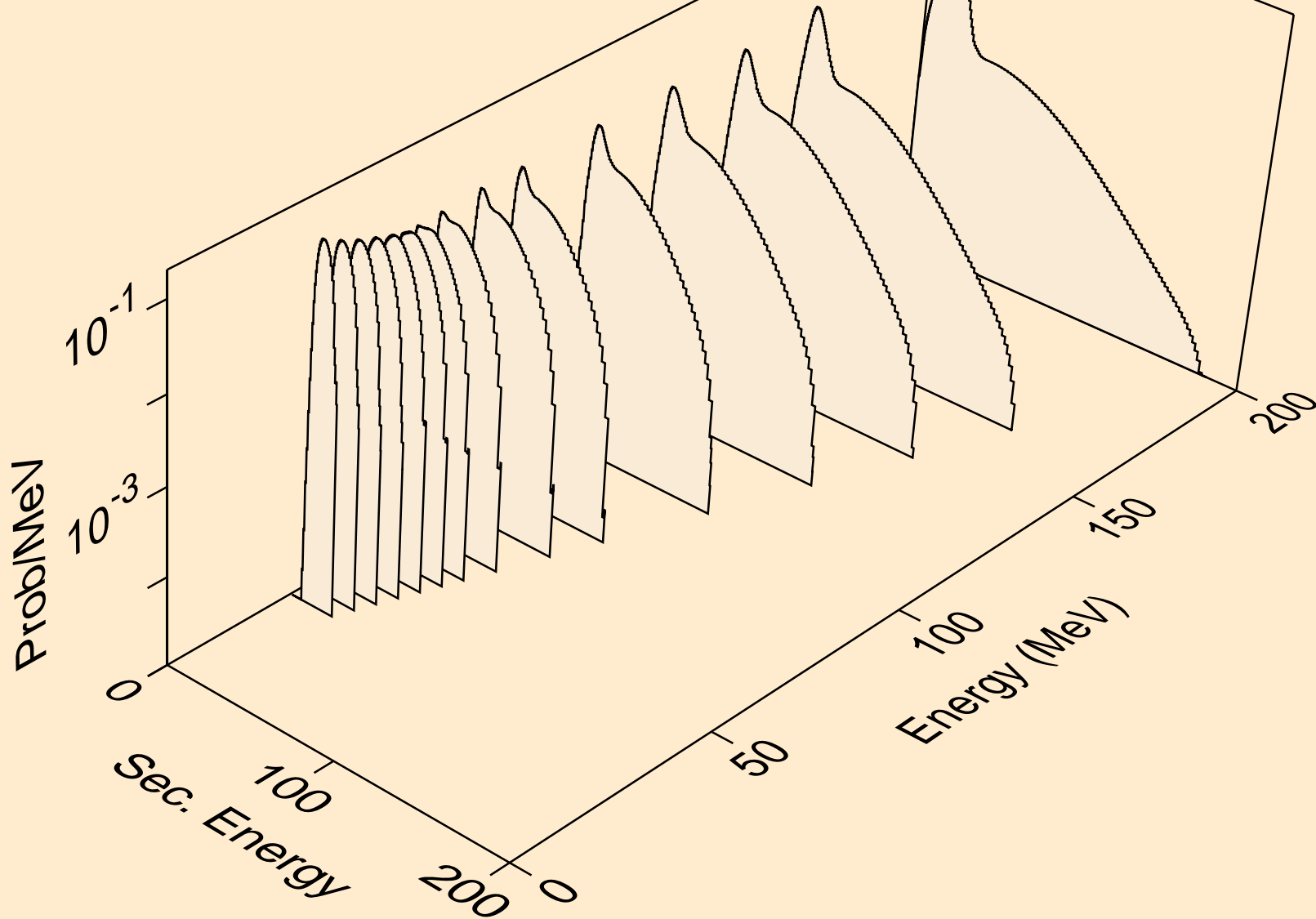

MO106 NEUTRON ACER TENDL-2019 LIBRARY; T=293.16K  
alphas from (n,n\*)a

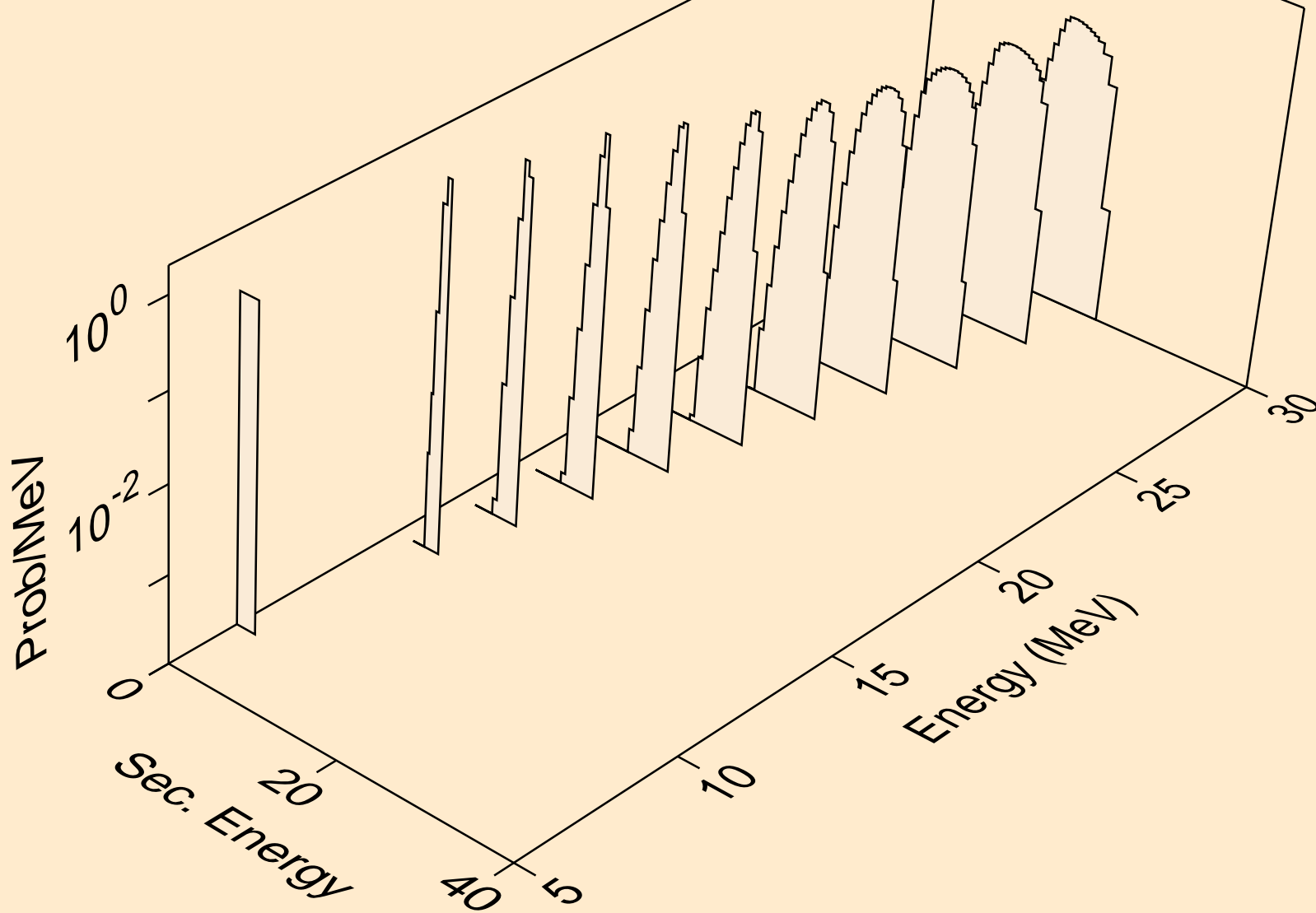

MO106 NEUTRON ACER TENDL-2019 LIBRARY; T=293.16K  
alphas from (n,2n)a

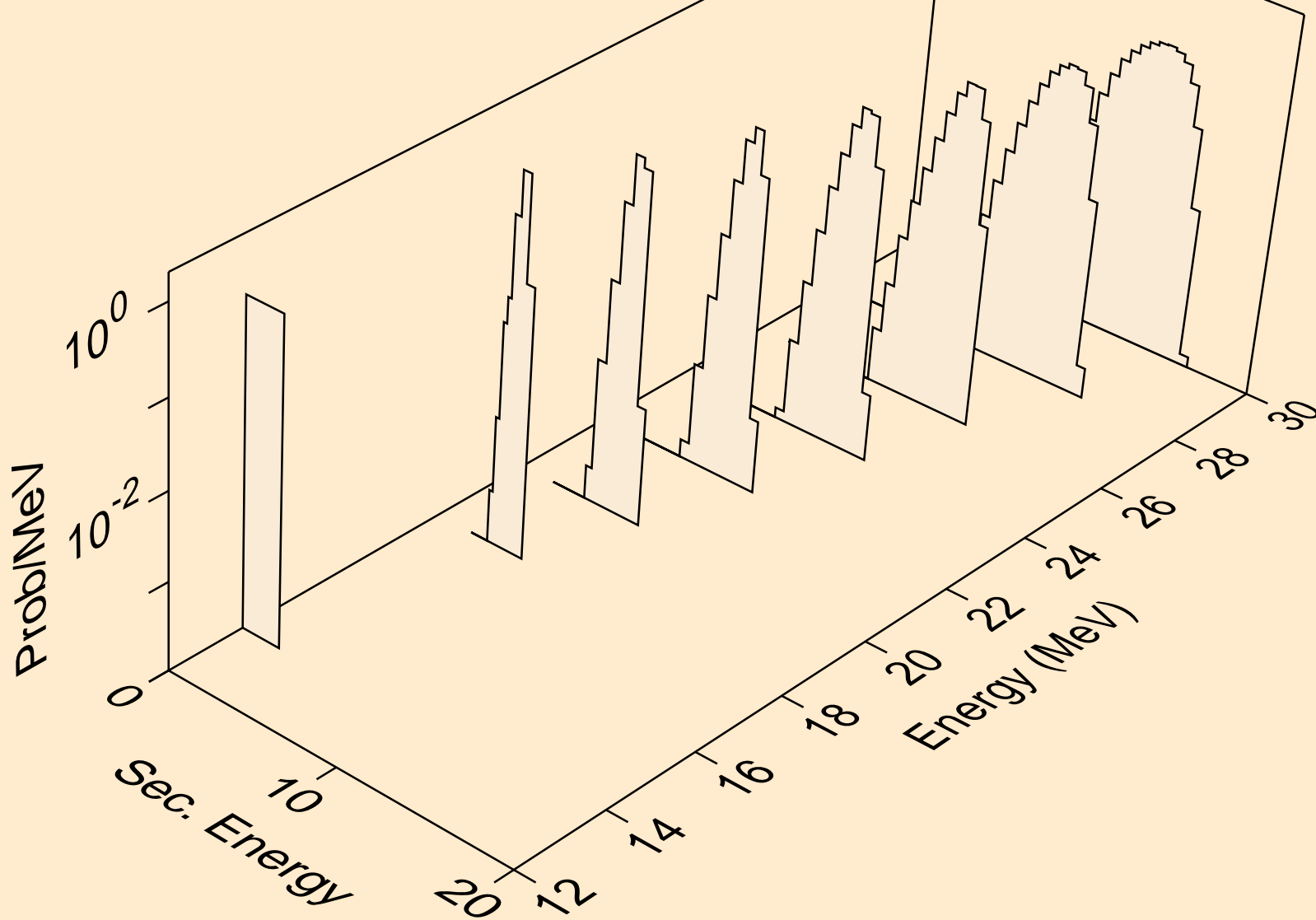

MO106 NEUTRON ACER TENDL-2019 LIBRARY; T=293.16K  
alphas from (n,3n)a

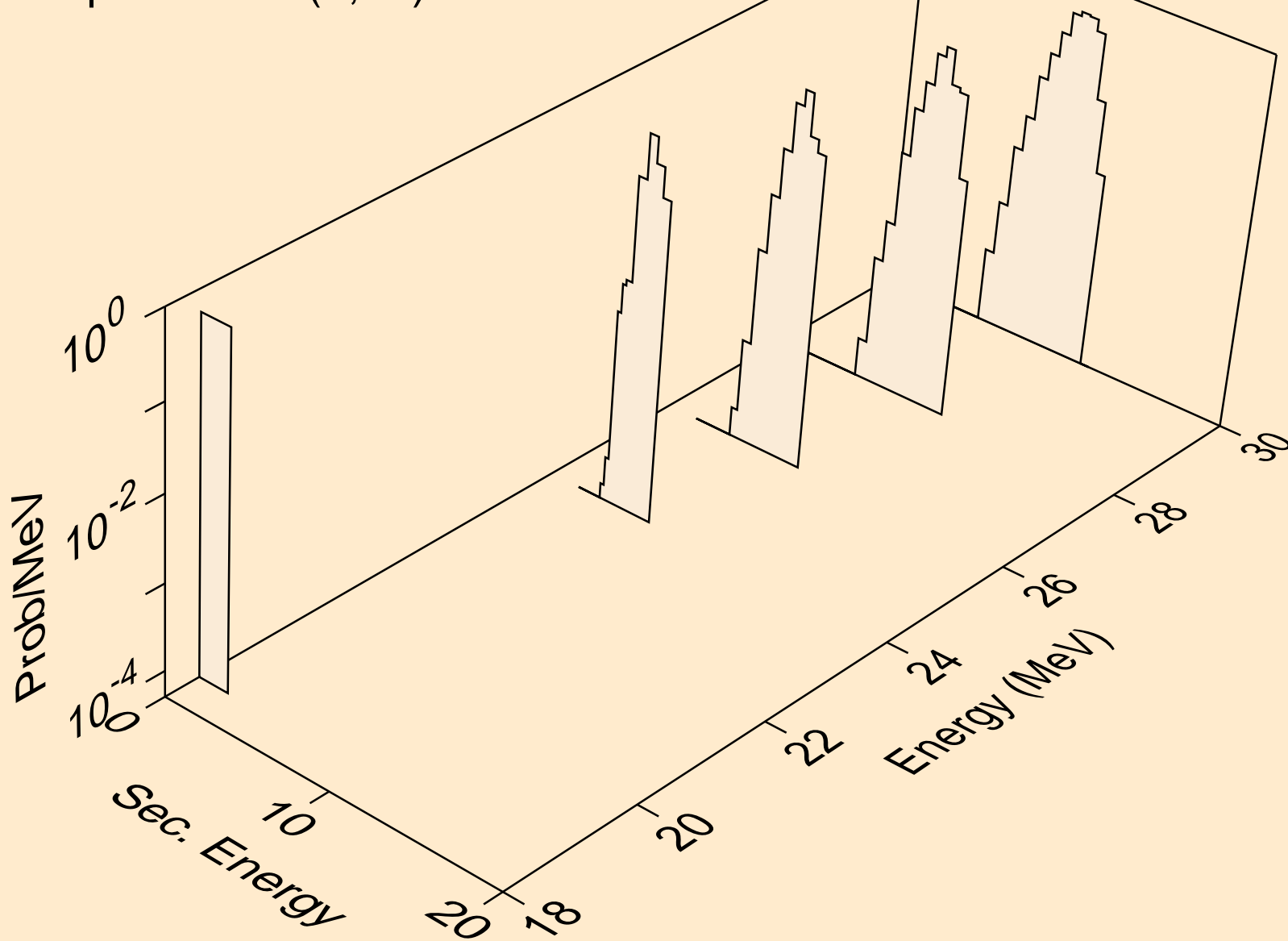



MO106 NEUTRON ACER TENDL-2019 LIBRARY; T=293.16K  
alphas from (n,a)

