

NA021 NEUTRON ACER TENDL-2019 LIBRARY; T=293.16K
Principal cross sections

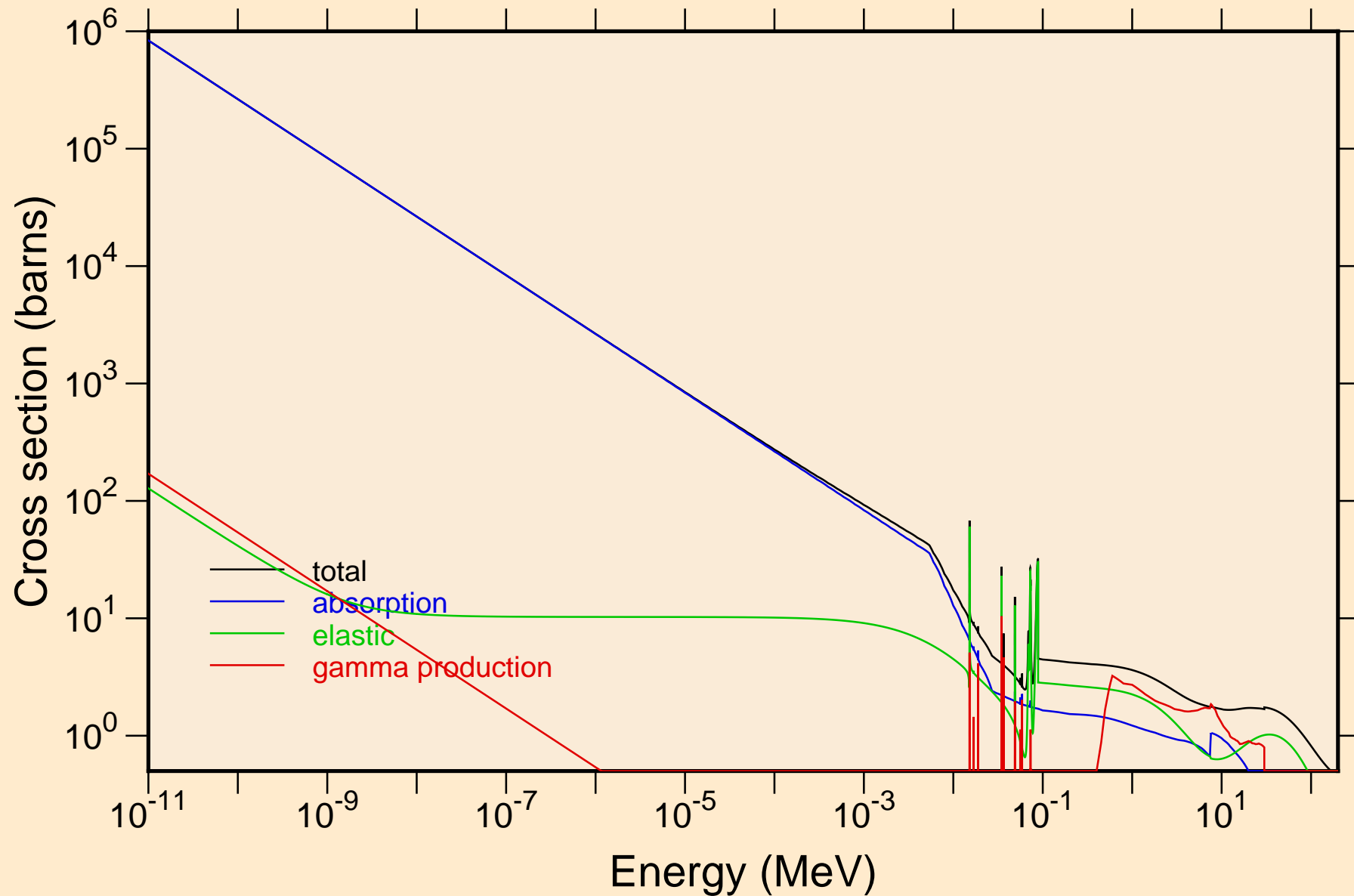

NA021 NEUTRON ACER TENDL-2019 LIBRARY; T=293.16K
resonance total cross section

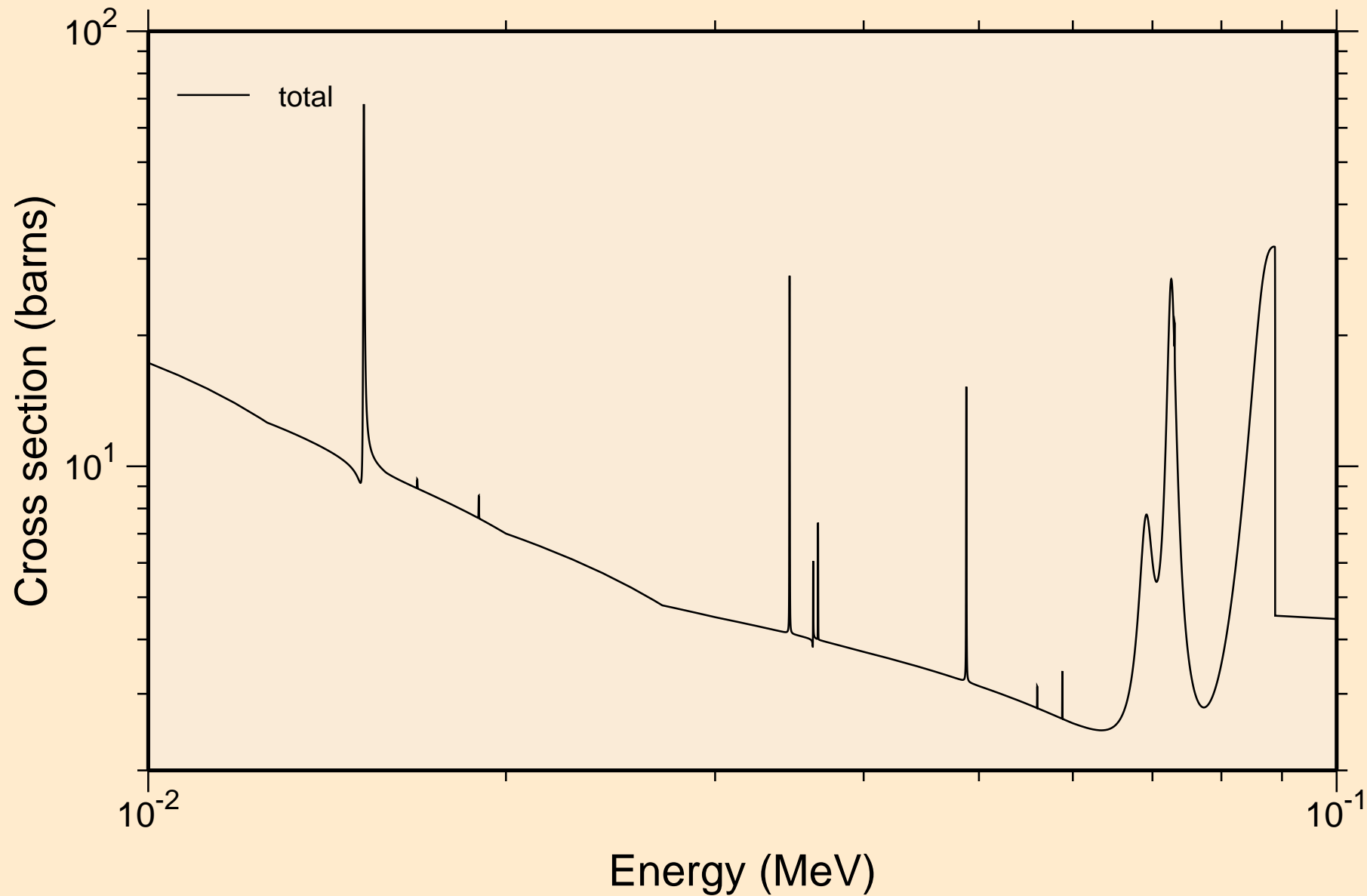

NA021 NEUTRON ACER TENDL-2019 LIBRARY; T=293.16K
resonance total cross section

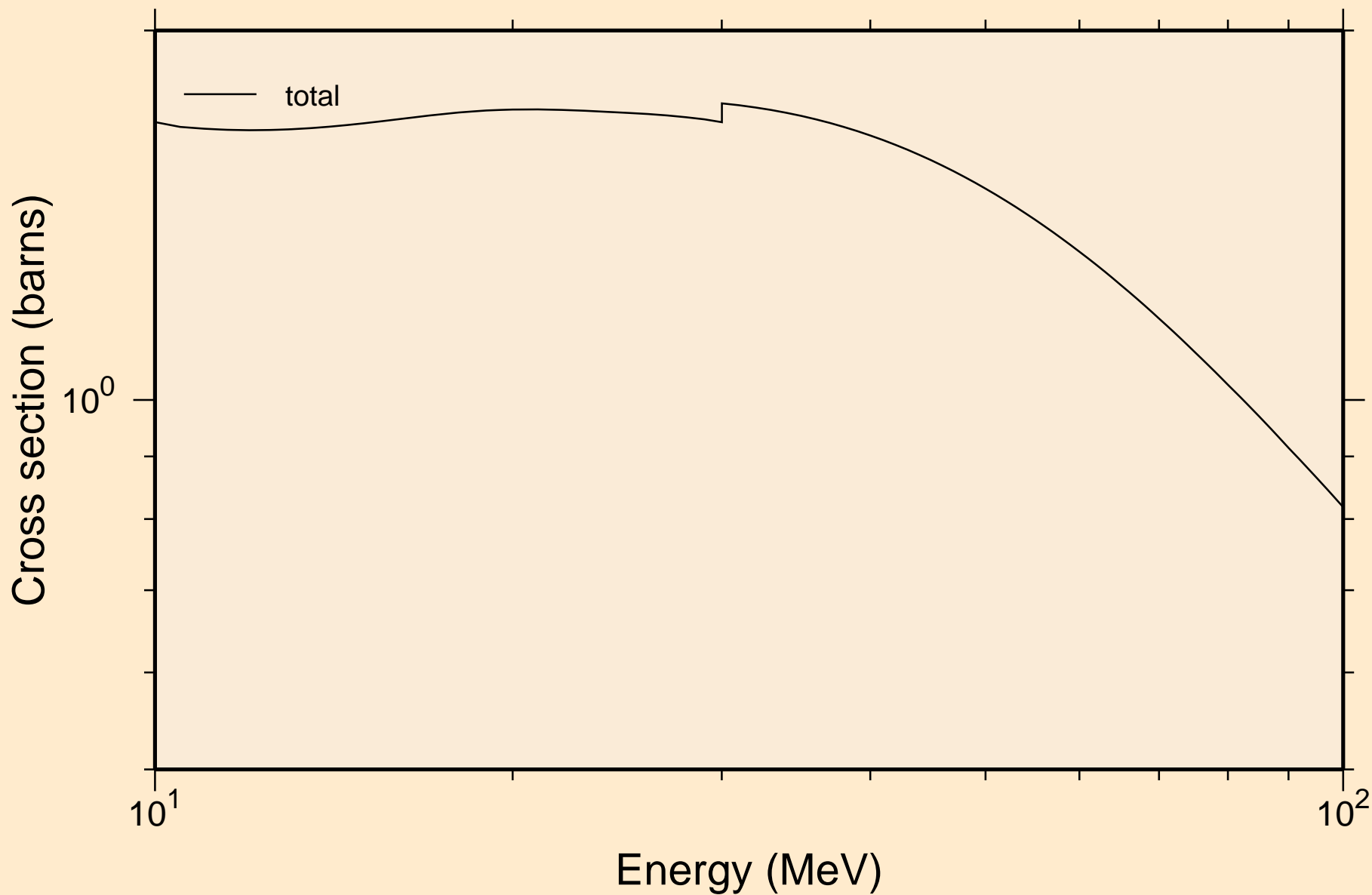

NA021 NEUTRON ACER TENDL-2019 LIBRARY; T=293.16K
resonance absorption cross sections

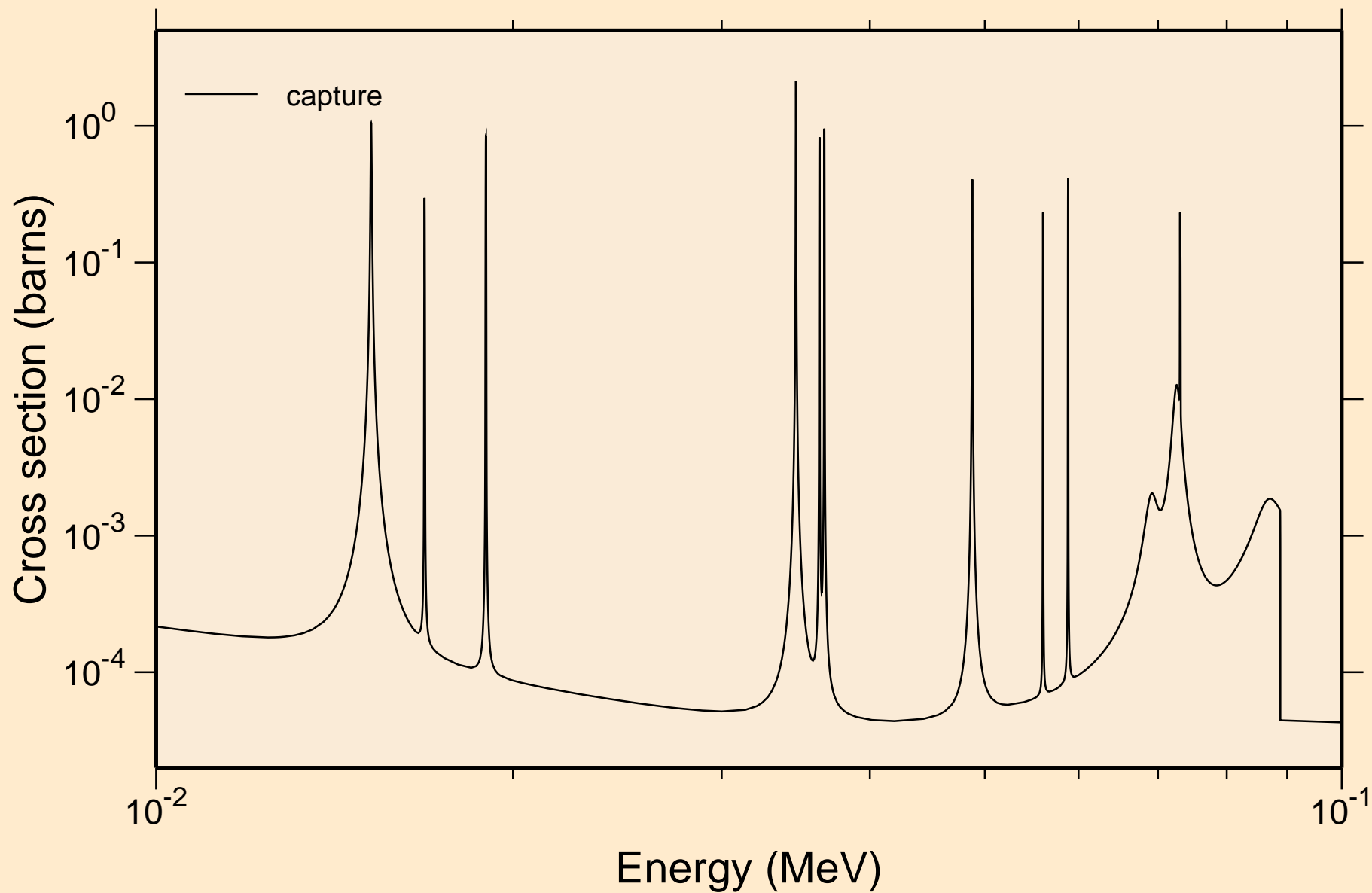

NA021 NEUTRON ACER TENDL-2019 LIBRARY; T=293.16K
resonance absorption cross sections

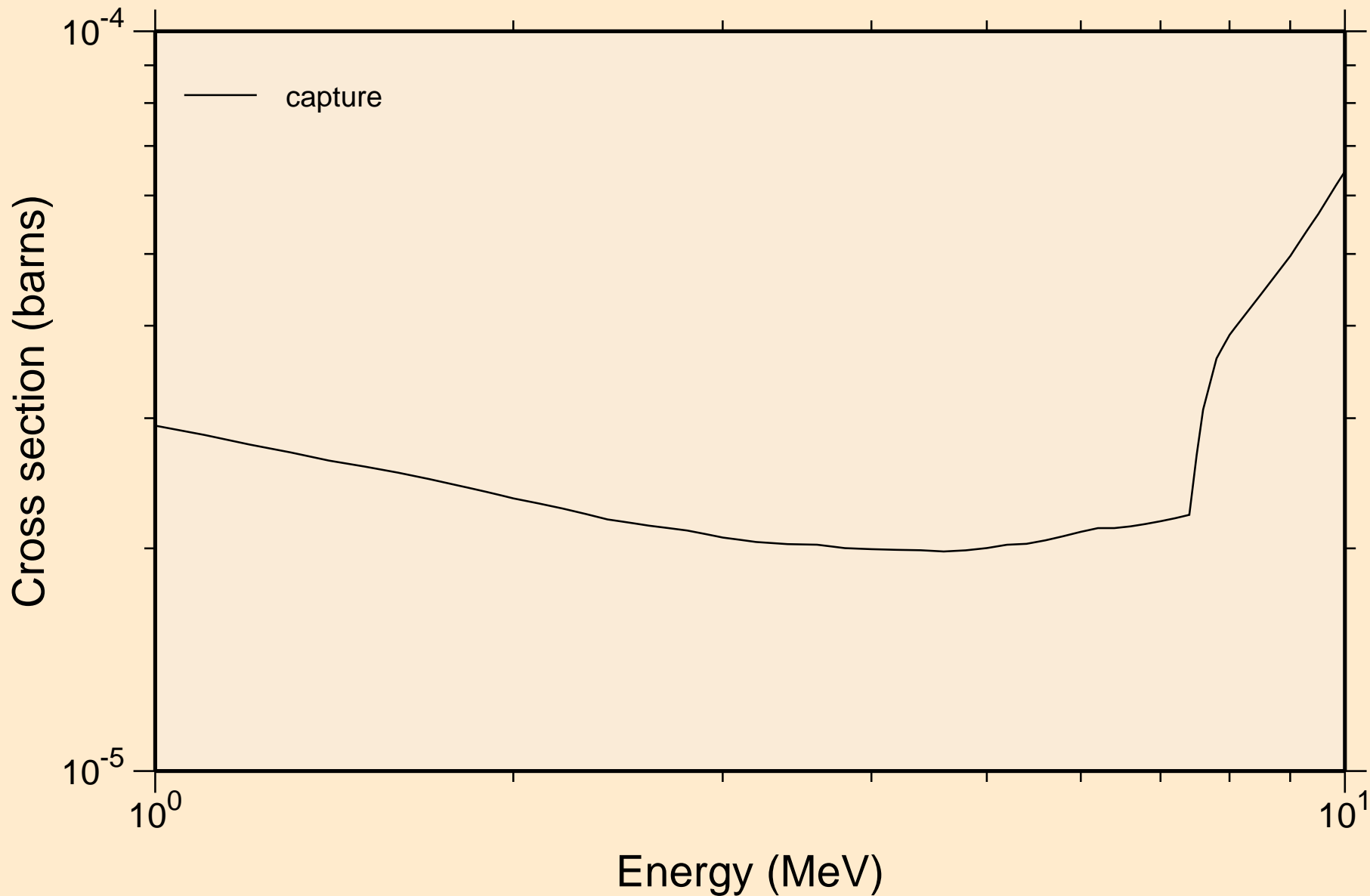

NA021 NEUTRON ACER TENDL-2019 LIBRARY; T=293.16K
Heating

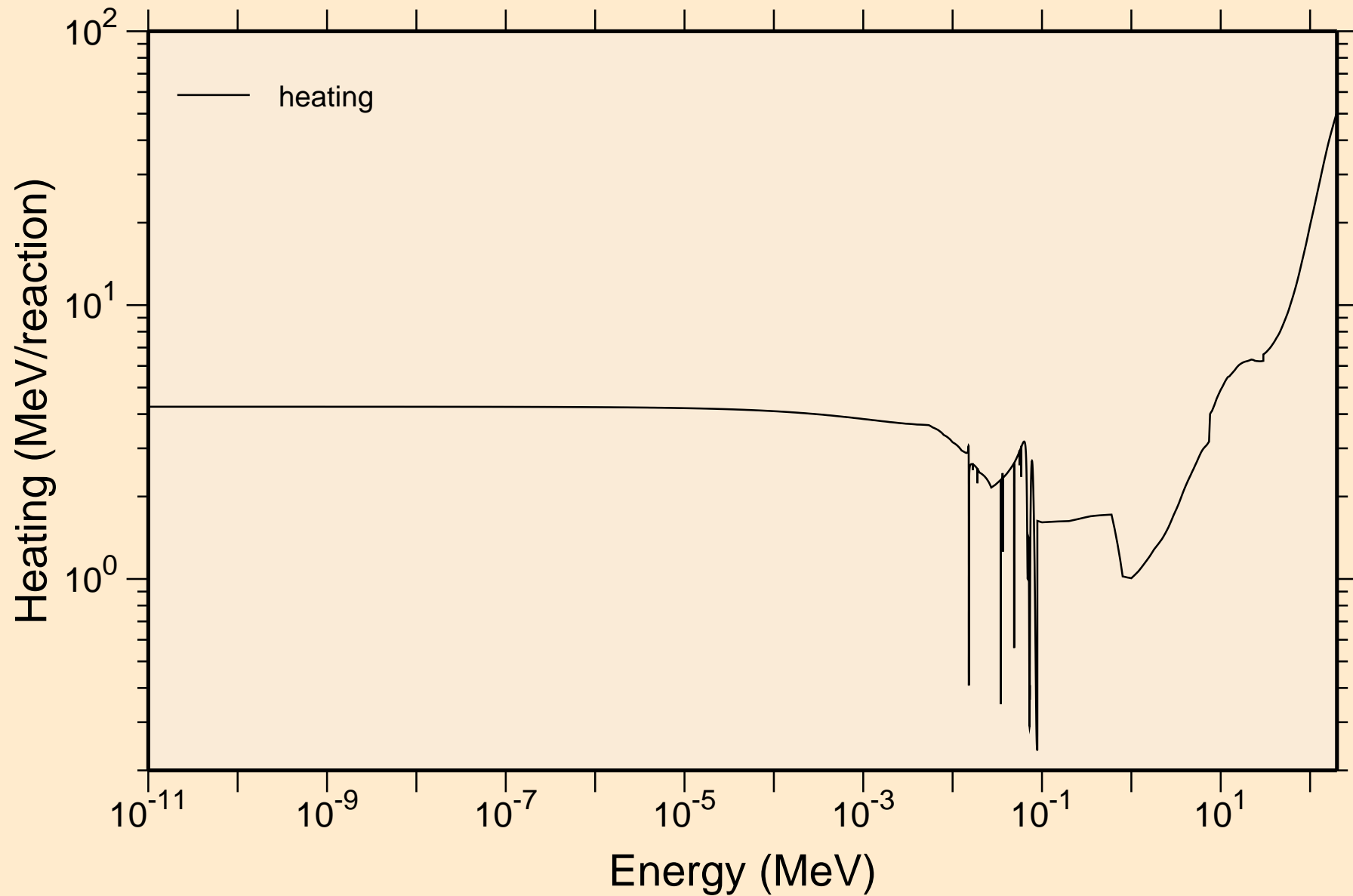

NA021 NEUTRON ACER TENDL-2019 LIBRARY; T=293.16K
Damage

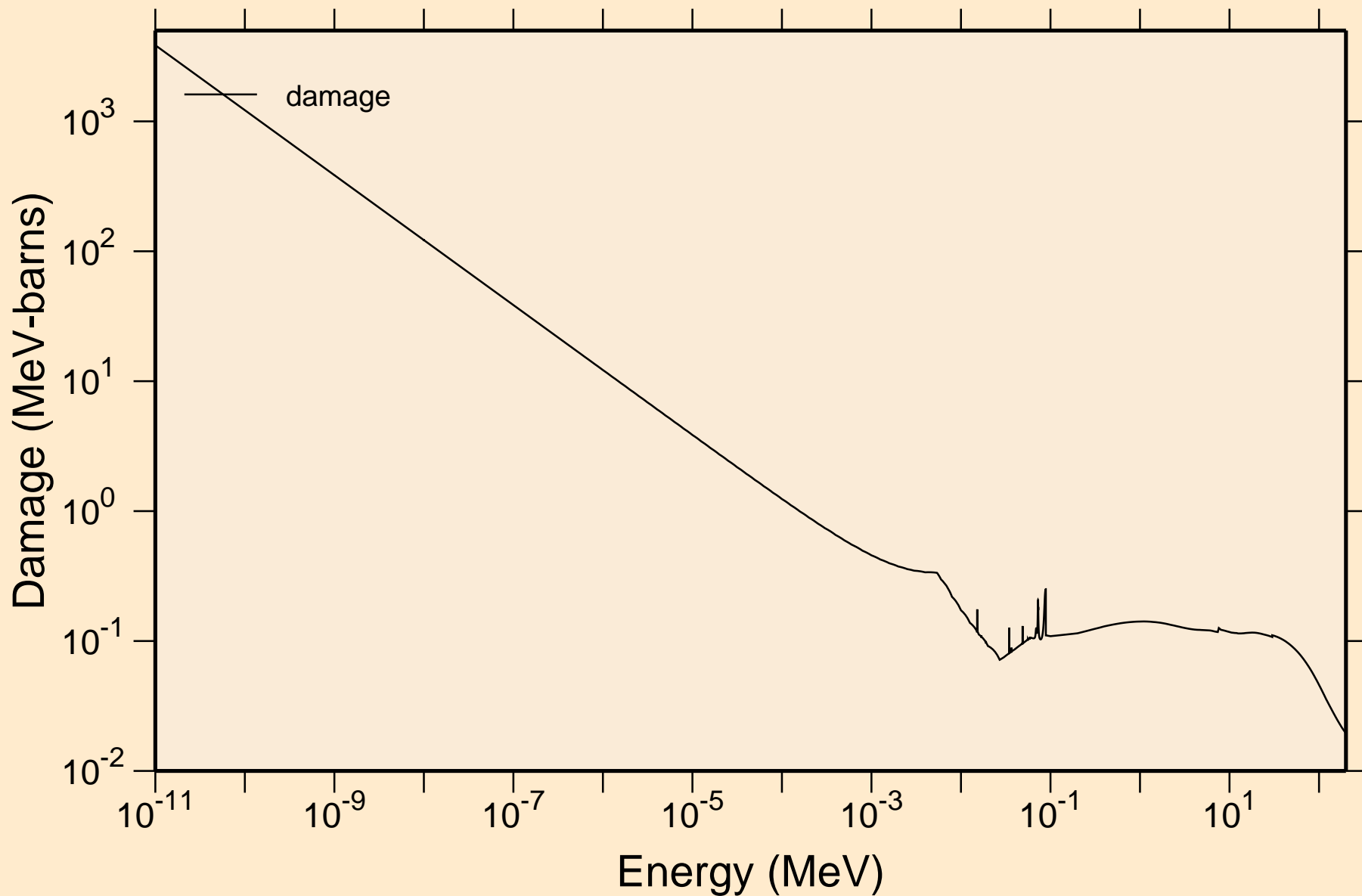

NA021 NEUTRON ACER TENDL-2019 LIBRARY; T=293.16K

Non-threshold reactions

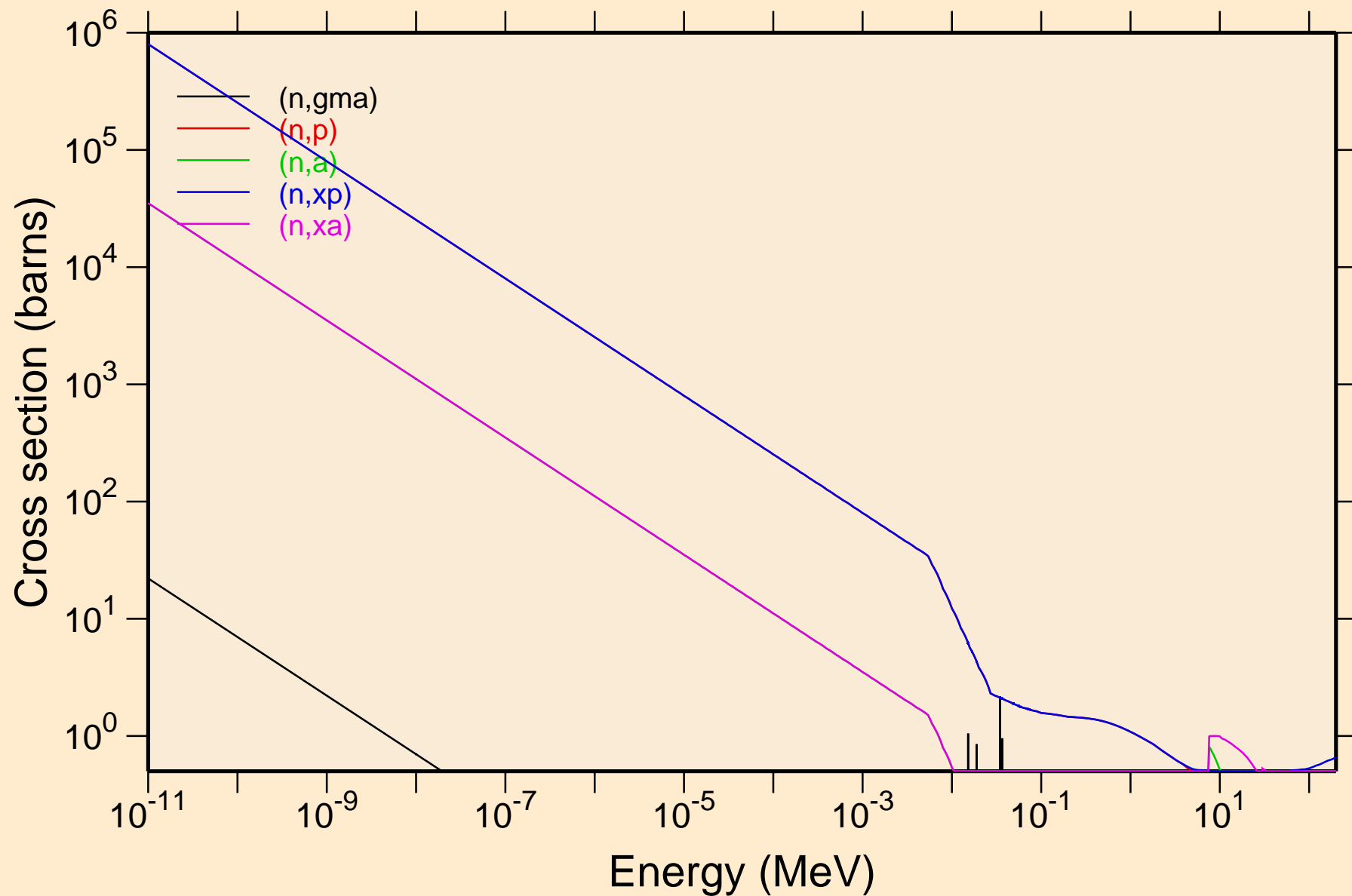

NA021 NEUTRON ACER TENDL-2019 LIBRARY; T=293.16K
Principal cross sections

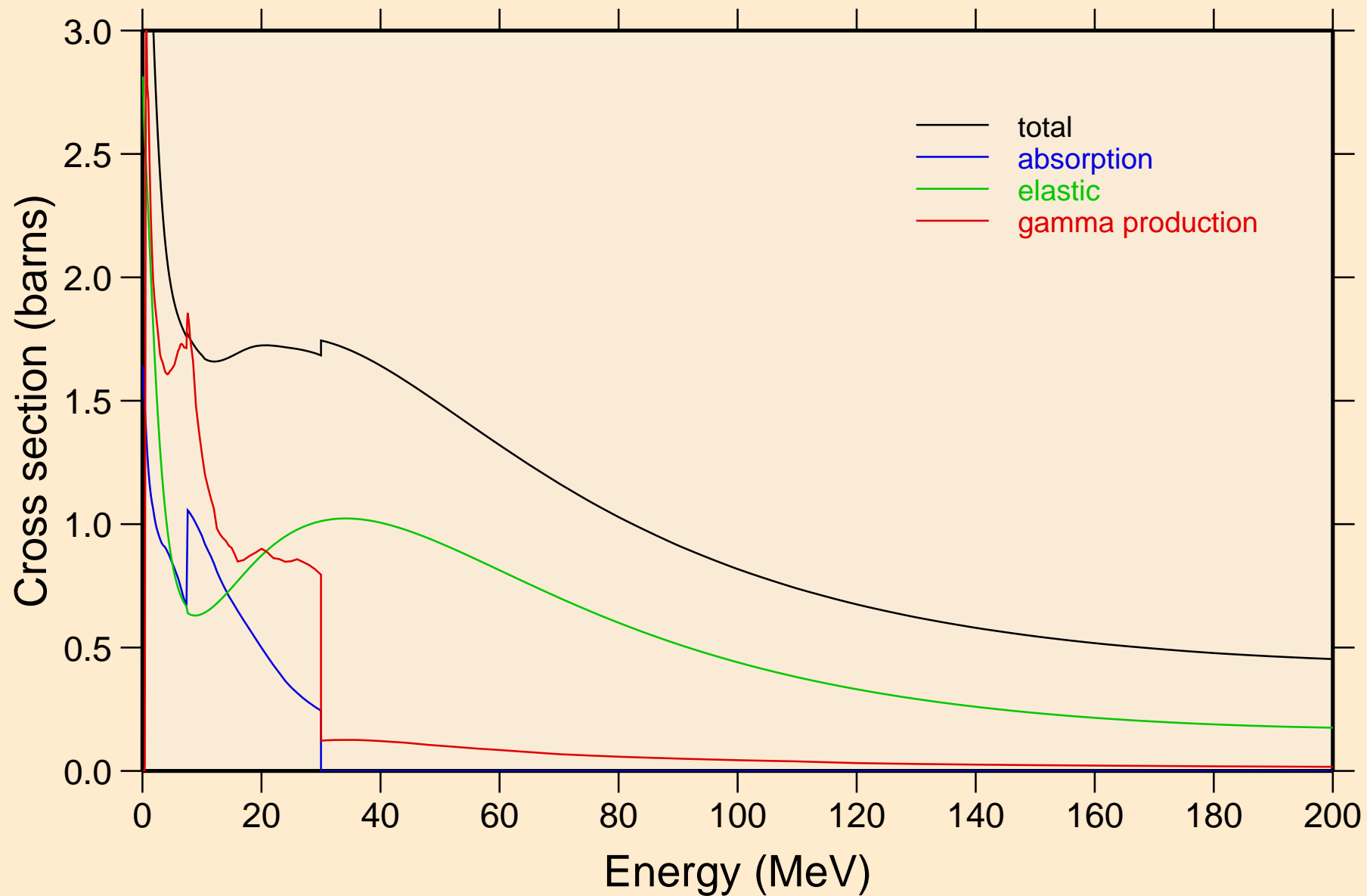

NA021 NEUTRON ACER TENDL-2019 LIBRARY; T=293.16K
Heating

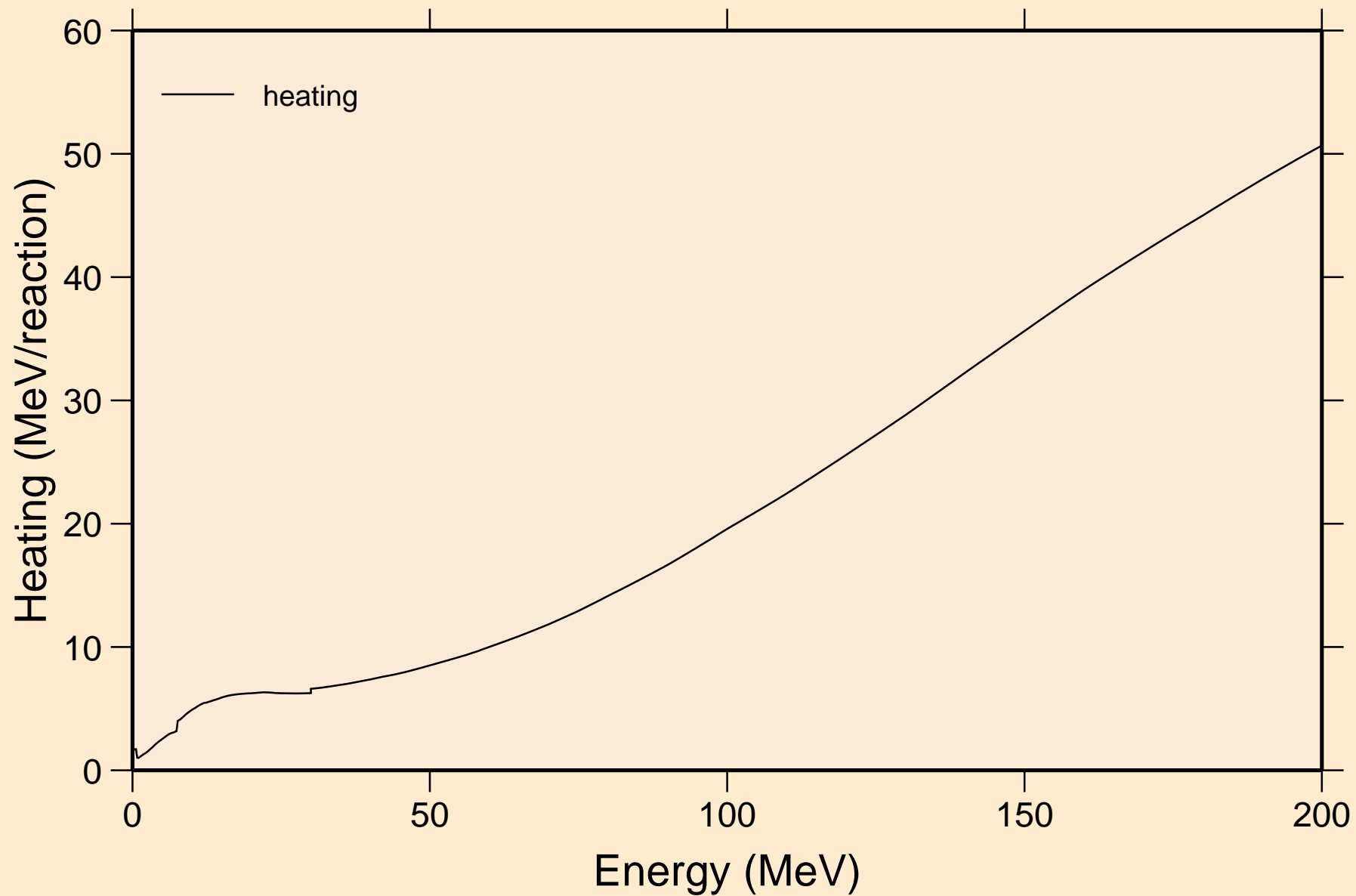

NA021 NEUTRON ACER TENDL-2019 LIBRARY; T=293.16K
Damage

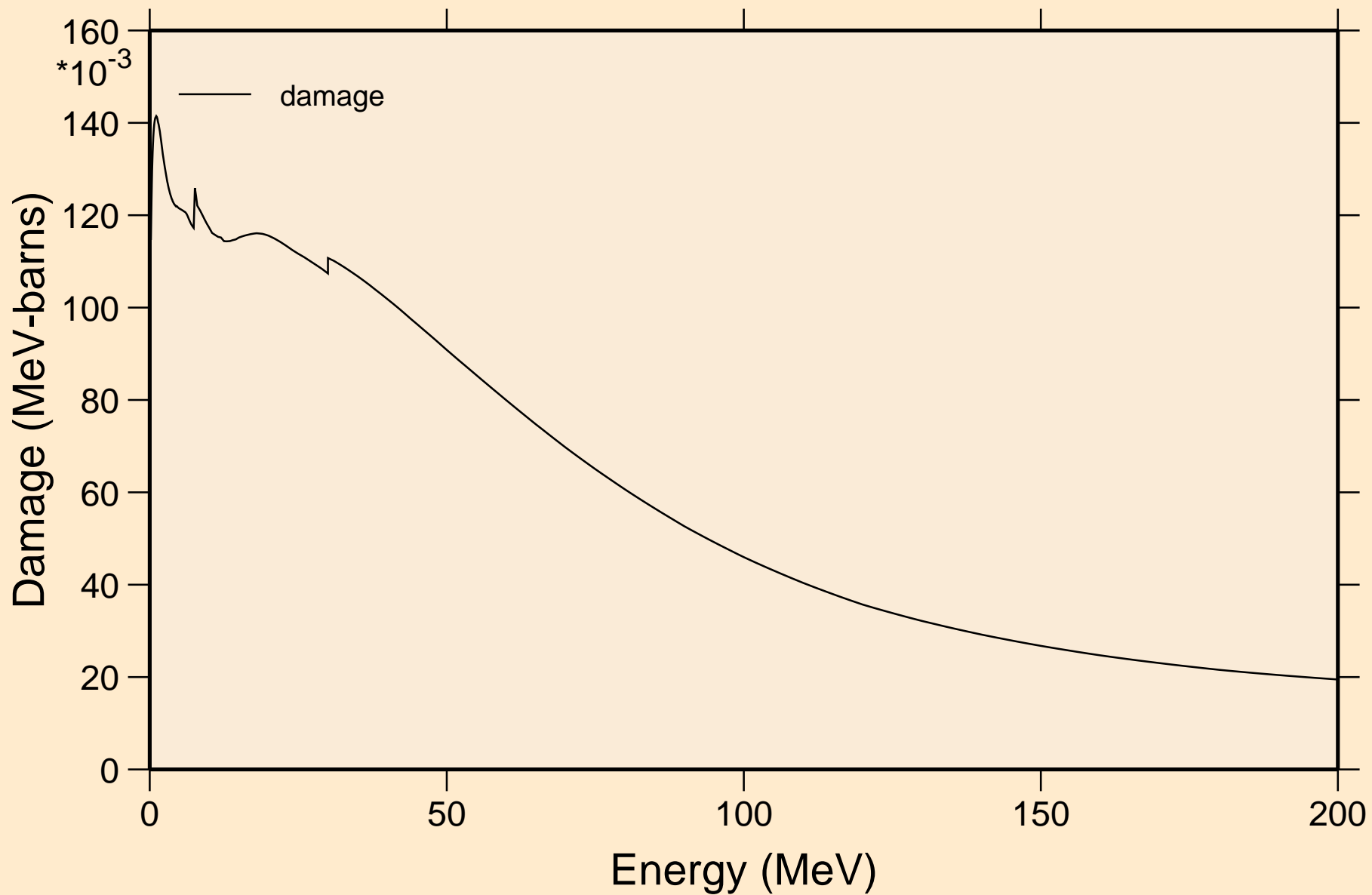

NA021 NEUTRON ACER TENDL-2019 LIBRARY; T=293.16K
Non-threshold reactions

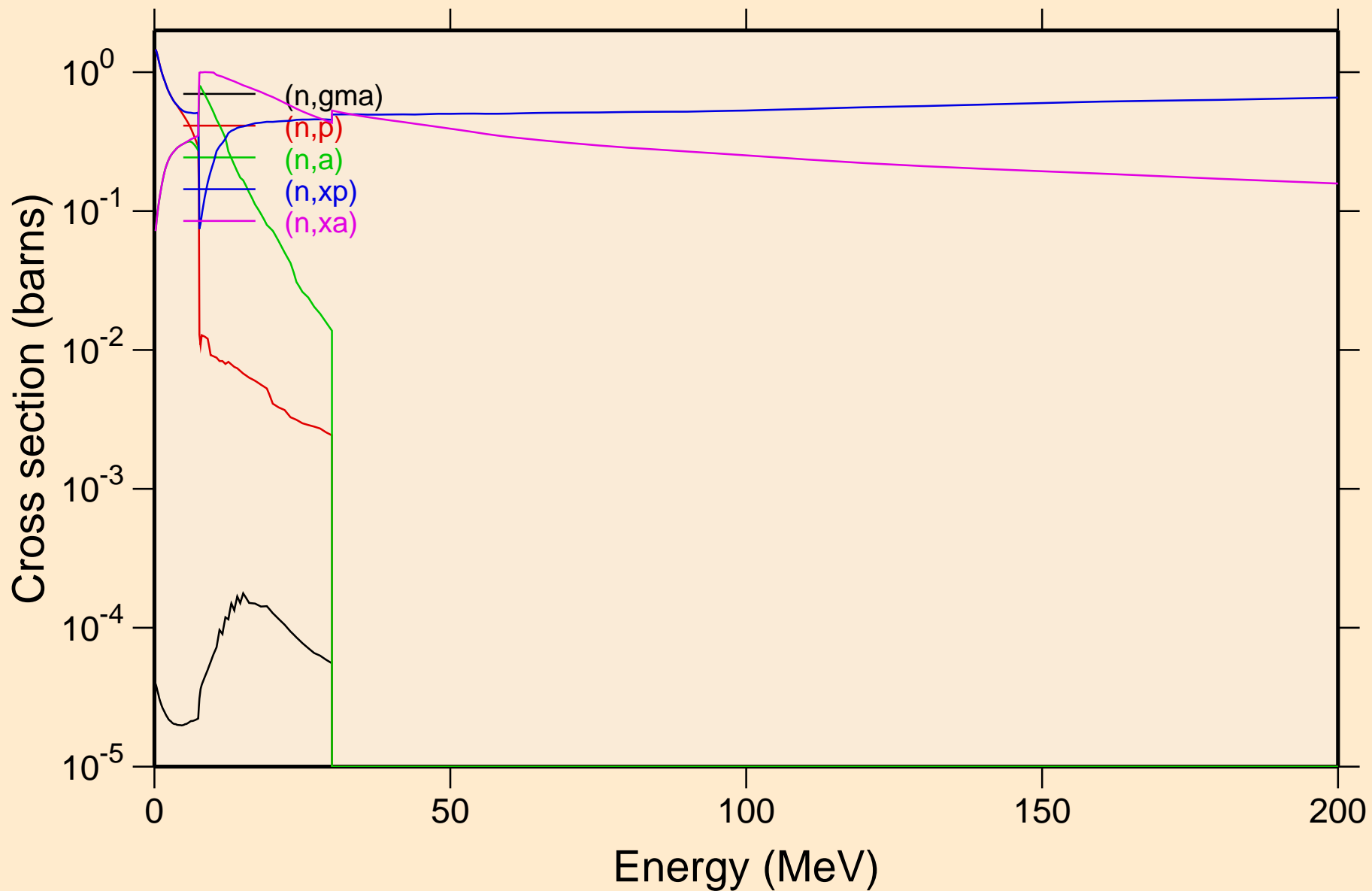

NA021 NEUTRON ACER TENDL-2019 LIBRARY; T=293.16K
Inelastic levels

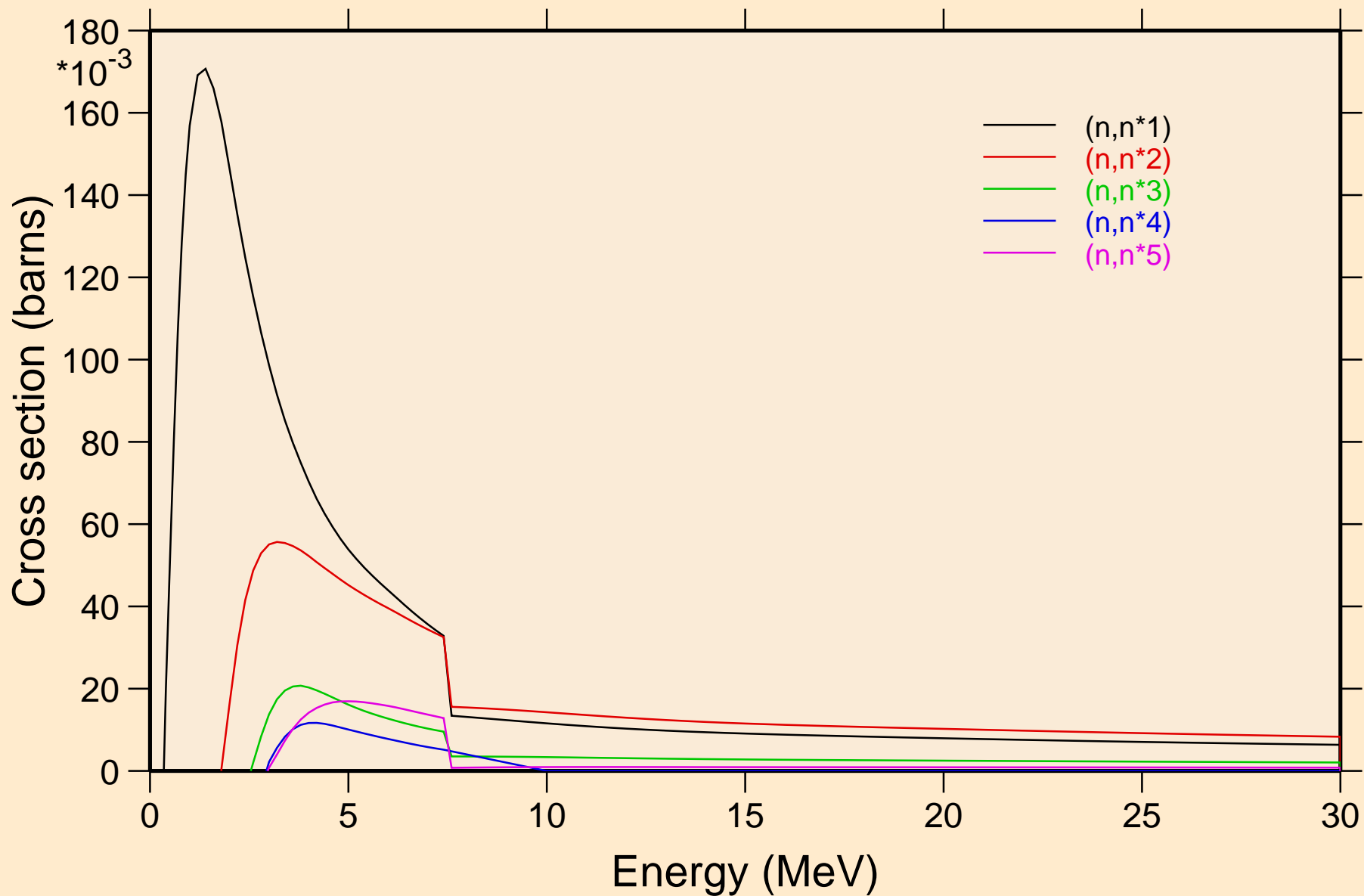

NA021 NEUTRON ACER TENDL-2019 LIBRARY; T=293.16K
Inelastic levels

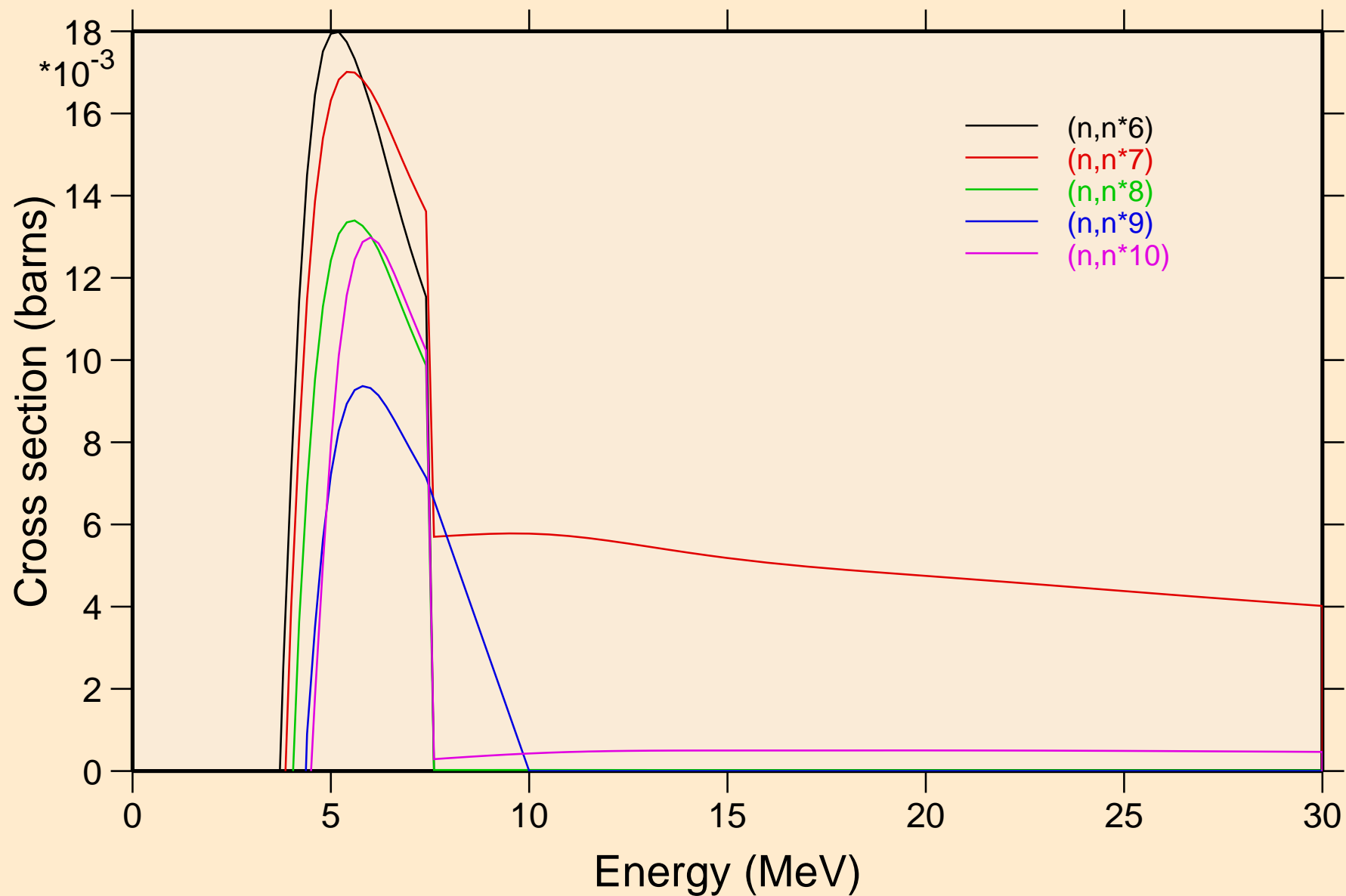

NA021 NEUTRON ACER TENDL-2019 LIBRARY; T=293.16K
Threshold reactions

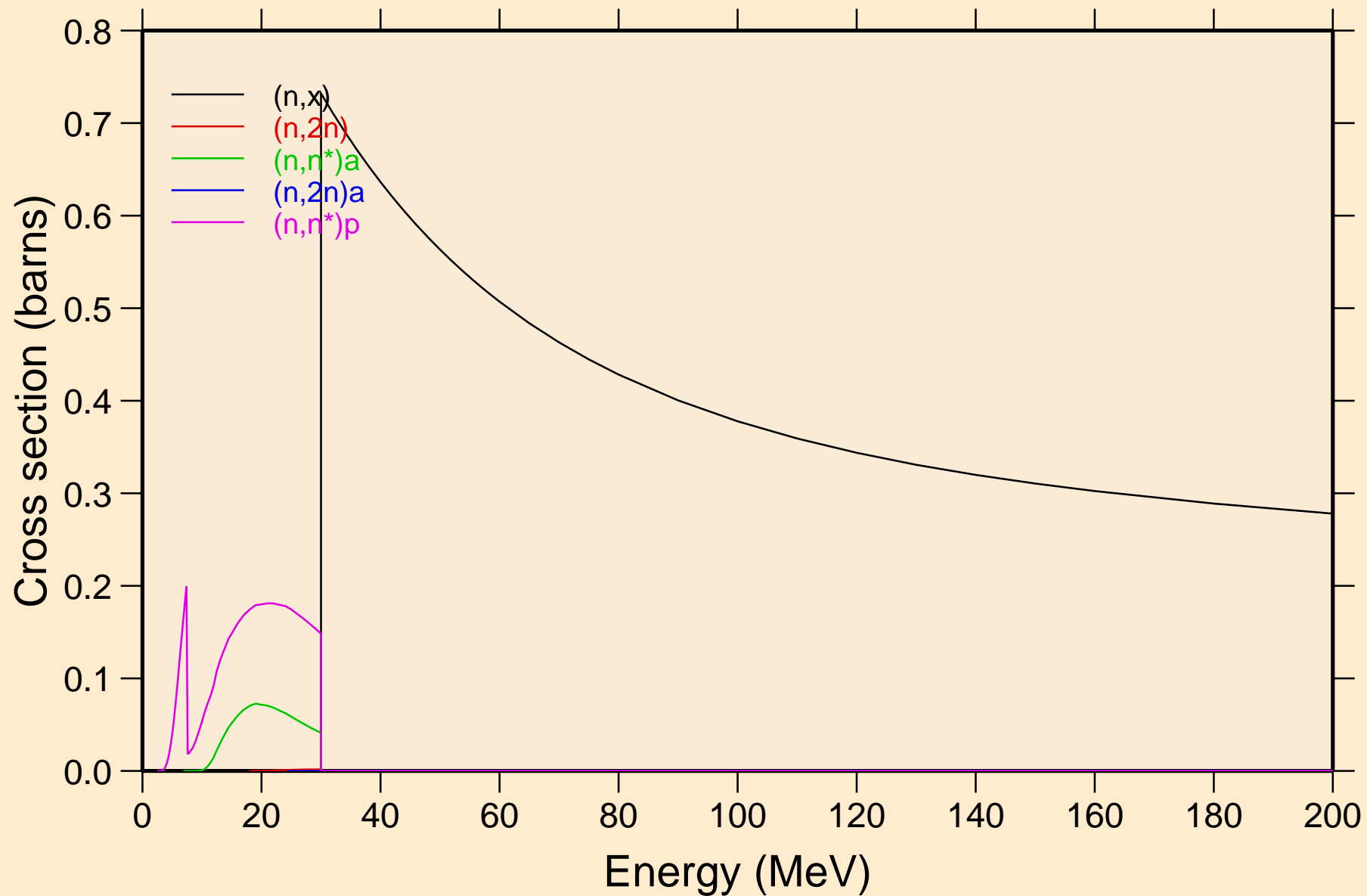

NA021 NEUTRON ACER TENDL-2019 LIBRARY; T=293.16K
Threshold reactions

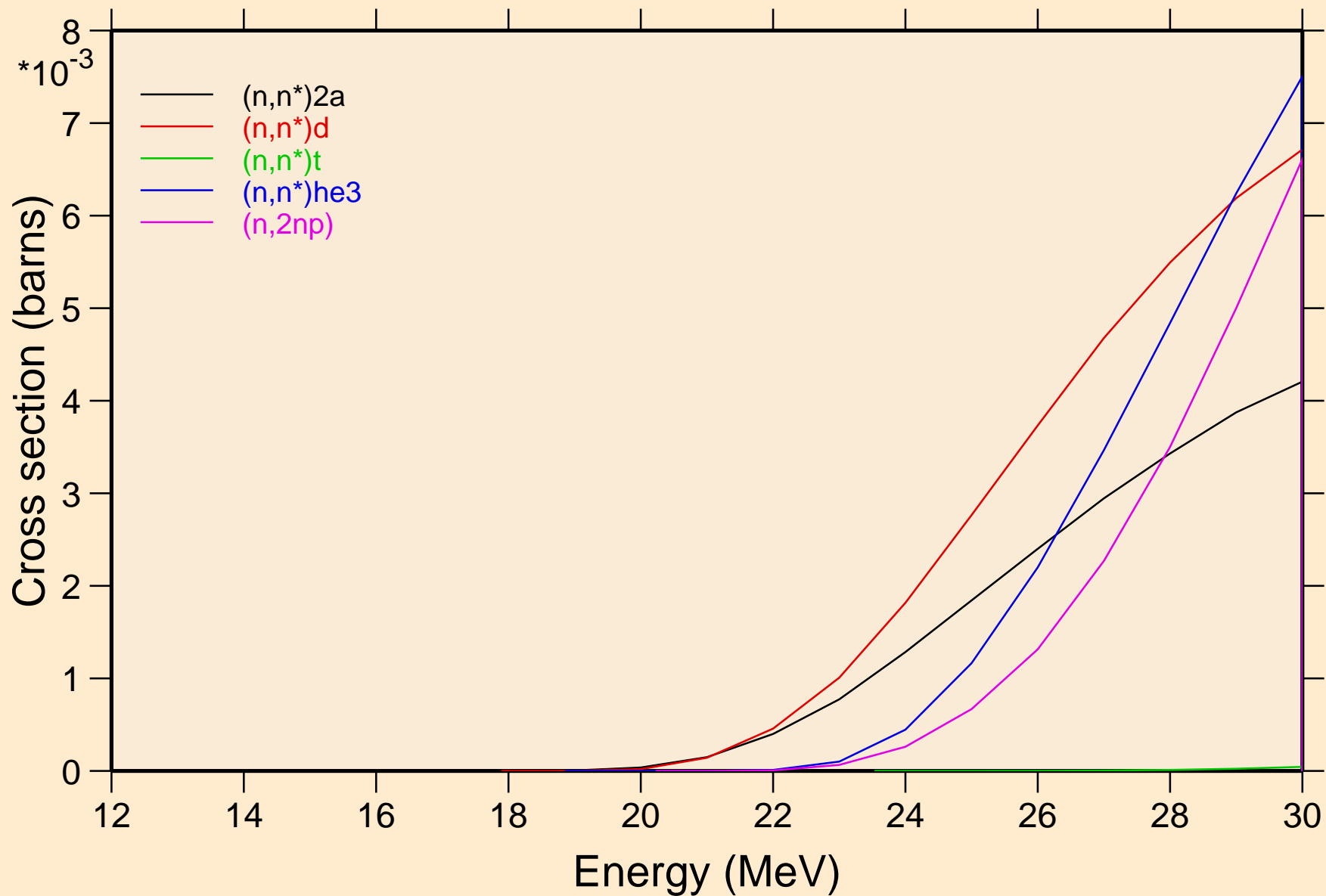

NA021 NEUTRON ACER TENDL-2019 LIBRARY; T=293.16K
Threshold reactions

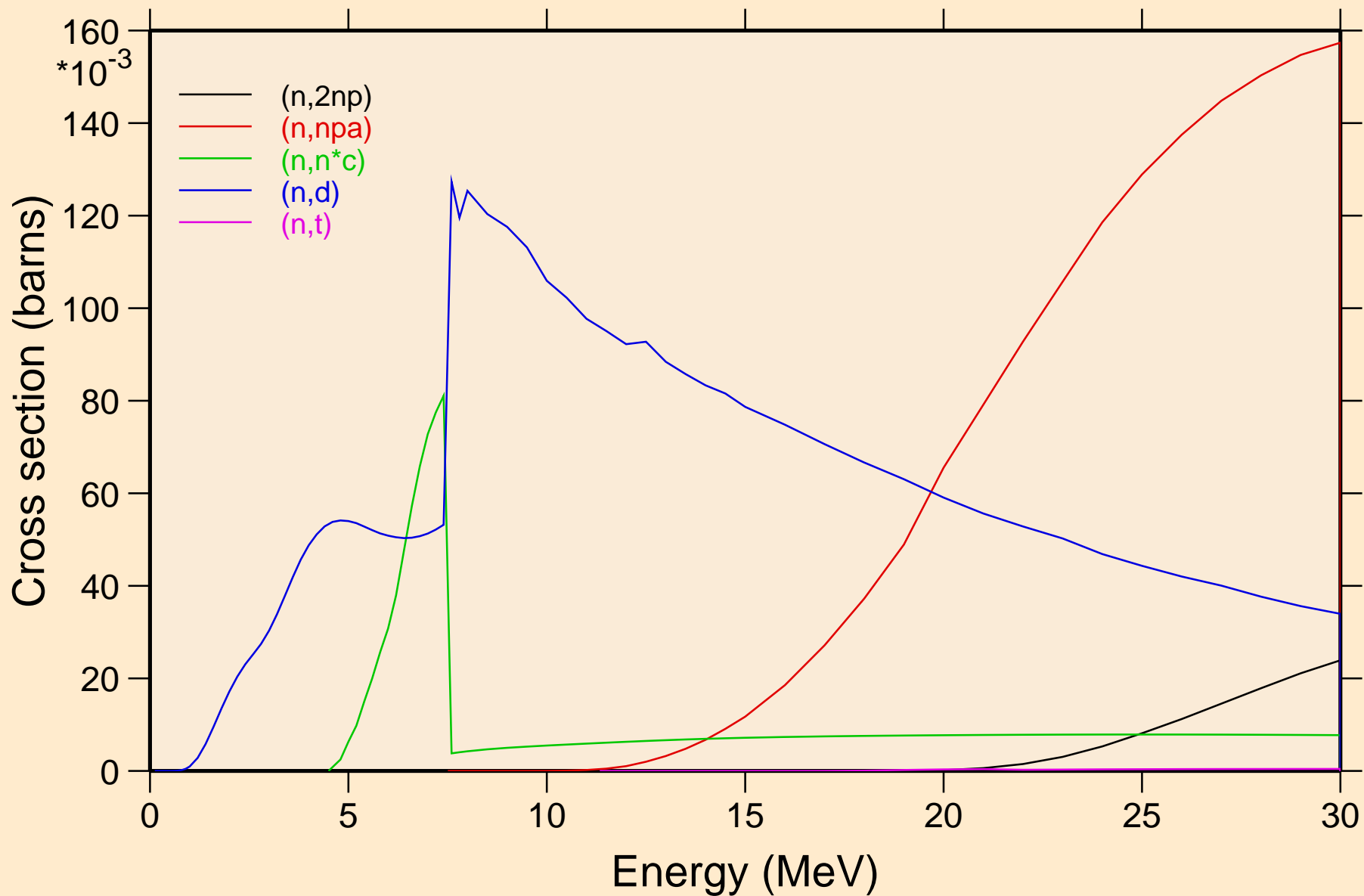

NA021 NEUTRON ACER TENDL-2019 LIBRARY; T=293.16K
Threshold reactions

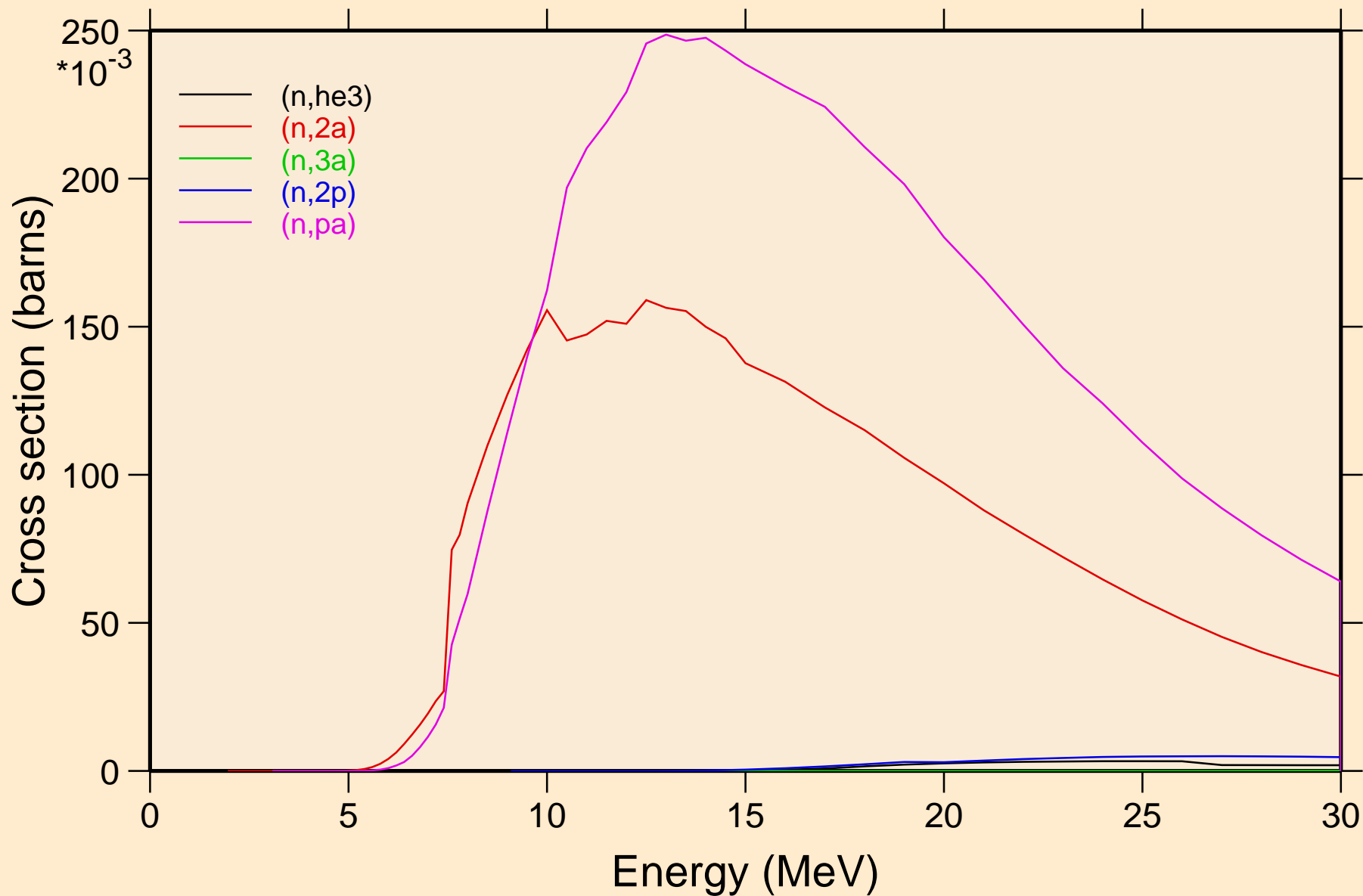

NA021 NEUTRON ACER TENDL-2019 LIBRARY; T=293.16K
Threshold reactions

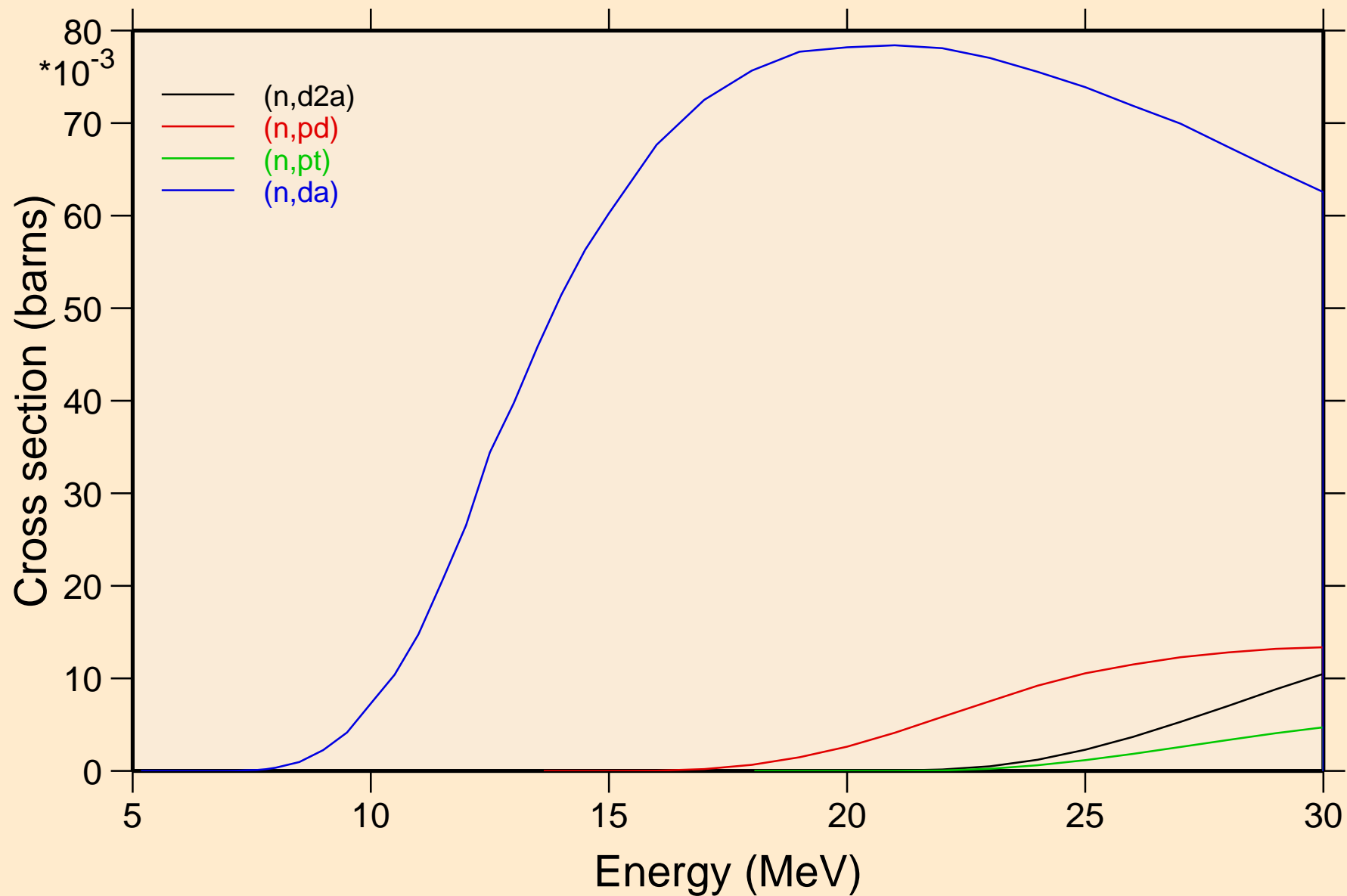

NA021 NEUTRON ACER TENDL-2019 LIBRARY; T=293.16K
Threshold reactions

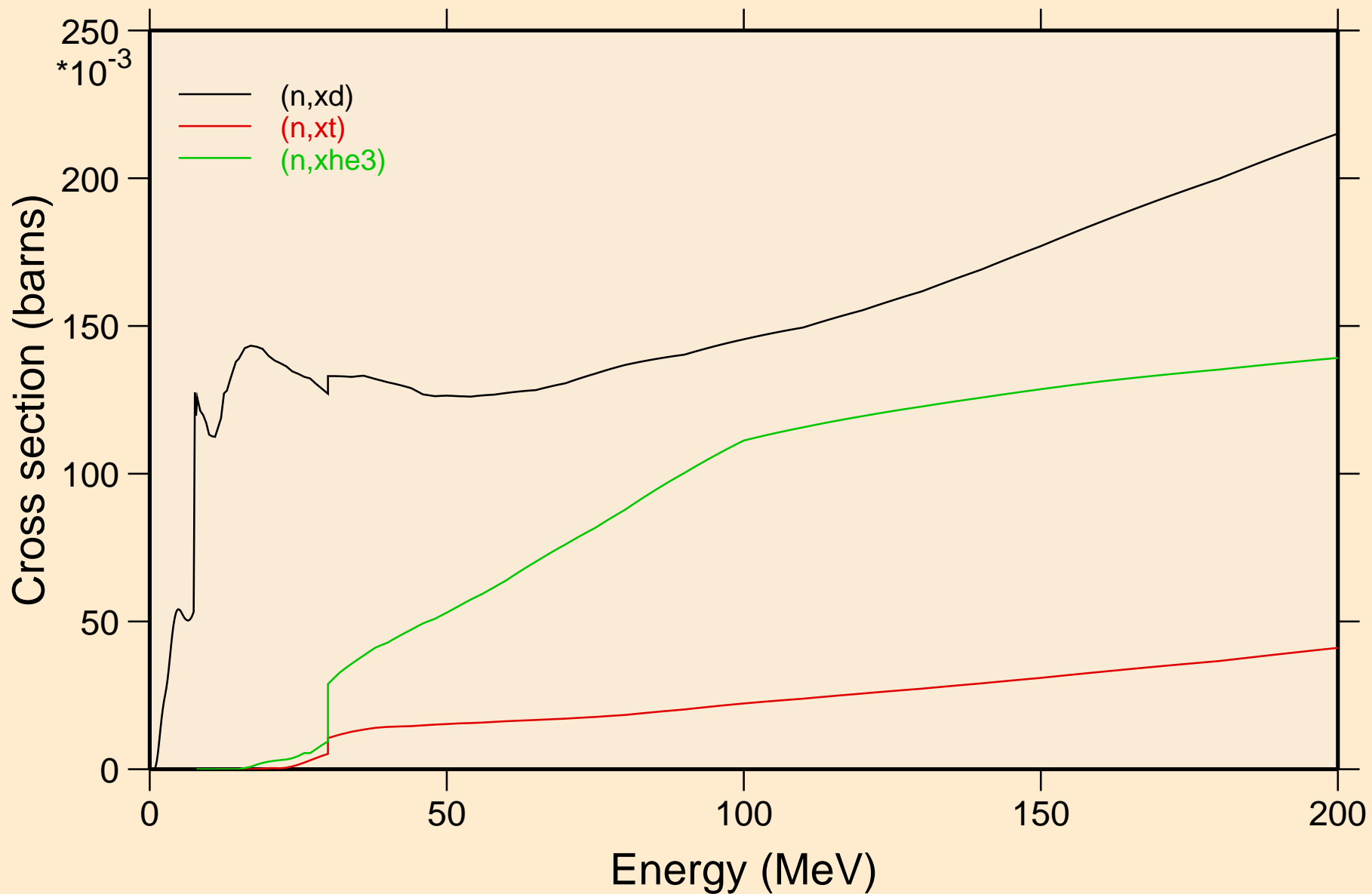

NA021 NEUTRON ACER TENDL-2019 LIBRARY; T=293.16K
angular distribution for elastic

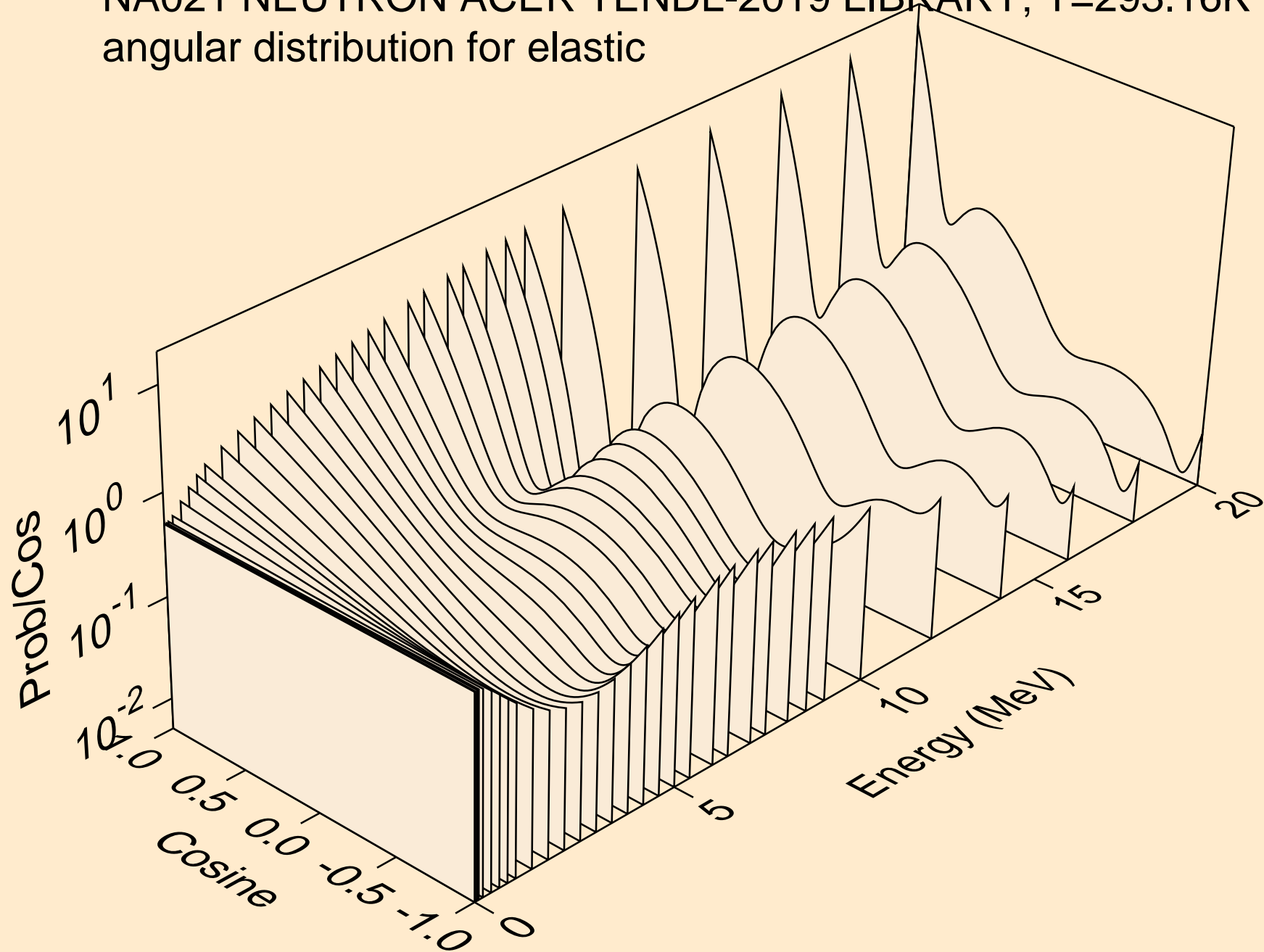

NA021 NEUTRON ACER TENDL-2019 LIBRARY; T=293.16K
angular distribution for elastic

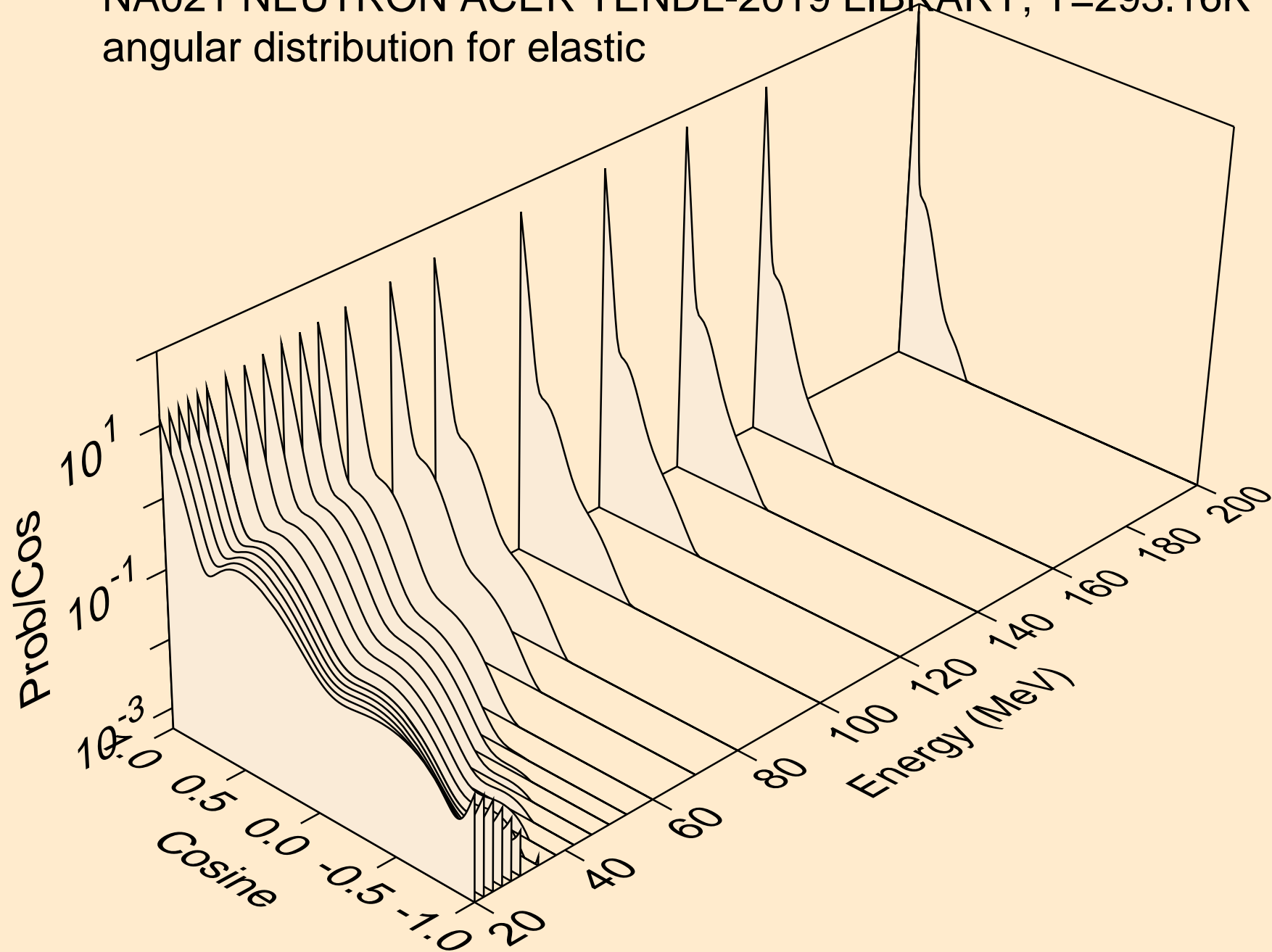

NA021 NEUTRON ACER TENDL-2019 LIBRARY; T=293.16K
angular distribution for (n,n*1)

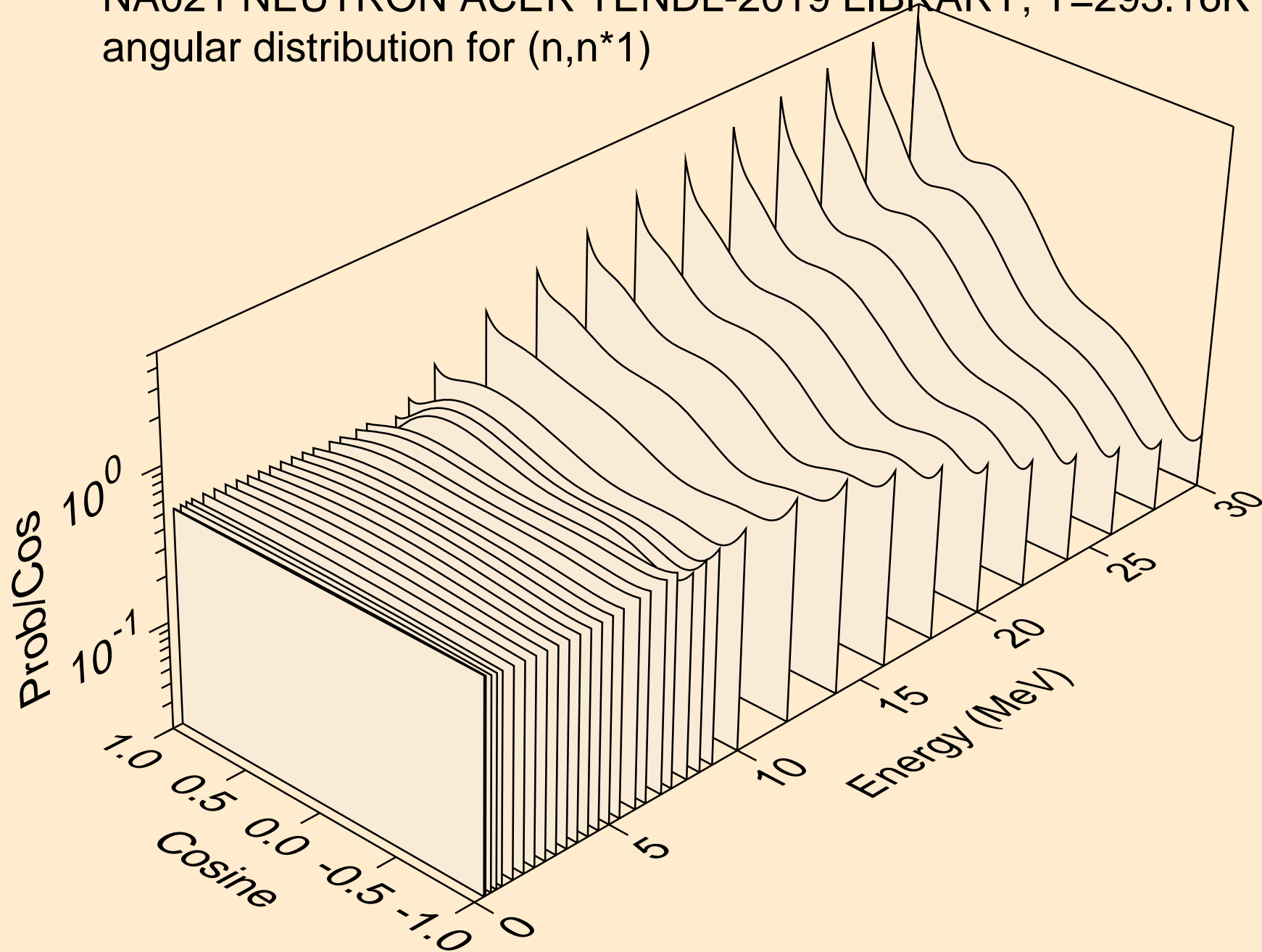

NA021 NEUTRON ACER TENDL-2019 LIBRARY; T=293.16K
angular distribution for (n,n*2)

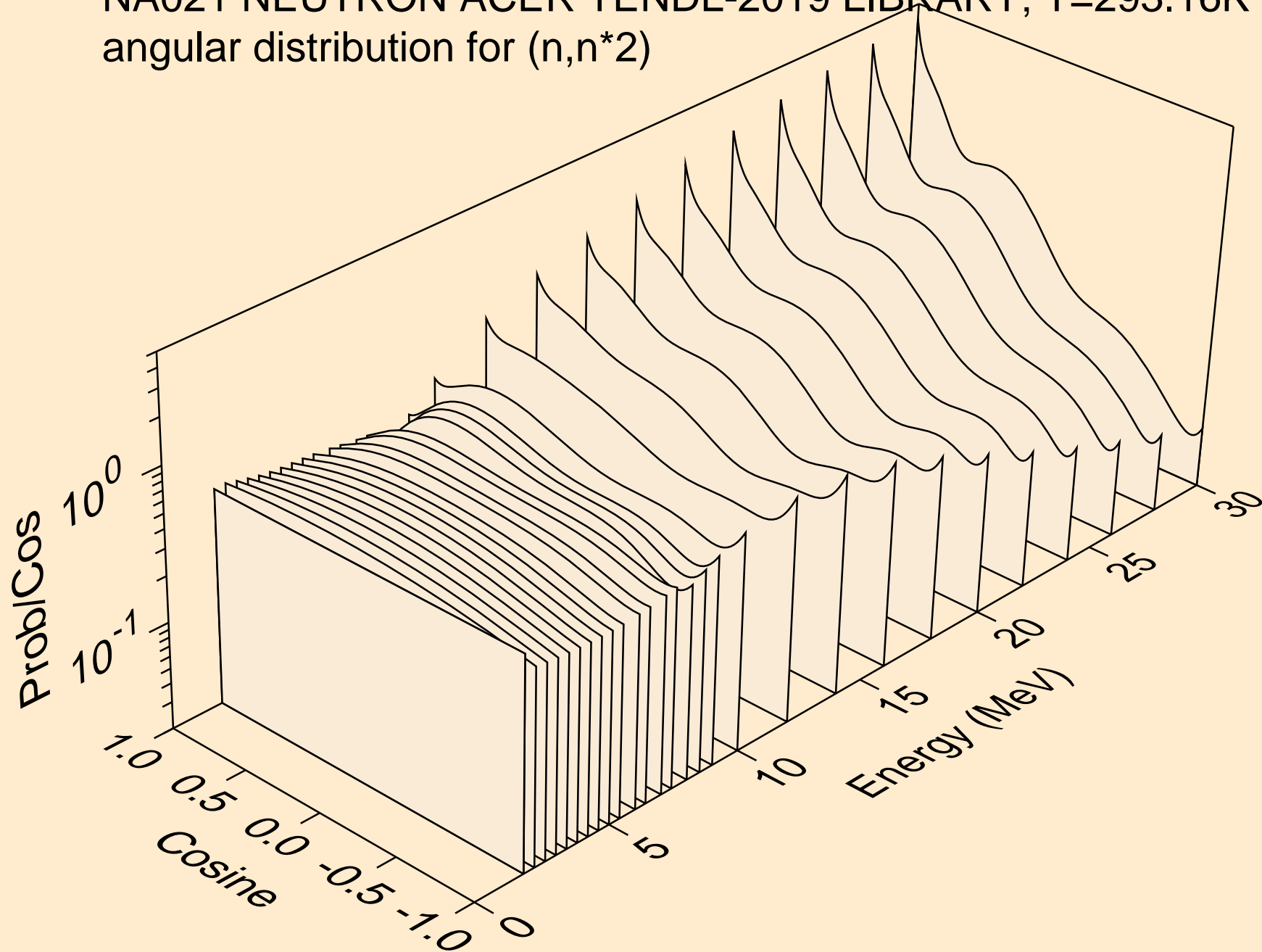

NA021 NEUTRON ACER TENDL-2019 LIBRARY; T=293.16K
angular distribution for (n,n*3)

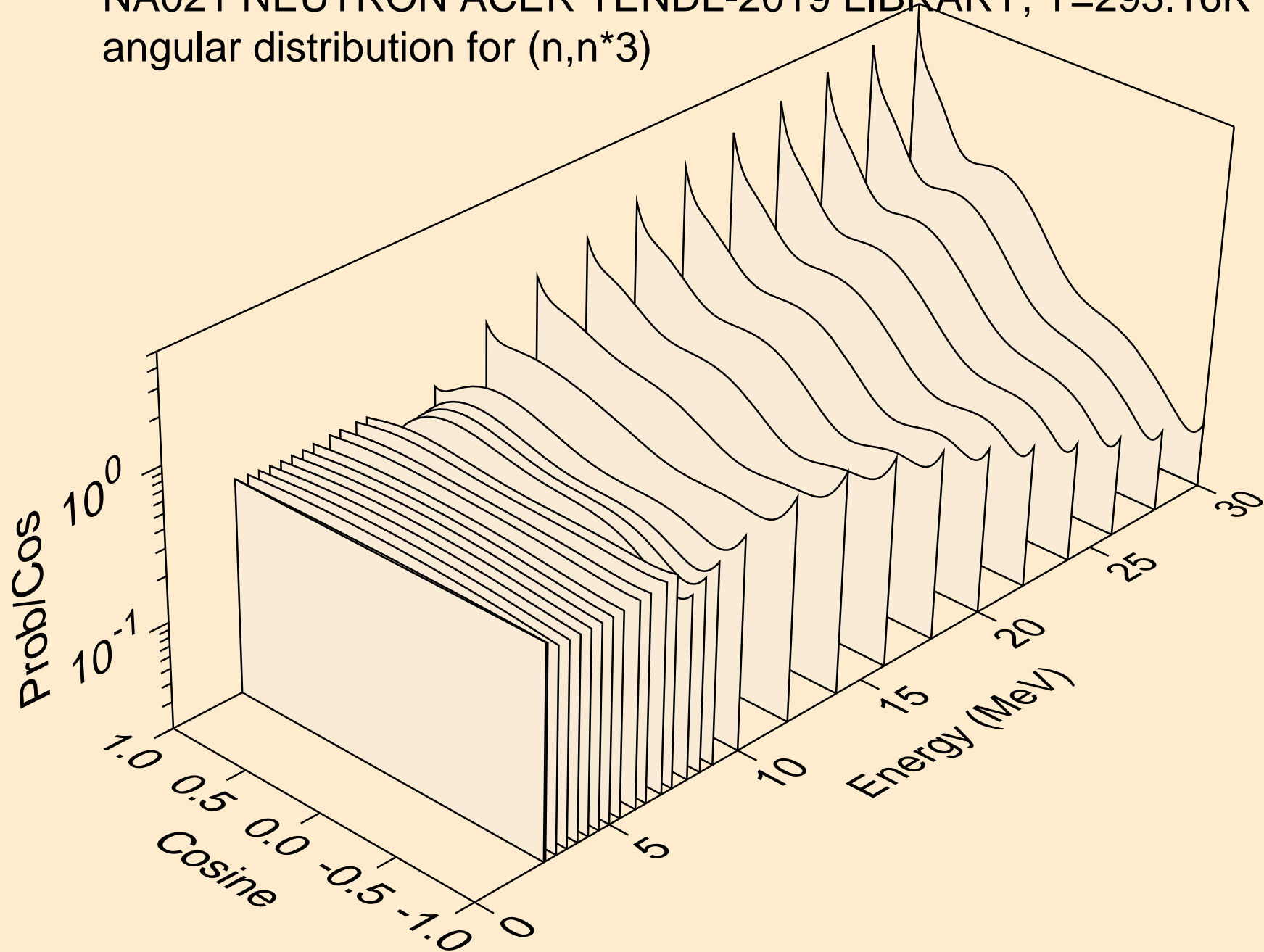

NA021 NEUTRON ACER TENDL-2019 LIBRARY; T=293.16K
angular distribution for (n,n*4)

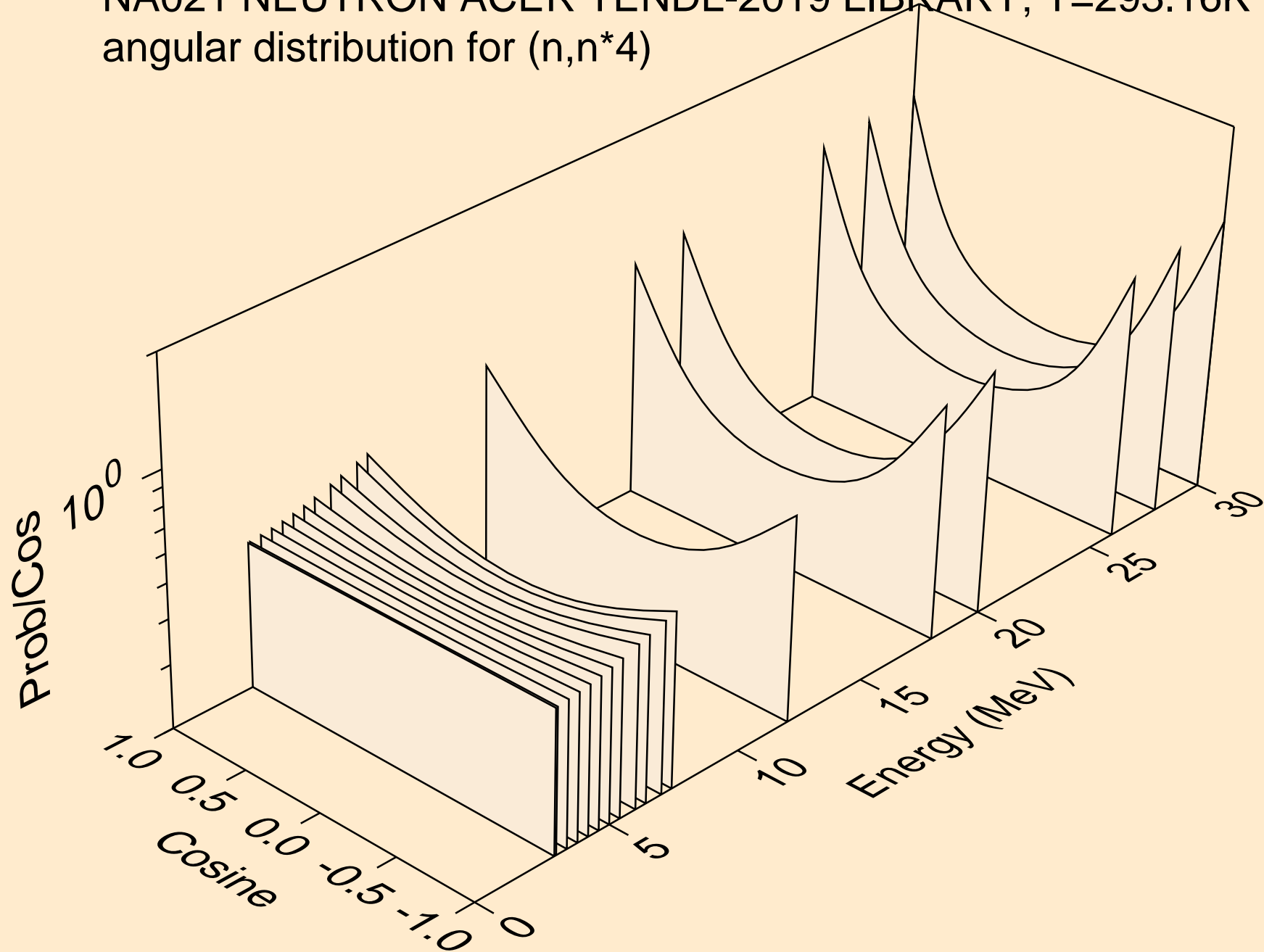

NA021 NEUTRON ACER TENDL-2019 LIBRARY; T=293.16K
angular distribution for (n,n*5)

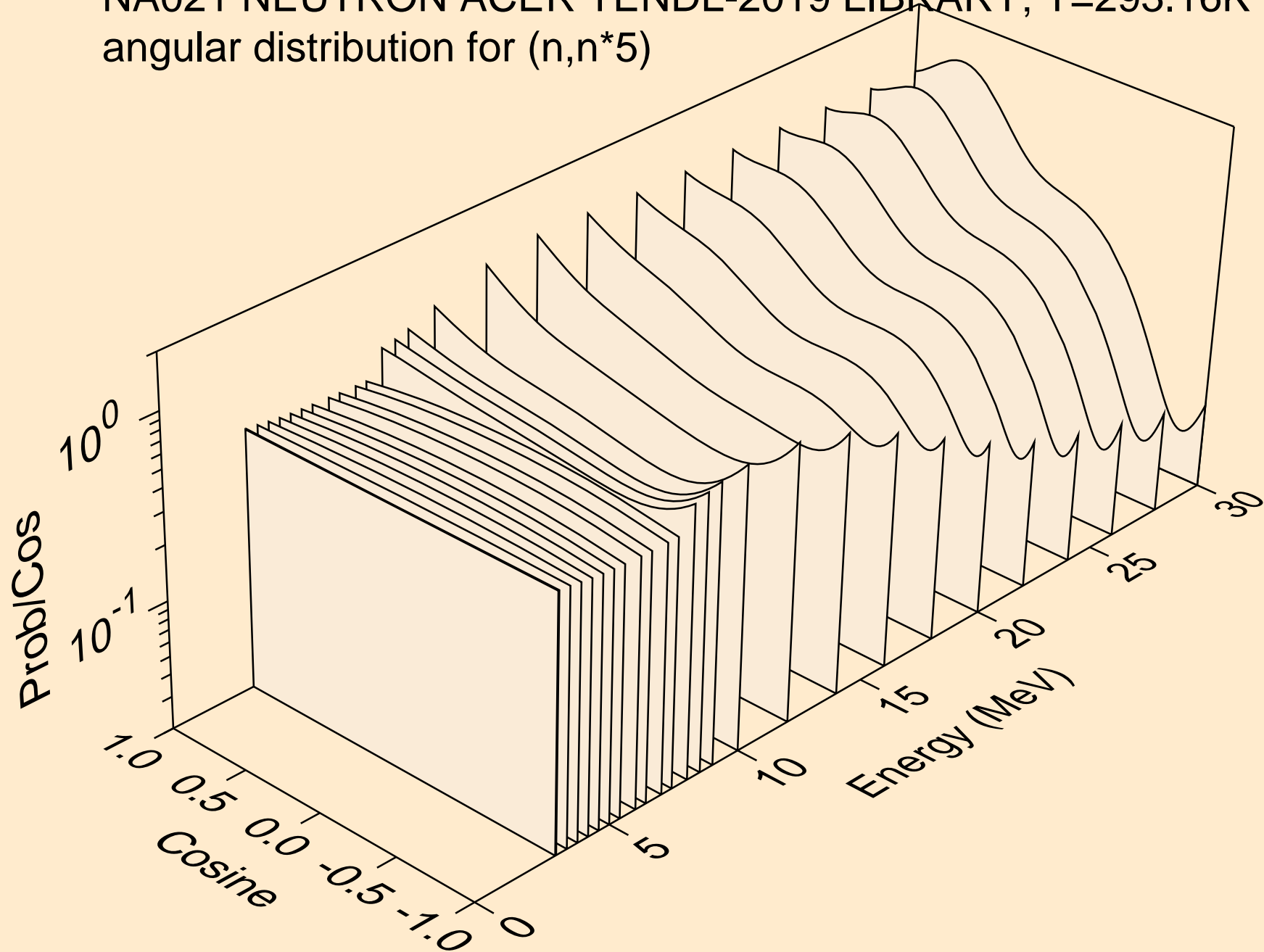

NA021 NEUTRON ACER TENDL-2019 LIBRARY; T=293.16K
angular distribution for (n,n*6)

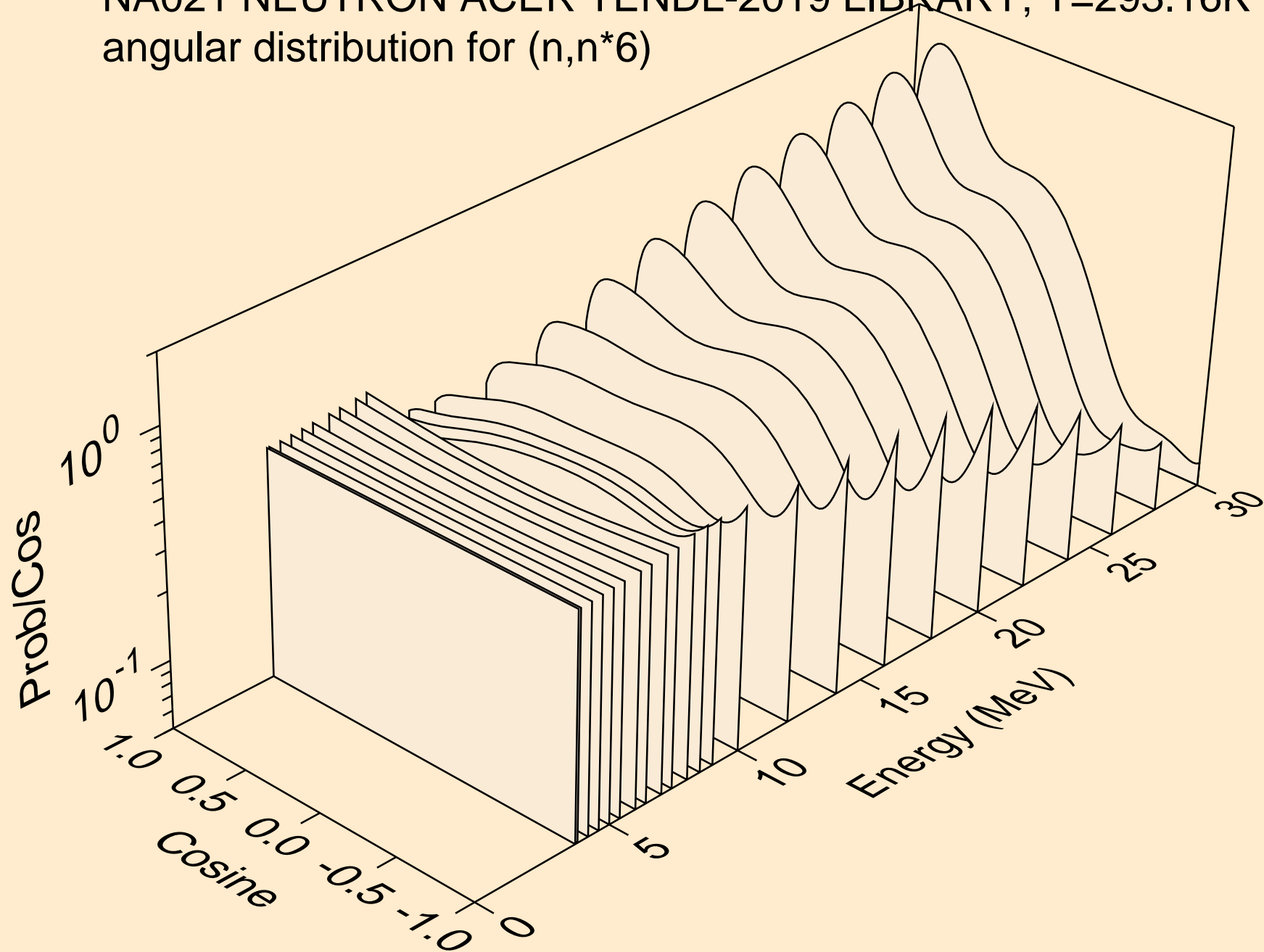

NA021 NEUTRON ACER TENDL-2019 LIBRARY; T=293.16K
angular distribution for (n,n*7)

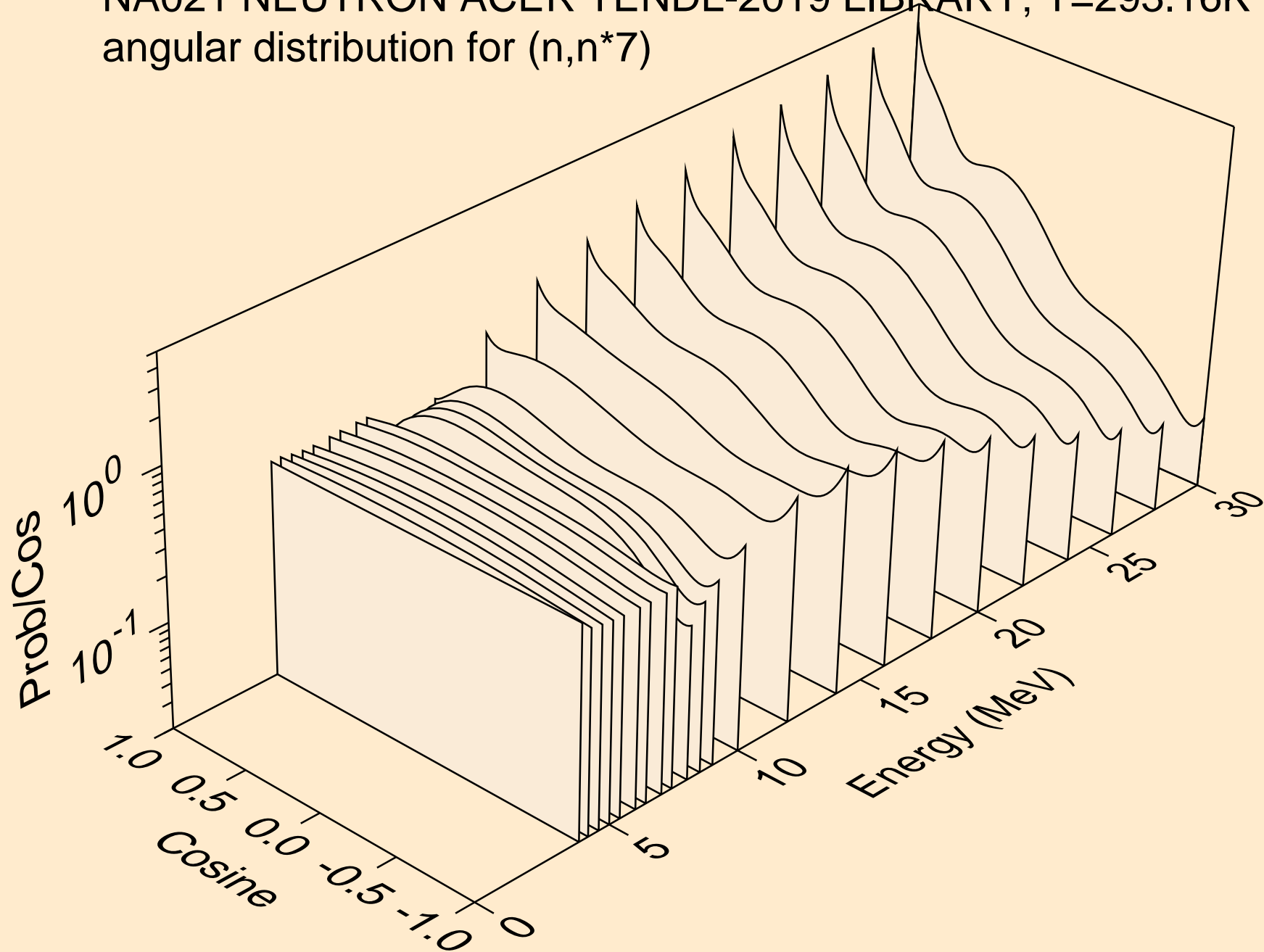

NA021 NEUTRON ACER TENDL-2019 LIBRARY; T=293.16K
angular distribution for (n,n*8)

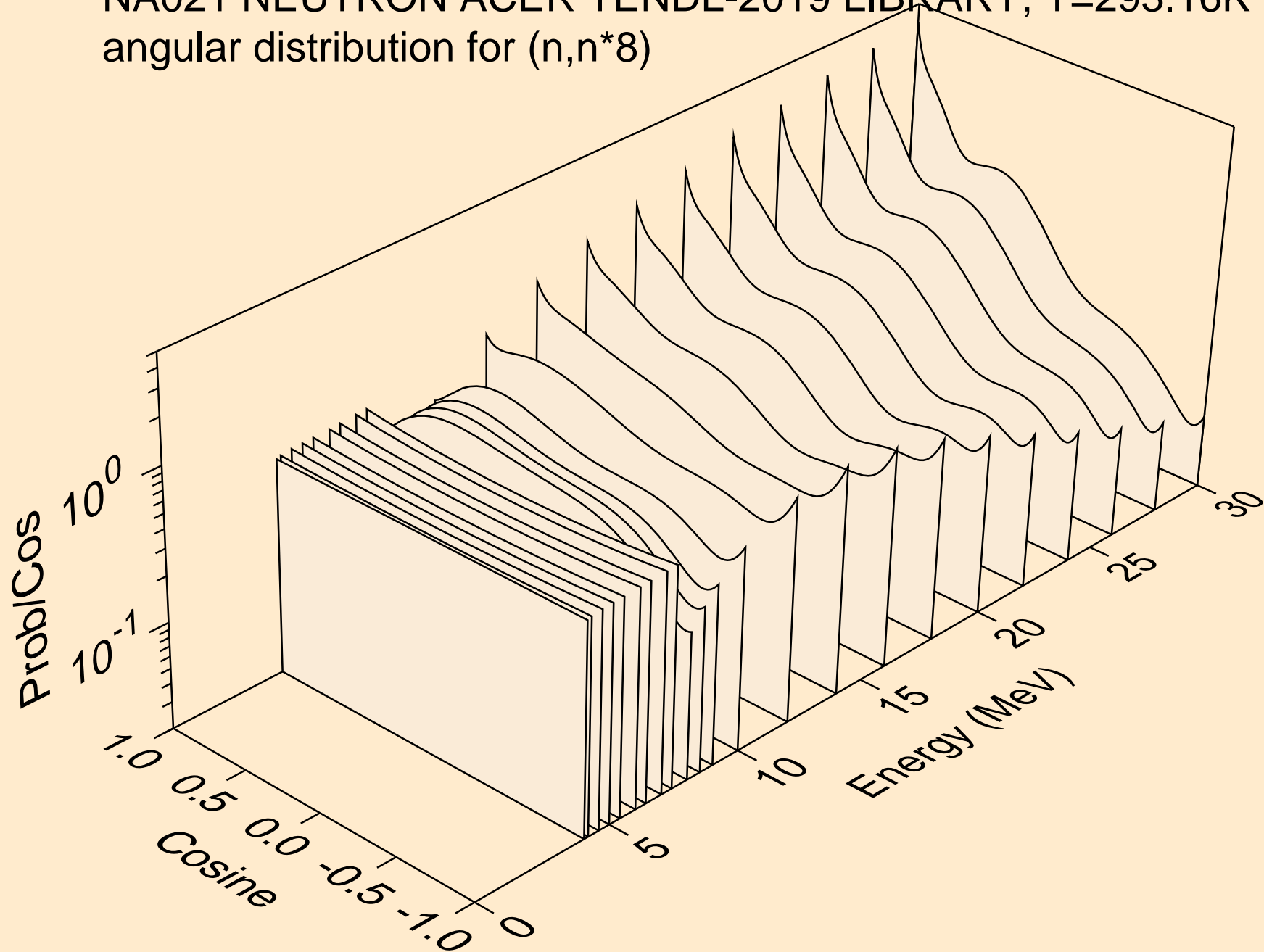

NA021 NEUTRON ACER TENDL-2019 LIBRARY; T=293.16K
angular distribution for (n,n*9)

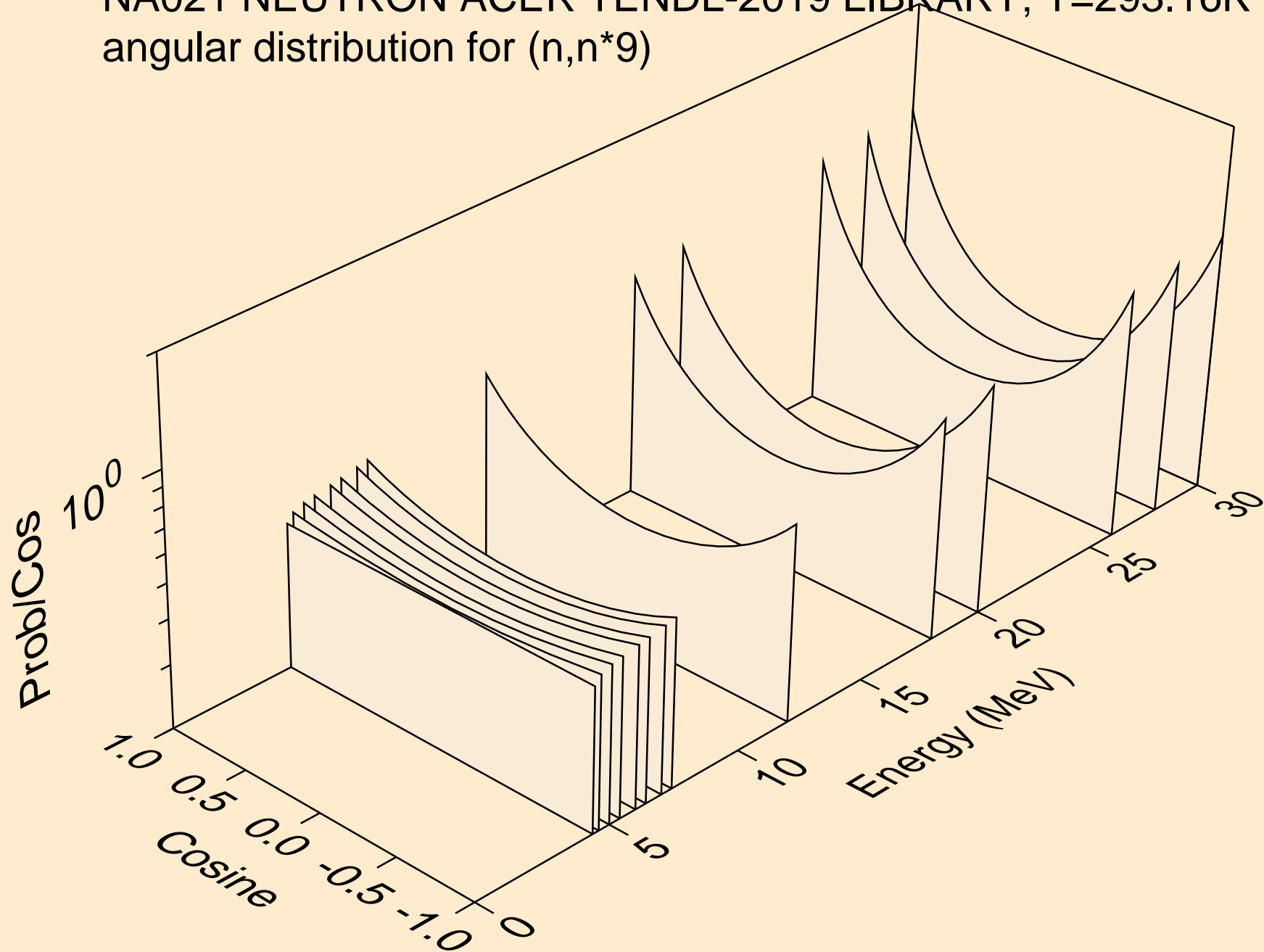

NA021 NEUTRON ACER TENDL-2019 LIBRARY; T=293.16K
angular distribution for (n,n*10)

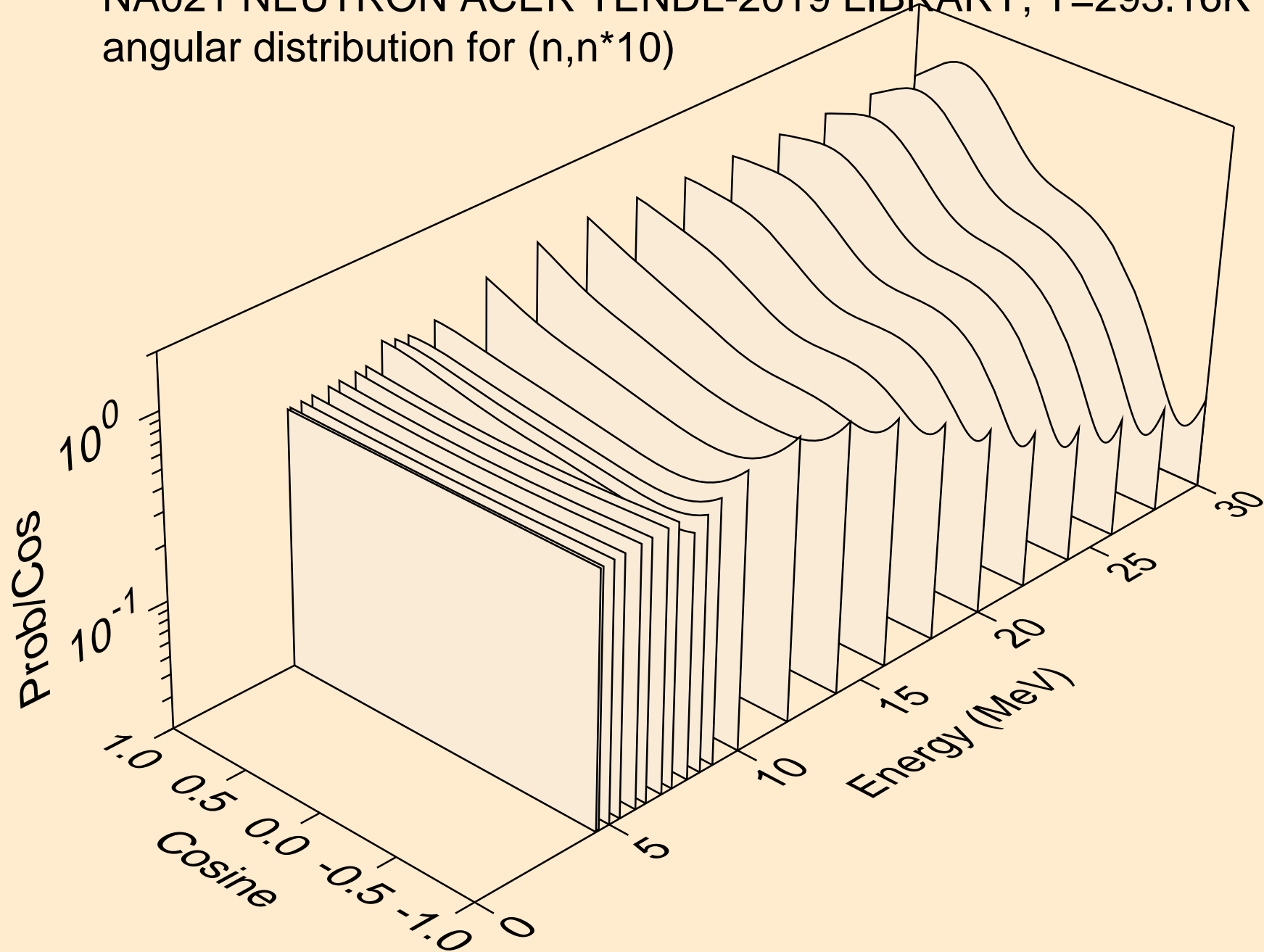

NA021 NEUTRON ACER TENDL-2019 LIBRARY; T=293.16K
Neutron emission for (n,x)

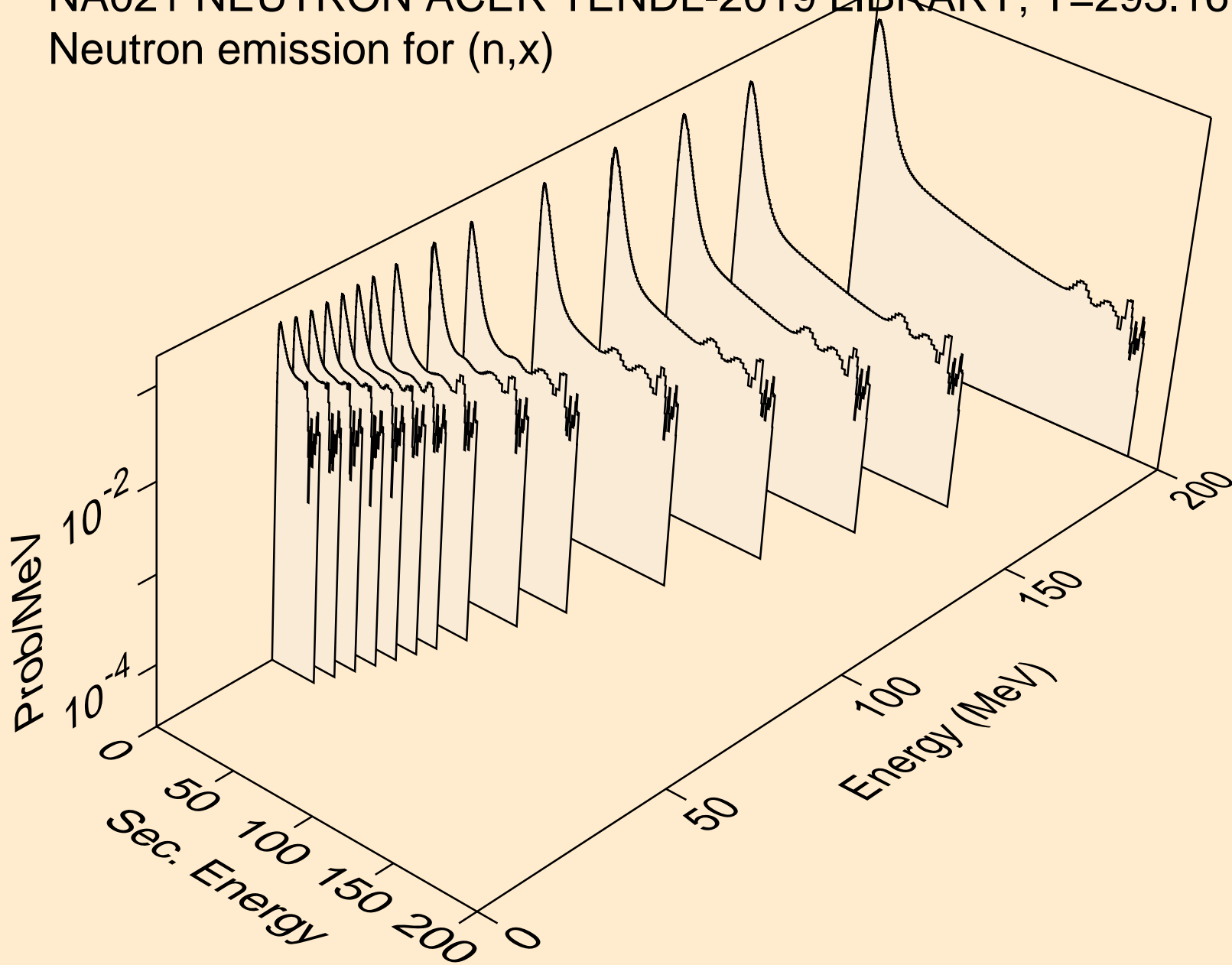

NA021 NEUTRON ACER TENDL-2019 LIBRARY; T=293.16K
Neutron emission for (n,2n)

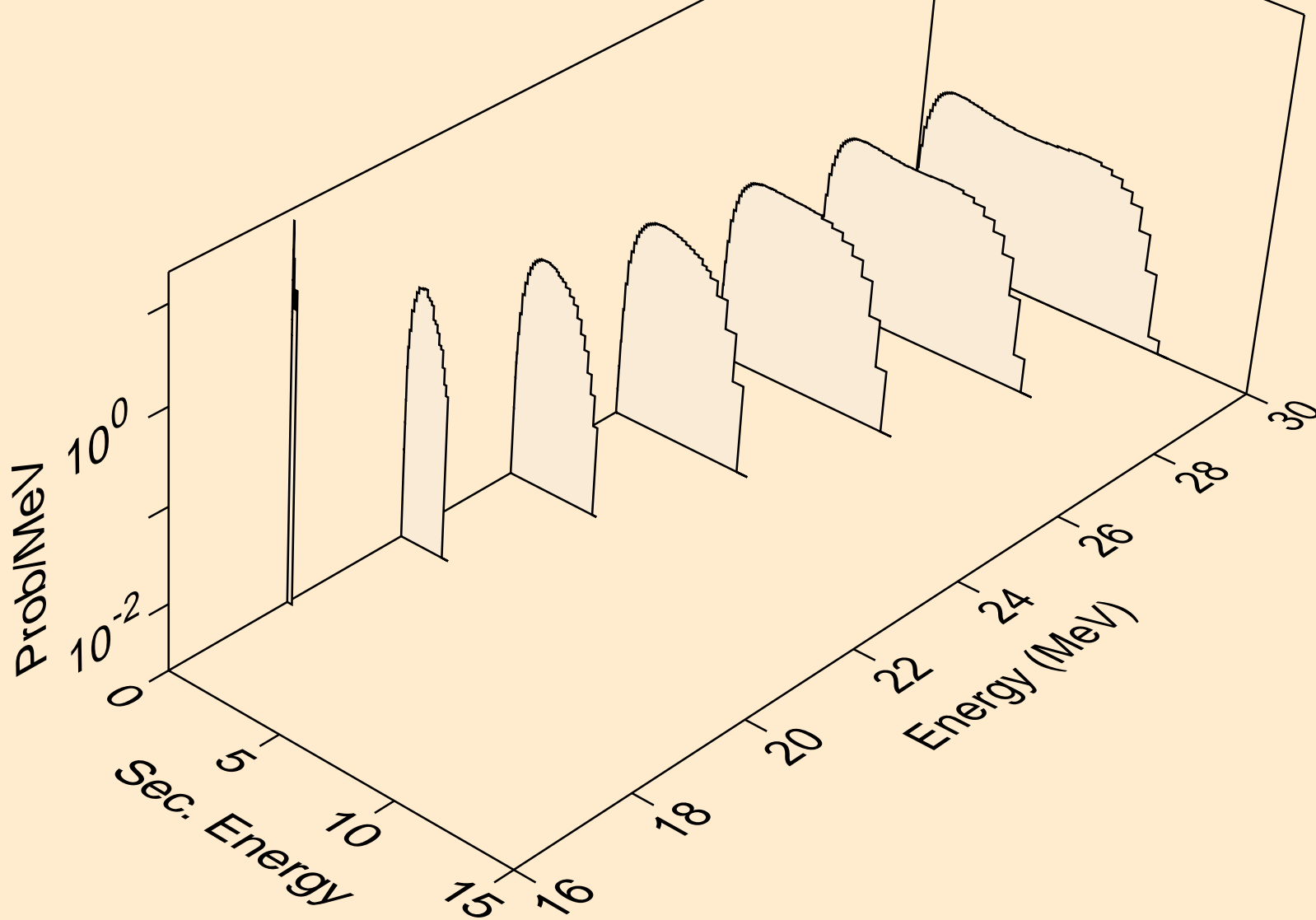

NA021 NEUTRON ACER TENDL-2019 LIBRARY; T=293.16K
Neutron emission for (n,n*)a

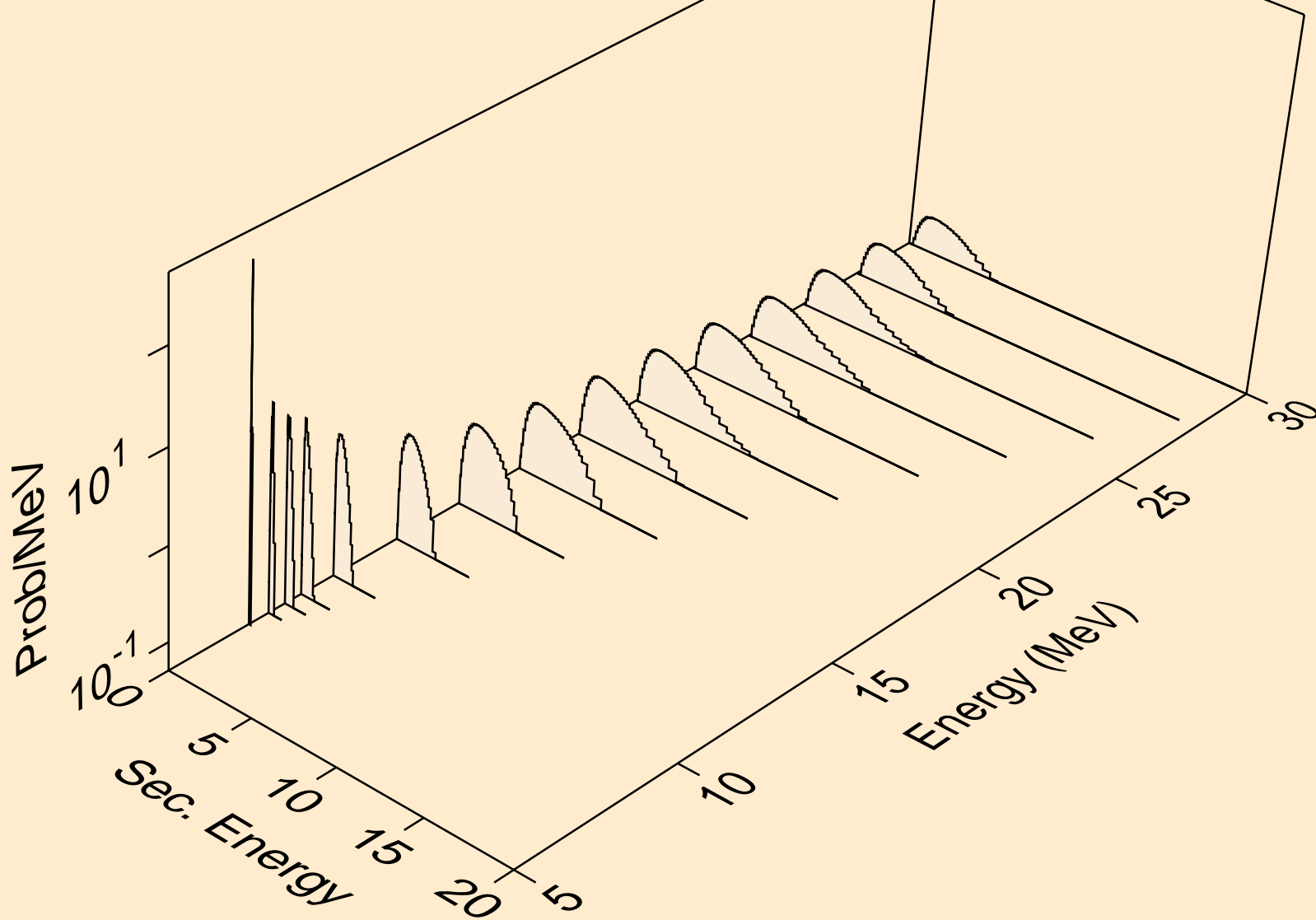

NA021 NEUTRON ACER TENDL-2019 LIBRARY; T=293.16K
Neutron emission for (n,2n)a

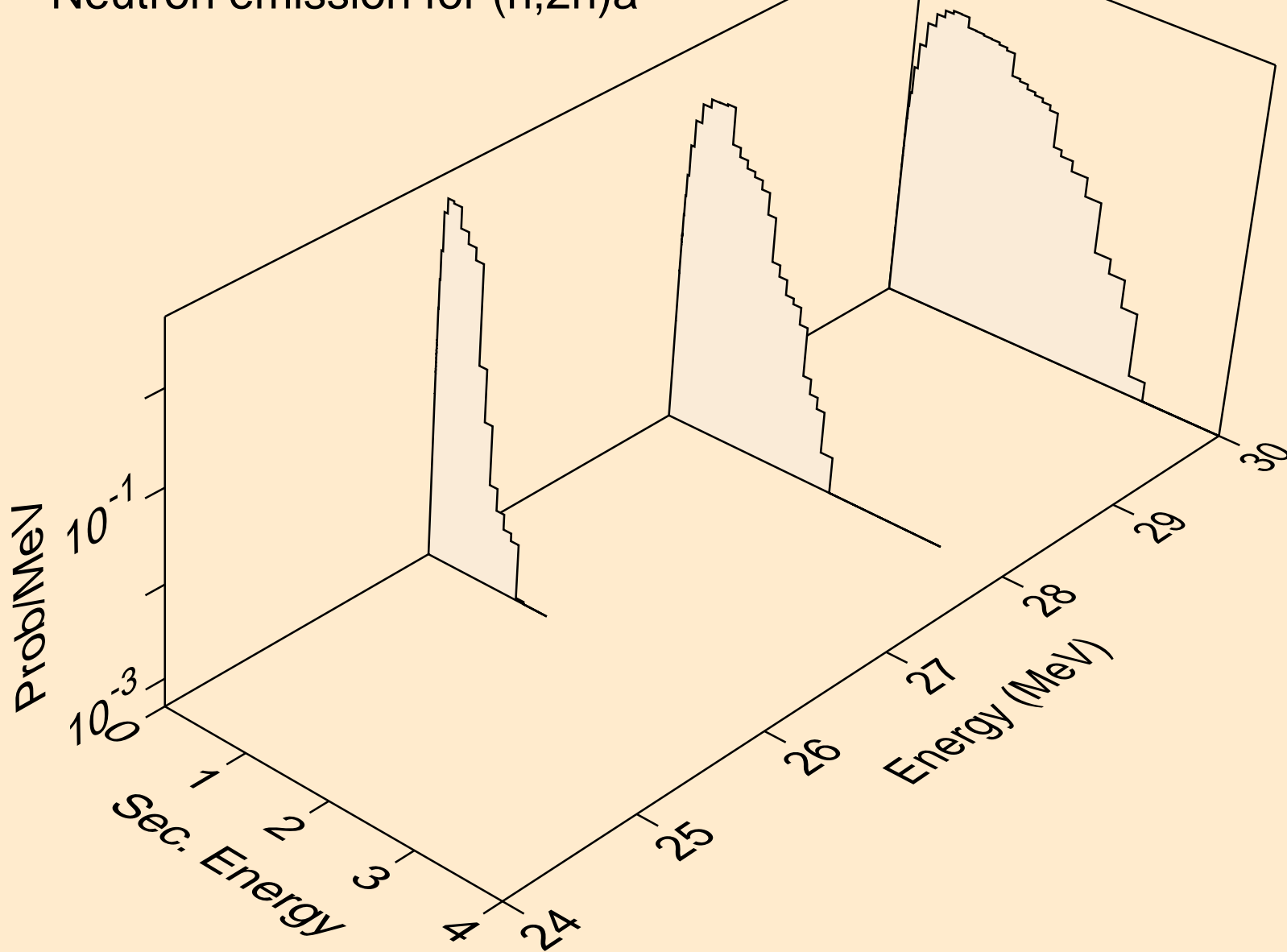

NA021 NEUTRON ACER TENDL-2019 LIBRARY; T=293.16K
Neutron emission for (n,n*)p

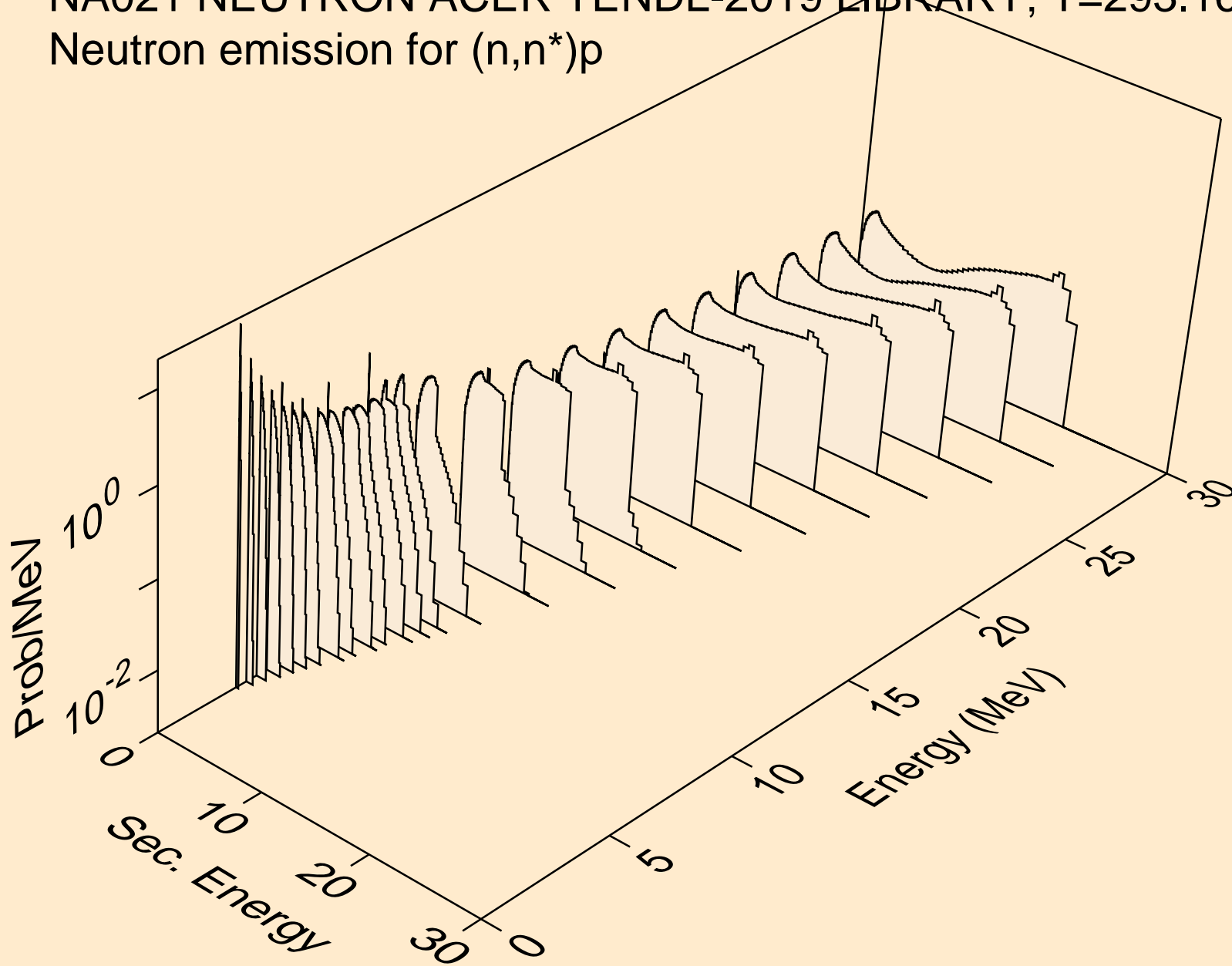

NA021 NEUTRON ACER TENDL-2019 LIBRARY; T=293.16K
Neutron emission for (n,n*)2a

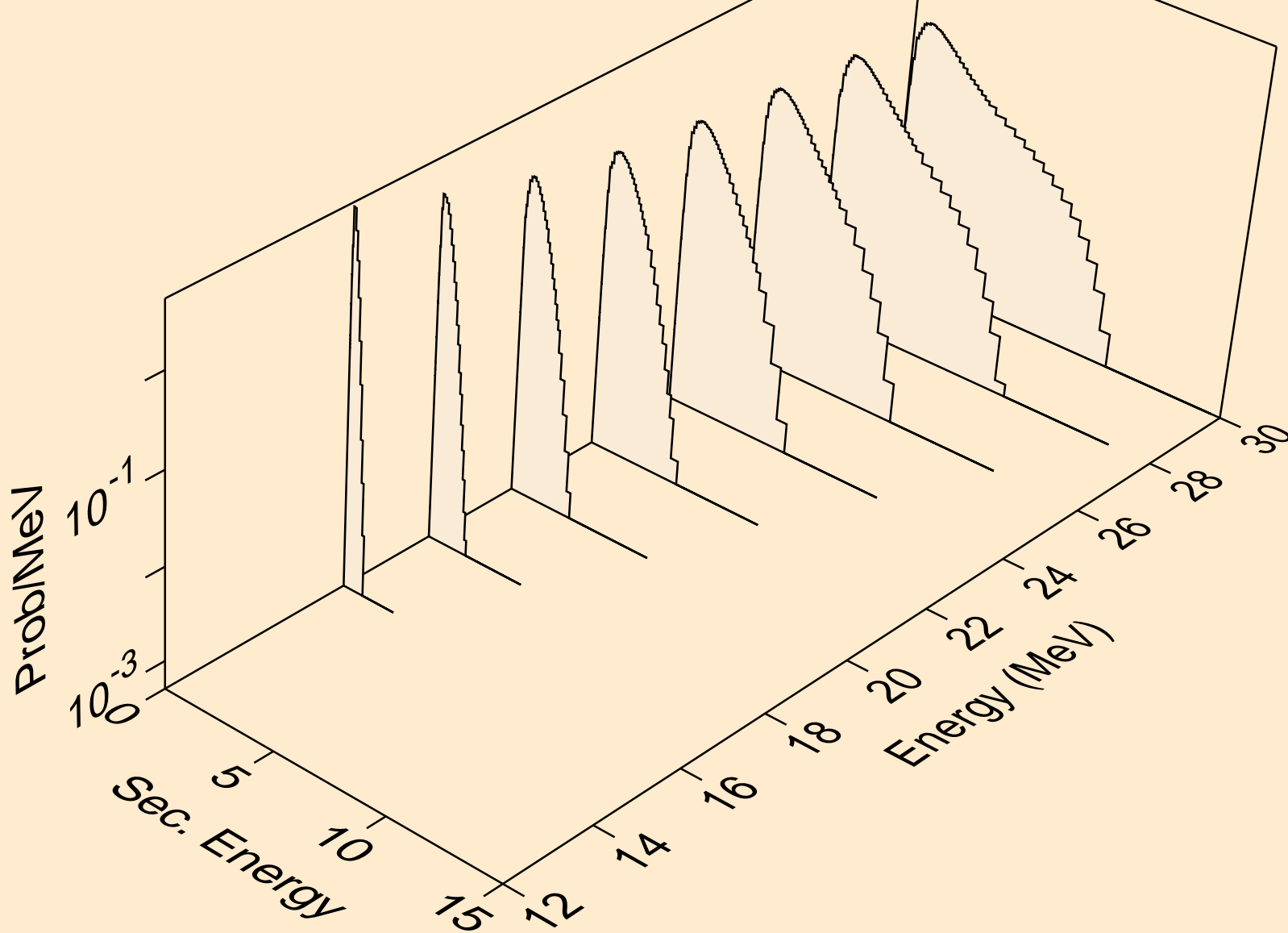

NA021 NEUTRON ACER TENDL-2019 LIBRARY; T=293.16K
Neutron emission for (n,n*)d

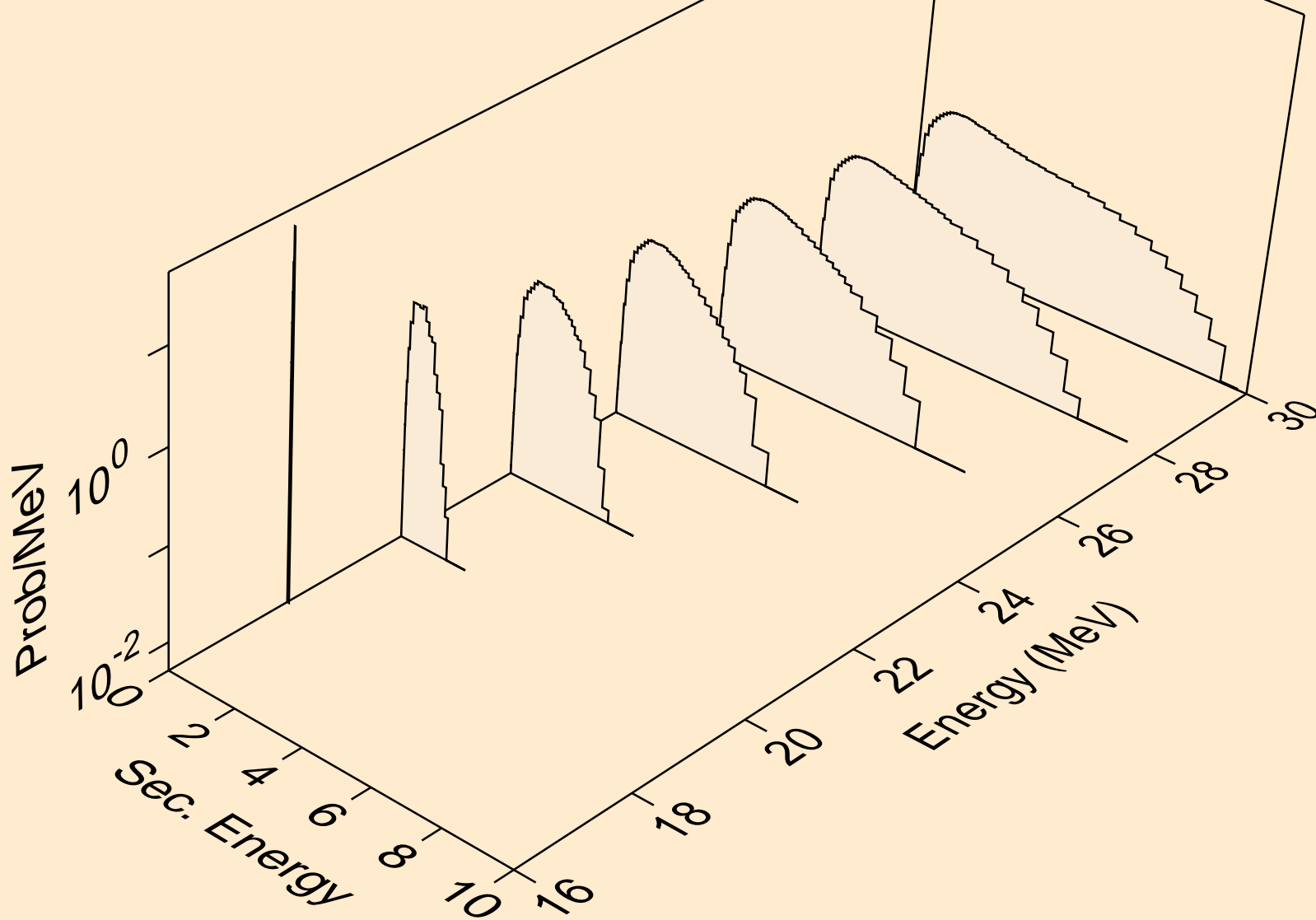

NA021 NEUTRON ACER TENDL-2019 LIBRARY; T=293.16K
Neutron emission for (n,n*)t

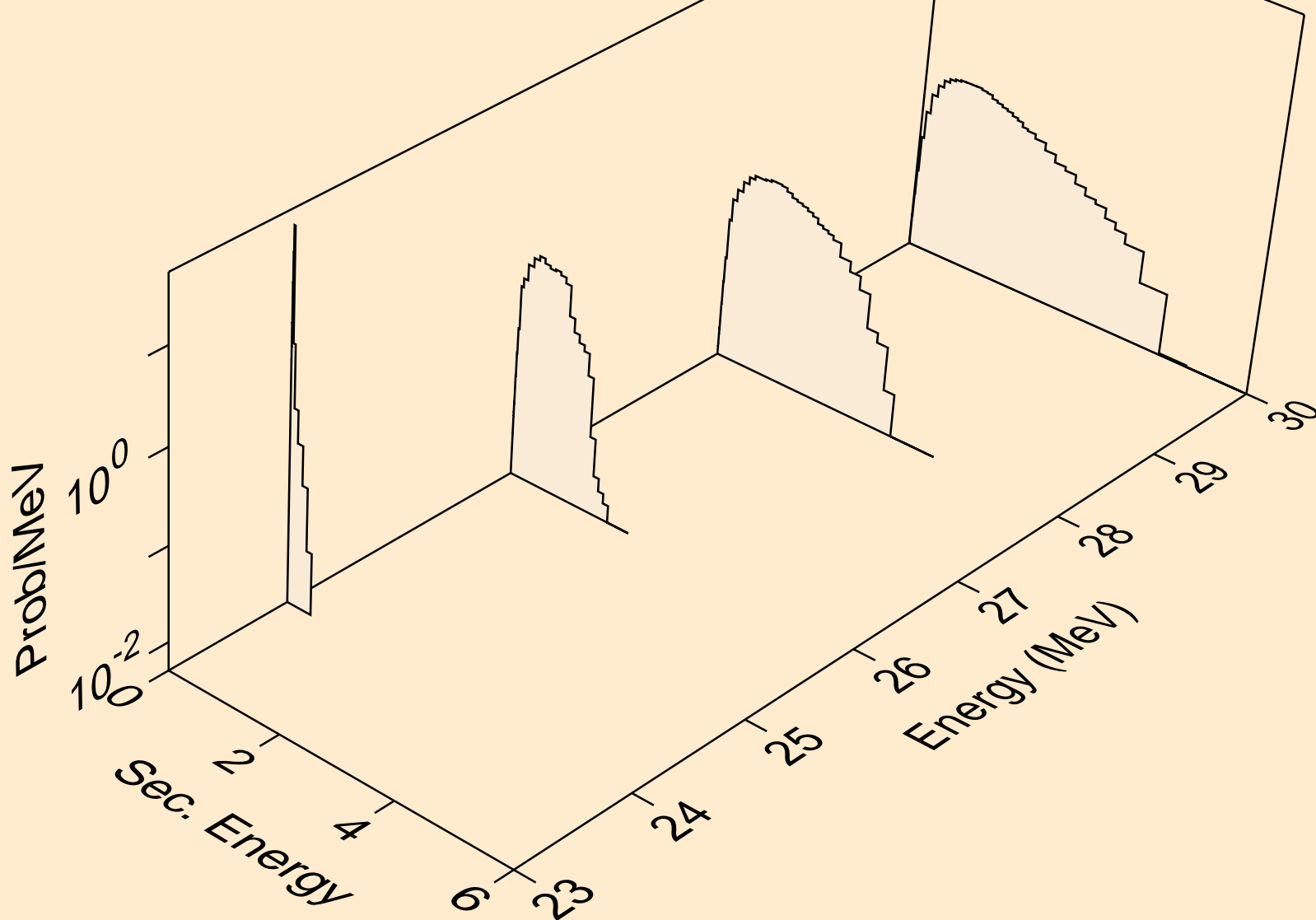

NA021 NEUTRON ACER TENDL-2019 LIBRARY; T=293.16K
Neutron emission for (n,n*)he3

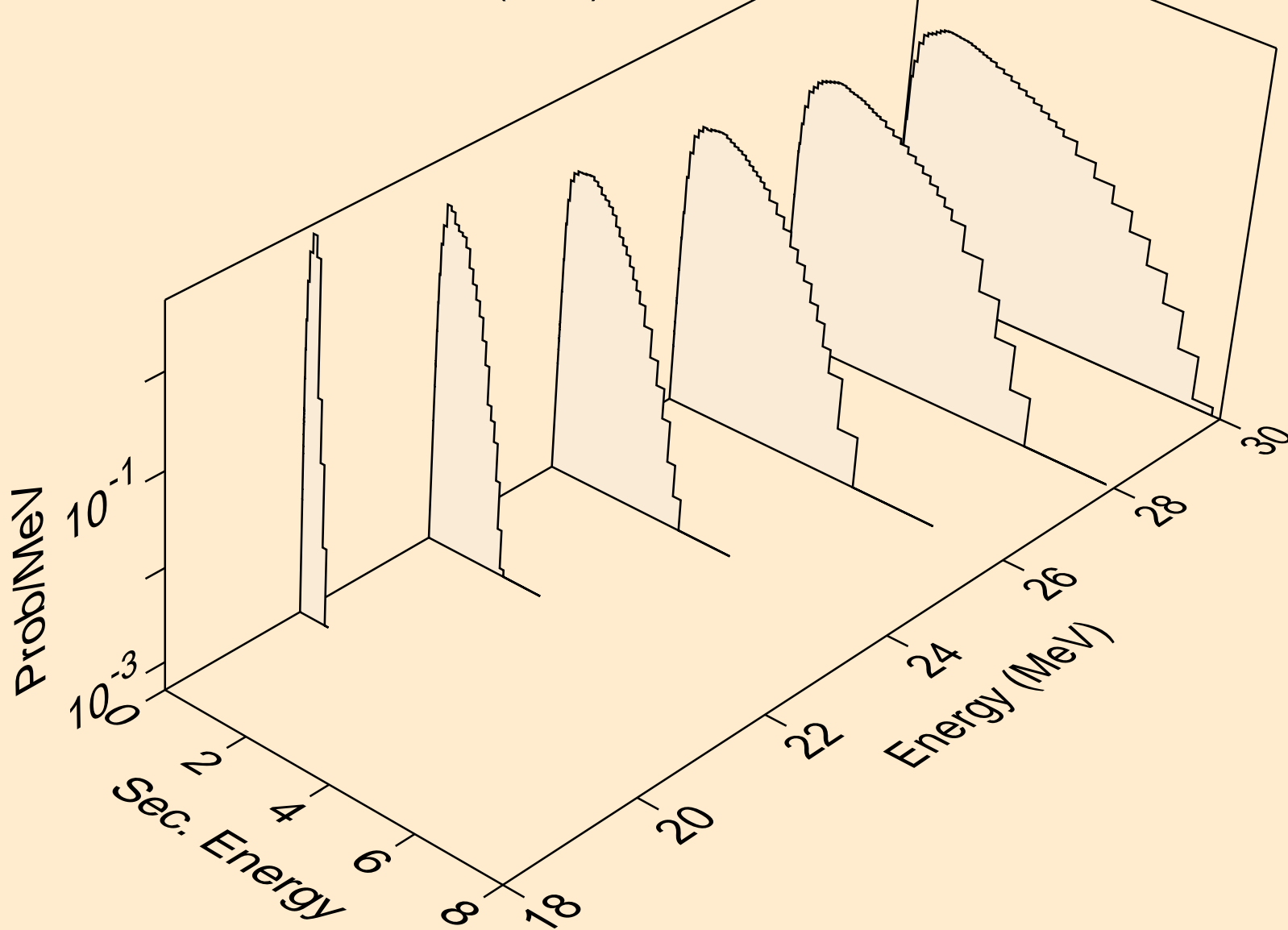

NA021 NEUTRON ACER TENDL-2019 LIBRARY; T=293.16K
Neutron emission for (n,2np)

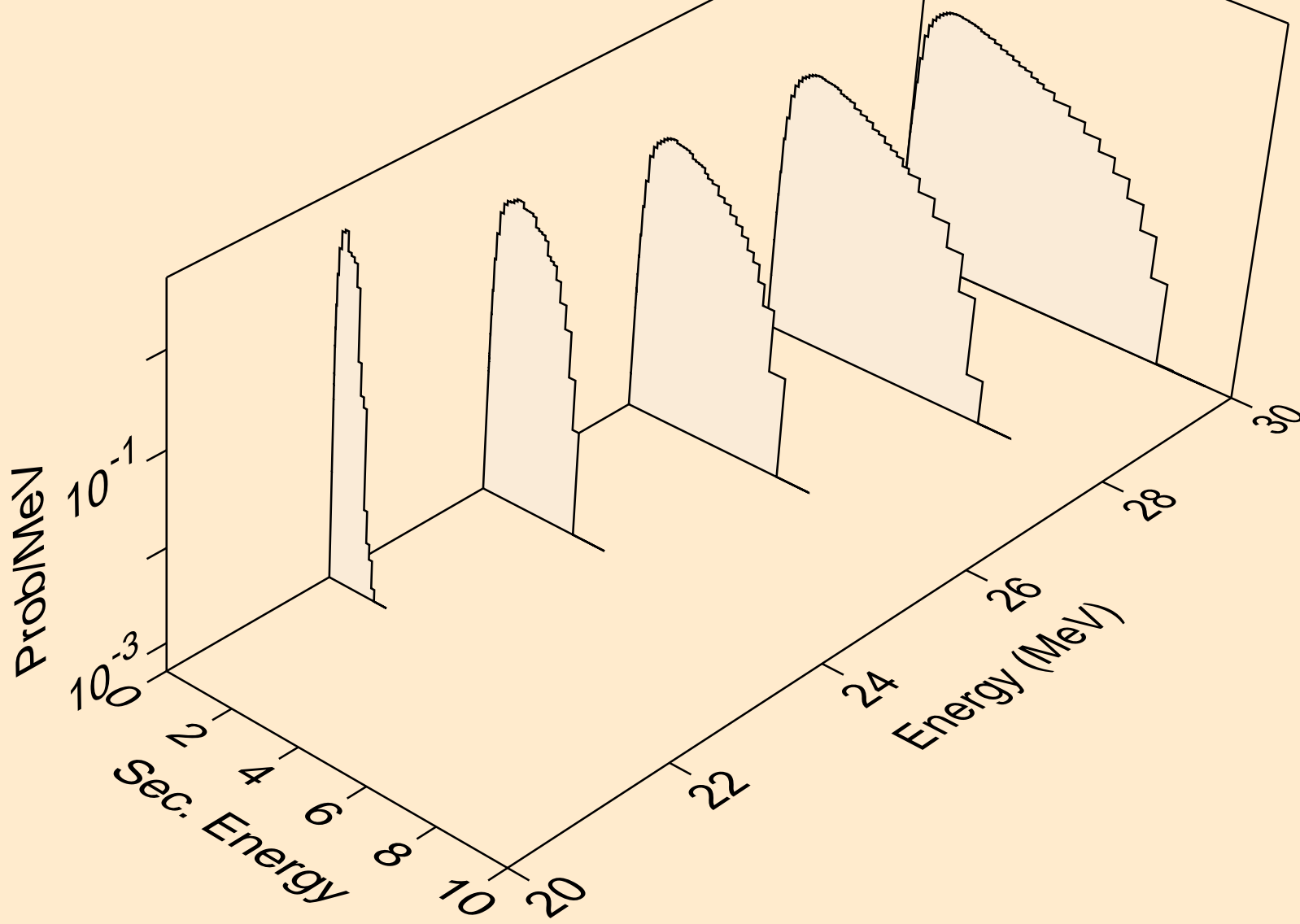

NA021 NEUTRON ACER TENDL-2019 LIBRARY; T=293.16K
Neutron emission for (n,2np)

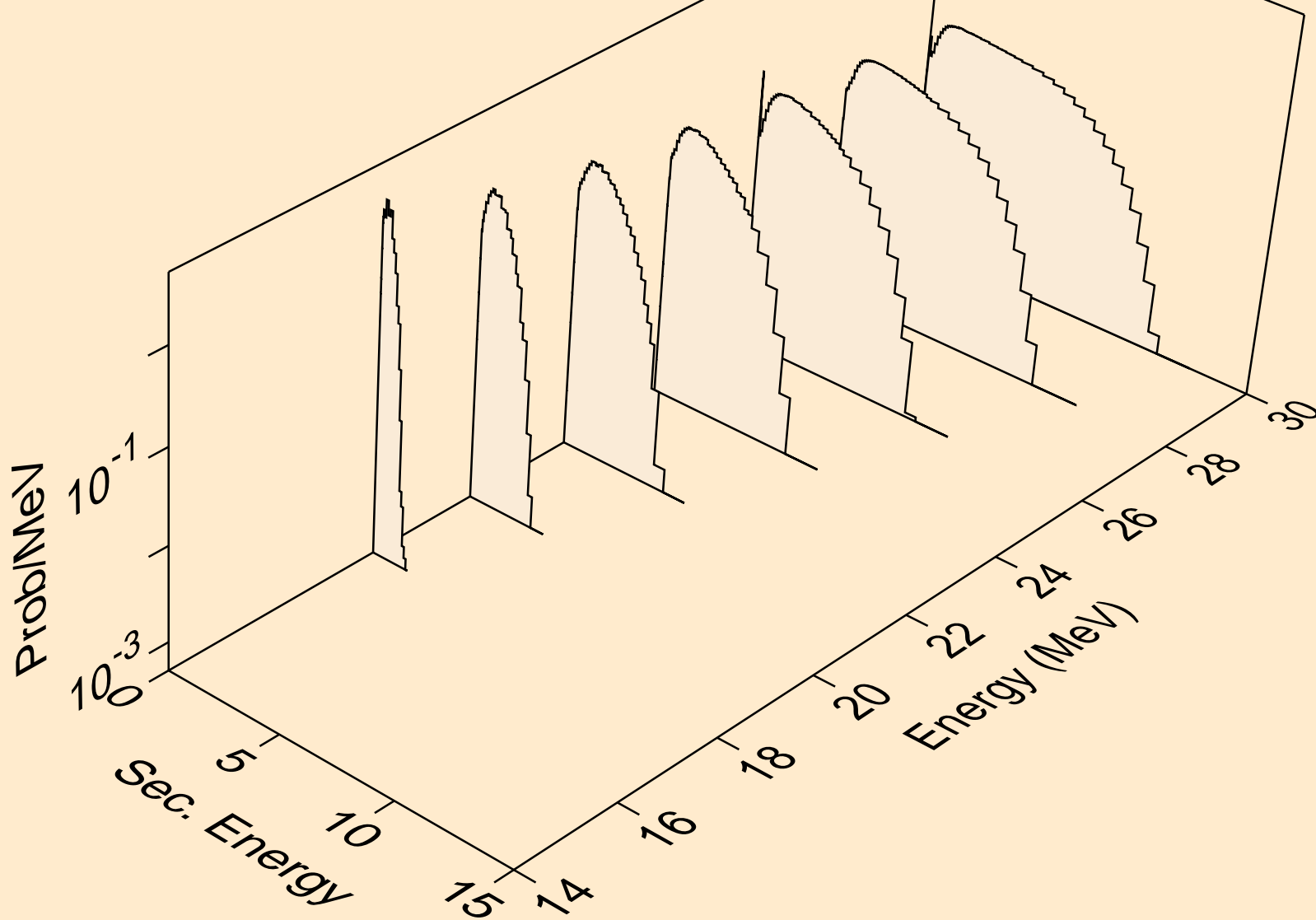

NA021 NEUTRON ACER TENDL-2019 LIBRARY; T=293.16K
Neutron emission for (n,npa)

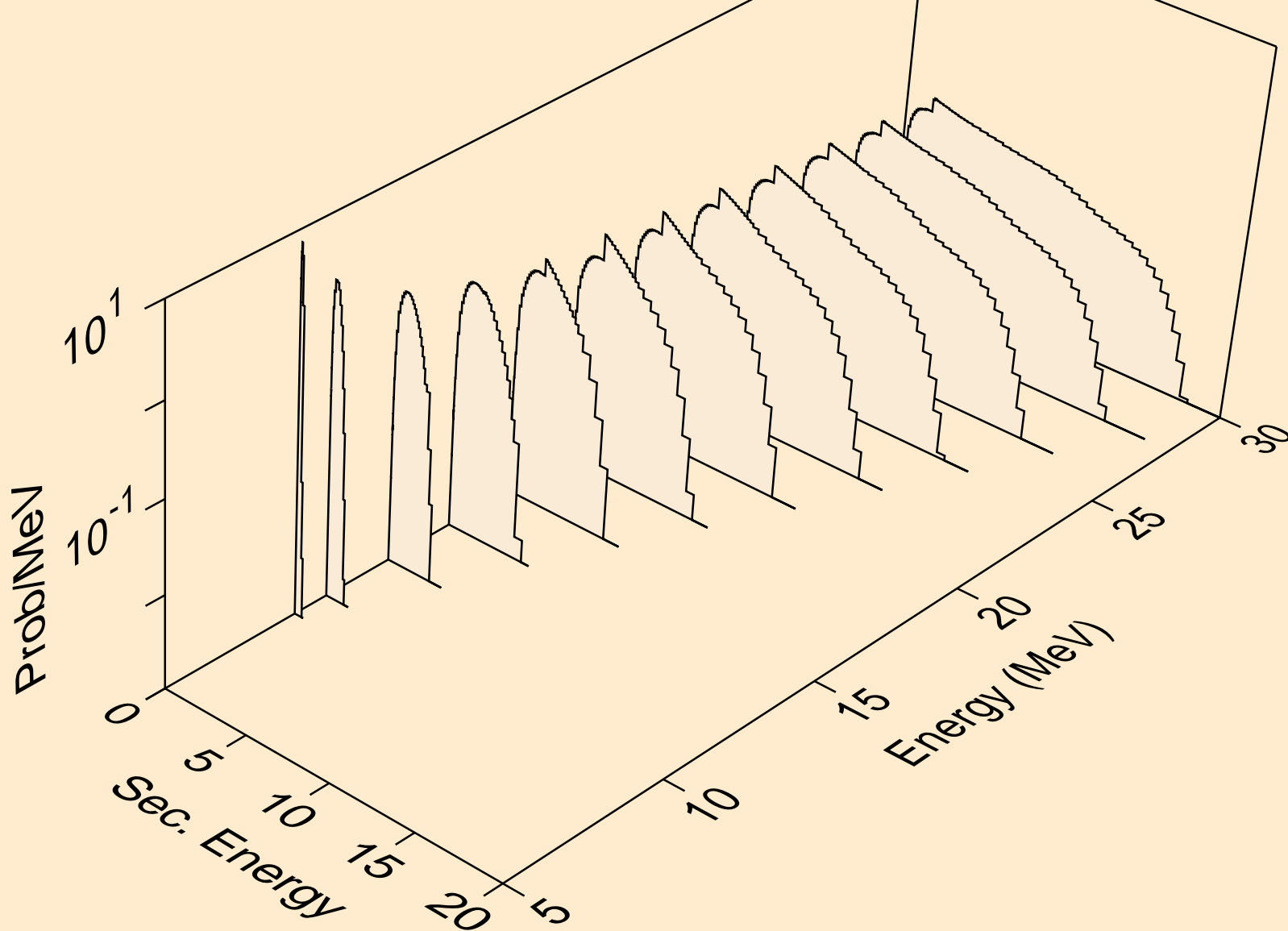

NA021 NEUTRON ACER TENDL-2019 LIBRARY; T=293.16K
Neutron emission for (n,n*c)

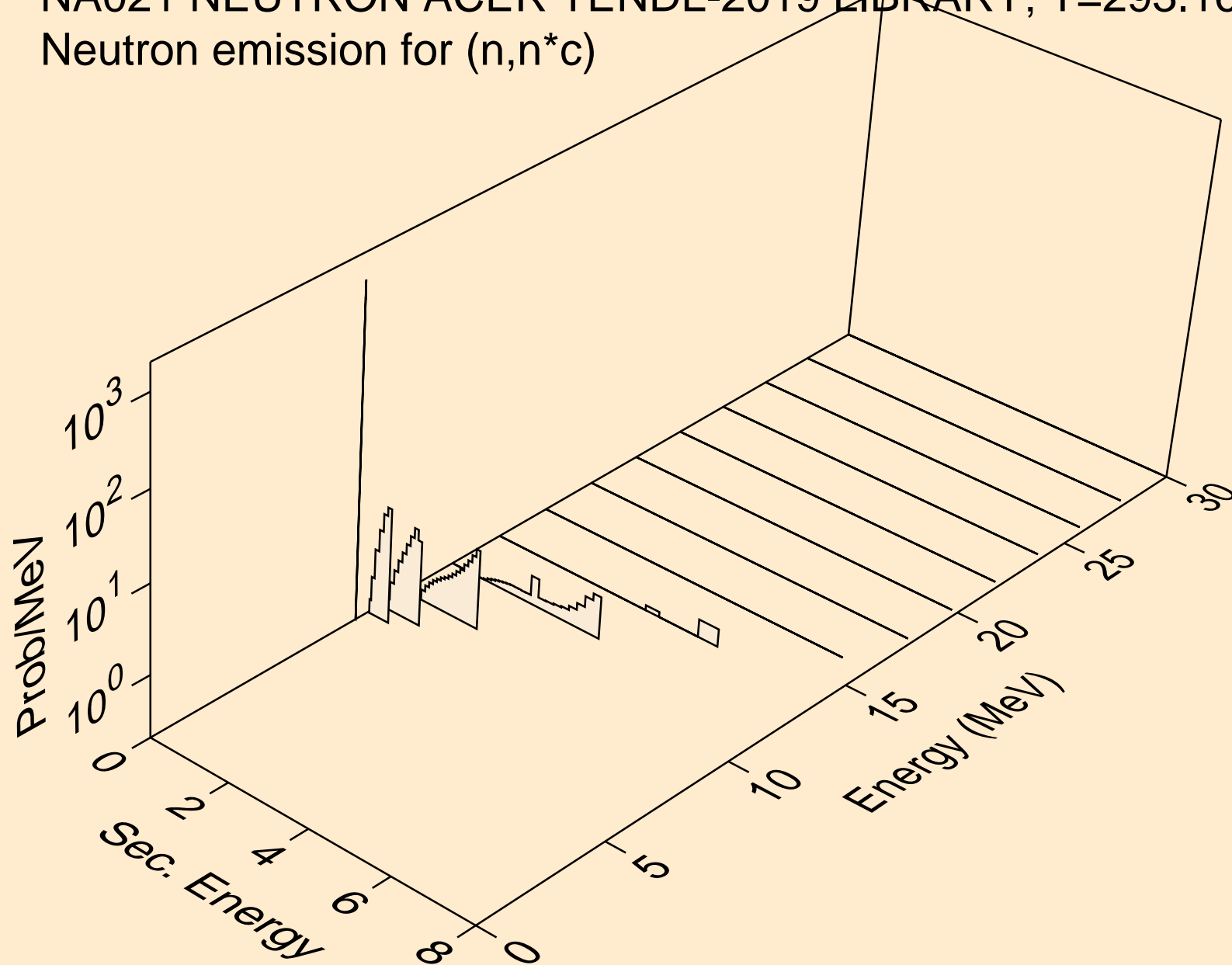

NA021 NEUTRON ACER TENDL-2019 LIBRARY; T=293.16K
Photon emission for (n,x)

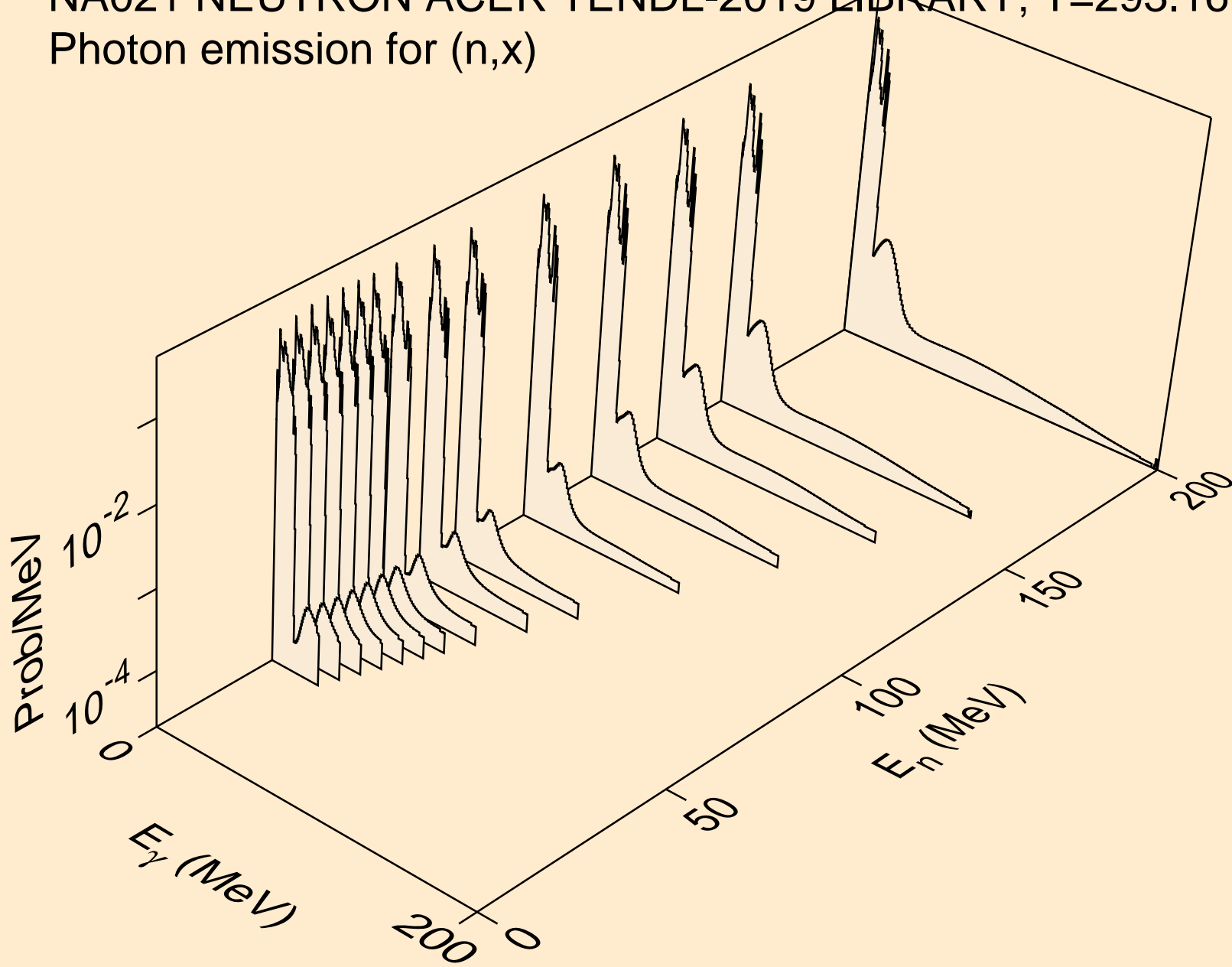

NA021 NEUTRON ACER TENDL-2019 LIBRARY; T=293.16K
Photon emission for (n,2n)

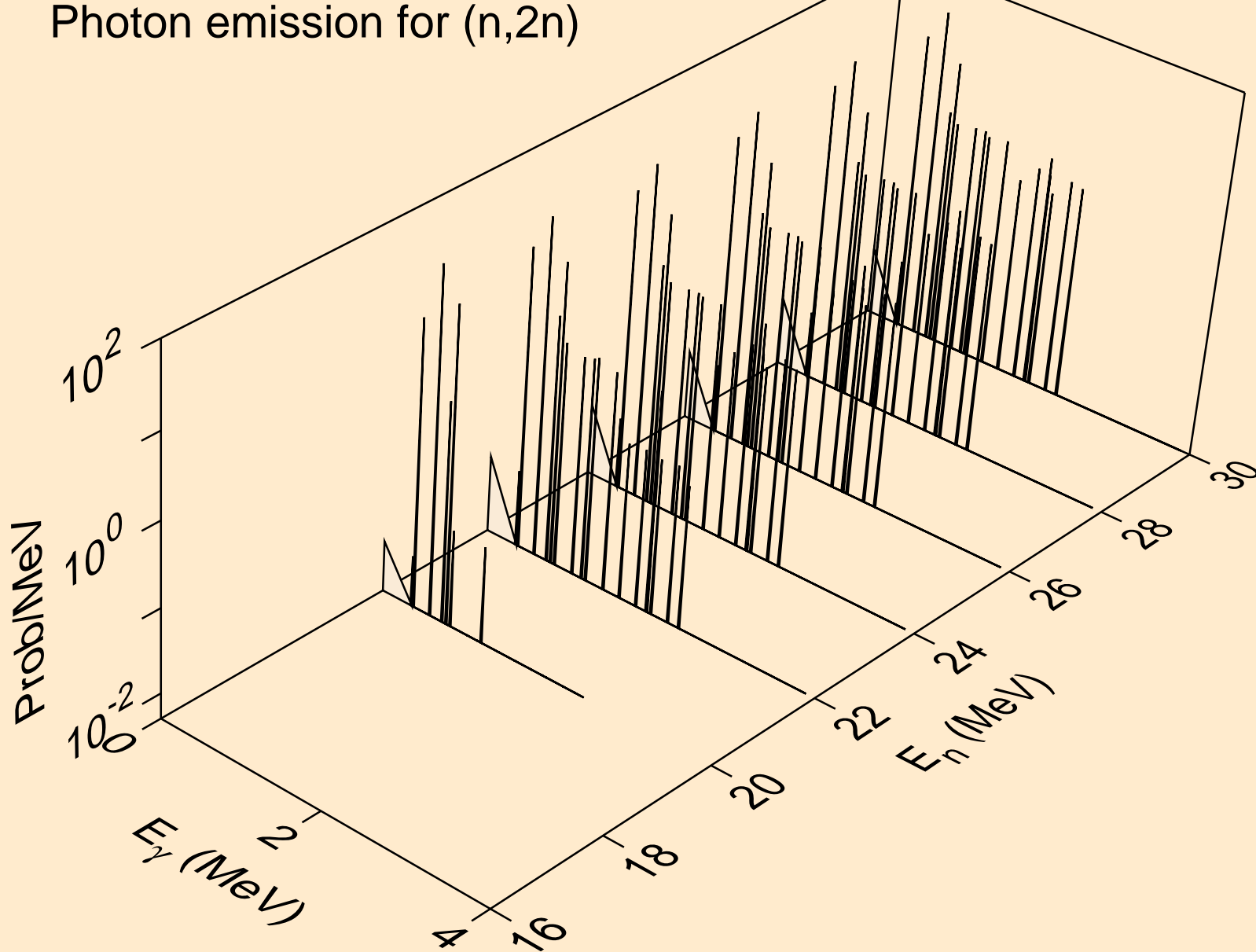

NA021 NEUTRON ACER TENDL-2019 LIBRARY; T=293.16K
Photon emission for (n,n*)a

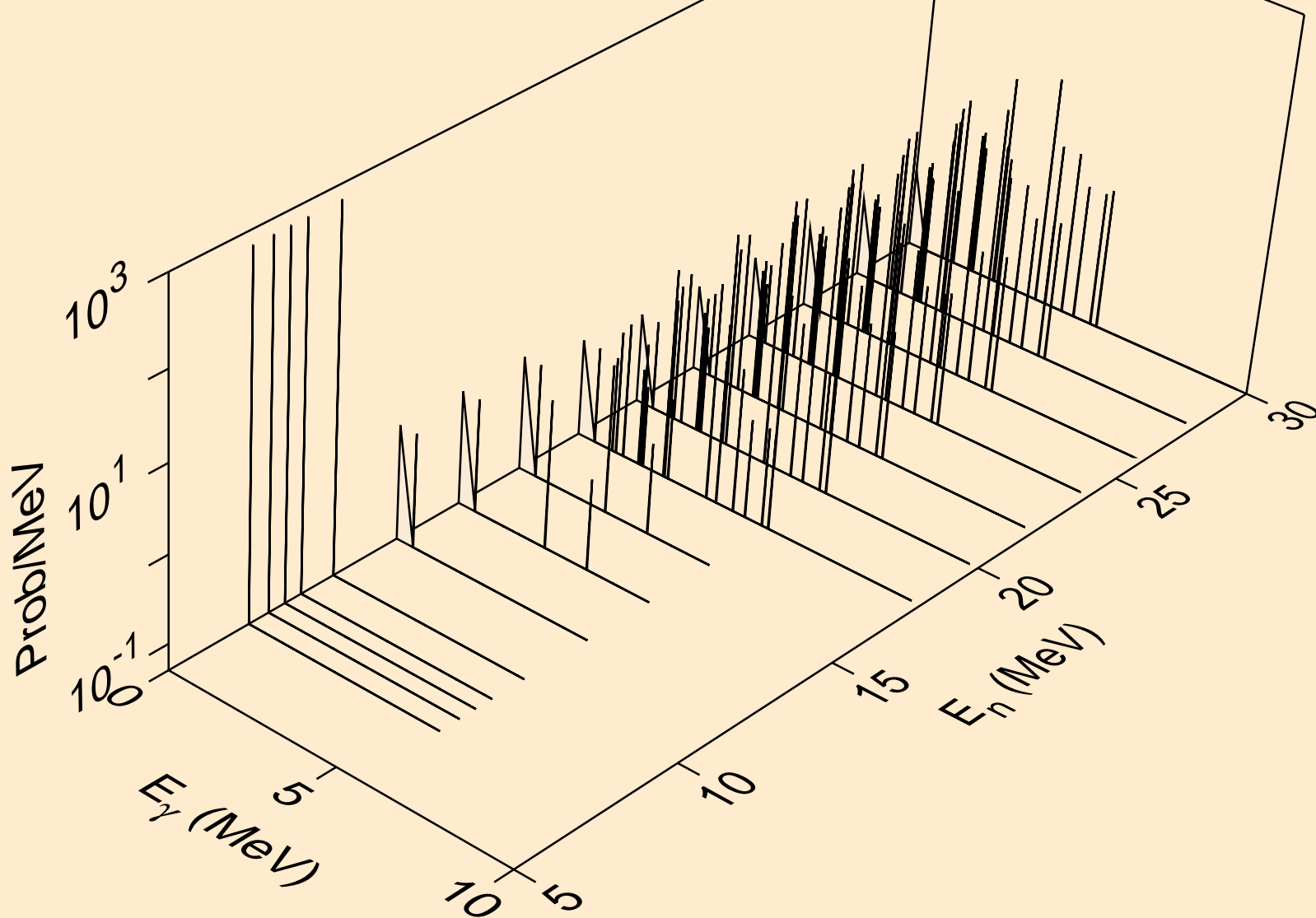

NA021 NEUTRON ACER TENDL-2019 LIBRARY; T=293.16K
Photon emission for (n,2n)a

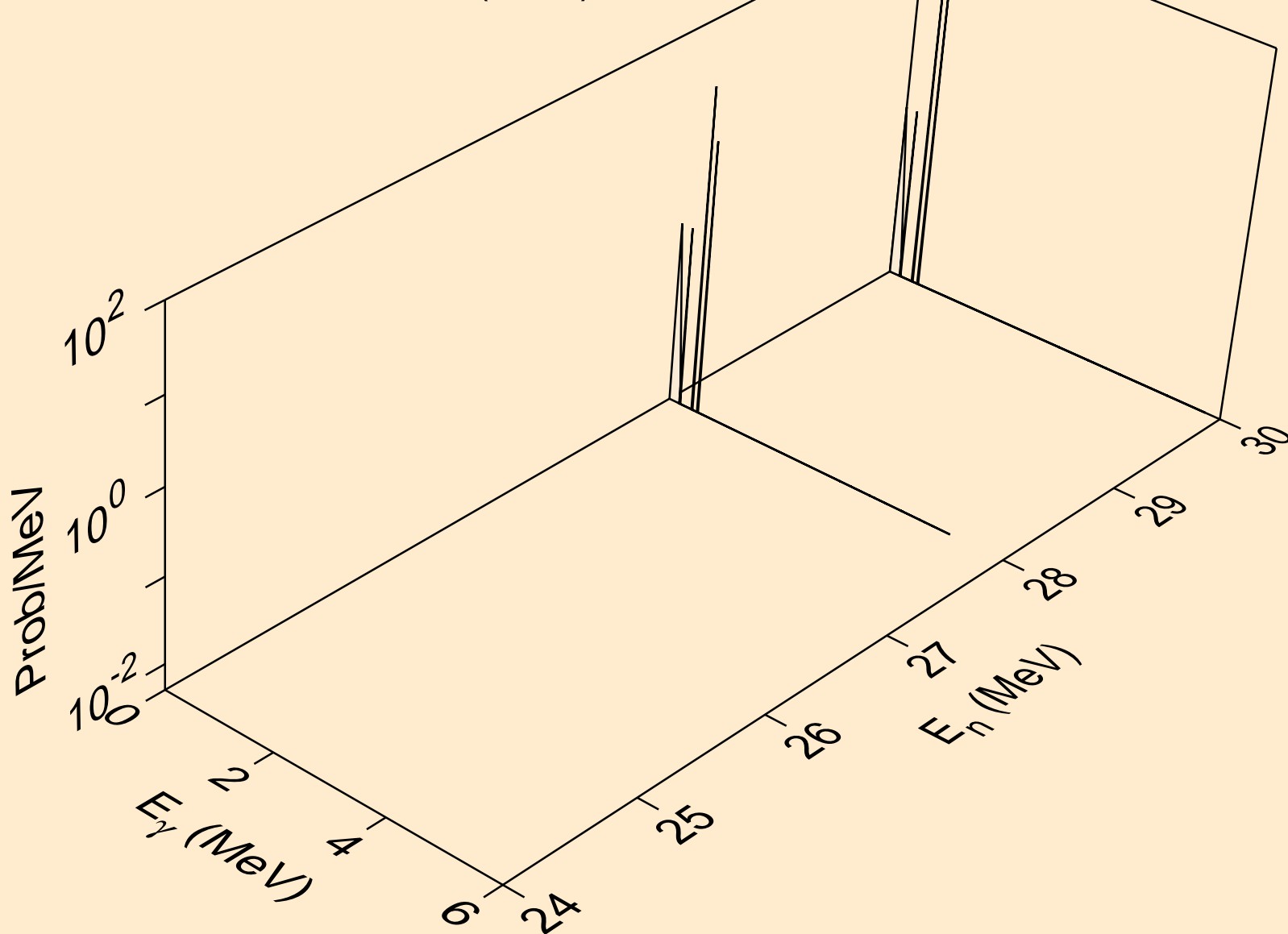

NA021 NEUTRON ACER TENDL-2019 LIBRARY; T=293.16K
Photon emission for (n,n*)p

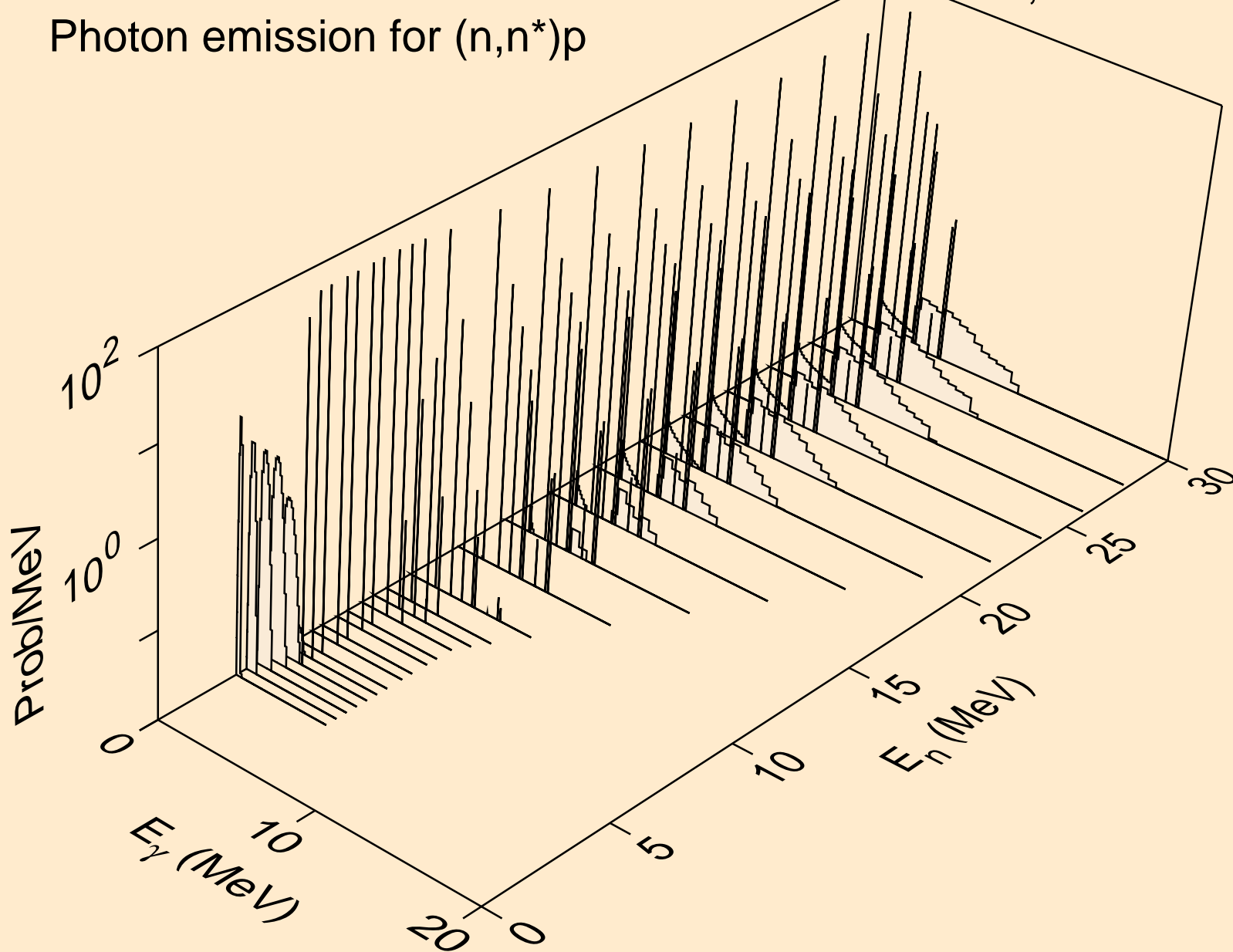

NA021 NEUTRON ACER TENDL-2019 LIBRARY; T=293.16K
Photon emission for (n,n*)2a

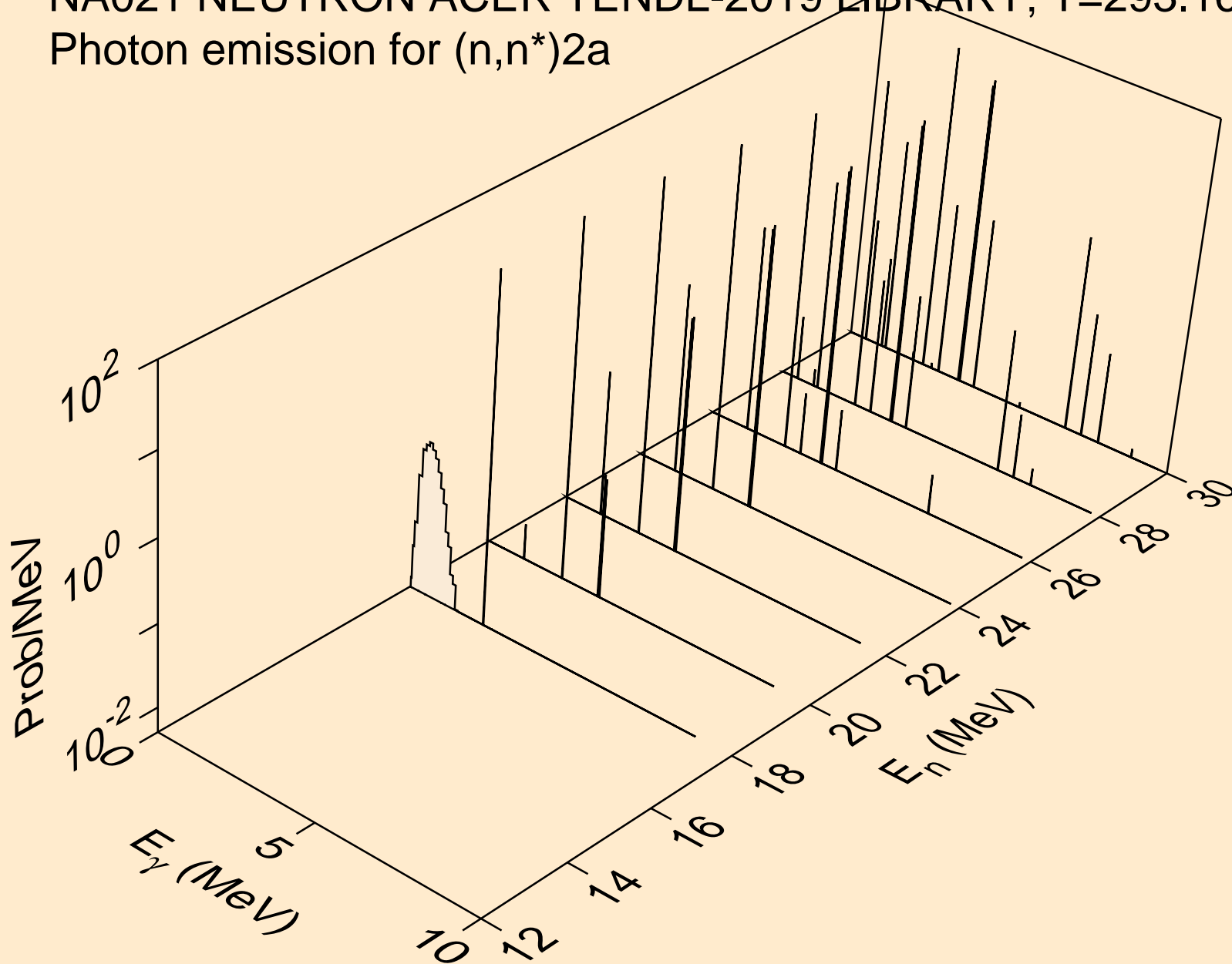

NA021 NEUTRON ACER TENDL-2019 LIBRARY; T=293.16K
Photon emission for (n,n*)d

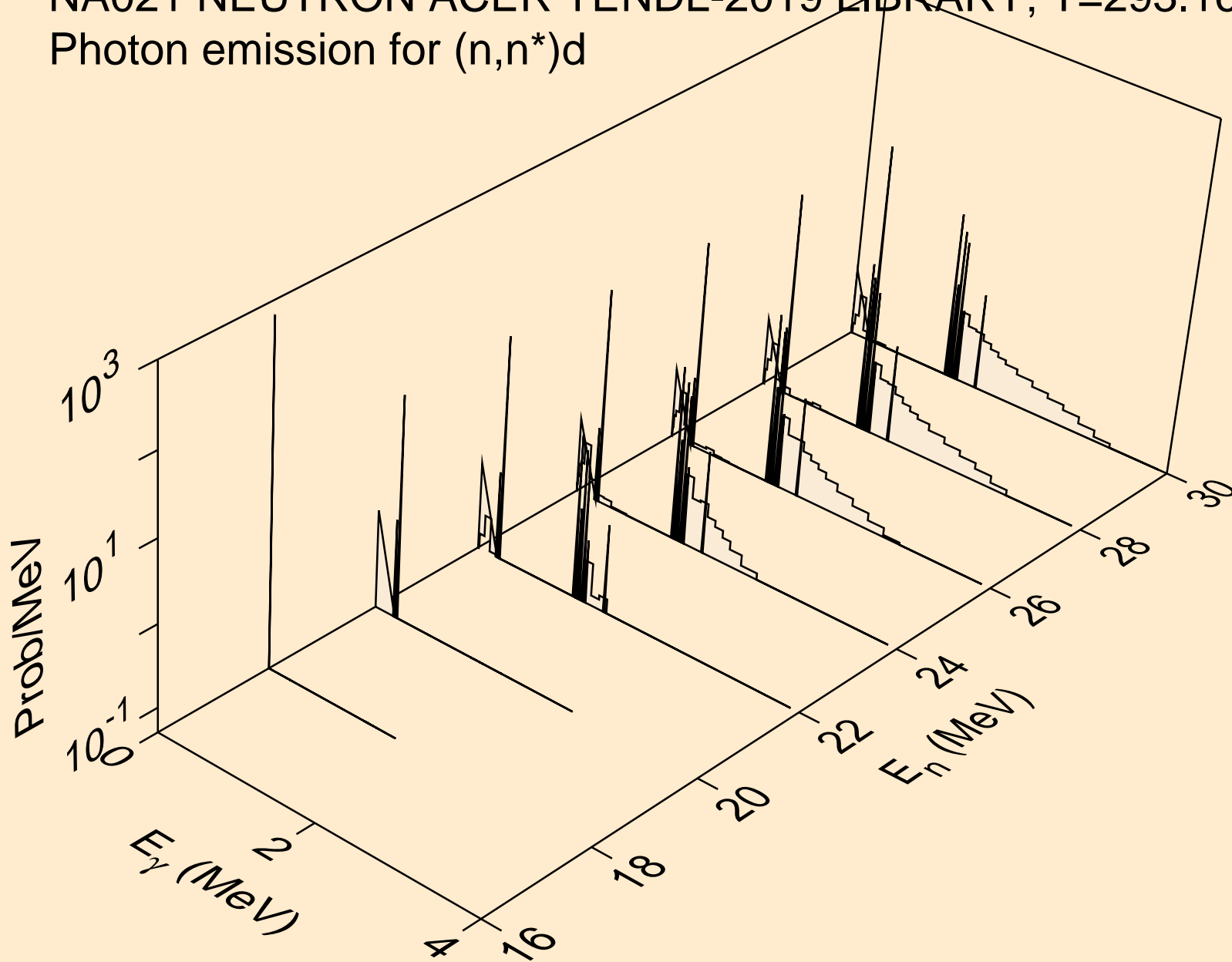

NA021 NEUTRON ACER TENDL-2019 LIBRARY; T=293.16K
Photon emission for (n,n*)t

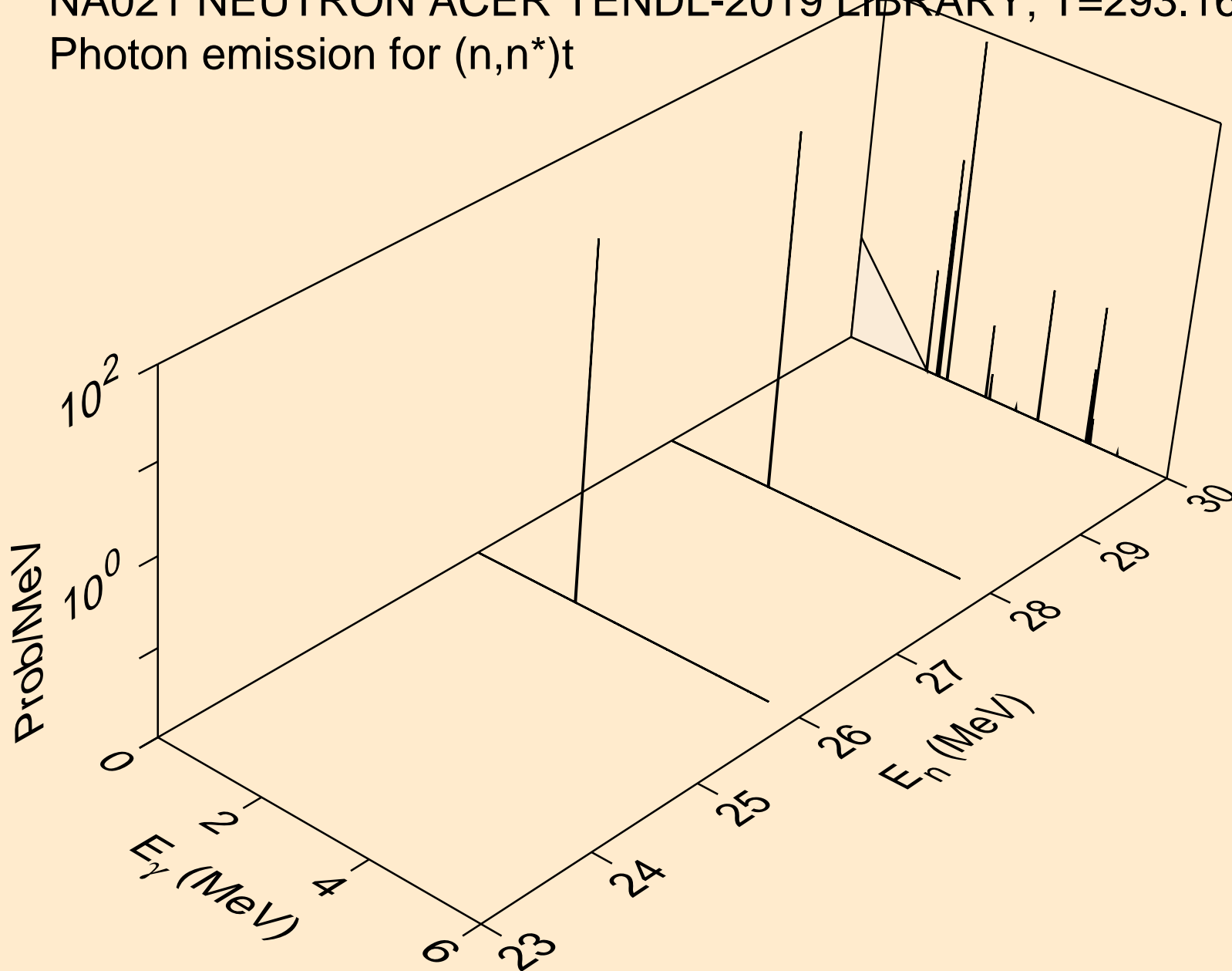

NA021 NEUTRON ACER TENDL-2019 LIBRARY; T=293.16K
Photon emission for (n,n*)he3

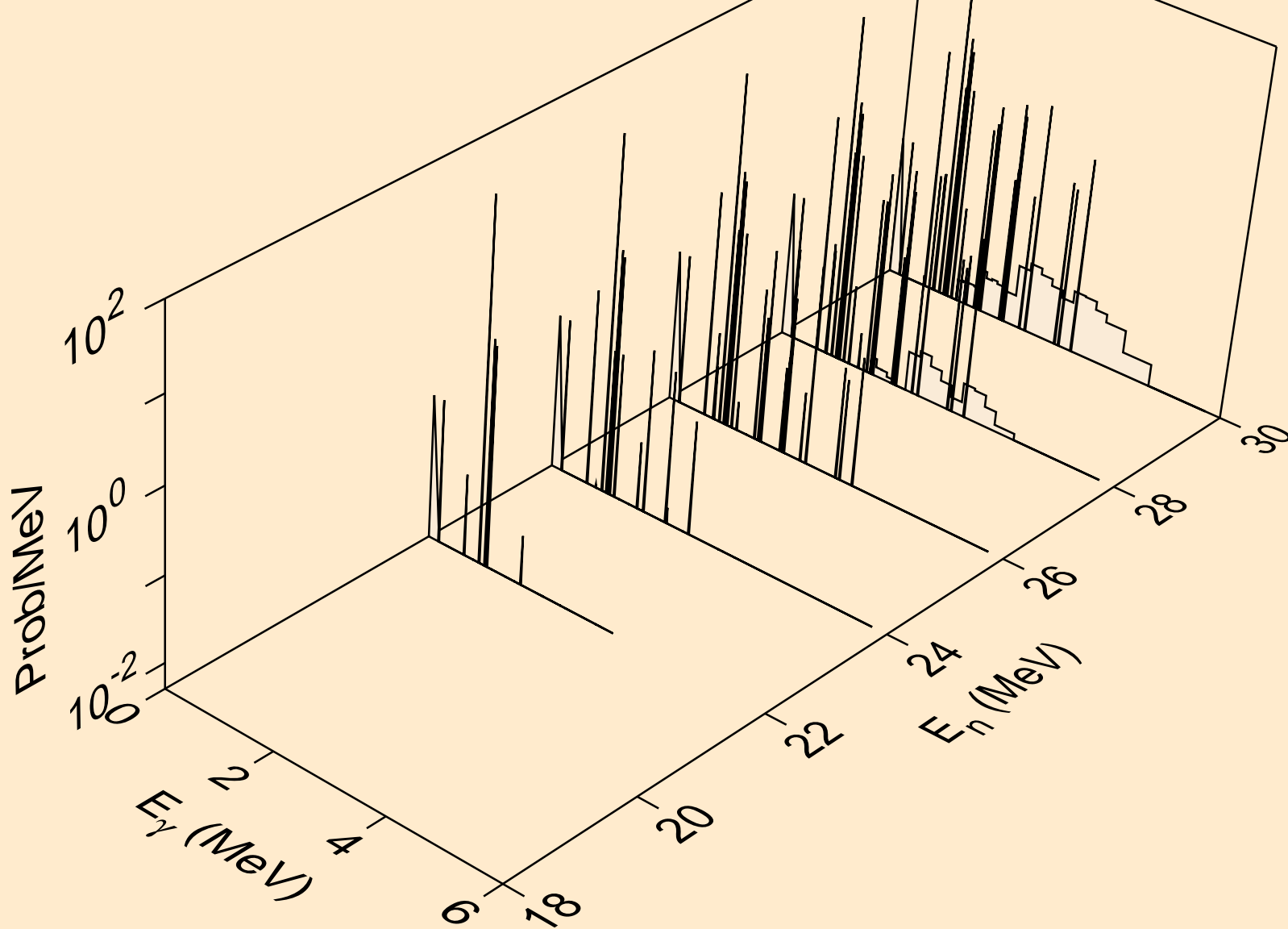

NA021 NEUTRON ACER TENDL-2019 LIBRARY; T=293.16K
Photon emission for (n,2np)

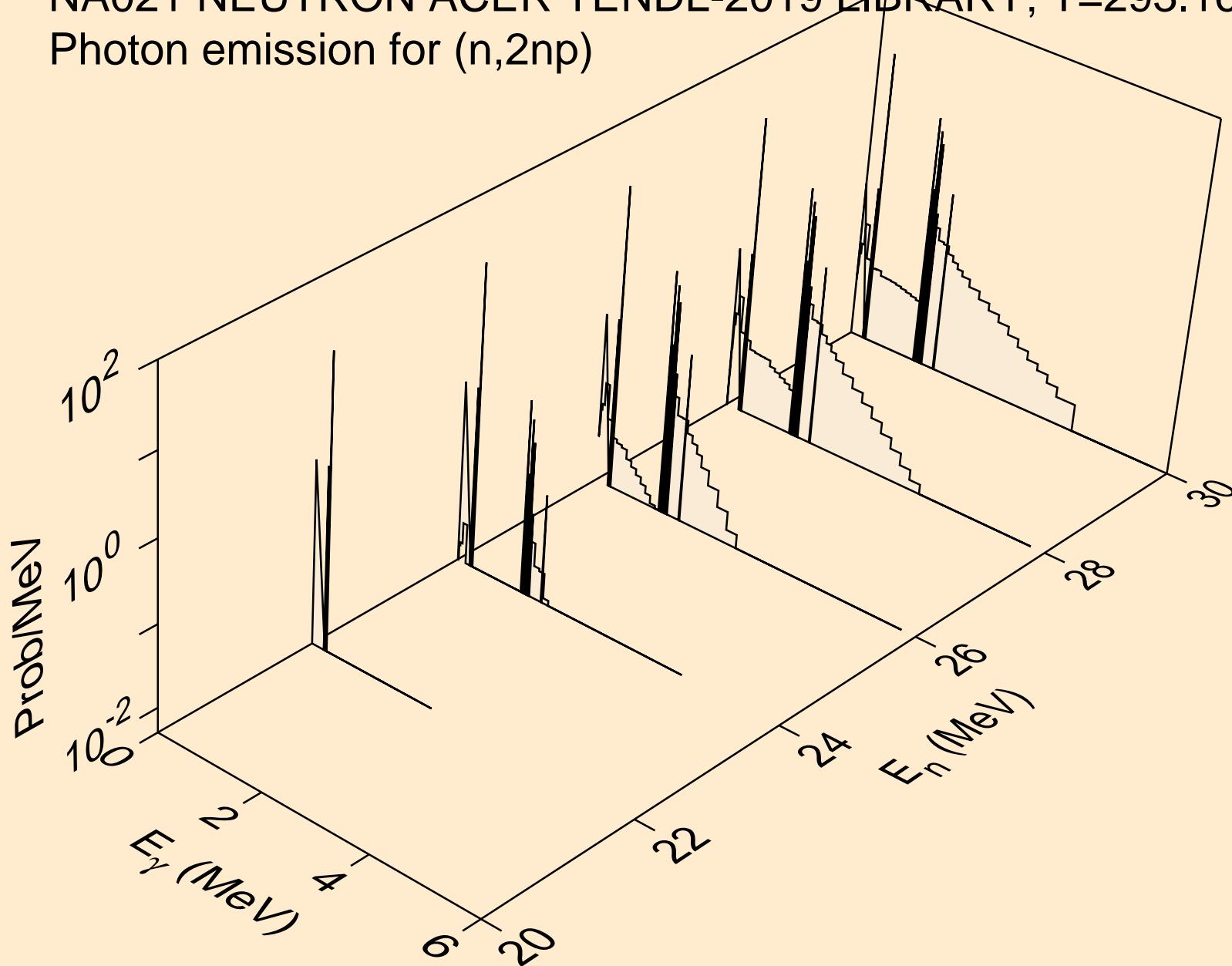

NA021 NEUTRON ACER TENDL-2019 LIBRARY; T=293.16K
Photon emission for (n,2np)

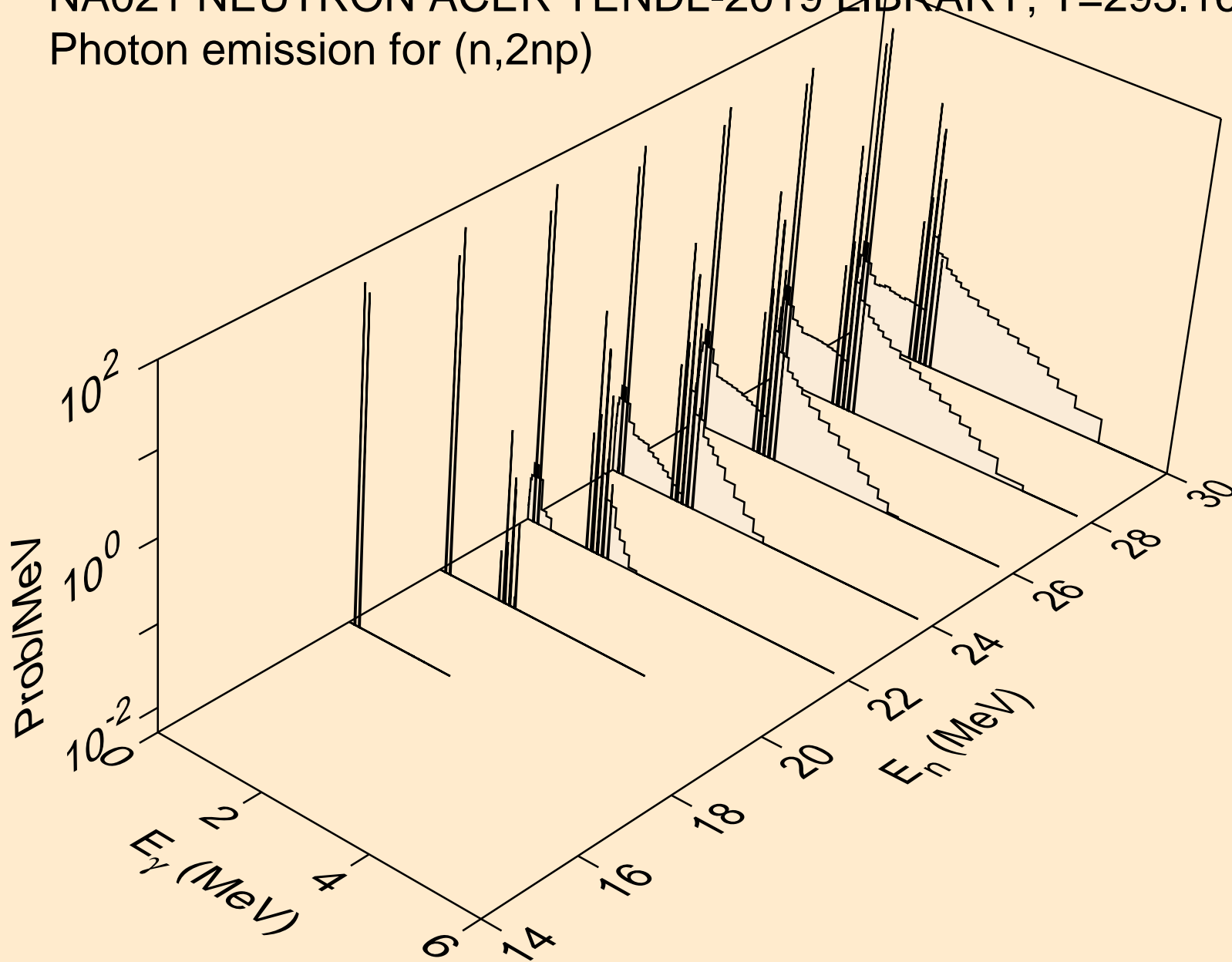

NA021 NEUTRON ACER TENDL-2019 LIBRARY; T=293.16K
Photon emission for (n,npa)

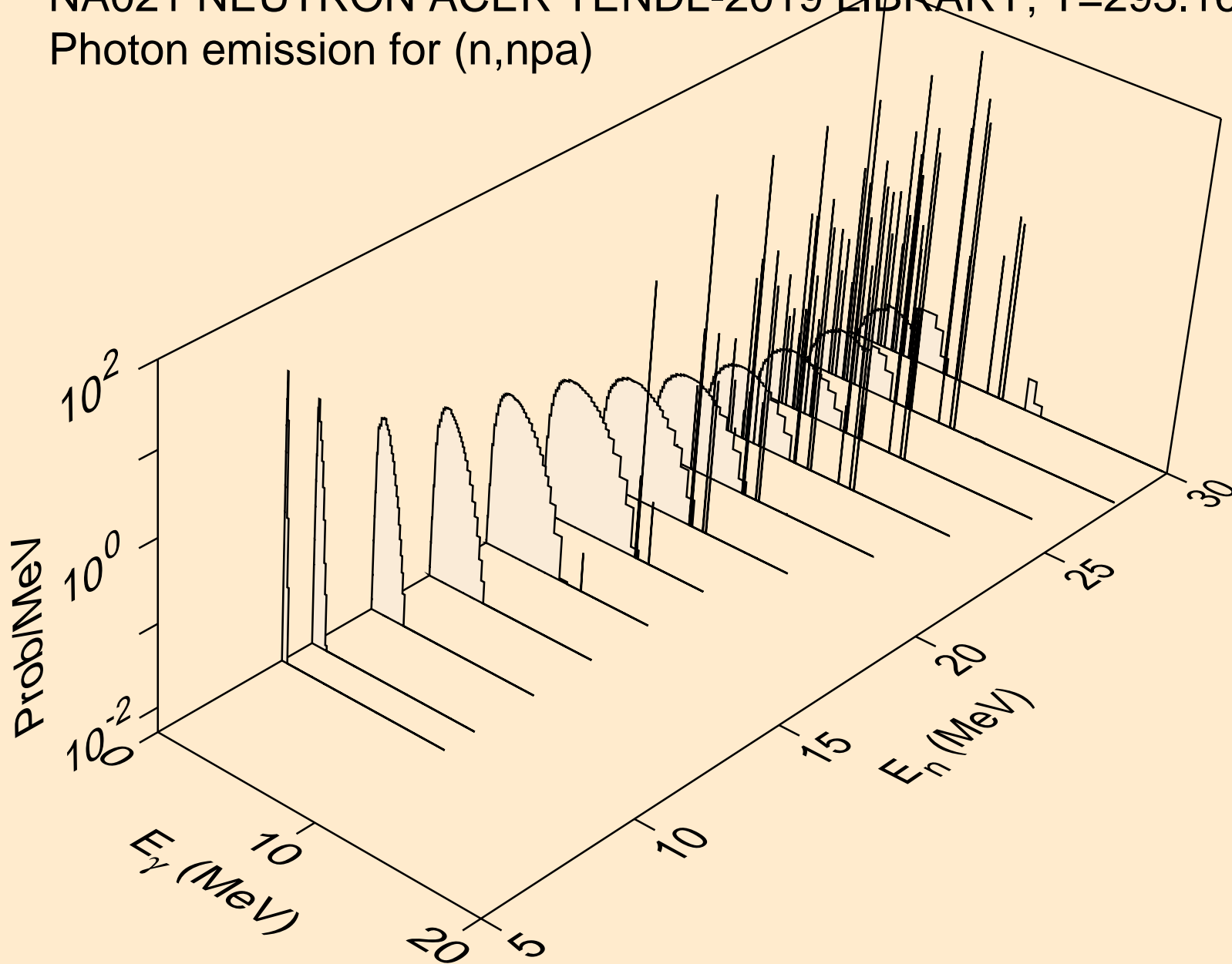

NA021 NEUTRON ACER TENDL-2019 LIBRARY; T=293.16K
Photon emission for (n,n*c)

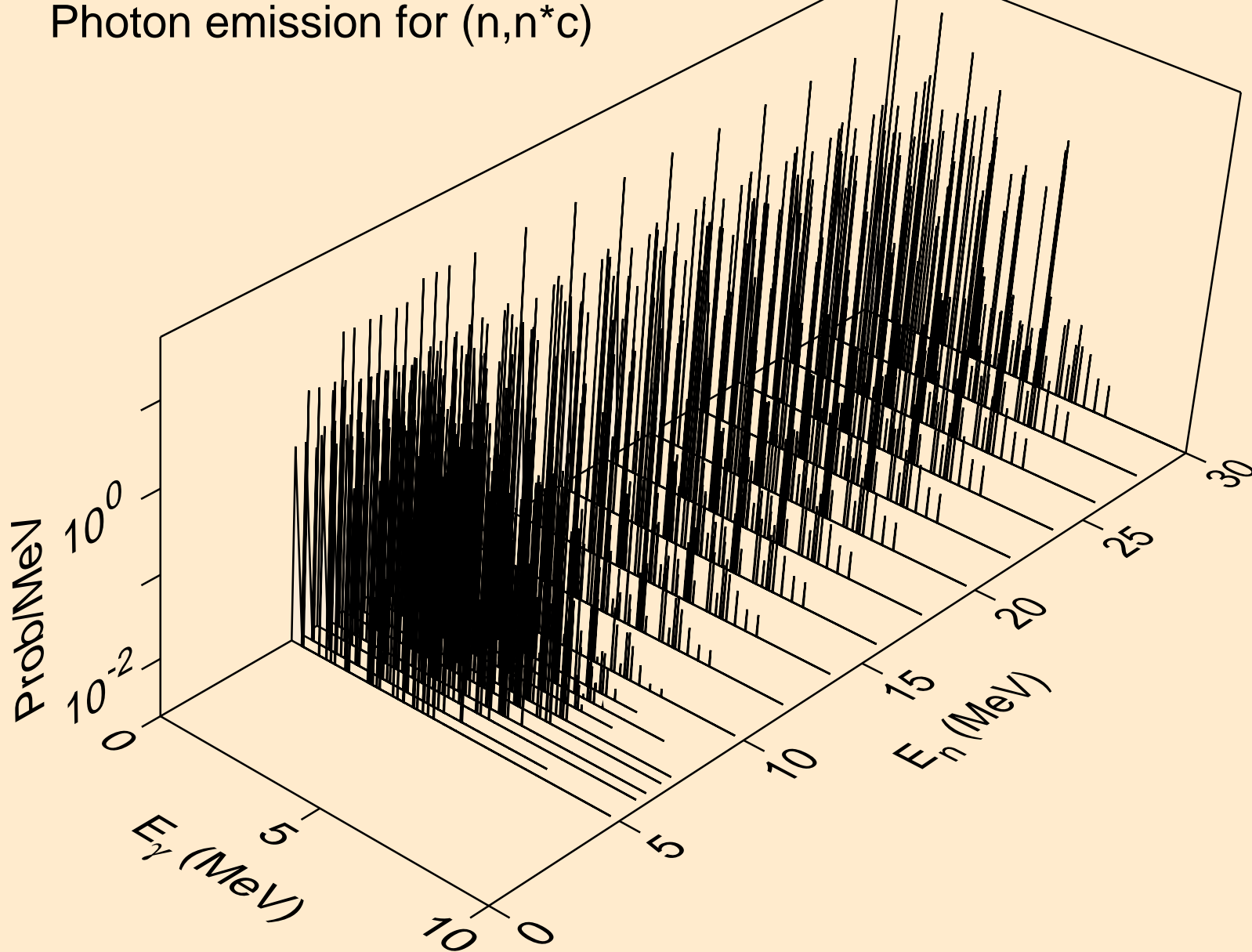

NA021 NEUTRON ACER TENDL-2019 LIBRARY; T=293.16K
Photon emission for (n,gma)

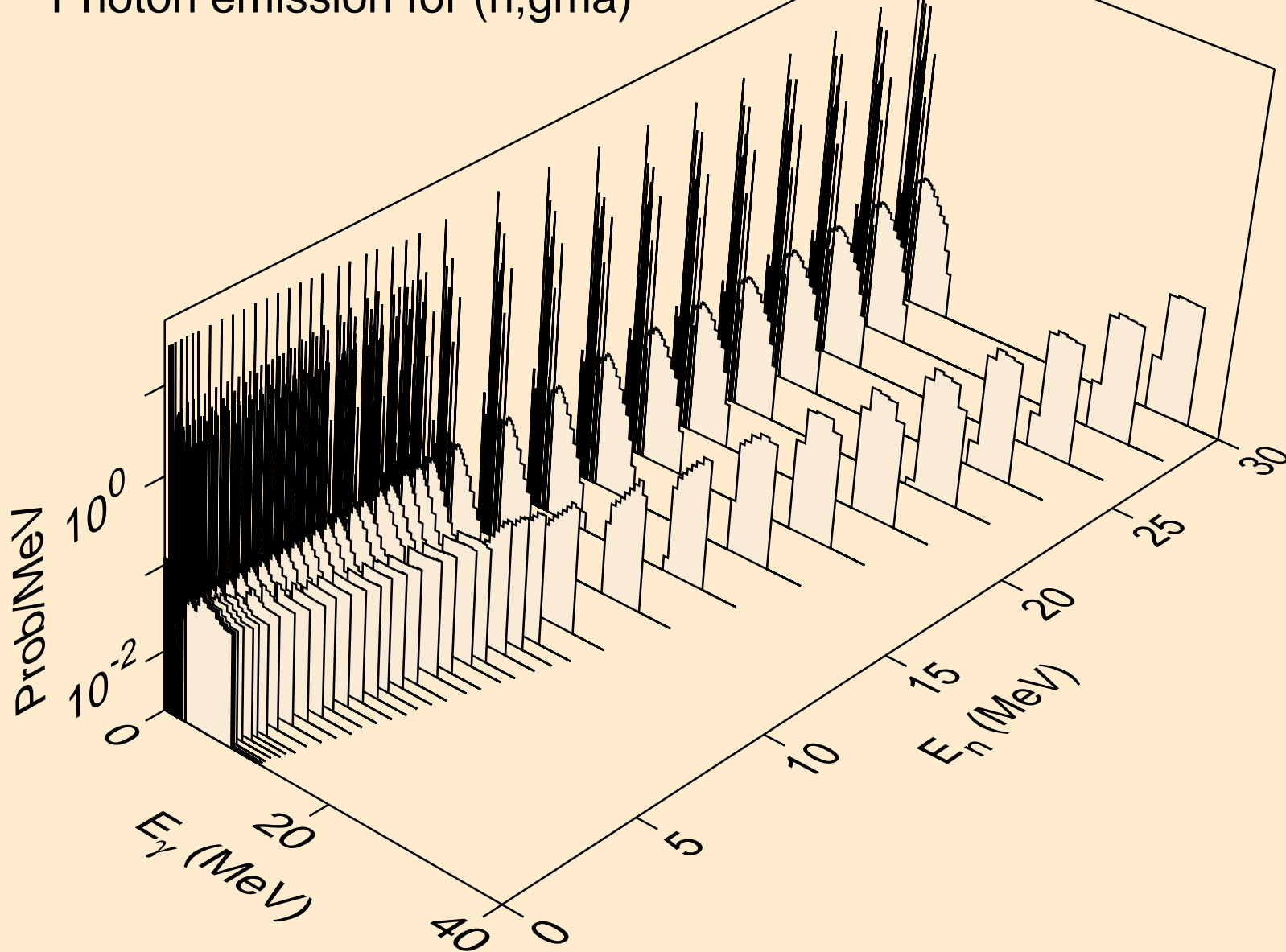

NA021 NEUTRON ACER TENDL-2019 LIBRARY; T=293.16K
Photon emission for (n,p)

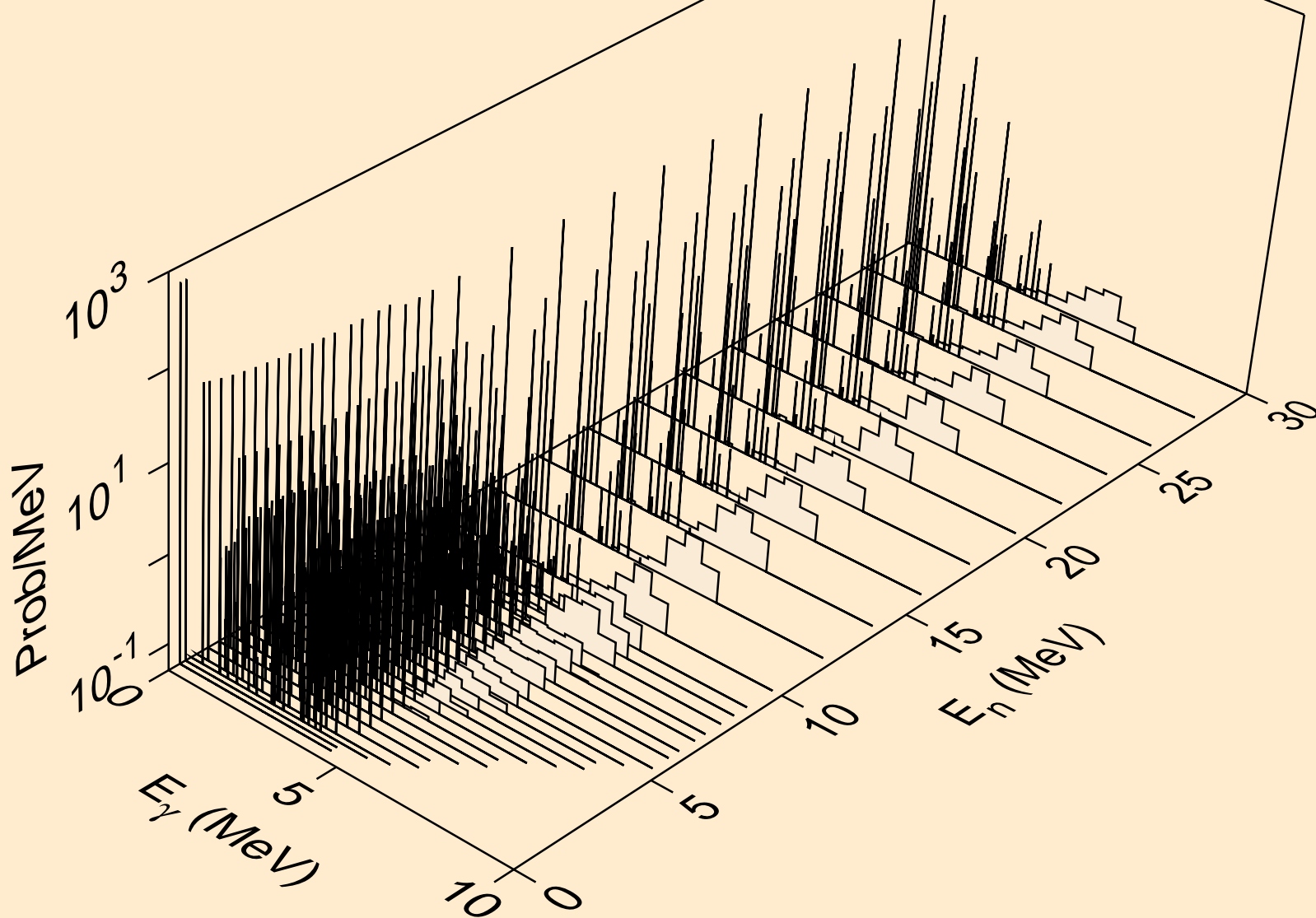

NA021 NEUTRON ACER TENDL-2019 LIBRARY; T=293.16K
Photon emission for (n,d)

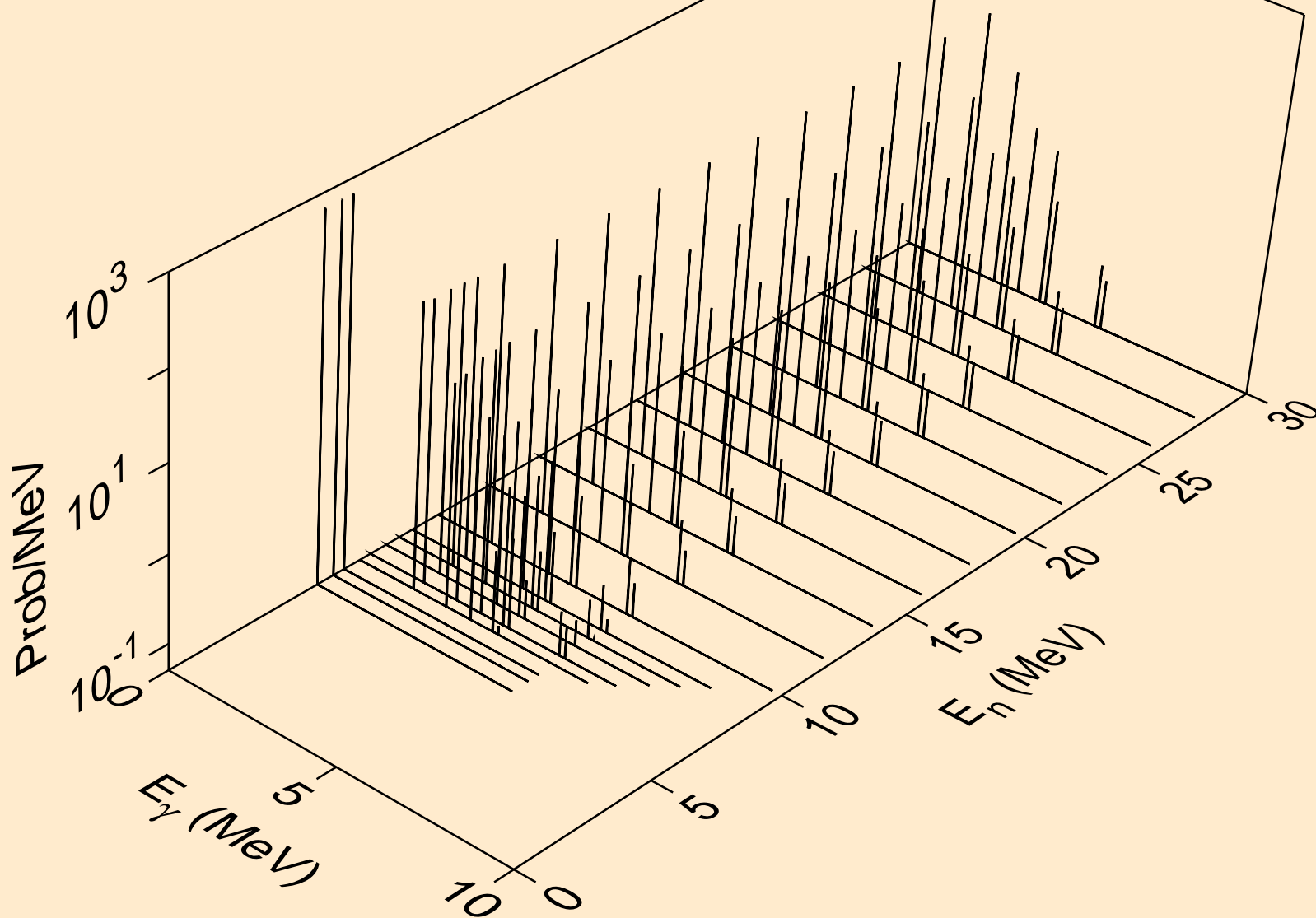

NA021 NEUTRON ACER TENDL-2019 LIBRARY; T=293.16K
Photon emission for (n,t)

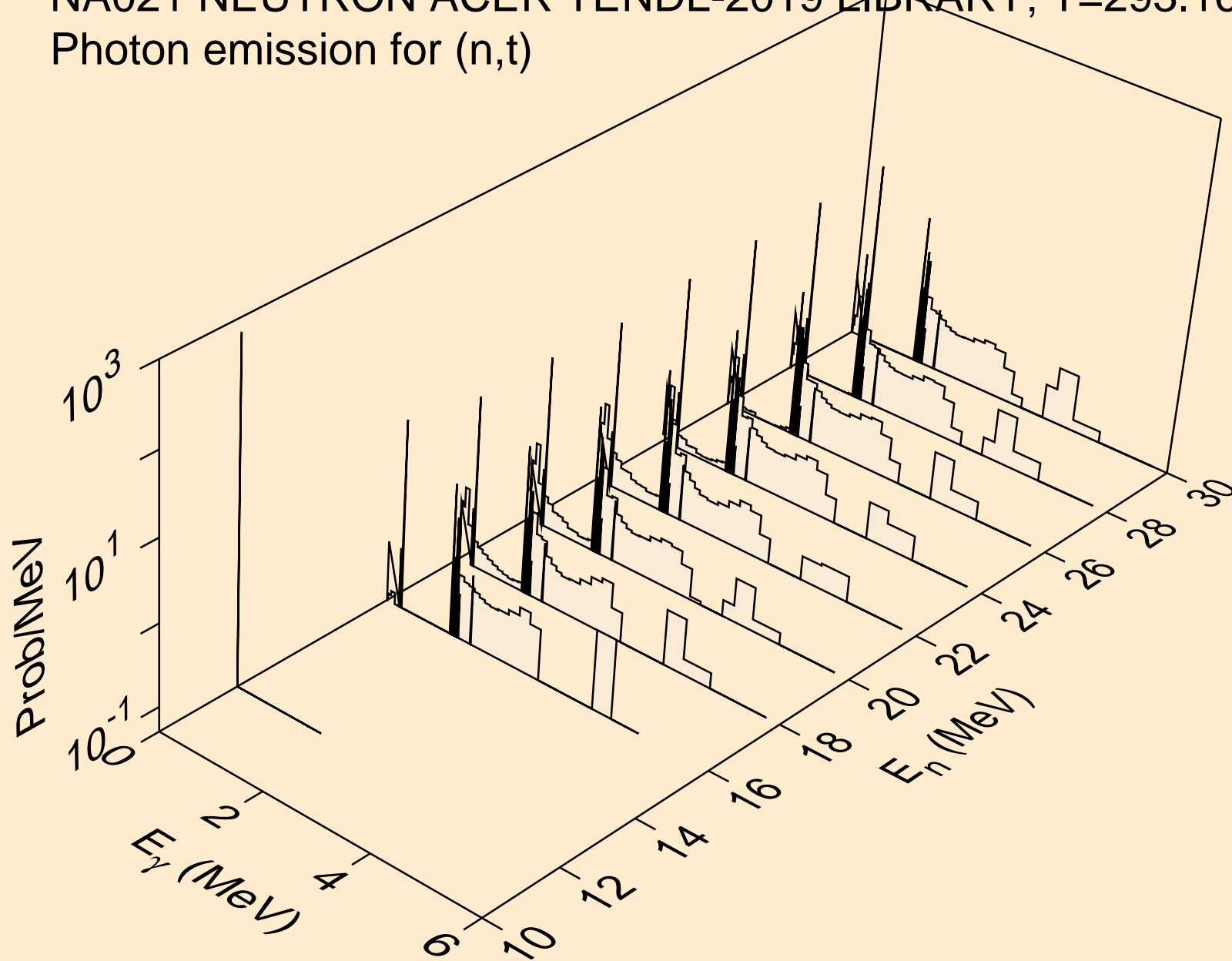

NA021 NEUTRON ACER TENDL-2019 LIBRARY; T=293.16K
Photon emission for (n,he3)

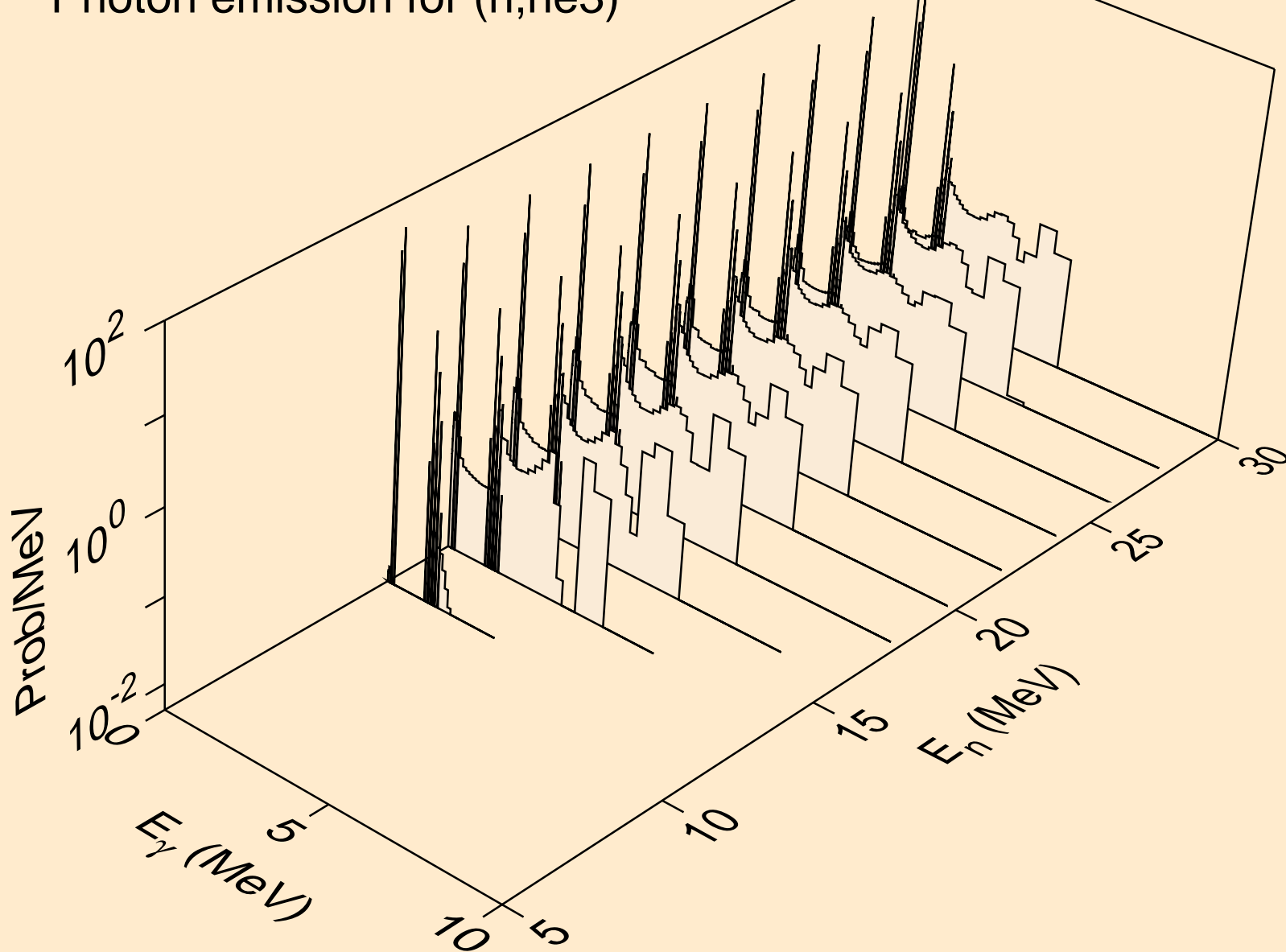

NA021 NEUTRON ACER TENDL-2019 LIBRARY; T=293.16K
Photon emission for (n,a)

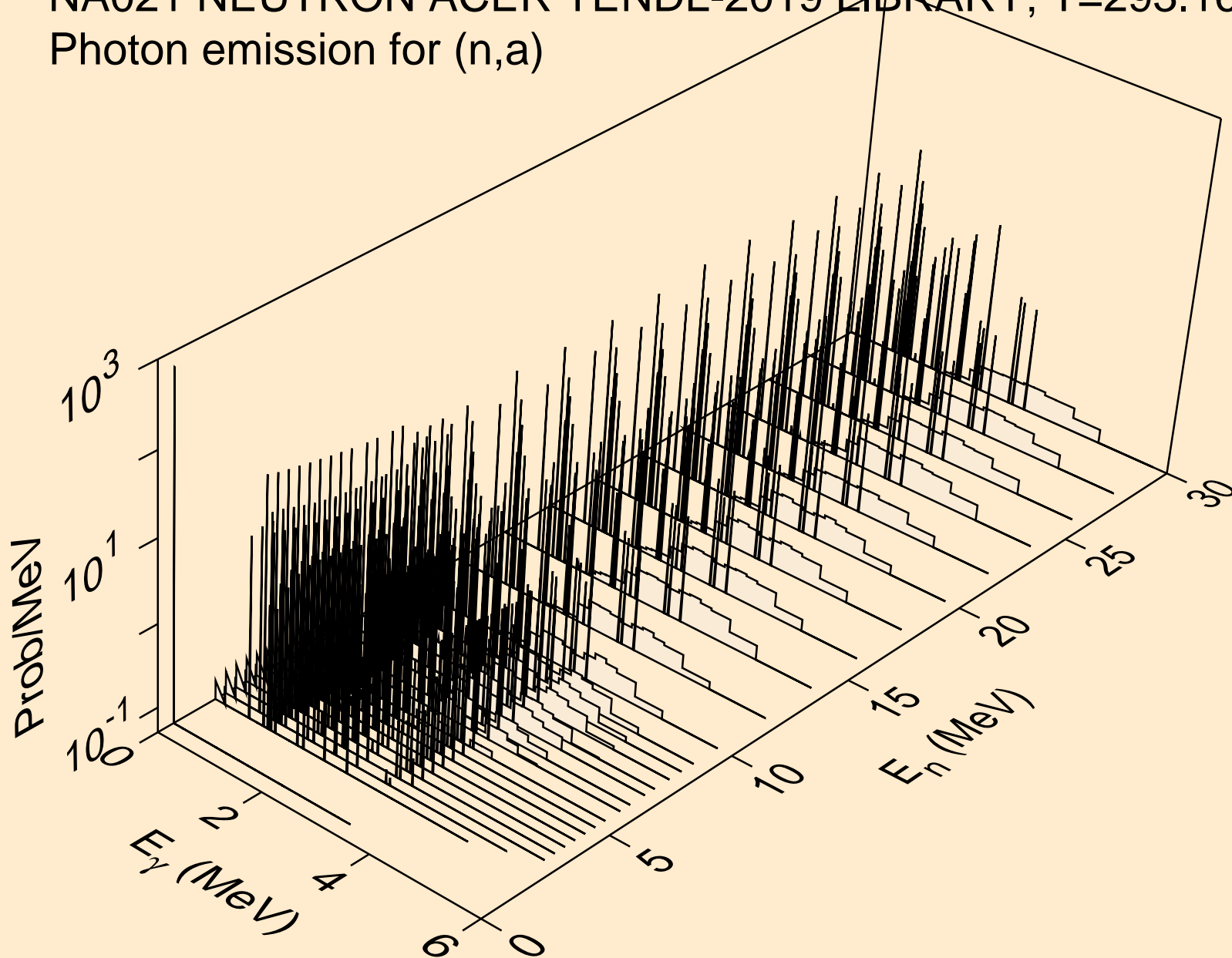

NA021 NEUTRON ACER TENDL-2019 LIBRARY; T=293.16K
Photon emission for (n,2a)

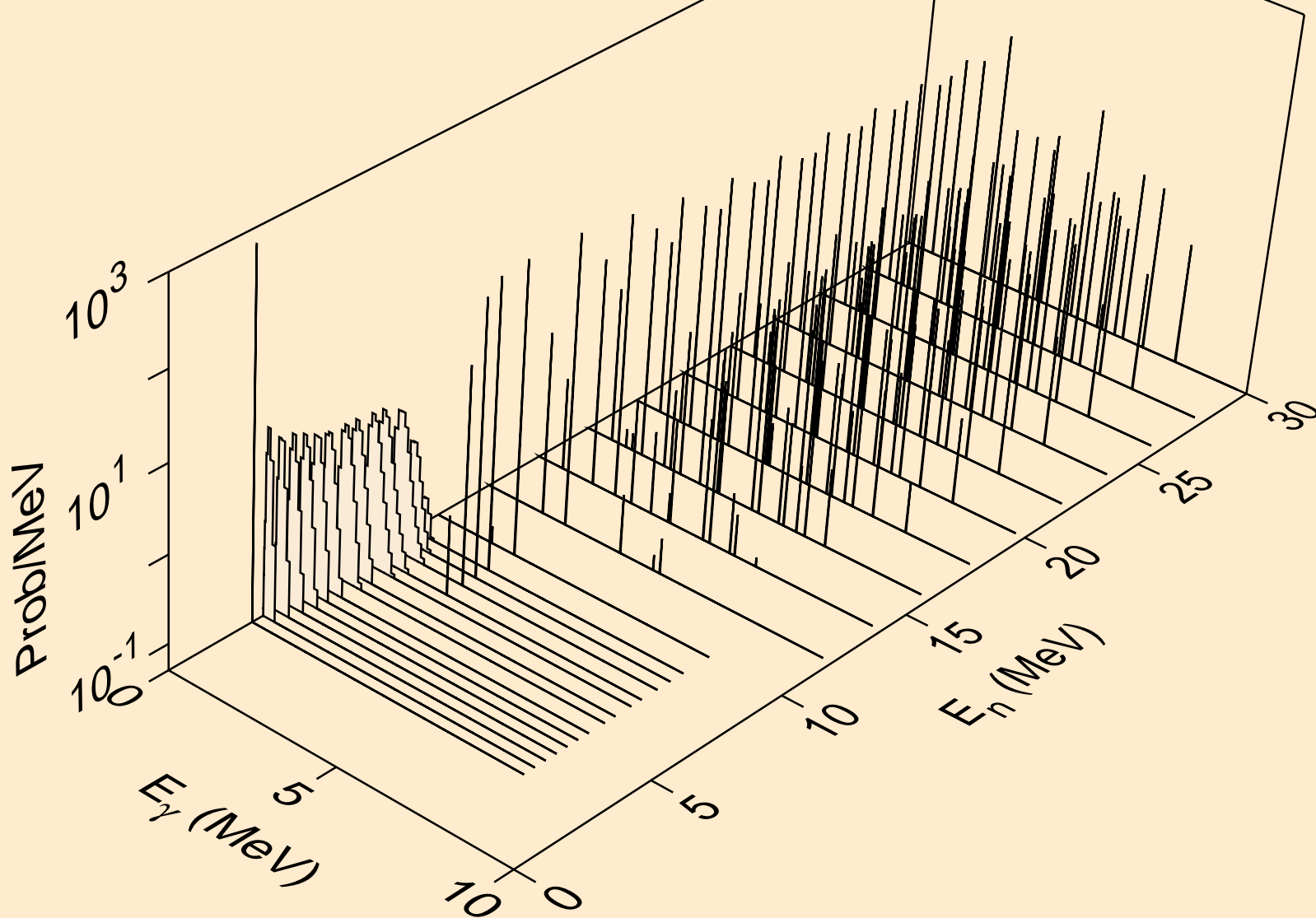

NA021 NEUTRON ACER TENDL-2019 LIBRARY; T=293.16K
Photon emission for (n,3a)

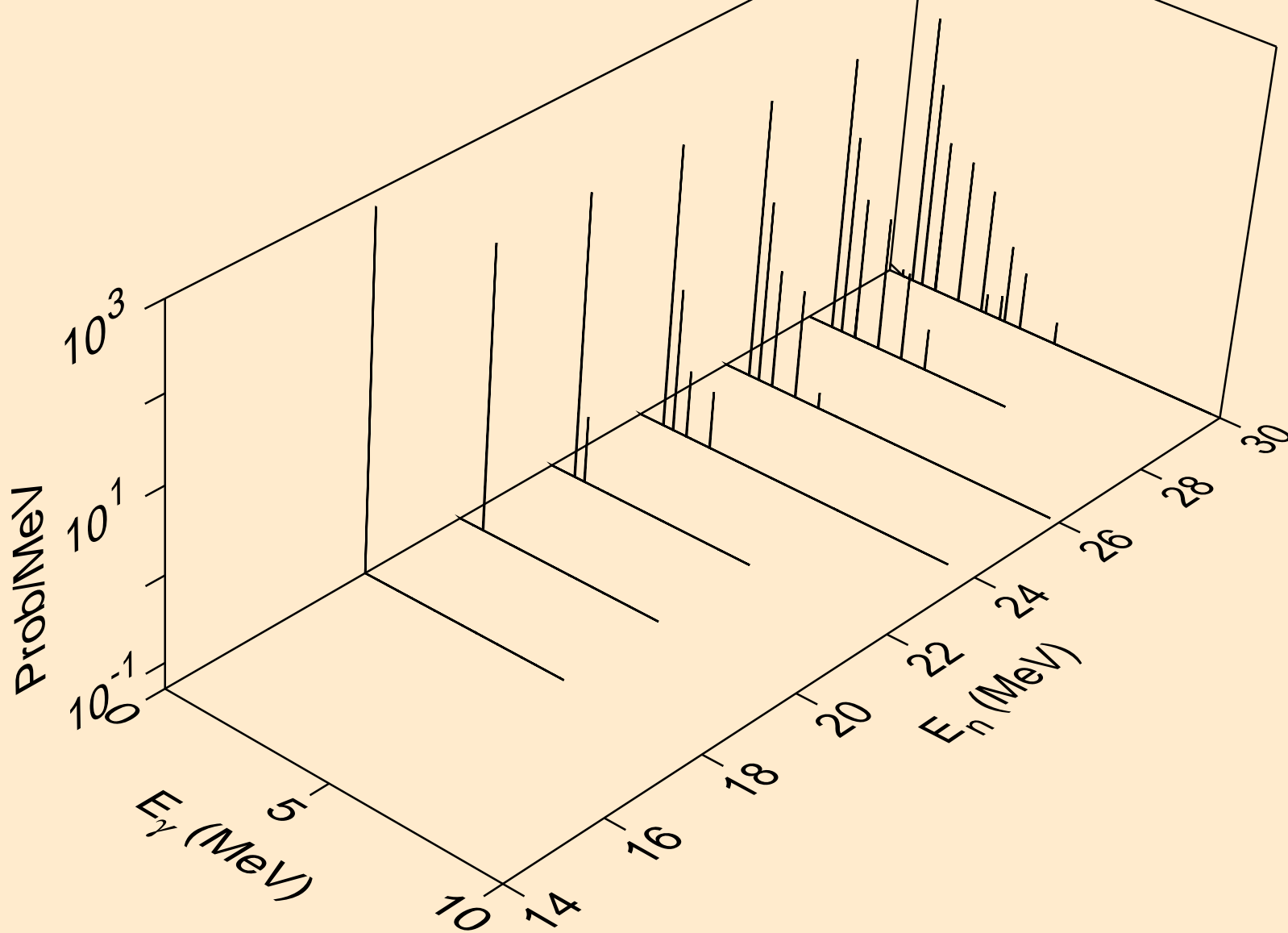

NA021 NEUTRON ACER TENDL-2019 LIBRARY; T=293.16K
Photon emission for (n,2p)

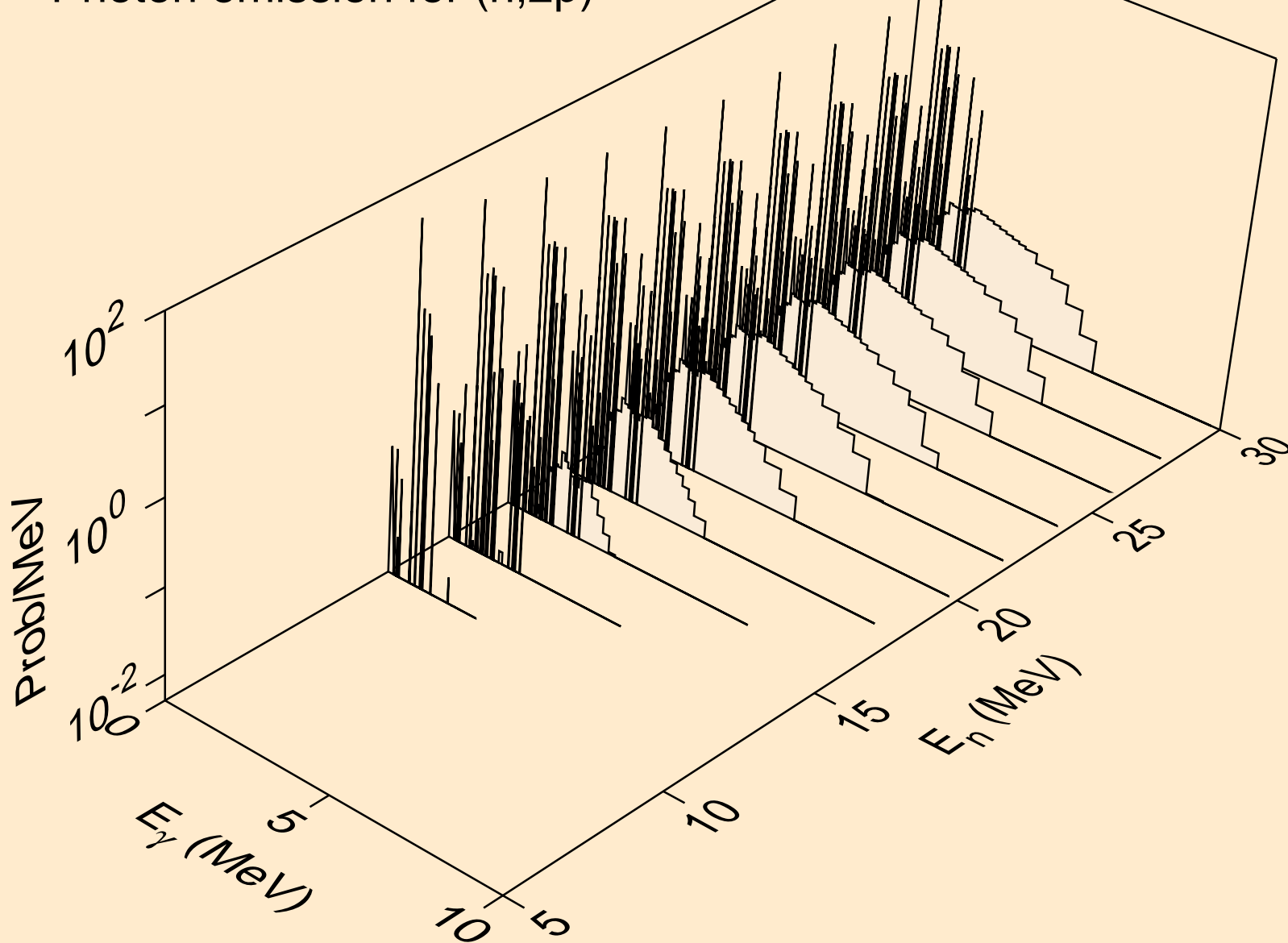

NA021 NEUTRON ACER TENDL-2019 LIBRARY; T=293.16K
Photon emission for (n,p α)

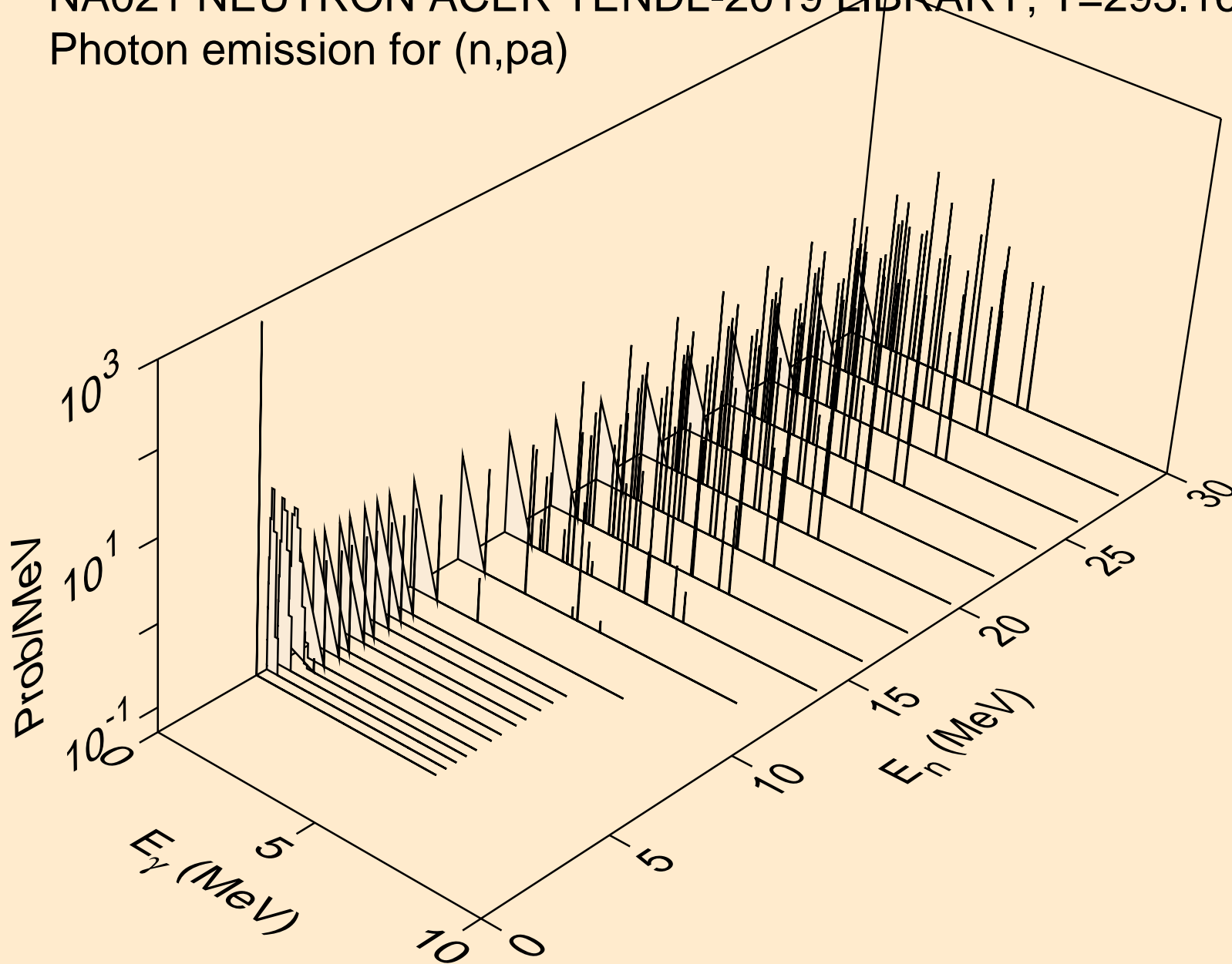

NA021 NEUTRON ACER TENDL-2019 LIBRARY; T=293.16K
Photon emission for (n,d2a)

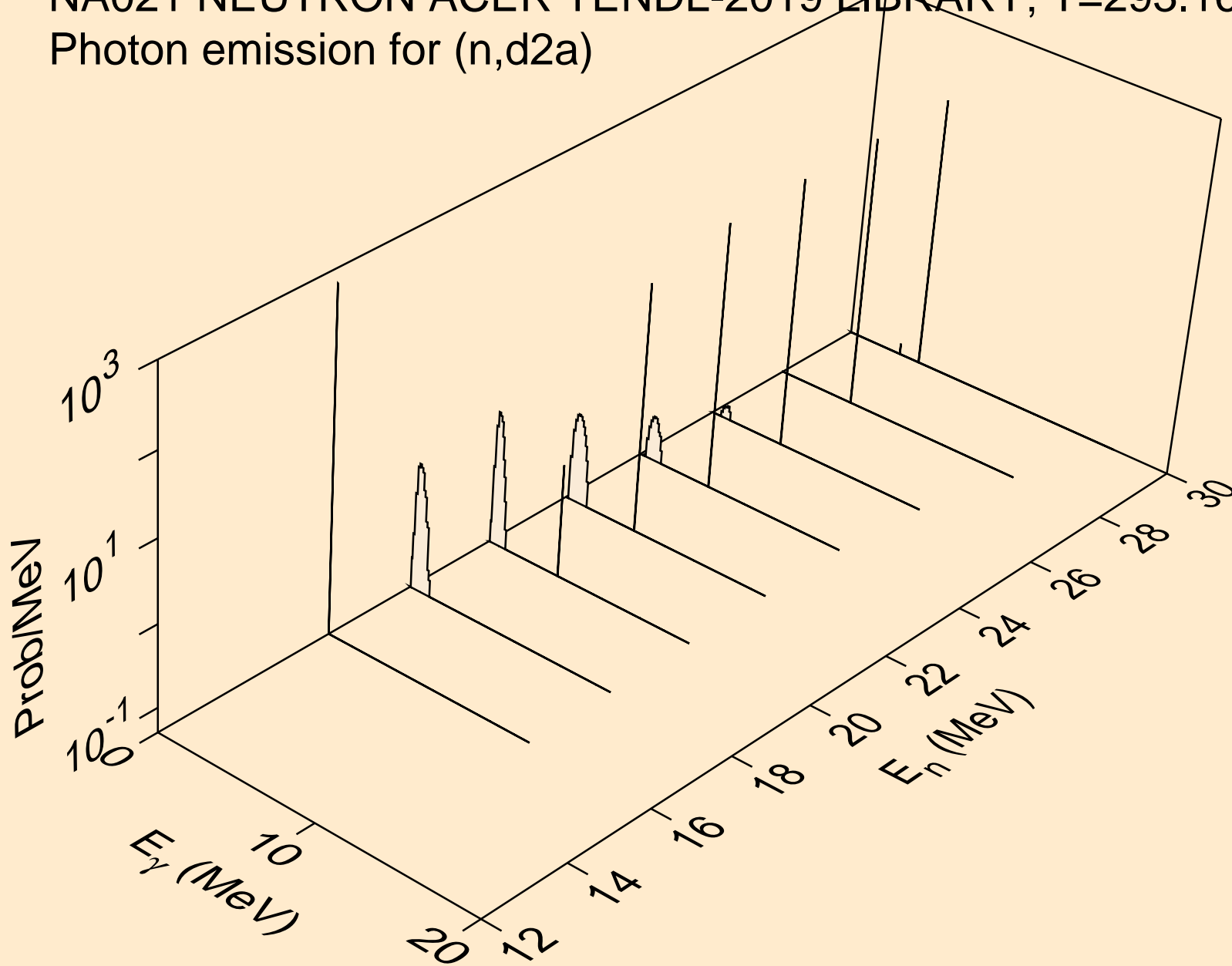

NA021 NEUTRON ACER TENDL-2019 LIBRARY; T=293.16K
Photon emission for (n,pd)

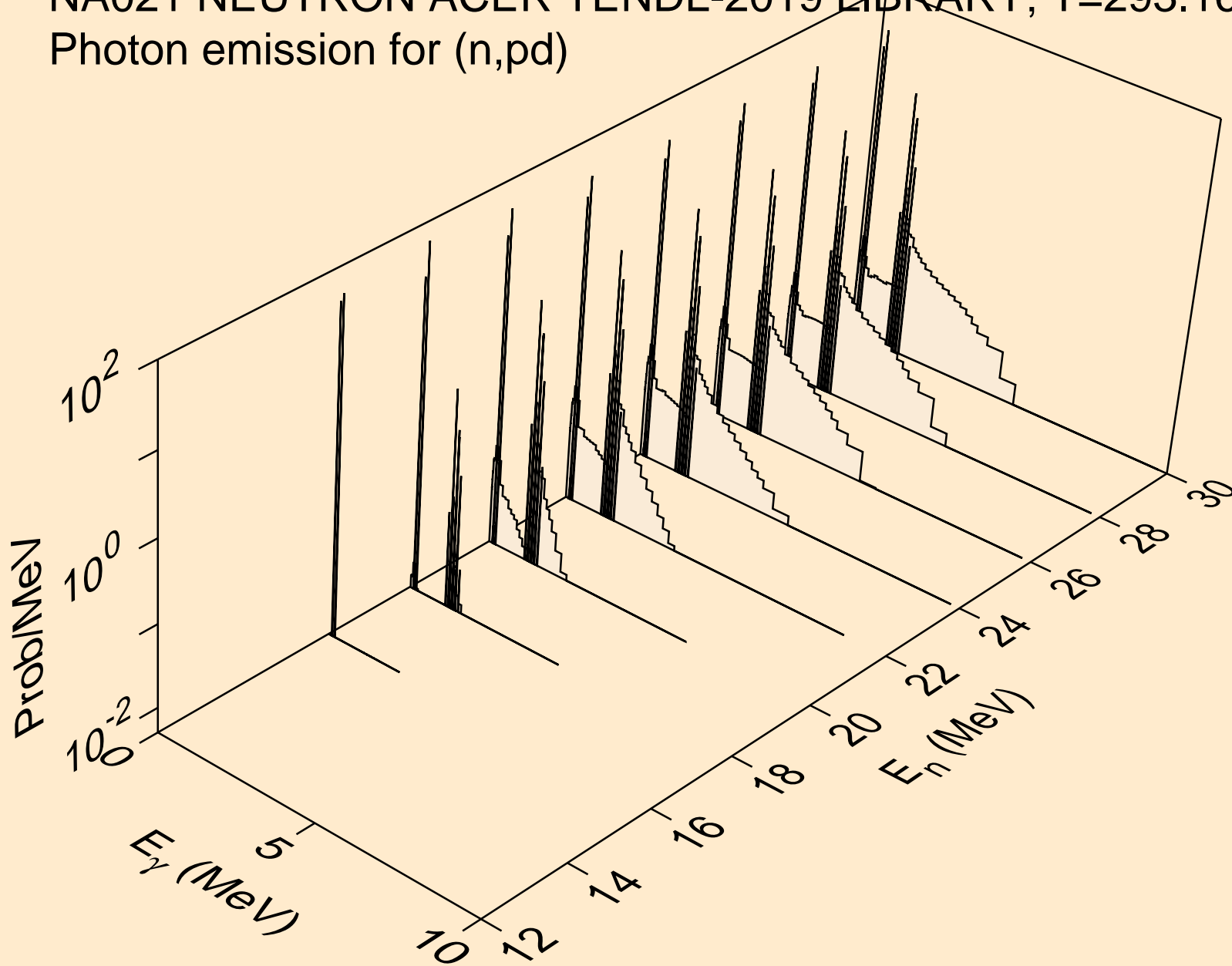

NA021 NEUTRON ACER TENDL-2019 LIBRARY; T=293.16K
Photon emission for (n,pt)

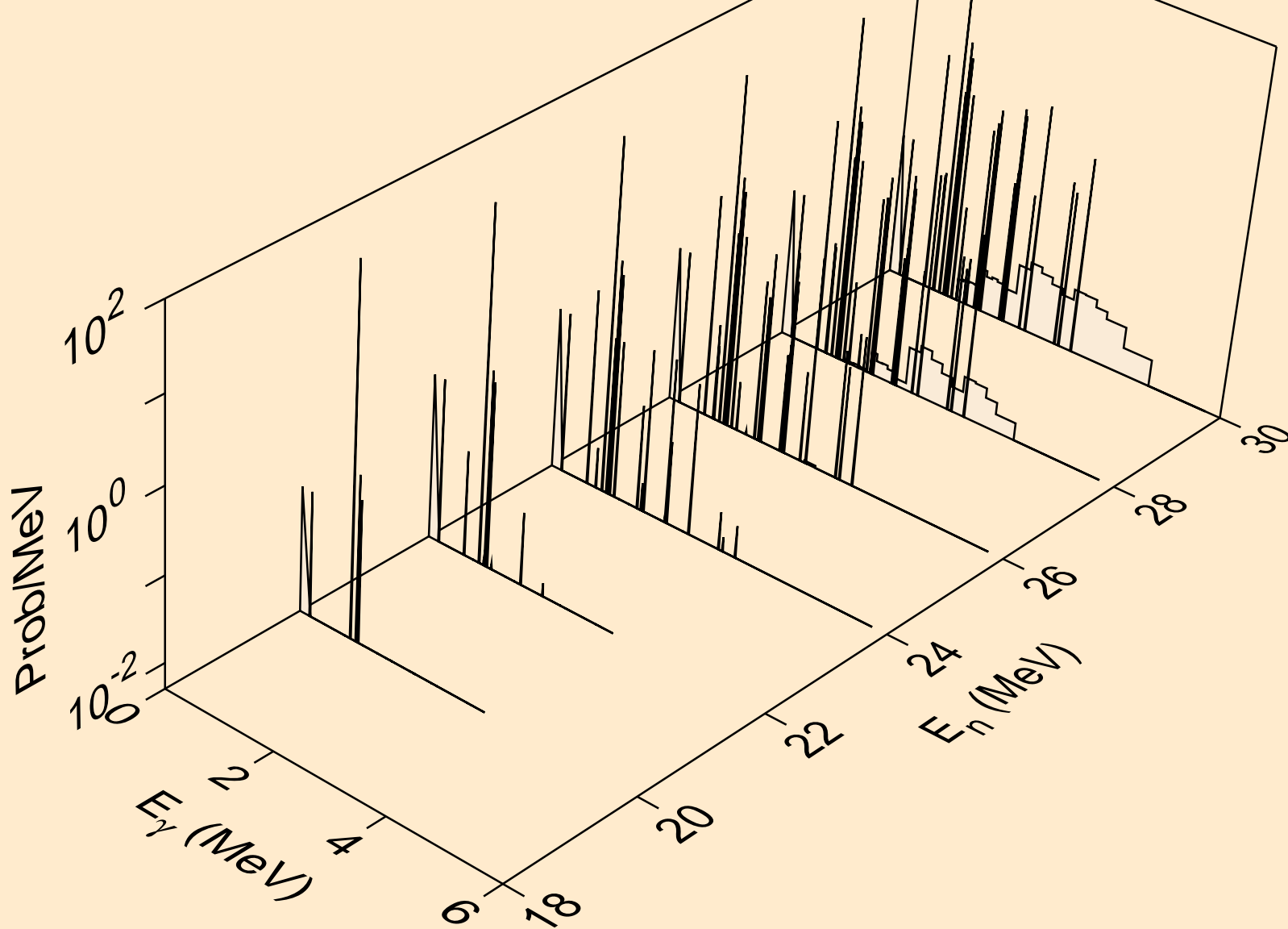

NA021 NEUTRON ACER TENDL-2019 LIBRARY; T=293.16K
Photon emission for (n,da)

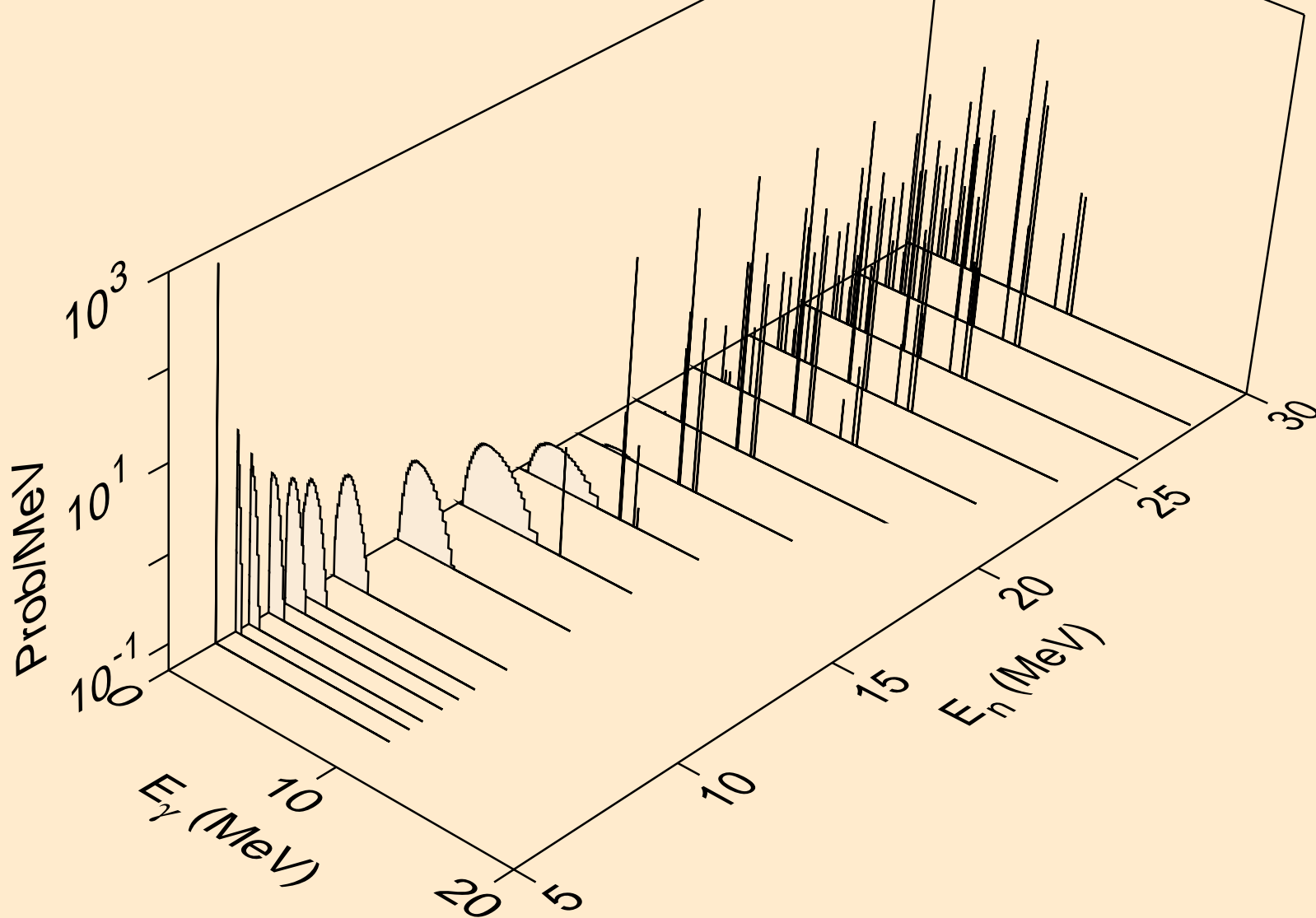

NA021 NEUTRON ACER TENDL-2019 LIBRARY; T=293.16K
thermal capture photon spectrum

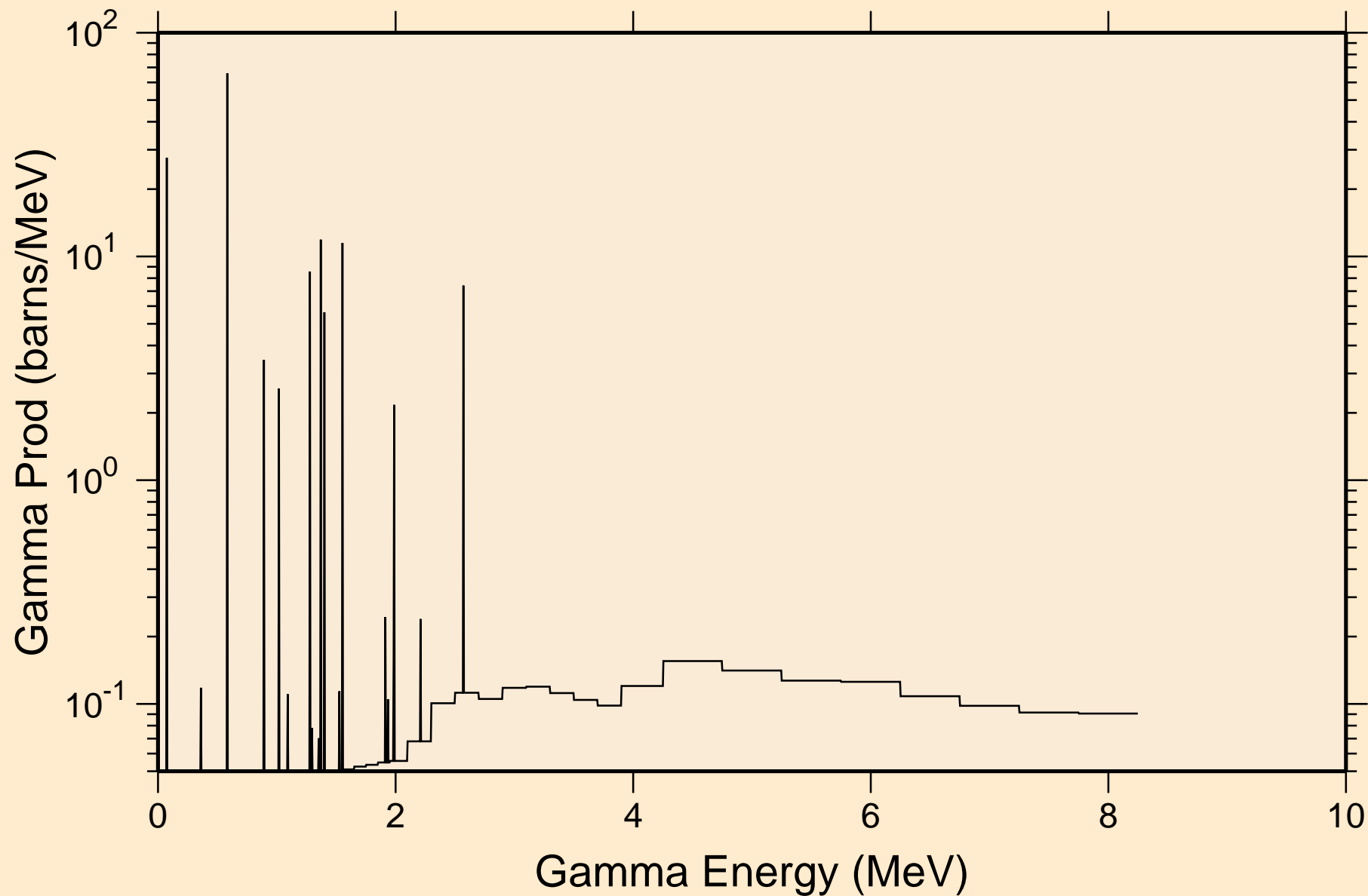

NA021 NEUTRON ACER TENDL-2019 LIBRARY; T=293.16K
14 MeV photon spectrum

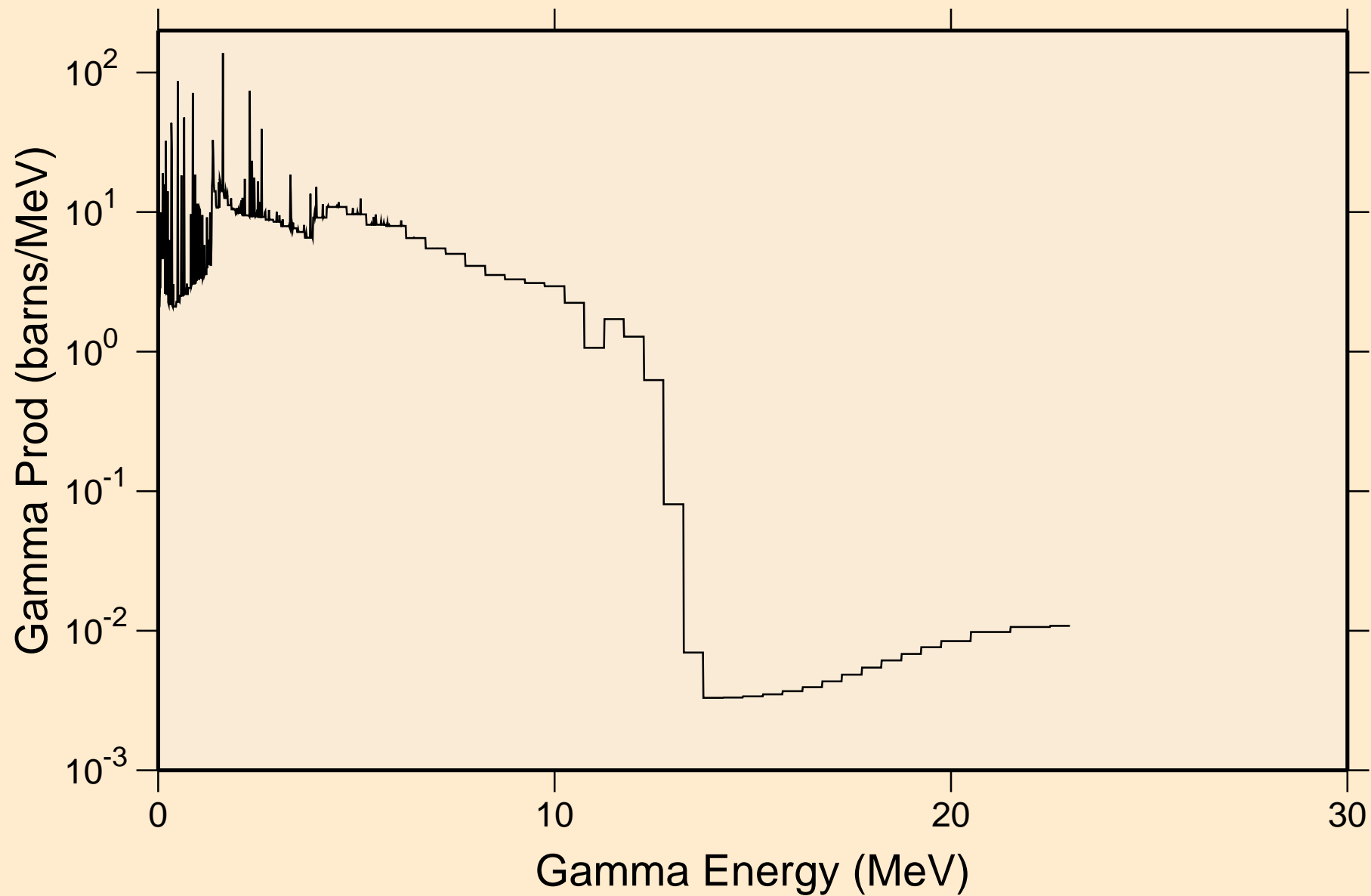

NA021 NEUTRON ACER TENDL-2019 LIBRARY; T=293.16K

Particle heating contributions

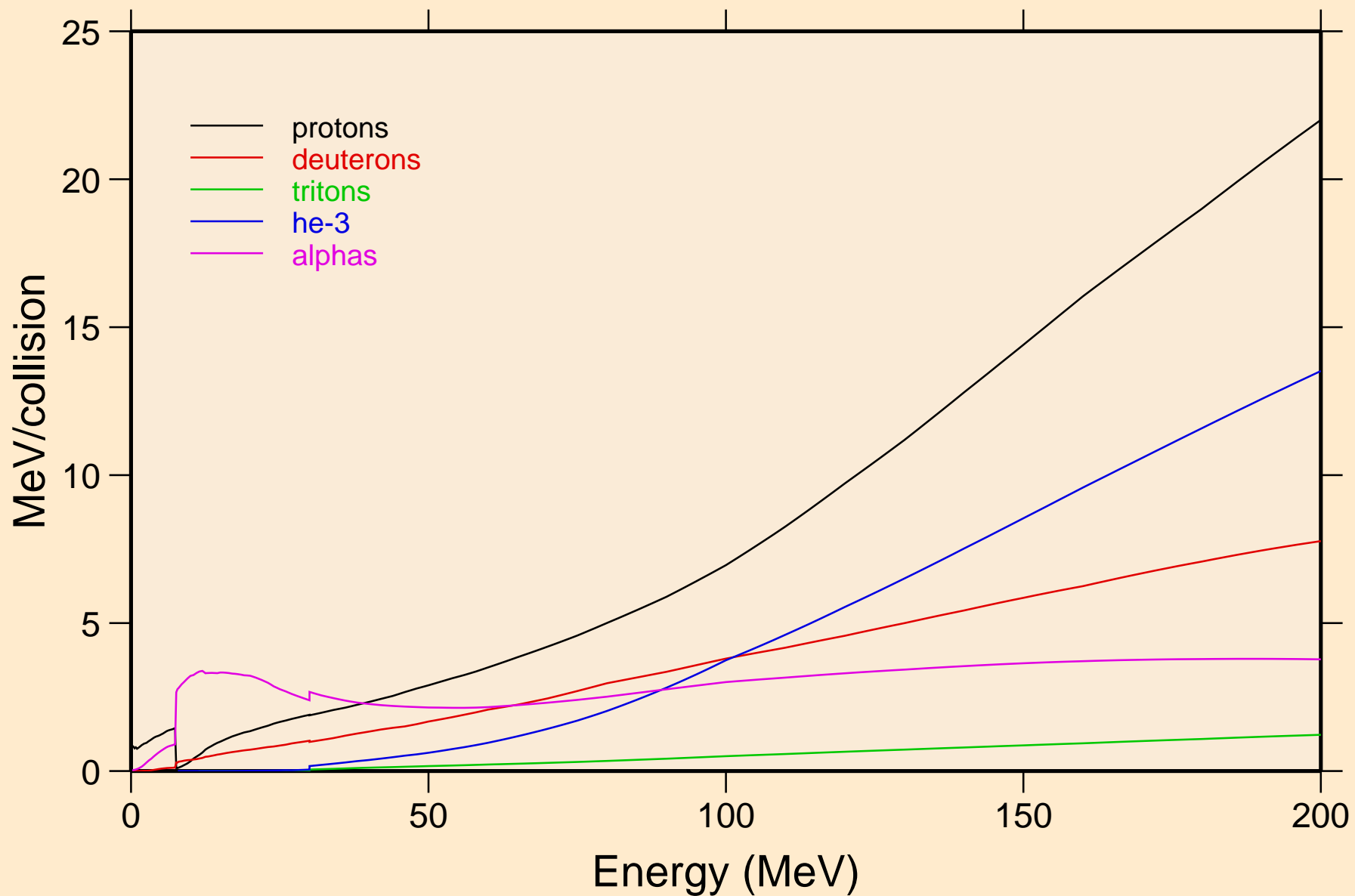

NA021 NEUTRON ACER TENDL-2019 LIBRARY; T=293.16K
Recoil Heating

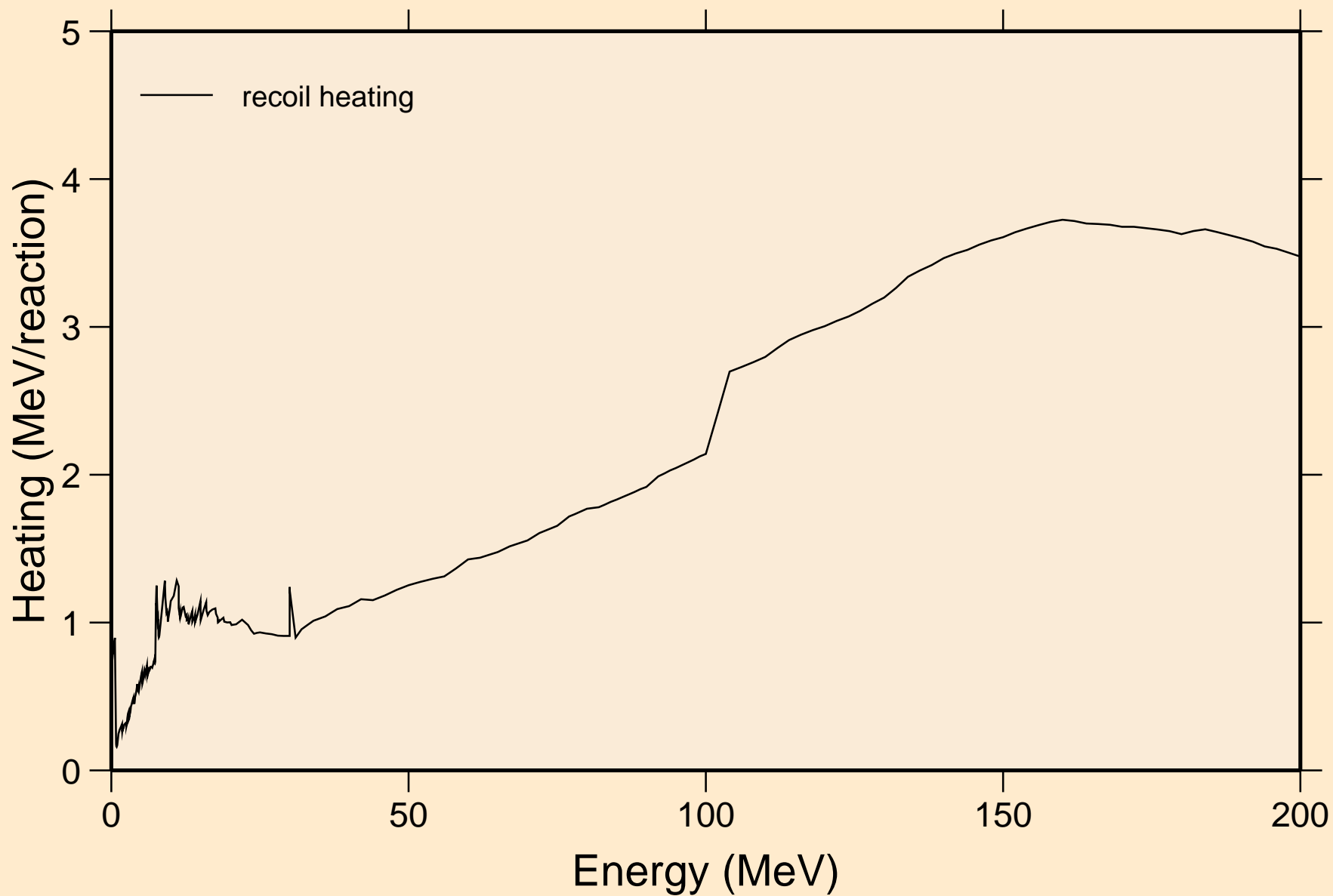

NA021 NEUTRON ACER TENDL-2019 LIBRARY; T=293.16K

Particle production cross sections

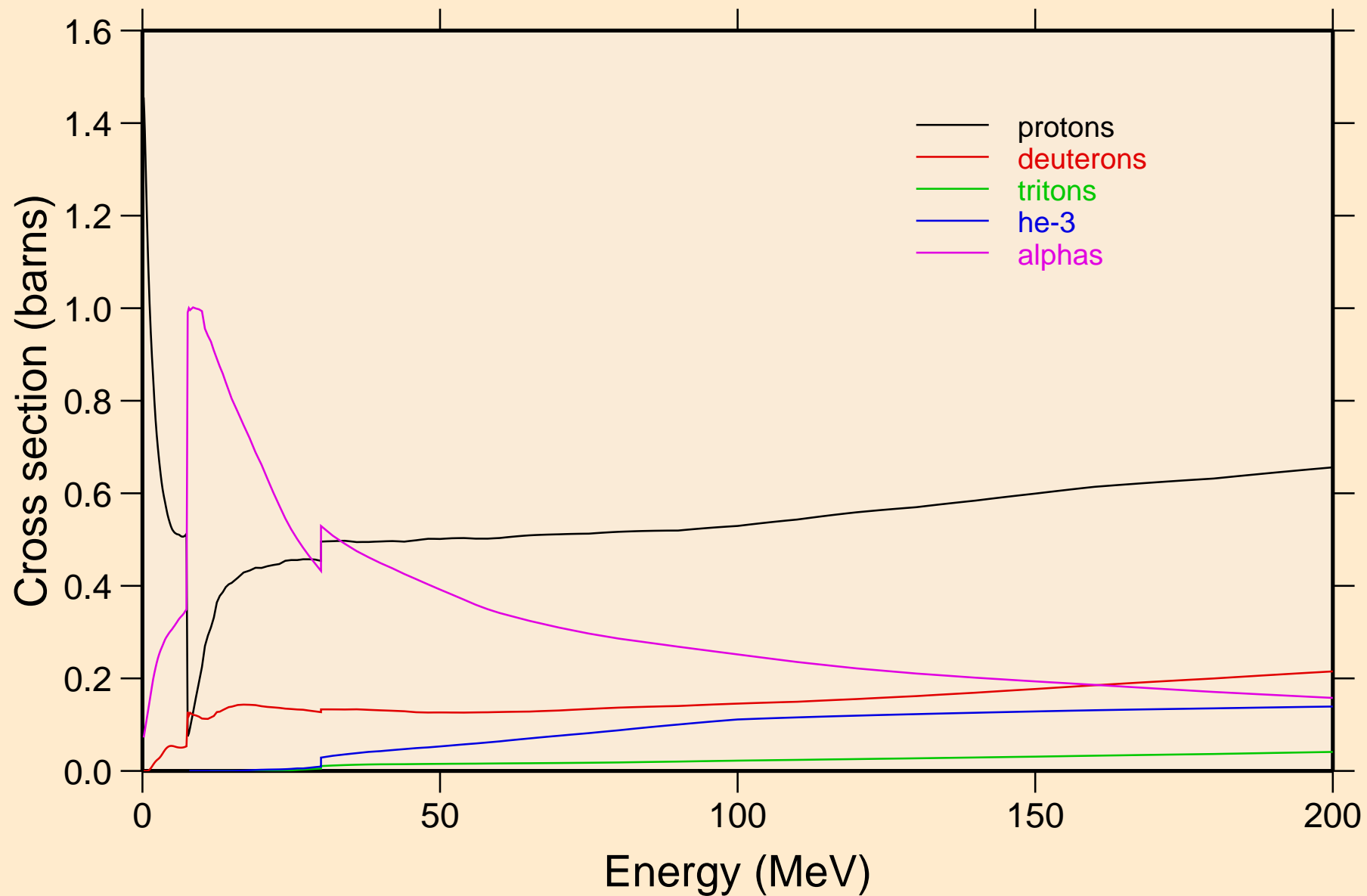

NA021 NEUTRON ACER TENDL-2019 LIBRARY; T=293.16K
protons from (n,x)

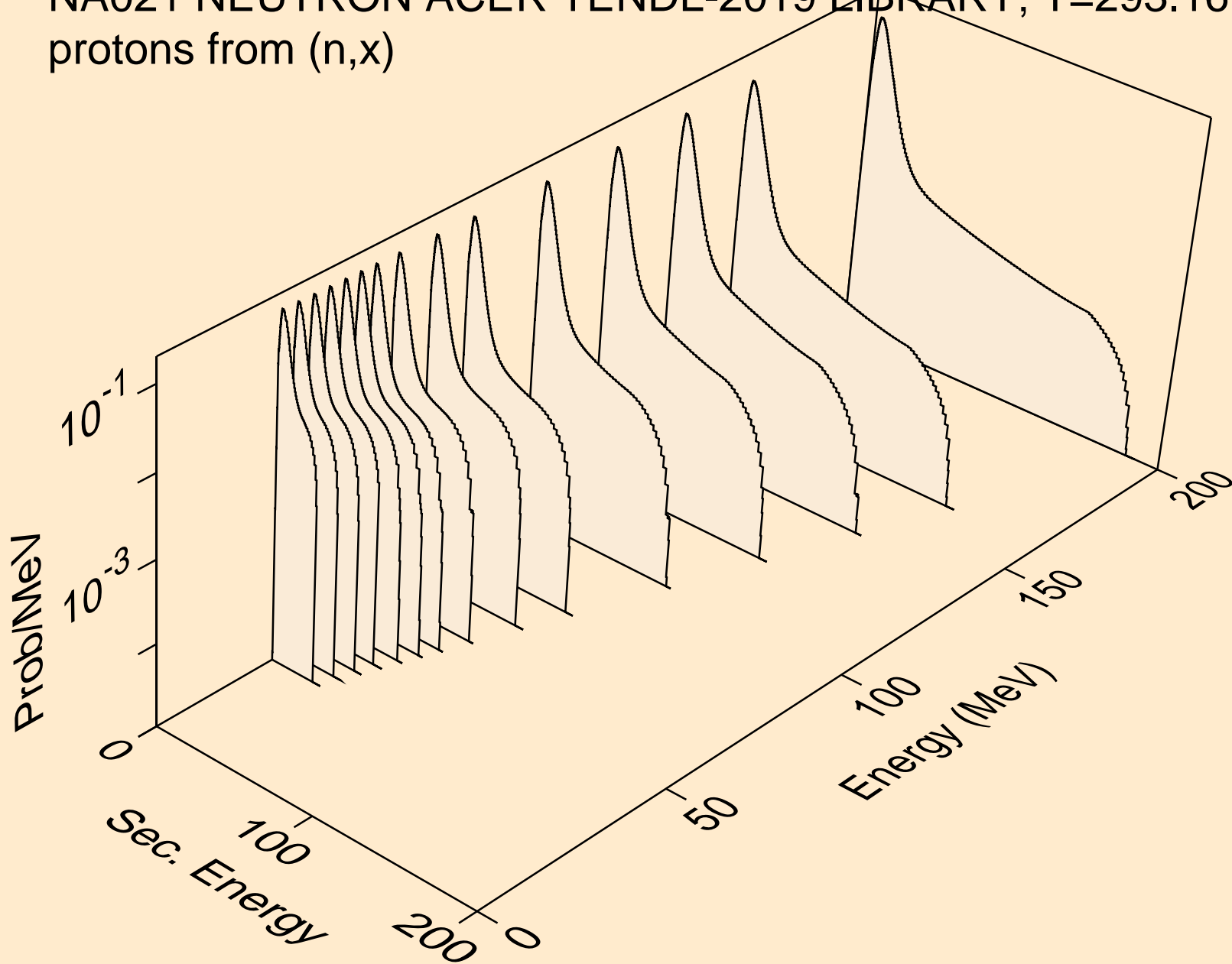

NA021 NEUTRON ACER TENDL-2019 LIBRARY; T=293.16K
protons from (n,n*)p

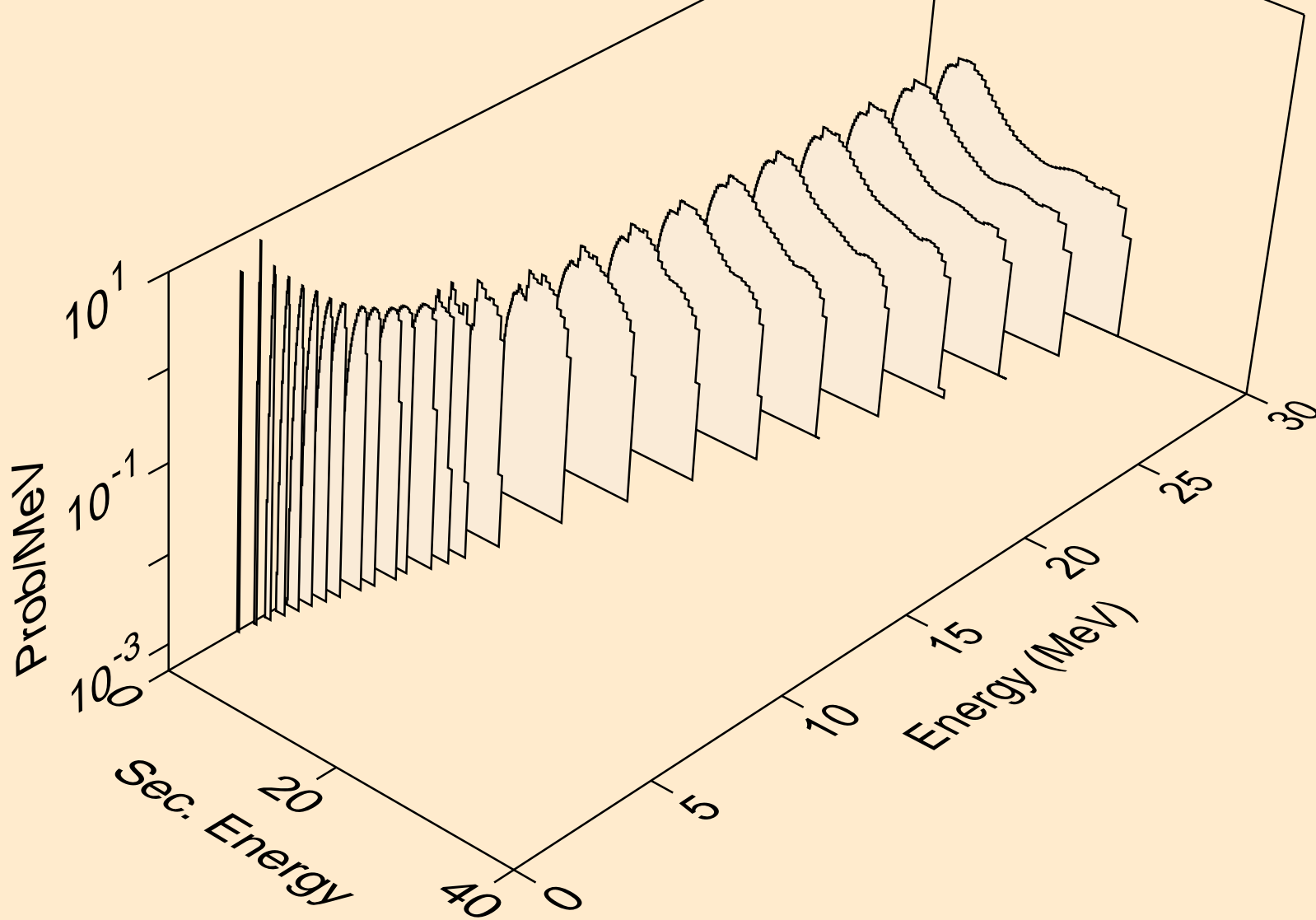

NA021 NEUTRON ACER TENDL-2019 LIBRARY; T=293.16K
protons from (n,2np)

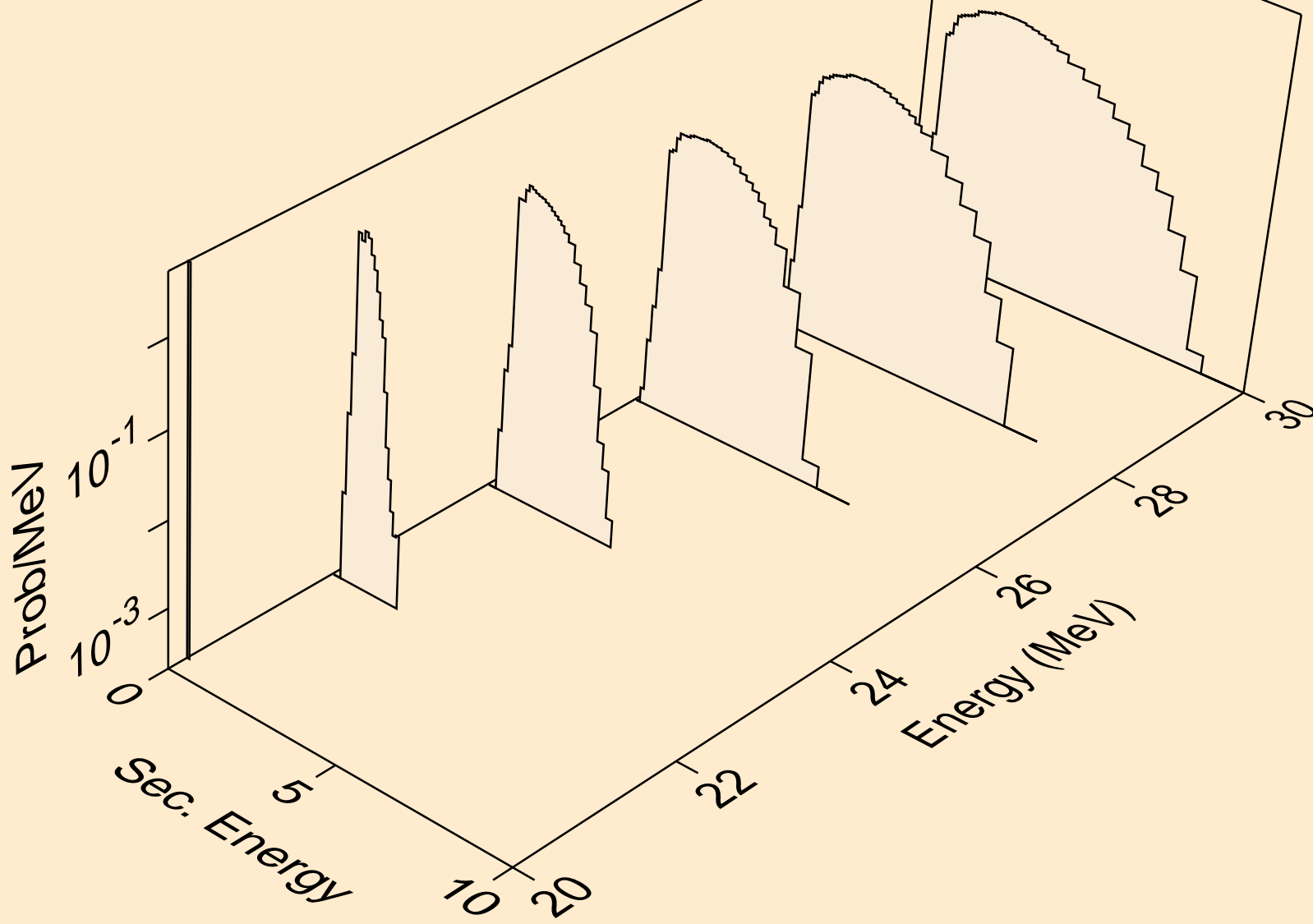

NA021 NEUTRON ACER TENDL-2019 LIBRARY; T=293.16K
protons from (n,2np)

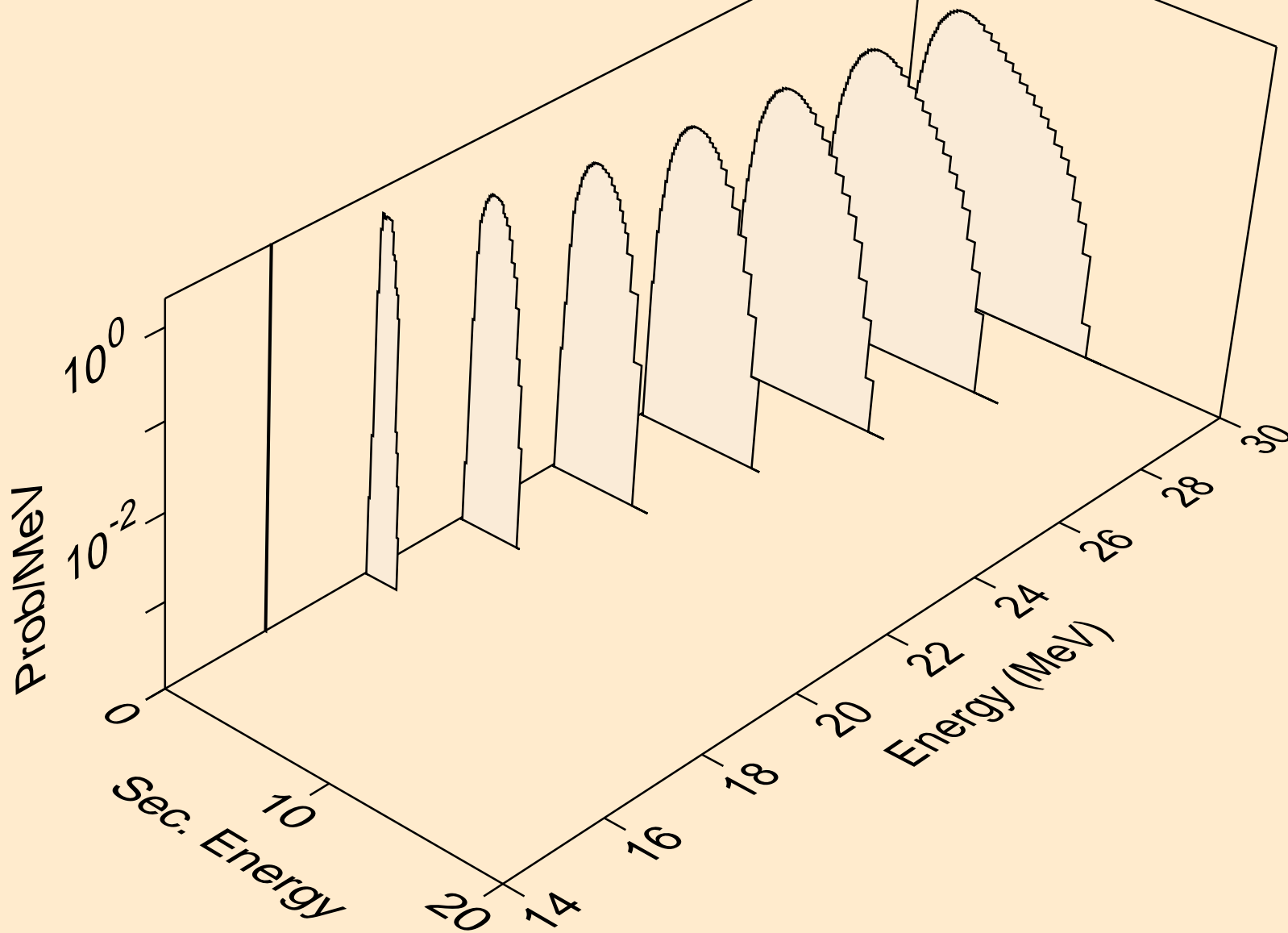

NA021 NEUTRON ACER TENDL-2019 LIBRARY; T=293.16K
protons from (n,npa)

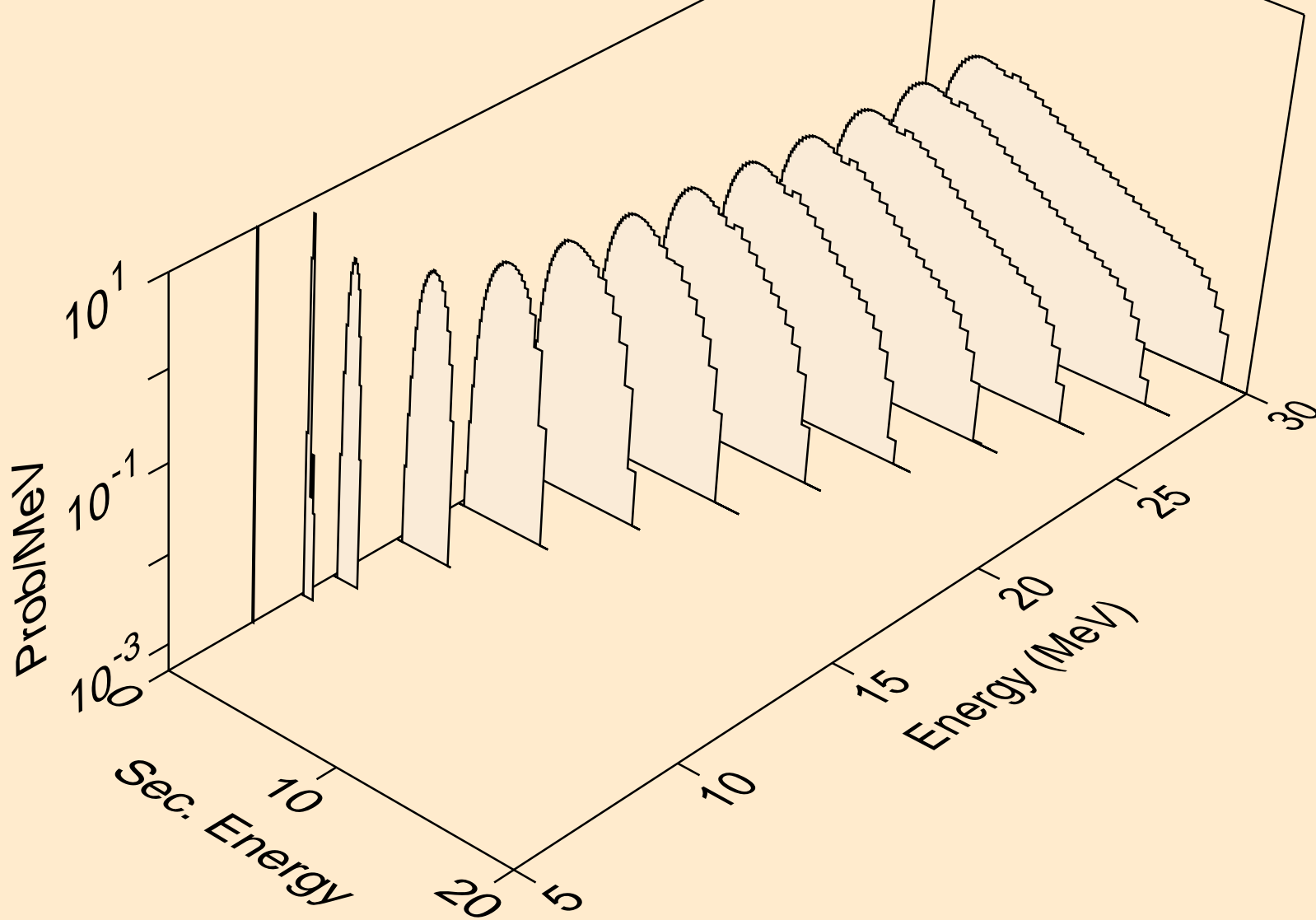

NA021 NEUTRON ACER TENDL-2019 LIBRARY; T=293.16K
protons from (n,p)

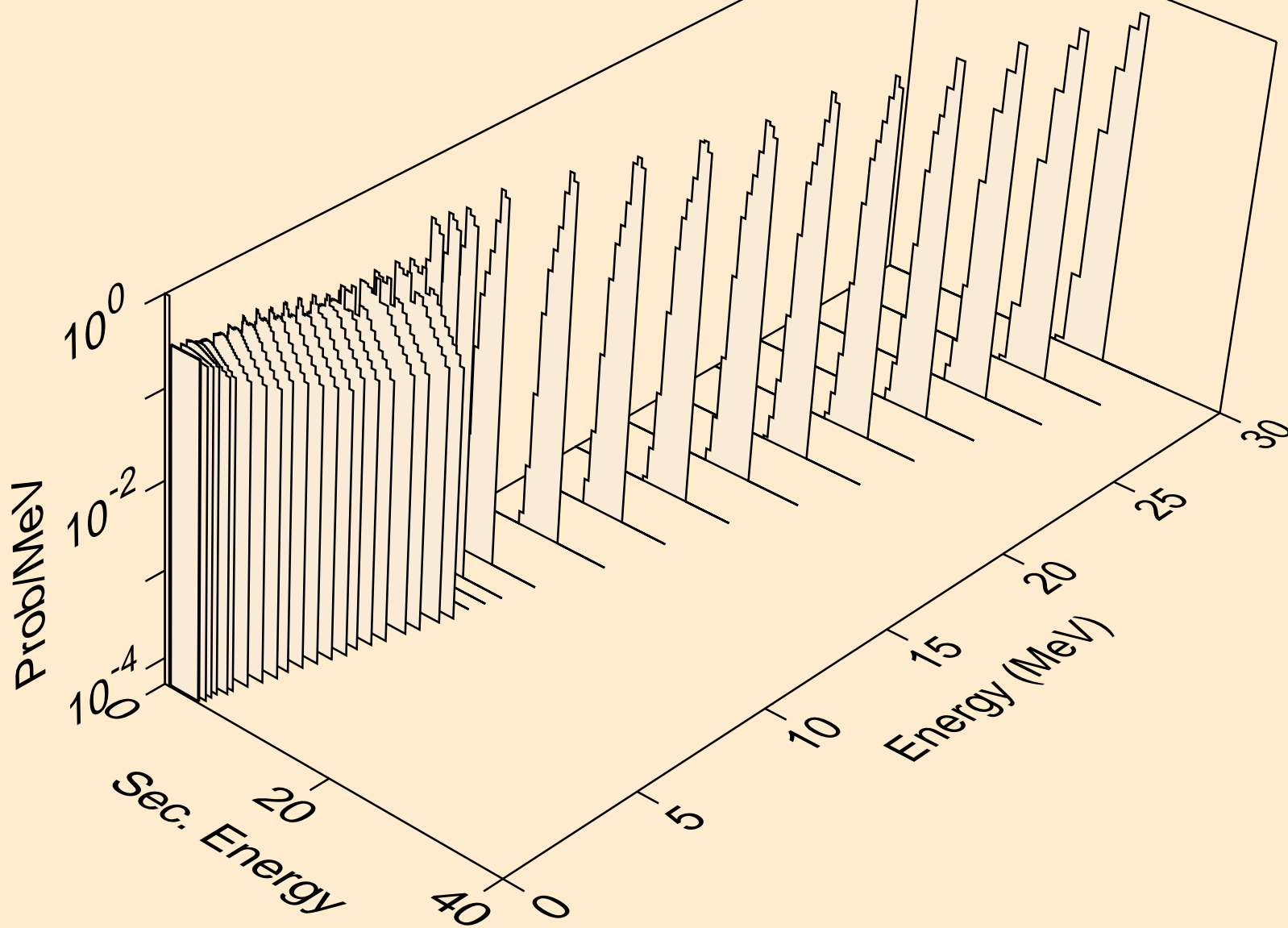

NA021 NEUTRON ACER TENDL-2019 LIBRARY; T=293.16K
protons from (n,2p)

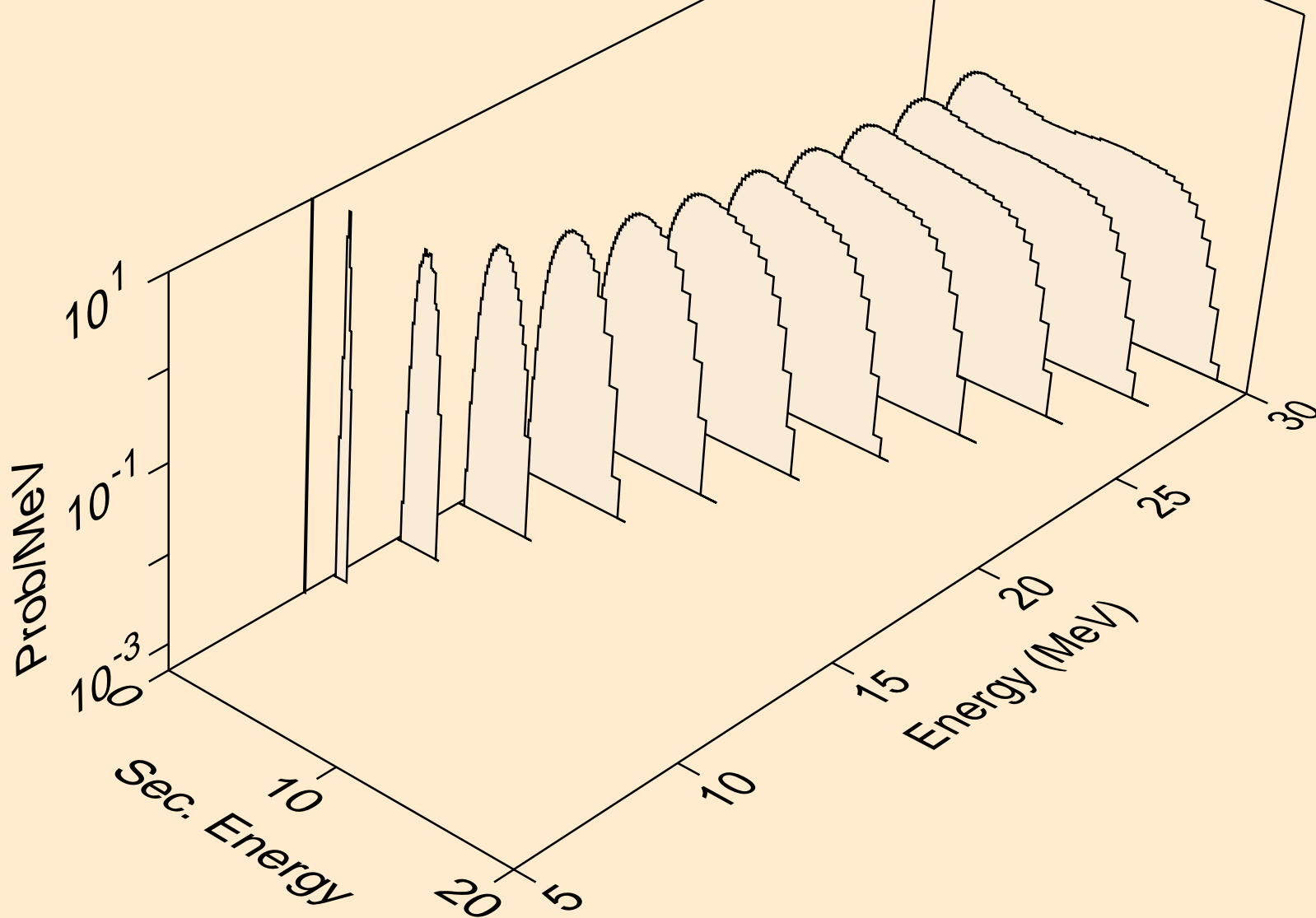

NA021 NEUTRON ACER TENDL-2019 LIBRARY; T=293.16K
protons from (n,p)

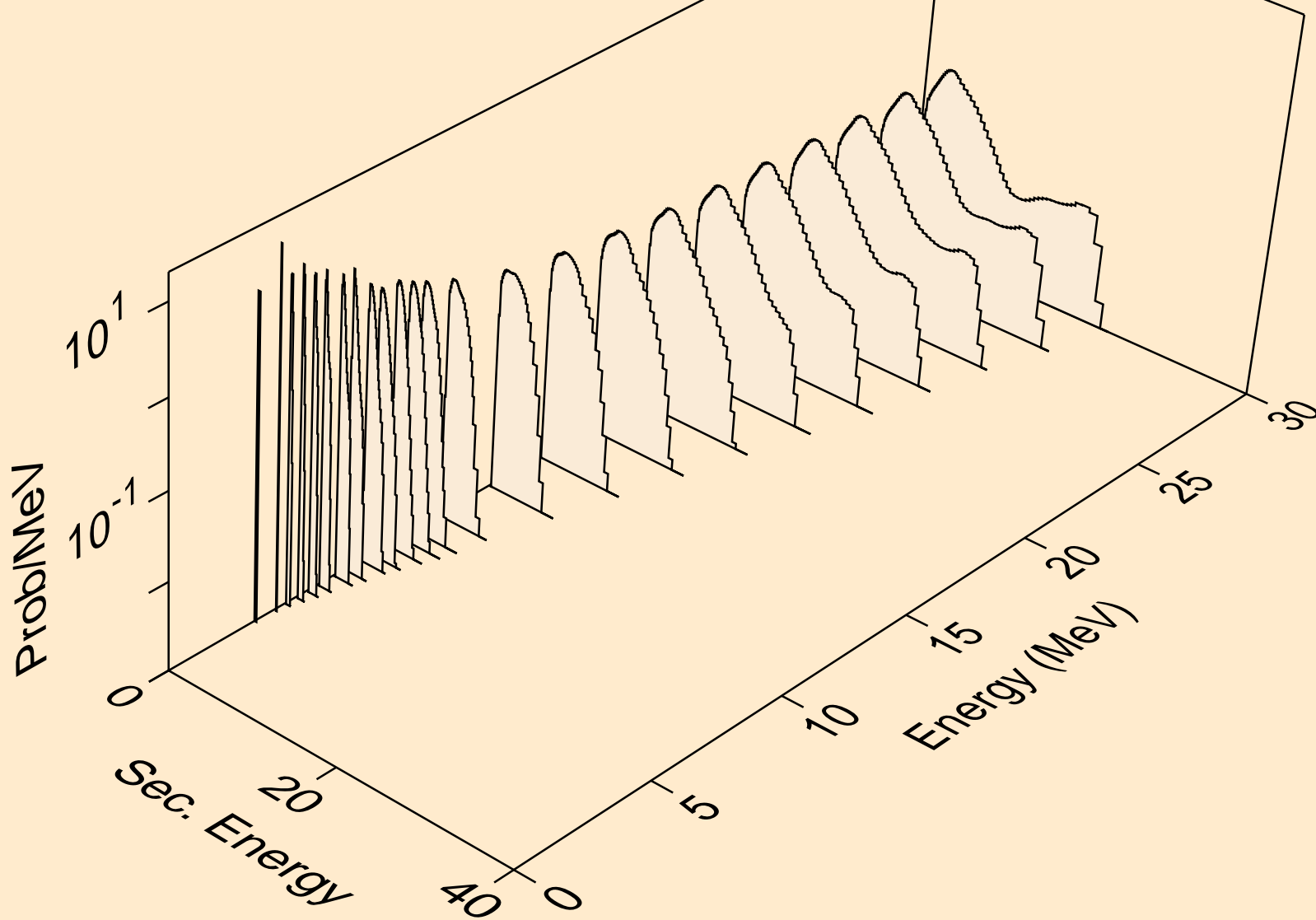

NA021 NEUTRON ACER TENDL-2019 LIBRARY; T=293.16K
protons from (n,pd)

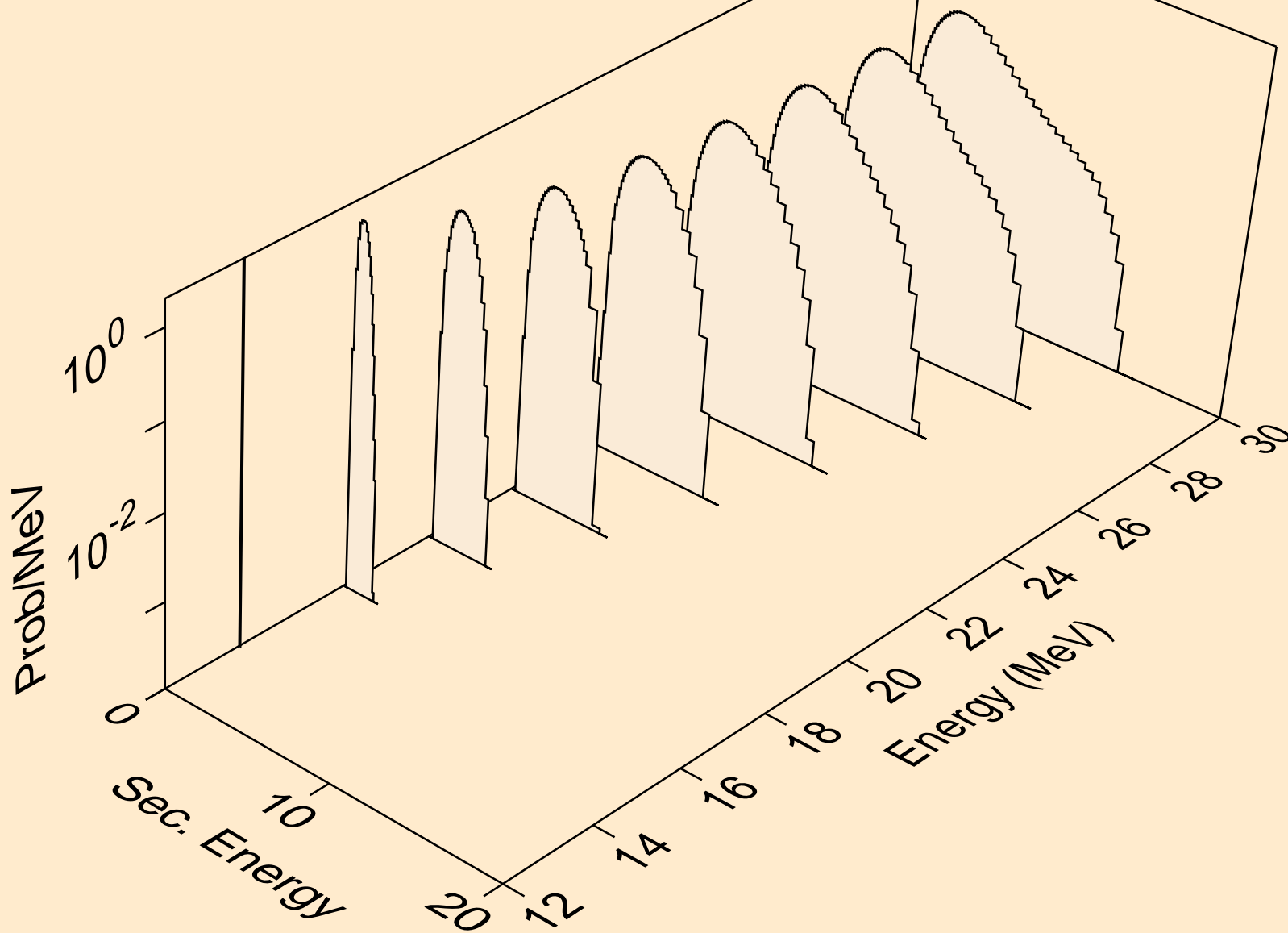

NA021 NEUTRON ACER TENDL-2019 LIBRARY; T=293.16K
protons from (n,pt)

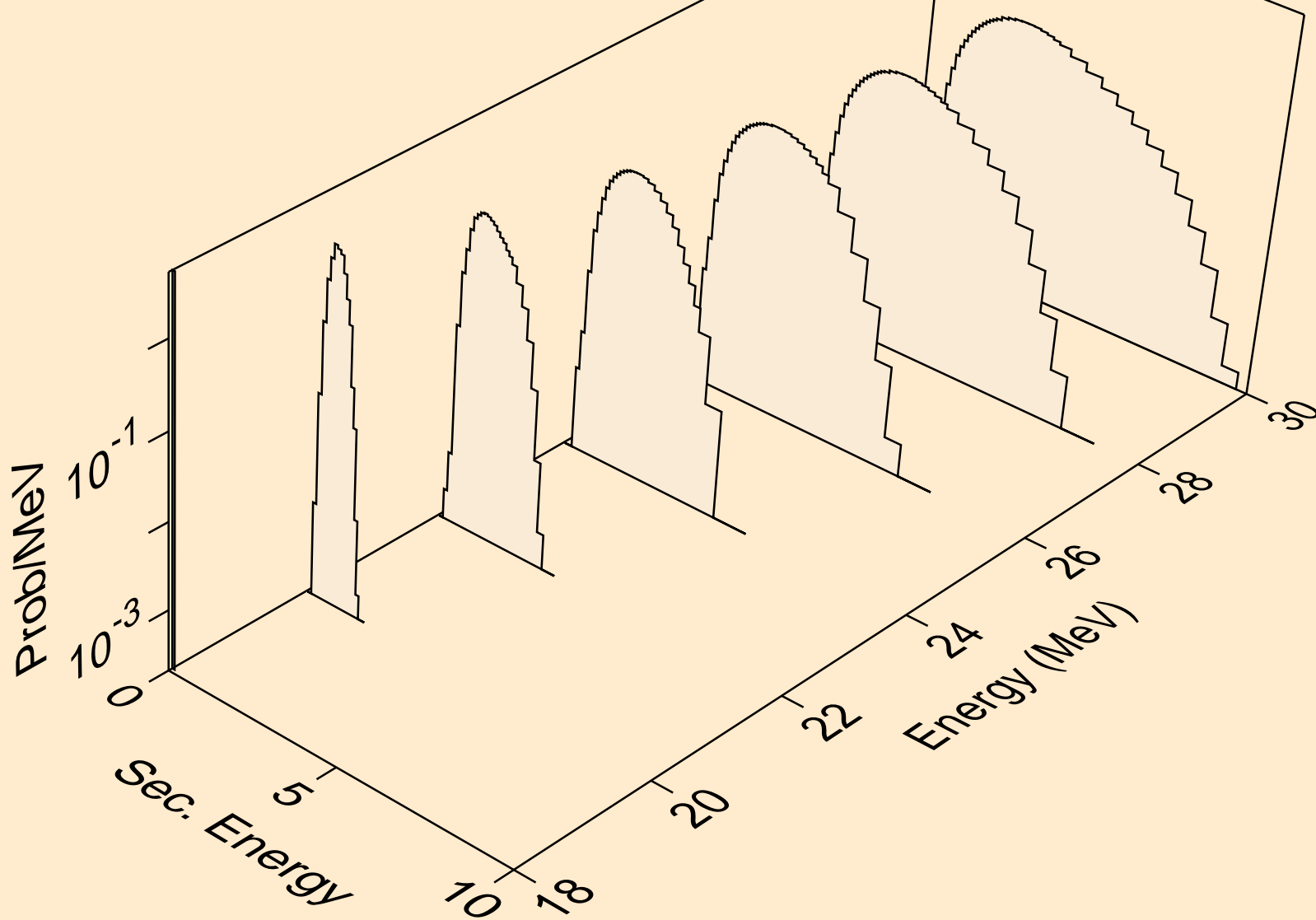

NA021 NEUTRON ACER TENDL-2019 LIBRARY; T=293.16K
deuterons from (n,x)

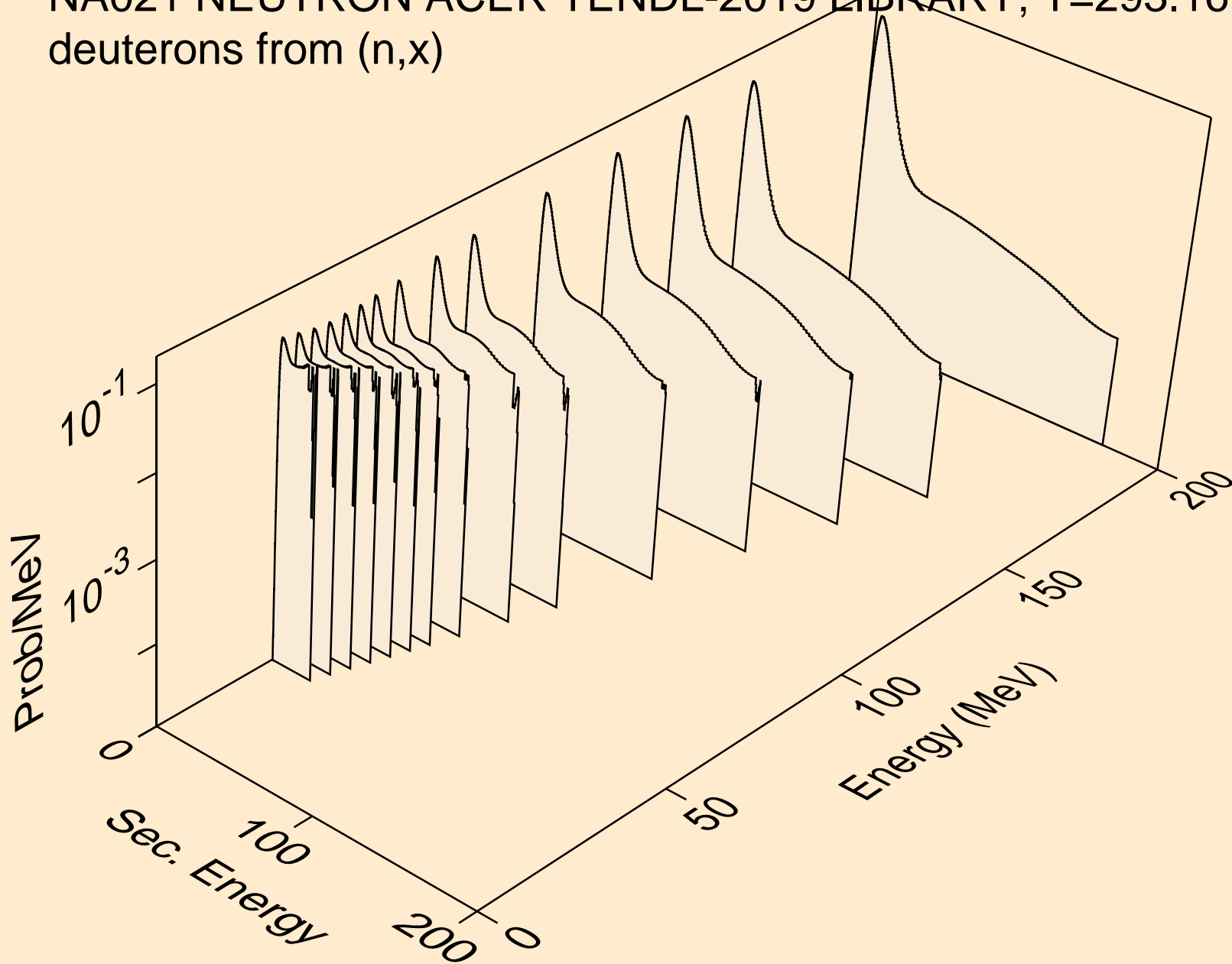

NA021 NEUTRON ACER TENDL-2019 LIBRARY; T=293.16K
deuterons from (n,n*)d

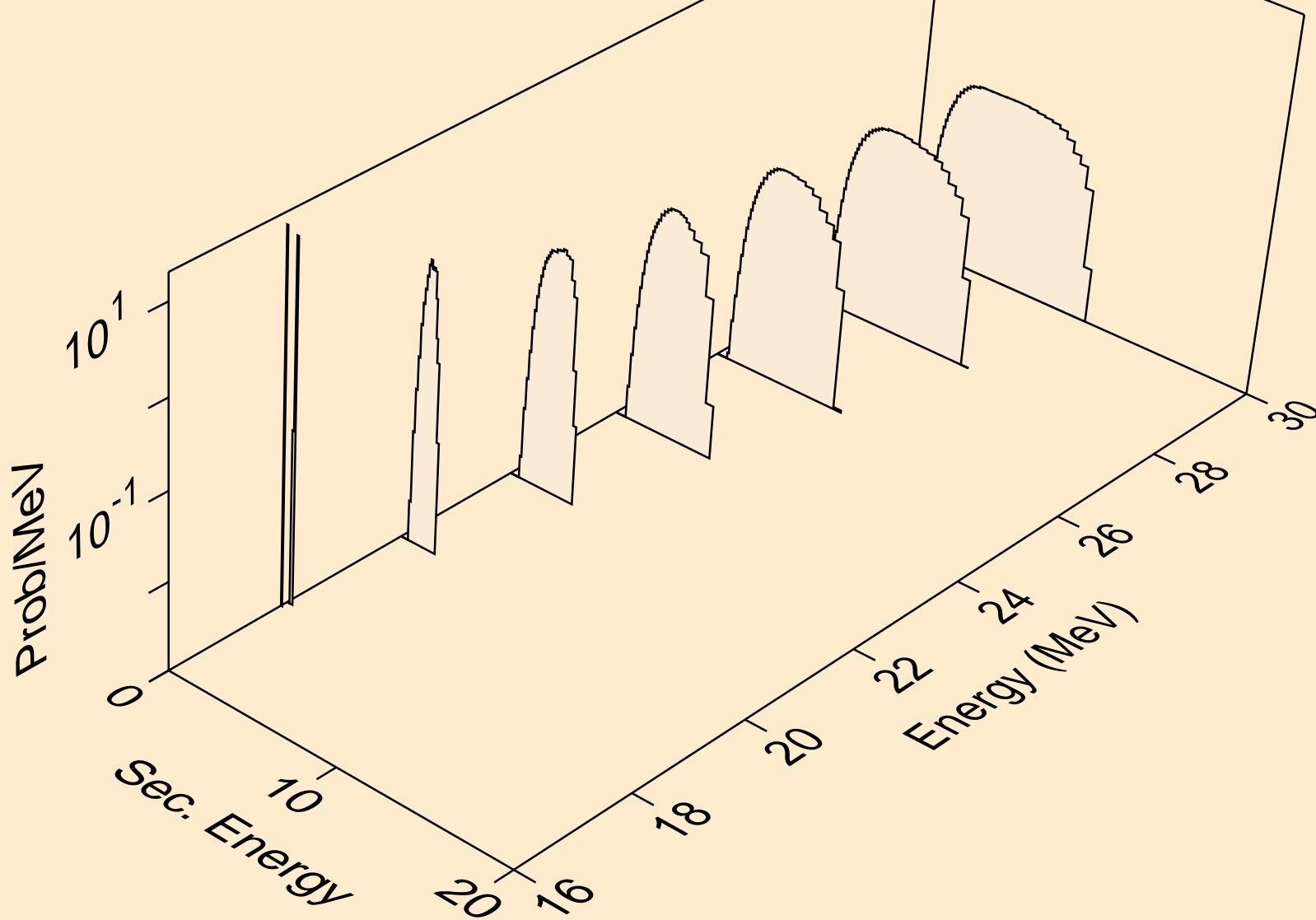

NA021 NEUTRON ACER TENDL-2019 LIBRARY; T=293.16K
deuterons from (n,d)

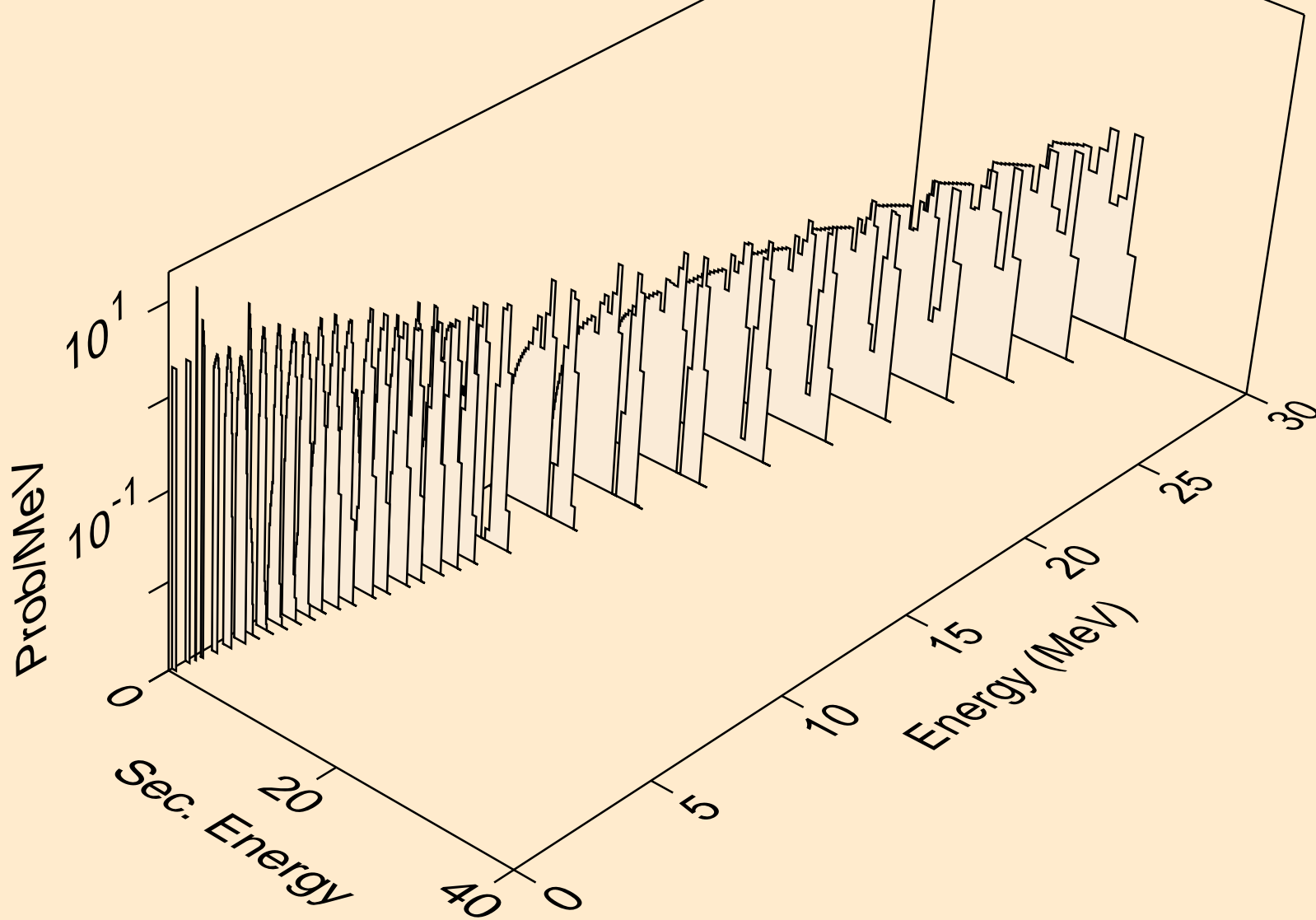

NA021 NEUTRON ACER TENDL-2019 LIBRARY; T=293.16K
deuterons from (n,d2a)

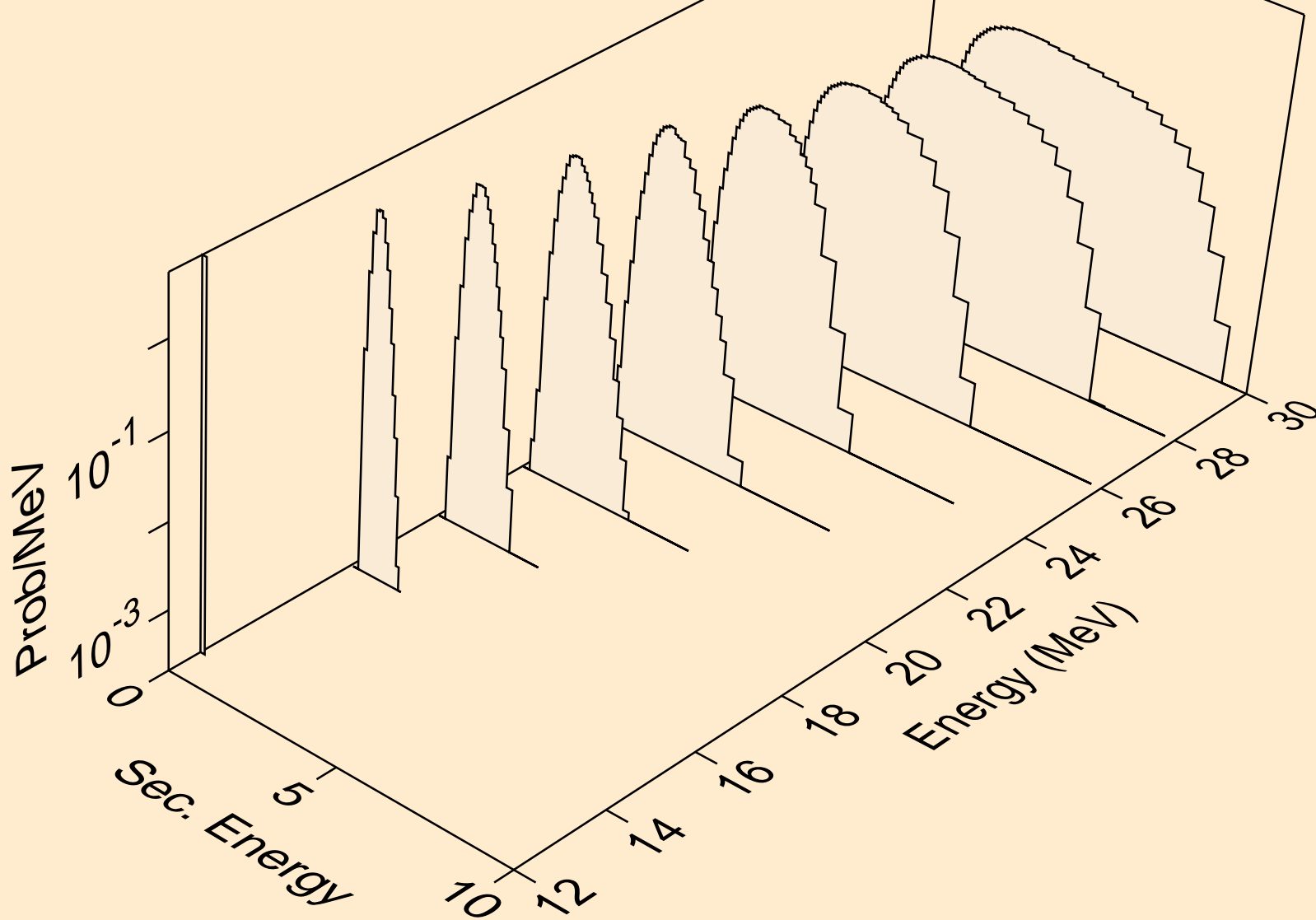

NA021 NEUTRON ACER TENDL-2019 LIBRARY; T=293.16K
deuterons from (n,pd)

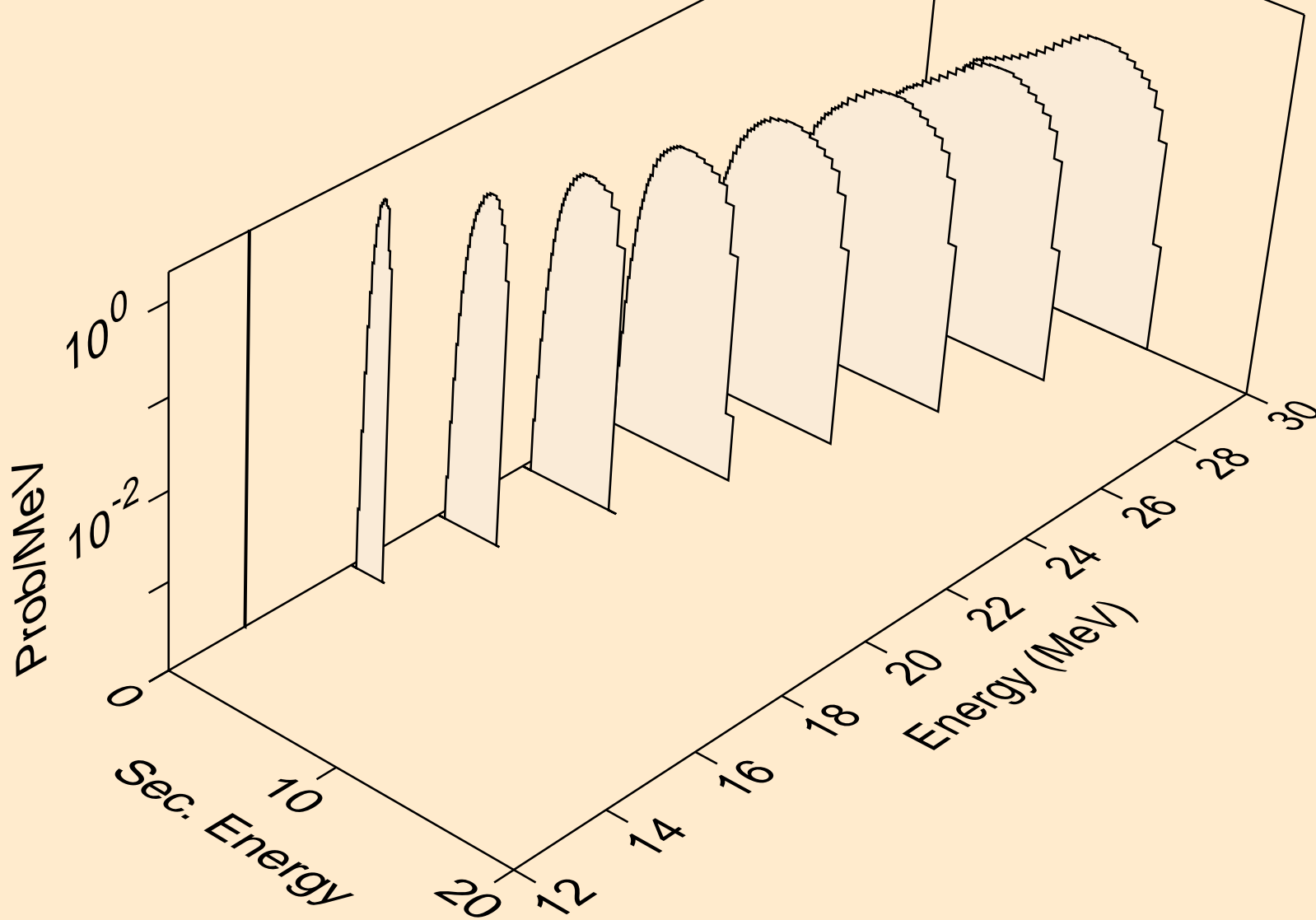

NA021 NEUTRON ACER TENDL-2019 LIBRARY; T=293.16K
deuterons from (n,da)

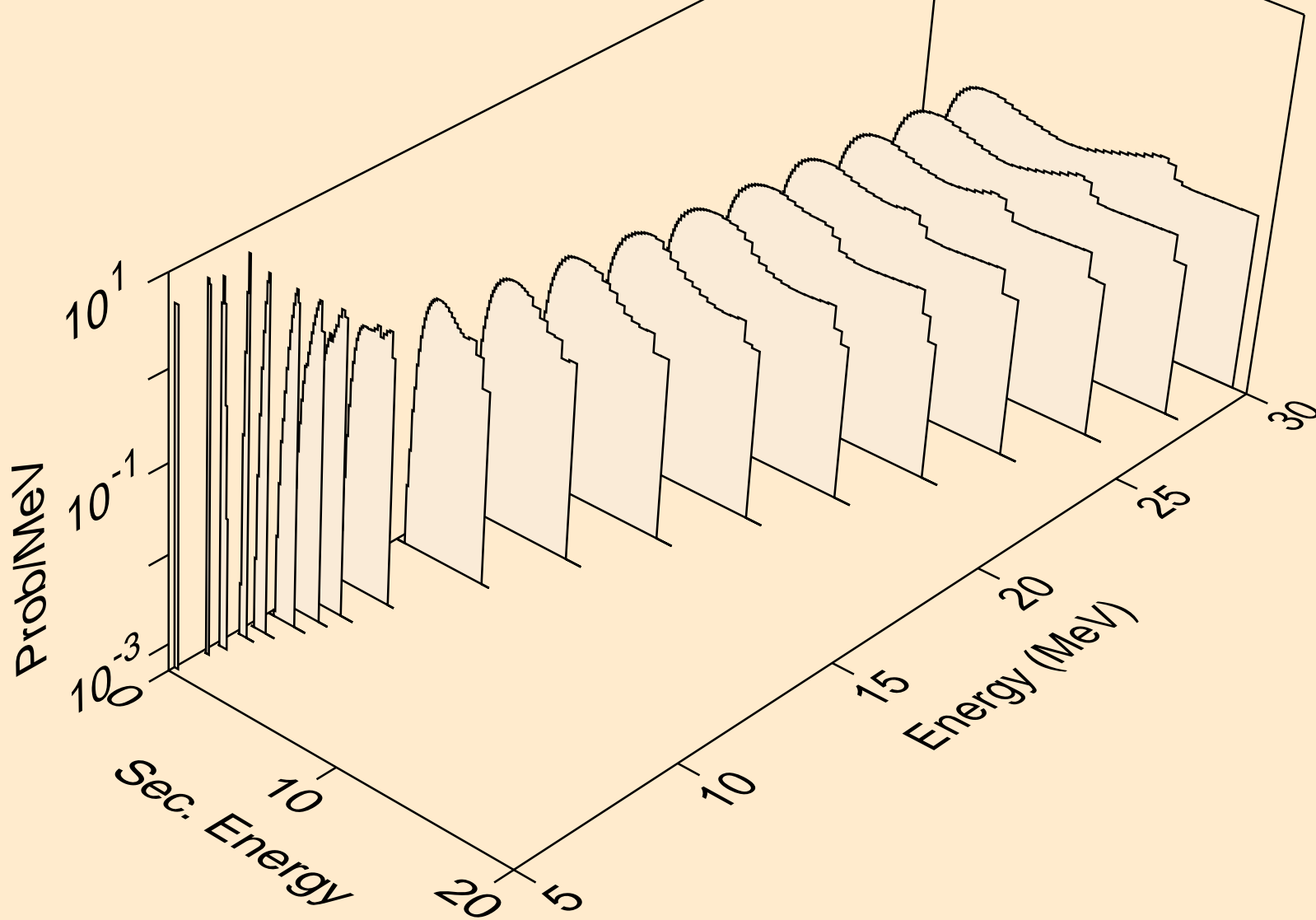

NA021 NEUTRON ACER TENDL-2019 LIBRARY; T=293.16K
tritons from (n,x)

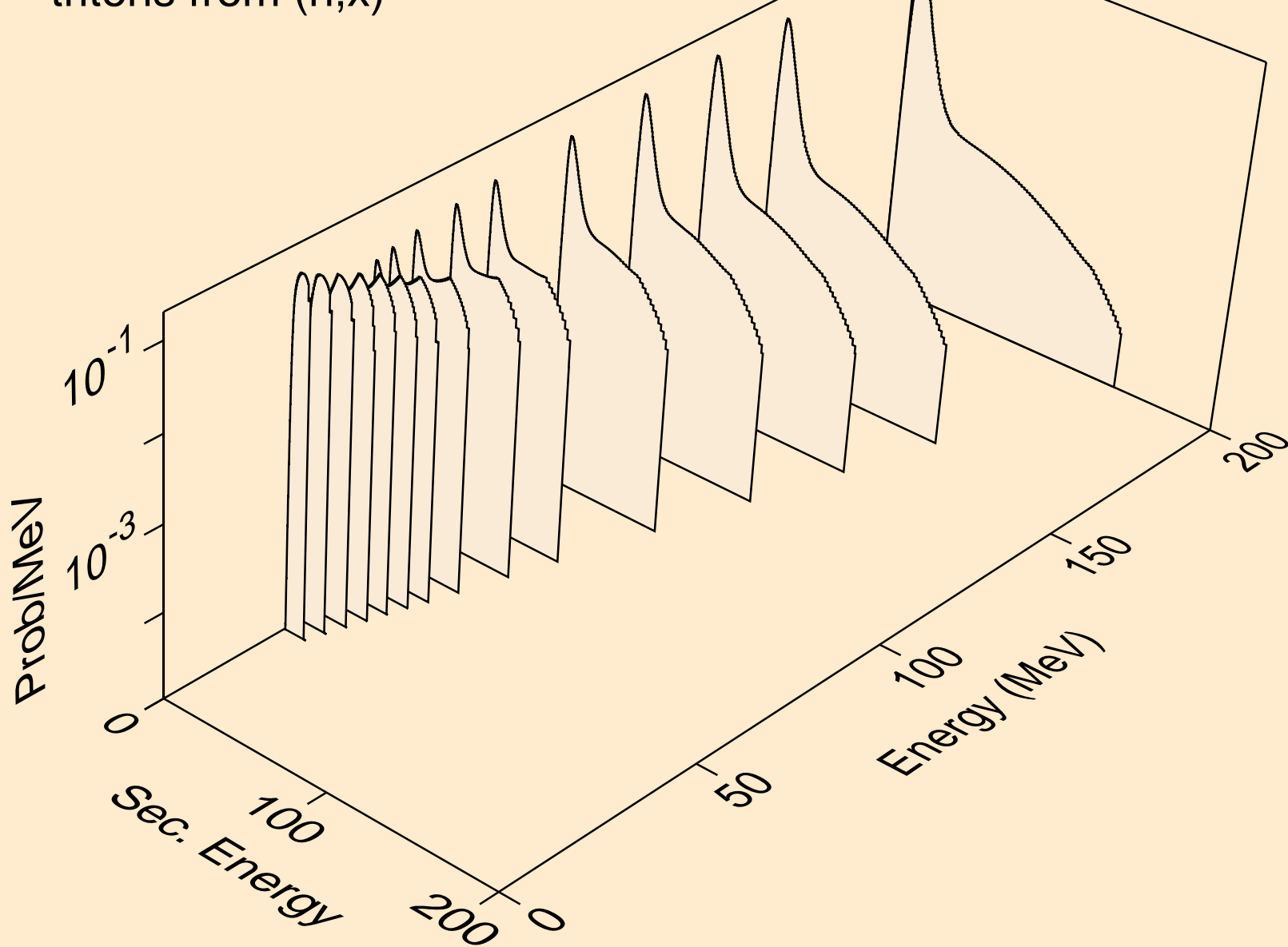

NA021 NEUTRON ACER TENDL-2019 LIBRARY; T=293.16K
tritons from (n,n*)t

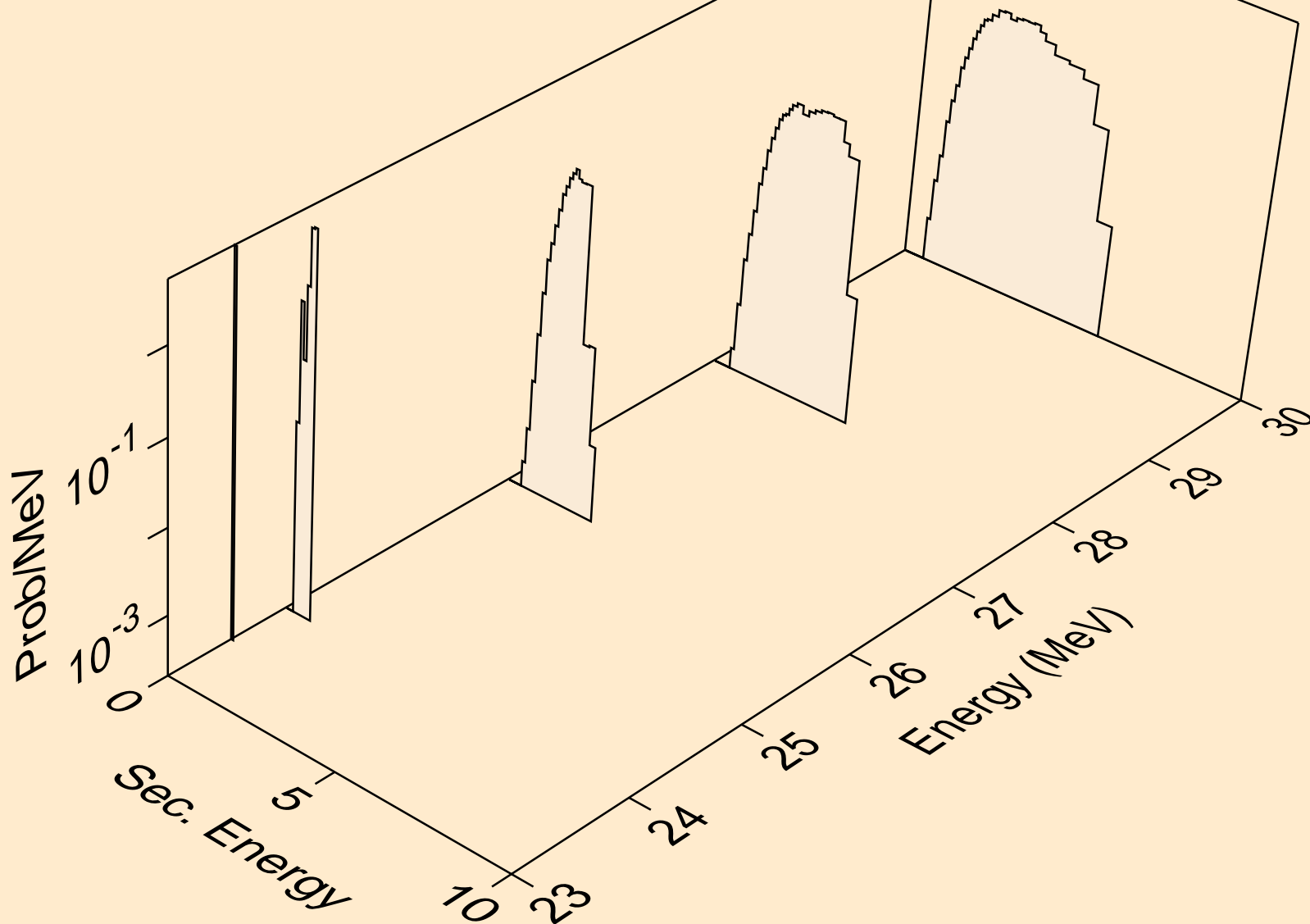

NA021 NEUTRON ACER TENDL-2019 LIBRARY; T=293.16K
tritons from (n,t)

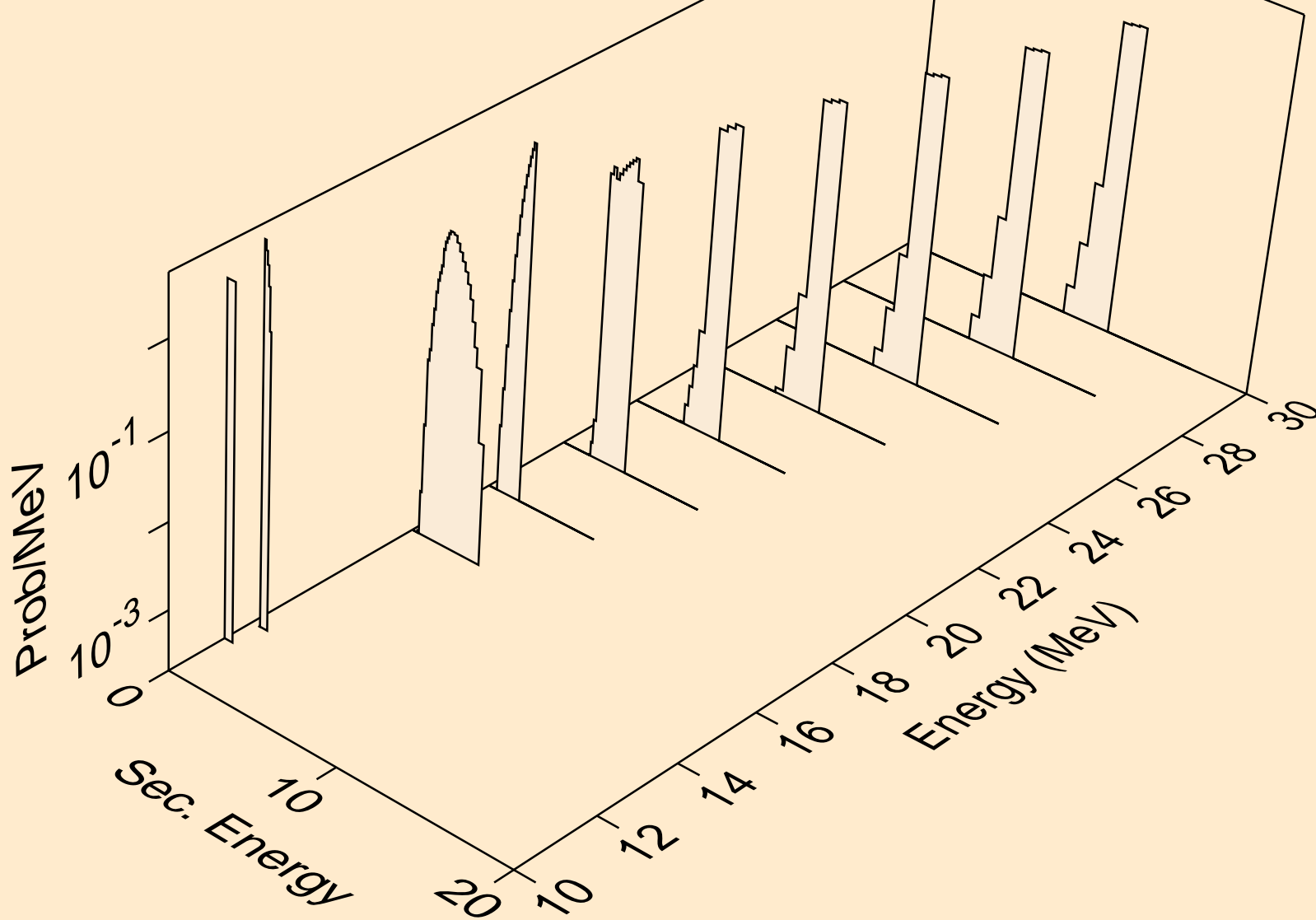

NA021 NEUTRON ACER TENDL-2019 LIBRARY; T=293.16K
tritons from (n,pt)

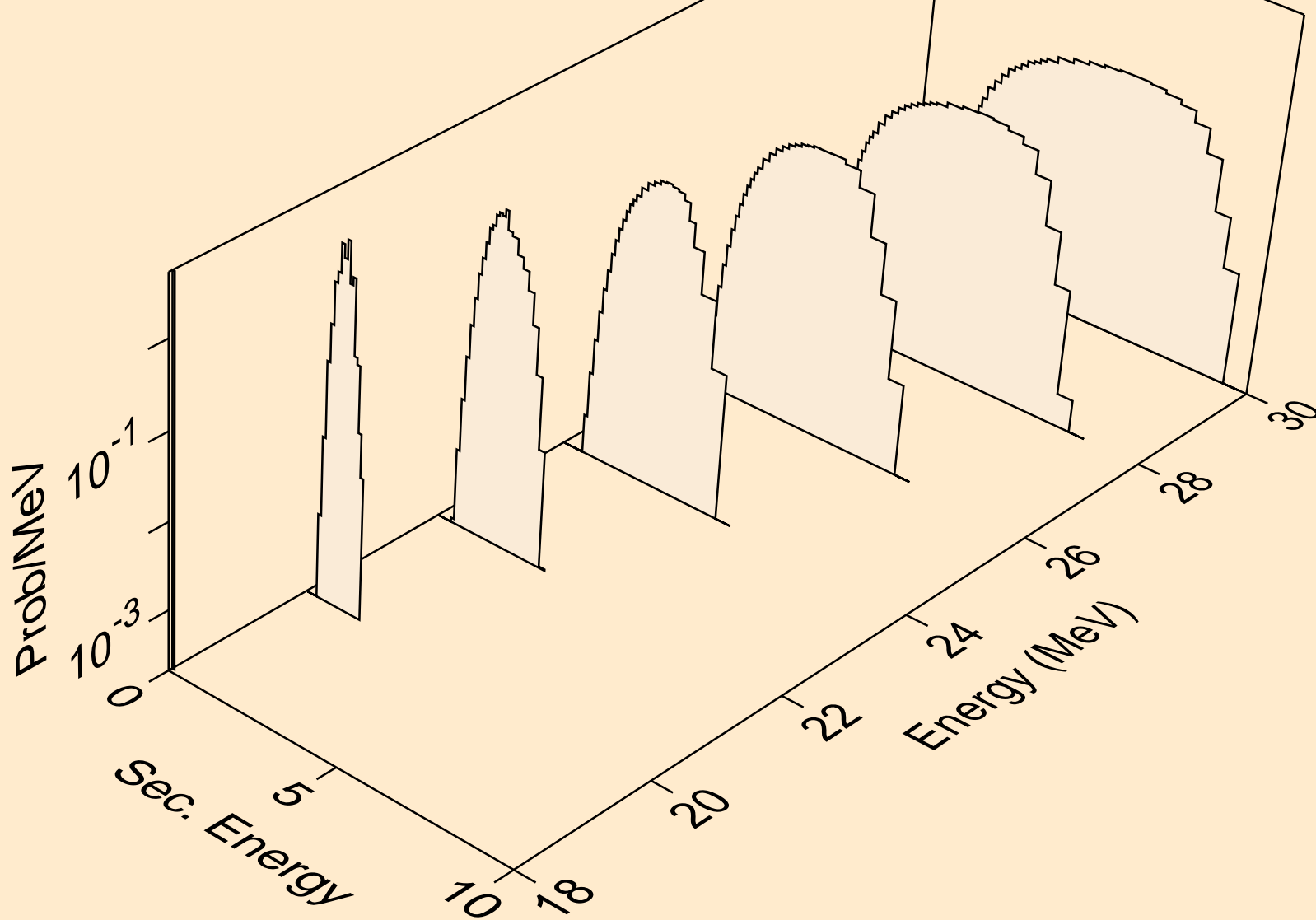

NA021 NEUTRON ACER TENDL-2019 LIBRARY; T=293.16K
he3s from (n,x)

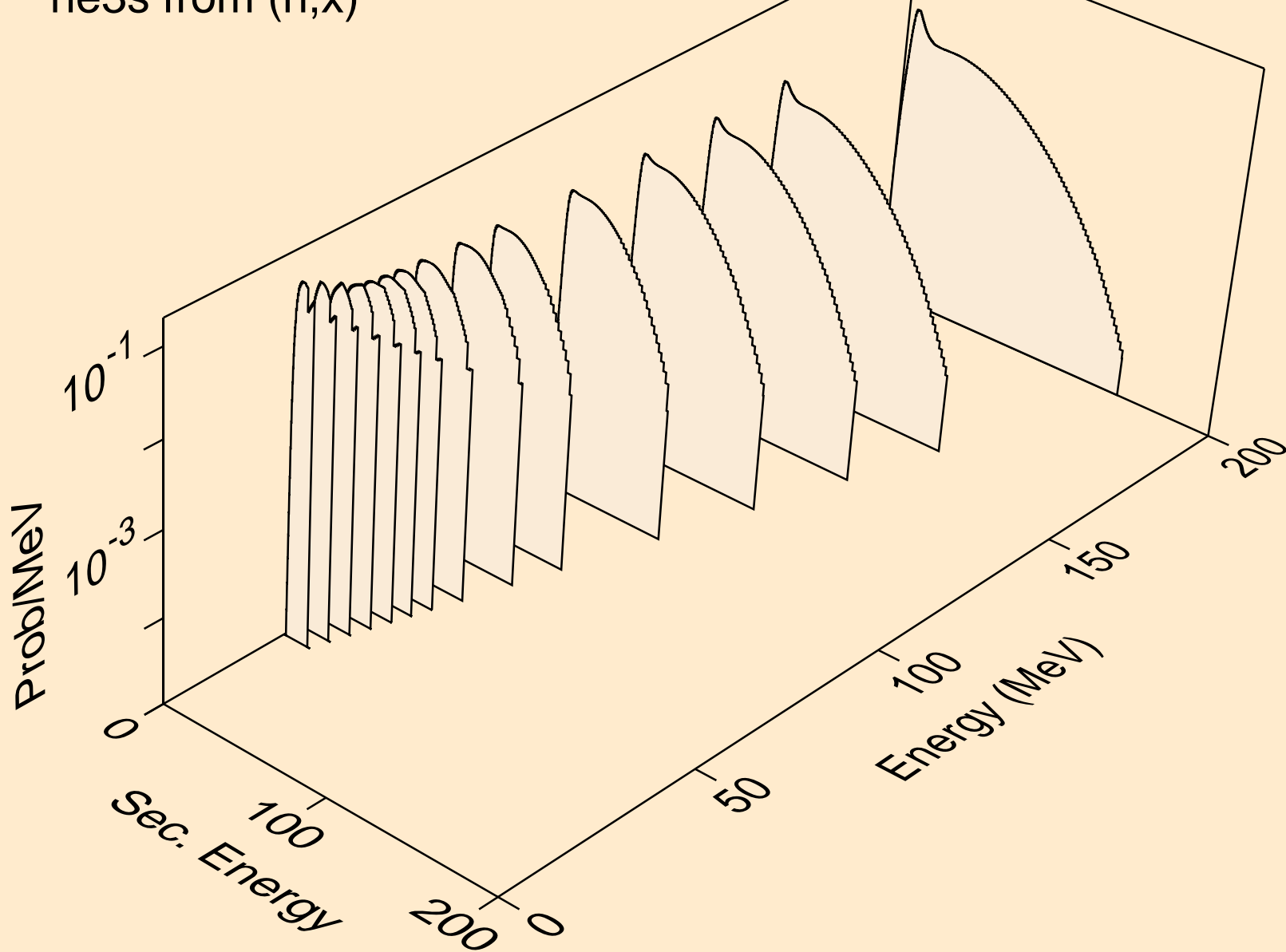

NA021 NEUTRON ACER TENDL-2019 LIBRARY; T=293.16K
he3s from (n,n*)he3

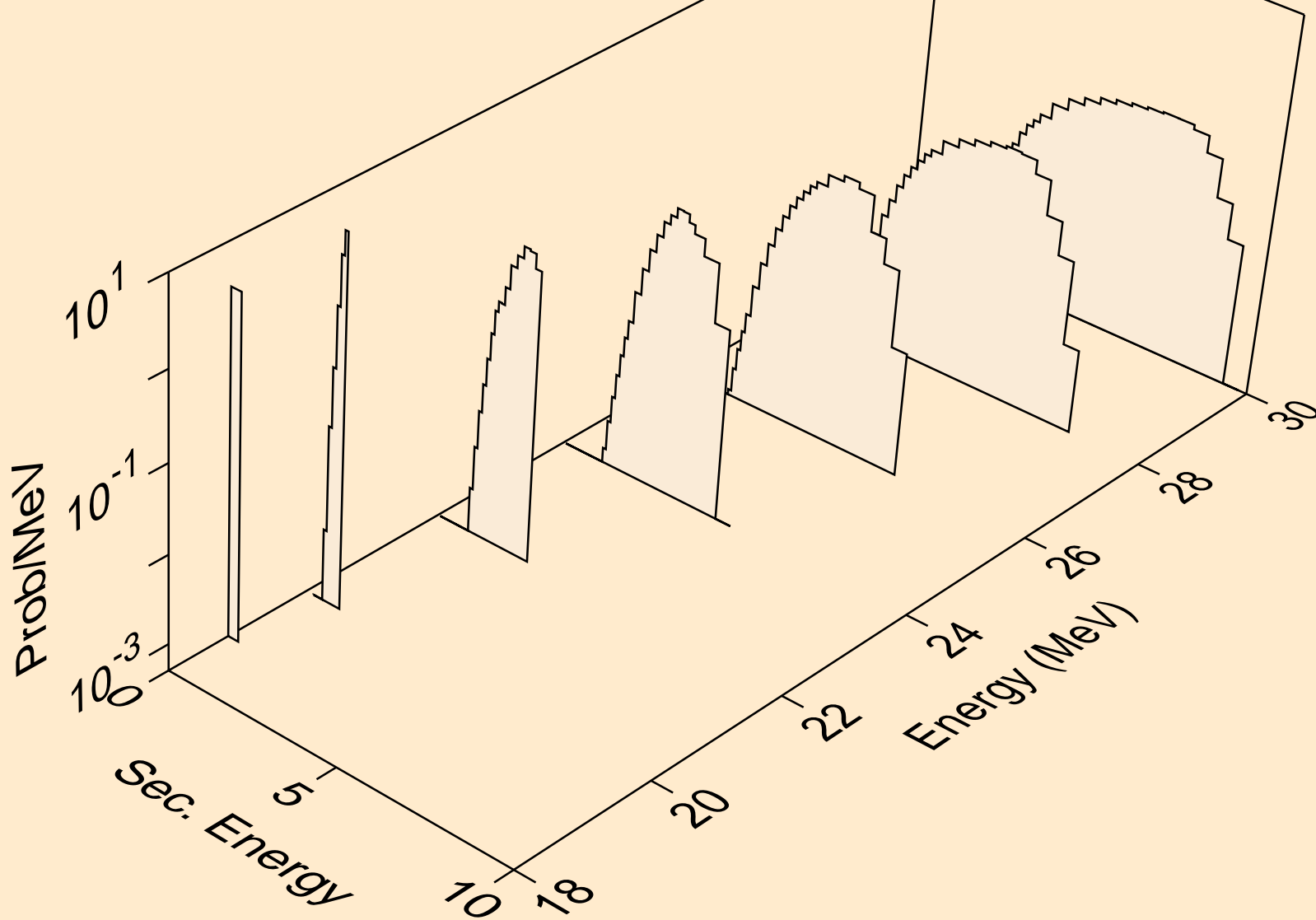

NA021 NEUTRON ACER TENDL-2019 LIBRARY; T=293.16K
he3s from (n,he3)

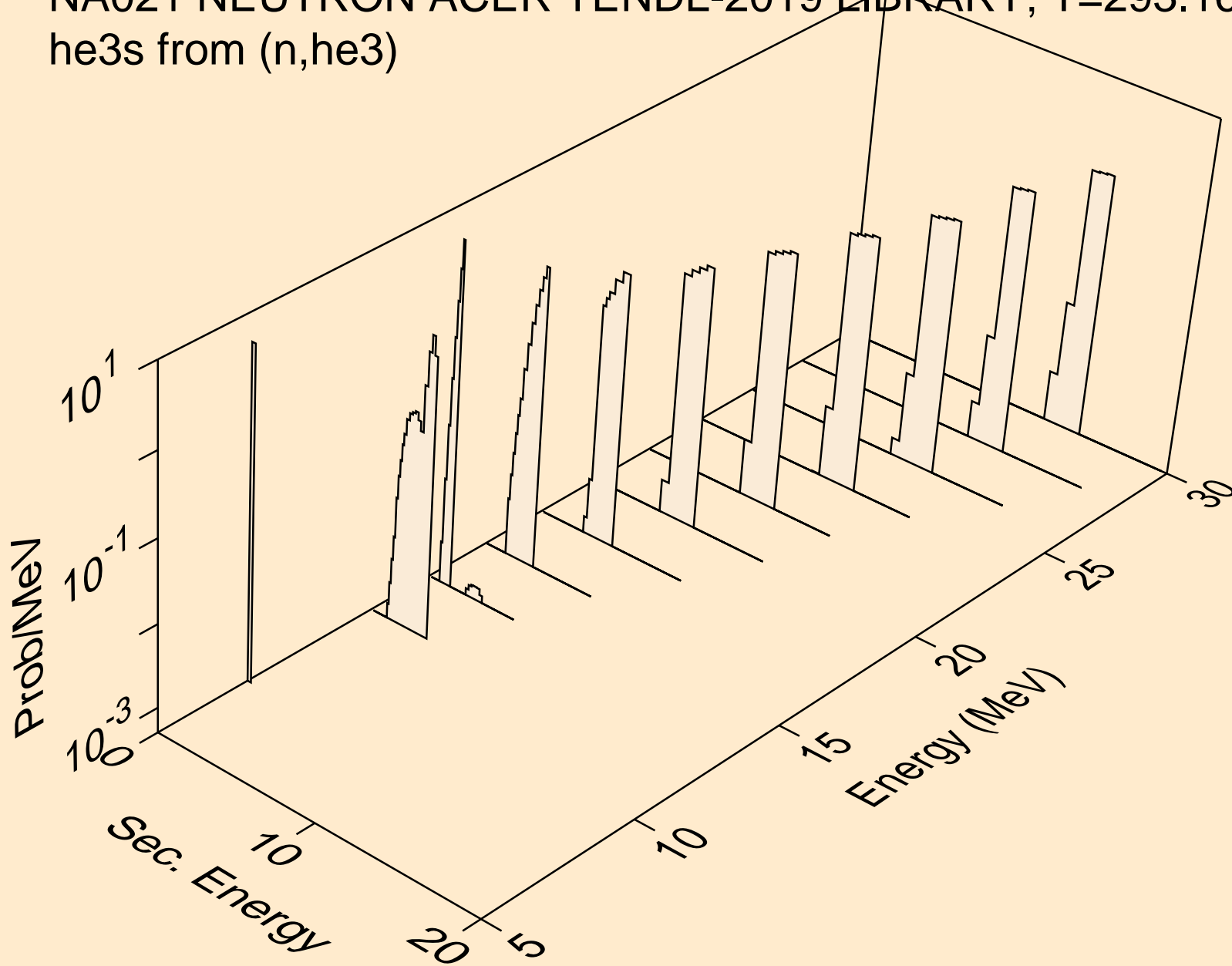

NA021 NEUTRON ACER TENDL-2019 LIBRARY; T=293.16K
alphas from (n,x)

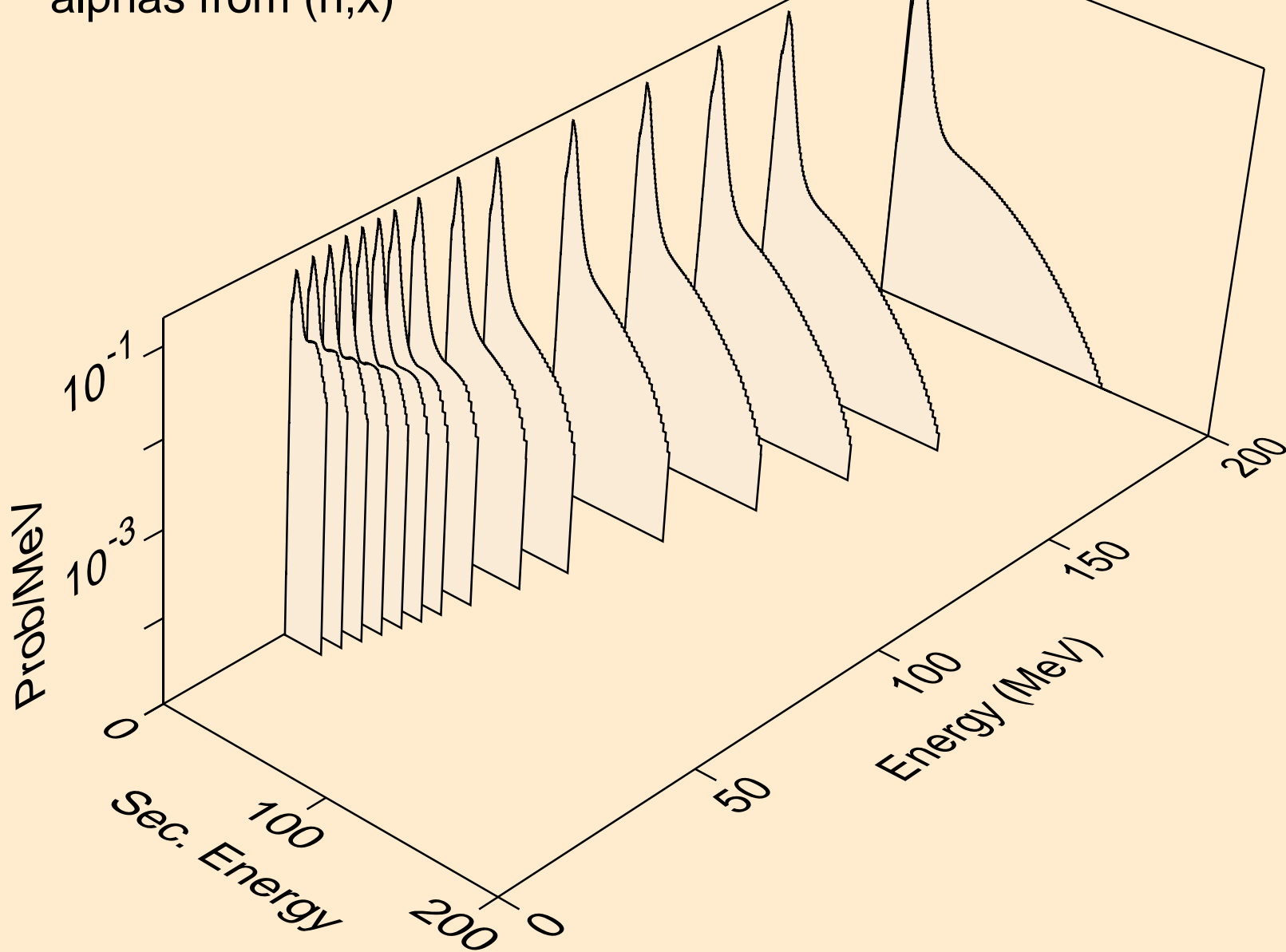

NA021 NEUTRON ACER TENDL-2019 LIBRARY; T=293.16K
alphas from (n,n*)a

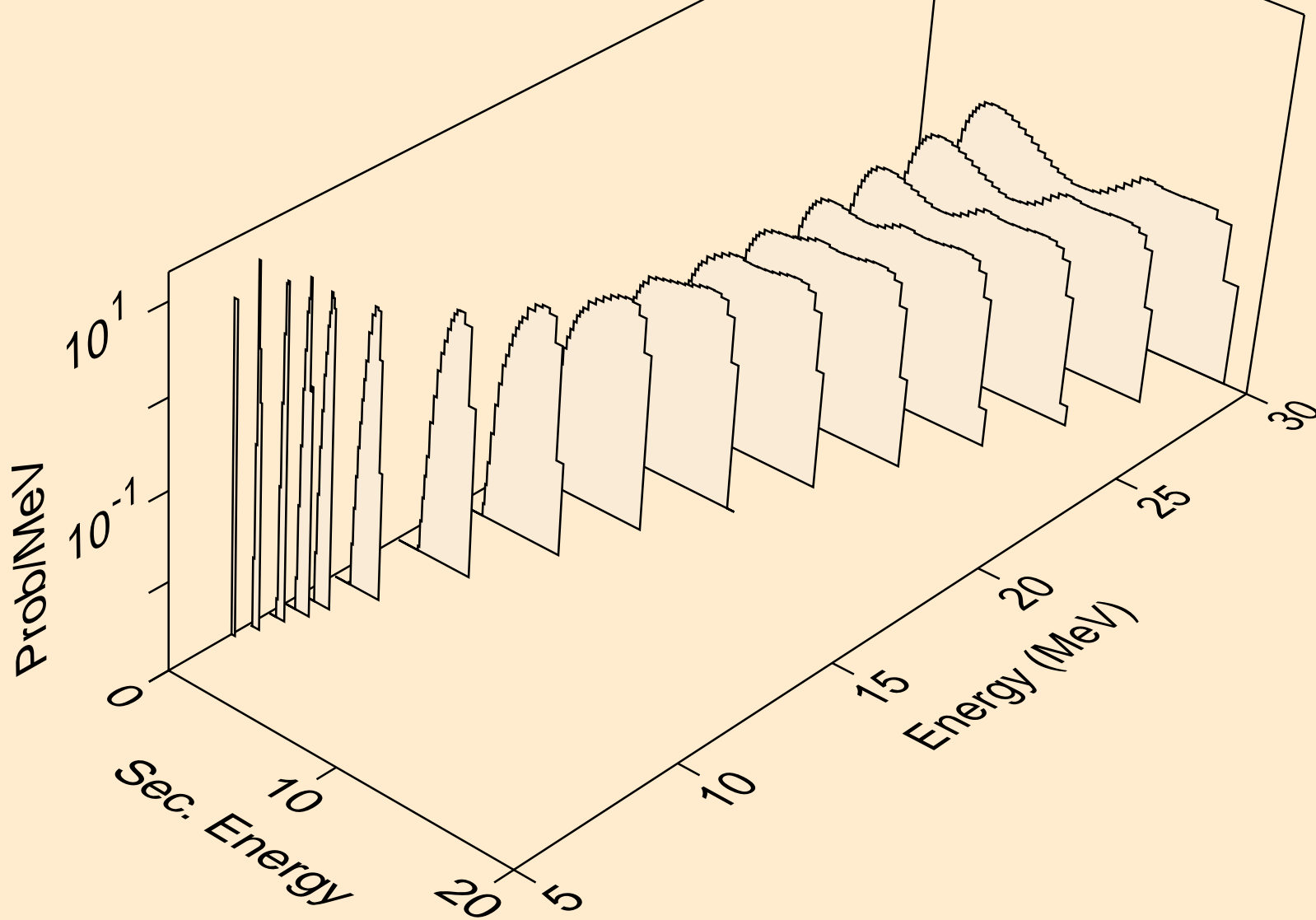

NA021 NEUTRON ACER TENDL-2019 LIBRARY; T=293.16K
alphas from (n,2n)a

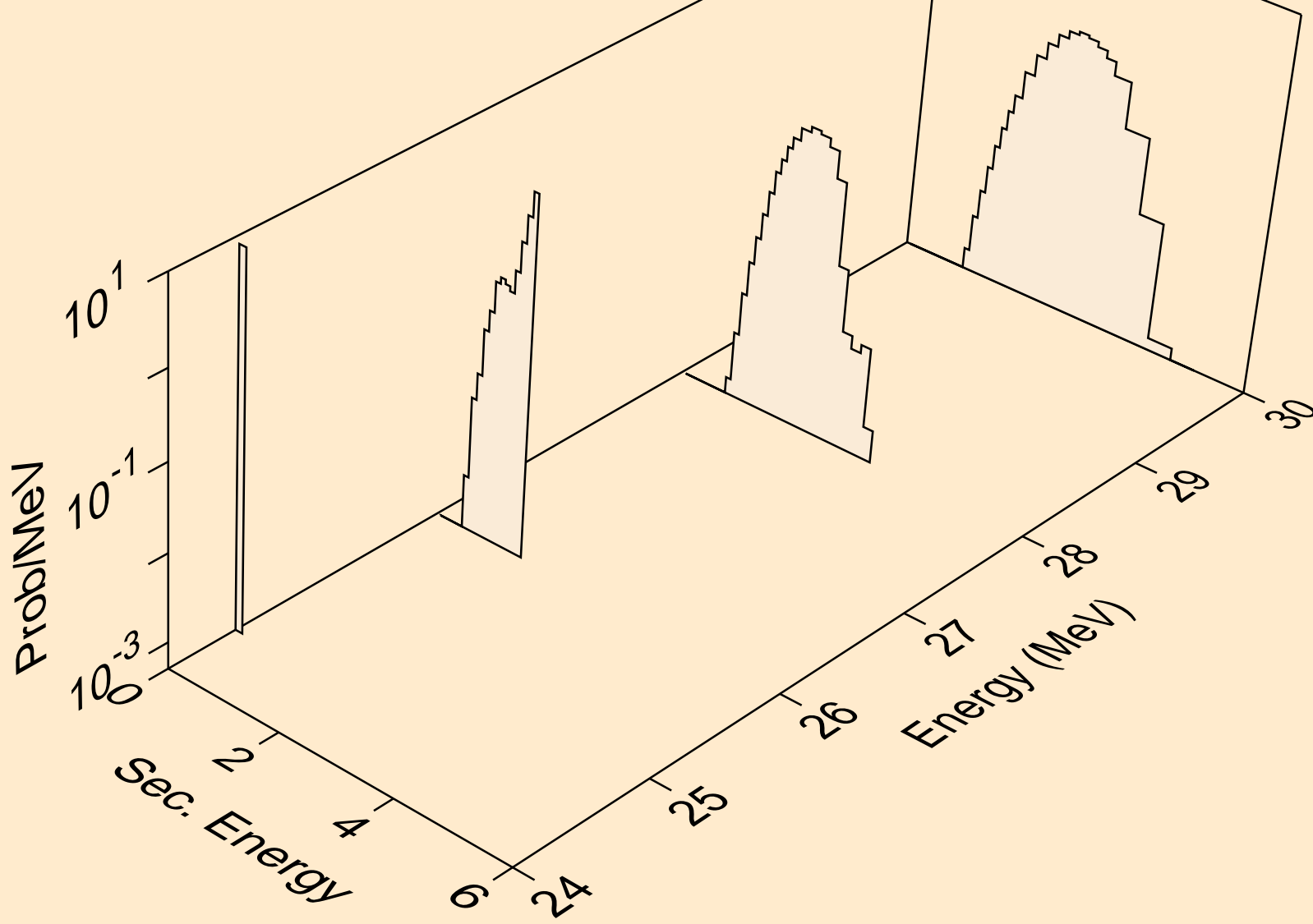

NA021 NEUTRON ACER TENDL-2019 LIBRARY; T=293.16K
alphas from (n,n*)2a

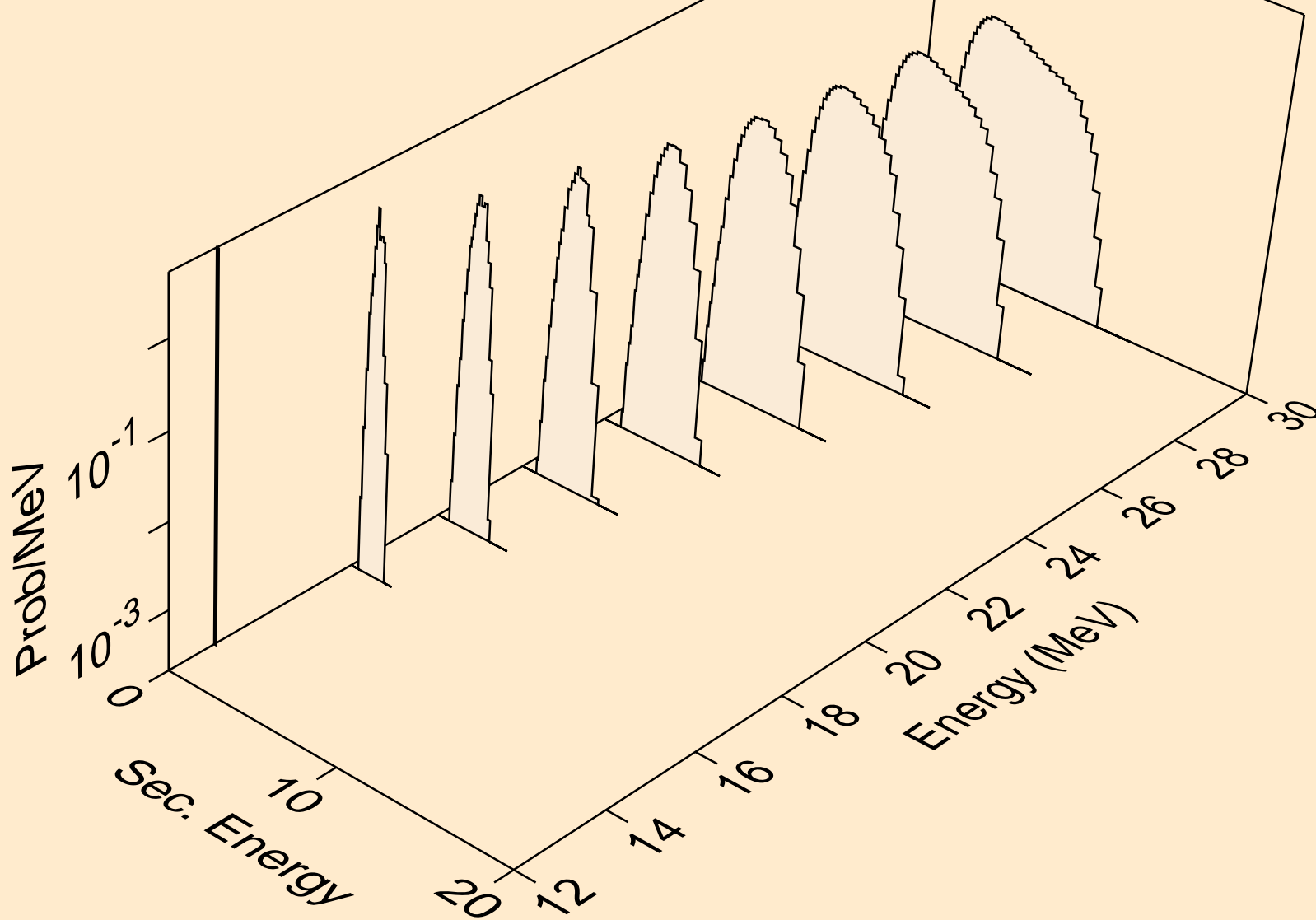

NA021 NEUTRON ACER TENDL-2019 LIBRARY; T=293.16K
alphas from (n,npa)

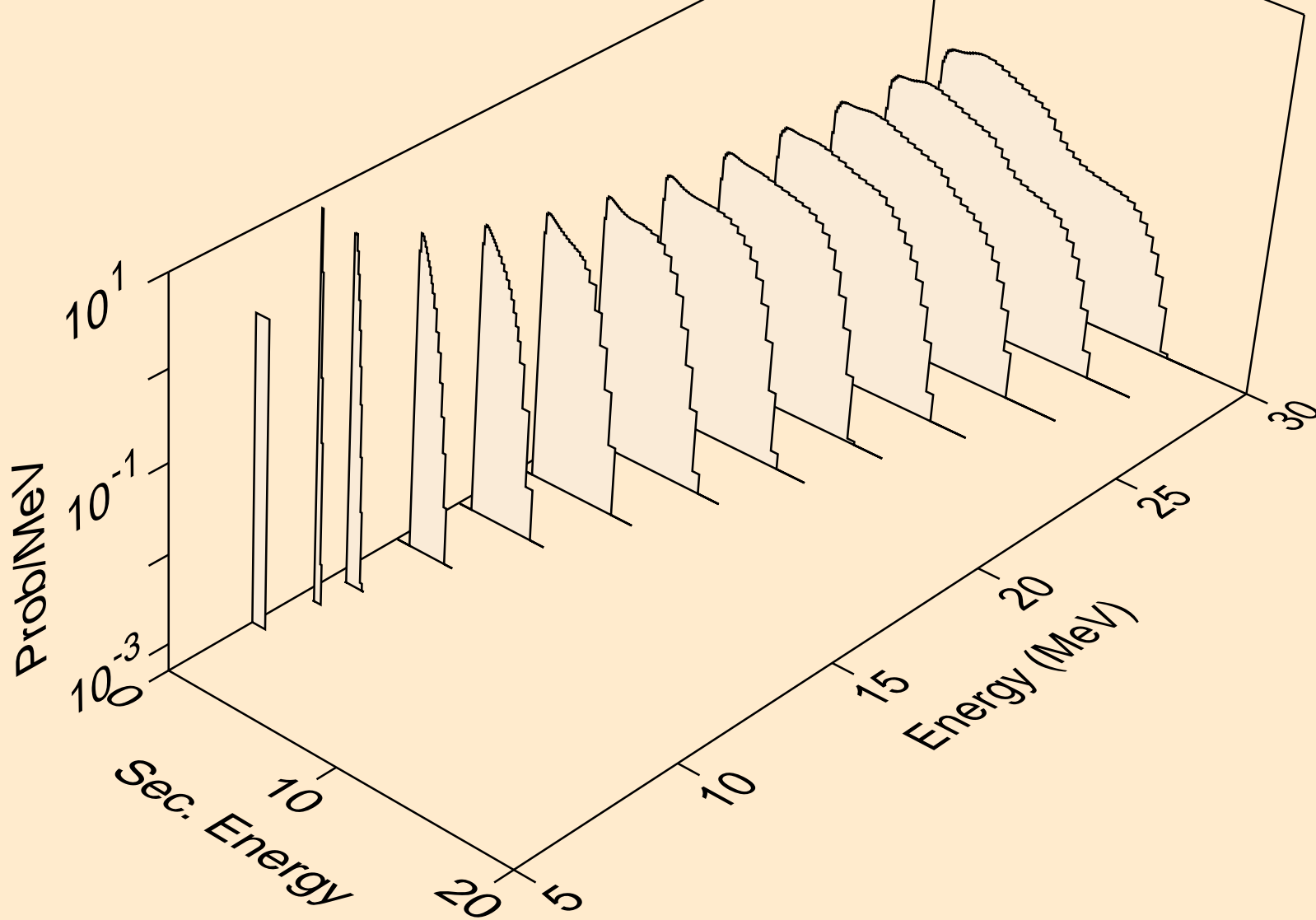

NA021 NEUTRON ACER TENDL-2019 LIBRARY; T=293.16K
alphas from (n,a)

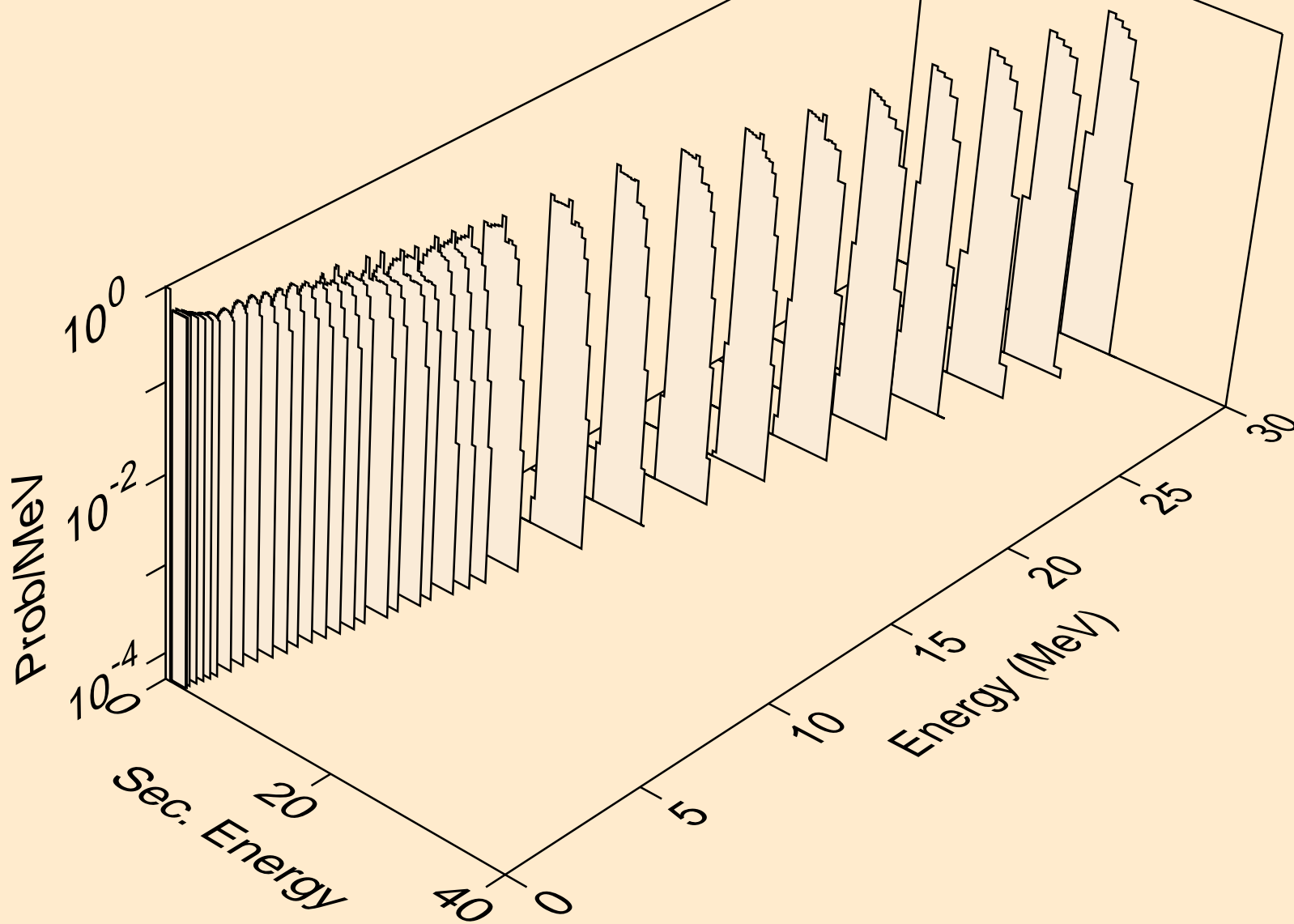

NA021 NEUTRON ACER TENDL-2019 LIBRARY; T=293.16K
alphas from (n,2a)

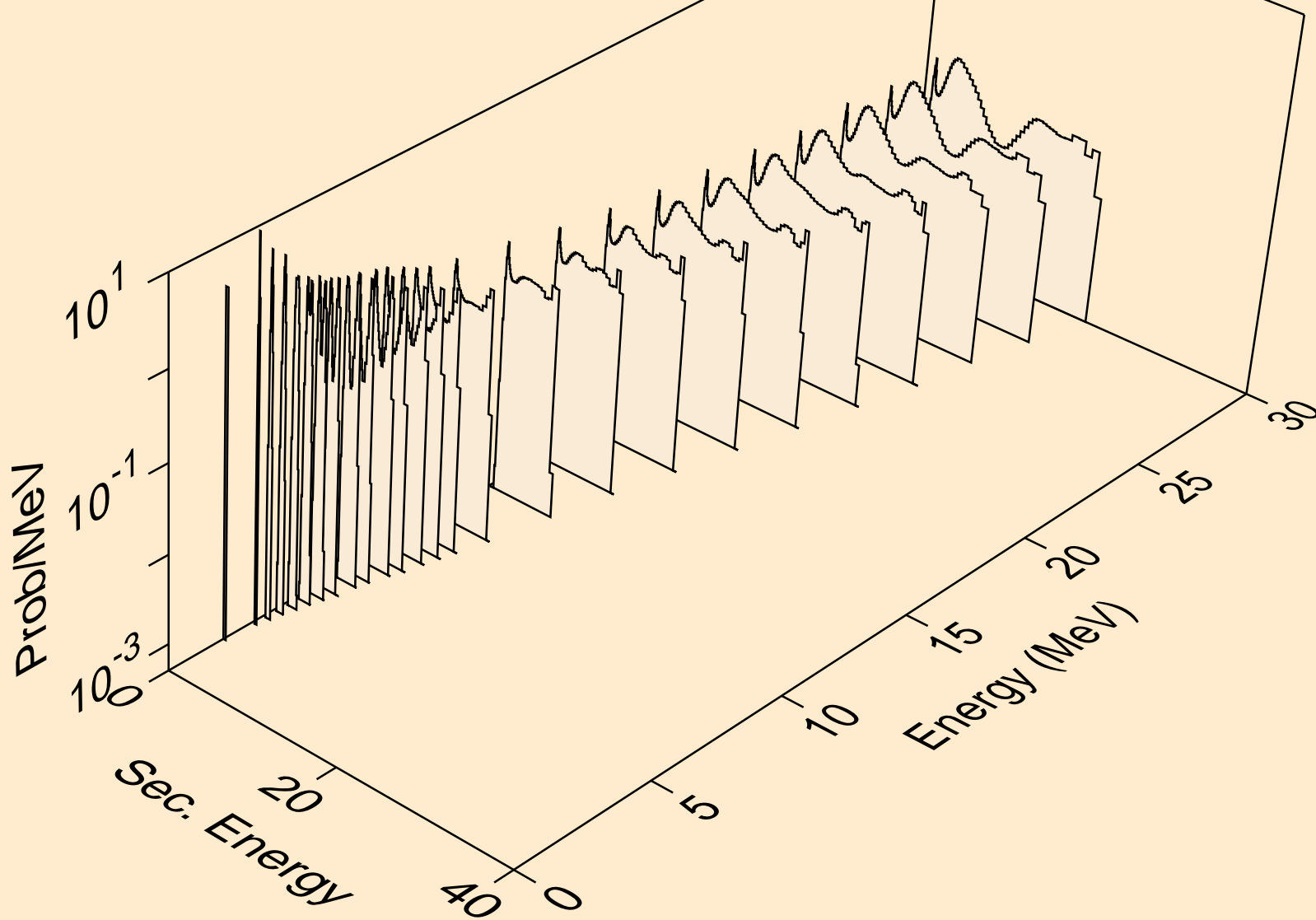

NA021 NEUTRON ACER TENDL-2019 LIBRARY; T=293.16K
alphas from (n,3a)

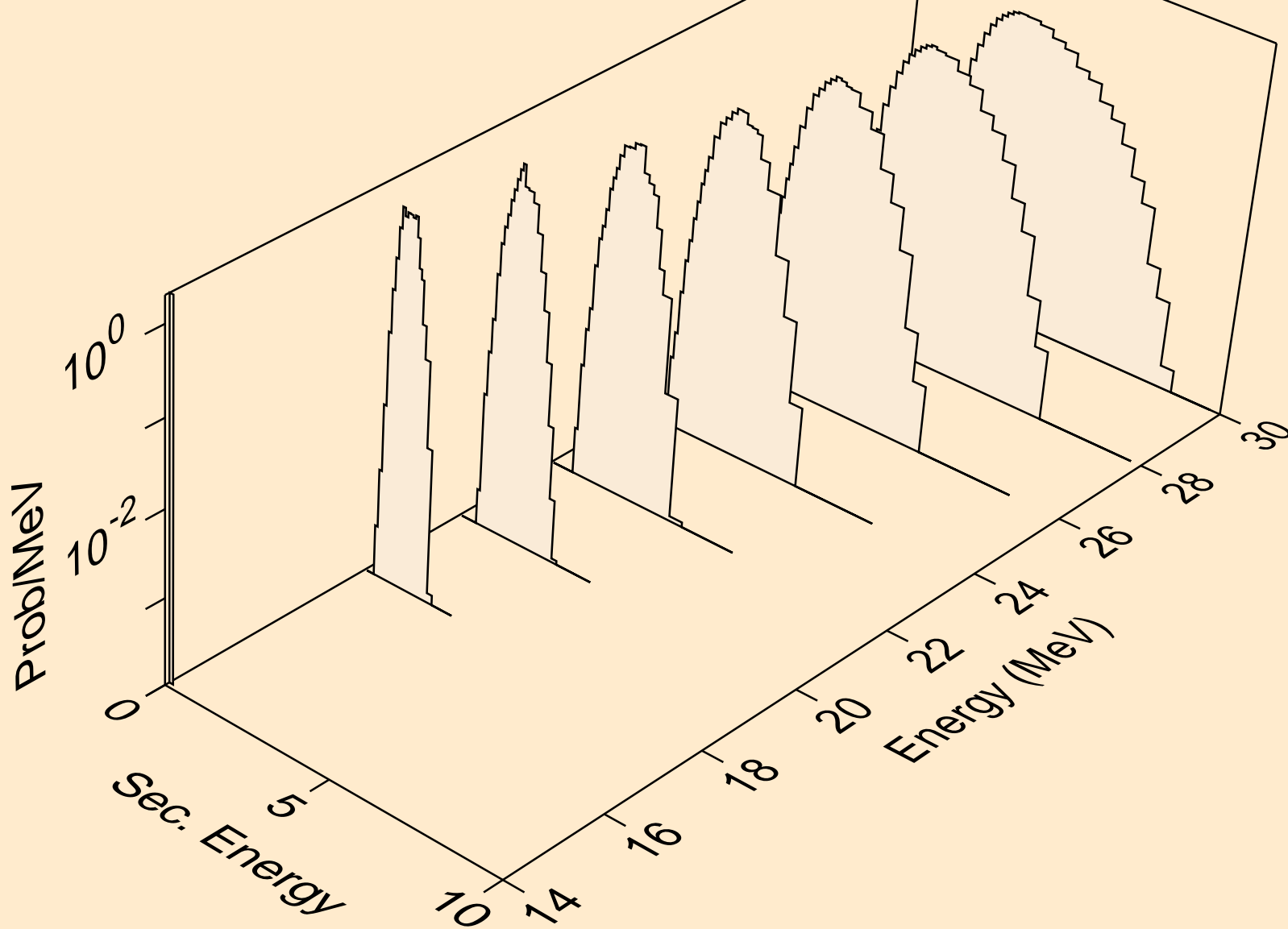

NA021 NEUTRON ACER TENDL-2019 LIBRARY; T=293.16K
alphas from (n,pa)

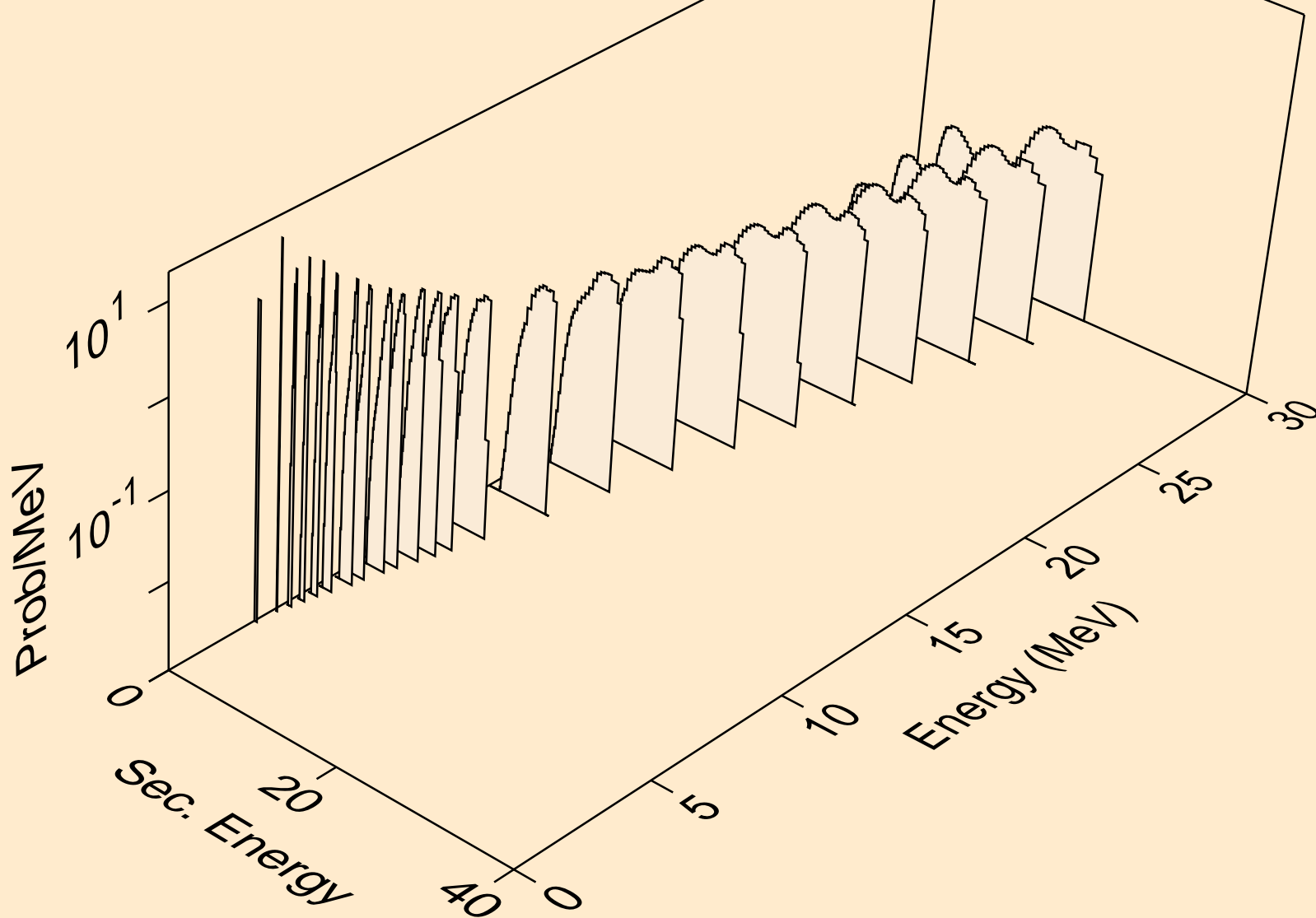

NA021 NEUTRON ACER TENDL-2019 LIBRARY; T=293.16K
alphas from (n,d2a)

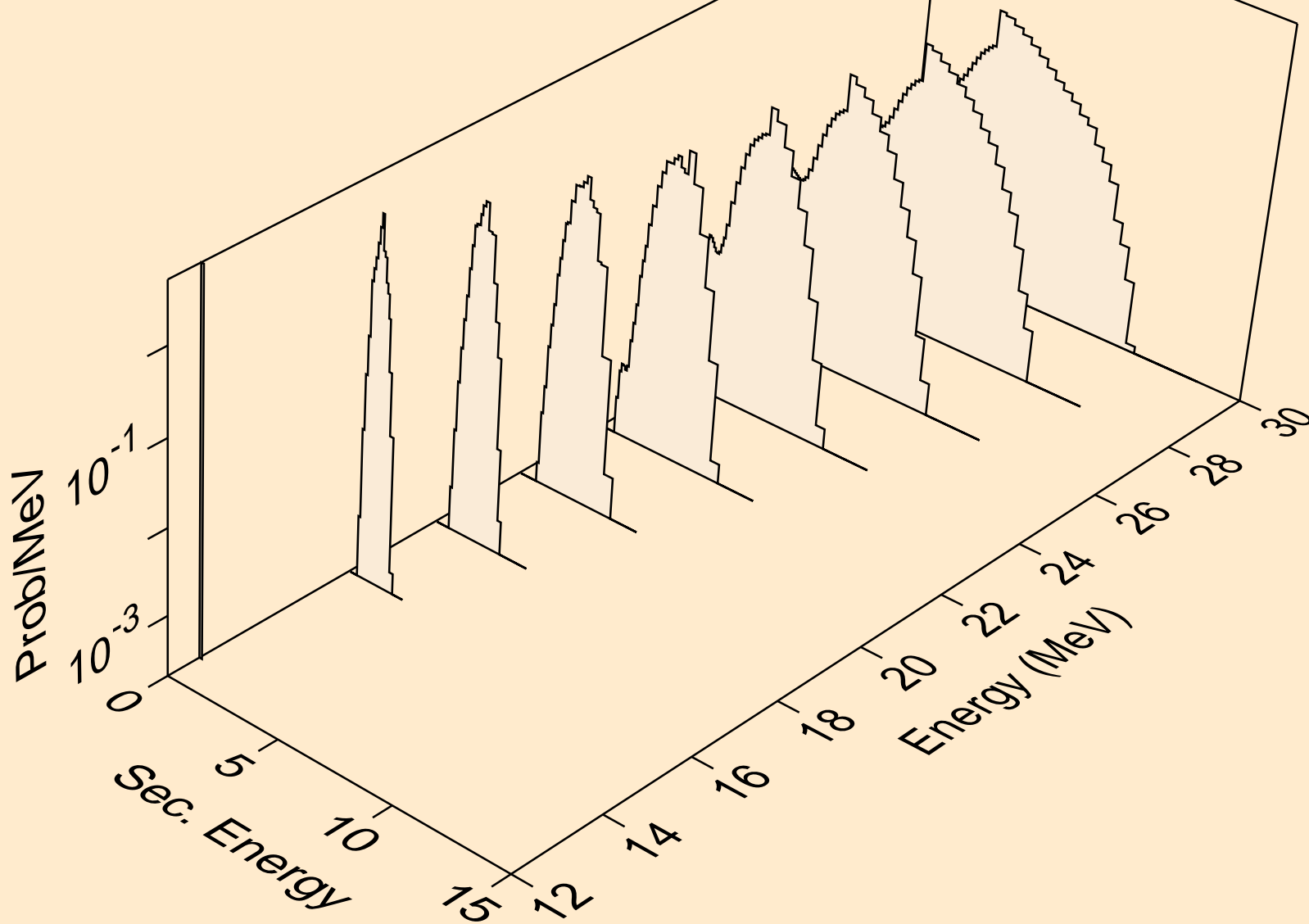

NA021 NEUTRON ACER TENDL-2019 LIBRARY; T=293.16K
alphas from (n,da)

