

Program EVALPLOT
(Version 2018-1)

by

Dermott E. Cullen
(Present Contact Information)

Dermott E. Cullen
1466 Hudson Way
Livermore, CA 94550
U.S.A.

Tele: 925-443-1911

E.Mail:redcullen1@comcast.net
Web:redcullen1.net/HOMEPAGE.NEW

Press Mouse Button to Start

MAT 1122

Major
293 Kelvin Cross Sections

11-Na-22

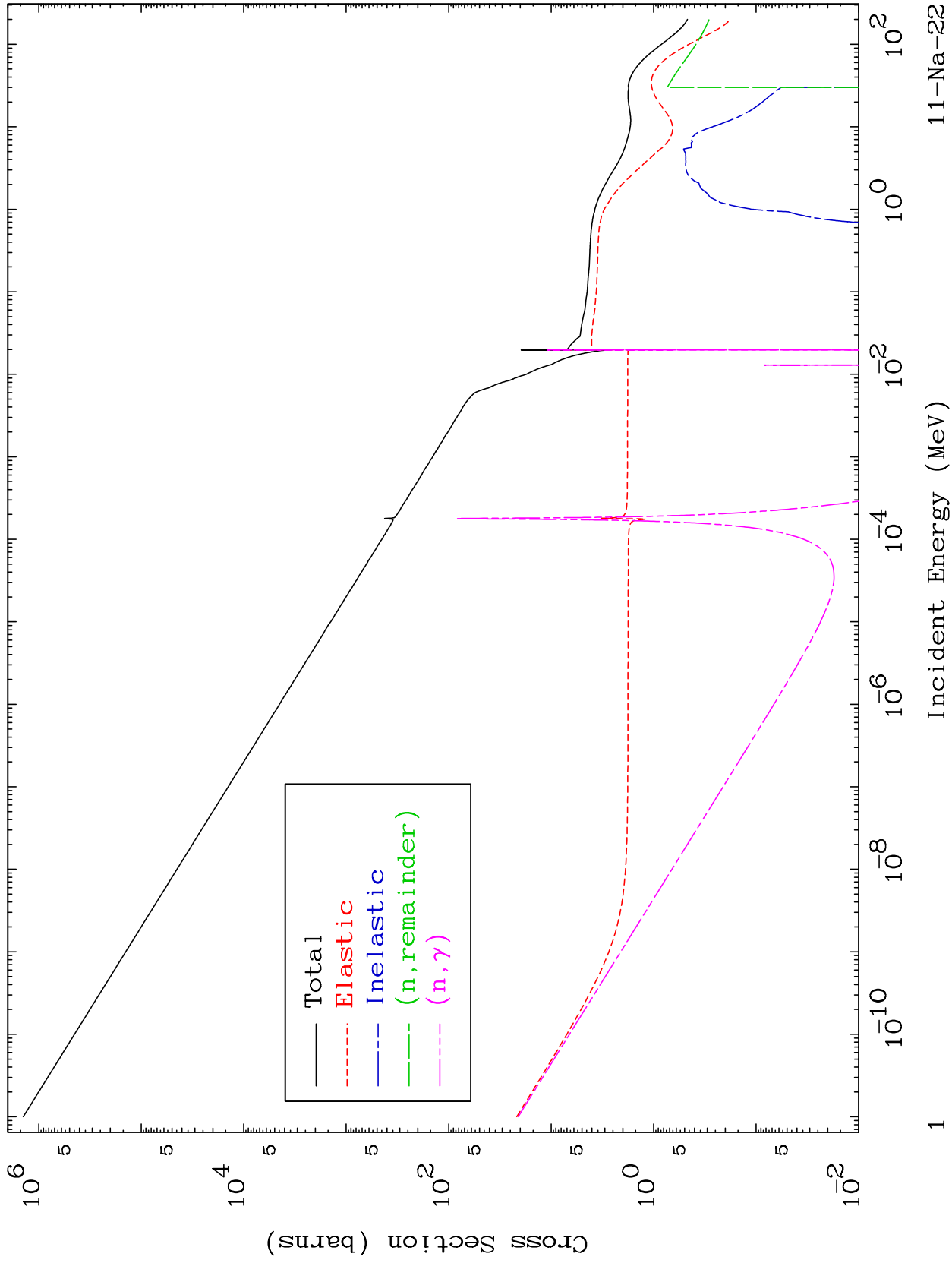

MAT 1122

Neutron Production 293 Kelvin Cross Sections

11-Na-22

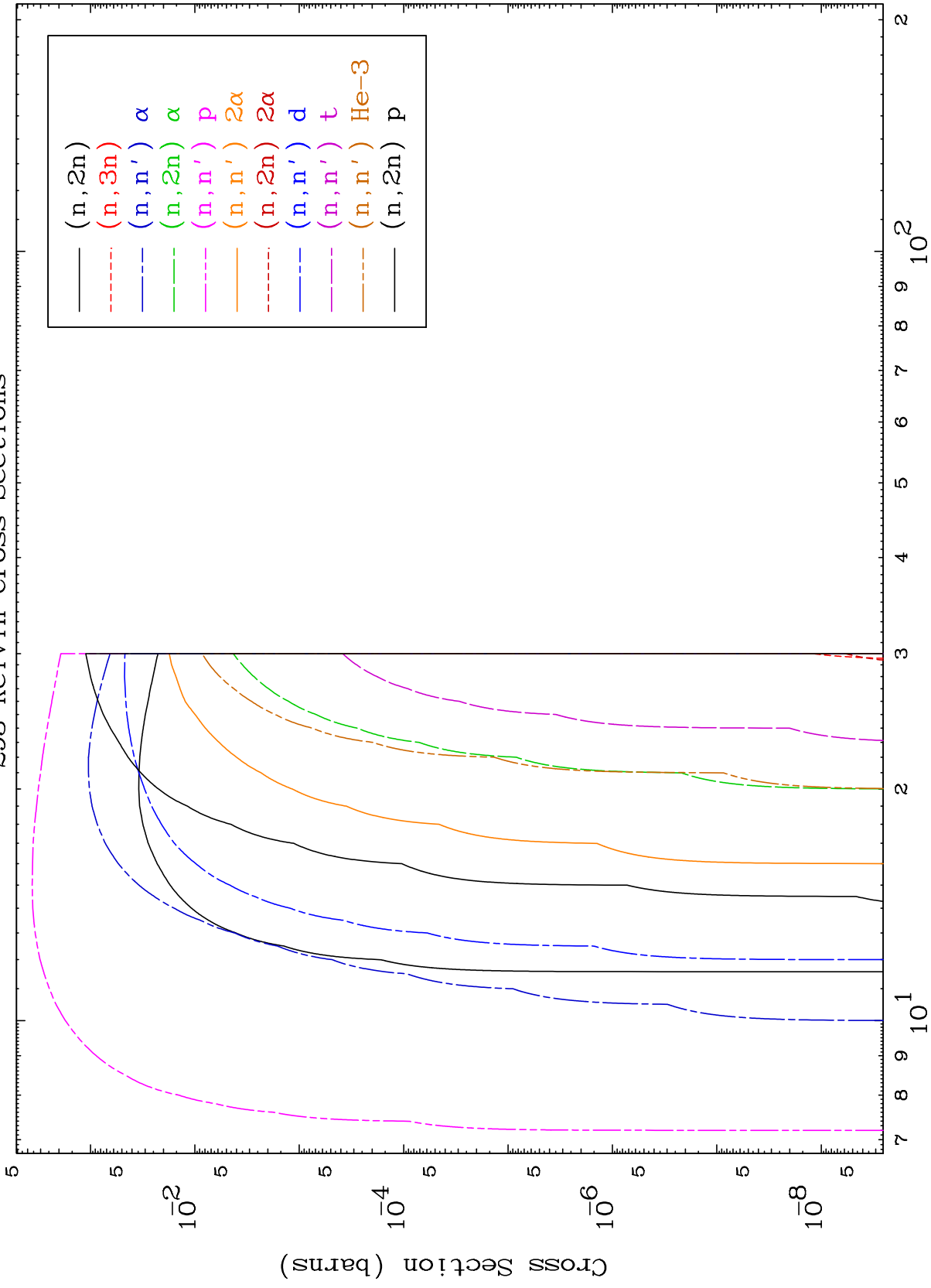

2

Incident Energy (MeV)

11-Na-22

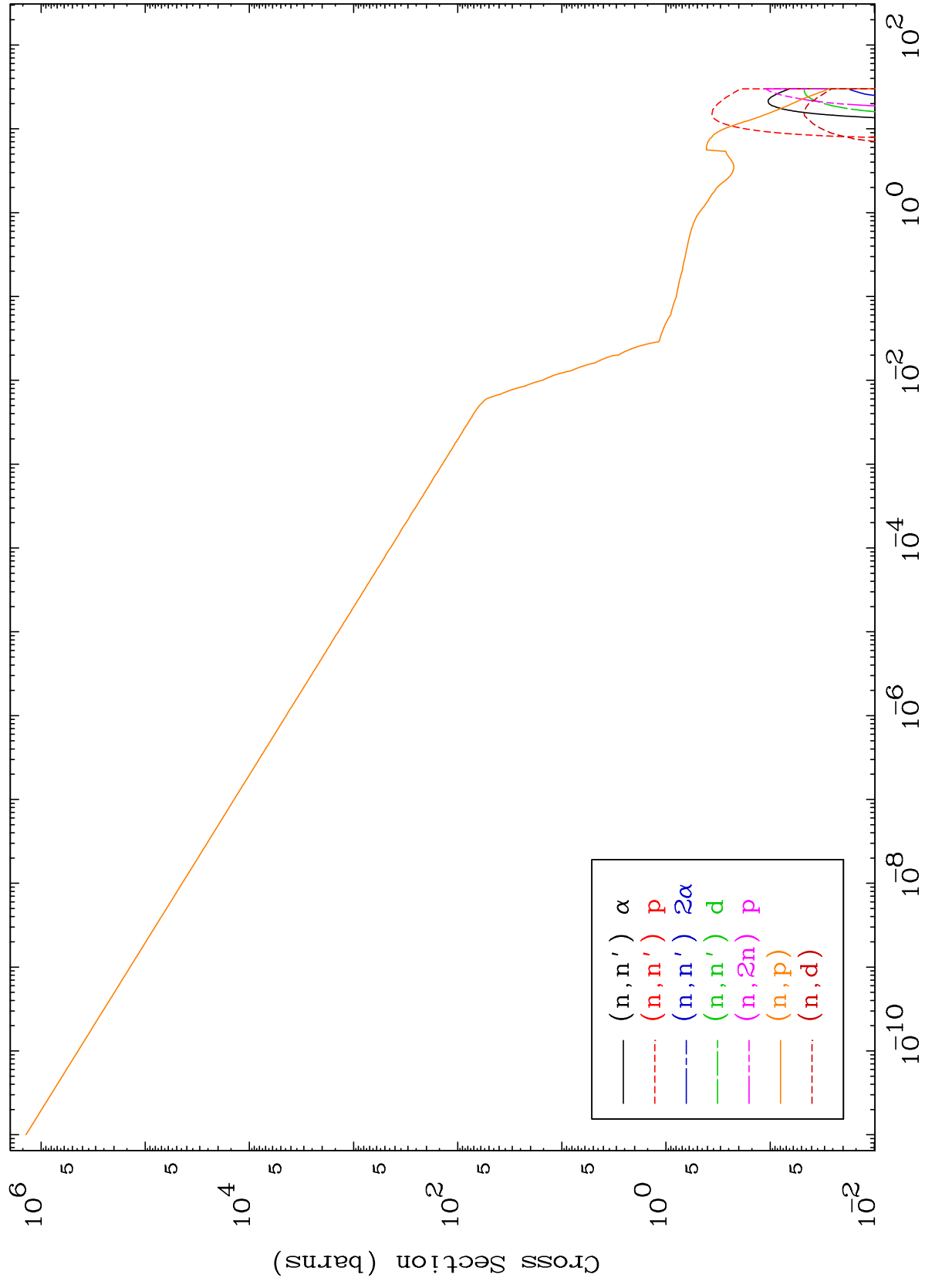

MAT 1122

Charged Particle
293 Kelvin Cross Sections

11-Na-22

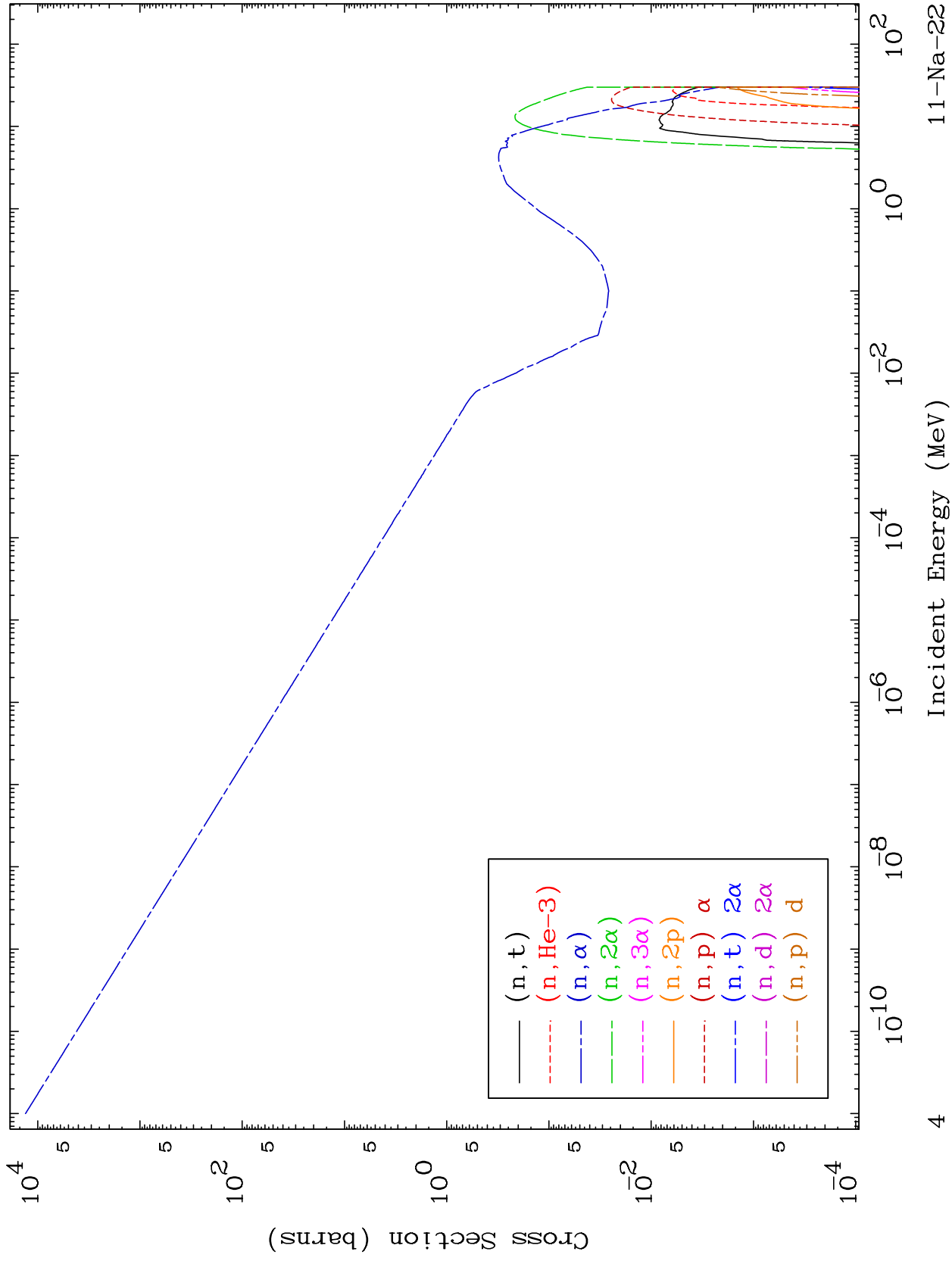

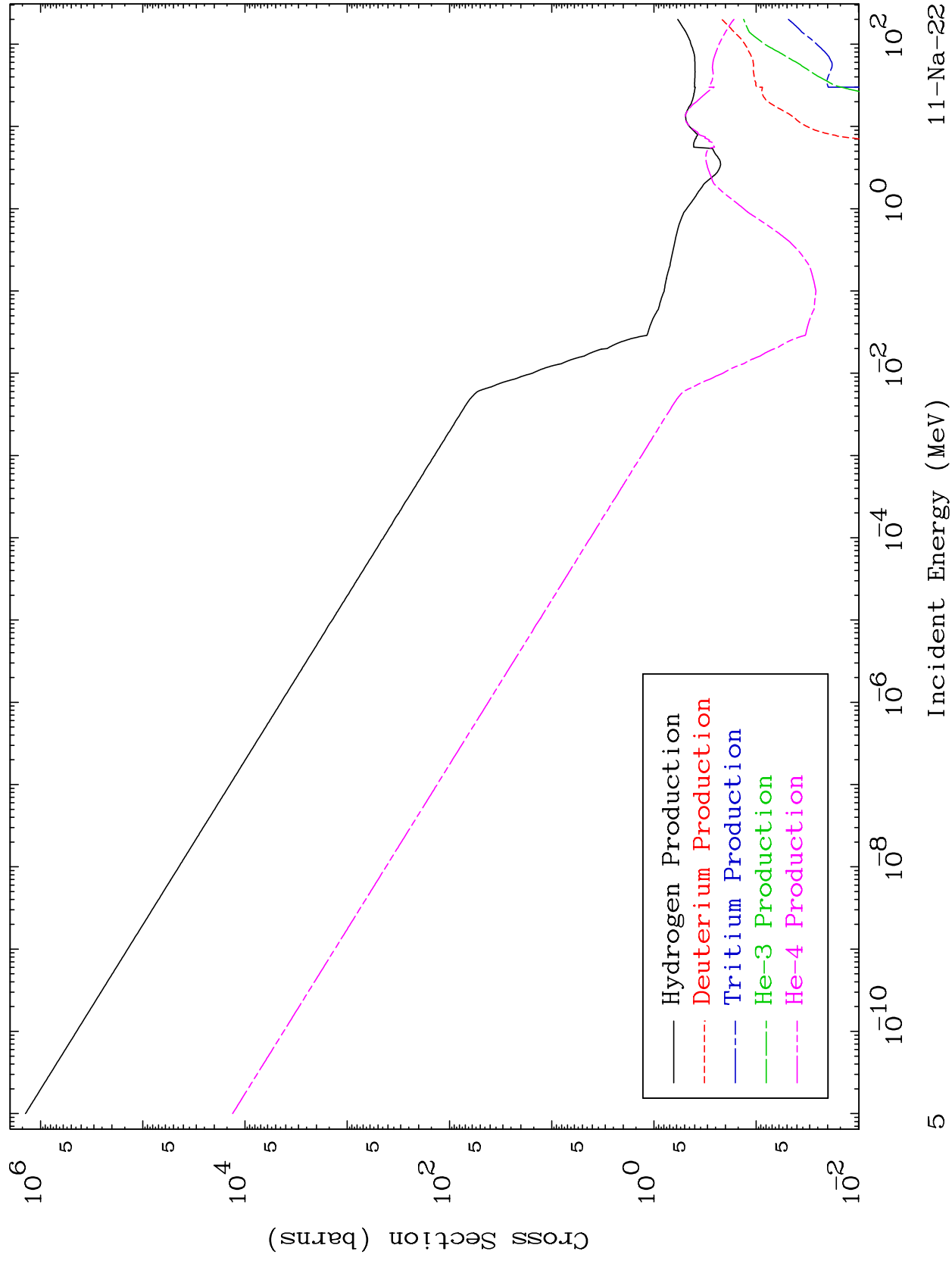

MAT 1122

(n,n') Level
293 Kelvin Cross Sections

11-Na-22

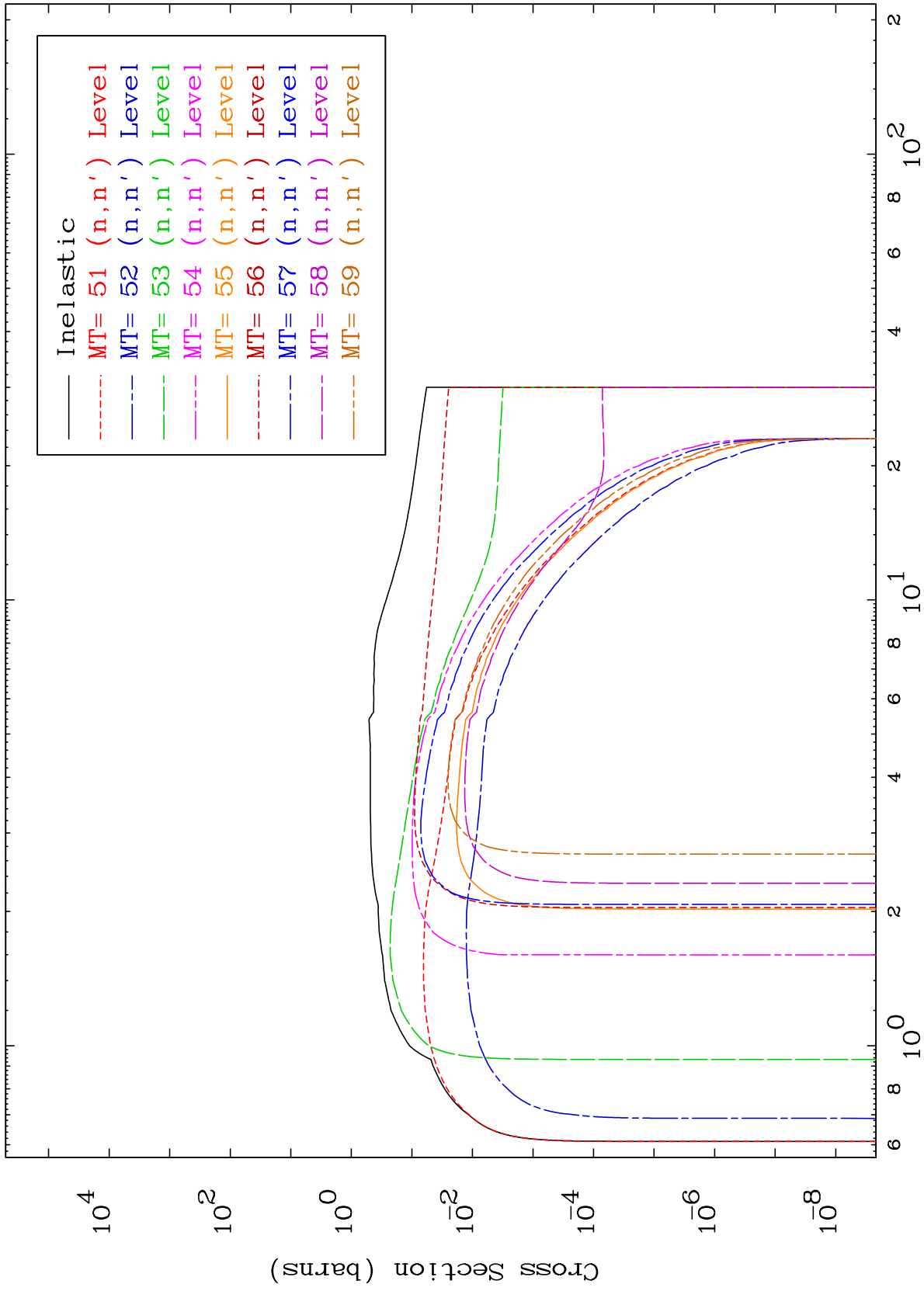

6

Incident Energy (MeV)

11-Na-22

MAT 1122

(n,n') Level

11-Na-22

293 Kelvin Cross Sections

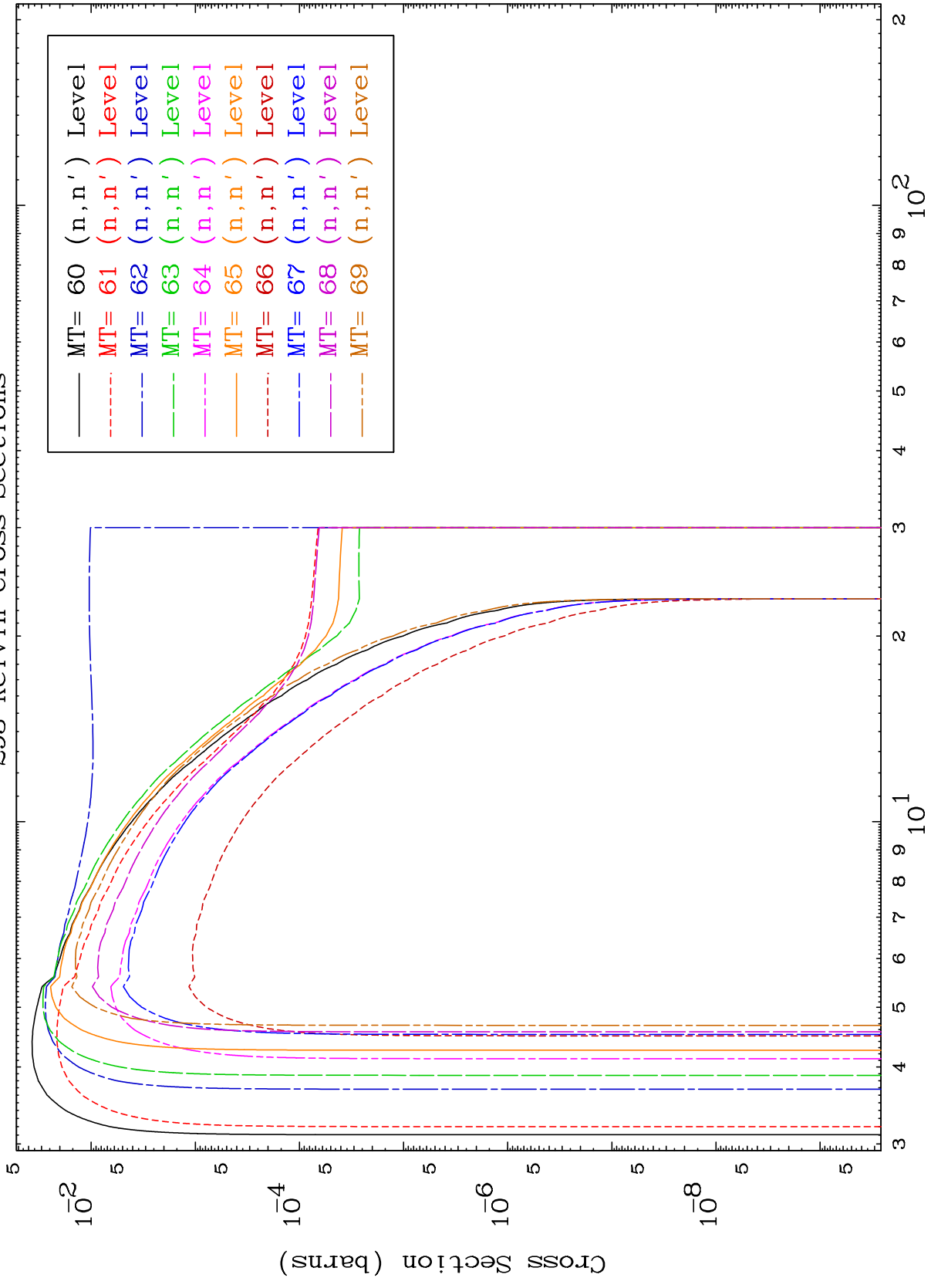

7

MAT 1122

(n,n') Level

11-Na-22

293 Kelvin Cross Sections

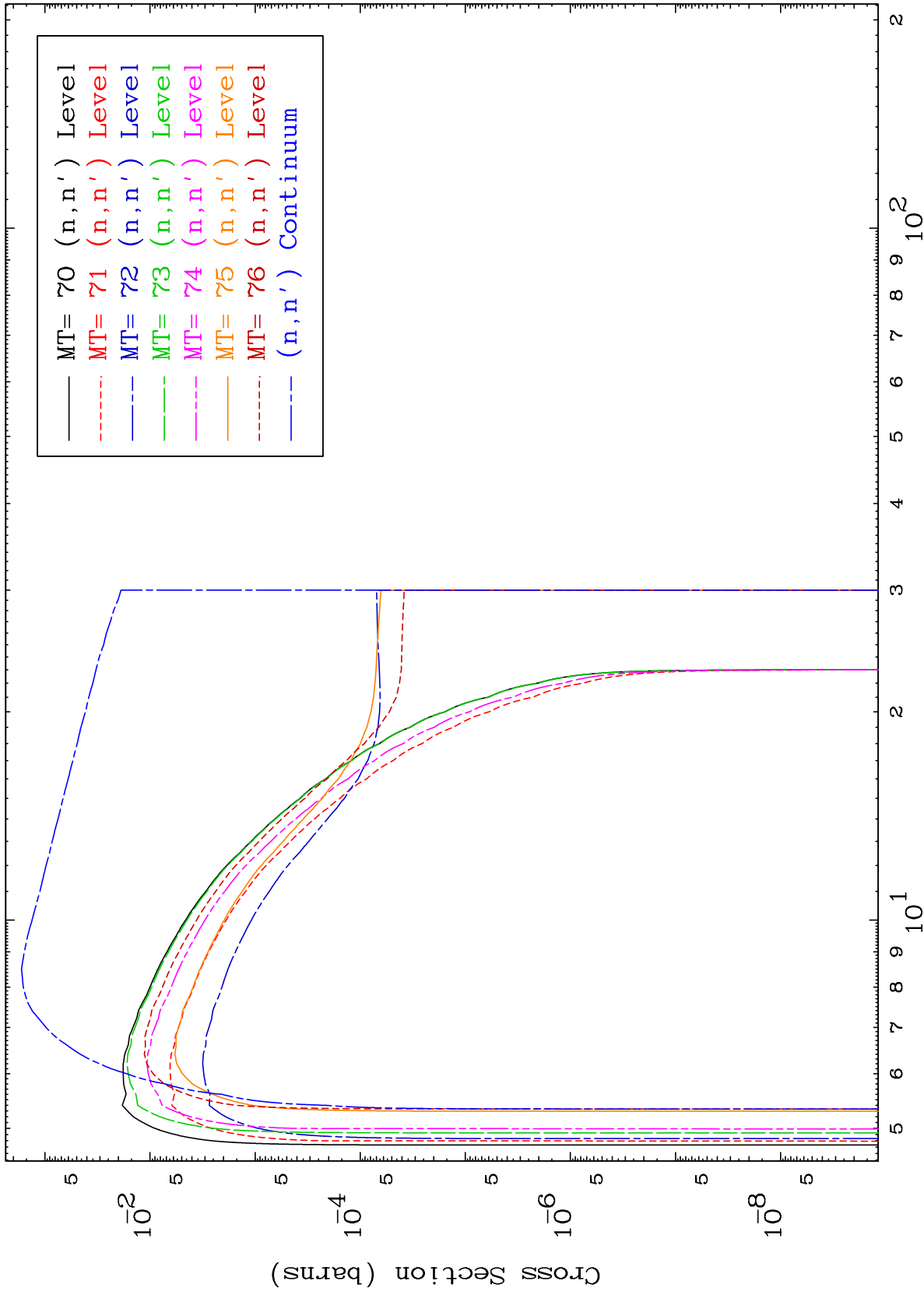

8

Incident Energy (MeV)

11-Na-22

MAT 1122

(n,p) Levels
293 Kelvin Cross Sections

11-Na-22

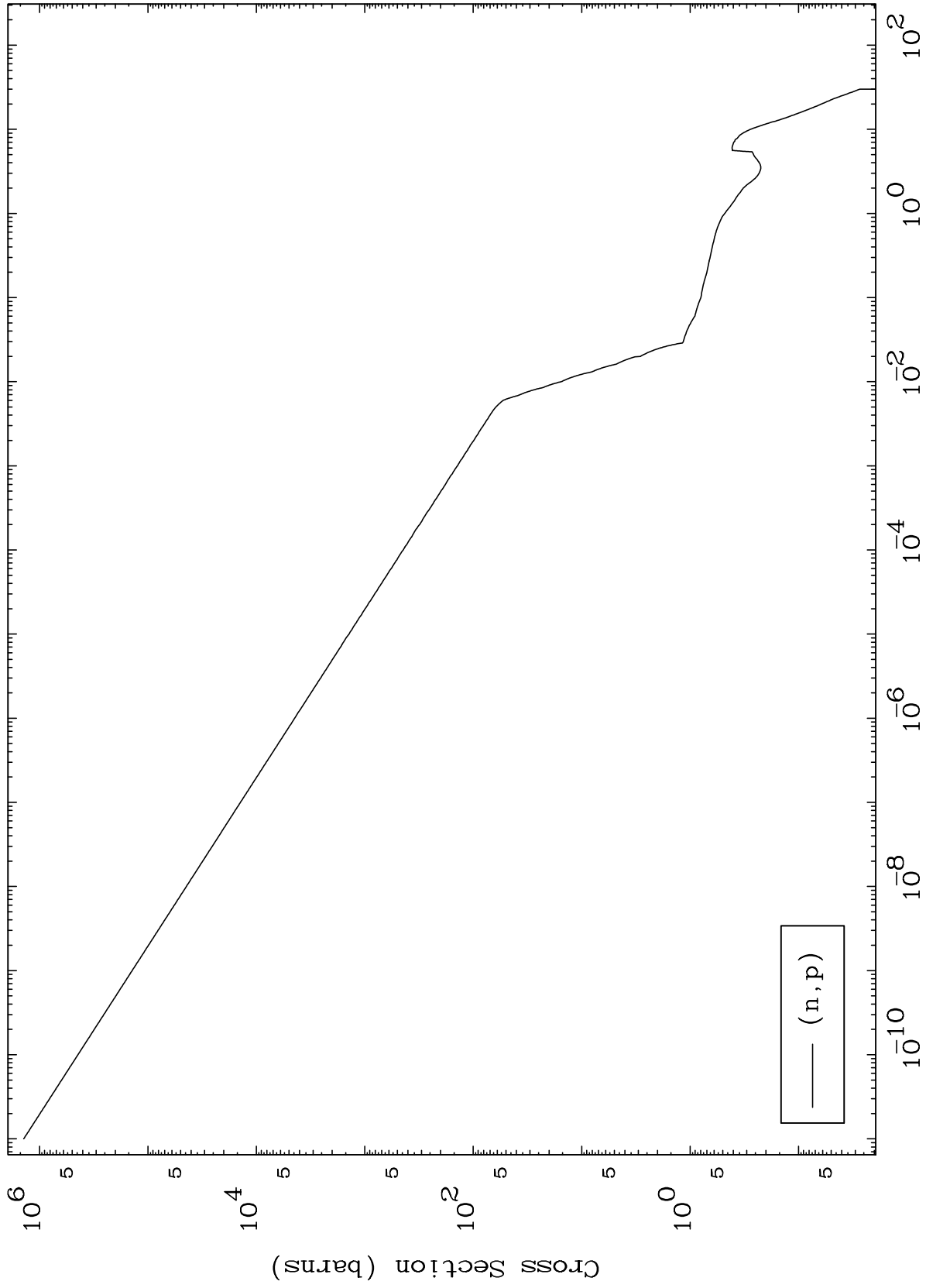

11-Na-22

MAT 1122

(n,d) Levels
293 Kelvin Cross Sections

11-Na-22

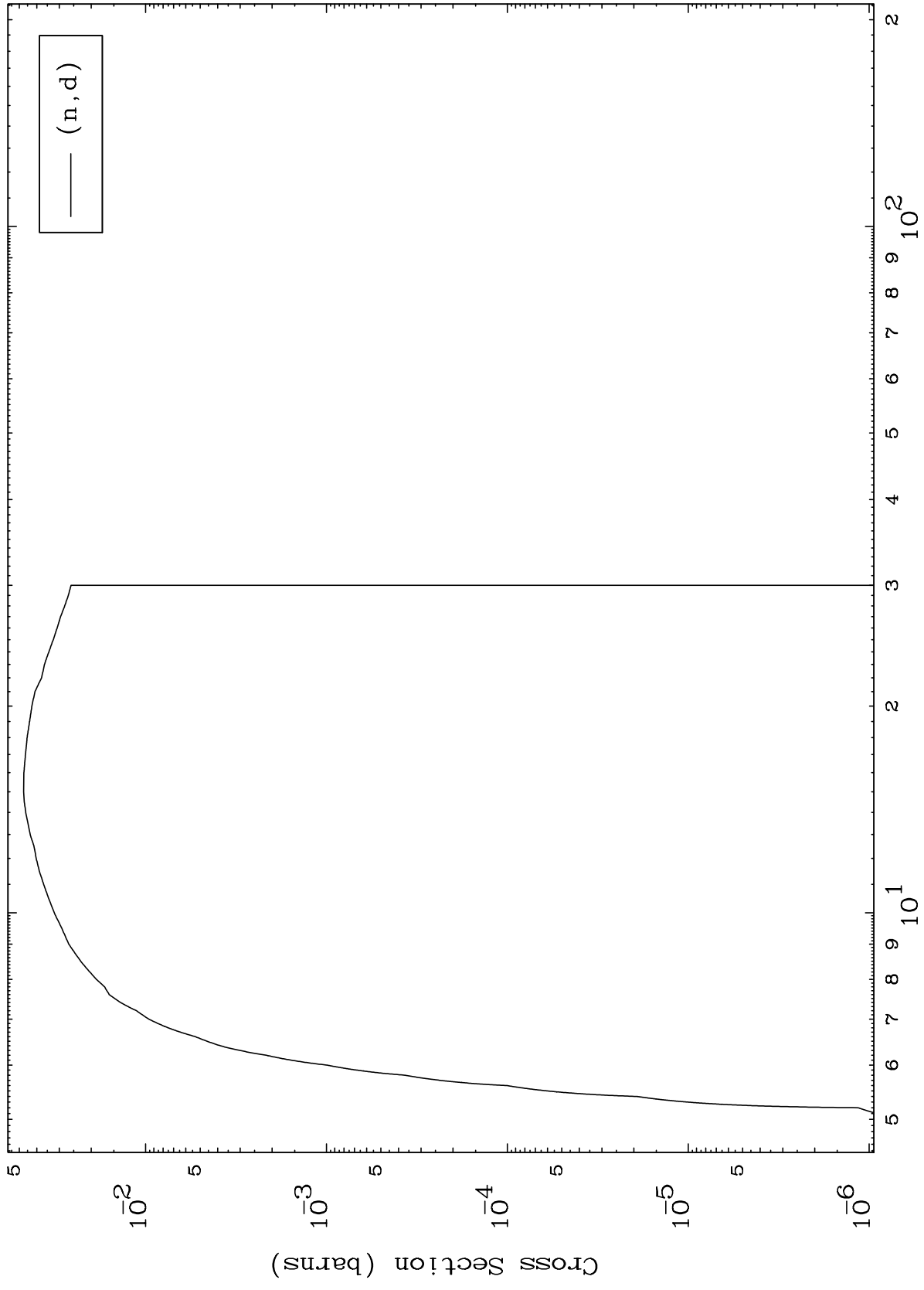

10

Incident Energy (MeV)

11-Na-22

MAT 1122

(n,t) Levels
293 Kelvin Cross Sections

11-Na-22

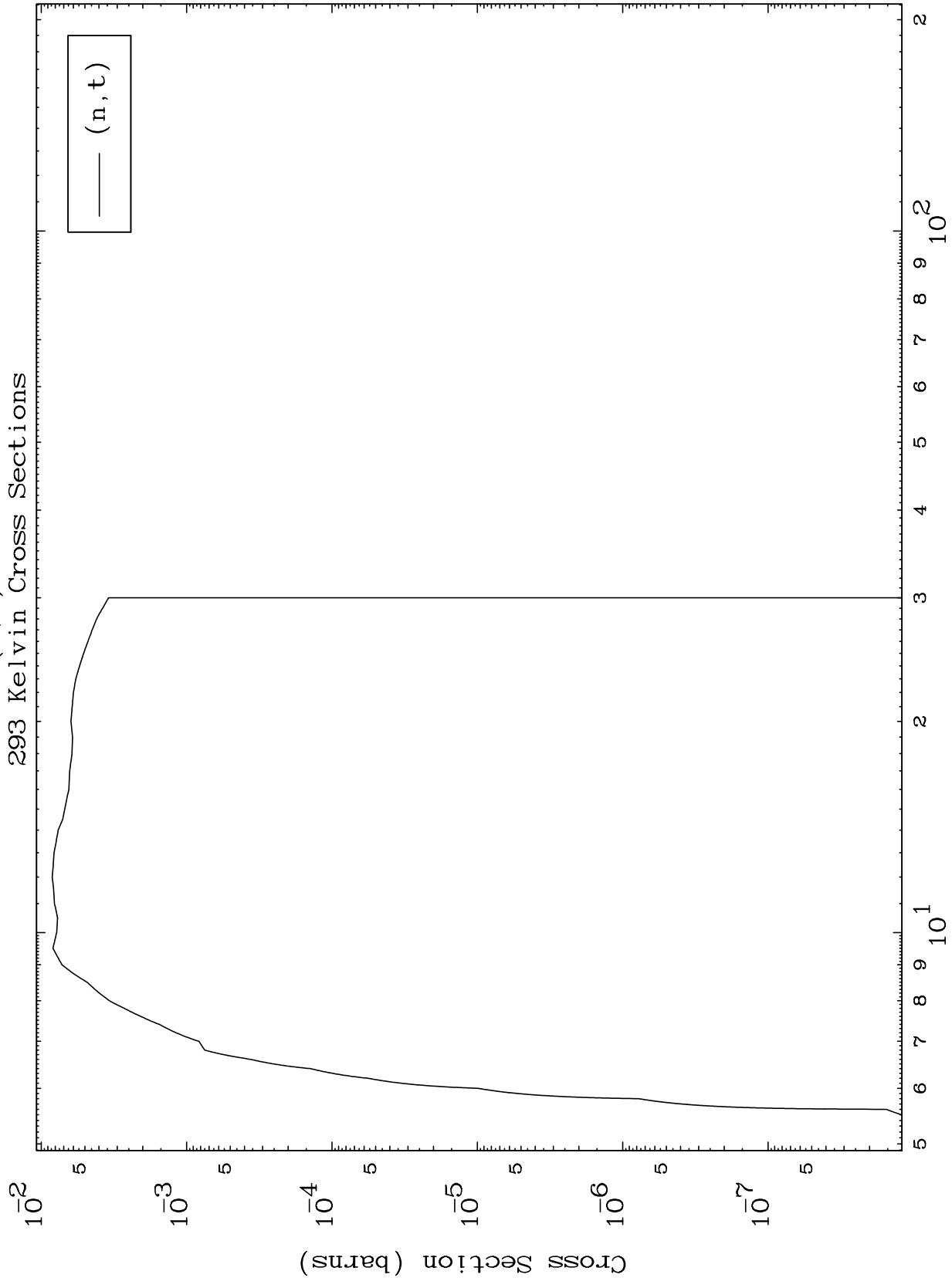

11

Incident Energy (MeV)

11-Na-22

MAT 1122

(n,He3) Levels
293 Kelvin Cross Sections

11-Na-22

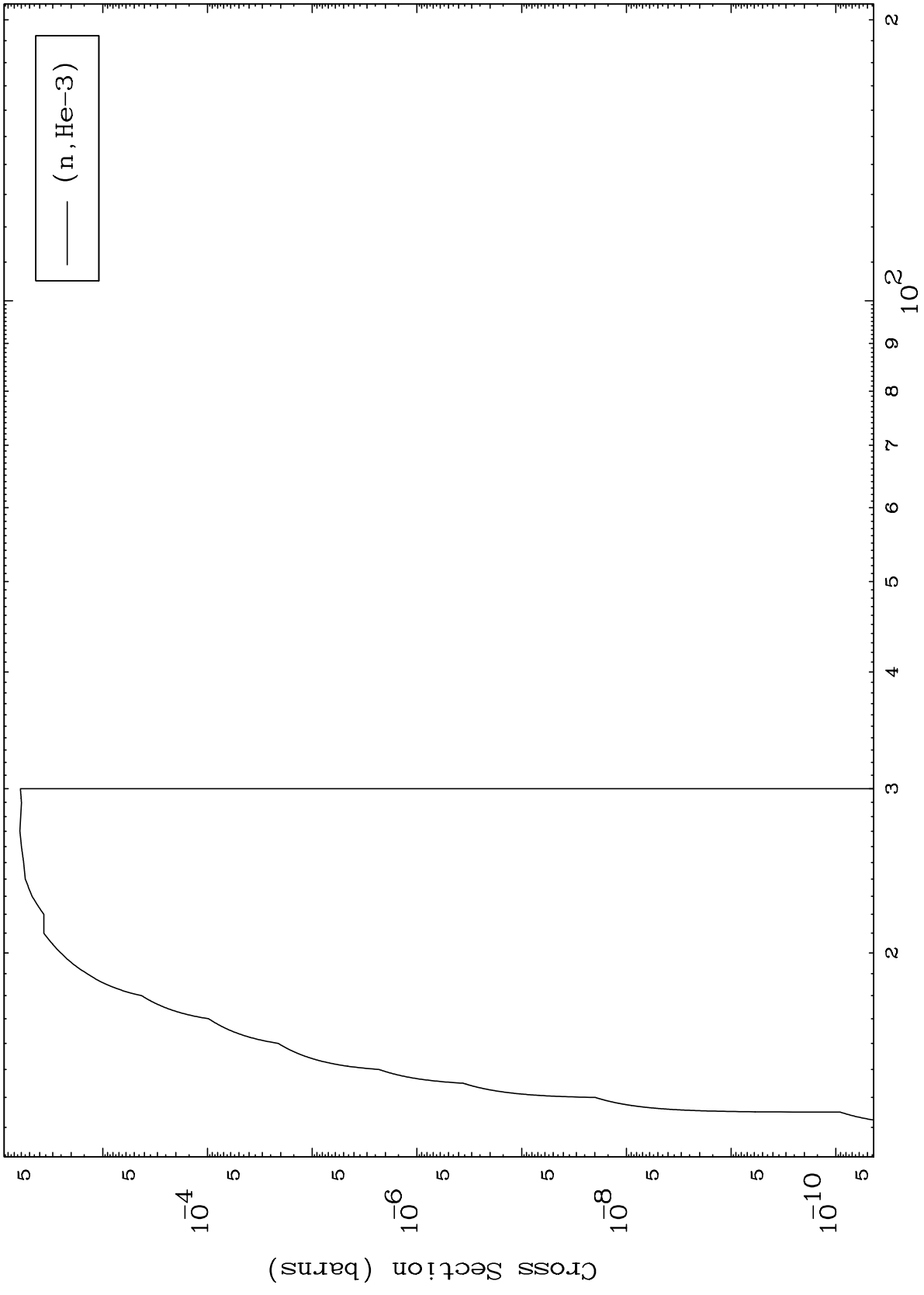

12

Incident Energy (MeV)

11-Na-22

MAT 1122

(n, α) Levels
293 Kelvin Cross Sections

11-Na-22

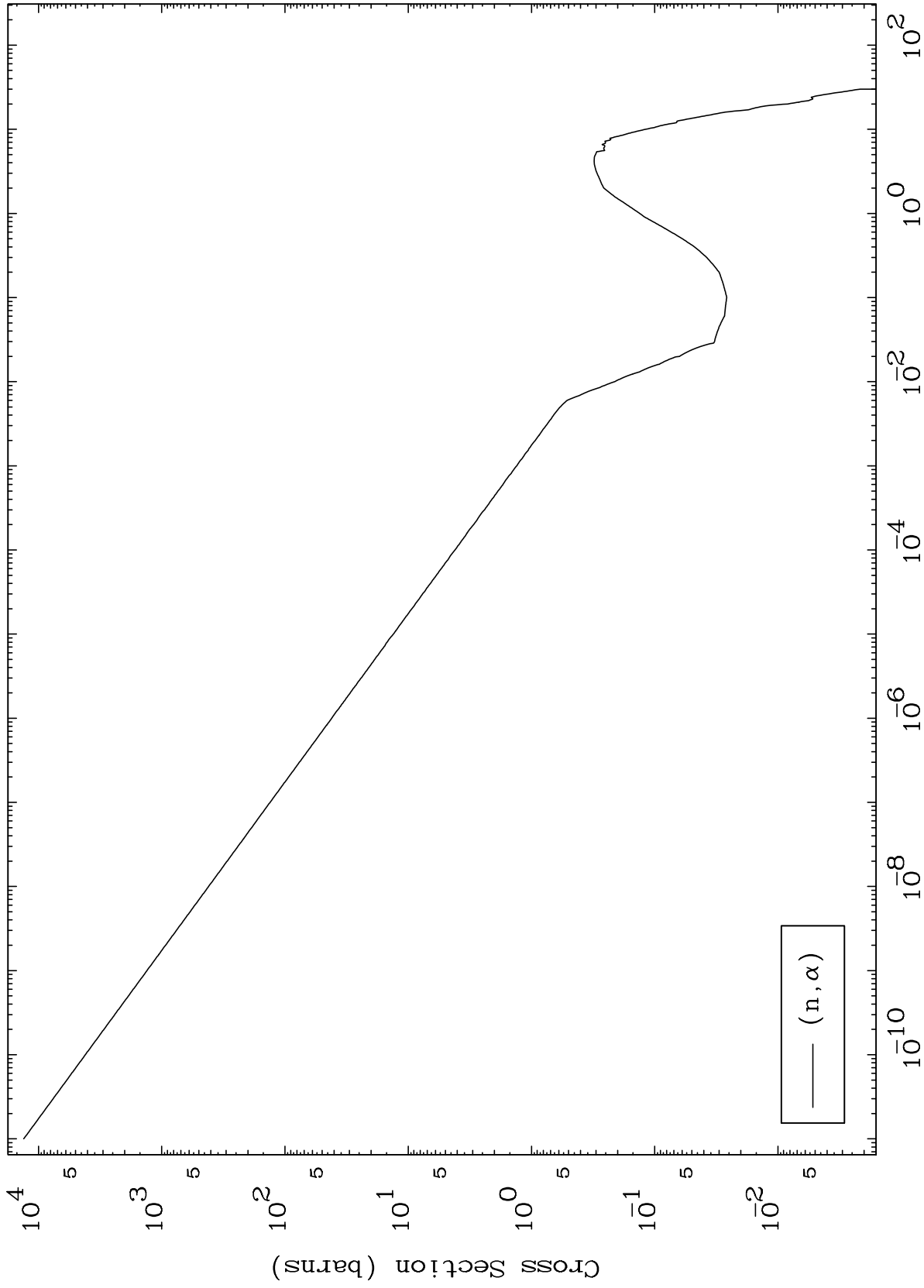

13

Incident Energy (MeV)

11-Na-22

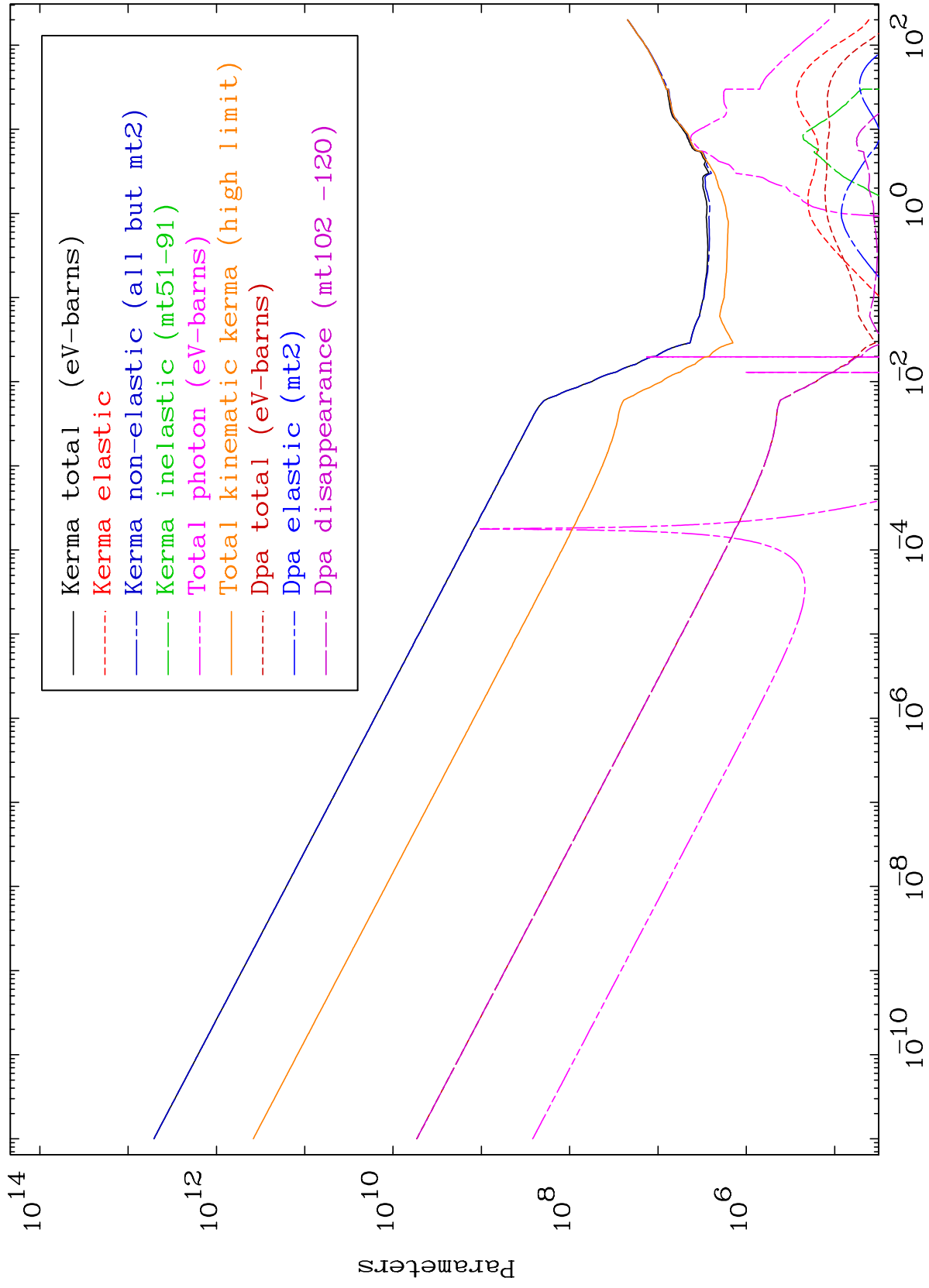

MAT 1122

Elastic Legendre Coefficients

11-Na-22

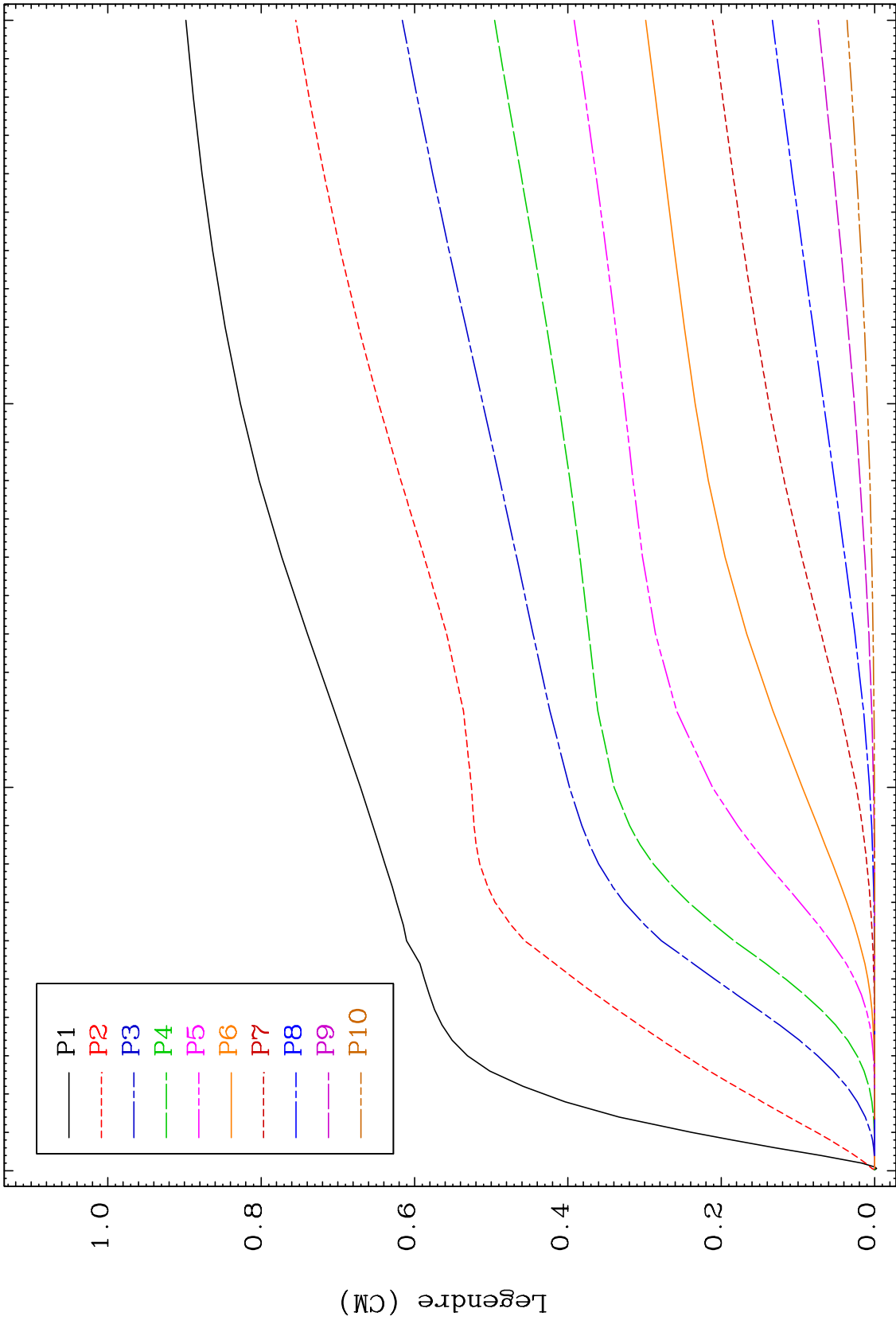

15

Incident Energy (MeV)

11-Na-22

MAT 1122

Elastic Legendre Coefficients

11-Na-22

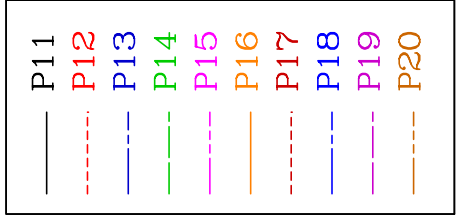
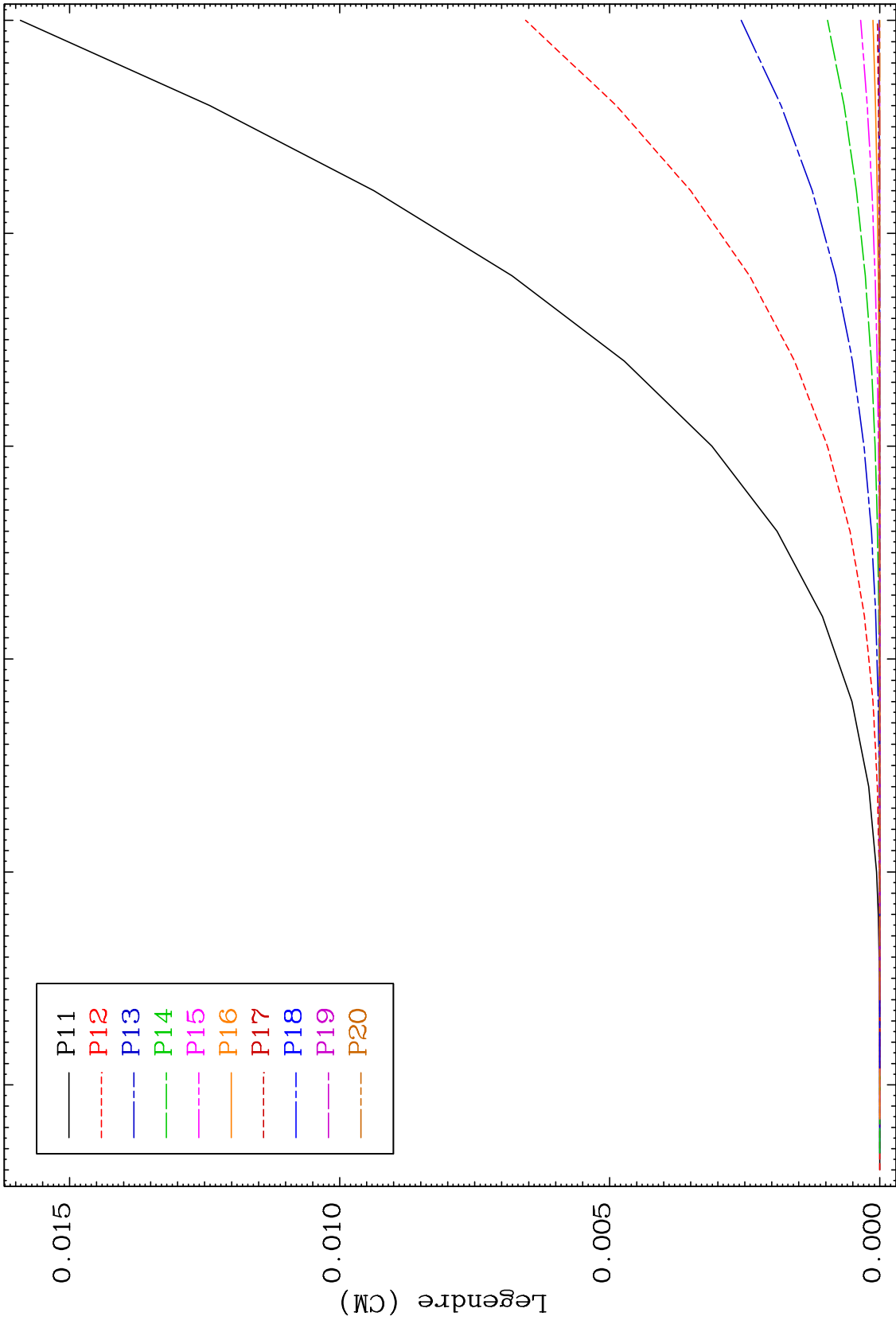

16

Incident Energy (MeV)

11-Na-22

MAT 1122

MT= 51 (n,n') Level
Legendre Coefficients

11-Na-22

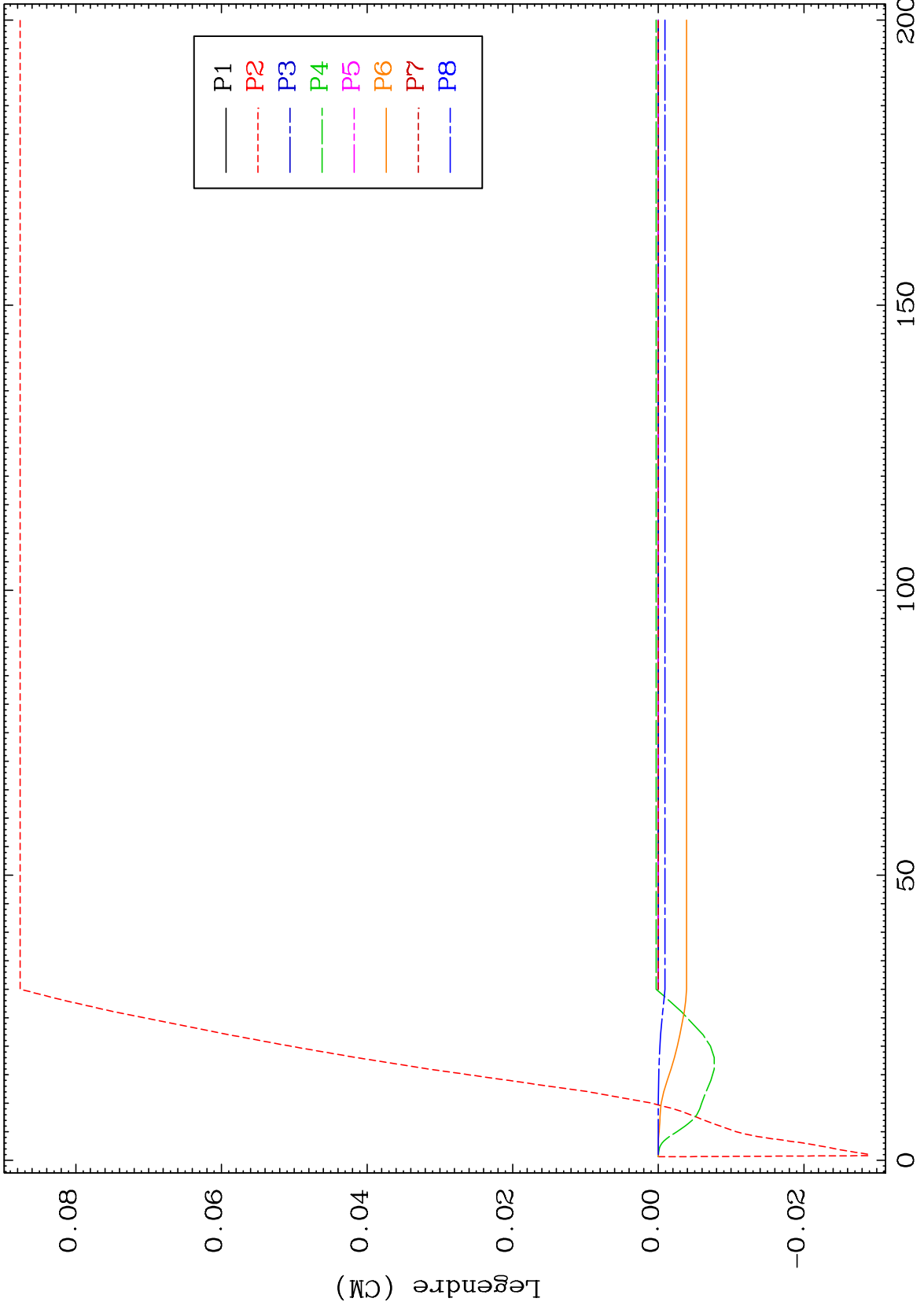

18

Incident Energy (MeV)

11-Na-22

MAT 1122 MT= 51 (n,n') Level Legendre Coefficients 11-Na-22

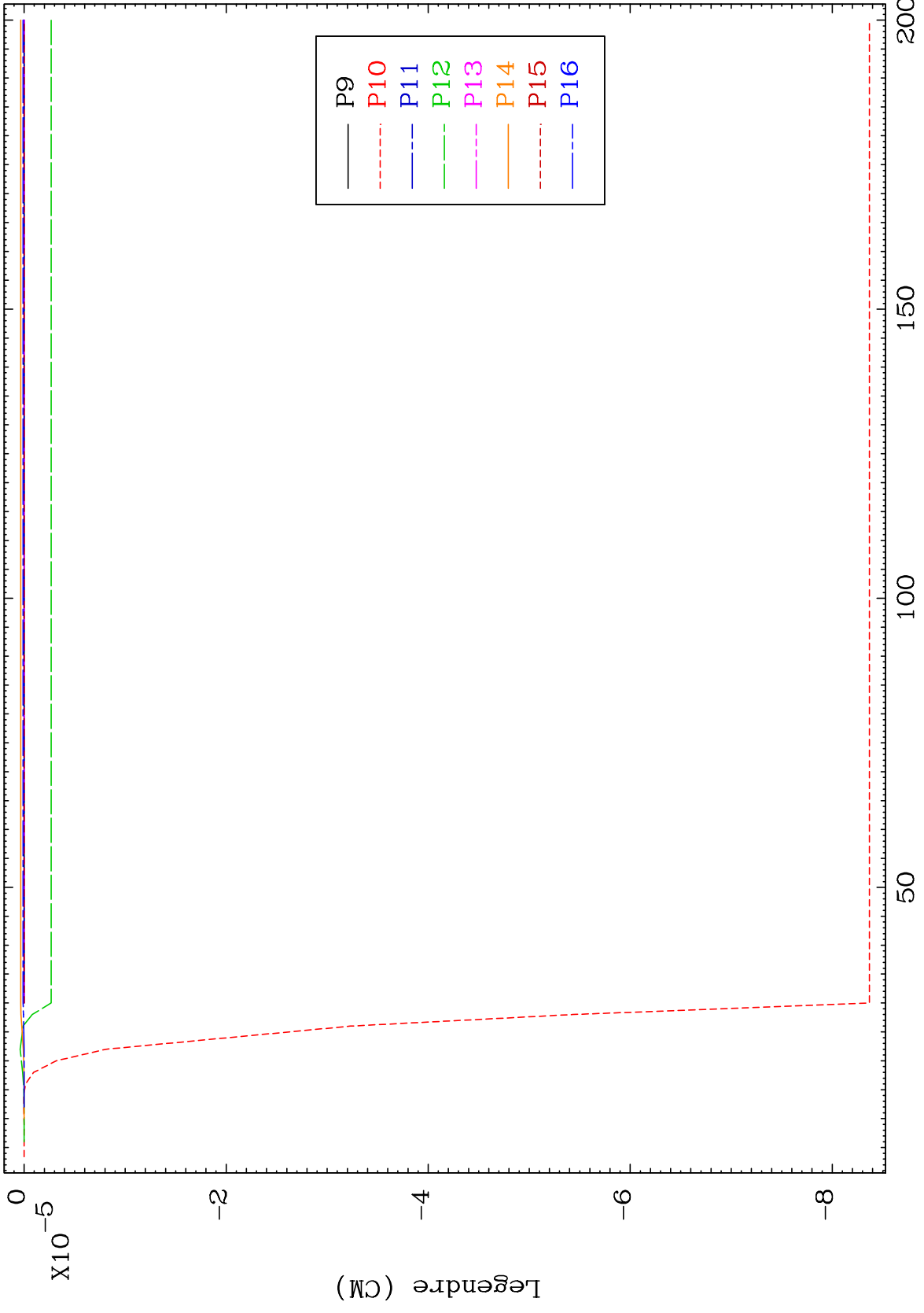

19 Incident Energy (MeV) 11-Na-22

MAT 1122 MT= 51 (n,n') Level Legendre Coefficients 11-Na-22

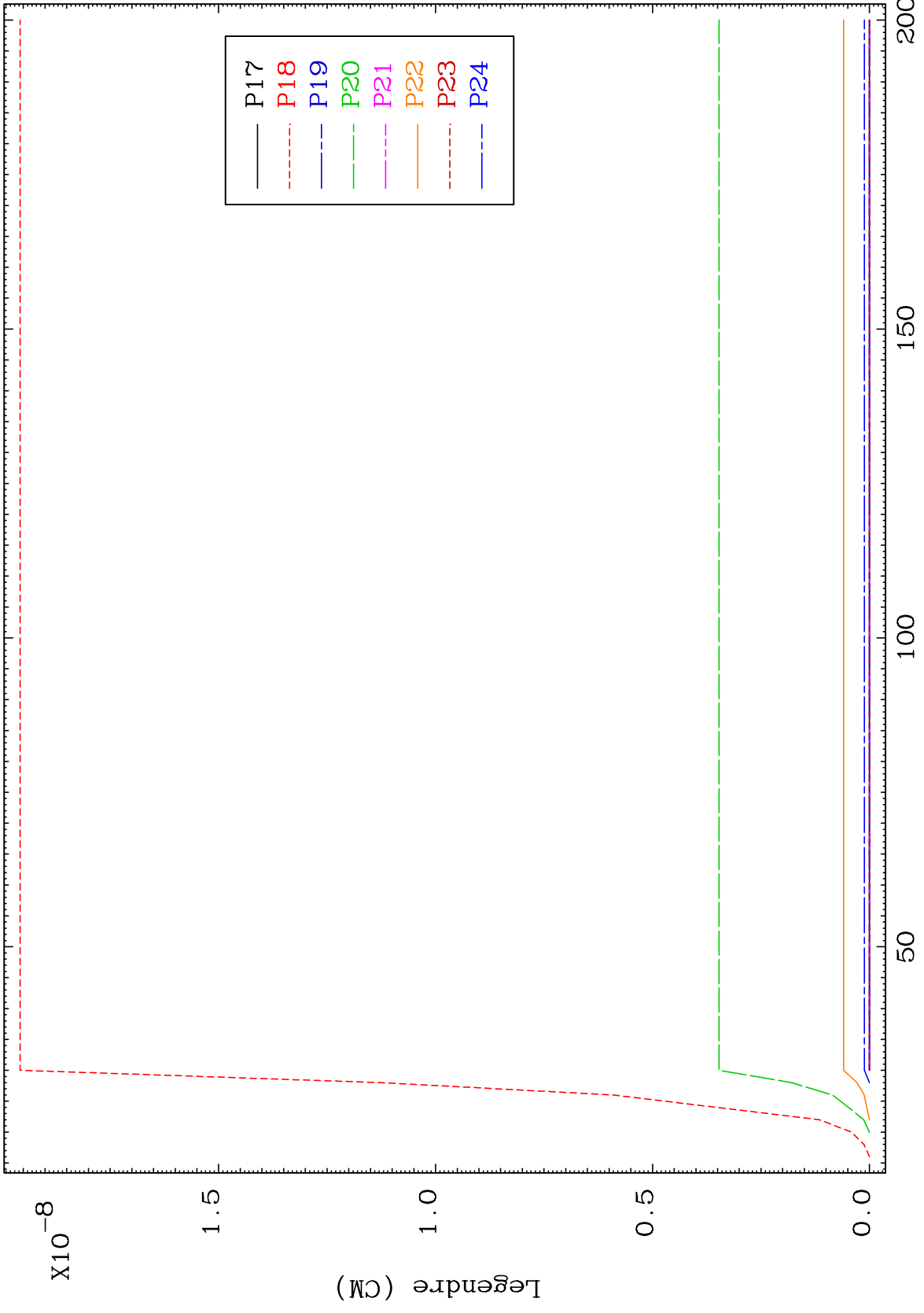

11-Na-22

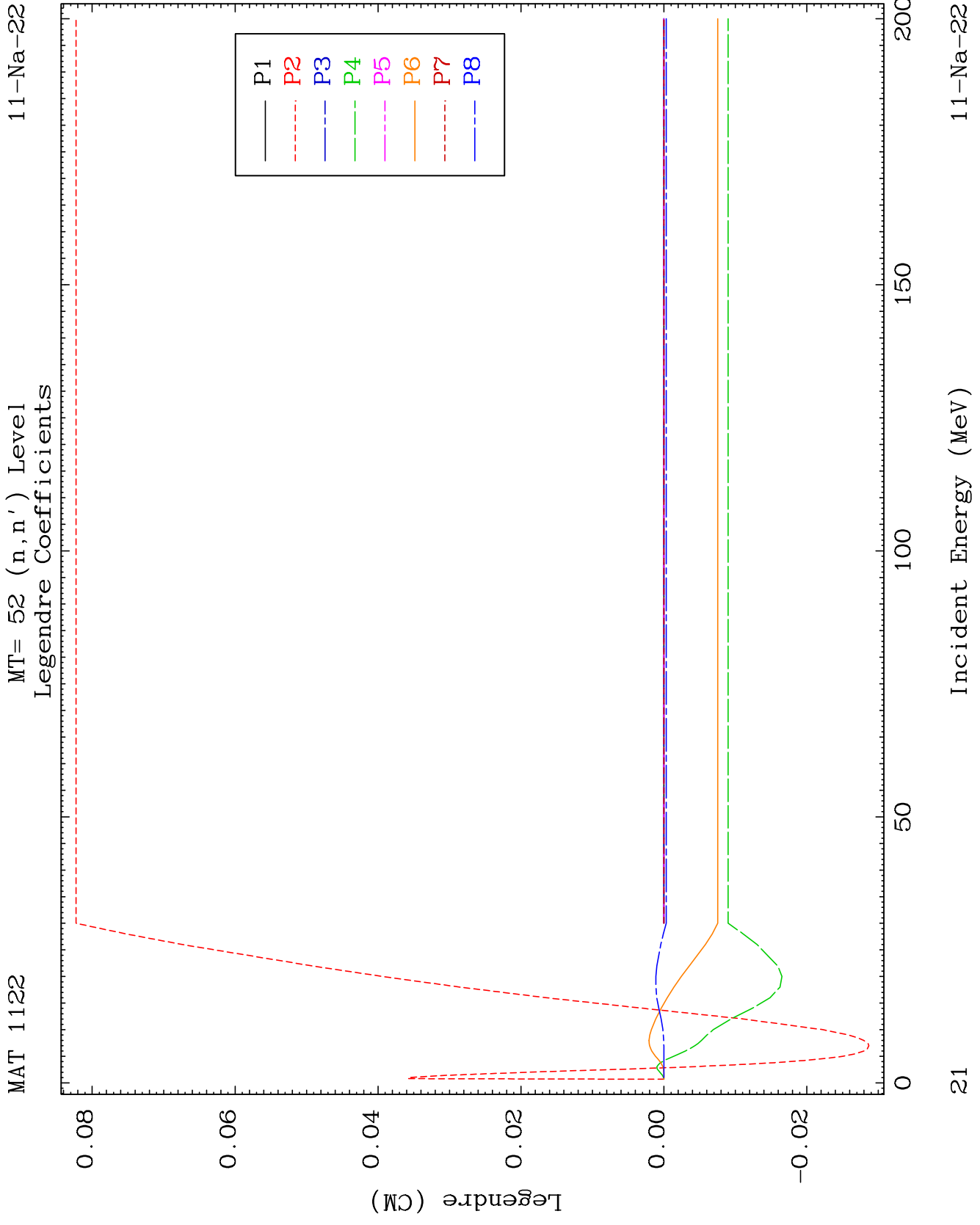

MAT 1122 MT= 52 (n,n') Level Legendre Coefficients 11-Na-22

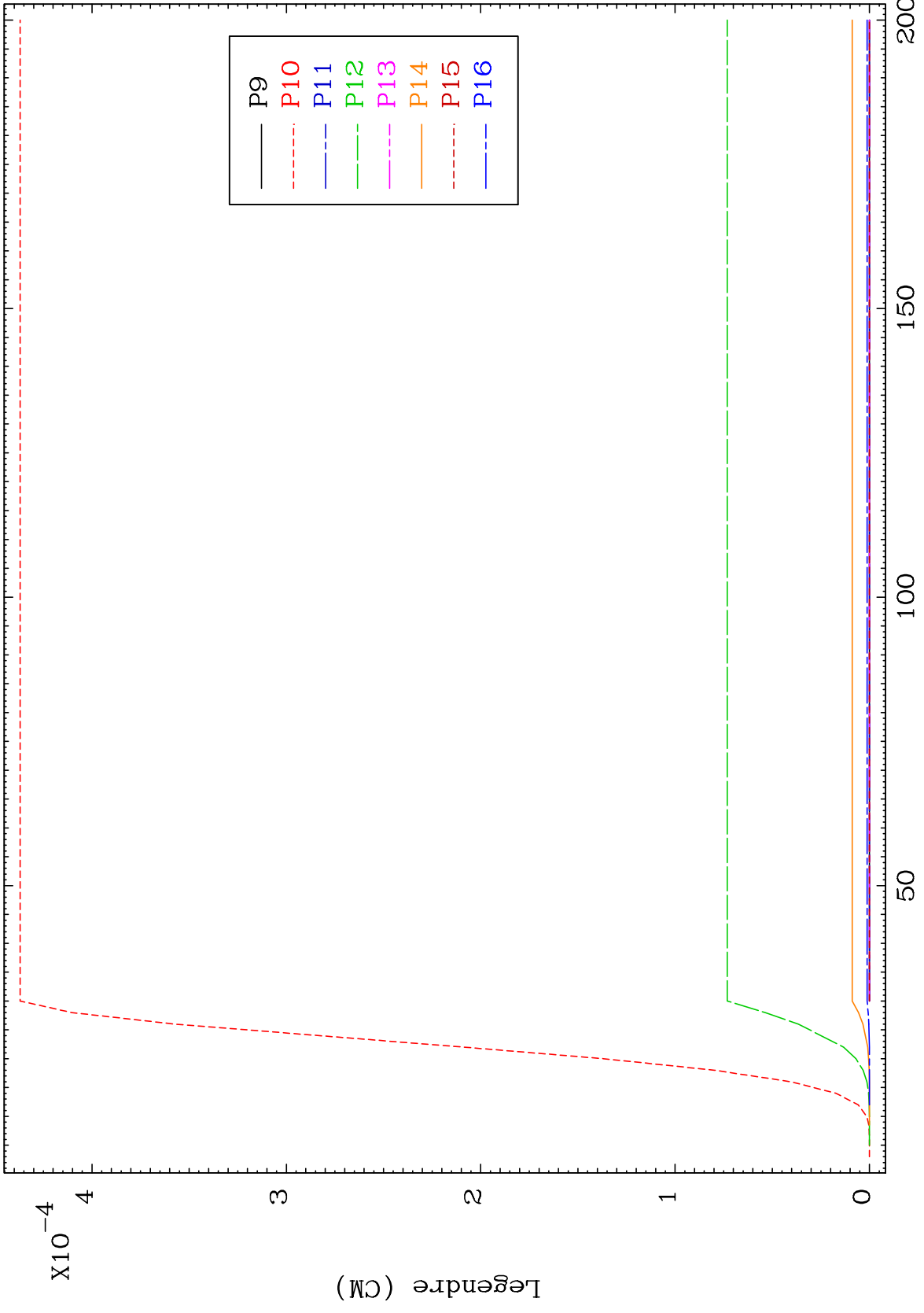

22 11-Na-22

MAT 1122 MT= 52 (n,n') Level Legendre Coefficients 11-Na-22

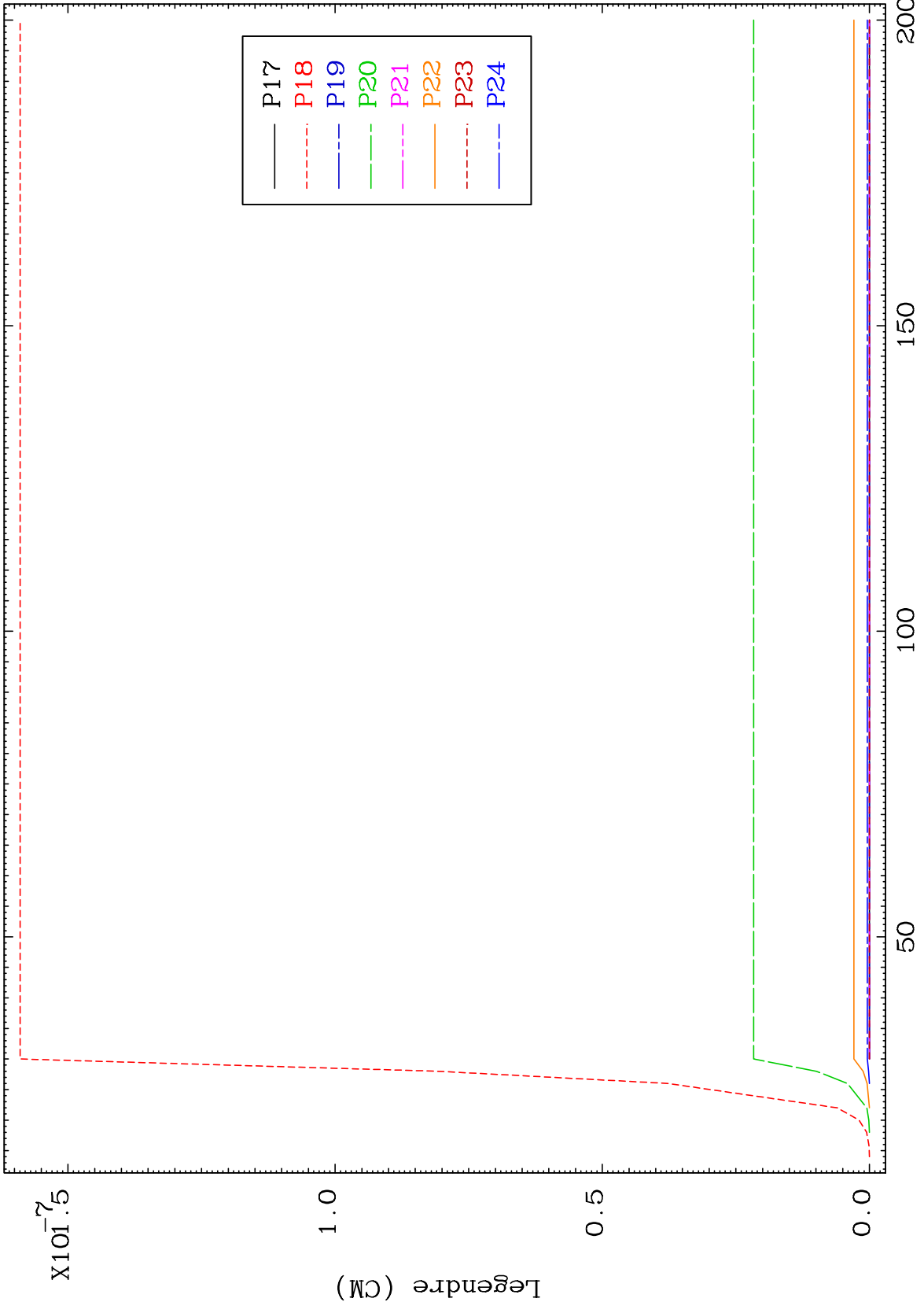

23 50 100 150 200 Incident Energy (MeV) 11-Na-22

MAT 1122

MT= 53 (n,n') Level
Legendre Coefficients

11-Na-22

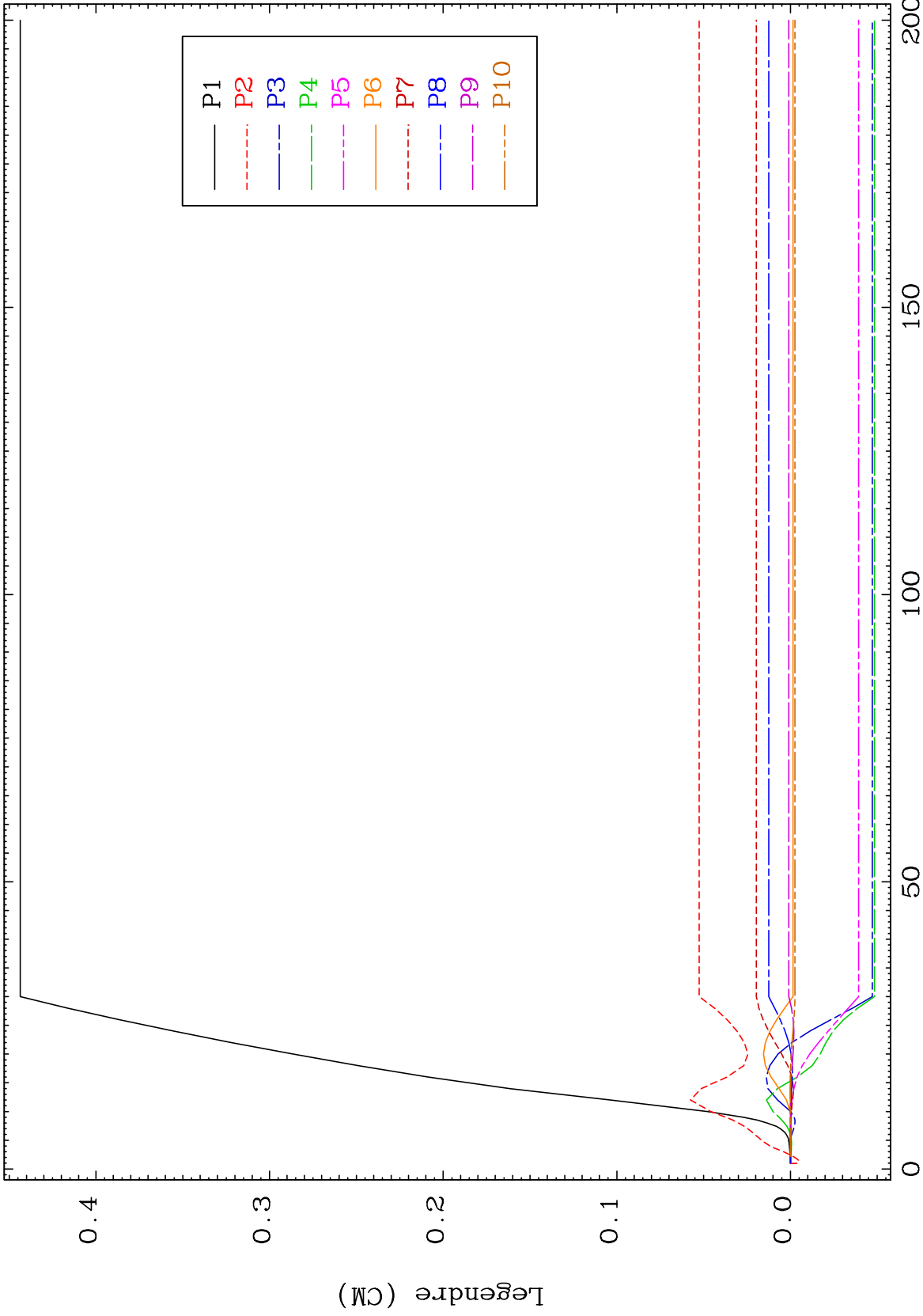

24

Incident Energy (MeV)

11-Na-22

MAT 1122 MT= 53 (n,n') Level Legendre Coefficients 11-Na-22

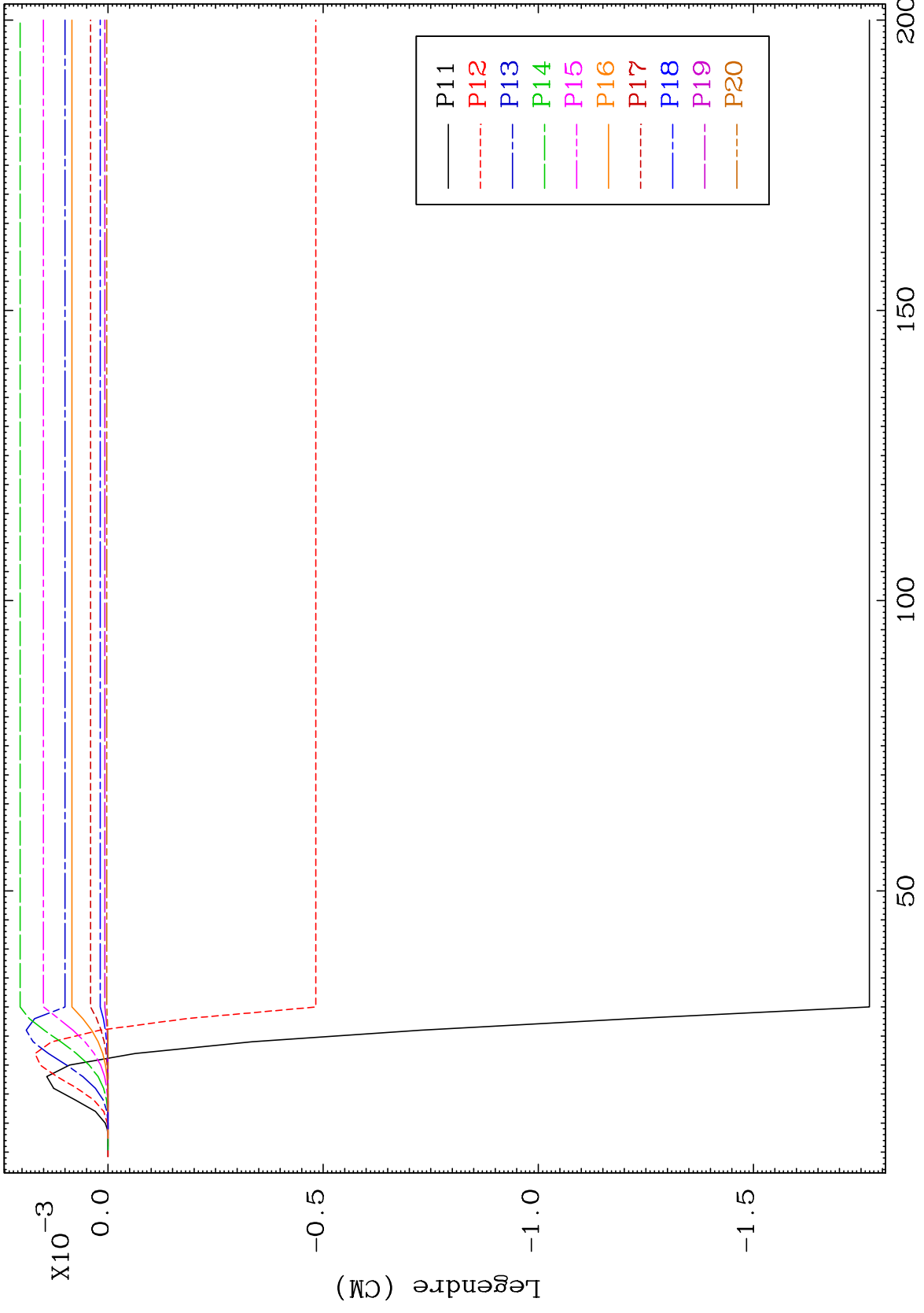

25 Incident Energy (MeV) 11-Na-22

MAT 1122

MT= 53 (n,n') Level
Legendre Coefficients

11-Na-22

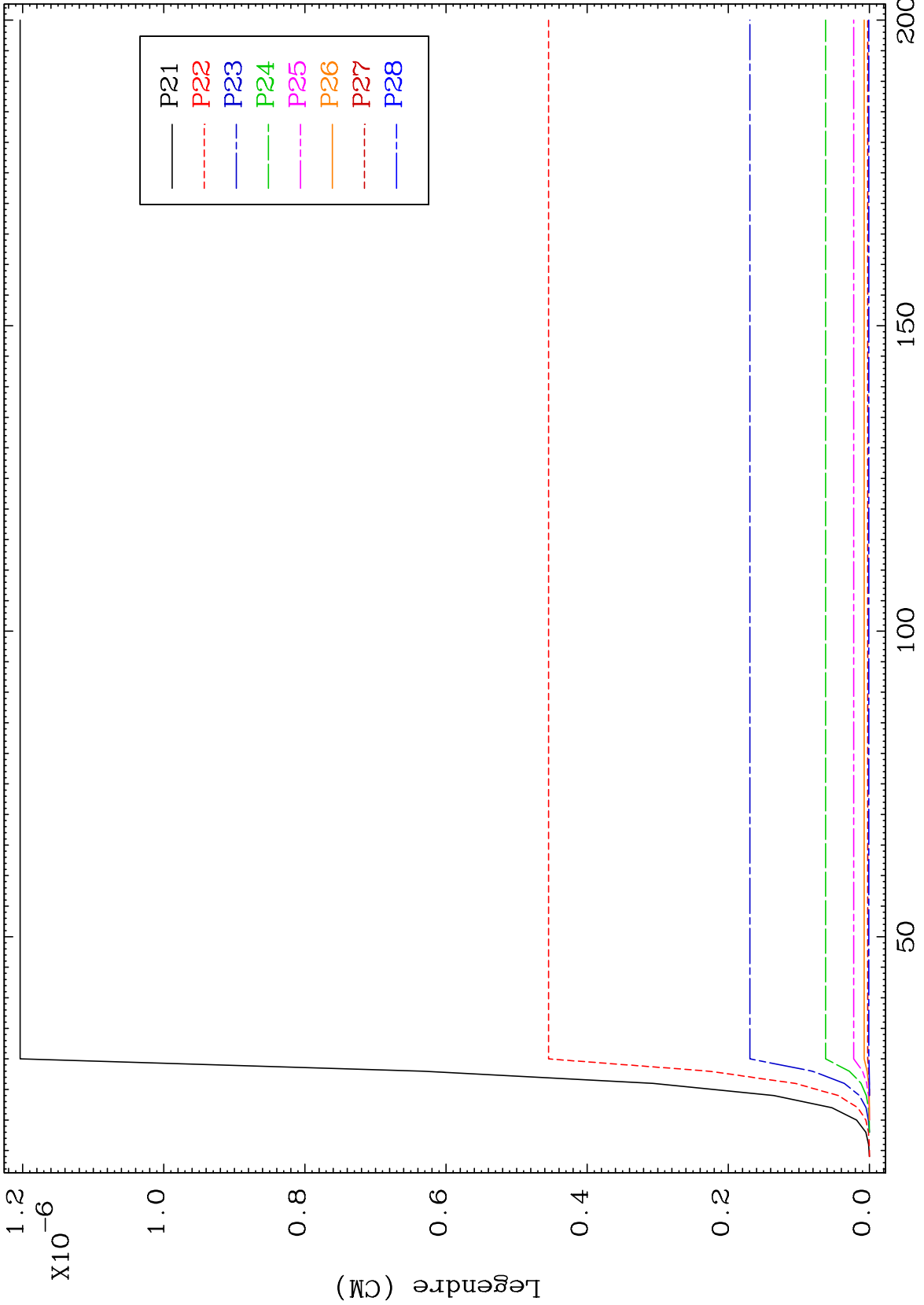

26

Incident Energy (MeV)

11-Na-22

MAT 1122 MT= 54 (n,n') Level Legendre Coefficients 11-Na-22

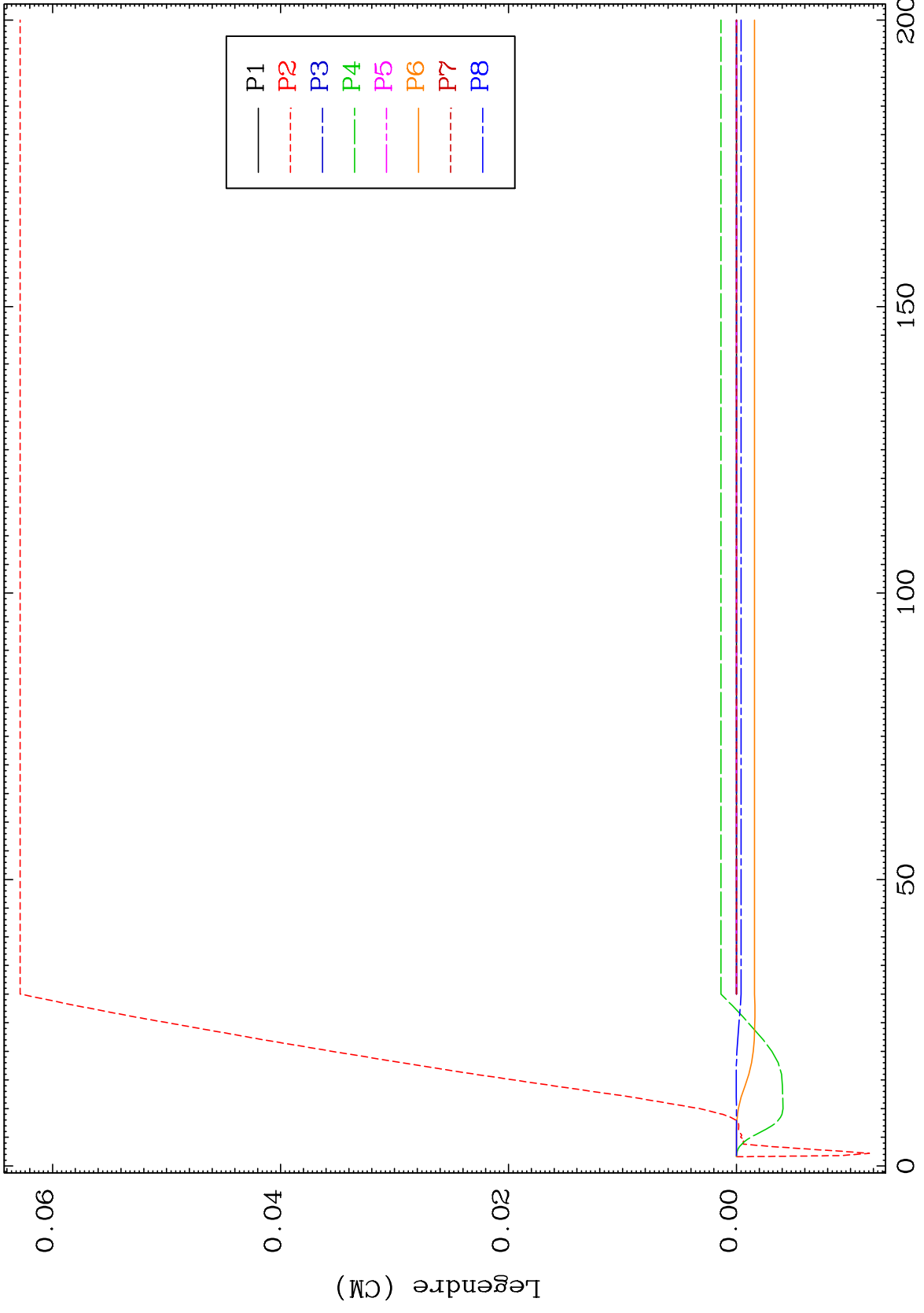

27 11-Na-22

MAT 1122

MT= 54 (n,n') Level
Legendre Coefficients

11-Na-22

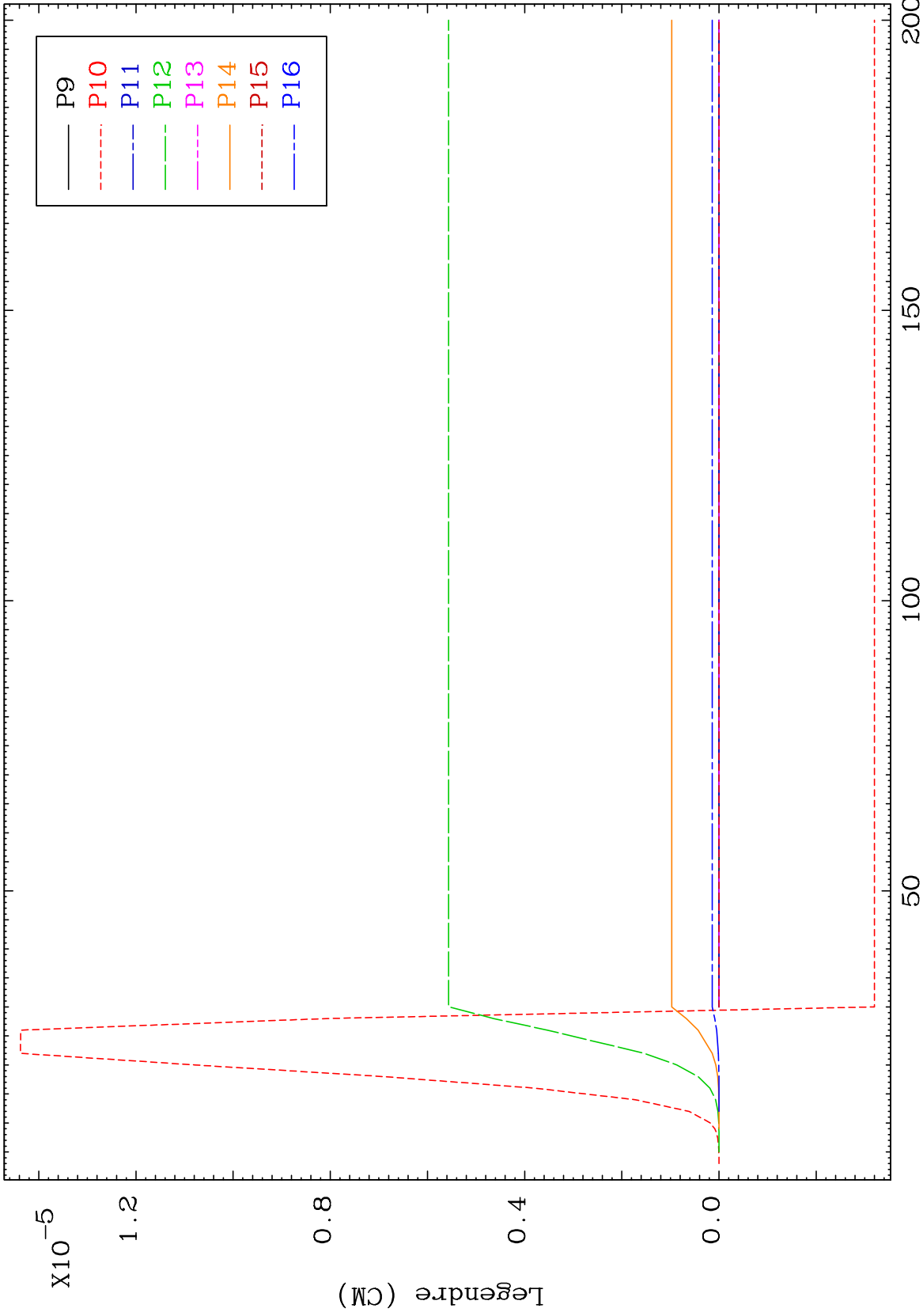

28

Incident Energy (MeV)

11-Na-22

MAT 1122 MT= 54 (n,n') Level Legendre Coefficients 11-Na-22

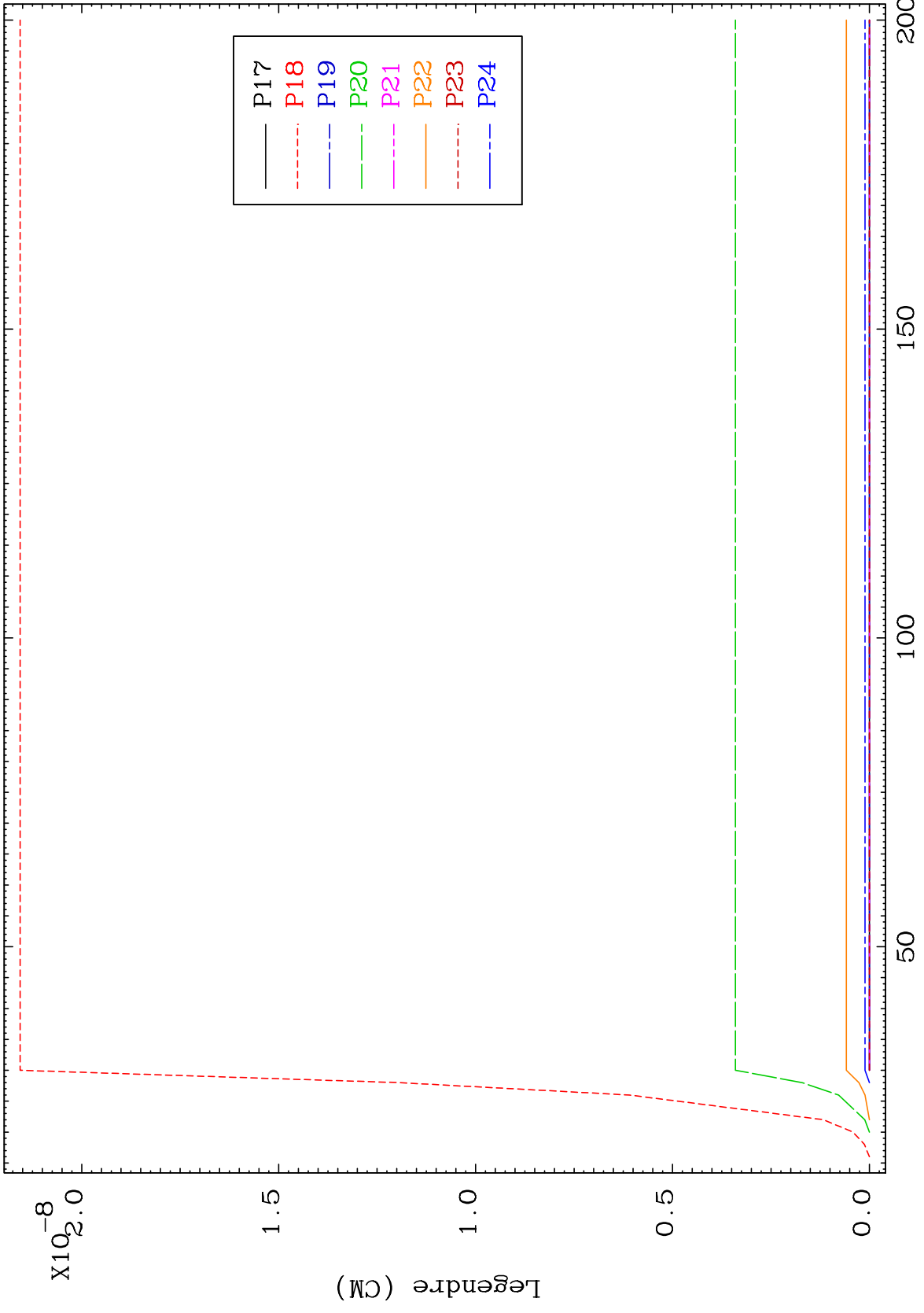

29 50 100 150 200 11-Na-22

MAT 1122 MT= 55 (n,n') Level Legendre Coefficients 11-Na-22

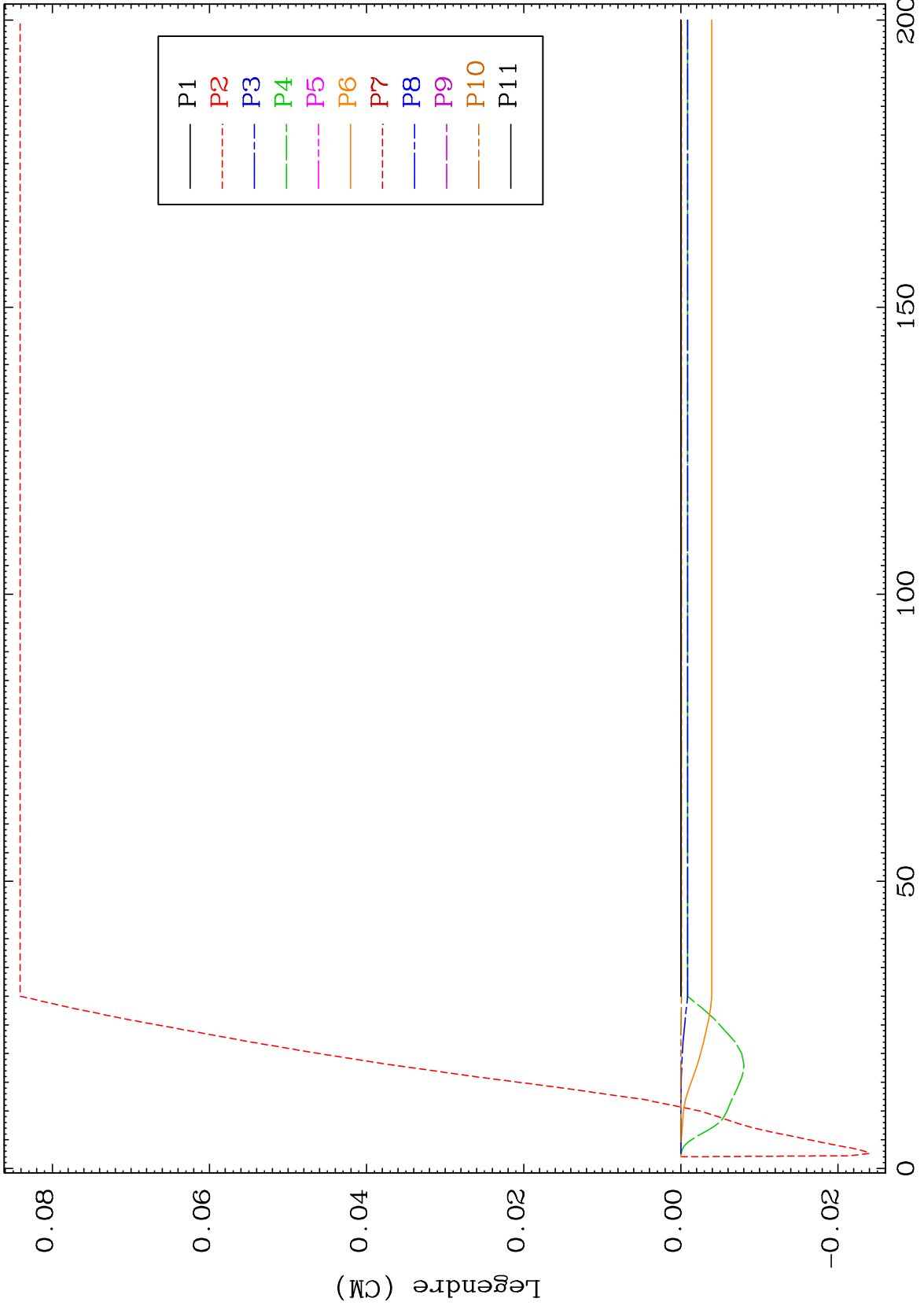

11-Na-22

MAT 1122

MT= 55 (n,n') Level
Legendre Coefficients

11-Na-22

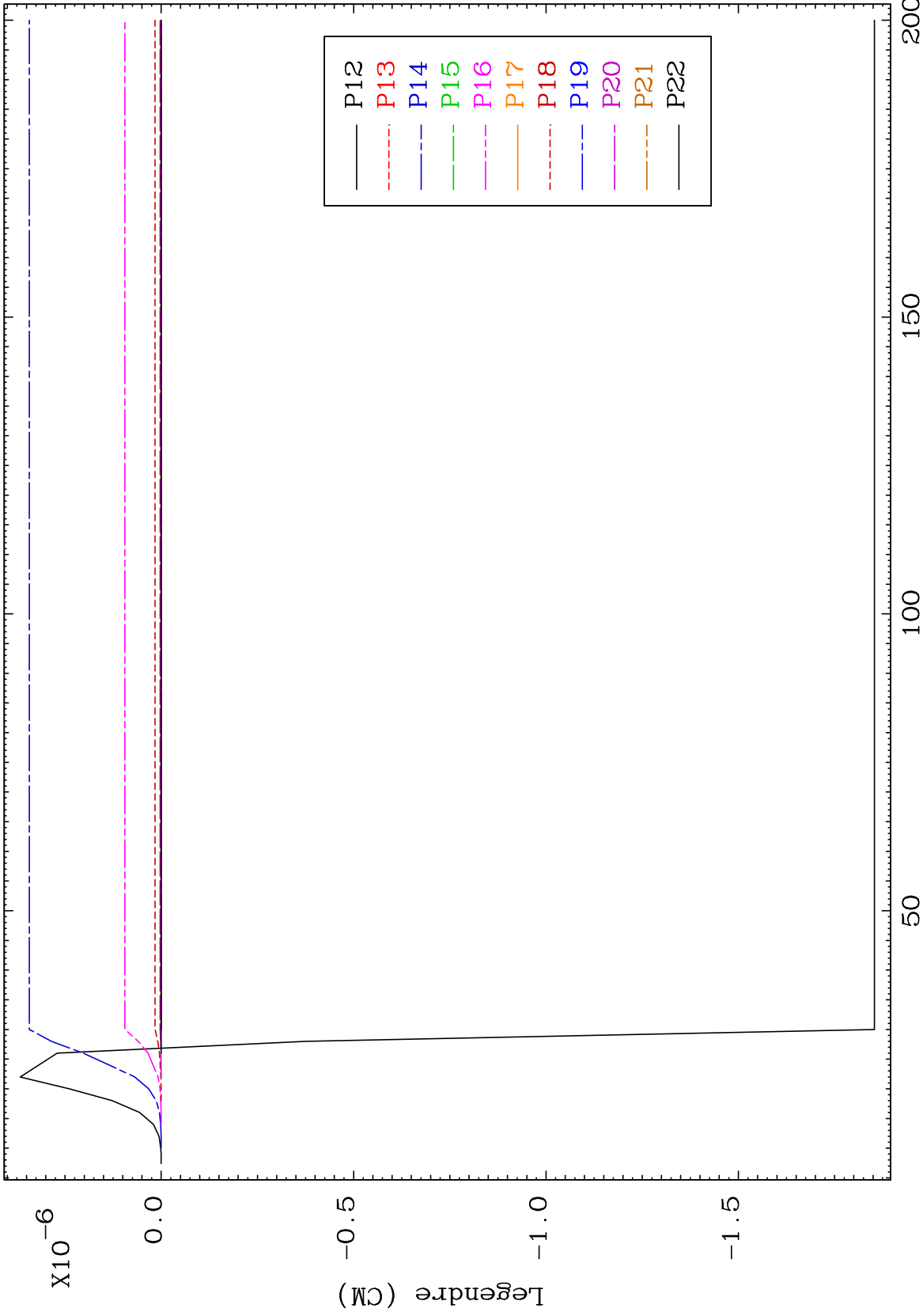

MAT 1122

MT= 56 (n,n') Level
Legendre Coefficients

11-Na-22

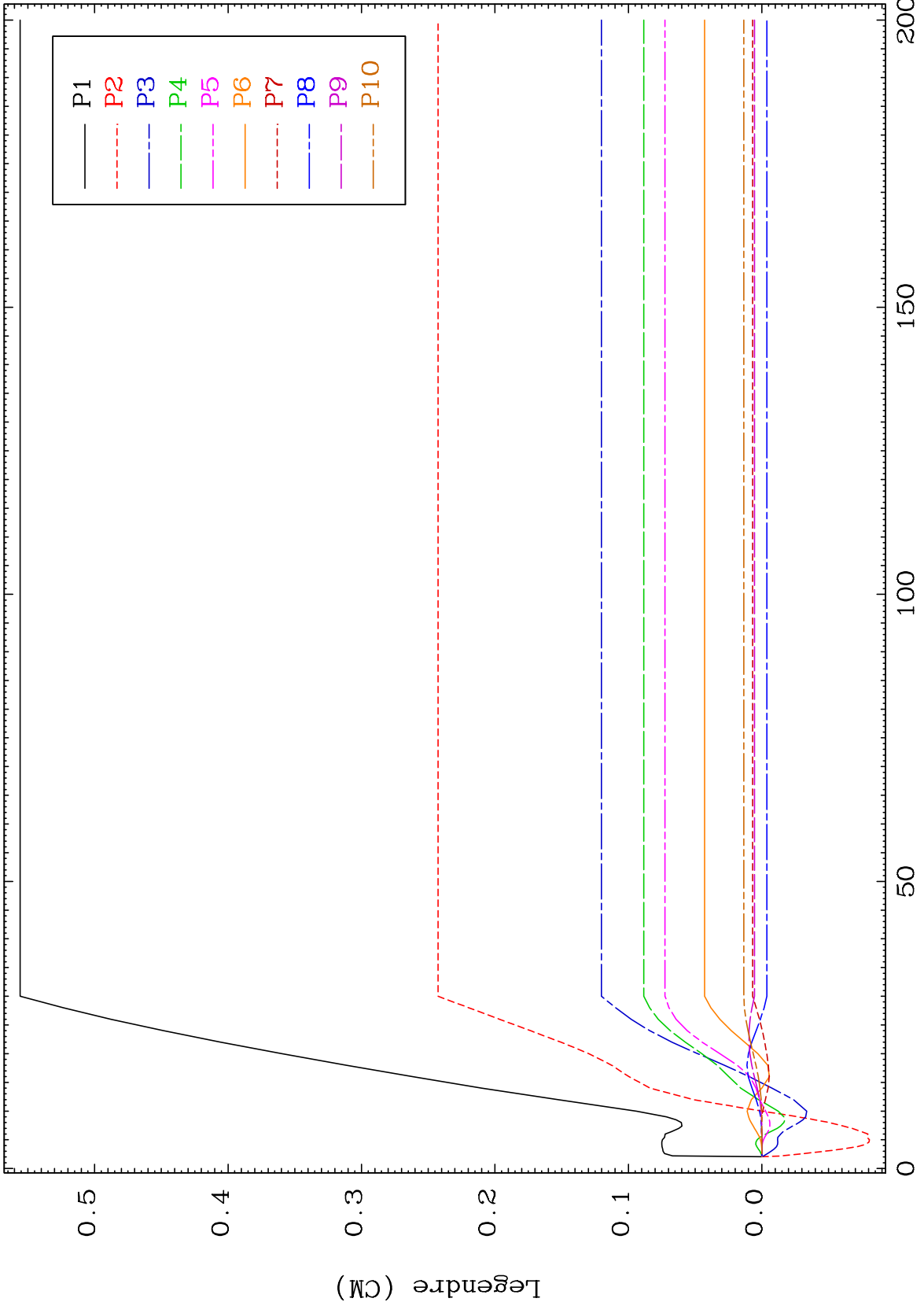

32

Incident Energy (MeV)

11-Na-22

MAT 1122

MT= 56 (n,n') Level
Legendre Coefficients

11-Na-22

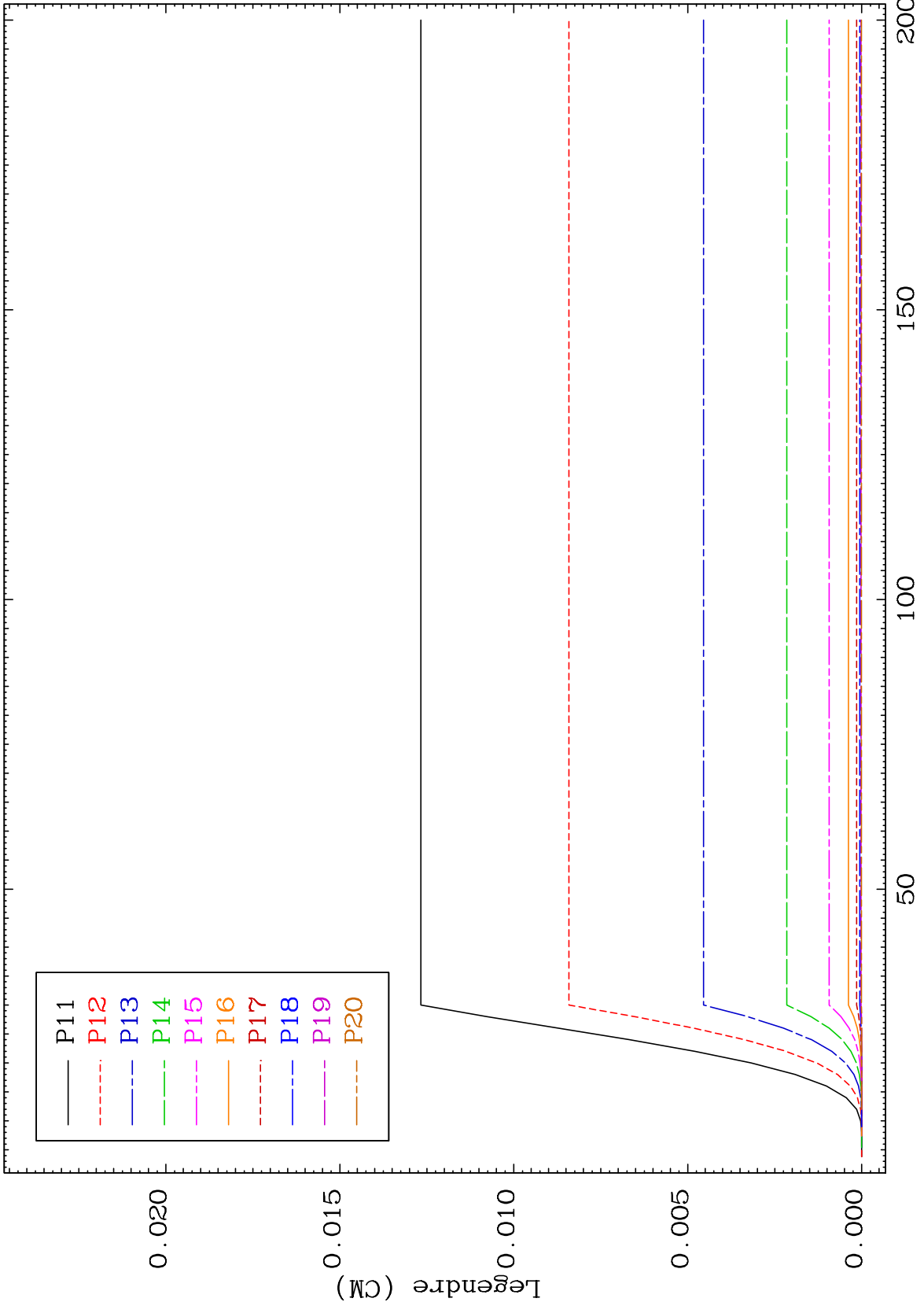

33

11-Na-22

MAT 1122

MT= 56 (n,n') Level
Legendre Coefficients

11-Na-22

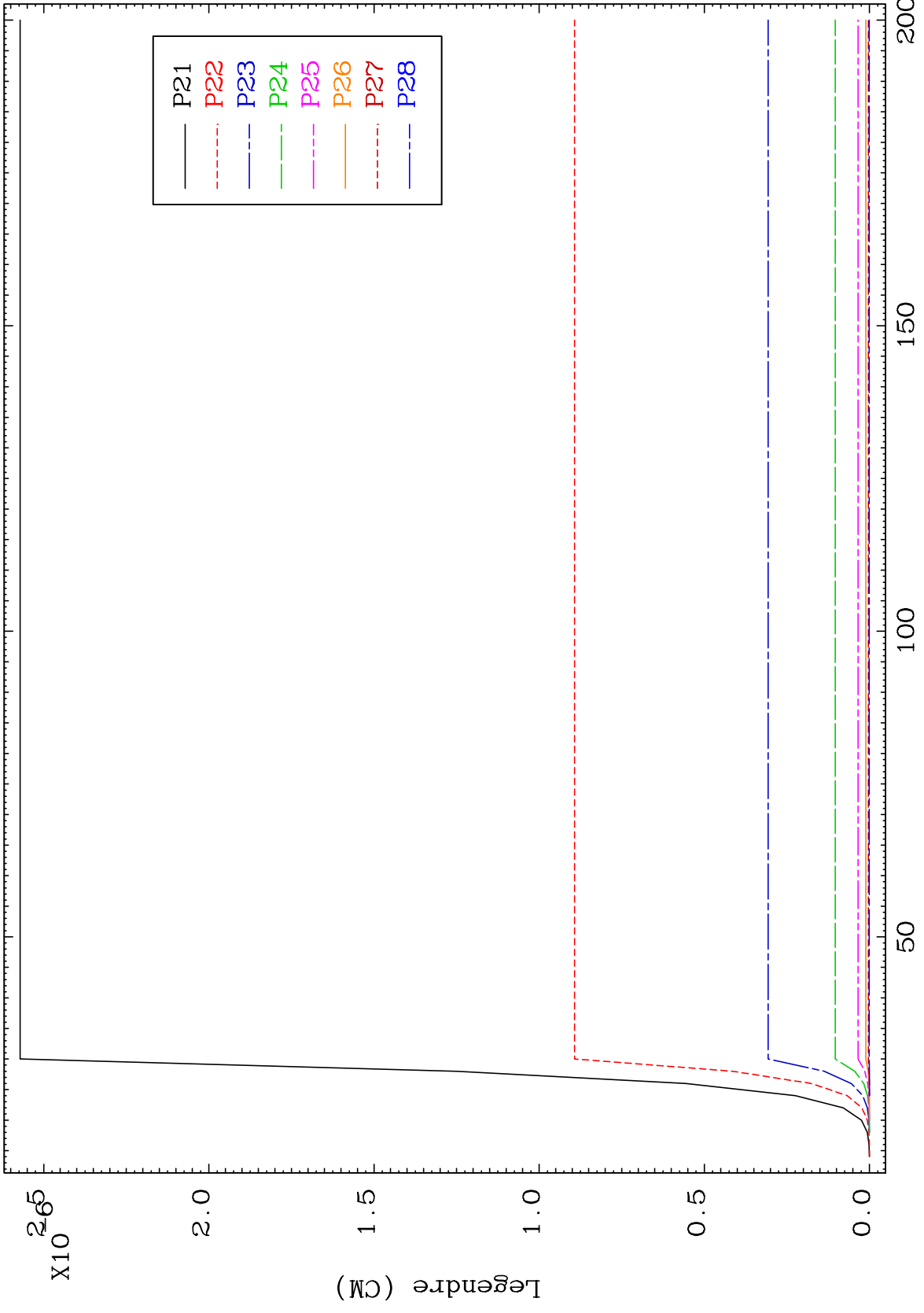

34

11-Na-22

MAT 1122 MT= 57 (n,n') Level Legendre Coefficients 11-Na-22

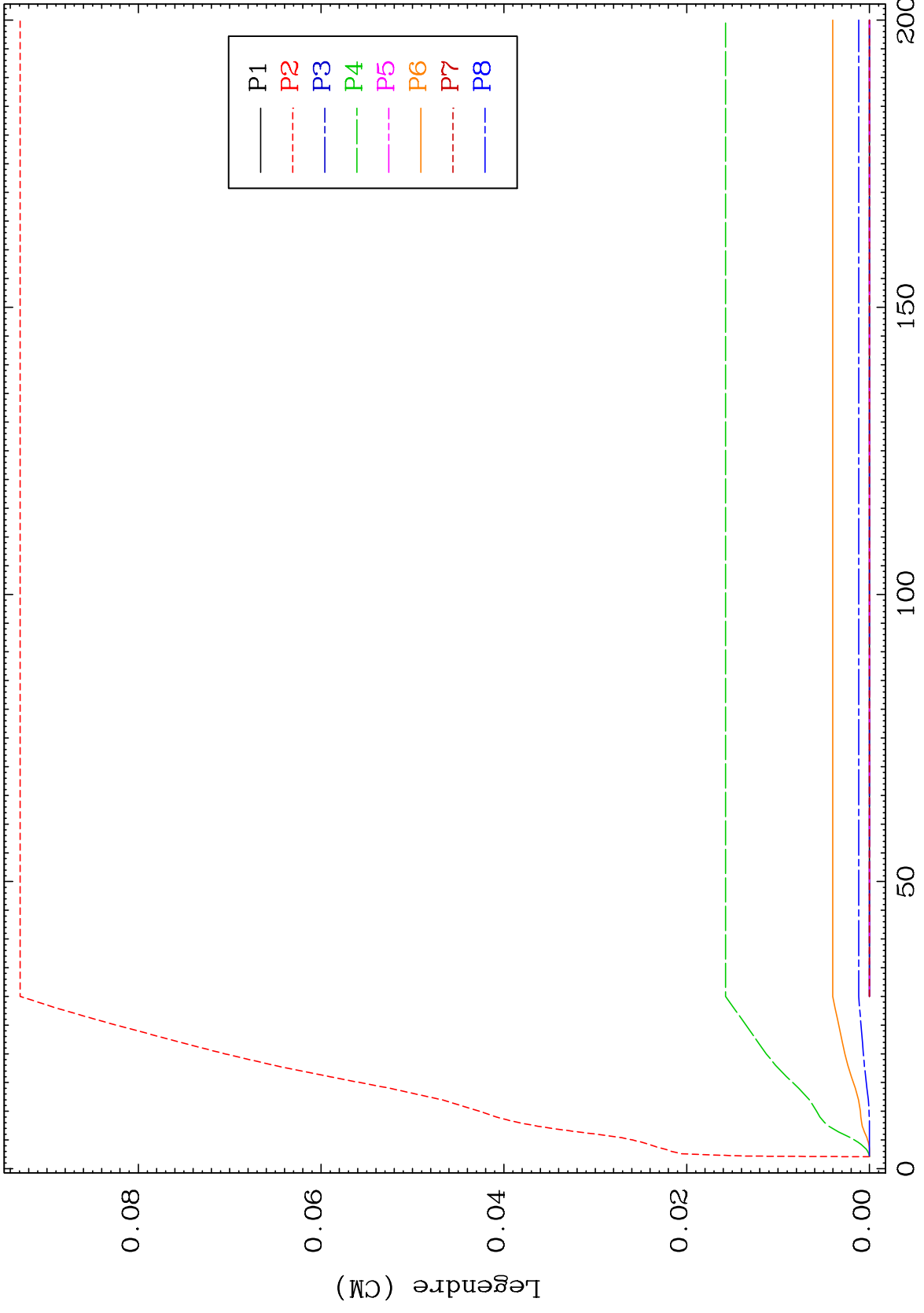

Legendre (CM) Incident Energy (MeV) 11-Na-22

MAT 1122 MT= 57 (n,n') Level Legendre Coefficients 11-Na-22

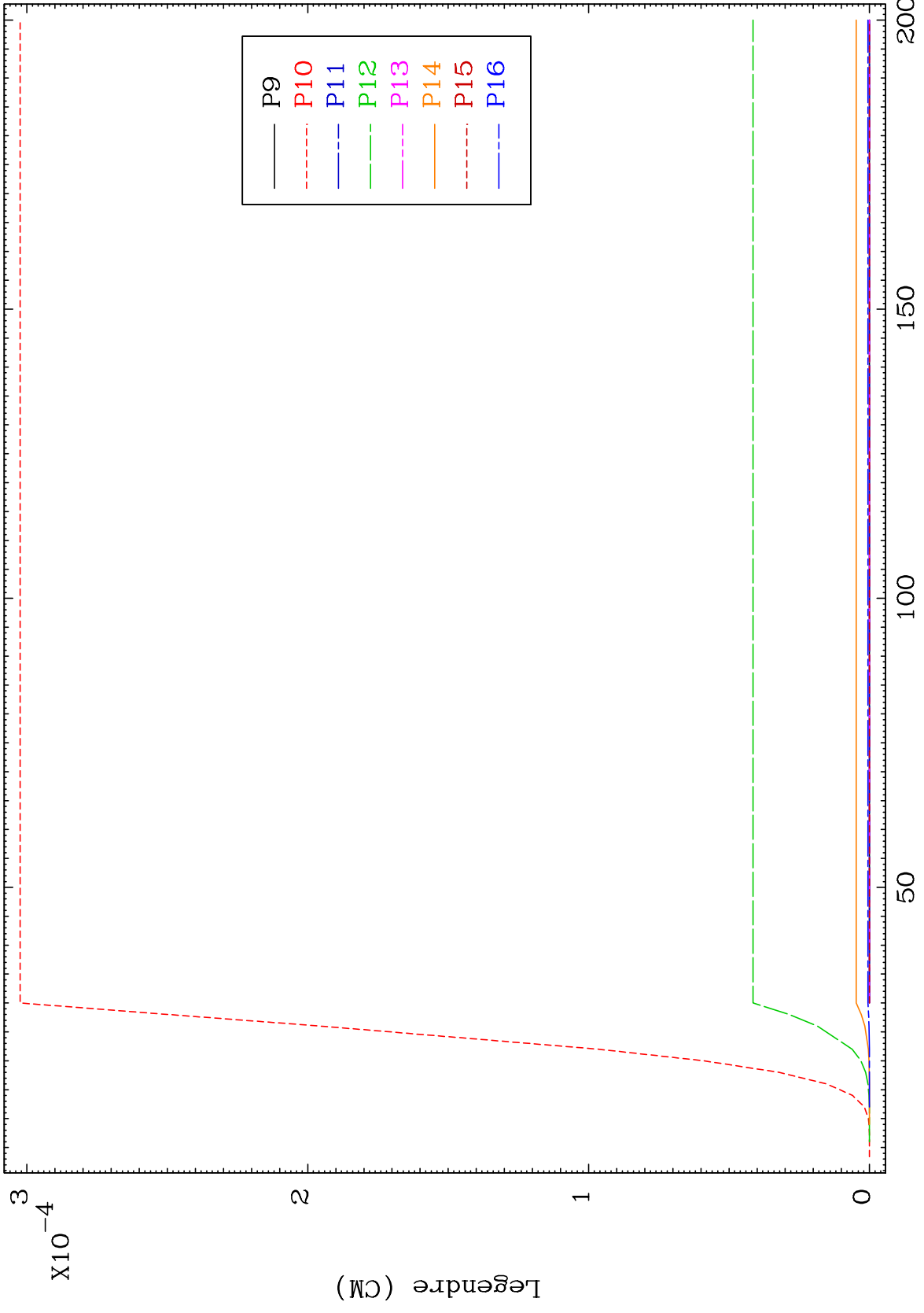

36 Incident Energy (MeV) 11-Na-22

MAT 1122 MT= 57 (n,n') Level Legendre Coefficients 11-Na-22

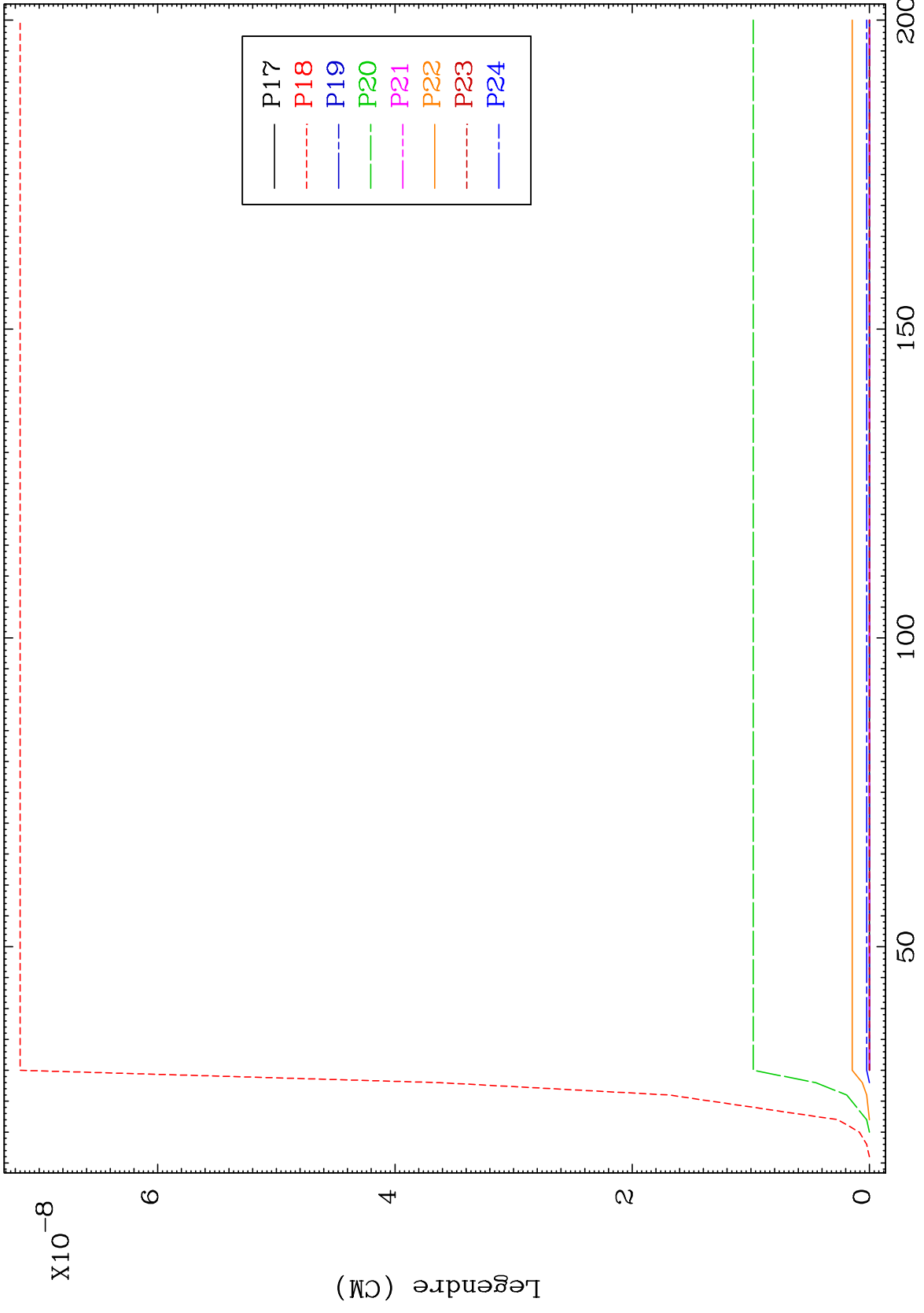

37 11-Na-22

MAT 1122

MT= 58 (n,n') Level
Legendre Coefficients

11-Na-22

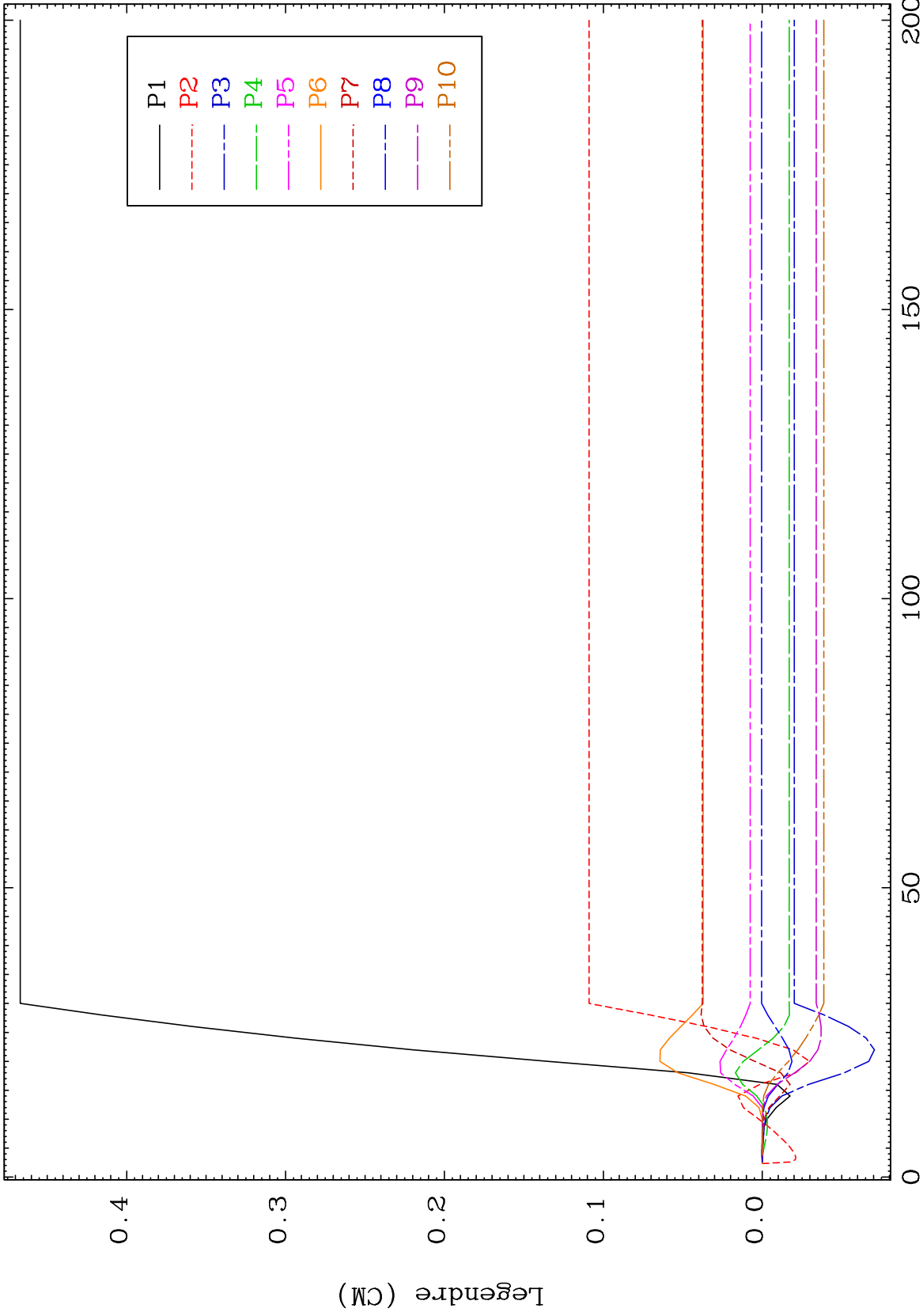

38

Incident Energy (MeV)

11-Na-22

MAT 1122 MT= 58 (n,n') Level Legendre Coefficients 11-Na-22

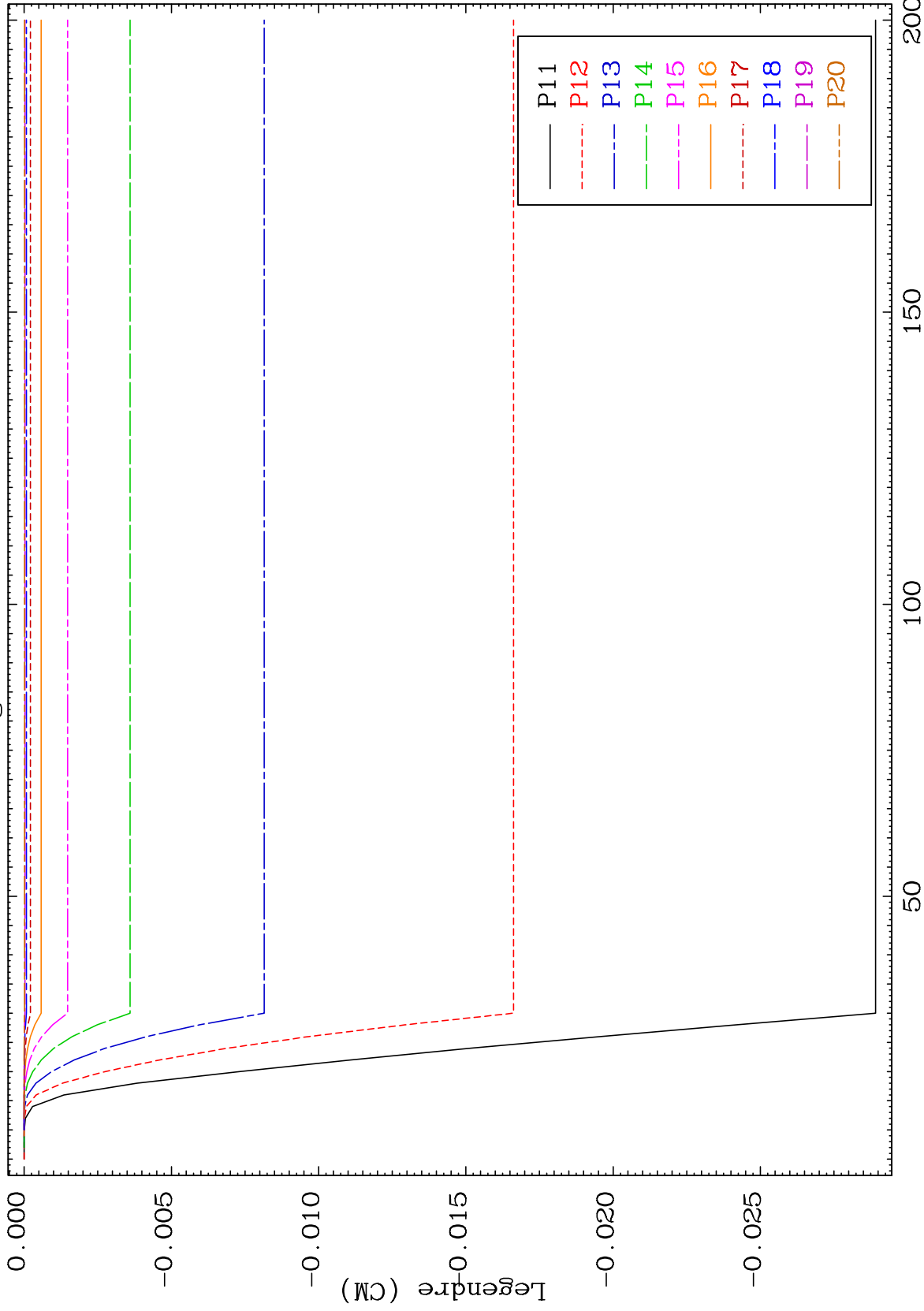

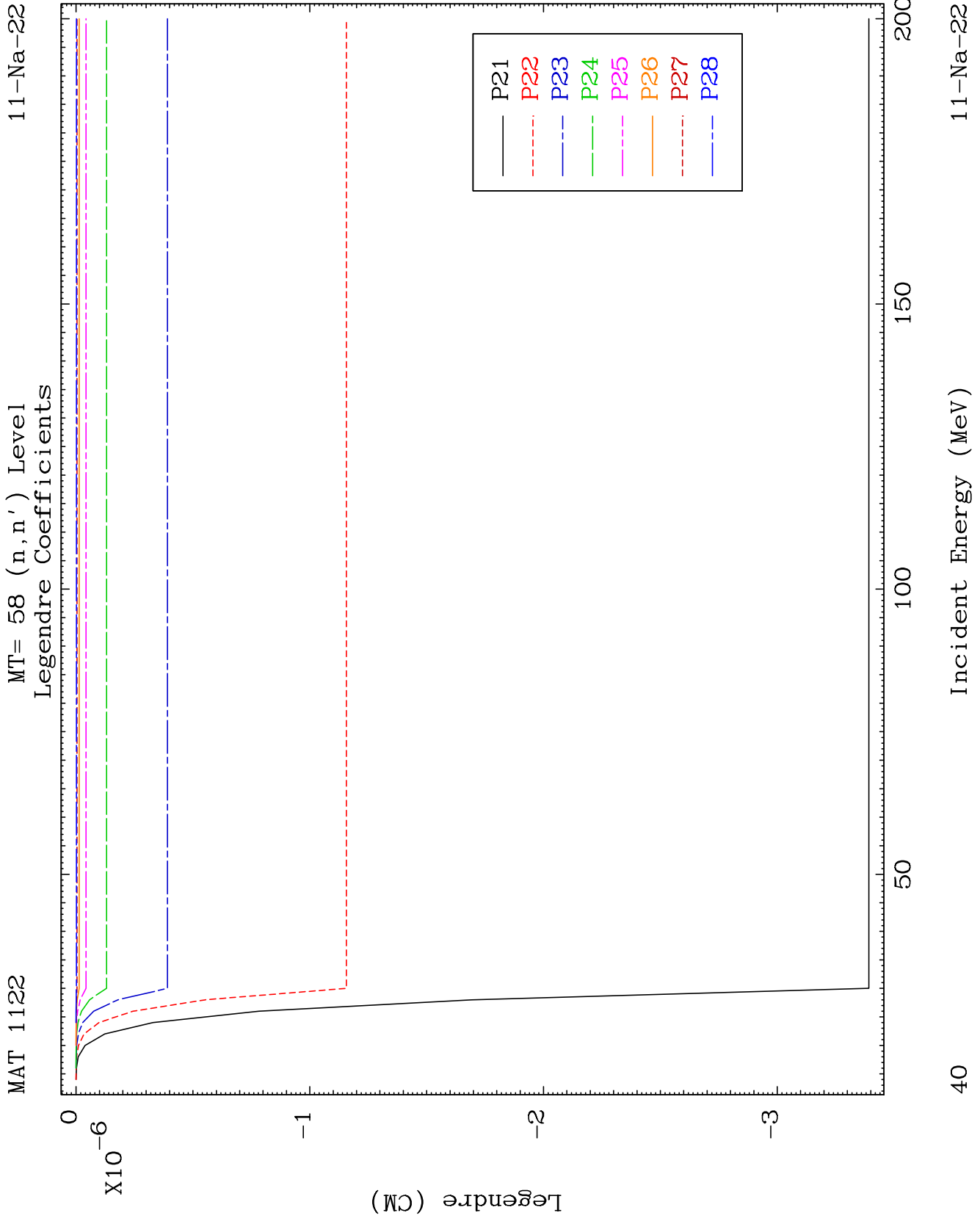

MAT 1122 MT= 59 (n,n') Level Legendre Coefficients 11-Na-22

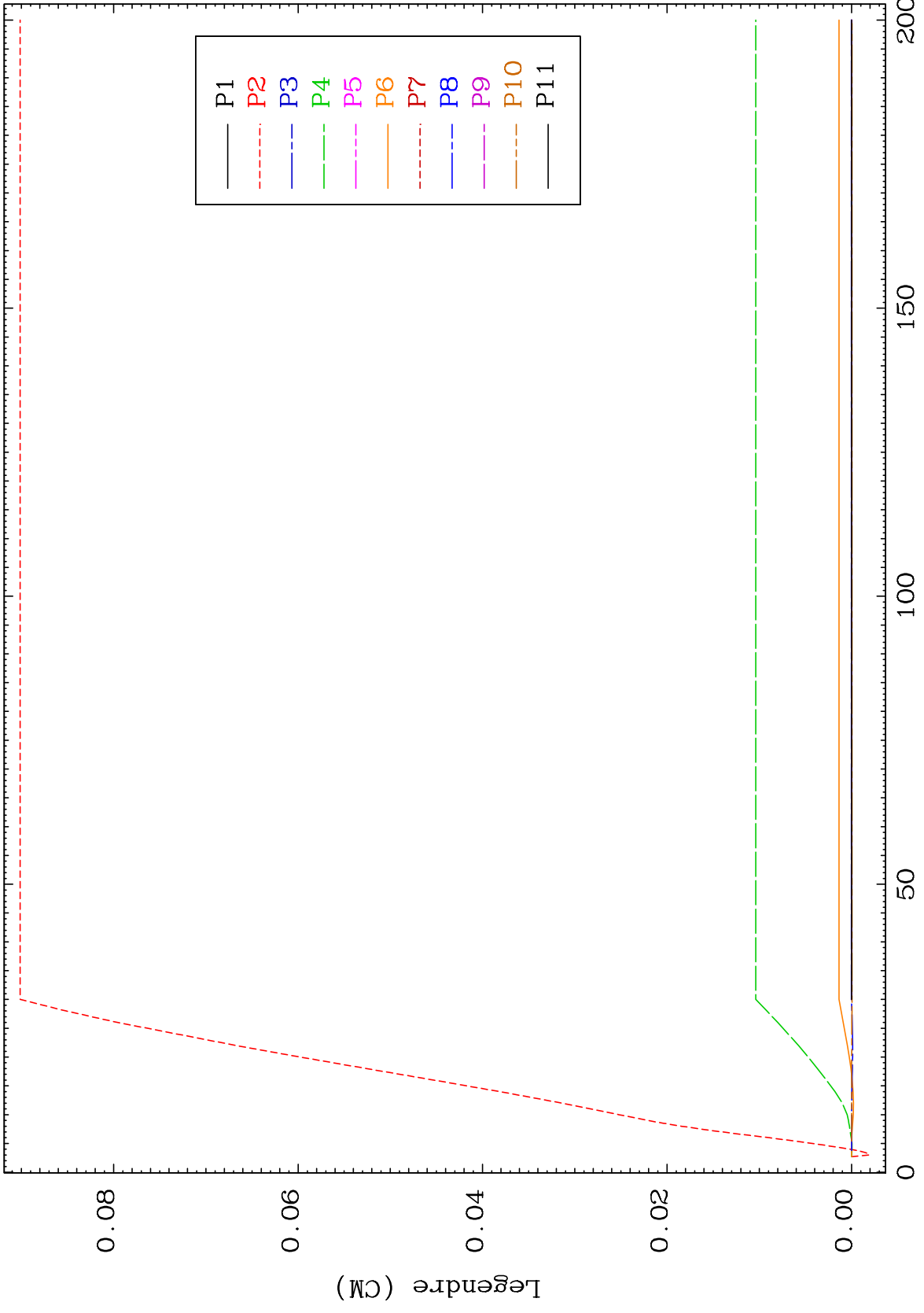

41 11-Na-22

MAT 1122 MT= 59 (n,n') Level Legendre Coefficients 11-Na-22

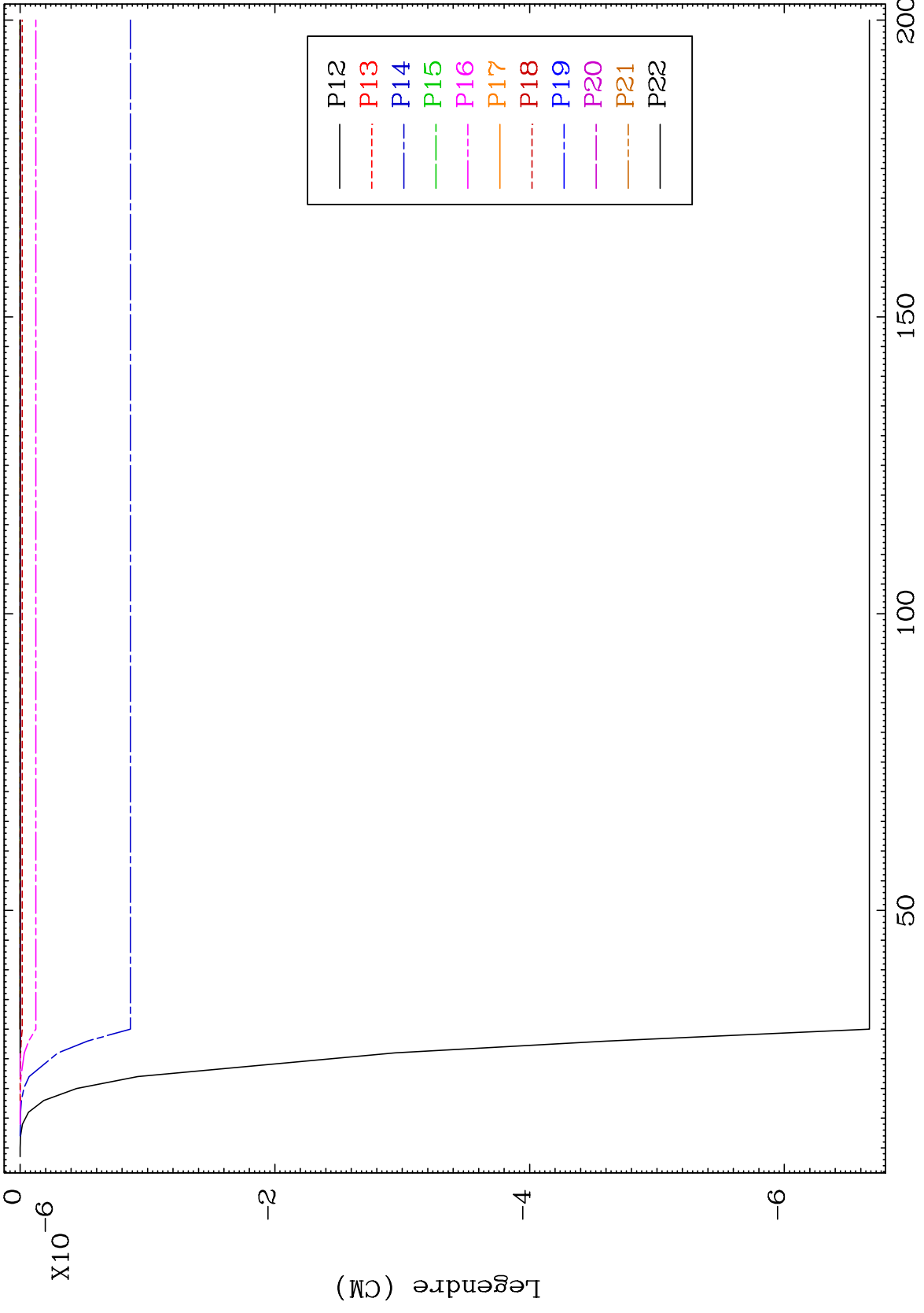

42 Incident Energy (MeV) 11-Na-22

MAT 1122 MT= 60 (n,n') Level Legendre Coefficients 11-Na-22

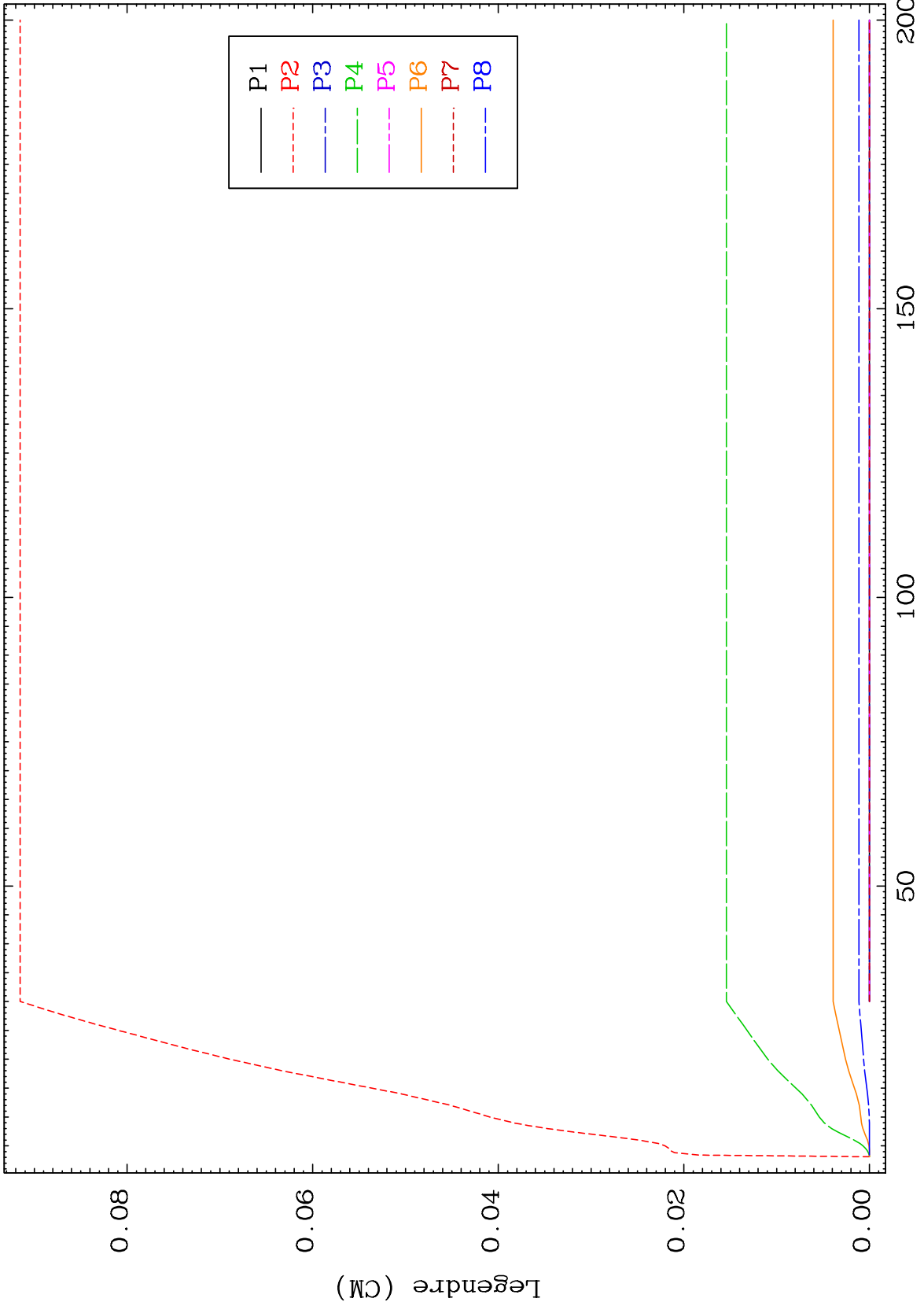

MAT 1122 MT= 60 (n,n') Level Legendre Coefficients 11-Na-22

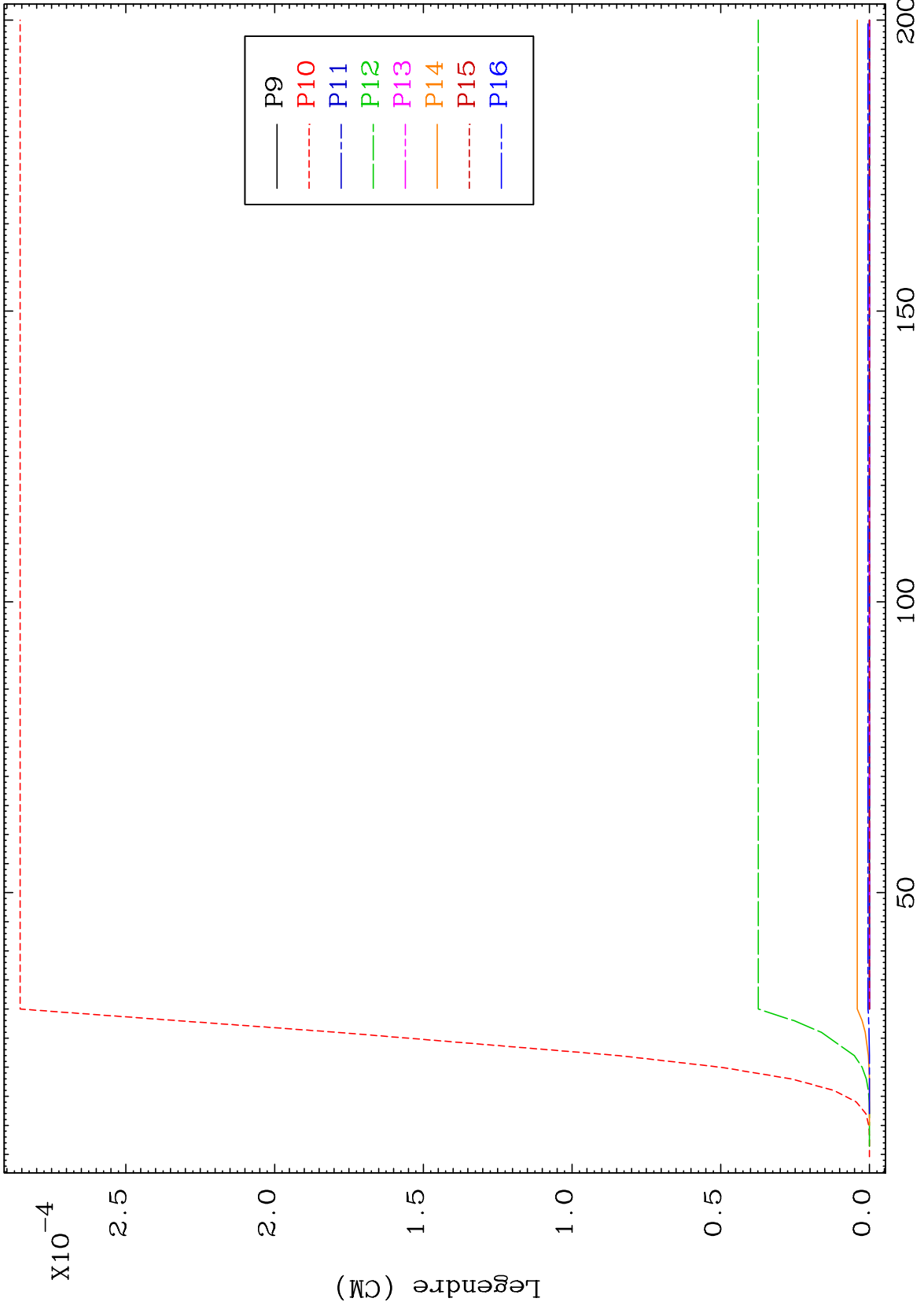

44 Incident Energy (MeV) 11-Na-22

MAT 1122 MT= 60 (n,n') Level Legendre Coefficients 11-Na-22

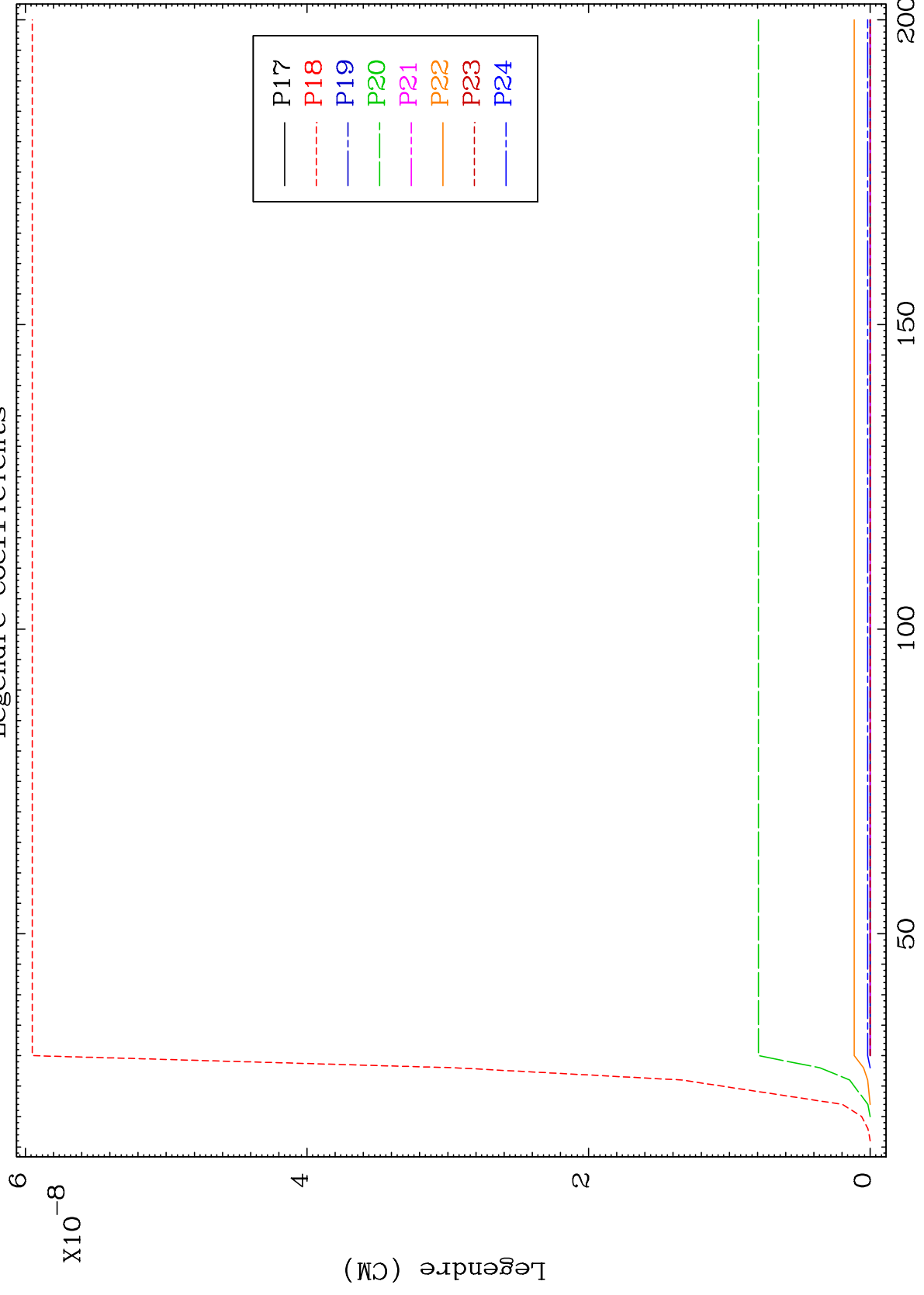

Legendre (CM) X10⁻⁸ Incident Energy (MeV) 11-Na-22

MAT 1122

MT= 61 (n,n') Level
Legendre Coefficients

11-Na-22

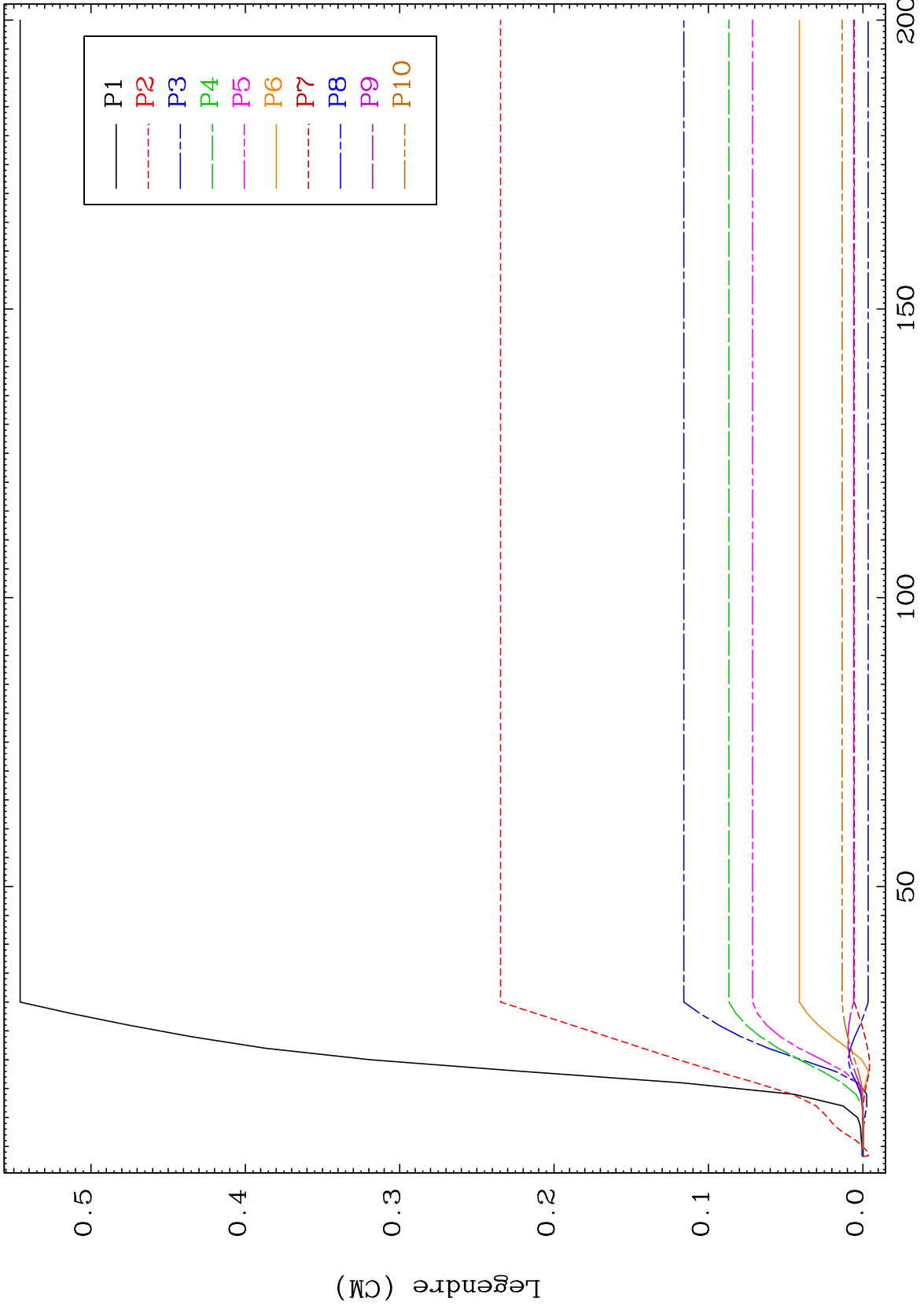

46

Incident Energy (MeV)

11-Na-22

MAT 1122

MT= 61 (n,n') Level
Legendre Coefficients

11-Na-22

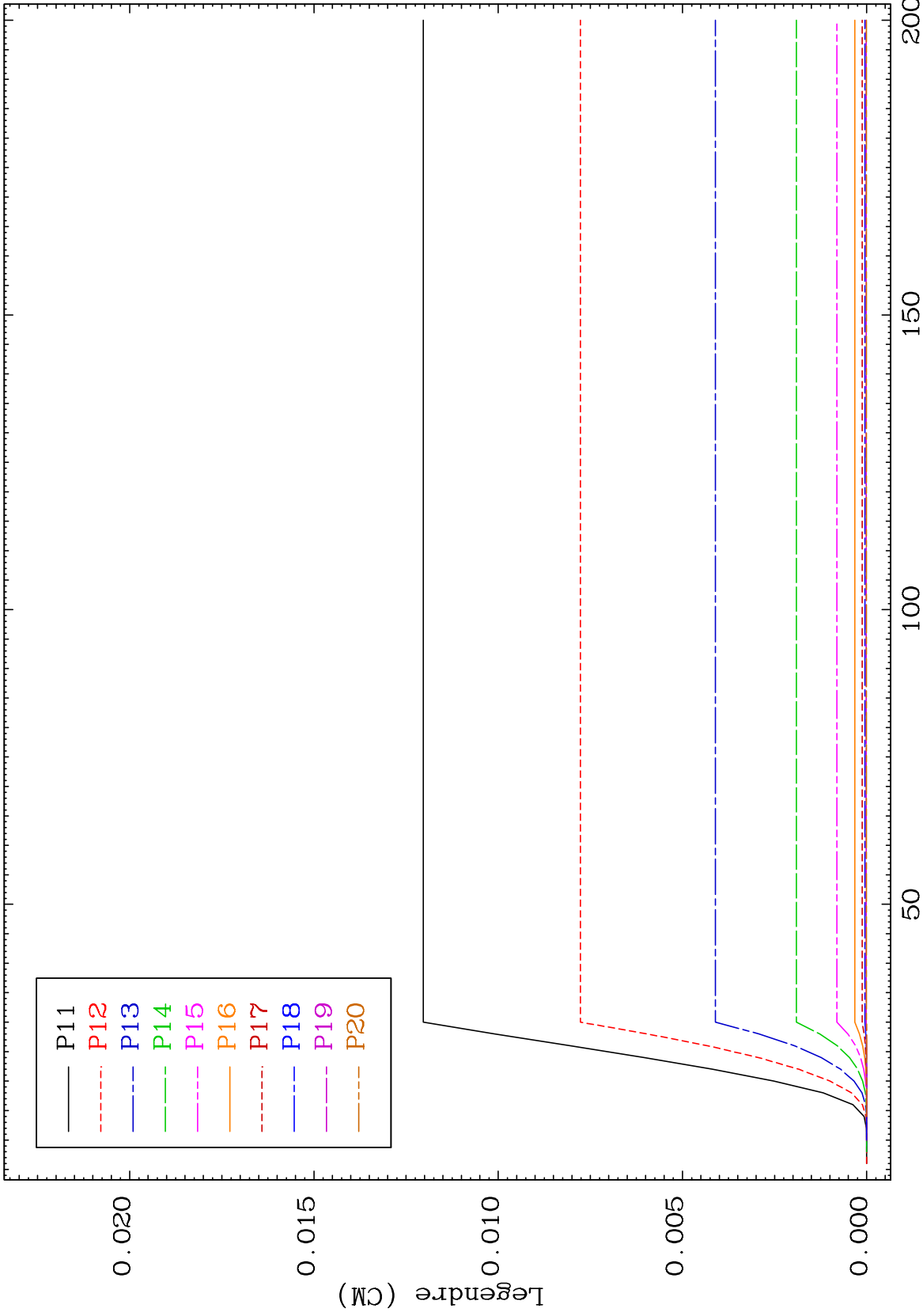

47

11-Na-22

MAT 1122 MT= 61 (n,n') Level Legendre Coefficients 11-Na-22

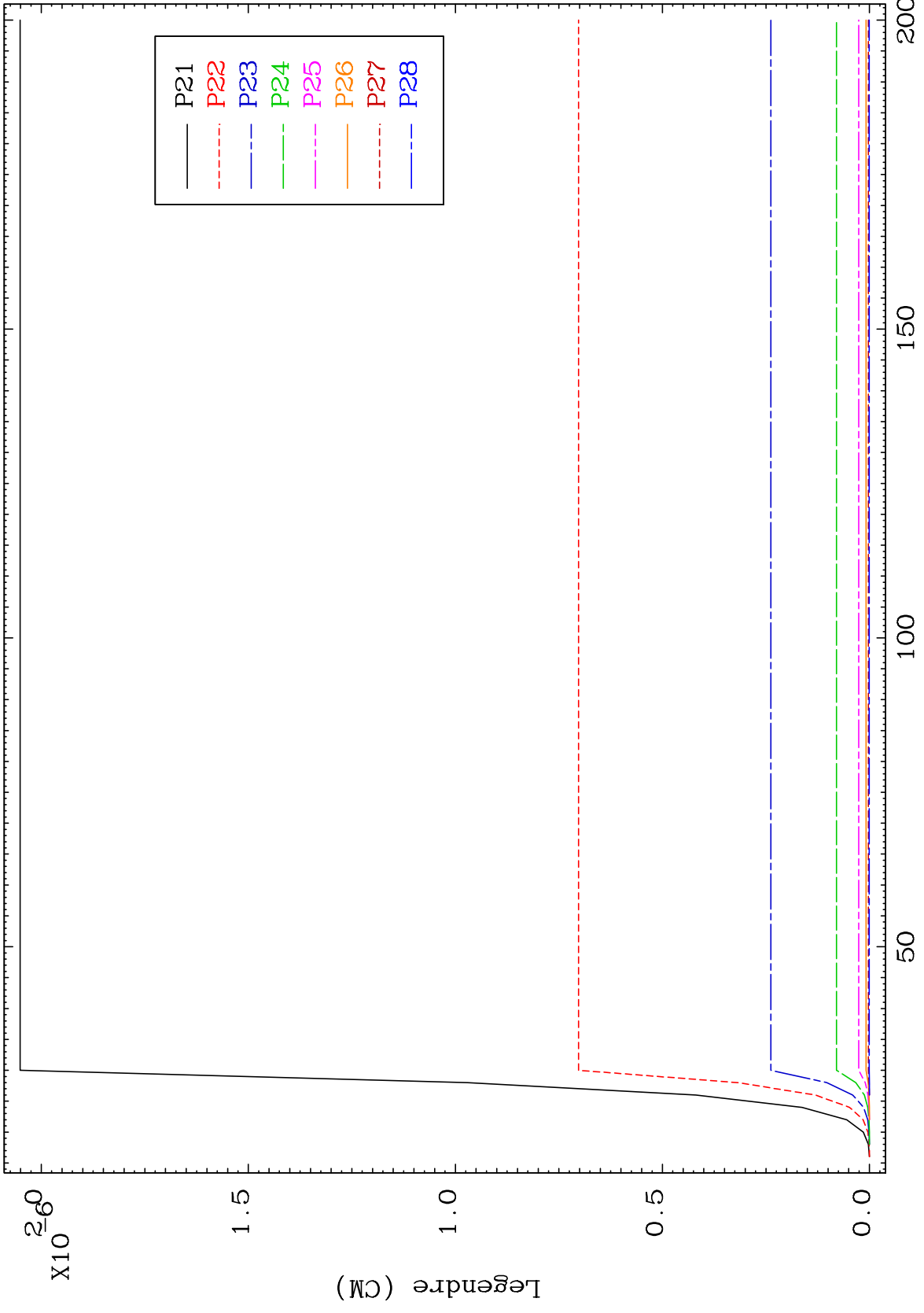

MAT 1122

MT= 62 (n,n') Level
Legendre Coefficients

11-Na-22

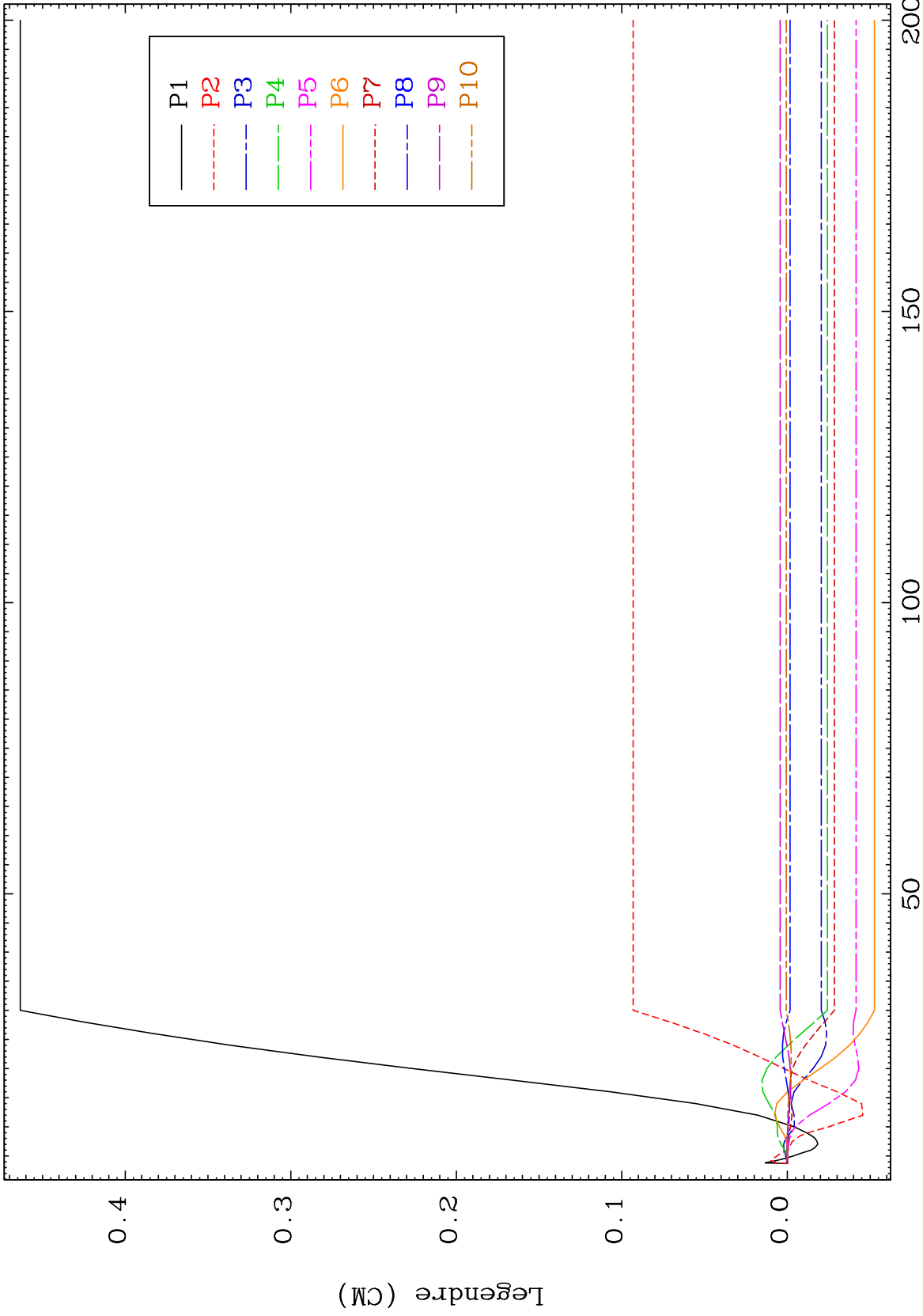

49

Incident Energy (MeV)

11-Na-22

MAT 1122

MT= 62 (n,n') Level
Legendre Coefficients

11-Na-22

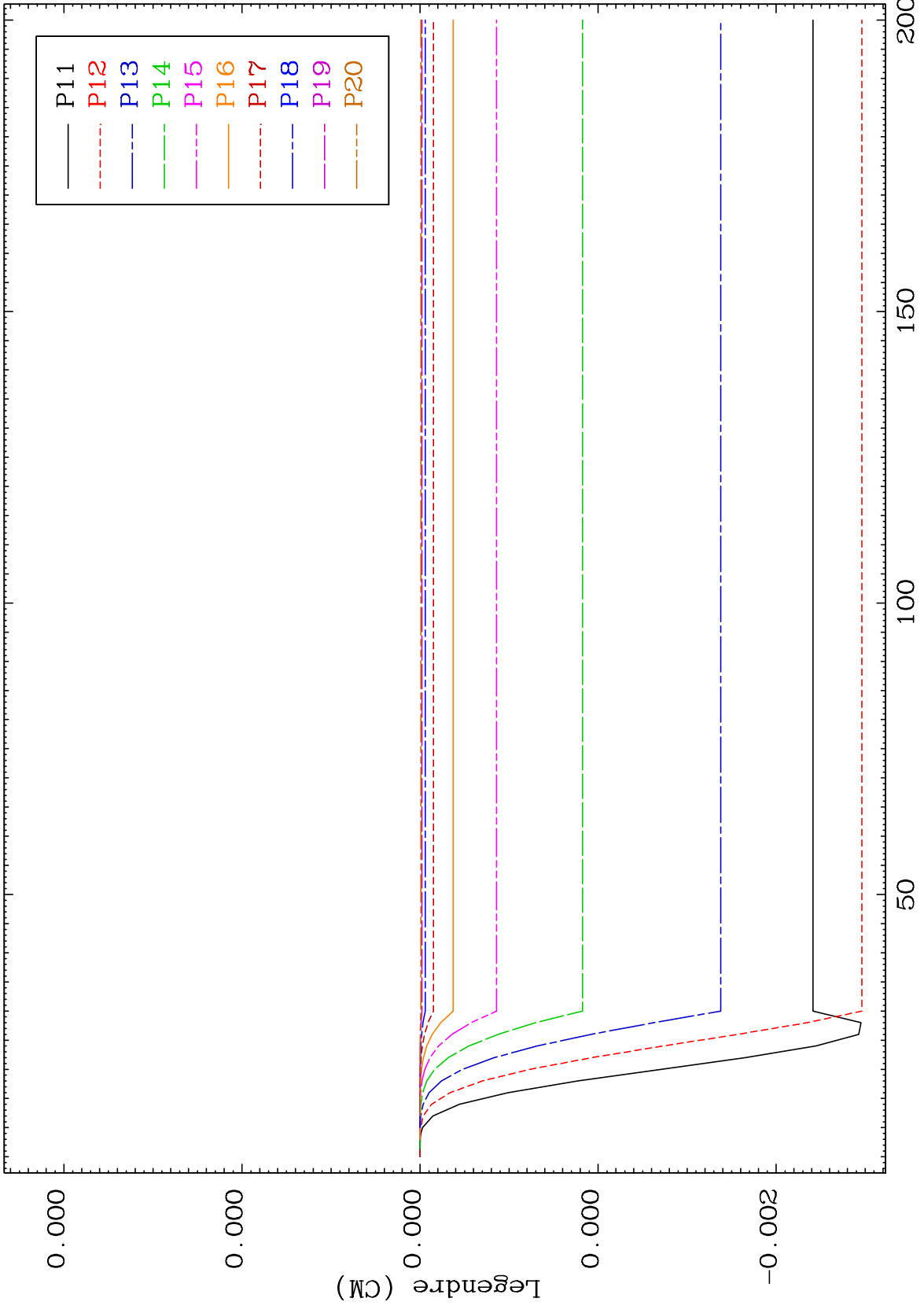

50

Incident Energy (MeV)

11-Na-22

MAT 1122

MT= 62 (n,n') Level
Legendre Coefficients

11-Na-22

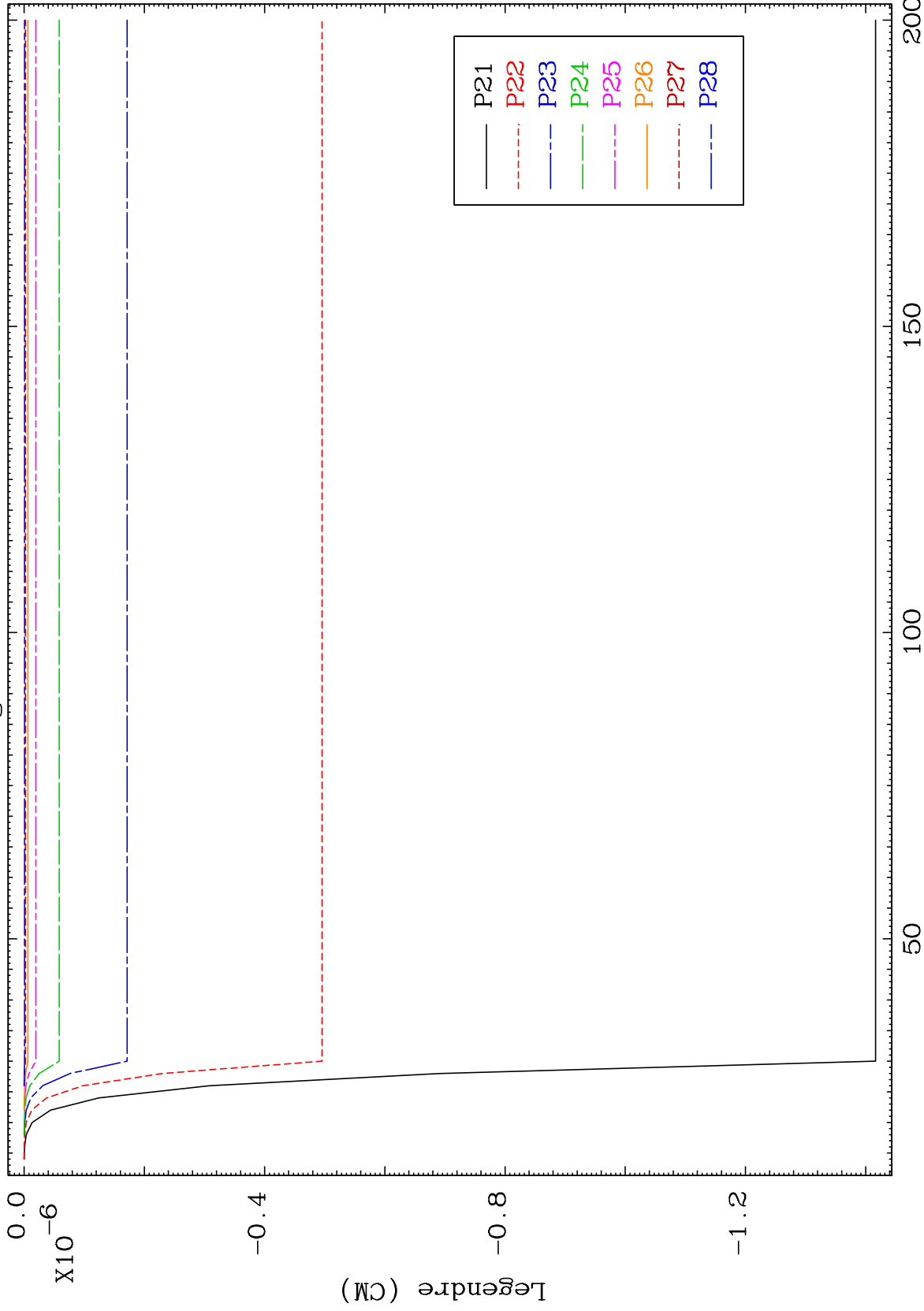

51

11-Na-22

MAT 1122

MT= 63 (n,n') Level
Legendre Coefficients

11-Na-22

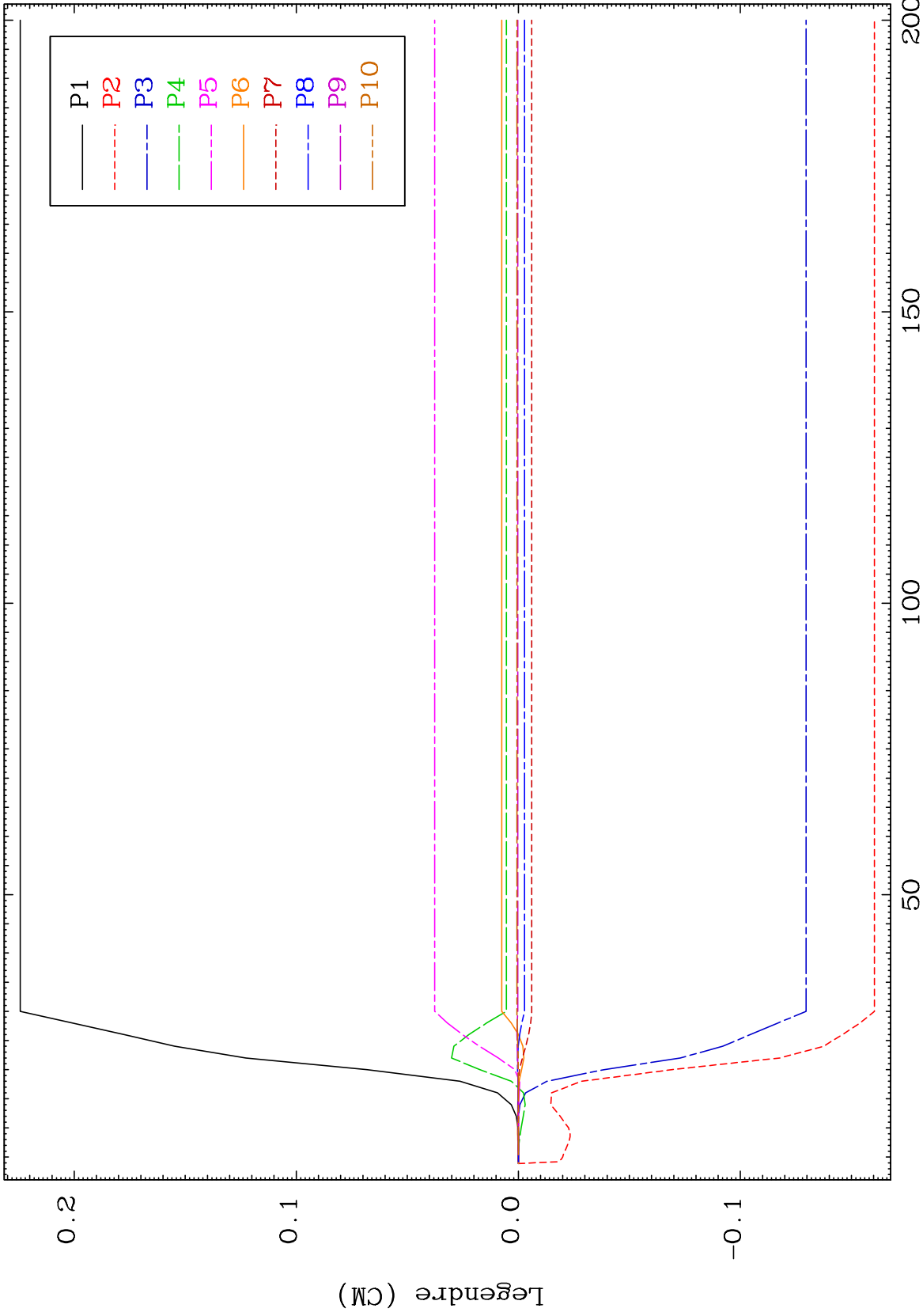

52

Incident Energy (MeV)

11-Na-22

MAT 1122

MT= 63 (n,n') Level
Legendre Coefficients

11-Na-22

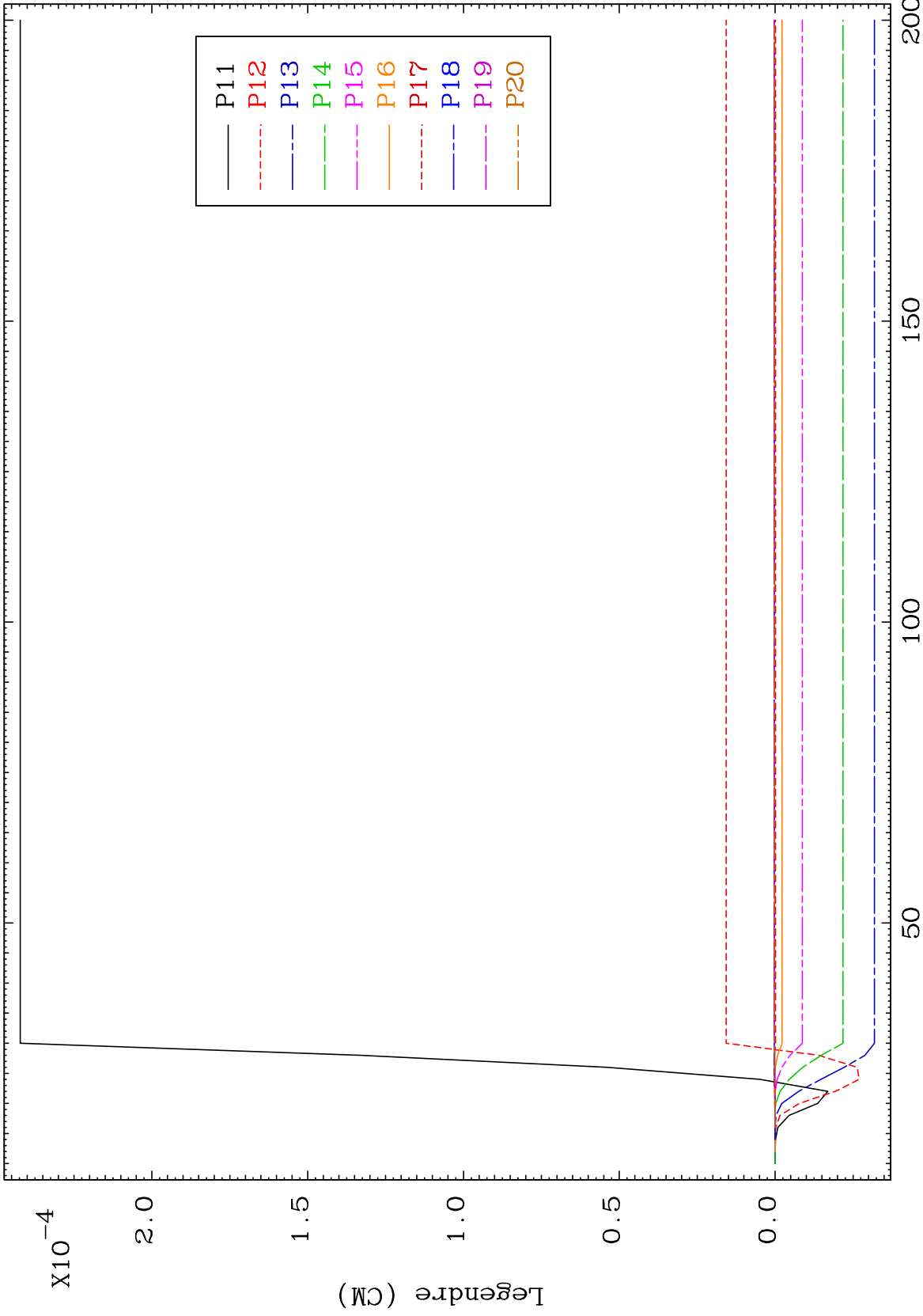

53

11-Na-22

MAT 1122

MT= 63 (n,n') Level
Legendre Coefficients

11-Na-22

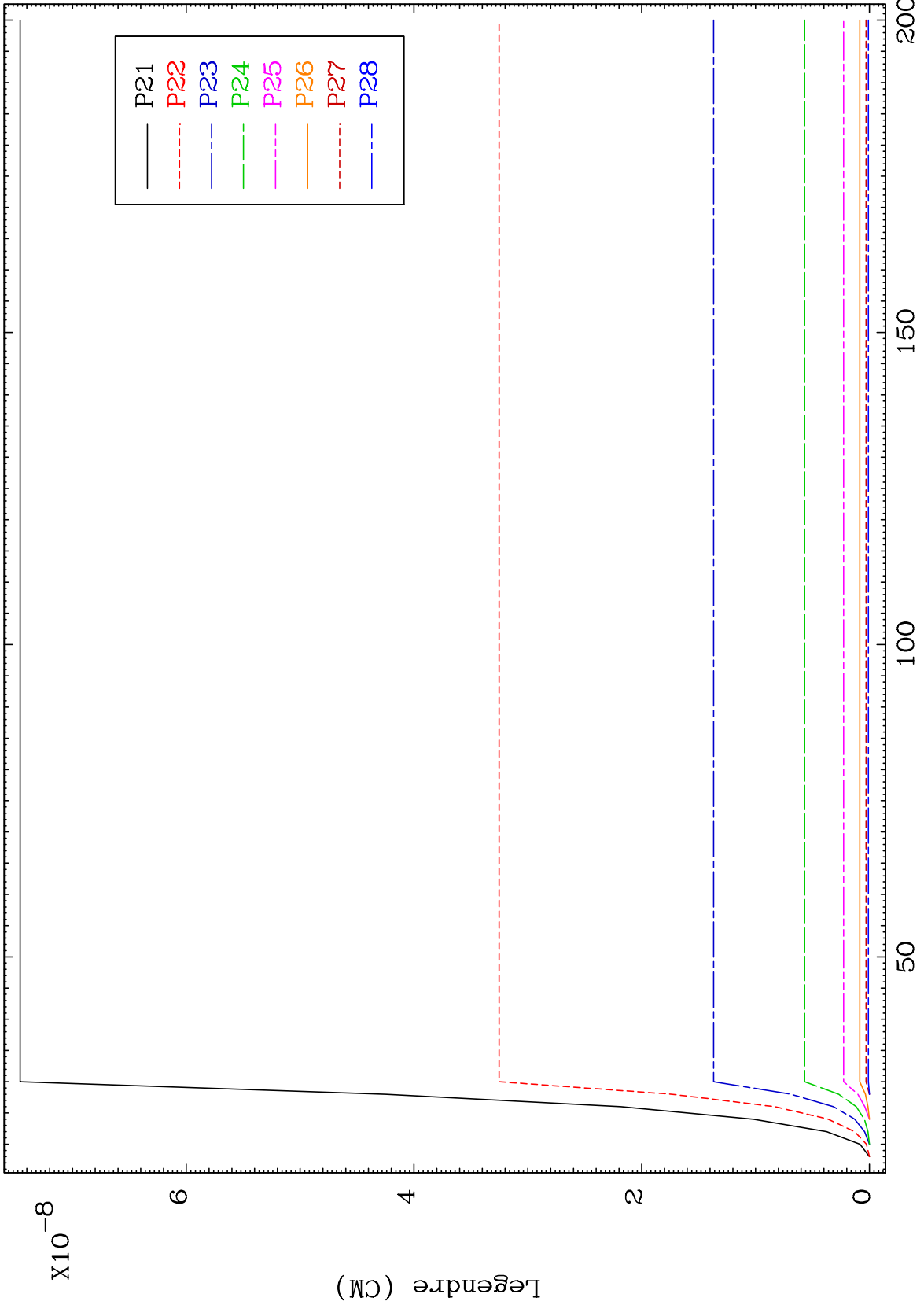

54

Incident Energy (MeV)

11-Na-22

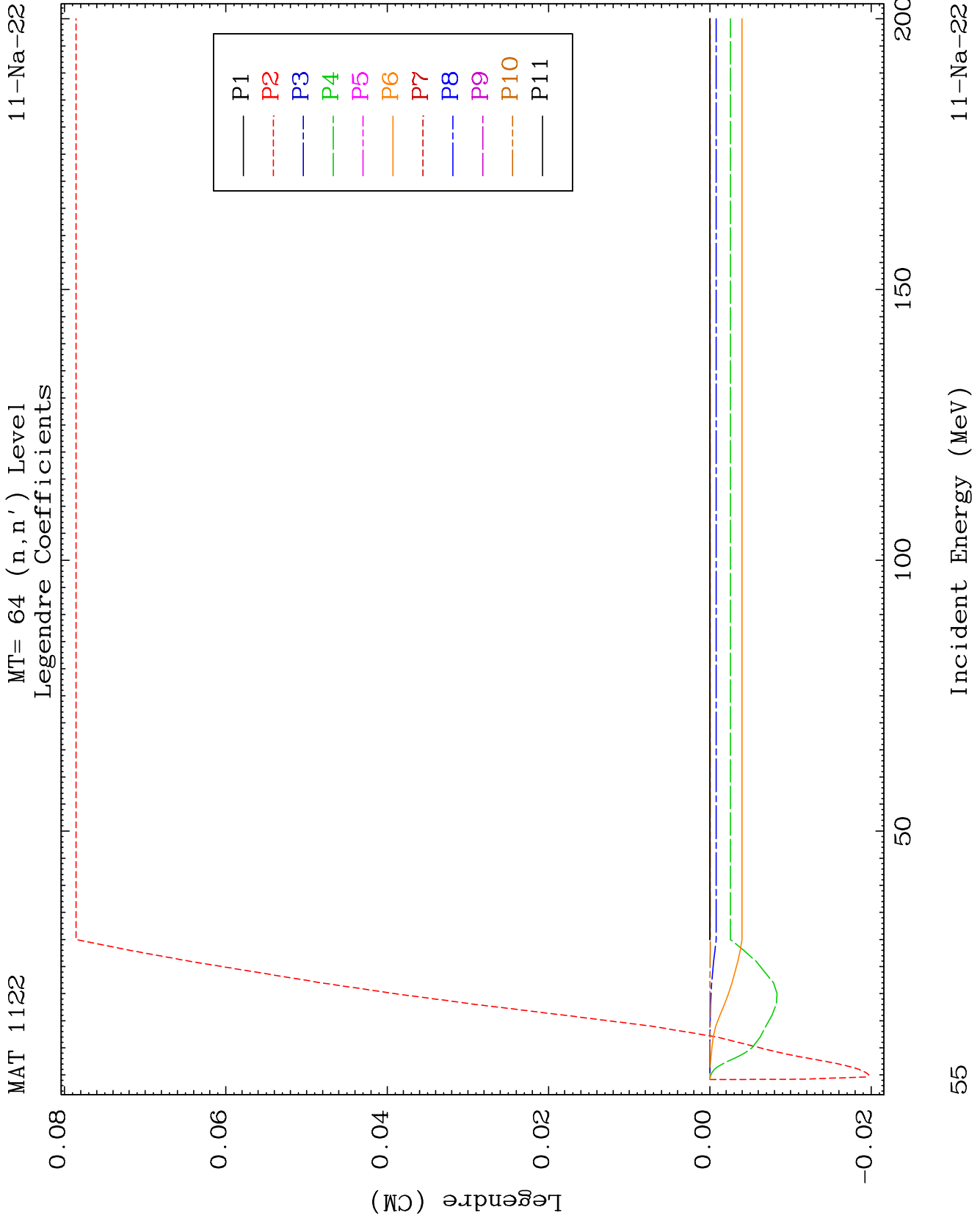

MAT 1122

MT= 64 (n,n') Level
Legendre Coefficients

11-Na-22

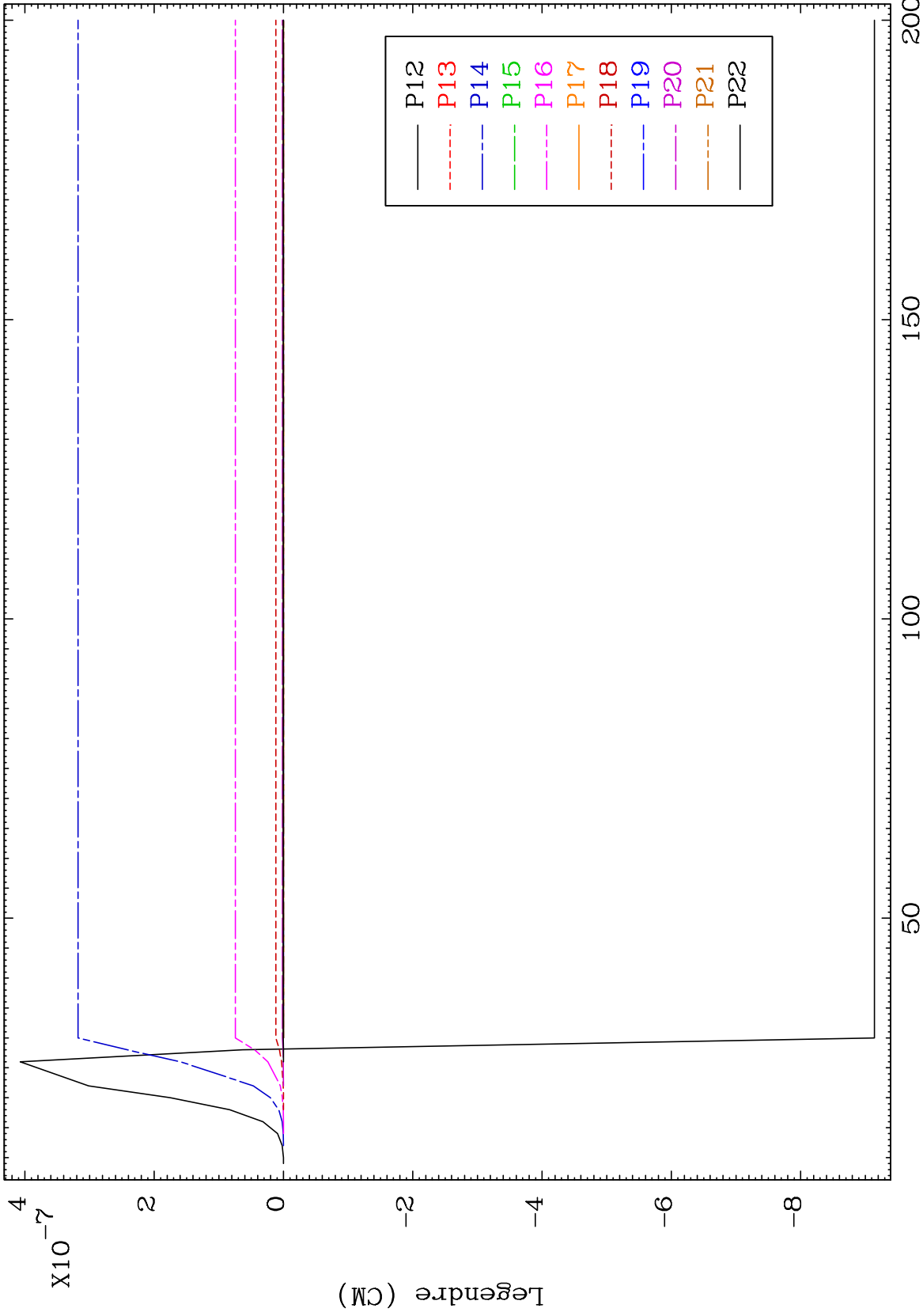

56

Incident Energy (MeV)

11-Na-22

MAT 1122 MT= 65 (n,n') Level Legendre Coefficients 11-Na-22

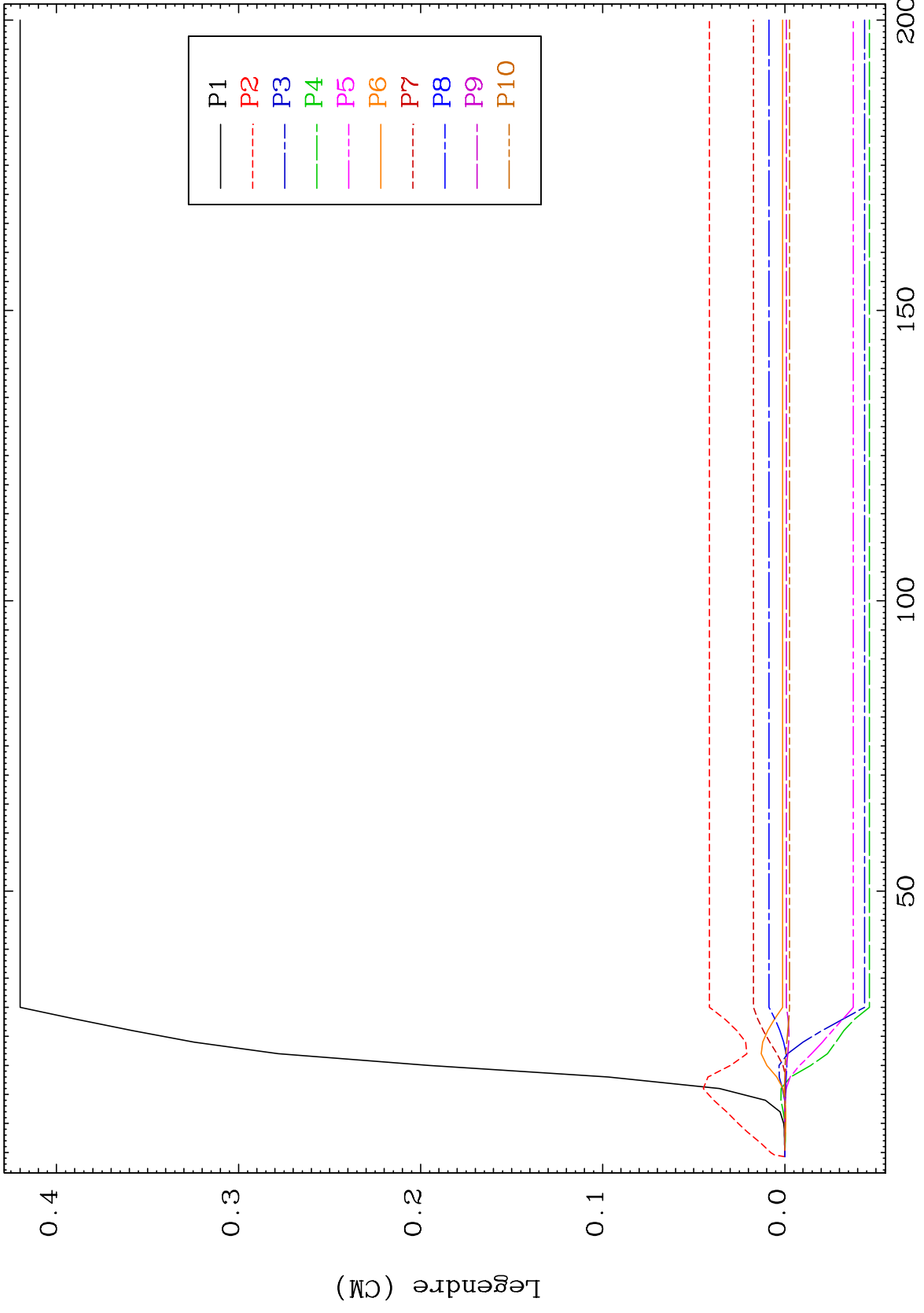

57 Incident Energy (MeV) 11-Na-22

MAT 1122 MT= 65 (n,n') Level Legendre Coefficients 11-Na-22

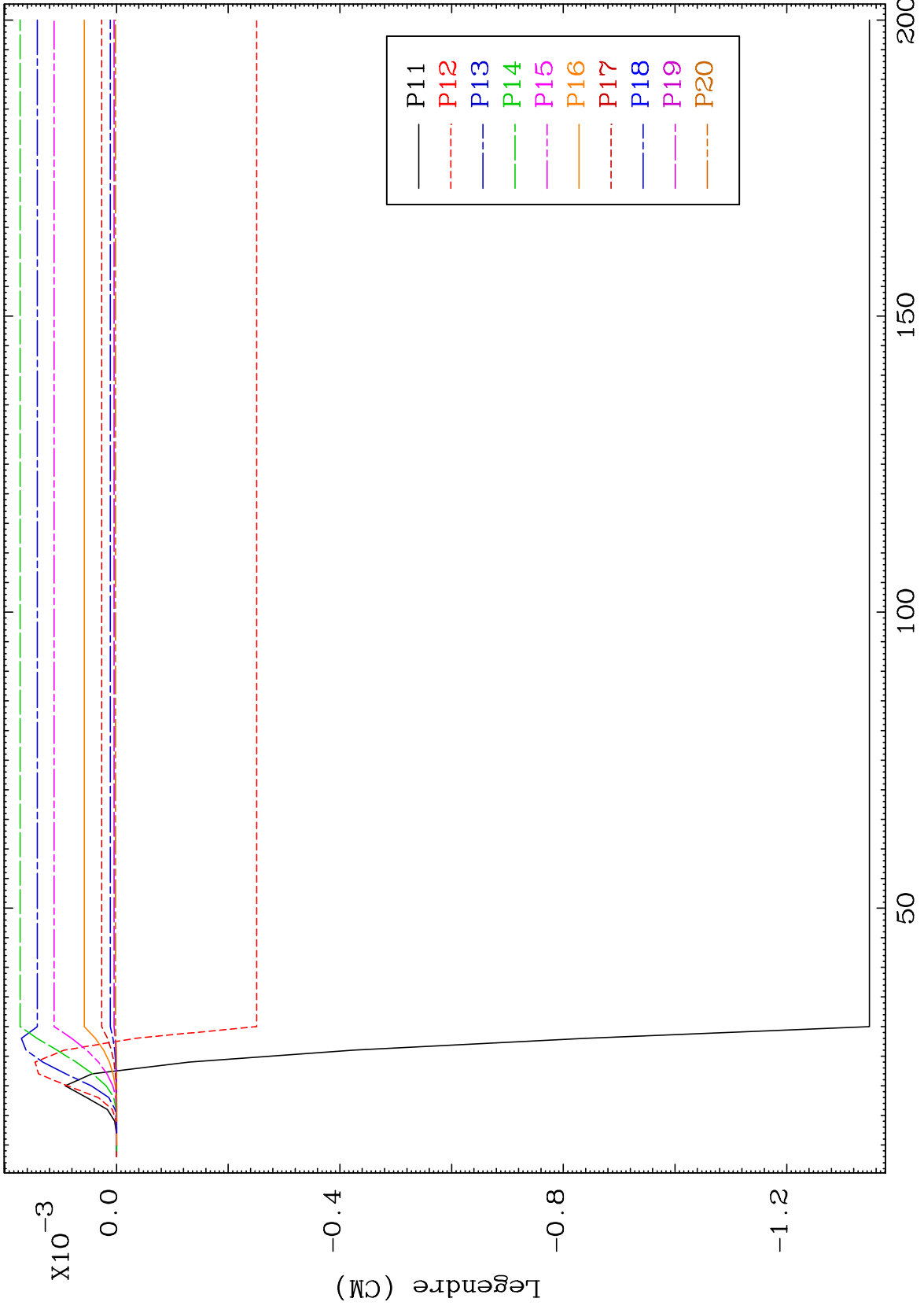

58 11-Na-22

MAT 1122

MT= 65 (n,n') Level
Legendre Coefficients

11-Na-22

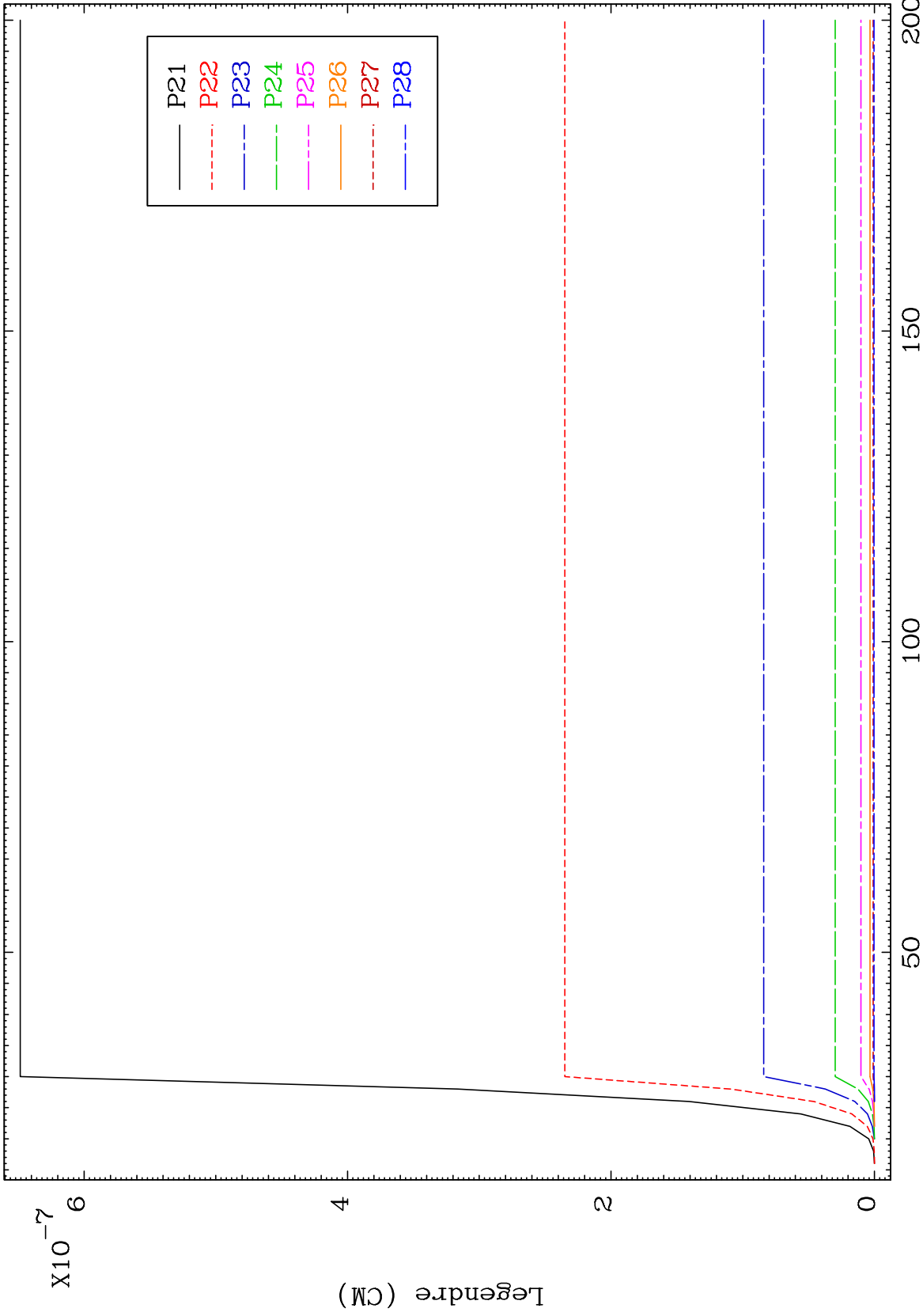

59

Incident Energy (MeV)

11-Na-22

MAT 1122 MT= 66 (n,n') Level Legendre Coefficients 11-Na-22

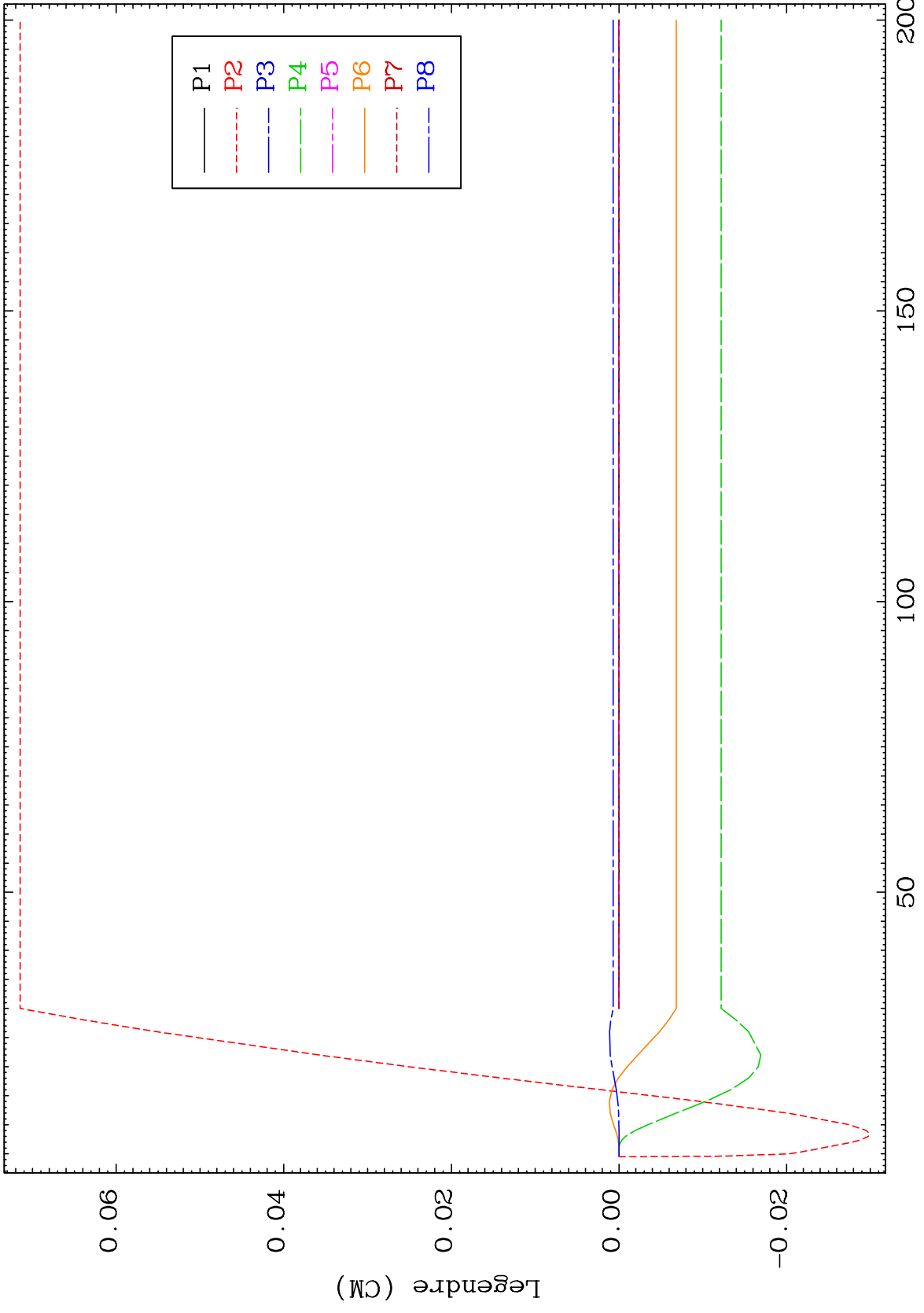

11-Na-22

MAT 1122 MT= 66 (n,n') Level Legendre Coefficients 11-Na-22

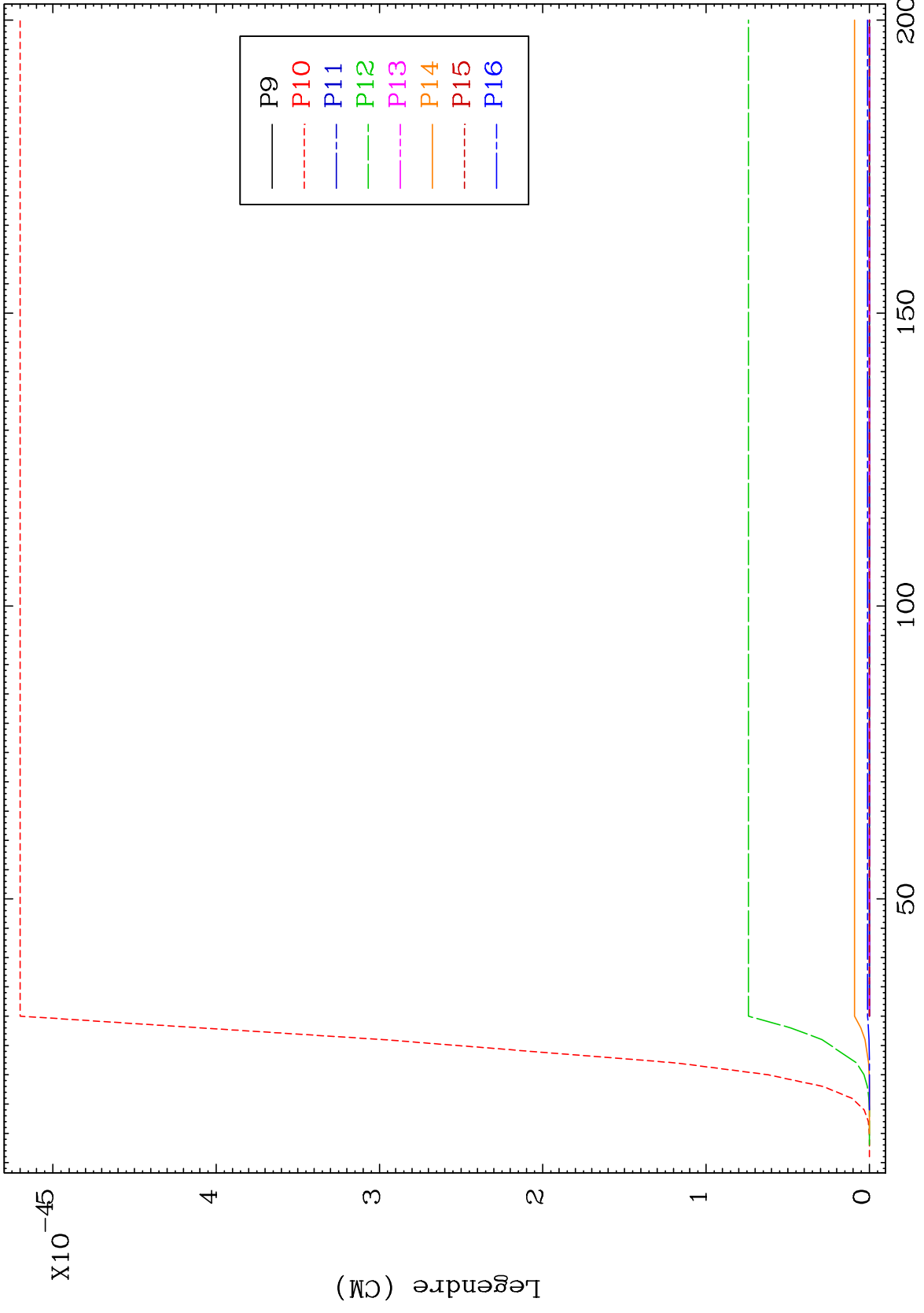

61 11-Na-22

MAT 1122 MT= 66 (n,n') Level Legendre Coefficients 11-Na-22

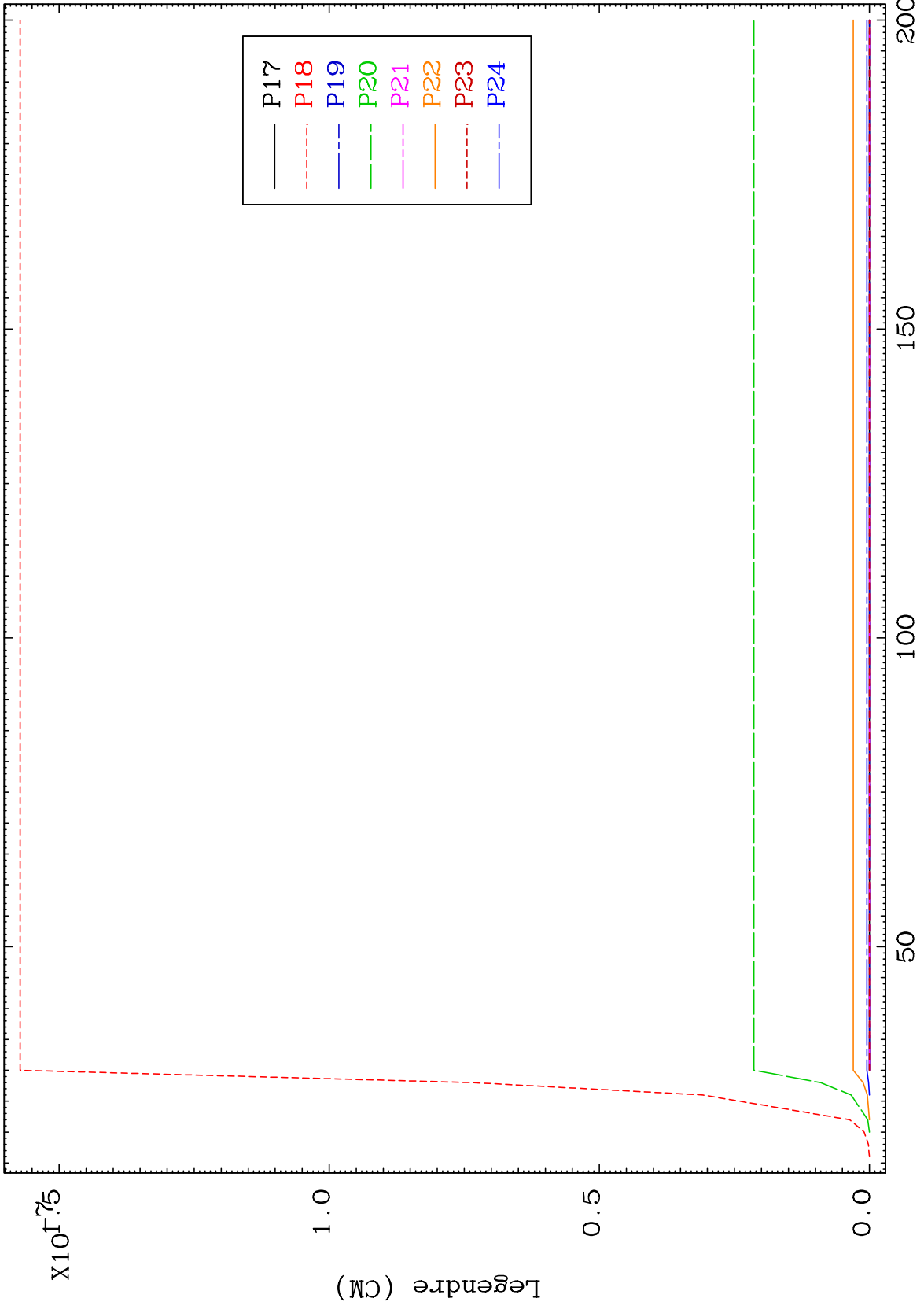

62 Incident Energy (MeV) 11-Na-22

MAT 1122

MT= 67 (n,n') Level
Legendre Coefficients

11-Na-22

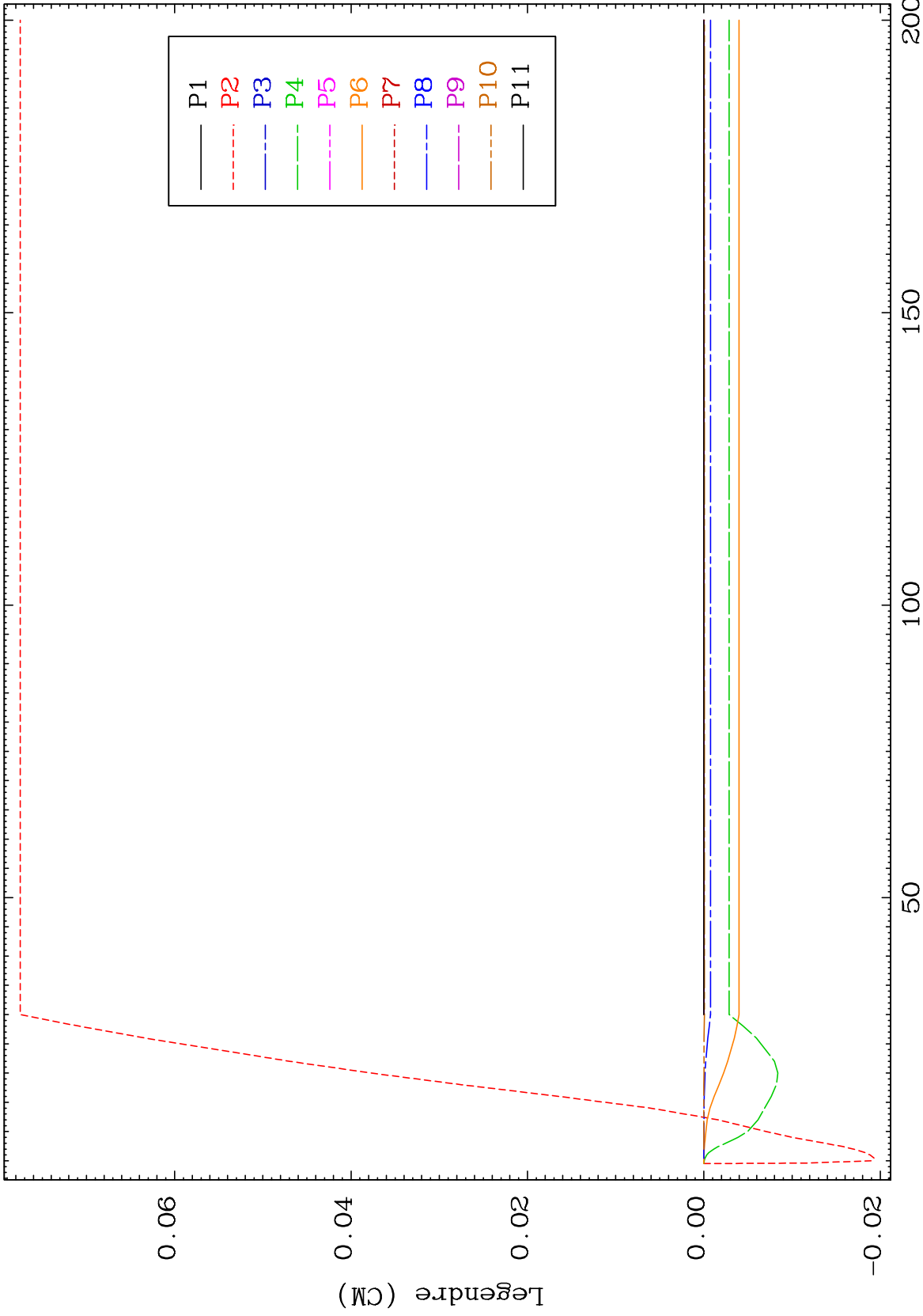

63

Incident Energy (MeV)

11-Na-22

MAT 1122

MT= 67 (n,n') Level
Legendre Coefficients

11-Na-22

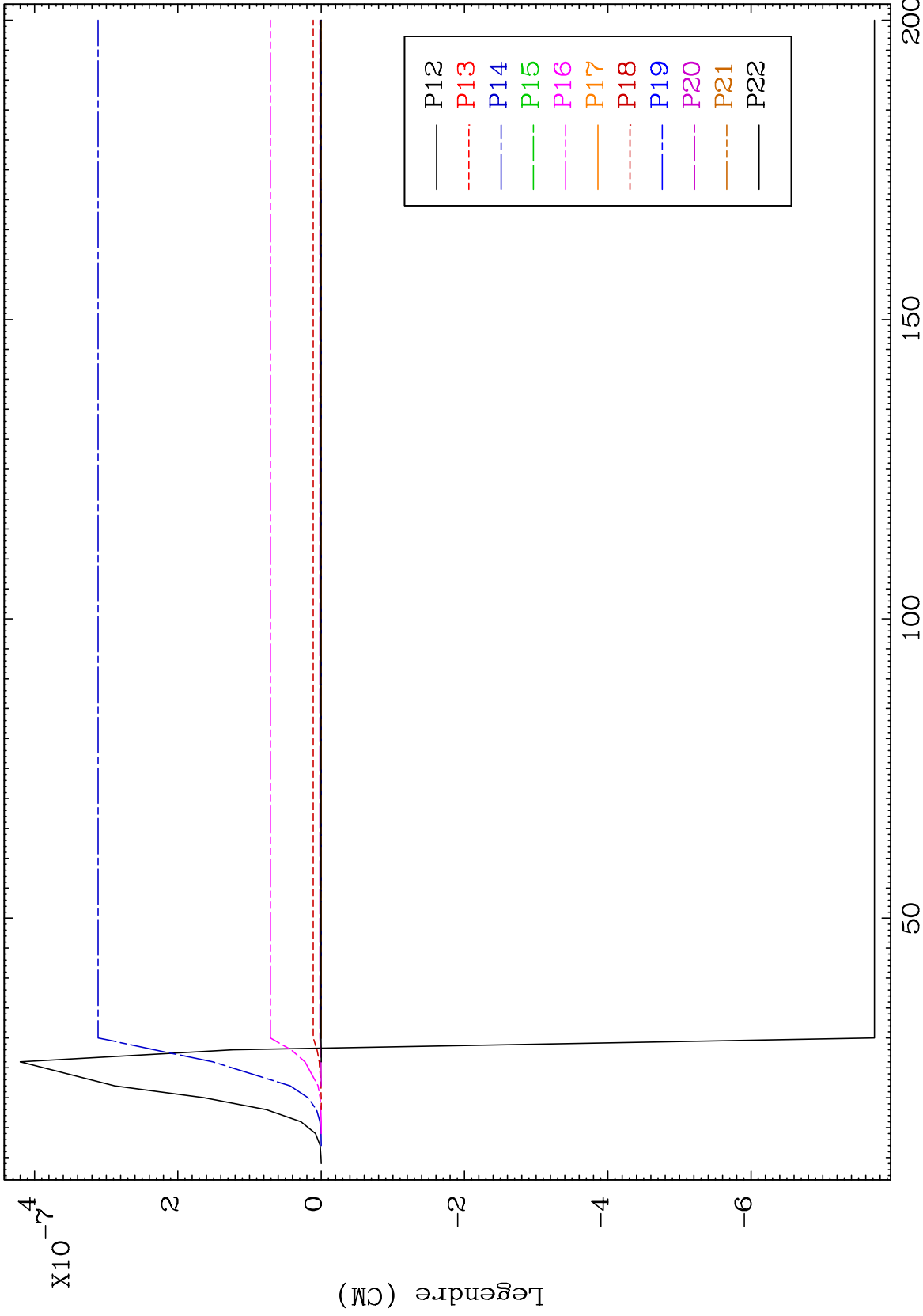

64

Incident Energy (MeV)

11-Na-22

MAT 1122

MT= 68 (n,n') Level
Legendre Coefficients

11-Na-22

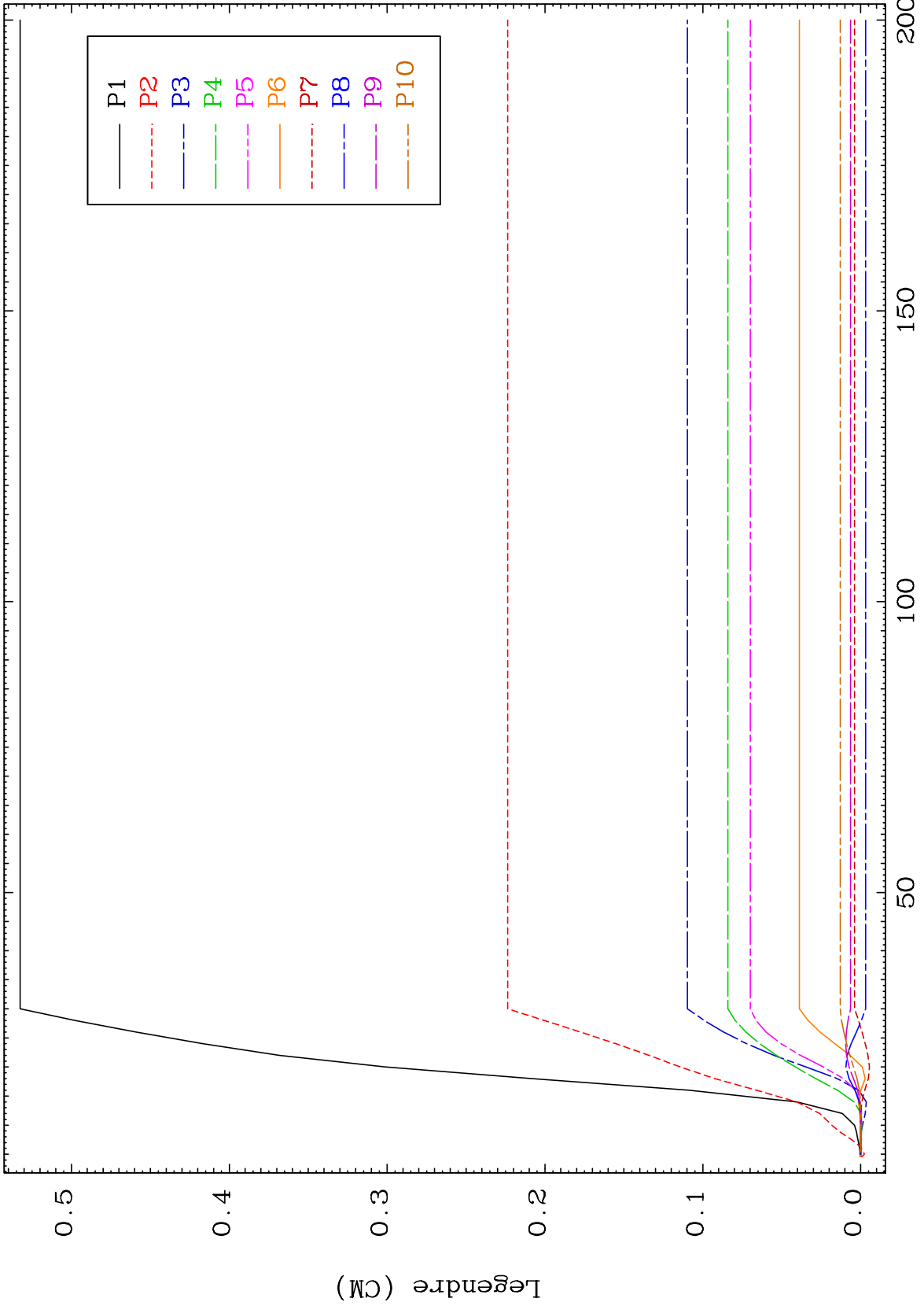

65

Incident Energy (MeV)

11-Na-22

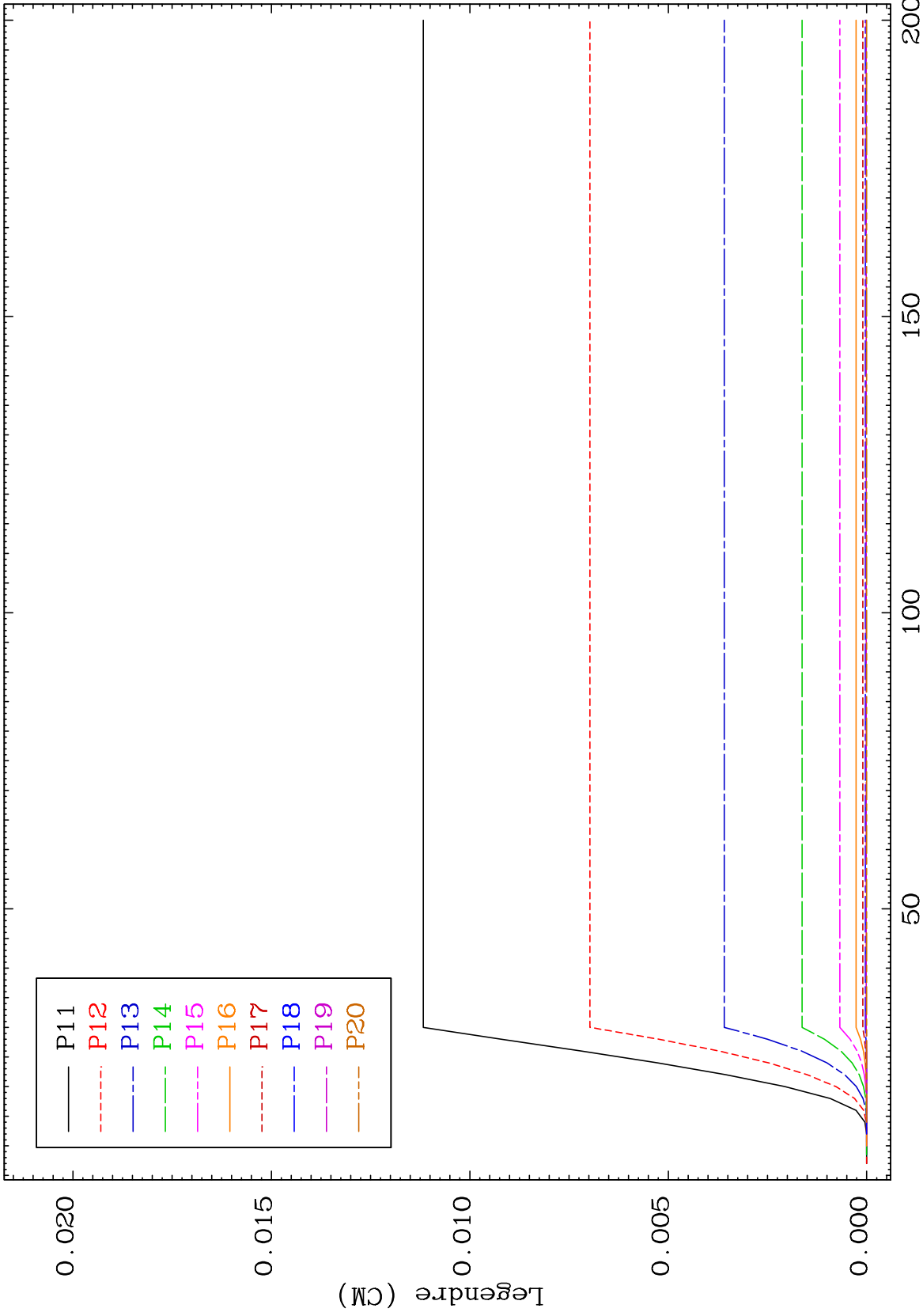

MAT 1122

MT= 68 (n,n') Level
Legendre Coefficients

11-Na-22

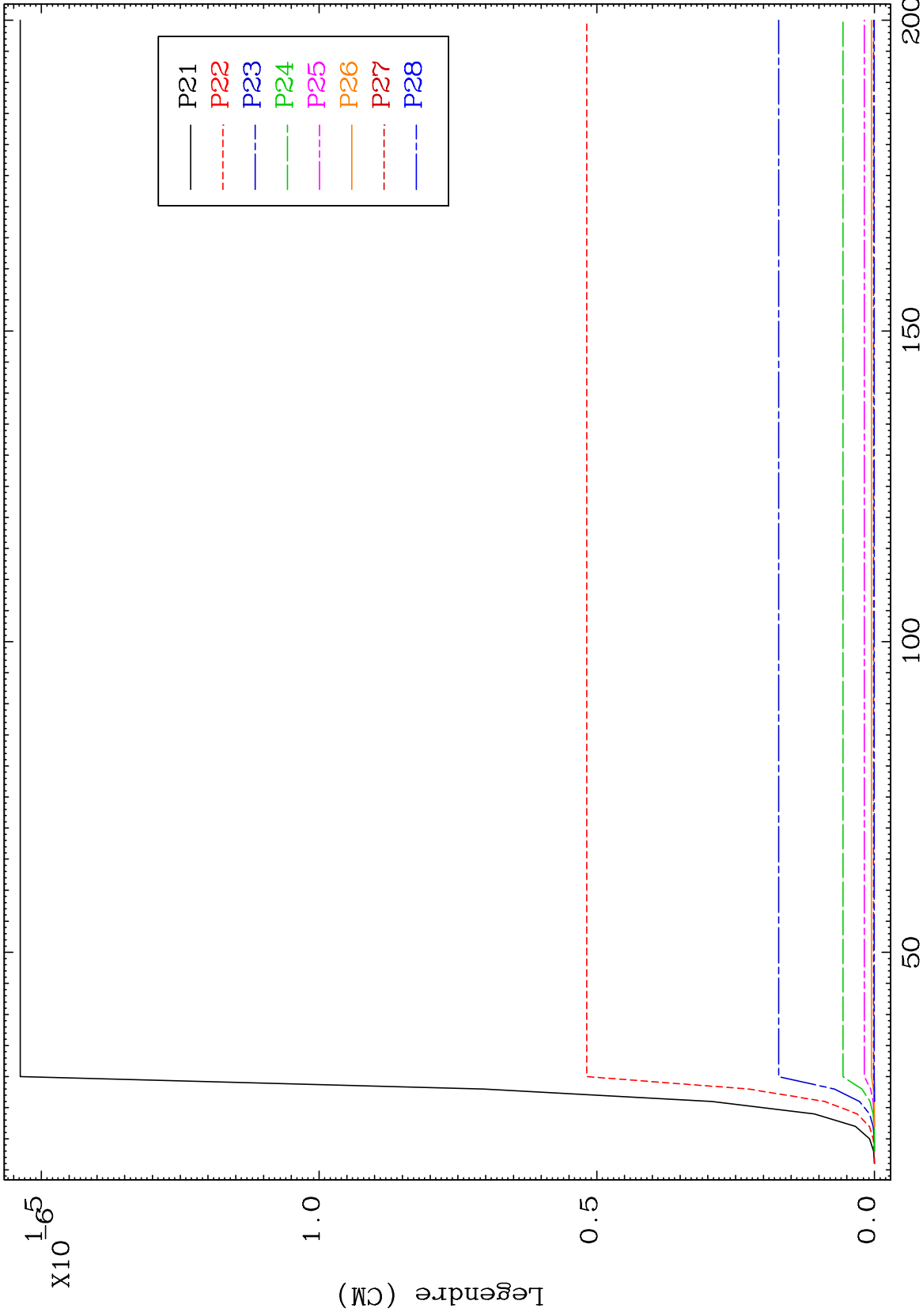

67

Incident Energy (MeV)

11-Na-22

MAT 1122 MT= 69 (n,n') Level Legendre Coefficients 11-Na-22

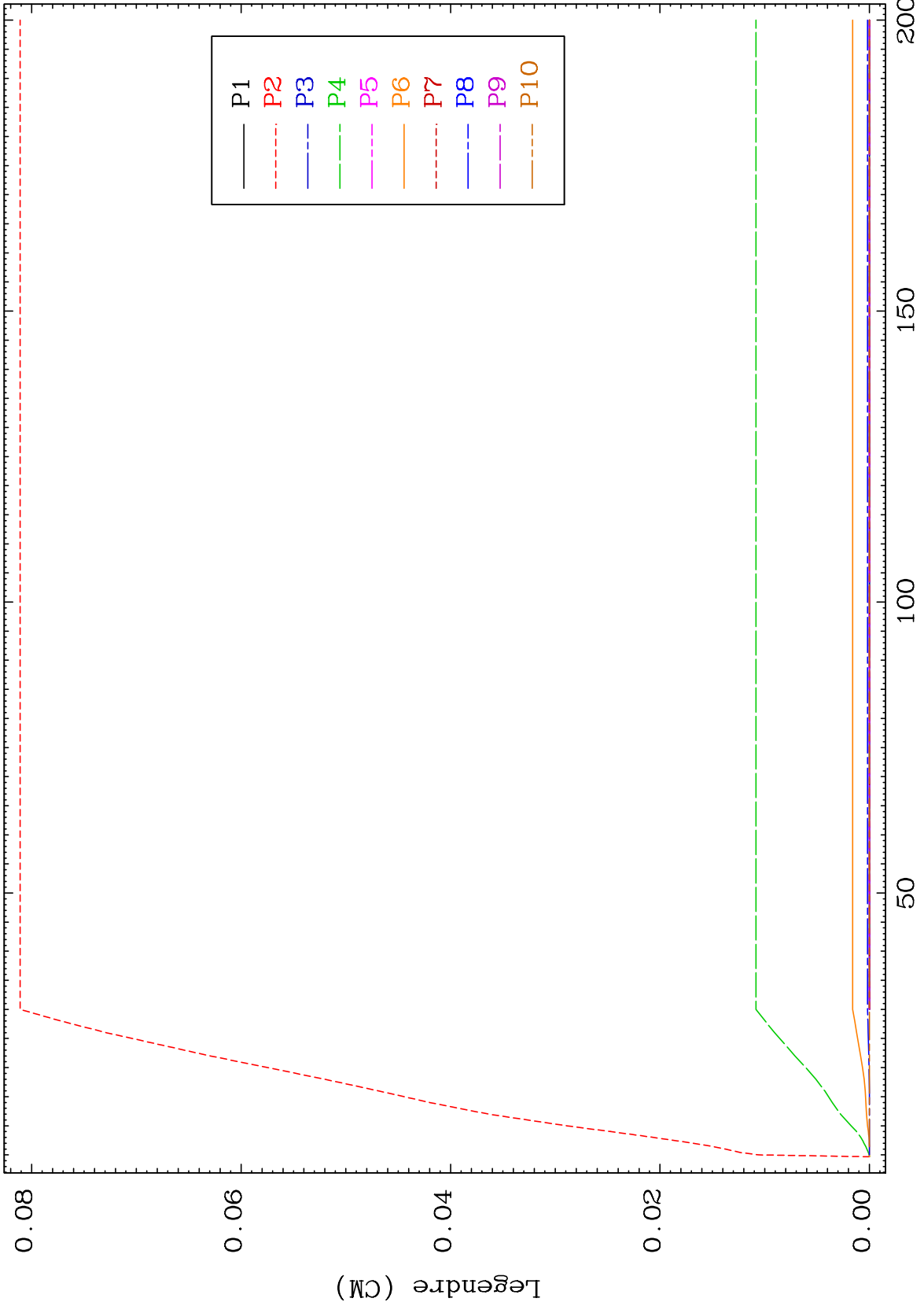

68 Incident Energy (MeV) 11-Na-22

MAT 1122 MT= 69 (n,n') Level Legendre Coefficients 11-Na-22

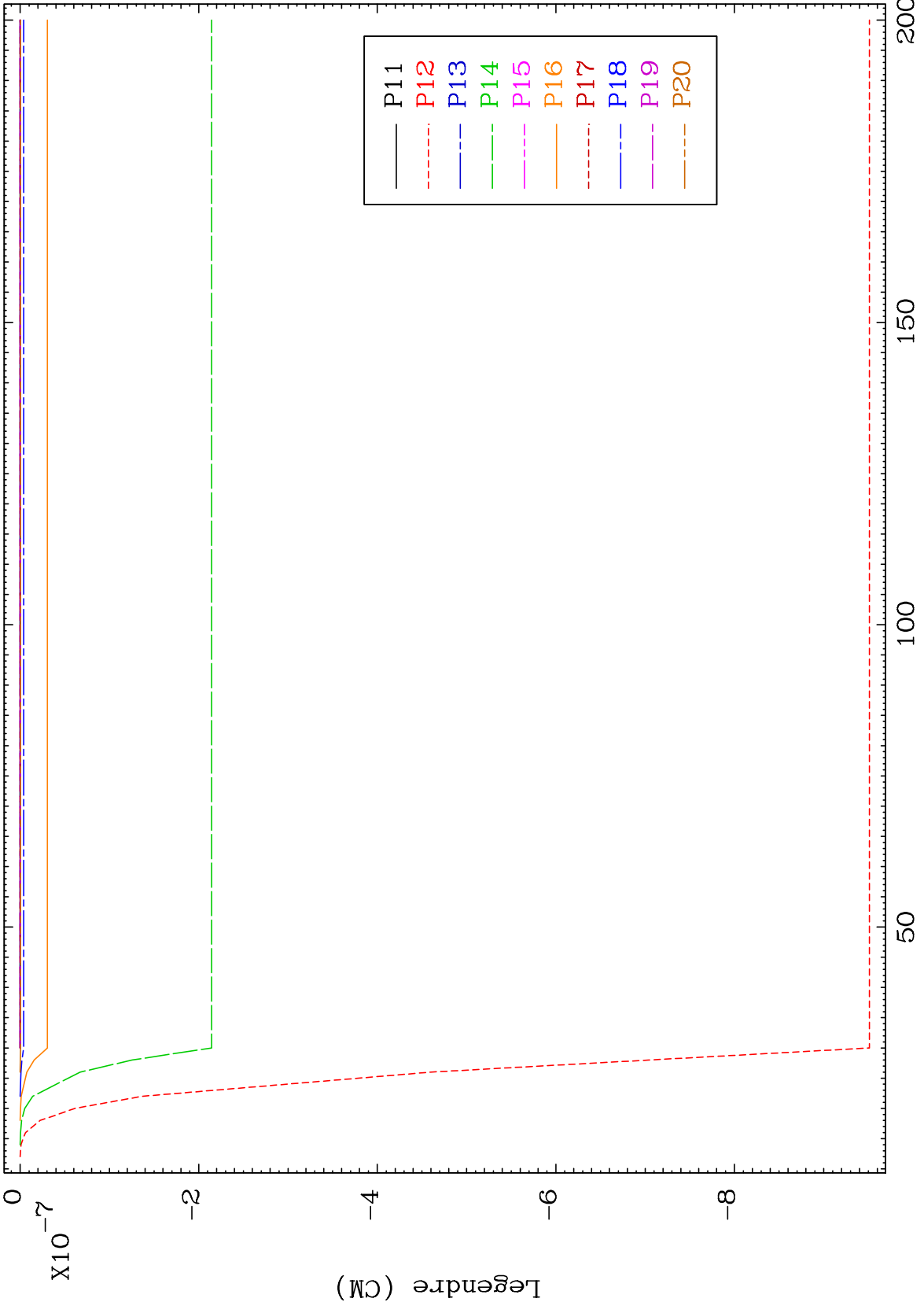

69 11-Na-22

MAT 1122 MT= 70 (n,n') Level Legendre Coefficients 11-Na-22

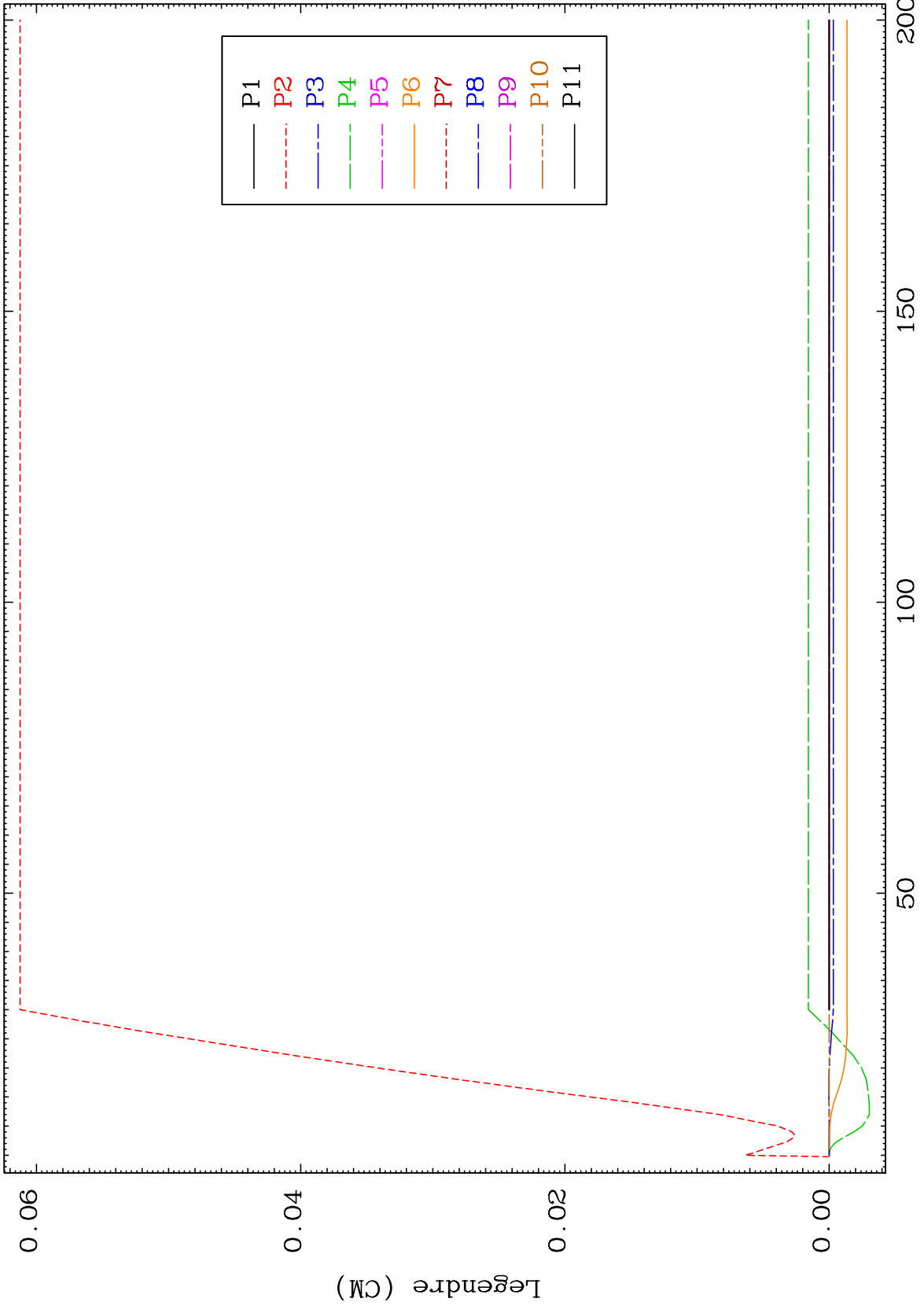

70 Incident Energy (MeV) 11-Na-22

MAT 1122

MT= 70 (n,n') Level
Legendre Coefficients

11-Na-22

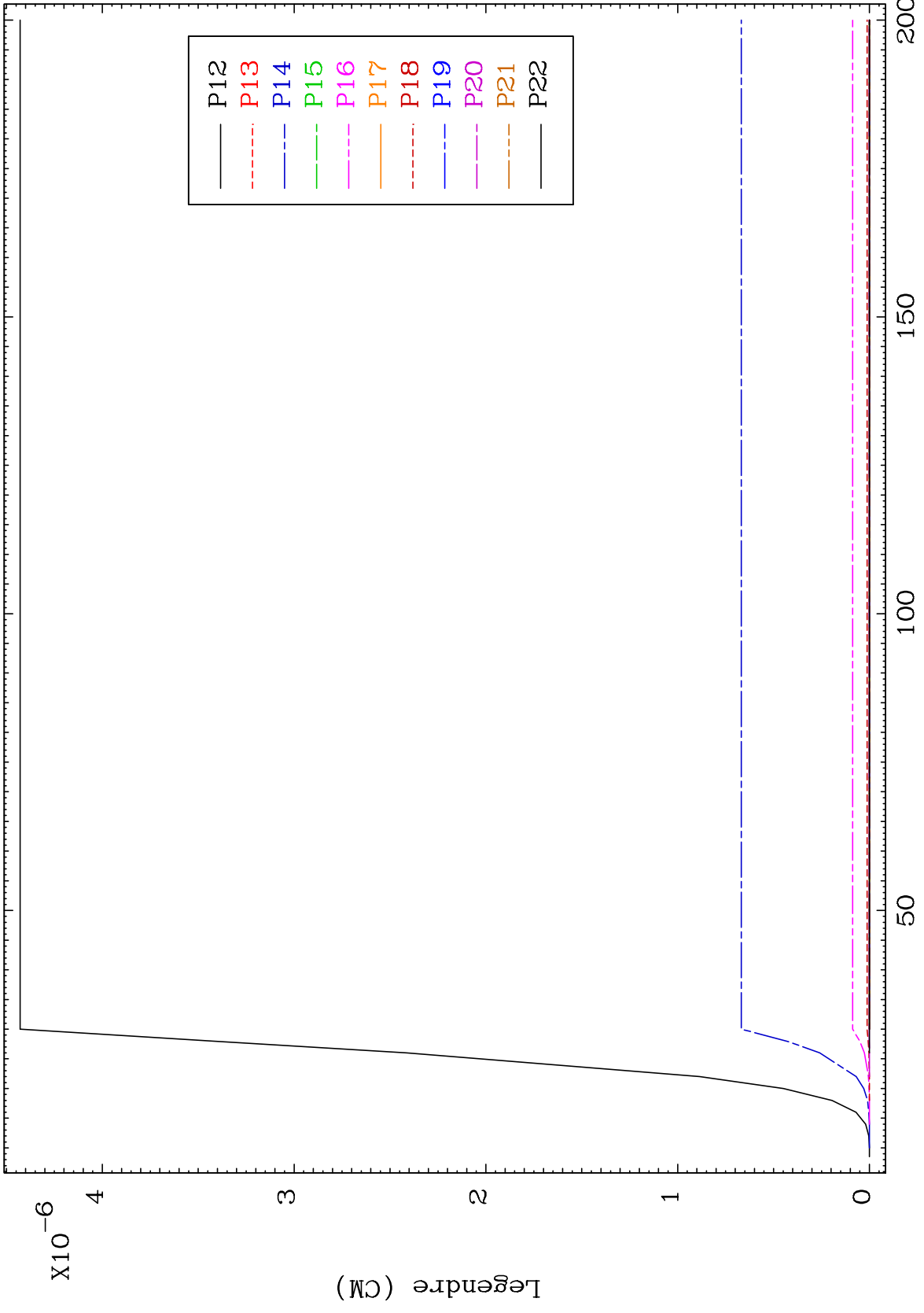

71

11-Na-22

MAT 1122 MT= 71 (n,n') Level Legendre Coefficients 11-Na-22

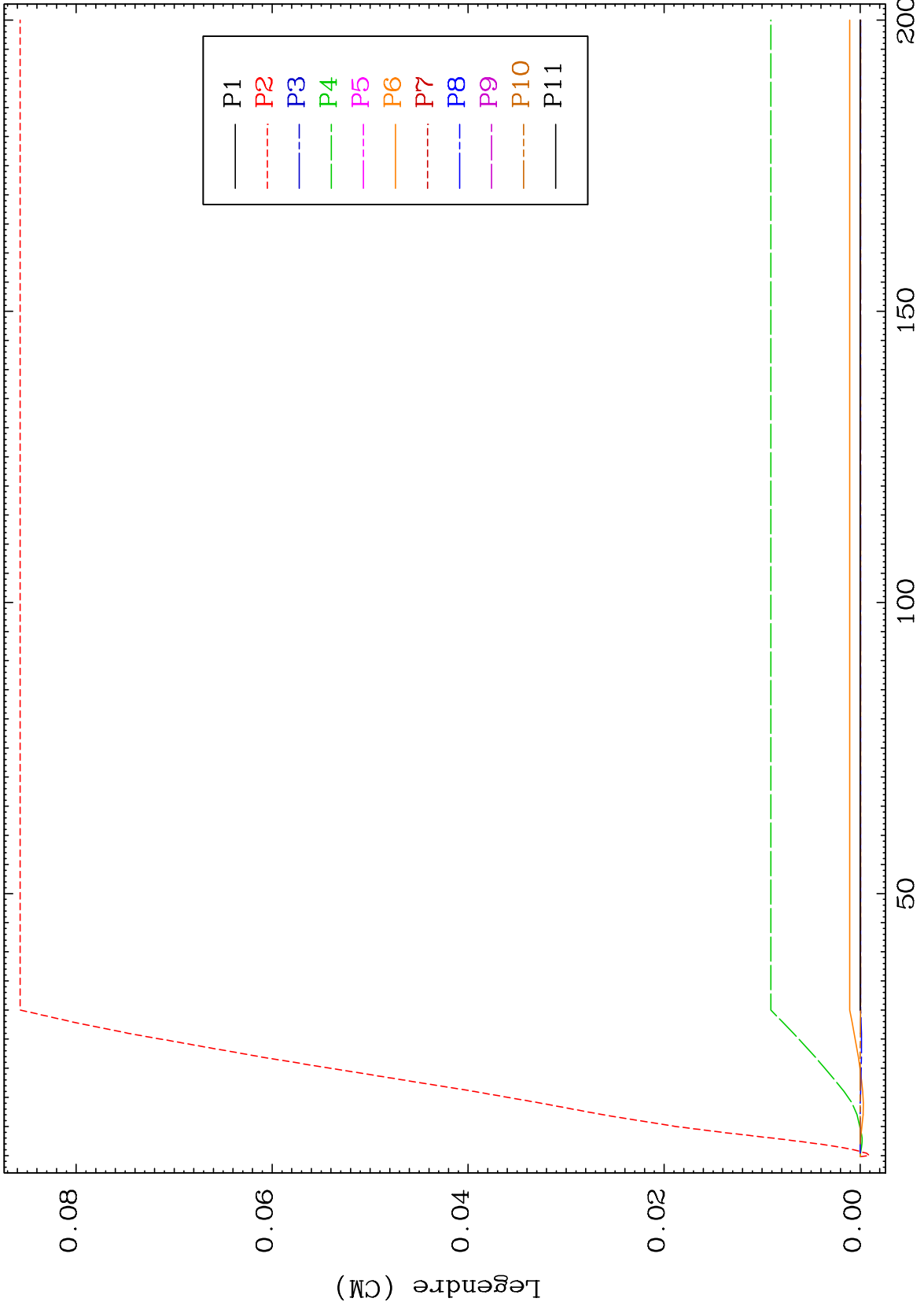

72 Incident Energy (MeV) 11-Na-22

MAT 1122 MT= 71 (n,n') Level Legendre Coefficients 11-Na-22

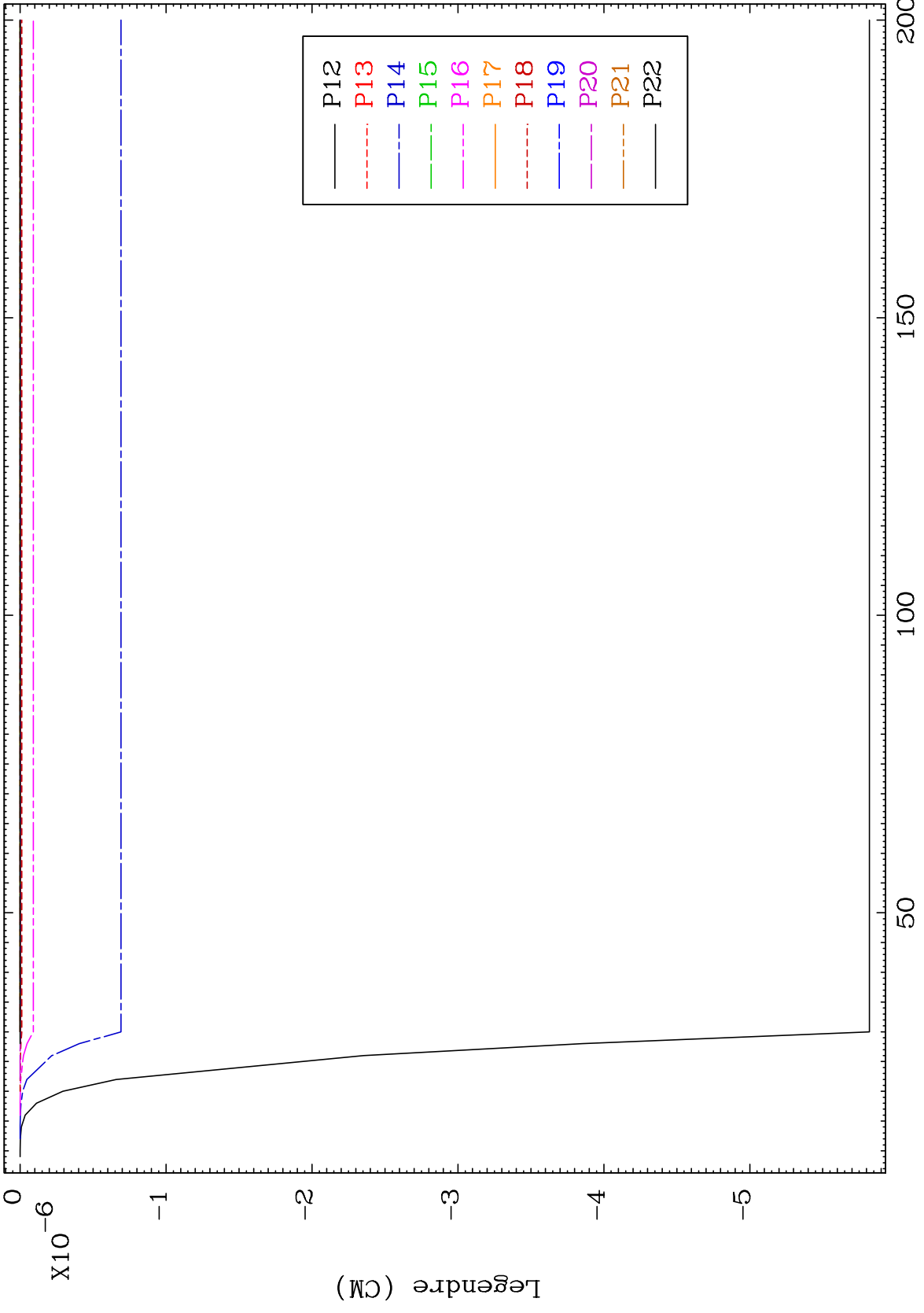

73 11-Na-22

MAT 1122

MT= 72 (n,n') Level
Legendre Coefficients

11-Na-22

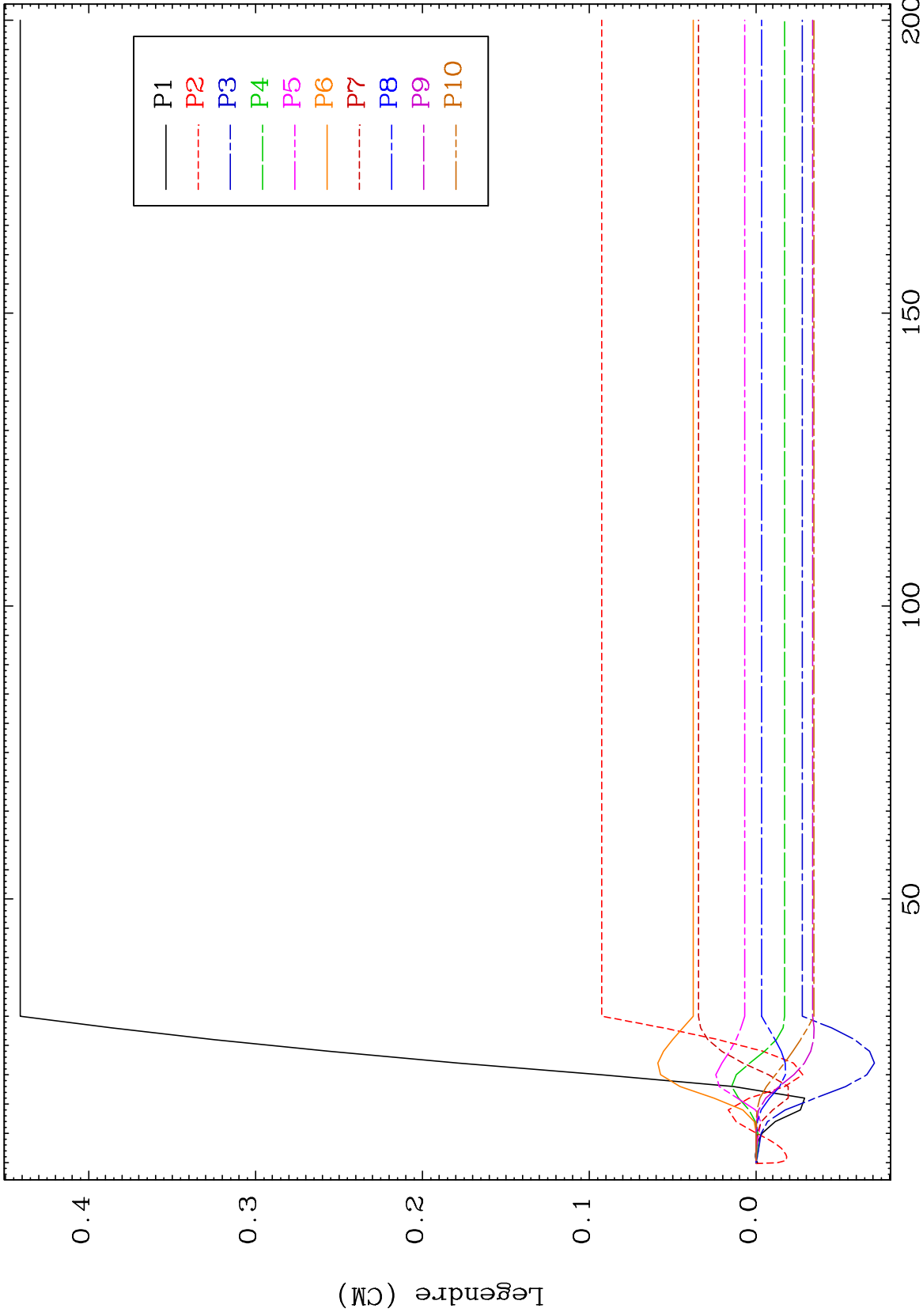

74

11-Na-22

MAT 1122 MT= 72 (n,n') Level Legendre Coefficients 11-Na-22

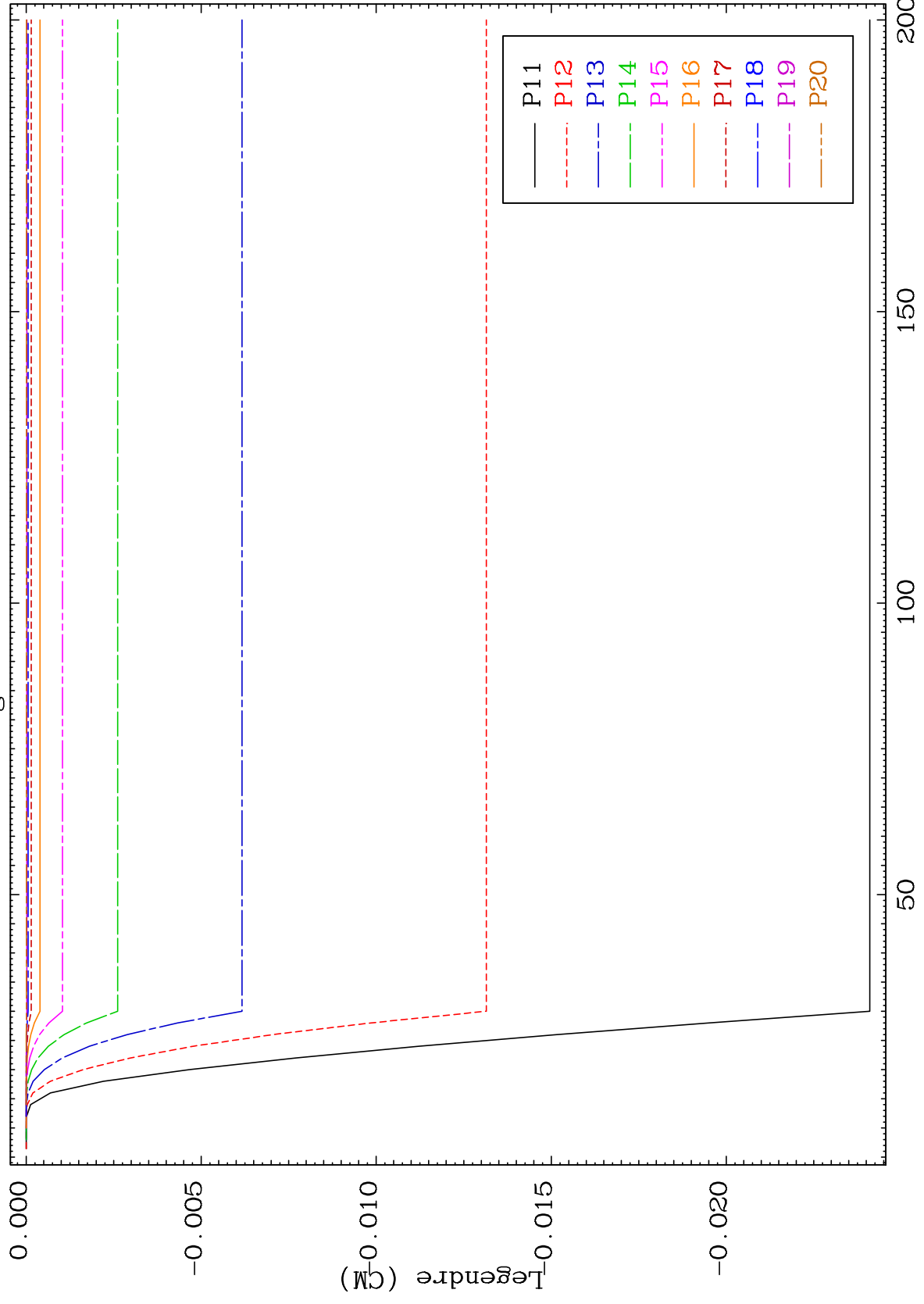

75 Incident Energy (MeV) 11-Na-22

MAT 1122 MT= 72 (n,n') Level Legendre Coefficients 11-Na-22

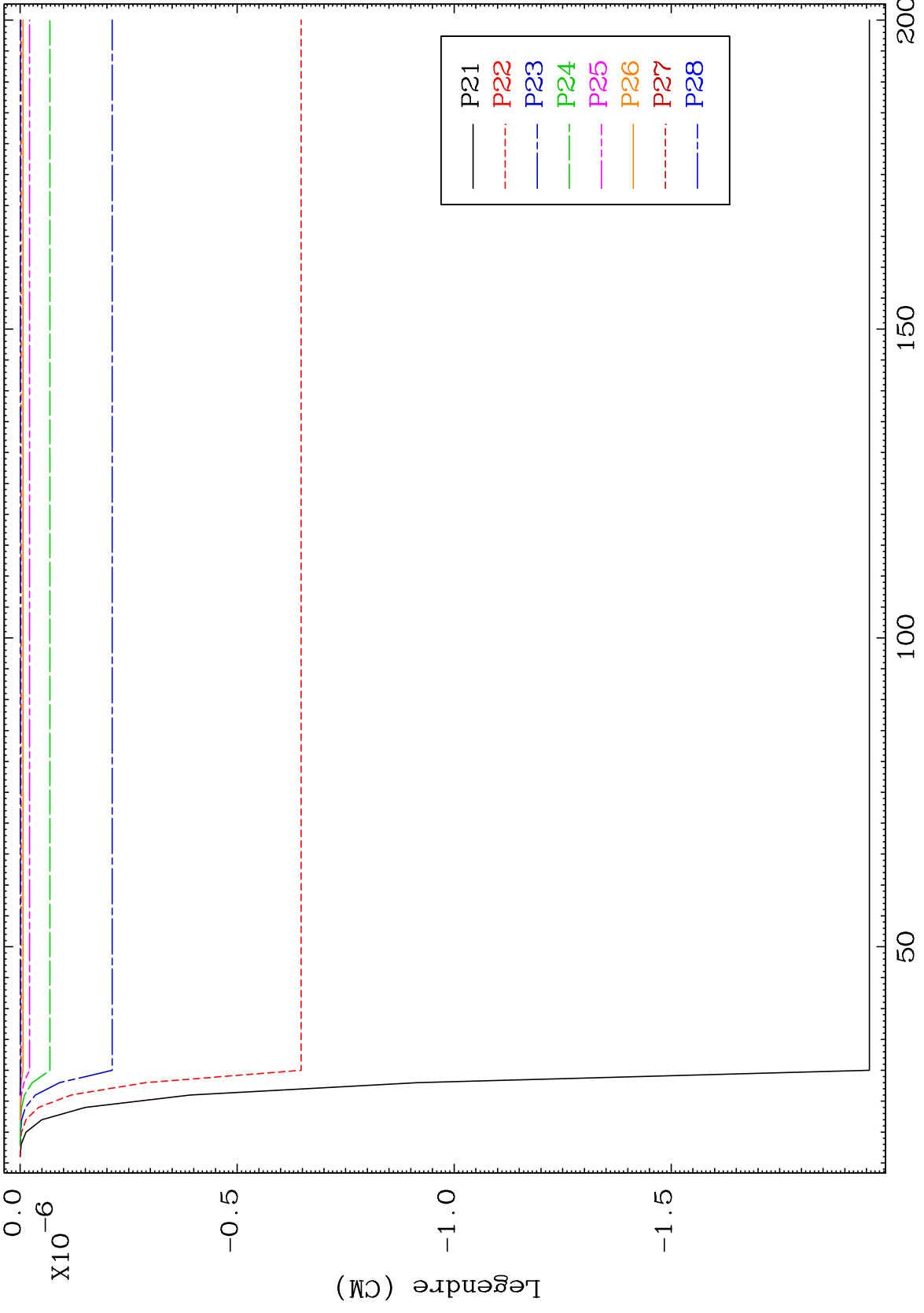

76 11-Na-22

MAT 1122 MT= 73 (n,n') Level Legendre Coefficients 11-Na-22

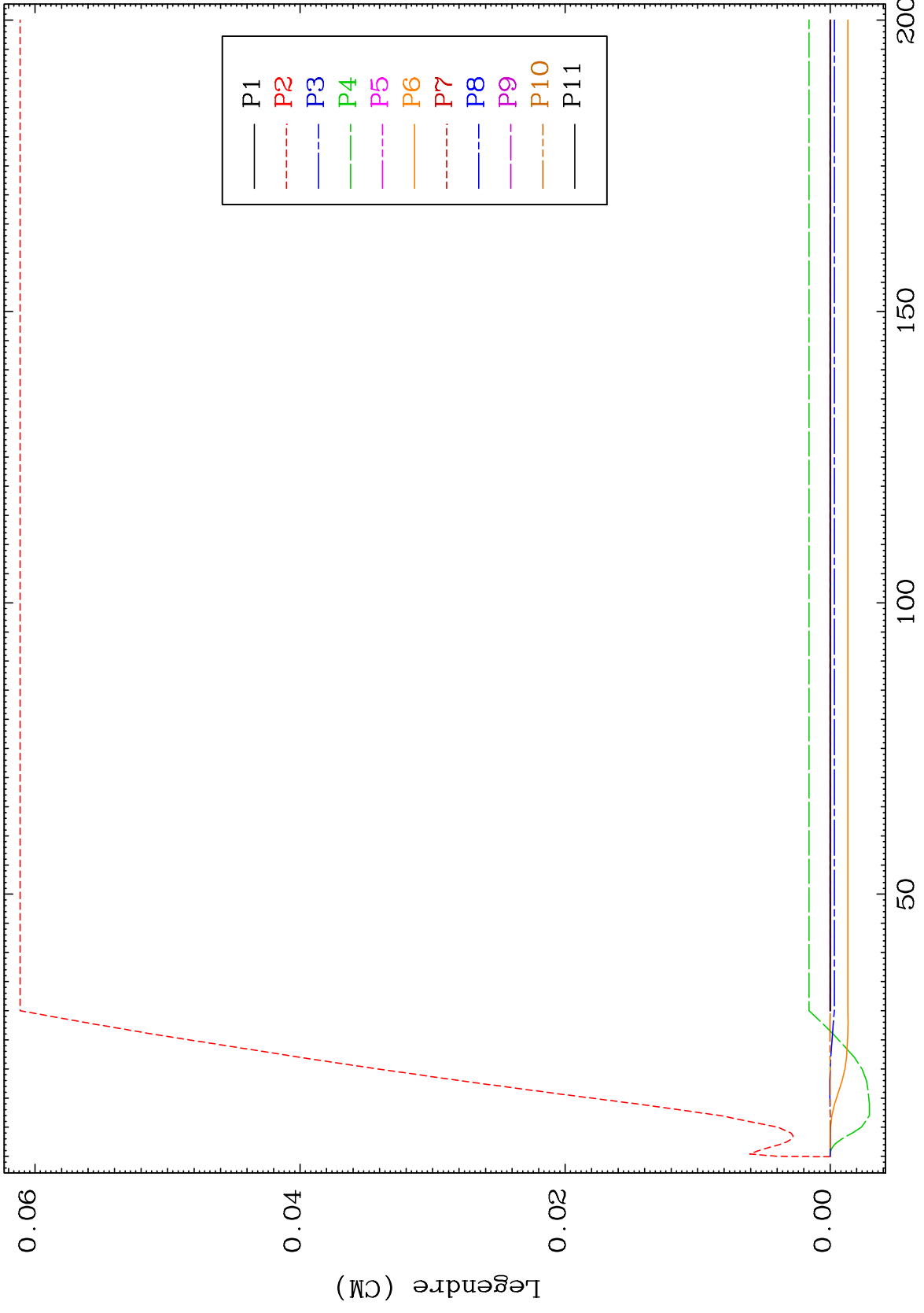

77 11-Na-22

MAT 1122

MT= 73 (n,n') Level
Legendre Coefficients

11-Na-22

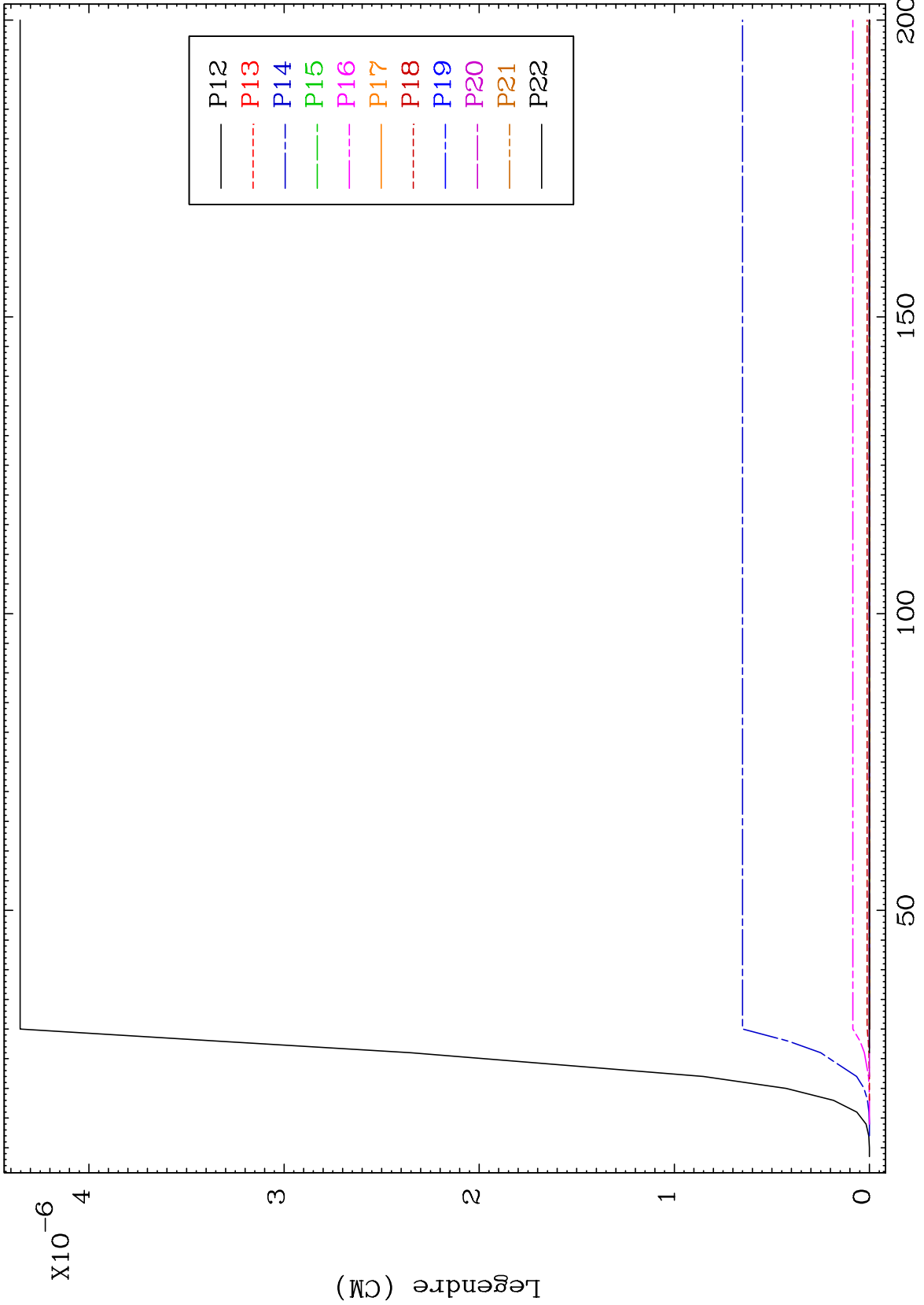

78

Incident Energy (MeV)

11-Na-22

MAT 1122 MT= 74 (n,n') Level Legendre Coefficients 11-Na-22

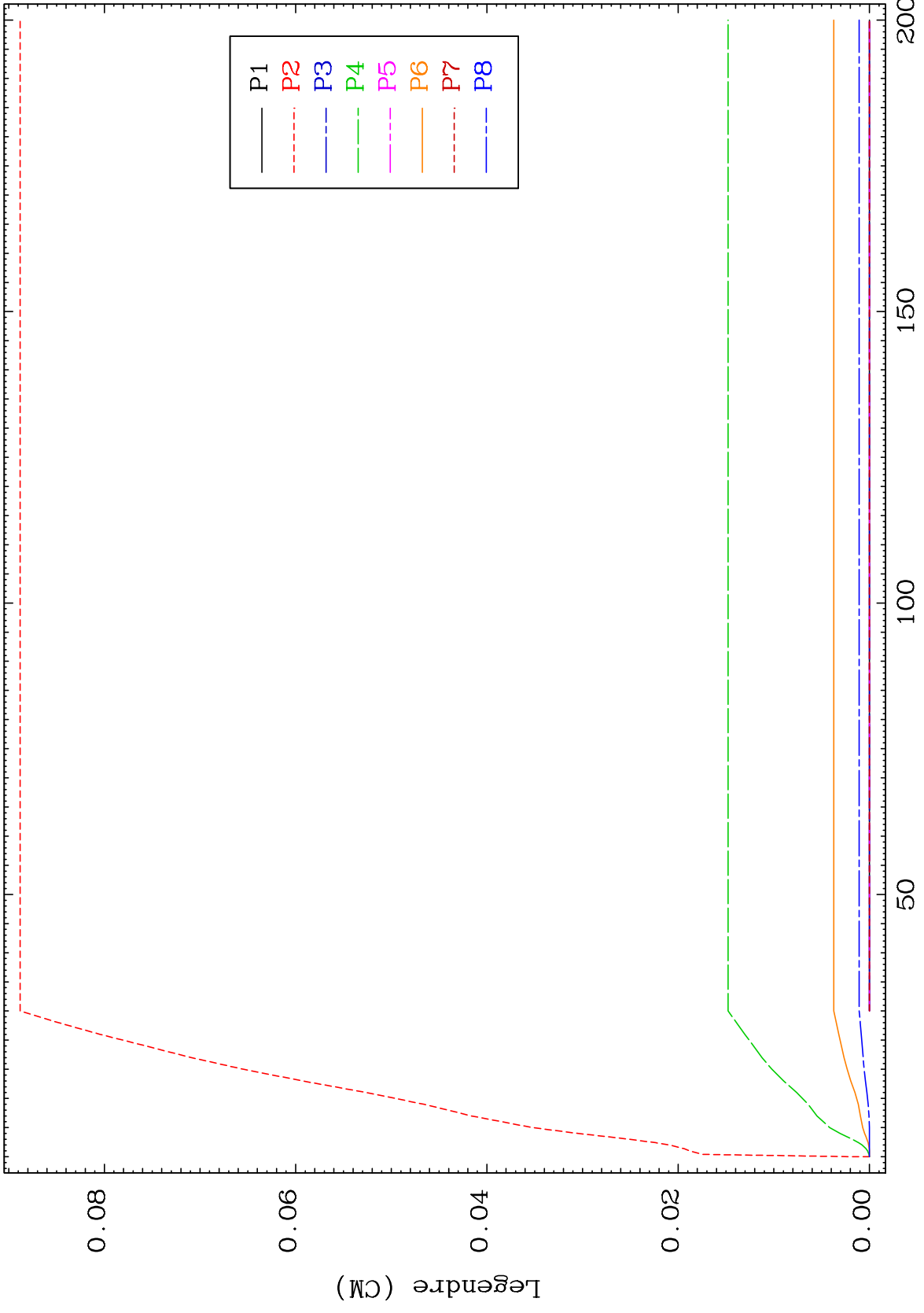

79 11-Na-22

MAT 1122 MT= 74 (n,n') Level Legendre Coefficients 11-Na-22

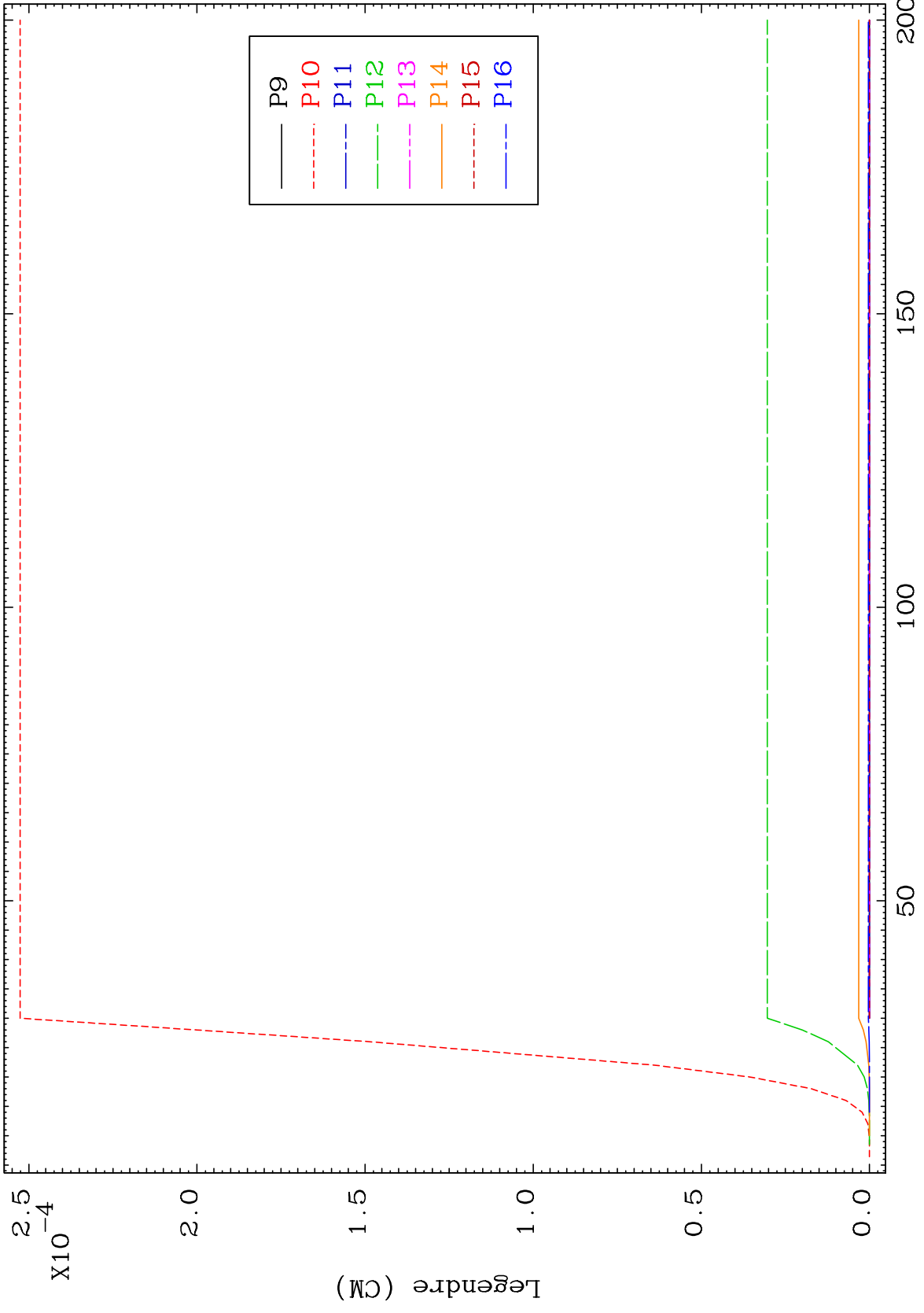

11-Na-22

MAT 1122 MT= 74 (n,n') Level Legendre Coefficients 11-Na-22

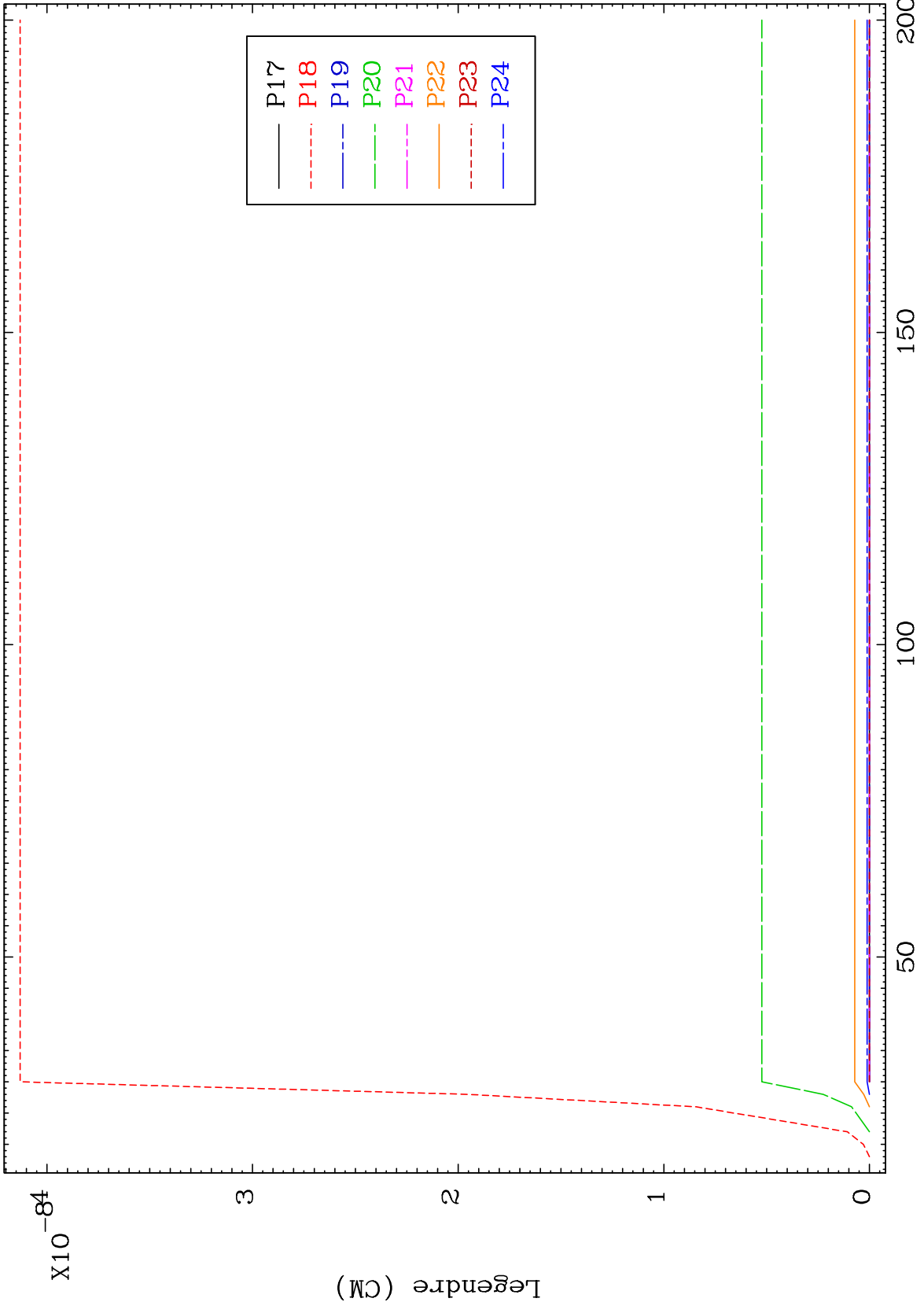

MAT 1122

MT= 75 (n,n') Level
Legendre Coefficients

11-Na-22

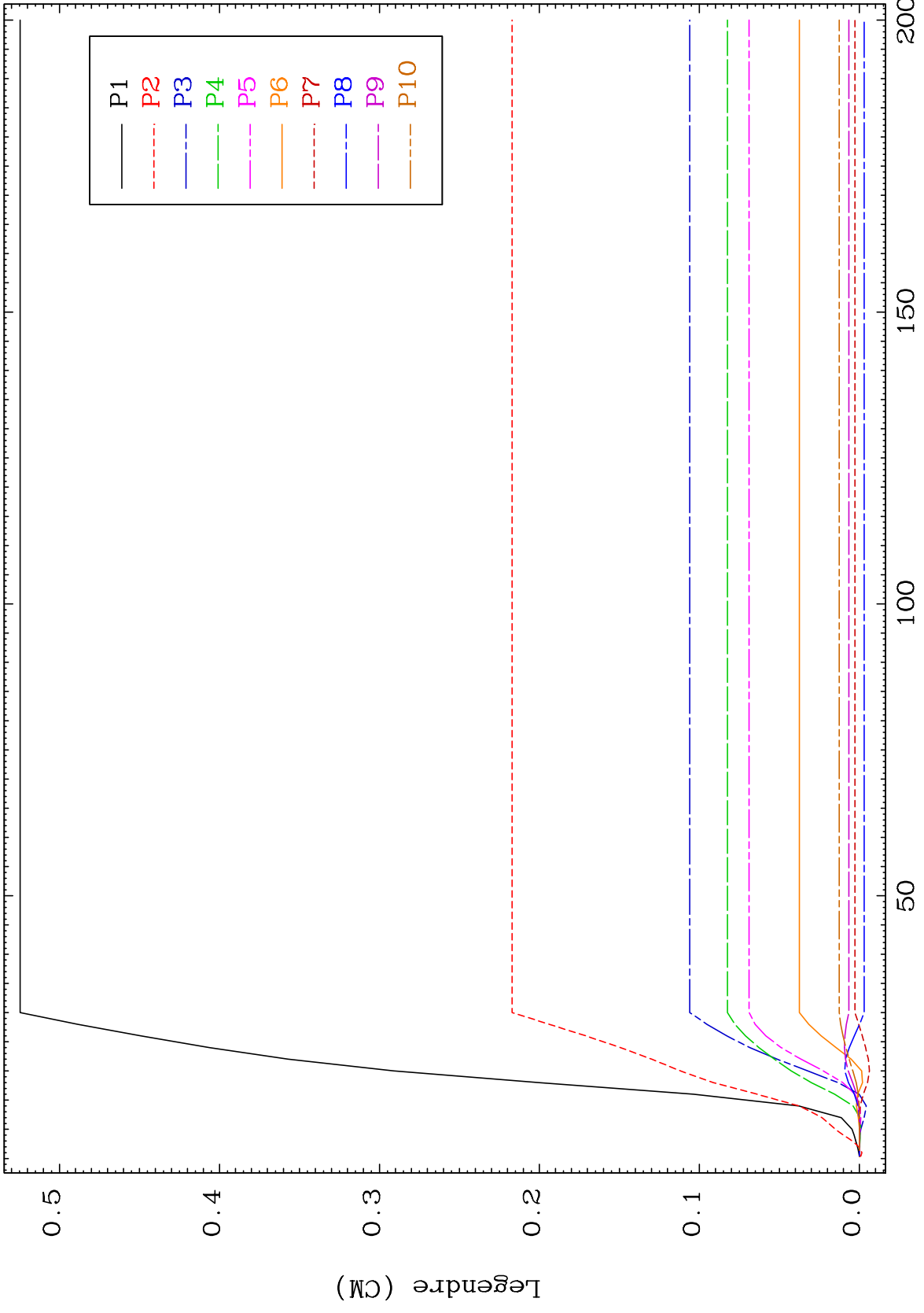

82

Incident Energy (MeV)

11-Na-22

MAT 1122

MT= 75 (n,n') Level
Legendre Coefficients

11-Na-22

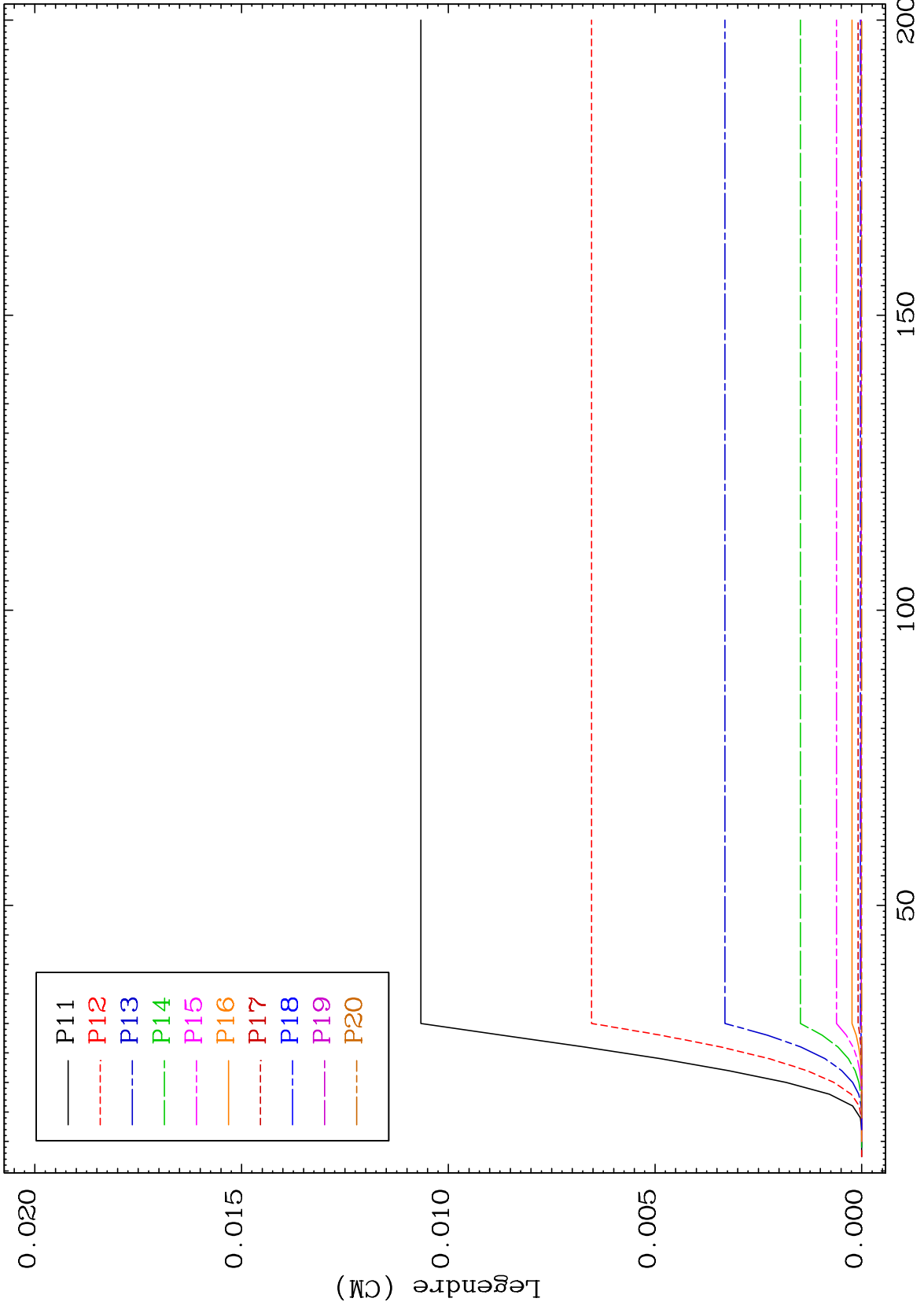

83

11-Na-22

MAT 1122 MT= 75 (n,n') Level Legendre Coefficients 11-Na-22

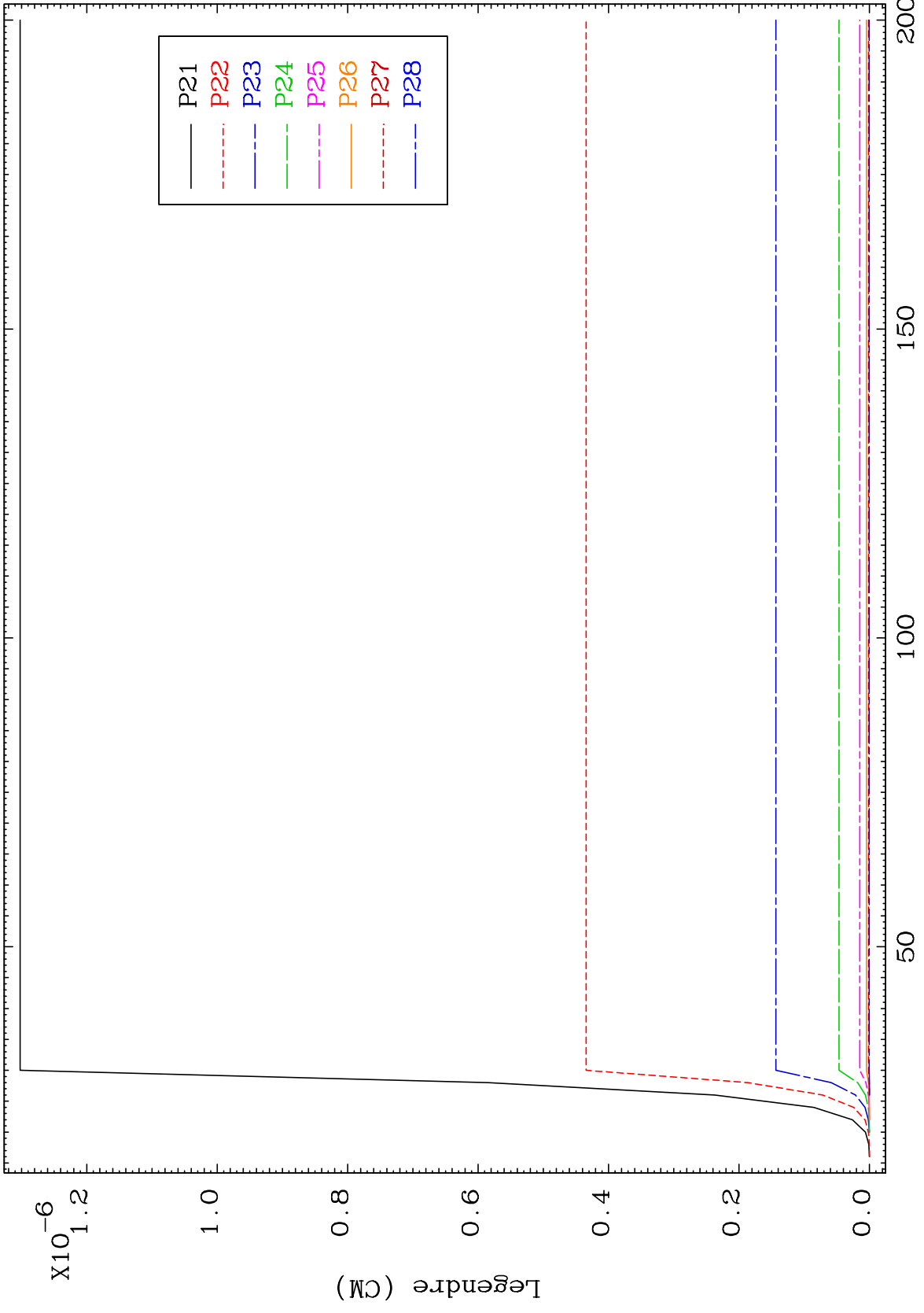

MAT 1122

MT= 76 (n,n') Level
Legendre Coefficients

11-Na-22

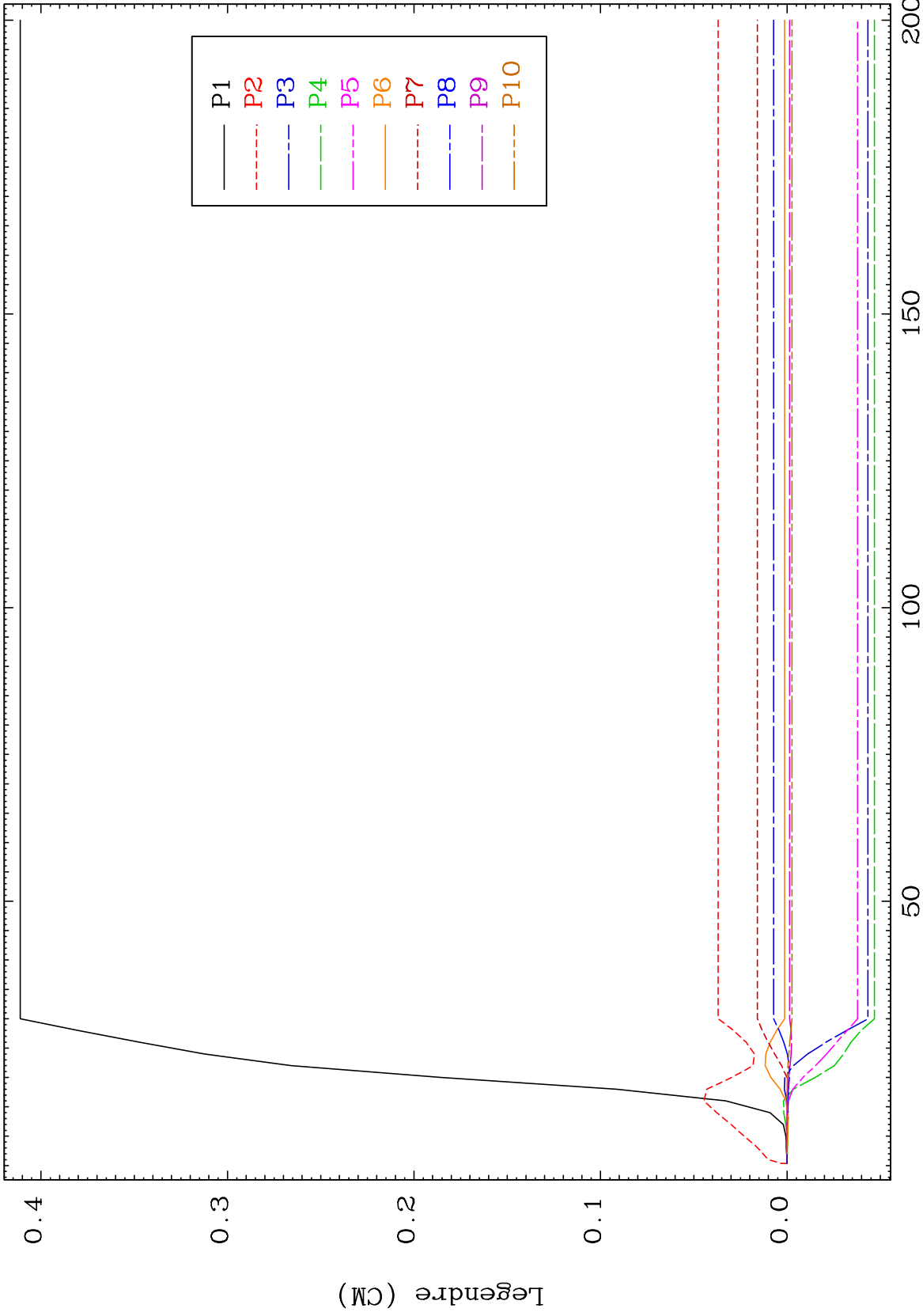

85

Incident Energy (MeV)

11-Na-22

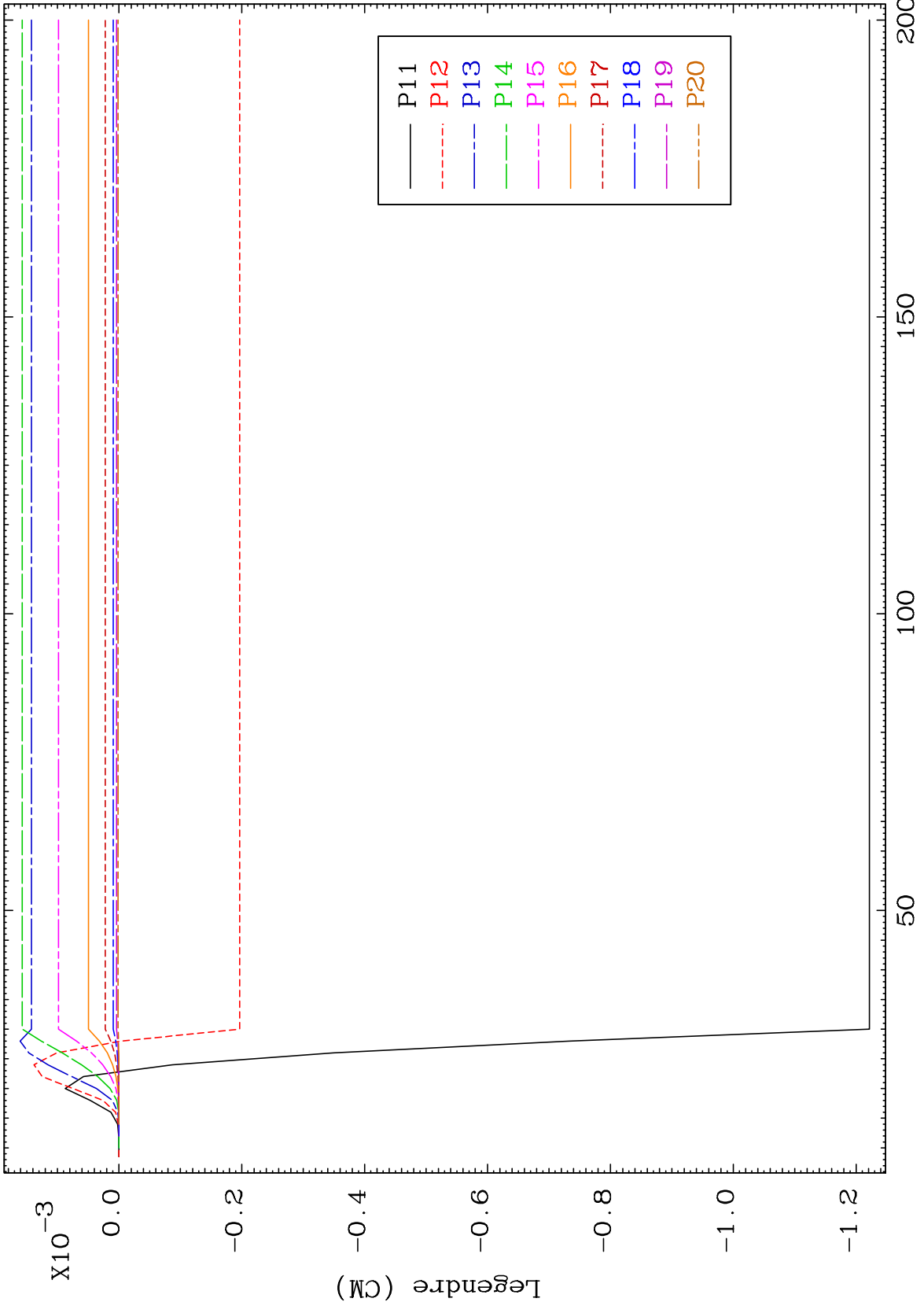

MAT 1122

MT= 76 (n,n') Level
Legendre Coefficients

11-Na-22

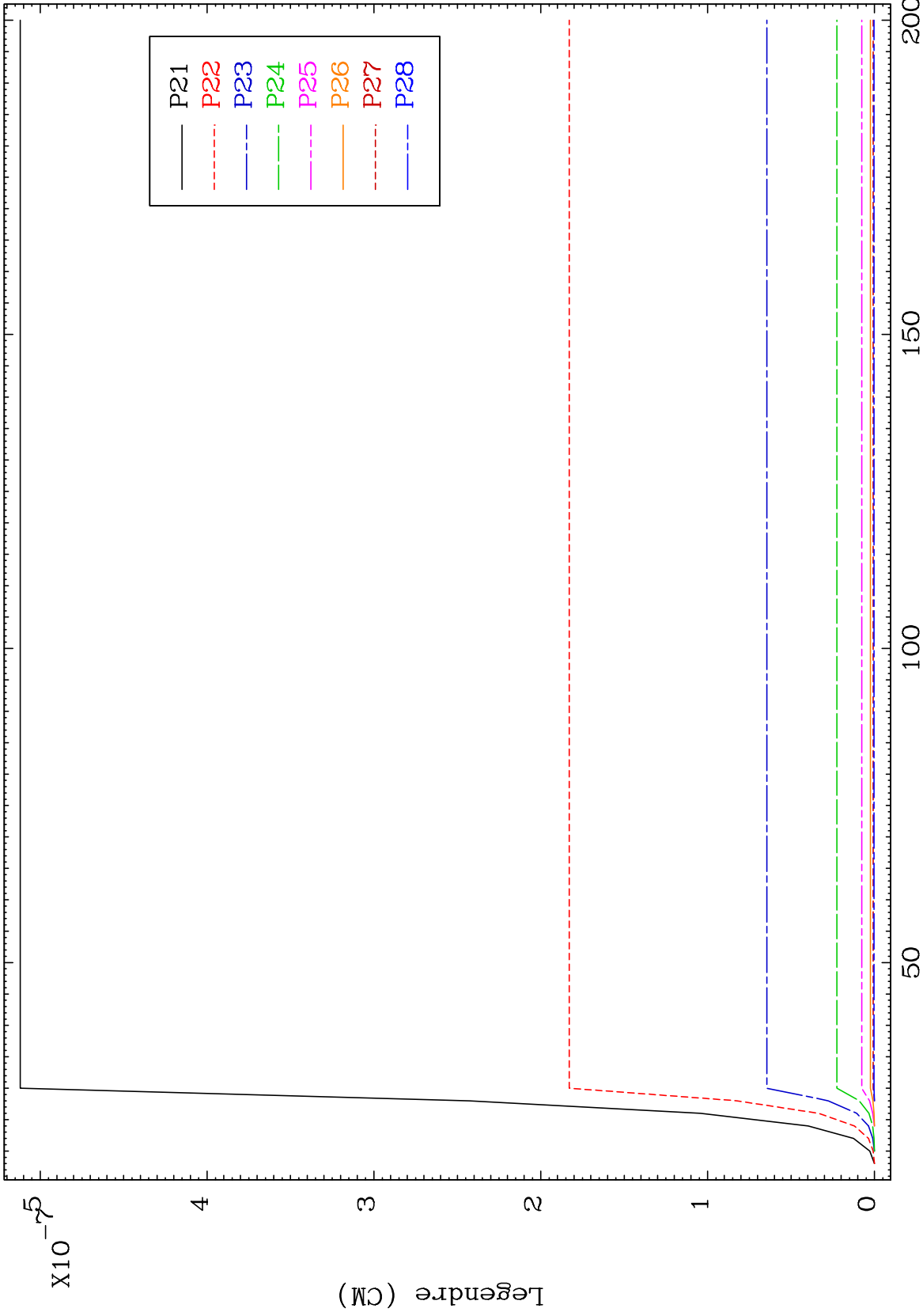

87

11-Na-22