

NB084 NEUTRON ACER TENDL-2019 LIBRARY; T=293.16K
Principal cross sections

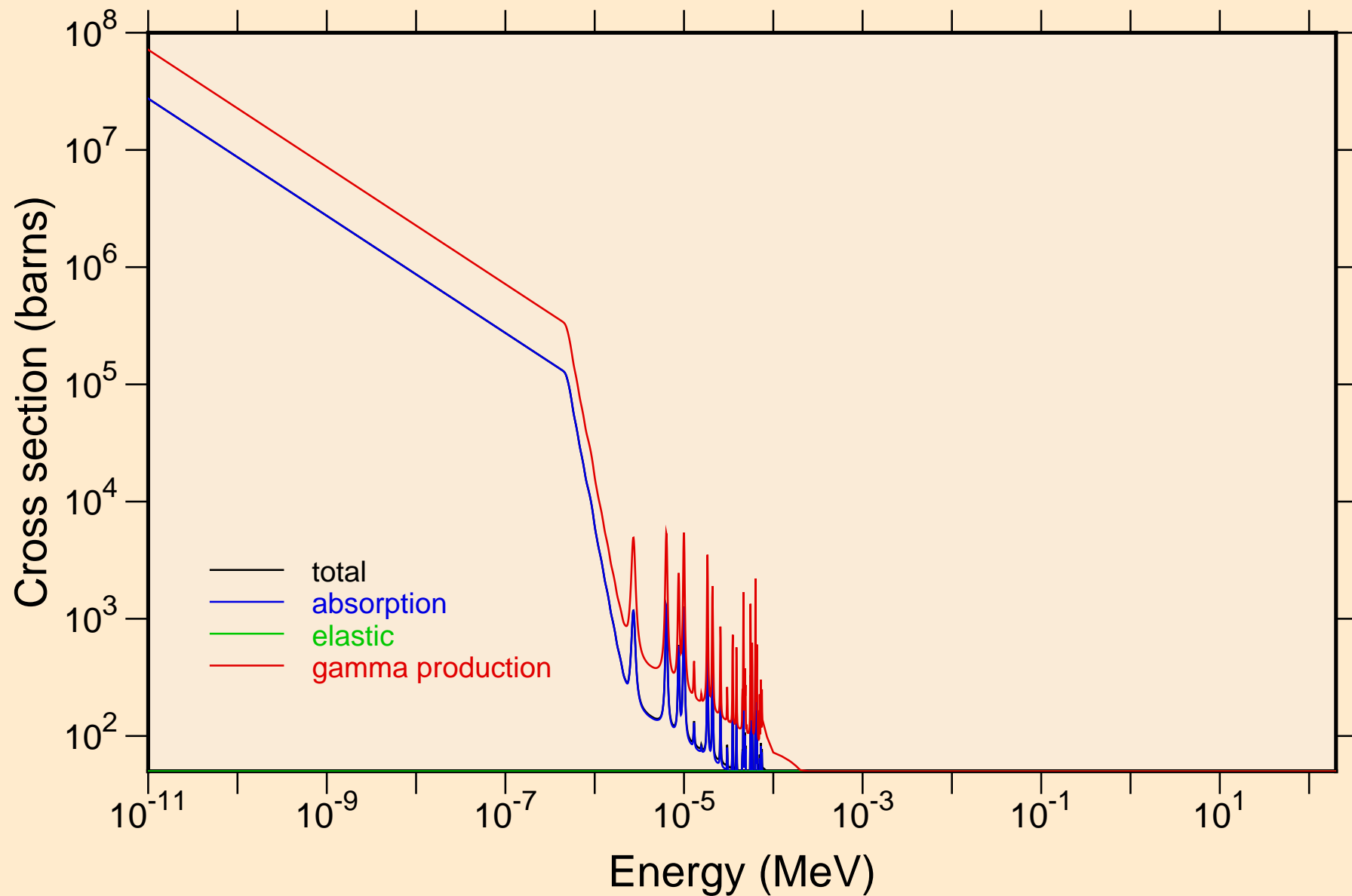

NB084 NEUTRON ACER TENDL-2019 LIBRARY; T=293.16K
resonance total cross section

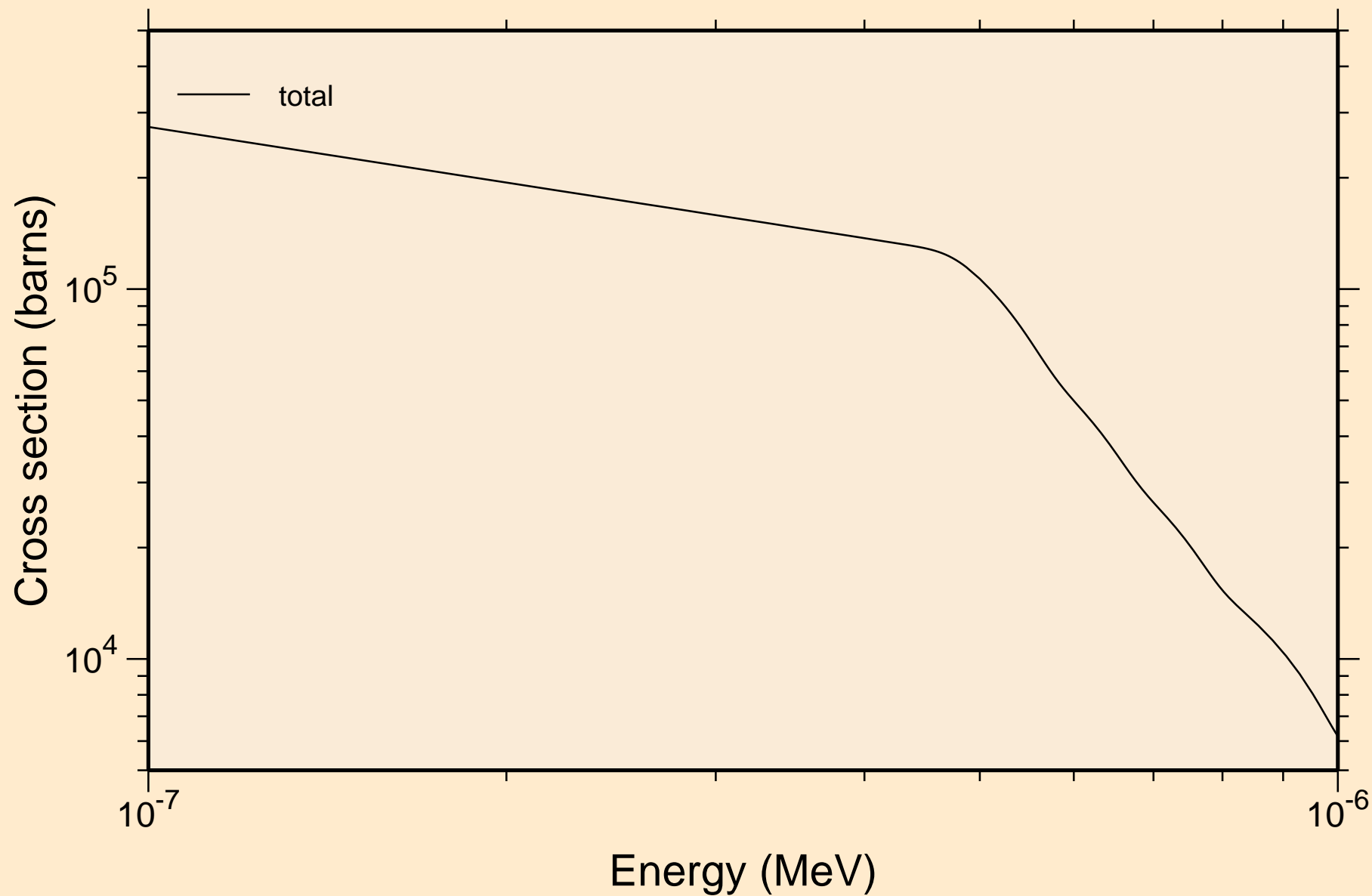

NB084 NEUTRON ACER TENDL-2019 LIBRARY; T=293.16K
resonance total cross section

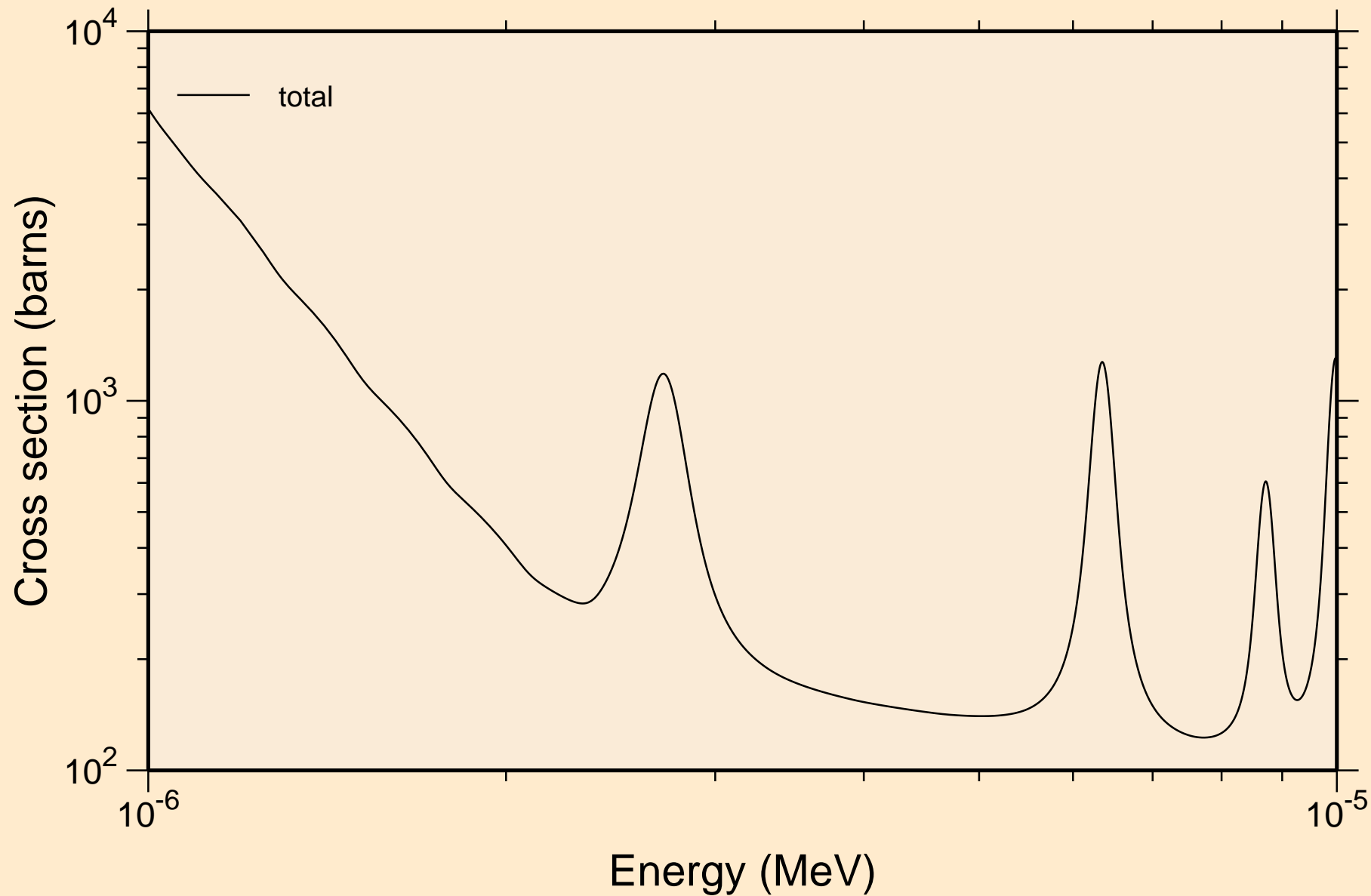

NB084 NEUTRON ACER TENDL-2019 LIBRARY; T=293.16K
resonance total cross section

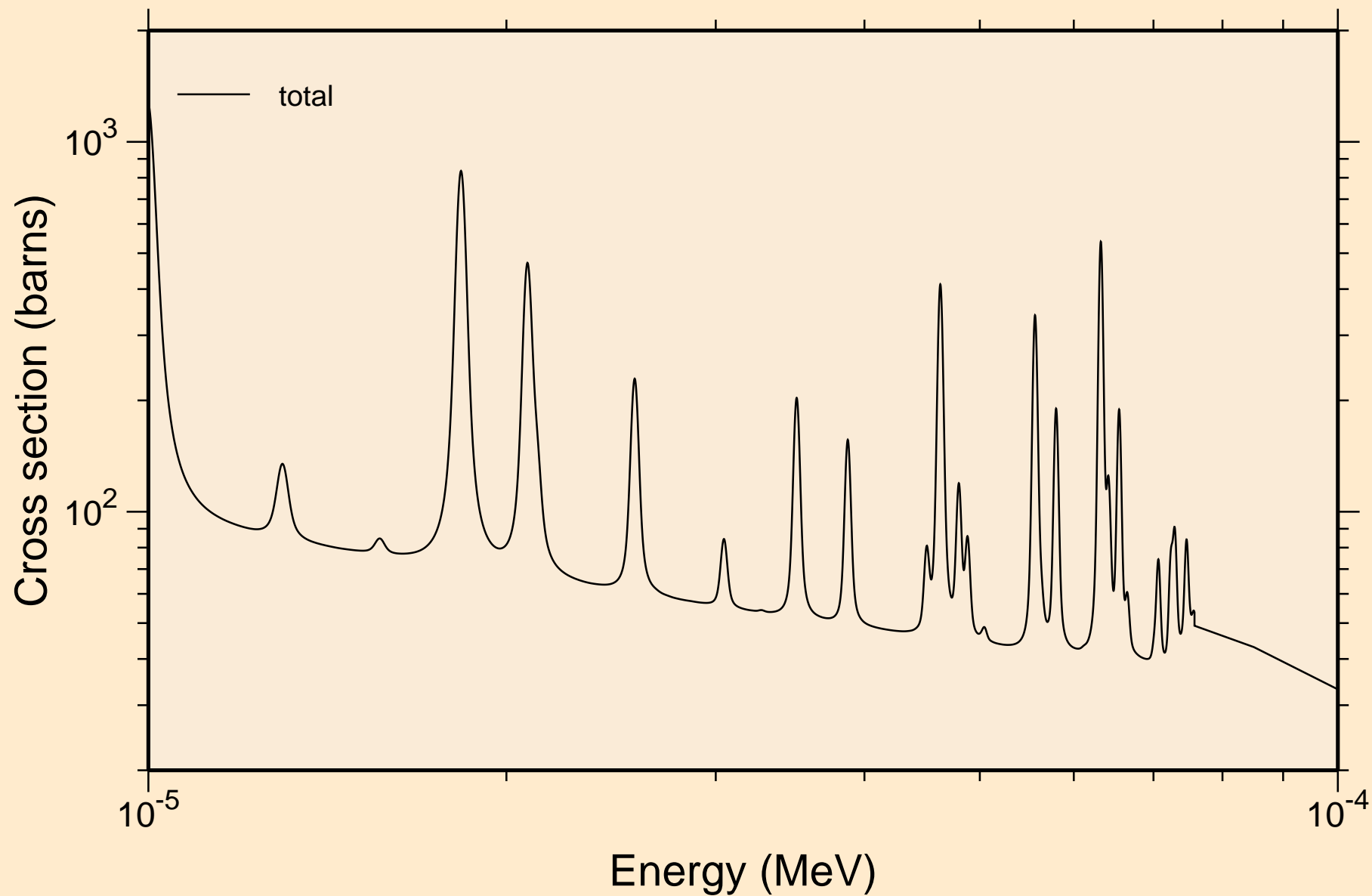

NB084 NEUTRON ACER TENDL-2019 LIBRARY; T=293.16K
resonance total cross section

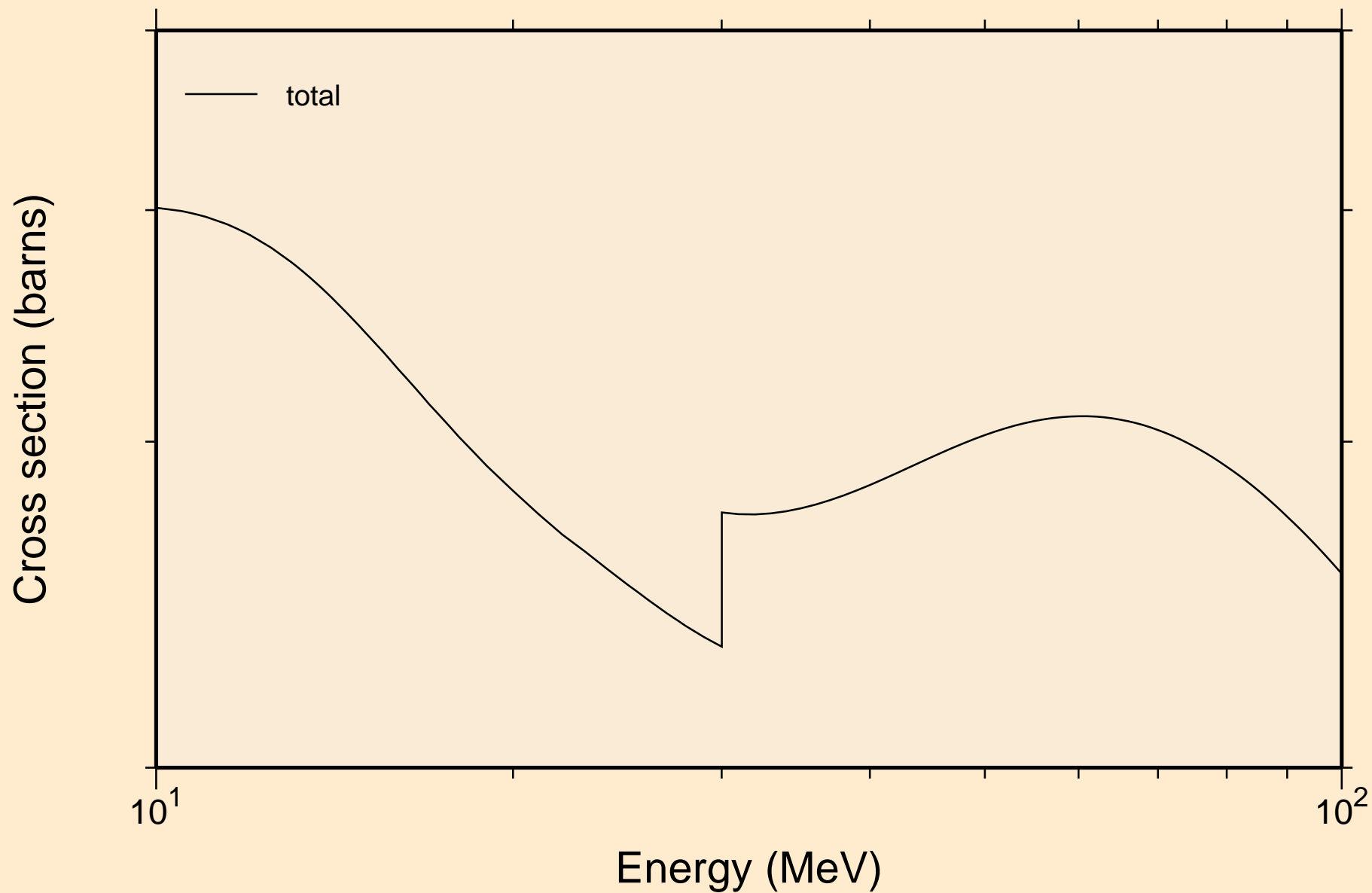

NB084 NEUTRON ACER TENDL-2019 LIBRARY; T=293.16K
resonance absorption cross sections

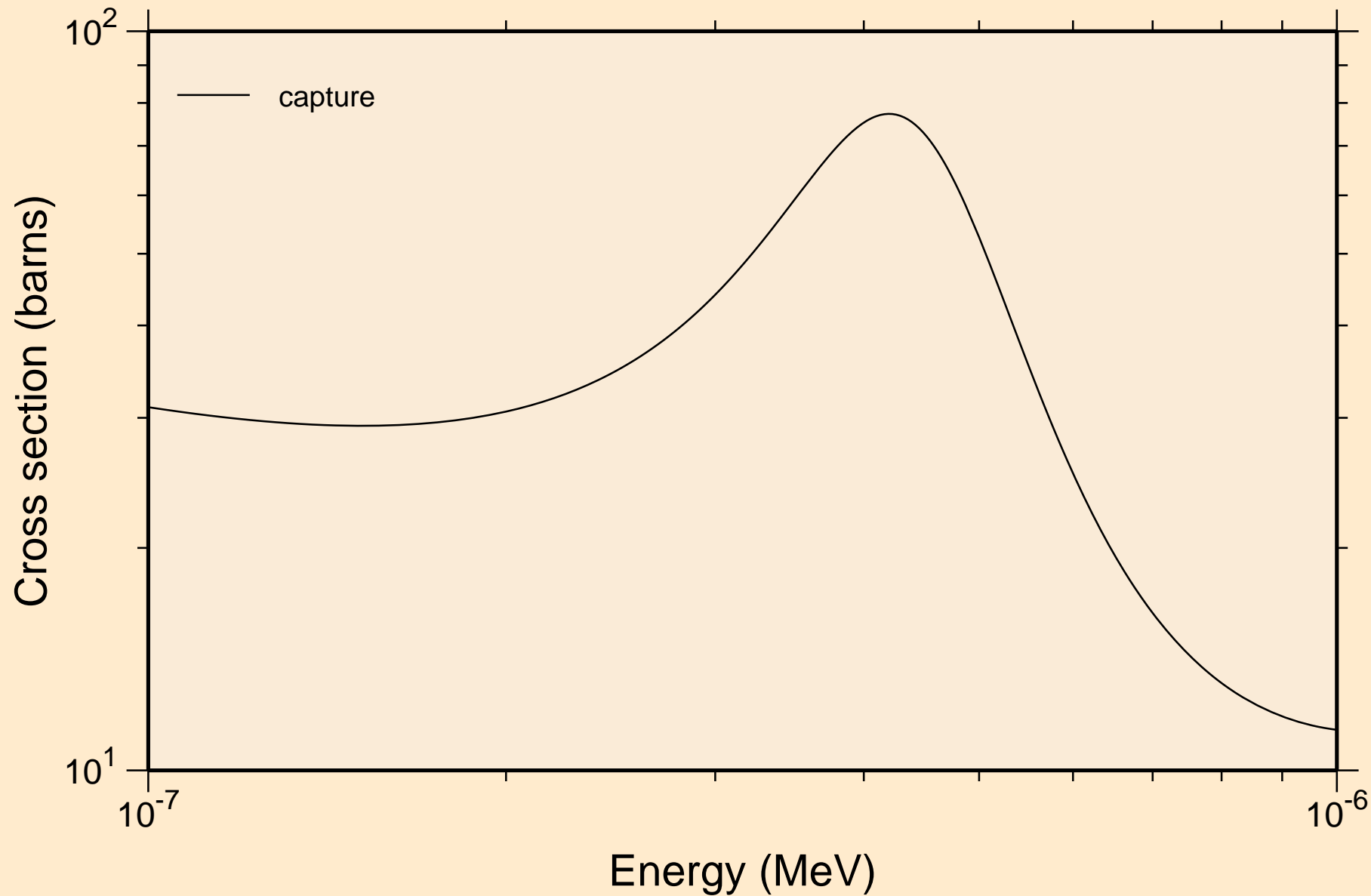

NB084 NEUTRON ACER TENDL-2019 LIBRARY; T=293.16K
resonance absorption cross sections

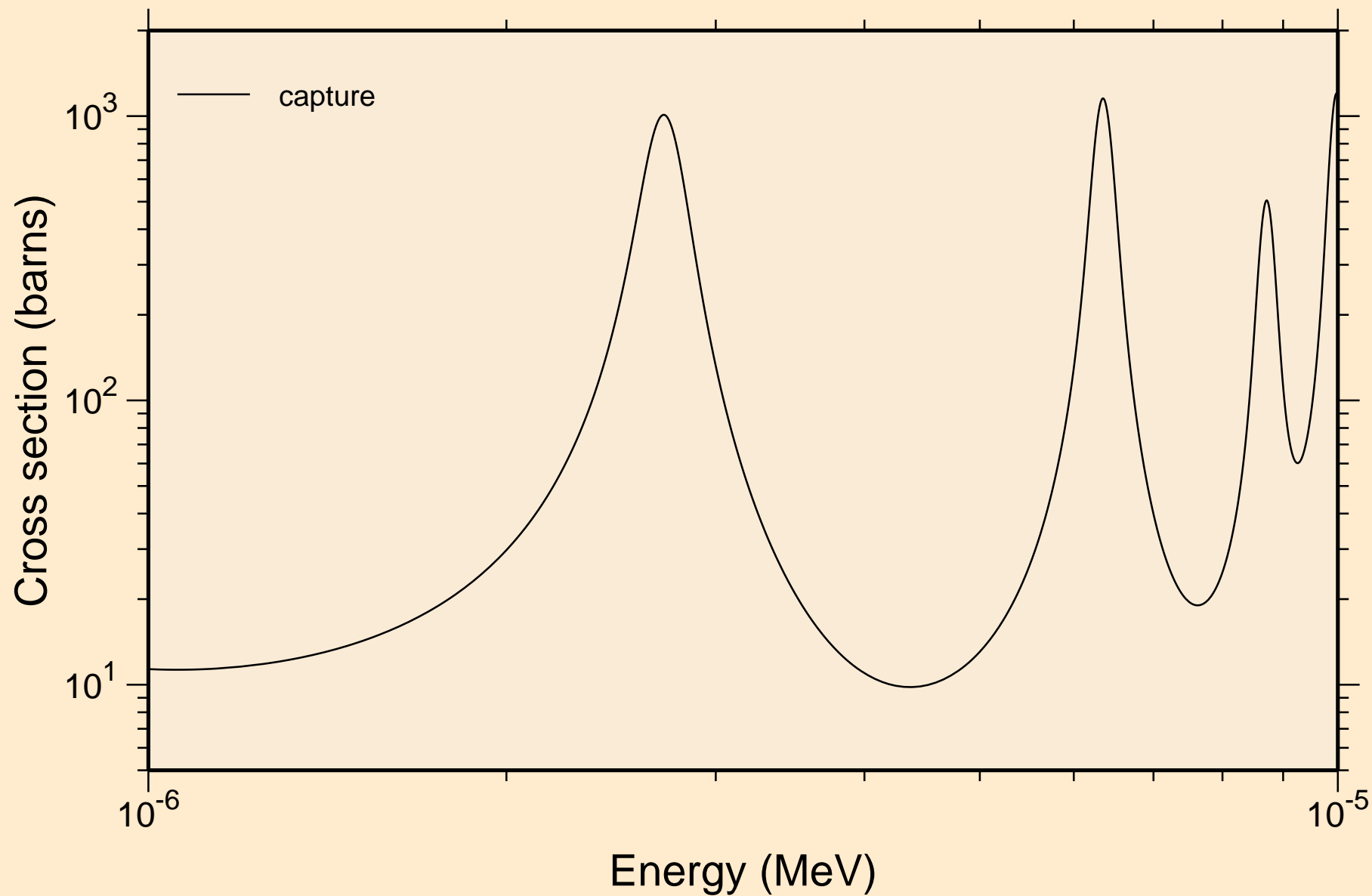

NB084 NEUTRON ACER TENDL-2019 LIBRARY; T=293.16K
resonance absorption cross sections

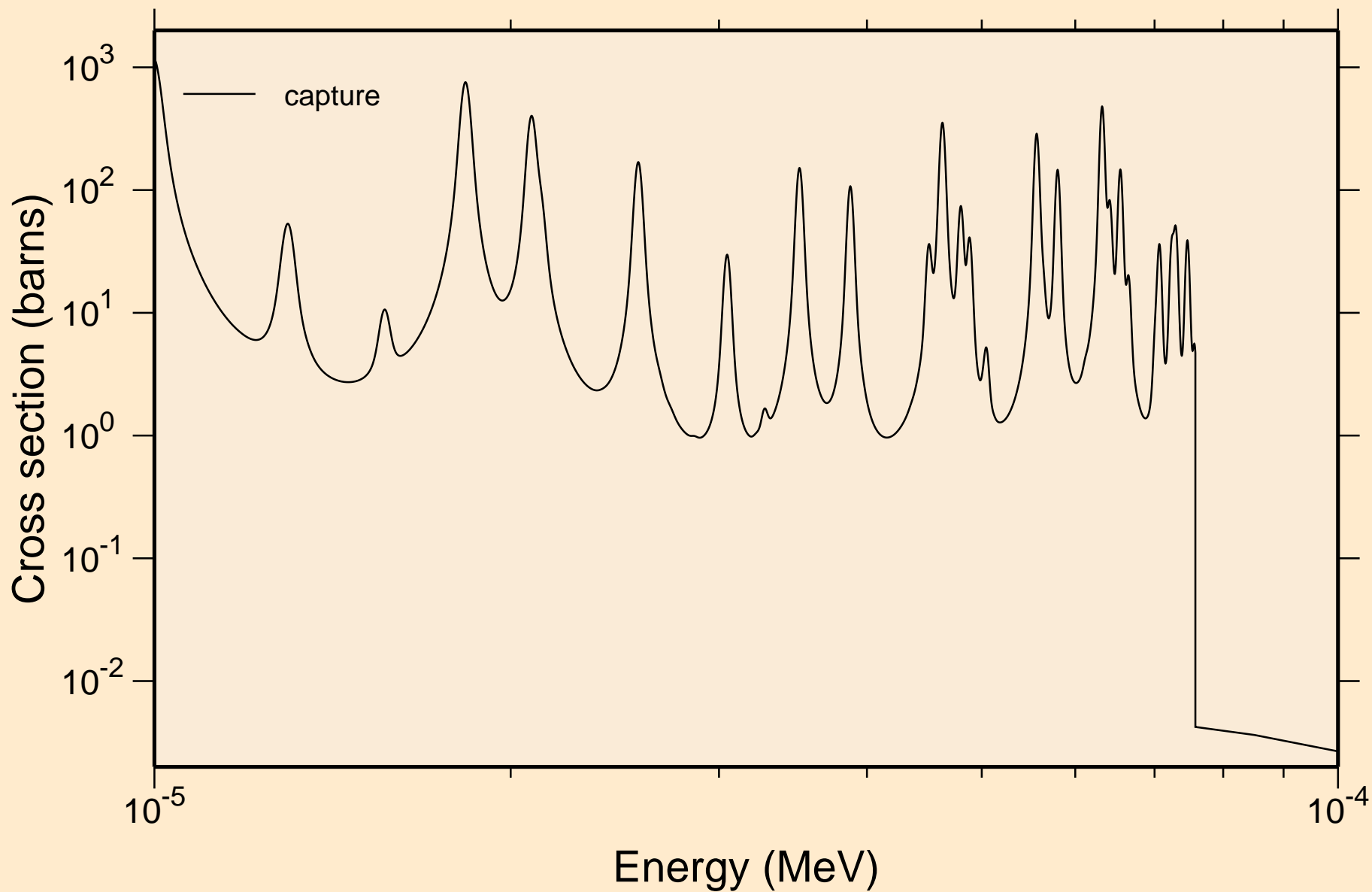

NB084 NEUTRON ACER TENDL-2019 LIBRARY; T=293.16K
resonance absorption cross sections

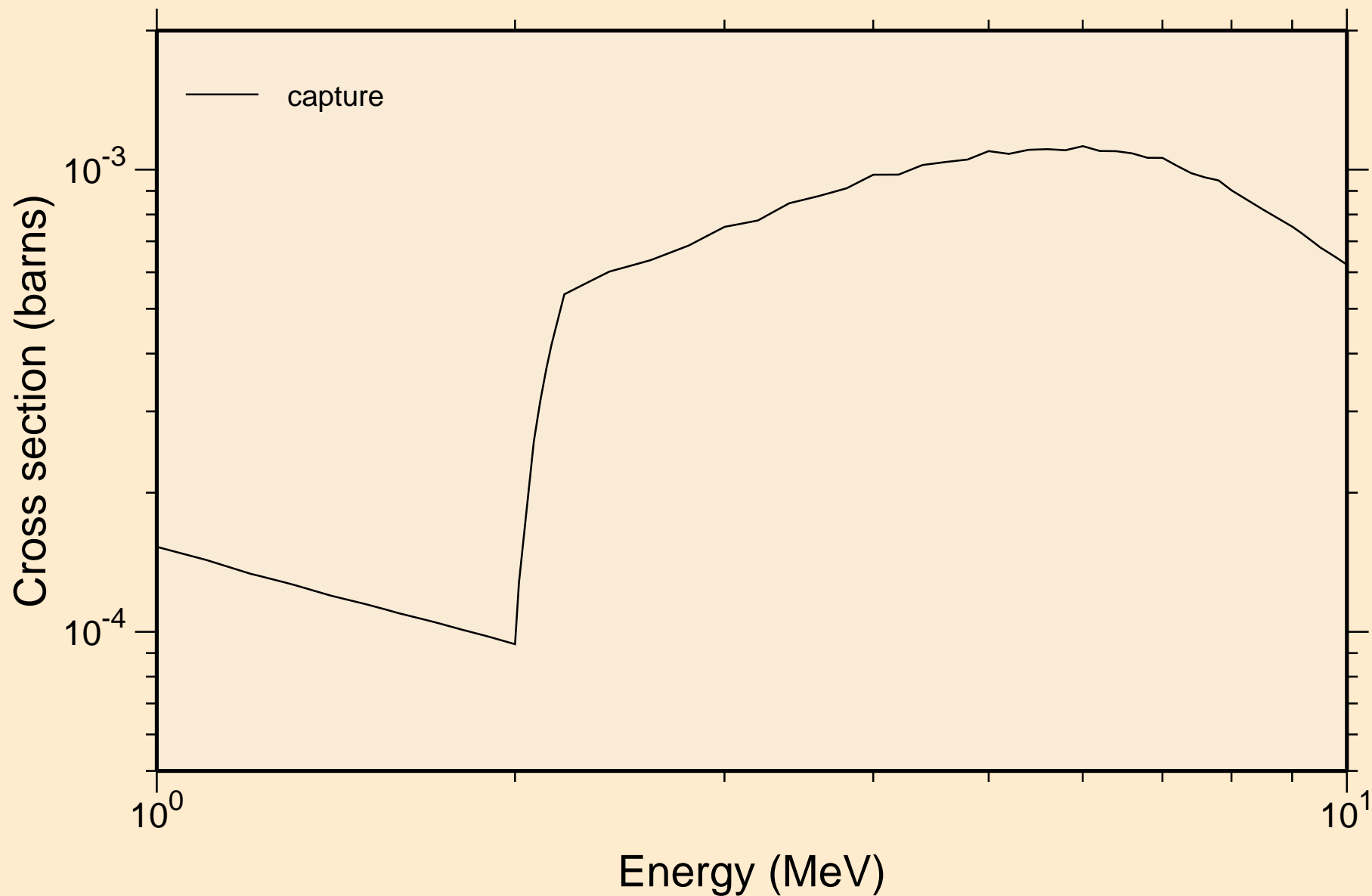

NB084 NEUTRON ACER TENDL-2019 LIBRARY; T=293.16K
Heating

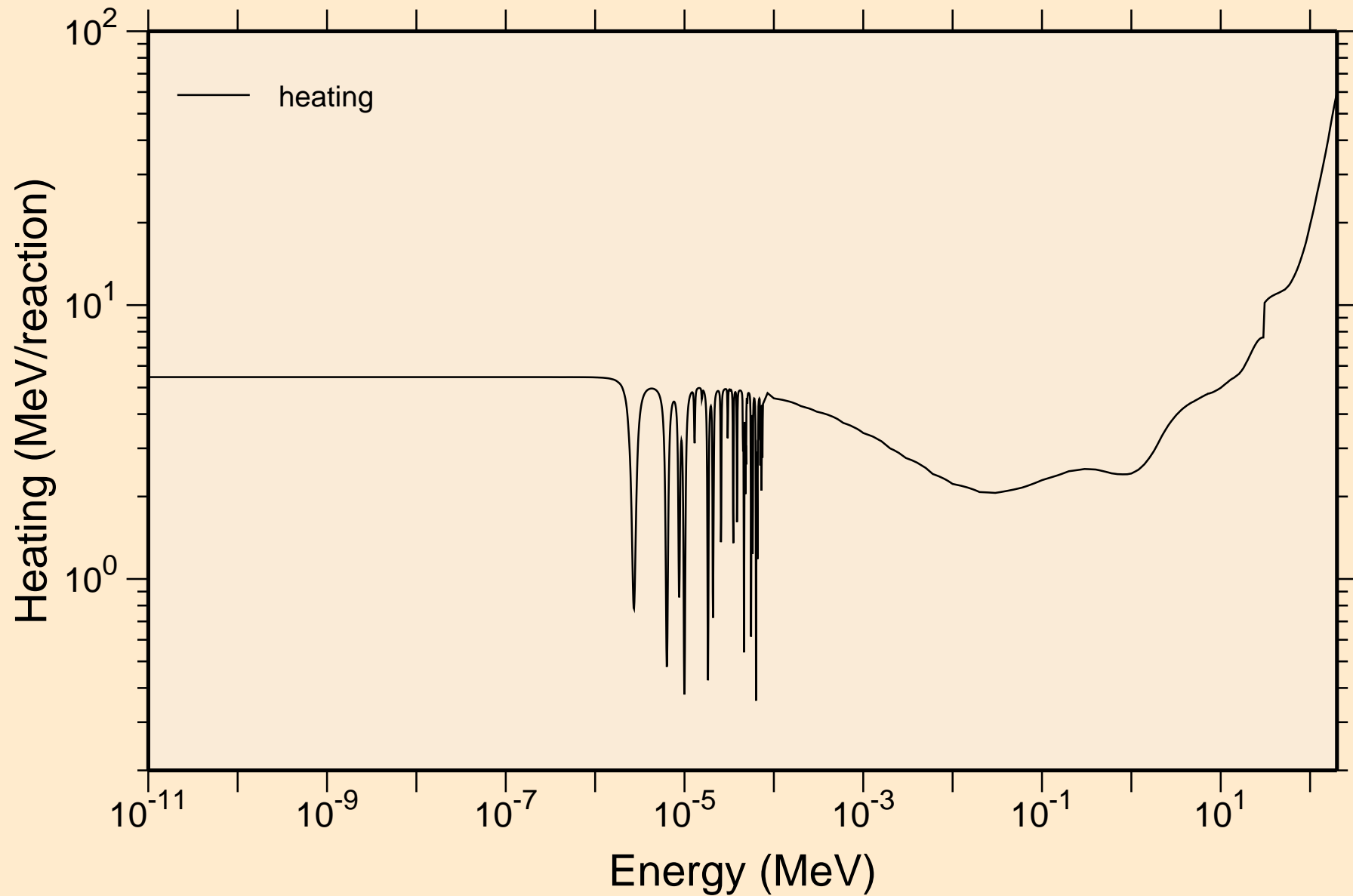

NB084 NEUTRON ACER TENDL-2019 LIBRARY; T=293.16K
Damage

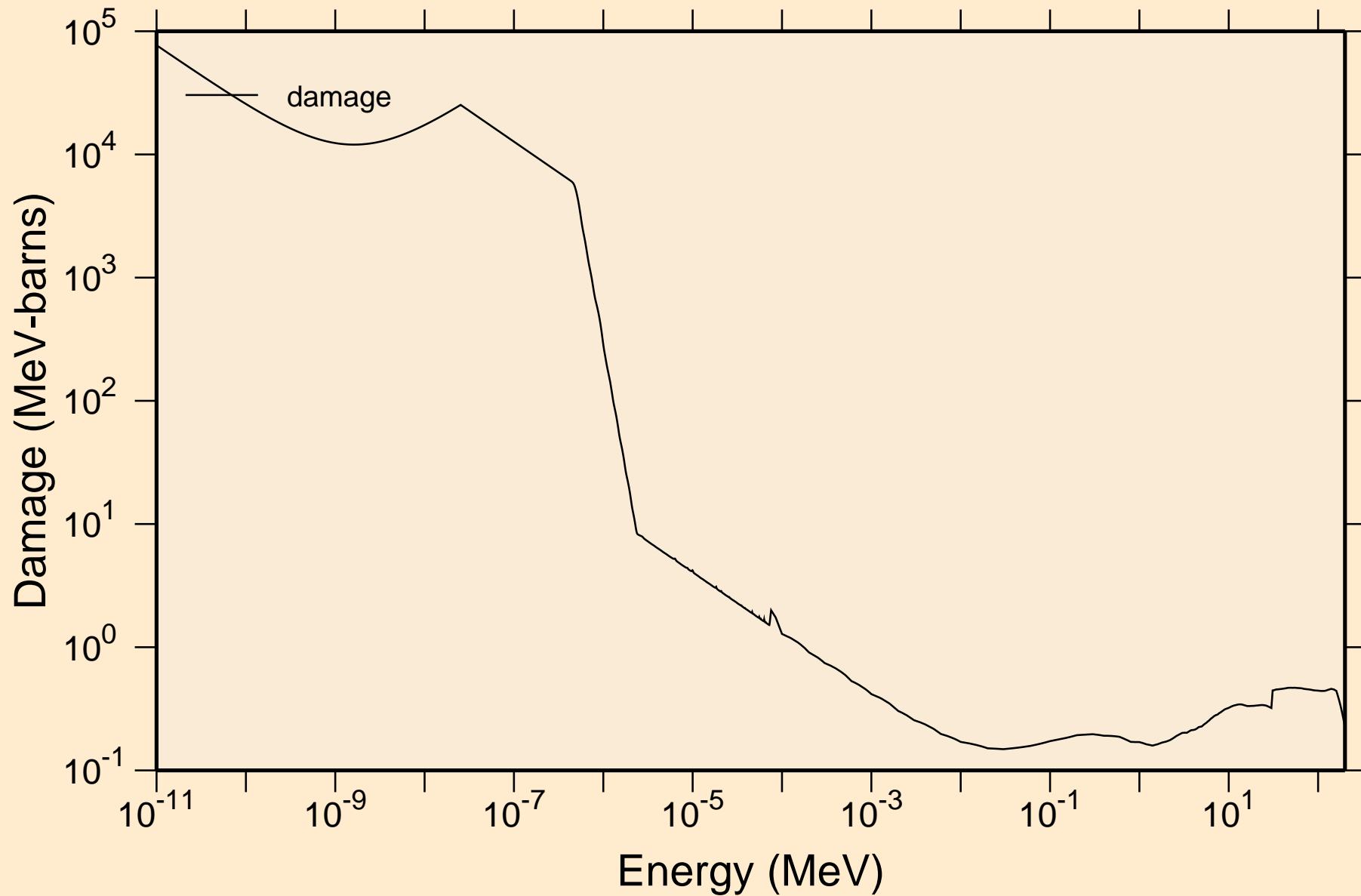

NB084 NEUTRON ACER TENDL-2019 LIBRARY; T=293.16K
Non-threshold reactions

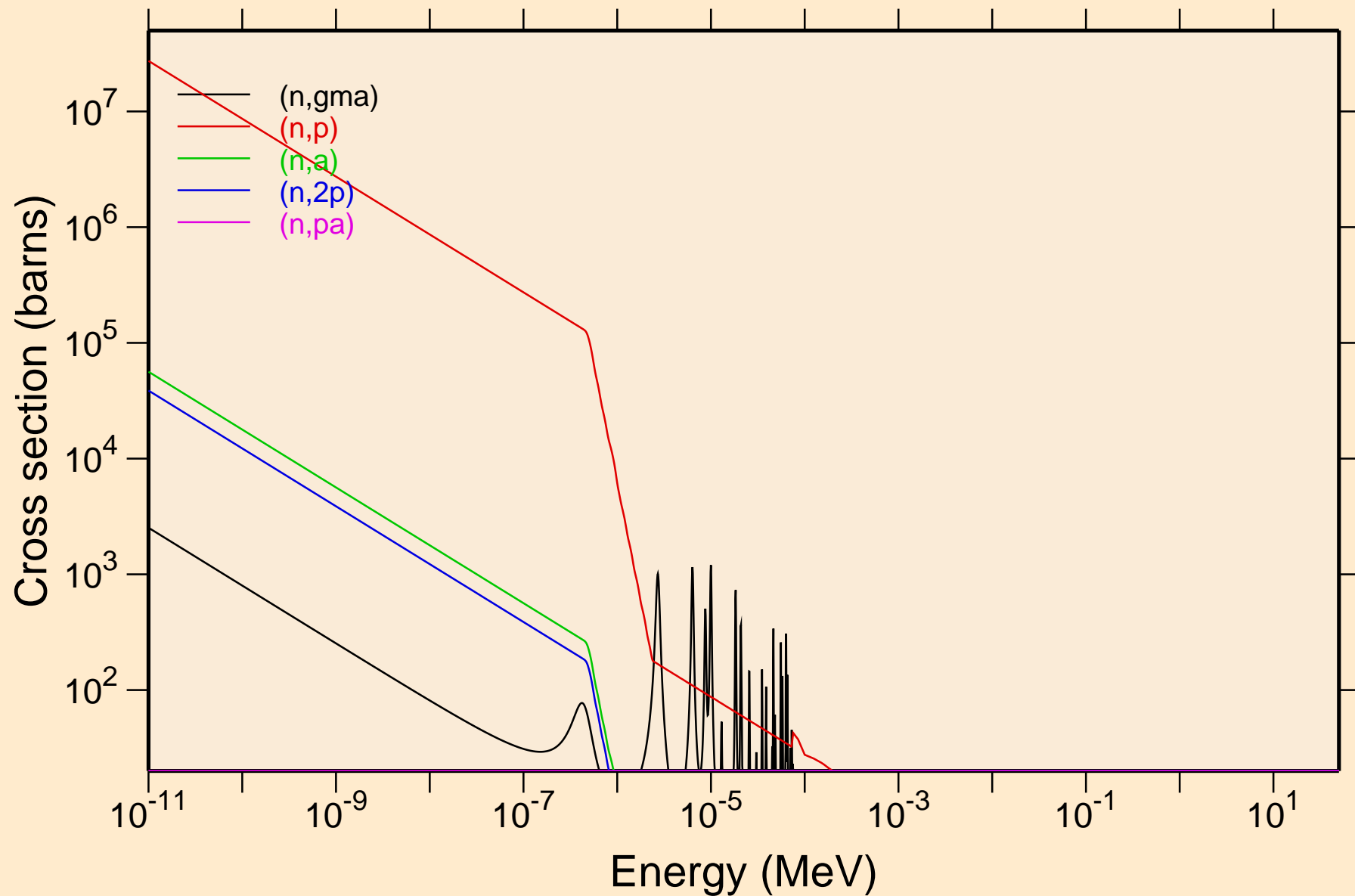

NB084 NEUTRON ACER TENDL-2019 LIBRARY; T=293.16K
Non-threshold reactions

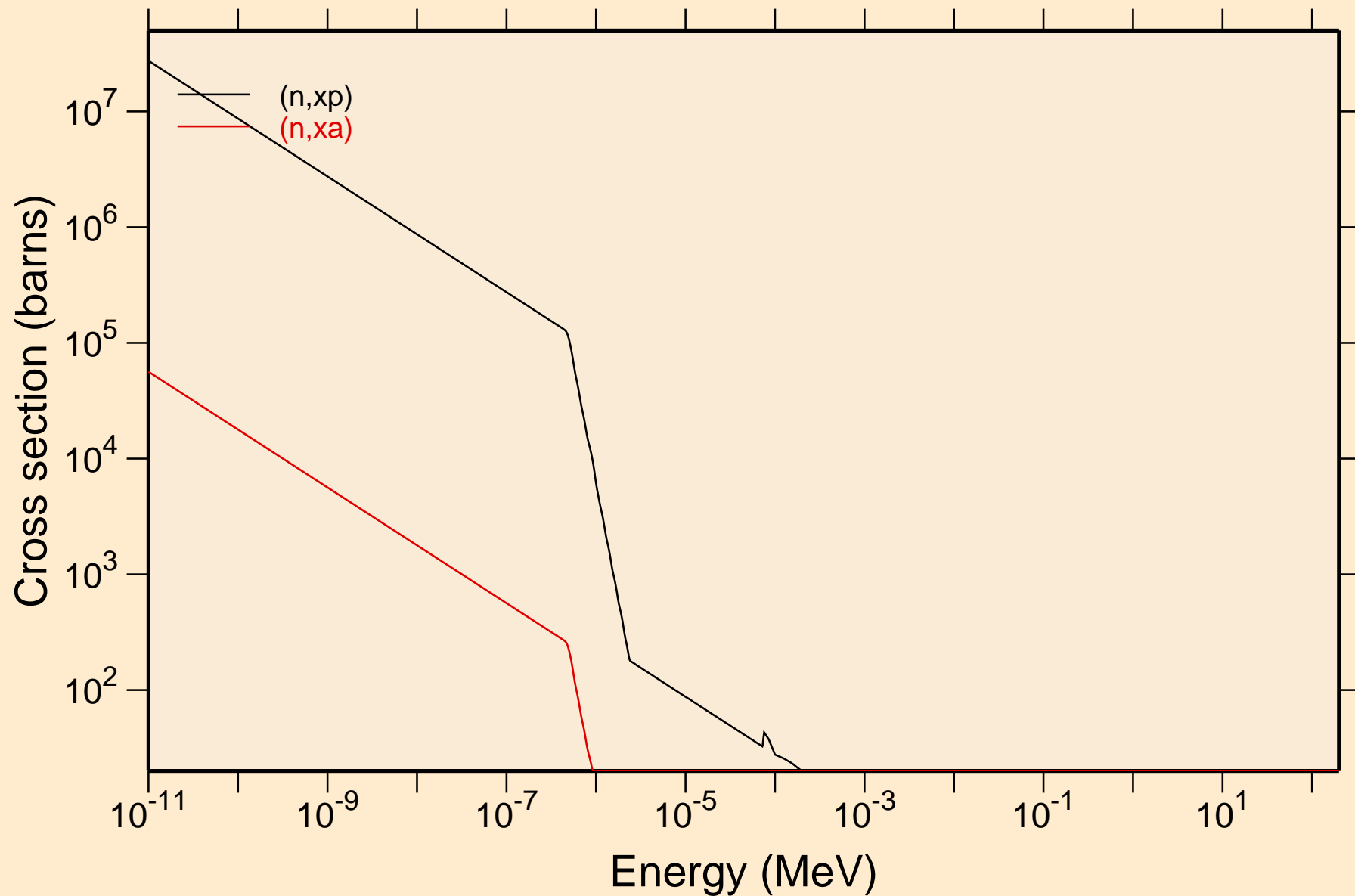

NB084 NEUTRON ACER TENDL-2019 LIBRARY; T=293.16K
Principal cross sections

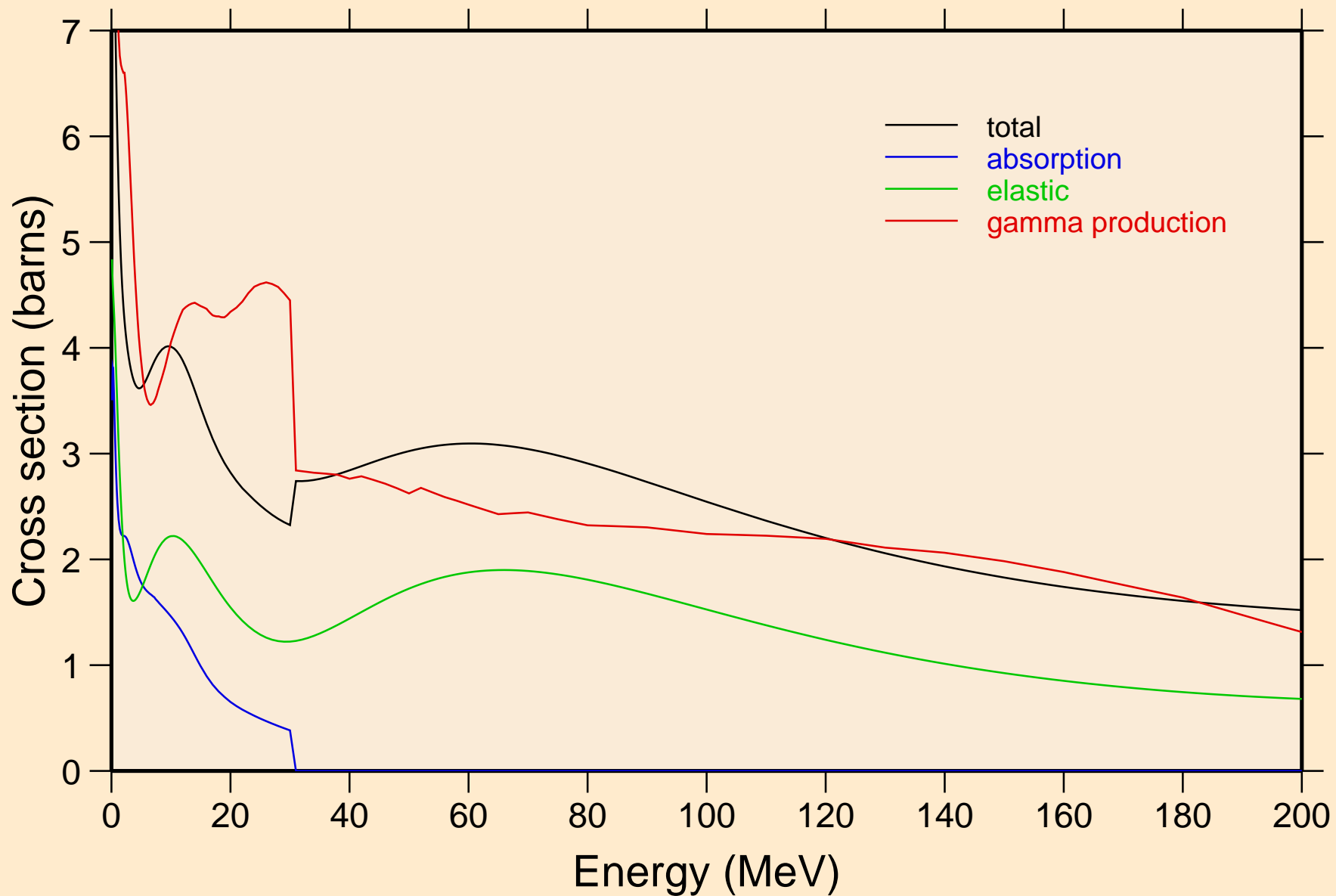

NB084 NEUTRON ACER TENDL-2019 LIBRARY; T=293.16K
Heating

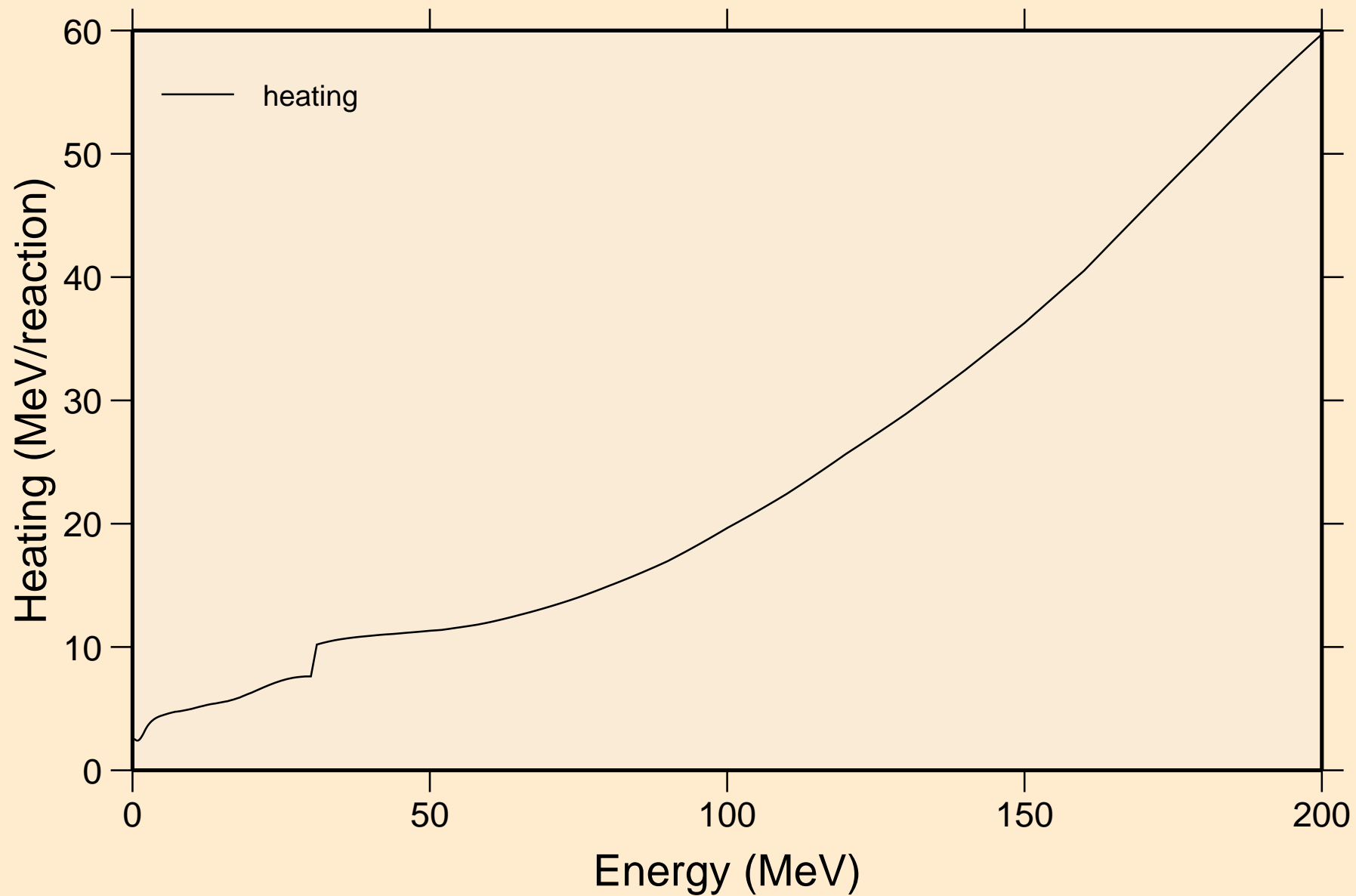

NB084 NEUTRON ACER TENDL-2019 LIBRARY; T=293.16K Damage

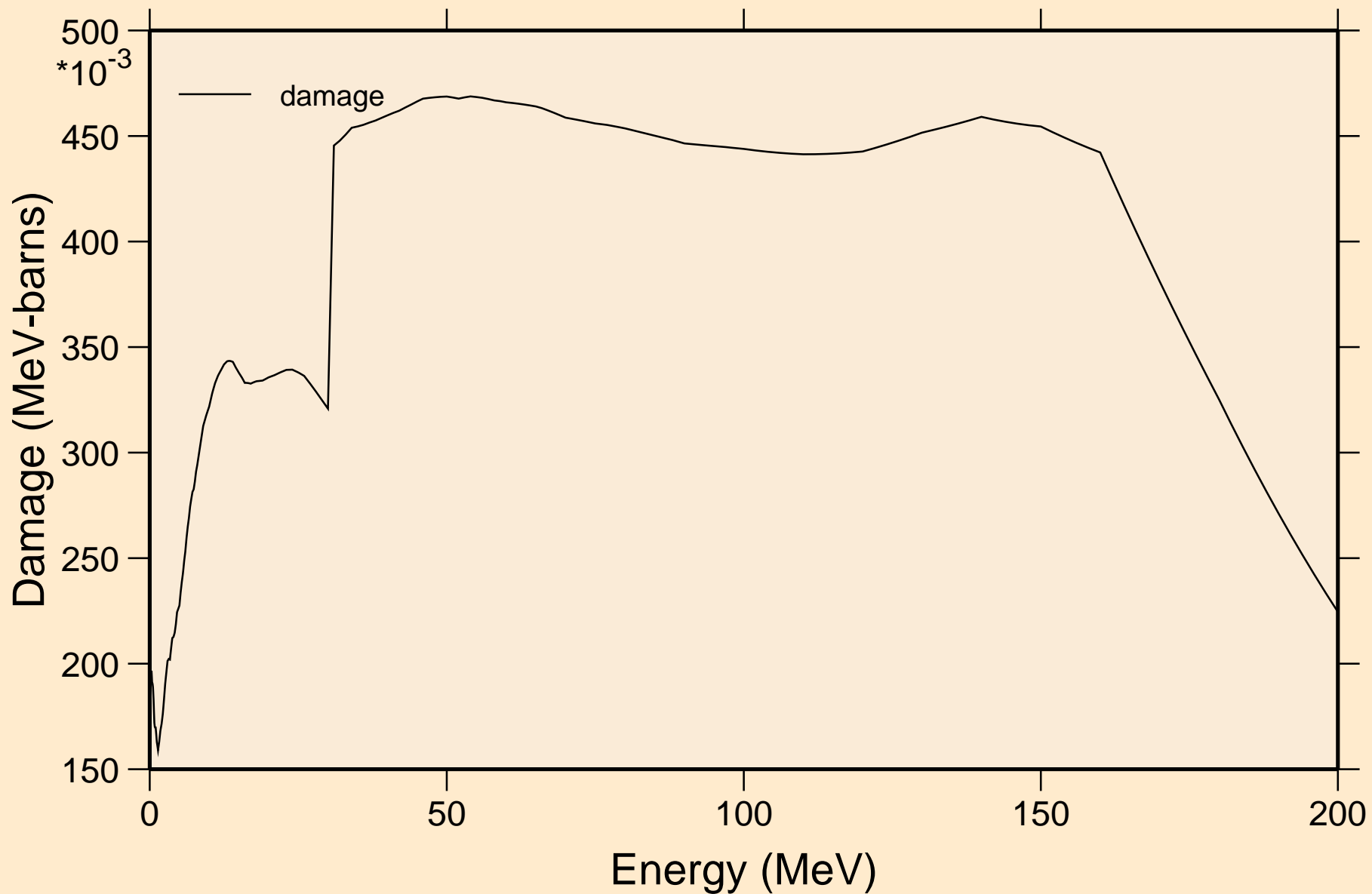

NB084 NEUTRON ACER TENDL-2019 LIBRARY; T=293.16K
Non-threshold reactions

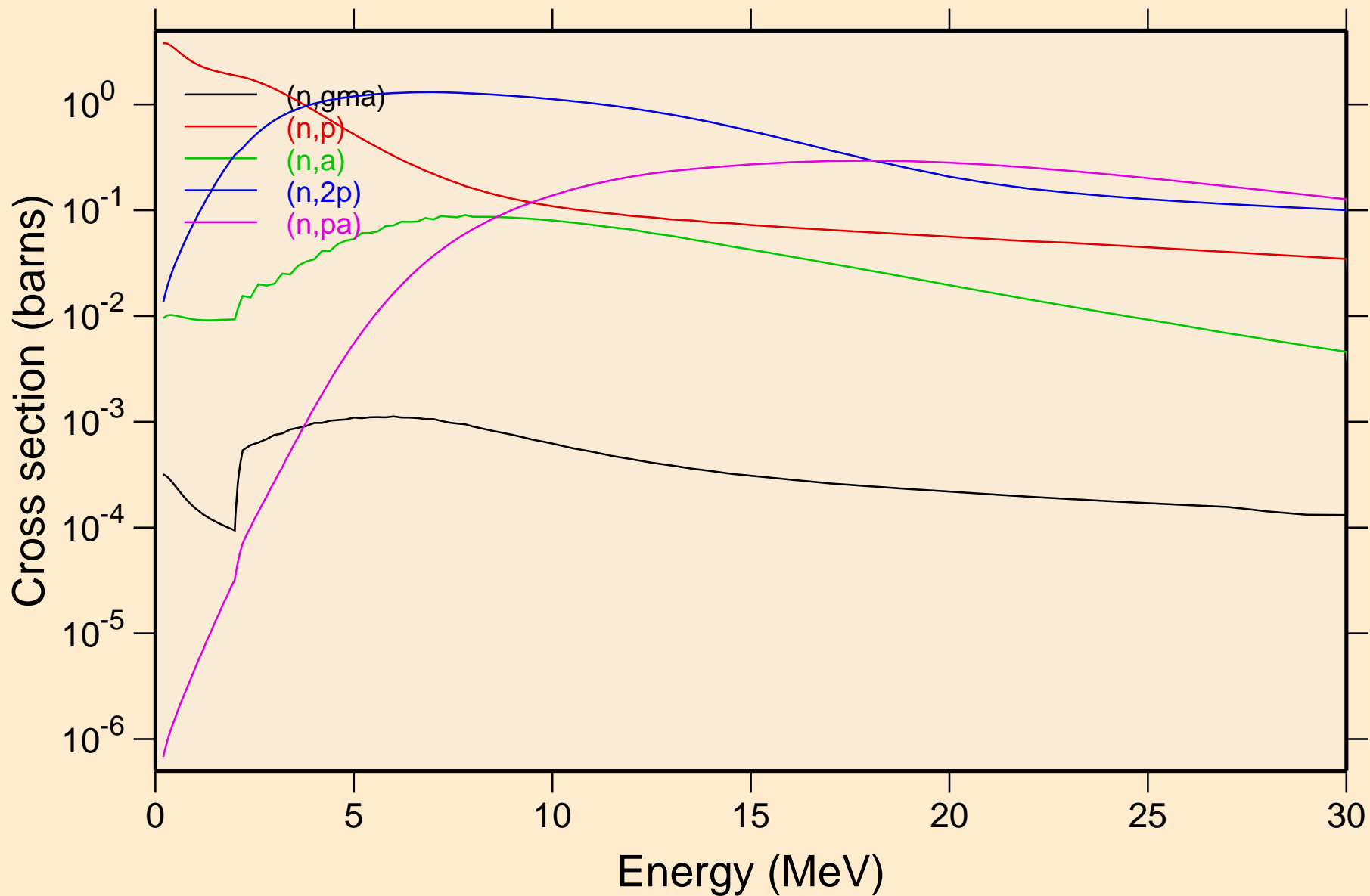

NB084 NEUTRON ACER TENDL-2019 LIBRARY; T=293.16K
Non-threshold reactions

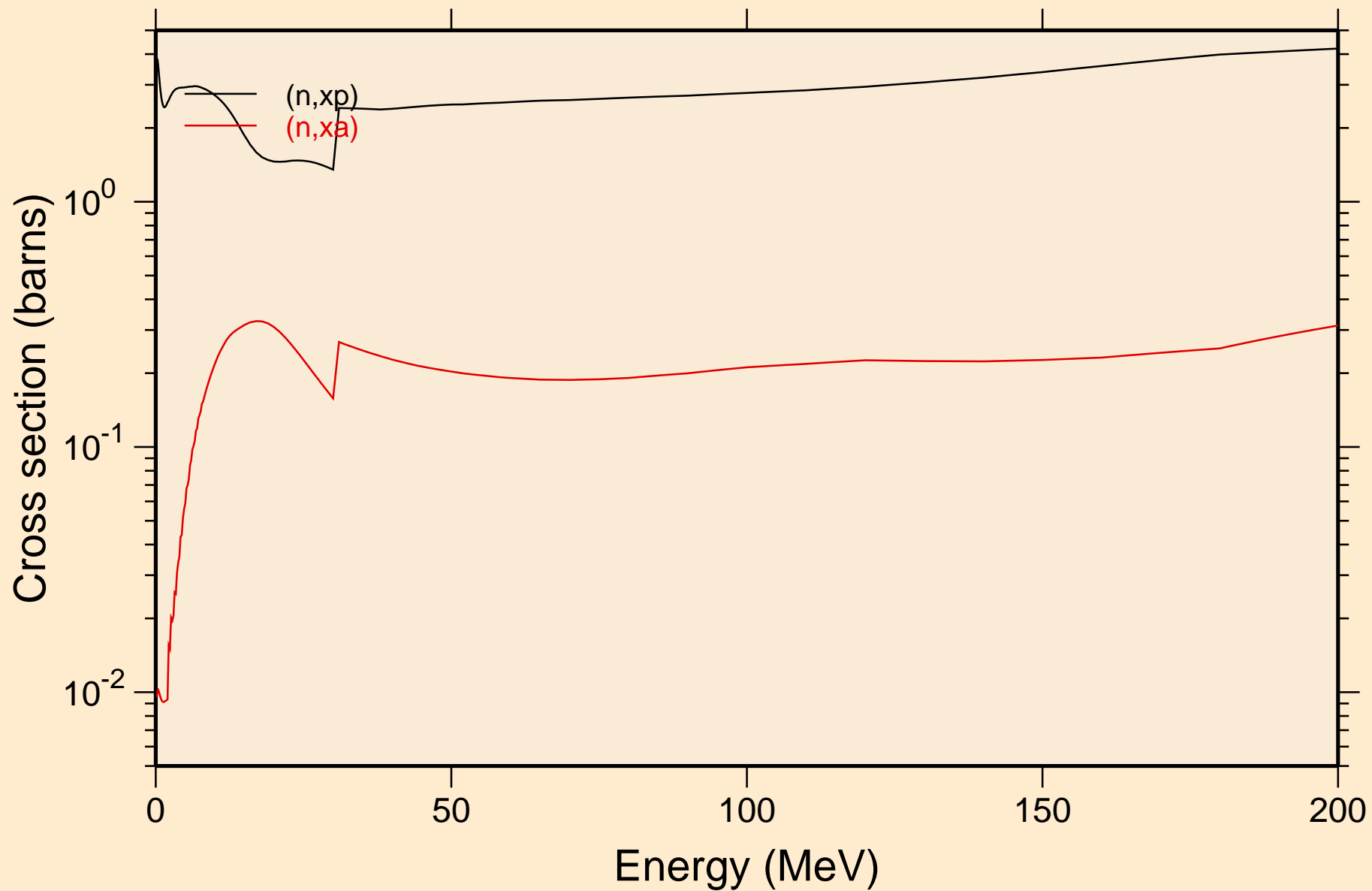

NB084 NEUTRON ACER TENDL-2019 LIBRARY; T=293.16K
Inelastic levels

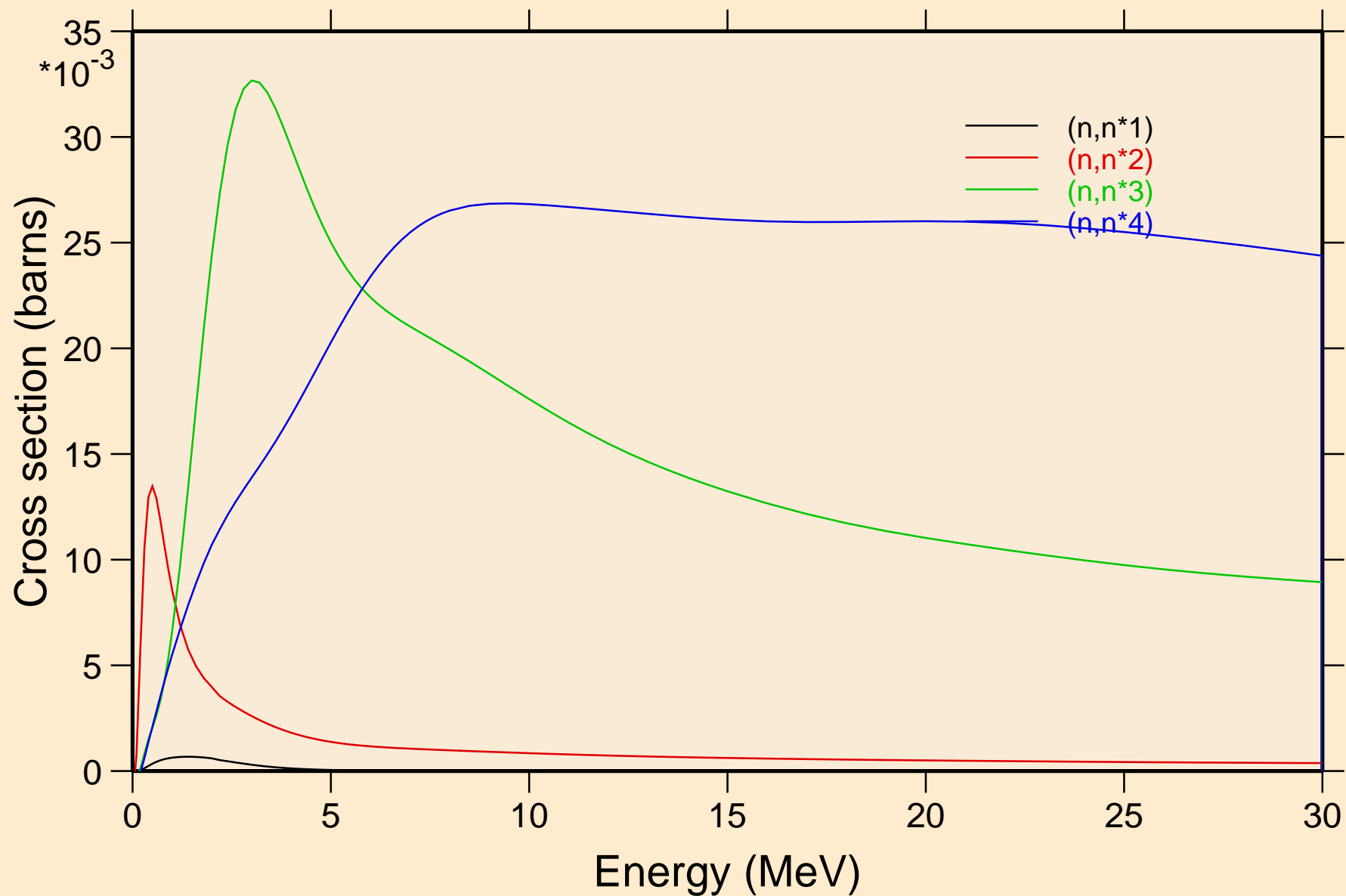

NB084 NEUTRON ACER TENDL-2019 LIBRARY; T=293.16K
Threshold reactions

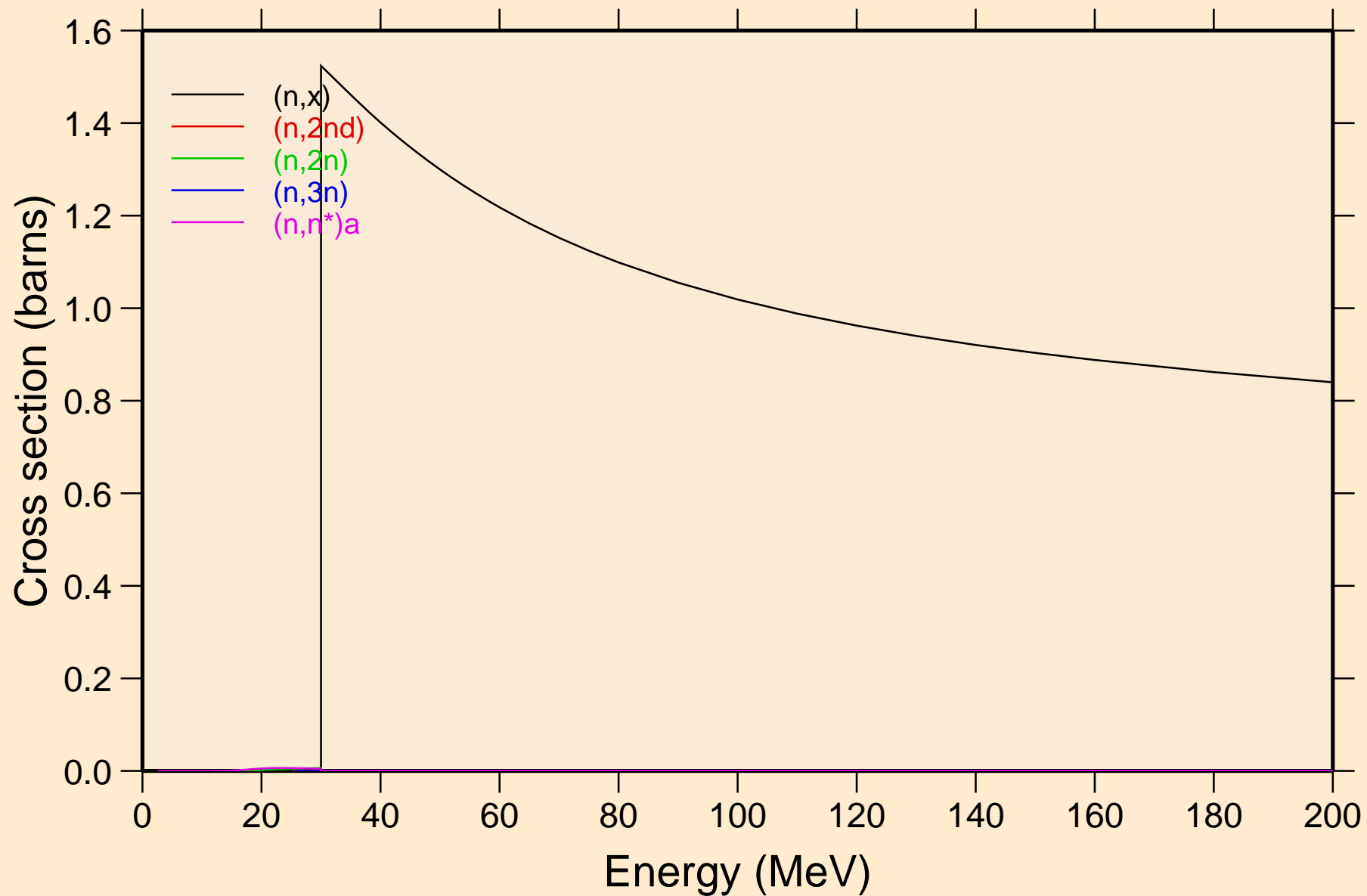

NB084 NEUTRON ACER TENDL-2019 LIBRARY; T=293.16K
Threshold reactions

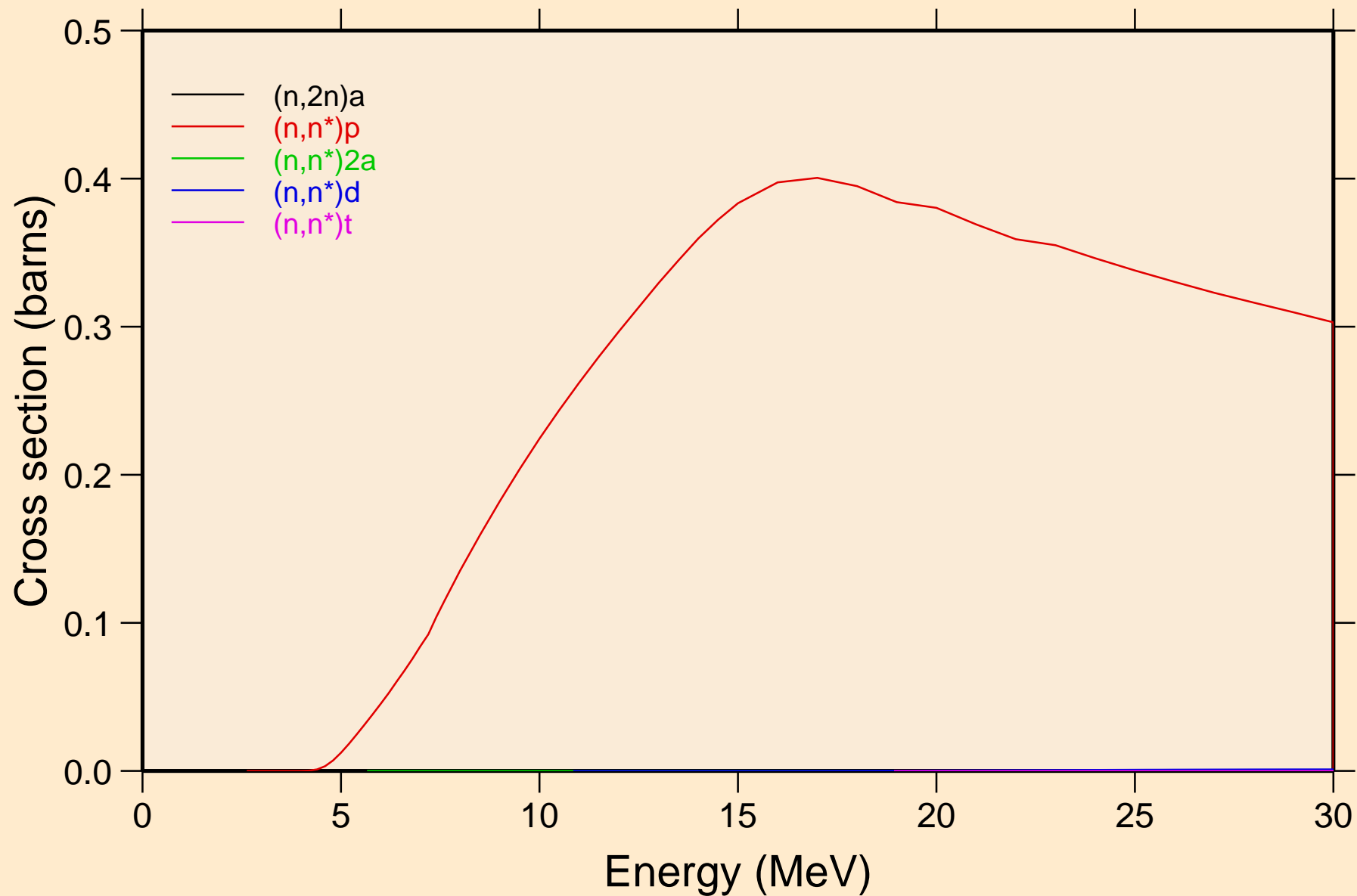

NB084 NEUTRON ACER TENDL-2019 LIBRARY; T=293.16K
Threshold reactions

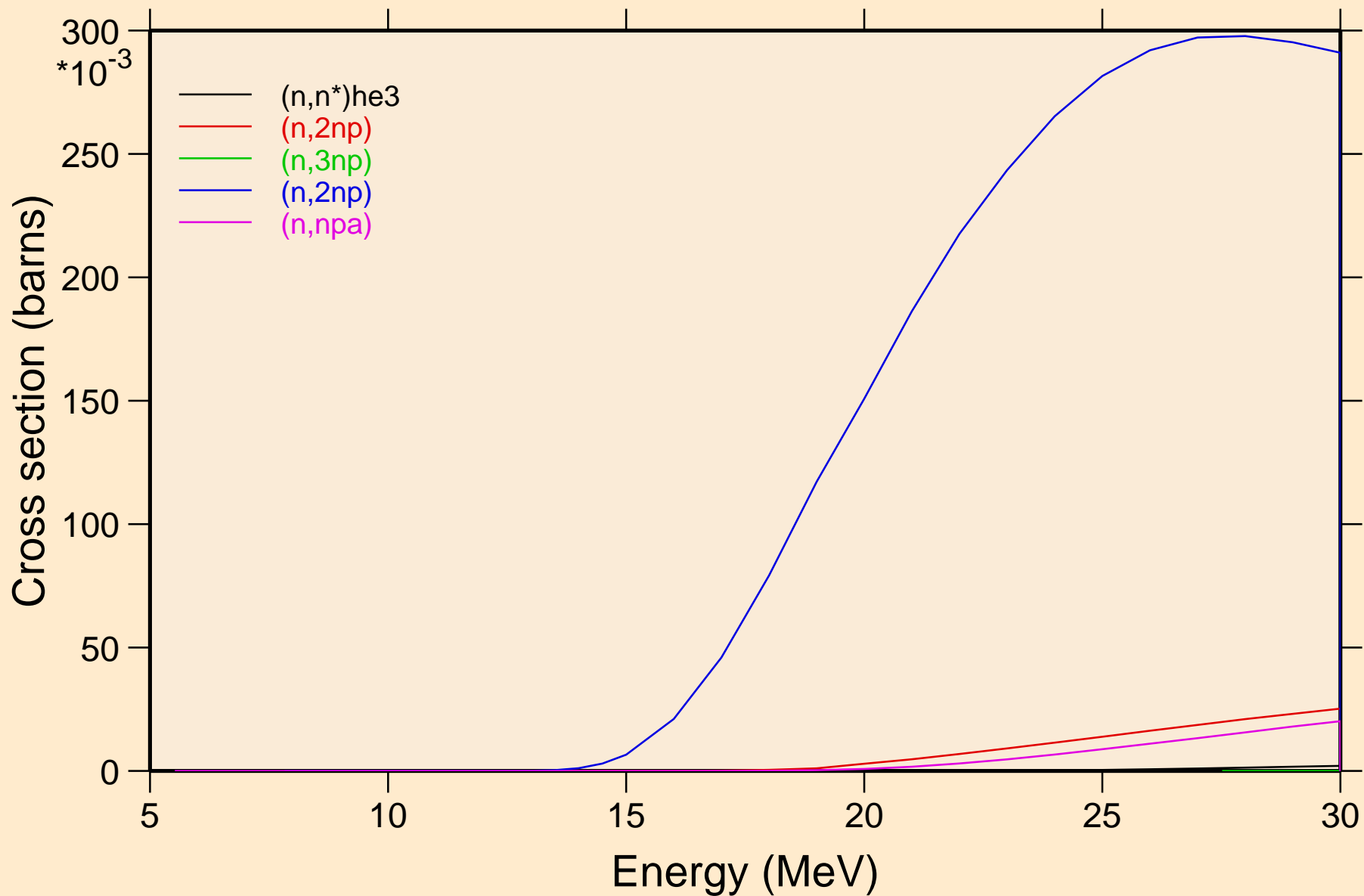

NB084 NEUTRON ACER TENDL-2019 LIBRARY; T=293.16K
Threshold reactions

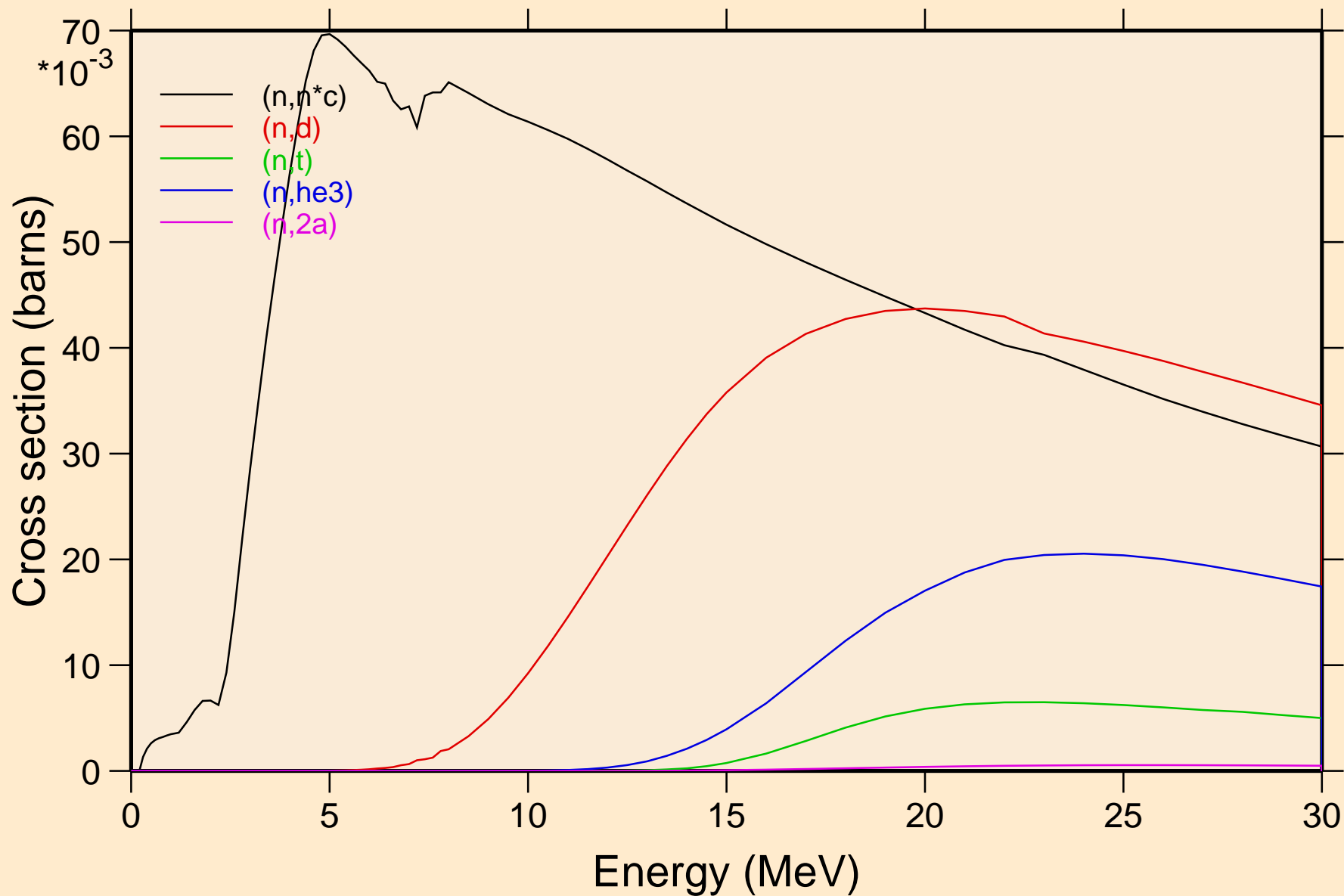

NB084 NEUTRON ACER TENDL-2019 LIBRARY; T=293.16K
Threshold reactions

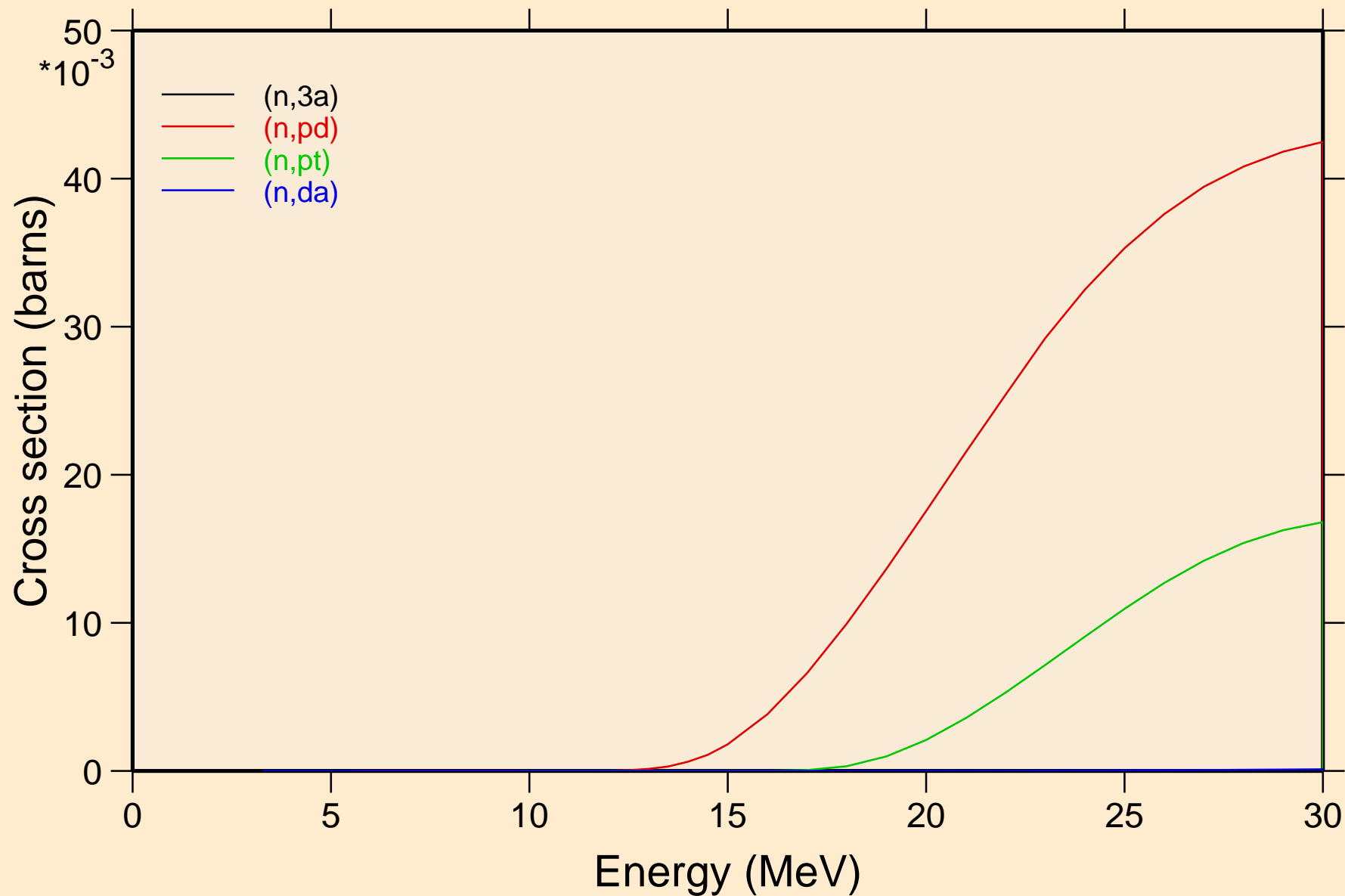

NB084 NEUTRON ACER TENDL-2019 LIBRARY; T=293.16K
Threshold reactions

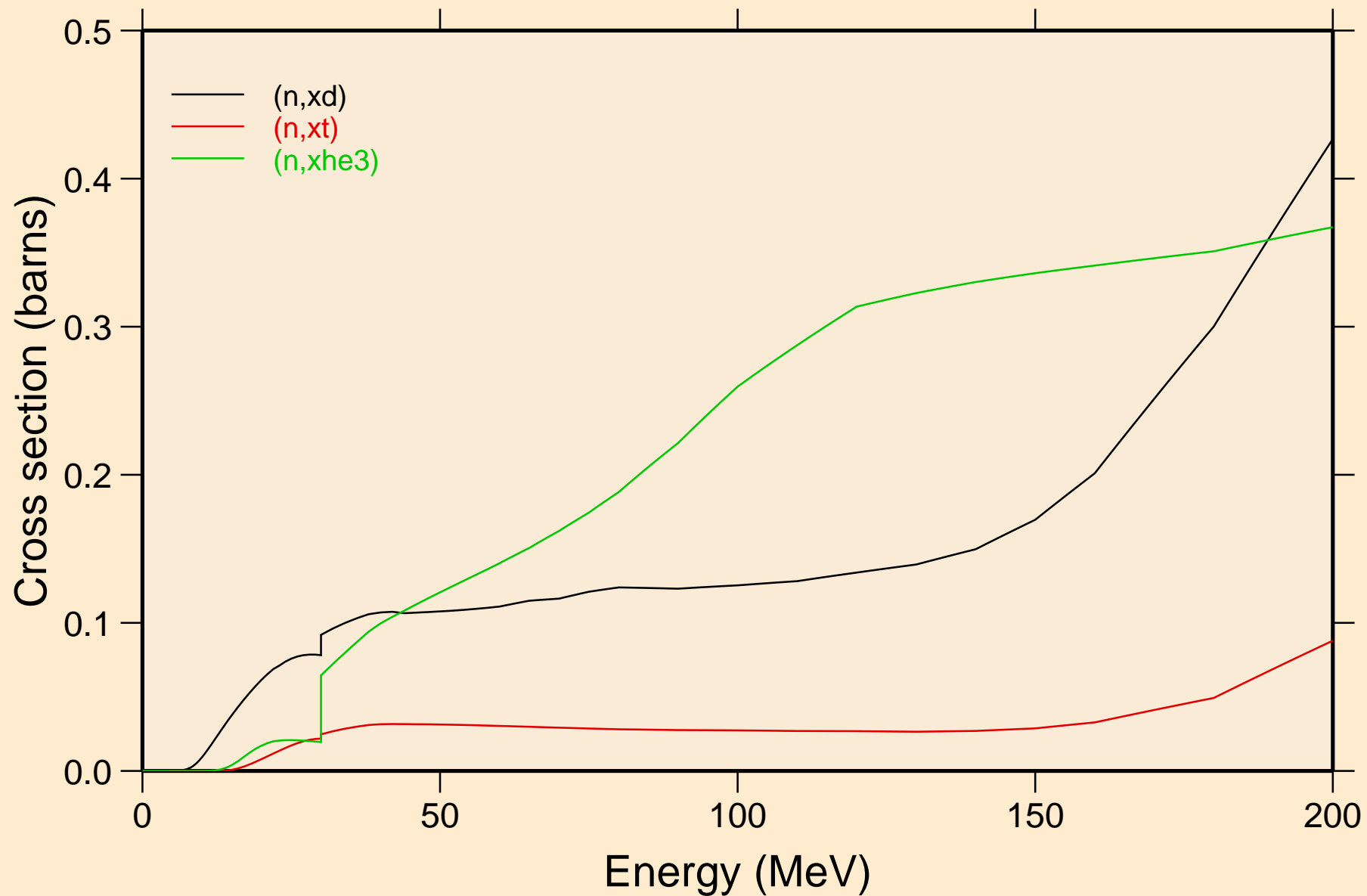

NB084 NEUTRON ACER TENDL-2019 LIBRARY; T=293.16K
angular distribution for elastic

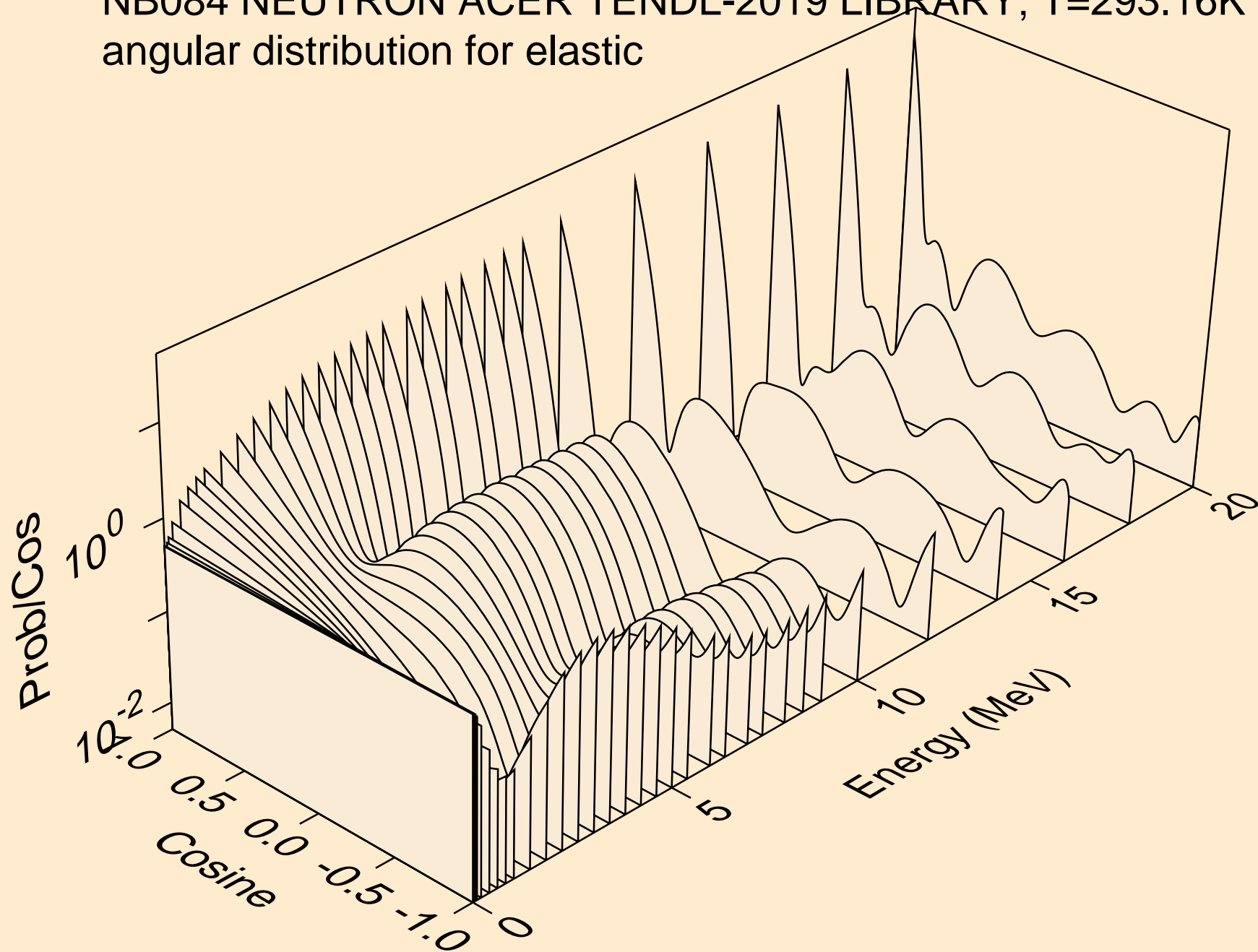

NB084 NEUTRON ACER TENDL-2019 LIBRARY; T=293.16K
angular distribution for elastic

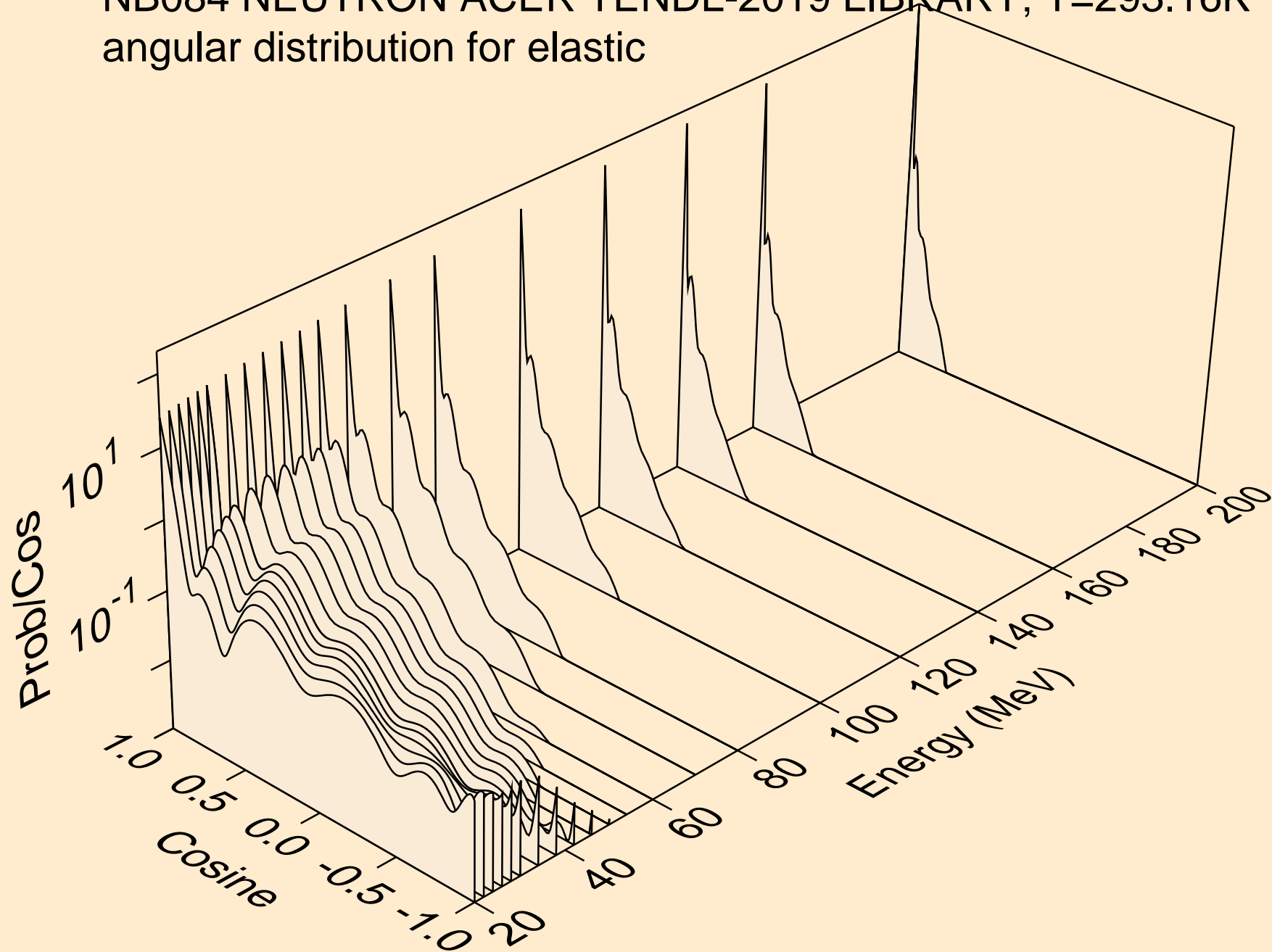

NB084 NEUTRON ACER TENDL-2019 LIBRARY; T=293.16K
angular distribution for (n,n*1)

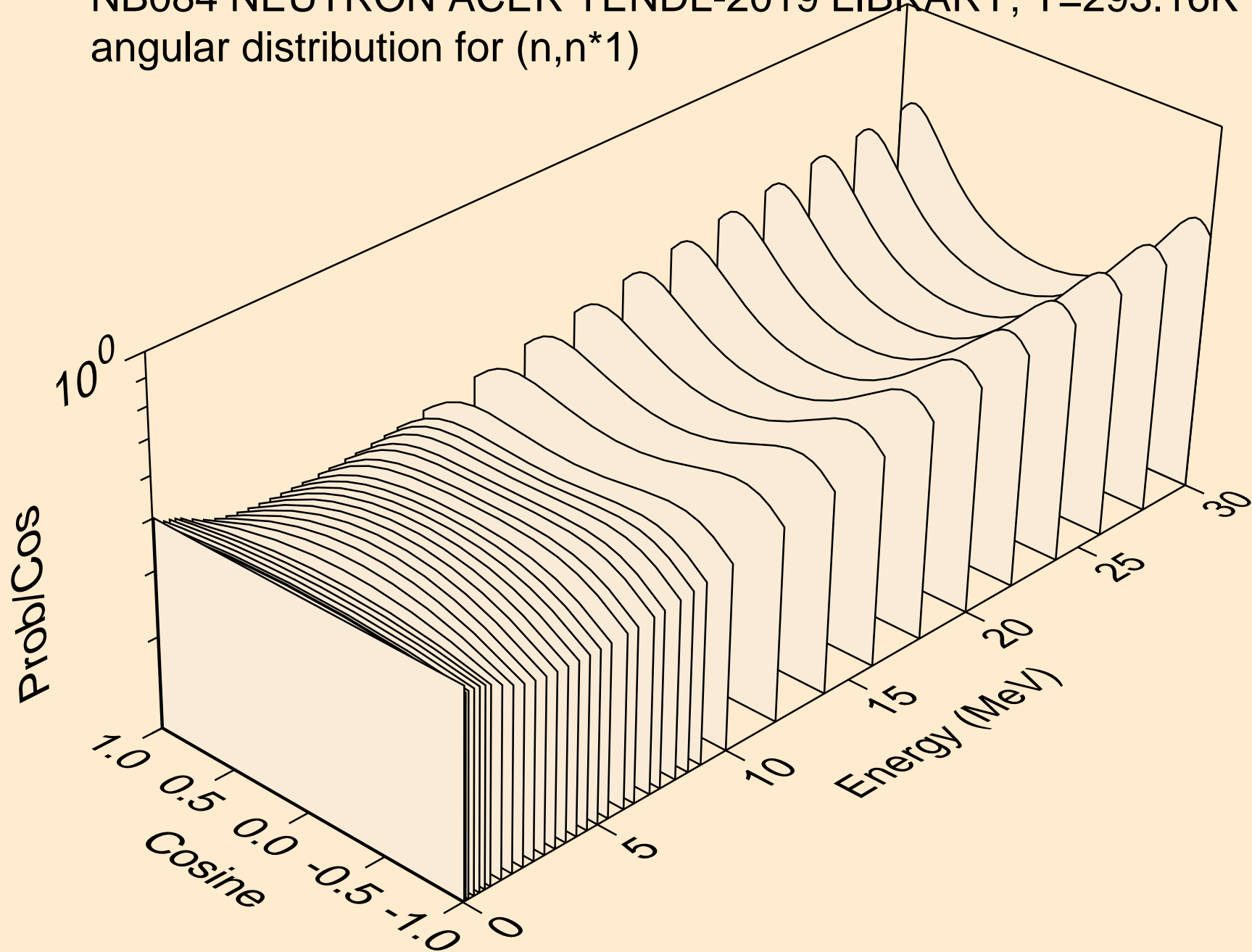

NB084 NEUTRON ACER TENDL-2019 LIBRARY; T=293.16K
angular distribution for (n,n*2)

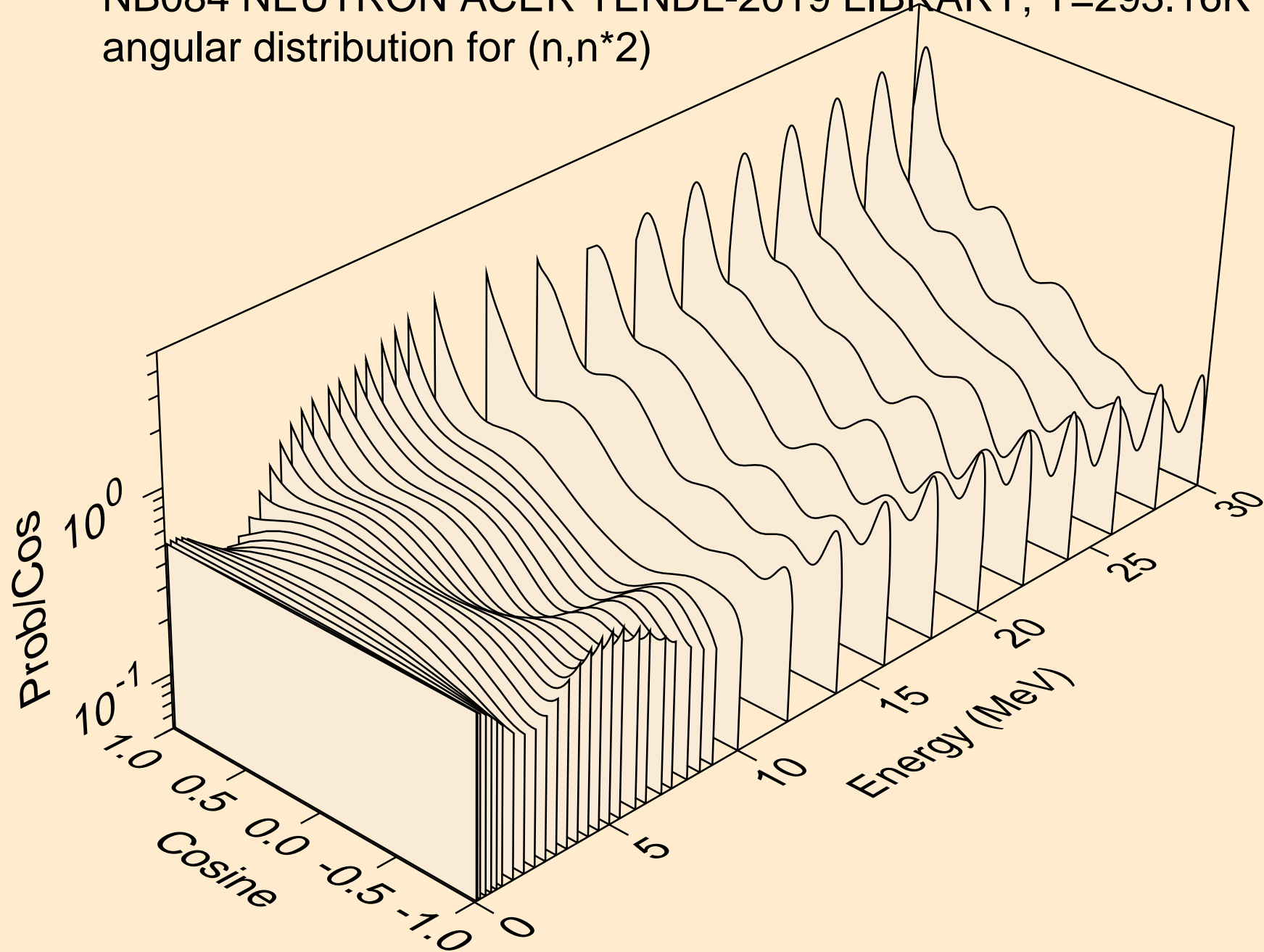

NB084 NEUTRON ACER TENDL-2019 LIBRARY; T=293.16K
angular distribution for (n,n*3)

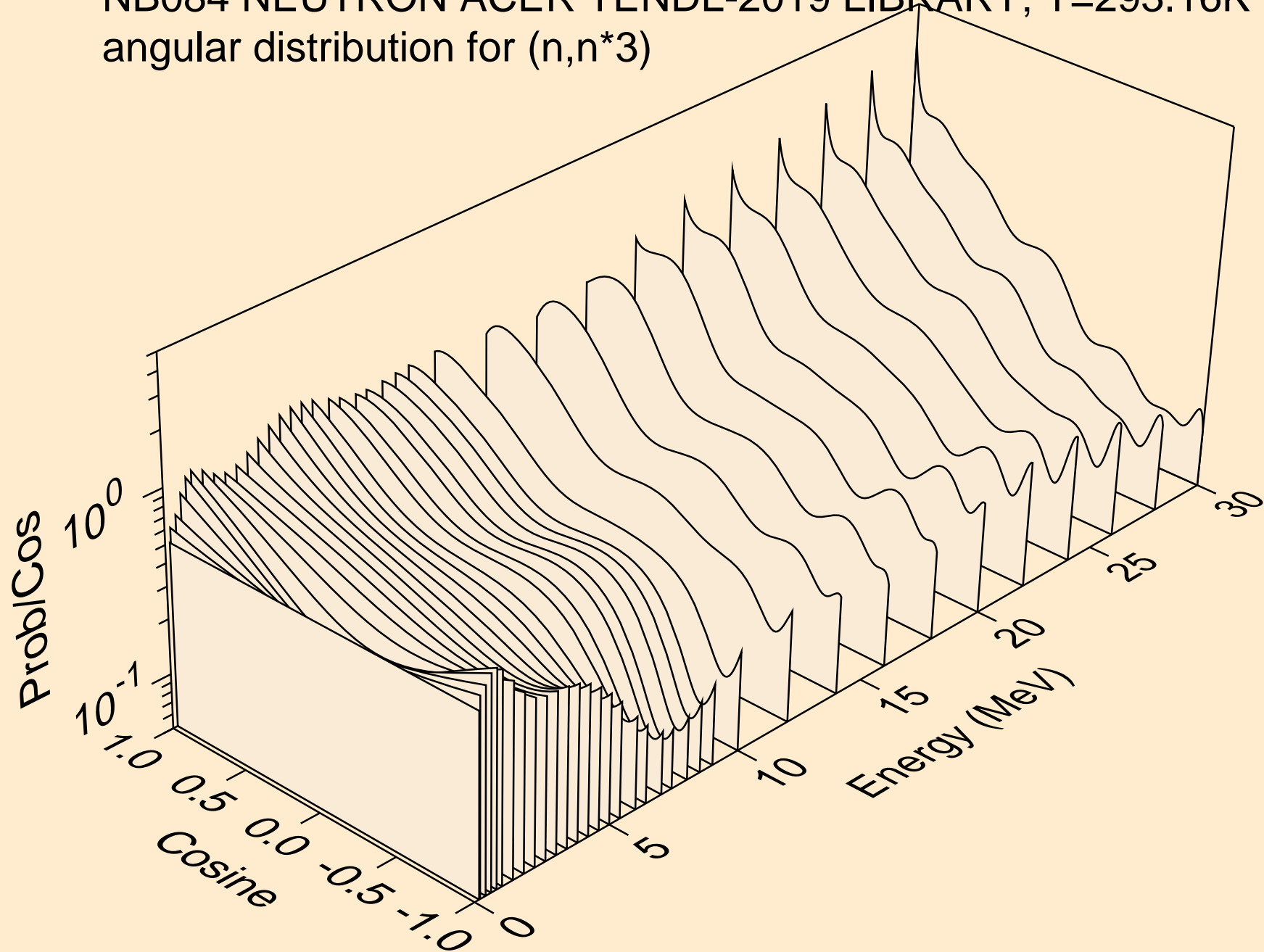

NB084 NEUTRON ACER TENDL-2019 LIBRARY; T=293.16K
angular distribution for (n,n*4)

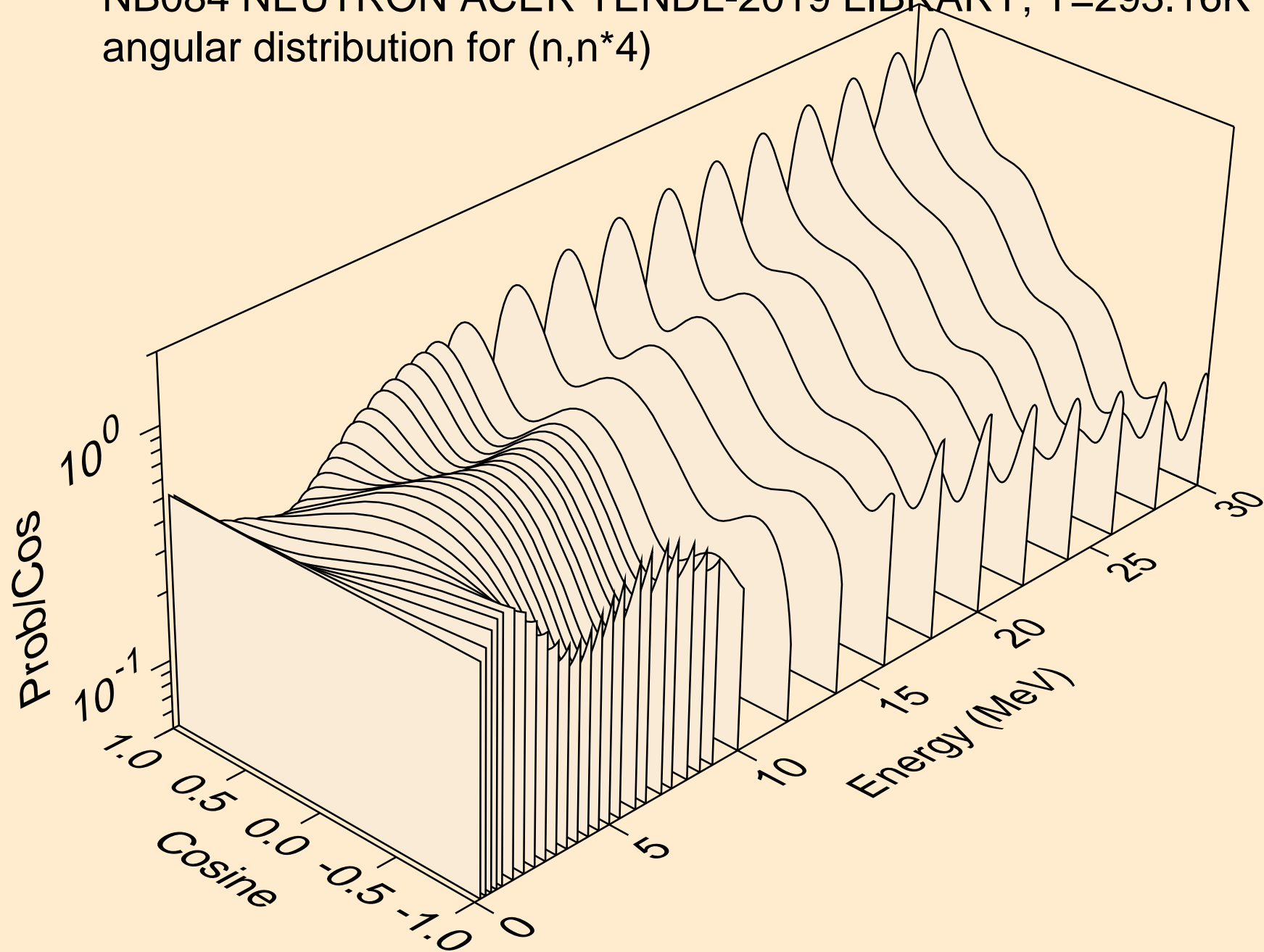

NB084 NEUTRON ACER TENDL-2019 LIBRARY; T=293.16K
Neutron emission for (n,x)

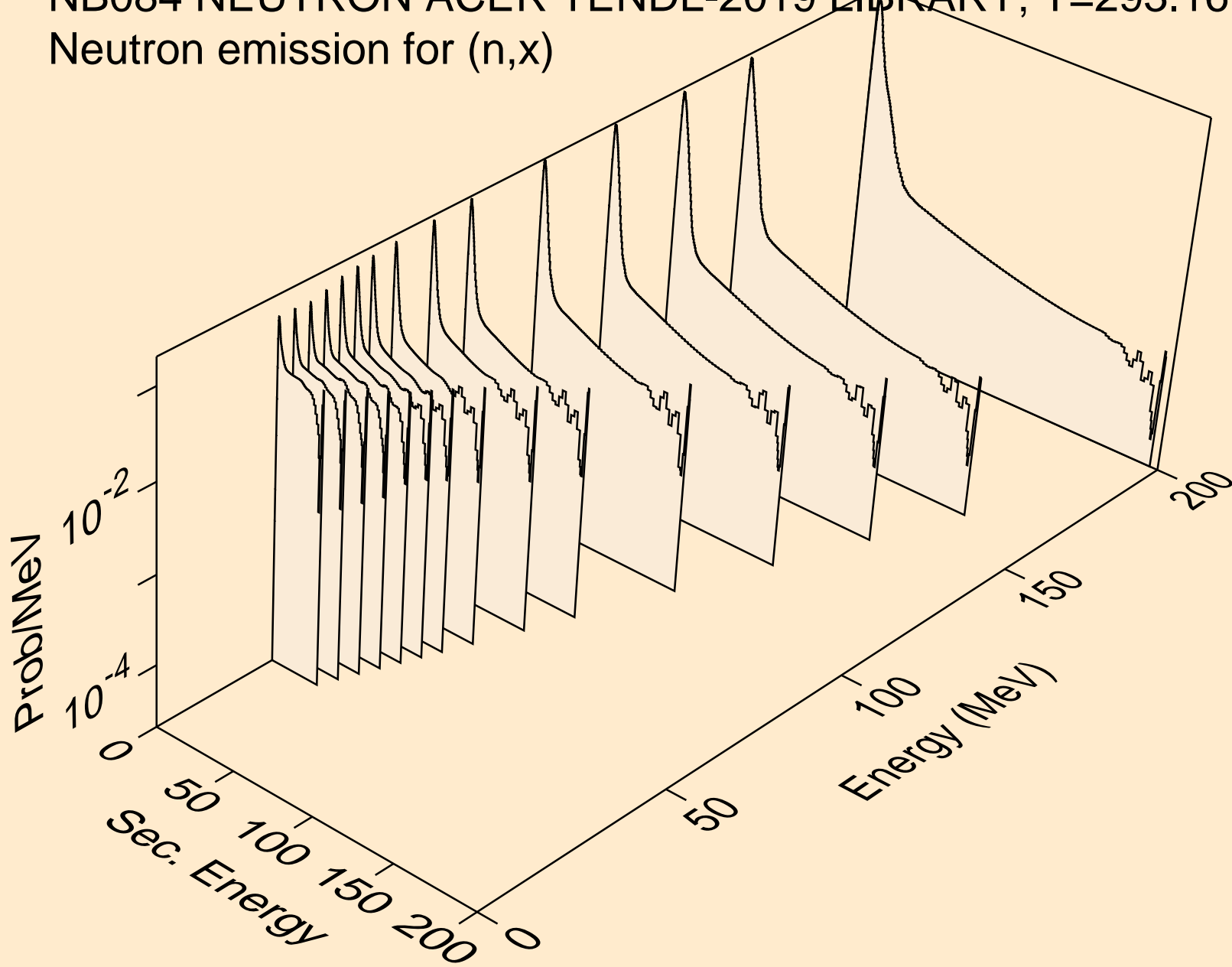

NB084 NEUTRON ACER TENDL-2019 LIBRARY; T=293.16K
Neutron emission for (n,2nd)

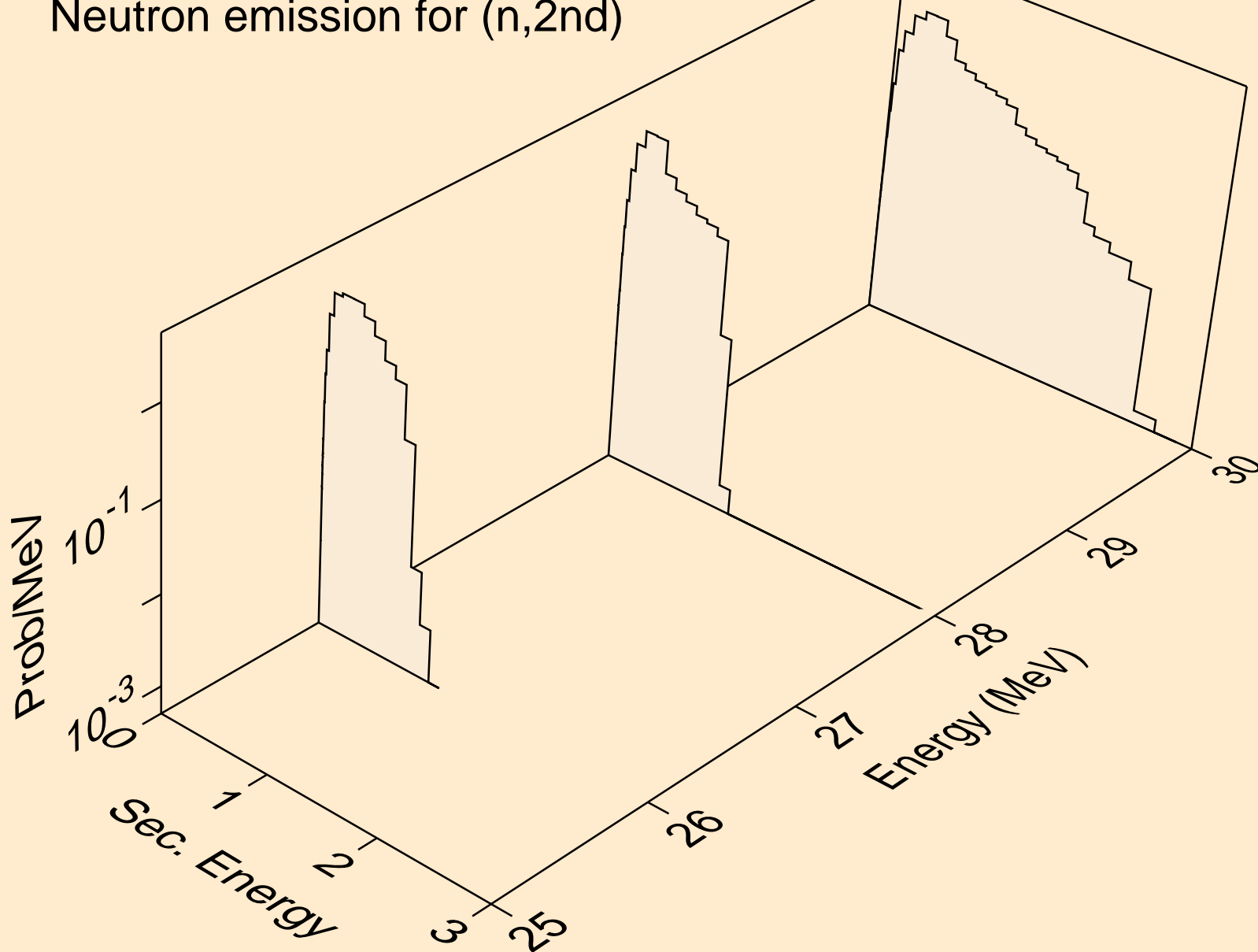

NB084 NEUTRON ACER TENDL-2019 LIBRARY; T=293.16K
Neutron emission for (n,2n)

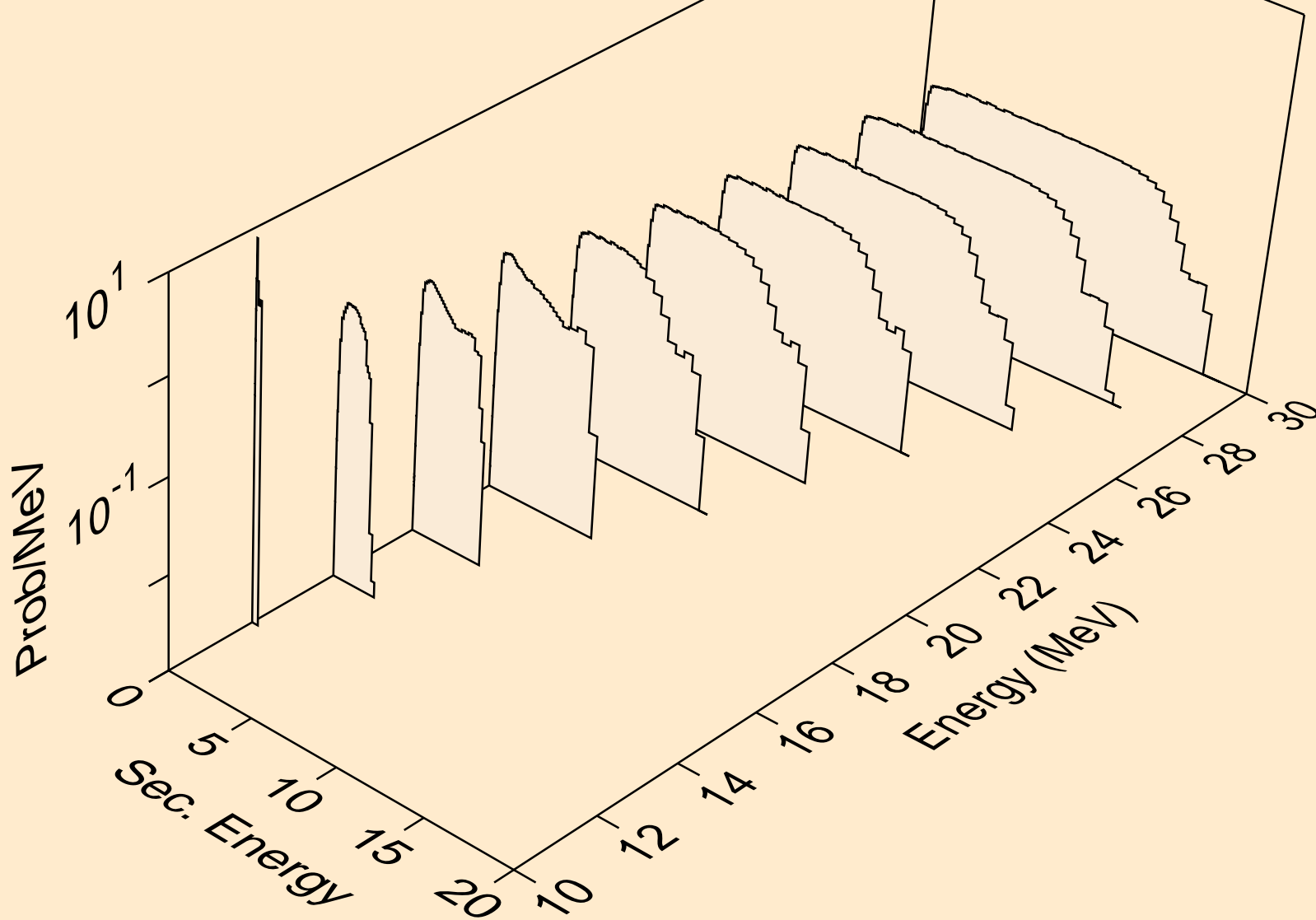

NB084 NEUTRON ACER TENDL-2019 LIBRARY; T=293.16K
Neutron emission for (n,3n)

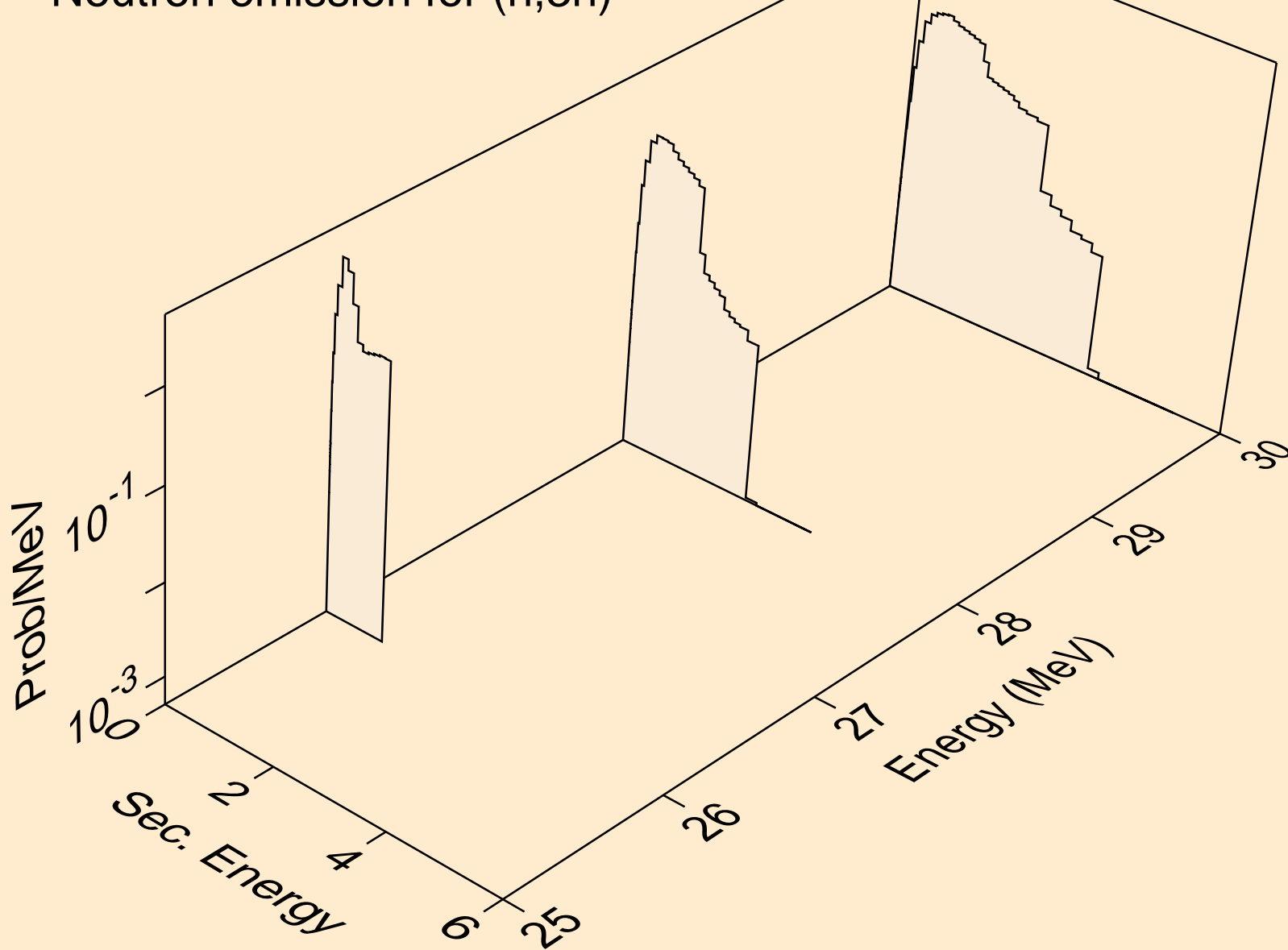

NB084 NEUTRON ACER TENDL-2019 LIBRARY; T=293.16K
Neutron emission for (n,n*)a

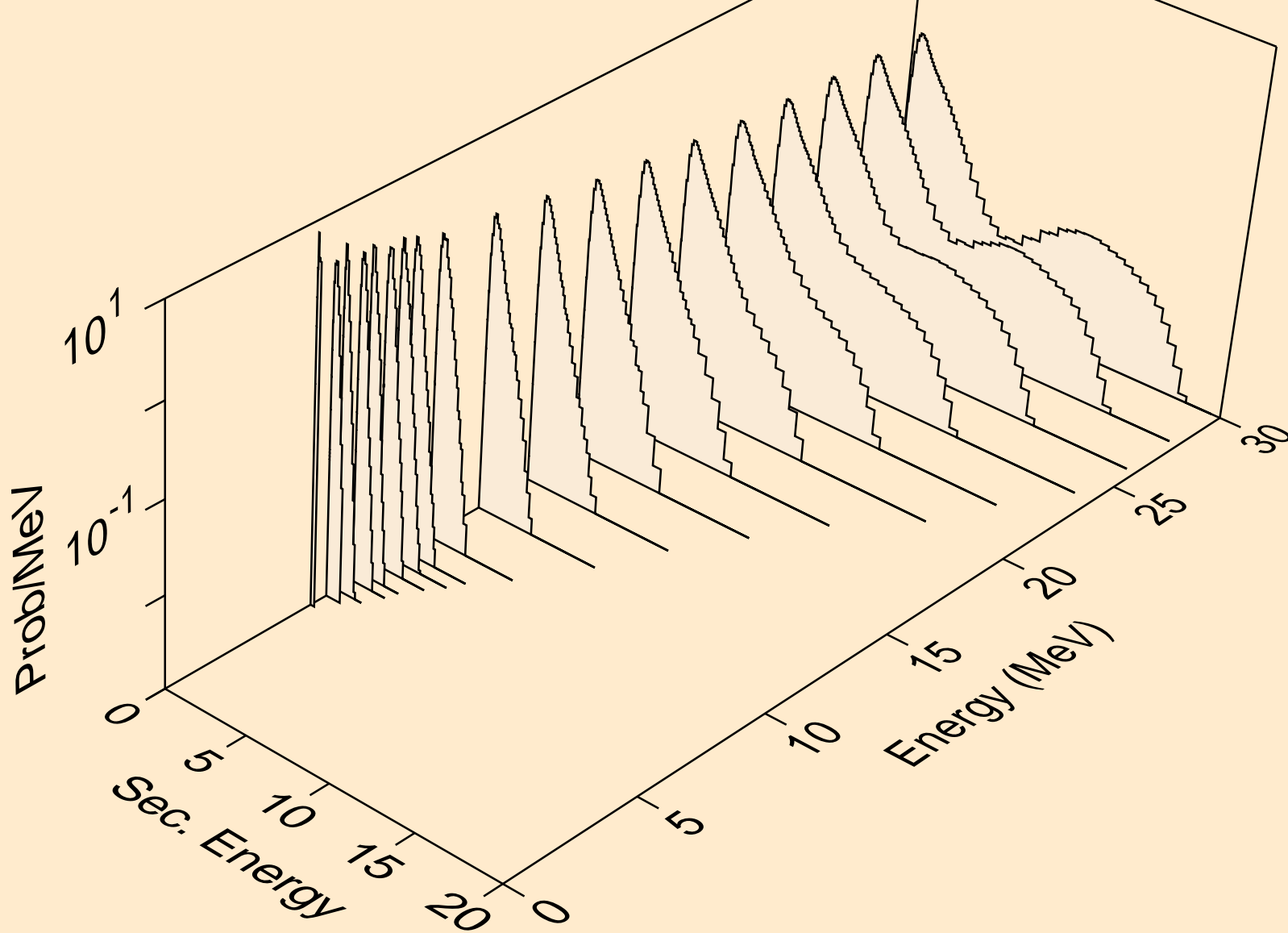

NB084 NEUTRON ACER TENDL-2019 LIBRARY; T=293.16K
Neutron emission for (n,2n)a

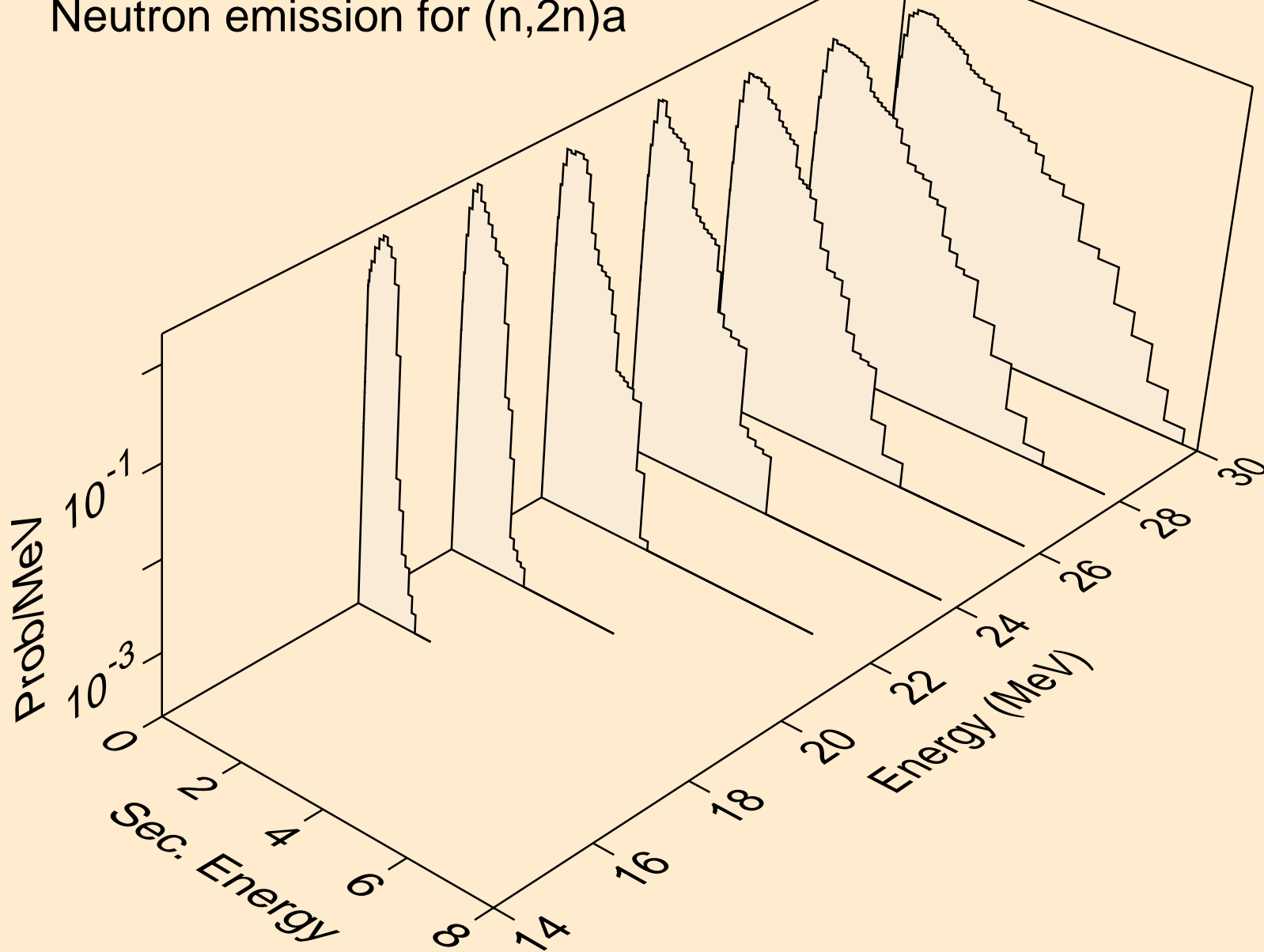

NB084 NEUTRON ACER TENDL-2019 LIBRARY; T=293.16K
Neutron emission for (n,n*)p

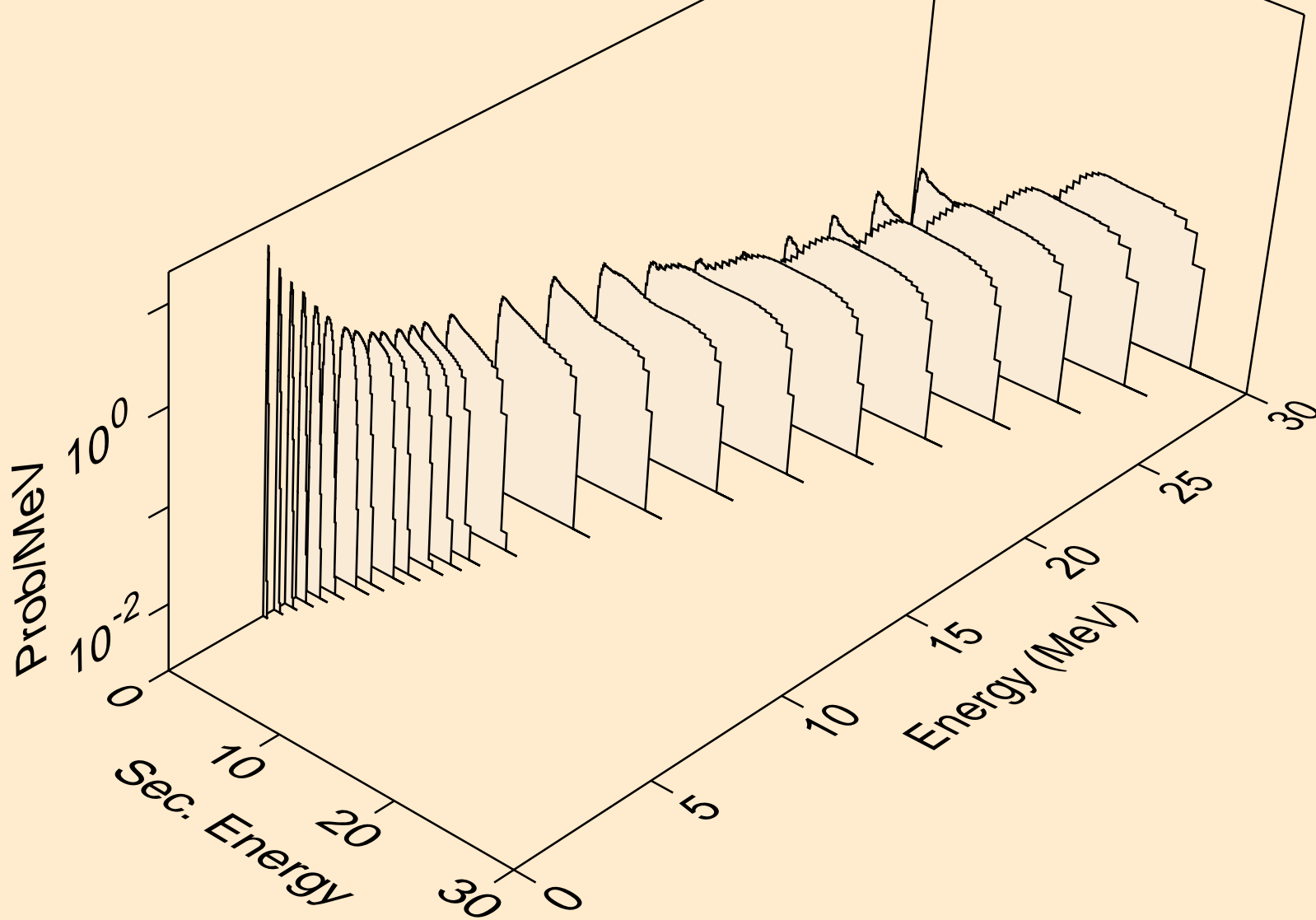

NB084 NEUTRON ACER TENDL-2019 LIBRARY; T=293.16K
Neutron emission for (n,n*)2a

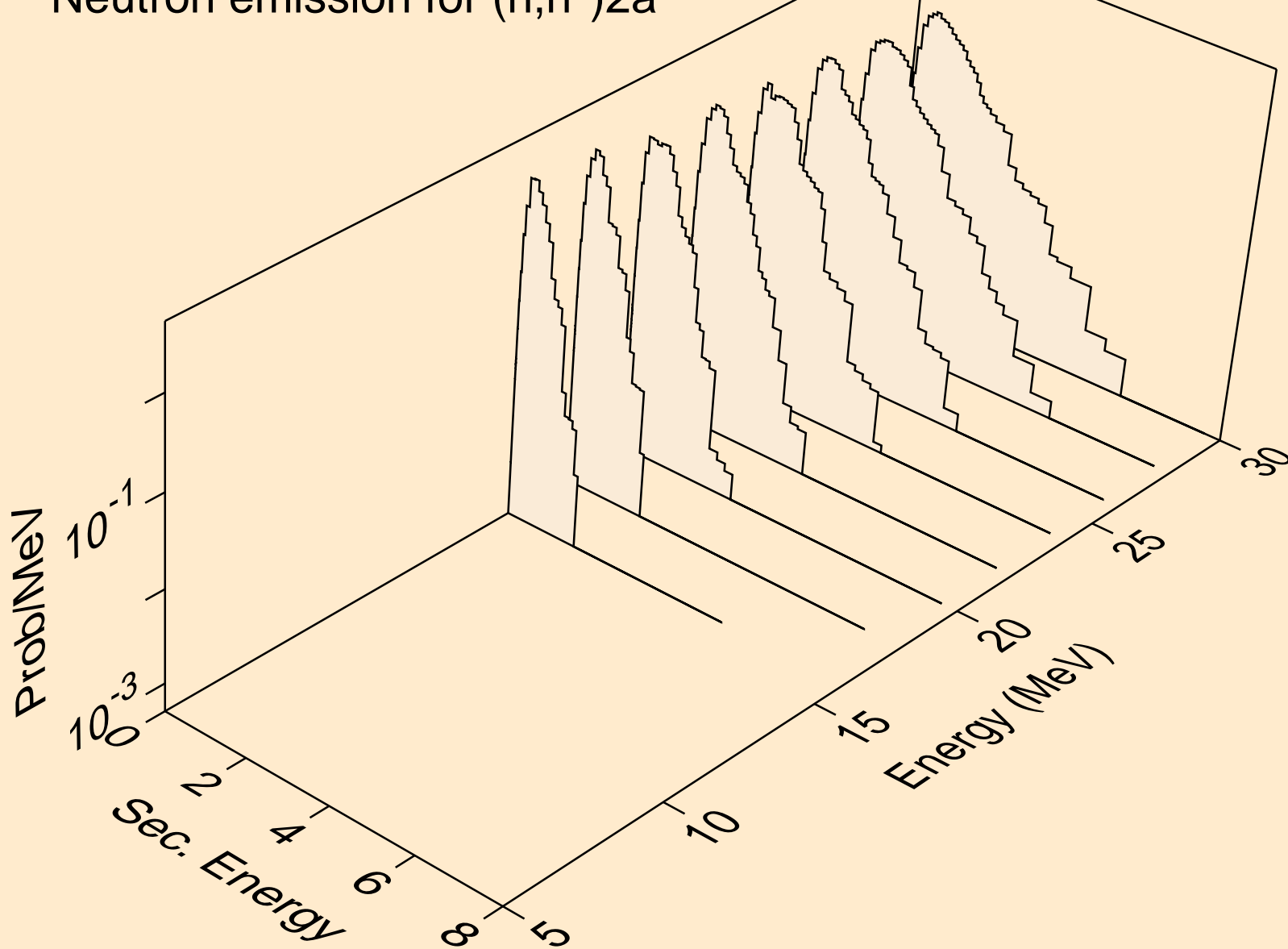

NB084 NEUTRON ACER TENDL-2019 LIBRARY; T=293.16K
Neutron emission for (n,n*)d

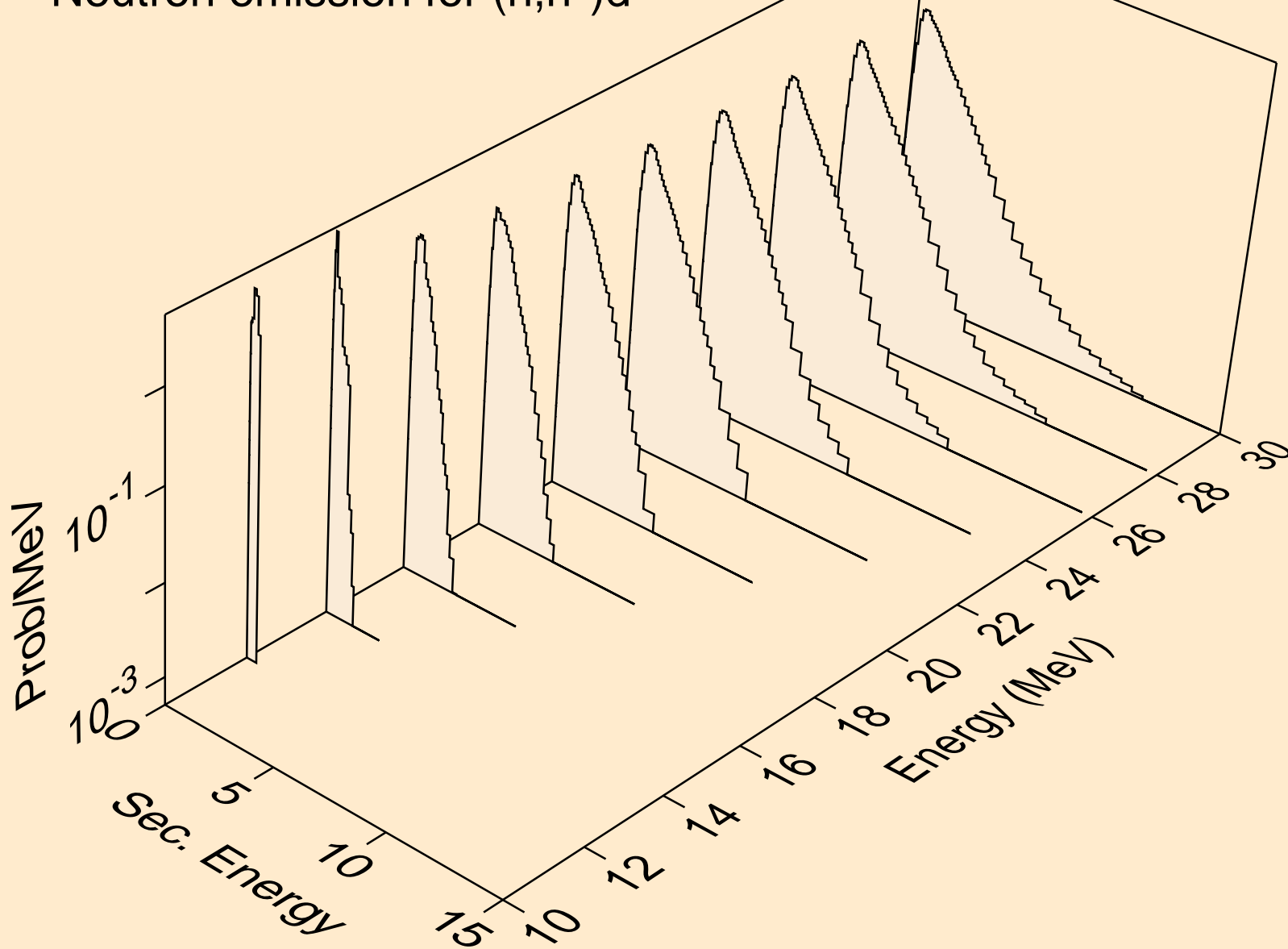

NB084 NEUTRON ACER TENDL-2019 LIBRARY; T=293.16K
Neutron emission for (n,n*)t

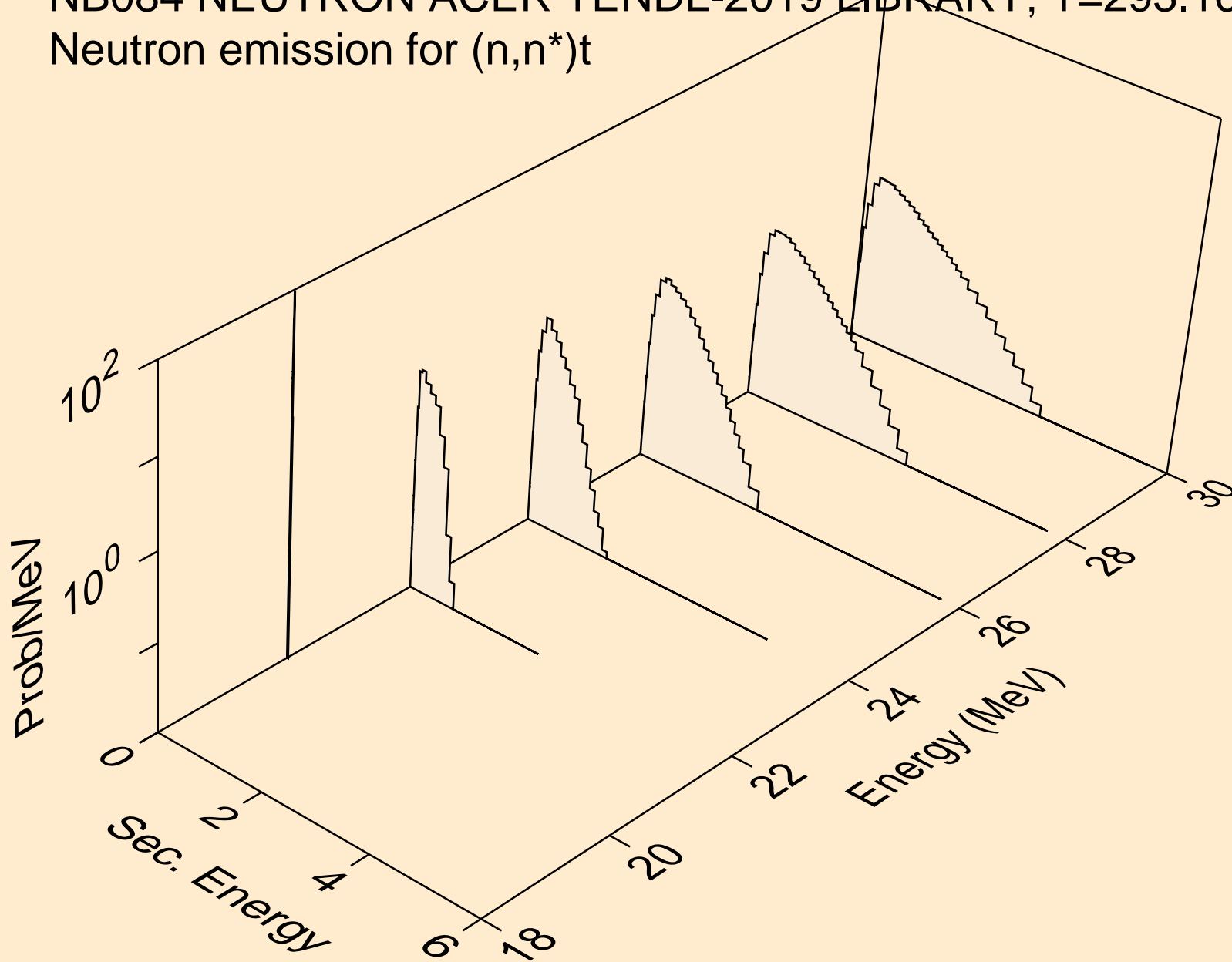

NB084 NEUTRON ACER TENDL-2019 LIBRARY; T=293.16K
Neutron emission for (n,n*)he3

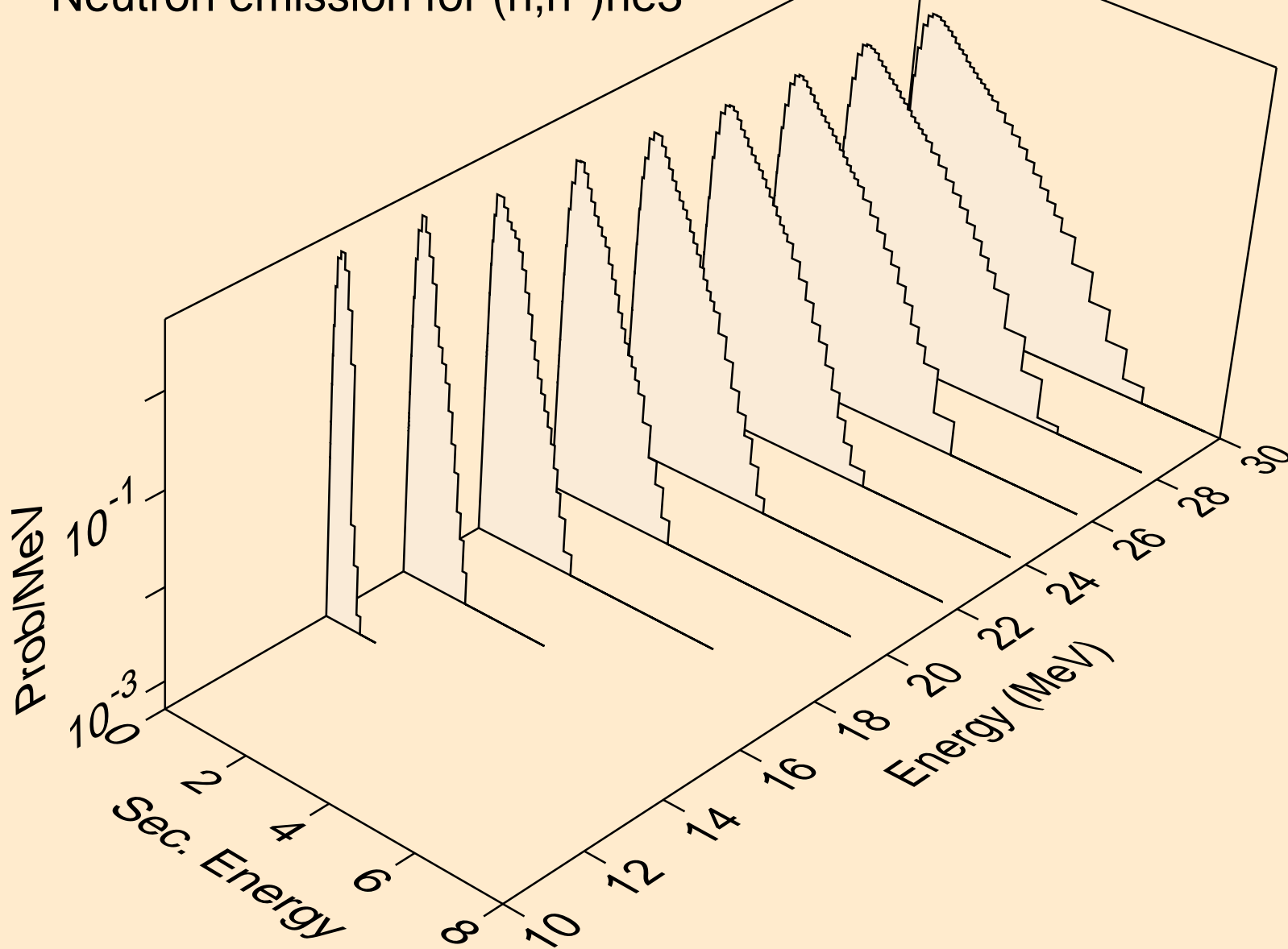

NB084 NEUTRON ACER TENDL-2019 LIBRARY; T=293.16K
Neutron emission for (n,2np)

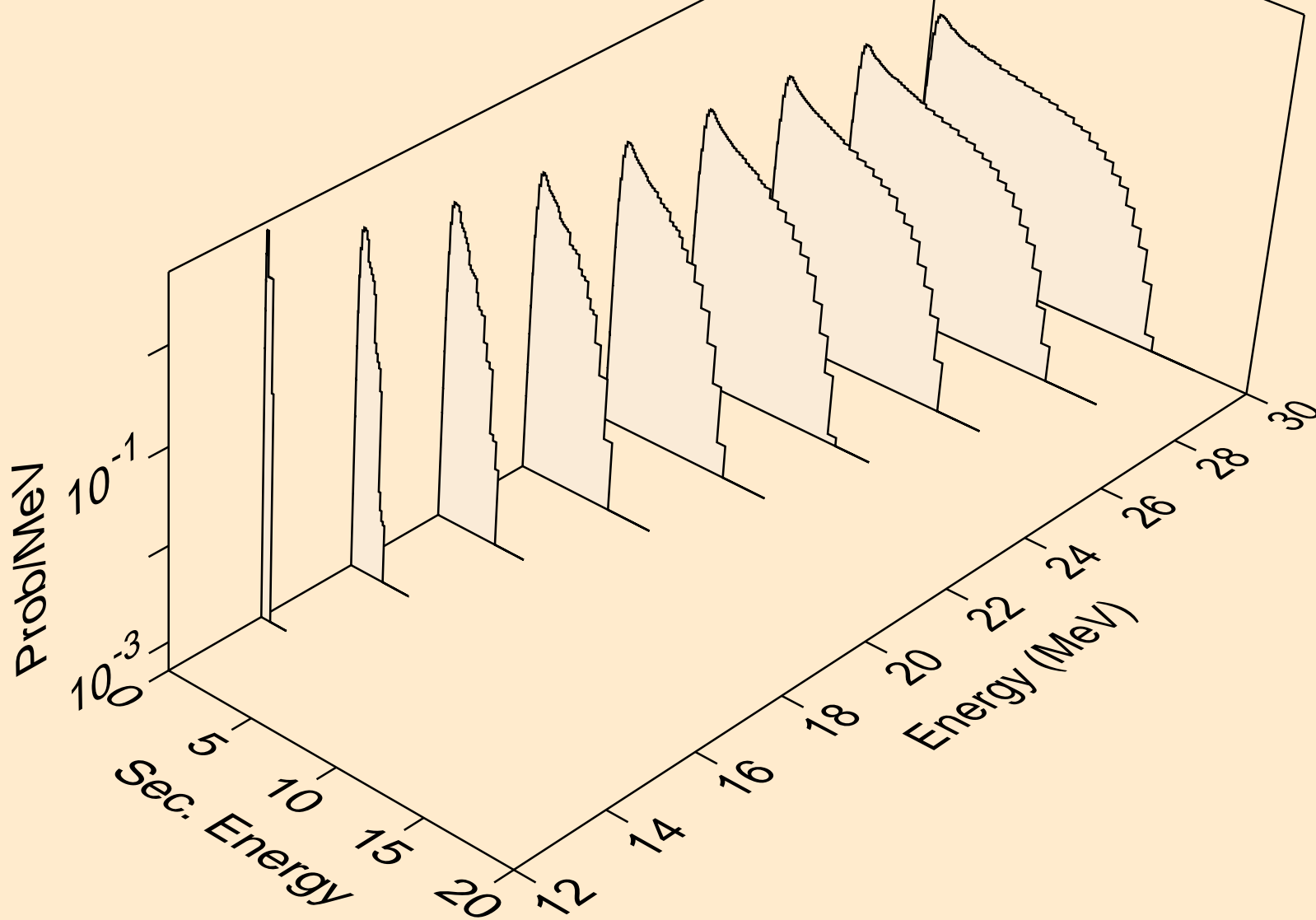

NB084 NEUTRON ACER TENDL-2019 LIBRARY; T=293.16K
Neutron emission for (n,3np)

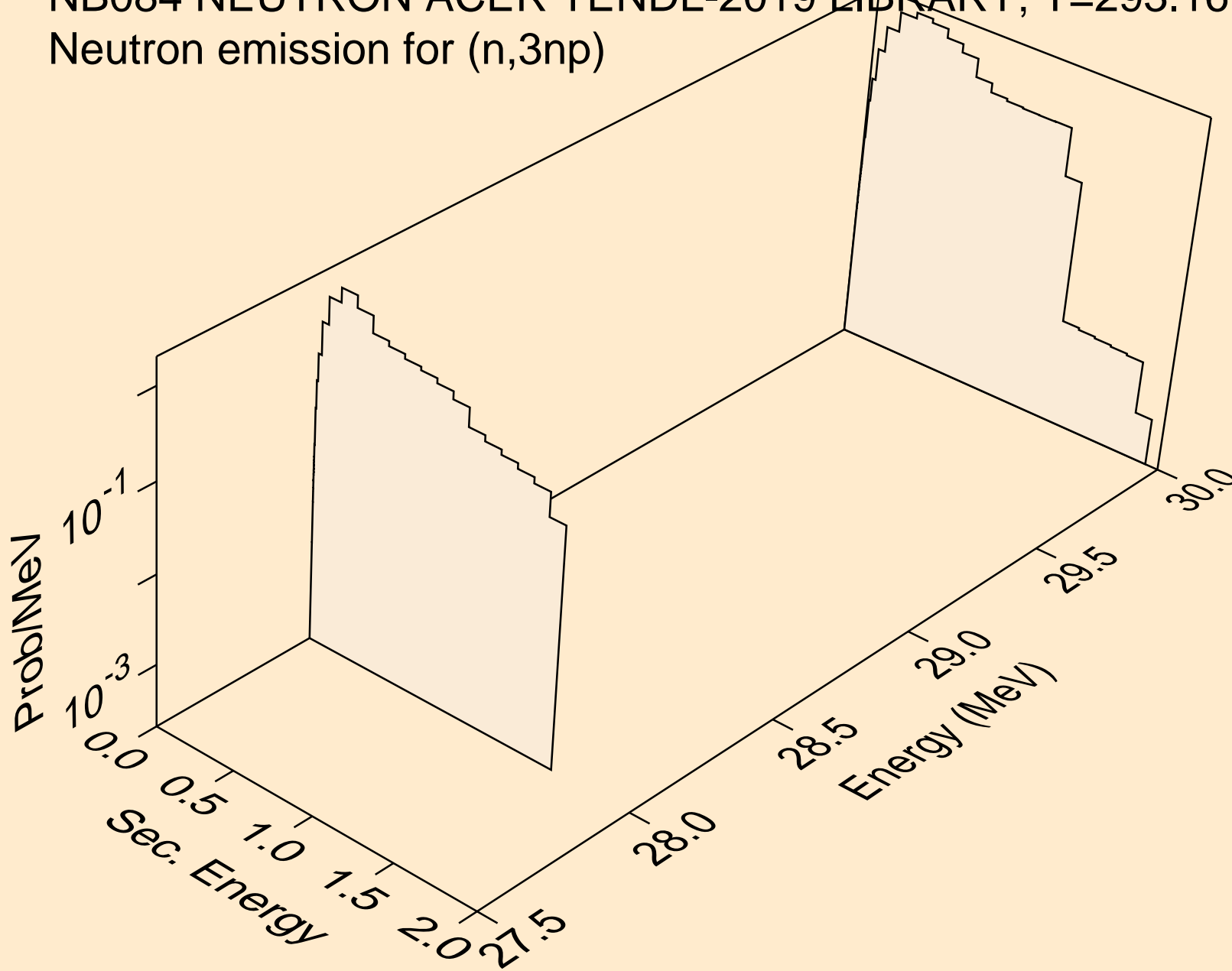

NB084 NEUTRON ACER TENDL-2019 LIBRARY; T=293.16K
Neutron emission for (n,2np)

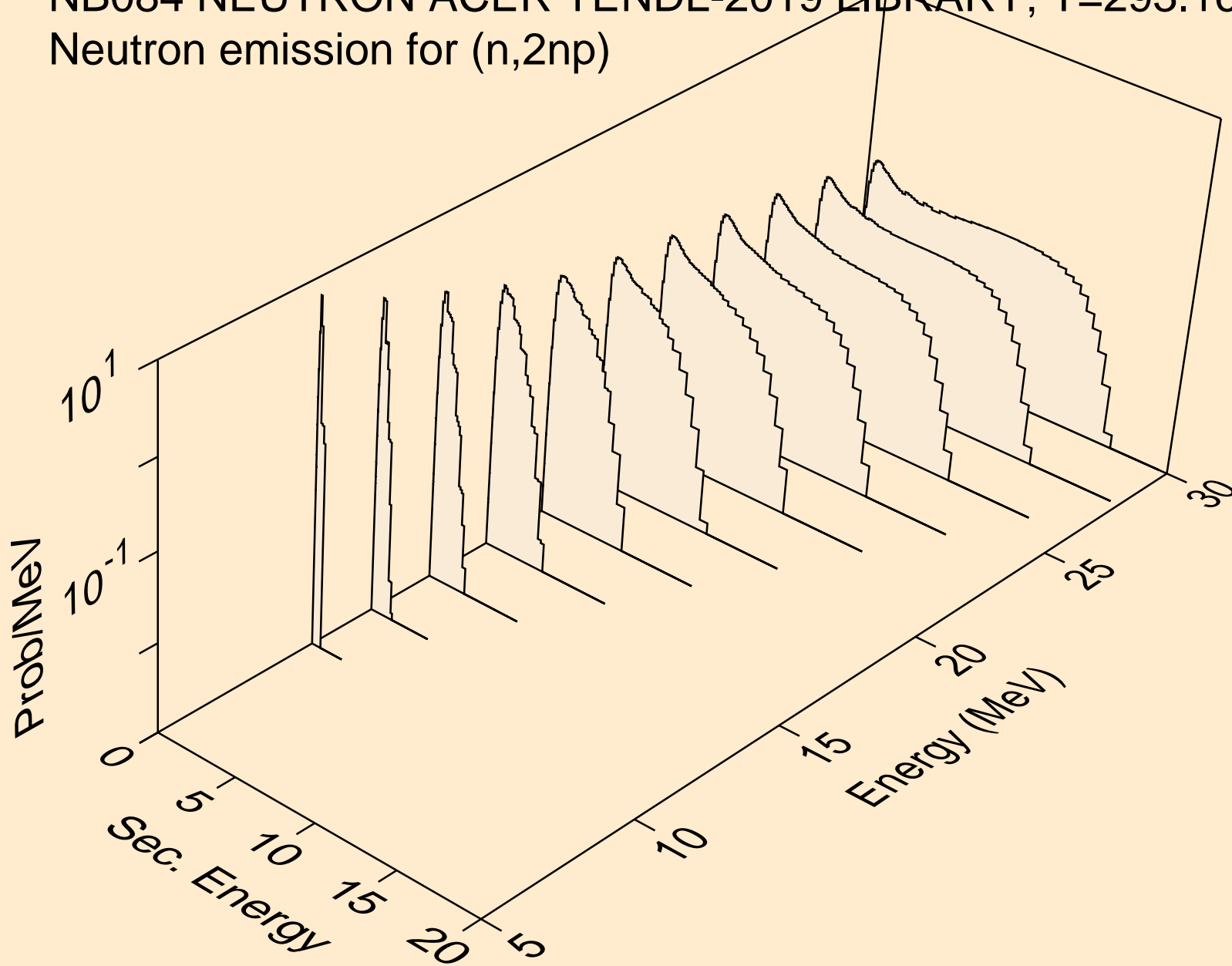

NB084 NEUTRON ACER TENDL-2019 LIBRARY; T=293.16K
Neutron emission for (n,npa)

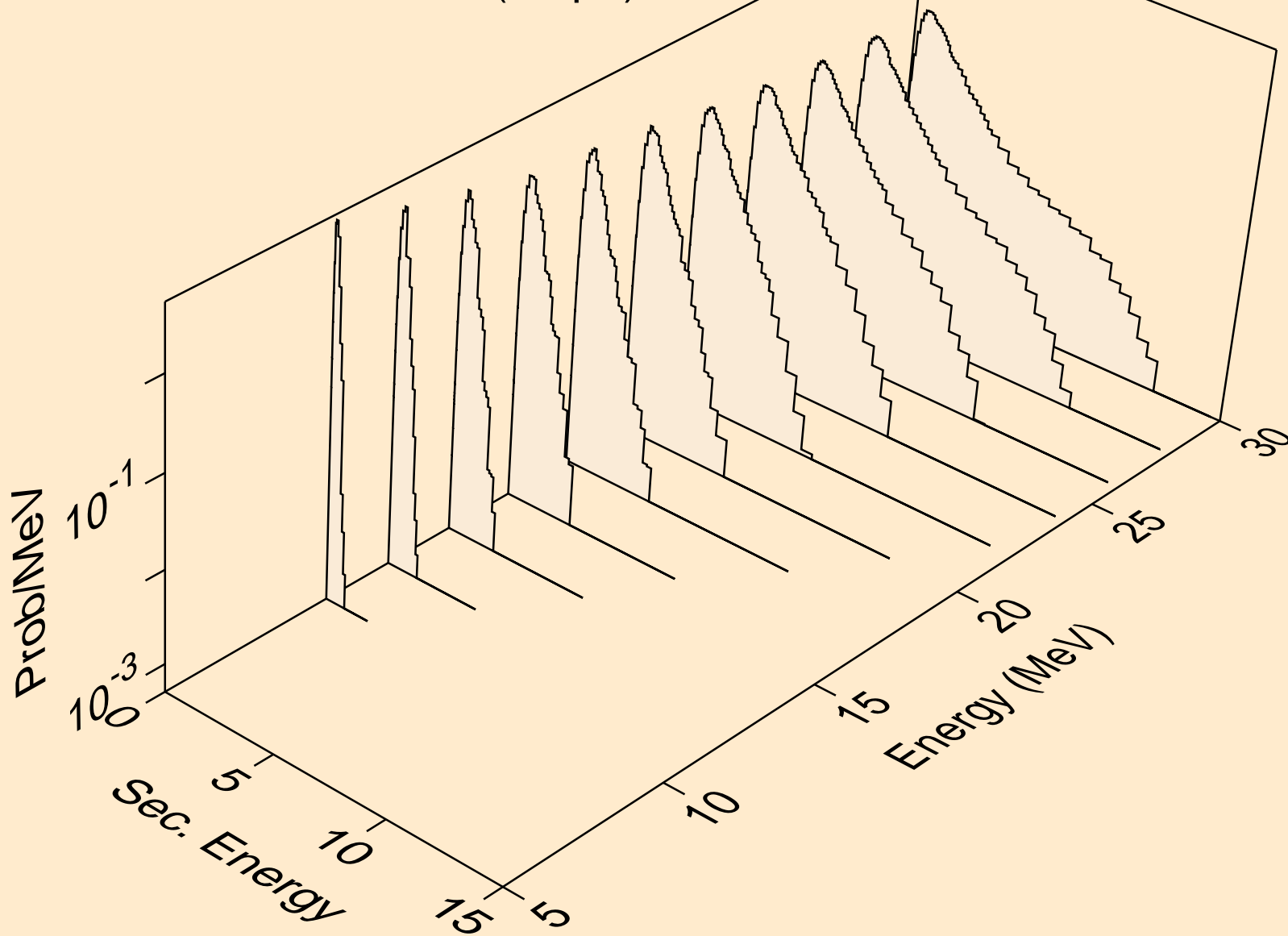

NB084 NEUTRON ACER TENDL-2019 LIBRARY; T=293.16K
Neutron emission for (n,n*c)

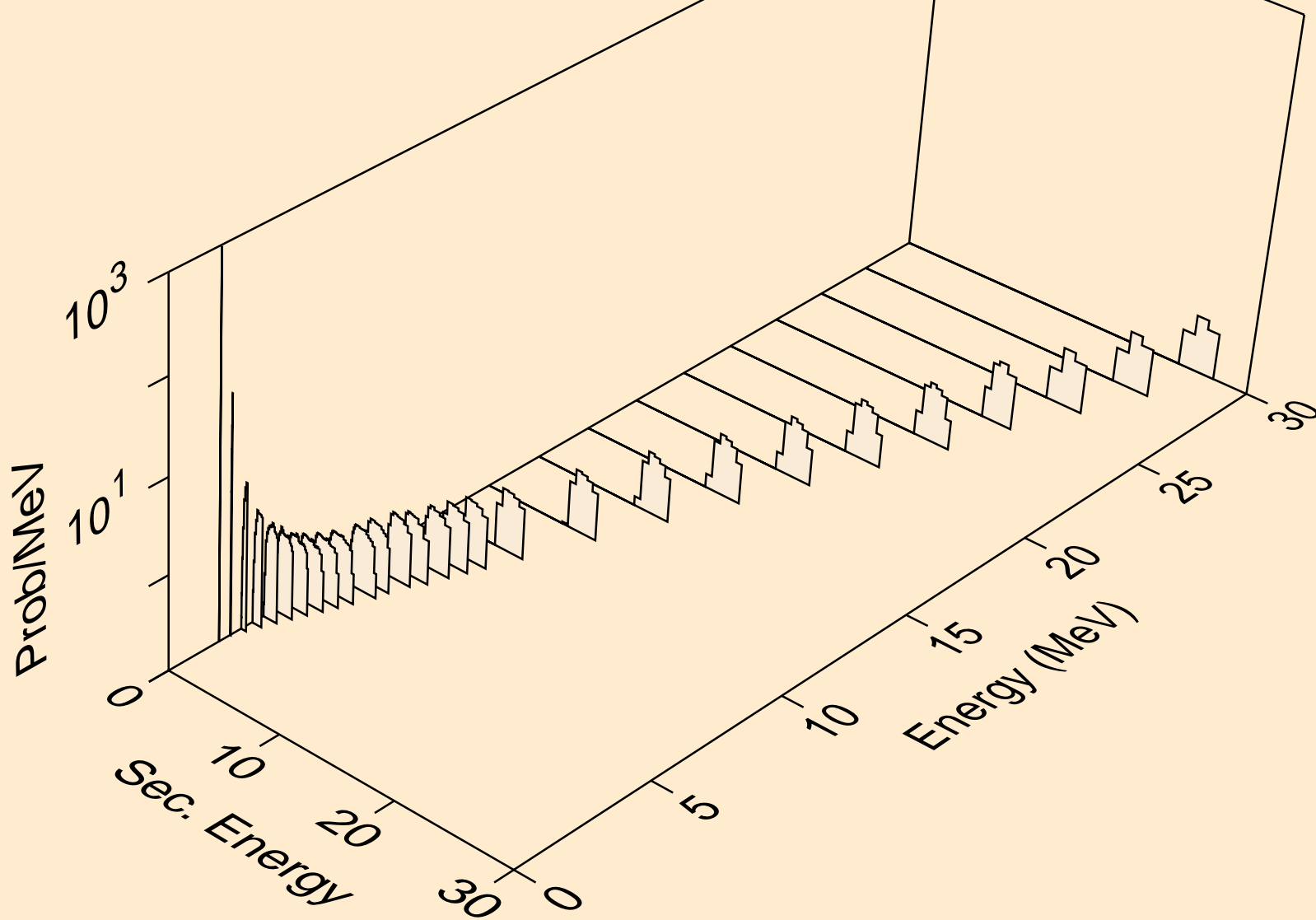

NB084 NEUTRON ACER TENDL-2019 LIBRARY; T=293.16K
Photon emission for (n,x)

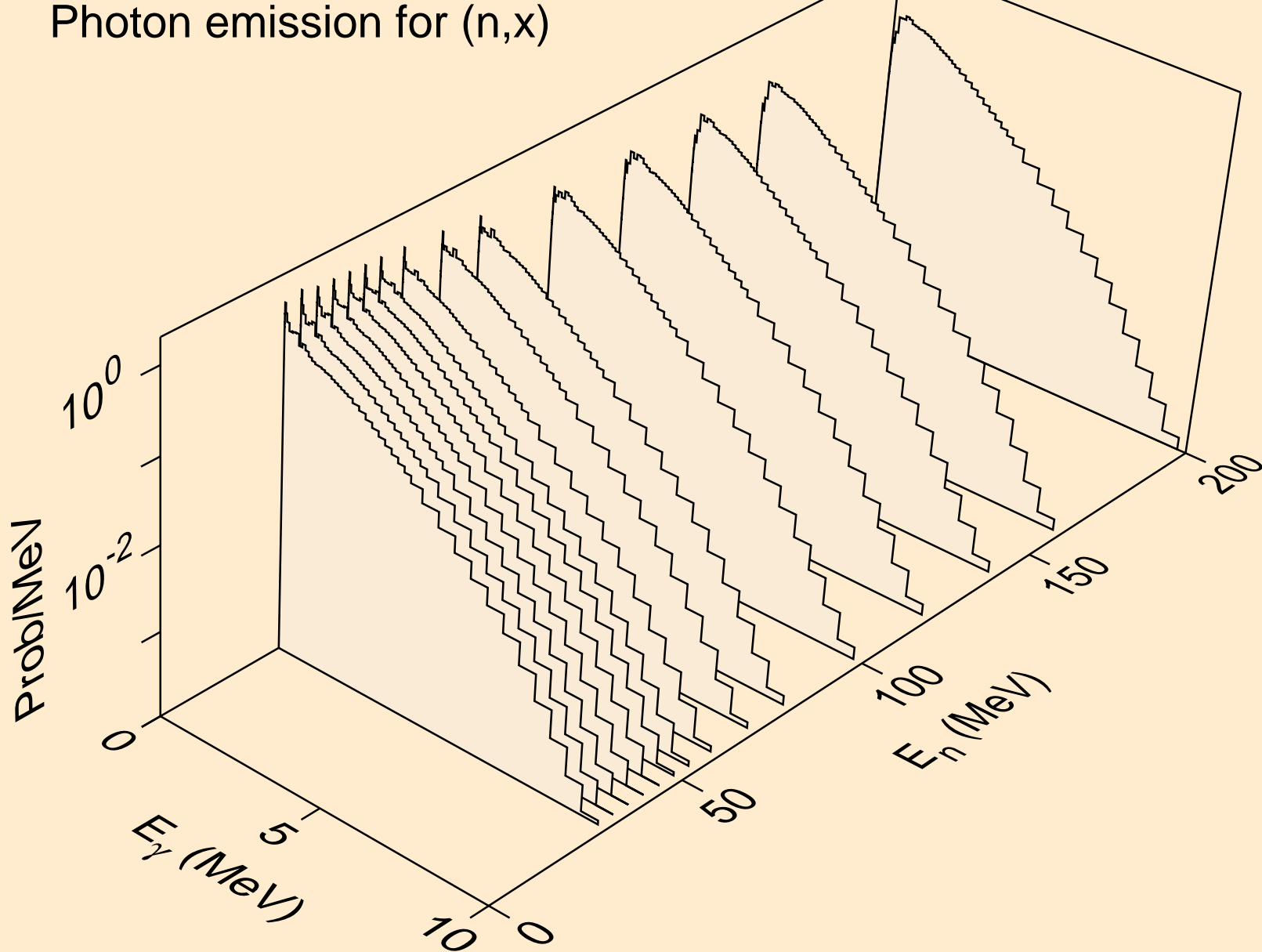

NB084 NEUTRON ACER TENDL-2019 LIBRARY; T=293.16K
Photon emission for (n,2nd)

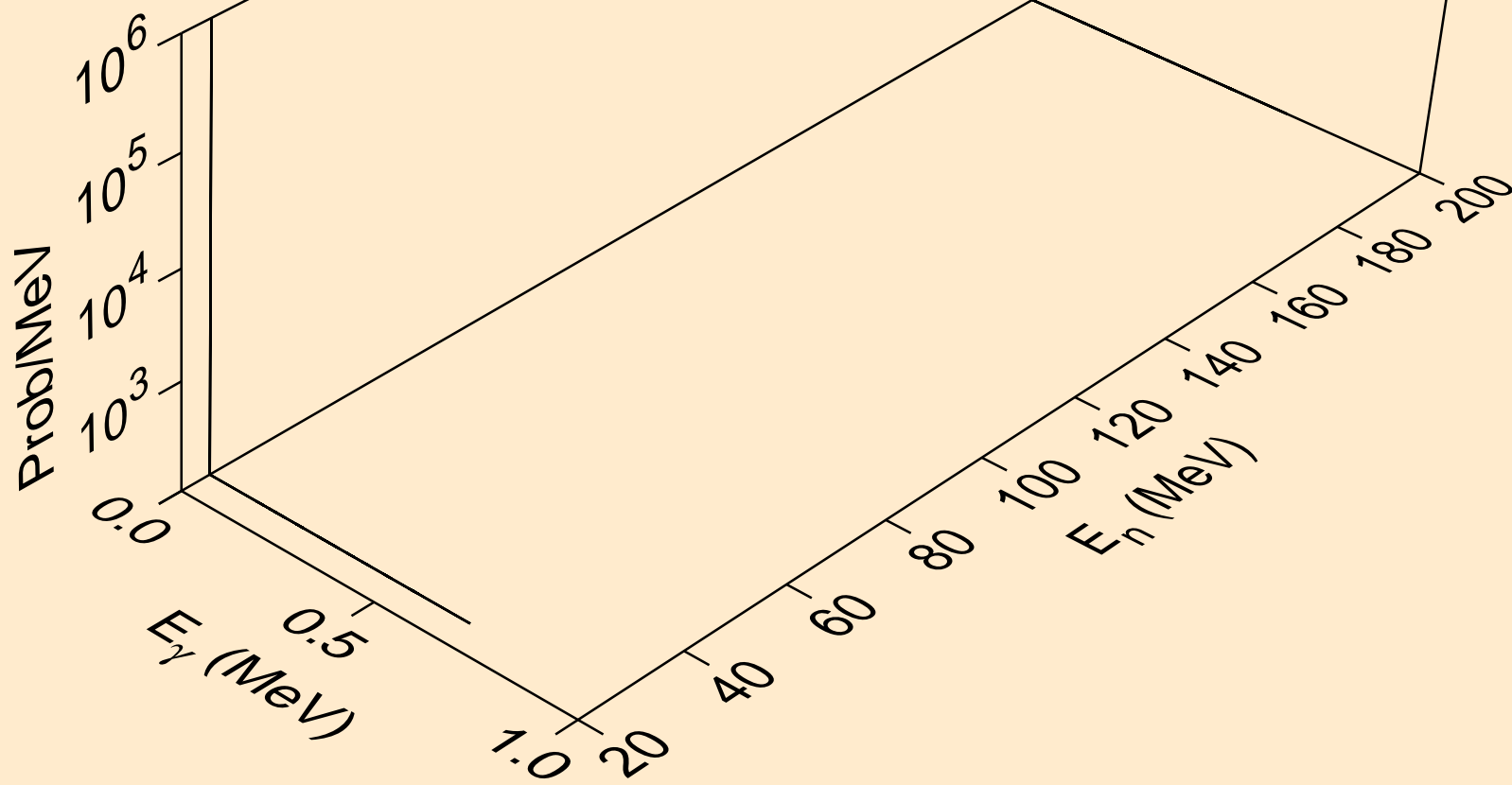

NB084 NEUTRON ACER TENDL-2019 LIBRARY; T=293.16K
Photon emission for (n,2n)

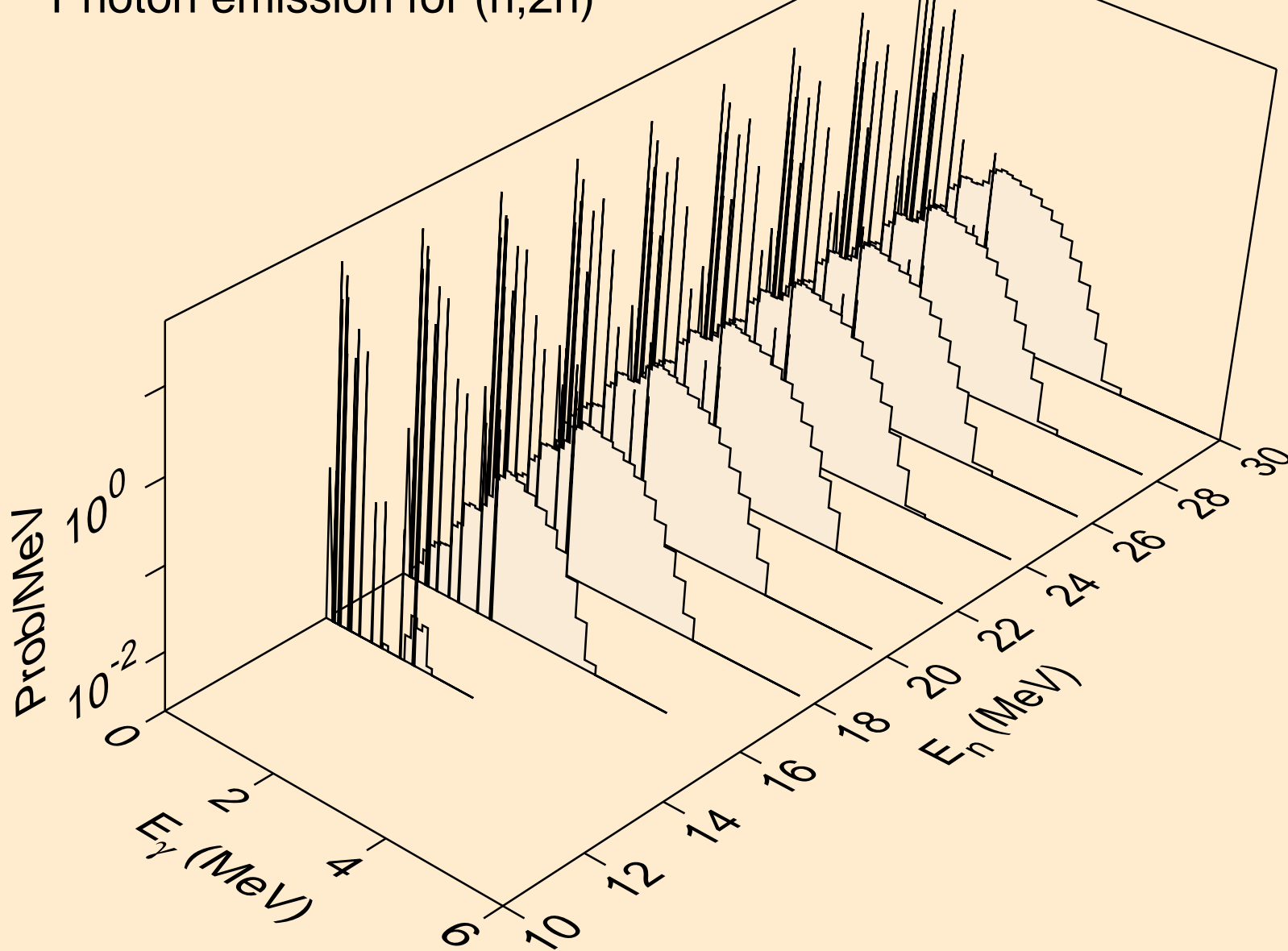

NB084 NEUTRON ACER TENDL-2019 LIBRARY; T=293.16K
Photon emission for (n,3n)

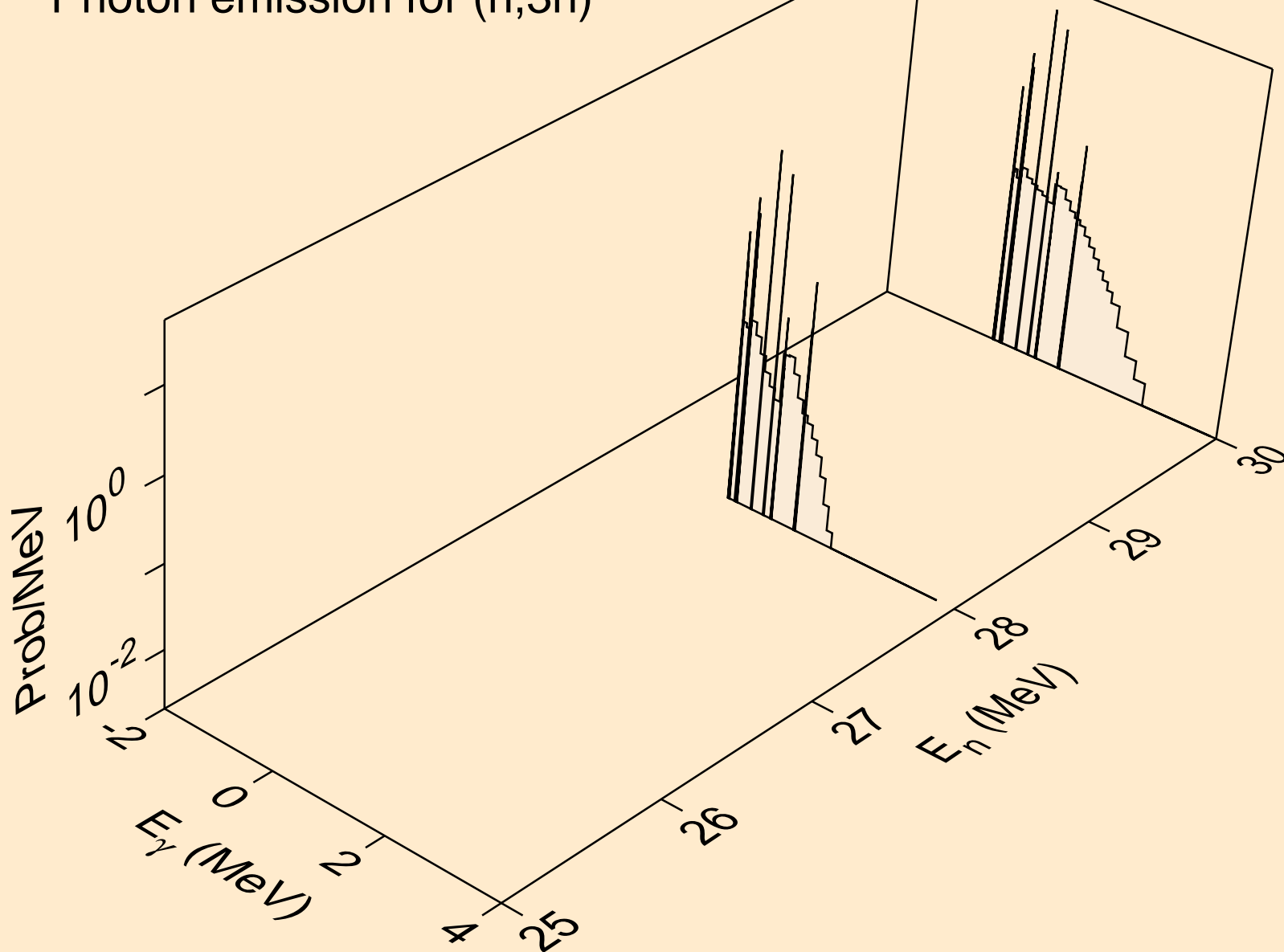

NB084 NEUTRON ACER TENDL-2019 LIBRARY; T=293.16K
Photon emission for (n,n*)a

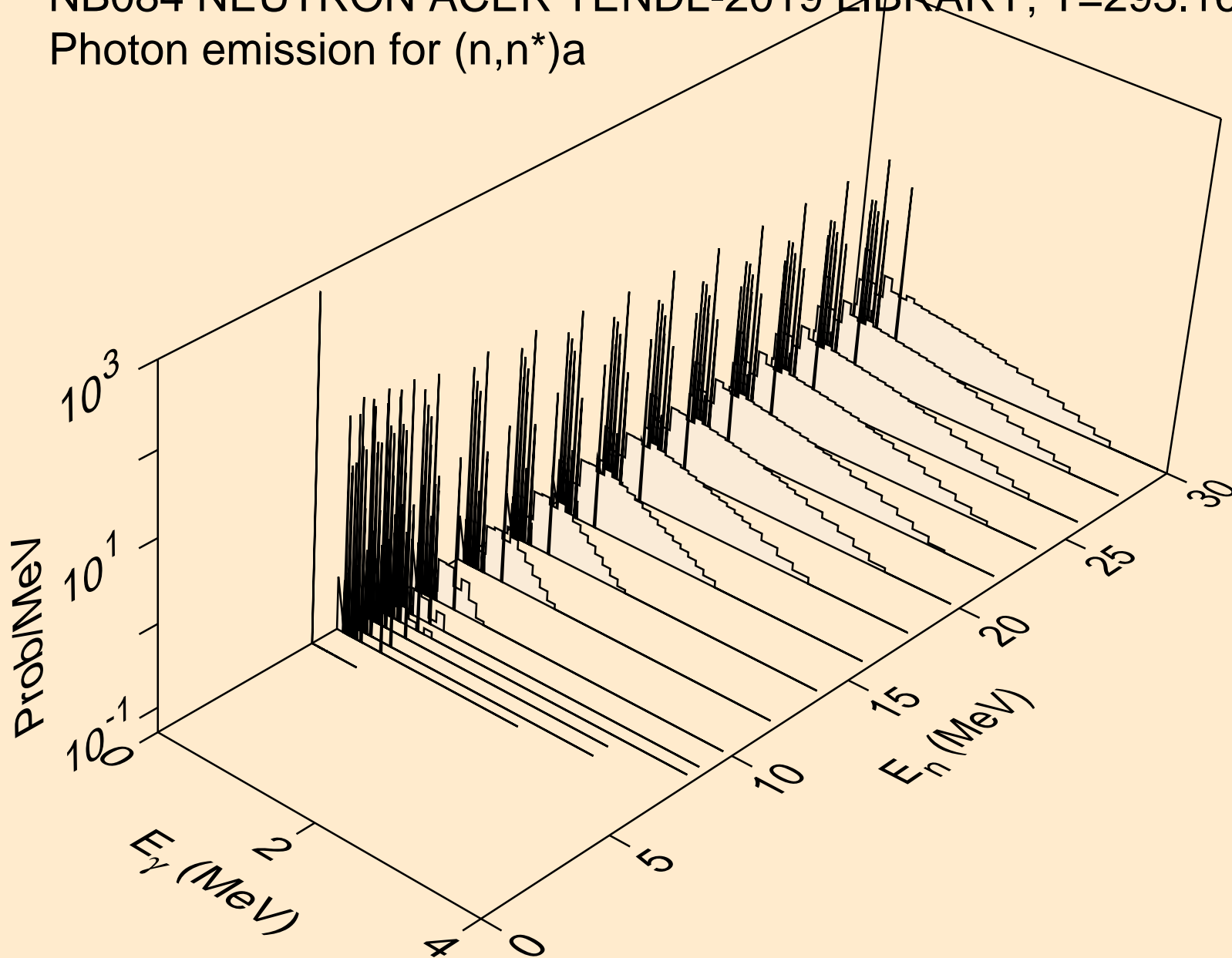

NB084 NEUTRON ACER TENDL-2019 LIBRARY; T=293.16K
Photon emission for (n,2n)a

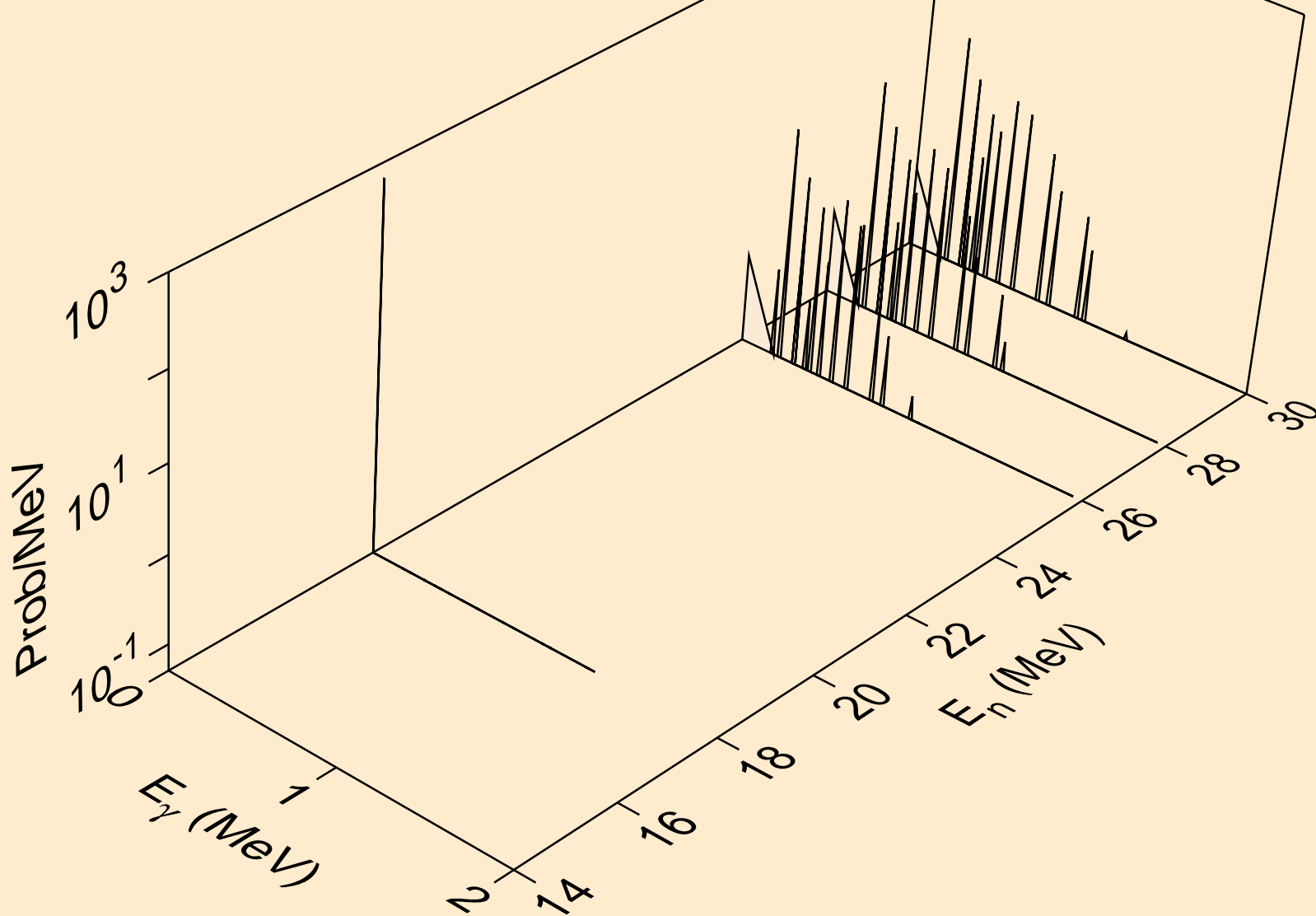

NB084 NEUTRON ACER TENDL-2019 LIBRARY; T=293.16K
Photon emission for (n,n*)p

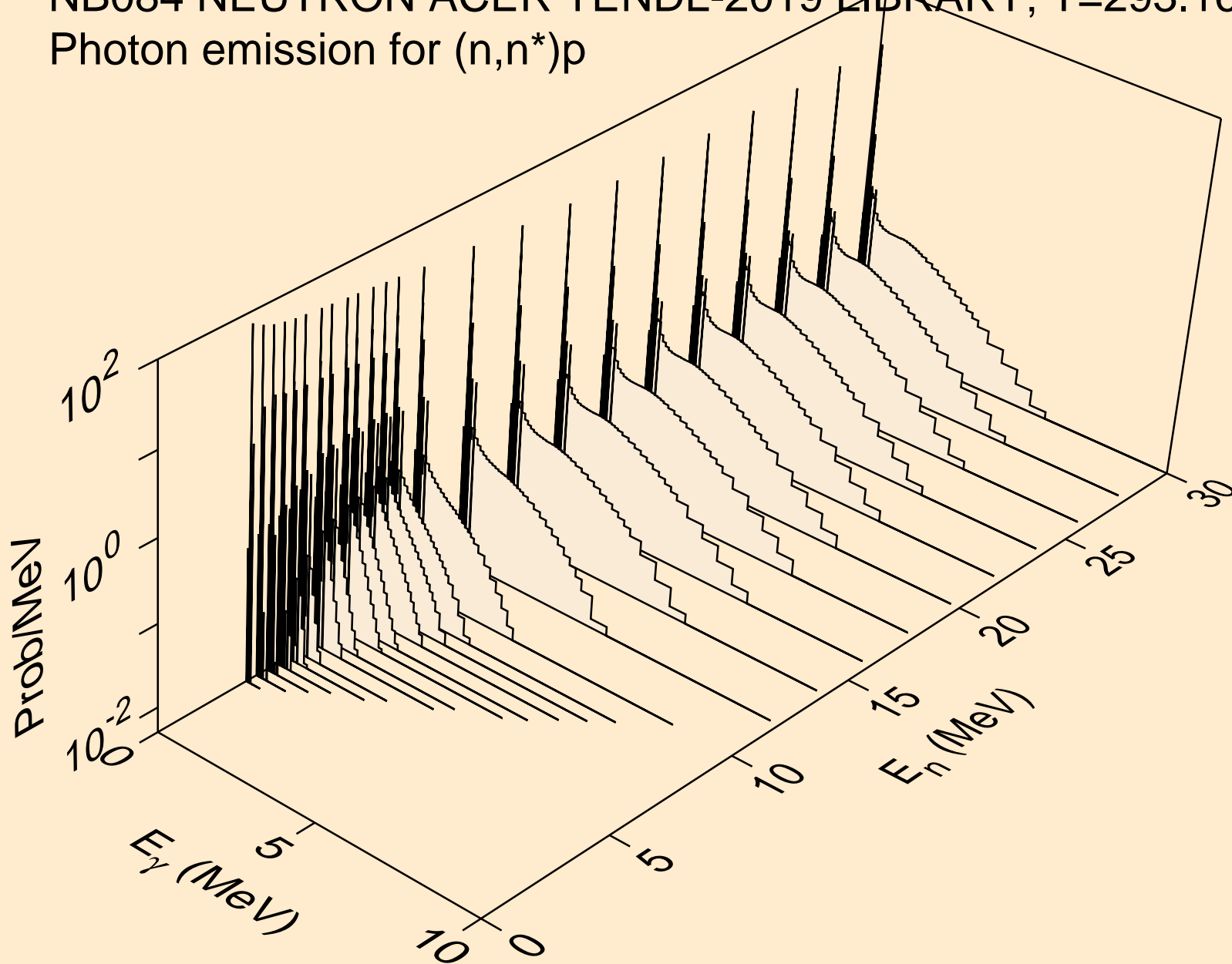

NB084 NEUTRON ACER TENDL-2019 LIBRARY; T=293.16K
Photon emission for (n,n*)2a

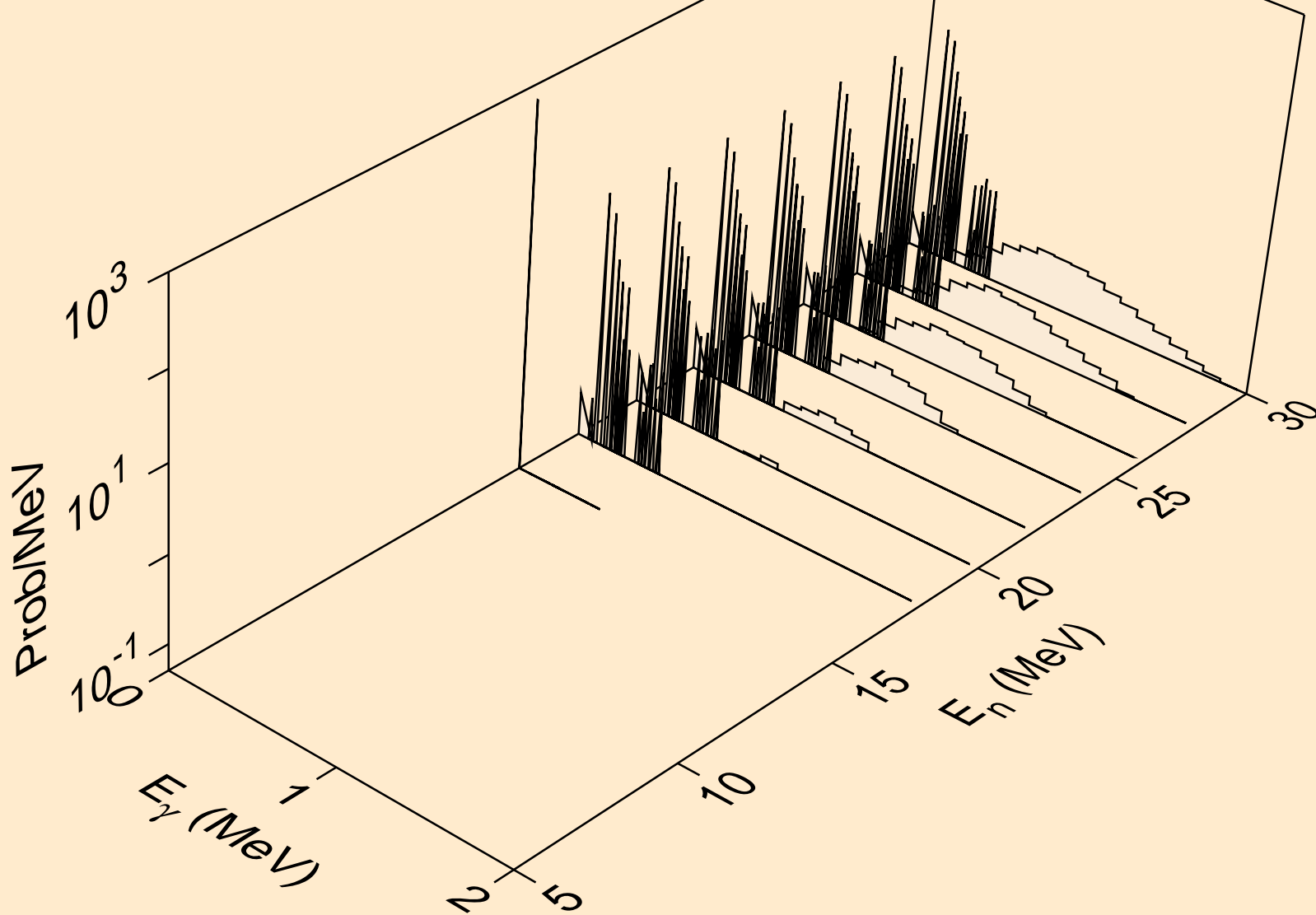

NB084 NEUTRON ACER TENDL-2019 LIBRARY; T=293.16K
Photon emission for (n,n*)d

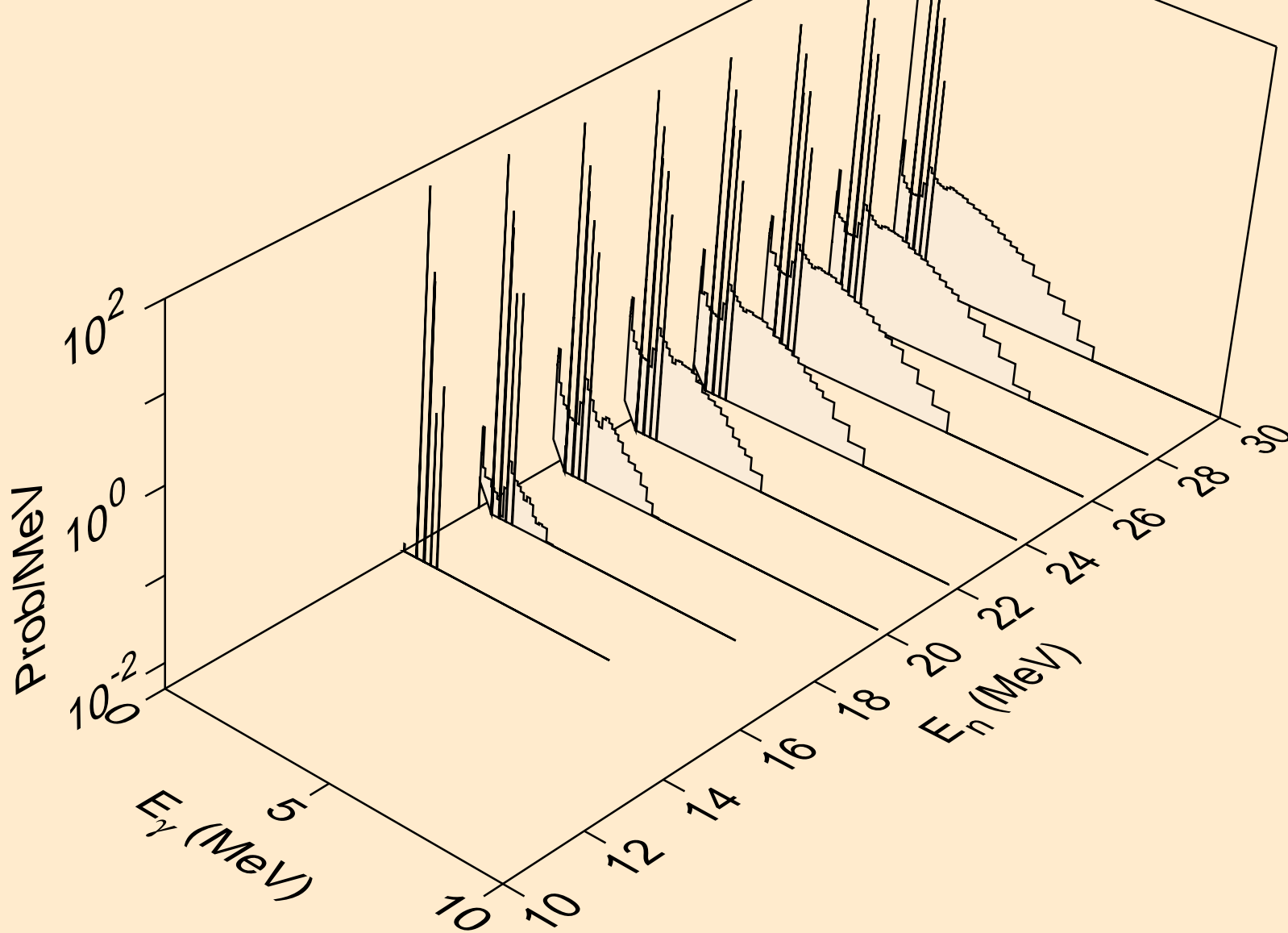

NB084 NEUTRON ACER TENDL-2019 LIBRARY; T=293.16K
Photon emission for (n,n*)t

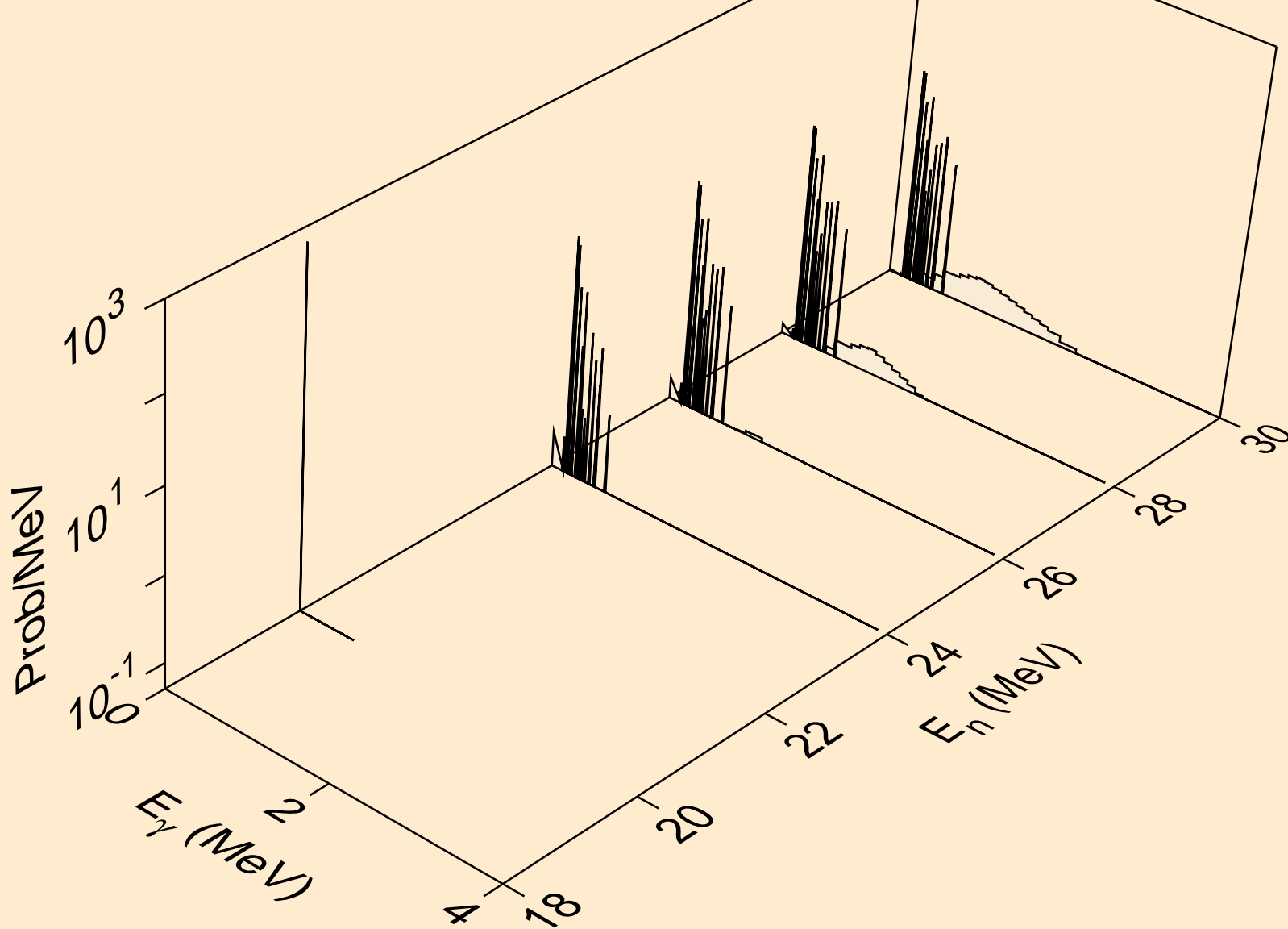

NB084 NEUTRON ACER TENDL-2019 LIBRARY; T=293.16K
Photon emission for (n,n*)he3

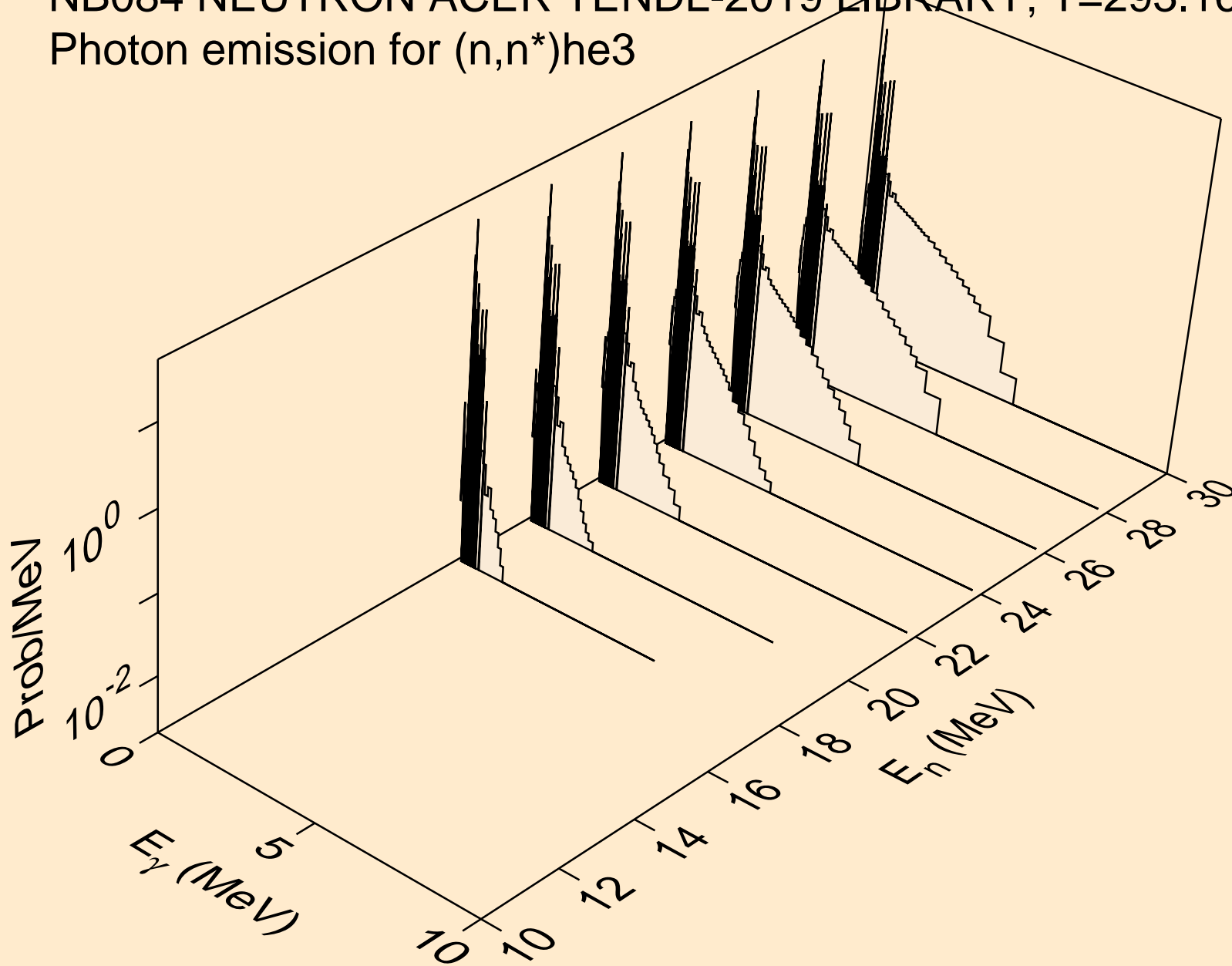

NB084 NEUTRON ACER TENDL-2019 LIBRARY; T=293.16K
Photon emission for (n,2np)

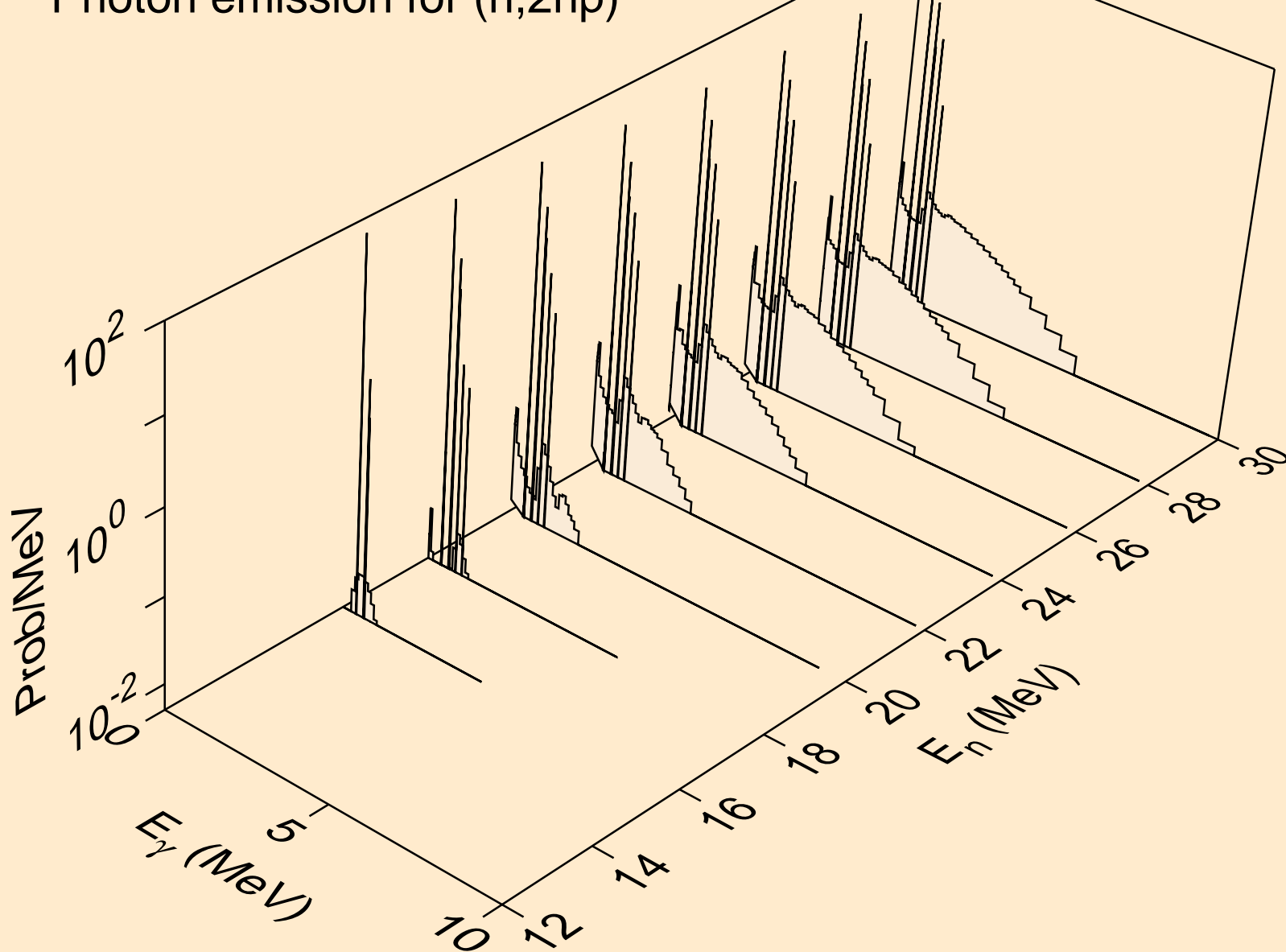

NB084 NEUTRON ACER TENDL-2019 LIBRARY; T=293.16K
Photon emission for (n,3np)

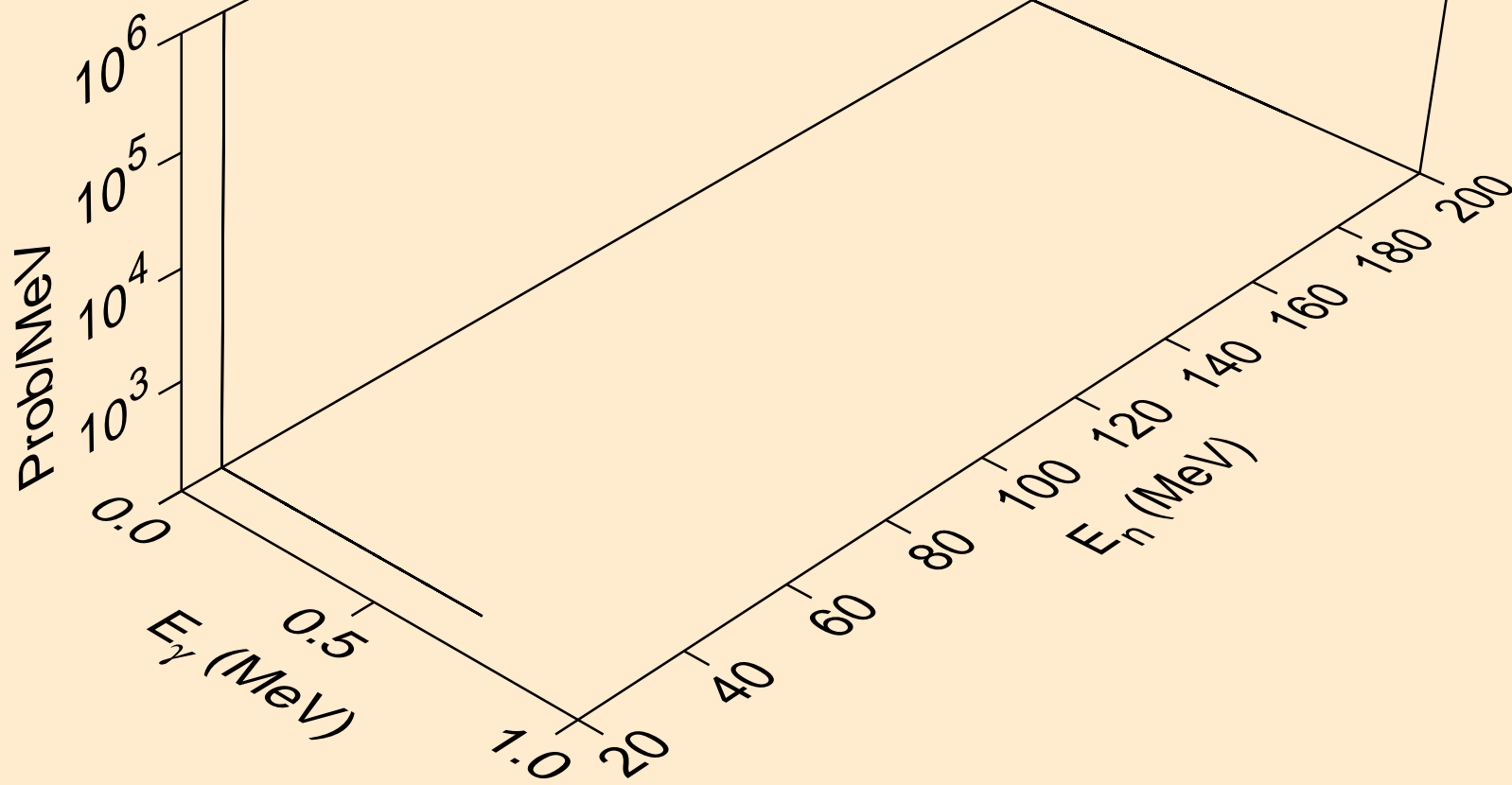

NB084 NEUTRON ACER TENDL-2019 LIBRARY; T=293.16K
Photon emission for (n,2np)

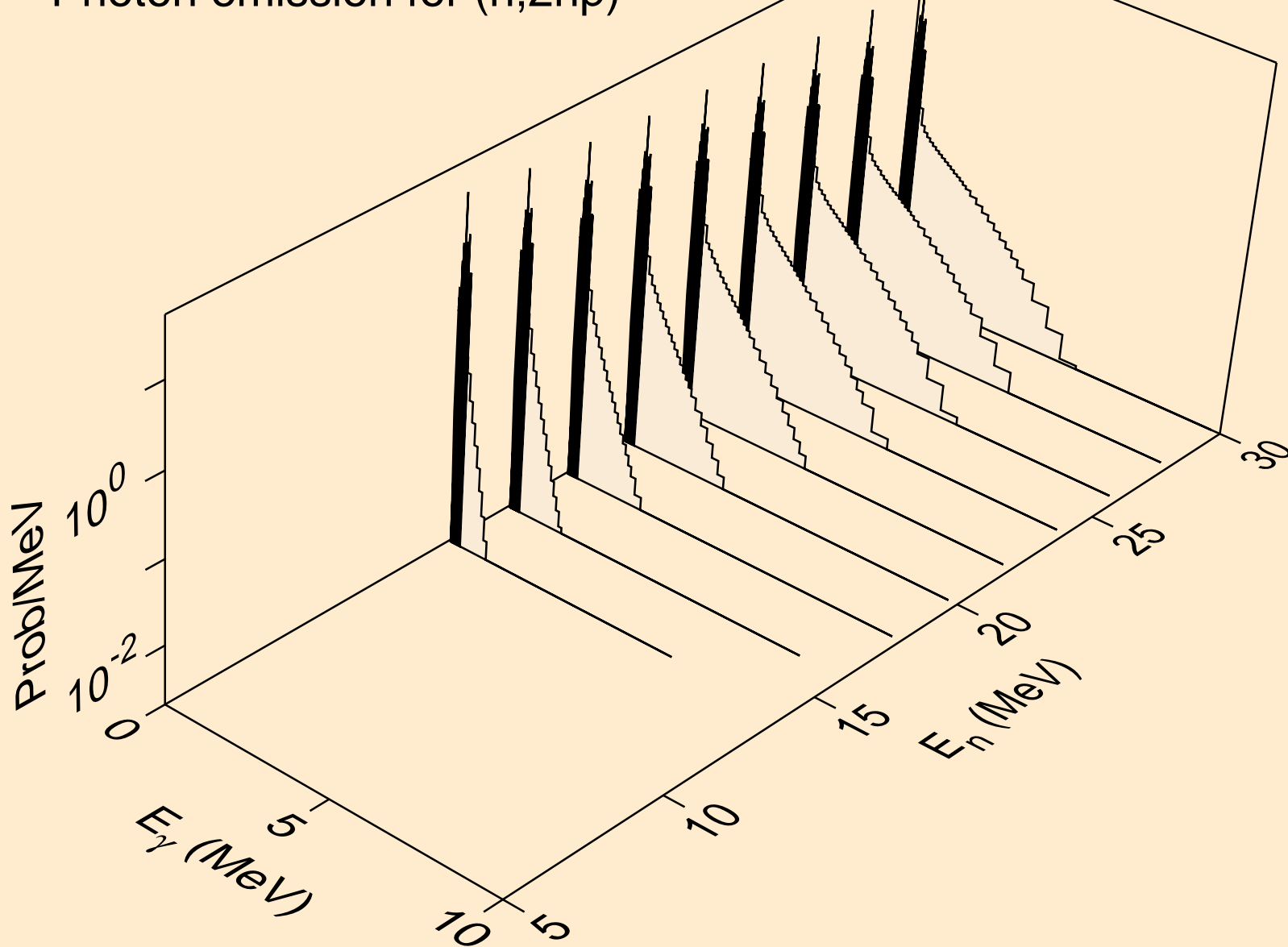

NB084 NEUTRON ACER TENDL-2019 LIBRARY; T=293.16K
Photon emission for (n,npa)

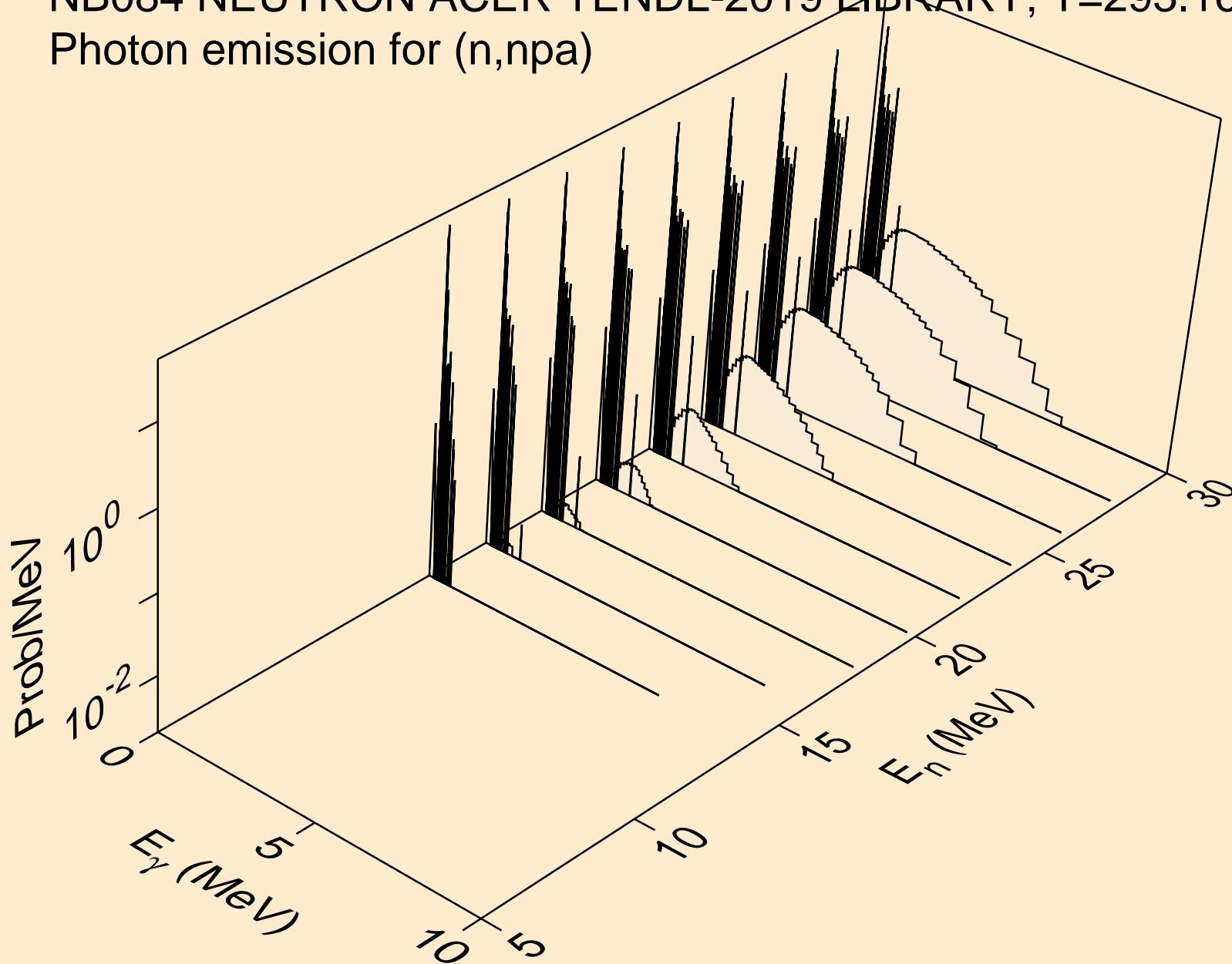

NB084 NEUTRON ACER TENDL-2019 LIBRARY; T=293.16K
Photon emission for (n,n*c)

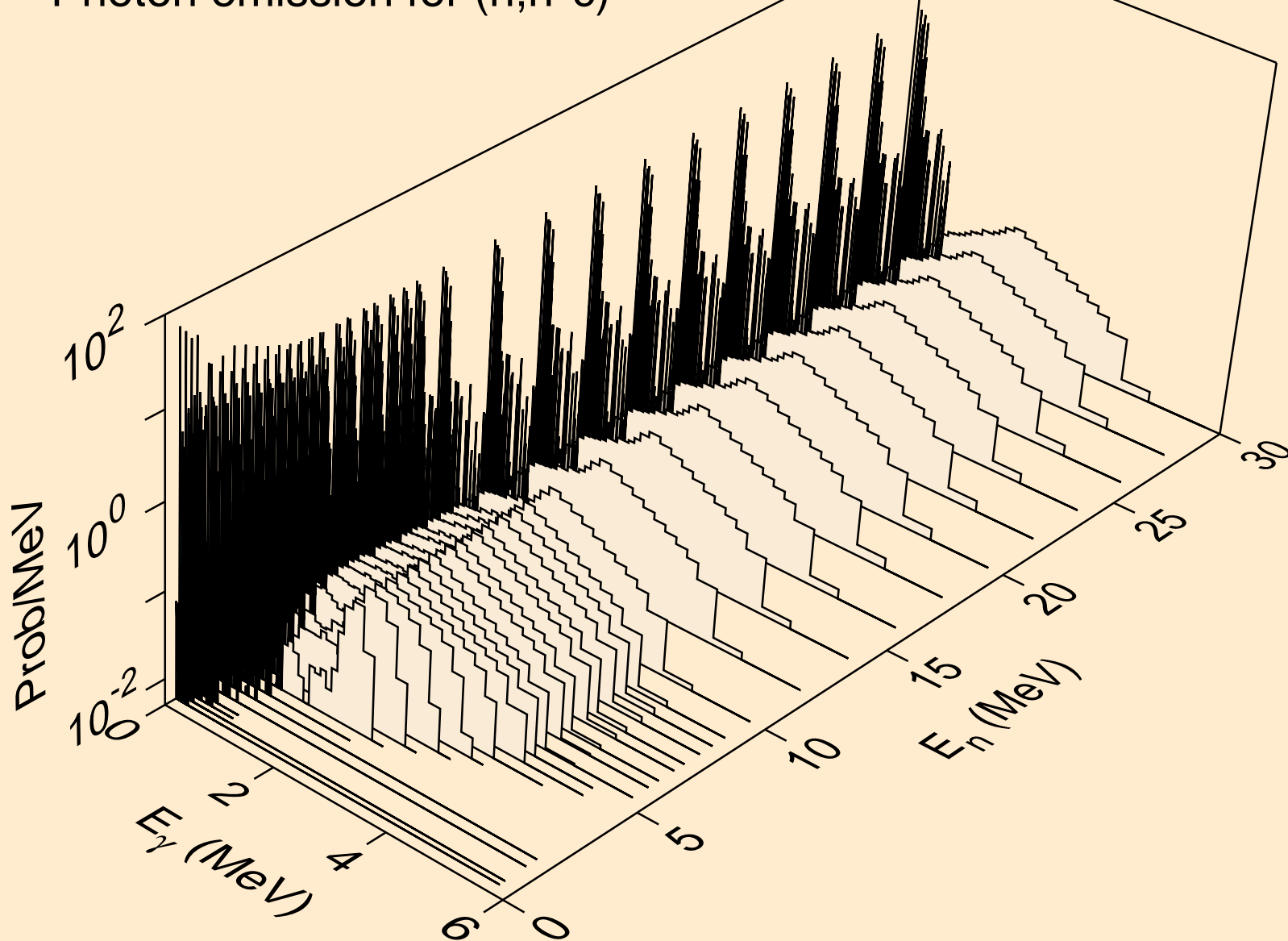

NB084 NEUTRON ACER TENDL-2019 LIBRARY; T=293.16K
Photon emission for (n,gma)

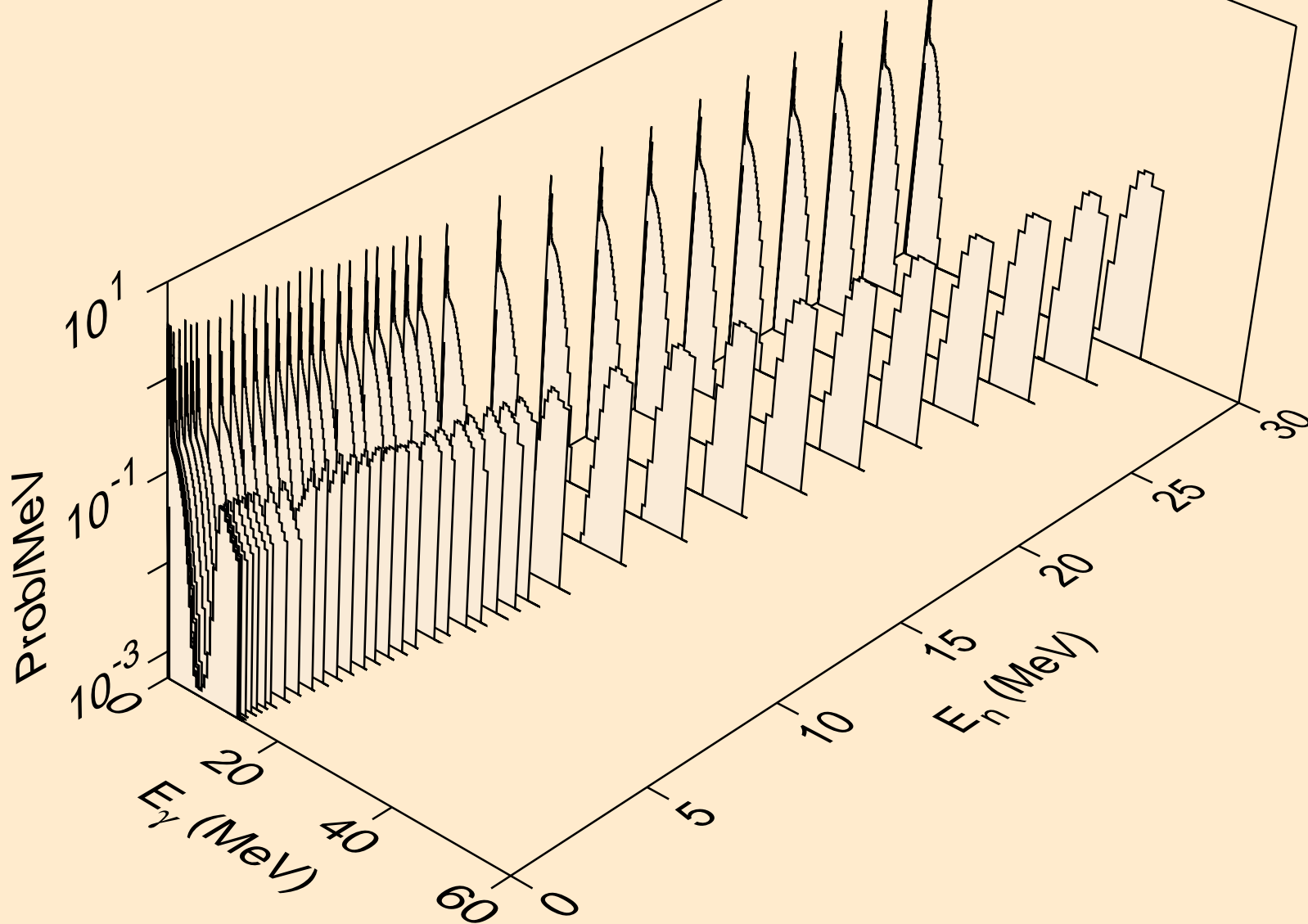

NB084 NEUTRON ACER TENDL-2019 LIBRARY; T=293.16K
Photon emission for (n,p)

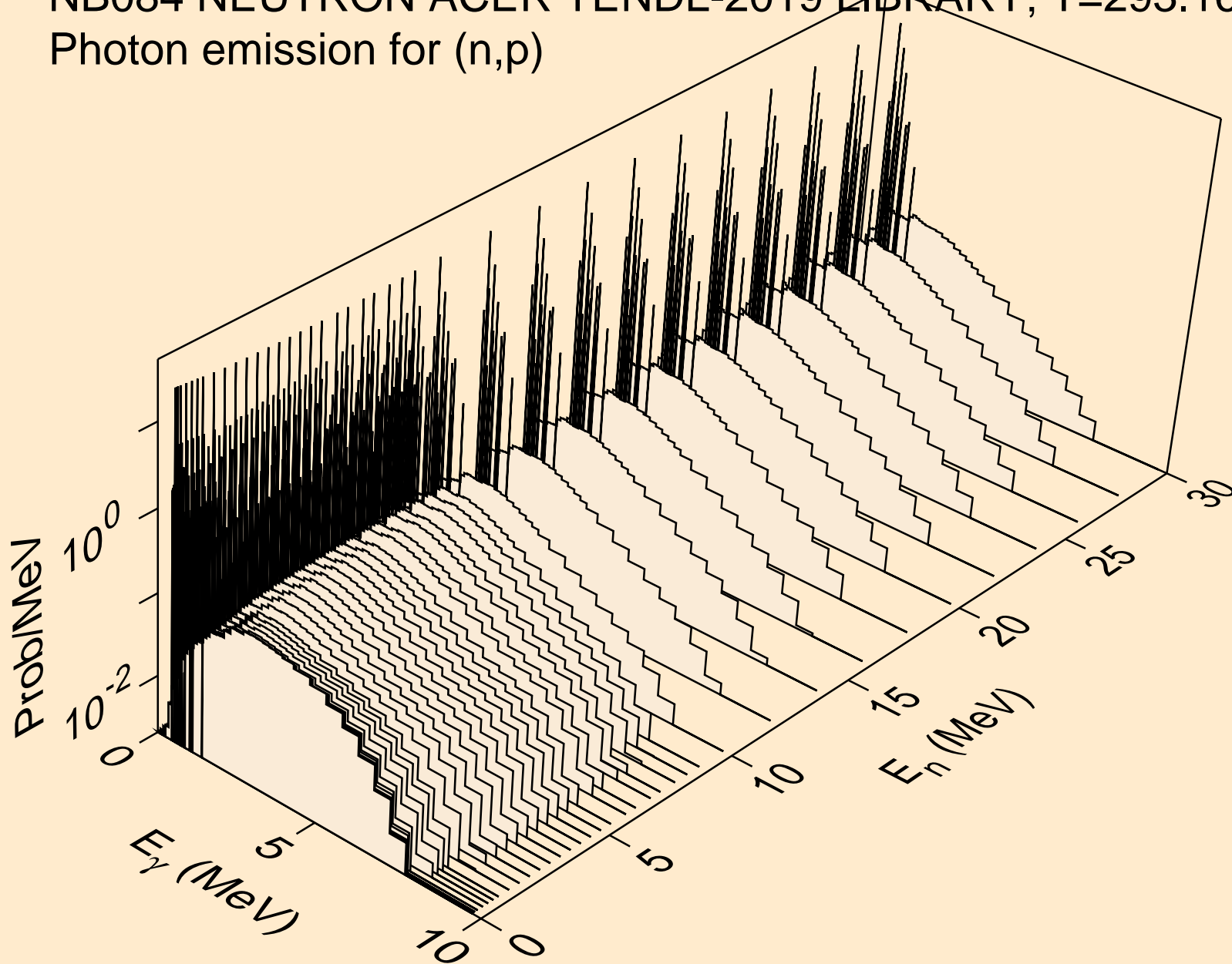

NB084 NEUTRON ACER TENDL-2019 LIBRARY; T=293.16K
Photon emission for (n,d)

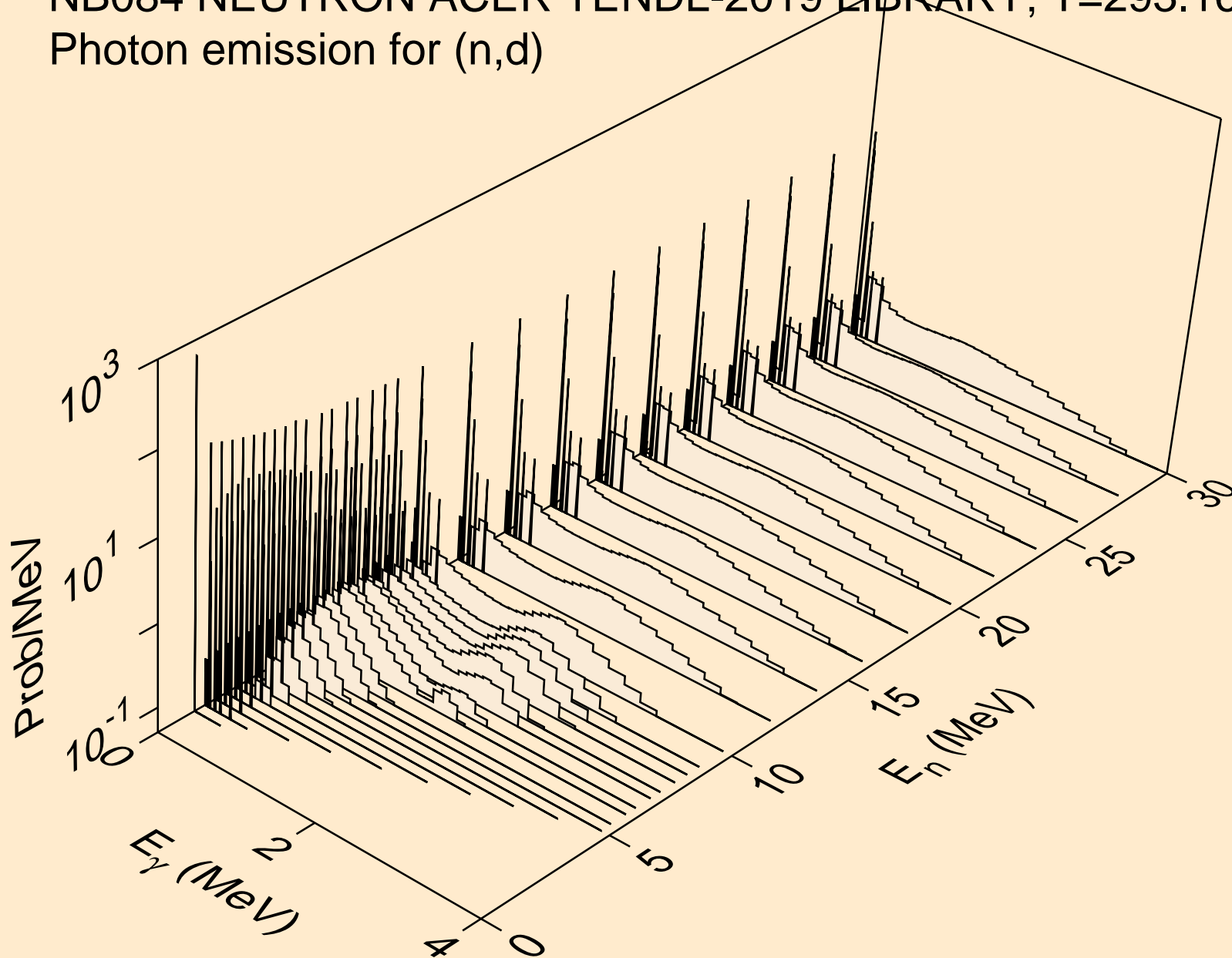

NB084 NEUTRON ACER TENDL-2019 LIBRARY; T=293.16K
Photon emission for (n,t)

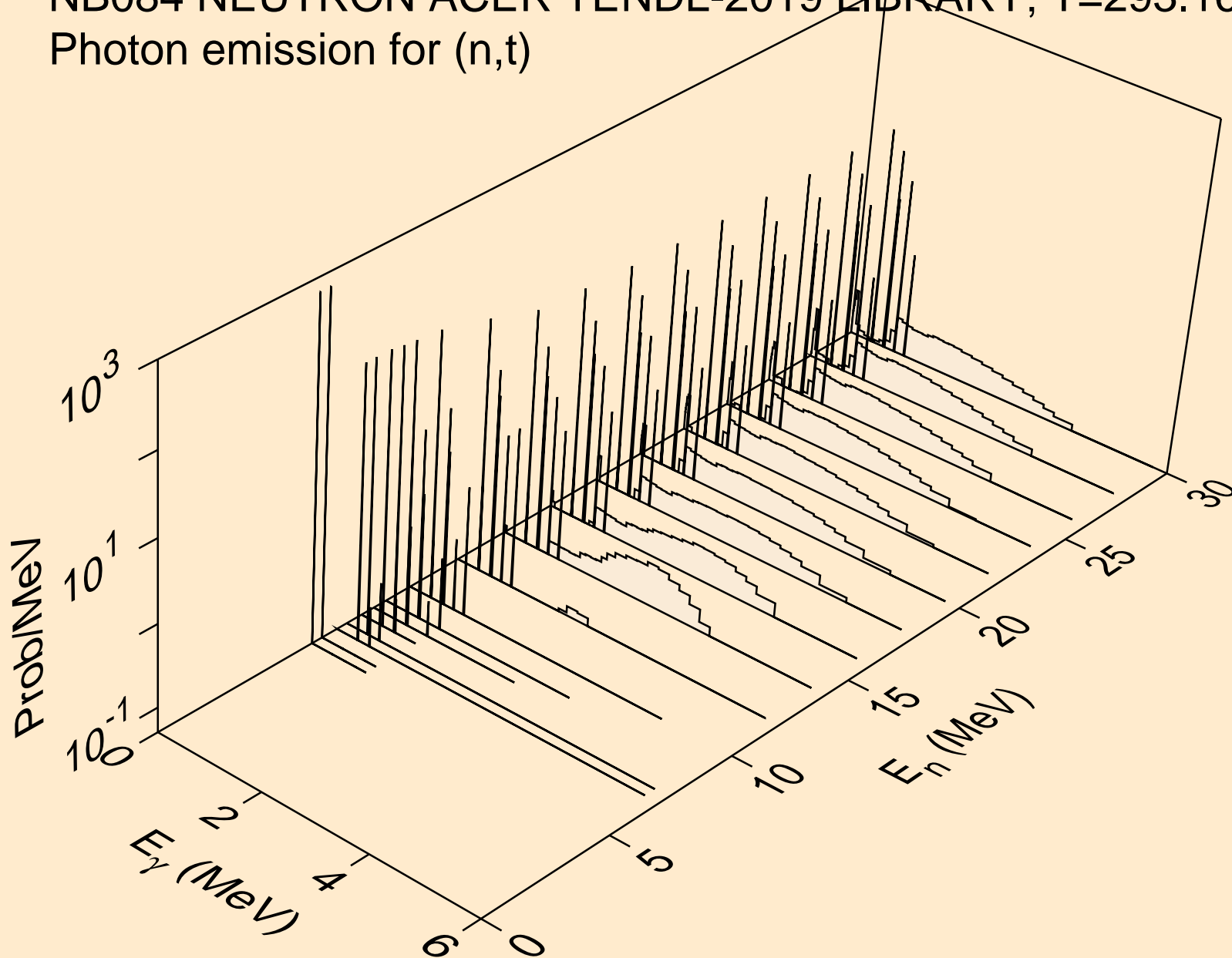

NB084 NEUTRON ACER TENDL-2019 LIBRARY; T=293.16K
Photon emission for (n,he3)

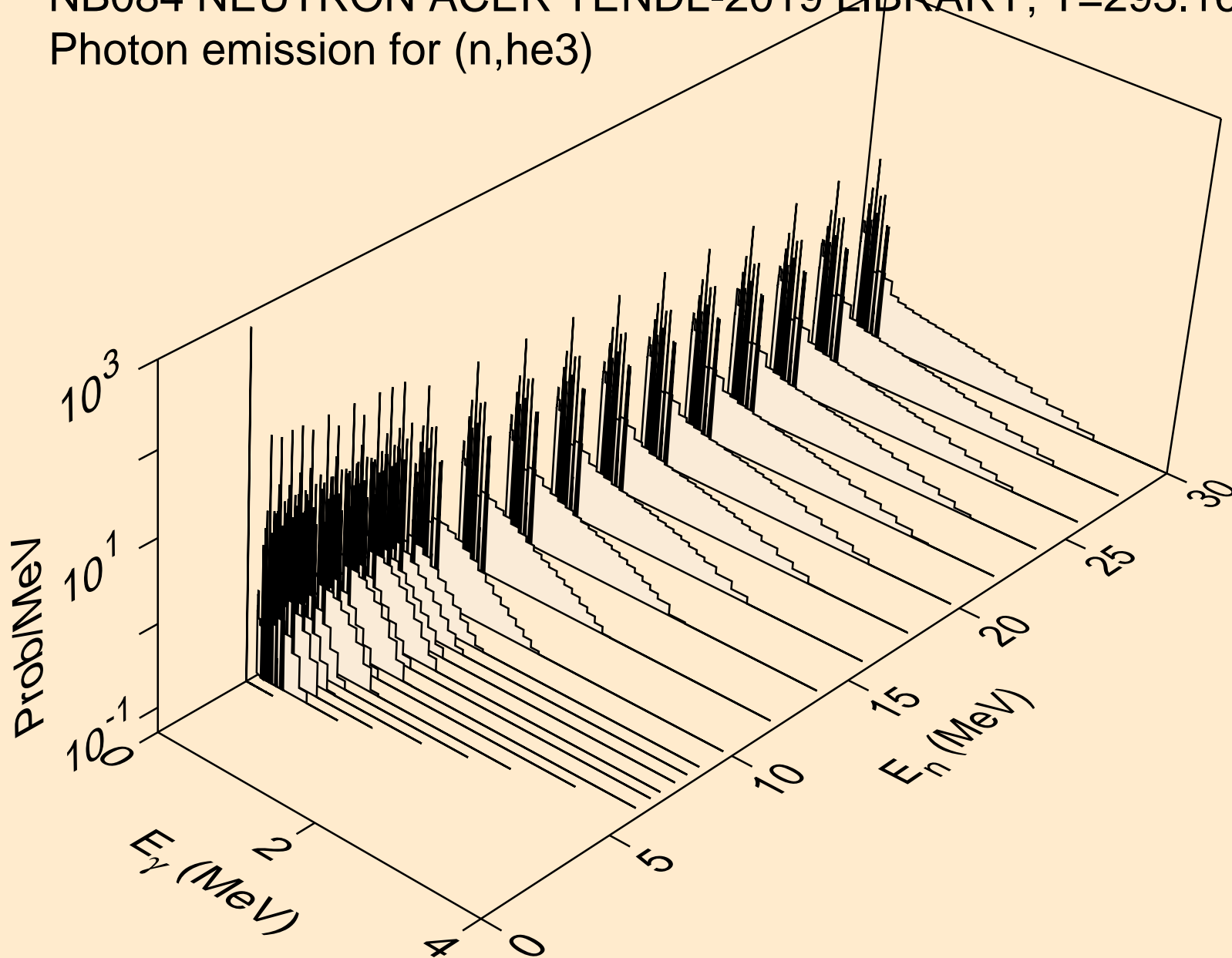

NB084 NEUTRON ACER TENDL-2019 LIBRARY; T=293.16K
Photon emission for (n,a)

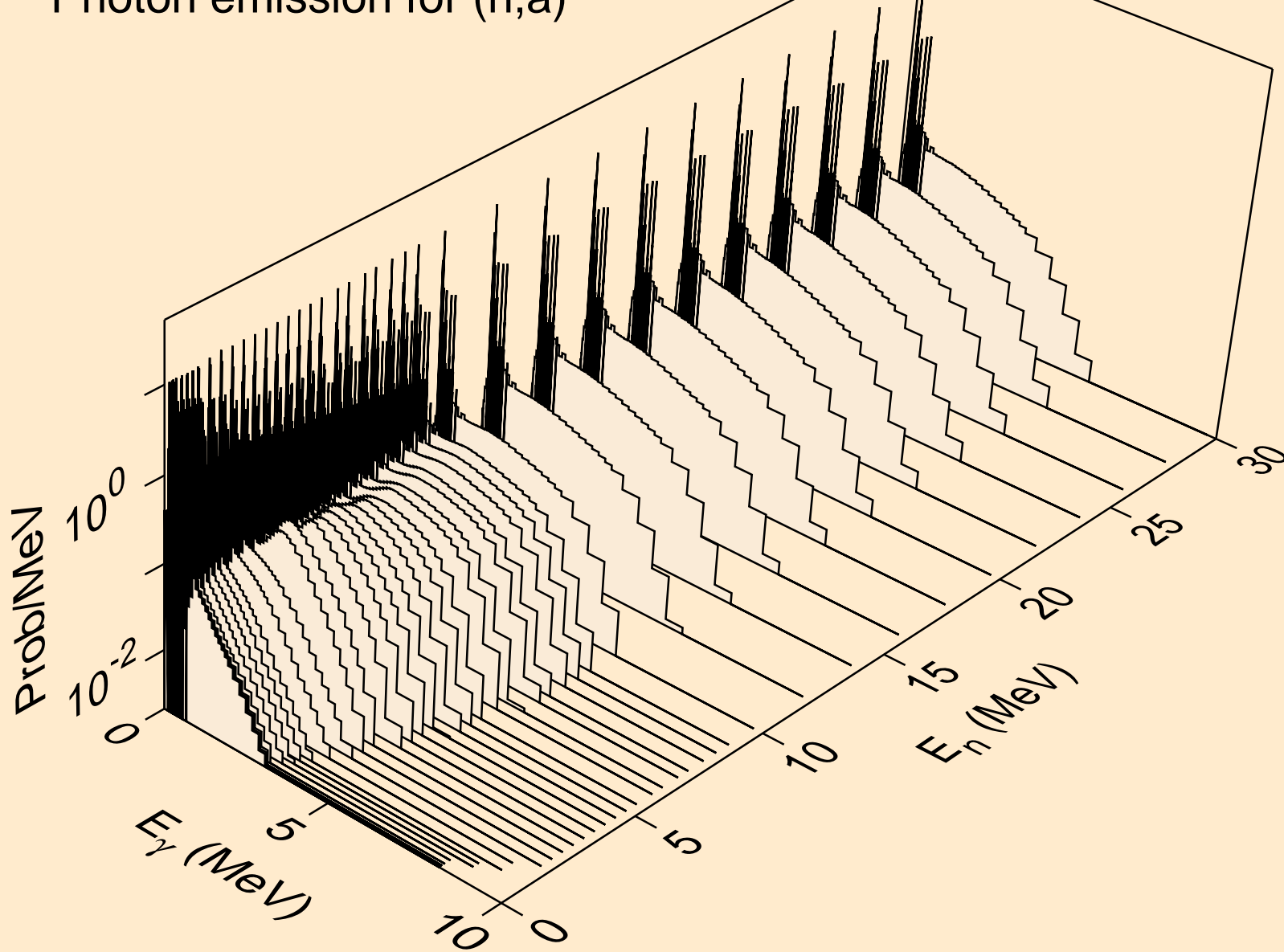

NB084 NEUTRON ACER TENDL-2019 LIBRARY; T=293.16K
Photon emission for (n,2a)

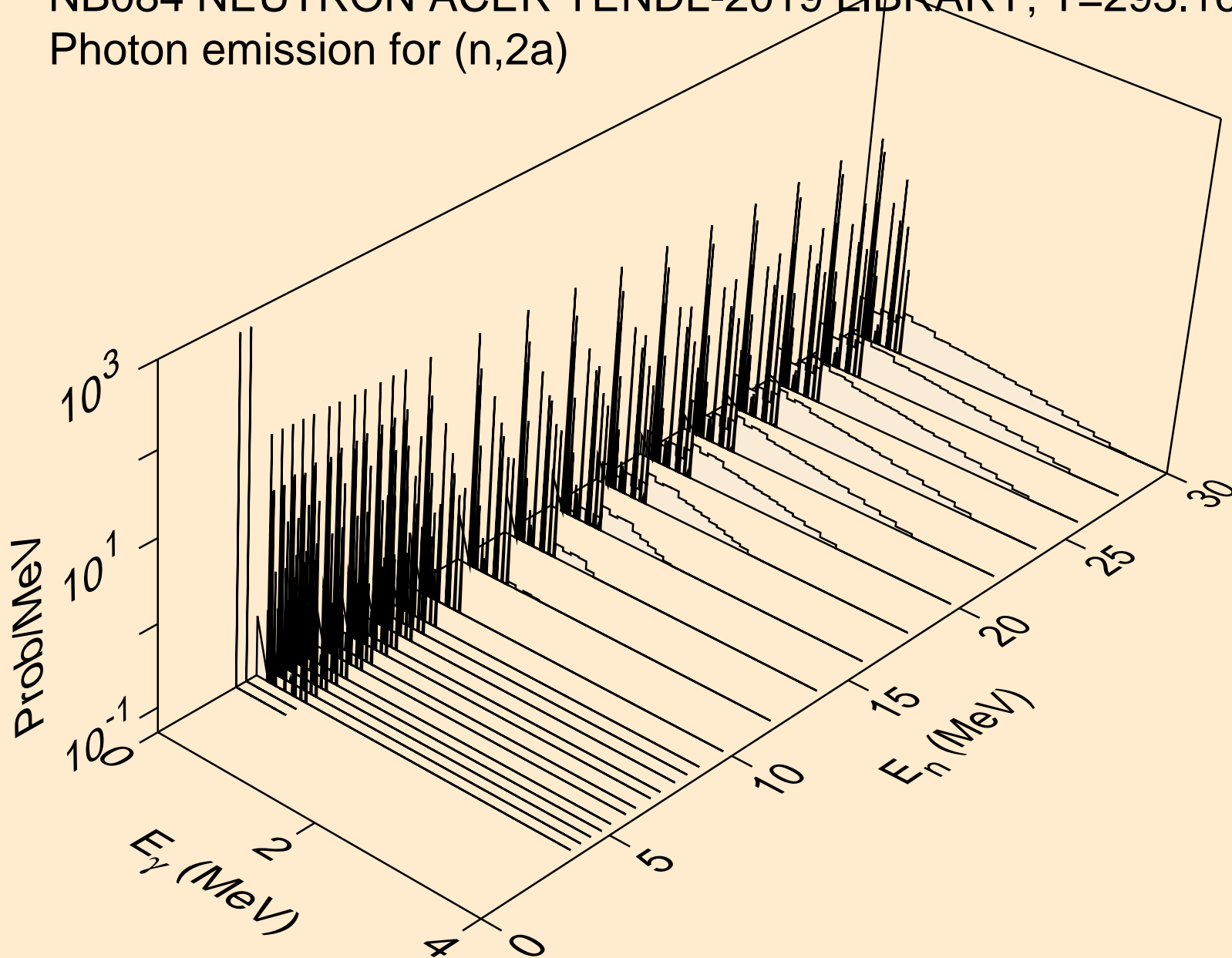

NB084 NEUTRON ACER TENDL-2019 LIBRARY; T=293.16K
Photon emission for (n,3a)

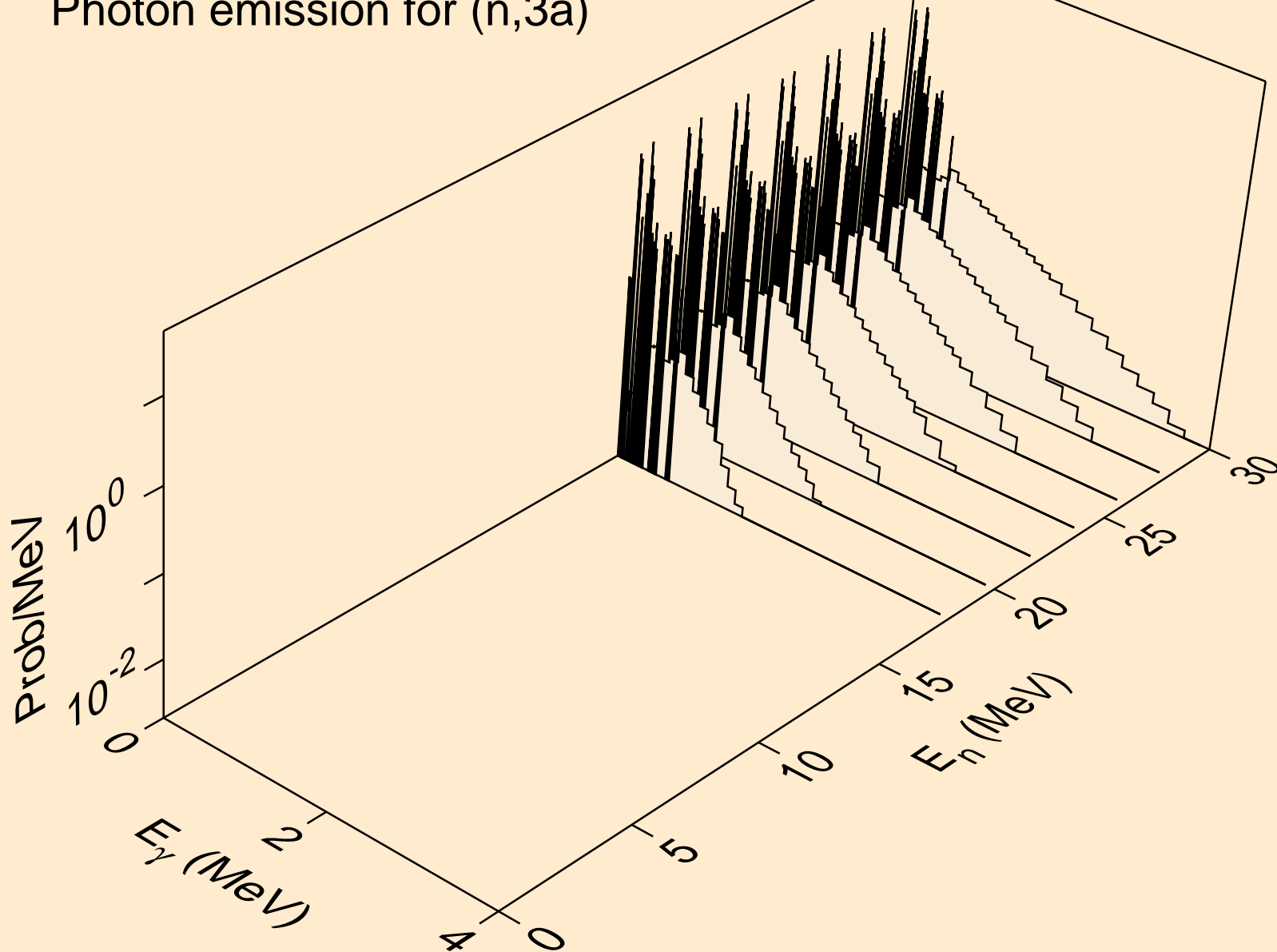

NB084 NEUTRON ACER TENDL-2019 LIBRARY; T=293.16K
Photon emission for (n,2p)

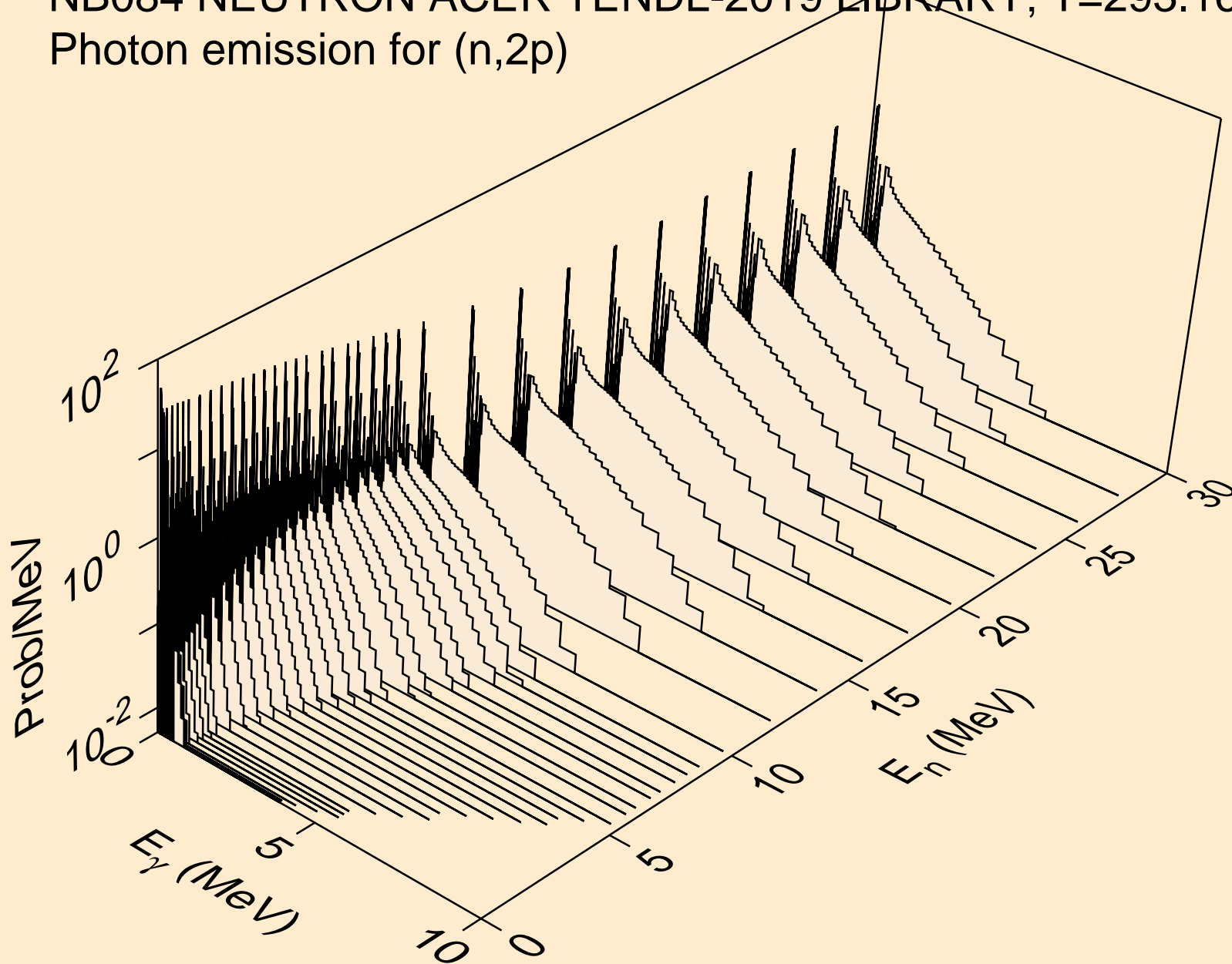

NB084 NEUTRON ACER TENDL-2019 LIBRARY; T=293.16K
Photon emission for (n,p α)

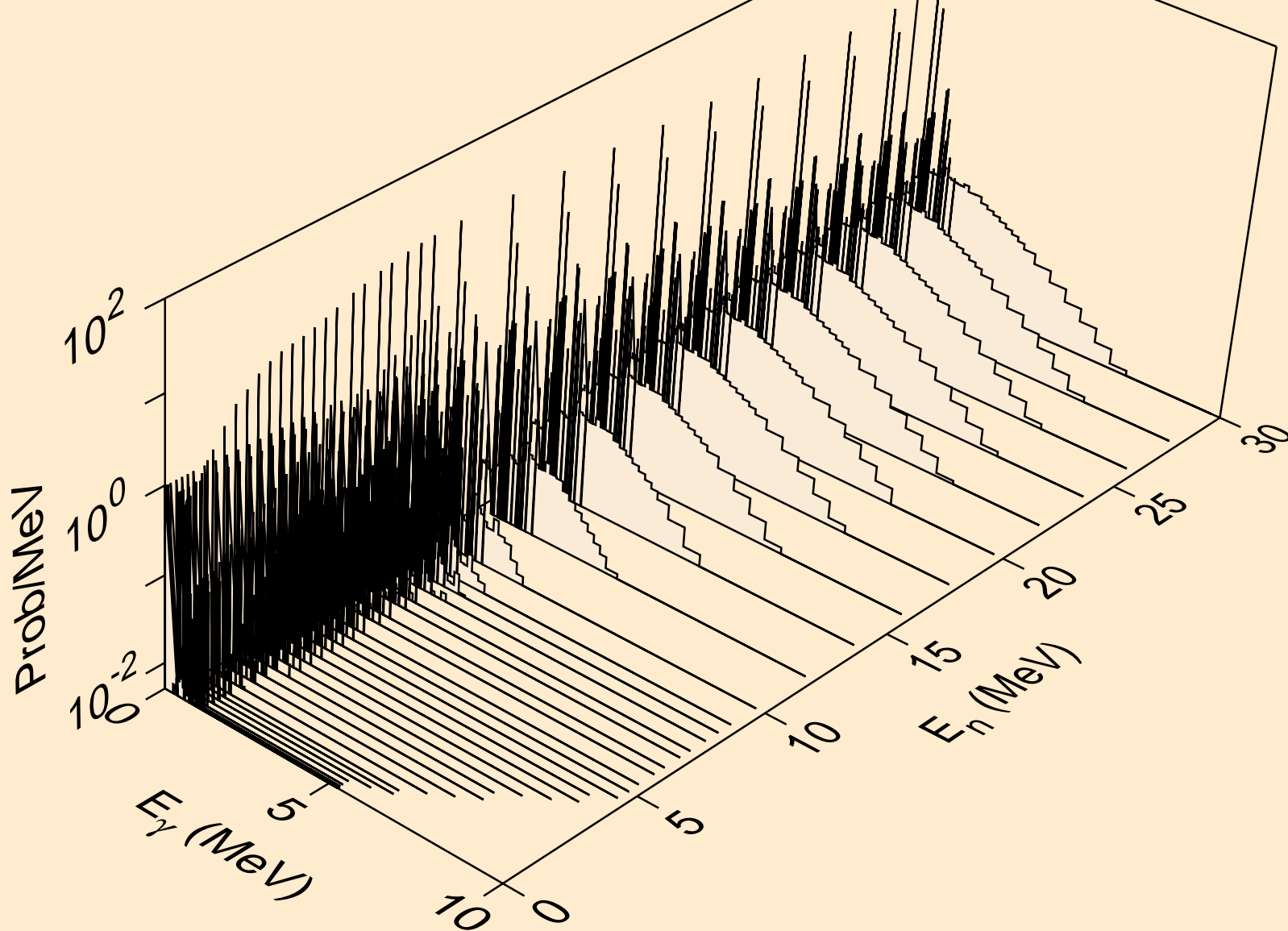

NB084 NEUTRON ACER TENDL-2019 LIBRARY; T=293.16K
Photon emission for (n,pd)

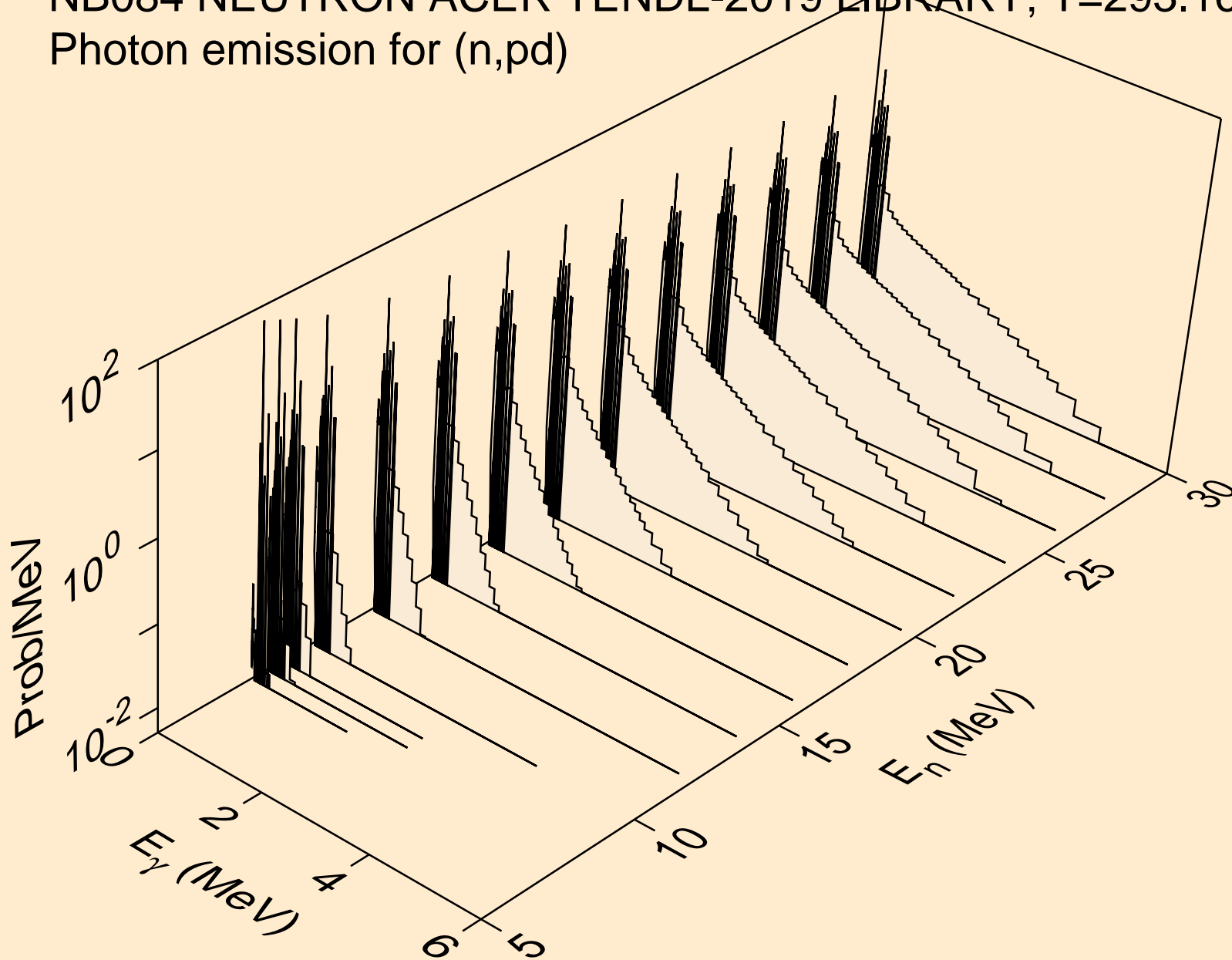

NB084 NEUTRON ACER TENDL-2019 LIBRARY; T=293.16K
Photon emission for (n,pt)

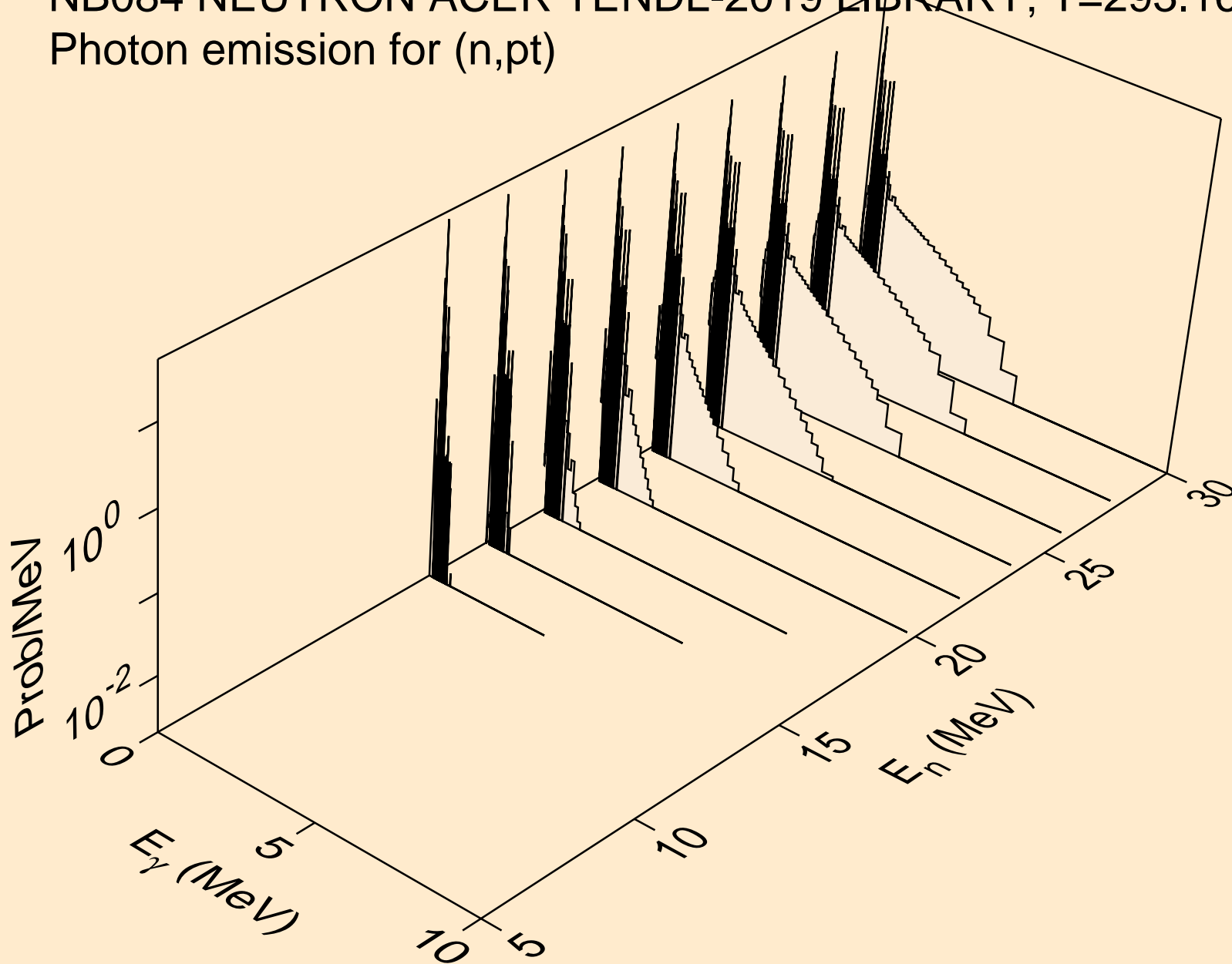

NB084 NEUTRON ACER TENDL-2019 LIBRARY; T=293.16K
Photon emission for (n,da)

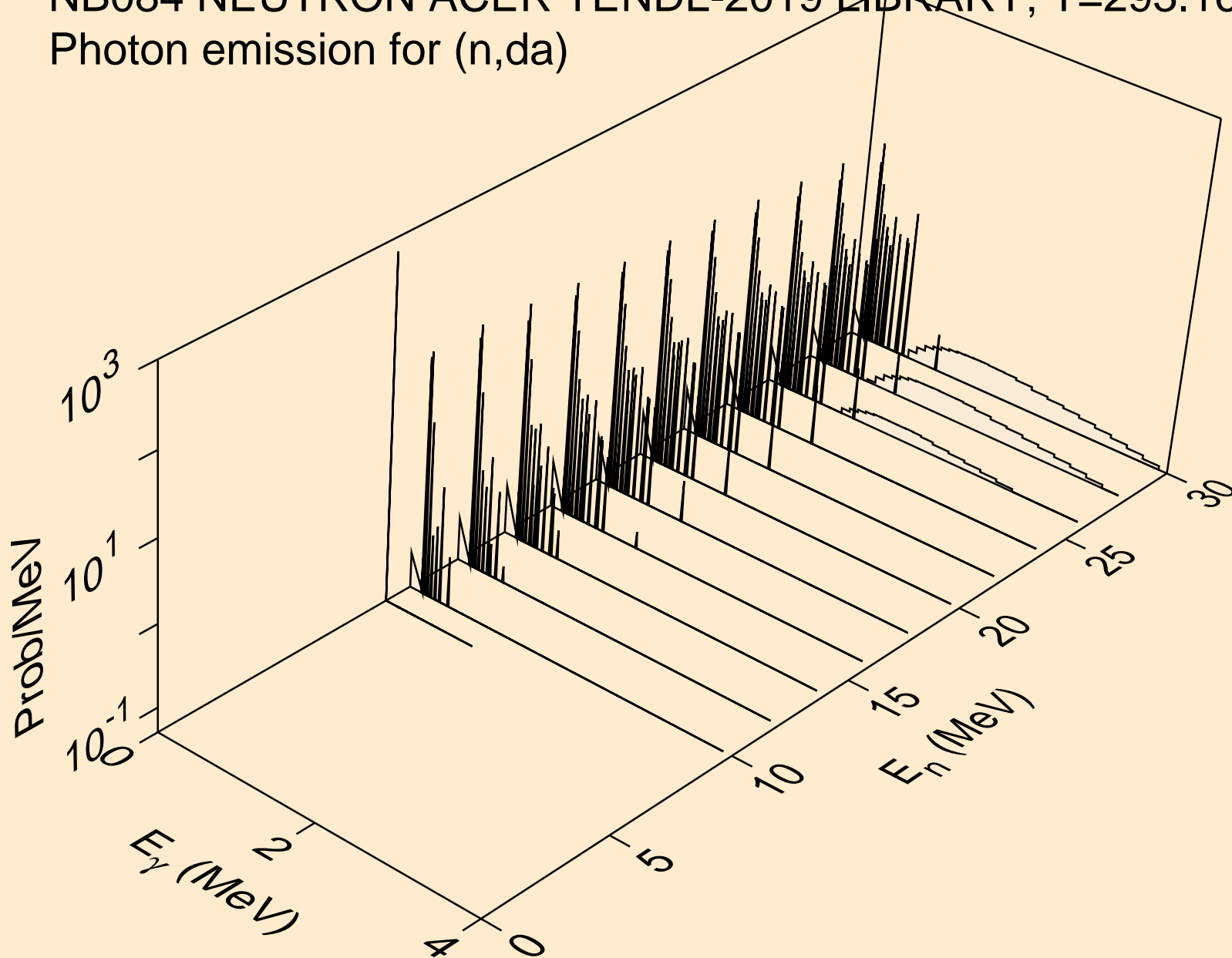

NB084 NEUTRON ACER TENDL-2019 LIBRARY; T=293.16K
thermal capture photon spectrum

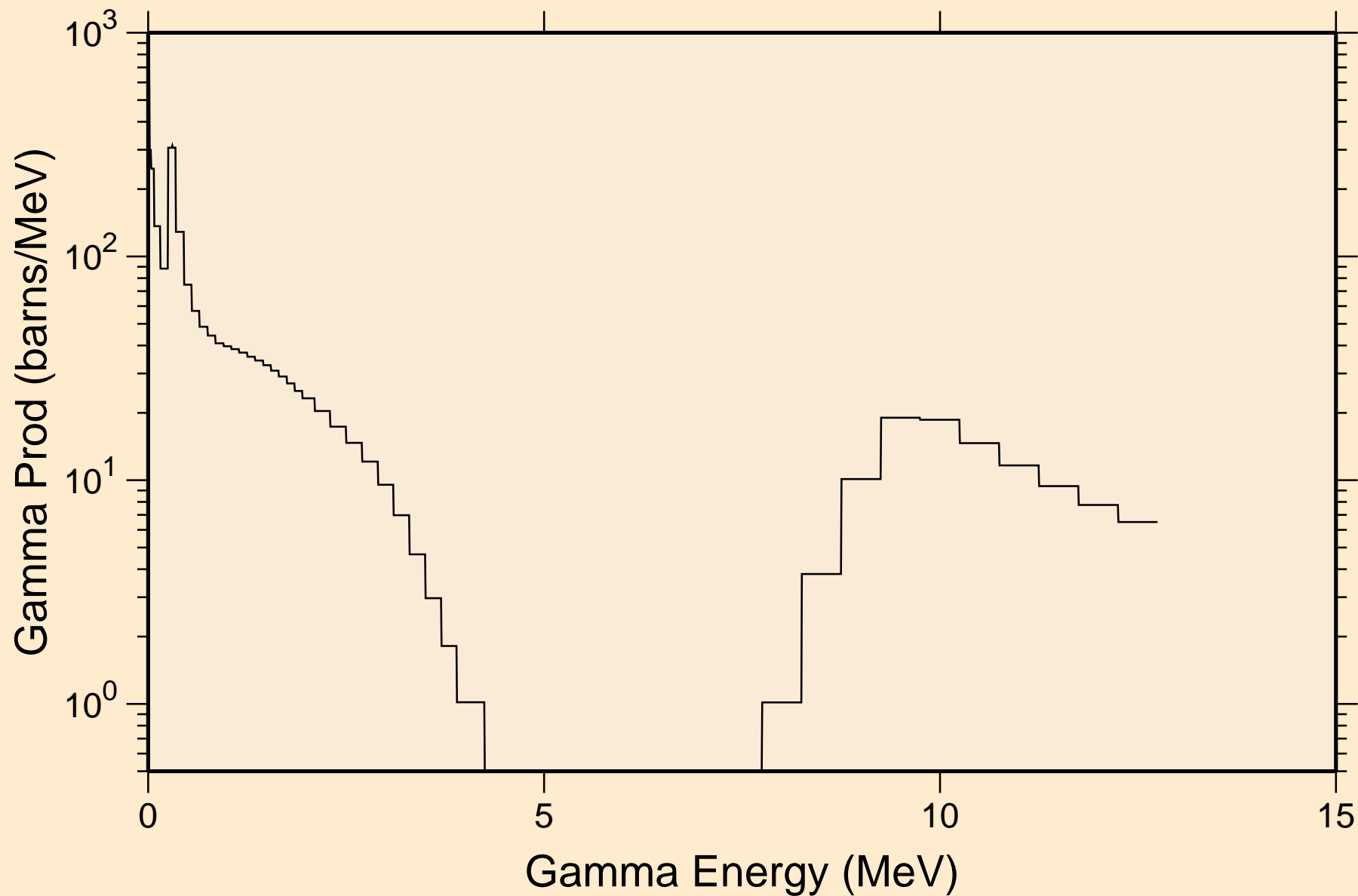

NB084 NEUTRON ACER TENDL-2019 LIBRARY; T=293.16K
14 MeV photon spectrum

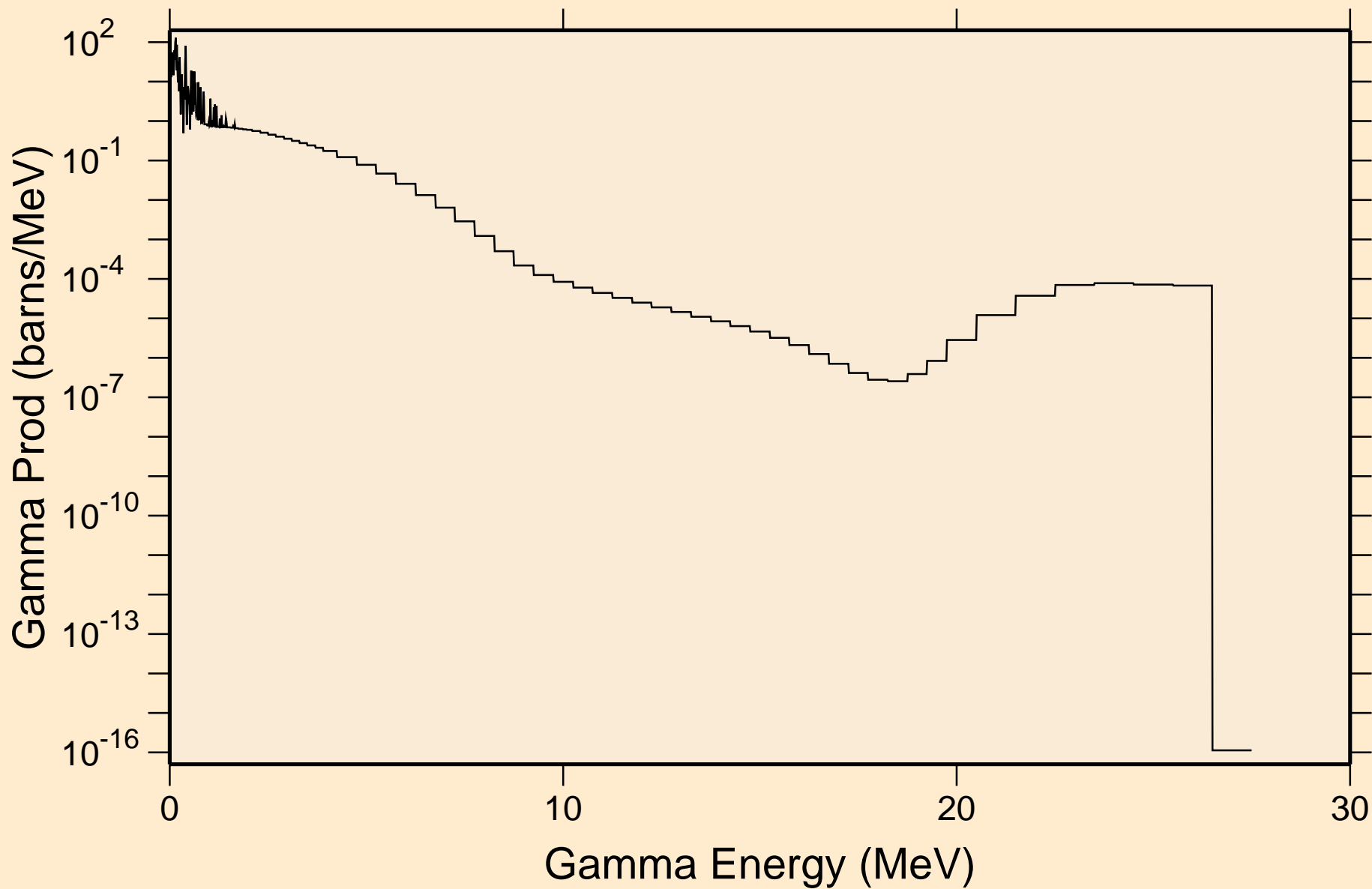

NB084 NEUTRON ACER TENDL-2019 LIBRARY; T=293.16K

Particle heating contributions

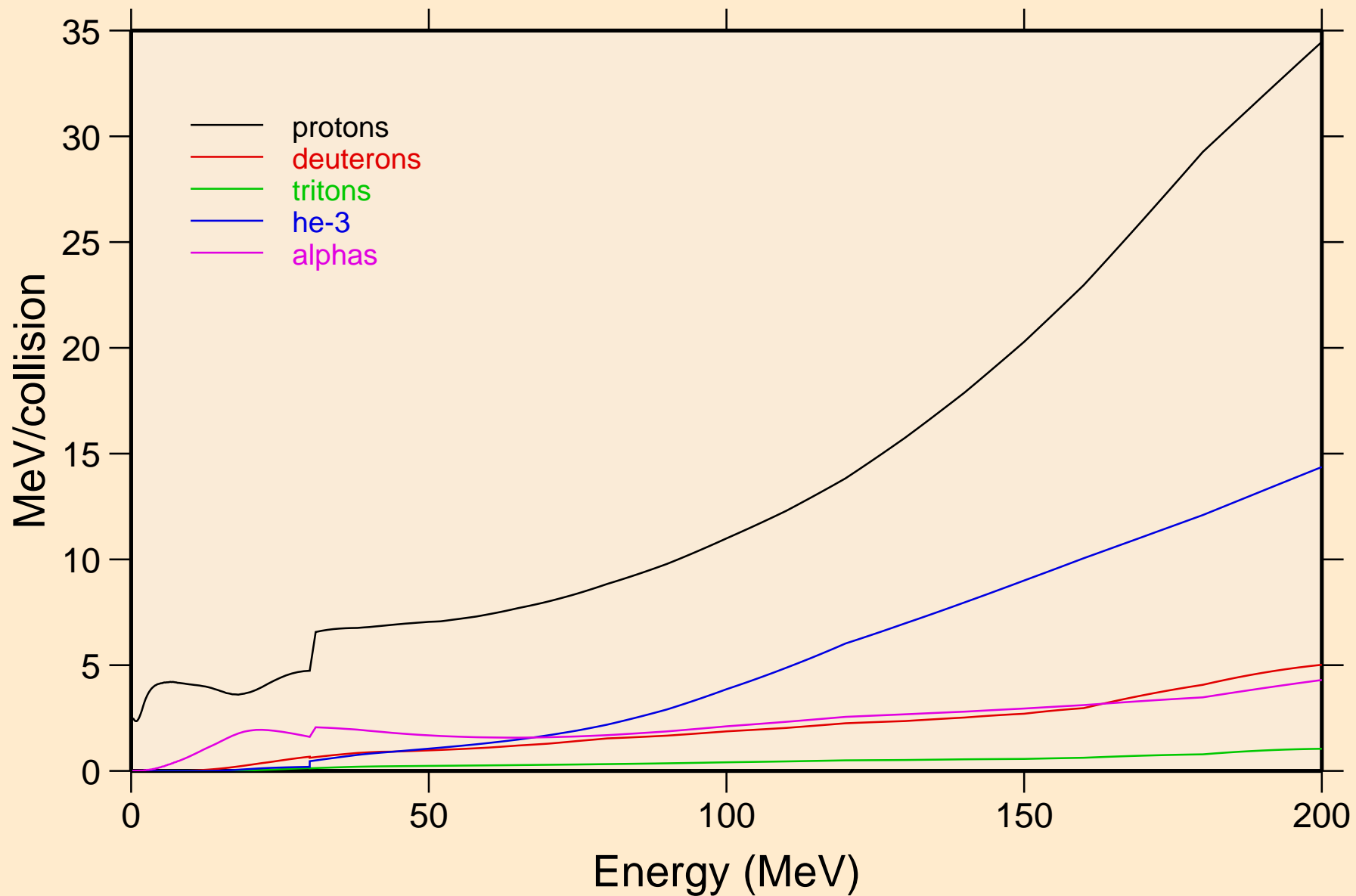

NB084 NEUTRON ACER TENDL-2019 LIBRARY; T=293.16K
Recoil Heating

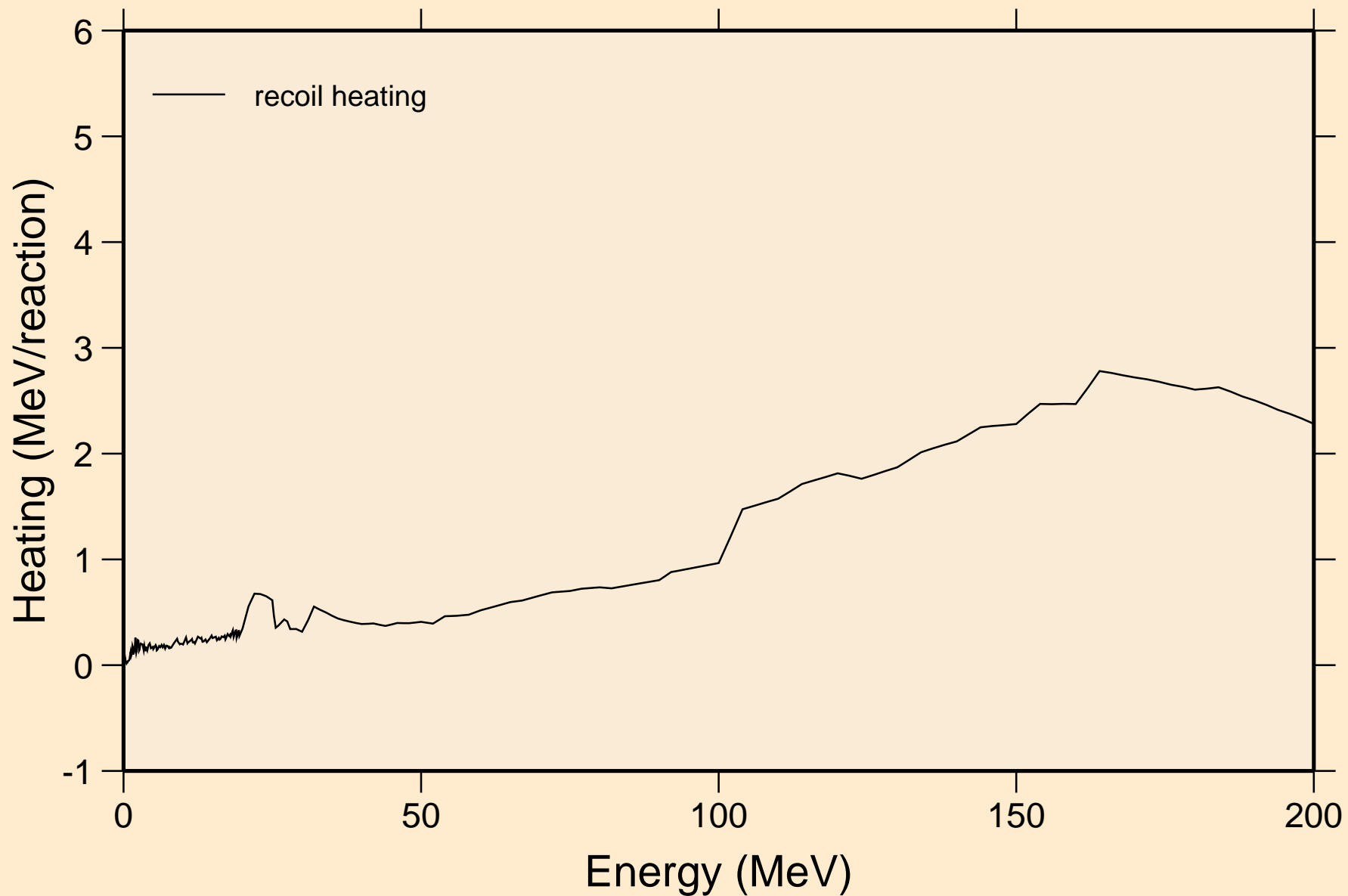

NB084 NEUTRON ACER TENDL-2019 LIBRARY; T=293.16K
Particle production cross sections

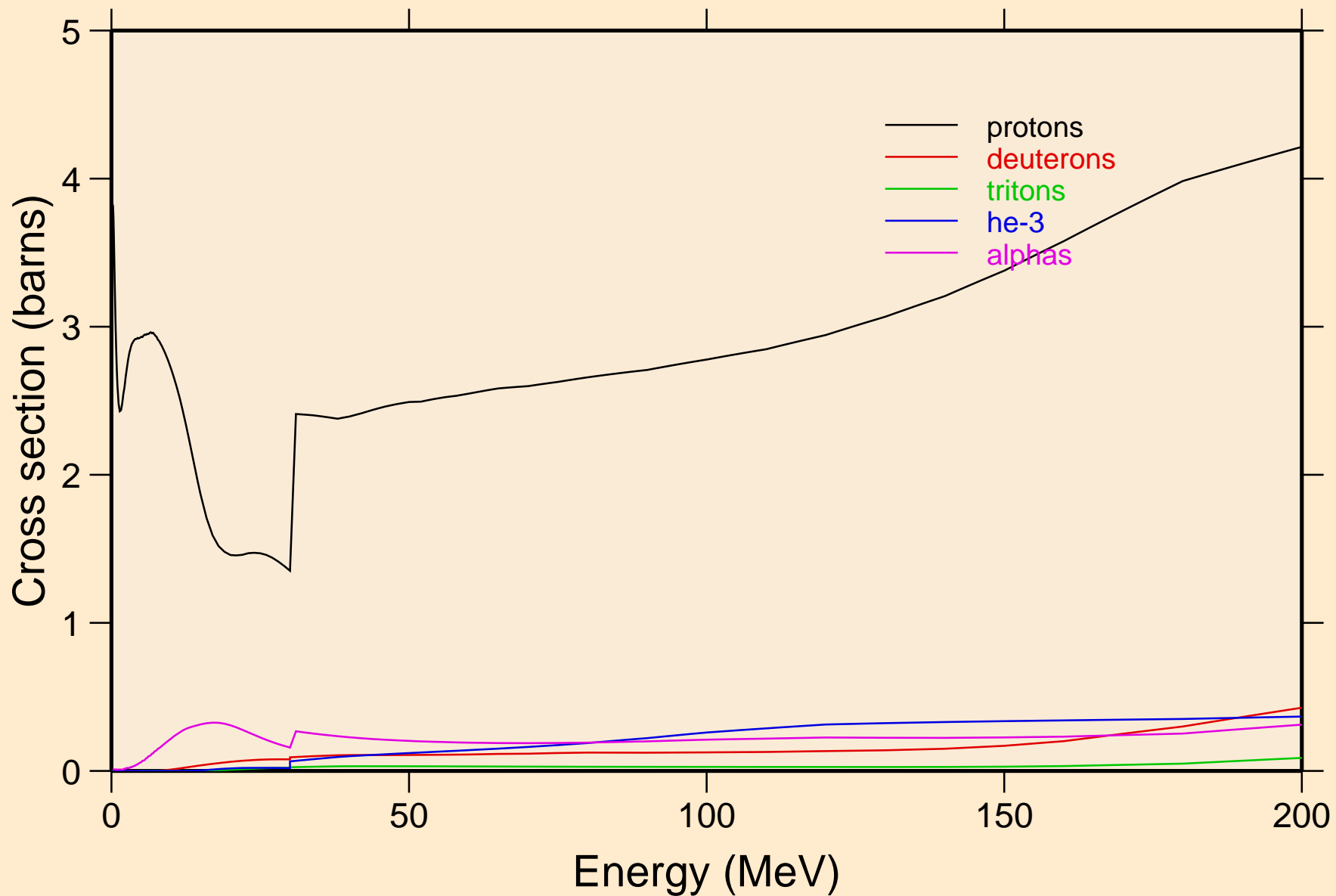

NB084 NEUTRON ACER TENDL-2019 LIBRARY; T=293.16K
protons from (n,x)

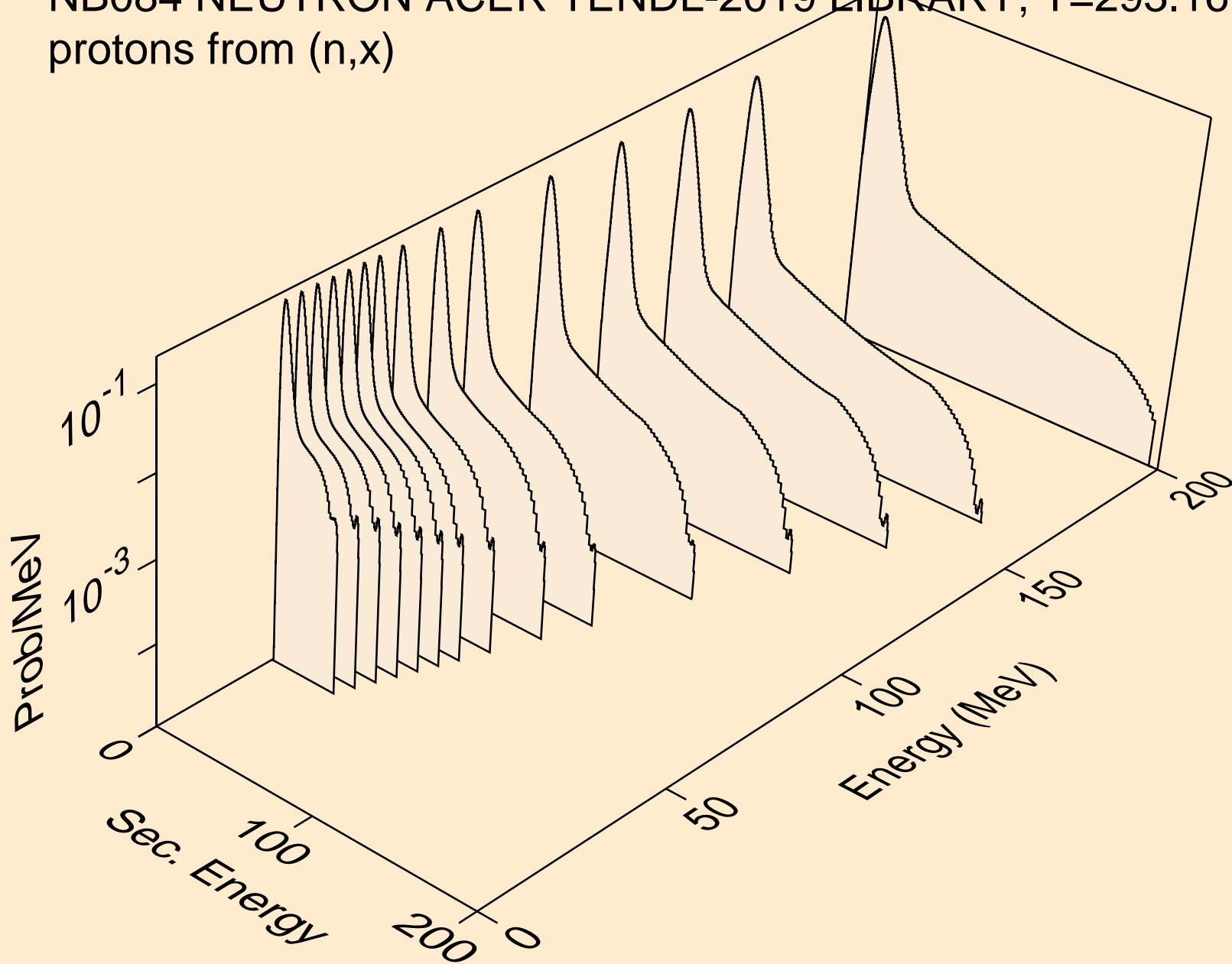

NB084 NEUTRON ACER TENDL-2019 LIBRARY; T=293.16K
protons from (n,n*)p

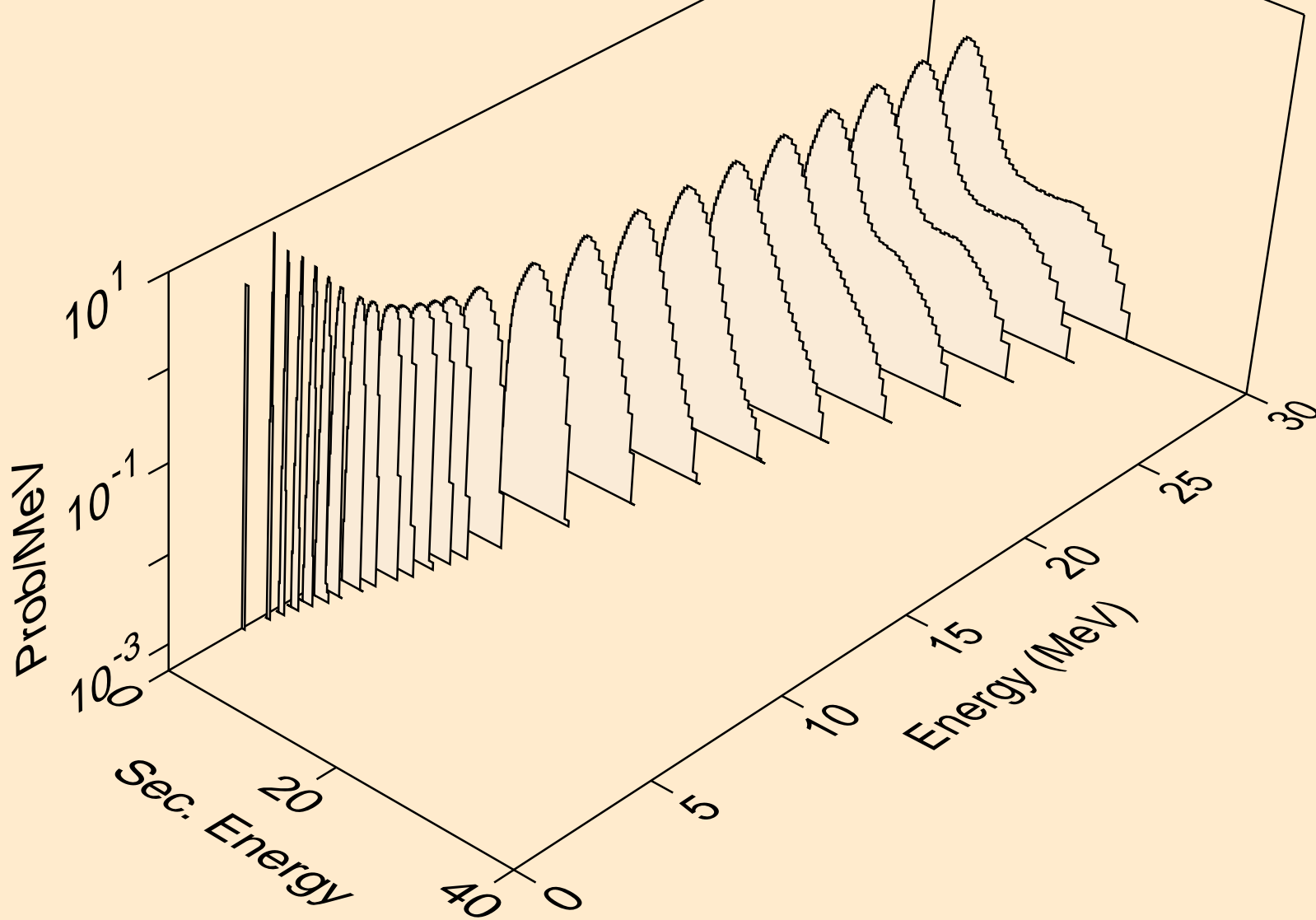

NB084 NEUTRON ACER TENDL-2019 LIBRARY; T=293.16K
protons from (n,2np)

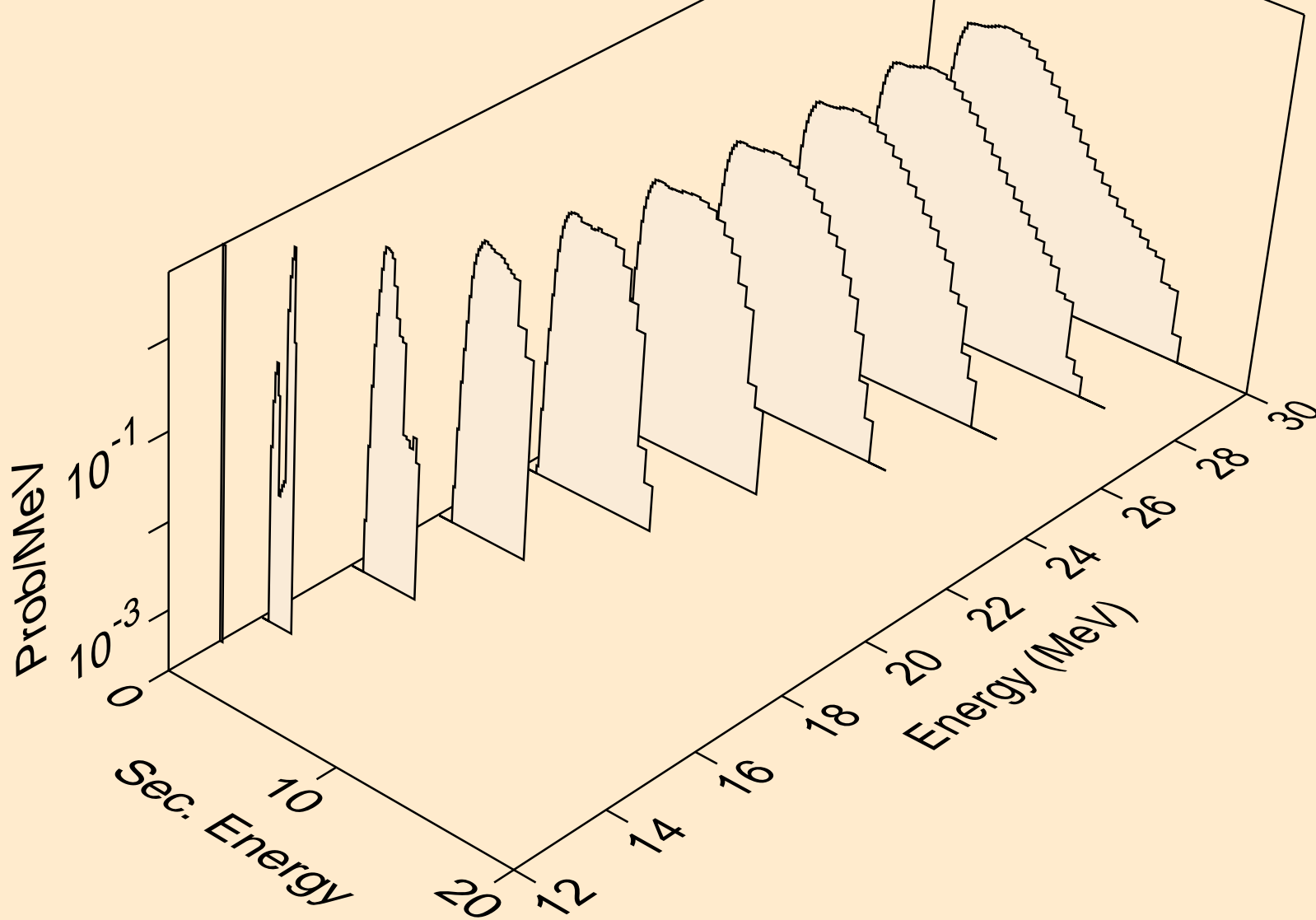

NB084 NEUTRON ACER TENDL-2019 LIBRARY; T=293.16K
protons from (n,3np)

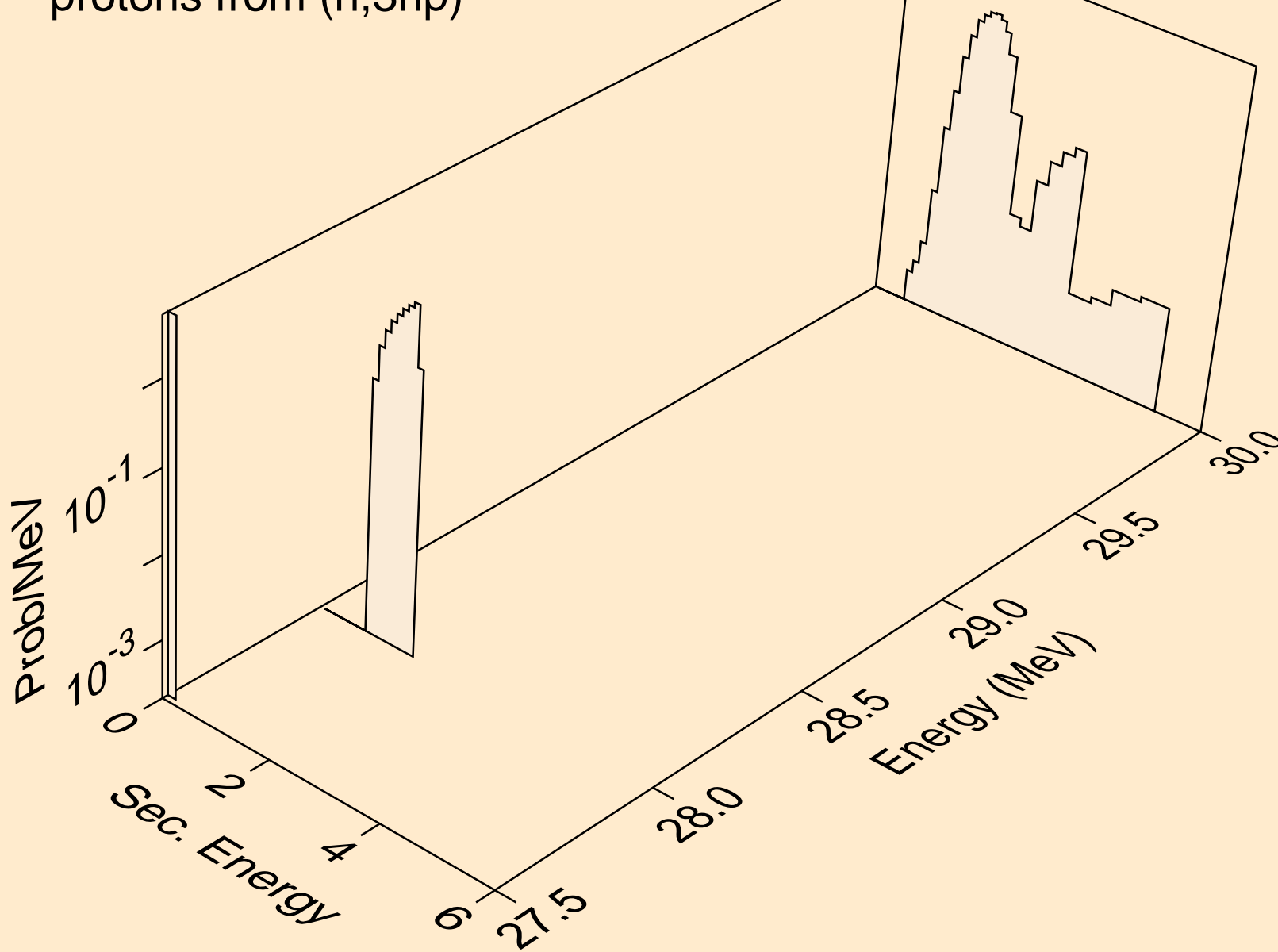

NB084 NEUTRON ACER TENDL-2019 LIBRARY; T=293.16K
protons from (n,2np)

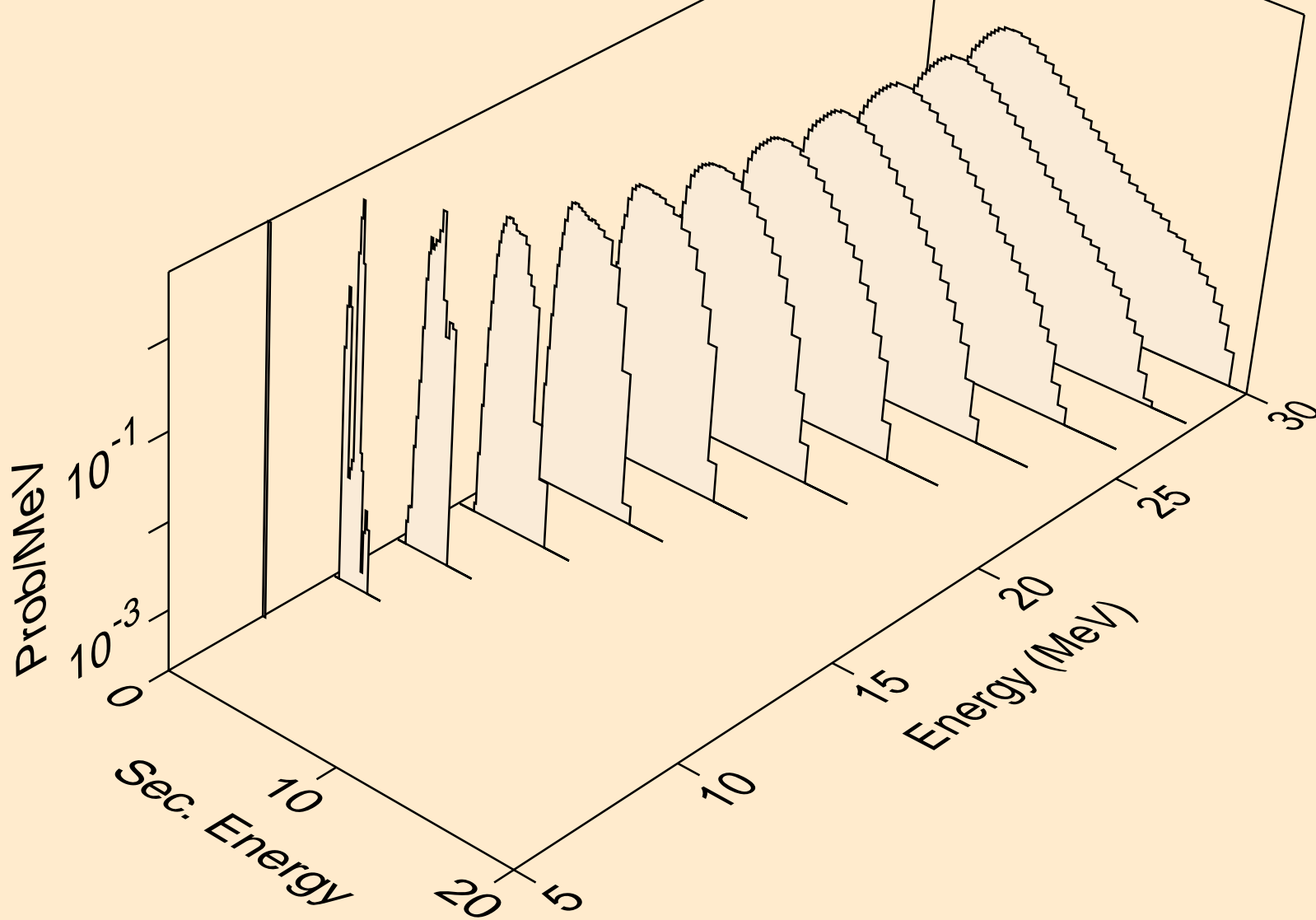

NB084 NEUTRON ACER TENDL-2019 LIBRARY; T=293.16K
protons from (n,npa)

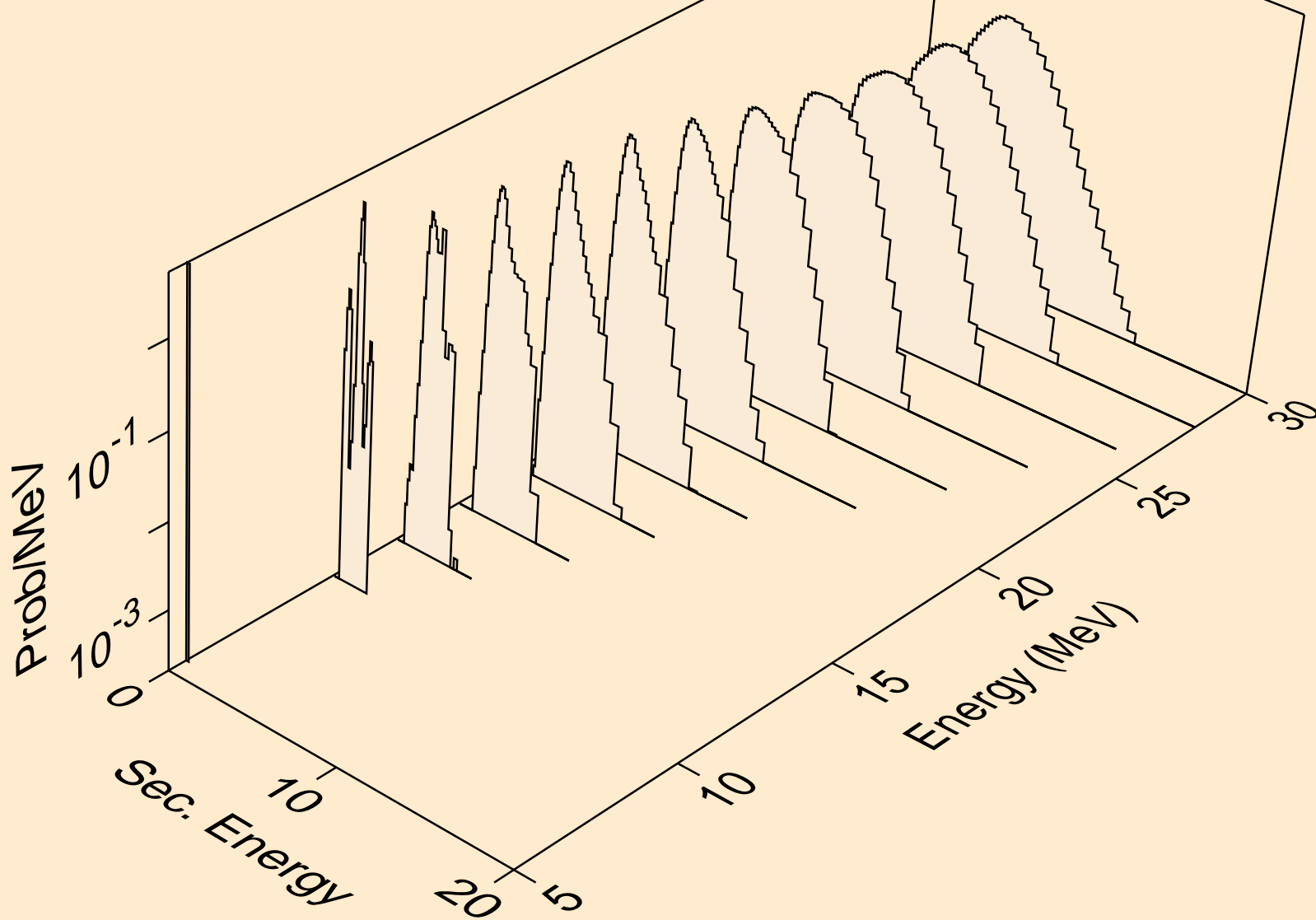

NB084 NEUTRON ACER TENDL-2019 LIBRARY; T=293.16K
protons from (n,p)

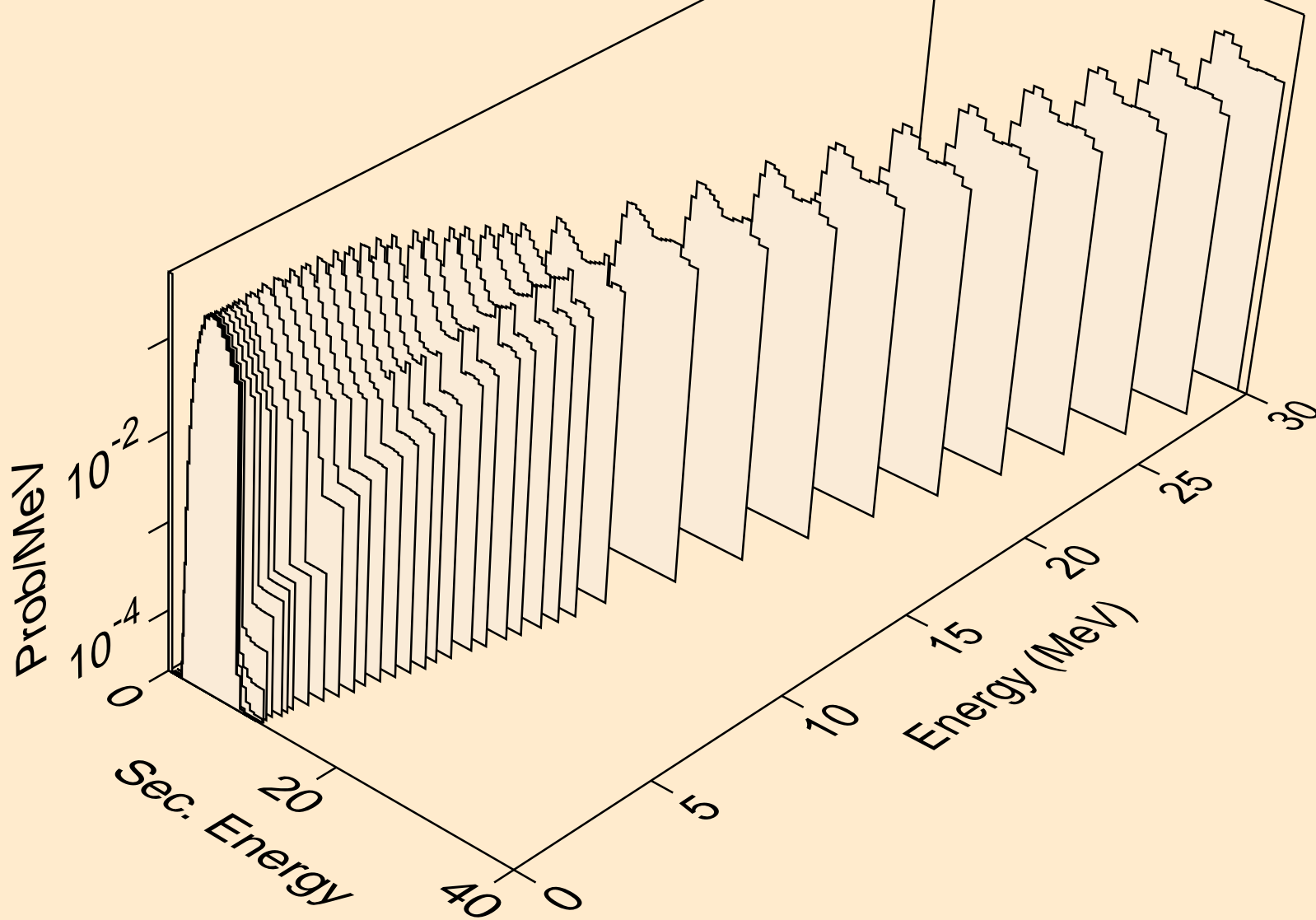

NB084 NEUTRON ACER TENDL-2019 LIBRARY; T=293.16K
protons from (n,2p)

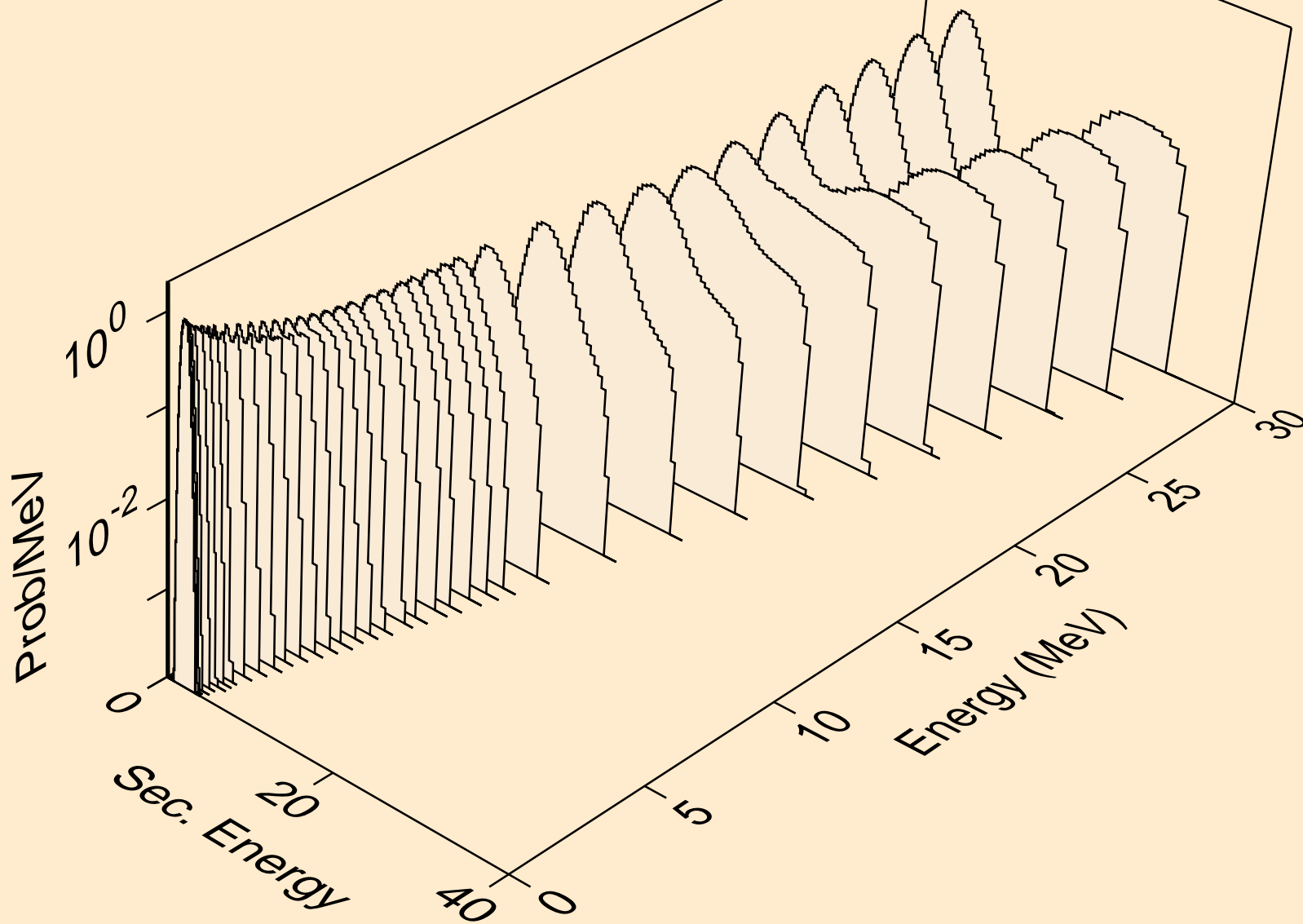

NB084 NEUTRON ACER TENDL-2019 LIBRARY; T=293.16K
protons from (n,p)

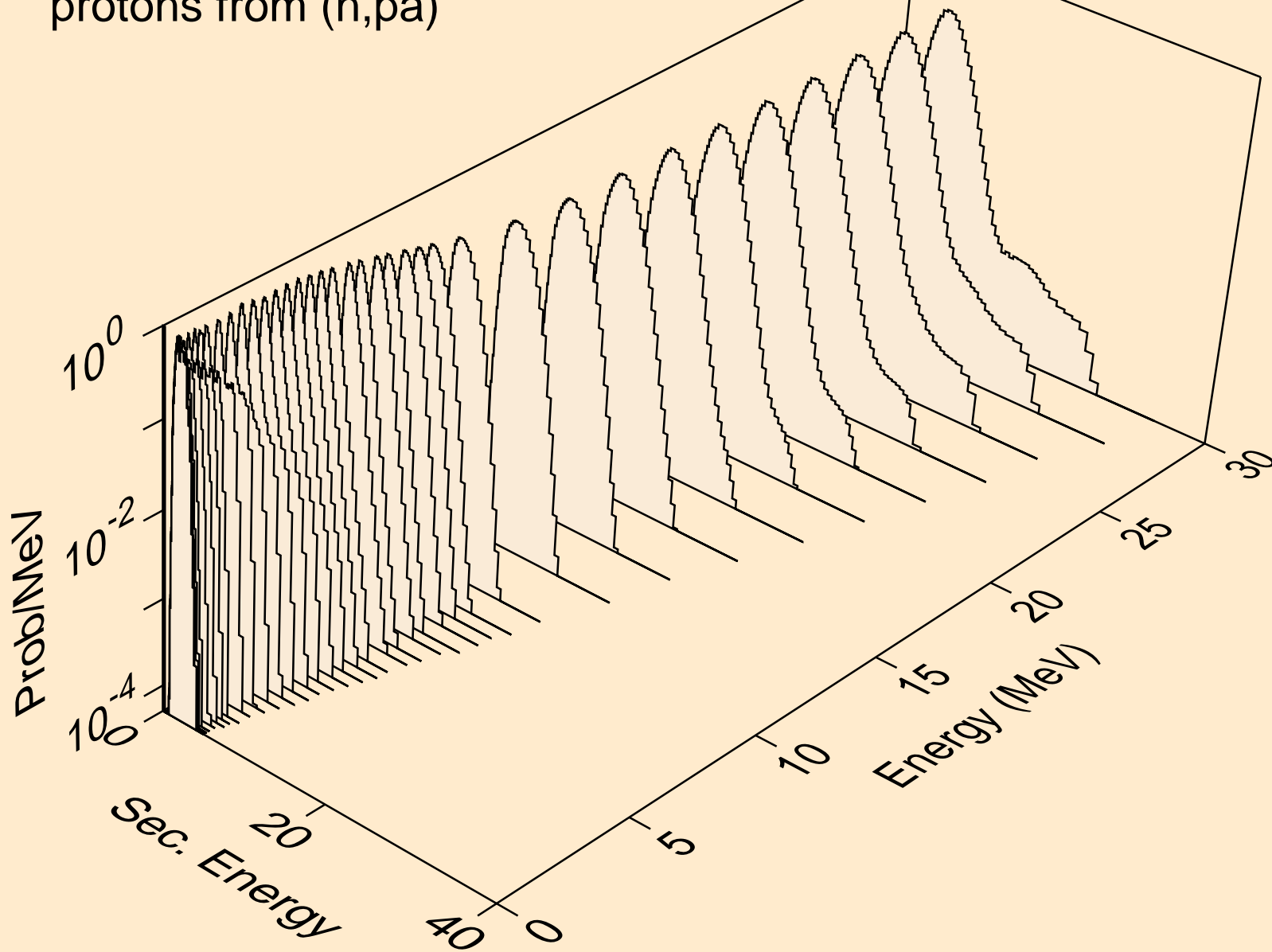

NB084 NEUTRON ACER TENDL-2019 LIBRARY; T=293.16K
protons from (n,pd)

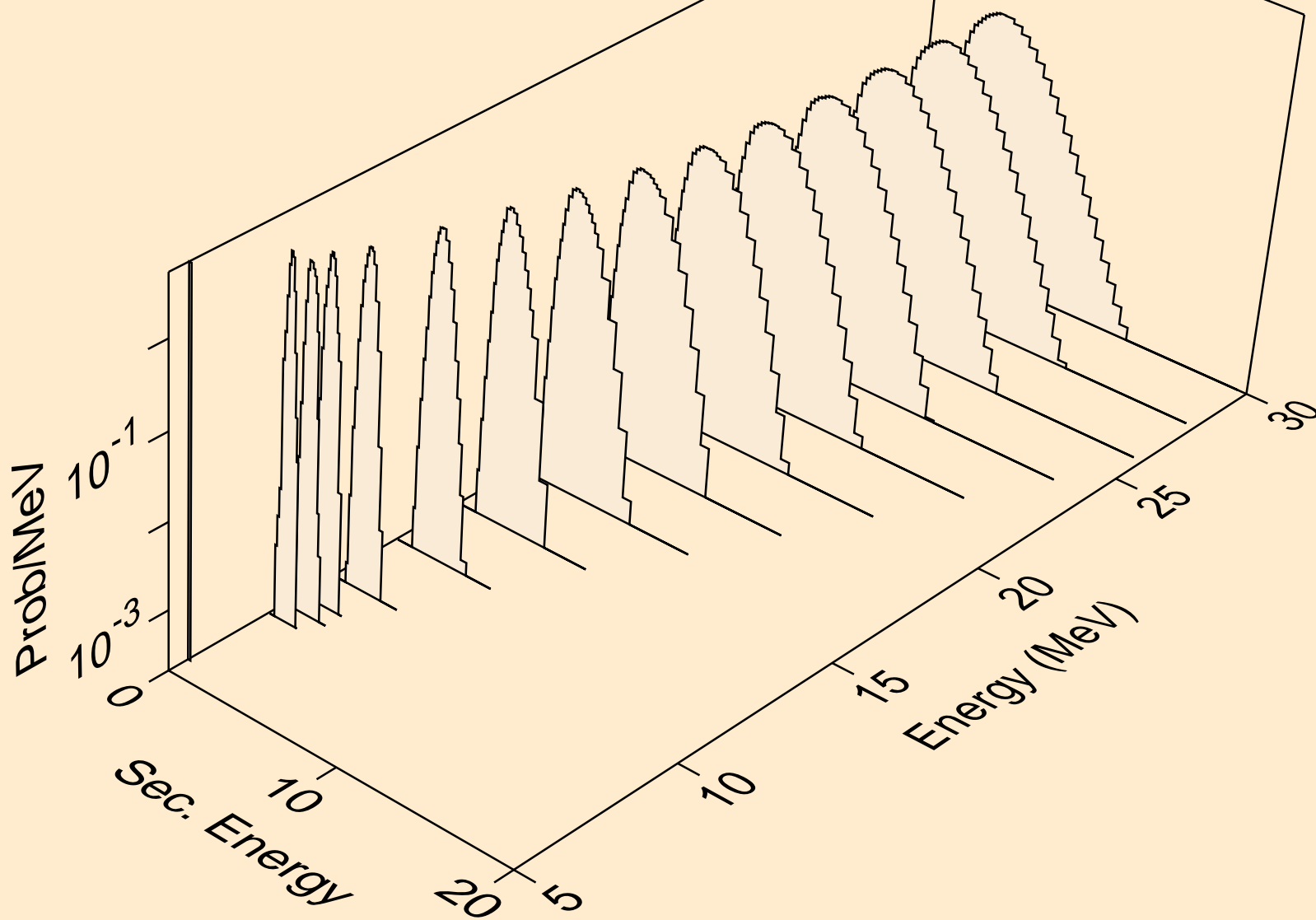

NB084 NEUTRON ACER TENDL-2019 LIBRARY; T=293.16K
protons from (n,pt)

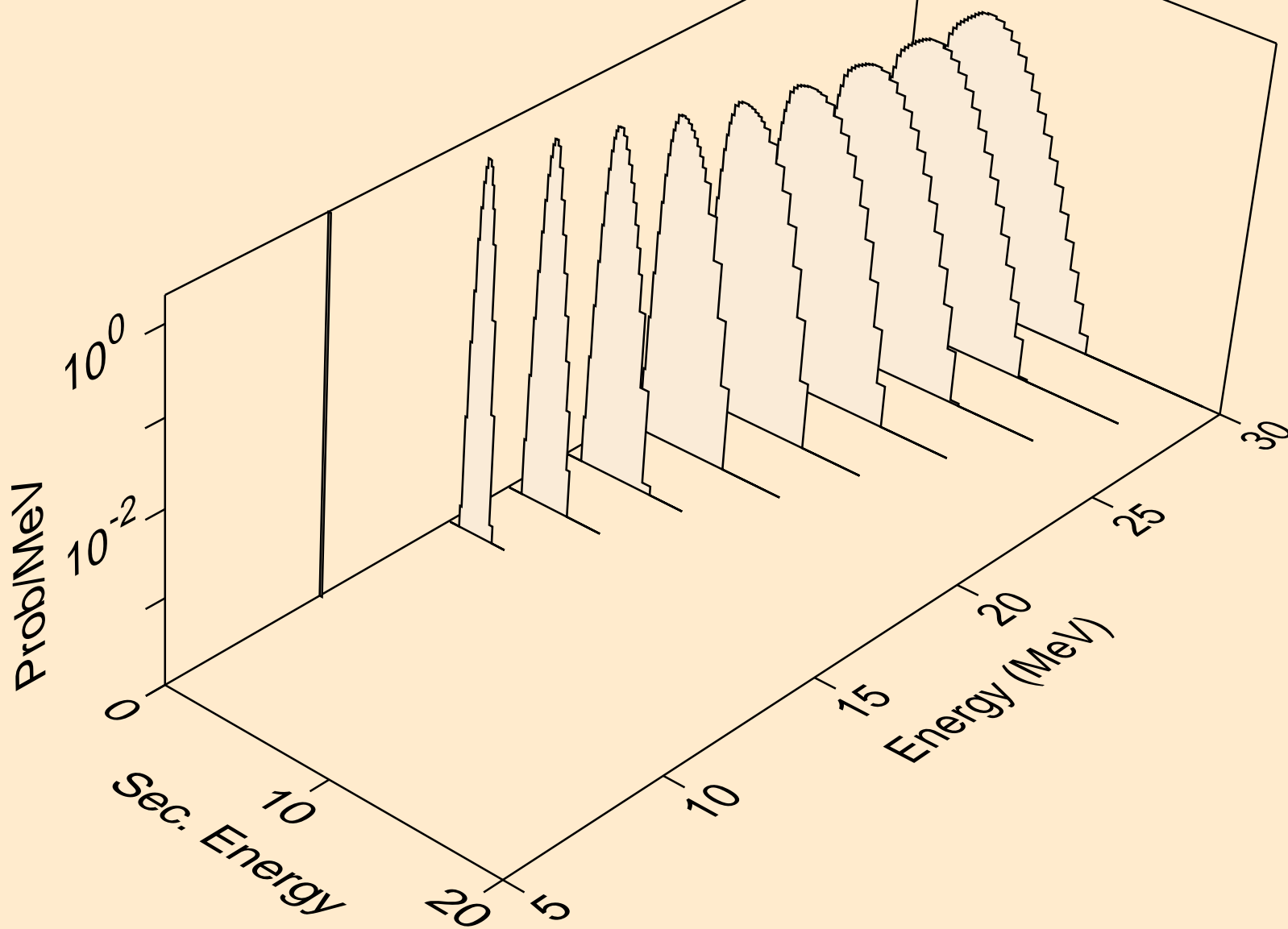

NB084 NEUTRON ACER TENDL-2019 LIBRARY; T=293.16K
deuterons from (n,x)

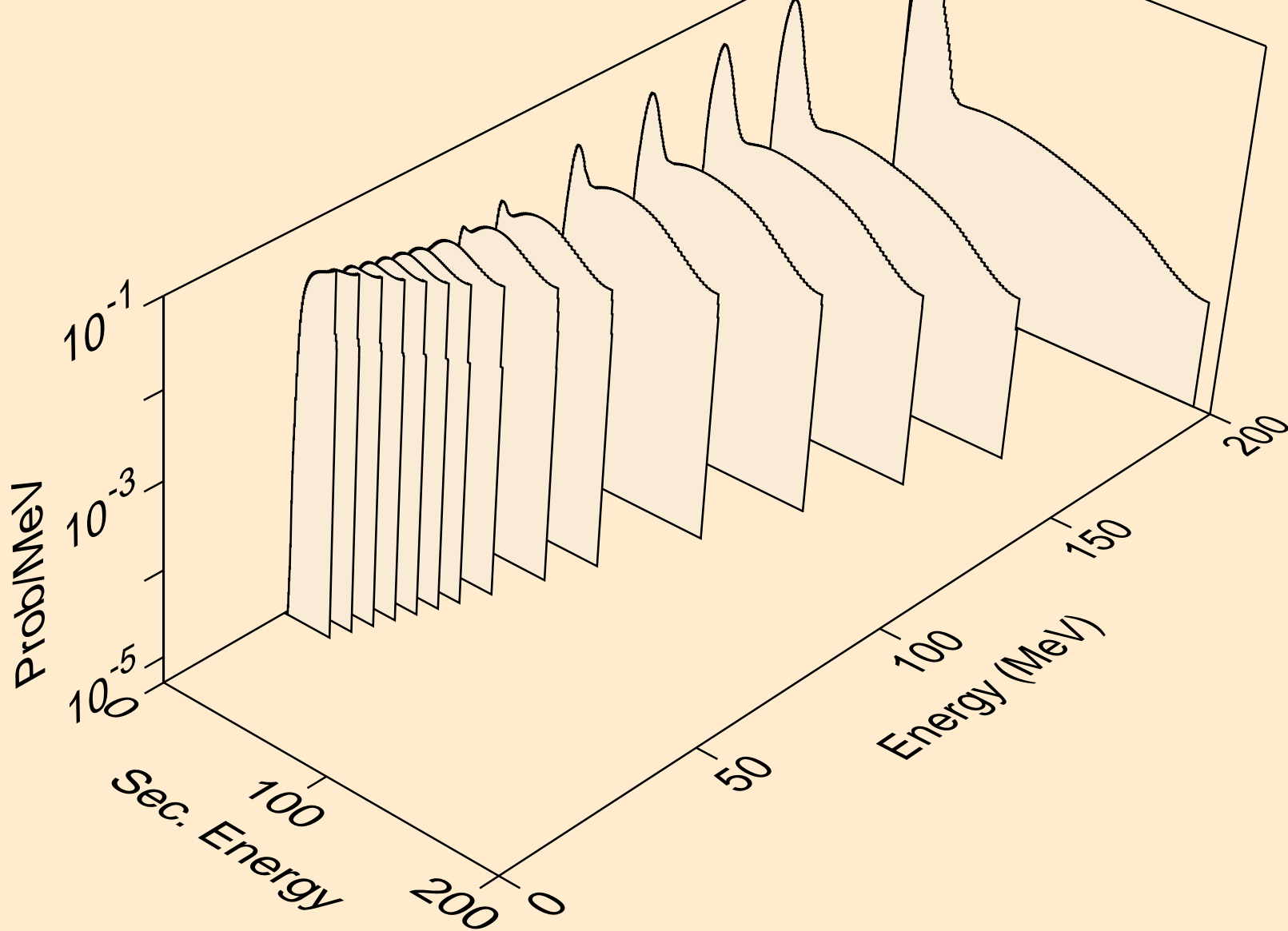

NB084 NEUTRON ACER TENDL-2019 LIBRARY; T=293.16K
deuterons from (n,2nd)

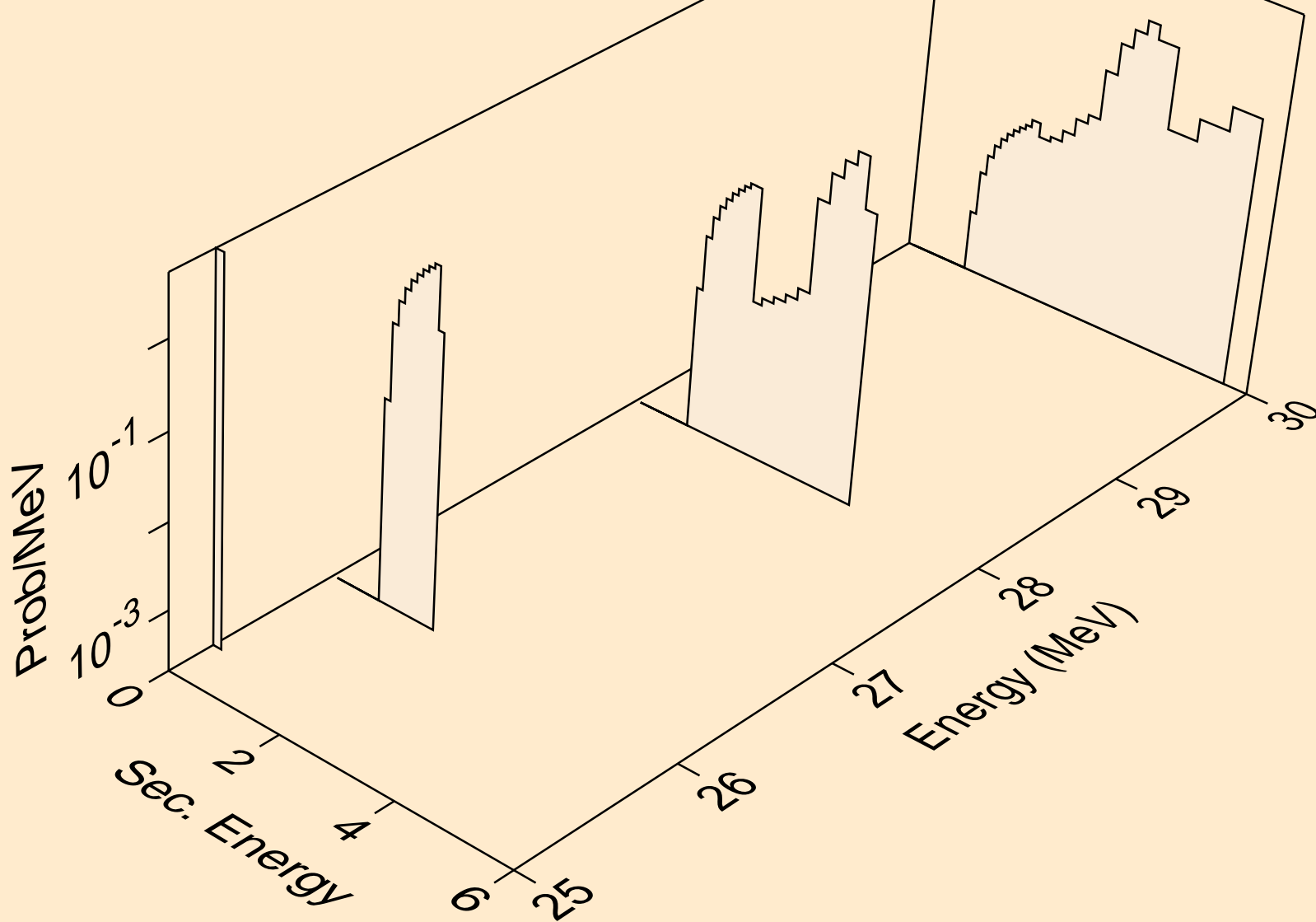

NB084 NEUTRON ACER TENDL-2019 LIBRARY; T=293.16K
deuterons from (n,n*)d

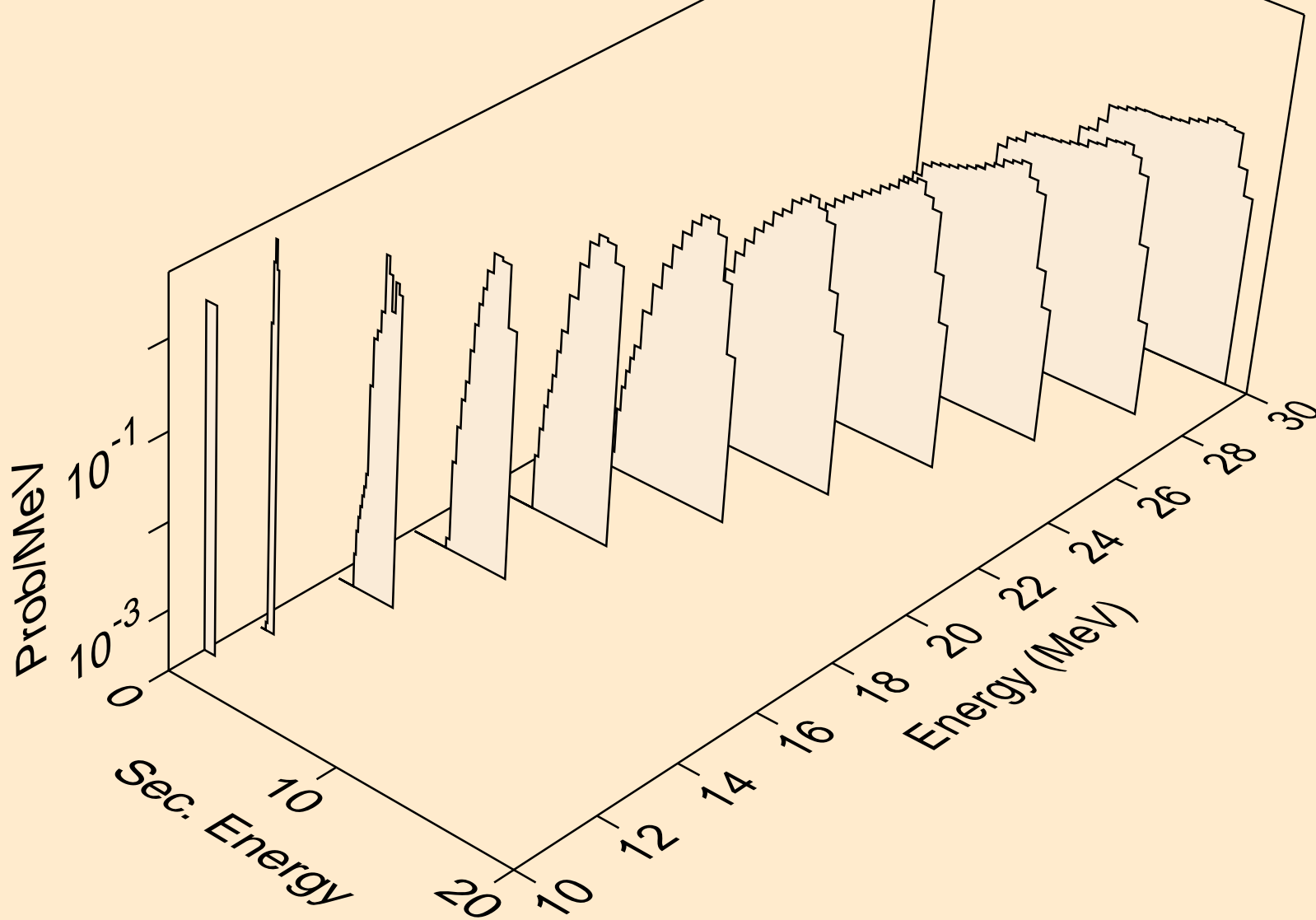

NB084 NEUTRON ACER TENDL-2019 LIBRARY; T=293.16K
deuterons from (n,d)

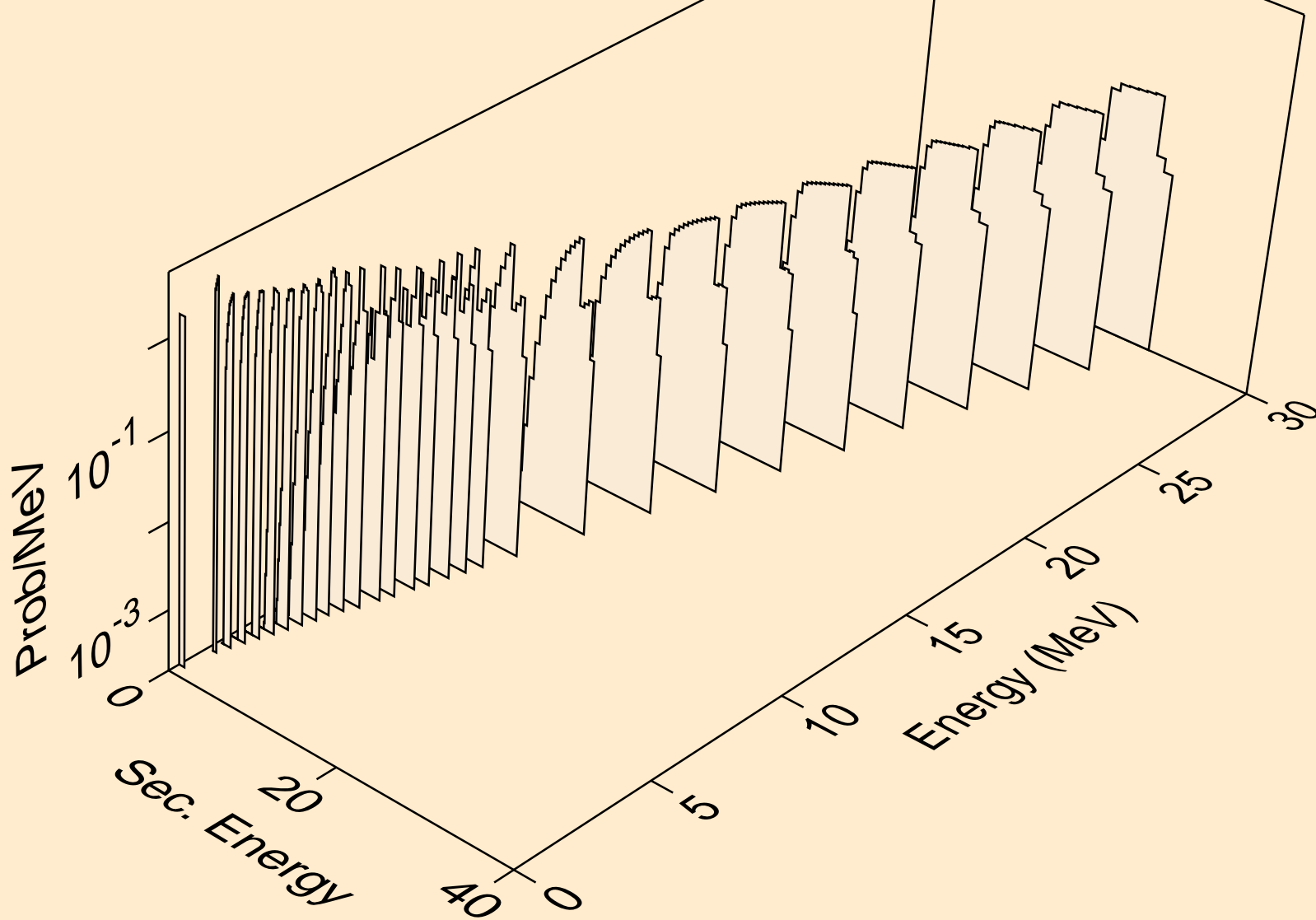

NB084 NEUTRON ACER TENDL-2019 LIBRARY; T=293.16K
deuterons from (n,pd)

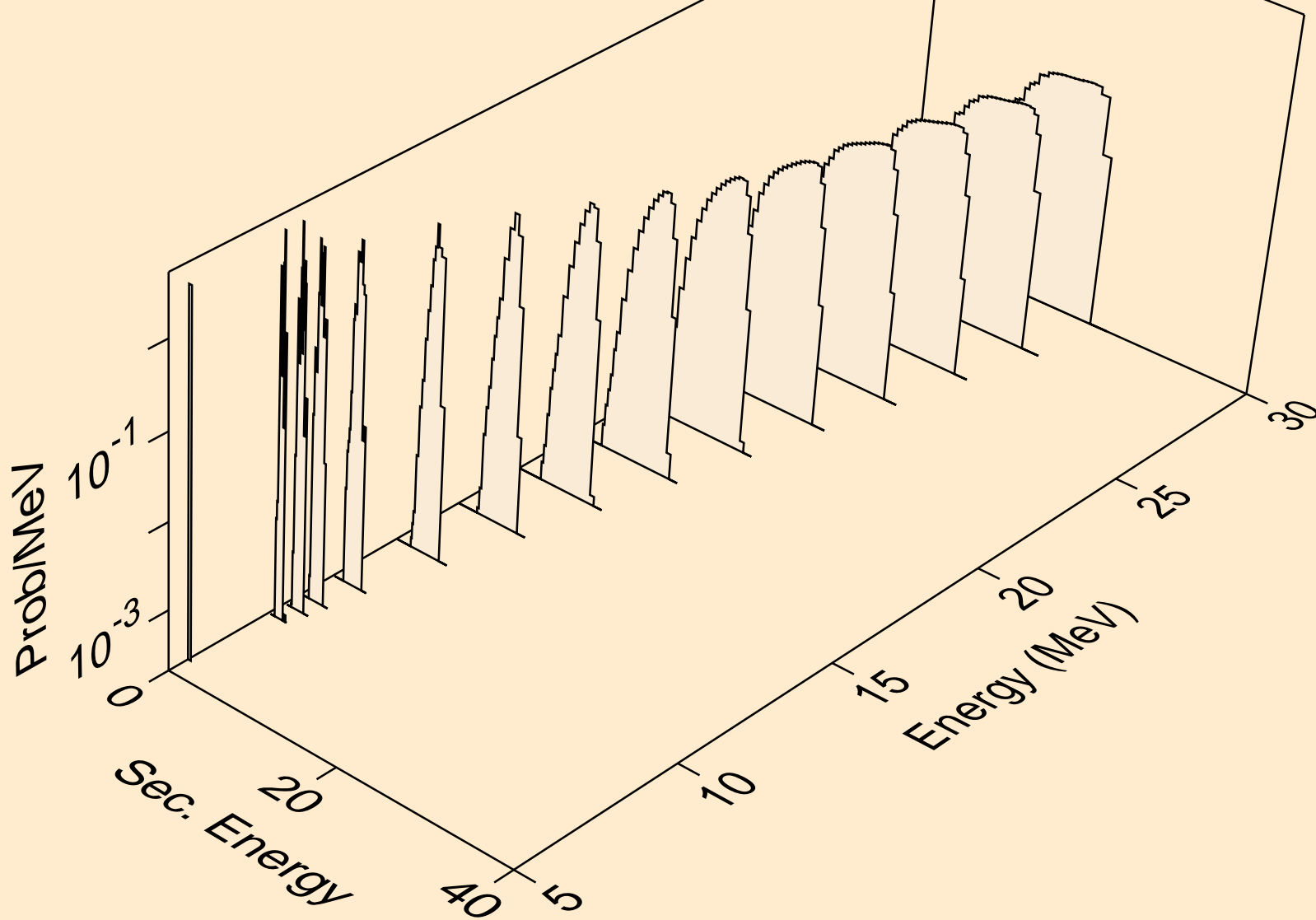

NB084 NEUTRON ACER TENDL-2019 LIBRARY; T=293.16K
deuterons from (n,da)

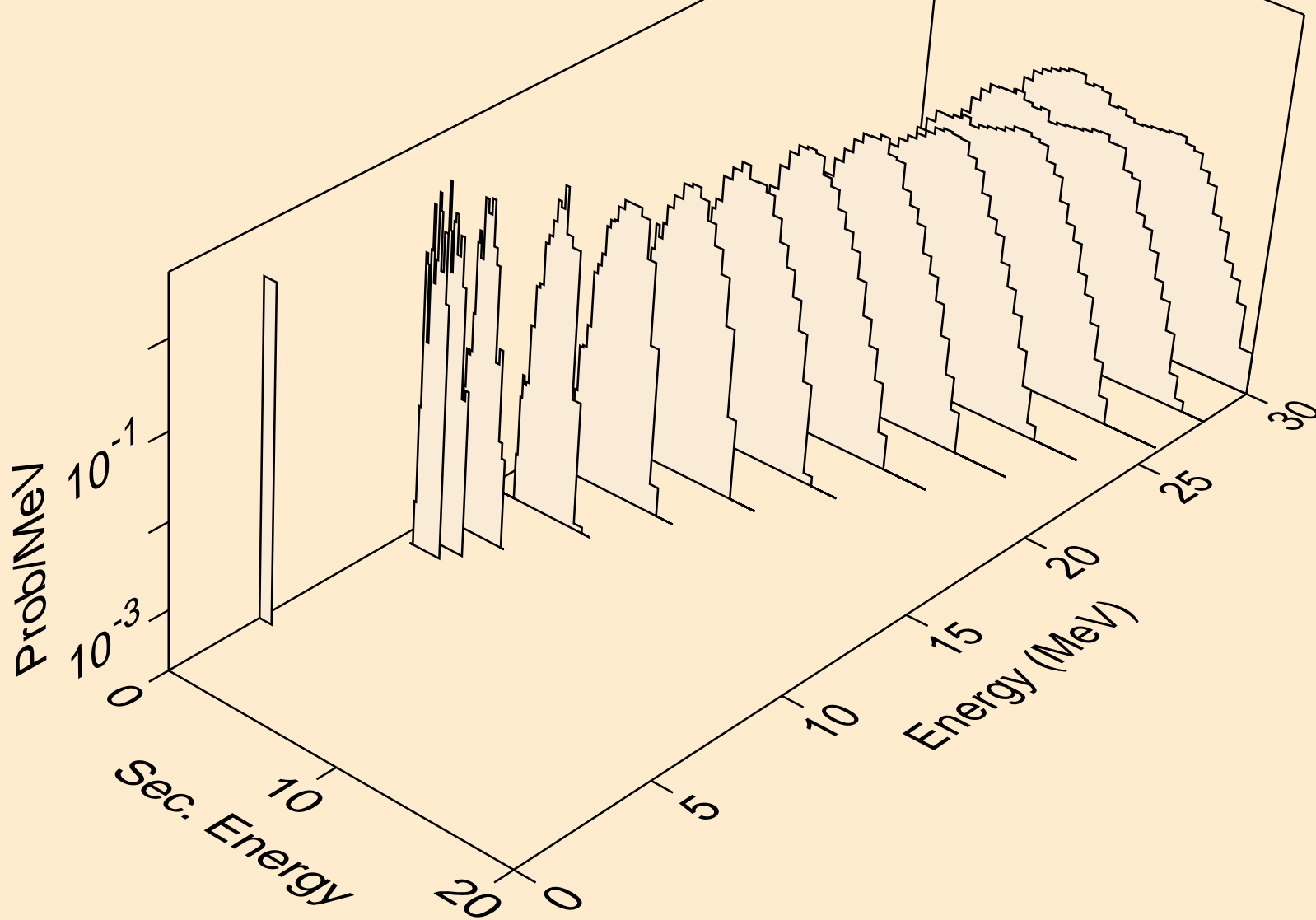

NB084 NEUTRON ACER TENDL-2019 LIBRARY; T=293.16K
tritons from (n,x)

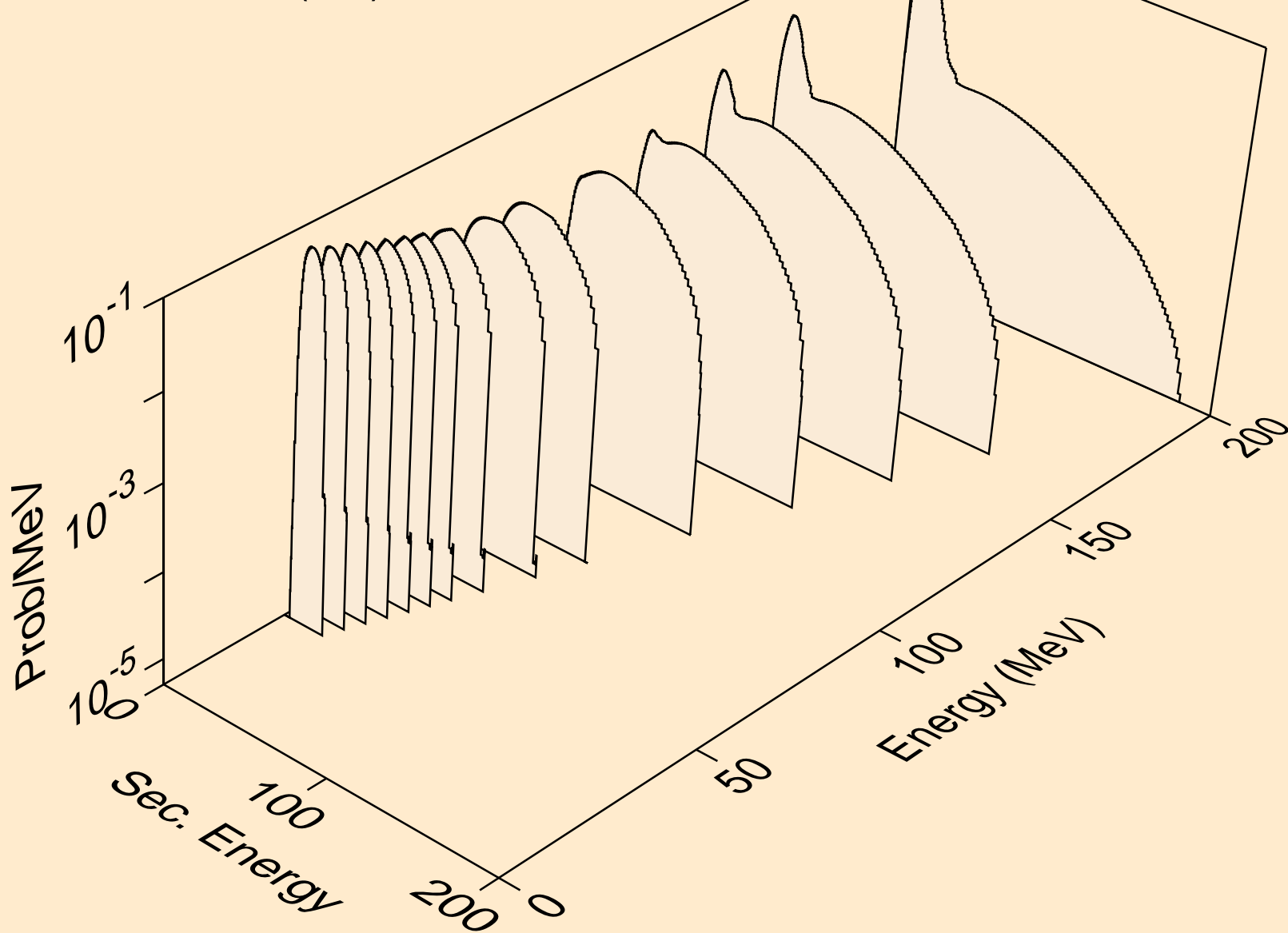

NB084 NEUTRON ACER TENDL-2019 LIBRARY; T=293.16K
tritons from (n,n*)t

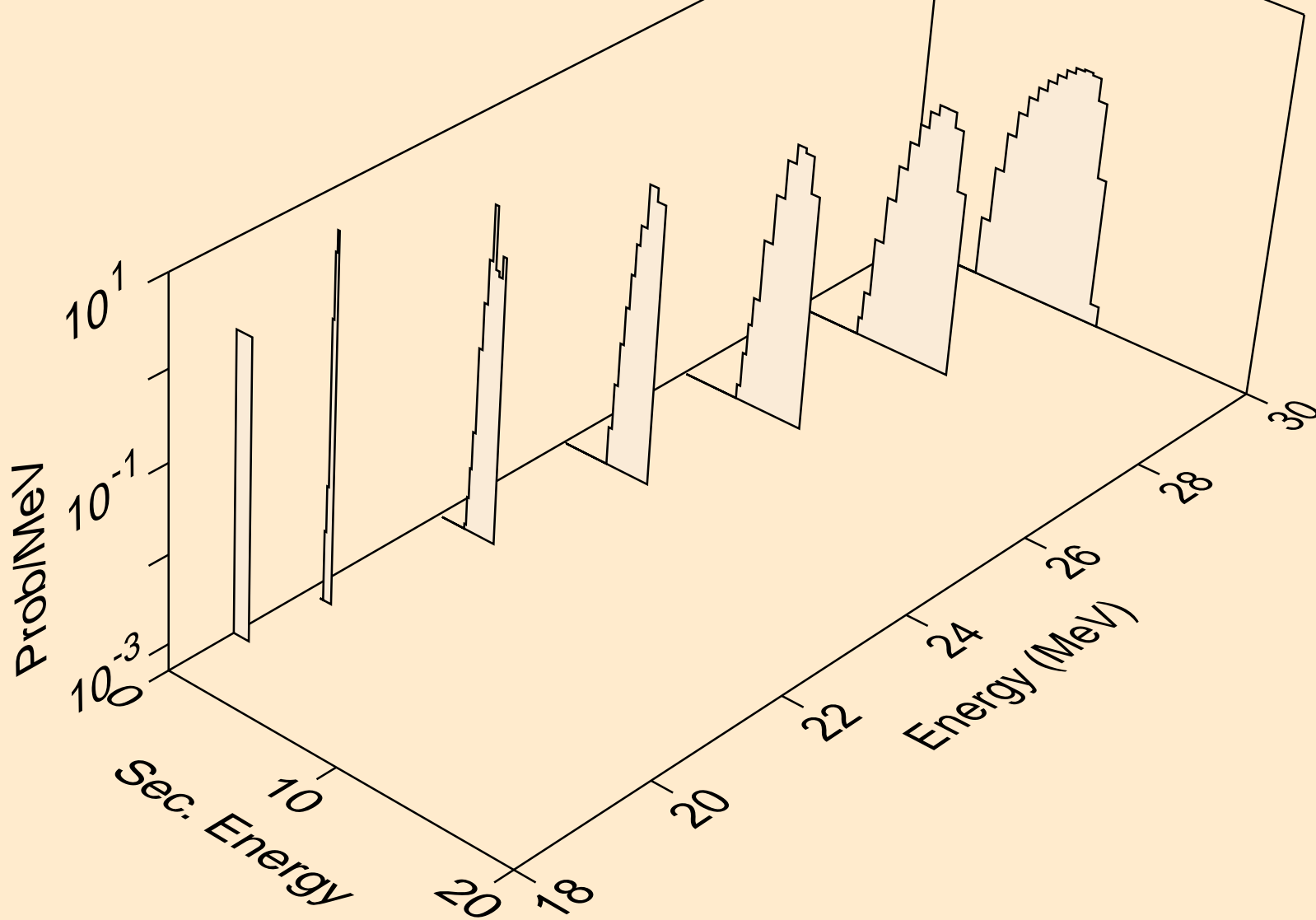

NB084 NEUTRON ACER TENDL-2019 LIBRARY; T=293.16K
tritons from (n,t)

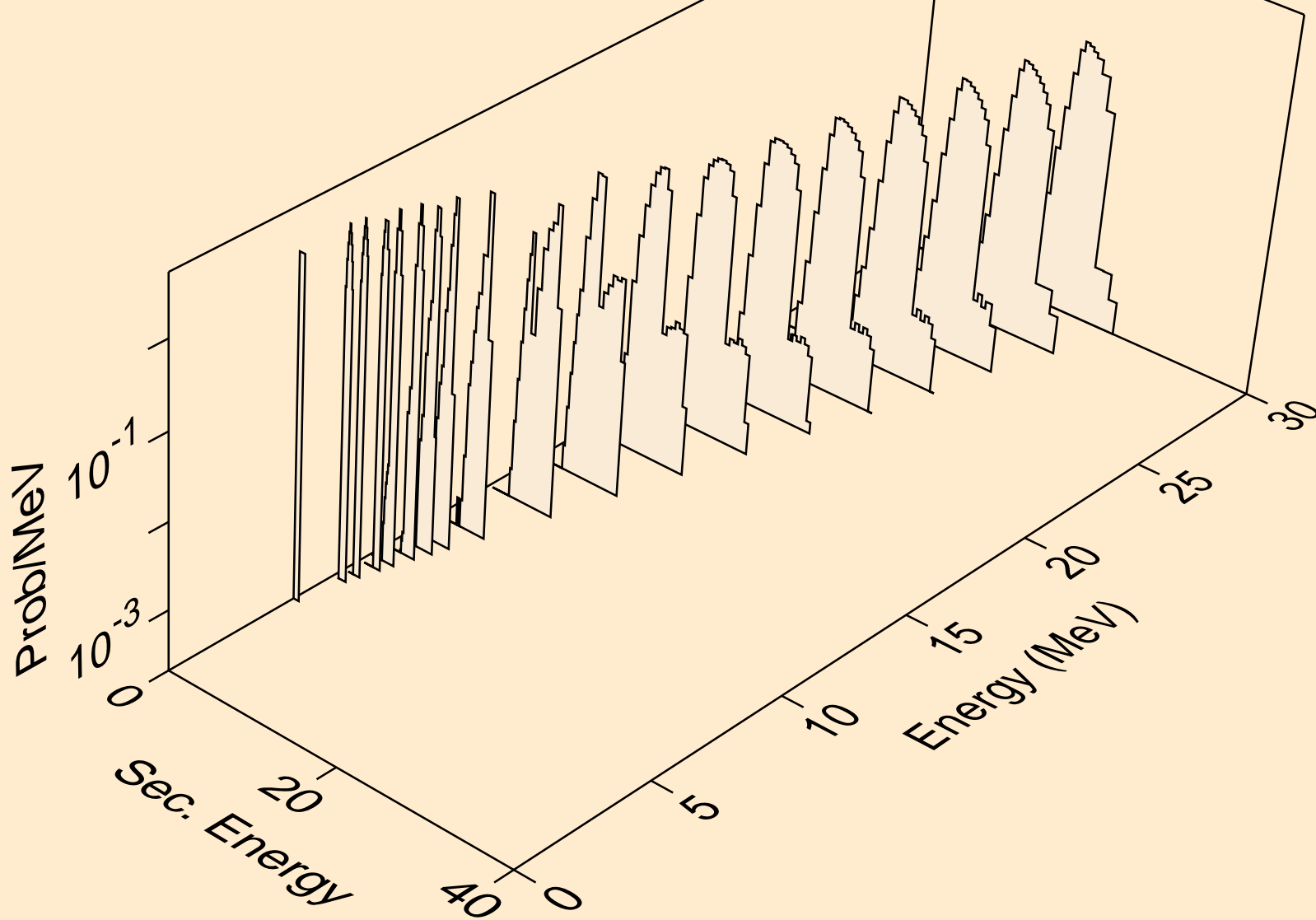

NB084 NEUTRON ACER TENDL-2019 LIBRARY; T=293.16K
tritons from (n,pt)

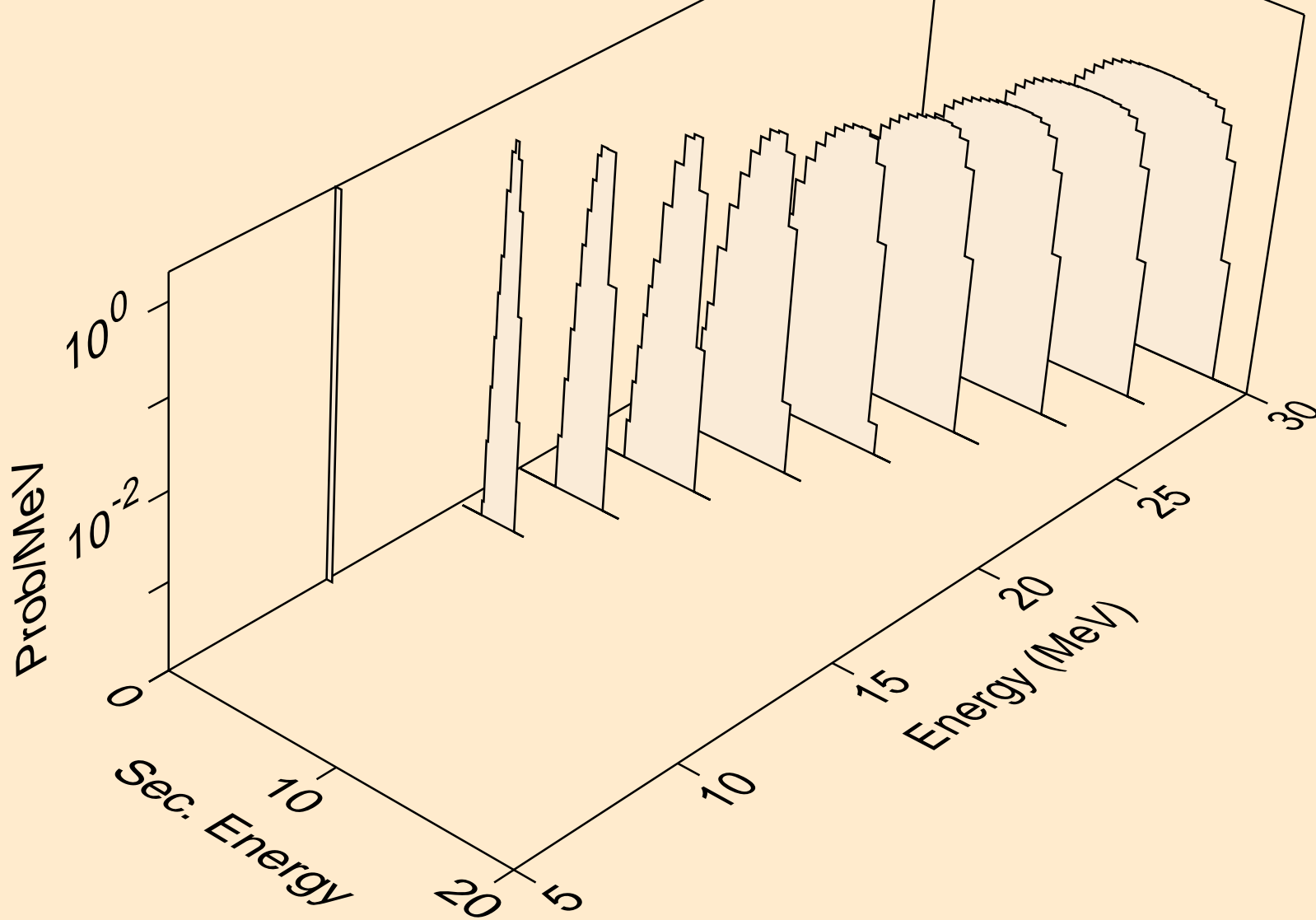

NB084 NEUTRON ACER TENDL-2019 LIBRARY; T=293.16K
he3s from (n,x)

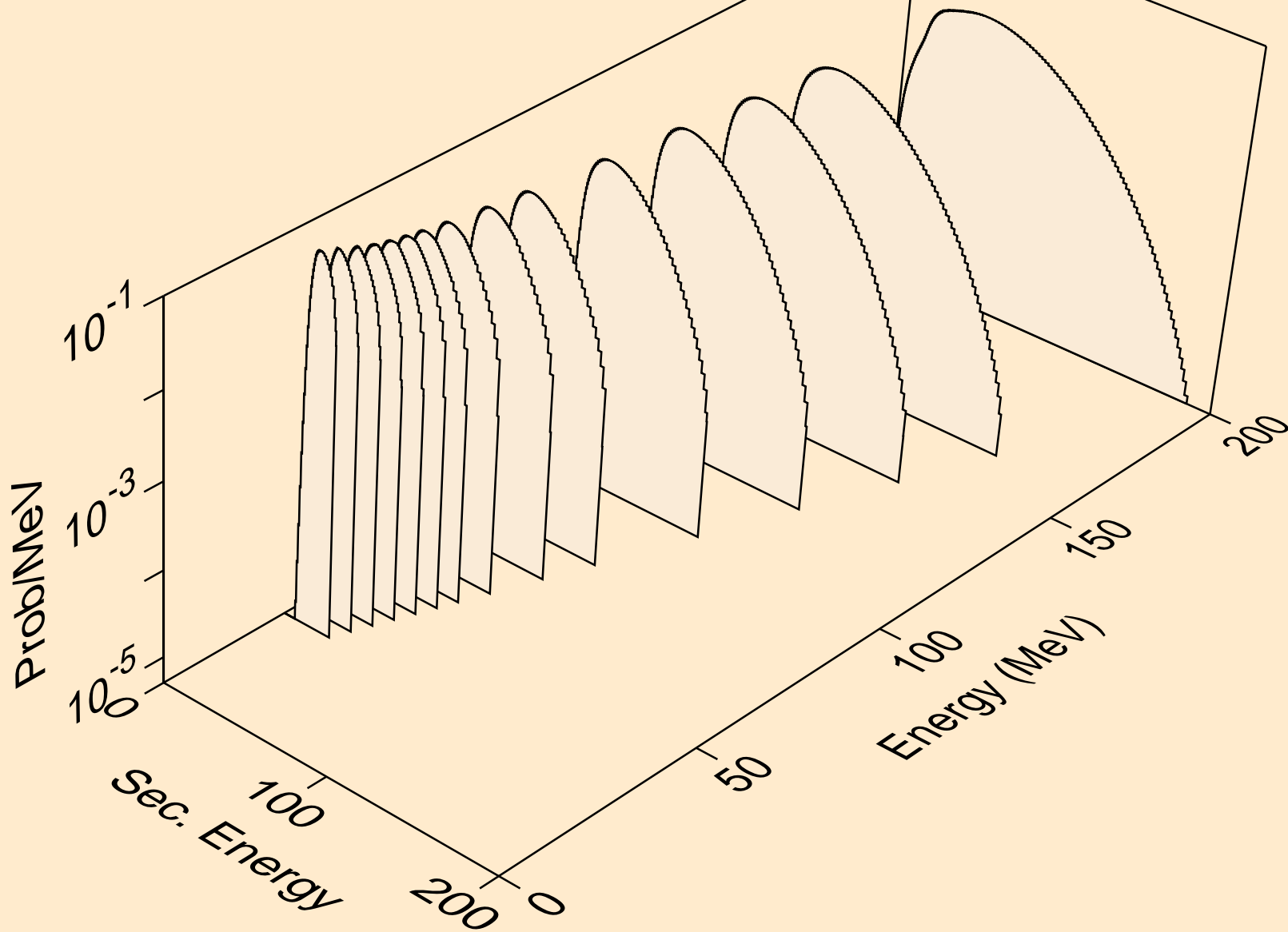

NB084 NEUTRON ACER TENDL-2019 LIBRARY; T=293.16K
he3s from (n,n*)he3

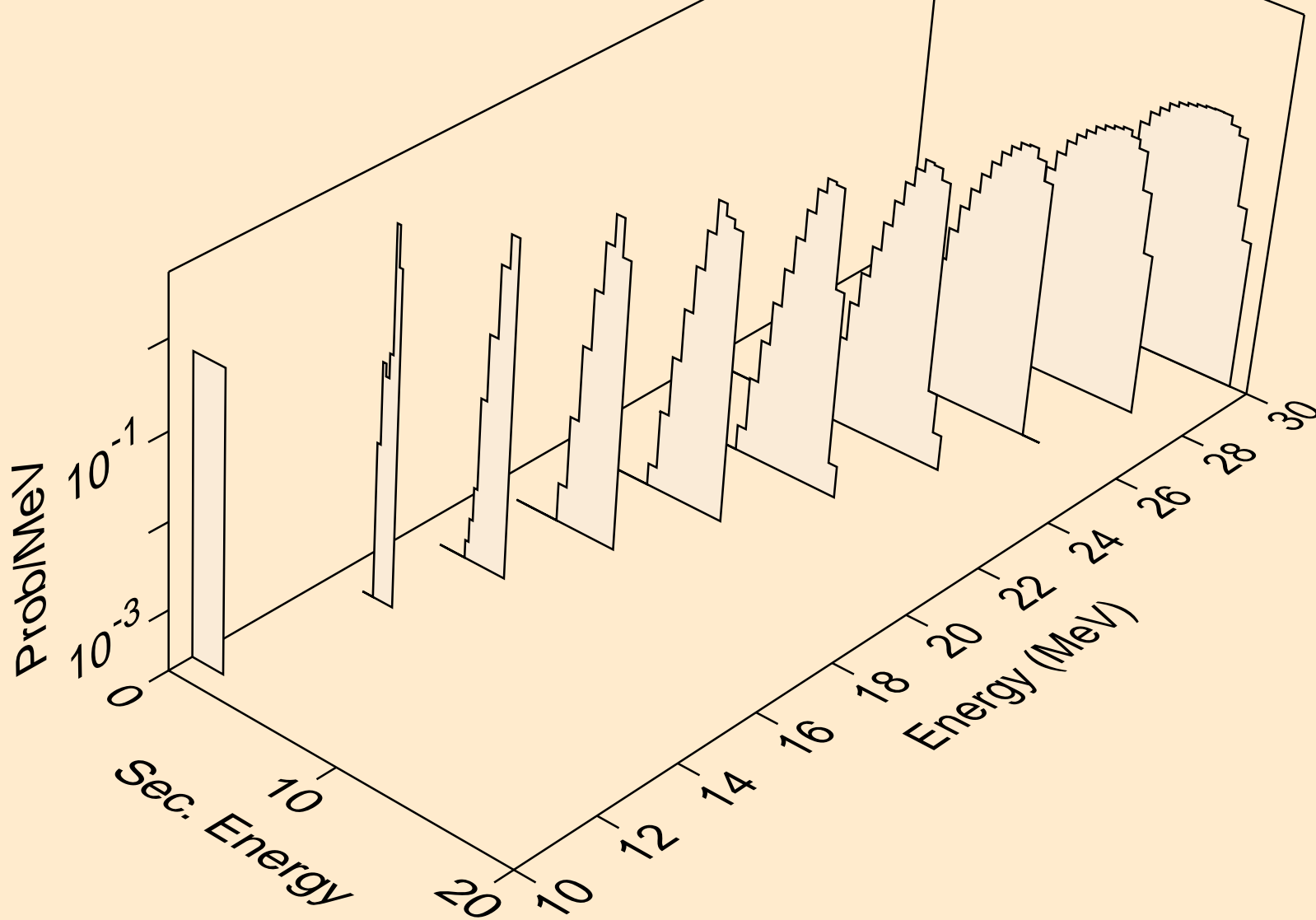

NB084 NEUTRON ACER TENDL-2019 LIBRARY; T=293.16K
he3s from (n,he3)

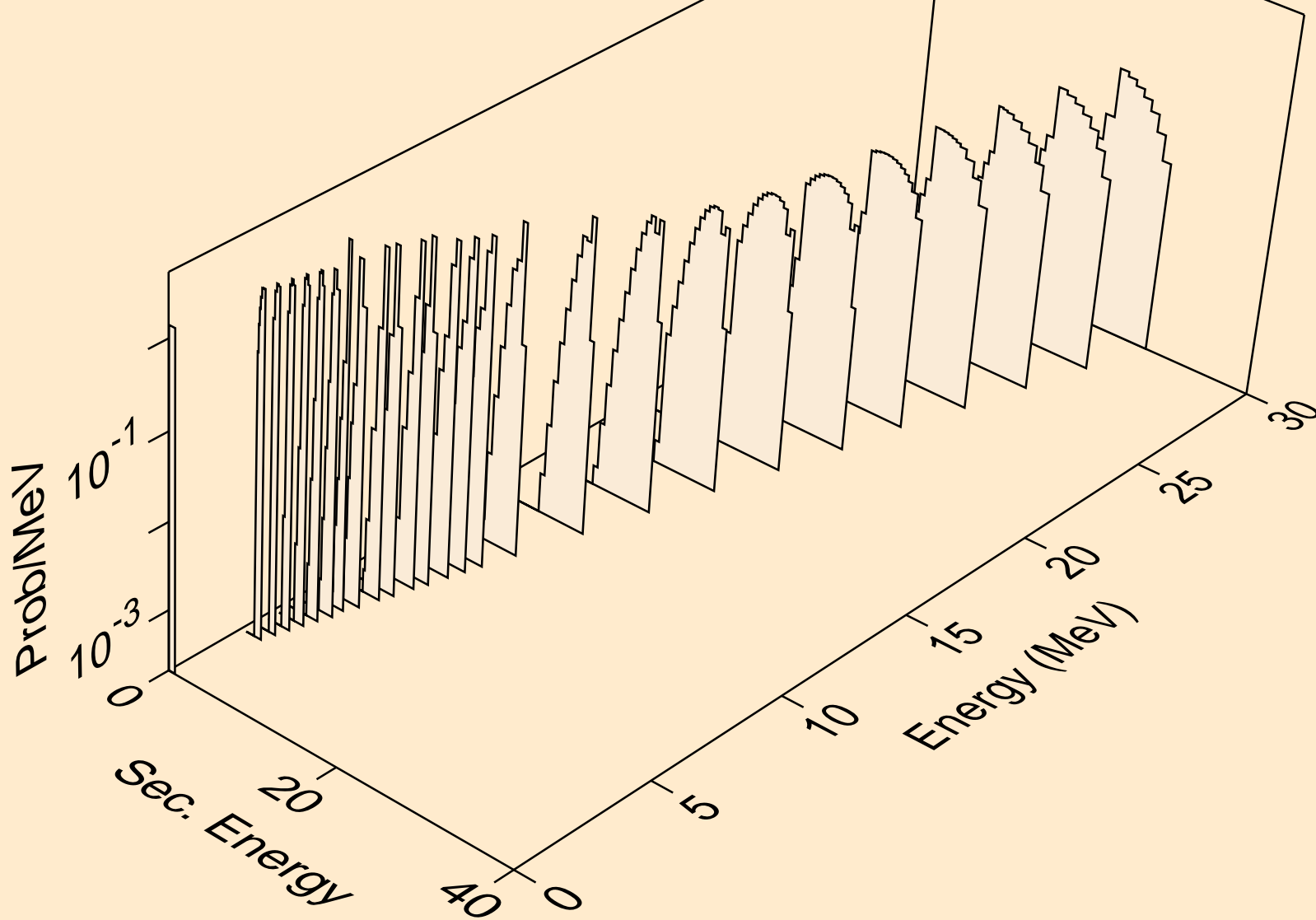

NB084 NEUTRON ACER TENDL-2019 LIBRARY; T=293.16K
alphas from (n,x)

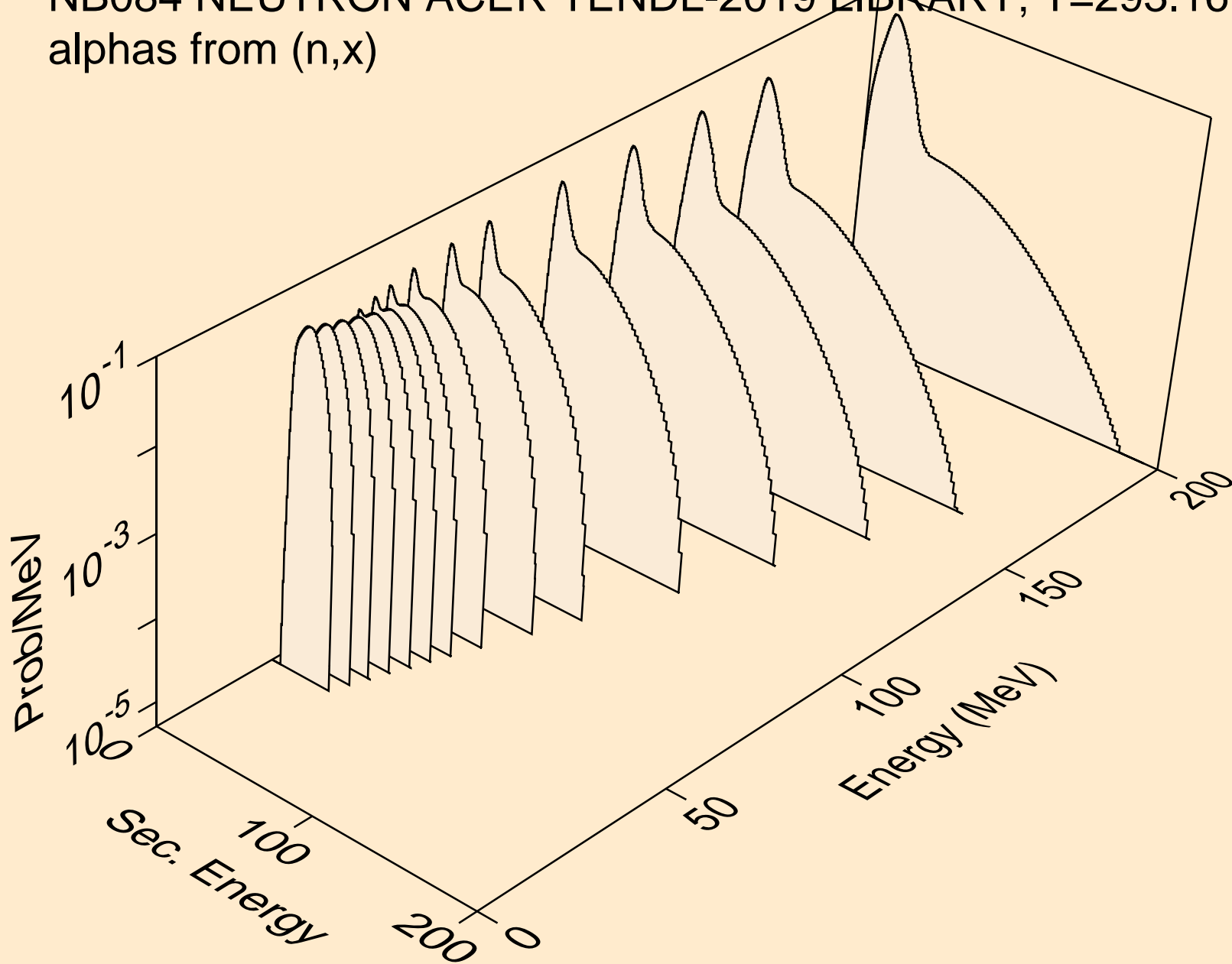

NB084 NEUTRON ACER TENDL-2019 LIBRARY; T=293.16K
alphas from (n,n*)a

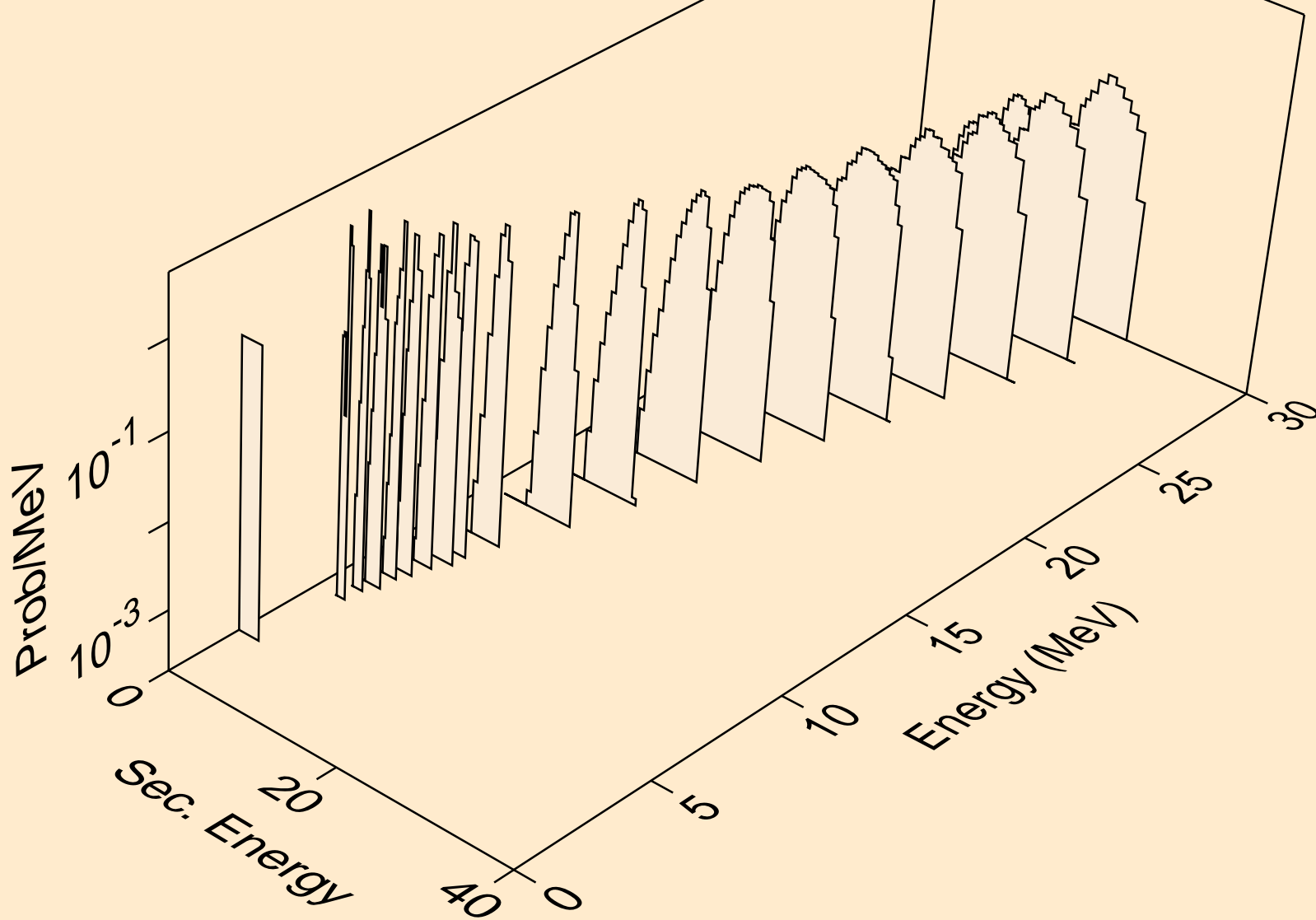

NB084 NEUTRON ACER TENDL-2019 LIBRARY; T=293.16K
alphas from (n,2n)a

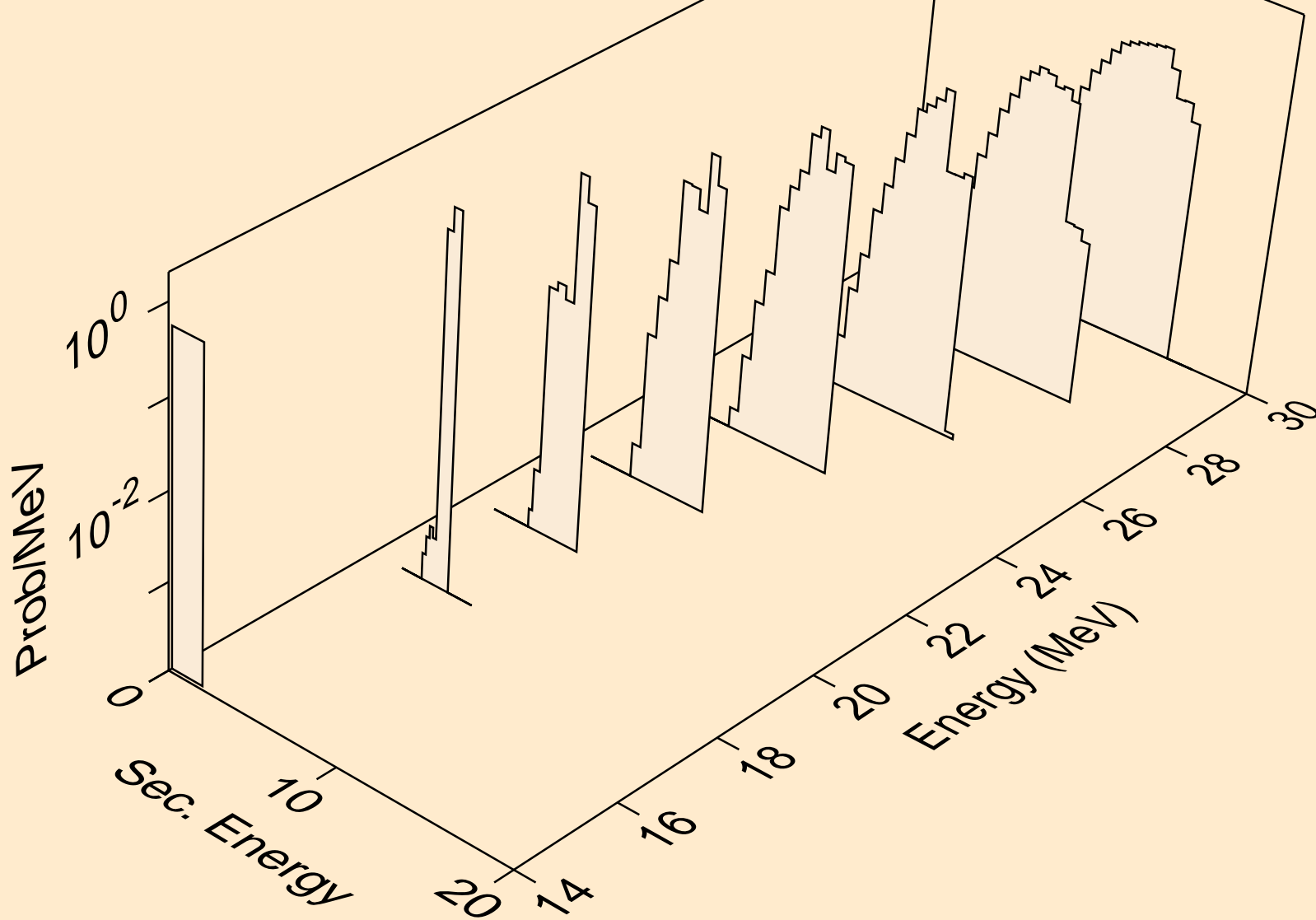

NB084 NEUTRON ACER TENDL-2019 LIBRARY; T=293.16K
alphas from (n,n*)2a

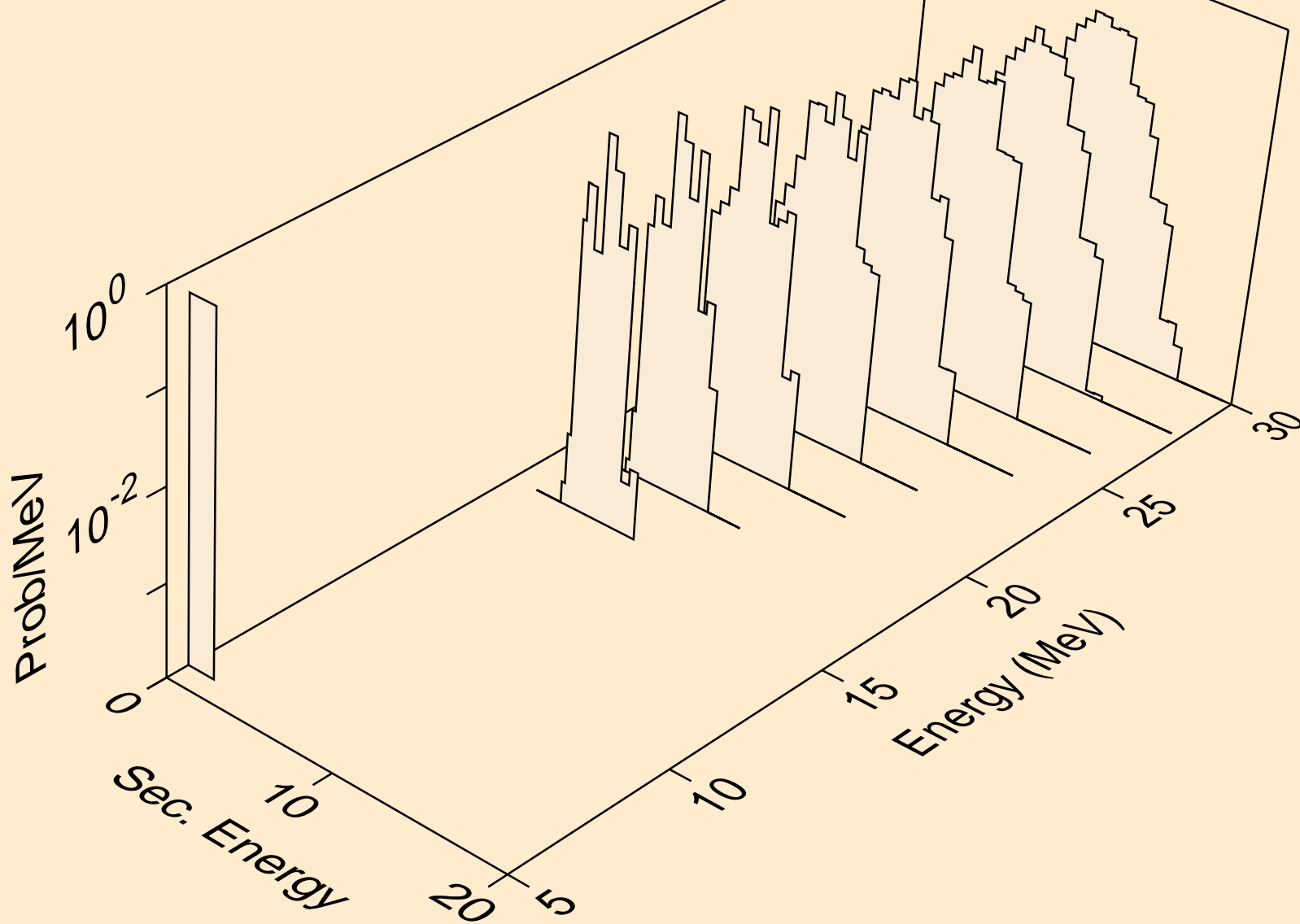

NB084 NEUTRON ACER TENDL-2019 LIBRARY; T=293.16K
alphas from (n,npa)

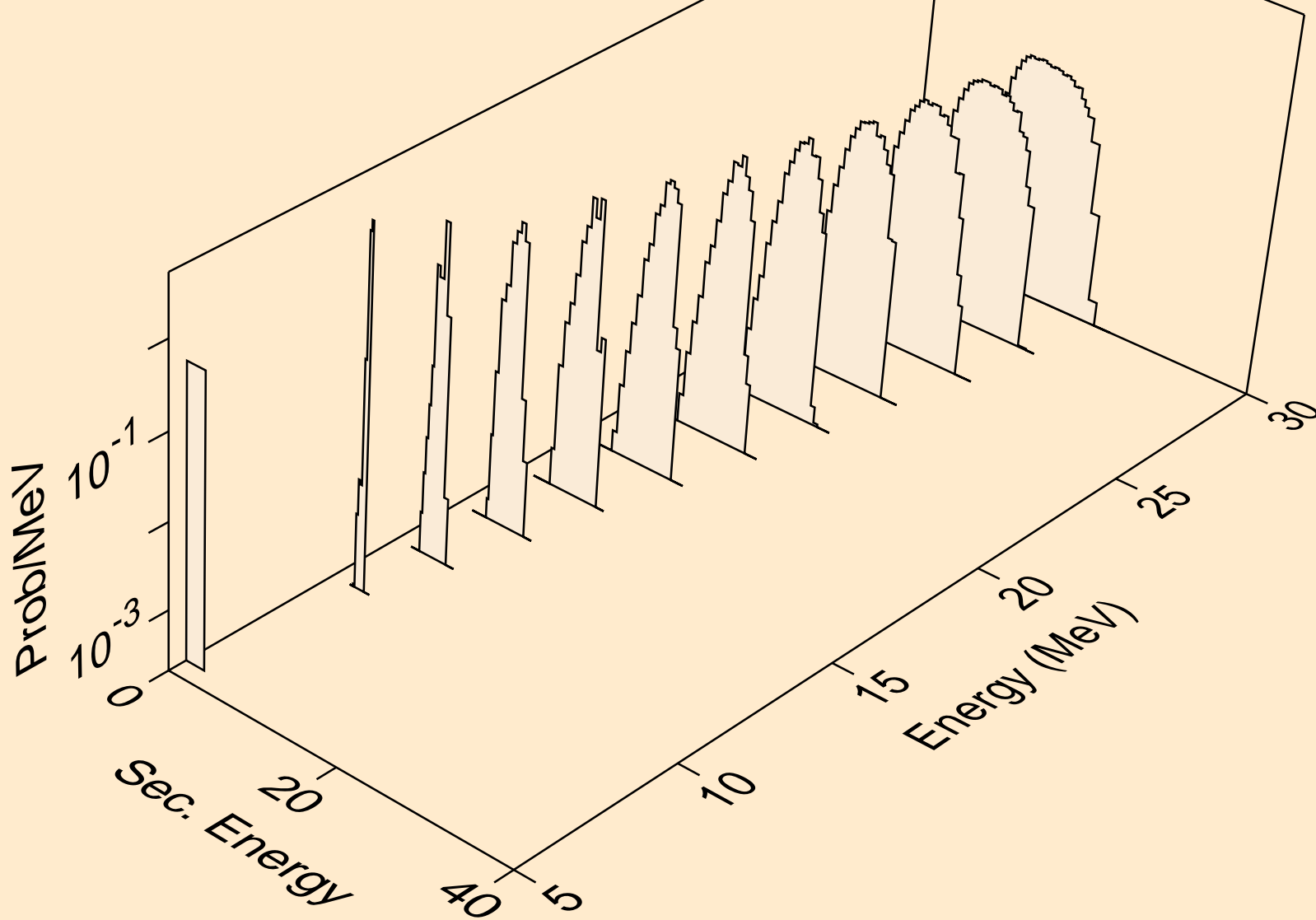

NB084 NEUTRON ACER TENDL-2019 LIBRARY; T=293.16K
alphas from (n,a)

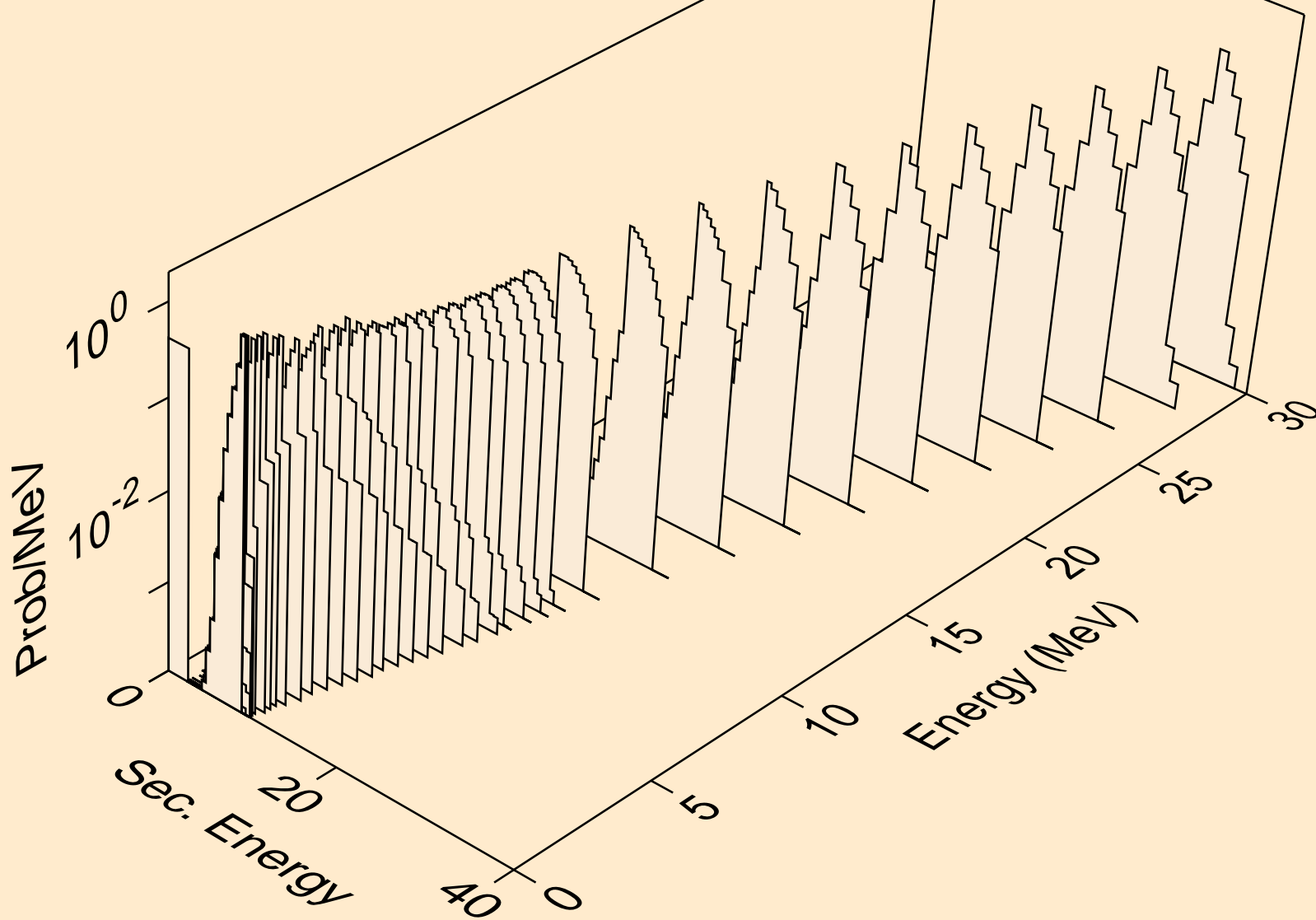

NB084 NEUTRON ACER TENDL-2019 LIBRARY; T=293.16K
alphas from (n,2a)

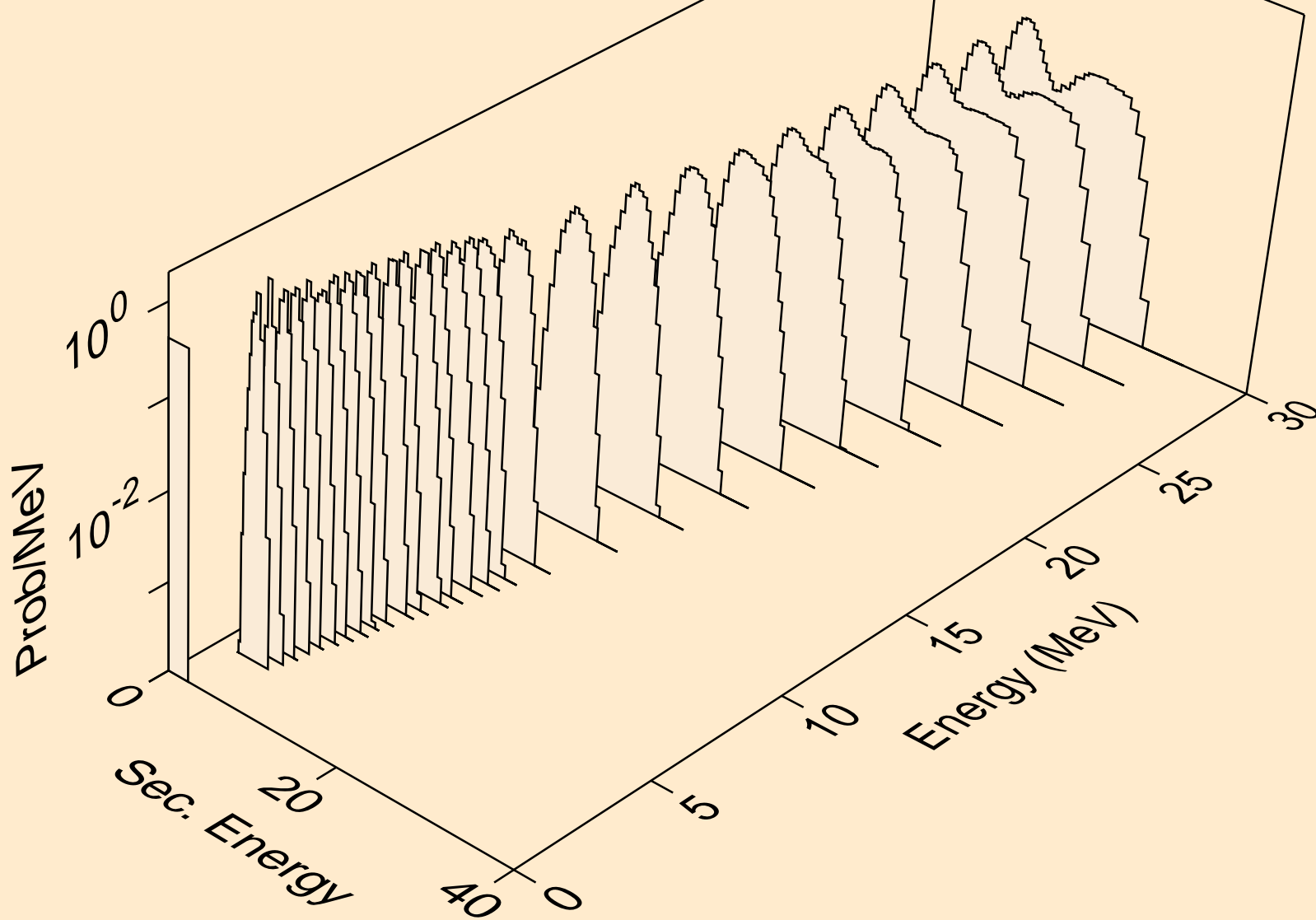

NB084 NEUTRON ACER TENDL-2019 LIBRARY; T=293.16K
alphas from (n,3a)

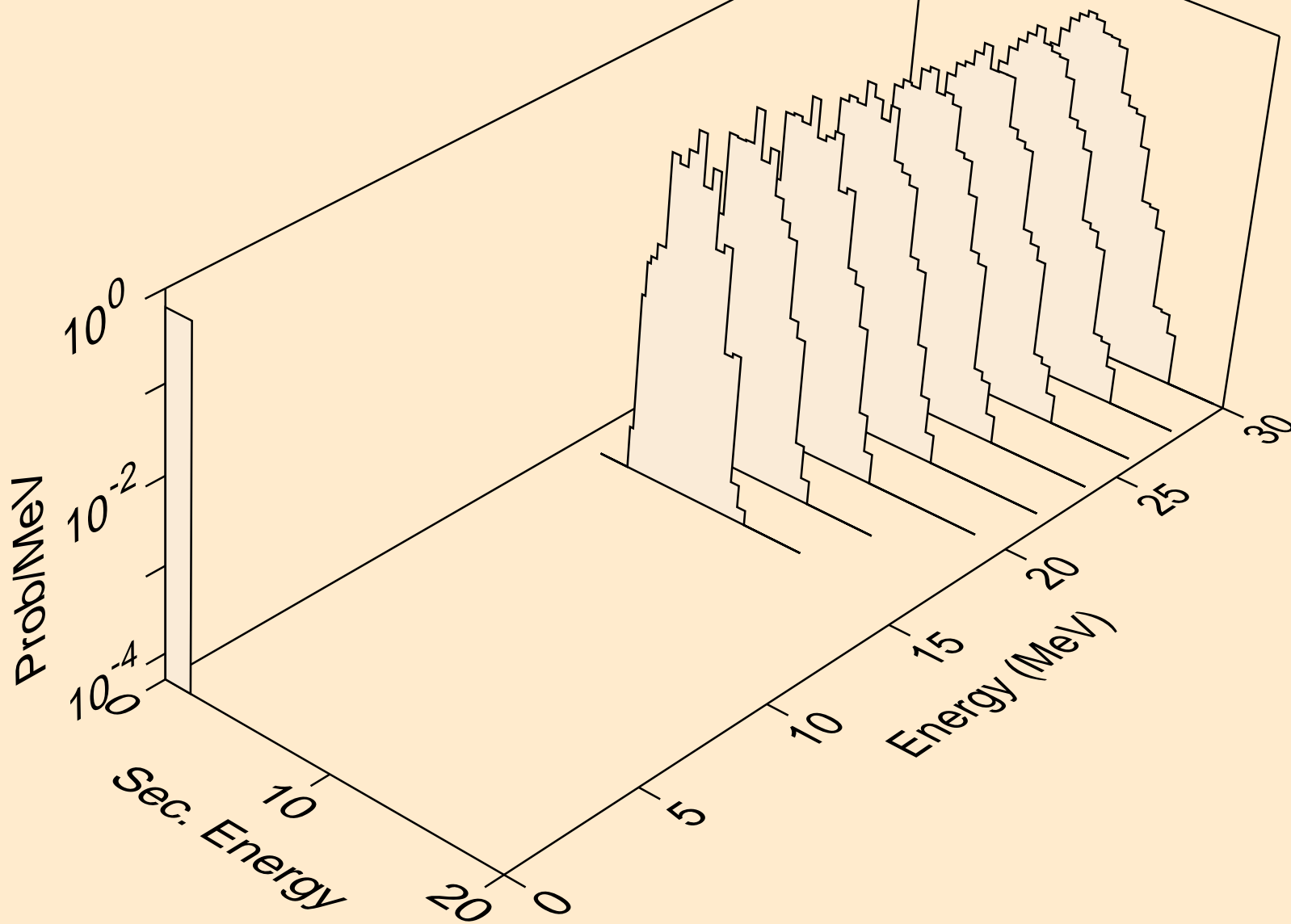

NB084 NEUTRON ACER TENDL-2019 LIBRARY; T=293.16K
alphas from (n,pa)

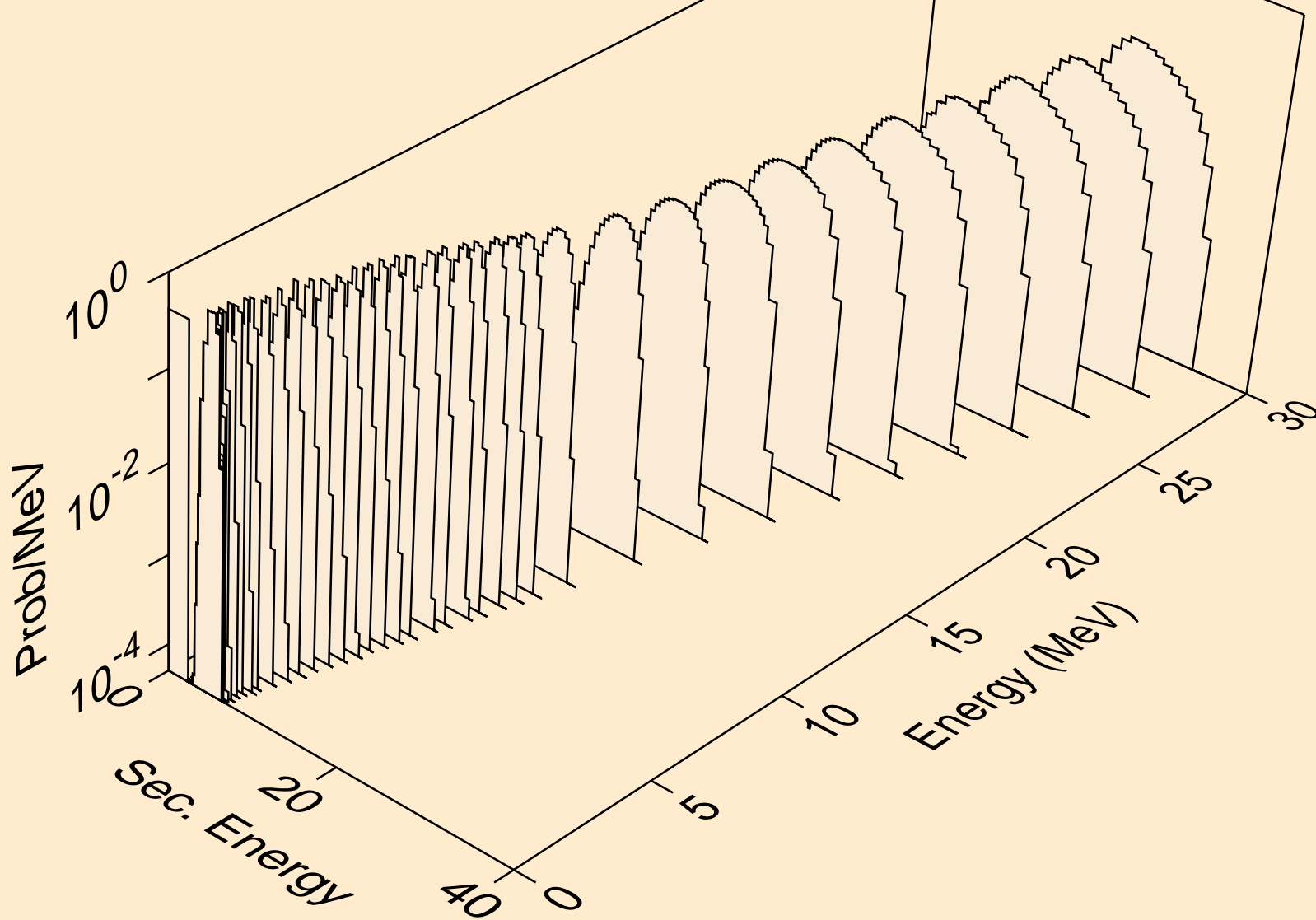

NB084 NEUTRON ACER TENDL-2019 LIBRARY; T=293.16K
alphas from (n,da)

