

NB089M NEUTRON ACER TENDL-2019 LIBRARY; T=293.16K  
Principal cross sections

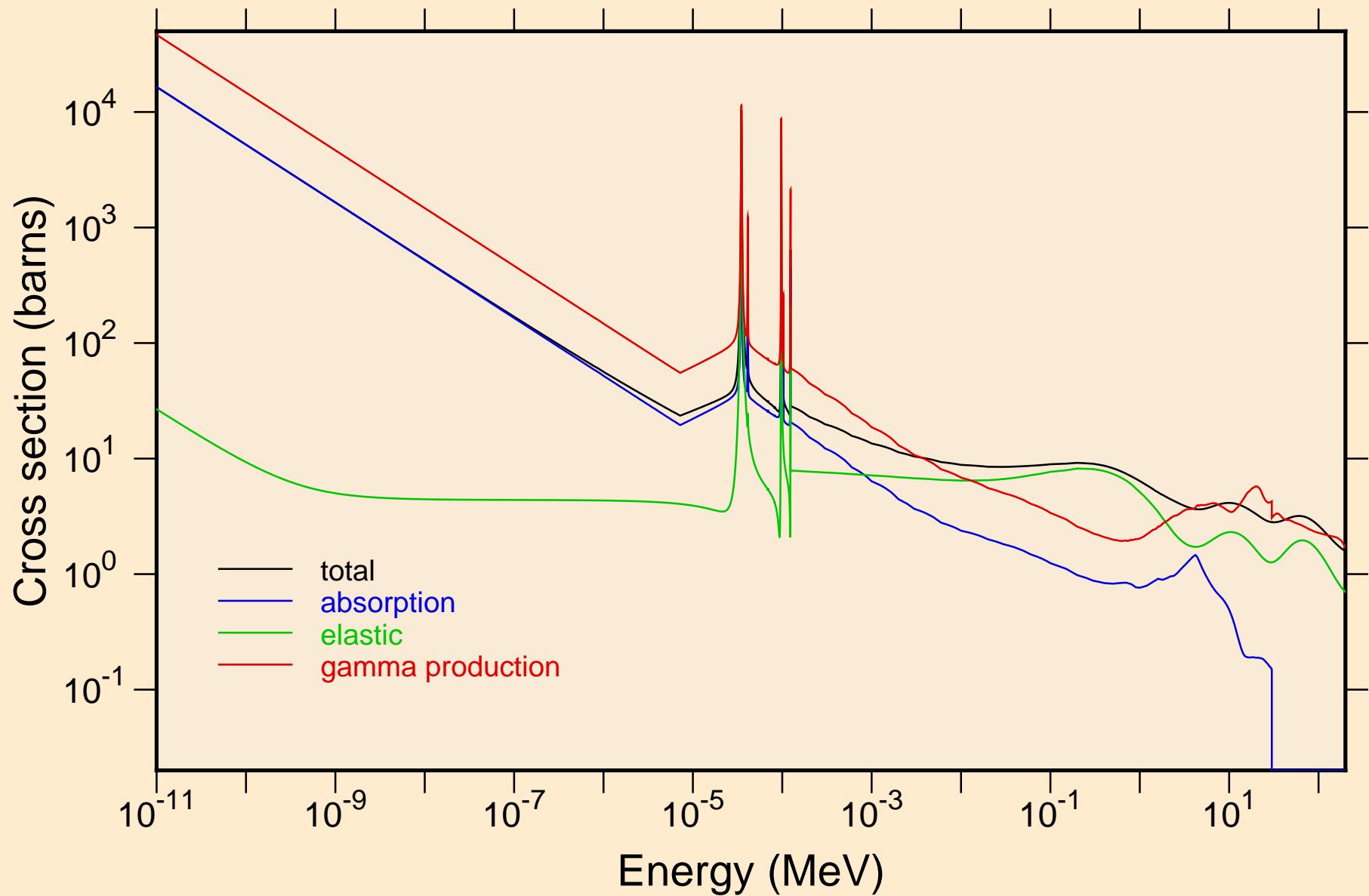

NB089M NEUTRON ACER TENDL-2019 LIBRARY; T=293.16K  
resonance total cross section

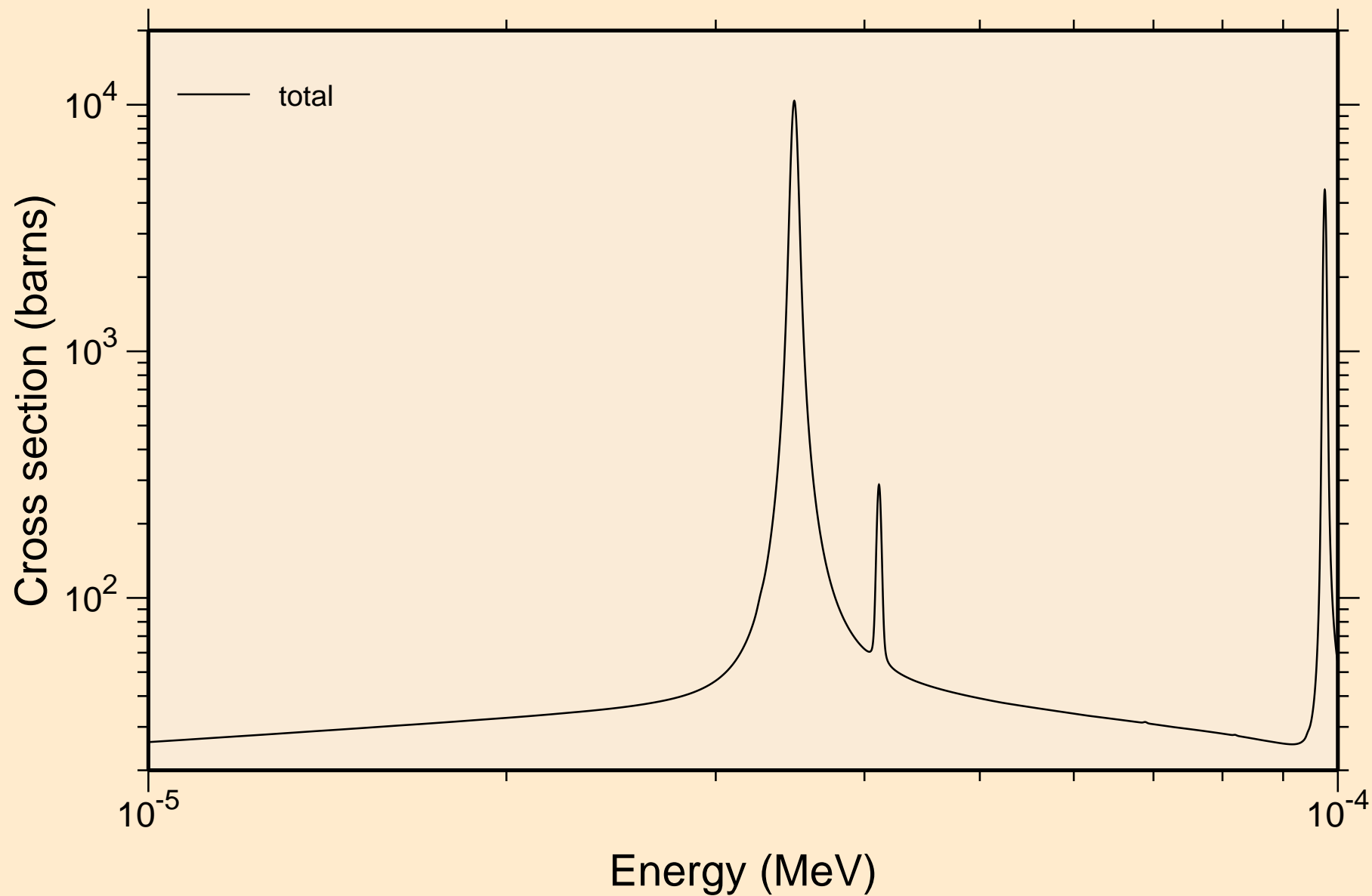

NB089M NEUTRON ACER TENDL-2019 LIBRARY; T=293.16K  
resonance total cross section

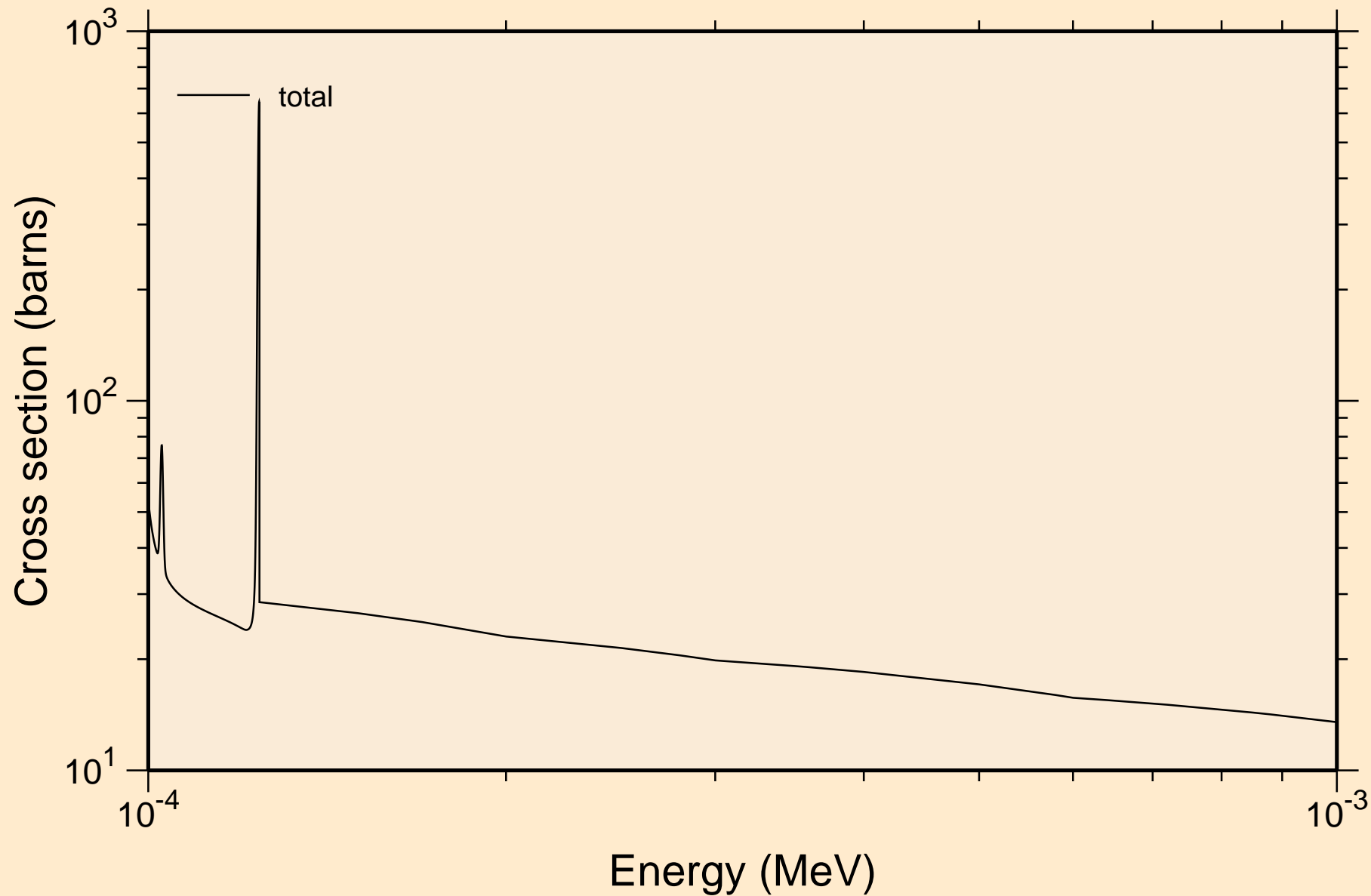

NB089M NEUTRON ACER TENDL-2019 LIBRARY; T=293.16K  
resonance total cross section

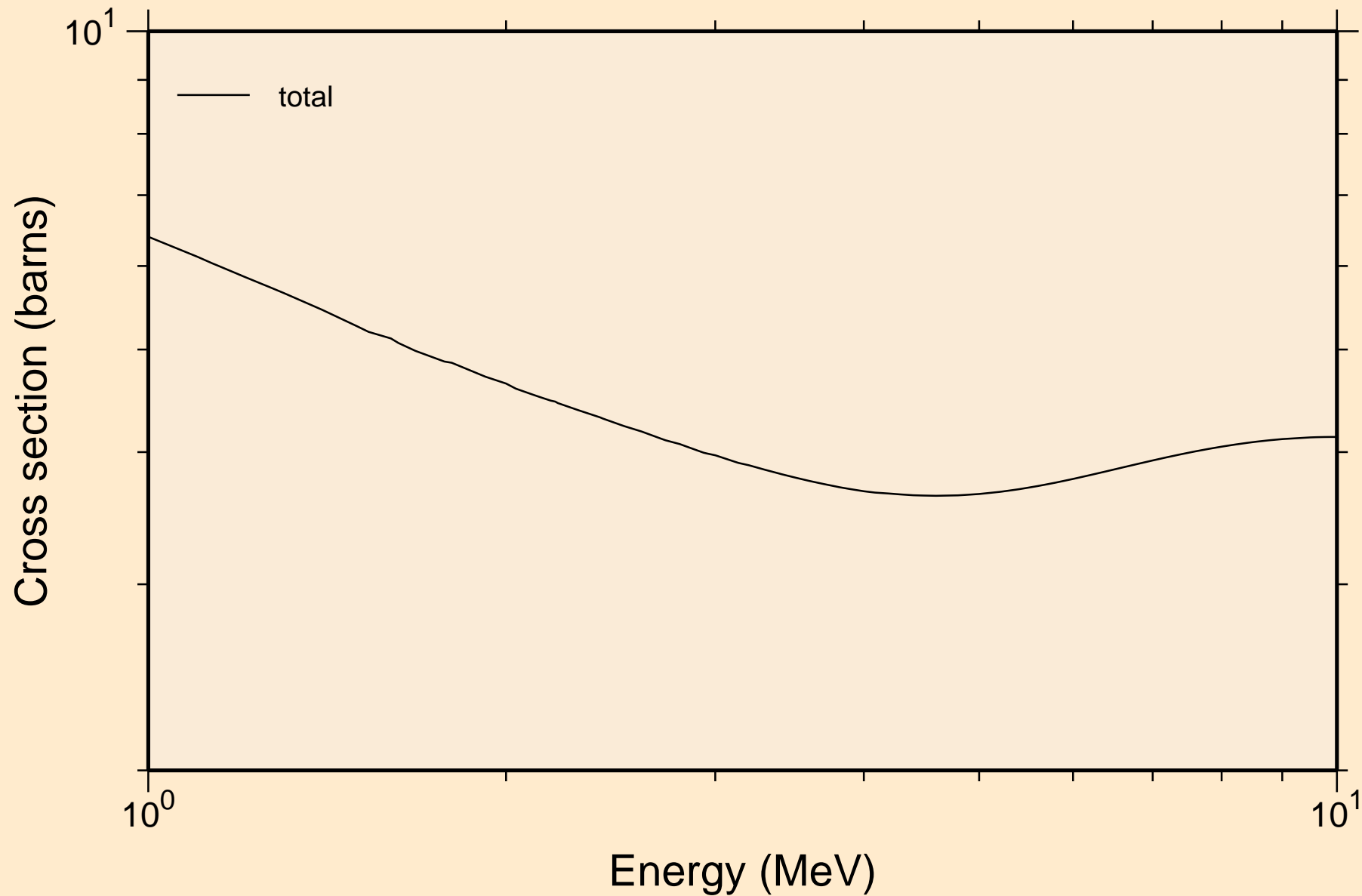

NB089M NEUTRON ACER TENDL-2019 LIBRARY; T=293.16K  
resonance absorption cross sections

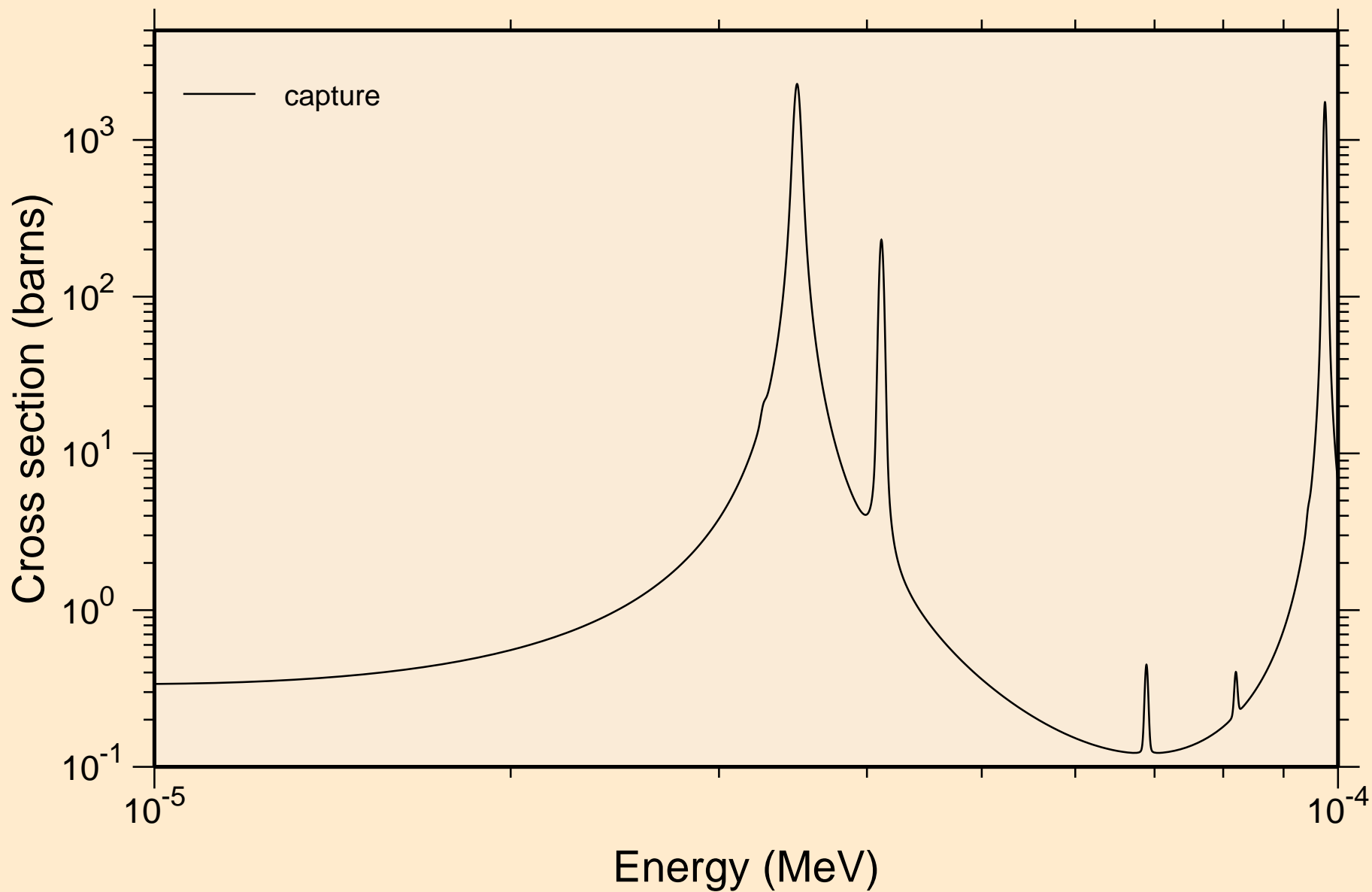

NB089M NEUTRON ACER TENDL-2019 LIBRARY; T=293.16K  
resonance absorption cross sections

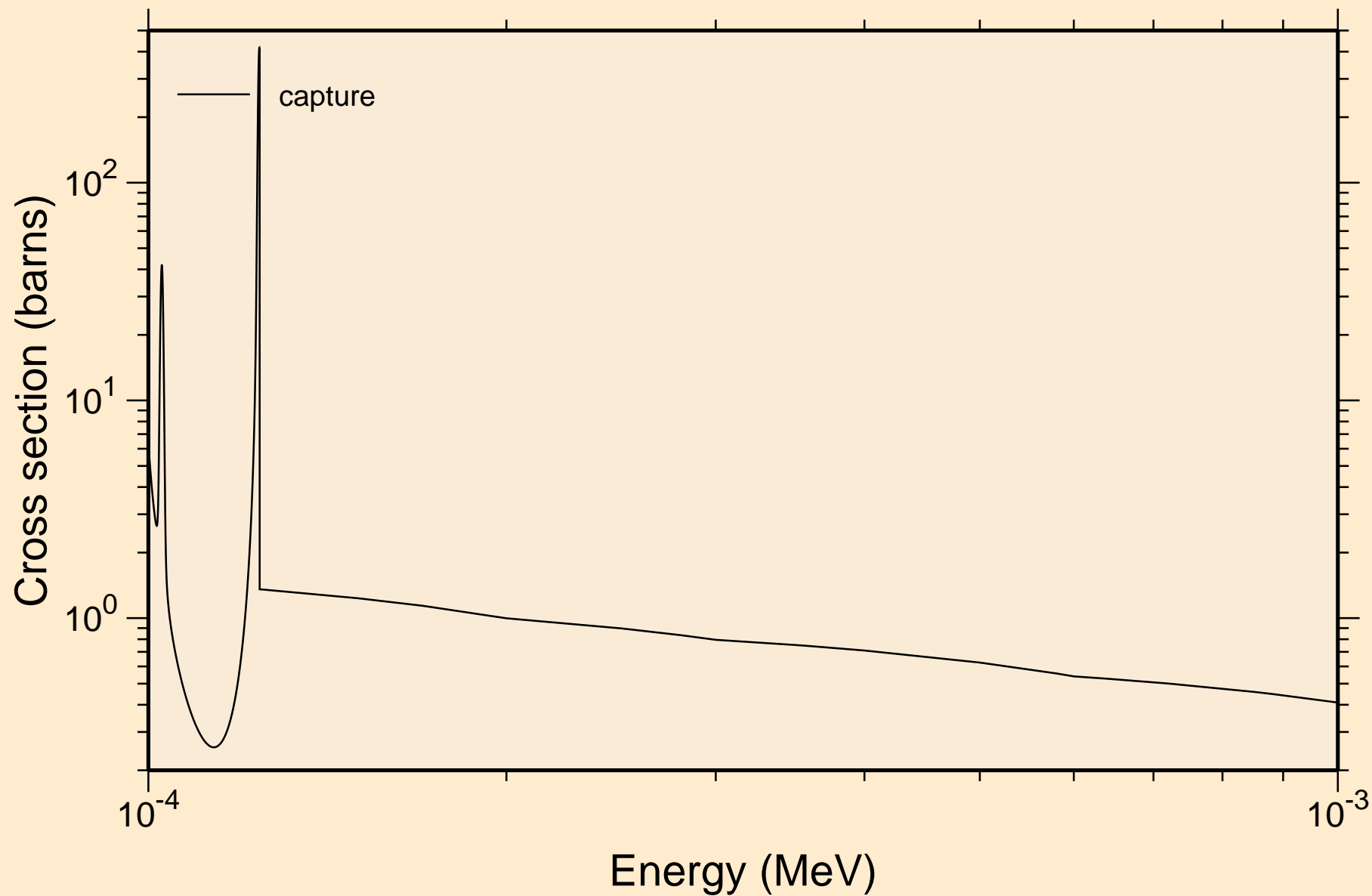

NB089M NEUTRON ACER TENDL-2019 LIBRARY; T=293.16K  
resonance absorption cross sections

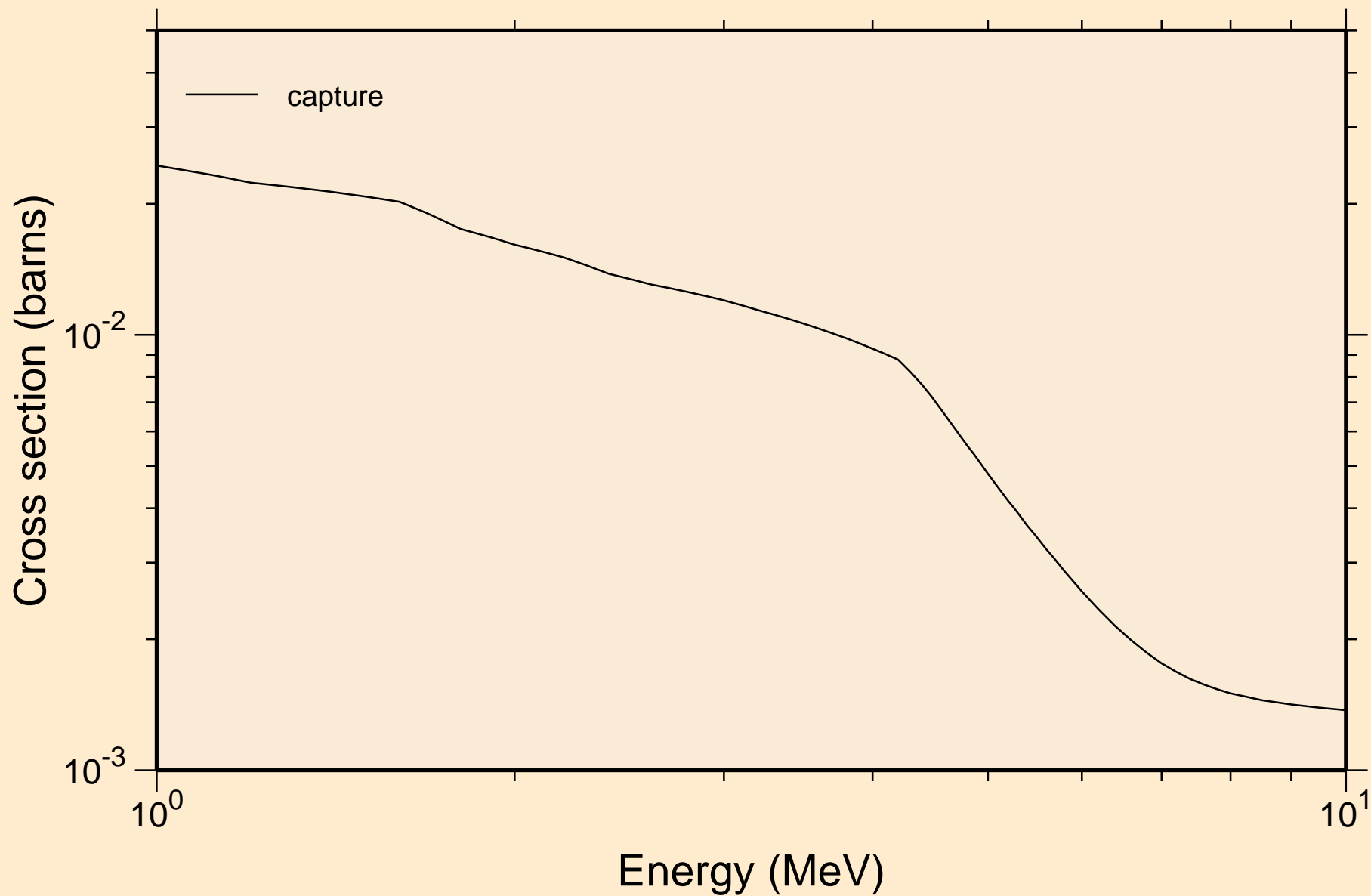

NB089M NEUTRON ACER TENDL-2019 LIBRARY; T=293.16K  
Heating

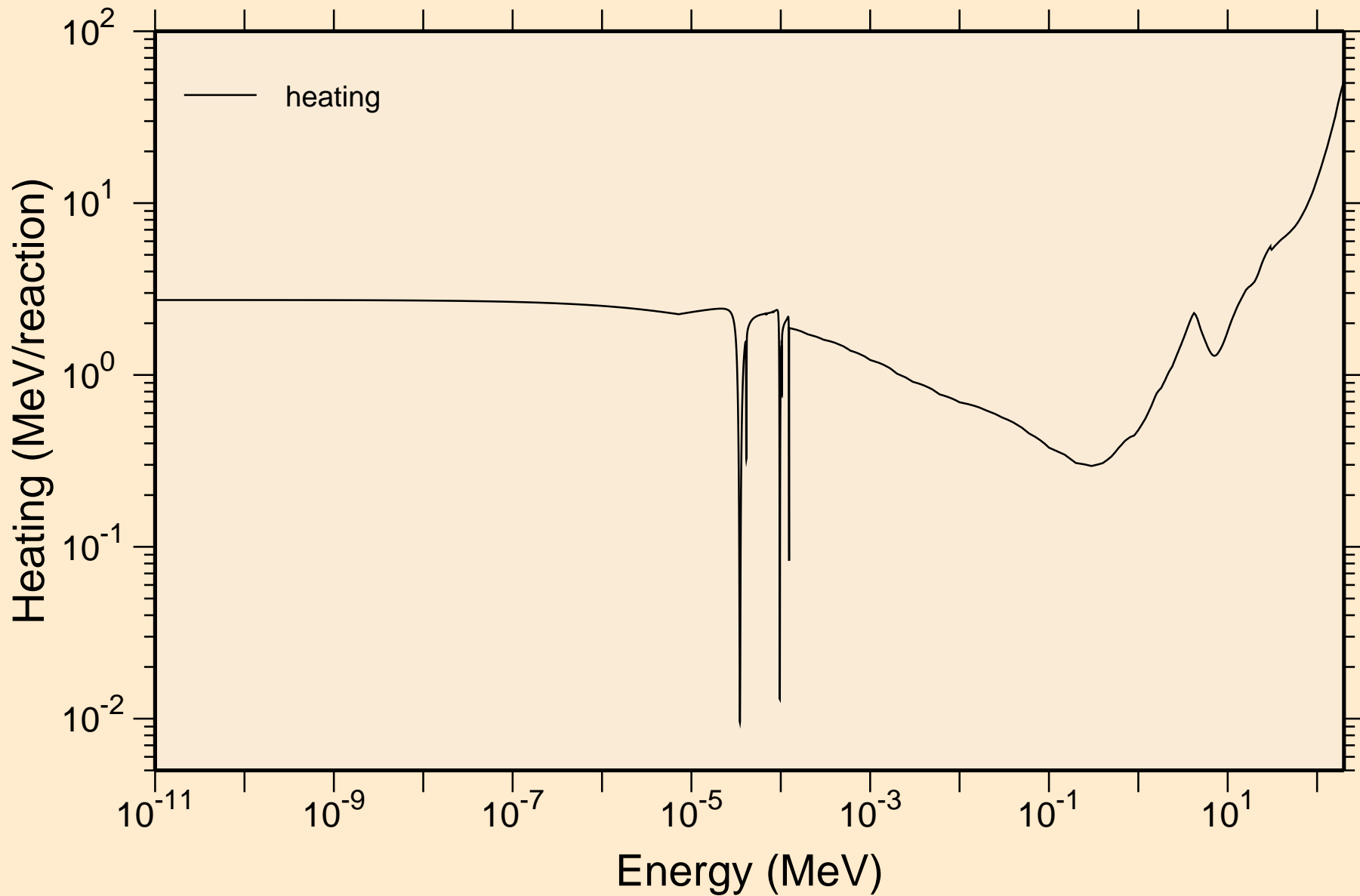



NB089M NEUTRON ACER TENDL-2019 LIBRARY; T=293.16K  
Damage

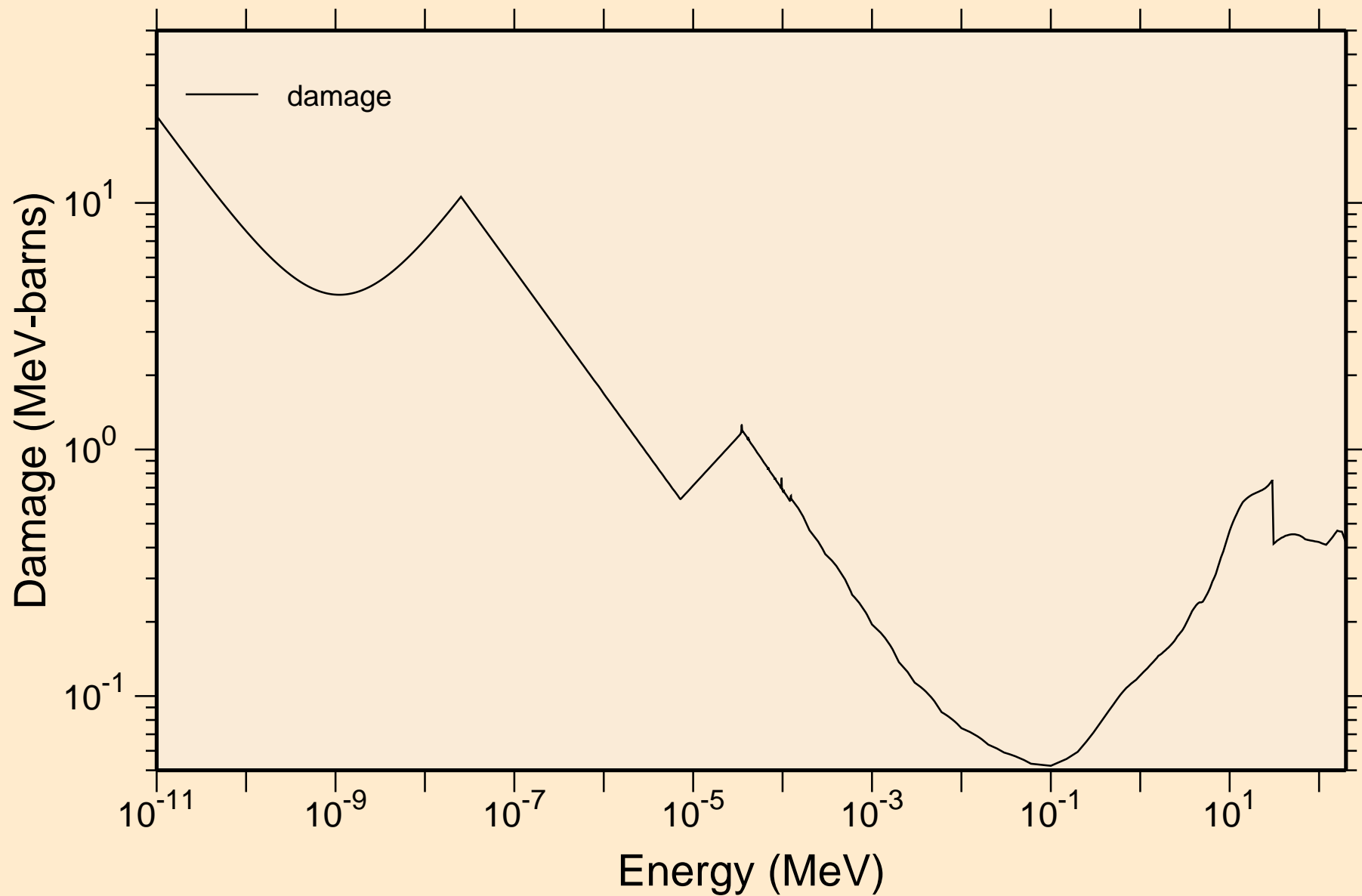

NB089M NEUTRON ACER TENDL-2019 LIBRARY; T=293.16K  
Non-threshold reactions

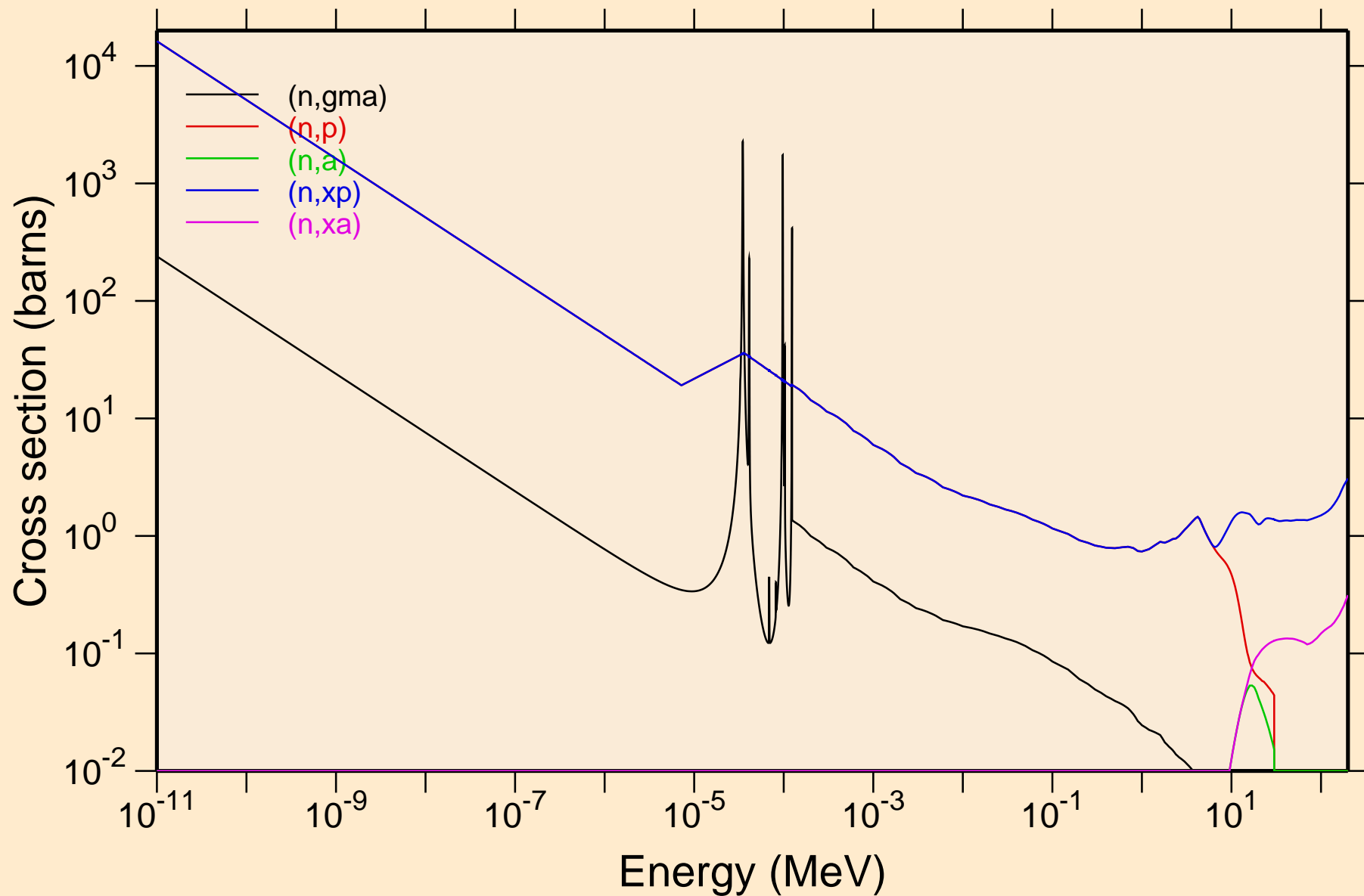

NB089M NEUTRON ACER TENDL-2019 LIBRARY; T=293.16K  
Principal cross sections

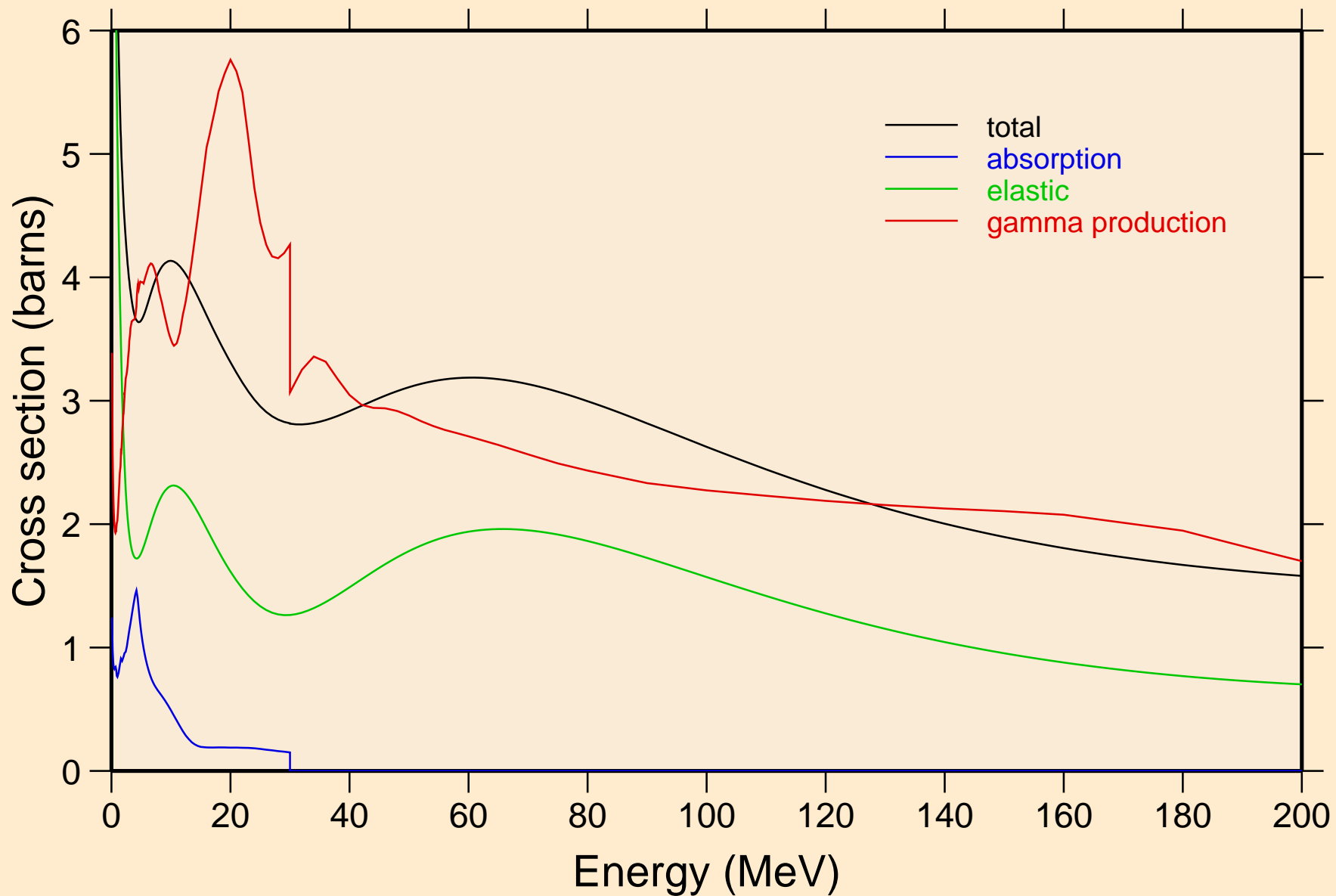

NB089M NEUTRON ACER TENDL-2019 LIBRARY; T=293.16K  
Heating

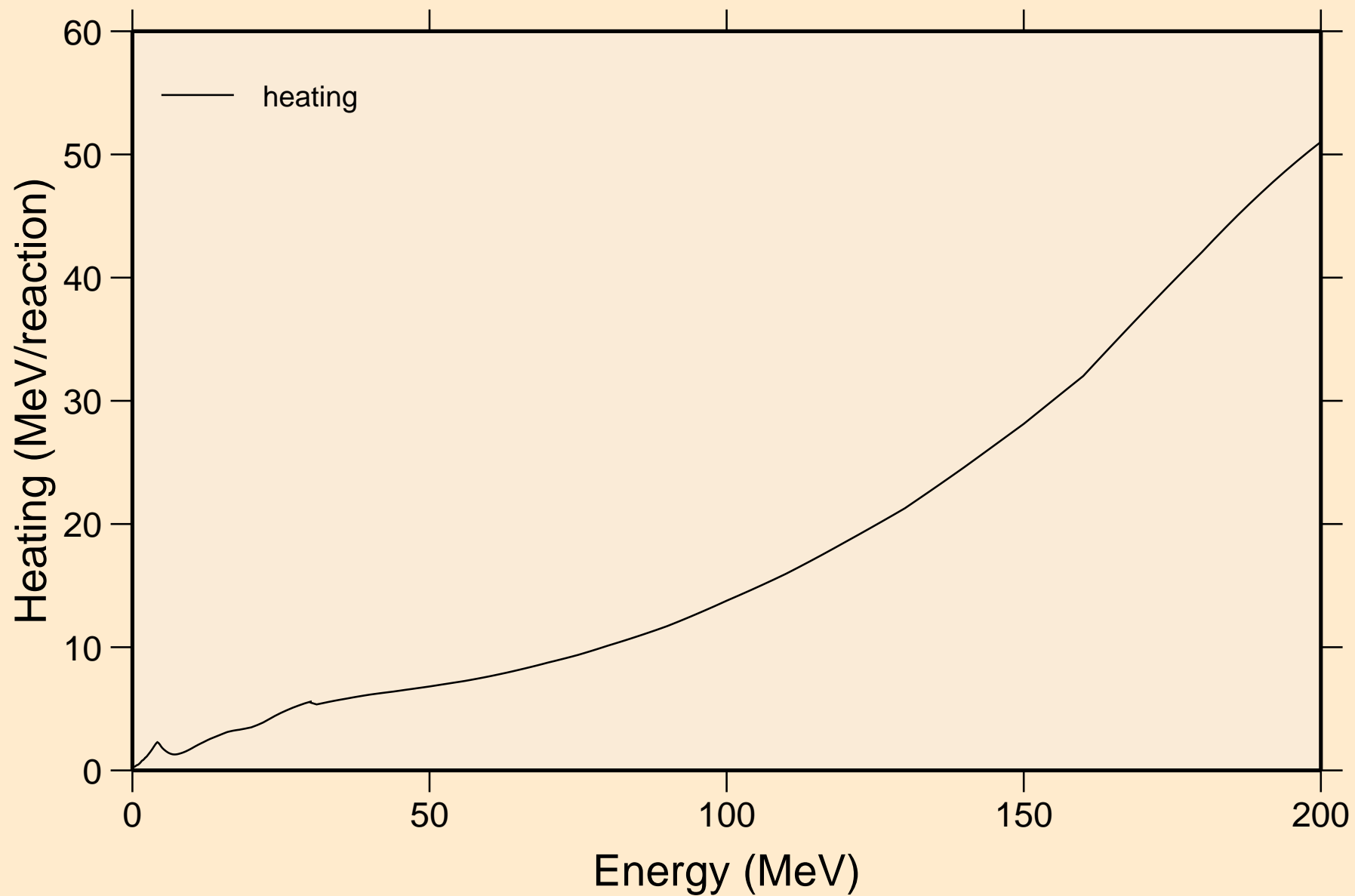

NB089M NEUTRON ACER TENDL-2019 LIBRARY; T=293.16K  
Damage

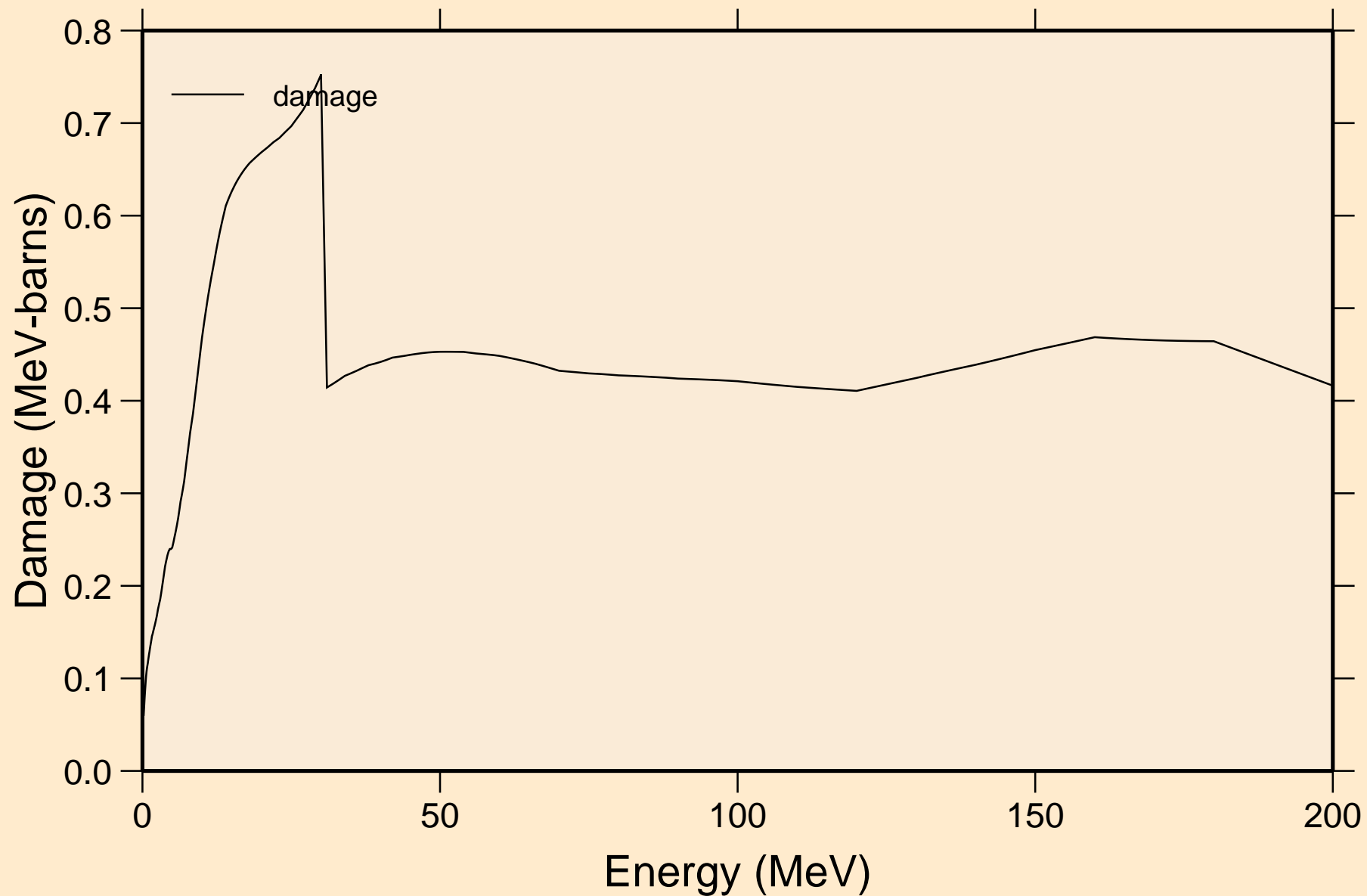

NB089M NEUTRON ACER TENDL-2019 LIBRARY; T=293.16K  
Non-threshold reactions

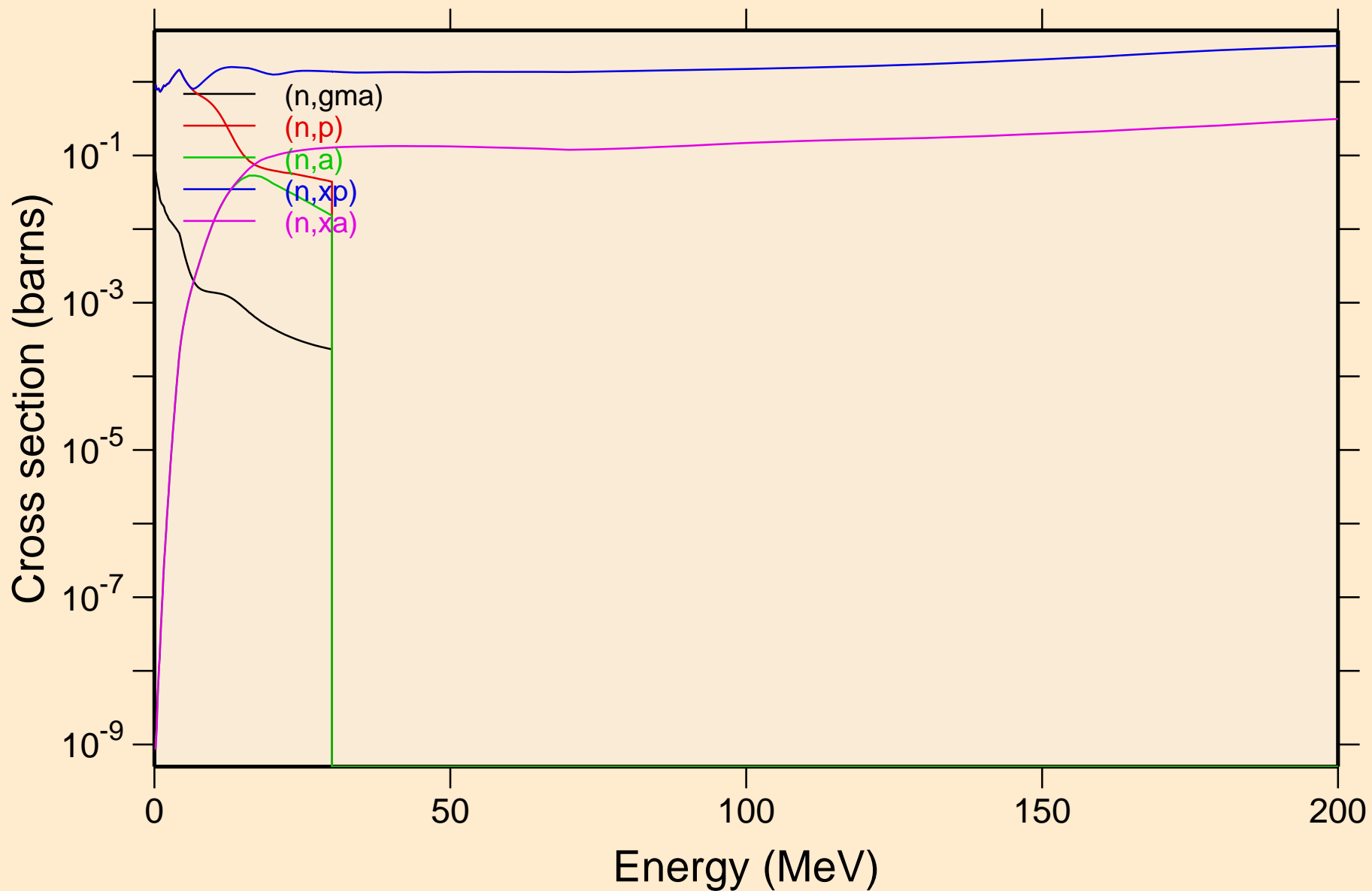

NB089M NEUTRON ACER TENDL-2019 LIBRARY; T=293.16K  
Inelastic levels

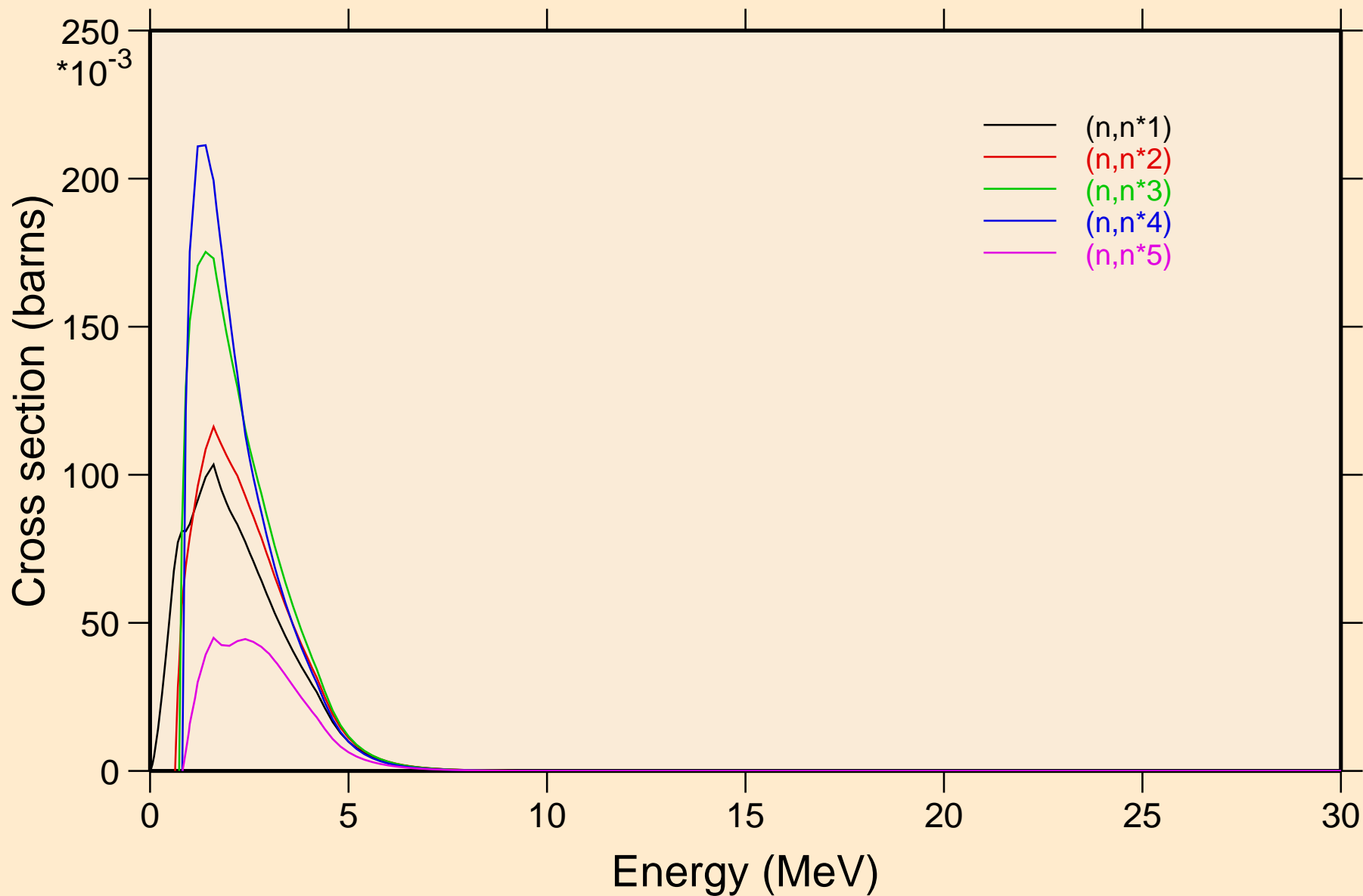

NB089M NEUTRON ACER TENDL-2019 LIBRARY; T=293.16K  
Inelastic levels

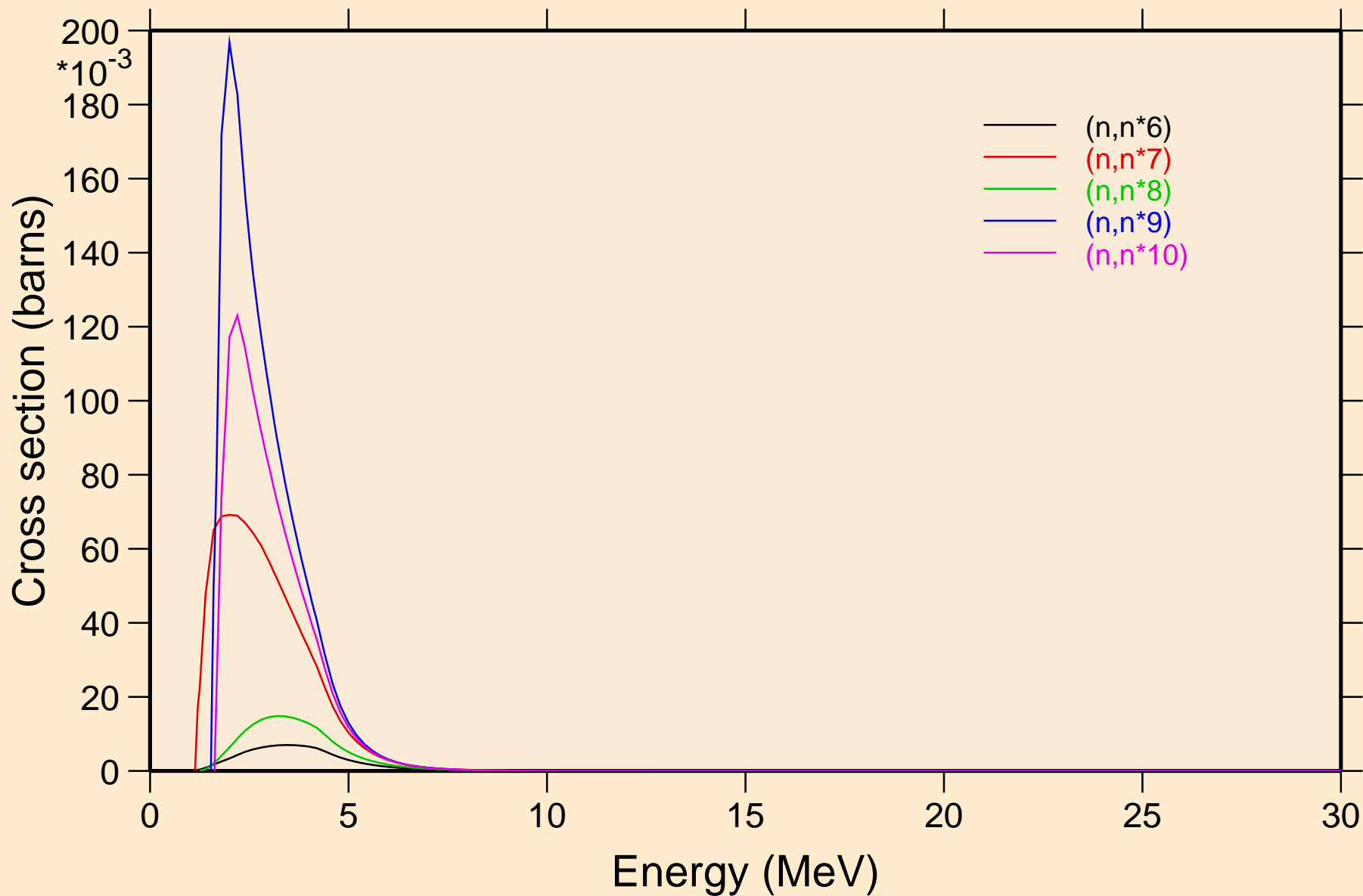



NB089M NEUTRON ACER TENDL-2019 LIBRARY; T=293.16K  
Inelastic levels

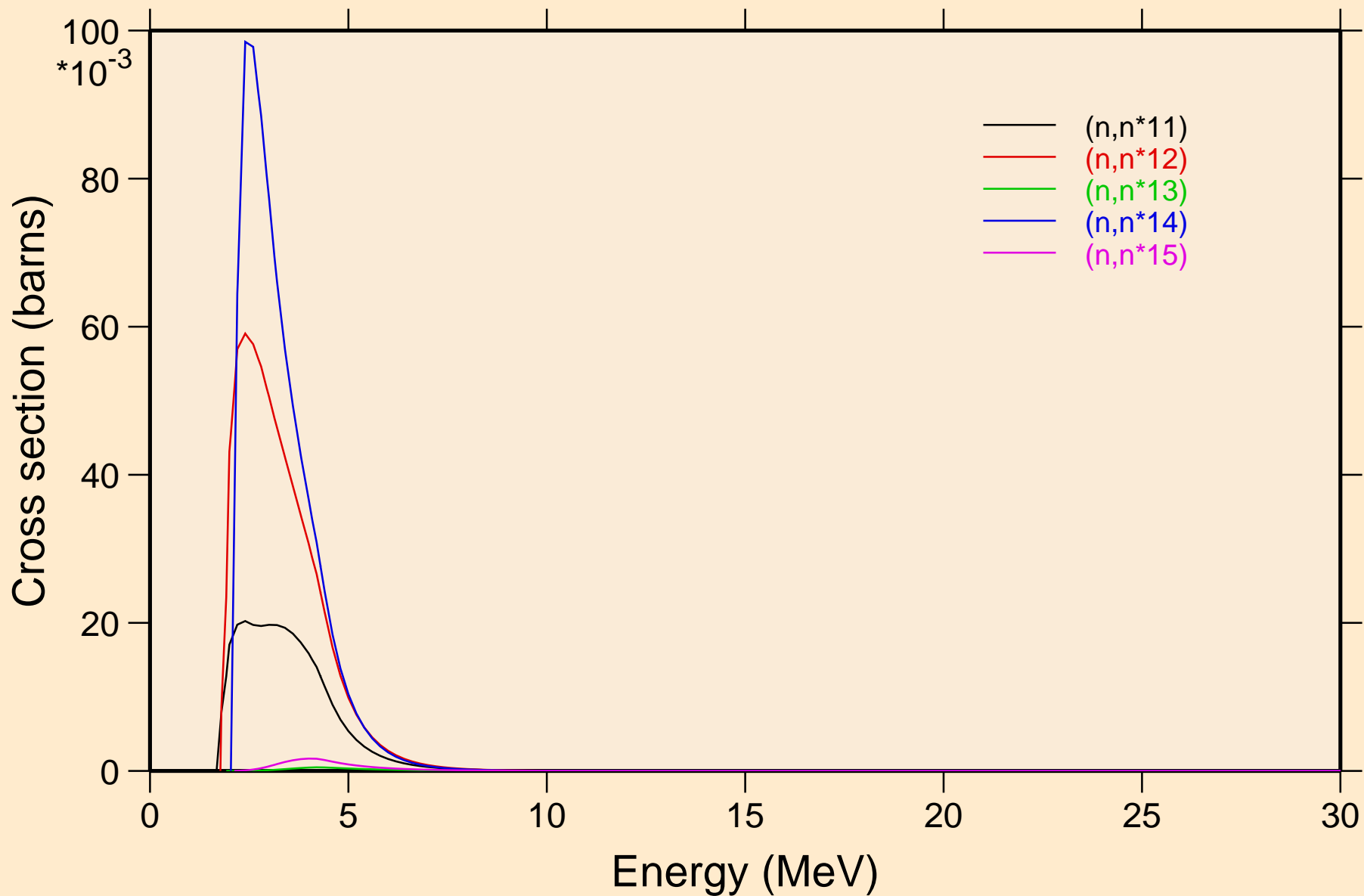

NB089M NEUTRON ACER TENDL-2019 LIBRARY; T=293.16K  
Inelastic levels

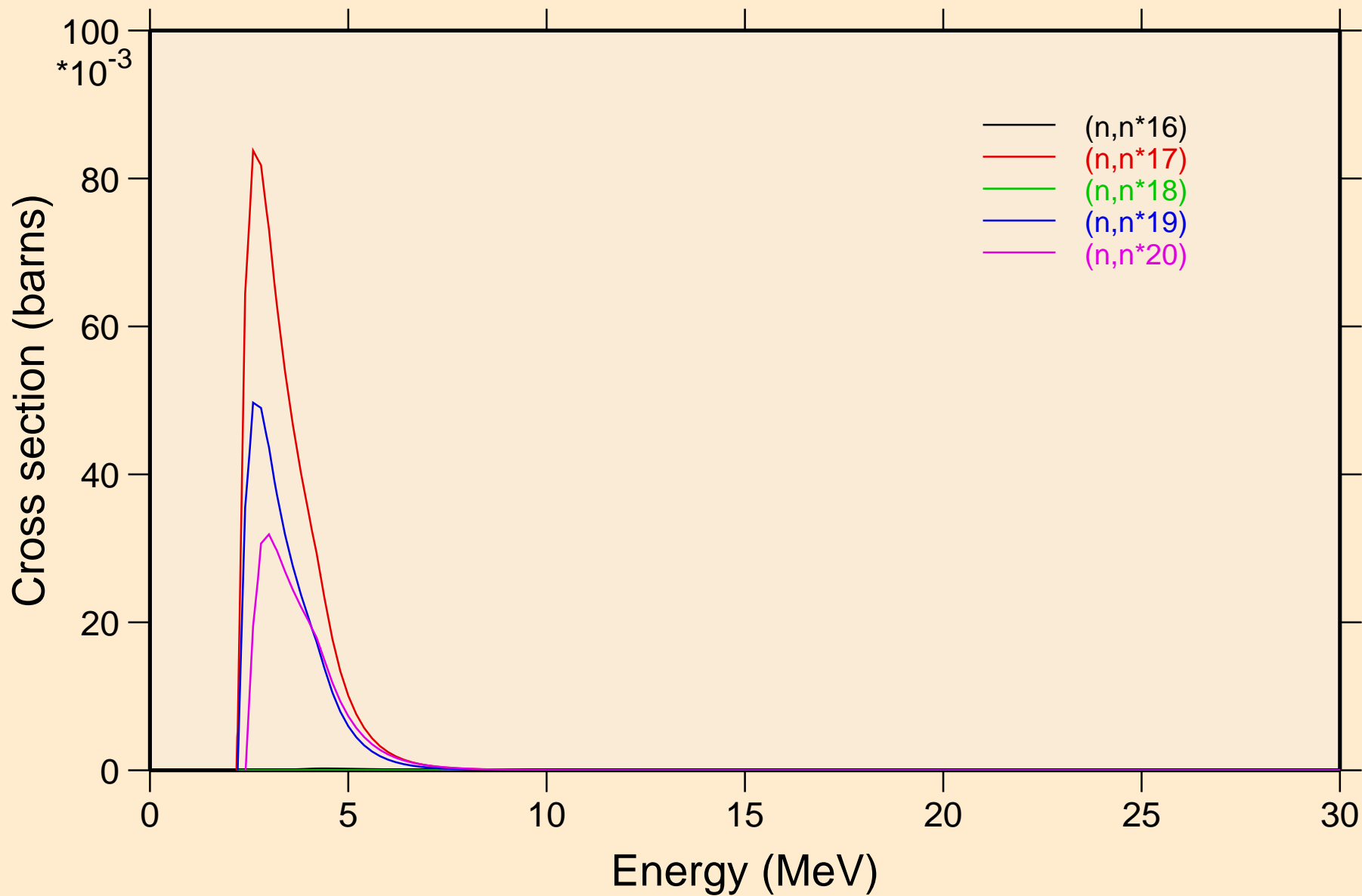

NB089M NEUTRON ACER TENDL-2019 LIBRARY; T=293.16K  
Inelastic levels

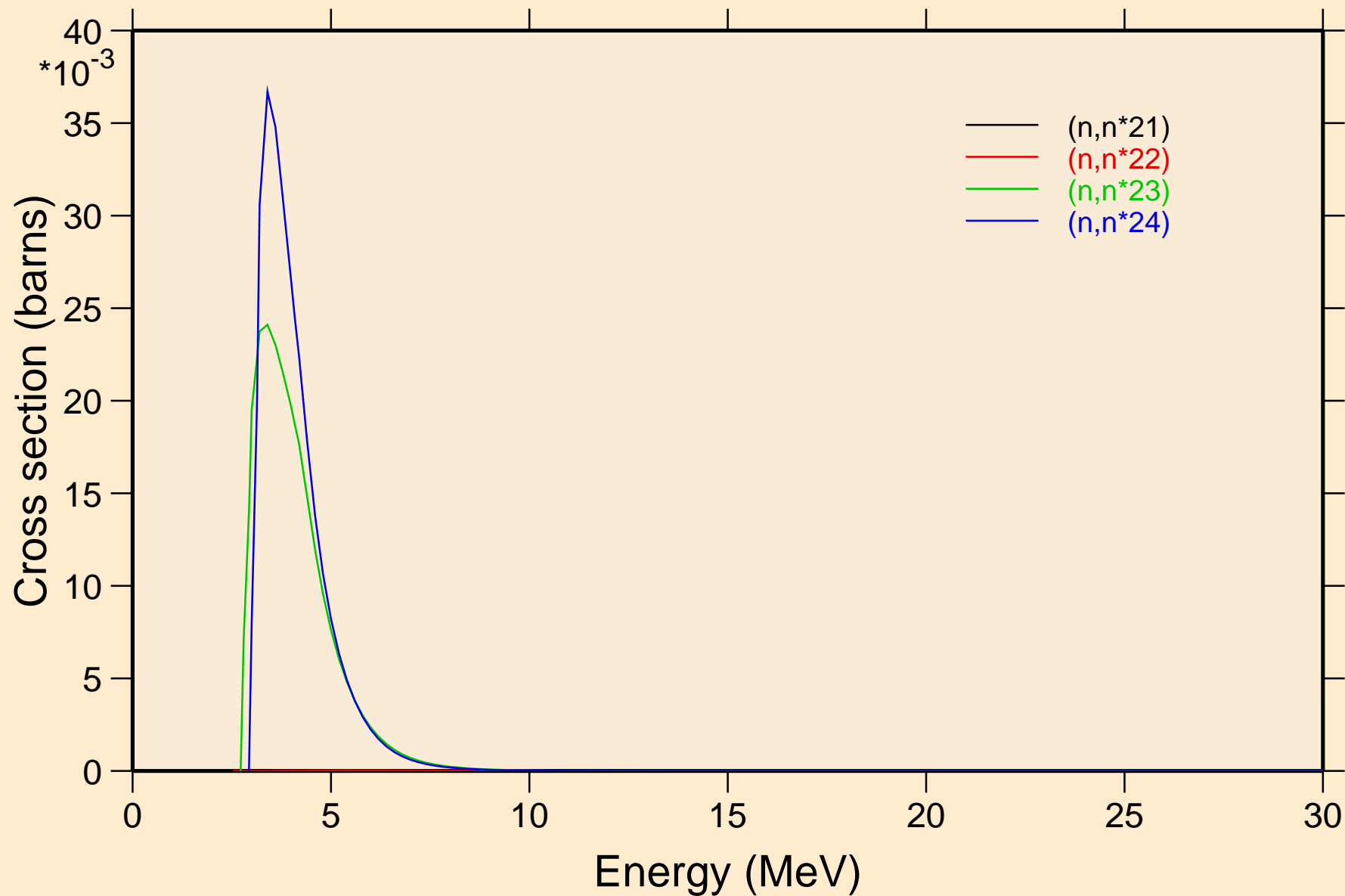

NB089M NEUTRON ACER TENDL-2019 LIBRARY; T=293.16K  
Threshold reactions

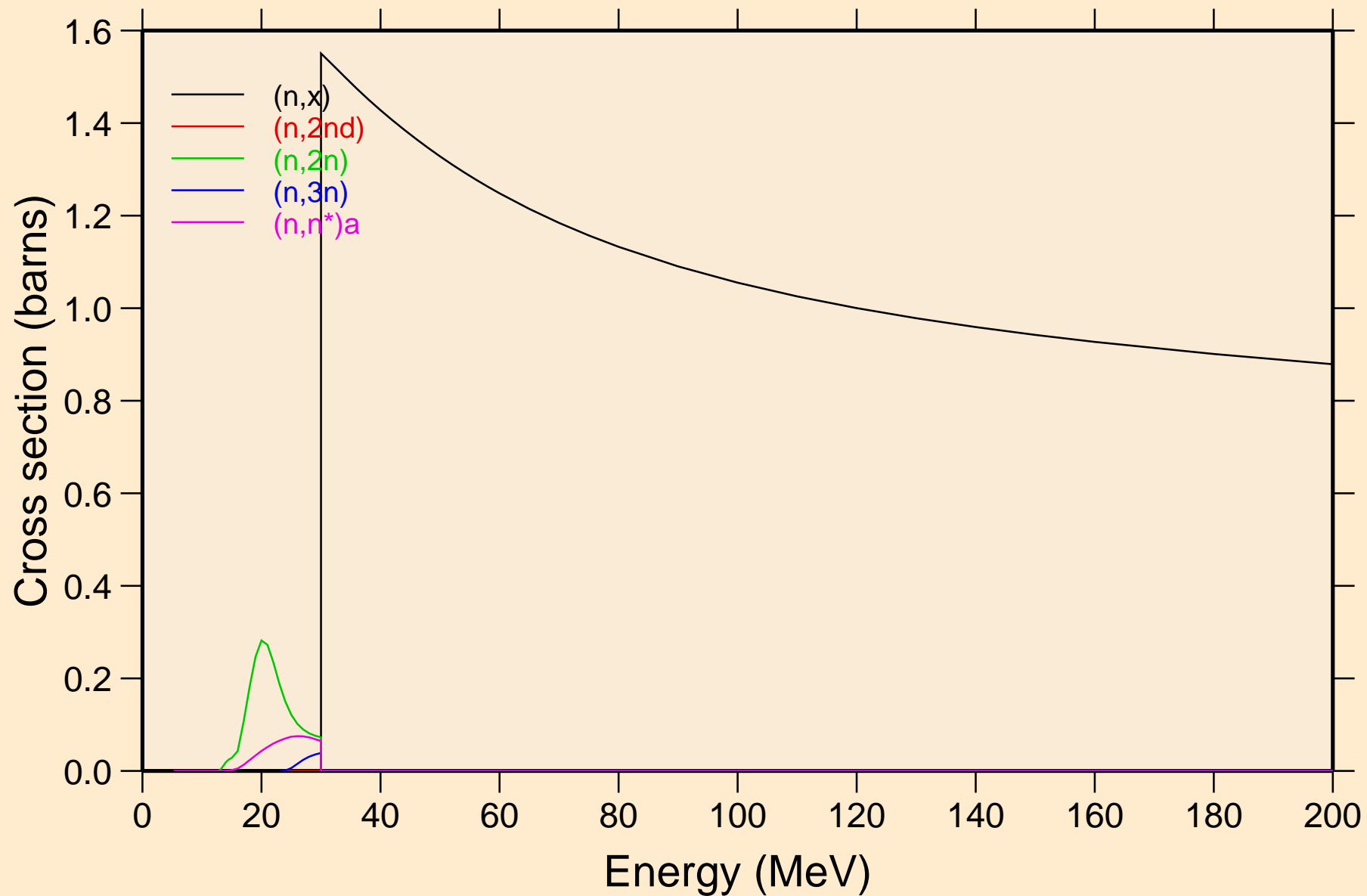

NB089M NEUTRON ACER TENDL-2019 LIBRARY; T=293.16K  
Threshold reactions

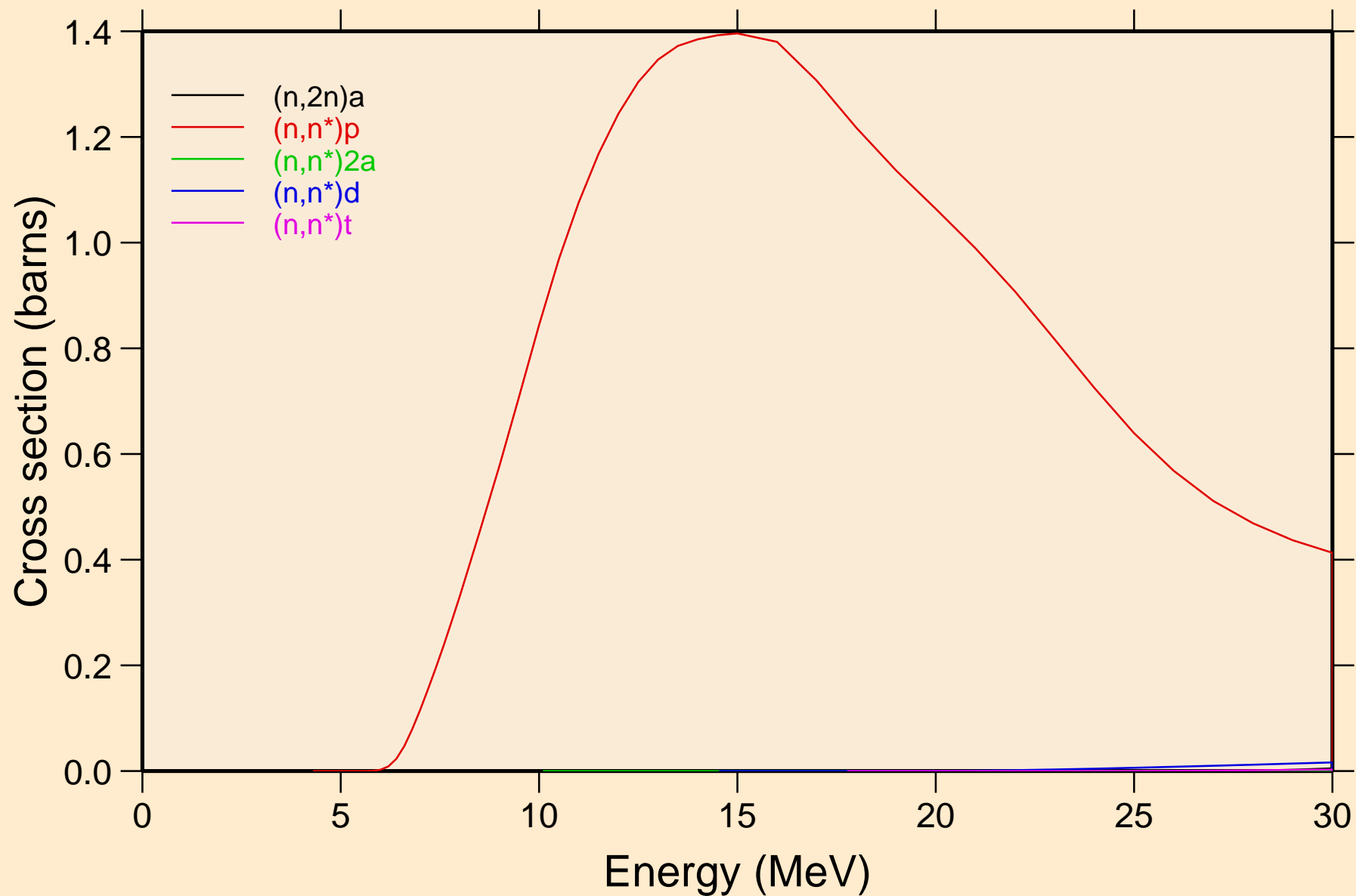

NB089M NEUTRON ACER TENDL-2019 LIBRARY; T=293.16K  
Threshold reactions

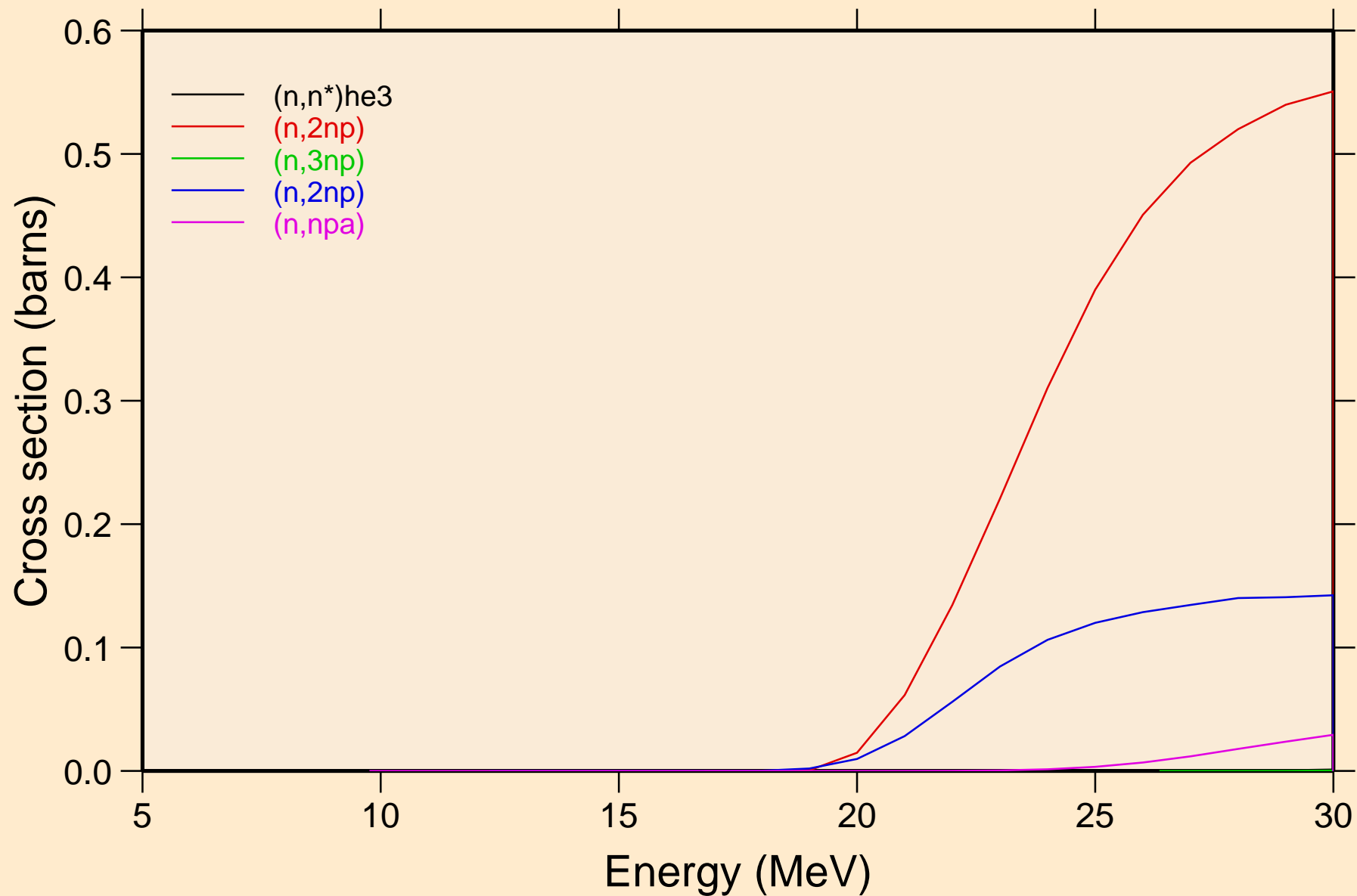

NB089M NEUTRON ACER TENDL-2019 LIBRARY; T=293.16K  
Threshold reactions

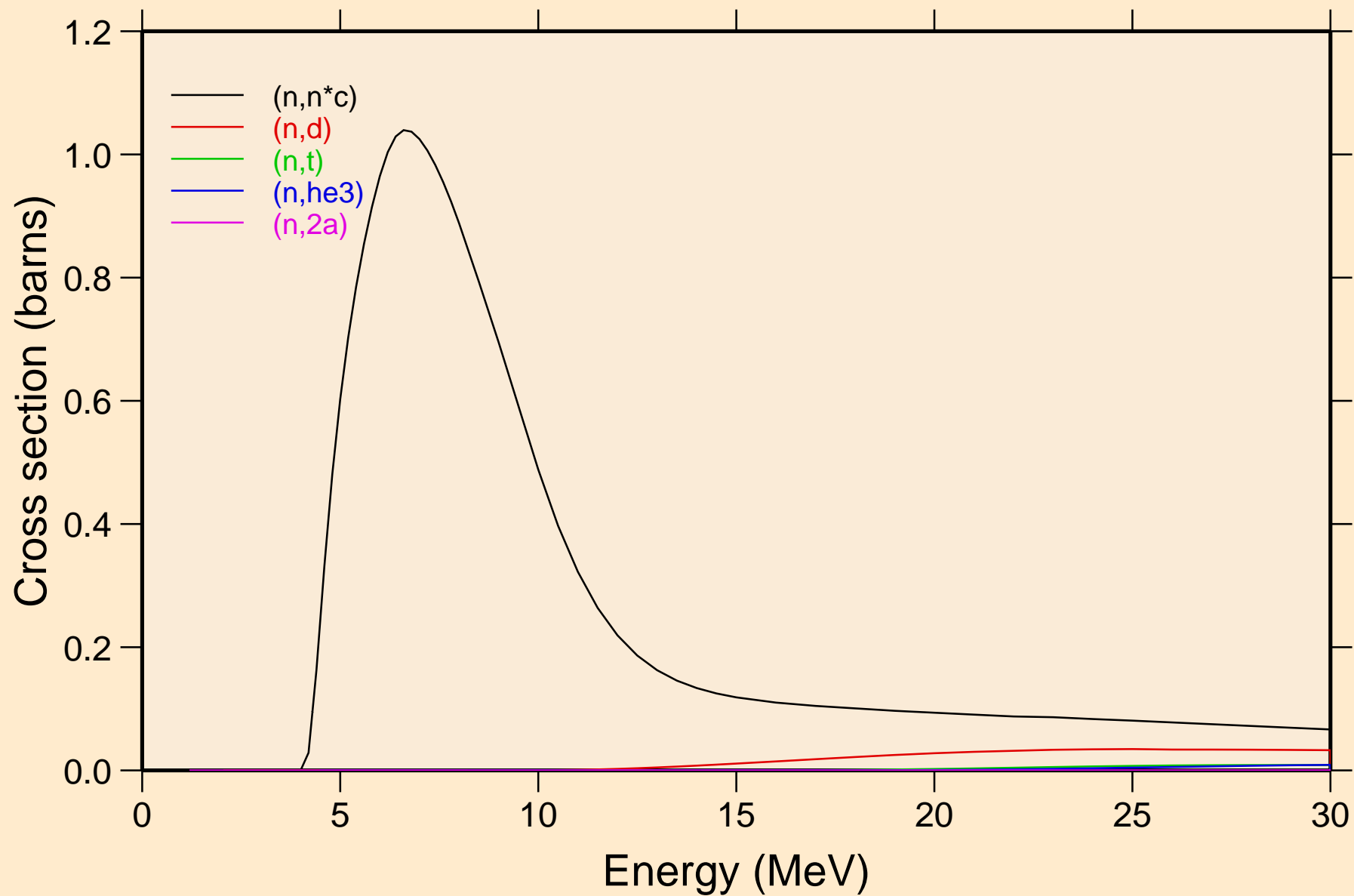

NB089M NEUTRON ACER TENDL-2019 LIBRARY; T=293.16K  
Threshold reactions

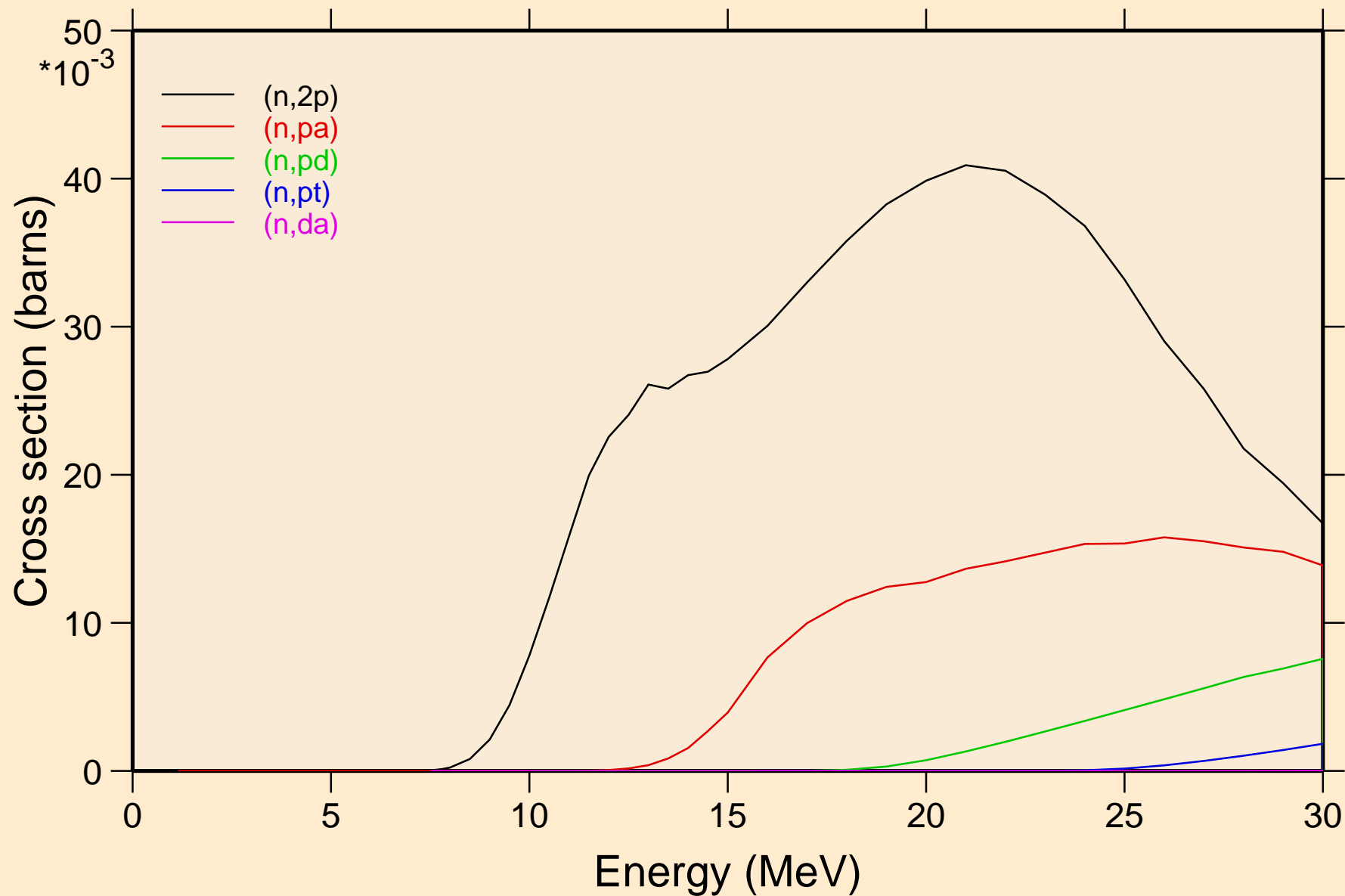



NB089M NEUTRON ACER TENDL-2019 LIBRARY; T=293.16K  
Threshold reactions

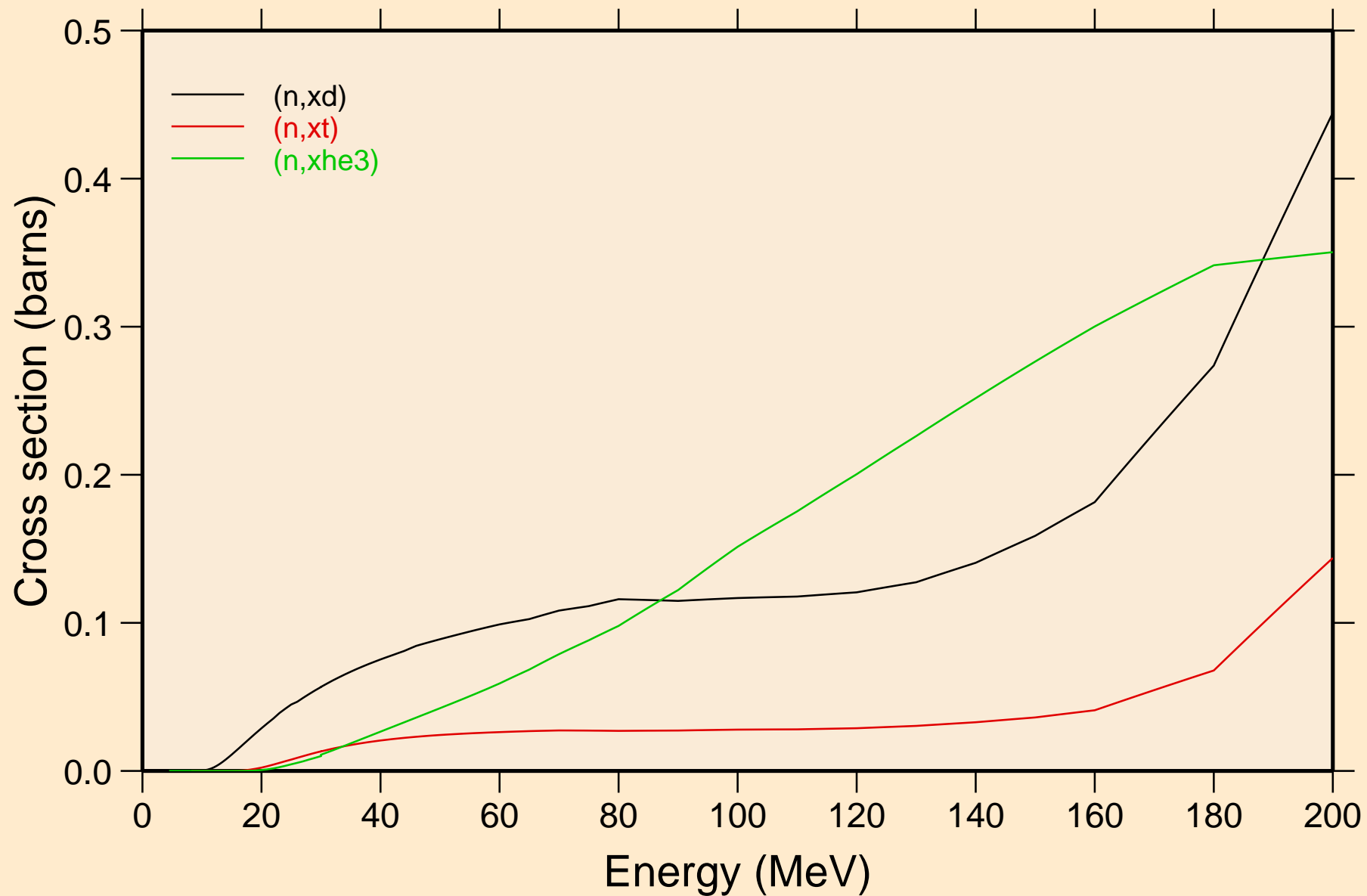

NB089M NEUTRON ACER TENDL-2019 LIBRARY; T=293.16K  
angular distribution for elastic

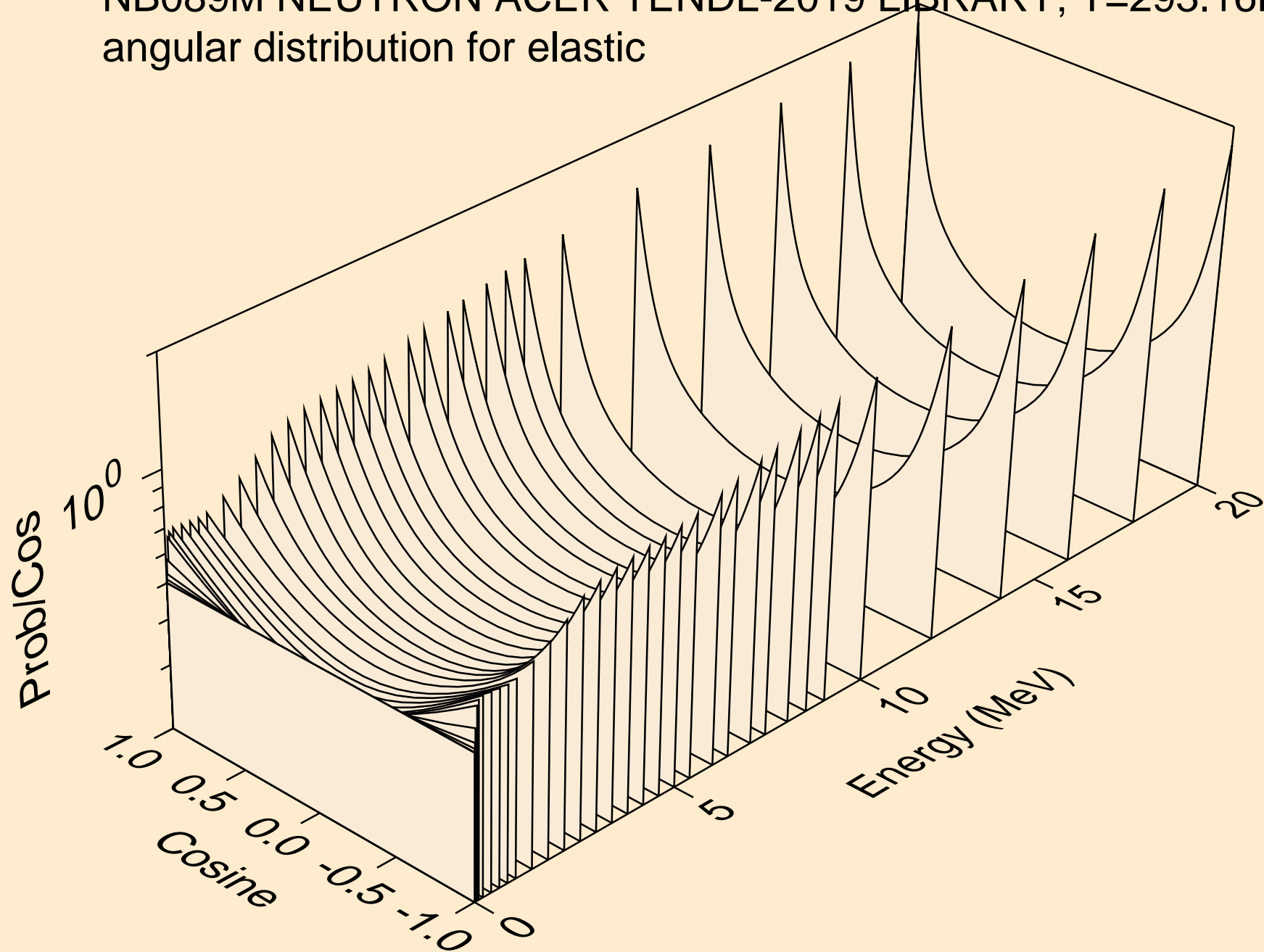

NB089M NEUTRON ACER TENDL-2019 LIBRARY; T=293.16K  
angular distribution for elastic

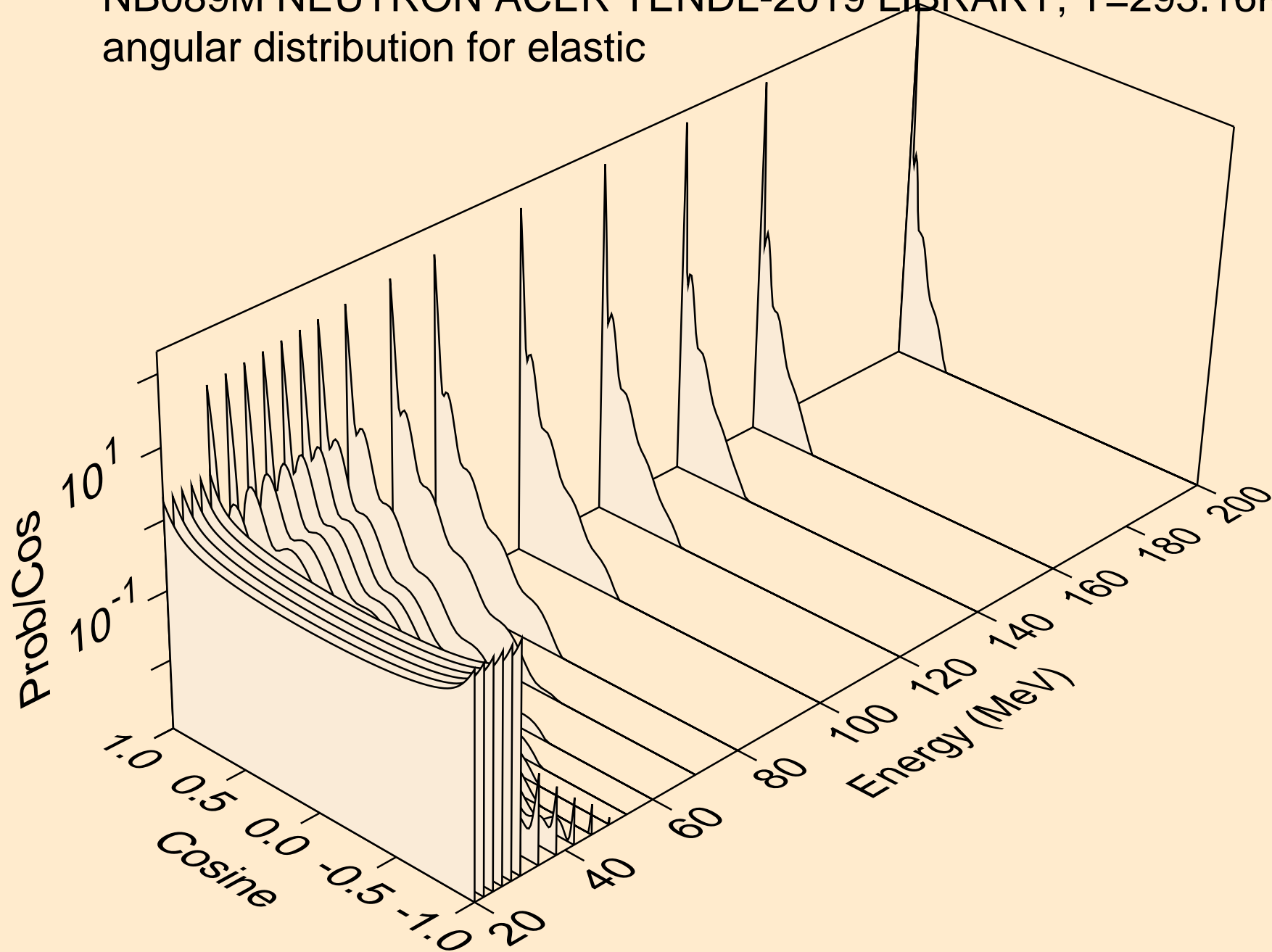

NB089M NEUTRON ACER TENDL-2019 LIBRARY; T=293.16K  
angular distribution for (n,n\*1)

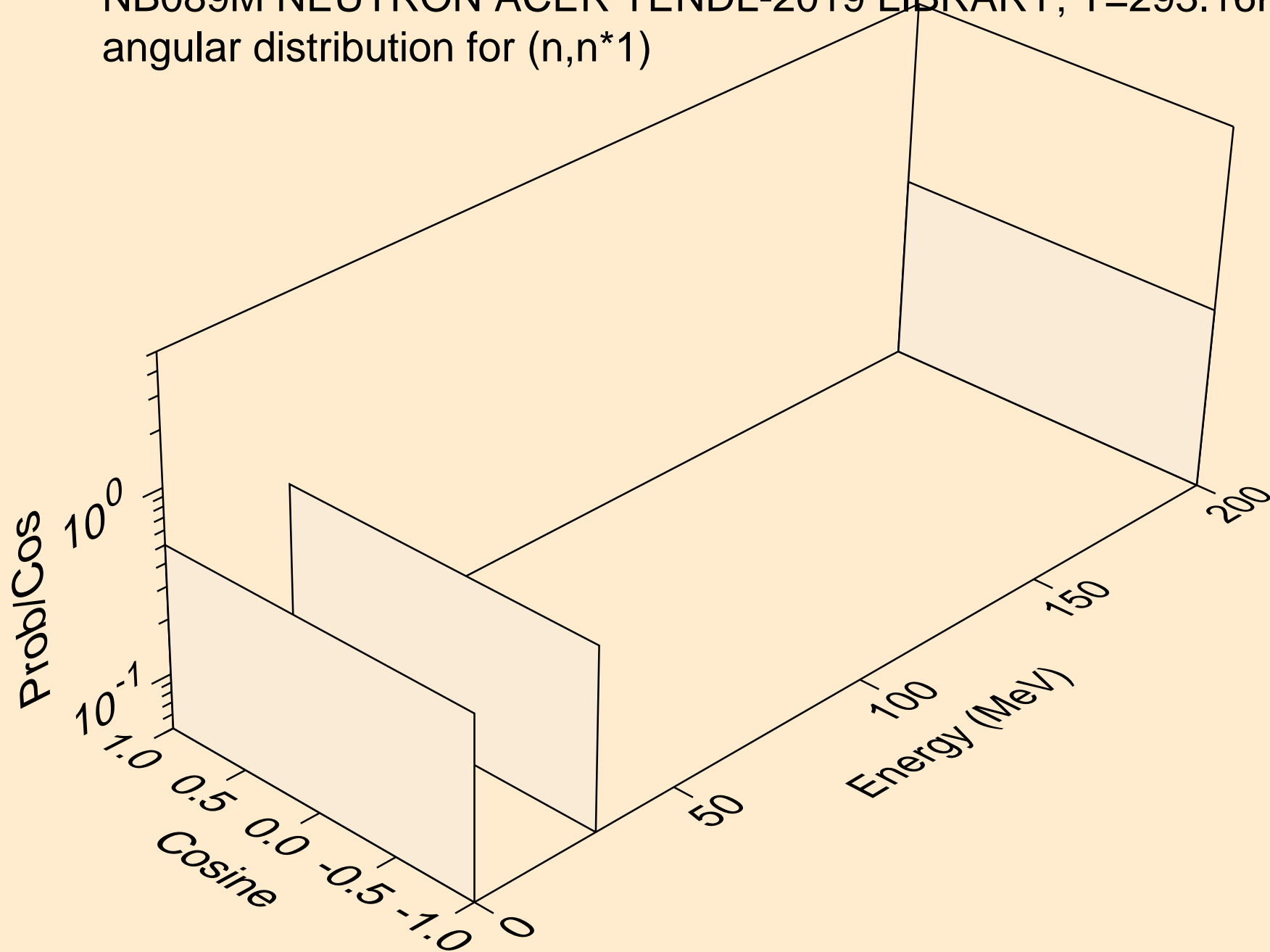

NB089M NEUTRON ACER TENDL-2019 LIBRARY; T=293.16K  
angular distribution for (n,n\*2)

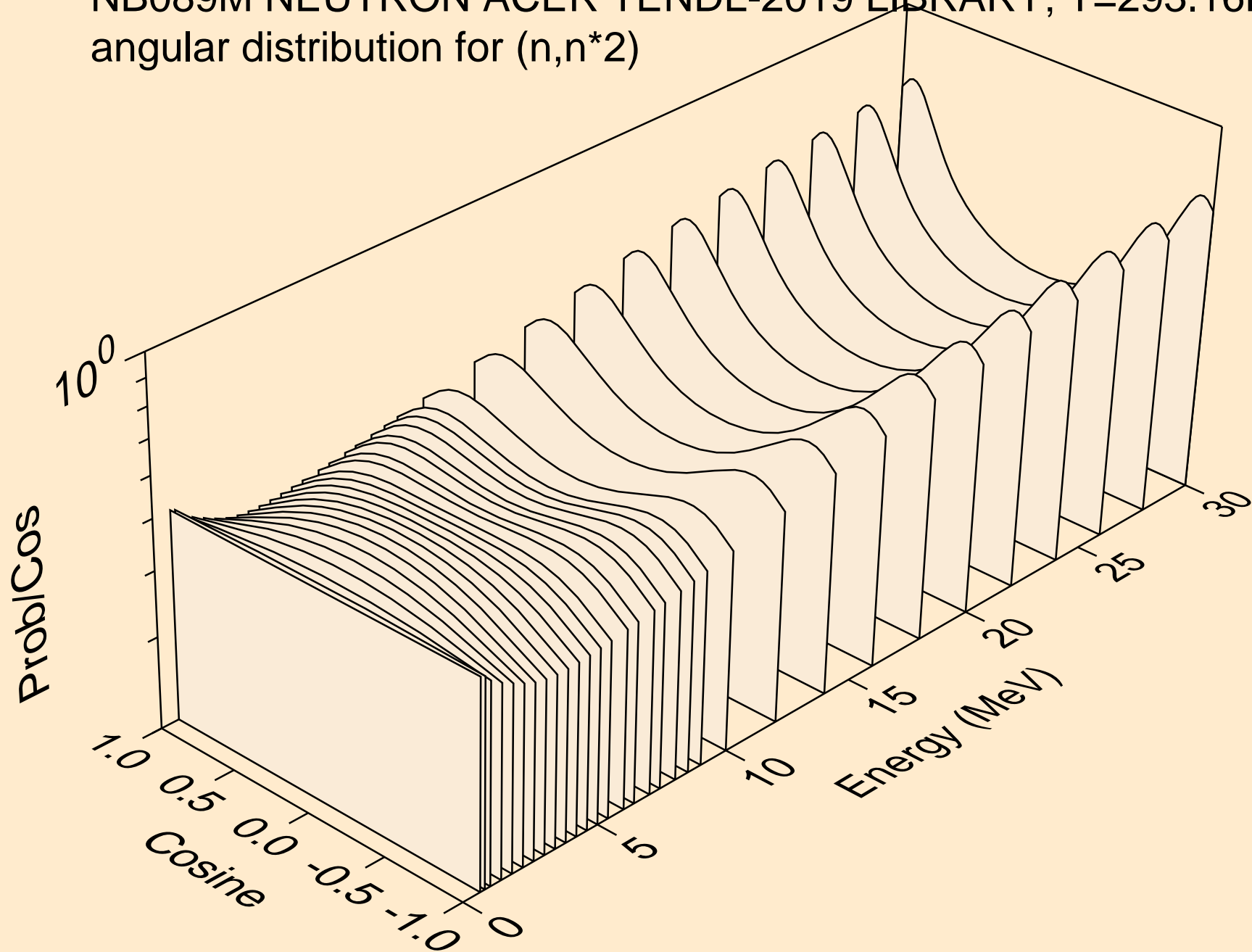

NB089M NEUTRON ACER TENDL-2019 LIBRARY; T=293.16K  
angular distribution for (n,n\*3)

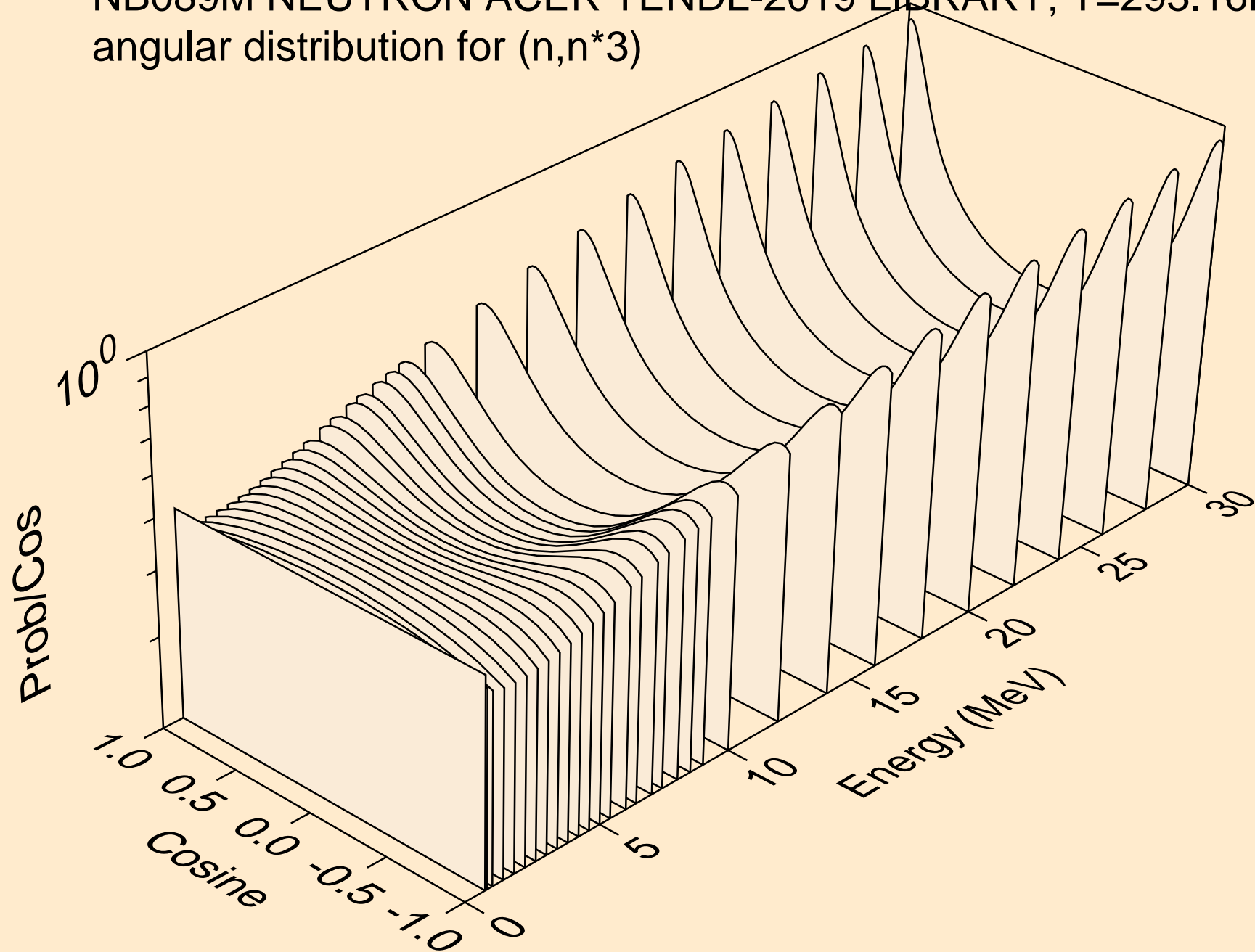

NB089M NEUTRON ACER TENDL-2019 LIBRARY; T=293.16K  
angular distribution for (n,n\*4)

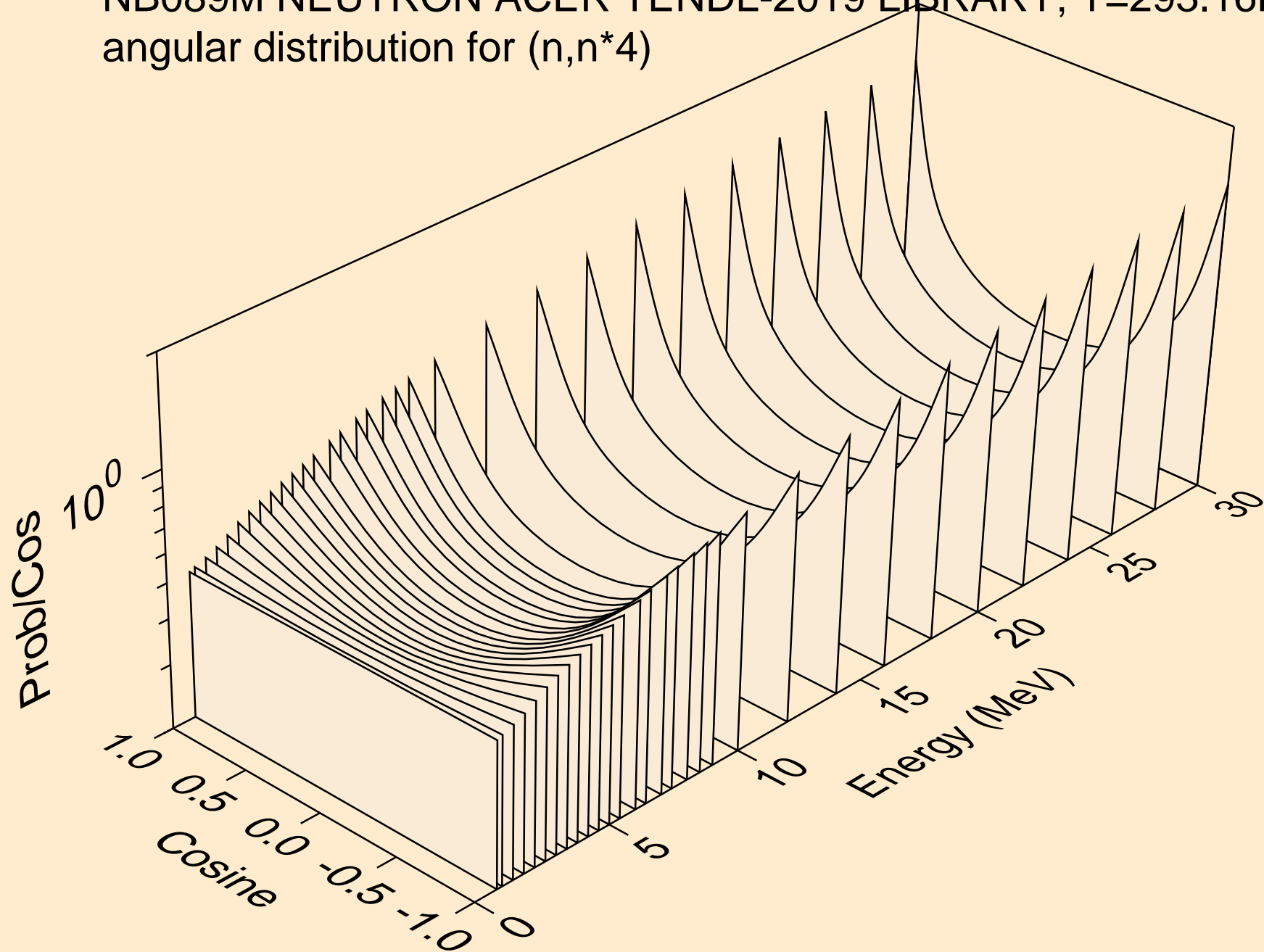

NB089M NEUTRON ACER TENDL-2019 LIBRARY; T=293.16K  
angular distribution for (n,n\*5)

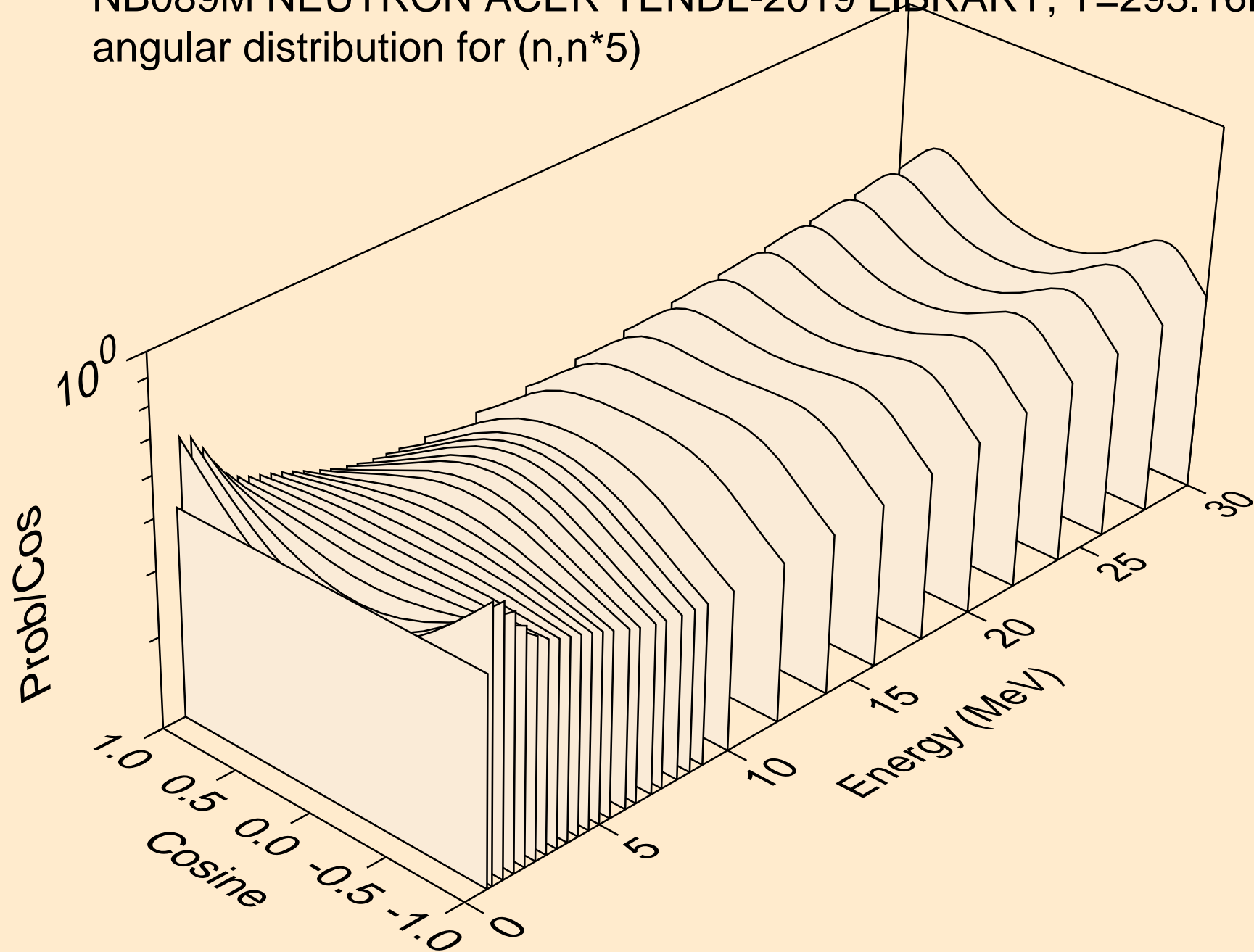



NB089M NEUTRON ACER TENDL-2019 LIBRARY; T=293.16K  
angular distribution for (n,n\*6)

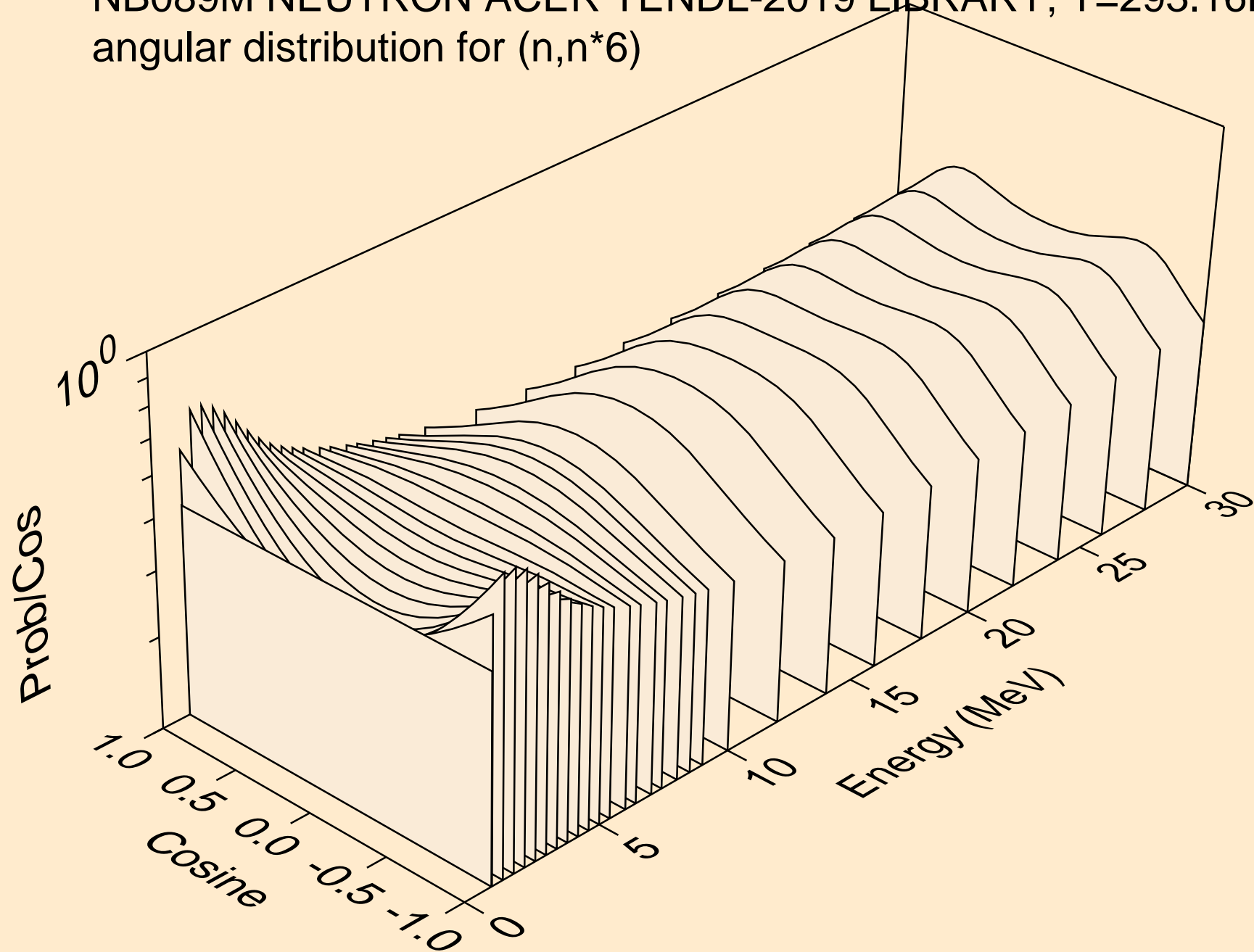

NB089M NEUTRON ACER TENDL-2019 LIBRARY; T=293.16K  
angular distribution for (n,n\*7)

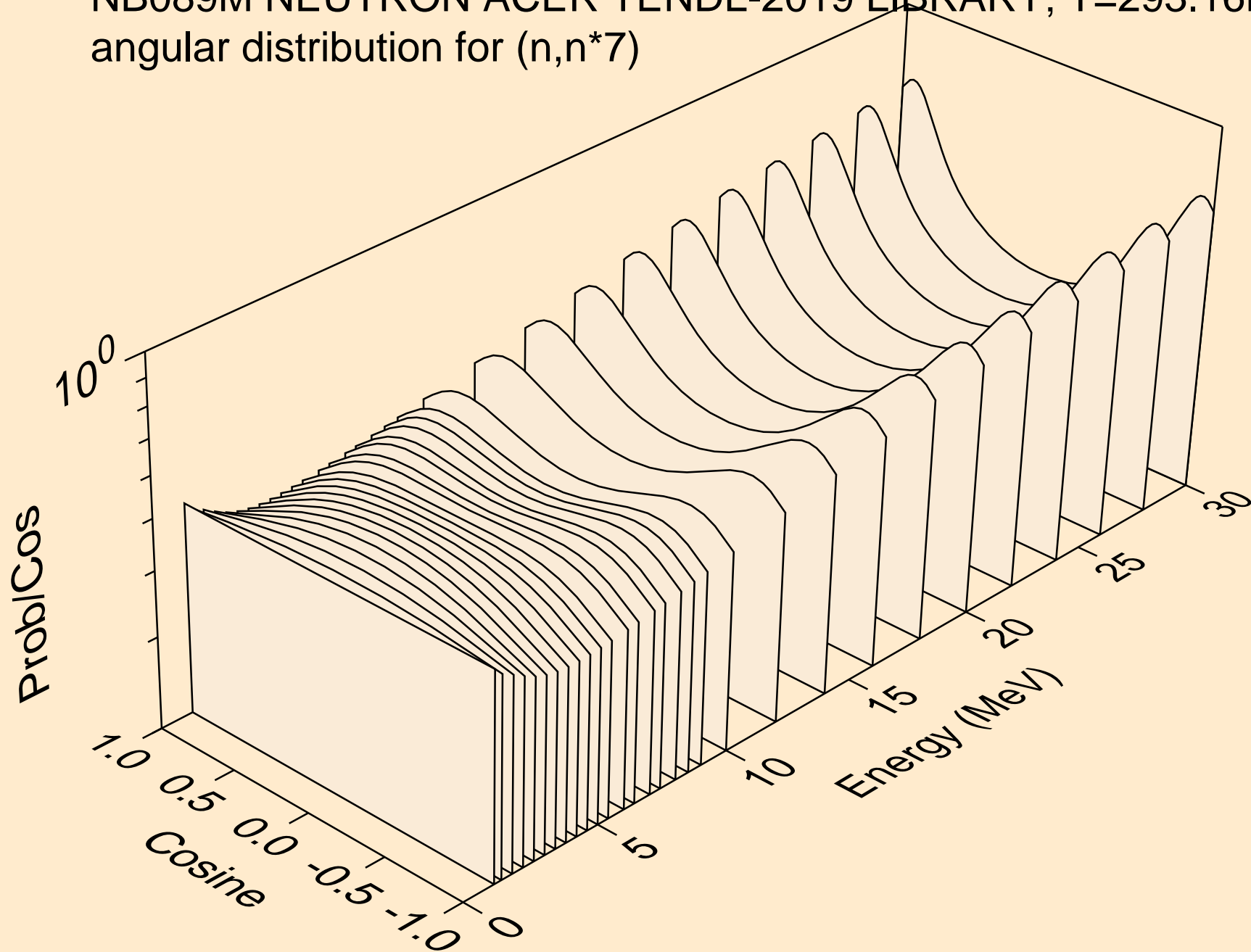

NB089M NEUTRON ACER TENDL-2019 LIBRARY; T=293.16K  
angular distribution for (n,n\*8)

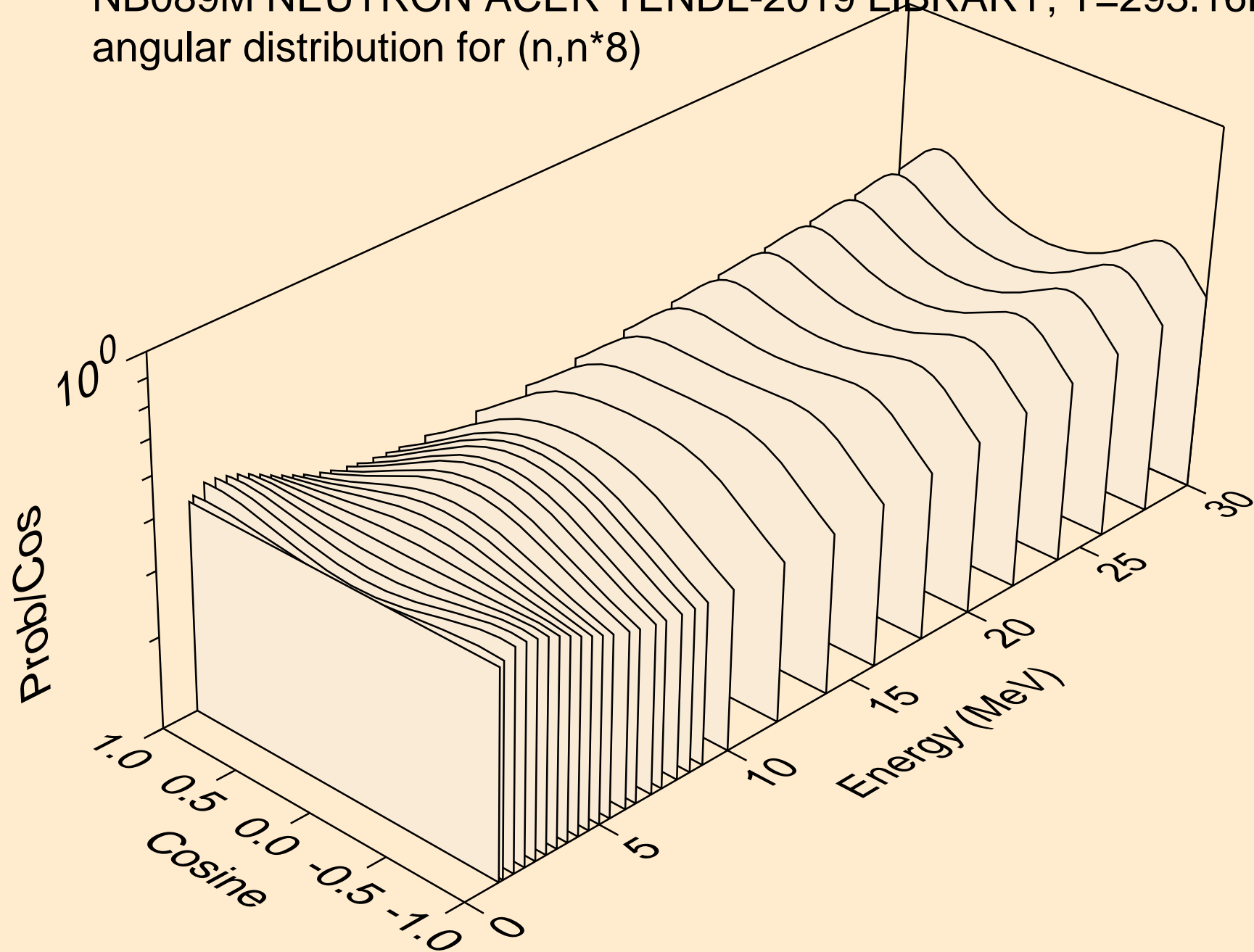

NB089M NEUTRON ACER TENDL-2019 LIBRARY; T=293.16K  
angular distribution for (n,n\*9)

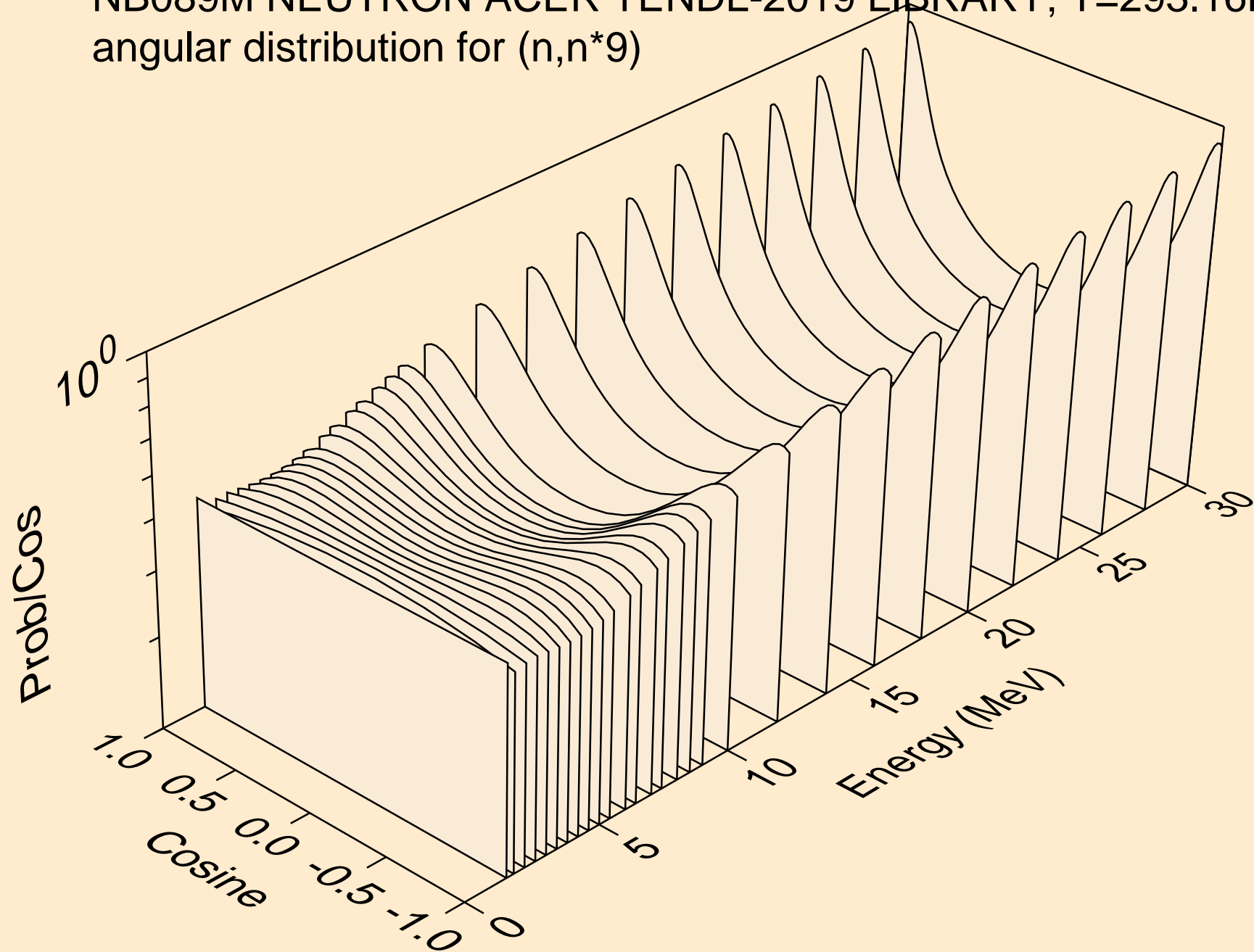

NB089M NEUTRON ACER TENDL-2019 LIBRARY; T=293.16K  
angular distribution for (n,n\*10)

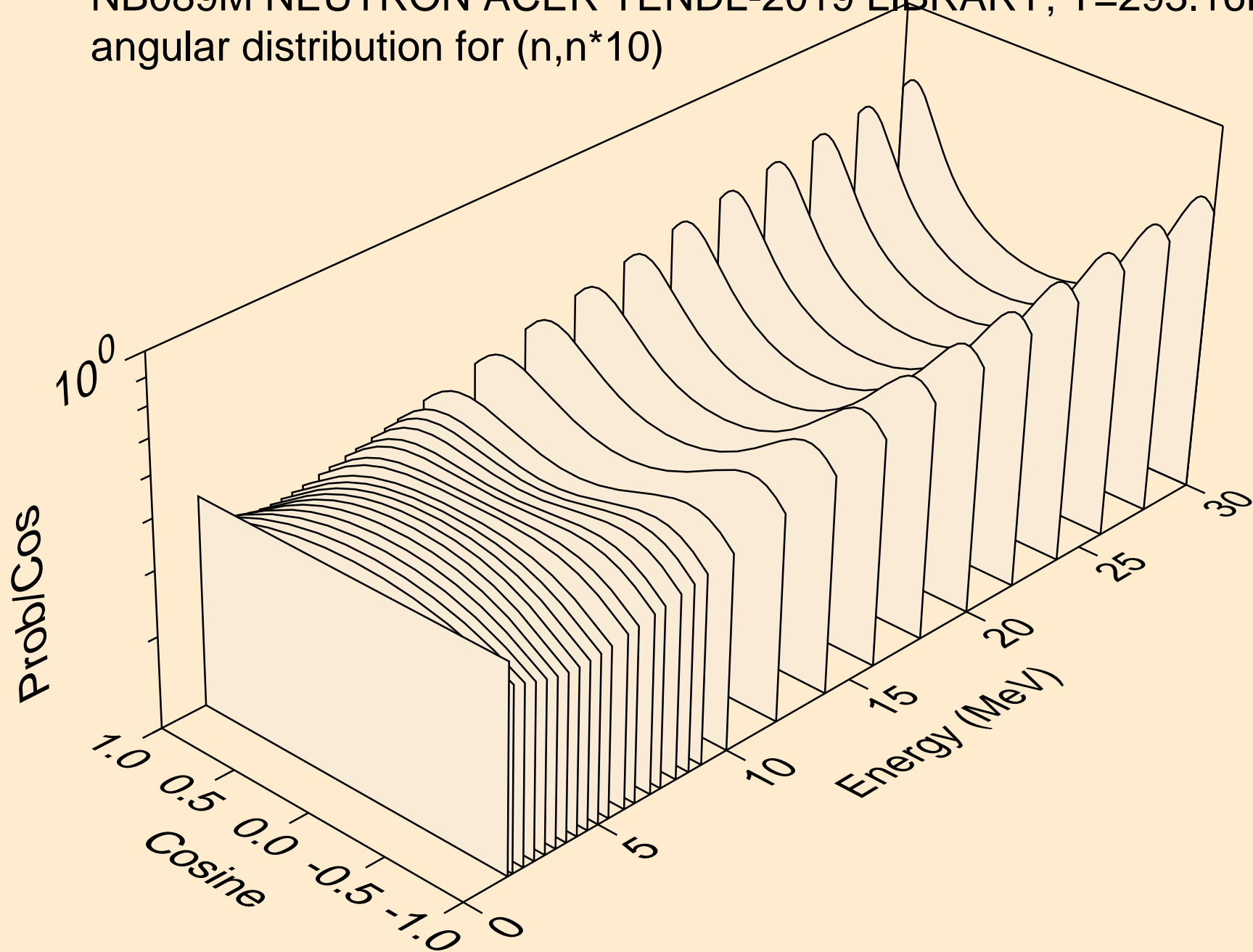

NB089M NEUTRON ACER TENDL-2019 LIBRARY; T=293.16K  
angular distribution for (n,n\*11)

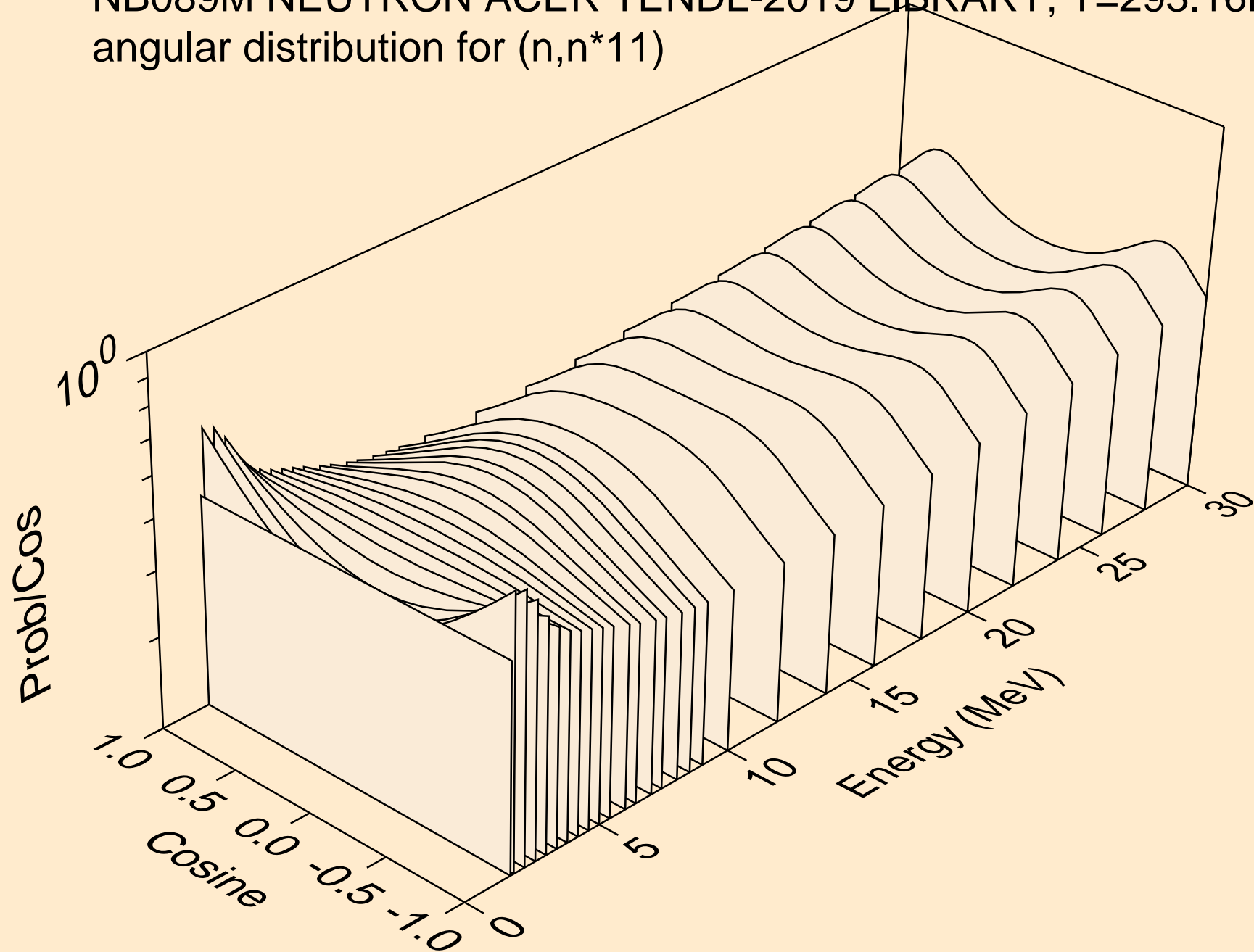

NB089M NEUTRON ACER TENDL-2019 LIBRARY; T=293.16K  
angular distribution for (n,n\*12)

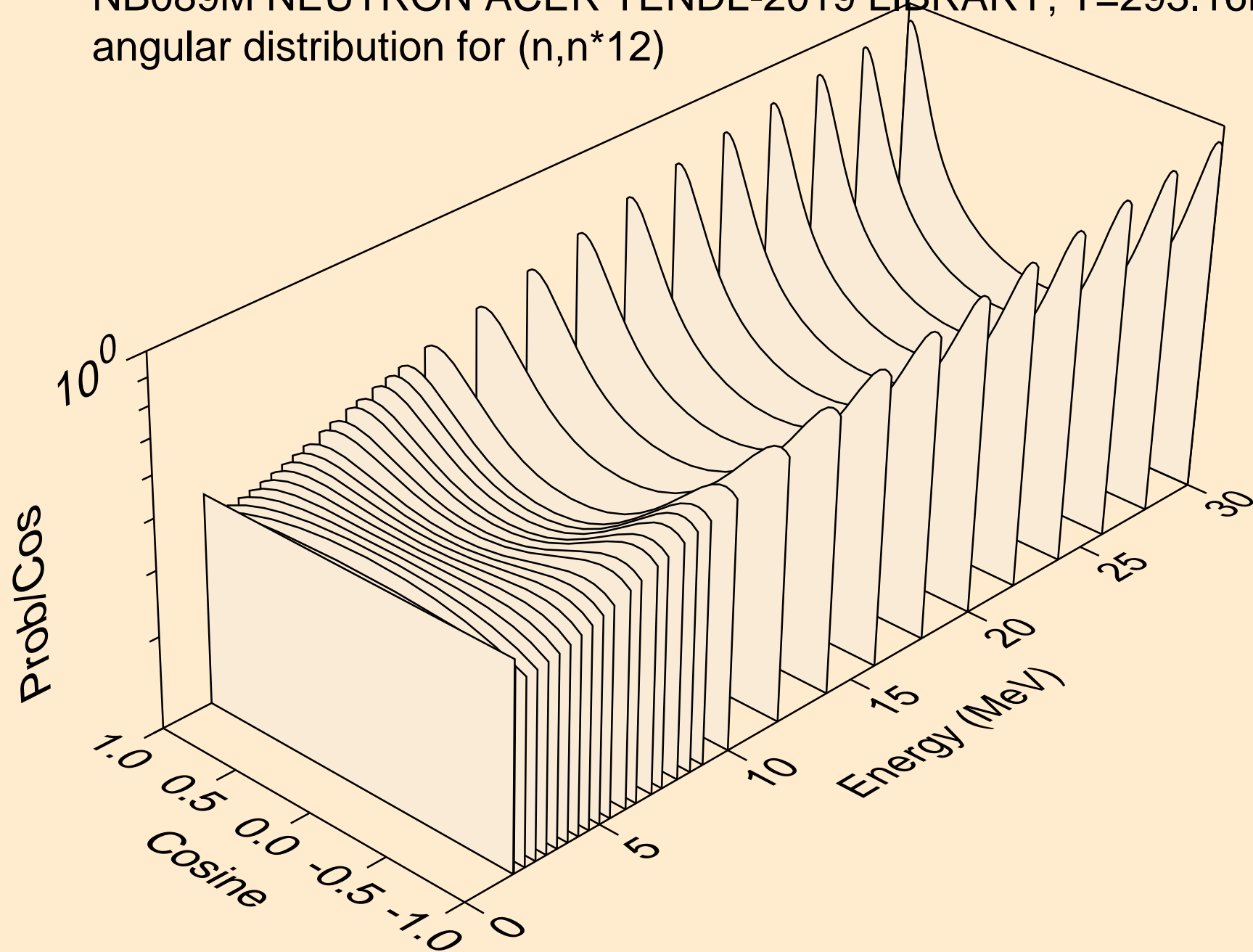

NB089M NEUTRON ACER TENDL-2019 LIBRARY; T=293.16K  
angular distribution for (n,n\*13)

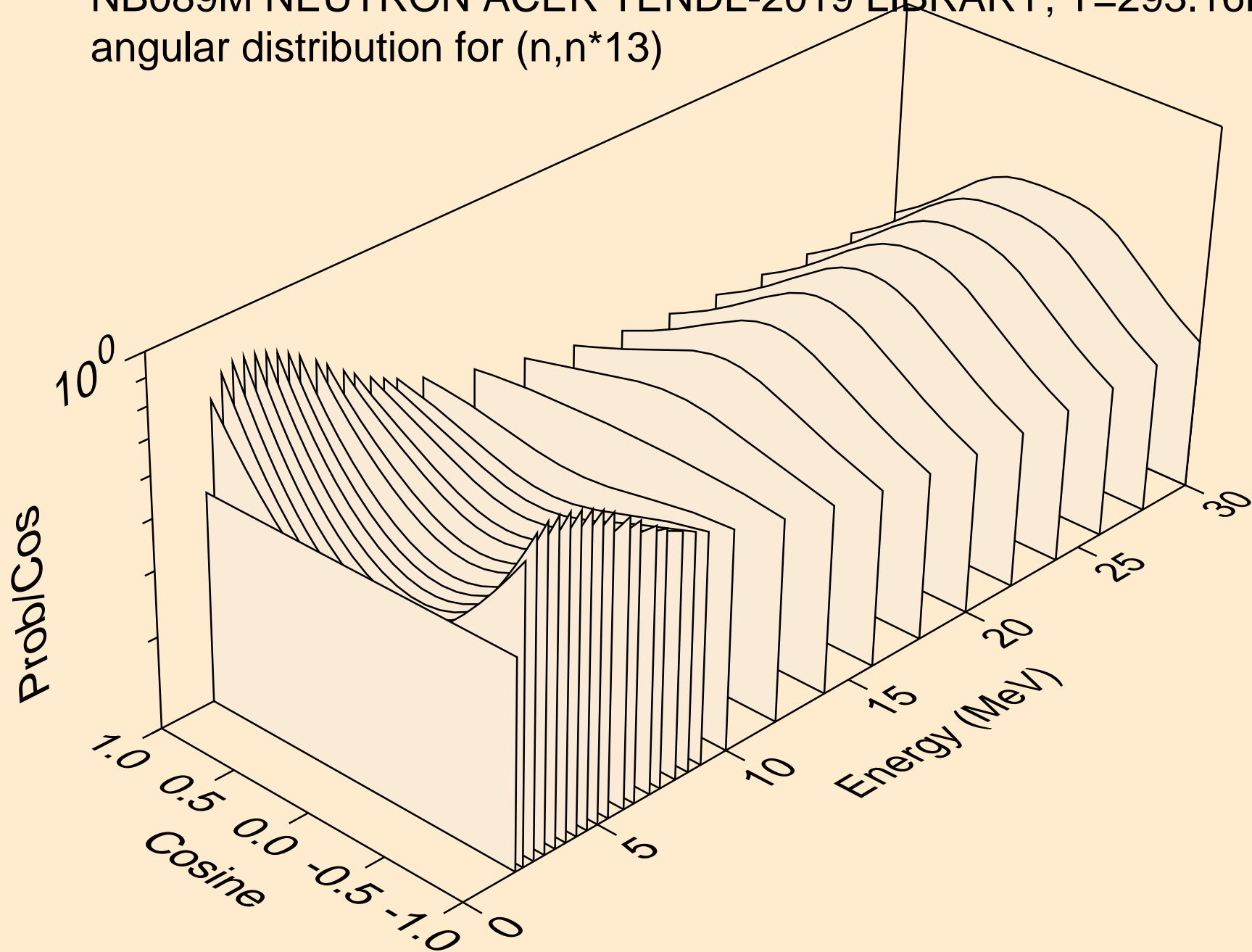



NB089M NEUTRON ACER TENDL-2019 LIBRARY; T=293.16K  
angular distribution for (n,n\*14)

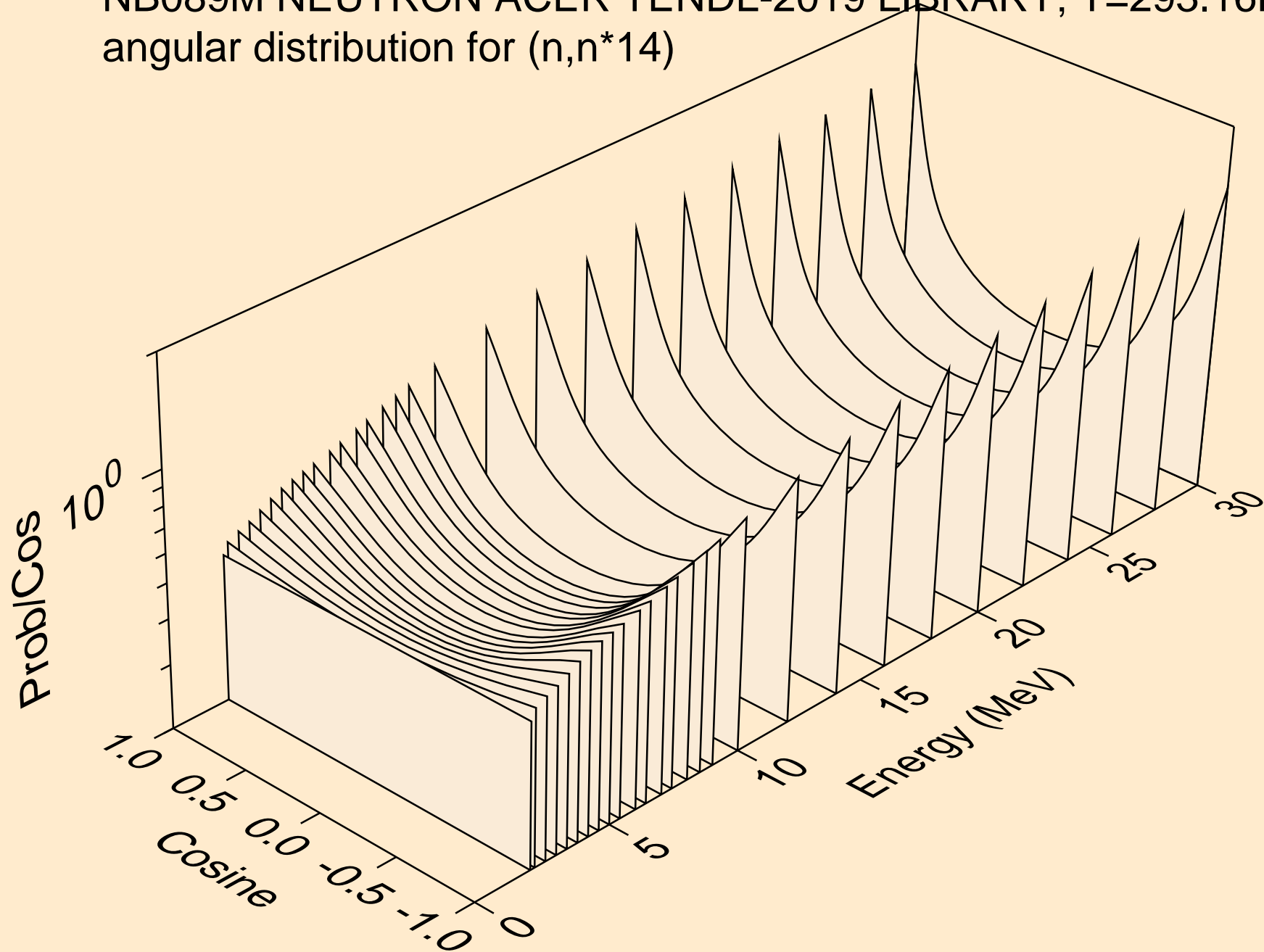

NB089M NEUTRON ACER TENDL-2019 LIBRARY; T=293.16K  
angular distribution for (n,n\*15)

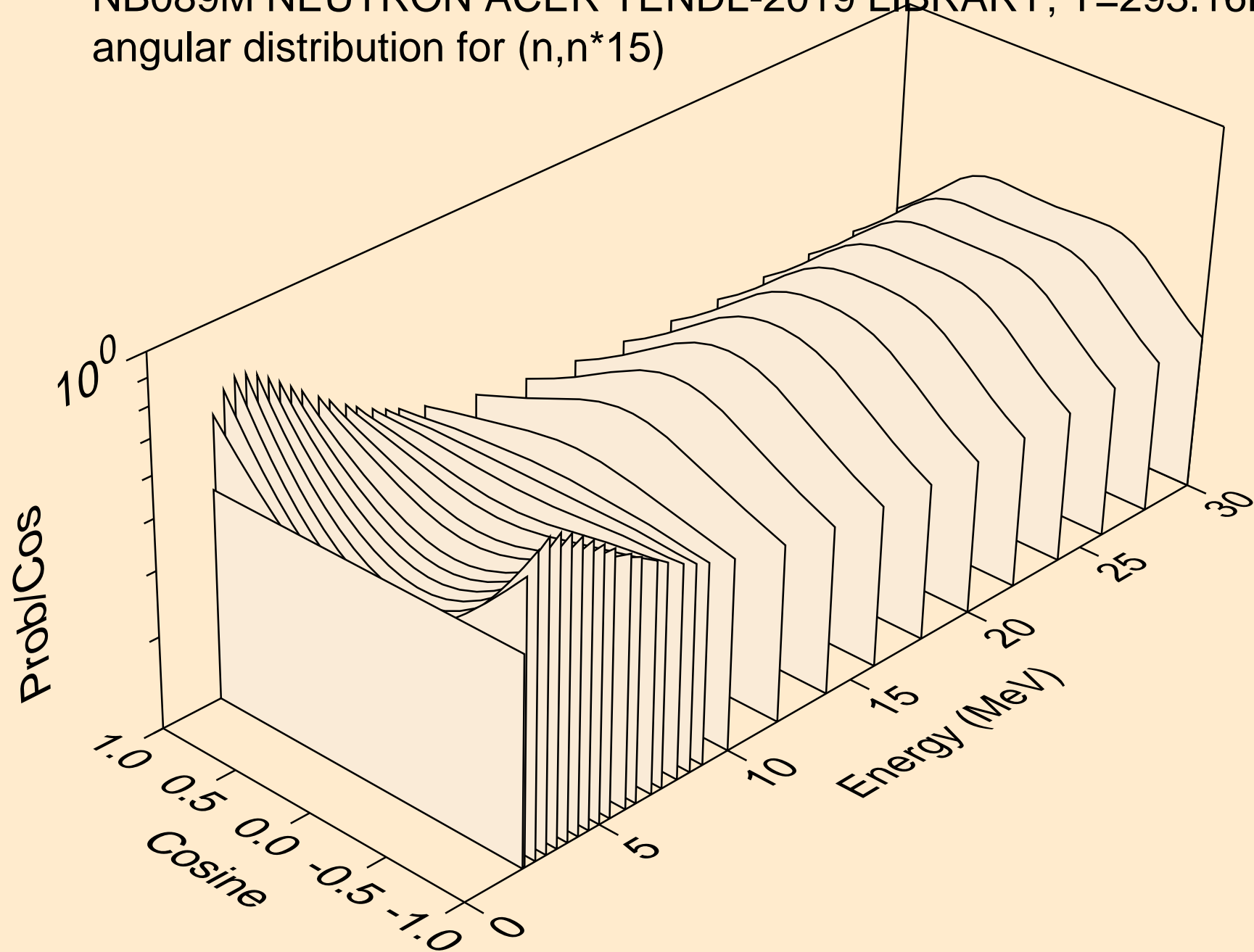

NB089M NEUTRON ACER TENDL-2019 LIBRARY; T=293.16K  
angular distribution for (n,n\*16)

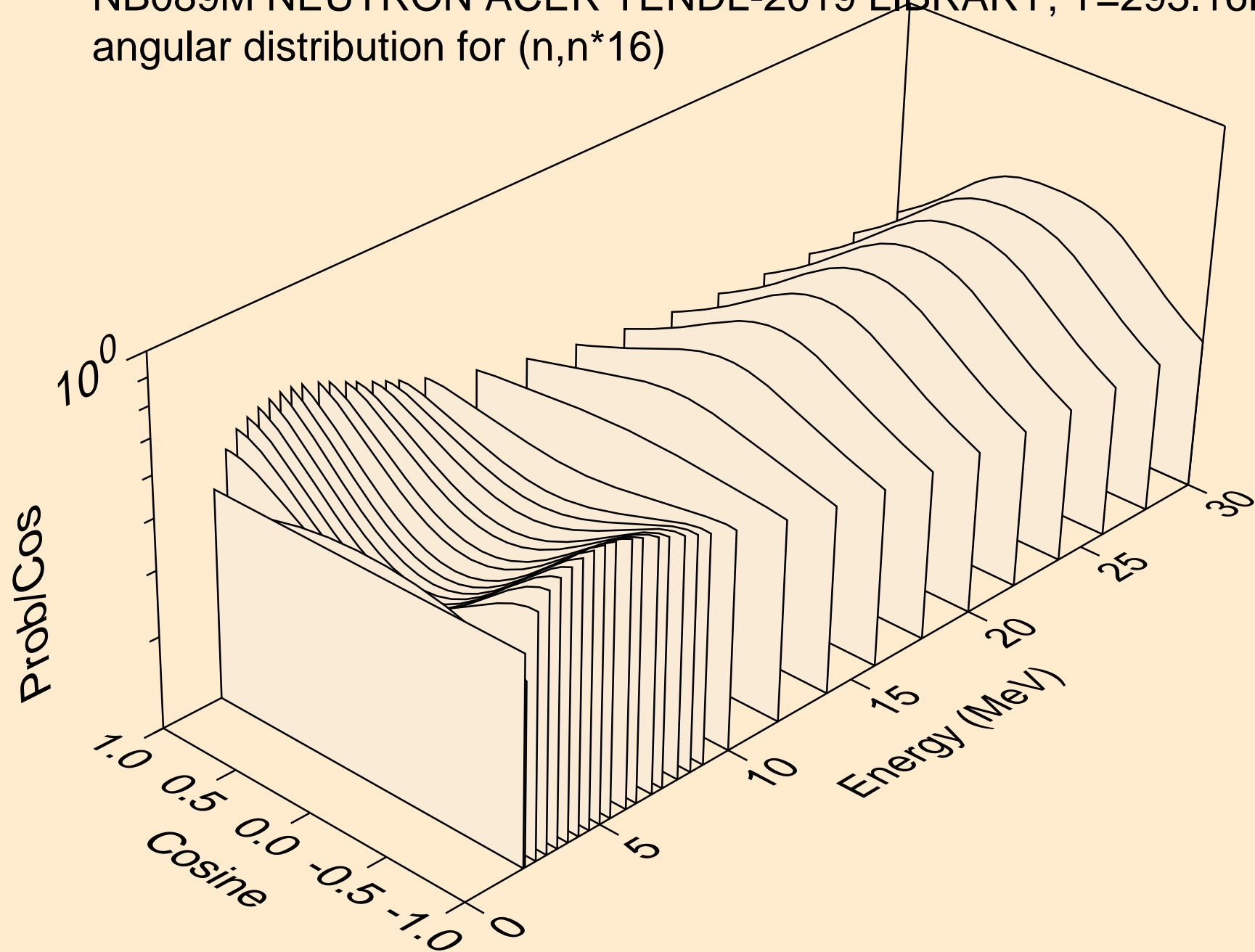

NB089M NEUTRON ACER TENDL-2019 LIBRARY; T=293.16K  
angular distribution for (n,n\*17)

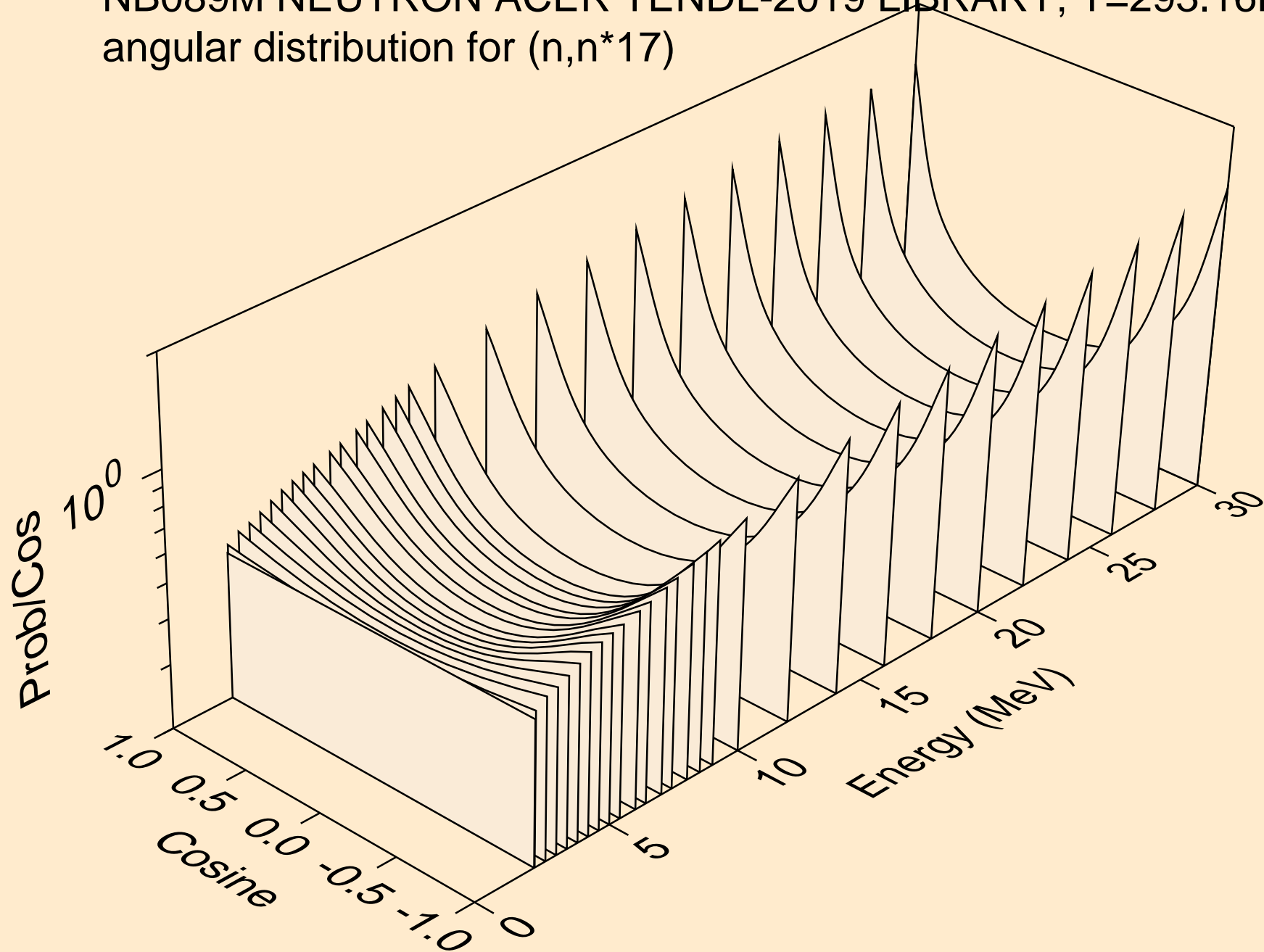

NB089M NEUTRON ACER TENDL-2019 LIBRARY; T=293.16K  
angular distribution for (n,n\*18)

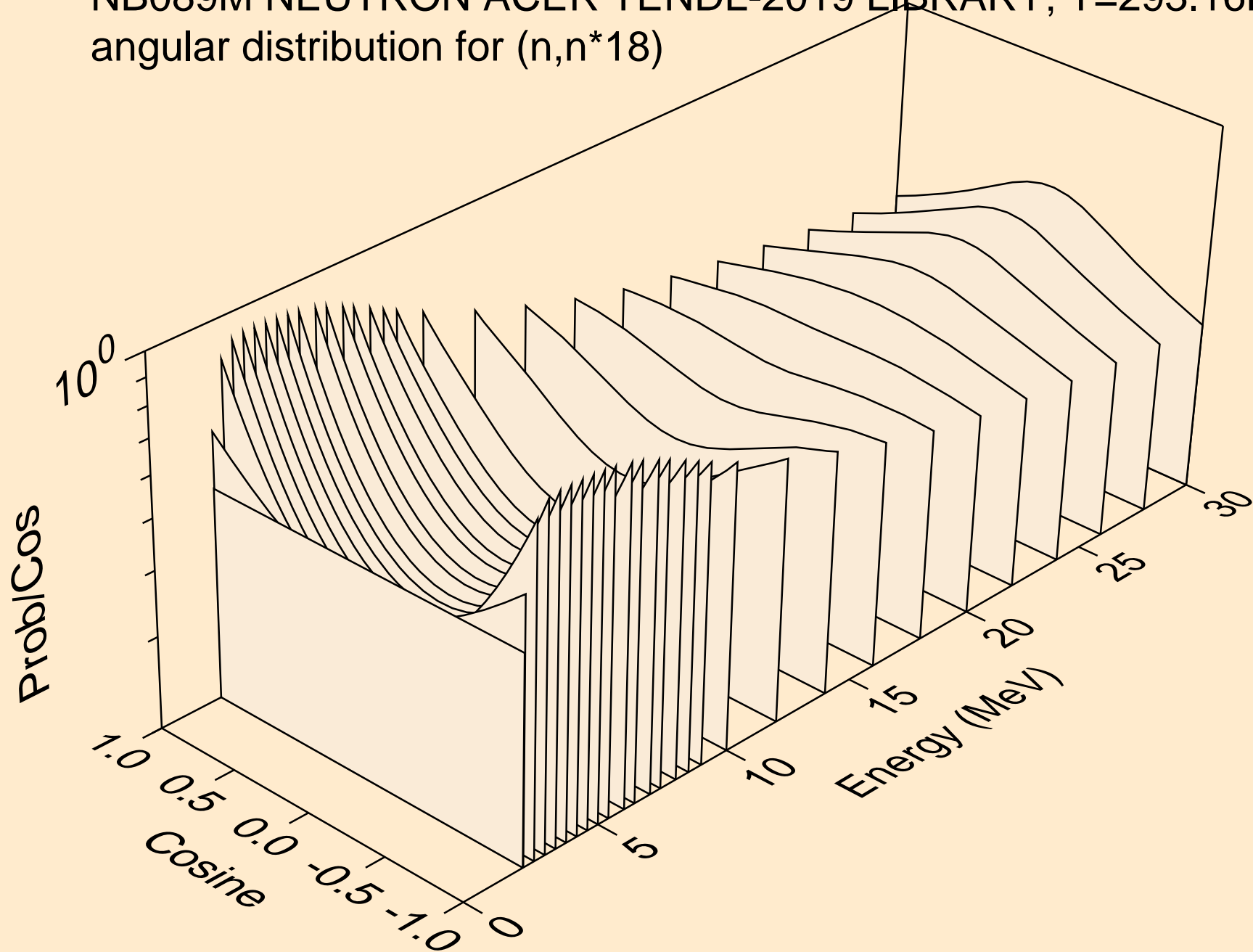

NB089M NEUTRON ACER TENDL-2019 LIBRARY; T=293.16K  
angular distribution for (n,n\*19)

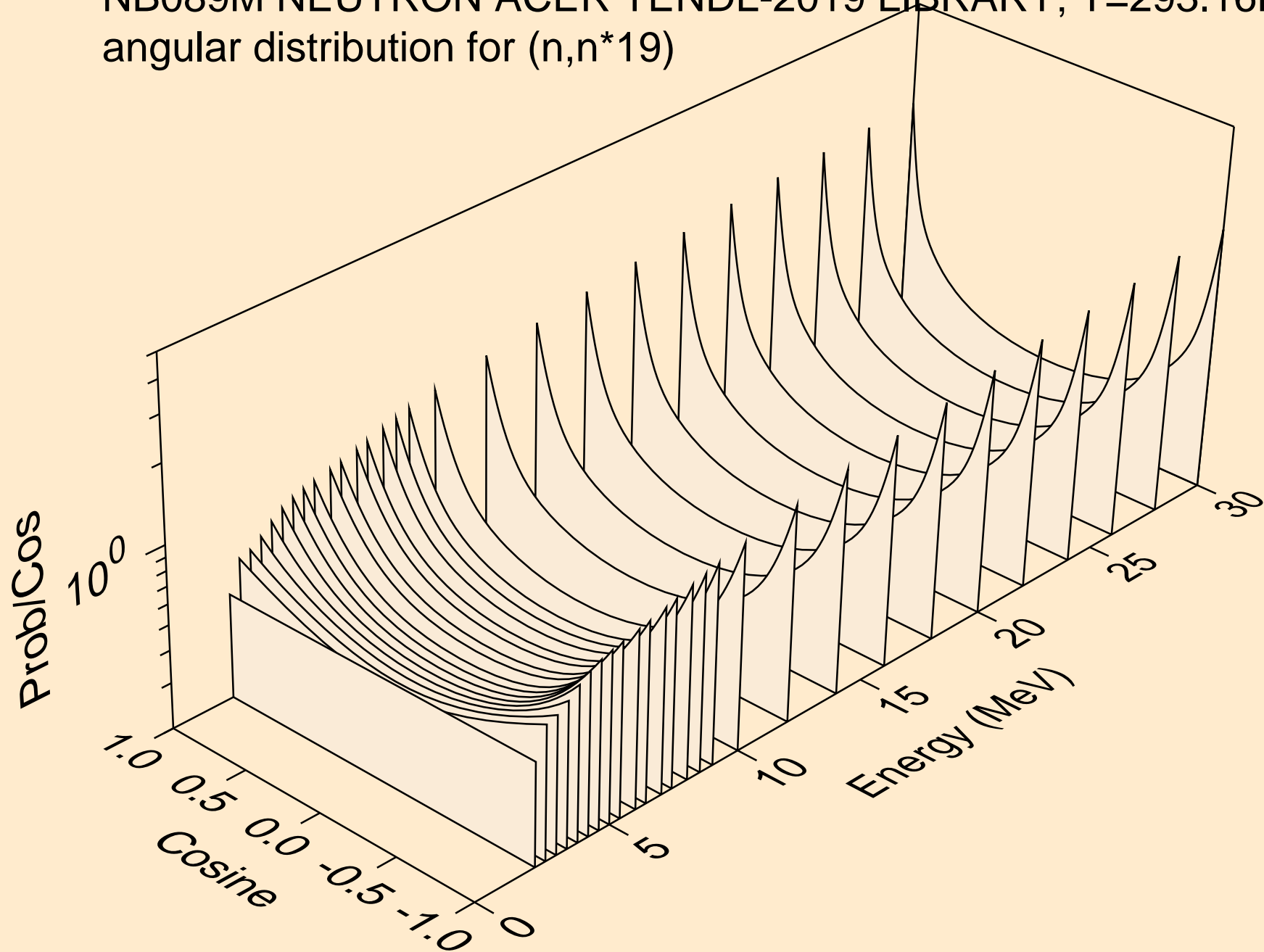

NB089M NEUTRON ACER TENDL-2019 LIBRARY; T=293.16K  
angular distribution for (n,n\*20)

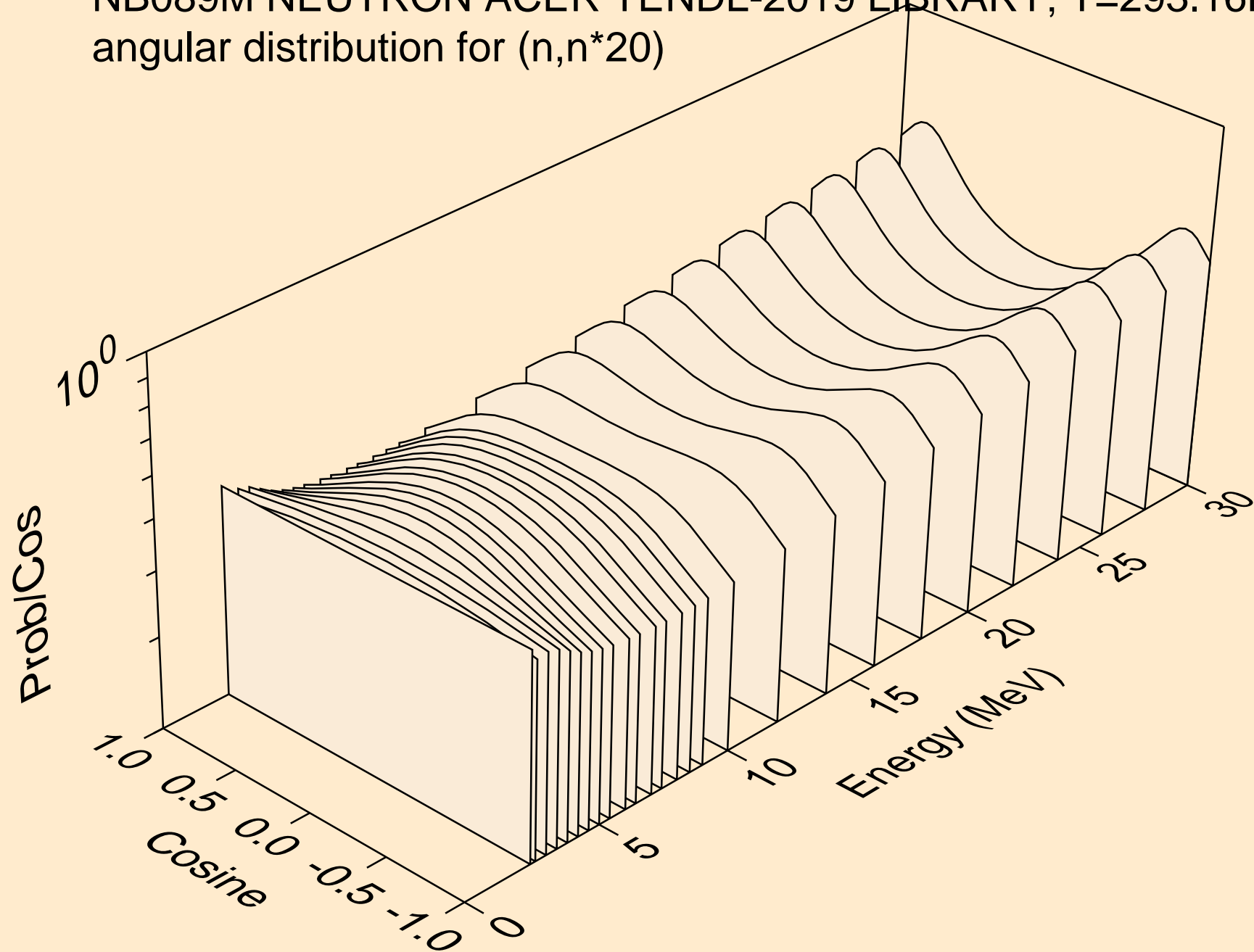

NB089M NEUTRON ACER TENDL-2019 LIBRARY; T=293.16K  
angular distribution for (n,n\*21)

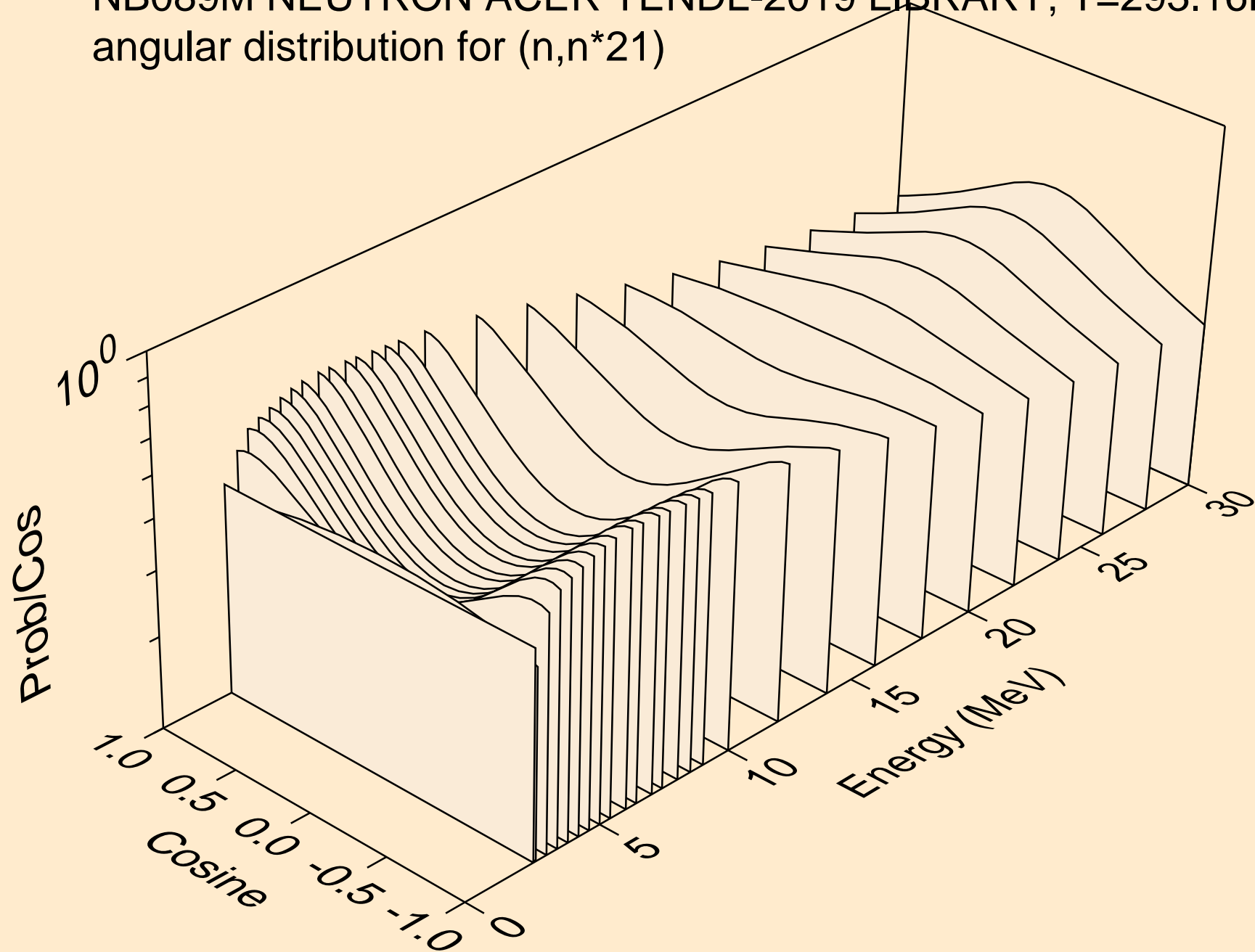



NB089M NEUTRON ACER TENDL-2019 LIBRARY; T=293.16K  
angular distribution for (n,n\*22)

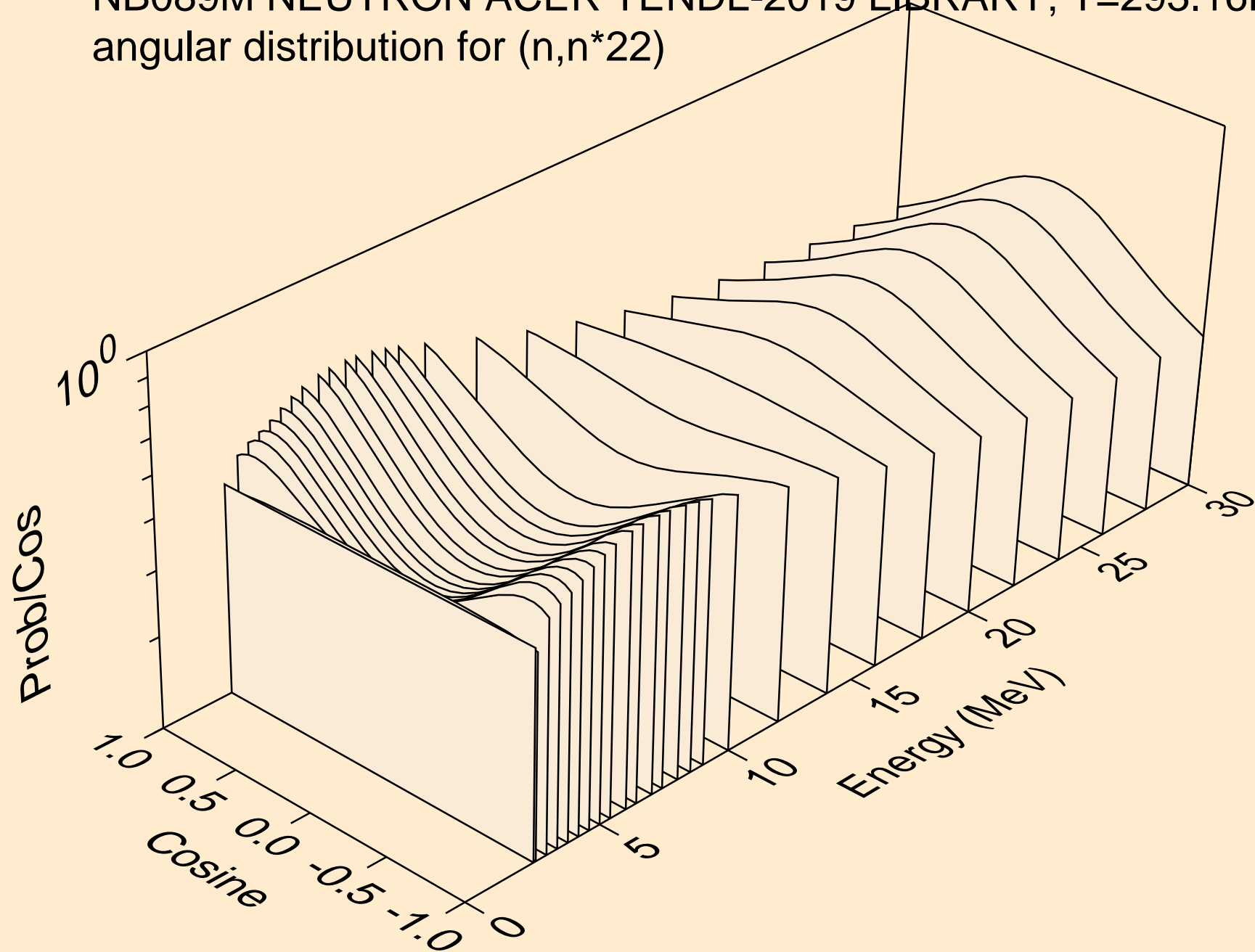

NB089M NEUTRON ACER TENDL-2019 LIBRARY; T=293.16K  
angular distribution for (n,n\*23)

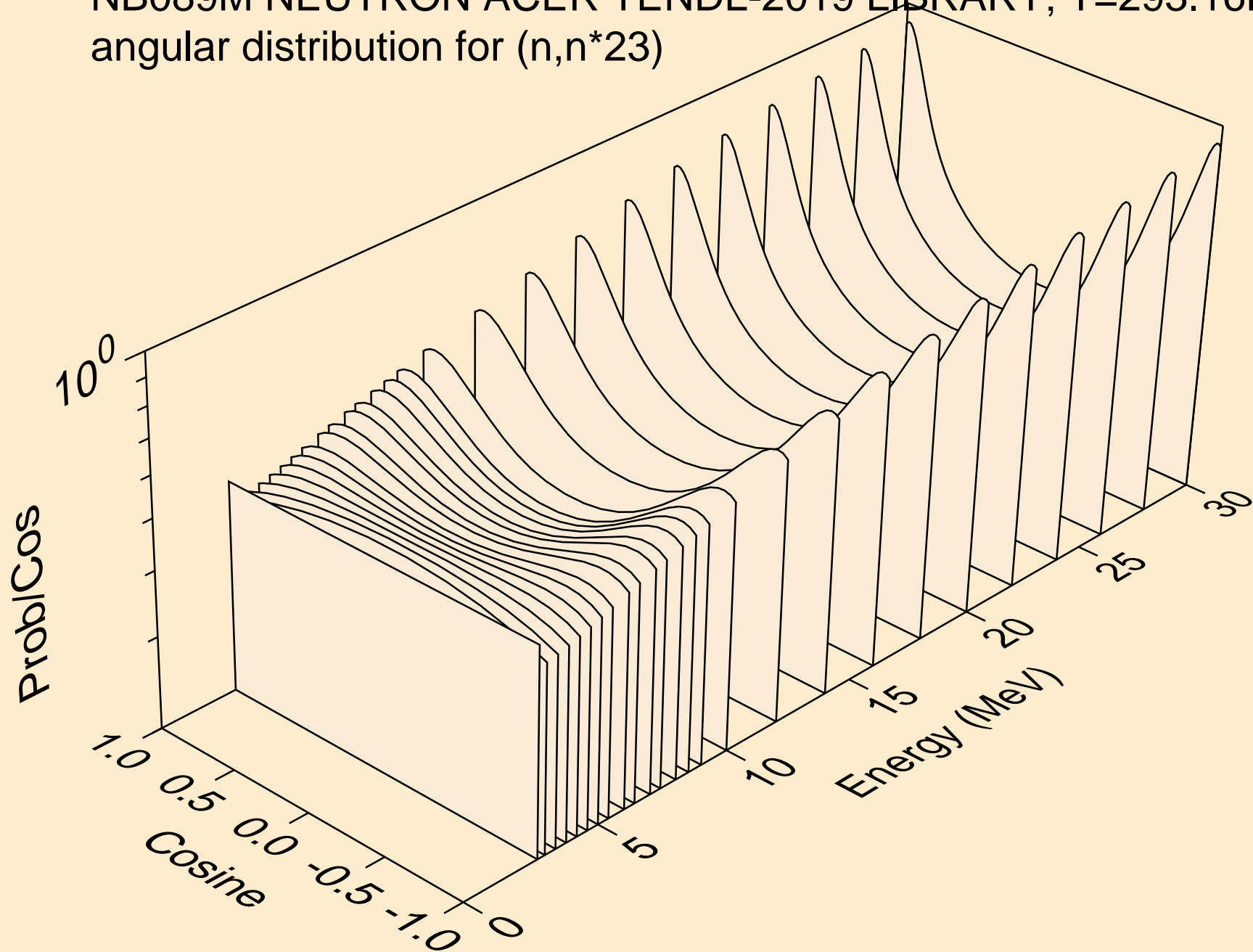

NB089M NEUTRON ACER TENDL-2019 LIBRARY; T=293.16K  
angular distribution for (n,n\*24)

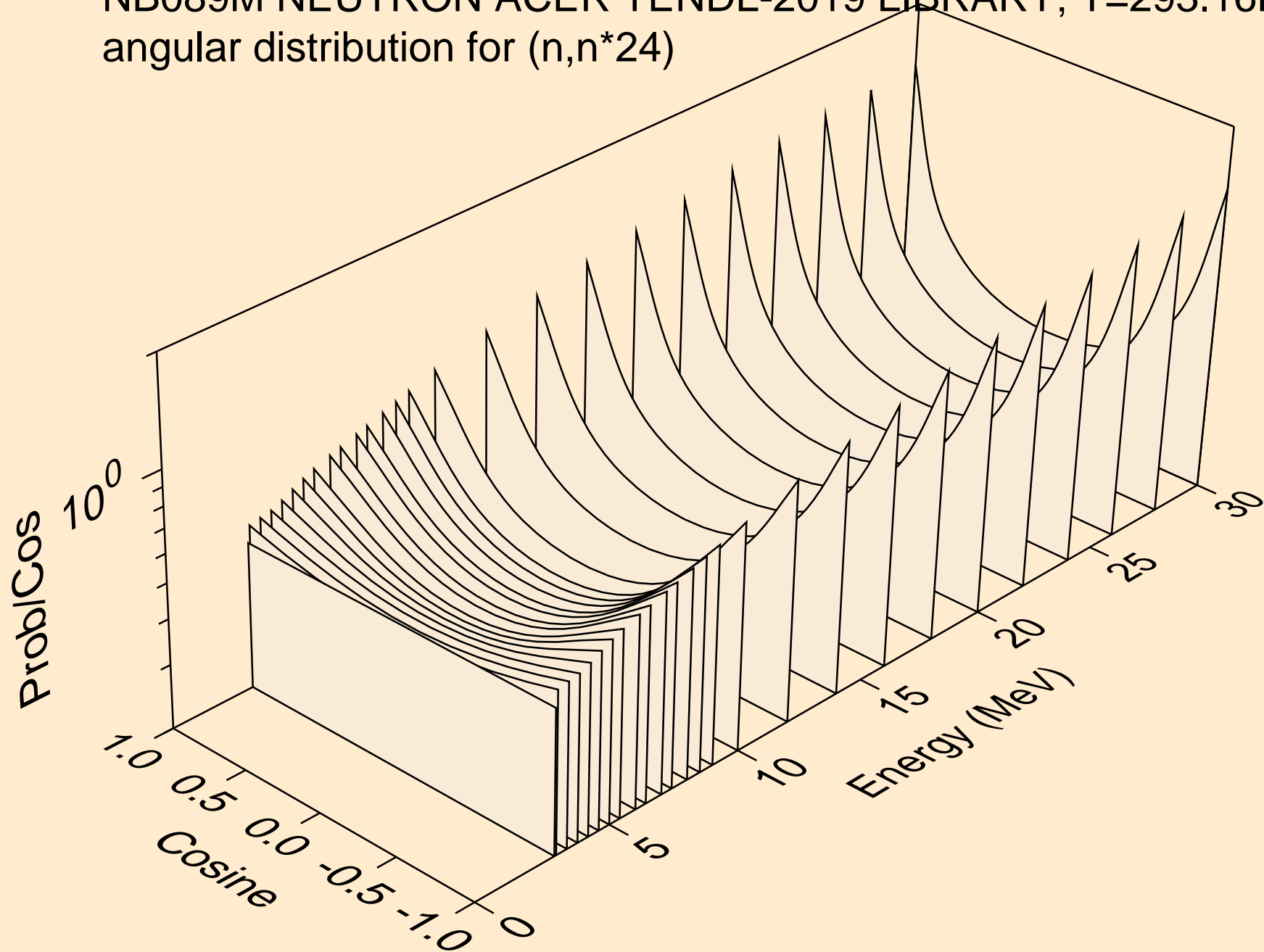

NB089M NEUTRON ACER TENDL-2019 LIBRARY; T=293.16K  
Neutron emission for (n,x)

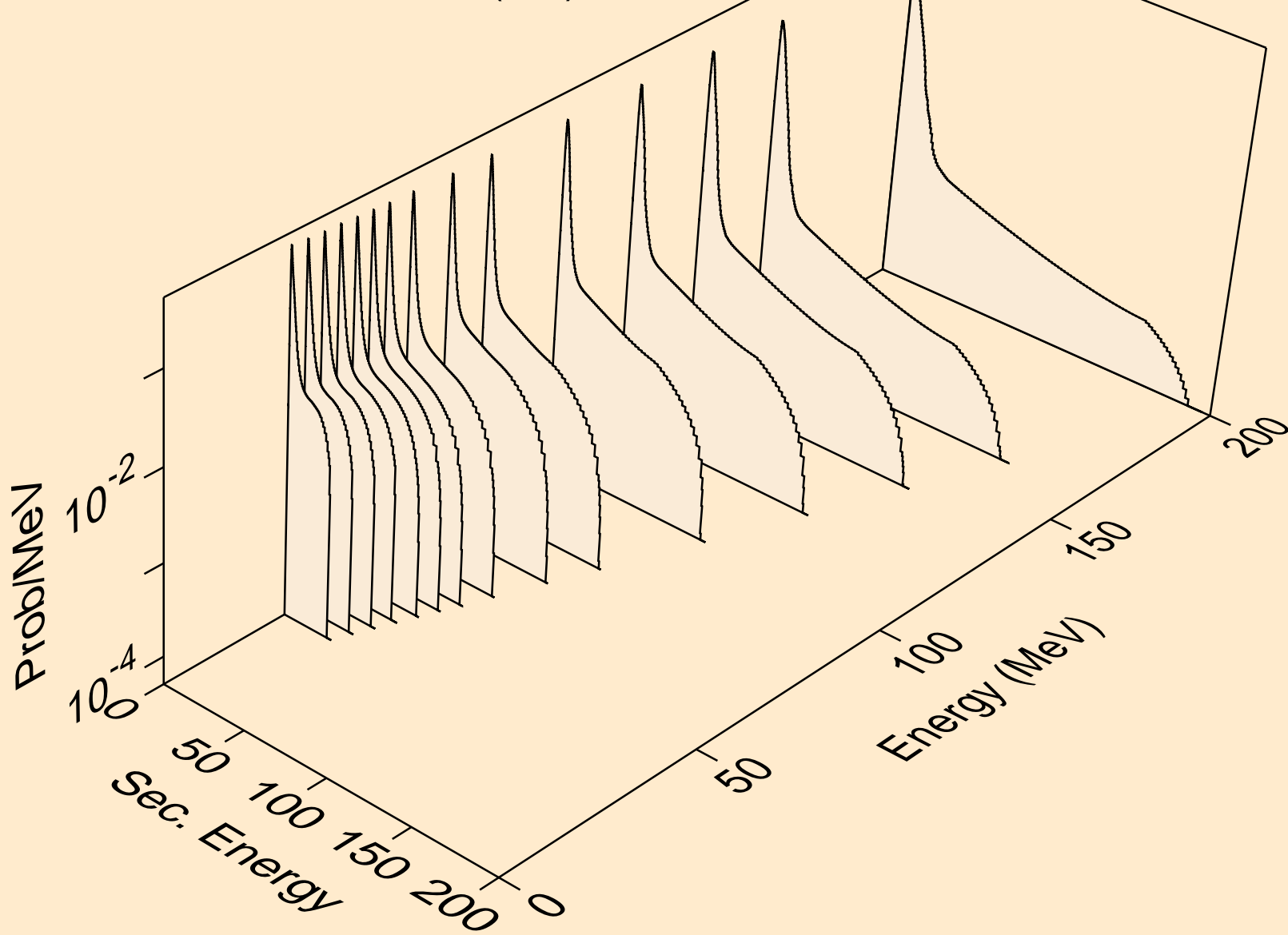

NB089M NEUTRON ACER TENDL-2019 LIBRARY; T=293.16K  
Neutron emission for (n,2nd)

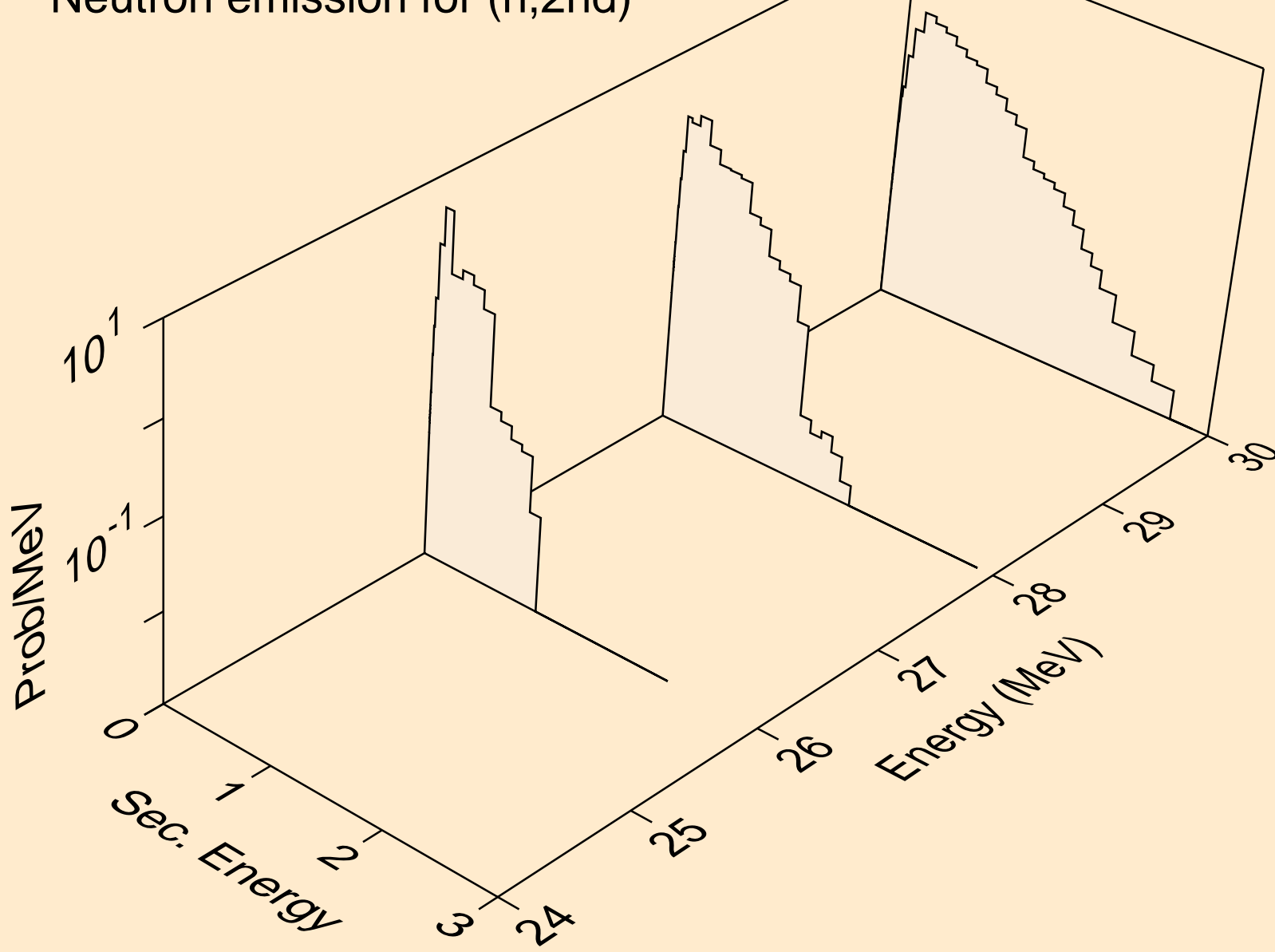

NB089M NEUTRON ACER TENDL-2019 LIBRARY; T=293.16K  
Neutron emission for (n,2n)

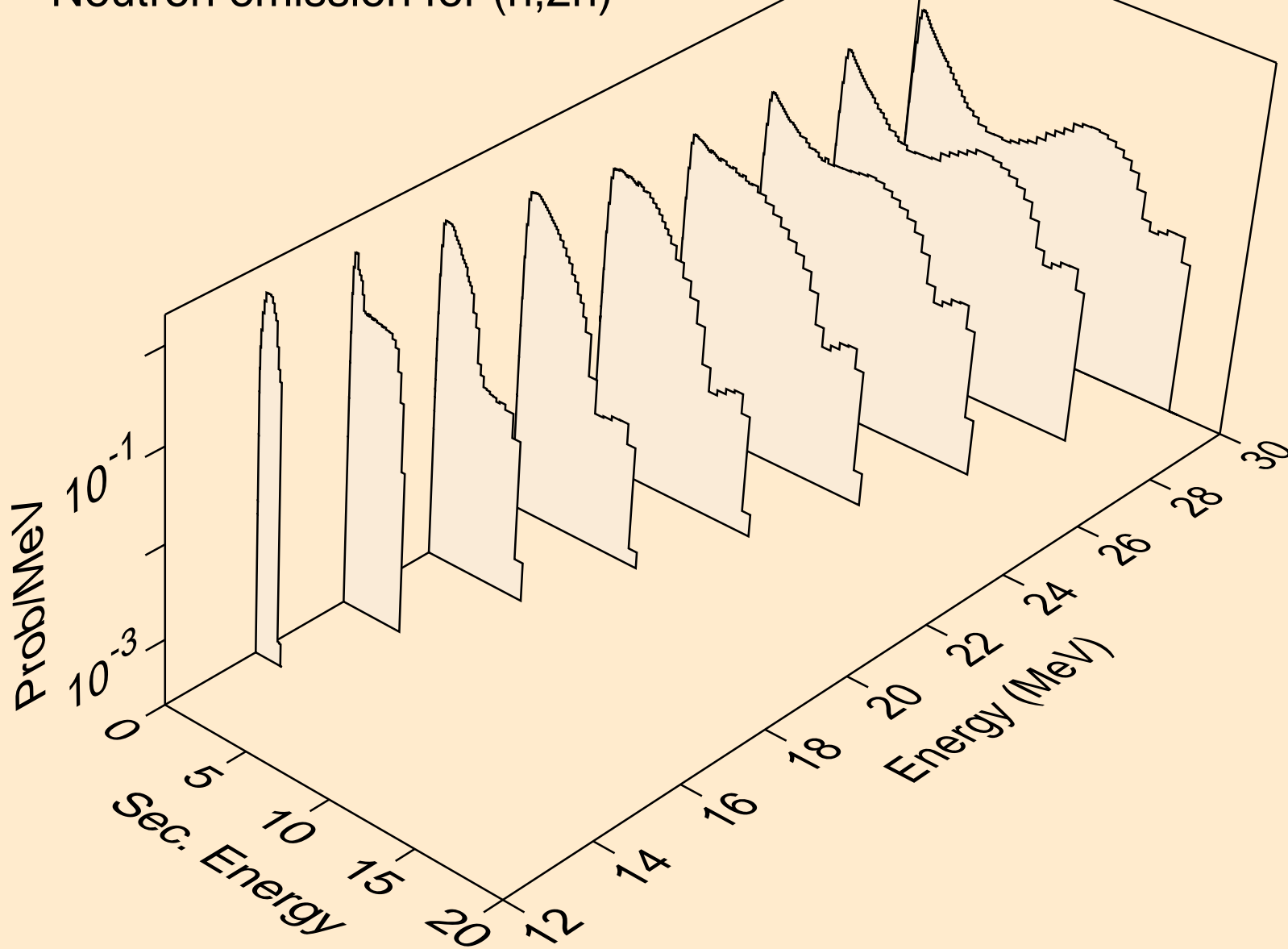

NB089M NEUTRON ACER TENDL-2019 LIBRARY; T=293.16K  
Neutron emission for (n,3n)

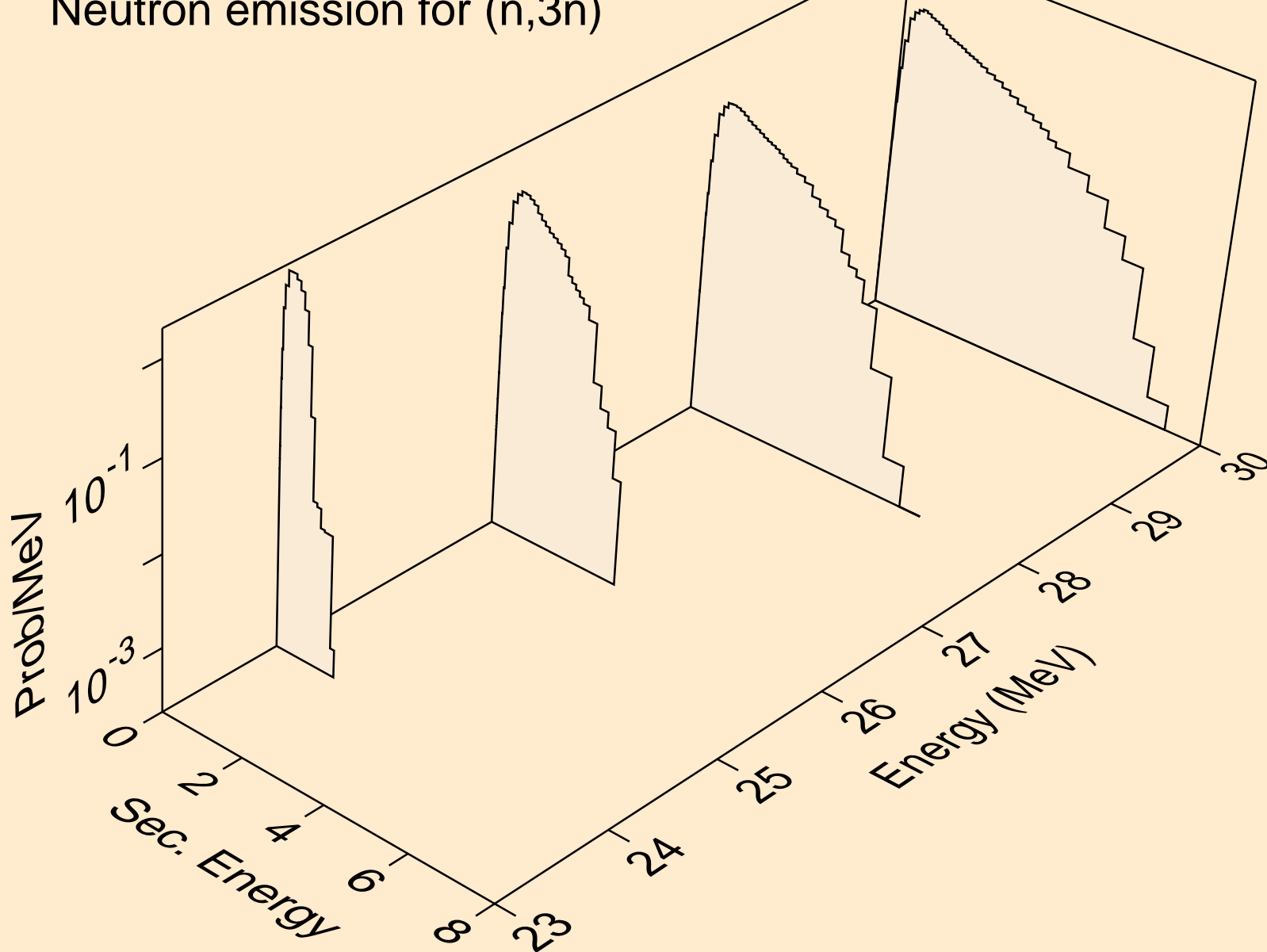

NB089M NEUTRON ACER TENDL-2019 LIBRARY; T=293.16K  
Neutron emission for (n,n\*)a

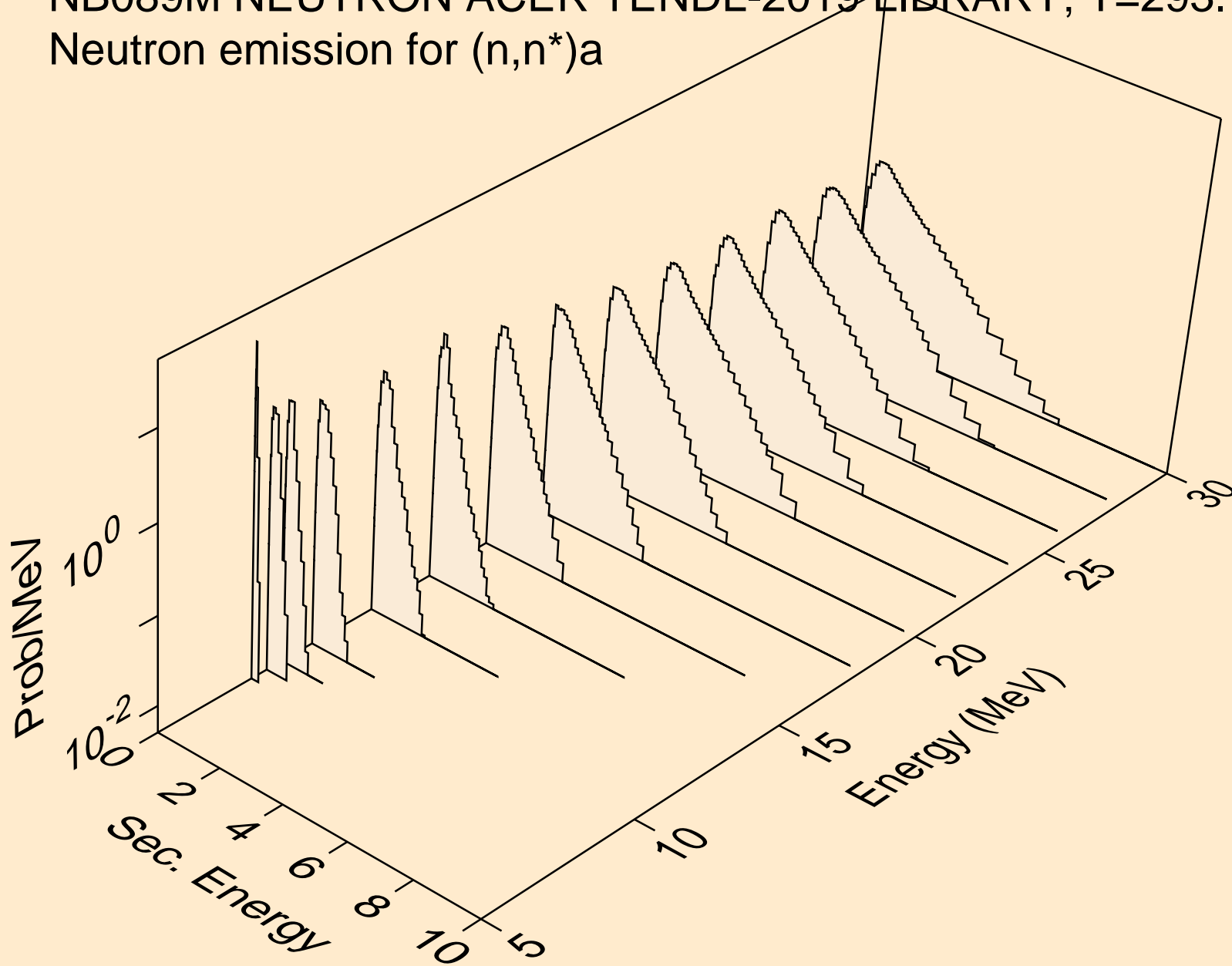



NB089M NEUTRON ACER TENDL-2019 LIBRARY; T=293.16K  
Neutron emission for (n,2n)a

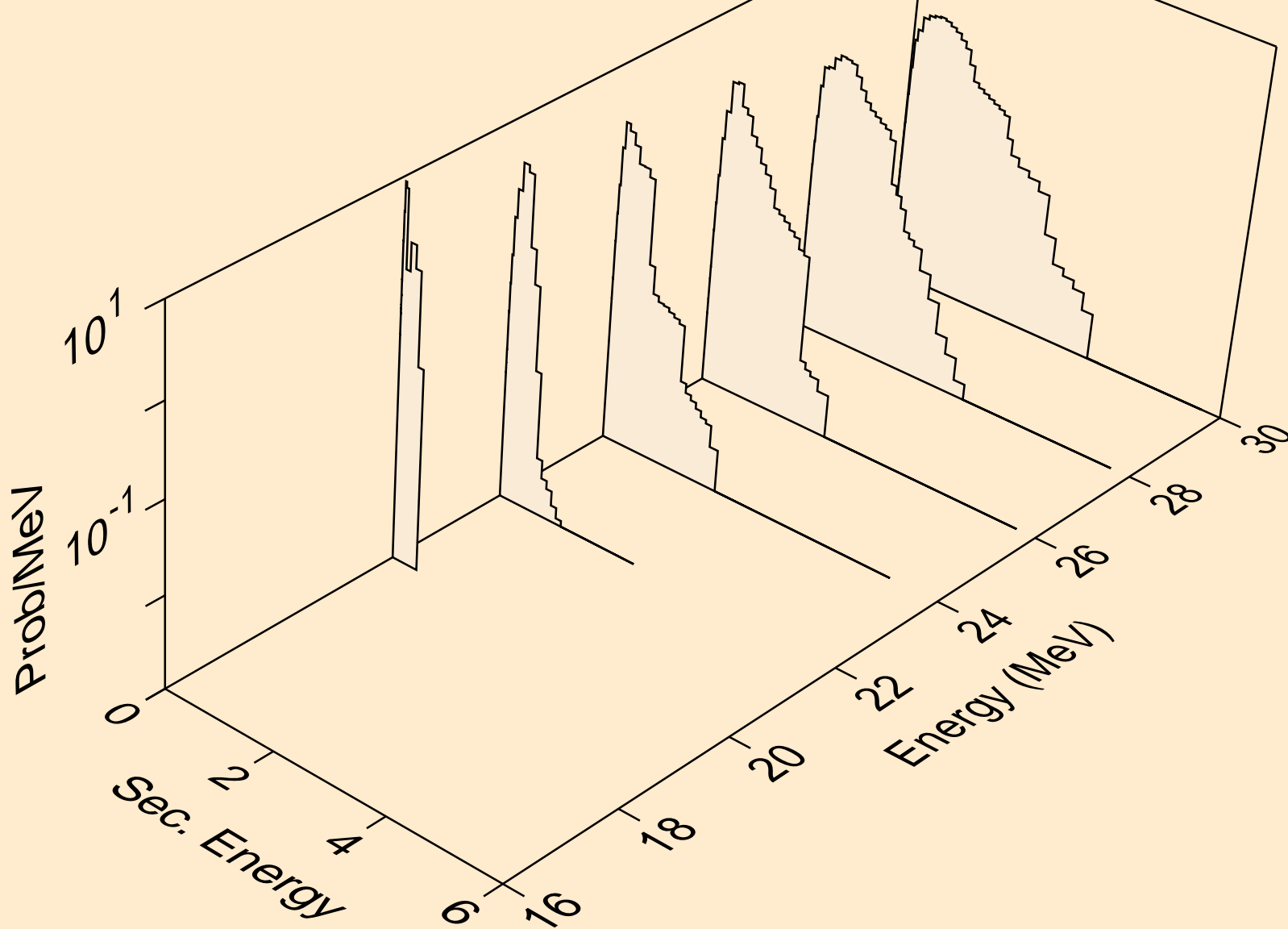

NB089M NEUTRON ACER TENDL-2019 LIBRARY; T=293.16K  
Neutron emission for (n,n\*)p

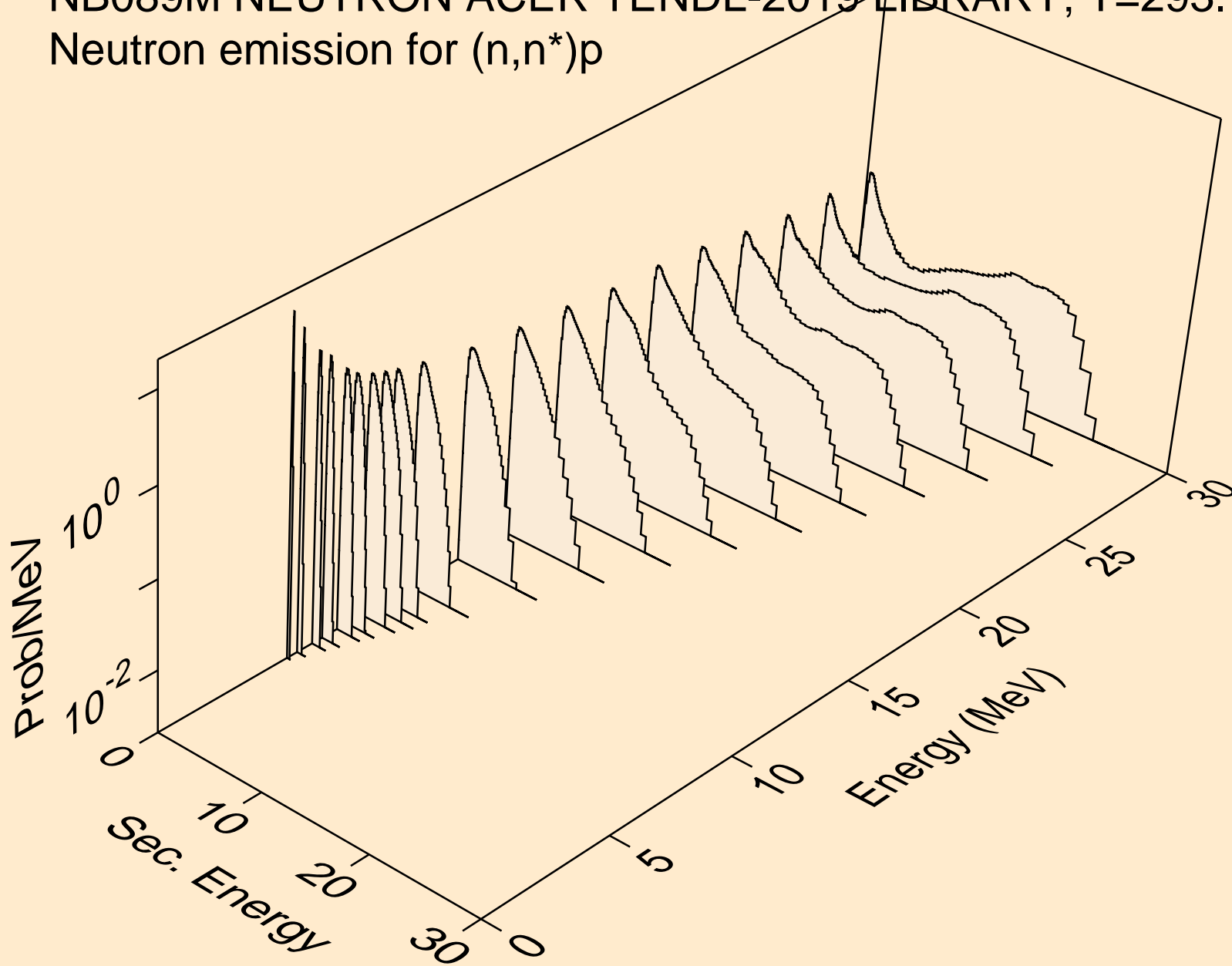

NB089M NEUTRON ACER TENDL-2019 LIBRARY; T=293.16K  
Neutron emission for (n,n\*)2a

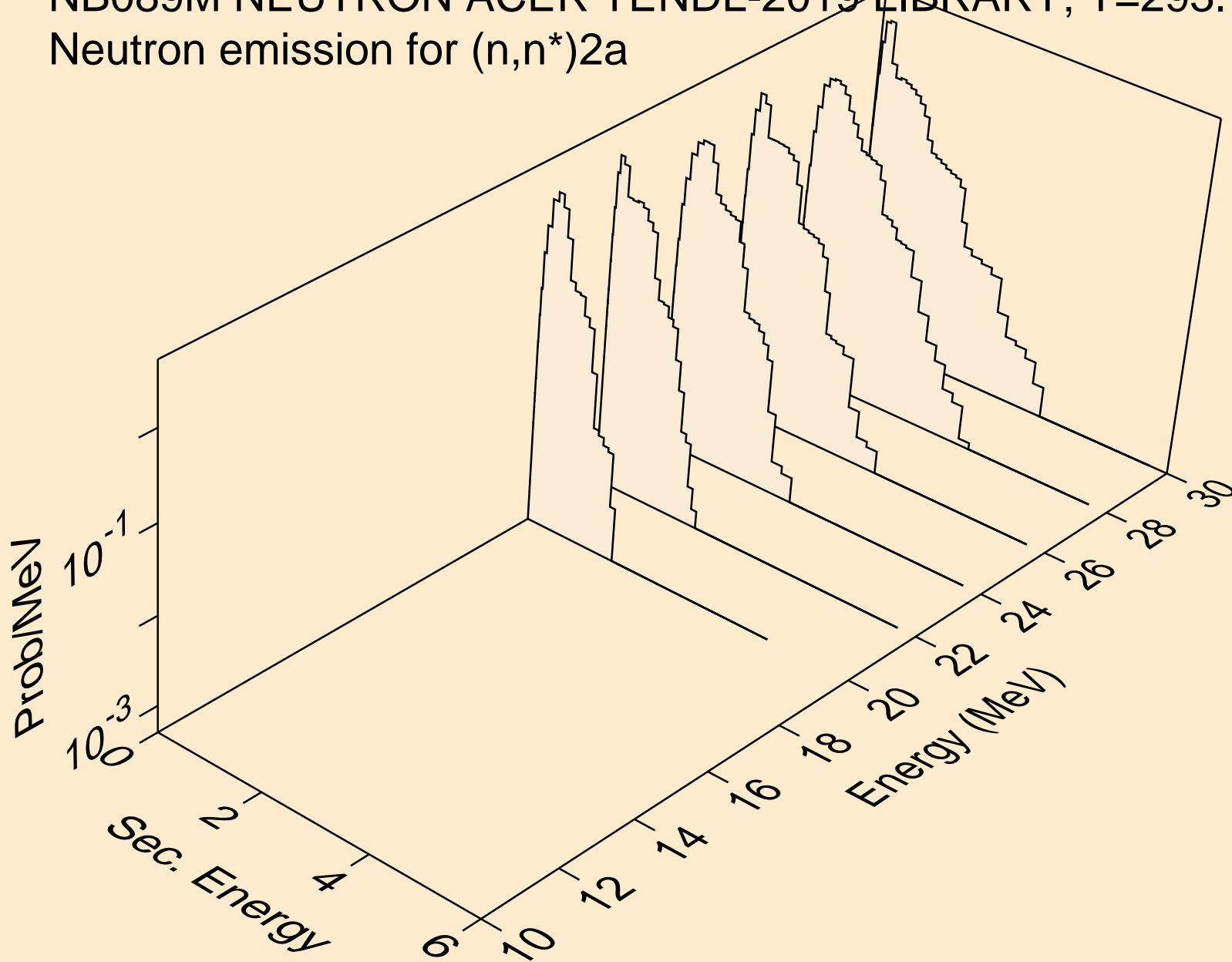

NB089M NEUTRON ACER TENDL-2019 LIBRARY; T=293.16K  
Neutron emission for (n,n\*)d

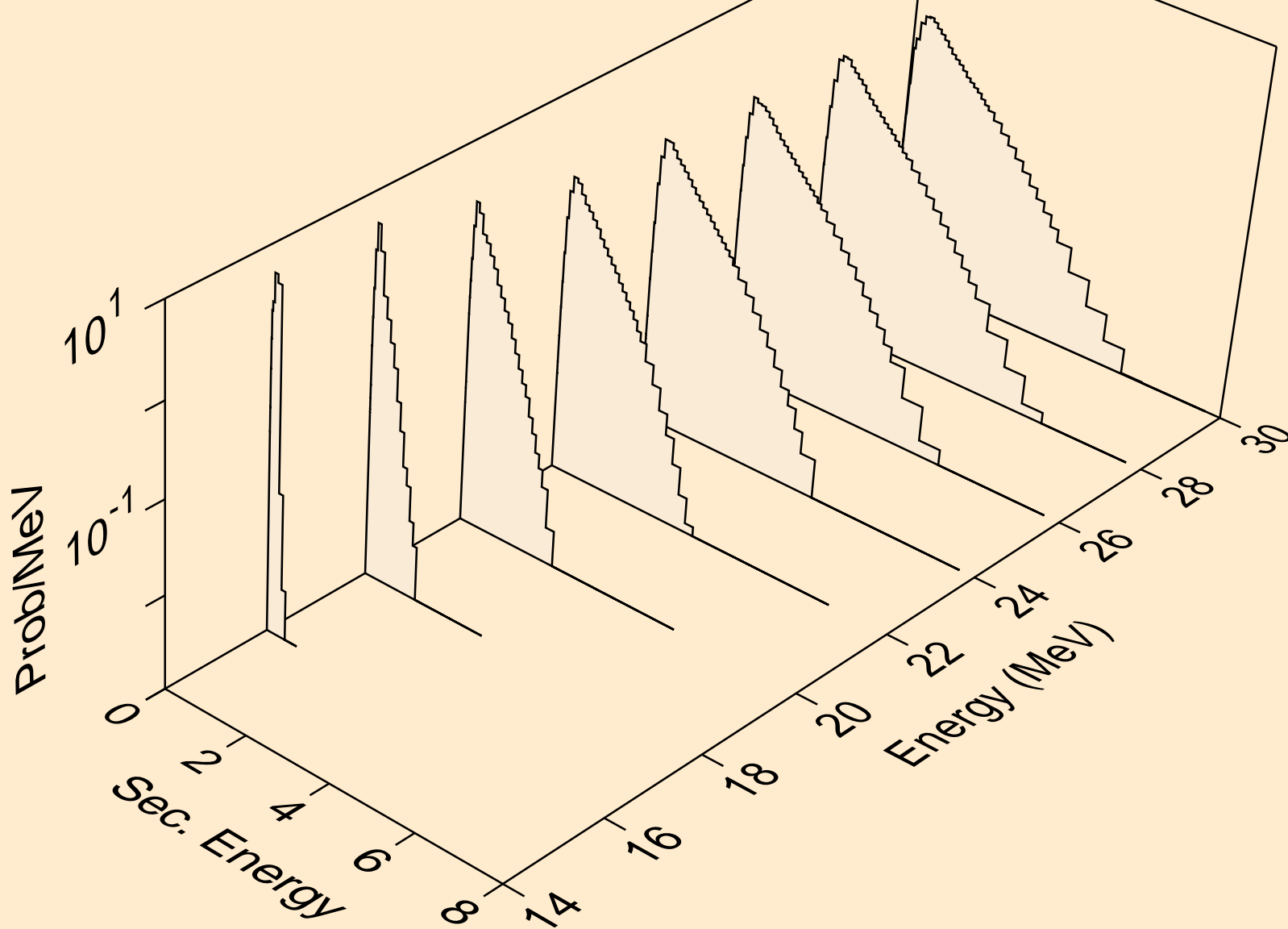

NB089M NEUTRON ACER TENDL-2019 LIBRARY; T=293.16K  
Neutron emission for (n,n\*)t

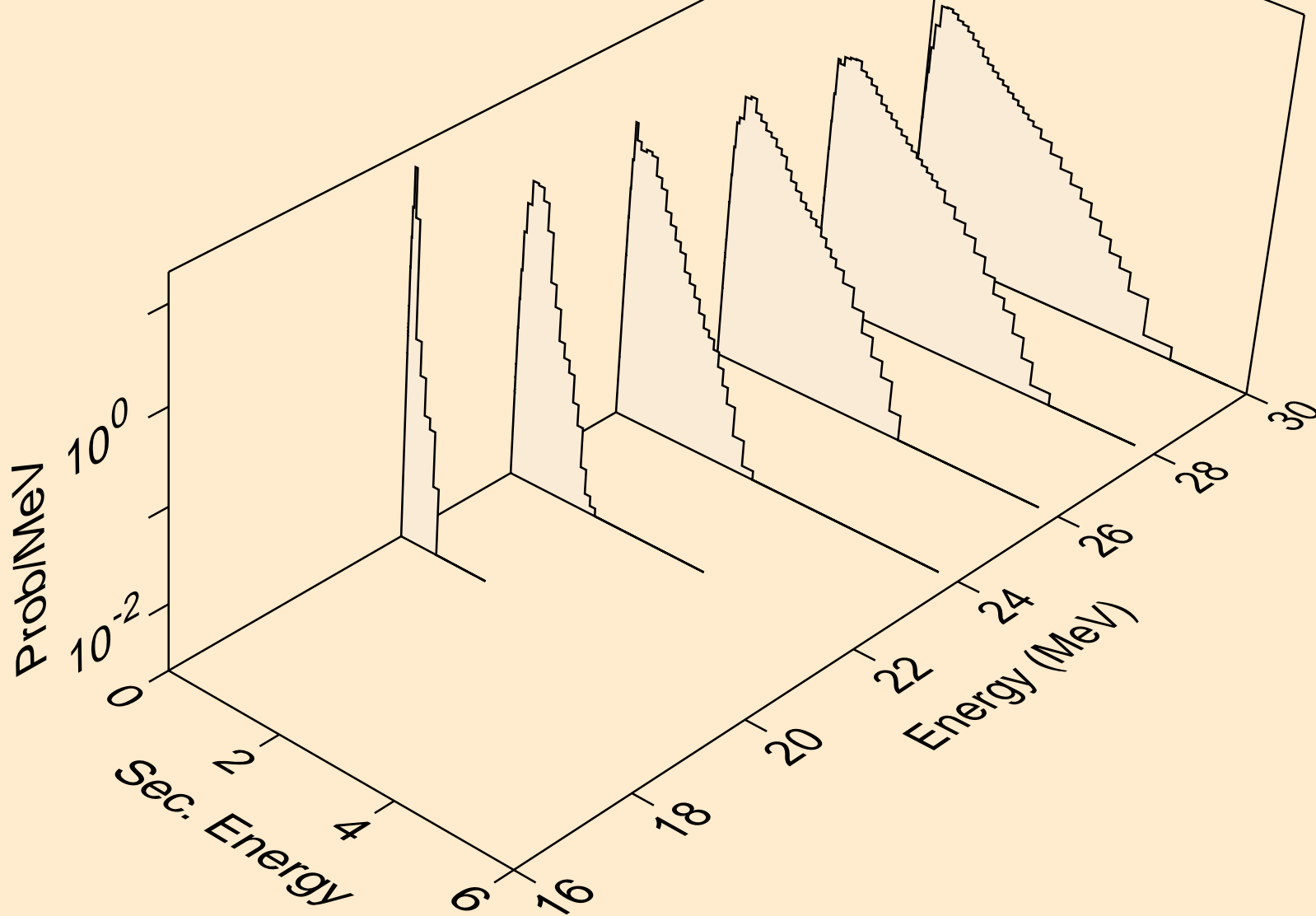

NB089M NEUTRON ACER TENDL-2019 LIBRARY; T=293.16K  
Neutron emission for (n,n\*)he3

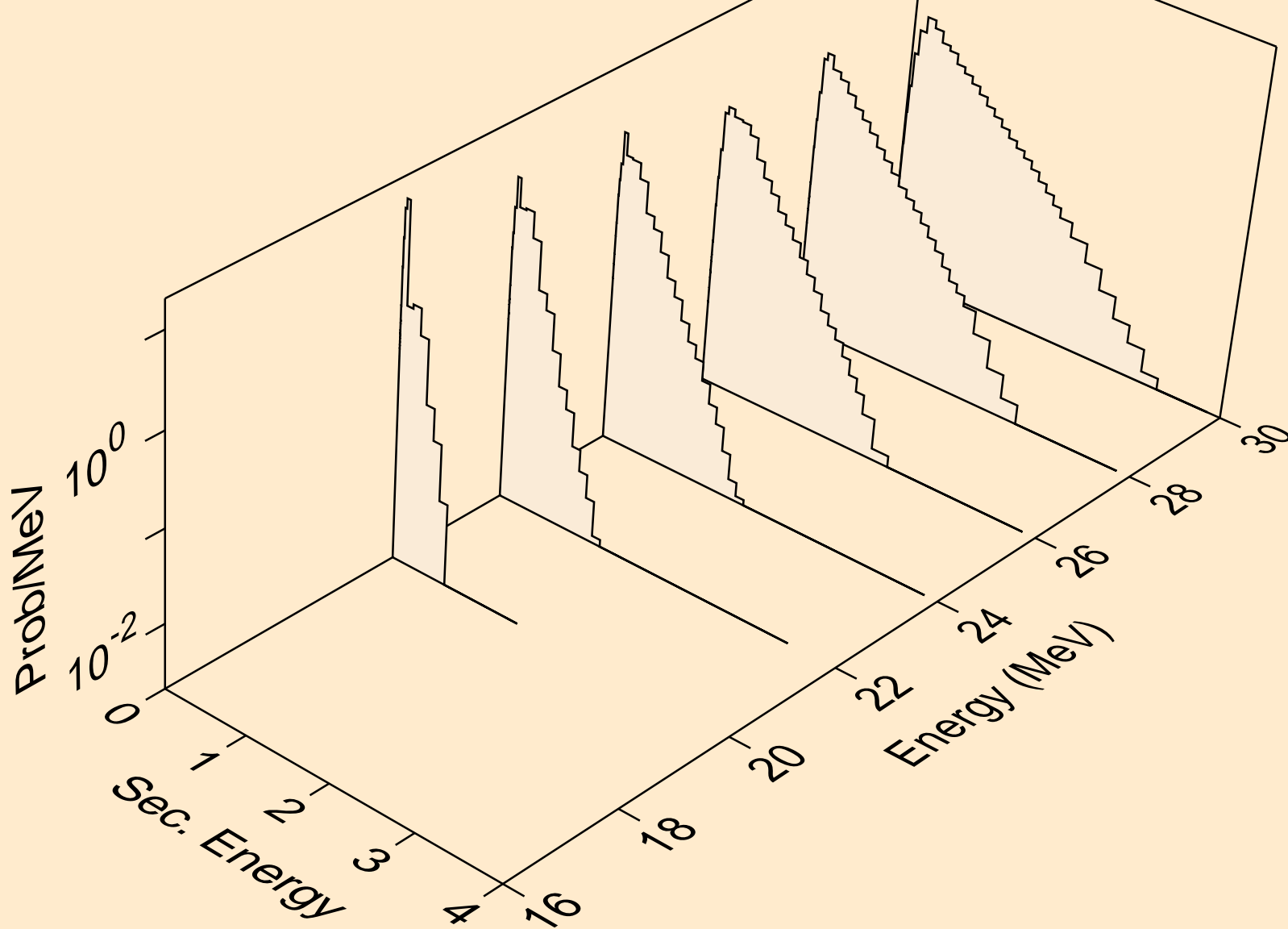

NB089M NEUTRON ACER TENDL-2019 LIBRARY; T=293.16K  
Neutron emission for (n,2np)

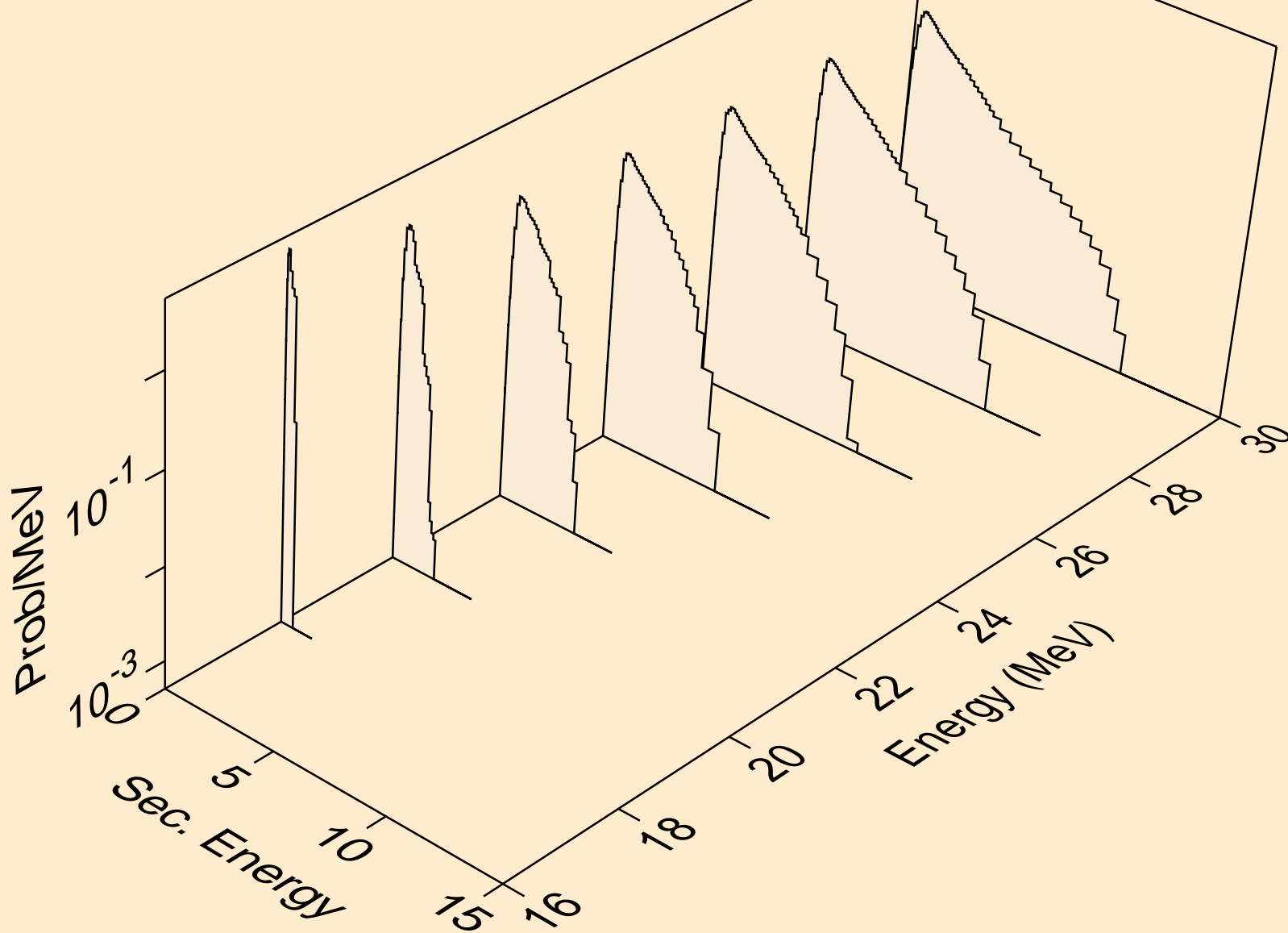

NB089M NEUTRON ACER TENDL-2019 LIBRARY; T=293.16K  
Neutron emission for (n,3np)

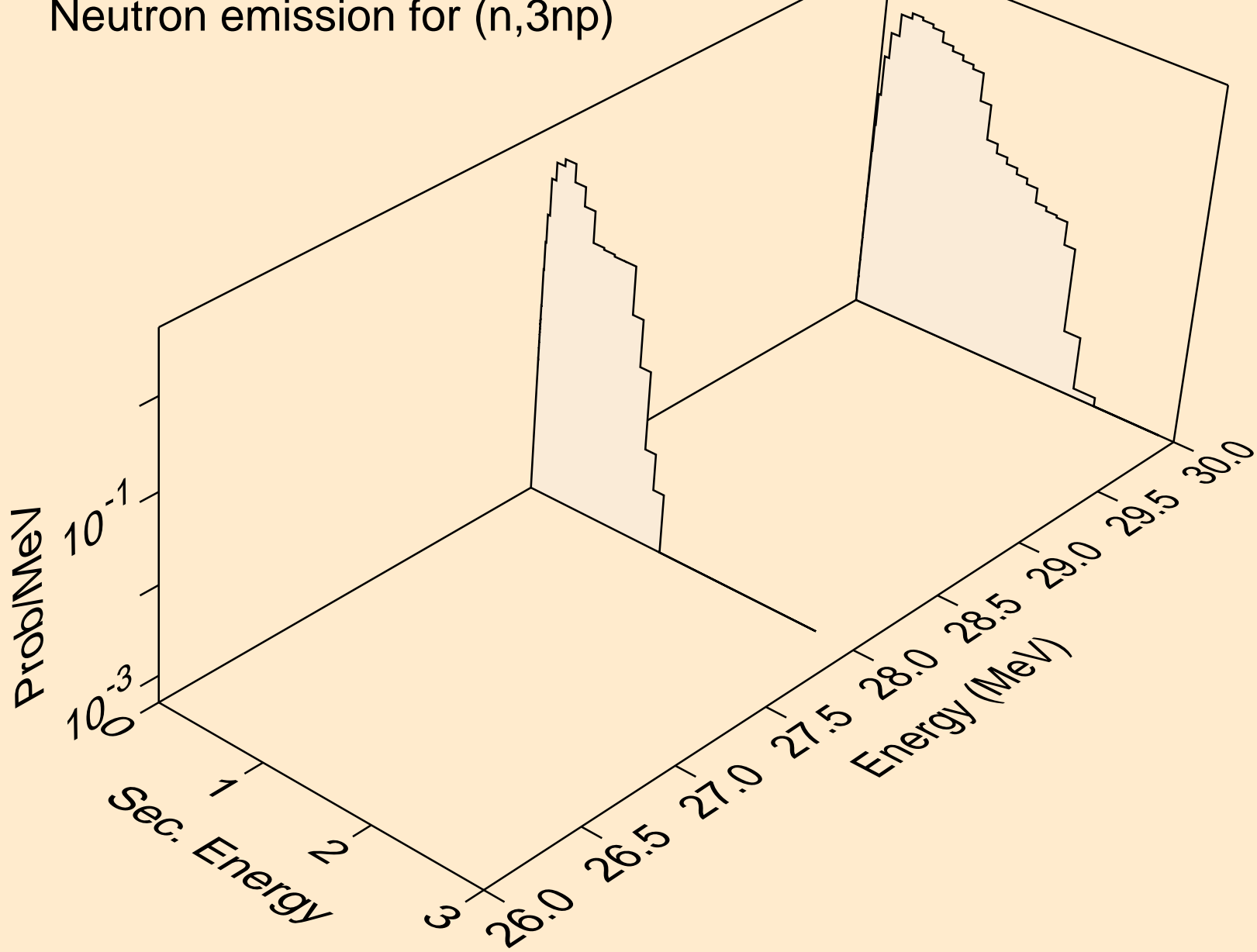



NB089M NEUTRON ACER TENDL-2019 LIBRARY; T=293.16K  
Neutron emission for (n,2np)

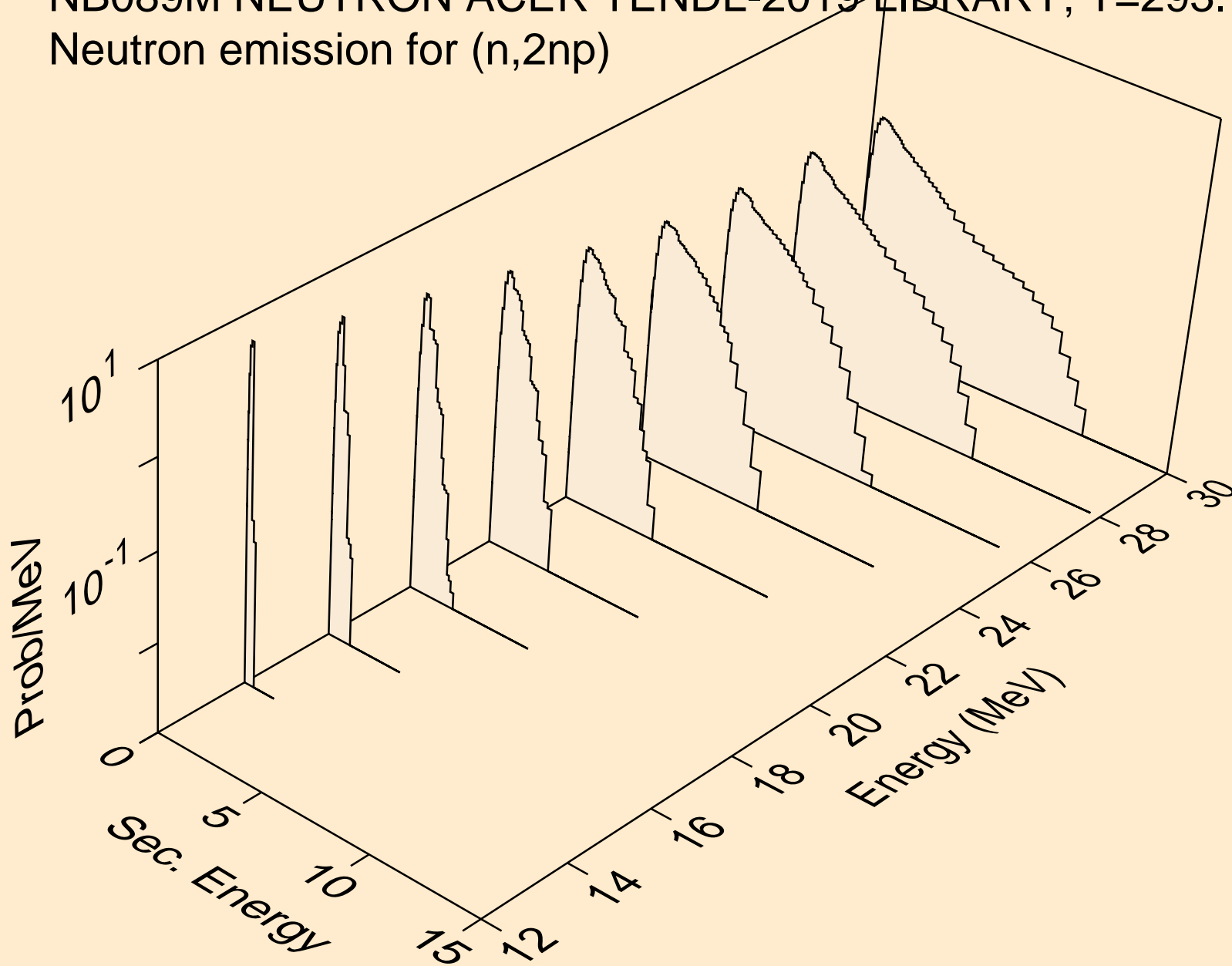

NB089M NEUTRON ACER TENDL-2019 LIBRARY; T=293.16K  
Neutron emission for (n,npa)

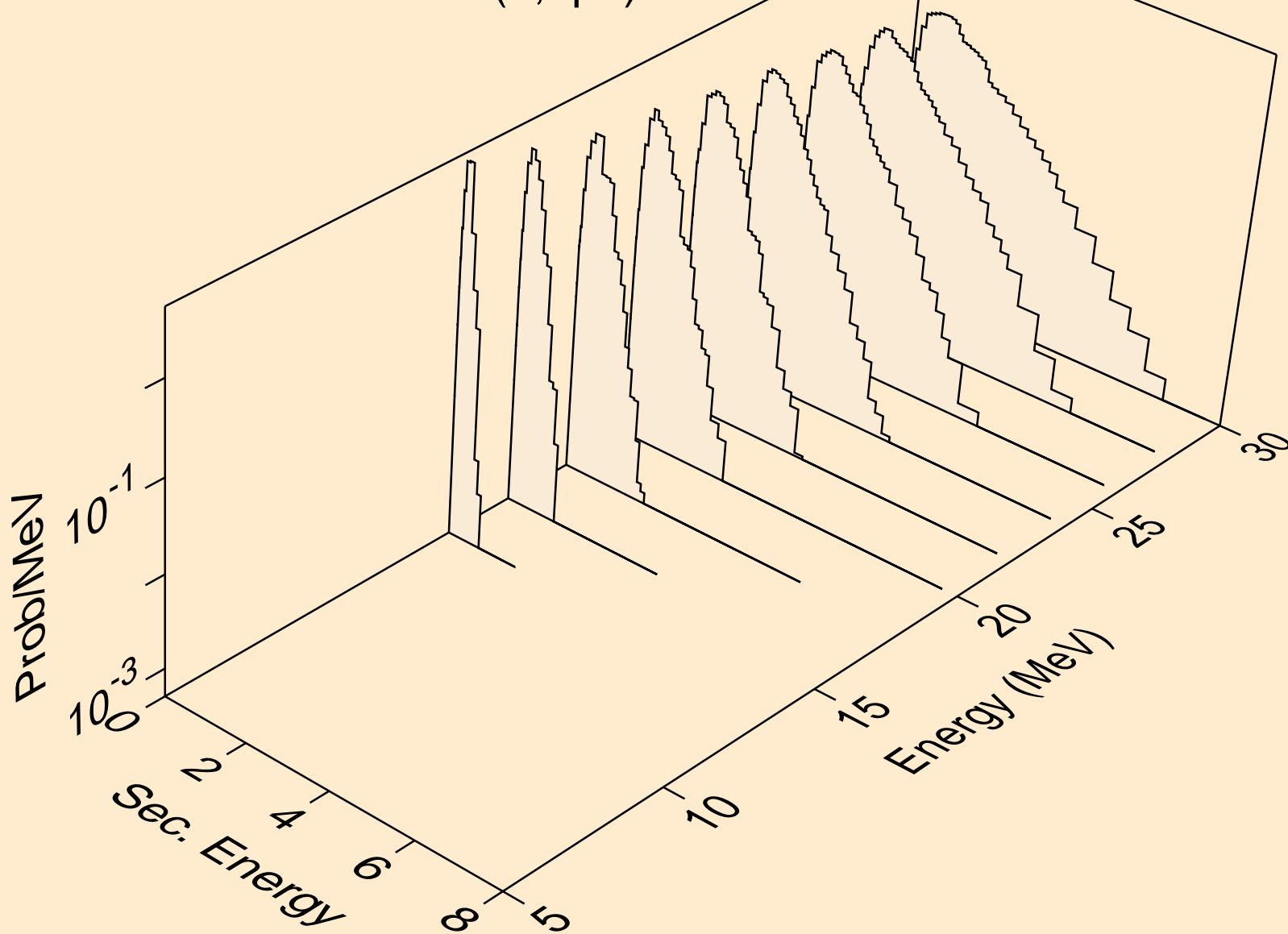

NB089M NEUTRON ACER TENDL-2019 LIBRARY; T=293.16K  
Neutron emission for (n,n\*c)

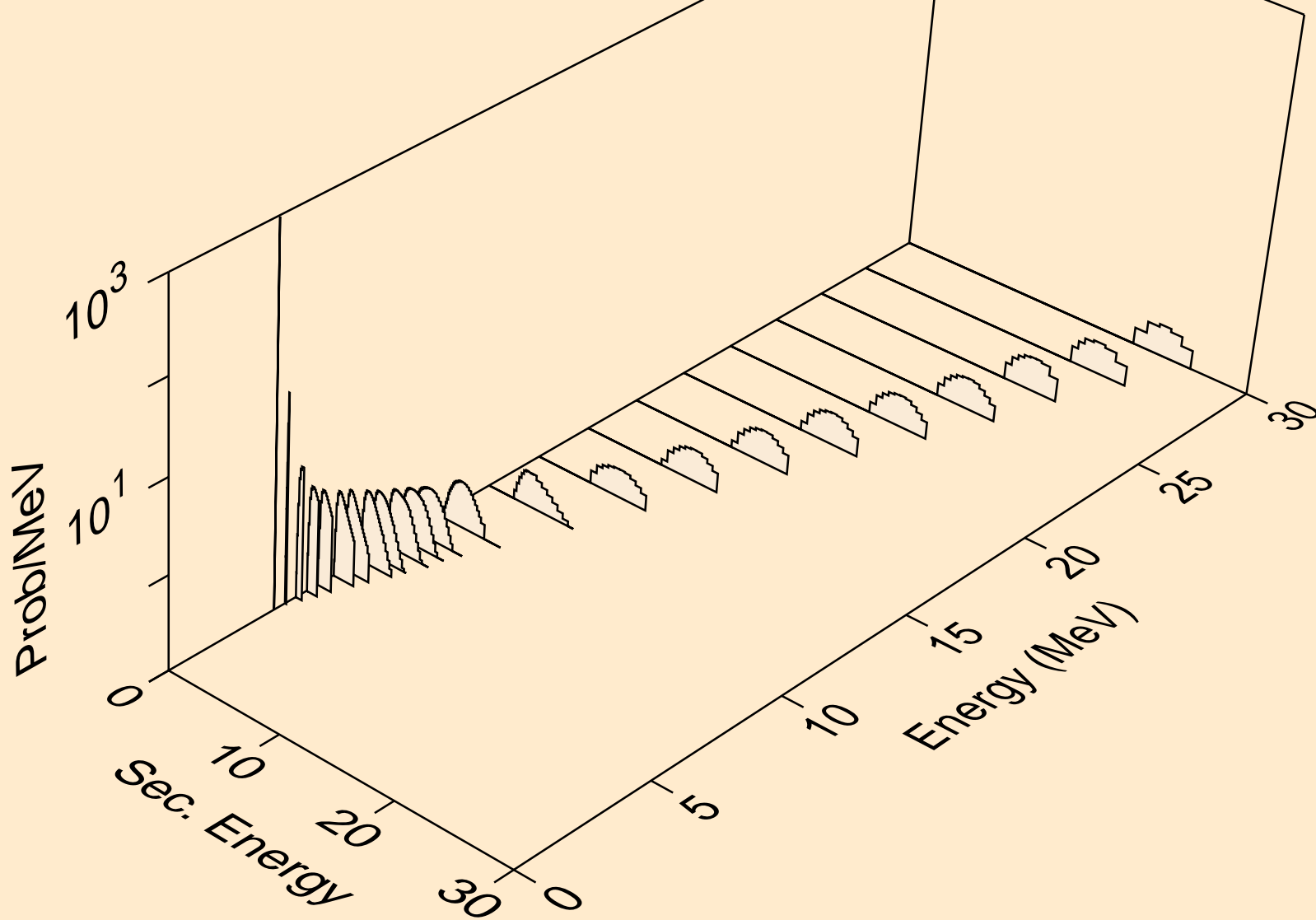

NB089M NEUTRON ACER TENDL-2019 LIBRARY; T=293.16K  
Photon emission for (n,x)

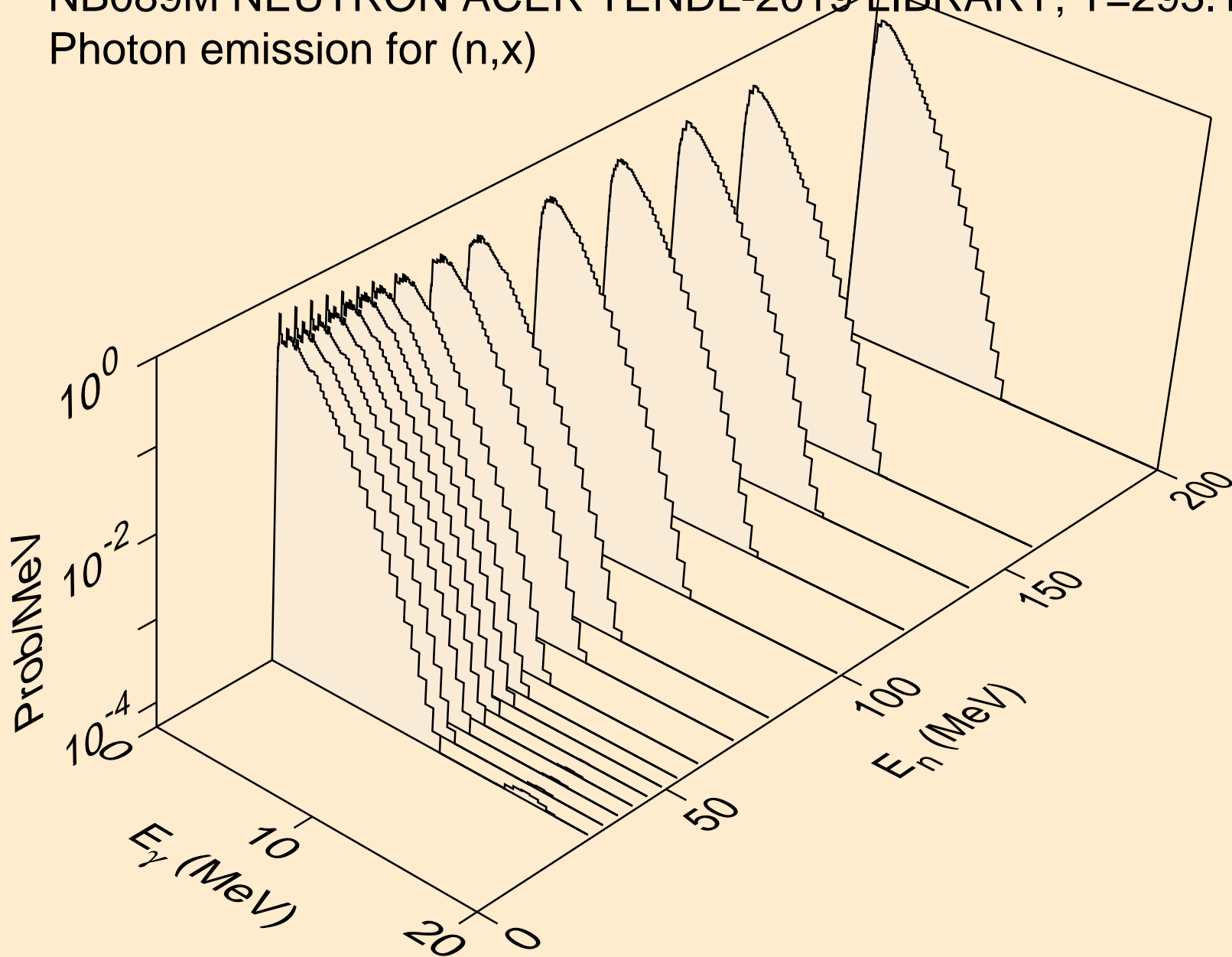

NB089M NEUTRON ACER TENDL-2019 LIBRARY; T=293.16K  
Photon emission for (n,2nd)

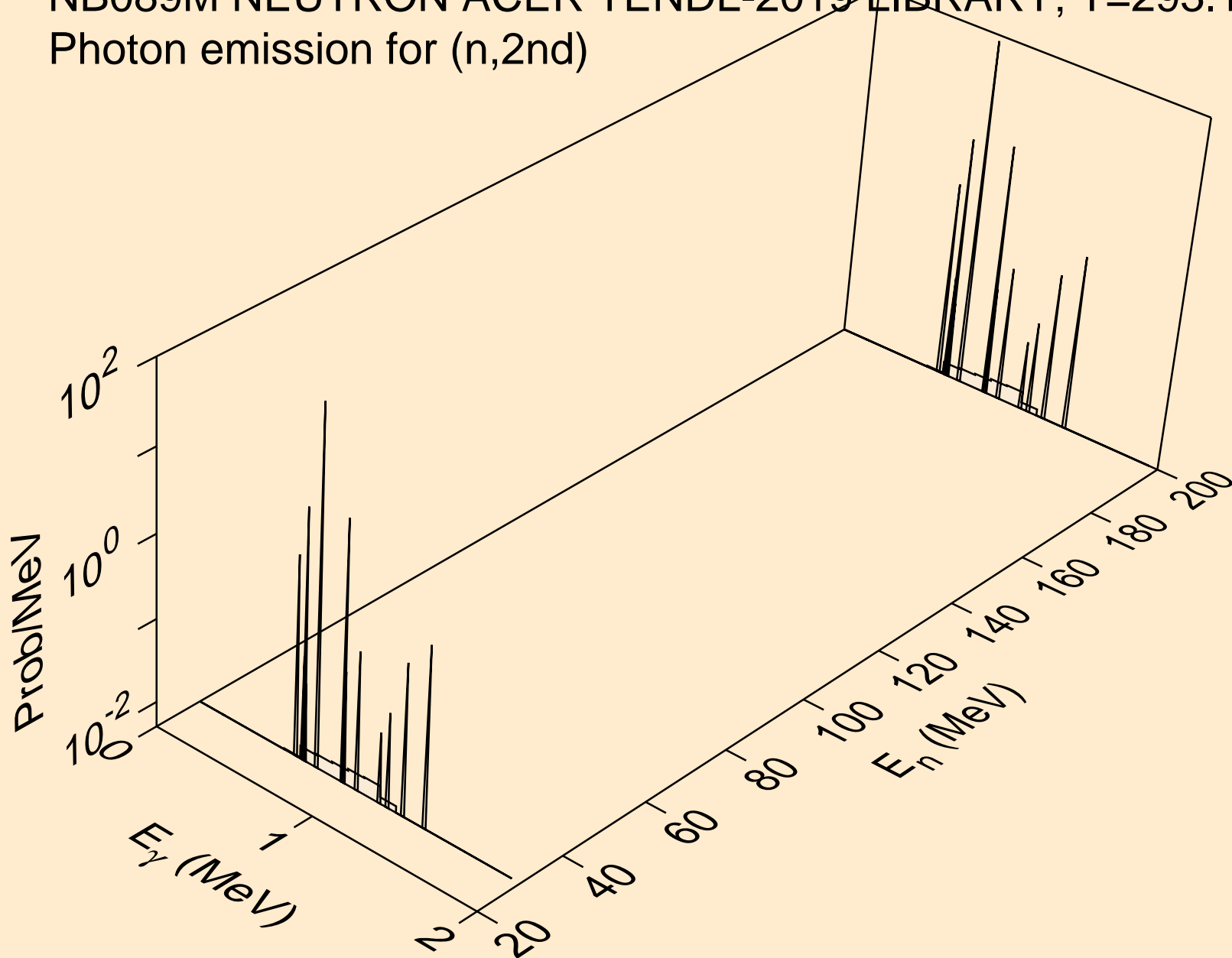

NB089M NEUTRON ACER TENDL-2019 LIBRARY; T=293.16K  
Photon emission for (n,2n)

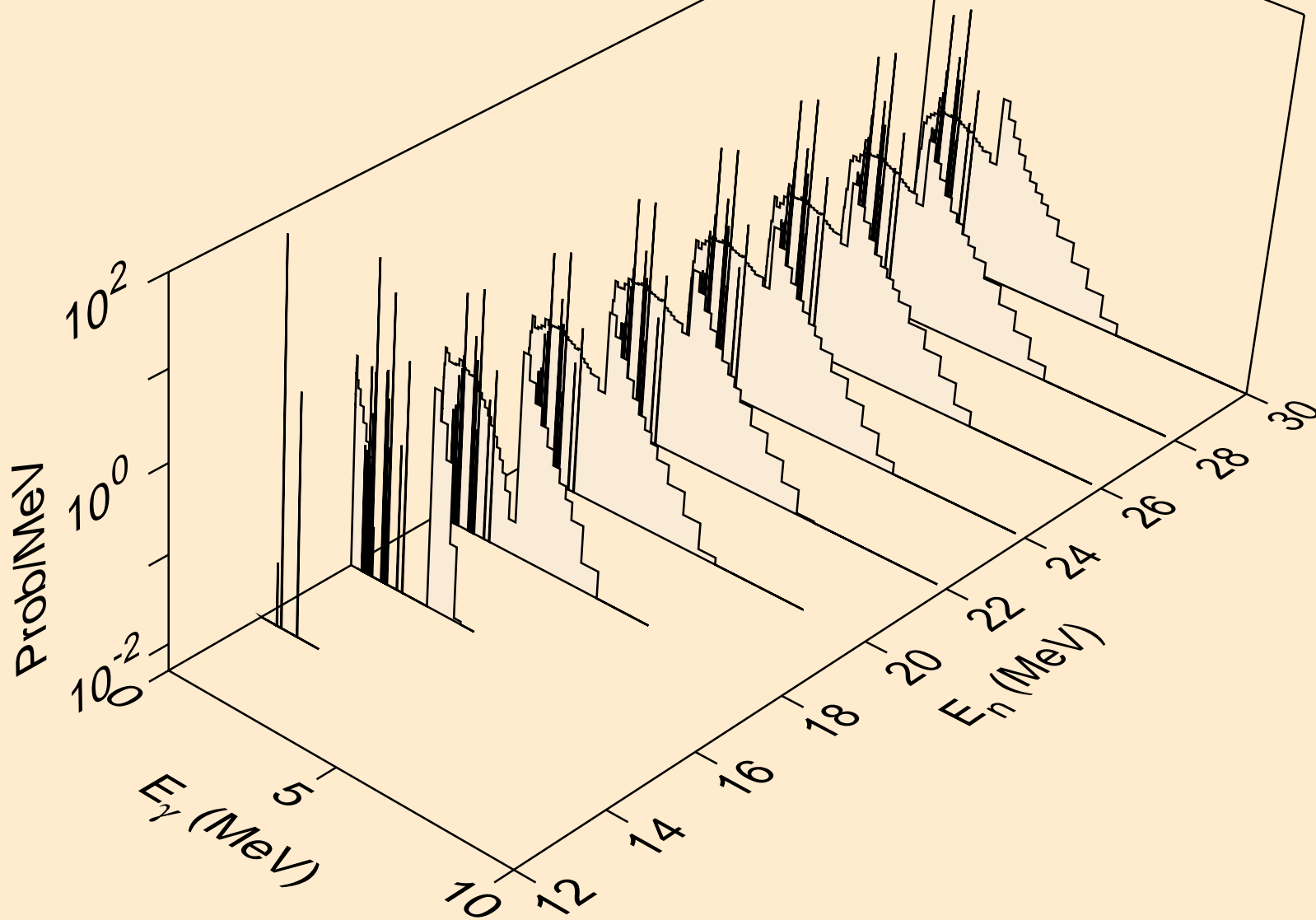

NB089M NEUTRON ACER TENDL-2019 LIBRARY; T=293.16K  
Photon emission for (n,3n)

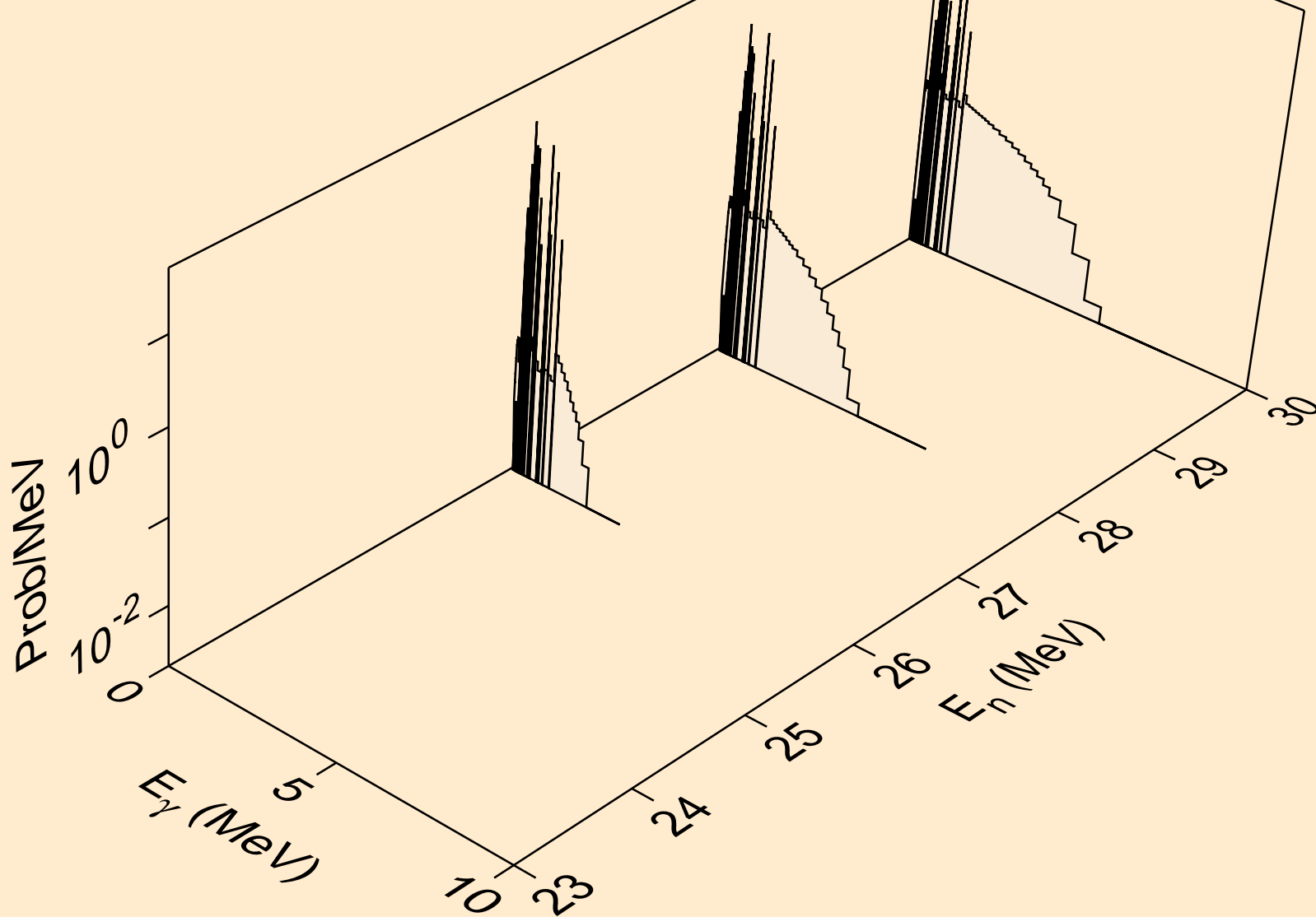

NB089M NEUTRON ACER TENDL-2019 LIBRARY; T=293.16K  
Photon emission for (n,n\*)a

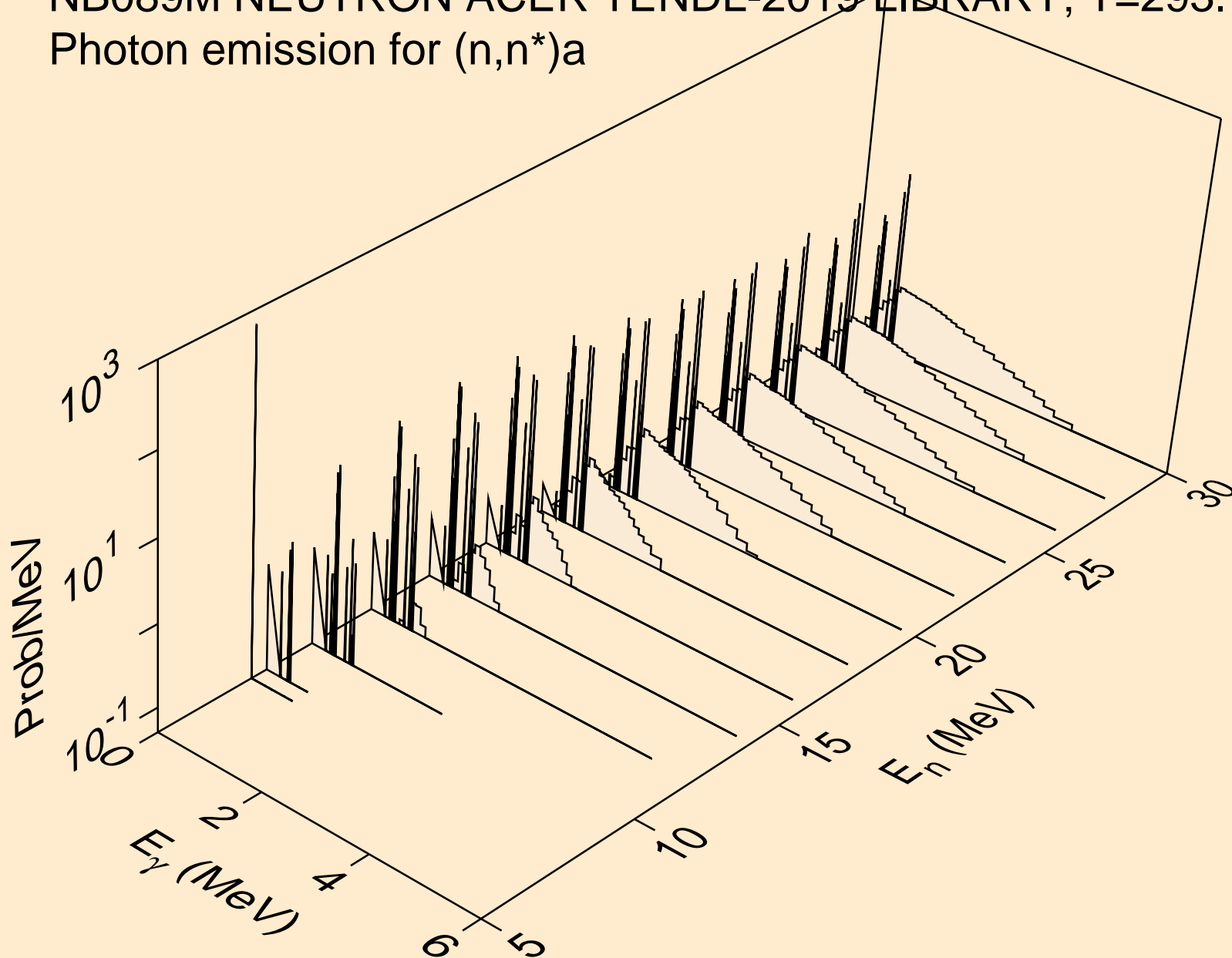



NB089M NEUTRON ACER TENDL-2019 LIBRARY; T=293.16K  
Photon emission for (n,2n)a

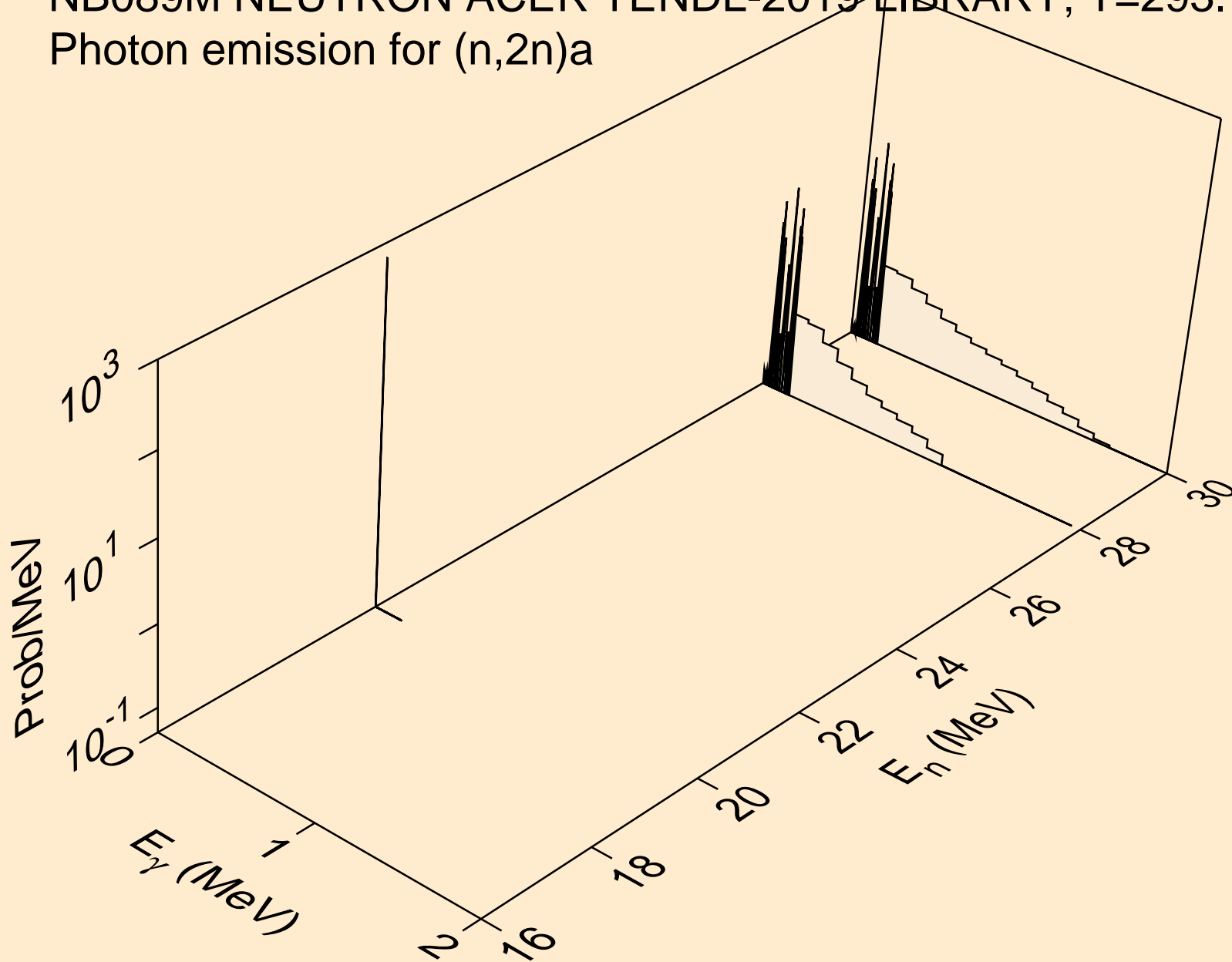

NB089M NEUTRON ACER TENDL-2019 LIBRARY; T=293.16K  
Photon emission for (n,n\*)p

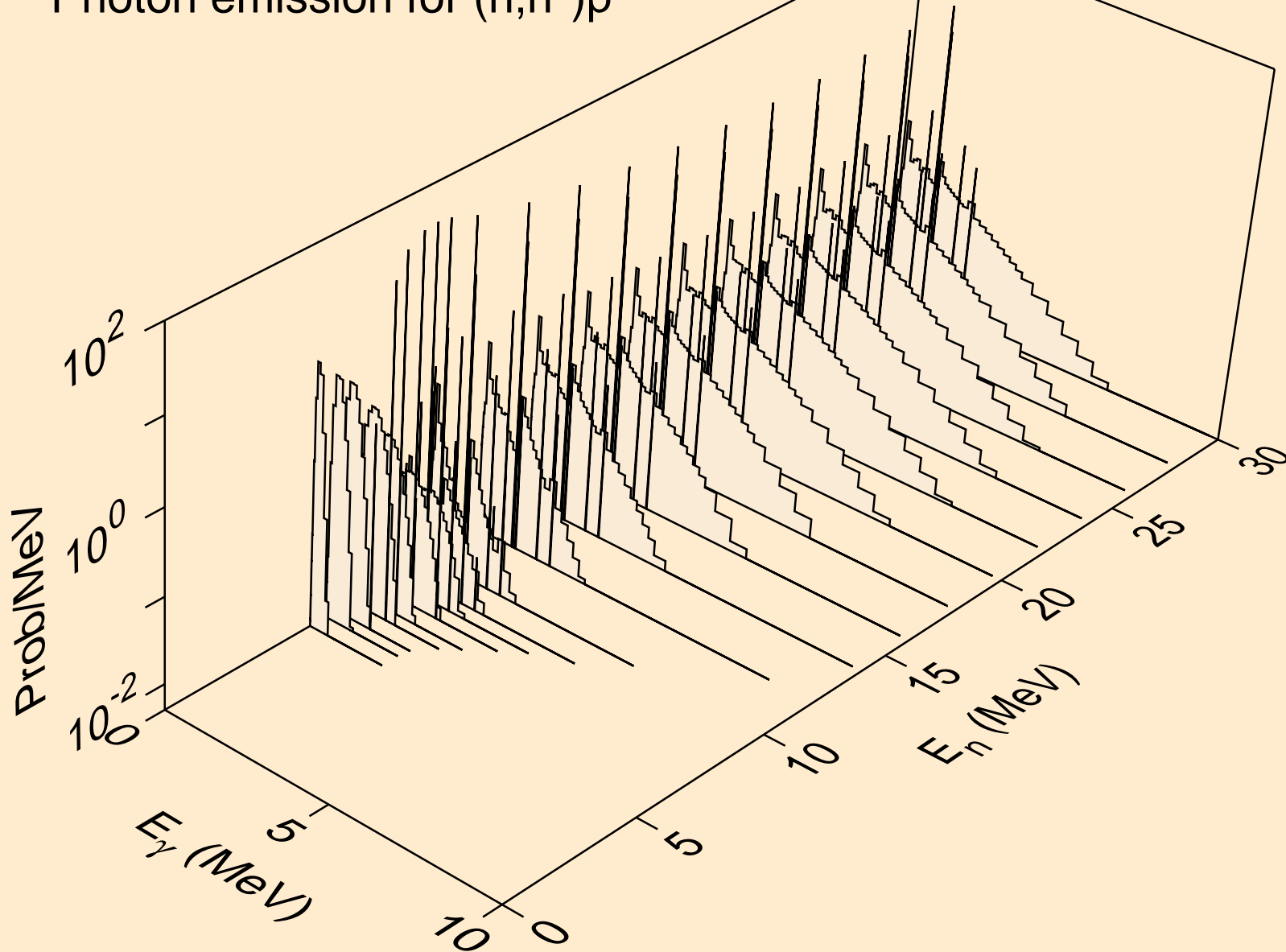

NB089M NEUTRON ACER TENDL-2019 LIBRARY; T=293.16K  
Photon emission for (n,n\*)2a

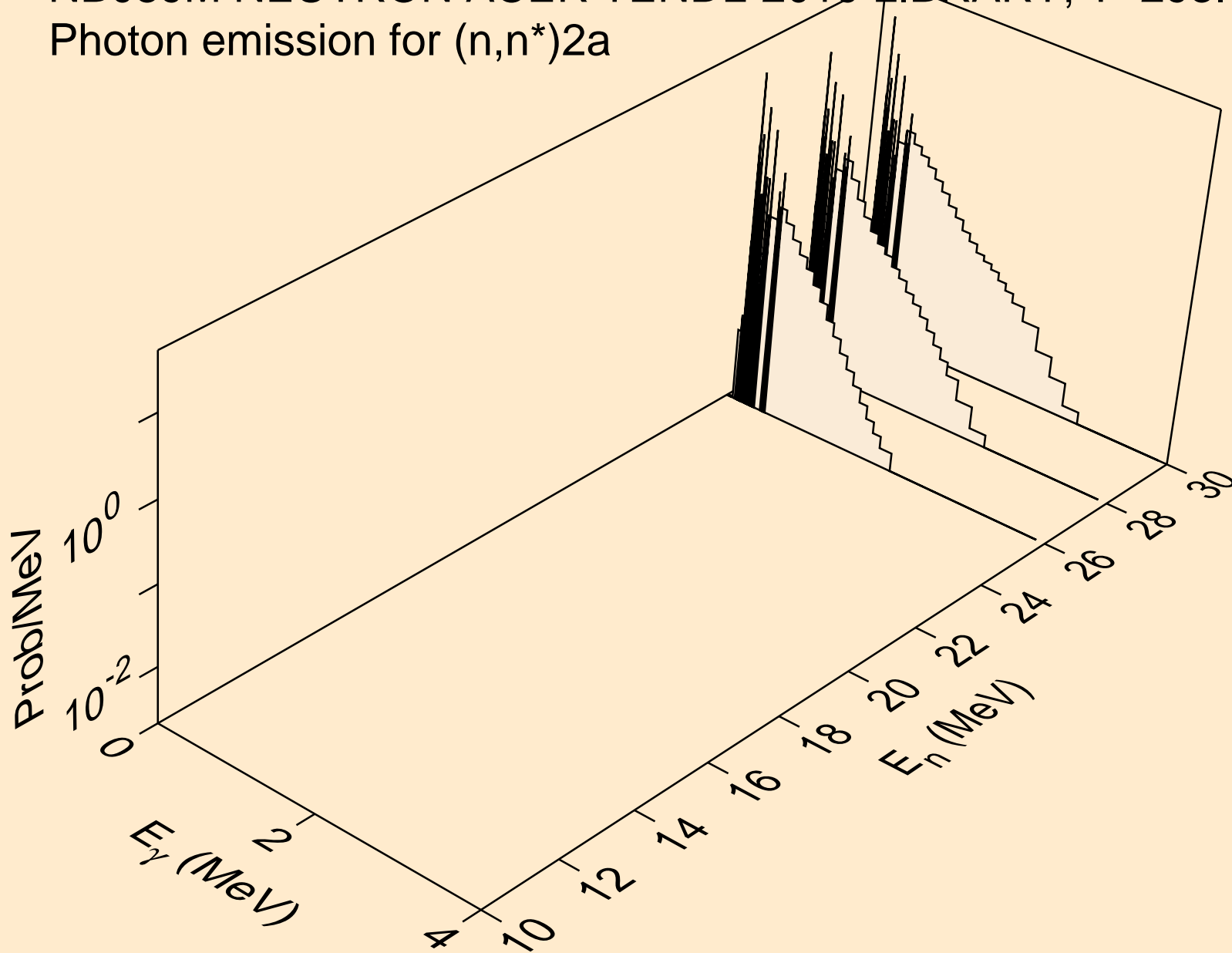

NB089M NEUTRON ACER TENDL-2019 LIBRARY; T=293.16K  
Photon emission for (n,n\*)d

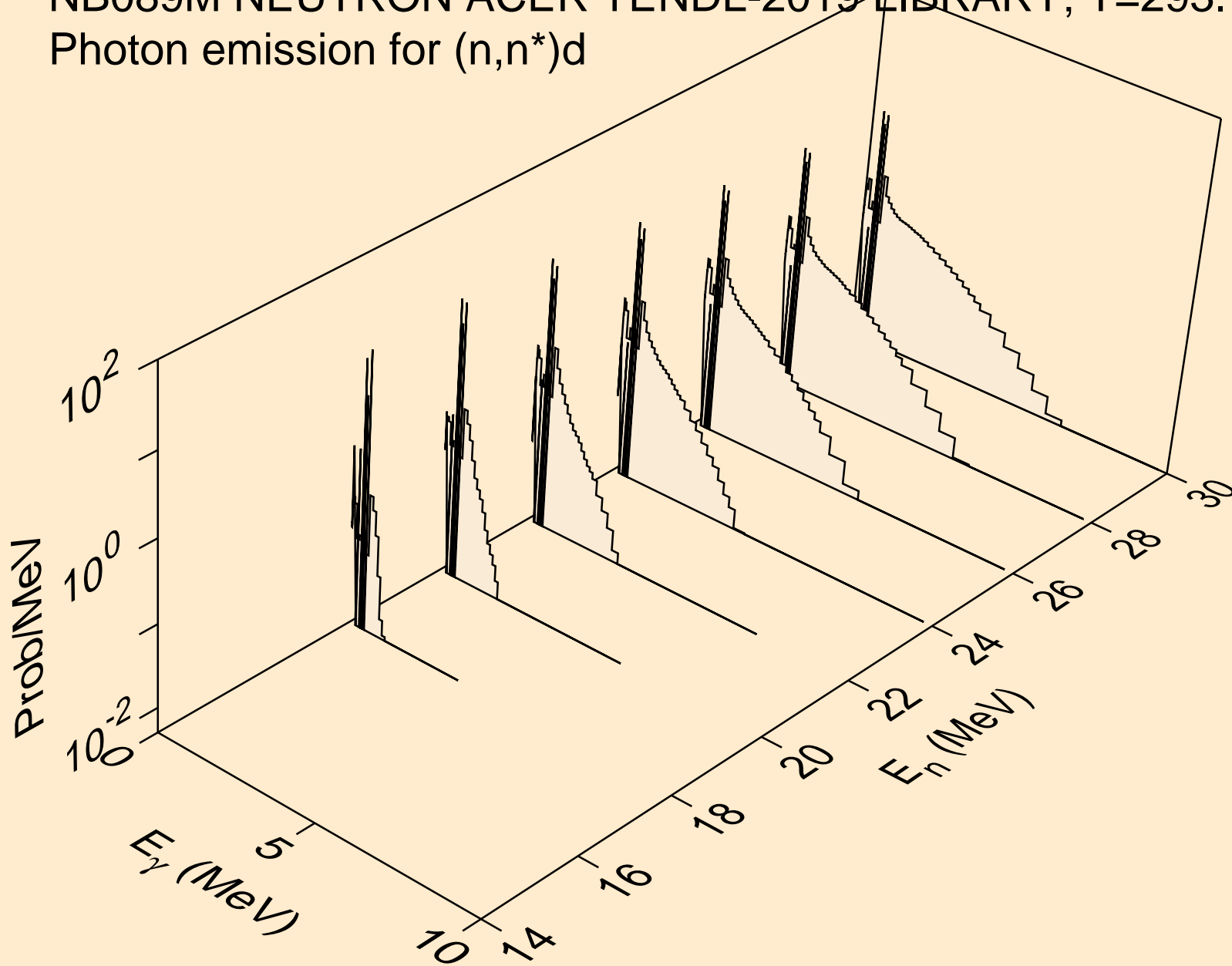

NB089M NEUTRON ACER TENDL-2019 LIBRARY; T=293.16K  
Photon emission for (n,n\*)t

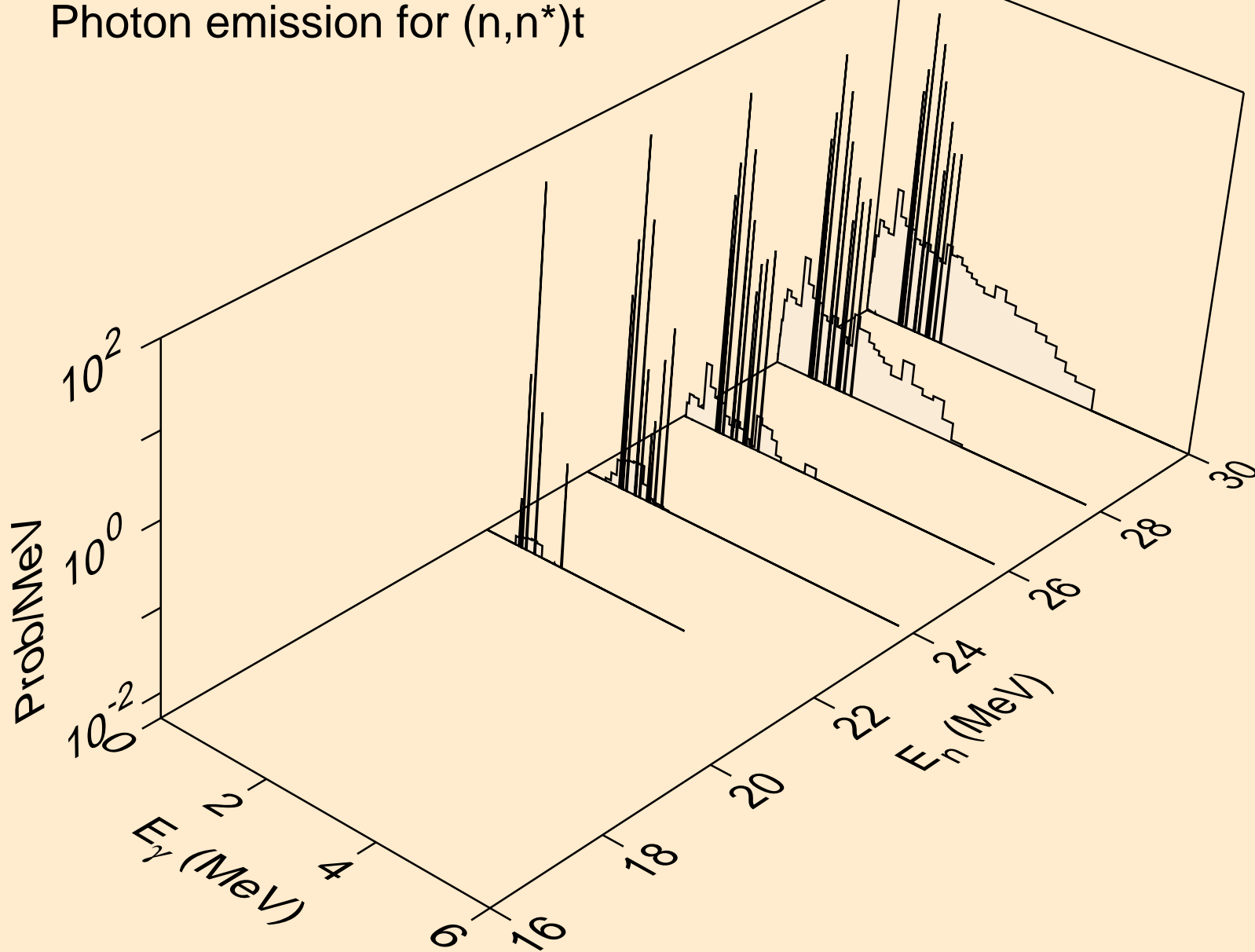

NB089M NEUTRON ACER TENDL-2019 LIBRARY; T=293.16K  
Photon emission for (n,n\*)he3

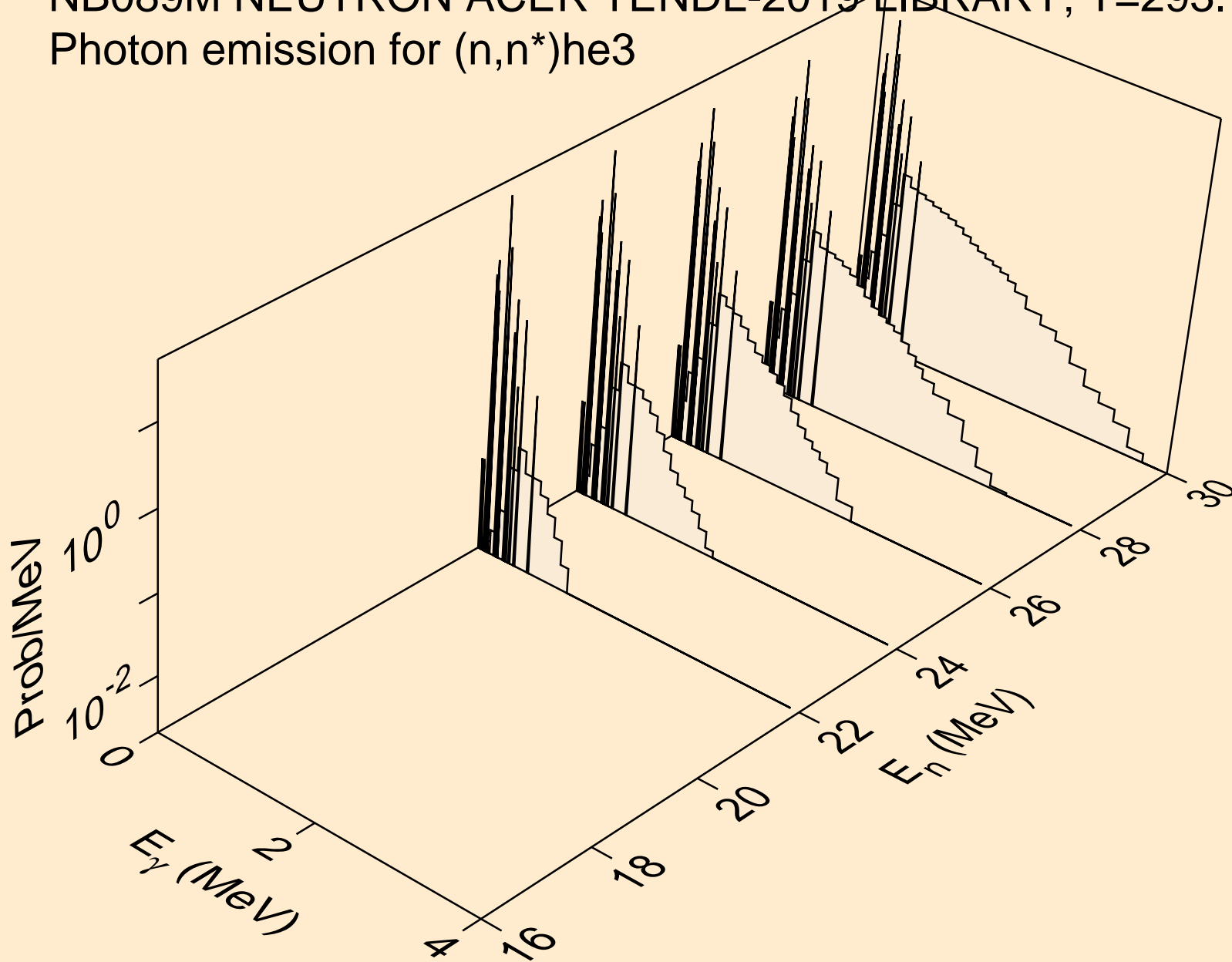

NB089M NEUTRON ACER TENDL-2019 LIBRARY; T=293.16K  
Photon emission for (n,2np)

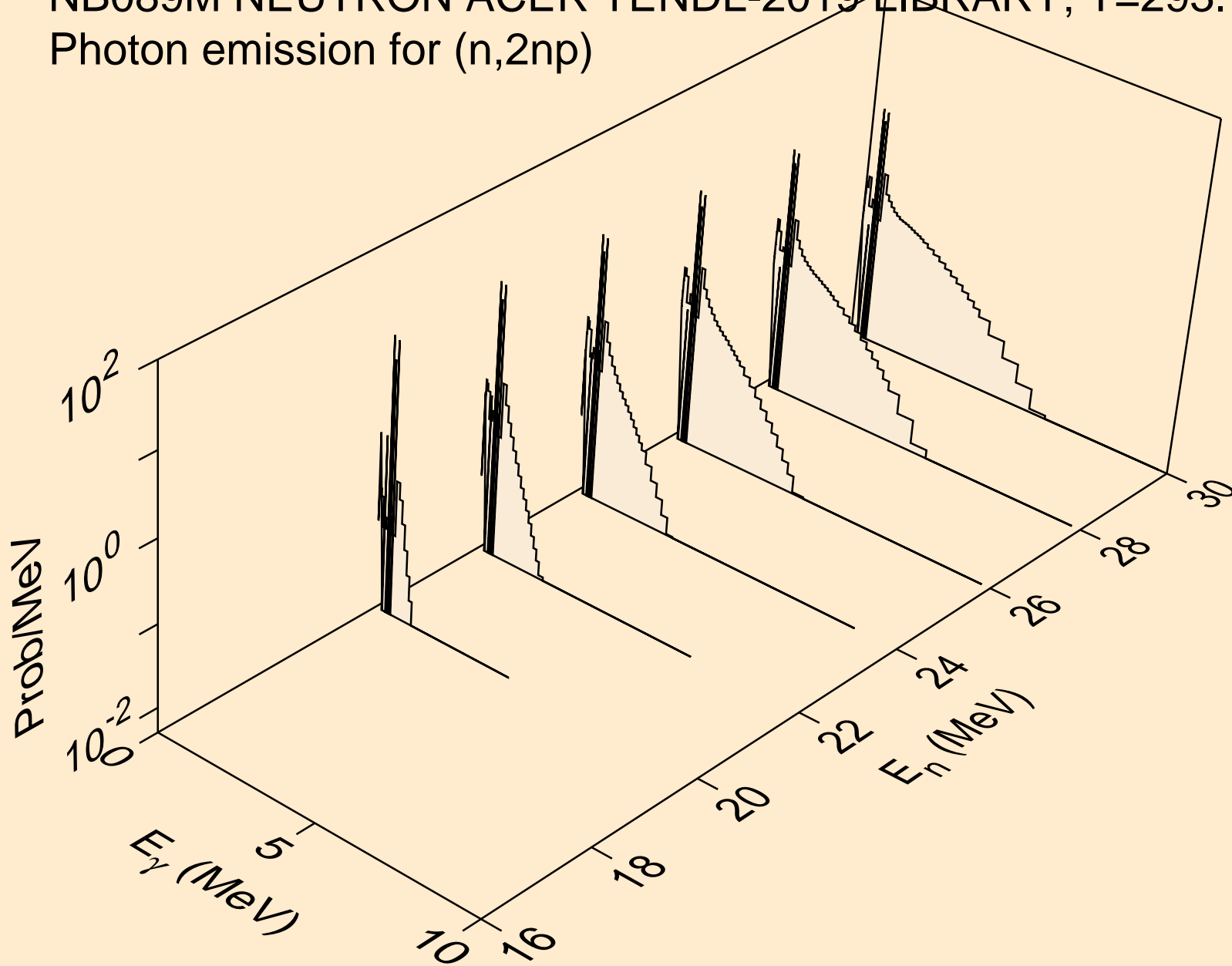

NB089M NEUTRON ACER TENDL-2019 LIBRARY; T=293.16K  
Photon emission for (n,3np)

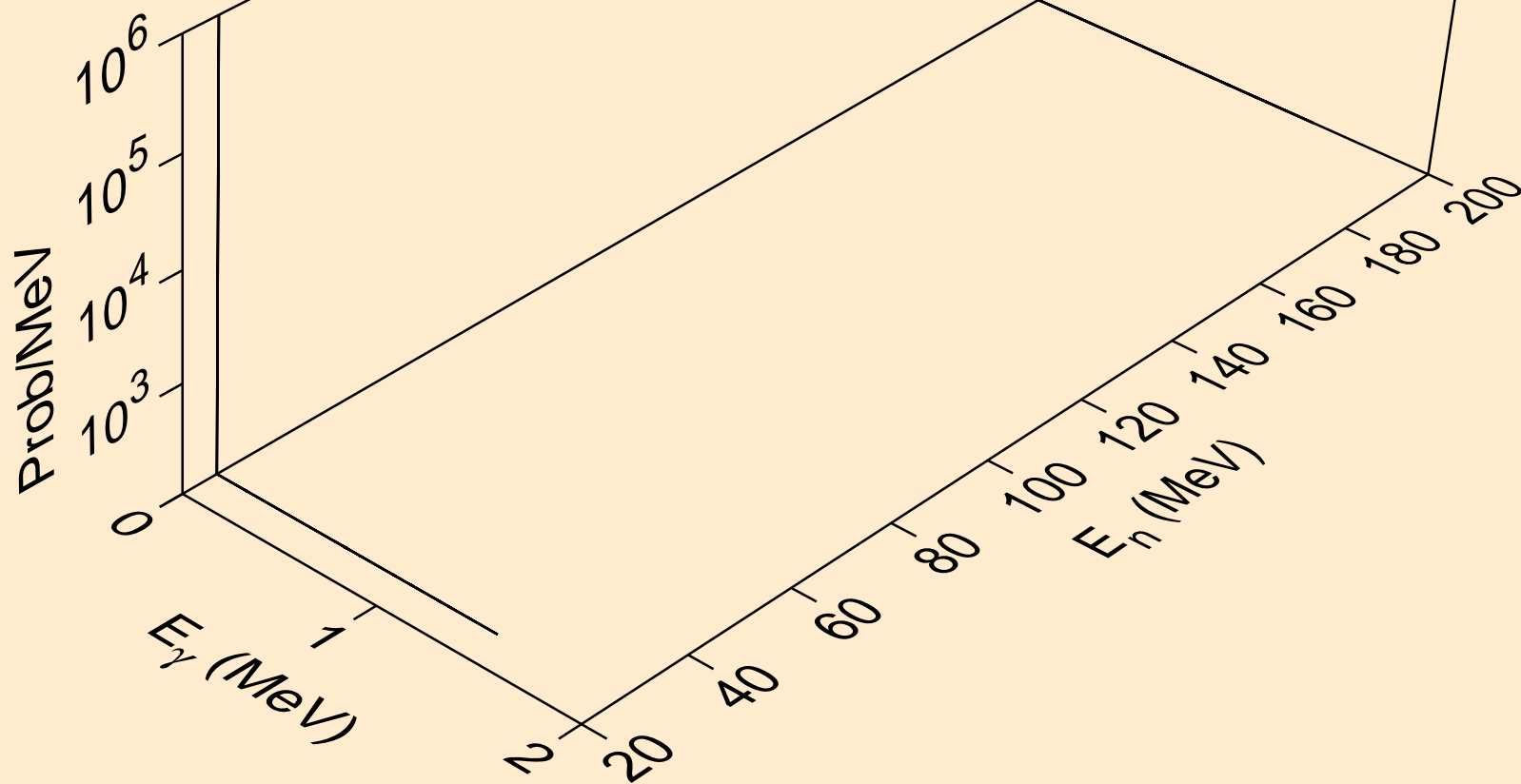



NB089M NEUTRON ACER TENDL-2019 LIBRARY; T=293.16K  
Photon emission for (n,2np)

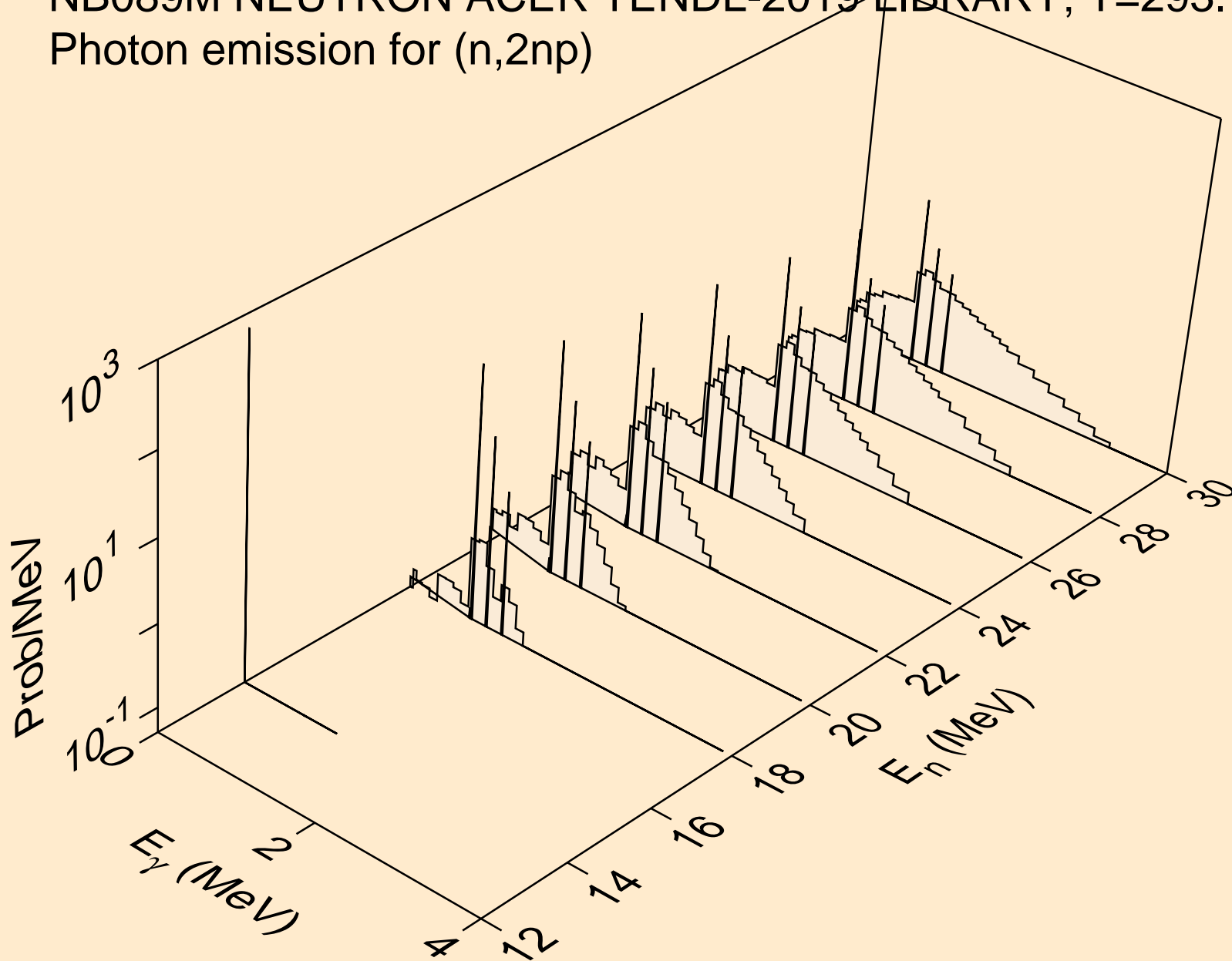

NB089M NEUTRON ACER TENDL-2019 LIBRARY; T=293.16K  
Photon emission for (n,npa)

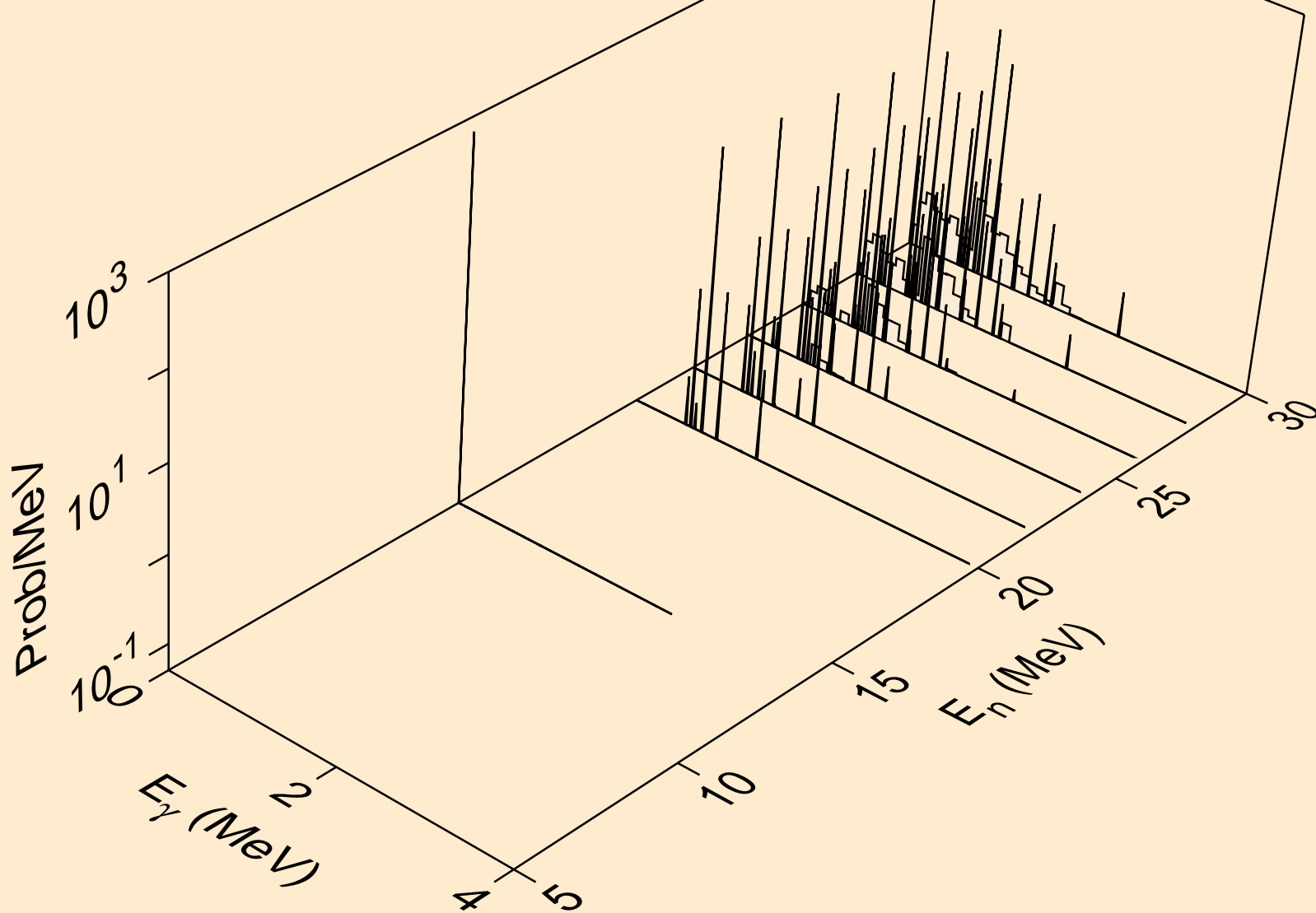

NB089M NEUTRON ACER TENDL-2019 LIBRARY; T=293.16K  
Photon emission for (n,n\*2)

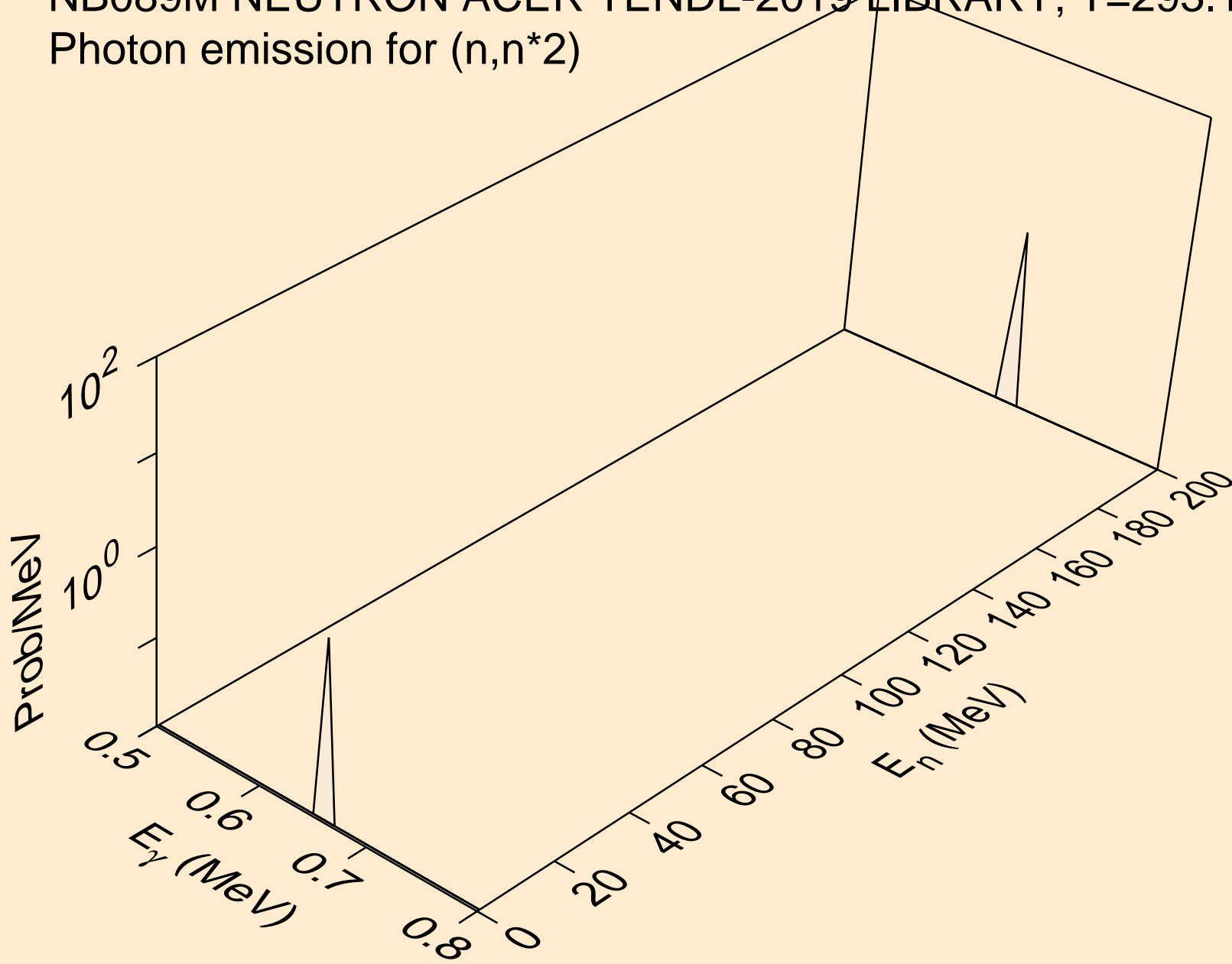

NB089M NEUTRON ACER TENDL-2019 LIBRARY; T=293.16K  
Photon emission for (n,n\*3)

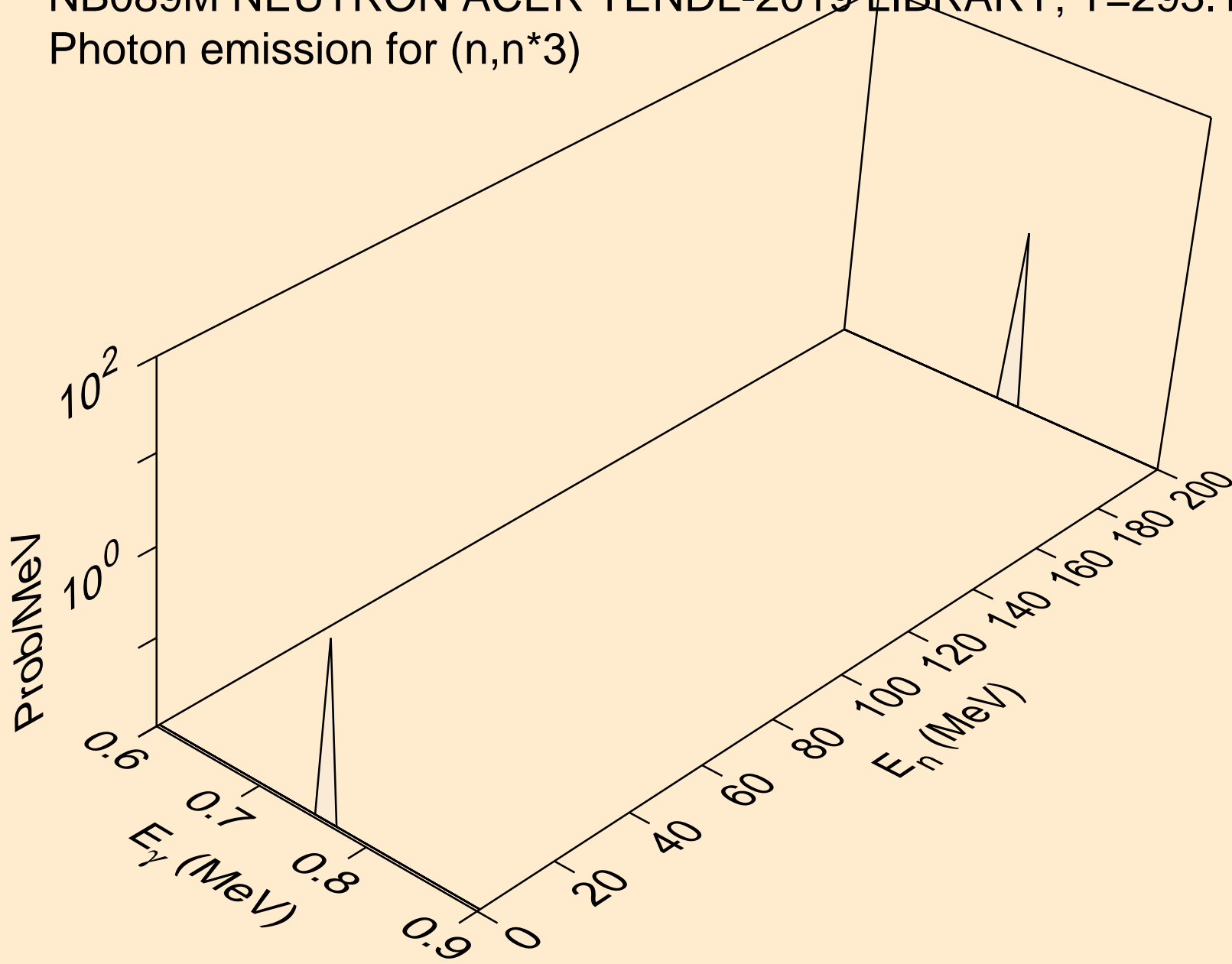

NB089M NEUTRON ACER TENDL-2019 LIBRARY; T=293.16K  
Photon emission for (n,n\*4)

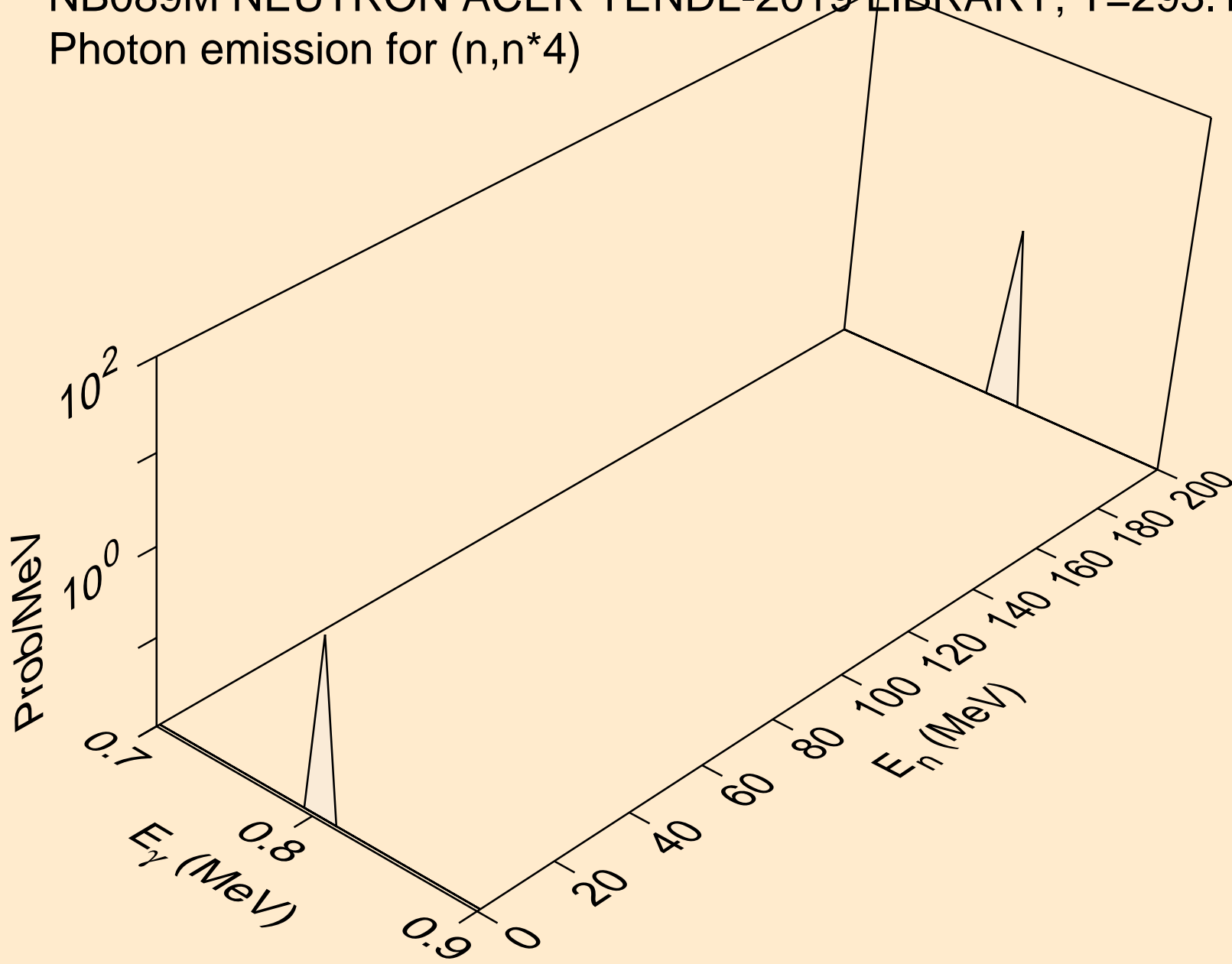

NB089M NEUTRON ACER TENDL-2019 LIBRARY; T=293.16K  
Photon emission for (n,n\*5)

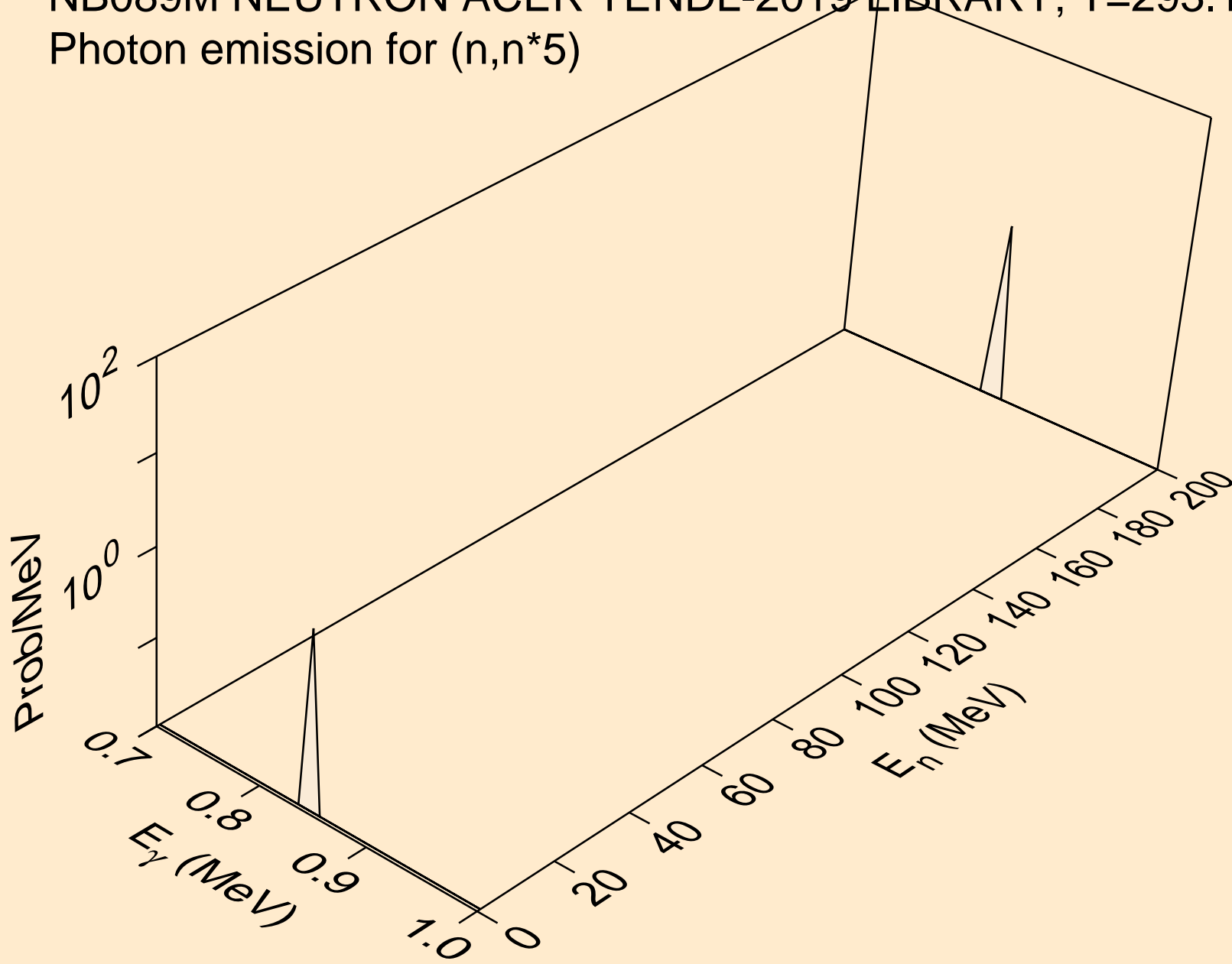

NB089M NEUTRON ACER TENDL-2019 LIBRARY; T=293.16K  
Photon emission for (n,n\*6)

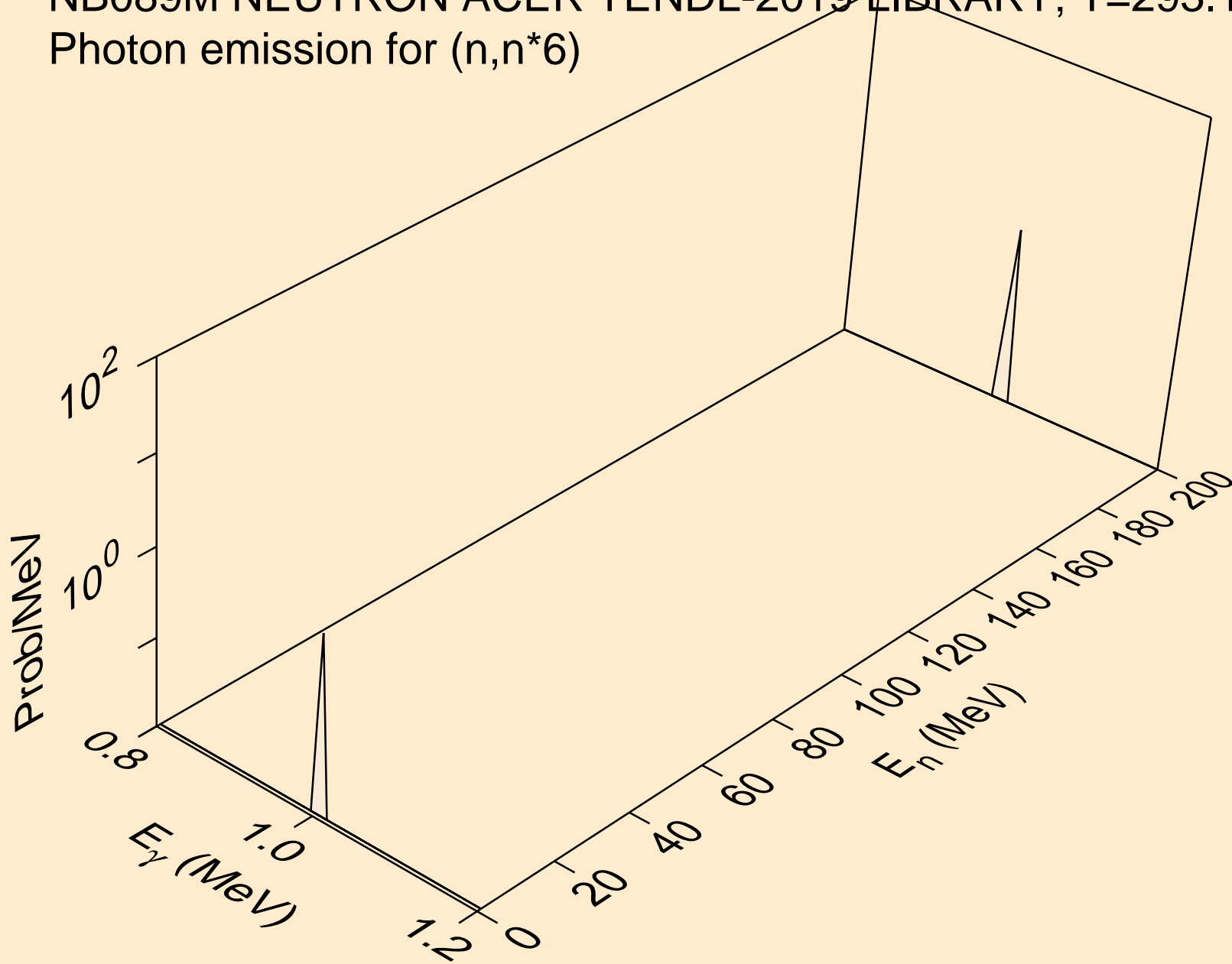

NB089M NEUTRON ACER TENDL-2019 LIBRARY; T=293.16K  
Photon emission for (n,n\*7)

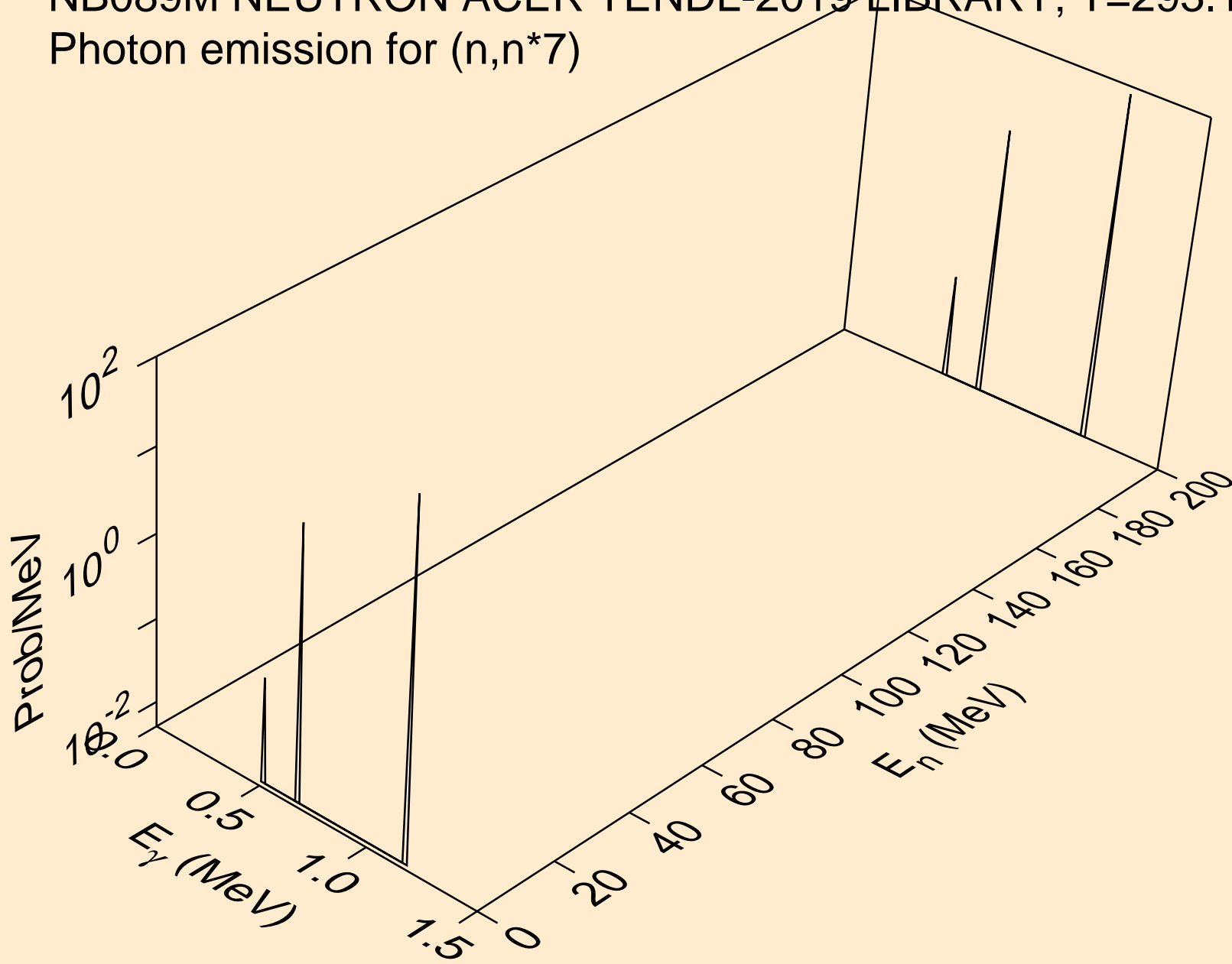



NB089M NEUTRON ACER TENDL-2019 LIBRARY; T=293.16K  
Photon emission for (n,n\*8)

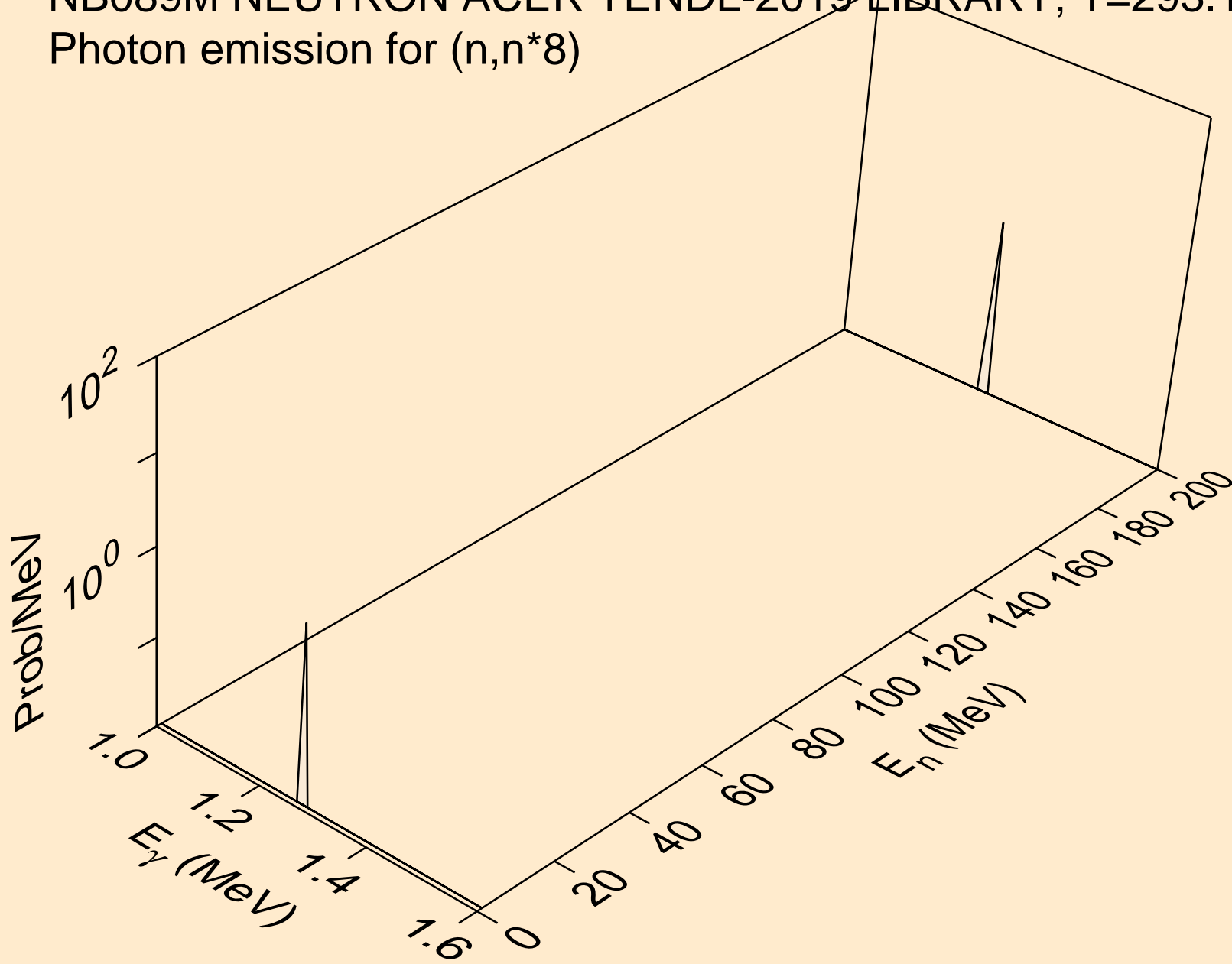

NB089M NEUTRON ACER TENDL-2019 LIBRARY; T=293.16K  
Photon emission for (n,n\*9)

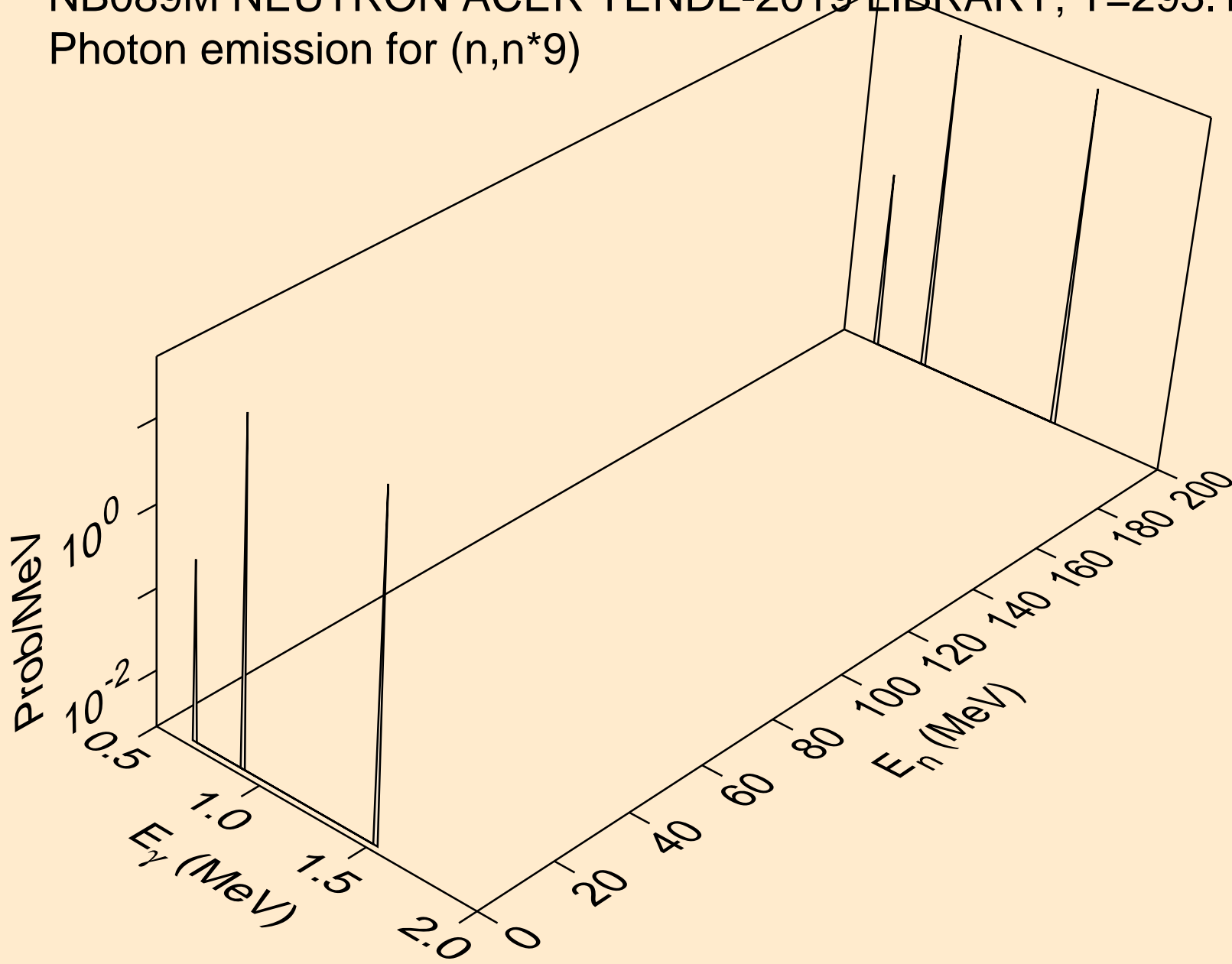

NB089M NEUTRON ACER TENDL-2019 LIBRARY; T=293.16K  
Photon emission for (n,n\*10)

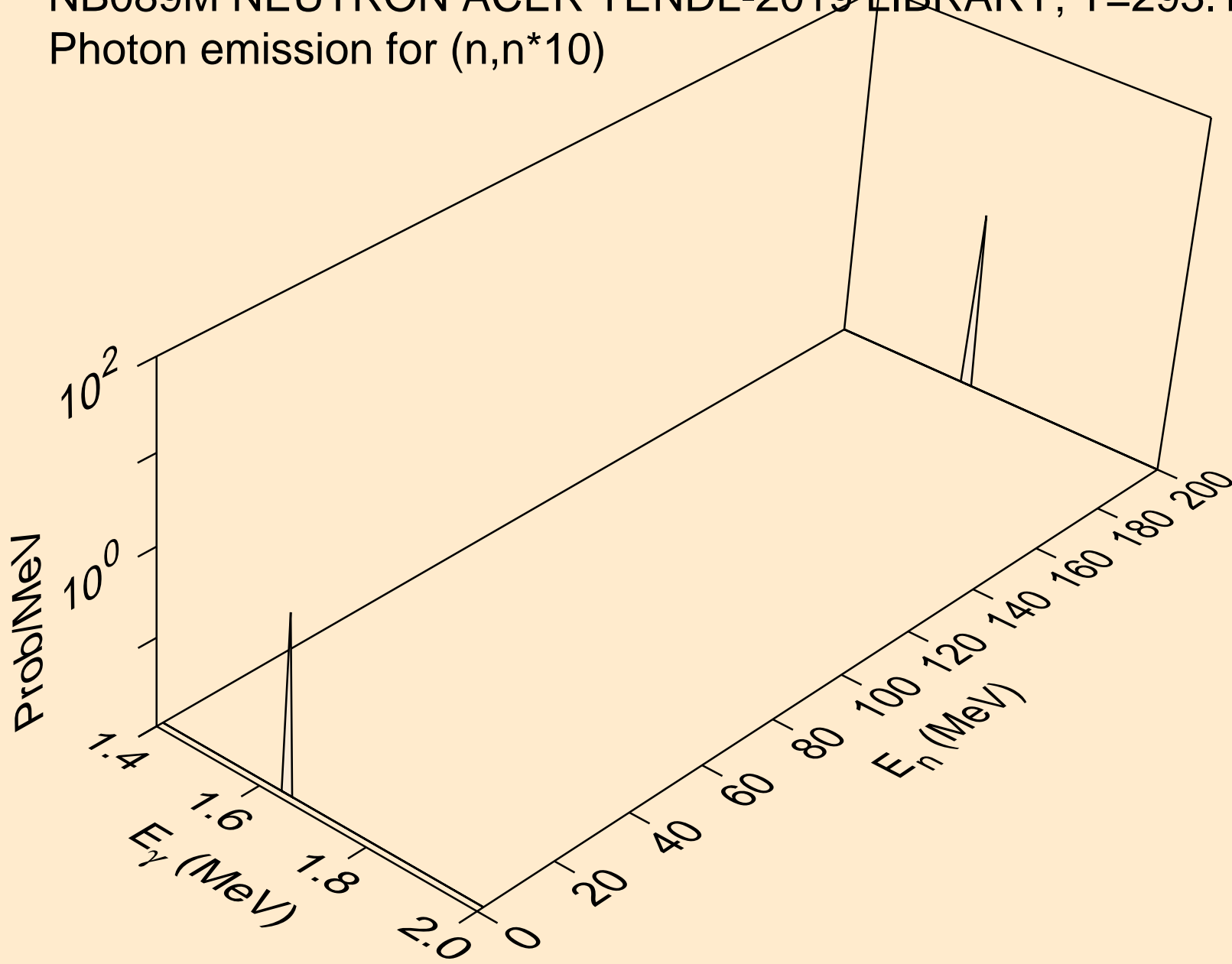

NB089M NEUTRON ACER TENDL-2019 LIBRARY; T=293.16K  
Photon emission for (n,n\*11)

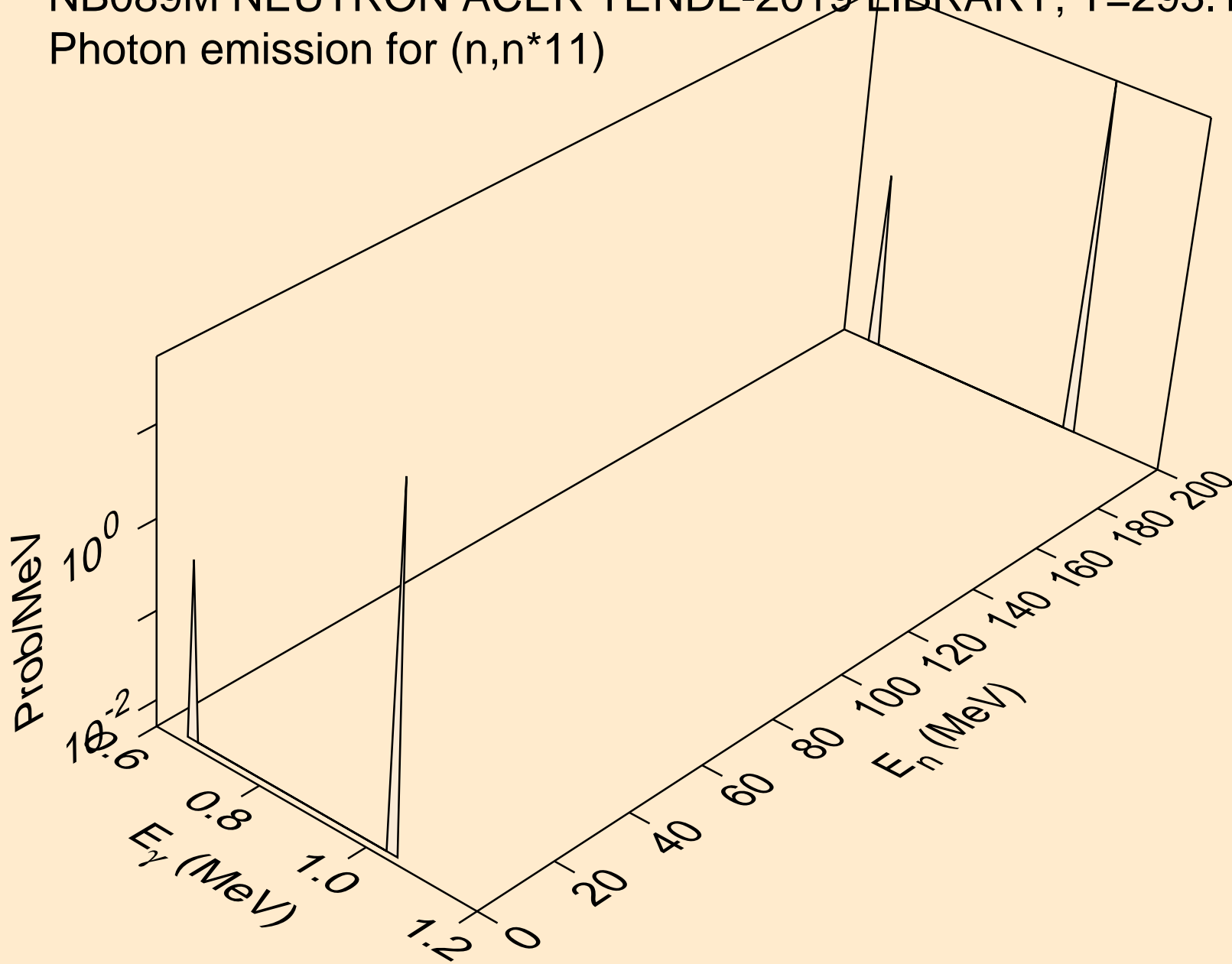

NB089M NEUTRON ACER TENDL-2019 LIBRARY; T=293.16K  
Photon emission for (n,n\*12)

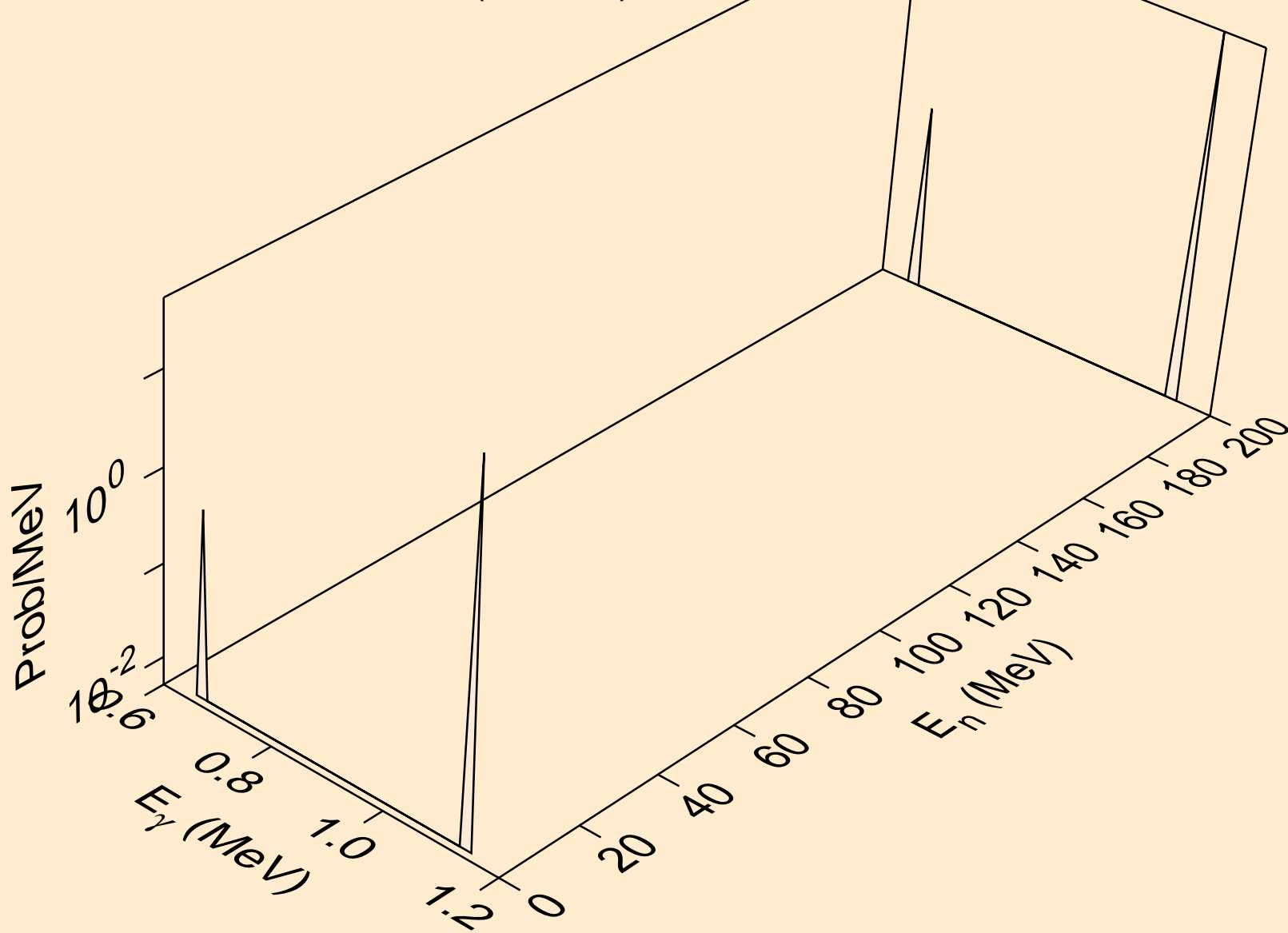

NB089M NEUTRON ACER TENDL-2019 LIBRARY; T=293.16K  
Photon emission for (n,n\*13)

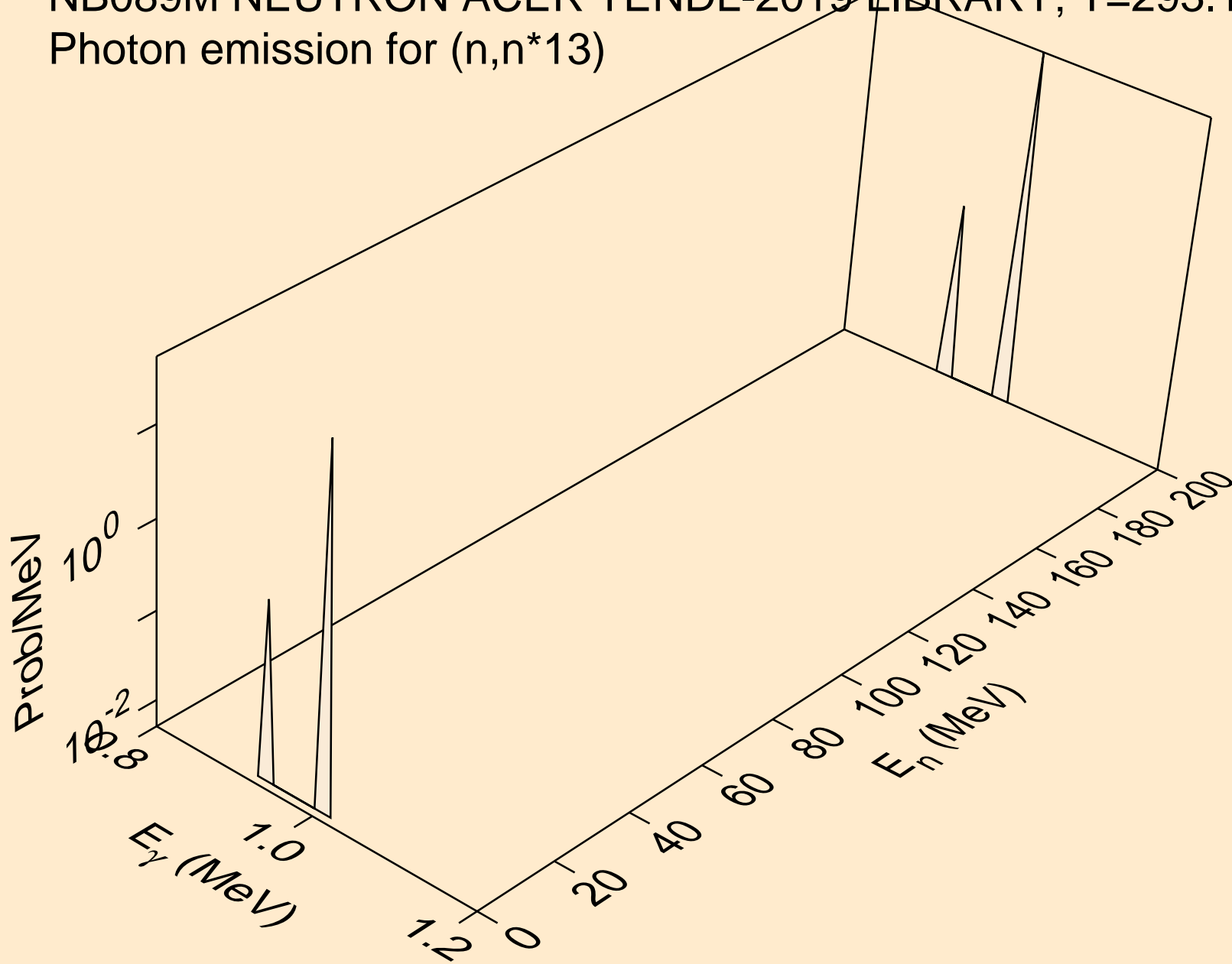

NB089M NEUTRON ACER TENDL-2019 LIBRARY; T=293.16K  
Photon emission for (n,n\*14)

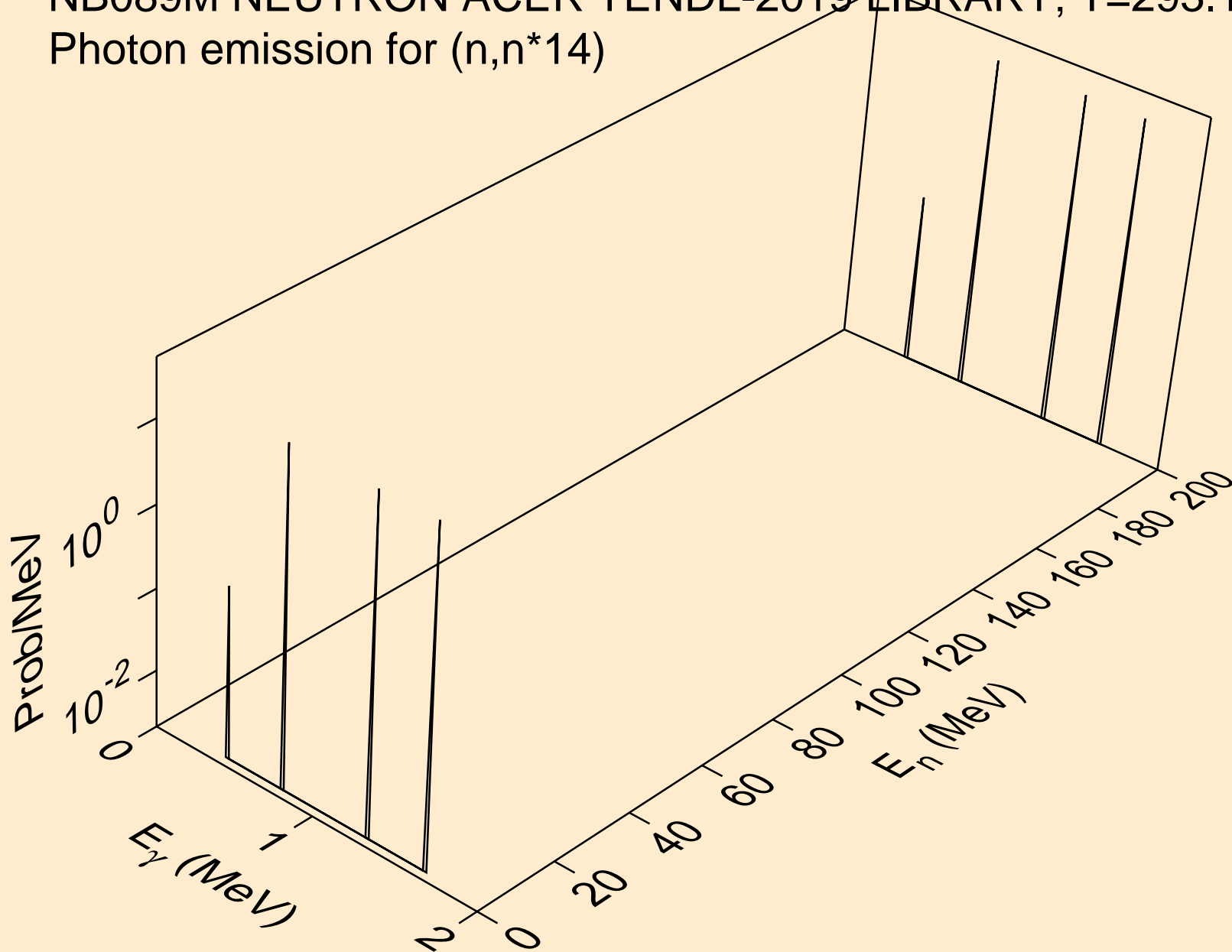

NB089M NEUTRON ACER TENDL-2019 LIBRARY; T=293.16K  
Photon emission for (n,n\*15)

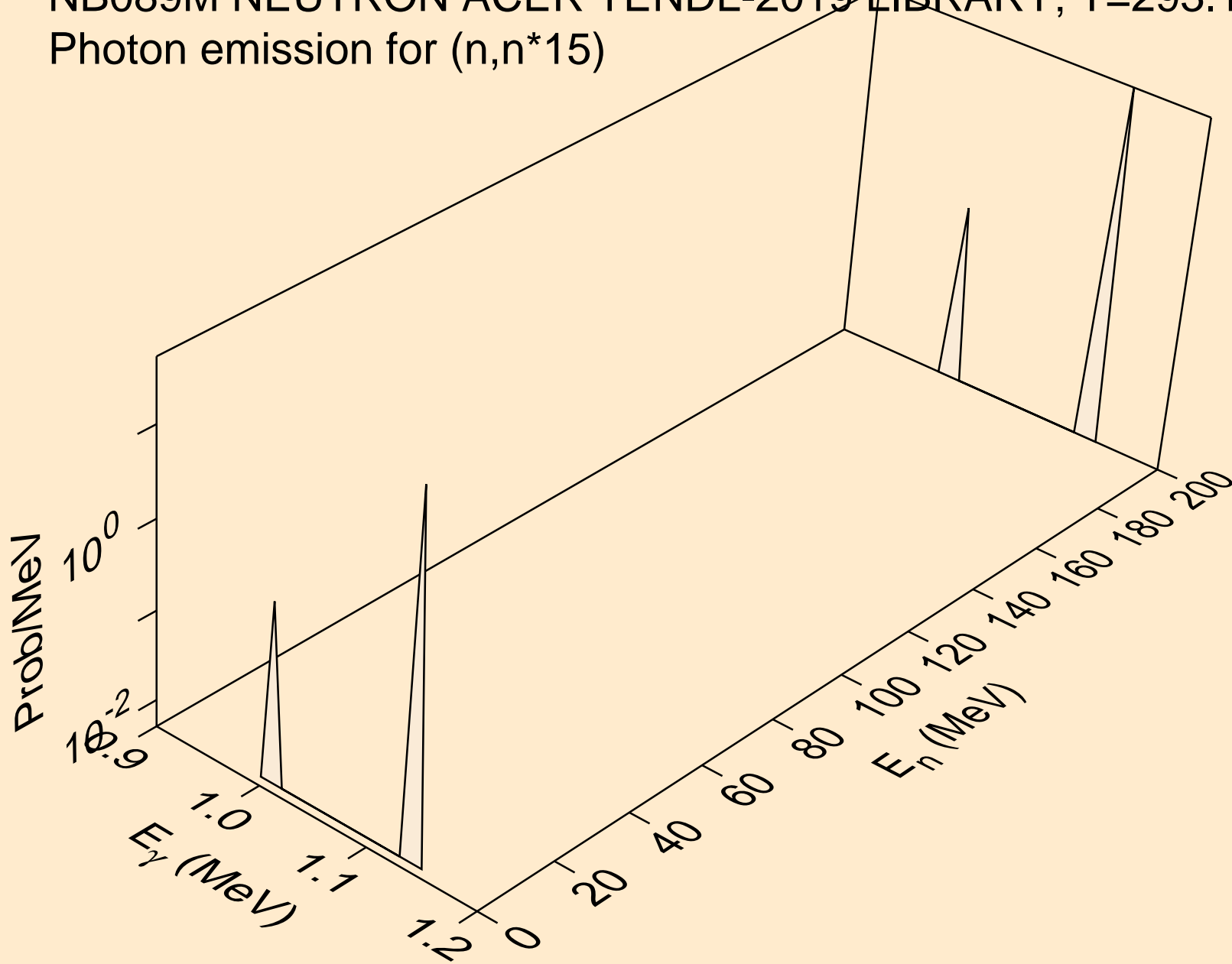



NB089M NEUTRON ACER TENDL-2019 LIBRARY; T=293.16K  
Photon emission for (n,n\*16)

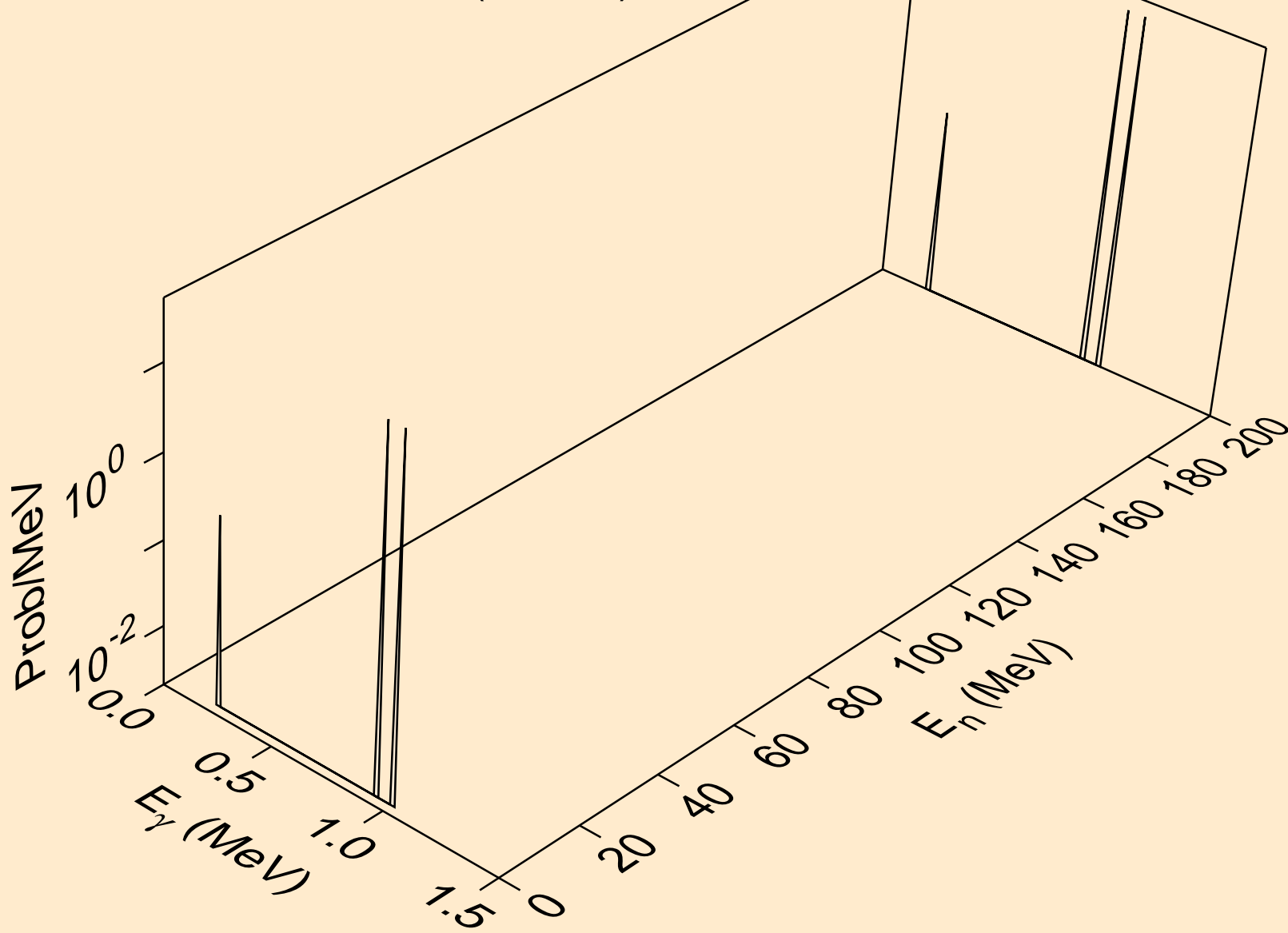

NB089M NEUTRON ACER TENDL-2019 LIBRARY; T=293.16K  
Photon emission for (n,n\*17)

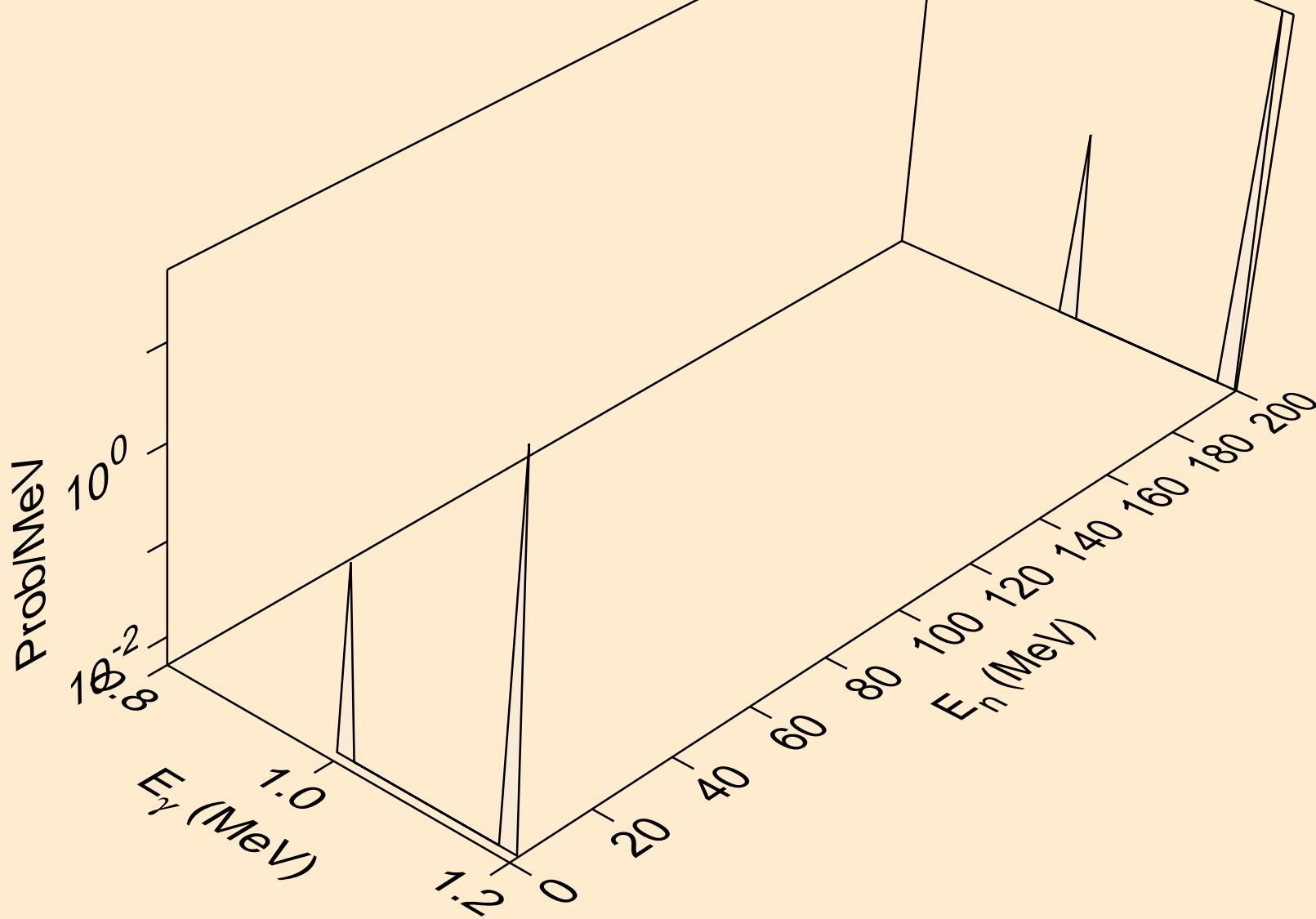

NB089M NEUTRON ACER TENDL-2019 LIBRARY; T=293.16K  
Photon emission for (n,n\*18)

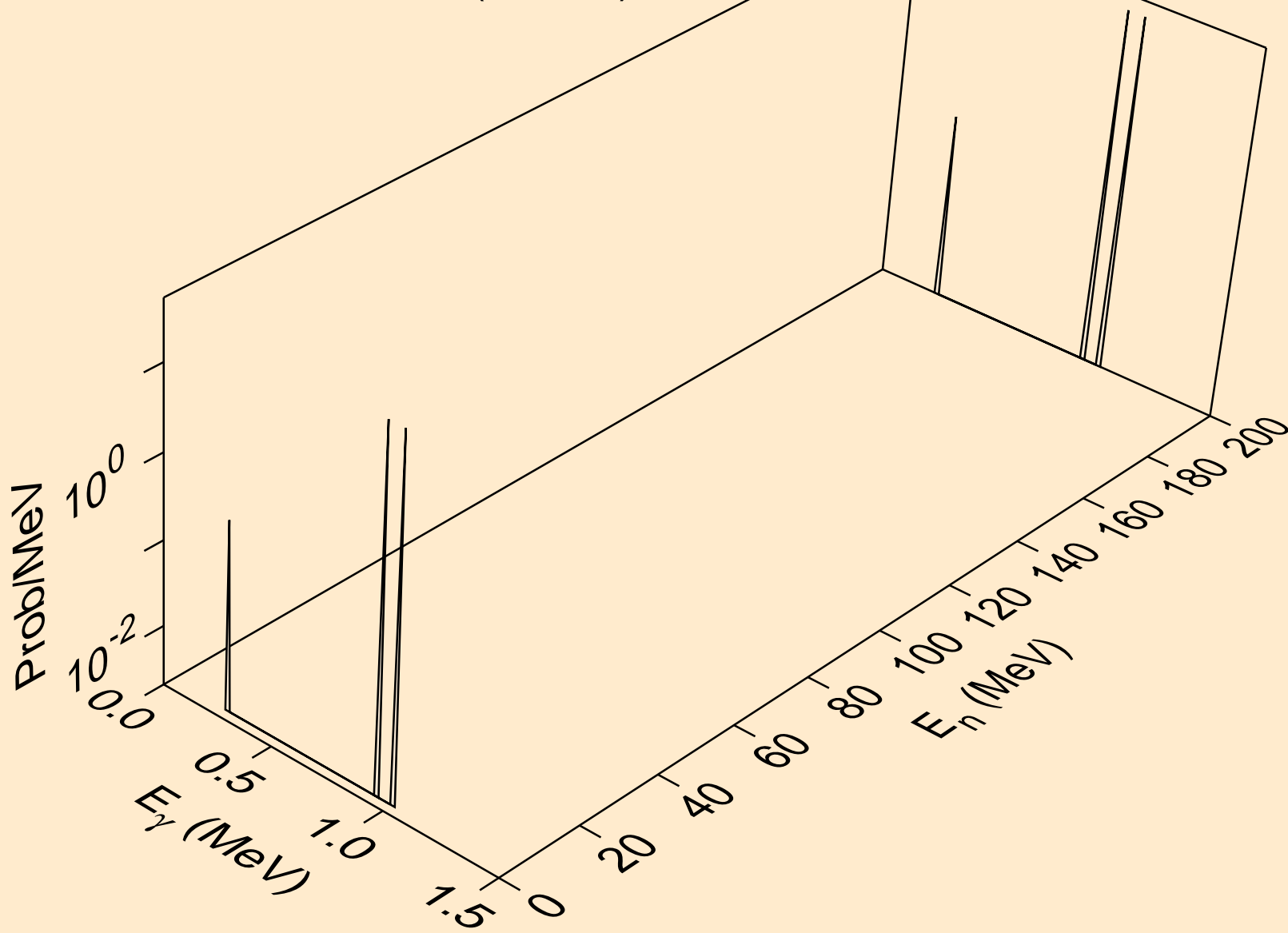

NB089M NEUTRON ACER TENDL-2019 LIBRARY; T=293.16K  
Photon emission for (n,n\*19)

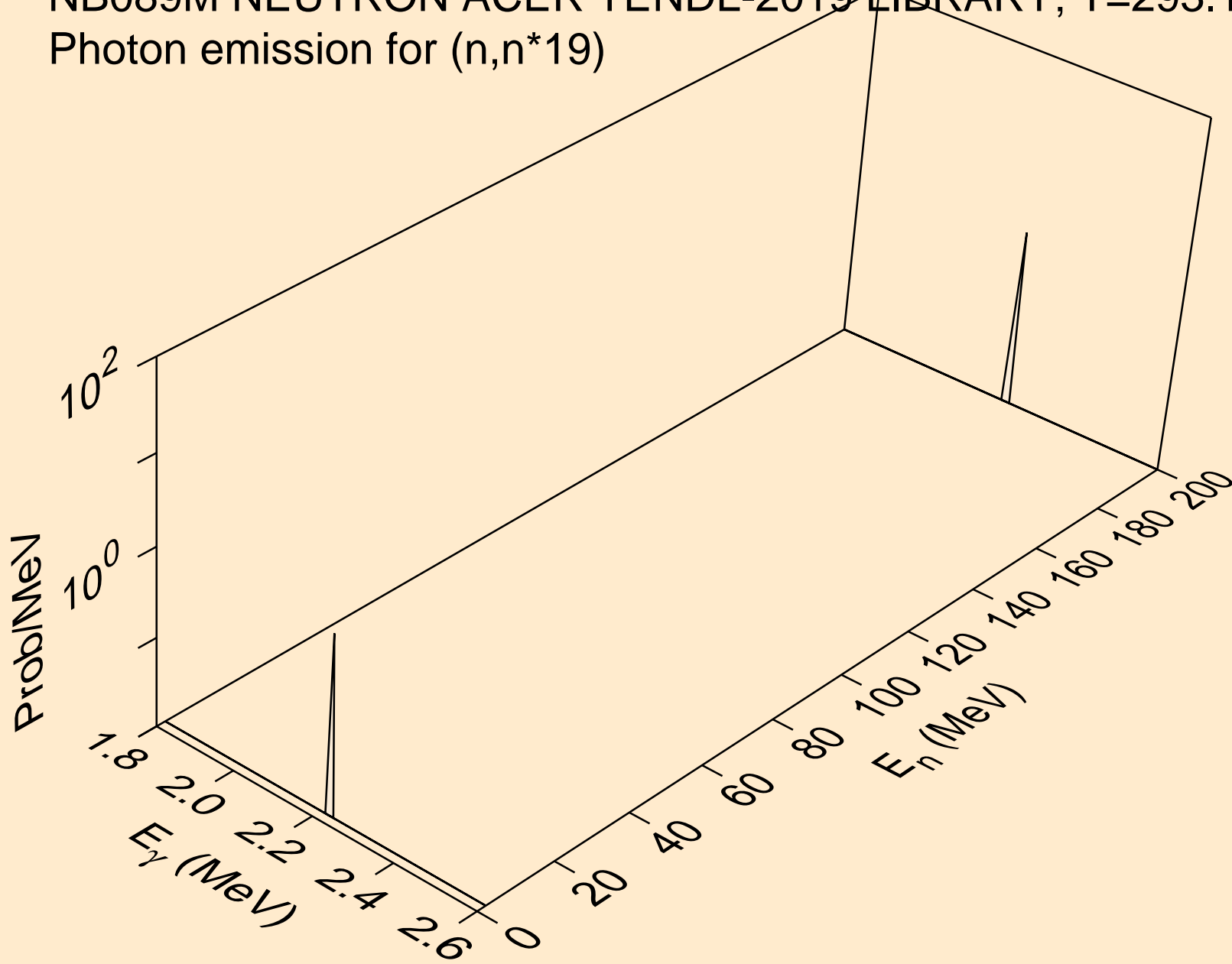

NB089M NEUTRON ACER TENDL-2019 LIBRARY; T=293.16K  
Photon emission for (n,n\*20)

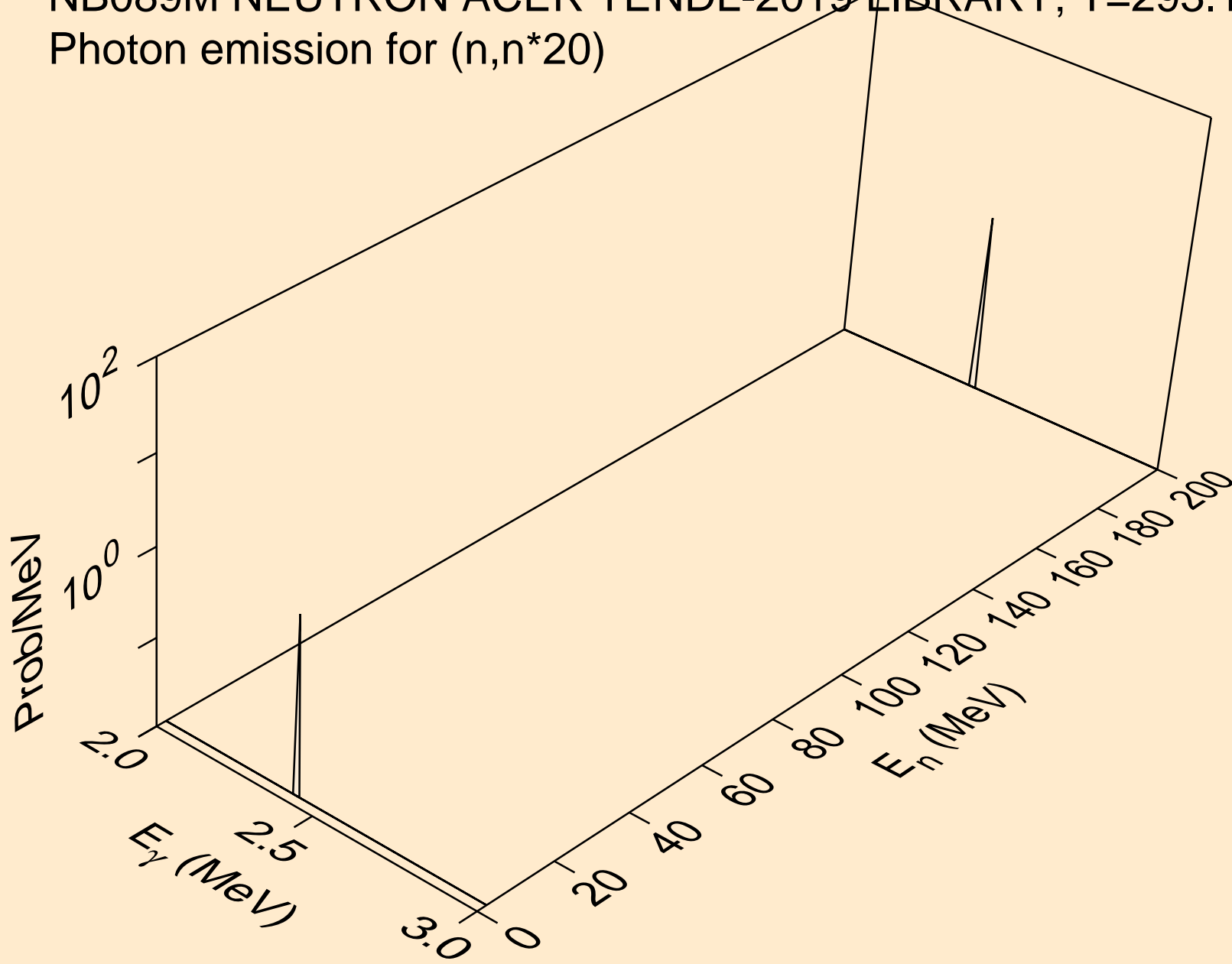

NB089M NEUTRON ACER TENDL-2019 LIBRARY; T=293.16K  
Photon emission for (n,n\*21)

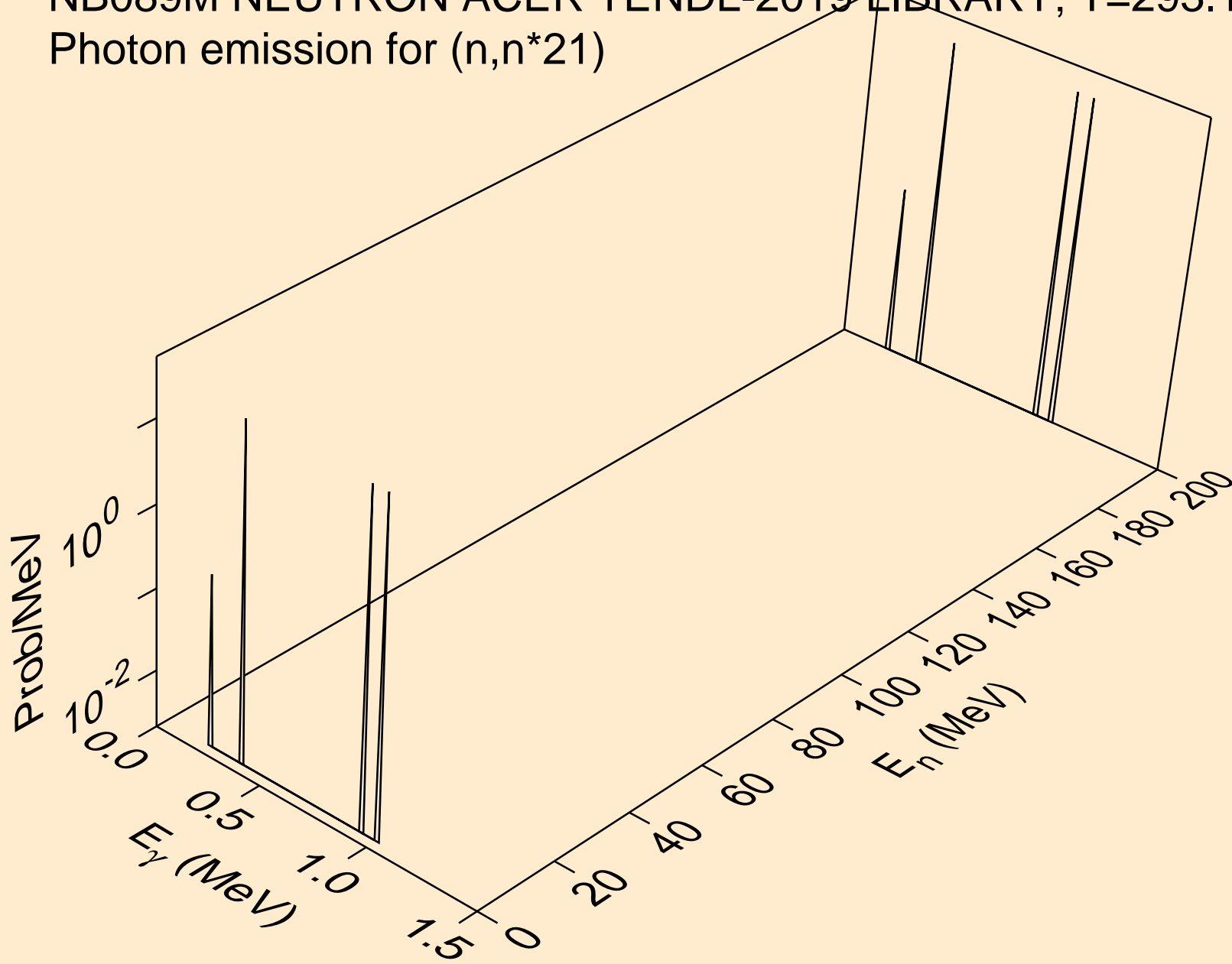

NB089M NEUTRON ACER TENDL-2019 LIBRARY; T=293.16K  
Photon emission for (n,n\*22)

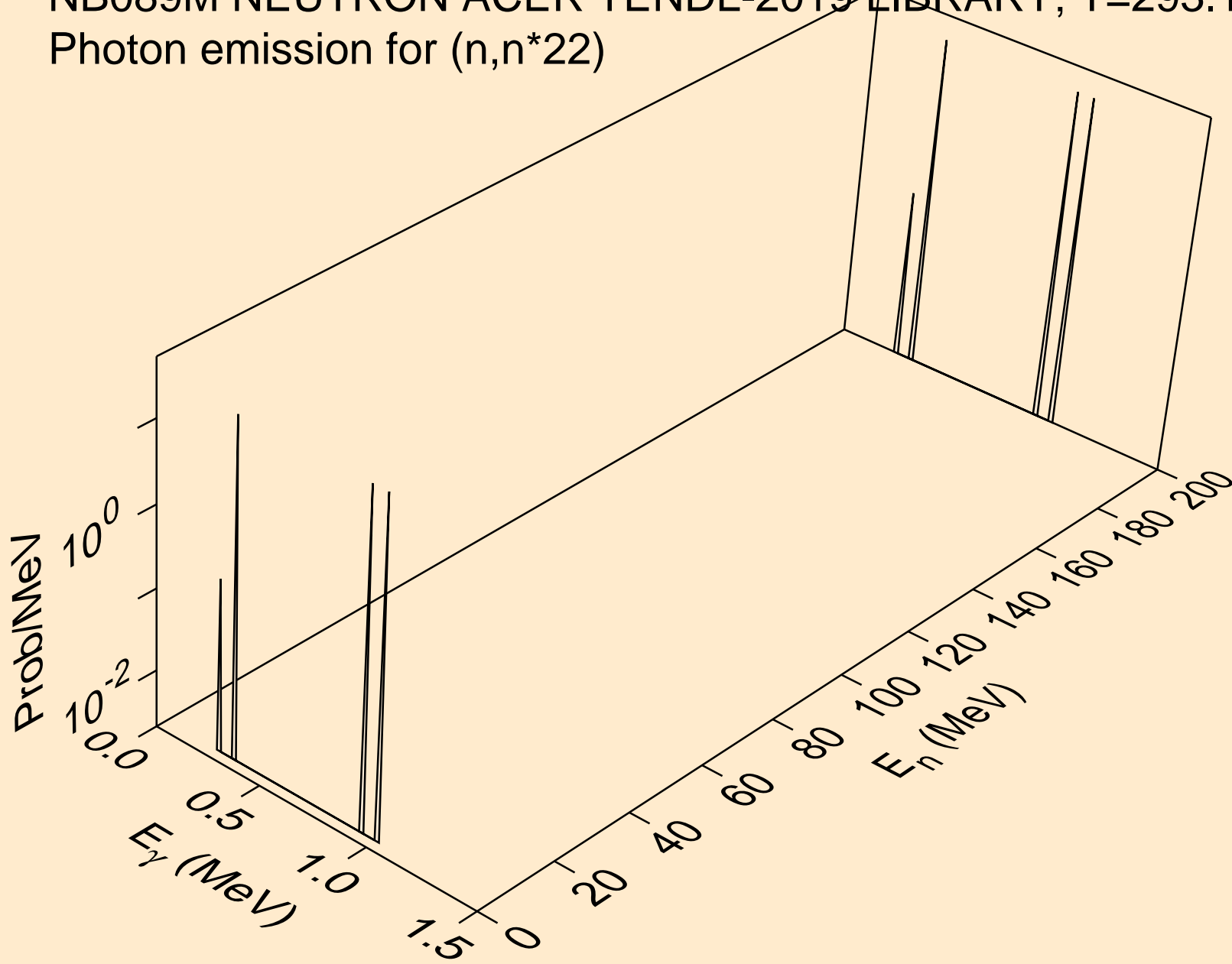

NB089M NEUTRON ACER TENDL-2019 LIBRARY; T=293.16K  
Photon emission for (n,n\*23)

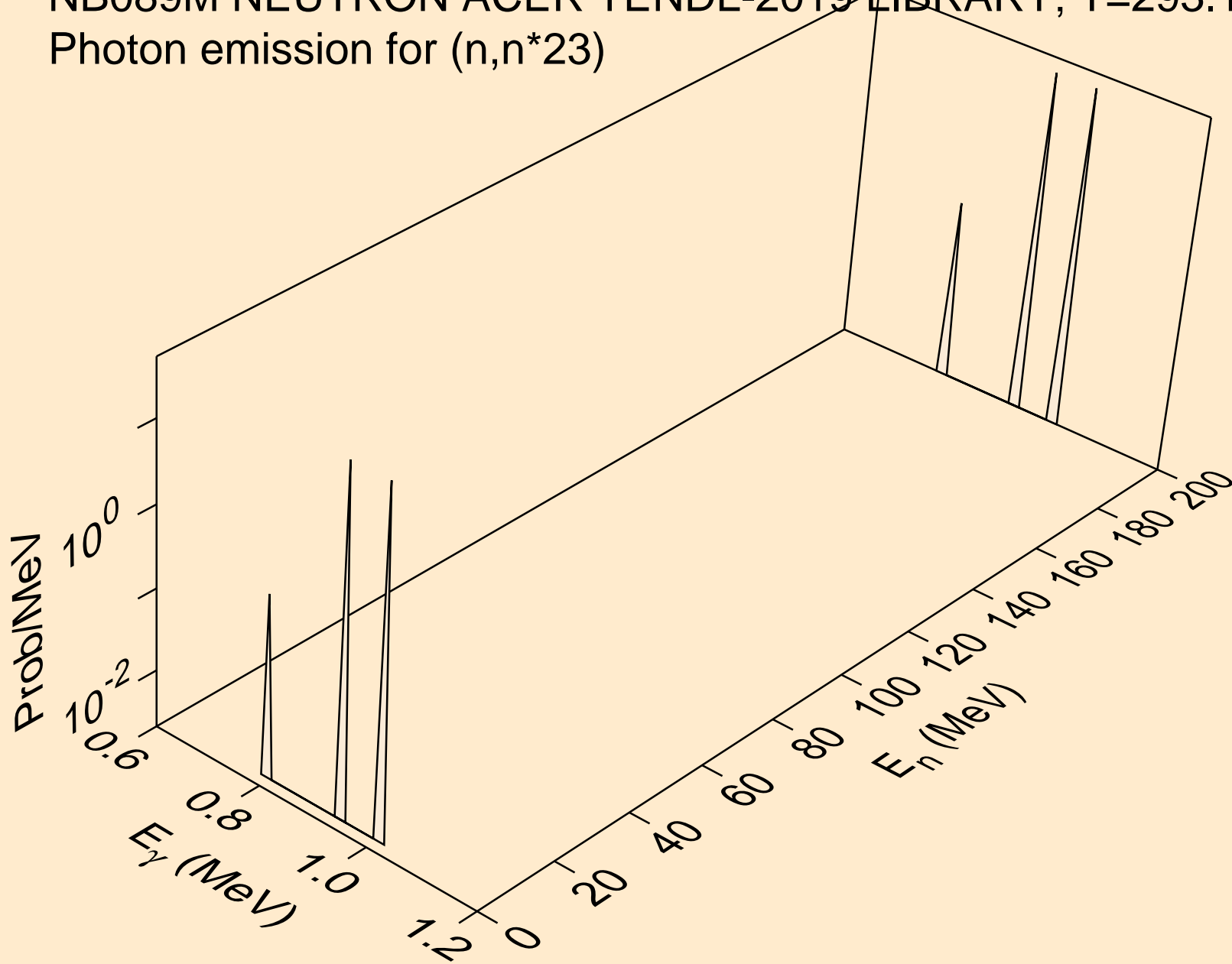



NB089M NEUTRON ACER TENDL-2019 LIBRARY; T=293.16K  
Photon emission for (n,n\*24)

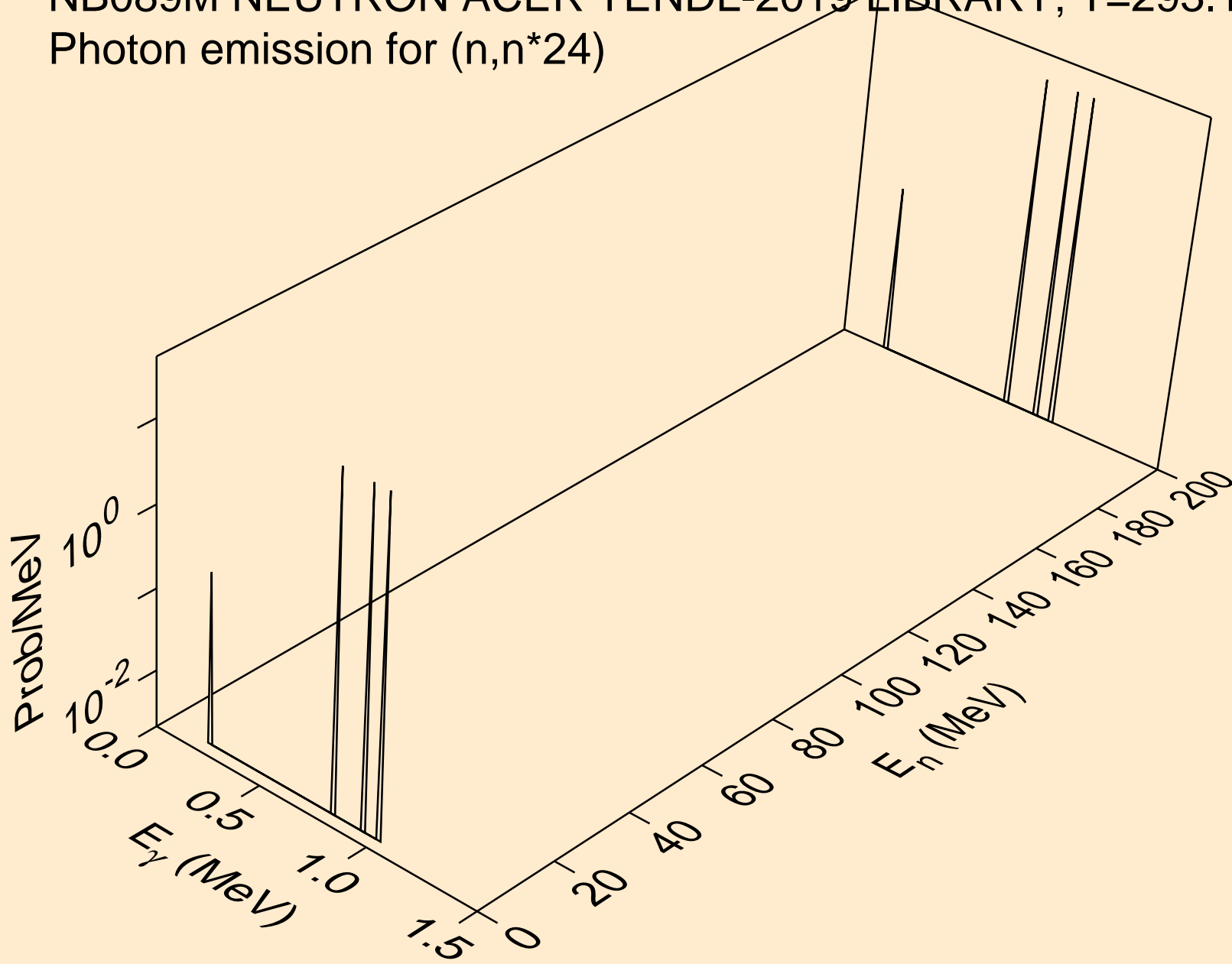

NB089M NEUTRON ACER TENDL-2019 LIBRARY; T=293.16K  
Photon emission for (n,n\*c)

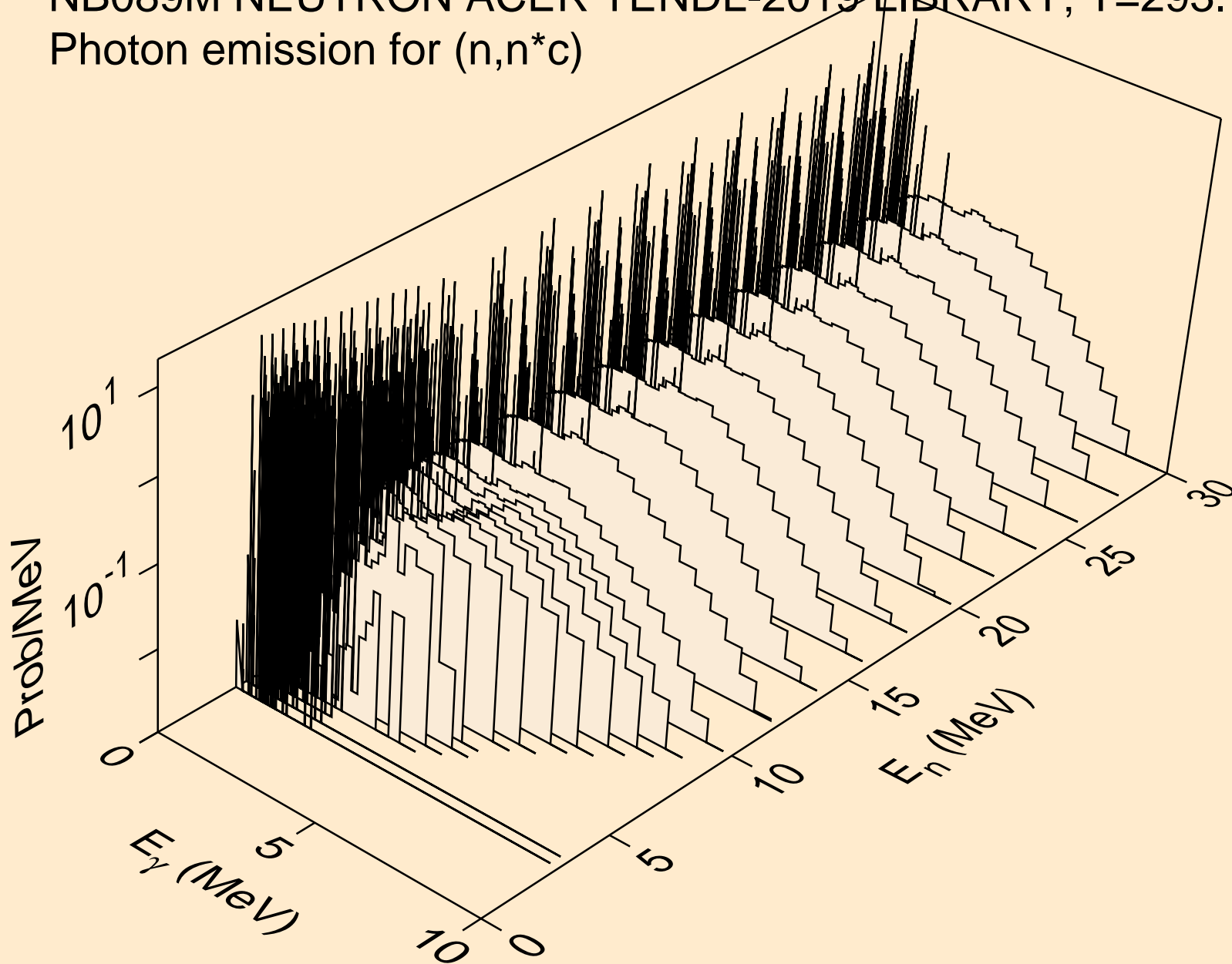

NB089M NEUTRON ACER TENDL-2019 LIBRARY; T=293.16K  
Photon emission for (n,gma)

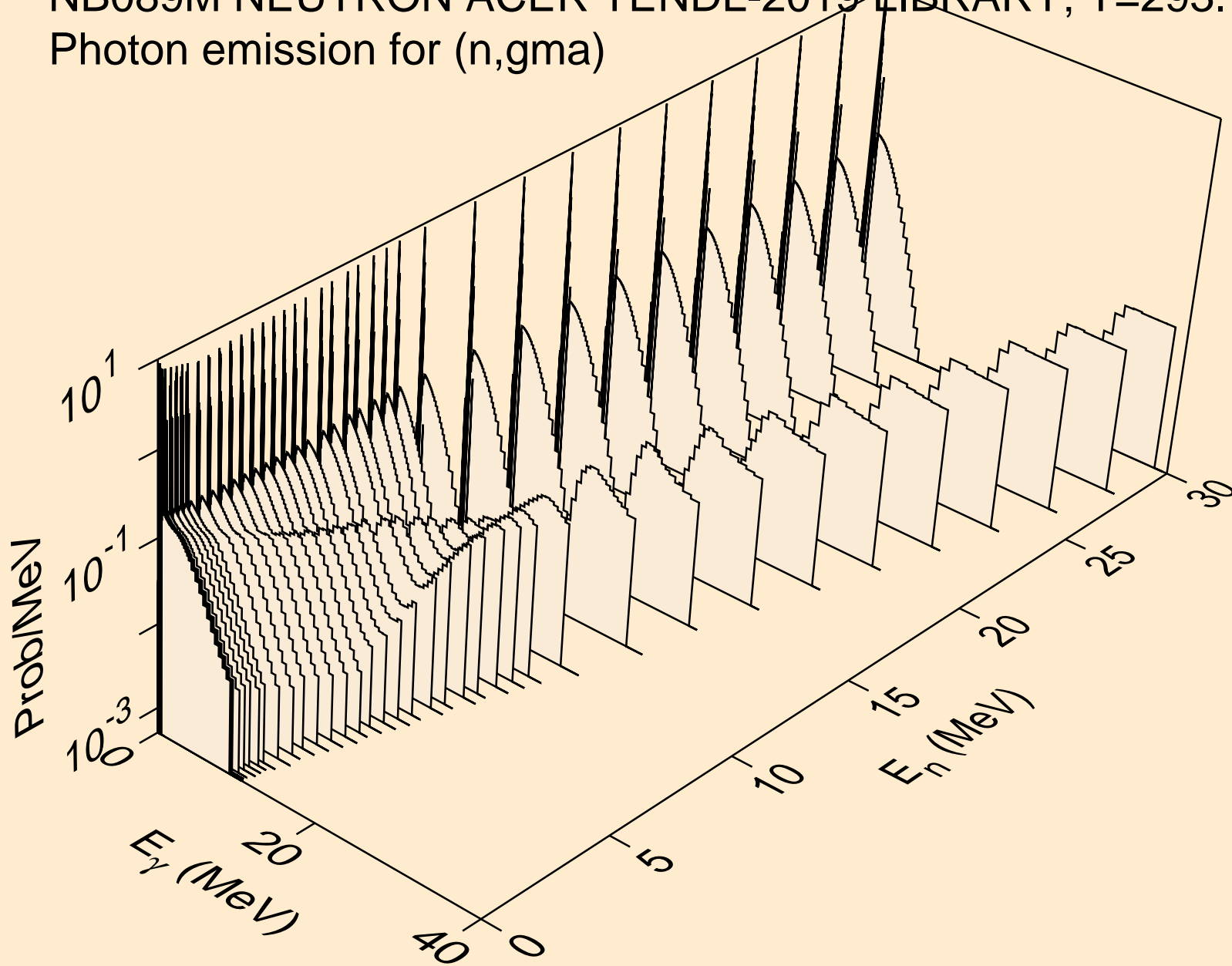

NB089M NEUTRON ACER TENDL-2019 LIBRARY; T=293.16K  
Photon emission for (n,p)

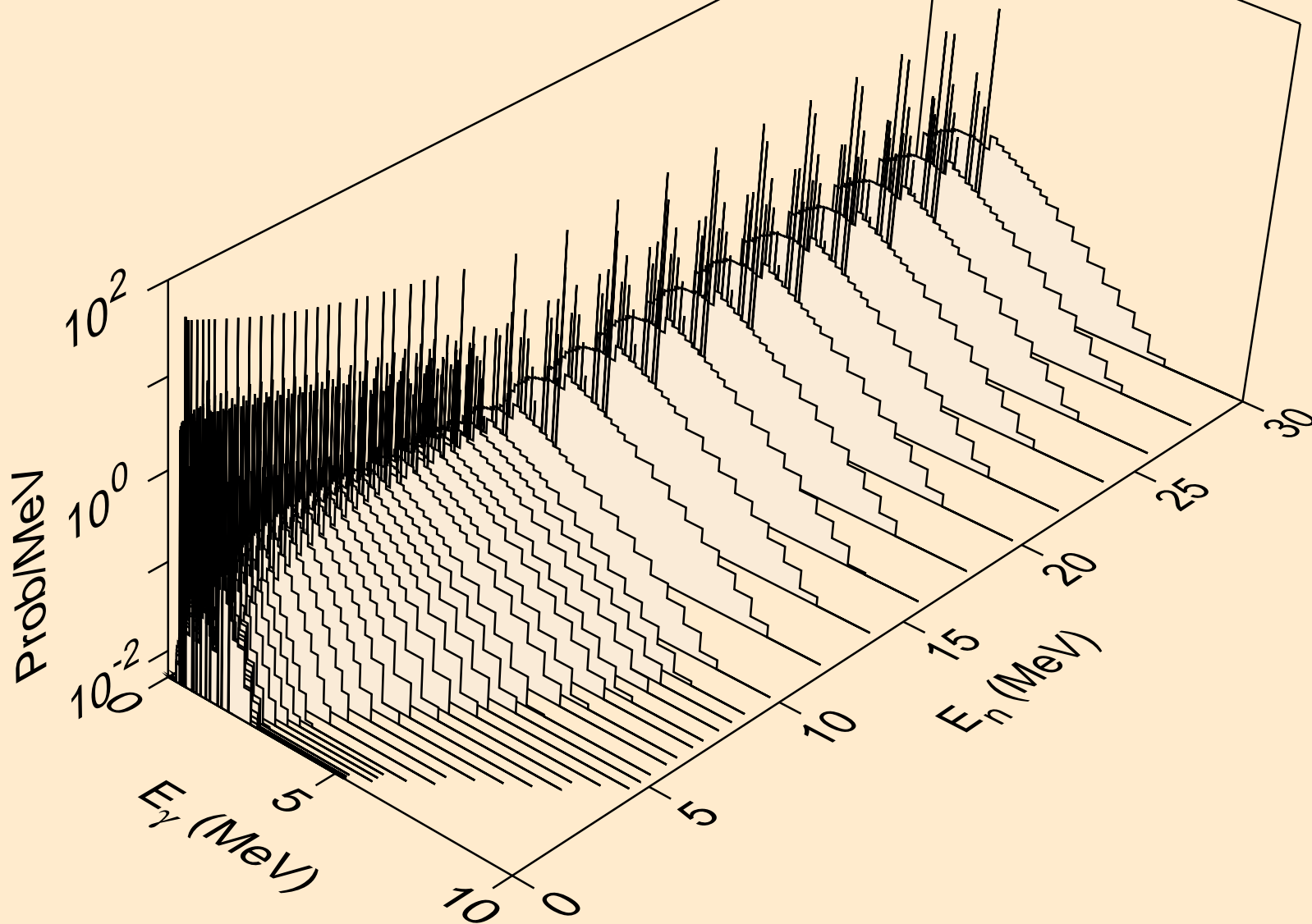

NB089M NEUTRON ACER TENDL-2019 LIBRARY; T=293.16K  
Photon emission for (n,d)

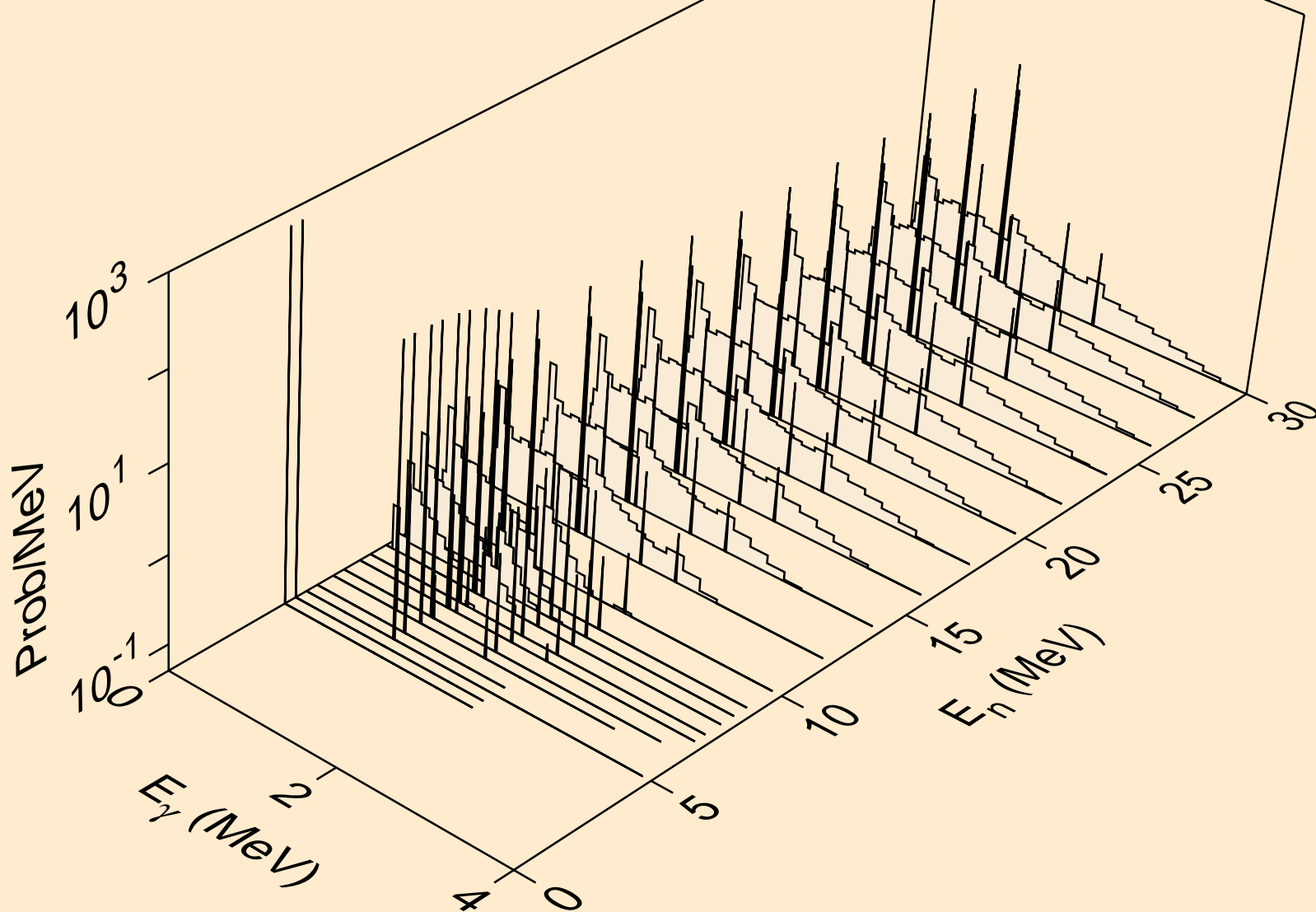

NB089M NEUTRON ACER TENDL-2019 LIBRARY; T=293.16K  
Photon emission for (n,t)

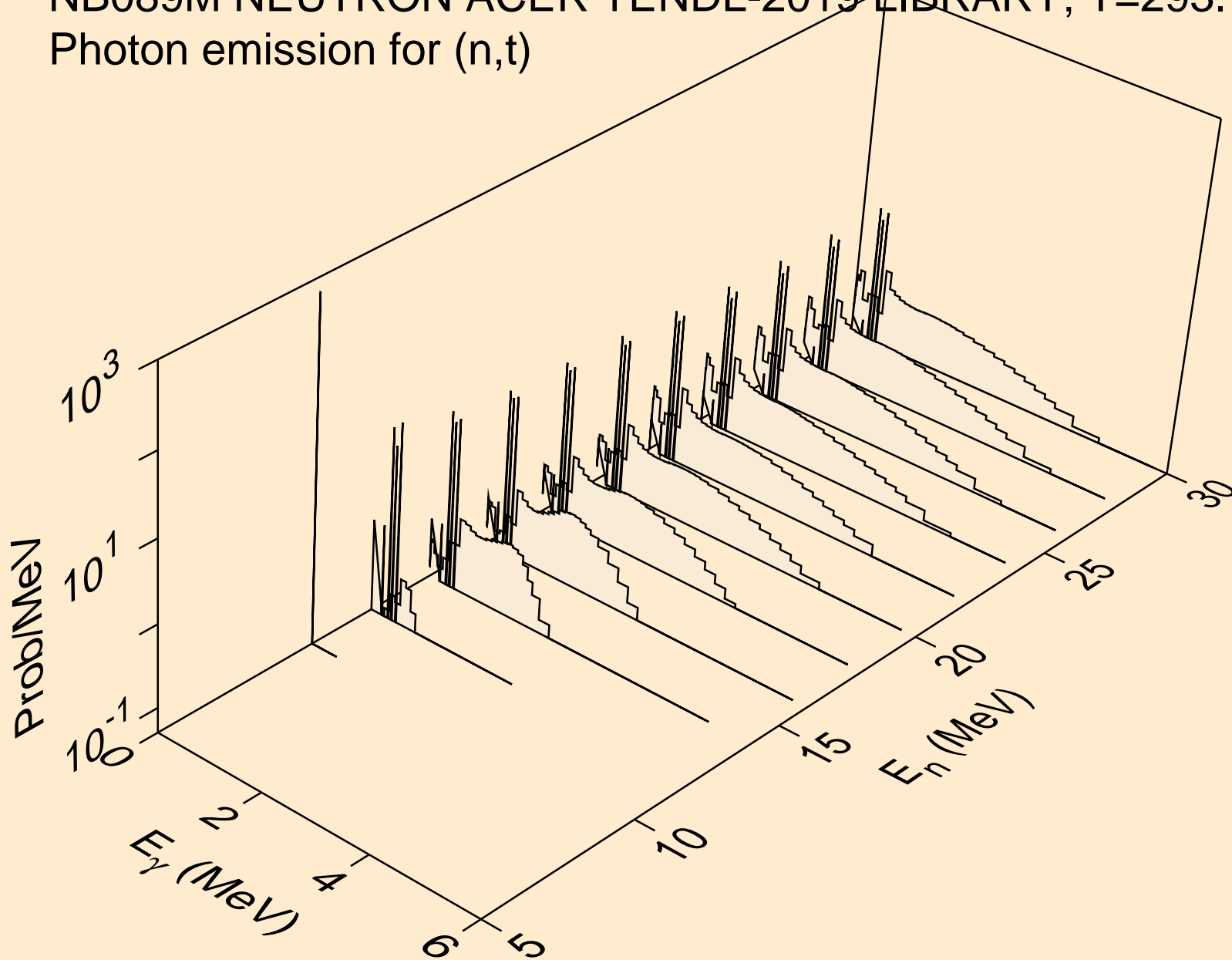

NB089M NEUTRON ACER TENDL-2019 LIBRARY; T=293.16K  
Photon emission for (n,he3)

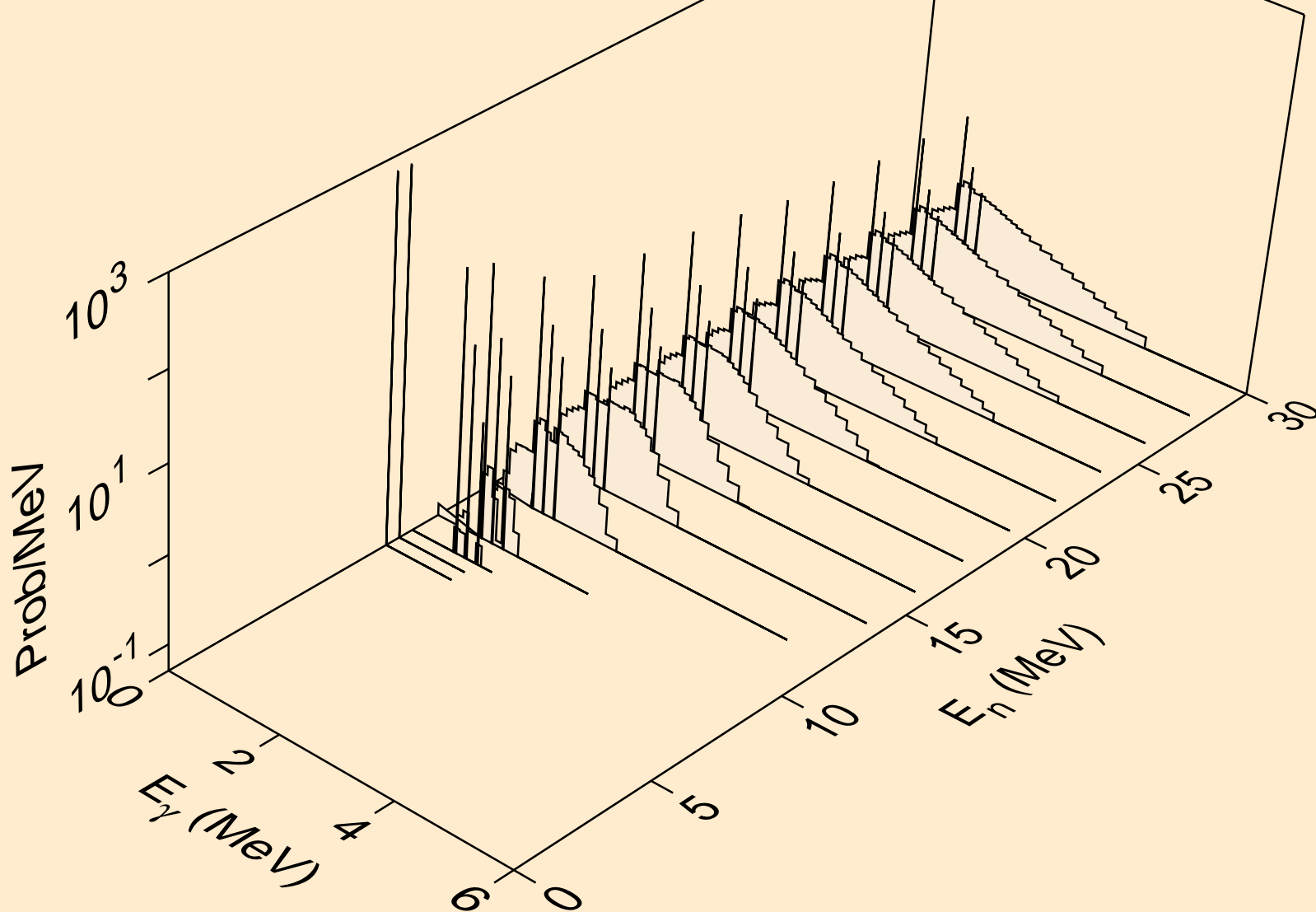

NB089M NEUTRON ACER TENDL-2019 LIBRARY; T=293.16K  
Photon emission for (n,a)

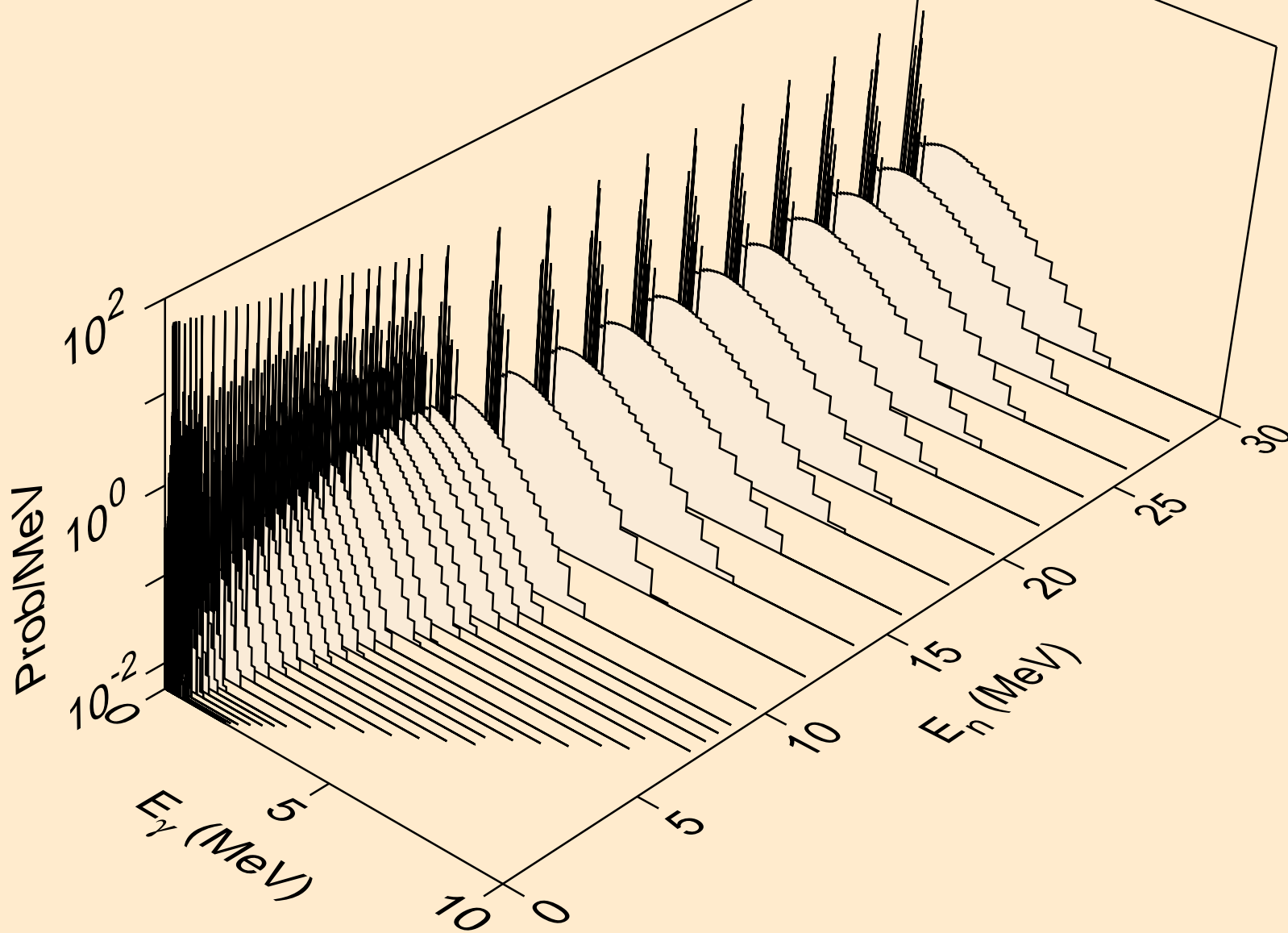



NB089M NEUTRON ACER TENDL-2019 LIBRARY; T=293.16K  
Photon emission for (n,2a)

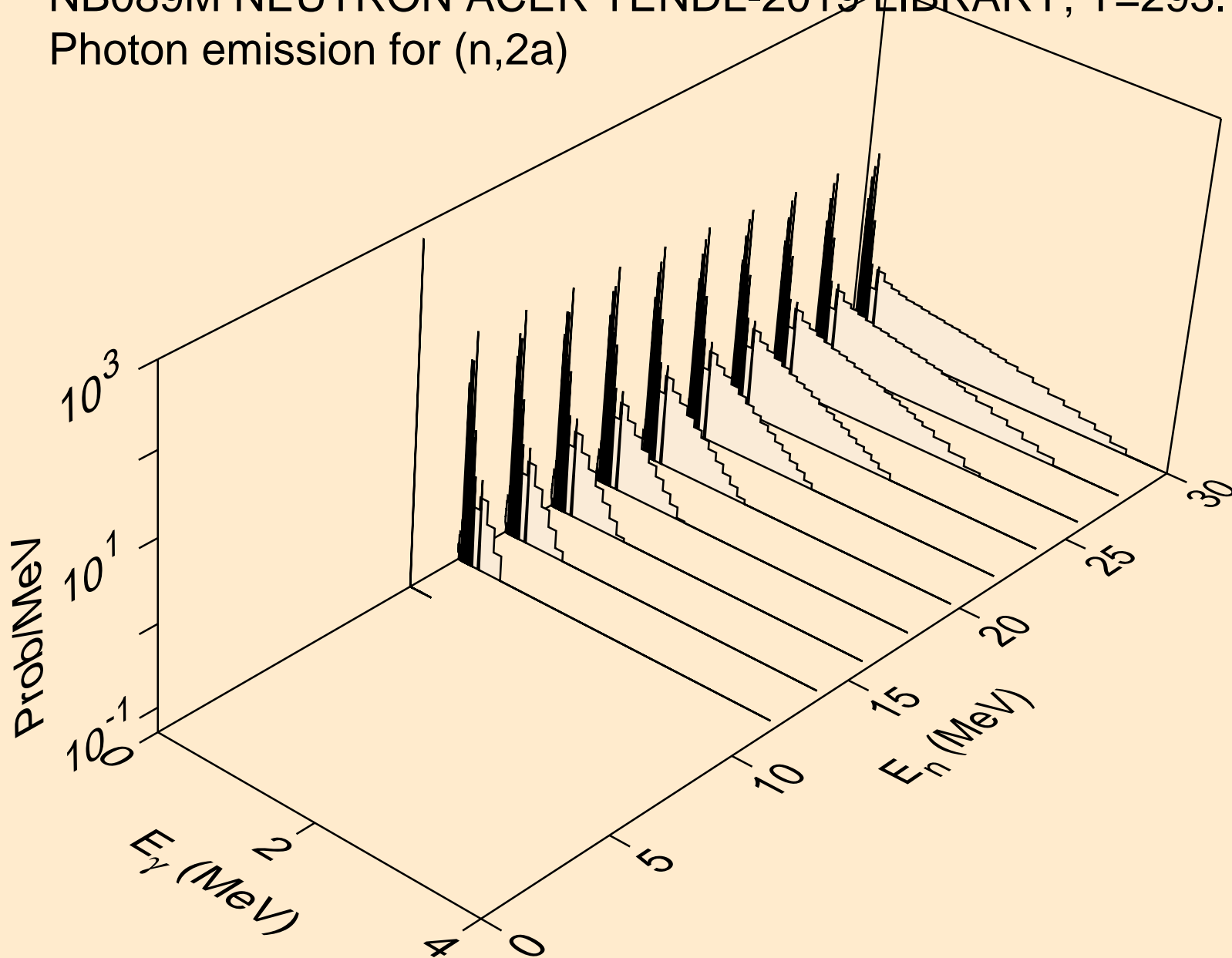

NB089M NEUTRON ACER TENDL-2019 LIBRARY; T=293.16K  
Photon emission for (n,2p)

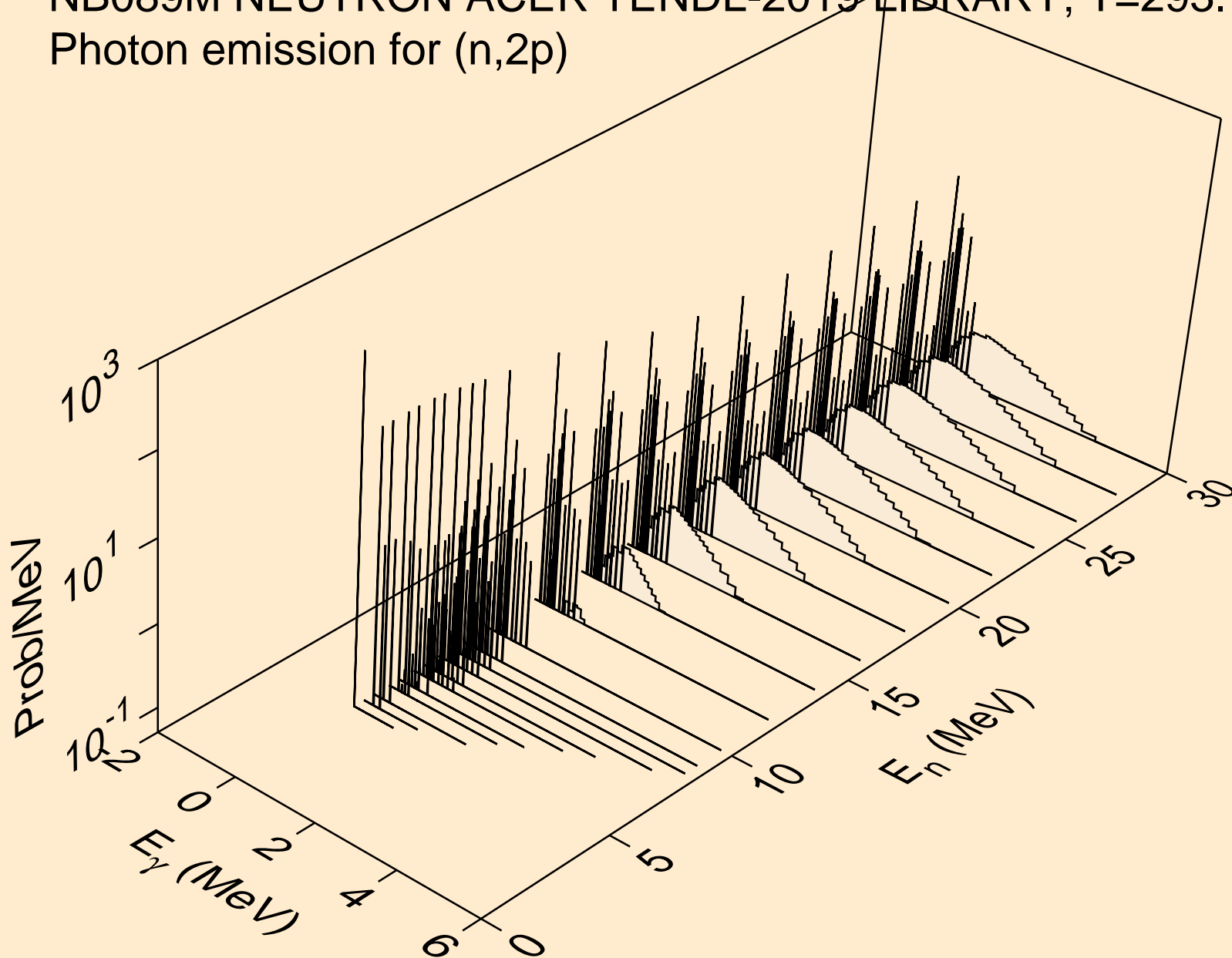

NB089M NEUTRON ACER TENDL-2019 LIBRARY; T=293.16K  
Photon emission for (n,p $\alpha$ )

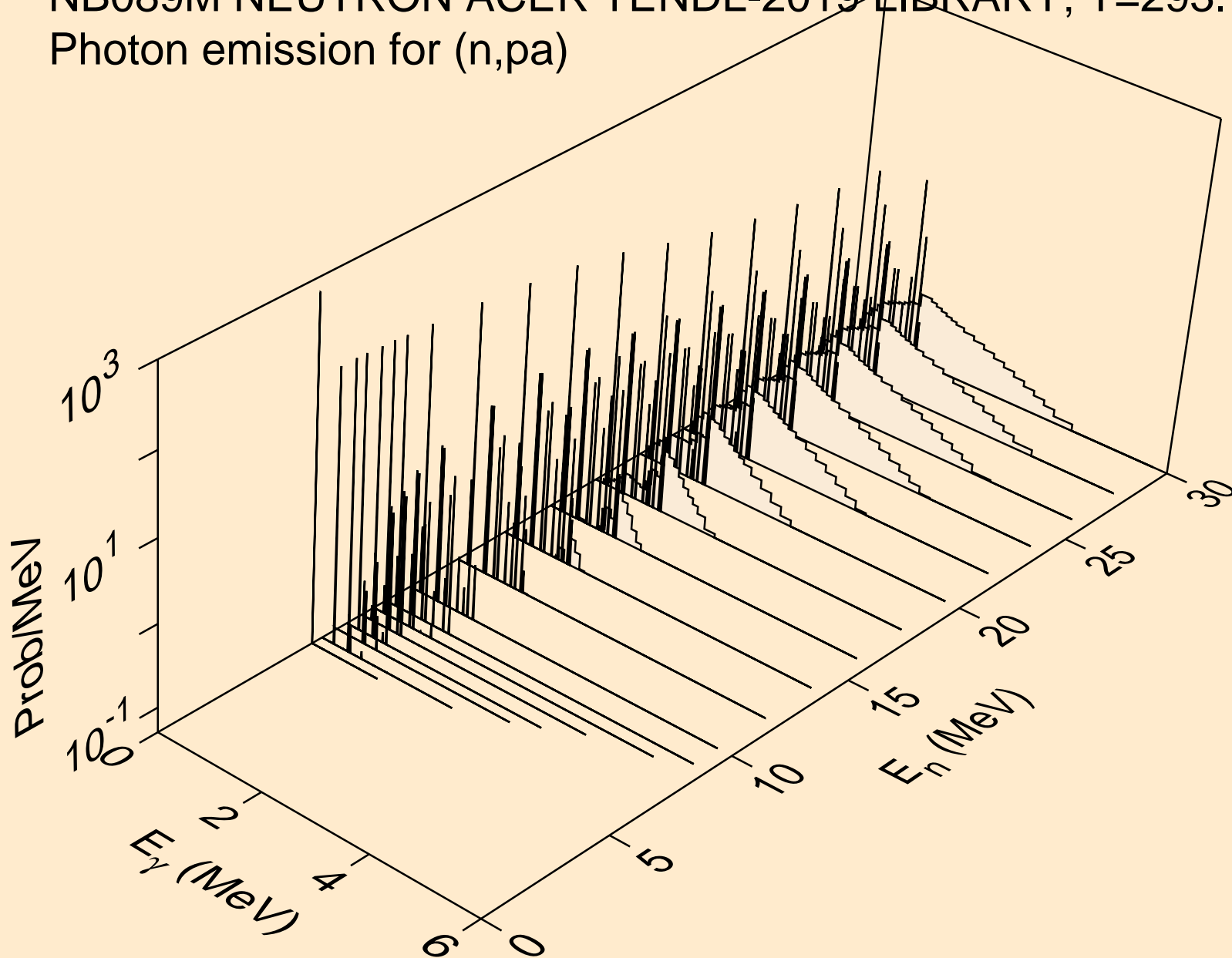

NB089M NEUTRON ACER TENDL-2019 LIBRARY; T=293.16K  
Photon emission for (n,pd)

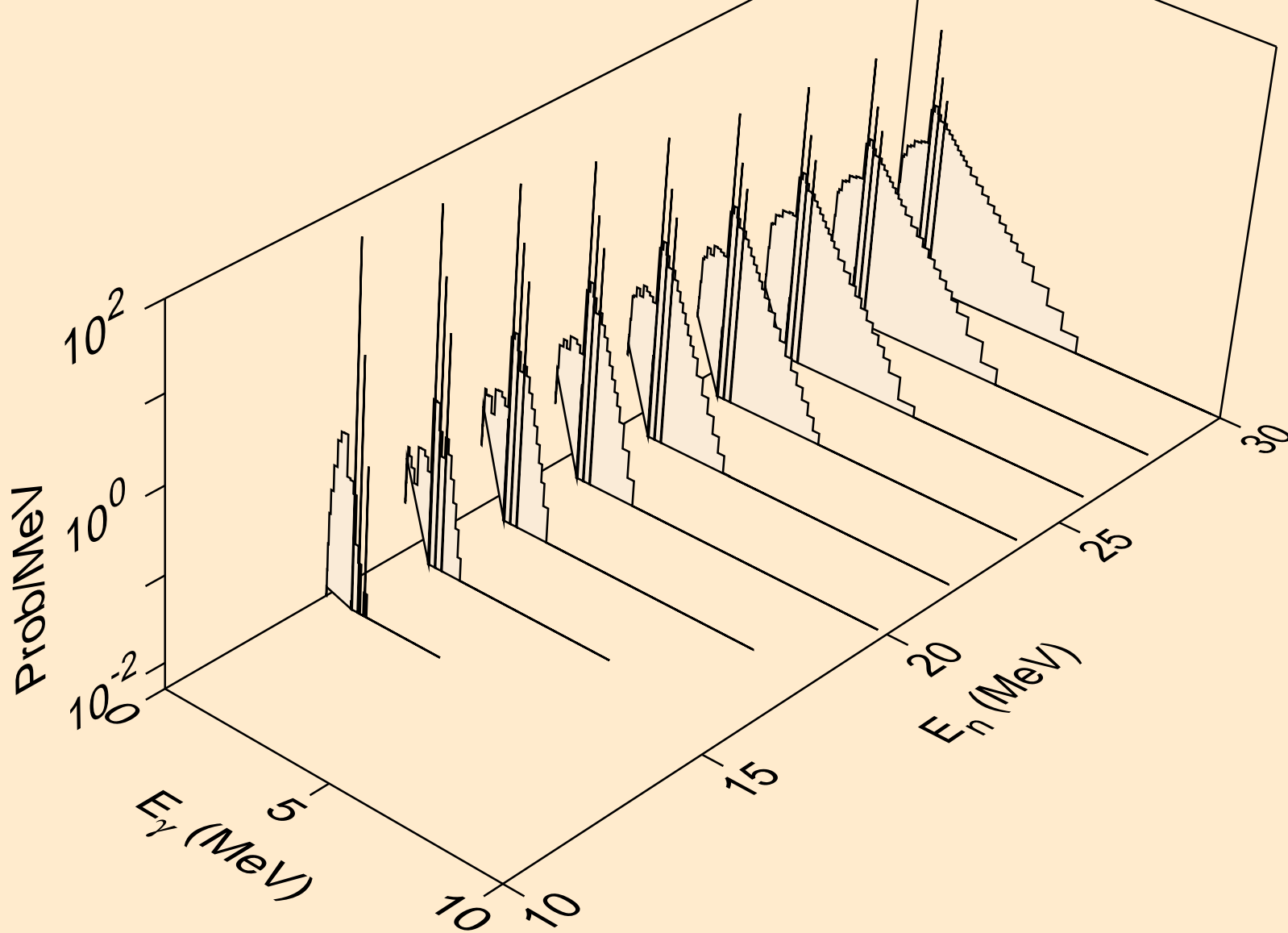

NB089M NEUTRON ACER TENDL-2019 LIBRARY; T=293.16K  
Photon emission for (n,pt)

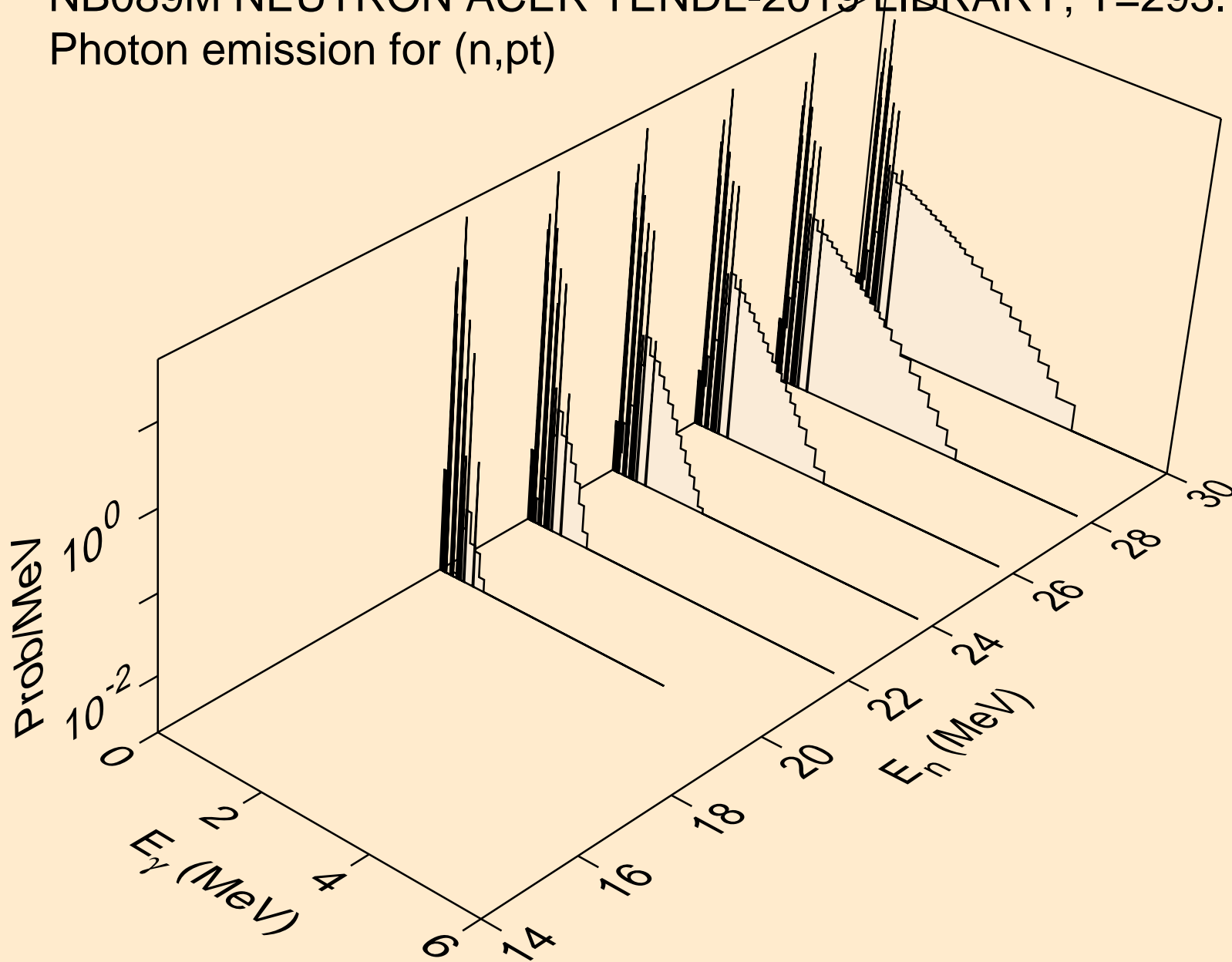

NB089M NEUTRON ACER TENDL-2019 LIBRARY; T=293.16K  
Photon emission for (n,da)

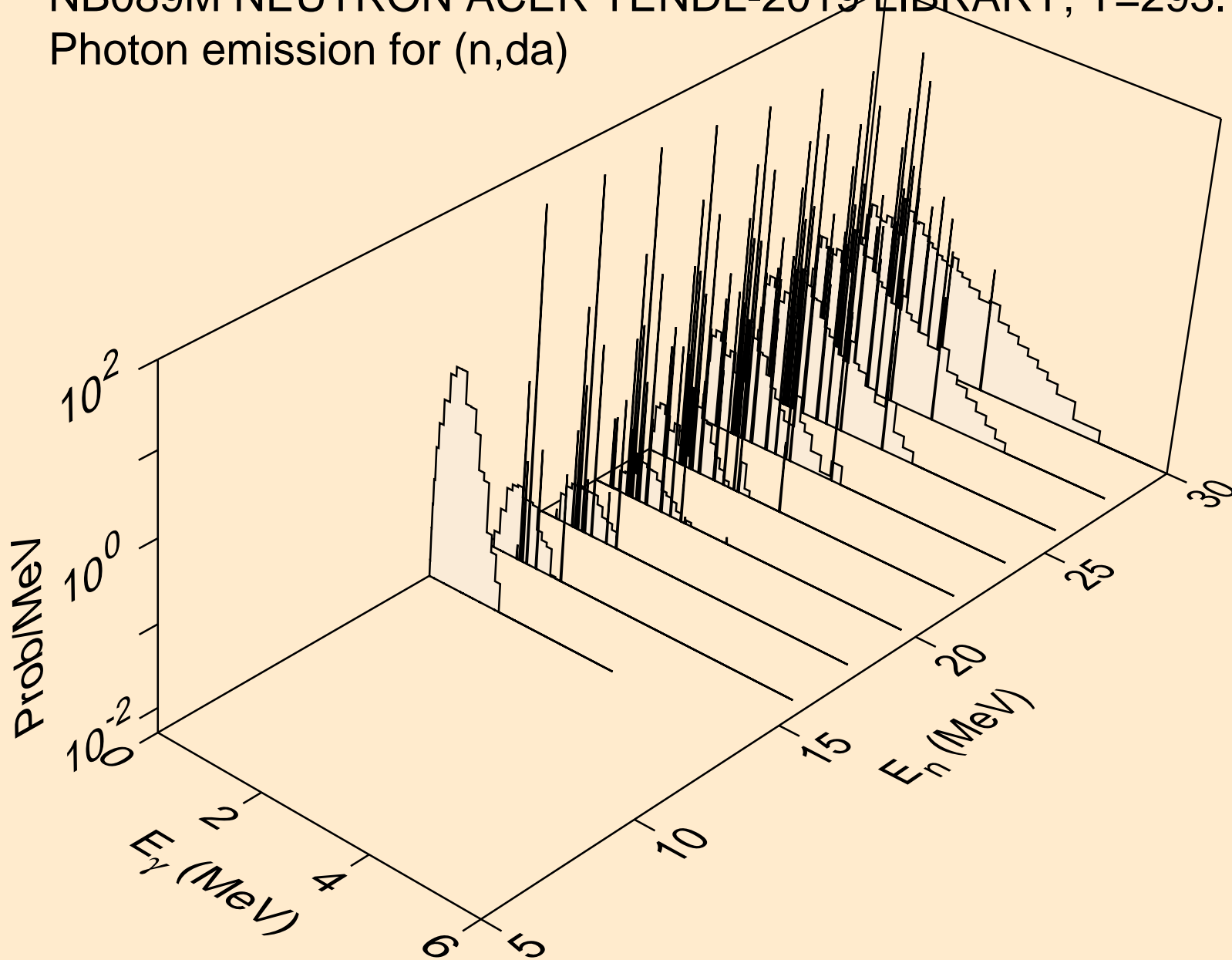

NB089M NEUTRON ACER TENDL-2019 LIBRARY; T=293.16K  
thermal capture photon spectrum

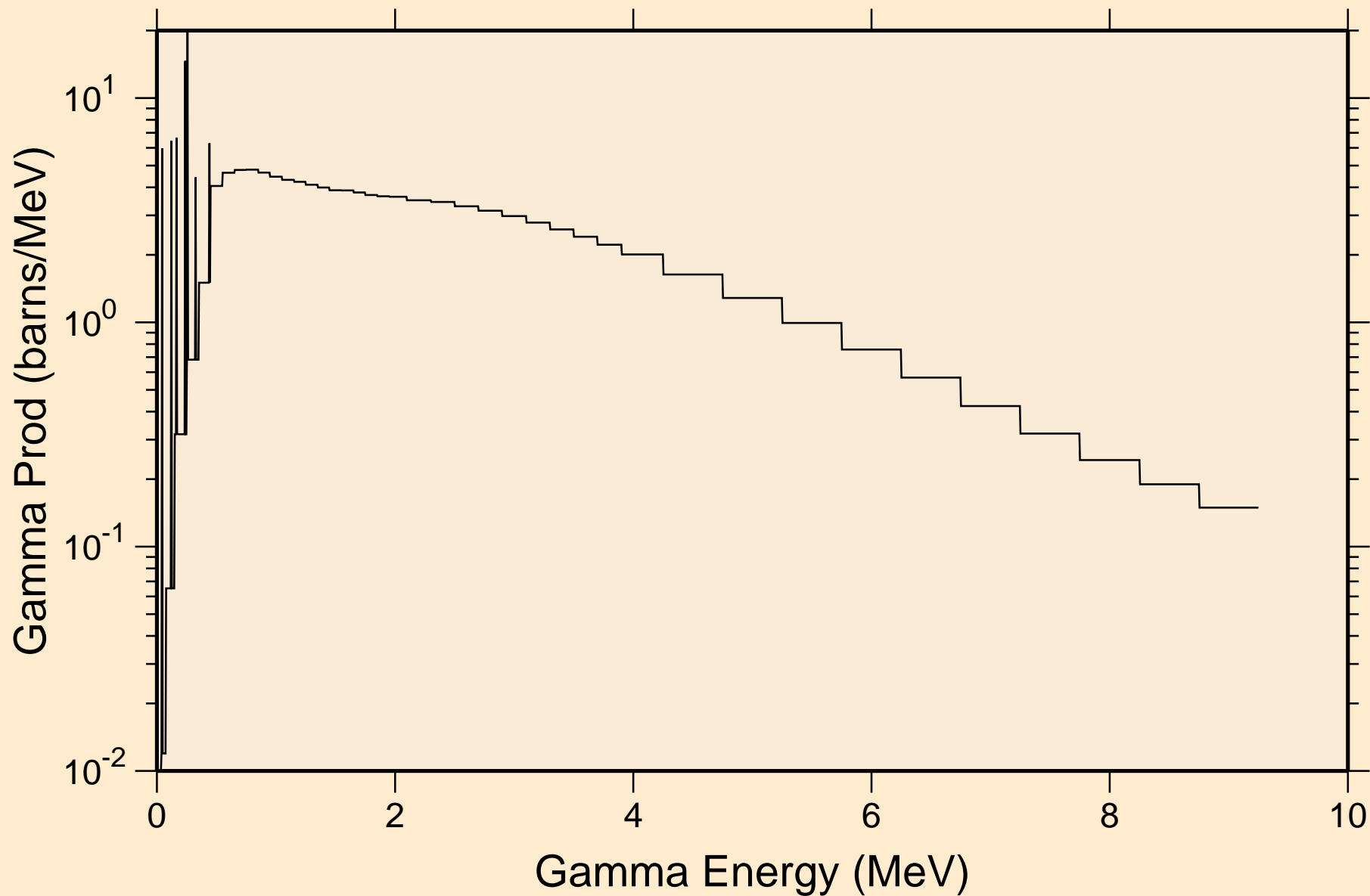

NB089M NEUTRON ACER TENDL-2019 LIBRARY; T=293.16K  
14 MeV photon spectrum

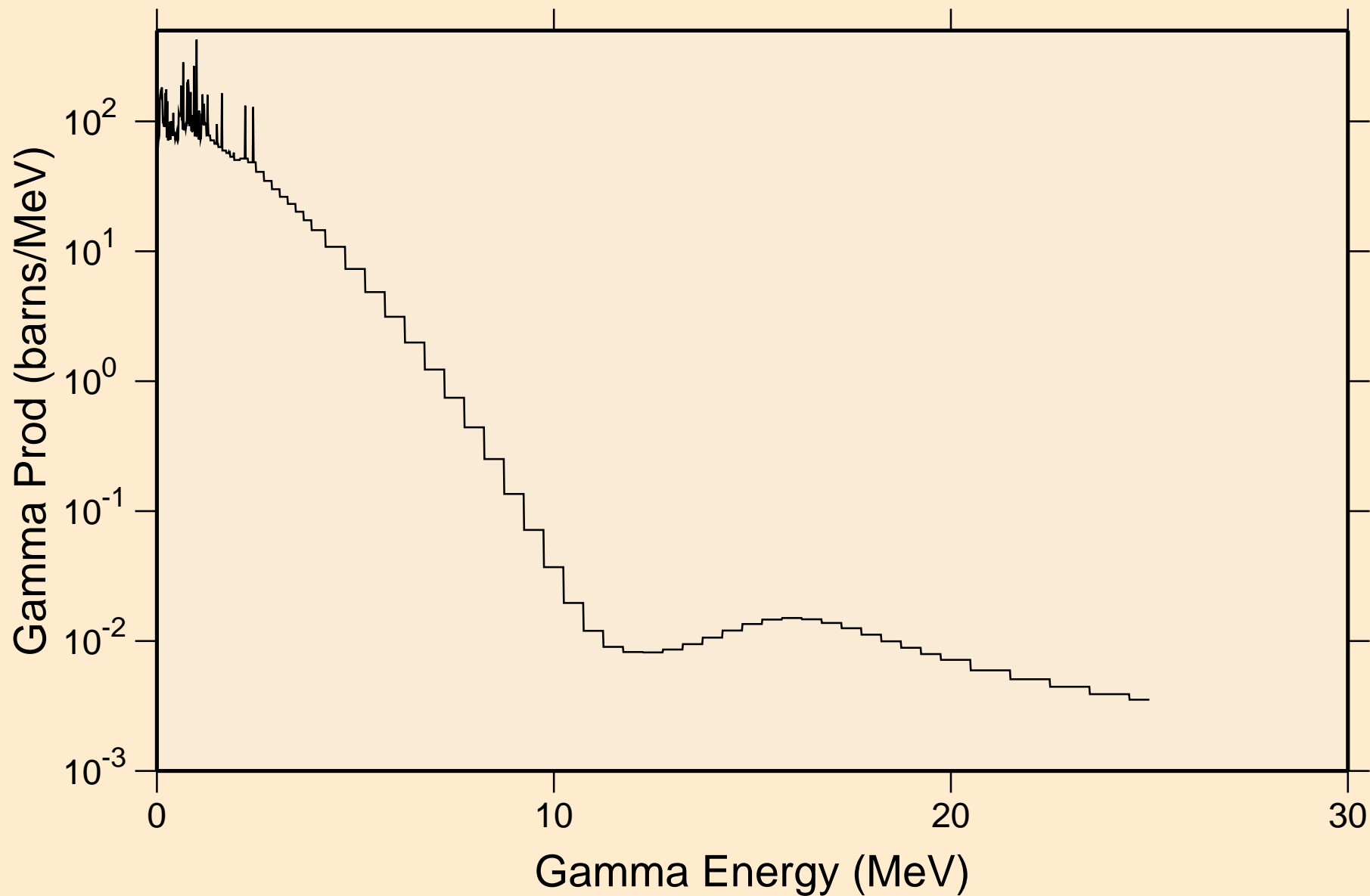



NB089M NEUTRON ACER TENDL-2019 LIBRARY; T=293.16K  
Particle heating contributions

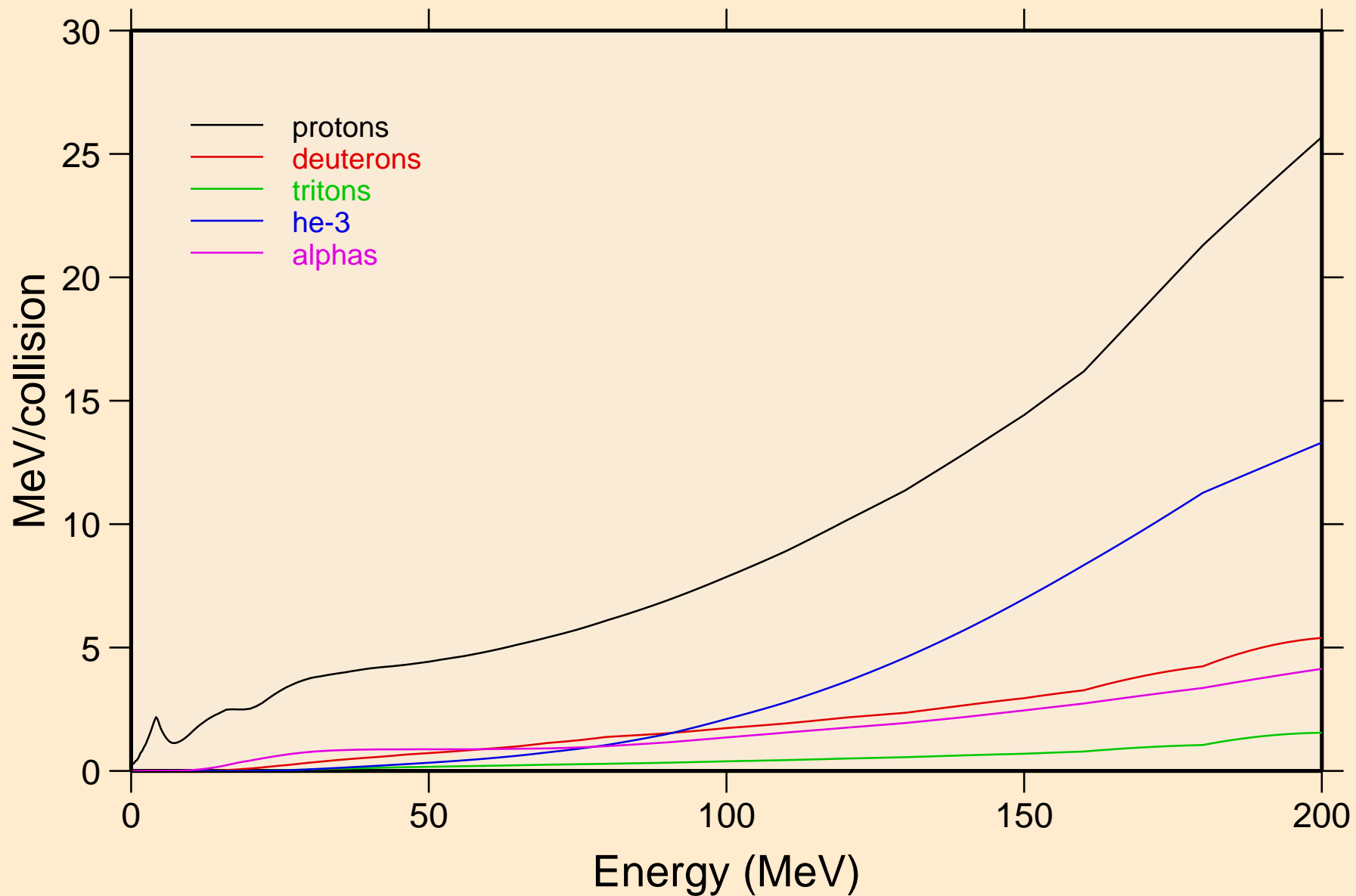

NB089M NEUTRON ACER TENDL-2019 LIBRARY; T=293.16K  
Recoil Heating

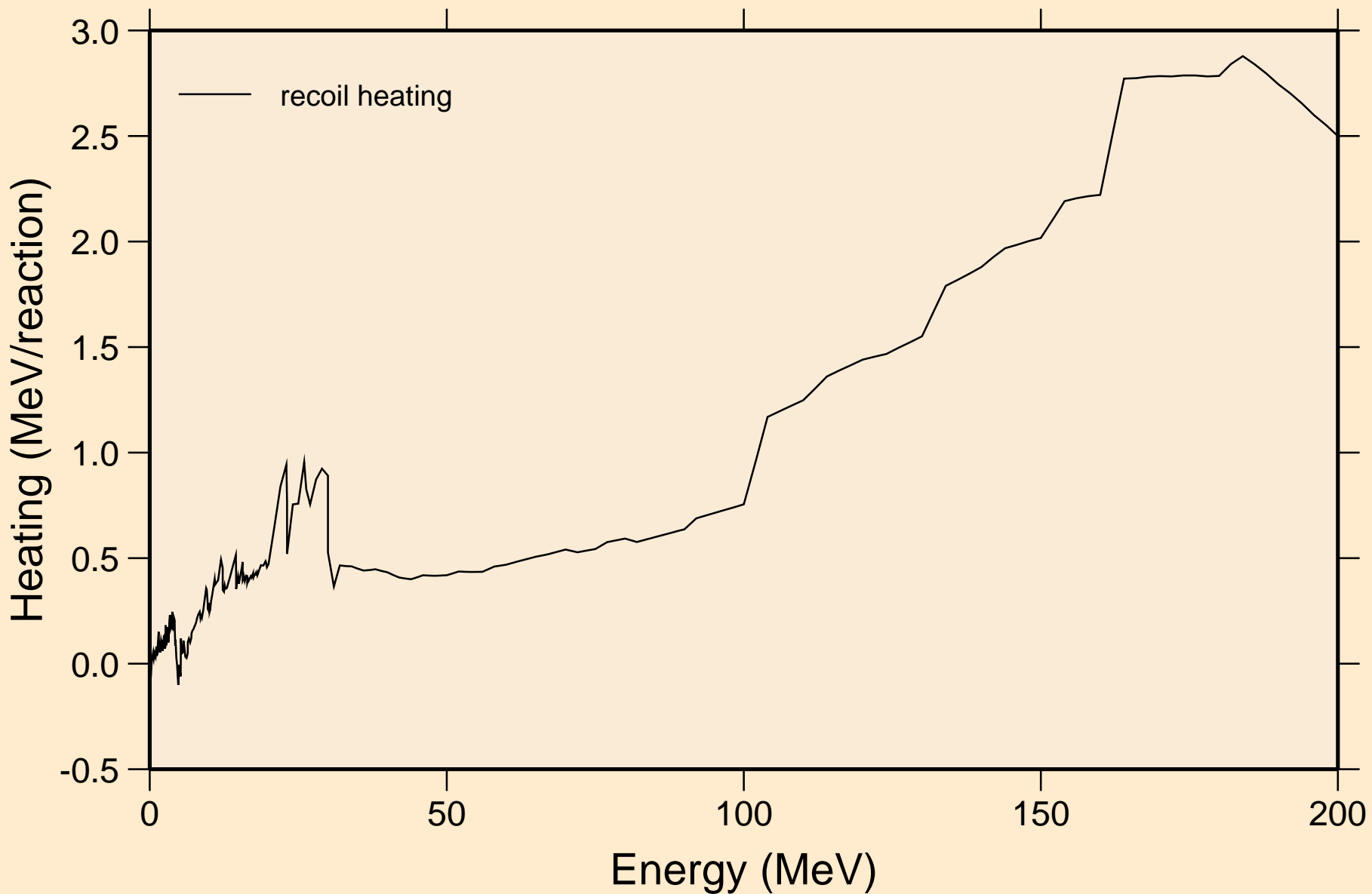

NB089M NEUTRON ACER TENDL-2019 LIBRARY; T=293.16K  
Particle production cross sections

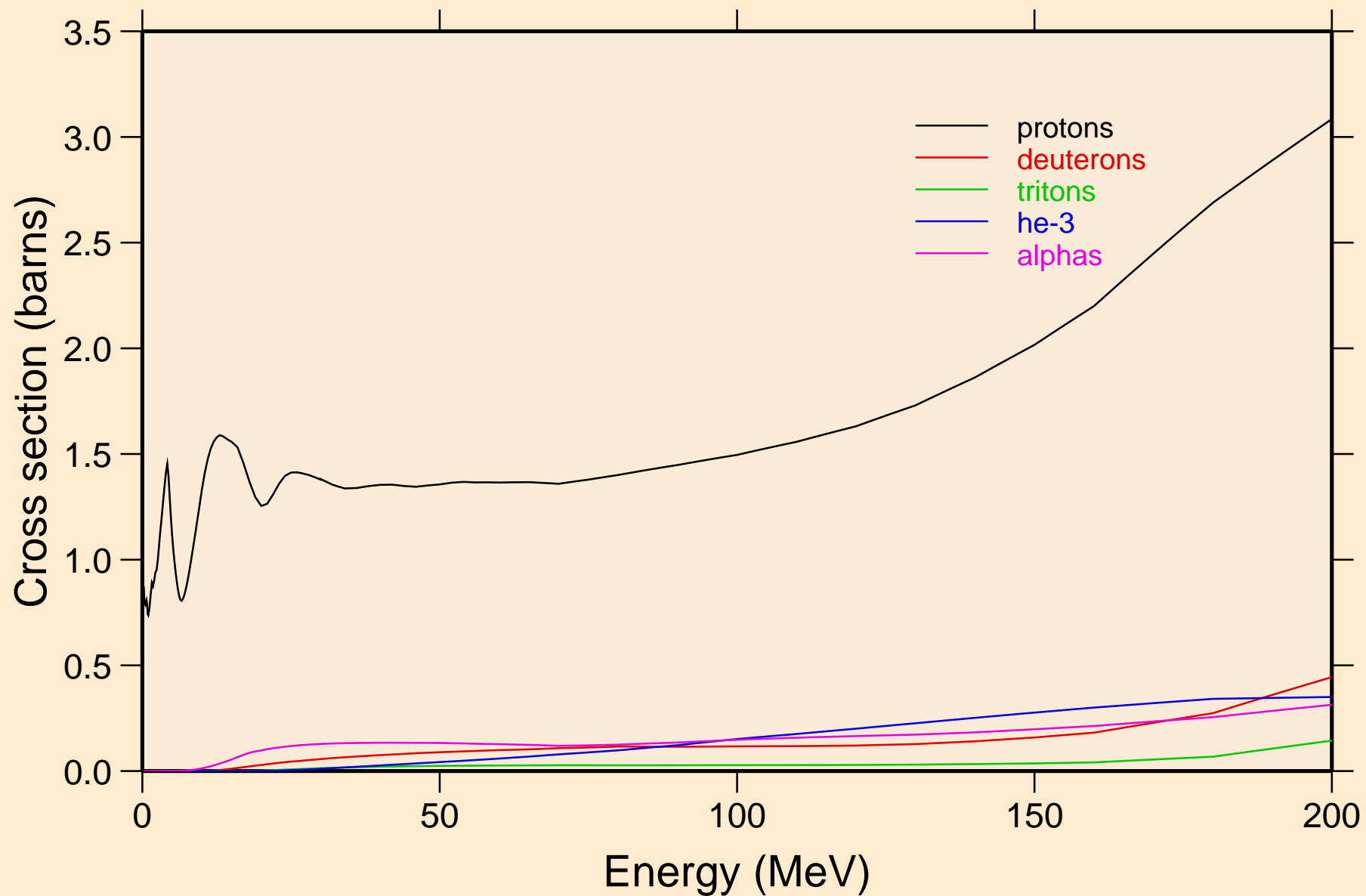

NB089M NEUTRON ACER TENDL-2019 LIBRARY; T=293.16K  
protons from (n,x)

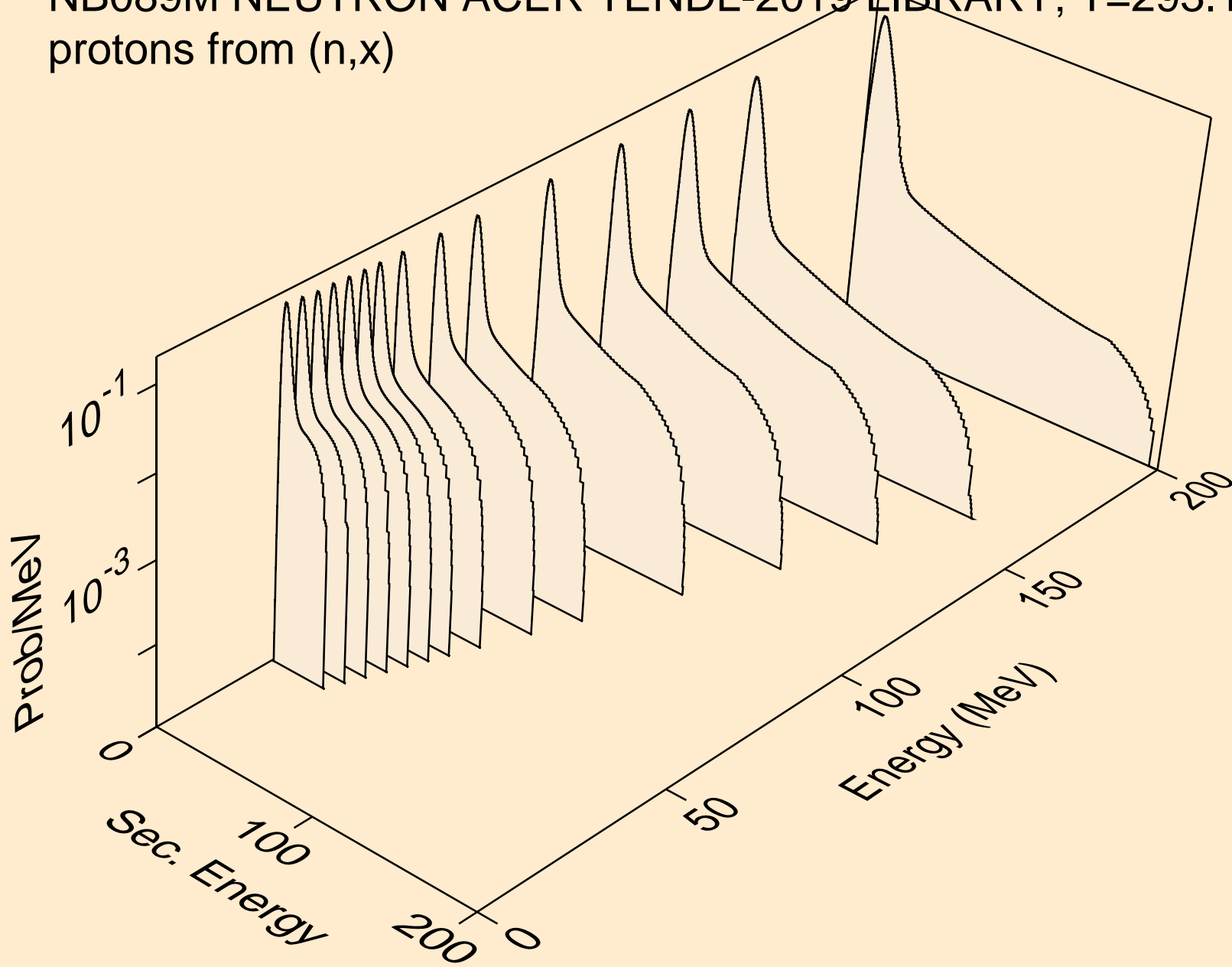

NB089M NEUTRON ACER TENDL-2019 LIBRARY; T=293.16K  
protons from (n,n\*)p

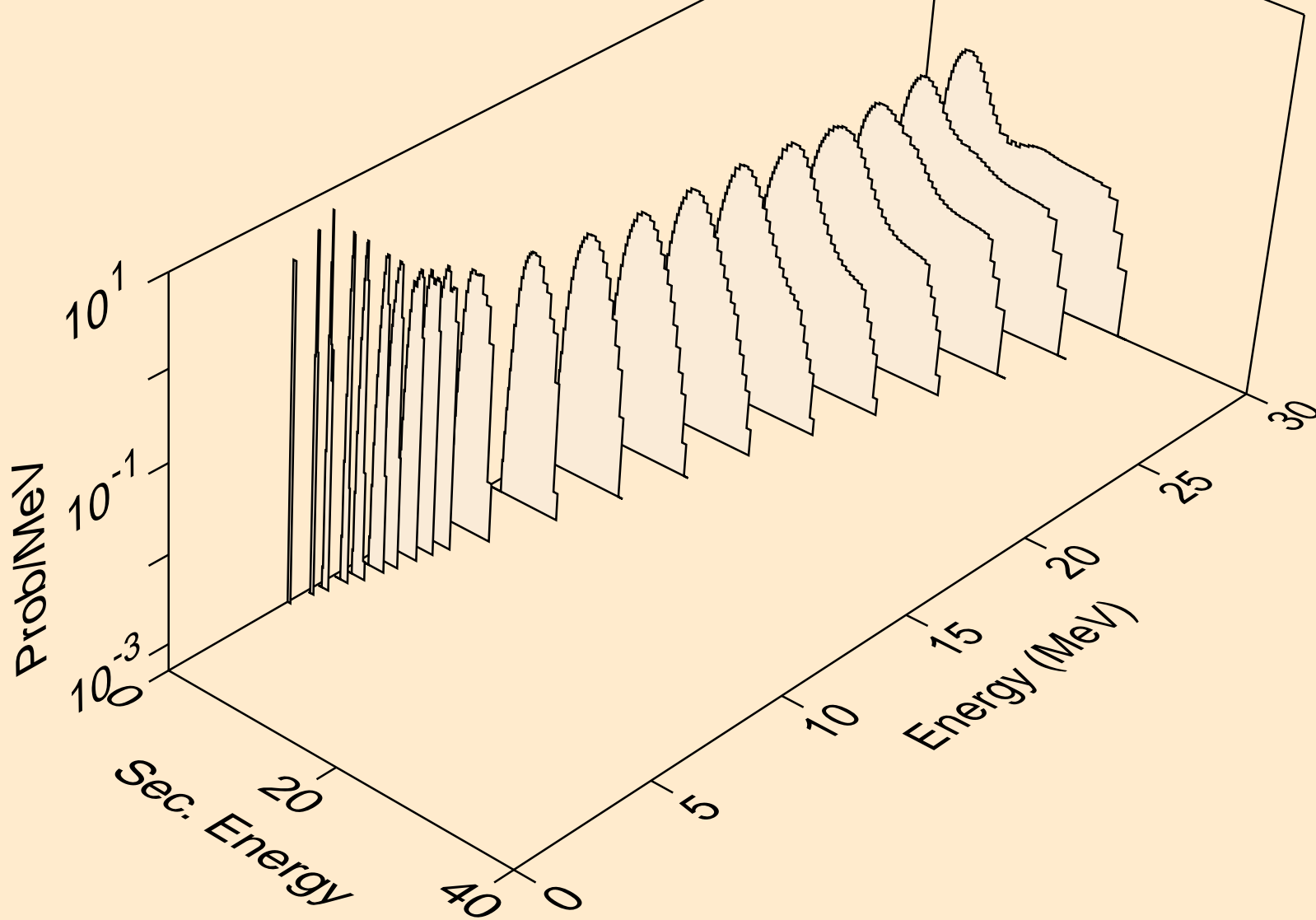

NB089M NEUTRON ACER TENDL-2019 LIBRARY; T=293.16K  
protons from (n,2np)

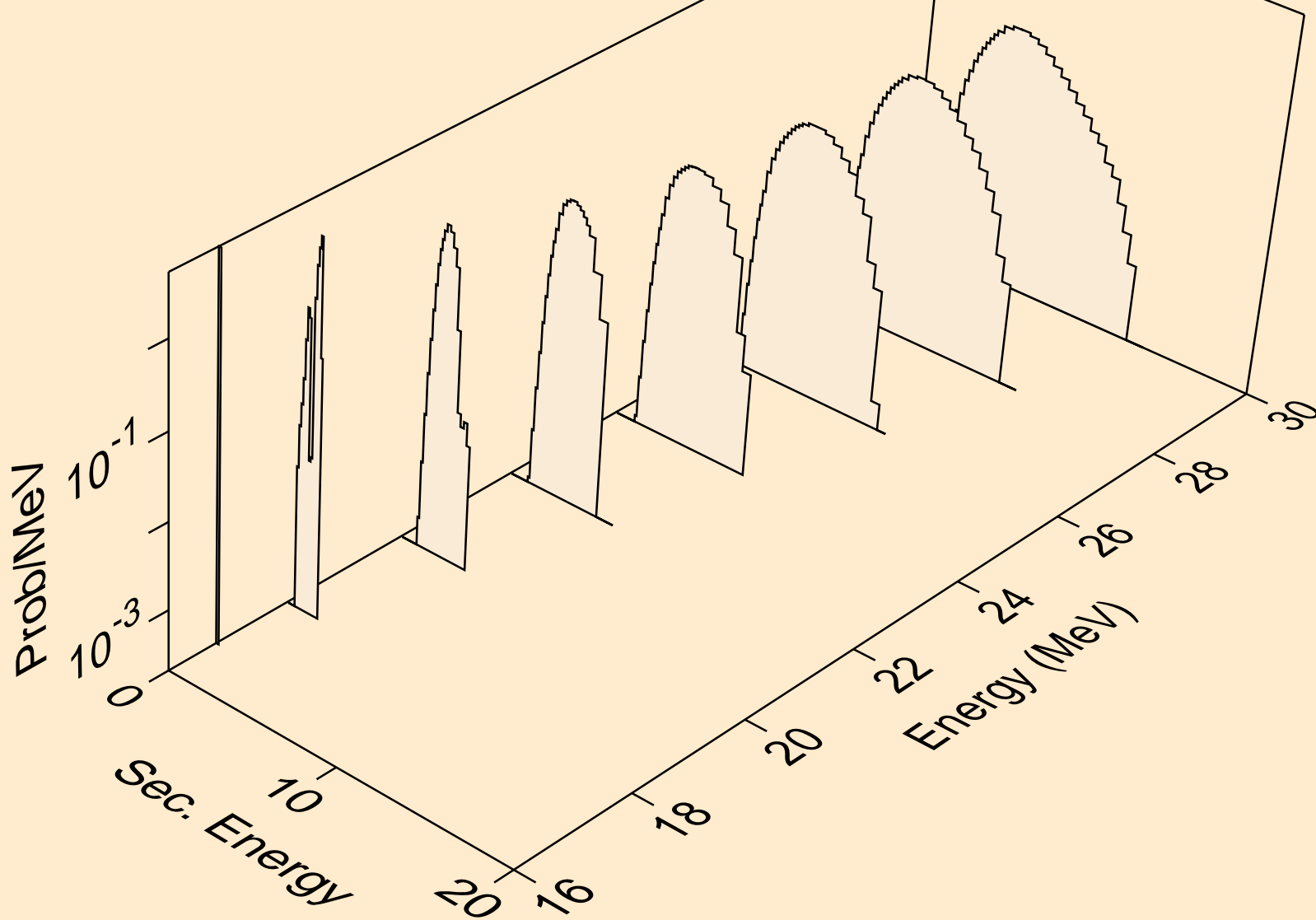

NB089M NEUTRON ACER TENDL-2019 LIBRARY; T=293.16K  
protons from (n,3np)

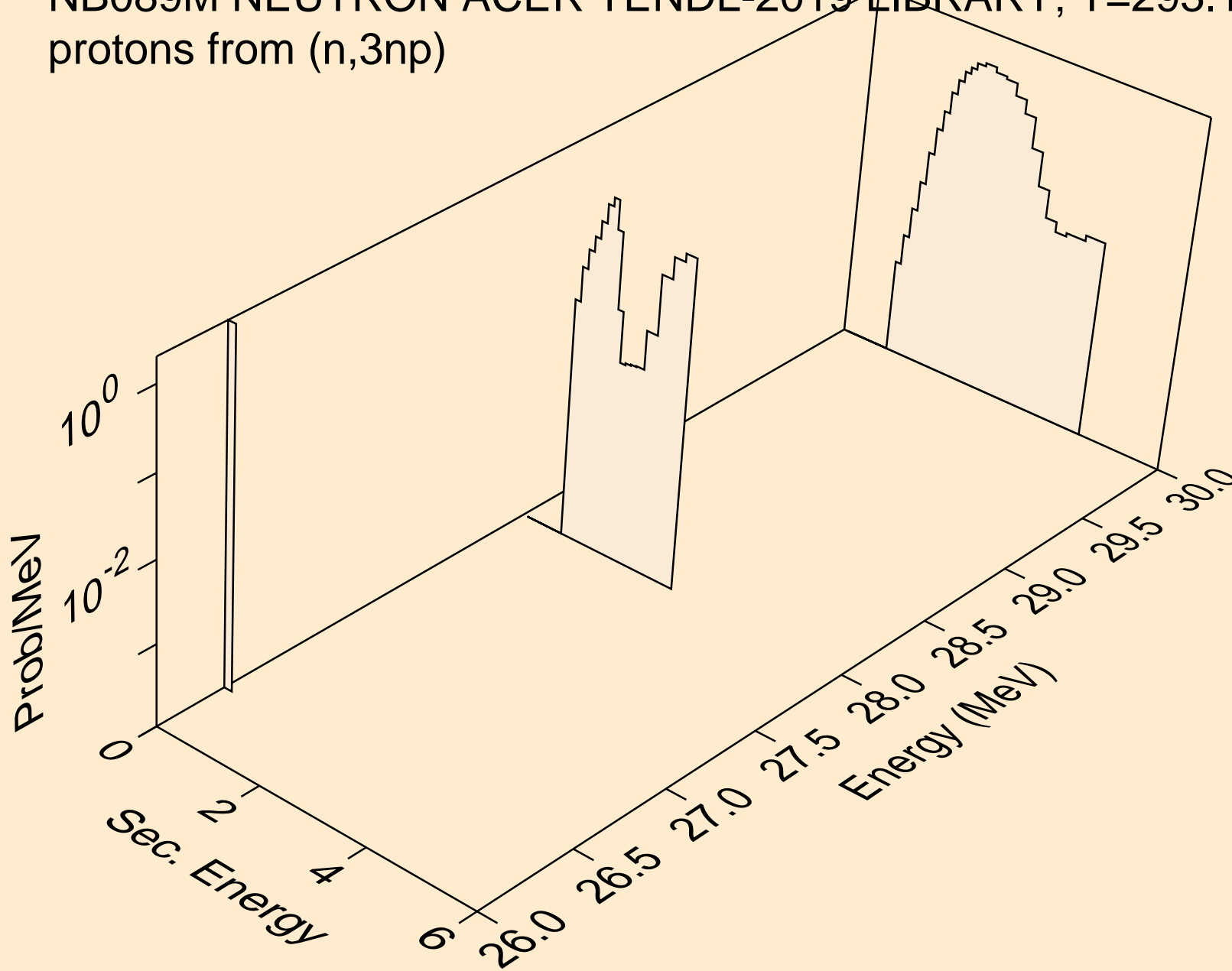

NB089M NEUTRON ACER TENDL-2019 LIBRARY; T=293.16K  
protons from (n,2np)

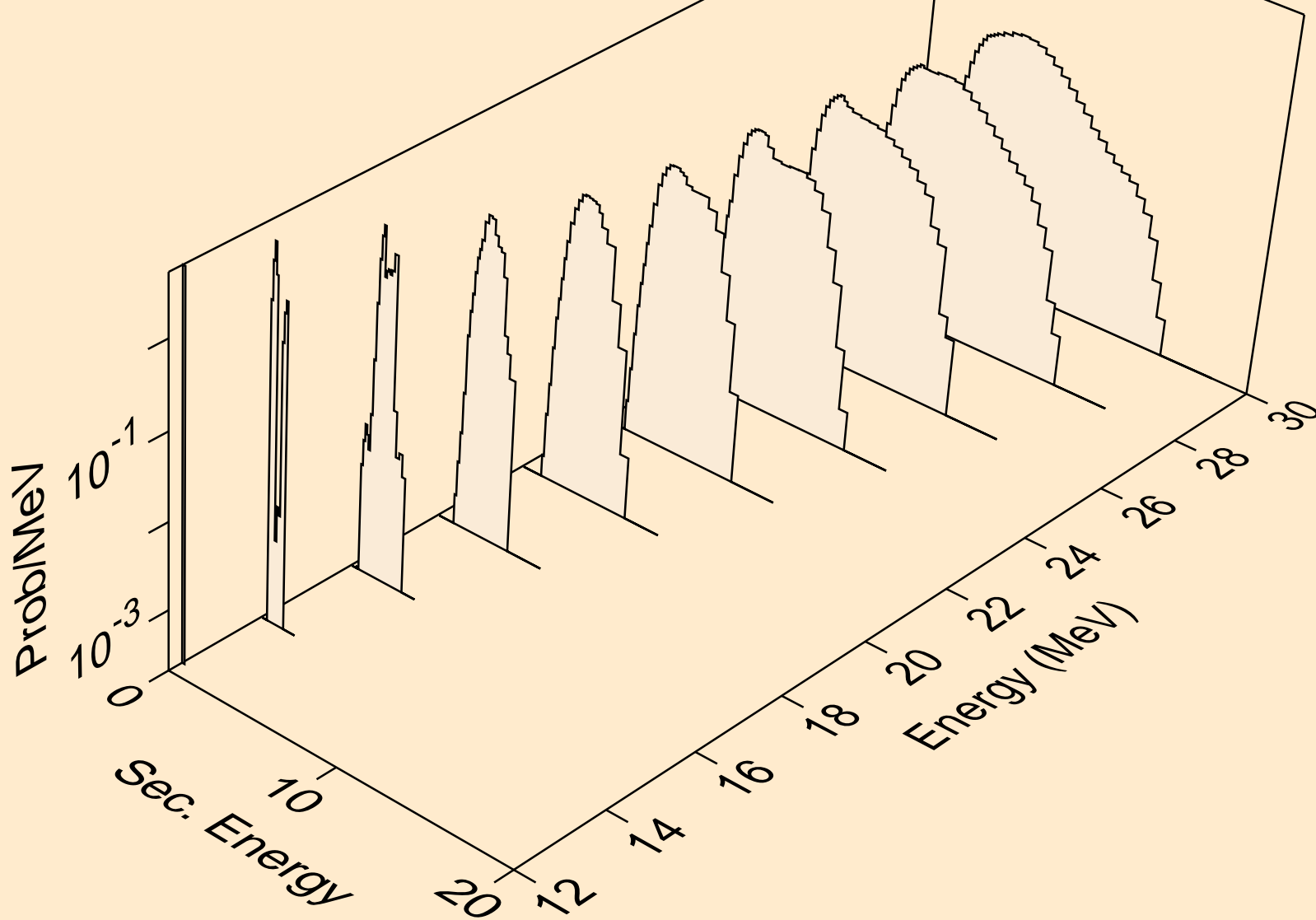



NB089M NEUTRON ACER TENDL-2019 LIBRARY; T=293.16K  
protons from (n,npa)

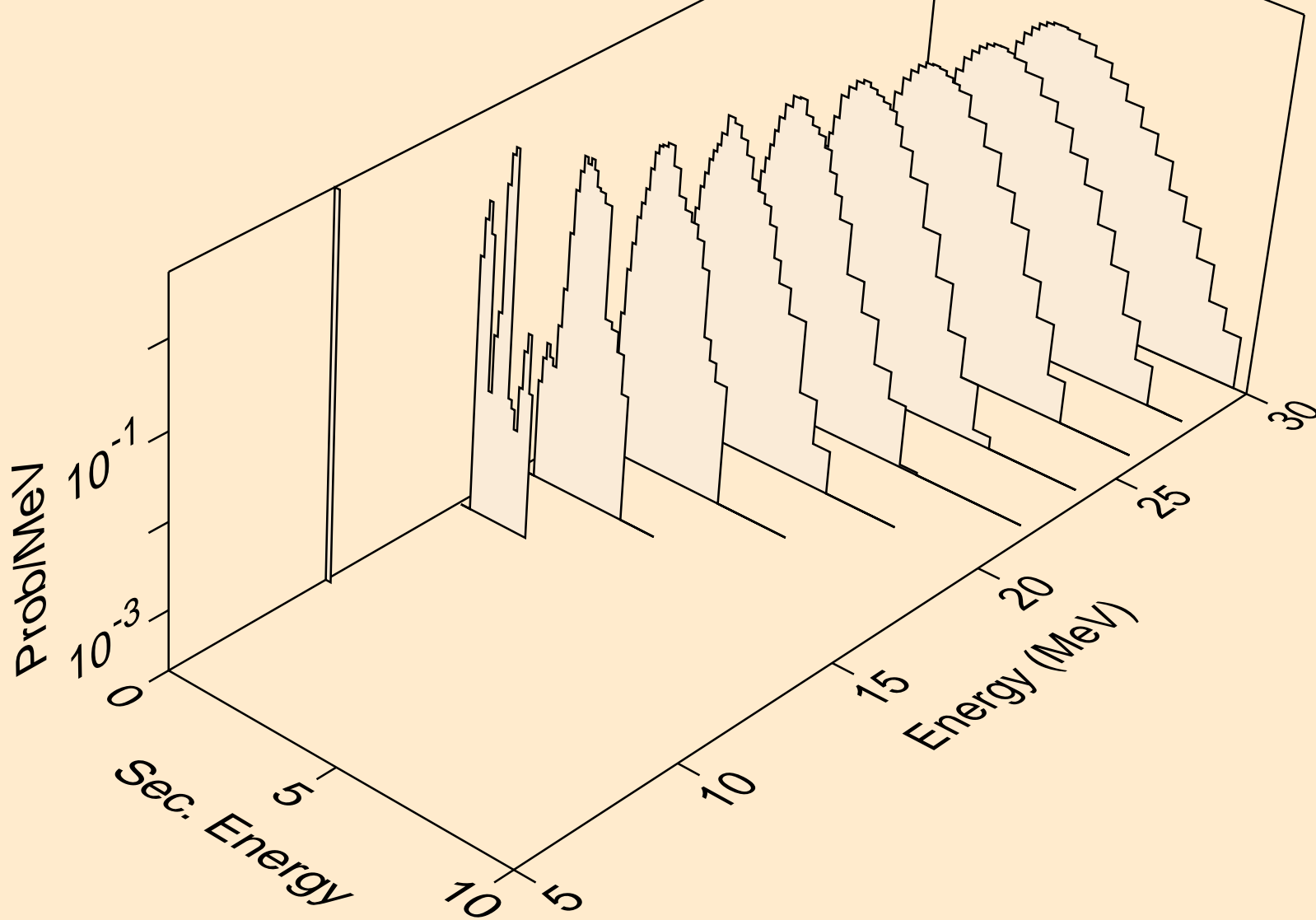

NB089M NEUTRON ACER TENDL-2019 LIBRARY; T=293.16K  
protons from (n,p)

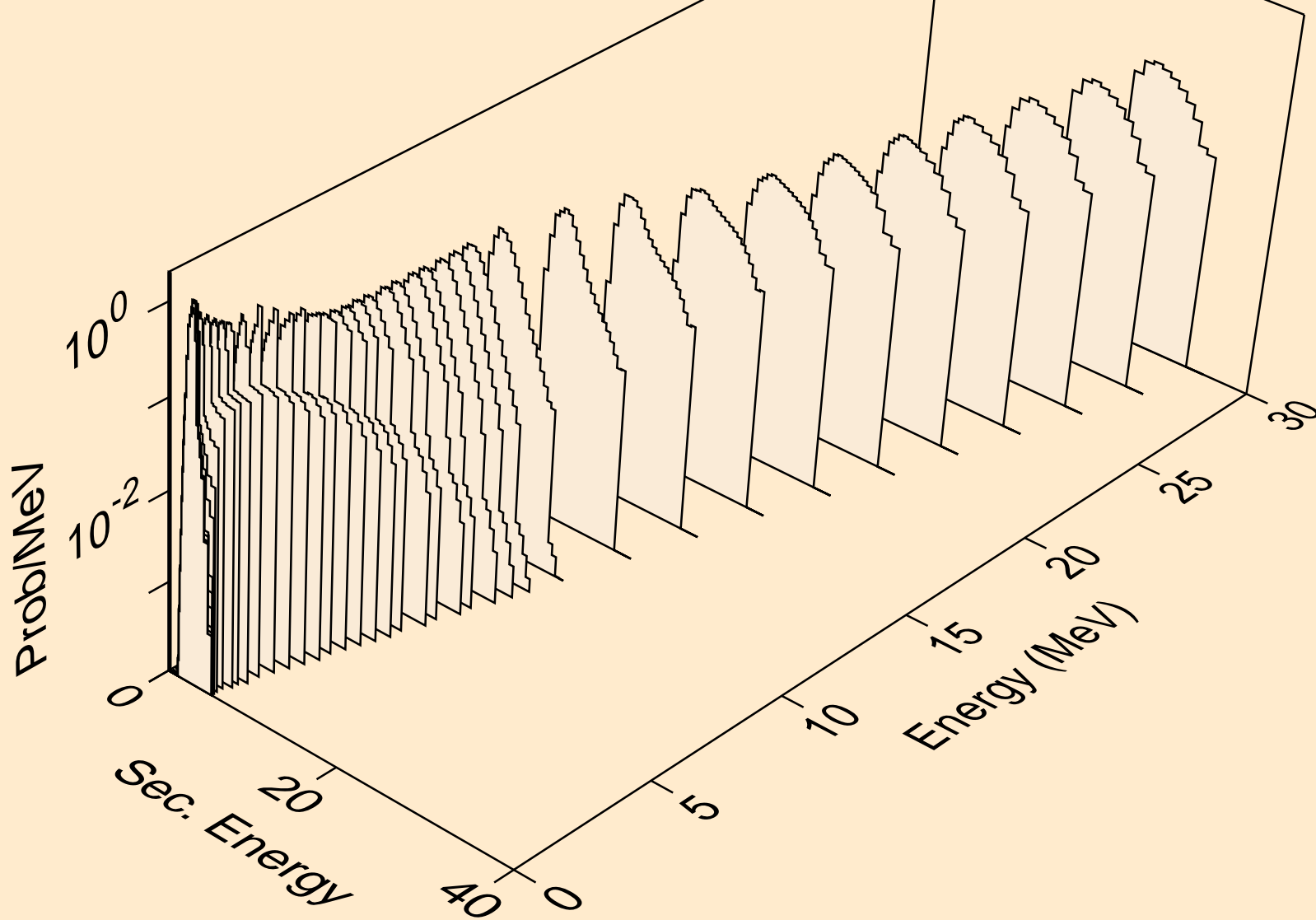

NB089M NEUTRON ACER TENDL-2019 LIBRARY; T=293.16K  
protons from (n,2p)

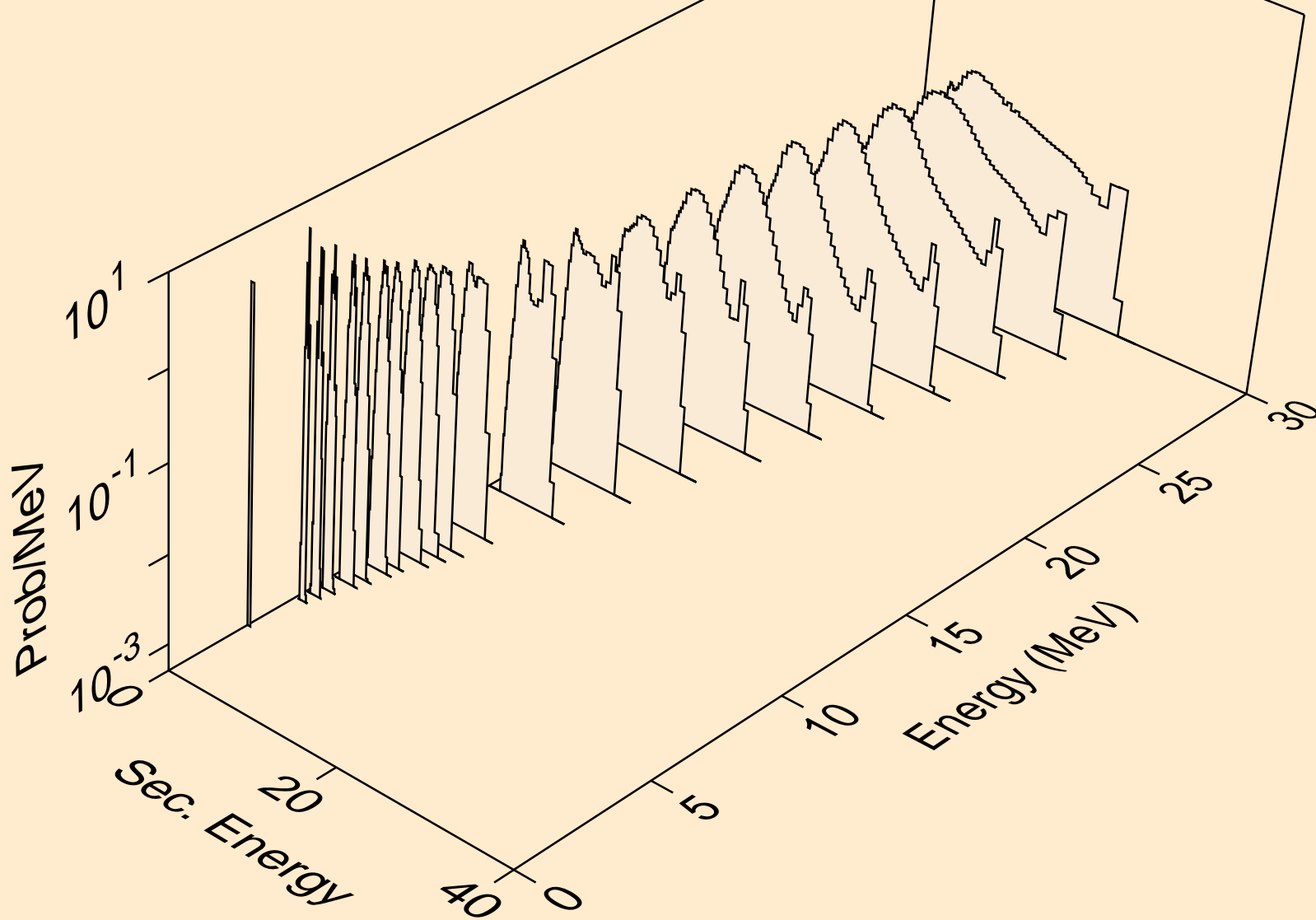

NB089M NEUTRON ACER TENDL-2019 LIBRARY; T=293.16K  
protons from (n,p)

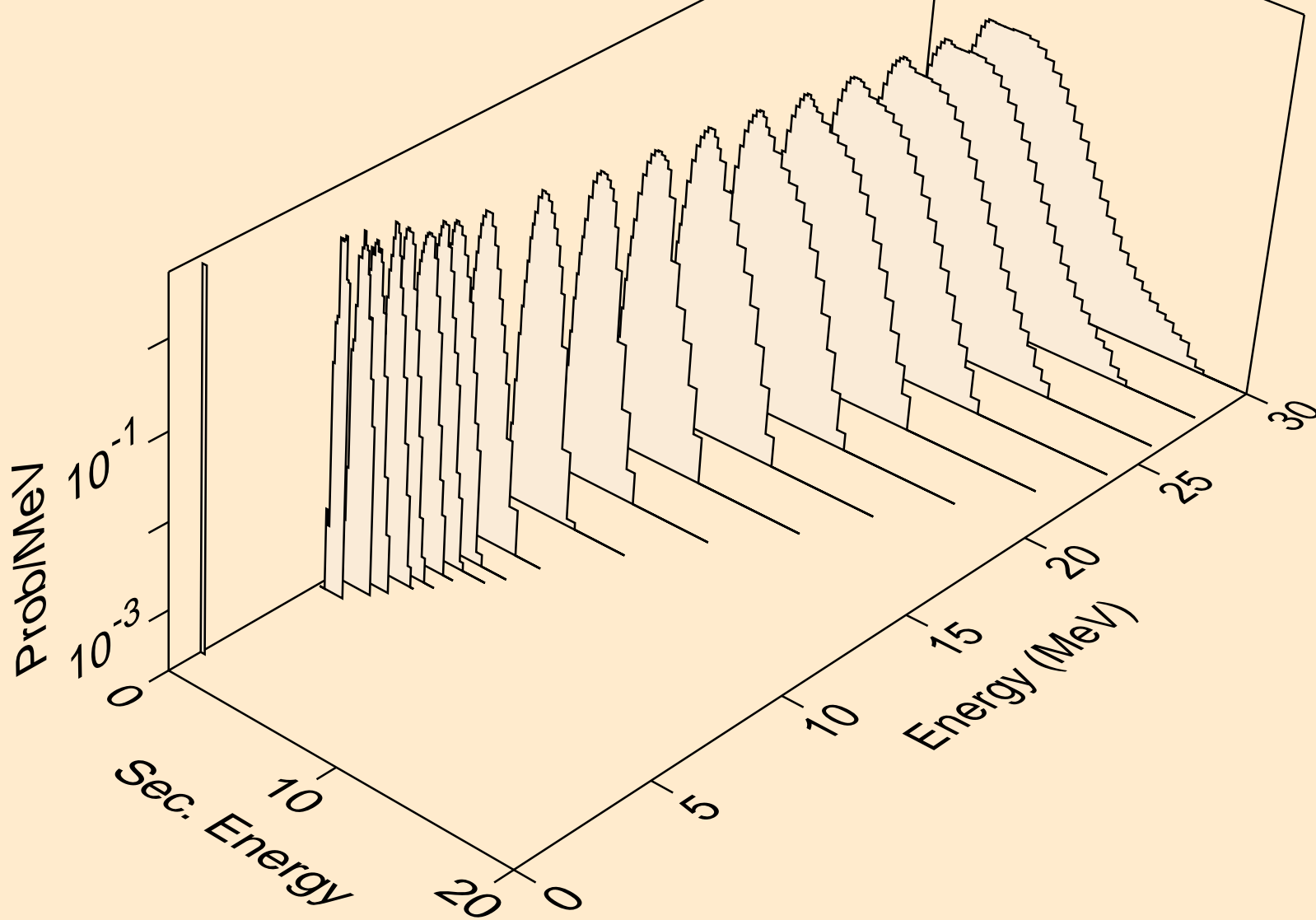

NB089M NEUTRON ACER TENDL-2019 LIBRARY; T=293.16K  
protons from (n,pd)

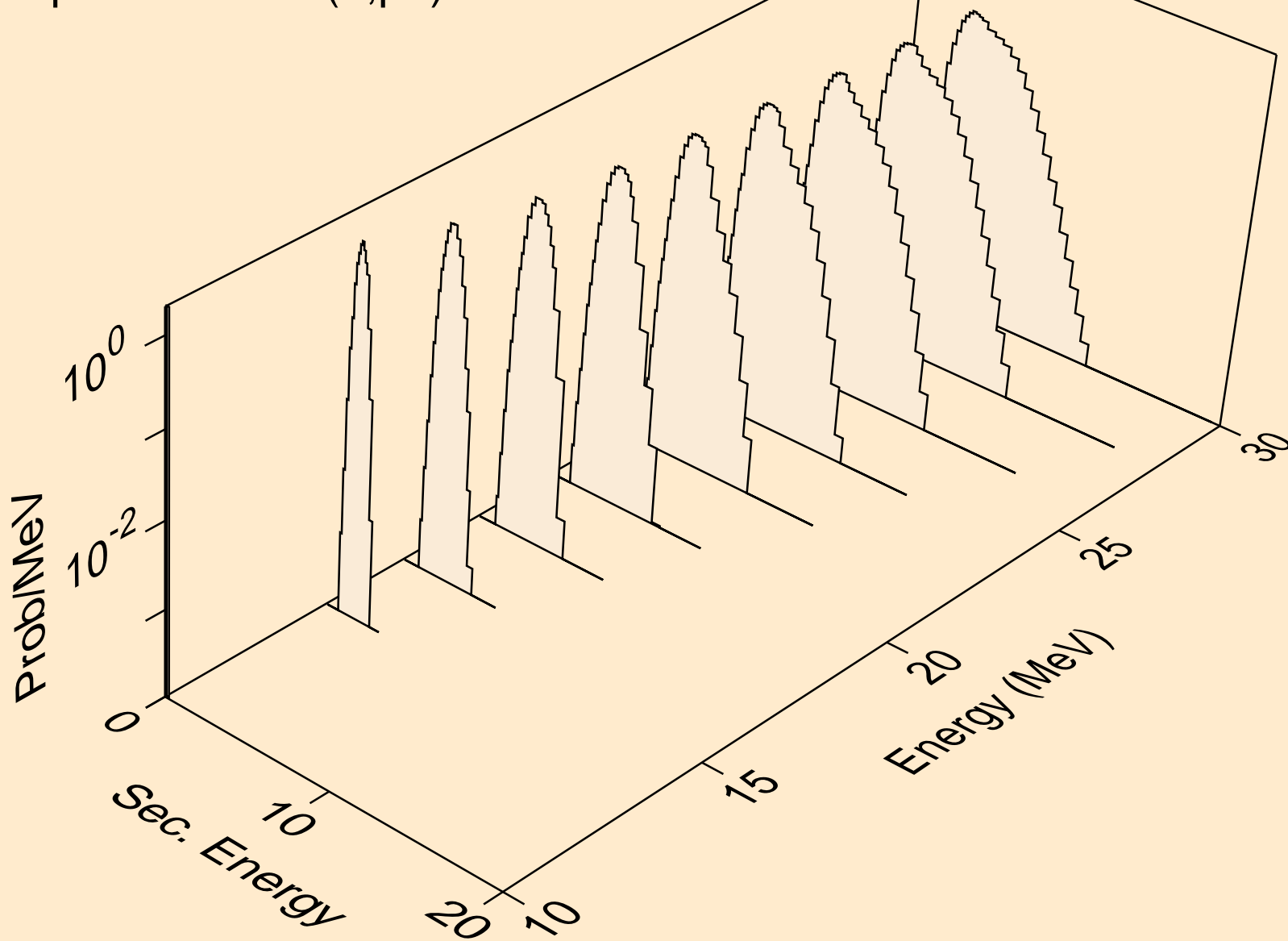

NB089M NEUTRON ACER TENDL-2019 LIBRARY; T=293.16K  
protons from (n,pt)

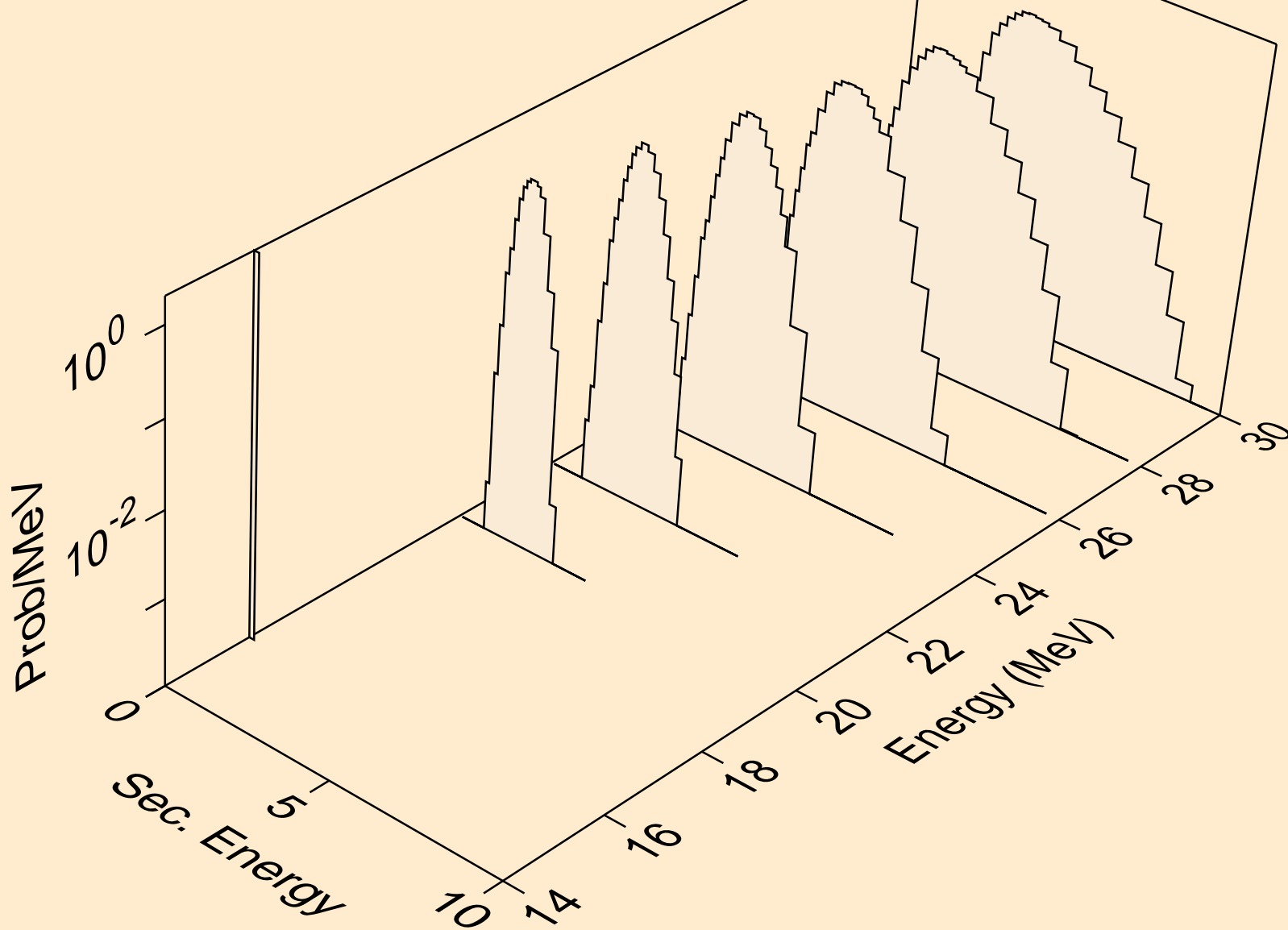

NB089M NEUTRON ACER TENDL-2019 LIBRARY; T=293.16K  
deuterons from (n,x)

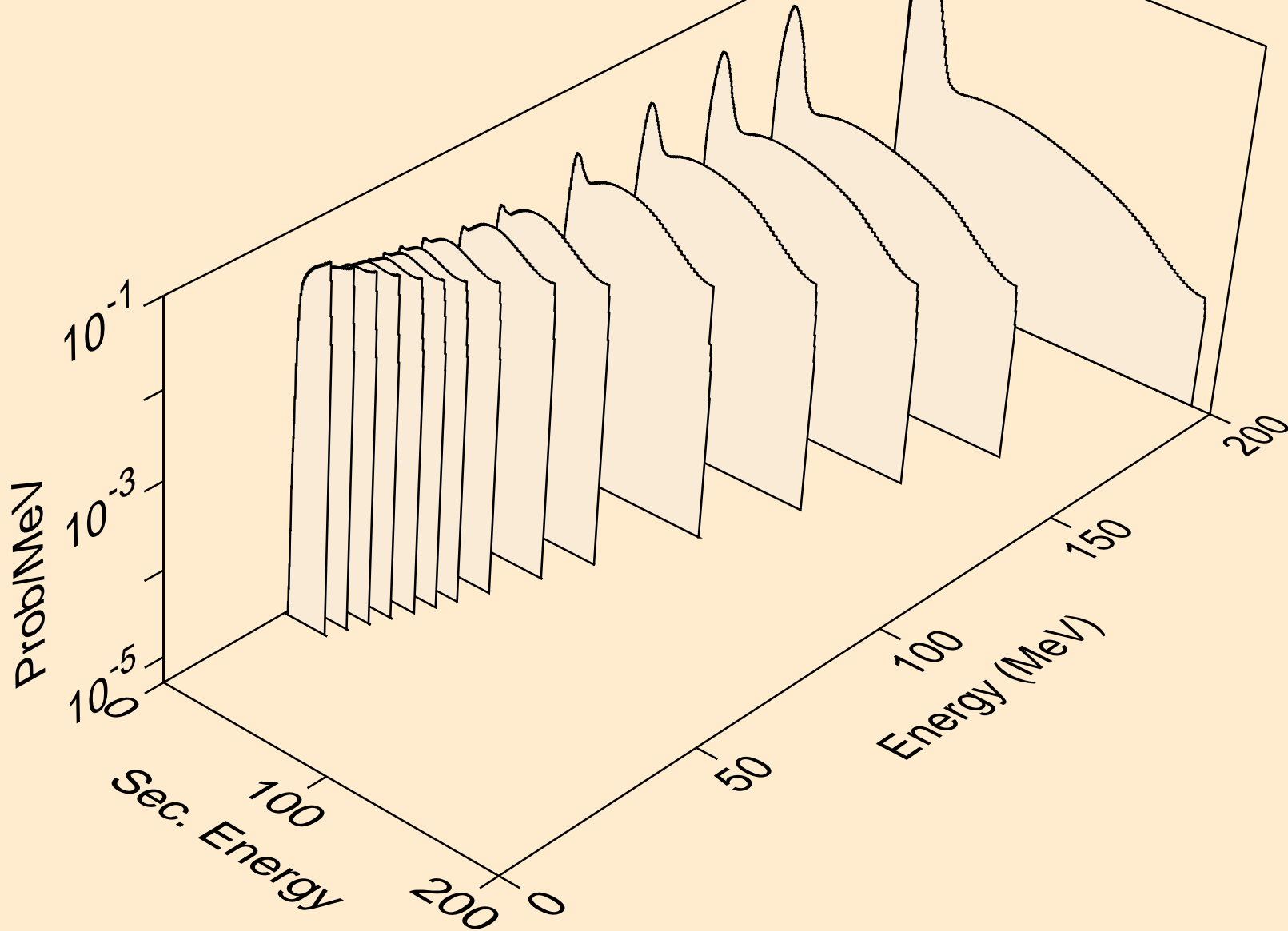

NB089M NEUTRON ACER TENDL-2019 LIBRARY; T=293.16K  
deuterons from (n,2nd)

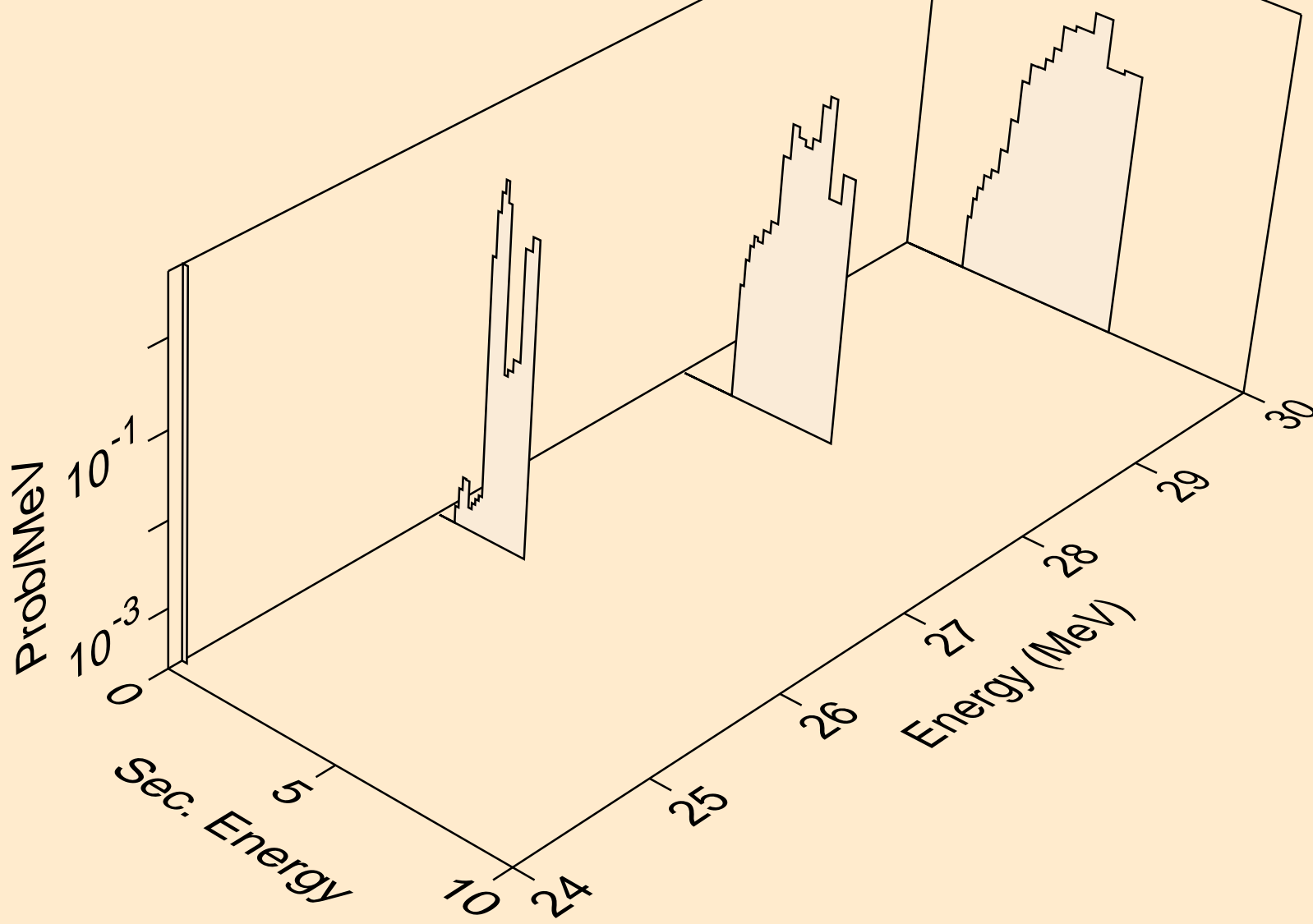



NB089M NEUTRON ACER TENDL-2019 LIBRARY; T=293.16K  
deuterons from (n,n\*)d

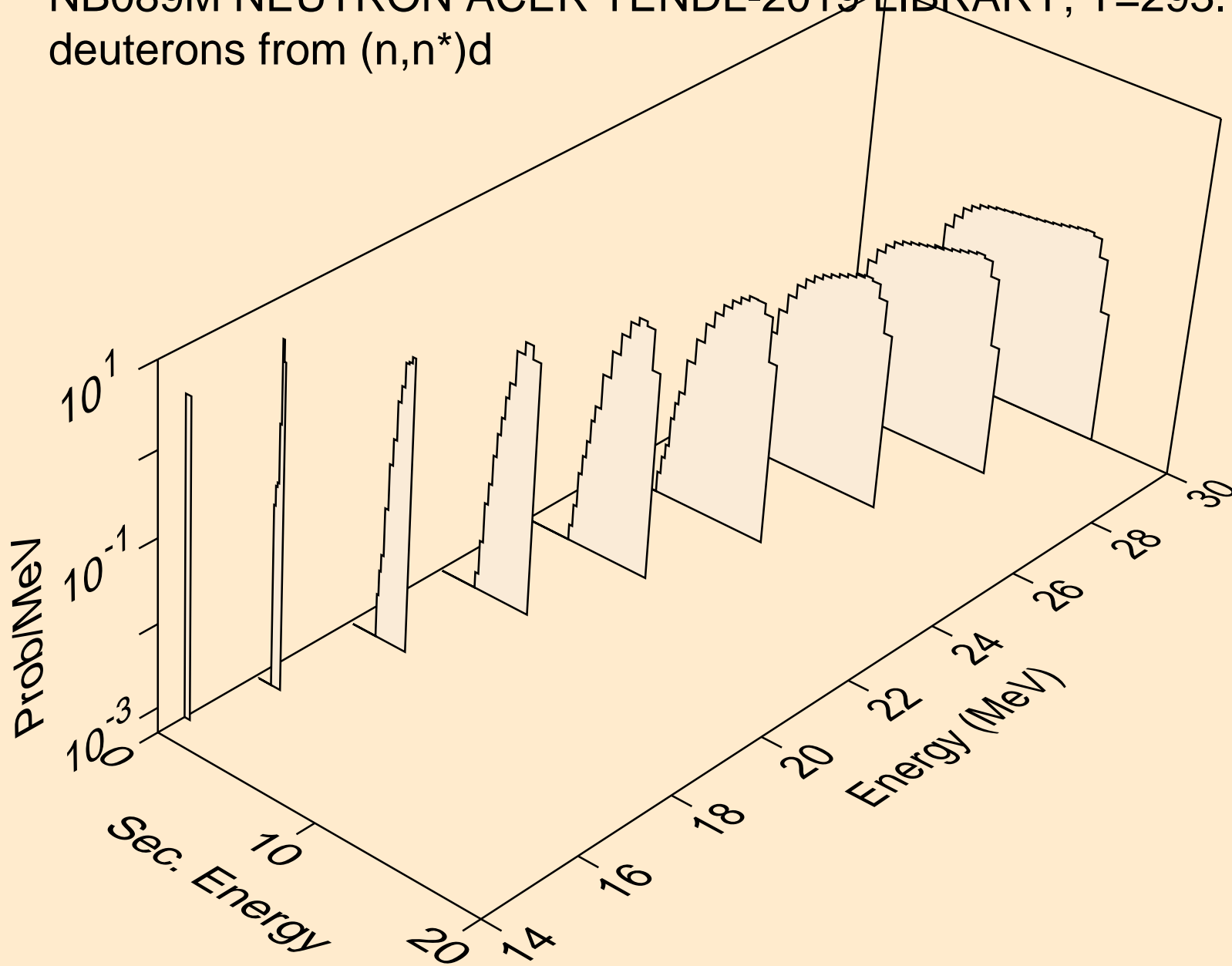

NB089M NEUTRON ACER TENDL-2019 LIBRARY; T=293.16K  
deuterons from (n,d)

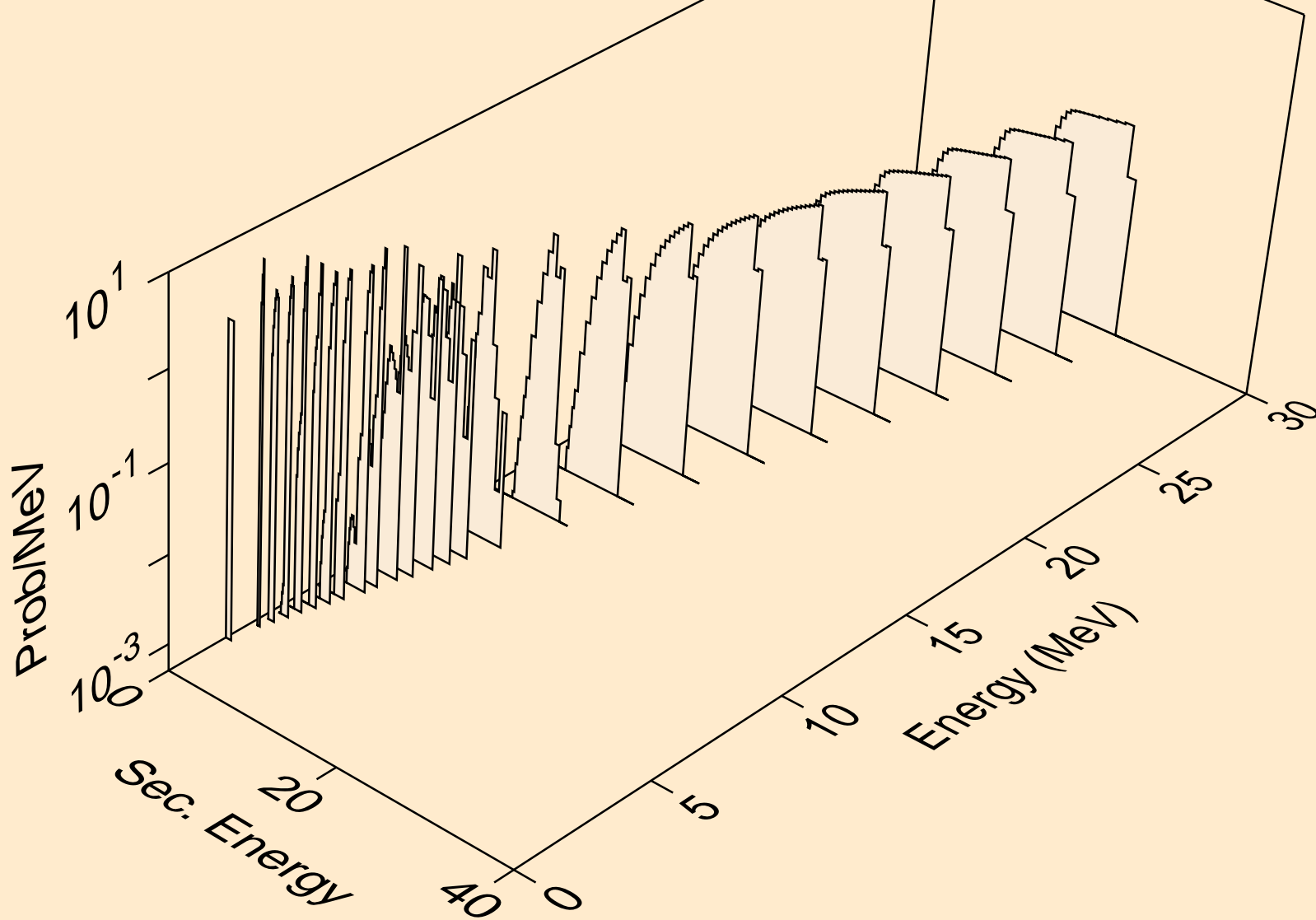

NB089M NEUTRON ACER TENDL-2019 LIBRARY; T=293.16K  
deuterons from (n,pd)

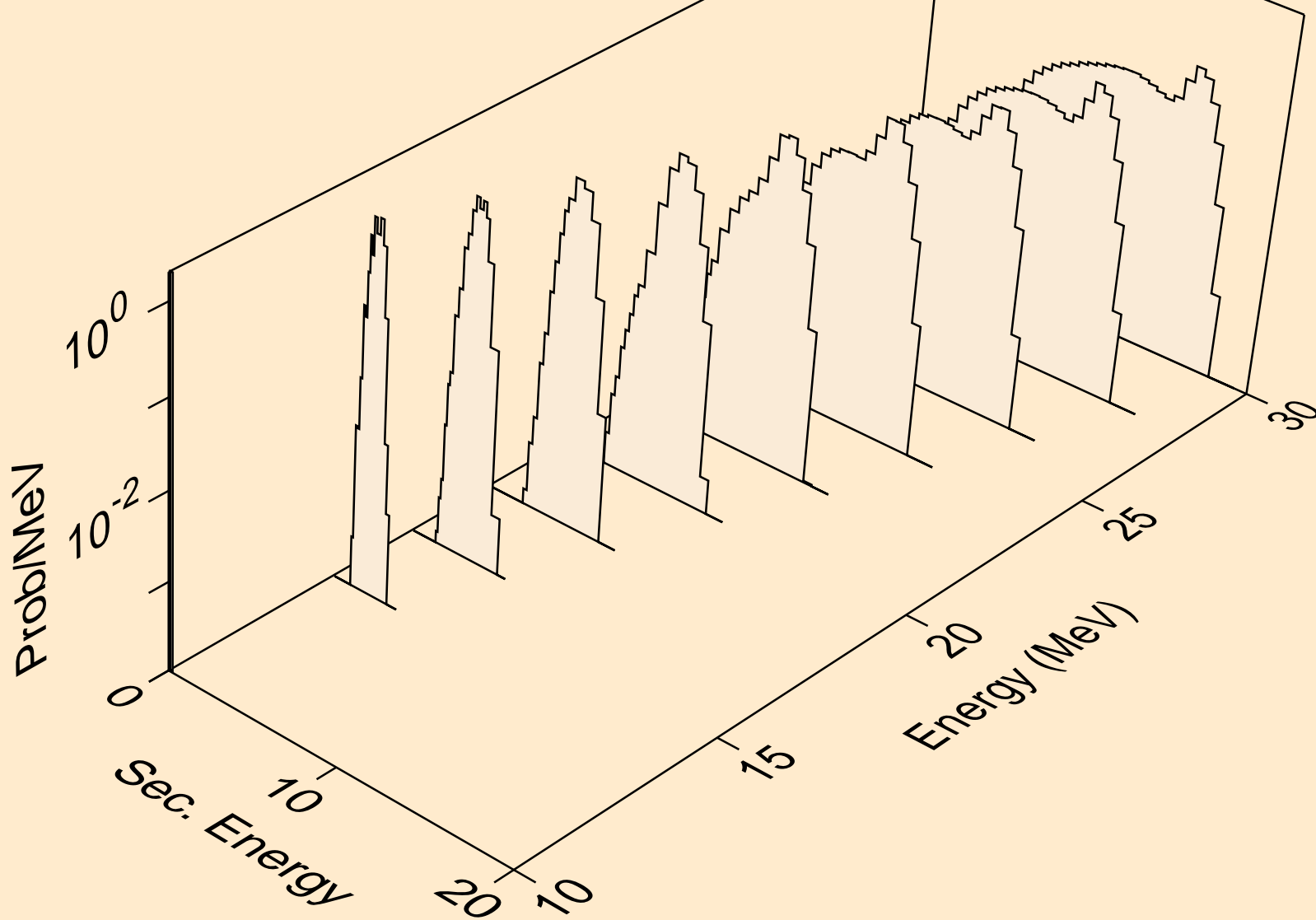

NB089M NEUTRON ACER TENDL-2019 LIBRARY; T=293.16K  
deuterons from (n,da)

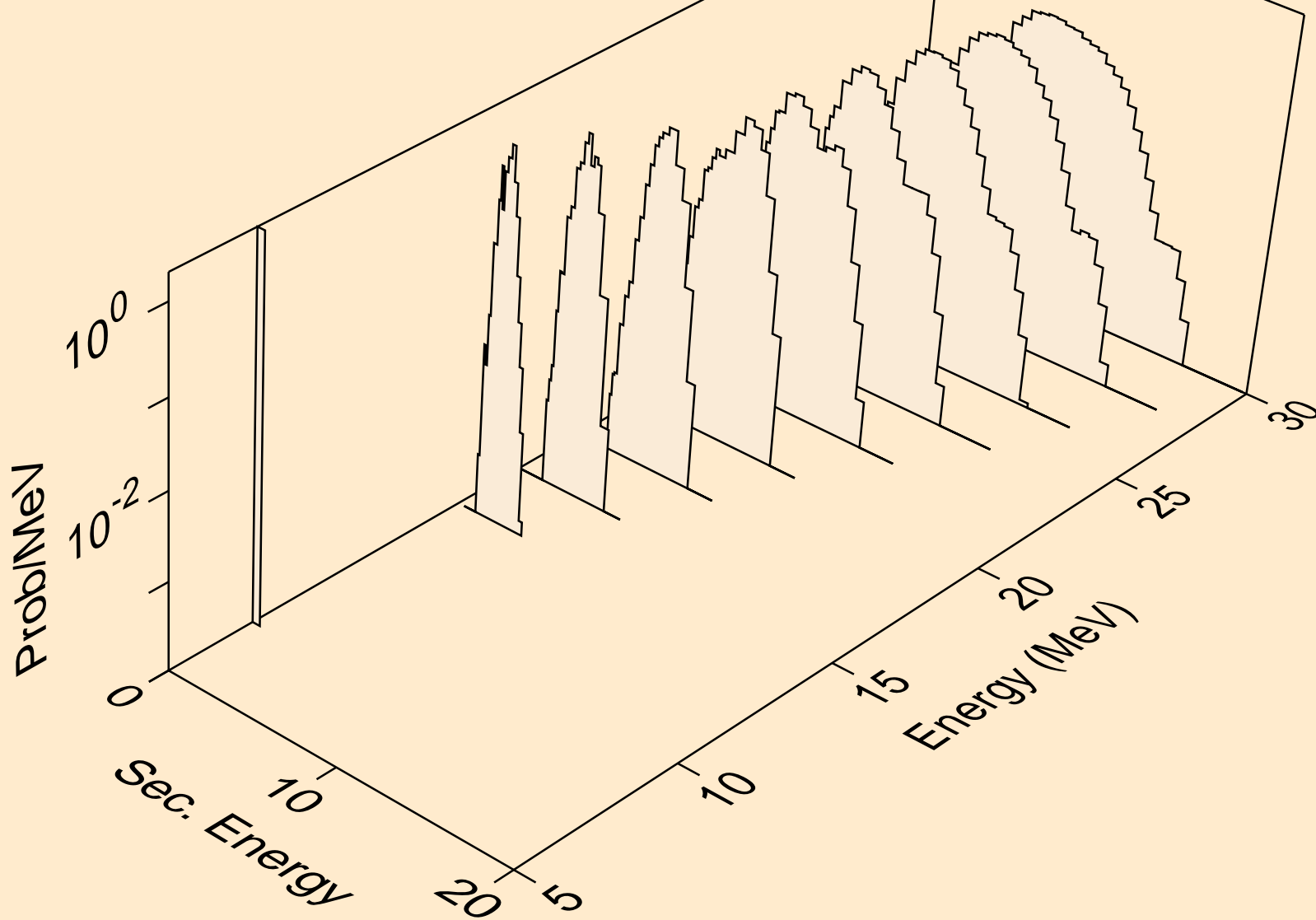

NB089M NEUTRON ACER TENDL-2019 LIBRARY; T=293.16K  
tritons from (n,x)

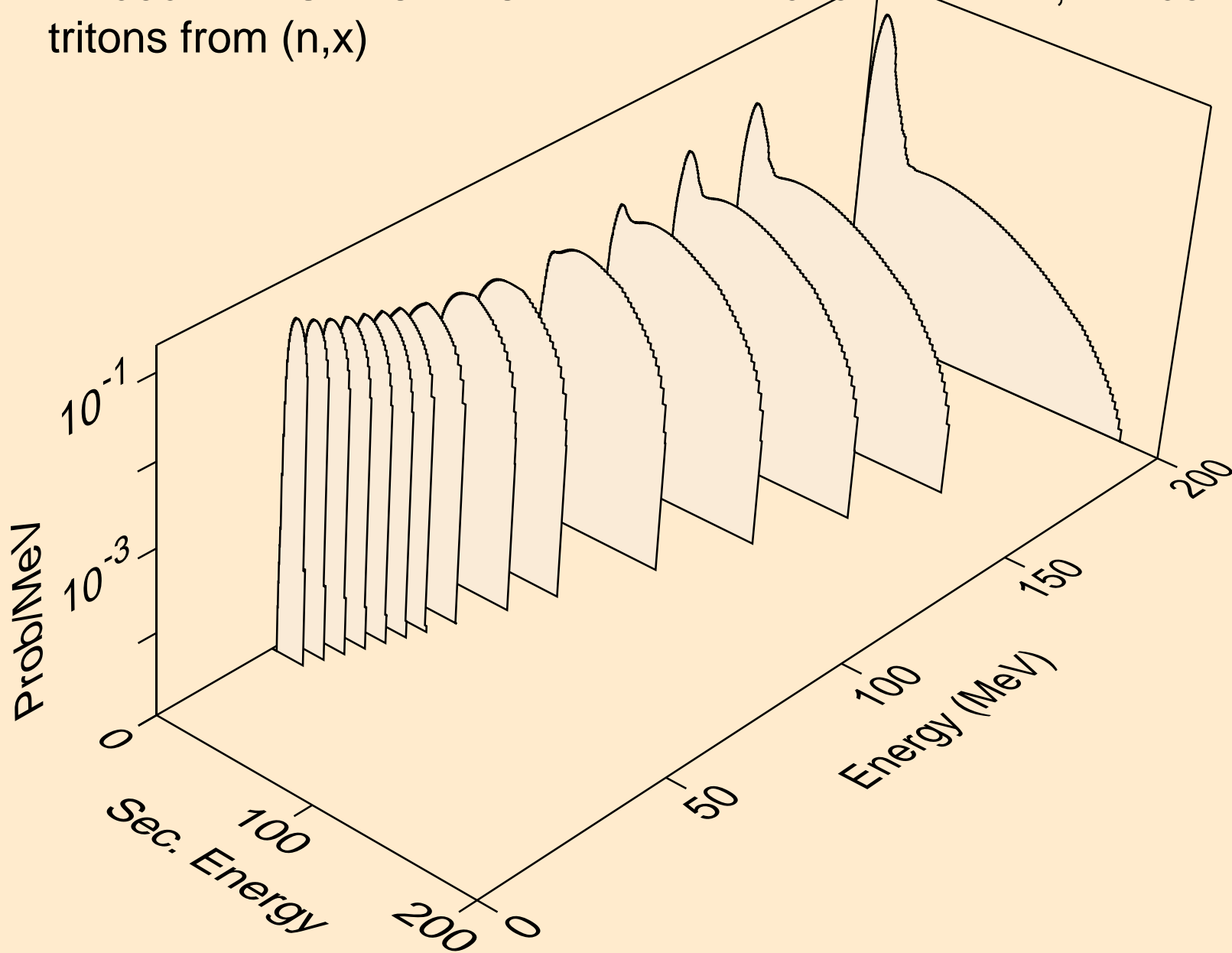

NB089M NEUTRON ACER TENDL-2019 LIBRARY; T=293.16K  
tritons from (n,n\*)t

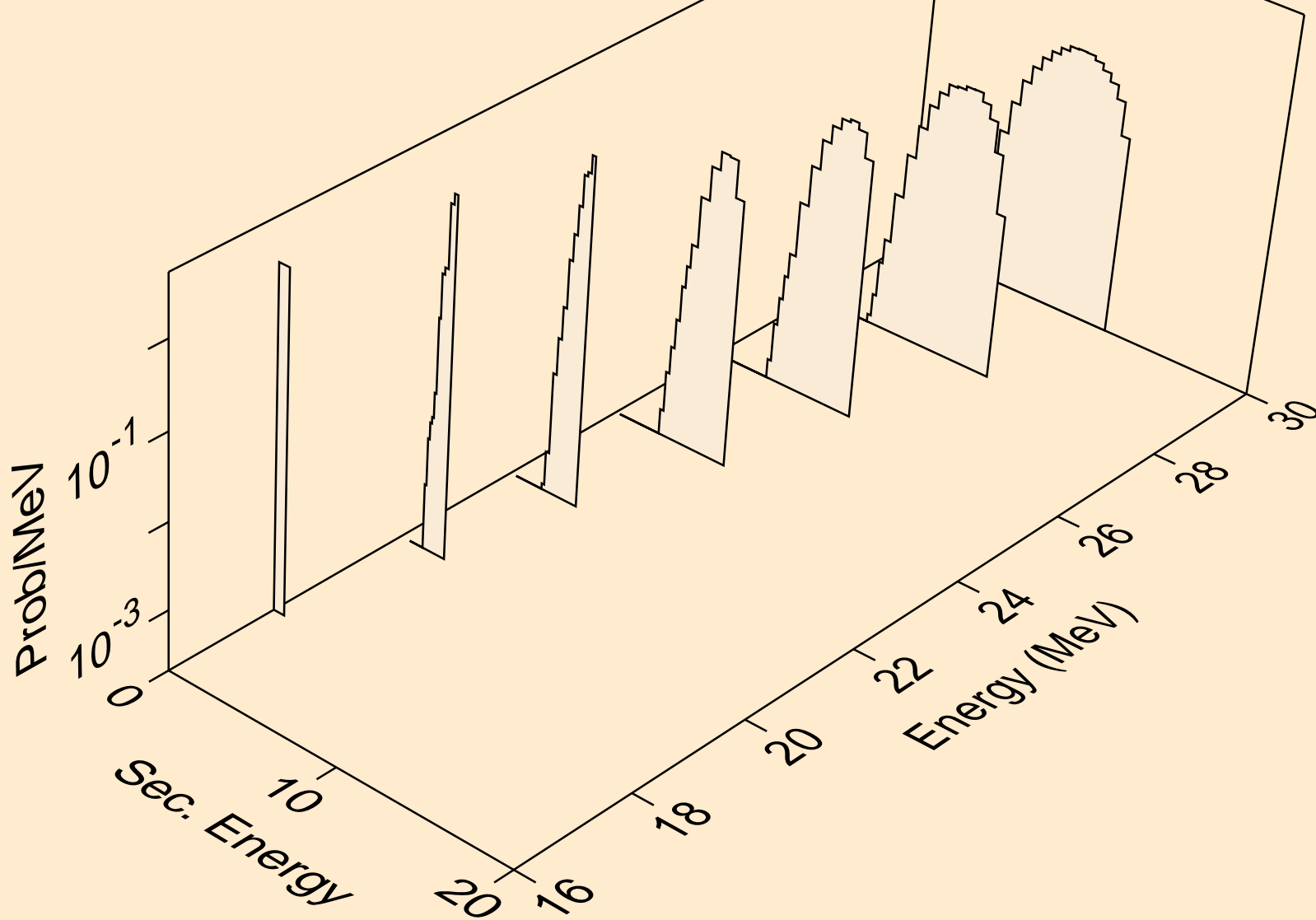

NB089M NEUTRON ACER TENDL-2019 LIBRARY; T=293.16K  
tritons from (n,t)

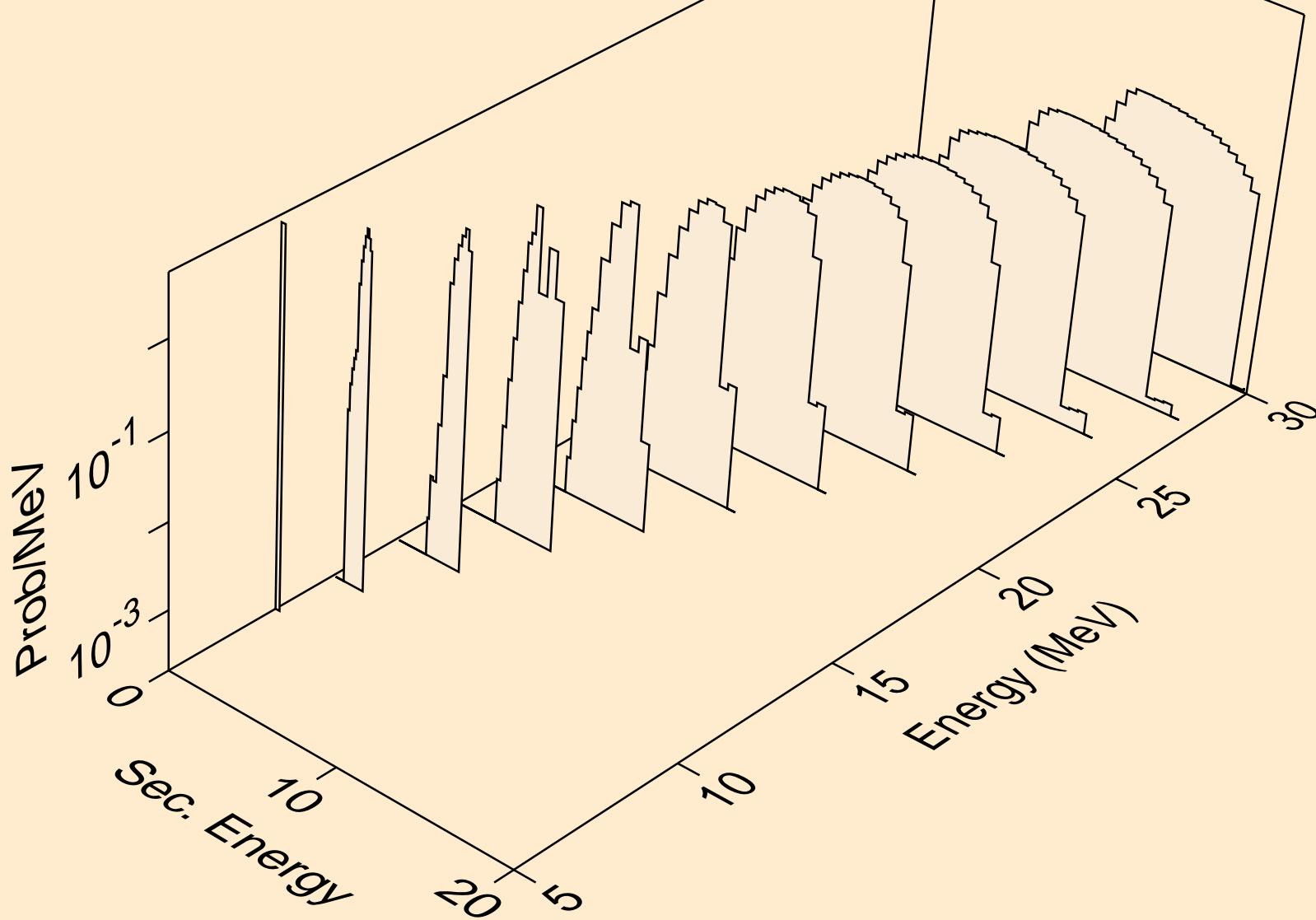

NB089M NEUTRON ACER TENDL-2019 LIBRARY; T=293.16K  
tritons from (n,pt)

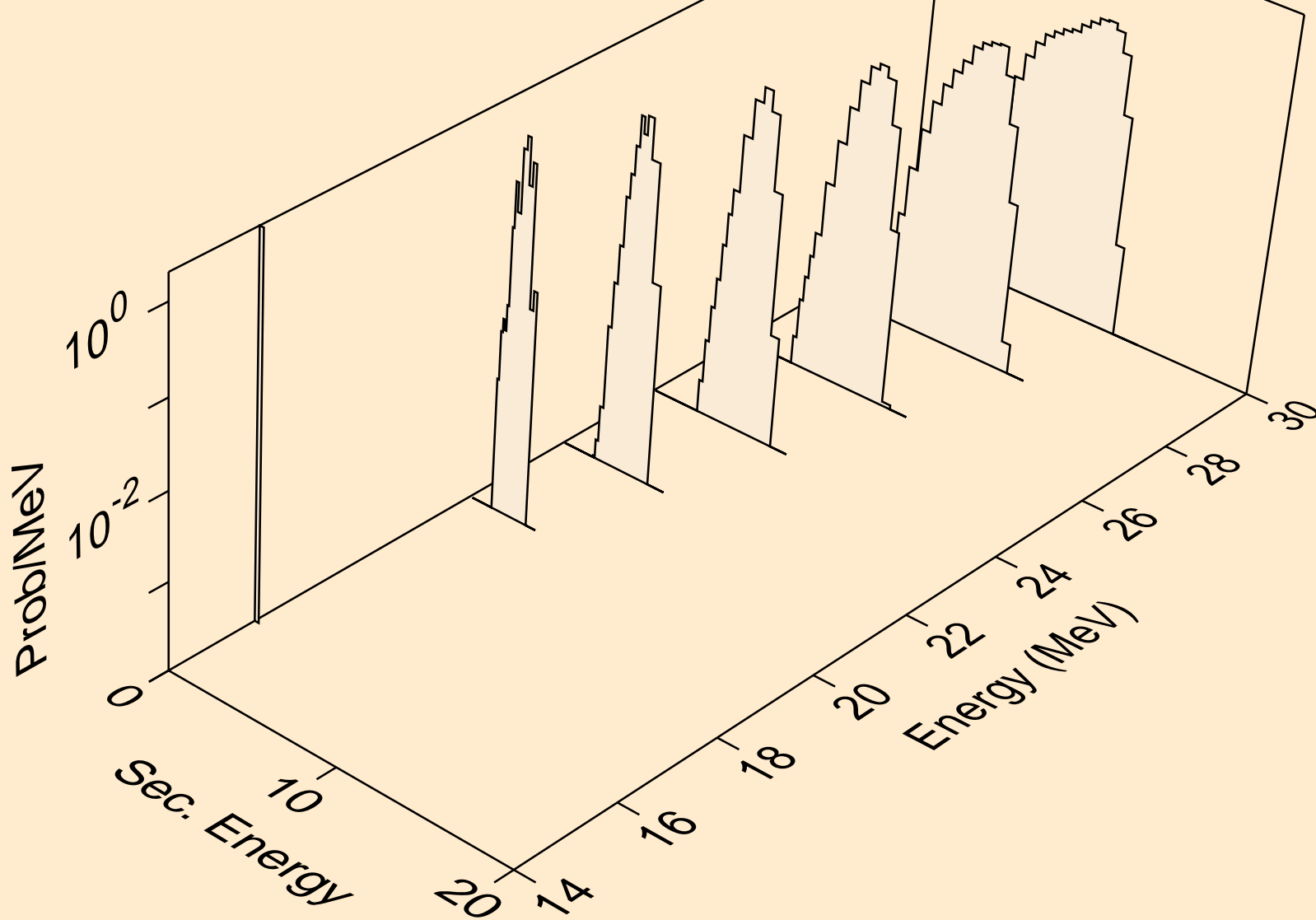



NB089M NEUTRON ACER TENDL-2019 LIBRARY; T=293.16K  
he3s from (n,x)

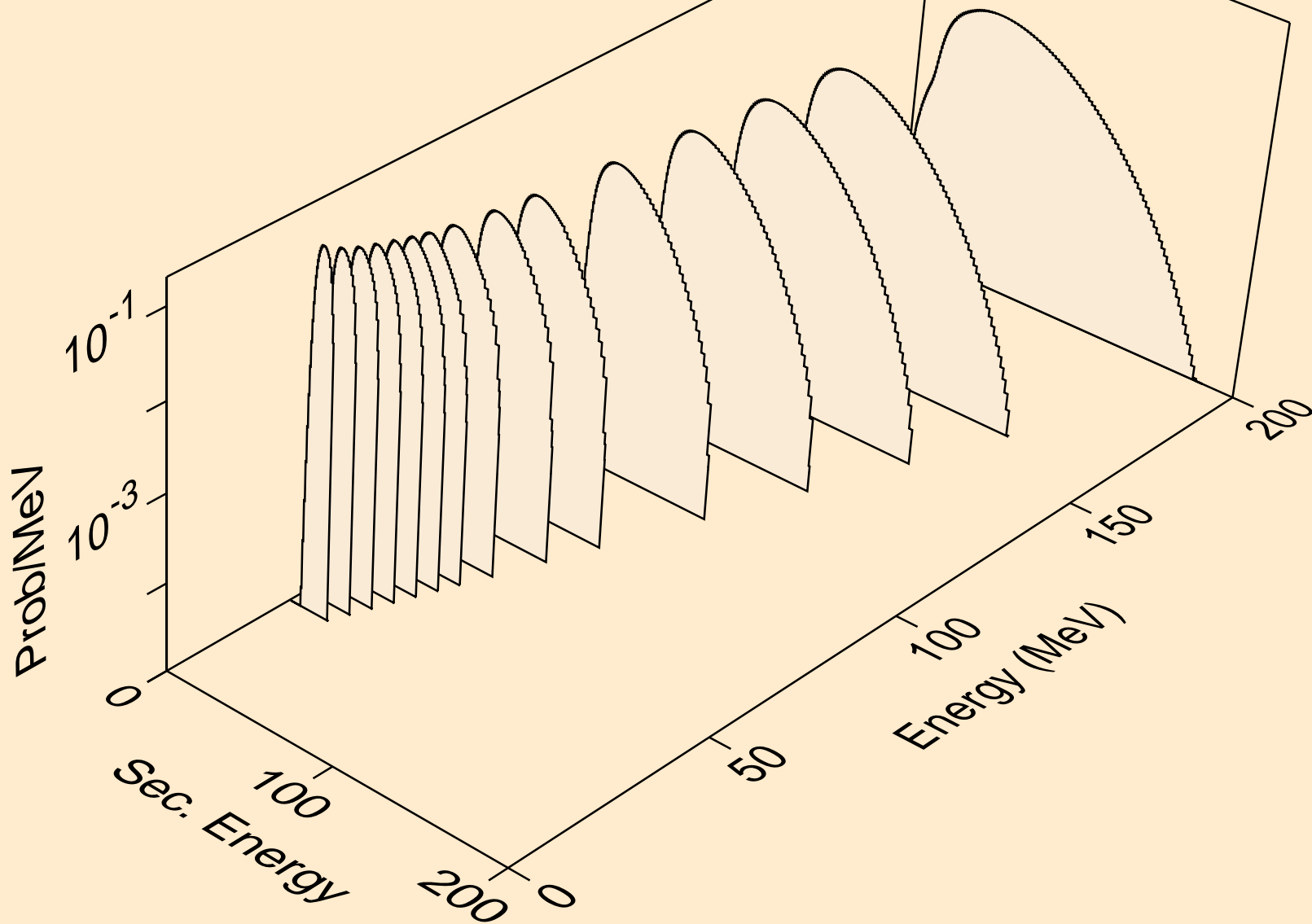

NB089M NEUTRON ACER TENDL-2019 LIBRARY; T=293.16K  
he3s from (n,n\*)he3

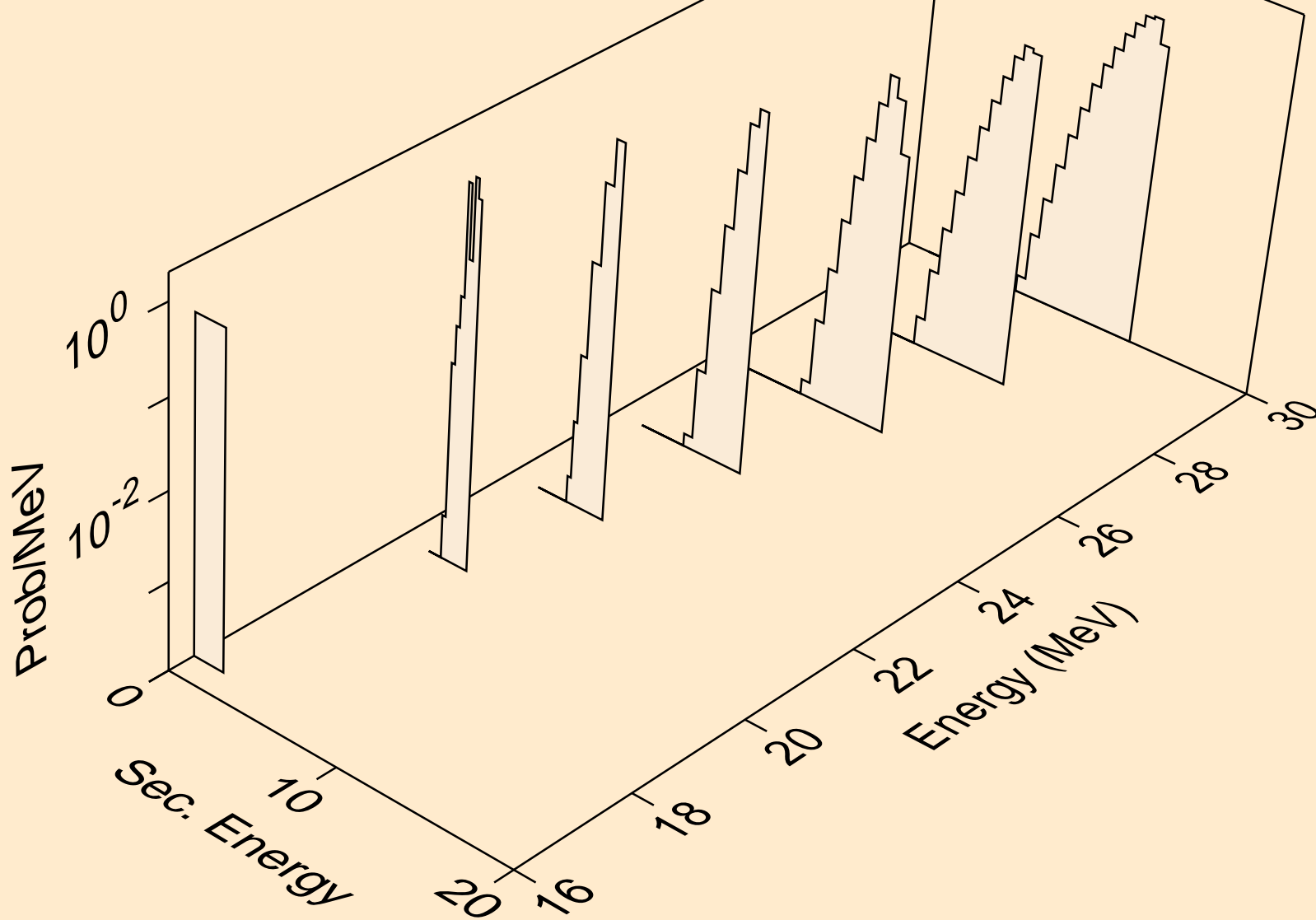

NB089M NEUTRON ACER TENDL-2019 LIBRARY; T=293.16K  
he3s from (n,he3)

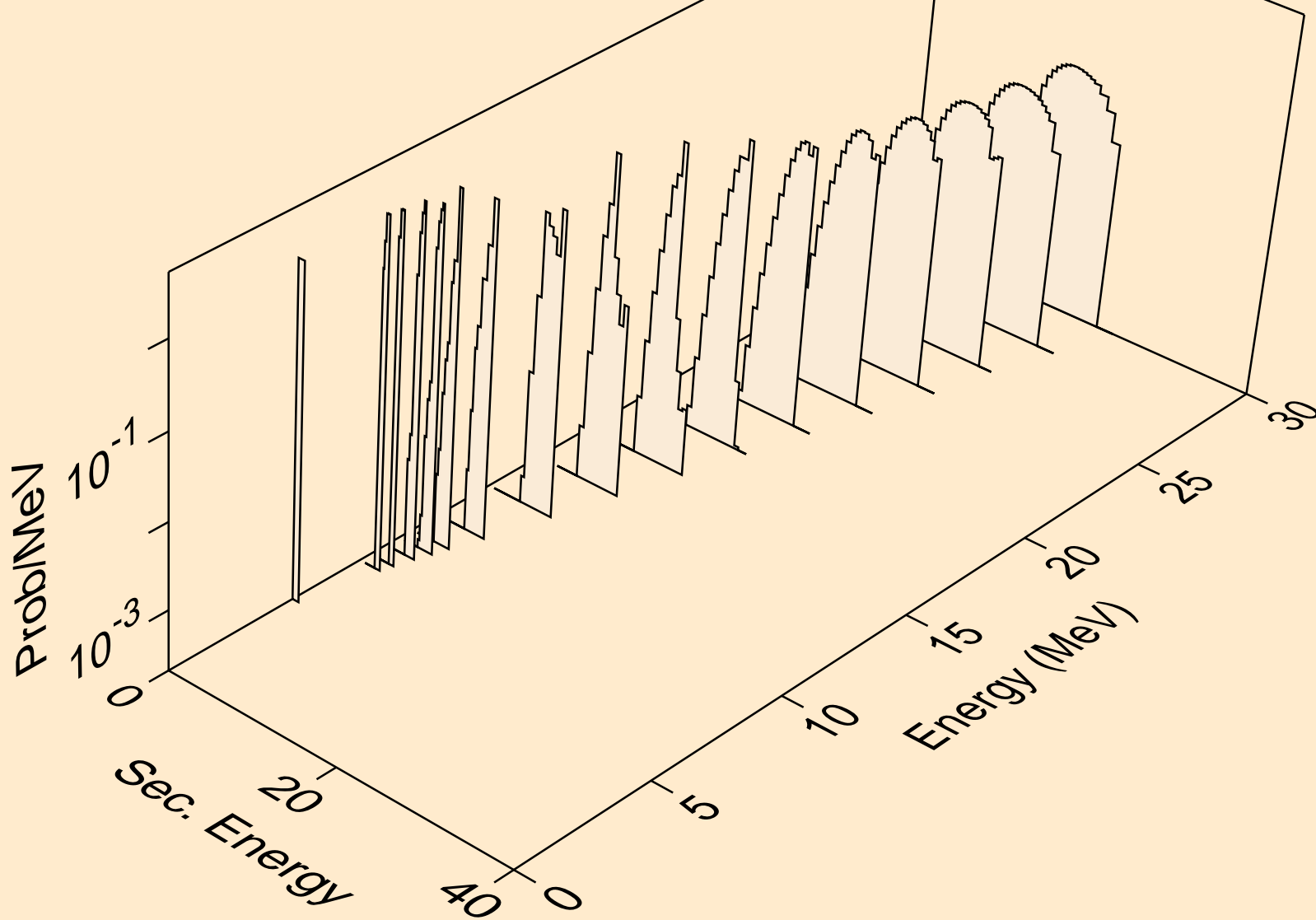

NB089M NEUTRON ACER TENDL-2019 LIBRARY; T=293.16K  
alphas from (n,x)

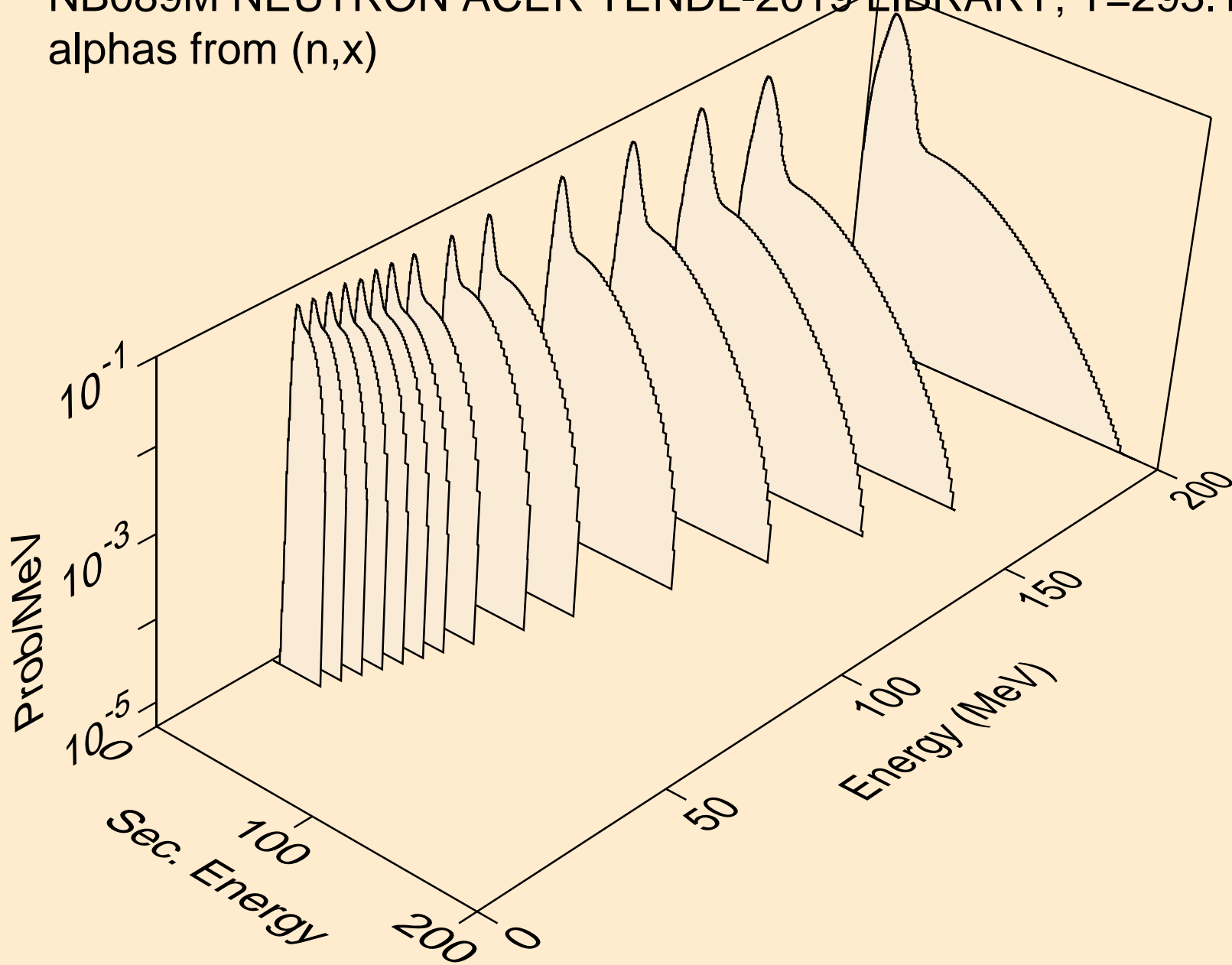

NB089M NEUTRON ACER TENDL-2019 LIBRARY; T=293.16K  
alphas from (n,n\*)a

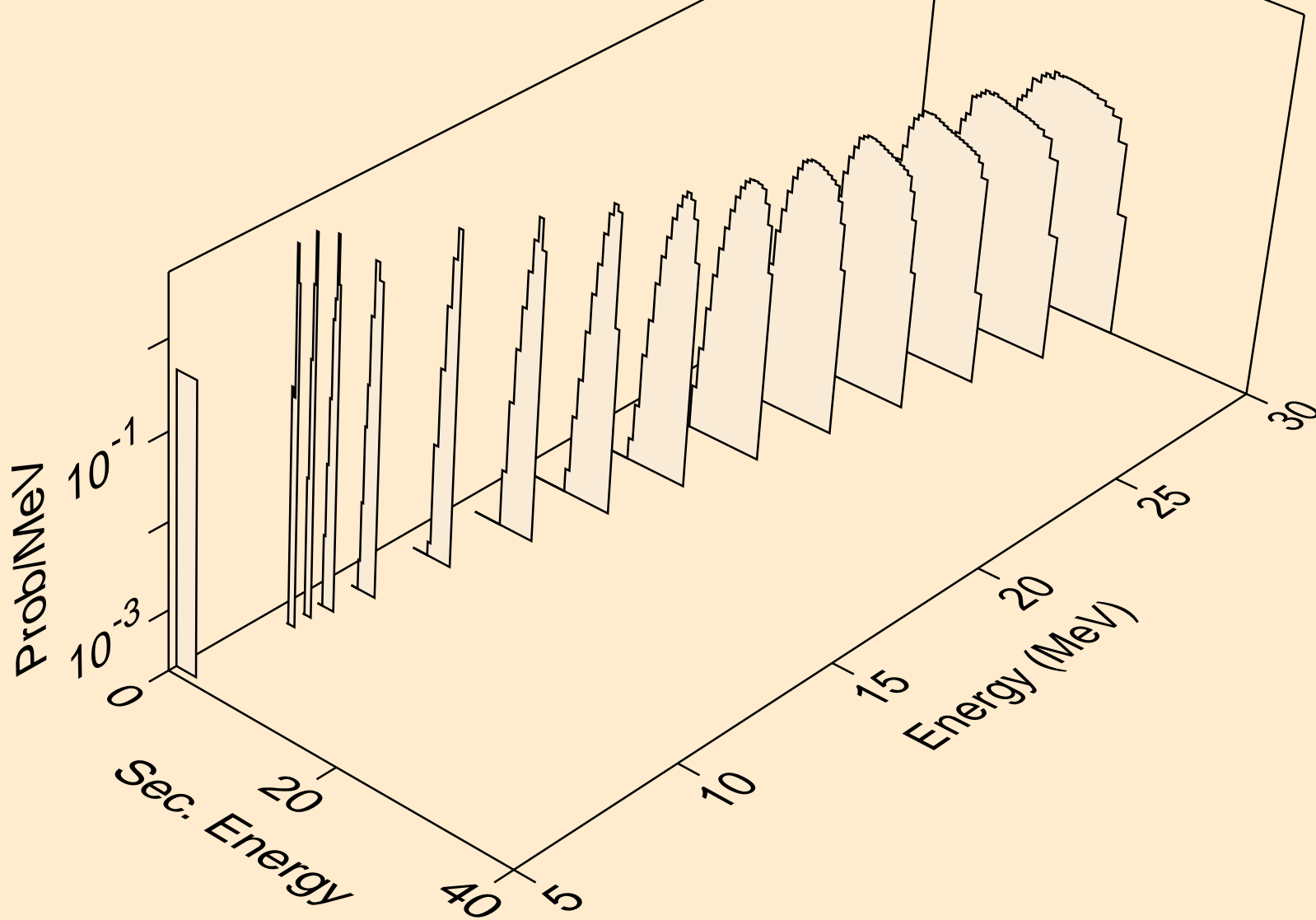

NB089M NEUTRON ACER TENDL-2019 LIBRARY; T=293.16K  
alphas from (n,2n)a

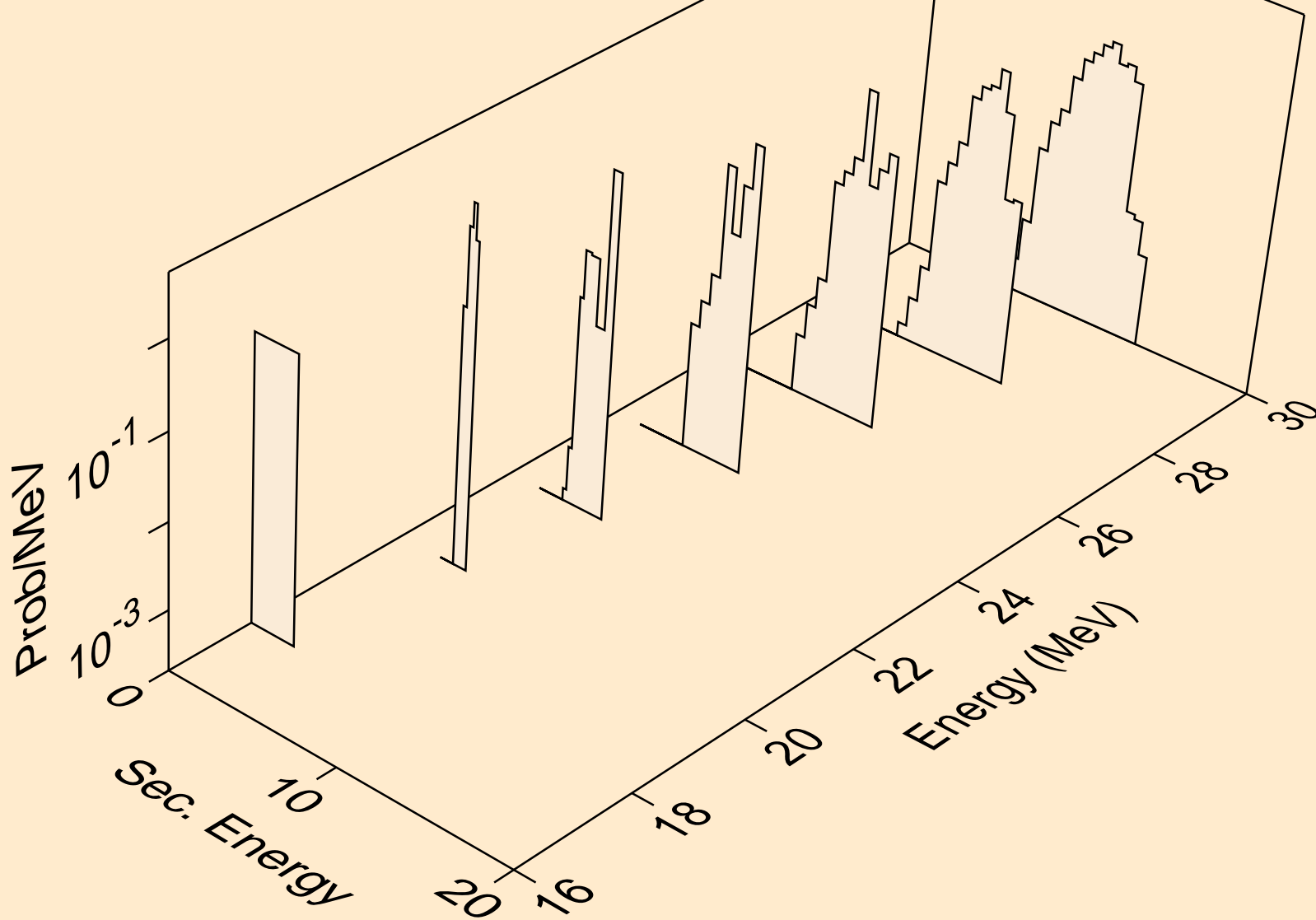

NB089M NEUTRON ACER TENDL-2019 LIBRARY; T=293.16K  
alphas from (n,n\*)2a

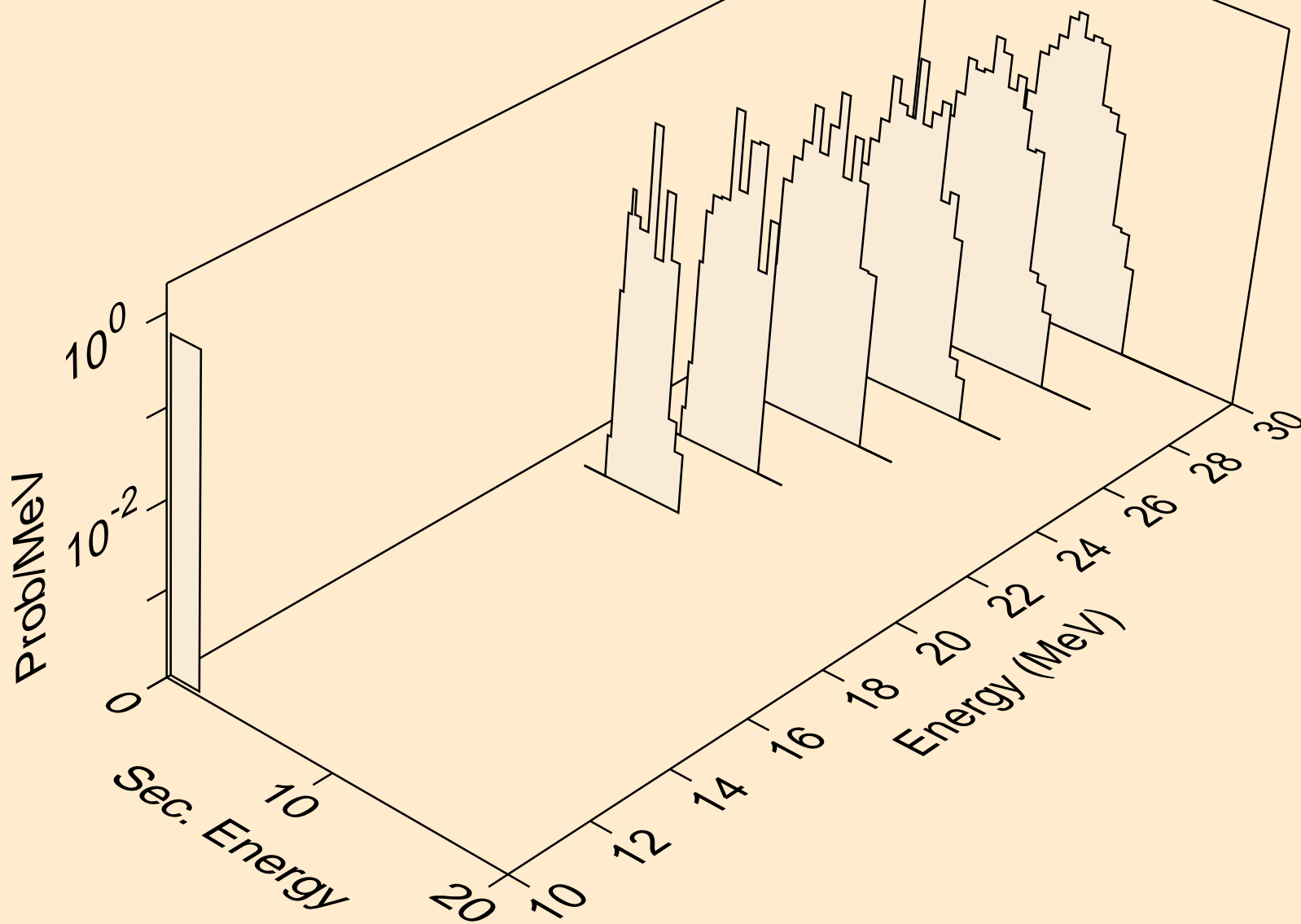

NB089M NEUTRON ACER TENDL-2019 LIBRARY; T=293.16K  
alphas from (n,npa)

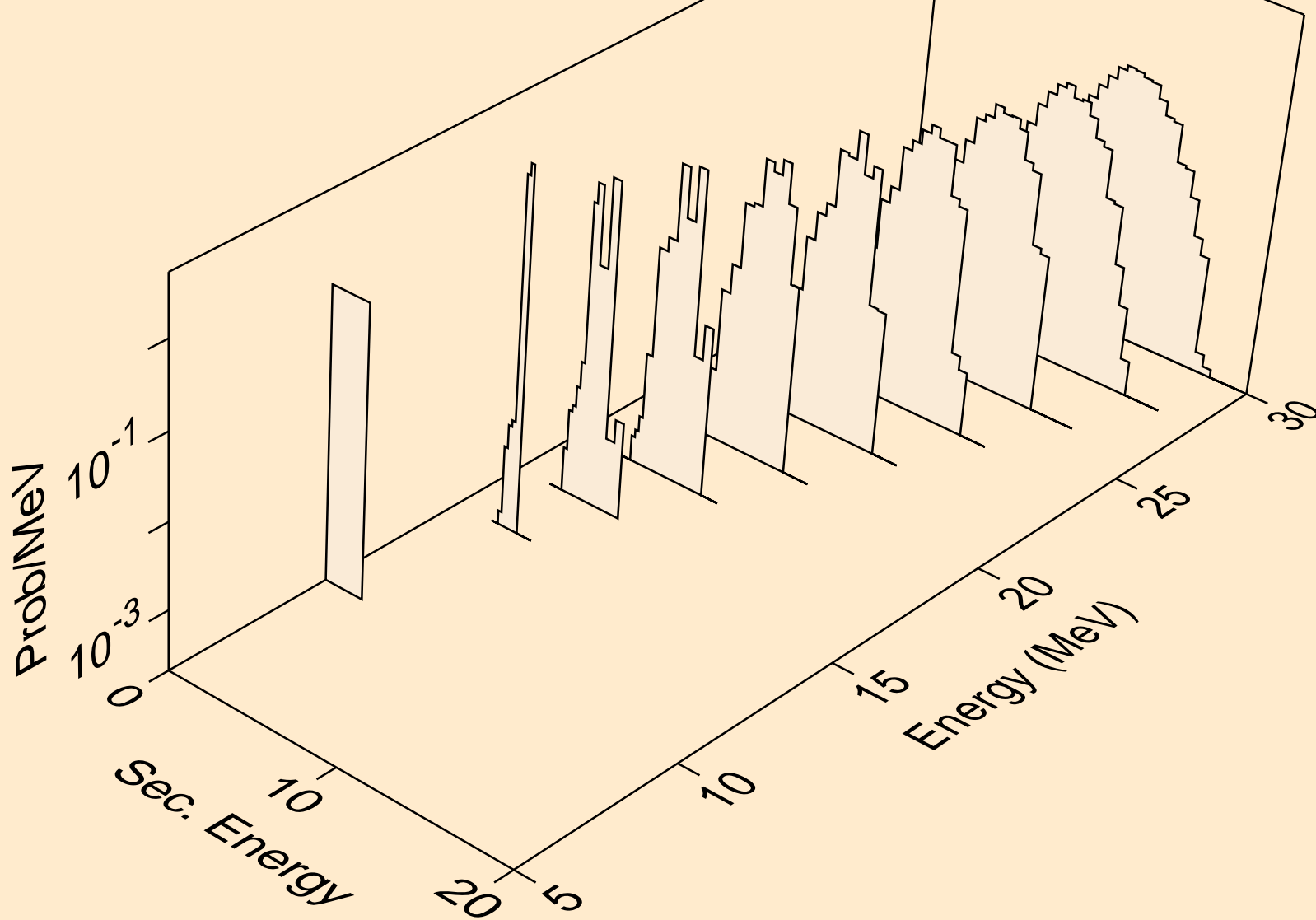



NB089M NEUTRON ACER TENDL-2019 LIBRARY; T=293.16K  
alphas from (n,a)

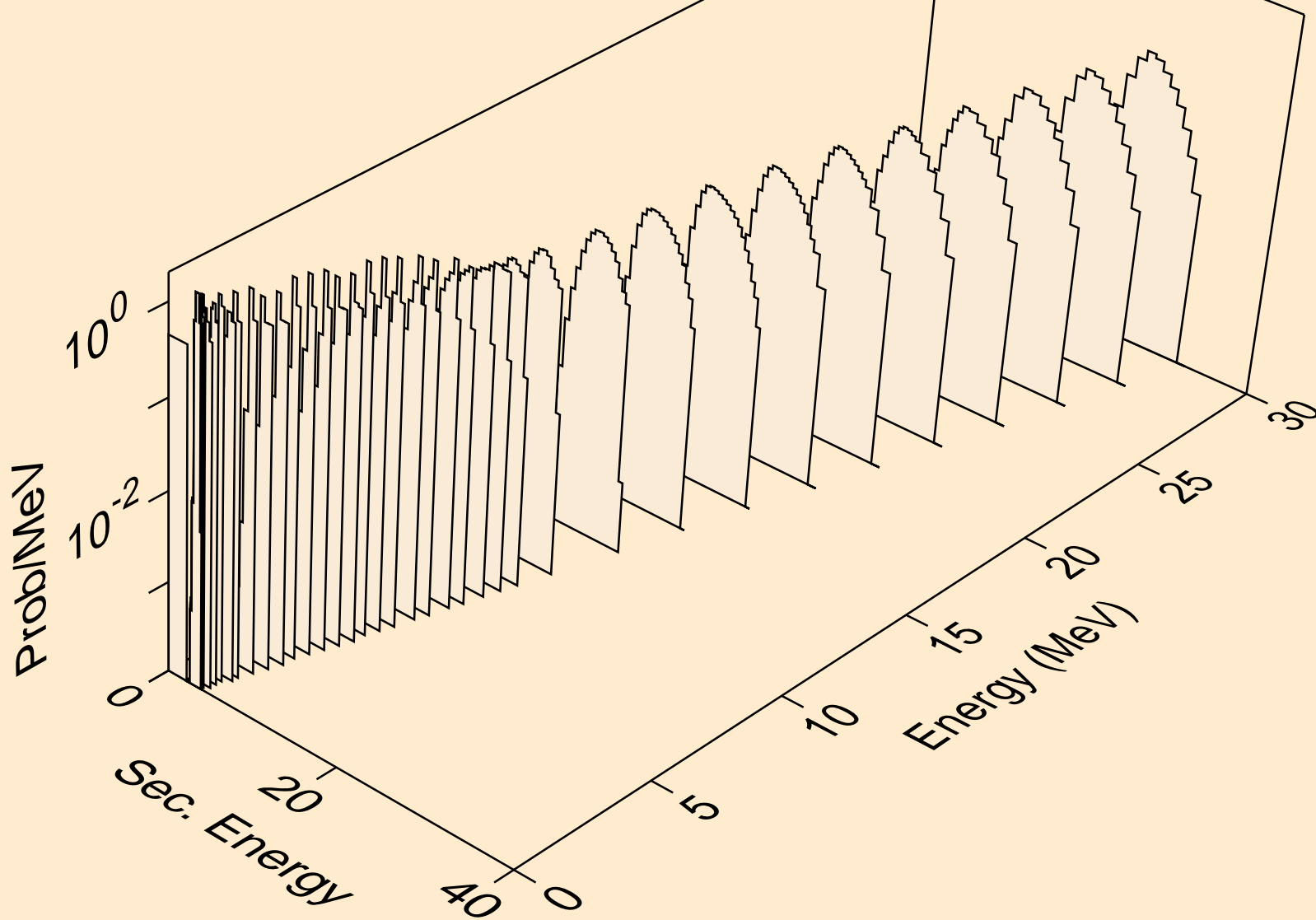

NB089M NEUTRON ACER TENDL-2019 LIBRARY; T=293.16K  
alphas from (n,2a)

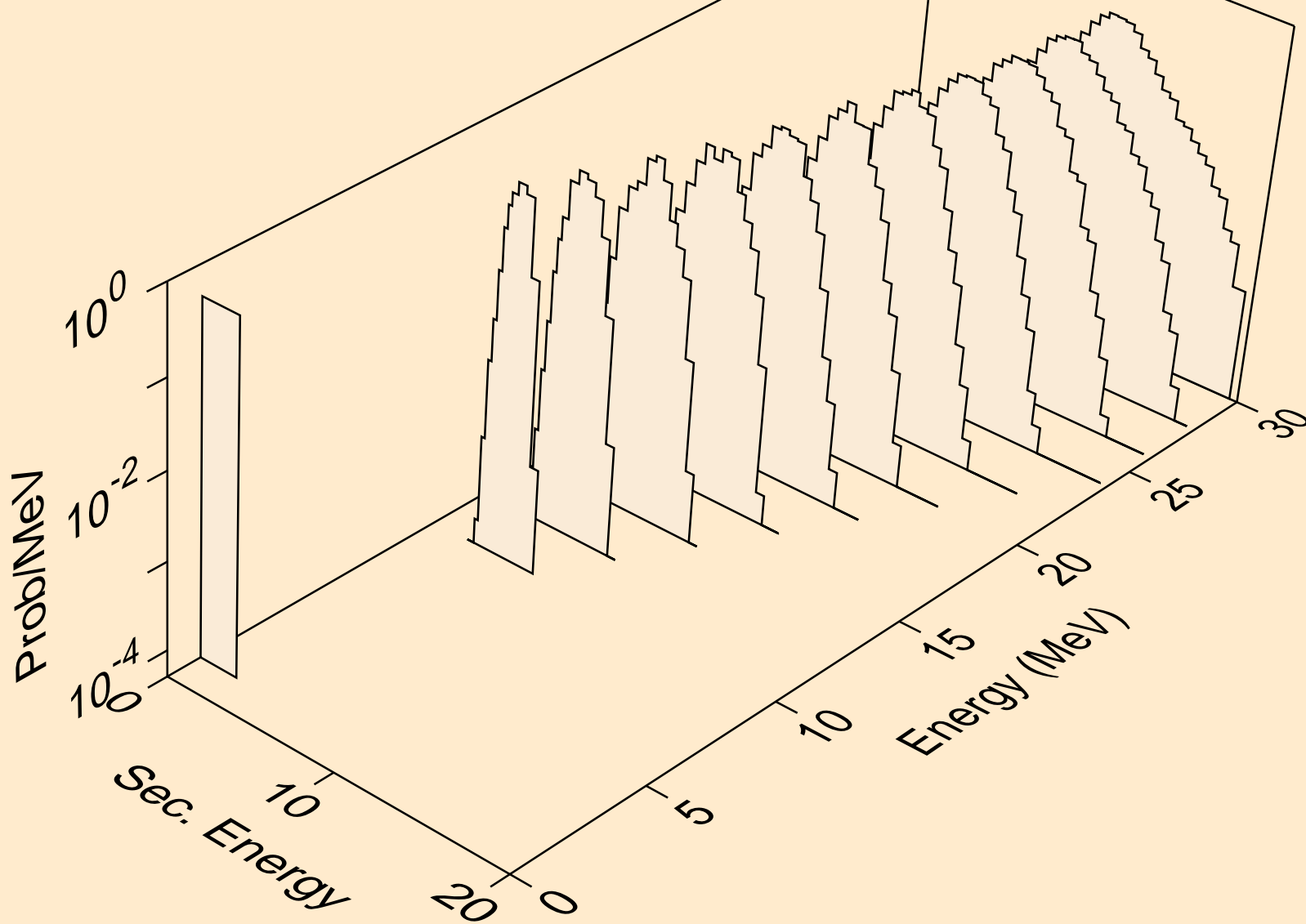

NB089M NEUTRON ACER TENDL-2019 LIBRARY; T=293.16K  
alphas from (n,pa)

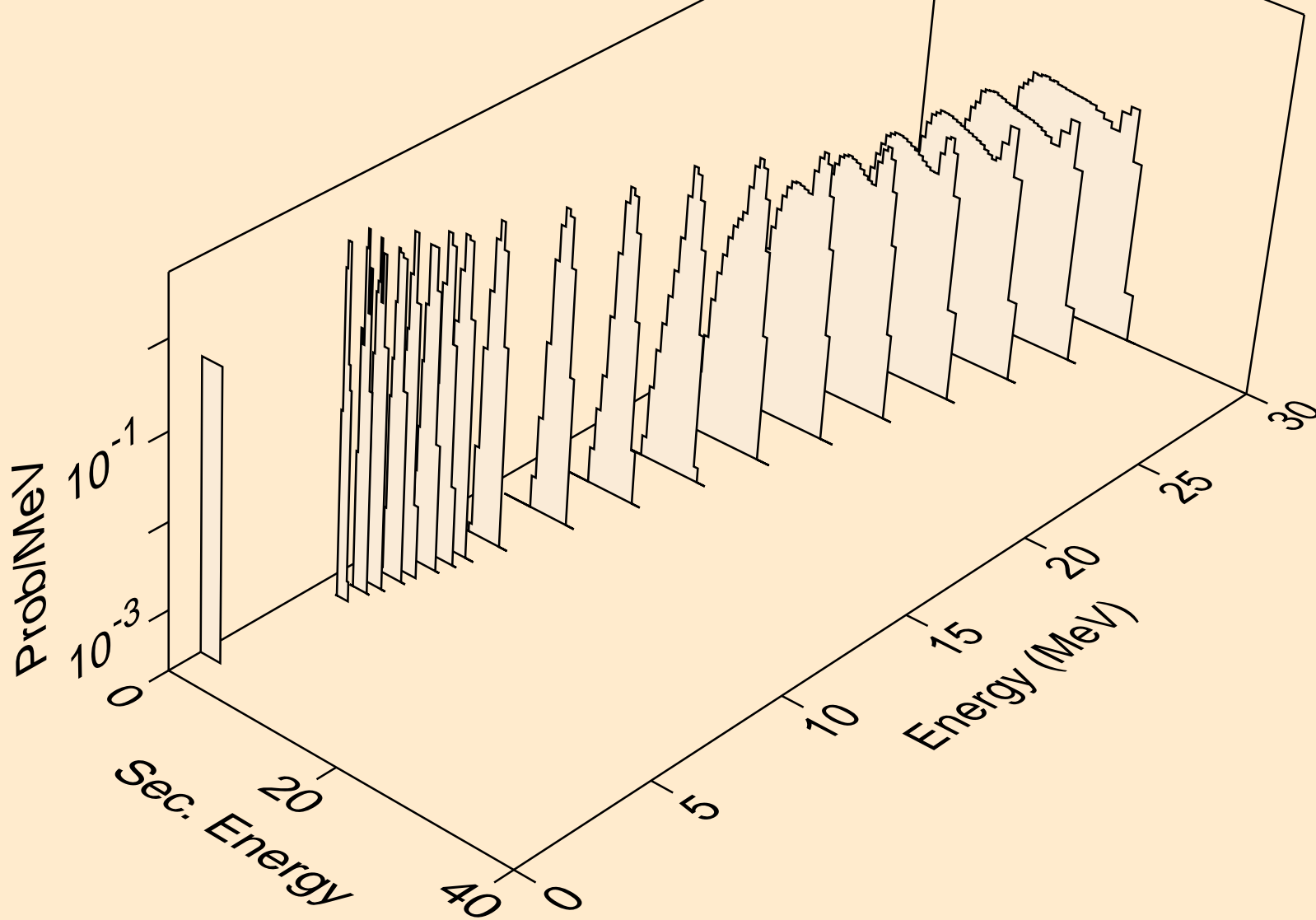

NB089M NEUTRON ACER TENDL-2019 LIBRARY; T=293.16K  
alphas from (n,da)

