

NE018 NEUTRON ACER TENDL-2019 LIBRARY; T=293.16K
Principal cross sections

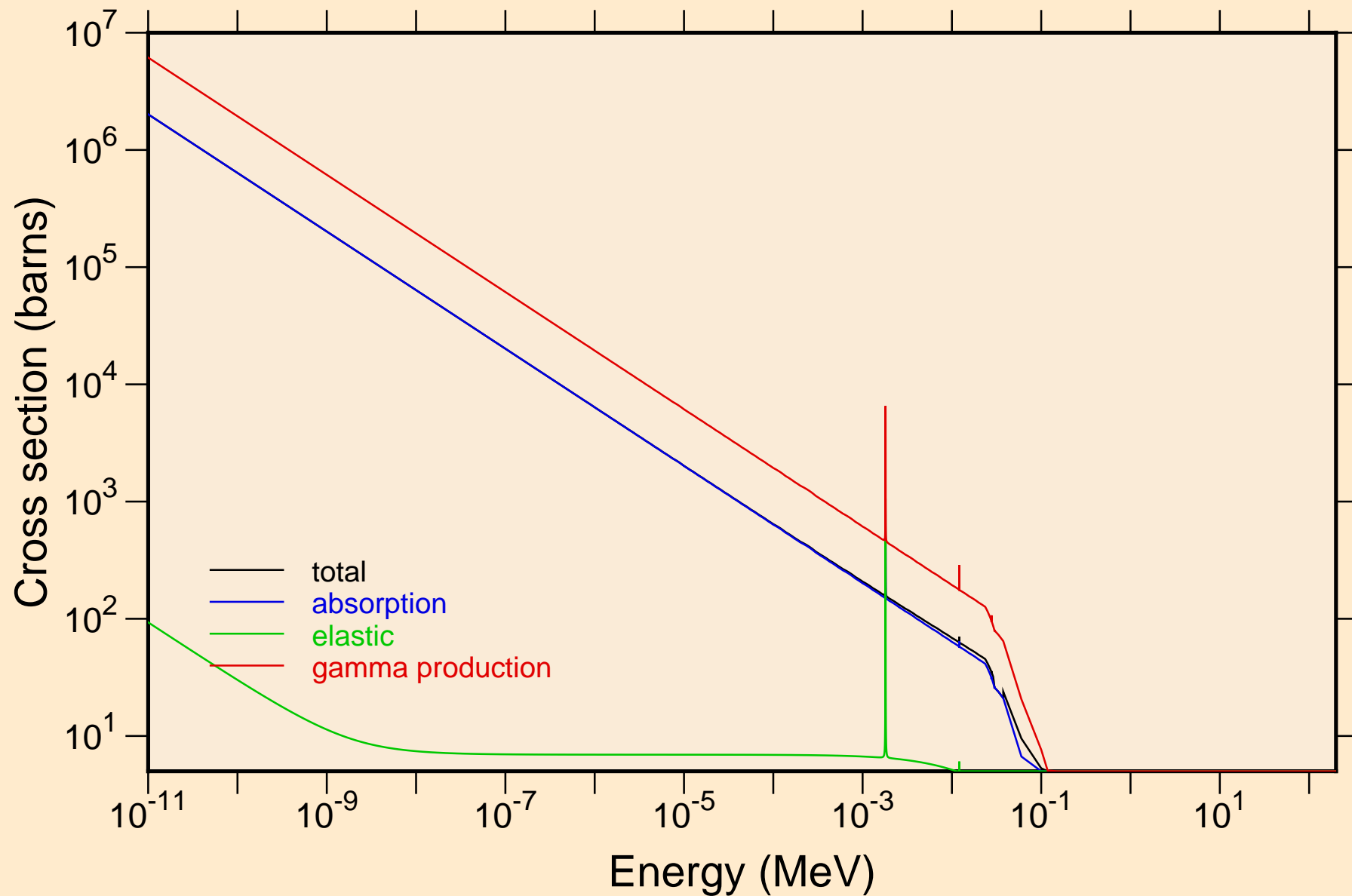

NE018 NEUTRON ACER TENDL-2019 LIBRARY; T=293.16K
resonance total cross section

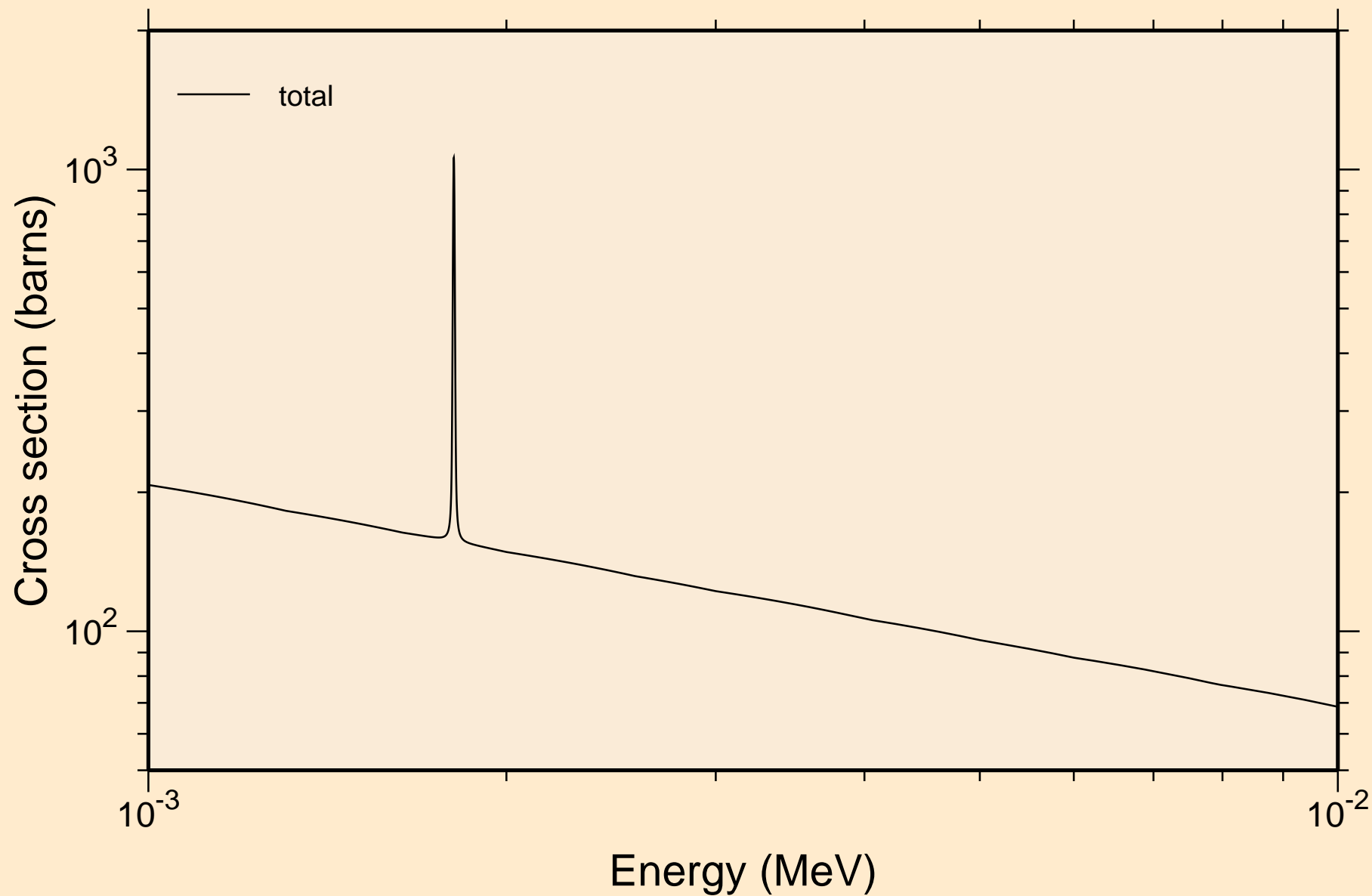

NE018 NEUTRON ACER TENDL-2019 LIBRARY; T=293.16K
resonance total cross section

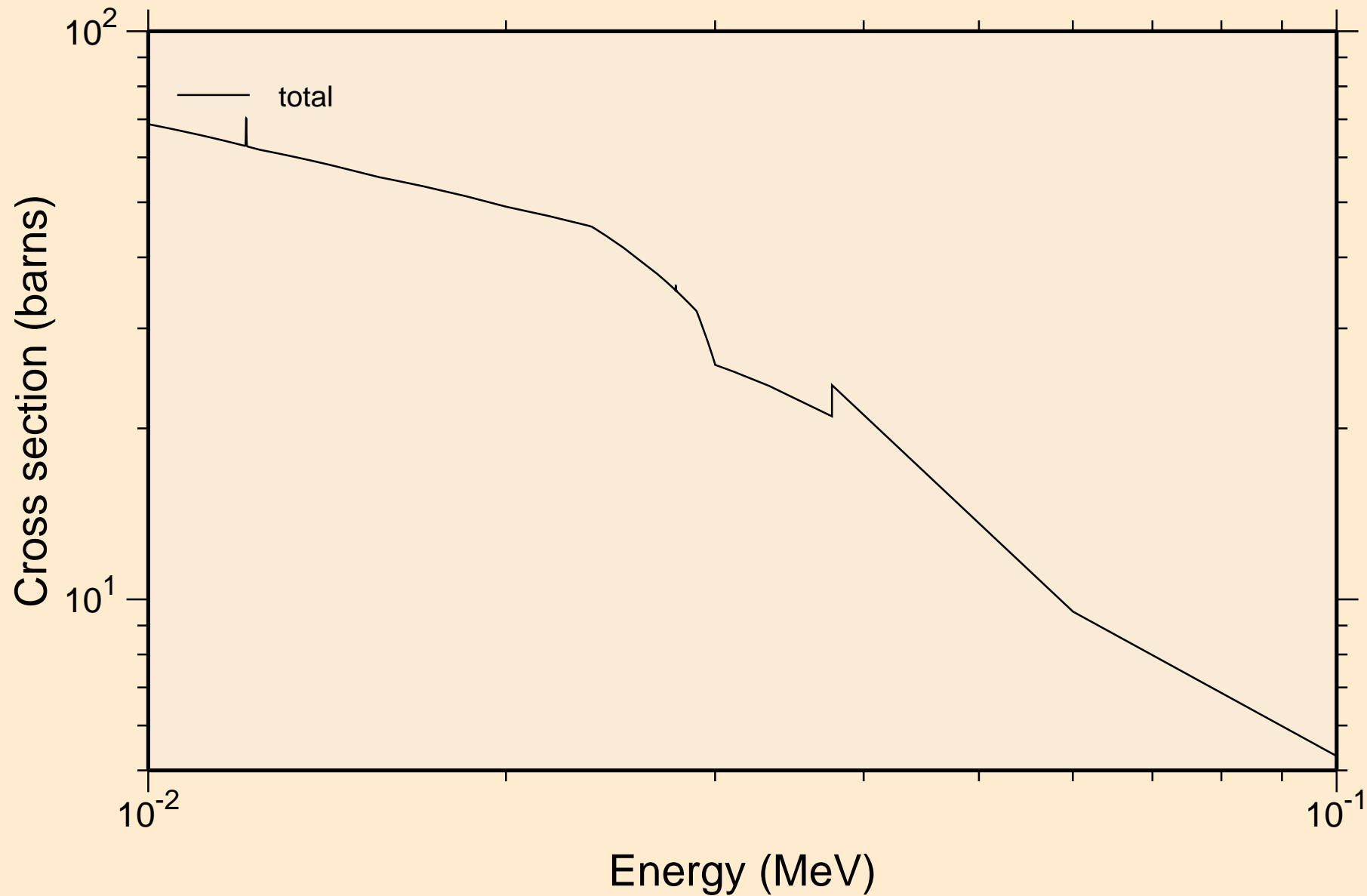

NE018 NEUTRON ACER TENDL-2019 LIBRARY; T=293.16K
resonance total cross section

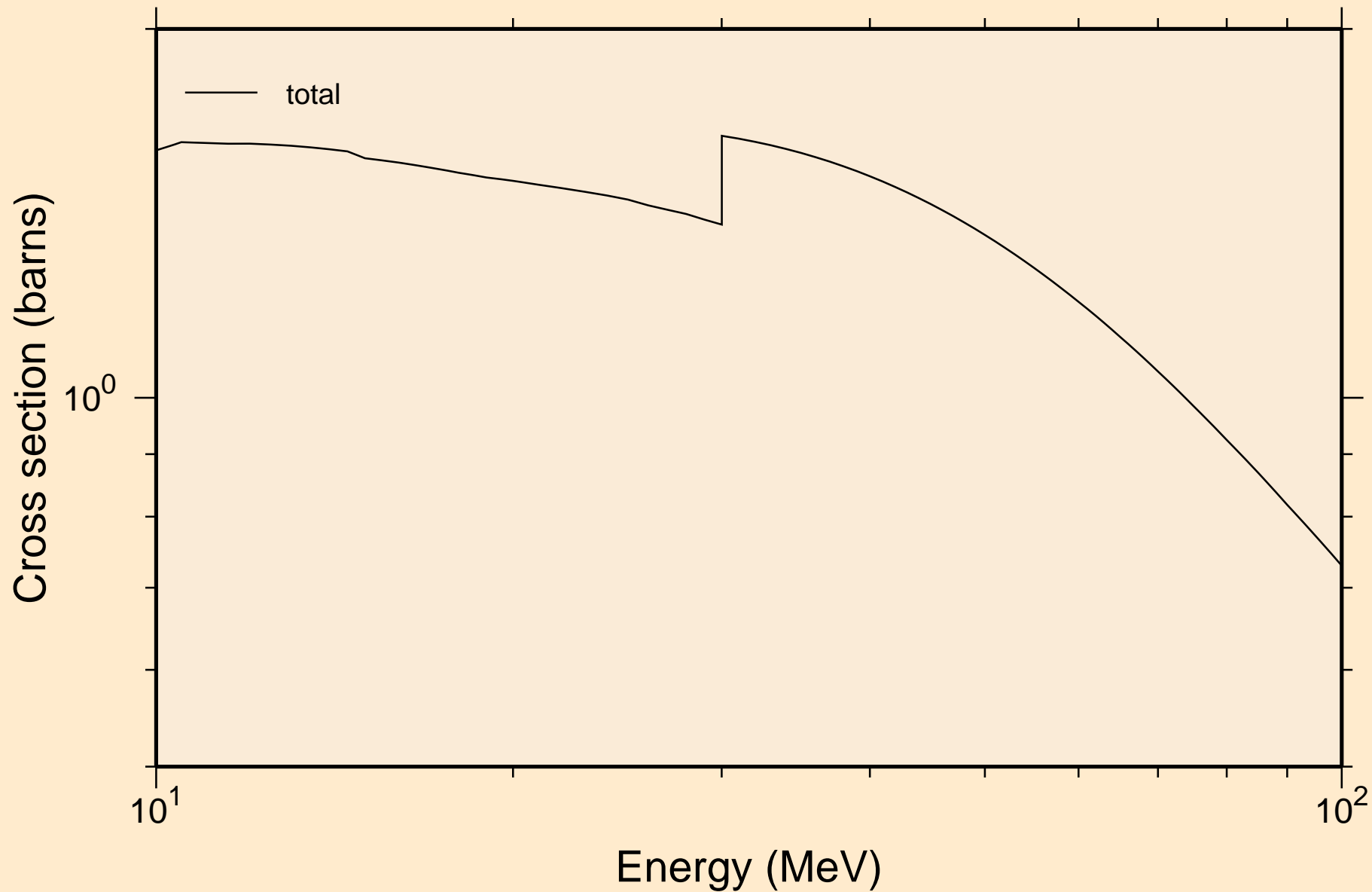

NE018 NEUTRON ACER TENDL-2019 LIBRARY; T=293.16K
resonance absorption cross sections

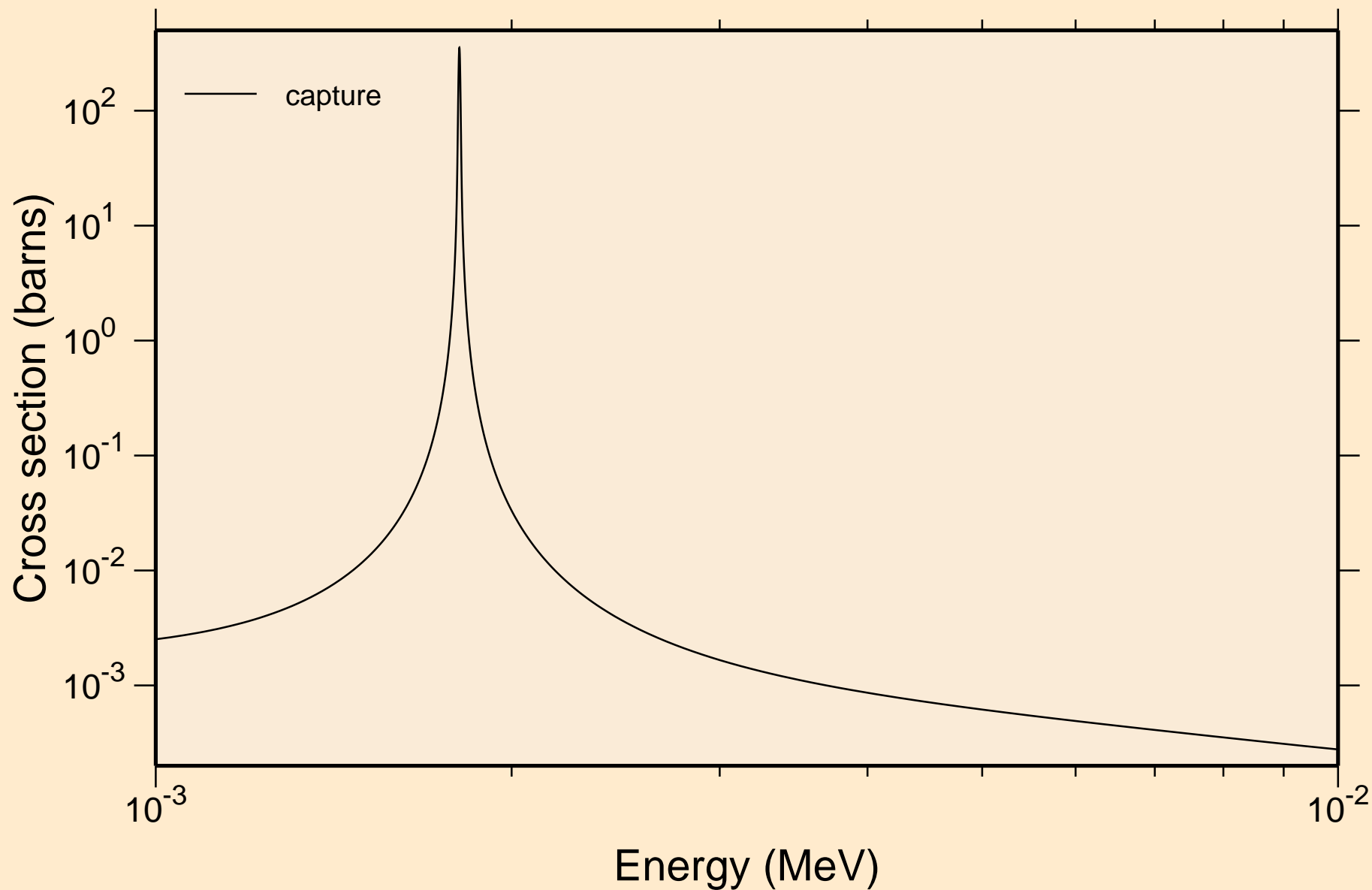

NE018 NEUTRON ACER TENDL-2019 LIBRARY; T=293.16K
resonance absorption cross sections

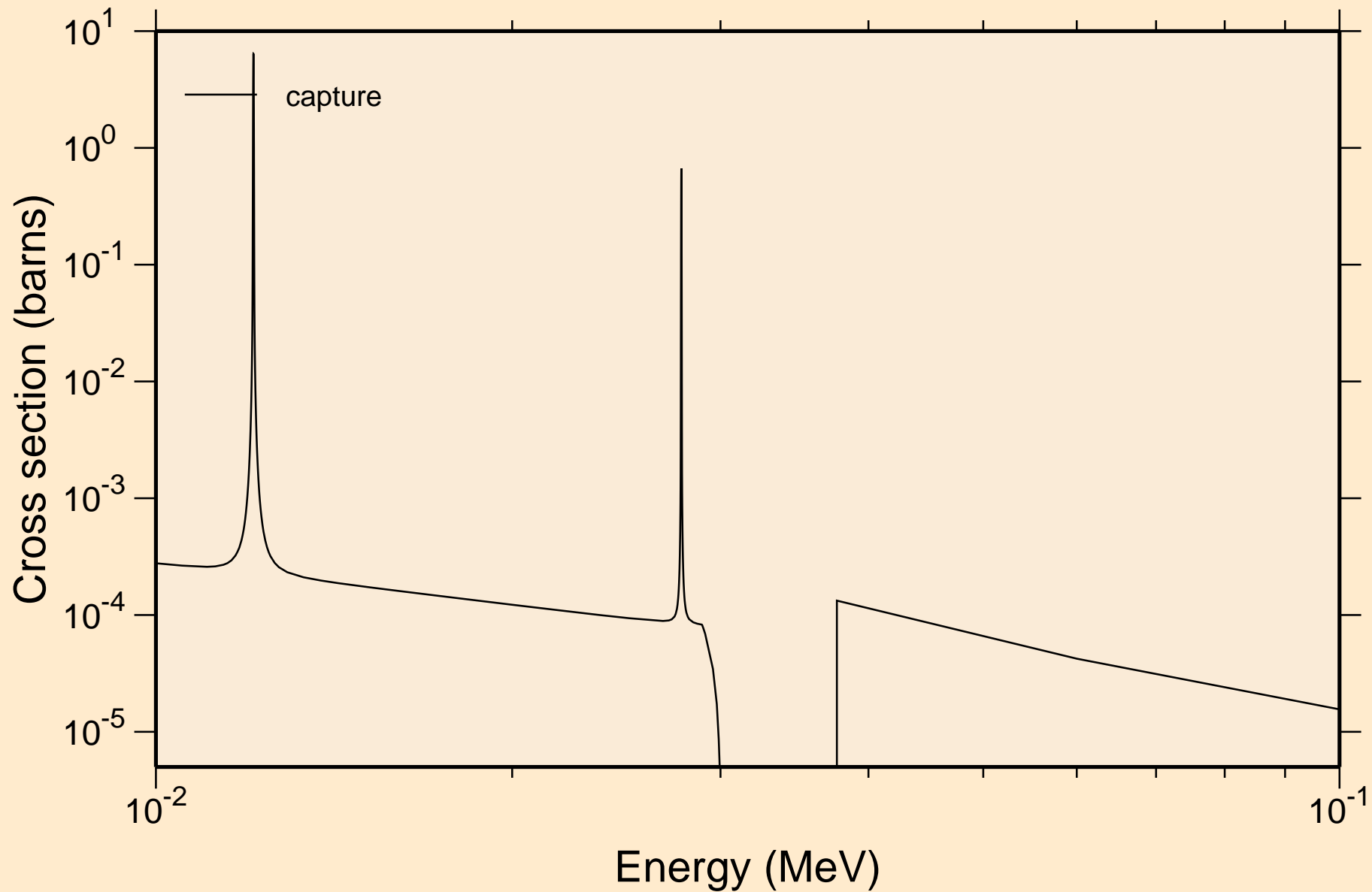

NE018 NEUTRON ACER TENDL-2019 LIBRARY; T=293.16K
resonance absorption cross sections

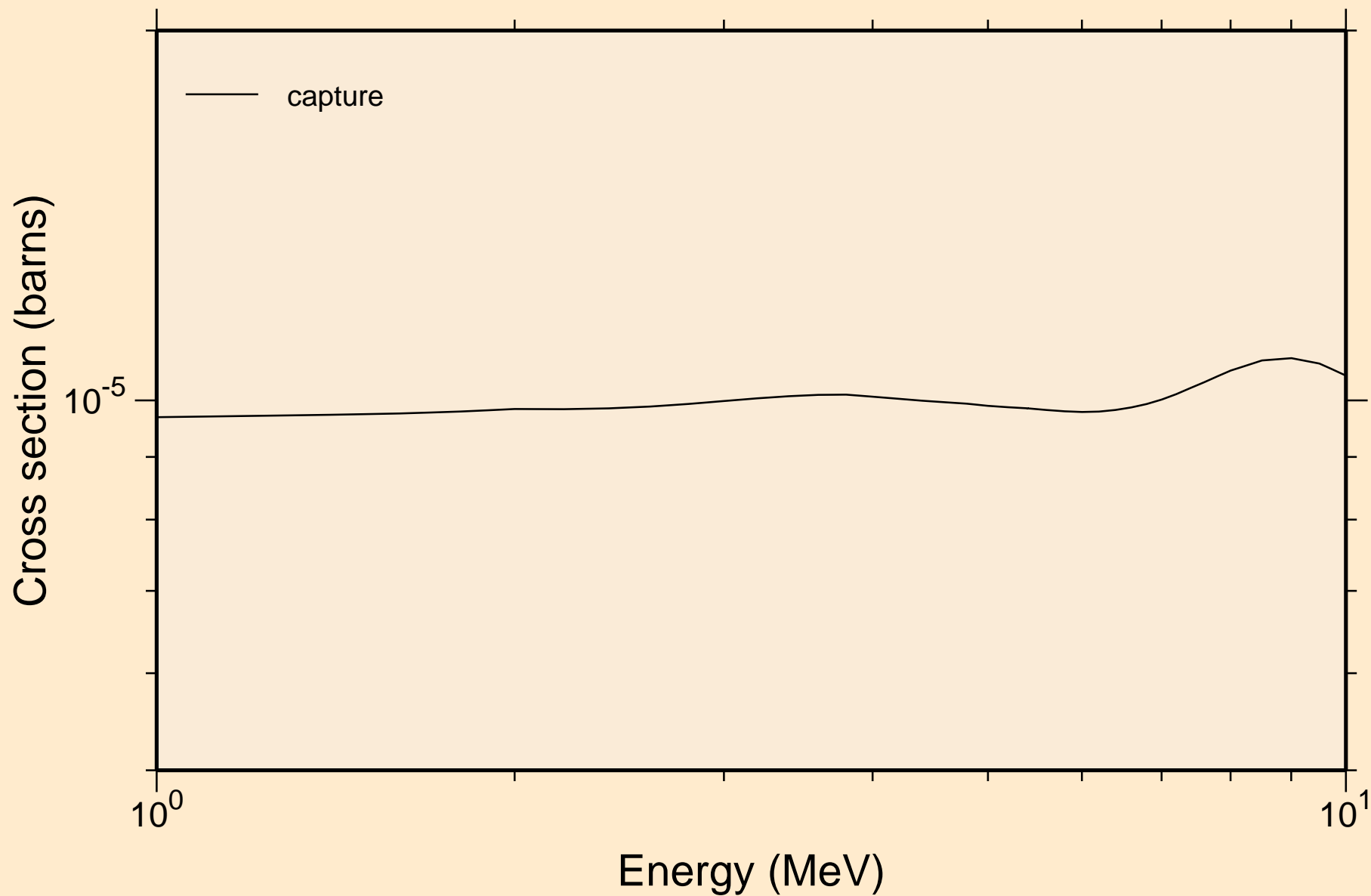

NE018 NEUTRON ACER TENDL-2019 LIBRARY; T=293.16K
Heating

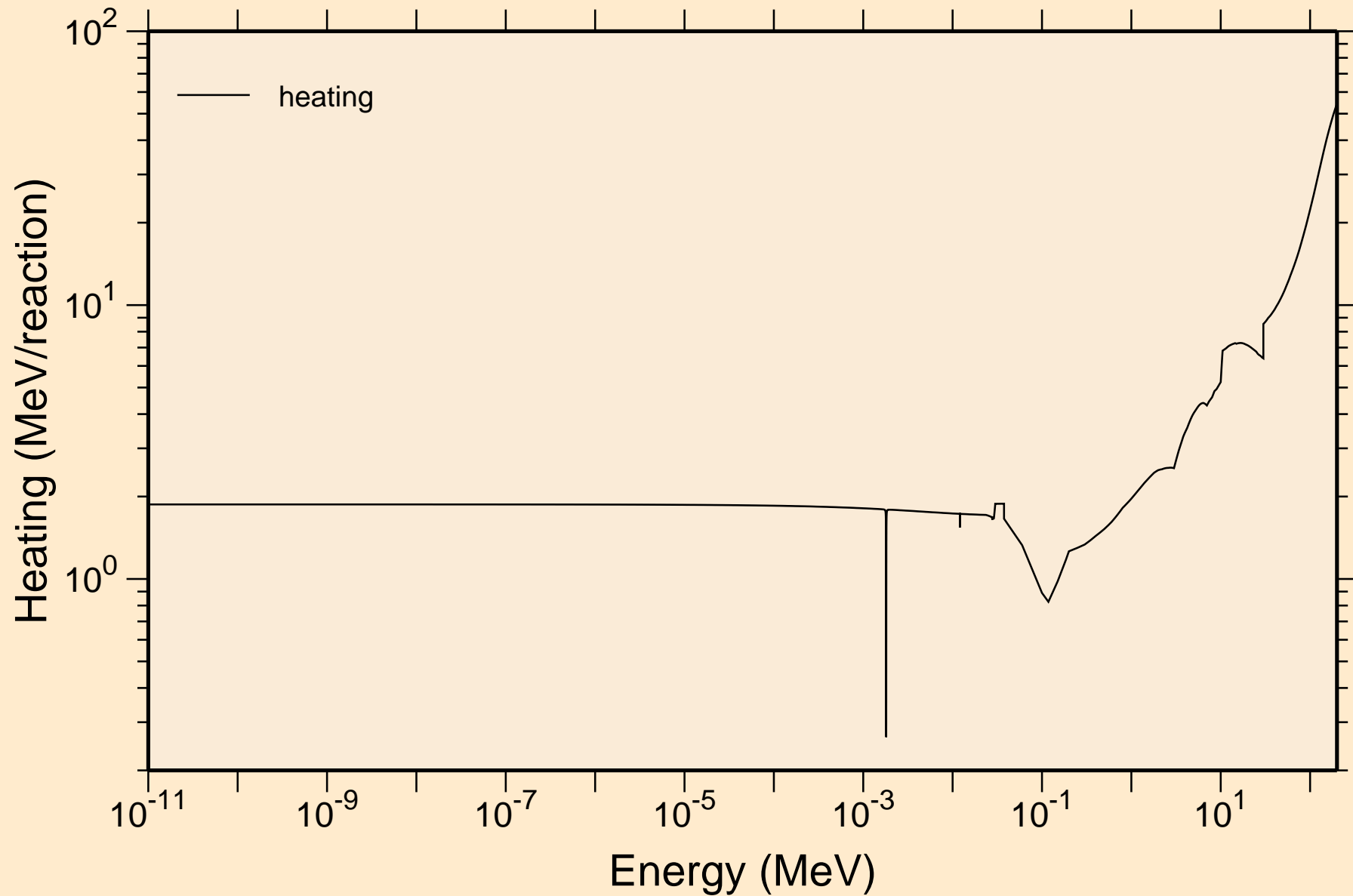

NE018 NEUTRON ACER TENDL-2019 LIBRARY; T=293.16K
Damage

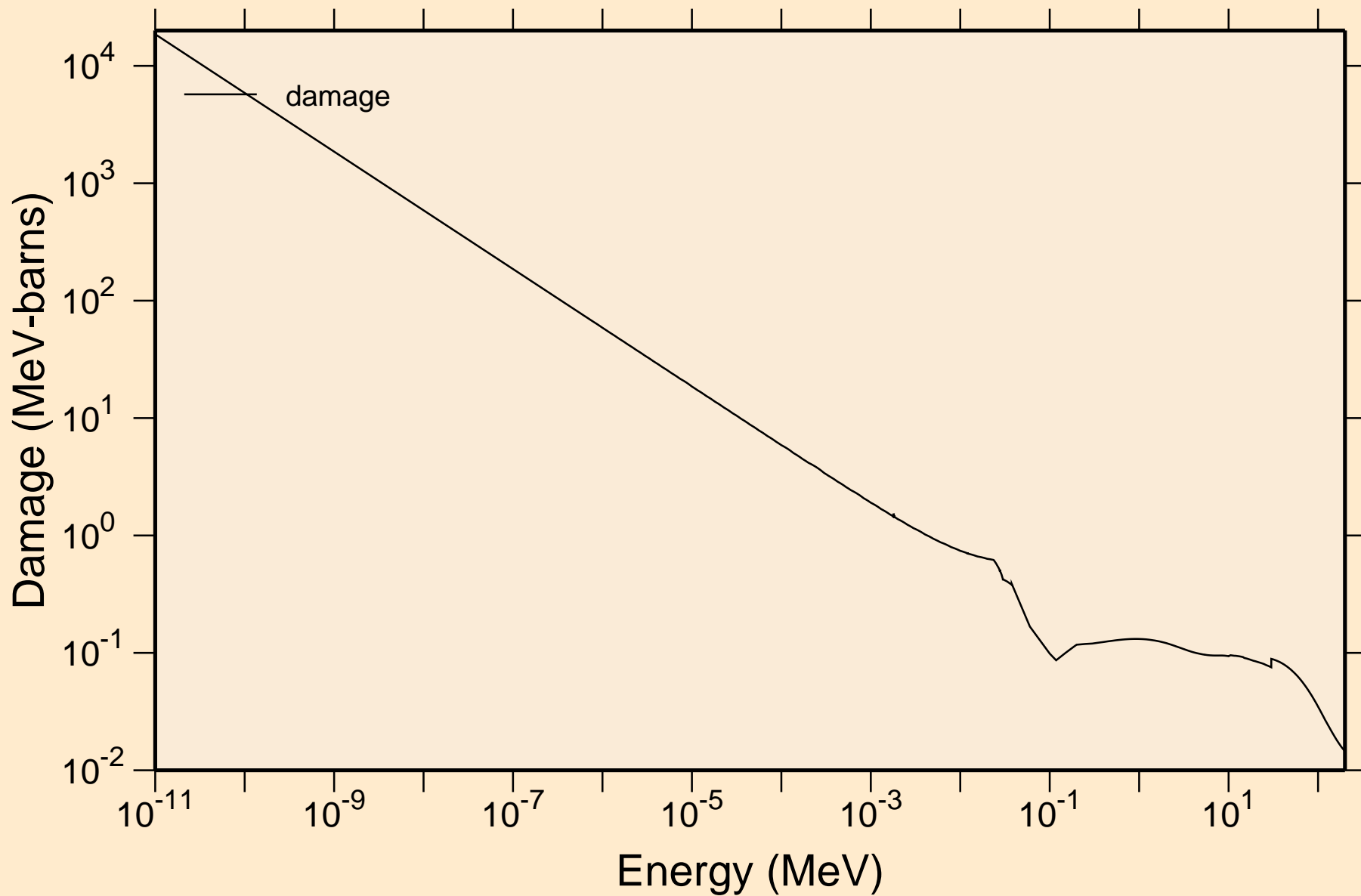

NE018 NEUTRON ACER TENDL-2019 LIBRARY; T=293.16K
Non-threshold reactions

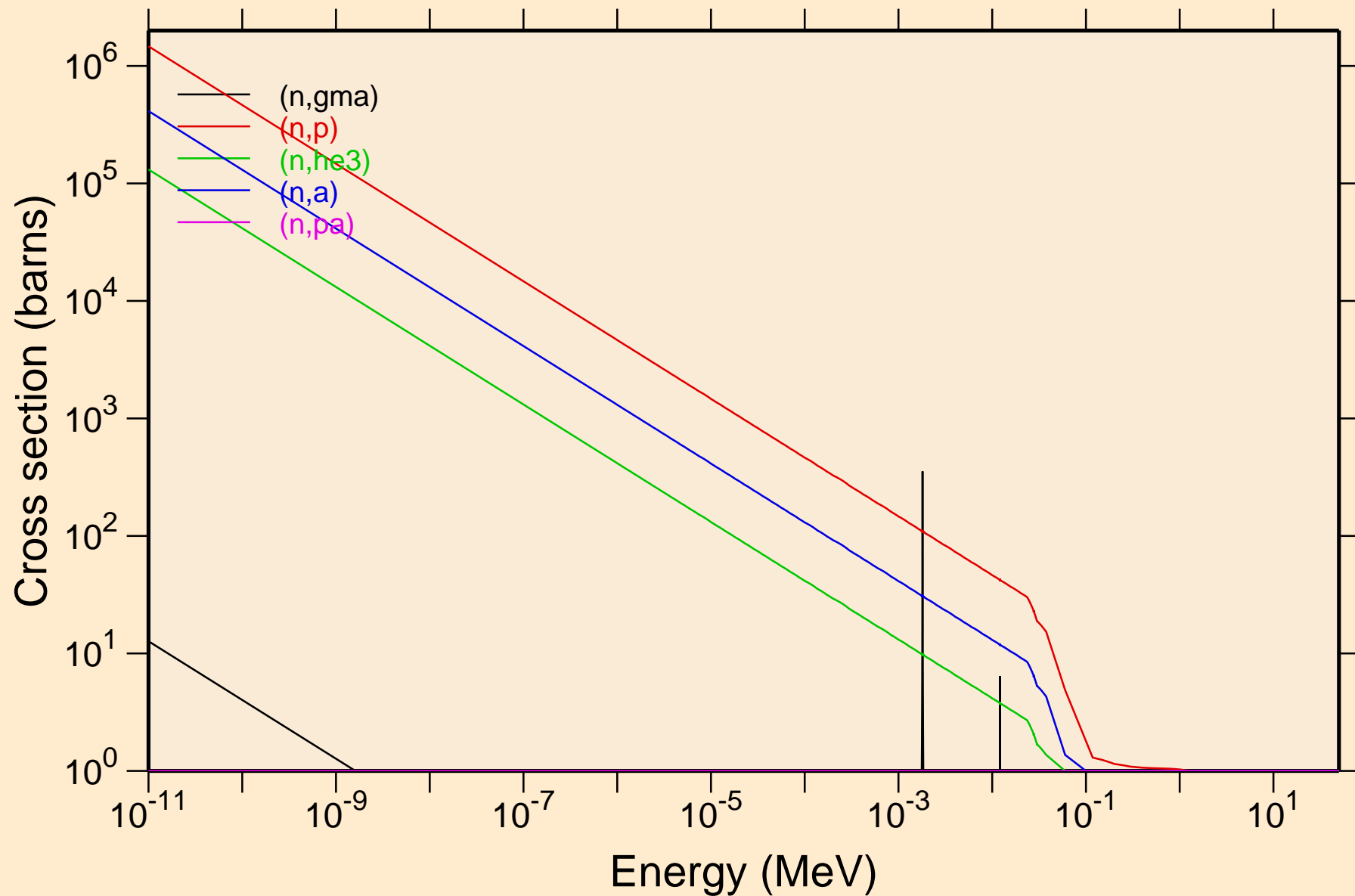

NE018 NEUTRON ACER TENDL-2019 LIBRARY; T=293.16K
Non-threshold reactions

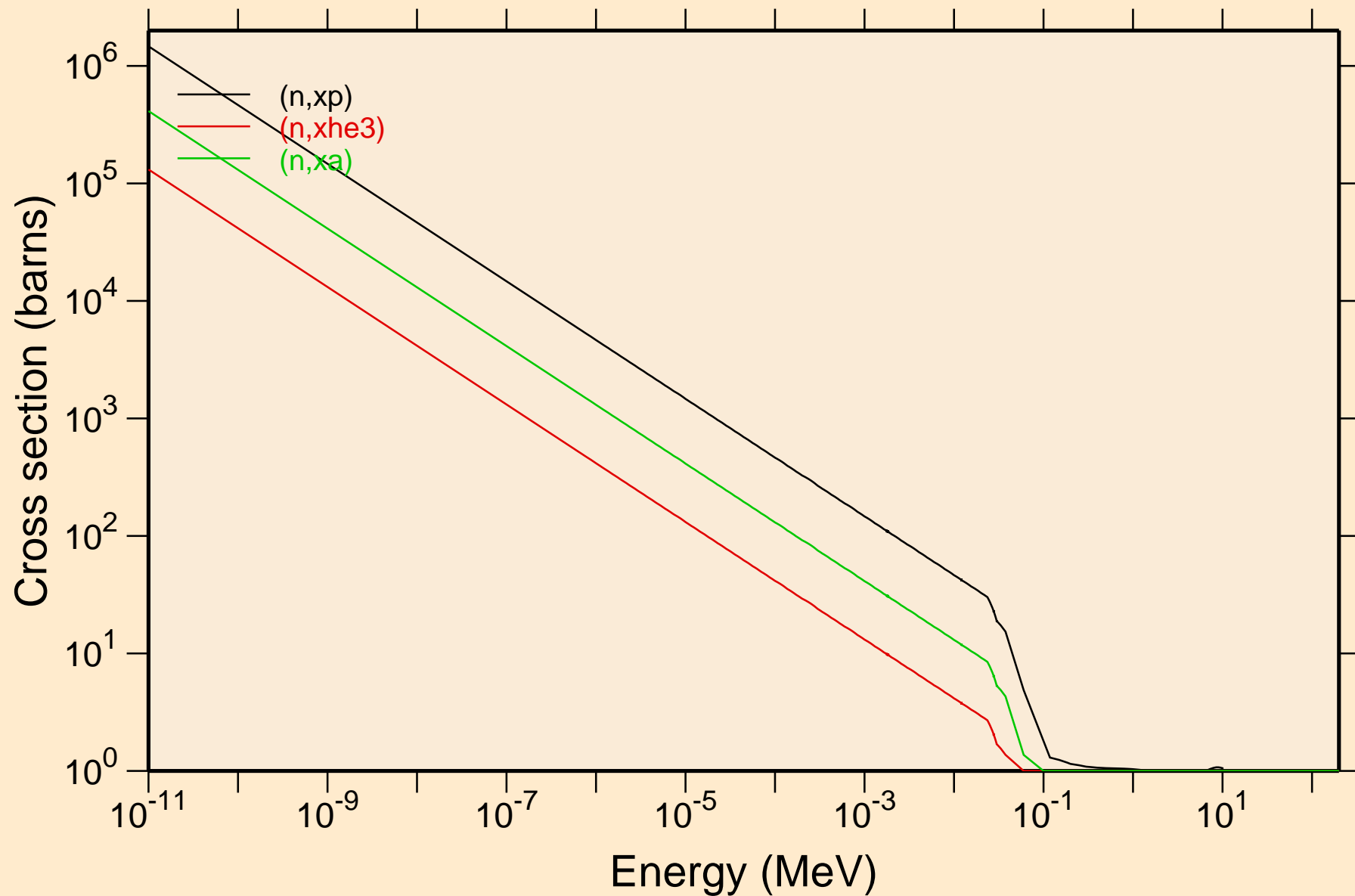

NE018 NEUTRON ACER TENDL-2019 LIBRARY; T=293.16K

Principal cross sections

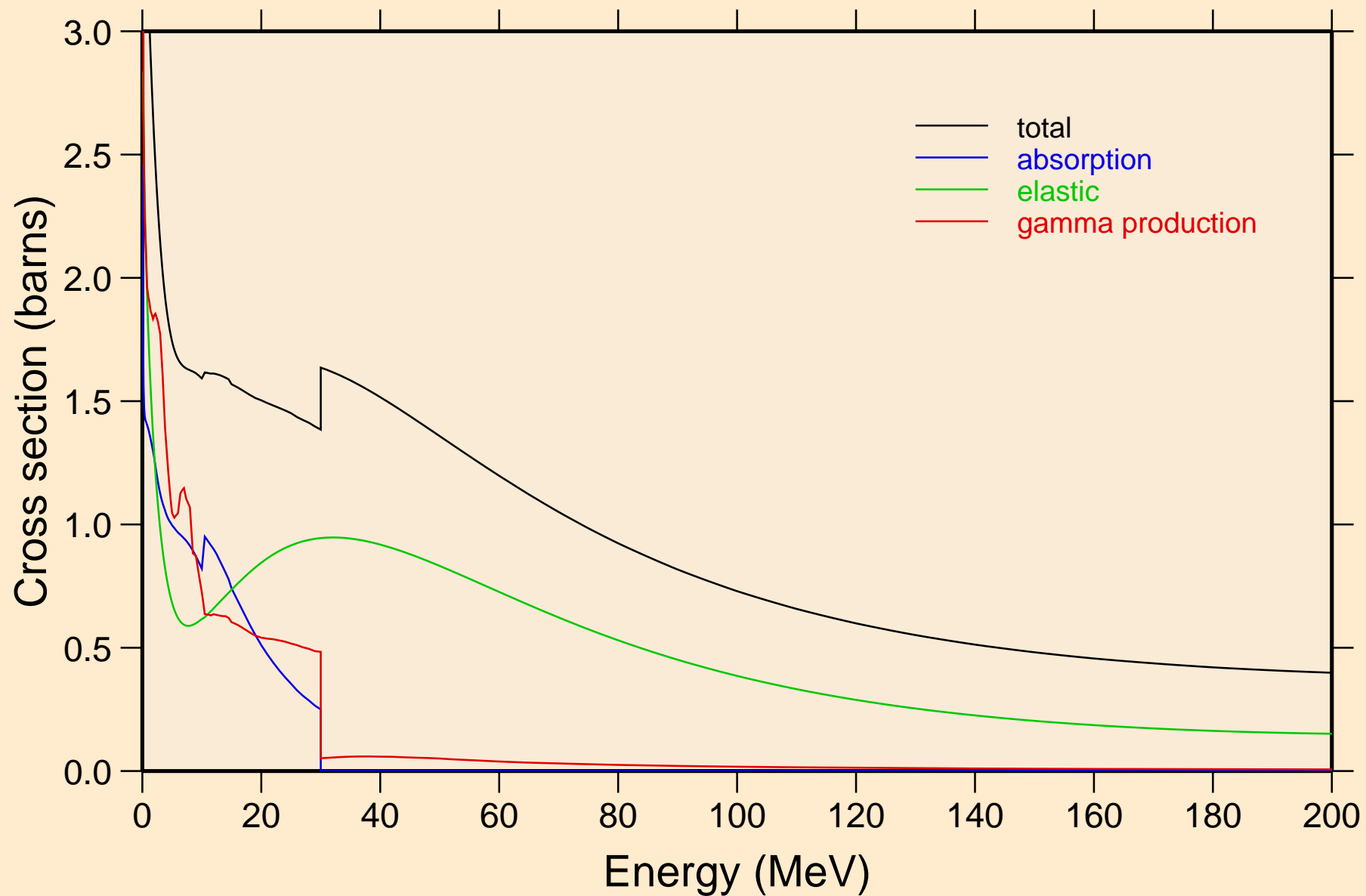

NE018 NEUTRON ACER TENDL-2019 LIBRARY; T=293.16K
Heating

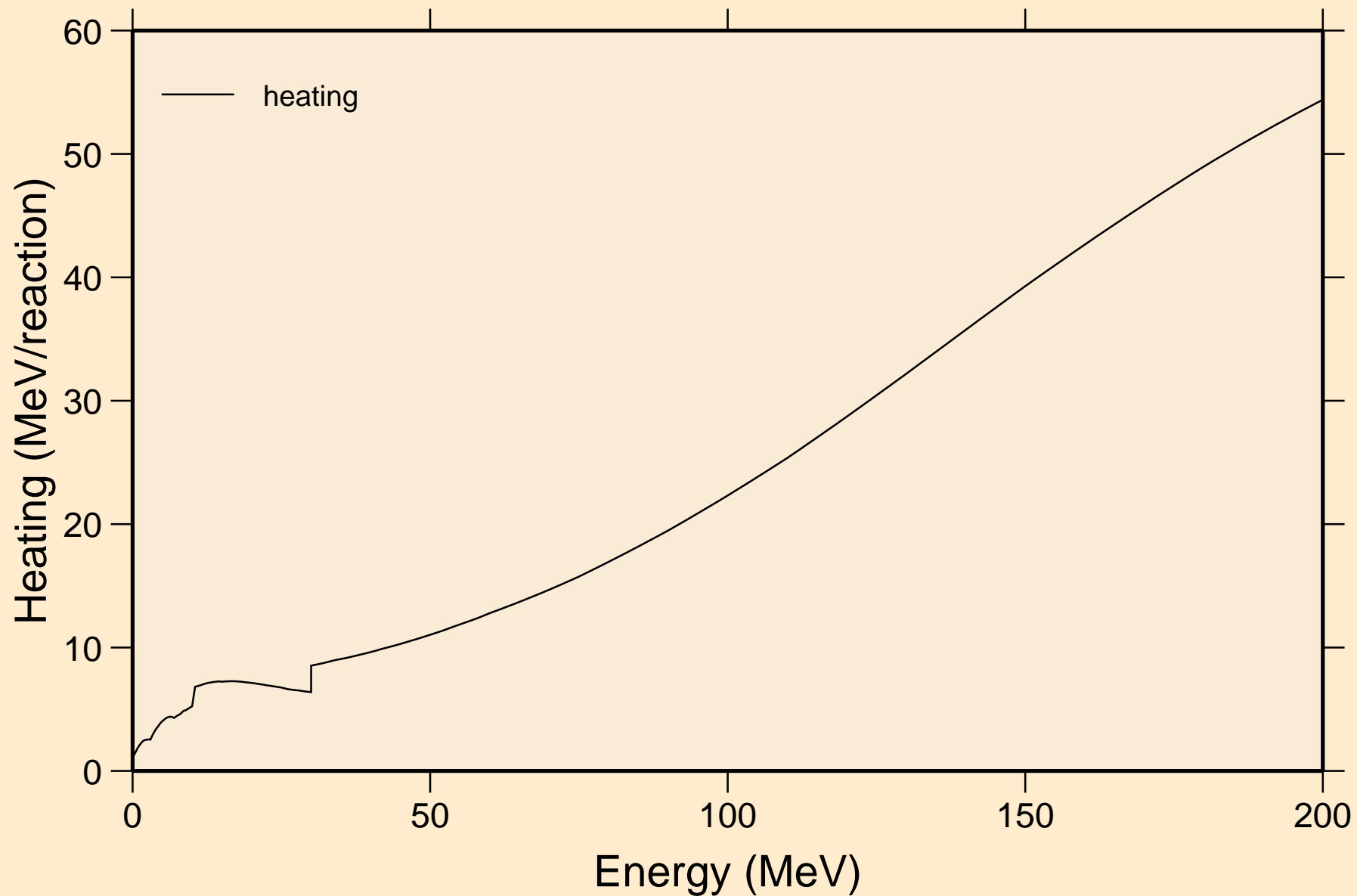

NE018 NEUTRON ACER TENDL-2019 LIBRARY; T=293.16K
Damage

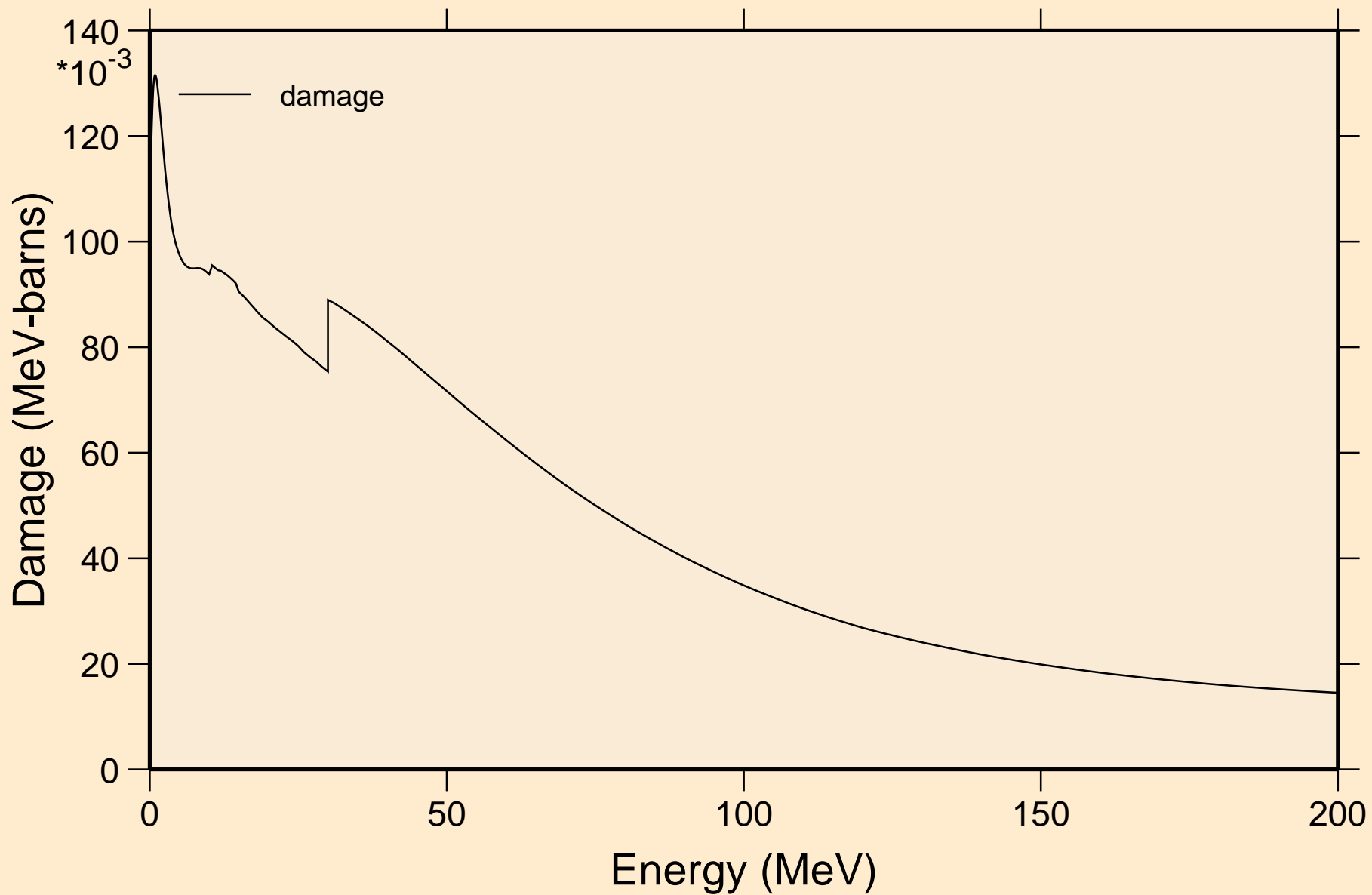

NE018 NEUTRON ACER TENDL-2019 LIBRARY; T=293.16K
Non-threshold reactions

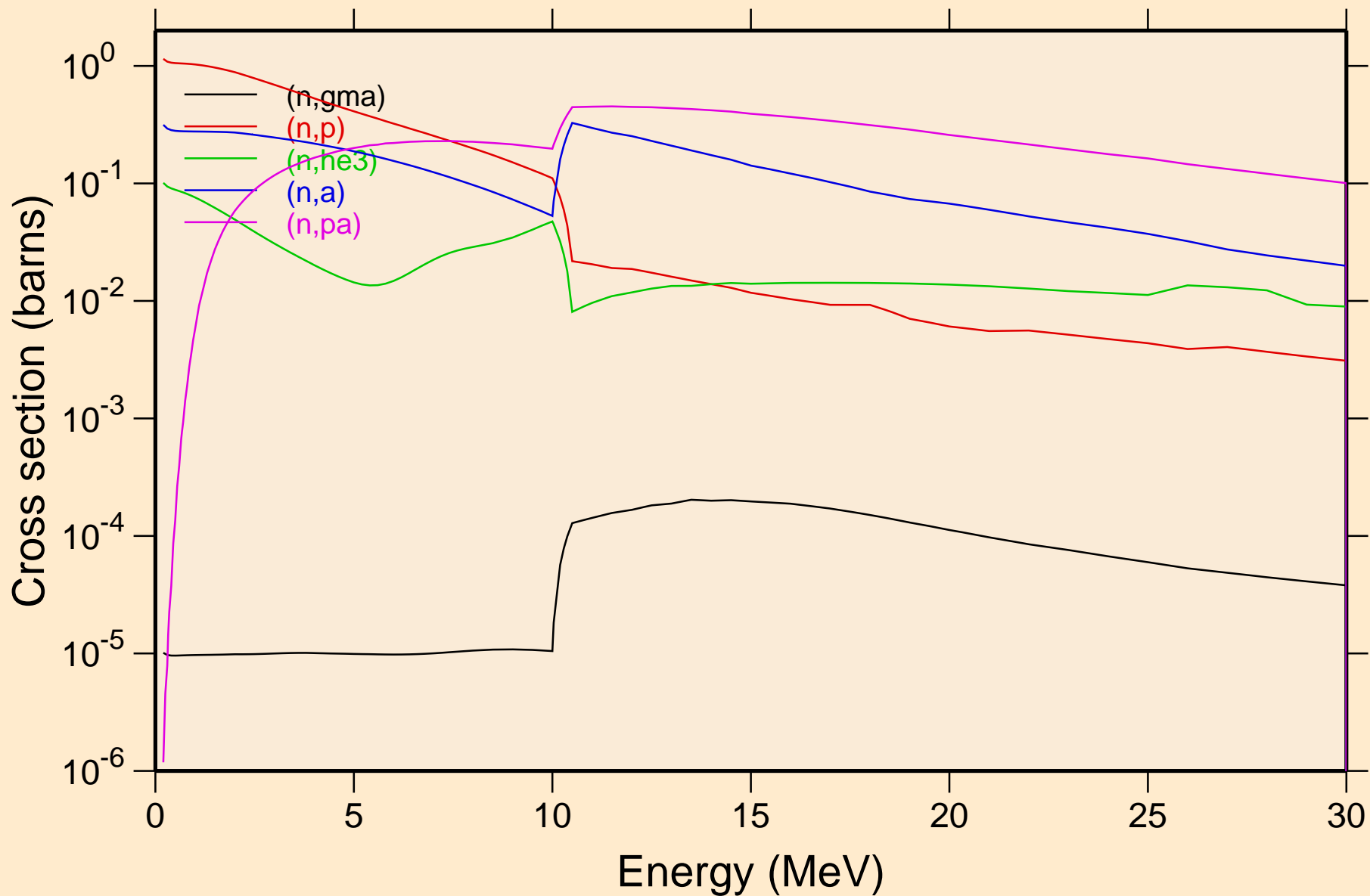

NE018 NEUTRON ACER TENDL-2019 LIBRARY; T=293.16K
Non-threshold reactions

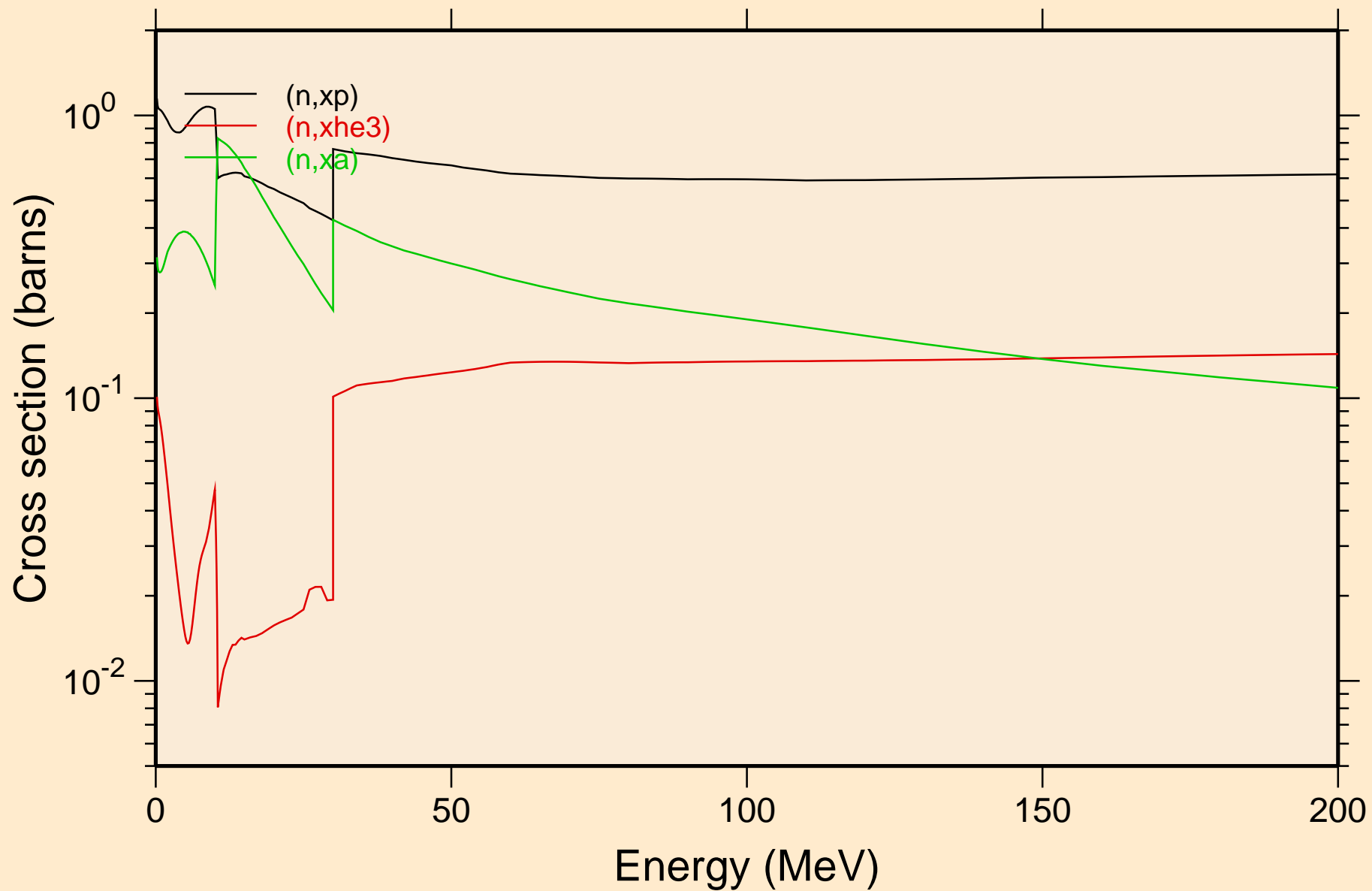

NE018 NEUTRON ACER TENDL-2019 LIBRARY; T=293.16K
Inelastic levels

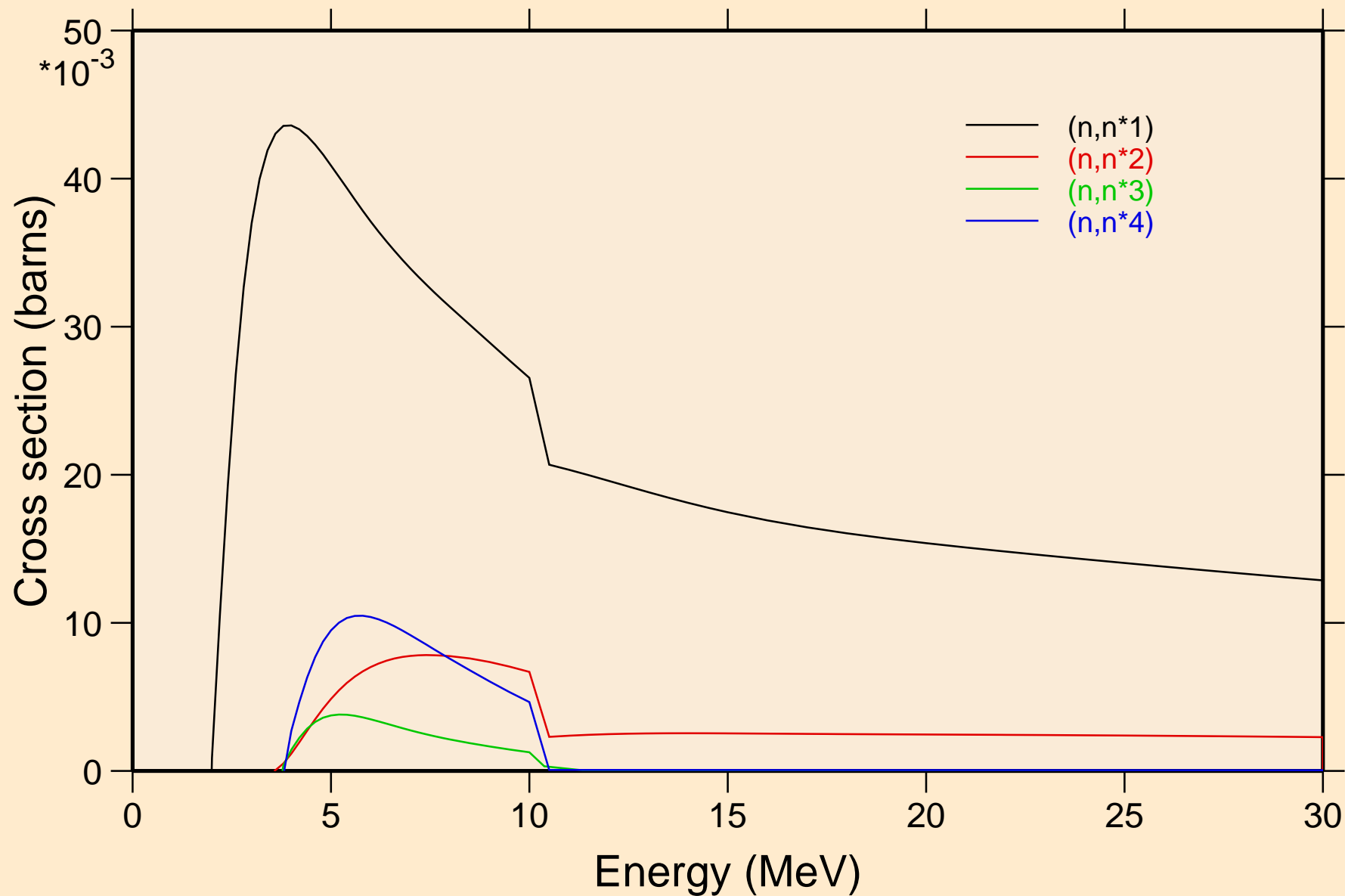

NE018 NEUTRON ACER TENDL-2019 LIBRARY; T=293.16K
Threshold reactions

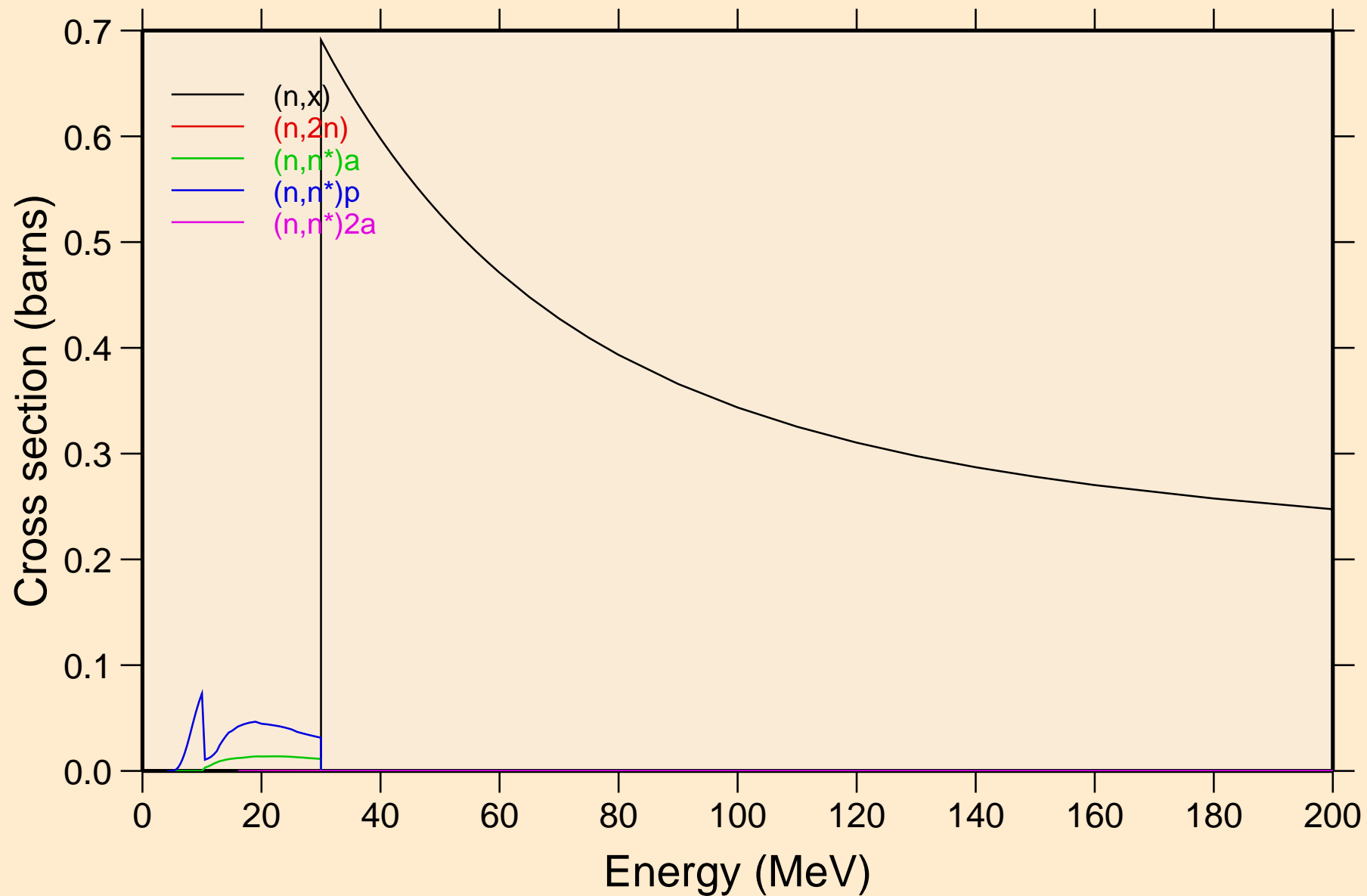

NE018 NEUTRON ACER TENDL-2019 LIBRARY; T=293.16K
Threshold reactions

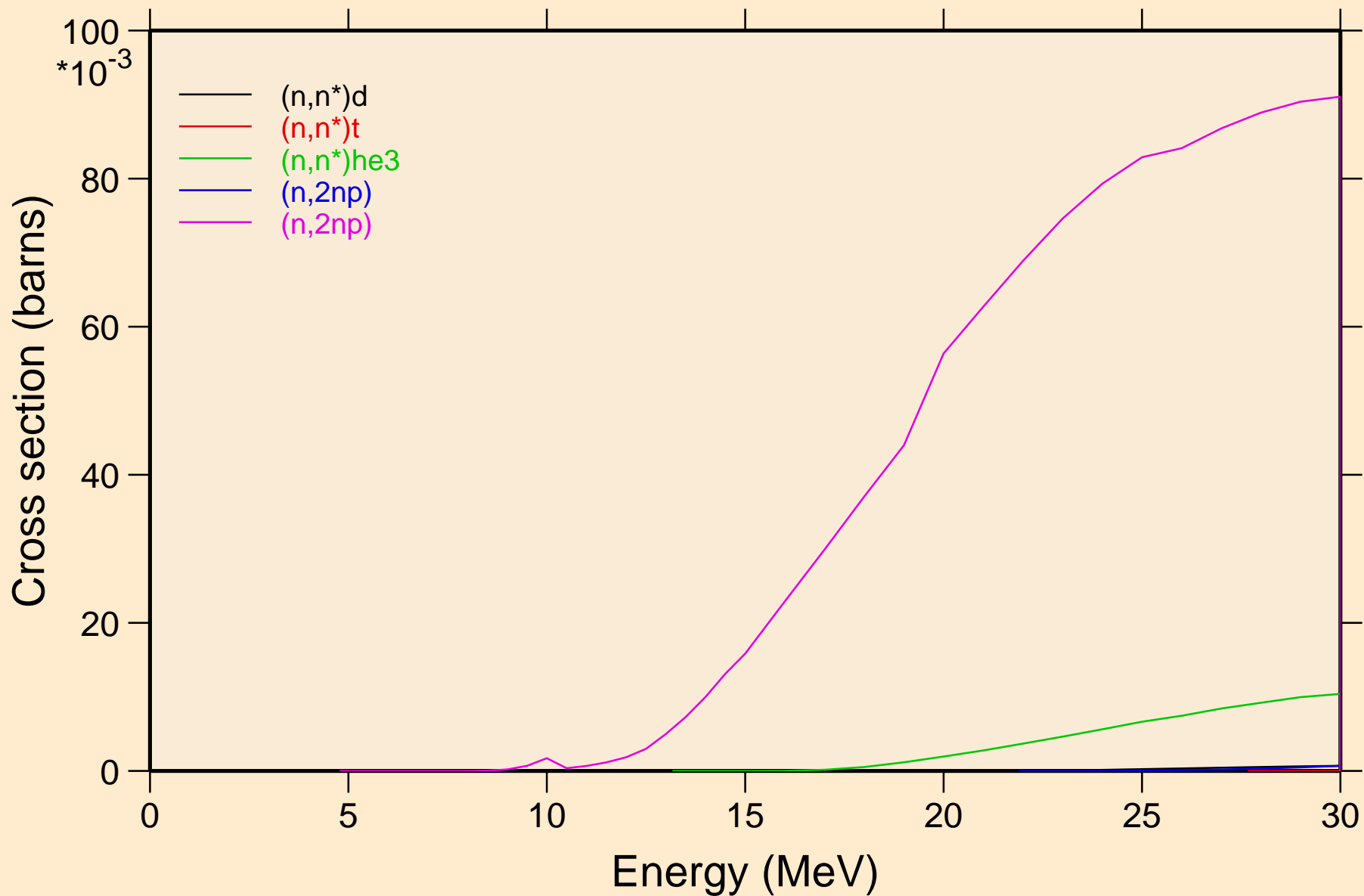

NE018 NEUTRON ACER TENDL-2019 LIBRARY; T=293.16K
Threshold reactions

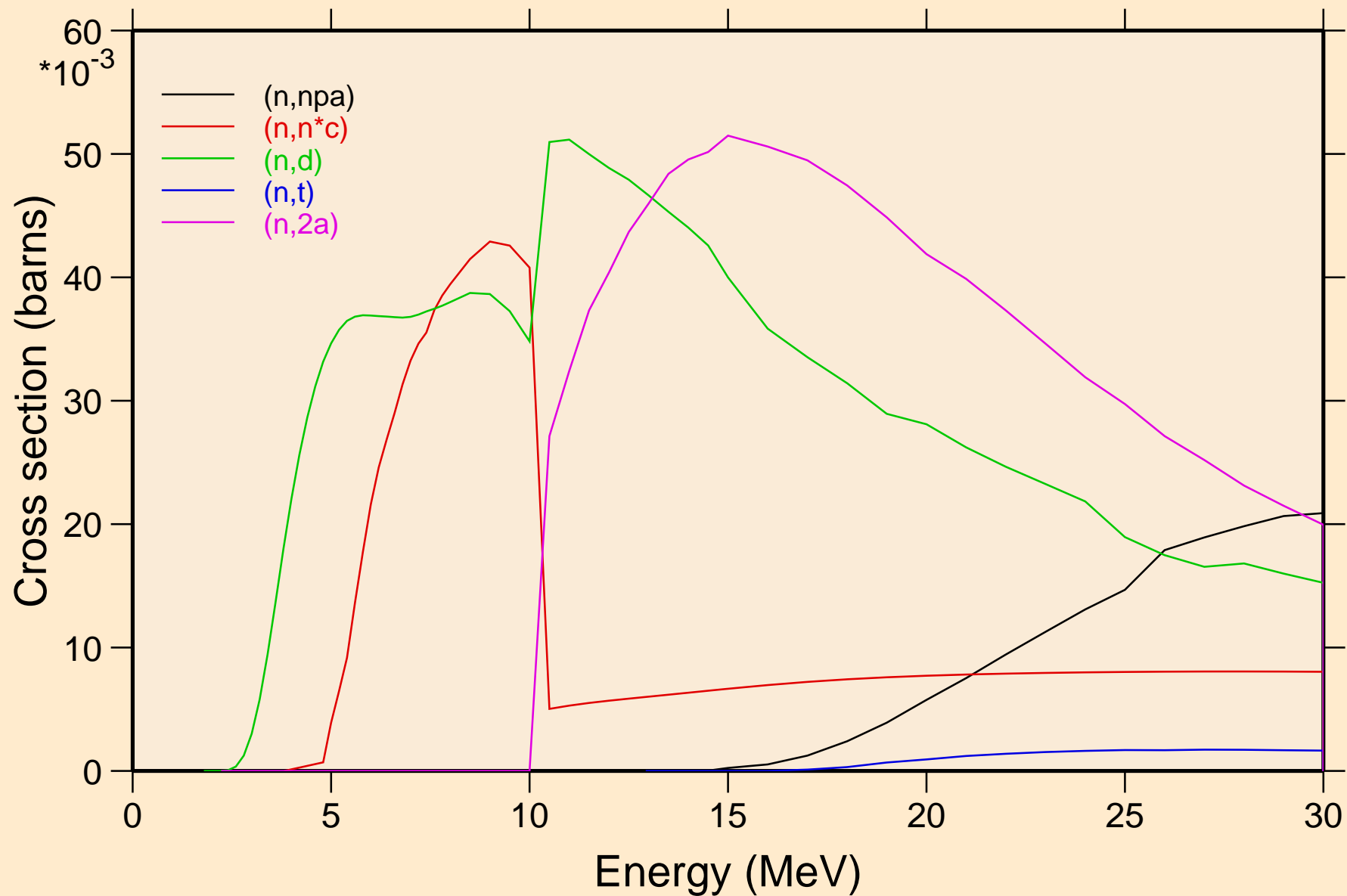

NE018 NEUTRON ACER TENDL-2019 LIBRARY; T=293.16K
Threshold reactions

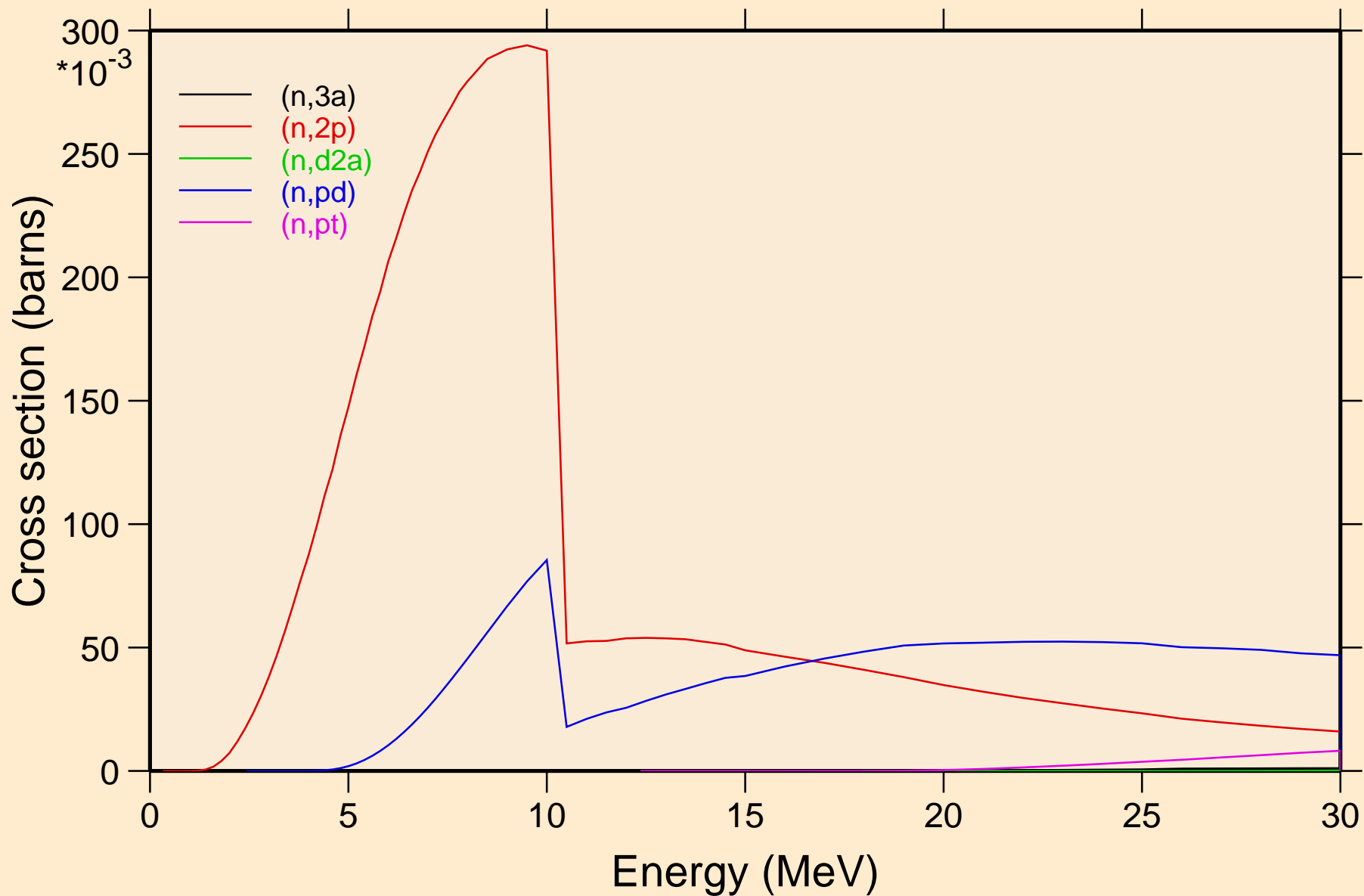

NE018 NEUTRON ACER TENDL-2019 LIBRARY; T=293.16K
Threshold reactions

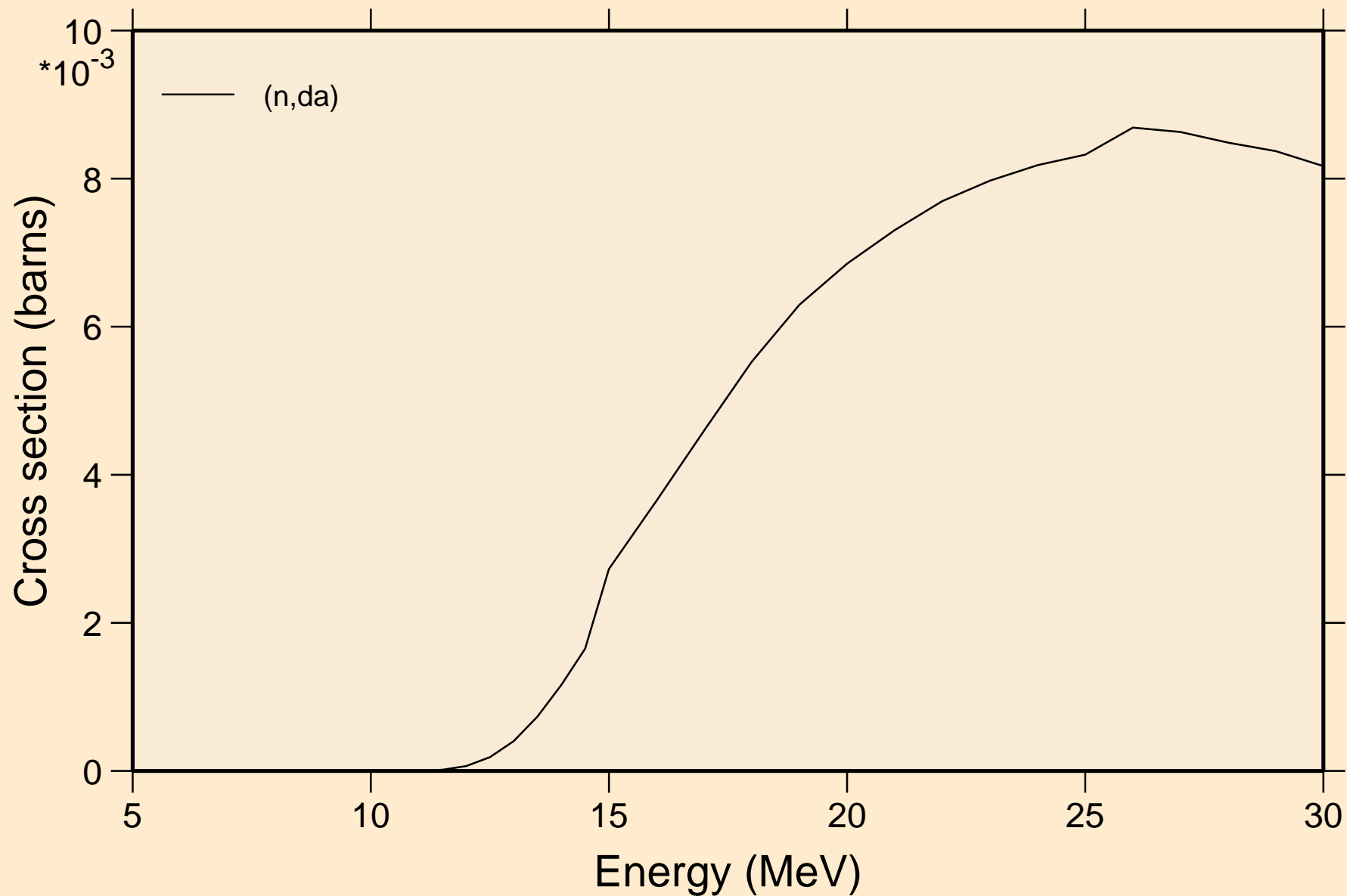

NE018 NEUTRON ACER TENDL-2019 LIBRARY; T=293.16K
Threshold reactions

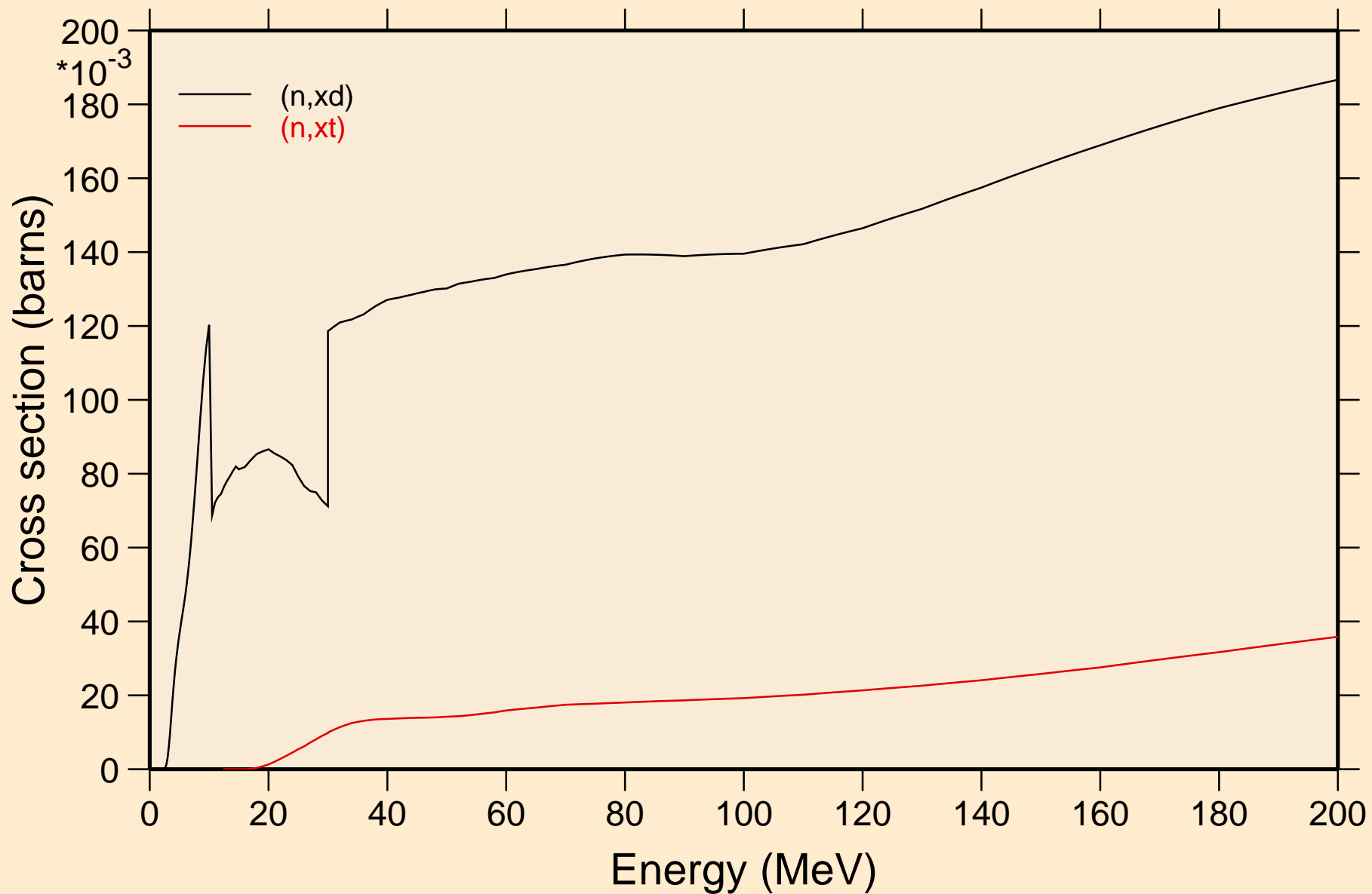

NE018 NEUTRON ACER TENDL-2019 LIBRARY; T=293.16K
angular distribution for elastic

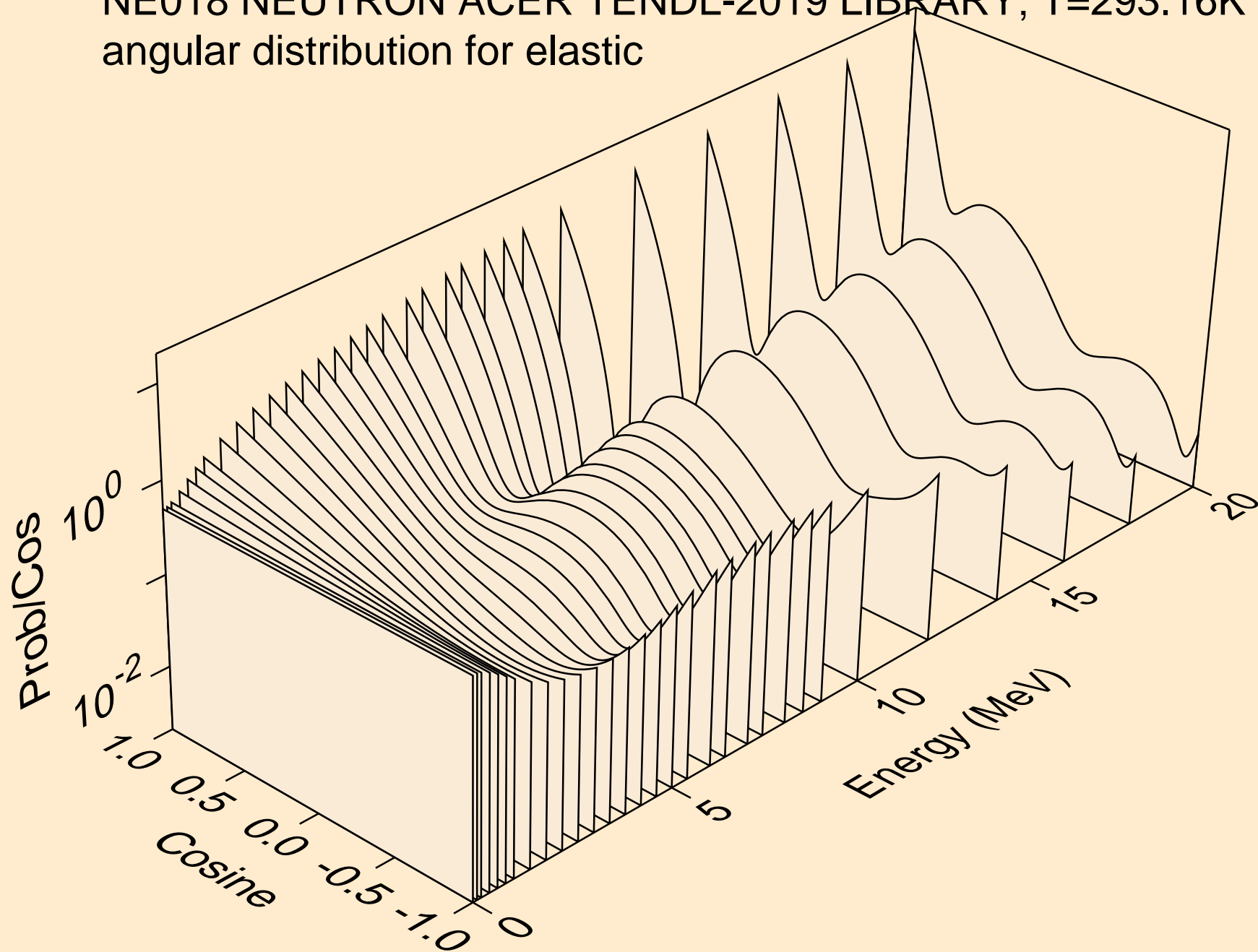

NE018 NEUTRON ACER TENDL-2019 LIBRARY; T=293.16K
angular distribution for elastic

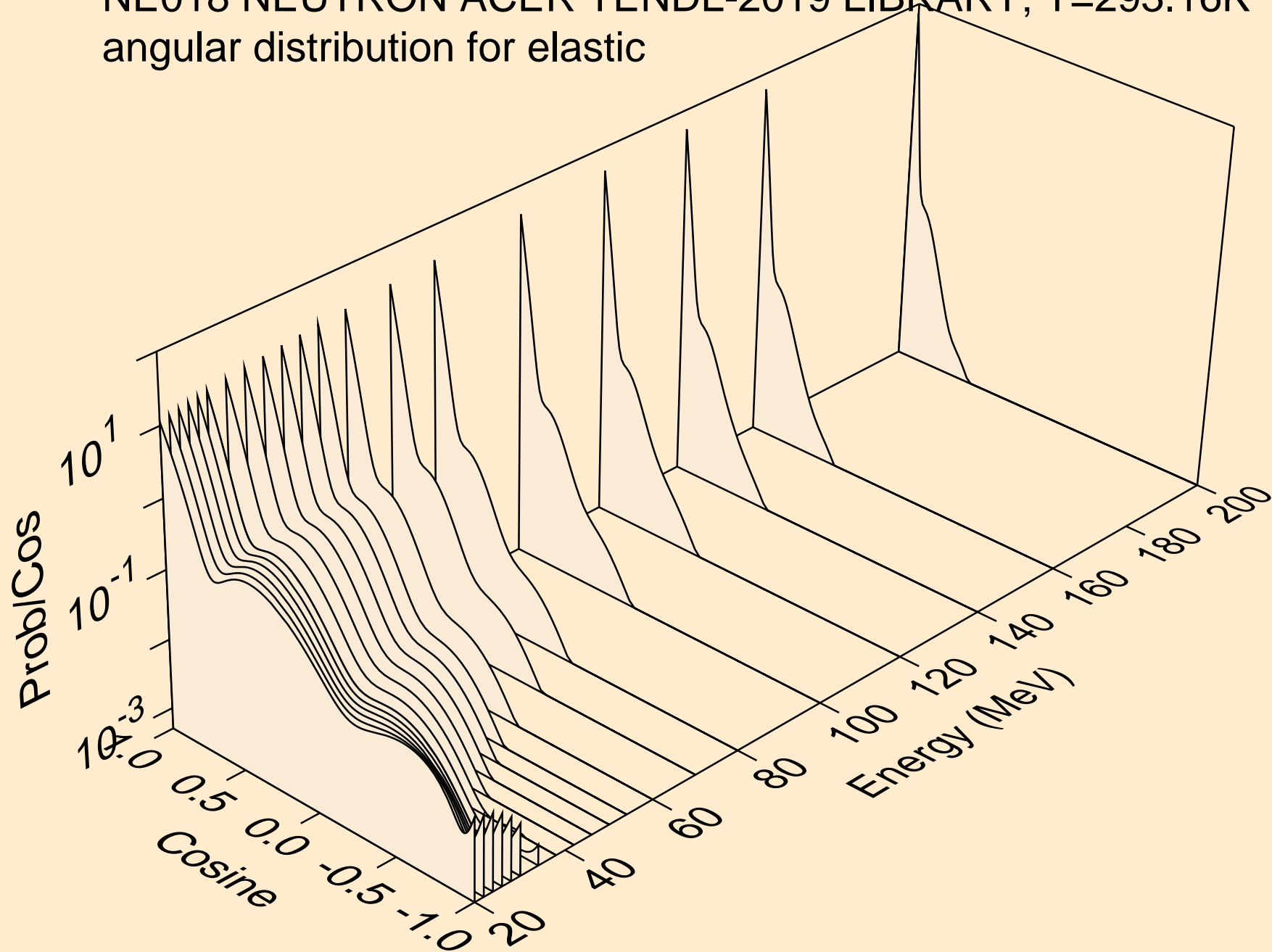

NE018 NEUTRON ACER TENDL-2019 LIBRARY; T=293.16K
angular distribution for (n,n*1)

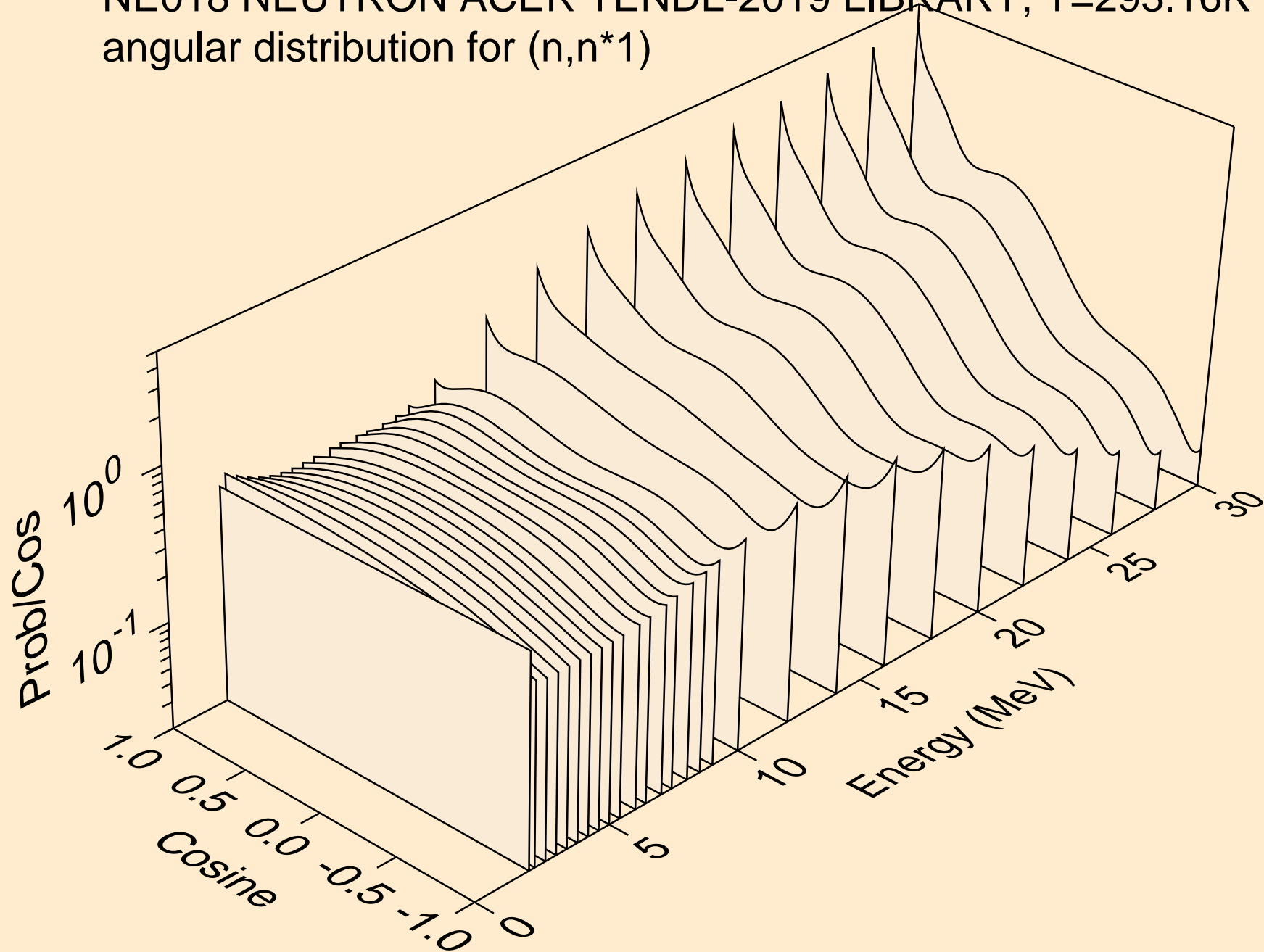

NE018 NEUTRON ACER TENDL-2019 LIBRARY; T=293.16K
angular distribution for (n,n*2)

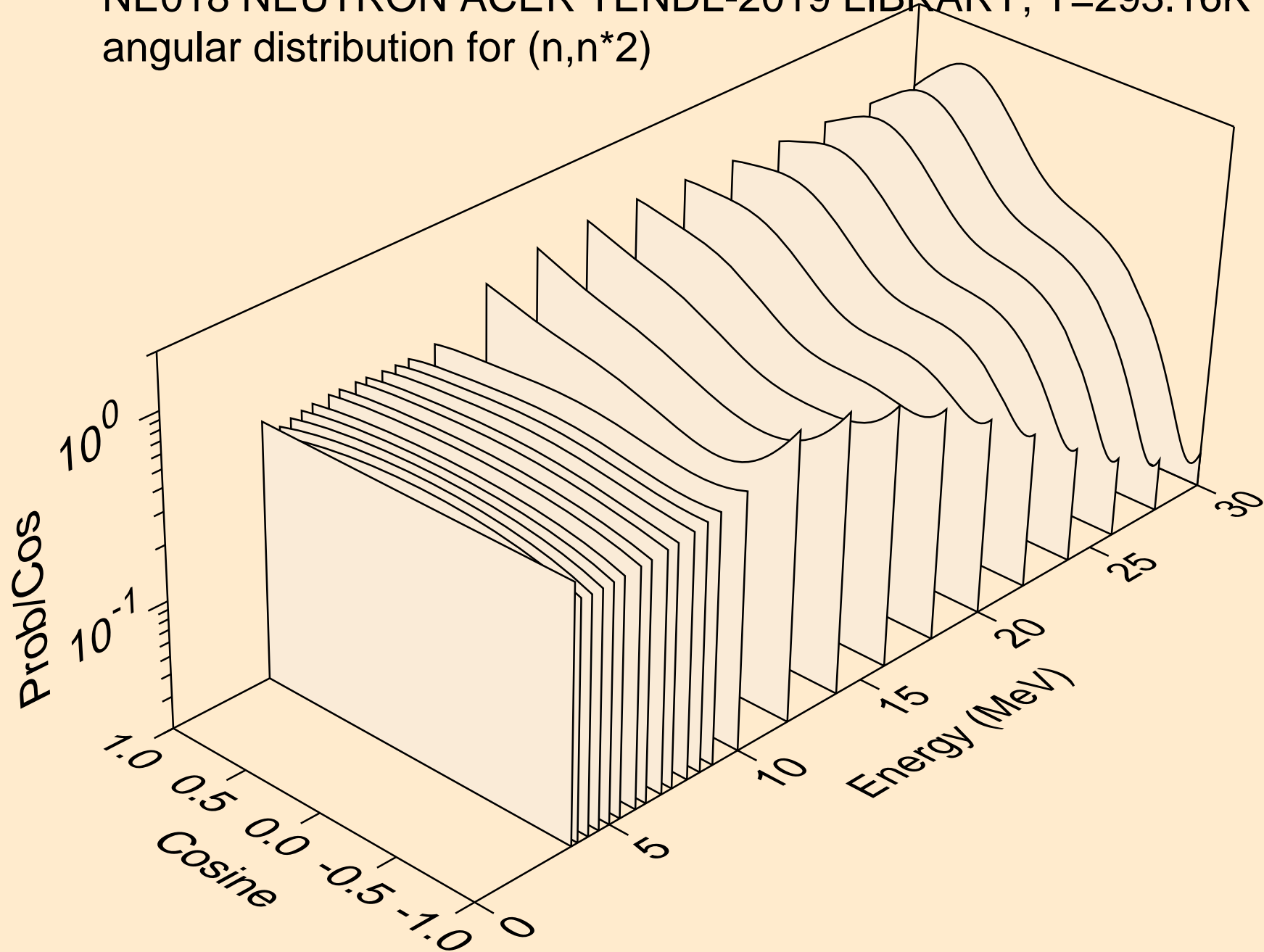

NE018 NEUTRON ACER TENDL-2019 LIBRARY; T=293.16K
angular distribution for (n,n*3)

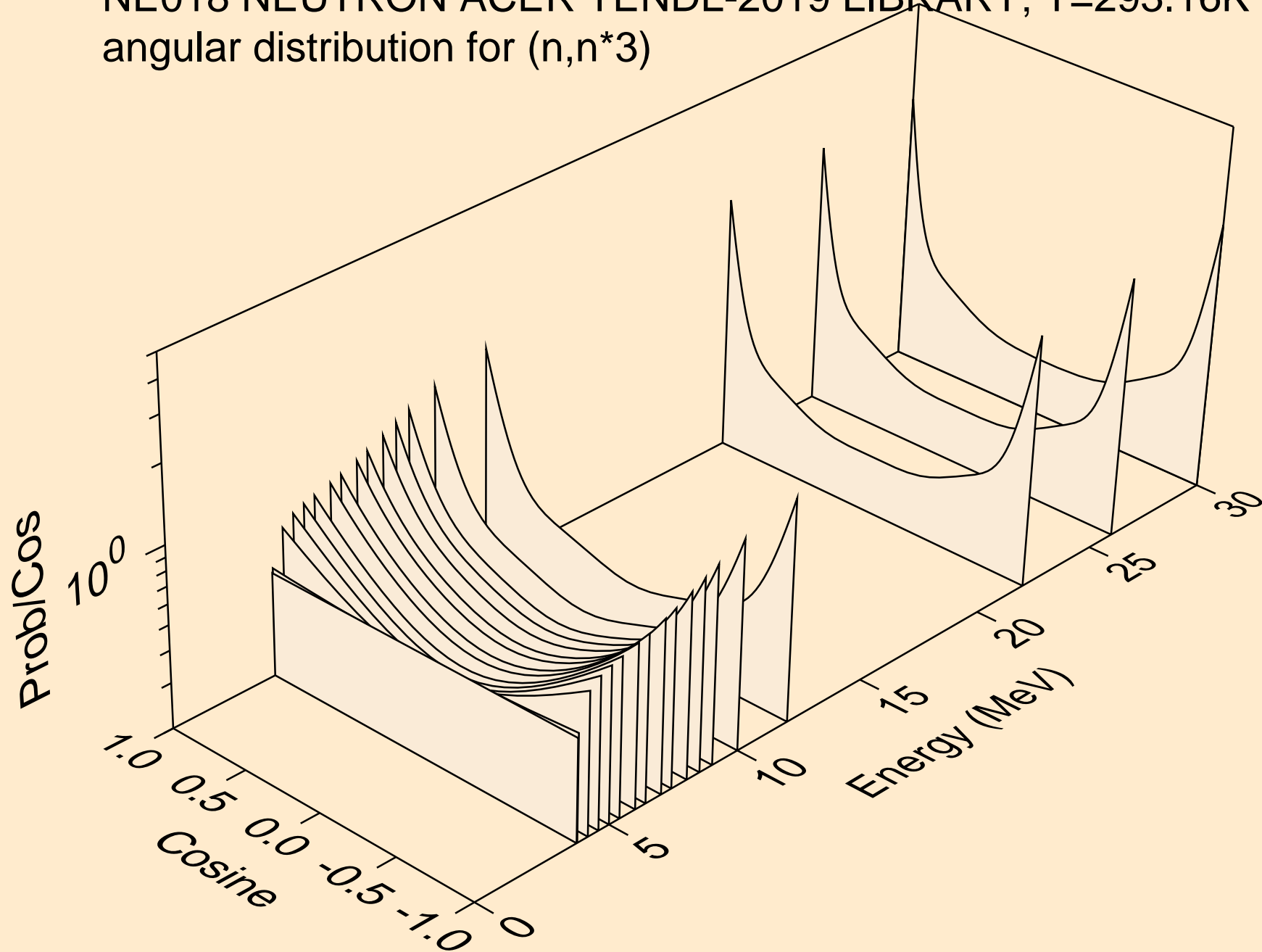

NE018 NEUTRON ACER TENDL-2019 LIBRARY; T=293.16K
angular distribution for (n,n*4)

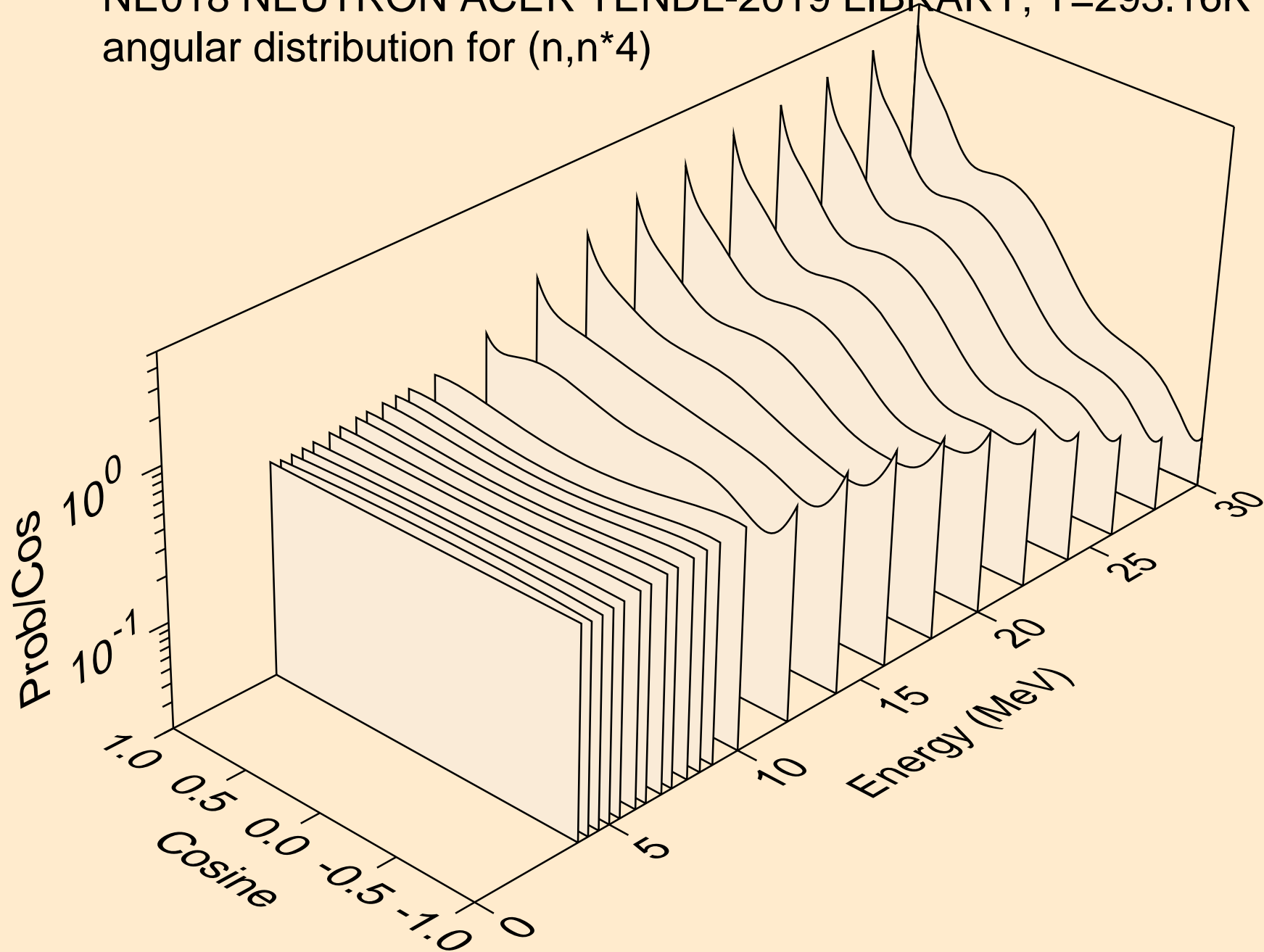

NE018 NEUTRON ACER TENDL-2019 LIBRARY; T=293.16K
Neutron emission for (n,x)

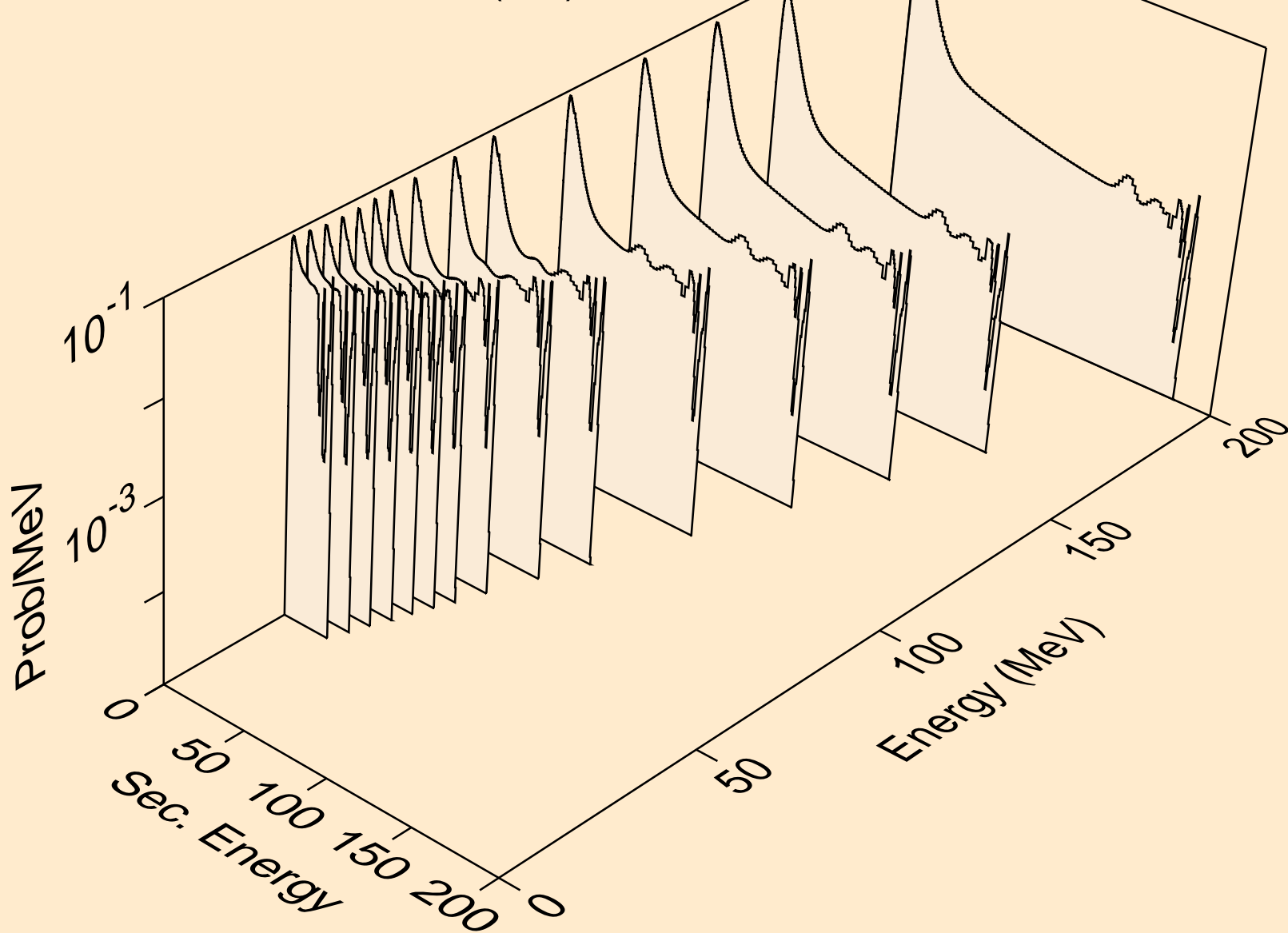

NE018 NEUTRON ACER TENDL-2019 LIBRARY; T=293.16K
Neutron emission for (n,2n)

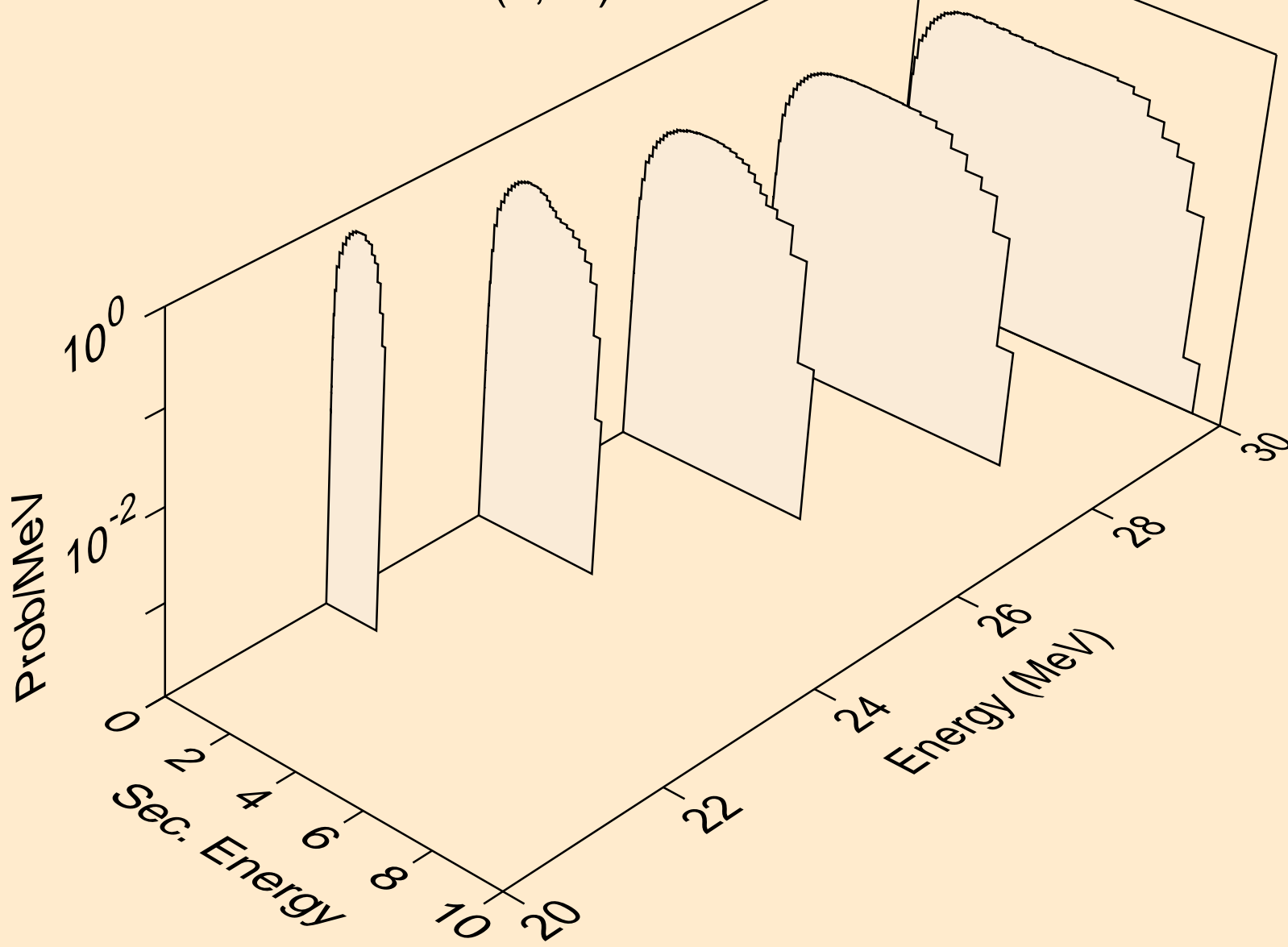

NE018 NEUTRON ACER TENDL-2019 LIBRARY; T=293.16K
Neutron emission for (n,n*)a

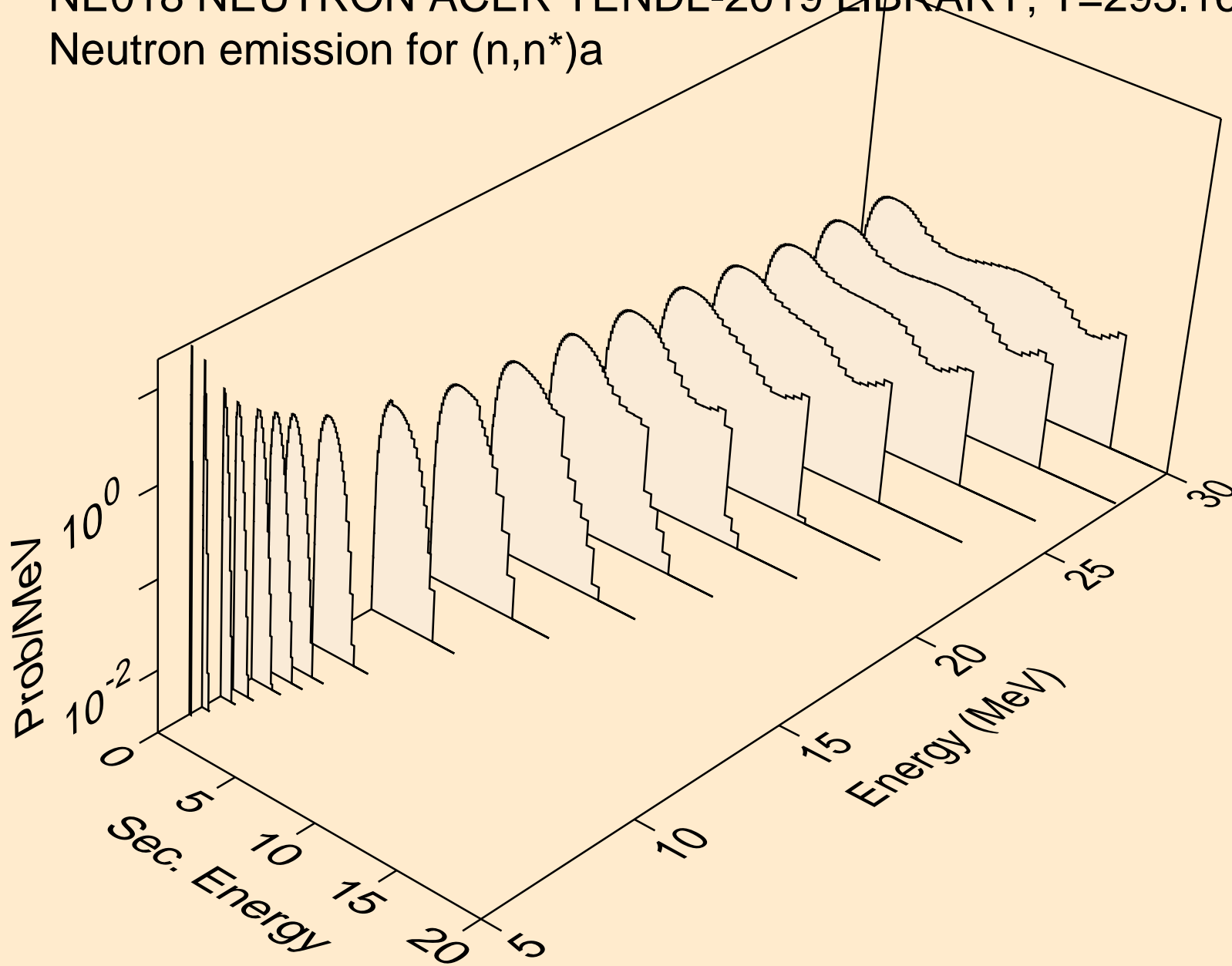

NE018 NEUTRON ACER TENDL-2019 LIBRARY; T=293.16K
Neutron emission for (n,n*)p

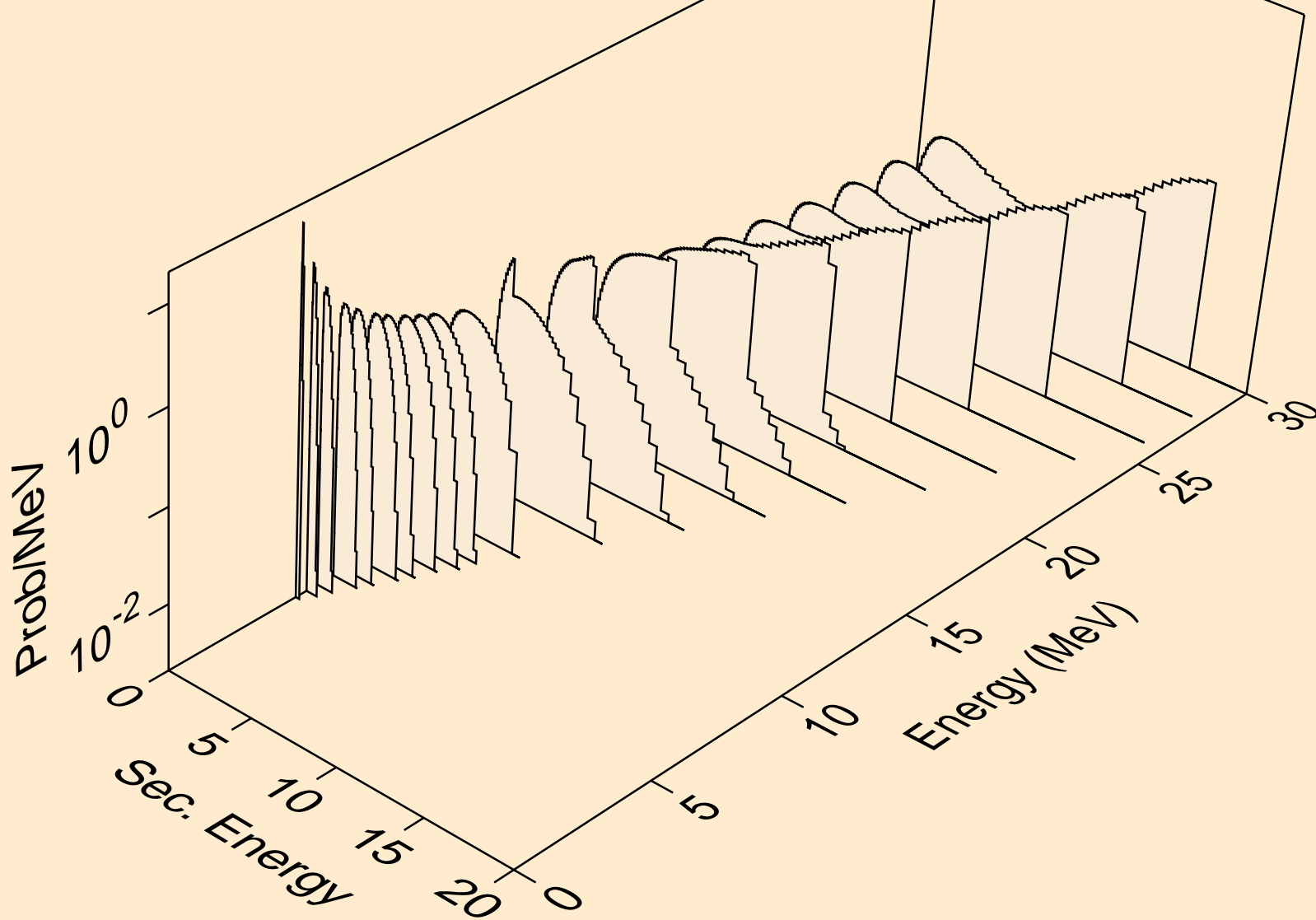

NE018 NEUTRON ACER TENDL-2019 LIBRARY; T=293.16K
Neutron emission for (n,n*)2a

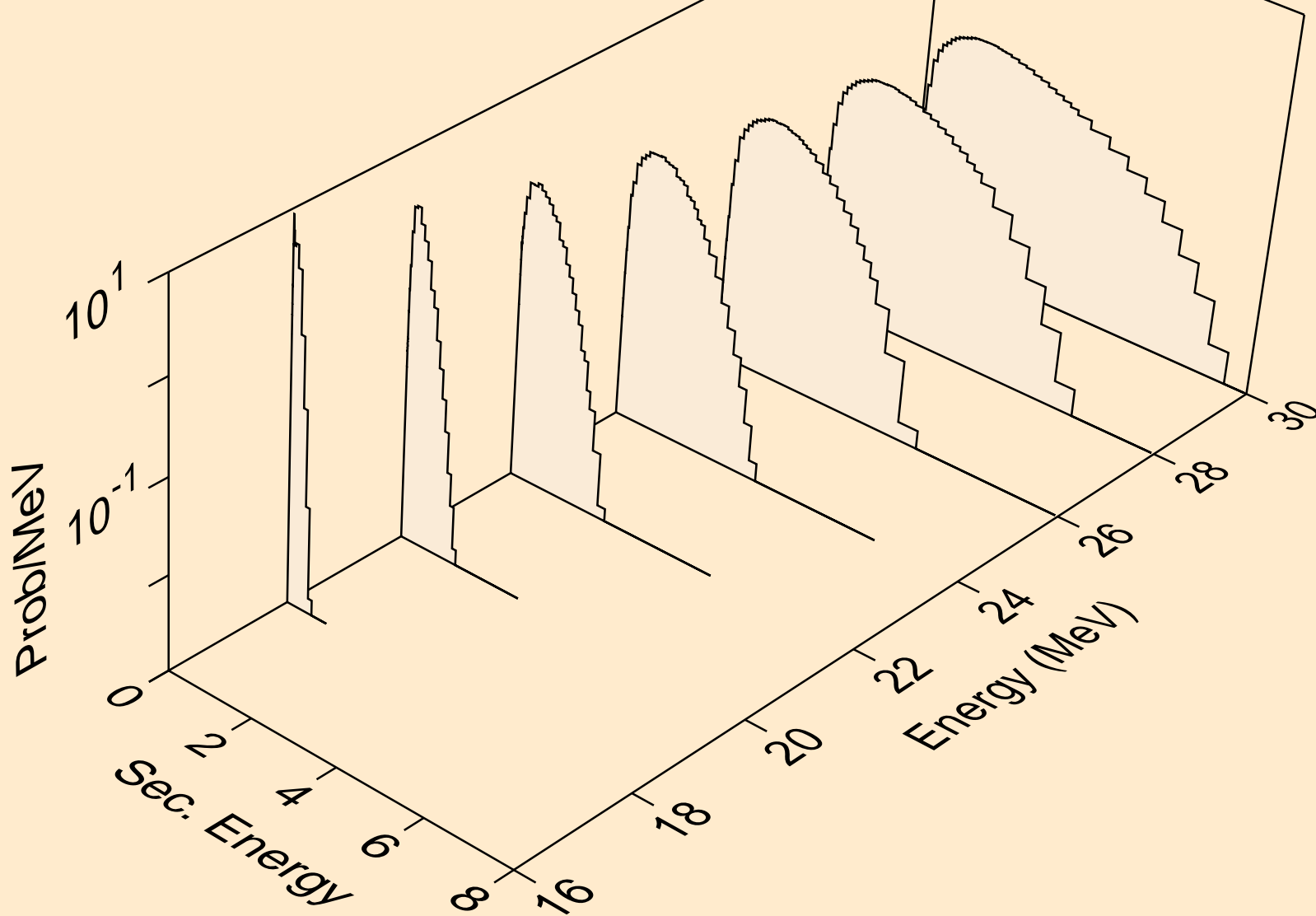

NE018 NEUTRON ACER TENDL-2019 LIBRARY; T=293.16K
Neutron emission for (n,n*)d

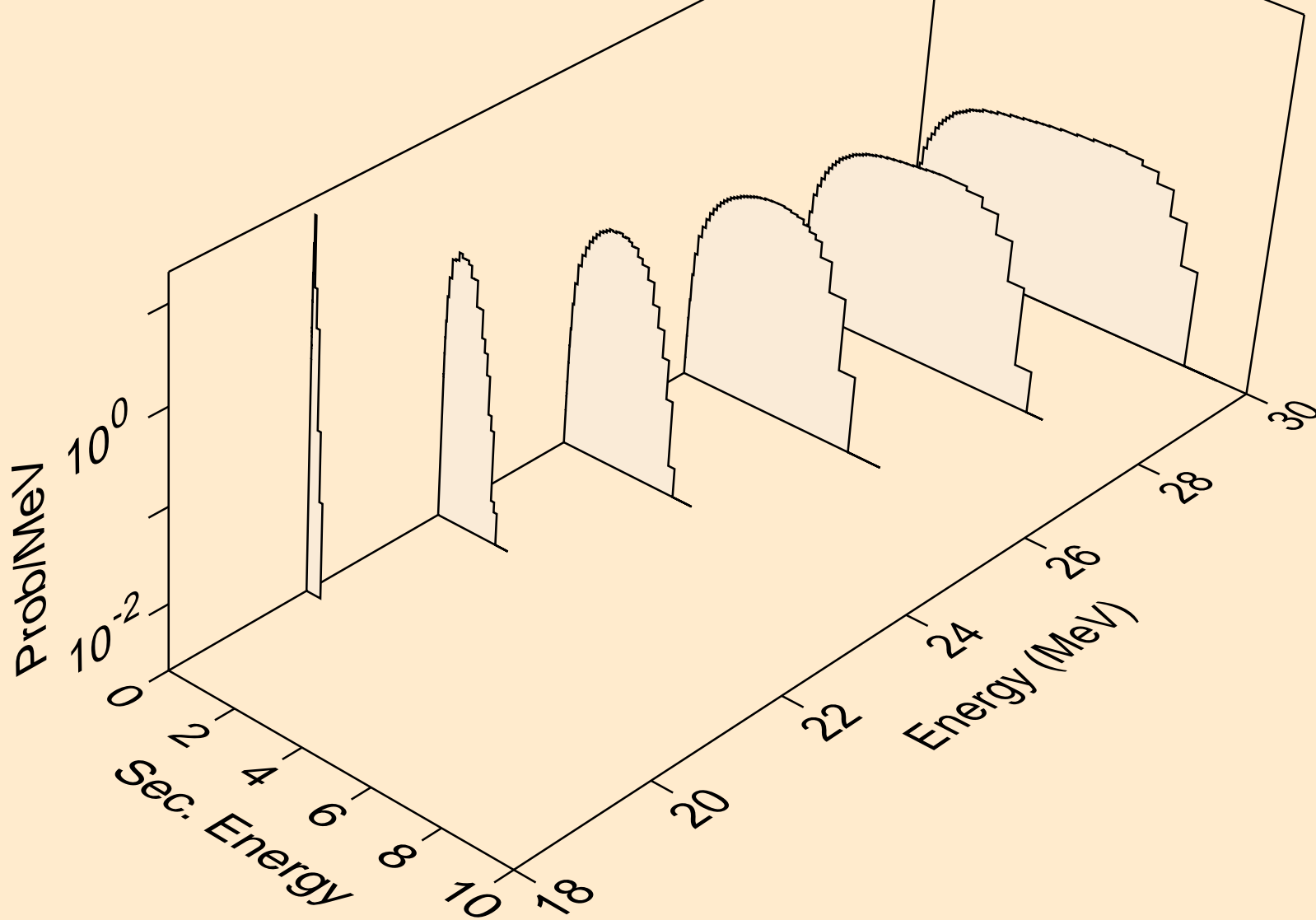

NE018 NEUTRON ACER TENDL-2019 LIBRARY; T=293.16K
Neutron emission for (n,n*)t

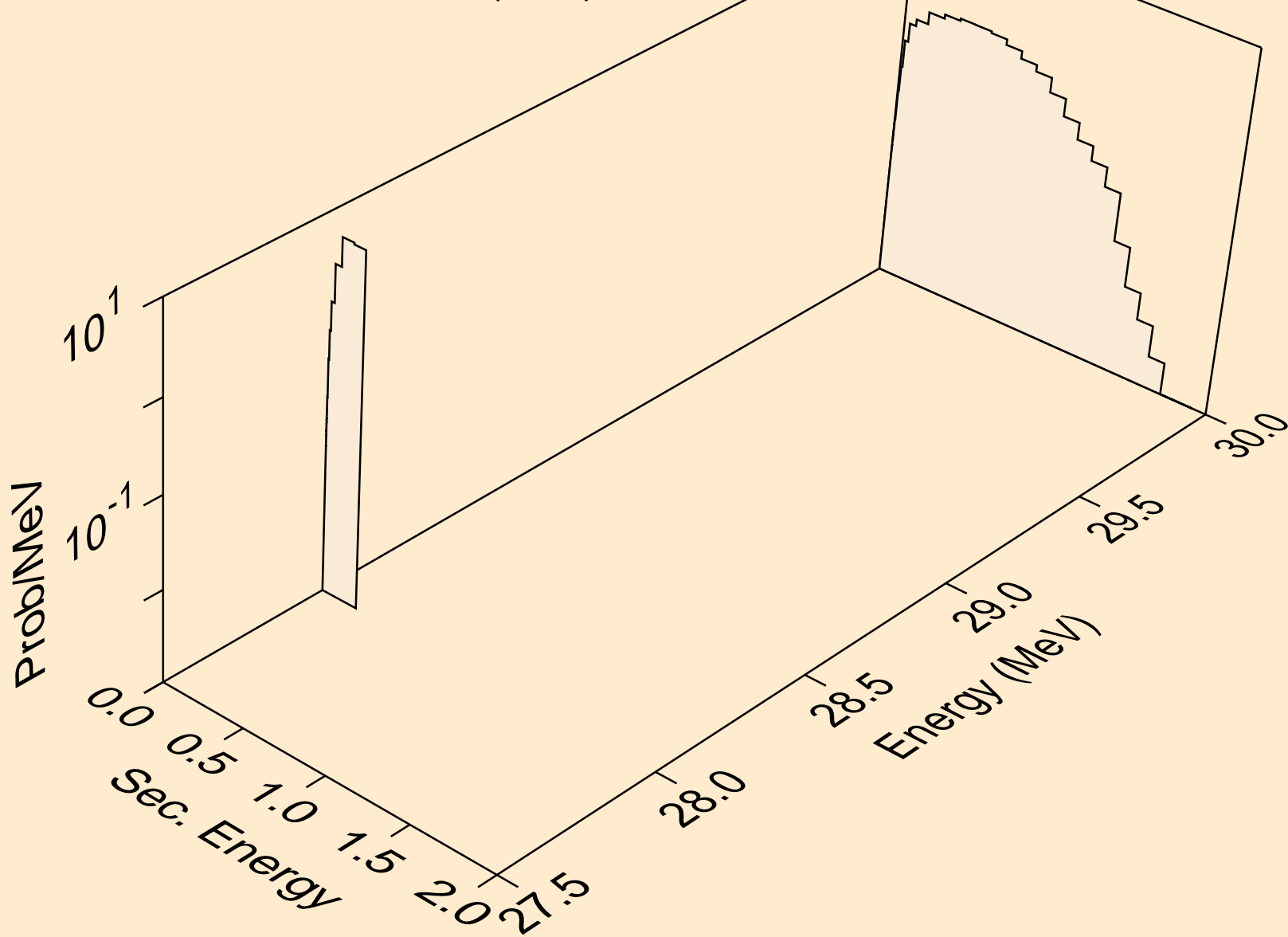

NE018 NEUTRON ACER TENDL-2019 LIBRARY; T=293.16K
Neutron emission for (n,n*)he3

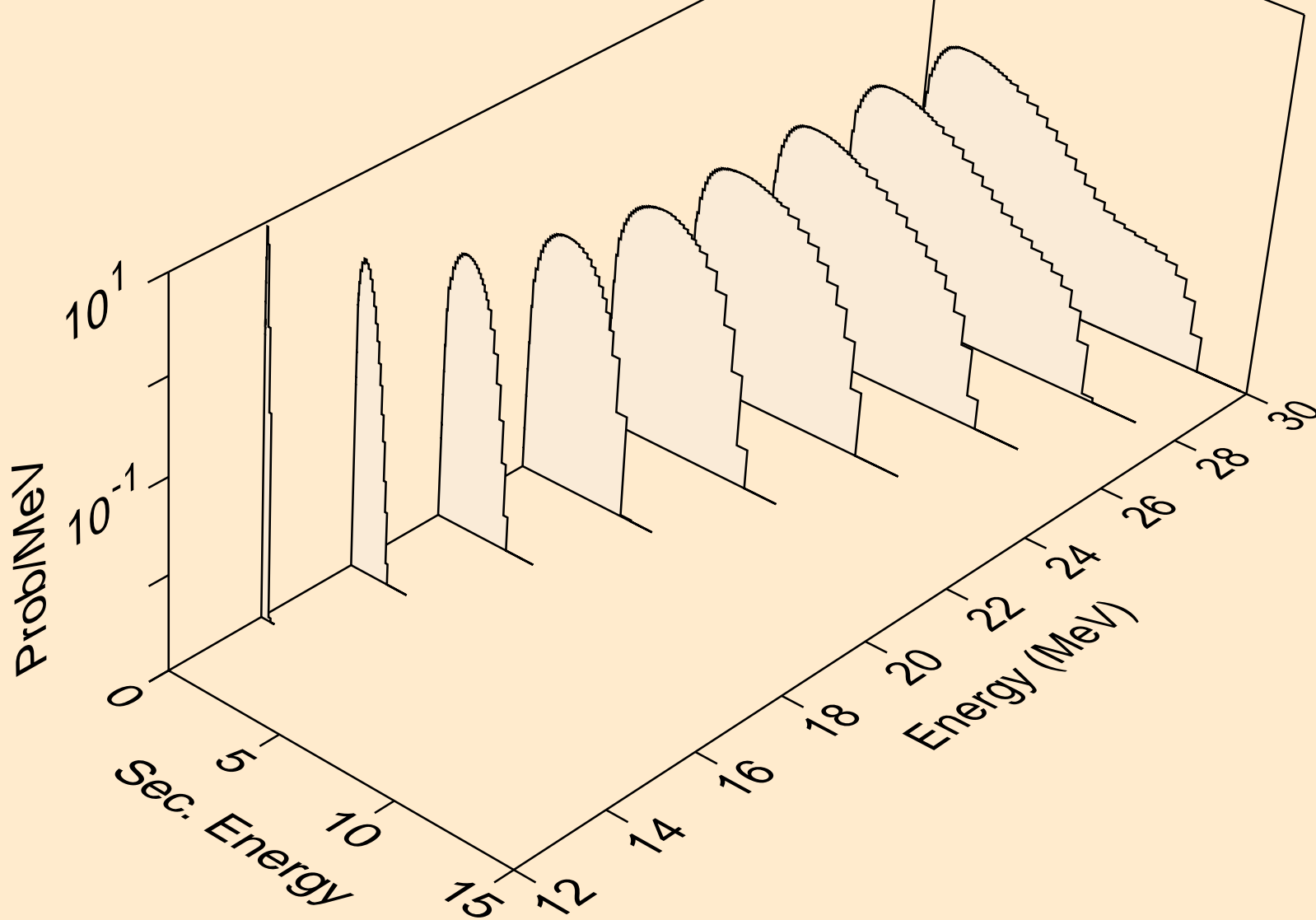

NE018 NEUTRON ACER TENDL-2019 LIBRARY; T=293.16K
Neutron emission for (n,2np)

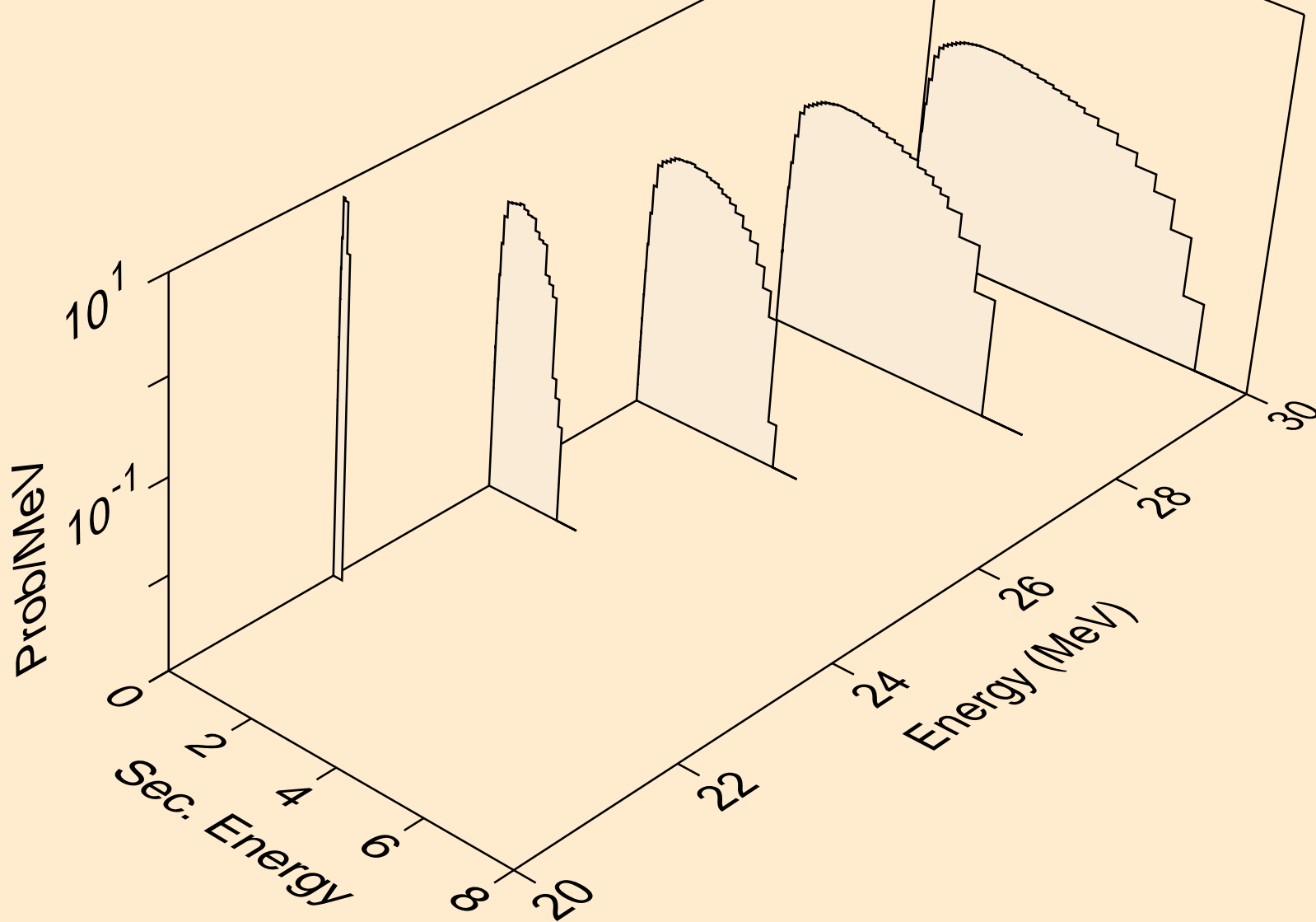

NE018 NEUTRON ACER TENDL-2019 LIBRARY; T=293.16K
Neutron emission for (n,2np)

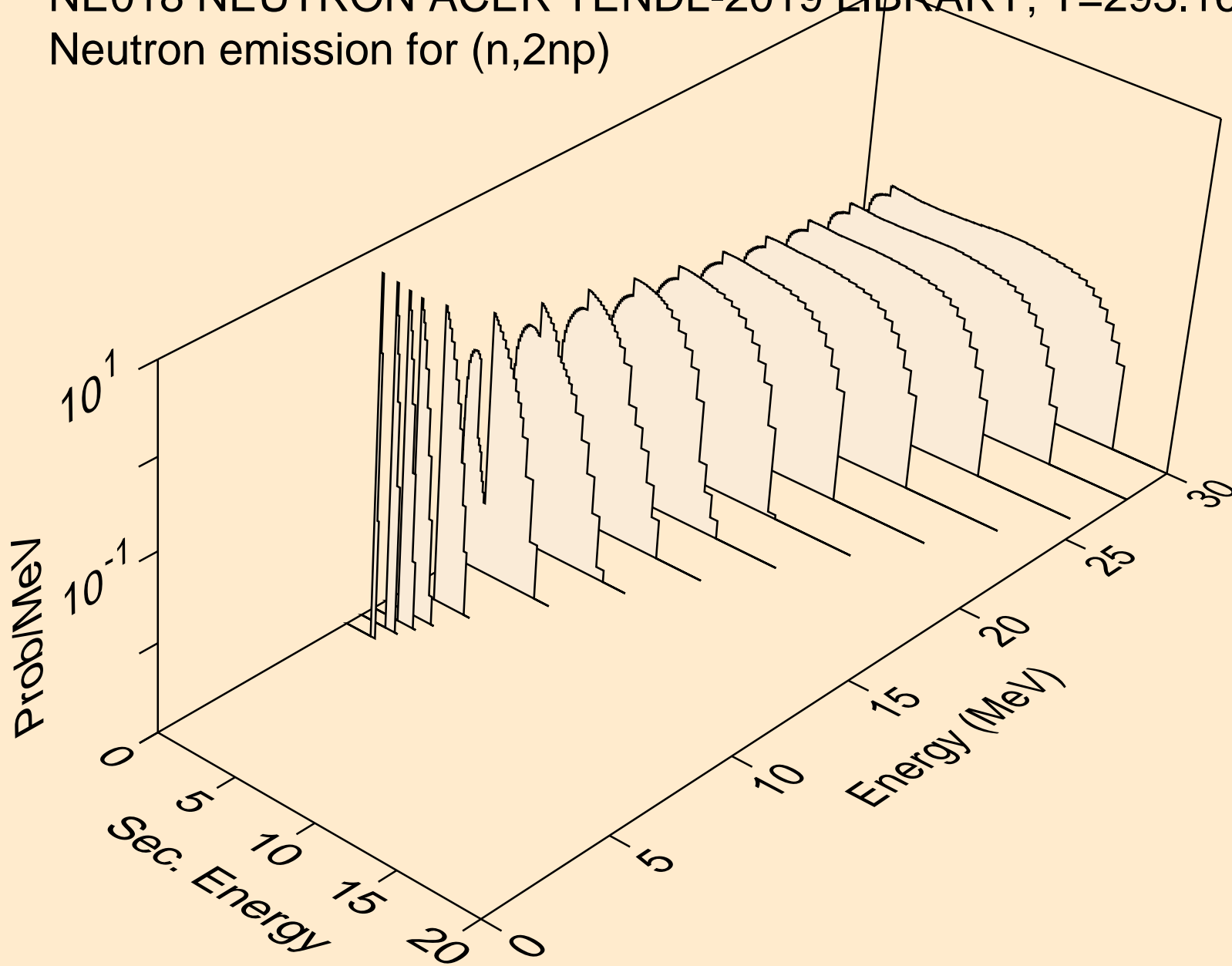

NE018 NEUTRON ACER TENDL-2019 LIBRARY; T=293.16K
Neutron emission for (n,npa)

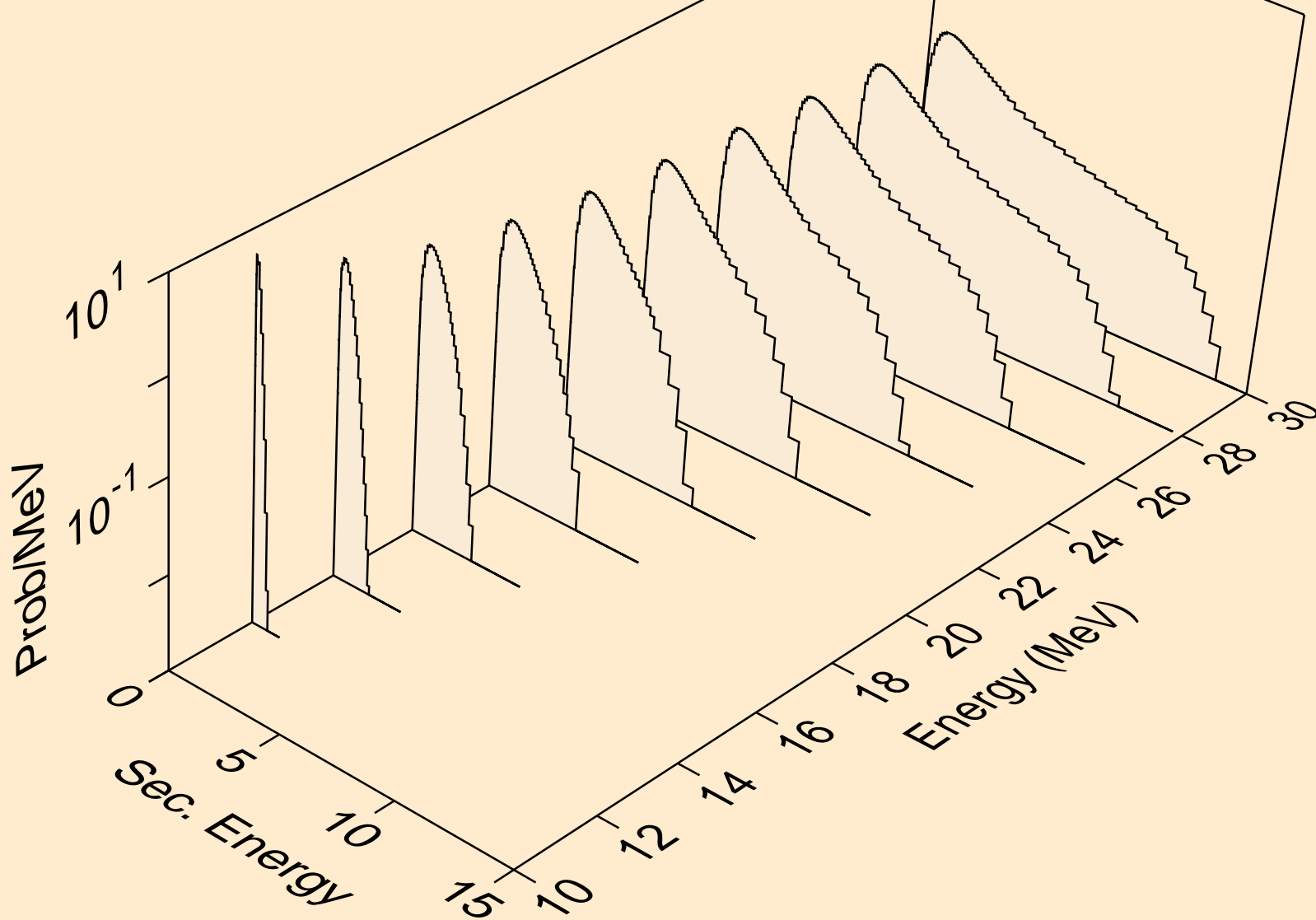

NE018 NEUTRON ACER TENDL-2019 LIBRARY; T=293.16K
Neutron emission for (n,n*c)

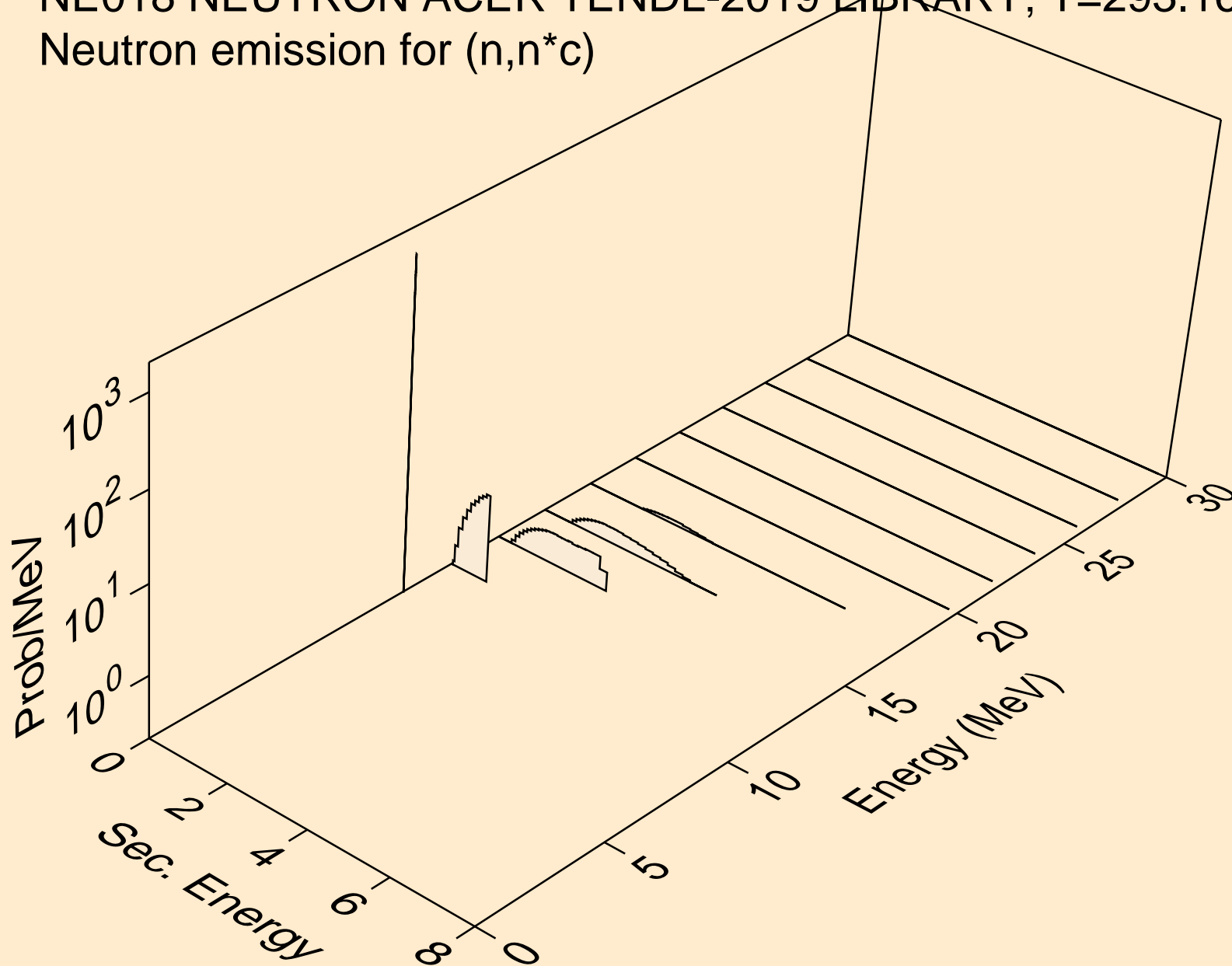

NE018 NEUTRON ACER TENDL-2019 LIBRARY; T=293.16K
Photon emission for (n,x)

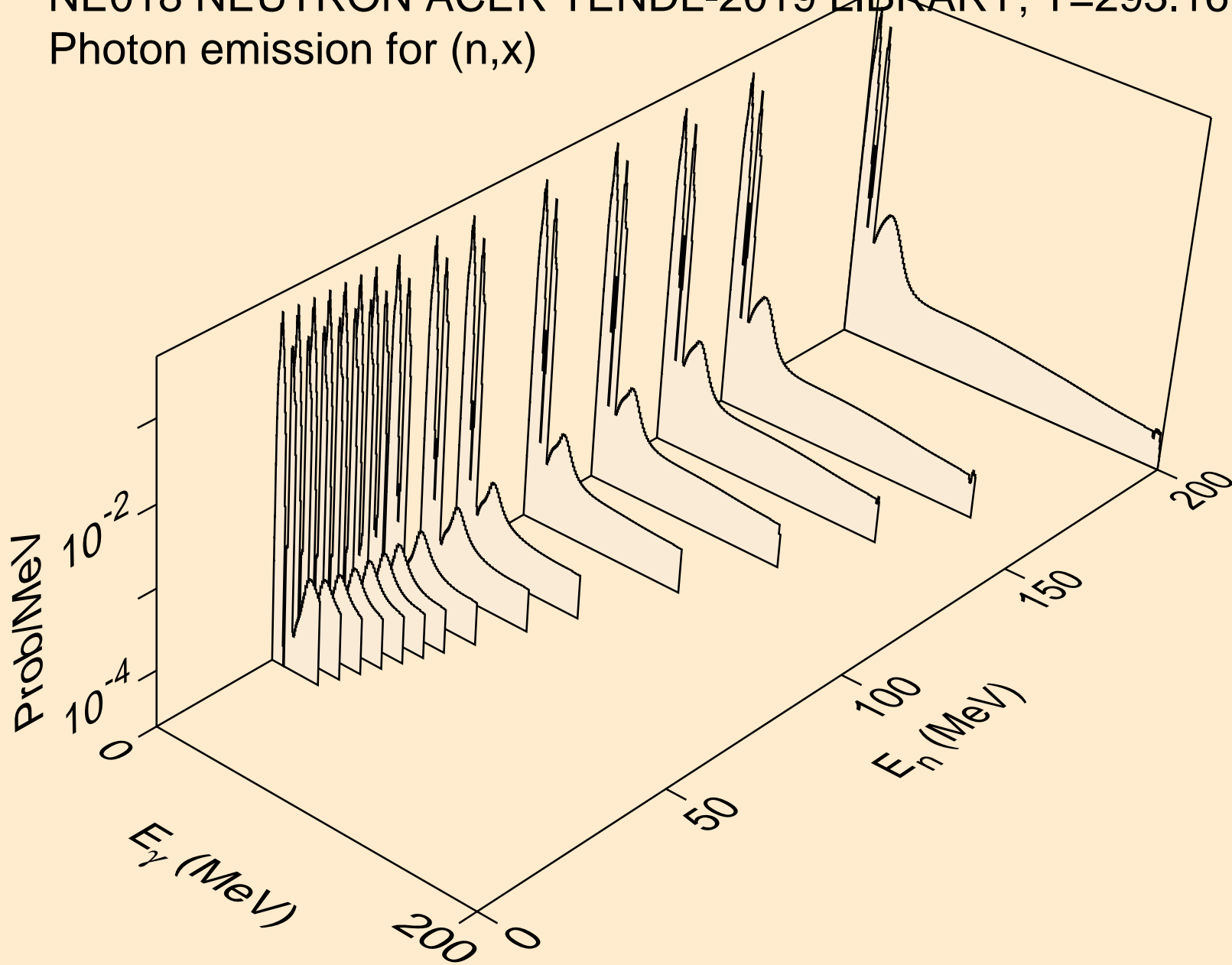

NE018 NEUTRON ACER TENDL-2019 LIBRARY; T=293.16K
Photon emission for (n,2n)

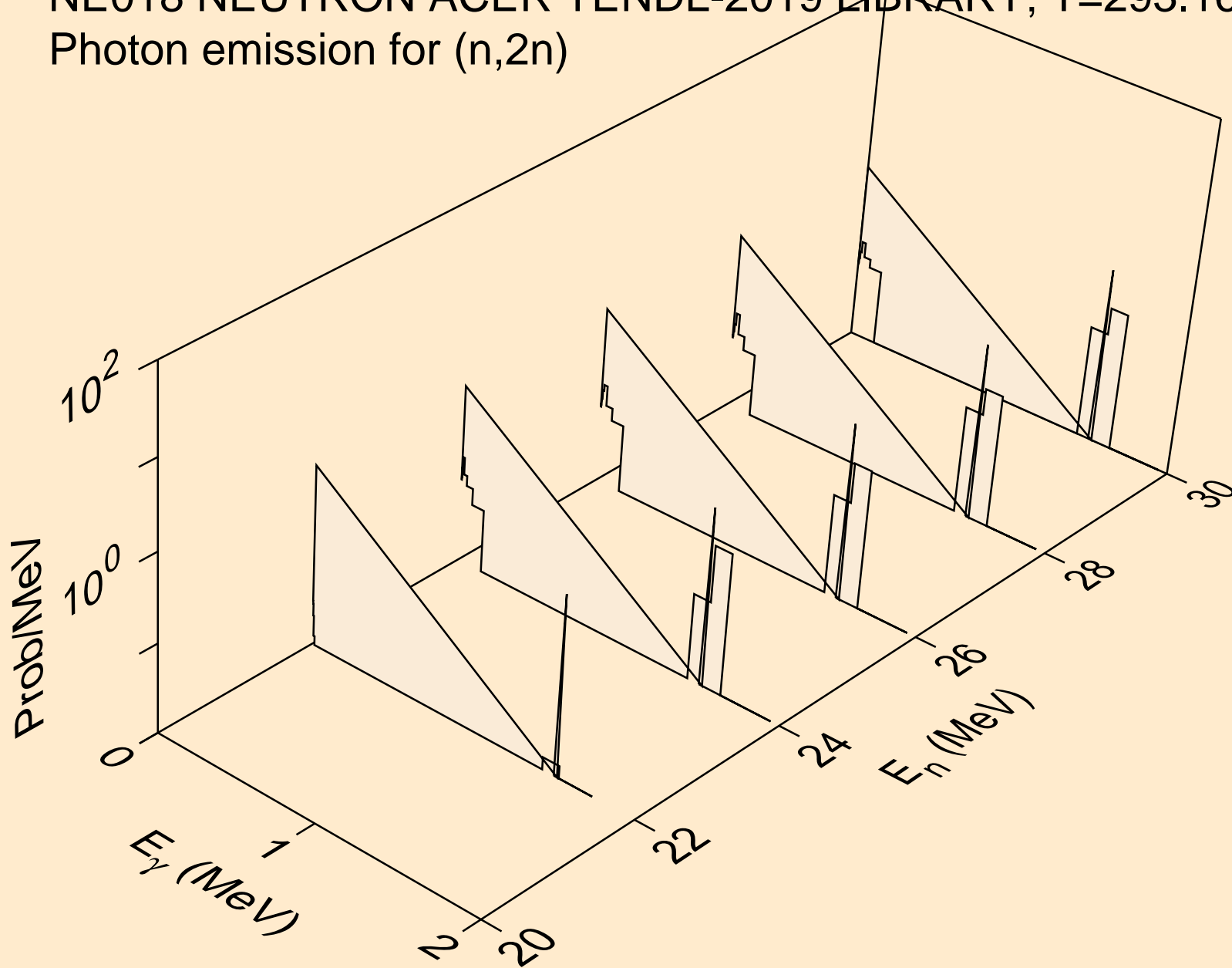

NE018 NEUTRON ACER TENDL-2019 LIBRARY; T=293.16K
Photon emission for (n,n*)a

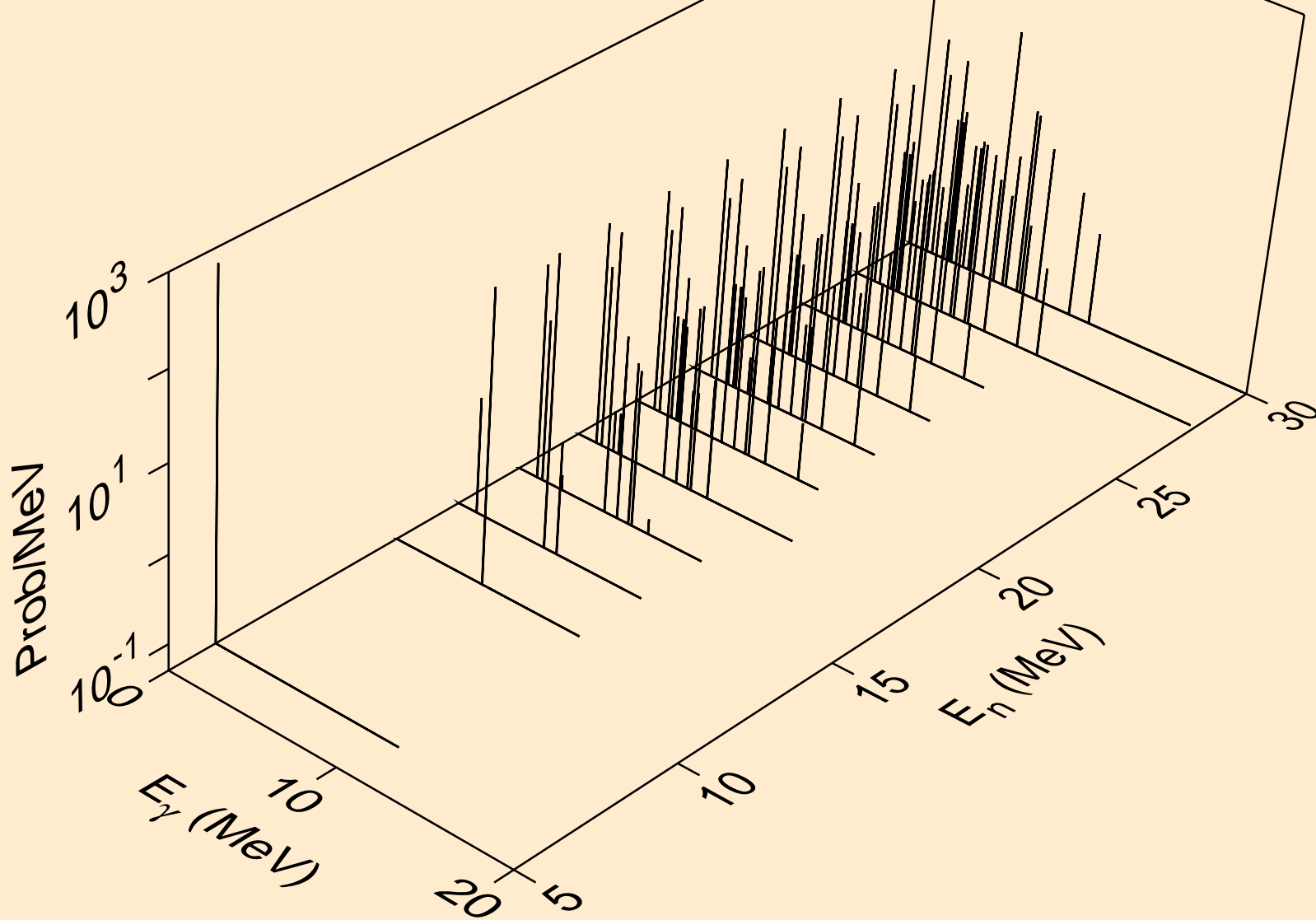

NE018 NEUTRON ACER TENDL-2019 LIBRARY; T=293.16K
Photon emission for (n,n*)p

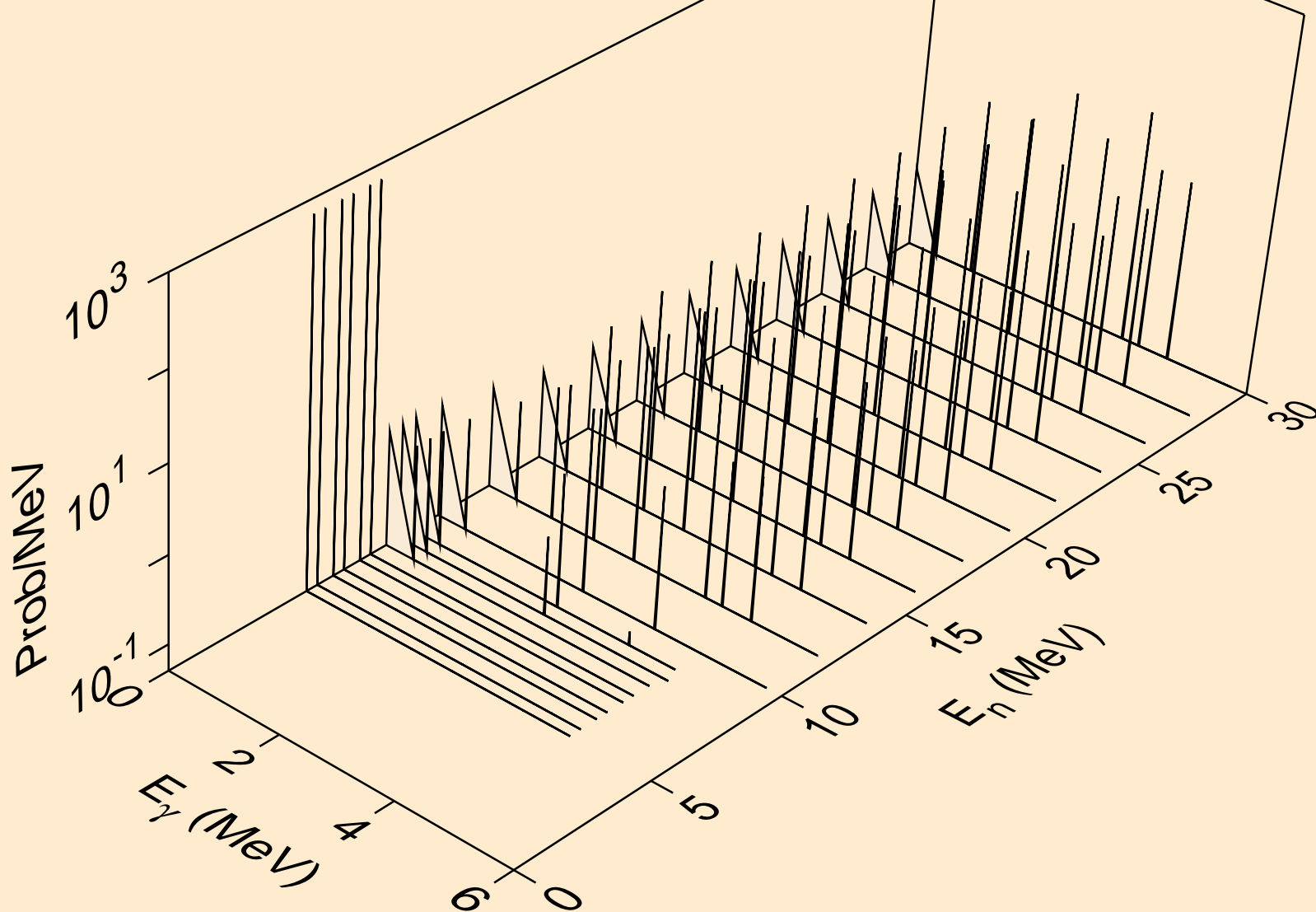

NE018 NEUTRON ACER TENDL-2019 LIBRARY; T=293.16K
Photon emission for (n,n*)2a

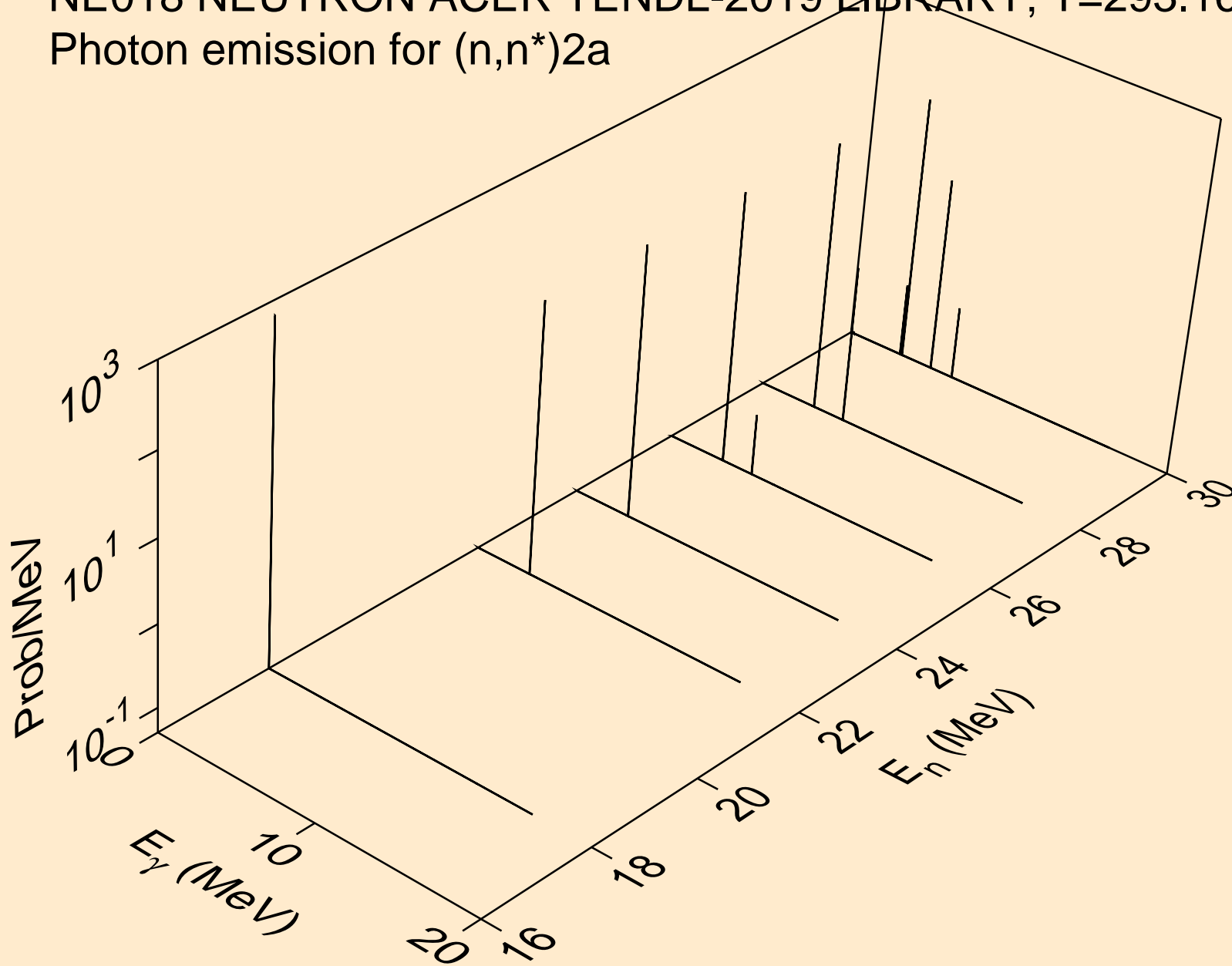

NE018 NEUTRON ACER TENDL-2019 LIBRARY; T=293.16K
Photon emission for (n,n*)d

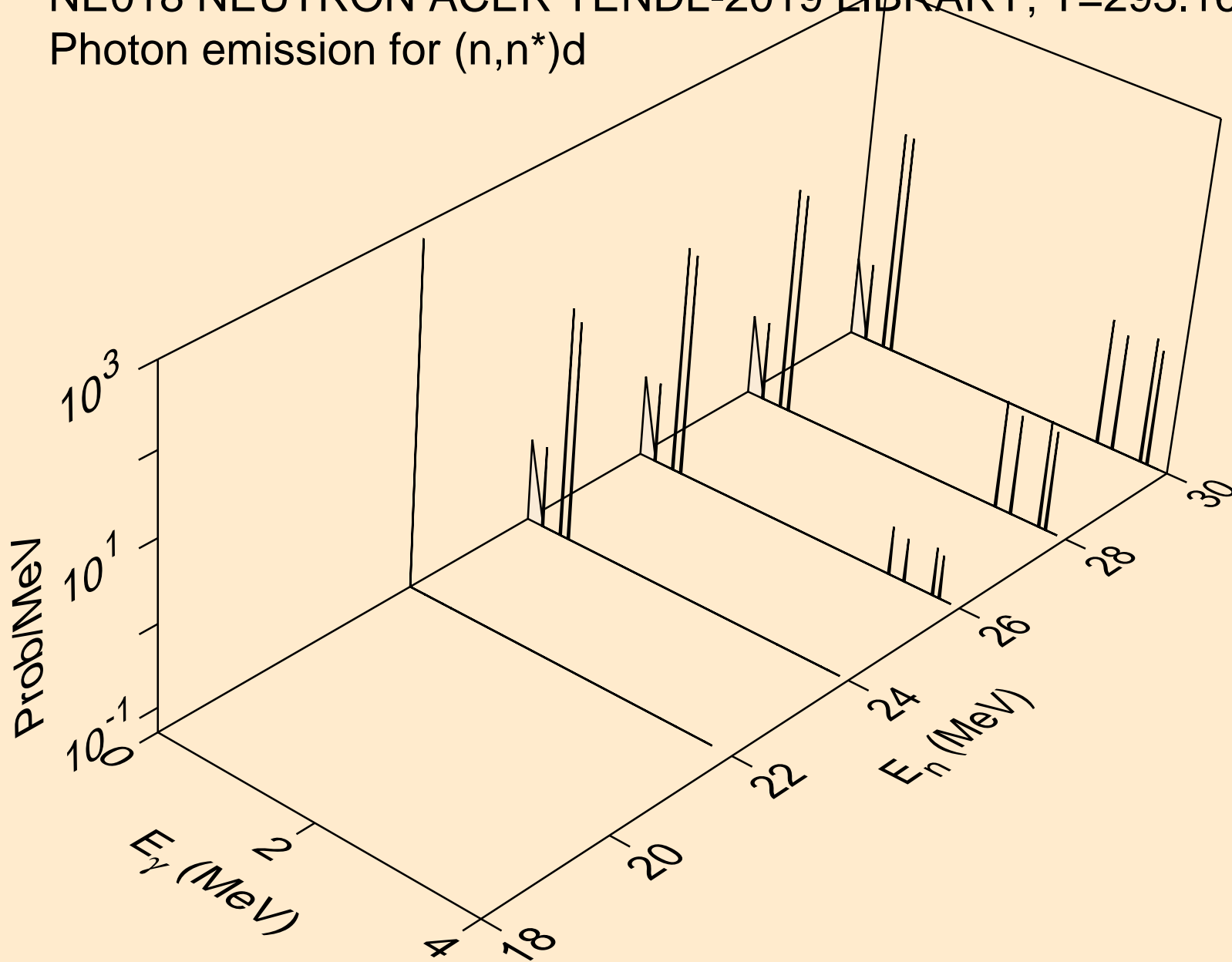

NE018 NEUTRON ACER TENDL-2019 LIBRARY; T=293.16K
Photon emission for (n,n*)t

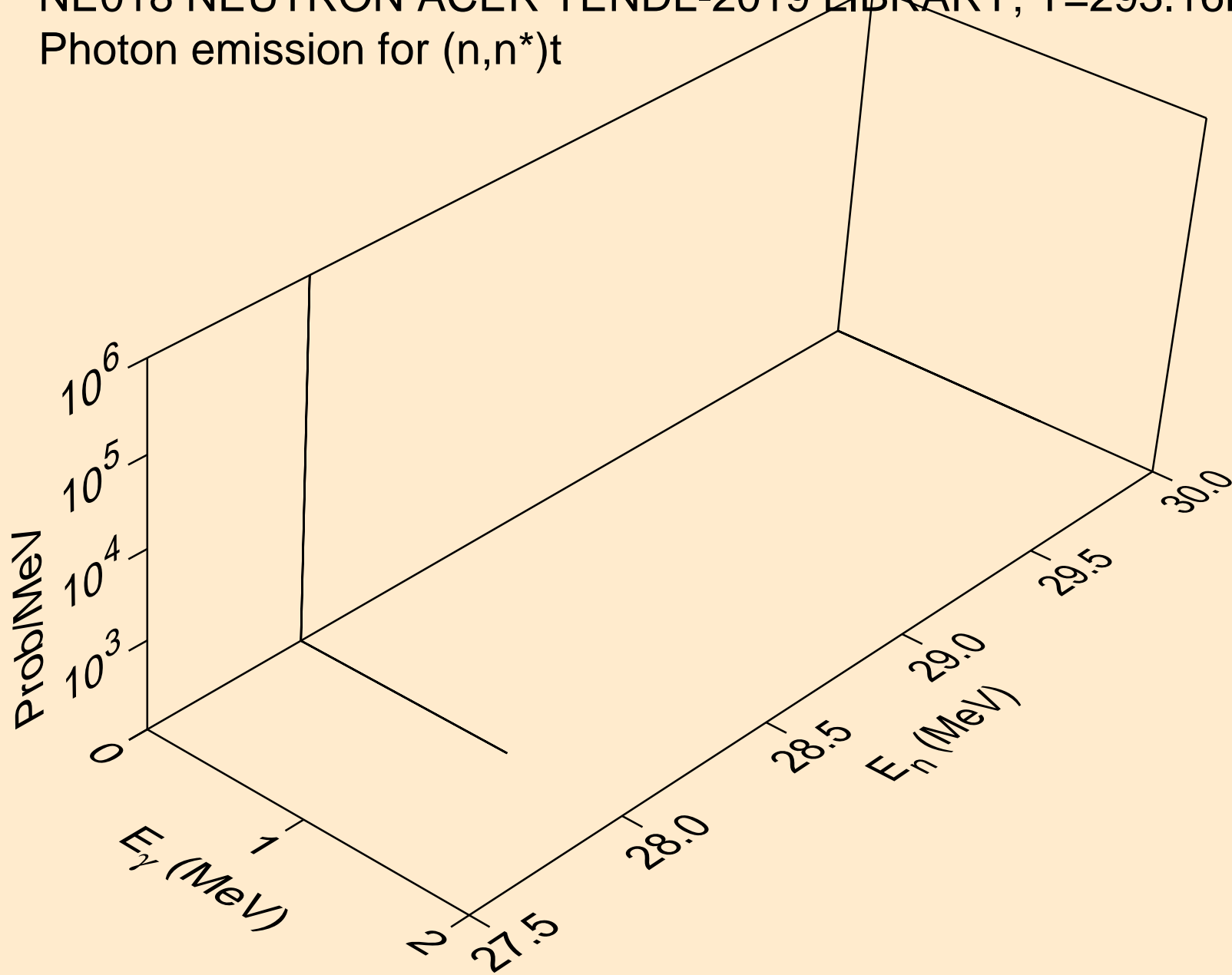

NE018 NEUTRON ACER TENDL-2019 LIBRARY; T=293.16K
Photon emission for (n,n*)he3

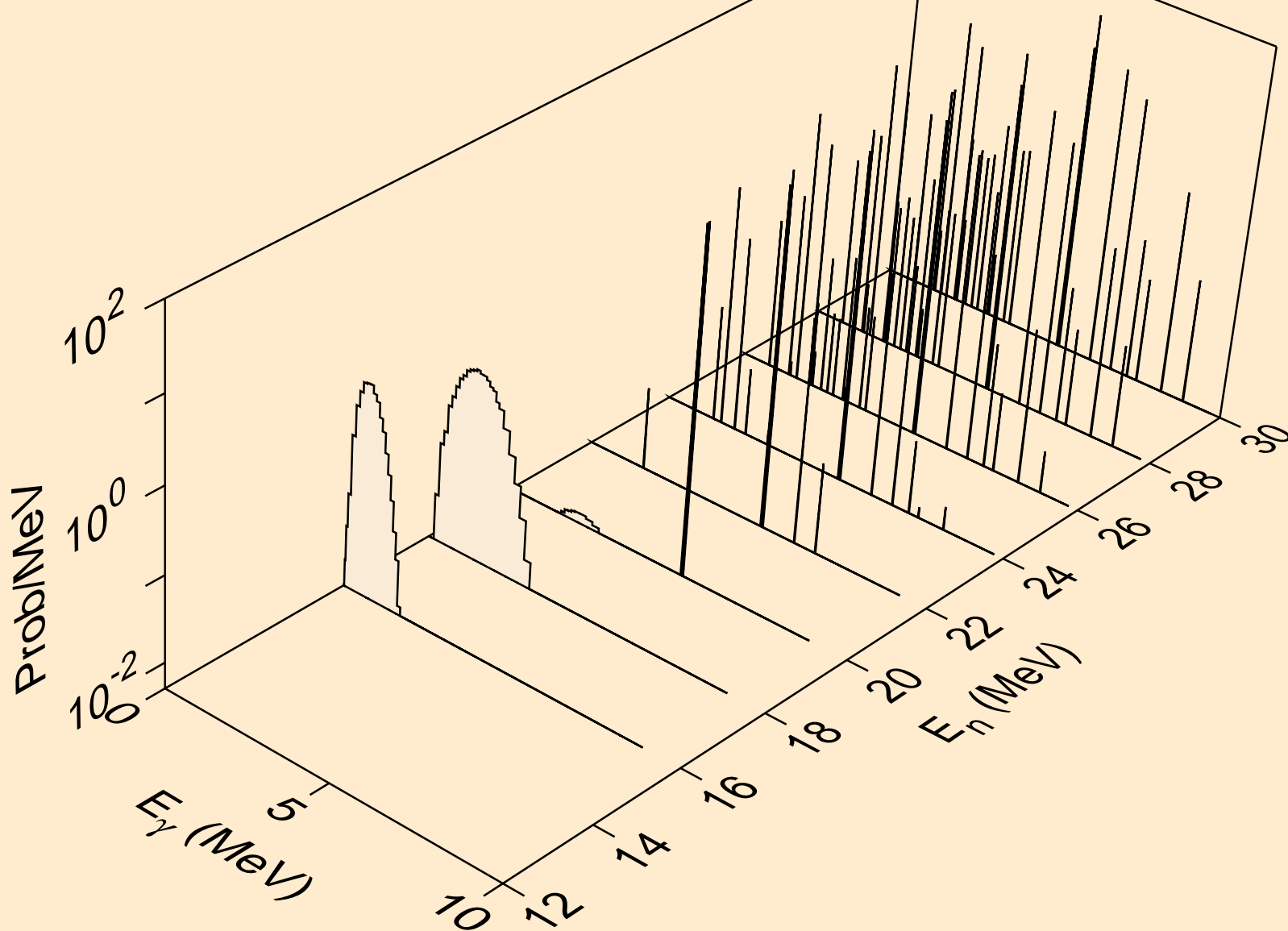

NE018 NEUTRON ACER TENDL-2019 LIBRARY; T=293.16K
Photon emission for (n,2np)

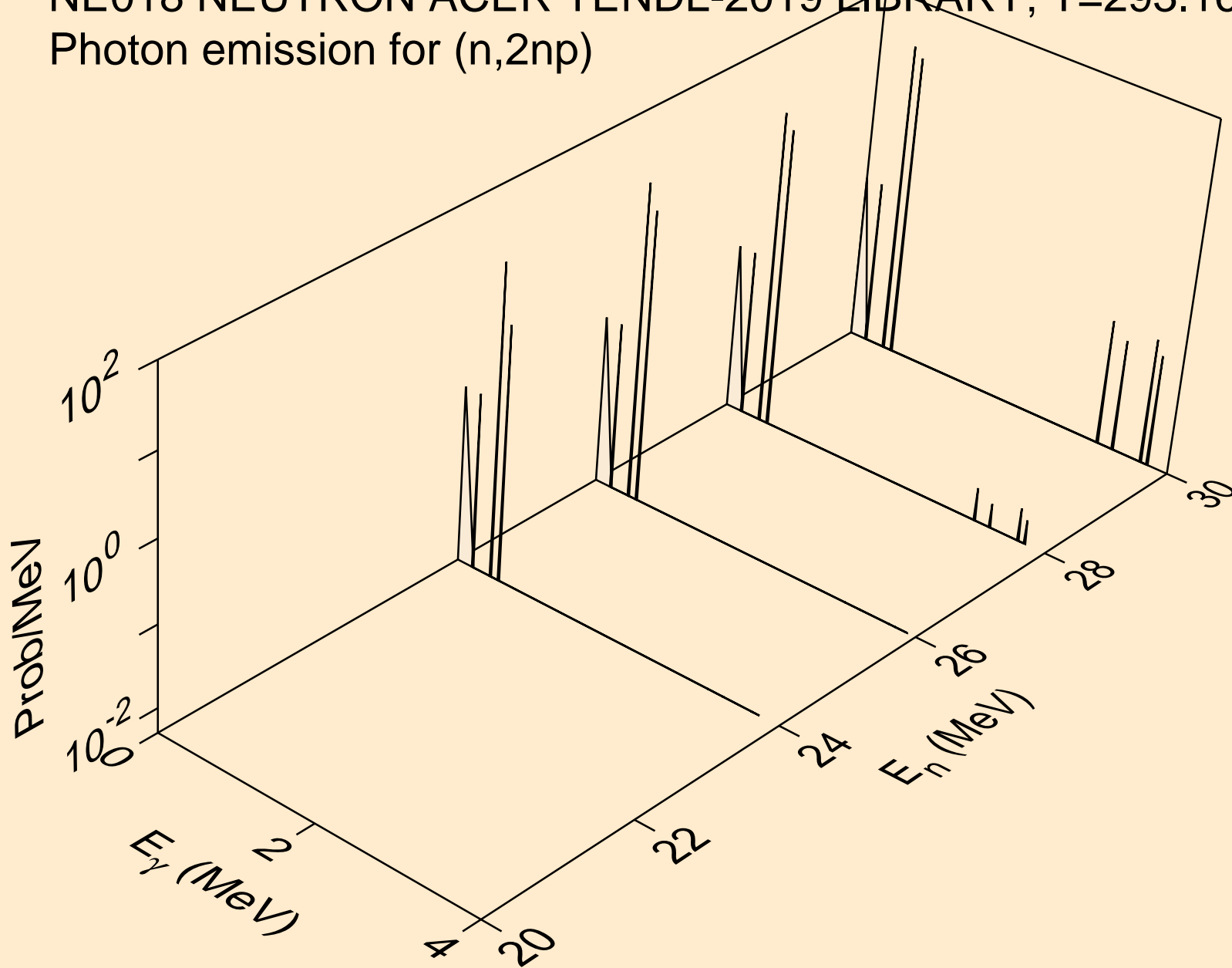

NE018 NEUTRON ACER TENDL-2019 LIBRARY; T=293.16K
Photon emission for (n,2np)

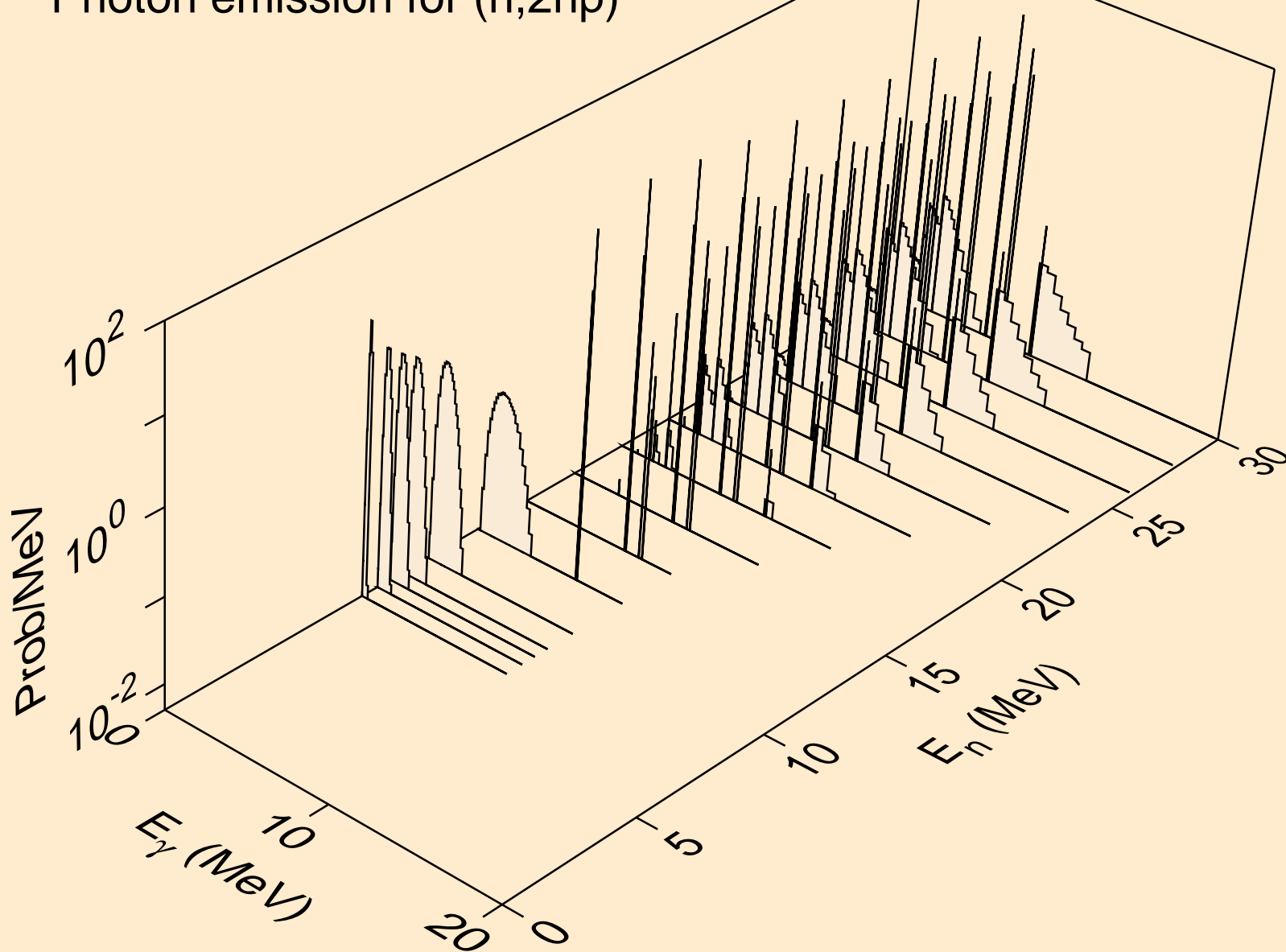

NE018 NEUTRON ACER TENDL-2019 LIBRARY; T=293.16K
Photon emission for (n,npa)

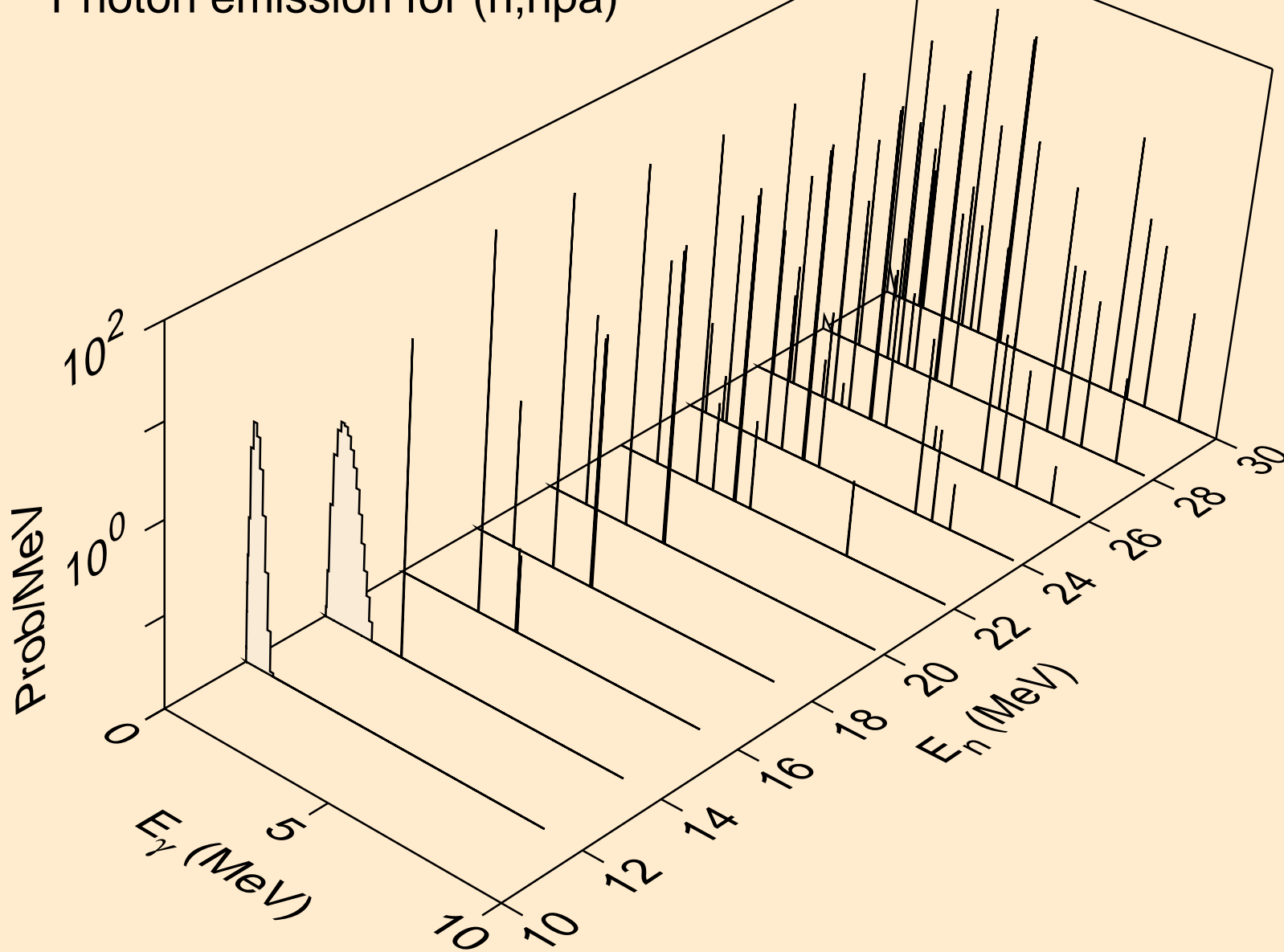

NE018 NEUTRON ACER TENDL-2019 LIBRARY; T=293.16K
Photon emission for (n,n*c)

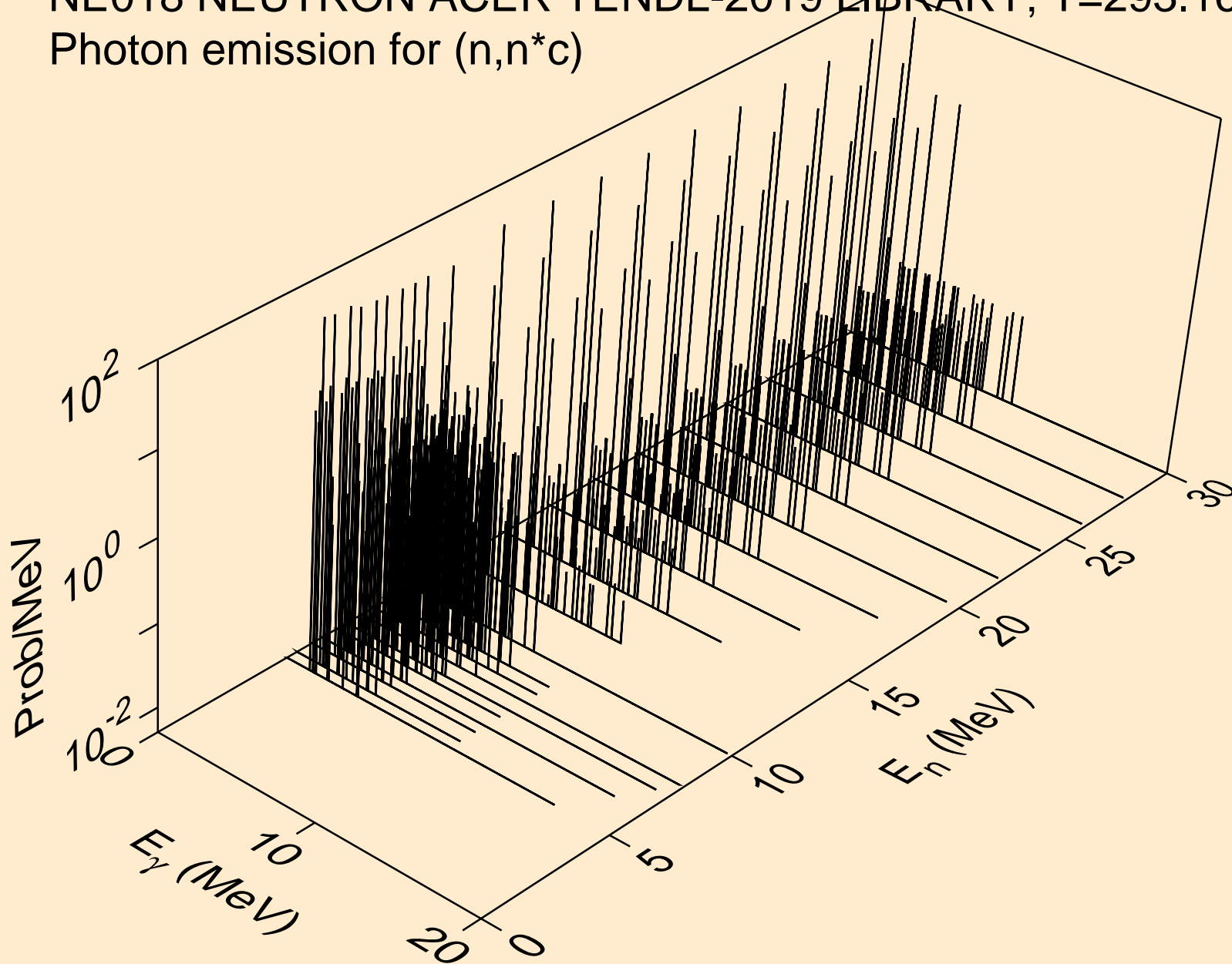

NE018 NEUTRON ACER TENDL-2019 LIBRARY; T=293.16K
Photon emission for (n,gma)

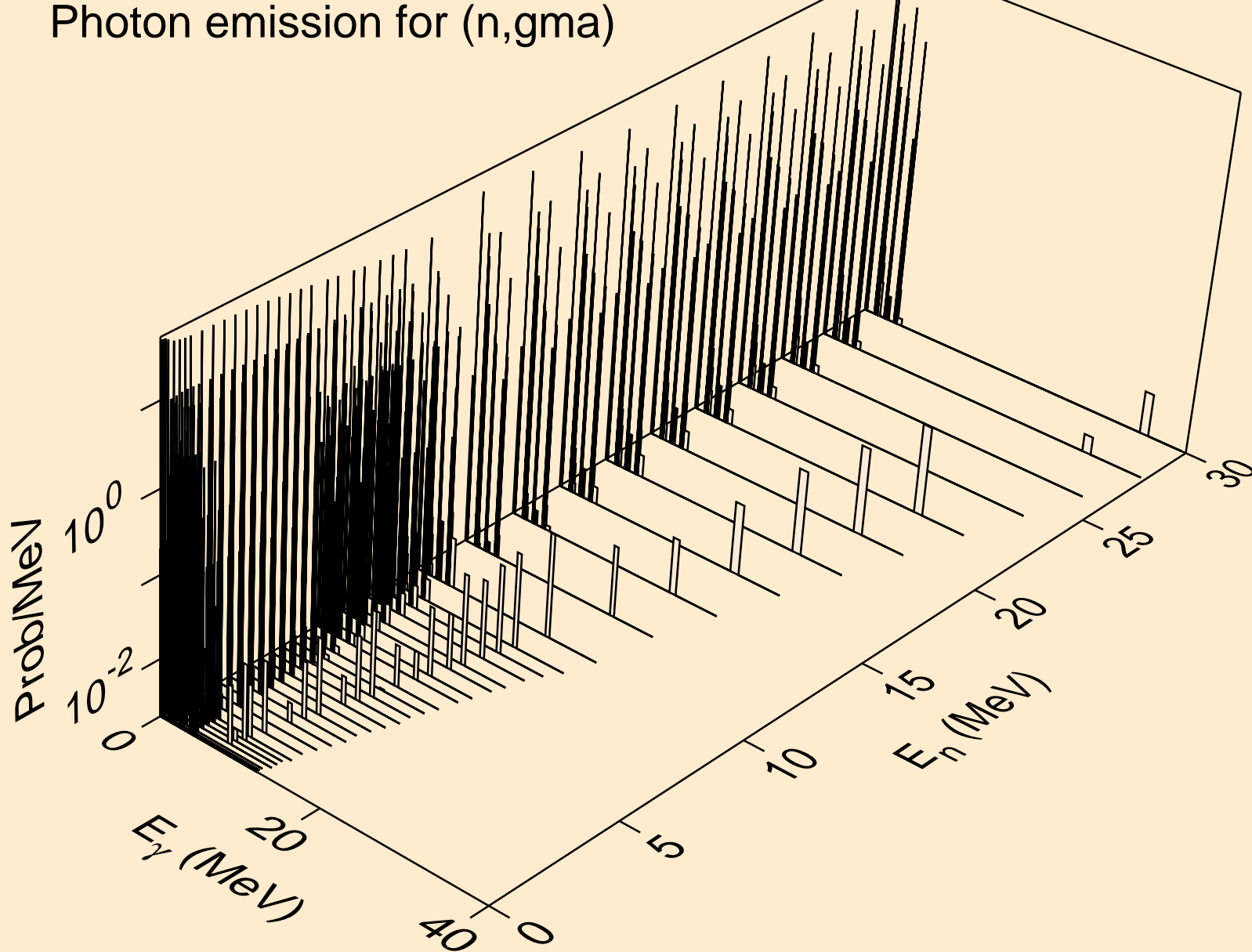

NE018 NEUTRON ACER TENDL-2019 LIBRARY; T=293.16K
Photon emission for (n,p)

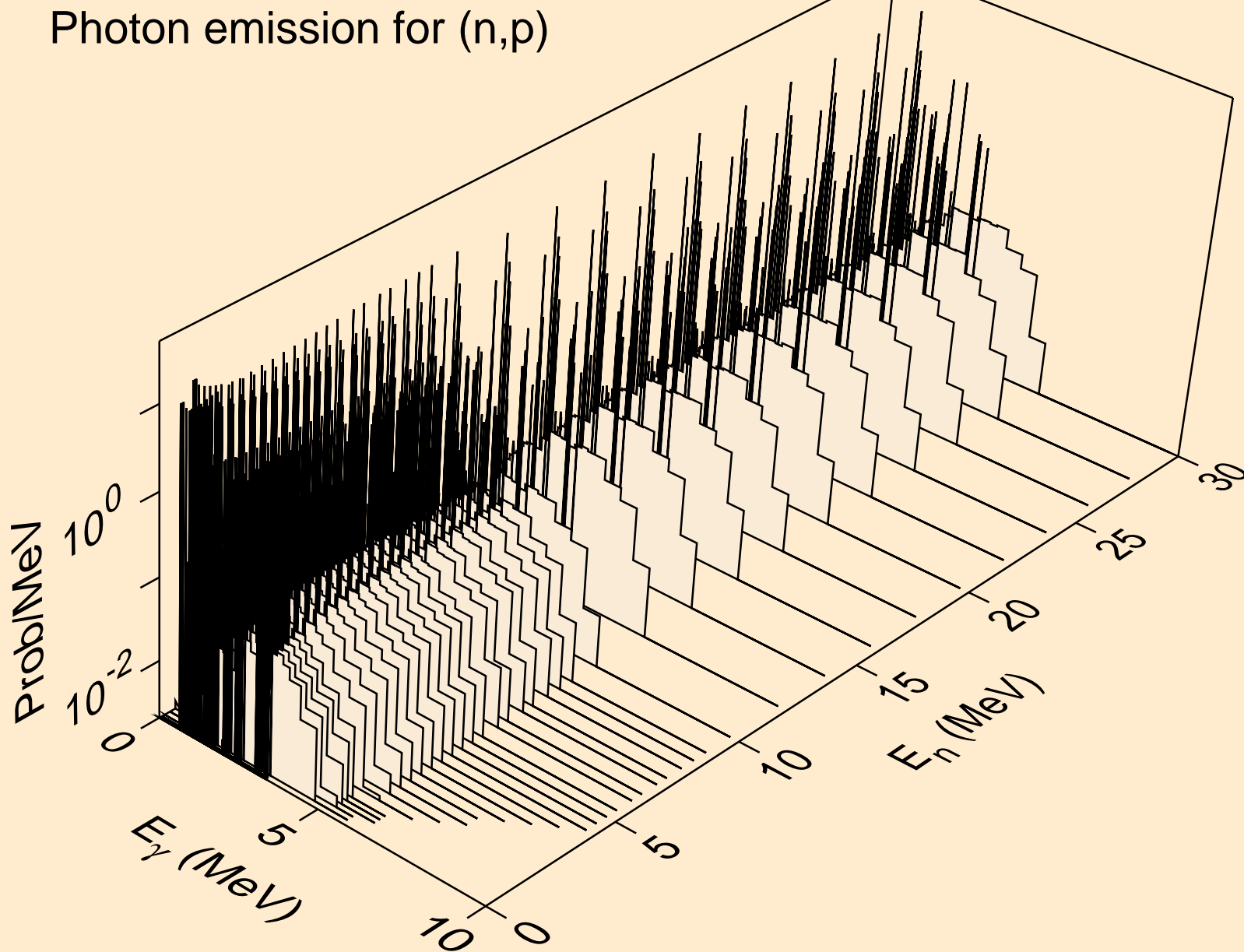

NE018 NEUTRON ACER TENDL-2019 LIBRARY; T=293.16K
Photon emission for (n,d)

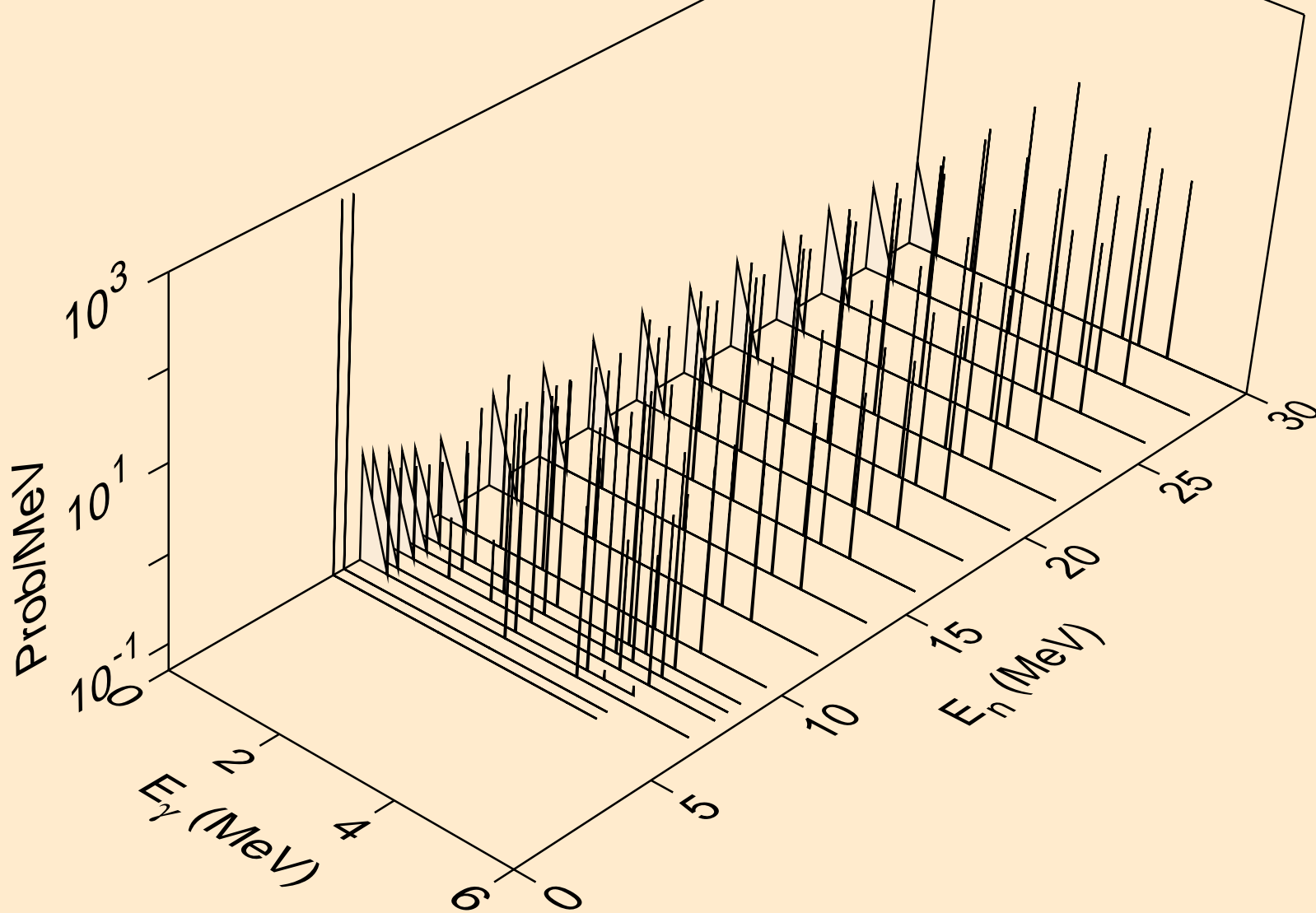

NE018 NEUTRON ACER TENDL-2019 LIBRARY; T=293.16K
Photon emission for (n,t)

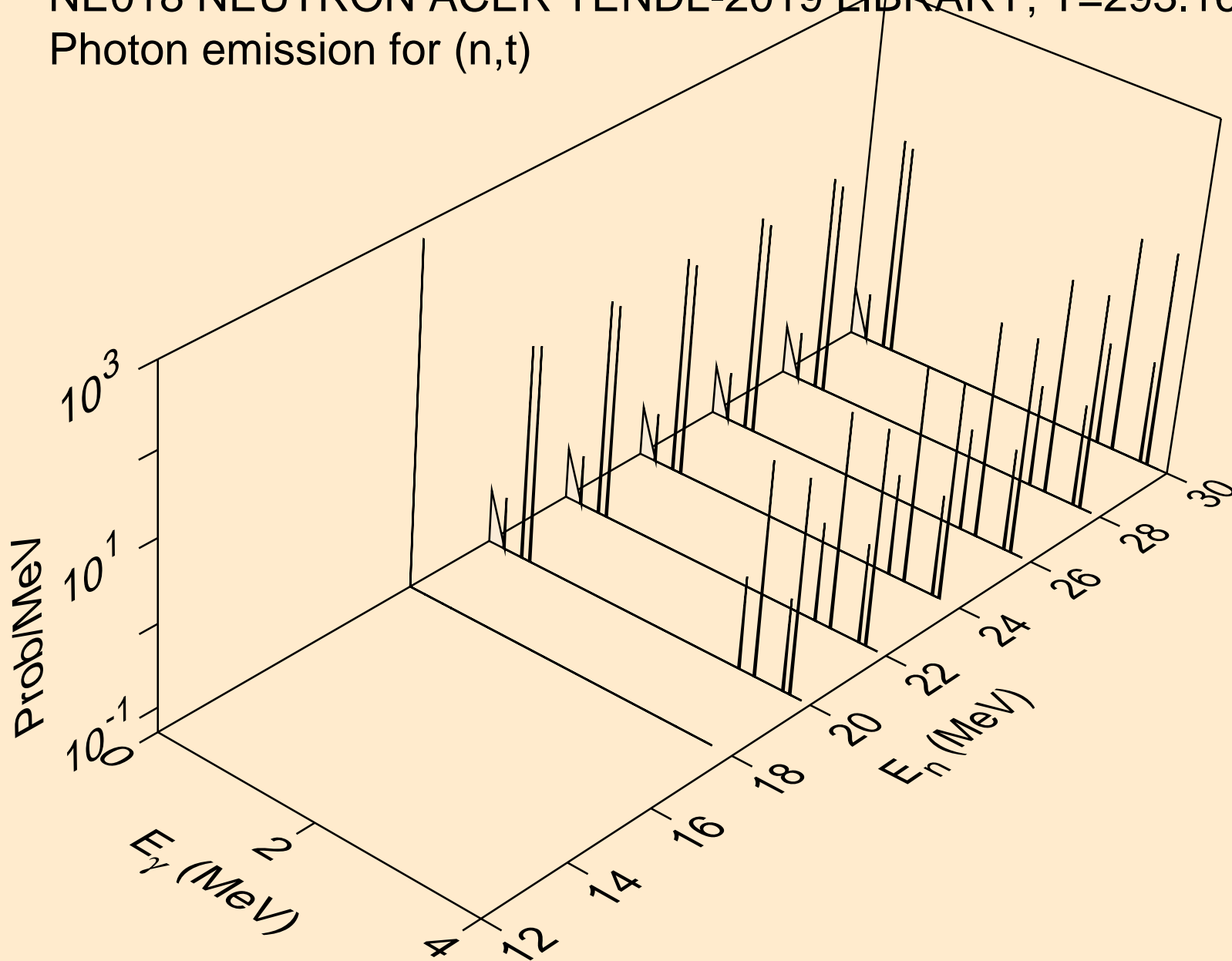

NE018 NEUTRON ACER TENDL-2019 LIBRARY; T=293.16K
Photon emission for (n,he3)

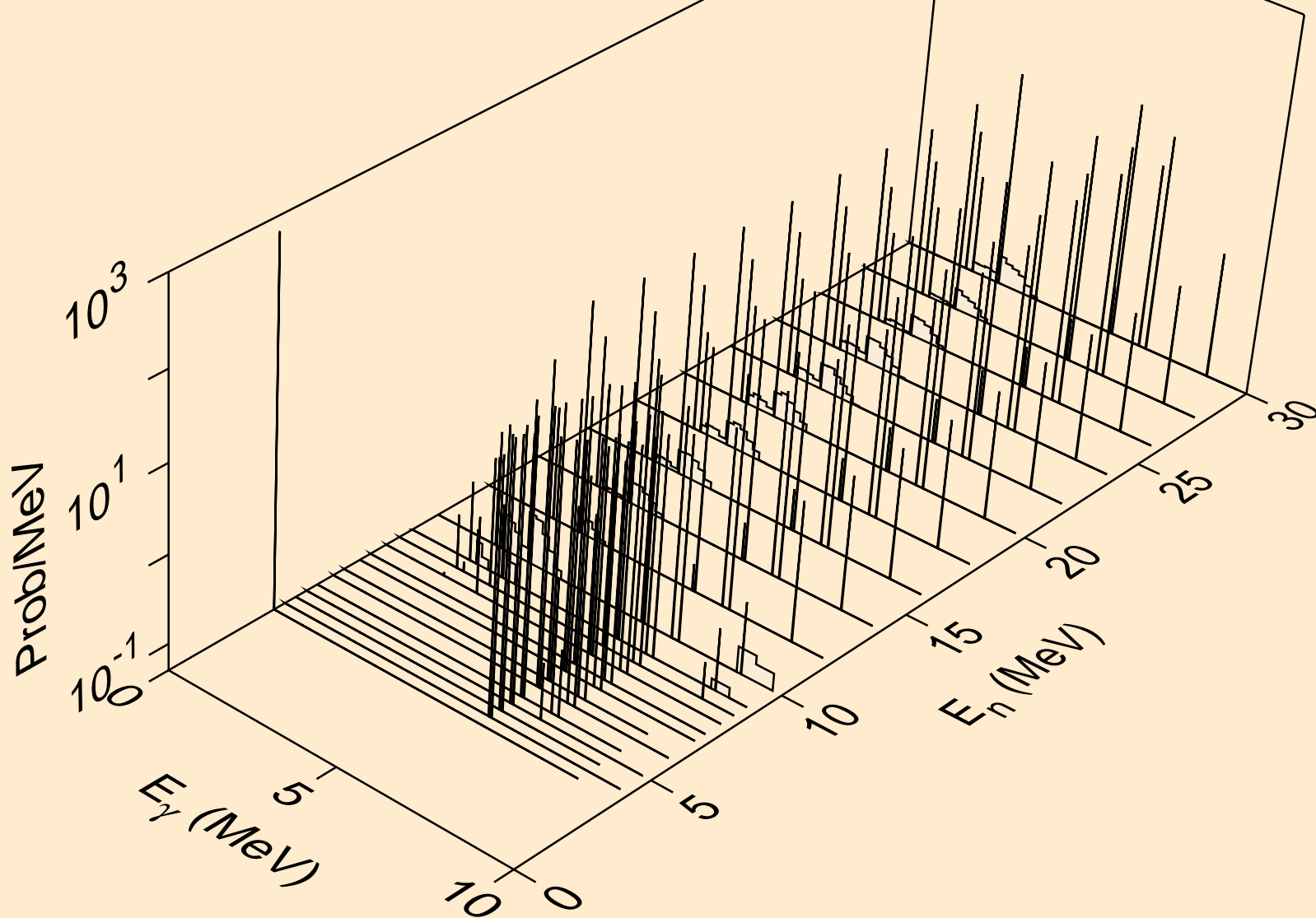

NE018 NEUTRON ACER TENDL-2019 LIBRARY; T=293.16K
Photon emission for (n,a)

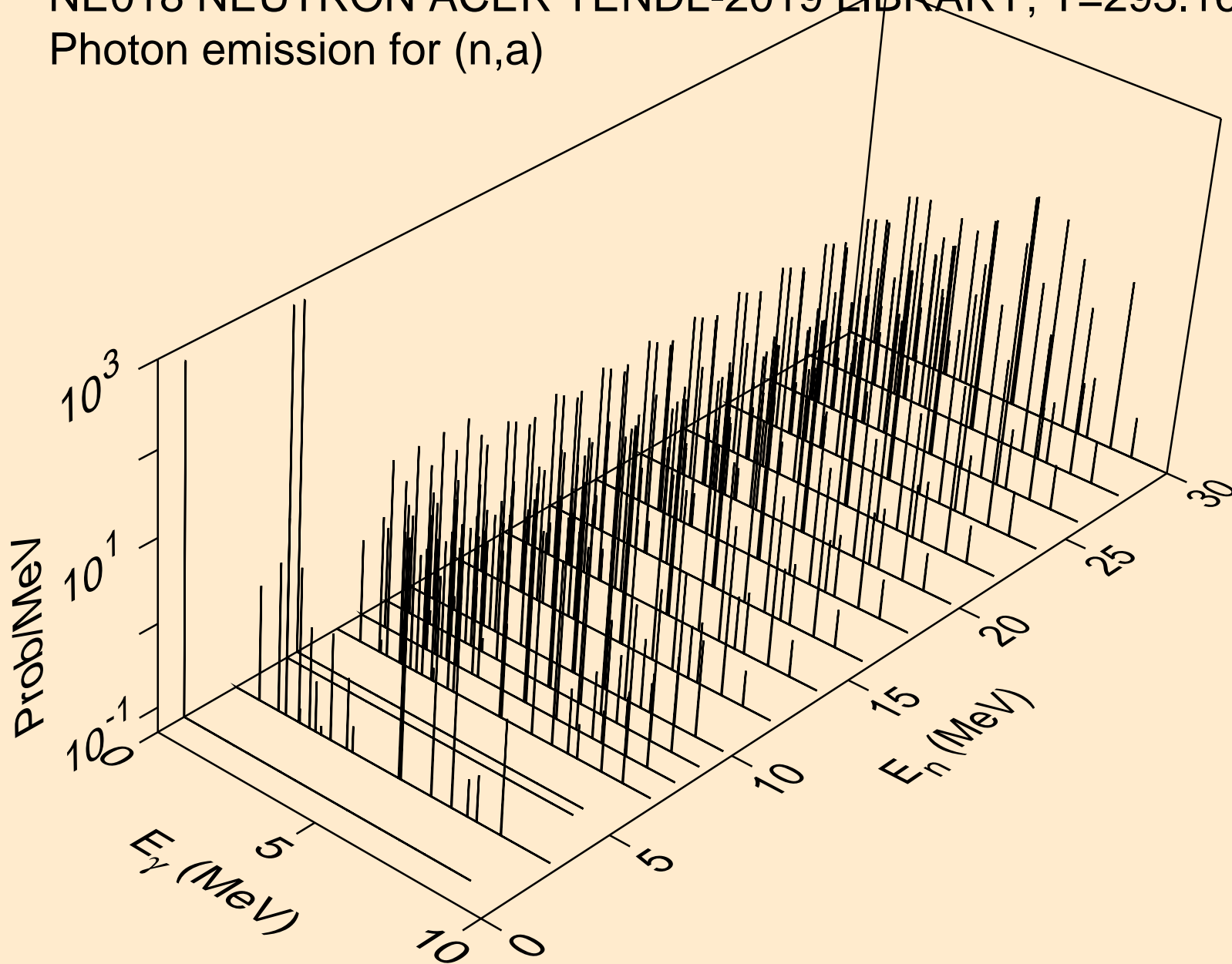

NE018 NEUTRON ACER TENDL-2019 LIBRARY; T=293.16K
Photon emission for (n,2a)

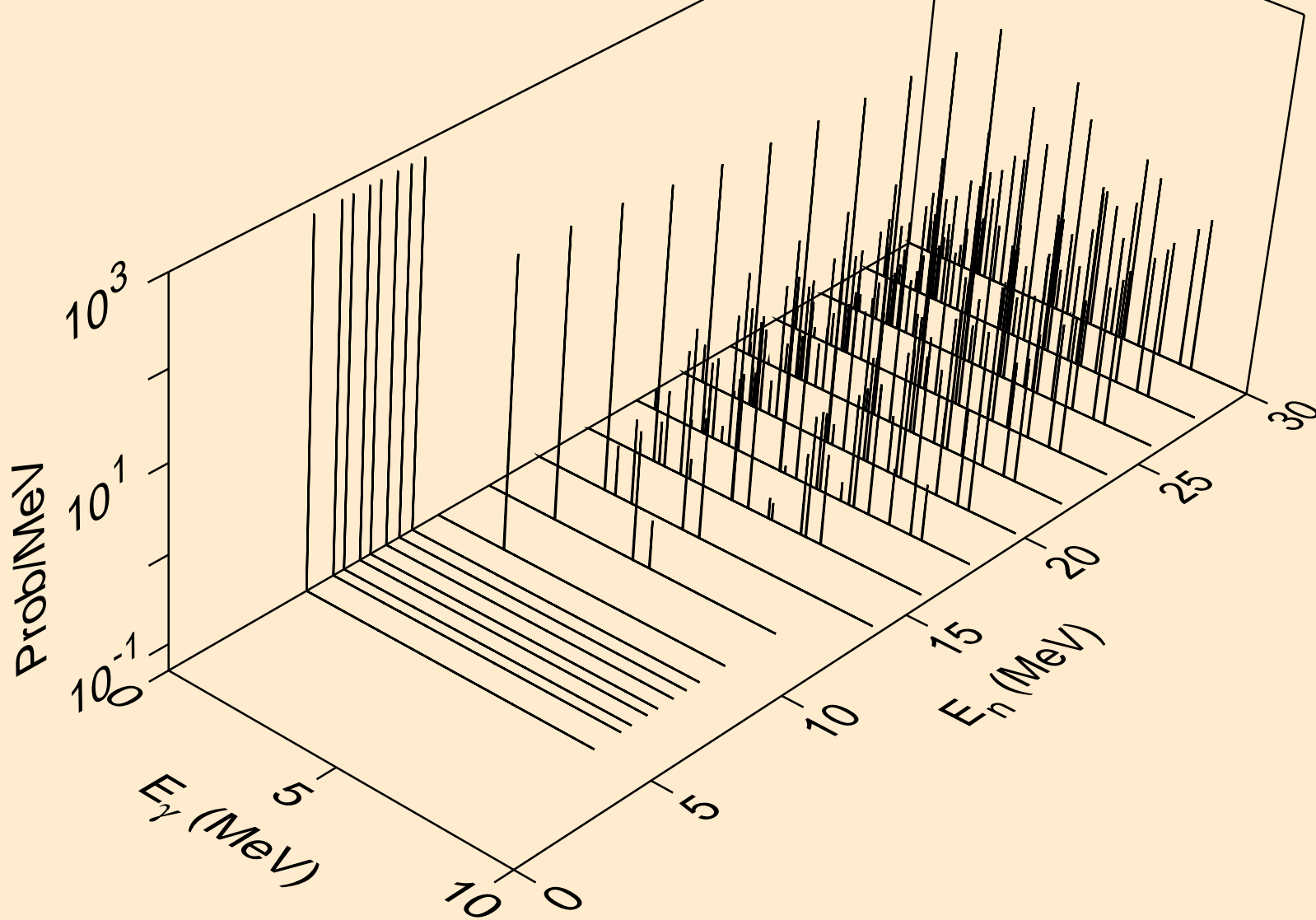

NE018 NEUTRON ACER TENDL-2019 LIBRARY; T=293.16K
Photon emission for (n,3a)

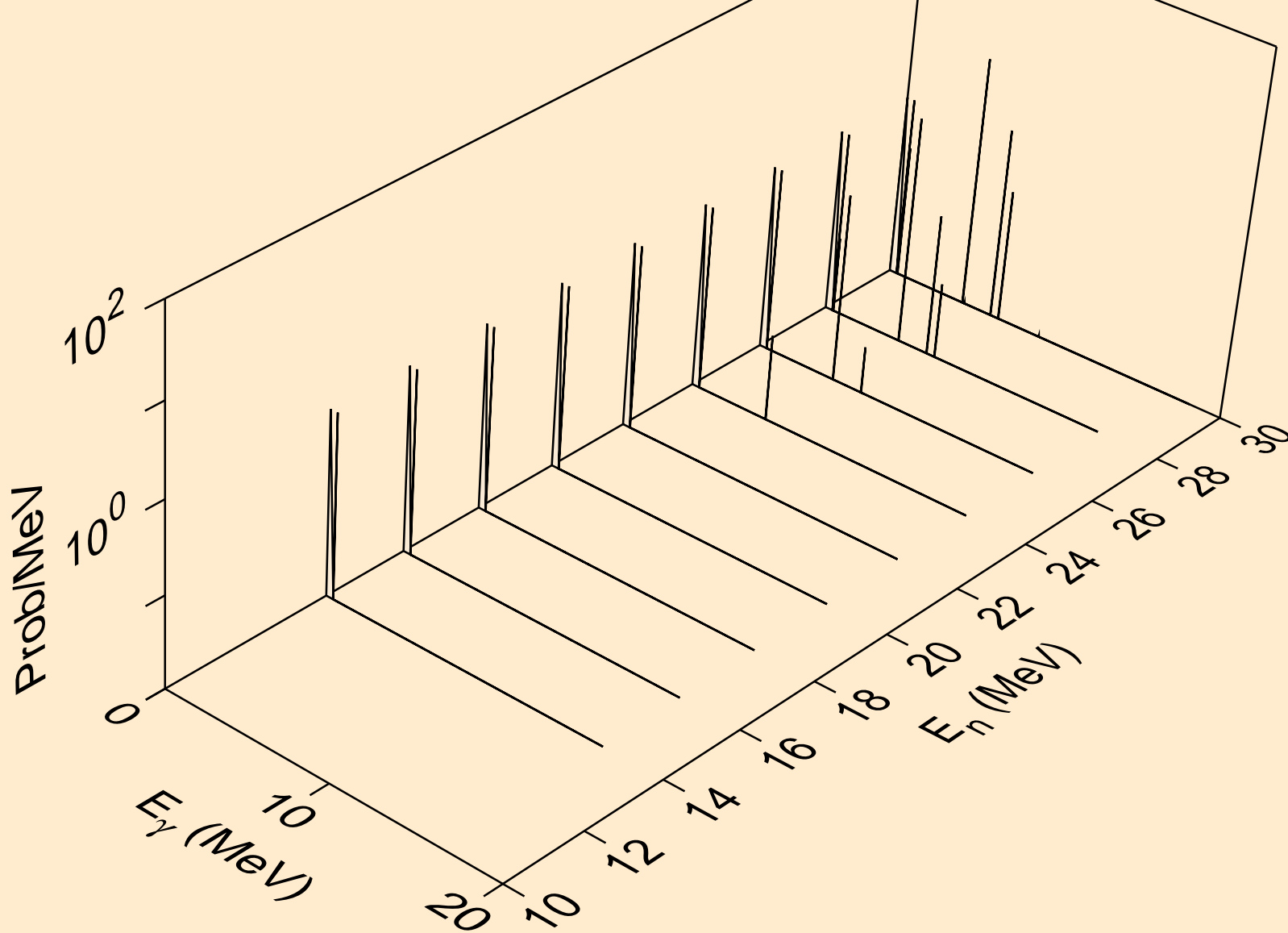

NE018 NEUTRON ACER TENDL-2019 LIBRARY; T=293.16K
Photon emission for (n,2p)

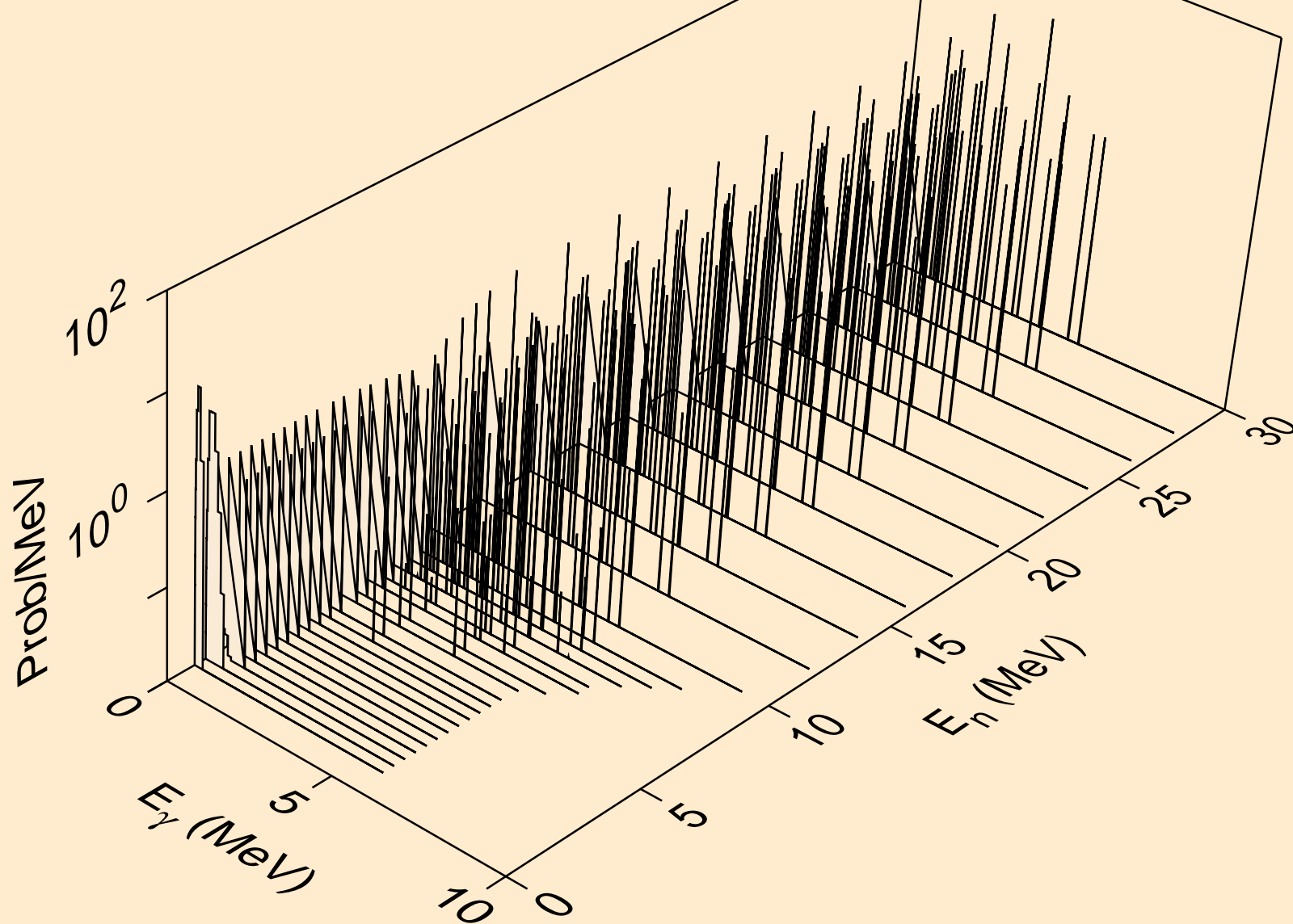

NE018 NEUTRON ACER TENDL-2019 LIBRARY; T=293.16K
Photon emission for (n,p α)

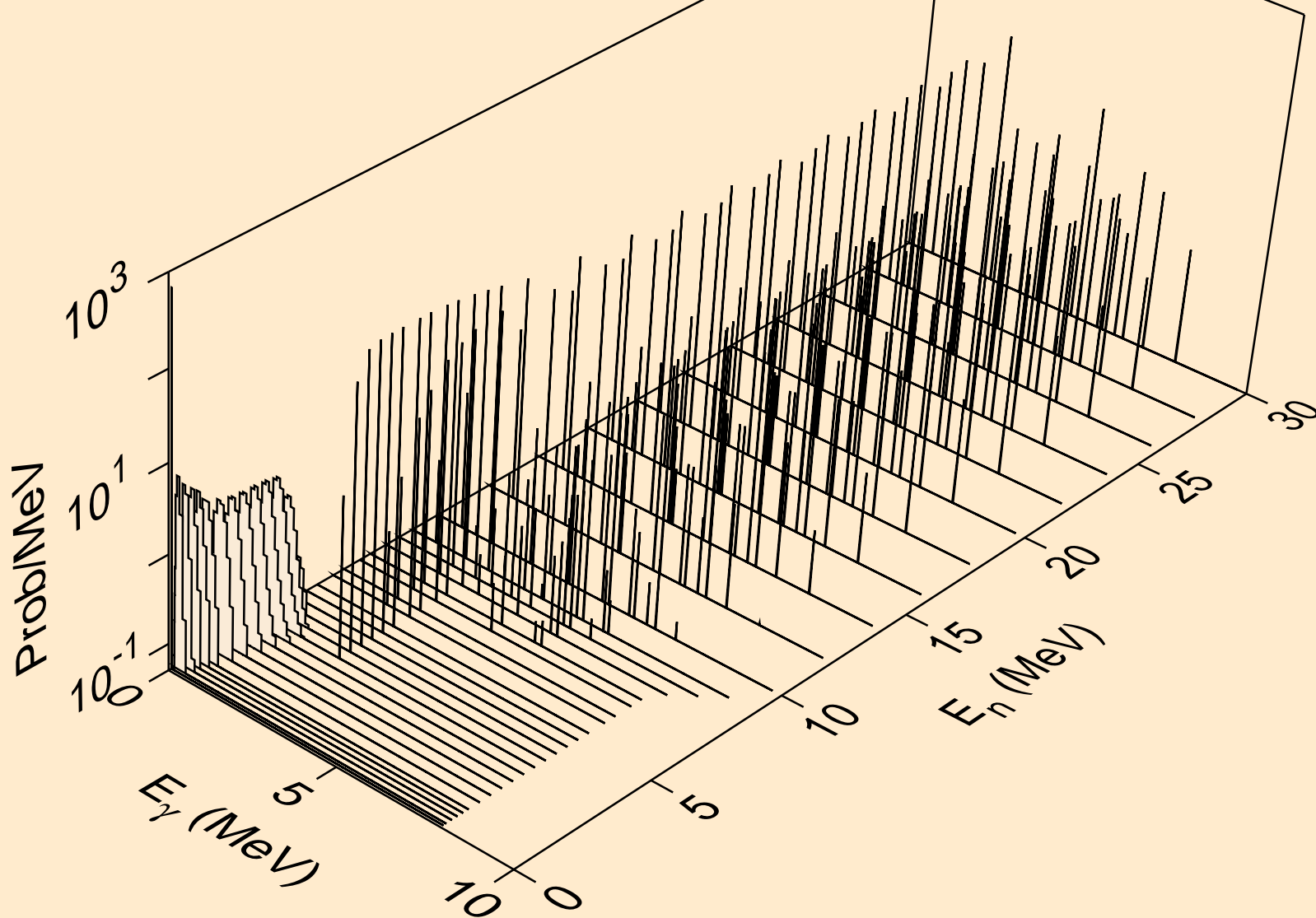

NE018 NEUTRON ACER TENDL-2019 LIBRARY; T=293.16K
Photon emission for (n,d2a)

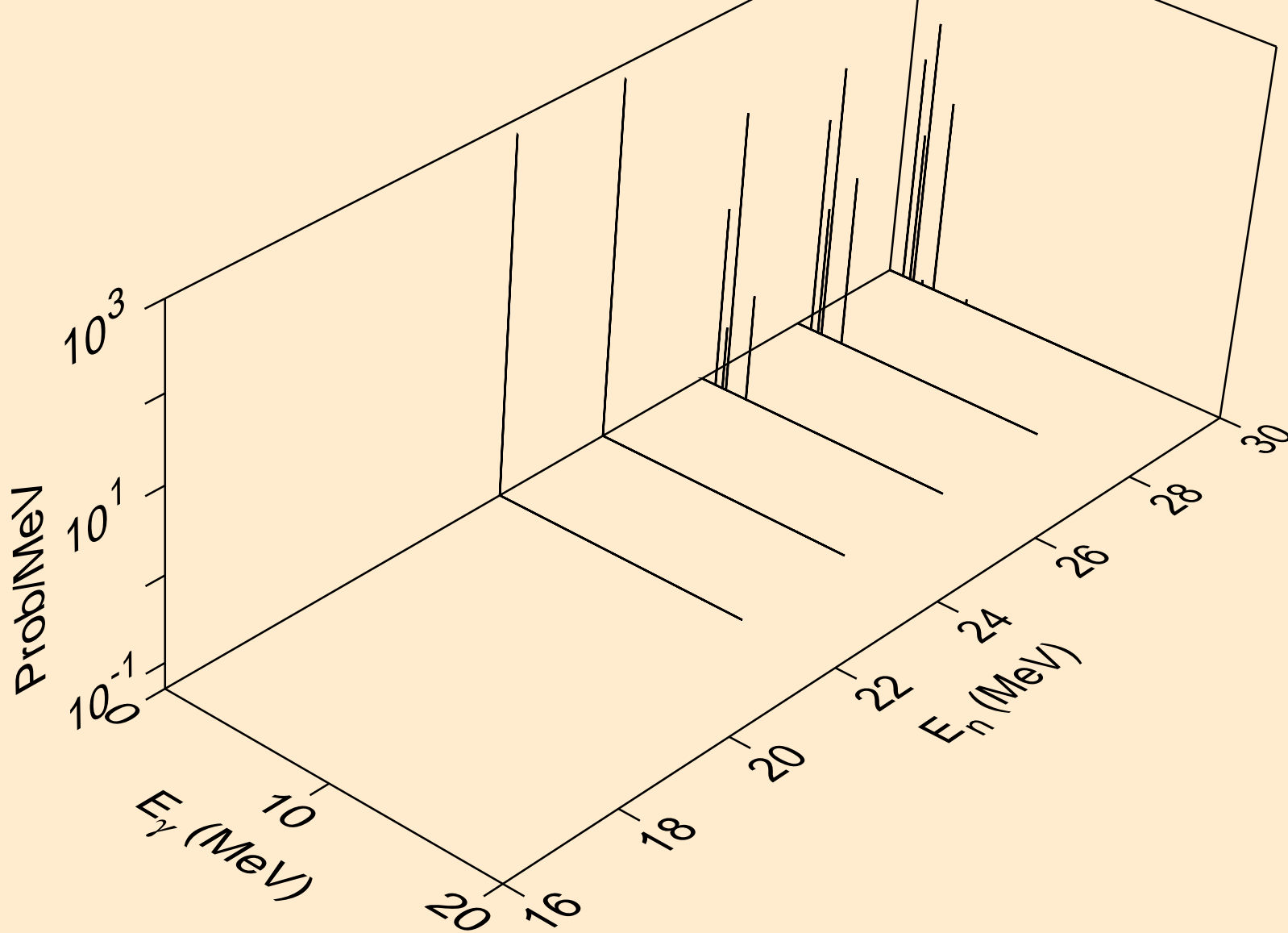

NE018 NEUTRON ACER TENDL-2019 LIBRARY; T=293.16K
Photon emission for (n,pd)

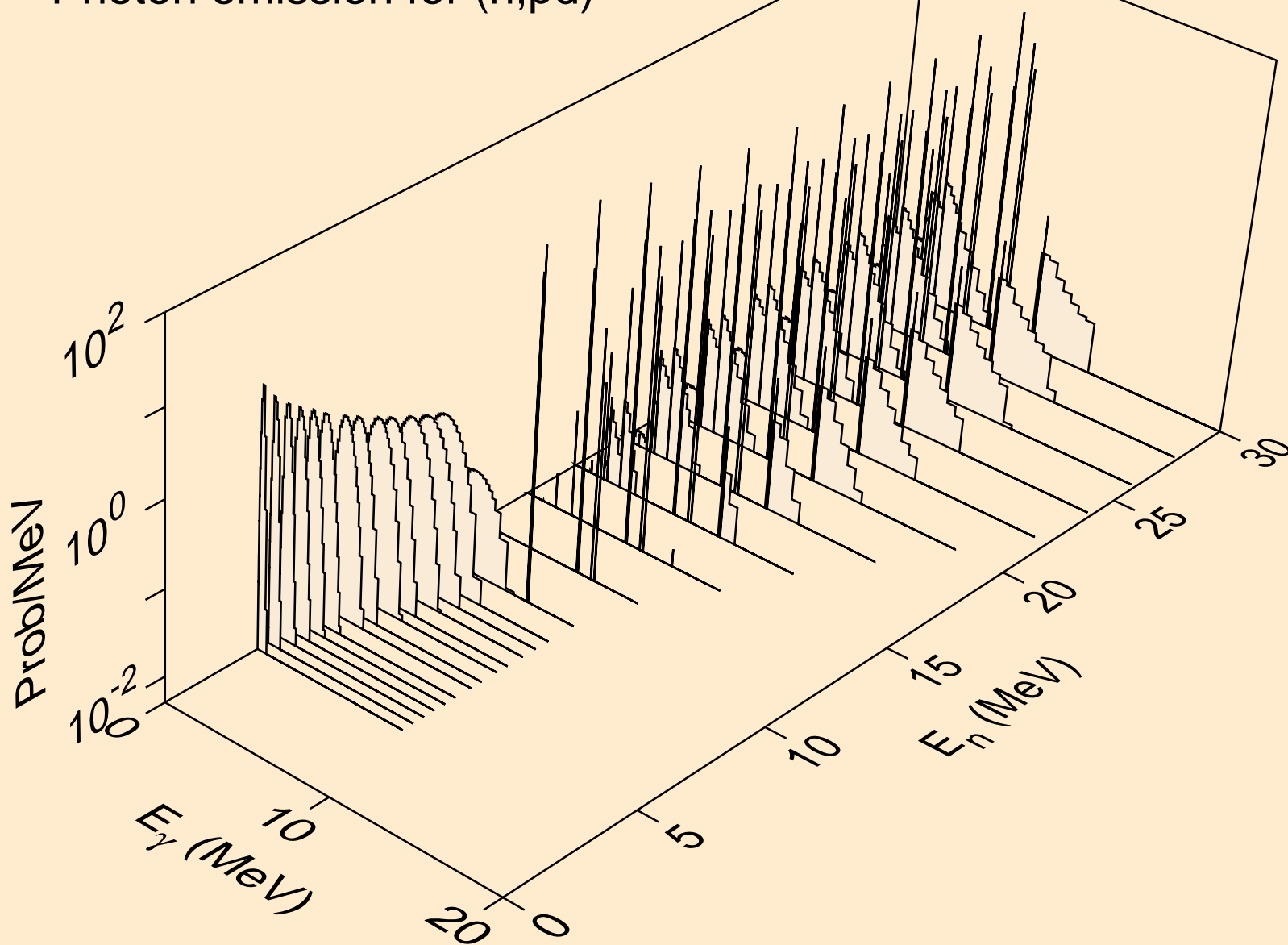

NE018 NEUTRON ACER TENDL-2019 LIBRARY; T=293.16K
Photon emission for (n,pt)

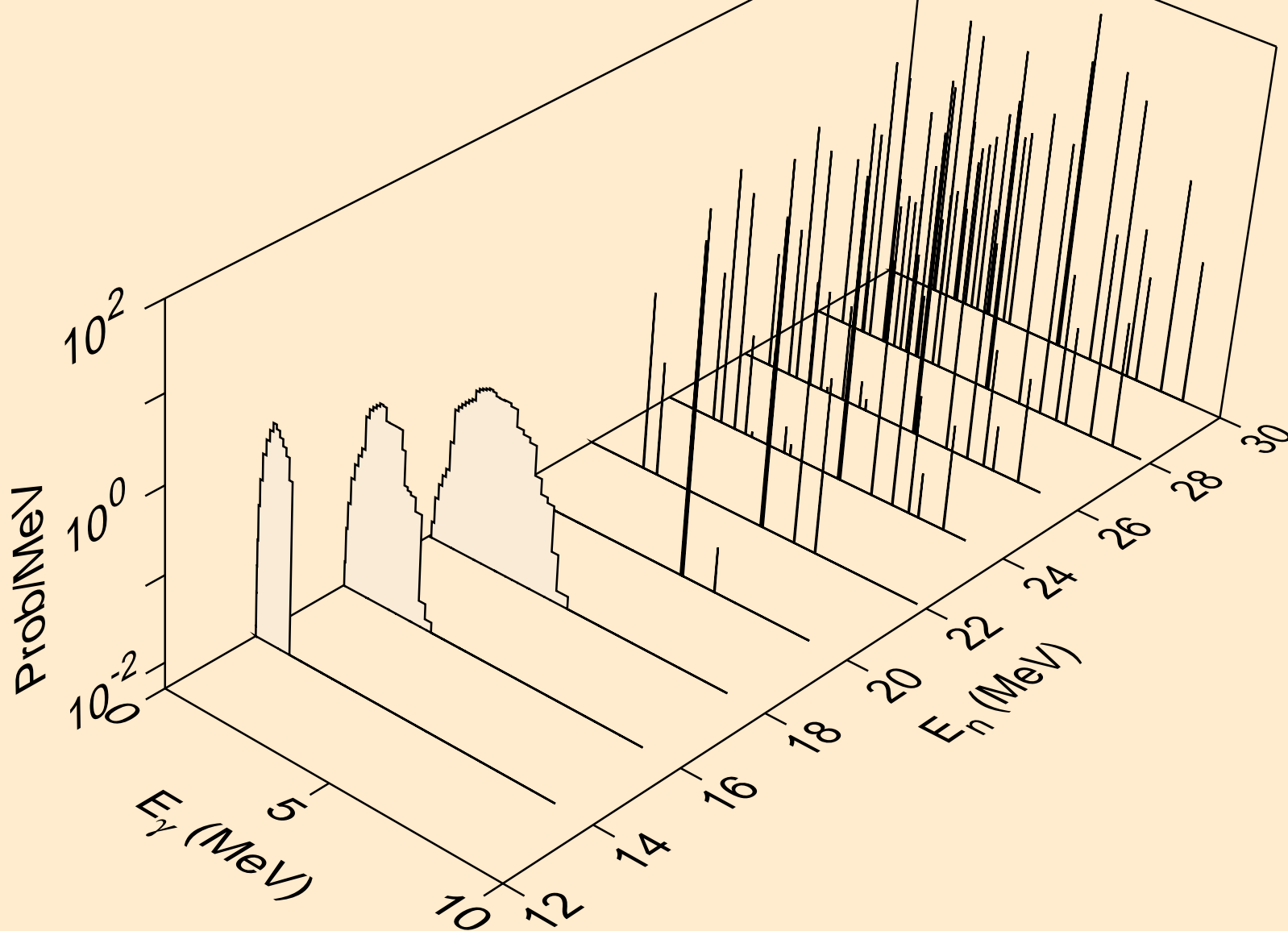

NE018 NEUTRON ACER TENDL-2019 LIBRARY; T=293.16K
Photon emission for (n,da)

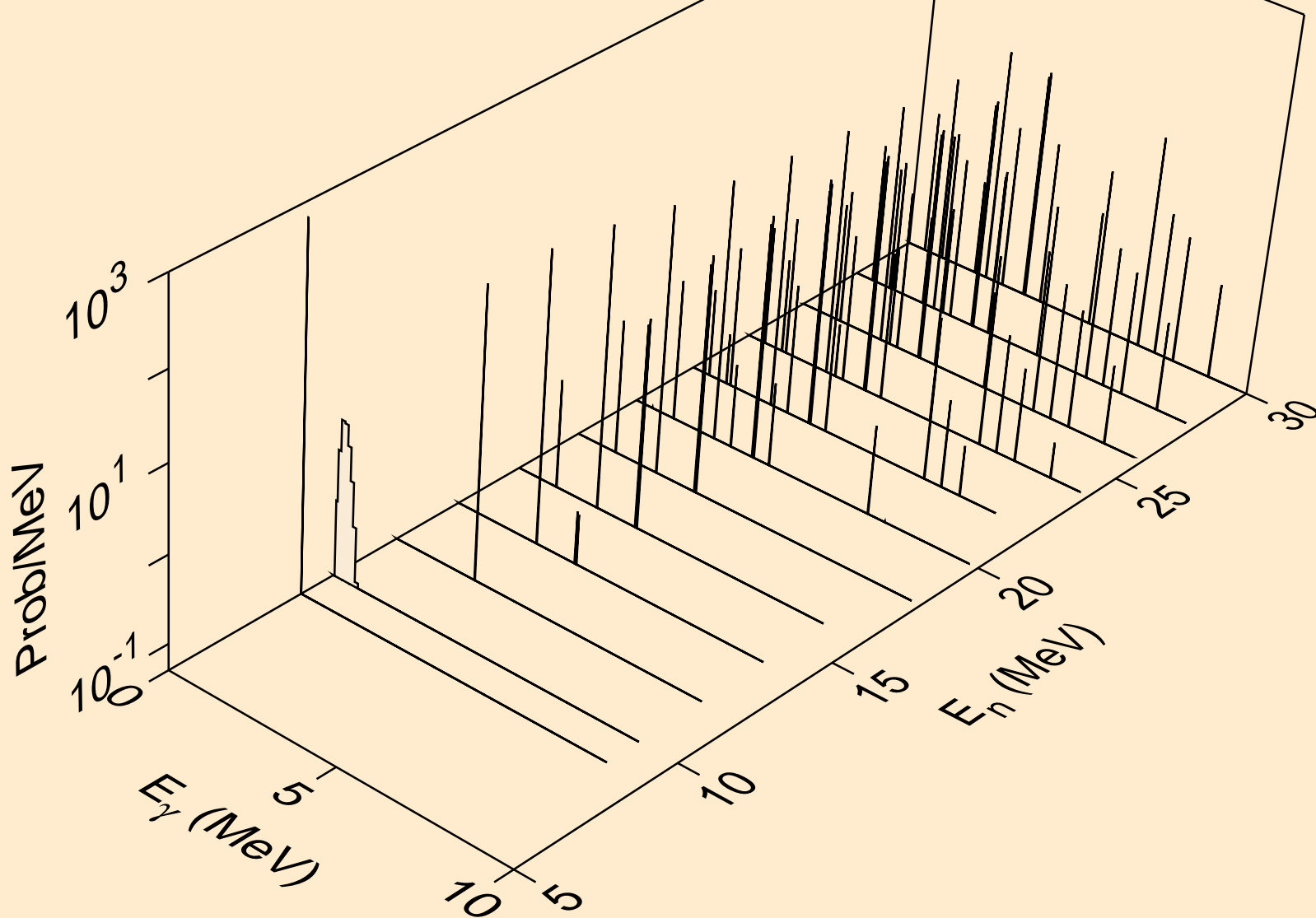

NE018 NEUTRON ACER TENDL-2019 LIBRARY; T=293.16K
thermal capture photon spectrum

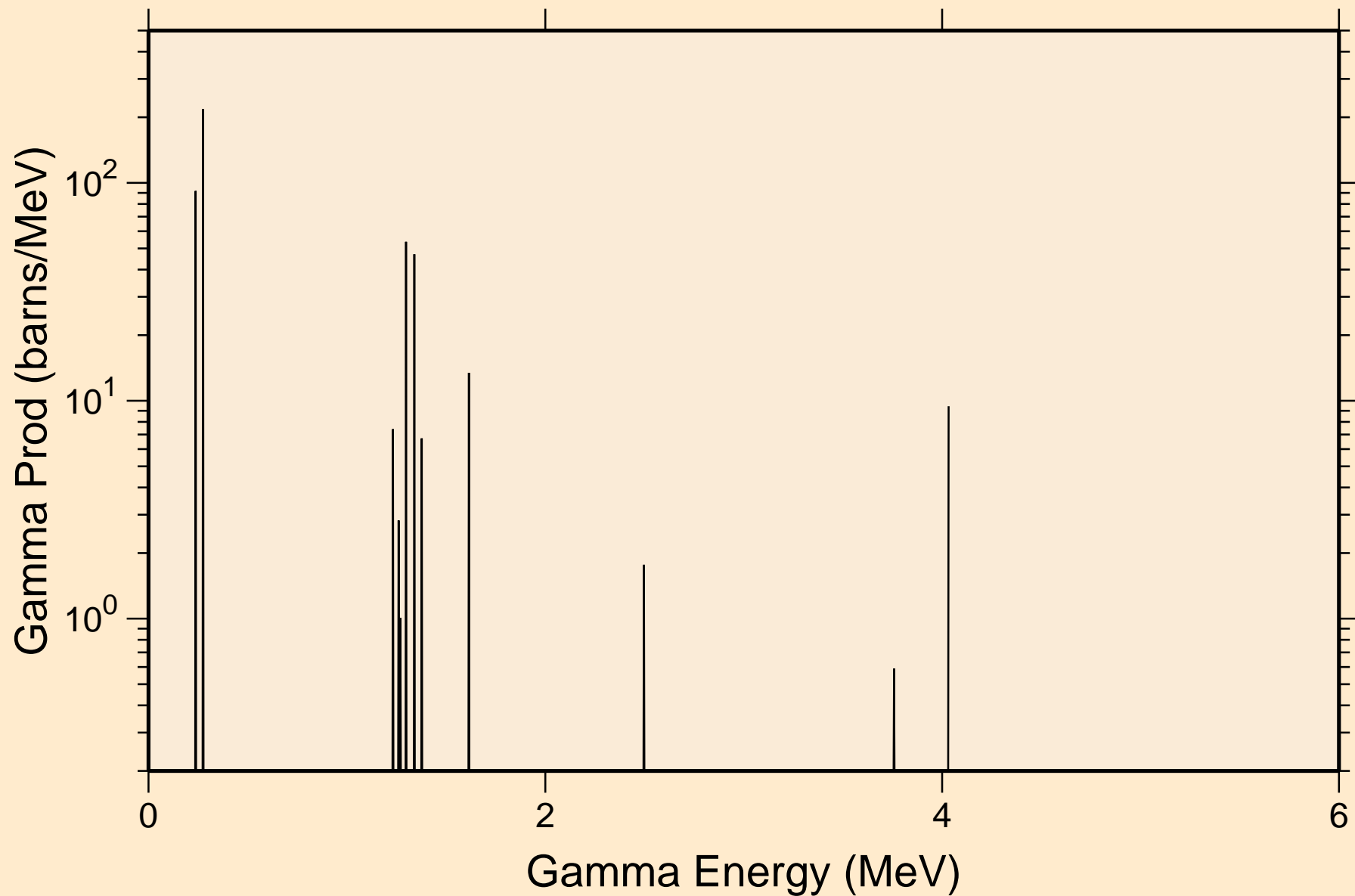

NE018 NEUTRON ACER TENDL-2019 LIBRARY; T=293.16K
14 MeV photon spectrum

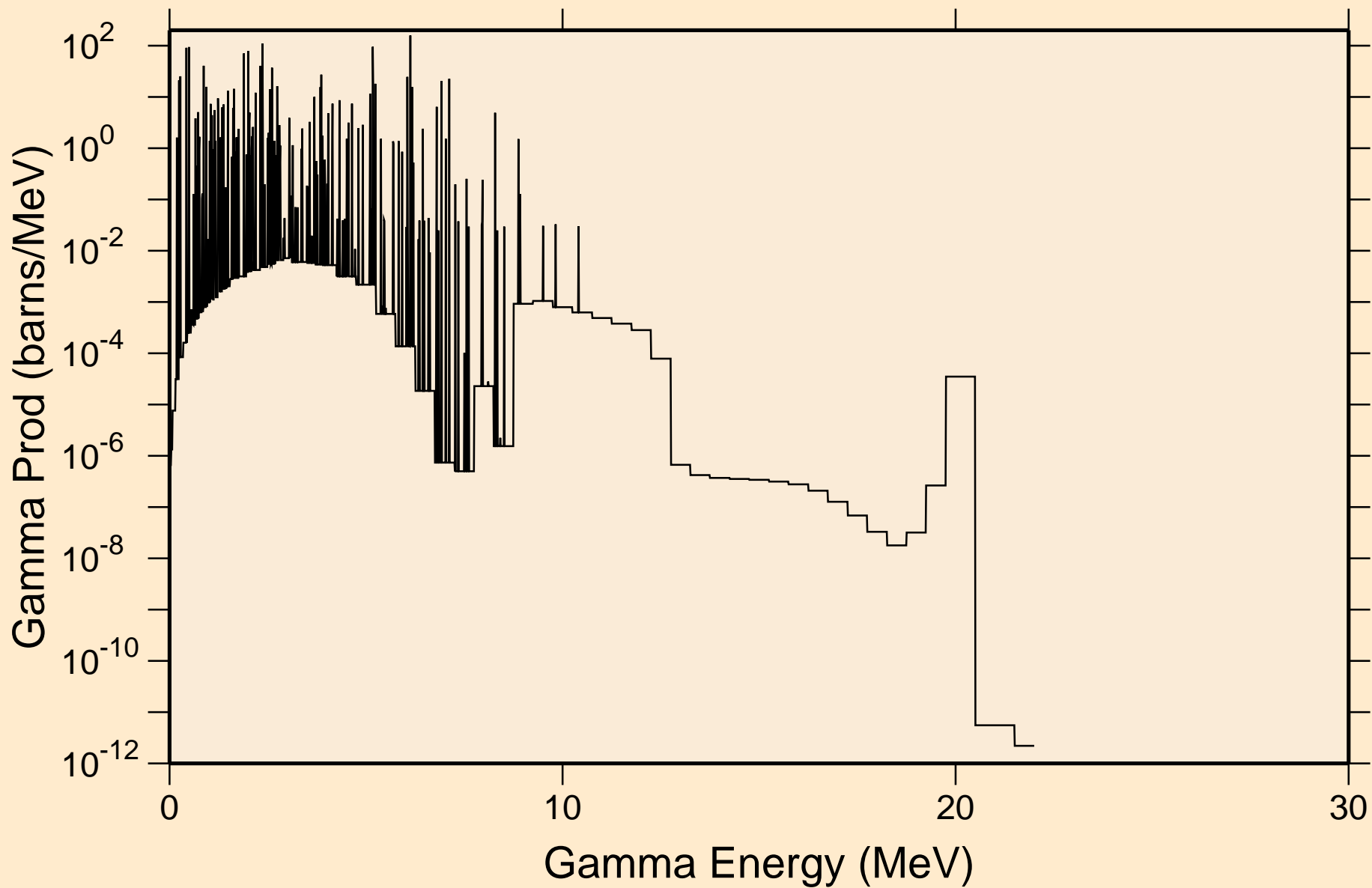

NE018 NEUTRON ACER TENDL-2019 LIBRARY; T=293.16K

Particle heating contributions

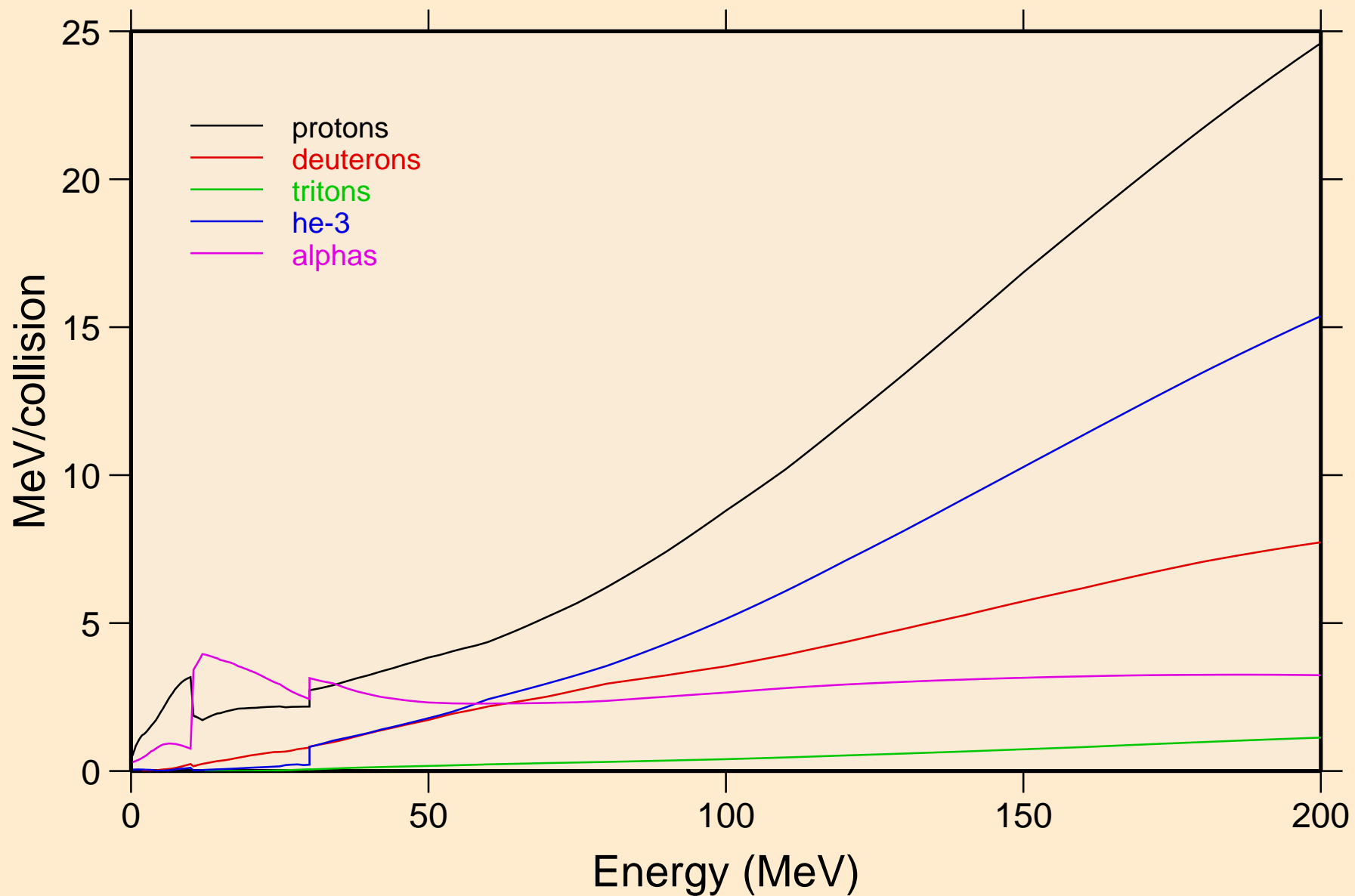

NE018 NEUTRON ACER TENDL-2019 LIBRARY; T=293.16K
Recoil Heating

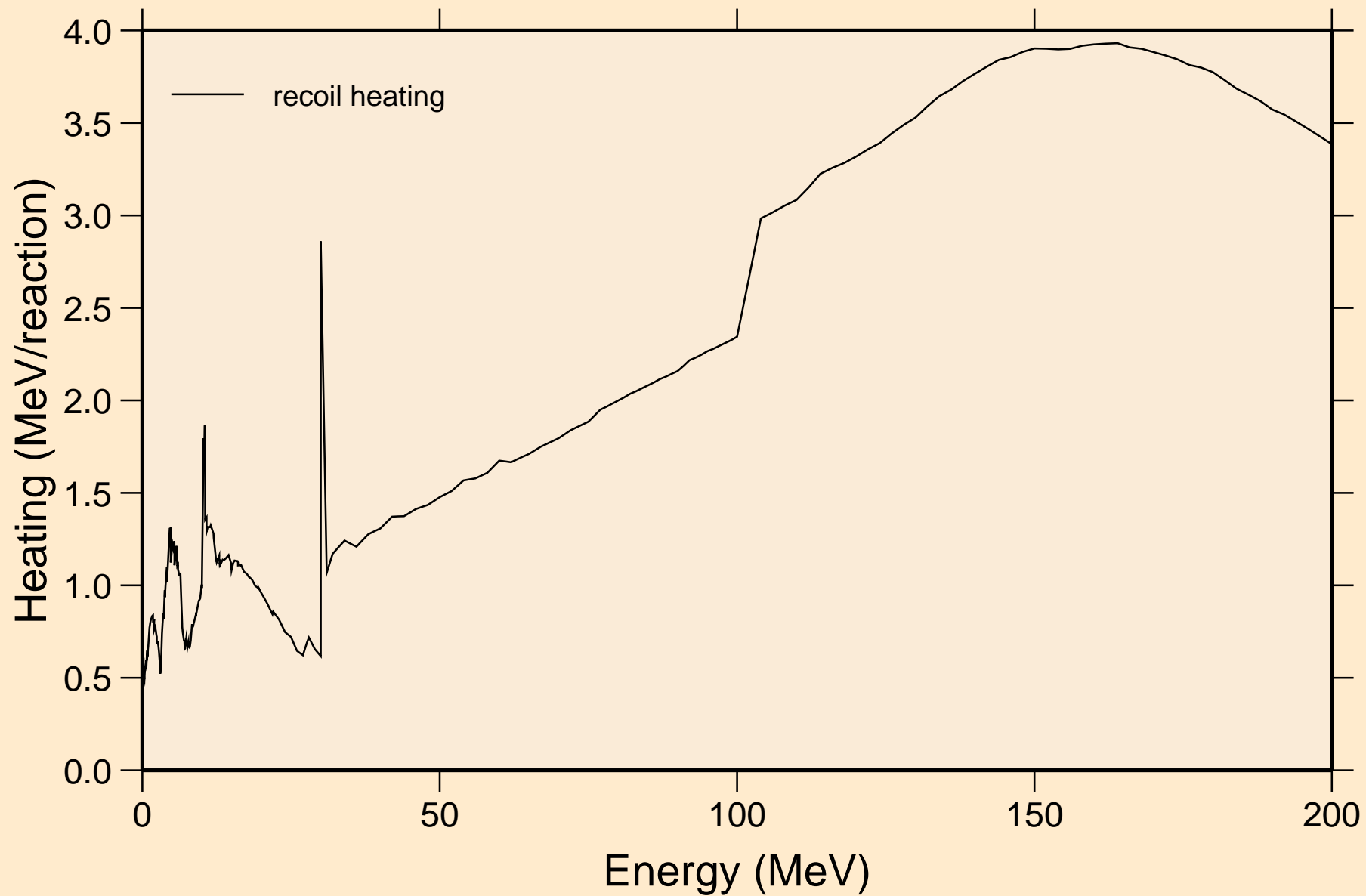

NE018 NEUTRON ACER TENDL-2019 LIBRARY; T=293.16K
Particle production cross sections

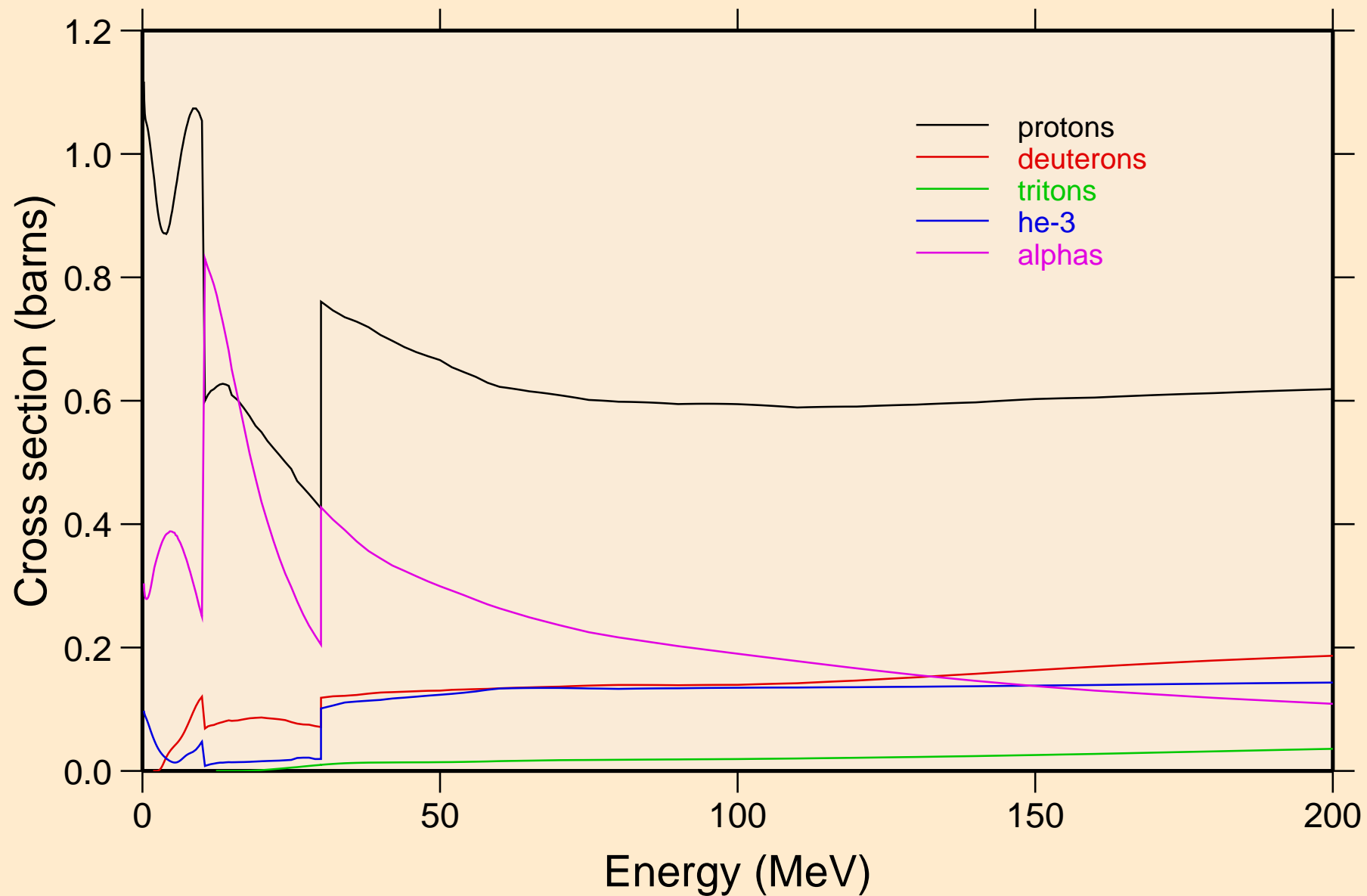

NE018 NEUTRON ACER TENDL-2019 LIBRARY; T=293.16K
protons from (n,x)

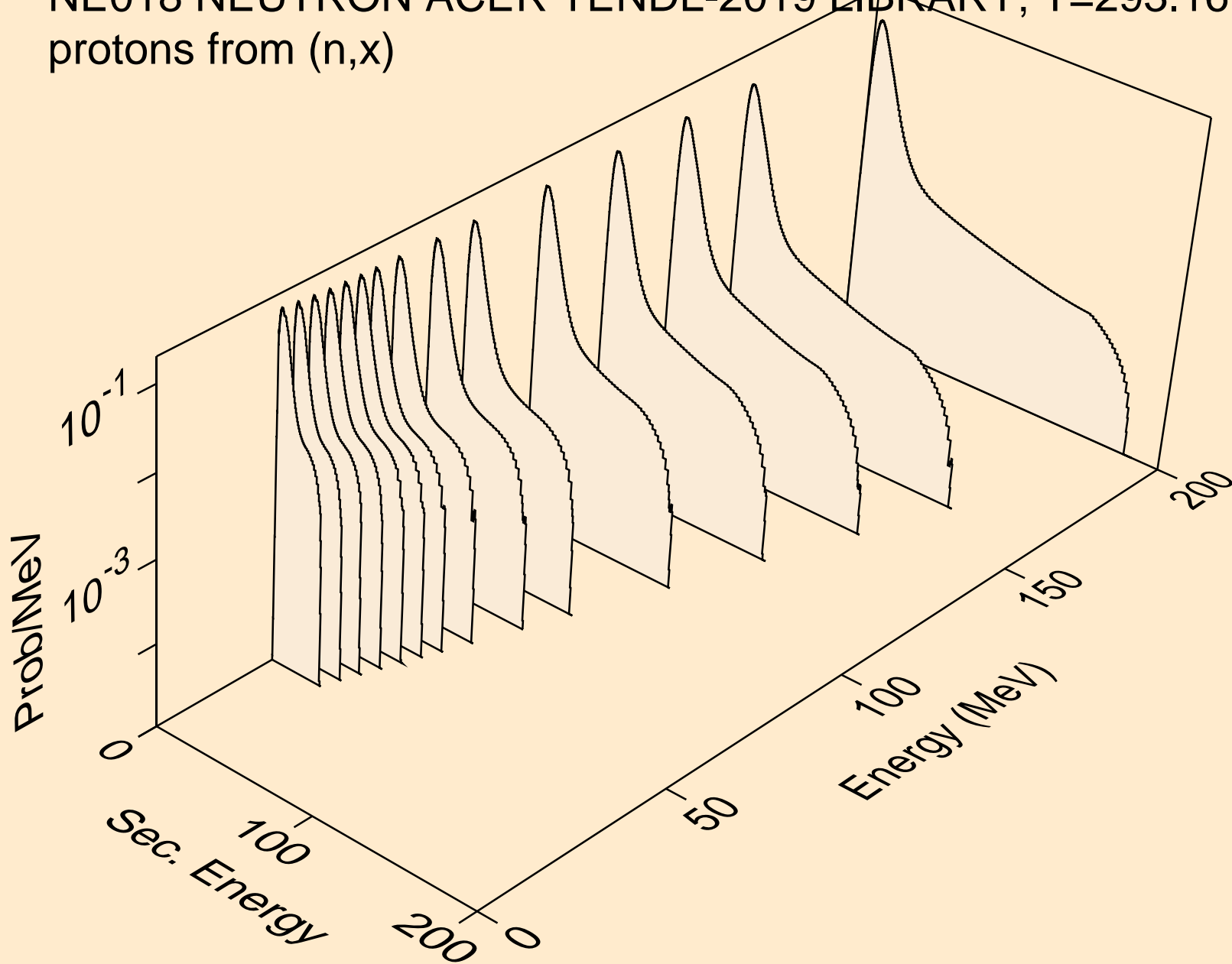

NE018 NEUTRON ACER TENDL-2019 LIBRARY; T=293.16K
protons from (n,n*)p

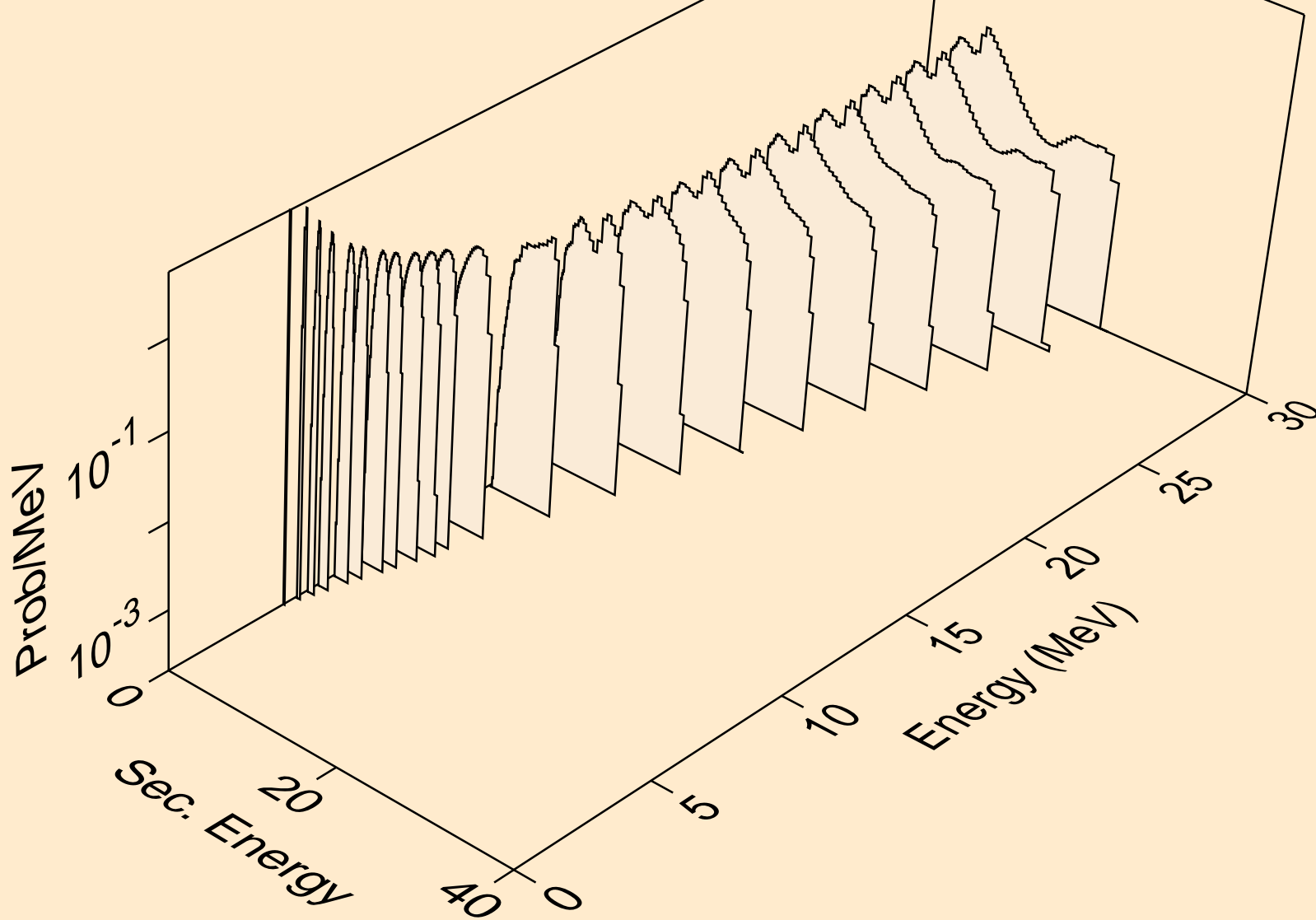

NE018 NEUTRON ACER TENDL-2019 LIBRARY; T=293.16K
protons from (n,2np)

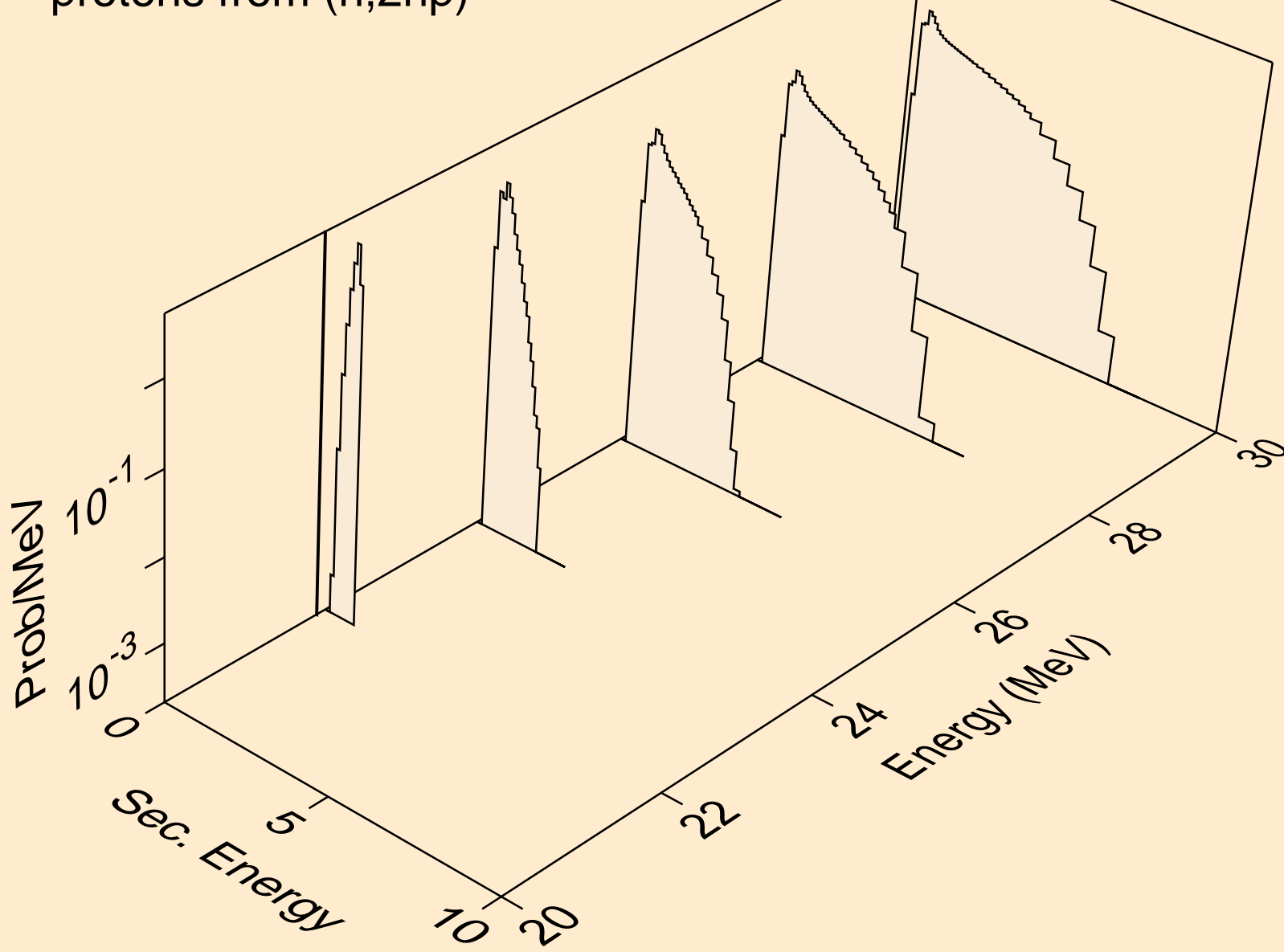

NE018 NEUTRON ACER TENDL-2019 LIBRARY; T=293.16K
protons from (n,2np)

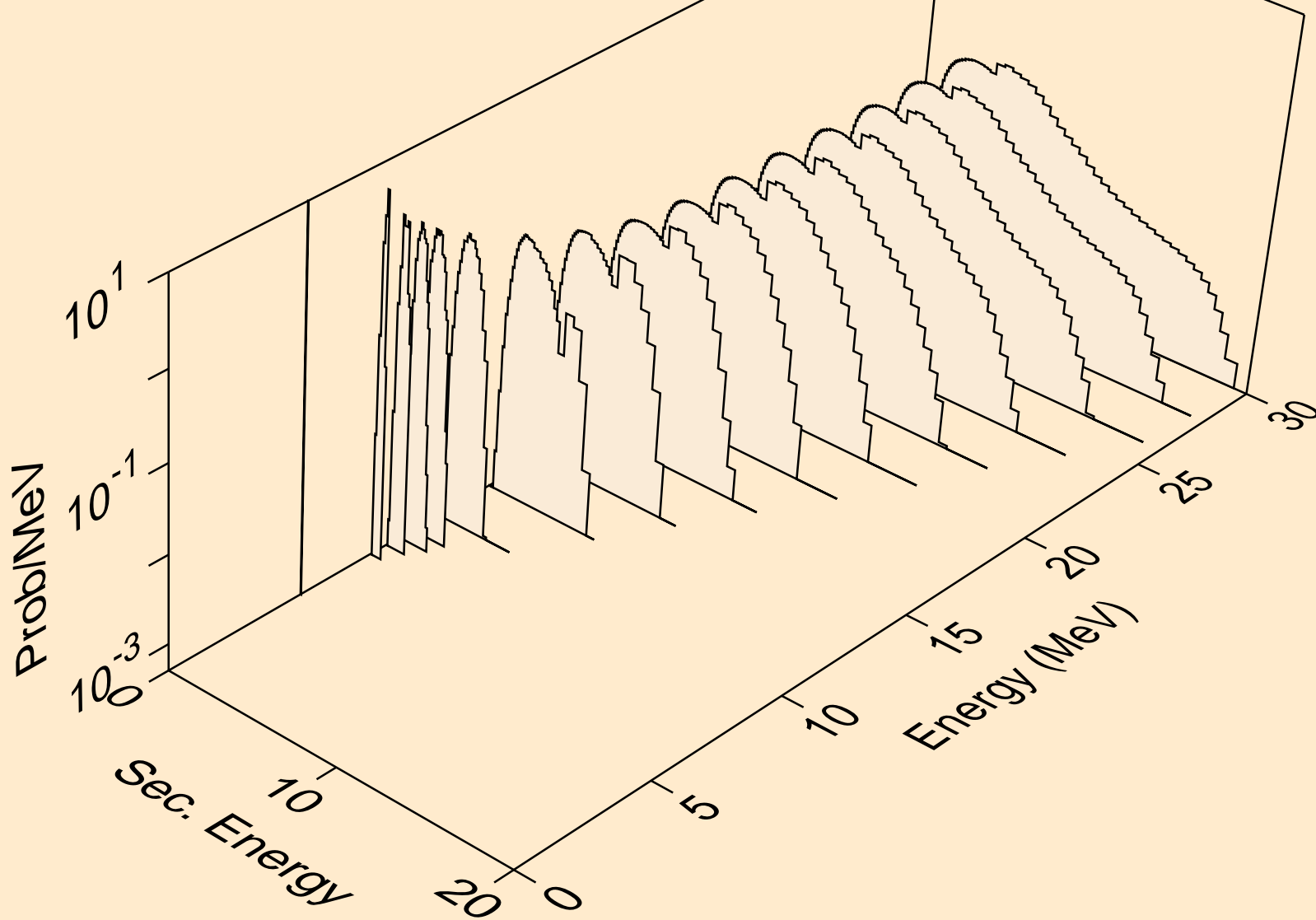

NE018 NEUTRON ACER TENDL-2019 LIBRARY; T=293.16K
protons from (n,npa)

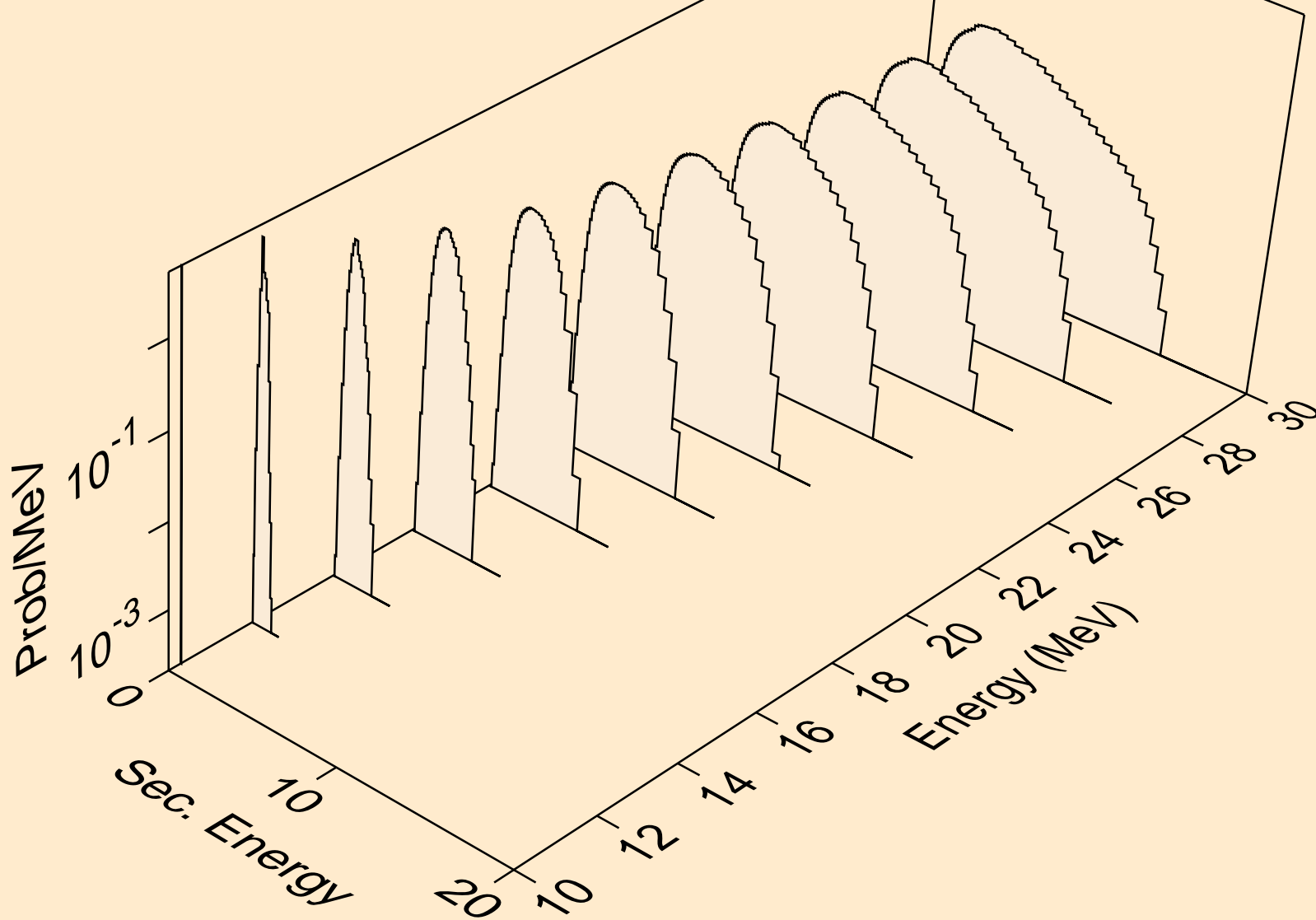

NE018 NEUTRON ACER TENDL-2019 LIBRARY; T=293.16K
protons from (n,p)

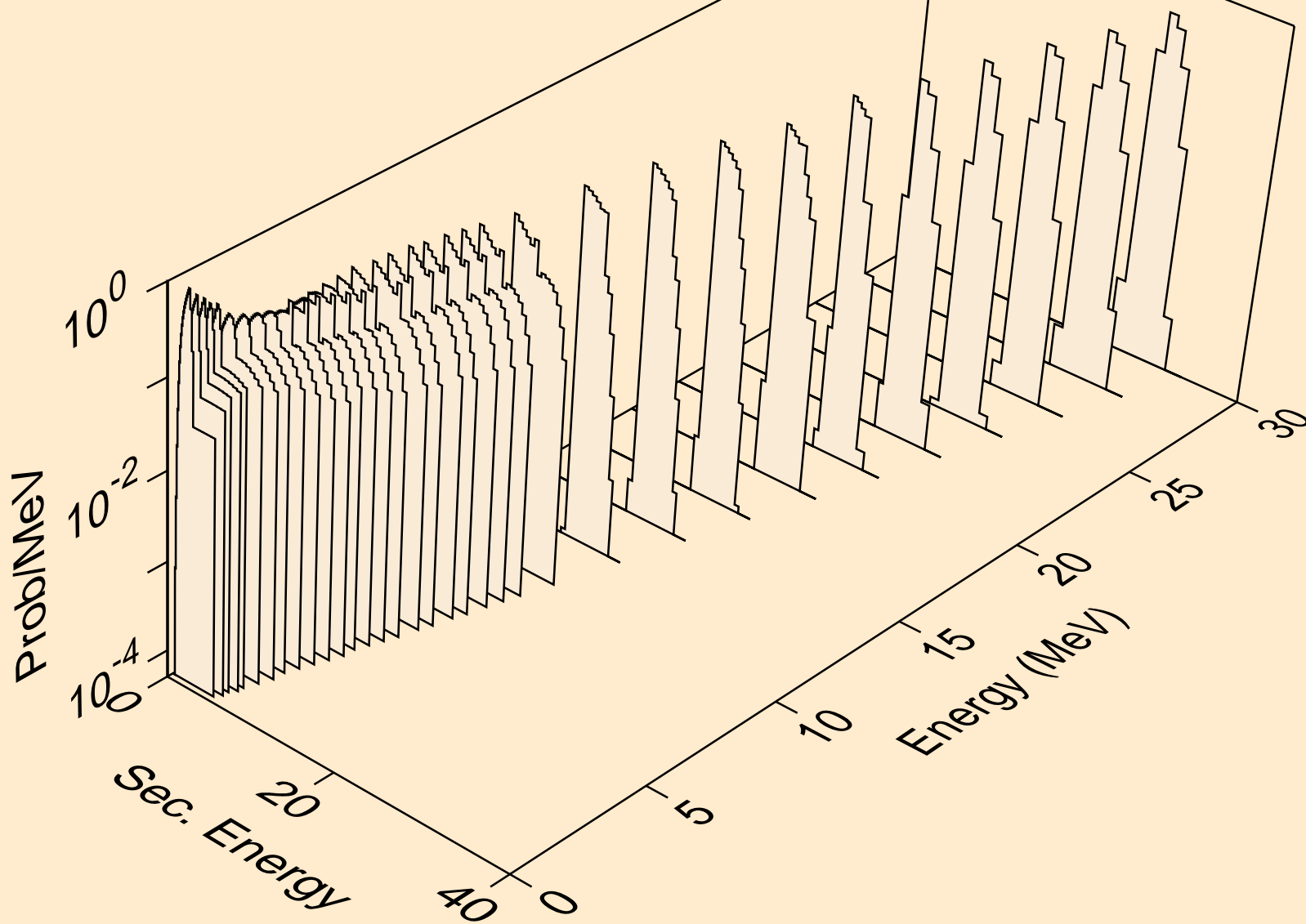

NE018 NEUTRON ACER TENDL-2019 LIBRARY; T=293.16K
protons from (n,2p)

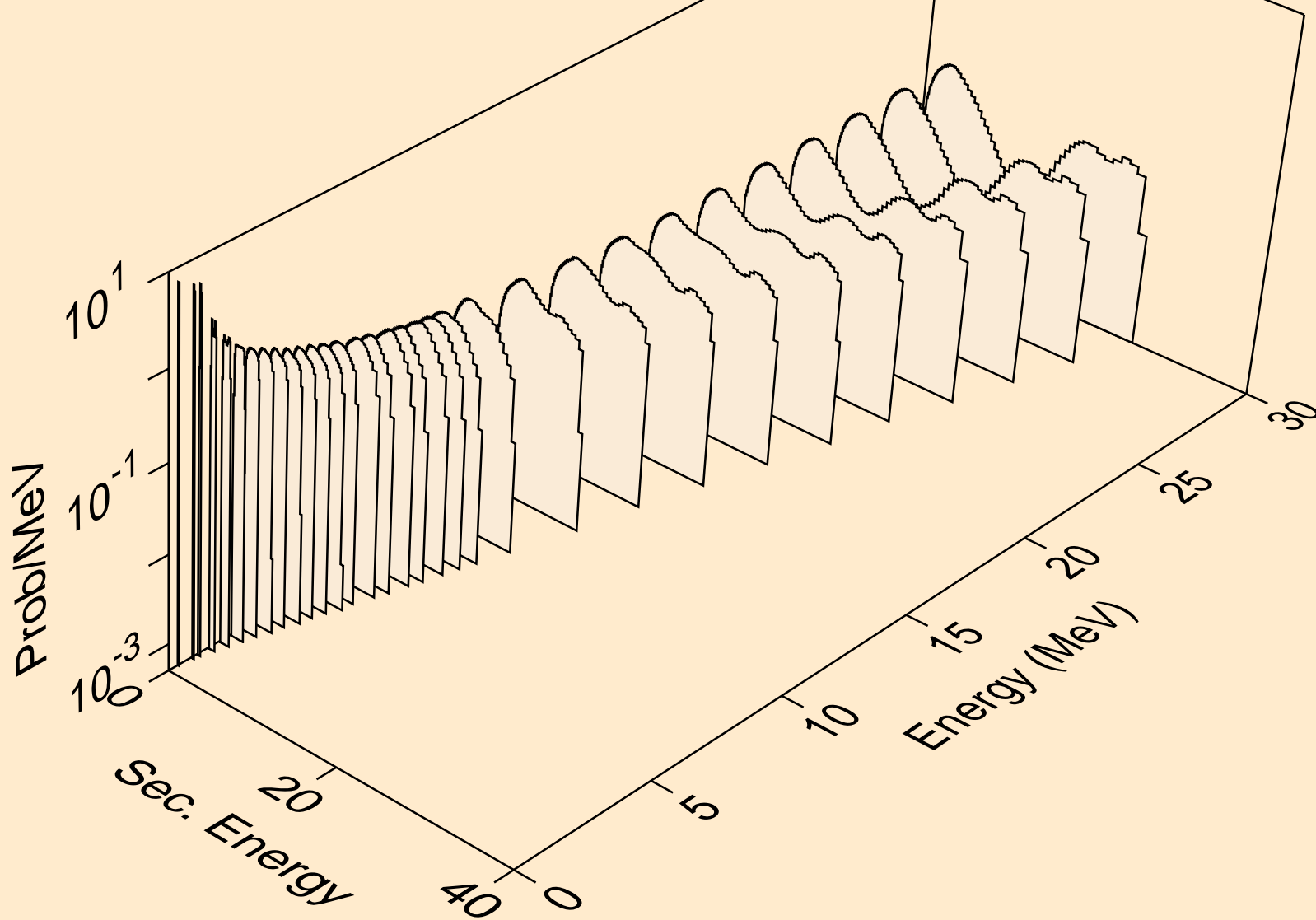

NE018 NEUTRON ACER TENDL-2019 LIBRARY; T=293.16K
protons from (n,p)

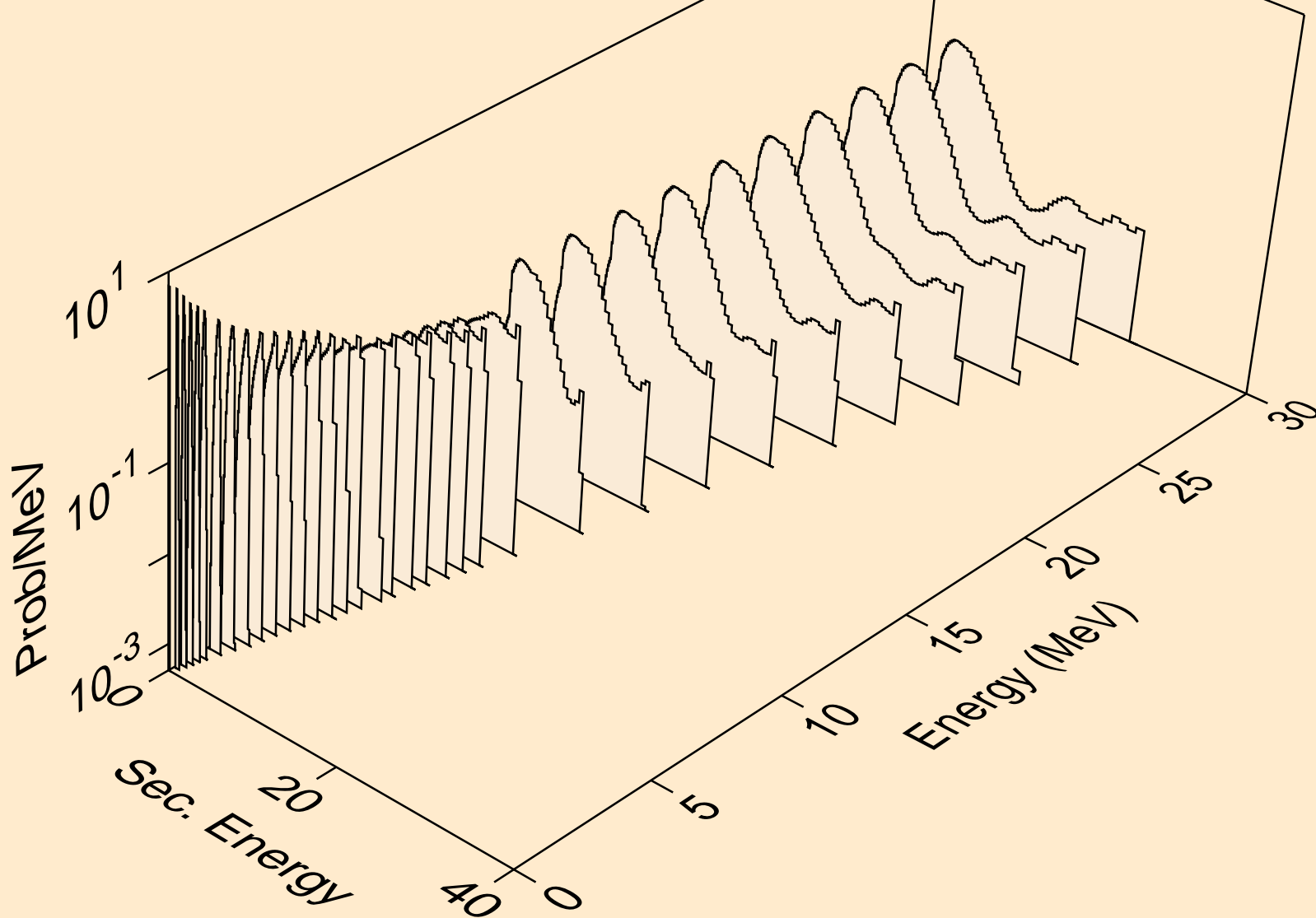

NE018 NEUTRON ACER TENDL-2019 LIBRARY; T=293.16K
protons from (n,pd)

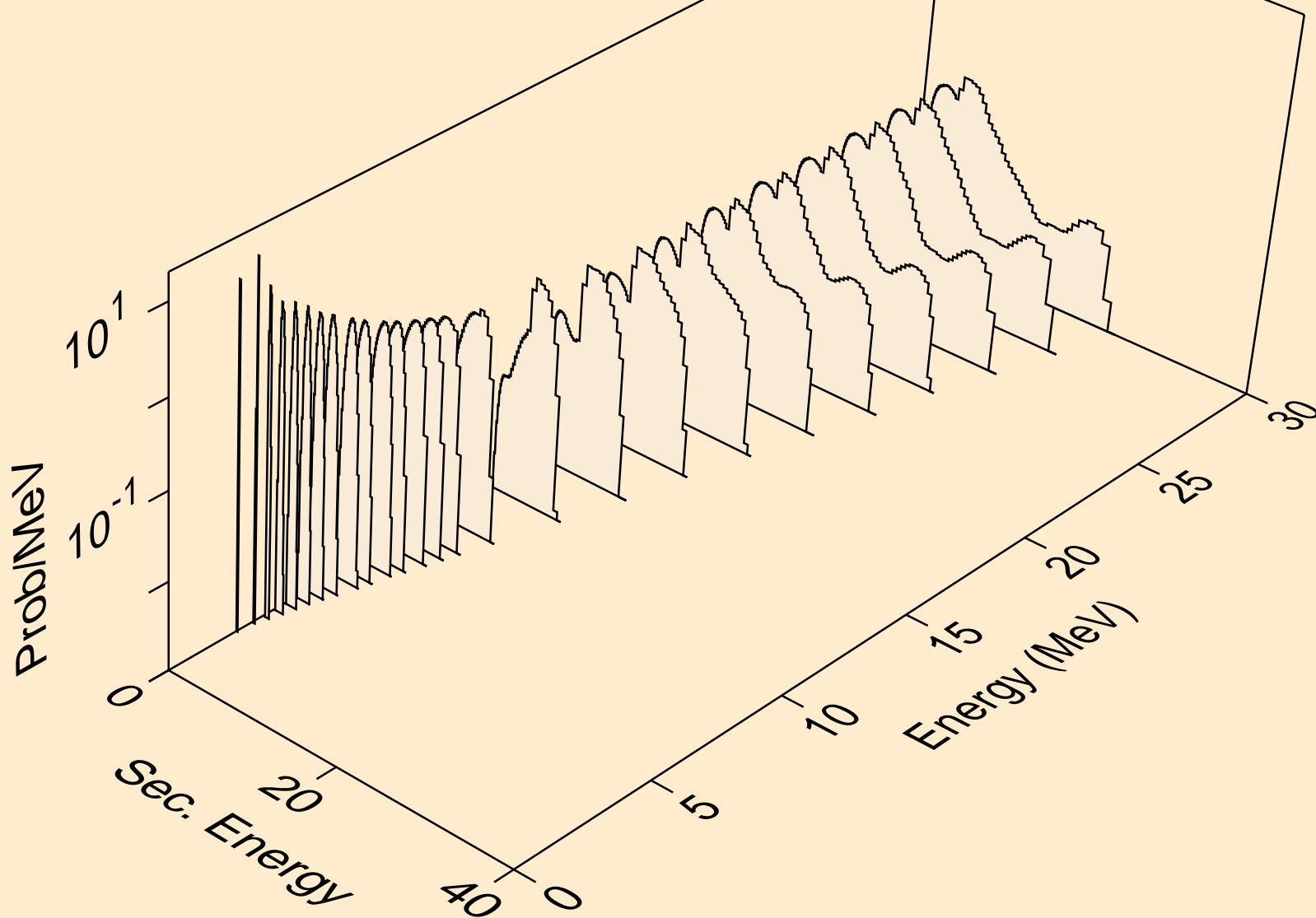

NE018 NEUTRON ACER TENDL-2019 LIBRARY; T=293.16K
protons from (n,pt)

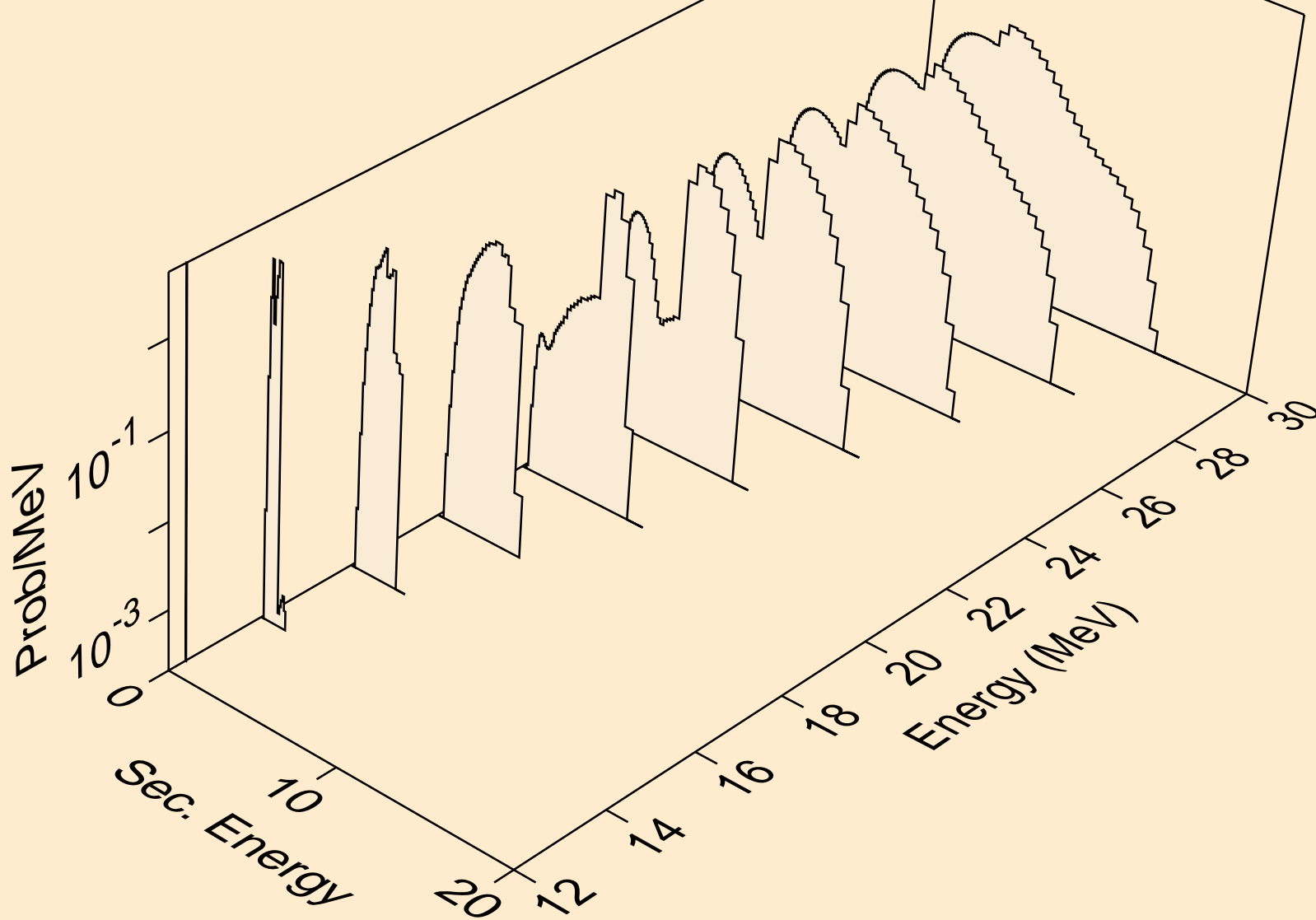

NE018 NEUTRON ACER TENDL-2019 LIBRARY; T=293.16K
deuterons from (n,x)

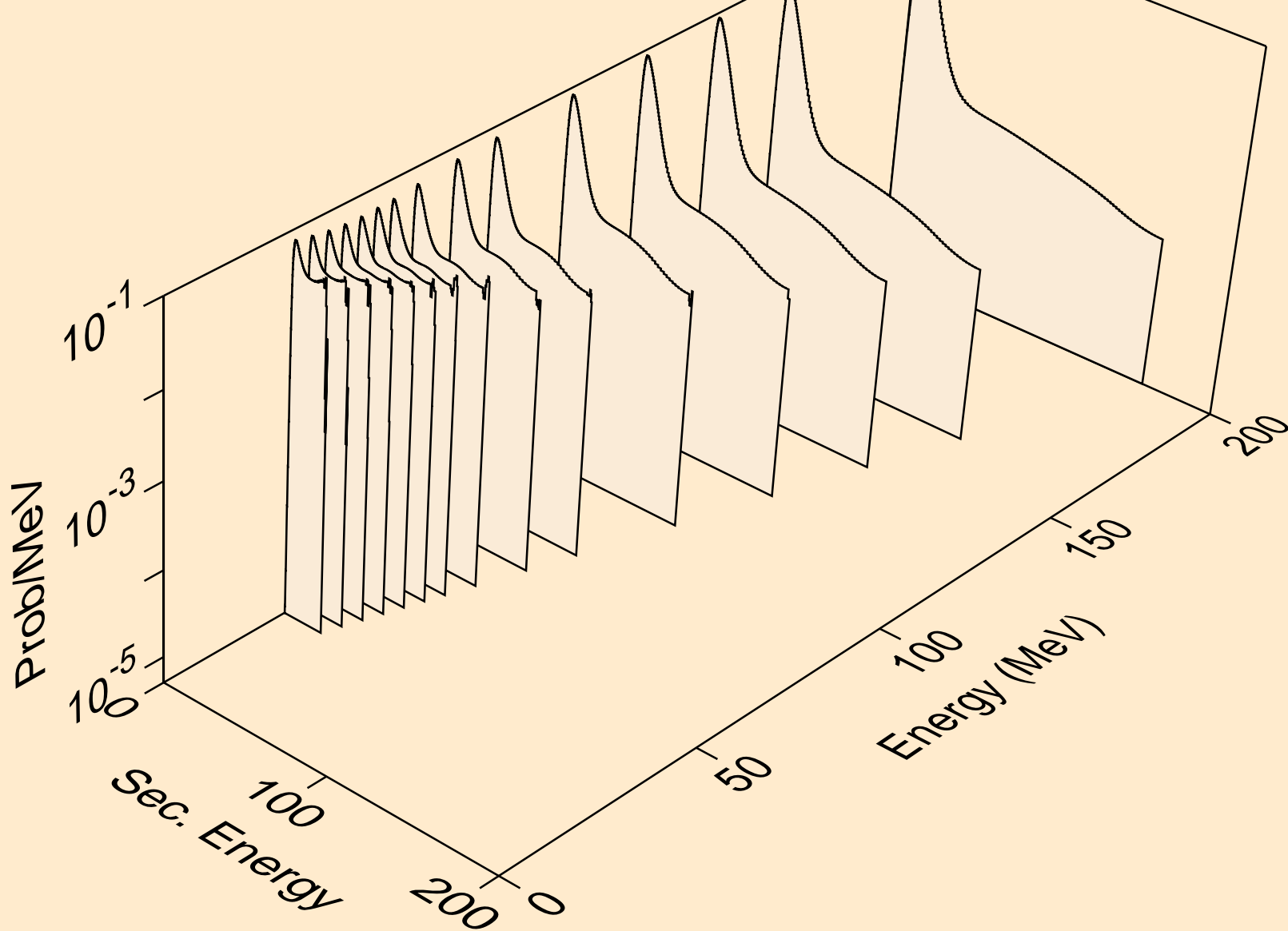

NE018 NEUTRON ACER TENDL-2019 LIBRARY; T=293.16K
deuterons from (n,n*)d

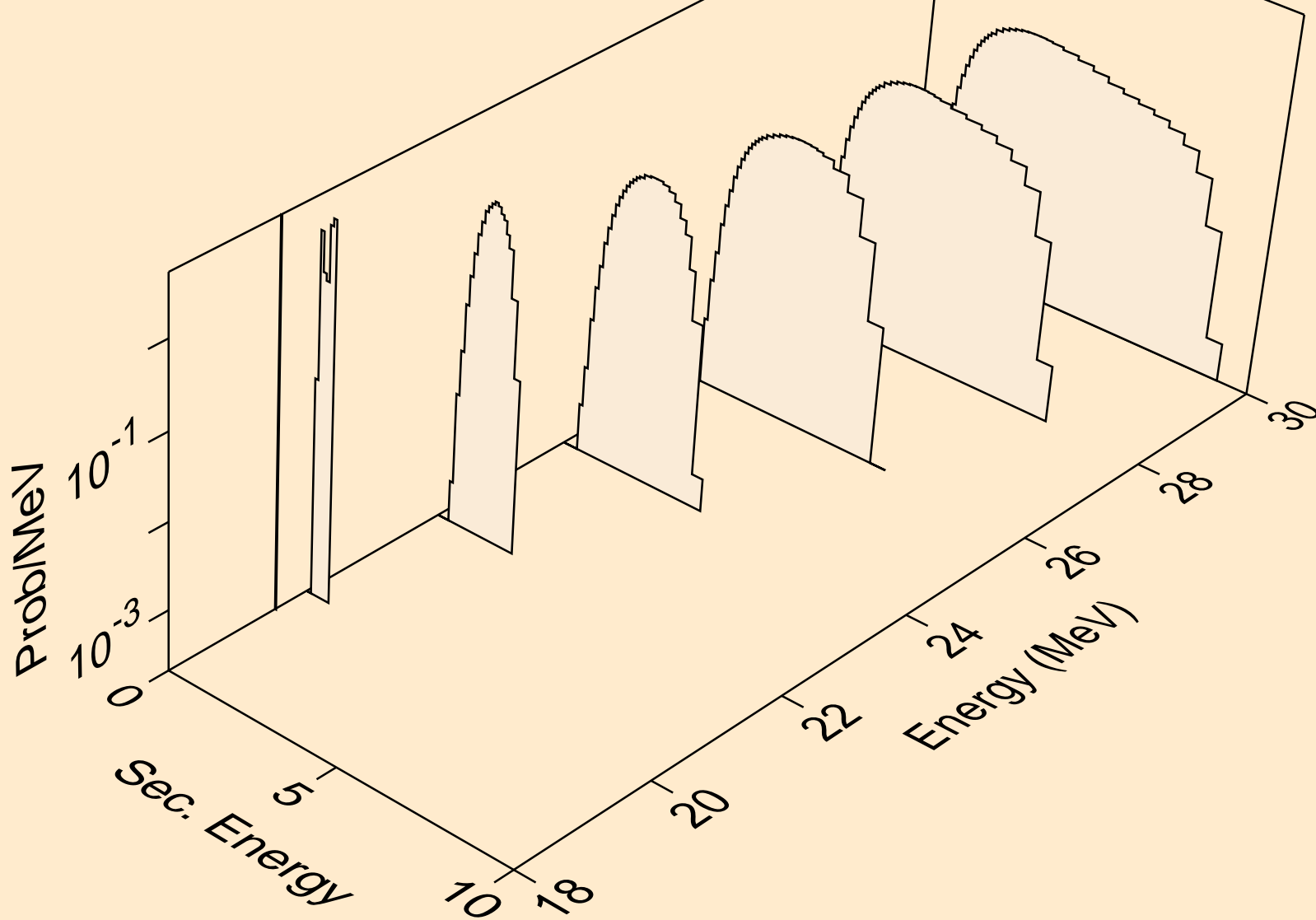

NE018 NEUTRON ACER TENDL-2019 LIBRARY; T=293.16K
deuterons from (n,d)

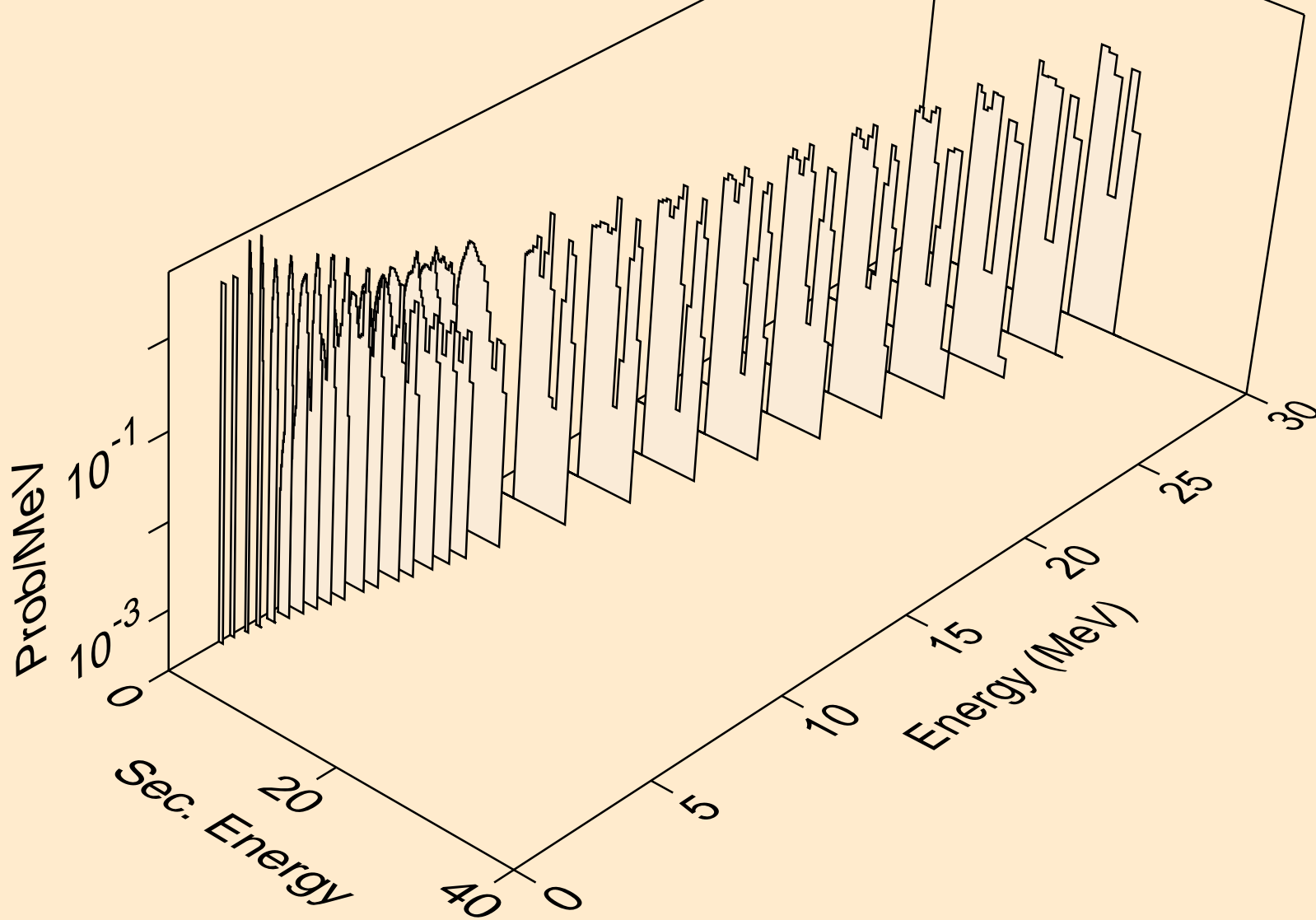

NE018 NEUTRON ACER TENDL-2019 LIBRARY; T=293.16K
deuterons from (n,d2a)

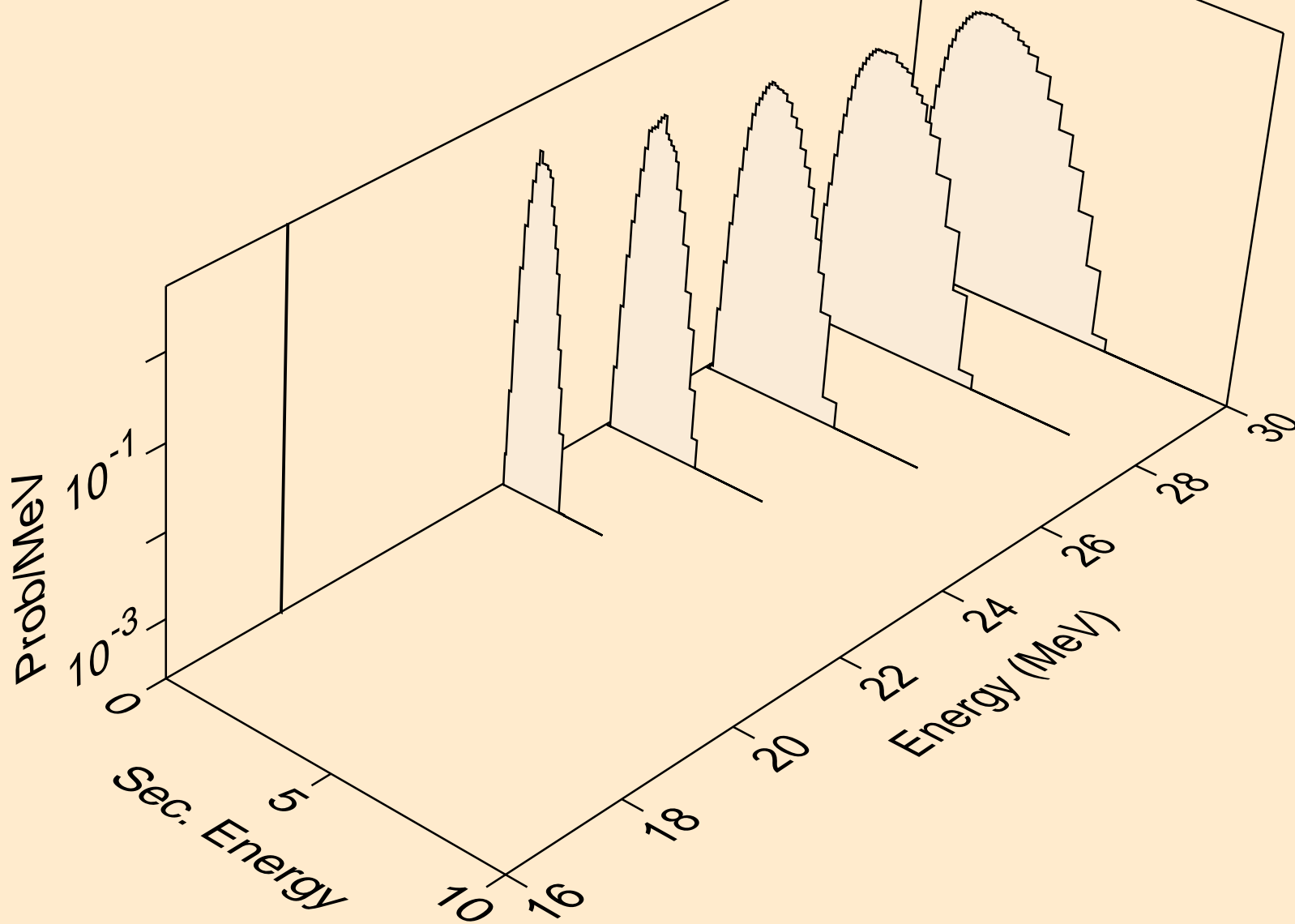

NE018 NEUTRON ACER TENDL-2019 LIBRARY; T=293.16K
deuterons from (n,pd)

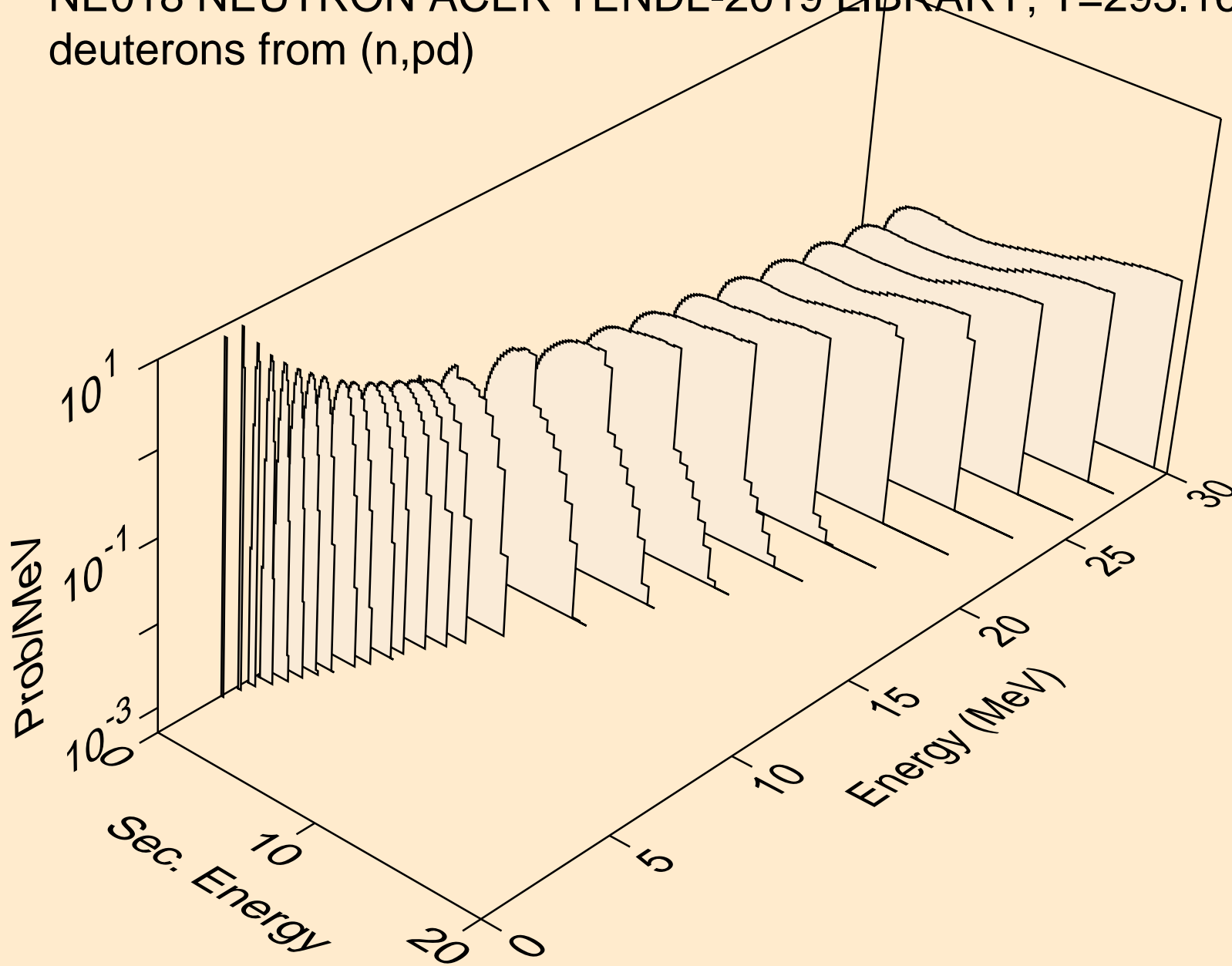

NE018 NEUTRON ACER TENDL-2019 LIBRARY; T=293.16K
deuterons from (n,da)

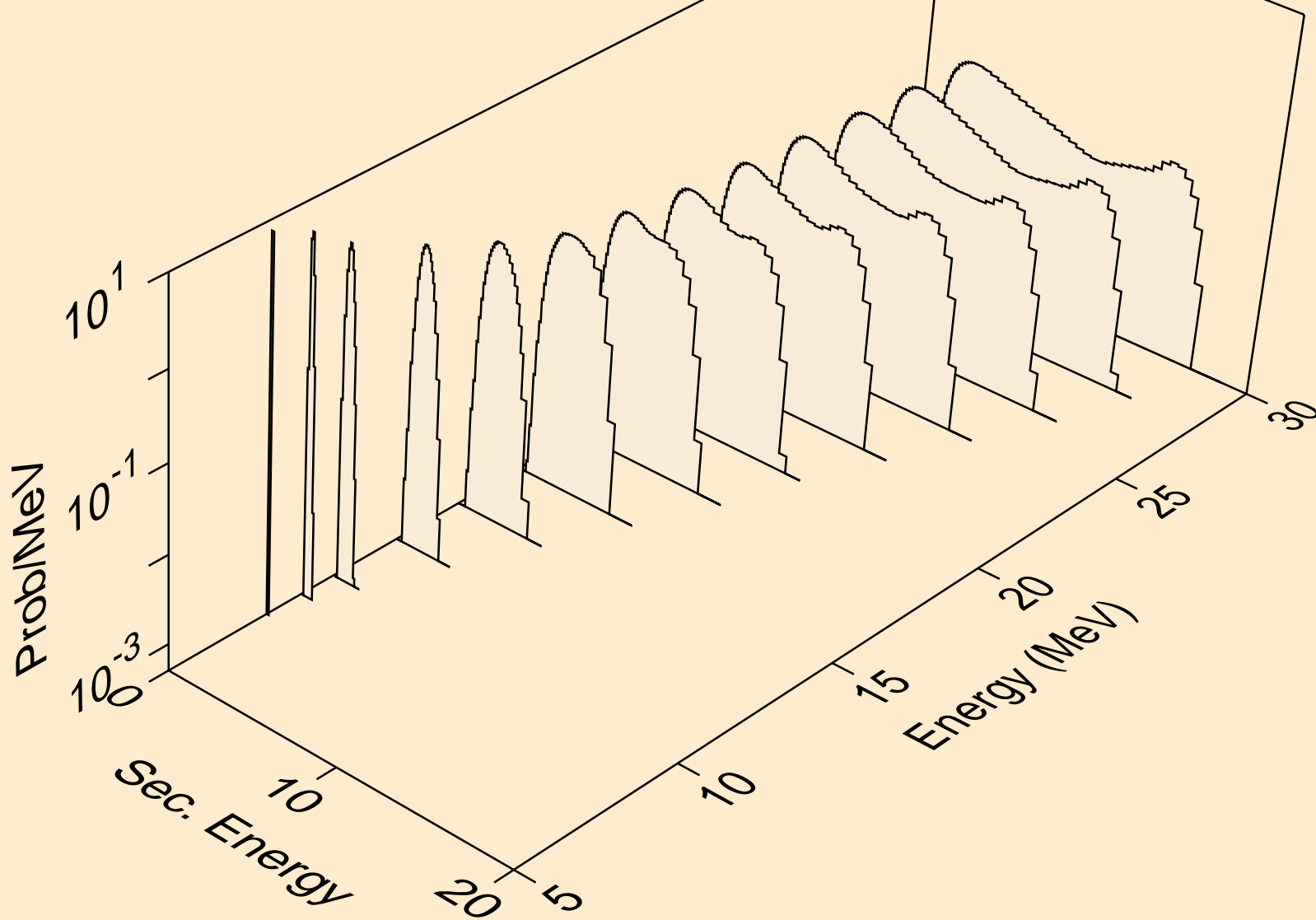

NE018 NEUTRON ACER TENDL-2019 LIBRARY; T=293.16K
tritons from (n,x)

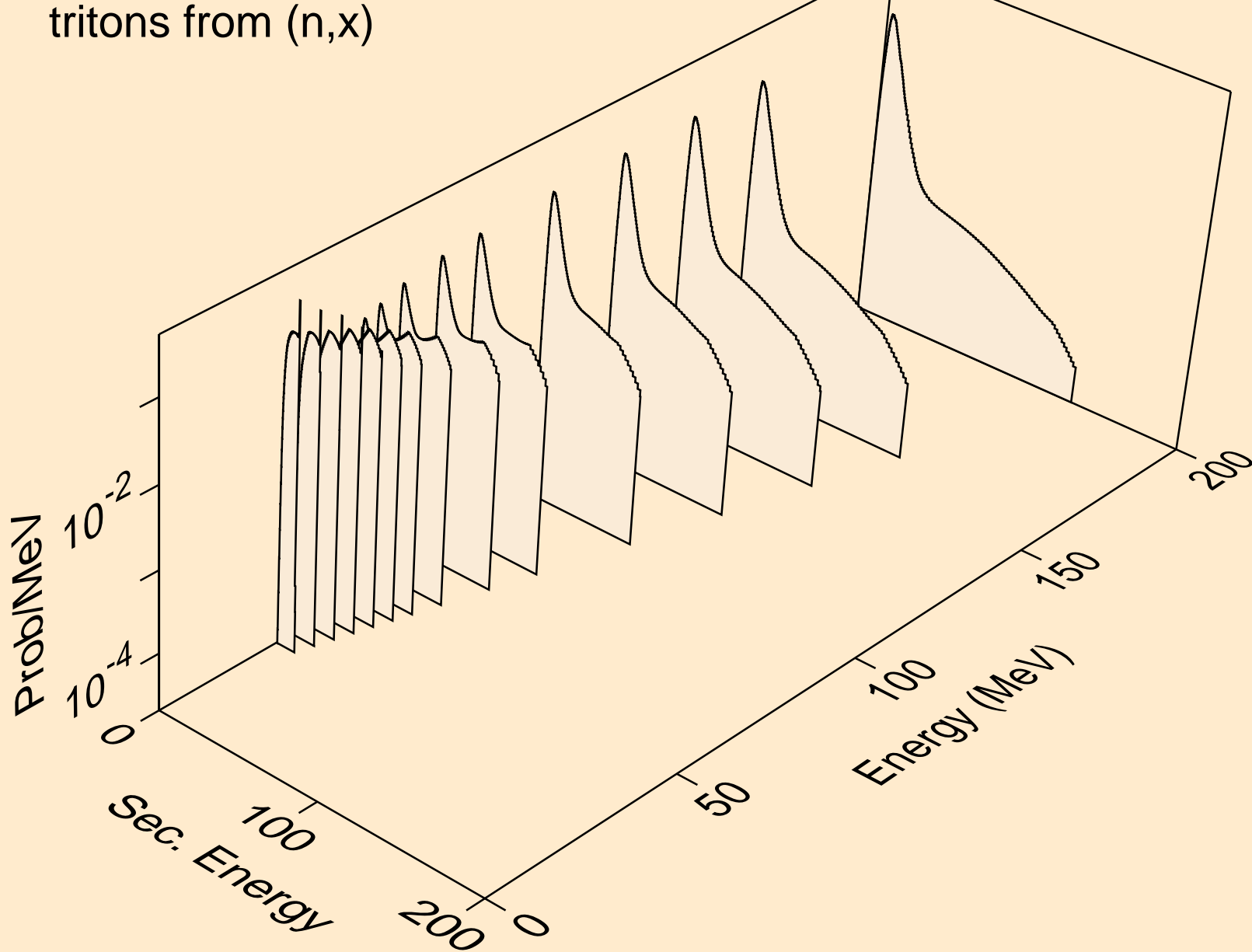

NE018 NEUTRON ACER TENDL-2019 LIBRARY; T=293.16K
tritons from (n,n*)t

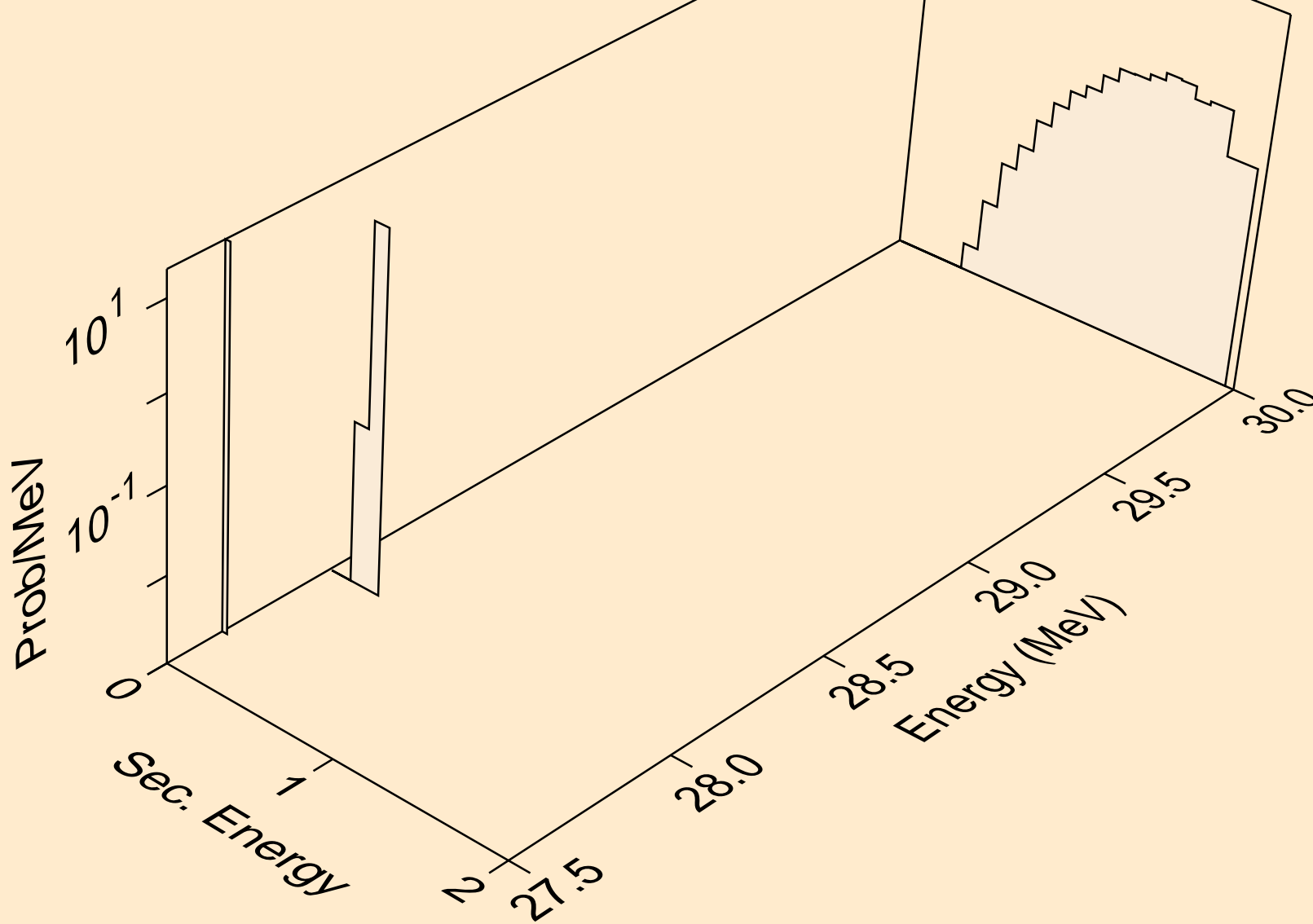

NE018 NEUTRON ACER TENDL-2019 LIBRARY; T=293.16K
tritons from (n,t)

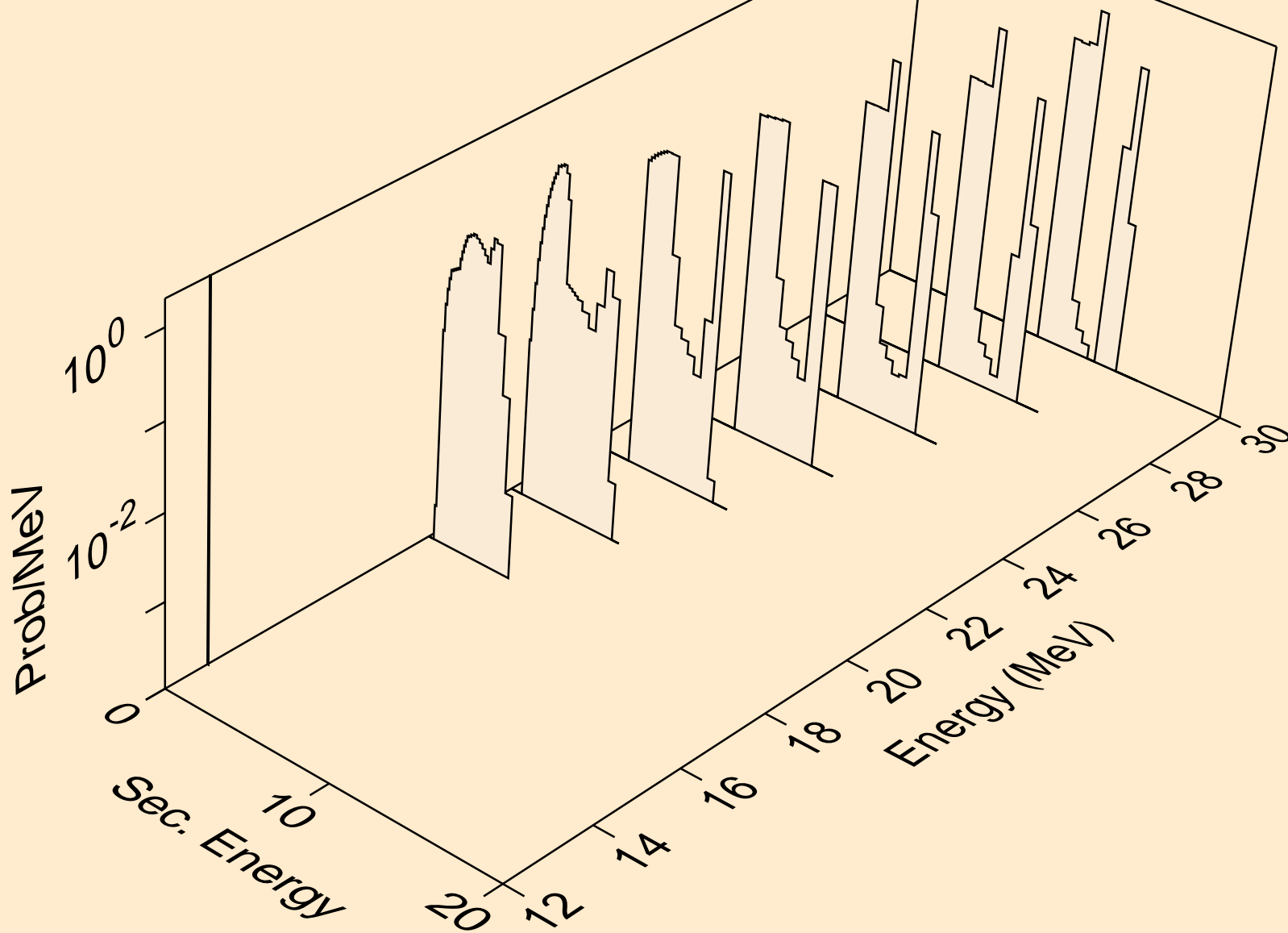

NE018 NEUTRON ACER TENDL-2019 LIBRARY; T=293.16K
tritons from (n,pt)

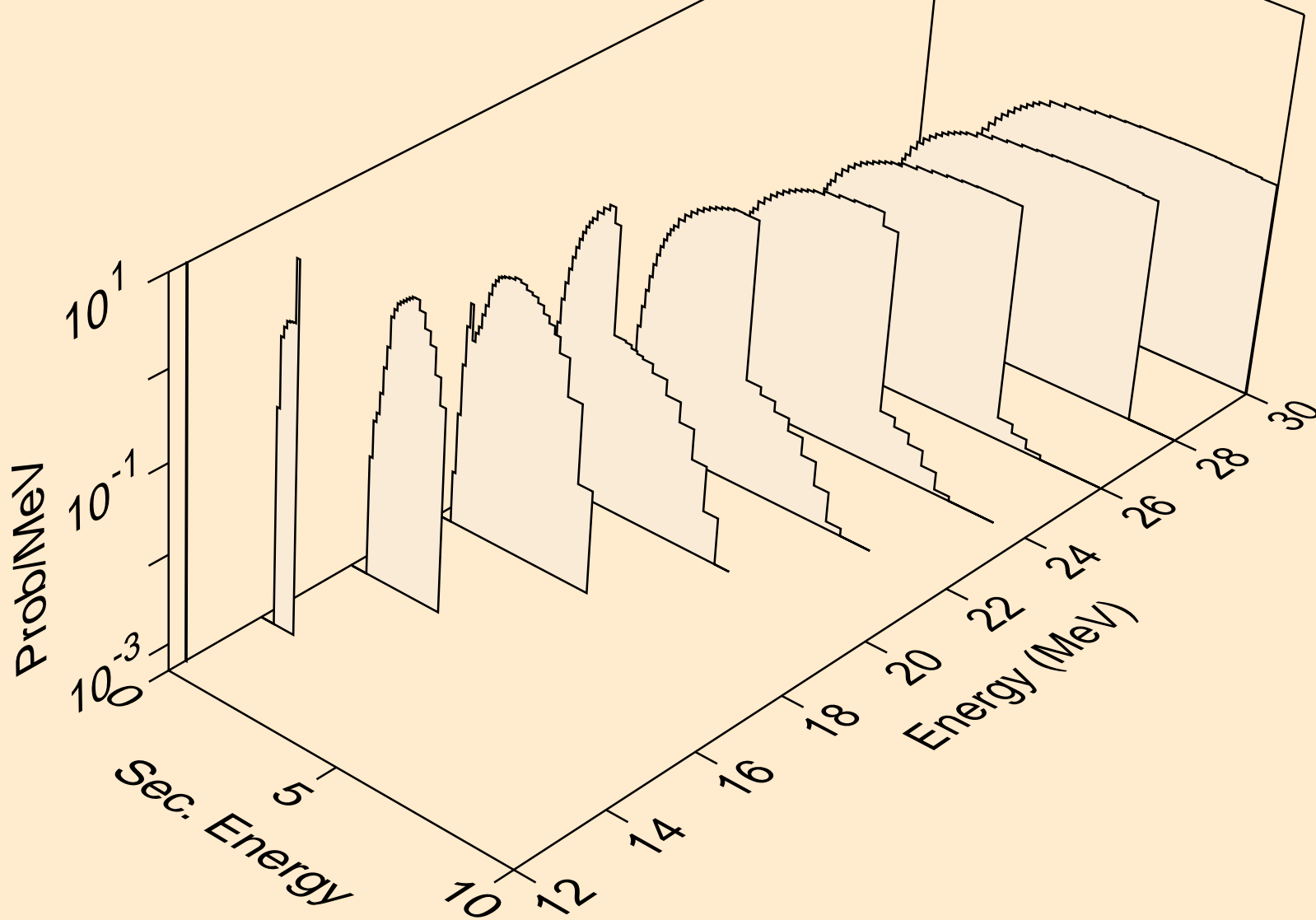

NE018 NEUTRON ACER TENDL-2019 LIBRARY; T=293.16K
he3s from (n,x)

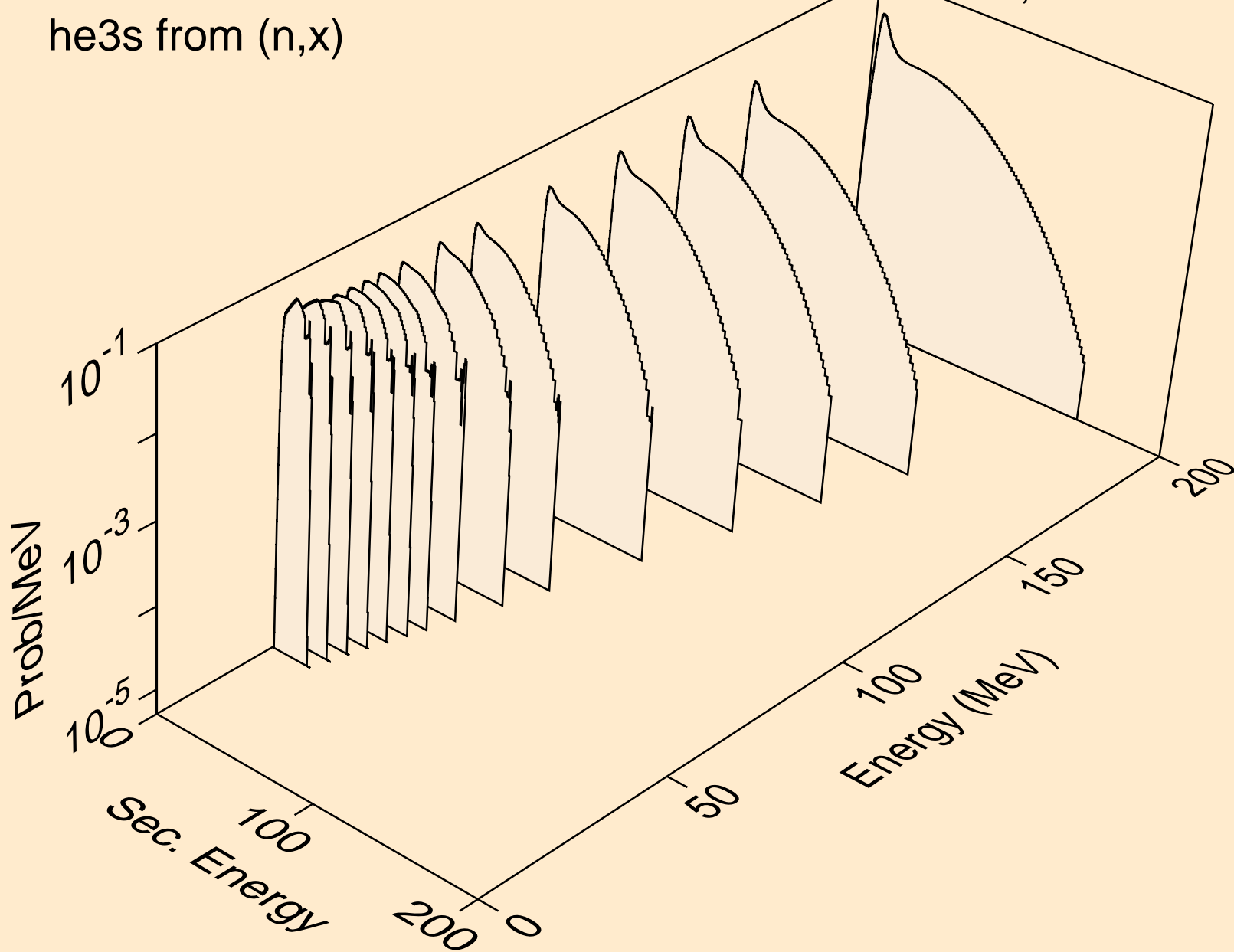

NE018 NEUTRON ACER TENDL-2019 LIBRARY; T=293.16K
he3s from (n,n*)he3

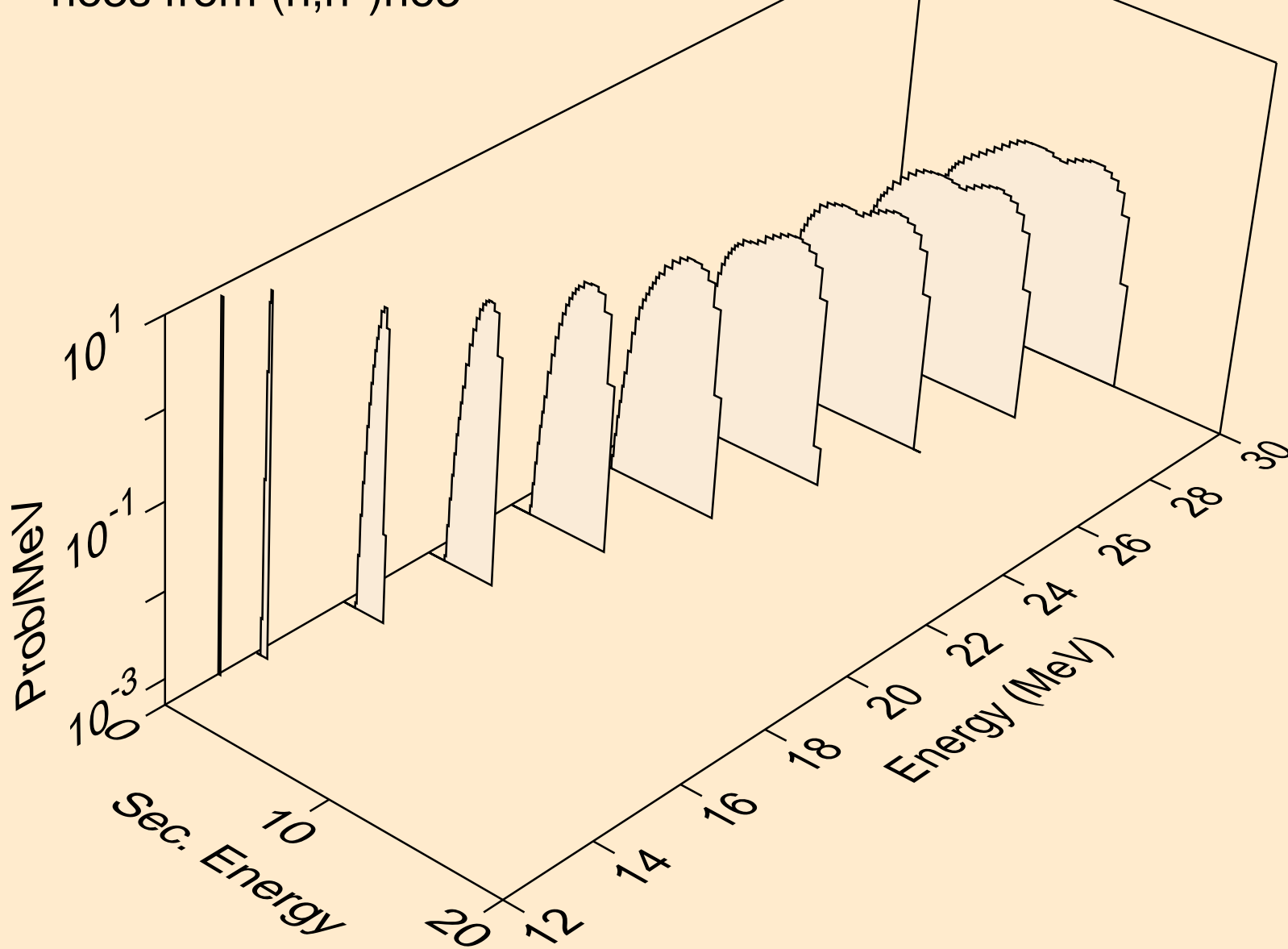

NE018 NEUTRON ACER TENDL-2019 LIBRARY; T=293.16K
he3s from (n,he3)

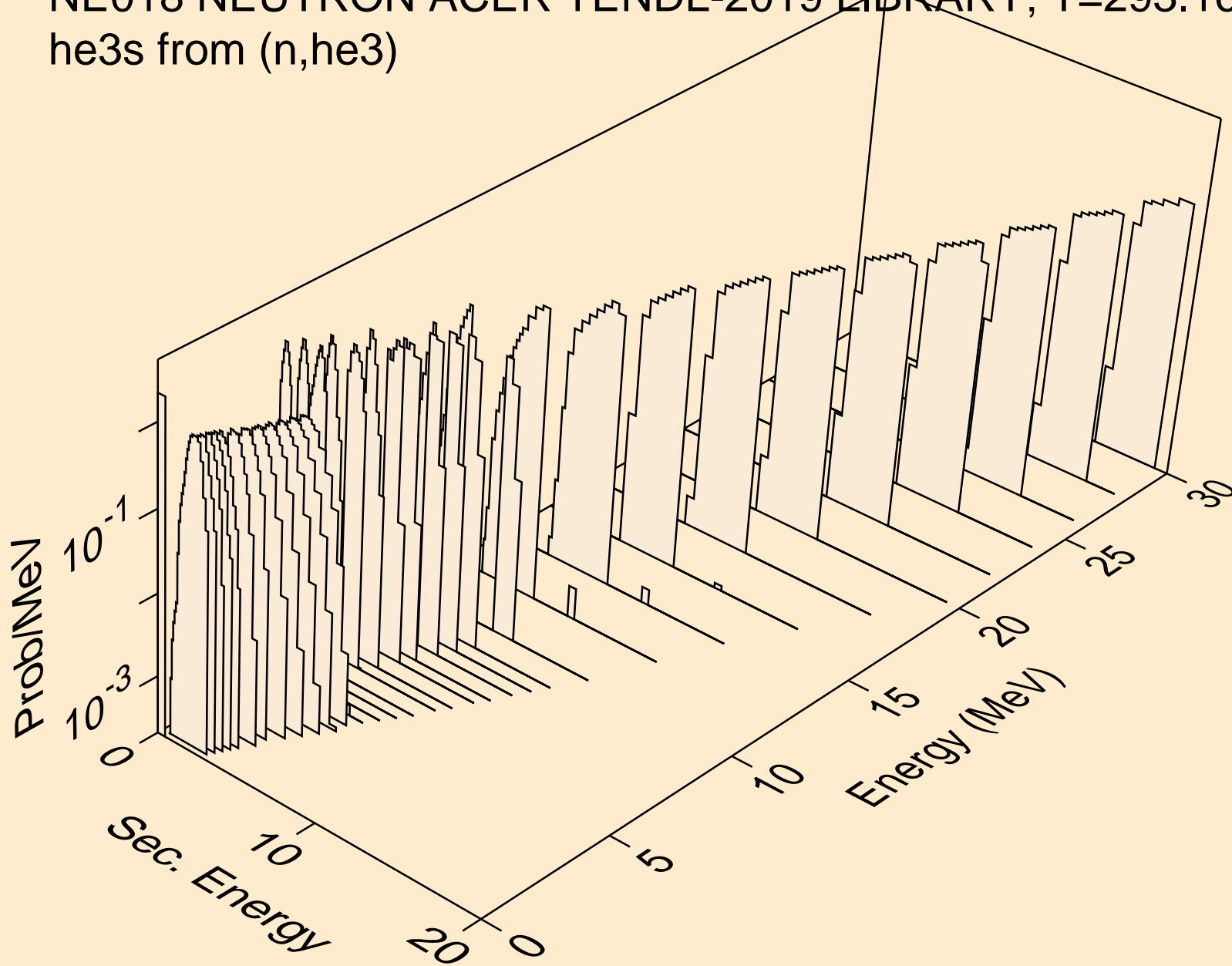

NE018 NEUTRON ACER TENDL-2019 LIBRARY; T=293.16K
alphas from (n,x)

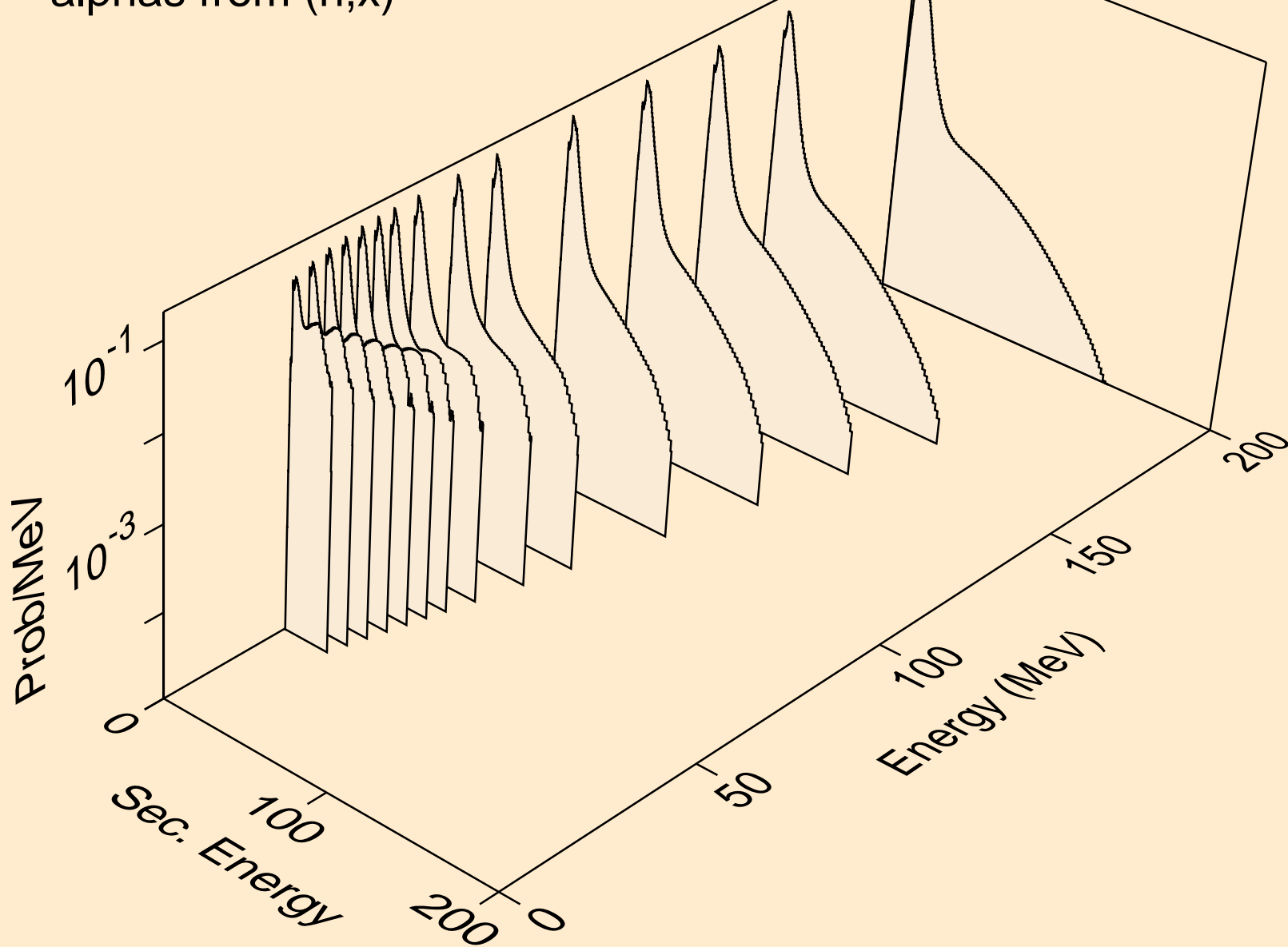

NE018 NEUTRON ACER TENDL-2019 LIBRARY; T=293.16K
alphas from (n,n*)a

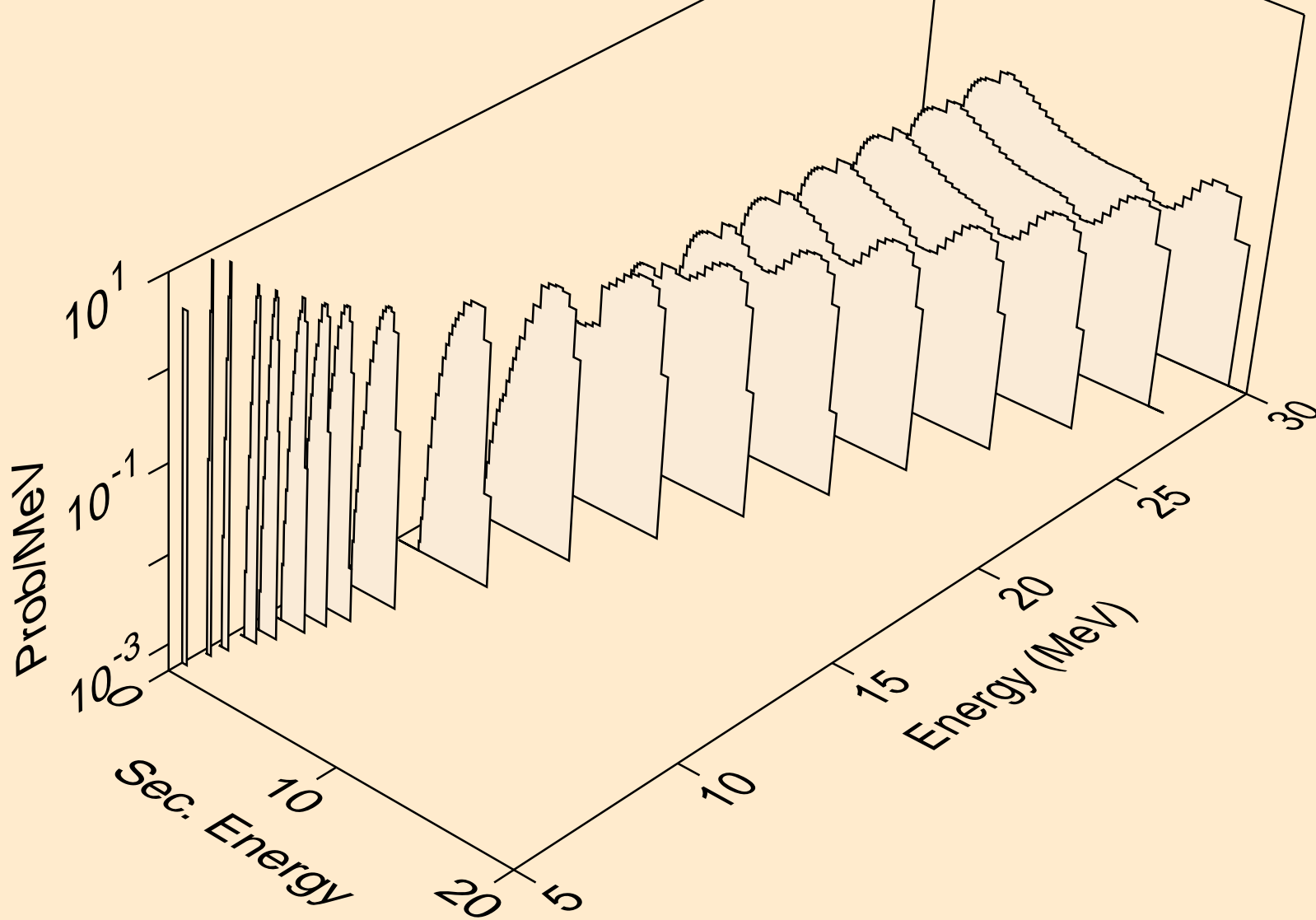

NE018 NEUTRON ACER TENDL-2019 LIBRARY; T=293.16K
alphas from (n,n*)2a

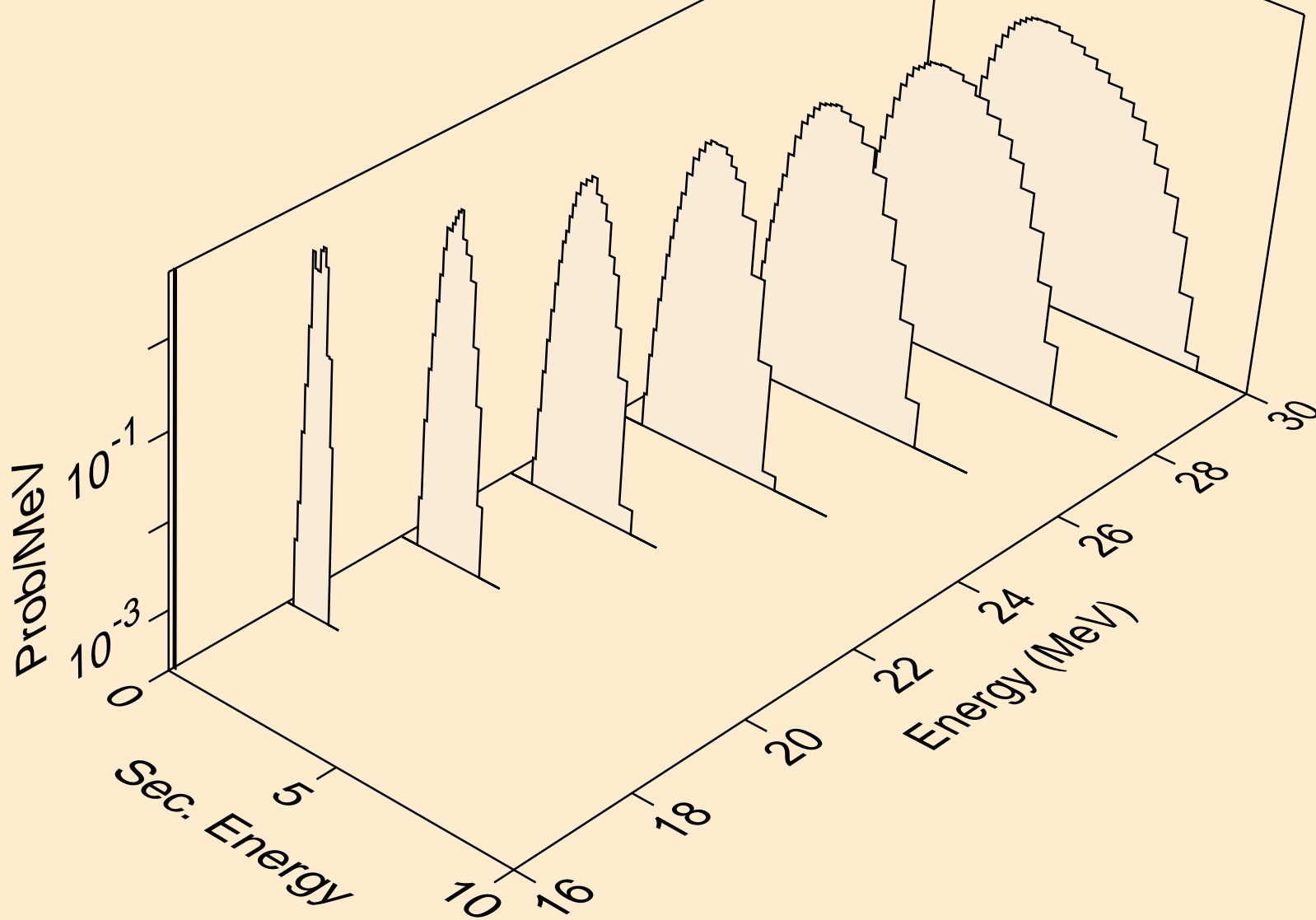

NE018 NEUTRON ACER TENDL-2019 LIBRARY; T=293.16K
alphas from (n,npa)

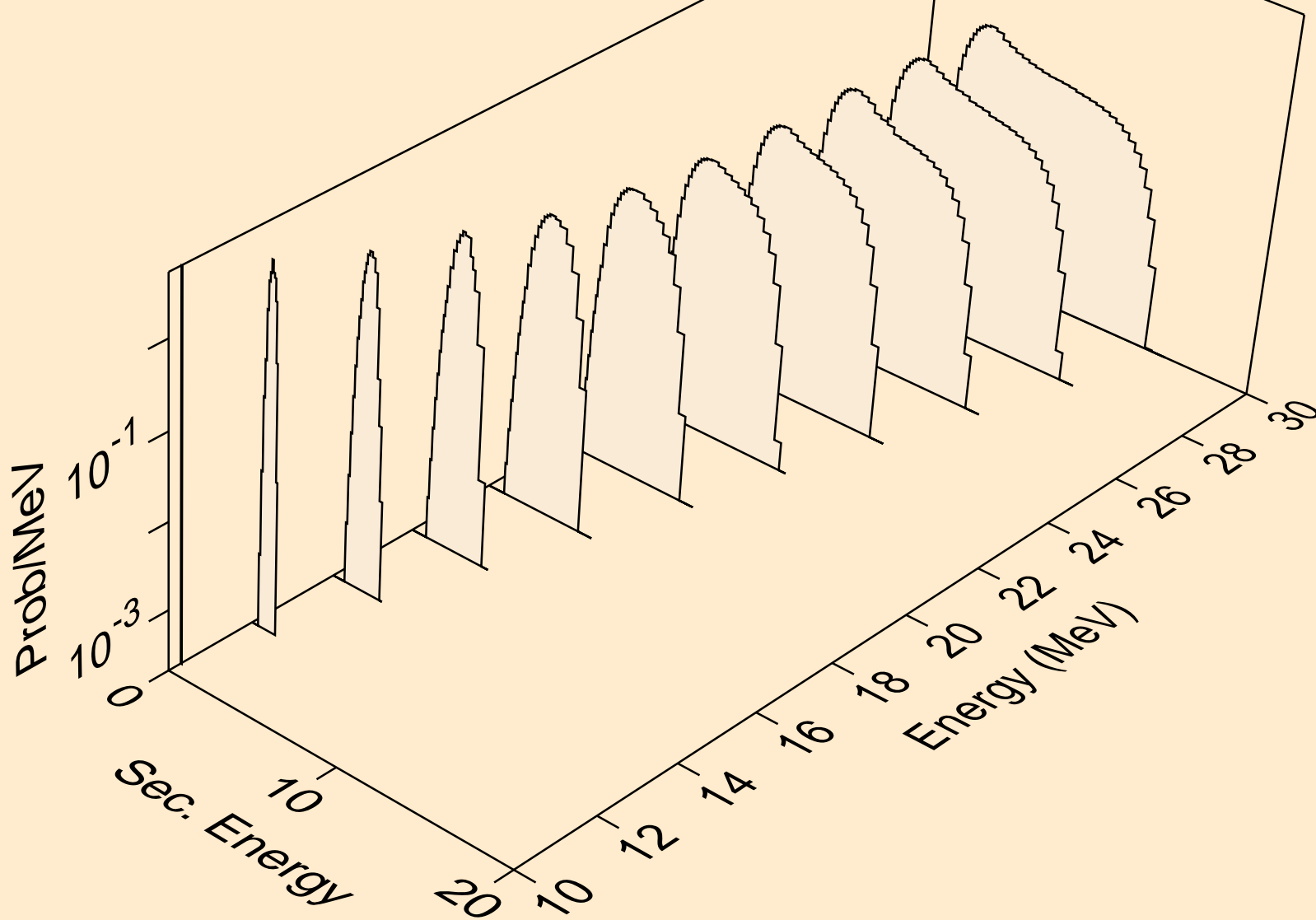

NE018 NEUTRON ACER TENDL-2019 LIBRARY; T=293.16K
alphas from (n,a)

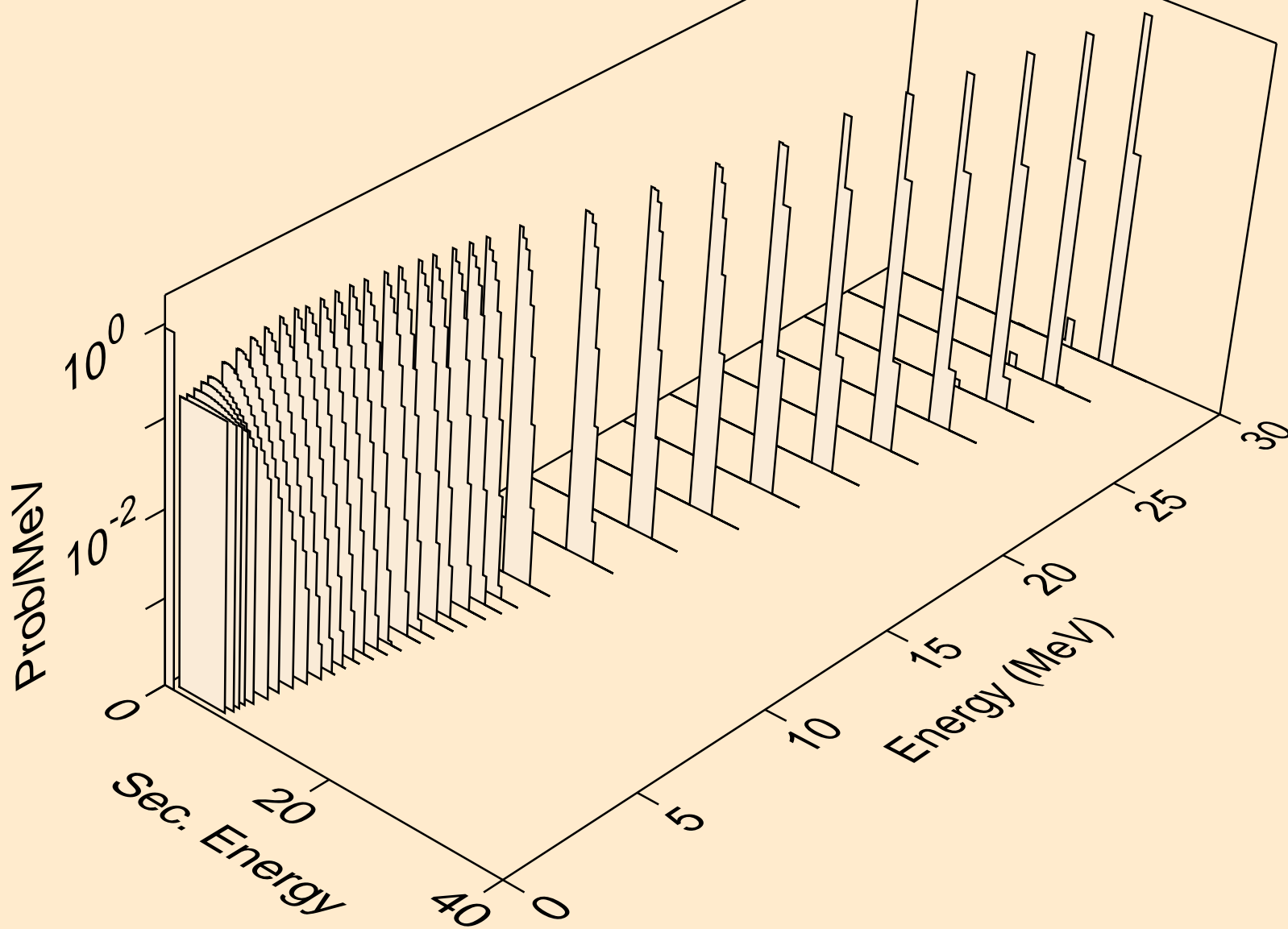

NE018 NEUTRON ACER TENDL-2019 LIBRARY; T=293.16K
alphas from (n,2a)

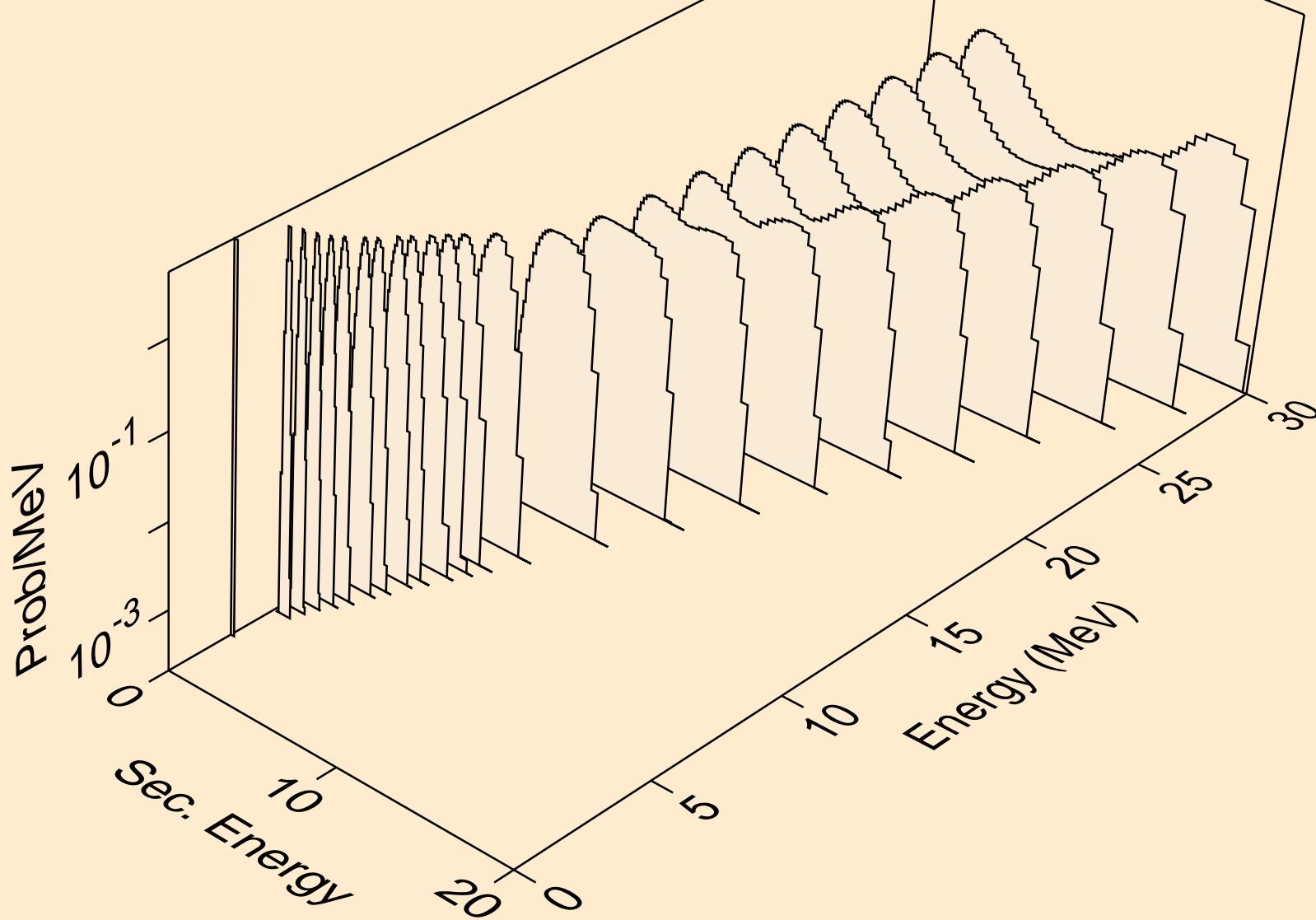

NE018 NEUTRON ACER TENDL-2019 LIBRARY; T=293.16K
alphas from (n,3a)

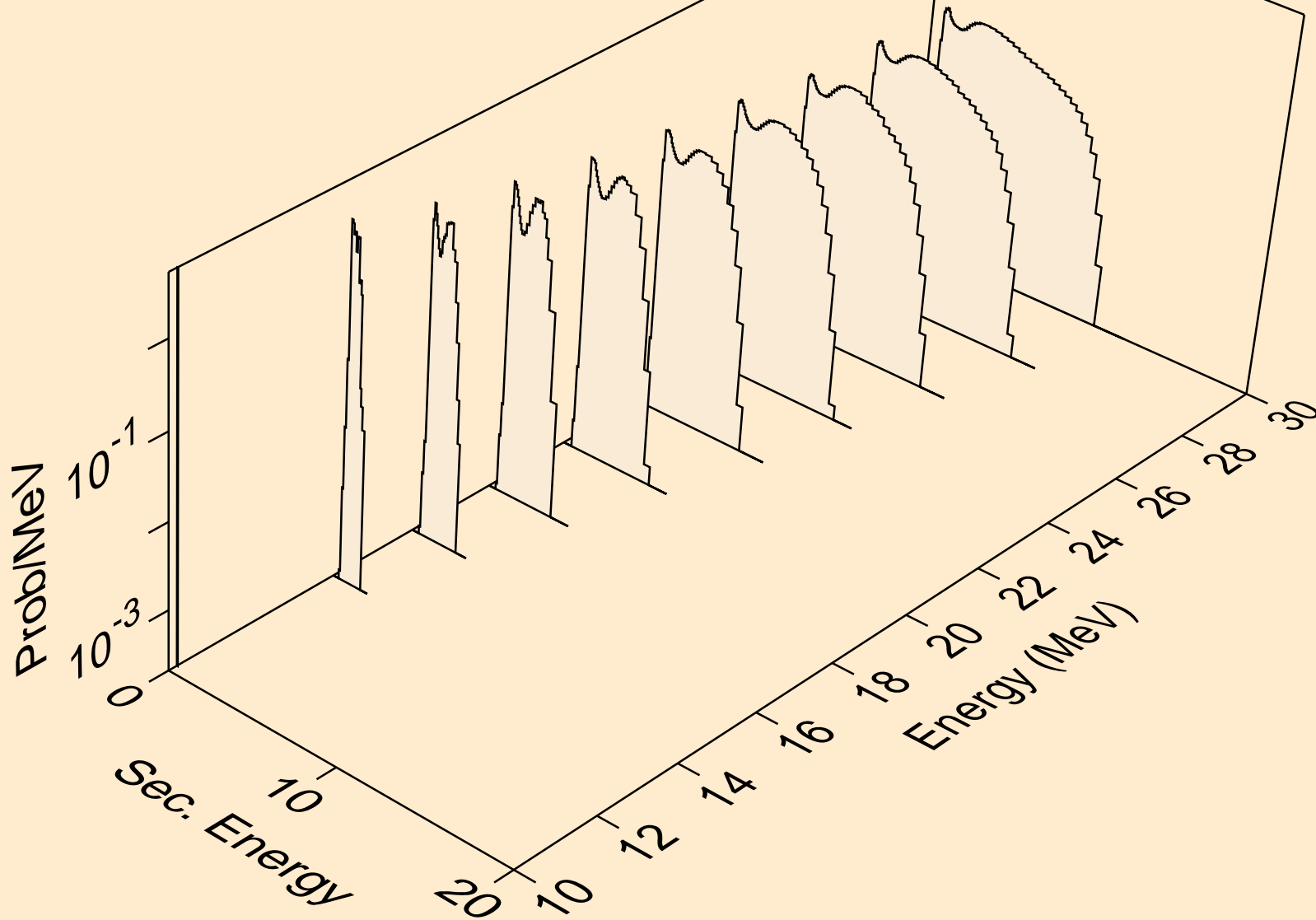

NE018 NEUTRON ACER TENDL-2019 LIBRARY; T=293.16K
alphas from (n,pa)

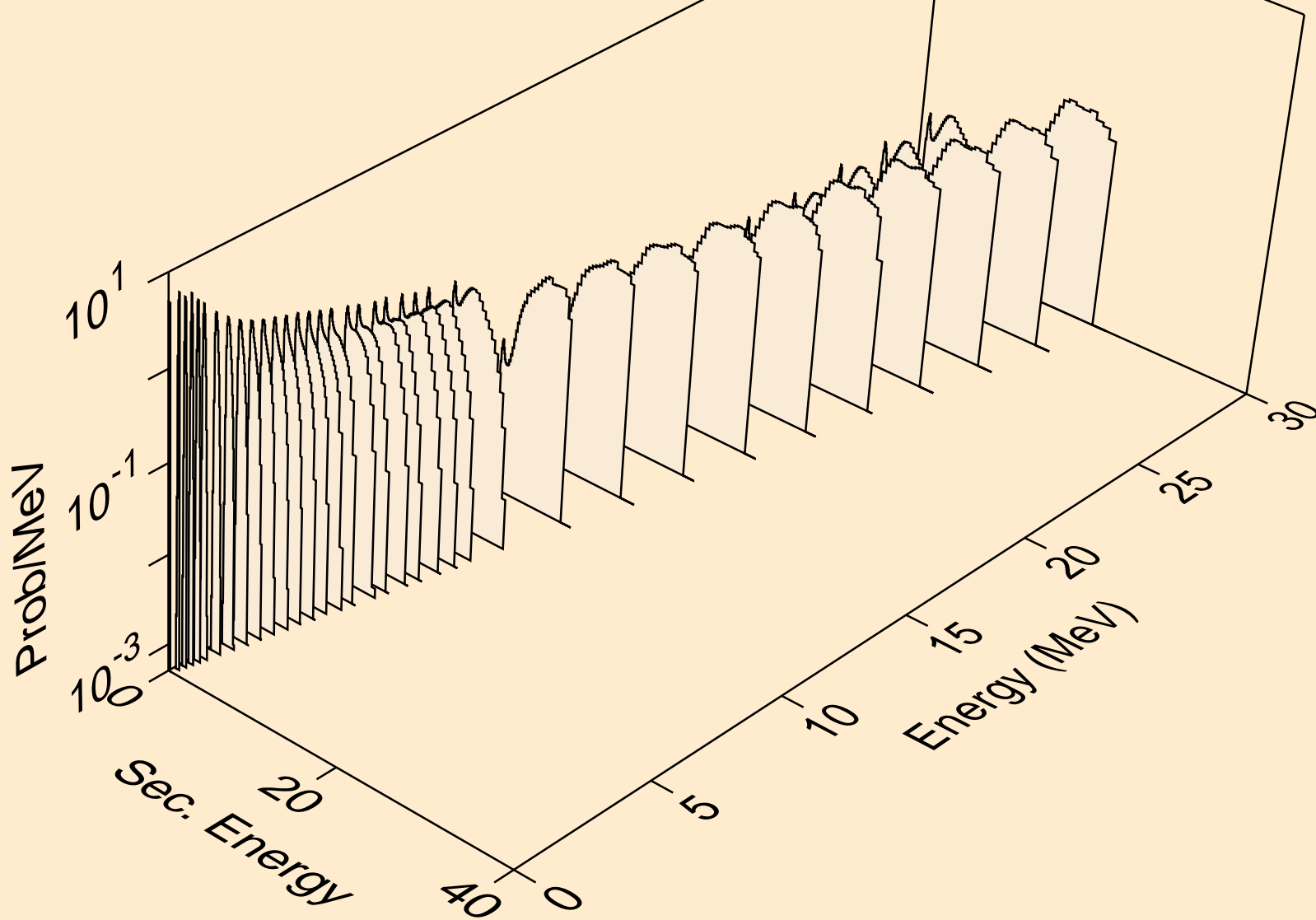

NE018 NEUTRON ACER TENDL-2019 LIBRARY; T=293.16K
alphas from (n,d2a)

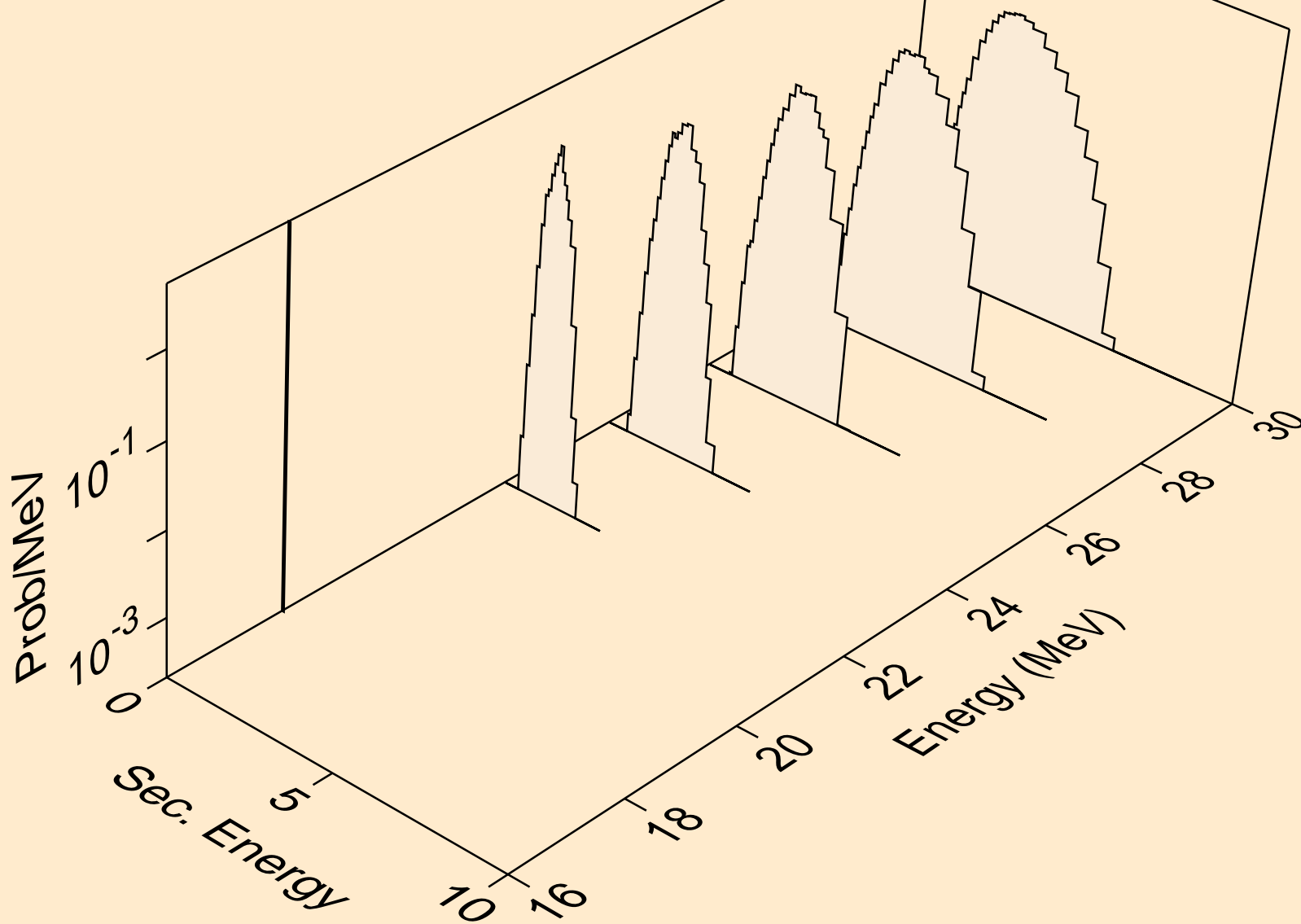

NE018 NEUTRON ACER TENDL-2019 LIBRARY; T=293.16K
alphas from (n,da)

