

O019 NEUTRON ACER TENDL-2019 LIBRARY; T=293.16K
Principal cross sections

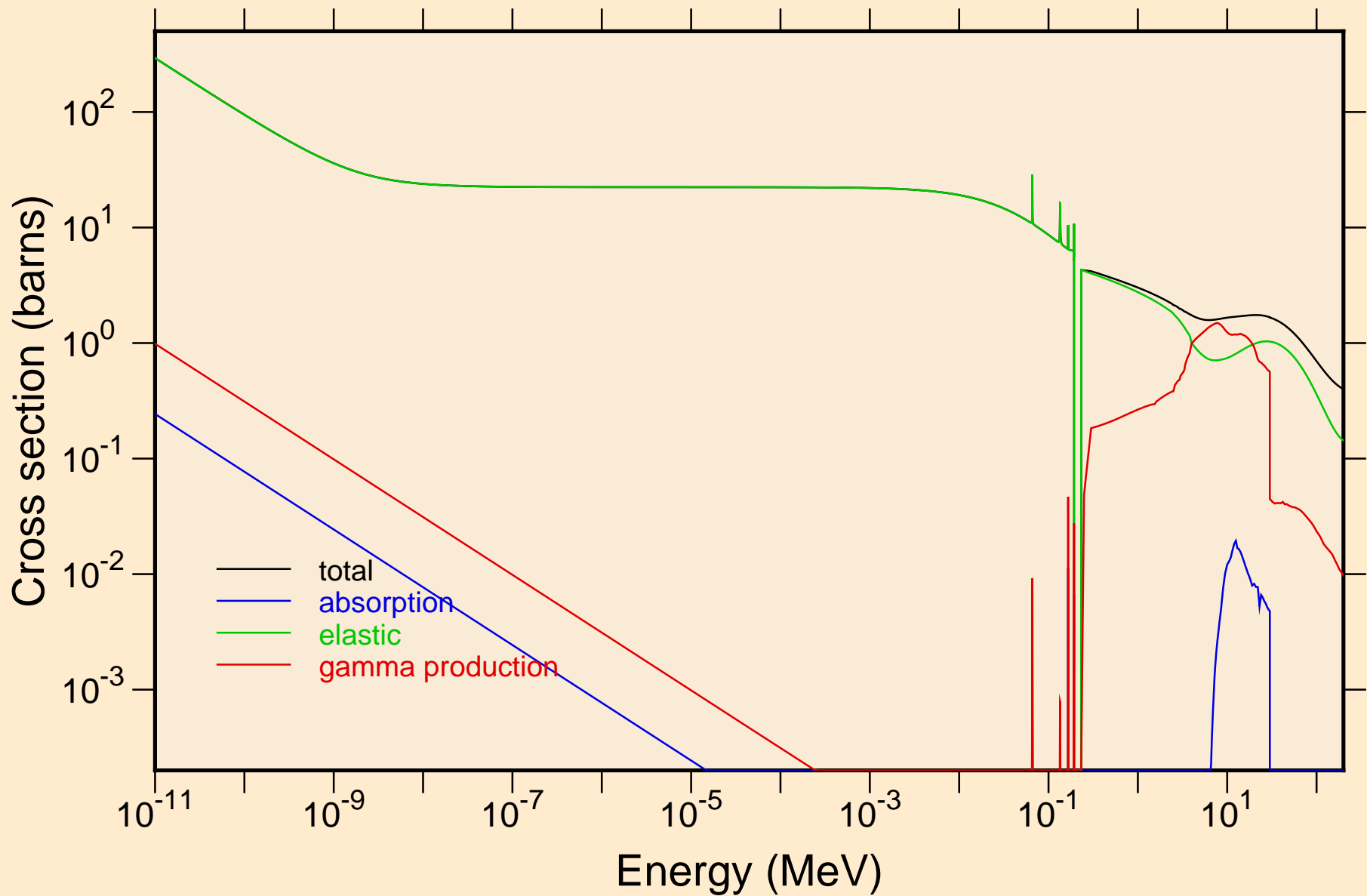

O019 NEUTRON ACER TENDL-2019 LIBRARY; T=293.16K
Heating

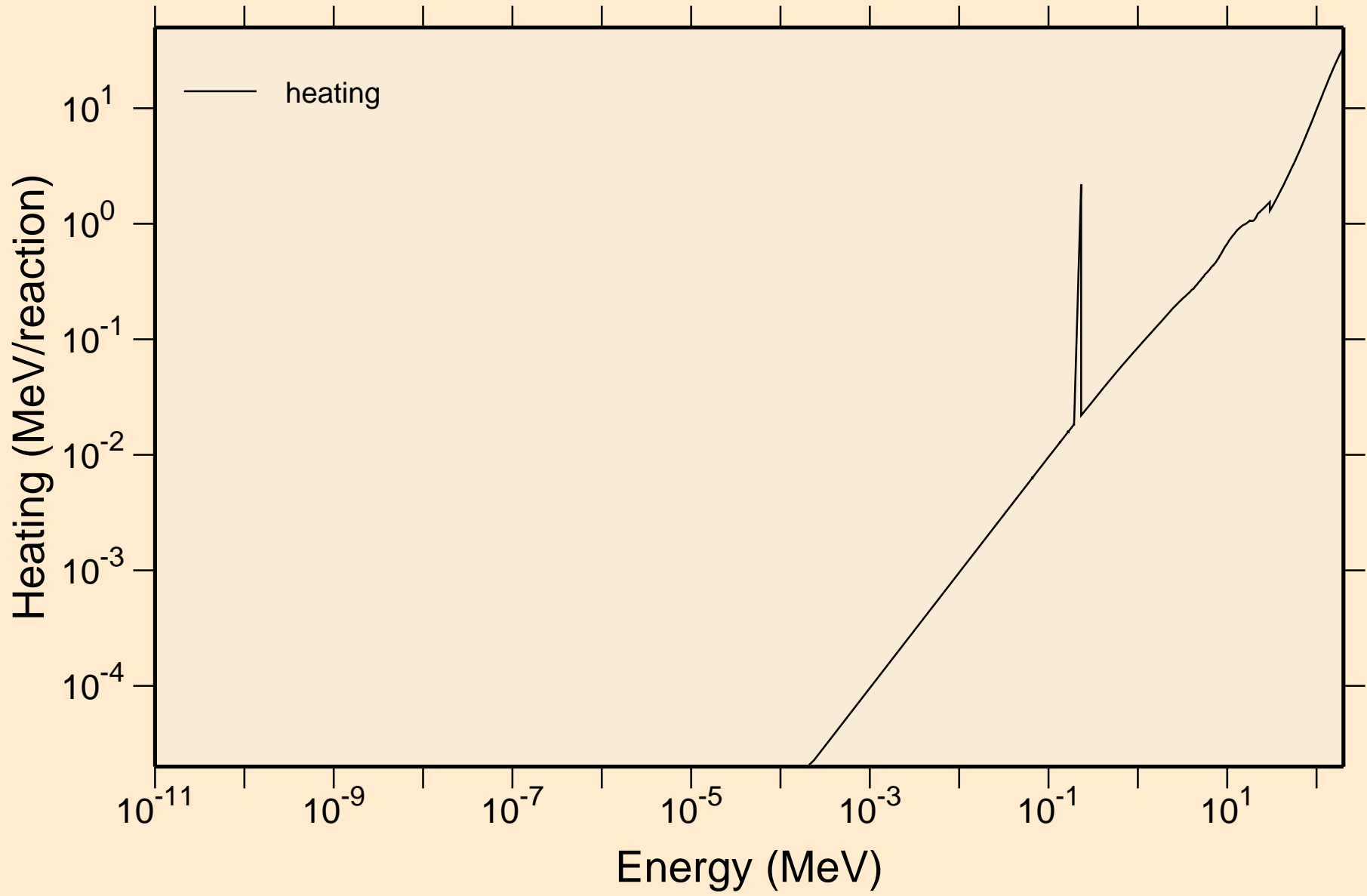

O019 NEUTRON ACER TENDL-2019 LIBRARY; T=293.16K
Damage

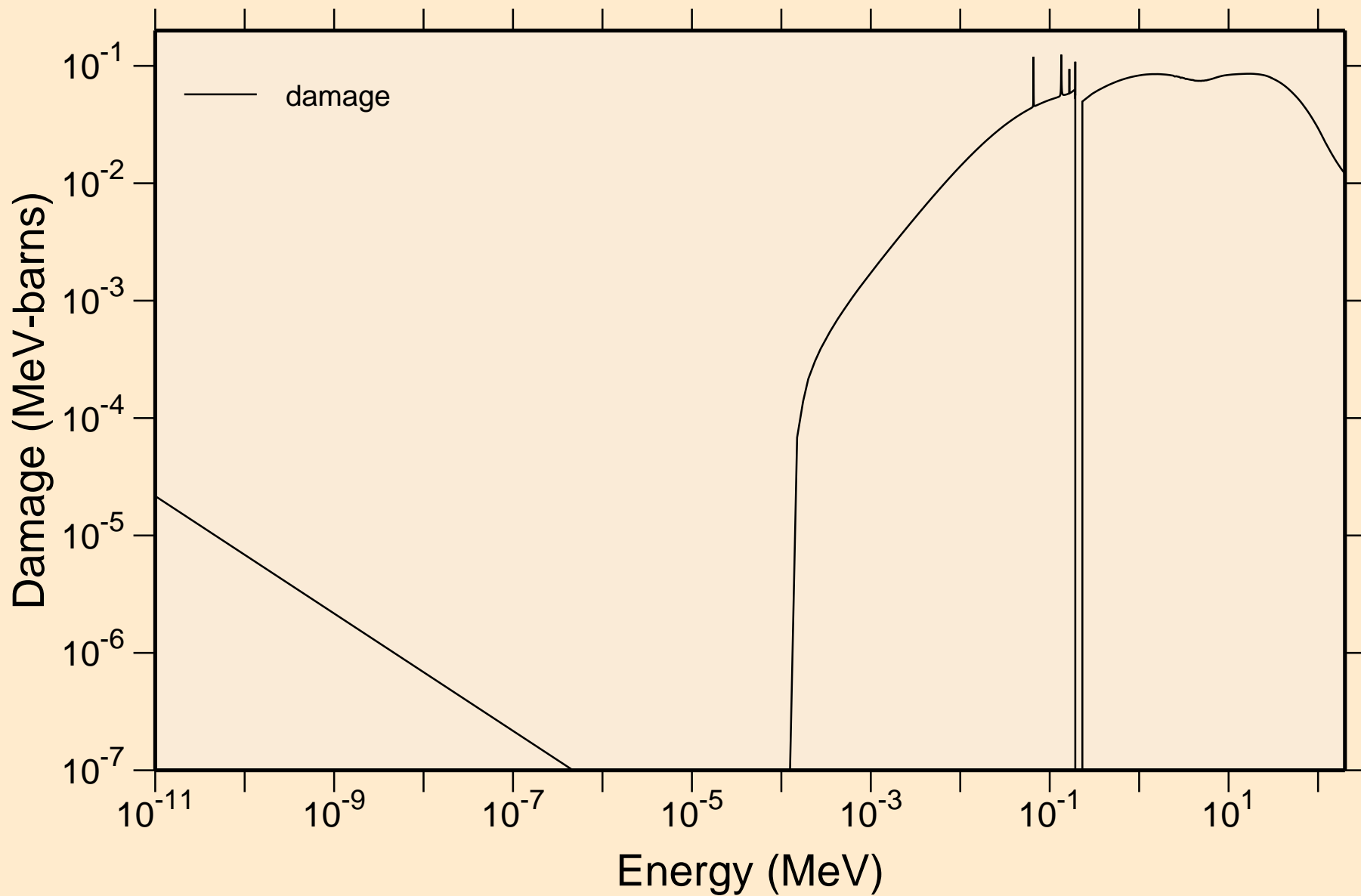

O019 NEUTRON ACER TENDL-2019 LIBRARY; T=293.16K
Non-threshold reactions

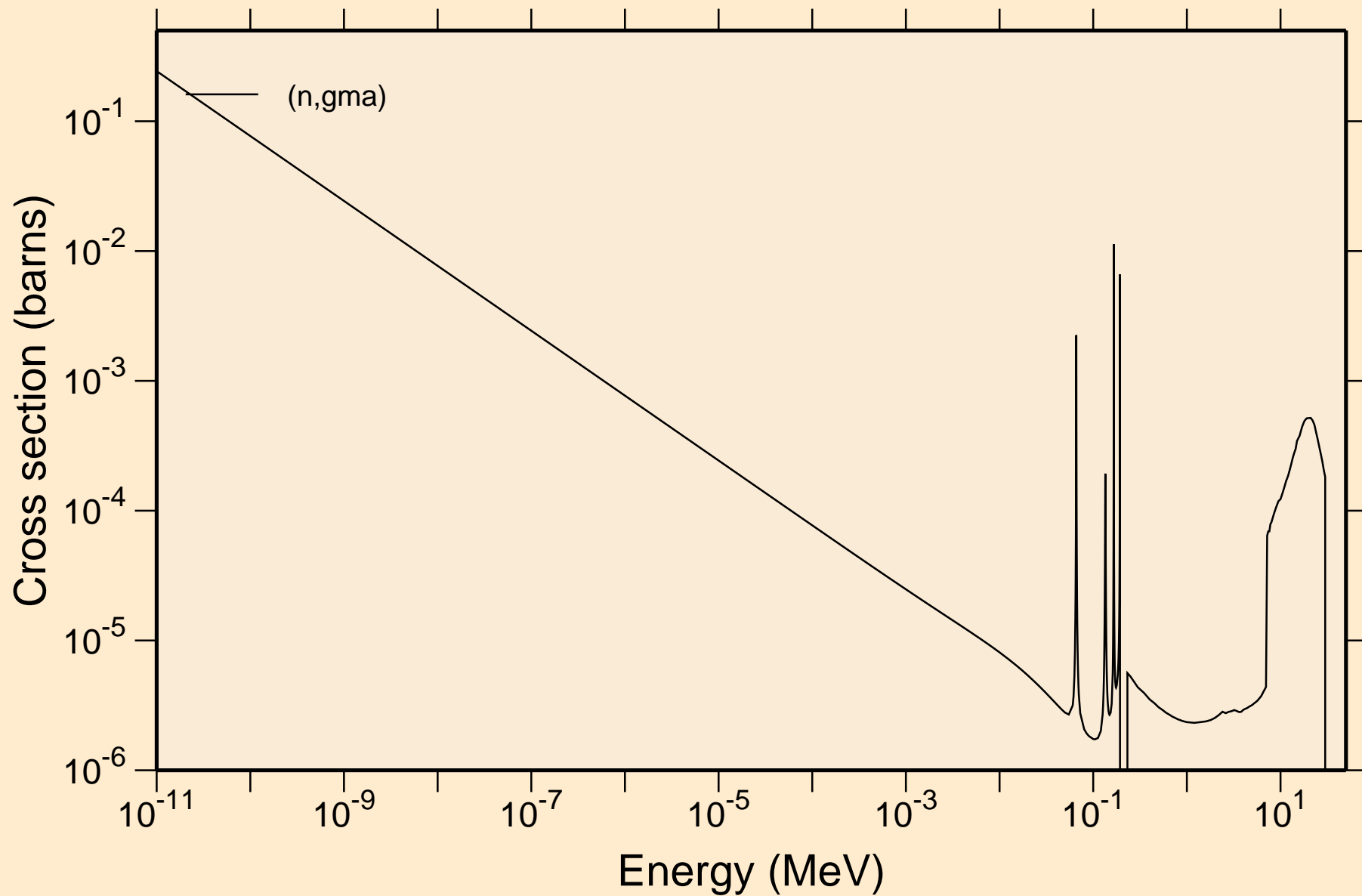

O019 NEUTRON ACER TENDL-2019 LIBRARY; T=293.16K
Principal cross sections

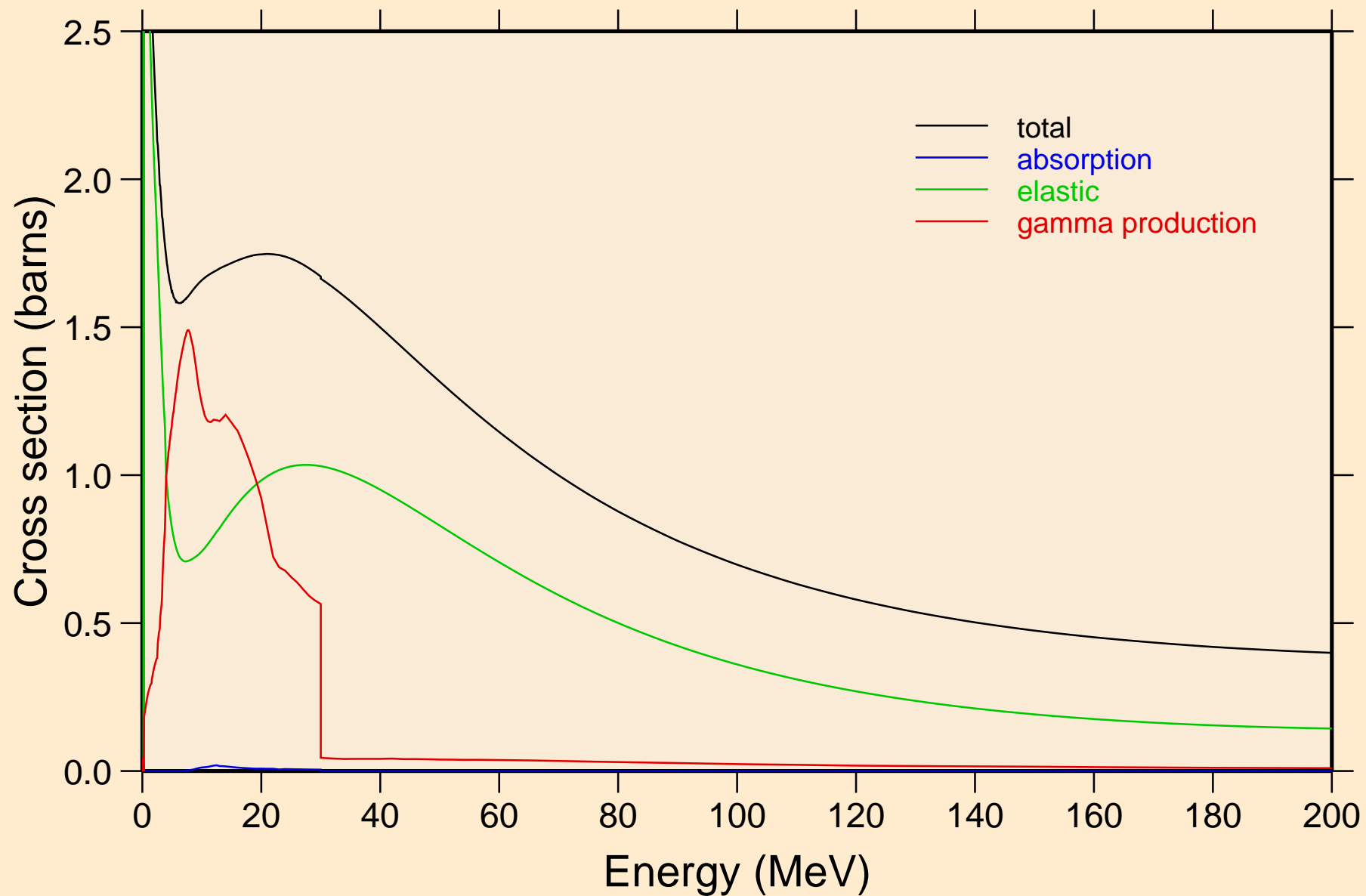

O019 NEUTRON ACER TENDL-2019 LIBRARY; T=293.16K
Heating

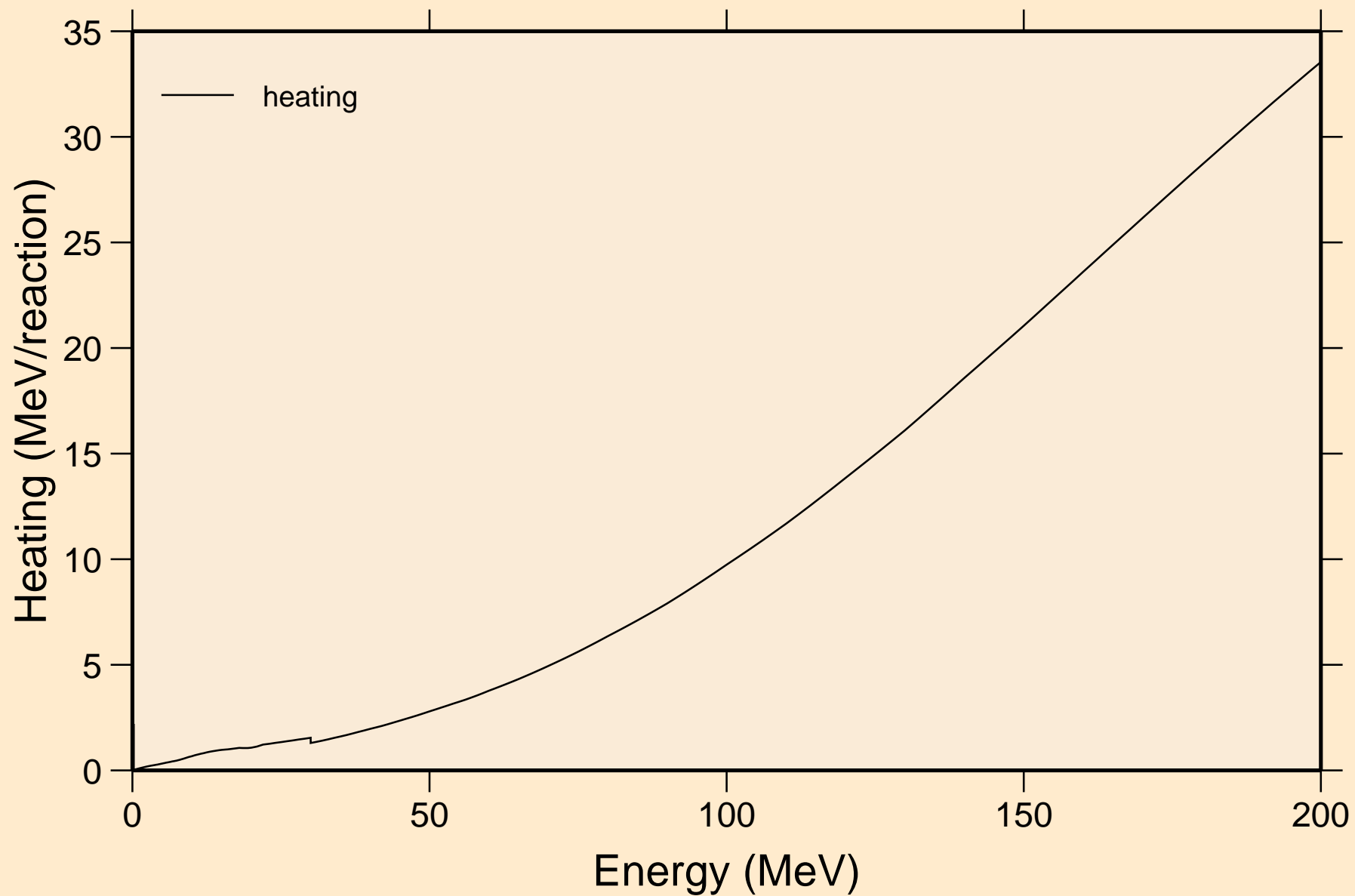

O019 NEUTRON ACER TENDL-2019 LIBRARY; T=293.16K
Damage

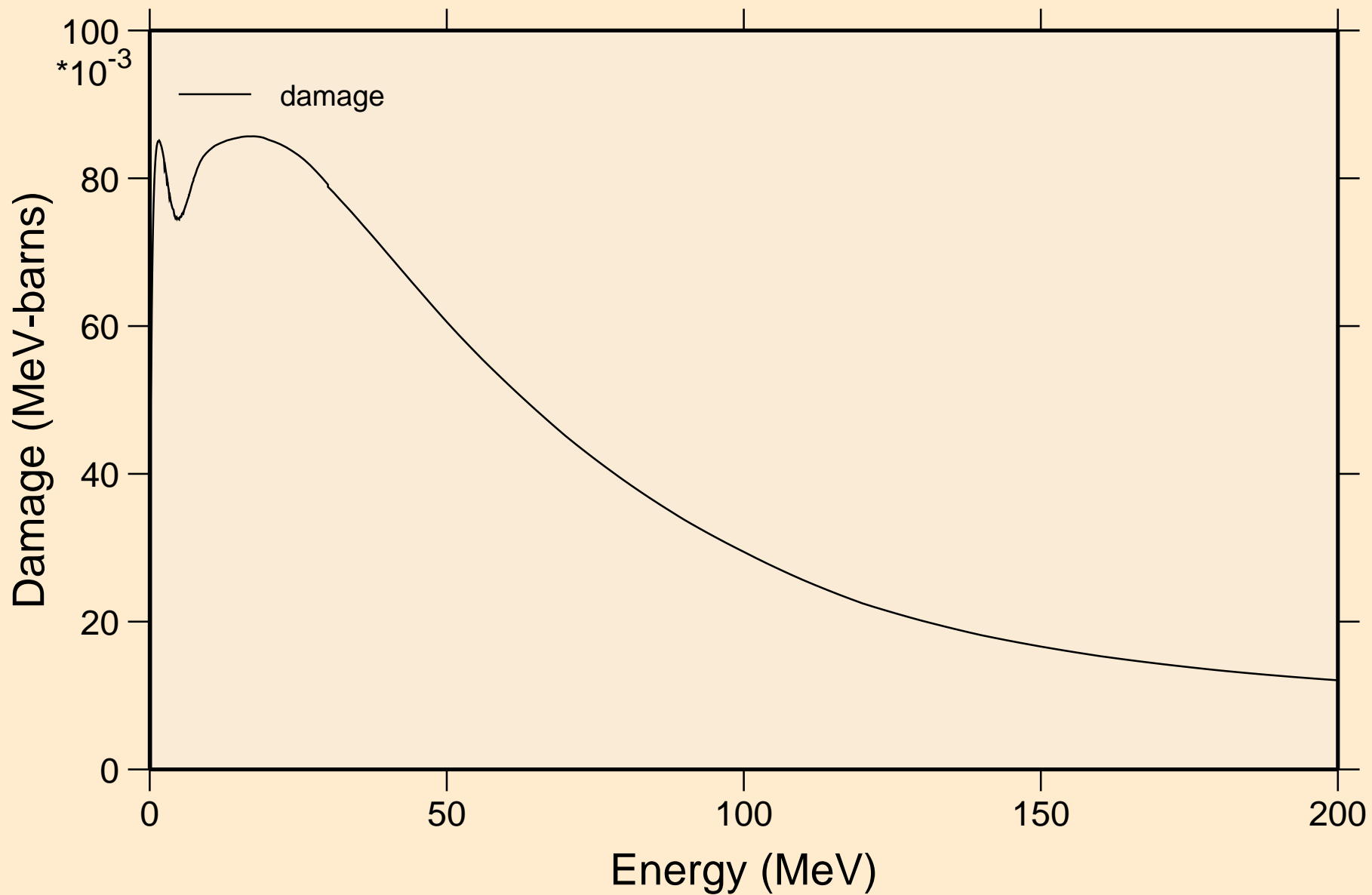

O019 NEUTRON ACER TENDL-2019 LIBRARY; T=293.16K
Non-threshold reactions

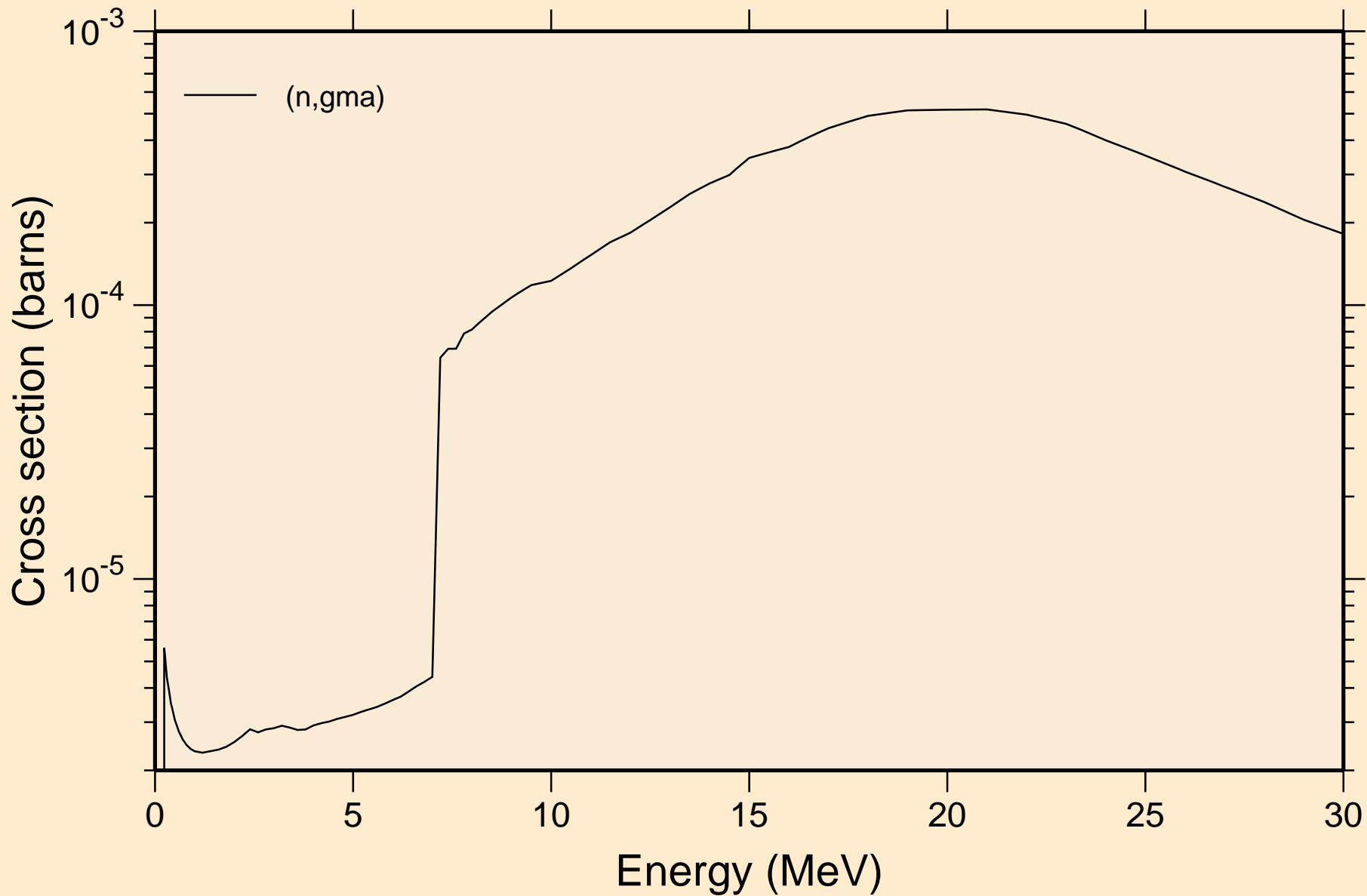

O019 NEUTRON ACER TENDL-2019 LIBRARY; T=293.16K
Inelastic levels

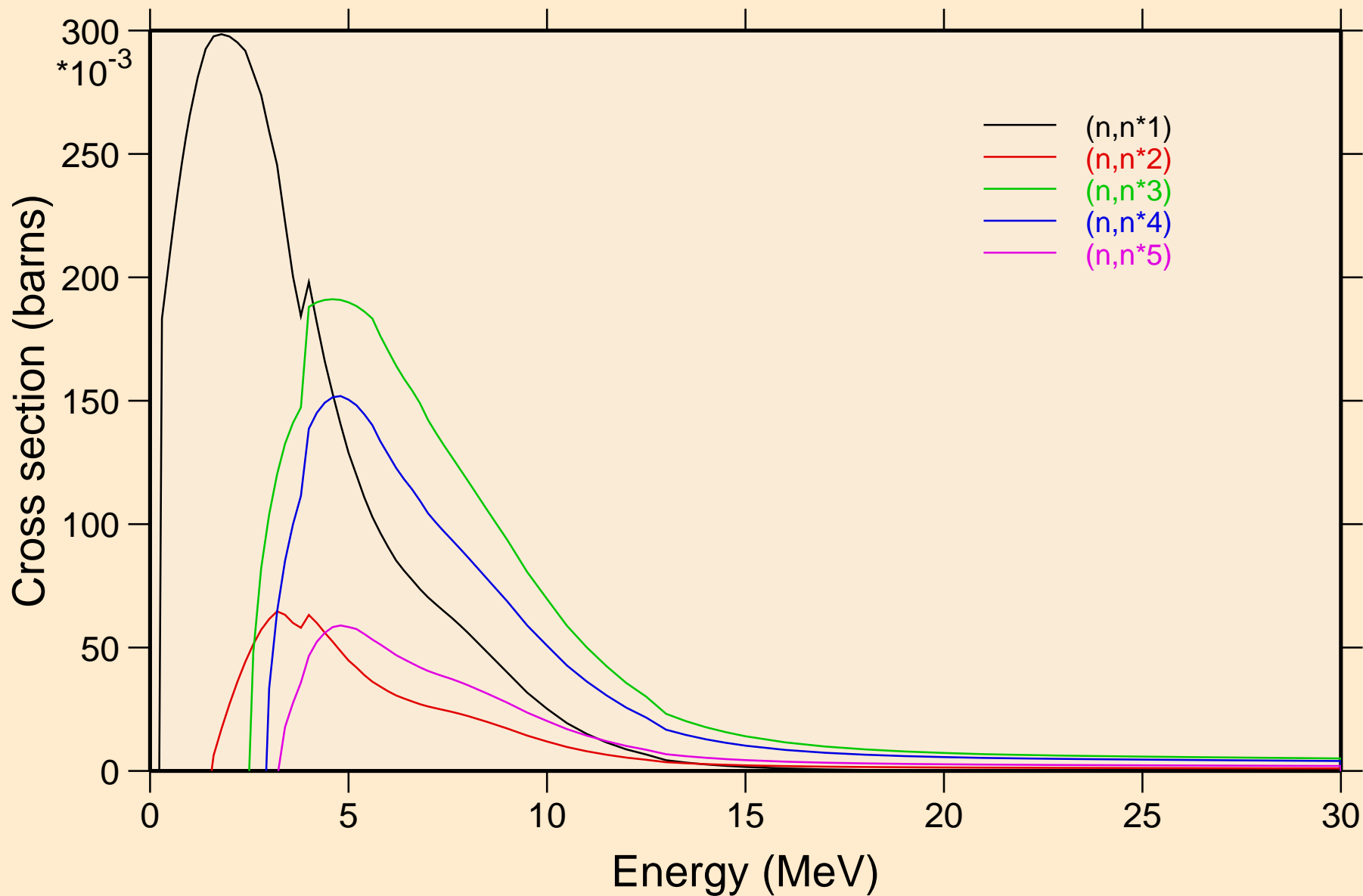

O019 NEUTRON ACER TENDL-2019 LIBRARY; T=293.16K
Inelastic levels

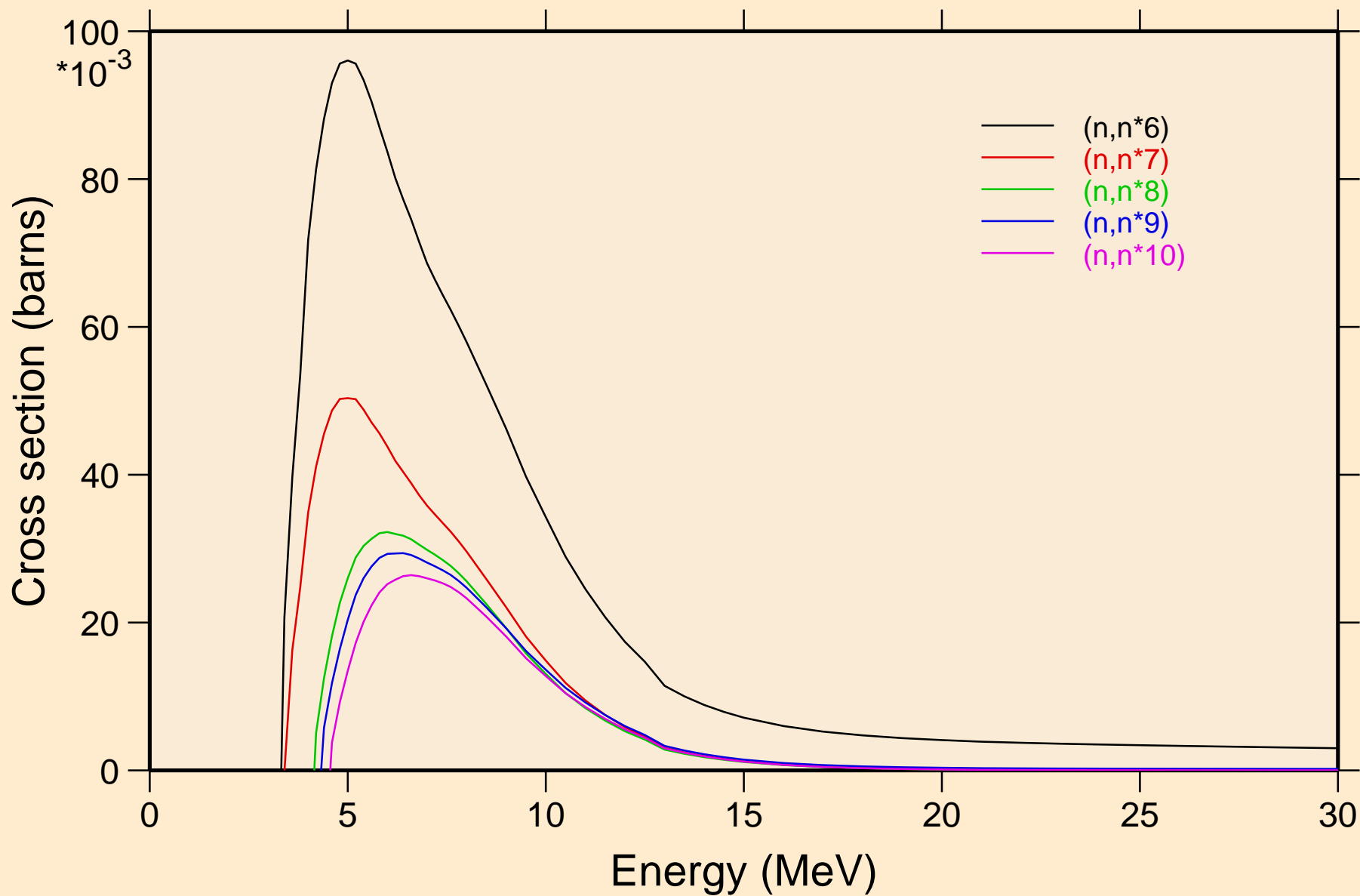

O019 NEUTRON ACER TENDL-2019 LIBRARY; T=293.16K
Inelastic levels

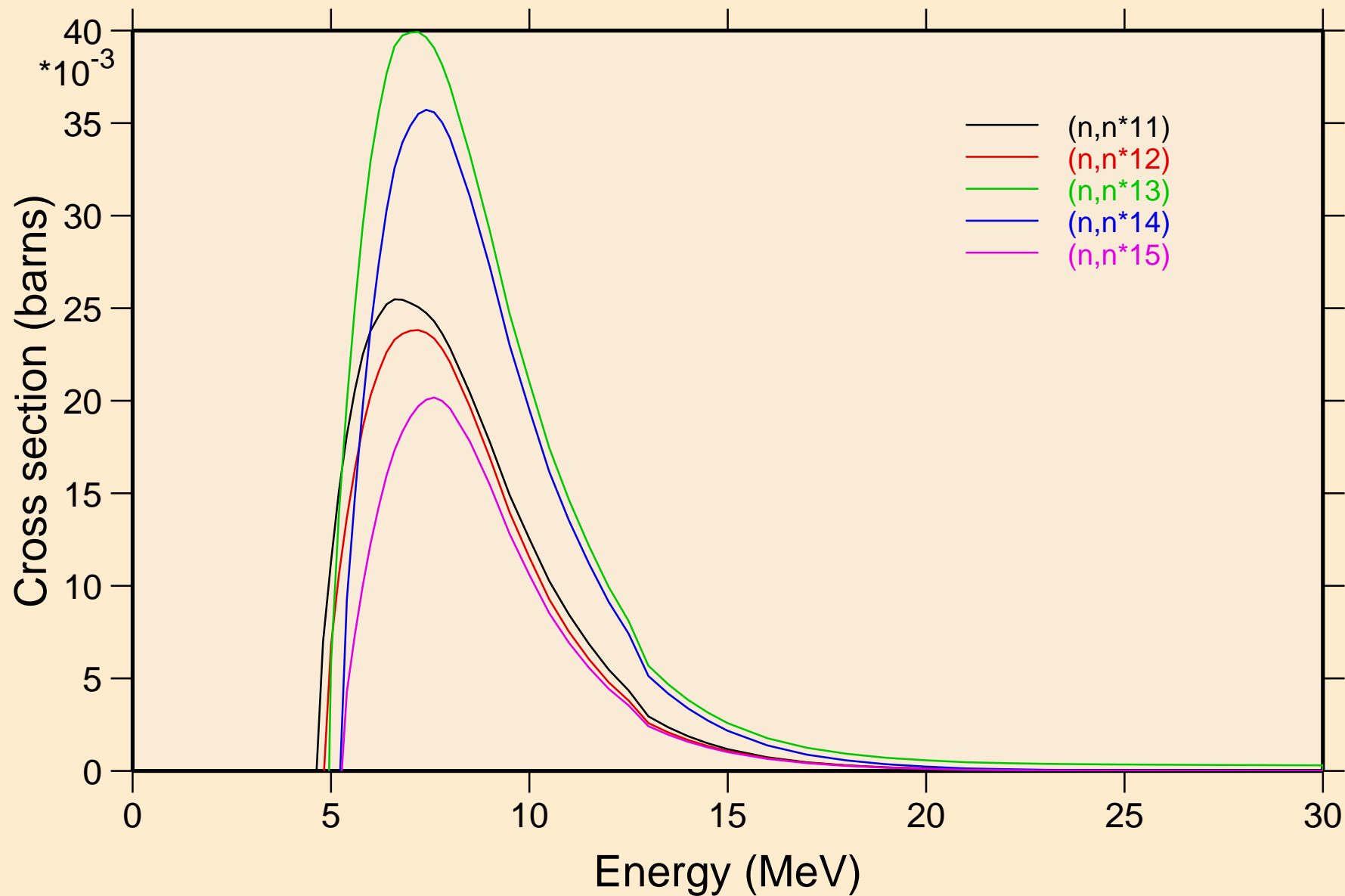

O019 NEUTRON ACER TENDL-2019 LIBRARY; T=293.16K
Inelastic levels

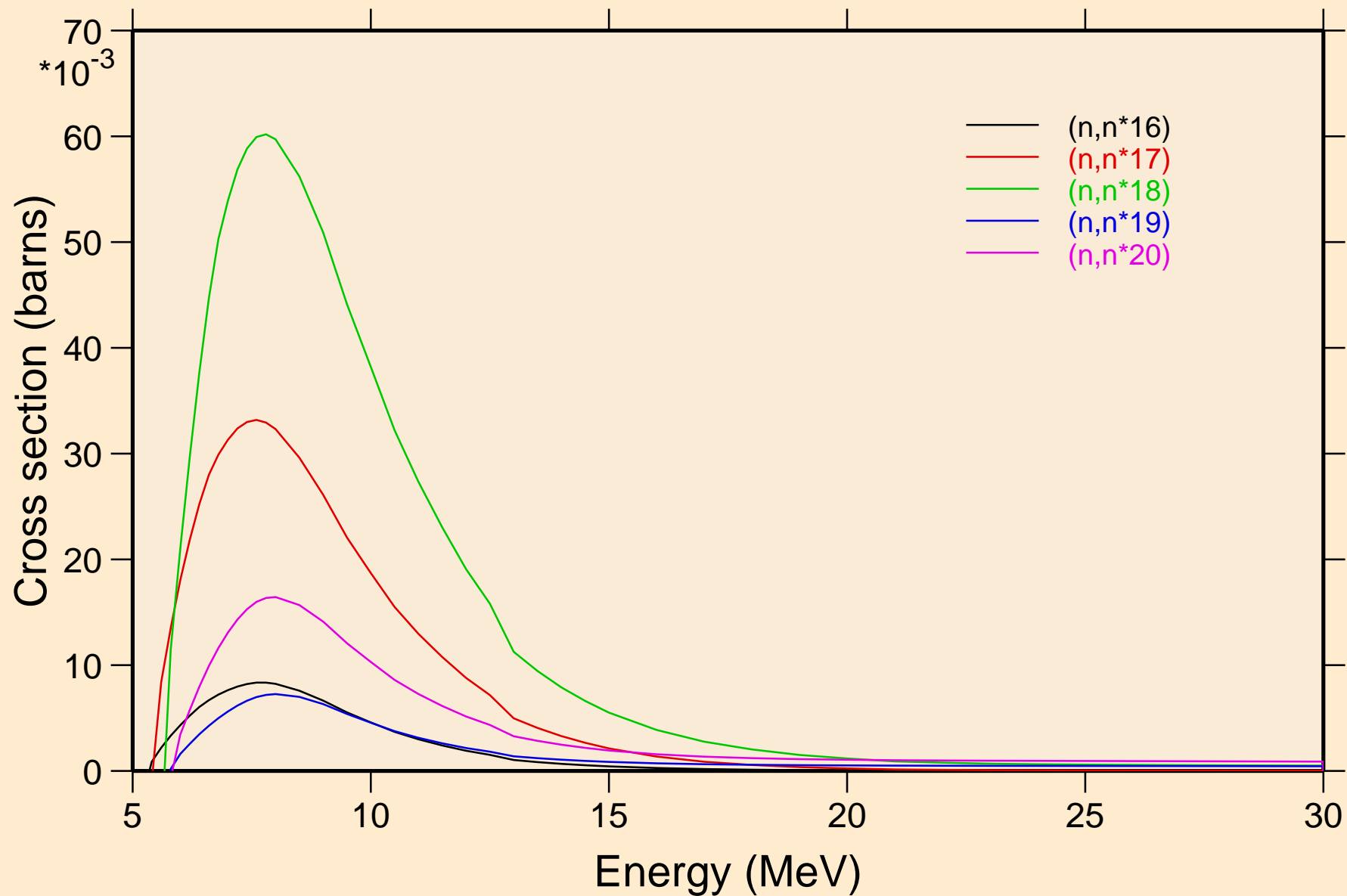

O019 NEUTRON ACER TENDL-2019 LIBRARY; T=293.16K
Inelastic levels

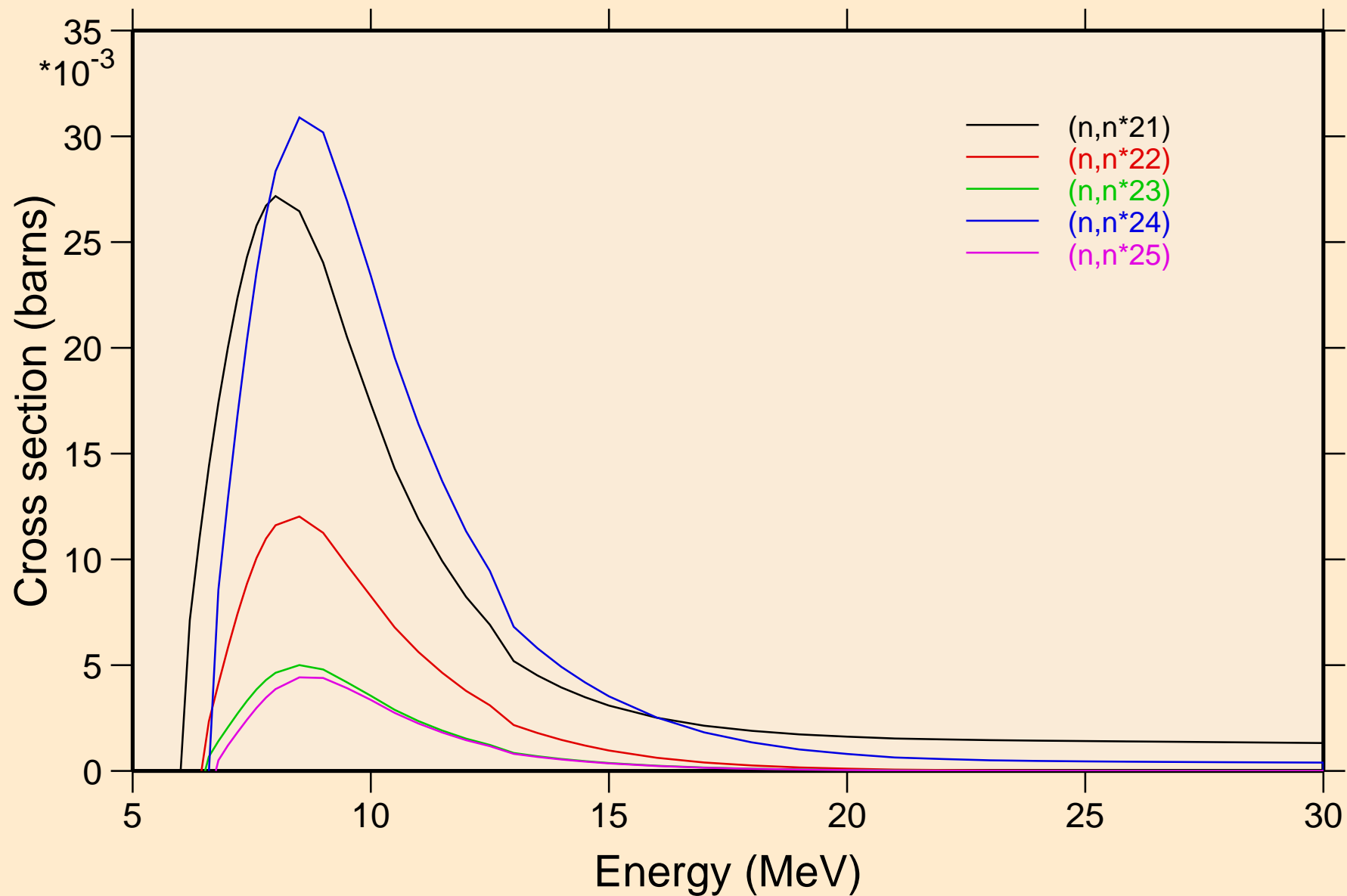

O019 NEUTRON ACER TENDL-2019 LIBRARY; T=293.16K
Inelastic levels

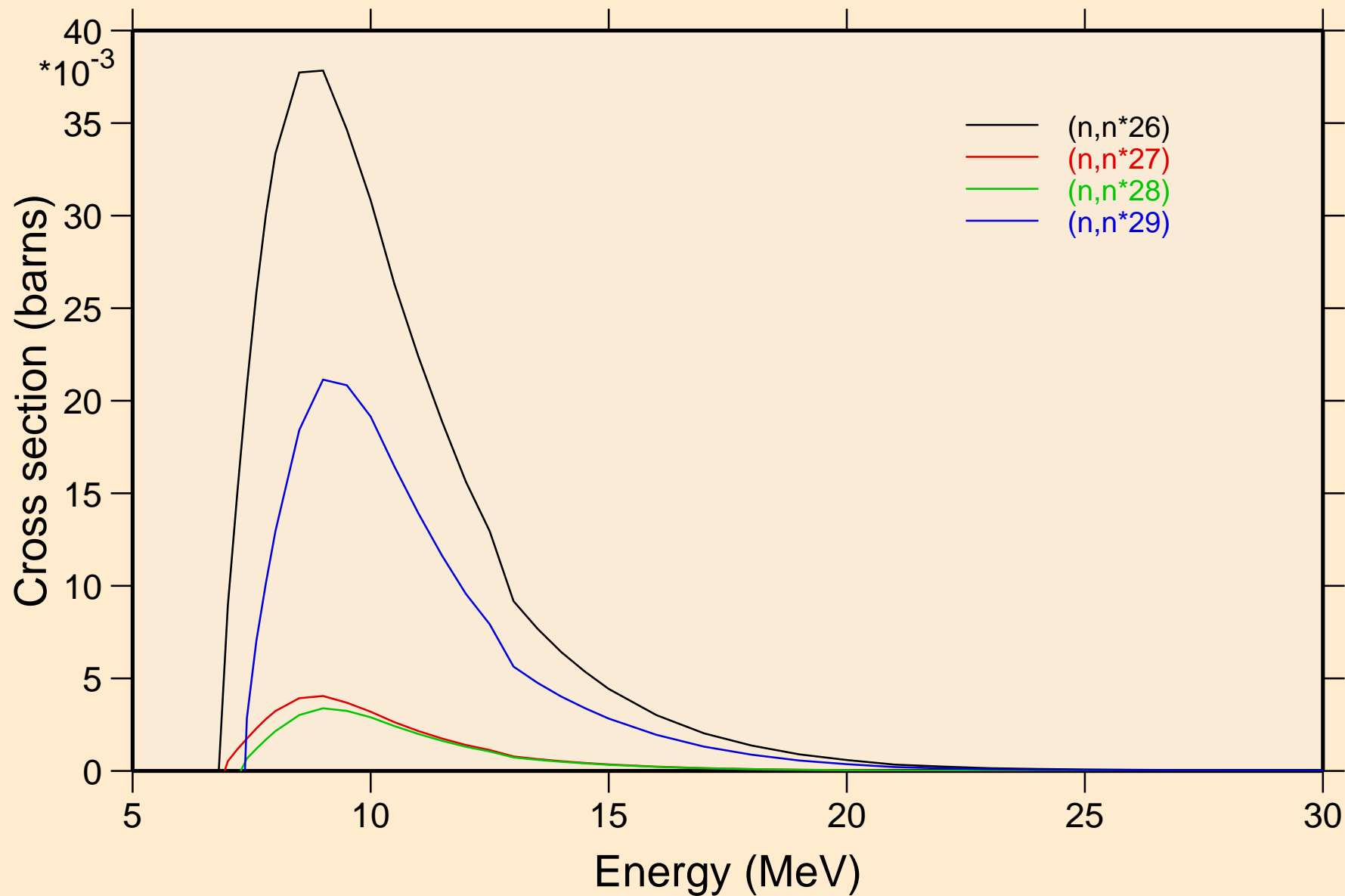

O019 NEUTRON ACER TENDL-2019 LIBRARY; T=293.16K
Threshold reactions

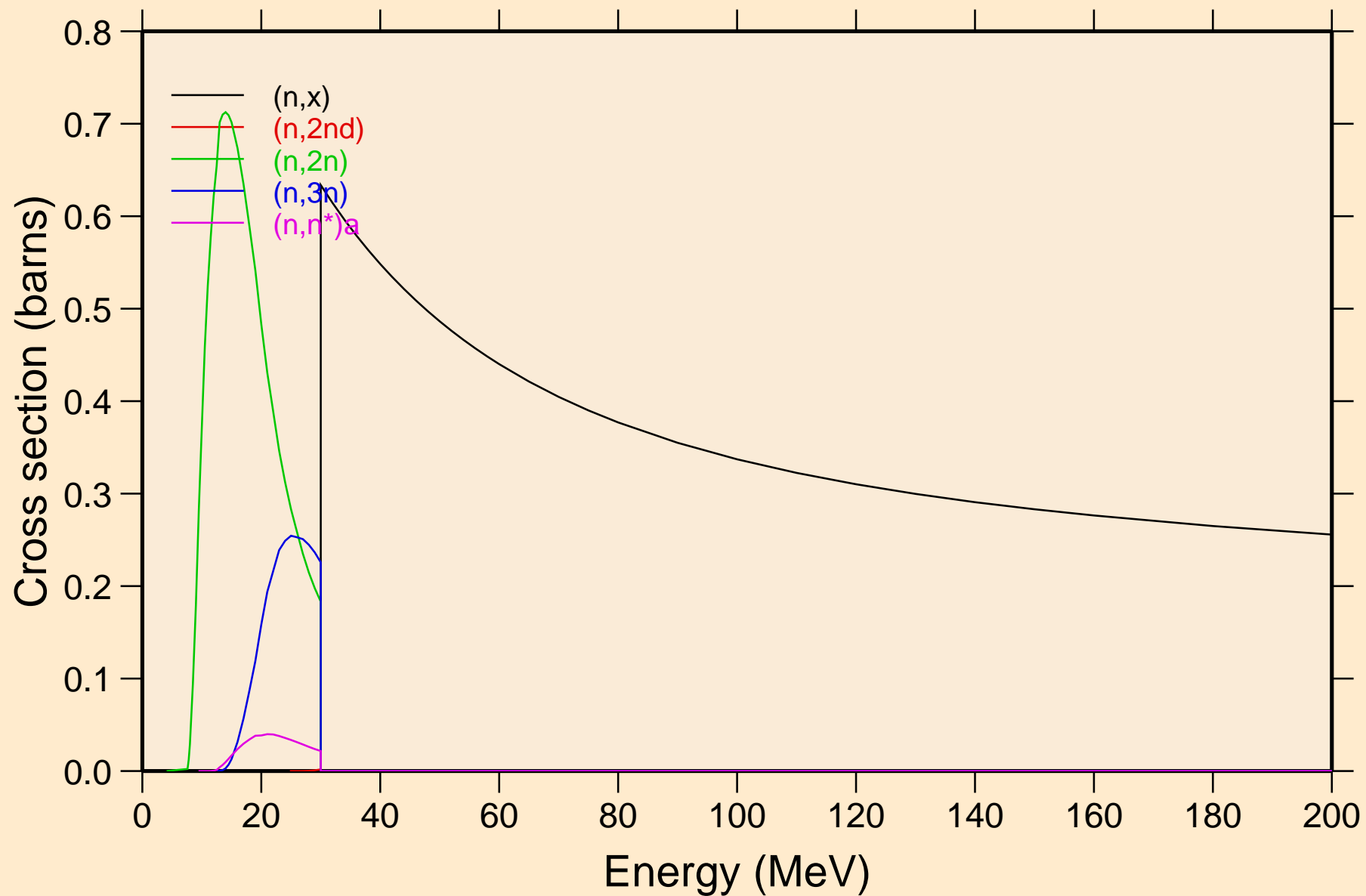

O019 NEUTRON ACER TENDL-2019 LIBRARY; T=293.16K
Threshold reactions

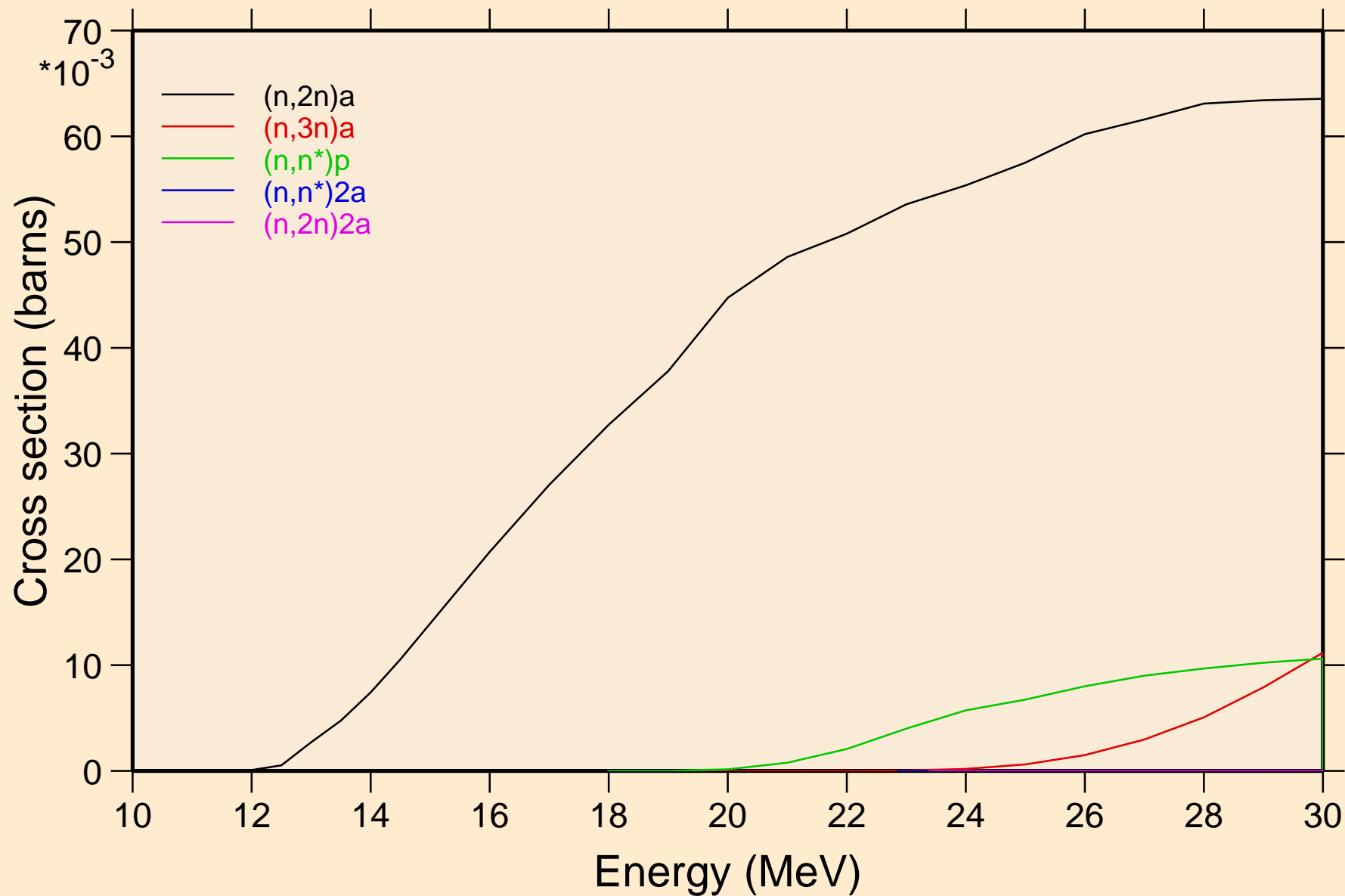

O019 NEUTRON ACER TENDL-2019 LIBRARY; T=293.16K
Threshold reactions

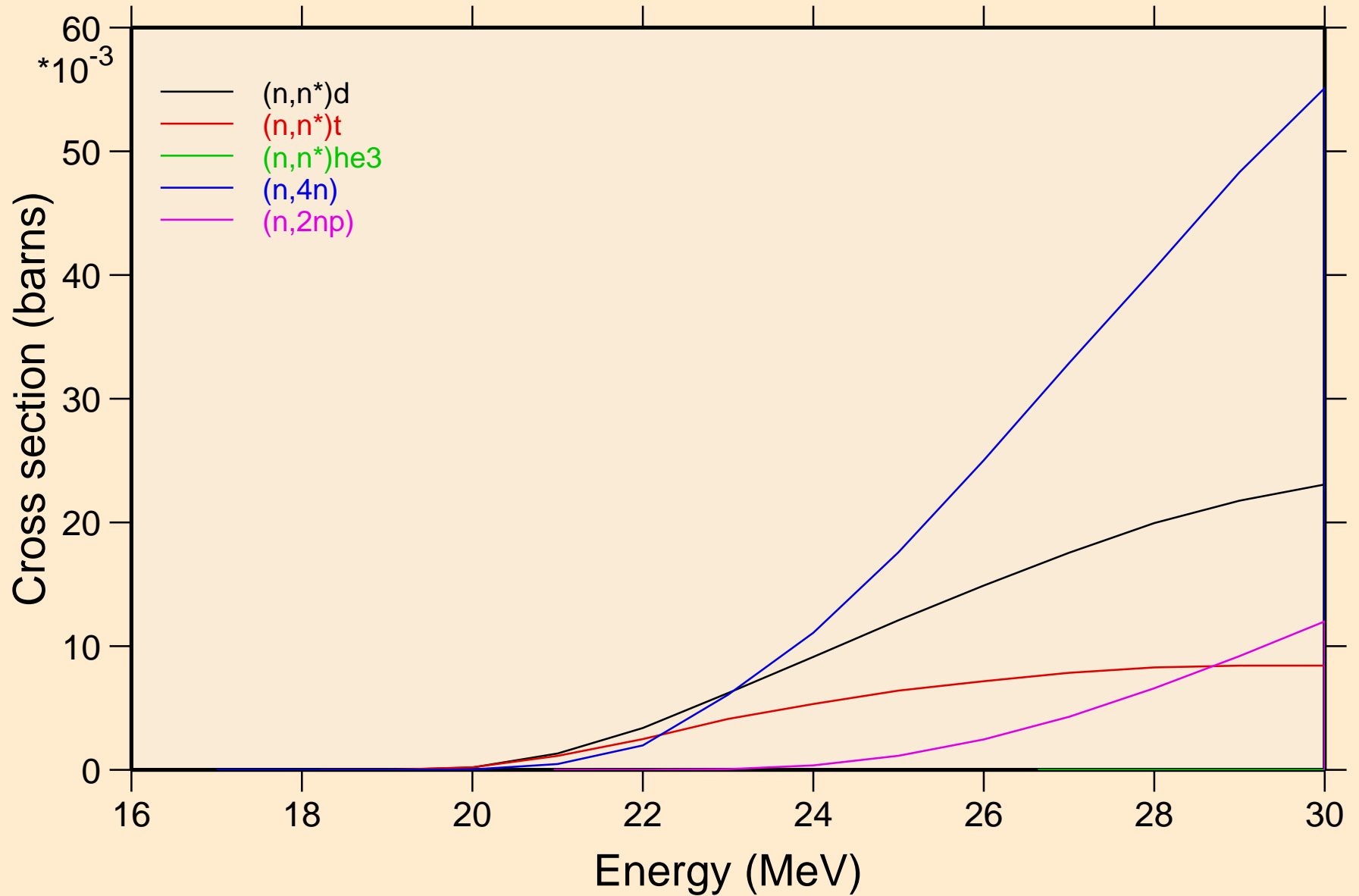

O019 NEUTRON ACER TENDL-2019 LIBRARY; T=293.16K
Threshold reactions

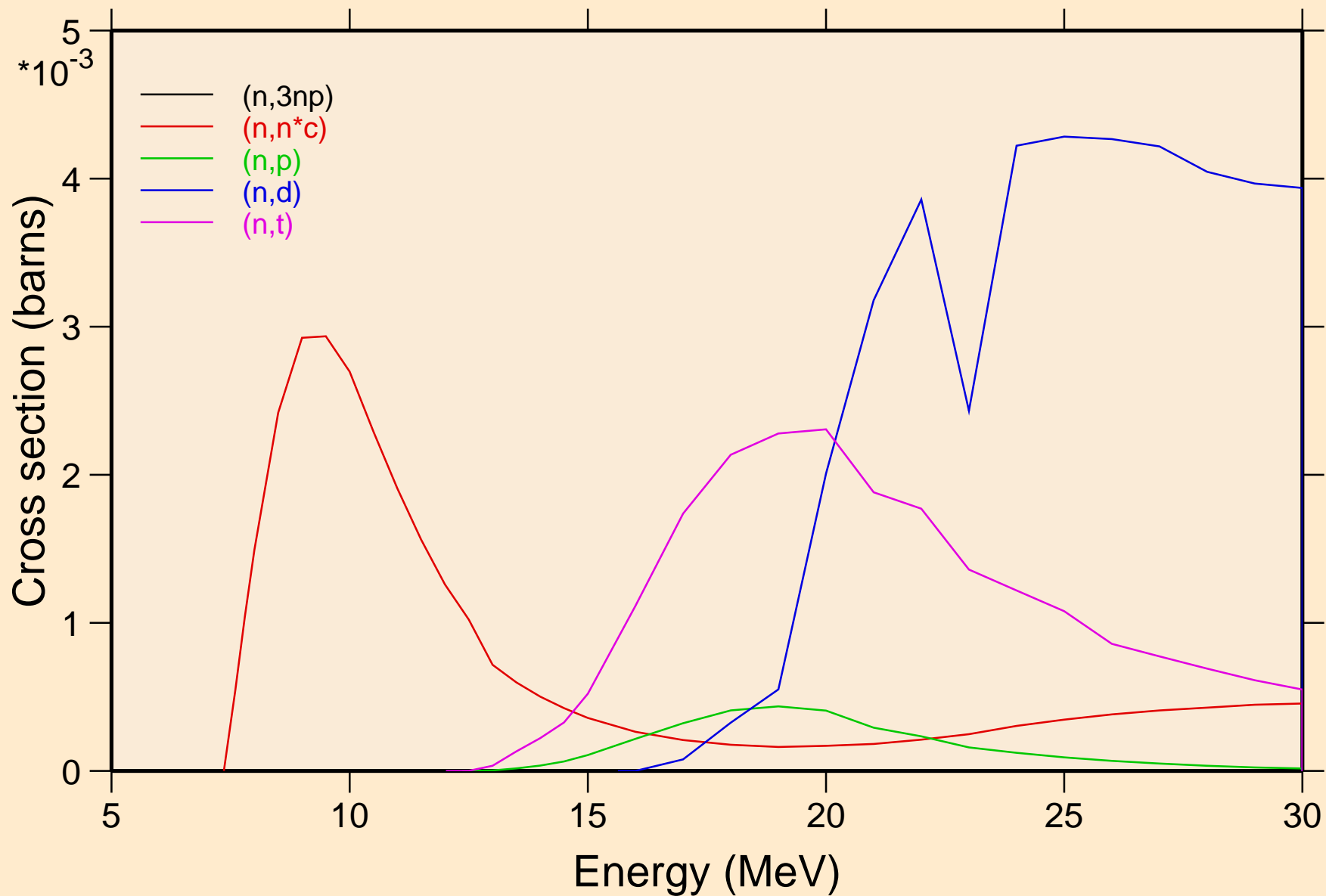

O019 NEUTRON ACER TENDL-2019 LIBRARY; T=293.16K
Threshold reactions

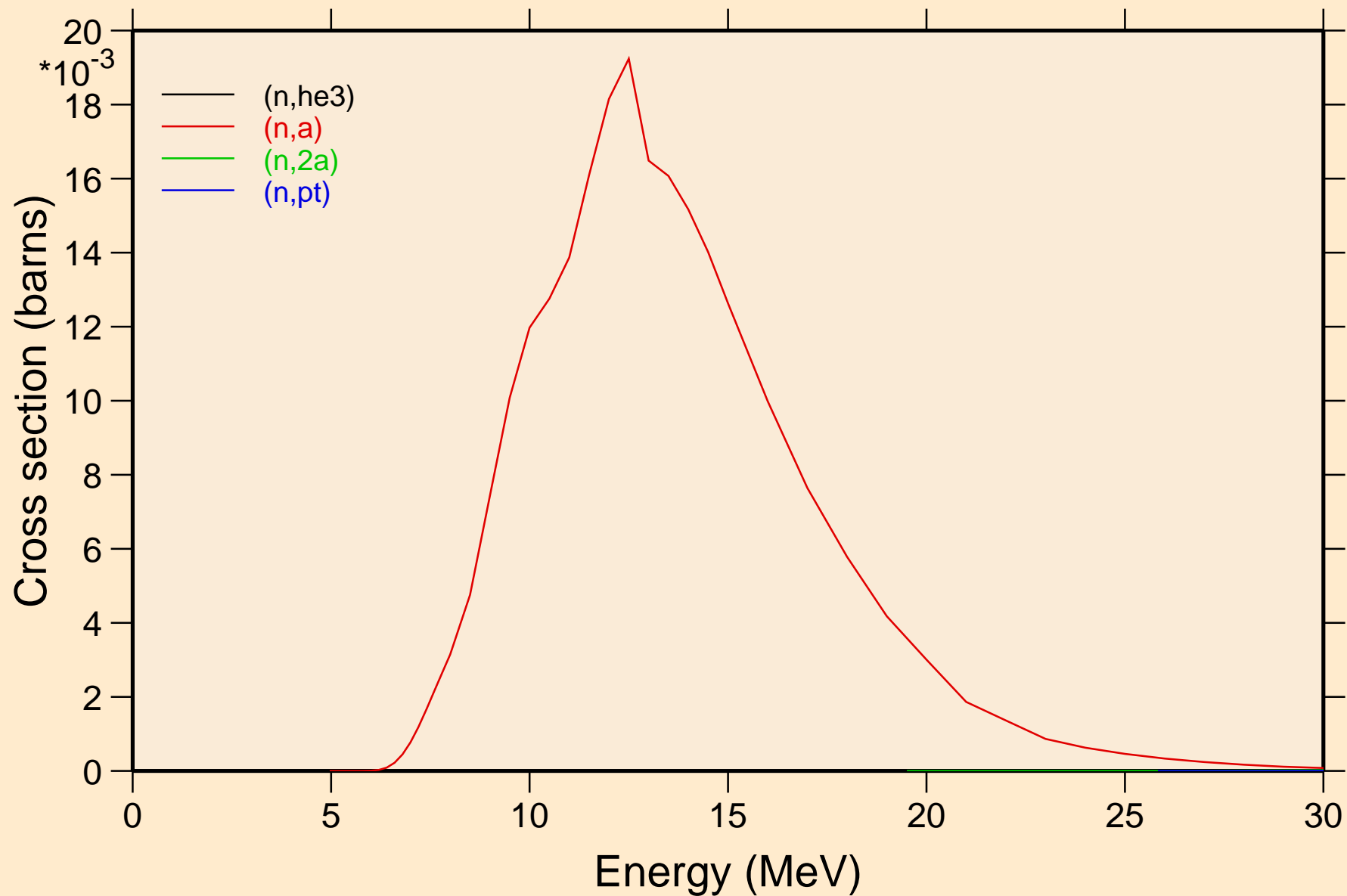

O019 NEUTRON ACER TENDL-2019 LIBRARY; T=293.16K

Threshold reactions

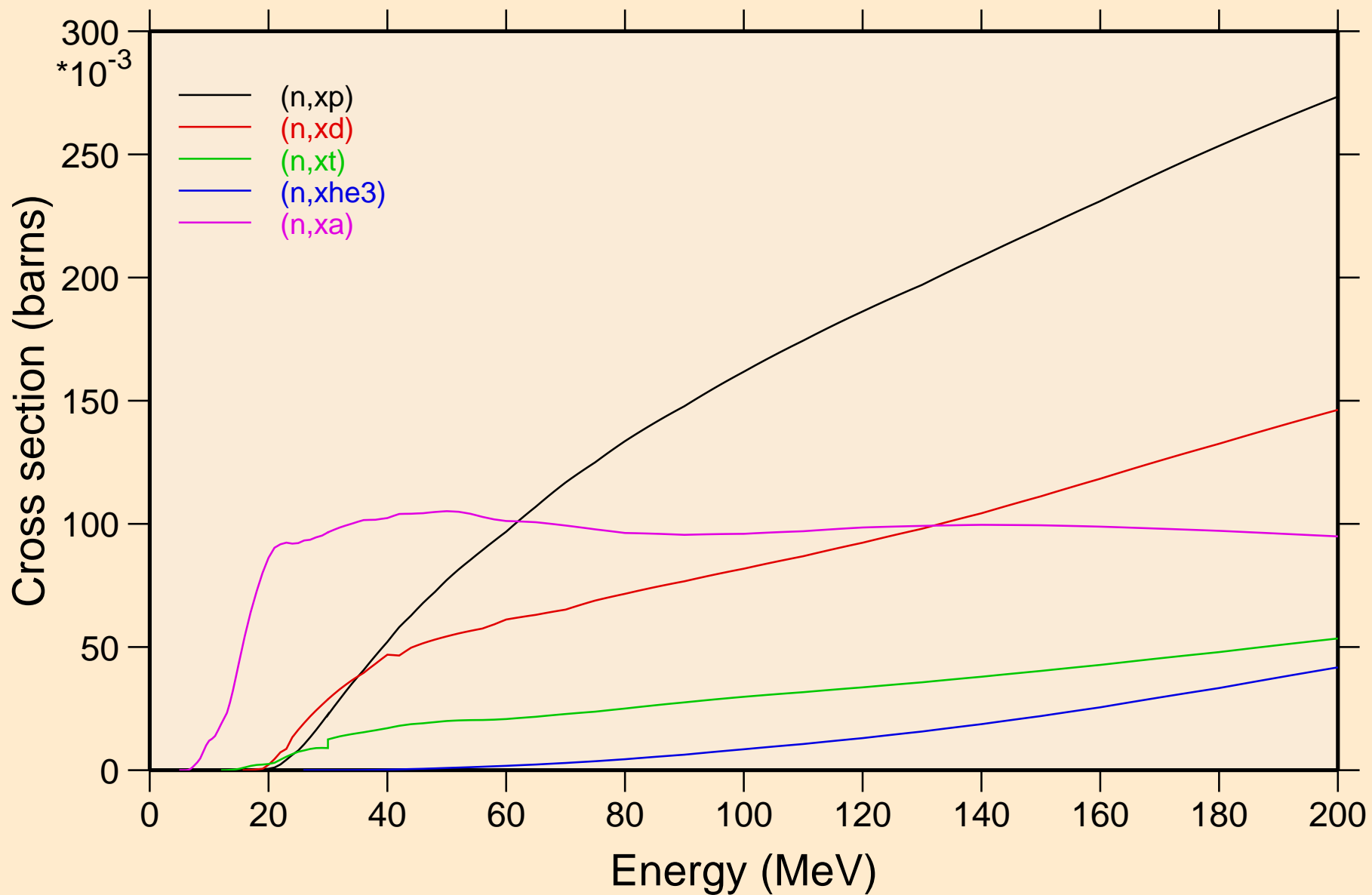

O019 NEUTRON ACER TENDL-2019 LIBRARY; T=293.16K
angular distribution for elastic

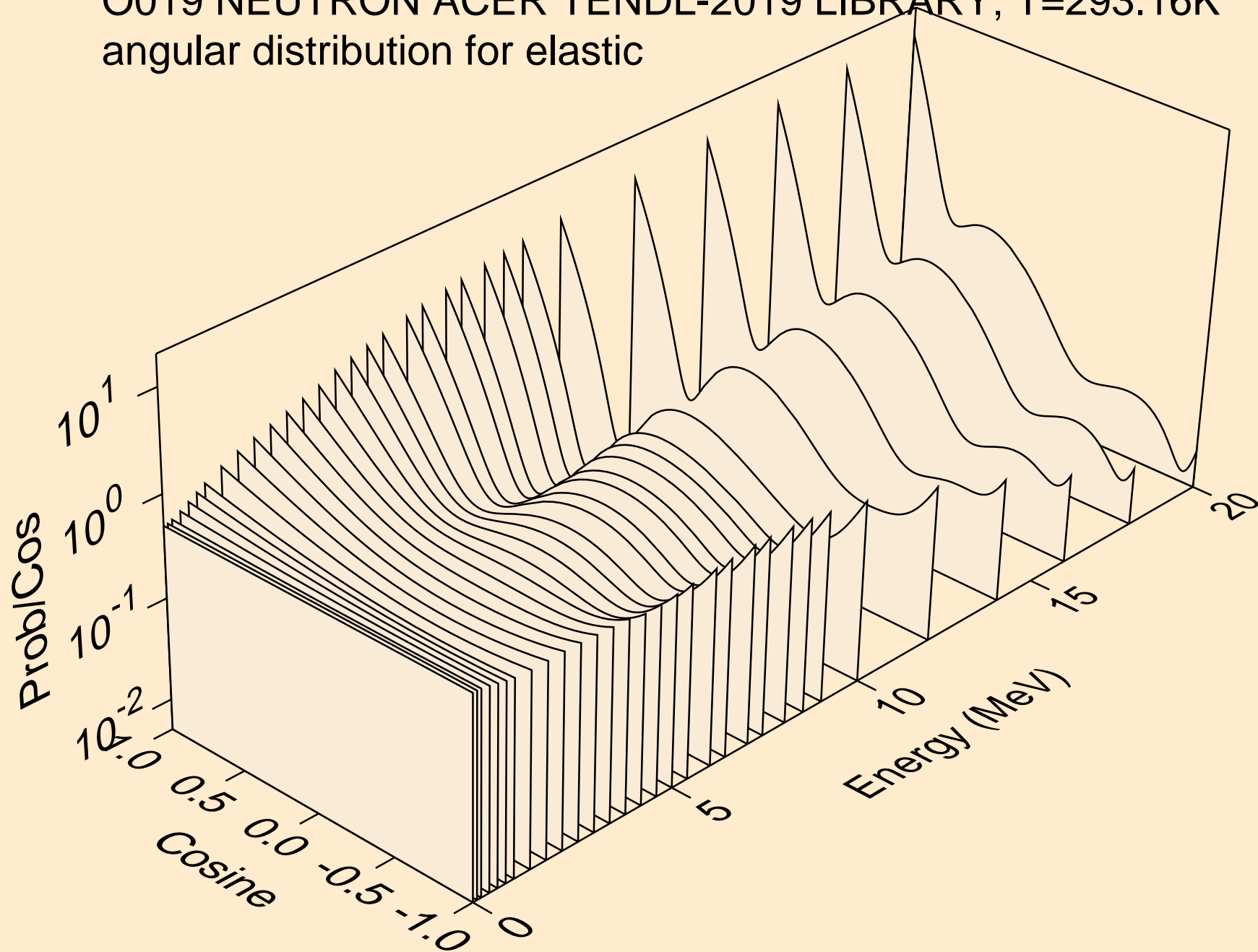

O019 NEUTRON ACER TENDL-2019 LIBRARY; T=293.16K
angular distribution for elastic

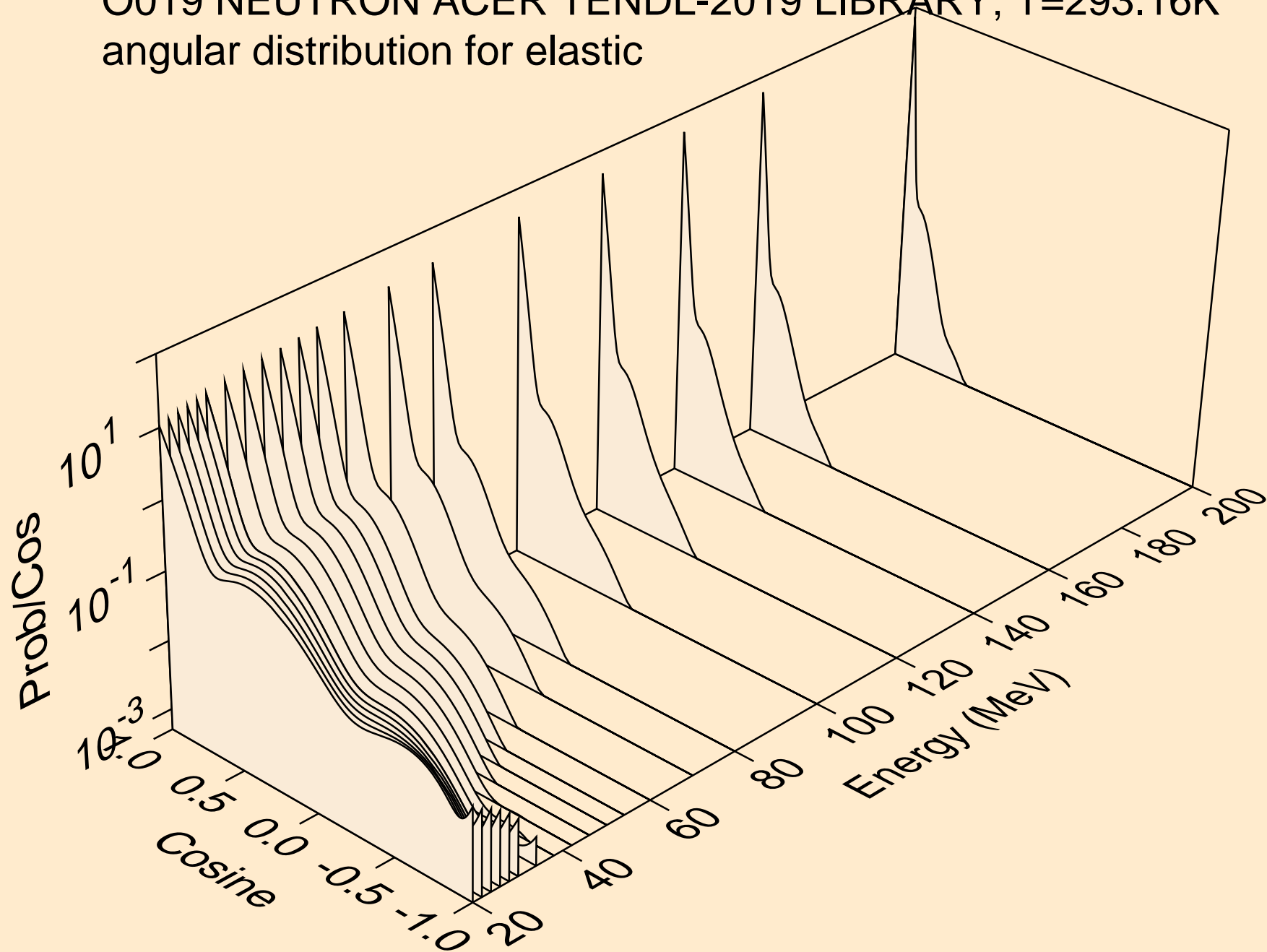

O019 NEUTRON ACER TENDL-2019 LIBRARY; T=293.16K
angular distribution for (n,n*1)

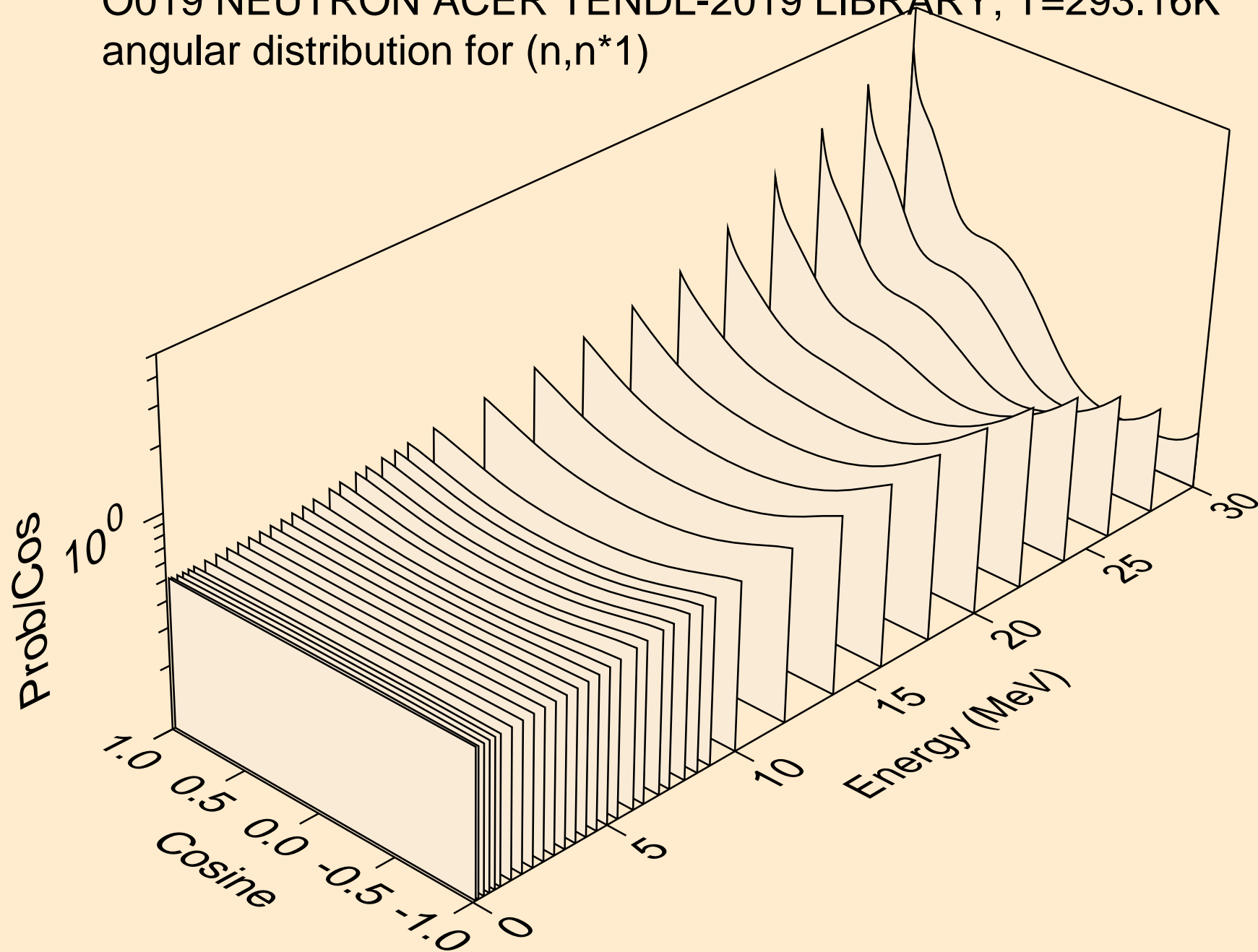

O019 NEUTRON ACER TENDL-2019 LIBRARY; T=293.16K
angular distribution for (n,n*2)

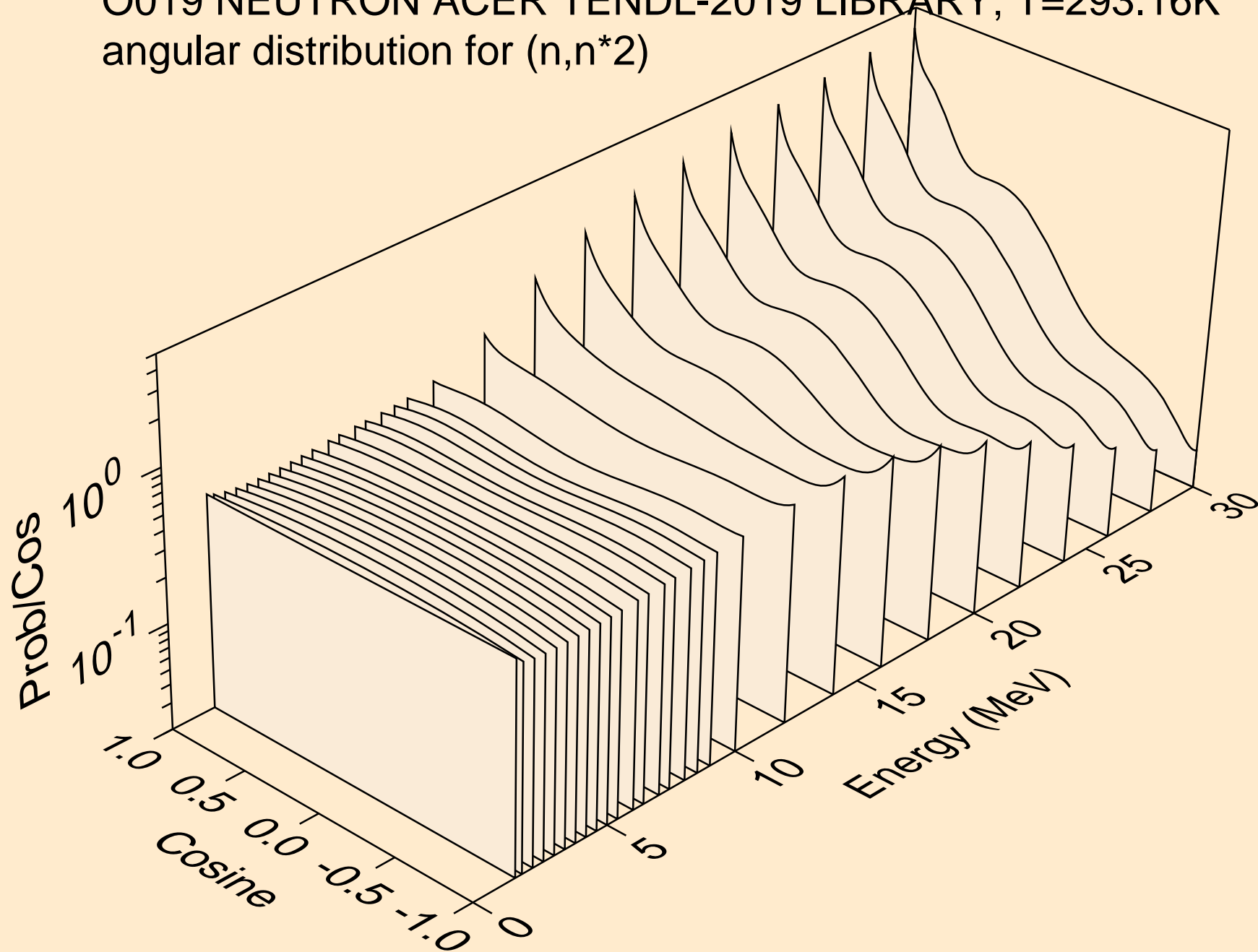

O019 NEUTRON ACER TENDL-2019 LIBRARY; T=293.16K
angular distribution for (n,n*3)

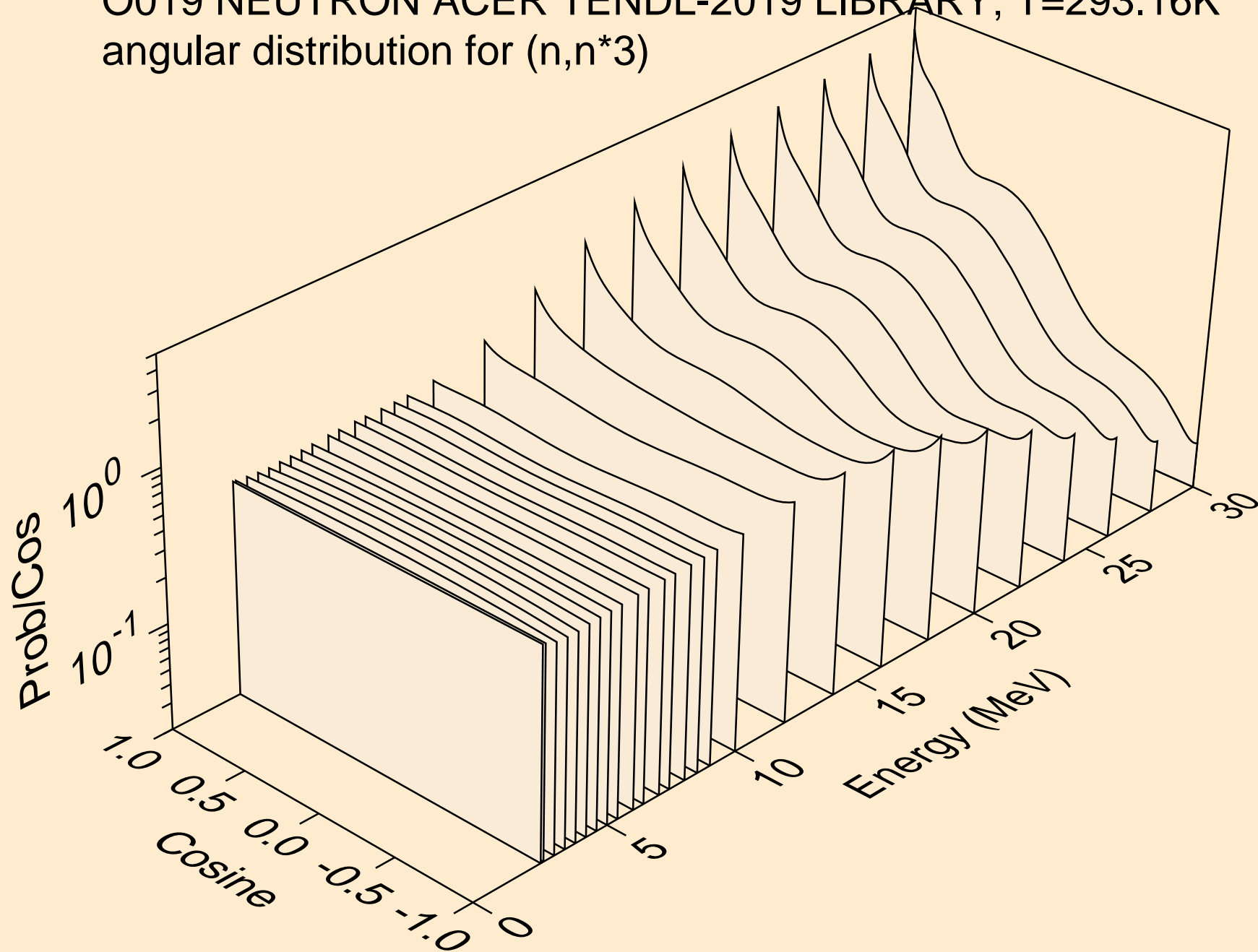

O019 NEUTRON ACER TENDL-2019 LIBRARY; T=293.16K
angular distribution for (n,n*4)

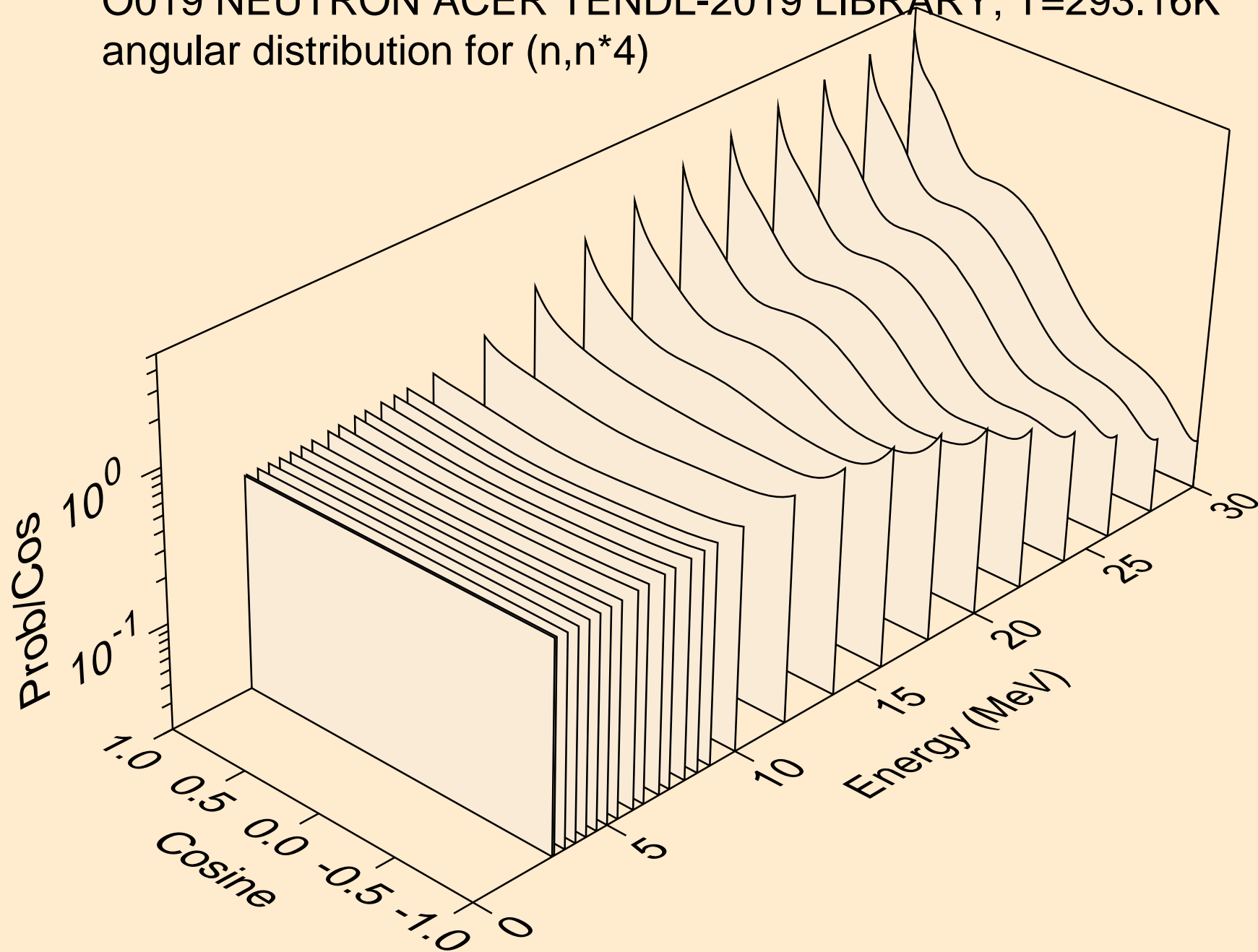

O019 NEUTRON ACER TENDL-2019 LIBRARY; T=293.16K
angular distribution for (n,n*5)

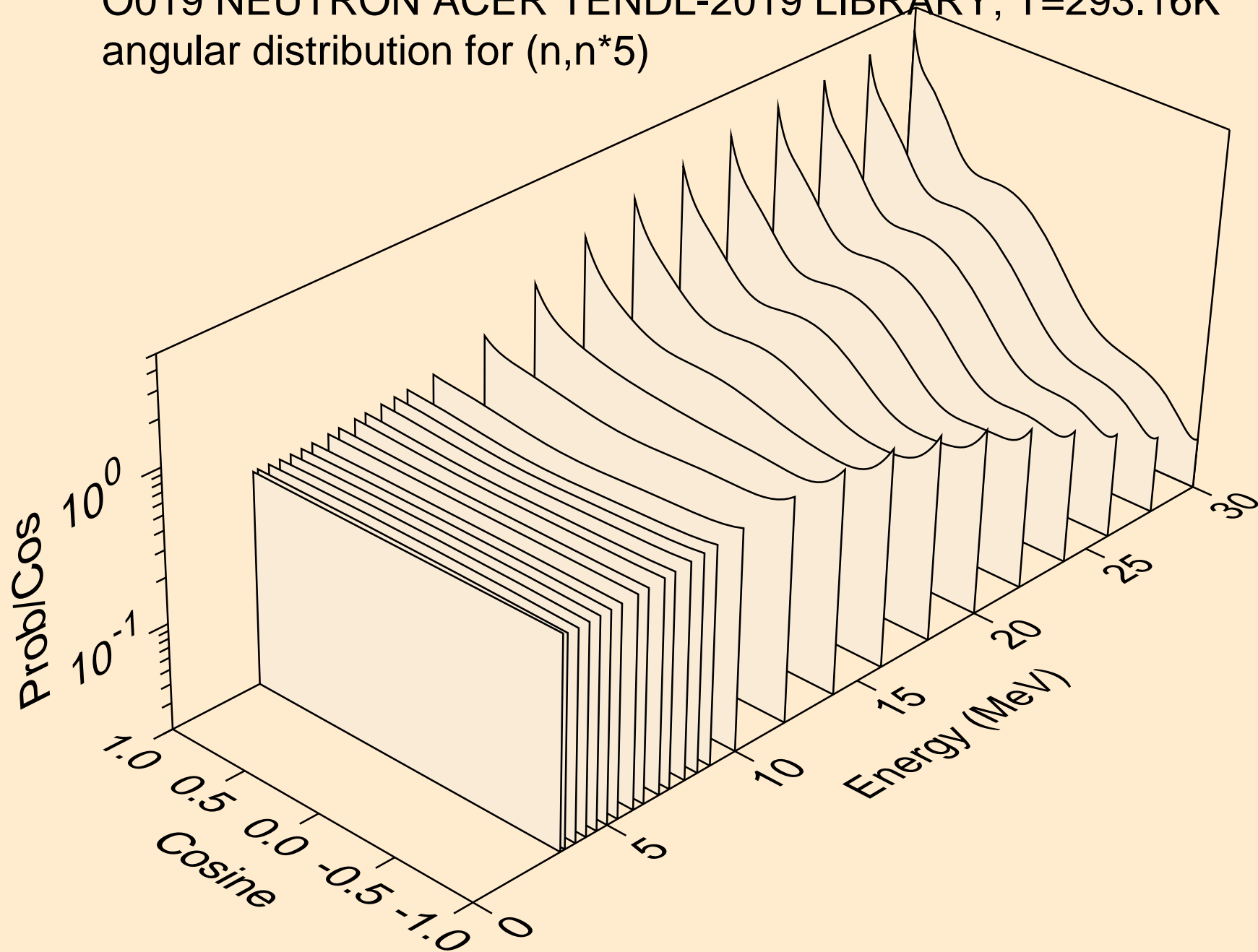

O019 NEUTRON ACER TENDL-2019 LIBRARY; T=293.16K
angular distribution for (n,n*6)

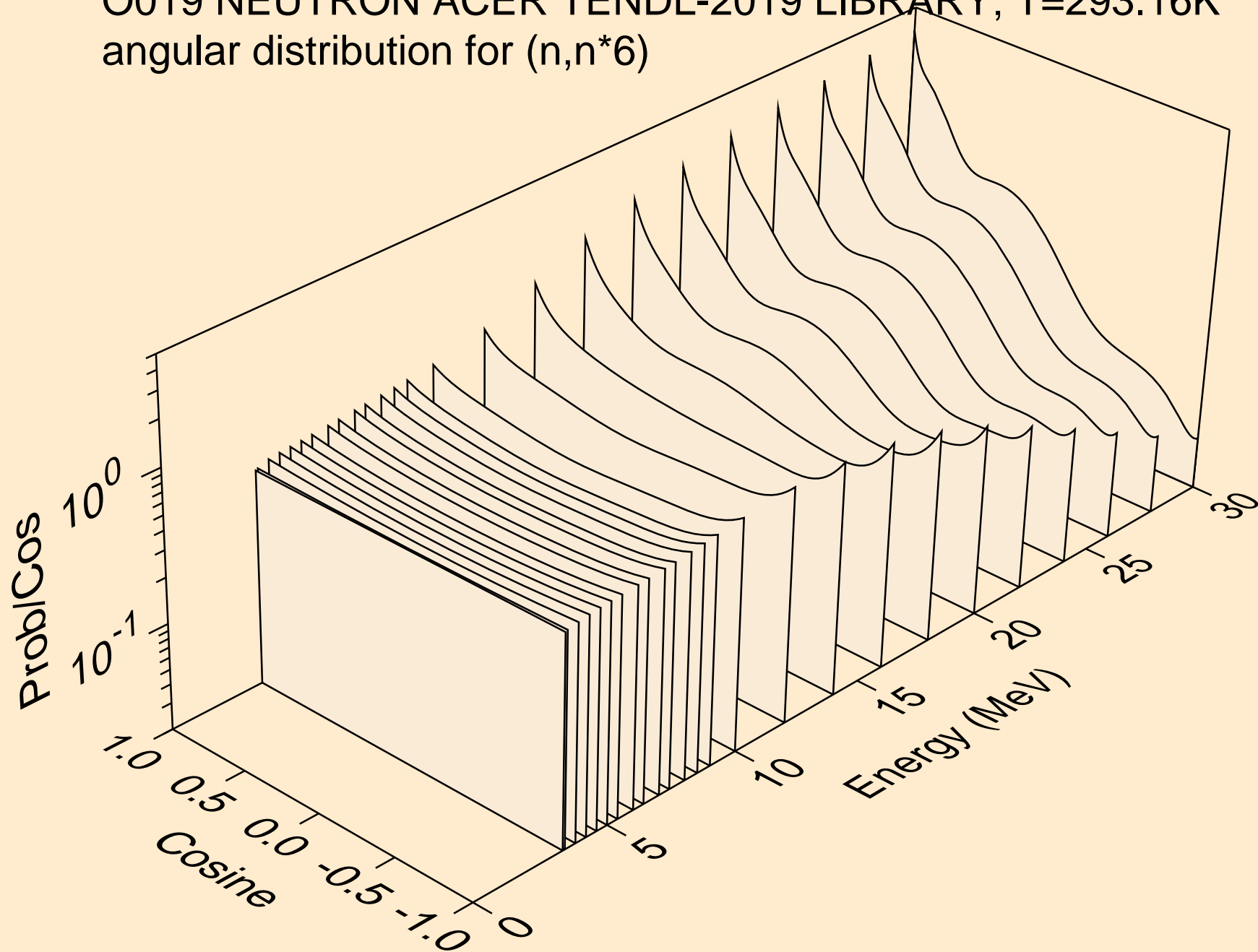

O019 NEUTRON ACER TENDL-2019 LIBRARY; T=293.16K
angular distribution for (n,n*7)

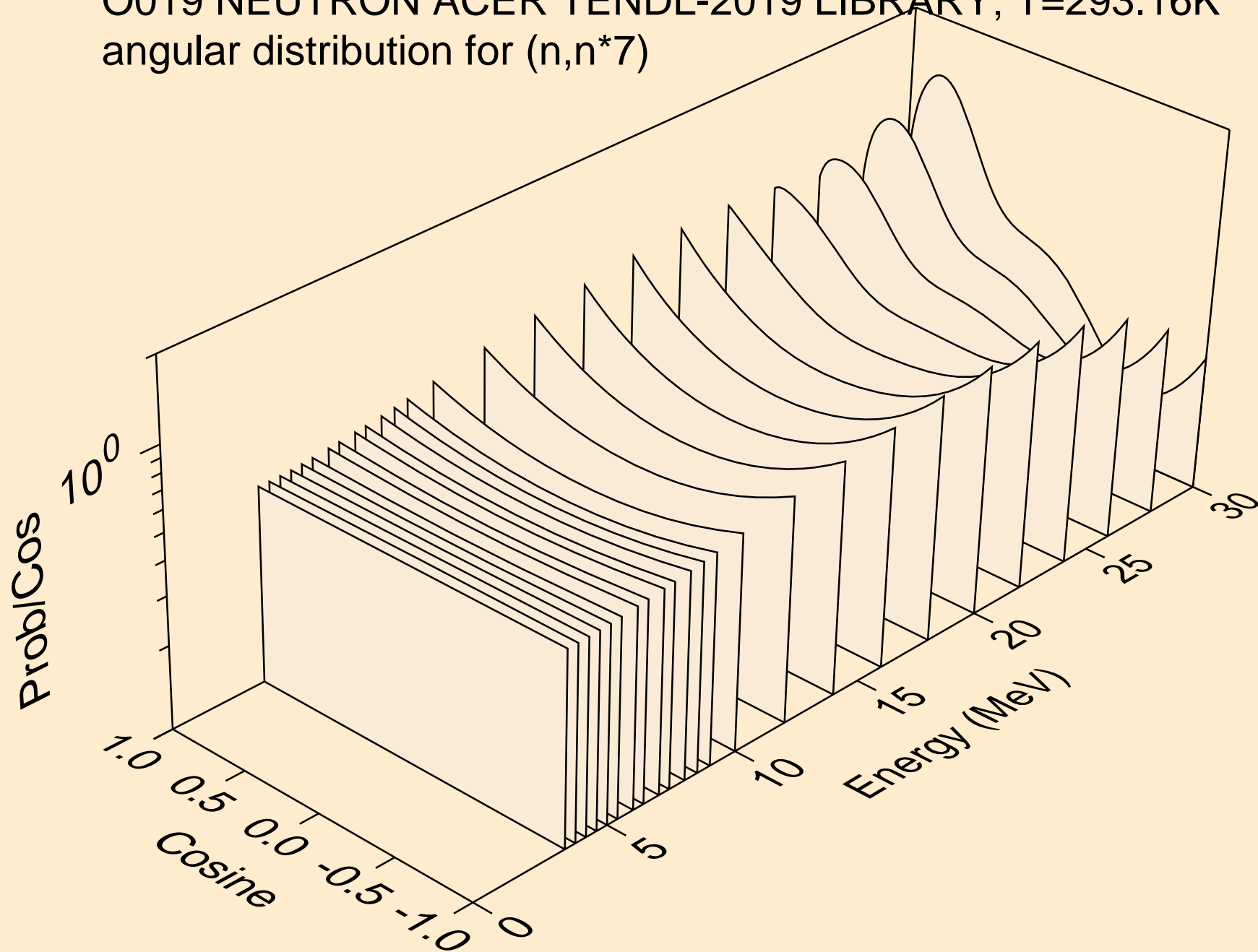

O019 NEUTRON ACER TENDL-2019 LIBRARY; T=293.16K
angular distribution for (n,n*8)

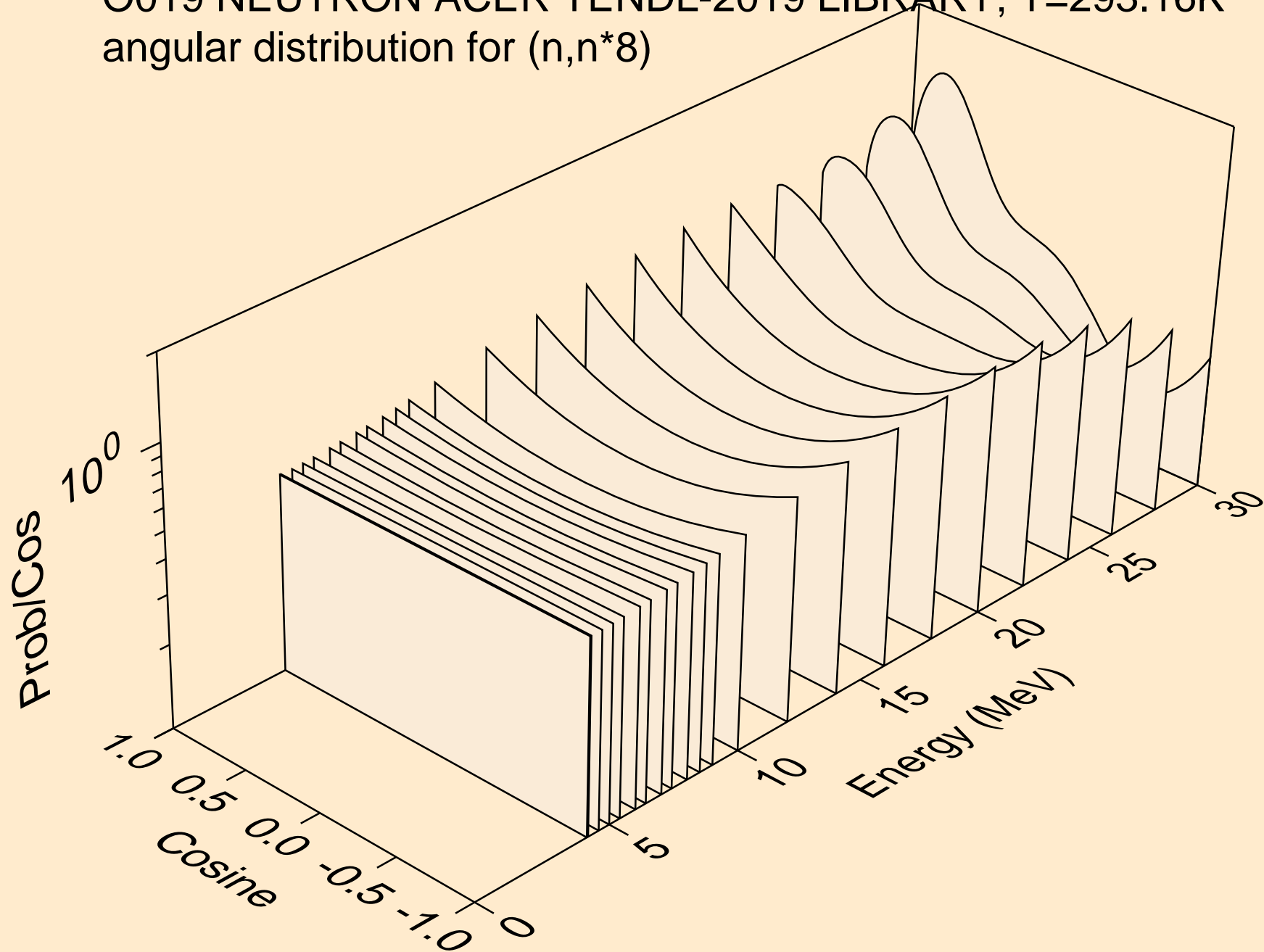

O019 NEUTRON ACER TENDL-2019 LIBRARY; T=293.16K
angular distribution for (n,n*9)

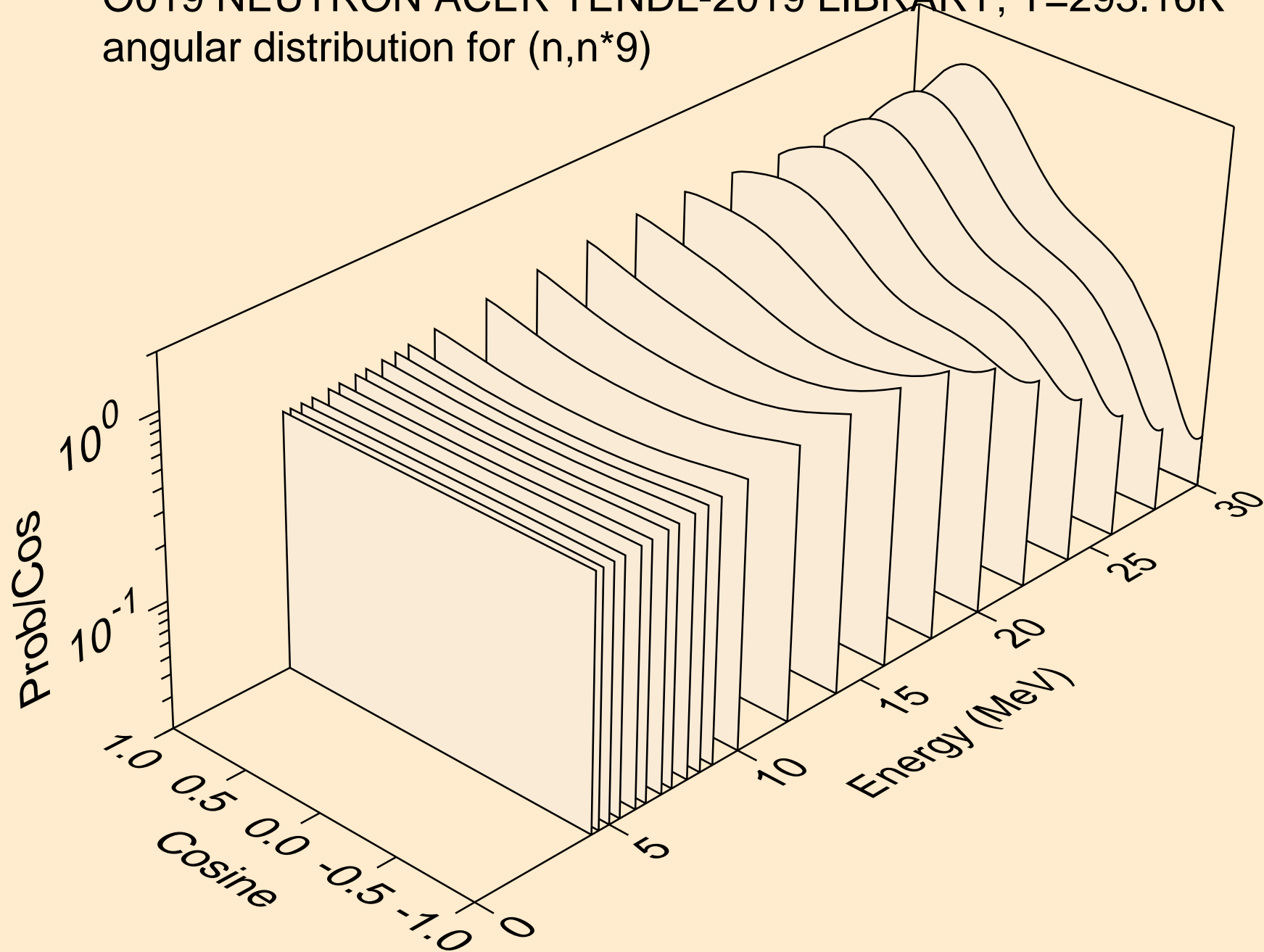

O019 NEUTRON ACER TENDL-2019 LIBRARY; T=293.16K
angular distribution for (n,n*10)

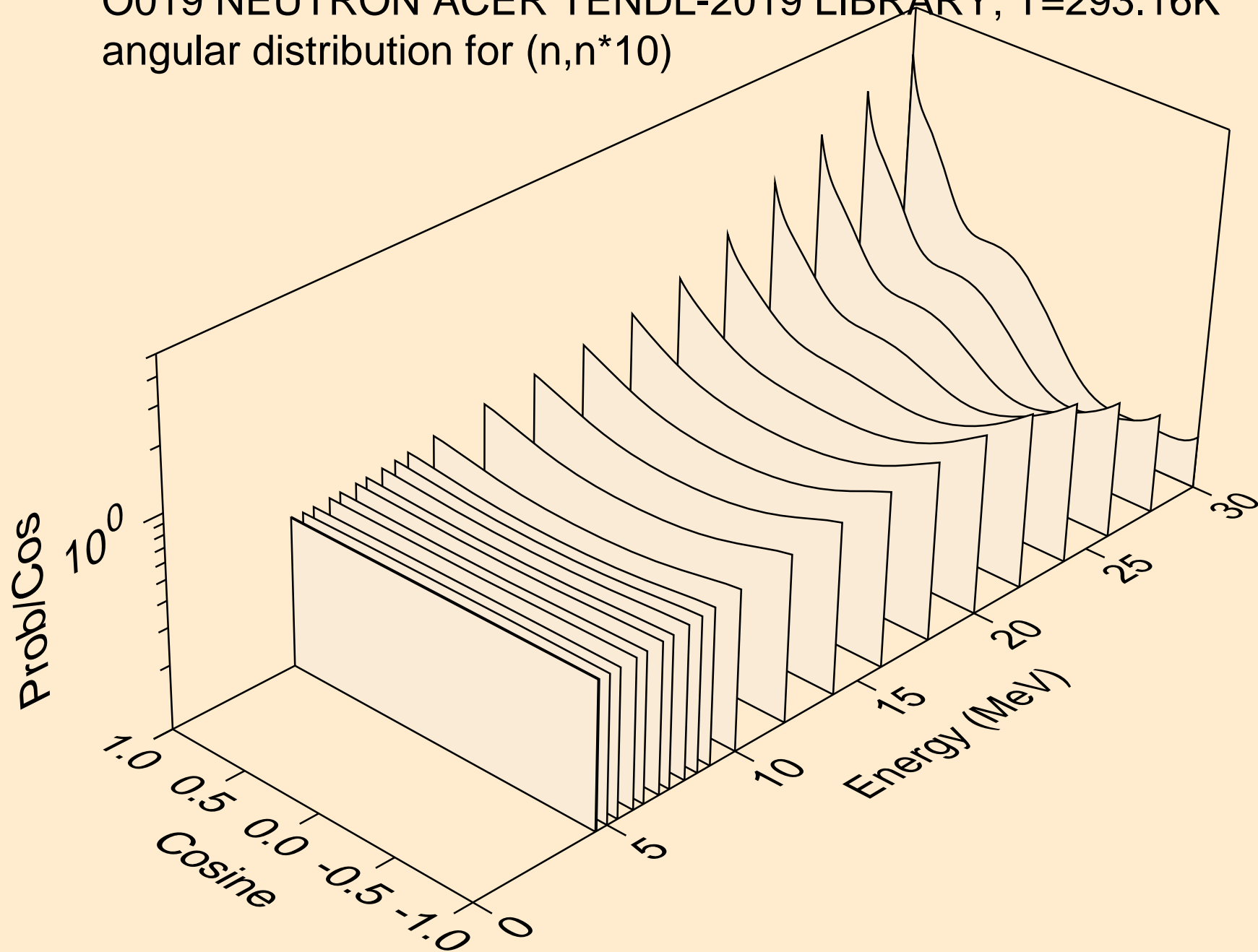

O019 NEUTRON ACER TENDL-2019 LIBRARY; T=293.16K
angular distribution for (n,n*11)

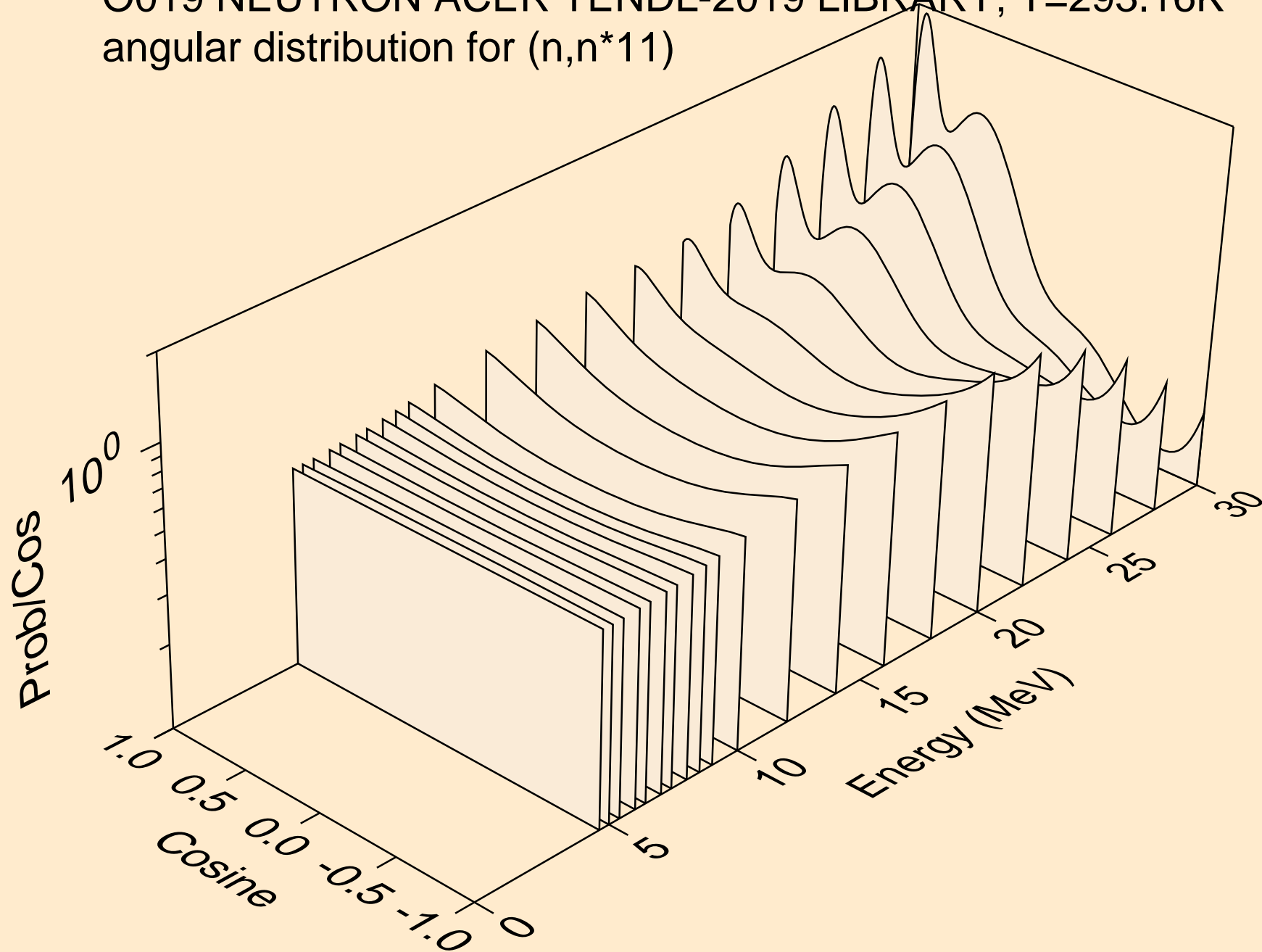

O019 NEUTRON ACER TENDL-2019 LIBRARY; T=293.16K
angular distribution for (n,n*12)

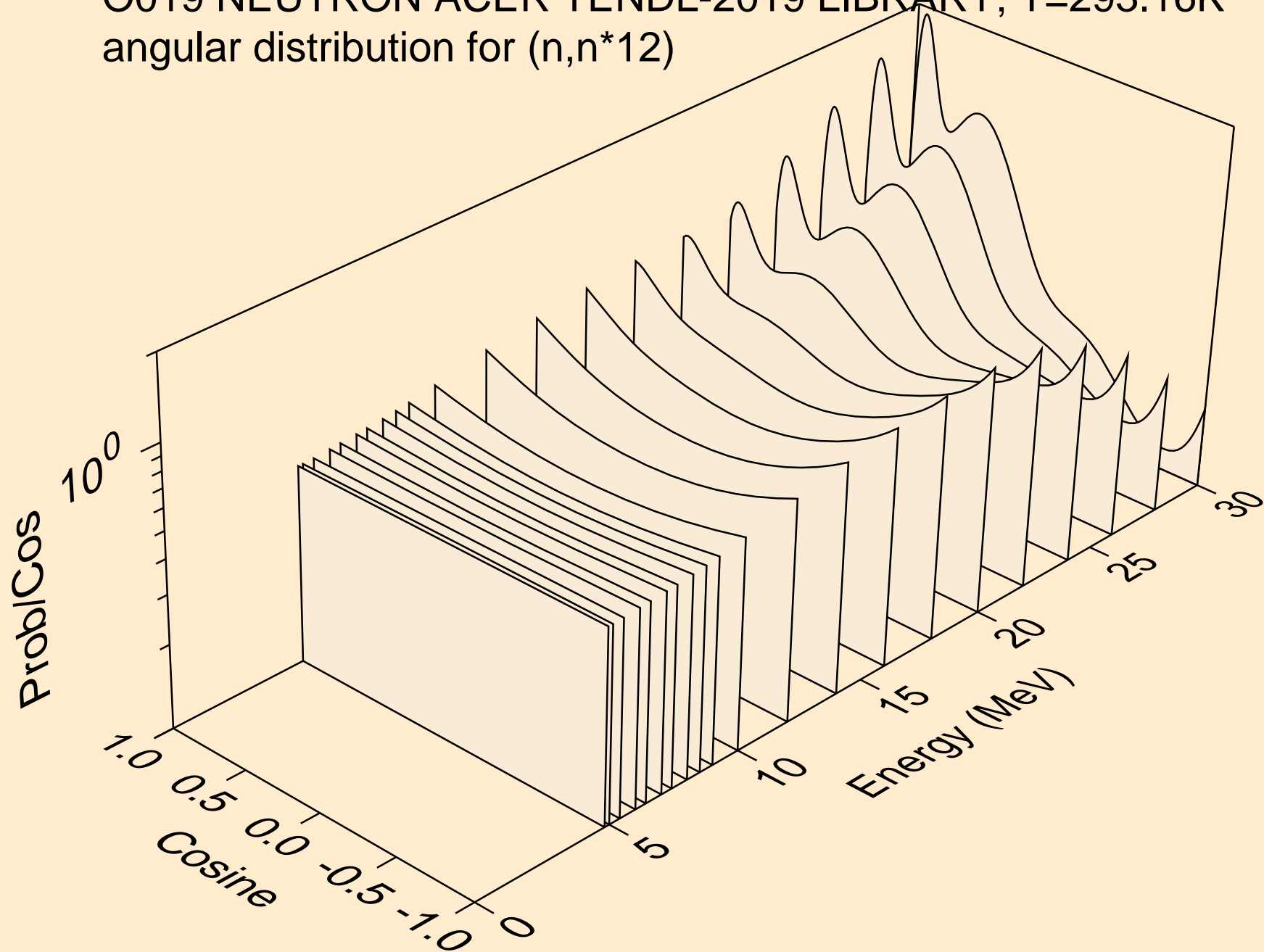

O019 NEUTRON ACER TENDL-2019 LIBRARY; T=293.16K
angular distribution for (n,n*13)

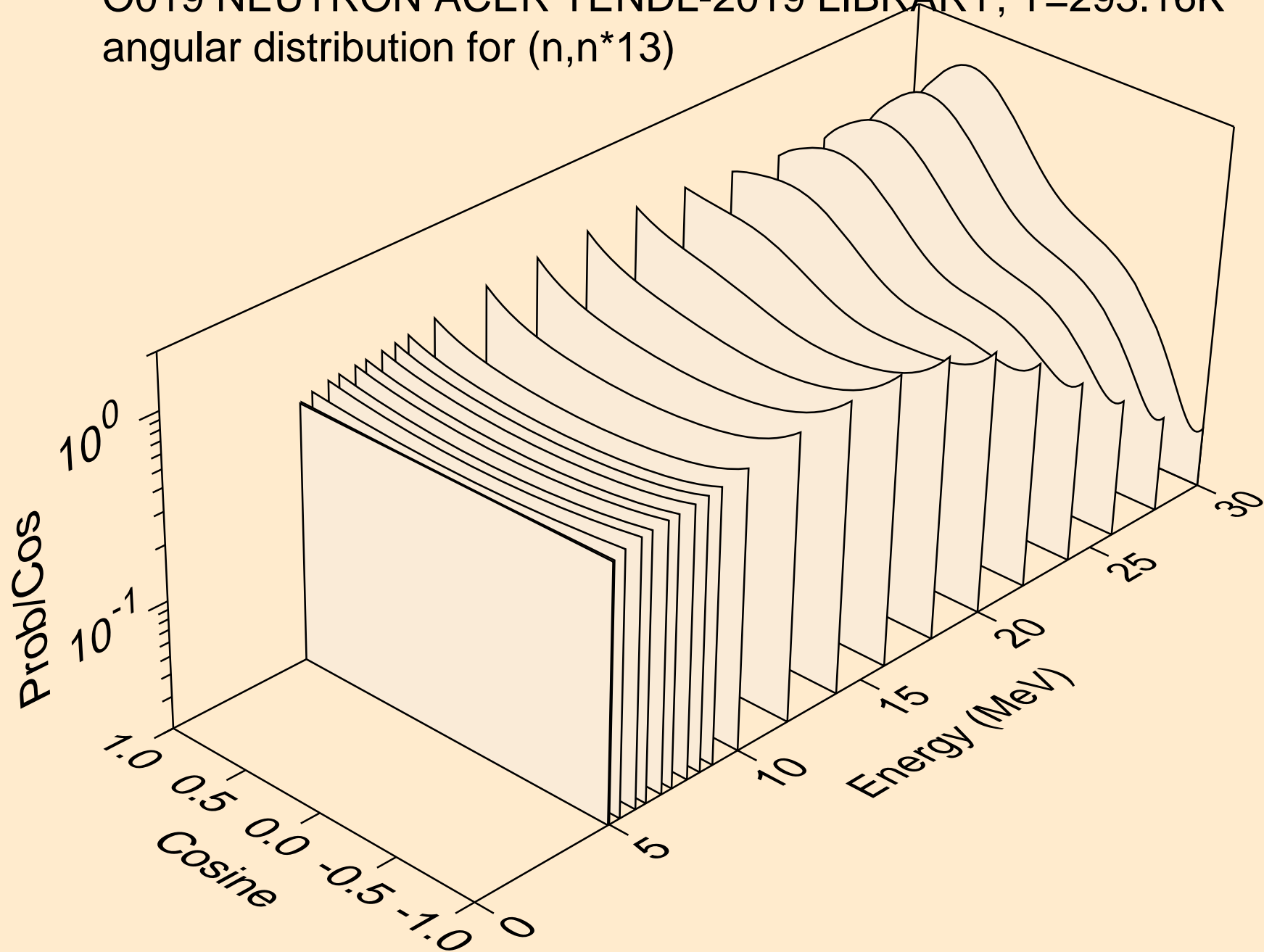

O019 NEUTRON ACER TENDL-2019 LIBRARY; T=293.16K
angular distribution for (n,n*14)

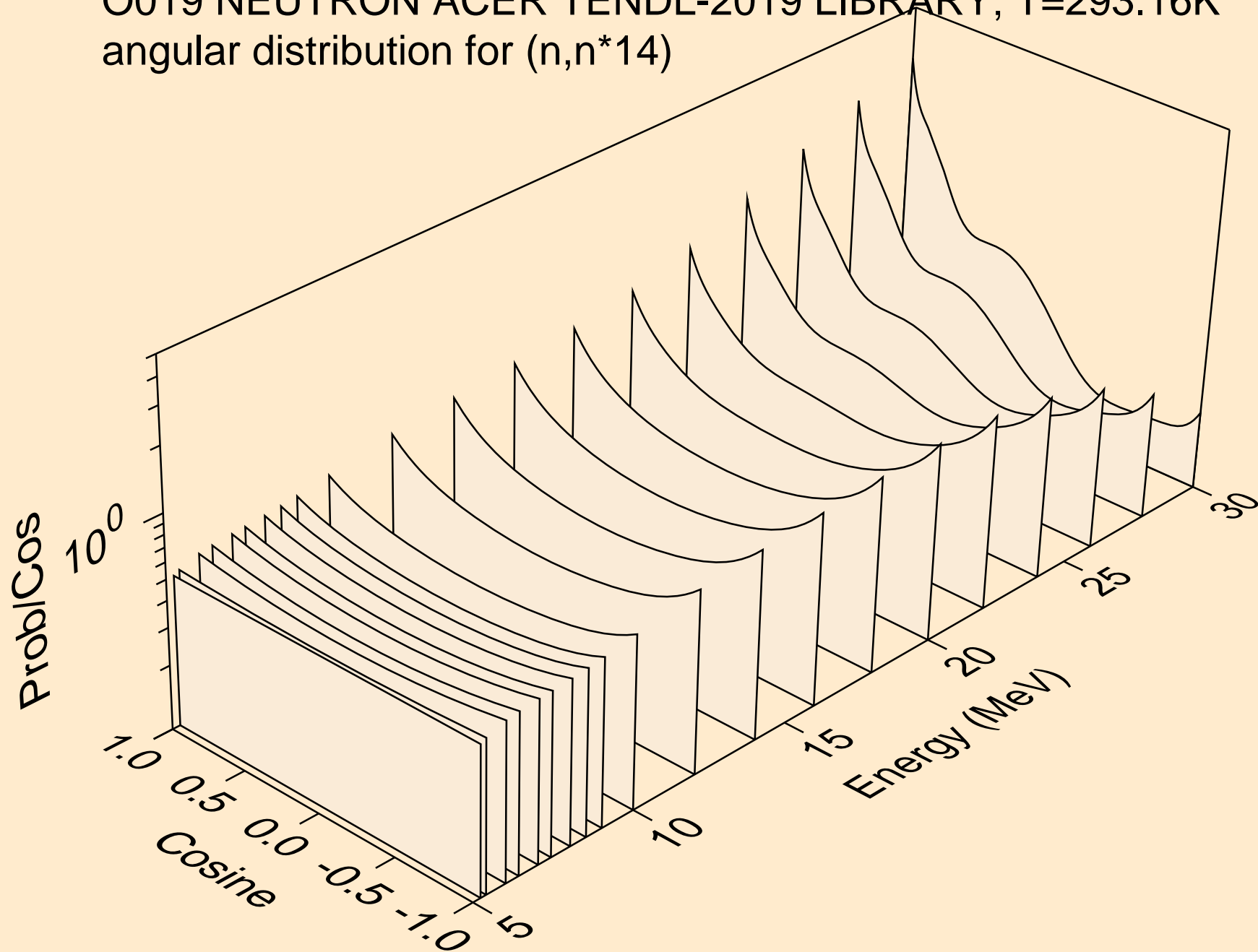

O019 NEUTRON ACER TENDL-2019 LIBRARY; T=293.16K
angular distribution for (n,n*15)

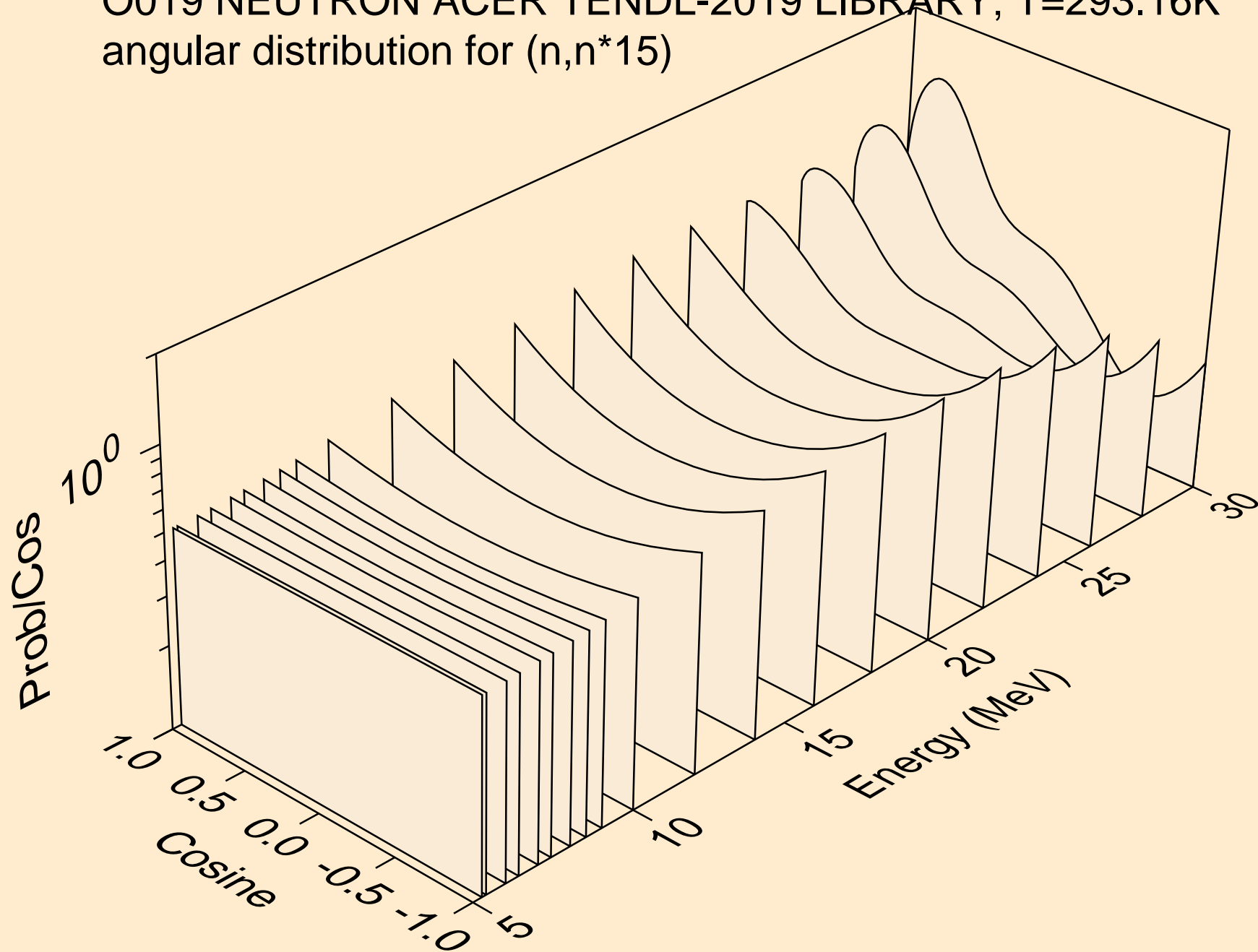

O019 NEUTRON ACER TENDL-2019 LIBRARY; T=293.16K
angular distribution for (n,n*16)

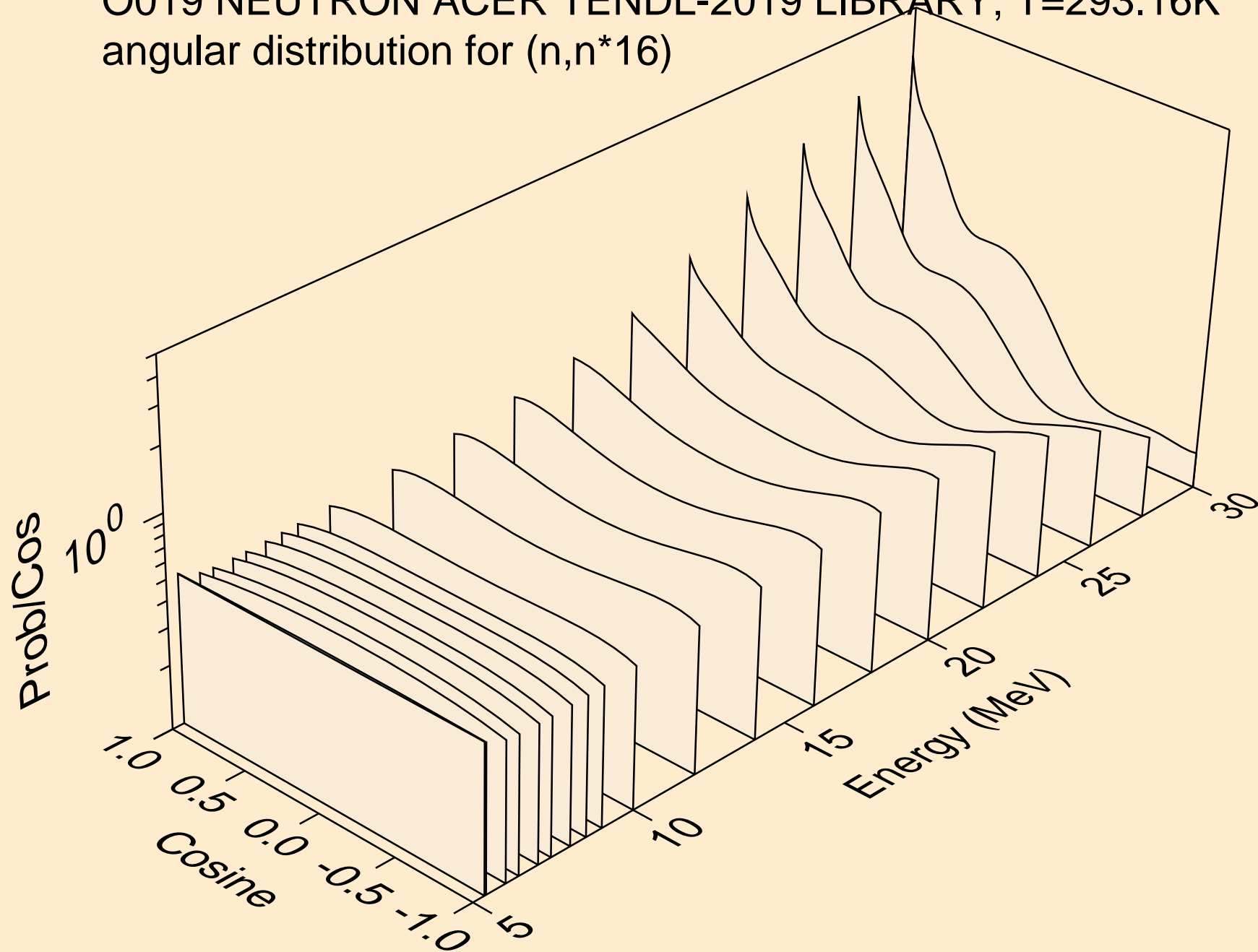

O019 NEUTRON ACER TENDL-2019 LIBRARY; T=293.16K
angular distribution for (n,n*17)

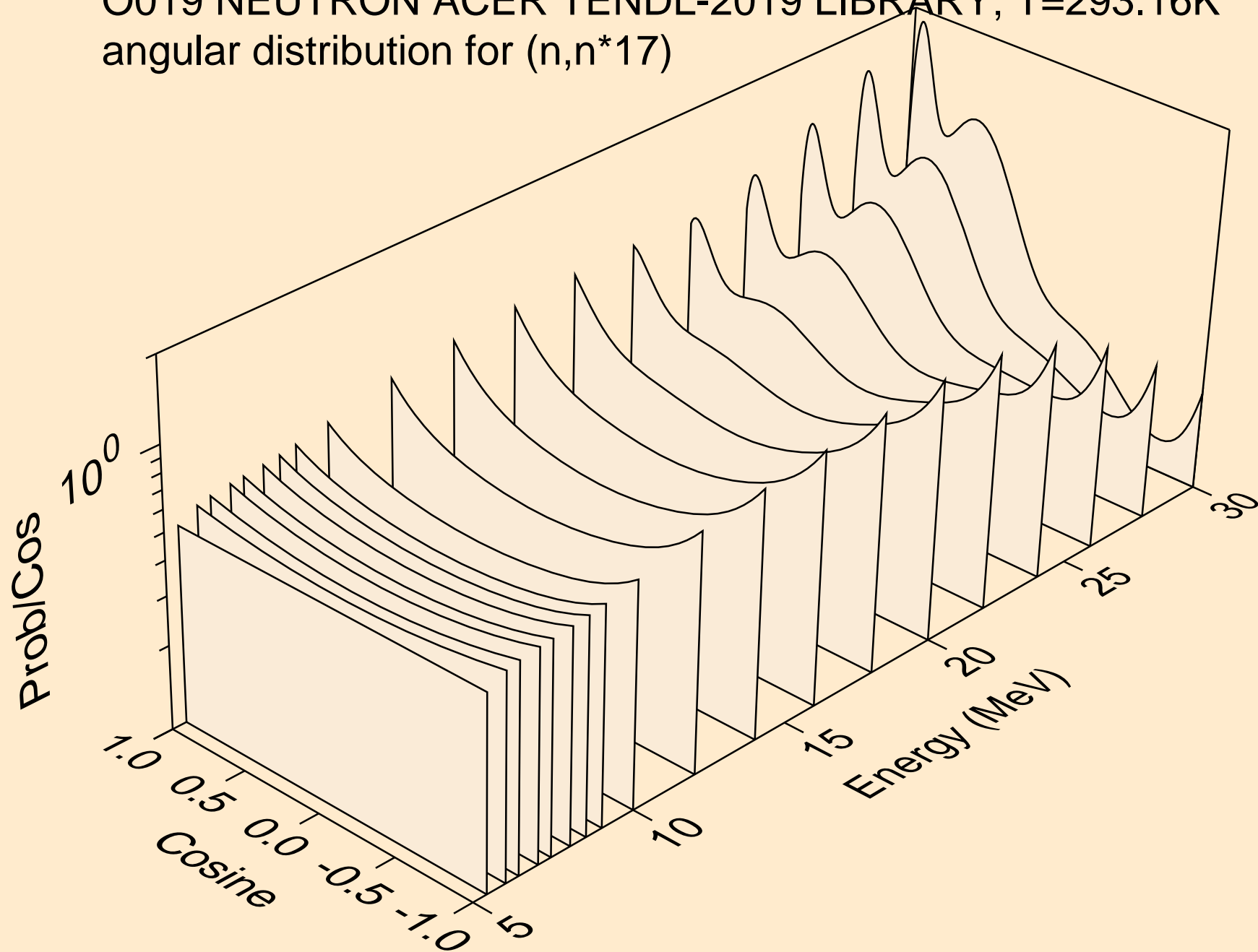

O019 NEUTRON ACER TENDL-2019 LIBRARY; T=293.16K
angular distribution for (n,n*18)

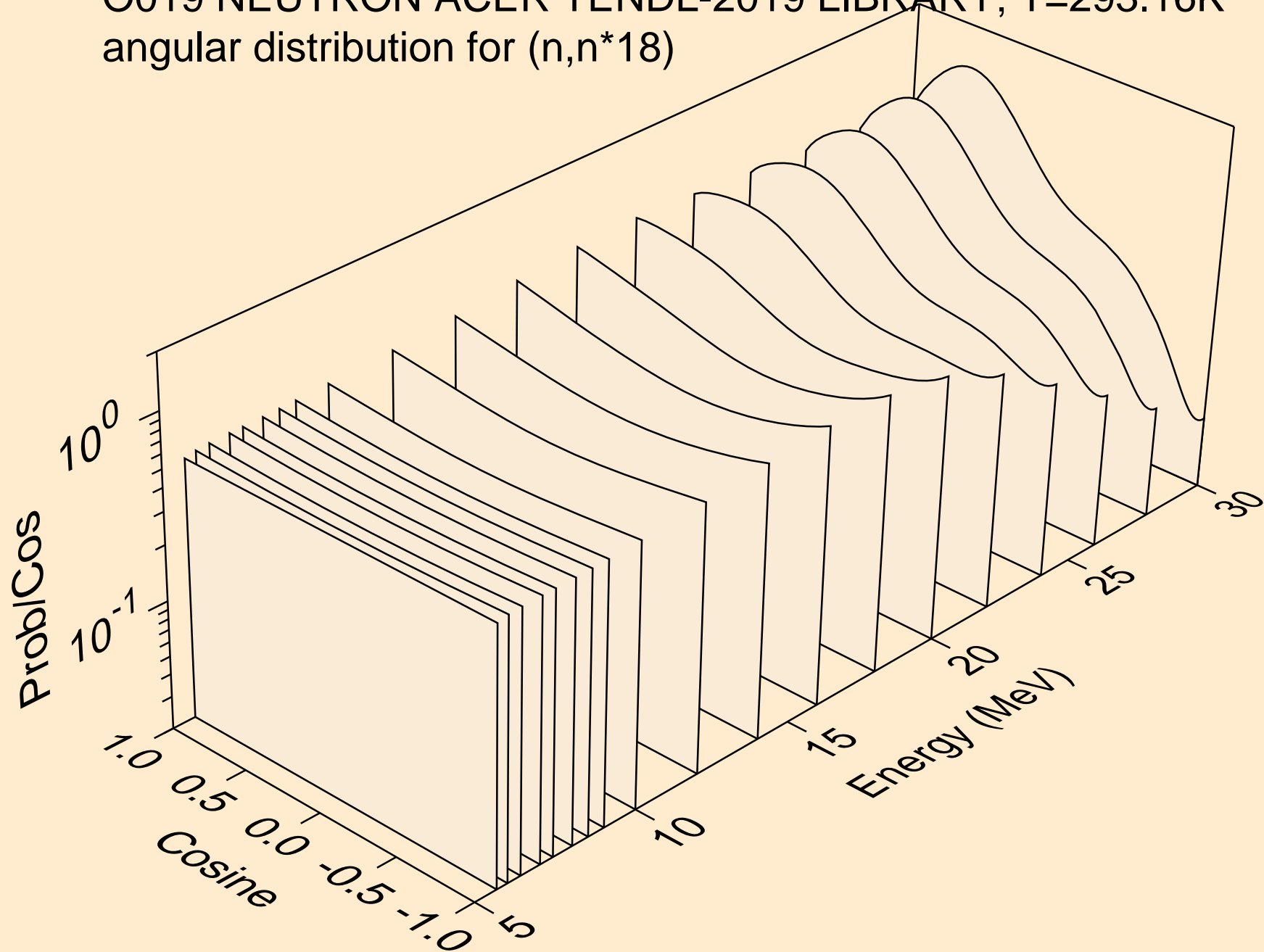

O019 NEUTRON ACER TENDL-2019 LIBRARY; T=293.16K
angular distribution for (n,n*19)

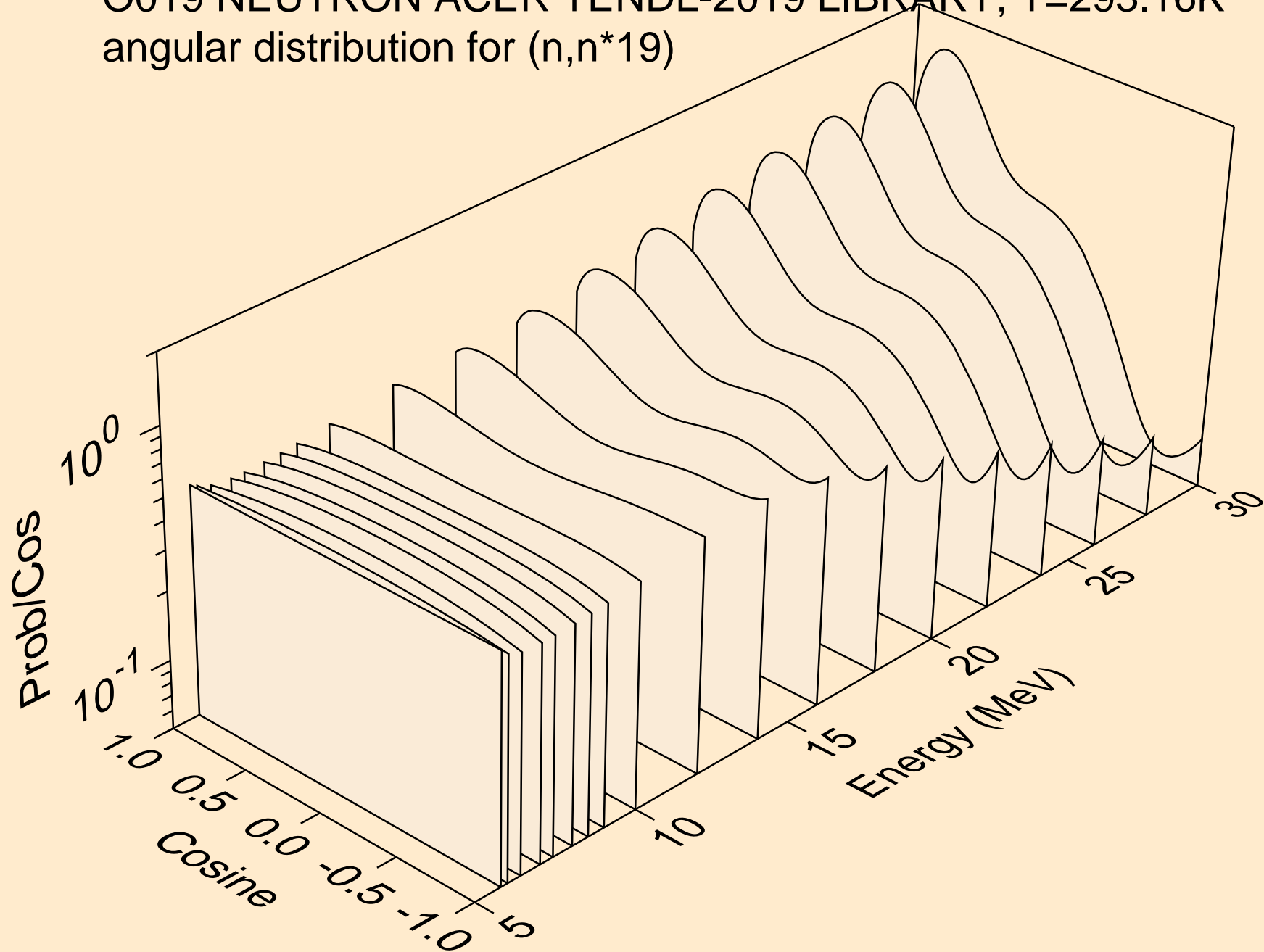

O019 NEUTRON ACER TENDL-2019 LIBRARY; T=293.16K
angular distribution for (n,n*20)

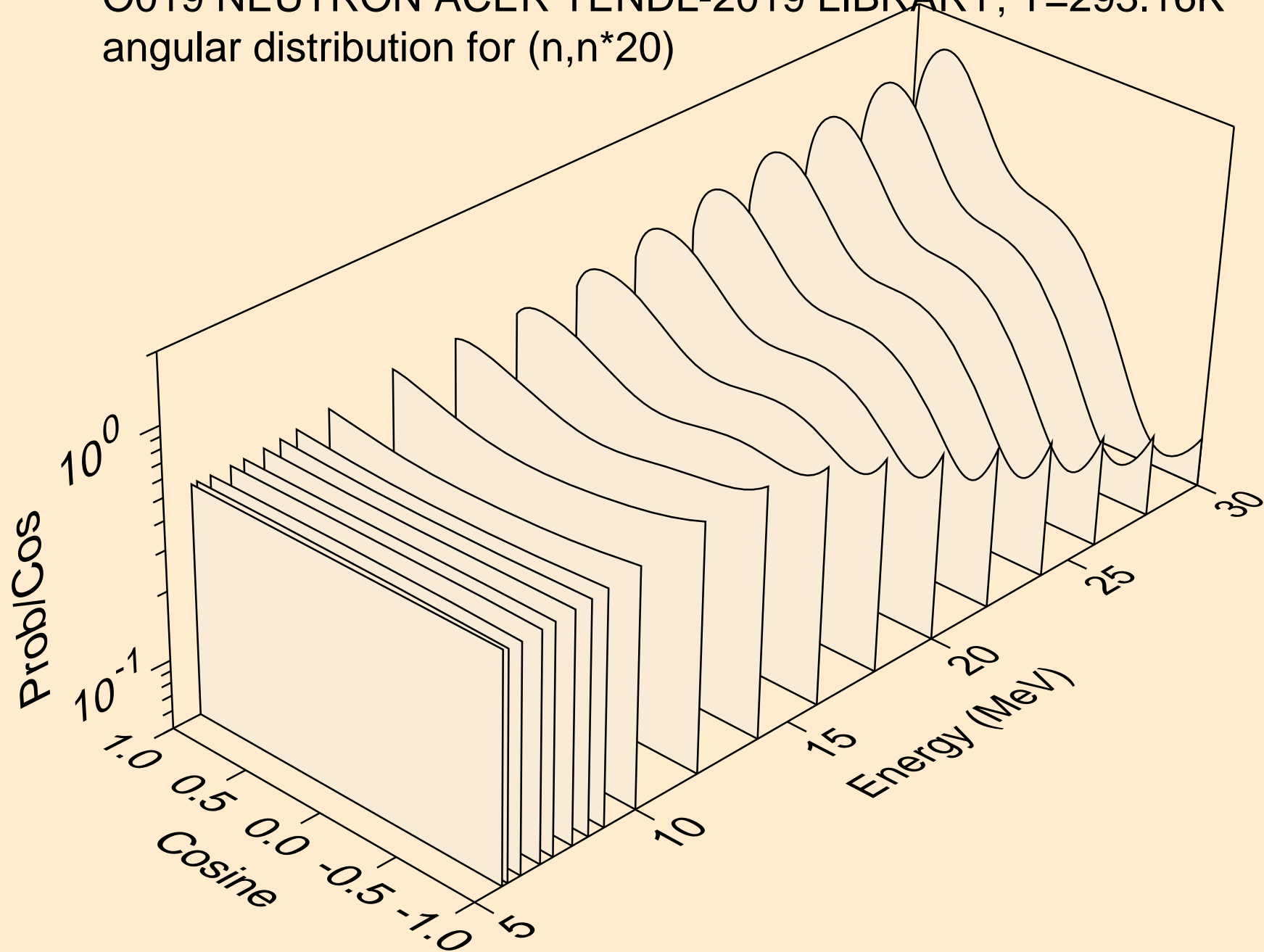

O019 NEUTRON ACER TENDL-2019 LIBRARY; T=293.16K
angular distribution for (n,n*21)

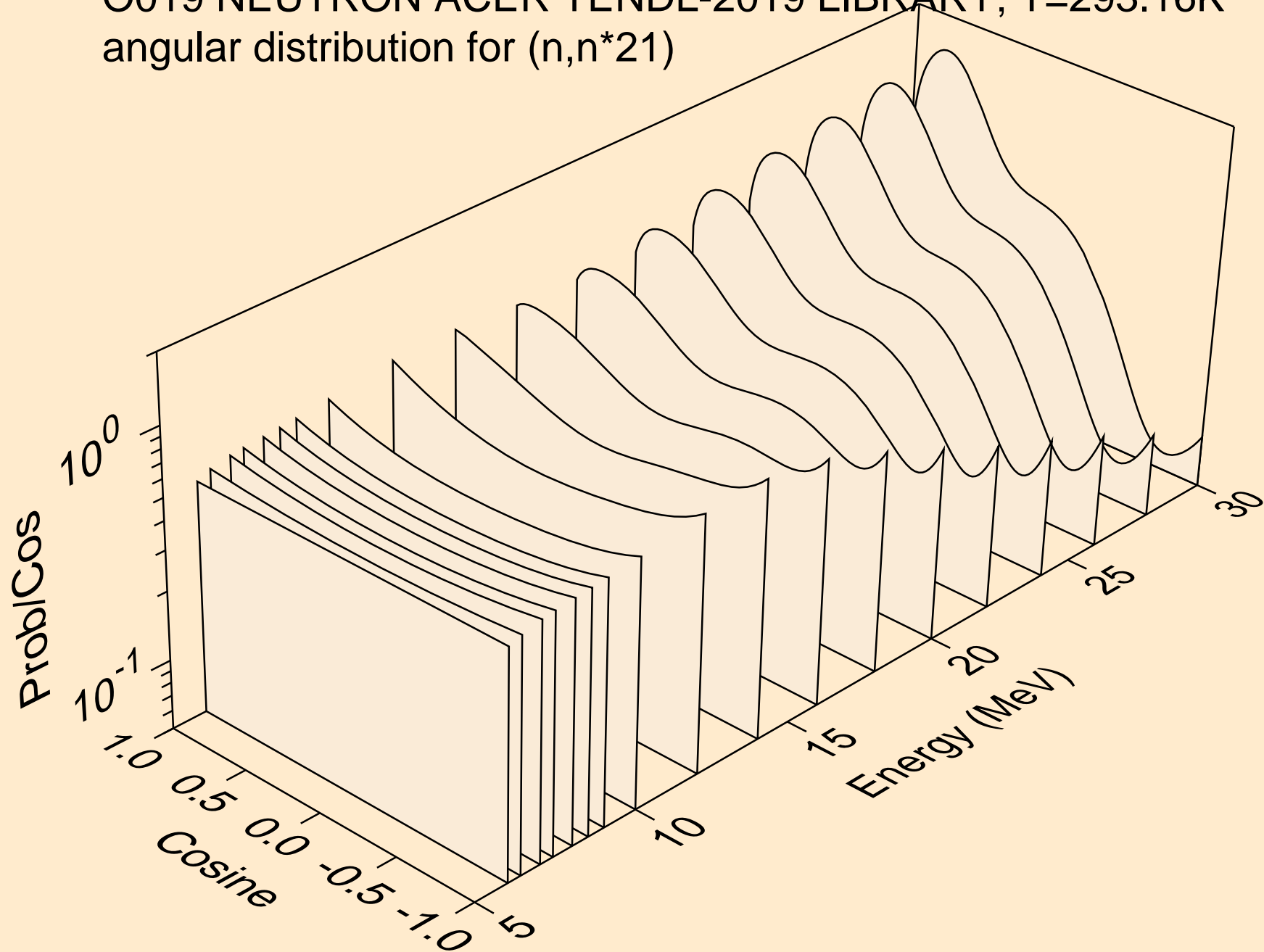

O019 NEUTRON ACER TENDL-2019 LIBRARY; T=293.16K
angular distribution for (n,n*22)

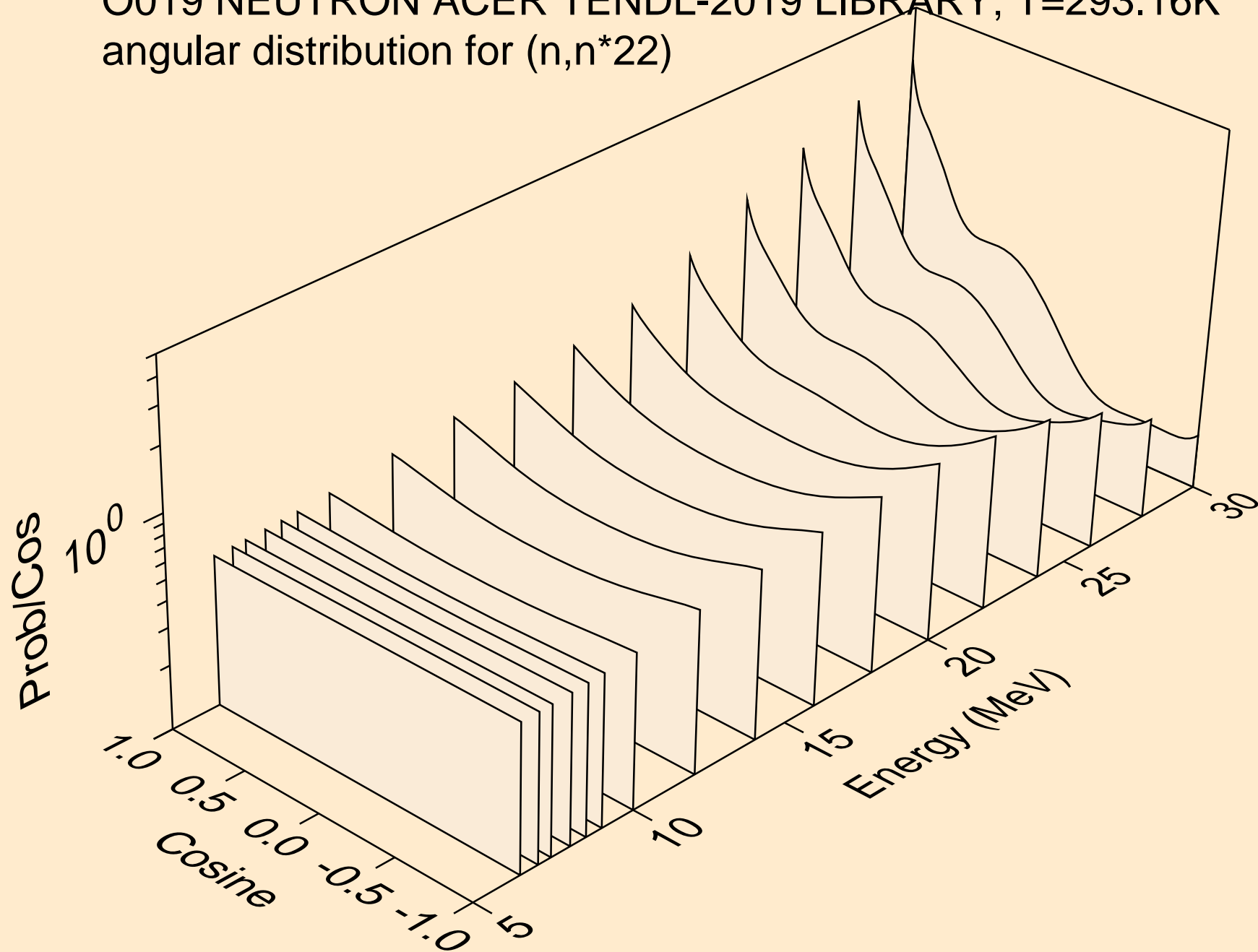

O019 NEUTRON ACER TENDL-2019 LIBRARY; T=293.16K
angular distribution for (n,n*23)

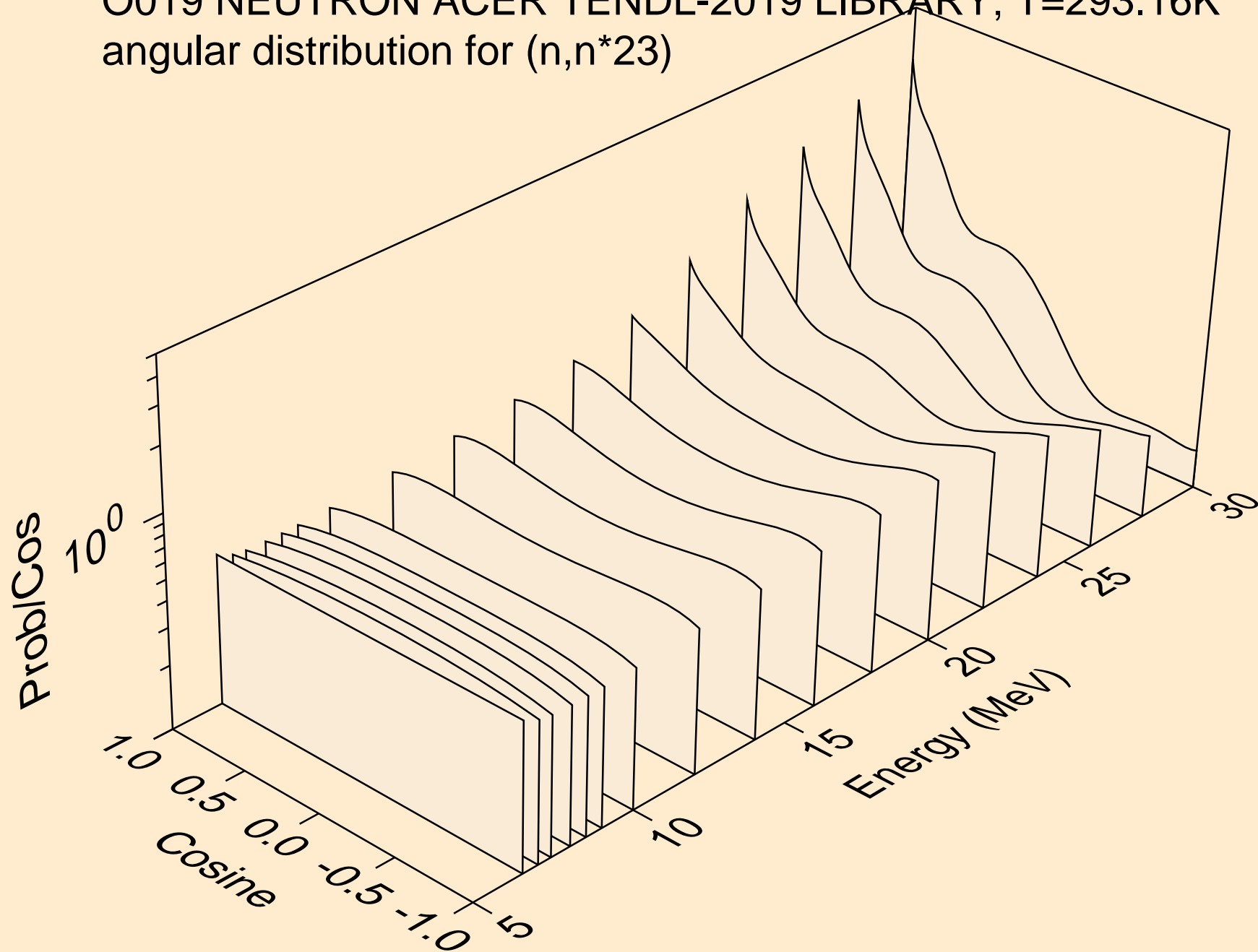

O019 NEUTRON ACER TENDL-2019 LIBRARY; T=293.16K
angular distribution for (n,n*24)

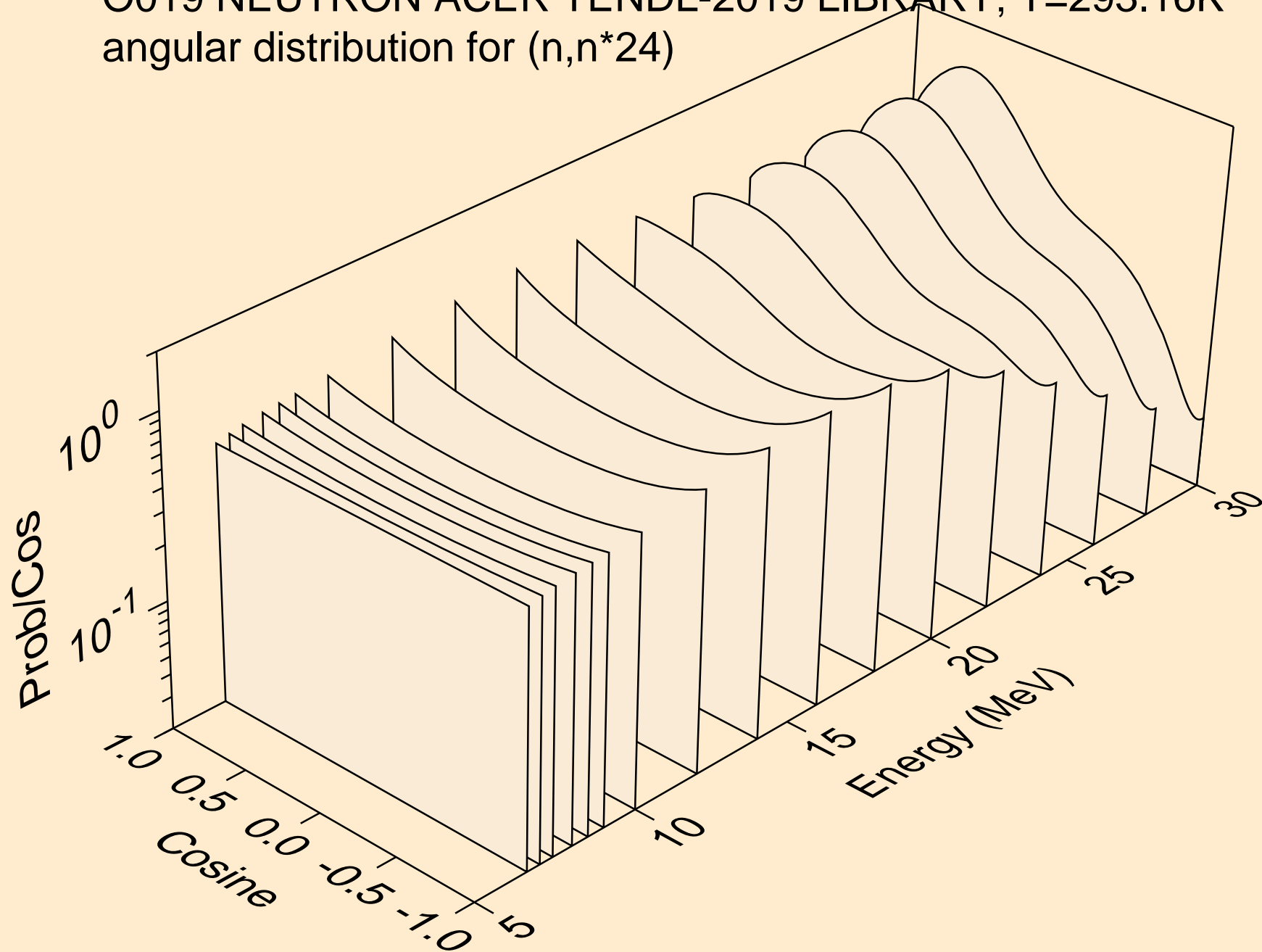

O019 NEUTRON ACER TENDL-2019 LIBRARY; T=293.16K
angular distribution for (n,n*25)

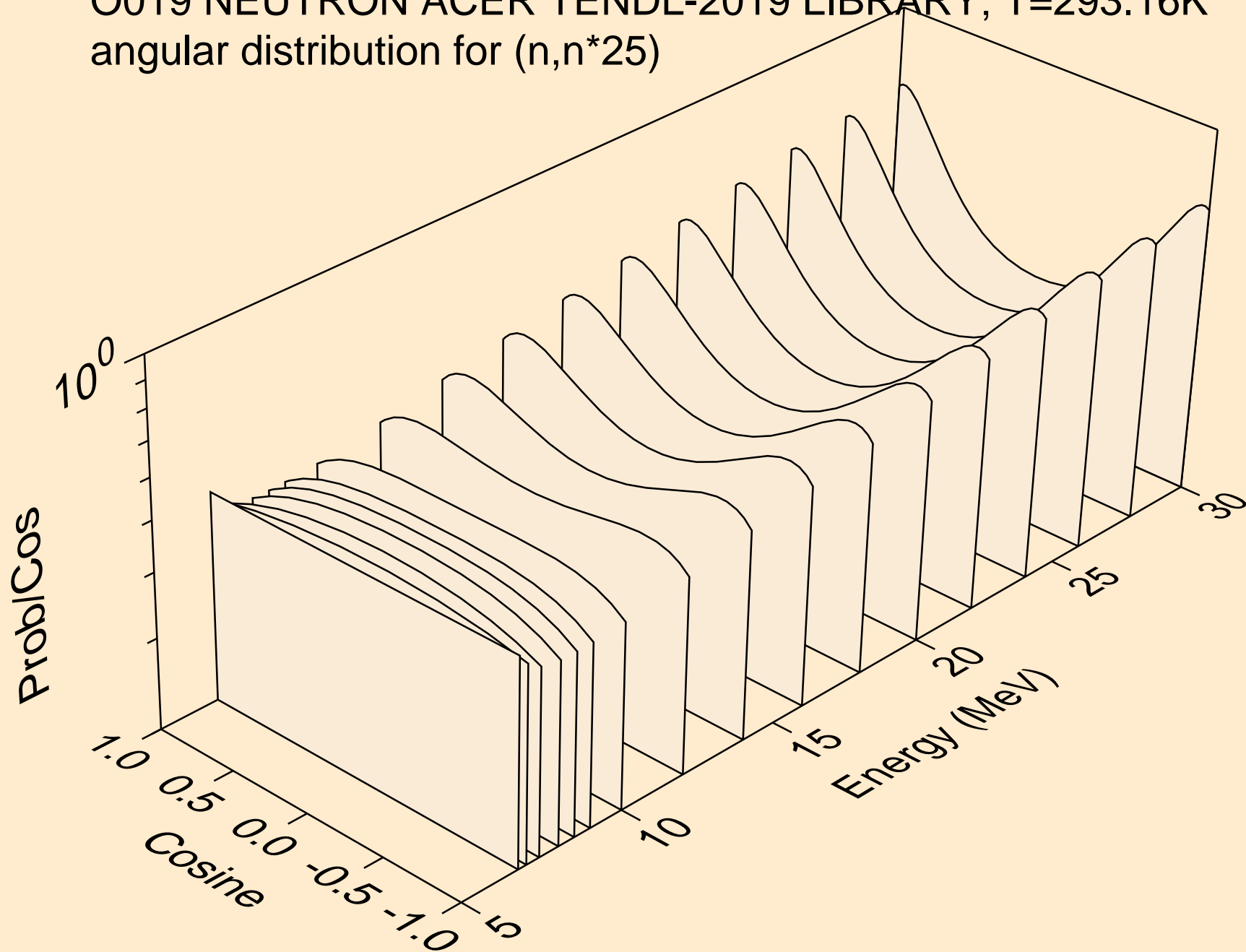

O019 NEUTRON ACER TENDL-2019 LIBRARY; T=293.16K
angular distribution for (n,n*26)

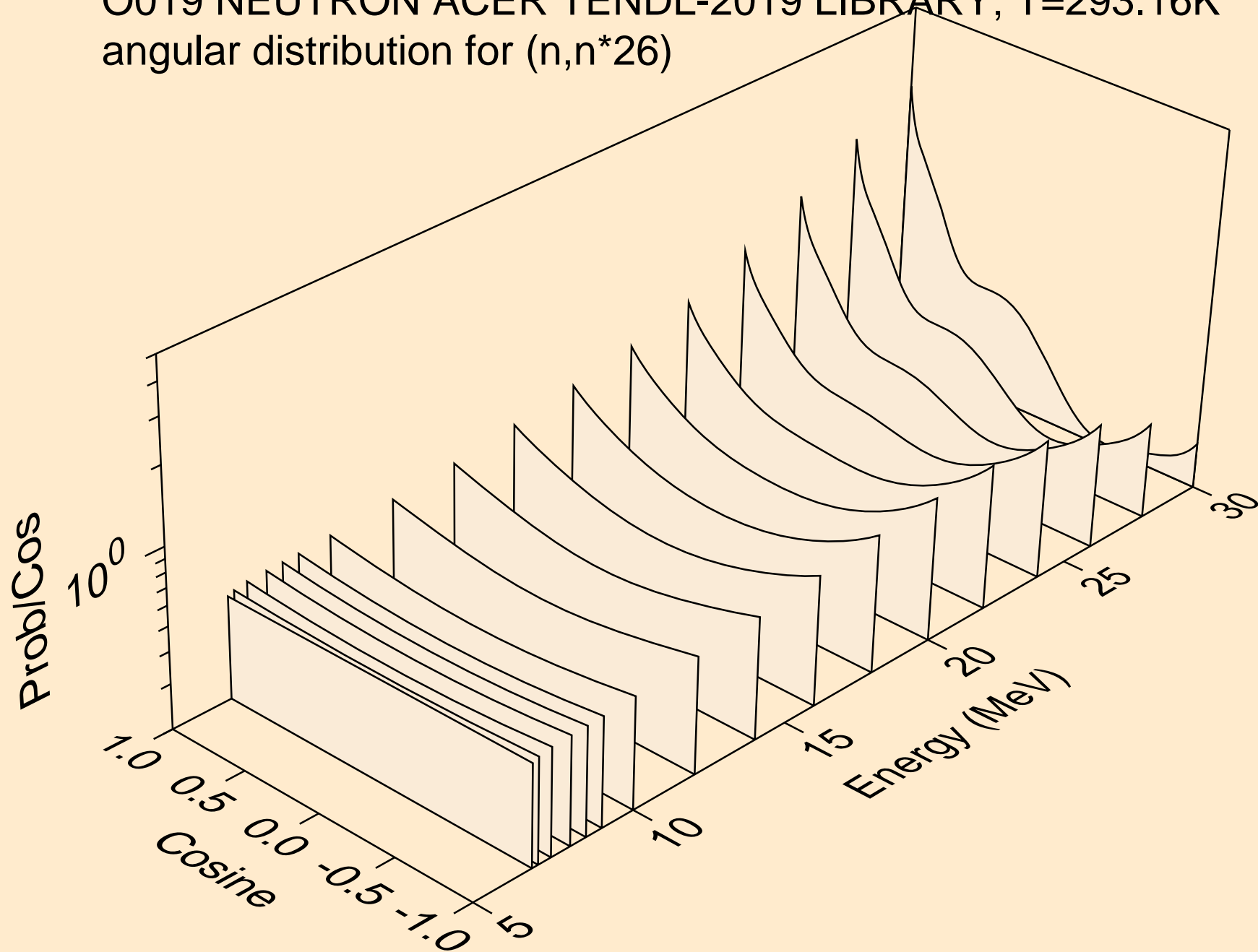

O019 NEUTRON ACER TENDL-2019 LIBRARY; T=293.16K
angular distribution for (n,n*27)

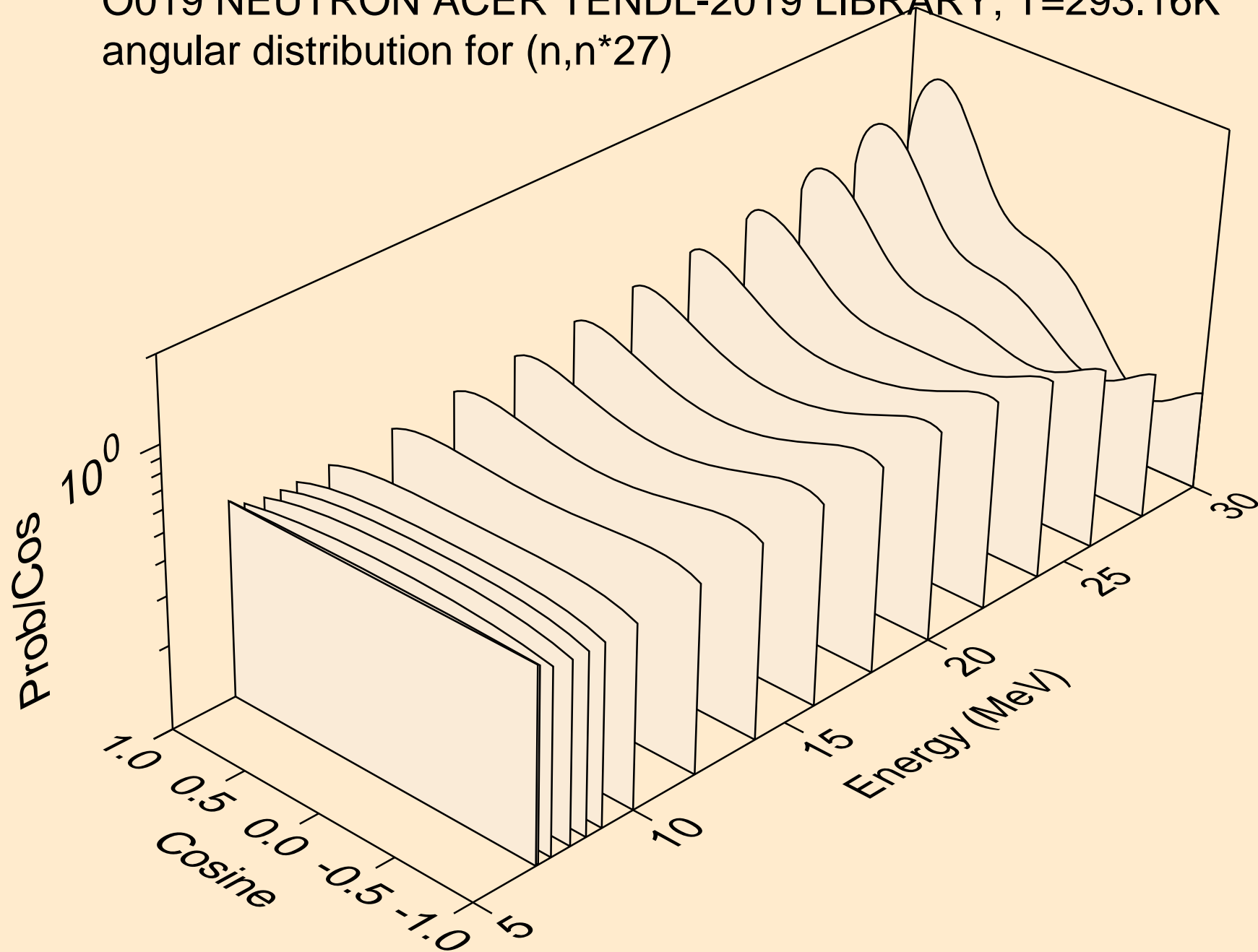

O019 NEUTRON ACER TENDL-2019 LIBRARY; T=293.16K
angular distribution for (n,n*28)

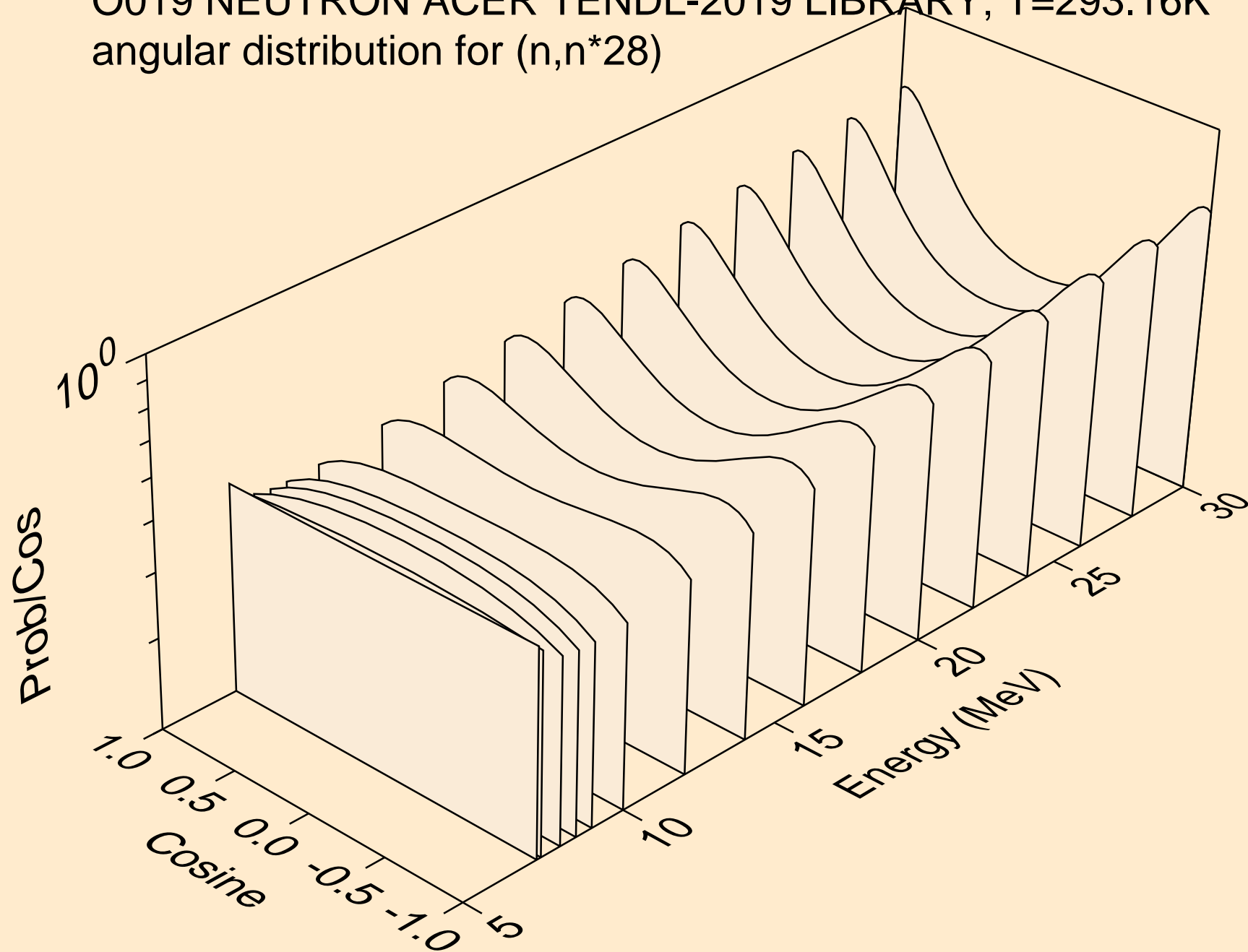

O019 NEUTRON ACER TENDL-2019 LIBRARY; T=293.16K
angular distribution for (n,n*29)

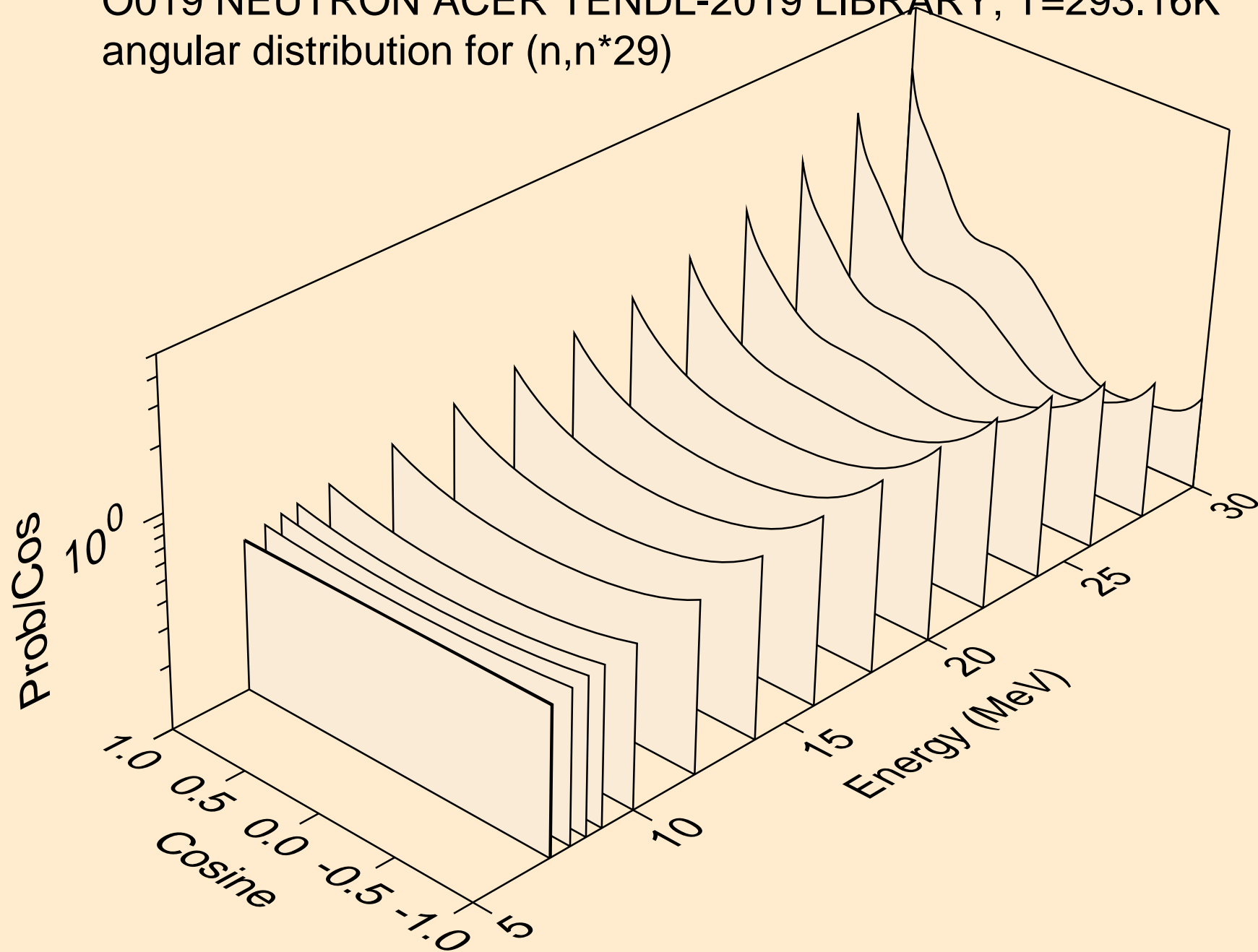

O019 NEUTRON ACER TENDL-2019 LIBRARY; T=293.16K
Neutron emission for (n,x)

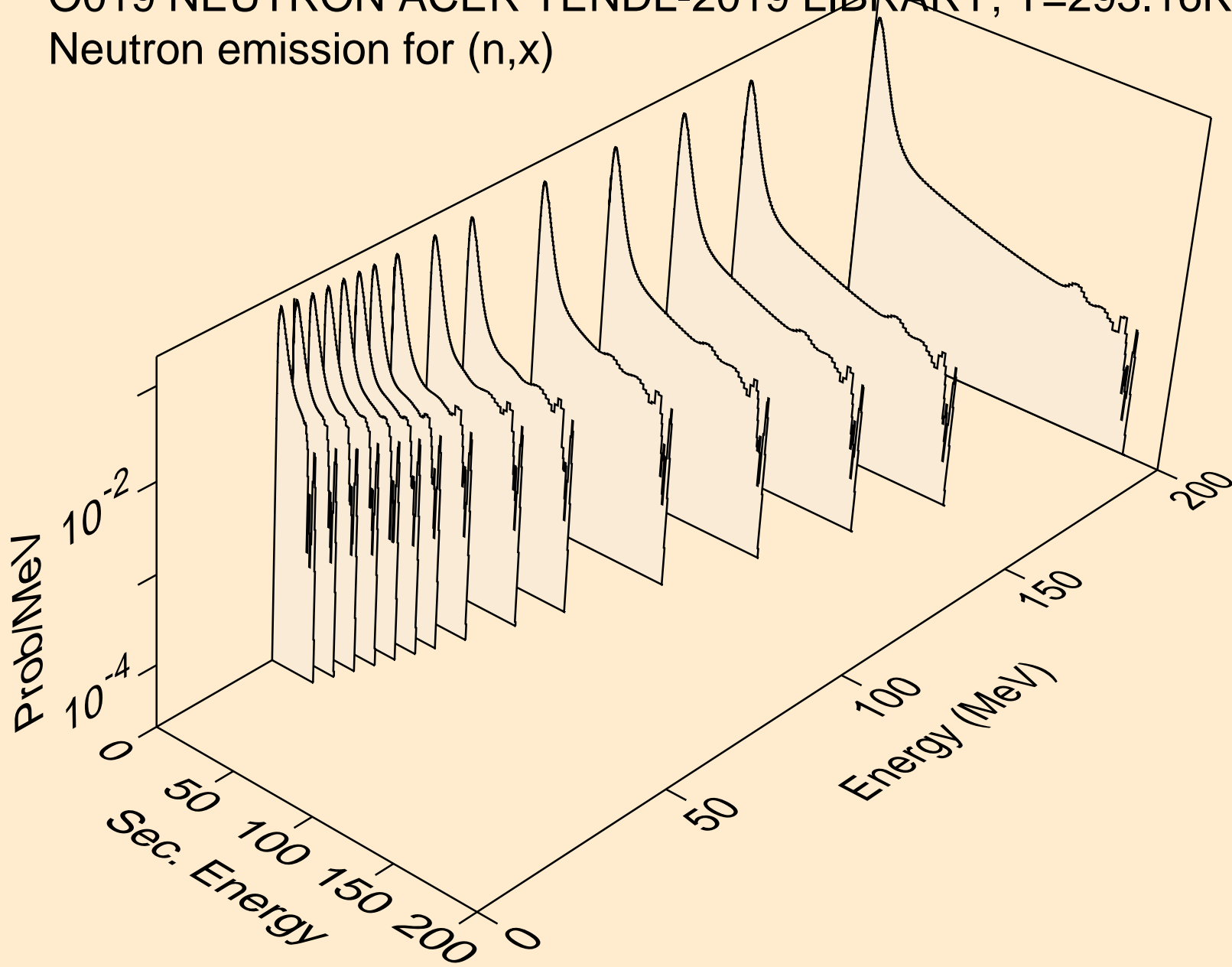

O019 NEUTRON ACER TENDL-2019 LIBRARY; T=293.16K
Neutron emission for (n,2nd)

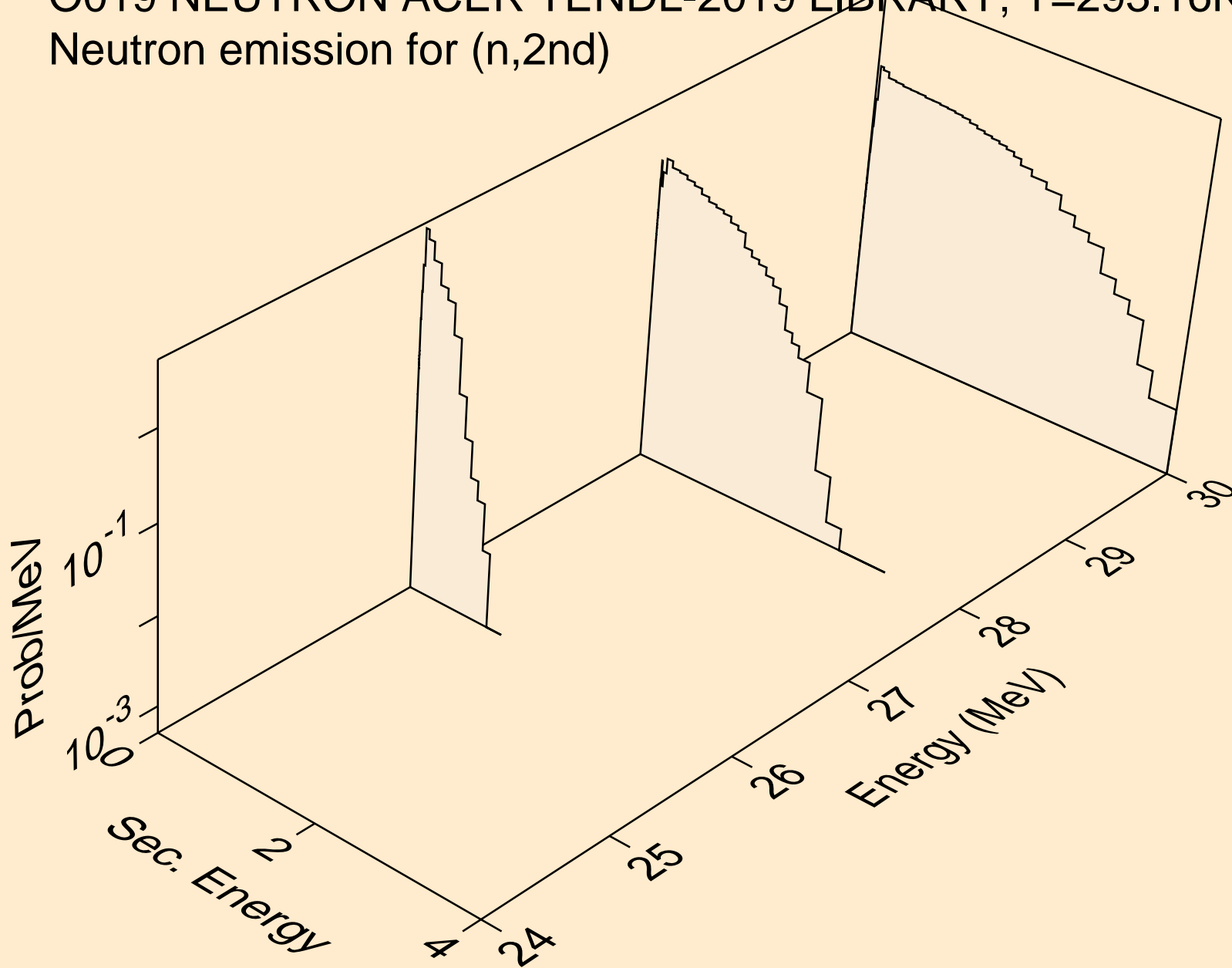

O019 NEUTRON ACER TENDL-2019 LIBRARY; T=293.16K
Neutron emission for (n,2n)

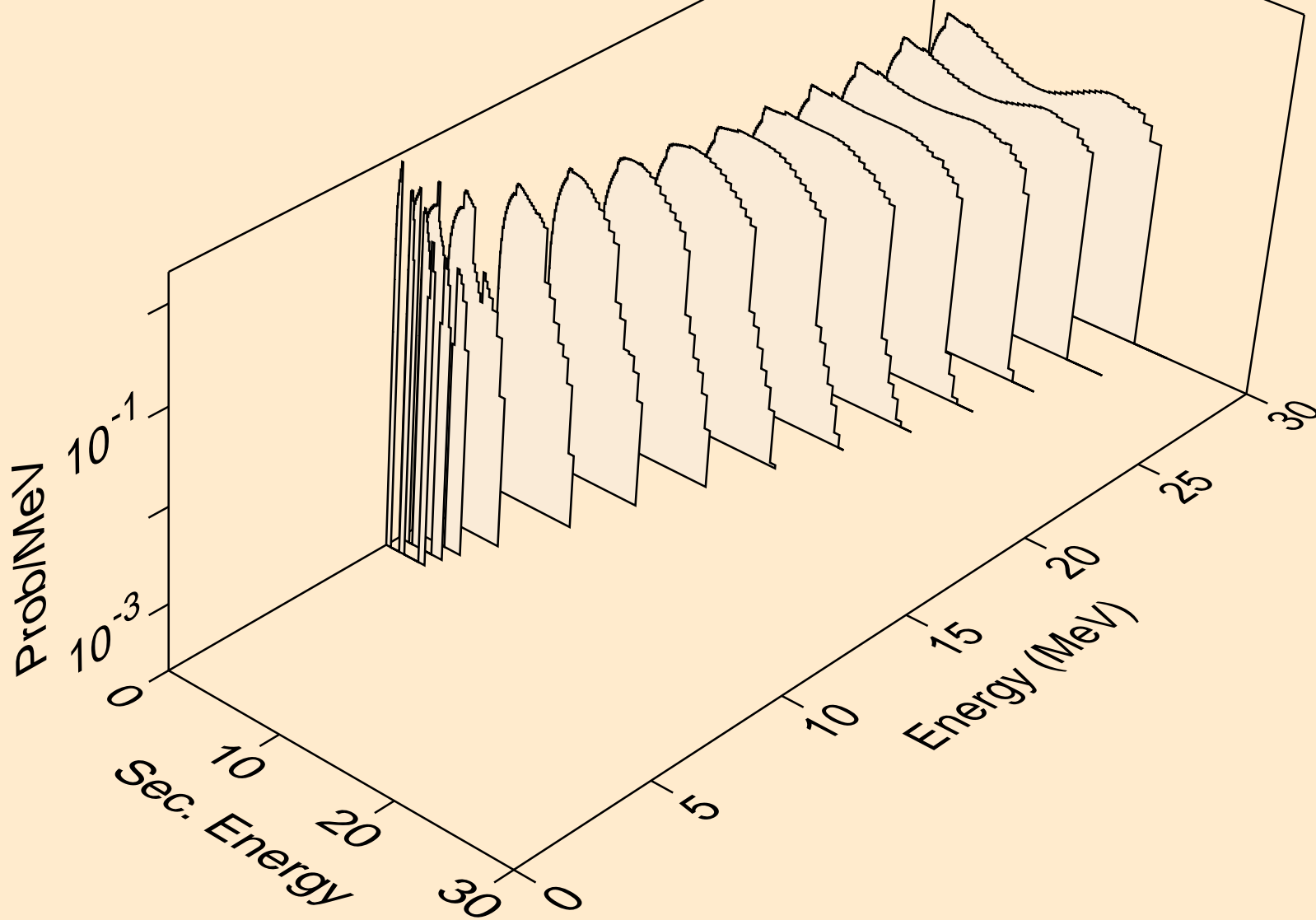

O019 NEUTRON ACER TENDL-2019 LIBRARY; T=293.16K
Neutron emission for (n,3n)

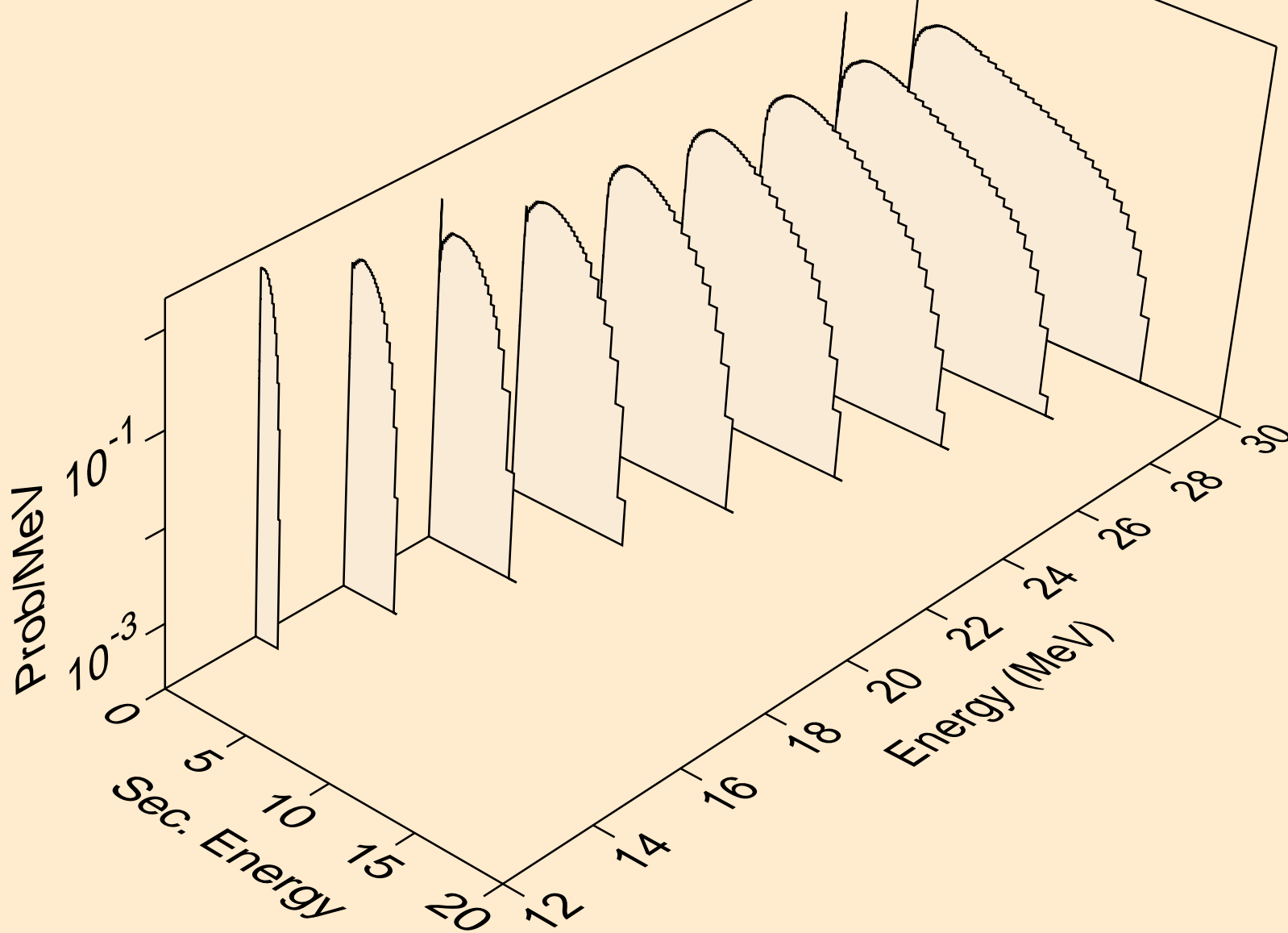

O019 NEUTRON ACER TENDL-2019 LIBRARY; T=293.16K
Neutron emission for (n,n*)a

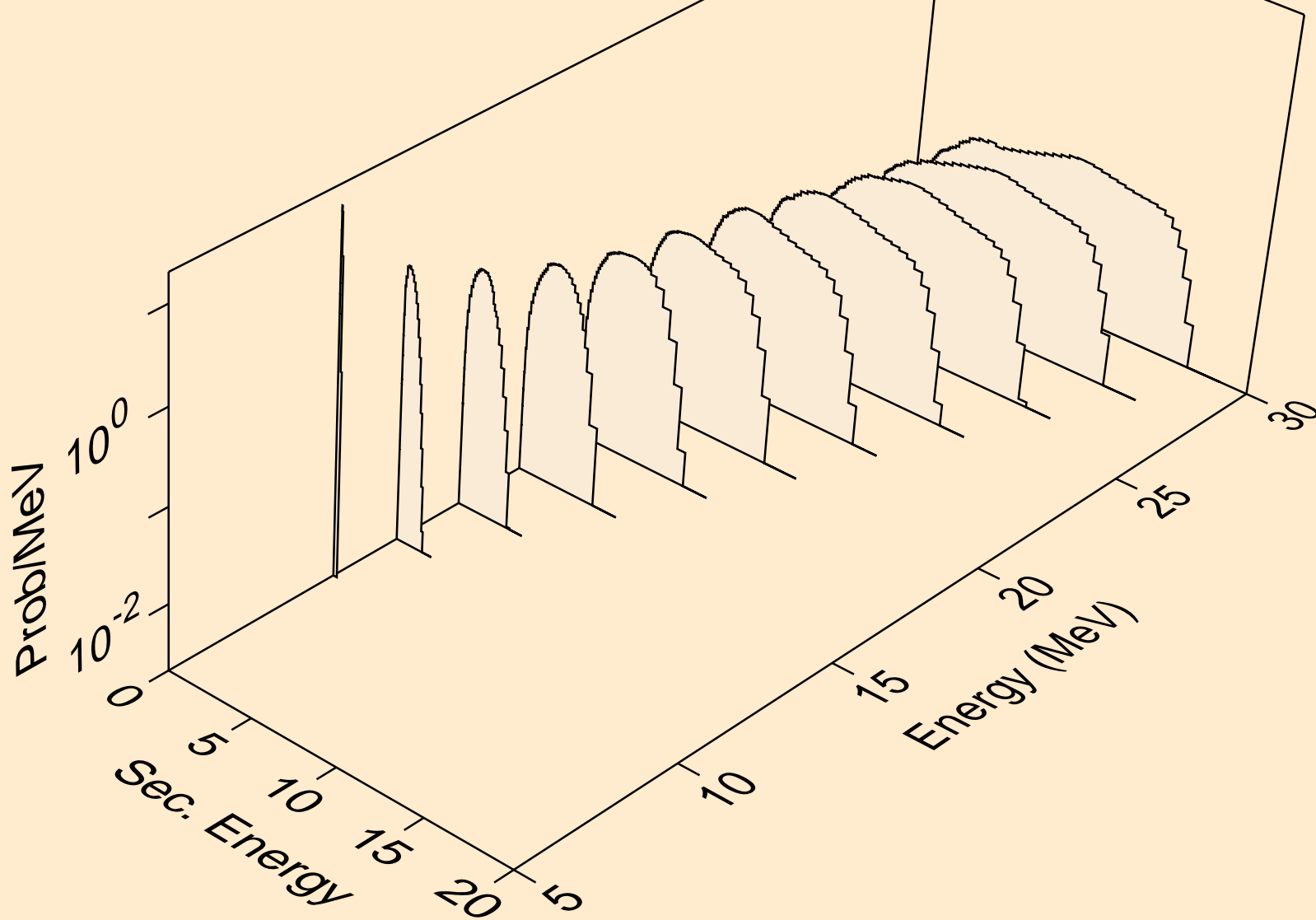

O019 NEUTRON ACER TENDL-2019 LIBRARY; T=293.16K
Neutron emission for (n,2n)a

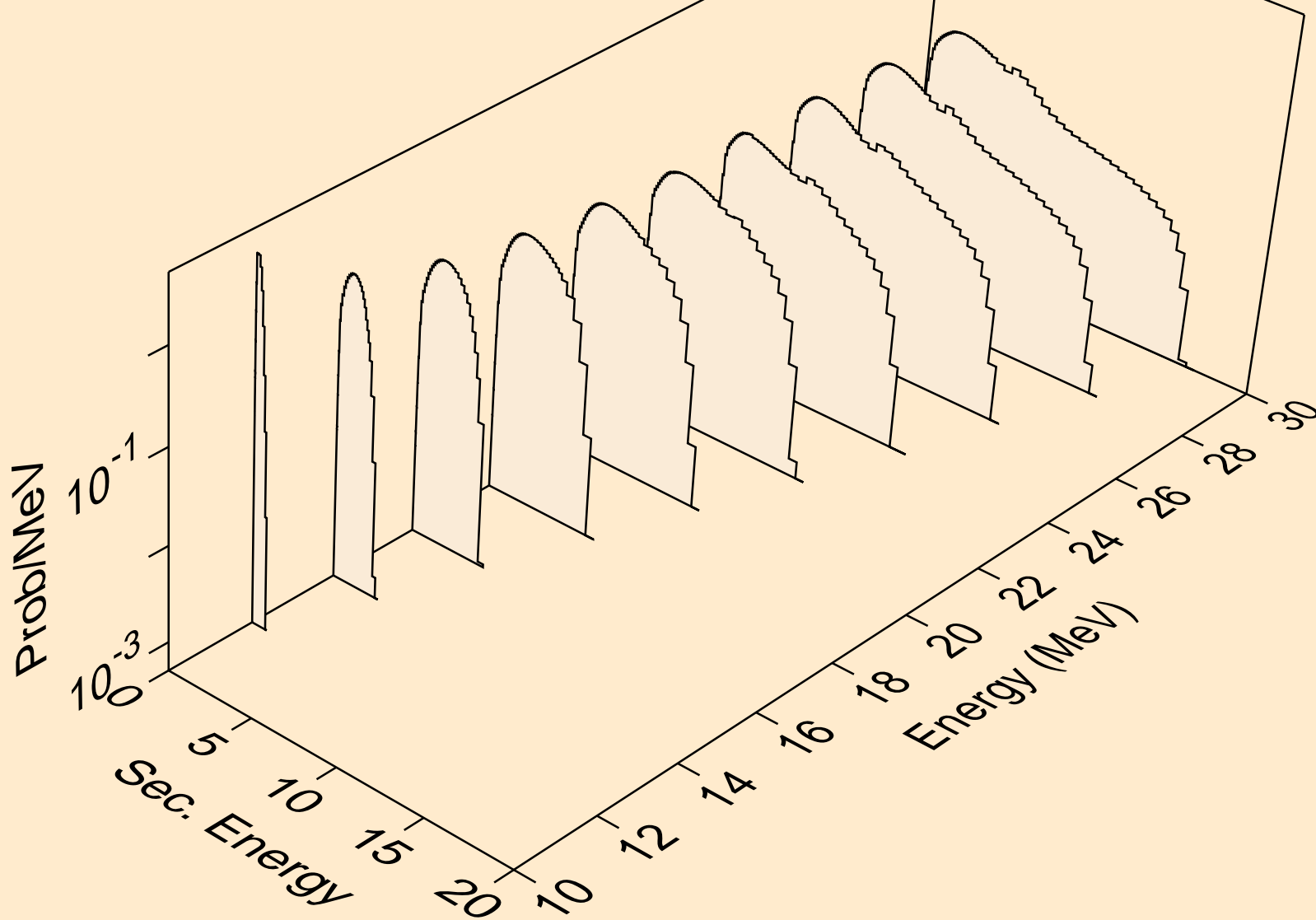

O019 NEUTRON ACER TENDL-2019 LIBRARY; T=293.16K
Neutron emission for (n,3n)a

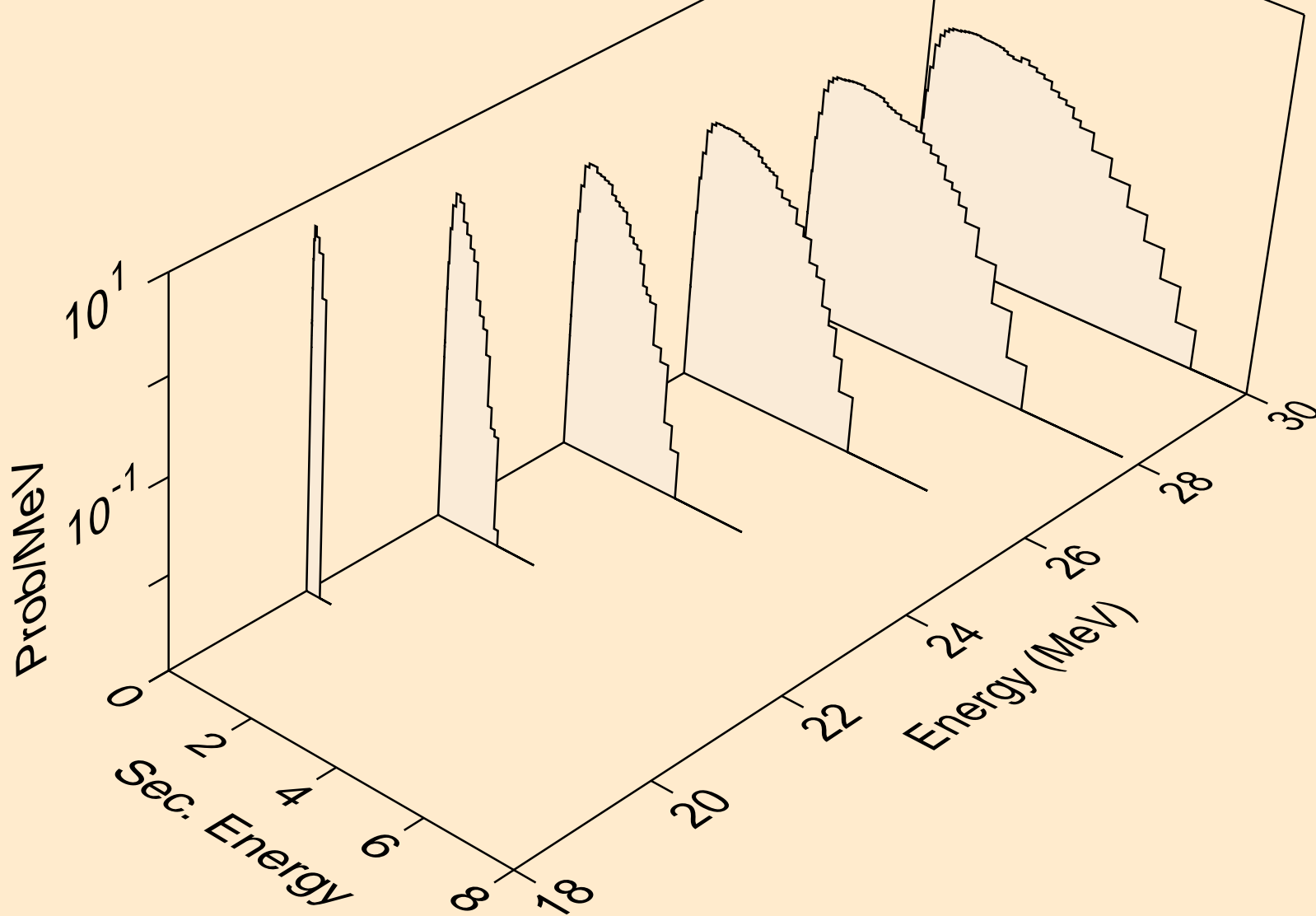

O019 NEUTRON ACER TENDL-2019 LIBRARY; T=293.16K
Neutron emission for (n,n*)p

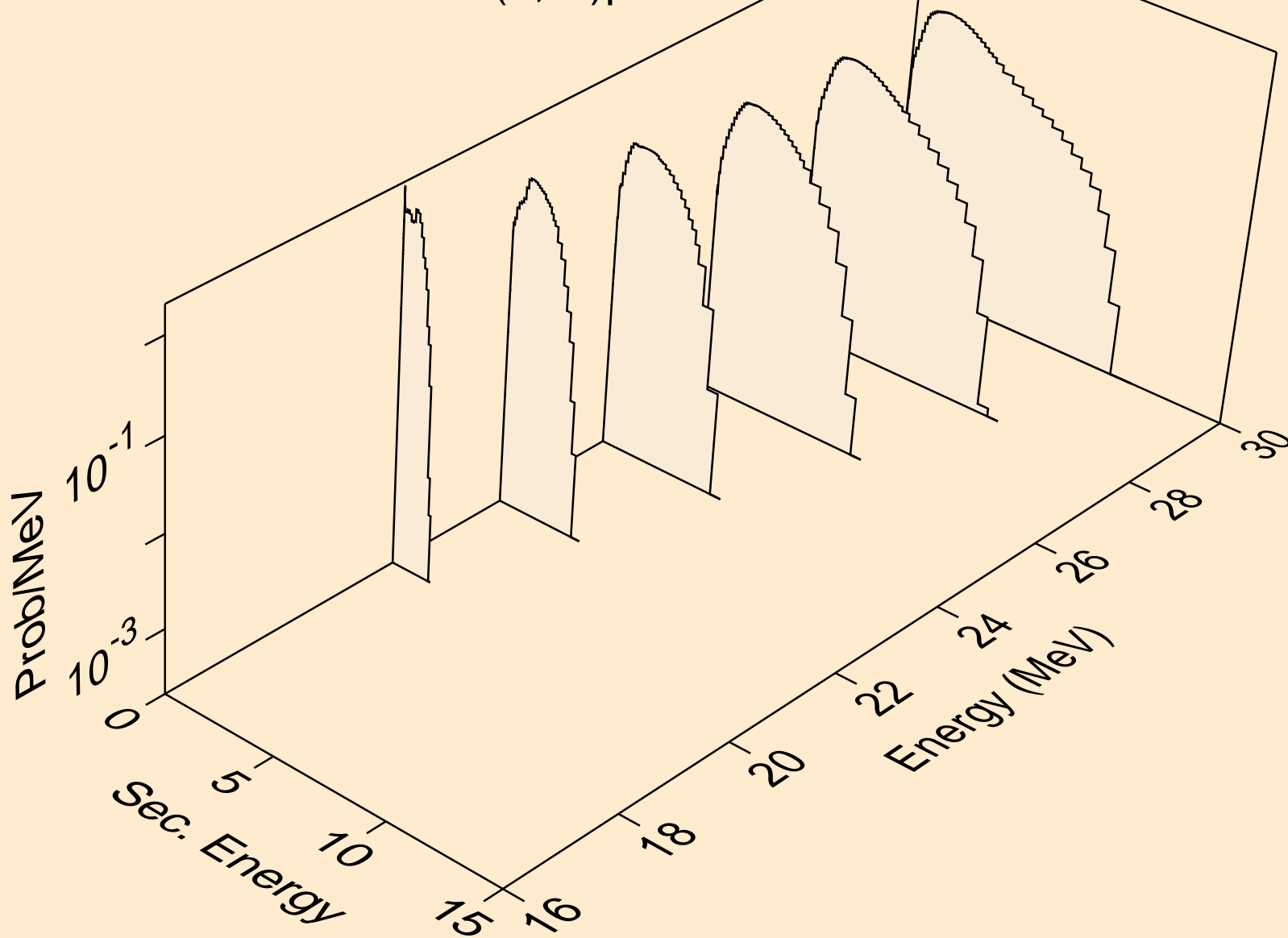

O019 NEUTRON ACER TENDL-2019 LIBRARY; T=293.16K
Neutron emission for (n,n*)2a

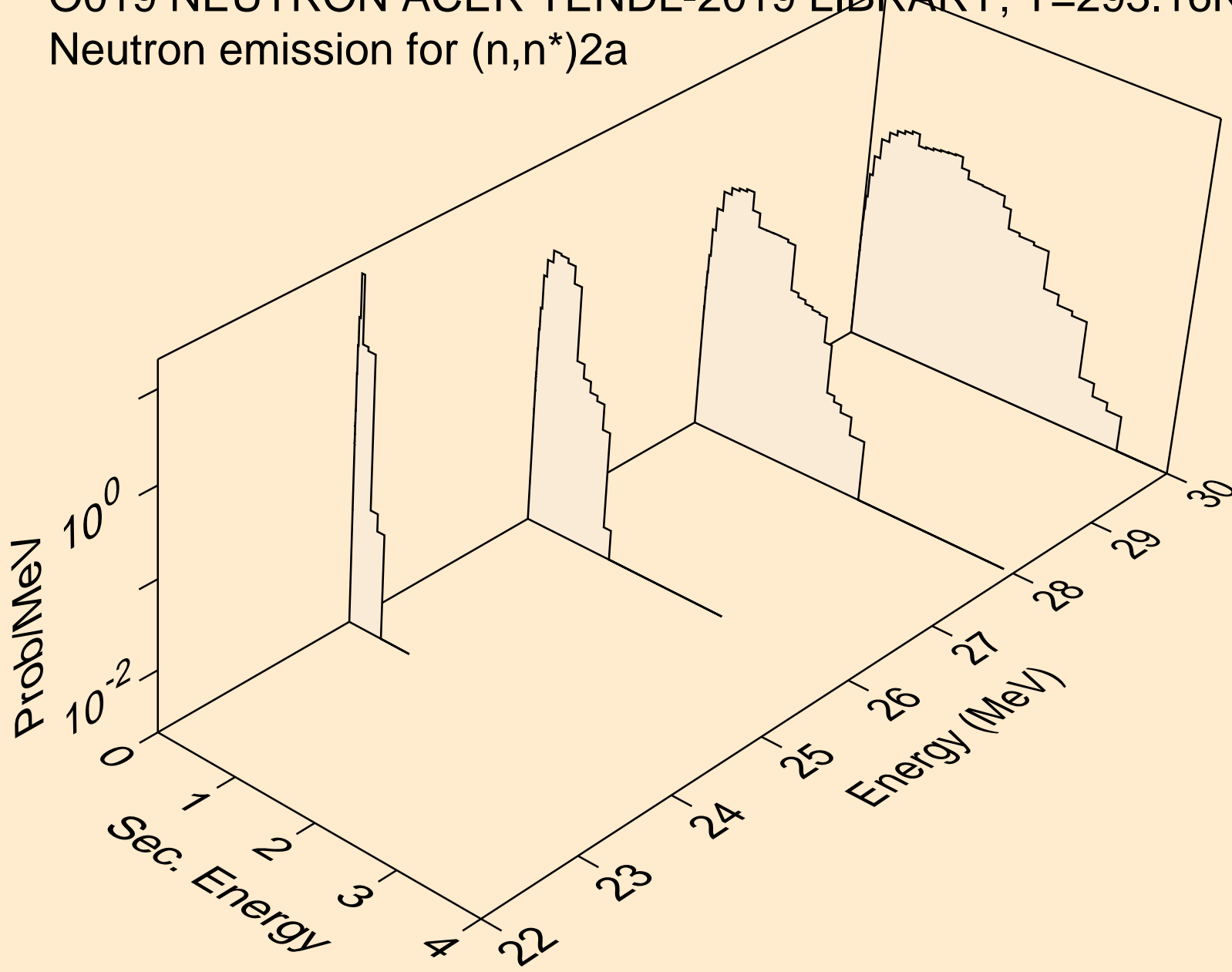

O019 NEUTRON ACER TENDL-2019 LIBRARY; T=293.16K
Neutron emission for (n,2n)2a

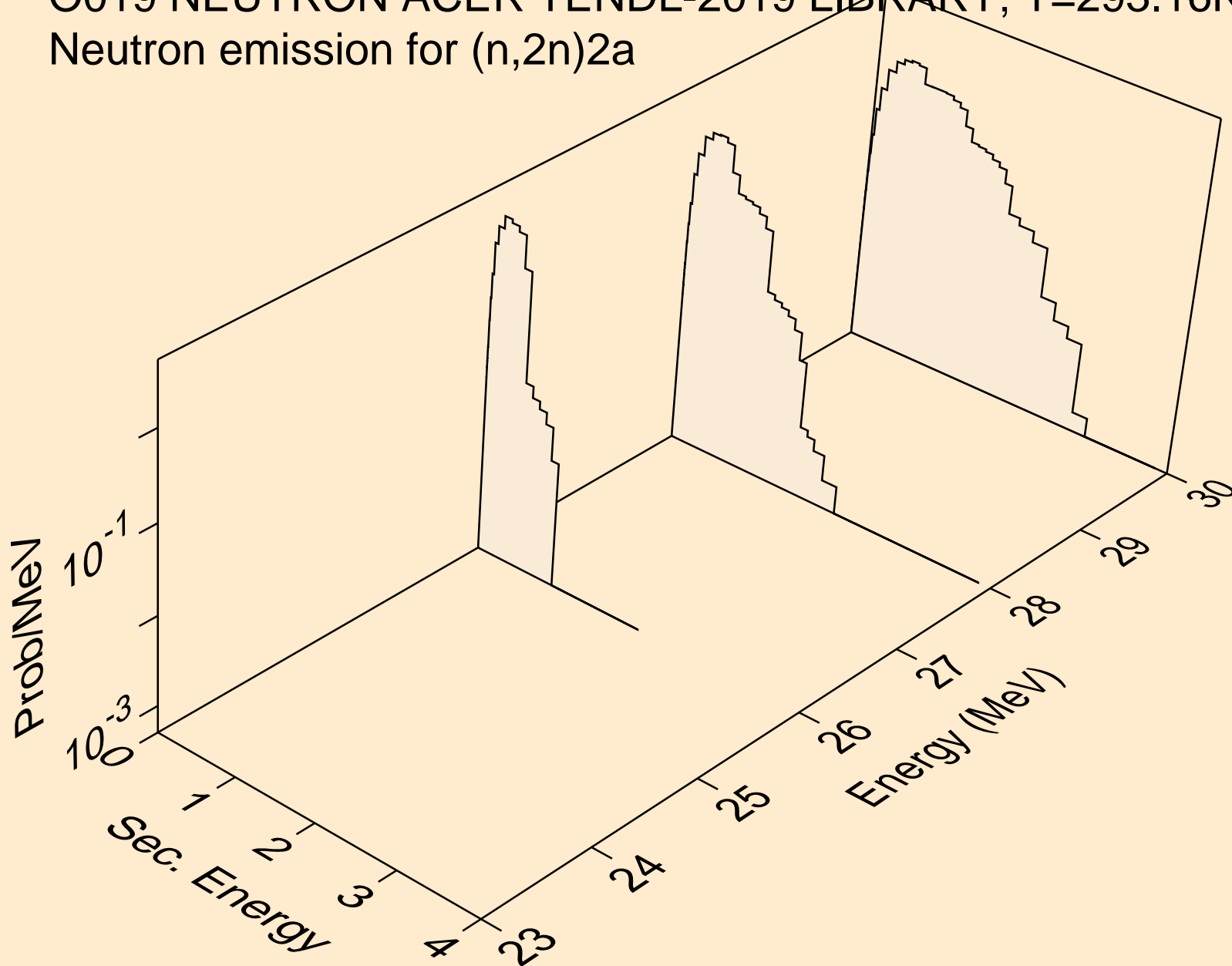

O019 NEUTRON ACER TENDL-2019 LIBRARY; T=293.16K
Neutron emission for (n,n*)d

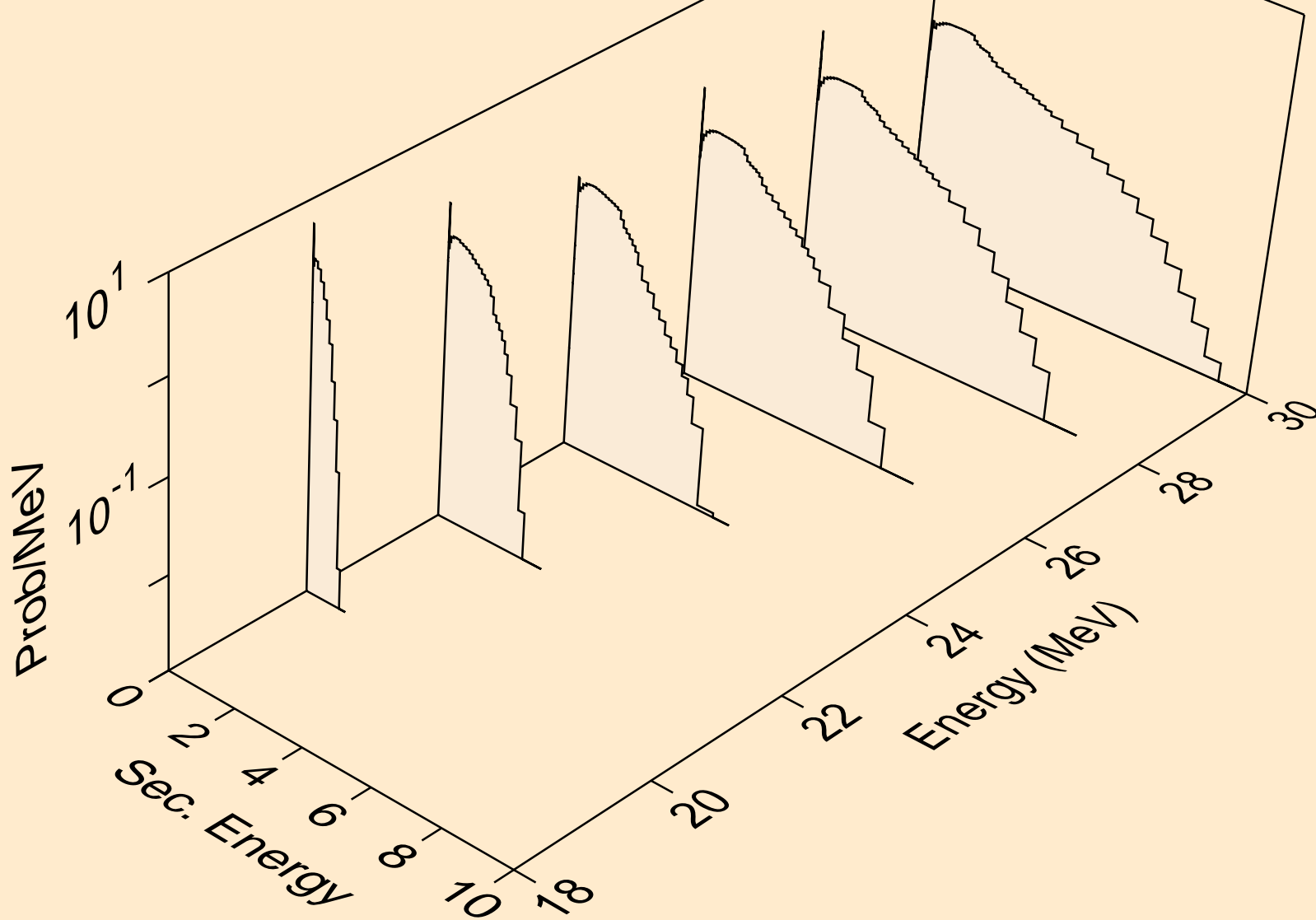

O019 NEUTRON ACER TENDL-2019 LIBRARY; T=293.16K
Neutron emission for (n,n*)t

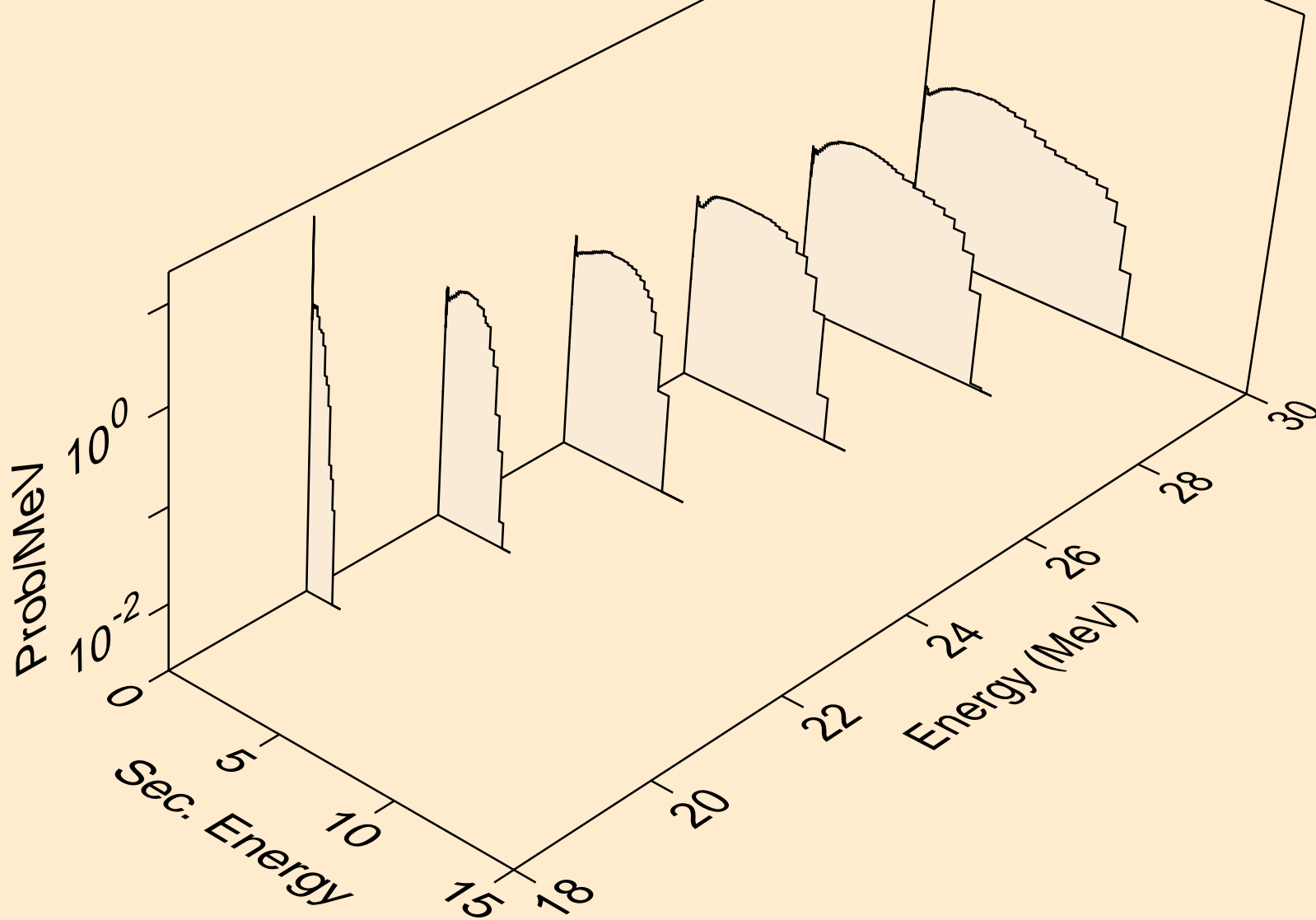

O019 NEUTRON ACER TENDL-2019 LIBRARY; T=293.16K
Neutron emission for (n,n*)he3

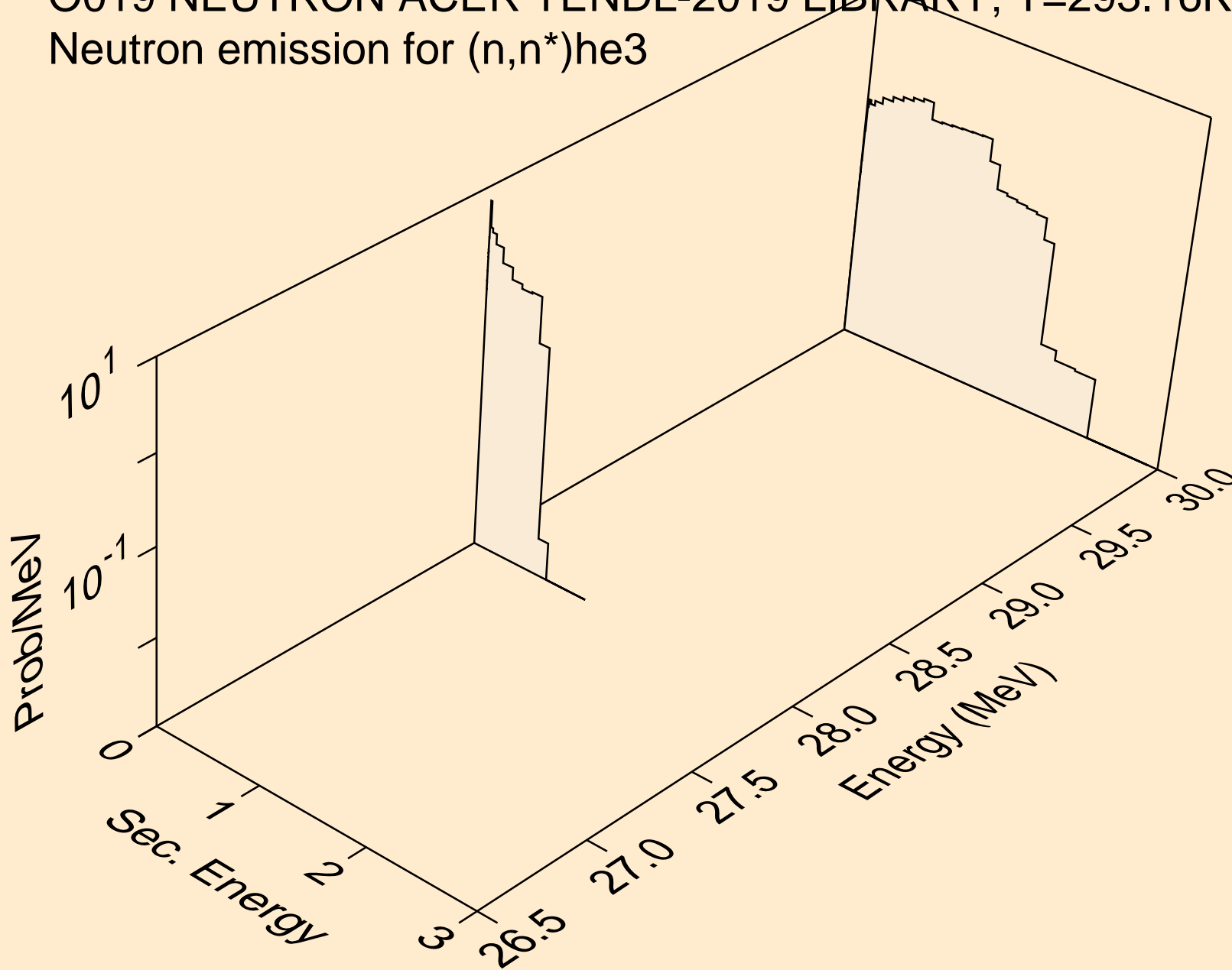

O019 NEUTRON ACER TENDL-2019 LIBRARY; T=293.16K
Neutron emission for (n,4n)

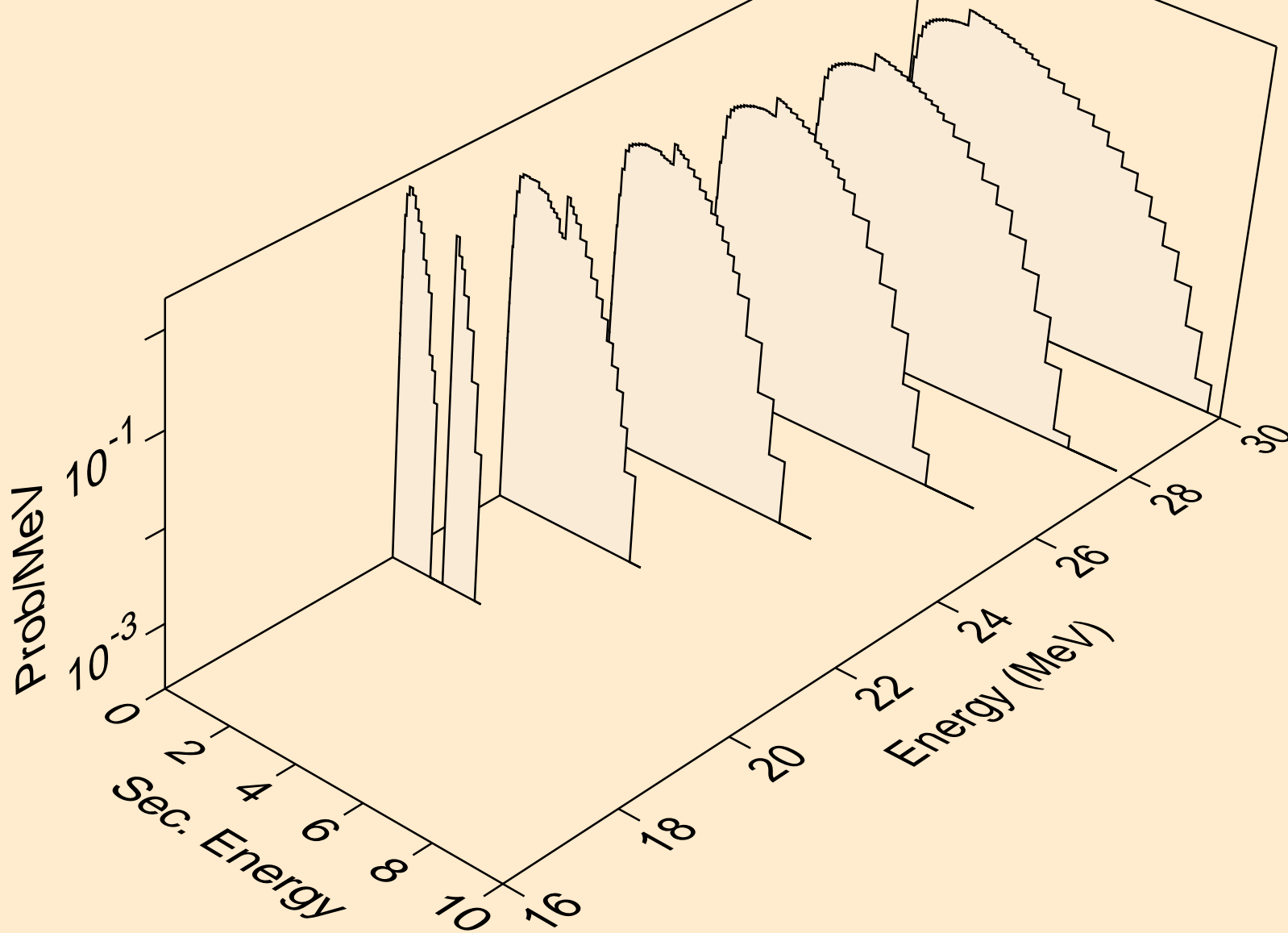

O019 NEUTRON ACER TENDL-2019 LIBRARY; T=293.16K
Neutron emission for (n,2np)

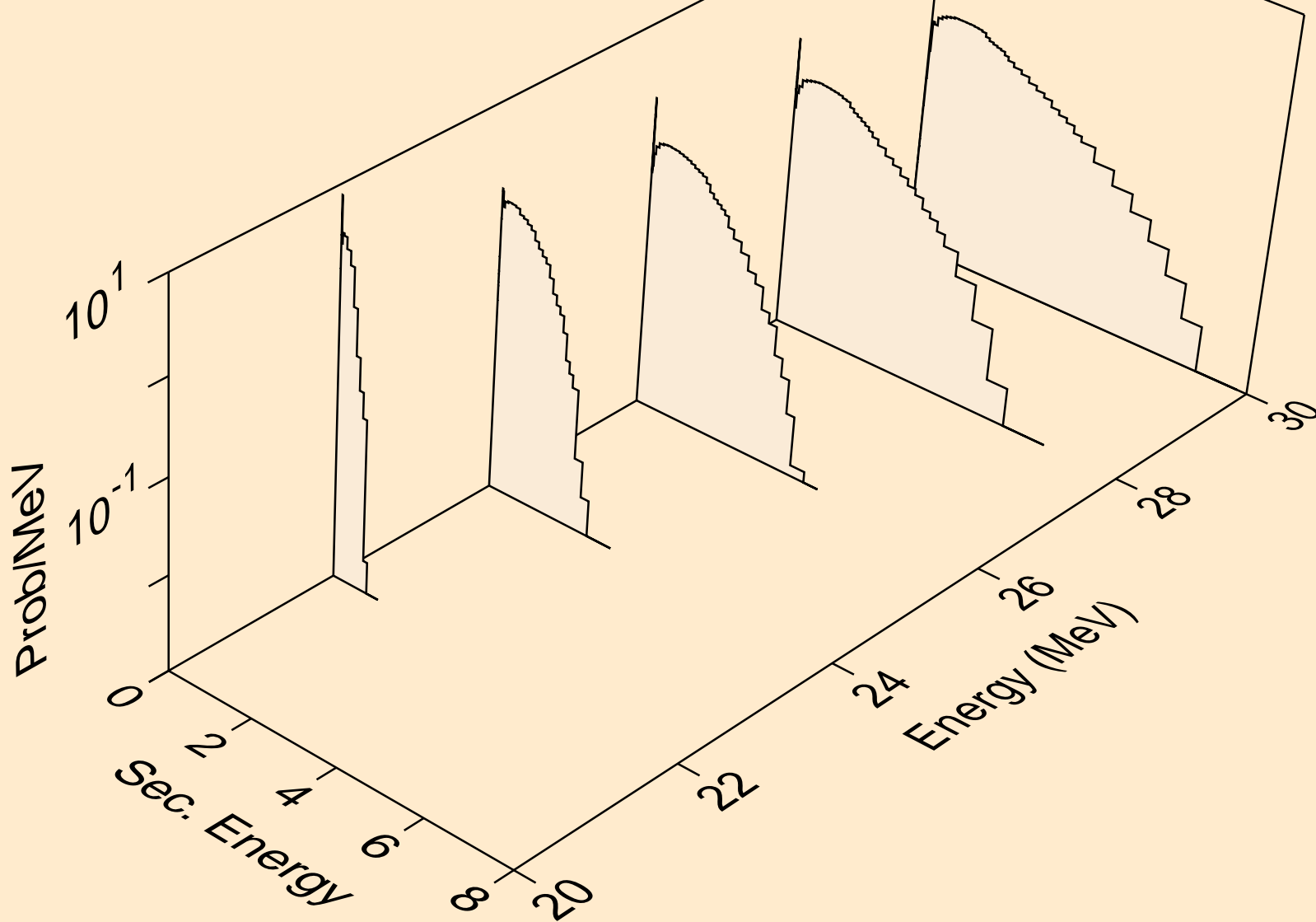

O019 NEUTRON ACER TENDL-2019 LIBRARY; T=293.16K
Neutron emission for (n,3np)

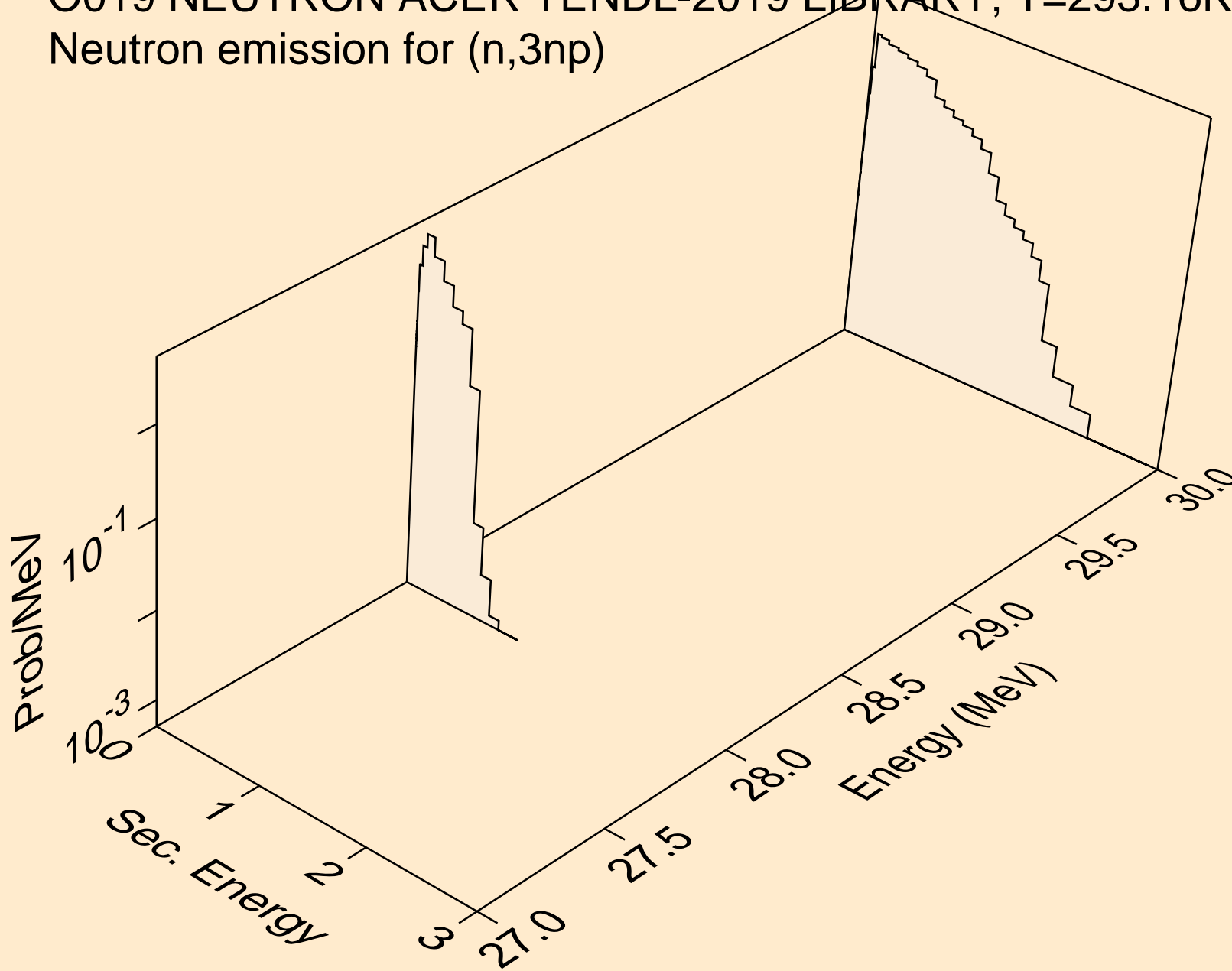

O019 NEUTRON ACER TENDL-2019 LIBRARY; T=293.16K
Neutron emission for (n,n*c)

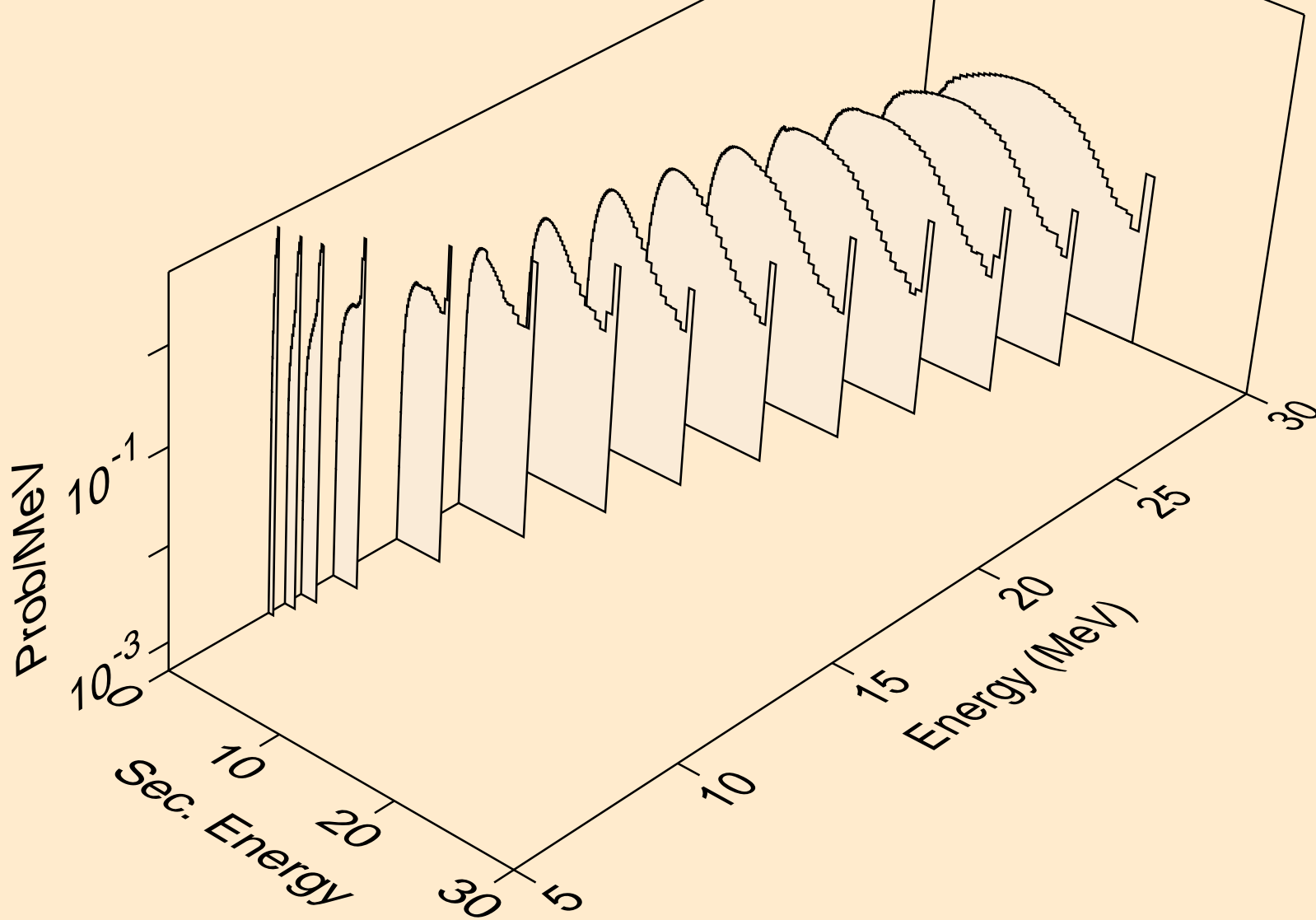

O019 NEUTRON ACER TENDL-2019 LIBRARY; T=293.16K
Photon emission for (n,x)

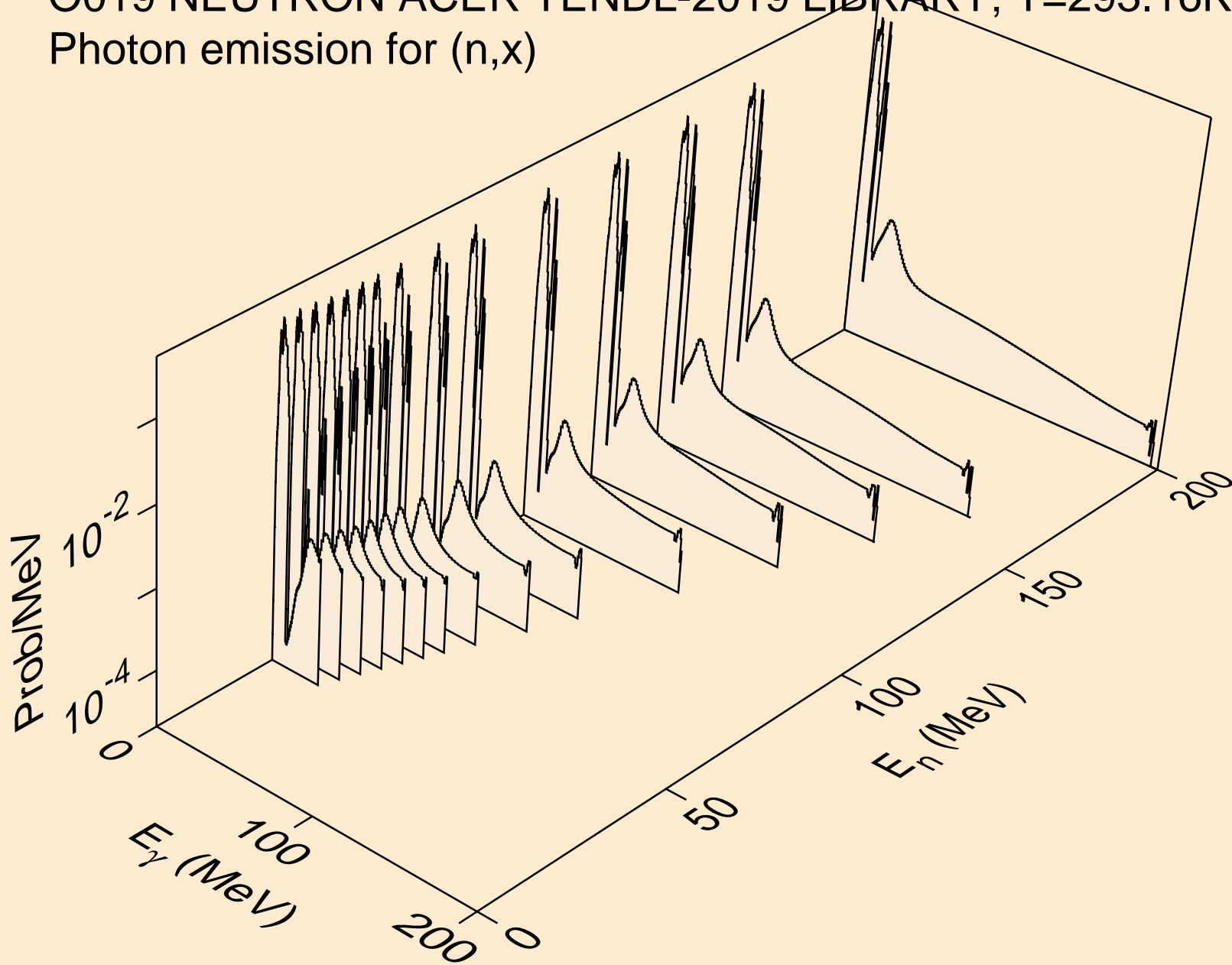

O019 NEUTRON ACER TENDL-2019 LIBRARY; T=293.16K
Photon emission for (n,2nd)

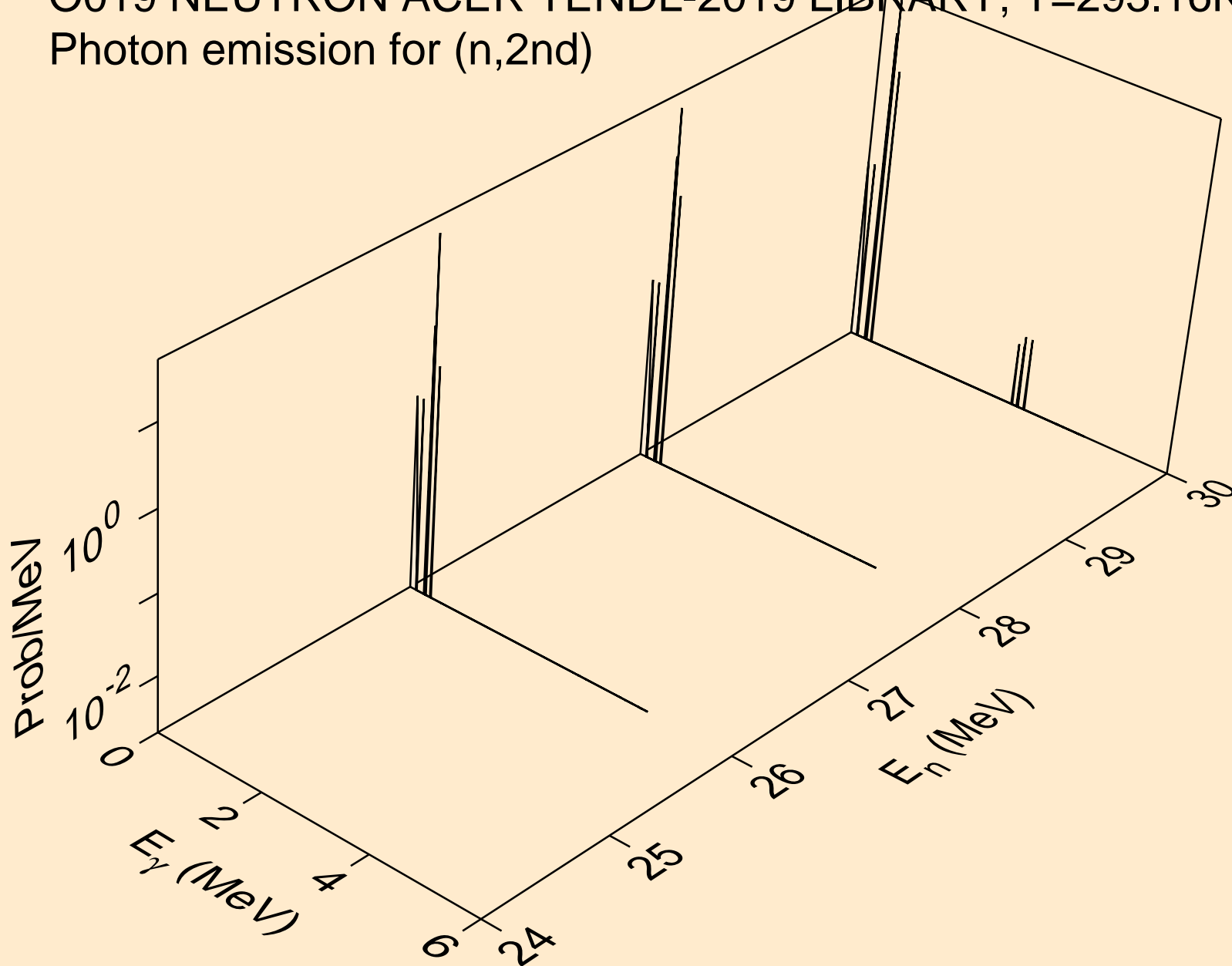

O019 NEUTRON ACER TENDL-2019 LIBRARY; T=293.16K
Photon emission for (n,2n)

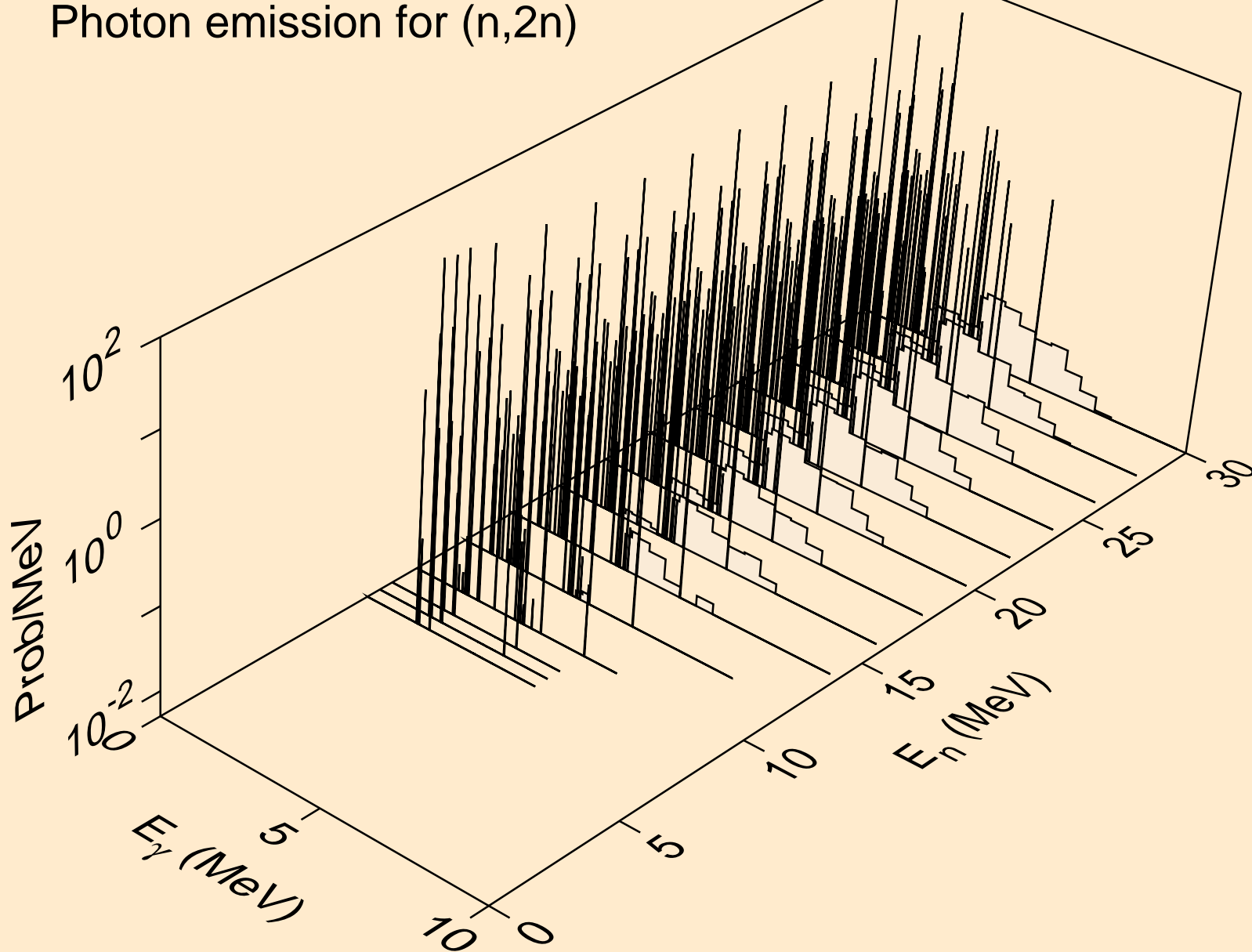

O019 NEUTRON ACER TENDL-2019 LIBRARY; T=293.16K
Photon emission for (n,3n)

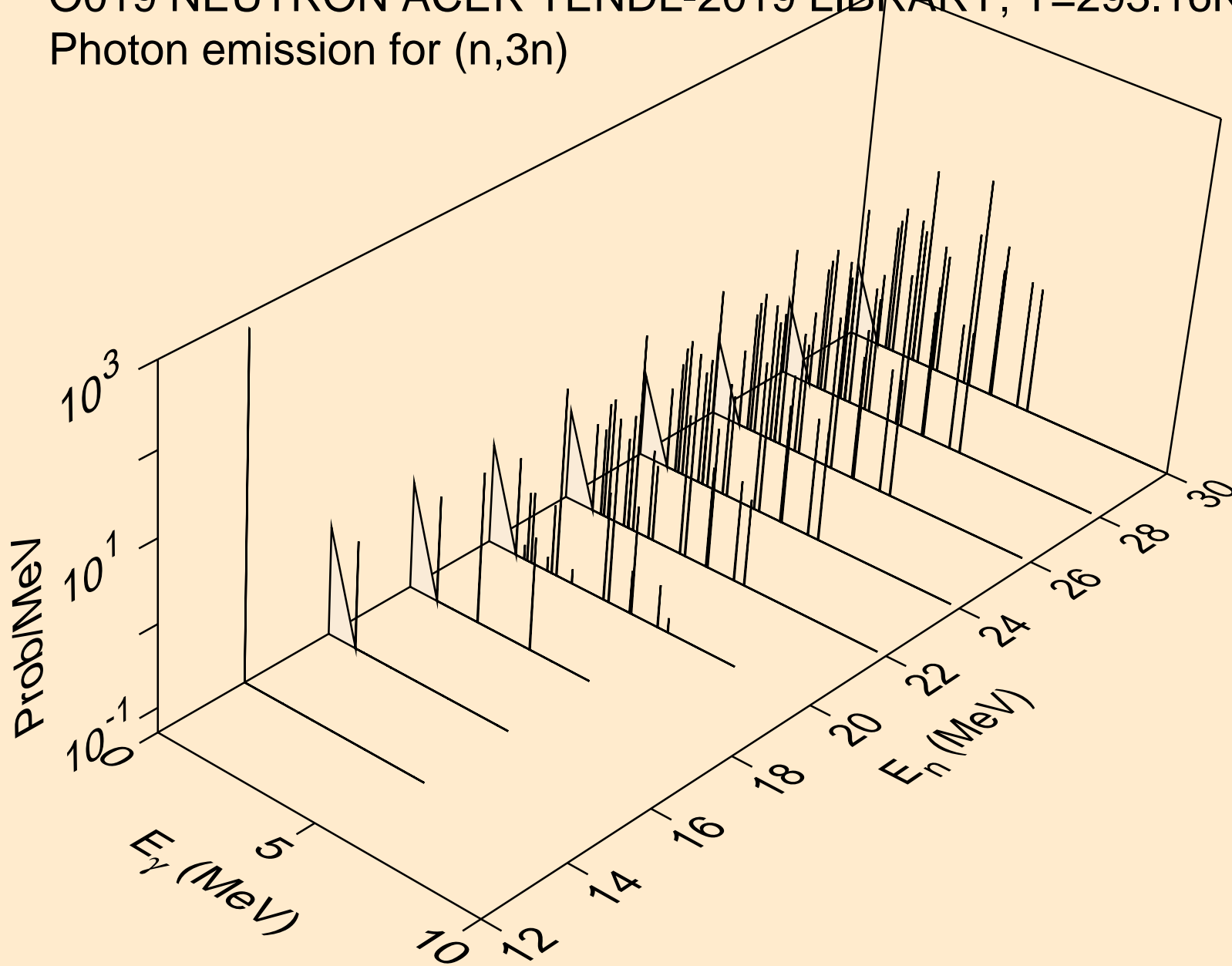

O019 NEUTRON ACER TENDL-2019 LIBRARY; T=293.16K
Photon emission for (n,n*)a

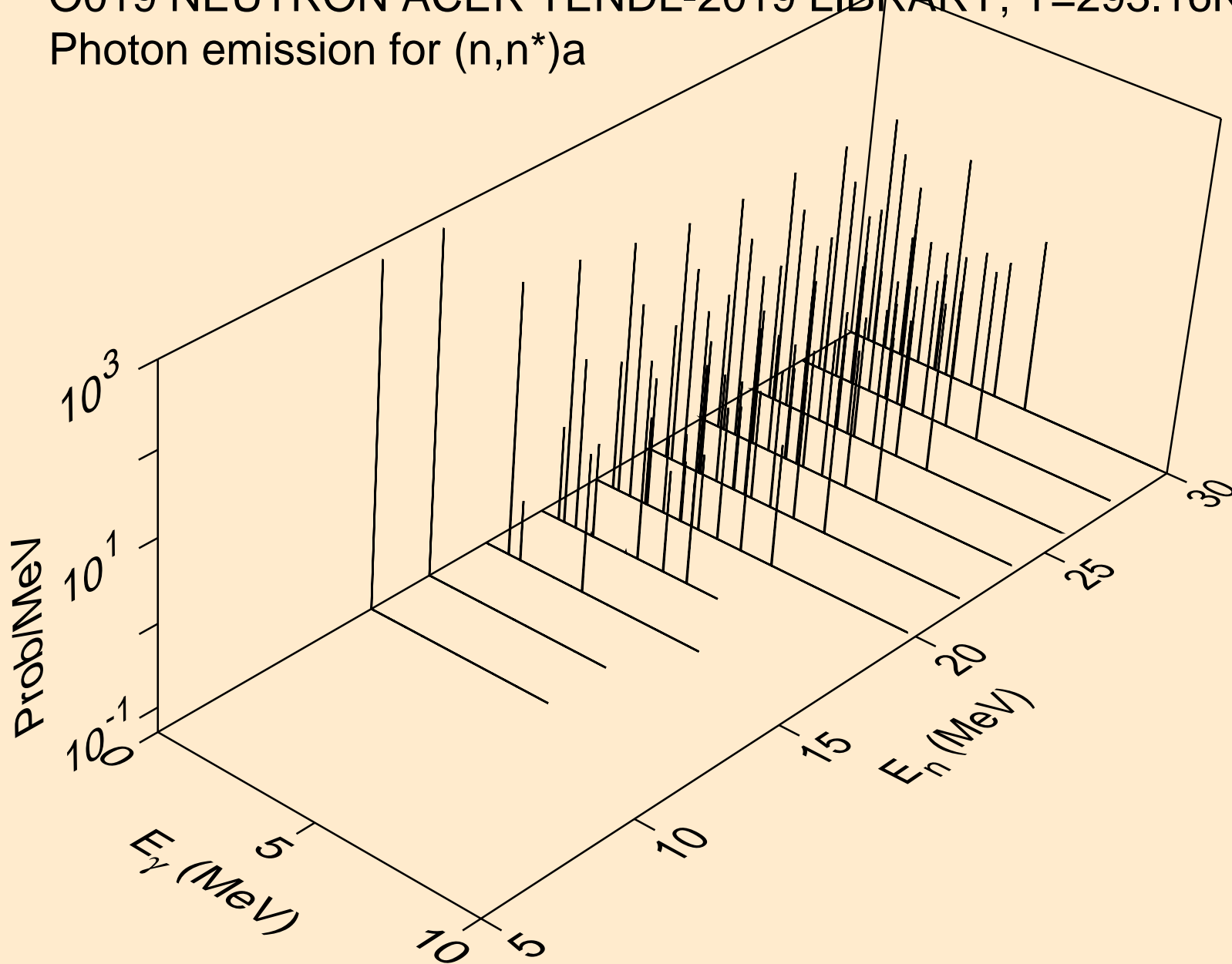

O019 NEUTRON ACER TENDL-2019 LIBRARY; T=293.16K
Photon emission for (n,2n)a

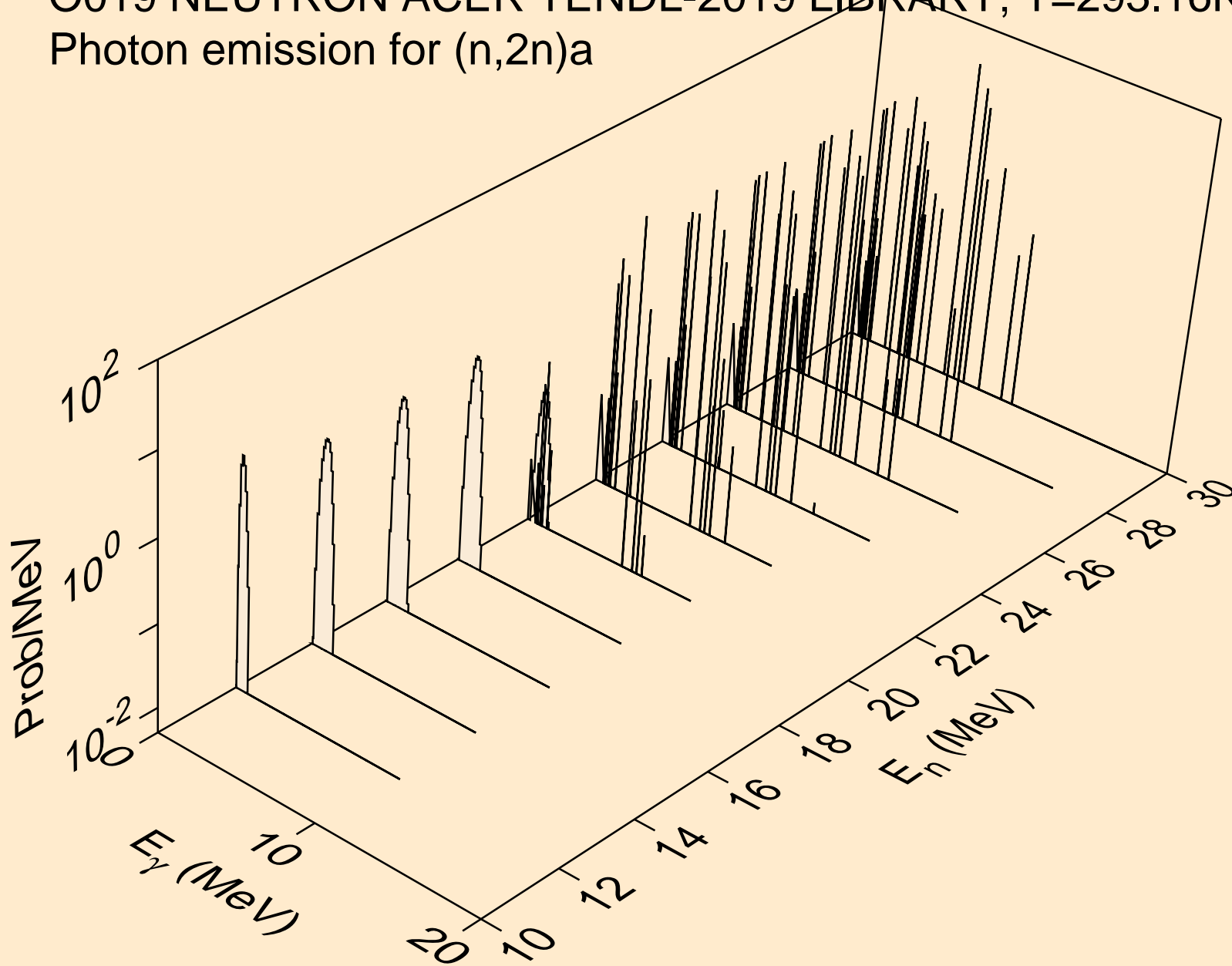

O019 NEUTRON ACER TENDL-2019 LIBRARY; T=293.16K
Photon emission for (n,3n)a

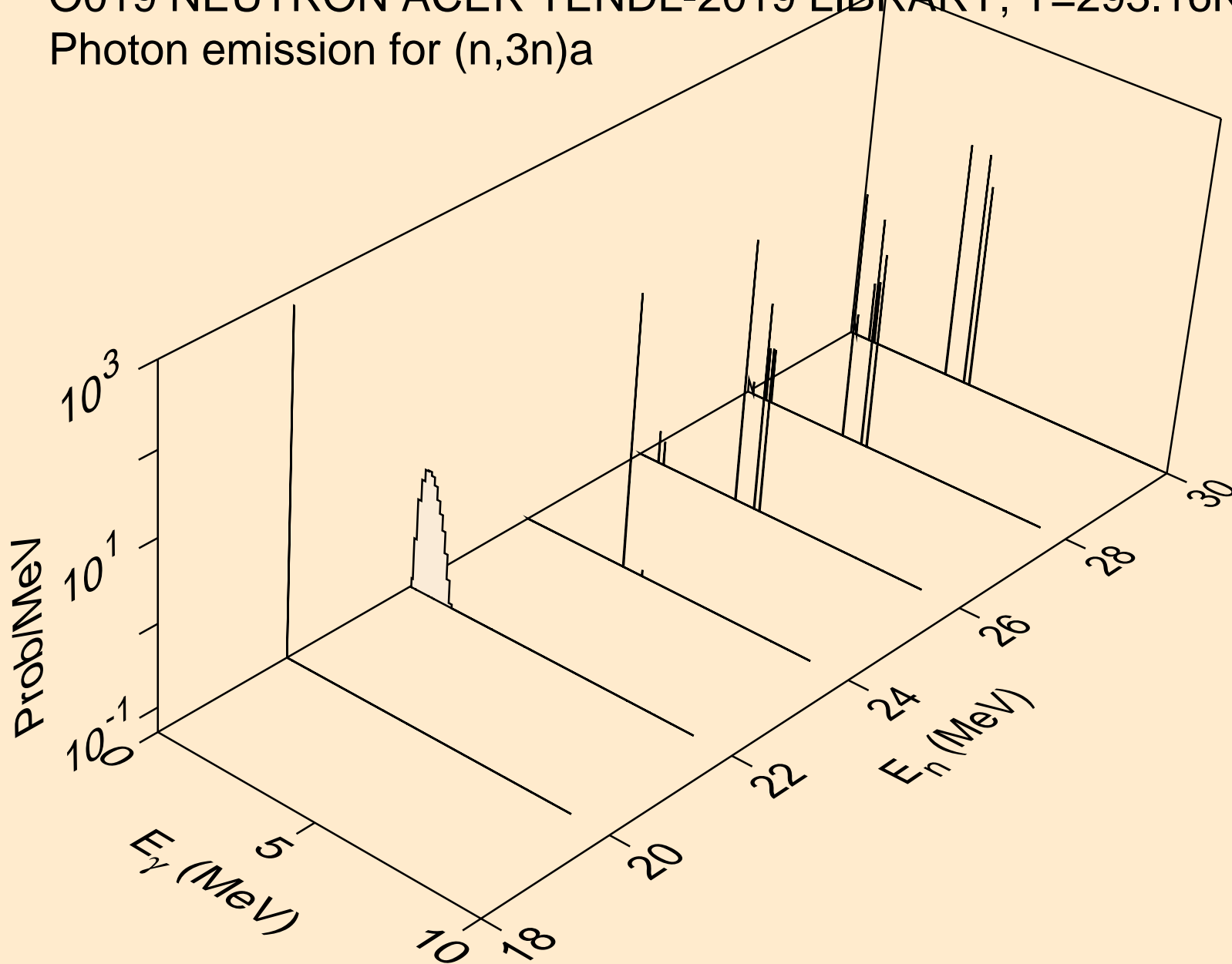

O019 NEUTRON ACER TENDL-2019 LIBRARY; T=293.16K
Photon emission for (n,n*)p

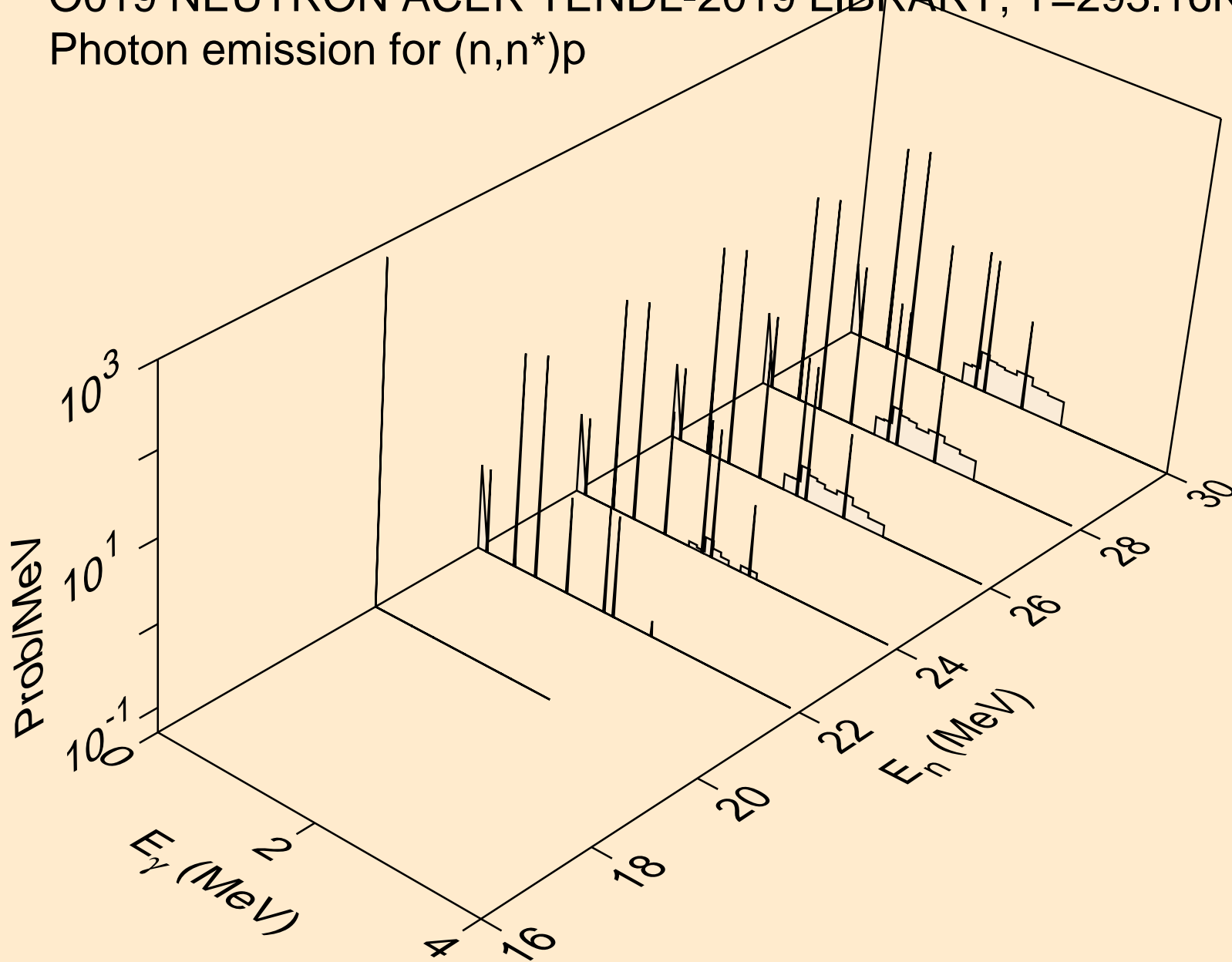

O019 NEUTRON ACER TENDL-2019 LIBRARY; T=293.16K
Photon emission for (n,n*)2a

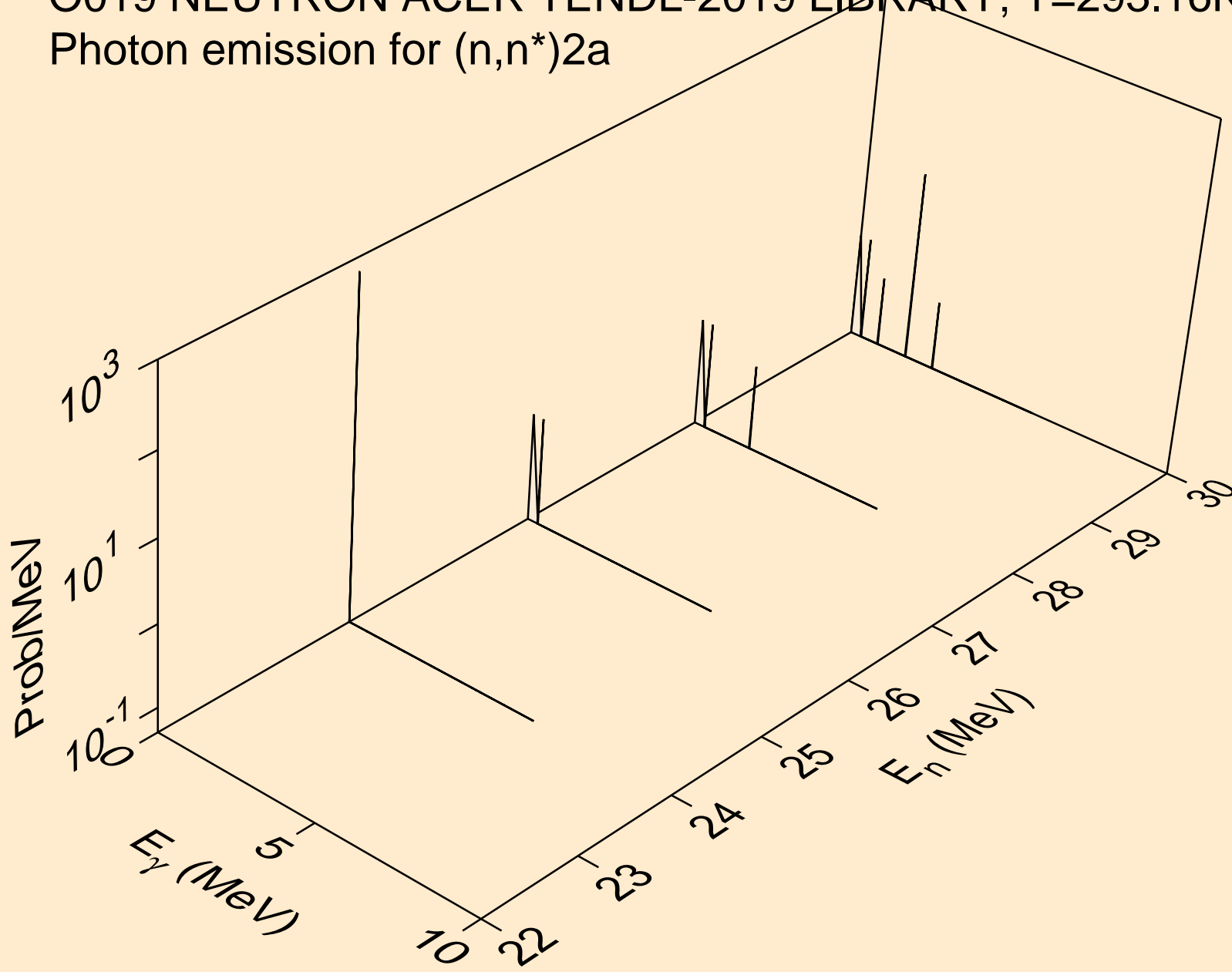

O019 NEUTRON ACER TENDL-2019 LIBRARY; T=293.16K
Photon emission for (n,2n)2a

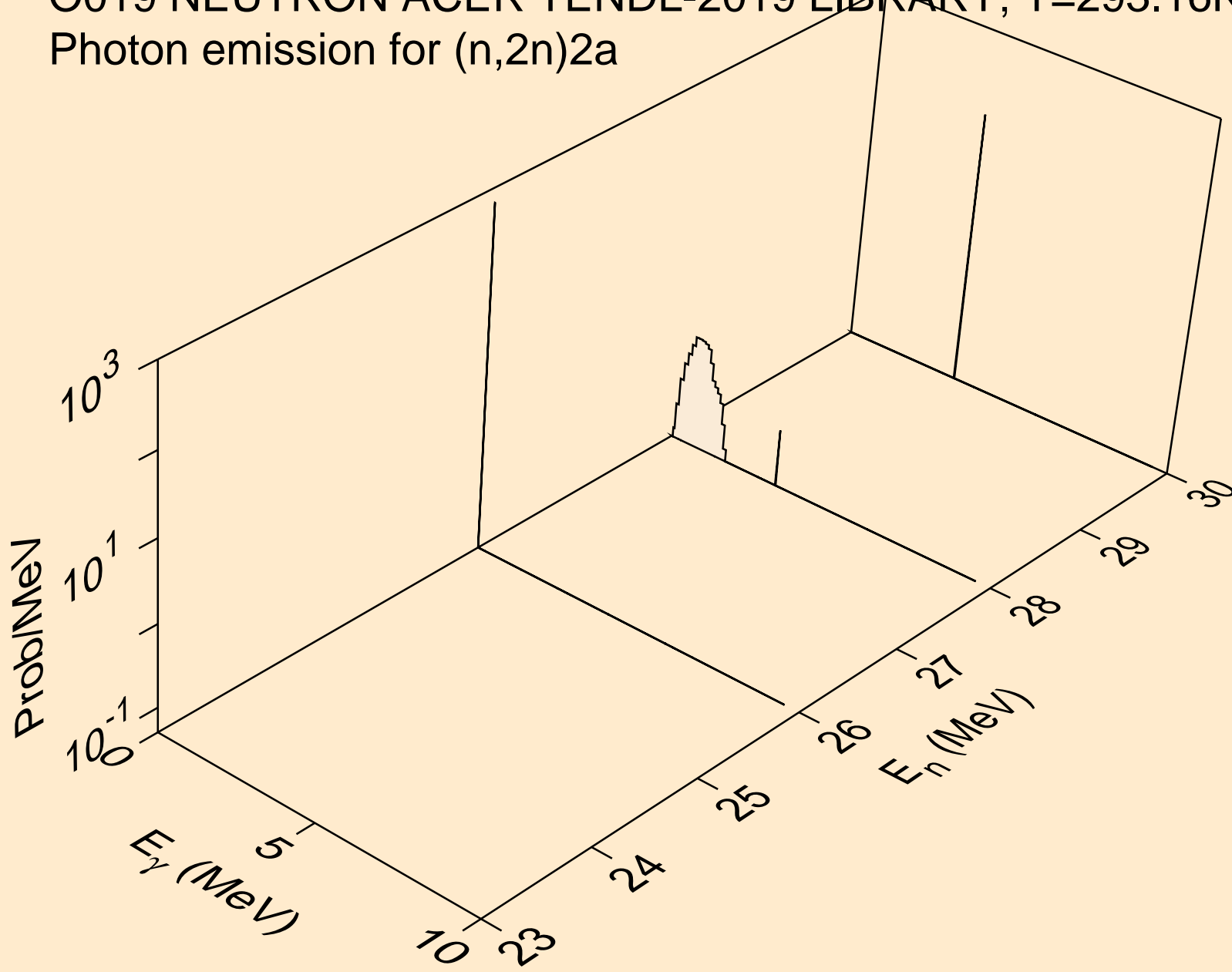

O019 NEUTRON ACER TENDL-2019 LIBRARY; T=293.16K
Photon emission for (n,n*)d

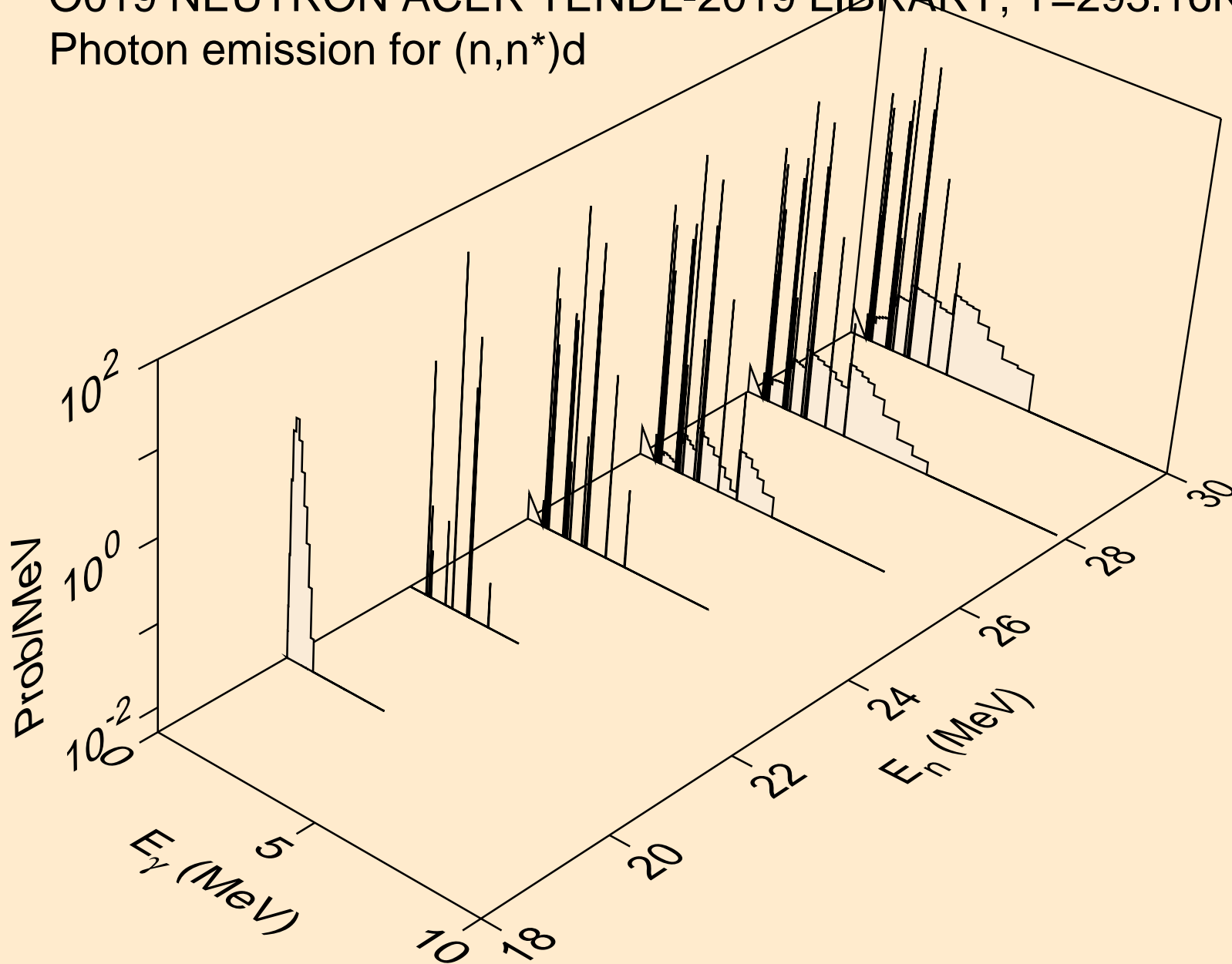

O019 NEUTRON ACER TENDL-2019 LIBRARY; T=293.16K
Photon emission for (n,n*)t

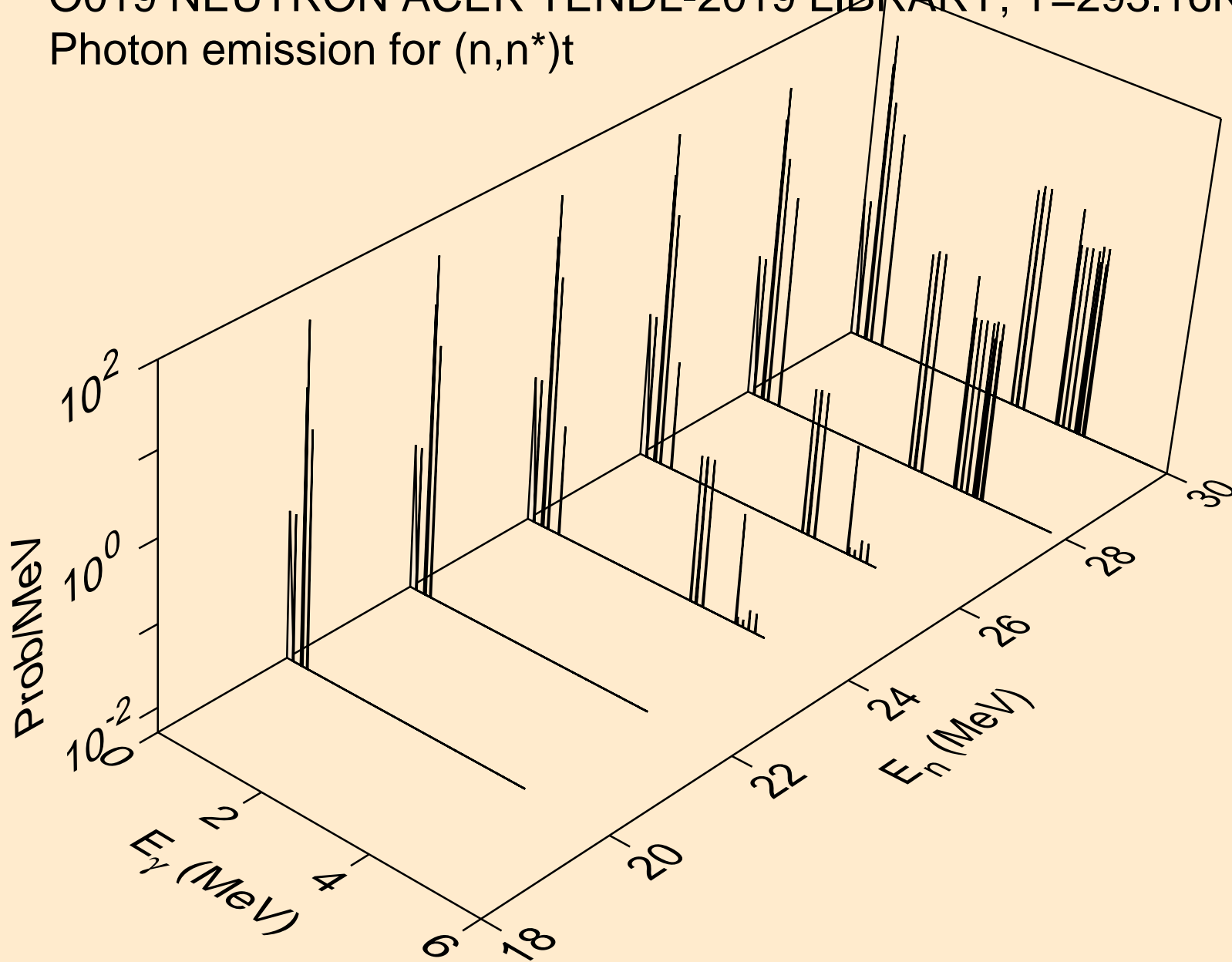

O019 NEUTRON ACER TENDL-2019 LIBRARY; T=293.16K
Photon emission for (n,n*)he3

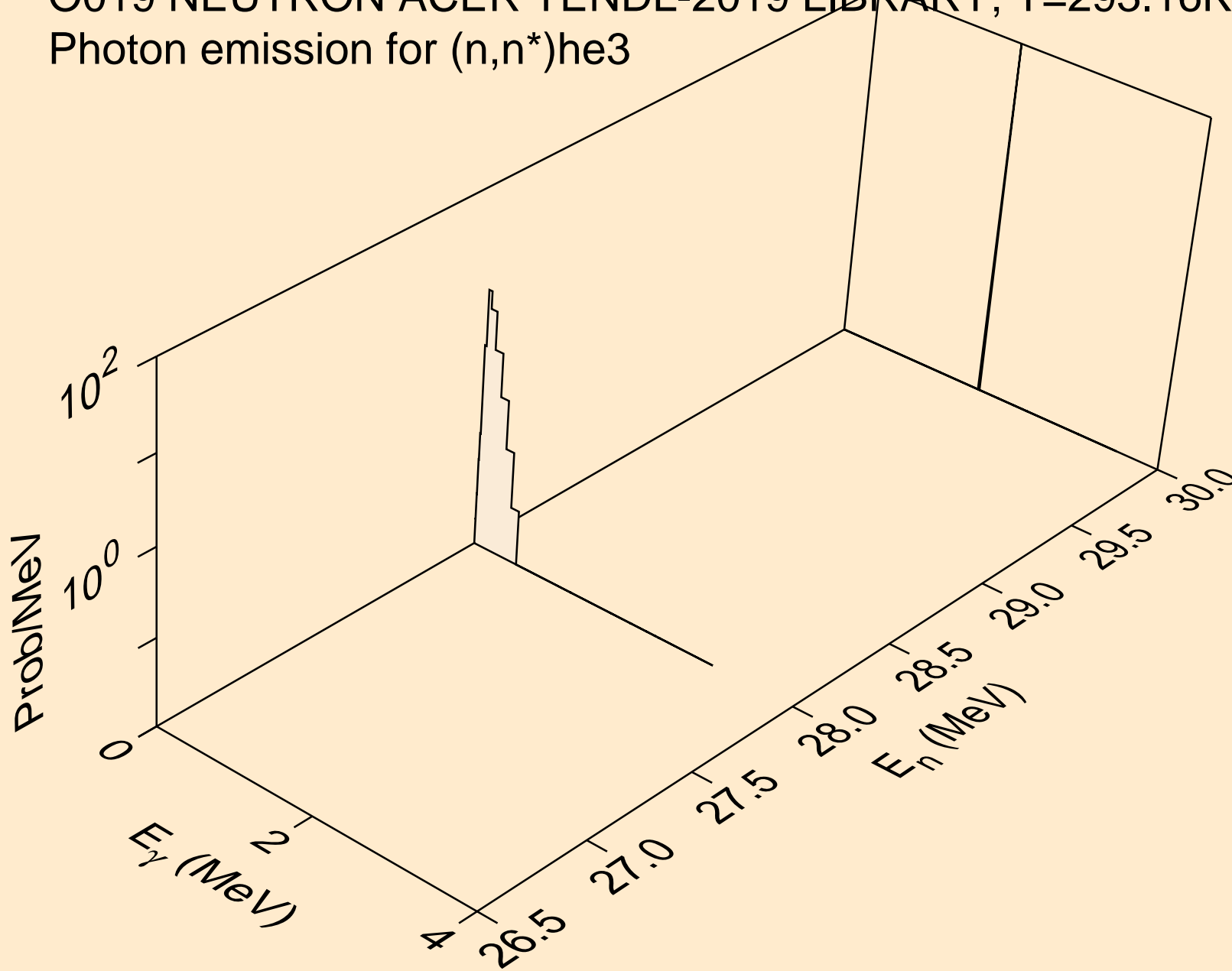

O019 NEUTRON ACER TENDL-2019 LIBRARY; T=293.16K
Photon emission for (n,4n)

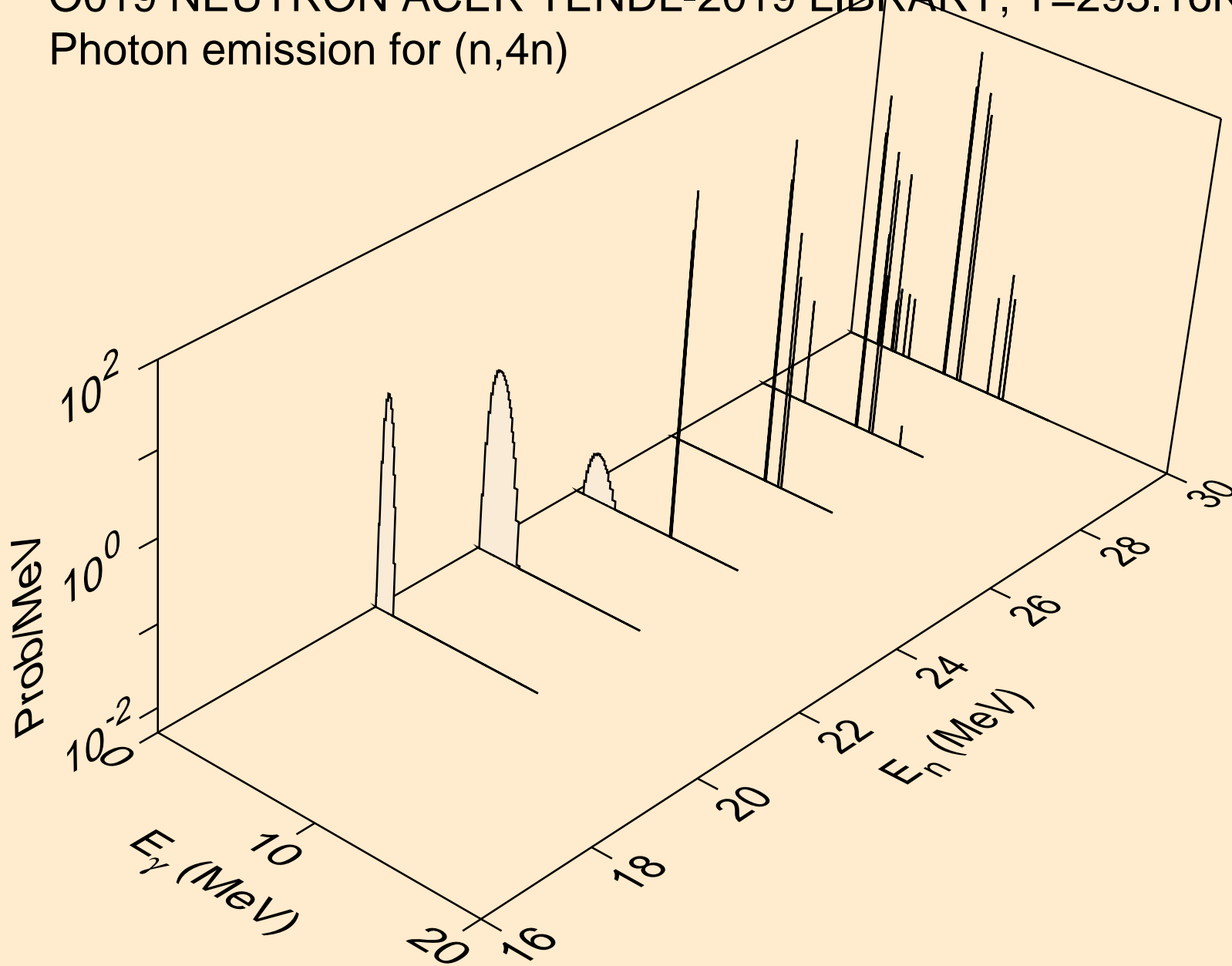

O019 NEUTRON ACER TENDL-2019 LIBRARY; T=293.16K
Photon emission for (n,2np)

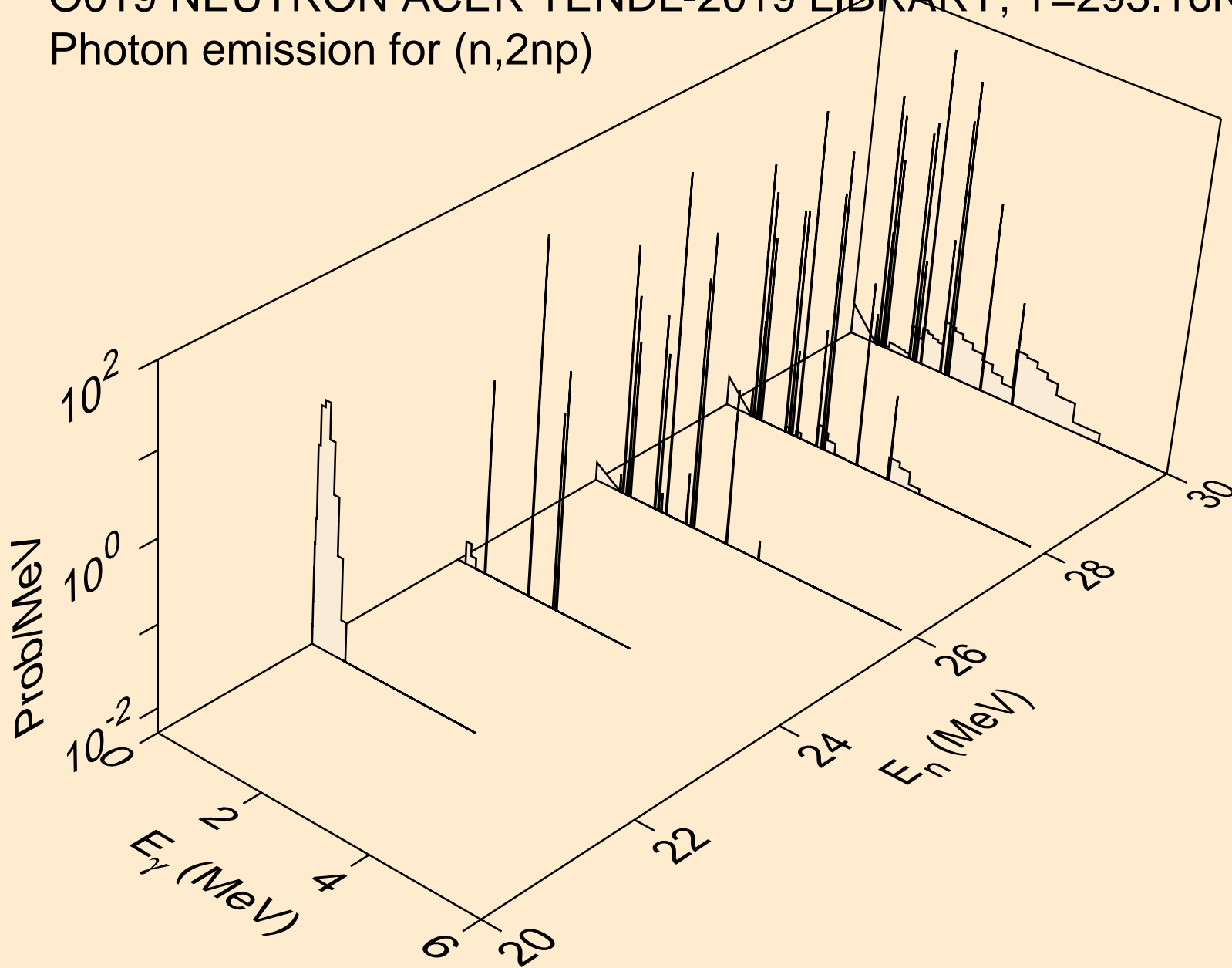

O019 NEUTRON ACER TENDL-2019 LIBRARY; T=293.16K
Photon emission for (n,3np)

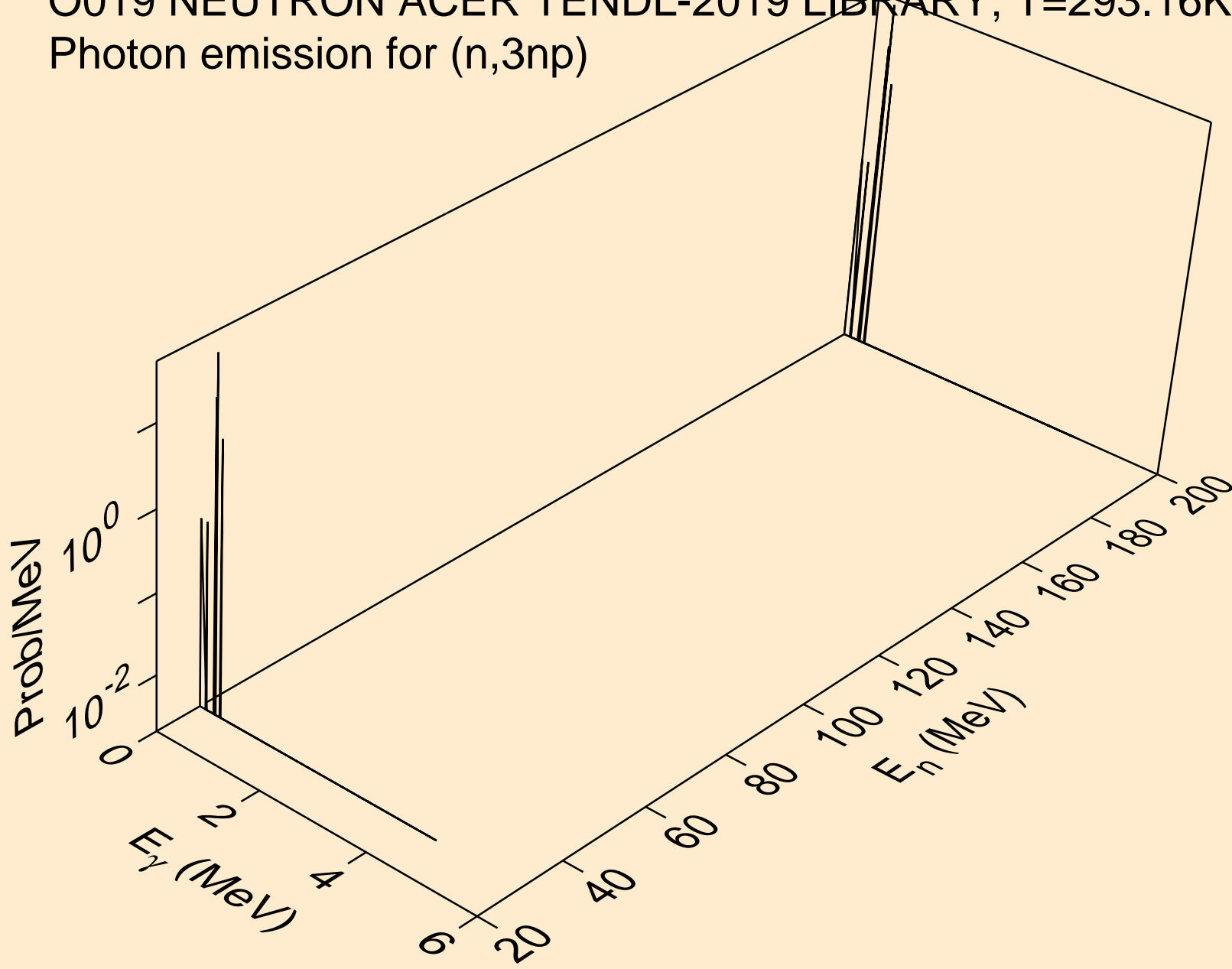

O019 NEUTRON ACER TENDL-2019 LIBRARY; T=293.16K
Photon emission for (n,n*c)

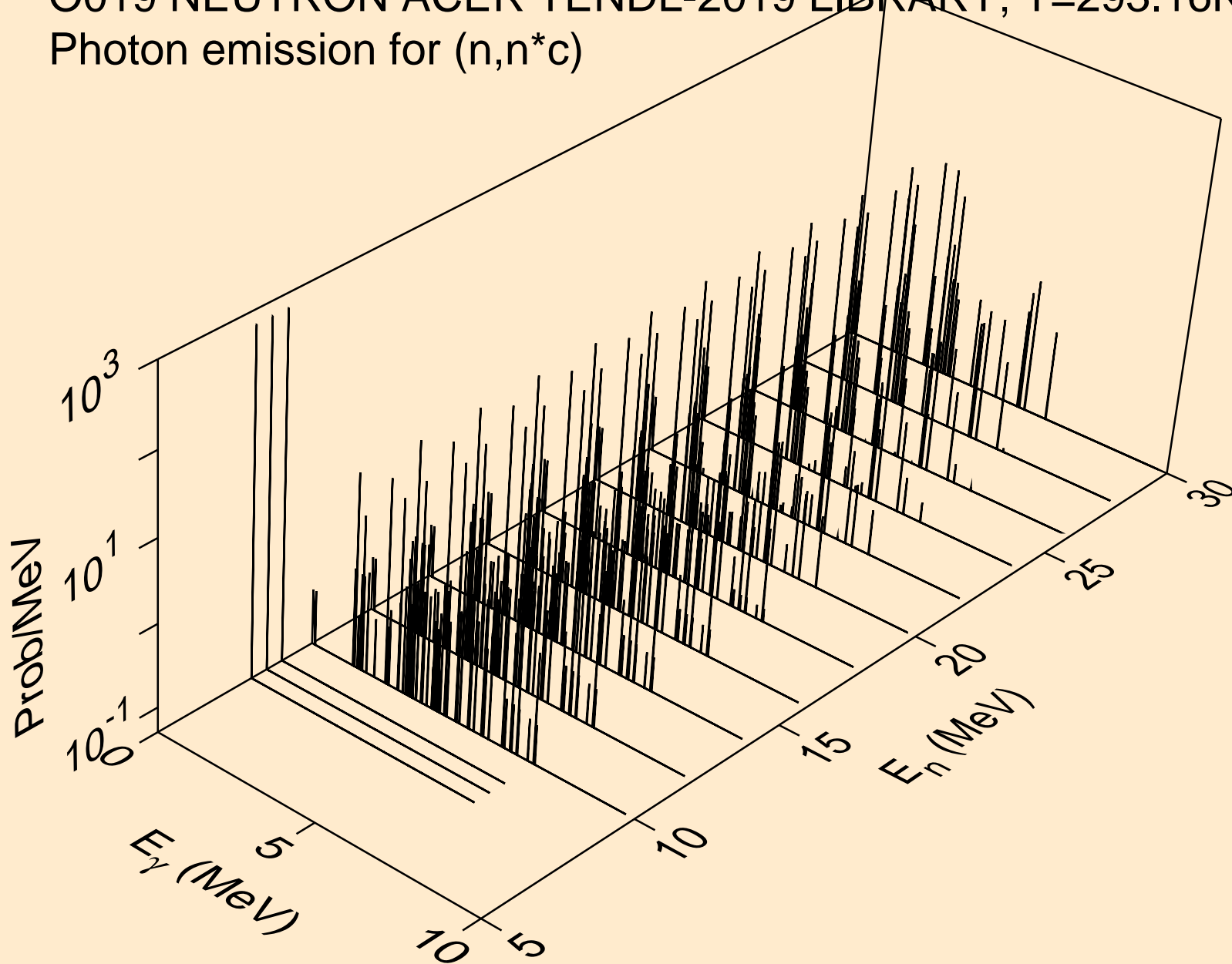

O019 NEUTRON ACER TENDL-2019 LIBRARY; T=293.16K
Photon emission for (n,gma)

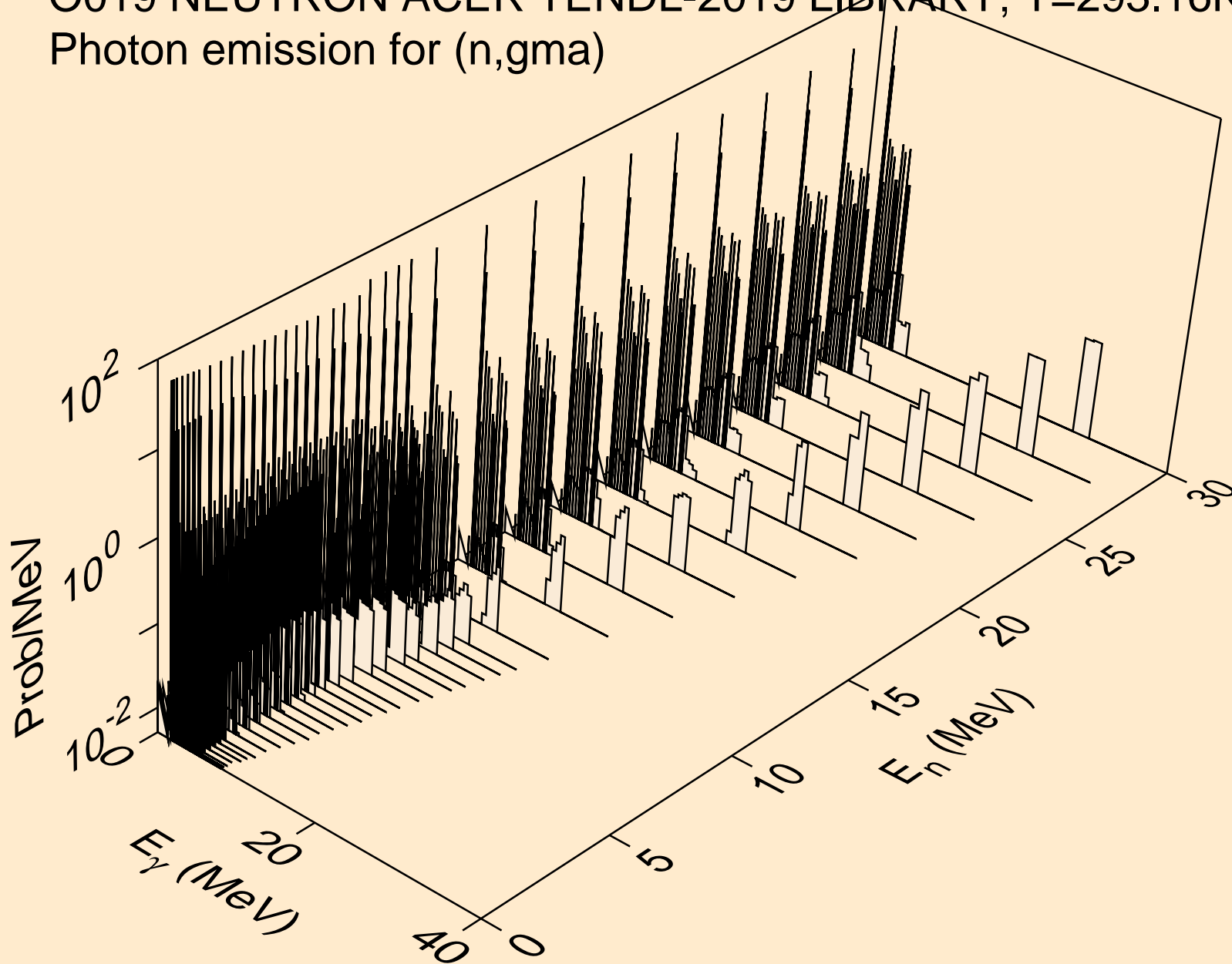

O019 NEUTRON ACER TENDL-2019 LIBRARY; T=293.16K
Photon emission for (n,p)

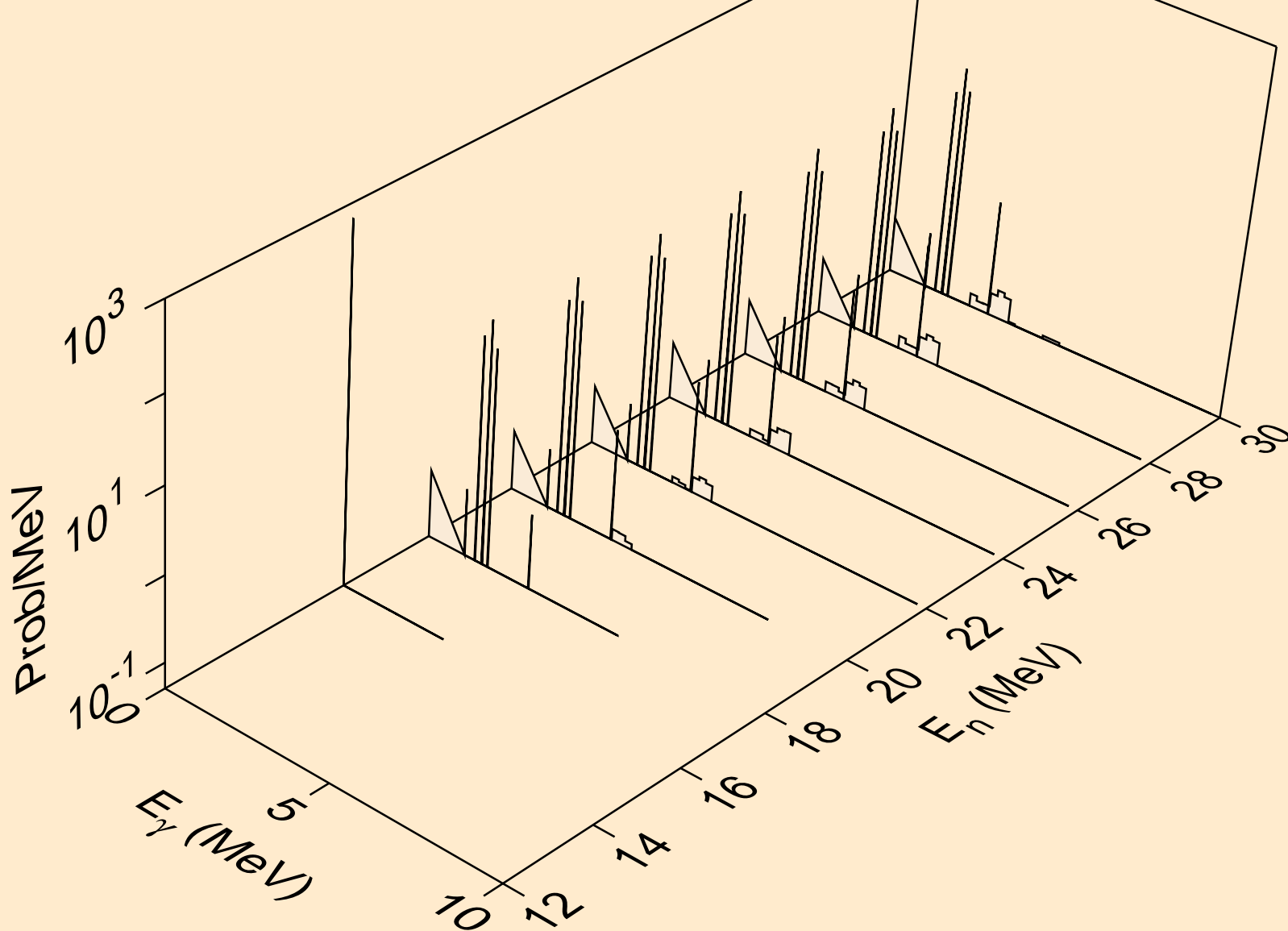

O019 NEUTRON ACER TENDL-2019 LIBRARY; T=293.16K
Photon emission for (n,d)

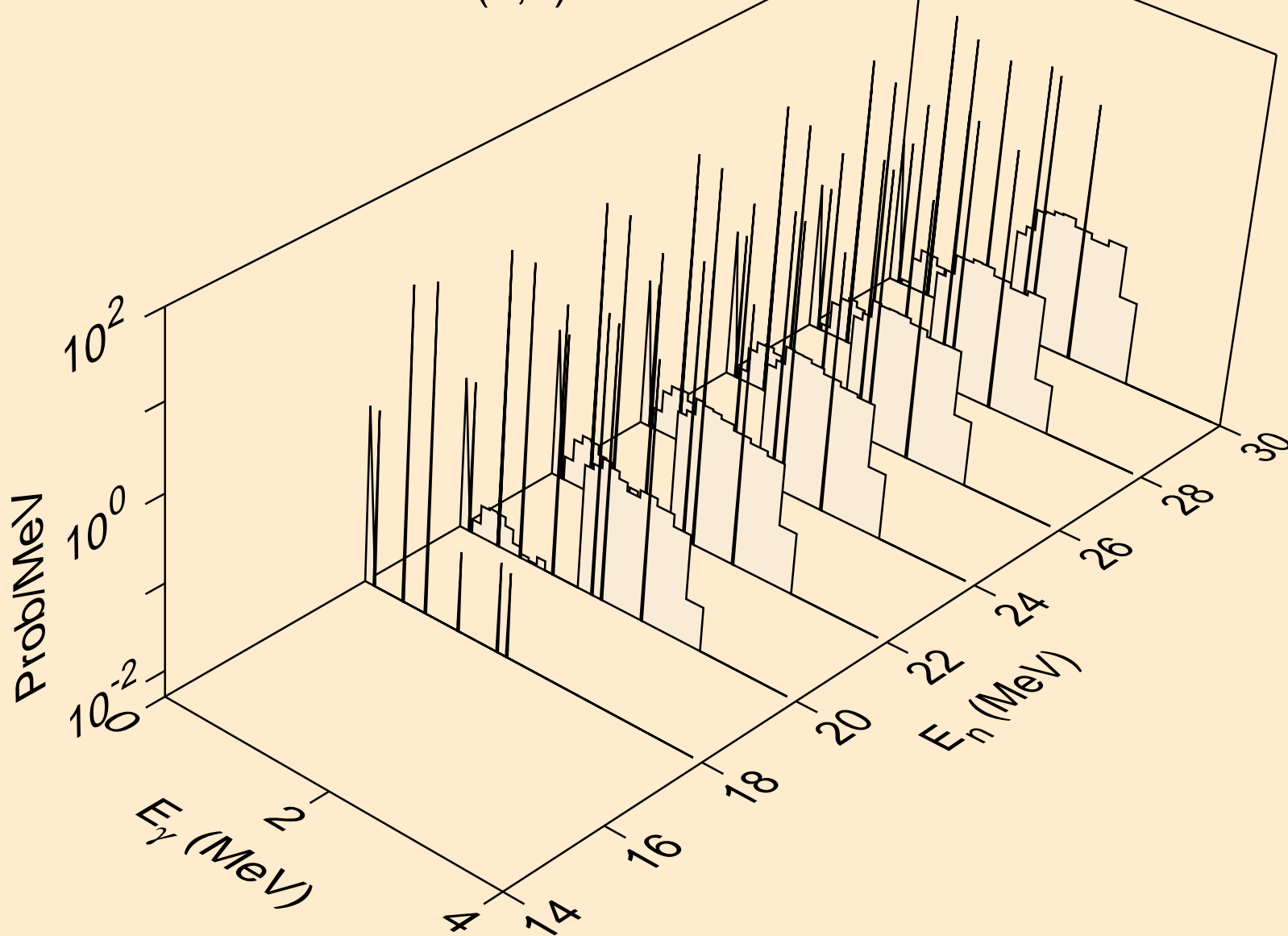

O019 NEUTRON ACER TENDL-2019 LIBRARY; T=293.16K
Photon emission for (n,t)

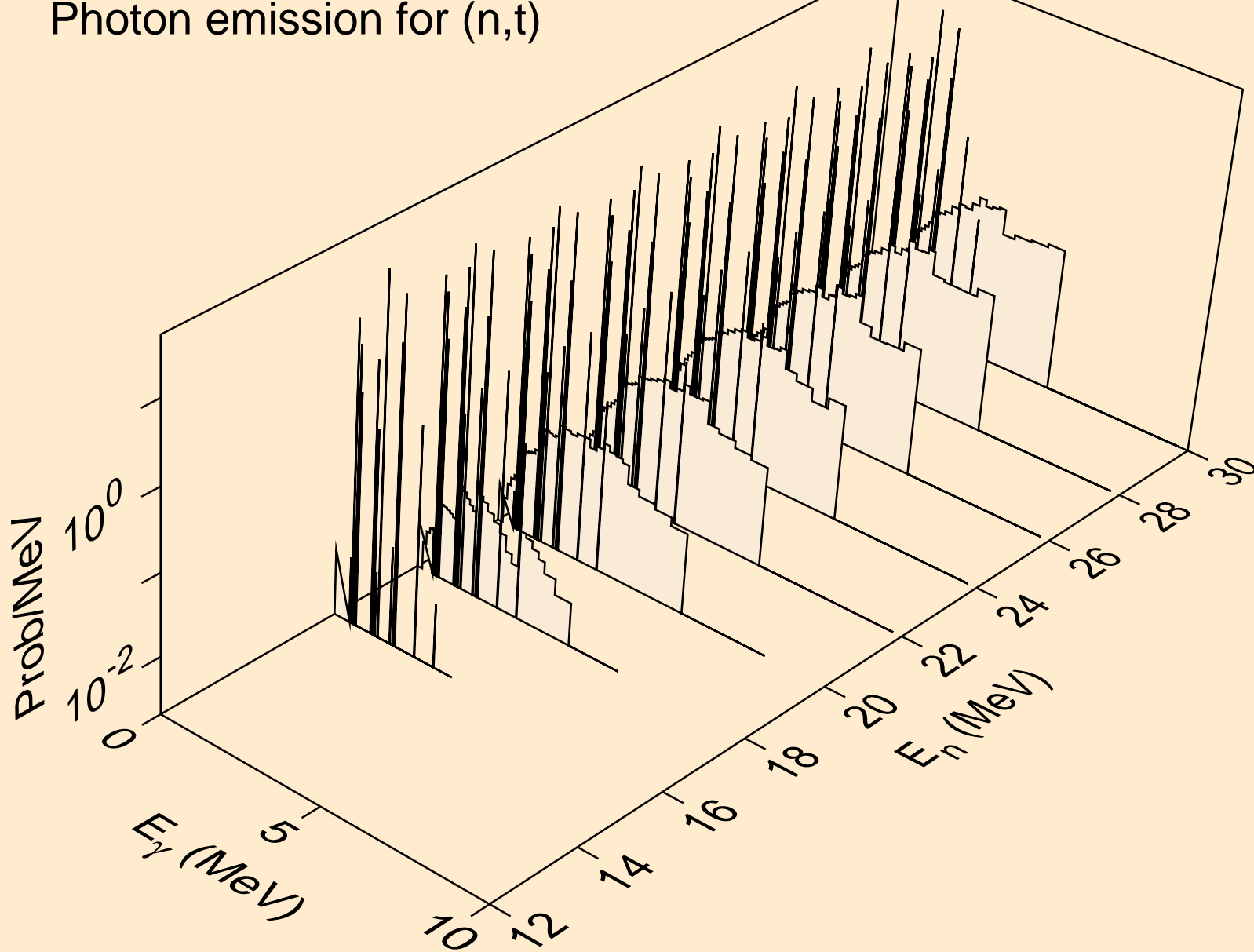

O019 NEUTRON ACER TENDL-2019 LIBRARY; T=293.16K
Photon emission for (n,he3)

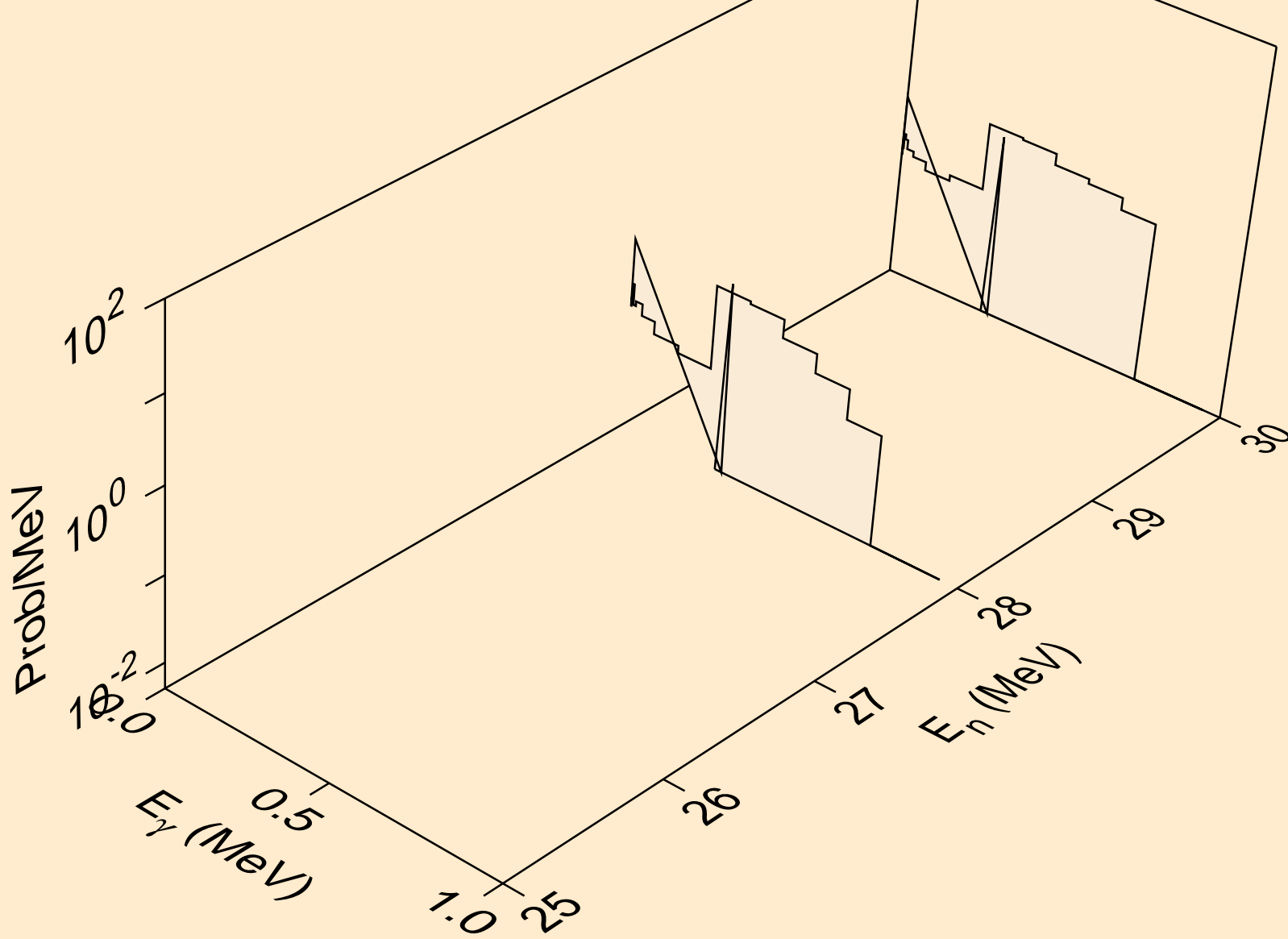

O019 NEUTRON ACER TENDL-2019 LIBRARY; T=293.16K
Photon emission for (n,a)

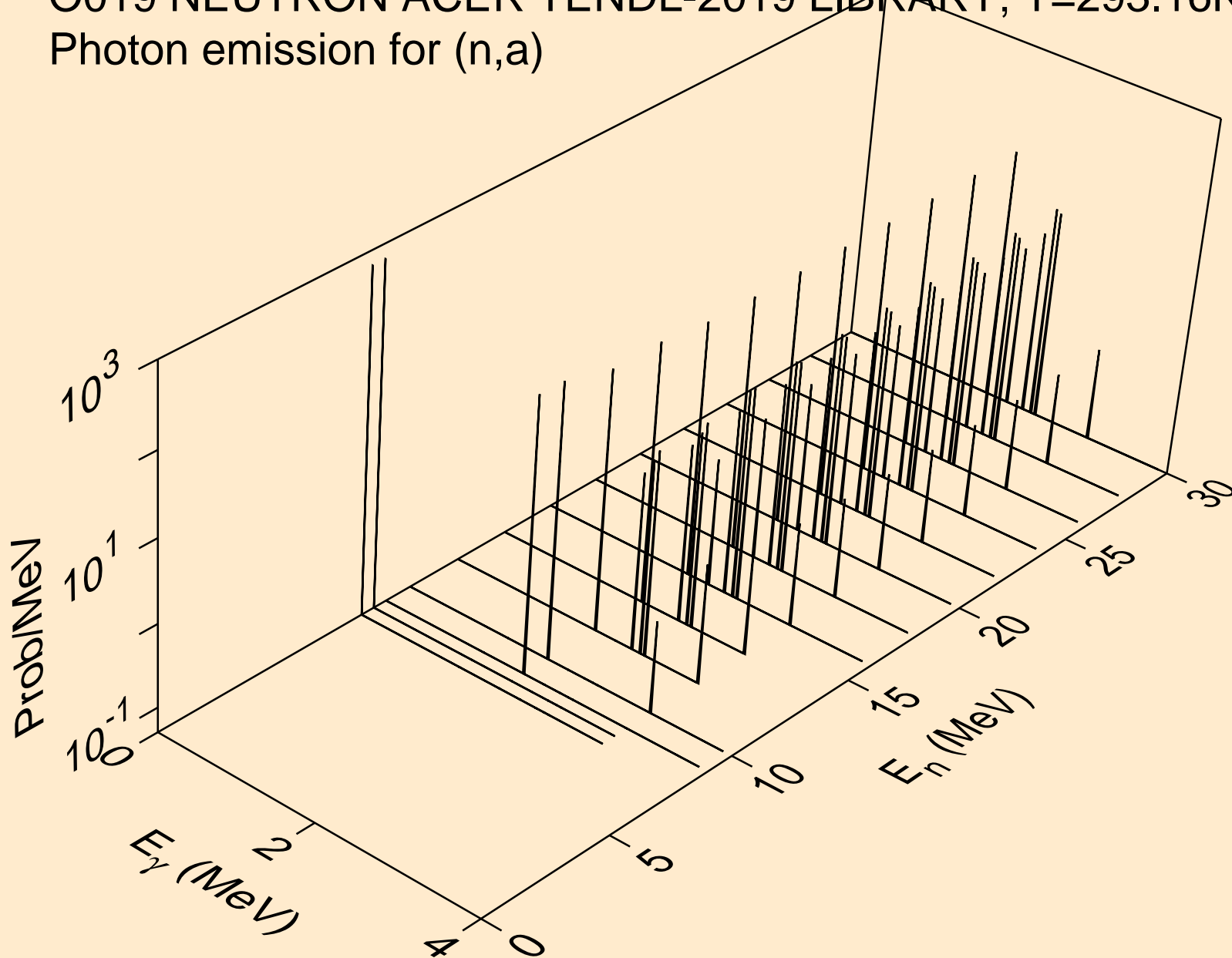

O019 NEUTRON ACER TENDL-2019 LIBRARY; T=293.16K
Photon emission for (n,2a)

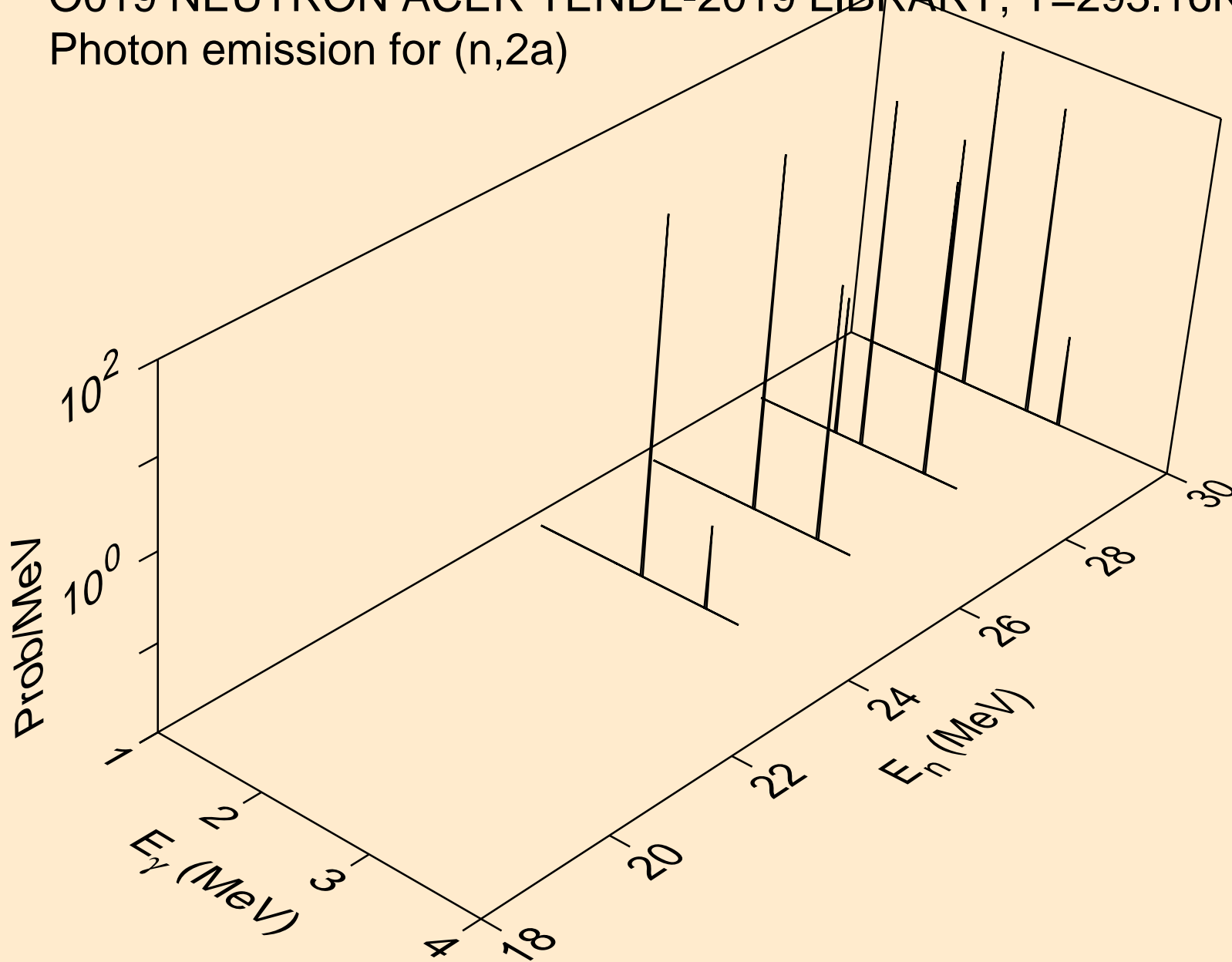

O019 NEUTRON ACER TENDL-2019 LIBRARY; T=293.16K
Photon emission for (n,pt)

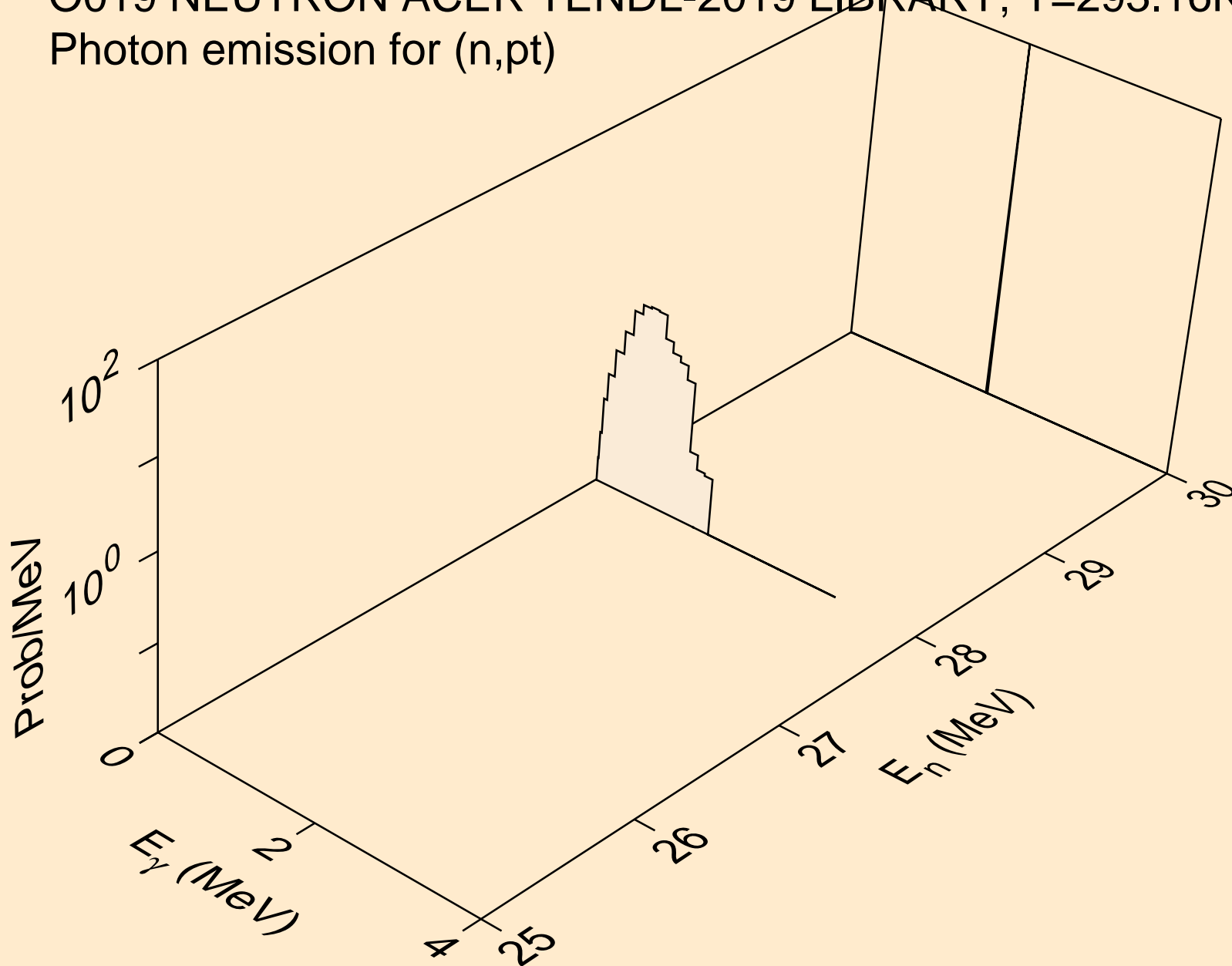

O019 NEUTRON ACER TENDL-2019 LIBRARY; T=293.16K
thermal capture photon spectrum

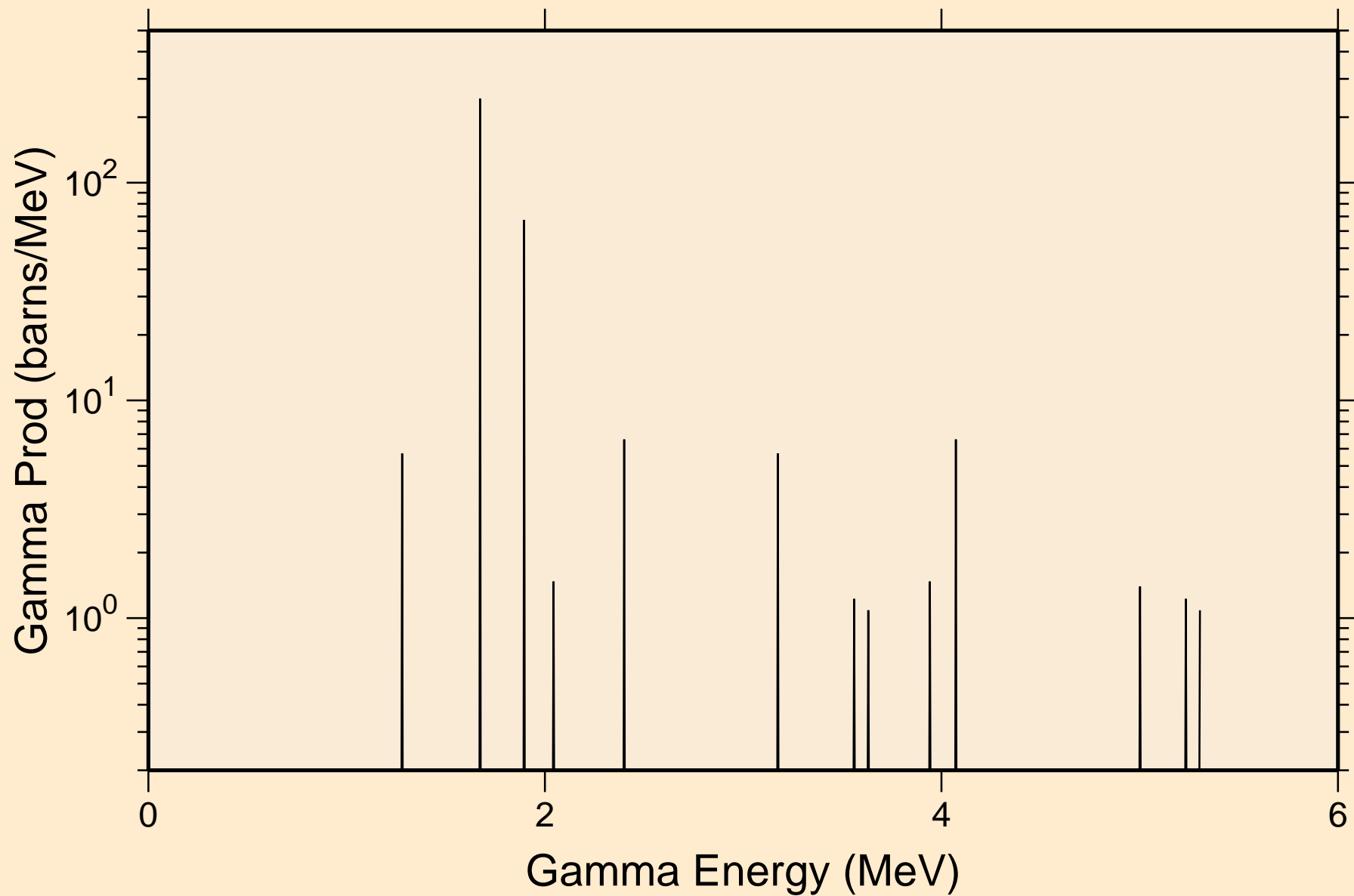

O019 NEUTRON ACER TENDL-2019 LIBRARY; T=293.16K
14 MeV photon spectrum

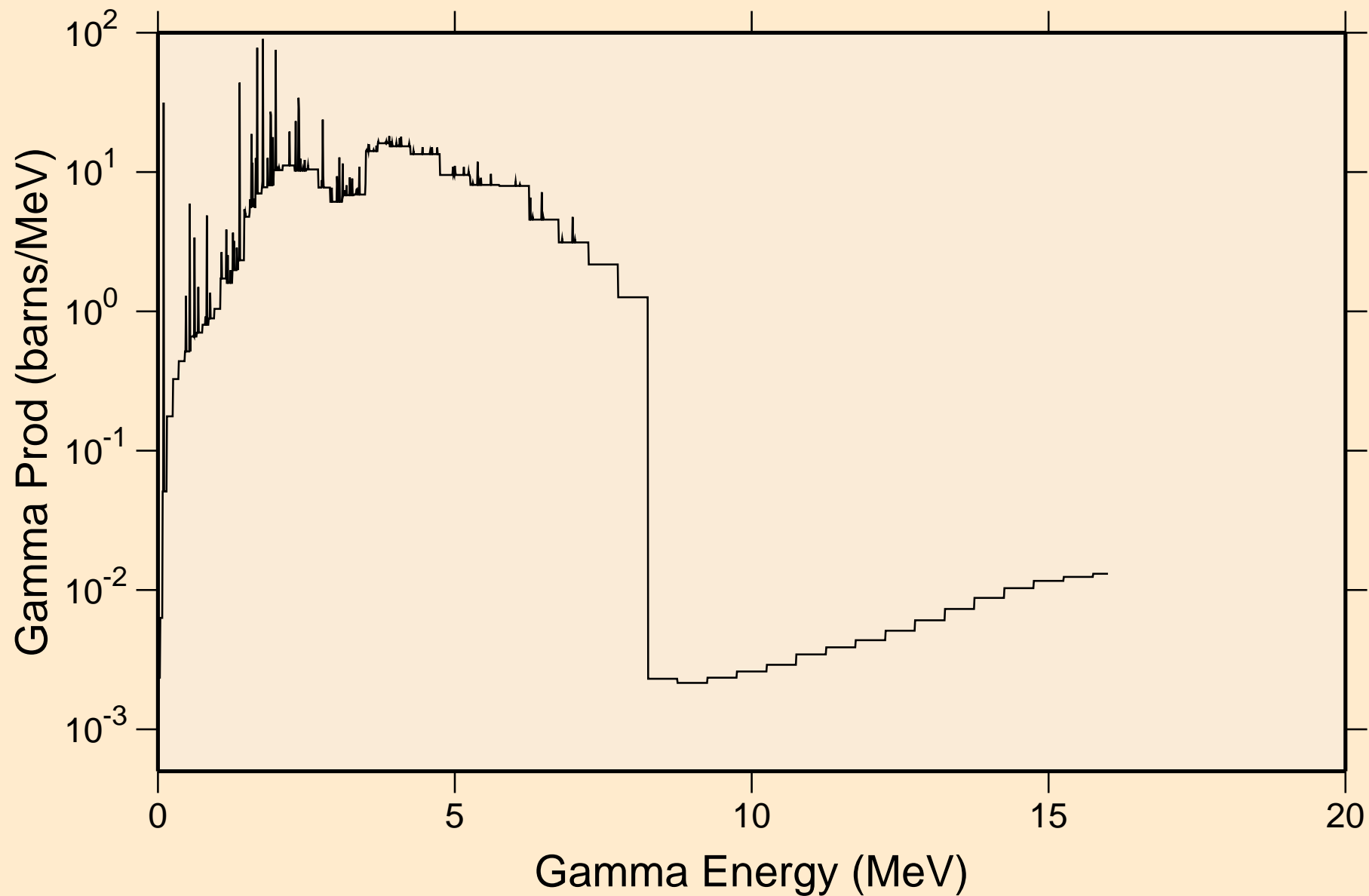

O019 NEUTRON ACER TENDL-2019 LIBRARY; T=293.16K

Particle heating contributions

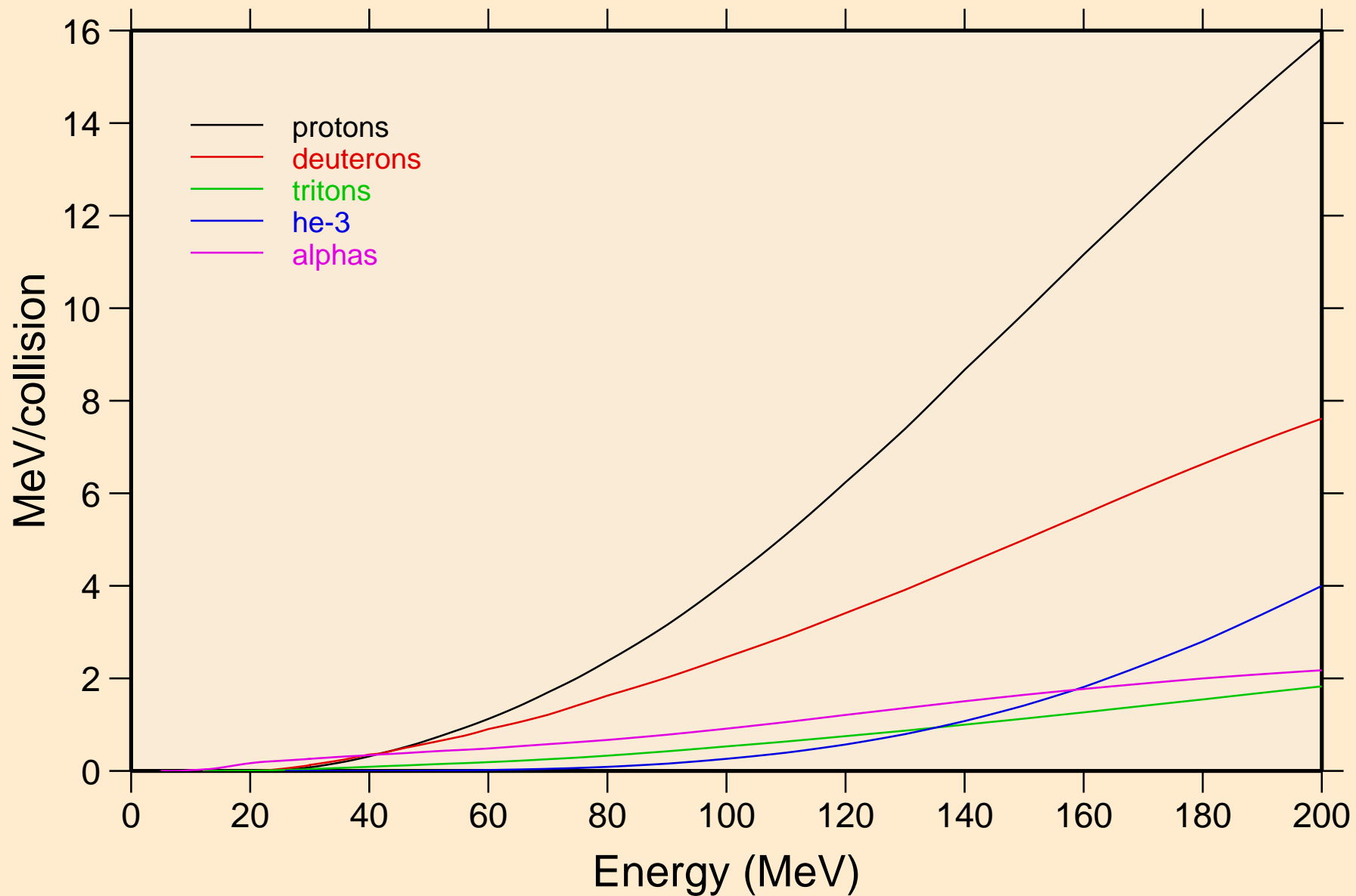

O019 NEUTRON ACER TENDL-2019 LIBRARY; T=293.16K
Recoil Heating

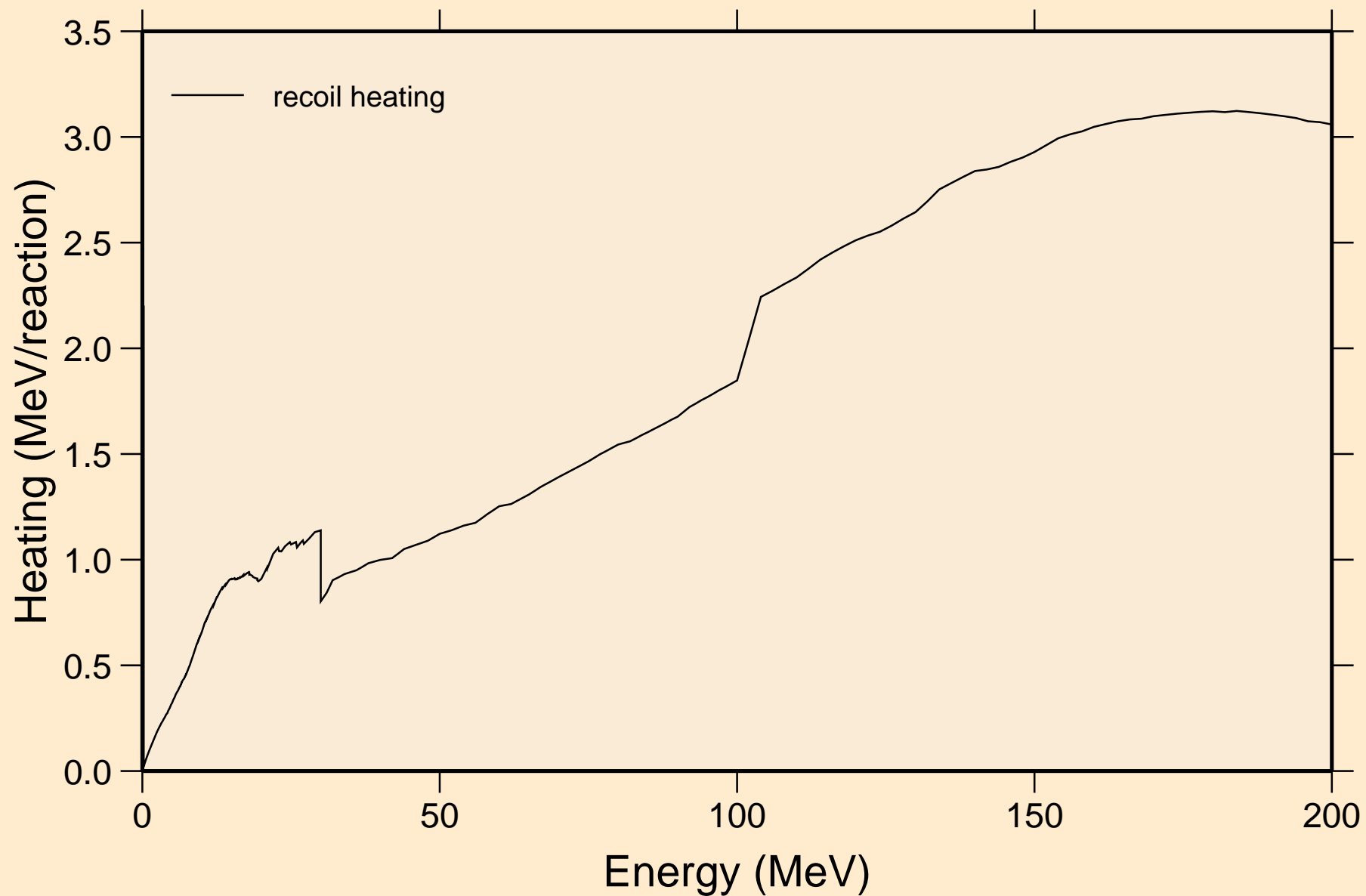

O019 NEUTRON ACER TENDL-2019 LIBRARY; T=293.16K
Particle production cross sections

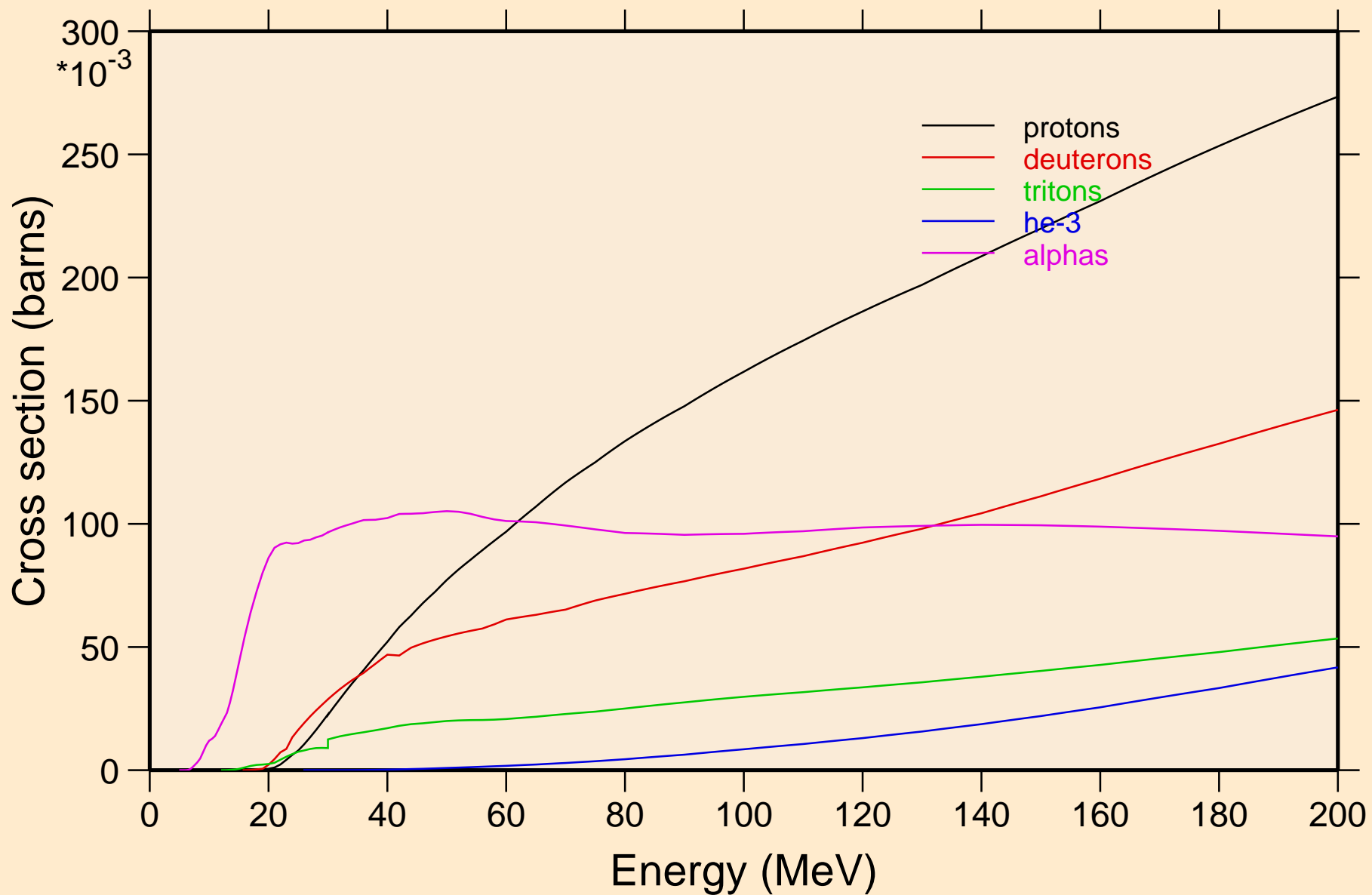

O019 NEUTRON ACER TENDL-2019 LIBRARY; T=293.16K
protons from (n,x)

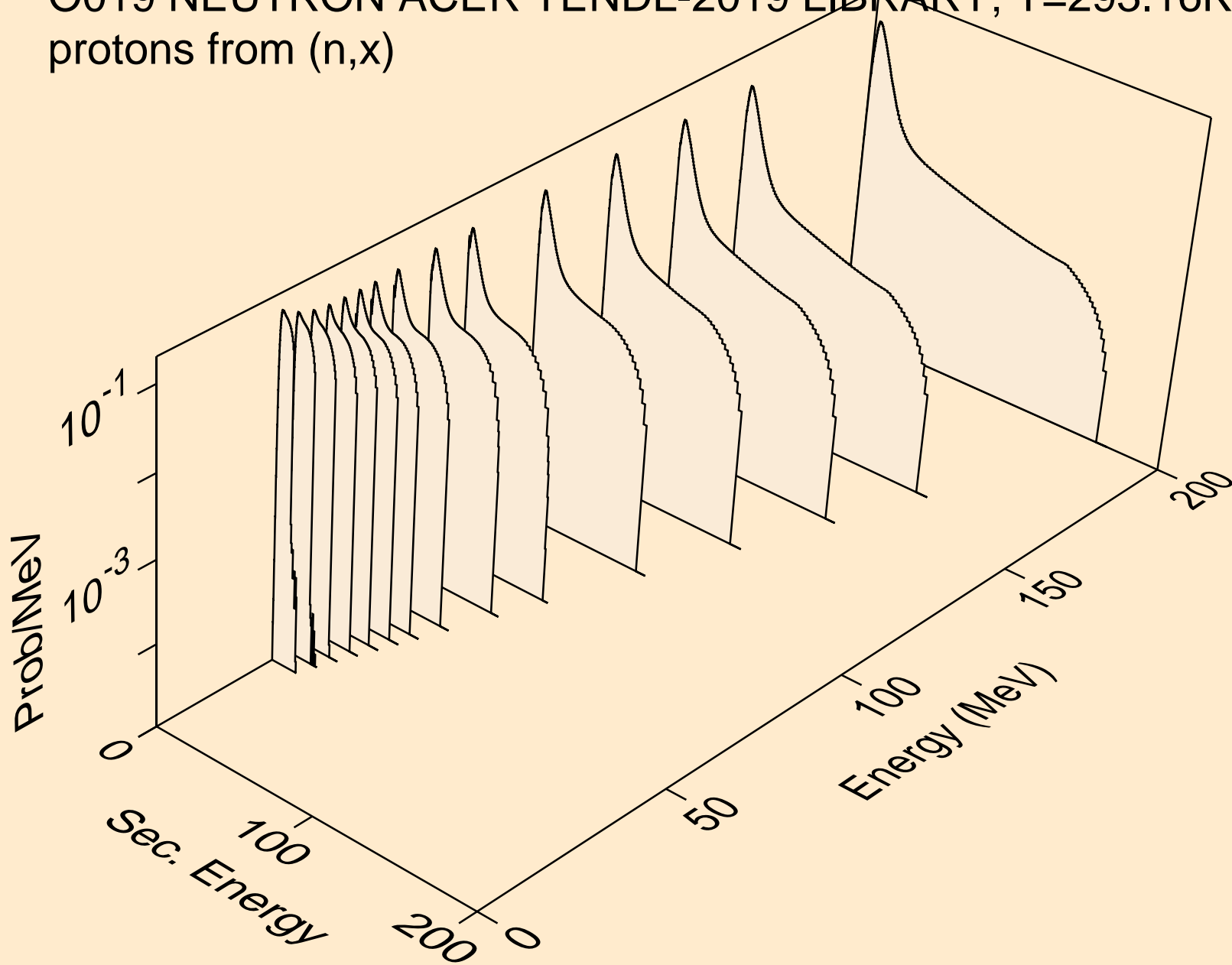

O019 NEUTRON ACER TENDL-2019 LIBRARY; T=293.16K
protons from (n,n*)p

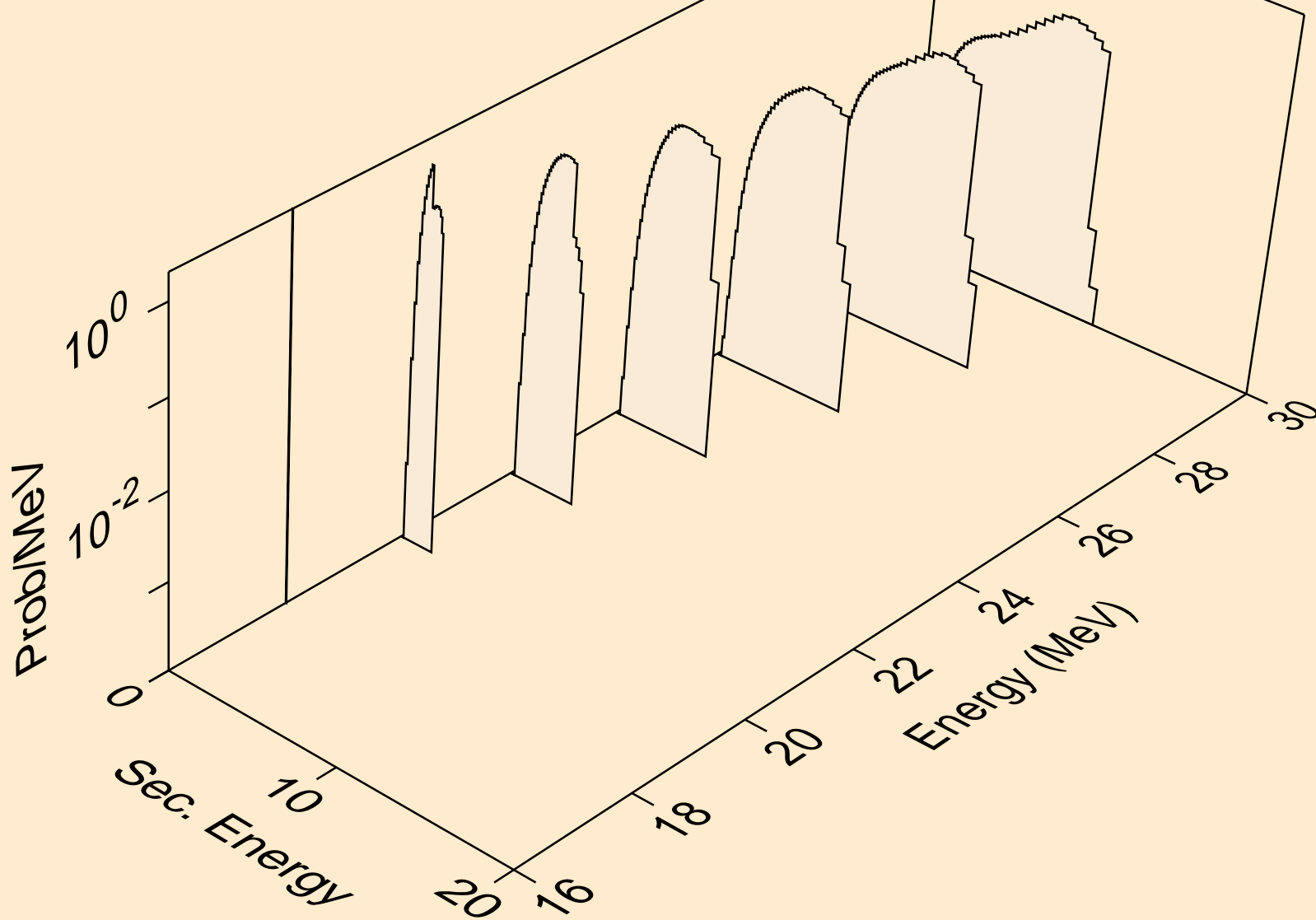

O019 NEUTRON ACER TENDL-2019 LIBRARY; T=293.16K
protons from (n,2np)

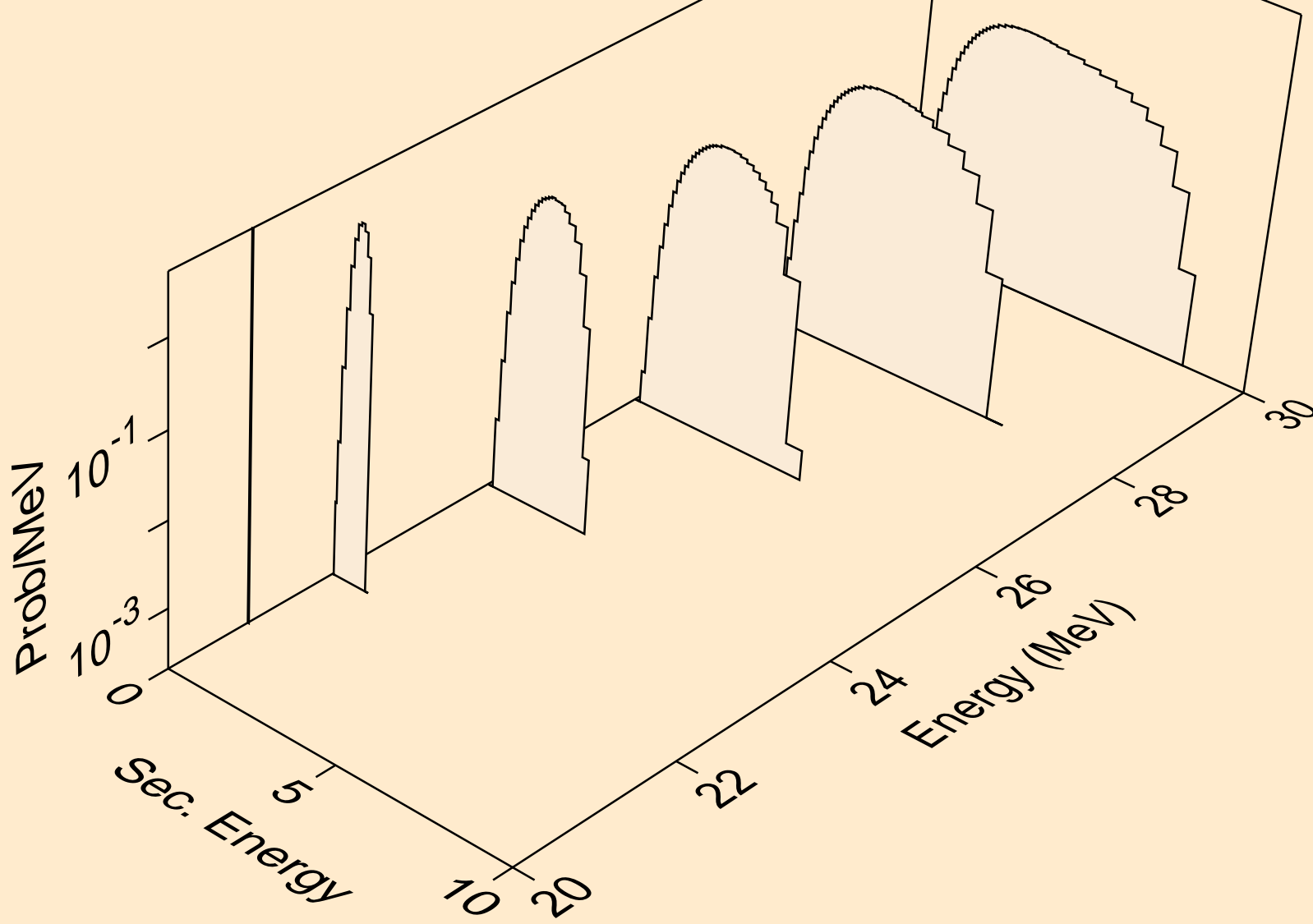

O019 NEUTRON ACER TENDL-2019 LIBRARY; T=293.16K
protons from (n,3np)

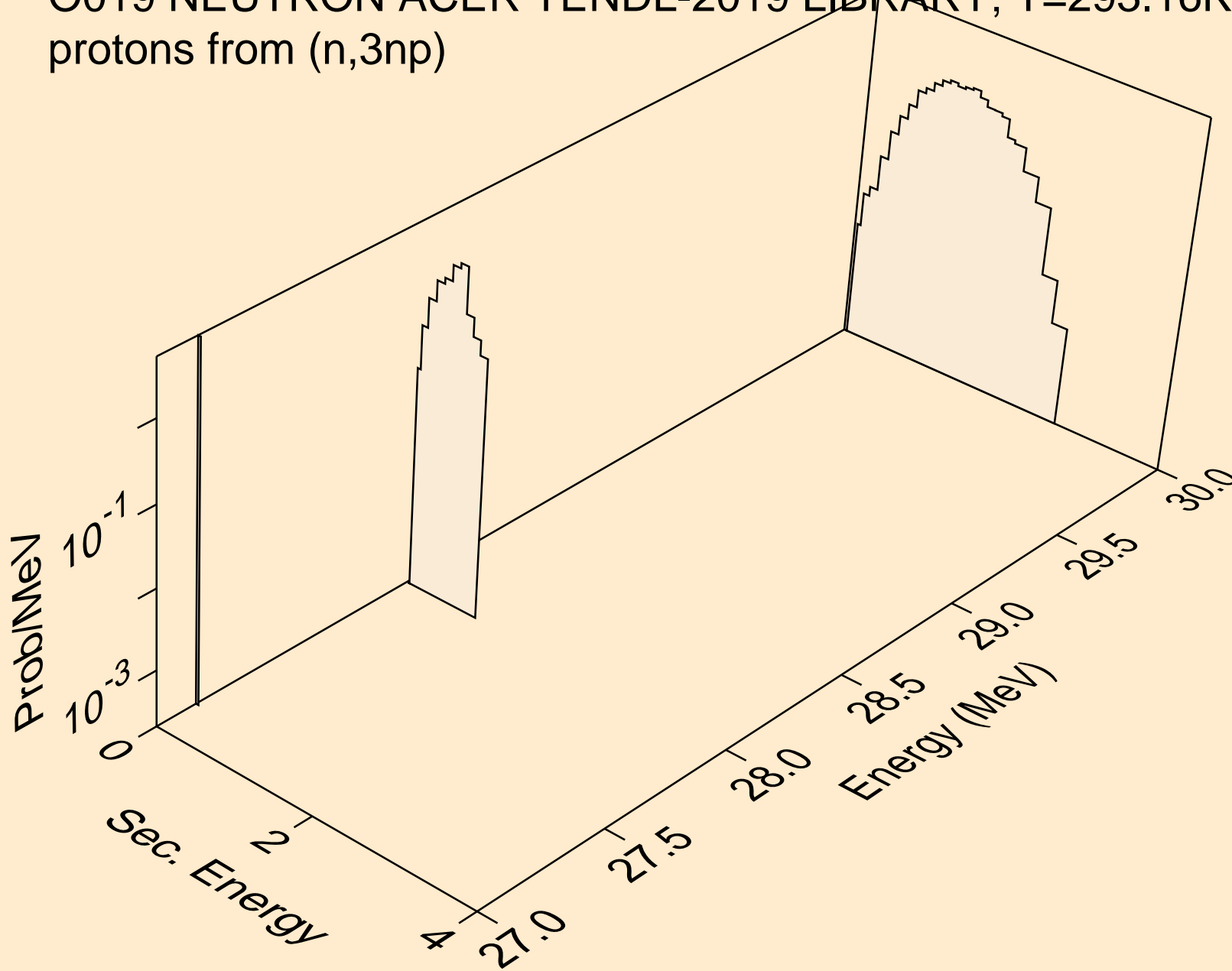

O019 NEUTRON ACER TENDL-2019 LIBRARY; T=293.16K
protons from (n,p)

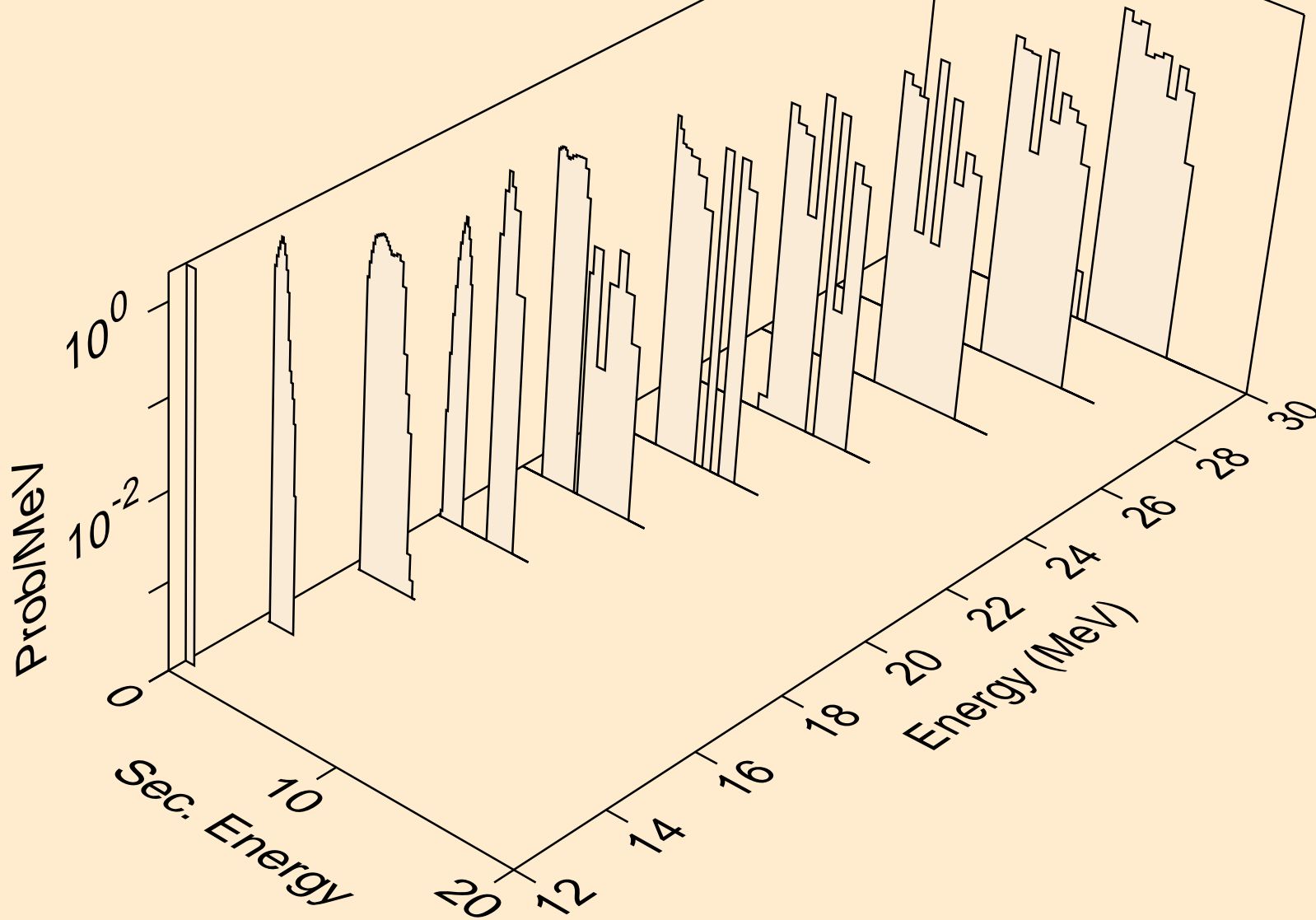

O019 NEUTRON ACER TENDL-2019 LIBRARY; T=293.16K
protons from (n,pt)

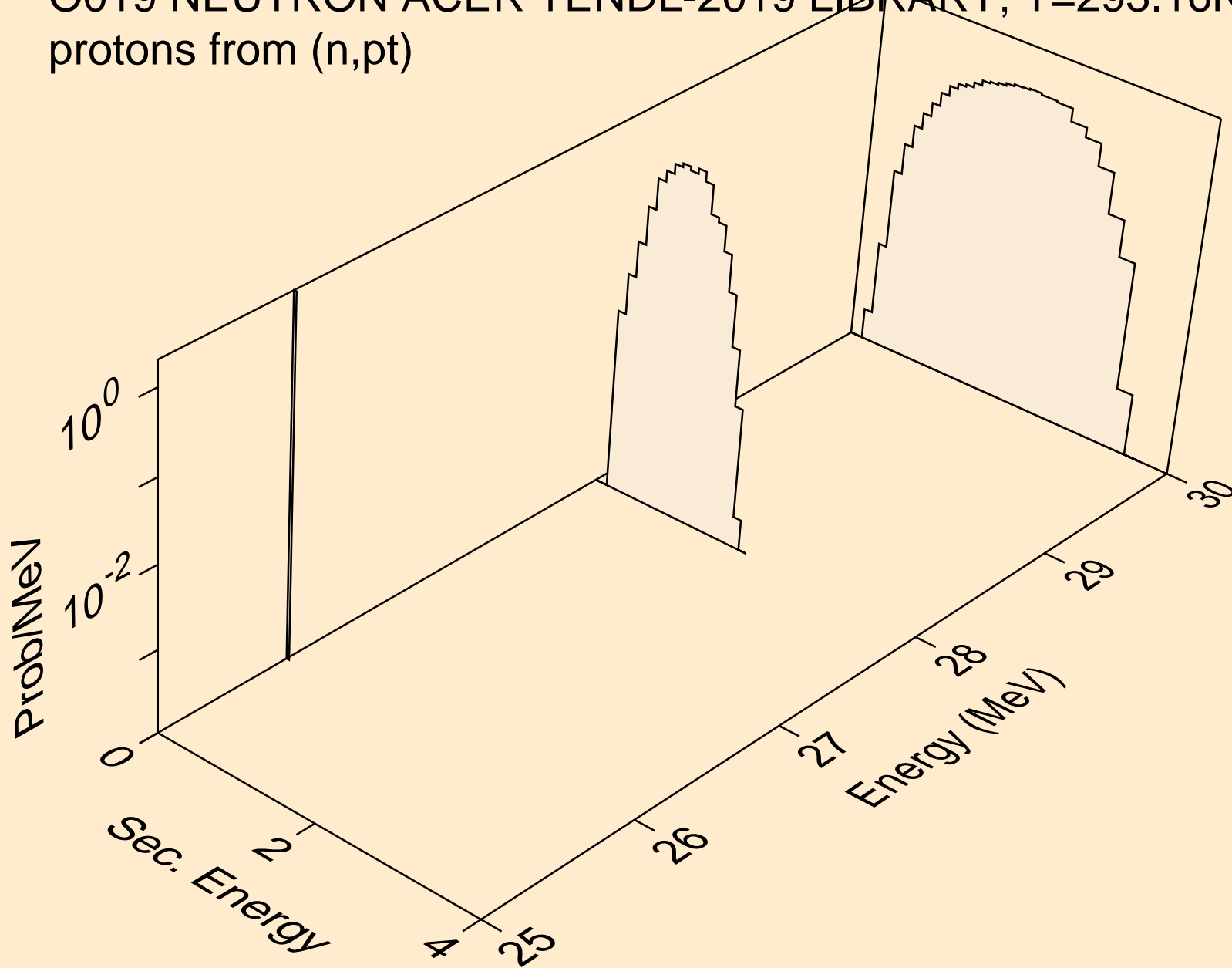

O019 NEUTRON ACER TENDL-2019 LIBRARY; T=293.16K
deuterons from (n,x)

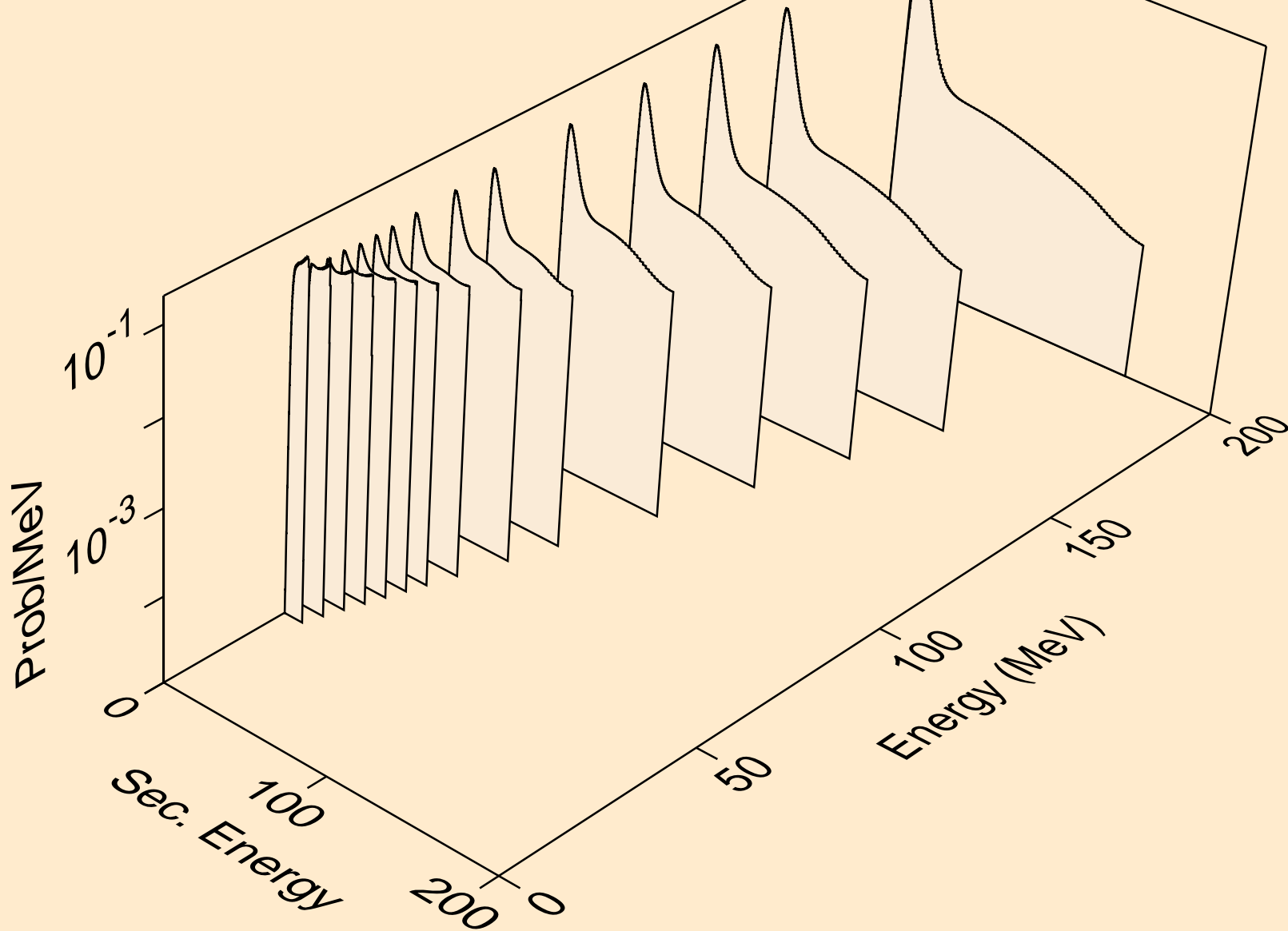

O019 NEUTRON ACER TENDL-2019 LIBRARY; T=293.16K
deuterons from (n,2nd)

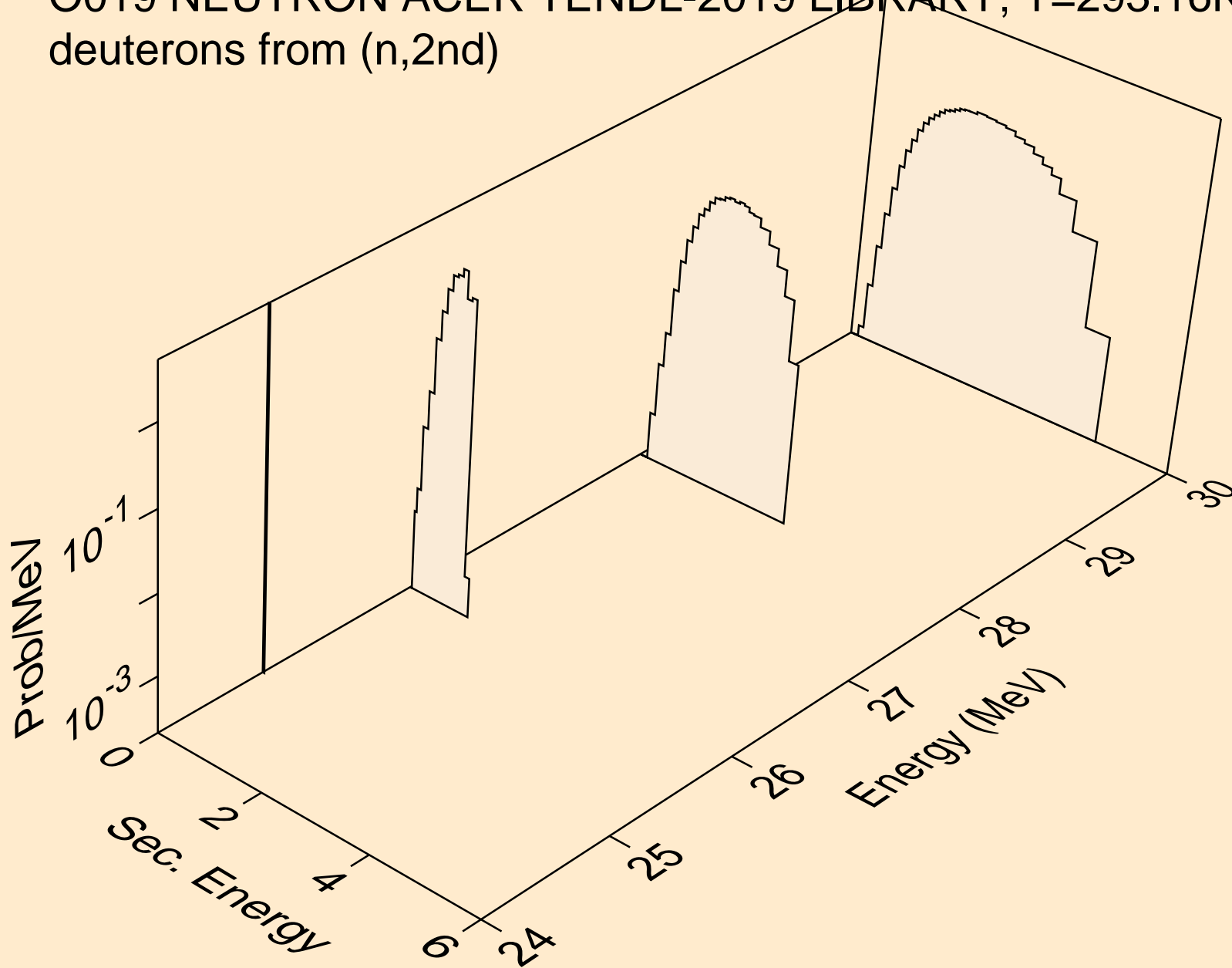

O019 NEUTRON ACER TENDL-2019 LIBRARY; T=293.16K
deuterons from (n,n*)d

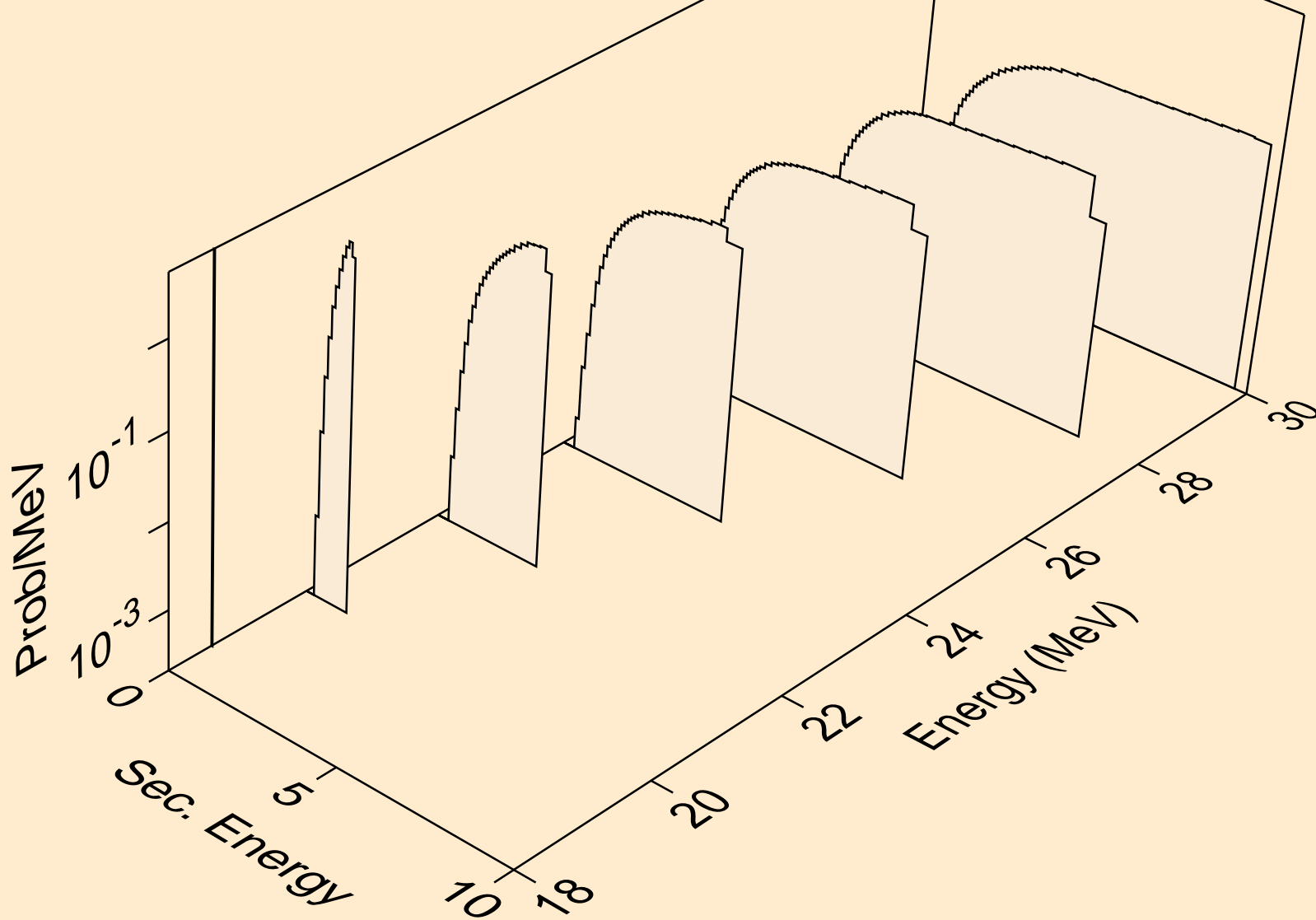

O019 NEUTRON ACER TENDL-2019 LIBRARY; T=293.16K
deuterons from (n,d)

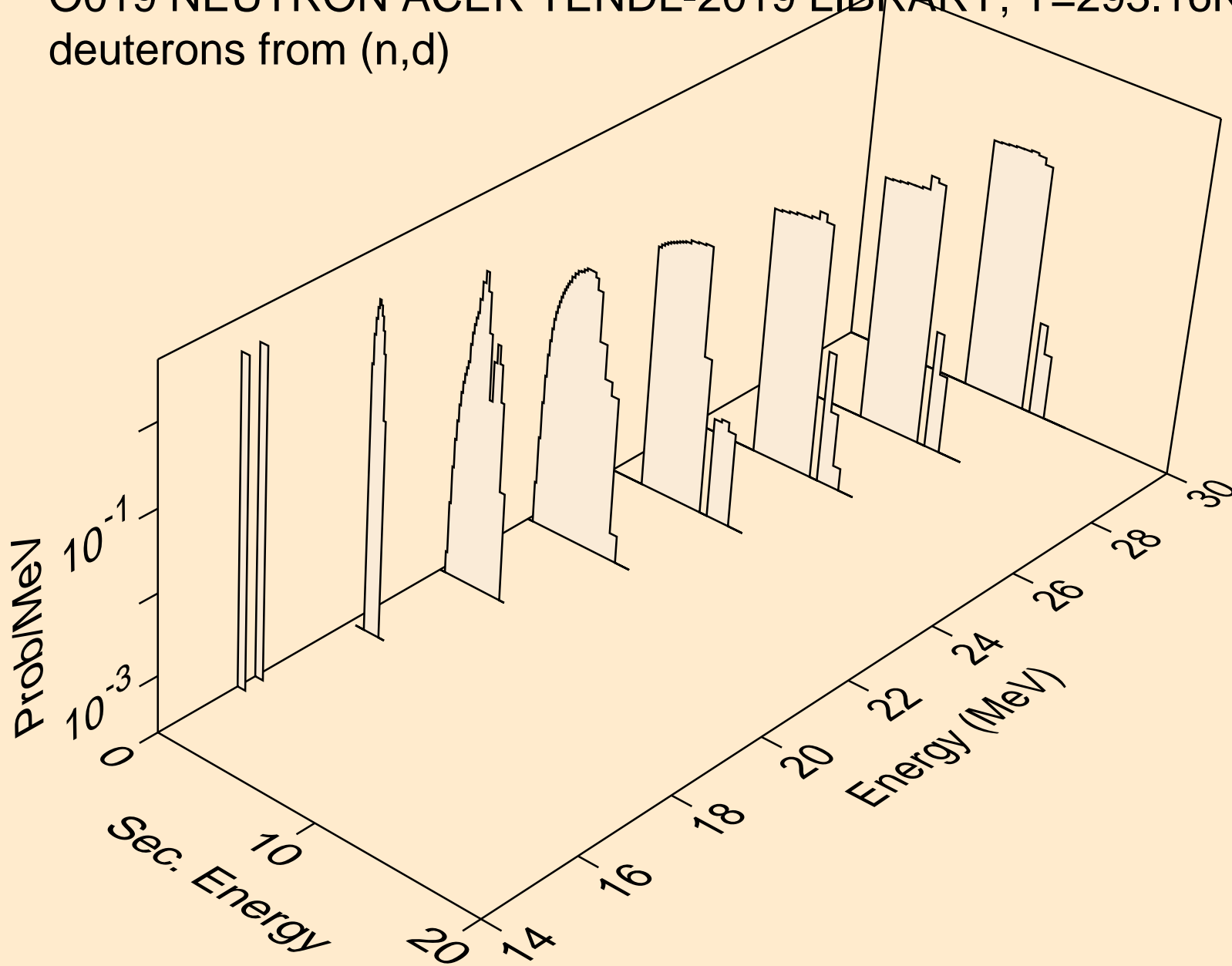

O019 NEUTRON ACER TENDL-2019 LIBRARY; T=293.16K
tritons from (n,x)

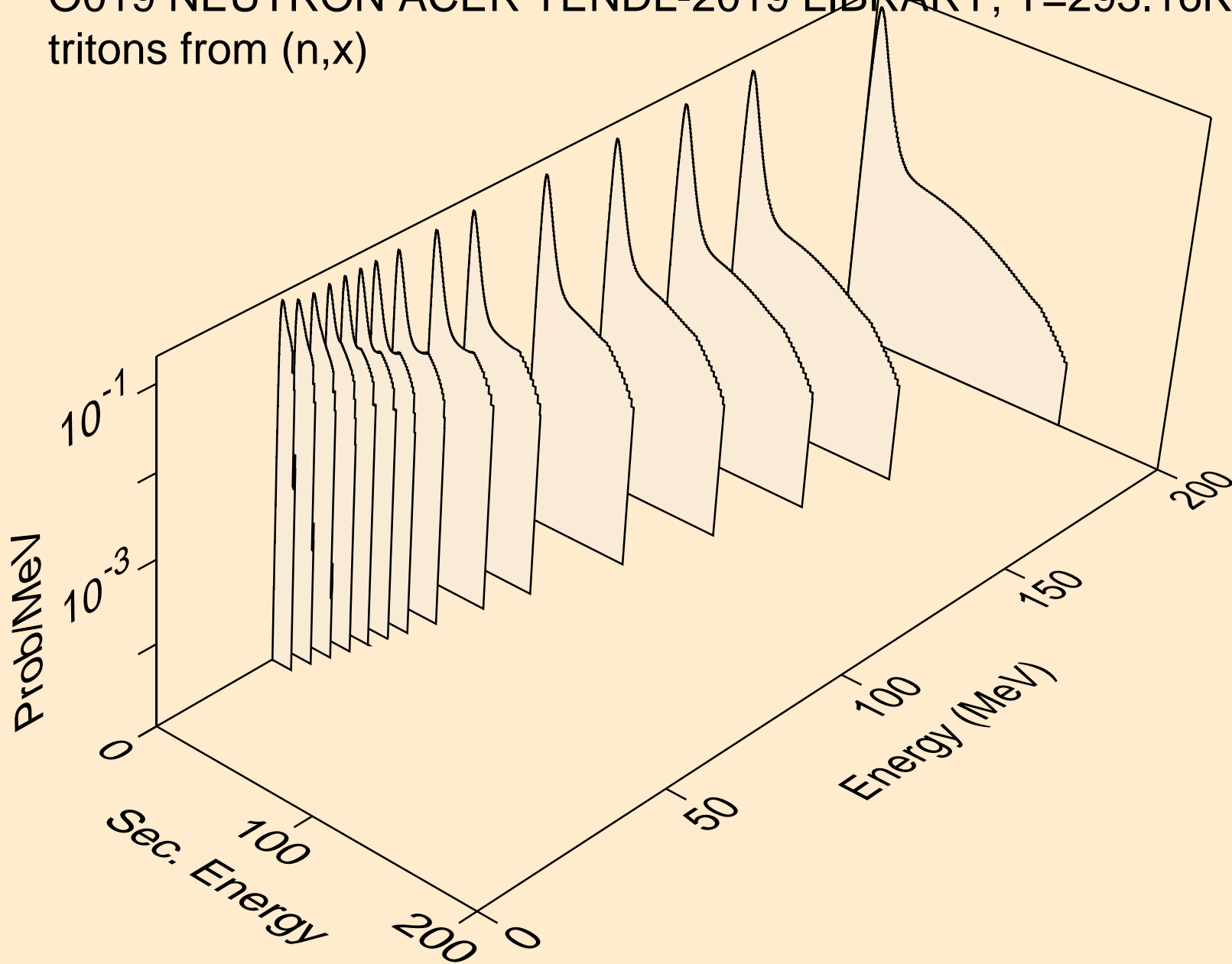

O019 NEUTRON ACER TENDL-2019 LIBRARY; T=293.16K
tritons from (n,n*)t

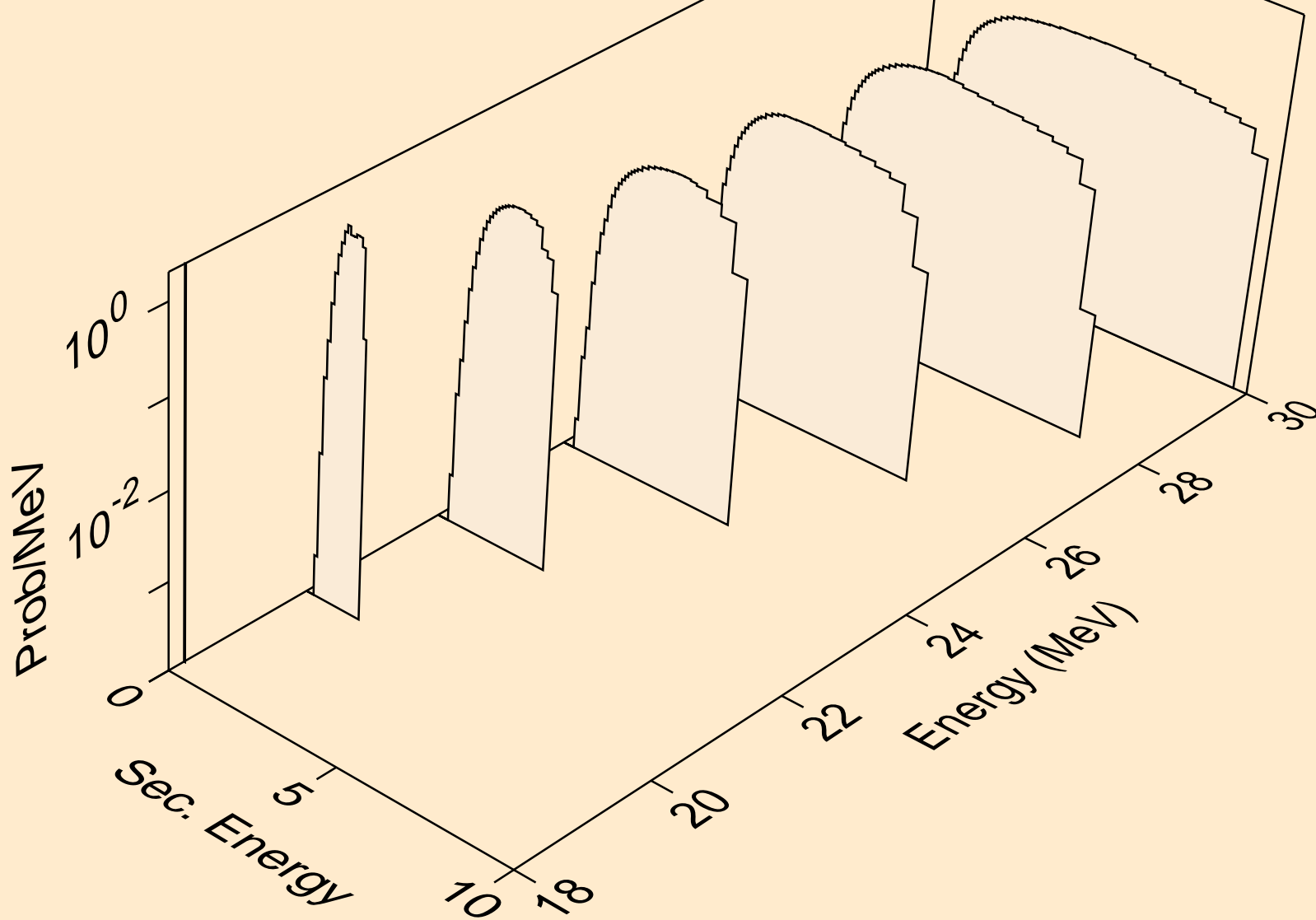

O019 NEUTRON ACER TENDL-2019 LIBRARY; T=293.16K
tritons from (n,t)

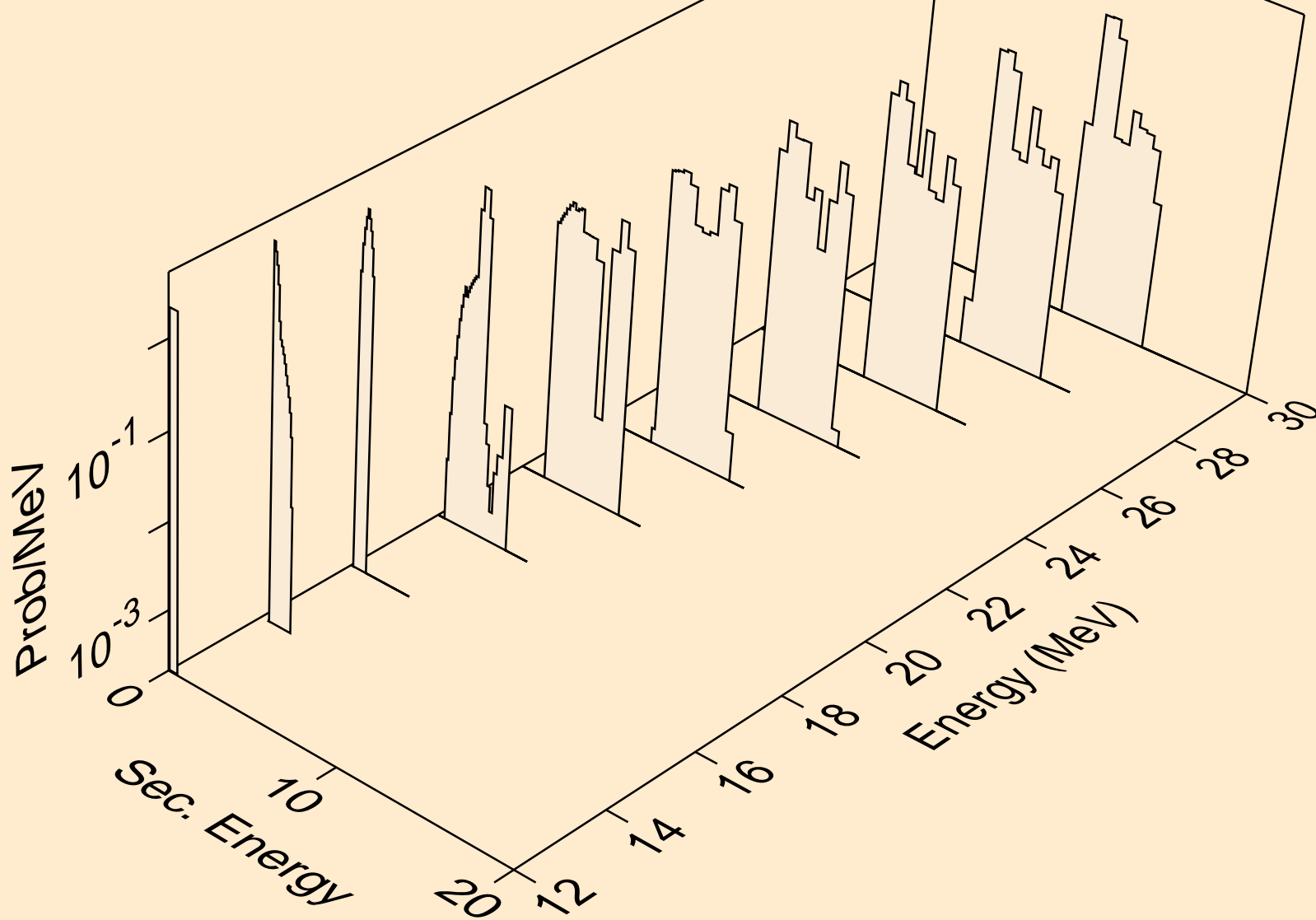

O019 NEUTRON ACER TENDL-2019 LIBRARY; T=293.16K
tritons from (n,pt)

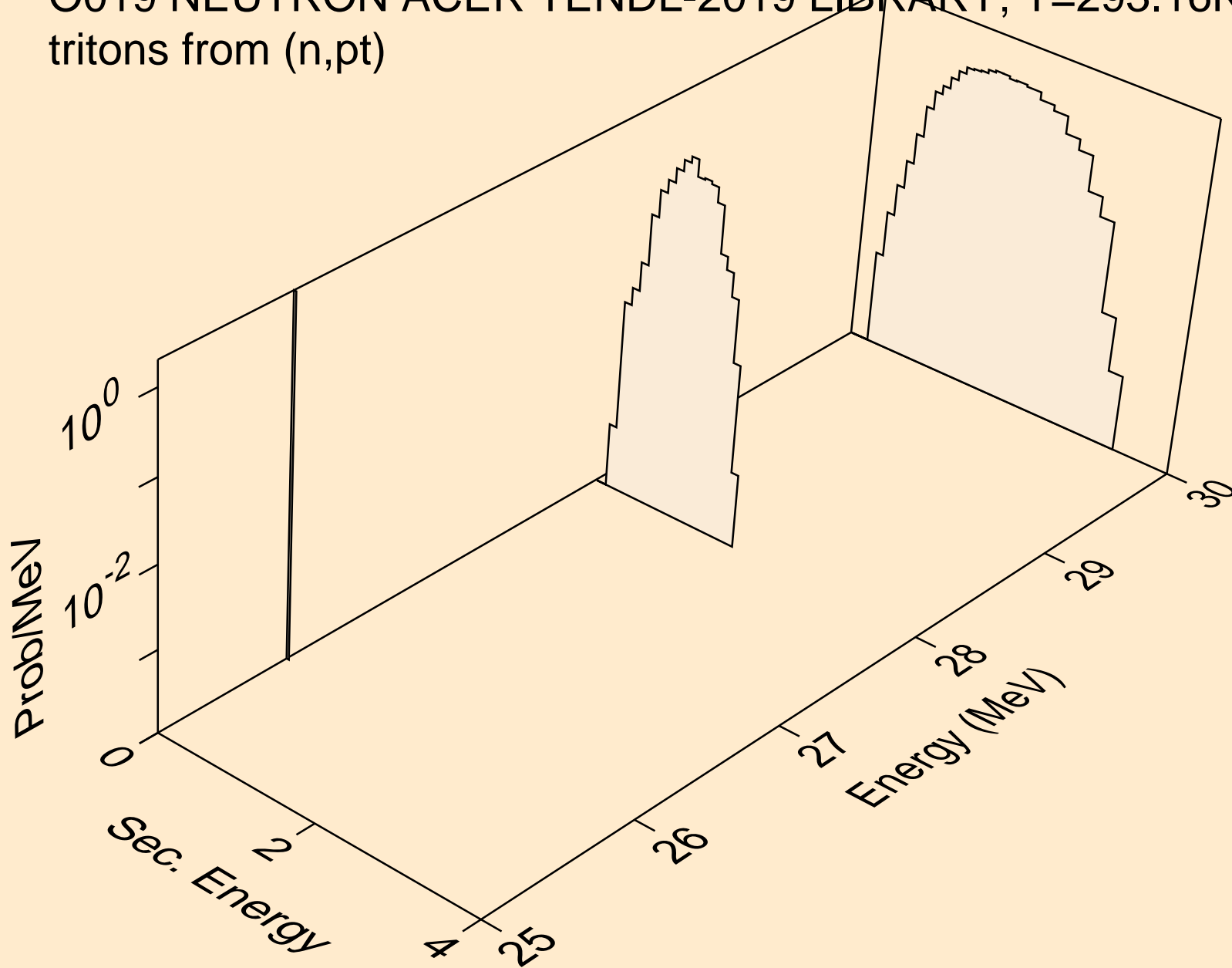

O019 NEUTRON ACER TENDL-2019 LIBRARY; T=293.16K
he3s from (n,x)

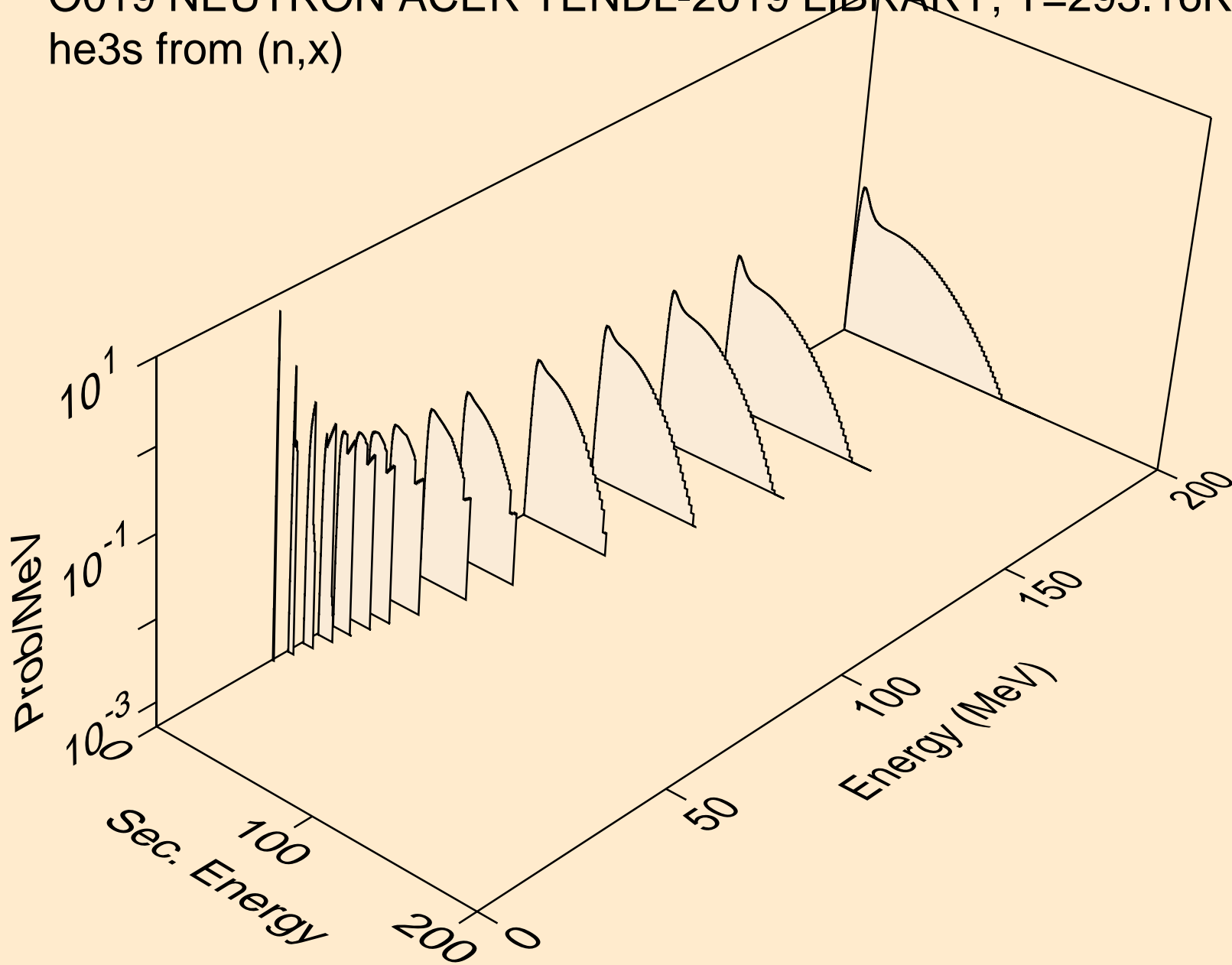

O019 NEUTRON ACER TENDL-2019 LIBRARY; T=293.16K
he3s from (n,n*)he3

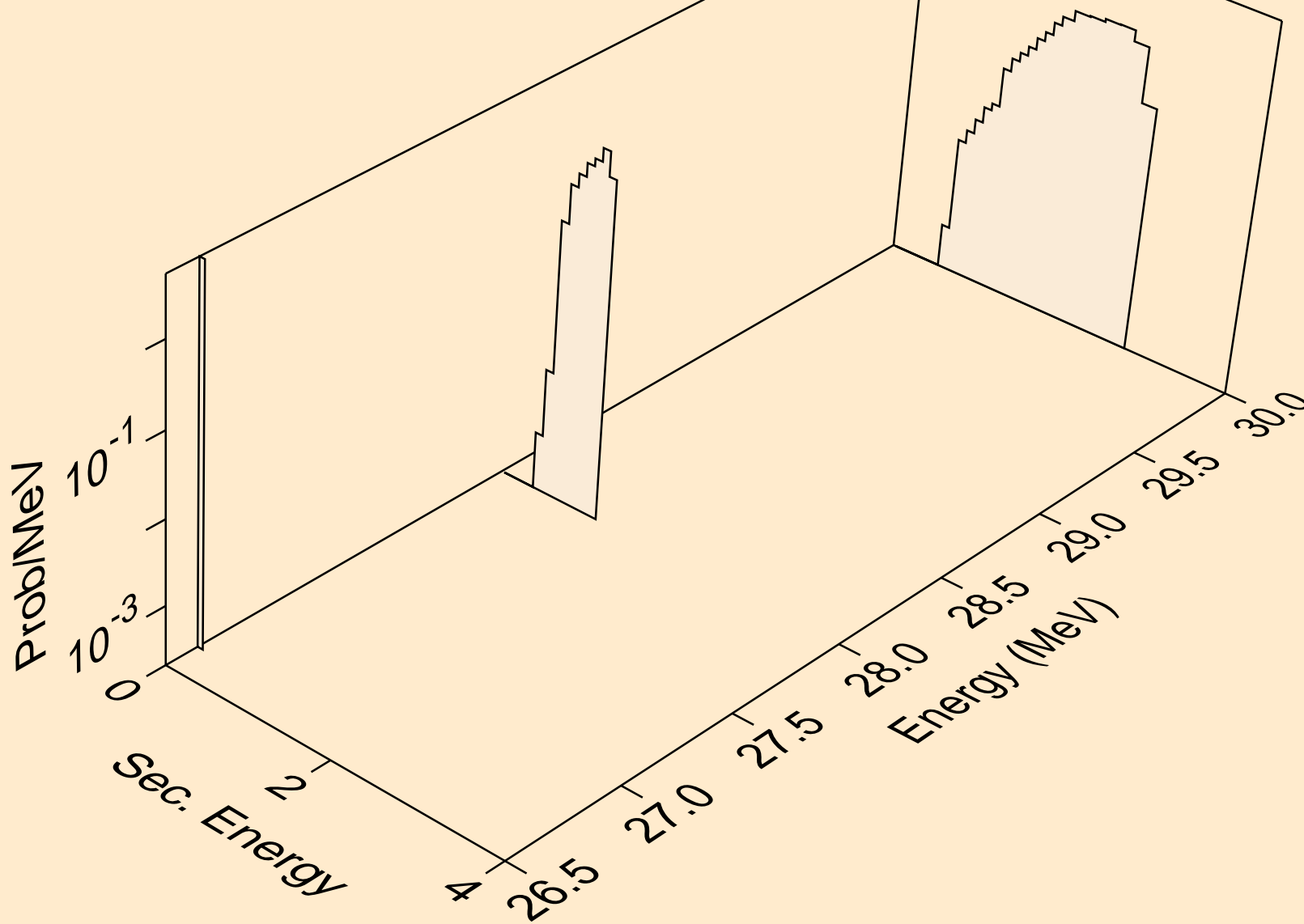

O019 NEUTRON ACER TENDL-2019 LIBRARY; T=293.16K
he3s from (n,he3)

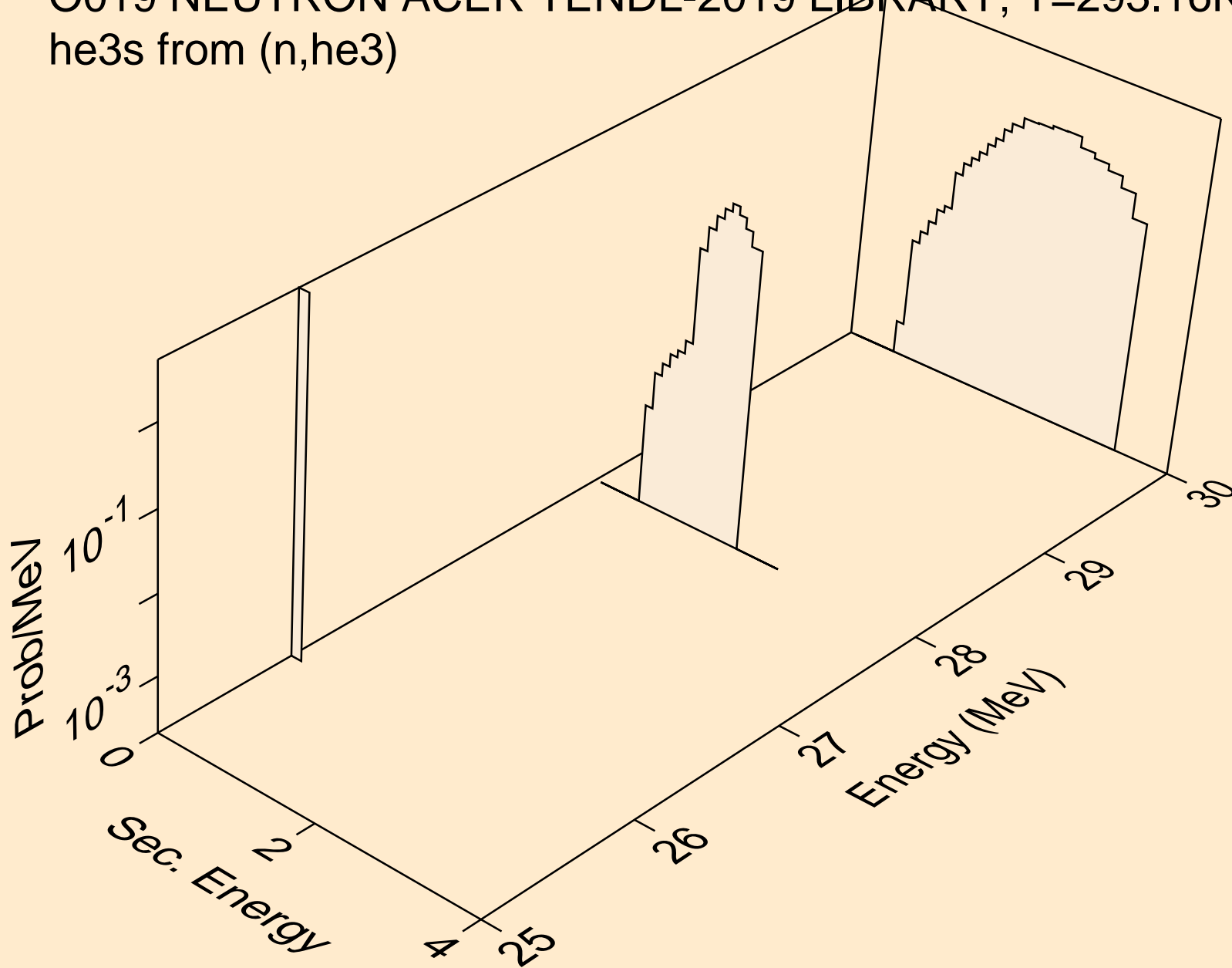

O019 NEUTRON ACER TENDL-2019 LIBRARY; T=293.16K
alphas from (n,x)

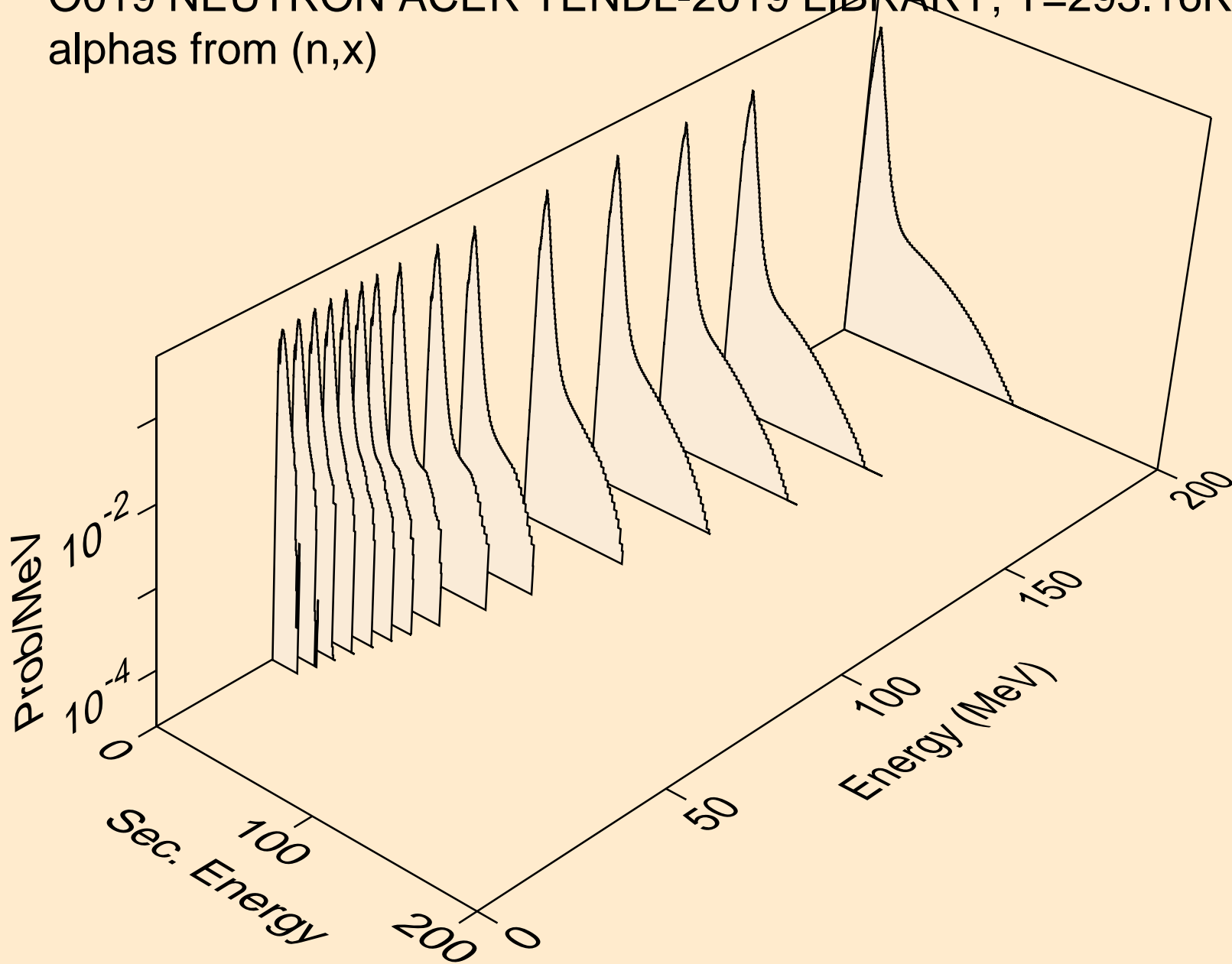

O019 NEUTRON ACER TENDL-2019 LIBRARY; T=293.16K
alphas from (n,n*)a

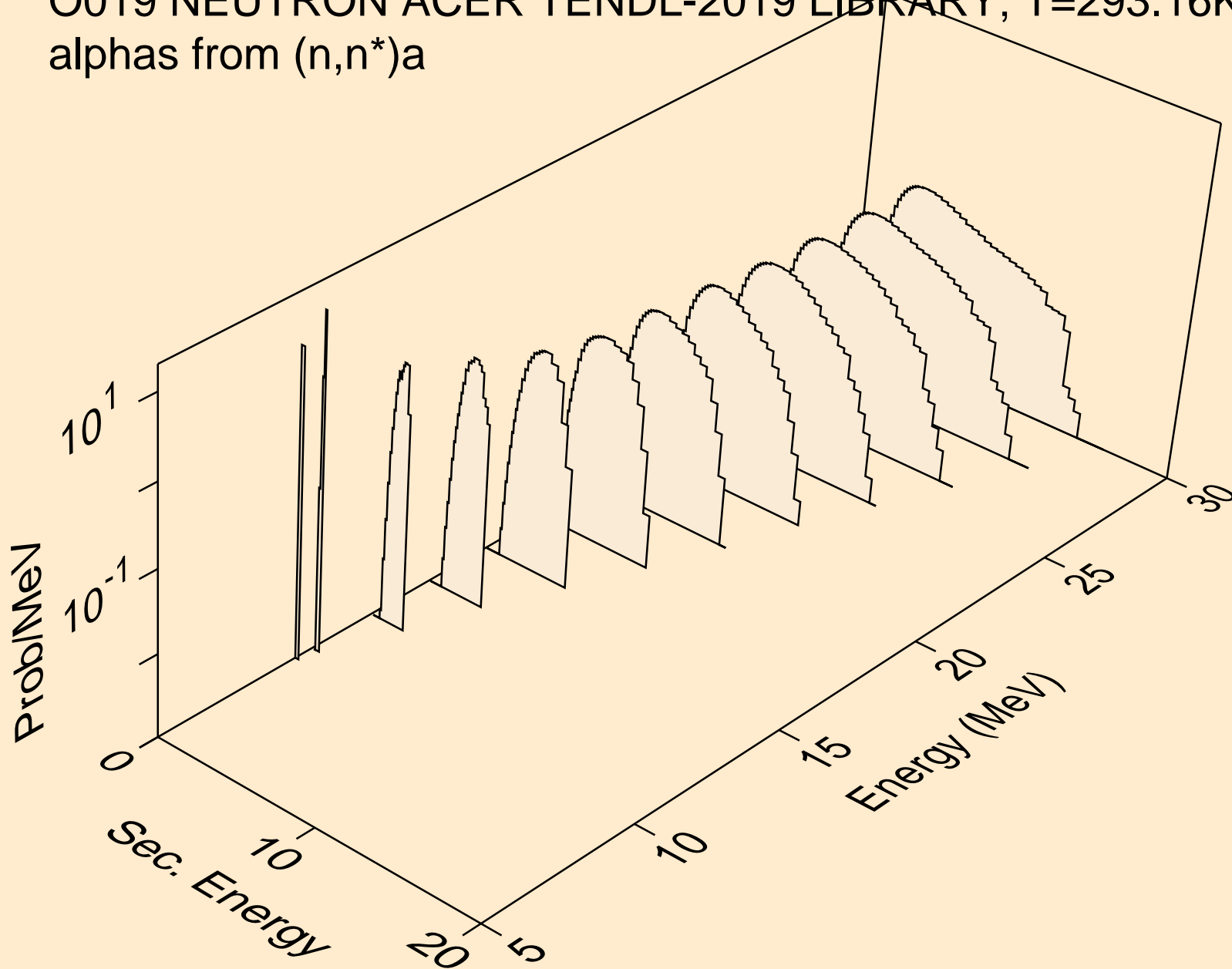

O019 NEUTRON ACER TENDL-2019 LIBRARY; T=293.16K
alphas from (n,2n)a

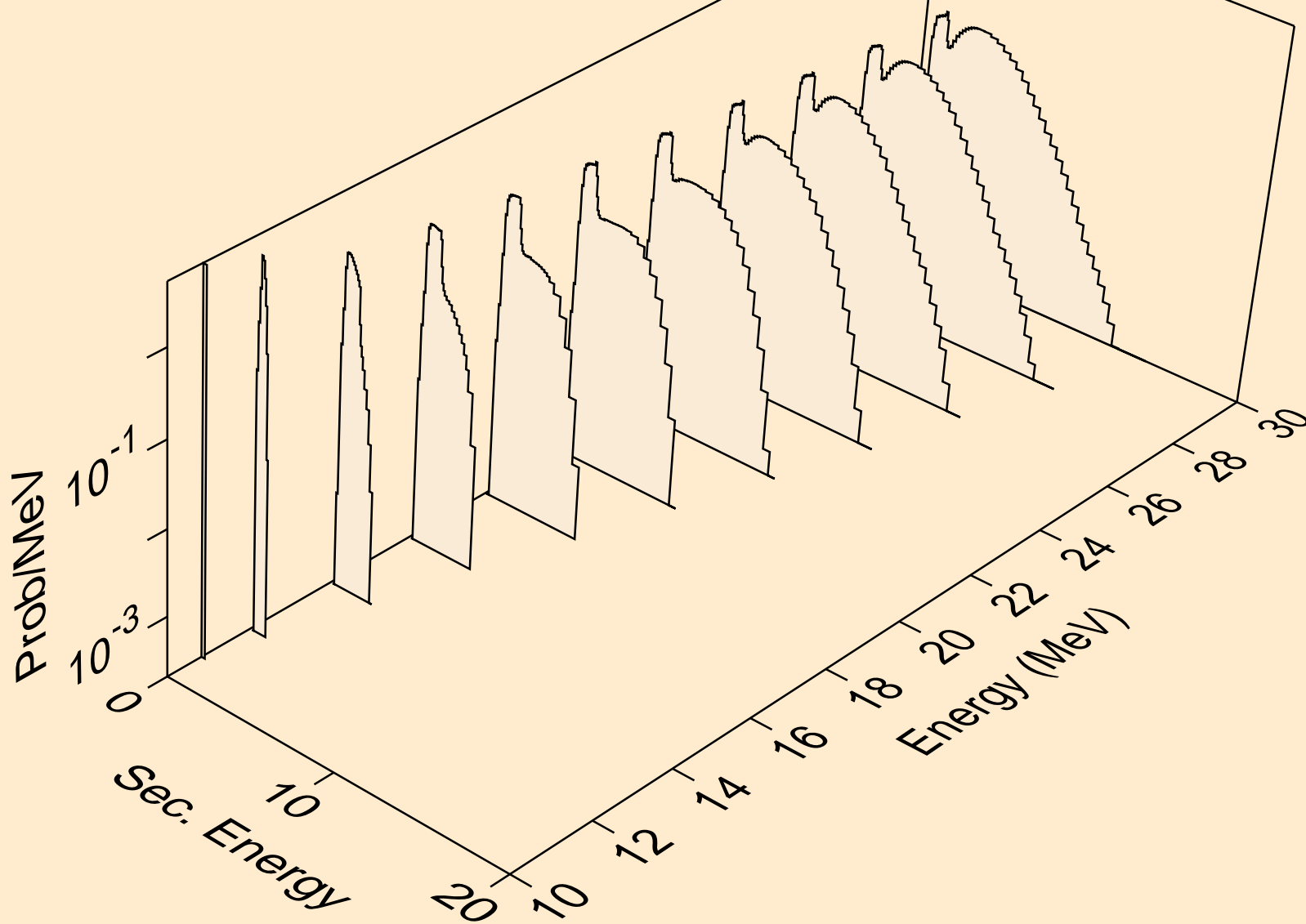

O019 NEUTRON ACER TENDL-2019 LIBRARY; T=293.16K
alphas from (n,3n)a

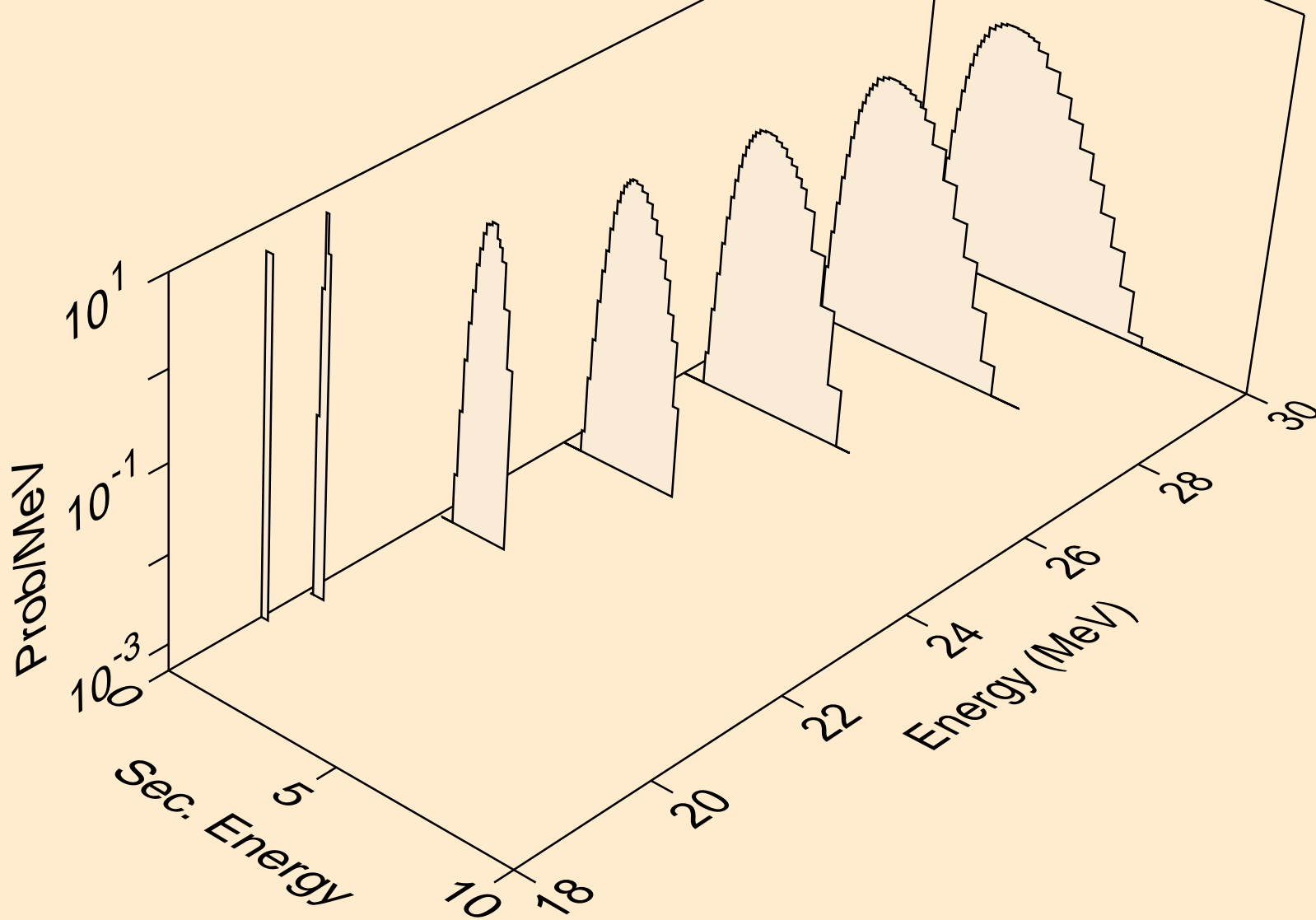

O019 NEUTRON ACER TENDL-2019 LIBRARY; T=293.16K
alphas from (n,n*)2a

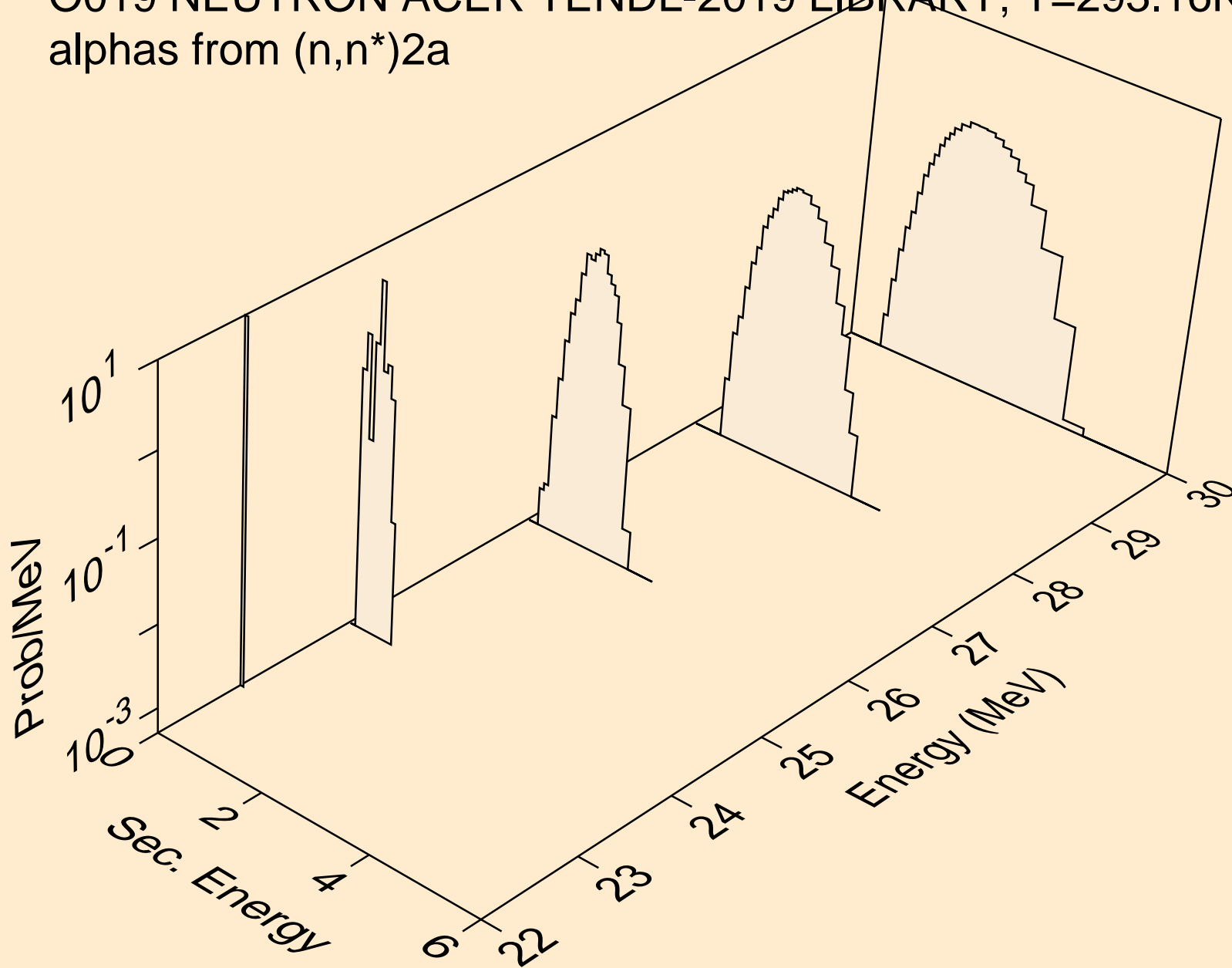

O019 NEUTRON ACER TENDL-2019 LIBRARY; T=293.16K
alphas from (n,2n)2a

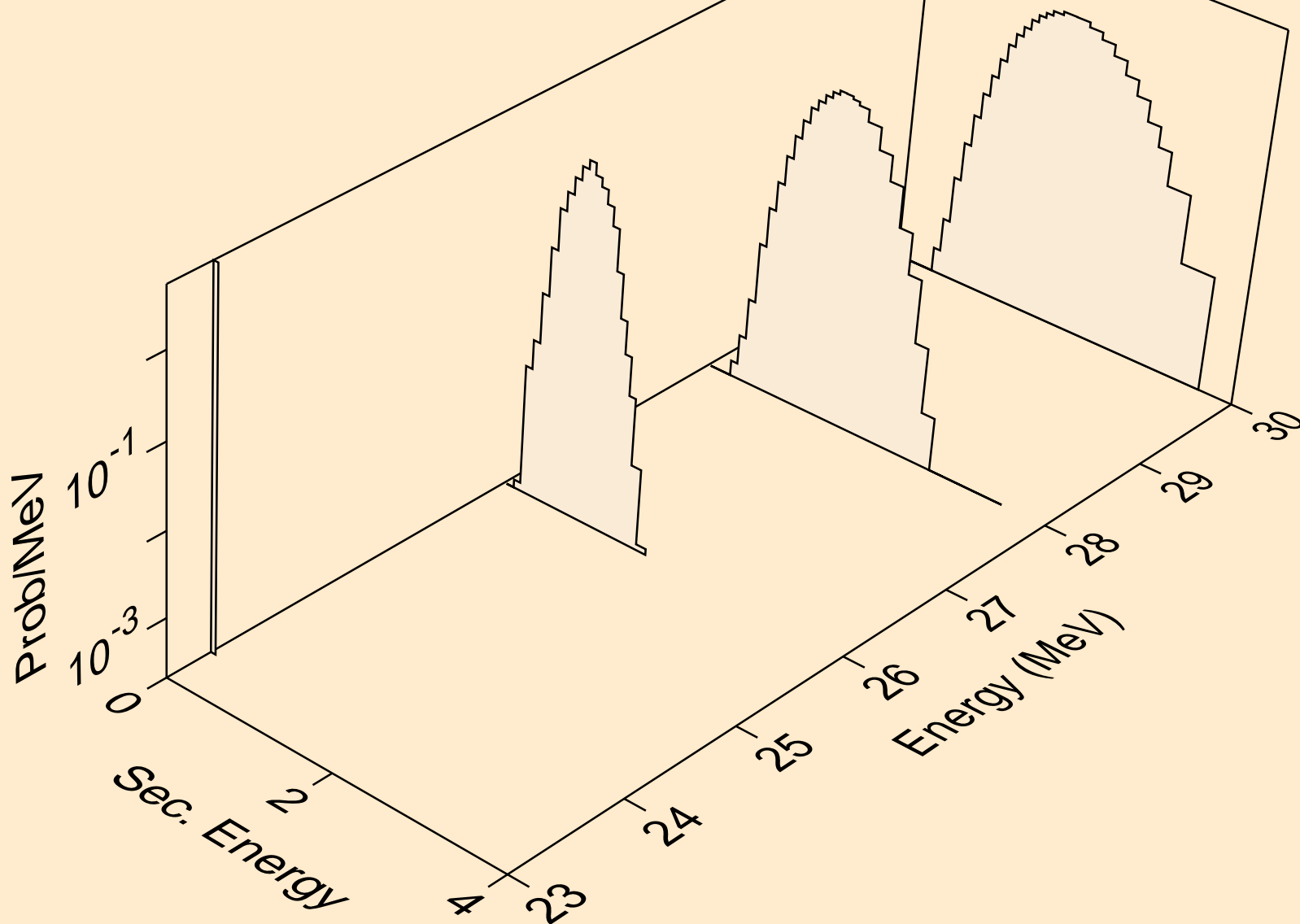

O019 NEUTRON ACER TENDL-2019 LIBRARY; T=293.16K
alphas from (n,a)

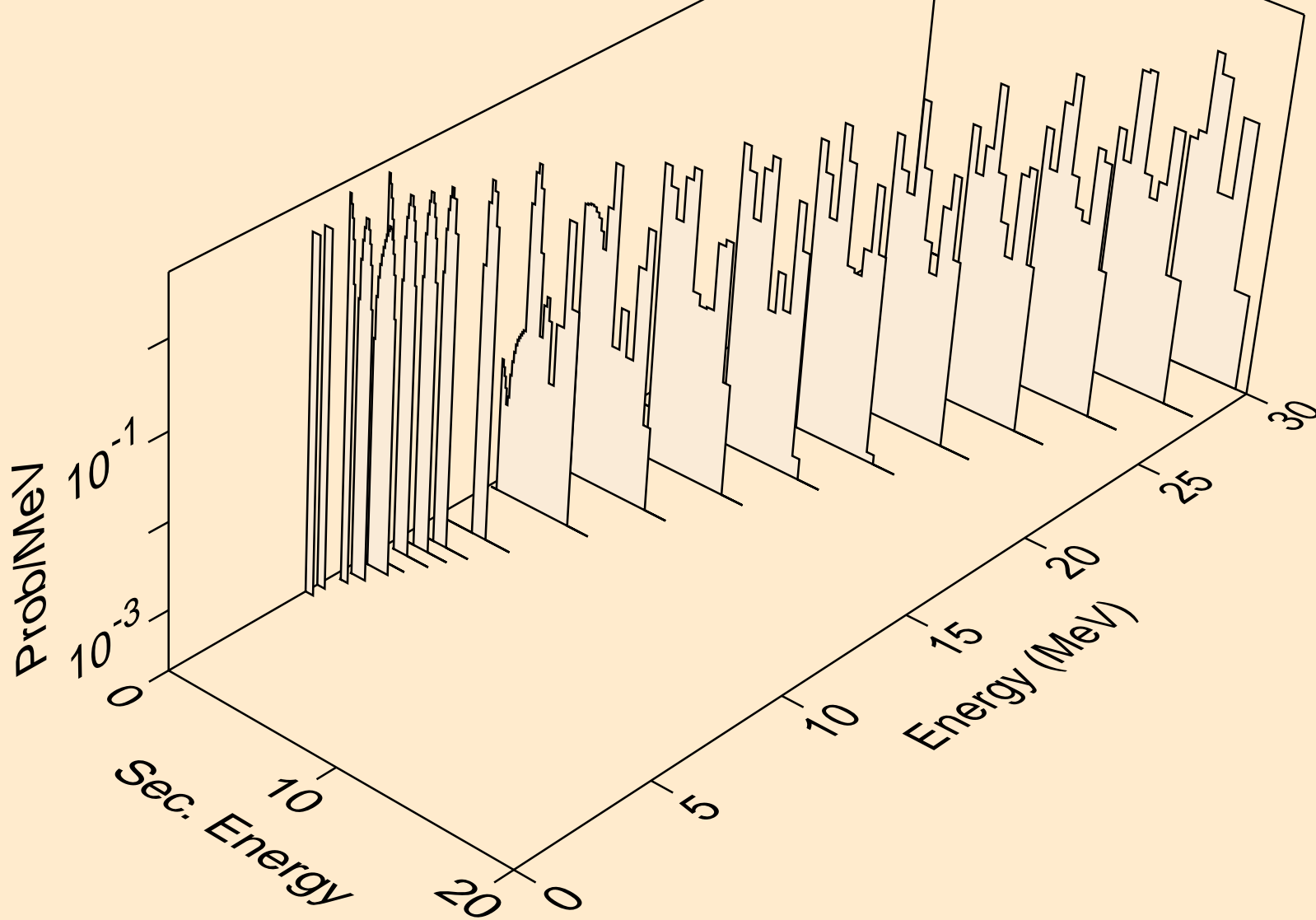

O019 NEUTRON ACER TENDL-2019 LIBRARY; T=293.16K
alphas from (n,2a)

