

OS179 NEUTRON ACER TENDL-2019 LIBRARY; T=293.16K  
Principal cross sections

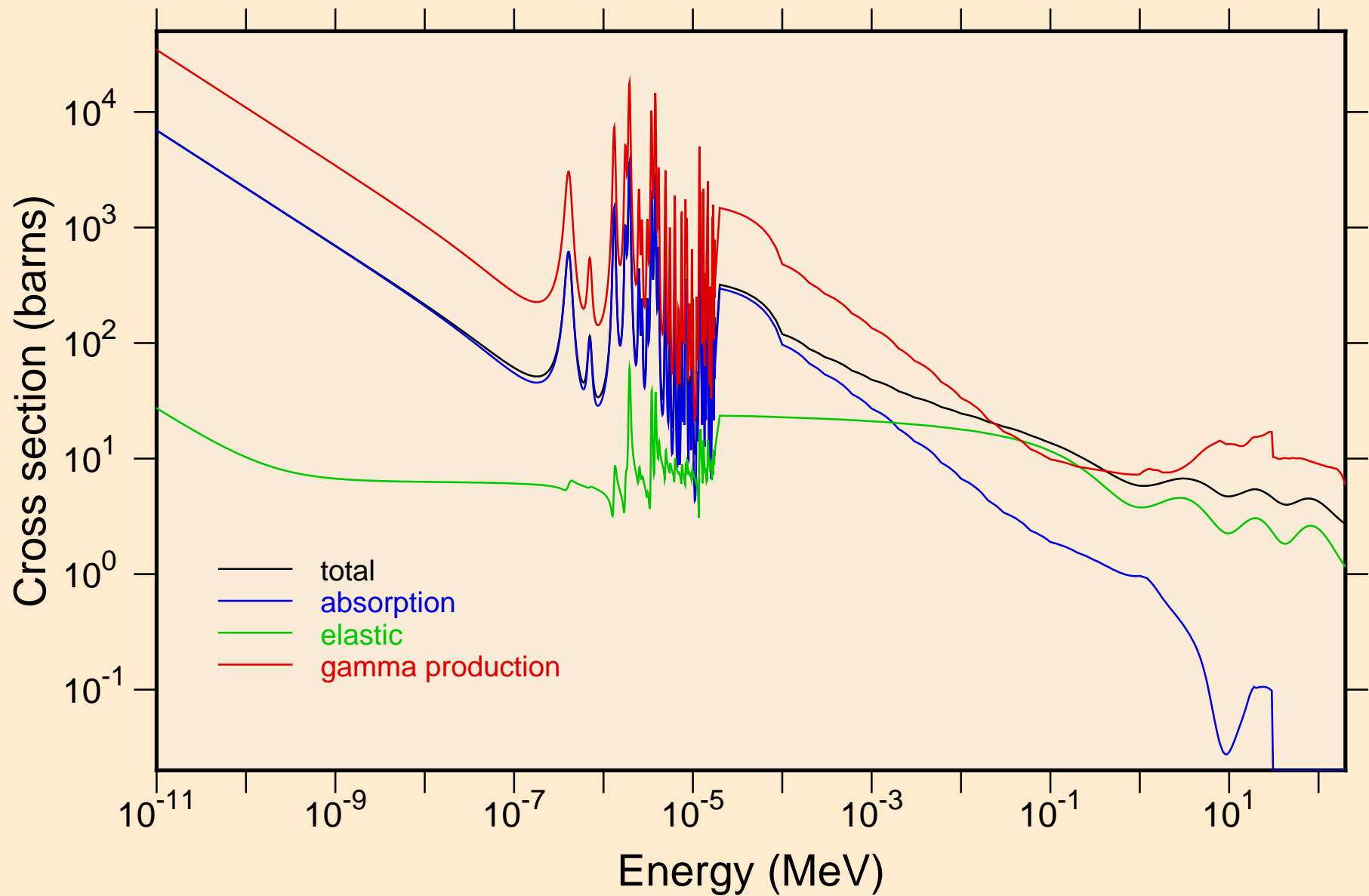

OS179 NEUTRON ACER TENDL-2019 LIBRARY; T=293.16K  
resonance total cross section

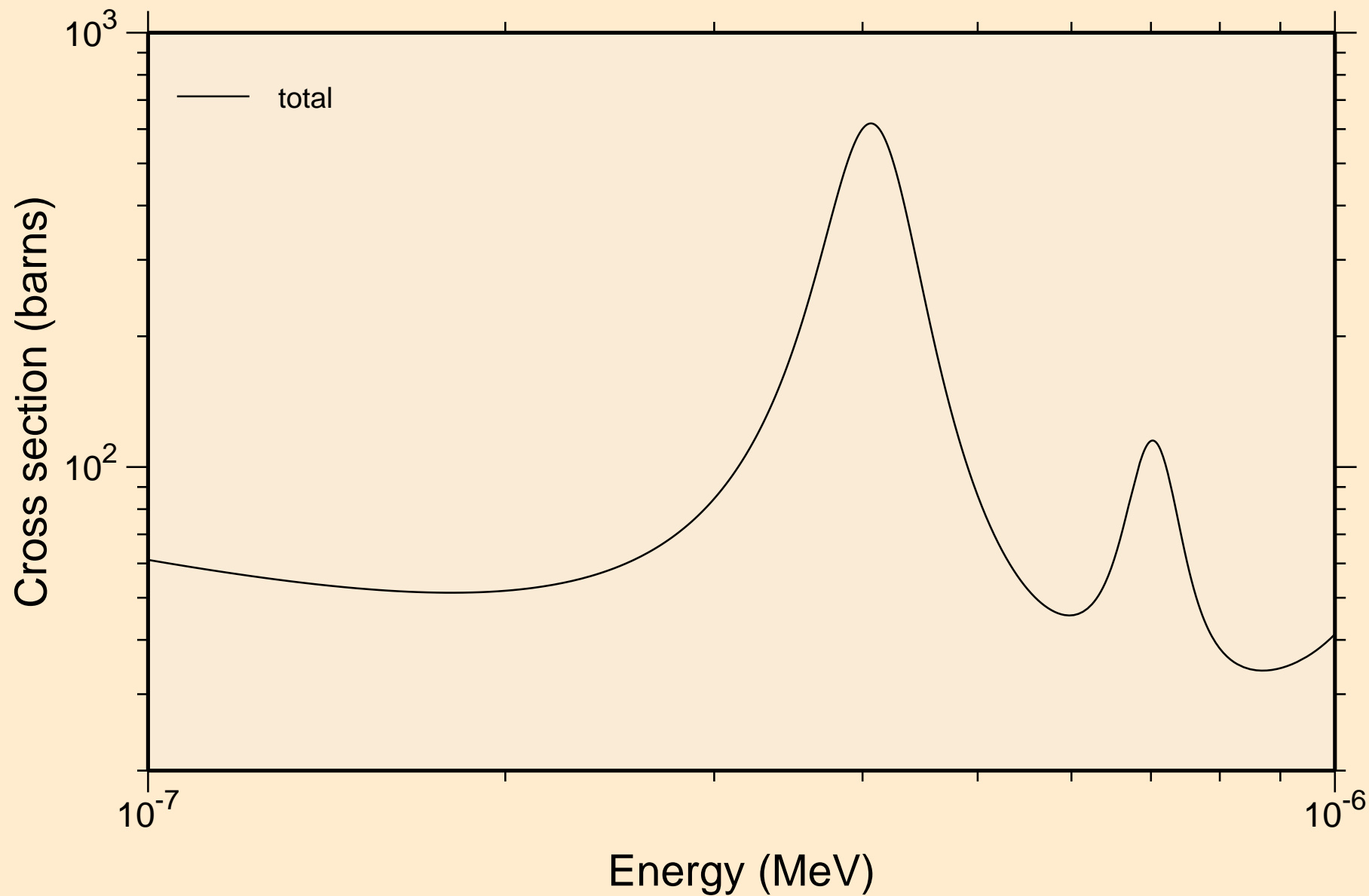

OS179 NEUTRON ACER TENDL-2019 LIBRARY; T=293.16K  
resonance total cross section

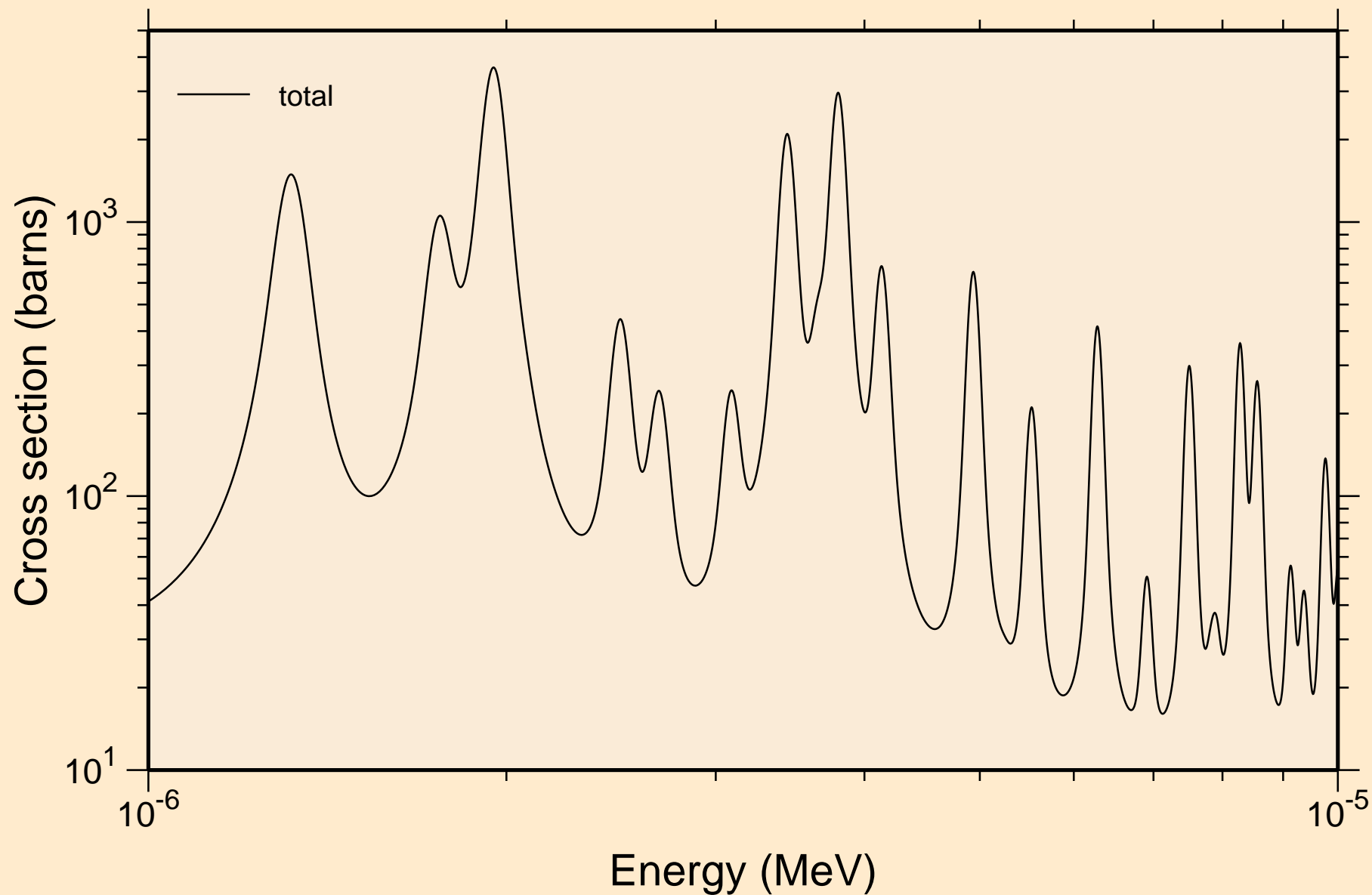

OS179 NEUTRON ACER TENDL-2019 LIBRARY; T=293.16K  
resonance total cross section

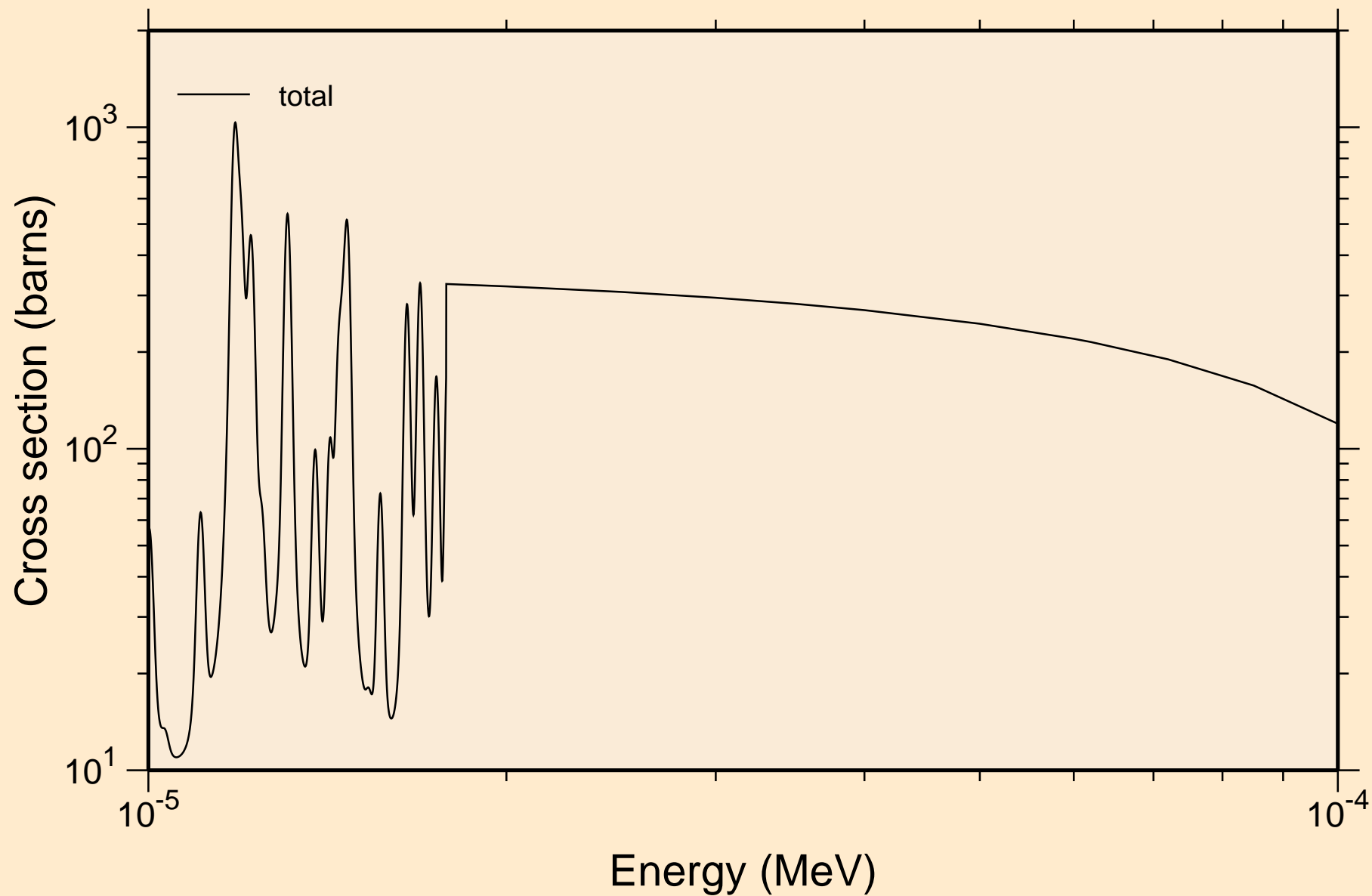

OS179 NEUTRON ACER TENDL-2019 LIBRARY; T=293.16K  
resonance total cross section

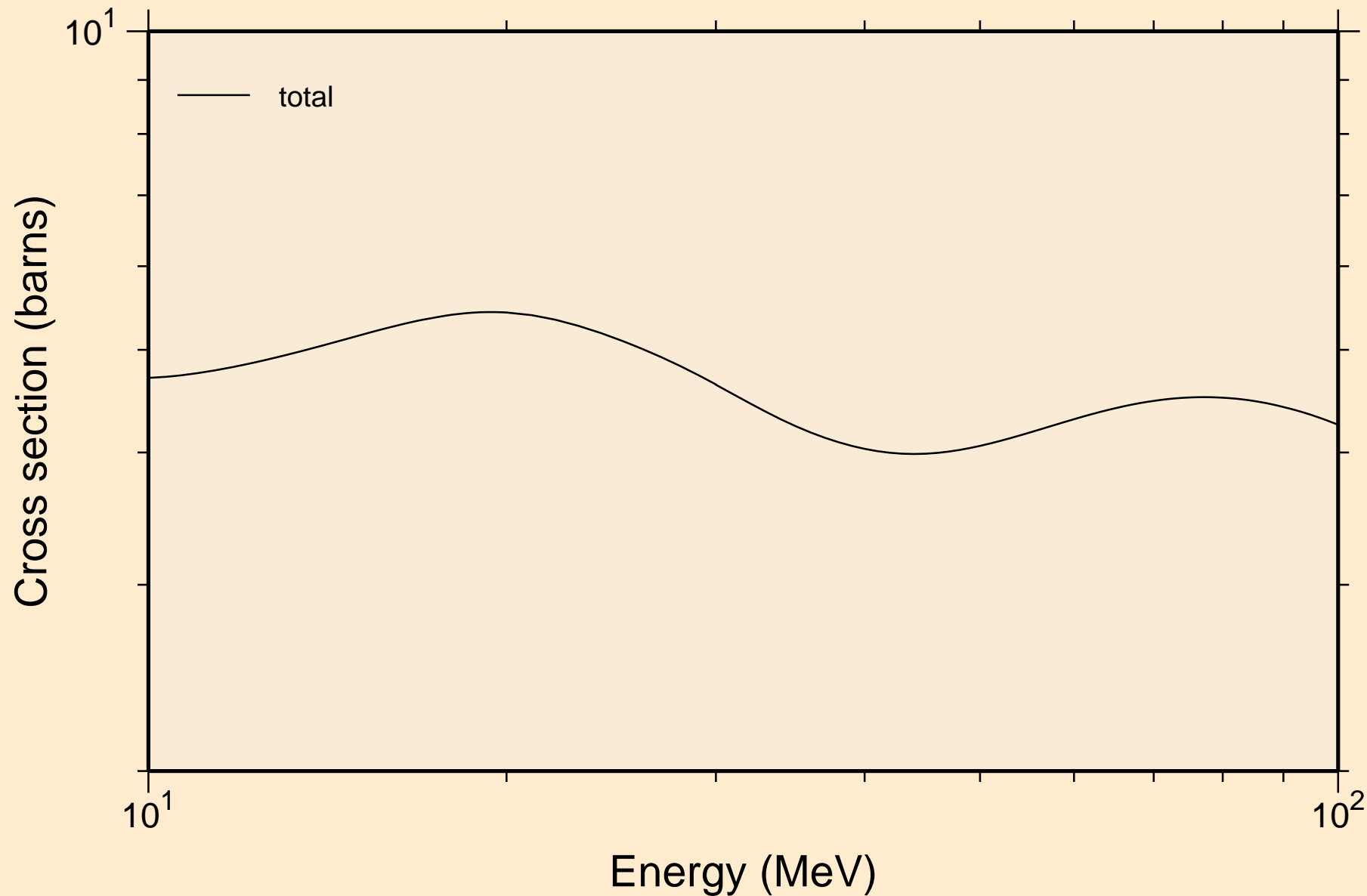

OS179 NEUTRON ACER TENDL-2019 LIBRARY; T=293.16K  
resonance absorption cross sections

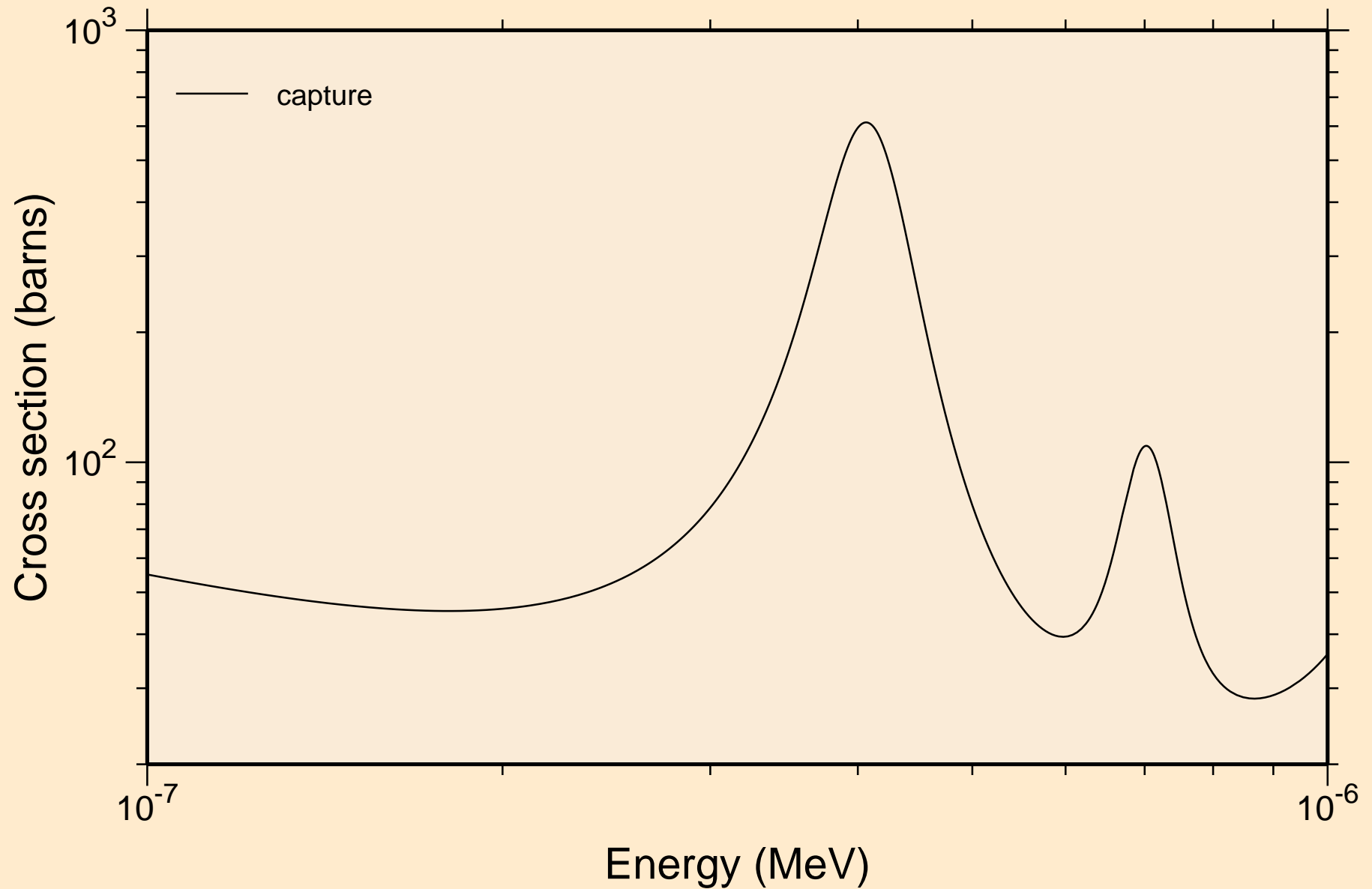

OS179 NEUTRON ACER TENDL-2019 LIBRARY; T=293.16K  
resonance absorption cross sections

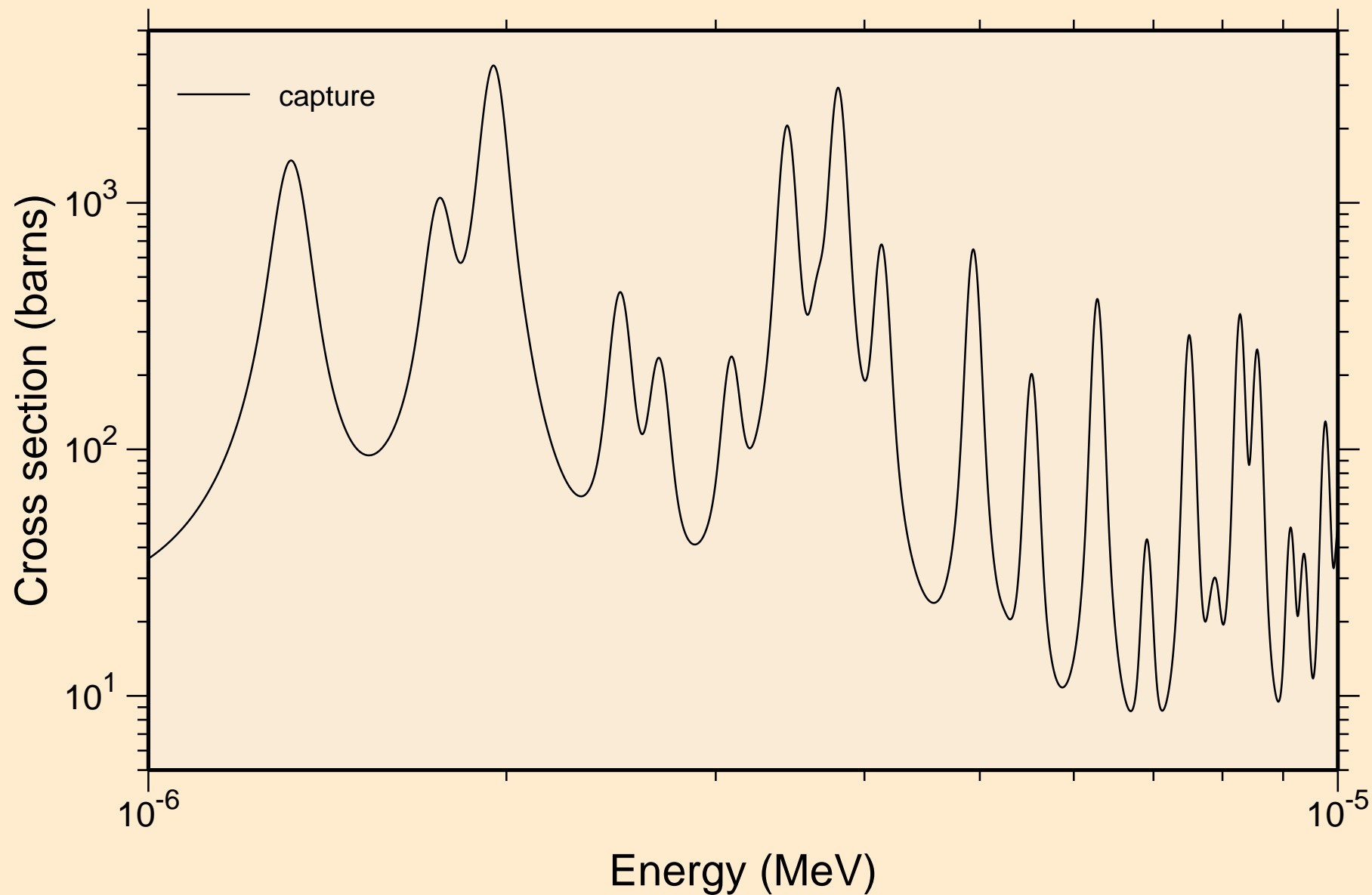

OS179 NEUTRON ACER TENDL-2019 LIBRARY; T=293.16K  
resonance absorption cross sections

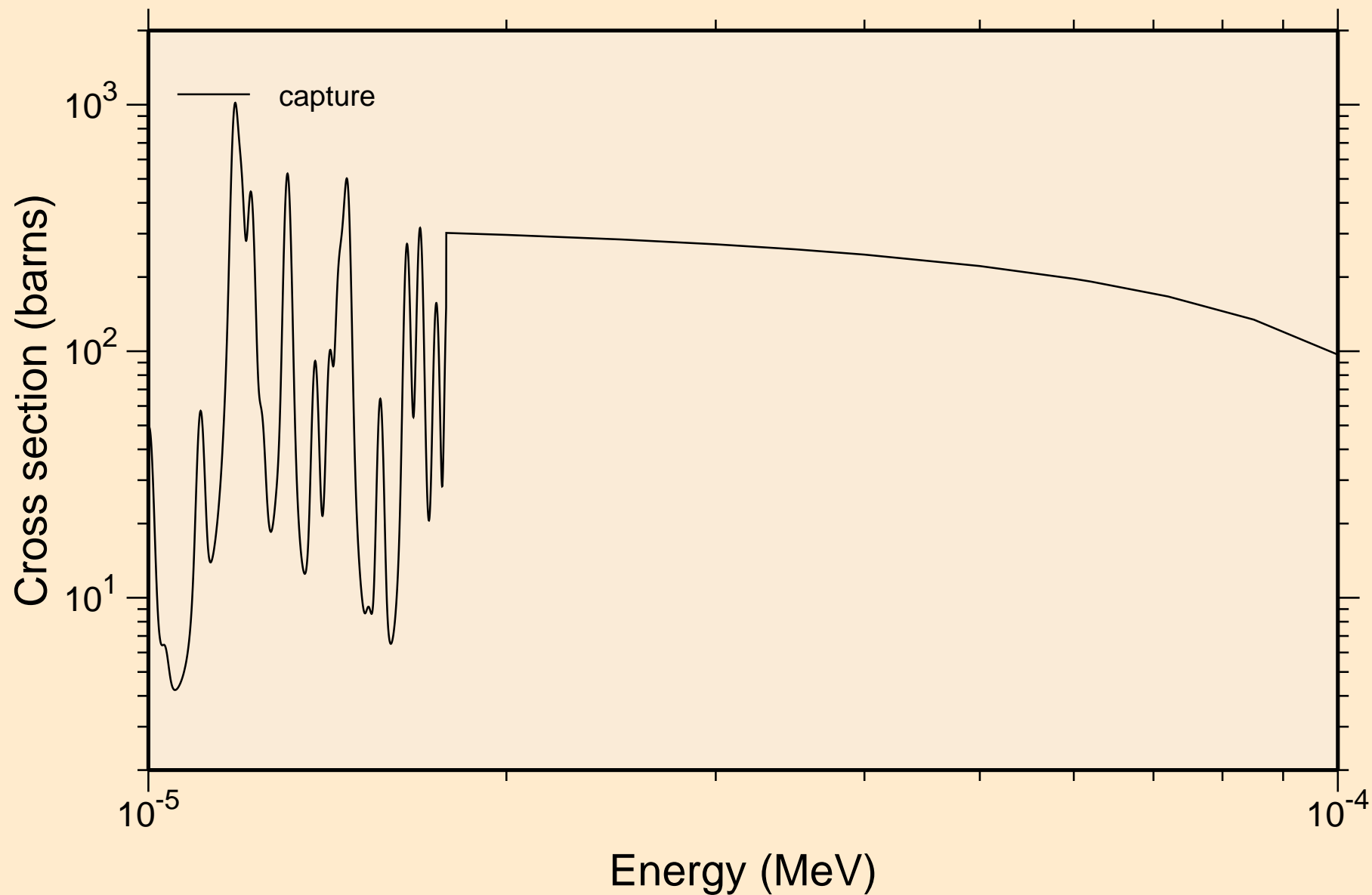



OS179 NEUTRON ACER TENDL-2019 LIBRARY; T=293.16K  
resonance absorption cross sections

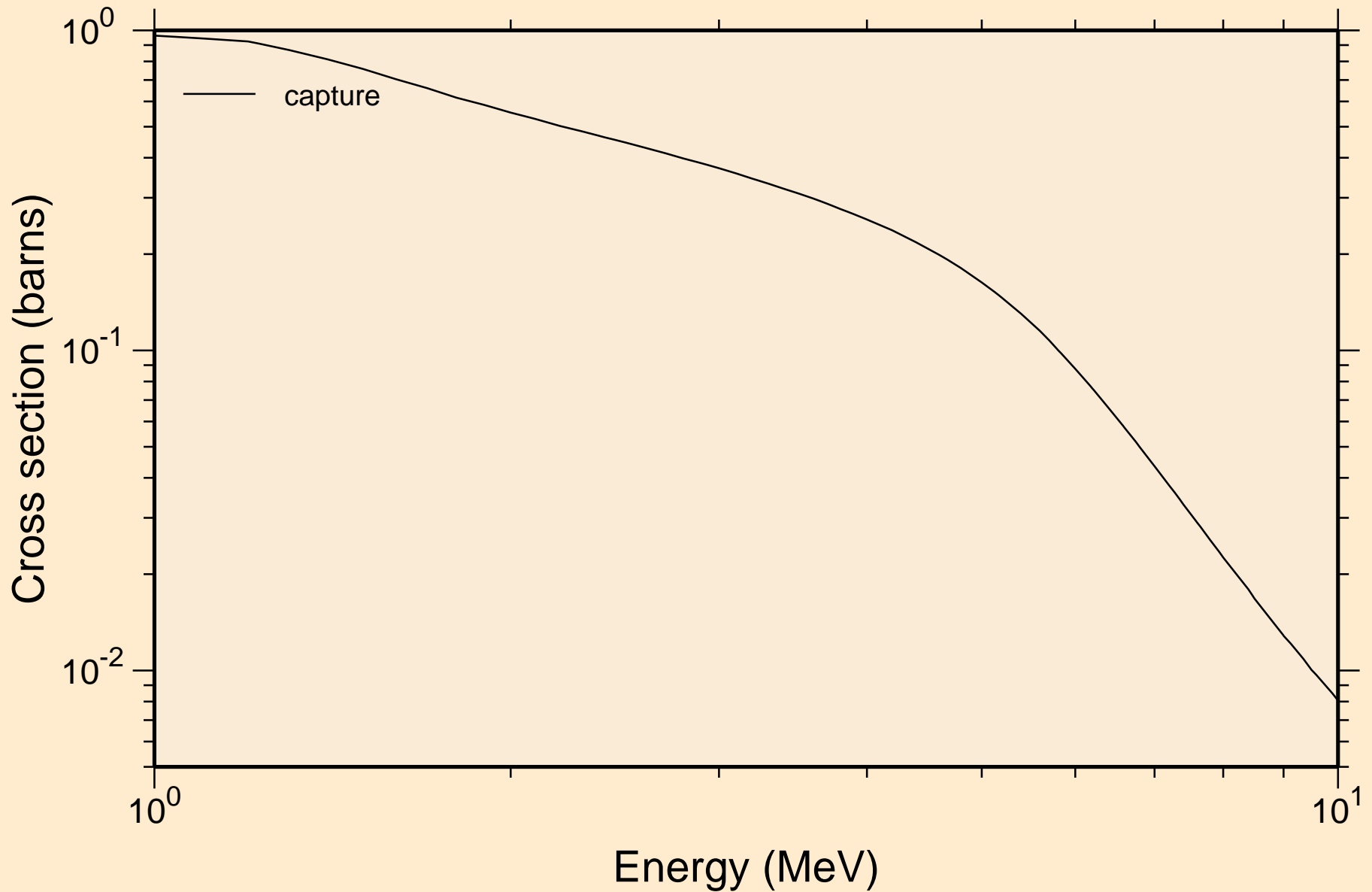

OS179 NEUTRON ACER TENDL-2019 LIBRARY; T=293.16K  
Heating

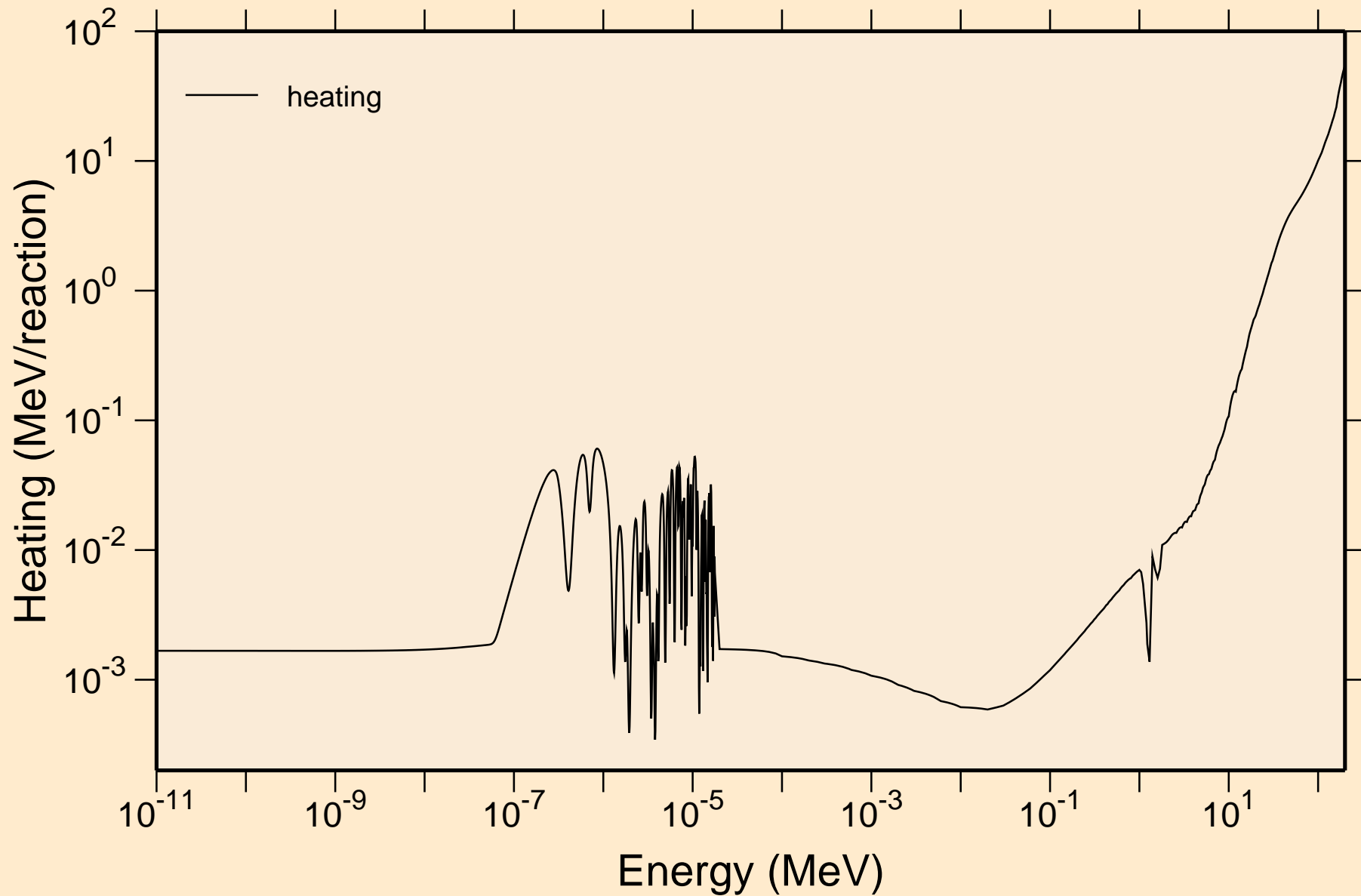

OS179 NEUTRON ACER TENDL-2019 LIBRARY; T=293.16K  
Damage

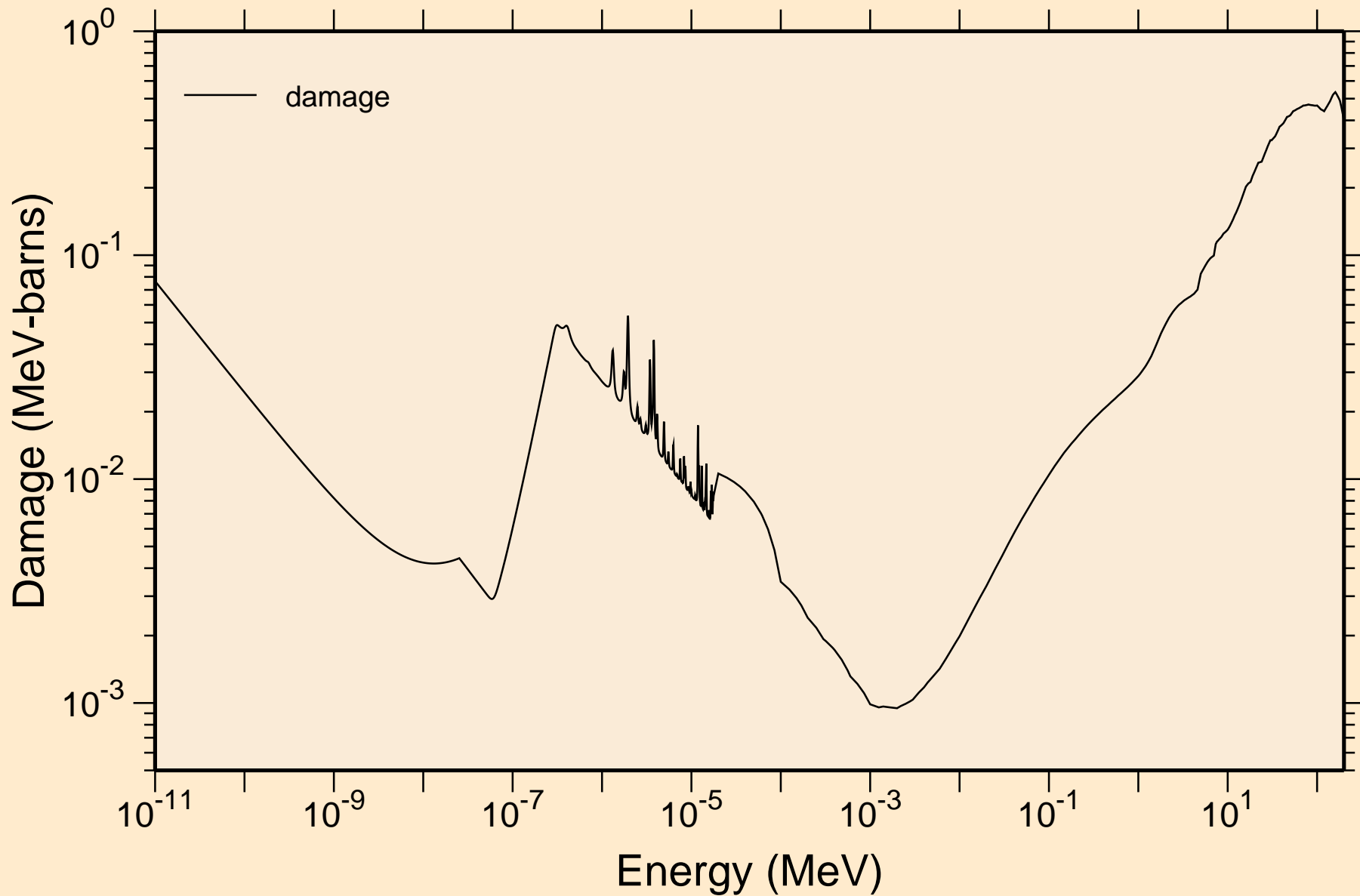

OS179 NEUTRON ACER TENDL-2019 LIBRARY; T=293.16K  
Non-threshold reactions

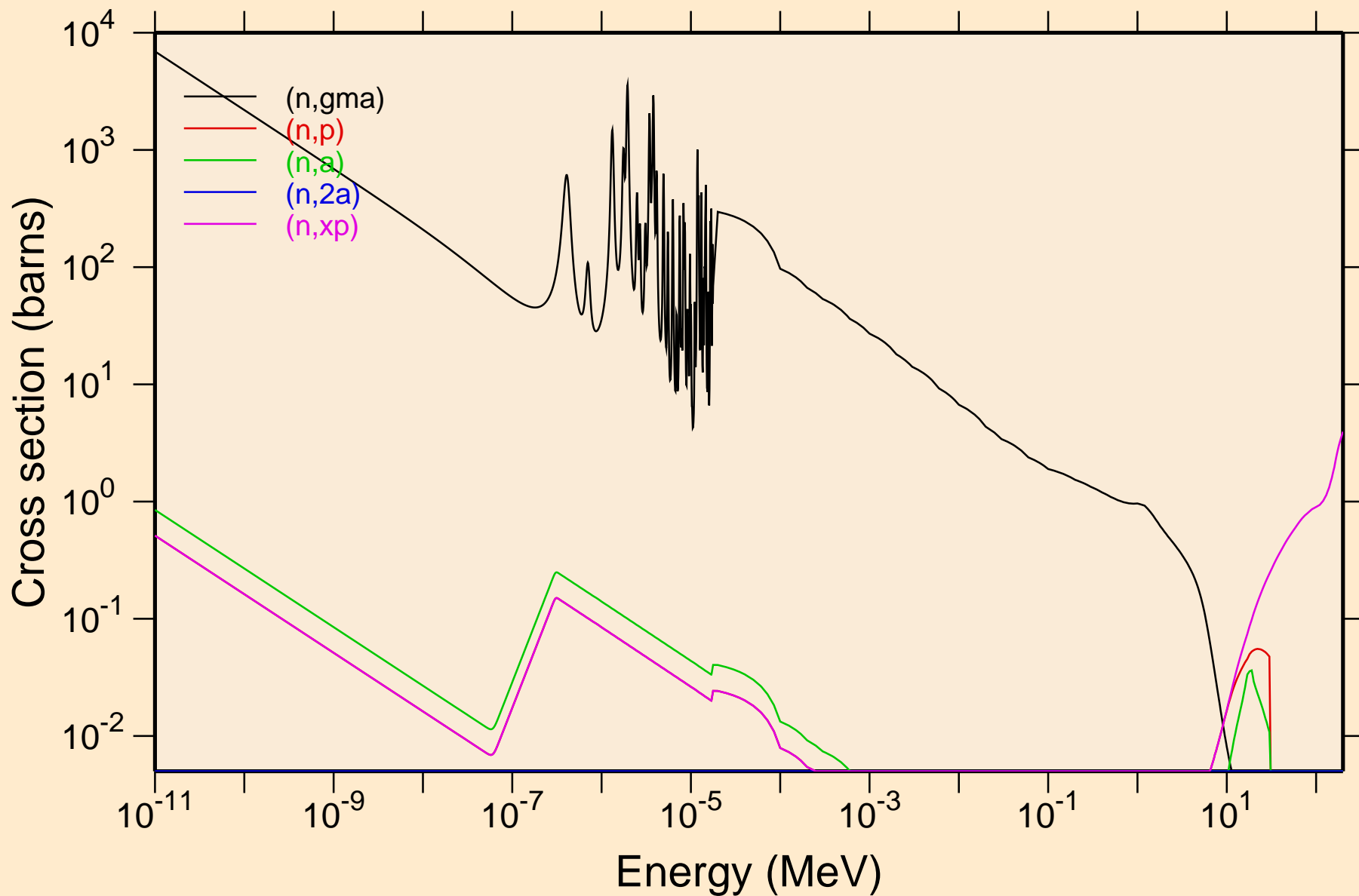

OS179 NEUTRON ACER TENDL-2019 LIBRARY; T=293.16K  
Non-threshold reactions

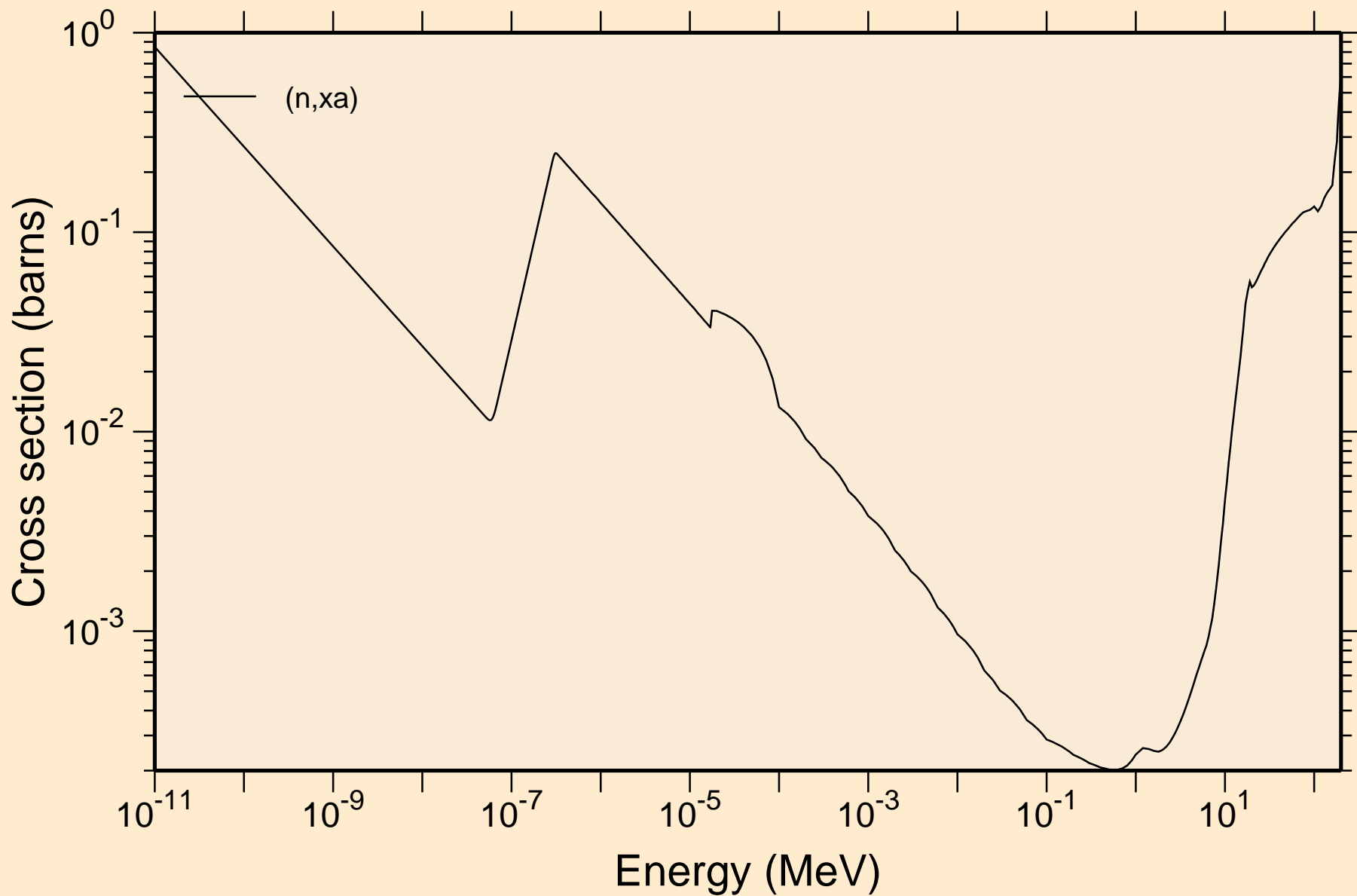

OS179 NEUTRON ACER TENDL-2019 LIBRARY; T=293.16K  
Principal cross sections

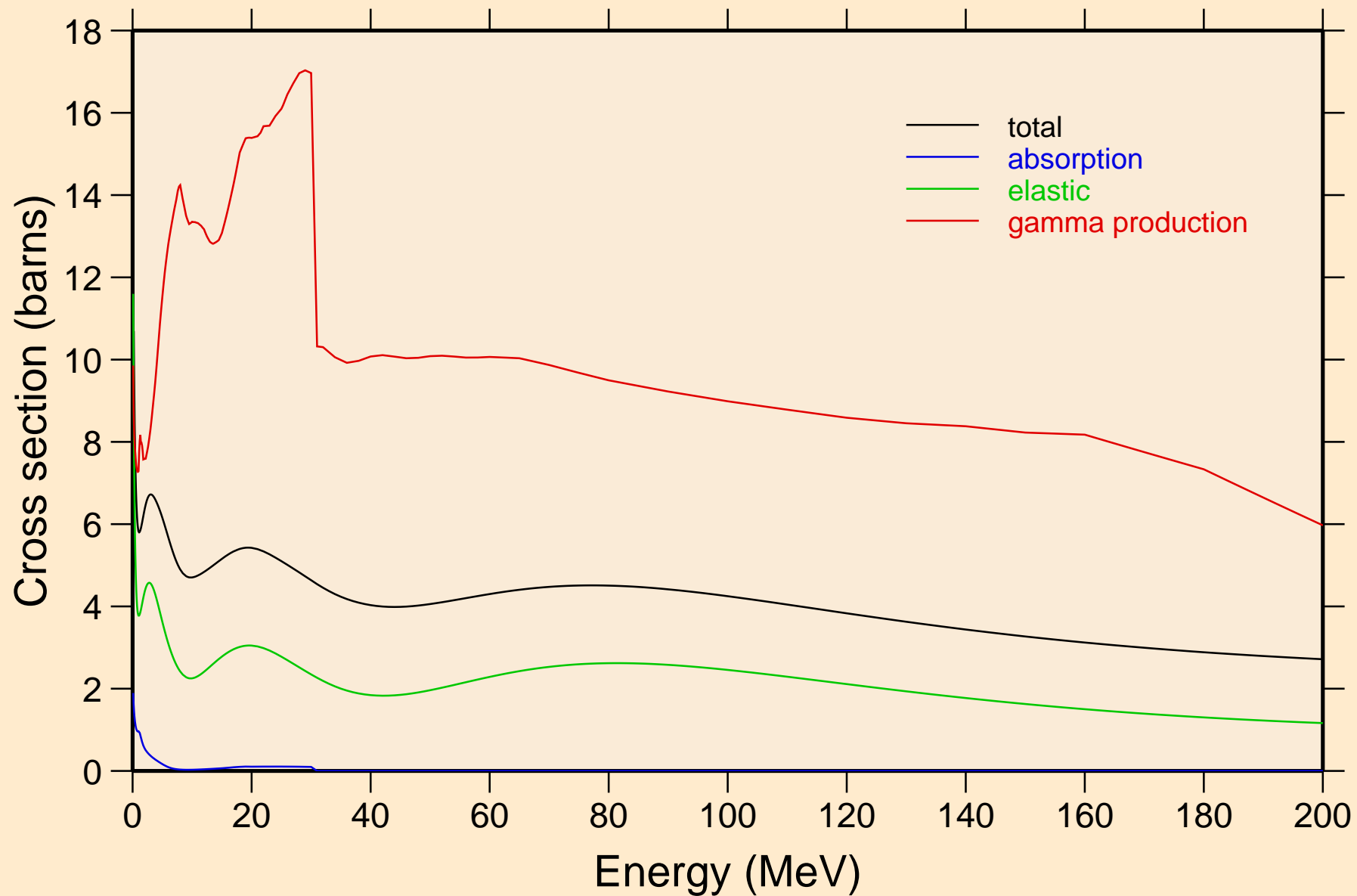

OS179 NEUTRON ACER TENDL-2019 LIBRARY; T=293.16K  
Heating

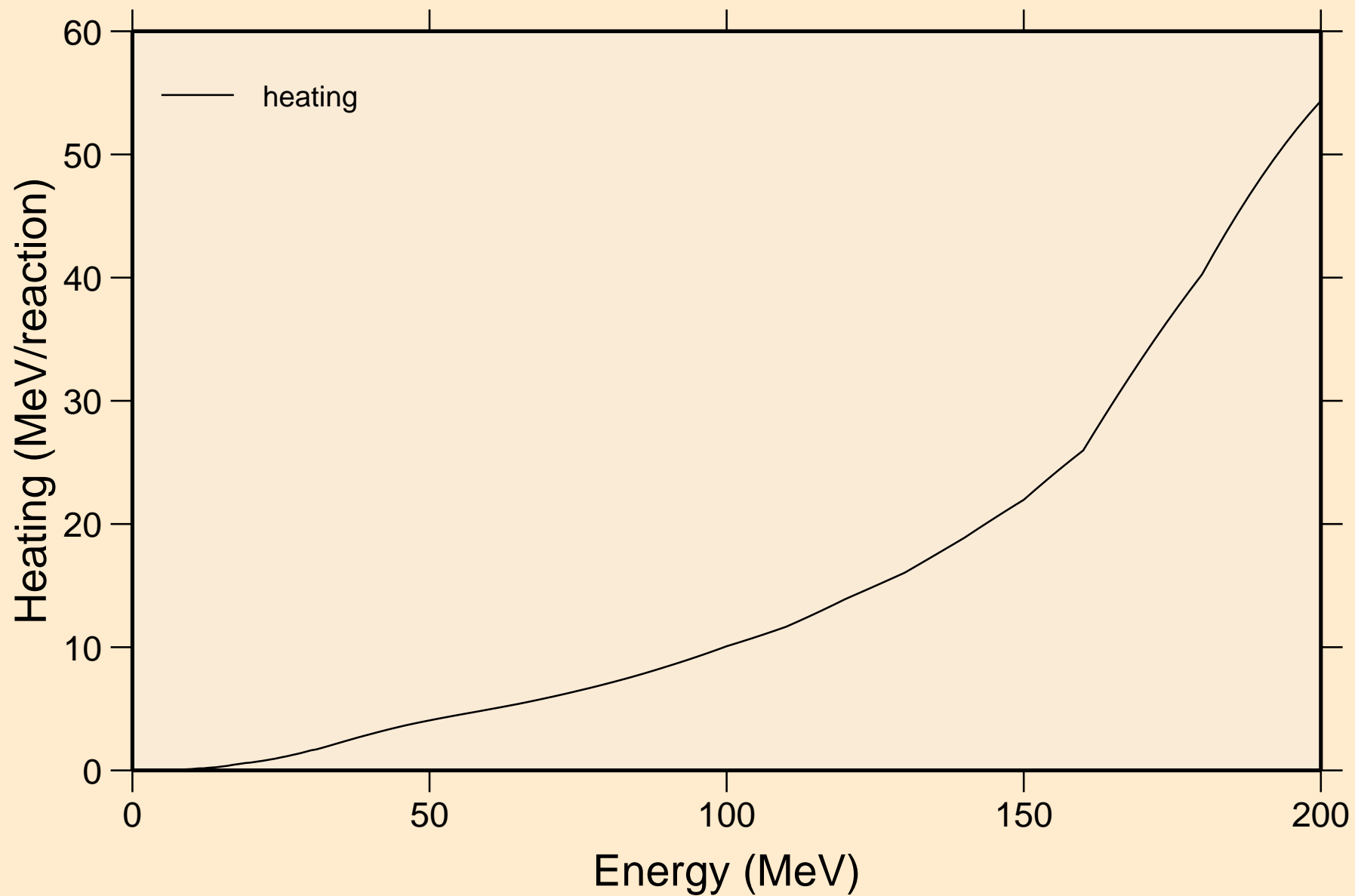

OS179 NEUTRON ACER TENDL-2019 LIBRARY; T=293.16K  
Damage

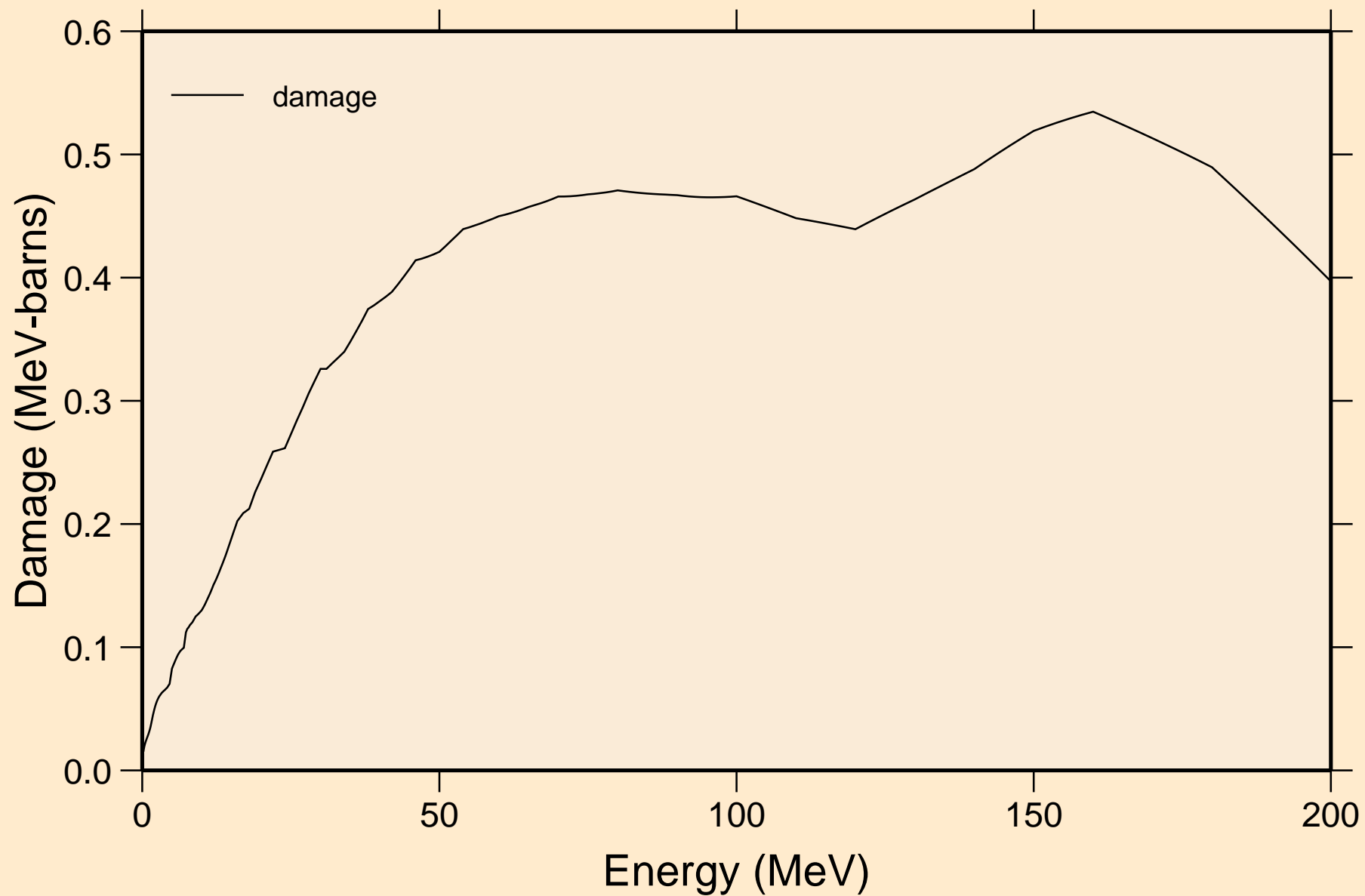



OS179 NEUTRON ACER TENDL-2019 LIBRARY; T=293.16K  
Non-threshold reactions

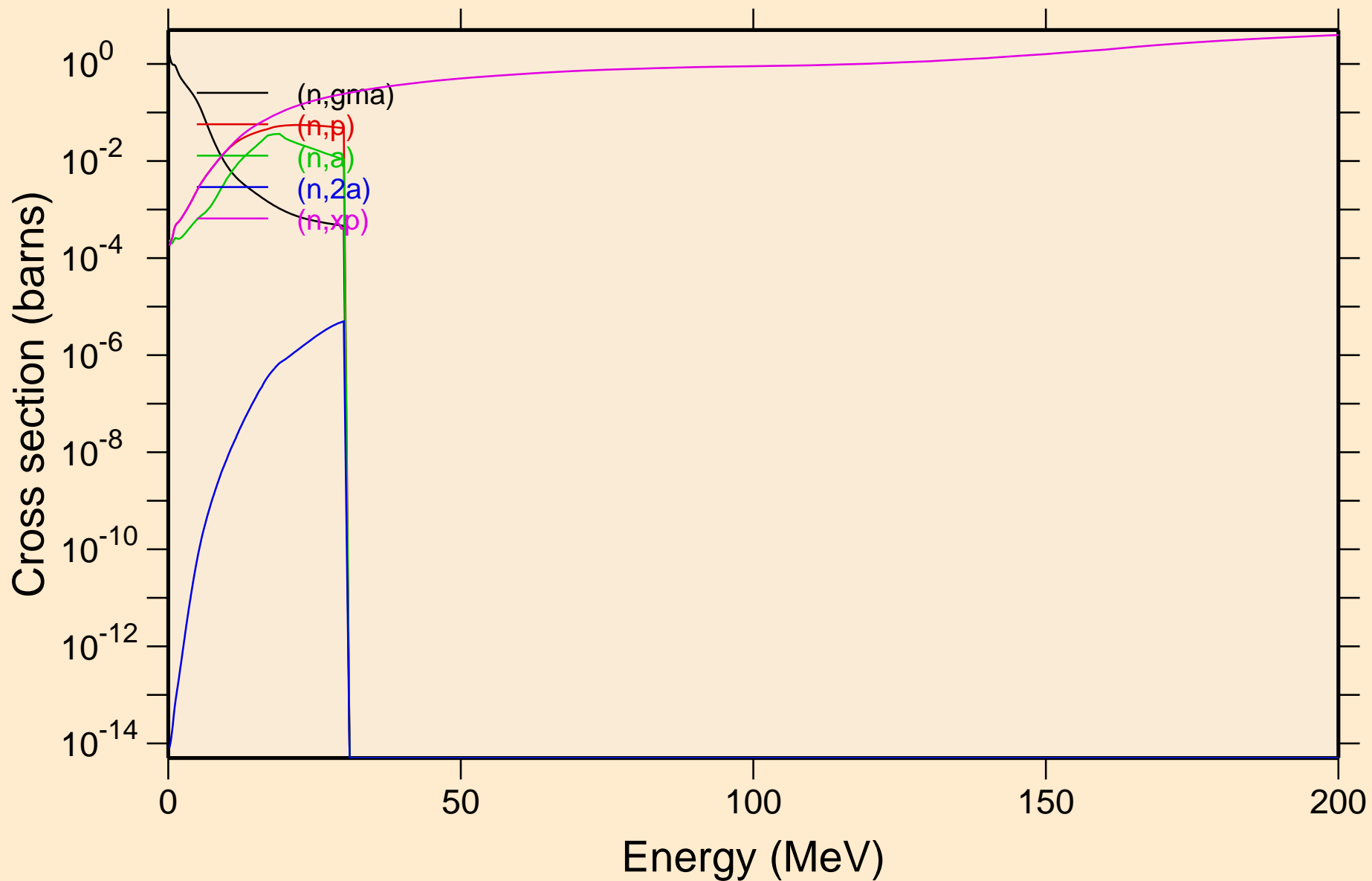

OS179 NEUTRON ACER TENDL-2019 LIBRARY; T=293.16K  
Non-threshold reactions

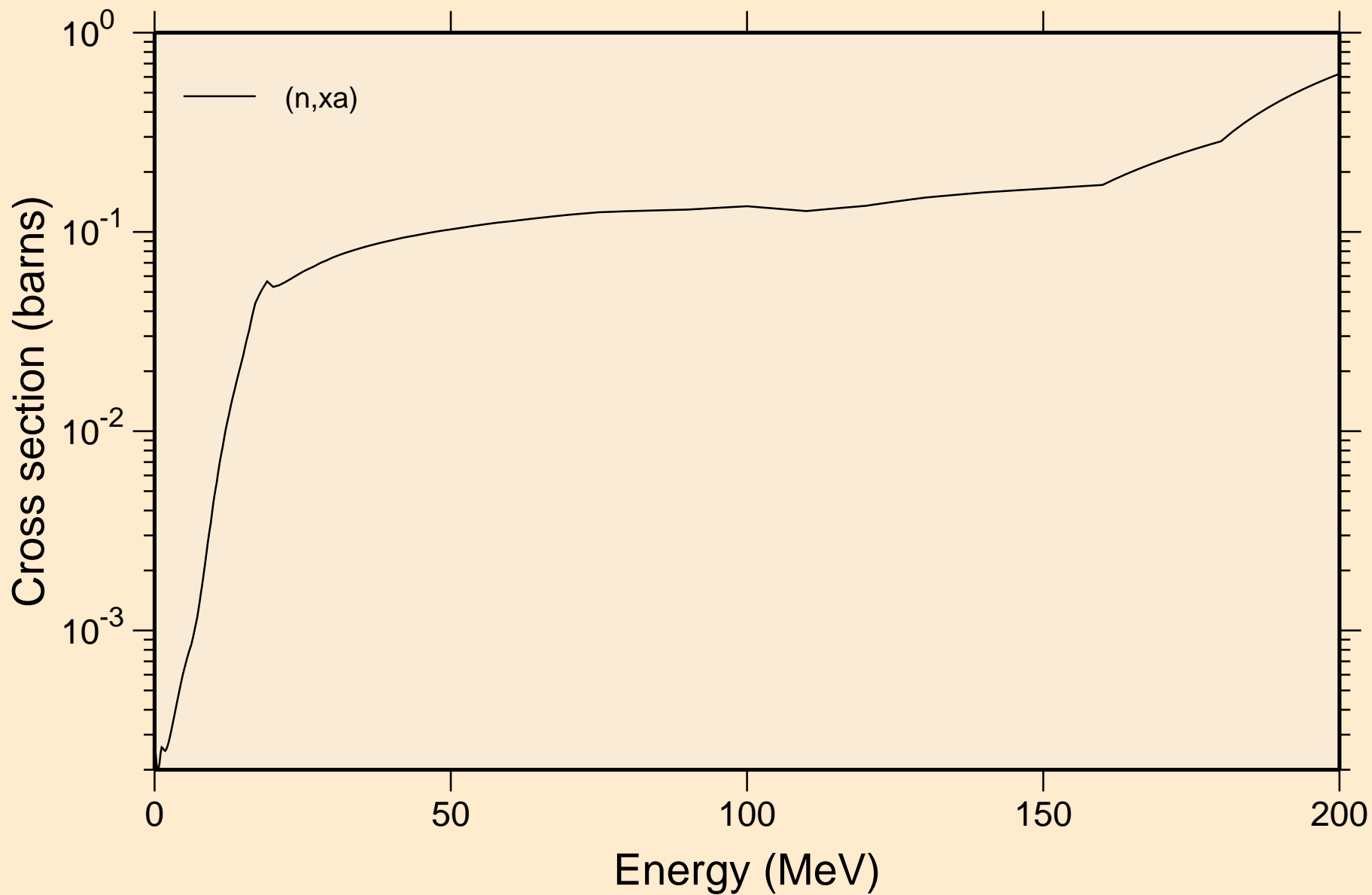

OS179 NEUTRON ACER TENDL-2019 LIBRARY; T=293.16K  
Inelastic levels

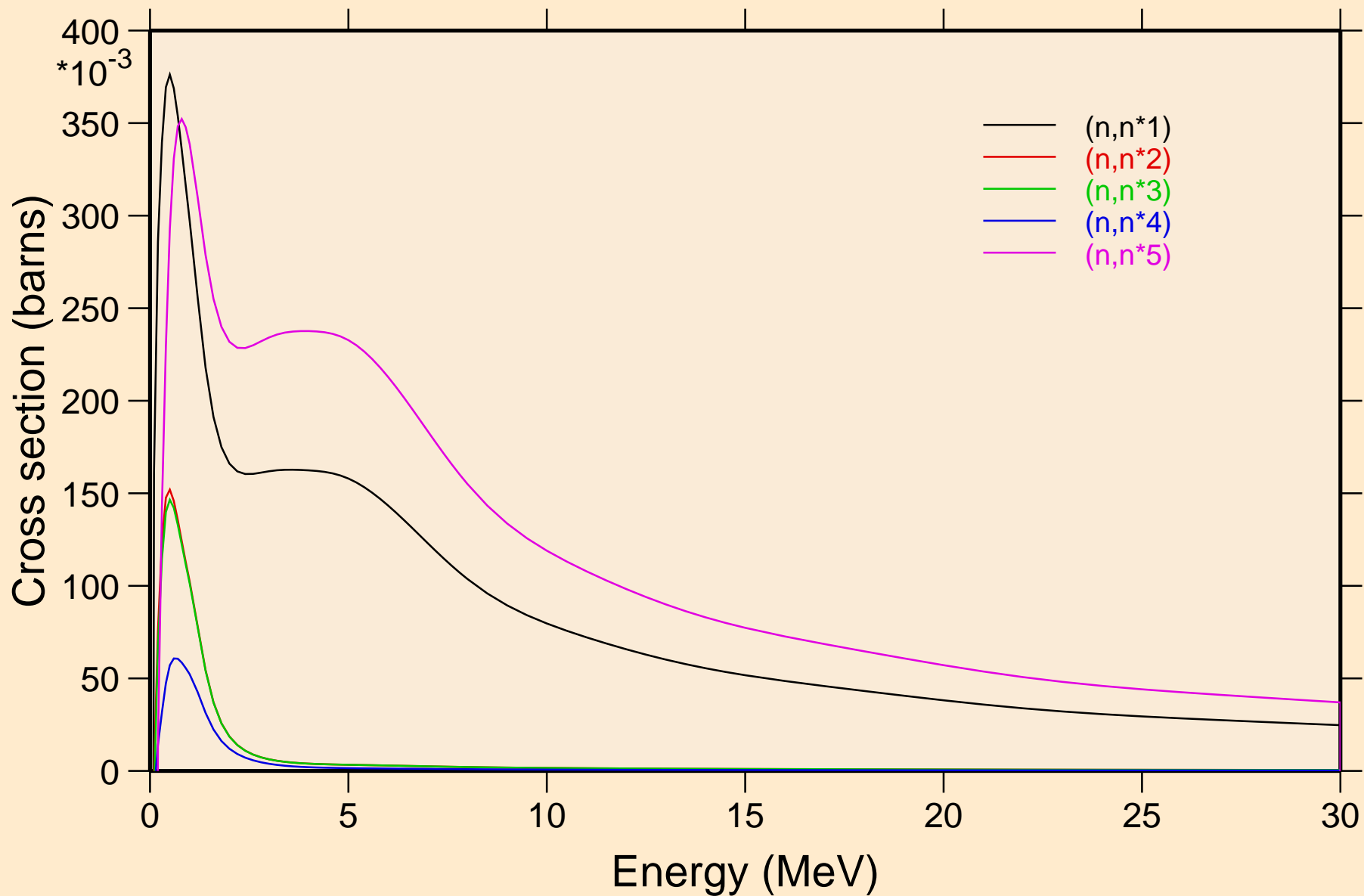

OS179 NEUTRON ACER TENDL-2019 LIBRARY; T=293.16K  
Inelastic levels

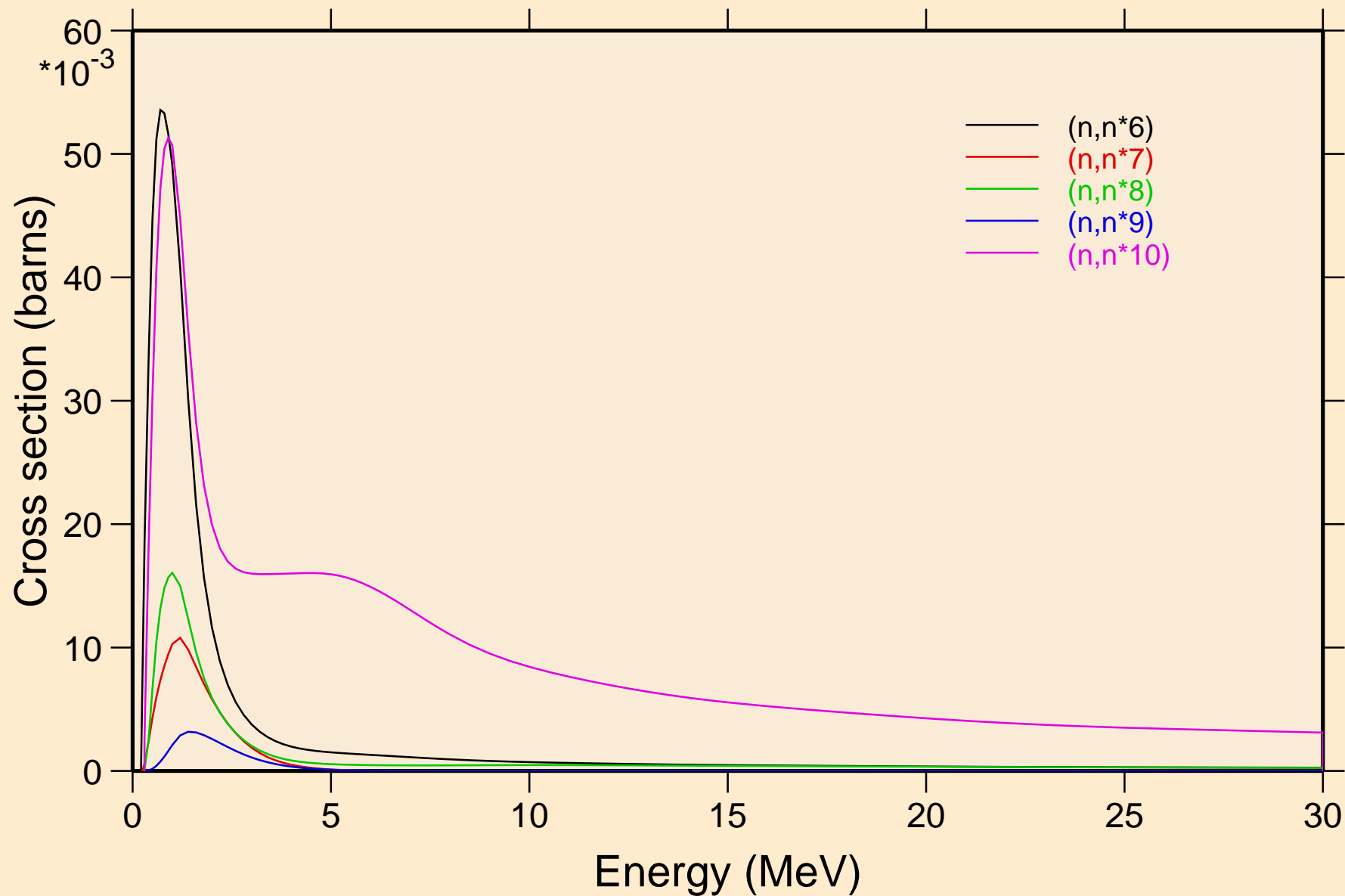

OS179 NEUTRON ACER TENDL-2019 LIBRARY; T=293.16K  
Inelastic levels

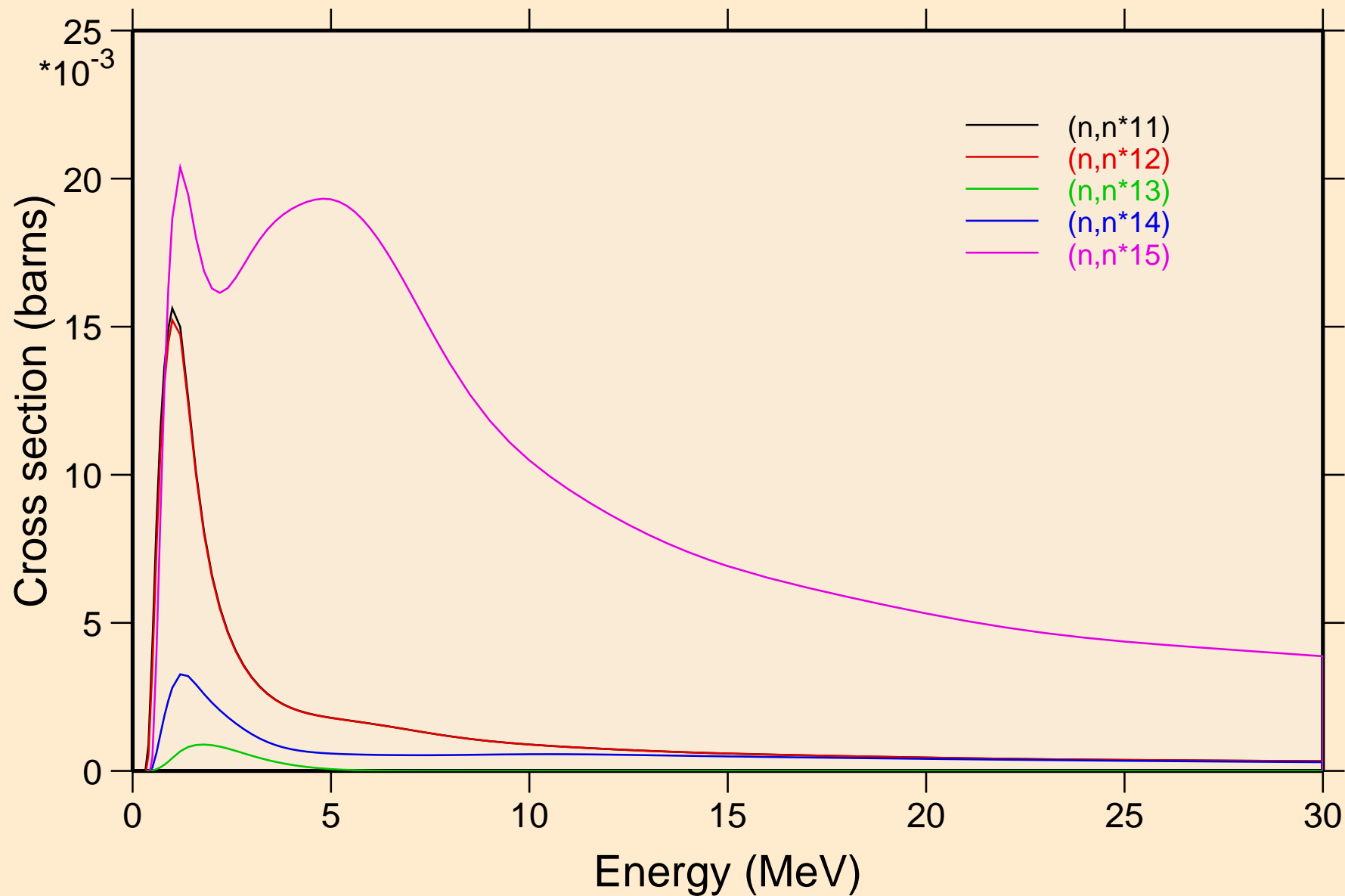

OS179 NEUTRON ACER TENDL-2019 LIBRARY; T=293.16K  
Threshold reactions

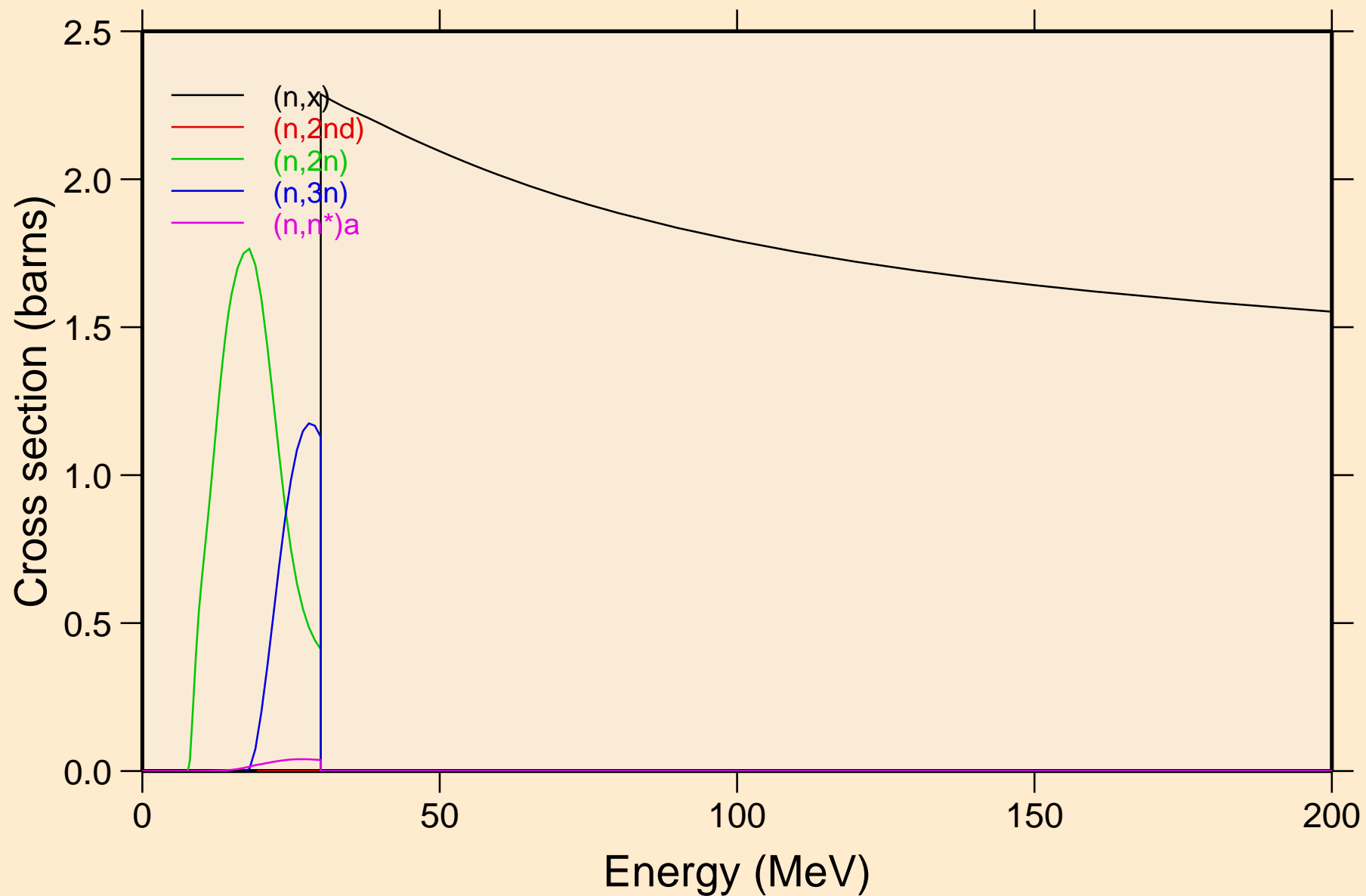

OS179 NEUTRON ACER TENDL-2019 LIBRARY; T=293.16K  
Threshold reactions

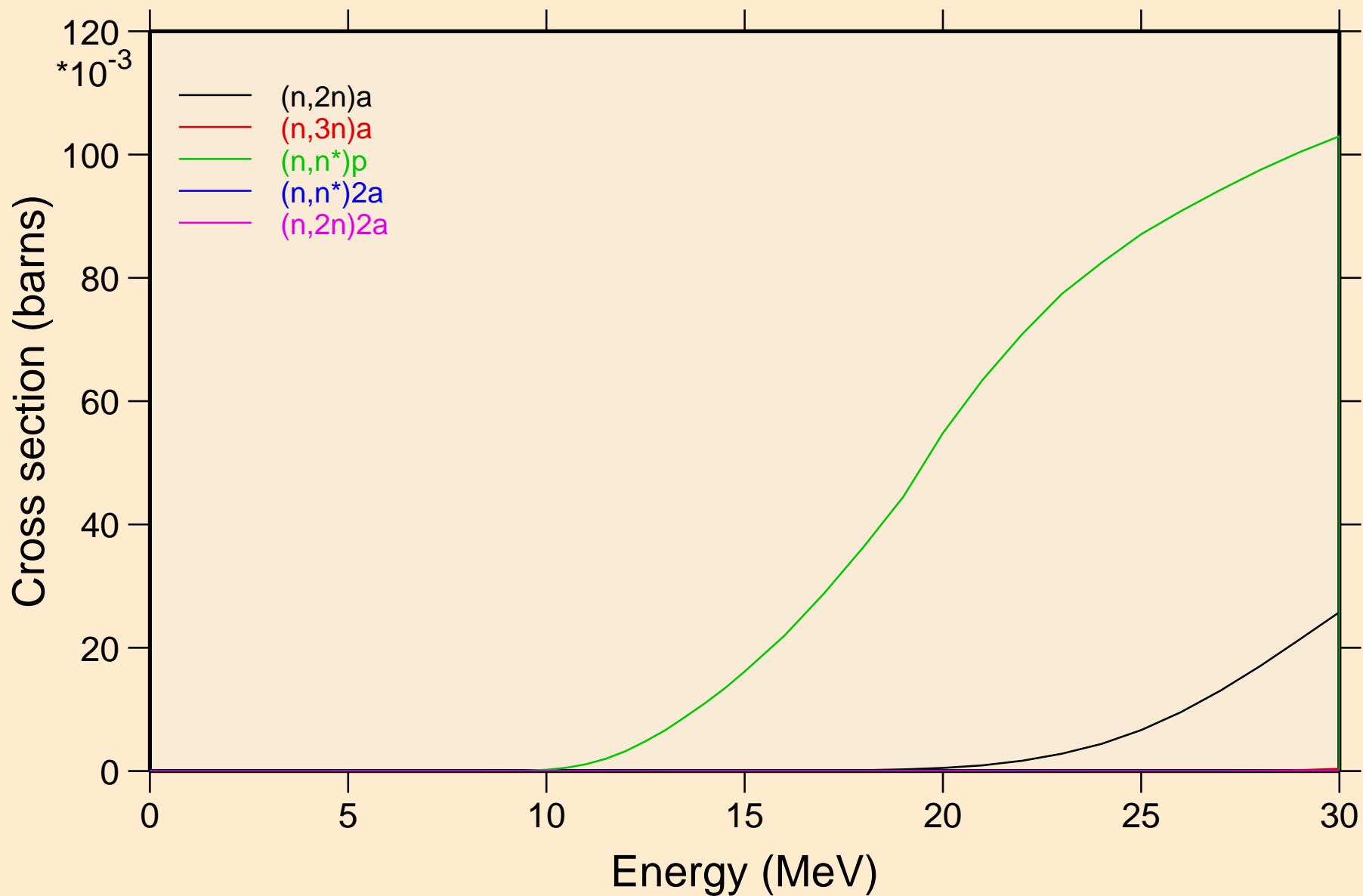

OS179 NEUTRON ACER TENDL-2019 LIBRARY; T=293.16K  
Threshold reactions

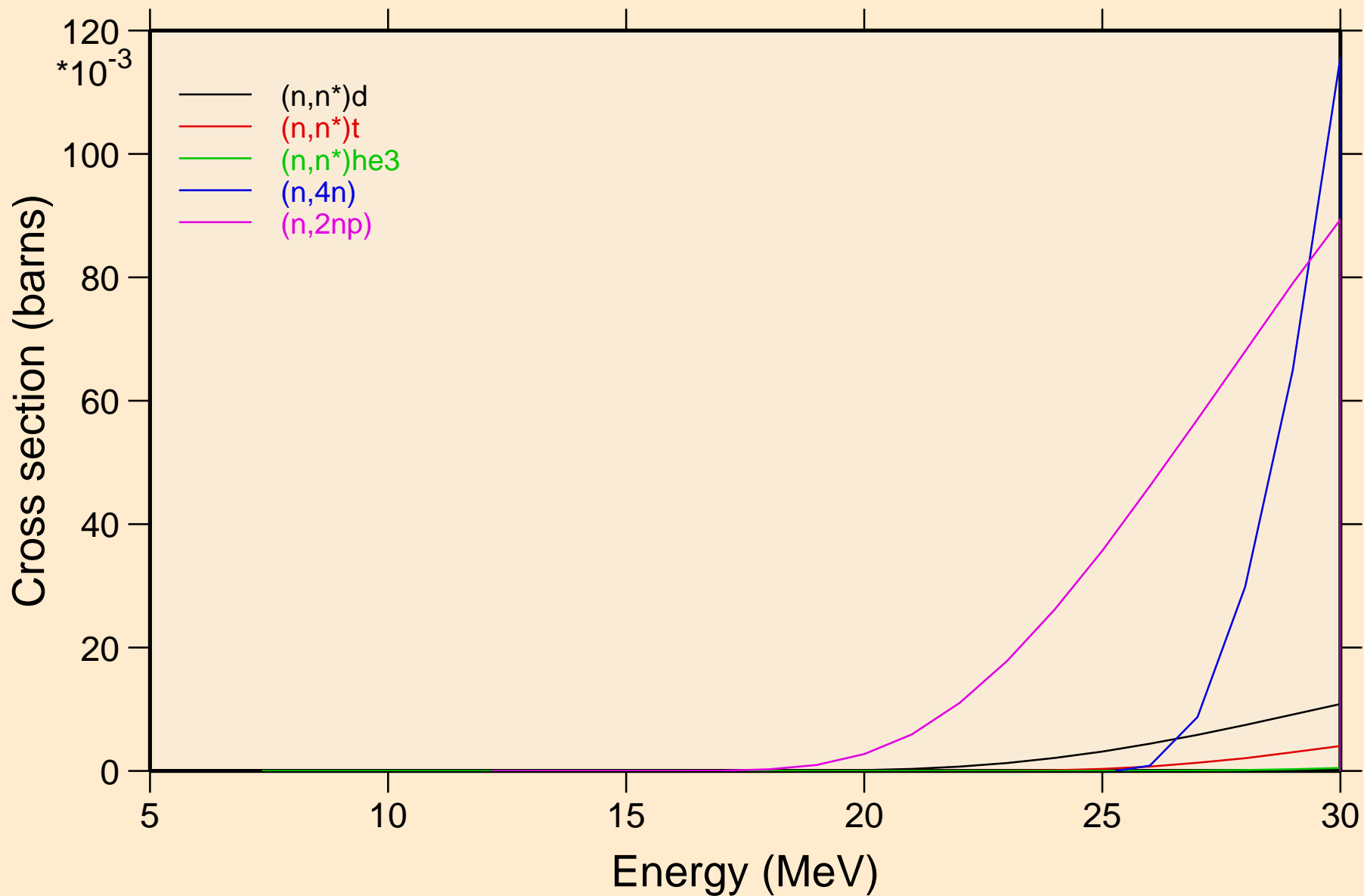



OS179 NEUTRON ACER TENDL-2019 LIBRARY; T=293.16K  
Threshold reactions

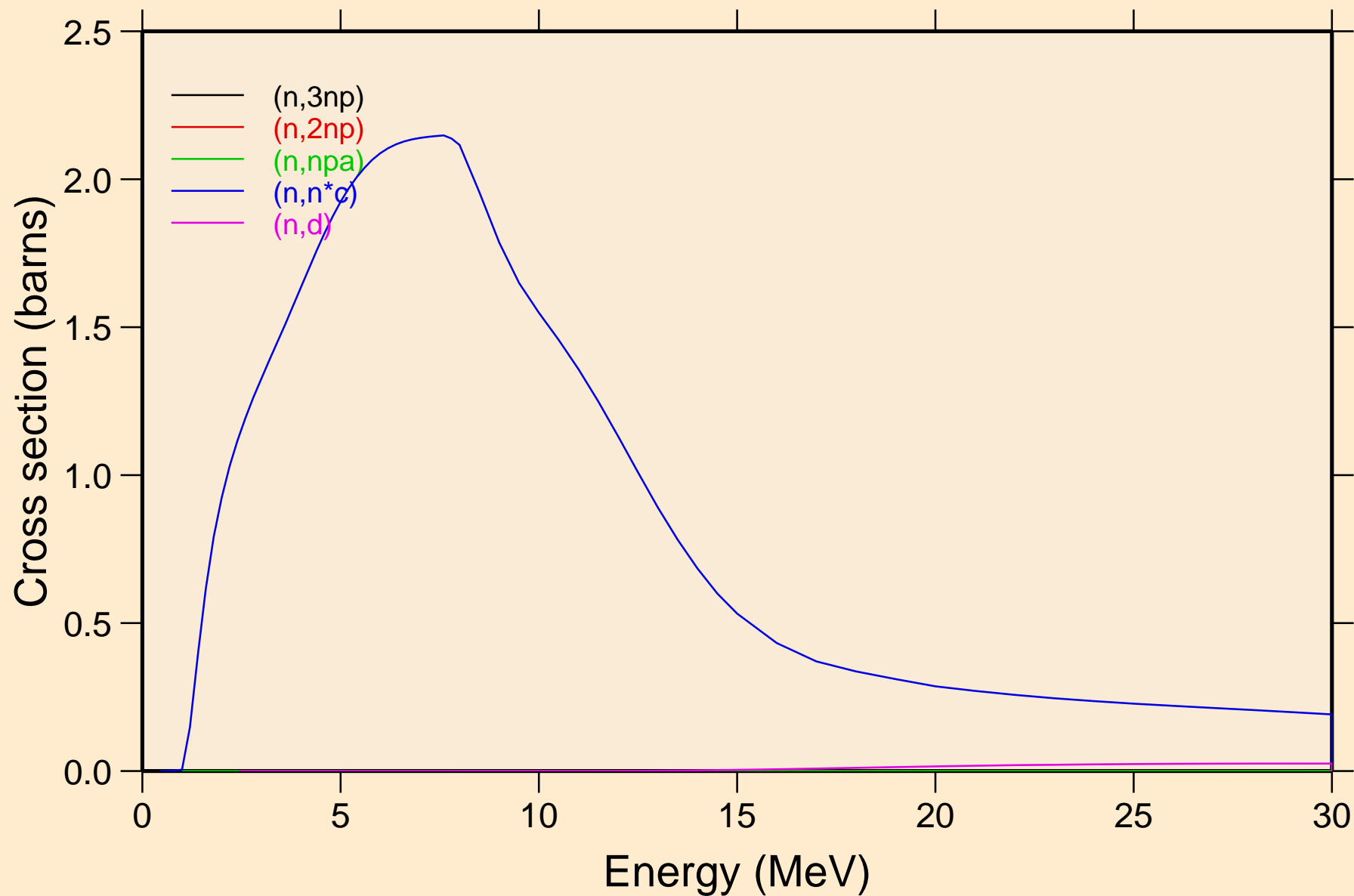

OS179 NEUTRON ACER TENDL-2019 LIBRARY; T=293.16K  
Threshold reactions

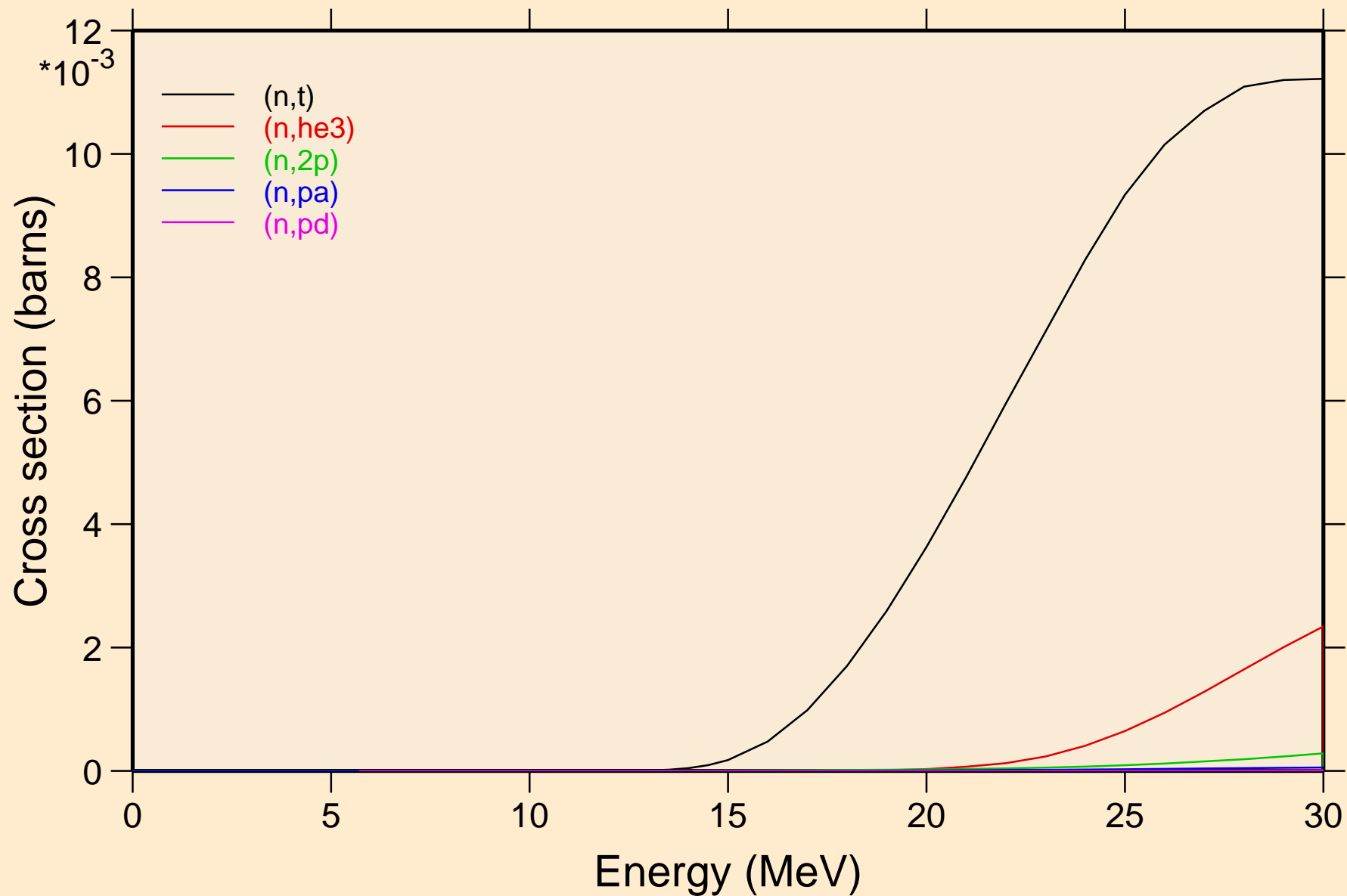

OS179 NEUTRON ACER TENDL-2019 LIBRARY; T=293.16K  
Threshold reactions

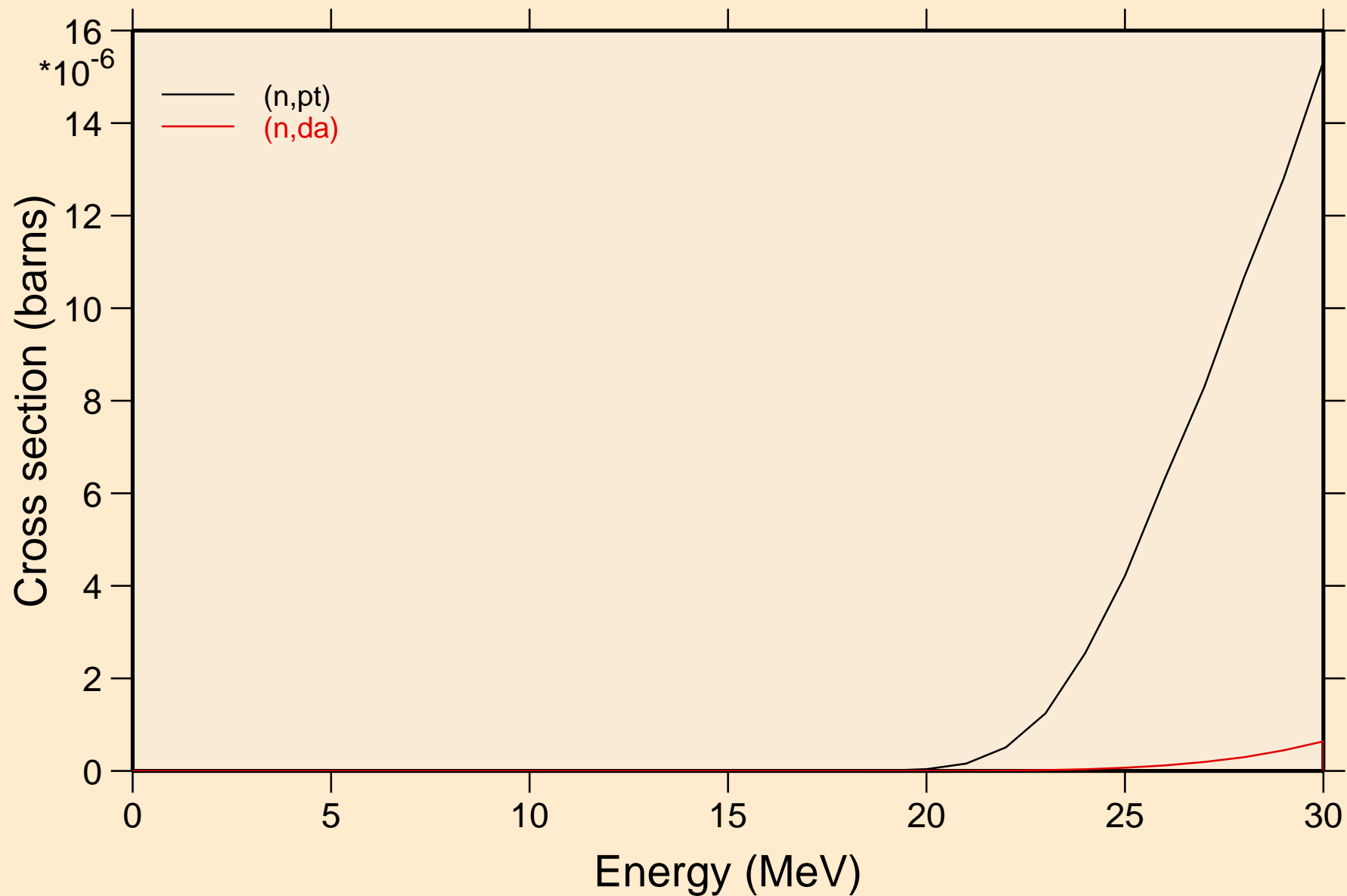

OS179 NEUTRON ACER TENDL-2019 LIBRARY; T=293.16K  
Threshold reactions

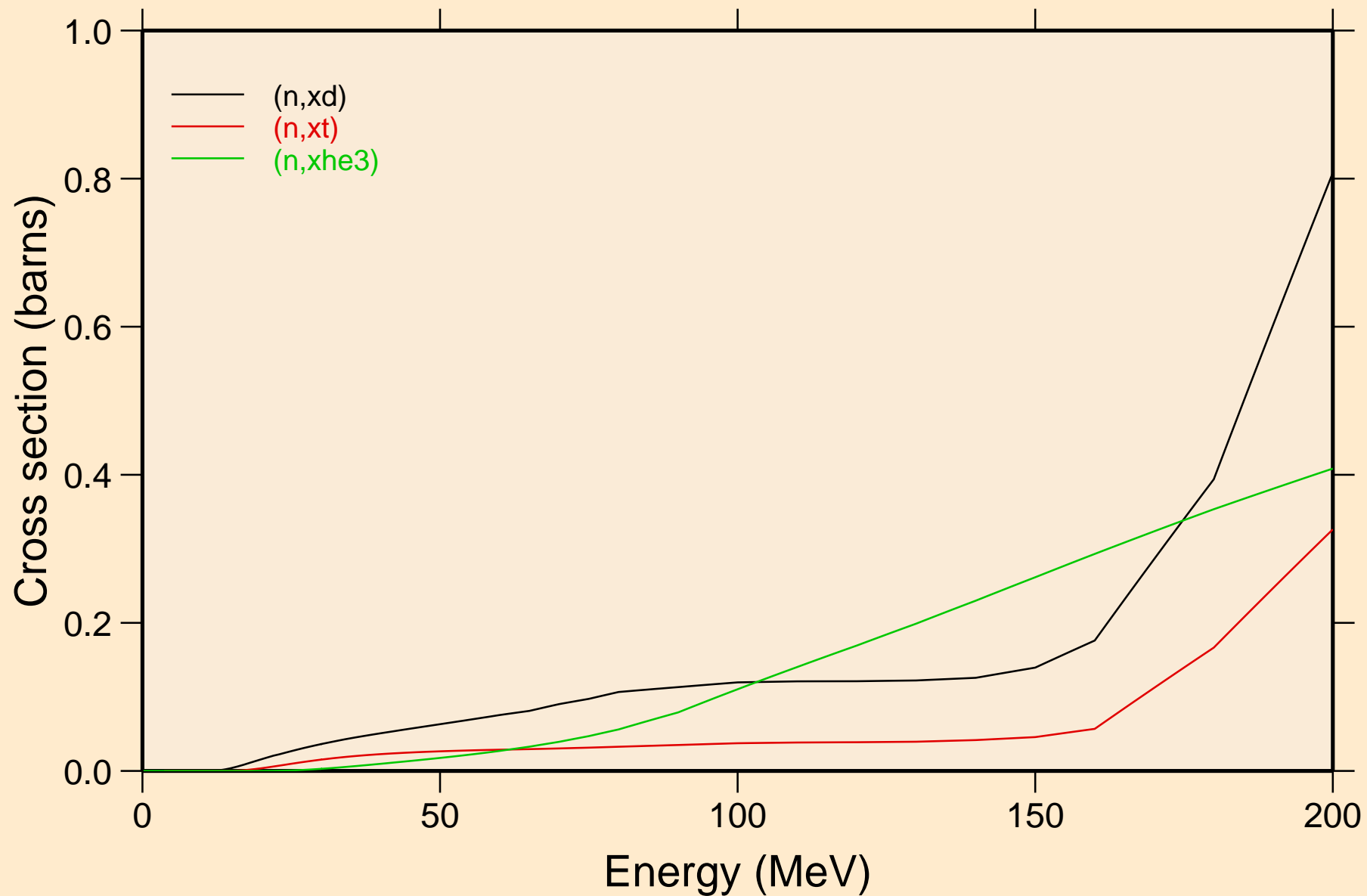

OS179 NEUTRON ACER TENDL-2019 LIBRARY; T=293.16K  
angular distribution for elastic

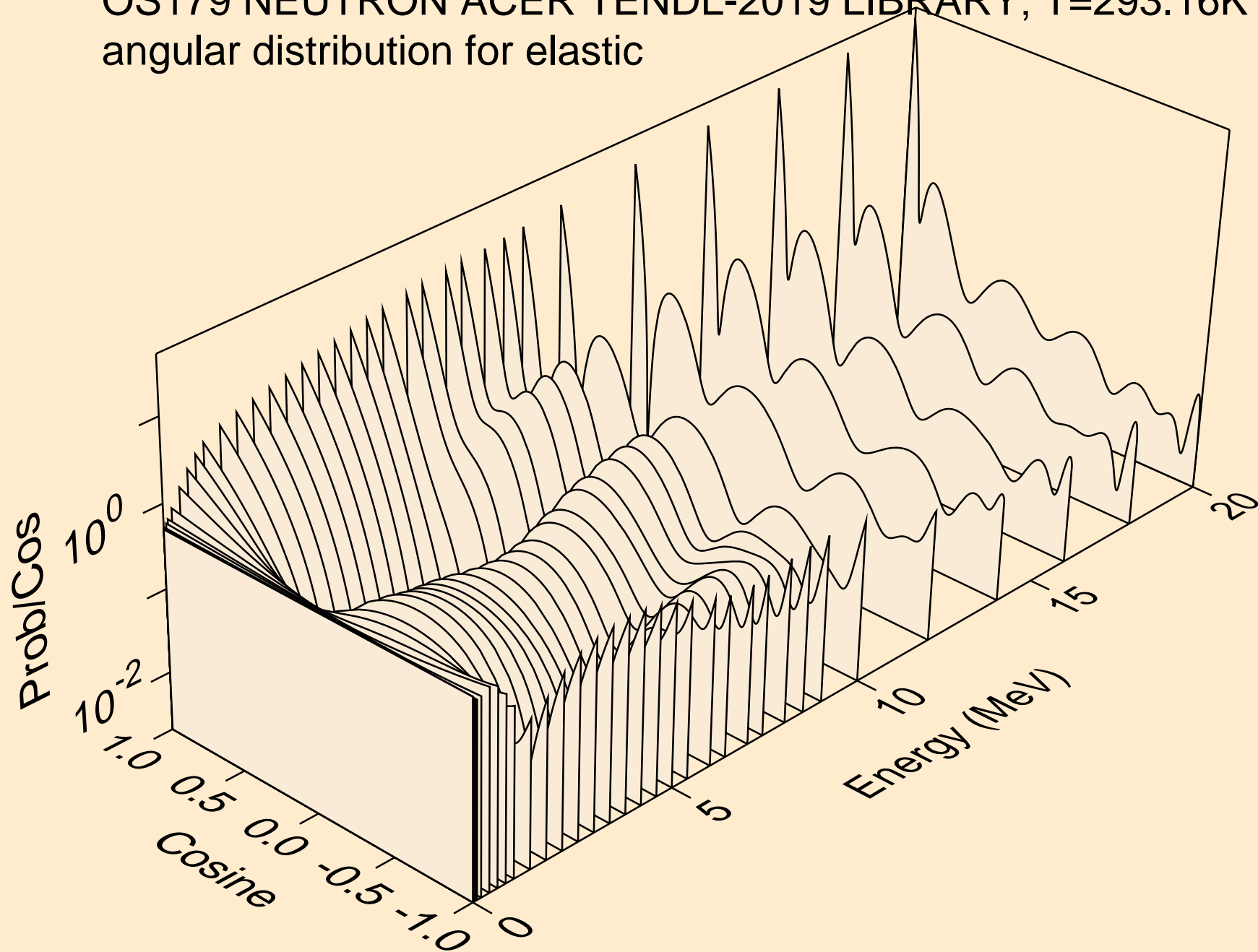

OS179 NEUTRON ACER TENDL-2019 LIBRARY; T=293.16K  
angular distribution for elastic

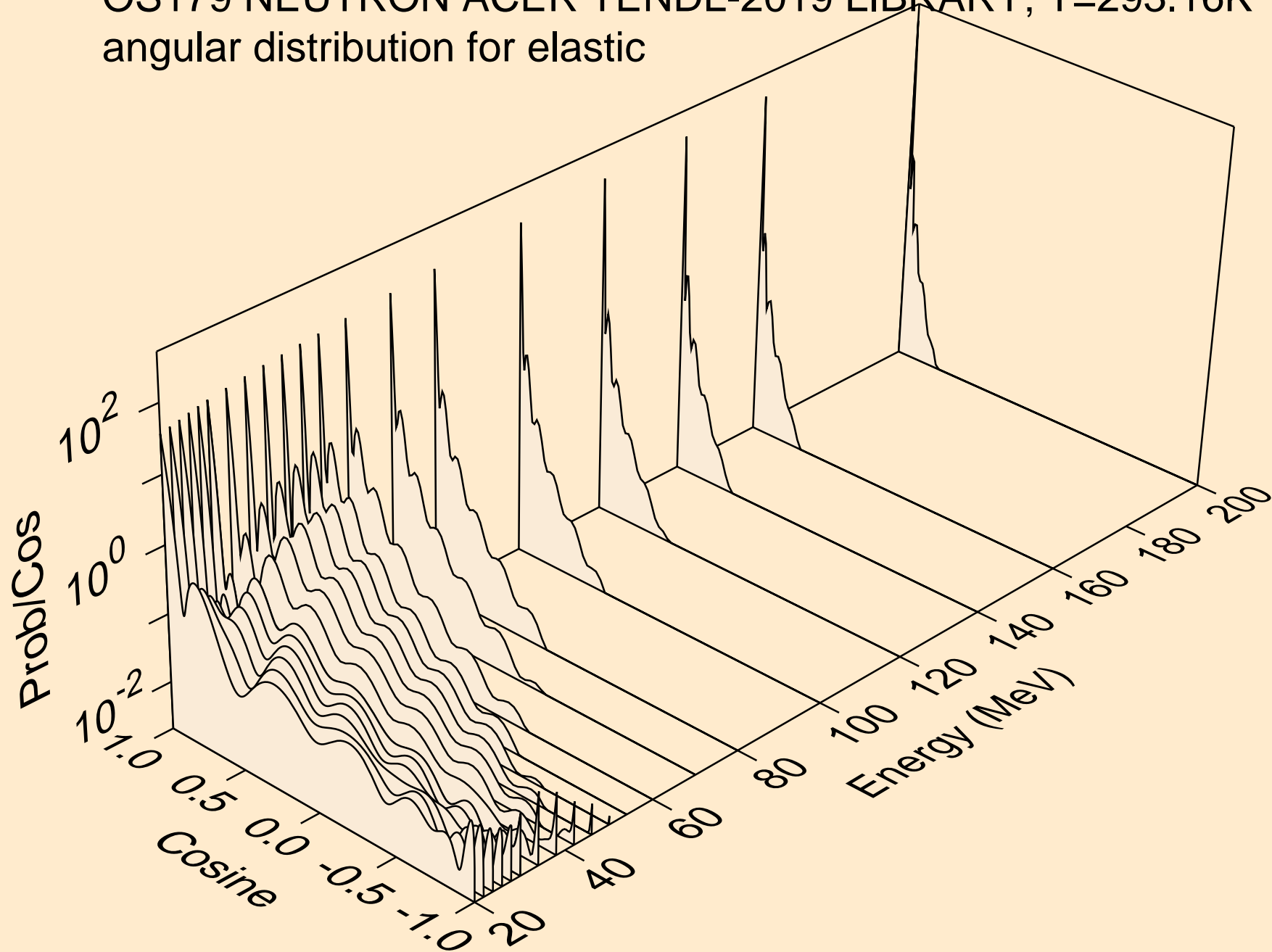

OS179 NEUTRON ACER TENDL-2019 LIBRARY; T=293.16K  
angular distribution for (n,n\*1)

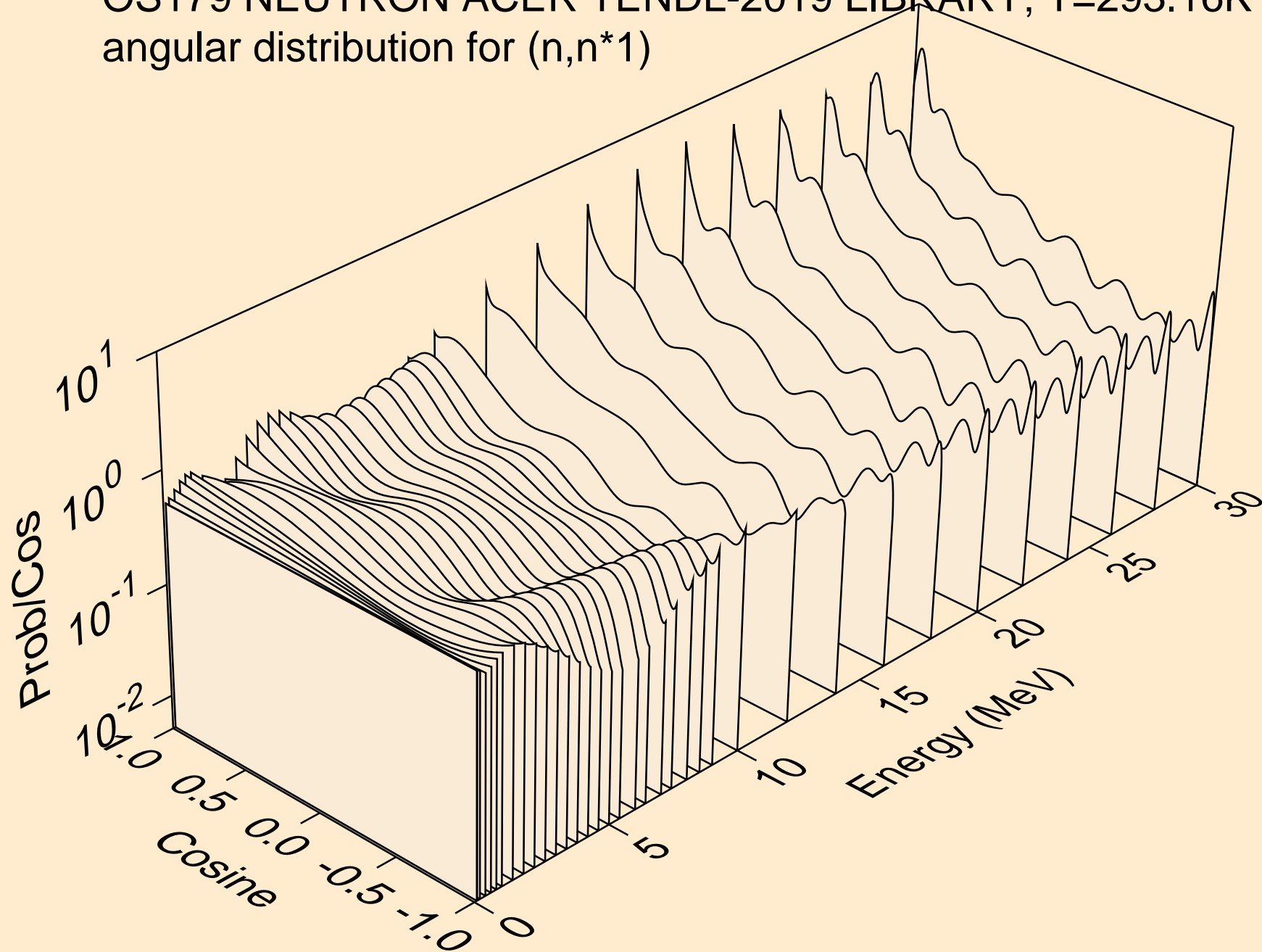

OS179 NEUTRON ACER TENDL-2019 LIBRARY; T=293.16K  
angular distribution for (n,n\*2)

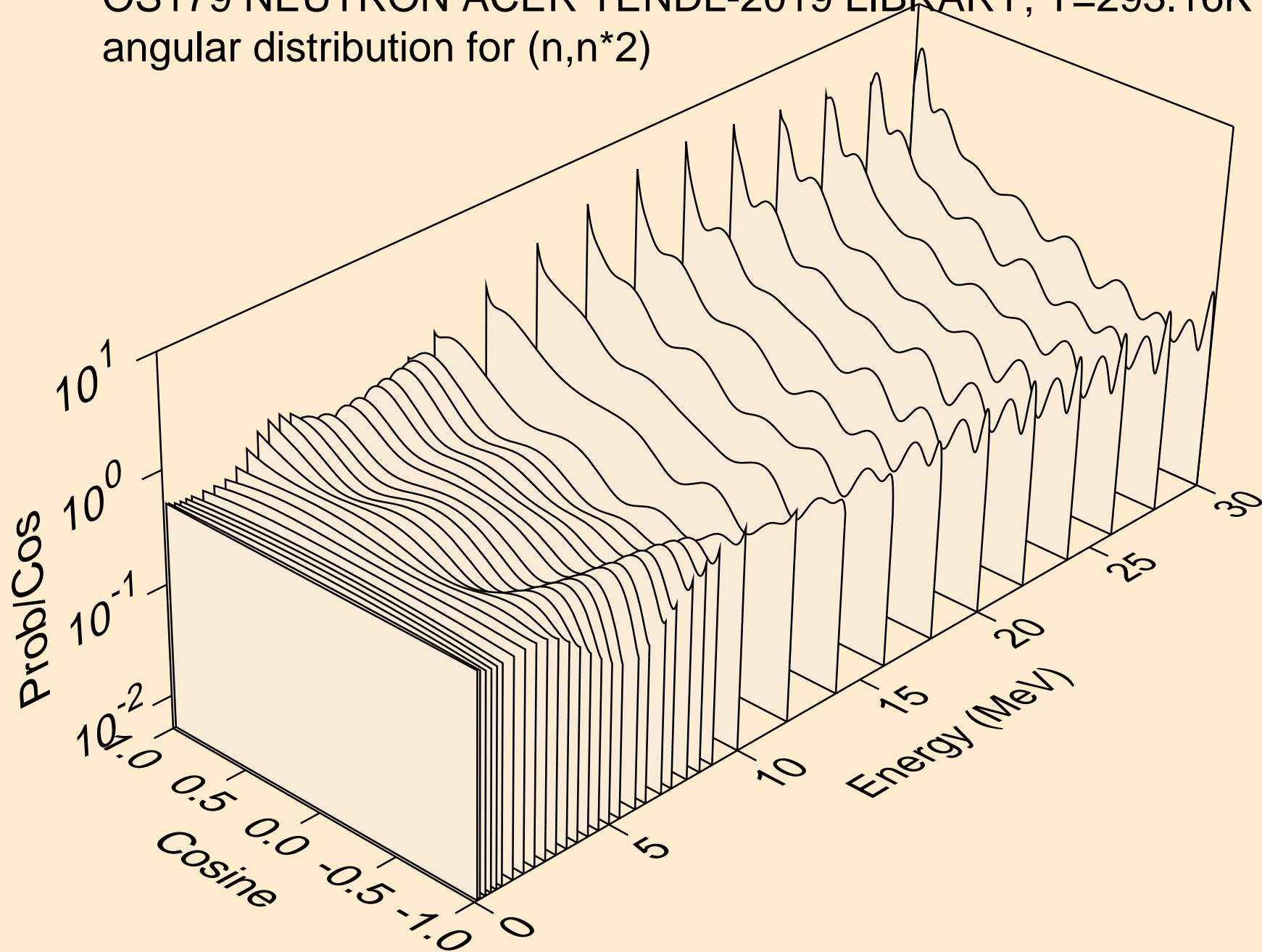



OS179 NEUTRON ACER TENDL-2019 LIBRARY; T=293.16K  
angular distribution for (n,n\*3)

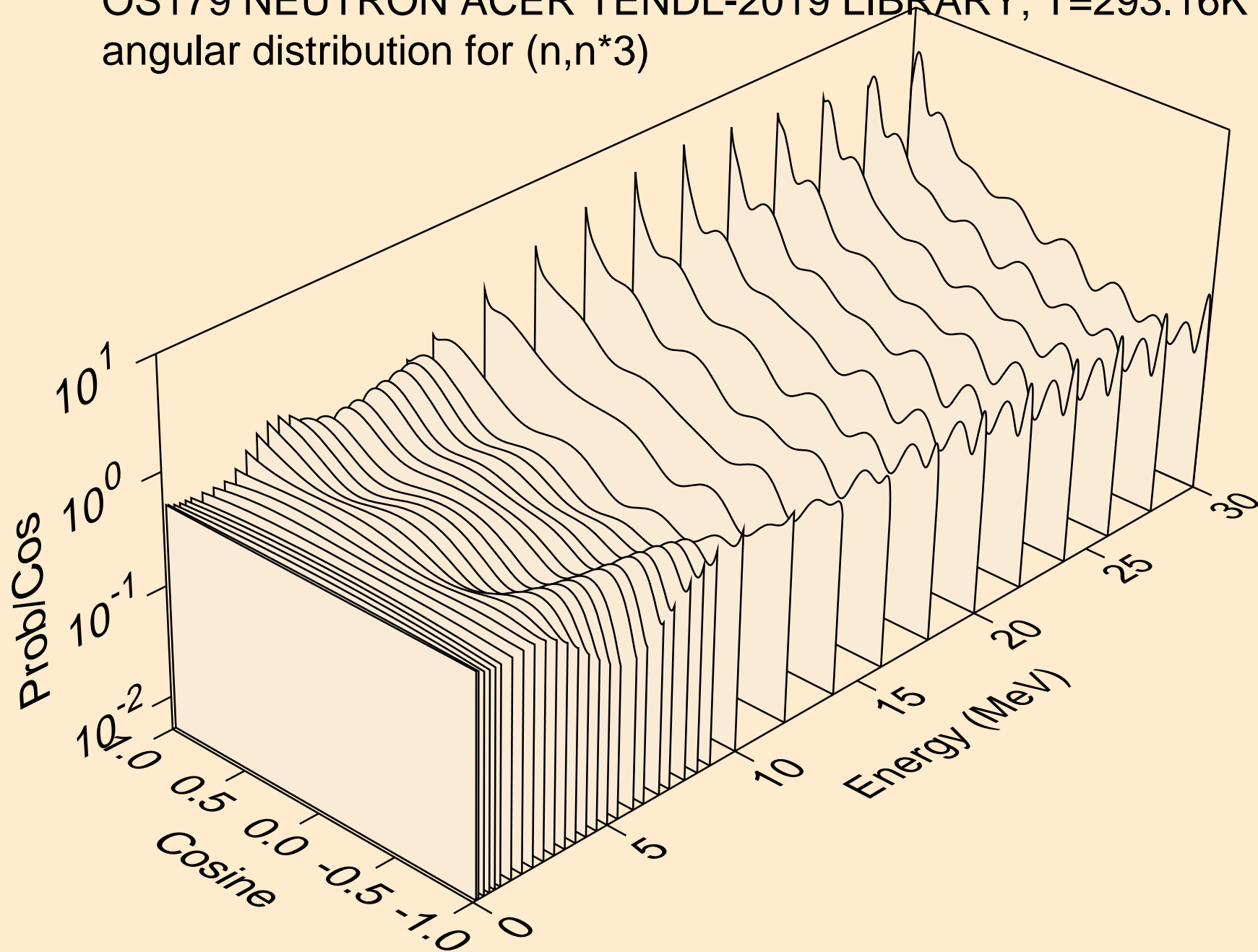

OS179 NEUTRON ACER TENDL-2019 LIBRARY; T=293.16K  
angular distribution for (n,n\*4)

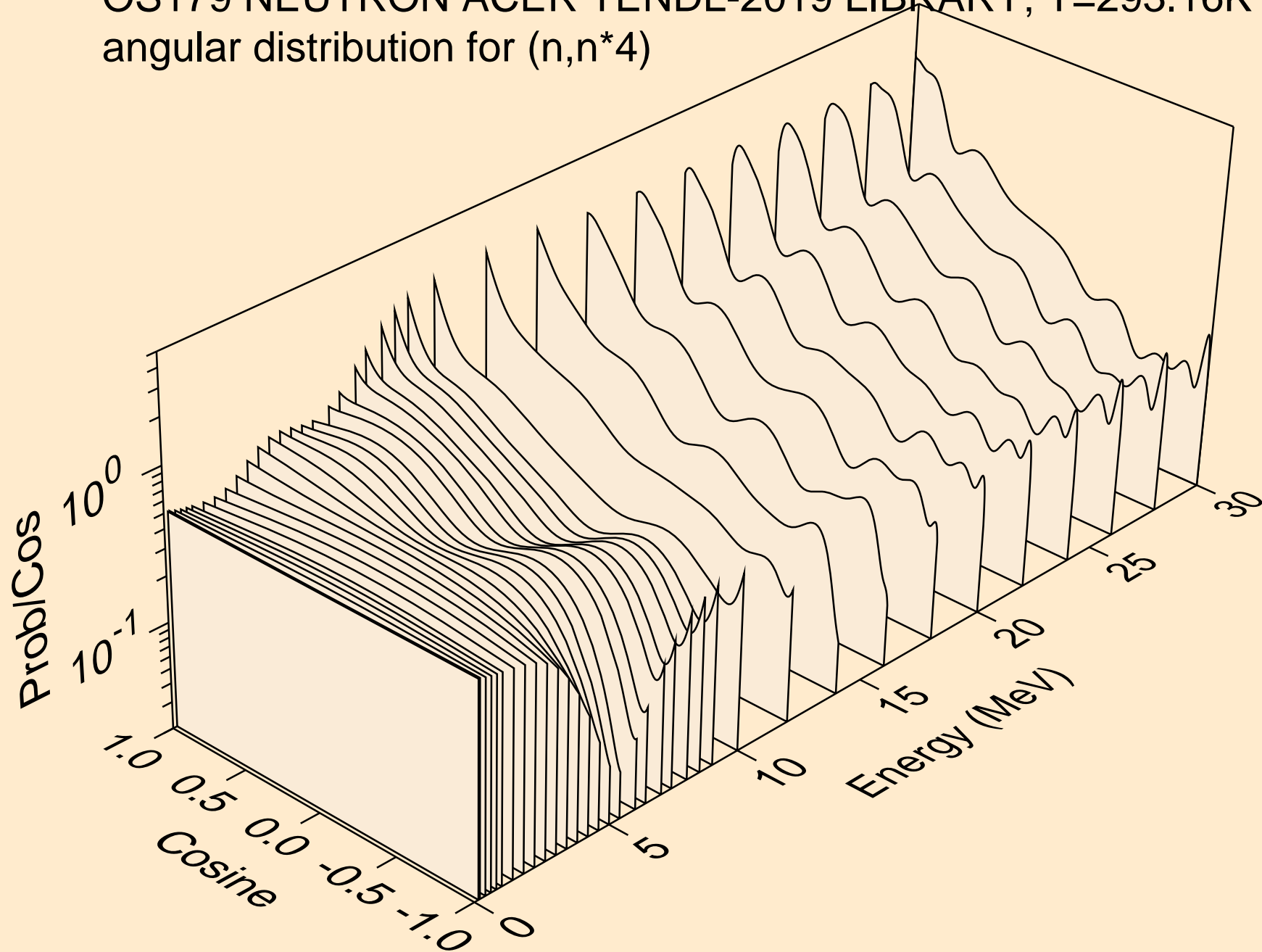

OS179 NEUTRON ACER TENDL-2019 LIBRARY; T=293.16K  
angular distribution for (n,n\*5)

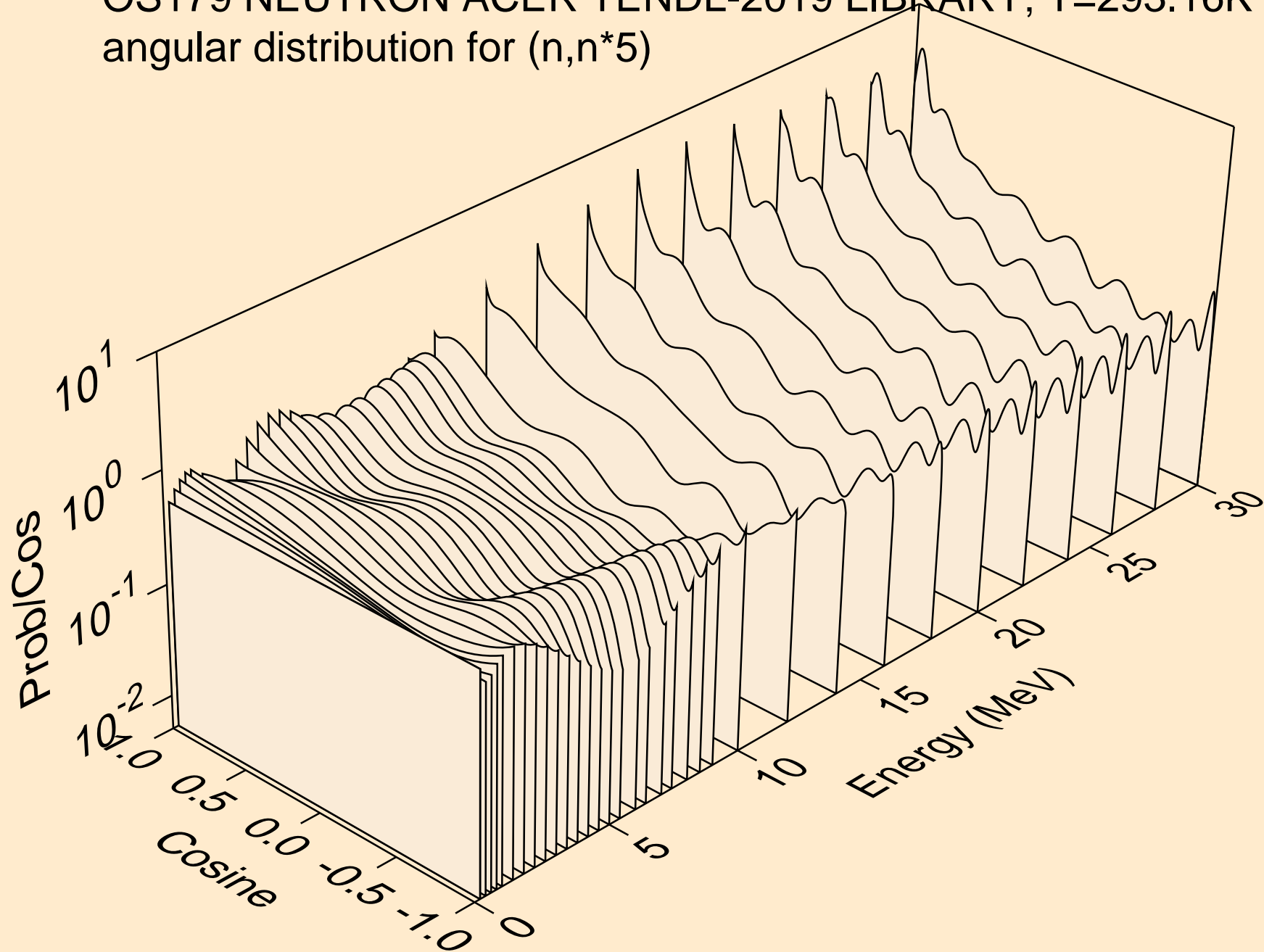

OS179 NEUTRON ACER TENDL-2019 LIBRARY; T=293.16K  
angular distribution for (n,n\*6)

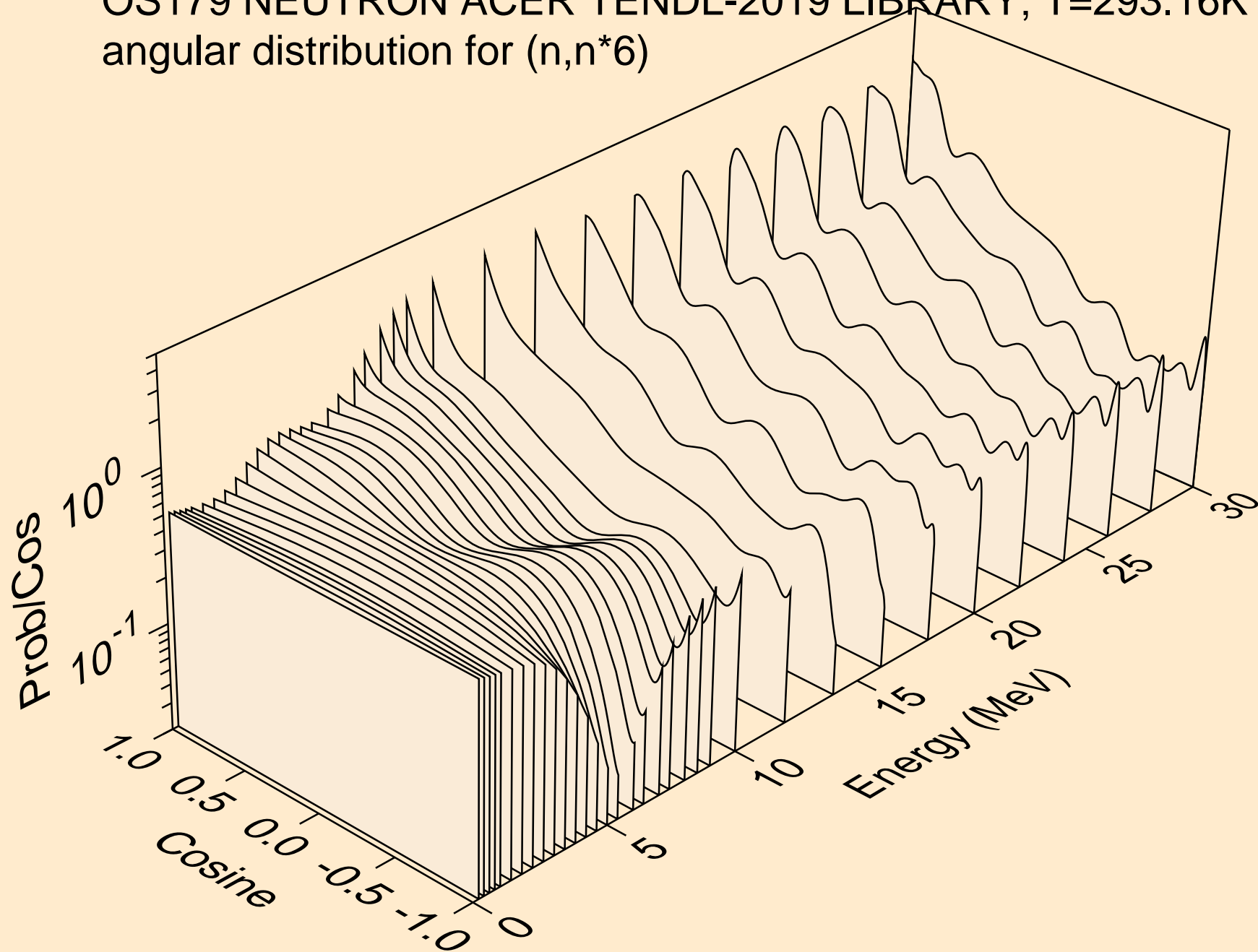

OS179 NEUTRON ACER TENDL-2019 LIBRARY; T=293.16K  
angular distribution for (n,n\*7)

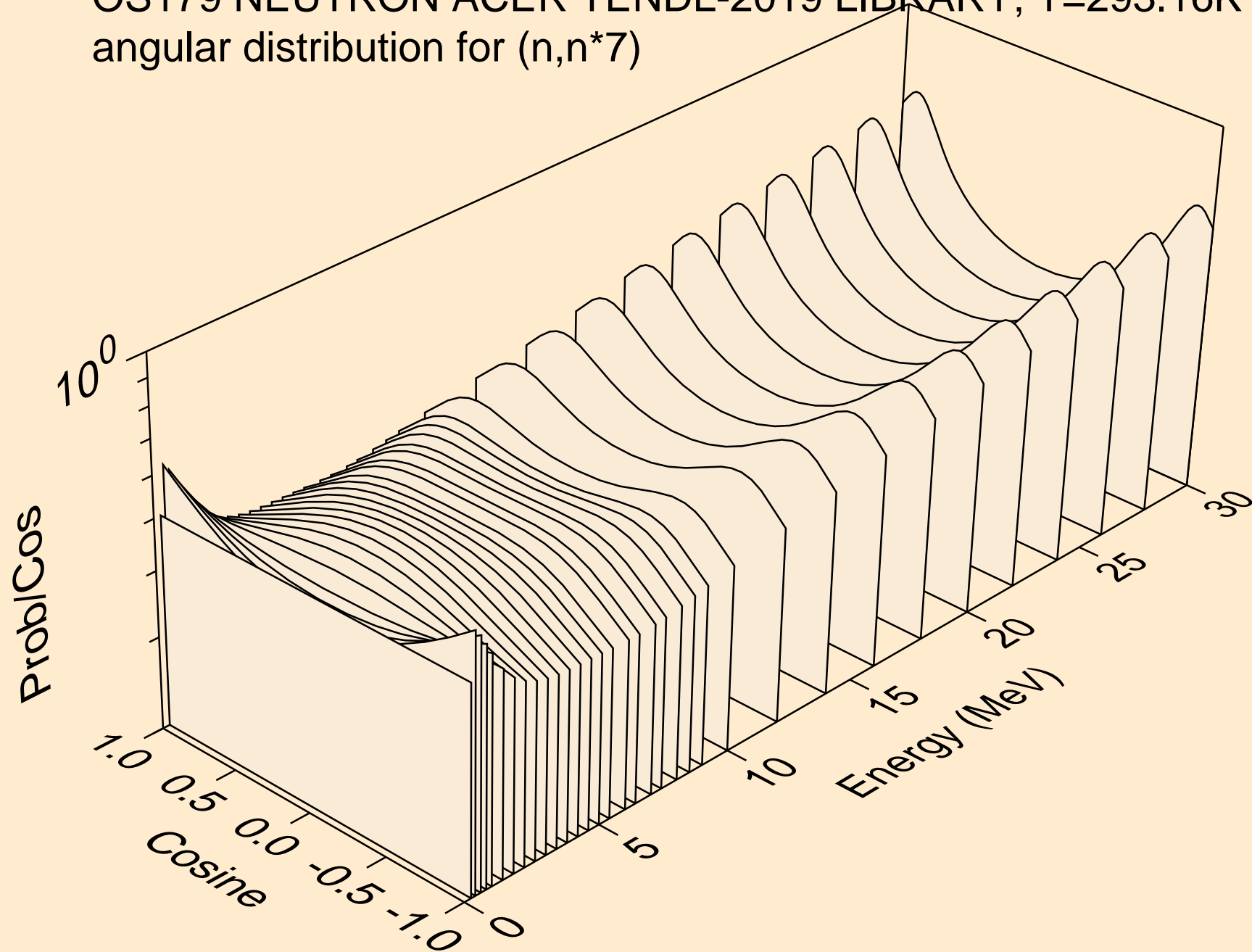

OS179 NEUTRON ACER TENDL-2019 LIBRARY; T=293.16K  
angular distribution for (n,n\*8)

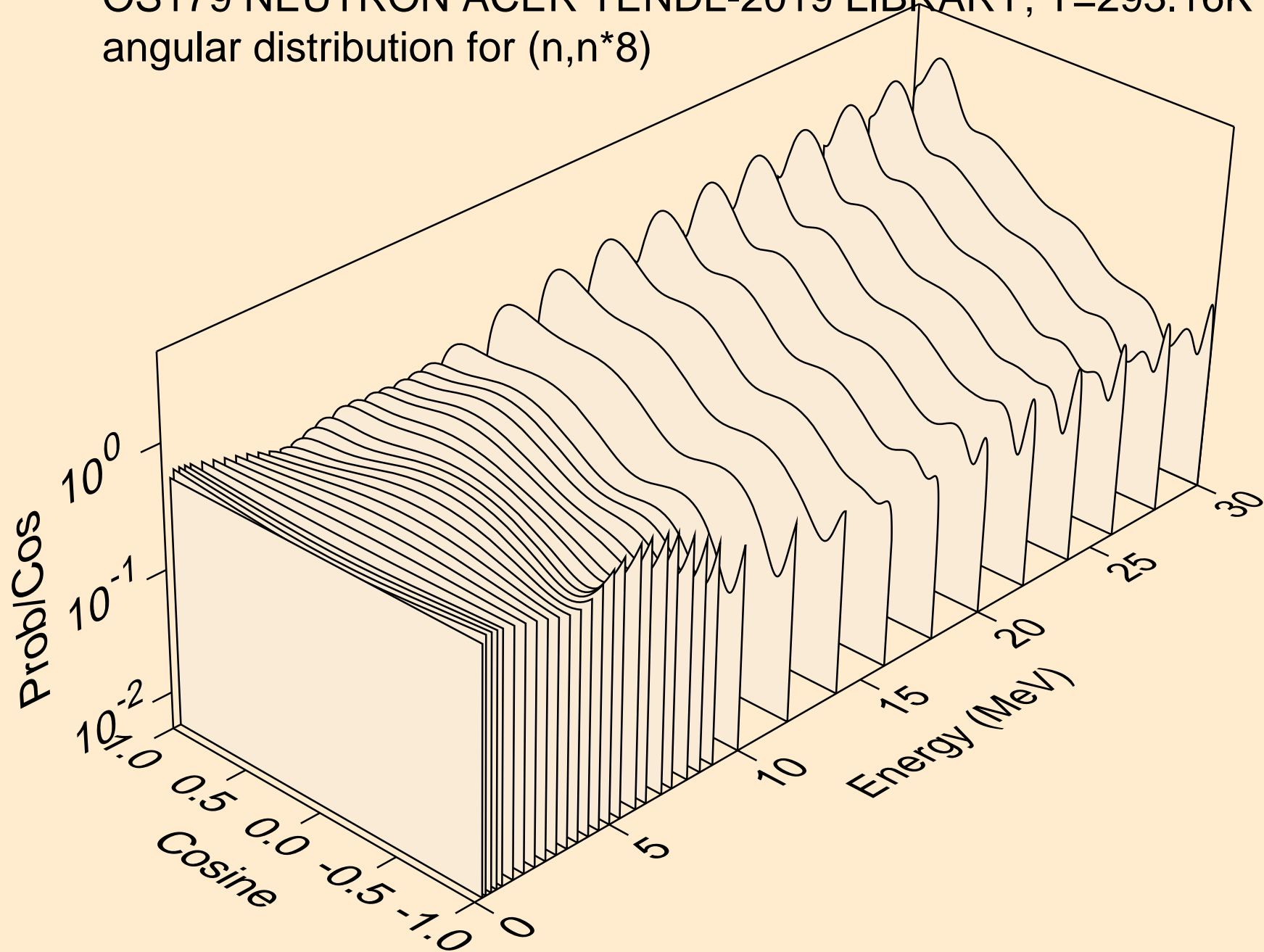

OS179 NEUTRON ACER TENDL-2019 LIBRARY; T=293.16K  
angular distribution for (n,n\*9)

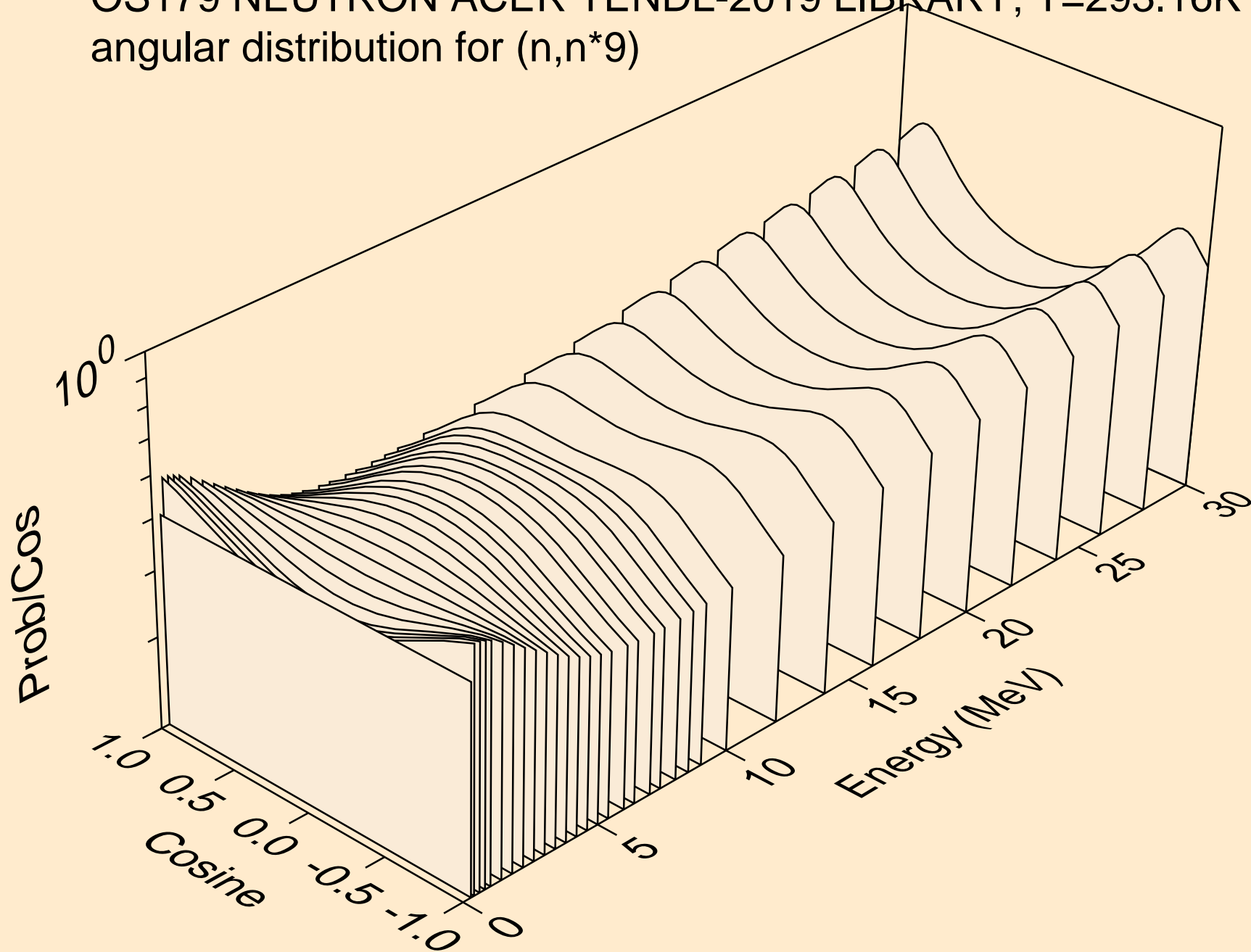

OS179 NEUTRON ACER TENDL-2019 LIBRARY; T=293.16K  
angular distribution for (n,n\*10)

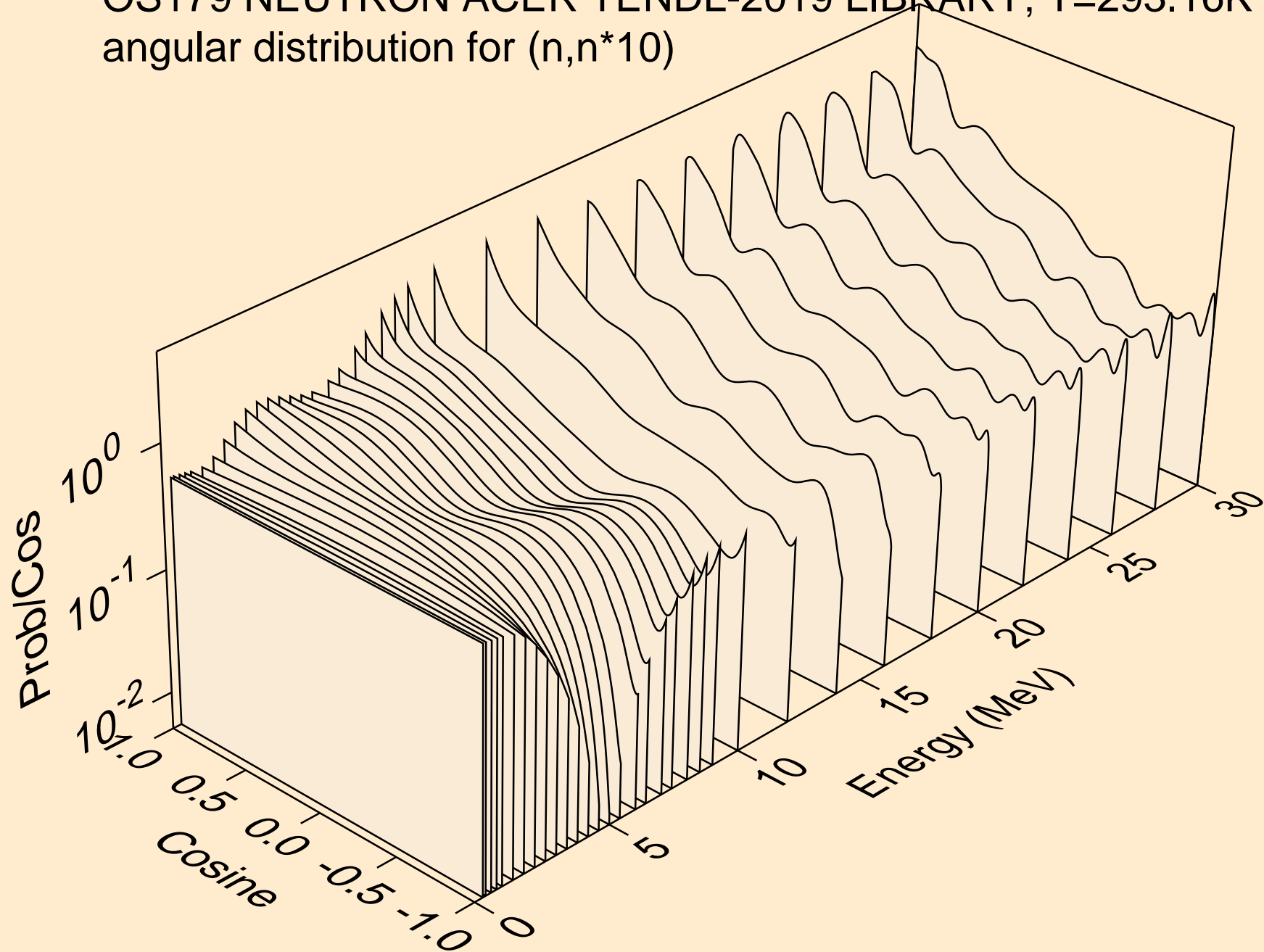



OS179 NEUTRON ACER TENDL-2019 LIBRARY; T=293.16K  
angular distribution for (n,n\*11)

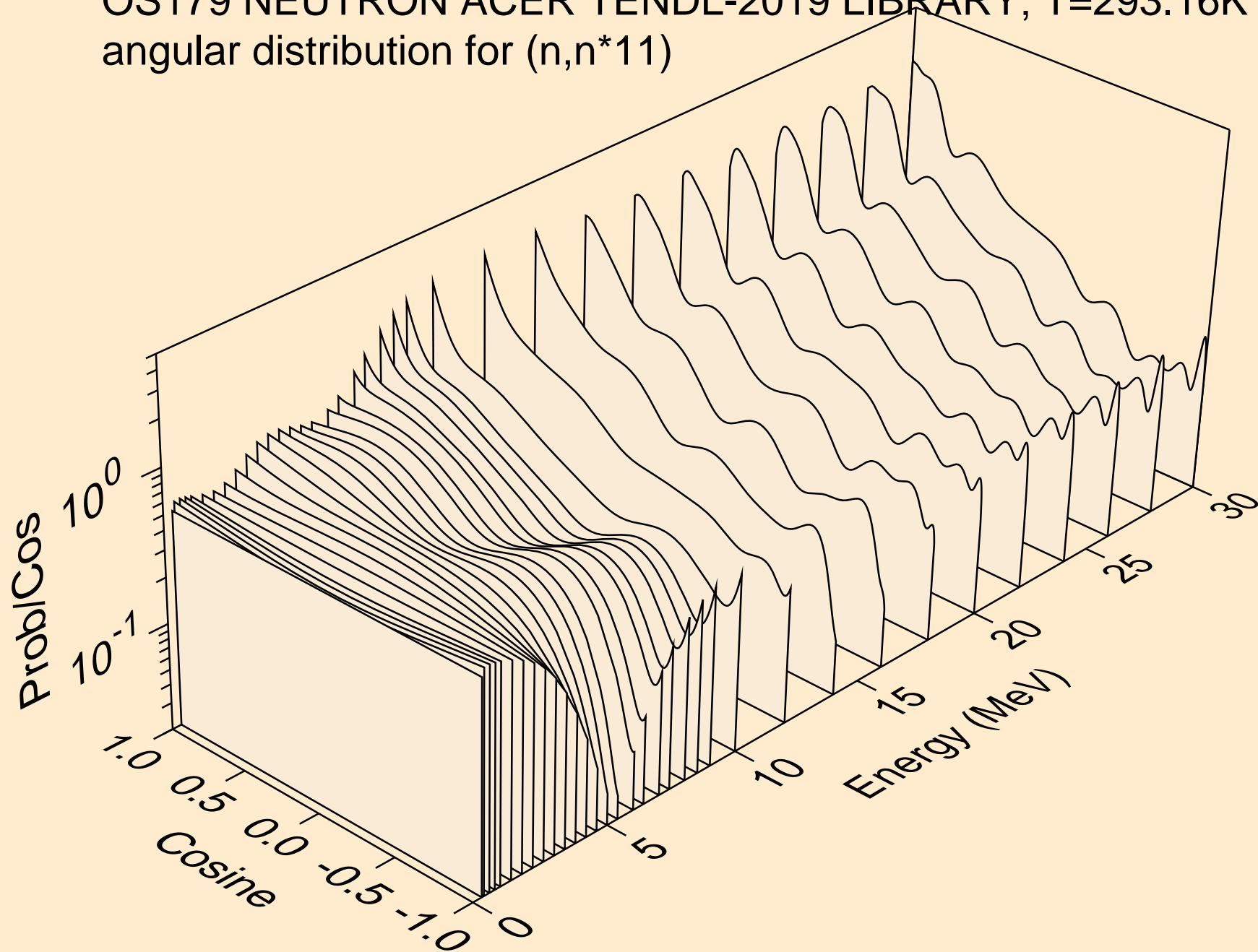

OS179 NEUTRON ACER TENDL-2019 LIBRARY; T=293.16K  
angular distribution for (n,n\*12)

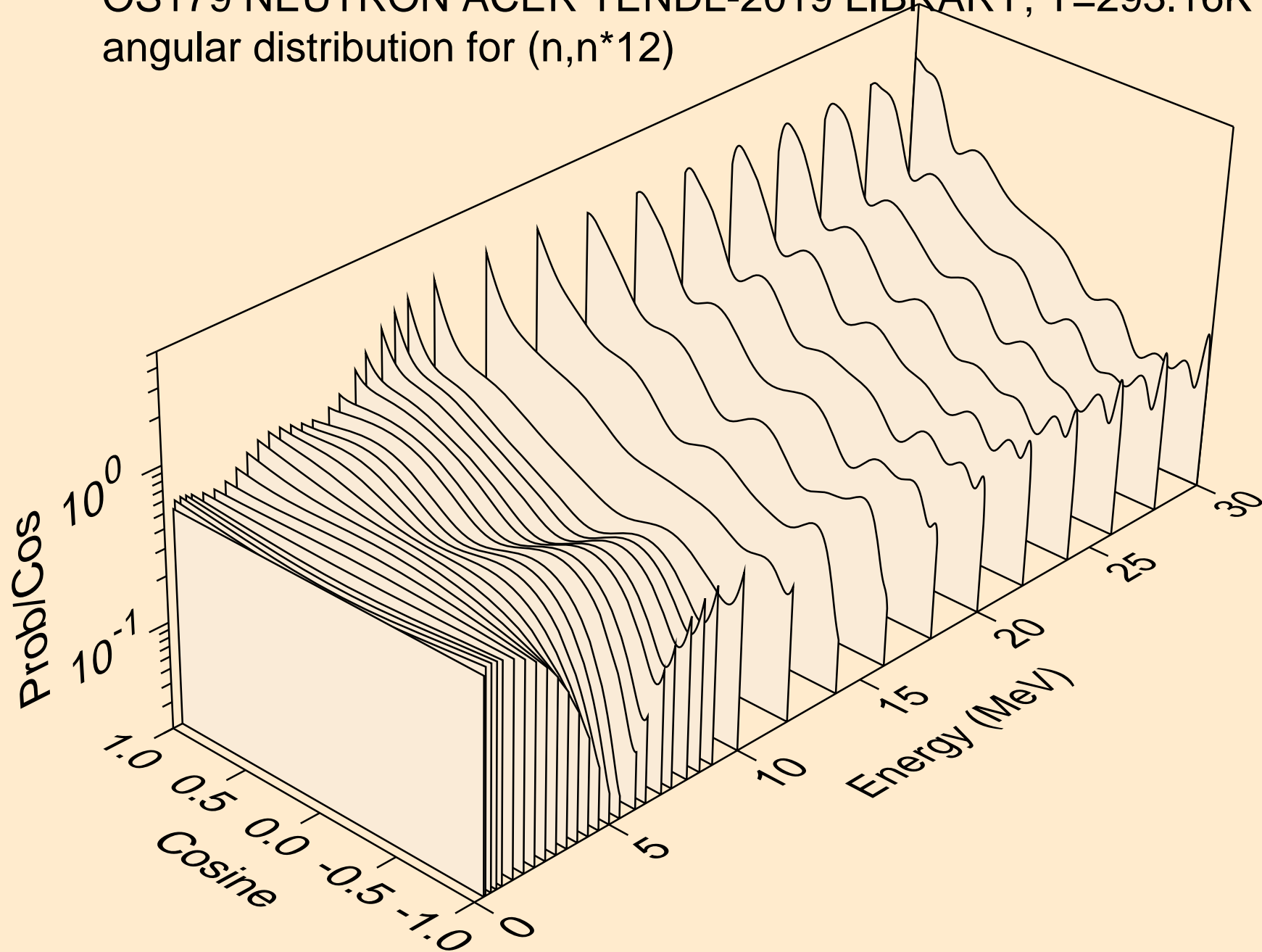

OS179 NEUTRON ACER TENDL-2019 LIBRARY; T=293.16K  
angular distribution for (n,n\*13)

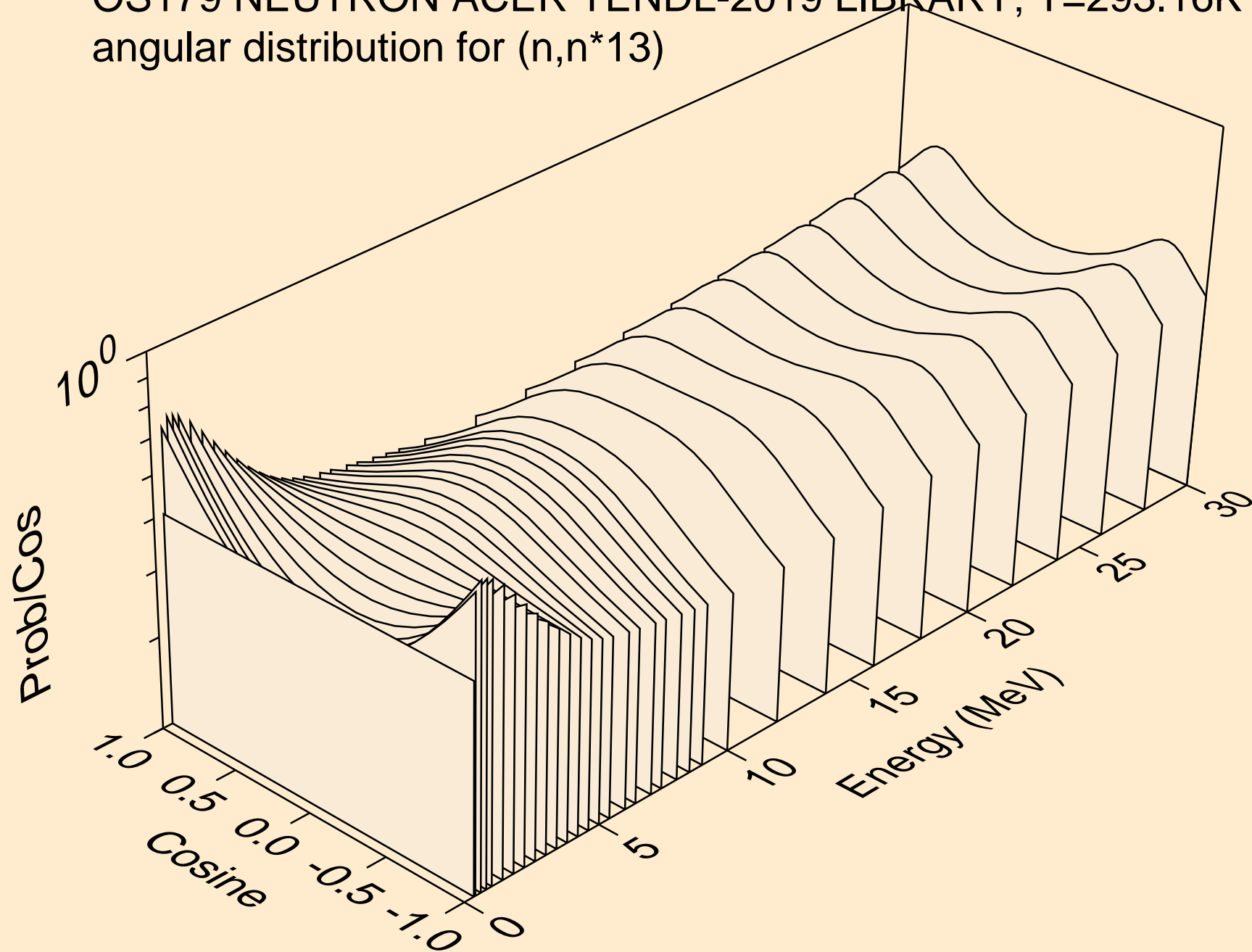

OS179 NEUTRON ACER TENDL-2019 LIBRARY; T=293.16K  
angular distribution for (n,n\*14)

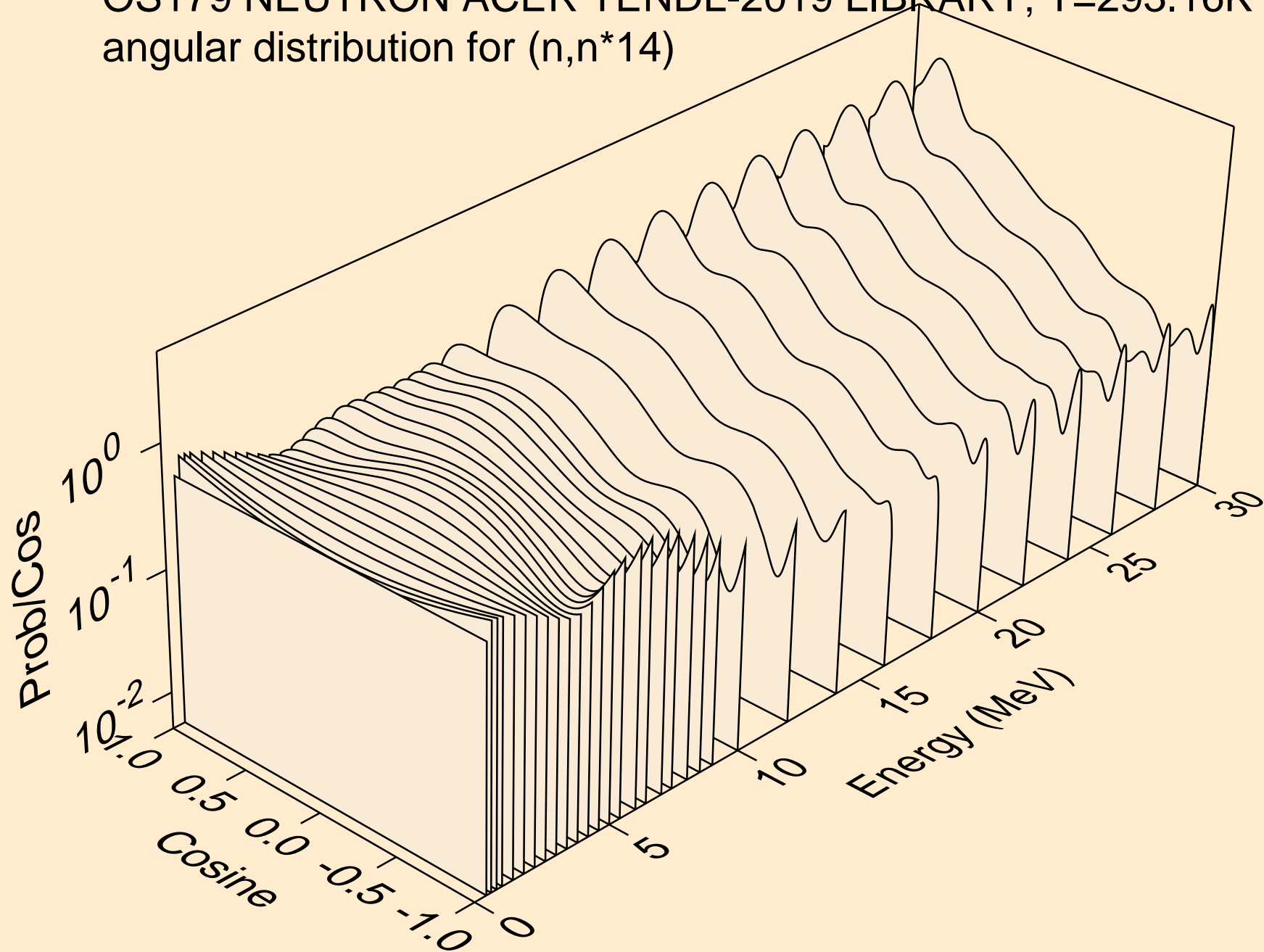

OS179 NEUTRON ACER TENDL-2019 LIBRARY; T=293.16K  
angular distribution for (n,n\*15)

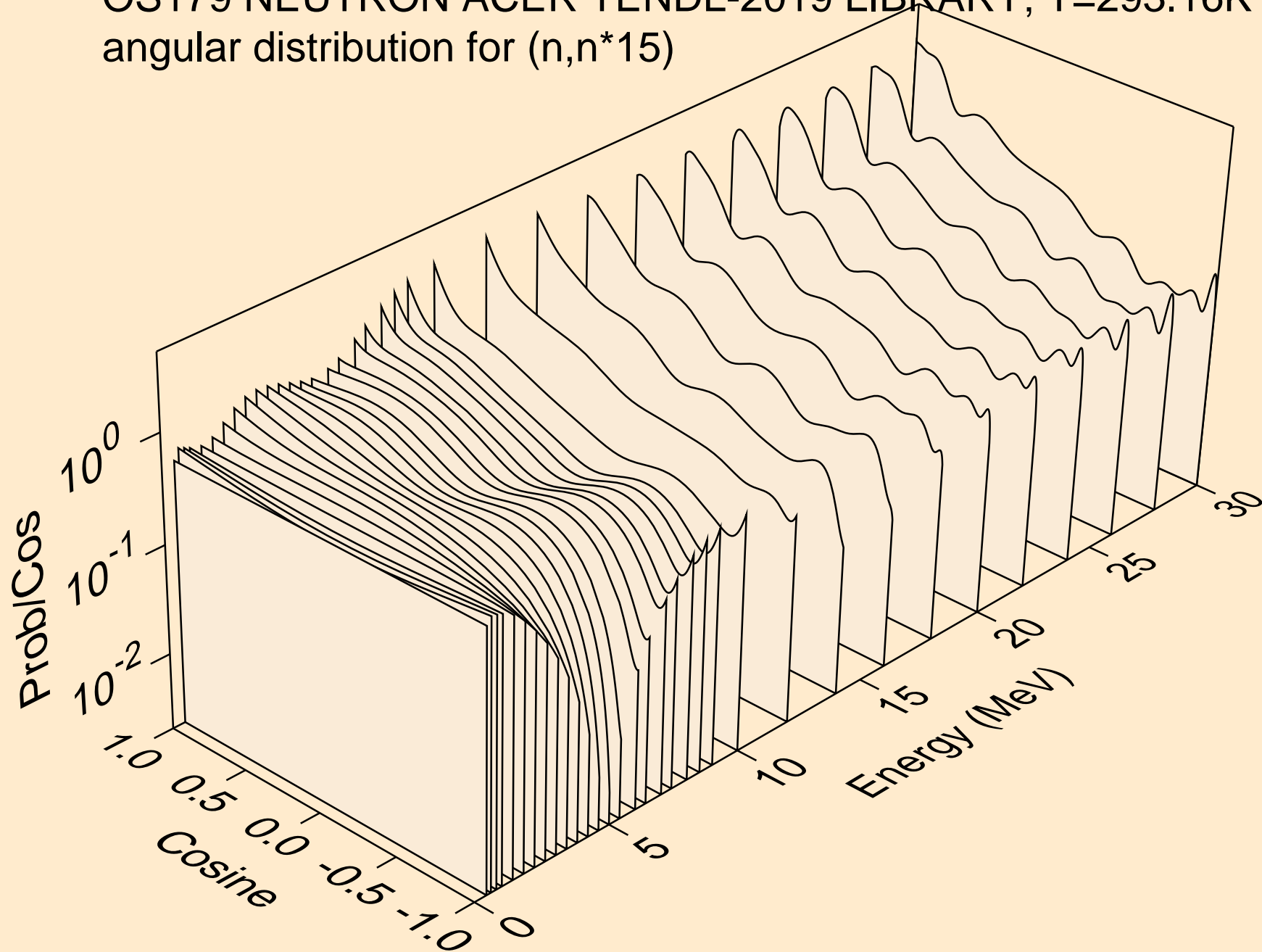

OS179 NEUTRON ACER TENDL-2019 LIBRARY; T=293.16K  
Neutron emission for (n,x)

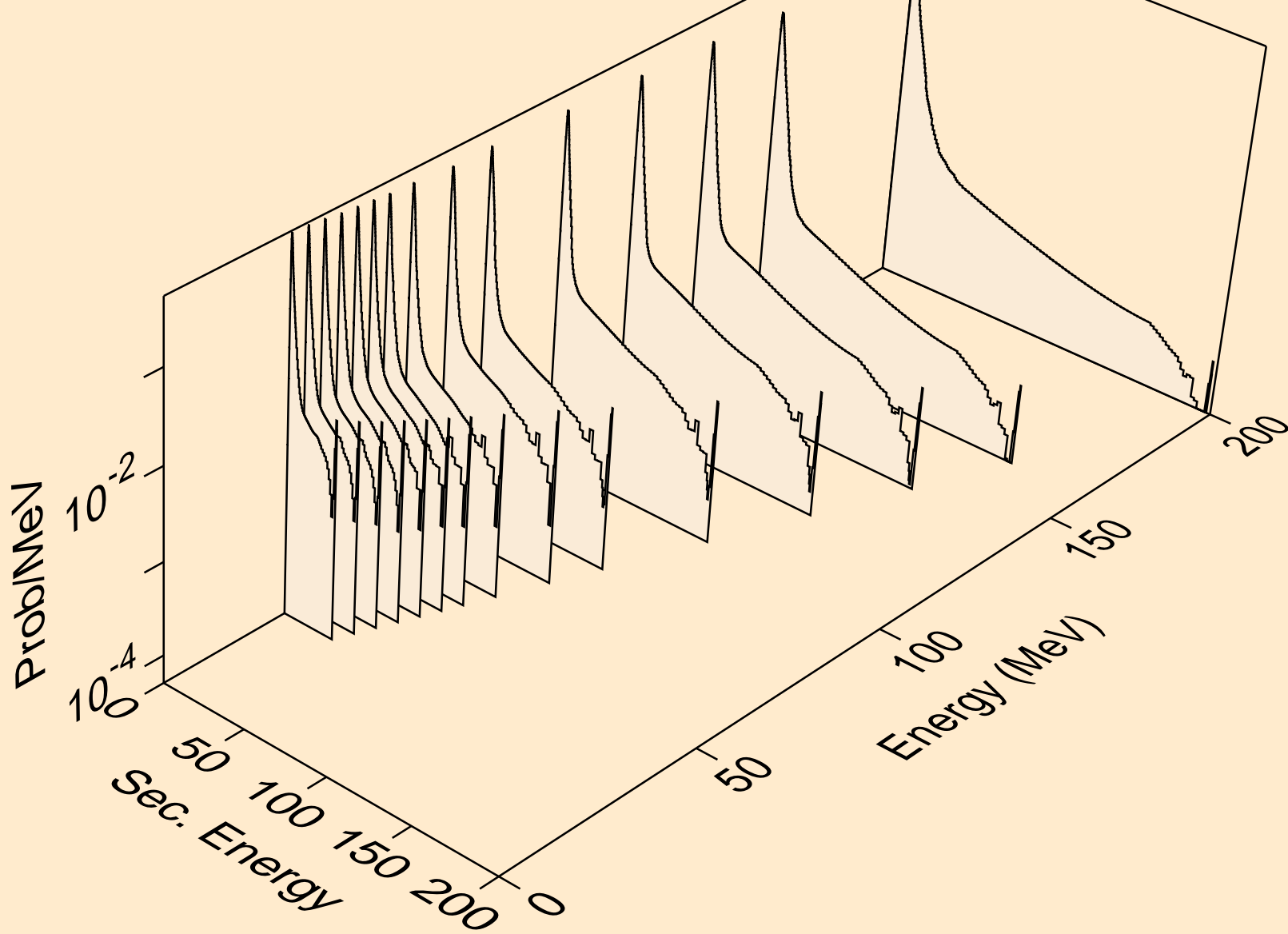

OS179 NEUTRON ACER TENDL-2019 LIBRARY; T=293.16K  
Neutron emission for (n,2nd)

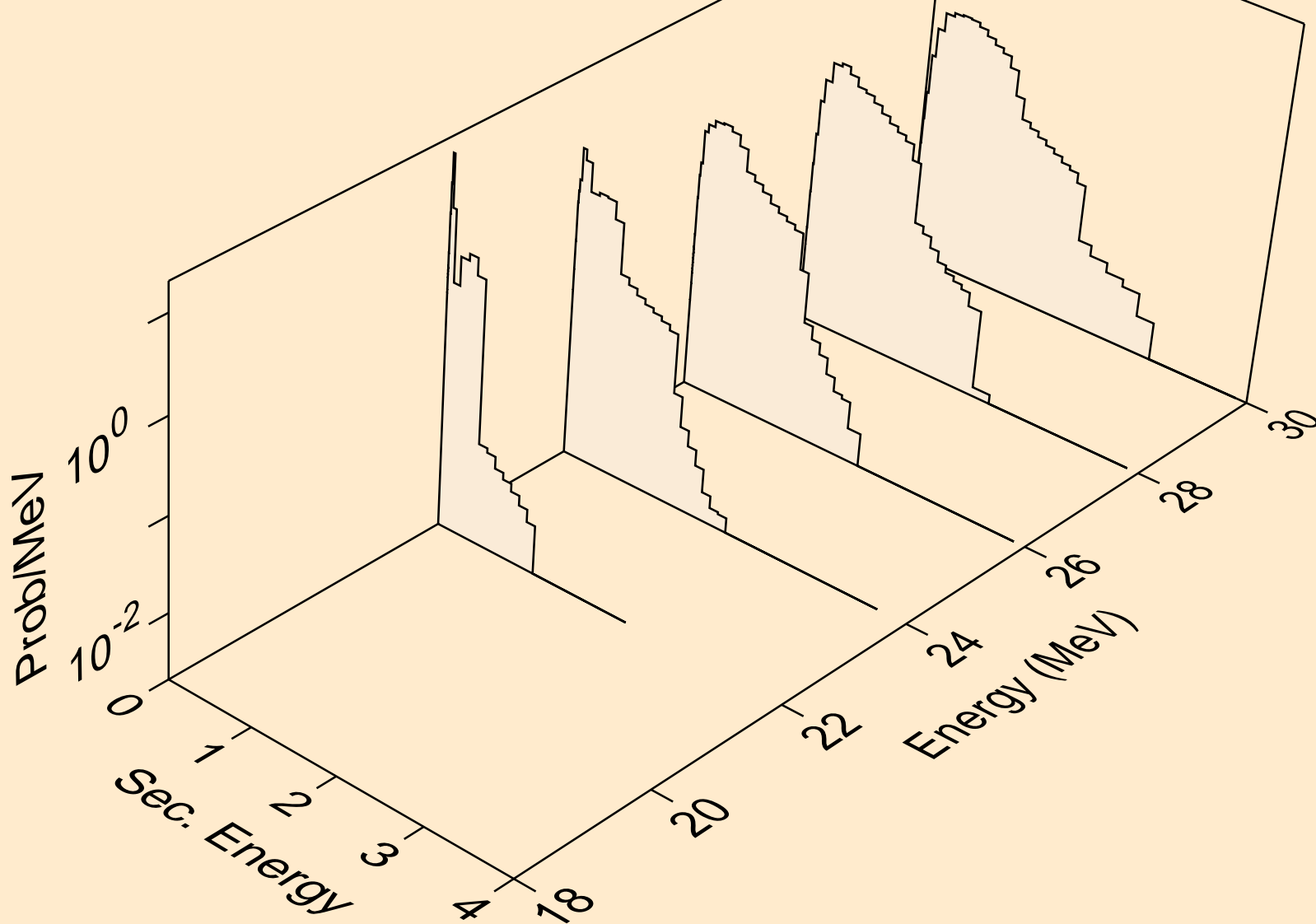

OS179 NEUTRON ACER TENDL-2019 LIBRARY; T=293.16K  
Neutron emission for (n,2n)

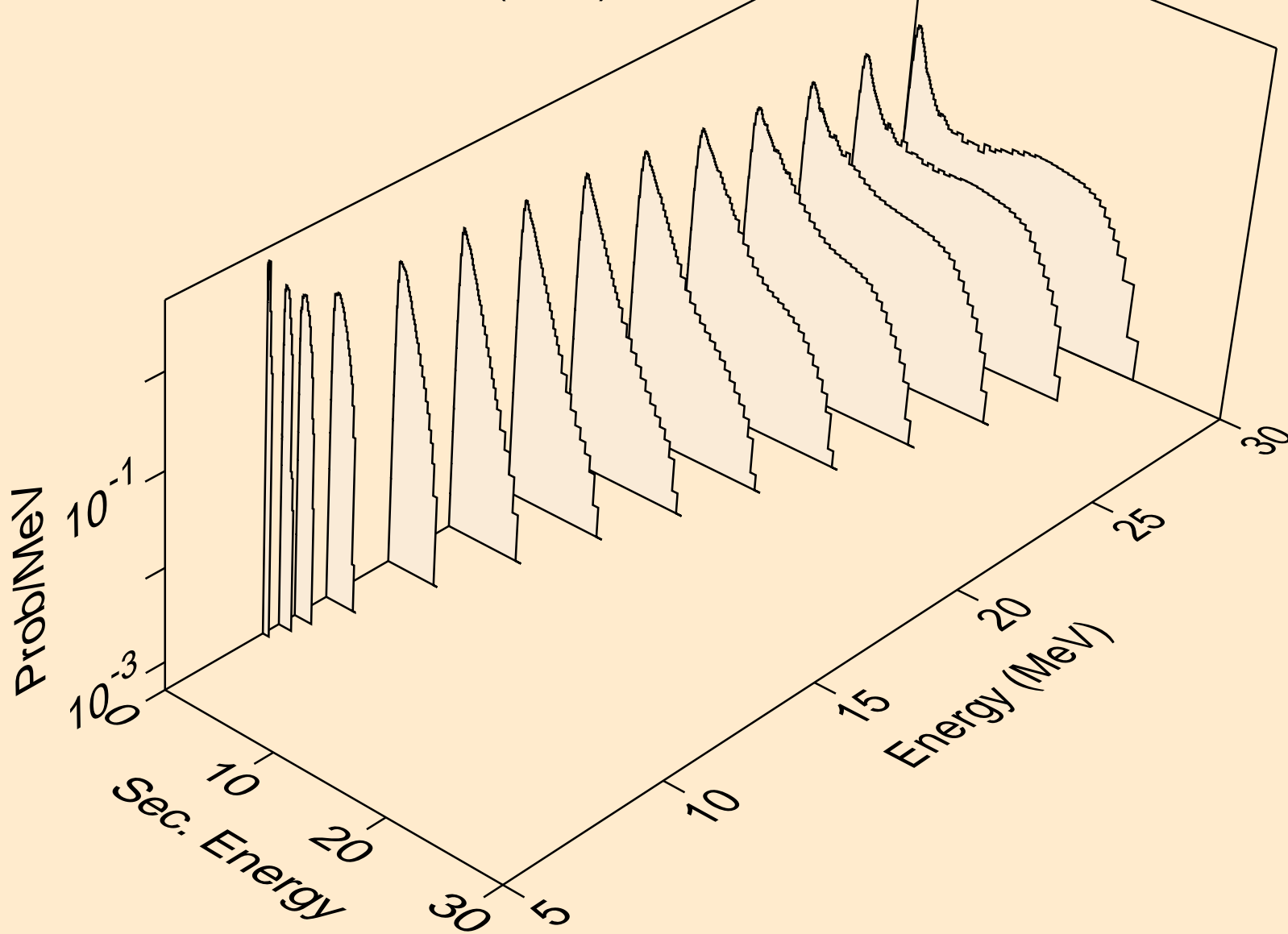



OS179 NEUTRON ACER TENDL-2019 LIBRARY; T=293.16K  
Neutron emission for (n,3n)

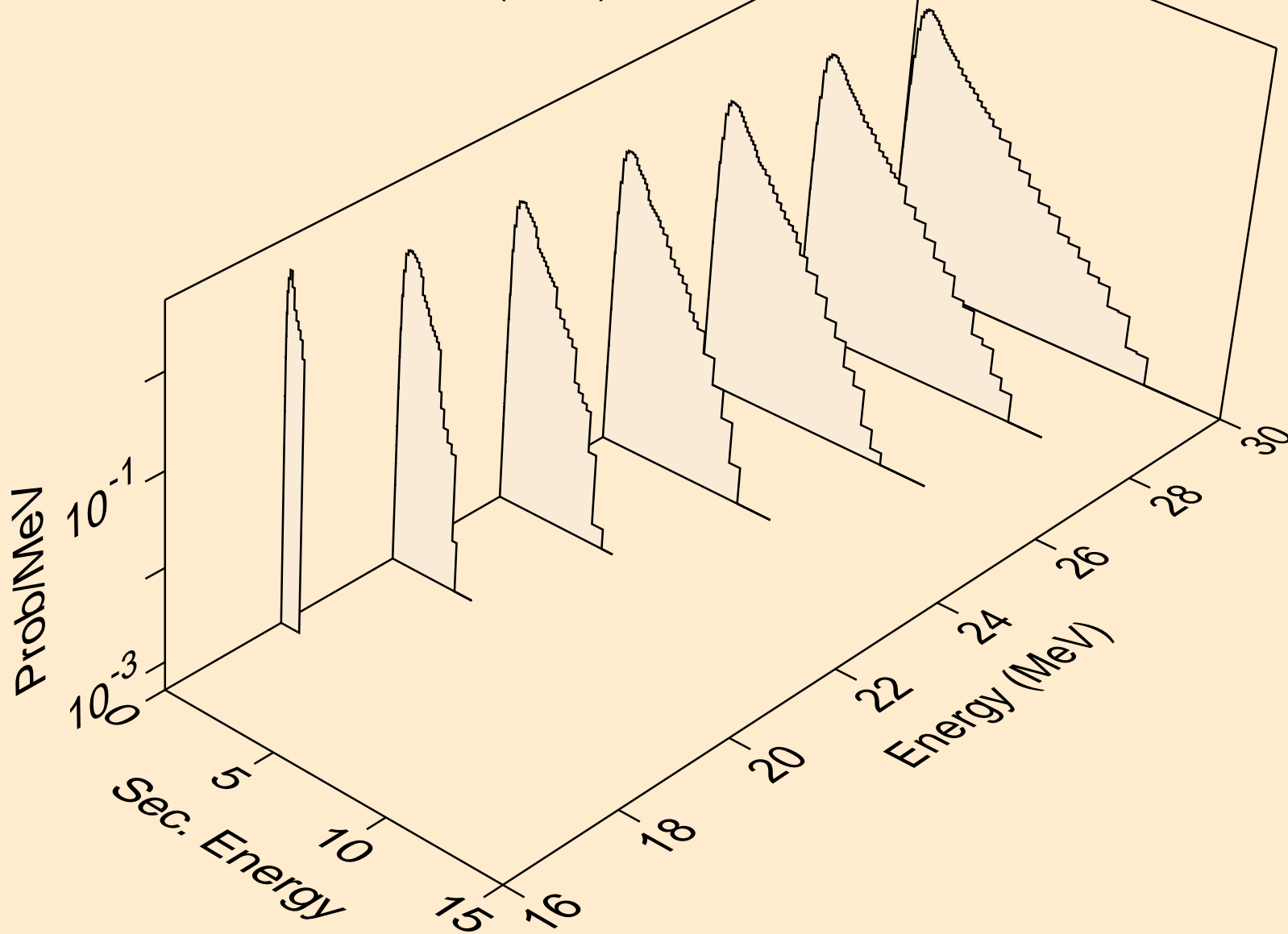

OS179 NEUTRON ACER TENDL-2019 LIBRARY; T=293.16K  
Neutron emission for (n,n\*)a

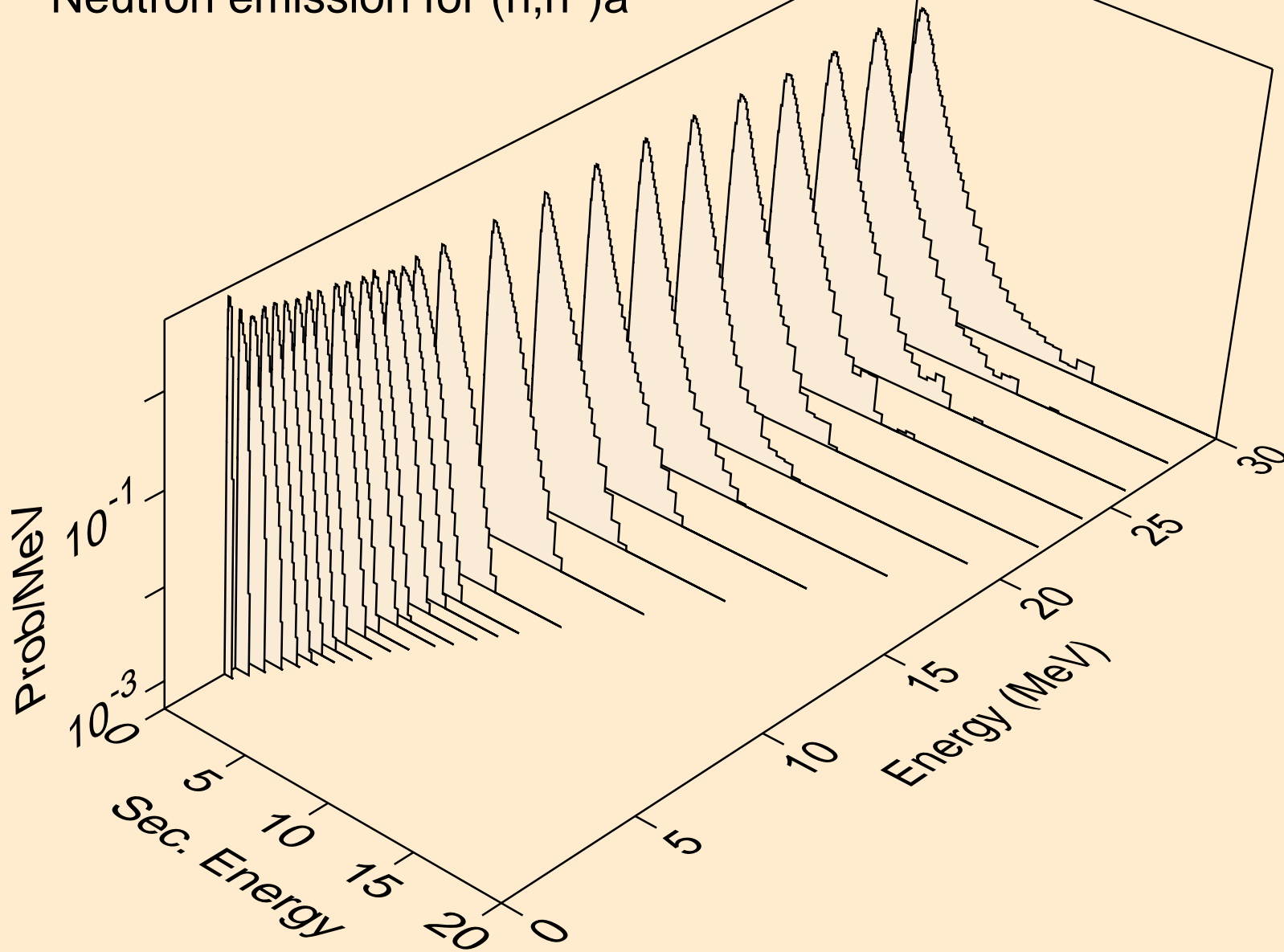

OS179 NEUTRON ACER TENDL-2019 LIBRARY; T=293.16K  
Neutron emission for (n,2n)a

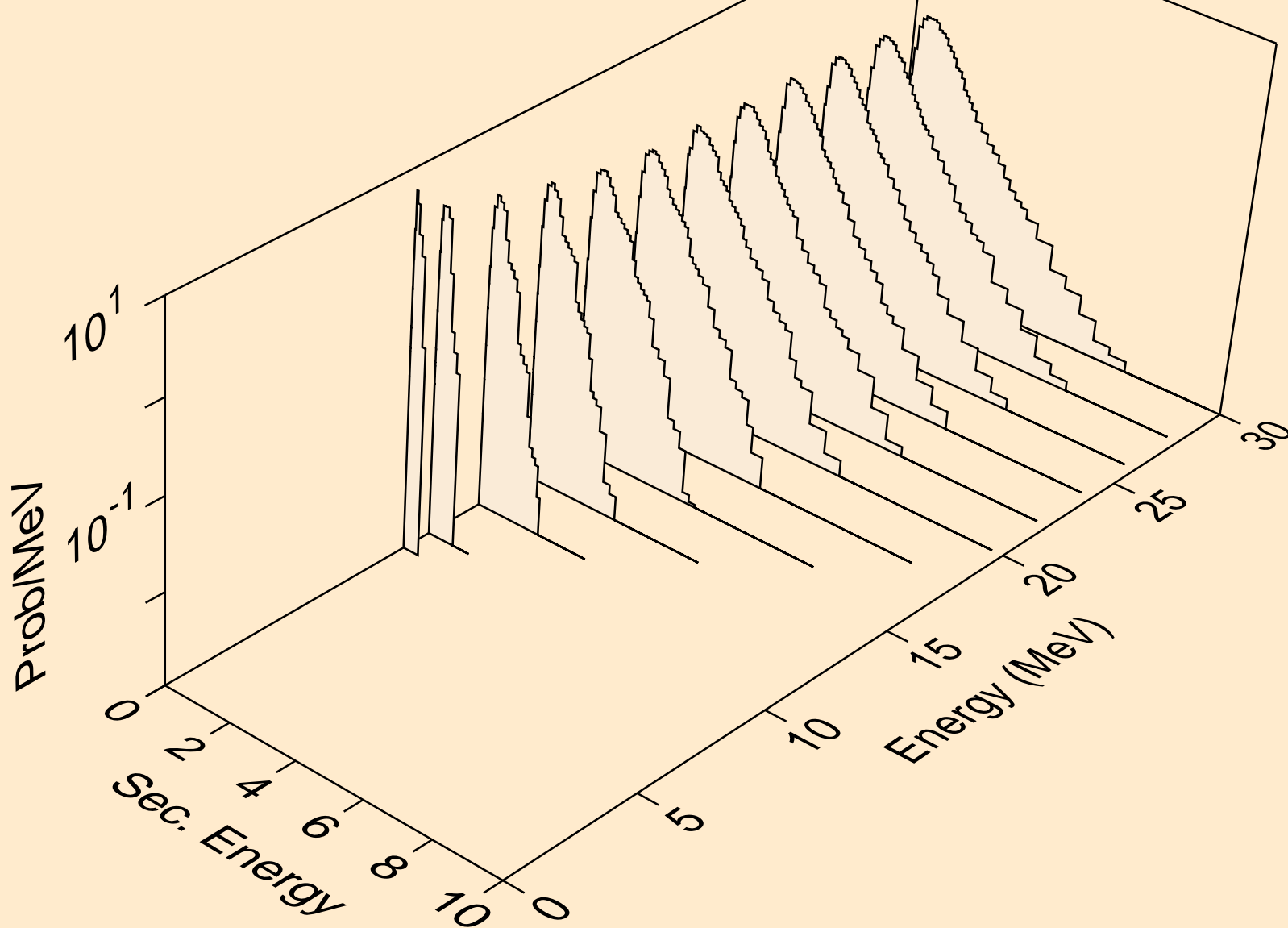

OS179 NEUTRON ACER TENDL-2019 LIBRARY; T=293.16K  
Neutron emission for (n,3n)a

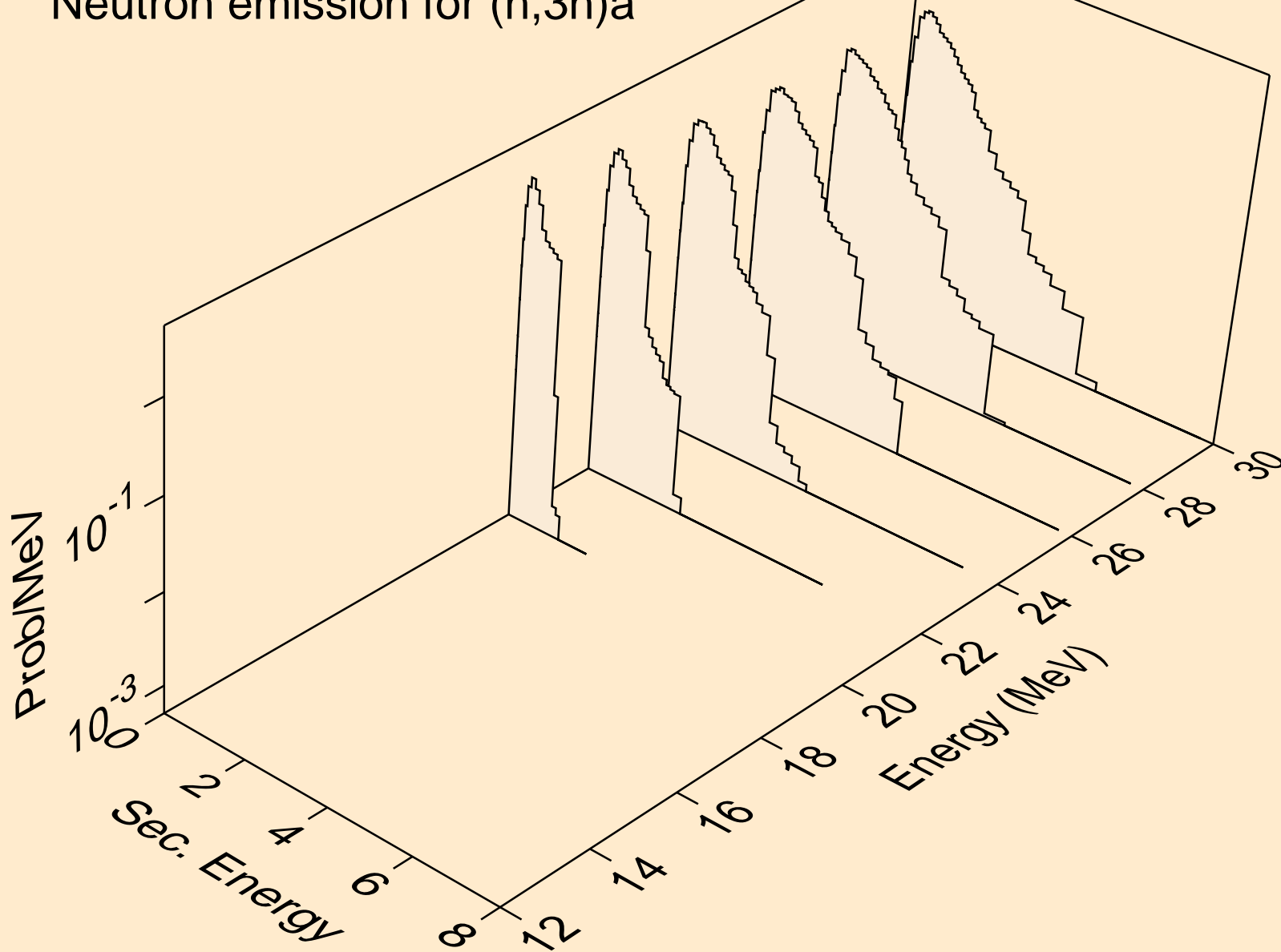

OS179 NEUTRON ACER TENDL-2019 LIBRARY; T=293.16K  
Neutron emission for (n,n\*)p

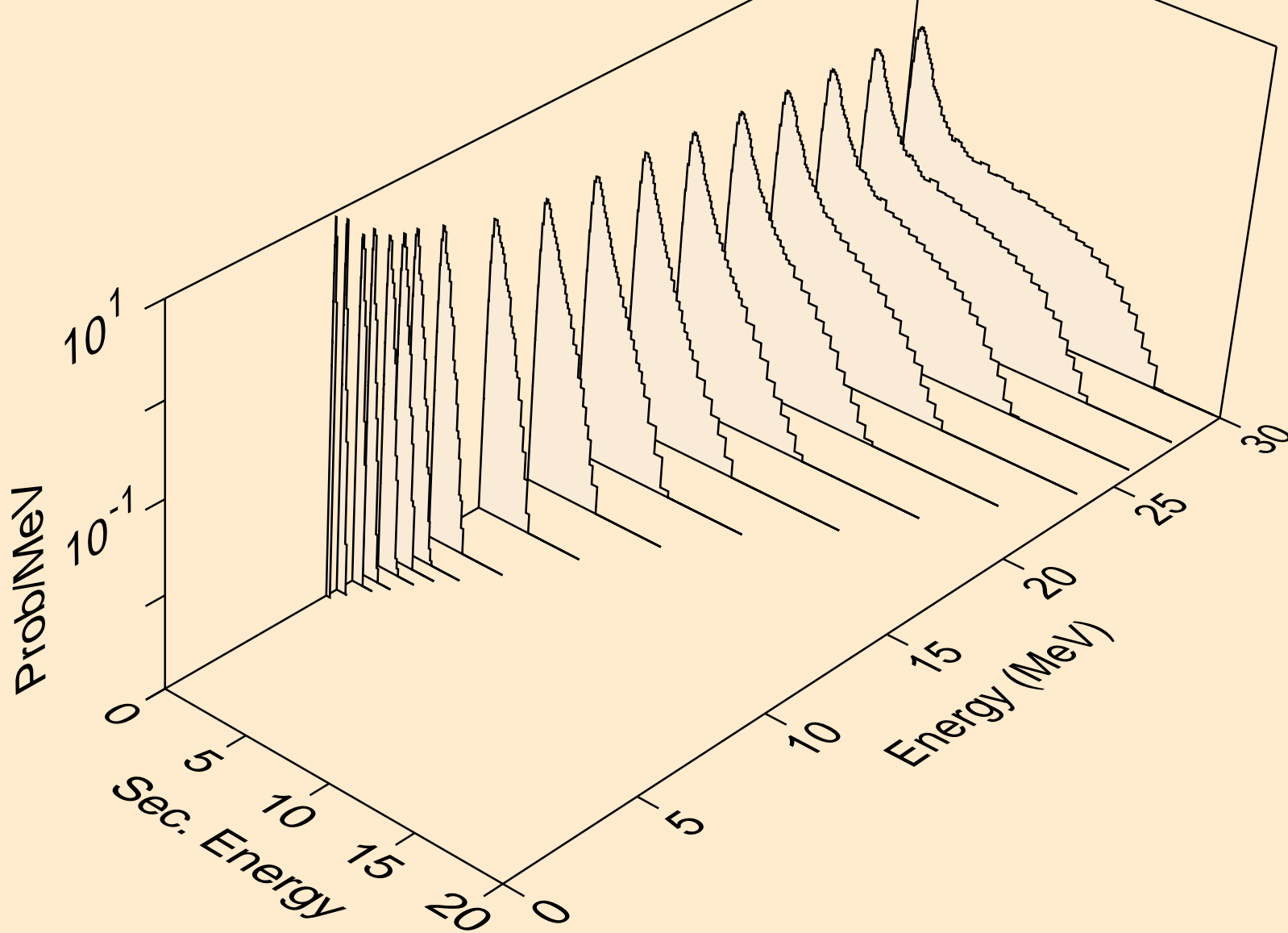

OS179 NEUTRON ACER TENDL-2019 LIBRARY; T=293.16K  
Neutron emission for (n,n\*)2a

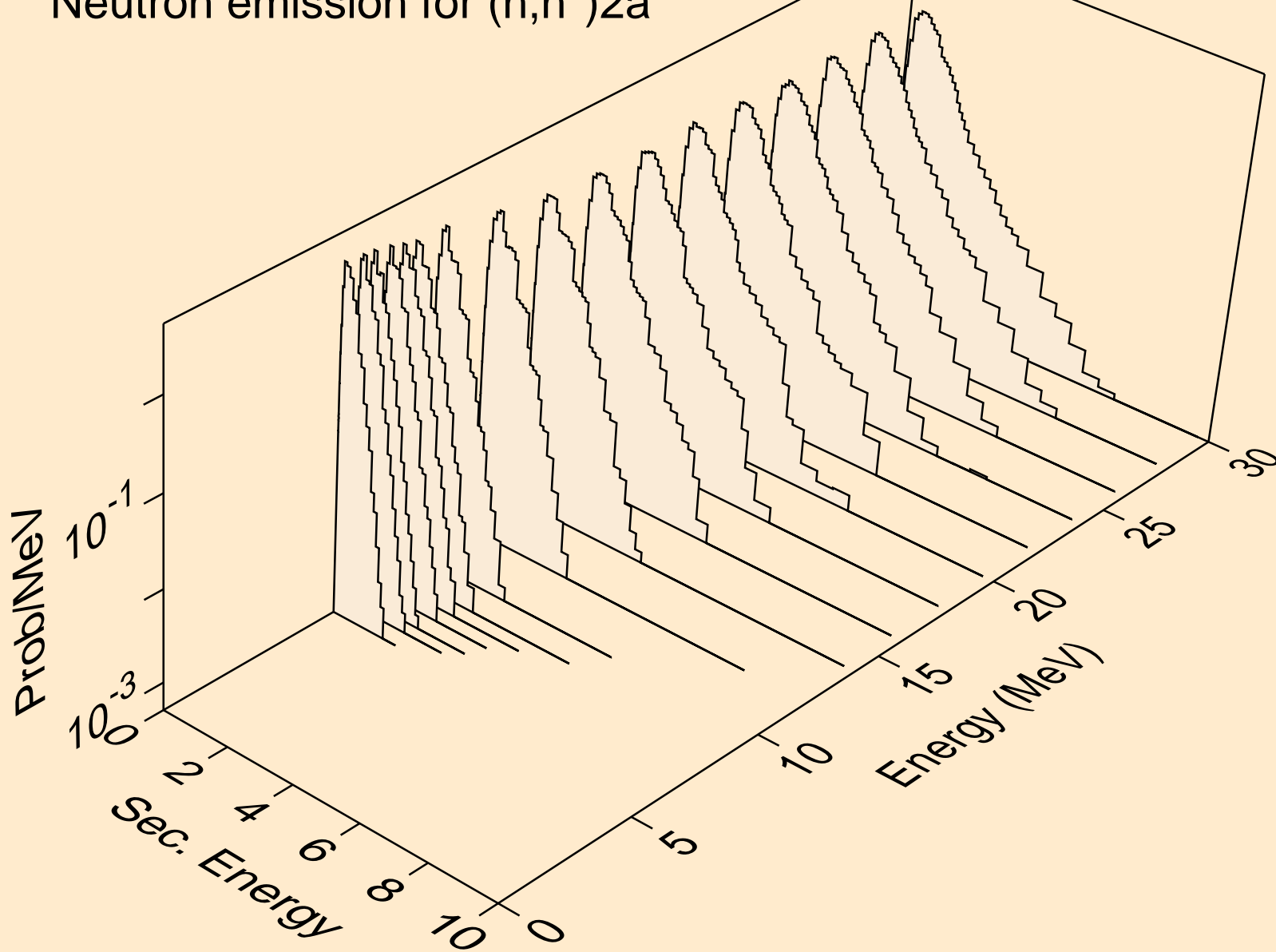

OS179 NEUTRON ACER TENDL-2019 LIBRARY; T=293.16K  
Neutron emission for (n,2n)2a

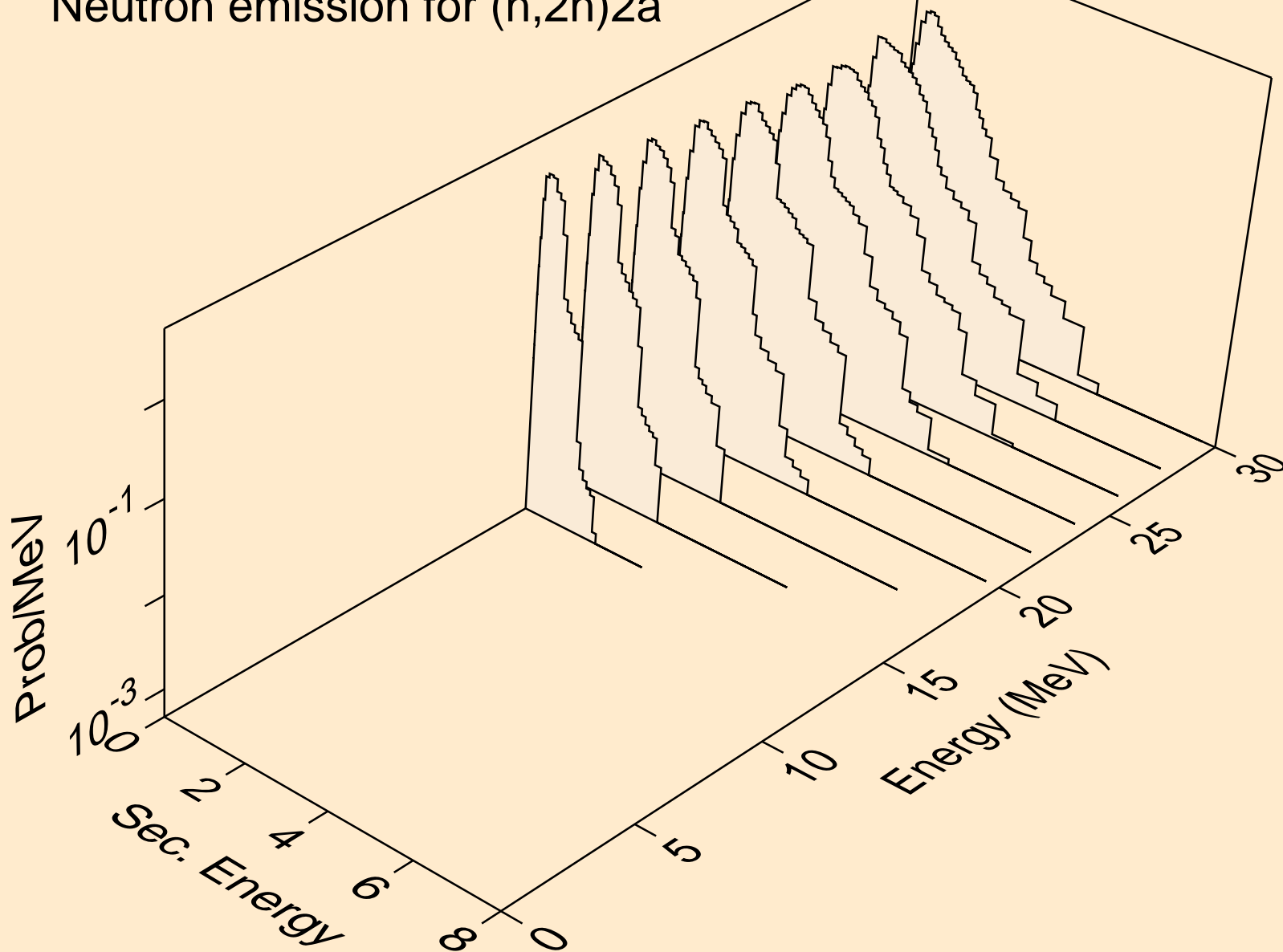

OS179 NEUTRON ACER TENDL-2019 LIBRARY; T=293.16K  
Neutron emission for (n,n\*)d

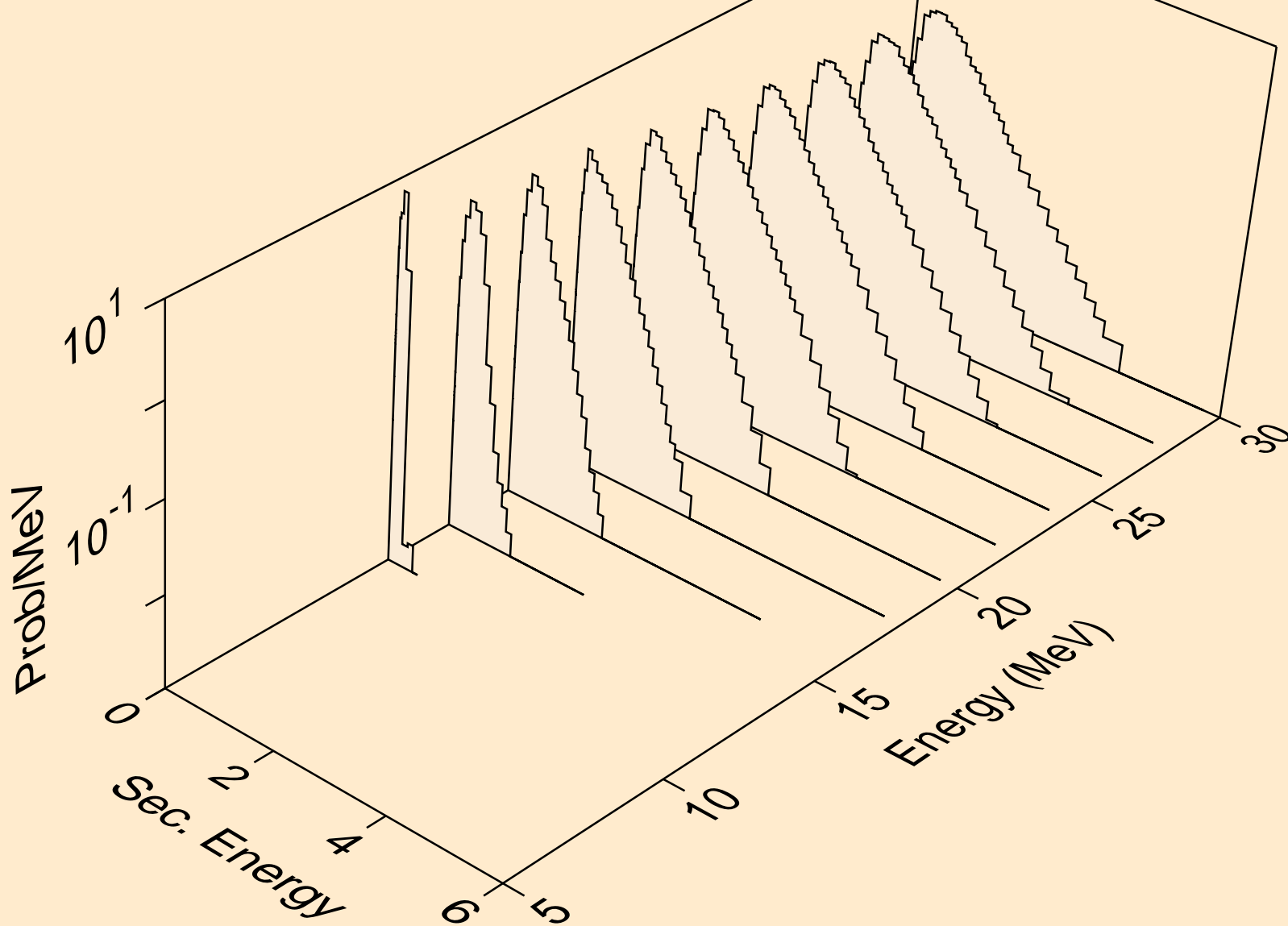



OS179 NEUTRON ACER TENDL-2019 LIBRARY; T=293.16K  
Neutron emission for (n,n\*)t

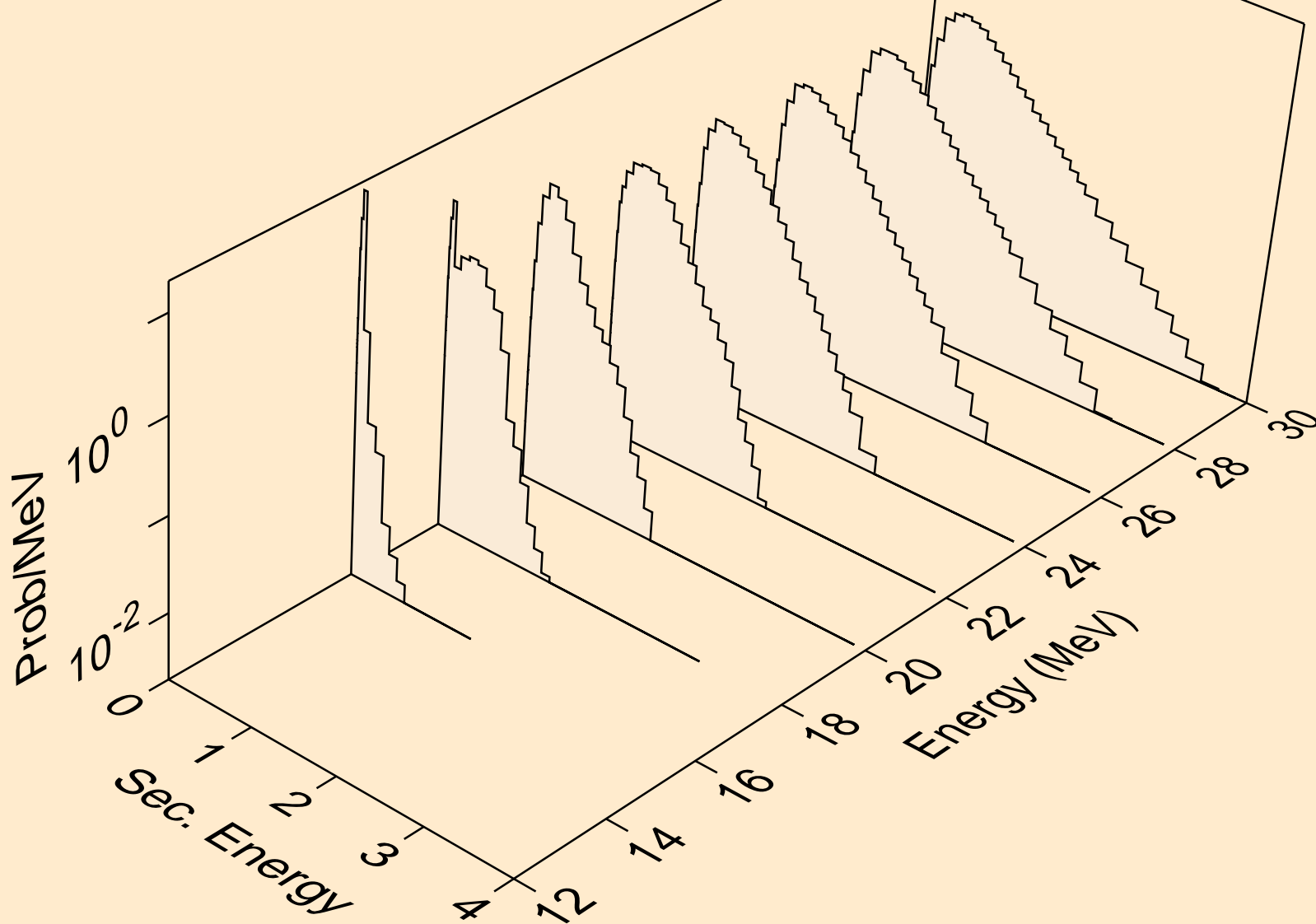

OS179 NEUTRON ACER TENDL-2019 LIBRARY; T=293.16K  
Neutron emission for (n,n\*)he3

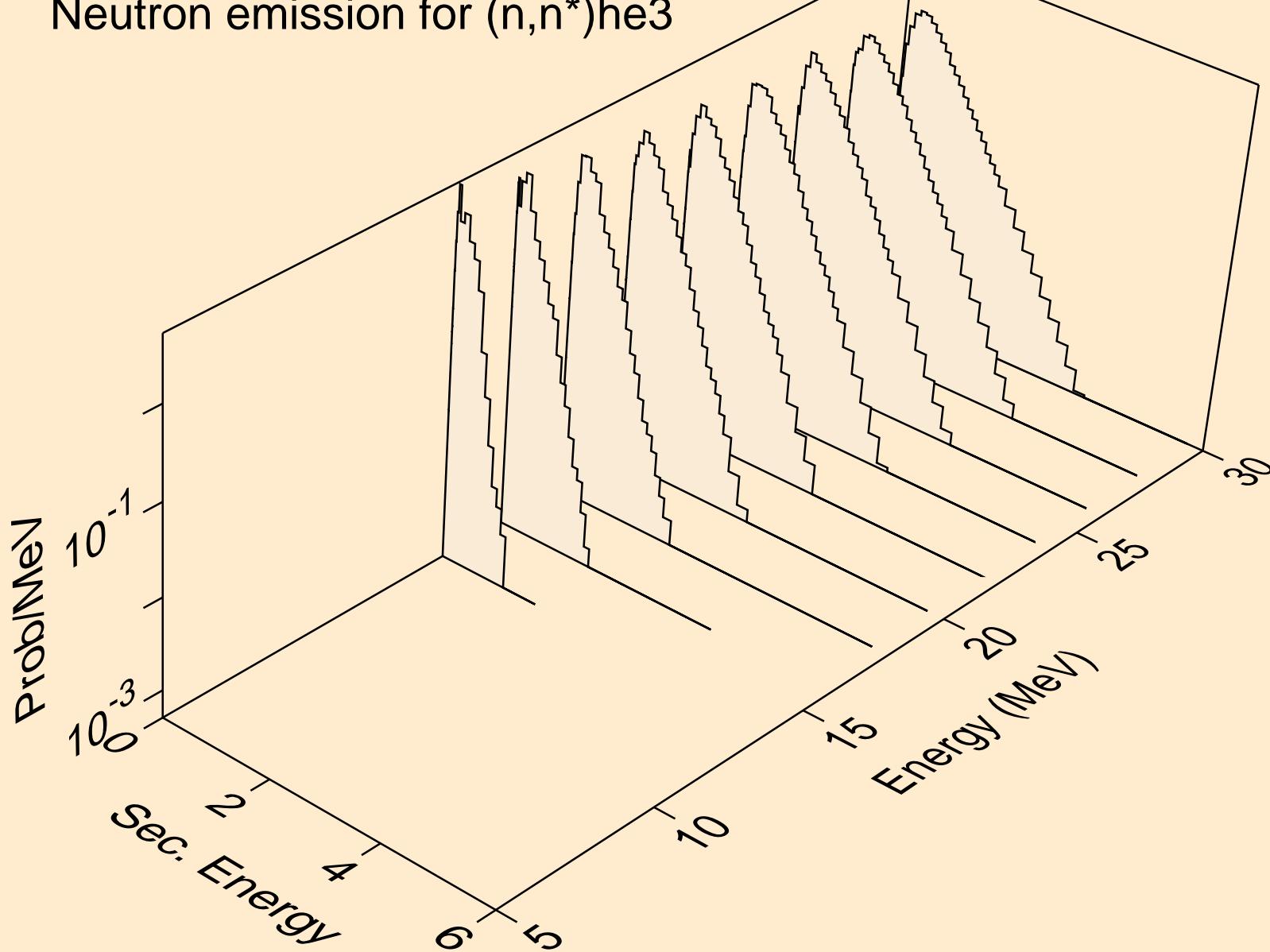

OS179 NEUTRON ACER TENDL-2019 LIBRARY; T=293.16K  
Neutron emission for (n,4n)

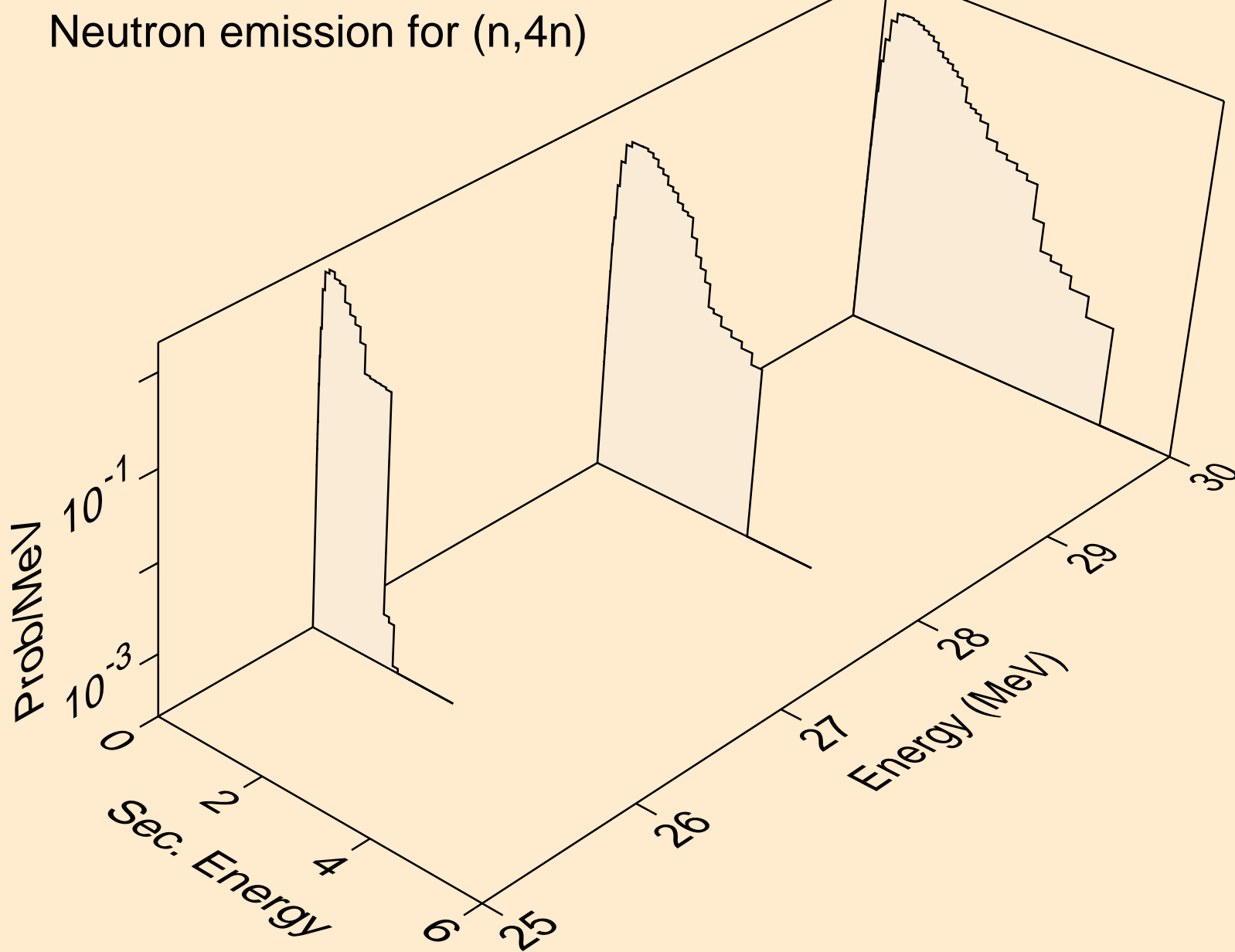

OS179 NEUTRON ACER TENDL-2019 LIBRARY; T=293.16K  
Neutron emission for (n,2np)

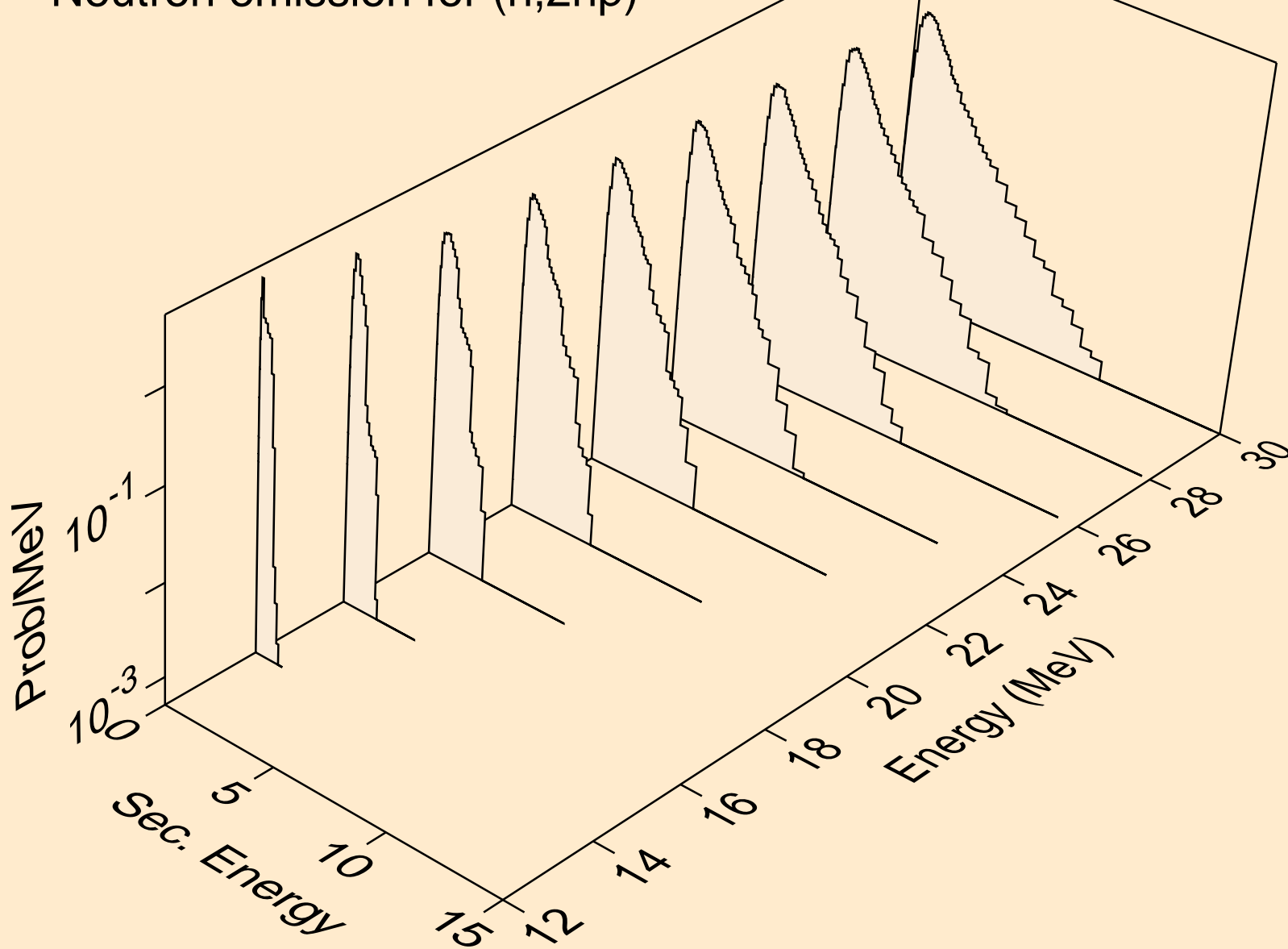

OS179 NEUTRON ACER TENDL-2019 LIBRARY; T=293.16K  
Neutron emission for (n,3np)

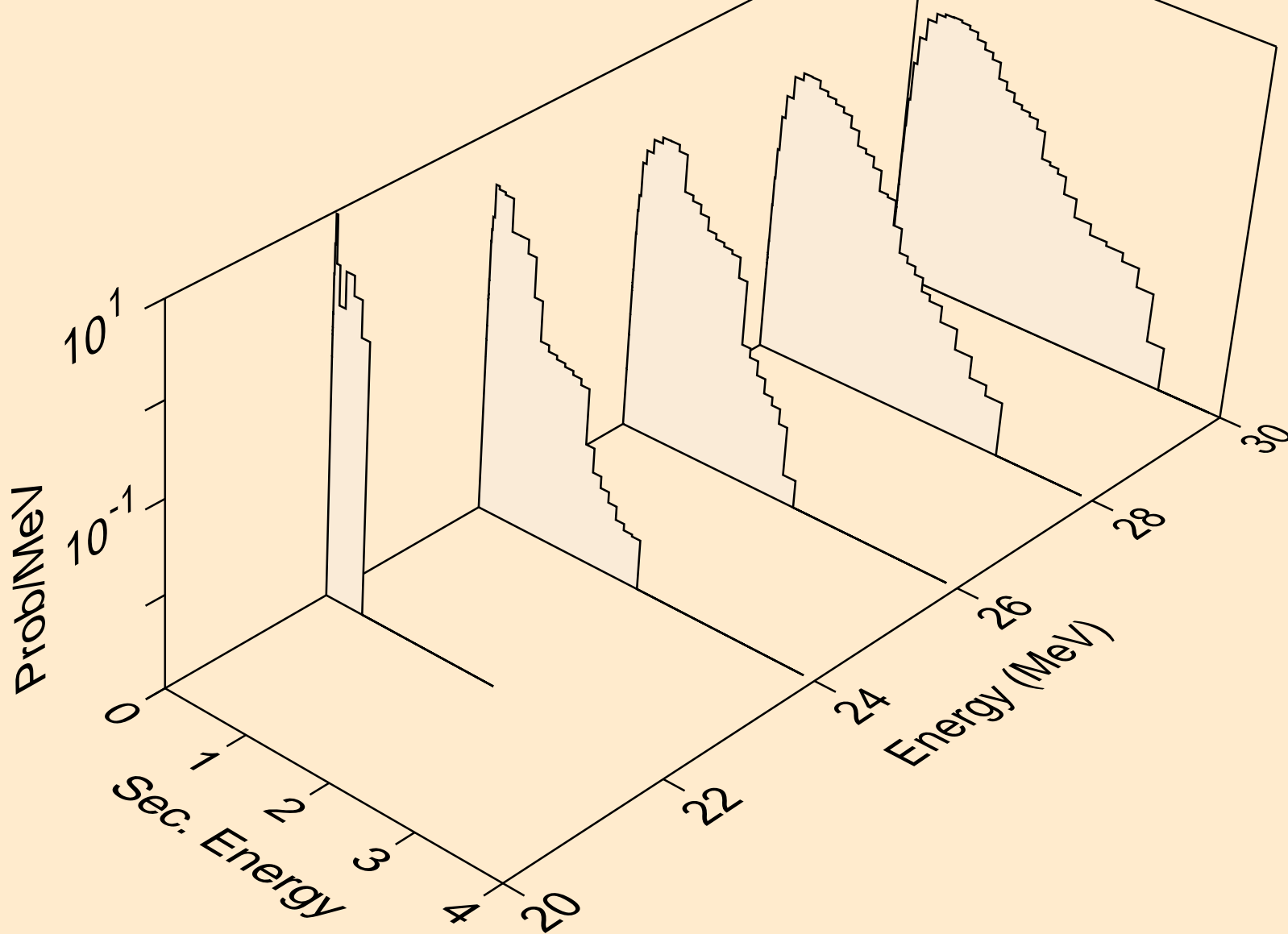

OS179 NEUTRON ACER TENDL-2019 LIBRARY; T=293.16K  
Neutron emission for (n,2np)

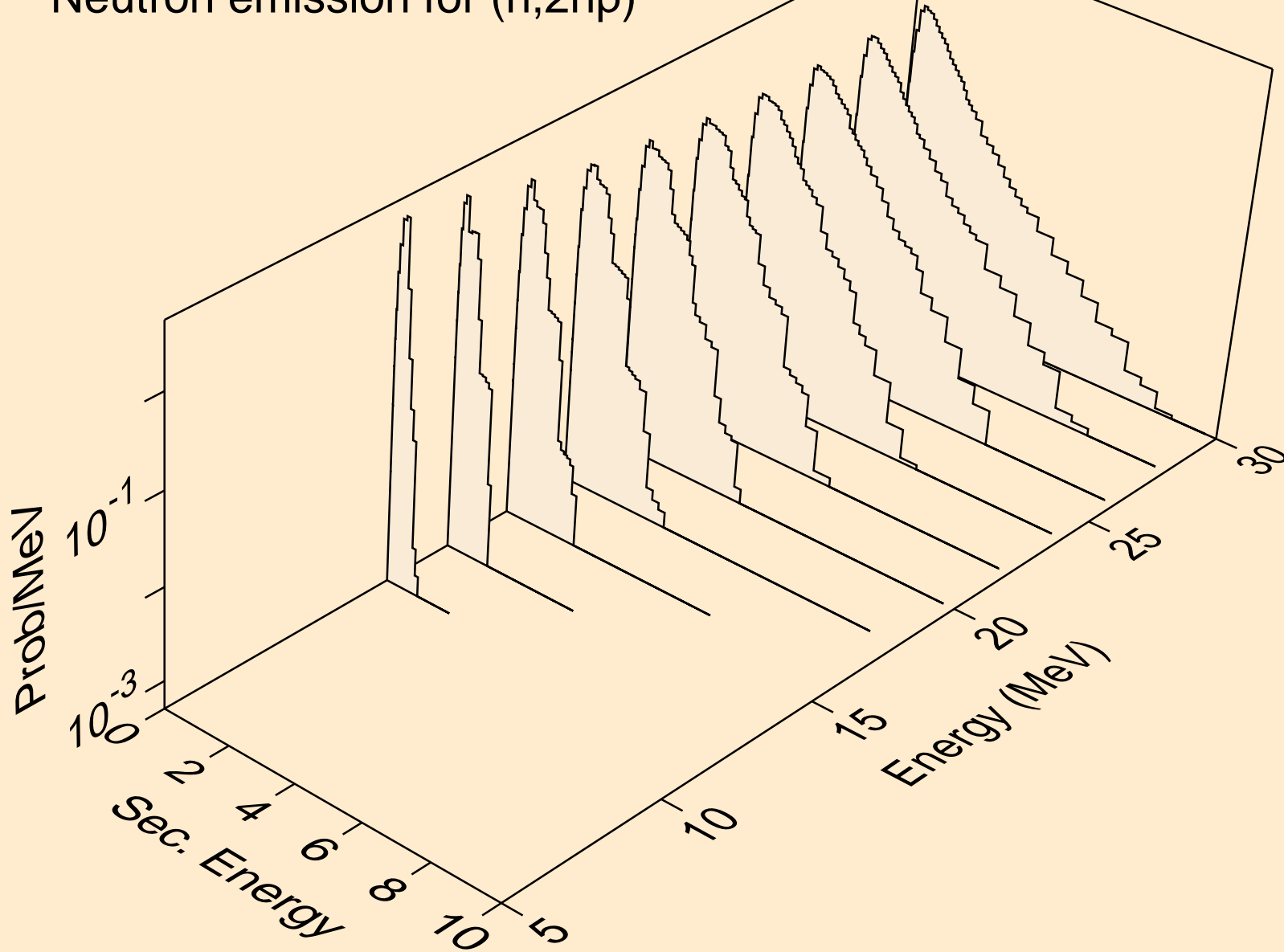

OS179 NEUTRON ACER TENDL-2019 LIBRARY; T=293.16K  
Neutron emission for (n,npa)

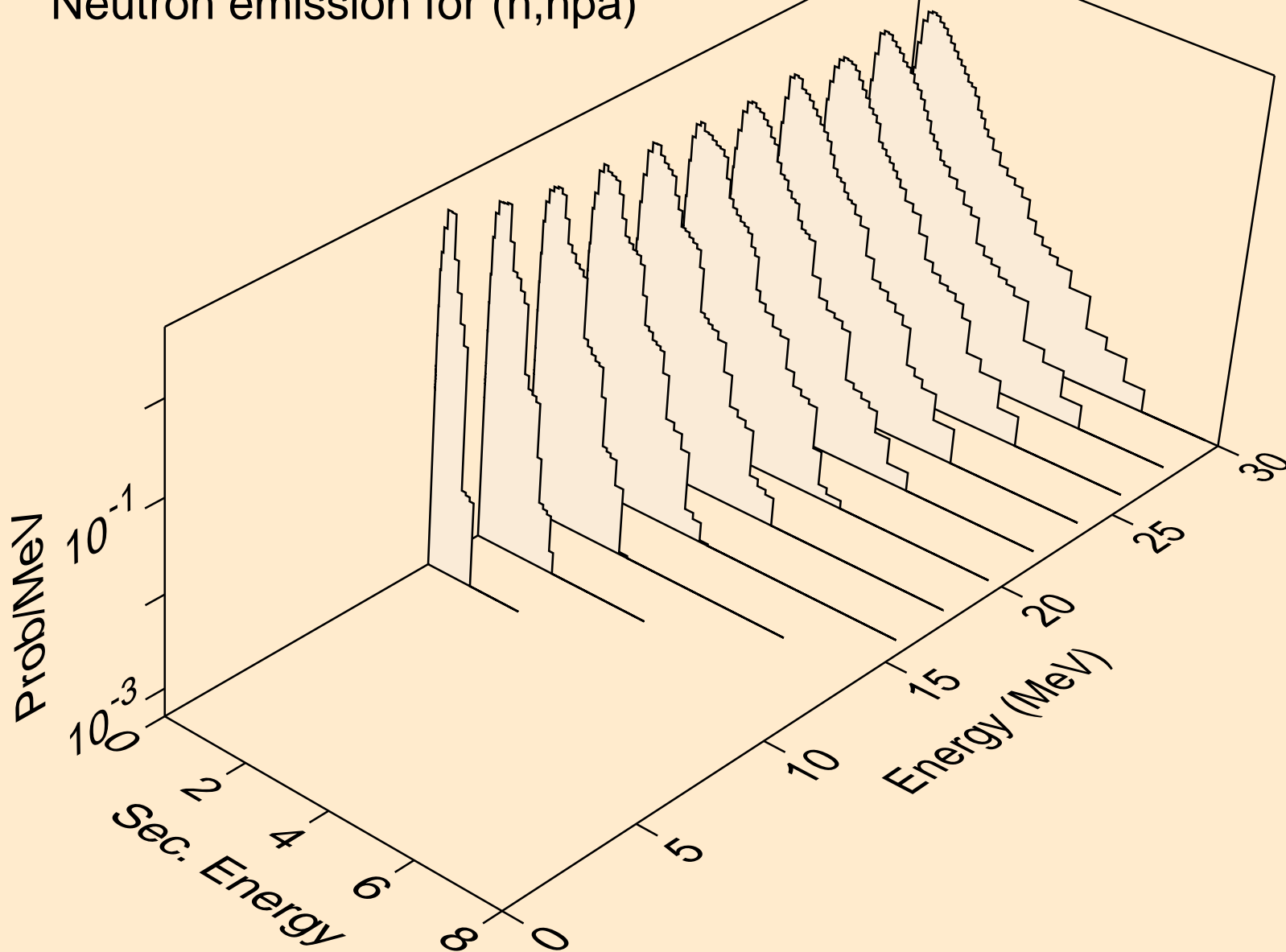

OS179 NEUTRON ACER TENDL-2019 LIBRARY; T=293.16K  
Neutron emission for (n,n\*c)

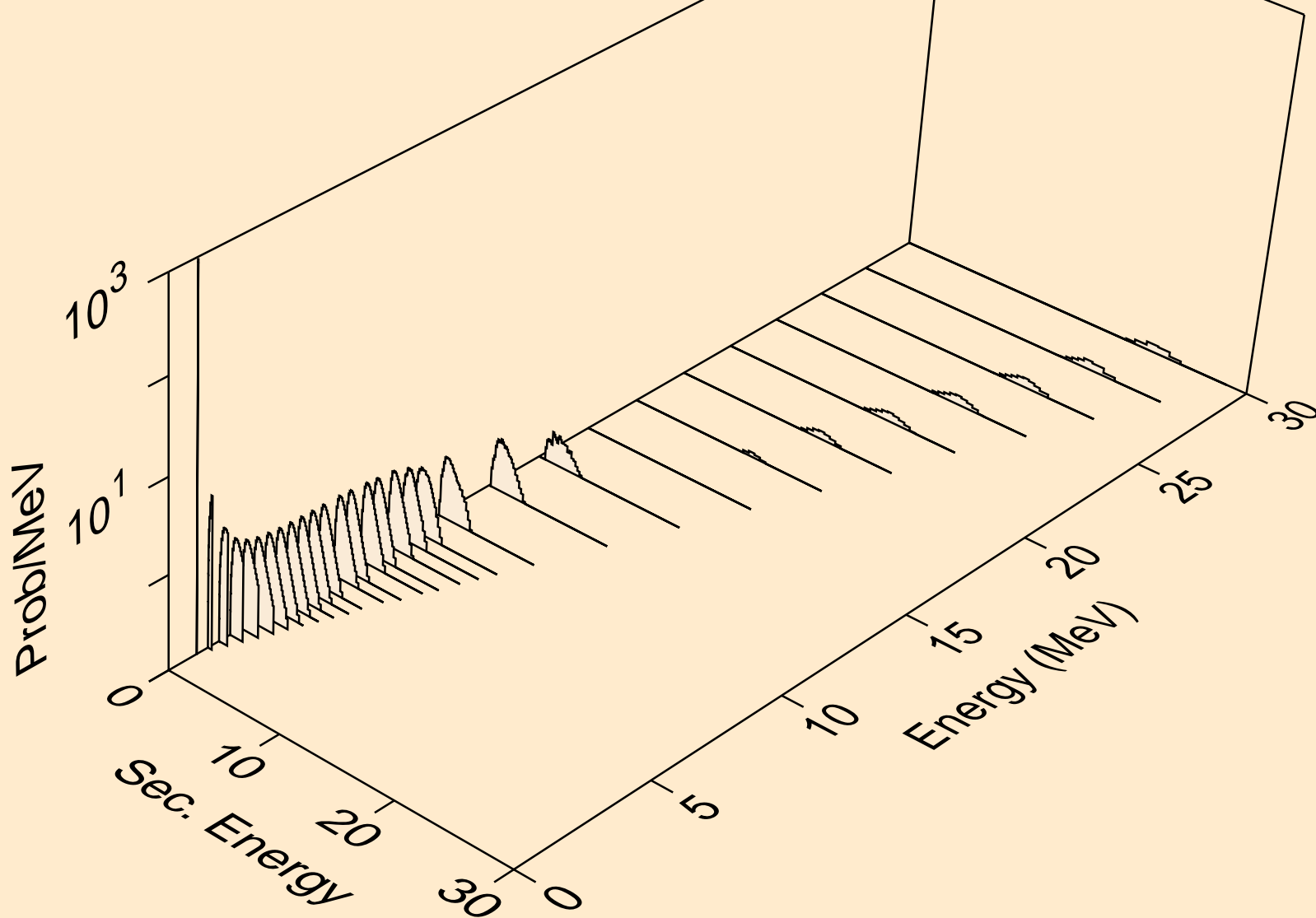



OS179 NEUTRON ACER TENDL-2019 LIBRARY; T=293.16K  
Photon emission for (n,x)

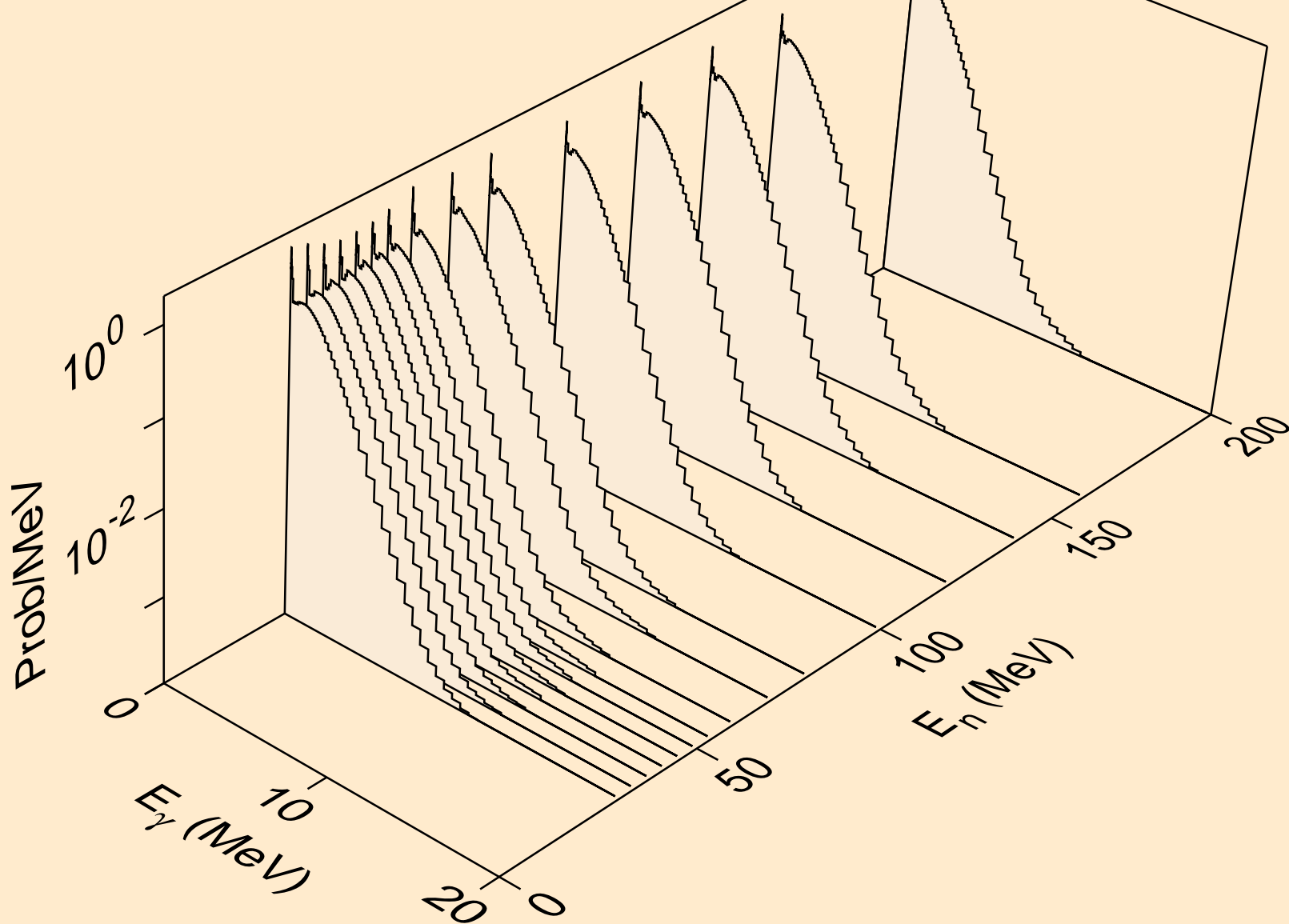

OS179 NEUTRON ACER TENDL-2019 LIBRARY; T=293.16K  
Photon emission for (n,2nd)

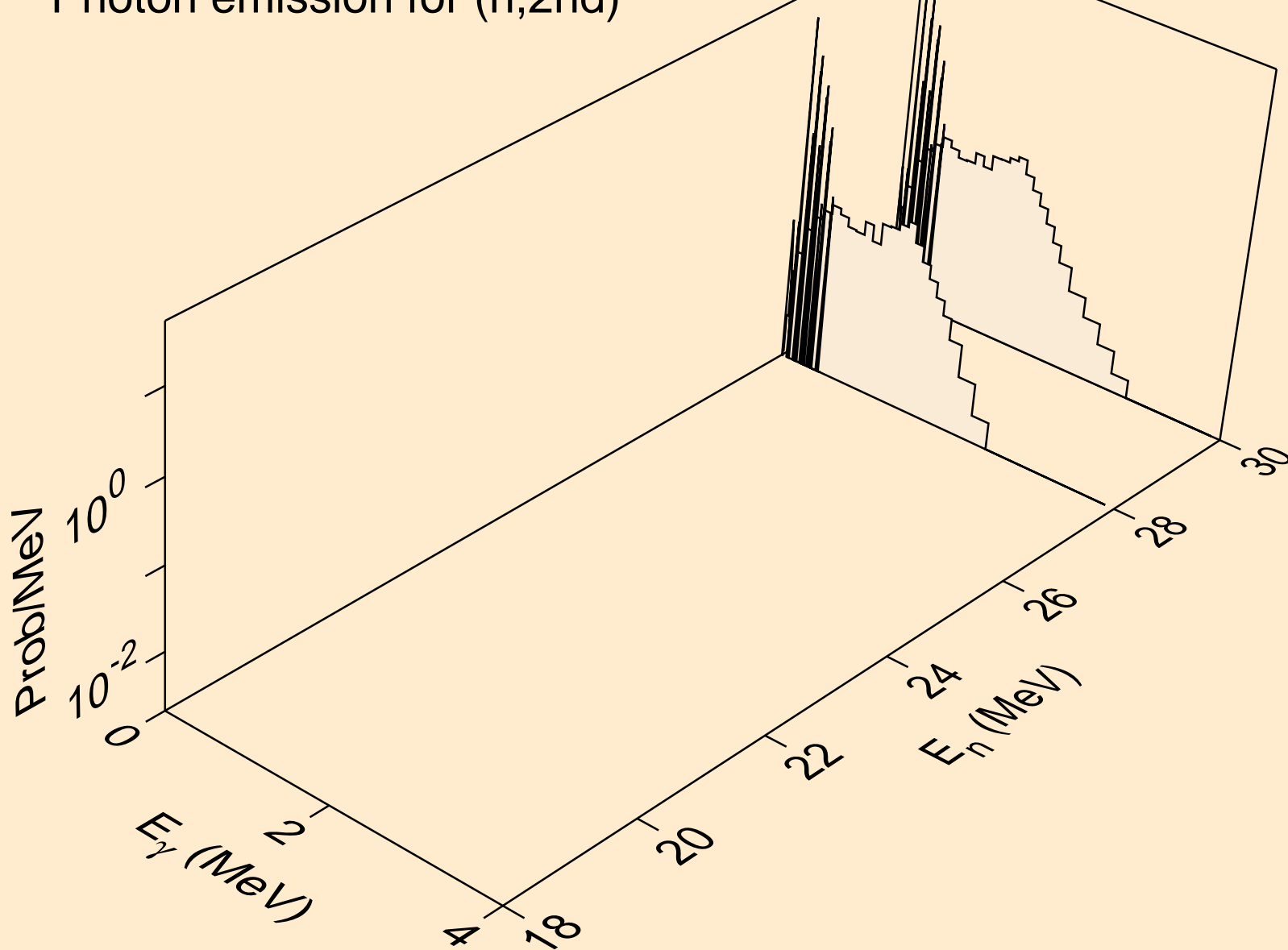

OS179 NEUTRON ACER TENDL-2019 LIBRARY; T=293.16K  
Photon emission for (n,2n)

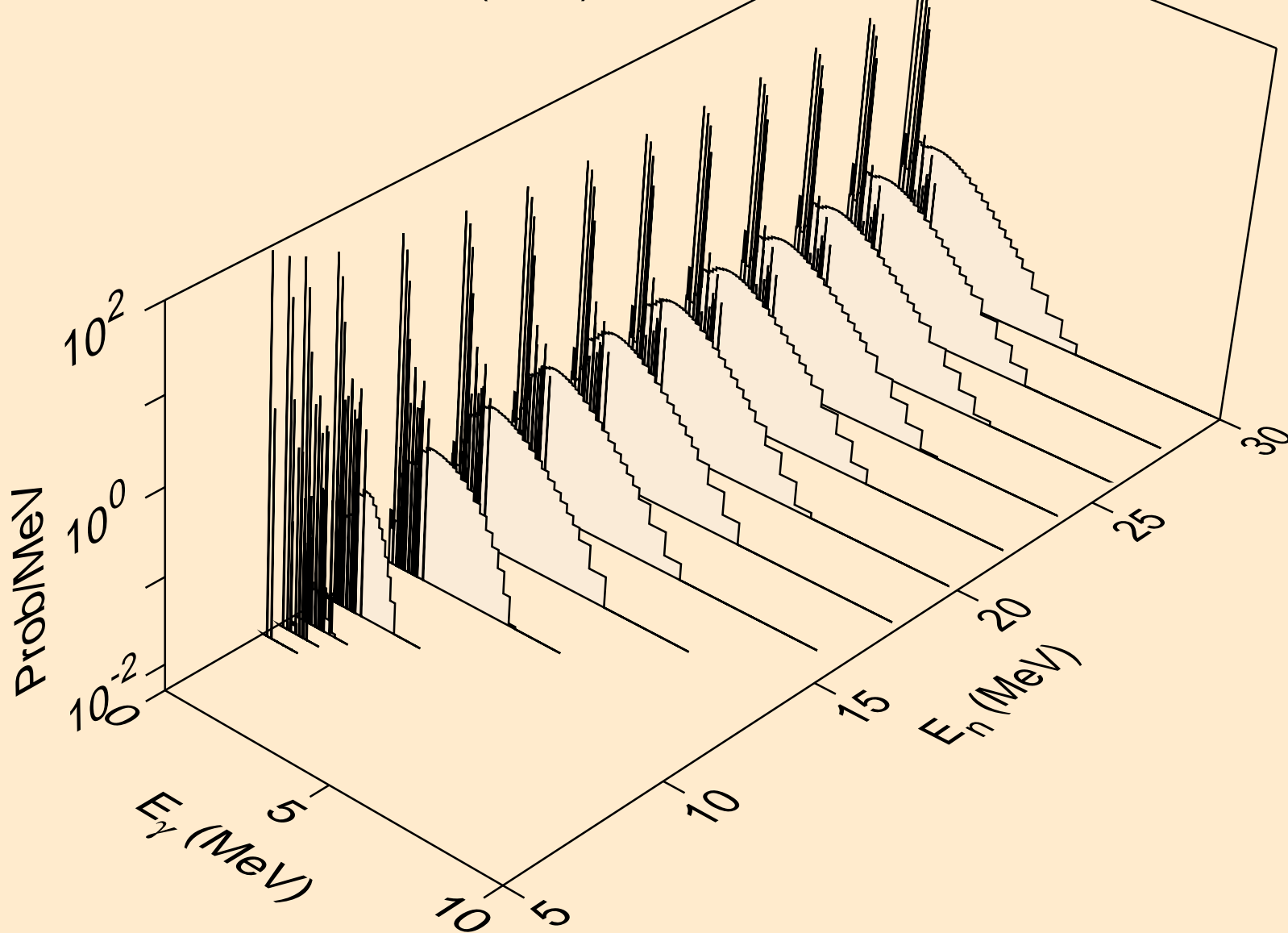

OS179 NEUTRON ACER TENDL-2019 LIBRARY; T=293.16K  
Photon emission for (n,3n)

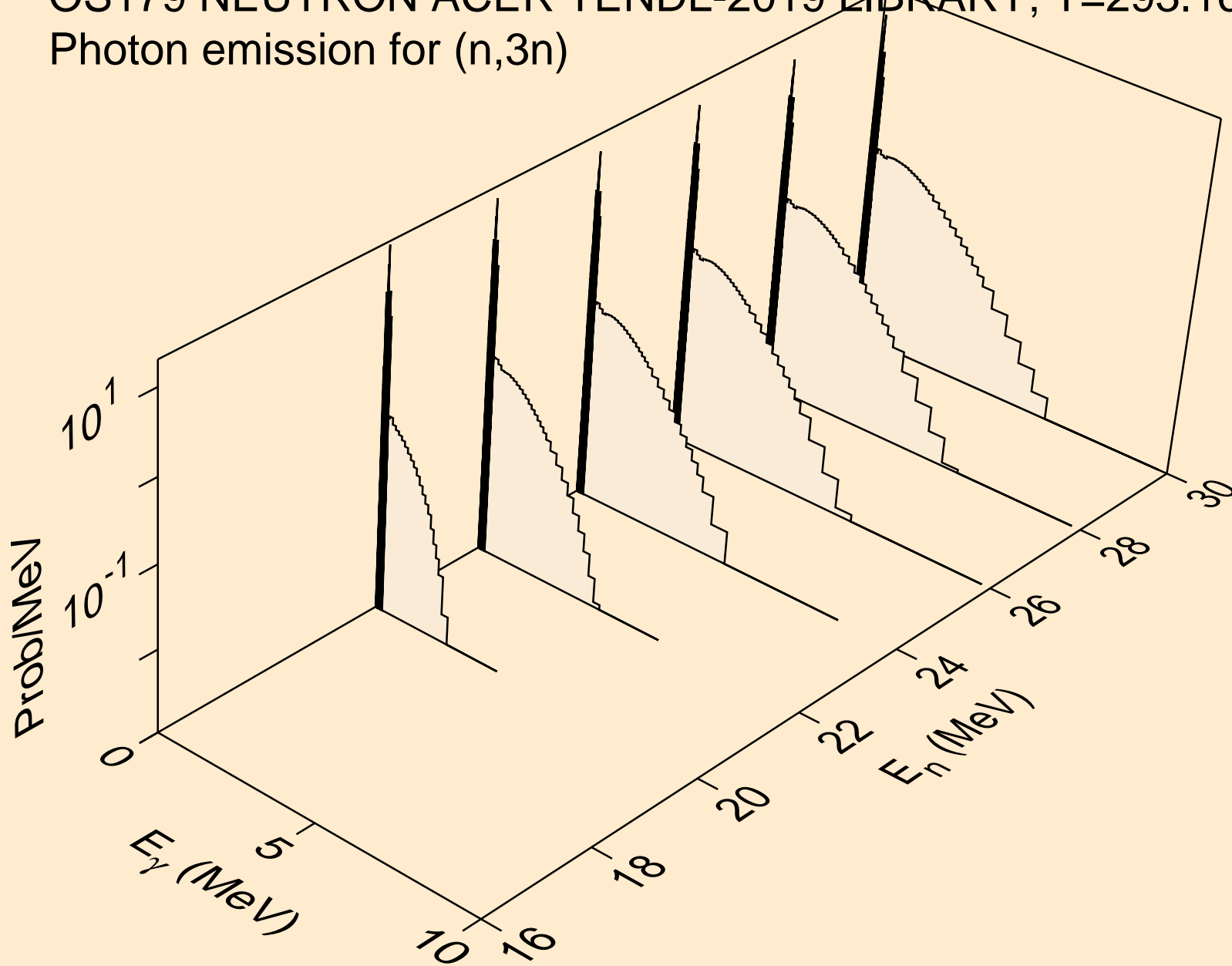

OS179 NEUTRON ACER TENDL-2019 LIBRARY; T=293.16K  
Photon emission for (n,n\*)a

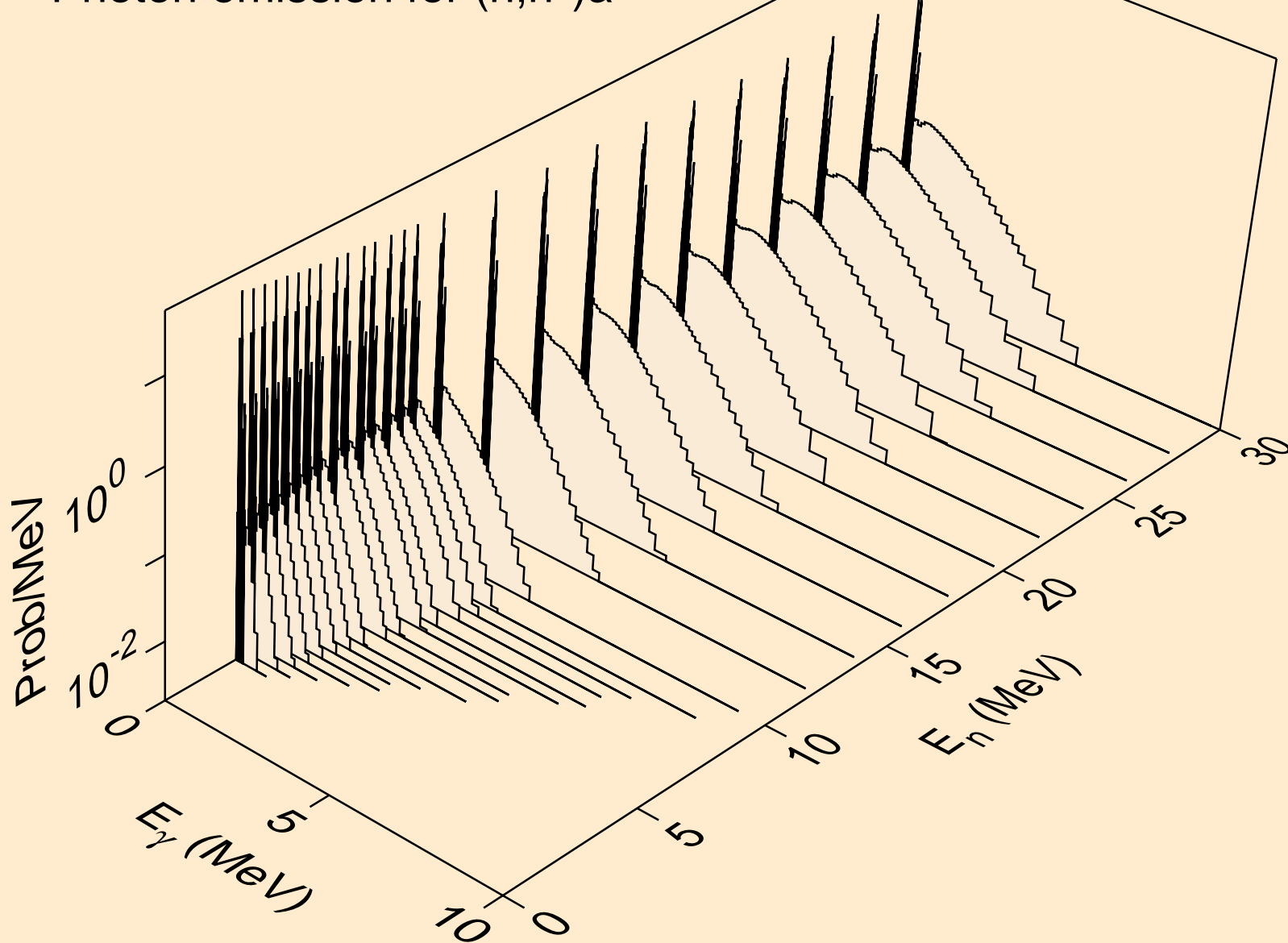

OS179 NEUTRON ACER TENDL-2019 LIBRARY; T=293.16K  
Photon emission for (n,2n) $\alpha$

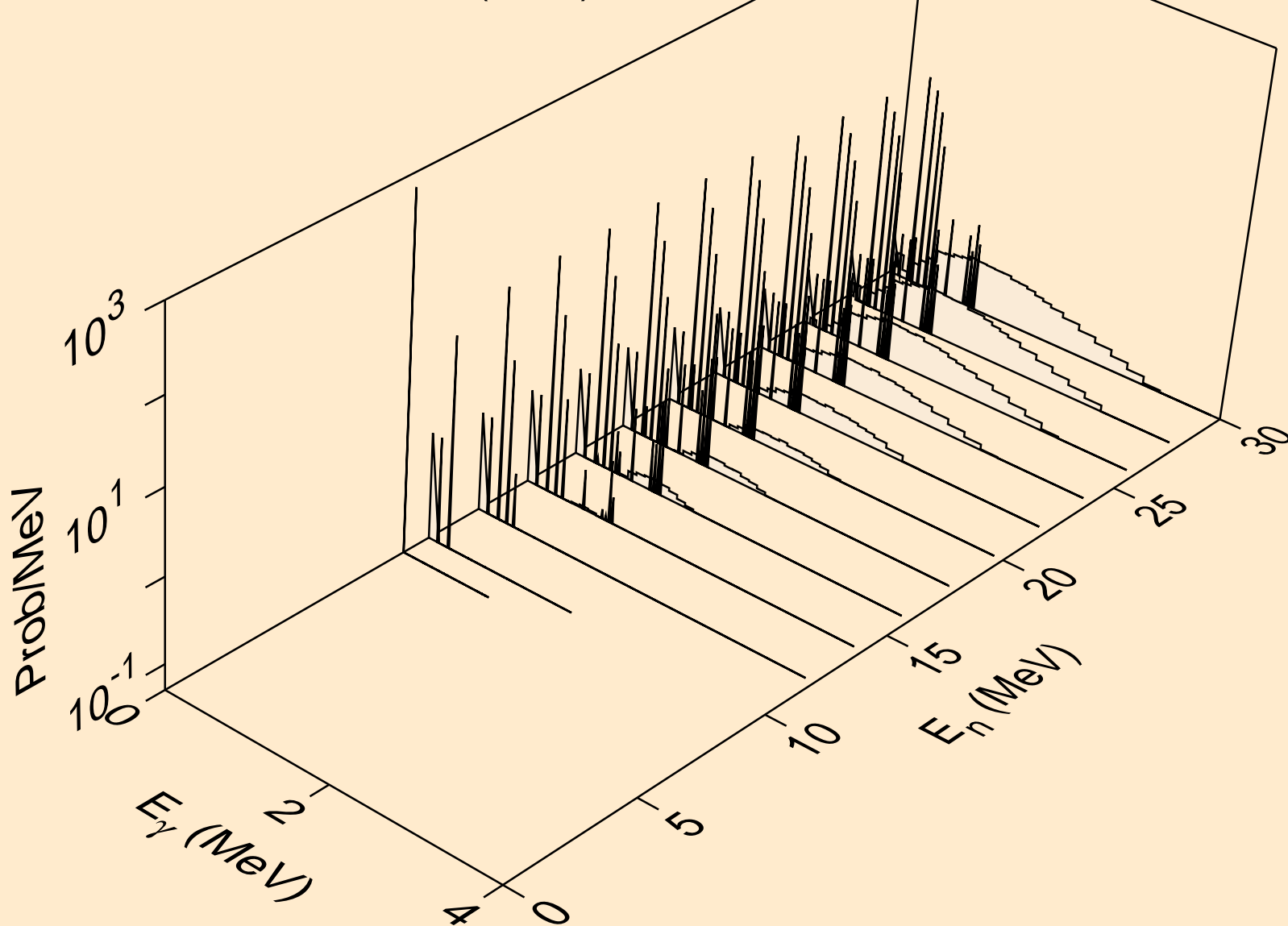

OS179 NEUTRON ACER TENDL-2019 LIBRARY; T=293.16K  
Photon emission for (n,3n)a

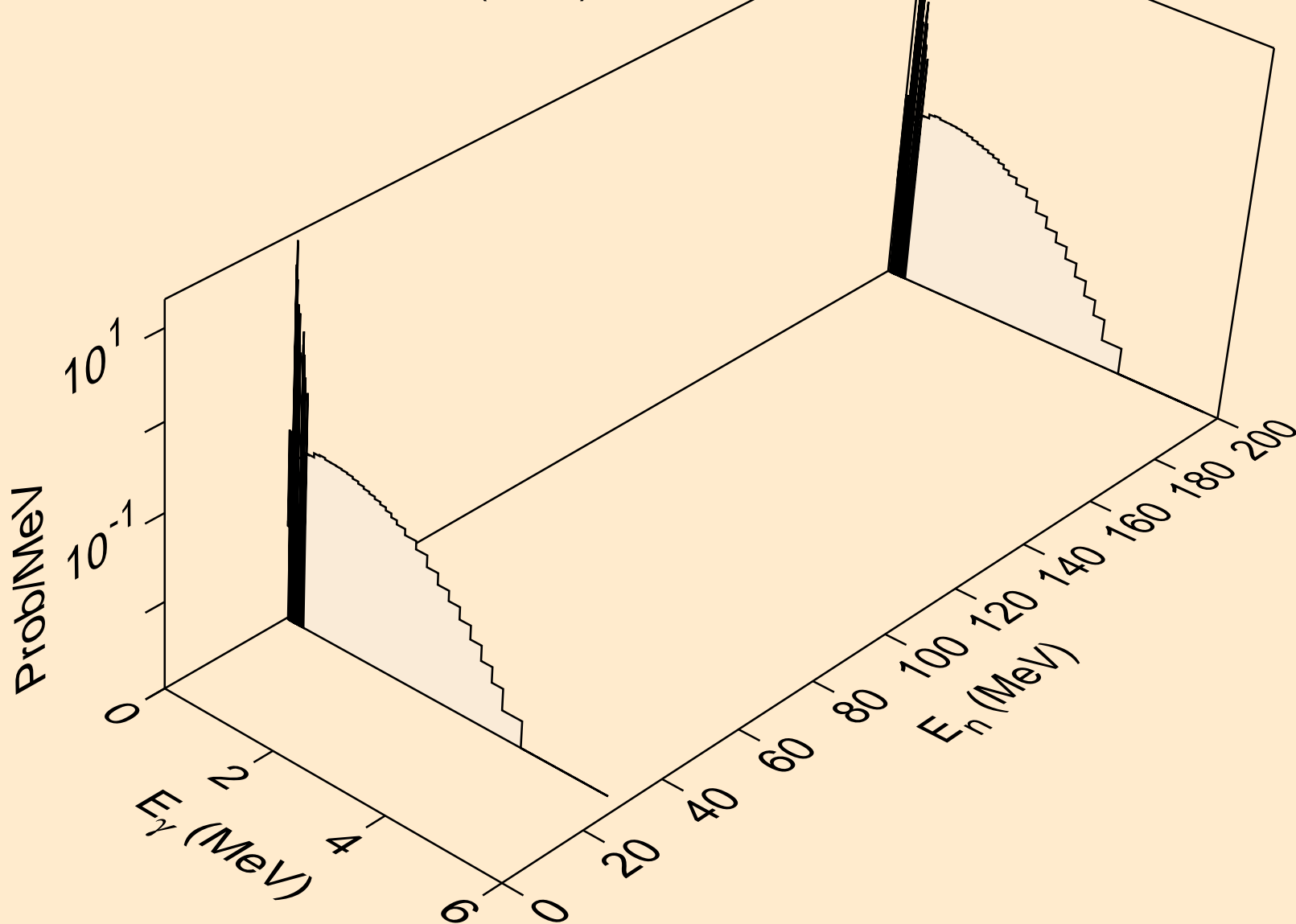

OS179 NEUTRON ACER TENDL-2019 LIBRARY; T=293.16K  
Photon emission for (n,n\*)p

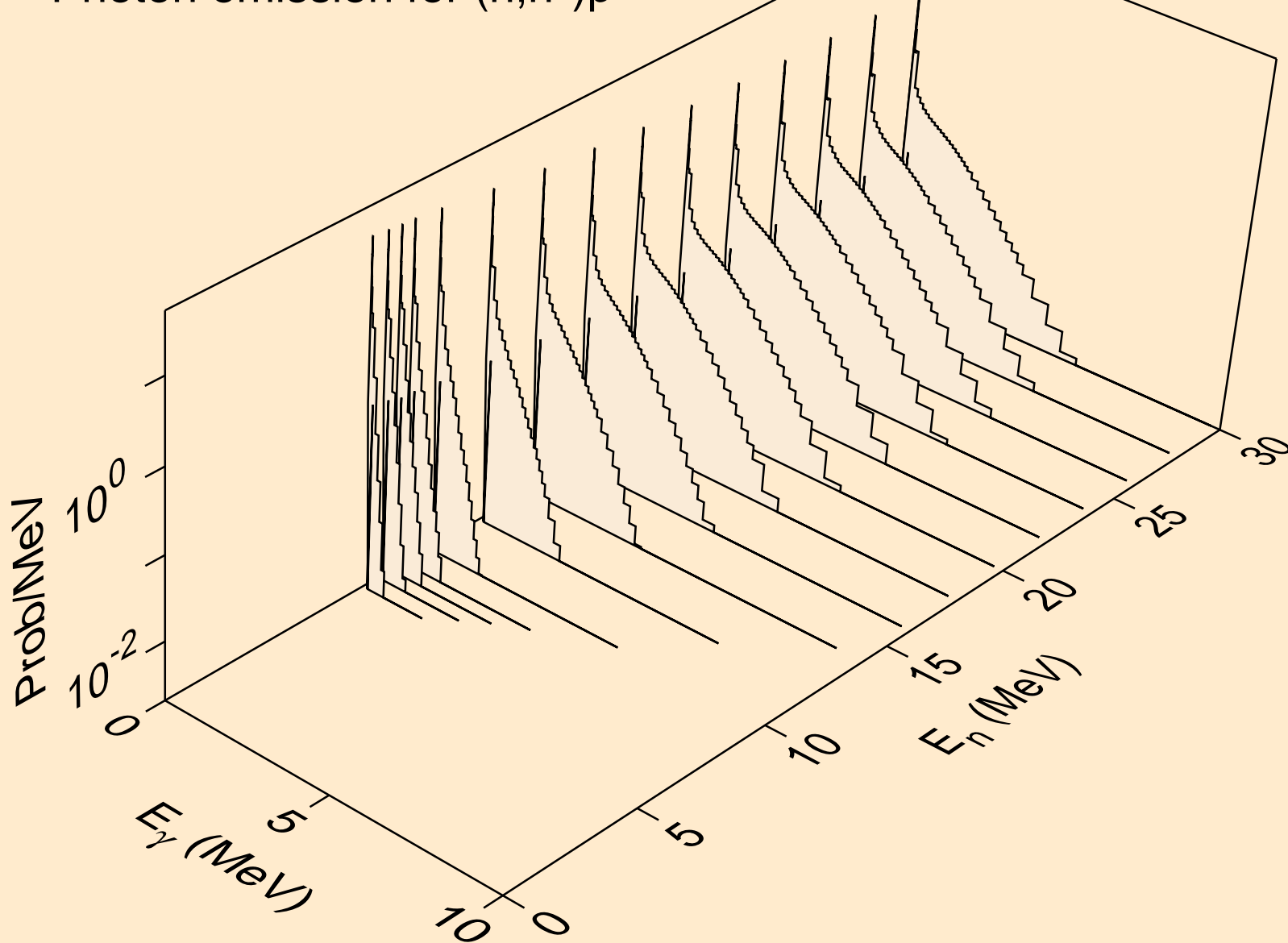



OS179 NEUTRON ACER TENDL-2019 LIBRARY; T=293.16K  
Photon emission for (n,n\*)2a

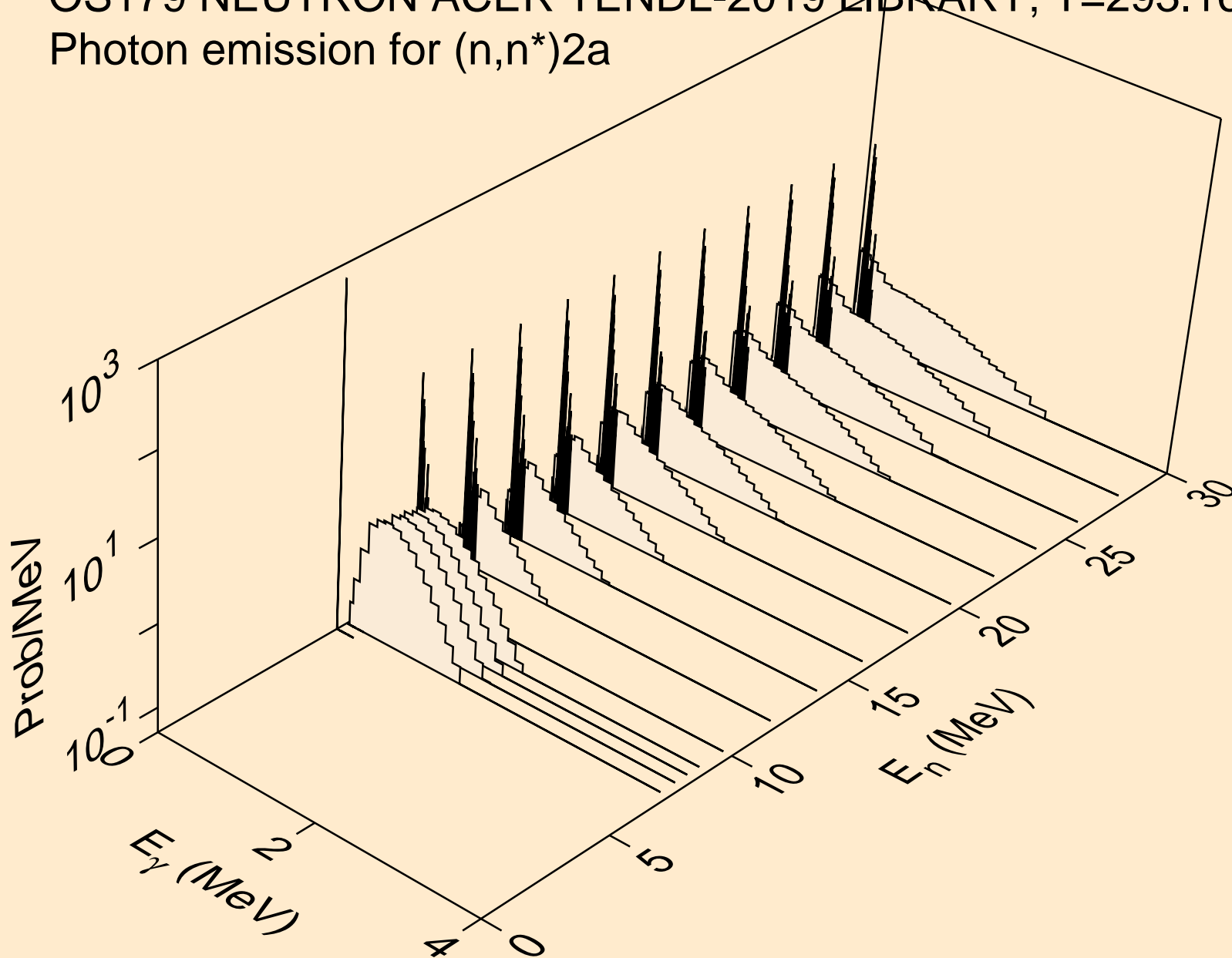

OS179 NEUTRON ACER TENDL-2019 LIBRARY; T=293.16K  
Photon emission for (n,2n)2a

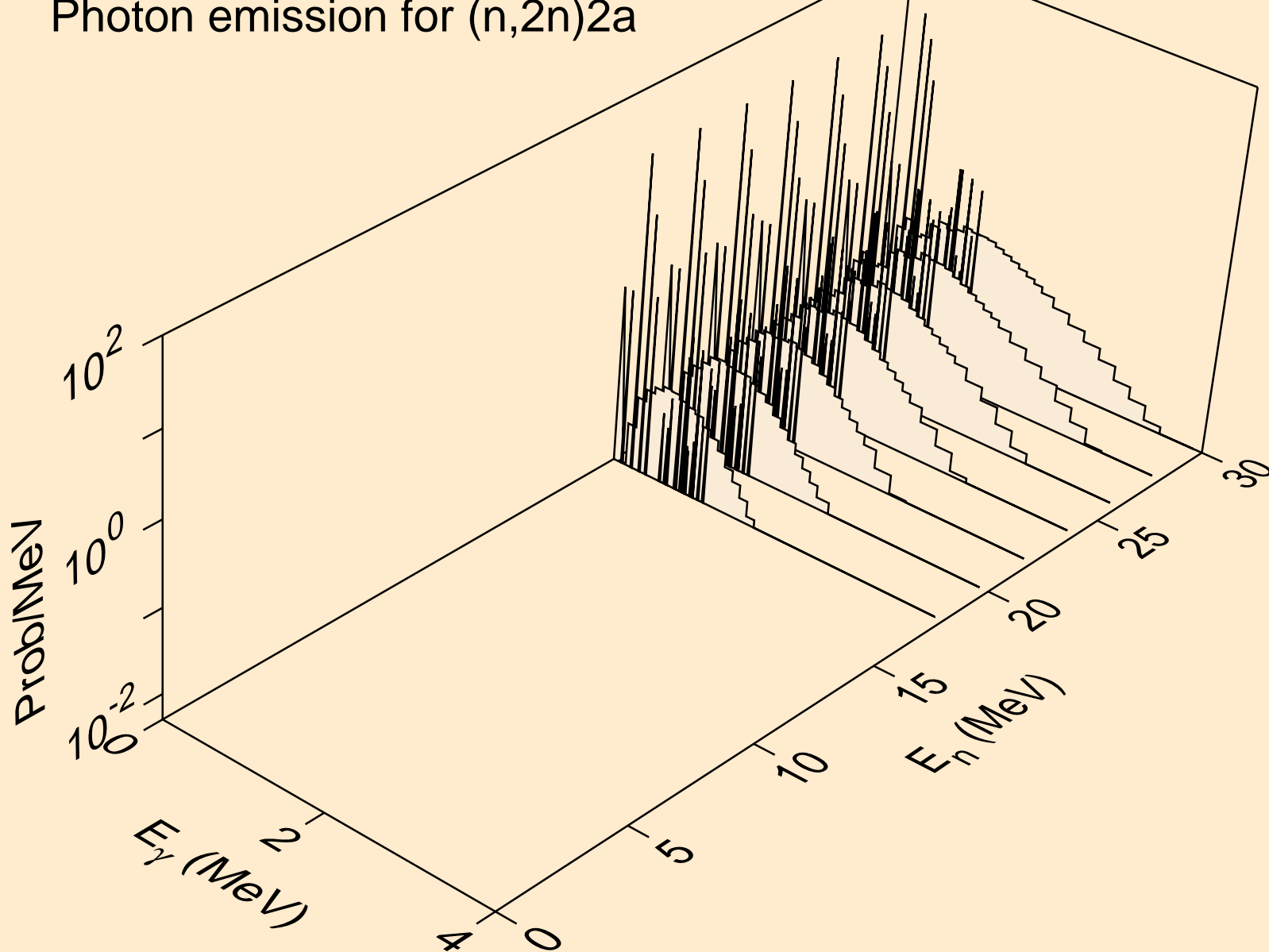

OS179 NEUTRON ACER TENDL-2019 LIBRARY; T=293.16K  
Photon emission for (n,n\*)d

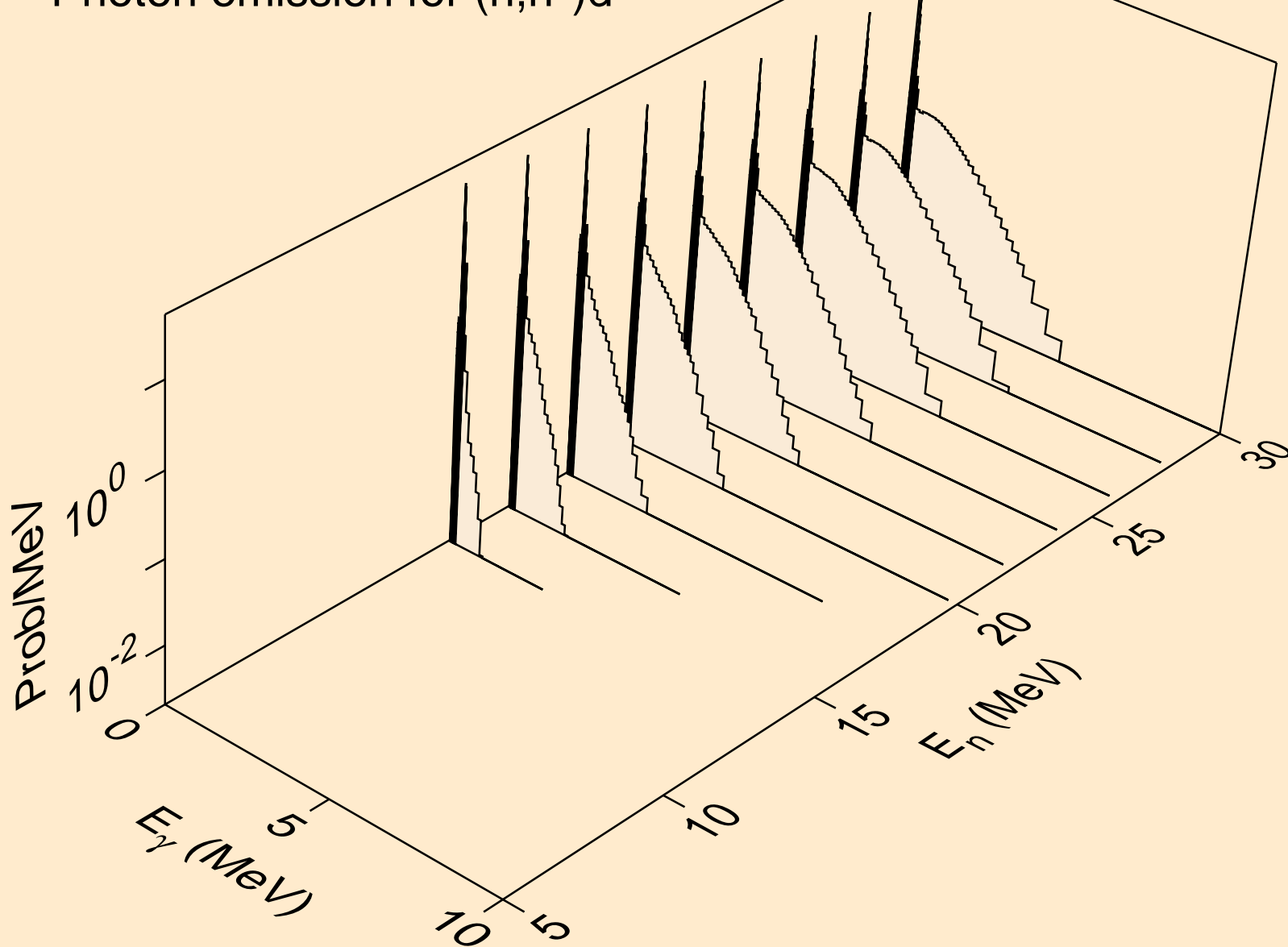

OS179 NEUTRON ACER TENDL-2019 LIBRARY; T=293.16K  
Photon emission for (n,n\*)t

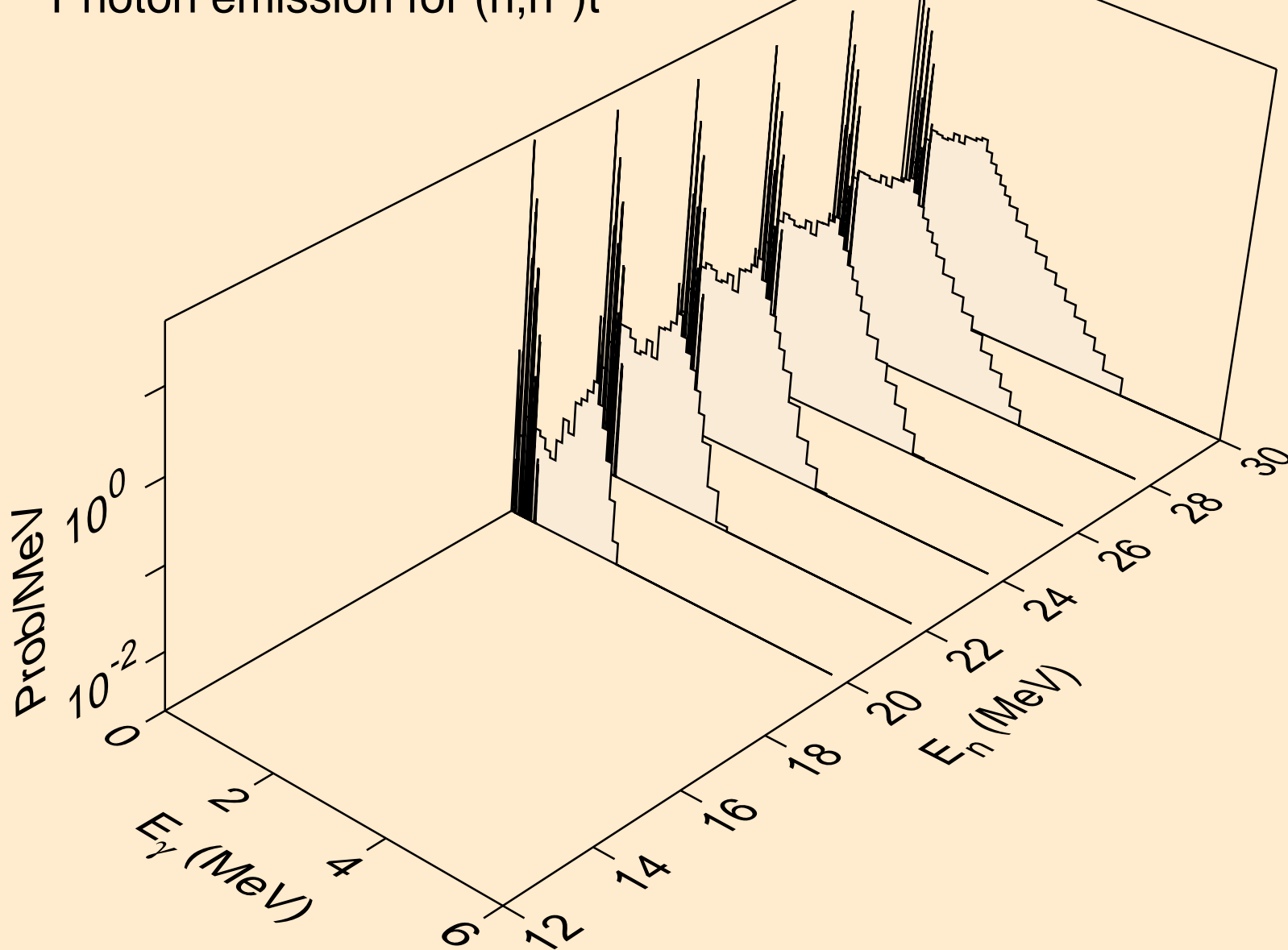

OS179 NEUTRON ACER TENDL-2019 LIBRARY; T=293.16K  
Photon emission for (n,n\*)he3

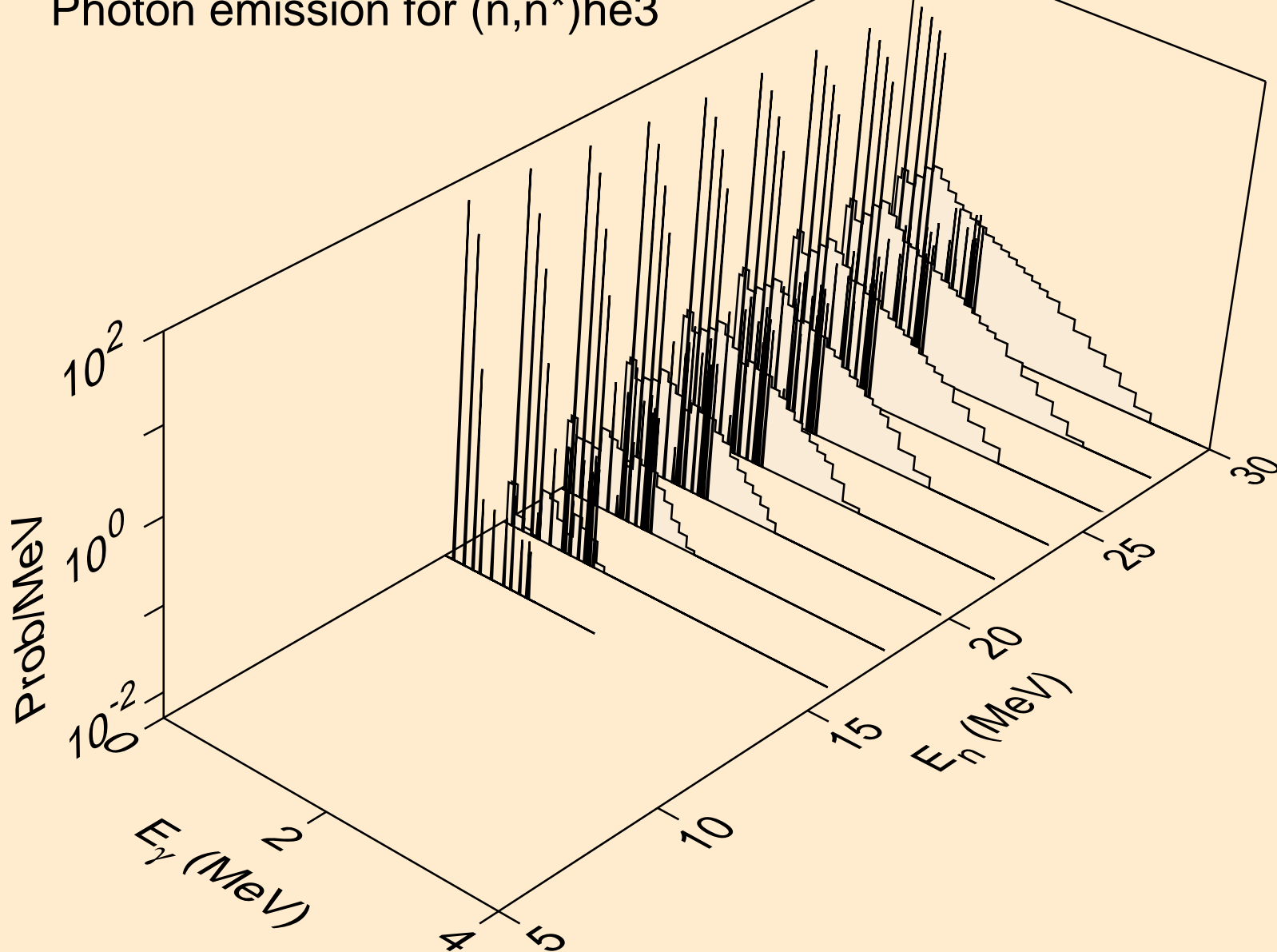

OS179 NEUTRON ACER TENDL-2019 LIBRARY; T=293.16K  
Photon emission for (n,4n)

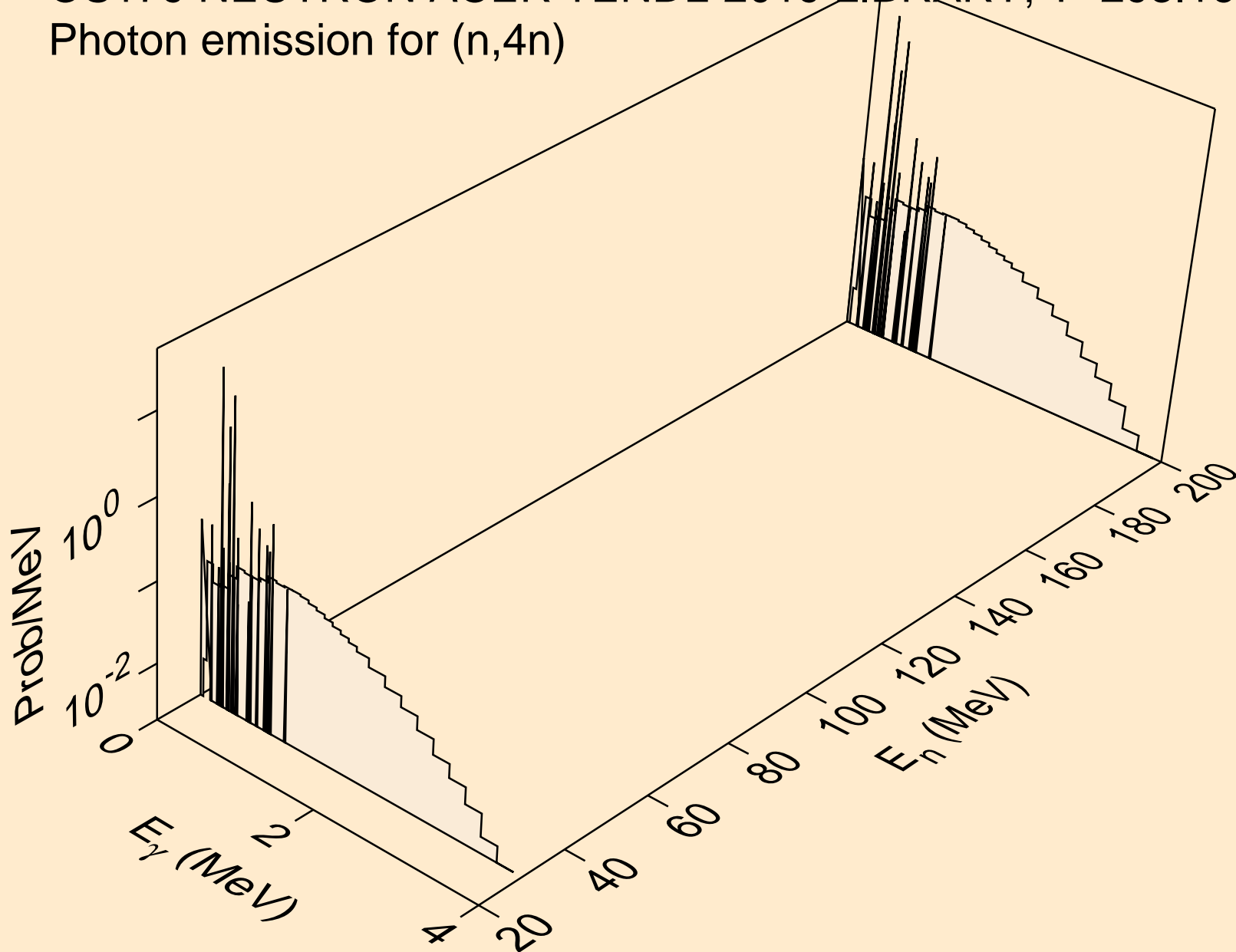

OS179 NEUTRON ACER TENDL-2019 LIBRARY; T=293.16K  
Photon emission for (n,2np)

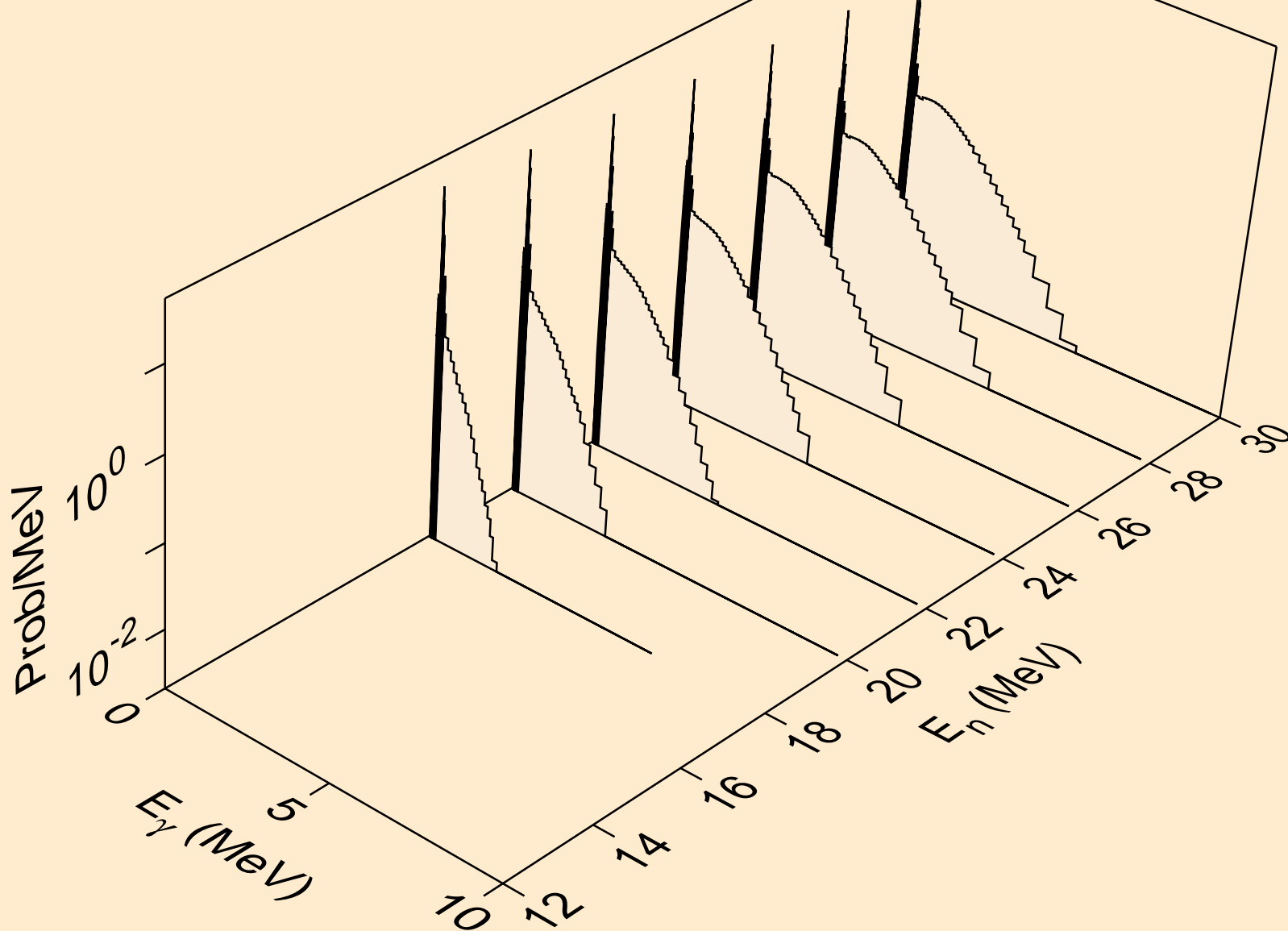

OS179 NEUTRON ACER TENDL-2019 LIBRARY; T=293.16K  
Photon emission for (n,3np)

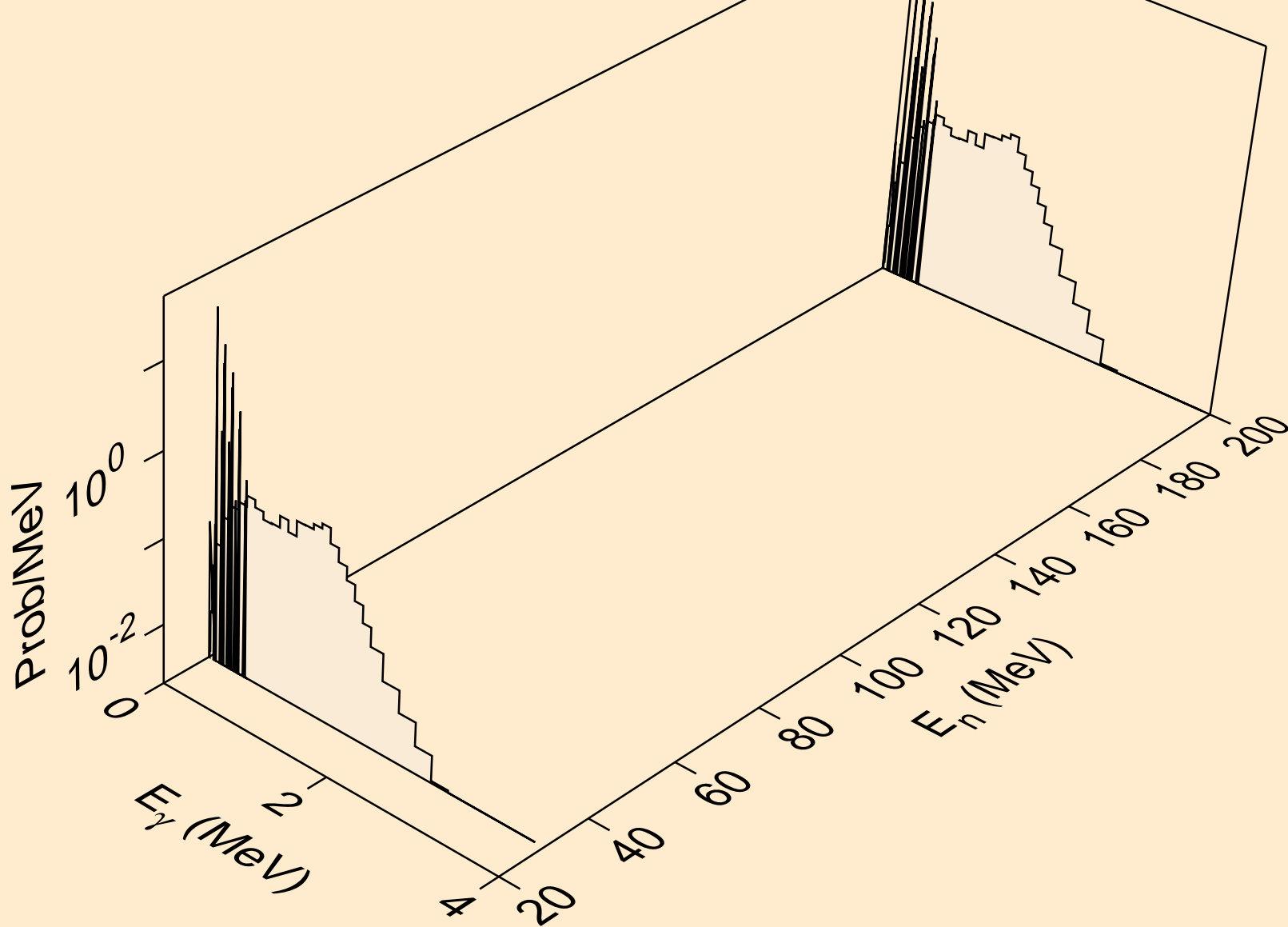



OS179 NEUTRON ACER TENDL-2019 LIBRARY; T=293.16K  
Photon emission for (n,2np)

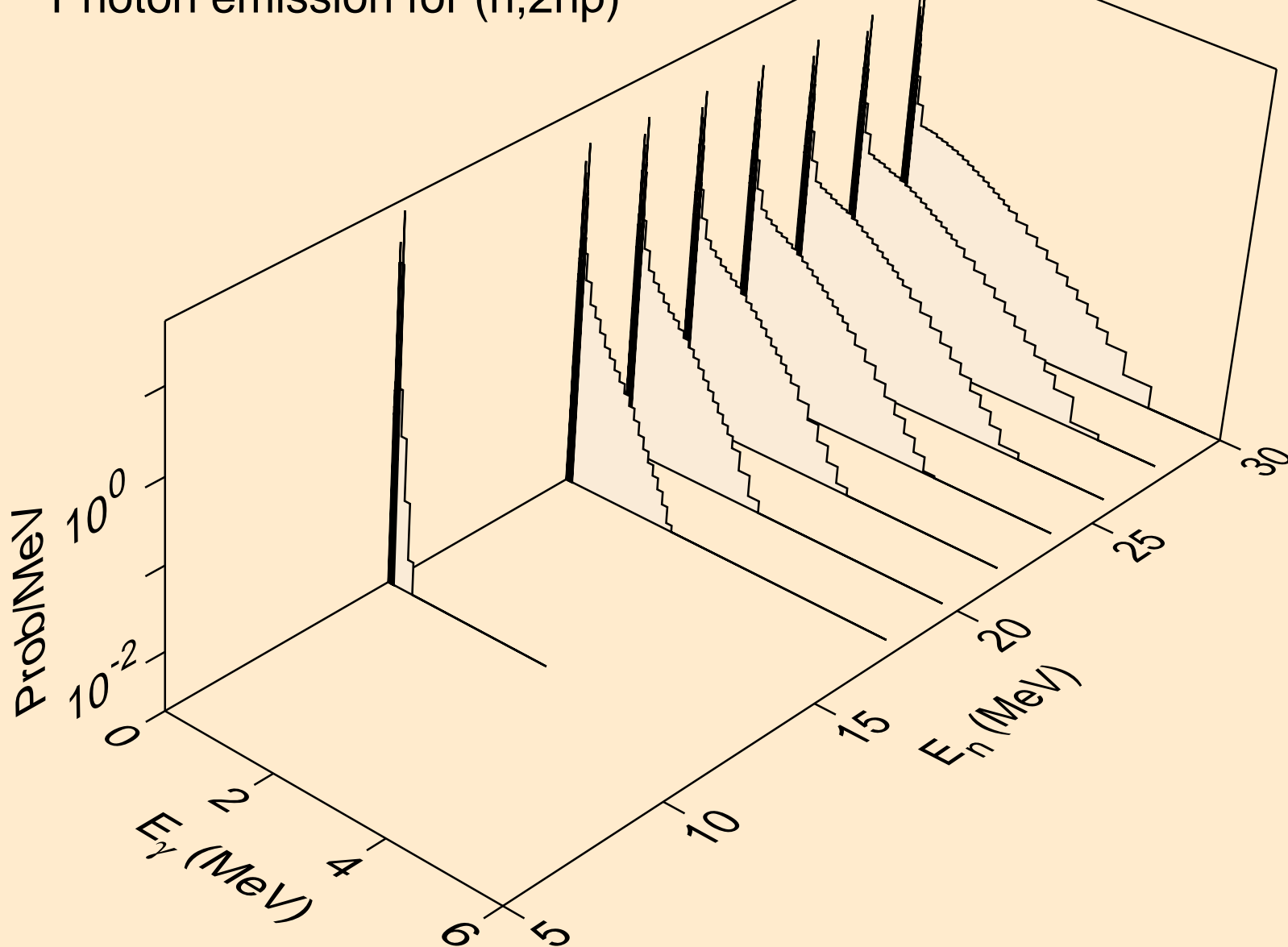

OS179 NEUTRON ACER TENDL-2019 LIBRARY; T=293.16K  
Photon emission for (n,npa)

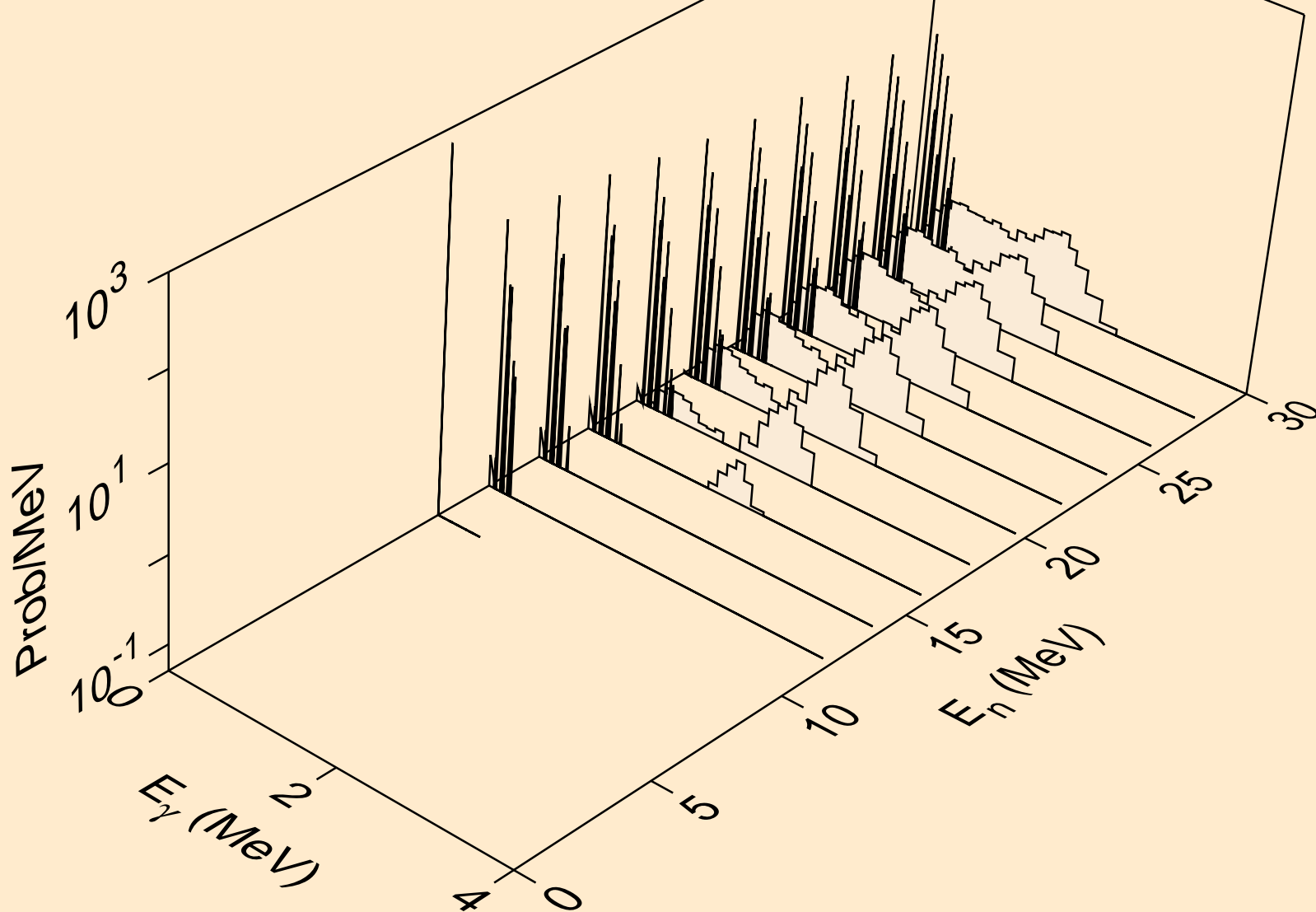

OS179 NEUTRON ACER TENDL-2019 LIBRARY; T=293.16K  
Photon emission for (n,n\*c)

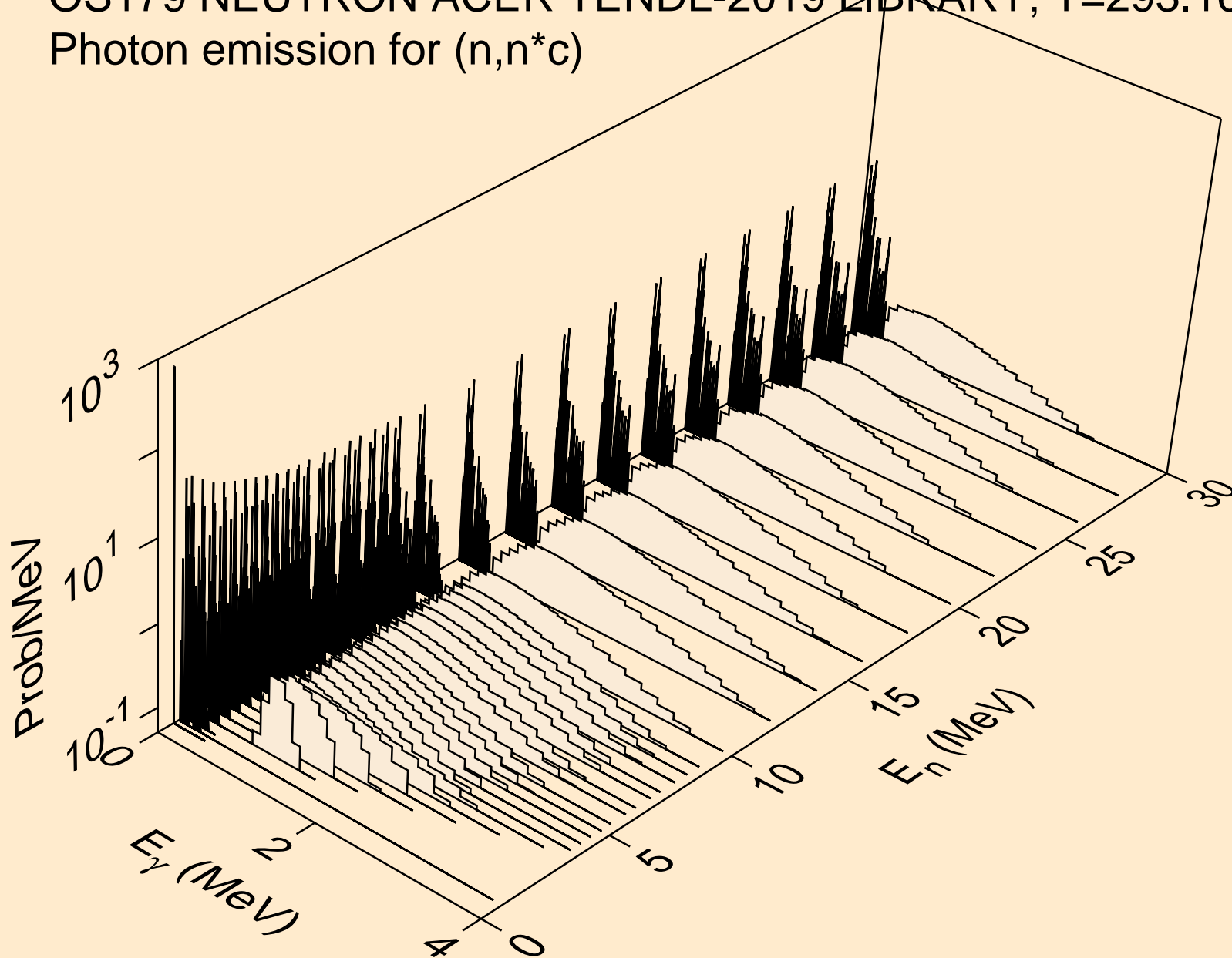

OS179 NEUTRON ACER TENDL-2019 LIBRARY; T=293.16K  
Photon emission for (n,gma)

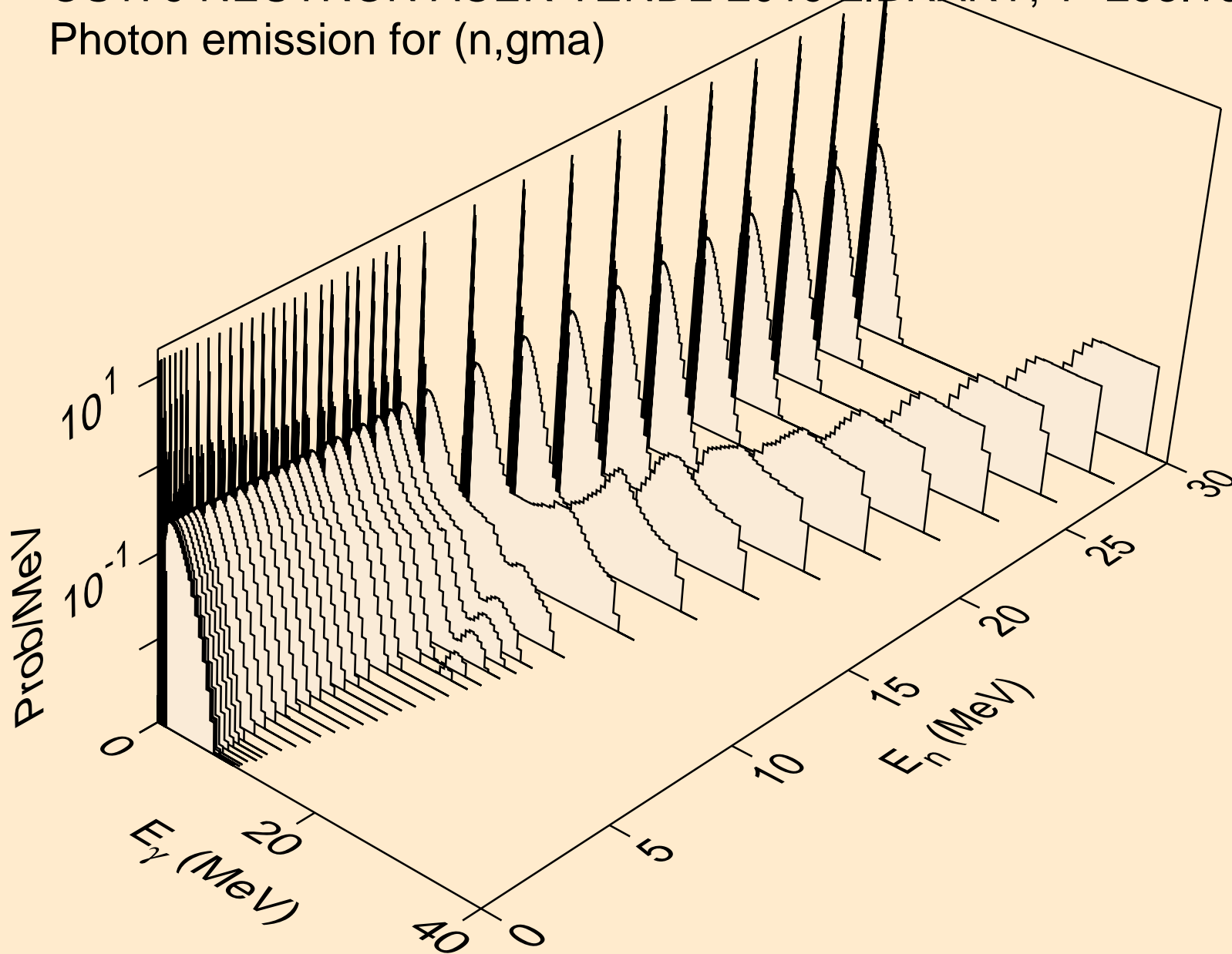

OS179 NEUTRON ACER TENDL-2019 LIBRARY; T=293.16K  
Photon emission for (n,p)

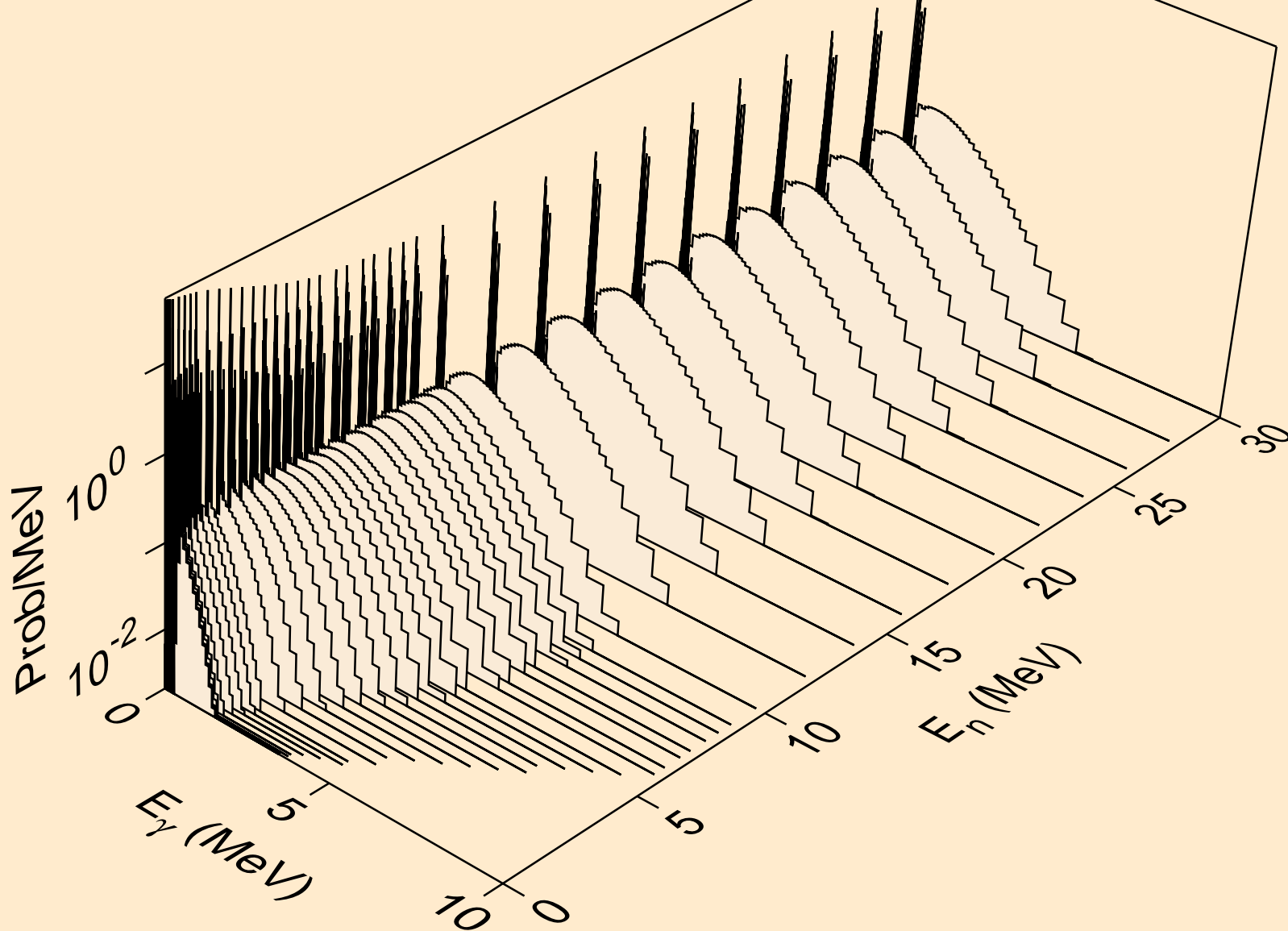

OS179 NEUTRON ACER TENDL-2019 LIBRARY; T=293.16K  
Photon emission for (n,d)

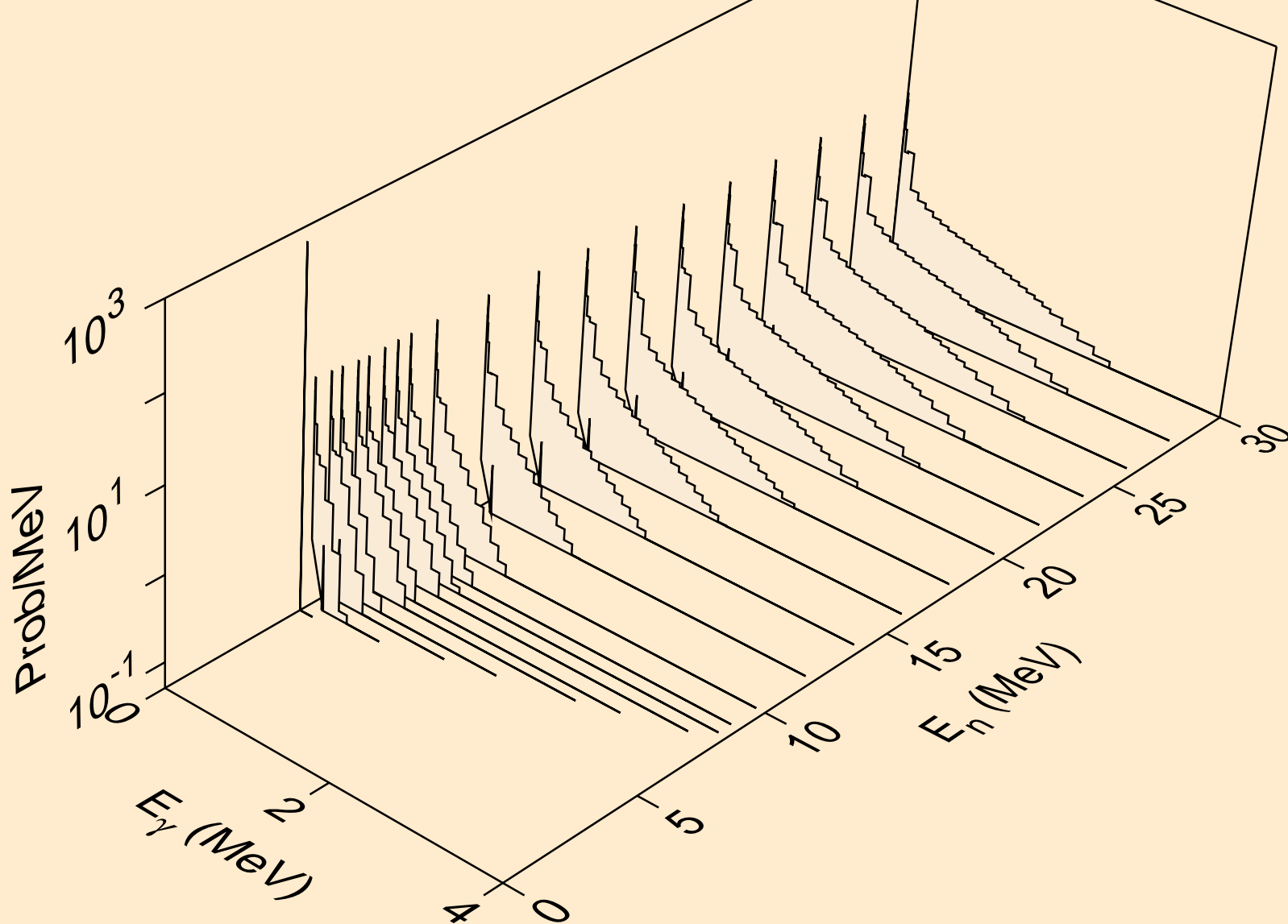

OS179 NEUTRON ACER TENDL-2019 LIBRARY; T=293.16K  
Photon emission for (n,t)

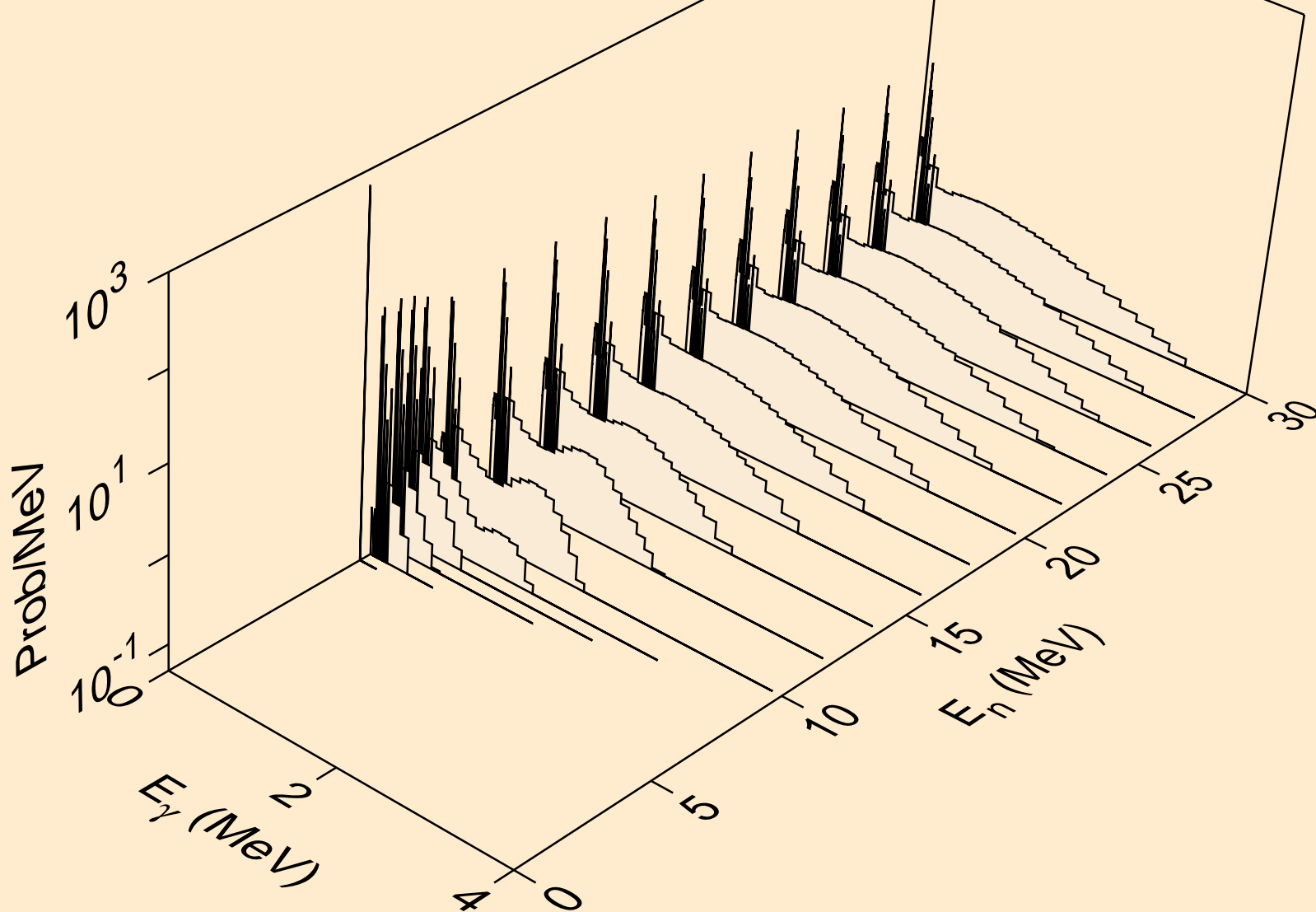

OS179 NEUTRON ACER TENDL-2019 LIBRARY; T=293.16K  
Photon emission for (n,he3)

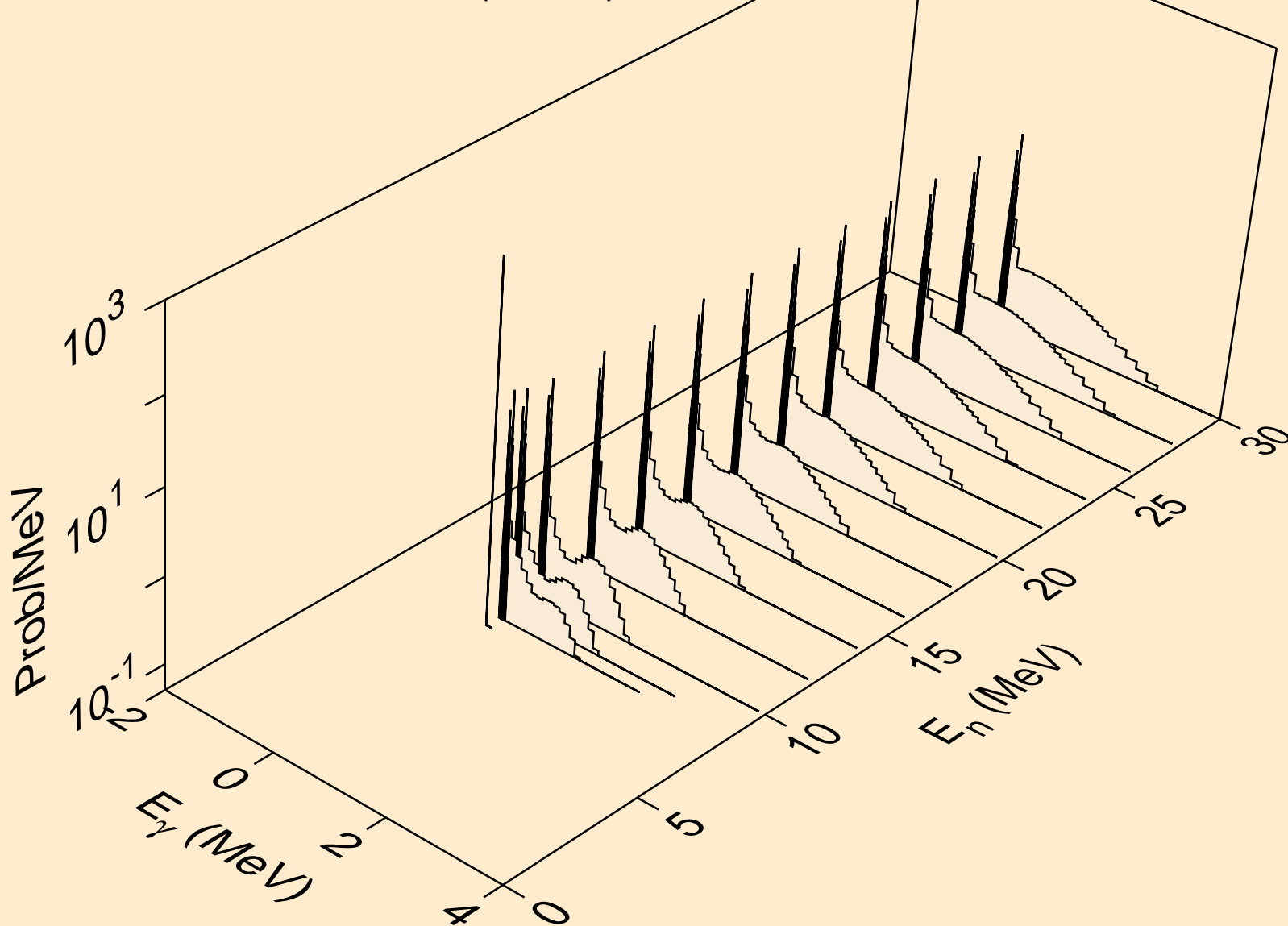



OS179 NEUTRON ACER TENDL-2019 LIBRARY; T=293.16K  
Photon emission for (n,a)

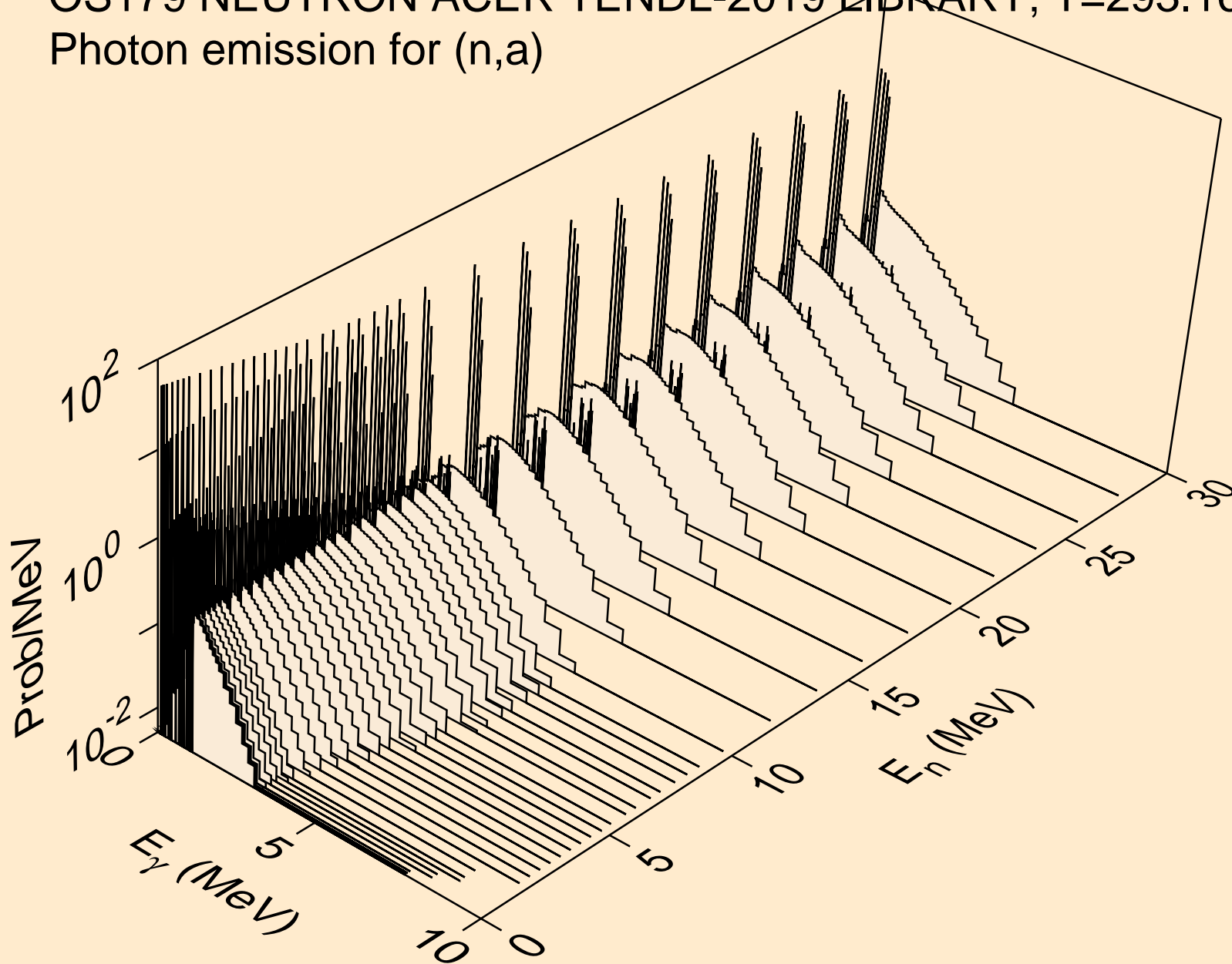

OS179 NEUTRON ACER TENDL-2019 LIBRARY; T=293.16K  
Photon emission for (n,2a)

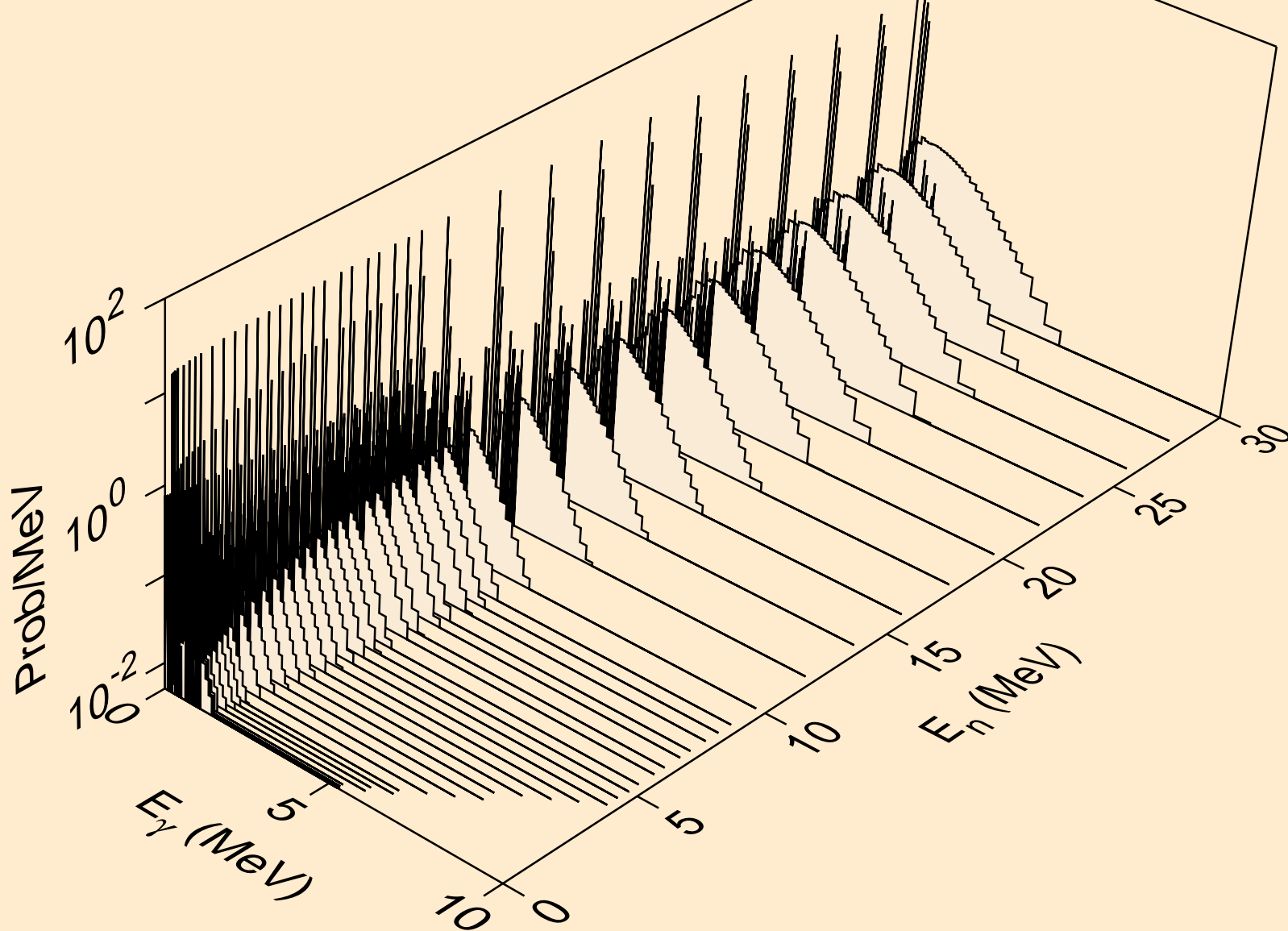

OS179 NEUTRON ACER TENDL-2019 LIBRARY; T=293.16K  
Photon emission for (n,2p)

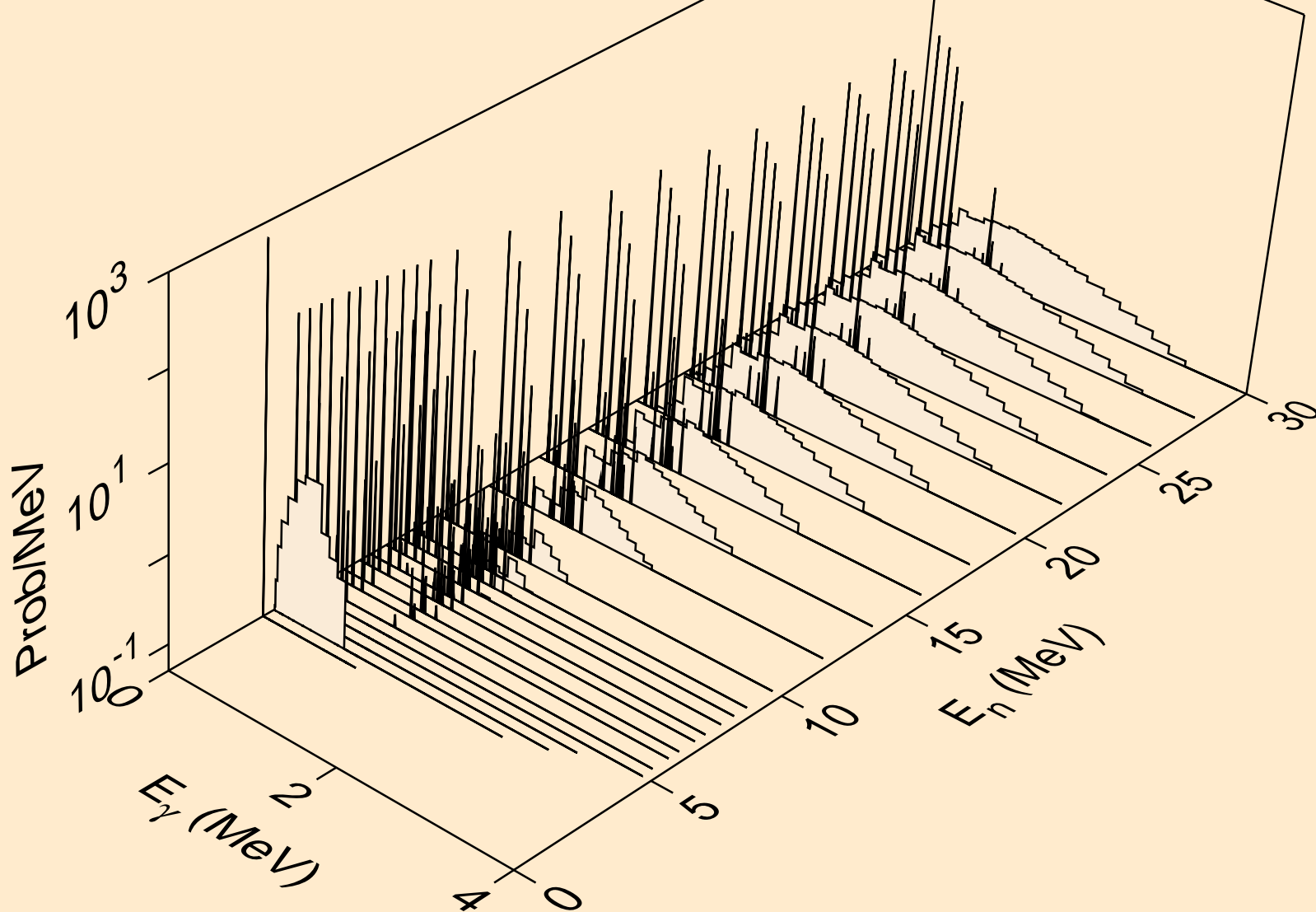

OS179 NEUTRON ACER TENDL-2019 LIBRARY; T=293.16K  
Photon emission for (n,p)

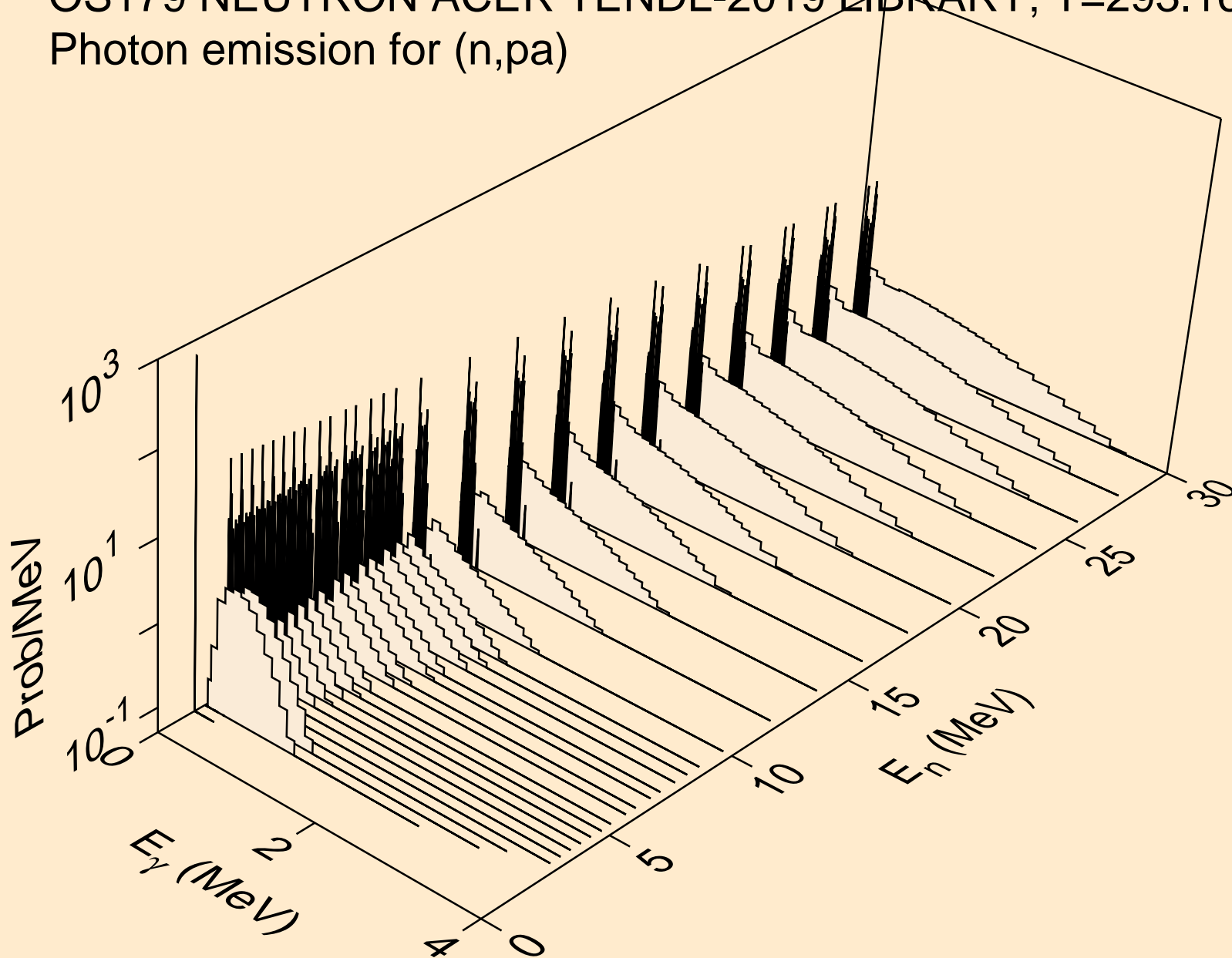

OS179 NEUTRON ACER TENDL-2019 LIBRARY; T=293.16K  
Photon emission for (n,pd)

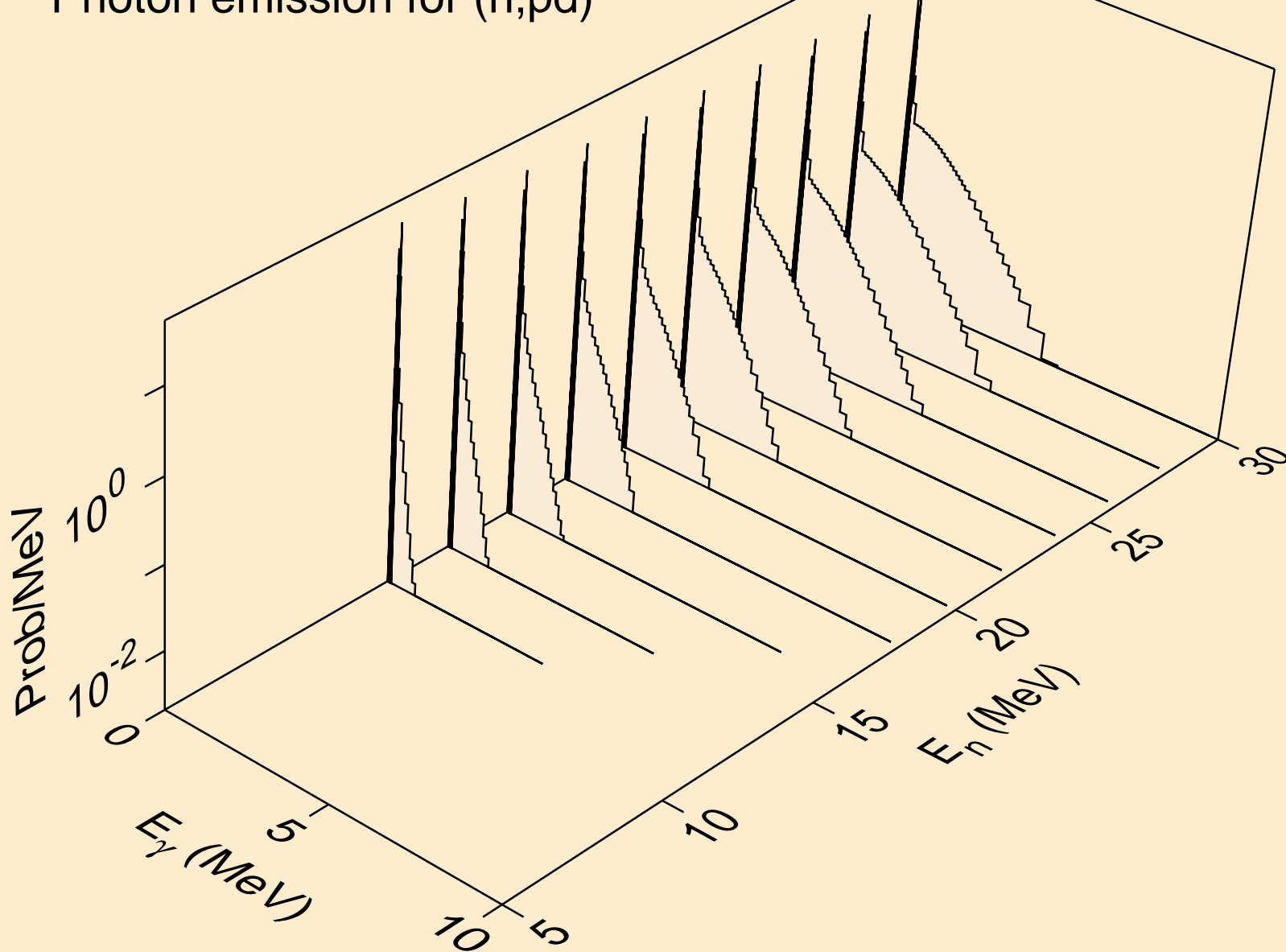

OS179 NEUTRON ACER TENDL-2019 LIBRARY; T=293.16K  
Photon emission for (n,pt)

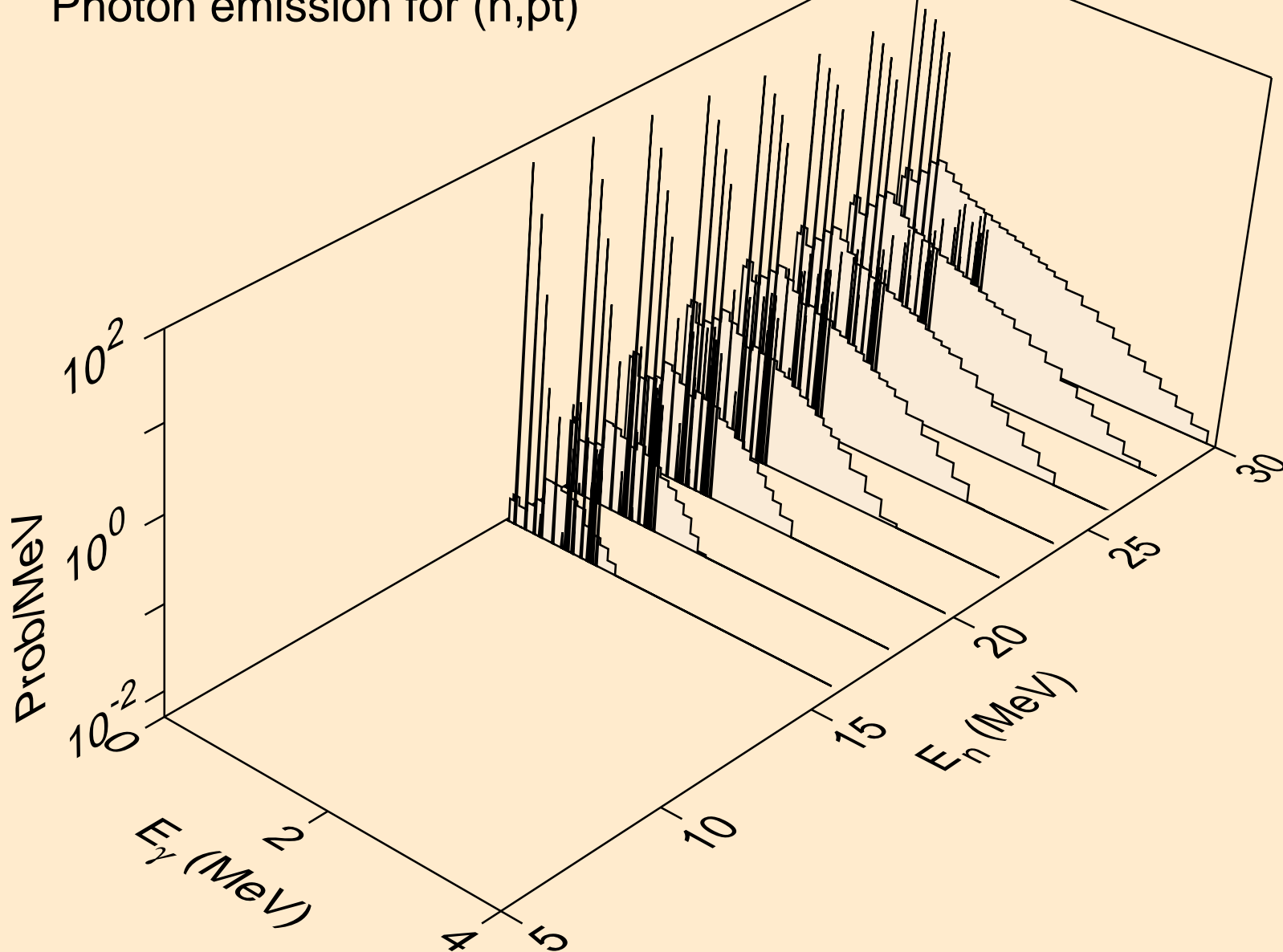

OS179 NEUTRON ACER TENDL-2019 LIBRARY; T=293.16K  
Photon emission for (n,da)

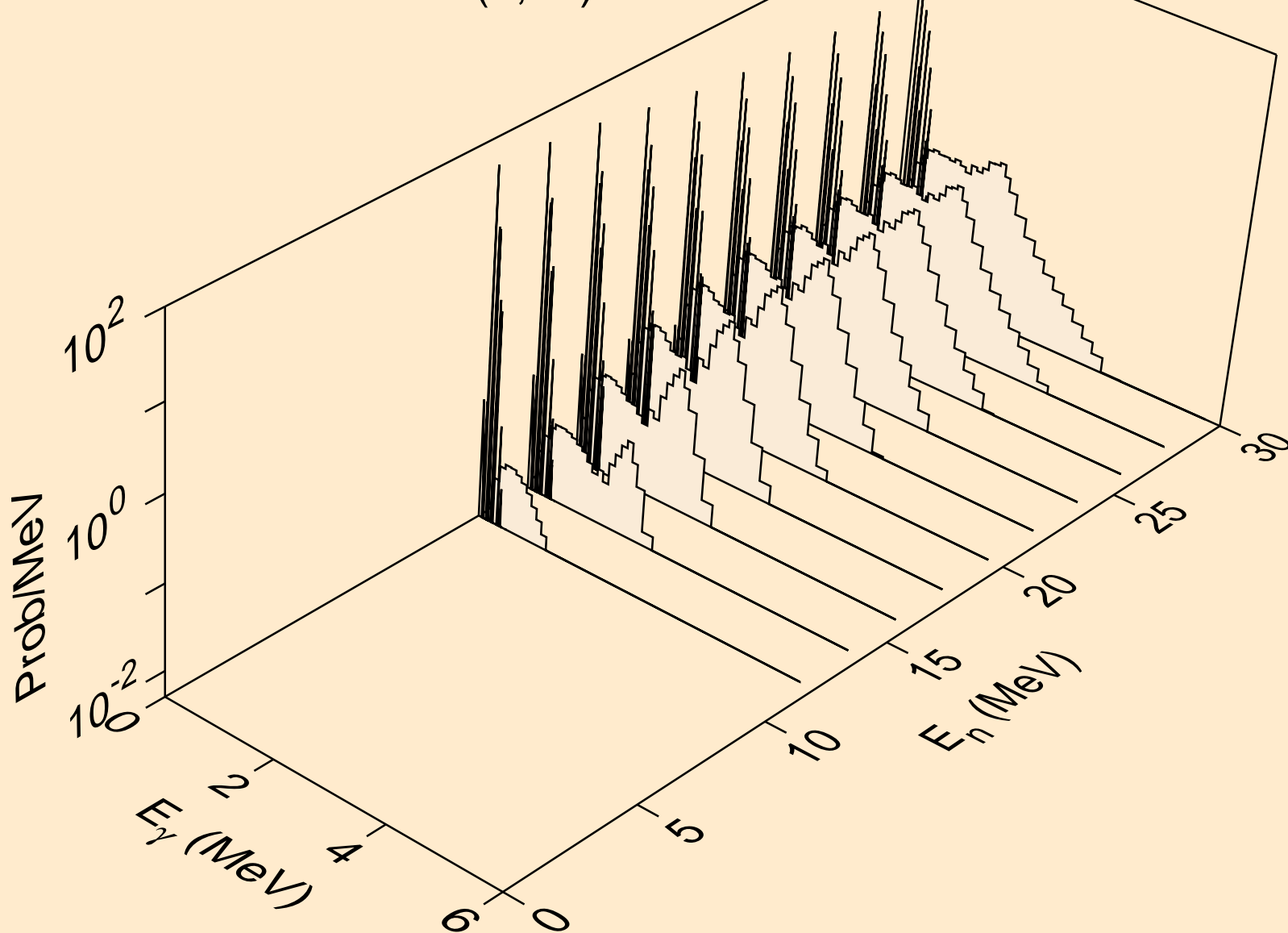

OS179 NEUTRON ACER TENDL-2019 LIBRARY; T=293.16K  
thermal capture photon spectrum

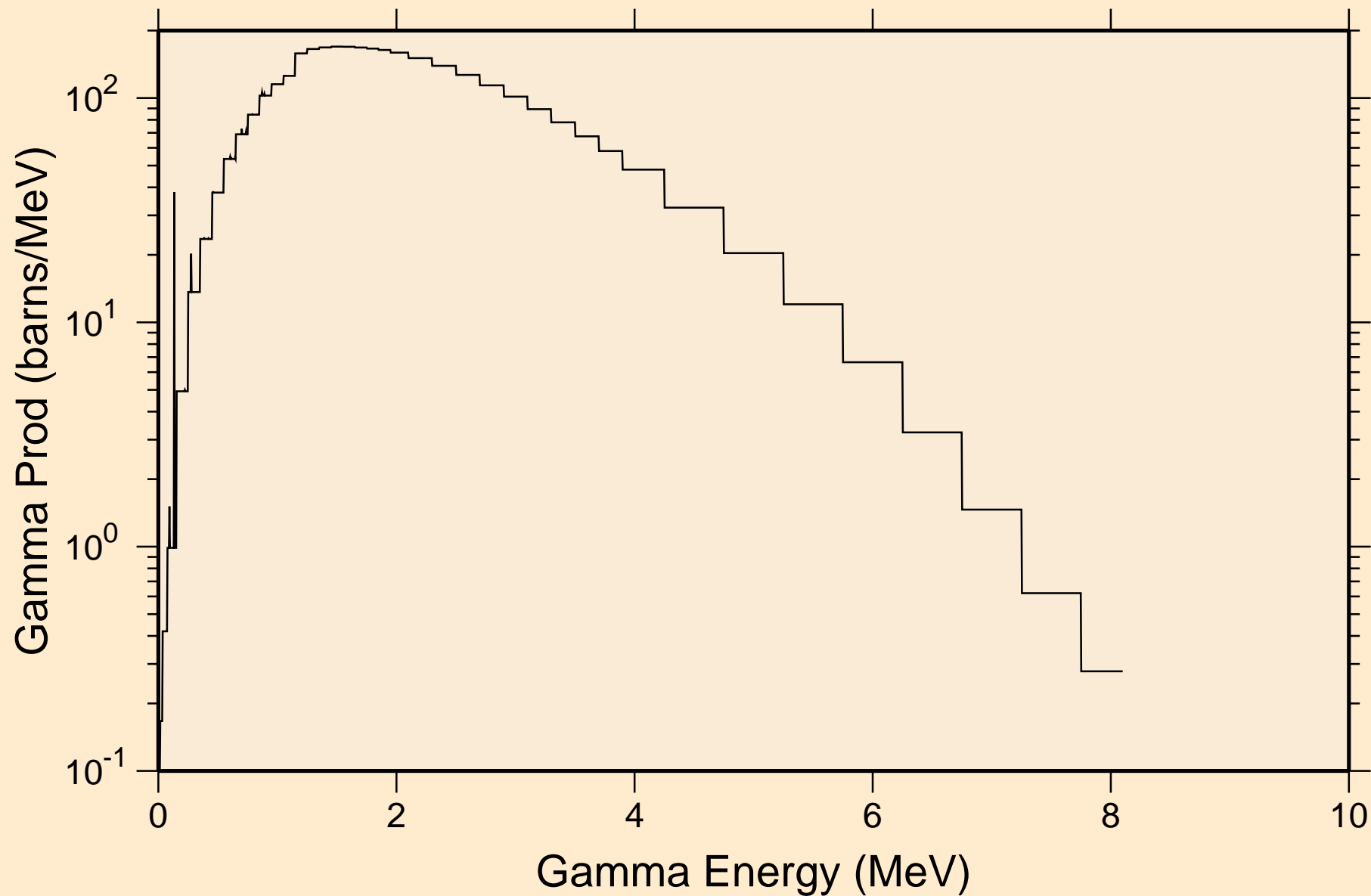



OS179 NEUTRON ACER TENDL-2019 LIBRARY; T=293.16K  
14 MeV photon spectrum

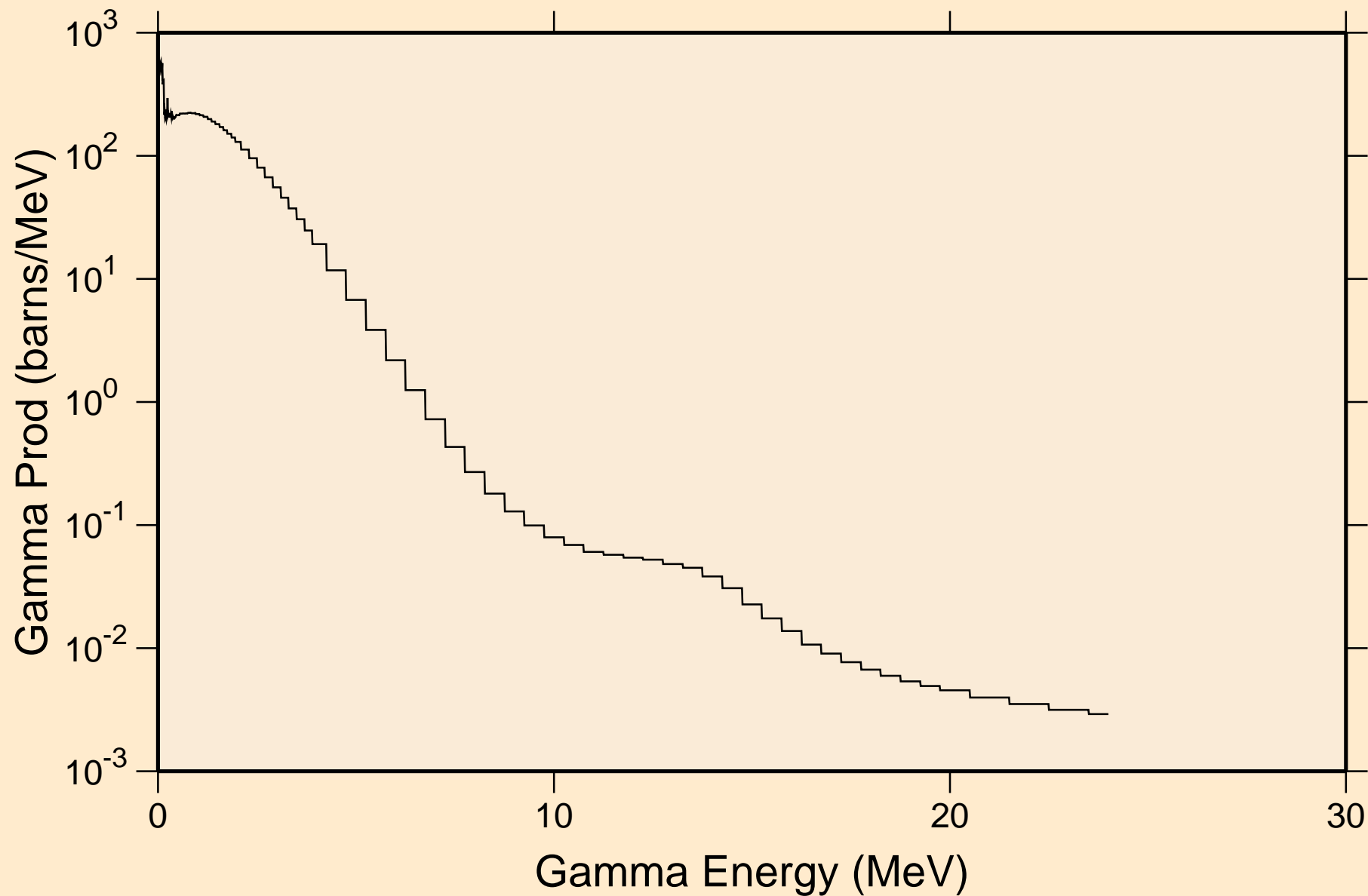

OS179 NEUTRON ACER TENDL-2019 LIBRARY; T=293.16K  
Particle heating contributions

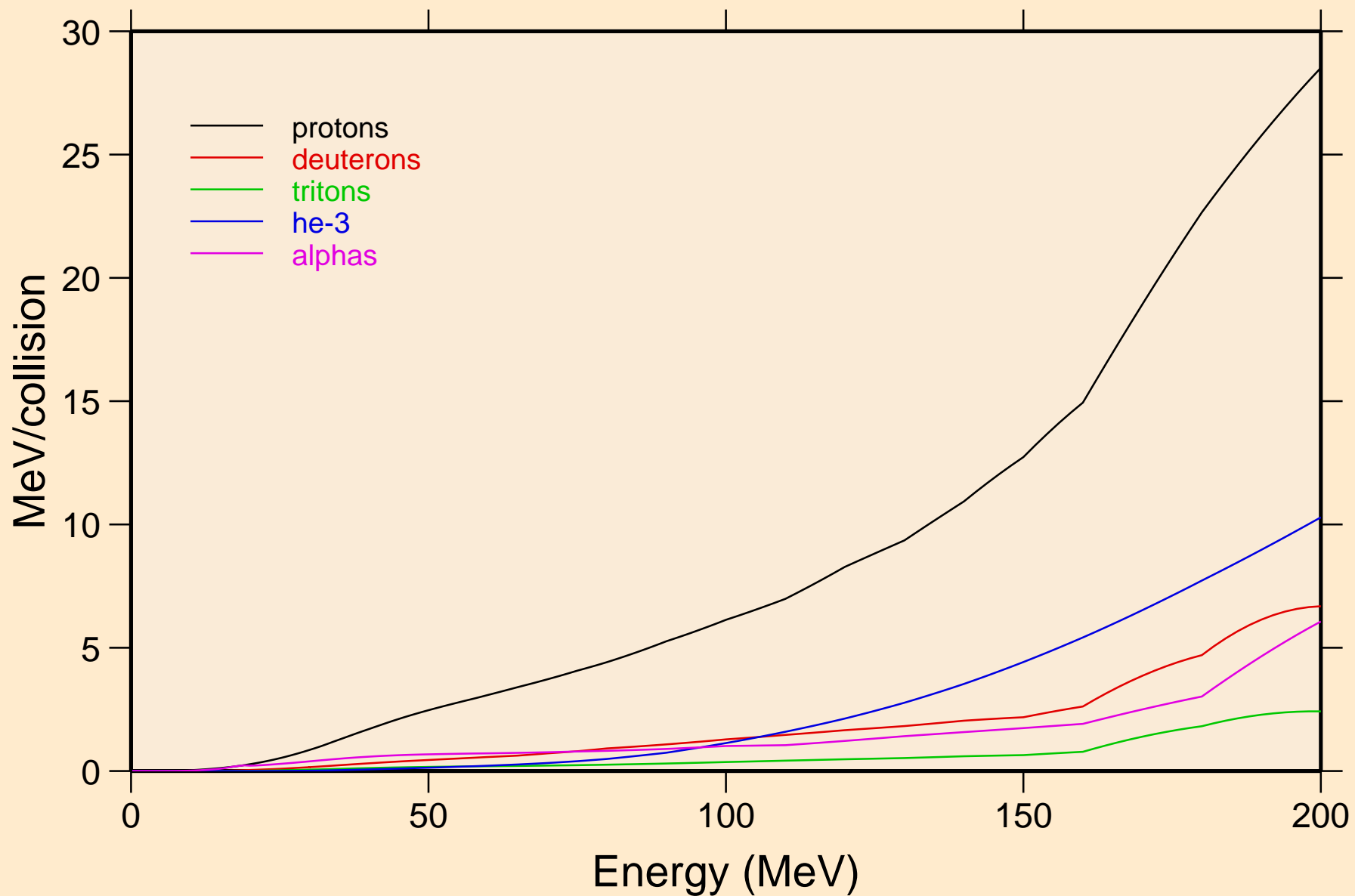

OS179 NEUTRON ACER TENDL-2019 LIBRARY; T=293.16K  
Recoil Heating

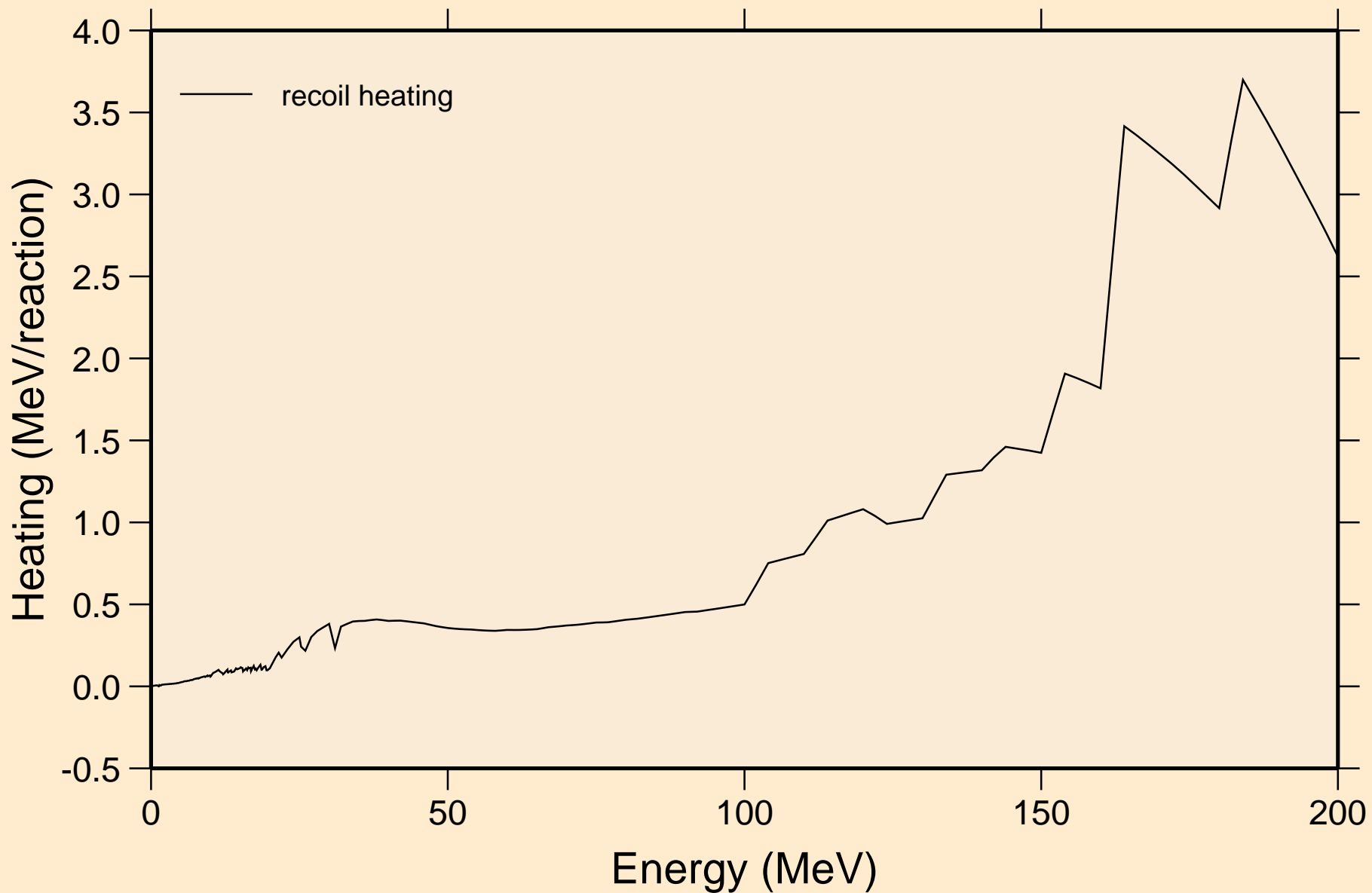

OS179 NEUTRON ACER TENDL-2019 LIBRARY; T=293.16K  
Particle production cross sections

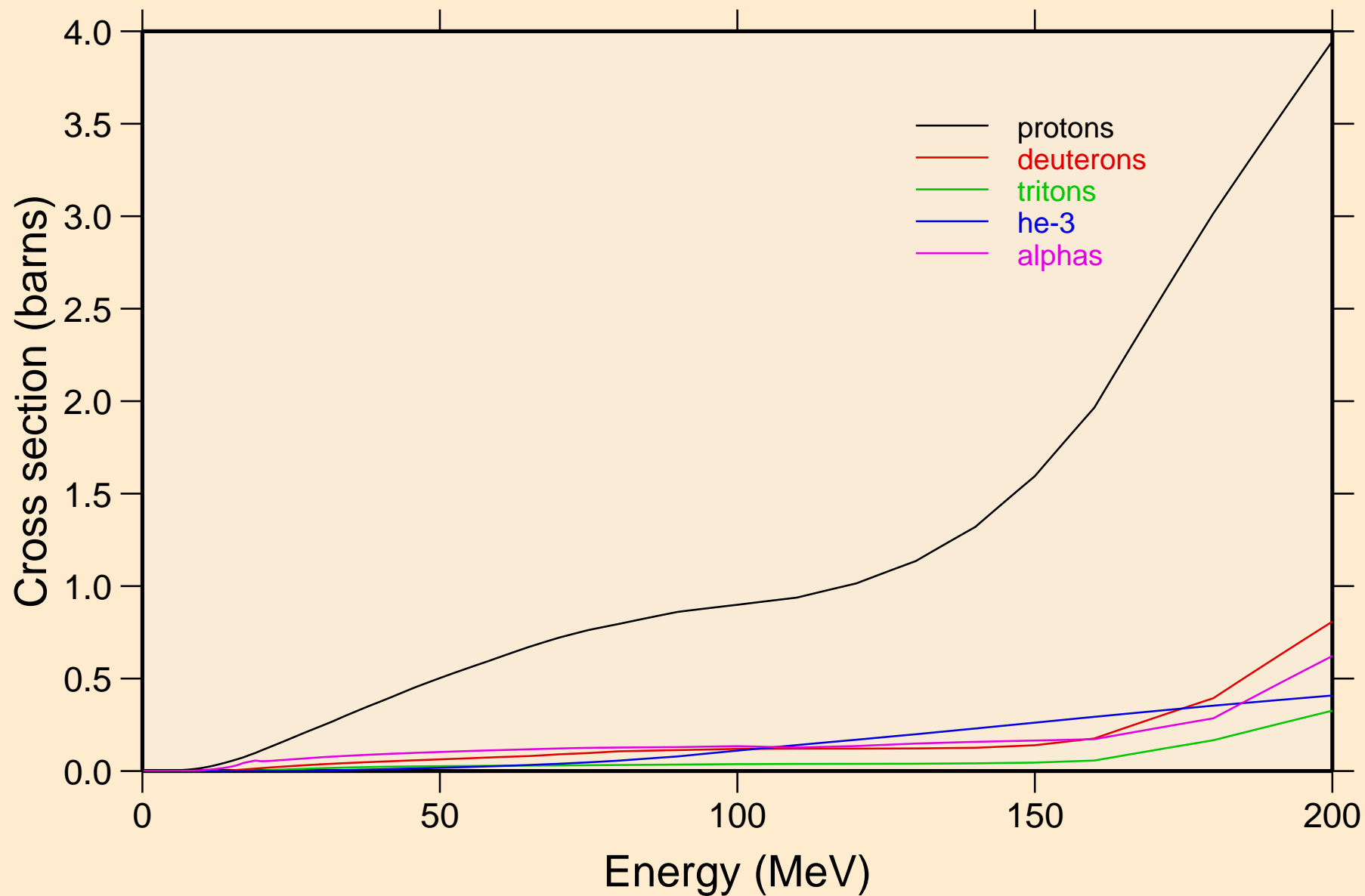

OS179 NEUTRON ACER TENDL-2019 LIBRARY; T=293.16K  
protons from (n,x)

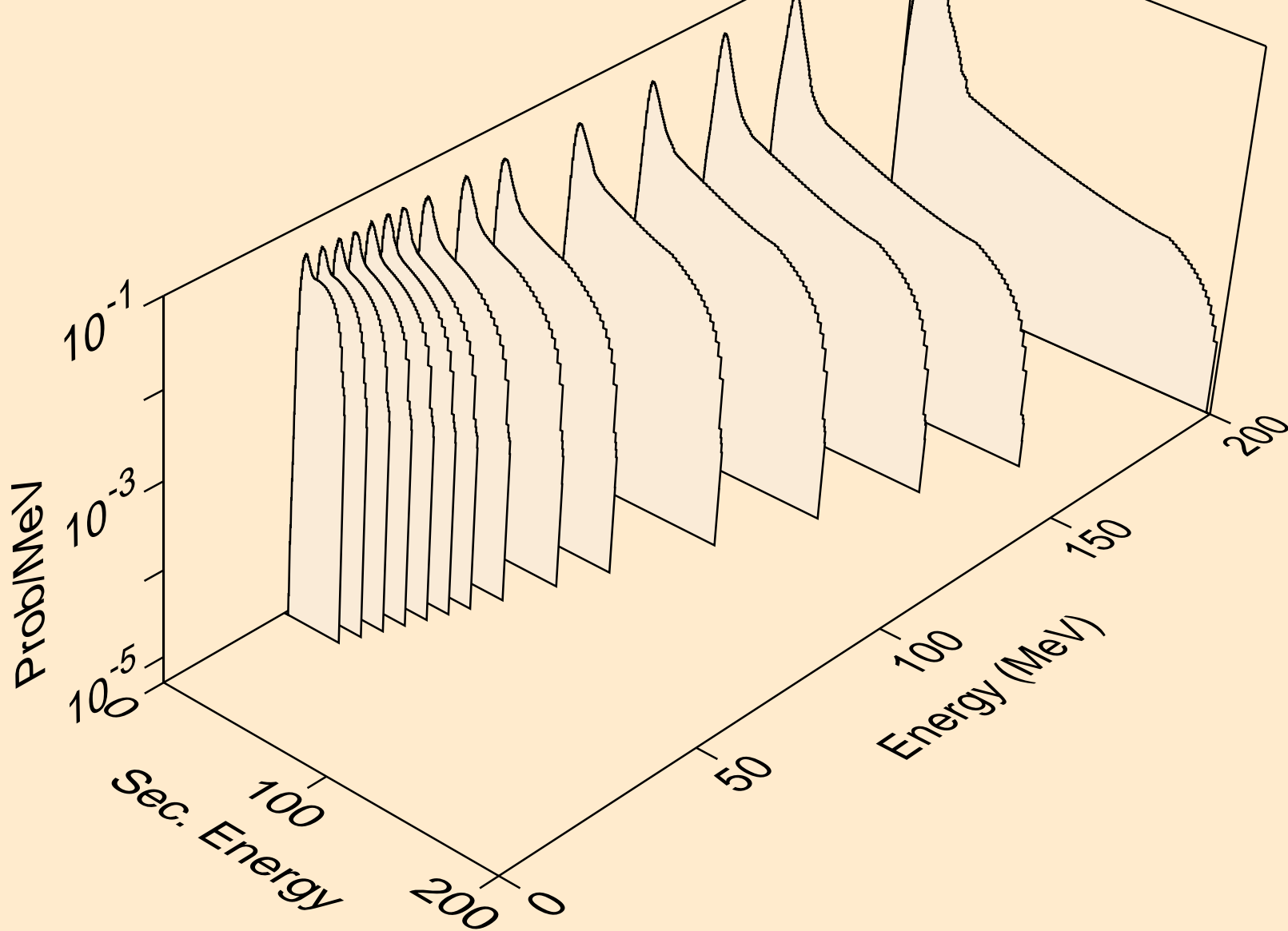

OS179 NEUTRON ACER TENDL-2019 LIBRARY; T=293.16K  
protons from (n,n\*)p

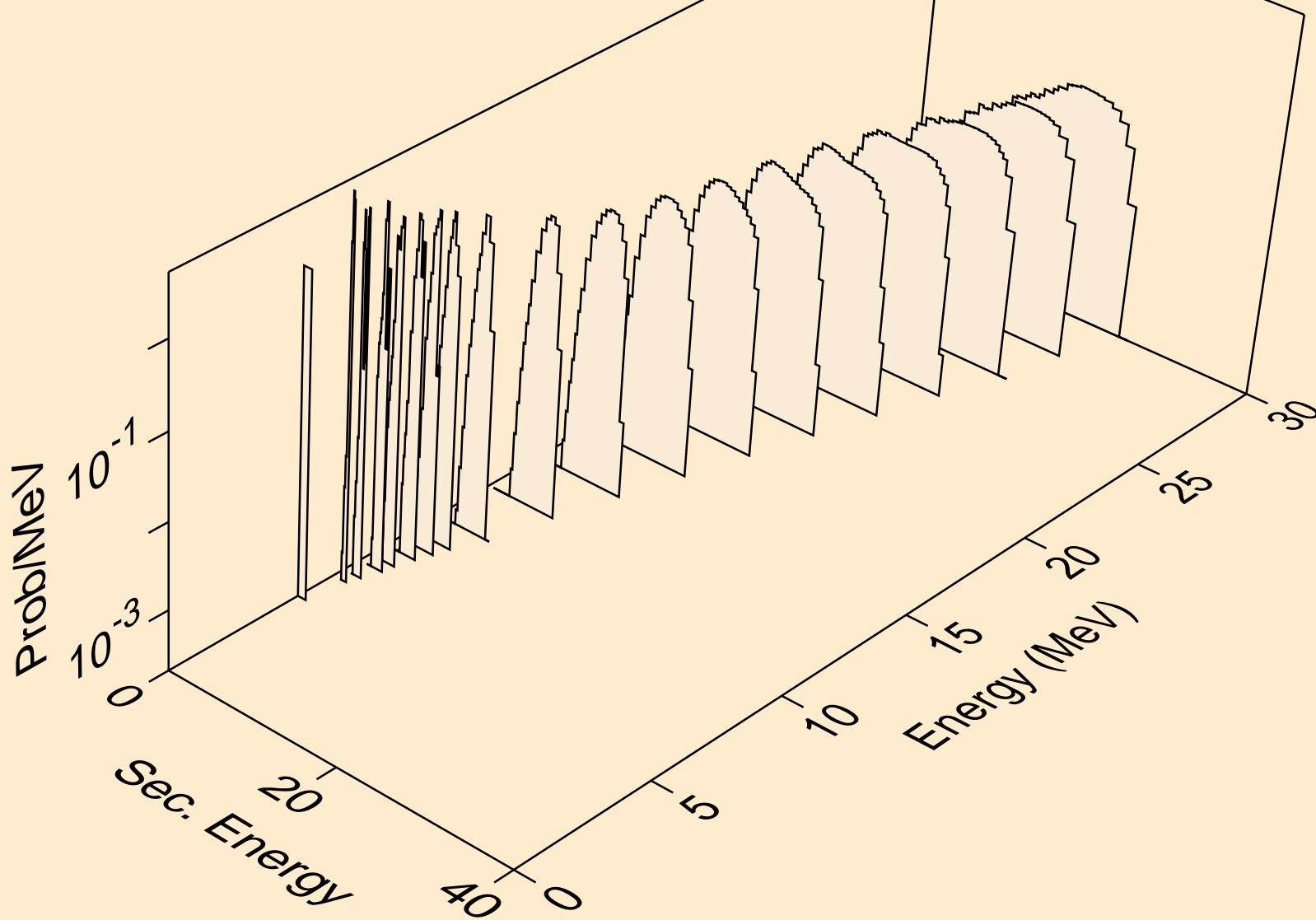

OS179 NEUTRON ACER TENDL-2019 LIBRARY; T=293.16K  
protons from (n,2np)

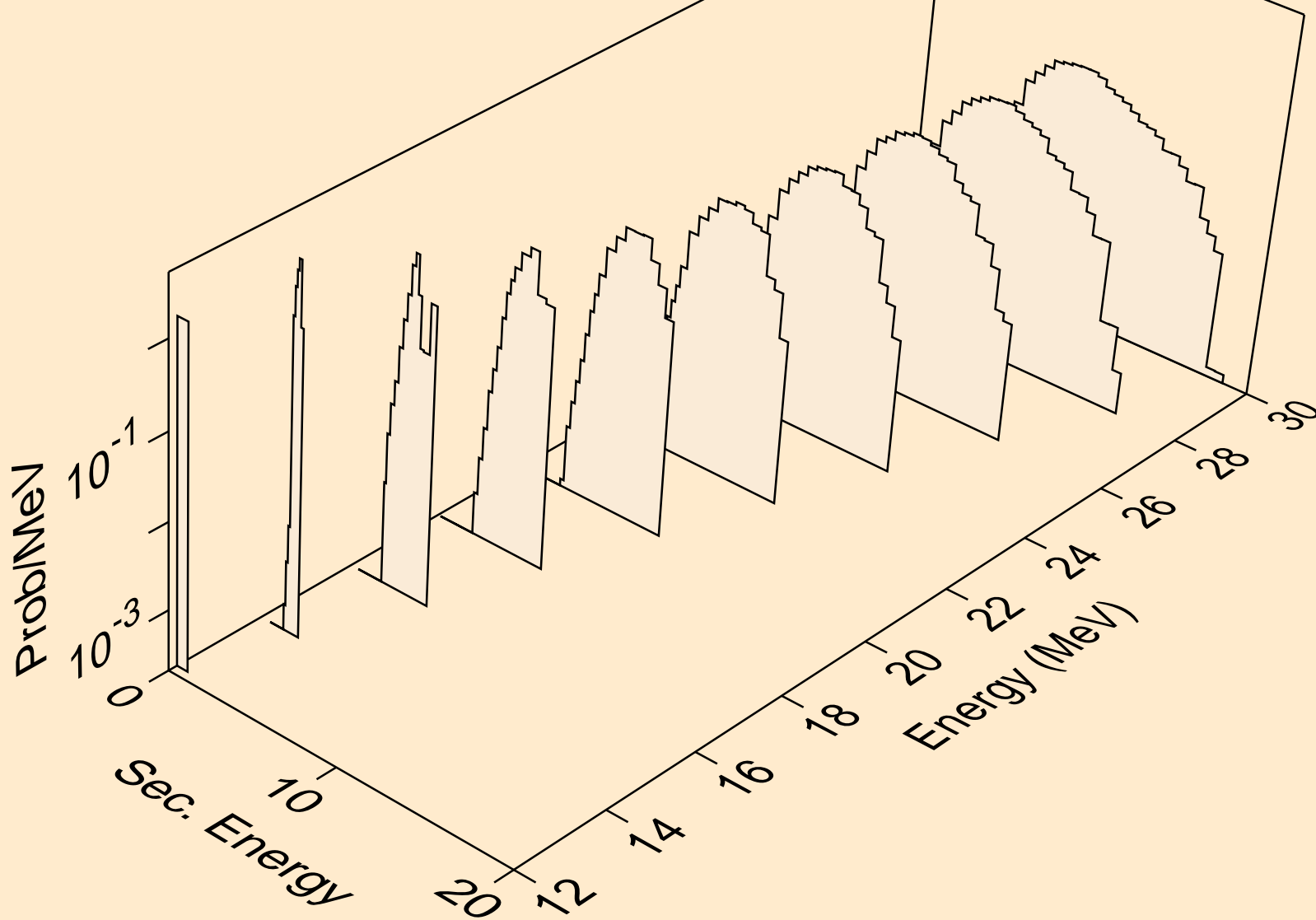

OS179 NEUTRON ACER TENDL-2019 LIBRARY; T=293.16K  
protons from (n,3np)

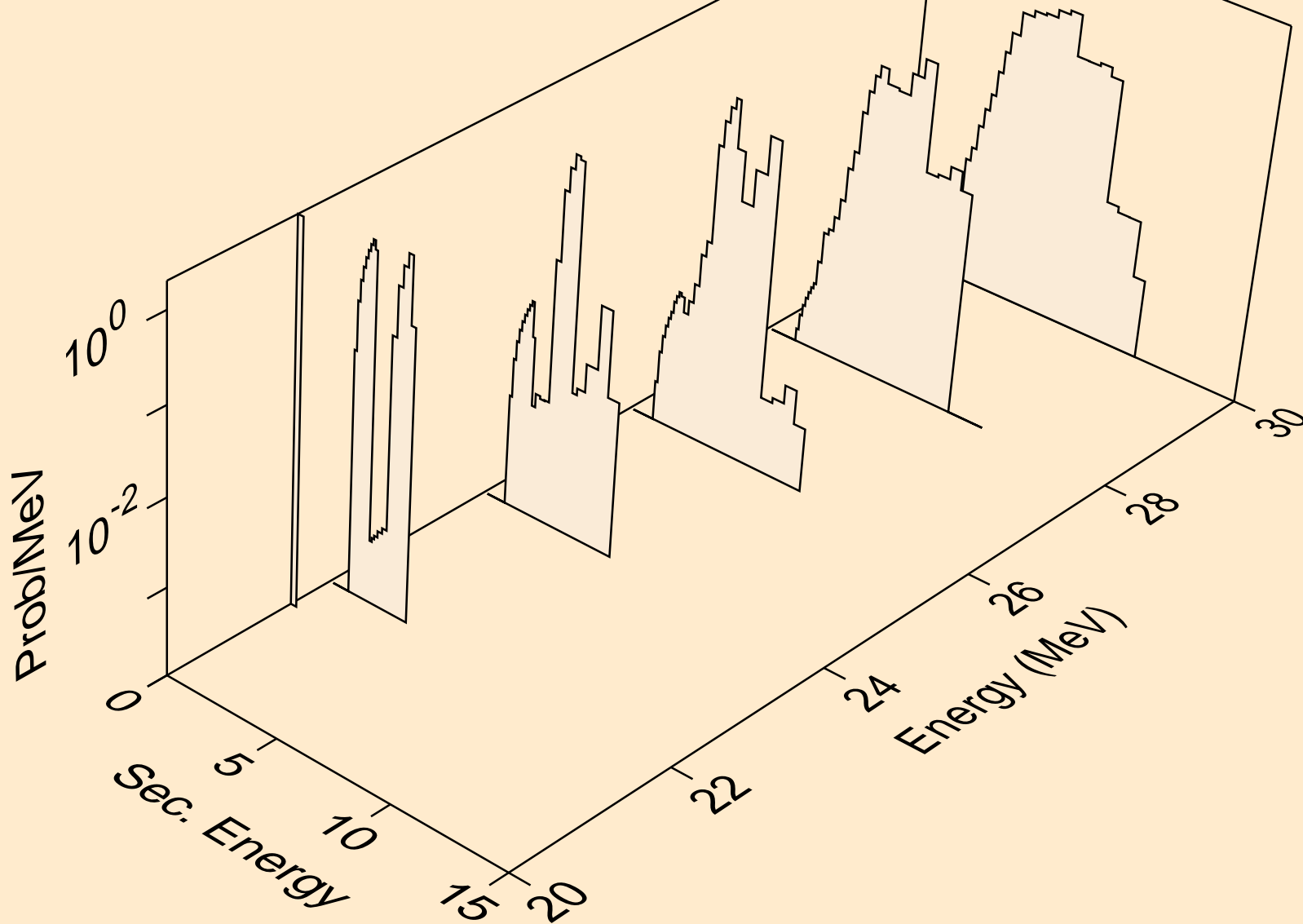



OS179 NEUTRON ACER TENDL-2019 LIBRARY; T=293.16K  
protons from (n,2np)

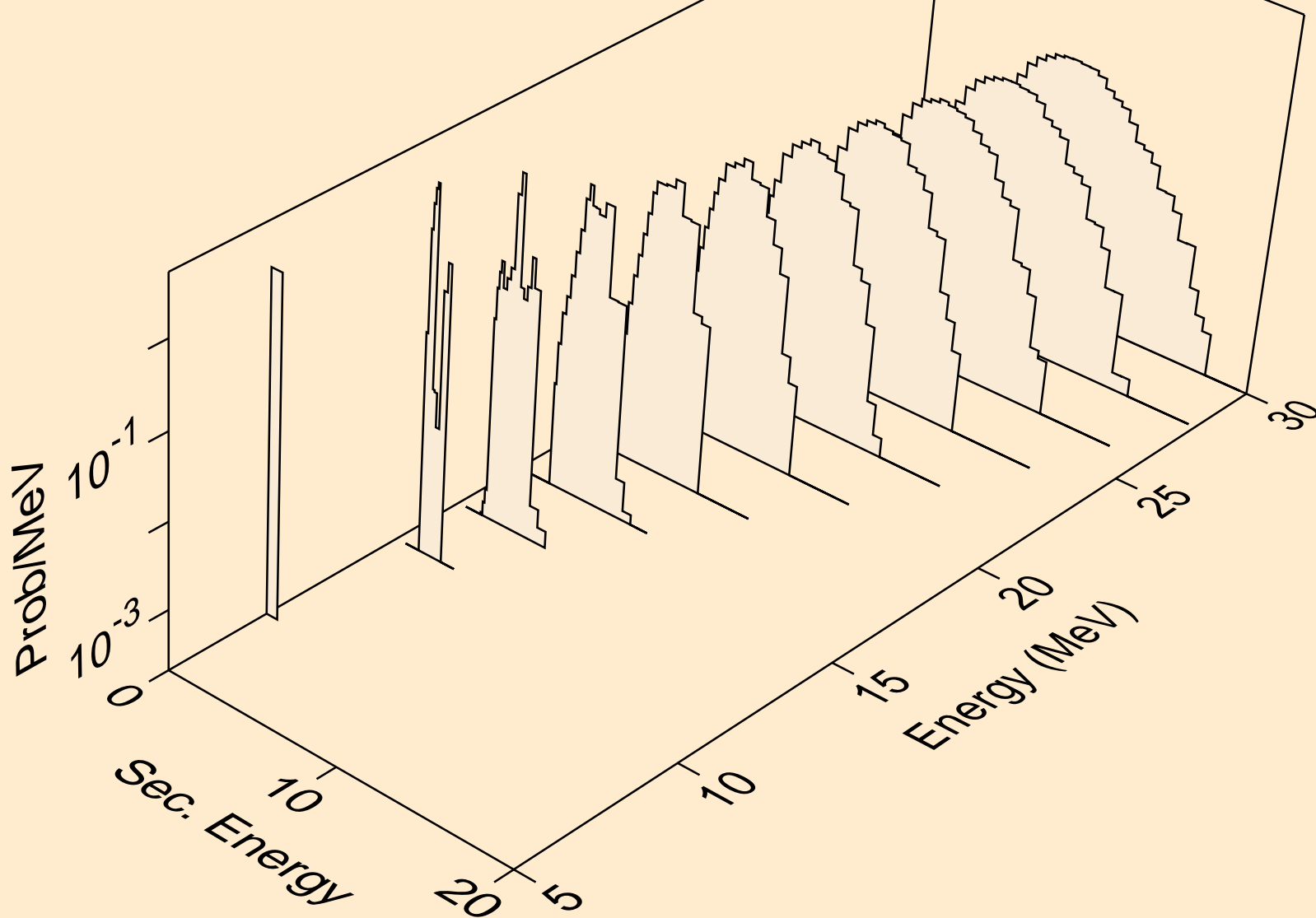

OS179 NEUTRON ACER TENDL-2019 LIBRARY; T=293.16K  
protons from (n,npa)

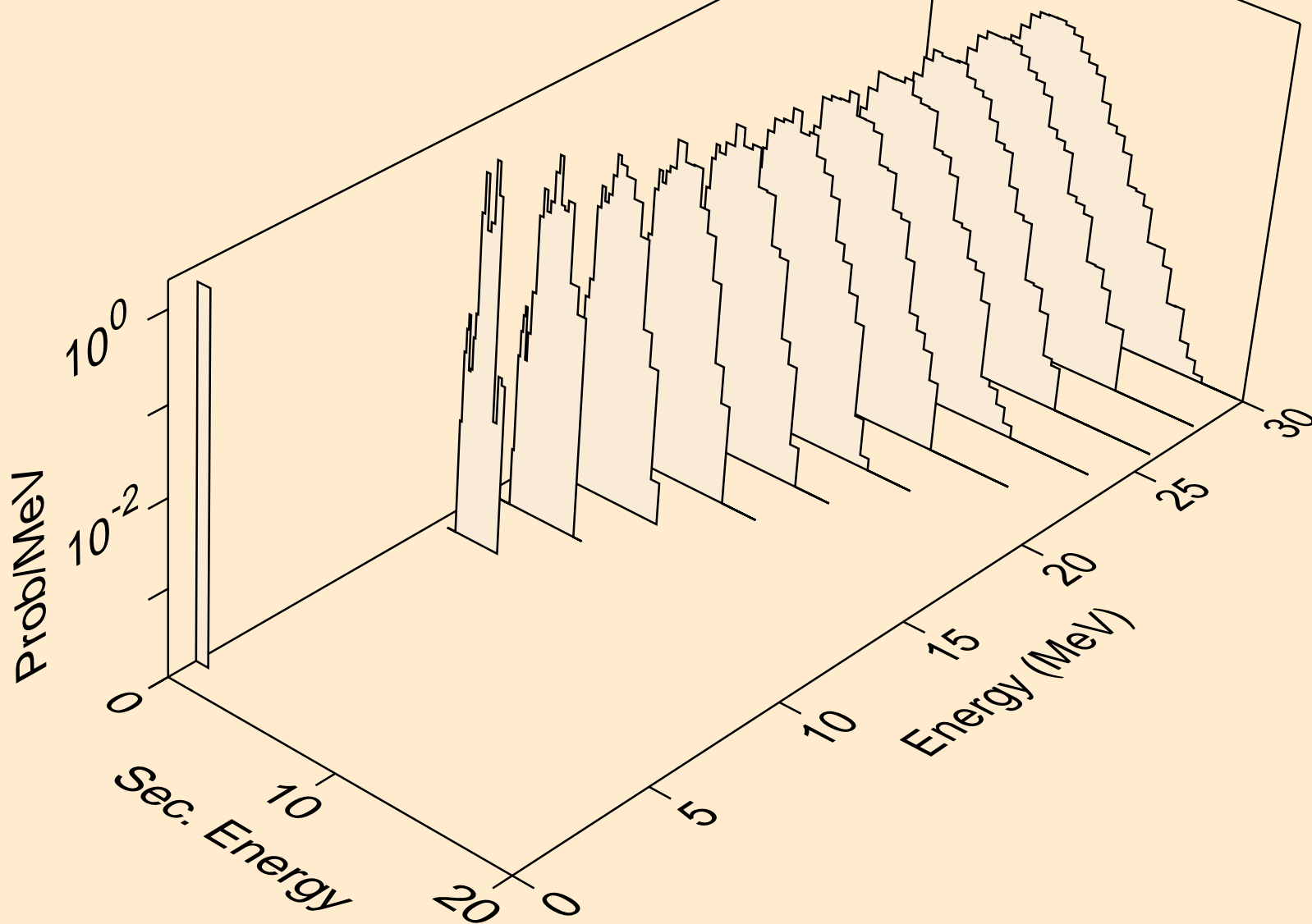

OS179 NEUTRON ACER TENDL-2019 LIBRARY; T=293.16K  
protons from (n,p)

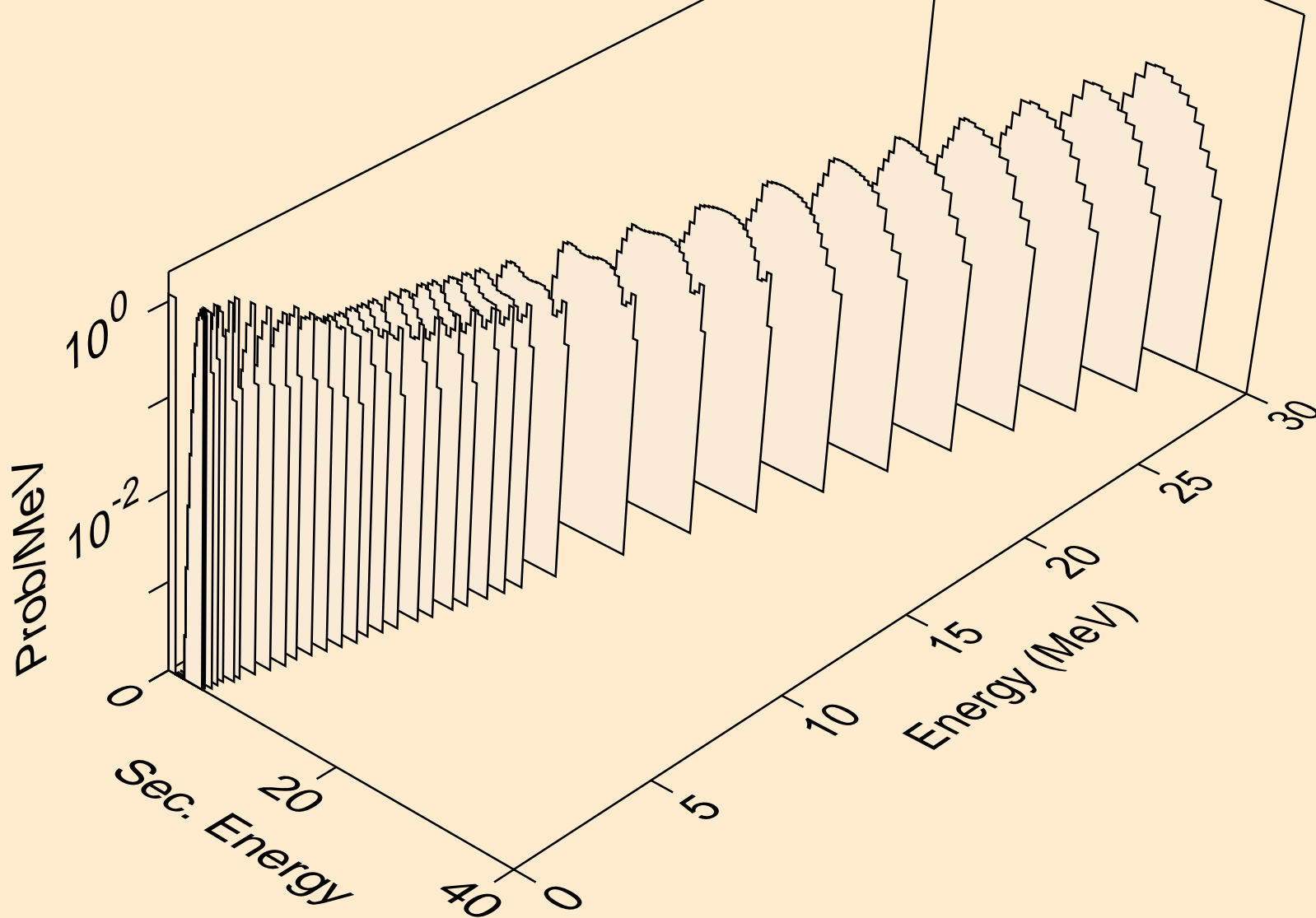

OS179 NEUTRON ACER TENDL-2019 LIBRARY; T=293.16K  
protons from (n,2p)

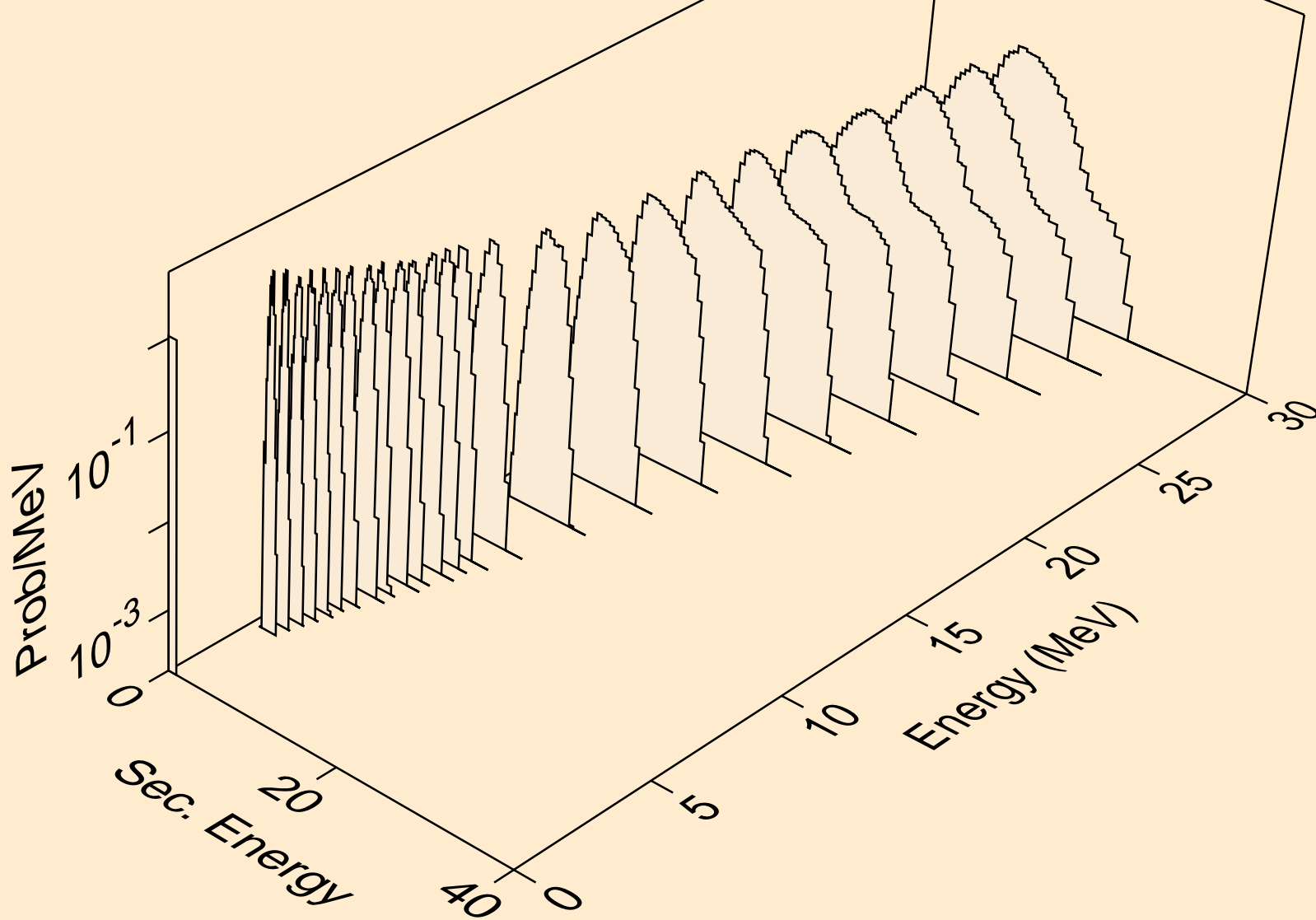

OS179 NEUTRON ACER TENDL-2019 LIBRARY; T=293.16K  
protons from (n,p)

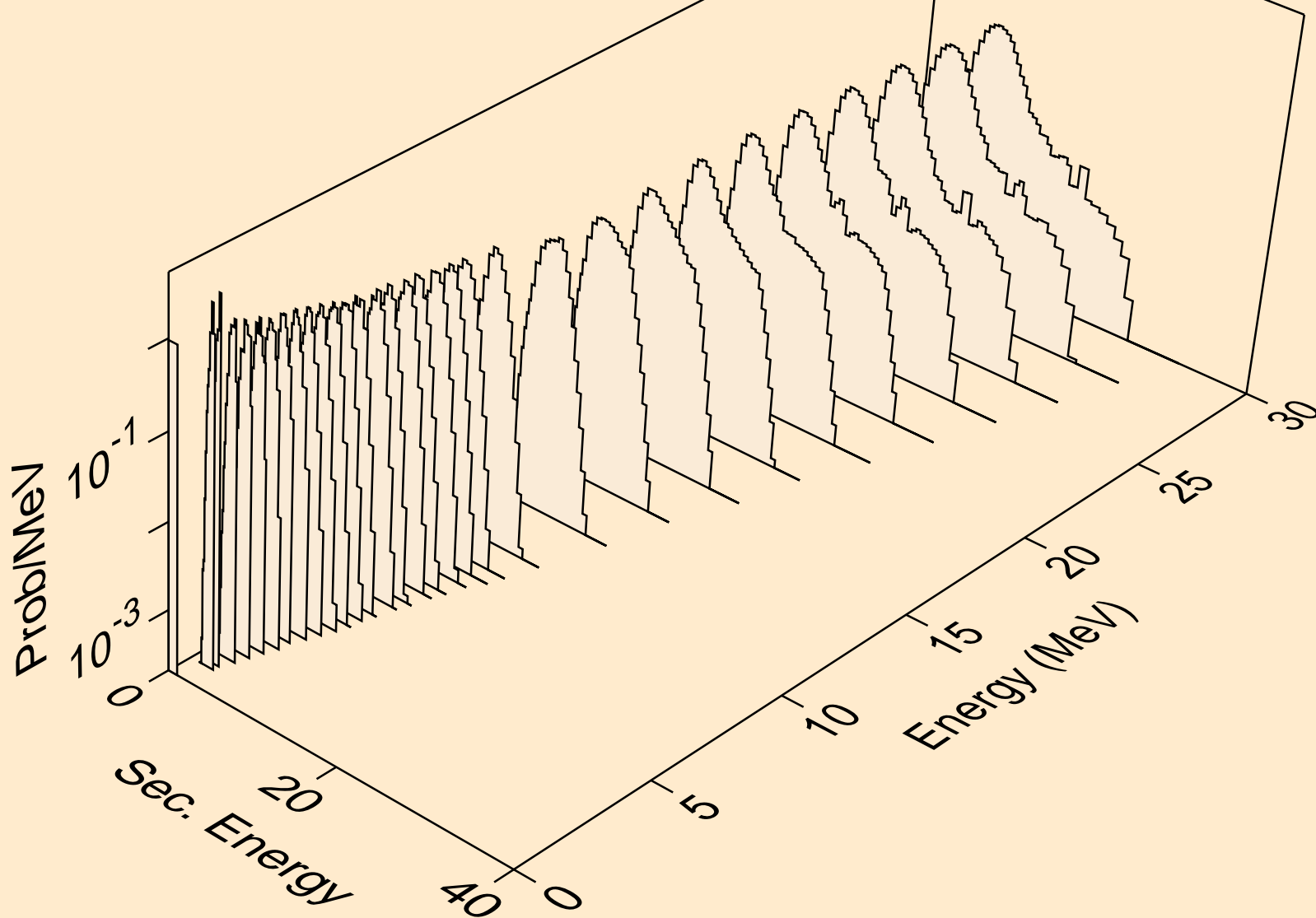

OS179 NEUTRON ACER TENDL-2019 LIBRARY; T=293.16K  
protons from (n,pd)

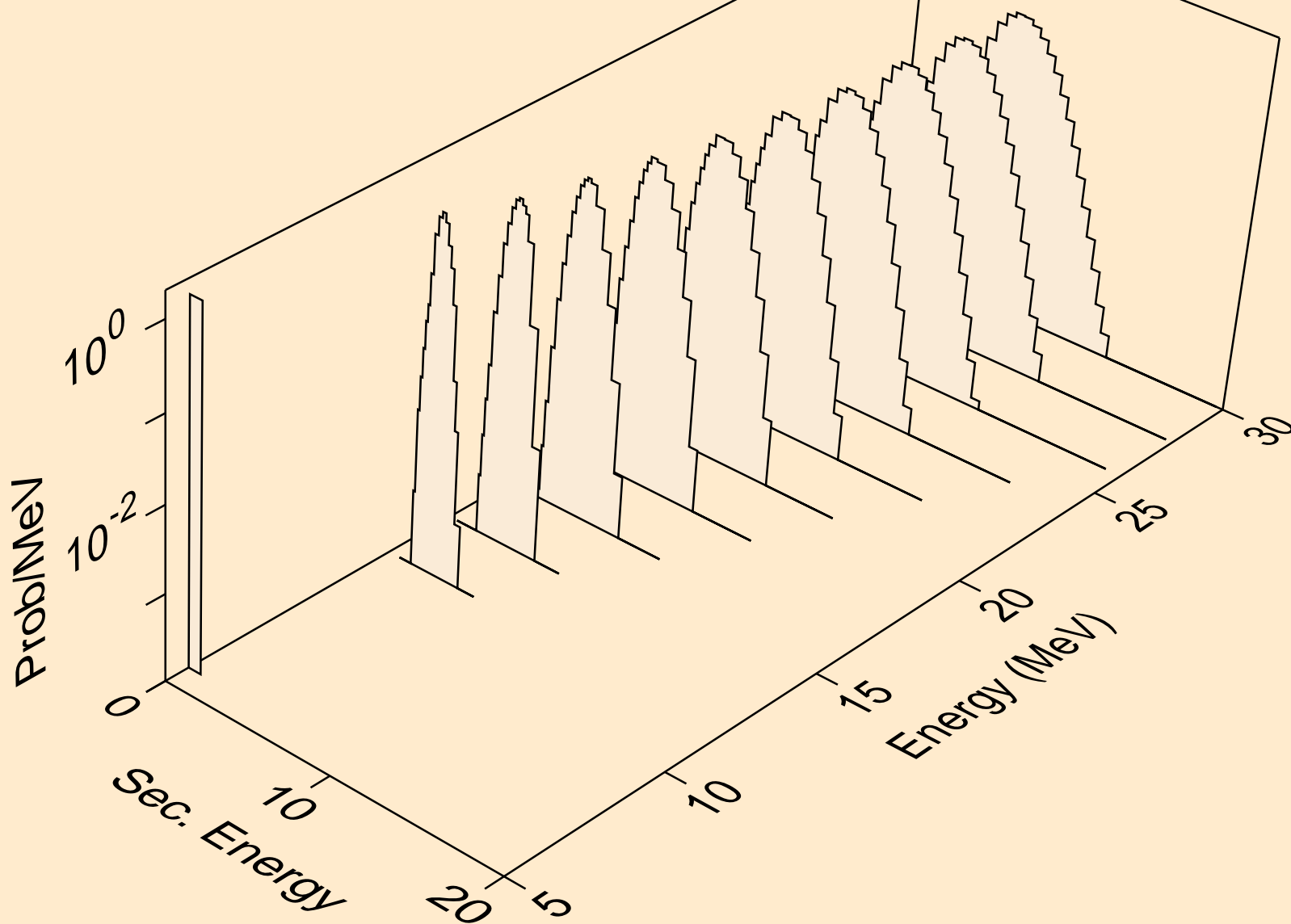

OS179 NEUTRON ACER TENDL-2019 LIBRARY; T=293.16K  
protons from (n,pt)

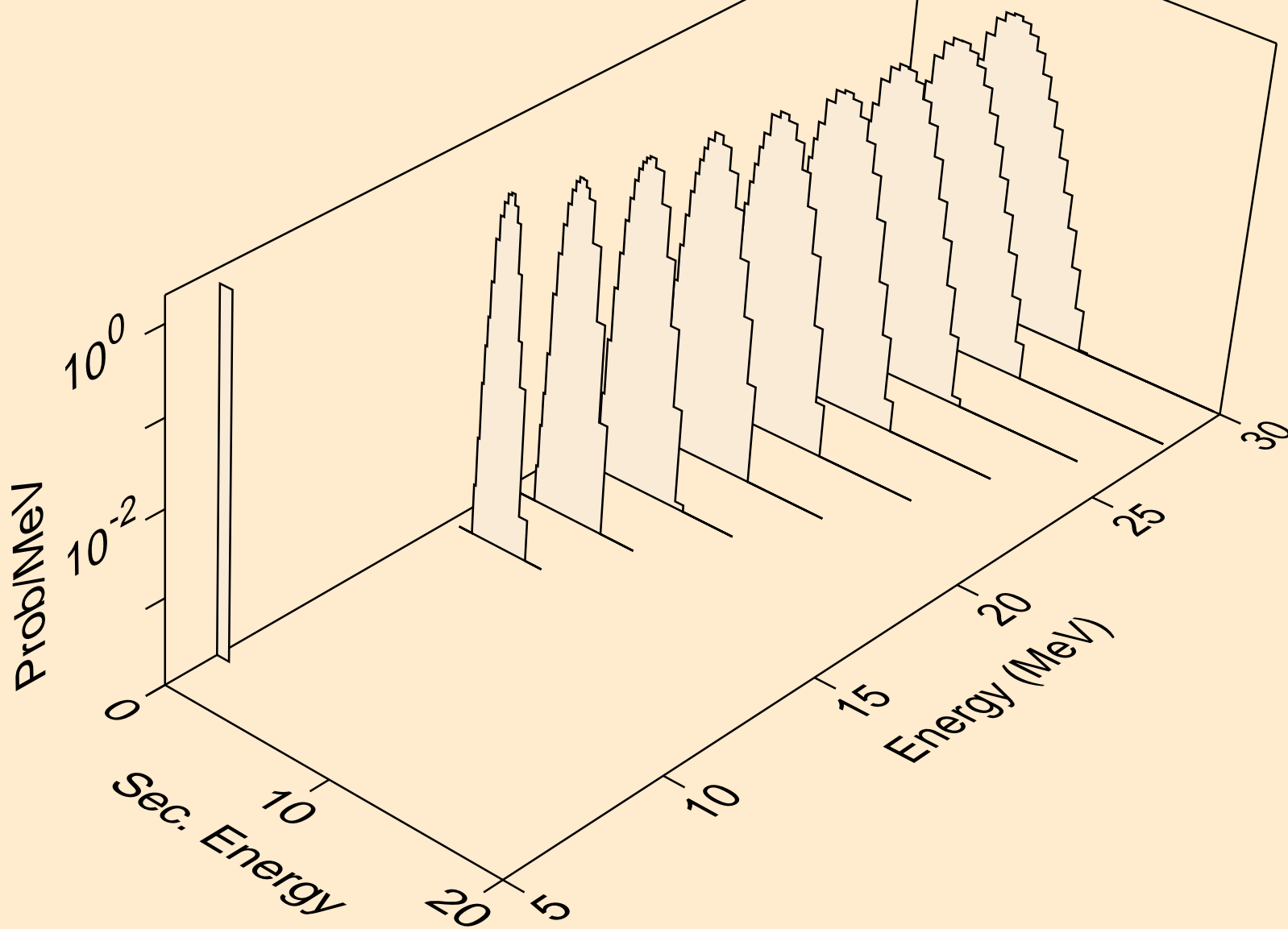

OS179 NEUTRON ACER TENDL-2019 LIBRARY; T=293.16K  
deuterons from (n,x)

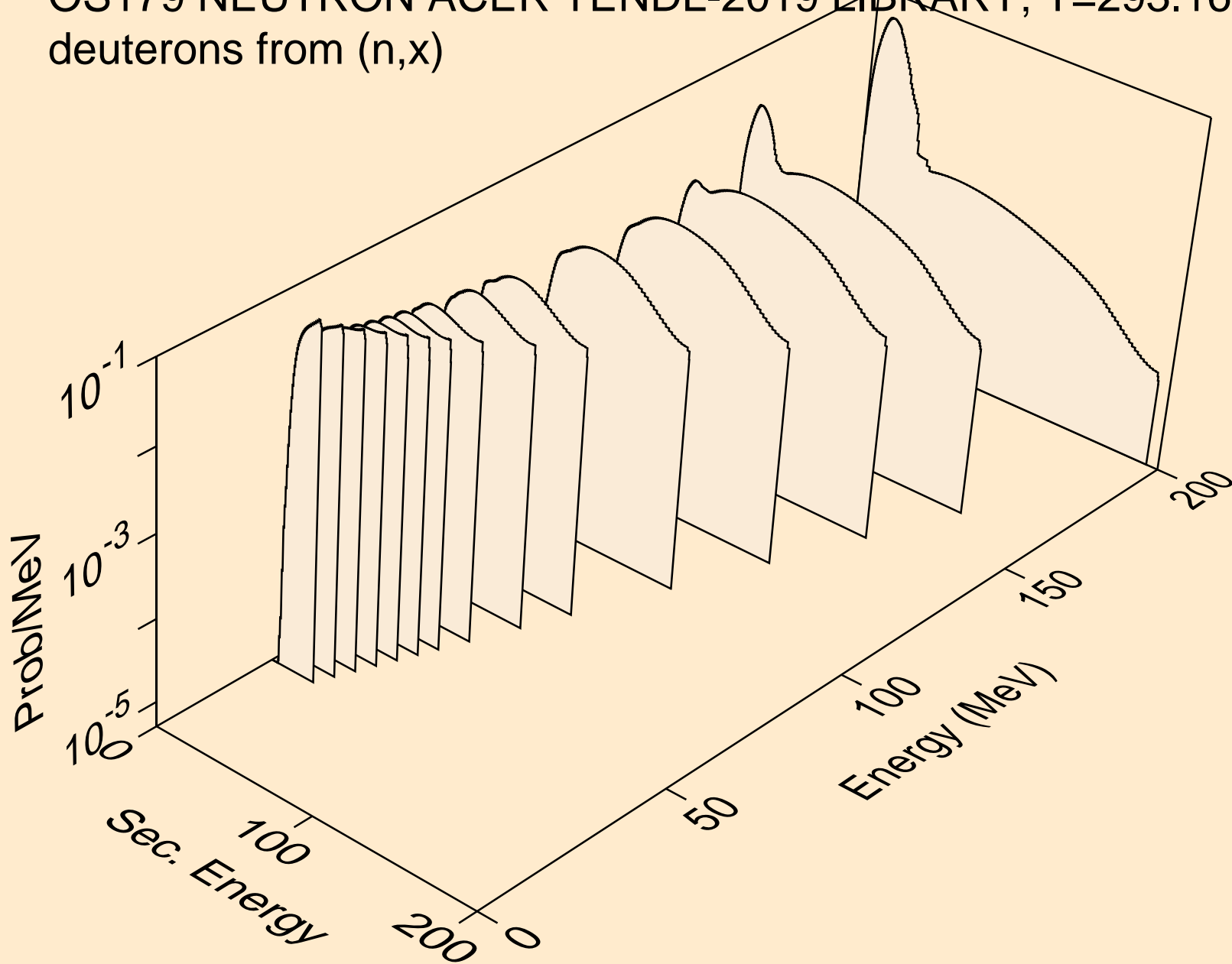



OS179 NEUTRON ACER TENDL-2019 LIBRARY; T=293.16K  
deuterons from (n,2nd)

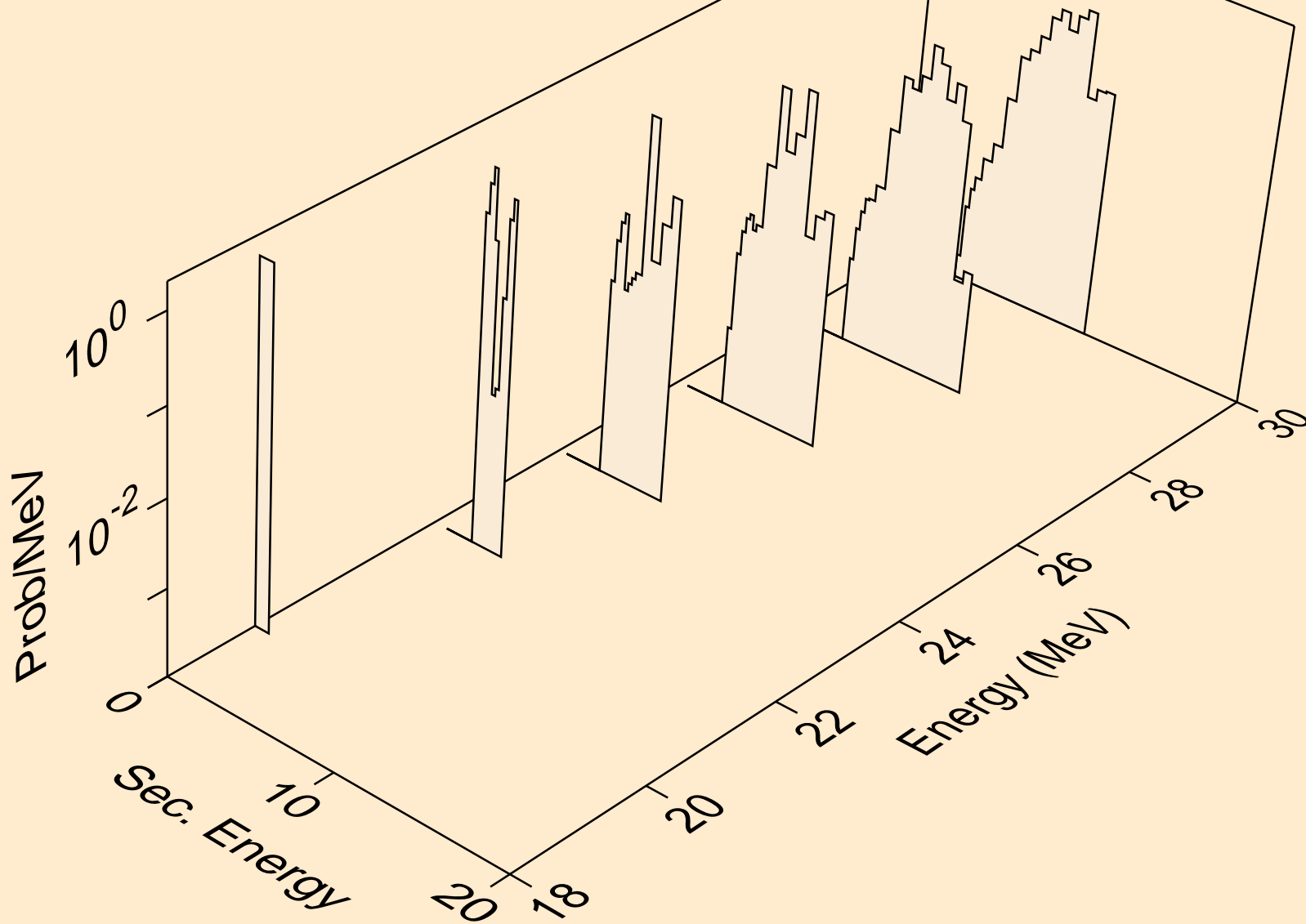

OS179 NEUTRON ACER TENDL-2019 LIBRARY; T=293.16K  
deuterons from (n,n\*)d

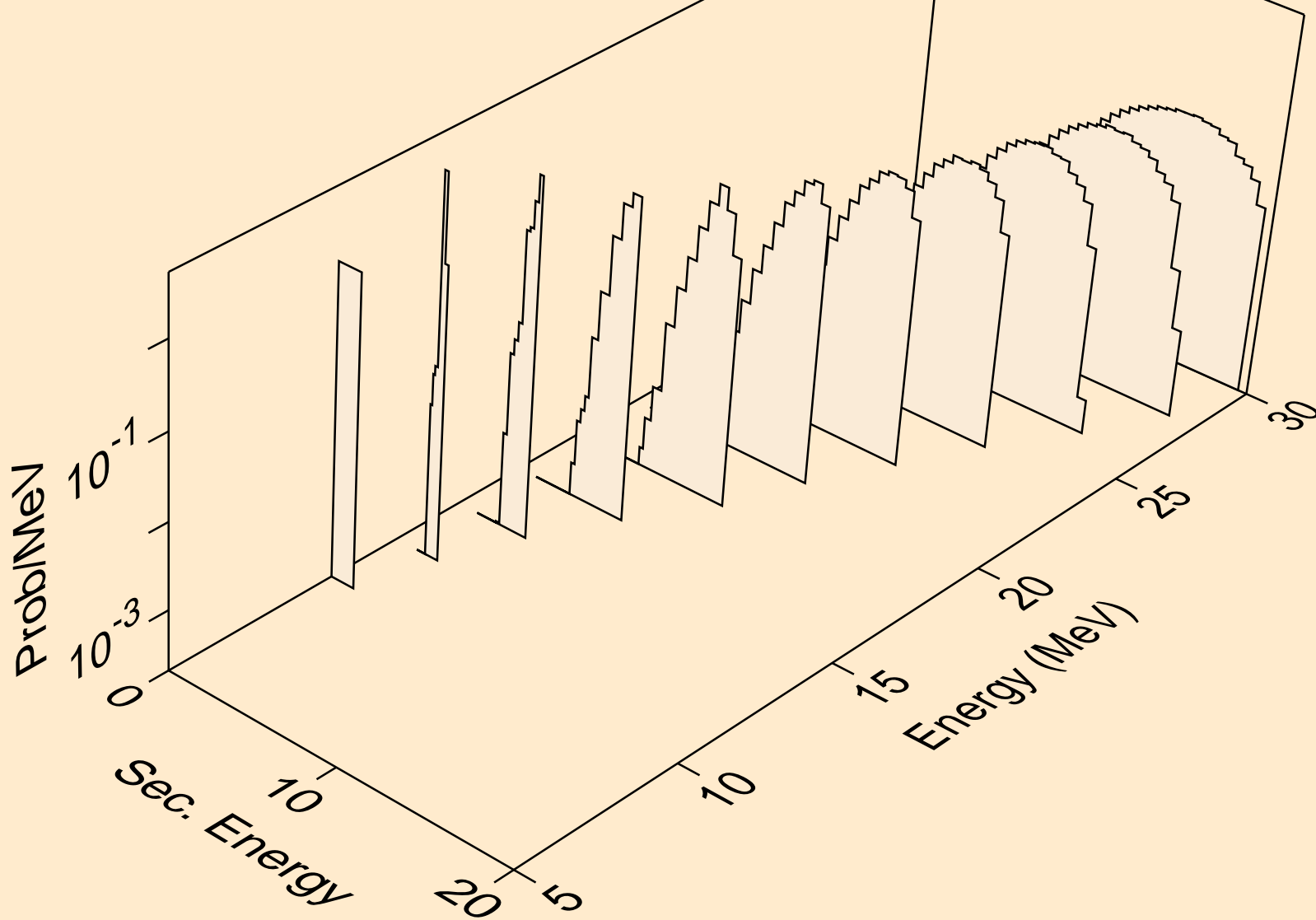

OS179 NEUTRON ACER TENDL-2019 LIBRARY; T=293.16K  
deuterons from (n,d)

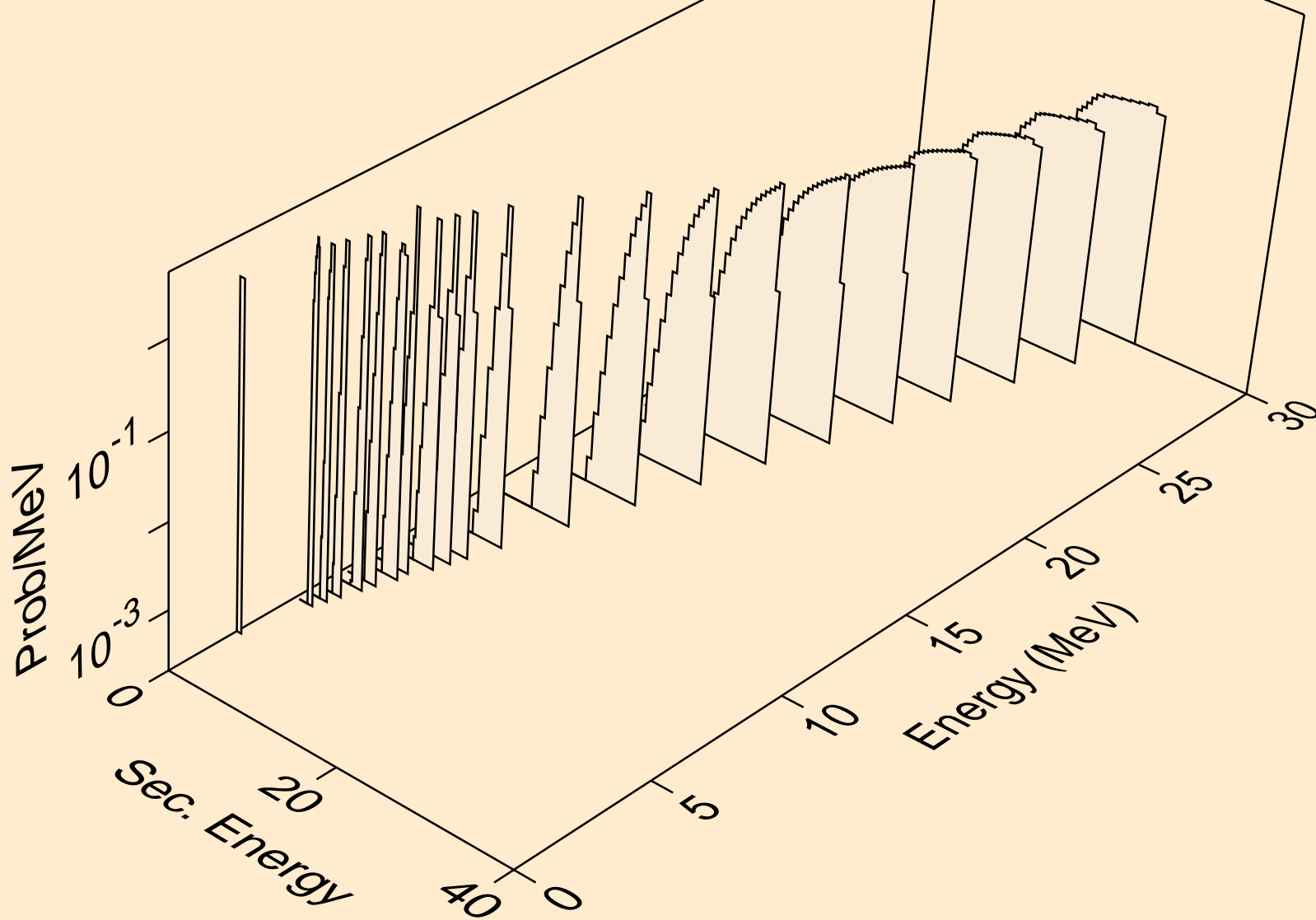

OS179 NEUTRON ACER TENDL-2019 LIBRARY; T=293.16K  
deuterons from (n,pd)

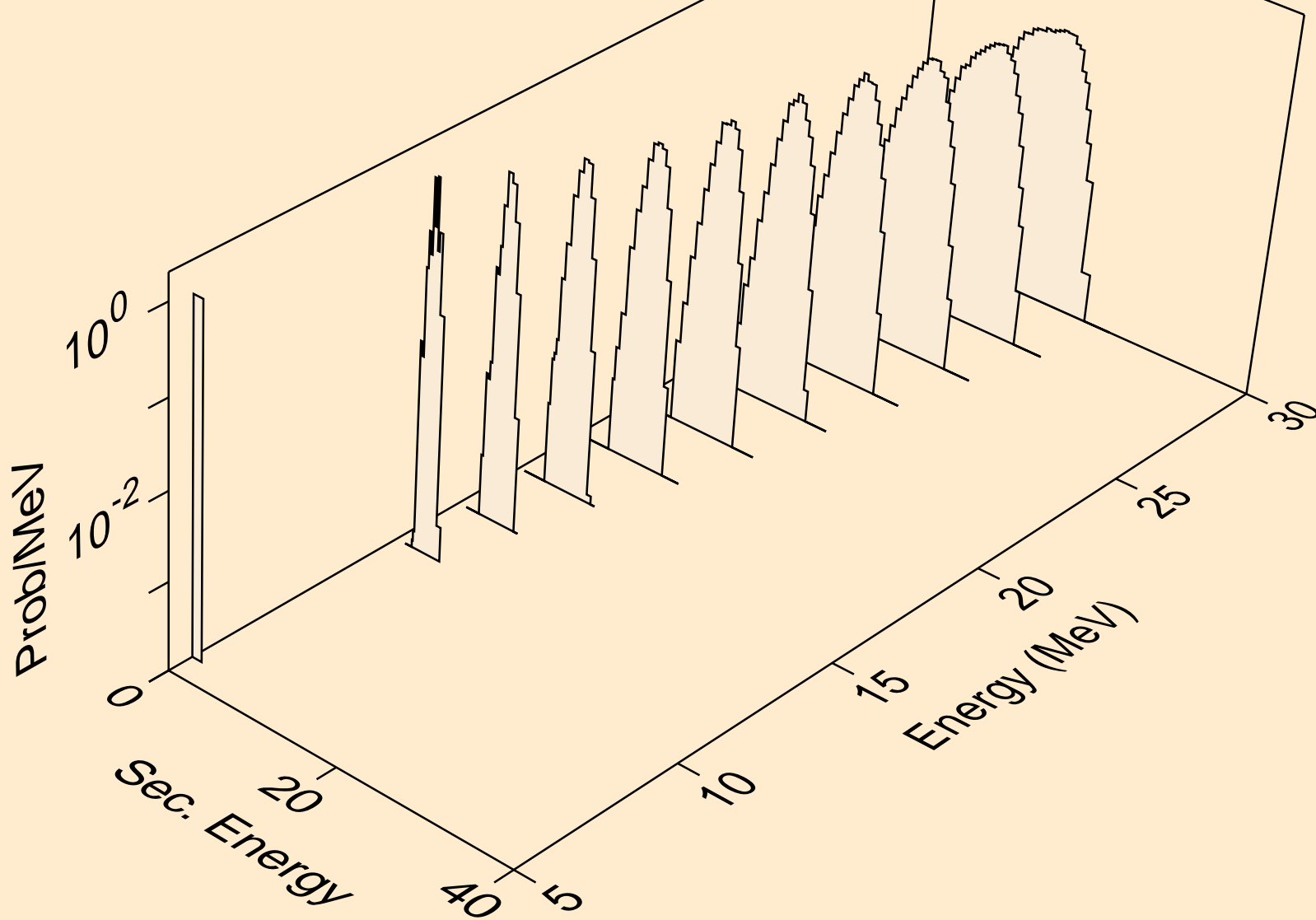

OS179 NEUTRON ACER TENDL-2019 LIBRARY; T=293.16K  
deuterons from (n,da)

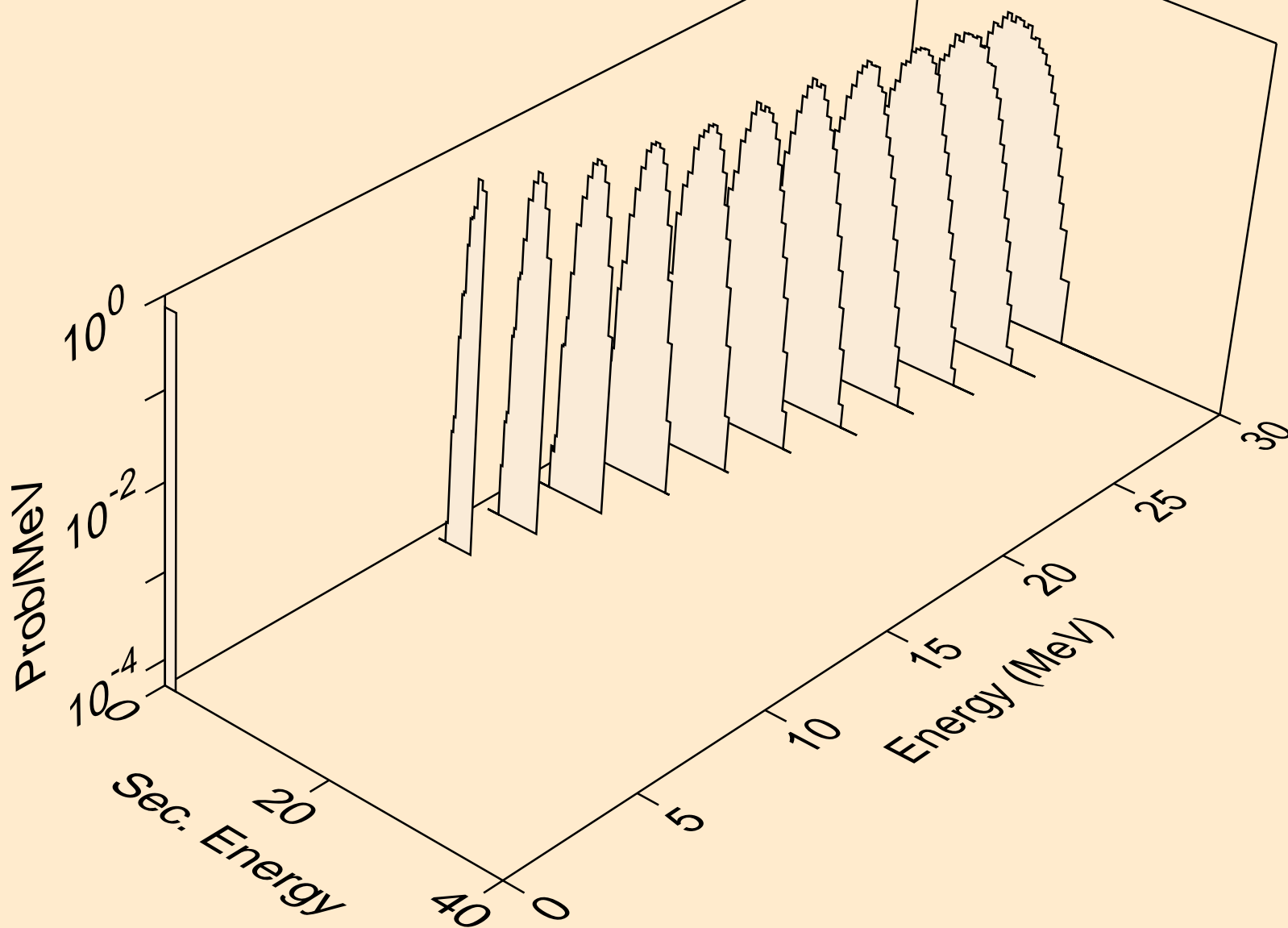

OS179 NEUTRON ACER TENDL-2019 LIBRARY; T=293.16K  
tritons from (n,x)

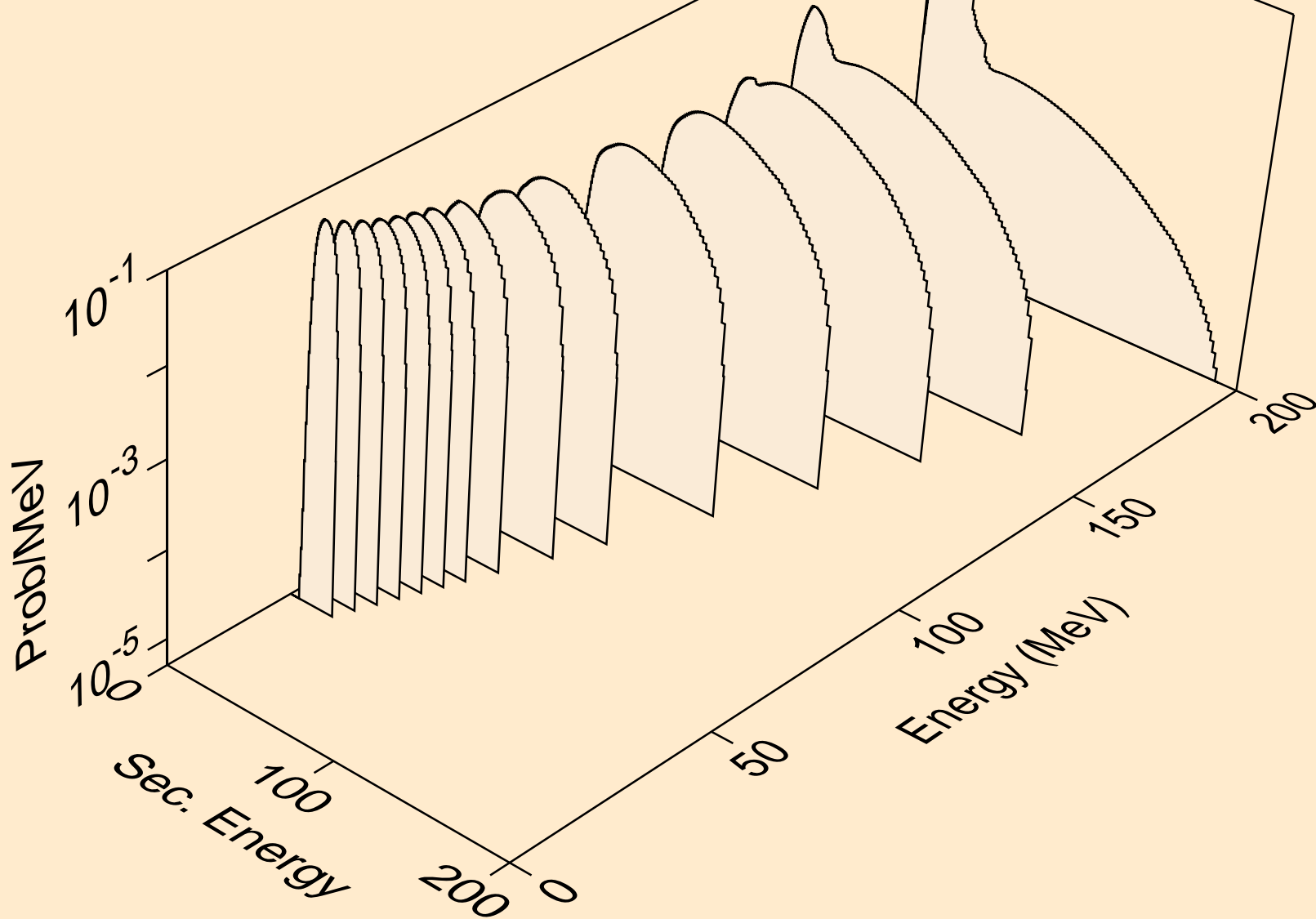

OS179 NEUTRON ACER TENDL-2019 LIBRARY; T=293.16K  
tritons from (n,n\*)t

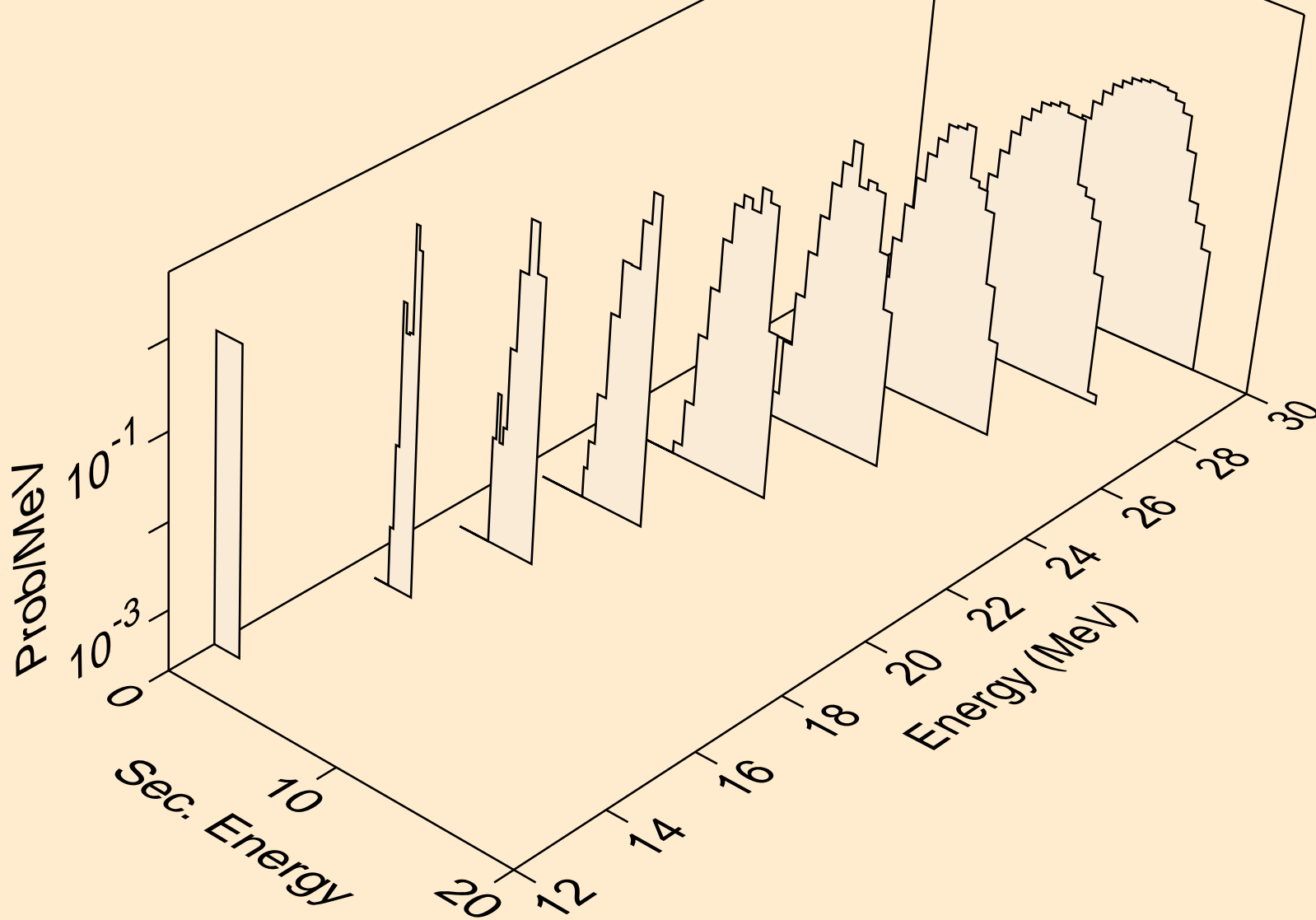

OS179 NEUTRON ACER TENDL-2019 LIBRARY; T=293.16K  
tritons from (n,t)

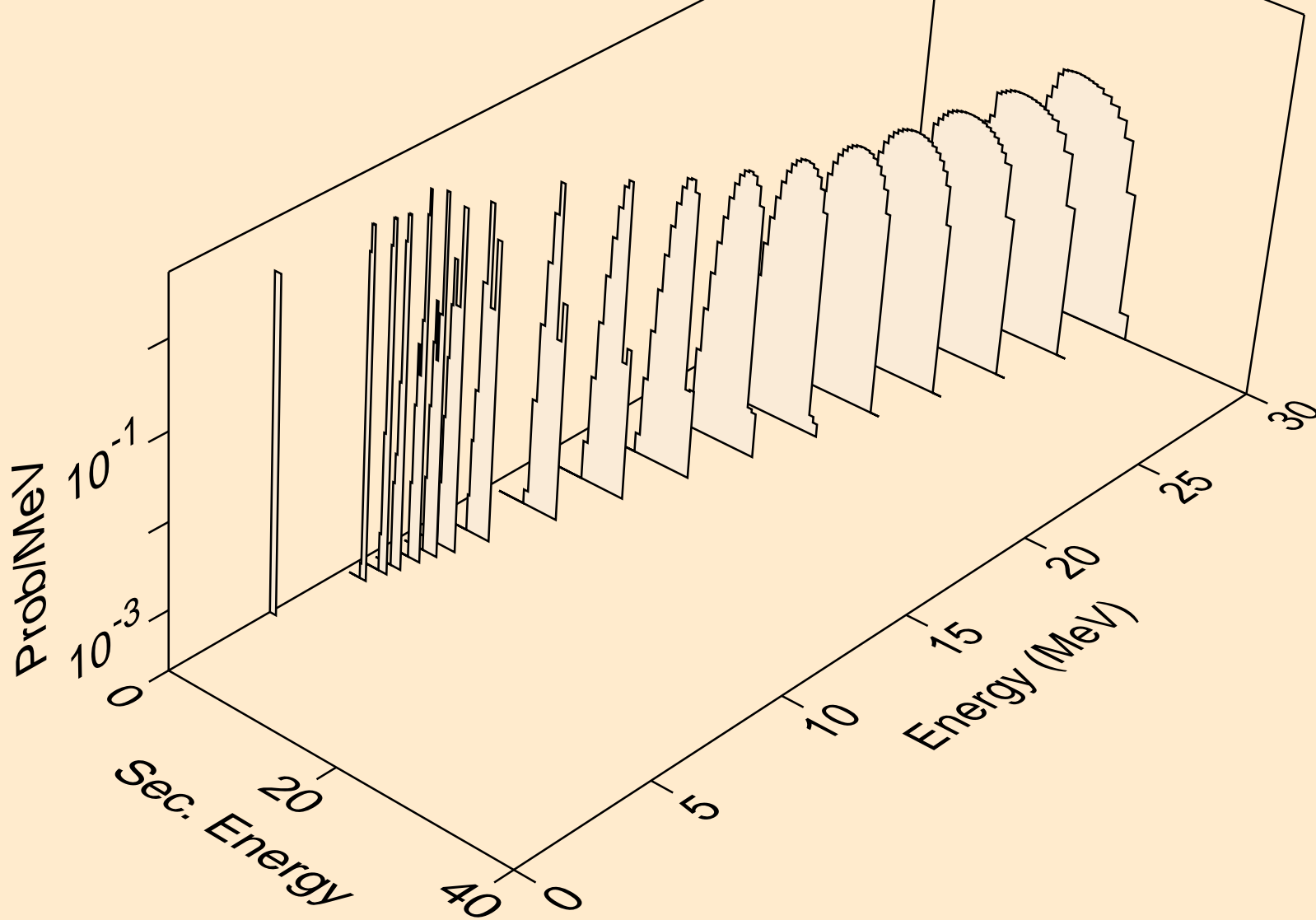



OS179 NEUTRON ACER TENDL-2019 LIBRARY; T=293.16K  
tritons from (n,pt)

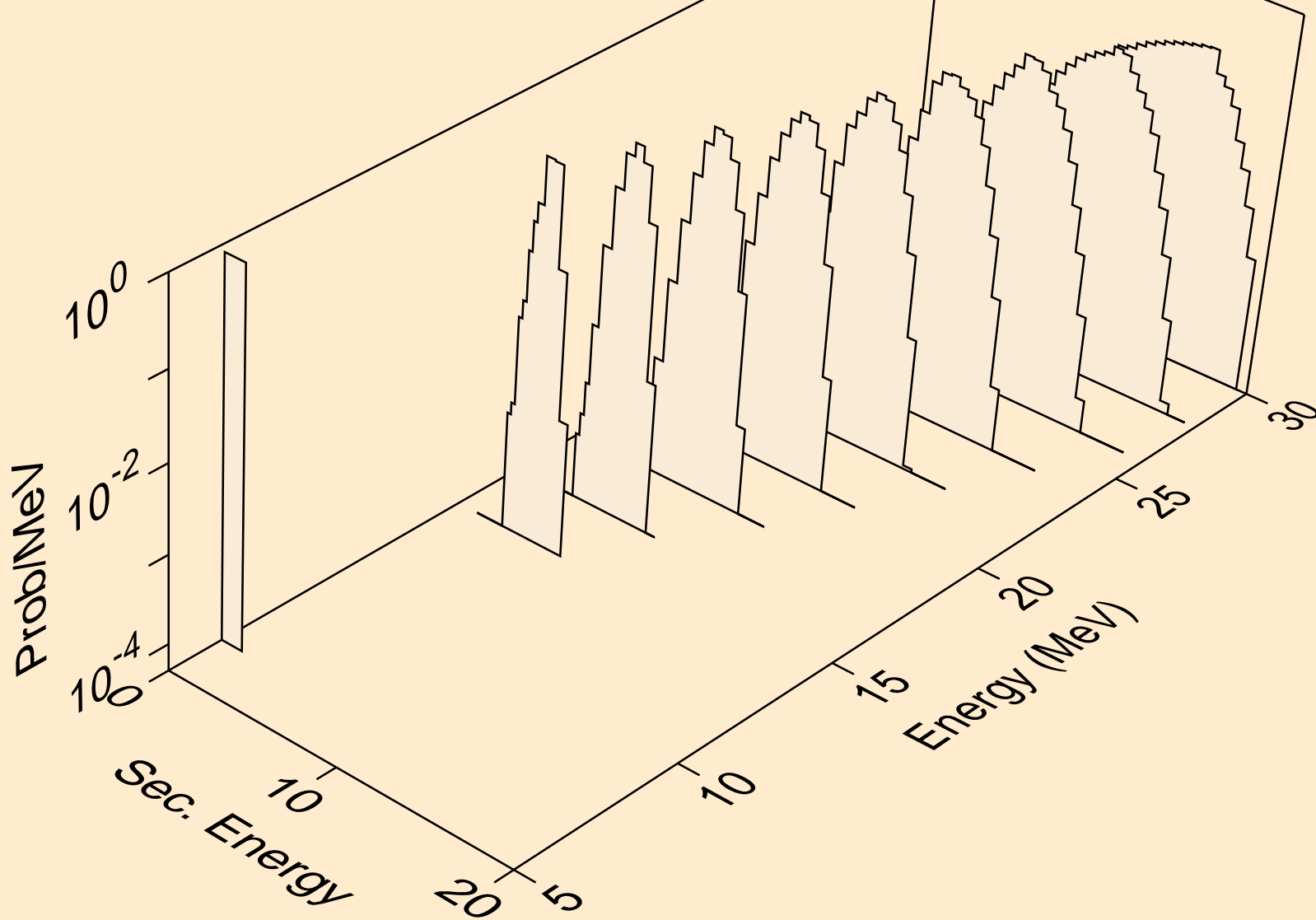

OS179 NEUTRON ACER TENDL-2019 LIBRARY; T=293.16K  
he3s from (n,x)

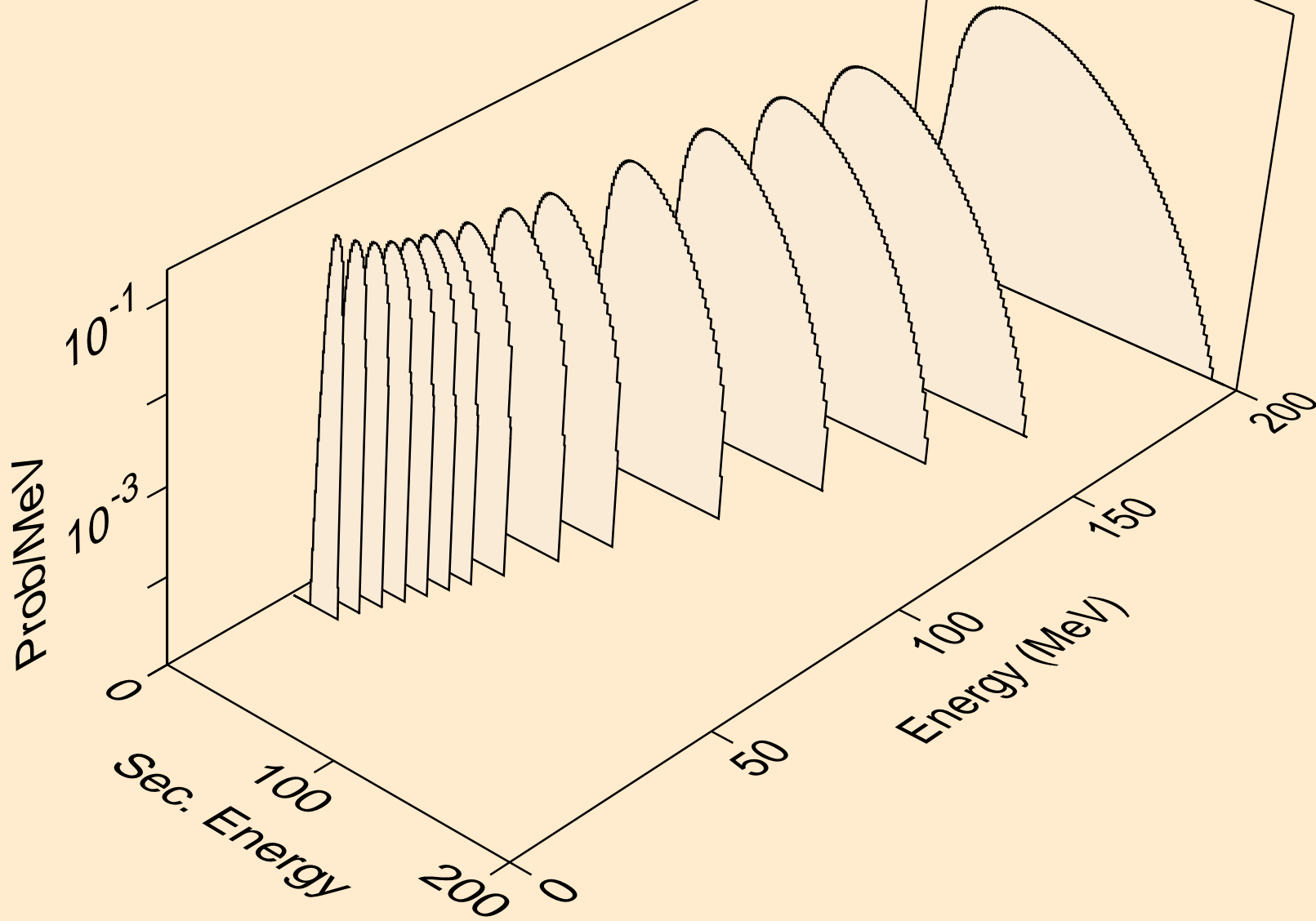

OS179 NEUTRON ACER TENDL-2019 LIBRARY; T=293.16K  
he3s from (n,n\*)he3

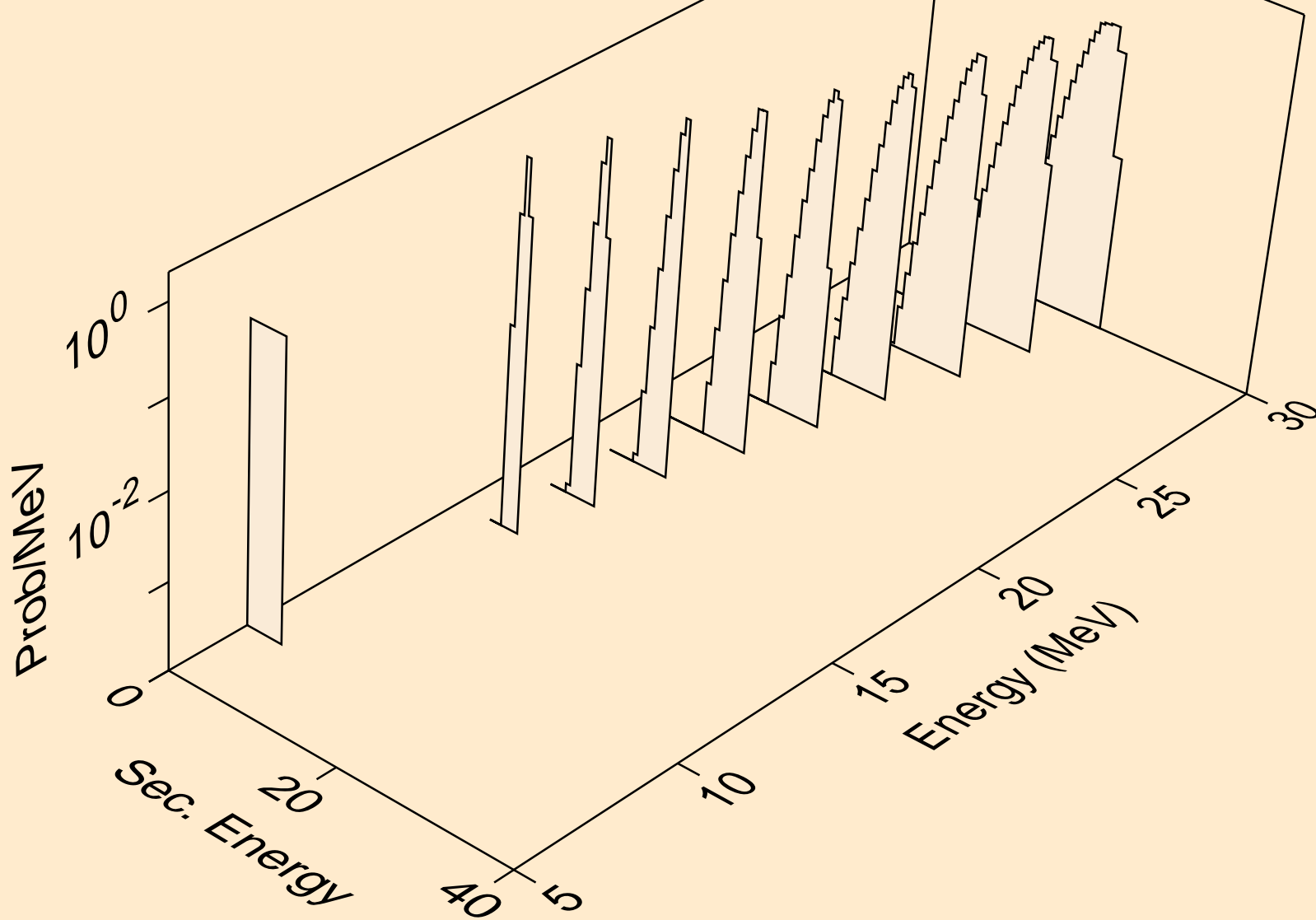

OS179 NEUTRON ACER TENDL-2019 LIBRARY; T=293.16K  
he3s from (n,he3)

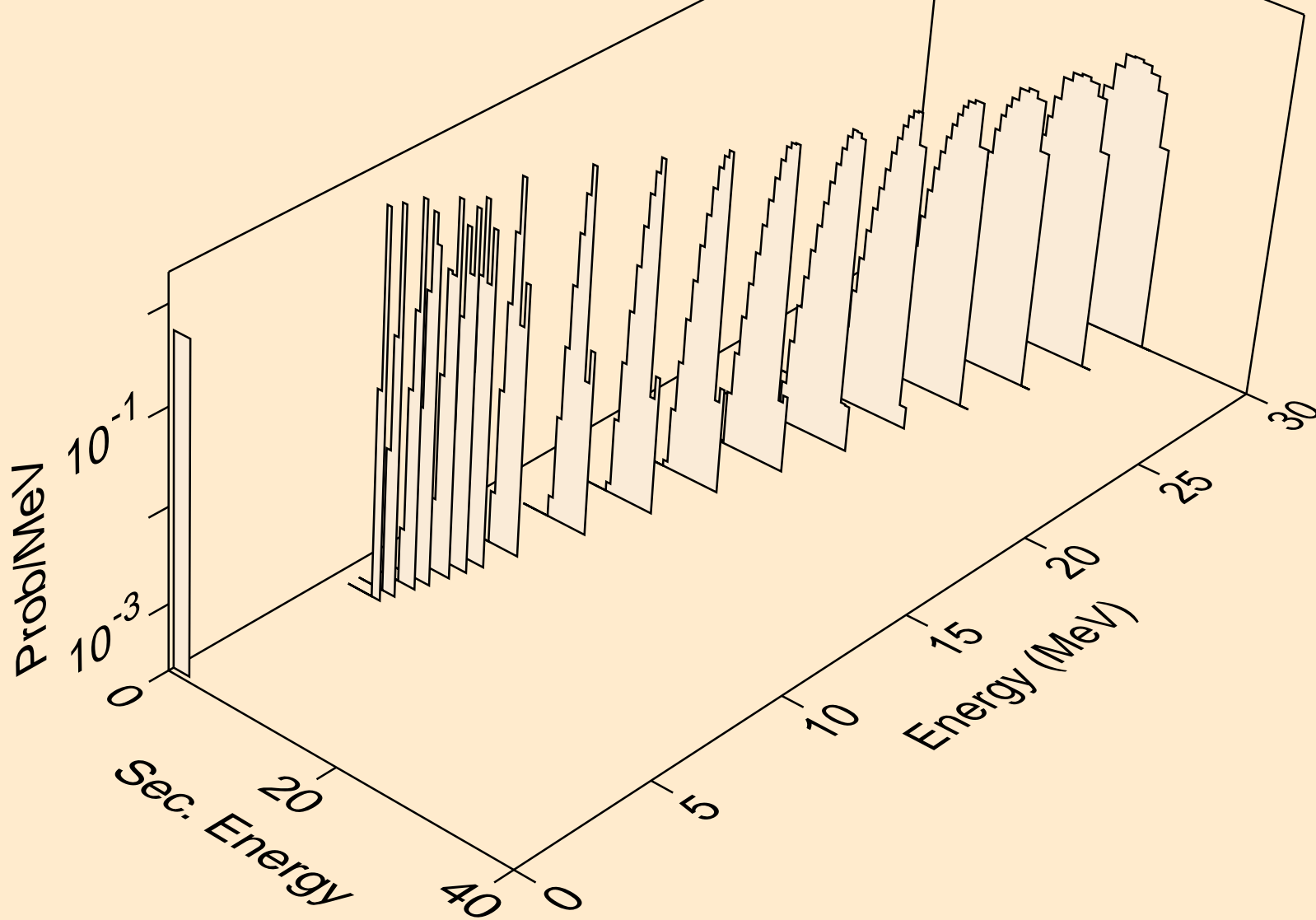

OS179 NEUTRON ACER TENDL-2019 LIBRARY; T=293.16K  
alphas from (n,x)

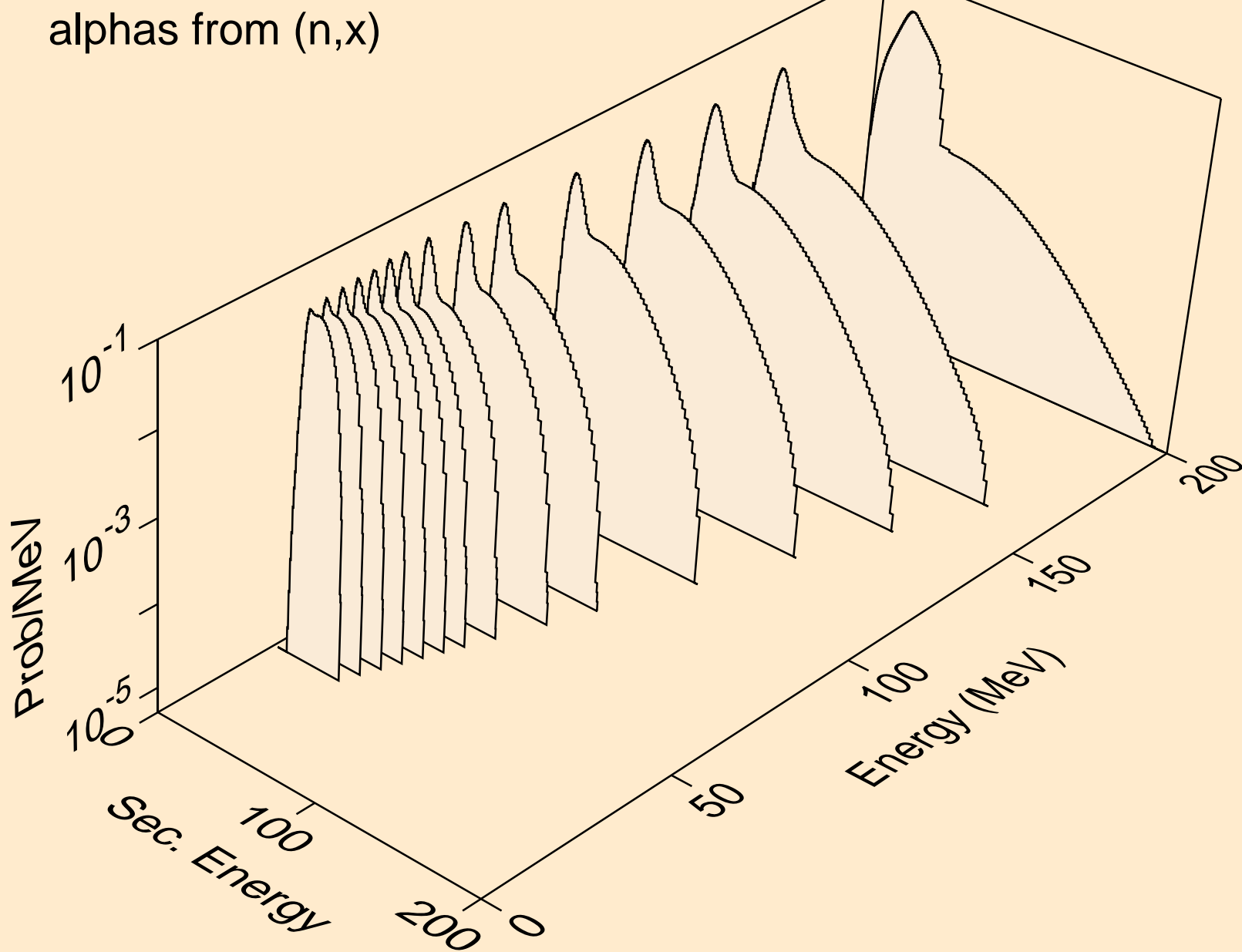

OS179 NEUTRON ACER TENDL-2019 LIBRARY; T=293.16K  
alphas from (n,n\*)a

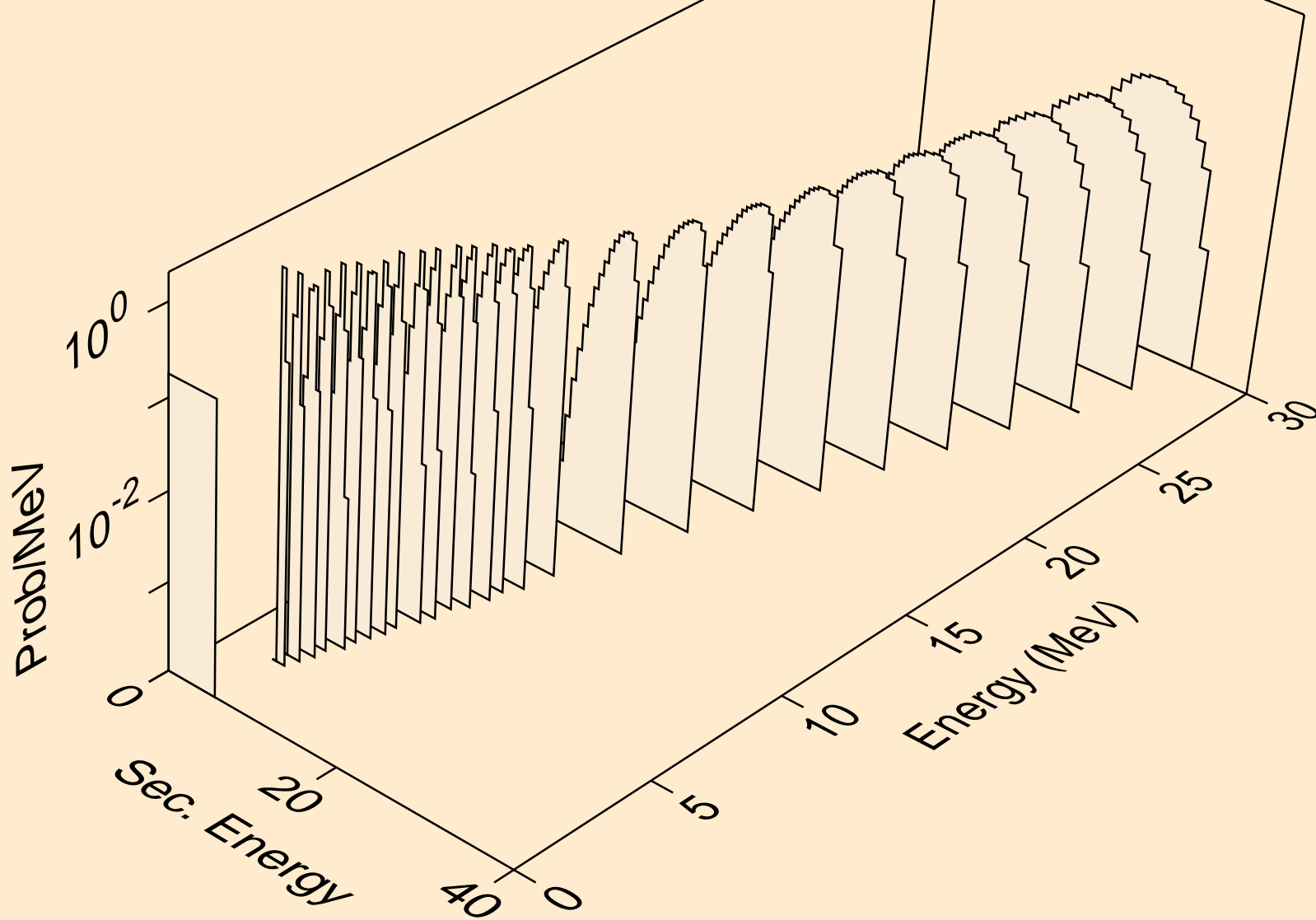

OS179 NEUTRON ACER TENDL-2019 LIBRARY; T=293.16K  
alphas from (n,2n)a

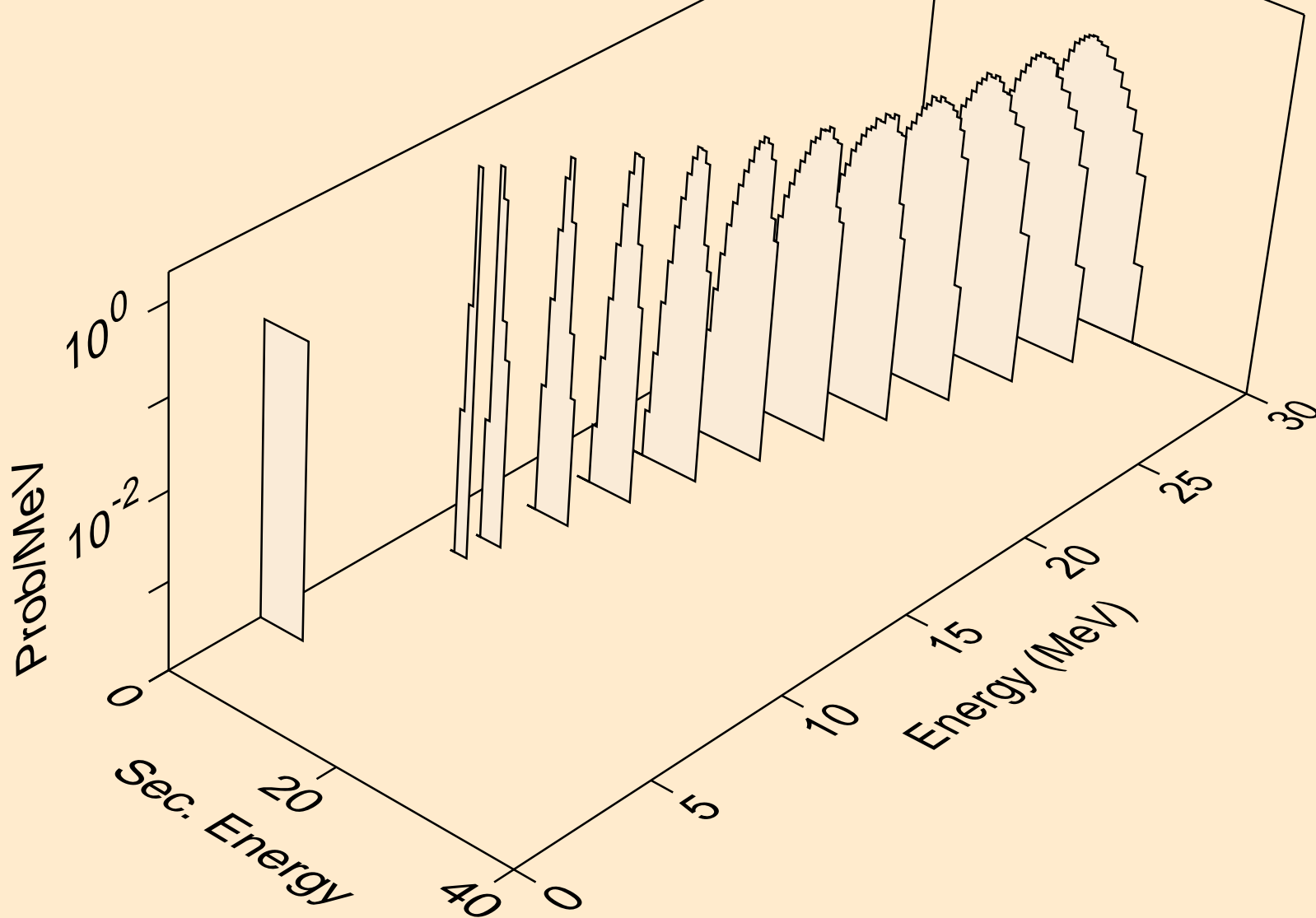

OS179 NEUTRON ACER TENDL-2019 LIBRARY; T=293.16K  
alphas from (n,3n)a

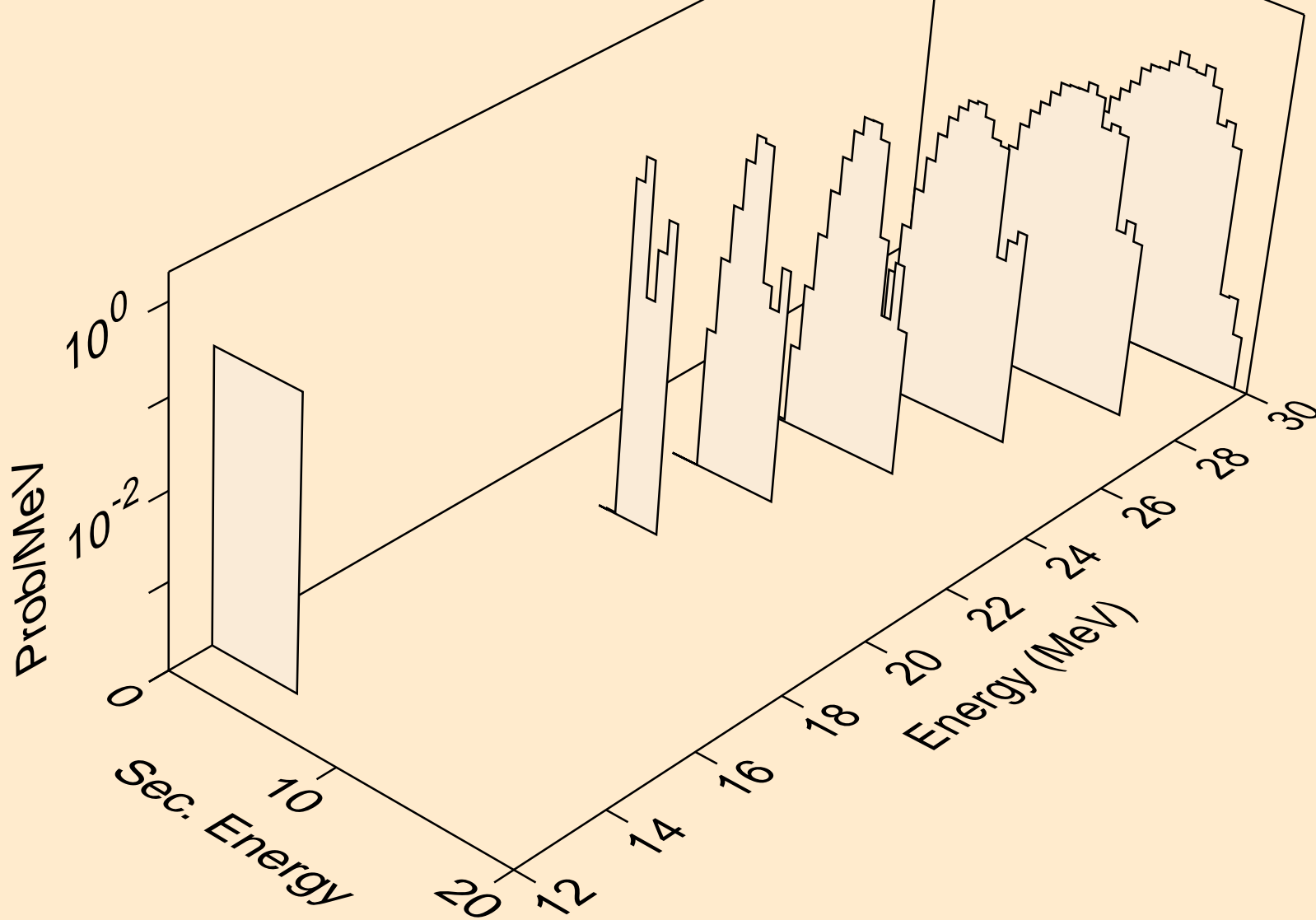



OS179 NEUTRON ACER TENDL-2019 LIBRARY; T=293.16K  
alphas from (n,n\*)2a

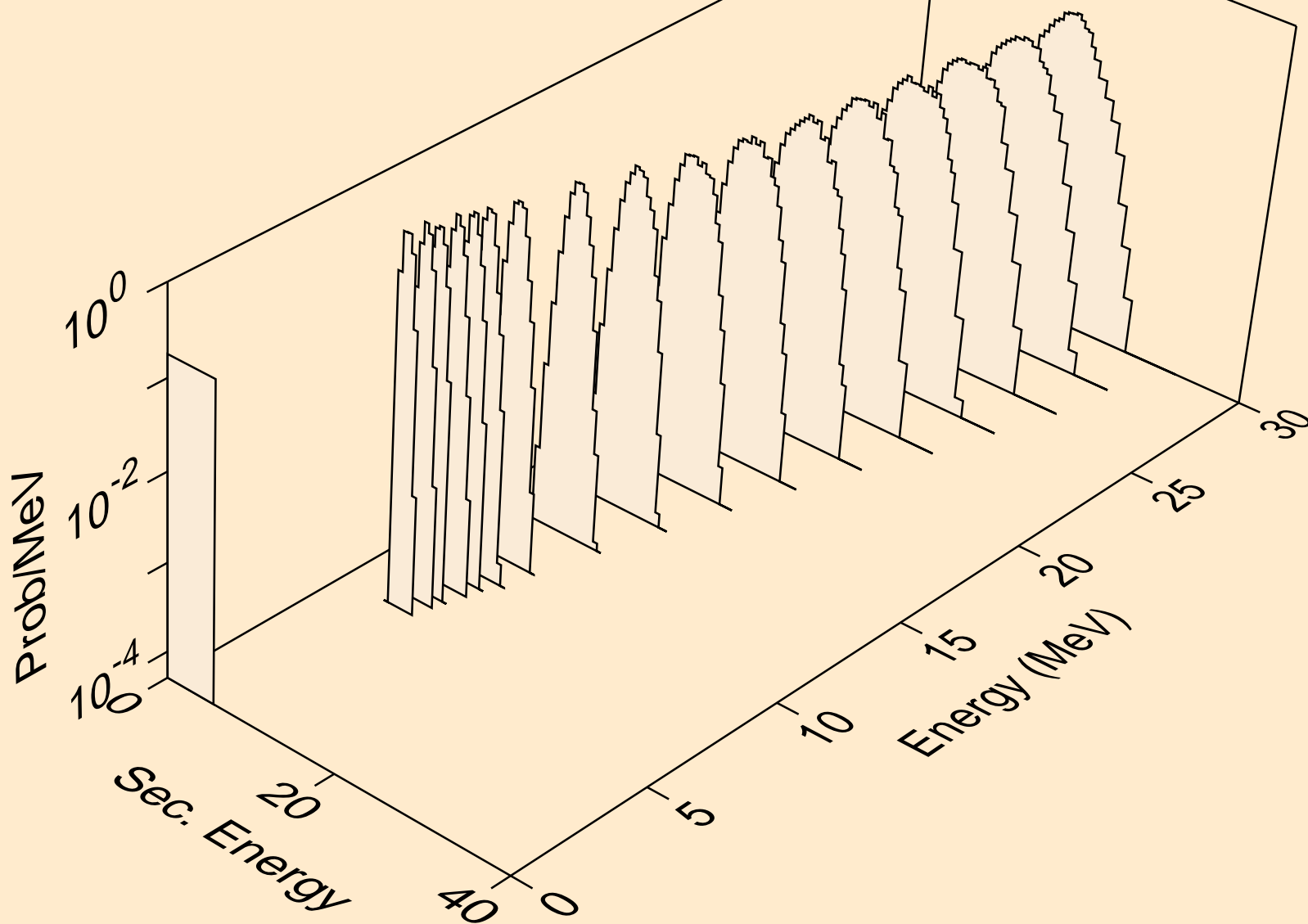

OS179 NEUTRON ACER TENDL-2019 LIBRARY; T=293.16K  
alphas from (n,2n)2a

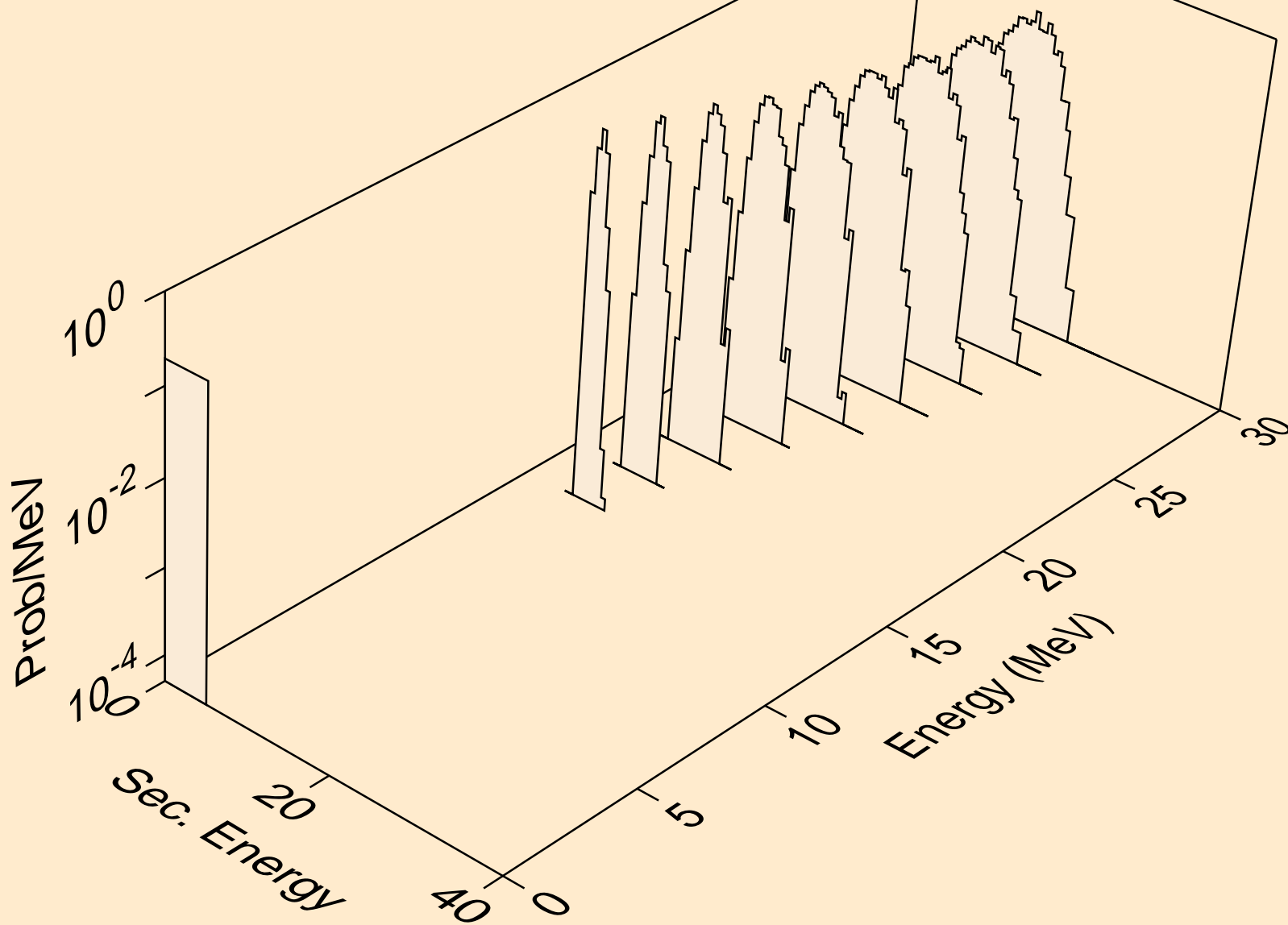

OS179 NEUTRON ACER TENDL-2019 LIBRARY; T=293.16K  
alphas from (n,npa)

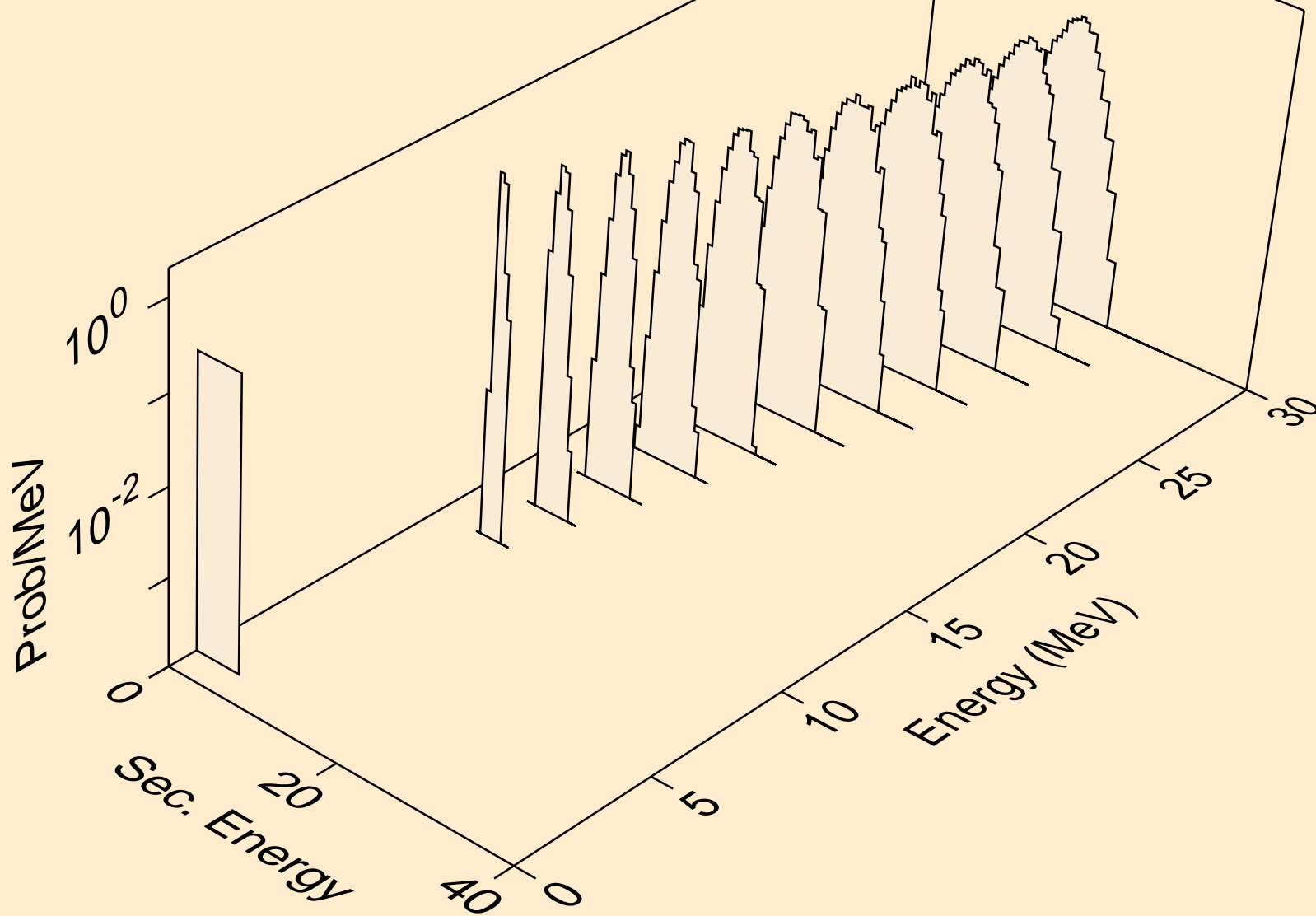

OS179 NEUTRON ACER TENDL-2019 LIBRARY; T=293.16K  
alphas from (n,a)

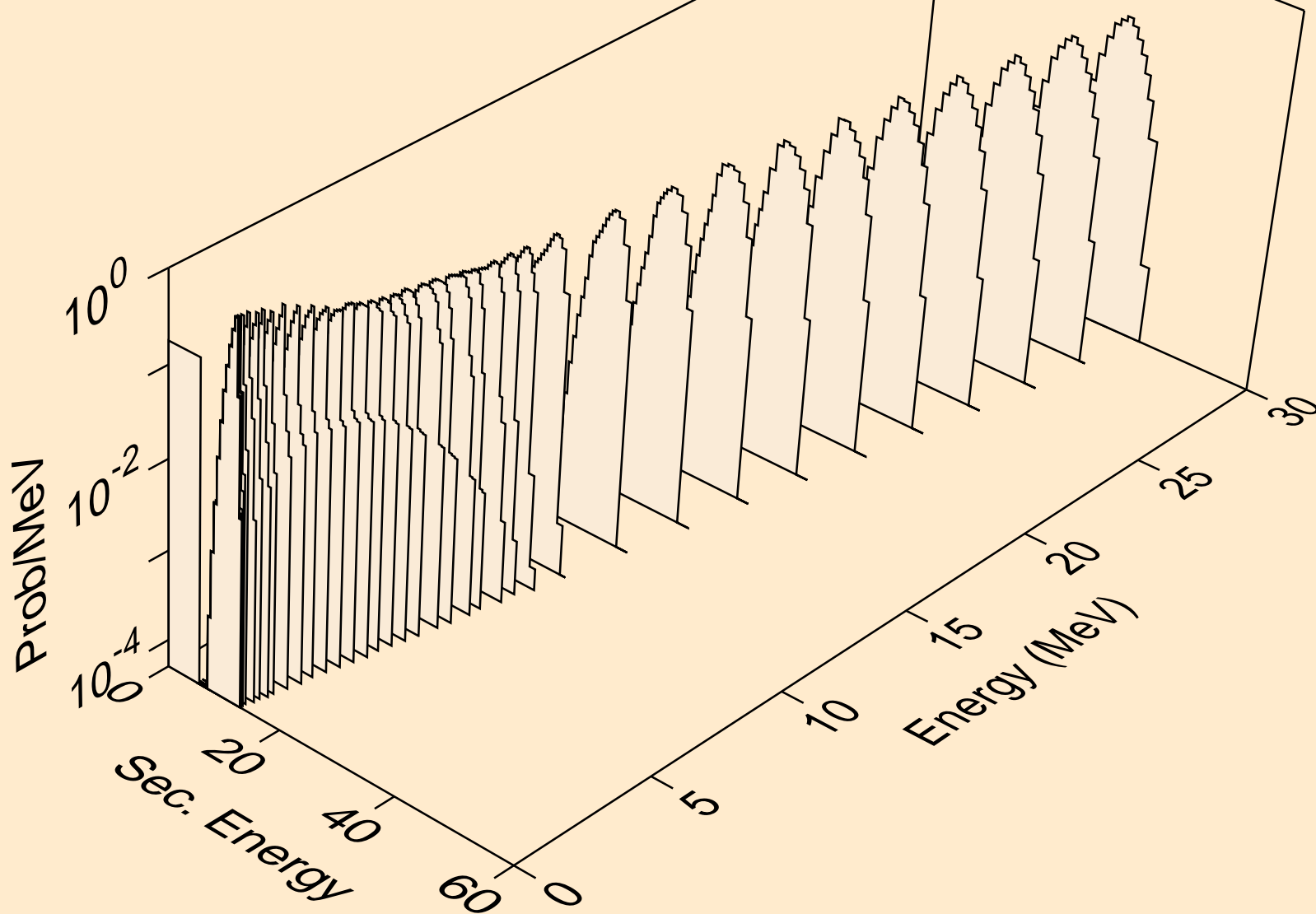

OS179 NEUTRON ACER TENDL-2019 LIBRARY; T=293.16K  
alphas from (n,2a)

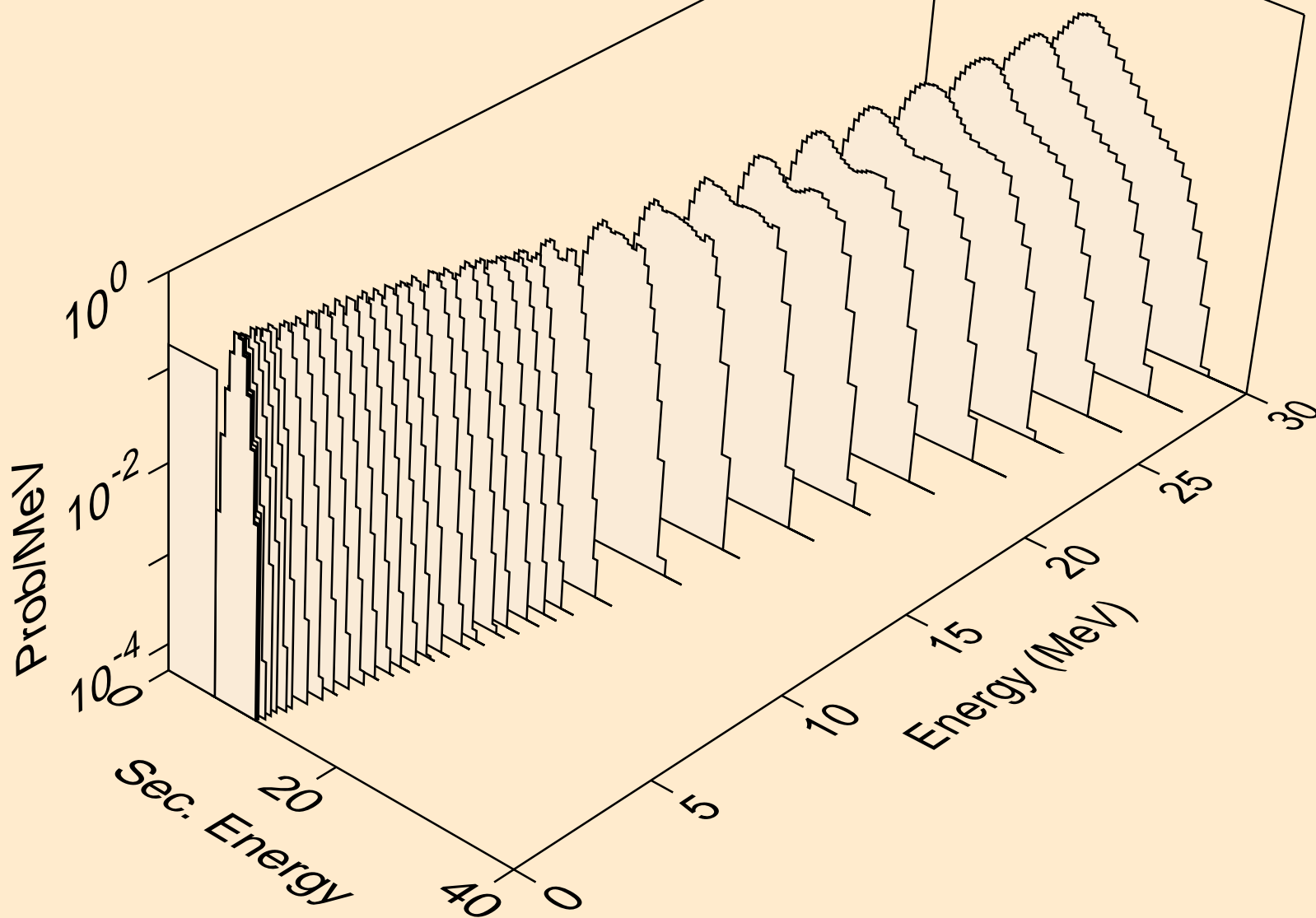

OS179 NEUTRON ACER TENDL-2019 LIBRARY; T=293.16K  
alphas from (n,p)

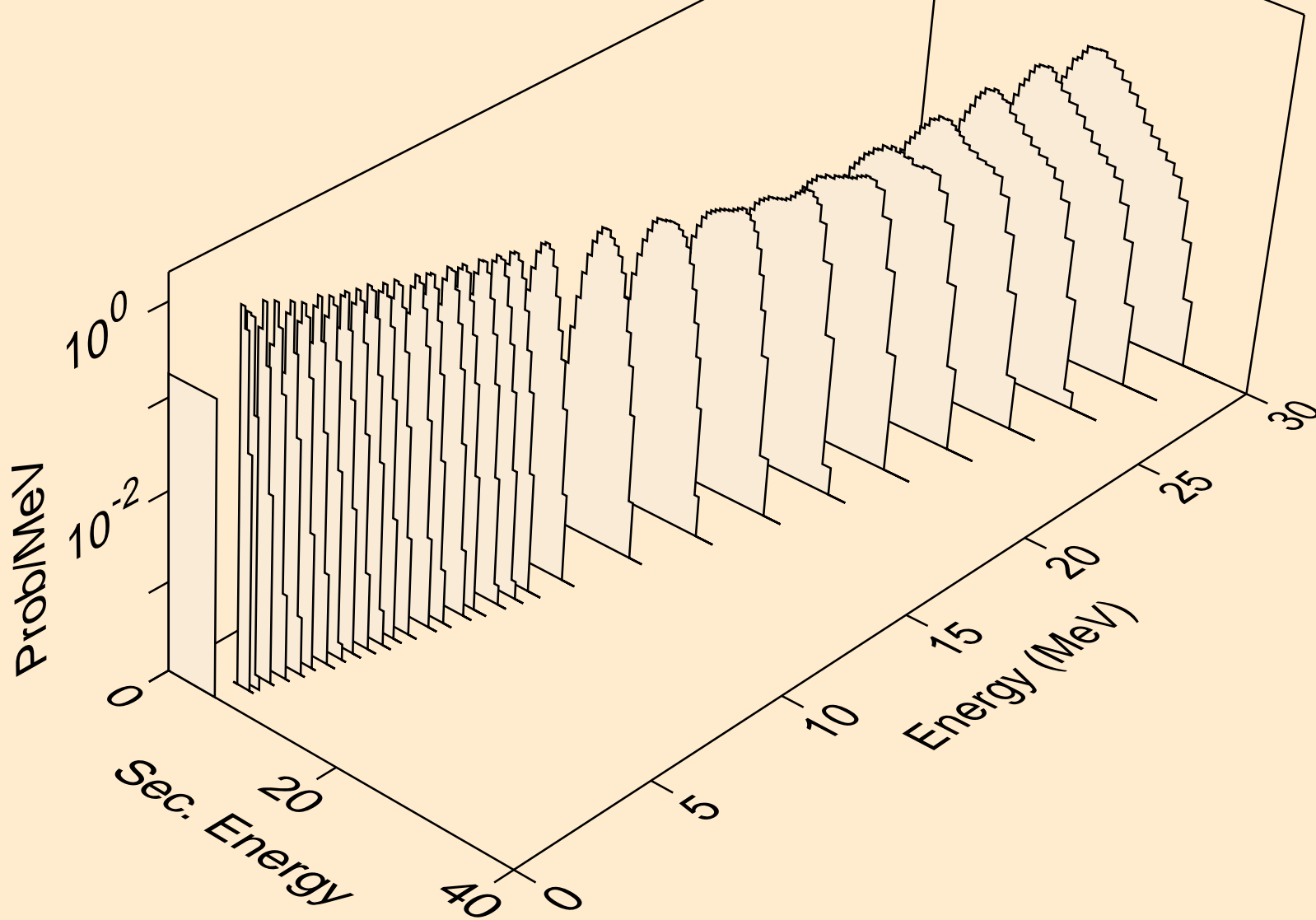

OS179 NEUTRON ACER TENDL-2019 LIBRARY; T=293.16K  
alphas from (n,da)

